

Int. Cl.: 33

Prior U.S. Cls.: 47 and 49

United States Patent and Trademark Office

Reg. No. 3,396,813

Registered Mar. 18, 2008

TRADEMARK
PRINCIPAL REGISTER



AGROS HOLDING S.A. (POLAND CORPORATION)

UL. ELEWATORSKA 20

15-950 BIALYSTOK, POLAND

FOR: VODKA, IN CLASS 33 (U.S. CLS. 47 AND 49).

FIRST USE 8-7-2003; IN COMMERCE 8-7-2003.

OWNER OF U.S. REG. NO. 2,858,179.

NO CLAIM IS MADE TO THE EXCLUSIVE RIGHT TO USE "ZUBRÓWKA" AND "BRAND", APART FROM THE MARK AS SHOWN.

"THE FOREIGN WORDING IN THE MARK TRANSLATES INTO ENGLISH AS 'SWEET-SCENTED GRASS HIERCHLOE' AND/OR 'A VODKA FLAVORED WITH THE SWEET-SCENTED GRASS HIERCHLOE'."

SER. NO. 75-127,541, FILED 7-1-1996.

FRED CARL, EXAMINING ATTORNEY

Int. Cl.: 42

Prior U.S. Cls.: 100 and 101

United States Patent and Trademark Office

Reg. No. 3,396,814

Registered Mar. 18, 2008

**SERVICE MARK
PRINCIPAL REGISTER**

INETSMART

ONGKO, PETER (INDONESIA INDIVIDUAL)
17111 BEACH BLVD. #208
HUNTINGTON BEACH, CA 92647

FOR: HOSTING THE WEB SITES OF OTHERS ON
A COMPUTER SERVER FOR A GLOBAL COMPU-
TER NETWORK AND DESIGNING AND IMPLE-

MENTING WEB SITES FOR OTHERS, IN CLASS 42
(U.S. CLS. 100 AND 101).

FIRST USE 6-3-1998; IN COMMERCE 6-3-1998.

SER. NO. 75-836,401, FILED 11-1-1999.

ALICE BENMAMAN, EXAMINING ATTORNEY

Int. Cl.: 28

Prior U.S. Cls.: 22, 23, 38 and 50

United States Patent and Trademark Office

Reg. No. 3,396,815

Registered Mar. 18, 2008

**TRADEMARK
PRINCIPAL REGISTER**

PIGGY SAYS

RICK GOODWIN ENTERPRISES, INC. (TENNESSEE CORPORATION)
1939 VOLUNTEER PARKWAY
BRISTOL, TN 37620

NO CLAIM IS MADE TO THE EXCLUSIVE RIGHT TO USE "PIGGY", APART FROM THE MARK AS SHOWN.

FOR: PLUSH TOYS, IN CLASS 28 (U.S. CLS. 22, 23, 38 AND 50).

SER. NO. 76-033,080, FILED 4-25-2000.

FIRST USE 11-25-1999; IN COMMERCE 11-25-1999.

LINDA POWELL, EXAMINING ATTORNEY

Int. Cl.: 11

Prior U.S. Cls.: 13, 21, 23, 31 and 34

United States Patent and Trademark Office

Reg. No. 3,396,816

Registered Mar. 18, 2008

**TRADEMARK
PRINCIPAL REGISTER**

POET

MUNRO CONCRETE PRODUCTS LTD. (CANADA CORPORATION)
RR#2
BARRIE, ONTARIO, CANADA L4M 4S4

FOR: NON-METAL TRAPS AND FITTINGS THEREFOR FOR USE IN CATCH BASINS AND MANHOLES OF STORM OR DRAINAGE WATER SYSTEMS, IN CLASS 11 (U.S. CLS. 13, 21, 23, 31 AND 34).

PRIORITY CLAIMED UNDER SEC. 44(D) ON CANADA APPLICATION NO. 1096420, FILED 3-16-2001, REG. NO. TMA606541, DATED 3-29-2004, EXPIRES 3-29-2019.

SER. NO. 76-266,534, FILED 6-4-2001.

WON TEAK OH, EXAMINING ATTORNEY

Int. Cl.: 32

Prior U.S. Cls.: 45, 46 and 48

United States Patent and Trademark Office

Reg. No. 3,396,817

Registered Mar. 18, 2008

TRADEMARK
PRINCIPAL REGISTER



OCEANIC BEVERAGES CO., INC. (TAIWAN CORPORATION)
10F 99 SEC. 3 CHUNG-YANG ROAD
SAN-CHUNG CITY, TAIPEI HSIEN, TAIWAN

FOR: SOFT DRINKS, FRUIT JUICE, DISTILLED WATER AND BOTTLED WATER, ALL FOR DRINKING, IN CLASS 32 (U.S. CLS. 45, 46 AND 48).

FIRST USE 11-0-1973; IN COMMERCE 0-0-1996.

NO CLAIM IS MADE TO THE EXCLUSIVE RIGHT TO USE "DUCKWEED" AND "FRUIT", APART FROM THE MARK AS SHOWN.

COLOR IS A FEATURE OF THE MARK. THE APPLE IS RED, THE TEXT AND LEAVES ARE GREEN, AND THE BACKGROUND IS YELLOW.

THE TRANSLITERATION OF THE FOREIGN WORDING ARE "PIN KU SI DA" WHICH MEANS "DUCKWEED", "FRUIT", "WEST" AND "TO BEAT" IN ENGLISH.

SER. NO. 76-304,857, FILED 8-24-2001.

ZHALEH DELANEY, EXAMINING ATTORNEY

Int. Cl.: 25

Prior U.S. Cls.: 22 and 39

United States Patent and Trademark Office

Reg. No. 3,396,818

Registered Mar. 18, 2008

TRADEMARK
PRINCIPAL REGISTER

TACO BLUE JEANS

TCO FRANQUIA LTDA. (BRAZIL LTD LIAB CO)
156, SALA 207 PARTE, MUNICIPIO DE TRES
RIOS, RUA DR. WALMIR PECANHA N
RIO DE JANEIRO, BRAZIL

FOR: KNITWEAR, NAMELY, KNIT SHIRTS;
SCARVES, BATHING TRUNKS, SWIMMING
TRUNKS, SWIMSUITS, SHORTS, BERMUDA
SHORTS, SHIRTS, T-SHIRTS, BEACHWEAR,
PANTS, COATS, JACKETS, SWEATERS, VESTS,
UNDERWEAR, OVERALLS, SOCKS, SKIRTS,
SHOES, TENNIS SHOES, BOOTS, SLIPPERS, SANDALS,
BELTS; CLOTHING MADE OF LEATHER,
NAMELY, LEATHER PANTS, VESTS, AND JACK-

ETS; HEADWEAR; EYESHADES, NAMELY, VISORS,
IN CLASS 25 (U.S. CLS. 22 AND 39).

PRIORITY CLAIMED UNDER SEC. 44(D) ON
BRAZIL APPLICATION NO. 824.037.405, FILED 9-
18-2001, REG. NO. 824.037.405, DATED 7-3-2007, EX-
PIRES 7-3-2017.

NO CLAIM IS MADE TO THE EXCLUSIVE
RIGHT TO USE "BLUE JEANS" , APART FROM
THE MARK AS SHOWN.

SER. NO. 76-325,159, FILED 10-4-2001.

GEORGE LORENZO, EXAMINING ATTORNEY

Int. Cl.: 36

Prior U.S. Cls.: 100, 101 and 102

United States Patent and Trademark Office

Reg. No. 3,396,819

Registered Mar. 18, 2008

**SERVICE MARK
PRINCIPAL REGISTER**

PAYMENT SOLUTIONS

PAYMENT SOLUTIONS (CALIFORNIA CORPORATION)
P.O. BOX 232220
SAN DIEGO, CA 921932220

OWNER OF U.S. REG. NOS. 2,056,416 AND 2,117,091.

FOR: CREDIT AND DEBIT CARD SERVICES; CHECK PROCESSING AND PAYMENT GUARANTEE SERVICES TO MERCHANTS; AND COLLECTION AGENCY SERVICES, IN CLASS 36 (U.S. CLS. 100, 101 AND 102).

SEC. 2(F).

SER. NO. 76-395,400, FILED 4-15-2002.

FIRST USE 4-1-1995; IN COMMERCE 7-21-1995.

GEORGE LORENZO, EXAMINING ATTORNEY

Int. Cl.: 25

Prior U.S. Cls.: 22 and 39

United States Patent and Trademark Office

Reg. No. 3,396,820

Registered Mar. 18, 2008

TRADEMARK
PRINCIPAL REGISTER

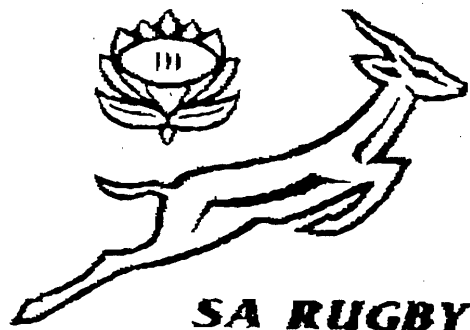

SOUTH AFRICAN RUGBY UNION (SOUTH
AFRICA CORPORATION)
SPORTS SCIENCE INSTITUTE BUILDING
5TH FLOOR, BOUNDARY ROAD
NEWLANDS, SOUTH AFRICA 7700

FOR: CLOTHING, NAMELY, T-SHIRTS, GOLF
SHIRTS, TRACKSUITS, JACKETS, SHORTS, PANTS,
SWEATSHIRTS AND SCARVES; FOOTWEAR,
HEADWEAR; SPORTSWEAR, NAMELY, T-SHIRTS,
GOLF SHIRTS, TRACKSUITS, JACKETS, SHORTS,
PANTS, SWEATSHIRTS, AND SCARVES; APRONS;
HOSIERY, IN CLASS 25 (U.S. CLS. 22 AND 39).

PRIORITY CLAIMED UNDER SEC. 44(D) ON
SOUTH AFRICA APPLICATION NO. 2002/16489,
FILED 10-22-2002, REG. NO. 2002/16489, DATED 10-
22-2002, EXPIRES 10-22-2013.

NO CLAIM IS MADE TO THE EXCLUSIVE
RIGHT TO USE "SA" AND "RUGBY", APART FROM
THE MARK AS SHOWN.

SER. NO. 76-465,996, FILED 11-4-2002.

TRICIA SONNEBORN, EXAMINING ATTORNEY

Int. Cl.: 25

Prior U.S. Cls.: 22 and 39

United States Patent and Trademark Office

Reg. No. 3,396,821

Registered Mar. 18, 2008

**TRADEMARK
PRINCIPAL REGISTER**

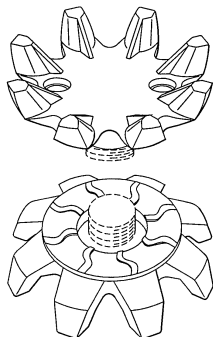

SOFTSPIKES, LLC (DELAWARE LTD LIAB JT ST
CO)
806 WEST DIAMOND AVE., SUITE 200
GAITHERSBURG, MD 20878

FOR: CLEATS FOR FOOTWEAR FOR SPORTS, IN
CLASS 25 (U.S. CLS. 22 AND 39).

FIRST USE 1-0-1999; IN COMMERCE 1-0-1999.

THE MARK CONSISTS OF A CLEAT IN THE
FORM OF A CENTRAL CIRCULAR HUB FROM
WHICH EIGHT TRACTION ELEMENTS EXTEND

OUTWARDLY AND DOWNWARDLY IN CANTILE-
VER FASHION TO SIMULATE LEGS OF A SPIDER.
THE DOTTED LINES ARE USED TO SHOW A
GENERIC FORM OF ATTACHING THE CLEAT
TO A SHOE.

SEC. 2(F).

SER. NO. 76-506,671, FILED 4-14-2003.

WILLIAM P. SHANAHAN, EXAMINING ATTOR-
NEY

Int. Cls.: 3, 6, 19 and 27

Prior U.S. Cls.: 1, 2, 4, 6, 12, 13, 14, 19, 20, 23, 25, 33, 37, 42, 50, 51 and 52

Reg. No. 3,396,822

United States Patent and Trademark Office

Registered Mar. 18, 2008

**TRADEMARK
PRINCIPAL REGISTER**

ARMSTRONG

AWI LICENSING COMPANY (DELAWARE CORPORATION)
802 WEST STREET
WILMINGTON, DE 19801

FOR: PRODUCTS USED FOR THE CARE OF FLOORS, WALLS AND OTHER SURFACES, NAME-
LY, ALL PURPOSE CLEANERS, POLISHES AND
WAXES, IN CLASS 3 (U.S. CLS. 1, 4, 6, 50, 51 AND 52).

FIRST USE 0-0-1955; IN COMMERCE 0-0-1955.

FOR: METAL CEILING PANELS AND SUSPEN-
DED CEILING SYSTEMS COMPRISED OF PANELS
AND SUPPORTS THEREFOR, IN CLASS 6 (U.S. CLS.
2, 12, 13, 14, 23, 25 AND 50).

FIRST USE 0-0-1941; IN COMMERCE 0-0-1941.

FOR: NON-METAL CEILING PANELS AND SUP-
PORTS THEREFOR; AND FLOORING MATERIAL,
NAMELY, WOOD AND LAMINATE FLOORING,
CERAMIC AND PORCELAIN TILE AND FLOOR-
ING UNDERLAYMENT, IN CLASS 19 (U.S. CLS. 1,
12, 33 AND 50).

FIRST USE 9-0-1996; IN COMMERCE 9-0-1996.

FOR: RESILIENT HARD SURFACED FLOOR
AND WALL COVERINGS, IN CLASS 27 (U.S. CLS.
19, 20, 37, 42 AND 50).

FIRST USE 0-0-1904; IN COMMERCE 0-0-1904.

THE MARK CONSISTS OF STANDARD CHAR-
ACTERS WITHOUT CLAIM TO ANY PARTICULAR
FONT, STYLE, SIZE, OR COLOR.

OWNER OF U.S. REG. NOS. 523,396, 2,227,937 AND
OTHERS.

SEC. 2(F).

SER. NO. 76-512,500, FILED 5-8-2003.

KATHERINE E. HALMEN, EXAMINING ATTOR-
NEY

Int. Cl.: 15

Prior U.S. Cls.: 2, 21 and 36

United States Patent and Trademark Office

Reg. No. 3,396,823

Registered Mar. 18, 2008

**TRADEMARK
PRINCIPAL REGISTER**

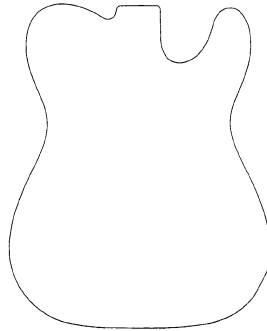

FENDER MUSICAL INSTRUMENTS CORPORATION (DELAWARE CORPORATION)
8860 E. CHAPARRAL ROAD, SUITE 100
SCOTTSDALE, AZ 85250

FOR: GUITAR BODIES, IN CLASS 15 (U.S. CLS. 2, 21 AND 36).

FIRST USE 0-0-1949; IN COMMERCE 0-0-1950.

OWNER OF U.S. REG. NOS. 2,051,790, 2,534,993 AND OTHERS.

THE MARK CONSISTS OF A FANCIFULLY SHAPED CONFIGURATION OF THE BODY PORTION OF A GUITAR.

SEC. 2(F).

SER. NO. 76-515,928, FILED 4-25-2003.

KARANENDRA S. CHHINA, EXAMINING ATTORNEY

Int. Cl.: 15

Prior U.S. Cls.: 2, 21 and 36

United States Patent and Trademark Office

Reg. No. 3,396,824

Registered Mar. 18, 2008

**TRADEMARK
PRINCIPAL REGISTER**

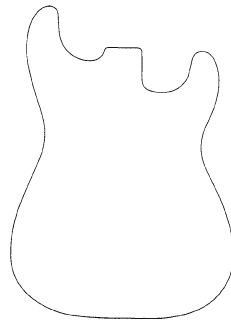

FENDER MUSICAL INSTRUMENTS CORPORATION (DELAWARE CORPORATION)
8860 E. CHAPARRAL ROAD, SUITE 100
SCOTTSDALE, AZ 85250

FOR: GUITAR BODIES, IN CLASS 15 (U.S. CLS. 2, 21 AND 36).

FIRST USE 0-0-1954; IN COMMERCE 0-0-1954.

OWNER OF U.S. REG. NOS. 2,051,790, 2,534,993 AND OTHERS.

THE MARK CONSISTS OF A FANCIFULLY SHAPED CONFIGURATION OF THE BODY PORTION OF A GUITAR.

SEC. 2(F).

SER. NO. 76-516,126, FILED 4-25-2003.

KARANENDRA S. CHHINA, EXAMINING ATTORNEY

Int. Cl.: 15

Prior U.S. Cls.: 2, 21 and 36

United States Patent and Trademark Office

Reg. No. 3,396,825

Registered Mar. 18, 2008

**TRADEMARK
PRINCIPAL REGISTER**

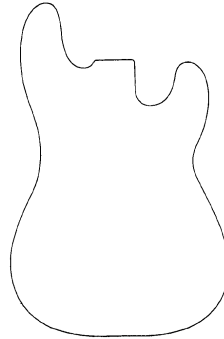

FENDER MUSICAL INSTRUMENTS CORPORATION (DELAWARE CORPORATION)
8860 E. CHAPARRAL ROAD
SUITE 100
SCOTTSDALE, AZ 85250

FOR: GUITAR BODIES, IN CLASS 15 (U.S. CLS. 2, 21 AND 36).

FIRST USE 0-0-1951; IN COMMERCE 0-0-1957.

OWNER OF U.S. REG. NOS. 2,051,790, 2,534,993 AND OTHERS.

THE MARK CONSISTS OF A FANCIFULLY SHAPED CONFIGURATION OF THE BODY PORTION OF A GUITAR.

SEC. 2(F).

SER. NO. 76-516,127, FILED 4-25-2003.

KARANENDRA S. CHHINA, EXAMINING ATTORNEY

Int. Cl.: 36

Prior U.S. Cls.: 100, 101 and 102

United States Patent and Trademark Office

Reg. No. 3,396,826

Registered Mar. 18, 2008

**SERVICE MARK
PRINCIPAL REGISTER**



BERTHOLON-ROWLAND CORP. (NEW YORK
CORPORATION)
100 BROADWAY
NEW YORK, NY 100051902

FIRST USE 12-0-1987; IN COMMERCE 12-0-1987.

SER. NO. 76-531,141, FILED 7-21-2003.

FOR: INSURANCE BROKERAGE AND ADMIN-
ISTRATION SERVICES, IN CLASS 36 (U.S. CLS. 100,
101 AND 102).

THEODORE MCBRIDE, EXAMINING ATTORNEY

Int. Cl.: 5

Prior U.S. Cls.: 6, 18, 44, 46, 51 and 52

United States Patent and Trademark Office

Reg. No. 3,396,827

Registered Mar. 18, 2008

**TRADEMARK
PRINCIPAL REGISTER**

WELLNESS ESSENTIALS

METAGENICS, INC. (CALIFORNIA CORPORATION)
100 AVENIDA LA PATA
SAN CLEMENTE, CA 92673

NO CLAIM IS MADE TO THE EXCLUSIVE RIGHT TO USE "WELLNESS", APART FROM THE MARK AS SHOWN.

FOR: DIETARY AND NUTRITIONAL SUPPLEMENTS, IN CLASS 5 (U.S. CLS. 6, 18, 44, 46, 51 AND 52).

SER. NO. 76-553,169, FILED 10-1-2003.

FIRST USE 8-27-1998; IN COMMERCE 8-27-1998.

KAREN M. STRYZ, EXAMINING ATTORNEY

Int. Cl.: 41

Prior U.S. Cls.: 100, 101 and 107

United States Patent and Trademark Office

Reg. No. 3,396,828

Registered Mar. 18, 2008

**SERVICE MARK
PRINCIPAL REGISTER**



PORTILLO, EDMUNDO (UNITED STATES INDIVIDUAL)
12613 GILDED SUN
EL PASO, TX 79936

FOR: PROVIDING A COMPETITIVE YOUTH SOCCER PROGRAM TO PARTICIPATE IN PLAYING THE SPORT OF SOCCER, IN CLASS 41 (U.S. CLS. 100, 101 AND 107).

FIRST USE 5-15-2000; IN COMMERCE 5-15-2000.

NO CLAIM IS MADE TO THE EXCLUSIVE RIGHT TO USE SOCCER EL PASO, TEXAS AND EST. 00' AND THE DEPICTION OF A SOCCER BALL, APART FROM THE MARK AS SHOWN.

SER. NO. 76-563,900, FILED 12-8-2003.

BRIDGETT SMITH, EXAMINING ATTORNEY

Int. Cl.: 35

Prior U.S. Cls.: 100, 101 and 102

United States Patent and Trademark Office

Reg. No. 3,396,829

Registered Mar. 18, 2008

**SERVICE MARK
PRINCIPAL REGISTER**

YOUR BACK OFFICE IS OUR FRONT OFFICE

CONTINUSERVE, LLC (MASSACHUSETTS LTD
LIAB CO)
124 MOUNT AUBURN STREET
CAMBRIDGE, MA 02138

FIRST USE 9-0-2003; IN COMMERCE 9-0-2003.

SER. NO. 76-571,047, FILED 1-20-2004.

FOR: BUSINESS PROCESS OUTSOURCING SER-
VICES IN THE FIELDS OF INFORMATION TECH-
NOLOGY AND TRANSACTION PROCESSING, IN
CLASS 35 (U.S. CLS. 100, 101 AND 102).

DAVID C. REIHNER, EXAMINING ATTORNEY

Int. Cl.: 36

Prior U.S. Cls.: 100, 101 and 102

United States Patent and Trademark Office

Reg. No. 3,396,830

Registered Mar. 18, 2008

**SERVICE MARK
PRINCIPAL REGISTER**

THE MELLON GROUP

BANK OF NEW YORK MELLON CORPORATION,
THE (DELAWARE CORPORATION)
ONE MELLON BANK CENTER
PITTSBURGH, PA 15258

FOR: FINANCIAL AND INVESTMENT MANAGEMENT AND ADVISORY SERVICES, IN CLASS 36 (U.S. CLS. 100, 101 AND 102).

FIRST USE 2-0-2002; IN COMMERCE 2-0-2002.

THE MARK CONSISTS OF STANDARD CHARACTERS WITHOUT CLAIM TO ANY PARTICULAR FONT, STYLE, SIZE, OR COLOR.

OWNER OF U.S. REG. NOS. 1,111,471, 2,721,673 AND OTHERS.

NO CLAIM IS MADE TO THE EXCLUSIVE RIGHT TO USE "GROUP", APART FROM THE MARK AS SHOWN.

SEC. 2(F).

SER. NO. 76-571,128, FILED 1-20-2004.

YONG KIM, EXAMINING ATTORNEY

Int. Cl.: 35

Prior U.S. Cls.: 100, 101 and 102

United States Patent and Trademark Office

Reg. No. 3,396,831

Registered Mar. 18, 2008

**SERVICE MARK
PRINCIPAL REGISTER**

AV DEALS

NETBORED INC. (CANADA CORPORATION)
423B WYECROFT RD.
OAKVILLE, ONTARIO, CANADA L6K 2H2

FOR: ON-LINE RETAIL STORES AND MAIL
ORDER SERVICES FEATURING CONSUMER
AND COMMERCIAL AUDIO AND VIDEO EQUIP-
MENT INCLUDING AUDIO COMPONENTS,
AUDIO SYSTEMS AND ACCESSORIES, TELEVI-
SIONS, TELEVISION SYSTEMS AND ACCESSOR-
IES, RADIOS, DIGITAL TAPE RECORDERS AND
VIDEO TAPE RECORDERS, IN CLASS 35 (U.S. CLS.
100, 101 AND 102).

FIRST USE 8-31-2000; IN COMMERCE 8-31-2000.

THE MARK CONSISTS OF STANDARD CHAR-
ACTERS WITHOUT CLAIM TO ANY PARTICULAR
FONT, STYLE, SIZE, OR COLOR.

NO CLAIM IS MADE TO THE EXCLUSIVE
RIGHT TO USE "AV", APART FROM THE MARK
AS SHOWN.

SEC. 2(F).

SER. NO. 76-583,506, FILED 3-26-2004.

STEVEN JACKSON, EXAMINING ATTORNEY

Int. Cl.: 25

Prior U.S. Cls.: 22 and 39

United States Patent and Trademark Office

Reg. No. 3,396,832

Registered Mar. 18, 2008

TRADEMARK
PRINCIPAL REGISTER

ΩΨΦ
1911

OMEGA PSI PHI FRATERNITY, INC. (D.C. CORPORATION)
3951 SNAPPINGER PARKWAY
DECATUR, GA 30035

FOR: CLOTHING, NAMELY, SHIRTS, POLO SHIRTS, SWEAT SHIRTS, T-SHIRTS, TANK TOPS, JACKETS, HATS, PANTS, SHOES, SOCKS, JOGGING SUITS, SHORTS, SWEAT SUITS, SWEAT PANTS, UNDERWEAR, SWIM WEAR, COATS, LEATHER COATS, BANDANNAS, BOOTS, SWEAT BANDS, GYM SHOES, AEROBIC SHOES, TENNIS SHOES, AND WALKING SHOES, IN CLASS 25 (U.S. CLS. 22 AND 39).

FIRST USE 1-1-1912; IN COMMERCE 1-1-1912.

THE NON-LATIN CHARACTER(S) IN THE MARK TRANSLITERATES INTO "OMEGA PSI PHI", AND THIS MEANS NOTHING IN PARTICULAR IN ENGLISH.

SEC. 2(F).

SER. NO. 76-593,849, FILED 5-24-2004.

MARLENE BELL, EXAMINING ATTORNEY

Int. Cl.: 36

Prior U.S. Cls.: 100, 101 and 102

United States Patent and Trademark Office

Reg. No. 3,396,833

Registered Mar. 18, 2008

**SERVICE MARK
PRINCIPAL REGISTER**



DORCHESTER CAPITAL MANAGEMENT COM-
PANY (DELAWARE CORPORATION)
170 WARRENTON DRIVE
HOUSTON, TX 77024

OWNER OF U.S. REG. NOS. 3,127,400 AND
3,177,469.

FOR: FINANCIAL ANALYSIS AND CONSULTA-
TION IN THE NATURE OF ANALYZING AND
COMPILING DATA FOR MEASURING THE PER-
FORMANCE OF FINANCIAL MARKETS AND PRO-
VIDING THAT DATA TO OTHERS, IN CLASS 36
(U.S. CLS. 100, 101 AND 102).

NO CLAIM IS MADE TO THE EXCLUSIVE
RIGHT TO USE "THE CAPITAL MARKETS INDEX",
APART FROM THE MARK AS SHOWN.

SER. NO. 76-608,542, FILED 8-25-2004.

FIRST USE 5-3-2006; IN COMMERCE 5-30-2006.

ANDREW RHIM, EXAMINING ATTORNEY

Int. Cl.: 16

Prior U.S. Cls.: 2, 5, 22, 23, 29, 37, 38 and 50

Reg. No. 3,396,834

United States Patent and Trademark Office

Registered Mar. 18, 2008

**TRADEMARK
PRINCIPAL REGISTER**



DCS DAYLIGHT CLEANING SYSTEMS INC.
(CANADA CORPORATION)
235 PARKRIDGE HILL S.E.
CALGARY, ALBERTA T2J 4Z7

PRIORITY CLAIMED UNDER SEC. 44(D) ON
CANADA APPLICATION NO. 1221103, FILED 6-21-
2004, REG. NO. TMA657821, DATED 2-2-2006, EX-
PIRES 2-2-2021.

FOR: OPERATION AND TRAINING MANUALS
RELATED TO JANITORIAL AND BUILDING
MAINTENANCE PRODUCTS, SERVICES AND
BUSINESSES; CATALOGUES, BROCHURES, LEAF-
LETS AND PAMPHLETS RELATED TO JANITORIAL
AND BUILDING MAINTENANCE PRODUCTS,
SERVICES AND BUSINESSES, IN CLASS 16 (U.S.
CLS. 2, 5, 22, 23, 29, 37, 38 AND 50).

NO CLAIM IS MADE TO THE EXCLUSIVE
RIGHT TO USE "CLEANING SYSTEMS", APART
FROM THE MARK AS SHOWN.

SER. NO. 76-608,661, FILED 8-23-2004.

ELLEN PERKINS, EXAMINING ATTORNEY

Int. Cls.: 9, 35, 36 and 42

Prior U.S. Cls.: 21, 23, 26, 36, 38, 100, 101 and 102

Reg. No. 3,396,835

United States Patent and Trademark Office

Registered Mar. 18, 2008

**TRADEMARK
SERVICE MARK
PRINCIPAL REGISTER**

UBIQUITY BANK

UBIQUITY BANK OF CANADA (CANADA CORPORATION)
SUITE 303, 32071 SOUTH FRASER WAY
ABBOTSFORD, BRITISH COLUMBIA, CANADA
V2T 1W3

FOR: COMPUTER SOFTWARE, NAMELY APPLICATION SOFTWARE AND INTRANET DATABASE MANAGEMENT SOFTWARE FOR USE BY FINANCIAL INSTITUTIONS IN THE FIELDS OF THE OPERATION OF DEPOSIT TAKING FINANCIAL INSTITUTIONS, FINANCIAL AND INVESTMENT RESEARCH, FINANCIAL AND ESTATE PLANNING AND MANAGEMENT, TRUST PLANNING AND MANAGEMENT, INSURANCE PLANNING AND MANAGEMENT, RECORDATION AND MANAGEMENT OF LEASE FINANCING AND WHOLESALE FINANCING, AND RECORDATION AND MANAGEMENT OF REAL ESTATE AND MORTGAGE BROKERAGE, IN CLASS 9 (U.S. CLS. 21, 23, 26, 36 AND 38).

FOR: COMPUTERIZED DATA PROCESSING SERVICES; PROVIDING MANAGEMENT SERVICES INCIDENTAL TO FINANCIAL AND INVESTMENT DEALER BROKERAGE SERVICES IN RESPECT OF SECURITIES, MUTUAL FUNDS, STOCKS, OPTIONS, COMMODITIES, FUTURES, AND MONEY MARKET PRODUCTS; PROVIDING MANAGEMENT AND ADMINISTRATIVE SERVICES RELATED TO THE OPERATION OF TRUSTS, IN CLASS 35 (U.S. CLS. 100, 101 AND 102).

FOR: BANKING SERVICES; SAFE DEPOSIT BOX SERVICES; BROKERAGE IN THE FIELD OF INSURANCE, STOCKS AND BONDS; MORTGAGE BANKING; CONSUMER LENDING; INVESTMENT BANKING SERVICES; INSURANCE BROKERAGE; INVESTMENT ADVICE; COMMERCIAL BANKING; COMMERCIAL LENDING; REAL ESTATE AND

MORTGAGE BROKERAGE SERVICES; CREDIT CARD SERVICES; FINANCIAL SERVICES, NAMELY, FINANCIAL INFORMATION PROVIDED BY ELECTRONIC MEANS, FINANCIAL INVESTMENT IN THE FIELD OF SECURITIES, FINANCIAL MANAGEMENT, FINANCIAL PLANNING, FINANCIAL PORTFOLIO MANAGEMENT, AND FINANCIAL SERVICES IN THE NATURE OF INVESTMENT SECURITY; FINANCING SERVICES; FINANCIAL AND INVESTMENT DEALER BROKERAGE SERVICES IN RESPECT OF SECURITIES, MUTUAL FUNDS, STOCKS, OPTIONS, COMMODITIES, FUTURES, AND MONEY MARKET PRODUCTS; PROVIDING PERSONAL AND CORPORATE FINANCIAL INVESTMENT AND CONSULTATION SERVICES; PROVIDING RESEARCH, ADVISORY AND INVESTMENT SERVICES INCIDENTAL TO FINANCIAL AND INVESTMENT DEALER BROKERAGE SERVICES IN RESPECT OF SECURITIES, MUTUAL FUNDS, STOCKS, OPTIONS, COMMODITIES, FUTURES, AND MONEY MARKET PRODUCTS; ADVISORY AND INVESTMENT SERVICES RELATED TO THE OPERATION OF TRUSTS, IN CLASS 36 (U.S. CLS. 100, 101 AND 102).

FOR: TECHNICAL SUPPORT SERVICES, NAMELY, TROUBLE SHOOTING OF COMPUTER HARDWARE AND SOFTWARE PROBLEMS; DESIGN, CREATION, HOSTING AND MAINTENANCE OF WEBSITES FOR OTHERS, IN CLASS 42 (U.S. CLS. 100 AND 101).

THE MARK CONSISTS OF STANDARD CHARACTERS WITHOUT CLAIM TO ANY PARTICULAR FONT, STYLE, SIZE, OR COLOR.

PRIORITY CLAIMED UNDER SEC. 44(D) ON CANADA APPLICATION NO. 1,229,322, FILED 9-3-

2004, REG. NO. TMA649,419, DATED 9-30-2005, EX-PIRES 9-30-2020.

SER. NO. 76-614,495, FILED 10-1-2004.

NO CLAIM IS MADE TO THE EXCLUSIVE RIGHT TO USE BANK, APART FROM THE MARK AS SHOWN.

GIANCARLO CASTRO, EXAMINING ATTORNEY

Int. Cl.: 3

Prior U.S. Cls.: 1, 4, 6, 50, 51 and 52

Reg. No. 3,396,836

United States Patent and Trademark Office

Registered Mar. 18, 2008

**TRADEMARK
PRINCIPAL REGISTER**

INKOMFE

JOY LIMITED (UNITED KINGDOM COMPANY)
31 NEW ROAD, THE STUDIO
WILSTONE, TRING
HERTFORDSHIRE, UNITED KINGDOM HP23 4NZ

FOR: NON-MEDICATED COSMETIC, TOILET, PERSONAL CLEANSING AND BATH PREPARATIONS FOR USE IN THE CARE AND APPEARANCE OF THE HAIR, SCALP, FACE, SKIN, NAILS AND EYES, NAMELY, SOAPS; HAIR SHAMPOOS AND CONDITIONERS, MOISTURIZERS AND RINSES; AEROSOL AND NON-AEROSOL HAIRSPRAYS; HAIR MOUSSES, FOAMS, GELS, STYLING SPRAYS AND STYLING LOTIONS; HAIR GLAZE AND WAXES; SCULPTING AND VOLUMIZING SPRAYS AND LOTIONS FOR HAIR; PERMANENT AND SEMI-PERMANENT HAIR COLORING PREPARATIONS; DEPILATORY PREPARATIONS; SUNSCREEN AND TANNING PREPARATIONS; PERFUMERY; DENTIFRICES; HAND AND BODY CREAMS AND LOTIONS; HAIR WAVING PREPARATIONS; PERMANENT WAVING, NEUTRALI-

ZERS FOR HAIR WAVING PREPARATIONS; PERFUMERY, COSMETIC PREPARATIONS FOR SKIN CARE, EYEBROW COSMETICS, FACE COSMETICS, RELAXERS AND HAIRDRESSING FOILS, IN CLASS 3 (U.S. CLS. 1, 4, 6, 50, 51 AND 52).

THE MARK CONSISTS OF STANDARD CHARACTERS WITHOUT CLAIM TO ANY PARTICULAR FONT, STYLE, SIZE, OR COLOR.

PRIORITY CLAIMED UNDER SEC. 44(D) ON ERPN CMNTY TM OFC APPLICATION NO. 3829678, FILED 5-11-2004, REG. NO. 003829678, DATED 5-11-2004, EXPIRES 5-11-2014.

THE WORD "INKOMFE" IS AN AFRICAN ZULU WORD FOR A POTATO PLANT OTHERWISE KNOWN AS HYPOXIS.

SER. NO. 76-619,118, FILED 11-3-2004.

KAREN K. BUSH, EXAMINING ATTORNEY

Int. Cl.: 44

Prior U.S. Cls.: 100 and 101

United States Patent and Trademark Office

Reg. No. 3,396,837

Registered Mar. 18, 2008

**SERVICE MARK
PRINCIPAL REGISTER**

WELLNESS BY DESIGN

ALEXIAN BROTHERS OF AMERICA, INC.
(TEXAS CORPORATION)
600 ALEXIAN WAY
ELK GROVE VILLAGE, IL 600073395

FOR: HEALTHCARE SERVICES, NAMELY, PROVIDING MEDICAL, PHYSICAL AND MENTAL ASSESSMENTS, RECOMMENDATIONS AND MONITORING AND TREATMENT FOR OLDER ADULTS , IN CLASS 44 (U.S. CLS. 100 AND 101).

FIRST USE 12-31-1999; IN COMMERCE 12-31-1999.

THE MARK CONSISTS OF STANDARD CHARACTERS WITHOUT CLAIM TO ANY PARTICULAR FONT, STYLE, SIZE, OR COLOR.

SER. NO. 76-620,353, FILED 11-12-2004.

LA TONIA FISHER, EXAMINING ATTORNEY

Int. Cl.: 36

Prior U.S. Cls.: 100, 101 and 102

United States Patent and Trademark Office

Reg. No. 3,396,838

Registered Mar. 18, 2008

**SERVICE MARK
PRINCIPAL REGISTER**

PANTHER CLUB

UNIVERSITY OF PITTSBURGH - OF THE COMMONWEALTH SYSTEM OF HIGHER EDUCATION (PENNSYLVANIA CORPORATION)

1710 CATHEDRAL OF LEARNING

PITTSBURGH, PA 15260

FOR: FUNDRAISING FOR UNIVERSITY ATHLETICS DIRECTED TOWARD SUPPORTERS OF THE UNIVERSITY OF PITTSBURGH ATHLETICS , IN CLASS 36 (U.S. CLS. 100, 101 AND 102).

FIRST USE 11-22-2004; IN COMMERCE 11-22-2004.

THE MARK CONSISTS OF STANDARD CHARACTERS WITHOUT CLAIM TO ANY PARTICULAR FONT, STYLE, SIZE, OR COLOR.

OWNER OF U.S. REG. NOS. 2,235,254, 2,736,342, AND 2,844,537.

NO CLAIM IS MADE TO THE EXCLUSIVE RIGHT TO USE "CLUB", APART FROM THE MARK AS SHOWN.

SER. NO. 76-626,236, FILED 12-22-2004.

MARK RADEMACHER, EXAMINING ATTORNEY

Int. Cls.: 35 and 38

Prior U.S. Cls.: 100, 101, 102 and 104

United States Patent and Trademark Office

Reg. No. 3,396,839

Registered Mar. 18, 2008

**SERVICE MARK
PRINCIPAL REGISTER**

IENTV

THOMAS PUBLISHING COMPANY (NEW YORK CORPORATION)
5 PENN PLAZA, 15TH FLOOR
NEW YORK, NY 10001

FOR: PROVIDING BUSINESS INFORMATION SERVICES IN THE NATURE OF INDUSTRIAL PRODUCT INFORMATION VIA THE INTERNET, IN CLASS 35 (U.S. CLS. 100, 101 AND 102).

FIRST USE 1-0-2005; IN COMMERCE 1-0-2005.

FOR: STREAMING OF VIDEO MATERIAL IN THE FIELDS OF INDUSTRIAL GOODS AND SERVICES ON THE INTERNET, IN CLASS 38 (U.S. CLS. 100, 101 AND 104).

FIRST USE 1-0-2005; IN COMMERCE 1-0-2005.

THE MARK CONSISTS OF STANDARD CHARACTERS WITHOUT CLAIM TO ANY PARTICULAR FONT, STYLE, SIZE, OR COLOR.

OWNER OF U.S. REG. NOS. 2,519,417 AND 2,981,984.

SER. NO. 76-631,223, FILED 2-14-2005.

MICHAEL LEWIS, EXAMINING ATTORNEY

Int. Cl.: 25

Prior U.S. Cls.: 22 and 39

United States Patent and Trademark Office

Reg. No. 3,396,840

Registered Mar. 18, 2008

TRADEMARK
PRINCIPAL REGISTER



KI KORPO - COMERCIO DE CONFECCOES
LTDA (BRAZIL CORPORATION)
RUA MORANGA, 460 PARTE - INHOAIBA
CAMPO GRANDERIO DE JANEIRO
RJ CEP 23.059-150, BRAZIL

FOR: CLOTHING, NAMELY, SWIMSUITS, BIKINIS, GYMNASTICS UNIFORMS, PANTS, BELTS, FOOTWEAR, HATS, T-SHIRTS, BLOUSES, SKIRTS, DRESSES, SHORTS, JACKETS, AND BEACHWEAR; WORK OUT OUTFITS NAMELY LEOTARDS; SPORTS TEAM WEAR, NAMELY, SPORTS JERSEYS AND BREECHES FOR SPORTS; NOT TO INCLUDE INTIMATE APPAREL, NAMELY, BRASSIERES AND PANTIES, IN CLASS 25 (U.S. CLS. 22 AND 39).

FIRST USE 8-0-2000; IN COMMERCE 8-0-2000.

NO CLAIM IS MADE TO THE EXCLUSIVE RIGHT TO USE "BEACH FITNESS", APART FROM THE MARK AS SHOWN.

THE USE OF GRAY TONES IS INTENDED TO INDICATE SHADING OR CONTRAST ONLY AND DOES NOT INDICATE COLOR.

THE MARK CONSISTS OF THE PHRASE, WORDS AND LETTERS: KI-KORPO BEACH FITNESS (AND DESIGN) AND IN PART, A STYLIZED SUN, INCLUDING ELEMENTS OF DESIGN CATEGORY 01.05 (SUN).

"KI-KORPO" IS A PHONETIC SPELLING OF THE TERM, "QUE CORPO", WITH AN ENGLISH TRANSLATION APPROXIMATING, "WHAT A BODY".

SER. NO. 76-631,516, FILED 2-17-2005.

CURTIS FRENCH, EXAMINING ATTORNEY

Int. Cls.: 9, 10, 42 and 44

Prior U.S. Cls.: 21, 23, 26, 36, 38, 39, 44, 100 and 101

Reg. No. 3,396,841

United States Patent and Trademark Office

Registered Mar. 18, 2008

**TRADEMARK
SERVICE MARK
PRINCIPAL REGISTER**

SONOPLATFORM

SONOMAX HEARING HEALTHCARE INC. (CANADA CORPORATION)
8375 MAYRAND STREET
MONTREAL, QUEBEC H4P 2E2, CANADA

FOR: SOUND FILTERING DEVICES FOR INSERTION INTO THE HUMAN EAR, NAMELY, MOULDS AND EAR PLUGS AND PARTS THEREFOR, IN CLASS 9 (U.S. CLS. 21, 23, 26, 36 AND 38).

FOR: HEARING AIDS AND PARTS THEREFOR, IN CLASS 10 (U.S. CLS. 26, 39 AND 44).

FOR: CONSULTING SERVICES AS TO APPARATUS AND EQUIPMENT, ENVIRONMENTAL FACTORS AND PROCEDURES TO BE FOLLOWED, ALL IN THE FIELD OF NOISE MANAGEMENT AND SOUND FILTERING, IN CLASS 42 (U.S. CLS. 100 AND 101).

FOR: MEDICAL CONSULTING SERVICES FOR HEARING AIDS, IN CLASS 44 (U.S. CLS. 100 AND 101).

THE MARK CONSISTS OF STANDARD CHARACTERS WITHOUT CLAIM TO ANY PARTICULAR FONT, STYLE, SIZE, OR COLOR.

PRIORITY CLAIMED UNDER SEC. 44(D) ON CANADA APPLICATION NO. 1258834, FILED 5-25-2005, REG. NO. TMA699104, DATED 10-22-2007, EXPIRES 10-22-2022.

SER. NO. 76-640,061, FILED 6-3-2005.

DOMINIC J. FERRAIUOLO, EXAMINING ATTORNEY

Int. Cls.: 35, 36, 37 and 39

Prior U.S. Cls.: 100, 101, 102, 103, 105 and 106

United States Patent and Trademark Office

Reg. No. 3,396,842

Registered Mar. 18, 2008

SERVICE MARK
PRINCIPAL REGISTER

Denny Hecker

DENNY HECKER'S AUTOMOTIVE GROUP, INC.
(MINNESOTA CORPORATION)
500 FORD ROAD
MINNEAPOLIS, MN 55426

FOR: AUTOMOBILE DEALERSHIPS AND ON-
LINE RETAIL STORE SERVICES FEATURING NEW
AND USED MOTOR VEHICLES, IN CLASS 35 (U.S.
CLS. 100, 101 AND 102).

FIRST USE 7-1-1987; IN COMMERCE 7-1-1987.

FOR: FINANCIAL SERVICES, NAMELY, REAL
ESTATE ACQUISITION SERVICES; REAL ESTATE
BROKERAGE; FINANCIAL SERVICES, NAMELY,
THE PURCHASE OF RESIDENTIAL MORTGAGES
ON BEHALF OF OTHERS; MORTGAGE PROCURE-
MENT FOR OTHERS, IN CLASS 36 (U.S. CLS. 100, 101
AND 102).

FIRST USE 3-1-2004; IN COMMERCE 3-1-2004.

FOR: MAINTENANCE AND REPAIR OF NEW
AND USED MOTOR VEHICLES, IN CLASS 37 (U.S.
CLS. 100, 103 AND 106).

FIRST USE 7-1-1987; IN COMMERCE 7-1-1987.

FOR: RENTAL OF NEW AND USED MOTOR
VEHICLES, IN CLASS 39 (U.S. CLS. 100 AND 105).

FIRST USE 1-1-2002; IN COMMERCE 1-1-2002.

THE NAME DENNY HECKER IDENTIFIES A
LIVING INDIVIDUAL WHOSE CONSENT IS OF
RECORD.

SER. NO. 76-642,805, FILED S.R. 7-14-2005 AM. P.R.
10-19-2007.

DAVID YONTEF, EXAMINING ATTORNEY

Int. Cl.: 45

Prior U.S. Cls.: 100 and 101

United States Patent and Trademark Office

Reg. No. 3,396,843

Registered Mar. 18, 2008

SERVICE MARK
PRINCIPAL REGISTER

Shadi.com
dreams into reality

SHADI.COM DIVISION OF AMPAK BILLING
CORP. (NEW YORK CORPORATION)
64 MARGES WAY
HOPEWELL JUNCTION, NY 12533

FOR: MARRIAGE PARTNER INTRODUCTION SERVICES, MARRIAGE BUREAUS, MARRIAGE COUNSELING, DATING SERVICES, MATRIMONIAL SERVICES FOR MATCH MAKING THROUGH WEBSITE, PERSONAL INTERACTION, PRINT MEDIA, TELEVISION AND OTHER MEDIA, PROVIDING AN ON-LINE COMPUTER DATABASE IN THE FIELDS OF MATRIMONIAL SERVICES, NAMELY, MARRIAGE PARTNER INTRODUCTION SERVICES, DATING SERVICES AND MARRIAGE COUNSELING FOR GLOBAL COMPUTER NETWORK WEBSITE USERS, IN CLASS 45 (U.S. CLS. 100 AND 101).

FIRST USE 8-11-1997; IN COMMERCE 8-11-1997.

NO CLAIM IS MADE TO THE EXCLUSIVE RIGHT TO USE "SHADI.COM", APART FROM THE MARK AS SHOWN.

THE MARK CONSISTS OF THE WORDING "SHADI.COM" AND "DREAMS INTO REALITY" WITH THE DESIGN ELEMENTS OF A TASSEL INTERTWINED IN THE LETTER "S" IN THE WORDING "SHADI.COM" AND A LINE BETWEEN THE WORDING "SHADI.COM" AND "DREAMS INTO REALITY".

THE FOREIGN WORDING IN THE MARK TRANSLATES INTO ENGLISH AS MARRIAGE AND WEDDING.

SER. NO. 76-643,117, FILED 7-19-2005.

AMY MCMENAMIN, EXAMINING ATTORNEY

Int. Cls.: 19 and 42

Prior U.S. Cls.: 1, 12, 33, 50, 100 and 101

United States Patent and Trademark Office

Reg. No. 3,396,844

Registered Mar. 18, 2008

**TRADEMARK
SERVICE MARK
PRINCIPAL REGISTER**

KEEPERS OF THE AMERICAN SPIRIT

LINCOLN LOGS, LTD. (NEW YORK CORPORATION)

RIVERSIDE DRIVE

CHESTERTOWN, NY 12817

FOR: PREFABRICATED HOME SYSTEMS COMPRISING SOLID TIMBER WALLS AND/OR WALL PANELS, FLOOR AND ROOF TRUSSES AND PANELS, WINDOWS AND DOORS; PREFABRICATED SOLARIUMS, IN CLASS 19 (U.S. CLS. 1, 12, 33 AND 50).

FIRST USE 9-0-1999; IN COMMERCE 9-0-1999.

FOR: CUSTOM DESIGN AND ENGINEERING OF HOUSE PLANS TO THE ORDER AND SPECIFICATION OF OTHERS, IN CLASS 42 (U.S. CLS. 100 AND 101).

FIRST USE 9-0-1999; IN COMMERCE 9-0-1999.

THE MARK CONSISTS OF STANDARD CHARACTERS WITHOUT CLAIM TO ANY PARTICULAR FONT, STYLE, SIZE, OR COLOR.

SER. NO. 76-643,752, FILED 7-27-2005.

ANNE E. GUSTASON, EXAMINING ATTORNEY

Int. Cl.: 9

Prior U.S. Cls.: 21, 23, 26, 36 and 38

Reg. No. 3,396,845

United States Patent and Trademark Office

Registered Mar. 18, 2008

**TRADEMARK
PRINCIPAL REGISTER**

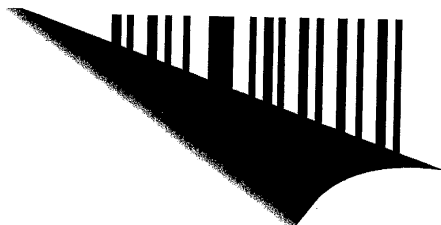

KABUSHIKI KAISHA SATO (JAPAN CORPORATION)
9-10, EBISU 4-CHOME
SHIBUYA-KU, TOKYO 150-0013, JAPAN

FOR: COMPUTER HARDWARE; PRINTERS; THERMAL PRINTERS; BARCODE PRINTERS; RADIO FREQUENCY IDENTIFICATION TAG READERS; RADIO FREQUENCY IDENTIFICATION TAG INTERROGATORS; RADIO FREQUENCY IDENTIFICATION TAG INTERROGATORS-RESPONDER; RADIO FREQUENCY IDENTIFICATION TAG WRITERS; ELECTRONICALLY ENCODED IDENTITY WRISTBANDS AND BRACELETS; ELECTRONICALLY ENCODED WRISTBANDS AND BRACELETS FOR INFORMATION AND IDENTIFICATION PURPOSES; WRISTBANDS AND BRACELETS COMPRISING INTEGRATED CIRCUIT CHIPS OR RADIO FREQUENCY IDENTIFICATION ELEMENTS OR TRANSPONDERS; ELECTRONICALLY ENCODED SECURITY PASSES; RADIO FREQUENCY IDENTIFICATION TAGS; COMPUTER SOFTWARE AND COMPUTER PROGRAMS FOR USE IN DATABASE MANAGEMENT, USE AS A SPREADSHEET, AND FOR DESIGNING, PRINTING, AND CREATING LABELS, TAGS, BARCODE LABELS IN THE FIELD OF PRINTER DRIVER AND PROTOCOL CONVER-

SION;ELECTRONIC PUBLICATIONS DOWNLOADABLE FROM THE INTERNET IN THE NATURE OF BROCHURES,PAMPHLETS AND INSTRUCTION MANUALS IN THE FIELDS OF COMPUTERS, PRINTERS, PRINTING SUPPLIES, BARCODE PRINTERS, RADIO FREQUENCY IDENTIFICATION TAGS AND SECURITY FOR THE PURPOSE OF SALES; BLANK CD-ROMS FOR SOUND OR VIDEO RECORDING OR COMPUTER DATA,CD-ROM DRIVES AND OR CD-ROM WRITERS; CD-ROMS AND COMPACT DISCS FEATURING SOFTWARE FOR USE IN DATABASE MANAGEMENT, USE AS A SPREAD SHEET, USE IN WORD PROCESSING, AND FOR DESIGNING, PRINTING, AND CREATING LABELS, TAGS, BARCODE LABELS, AND OTHER PRINTED MATTER; CD-ROMS AND COMPACT DISCS FEATURING COMPUTER SOFTWARE FOR PROTOCOL-CONVERSION AND PRINTER DRIVERS, IN CLASS 9 (U.S. CLS. 21, 23, 26, 36 AND 38).

FIRST USE 0-0-2003; IN COMMERCE 0-0-2003.

SER. NO. 76-643,779, FILED 7-28-2005.

ELI HELLMAN, EXAMINING ATTORNEY

Int. Cl.: 30

Prior U.S. Cl.: 46

United States Patent and Trademark Office

Reg. No. 3,396,846

Registered Mar. 18, 2008

**TRADEMARK
PRINCIPAL REGISTER**

DONG SUH

DONG SUH FOODS CORPORATION (REPUBLIC
OF KOREA CORPORATION)
411-1, CHEONGCHEON 2-DONG
BUPYUNG-KU, REPUBLIC OF KOREA

FOR: TEA, IN CLASS 30 (U.S. CL. 46).

FIRST USE 9-0-1970; IN COMMERCE 8-0-2002.

THE MARK CONSISTS OF STANDARD CHAR-
ACTERS WITHOUT CLAIM TO ANY PARTICULAR
FONT, STYLE, SIZE, OR COLOR.

OWNER OF U.S. REG. NO. 3,019,185.

THE ENGLISH TRANSLATION OF DONG SUH IS
"EAST" AND "WEST".

SER. NO. 76-644,868, FILED 8-15-2005.

MATTHEW EINSTEIN, EXAMINING ATTORNEY

Int. Cl.: 3

Prior U.S. Cls.: 1, 4, 6, 50, 51 and 52

United States Patent and Trademark Office

Reg. No. 3,396,847

Registered Mar. 18, 2008

**TRADEMARK
PRINCIPAL REGISTER**

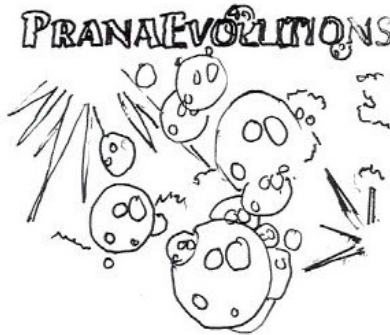

PRANA EVOLUTIONS (FLORIDA LIMITED LIABILITY CORPORATION)
2803 E. CERVANTES ST.
PENSACOLA, FL 32503

THE MARK CONSISTS OF THE WORDS PRANA EVOLUTIONS WITH BUBBLES AND SUN BURSTS IN THE FORM OF RAYS.

FOR: NON-MEDICATED SKIN CARE PREPARATIONS IN THE NATURE OF GELS, CREAMS AND SPRAYS, IN CLASS 3 (U.S. CLS. 1, 4, 6, 50, 51 AND 52).

SER. NO. 76-646,767, FILED 9-14-2005.

FIRST USE 7-14-2005; IN COMMERCE 7-14-2005.

MICHAEL KEATING, EXAMINING ATTORNEY

Int. Cls.: 9, 35 and 41

Prior U.S. Cls.: 21, 23, 26, 36, 38, 100, 101, 102 and 107

United States Patent and Trademark Office

Reg. No. 3,396,848

Registered Mar. 18, 2008

**TRADEMARK
SERVICE MARK
PRINCIPAL REGISTER**



VISION 4 MUSIC, INC. (DELAWARE CORPORATION)

103 EAST BRIDLE PATH
HOCKESSIN, DE 197079409

FOR: PRERECORDED CDS, DVDS, VIDEOTAPES AND LASER DISKS FEATURING MUSIC AND INFORMATION IN THE FIELD OF MUSIC AND COMMENTARY ABOUT MUSIC AND ENTERTAINERS IN THE FORM OF VIDEOS; DOWNLOADABLE PRERECORDED MUSIC AND MUSIC VIDEOS, IN CLASS 9 (U.S. CLS. 21, 23, 26, 36 AND 38).

FIRST USE 8-0-2005; IN COMMERCE 8-0-2005.

FOR: ONLINE RETAIL STORE SERVICES FEATURING AUDIO AND VISUAL RECORDINGS, IN CLASS 35 (U.S. CLS. 100, 101 AND 102).

FIRST USE 8-0-2005; IN COMMERCE 8-0-2005.

FOR: PRODUCTION OF AUDIO AND VISUAL RECORDINGS, IN CLASS 41 (U.S. CLS. 100, 101 AND 107).

FIRST USE 8-0-2005; IN COMMERCE 8-0-2005.

SER. NO. 76-648,942, FILED 10-21-2005.

PETER B. BROMAGHIM, EXAMINING ATTORNEY

Int. Cl.: 43

Prior U.S. Cls.: 100 and 101

United States Patent and Trademark Office

Reg. No. 3,396,849

Registered Mar. 18, 2008

**SERVICE MARK
PRINCIPAL REGISTER**

MOONSHADOWS

C & M PEACE ENTERPRISES, INC. (FLORIDA
CORPORATION)
939 N. FEDERAL HIGHWAY
HOLLYWOOD, FL 33020

THE MARK CONSISTS OF STANDARD CHAR-
ACTERS WITHOUT CLAIM TO ANY PARTICULAR
FONT, STYLE, SIZE, OR COLOR.

FOR: TAVERN AND RESTAURANT SERVICES,
IN CLASS 43 (U.S. CLS. 100 AND 101).

SER. NO. 76-652,430, FILED 12-27-2005.

FIRST USE 4-28-2005; IN COMMERCE 4-28-2005.

ALLISON SCHRODY, EXAMINING ATTORNEY

Int. Cl.: 7

Prior U.S. Cls.: 13, 19, 21, 23, 31, 34 and 35

United States Patent and Trademark Office

Reg. No. 3,396,850

Registered Mar. 18, 2008

**TRADEMARK
PRINCIPAL REGISTER**



CW AUTOMOTIVE, INC. (NEW YORK CORPORATION)
17 WINTHROP AVENUE
SYOSSET, NY 11791

FOR: WATER PUMPS FOR LAND VEHICLES, IN CLASS 7 (U.S. CLS. 13, 19, 21, 23, 31, 34 AND 35).

FIRST USE 4-20-2004; IN COMMERCE 4-20-2004.

NO CLAIM IS MADE TO THE EXCLUSIVE RIGHT TO USE "AUTOMOTIVE", APART FROM THE MARK AS SHOWN.

THE COLOR(S) GRAY, NAVY BLUE, BLACK AND WHITE IS/ARE CLAIMED AS A FEATURE OF THE MARK.

THE MARK CONSISTS OF THE COLOR WHITE APPEARS IN UPPER PORTION OF THE WORDING CW AUTOMOTIVE; THE COLOR GRAY APPEARS IN LOWER PORTION OF THE WORD CW AUTOMOTIVE; THE COLOR BLACK APPEARS IN THE LEFT HALF OF THE RECTANGULAR BACKGROUND; THE COLOR NAVY BLUE APPEARS IN THE RIGHT HALF OF THE RECTANGULAR BACKGROUND.

SER. NO. 76-653,029, FILED 1-6-2006.

JOHN SCHUYLER YARD, EXAMINING ATTORNEY

Int. Cl.: 7

Prior U.S. Cls.: 13, 19, 21, 23, 31, 34 and 35

United States Patent and Trademark Office

Reg. No. 3,396,851

Registered Mar. 18, 2008

**TRADEMARK
PRINCIPAL REGISTER**



THE SCOTT FETZER COMPANY (DELAWARE
CORPORATION)
28800 CLEMENS ROAD
WESTLAKE, OH 44145

NO CLAIM IS MADE TO THE EXCLUSIVE
RIGHT TO USE "POWER PAN", APART FROM
THE MARK AS SHOWN.

FOR: HAND-HELD PORTABLE VACUUM CLEA-
NERS, IN CLASS 7 (U.S. CLS. 13, 19, 21, 23, 31, 34 AND
35).

SER. NO. 76-653,701, FILED 1-20-2006.

FIRST USE 7-19-2006; IN COMMERCE 7-19-2006.

MICHAEL GAAFAR, EXAMINING ATTORNEY

Int. Cl.: 35

Prior U.S. Cls.: 100, 101 and 102

United States Patent and Trademark Office

Reg. No. 3,396,852

Registered Mar. 18, 2008

**SERVICE MARK
PRINCIPAL REGISTER**

ATLANTA INTERNATIONAL BRIDAL & SPECIAL OCCASION MARKET

AMC, INC. (GEORGIA CORPORATION)
240 PEACHTREE STREET, N.W., SUITE 2200
ATLANTA, GA 30303

OWNER OF U.S. REG. NOS. 1,197,345, 2,914,162
AND OTHERS.

FOR: ARRANGING AND CONDUCTING TRADE
SHOWS IN THE FIELD OF BRIDAL, PROM, PA-
GEANT AND SPECIAL OCCASION APPAREL AND
ACCESSORIES, IN CLASS 35 (U.S. CLS. 100, 101 AND
102).

NO CLAIM IS MADE TO THE EXCLUSIVE
RIGHT TO USE "BRIDAL & SPECIAL OCCASION
MARKET", APART FROM THE MARK AS SHOWN.

FIRST USE 4-0-2004; IN COMMERCE 4-0-2004.

SEC. 2(F) AS TO "ATLANTA INTERNATIONAL".

THE MARK CONSISTS OF STANDARD CHAR-
ACTERS WITHOUT CLAIM TO ANY PARTICULAR
FONT, STYLE, SIZE, OR COLOR.

SER. NO. 76-656,962, FILED 3-20-2006.

BRIAN PINO, EXAMINING ATTORNEY

Int. Cl.: 37

Prior U.S. Cls.: 100, 103 and 106

United States Patent and Trademark Office

Reg. No. 3,396,853

Registered Mar. 18, 2008

**SERVICE MARK
PRINCIPAL REGISTER**

U.S. BRICK & BLOCK SYSTEMS, INC.

U.S. BRICK & BLOCK SYSTEMS, INC. (FLORIDA CORPORATION)
2701 REESE ROAD
FORT LAUDERDALE, FL 33314

FOR: CONSTRUCTION SERVICES, NAMELY, CUSTOM CONSTRUCTION FOR RESIDENTIAL AND COMMERCIAL PROPERTIES, IN CLASS 37 (U.S. CLS. 100, 103 AND 106).

FIRST USE 6-0-1998; IN COMMERCE 6-0-1998.

THE MARK CONSISTS OF STANDARD CHARACTERS WITHOUT CLAIM TO ANY PARTICULAR FONT, STYLE, SIZE, OR COLOR.

OWNER OF U.S. REG. NO. 2,369,540.

NO CLAIM IS MADE TO THE EXCLUSIVE RIGHT TO USE "BRICK & BLOCK SYSTEMS, INC.", APART FROM THE MARK AS SHOWN.

SEC. 2(F).

SER. NO. 76-657,526, FILED 3-30-2006.

SETH A. RAPPAPORT, EXAMINING ATTORNEY

Int. Cls.: 25, 28 and 35

Prior U.S. Cls.: 22, 23, 38, 39, 50, 100, 101 and 102

United States Patent and Trademark Office

Reg. No. 3,396,854

Registered Mar. 18, 2008

**TRADEMARK
SERVICE MARK
PRINCIPAL REGISTER**



RANCHO MIRAGE GOLF, INC. (CALIFORNIA CORPORATION)
42-412 BOB HOPE DRIVE
RANCHO MIRAGE, CA 92270

FOR: WOMEN'S GOLF CLOTHING, NAMELY, SHIRTS, PANTS, SKIRTS AND SHOES, IN CLASS 25 (U.S. CLS. 22 AND 39).

FIRST USE 11-10-1995; IN COMMERCE 11-10-1995.

FOR: WOMEN'S GOLF CLUBS, WOMEN'S GOLF GLOVES, GOLF BAGS, GOLF BALLS, AND GOLF TEES, IN CLASS 28 (U.S. CLS. 22, 23, 38 AND 50).

FIRST USE 11-10-1995; IN COMMERCE 11-10-1995.

FOR: RETAIL GOLF STORE, IN CLASS 35 (U.S. CLS. 100, 101 AND 102).

FIRST USE 11-10-1995; IN COMMERCE 11-10-1995.

THE MARK CONSISTS OF TWO WOMEN STANDING SIDE BY SIDE. THE WOMAN ON THE LEFT IS HOLDING A PENCIL IN HER RIGHT HAND AND A CARD IN HER LEFT HAND. THE WOMAN ON THE RIGHT IS HOLDING A GOLF CLUB IN HER RIGHT HAND. EACH WOMAN IS WEARING A SLEEVELESS DRESS, SOX, SHOES, AND A BERET. A GOLF COURSE IS REPRESENTED IN THE BACKGROUND.

SER. NO. 76-658,556, FILED 4-17-2006.

CHRISTOPHER BUONGIORNO, EXAMINING ATTORNEY

Int. Cl.: 35

Prior U.S. Cls.: 100, 101 and 102

United States Patent and Trademark Office

Reg. No. 3,396,855

Registered Mar. 18, 2008

**SERVICE MARK
PRINCIPAL REGISTER**



SNBT DIAMONDS & JEWELRY, LTD. (TEXAS
PARTNERSHIP)
2221 SOUTH VOSS, SUITE 101
HOUSTON, TX 77057

FIRST USE 1-3-2005; IN COMMERCE 1-3-2005.

SER. NO. 76-659,137, FILED 4-27-2006.

FOR: RETAIL JEWELRY STORES, IN CLASS 35
(U.S. CLS. 100, 101 AND 102).

MARLENE BELL, EXAMINING ATTORNEY

Int. Cl.: 25

Prior U.S. Cls.: 22 and 39

United States Patent and Trademark Office

Reg. No. 3,396,856

Registered Mar. 18, 2008

**TRADEMARK
PRINCIPAL REGISTER**

Pima Touch

MARCOS, PEDRO (UNITED STATES INDIVIDUAL)
32-24 77 STREET
EAST ELMHURST, NY 11370

FOR: CLOTHING, NAMELY, PANTS, SHIRTS, BLOUSES, DRESSES, JACKETS COMPRISED SUBSTANTIALLY IN PART OF COTTON, IN CLASS 25 (U.S. CLS. 22 AND 39).

FIRST USE 2-1-2006; IN COMMERCE 2-1-2006.

THE MARK CONSISTS OF STANDARD CHARACTERS WITHOUT CLAIM TO ANY PARTICULAR FONT, STYLE, SIZE, OR COLOR.

NO CLAIM IS MADE TO THE EXCLUSIVE RIGHT TO USE "PIMA", APART FROM THE MARK AS SHOWN.

SER. NO. 76-659,138, FILED 4-27-2006.

EDWARD FENNESSY, EXAMINING ATTORNEY

Int. Cl.: 41

Prior U.S. Cls.: 100, 101 and 107

United States Patent and Trademark Office

Reg. No. 3,396,857

Registered Mar. 18, 2008

**SERVICE MARK
PRINCIPAL REGISTER**



KENT COUNTY (MICHIGAN MUNICIPAL CORPORATION)
300 MONROE AVENUE
GRAND RAPIDS, MI 49503

FOR: RECREATIONAL SERVICES, NAMELY, OPERATION AND MAINTENANCE OF OUTDOOR TRAILS FOR NON-MOTORIZED VEHICLES, IN CLASS 41 (U.S. CLS. 100, 101 AND 107).

FIRST USE 6-0-1992; IN COMMERCE 6-0-1992.

NO CLAIM IS MADE TO THE EXCLUSIVE RIGHT TO USE KENT TRAILS, APART FROM THE MARK AS SHOWN.

THE MARK CONSISTS OF FOUR BOXES ON TOP OF EACH OTHER. THE FIRST BOX CONTAINS THE WORDS KENT TRAILS, THE SECOND BOX CONTAINS A PICTURE OF SOMEONE WALKING, THE THIRD BOX CONTAINS A PICTURE OF SOMEONE SKIING AND THE FOURTH BOX CONTAINS A PICTURE OF SOMEONE BICYCLING.

SER. NO. 76-659,258, FILED 4-28-2006.

JILL C. ALT, EXAMINING ATTORNEY

Int. Cl.: 30

Prior U.S. Cl.: 46

United States Patent and Trademark Office

Reg. No. 3,396,858

Registered Mar. 18, 2008

**TRADEMARK
PRINCIPAL REGISTER**

CORN CRUNCH

PRAIRIE FOODS, INC. (ILLINOIS CORPORATION)

100 E. THIRD STREET

PLEASANT PLAINS, IL 62677

FOR: FLAVORED CORN-BASED SNACK FOODS,
IN CLASS 30 (U.S. CL. 46).

FIRST USE 10-9-2001; IN COMMERCE 10-9-2001.

THE MARK CONSISTS OF STANDARD CHARACTERS WITHOUT CLAIM TO ANY PARTICULAR FONT, STYLE, SIZE, OR COLOR.

NO CLAIM IS MADE TO THE EXCLUSIVE RIGHT TO USE "CORN", APART FROM THE MARK AS SHOWN.

SER. NO. 76-660,153, FILED 5-17-2006.

MARY ROSSMAN, EXAMINING ATTORNEY

Int. Cls.: 9, 18, 25, 28 and 41

**Prior U.S. Cls.: 1, 2, 3, 21, 22, 23, 26, 36, 38, 39, 41, 50,
100, 101 and 107**

Reg. No. 3,396,859

United States Patent and Trademark Office

Registered Mar. 18, 2008

**TRADEMARK
SERVICE MARK
PRINCIPAL REGISTER**

AQUA  LUNG

LA SPIROTECHNIQUE INDUSTRIELLE ET
COMMERCIALE (FRANCE CORPORATION)
ZONE INDUSTRIELLE T
CARROS, FRANCE 06510

FOR: BREATHING APPARATUS FOR SCUBA
DIVING, NAMELY, GAS REGULATORS FOR SCU-
BA DIVING; SNORKELS FOR AQUATICS; DIVING
MASKS; GOGGLES FOR DIVING, SWIMMING,
AND SCUBA, IN CLASS 9 (U.S. CLS. 21, 23, 26, 36
AND 38).

FIRST USE 9-30-1996; IN COMMERCE 9-30-1996.

FOR: SPORT BAGS, IN CLASS 18 (U.S. CLS. 1, 2, 3,
22 AND 41).

FIRST USE 9-30-1996; IN COMMERCE 9-30-1996.

FOR: CLOTHING, NAMELY, SHIRTS, BOOTS,
GLOVES, WET SUITS, IN CLASS 25 (U.S. CLS. 22
AND 39).

FIRST USE 9-30-1996; IN COMMERCE 9-30-1996.

FOR: DIVING AND SWIMMING FLIPPERS, IN
CLASS 28 (U.S. CLS. 22, 23, 38 AND 50).

FIRST USE 9-30-1996; IN COMMERCE 9-30-1996.

FOR: EDUCATIONAL SERVICES, NAMELY,
PROVIDING CLASSES, SEMINARS, WORKSHOPS
AND TRAINING IN THE FIELD OF SCUBA DIV-
ING; ORGANIZING CULTURAL AND LEISURE
ACTIVITIES, NAMELY, SNORKELING AND SCU-
BA DIVING, IN CLASS 41 (U.S. CLS. 100, 101 AND
107).

FIRST USE 9-30-1996; IN COMMERCE 9-30-1996.

NO CLAIM IS MADE TO THE EXCLUSIVE
RIGHT TO USE "AQUA", APART FROM THE
MARK AS SHOWN.

SER. NO. 76-660,740, FILED 5-30-2006.

LINDA ORNDORFF, EXAMINING ATTORNEY

Int. Cl.: 41

Prior U.S. Cls.: 100, 101 and 107

United States Patent and Trademark Office

Reg. No. 3,396,860

Registered Mar. 18, 2008

**SERVICE MARK
PRINCIPAL REGISTER**



**CHILDCARE
EDUCATION INSTITUTE**

CHILDCARE EDUCATION INSTITUTE, LLC
(GEORGIA LTD LIAB CO)
3059 PEACHTREE INDUSTRIAL BLVD.
SUITE 100
DULUTH, GA 30097

FIRST USE 3-6-2005; IN COMMERCE 3-6-2005.

FOR: EDUCATIONAL SERVICES, NAMELY,
PROVIDING COURSES OF INSTRUCTION AT
THE POSTSECONDARY LEVEL IN THE FIELD OF
CHILDCARE AND EARLY CHILDHOOD; PROVID-
ING TRAINING IN THE FIELD OF CHILDCARE
AND EARLY CHILDHOOD, IN CLASS 41 (U.S. CLS.
100, 101 AND 107).

NO CLAIM IS MADE TO THE EXCLUSIVE
RIGHT TO USE "CHILDCARE EDUCATION INSTI-
TUTE", APART FROM THE MARK AS SHOWN.

SER. NO. 76-661,144, FILED 6-6-2006.

ALYSSA PALADINO, EXAMINING ATTORNEY

Int. Cls.: 37, 43 and 44

Prior U.S. Cls.: 100, 101, 103 and 106

United States Patent and Trademark Office

Reg. No. 3,396,861

Registered Mar. 18, 2008

**SERVICE MARK
PRINCIPAL REGISTER**

LOVE A CHILD

LOVE A CHILD, INC. (FLORIDA CORPORATION)
P.O. BOX 11000
NAPLES, FL 341011000

FOR: CHARITABLE SERVICES, NAMELY, RENOVATING AND CONSTRUCTING HOMES FOR LOW INCOME FAMILIES, IN CLASS 37 (U.S. CLS. 100, 103 AND 106).

FIRST USE 11-0-1985; IN COMMERCE 11-0-1985.

FOR: CHARITABLE SERVICES, NAMELY, PROVIDING FOOD AND FEEDING PROGRAMS FOR NEEDY PERSONS, IN CLASS 43 (U.S. CLS. 100 AND 101).

FIRST USE 11-0-1985; IN COMMERCE 11-0-1985.

FOR: CHARITABLE SERVICES, NAMELY, PROVIDING MEDICINE AND MEDICAL CLINICS FOR NEEDY PERSONS, IN CLASS 44 (U.S. CLS. 100 AND 101).

FIRST USE 11-0-1985; IN COMMERCE 11-0-1985.

THE MARK CONSISTS OF STANDARD CHARACTERS WITHOUT CLAIM TO ANY PARTICULAR FONT, STYLE, SIZE, OR COLOR.

OWNER OF U.S. REG. NO. 2,368,860.

SER. NO. 76-661,285, FILED 6-8-2006.

RONALD MCMORROW, EXAMINING ATTORNEY

Int. Cl.: 45

Prior U.S. Cls.: 100 and 101

United States Patent and Trademark Office

Reg. No. 3,396,862

Registered Mar. 18, 2008

**SERVICE MARK
PRINCIPAL REGISTER**

The logo for "Pet-to-go" is written in a bold, italicized, sans-serif font. The letters are black with a white outline, giving it a 3D or shadowed appearance. The "o" in "to" is a solid black circle.

VALLEY FEED AND SUPPLY, INC. (TEXAS
CORPORATION)
368 N. YARBROUGH DRIVE
EL PASO, TX 79915

FIRST USE 10-0-2005; IN COMMERCE 10-0-2005.

FOR: DOMESTIC ANIMAL ADOPTION SERVI-
CES, AND ARRANGEMENT OF HOMELESS DO-
MESTIC ANIMALS TO BE PLACED IN HOMES, IN
CLASS 45 (U.S. CLS. 100 AND 101).

SER. NO. 76-662,048, FILED 6-22-2006.

SUSAN LESLIE DUBOIS, EXAMINING ATTORNEY

Int. Cl.: 41

Prior U.S. Cls.: 100, 101 and 107

United States Patent and Trademark Office

Reg. No. 3,396,863

Registered Mar. 18, 2008

SERVICE MARK
PRINCIPAL REGISTER



CLEAR PHOENIX MEDIA (NEW JERSEY CORPORATION)
91 CLINTON ROAD
SUITE 1D
FAIRFIELD, NJ 07004

FOR: MAGAZINE PUBLICATION IN VARIOUS
FIELDS OF JAPANESE CULTURE, IN CLASS 41
(U.S. CLS. 100, 101 AND 107).

FIRST USE 5-18-2006; IN COMMERCE 5-18-2006.

THE COLOR(S) PURPLE IS/ARE CLAIMED AS A
FEATURE OF THE MARK.

THE MARK CONSISTS OF PURPLE LETTERING.

SER. NO. 76-663,124, FILED 7-17-2006.

RONALD AIKENS, EXAMINING ATTORNEY

Int. Cl.: 11

Prior U.S. Cls.: 13, 21, 23, 31 and 34

Reg. No. 3,396,864

United States Patent and Trademark Office

Registered Mar. 18, 2008

**TRADEMARK
PRINCIPAL REGISTER**



JIALE GLASSWARE MANUFACTORY CO., LTD.
(CHINA CORPORATION)
JUZHOU 2ND INDUSTRIAL AREA
SHIJIE TWON
DONGGUAN CITY, GUANG DONG, CHINA

FOR: TOILET BOWLS; BATHROOM FACILITIES,
NAMELY, TOILETS BATHTUBS AND SHOWERS;
FLUSH LEVERS; FAUCETS; DRAIN STRUCTURES
FOR USE IN SPAS, STEAM ROOMS AND BATHS;
WATER PURIFYING APPARATUS; WATER FOUN-

TAIN; DISINFECTANT DISPENSERS FOR TOILETS;
AND DISINFECTANT APPARATUS FOR INDUS-
TRIAL AND HOME PURPOSES, IN CLASS 11 (U.S.
CLS. 13, 21, 23, 31 AND 34).

FIRST USE 4-1-2006; IN COMMERCE 4-1-2006.

SER. NO. 76-663,358, FILED 7-19-2006.

RENEE SERVANCE, EXAMINING ATTORNEY

Int. Cl.: 24

Prior U.S. Cls.: 42 and 50

United States Patent and Trademark Office

Reg. No. 3,396,865

Registered Mar. 18, 2008

**TRADEMARK
PRINCIPAL REGISTER**

JINDA

ZHEJIANG JINDA NEW MATERIALS CO., LTD.
(CHINA CORPORATION), DBA HAINING JINDA COATING CO., LTD.
MAQIAO, HAINING, ZHEJIANG
314419, P. R., CHINA

FOR: VINYL, POLYURETHANE AND CLOTH TEXTILES FOR USE IN THE MANUFACTURE OF TRUCK COVERS, TENTS, INFLATABLE BOUNCERS, BANNERS, ARCHITECTURAL CONSTRUCTION MEMBRANES, GEOGRIDS, GEOTEXTILES, AND LAND FILL GEOMEMBRANES; TEXTILE FABRICS FOR HOME AND COMMERCIAL INTERIORS; TEXTILE FABRICS FOR THE MANUFACTURE OF CLOTHING, IN CLASS 24 (U.S. CLS. 42 AND 50).

FIRST USE 0-0-2003; IN COMMERCE 0-0-2003.

THE MARK CONSISTS OF STANDARD CHARACTERS WITHOUT CLAIM TO ANY PARTICULAR FONT, STYLE, SIZE, OR COLOR.

THE WORDING "JINDA" HAS NO MEANING IN A FOREIGN LANGUAGE.

SER. NO. 76-664,229, FILED 8-7-2006.

CHERYL CLAYTON, EXAMINING ATTORNEY

Int. Cl.: 41

Prior U.S. Cls.: 100, 101 and 107

United States Patent and Trademark Office

Reg. No. 3,396,866

Registered Mar. 18, 2008

**SERVICE MARK
PRINCIPAL REGISTER**

THINK ABOUT TOMORROW

MASSACHUSETTS HIGHER EDUCATION ASSISTANCE CORPORATION (MASSACHUSETTS NOT-FOR-PROFIT CORPORATION), DBA AMERICAN STUDENT ASSISTANCE
100 CAMBRIDGE STREET
BOSTON, MA 02114

FOR: EDUCATION SERVICES, NAMELY, PROVIDING INFORMATIONAL TRAINING PROGRAMS FOR BORROWERS AND THE STUDENT LENDING COMMUNITY CONCERNING FINANCIAL AID AND DISTRIBUTING PRINTED COURSE MATERIALS IN CONNECTION THEREWITH, IN CLASS 41 (U.S. CLS. 100, 101 AND 107).

FIRST USE 6-1-2005; IN COMMERCE 6-1-2005.

THE MARK CONSISTS OF STANDARD CHARACTERS WITHOUT CLAIM TO ANY PARTICULAR FONT, STYLE, SIZE, OR COLOR.

OWNER OF U.S. REG. NO. 3,213,802.

SER. NO. 76-664,488, FILED 8-11-2006.

SARA THOMAS, EXAMINING ATTORNEY

Int. Cl.: 35

Prior U.S. Cls.: 100, 101 and 102

United States Patent and Trademark Office

Reg. No. 3,396,867

Registered Mar. 18, 2008

**SERVICE MARK
PRINCIPAL REGISTER**

THINK ABOUT TOMORROW

MASSACHUSETTS HIGHER EDUCATION ASSIS-
TANCE CORPORATION (MASSACHUSETTS
NOT-FOR-PROFIT CORPORATION), DBA
AMERICAN STUDENT ASSISTANCE
100 CAMBRIDGE STREET
BOSTON, MA 02114

FOR: BUSINESS INFORMATION SERVICES PRO-
VIDING LENDERS AND GUARANTORS WITH
INFORMATION AND GUIDANCE IN THE MAN-
AGEMENT AND UNDERTAKING OF STUDENT
LENDING AND FINANCIAL ASSISTANCE, IN
CLASS 35 (U.S. CLS. 100, 101 AND 102).

FIRST USE 6-1-2005; IN COMMERCE 6-1-2005.

THE MARK CONSISTS OF STANDARD CHAR-
ACTERS WITHOUT CLAIM TO ANY PARTICULAR
FONT, STYLE, SIZE, OR COLOR.

OWNER OF U.S. REG. NO. 3,213,802.

SER. NO. 76-664,489, FILED 8-11-2006.

SARA THOMAS, EXAMINING ATTORNEY

Int. Cl.: 36

Prior U.S. Cls.: 100, 101 and 102

United States Patent and Trademark Office

Reg. No. 3,396,868

Registered Mar. 18, 2008

**SERVICE MARK
PRINCIPAL REGISTER**



ATLANTIC NATIONAL BANK (UNITED STATES
FEDERALLY CHARTERED NATIONAL
BANK)
710 GLOUCESTER STREET
BRUNSWICK, GA 315207044

FOR: BANKING SERVICES, IN CLASS 36 (U.S.
CLS. 100, 101 AND 102).

FIRST USE 8-31-1998; IN COMMERCE 8-31-1998.

NO CLAIM IS MADE TO THE EXCLUSIVE
RIGHT TO USE "NATIONAL BANK" AND "BRUNSWICK
GEORGIA", APART FROM THE MARK AS
SHOWN.

THE COLOR(S) BLUE AND YELLOW IS/ARE
CLAIMED AS A FEATURE OF THE MARK.

THE COLOR BLUE APPEARS IN THE WORDING
ATLANTIC NATIONAL BANK BRUNSWICK
GEORGIA AND IN THE UPPER AND LOWER
BAND OF THE FLAG AND YELLOW IN THE
MIDDLE BAND OF THE FLAG AND THE LINE
BELOW THE WORDING ATLANTIC.

SER. NO. 76-664,751, FILED 8-11-2006.

ALICE BENMAMAN, EXAMINING ATTORNEY

Int. Cl.: 9

Prior U.S. Cls.: 21, 23, 26, 36 and 38

United States Patent and Trademark Office

Reg. No. 3,396,869

Registered Mar. 18, 2008

**TRADEMARK
PRINCIPAL REGISTER**

A GUIDING LIGHT FOR SECURITY

SECURE VANTAGE TECHNOLOGIES, INC.
(COLORADO CORPORATION)
4316 WEST COUNTY ROAD 4
BERTHOUD, CO 80513

FOR: DOWNLOADABLE COMPUTER SOFTWARE FOR HARDWARE AND SOFTWARE SECURITY AND HARDWARE AND SOFTWARE SECURITY COMPLIANCE AUDITING, CONTROL, AND REPORTING, IN CLASS 9 (U.S. CLS. 21, 23, 26, 36 AND 38).

FIRST USE 5-25-2006; IN COMMERCE 5-25-2006.

THE MARK CONSISTS OF STANDARD CHARACTERS WITHOUT CLAIM TO ANY PARTICULAR FONT, STYLE, SIZE, OR COLOR.

SER. NO. 76-665,635, FILED 9-5-2006.

LOURDES AYALA, EXAMINING ATTORNEY

Int. Cl.: 25

Prior U.S. Cls.: 22 and 39

United States Patent and Trademark Office

Reg. No. 3,396,870

Registered Mar. 18, 2008

**TRADEMARK
PRINCIPAL REGISTER**

HIPS AND CURVES

CMI ENTERPRISES, LLC (CALIFORNIA LTD
LIAB CO)
2726 2ND STREET
SANTA MONICA, CA 90405

FOR: CLOTHING, NAMELY, WOMEN'S AND
MEN'S CLOTHING, UNDERWEAR AND SHOES,
NAMELY, BABYDOLL PAJAMAS, BIKINIS, BODY-
STOCKINGS, BOOTS, BRAS, BRIDAL LINGERIE,
BUSTIERS, CAMISOLES, CAT SUITS, CHEMISES,
CORSETS, DRESSES, FEATHER BOAS, FISHNET
STOCKINGS, G-STRINGS, GARTER BELTS,
GLOVES, HATS, HOSIERY, LINGERIE, SKIRTS,
NIGHTGOWNS, NIGHTIES, PANTIES, PANTY-
HOSE, PEIGNOIRS, PUMPS, WOMEN'S ROBES,
SHOES, STOCKINGS, TEDDIES, TEDDIETTES, WO-
MEN'S UNDERWEAR, WOMEN'S THONG BIKINIS,
THONG PANTIES, BLINDFOLDS, MEN'S THONGS,
BUN-HUGGER BRIEFS, CAMOUFLAGE BRIEFS,

BOXER SHORTS, MEN'S ROBES, MEN'S UNDER-
WEAR, T-SHIRTS, HATS, AND ADULT COSTUMES,
NAMELY, NURSE, SCHOOL GIRL AND FRENCH
MAID COSTUMES, IN CLASS 25 (U.S. CLS. 22 AND
39).

FIRST USE 8-1-2000; IN COMMERCE 8-1-2000.

THE MARK CONSISTS OF STANDARD CHAR-
ACTERS WITHOUT CLAIM TO ANY PARTICULAR
FONT, STYLE, SIZE, OR COLOR.

OWNER OF U.S. REG. NO. 2,693,220.

SER. NO. 76-666,478, FILED 9-22-2006.

KAPIL BHANOT, EXAMINING ATTORNEY

Int. Cl.: 5

Prior U.S. Cls.: 6, 18, 44, 46, 51 and 52

United States Patent and Trademark Office

Reg. No. 3,396,871

Registered Mar. 18, 2008

**TRADEMARK
PRINCIPAL REGISTER**

DIOXYCHLOR

CRB INC. (CALIFORNIA CORPORATION), DBA
AMERICAN BIOLOGICS
1180 WALNUT AVENUE
CHULA VISTA, CA 92011

THE MARK CONSISTS OF STANDARD CHAR-
ACTERS WITHOUT CLAIM TO ANY PARTICULAR
FONT, STYLE, SIZE, OR COLOR.

FOR: HOMEOPATHIC MEDICAL PREPARA-
TIONS FOR USE AS A VIRAL STATIC AGENT, IN
CLASS 5 (U.S. CLS. 6, 18, 44, 46, 51 AND 52).

SER. NO. 76-666,798, FILED 9-29-2006.

FIRST USE 2-28-1986; IN COMMERCE 2-28-1986.

MICHAEL ENGEL, EXAMINING ATTORNEY

Int. Cls.: 35 and 45

Prior U.S. Cls.: 100, 101 and 102

United States Patent and Trademark Office

Reg. No. 3,396,872

Registered Mar. 18, 2008

**SERVICE MARK
PRINCIPAL REGISTER**

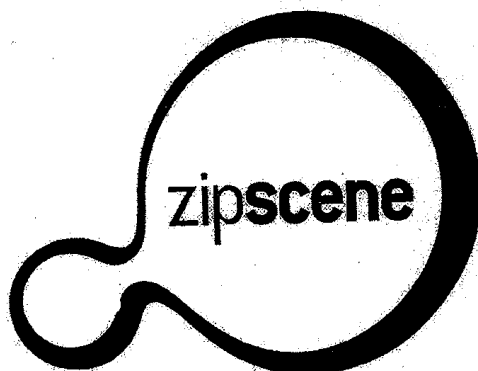

TXTBUZZ INC. (OHIO CORPORATION)
2118 SAINT JAMES AVENUE, SUITE 4
CINCINNATI, OH 45206

FOR: ADVERTISING AND PUBLICITY SERVICES, NAMELY, PROMOTING THE GOODS, SERVICES, BRAND IDENTITY AND COMMERCIAL INFORMATION AND NEWS OF THIRD PARTIES THROUGH ON-LINE MEDIUM; CARD-BASED CUSTOMER LOYALTY SERVICES FOR COMMERCIAL, PROMOTIONAL AND/OR ADVERTISING PURPOSES; COMPUTER SERVICES, NAMELY, PROVIDING A WEBSITE AND DATABASE FOR ADVERTISING VIA THE INTERNET, IN CLASS 35 (U.S. CLS. 100, 101 AND 102).

FIRST USE 5-0-2005; IN COMMERCE 5-0-2005.

FOR: ONLINE SOCIAL NETWORKING SERVICES, VIA THE INTERNET; COMPUTER SERVICES, NAMELY, PROVIDING A WEBSITE AND DATABASE FOR SOCIAL NETWORKING, AND SOCIAL COMMUNICATIONS AND INTERACTION, VIA THE INTERNET, IN CLASS 45 (U.S. CLS. 100 AND 101).

FIRST USE 5-0-2005; IN COMMERCE 5-0-2005.

SER. NO. 76-666,911, FILED 10-3-2006.

CHRISTINA SOBRAL, EXAMINING ATTORNEY

Int. Cl.: 41

Prior U.S. Cls.: 100, 101 and 107

United States Patent and Trademark Office

Reg. No. 3,396,873

Registered Mar. 18, 2008

SERVICE MARK
PRINCIPAL REGISTER



AMERICAN TAEKWONDO ASSOCIATION, INC.
(ARKANSAS CORPORATION), DBA AMERICAN TAEKWONDO ASSOCIATION
6210 BASELINE ROAD
LITTLE ROCK, AR 72209

FOR: INSTRUCTION IN MARTIAL ARTS, IN CLASS 41 (U.S. CLS. 100, 101 AND 107).

FIRST USE 10-20-1991; IN COMMERCE 10-20-1991.

OWNER OF U.S. REG. NO. 1,740,680.

NO CLAIM IS MADE TO THE EXCLUSIVE RIGHT TO USE "WORLD TRADITIONAL TAEK-

WONDO UNION AND ITS KOREAN EQUIVALENT", APART FROM THE MARK AS SHOWN.

THE FOREIGN WORDING IN THE MARK TRANSLATES TO WORLD TRADITIONAL TAEKWONDO UNION.

THE transliteration of the Korean characters is SAEGAE JUNG PONG TAKEWONDO YEON HAP.

SER. NO. 76-668,358, FILED 11-1-2006.

LESLEY LAMOTHE, EXAMINING ATTORNEY

Int. Cl.: 7

Prior U.S. Cls.: 13, 19, 21, 23, 31, 34 and 35

Reg. No. 3,396,874

United States Patent and Trademark Office

Registered Mar. 18, 2008

**TRADEMARK
PRINCIPAL REGISTER**

AIR 2 GO

JENNY PRODUCTS, INCORPORATED (PENNSYLVANIA CORPORATION)
850 NORTH PLEASANT AVENUE
SOMERSET, PA 15501

THE MARK CONSISTS OF STANDARD CHARACTERS WITHOUT CLAIM TO ANY PARTICULAR FONT, STYLE, SIZE, OR COLOR.

FOR: AIR COMPRESSORS, IN CLASS 7 (U.S. CLS. 13, 19, 21, 23, 31, 34 AND 35).

SER. NO. 76-668,447, FILED 11-2-2006.

FIRST USE 9-1-2006; IN COMMERCE 9-1-2006.

PAUL MORENO, EXAMINING ATTORNEY

Int. Cl.: 20

Prior U.S. Cls.: 2, 13, 22, 25, 32 and 50

United States Patent and Trademark Office

Reg. No. 3,396,875

Registered Mar. 18, 2008

**TRADEMARK
PRINCIPAL REGISTER**

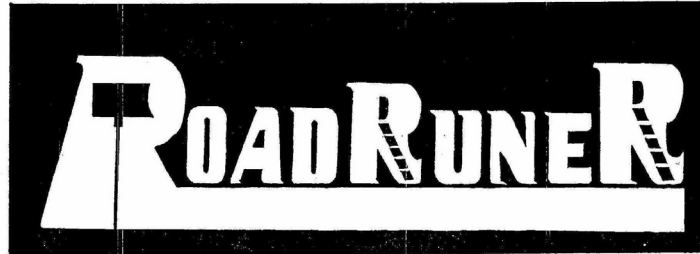

STEEL CITY CORPORATION, THE (OHIO CORPORATION)
190 N. MERIDIAN RD.
YOUNGSTOWN, OH 44501

OWNER OF U.S. REG. NO. 1,367,673.

FOR: NON-METAL NEWSPAPER ROUTE TUBES,
IN CLASS 20 (U.S. CLS. 2, 13, 22, 25, 32 AND 50).

SER. NO. 76-668,496, FILED 11-6-2006.

FIRST USE 11-0-1969; IN COMMERCE 11-0-1969.

CHERYL CLAYTON, EXAMINING ATTORNEY

Int. Cl.: 9

Prior U.S. Cls.: 21, 23, 26, 36 and 38

United States Patent and Trademark Office

Reg. No. 3,396,876

Registered Mar. 18, 2008

**TRADEMARK
PRINCIPAL REGISTER**

ECOCHIP

KABUSHIKI KAISHA TOSHIBA (JAPAN CORPORATION)
1-1, SHIBAURA 1-CHOME
MINATO-KU, TOKYO, JAPAN

FOR: INTEGRATED CIRCUIT CHIPS; INTEGRATED CIRCUIT MODULES WITH BUILT-IN INTEGRATED CIRCUIT CHIPS, IN CLASS 9 (U.S. CLS. 21, 23, 26, 36 AND 38).

THE MARK CONSISTS OF STANDARD CHARACTERS WITHOUT CLAIM TO ANY PARTICULAR FONT, STYLE, SIZE, OR COLOR.

PRIORITY CLAIMED UNDER SEC. 44(D) ON JAPAN APPLICATION NO. 2006-084744, FILED 9-12-2006, REG. NO. 5086286, DATED 10-26-2007, EXPIRES 10-26-2017.

SER. NO. 76-668,683, FILED 11-7-2006.

KELLEY WELLS, EXAMINING ATTORNEY

Int. Cl.: 36

Prior U.S. Cls.: 100, 101 and 102

United States Patent and Trademark Office

Reg. No. 3,396,877

Registered Mar. 18, 2008

**SERVICE MARK
PRINCIPAL REGISTER**

HARTZ CAPITAL, INC.

HARTZ CAPITAL, INC. (NEW JERSEY CORPORATION)
400 PLAZA DRIVE
SECAUCUS, NJ 07094

FOR: PROVIDING INVESTMENT ANALYSIS,
MANAGEMENT AND ADVICE TO OTHERS, IN
CLASS 36 (U.S. CLS. 100, 101 AND 102).

FIRST USE 0-0-1997; IN COMMERCE 0-0-1997.

THE MARK CONSISTS OF STANDARD CHARACTERS WITHOUT CLAIM TO ANY PARTICULAR FONT, STYLE, SIZE, OR COLOR.

NO CLAIM IS MADE TO THE EXCLUSIVE RIGHT TO USE "CAPITAL, INC.", APART FROM THE MARK AS SHOWN.

SEC. 2(F) AS TO HARTZ.

SER. NO. 76-668,874, FILED 11-13-2006.

KATHLEEN M. VANSTON, EXAMINING ATTORNEY

Int. Cl.: 32

Prior U.S. Cls.: 45, 46 and 48

United States Patent and Trademark Office

Reg. No. 3,396,878

Registered Mar. 18, 2008

**TRADEMARK
PRINCIPAL REGISTER**

PEOPLE WILL LIKE YOU LESS

GRUBBS, ROGER STEVEN (UNITED STATES
INDIVIDUAL)
1603 ENGLISH LANE
VAN BUREN, AR 72956

THE MARK CONSISTS OF STANDARD CHAR-
ACTERS WITHOUT CLAIM TO ANY PARTICULAR
FONT, STYLE, SIZE, OR COLOR.

FOR: WEIGHT LOSS PRODUCTS, NAMELY,
BOTTLED WATER, IN CLASS 32 (U.S. CLS. 45, 46
AND 48).

SER. NO. 76-668,950, FILED 11-13-2006.

FIRST USE 9-12-2006; IN COMMERCE 9-12-2006.

MICHELE SWAIN, EXAMINING ATTORNEY

Int. Cl.: 40

Prior U.S. Cls.: 100, 103 and 106

United States Patent and Trademark Office

Reg. No. 3,396,879

Registered Mar. 18, 2008

**SERVICE MARK
PRINCIPAL REGISTER**

VARIX

ALLAIRE, ROSS (UNITED STATES INDIVIDUAL)
2120 PORTERFIELD WAY
UPLAND, CA 91786

THE MARK CONSISTS OF STANDARD CHARACTERS WITHOUT CLAIM TO ANY PARTICULAR FONT, STYLE, SIZE, OR COLOR.

FOR: APPLYING COATING TO BATTERIES FOR THE PREVENTION OF SULFATE BUILD-UP ON LEAD PLATES, IN CLASS 40 (U.S. CLS. 100, 103 AND 106).

SER. NO. 76-669,097, FILED 11-16-2006.

FIRST USE 9-1-2006; IN COMMERCE 9-1-2006.

KELLY BOULTON, EXAMINING ATTORNEY

Int. Cls.: 9, 16, 20, 24 and 26

**Prior U.S. Cls.: 2, 5, 13, 21, 22, 23, 25, 26, 29, 32, 36,
37, 38, 39, 40, 42 and 50**

Reg. No. 3,396,880

United States Patent and Trademark Office

Registered Mar. 18, 2008

**TRADEMARK
PRINCIPAL REGISTER**

WOODY'S

INTERNATIONAL ENGINEERING & MANUFACTURING INC. (MICHIGAN CORPORATION), DBA INTERNATIONAL ENGINEERING AND INTERNATIONAL ENGINEERING CO.

6054 NORTH M-30
HOPE, MI 48628

FOR: SERIES OF PRE-RECORDED VIDEO DISCS FEATURING INFORMATION ABOUT TRACTION CONTROL, IN CLASS 9 (U.S. CLS. 21, 23, 26, 36 AND 38).

FIRST USE 8-12-1998; IN COMMERCE 8-12-1998.

FOR: TRACKING MARK IMPLEMENTS, NAMELY, A MARKING PEN; PLASTIC SHOW BAGS, NAMELY, PLASTIC SHOPPING BAGS, IN CLASS 16 (U.S. CLS. 2, 5, 22, 23, 29, 37, 38 AND 50).

FIRST USE 3-1-1998; IN COMMERCE 7-31-1997.

FOR: NOVELTY PLASTIC BANNERS AND PLASTIC NOVELTY LICENSE PLATES, IN CLASS 20 (U.S. CLS. 2, 13, 22, 25, 32 AND 50).

FIRST USE 11-14-1974; IN COMMERCE 11-14-1974.

FOR: CLOTH FLAGS, IN CLASS 24 (U.S. CLS. 42 AND 50).

FIRST USE 5-1-1994; IN COMMERCE 4-10-2001.

FOR: CLOTH PATCHES FOR CLOTHING, IN CLASS 26 (U.S. CLS. 37, 39, 40, 42 AND 50).

FIRST USE 1-30-1974; IN COMMERCE 1-30-1974.

THE MARK CONSISTS OF STANDARD CHARACTERS WITHOUT CLAIM TO ANY PARTICULAR FONT, STYLE, SIZE, OR COLOR.

SER. NO. 76-669,296, FILED 11-20-2006.

CHRISTINA SOBRAL, EXAMINING ATTORNEY

Int. Cls.: 35, 37, 39, 41, 42, 44 and 45

Prior U.S. Cls.: 100, 101, 102, 103, 105, 106 and 107

United States Patent and Trademark Office

Reg. No. 3,396,881

Registered Mar. 18, 2008

**SERVICE MARK
PRINCIPAL REGISTER**



BRISTOW GROUP INC. (DELAWARE CORPORATION)
2000 WEST SAM HOUSTON PARKWAY SOUTH
SUITE 2700
HOUSTON, TX 77042

FOR: OPERATION OF BUSINESS FOR OTHERS, NAMELY, HELICOPTER AND AIRPLANE TRANSPORTATION AND OFFSHORE OIL AND GAS WELL DRILLING, IN CLASS 35 (U.S. CLS. 100, 101 AND 102).

FIRST USE 1-30-2006; IN COMMERCE 1-30-2006.

FOR: MAINTENANCE AND REPAIR OF AIRPLANES AND HELICOPTERS, IN CLASS 37 (U.S. CLS. 100, 103 AND 106).

FIRST USE 1-30-2006; IN COMMERCE 1-30-2006.

FOR: HELICOPTER TRANSPORT; RESCUE SERVICES, IN CLASS 39 (U.S. CLS. 100 AND 105).

FIRST USE 1-30-2006; IN COMMERCE 1-30-2006.

FOR: TRAINING IN THE FIELDS OF AIRCRAFT AND HELICOPTER FLIGHT, ENGINEERING AND SEARCH AND RESCUE, IN CLASS 41 (U.S. CLS. 100, 101 AND 107).

FIRST USE 1-30-2006; IN COMMERCE 1-30-2006.

FOR: AIRPLANE AND HELICOPTER DESIGN CONSULTATION; OIL AND GAS WELL DRILLING SUPPORT SERVICES, NAMELY, PROVIDING MEASUREMENTS AND DOWNHOLE TELEMETRY WHILE DRILLING, IN CLASS 42 (U.S. CLS. 100 AND 101).

FIRST USE 1-30-2006; IN COMMERCE 1-30-2006.

FOR: EMERGENCY MEDICAL RESPONSE SERVICES, IN CLASS 44 (U.S. CLS. 100 AND 101).

FIRST USE 1-30-2006; IN COMMERCE 1-30-2006.

FOR: FIRE FIGHTING; PROVIDING CONSULTATION IN THE FIELD OF EMERGENCY RESPONSE FOR THE OIL AND GAS WELL DRILLING INDUSTRY, IN CLASS 45 (U.S. CLS. 100 AND 101).

FIRST USE 1-30-2006; IN COMMERCE 1-30-2006.

THE MARK CONSISTS OF A PINWHEEL DESIGN WITHOUT CLAIM TO ANY PARTICULAR SIZE OR COLOR.

SER. NO. 76-669,397, FILED 11-22-2006.

IRA J. GOODSaid, EXAMINING ATTORNEY

Int. Cl.: 9

Prior U.S. Cls.: 21, 23, 26, 36 and 38

Reg. No. 3,396,882

United States Patent and Trademark Office

Registered Mar. 18, 2008

**TRADEMARK
PRINCIPAL REGISTER**

BILLY DA KID

REGULATOR RECORDS, INC. (NEW JERSEY CORPORATION)
P.O. BOX 1029
CLIFTON, NJ 07014

FOR: AUDIO RECORDINGS FEATURING MUSIC, LYRICS, AND SPEECH IN THE FIELD OF RAP MUSIC; AUDIO TAPES, CD'S, AND VIDEO TAPES FEATURING MUSIC; PRERECORDED AUDIO TAPES, CD'S, AND VIDEO TAPES FEATURING MUSIC AND LYRICS; COMPACT DISKS FEATURING MUSIC AND LYRICS; PRERECORDED DVD'S FEATURING MUSICAL PERFORMANCES; AND, VIDEO RECORDINGS FEATURING MUSIC, IN CLASS 9 (U.S. CLS. 21, 23, 26, 36 AND 38).

FIRST USE 11-10-1999; IN COMMERCE 11-10-1999.

THE MARK CONSISTS OF STANDARD CHARACTERS WITHOUT CLAIM TO ANY PARTICULAR FONT, STYLE, SIZE, OR COLOR.

THE MARK BILLY DA KID DOES NOT IDENTIFY A LIVING INDIVIDUAL

SER. NO. 76-669,519, FILED 11-27-2006.

JOHN DWYER, EXAMINING ATTORNEY

Int. Cl.: 43

Prior U.S. Cls.: 100 and 101

United States Patent and Trademark Office

Reg. No. 3,396,883

Registered Mar. 18, 2008

SERVICE MARK
PRINCIPAL REGISTER



BUDDIES BBQ & SOUTHERN FOOD COMPANY,
LLC (FLORIDA LTD LIAB CO)
7850 CANTERBURY CIR
LAKELAND, FL 33810

NO CLAIM IS MADE TO THE EXCLUSIVE
RIGHT TO USE "BBQ", APART FROM THE MARK
AS SHOWN.

FOR: RESTAURANT SERVICES, TAKE-OUT RES-
TAURANT SERVICES, CATERING SERVICES, IN
CLASS 43 (U.S. CLS. 100 AND 101).

SER. NO. 76-669,680, FILED 11-29-2006.

FIRST USE 11-1-2006; IN COMMERCE 11-1-2006.

BRIDGETT SMITH, EXAMINING ATTORNEY

Int. Cl.: 16

Prior U.S. Cls.: 2, 5, 22, 23, 29, 37, 38 and 50

United States Patent and Trademark Office

Reg. No. 3,396,884

Registered Mar. 18, 2008

**TRADEMARK
PRINCIPAL REGISTER**

The image shows the trademark 'Captain Outrageous' written in a cursive, handwritten style. The word 'Captain' is on the top line and 'Outrageous' is on the bottom line, with a large, sweeping flourish that connects the two words and extends to the right.

CAPTAIN OUTRAGEOUS OF KEY WEST, CORP.
(FLORIDA CORPORATION)
9995 GATE PARKWAY, SUITE 190
JACKSONVILLE, FL 32246

THE NAME CAPTAIN OUTRAGEOUS IDENTIFIES A LIVING INDIVIDUAL WHOSE CONSENT IS OF RECORD.

FOR: WORKS OF ART, NAMELY, PAINTINGS
AND ART PICTURES, IN CLASS 16 (U.S. CLS. 2, 5, 22,
23, 29, 37, 38 AND 50).

SER. NO. 76-669,863, FILED 12-4-2006.

FIRST USE 4-13-1990; IN COMMERCE 6-0-1999.

JOHN WILKE, EXAMINING ATTORNEY

Int. Cl.: 16

Prior U.S. Cls.: 2, 5, 22, 23, 29, 37, 38 and 50

United States Patent and Trademark Office

Reg. No. 3,396,885

Registered Mar. 18, 2008

**TRADEMARK
PRINCIPAL REGISTER**

VERSABOARD

ELWOOD PACKAGING, INC. (ILLINOIS CORPORATION)
5200 W. ROOSEVELT ROAD
CHICAGO, IL 60644

THE MARK CONSISTS OF STANDARD CHARACTERS WITHOUT CLAIM TO ANY PARTICULAR FONT, STYLE, SIZE, OR COLOR.

FOR: SOLID FIBERBOARD BOXES, IN CLASS 16 (U.S. CLS. 2, 5, 22, 23, 29, 37, 38 AND 50).

SER. NO. 76-669,965, FILED 12-5-2006.

FIRST USE 10-23-2006; IN COMMERCE 10-23-2006.

JENNIFER VASQUEZ, EXAMINING ATTORNEY

Int. Cl.: 35

Prior U.S. Cls.: 100, 101 and 102

United States Patent and Trademark Office

Reg. No. 3,396,886

Registered Mar. 18, 2008

**SERVICE MARK
PRINCIPAL REGISTER**



BRIAN TRACY INTERNATIONAL, INC. (CALIFORNIA CORPORATION)
462 STEVENS AVE. SUITE 202
SOLANA BEACH, CA 92075

FOR: FRANCHISING SERVICES, NAMELY, OFFERING TECHNICAL ASSISTANCE IN ESTABLISHING, OPERATING, MARKETING, AND DEVELOPING FRANCHISED BUSINESSES THAT PROVIDE PROFESSIONAL AND PERSONAL DEVELOPMENT COACHING SERVICES TO ORGANIZATIONS AND INDIVIDUALS, IN CLASS 35 (U.S. CLS. 100, 101 AND 102).

FIRST USE 4-30-2004; IN COMMERCE 4-30-2004.

OWNER OF U.S. REG. NO. 3,238,427.

NO CLAIM IS MADE TO THE EXCLUSIVE RIGHT TO USE "COACHING EXCELLENCE", APART FROM THE MARK AS SHOWN.

THE NAME SHOWN IN THE MARK IDENTIFIES BRIAN TRACY WHOSE CONSENT IS OF RECORD.

THE COLOR(S) GRAY, BLUE AND BLACK IS/ARE CLAIMED AS A FEATURE OF THE MARK.

THE MARK CONSISTS OF THE TERM "FOCAL" APPEARING IN A STYLIZED GRAY FONT SLIGHTLY ABOVE AND IMMEDIATELY TO THE LEFT OF THE TERM "POINT" WHICH APPEARS IN A STYLIZED BLACK FONT, WITH THE TERMS "POWERED BY BRIAN TRACY" DEPICTED IN A SMALL STYLIZED BLACK FONT IMMEDIATELY BELOW THE TERM "FOCAL" AND THE TERMS "COACHING EXCELLENCE" DEPICTED IN A LARGER STYLIZED BLUE FONT AT THE BOTTOM OF THE MARK AND OFF-CENTERED SLIGHTLY TO THE RIGHT, AND WITH A STYLIZED BLUE SLASH DESIGN APPEARING CENTERED IMMEDIATELY ABOVE THE WORD COMPONENTS OF THE MARK.

SER. NO. 76-669,995, FILED 12-6-2006.

LESLEY LAMOTHE, EXAMINING ATTORNEY

Int. Cl.: 25

Prior U.S. Cls.: 22 and 39

United States Patent and Trademark Office

Reg. No. 3,396,887

Registered Mar. 18, 2008

**TRADEMARK
PRINCIPAL REGISTER**

FIGHT GRAVITY

AADLAND, CHIP (UNITED STATES INDIVIDUAL)
8320 EAST CRESTWOOD
SCOTTSDALE, AZ 85250

THE MARK CONSISTS OF STANDARD CHARACTERS WITHOUT CLAIM TO ANY PARTICULAR FONT, STYLE, SIZE, OR COLOR.

FOR: CLOTHING, NAMELY, T-SHIRTS, HIKING SHIRTS, CAPS, SHORTS, PANTS, JACKETS, IN CLASS 25 (U.S. CLS. 22 AND 39).

SER. NO. 76-670,101, FILED 12-8-2006.

FIRST USE 0-0-1984; IN COMMERCE 0-0-1984.

GEORGIA CARTY, EXAMINING ATTORNEY

Int. Cl.: 36

Prior U.S. Cls.: 100, 101 and 102

United States Patent and Trademark Office

Reg. No. 3,396,888

Registered Mar. 18, 2008

**SERVICE MARK
PRINCIPAL REGISTER**



LEVEL FOUR GROUP, LLC (TEXAS LTD LIAB
CO)
5601 DEMOCRACY DR., SUITE 170
PLANO, TX 75024

FOR: FINANCIAL SERVICES, NAMELY, INVEST-
MENT AND FINANCIAL CONSULTATION; ASSET
MANAGEMENT SERVICES; INVESTMENT MAN-
AGEMENT SERVICES AND INSURANCE SERVI-
CES, NAMELY, INSURANCE BROKERAGE AND

CONSULTATION SERVICES, IN CLASS 36 (U.S. CLS.
100, 101 AND 102).

FIRST USE 11-20-2006; IN COMMERCE 11-20-2006.

SER. NO. 76-670,273, FILED 12-13-2006.

GINA HAYES, EXAMINING ATTORNEY

Int. Cl.: 16

Prior U.S. Cls.: 2, 5, 22, 23, 29, 37, 38 and 50

United States Patent and Trademark Office

Reg. No. 3,396,889

Registered Mar. 18, 2008

TRADEMARK
PRINCIPAL REGISTER



Are We So Different?

AMERICAN ANTHROPOLOGICAL ASSOCIATION (D.C. CORPORATION)
2200 WILSON BOULEVARD, SUITE 600
ARLINGTON, VA 222013357

FOR: PRINTED BOOKS, BOOKLETS, CATALOGUES, PAMPHLETS, INFORMATIONAL FLYERS, POSTCARDS, REPORTS, MAGAZINES, NEWSLETTERS, WORKBOOKS AND A SERIES OF WRITTEN ARTICLES ON THE SUBJECT OF THE ANTHROPOLOGICAL AND SCIENTIFIC STUDY OF RACE AND ON THE SUBJECT OF MUSEUM EXHIBITIONS FEATURING DISPLAYS AND COMMENTARY ON THE ANTHROPOLOGICAL AND SCIENTIFIC STUDY OF RACE; PRINTED EDUCATIONAL MATERIALS ON THE ANTHROPOLOGICAL AND SCIENTIFIC STUDY OF RACE; PRINTED INFORMATIONAL FOLDERS ON THE SUBJECT OF THE ANTHROPOLOGICAL AND SCIENTIFIC STUDY OF RACE, IN CLASS 16 (U.S. CLS. 2, 5, 22, 23, 29, 37, 38 AND 50).

FIRST USE 10-28-2006; IN COMMERCE 10-28-2006.

NO CLAIM IS MADE TO THE EXCLUSIVE RIGHT TO USE "RACE", APART FROM THE MARK AS SHOWN.

THE MARK CONSISTS OF FOUR SQUARES, EACH APPEARING IN ONE OF FOUR QUADRANTS, ALONG WITH THE WORD RACE IN STYLIZED, UPPERCASE TEXT, APPEARING TO THE RIGHT OF THE FOUR SQUARES. THE WORDS ARE WE SO DIFFERENT? APPEAR IN SMALLER, STYLIZED, MIXED CASE TEXT JUST BELOW THE WORD RACE.

SER. NO. 76-670,291, FILED 12-13-2006.

CHARLOTTE CORWIN, EXAMINING ATTORNEY

Int. Cl.: 36

Prior U.S. Cls.: 100, 101 and 102

United States Patent and Trademark Office

Reg. No. 3,396,890

Registered Mar. 18, 2008

SERVICE MARK
PRINCIPAL REGISTER



FIRST CHILDREN'S FINANCE (MINNESOTA CORPORATION)
212 THIRD AVENUE NORTH, SUITE 310
MINNEAPOLIS, MN 554011437

FOR: LOAN FINANCING, GUARANTEE ASSURANCE UNDERWRITING SERVICES AND FINANCIAL GUARANTY SURETY SERVICES, IN CLASS 36 (U.S. CLS. 100, 101 AND 102).

FIRST USE 11-1-2006; IN COMMERCE 11-1-2006.

OWNER OF U.S. REG. NO. 2,269,997.

NO CLAIM IS MADE TO THE EXCLUSIVE RIGHT TO USE "FIRST CHILDREN'S FINANCE", APART FROM THE MARK AS SHOWN.

SER. NO. 76-670,310, FILED 12-14-2006.

JANICE L. MCMORROW, EXAMINING ATTORNEY

Int. Cl.: 41

Prior U.S. Cls.: 100, 101 and 107

United States Patent and Trademark Office

Reg. No. 3,396,891

Registered Mar. 18, 2008

SERVICE MARK
PRINCIPAL REGISTER



FIRST CHILDREN'S FINANCE (MINNESOTA CORPORATION)
212 THIRD AVENUE NORTH, SUITE 310
MINNEAPOLIS, MN 554011437

FOR: EDUCATION SERVICES, NAMELY, PROVIDING TRAINING, CLASSES, SEMINARS, WORKSHOPS IN THE FIELDS OF FINANCING, BUSINESS, MARKETING, HUMAN RESOURCES, FUND RAISING FROM PUBLIC AND PRIVATE SOURCES, ORGANIZATIONAL DEVELOPMENT, LEADERSHIP, AND BOARD GOVERNANCE; PROVIDING INFORMATION ON-LINE IN THE FIELD OF EARLY CHILDHOOD EDUCATION AND CHILD CARE; PROVIDING ON-LINE PUBLICATIONS IN THE NATURE OF FORMS, TEMPLATES, MEASUREMENT TOOLS, QUESTIONNAIRES, CHECKLISTS,

AND SAMPLE DOCUMENTS, IN THE FIELD OF EARLY CHILDHOOD EDUCATION AND CHILD CARE, IN CLASS 41 (U.S. CLS. 100, 101 AND 107).

FIRST USE 11-1-2006; IN COMMERCE 11-1-2006.

OWNER OF U.S. REG. NO. 2,269,997.

NO CLAIM IS MADE TO THE EXCLUSIVE RIGHT TO USE "FIRST CHILDREN'S FINANCE", APART FROM THE MARK AS SHOWN.

SER. NO. 76-670,320, FILED 12-14-2006.

JANICE L. MCMORROW, EXAMINING ATTORNEY

Int. Cl.: 37

Prior U.S. Cls.: 100, 103 and 106

United States Patent and Trademark Office

Reg. No. 3,396,892

Registered Mar. 18, 2008

**SERVICE MARK
PRINCIPAL REGISTER**

WE VALUE WHAT YOU VALUE

ALLEN EDWIN COMPANY, INC. (MICHIGAN
CORPORATION)
2186 EAST CENTRE STREET
PORTAGE, MI 49002

THE MARK CONSISTS OF STANDARD CHAR-
ACTERS WITHOUT CLAIM TO ANY PARTICULAR
FONT, STYLE, SIZE, OR COLOR.

FOR: RESIDENTIAL HOME BUILDING SERVI-
CES, IN CLASS 37 (U.S. CLS. 100, 103 AND 106).

SER. NO. 76-670,321, FILED 12-14-2006.

FIRST USE 9-30-2006; IN COMMERCE 9-30-2006.

MELVIN AXILBUND, EXAMINING ATTORNEY

Int. Cls.: 30 and 32

Prior U.S. Cls.: 45, 46 and 48

United States Patent and Trademark Office

Reg. No. 3,396,893

Registered Mar. 18, 2008

**TRADEMARK
PRINCIPAL REGISTER**

MARIMBA

VILLASANA, CARLOS (UNITED STATES INDIVIDUAL)

3401 RESERVE DR. NE
ATLANTA, GA 30319

FOR: FROZEN CONFECTIONS, NAMELY, ICE CREAM, FROZEN YOGURT, AND SORBETS, ALL OF THE FOREGOING IN A VARIETY OF FLAVORS AND BLENDED WITH MIX-INS IN THE NATURE OF FRUITS AND NUTS; ICE-CREAM BARS, FRUIT ICE BARS, FRUIT ICES, CONES FOR ICE CREAM, WAFFLE CONES FOR ICE CREAM, WAFFLE BOWLS FOR ICE CREAM, ICE CREAM SUNDAES, SHAKES AND MALT FOR FOOD PURPOSES, IN CLASS 30 (U.S. CL. 46).

FIRST USE 10-1-2006; IN COMMERCE 2-15-2006.

FOR: SMOOTHIES; FROZEN FRUIT-BEVERAGES, FRUIT JUICES, FRUIT FLAVORED BEVERAGES, AND NON-ALCOHOLIC BEVERAGES CONTAINING FRUIT JUICES, IN CLASS 32 (U.S. CLS. 45, 46 AND 48).

FIRST USE 10-1-2006; IN COMMERCE 2-15-2006.

THE MARK CONSISTS OF STANDARD CHARACTERS WITHOUT CLAIM TO ANY PARTICULAR FONT, STYLE, SIZE, OR COLOR.

THE ENGLISH TRANSLATION OF THE WORD "MARIMBA" IN THE MARK IS "XYLOPHONE."

SER. NO. 76-670,568, FILED 12-20-2006.

KIMBERLY PERRY, EXAMINING ATTORNEY

Int. Cl.: 25

Prior U.S. Cls.: 22 and 39

United States Patent and Trademark Office

Reg. No. 3,396,894

Registered Mar. 18, 2008

**TRADEMARK
PRINCIPAL REGISTER**



ACTIVE CREATIONS (TENNESSEE LTD LIAB
CO)
1122 GREGORY DRIVE
GALLATIN, TN 37066

FIRST USE 1-1-2005; IN COMMERCE 1-1-2005.

SER. NO. 76-670,580, FILED 12-20-2006.

FOR: HEADWEAR, IN CLASS 25 (U.S. CLS. 22
AND 39).

JORDAN BAKER, EXAMINING ATTORNEY

Int. Cl.: 25

Prior U.S. Cls.: 22 and 39

United States Patent and Trademark Office

Reg. No. 3,396,895

Registered Mar. 18, 2008

**TRADEMARK
PRINCIPAL REGISTER**



ACTIVE CREATIONS (TENNESSEE LTD LIAB
CO)
1122 GREGORY DRIVE
GALLATIN, TN 37066

FIRST USE 1-1-2005; IN COMMERCE 1-1-2005.

SER. NO. 76-670,581, FILED 12-20-2006.

FOR: HEADWEAR; APPAREL, NAMELY SHIRTS,
JACKETS, PANTS, AND SHORTS, IN CLASS 25 (U.S.
CLS. 22 AND 39).

JORDAN BAKER, EXAMINING ATTORNEY

Int. Cl.: 14

Prior U.S. Cls.: 2, 27, 28 and 50

United States Patent and Trademark Office

Reg. No. 3,396,896

Registered Mar. 18, 2008

**TRADEMARK
PRINCIPAL REGISTER**

Stephen Dweck



DWECK INDUSTRIES, INC. (NEW YORK CORPORATION)

21 WEST 38TH STREET
NEW YORK, NY 10018

FOR: JEWELRY, IN CLASS 14 (U.S. CLS. 2, 27, 28 AND 50).

FIRST USE 12-1-1990; IN COMMERCE 12-1-1990.

OWNER OF U.S. REG. NOS. 1,734,413, 3,084,346 AND OTHERS.

THE NAME STEPHEN DWECK IDENTIFIES A LIVING INDIVIDUAL WHO CONSENT IS OF RECORD.

SER. NO. 76-670,994, FILED 1-3-2007.

LESLIE RICHARDS, EXAMINING ATTORNEY

Int. Cl.: 35

Prior U.S. Cls.: 100, 101 and 102

United States Patent and Trademark Office

Reg. No. 3,396,897

Registered Mar. 18, 2008

**SERVICE MARK
PRINCIPAL REGISTER**

SUPERIOR SERVICE. NATIONAL COVERAGE.

ROOFLINK (TEXAS NON-PROFIT CORPORATION), DBA NATIONAL ROOFING PARTNERS

4020 N. MACARTHUR BOULEVARD
SUITE 122-165
IRVING, TX 750386422

FOR: TRADE ASSOCIATION SERVICES, NAME-
LY, PROVIDING BUSINESS PRODUCT AND SER-
VICE INFORMATION TO, AND PROMOTING THE
INTERESTS OF BUSINESSES WITHIN THE ROOF-
ING, SHEET METAL, AND WATER PROOFING

INDUSTRY, IN CLASS 35 (U.S. CLS. 100, 101 AND 102).

FIRST USE 6-0-2006; IN COMMERCE 6-0-2006.

THE MARK CONSISTS OF STANDARD CHAR-
ACTERS WITHOUT CLAIM TO ANY PARTICULAR
FONT, STYLE, SIZE, OR COLOR.

SER. NO. 76-671,173, FILED 1-9-2007.

BENJAMIN OKEKE, EXAMINING ATTORNEY

Int. Cl.: 37

Prior U.S. Cls.: 100, 103 and 106

United States Patent and Trademark Office

Reg. No. 3,396,898

Registered Mar. 18, 2008

**SERVICE MARK
PRINCIPAL REGISTER**

BEDROC

BEDROC CONTRACTING, LLC (NEW JERSEY
LTD LIAB CO)
340 ORIENT WAY
LYNDHURST, NJ 07071

FOR: EXCAVATION, DECONSTRUCTION AND
DEMOLITION SERVICES, NAMELY, BUILDING
DEMOLITION AND BUILDING DECONSTRUCTION,
REMOVAL OF SOILS AND CONSTRUCTION
DEBRIS; ENVIRONMENTAL REMEDIATION SER-
VICES, NAMELY, DISPOSAL OF CONTAMINATED
SOILS, CONSTRUCTION DEBRIS, BUILDING MA-

TERIALS AND UNDERGROUND STORAGE
TANKS, IN CLASS 37 (U.S. CLS. 100, 103 AND 106).

FIRST USE 6-17-2004; IN COMMERCE 9-30-2004.

THE MARK CONSISTS OF STANDARD CHAR-
ACTERS WITHOUT CLAIM TO ANY PARTICULAR
FONT, STYLE, SIZE, OR COLOR.

SER. NO. 76-671,964, FILED 1-29-2007.

ALYSSA PALADINO, EXAMINING ATTORNEY

Int. Cl.: 30

Prior U.S. Cl.: 46

United States Patent and Trademark Office

Reg. No. 3,396,899

Registered Mar. 18, 2008

**TRADEMARK
PRINCIPAL REGISTER**

LINDT & SPRÜNGLI

CHOCOLADEFABRIKEN LINDT & SPRÜNGLI
AG (SWITZERLAND CORPORATION)
SEESTRAßE 204
CH-8802 KILCHBERG, SWITZERLAND

FOR: CHOCOLATE; CHOCOLATE GOODS,
NAMELY, CHOCOLATE BARS, CHOCOLATE
TRUFFLES, FLAVORED CHOCOLATE, FILLED
CHOCOLATE, CHOCOLATE CANDIES, IN CLASS
30 (U.S. CL. 46).

FIRST USE 12-31-1925; IN COMMERCE 12-31-1925.

THE MARK CONSISTS OF STANDARD CHAR-
ACTERS WITHOUT CLAIM TO ANY PARTICULAR
FONT, STYLE, SIZE, OR COLOR.

OWNER OF U.S. REG. NOS. 87,306, 2,031,928 AND
OTHERS.

SER. NO. 76-672,507, FILED 2-9-2007.

TINA BROWN, EXAMINING ATTORNEY

Int. Cl.: 5

Prior U.S. Cls.: 6, 18, 44, 46, 51 and 52

Reg. No. 3,396,900

United States Patent and Trademark Office

Registered Mar. 18, 2008

**TRADEMARK
PRINCIPAL REGISTER**

DUAL HEALTH PACK

GREAT AMERICAN PRODUCTS, INC. (FLORIDA CORPORATION)
101 MATTIE M. KELLY BOULEVARD
DESTIN, FL 32541

FOR: DIETARY MULTIVITAMIN AND OMEGA 3 SUPPLEMENT, IN CLASS 5 (U.S. CLS. 6, 18, 44, 46, 51 AND 52).

FIRST USE 10-18-2006; IN COMMERCE 10-18-2006.

THE MARK CONSISTS OF STANDARD CHARACTERS WITHOUT CLAIM TO ANY PARTICULAR FONT, STYLE, SIZE, OR COLOR.

NO CLAIM IS MADE TO THE EXCLUSIVE RIGHT TO USE "DUAL" AND "PACK", APART FROM THE MARK AS SHOWN.

SER. NO. 76-672,591, FILED 2-12-2007.

ALLISON HOLTZ, EXAMINING ATTORNEY

Int. Cls.: 9 and 41

Prior U.S. Cls.: 21, 23, 26, 36, 38, 100, 101 and 107

United States Patent and Trademark Office

Reg. No. 3,396,901

Registered Mar. 18, 2008

**TRADEMARK
SERVICE MARK
PRINCIPAL REGISTER**

MIDDLE CLASS MILLIONAIRES

BEATTIE, ROGER L. (UNITED STATES INDIVIDUAL)
3039 SOUTH 600 WEST
BOUNTIFUL, UT 84011

FOR: COMPUTER SOFTWARE FOR USE IN REAL ESTATE INVESTMENT AND FINANCIAL PLANNING, IN CLASS 9 (U.S. CLS. 21, 23, 26, 36 AND 38).

FIRST USE 1-28-2005; IN COMMERCE 1-28-2005.

FOR: EDUCATIONAL SERVICES, NAMELY, CONDUCTING CLASSES, SEMINARS, AND WORKSHOPS IN THE FIELDS OF REAL ESTATE INVESTMENT AND FINANCIAL PLANNING; TRAINING

SERVICES IN THE FIELDS OF REAL ESTATE INVESTMENT AND FINANCIAL PLANNING, IN CLASS 41 (U.S. CLS. 100, 101 AND 107).

FIRST USE 3-31-2006; IN COMMERCE 10-25-2006.

THE MARK CONSISTS OF STANDARD CHARACTERS WITHOUT CLAIM TO ANY PARTICULAR FONT, STYLE, SIZE, OR COLOR.

SER. NO. 76-672,942, FILED 2-21-2007.

AMOS T. MATTHEWS, JR., EXAMINING ATTORNEY

Int. Cls.: 14 and 25

Prior U.S. Cls.: 2, 22, 27, 28, 39 and 50

United States Patent and Trademark Office

Reg. No. 3,396,902

Registered Mar. 18, 2008

**TRADEMARK
PRINCIPAL REGISTER**

CP FUSAO

PHILIP, CHRISTINE (UNITED STATES INDIVIDUAL)
3481 LAKESIDE DRIVE NE, SUITE 1506
ATLANTA, GA 30326

FOR: ANKLE BRACELETS; BRACELETS; BRACELETS OF PRECIOUS METAL; BROOCHES; CHOKERS; CLIP EARRINGS; CLOISONNE PINS; COSTUME JEWELRY; EAR CLIPS; EAR STUDS; EARRINGS; JEWEL CHAINS; JEWEL PENDANTS; JEWELRY; JEWELRY CHAINS; JEWELRY FOR THE HEAD; JEWELRY, NAMELY, AMULETS; JEWELRY, NAMELY, CROSSES; NECK CHAINS; NECKLACES; ORNAMENTAL PINS; PEARLS; PENDANTS; PINS BEING JEWELRY; RINGS; RINGS BEING JEWELRY; TIARAS; AND WEDDING BANDS, IN CLASS 14 (U.S. CLS. 2, 27, 28 AND 50).

FIRST USE 2-5-2007; IN COMMERCE 2-5-2007.

FOR: BLOUSES; BLOUSONS; CAFTANS (KAF-TANS); CHEMISES; CLOTHING, NAMELY, FOLK COSTUMES; CLOTHING, NAMELY, WRAP-AROUNDS; DRESSES; EVENING DRESSES; EVENING GOWNS; FULL-LENGTH KIMONOS (NAGAGI); GOWNS; KIMONOS; PAREOS; PAREUS; SARIS; SARONGS; SERAPES; SKIRTS AND DRESSES; WEDDING DRESSES; WEDDING GOWNS; WRAPS; ASCOTS; FOULARDS; SCARVES; GLOVES; BATHING COSTUMES; BATHING COSTUMES FOR WOMEN; BATHING SUITS; BIKINIS; TANKINIS; BATHROBES; BEACH COVER-UPS; BEACHWEAR; BED JACKETS; BRAS; BRASSIERES; BUSTIERS; CAPS; HATS; SHOES; COATS; JACKETS; DRESS SUITS; FOOTWEAR; FOOTWEAR FOR WOMEN; FROCKS; HEAD SCARVES; HEADWEAR; HOSI-

ERY; JUMPERS; JUMPSUITS; KNIT SHIRTS; LADIES' UNDERWEAR; LINGERIE; LONG JACKETS; LOUNGEWEAR; MANTLES; MINISKIRTS; MUFFLERS; NEGLIGEEES; NIGHT GOWNS; NIGHT SHIRTS; NIGHT DRESSES; NIGHTIES; NIGHTWEAR; OVERCOATS; PANTIES, SHORTS AND BRIEFS; PANTS; PANTSUITS; PANTYHOSE; PEIGNOIRS; PETTICOATS; PULLOVERS; RAIN JACKETS; RAINCOATS; RAINWEAR; SHAWLS; SHIFTS; SHIRTS; SHORTS; SILK SCARVES; SLACKS; SLEEP SHIRTS; SLIPPERS; SMOCKS; SNEAKERS; SOCKS AND STOCKINGS; SUITS; SWEAT SUITS; SWEATERS; SWIM WEAR; SWIMMING COSTUMES; SWIMSUITS; TANK TOPS; TEDDIES; THONGS; TOPCOATS; TROUSERS; T-SHIRTS; UNDERCLOTHES; UNDERGARMENTS; UNDERWEAR; UNDERPANTS; UNDERSHIRTS; UNDERSKIRTS, IN CLASS 25 (U.S. CLS. 22 AND 39).

FIRST USE 2-5-2007; IN COMMERCE 2-5-2007.

THE MARK CONSISTS OF STANDARD CHARACTERS WITHOUT CLAIM TO ANY PARTICULAR FONT, STYLE, SIZE, OR COLOR.

THE NAME(S), PORTRAIT(S), AND/OR SIGNATURE(S) SHOWN IN THE MARK DOES NOT IDENTIFY A PARTICULAR LIVING INDIVIDUAL.

THE FOREIGN WORDING IN THE MARK TRANSLATES INTO ENGLISH AS FUSION.

SER. NO. 76-673,086, FILED 2-23-2007.

MICHAEL KEATING, EXAMINING ATTORNEY

Int. Cl.: 30

Prior U.S. Cl.: 46

United States Patent and Trademark Office

Reg. No. 3,396,903

Registered Mar. 18, 2008

**TRADEMARK
PRINCIPAL REGISTER**

SURF SWEETS

GSH HOLDINGS, INC (DELAWARE CORPORATION)

2200 DELAWARE AVENUE

SANTA CRUZ, CA 95062

FOR: CANDY AND ORGANIC CANDY, IN CLASS 30 (U.S. CL. 46).

FIRST USE 8-23-2006; IN COMMERCE 8-23-2006.

THE MARK CONSISTS OF STANDARD CHARACTERS WITHOUT CLAIM TO ANY PARTICULAR FONT, STYLE, SIZE, OR COLOR.

NO CLAIM IS MADE TO THE EXCLUSIVE RIGHT TO USE "SWEETS", APART FROM THE MARK AS SHOWN.

SER. NO. 76-673,157, FILED 2-26-2007.

TASHIA BUNCH, EXAMINING ATTORNEY

Int. Cl.: 41

Prior U.S. Cls.: 100, 101 and 107

United States Patent and Trademark Office

Reg. No. 3,396,904

Registered Mar. 18, 2008

SERVICE MARK
PRINCIPAL REGISTER



ABILITY MOUNTAIN INSTITUTE (CALIFORNIA CORPORATION)
1907 MAGDALENA CIR.
APT. 41
SANTA CLARA, CA 95051

FOR: EDUCATIONAL SERVICES, NAMELY, PROVIDING COURSES IN THE FIELD OF CHINESE CULTURE AND LANGUAGE TRAINING, IN CLASS 41 (U.S. CLS. 100, 101 AND 107).

FIRST USE 12-1-2006; IN COMMERCE 12-1-2006.

THE MARK CONSISTS OF A CIRCLE WITH A THICK BLACK BORDER, WITH ENGLISH TEXT, CHINESE CHARACTERS AND A CARTOON OF AN OLD MAN SHOULDERING A DIGGING TOOL. AT THE TOP OF THE CIRCLE, WRITTEN IN WHITE ON THE BLACK BORDER, IS THE TEXT "ABILITY

MOUNTAIN". AT THE BOTTOM OF THE CIRCLE, WRITTEN IN WHITE ON THE BLACK BORDER, ARE THE CHINESE CHARACTERS WHICH REPRESENT THE NAME OF ABILITY MOUNTAIN INSTITUTE.

THE ENGLISH TRANSLATION OF THE CHINESE CHARACTERS IS "ABILITY MOUNTAIN INSTITUTE."

THE ENGLISH TRANSLITERATION OF THE MARK IN THE CHINESE LANGUAGE IS "YISHAN XUE YUAN."

SER. NO. 76-673,232, FILED 2-26-2007.

ANNE MADDEN, EXAMINING ATTORNEY

Int. Cls.: 11, 17 and 19

Prior U.S. Cls.: 1, 5, 12, 13, 21, 23, 31, 33, 34, 35 and 50

United States Patent and Trademark Office

Reg. No. 3,396,905

Registered Mar. 18, 2008

**TRADEMARK
PRINCIPAL REGISTER**

SIMPLE-SEPTIC

PRESBY ENVIRONMENTAL, INC. (NEW HAMPSHIRE CORPORATION)

P. O. BOX 617, ROUTE 117

SUGAR HILL, NH 03585

FOR: WATER FILTERING DEVICES, NAMELY, WATER PURIFICATION UNITS FOR WASTE WATER TREATMENT CONSISTING OF PREFORATED NON-METALLIC WASTE PIPE WITH MULTILAYER FABRIC THEREON WHICH HAS BEEN TREATED WITH BACTERIA AND/OR MICROBES FOR USE IN WASTE WATER AND SEPTIC WASTE TREATMENT; PIPES BEING PARTS OF SANITARY FACILITIES, NAMELY, PERFORATED NON-METALLIC WASTE PIPE WITH MULTILAYER FABRIC THEREON WHICH HAS BEEN TREATED WITH BACTERIA AND OR MICROBES FOR USE IN WASTE WATER AND SEPTIC WASTE TREATMENT; WATER FILTERING DEVICES, NAMELY, MULTILAYER FABRIC WHICH HAS BEEN TREATED WITH BACTERIA AND/OR MICROBES FOR USE IN WASTE WATER AND SEPTIC WASTE TREATMENT, IN CLASS 11 (U.S. CLS. 13, 21, 23, 31 AND 34).

FIRST USE 4-0-1999; IN COMMERCE 4-0-1999.

FOR: FLEXIBLE PLUMBING PIPES OF PLASTIC, NAMELY, PERFORATED NON-METALLIC WASTE PIPE WITH MULTILAYER FABRIC THEREON WHICH HAS BEEN TREATED WITH BACTERIA AND/OR MICROBES FOR USE IN WASTE WATER AND SEPTIC WASTE TREATMENT, IN CLASS 17 (U.S. CLS. 1, 5, 12, 13, 35 AND 50).

FIRST USE 4-0-1999; IN COMMERCE 4-0-1999.

FOR: NON-METAL SEWER PIPES, NAMELY, PERFORATED NON-METALLIC WASTE PIPE WITH MULTILAYER FABRIC THEREON WHICH HAS BEEN TREATED WITH BACTERIA AND/OR MICROBES FOR USE IN WASTE WATER AND SEPTIC WASTE TREATMENT, IN CLASS 19 (U.S. CLS. 1, 12, 33 AND 50).

FIRST USE 4-0-1999; IN COMMERCE 4-0-1999.

THE MARK CONSISTS OF STANDARD CHARACTERS WITHOUT CLAIM TO ANY PARTICULAR FONT, STYLE, SIZE, OR COLOR.

SER. NO. 76-673,717, FILED 3-7-2007.

MARY CRAWFORD, EXAMINING ATTORNEY

Int. Cl.: 35

Prior U.S. Cls.: 100, 101 and 102

United States Patent and Trademark Office

Reg. No. 3,396,906

Registered Mar. 18, 2008

SERVICE MARK
PRINCIPAL REGISTER



HOFFMAN, ANDREA (UNITED STATES INDIVIDUAL)
16 CLUBHOUSE ROAD
HAMBURG, NJ 07419

FOR: BUSINESS CONSULTING; MARKETING CONSULTING AND MARKET RESEARCH, IN CLASS 35 (U.S. CLS. 100, 101 AND 102).

FIRST USE 8-15-2006; IN COMMERCE 8-15-2006.

NO CLAIM IS MADE TO THE EXCLUSIVE RIGHT TO USE "DIVERSITY" AND "HELPING CLIENTS REACH THE AFFLUENT ETHNIC CONSUMER", APART FROM THE MARK AS SHOWN.

SER. NO. 76-674,089, FILED 3-15-2007.

RUDY R. SINGLETON, EXAMINING ATTORNEY

Int. Cl.: 14

Prior U.S. Cls.: 2, 27, 28 and 50

United States Patent and Trademark Office

Reg. No. 3,396,907

Registered Mar. 18, 2008

**TRADEMARK
PRINCIPAL REGISTER**

TRACEY MAYER

TRACEY MAYER, INC. (ILLINOIS CORPORATION)
1 SOUTH GEORGE STREET
MT. PROSPECT, IL 60056

"THE NAME(S), PORTRAIT(S), AND/OR SIGNATURE(S) SHOWN IN THE MARK IDENTIFIES TRACEY MAYER, WHOSE CONSENT(S) TO REGISTER IS SUBMITTED."

FOR: JEWELRY, IN CLASS 14 (U.S. CLS. 2, 27, 28 AND 50).

FIRST USE 9-0-2006; IN COMMERCE 9-0-2006.

SER. NO. 76-674,258, FILED 3-19-2007.

THE MARK CONSISTS OF STANDARD CHARACTERS WITHOUT CLAIM TO ANY PARTICULAR FONT, STYLE, SIZE, OR COLOR.

PETER B. BROMAGHIM, EXAMINING ATTORNEY

Int. Cl.: 35

Prior U.S. Cls.: 100, 101 and 102

United States Patent and Trademark Office

Reg. No. 3,396,908

Registered Mar. 18, 2008

**SERVICE MARK
PRINCIPAL REGISTER**

weirdware

TRUSTIN TECHNOLOGY, LLC (CALIFORNIA
LTD LIAB CO)
9231 IRVINE BLVD.
IRVINE, CA 92618

FOR: PROCUREMENT SERVICES FOR OTHERS,
NAMELY THE PURCHASING AND RESALE OF
COMPUTER AND ELECTRONIC HARDWARE,
COMPUTER SOFTWARE AND RELATED PERIPH-
ERALS, IN CLASS 35 (U.S. CLS. 100, 101 AND 102).

FIRST USE 6-1-2005; IN COMMERCE 10-1-2005.

THE MARK CONSISTS OF STANDARD CHAR-
ACTERS WITHOUT CLAIM TO ANY PARTICULAR
FONT, STYLE, SIZE, OR COLOR.

SER. NO. 76-674,500, FILED 3-23-2007.

PRISCILLA MILTON, EXAMINING ATTORNEY

Int. Cl.: 36

Prior U.S. Cls.: 100, 101 and 102

United States Patent and Trademark Office

Reg. No. 3,396,909

Registered Mar. 18, 2008

SERVICE MARK
PRINCIPAL REGISTER

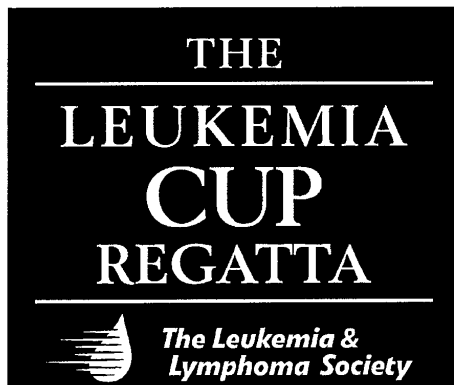

THE LEUKEMIA & LYMPHOMA SOCIETY, INC.
(NEW YORK NOT-FOR-PROFIT CORPORATION)

1311 MAMARONECK AVENUE
WHITE PLAINS, NY 10605

FOR: CHARITABLE FUND RAISING FOR LEUKEMIA RESEARCH, PATIENT AID AND PUBLIC AND PROFESSIONAL EDUCATION, IN CLASS 36 (U.S. CLS. 100, 101 AND 102).

FIRST USE 9-0-2003; IN COMMERCE 9-0-2003.

OWNER OF U.S. REG. NOS. 2,123,414, 2,396,611, AND 2,892,860.

NO CLAIM IS MADE TO THE EXCLUSIVE RIGHT TO USE "THE LEUKEMIA CUP REGATTA" AND "THE LEUKEMIA & LYMPHOMA SOCIETY", APART FROM THE MARK AS SHOWN.

SER. NO. 76-675,077, FILED 4-5-2007.

ANDREA K. NADELMAN, EXAMINING ATTORNEY

Int. Cl.: 36

Prior U.S. Cls.: 100, 101 and 102

United States Patent and Trademark Office

Reg. No. 3,396,910

Registered Mar. 18, 2008

**SERVICE MARK
PRINCIPAL REGISTER**

LEUKEMIA CUP REGATTA

THE LEUKEMIA & LYMPHOMA SOCIETY, INC.
(NEW YORK NOT-FOR-PROFIT CORPORATION)
1311 MAMARONECK AVENUE
WHITE PLAINS, NY 10605

FOR: CHARITABLE FUND RAISING FOR LEUKEMIA RESEARCH, PATIENT AID AND PUBLIC AND PROFESSIONAL EDUCATION, IN CLASS 36 (U.S. CLS. 100, 101 AND 102).

FIRST USE 0-0-1993; IN COMMERCE 0-0-1993.

THE MARK CONSISTS OF STANDARD CHARACTERS WITHOUT CLAIM TO ANY PARTICULAR FONT, STYLE, SIZE, OR COLOR.

OWNER OF U.S. REG. NO. 2,123,414.

NO CLAIM IS MADE TO THE EXCLUSIVE RIGHT TO USE "REGATTA", APART FROM THE MARK AS SHOWN.

SEC. 2(F).

SER. NO. 76-675,078, FILED 4-5-2007.

ANDREA K. NADELMAN, EXAMINING ATTORNEY

Int. Cl.: 45

Prior U.S. Cls.: 100 and 101

United States Patent and Trademark Office

Reg. No. 3,396,911

Registered Mar. 18, 2008

**SERVICE MARK
PRINCIPAL REGISTER**

**TRANSFORMATIONAL
ENERGY
RELEASE**

HARRIS, LAWRENCE J. (UNITED STATES IN-
DIVIDUAL)
160 CYPRESS CLUB DRIVE, APT. 609
POMPANO BEACH, FL 33060

FOR: SPIRITUAL COUNSELING AND THERAPY,
NAMELY, PROVIDING COUNSELING AND NON-
MEDICAL/SPIRITUAL THERAPY TO RELEASE
FEARS, NEGATIVE EMOTIONS AND BELIEFS , IN
CLASS 45 (U.S. CLS. 100 AND 101).

FIRST USE 5-6-1996; IN COMMERCE 5-6-1996.

THE MARK CONSISTS OF STANDARD CHAR-
ACTERS WITHOUT CLAIM TO ANY PARTICULAR
FONT, STYLE, SIZE, OR COLOR.

OWNER OF U.S. REG. NO. 2,557,451.

SEC. 2(F).

SER. NO. 76-675,241, FILED 4-9-2007.

MATTHEW EINSTEIN, EXAMINING ATTORNEY

Prior U.S. Cl.: A

United States Patent and Trademark Office

Reg. No. 3,396,912

Registered Mar. 18, 2008

CERTIFICATION MARK
PRINCIPAL REGISTER



HARDWOOD PLYWOOD & VENEER ASSOCIATION (ILLINOIS CORPORATION)
1825 MICHAEL FARADAY DRIVE
RESTON, VA 20190

FOR: HARDWOOD PLYWOOD, IN CLASS A (U.S. CL. A).

FIRST USE 5-1-1993; IN COMMERCE 6-1-1993.

NO CLAIM IS MADE TO THE EXCLUSIVE RIGHT TO USE "ASSOCIATION", APART FROM THE MARK AS SHOWN.

THE MARK CONSISTS OF AN OBLONG SHAPE WITH THE LETTERS "HPVA". THE WORDING "HARDWOOD PLYWOOD AND VENEER ASSOCIATION" ENCIRCLES THE OBLONG. A STAR AP-

PEARS BEFORE THE WORD "HARDWOOD" AND AFTER "ASSOCIATION".

THE CERTIFICATION MARK IS USED BY AUTHORIZED PERSONS TO CERTIFY THAT THE PRODUCT BEARING THE MARK CONFORMS TO THE CERTIFICATION STANDARDS FOR FLAME SPREAD PERFORMANCE, FORMALDEHYDE EMISSION AND STRUCTURAL PROPERTIES OF HARDWOOD PLYWOOD.

SEC. 2(F) AS TO "HARDWOOD PLYWOOD AND VENEER ASSOCIATION".

SER. NO. 76-675,323, FILED 4-10-2007.

ROSELLE HERRERA, EXAMINING ATTORNEY

Int. Cls.: 35 and 40

Prior U.S. Cls.: 100, 101, 102, 103 and 106

United States Patent and Trademark Office

Reg. No. 3,396,913

Registered Mar. 18, 2008

**SERVICE MARK
PRINCIPAL REGISTER**



OAK CREEK

AMERICAN HOMESTAR CORPORATION
(TEXAS CORPORATION)
SOUTH SHORE BLVD.
SUITE 300
LEAGUE CITY, TX 77573

FOR: RETAIL STORE SERVICES FEATURING
MODULAR, MANUFACTURED AND MOBILE
HOMES, IN CLASS 35 (U.S. CLS. 100, 101 AND 102).

FIRST USE 4-1-1986; IN COMMERCE 4-1-1986.

FOR: MANUFACTURE OF MODULAR, MANU-
FACTURED AND MOBILE HOMES TO THE OR-

DER AND SPECIFICATION OF OTHERS, IN CLASS
40 (U.S. CLS. 100, 103 AND 106).

FIRST USE 6-6-1983; IN COMMERCE 6-6-1983.

OWNER OF U.S. REG. NO. 1,359,128.

THE MARK CONSISTS OF A STYLIZED TREE
DESIGN.

SER. NO. 76-675,400, FILED 4-12-2007.

BARBARA BROWN, EXAMINING ATTORNEY

Int. Cl.: 1

Prior U.S. Cls.: 1, 5, 6, 10, 26 and 46

Reg. No. 3,396,914

United States Patent and Trademark Office

Registered Mar. 18, 2008

**TRADEMARK
PRINCIPAL REGISTER**

CONVALEX

INLAND VACUUM INDUSTRIES, INC. (FLORIDA CORPORATION)
35 HOWARD AVENUE
CHURCHVILLE, NY 14428

THE MARK CONSISTS OF STANDARD CHARACTERS WITHOUT CLAIM TO ANY PARTICULAR FONT, STYLE, SIZE, OR COLOR.

FOR: VACUUM PUMP FLUIDS FOR USE IN DIFFUSION VACUUM PUMPS, IN CLASS 1 (U.S. CLS. 1, 5, 6, 10, 26 AND 46).

SER. NO. 76-675,457, FILED 4-13-2007.

FIRST USE 12-31-1963; IN COMMERCE 12-31-1963.

SHAUNIA CARLYLE, EXAMINING ATTORNEY

Int. Cl.: 5

Prior U.S. Cls.: 6, 18, 44, 46, 51 and 52

United States Patent and Trademark Office

Reg. No. 3,396,915

Registered Mar. 18, 2008

**TRADEMARK
PRINCIPAL REGISTER**

NATUZYME

BIOPROTON PTY LTD (AUSTRALIA CORPORATION)
38/141 STATION ROAD
SUNNYBANK QLD 4109, AUSTRALIA

FOR: ANIMAL FEED SUPPLEMENTS, NAMELY, ENZYME SUPPLEMENTS ENHANCING DIGESTIBILITY OF ANIMAL FEED; VETERINARY CHEMICALS, NAMELY, BIOCHEMICAL PREPARATIONS FOR VETERINARY USE, IN CLASS 5 (U.S. CLS. 6, 18, 44, 46, 51 AND 52).

THE MARK CONSISTS OF STANDARD CHARACTERS WITHOUT CLAIM TO ANY PARTICULAR FONT, STYLE, SIZE, OR COLOR.

PRIORITY CLAIMED UNDER SEC. 44(D) ON AUSTRALIA APPLICATION NO. 1160403, FILED 2-9-2007, REG. NO. 1160403, DATED 2-9-2007, EXPIRES 2-9-2017.

SER. NO. 76-675,866, FILED 4-23-2007.

CHRISTINA SOBRAL, EXAMINING ATTORNEY

Int. Cl.: 5

Prior U.S. Cls.: 6, 18, 44, 46, 51 and 52

United States Patent and Trademark Office

Reg. No. 3,396,916

Registered Mar. 18, 2008

**TRADEMARK
PRINCIPAL REGISTER**

BIOPROTON

BIOPROTON PTY LTD (AUSTRALIA CORPORATION)

38/141 STATION ROAD

SUNNYBANK QLD 4109, AUSTRALIA

FOR: ANIMAL FEED SUPPLEMENTS, NAMELY, ENZYME SUPPLEMENTS ENHANCING DIGESTIBILITY OF ANIMAL FEED; VETERINARY CHEMICALS, NAMELY, BIOCHEMICAL PREPARATIONS FOR VETERINARY USE, IN CLASS 5 (U.S. CLS. 6, 18, 44, 46, 51 AND 52).

THE MARK CONSISTS OF STANDARD CHARACTERS WITHOUT CLAIM TO ANY PARTICULAR FONT, STYLE, SIZE, OR COLOR.

PRIORITY CLAIMED UNDER SEC. 44(D) ON AUSTRALIA APPLICATION NO. 1160398, FILED 2-9-2007, REG. NO. 1160398, DATED 2-9-2007, EXPIRES 2-9-2017.

SER. NO. 76-675,867, FILED 4-23-2007.

CHRISTINA SOBRAL, EXAMINING ATTORNEY

Int. Cl.: 19

Prior U.S. Cls.: 1, 12, 33 and 50

United States Patent and Trademark Office

Reg. No. 3,396,917

Registered Mar. 18, 2008

**TRADEMARK
PRINCIPAL REGISTER**

FLEXX  BLOCK

Insulated Concrete Form

by Lite-Form Technologies

LITE-FORM TECHNOLOGIES LLC (NEBRASKA
LTD LIAB CO)
1950 W 29TH STREET
SOUTH SIOUX CITY, NE 68776

FOR: NON-METAL BUILDING MATERIALS,
NAMELY, INSULATED CONCRETE FORMS USED
IN THE CONSTRUCTION TRADE FOR ENERGY
EFFICIENT HOMES AND COMMERCIAL BUILD-
INGS, IN CLASS 19 (U.S. CLS. 1, 12, 33 AND 50).

FIRST USE 1-1-2007; IN COMMERCE 1-1-2007.

OWNER OF U.S. REG. NO. 1,812,162.

NO CLAIM IS MADE TO THE EXCLUSIVE
RIGHT TO USE "BLOCK" AND "INSULATED CON-
CRETE FORM" AND "TECHNOLOGIES", APART
FROM THE MARK AS SHOWN.

SER. NO. 76-675,882, FILED 4-23-2007.

JANICE L. MCMORROW, EXAMINING ATTOR-
NEY

Int. Cls.: 9 and 16

Prior U.S. Cls.: 2, 5, 21, 22, 23, 26, 29, 36, 37, 38 and 50

Reg. No. 3,396,918

United States Patent and Trademark Office

Registered Mar. 18, 2008

**TRADEMARK
PRINCIPAL REGISTER**

HEART OF THE MATTER SERIES

HOPE FOR THE HEART, INC. (TEXAS CORPORATION)
12377 MERIT DRIVE, SUITE 300
DALLAS, TX 75251

FOR: SERIES OF PRE-RECORDED AUDIO CASSETTES AND CDS IN THE FIELD OF RELIGION; CD CASES AND AUDIO CASSETTE CASES; AUDIO VISUAL RESOURCE MATERIALS CONSISTING OF PRE-RECORDED AUDIO CASSETTES AND CDS AND CONTAINING BOOKS, WRITTEN MATERIALS AND PRINTED SCRIPTURE MEMORY CARDS WITH CARD HOLDERS , SOLD AS A UNIT, FOR USE IN THE FIELD OF RELIGION, IN CLASS 9 (U.S. CLS. 21, 23, 26, 36 AND 38).

FIRST USE 12-31-2000; IN COMMERCE 12-31-2000.

FOR: SERIES OF BOOKS, WRITTEN MATERIALS AND SCRIPTURE MEMORY CARDS WITH CARD HOLDERS IN THE FIELD OF RELIGION, IN CLASS 16 (U.S. CLS. 2, 5, 22, 23, 29, 37, 38 AND 50).

FIRST USE 12-31-2000; IN COMMERCE 12-31-2000.

THE MARK CONSISTS OF STANDARD CHARACTERS WITHOUT CLAIM TO ANY PARTICULAR FONT, STYLE, SIZE, OR COLOR.

NO CLAIM IS MADE TO THE EXCLUSIVE RIGHT TO USE "SERIES", APART FROM THE MARK AS SHOWN.

SER. NO. 76-676,018, FILED 4-26-2007.

HENRY S. ZAK, EXAMINING ATTORNEY

Int. Cl.: 5

Prior U.S. Cls.: 6, 18, 44, 46, 51 and 52

Reg. No. 3,396,919

United States Patent and Trademark Office

Registered Mar. 18, 2008

**TRADEMARK
PRINCIPAL REGISTER**

B. E. TURMERIC 7X

ORCAS INTERNATIONAL, INC. (NEW JERSEY CORPORATION)
230 ROUTE 206, BUILDING 4
SUITE 3
FLANDERS, NJ 07836

FOR: NUTRITIONAL SUPPLEMENTS IN POWDER, TABLET, CAPSULE, AND LIQUID FORM, IN CLASS 5 (U.S. CLS. 6, 18, 44, 46, 51 AND 52).

FIRST USE 3-14-2007; IN COMMERCE 3-14-2007.

THE MARK CONSISTS OF STANDARD CHARACTERS WITHOUT CLAIM TO ANY PARTICULAR FONT, STYLE, SIZE, OR COLOR.

NO CLAIM IS MADE TO THE EXCLUSIVE RIGHT TO USE "TURMERIC", APART FROM THE MARK AS SHOWN.

SER. NO. 76-676,026, FILED 4-26-2007.

HENRY S. ZAK, EXAMINING ATTORNEY

Int. Cl.: 9

Prior U.S. Cls.: 21, 23, 26, 36 and 38

United States Patent and Trademark Office

Reg. No. 3,396,920

Registered Mar. 18, 2008

**TRADEMARK
PRINCIPAL REGISTER**

MICROLITE

STYLE EYES, INC. (CALIFORNIA CORPORATION)
824 W. 18TH STREET
COSTA MESA, CA 92627

FOR: SUNGLASSES, IN CLASS 9 (U.S. CLS. 21, 23, 26, 36 AND 38).

FIRST USE 4-1-1987; IN COMMERCE 4-1-1987.

THE MARK CONSISTS OF STANDARD CHARACTERS WITHOUT CLAIM TO ANY PARTICULAR FONT, STYLE, SIZE, OR COLOR.

OWNER OF U.S. REG. NO. 1,590,588.

SER. NO. 76-676,103, FILED 4-27-2007.

JULIE GUTTADAURO, EXAMINING ATTORNEY

Int. Cl.: 16

Prior U.S. Cls.: 2, 5, 22, 23, 29, 37, 38 and 50

United States Patent and Trademark Office

Reg. No. 3,396,921

Registered Mar. 18, 2008

**TRADEMARK
PRINCIPAL REGISTER**



GALILEO PRESS GMBH (FED REP GERMANY
LTD LIAB CO)
RHEINWERKALLEE 4
53227 BONN, FED REP GERMANY

FOR: PRINTED MATTER, NAMELY, BOOKS, GUIDES, NEWSLETTERS, MAGAZINES, REPORTS, JOURNALS AND TECHNICAL INSTRUCTION MANUALS DEALING PRIMARILY WITH ONE OR MORE OF THE FOLLOWING SUBJECTS: PHOTOGRAPHY, GRAPHIC DESIGN, VIDEO AND AUDIO PRODUCTION, TECHNICAL AND BUSINESS-RELATED ENTERPRISE RESOURCE PLANNING (ERP) SYSTEMS TOPICS, AND THE DESIGN, DEVELOPMENT, IMPLEMENTATION, SUPPORT, MANAGEMENT, AND/OR USE OF INFORMATION TECHNOLOGY; BUT EXCLUDING ALL OF THE FOLLOWING: BOOKS, GUIDES, NEWSLETTERS, MAGAZINES, REPORTS AND OTHER PRINTED PUBLICATIONS DEALING PRIMARILY WITH OR USED PRIMARILY FOR ON-LINE OR OTHER TYPES OF TRAVEL RESERVATIONS, TRAVEL ARRANGEMENTS, TRAVEL ACCOMMODATIONS, TRAVEL BOOKINGS, TRAVEL MANAGEMENT OR TRAVEL ADMINISTRATION, THE RESERVATION AND BOOKING OF TRAVEL ARRANGEMENTS, THE MAKING OF RESERVATIONS AND BOOKING FOR TRANSPORTATION, TRAVEL, LODGING, ENTERTAINMENT, AUTO LEASING OR TRAVEL SERVICES, AND TRAVEL AGENCY OPERATIONS AND TRAVEL AGENCY MANAGEMENT, INFORMATION, PHOTOGRAPHS AND

GRAPHICS IN THE FIELD OF WEATHER FOR USE PRIMARILY BY WEATHER PRESENTERS, FORECASTERS AND PROFESSIONALS, GLOBAL POSITIONING SYSTEMS, THE PROVIDING OF COMPREHENSIVE MONITORING OF MEDIA OUTLETS, INSTRUCTION ON ETHICAL SALES TECHNIQUES, CHILDREN'S BOOKS, CHILDREN'S GAMES, CHILDREN'S EDUCATIONAL MATERIALS, CHILDREN'S ENTERTAINMENT, CHILDREN'S LEARNING ACTIVITIES, AND FILMS AND IMAGES FOR CHILDREN, MANAGING THE LESSONS, ACHIEVEMENTS, DEVELOPMENTS, OBSERVATIONS, ACTIVITIES AND REPORTS OF CHILDREN, THE PROCESSING, RATING AND CODING OF INSURANCE POLICIES, MEASUREMENT SYSTEMS FOR USE IN QUALITY CONTROL AND MANUFACTURING, IN VITRO EXPERIMENTS IN THE PHARMACEUTICAL INDUSTRY, DIVE COMPUTERS, AND DIGITAL LOUD SPEAKER MANAGEMENT SYSTEMS, IN CLASS 16 (U.S. CLS. 2, 5, 22, 23, 29, 37, 38 AND 50).

FIRST USE 9-9-2002; IN COMMERCE 9-9-2002.

NO CLAIM IS MADE TO THE EXCLUSIVE RIGHT TO USE "PRESS", APART FROM THE MARK AS SHOWN.

SER. NO. 76-676,134, FILED 4-27-2007.

SUSAN STIGLITZ, EXAMINING ATTORNEY

Int. Cls.: 35, 41 and 44

Prior U.S. Cls.: 100, 101, 102 and 107

United States Patent and Trademark Office

Reg. No. 3,396,922

Registered Mar. 18, 2008

**SERVICE MARK
PRINCIPAL REGISTER**

CYF

AMERICAN PSYCHOLOGICAL ASSOCIATION
(D.C. NOT-FOR-PROFIT CORPORATION)
750 FIRST STREET N.E.
WASHINGTON, DC 200024242

FOR: PUBLIC ADVOCACY TO PROMOTE
AWARENESS OF HEALTH, HUMAN WELFARE
AND SOCIAL RESPONSIBILITY ACTIVITIES IN
THE AREAS OF CHILDREN, YOUTH AND FAMIL-
IES, IN CLASS 35 (U.S. CLS. 100, 101 AND 102).

FIRST USE 0-0-1986; IN COMMERCE 0-0-1986.

FOR: EDUCATIONAL SERVICES, NAMELY,
CONDUCTING CONFERENCES IN THE FIELD OF
PSYCHOLOGY AND SOCIAL SCIENCES, IN CLASS
41 (U.S. CLS. 100, 101 AND 107).

FIRST USE 0-0-1986; IN COMMERCE 0-0-1986.

FOR: CONSULTATION IN THE FIELDS OF PSY-
CHOLOGY AND SOCIAL PSYCHOLOGY, IN CLASS
44 (U.S. CLS. 100 AND 101).

FIRST USE 0-0-1986; IN COMMERCE 0-0-1986.

THE MARK CONSISTS OF STANDARD CHAR-
ACTERS WITHOUT CLAIM TO ANY PARTICULAR
FONT, STYLE, SIZE, OR COLOR.

SER. NO. 76-676,210, FILED 4-30-2007.

JOHN DWYER, EXAMINING ATTORNEY

Int. Cl.: 35

Prior U.S. Cls.: 100, 101 and 102

United States Patent and Trademark Office

Reg. No. 3,396,923

Registered Mar. 18, 2008

**SERVICE MARK
PRINCIPAL REGISTER**

FREIGHT SALES

FREIGHT SALES CARPET AND TILE OF POLK
COUNTY, L.L.C. (FLORIDA LIMITED LIABILITY CORPORATION)
3330 U.S. HIGHWAY 92 EAST
LAKELAND, FL 33801

FOR: RETAIL STORE SERVICES FEATURING
FLOORING PRODUCTS, IN CLASS 35 (U.S. CLS. 100,
101 AND 102).

FIRST USE 0-0-1966; IN COMMERCE 0-0-1966.

THE MARK CONSISTS OF STANDARD CHARACTERS WITHOUT CLAIM TO ANY PARTICULAR FONT, STYLE, SIZE, OR COLOR.

NO CLAIM IS MADE TO THE EXCLUSIVE RIGHT TO USE SALES, APART FROM THE MARK AS SHOWN.

SER. NO. 76-676,275, FILED 5-1-2007.

FRANK LATTUCA, EXAMINING ATTORNEY

Int. Cl.: 5

Prior U.S. Cls.: 6, 18, 44, 46, 51 and 52

Reg. No. 3,396,924

United States Patent and Trademark Office

Registered Mar. 18, 2008

**TRADEMARK
PRINCIPAL REGISTER**

**MUSCLE & JOINT
A-MAX GOLD**

PEBLE CORP. (CALIFORNIA CORPORATION)
2507 ARTESIA BLVD.
TORRANCE, CA 90504

FOR: DIETARY SUPPLEMENTS, IN CLASS 5 (U.S.
CLS. 6, 18, 44, 46, 51 AND 52).

FIRST USE 4-1-2007; IN COMMERCE 4-1-2007.

THE MARK CONSISTS OF STANDARD CHAR-
ACTERS WITHOUT CLAIM TO ANY PARTICULAR
FONT, STYLE, SIZE, OR COLOR.

NO CLAIM IS MADE TO THE EXCLUSIVE
RIGHT TO USE "MUSCLE & JOINT", APART FROM
THE MARK AS SHOWN.

SER. NO. 76-677,084, FILED 5-18-2007.

RAMONA ORTIGA, EXAMINING ATTORNEY

Int. Cl.: 7

Prior U.S. Cls.: 13, 19, 21, 23, 31, 34 and 35

Reg. No. 3,396,925

United States Patent and Trademark Office

Registered Mar. 18, 2008

**TRADEMARK
PRINCIPAL REGISTER**

IDC SELECT

INDEPENDENT DISTRIBUTORS COOPERATIVE
- USA (INDIANA CORPORATION)
933 WESTERN DRIVE
INDIANAPOLIS, IN 46242

FOR: INDUSTRIAL POWER TRANSMISSION
PRODUCTS FOR MACHINES, NAMELY, BEAR-
INGS, BUSHINGS, BRONZE STOCK FOR MACHIN-
ING BRONZE BUSHINGS, ROLLER CHAIN, SHAFT
COUPLINGS, HOUSINGS FOR ENCASING LARGE
SPHERICAL BEARINGS, IDLERS, KEYSTOCK FOR
CUTTING AND MACHINING KEYWAYS USED ON
POWER TRANSMISSION SHAFTING, MOTORS,

MOUNTED BEARING UNITS, O-RINGS, PULLEYS,
SHAFT COLLARS, SHAFTING, SHEAVES, SPROCK-
ETS, TENSIONERS, AND TORQUE LIMITERS, IN
CLASS 7 (U.S. CLS. 13, 19, 21, 23, 31, 34 AND 35).

FIRST USE 2-0-2006; IN COMMERCE 2-0-2006.

OWNER OF U.S. REG. NO. 2,100,634.

SER. NO. 76-677,454, FILED 5-29-2007.

KAREN K. BUSH, EXAMINING ATTORNEY

Int. Cls.: 35, 41 and 42

Prior U.S. Cls.: 100, 101, 102 and 107

United States Patent and Trademark Office

Reg. No. 3,396,926

Registered Mar. 18, 2008

**SERVICE MARK
PRINCIPAL REGISTER**

EVOLUTIONARY IT

EVOLUTIONARY IT (MASSACHUSETTS CORPORATION)

164 PARK ST
WEST ROXBURY, MA 02132

FOR: BUSINESS MANAGEMENT IN THE FIELD OF INFORMATION TECHNOLOGY, IN CLASS 35 (U.S. CLS. 100, 101 AND 102).

FIRST USE 1-1-2004; IN COMMERCE 1-1-2004.

FOR: TRAINING SERVICES IN THE FIELD OF INFORMATION TECHNOLOGY, IN CLASS 41 (U.S. CLS. 100, 101 AND 107).

FIRST USE 1-1-2004; IN COMMERCE 1-1-2004.

FOR: CONSULTATION IN THE FIELD OF INFORMATION TECHNOLOGY, IN CLASS 42 (U.S. CLS. 100 AND 101).

FIRST USE 1-1-2004; IN COMMERCE 1-1-2004.

THE MARK CONSISTS OF STANDARD CHARACTERS WITHOUT CLAIM TO ANY PARTICULAR FONT, STYLE, SIZE, OR COLOR.

NO CLAIM IS MADE TO THE EXCLUSIVE RIGHT TO USE "IT", APART FROM THE MARK AS SHOWN.

SER. NO. 76-677,472, FILED 5-29-2007.

LESLEY LAMOTHE, EXAMINING ATTORNEY

Int. Cl.: 36

Prior U.S. Cls.: 100, 101 and 102

United States Patent and Trademark Office

Reg. No. 3,396,927

Registered Mar. 18, 2008

**SERVICE MARK
PRINCIPAL REGISTER**

LYTLE STATE BANK

LYTLE STATE BANK (TEXAS STATE BANK)
PO BOX 575
14631 S. FM 2790 W.
LYTLE, TX 78052

NO CLAIM IS MADE TO THE EXCLUSIVE
RIGHT TO USE "STATE BANK", APART FROM
THE MARK AS SHOWN.

FOR: BANKING SERVICES, IN CLASS 36 (U.S.
CLS. 100, 101 AND 102).

SEC. 2(F).

FIRST USE 9-17-1910; IN COMMERCE 9-17-1910.

SER. NO. 76-677,734, FILED 6-1-2007.

THE MARK CONSISTS OF STANDARD CHAR-
ACTERS WITHOUT CLAIM TO ANY PARTICULAR
FONT, STYLE, SIZE, OR COLOR.

ODESSA BIBBINS, EXAMINING ATTORNEY

Int. Cl.: 35

Prior U.S. Cls.: 100, 101 and 102

United States Patent and Trademark Office

Reg. No. 3,396,928

Registered Mar. 18, 2008

**SERVICE MARK
PRINCIPAL REGISTER**

ART JURIS

ART JURIS GALLERIES (FLORIDA SOLE PROPRIETORSHIP)
P. O. DRAWER 9237
FT. LAUDERDALE, FL 333109237

FOR: ART GALLERIES, NAMELY, GALLERIES DISPLAYING THE WORK PRODUCT OF ARTISTS IN EVERY MEDIUM IN WHICH ONE OR MORE ASPECTS OF THE AMERICAN LEGAL SYSTEM ARE RENDERED/DISPLAYED/ INTERPRETED, IN CLASS 35 (U.S. CLS. 100, 101 AND 102).

FIRST USE 8-28-2006; IN COMMERCE 4-6-2007.

THE MARK CONSISTS OF STANDARD CHARACTERS WITHOUT CLAIM TO ANY PARTICULAR FONT, STYLE, SIZE, OR COLOR.

NO CLAIM IS MADE TO THE EXCLUSIVE RIGHT TO USE "ART", APART FROM THE MARK AS SHOWN.

SER. NO. 76-677,888, FILED 6-6-2007.

MATTHEW EINSTEIN, EXAMINING ATTORNEY

Int. Cl.: 35

Prior U.S. Cls.: 100, 101 and 102

United States Patent and Trademark Office

Reg. No. 3,396,929

Registered Mar. 18, 2008

**SERVICE MARK
PRINCIPAL REGISTER**



EXPONENTIALLY...The Most Powerful Advertising

ANTON PUBLISHING INC. (DELAWARE CORPORATION)
P.O. BOX 2638
RANCHO MIRAGE, CA 92270

FIRST USE 5-0-2007; IN COMMERCE 5-0-2007.

FOR: ON-LINE ADVERTISING AND MARKETING SERVICES; CUSTOMER REFERRAL SERVICES FOR COMMERCIAL AND RETAIL PURPOSES; CUSTOMER RETENTION SERVICES THROUGH THE DISTRIBUTION OF PROMOTIONAL MATERIALS AND REWARDS, IN CLASS 35 (U.S. CLS. 100, 101 AND 102).

NO CLAIM IS MADE TO THE EXCLUSIVE RIGHT TO USE "WORD OF MOUTH" AND "THE MOST POWERFUL ADVERTISING", APART FROM THE MARK AS SHOWN.

SER. NO. 76-678,098, FILED 6-11-2007.

LINDA E. BLOHM, EXAMINING ATTORNEY

Int. Cl.: 35

Prior U.S. Cls.: 100, 101 and 102

United States Patent and Trademark Office

Reg. No. 3,396,930

Registered Mar. 18, 2008

**SERVICE MARK
PRINCIPAL REGISTER**



ANTON PUBLISHING INC. (DELAWARE CORPORATION)
P.O. BOX 2638
RANCHO MIRAGE, CA 92270

FOR: ON-LINE ADVERTISING AND MARKETING SERVICES; CUSTOMER REFERRAL SERVICES FOR COMMERCIAL AND RETAIL PURPOSES; CUSTOMER RETENTION SERVICES THROUGH THE DISTRIBUTION OF PROMOTIONAL MATERI-

ALS AND REWARDS, IN CLASS 35 (U.S. CLS. 100, 101 AND 102).

FIRST USE 5-0-2007; IN COMMERCE 5-0-2007.

SER. NO. 76-678,099, FILED 6-11-2007.

LINDA E. BLOHM, EXAMINING ATTORNEY

Int. Cl.: 29

Prior U.S. Cl.: 46

United States Patent and Trademark Office

Reg. No. 3,396,931

Registered Mar. 18, 2008

**TRADEMARK
PRINCIPAL REGISTER**

MORGAN RANCH

MORGAN RANCH BEEF, INC. (NEBRASKA
CORPORATION)
83583 GRACIE CREEK AVENUE
BURWELL, NE 68823

NO CLAIM IS MADE TO THE EXCLUSIVE
RIGHT TO USE "RANCH", APART FROM THE
MARK AS SHOWN.

FOR: BEEF, IN CLASS 29 (U.S. CL. 46).

FIRST USE 4-16-1956; IN COMMERCE 4-16-1956.

SER. NO. 76-678,143, FILED 6-12-2007.

THE MARK CONSISTS OF STANDARD CHAR-
ACTERS WITHOUT CLAIM TO ANY PARTICULAR
FONT, STYLE, SIZE, OR COLOR.

KRISTINA MORRIS, EXAMINING ATTORNEY

Int. Cl.: 3

Prior U.S. Cls.: 1, 4, 6, 50, 51 and 52

United States Patent and Trademark Office

Reg. No. 3,396,932

Registered Mar. 18, 2008

**TRADEMARK
PRINCIPAL REGISTER**



ROCCO ALTOBELLI, INC. (MINNESOTA CORPORATION)
14301 BURNSVILLE PARKWAY WEST
BURNSVILLE, MN 55306

FOR: BEAUTY AND SKIN CARE PRODUCTS, NAMELY, MAKE-UP, FACE CREAMS, TONER AND ASTRINGENTS, IN CLASS 3 (U.S. CLS. 1, 4, 6, 50, 51 AND 52).

FIRST USE 11-0-1975; IN COMMERCE 11-0-1975.

OWNER OF U.S. REG. NO. 1,477,305.

THE MARK CONSISTS OF A STYLIZED CAPITAL "A" WITH A SMALL "R" IN THE CENTER OF THE "A" .

SER. NO. 76-678,353, FILED 6-18-2007.

JAMES STEIN, EXAMINING ATTORNEY

Int. Cl.: 3

Prior U.S. Cls.: 1, 4, 6, 50, 51 and 52

Reg. No. 3,396,933

United States Patent and Trademark Office

Registered Mar. 18, 2008

**TRADEMARK
PRINCIPAL REGISTER**

rocco altobelli

ROCCO ALTOBELLI, INC. (MINNESOTA CORPORATION)

14301 BURNSVILLE PARKWAY WEST

BURNSVILLE, MN 55306

FOR: BEAUTY AND SKIN CARE PRODUCTS, NAMELY, MAKE-UP, FACE CREAMS, TONER AND ASTRINGENTS, IN CLASS 3 (U.S. CLS. 1, 4, 6, 50, 51 AND 52).

FIRST USE 11-0-1975; IN COMMERCE 11-0-1975.

THE MARK CONSISTS OF STANDARD CHARACTERS WITHOUT CLAIM TO ANY PARTICULAR FONT, STYLE, SIZE, OR COLOR.

OWNER OF U.S. REG. NO. 1,473,796.

"ROCCO ALTOBELLI" IDENTIFIES A LIVING INDIVIDUAL WHOSE CONSENT IS ATTACHED HERETO.

SER. NO. 76-678,397, FILED 6-18-2007.

JAMES STEIN, EXAMINING ATTORNEY

Int. Cls.: 1, 5 and 31

Prior U.S. Cls.: 1, 5, 6, 10, 18, 26, 44, 46, 51 and 52

United States Patent and Trademark Office

Reg. No. 3,396,934

Registered Mar. 18, 2008

**TRADEMARK
PRINCIPAL REGISTER**

LEBANON

LEBANON SEABOARD CORPORATION (PENN-
SYLVANIA CORPORATION)
1600 E. CUMBERLAND ST.
LEBANON, PA 17042

FOR: FERTILIZER, IN CLASS 1 (U.S. CLS. 1, 5, 6,
10, 26 AND 46).

FIRST USE 0-0-1952; IN COMMERCE 0-0-1952.

FOR: HERBICIDES, INSECTICIDES, PESTICIDES,
IN CLASS 5 (U.S. CLS. 6, 18, 44, 46, 51 AND 52).

FIRST USE 0-0-1952; IN COMMERCE 0-0-1952.

FOR: GRASS SEED AND BIRD SEED, IN CLASS
31 (U.S. CLS. 1 AND 46).

FIRST USE 1-5-1989; IN COMMERCE 1-5-1989.

THE MARK CONSISTS OF STANDARD CHAR-
ACTERS WITHOUT CLAIM TO ANY PARTICULAR
FONT, STYLE, SIZE, OR COLOR.

OWNER OF U.S. REG. NO. 1,107,644.

SEC. 2(F).

SER. NO. 76-678,784, FILED 6-27-2007.

RICHARD A. STRASER, EXAMINING ATTORNEY

Int. Cl.: 35

Prior U.S. Cls.: 100, 101 and 102

United States Patent and Trademark Office

Reg. No. 3,396,935

Registered Mar. 18, 2008

**SERVICE MARK
PRINCIPAL REGISTER**

OnePIN

ONEPIN, INC. (DELAWARE CORPORATION)
2200 WEST PARK DRIVE
WESTBOROUGH, MA 01581

FOR: BUSINESS SERVICES, NAMELY, GLOBAL COMPUTER NETWORK DATABASE MANAGEMENT SERVICES FOR PROVIDING USERS OF THE SERVICES WITH THE ABILITY TO STORE IN THE DATABASE THEIR CONTACT INFORMATION, NAMELY, TELEPHONE AND ADDRESS INFORMATION, AND TO ALLOW USERS TO RETRIEVE CONTACT INFORMATION OF OTHER USERS, IN CLASS 35 (U.S. CLS. 100, 101 AND 102).

FIRST USE 7-6-1998; IN COMMERCE 7-6-1998.

THE MARK CONSISTS OF STANDARD CHARACTERS WITHOUT CLAIM TO ANY PARTICULAR FONT, STYLE, SIZE, OR COLOR.

OWNER OF U.S. REG. NO. 2,667,355.

SEC. 2(F).

SER. NO. 76-678,938, FILED 6-28-2007.

JOHN KELLY, EXAMINING ATTORNEY

Int. Cl.: 41

Prior U.S. Cls.: 100, 101 and 107

United States Patent and Trademark Office

Reg. No. 3,396,936

Registered Mar. 18, 2008

**SERVICE MARK
PRINCIPAL REGISTER**



ALBERT C. PIERRE COMMUNITY SERVICE
CENTER, INC. (FLORIDA NOT-FOR-PROFIT
CORPORATION)
8017 NE 2ND AVENUE
MIAMI, FL 33238

FOR: EDUCATION SERVICES, NAMELY, PRO-
VIDING CLASSES, SEMINARS, AND WORKSHOPS
IN THE FIELD OF SUPPORTING, ADVOCATING,
AND MAINTAINING POSITIVE LIFESTYLES FOR
YOUTH, IN CLASS 41 (U.S. CLS. 100, 101 AND 107).

FIRST USE 1-1-2005; IN COMMERCE 1-1-2005.

THE COLOR(S) YELLOW, BLUE, WHITE, AND
BLACK IS/ARE CLAIMED AS A FEATURE OF THE
MARK.

THE MARK CONSISTS OF THE WORD PURE IN
BLUE WITH BLACK BORDER, REALITY IN WHITE
WITH BLUE BORDER, ALL SURROUNDED BY A
YELLOW BORDER WITH JAGGED BLUE OUT-
LINE, A WHITE DOVE TO THE TOP RIGHT, AND
BELOW, THE PHRASE SET APART BY DIVINE
DESIGN IN YELLOW.

SER. NO. 76-679,043, FILED 7-2-2007.

MICHAEL LITZAU, EXAMINING ATTORNEY

Int. Cl.: 16

Prior U.S. Cls.: 2, 5, 22, 23, 29, 37, 38 and 50

United States Patent and Trademark Office

Reg. No. 3,396,937

Registered Mar. 18, 2008

**TRADEMARK
PRINCIPAL REGISTER**

Re-Fire, Don't Retire

BARNETT, CYNTHIA (UNITED STATES INDIVIDUAL)

16 WASHINGTON STREET
P.O. BOX 702
NORWALK, CT 06854

FOR: PRINTED TRAINING MANUALS AND SERIES OF BOOKS IN THE FIELD OF LIFESTYLE PLANNING FOR RETIREMENT, IN CLASS 16 (U.S. CLS. 2, 5, 22, 23, 29, 37, 38 AND 50).

FIRST USE 9-0-2006; IN COMMERCE 9-0-2006.

THE MARK CONSISTS OF STANDARD CHARACTERS WITHOUT CLAIM TO ANY PARTICULAR FONT, STYLE, SIZE, OR COLOR.

SER. NO. 76-679,107, FILED 7-5-2007.

ELISSA GARBER KON, EXAMINING ATTORNEY

Int. Cl.: 33

Prior U.S. Cls.: 47 and 49

United States Patent and Trademark Office

Reg. No. 3,396,938

Registered Mar. 18, 2008

**TRADEMARK
PRINCIPAL REGISTER**

STANDING TALL WITH CRISTALL

CRISTALL U.S.A., INC. (FLORIDA CORPORATION)
902 CLINT MOORE ROAD
SUITE 146
BOCA RATON, FL 33487

FOR: ALCOHOLIC BEVERAGES, NAMELY, VODKA, IN CLASS 33 (U.S. CLS. 47 AND 49).

FIRST USE 2-26-2007; IN COMMERCE 2-26-2007.

THE MARK CONSISTS OF STANDARD CHARACTERS WITHOUT CLAIM TO ANY PARTICULAR FONT, STYLE, SIZE, OR COLOR.

OWNER OF U.S. REG. NOS. 2,301,166, 2,770,506 AND OTHERS.

SER. NO. 76-679,221, FILED 7-9-2007.

LINDA M. KING, EXAMINING ATTORNEY

Int. Cl.: 42

Prior U.S. Cls.: 100 and 101

United States Patent and Trademark Office

Reg. No. 3,396,939

Registered Mar. 18, 2008

**SERVICE MARK
PRINCIPAL REGISTER**

TRUDY DUJARDIN

TRUDY DUJARDIN LLC (CONNECTICUT LTD
LIAB CO)
88 OLD SAUGATUCK ROAD
EAST NORWALK, CT 06855

FOR: DESIGN FOR OTHERS IN THE FIELDS OF HOME, INTERIOR, FURNITURE AND FURNISHING DESIGN; PROVIDING INFORMATION IN THE FIELD OF RESIDENTIAL ARCHITECTURE, INTERIOR DESIGN AND DECORATION; CONSULTING SERVICES, NAMELY INTERIOR DECORATION AND DESIGN; DESIGN OF DINNERWARE AND TABLE UTENSILS, FURNITURE, WALL COVERINGS, FLOOR COVERINGS AND FABRICS; RESEARCH AND DESIGN FOR OTHERS IN THE FIELD OF SUSTAINABLE DESIGN AND

ANALYSIS OF ENVIRONMENTAL IMPACT, IN CLASS 42 (U.S. CLS. 100 AND 101).

FIRST USE 12-31-1986; IN COMMERCE 12-31-1986.

THE MARK CONSISTS OF STANDARD CHARACTERS WITHOUT CLAIM TO ANY PARTICULAR FONT, STYLE, SIZE, OR COLOR.

THE NAME TRUDY DUJARDIN IDENTIFIES A LIVING INDIVIDUAL WHOSE CONSENT IS OF RECORD.

SER. NO. 76-679,480, FILED 7-13-2007.

MICHAEL ENGEL, EXAMINING ATTORNEY

Int. Cl.: 35

Prior U.S. Cls.: 100, 101 and 102

United States Patent and Trademark Office

Reg. No. 3,396,940

Registered Mar. 18, 2008

**SERVICE MARK
PRINCIPAL REGISTER**

I'M CHOICE

INDIEPENDENCEMUSIC.NET, INC. (NEVADA CORPORATION)
2855 BROOKSIDE ROAD
LAKE OSWEGO, OR 97035

FOR: ONLINE RETAIL STORE SERVICES FEATURING DOWNLOADABLE, PRERECORDED MUSIC AND VIDEO; DISSEMINATION OF ADVERTISING FOR OTHERS USING THE INTERNET; AND ENTERTAINMENT MARKETING SERVICES, NAMELY, MARKETING, PROMOTION AND ADVERTISING FOR INDEPENDENT RE-

CORDING ARTISTS, IN CLASS 35 (U.S. CLS. 100, 101 AND 102).

FIRST USE 4-1-2007; IN COMMERCE 4-1-2007.

THE MARK CONSISTS OF STANDARD CHARACTERS WITHOUT CLAIM TO ANY PARTICULAR FONT, STYLE, SIZE, OR COLOR.

SER. NO. 76-679,512, FILED 7-13-2007.

CHRIS WELLS, EXAMINING ATTORNEY

Int. Cl.: 10

Prior U.S. Cls.: 26, 39 and 44

United States Patent and Trademark Office

Reg. No. 3,396,941

Registered Mar. 18, 2008

**TRADEMARK
PRINCIPAL REGISTER**

GRADIENT-3

ULTIMATE WIREFORMS, INC. (CONNECTICUT
CORPORATION)
200 CENTRAL STREET
BRISTOL, CT 06010

THE MARK CONSISTS OF STANDARD CHAR-
ACTERS WITHOUT CLAIM TO ANY PARTICULAR
FONT, STYLE, SIZE, OR COLOR.

FOR: ORTHODONTIC APPLIANCES, IN CLASS
10 (U.S. CLS. 26, 39 AND 44).

SER. NO. 76-679,533, FILED 7-16-2007.

FIRST USE 7-11-2007; IN COMMERCE 7-11-2007.

RENEE MCCRAY, EXAMINING ATTORNEY

Int. Cl.: 5

Prior U.S. Cls.: 6, 18, 44, 46, 51 and 52

Reg. No. 3,396,942

United States Patent and Trademark Office

Registered Mar. 18, 2008

**TRADEMARK
PRINCIPAL REGISTER**

SeroLite

RENEWAL FOR LIFE, LLC (ARIZONA LTD LIAB
CO)
34155 N SCOTTSDALE RD
SCOTTSDALE, AZ 85266

THE MARK CONSISTS OF STANDARD CHAR-
ACTERS WITHOUT CLAIM TO ANY PARTICULAR
FONT, STYLE, SIZE, OR COLOR.

FOR: DIETARY SUPPLEMENTS, IN CLASS 5 (U.S.
CLS. 6, 18, 44, 46, 51 AND 52).

SER. NO. 76-679,536, FILED 7-16-2007.

FIRST USE 4-19-2007; IN COMMERCE 4-20-2007.

DAVID ELTON, EXAMINING ATTORNEY

Int. Cl.: 5

Prior U.S. Cls.: 6, 18, 44, 46, 51 and 52

United States Patent and Trademark Office

Reg. No. 3,396,943

Registered Mar. 18, 2008

**TRADEMARK
PRINCIPAL REGISTER**

SeroBoost

RENEWAL FOR LIFE, LLC (ARIZONA CORPORATION)
34155 N SCOTTSDALE RD
SCOTTSDALE, AZ 85266

THE MARK CONSISTS OF STANDARD CHARACTERS WITHOUT CLAIM TO ANY PARTICULAR FONT, STYLE, SIZE, OR COLOR.

FOR: DIETARY SUPPLEMENTS, IN CLASS 5 (U.S. CLS. 6, 18, 44, 46, 51 AND 52).

SER. NO. 76-679,545, FILED 7-16-2007.

FIRST USE 4-19-2007; IN COMMERCE 4-20-2007.

DAVID ELTON, EXAMINING ATTORNEY

Int. Cl.: 25

Prior U.S. Cls.: 22 and 39

United States Patent and Trademark Office

Reg. No. 3,396,944

Registered Mar. 18, 2008

**TRADEMARK
PRINCIPAL REGISTER**

NIC NAK

NICNAK, LLC (CALIFORNIA LTD LIAB CO)
9101 WINNETKA AVENUE
CHATSWORTH, CA 91311

THE MARK CONSISTS OF STANDARD CHAR-
ACTERS WITHOUT CLAIM TO ANY PARTICULAR
FONT, STYLE, SIZE, OR COLOR.

FOR: CLOTHING, NAMELY, SHORTS, SKIRTS,
SHIRTS AND TOPS FOR MEN, WOMEN AND
BABIES, IN CLASS 25 (U.S. CLS. 22 AND 39).

SER. NO. 76-679,592, FILED 7-16-2007.

FIRST USE 3-31-2004; IN COMMERCE 4-19-2004.

RENEE MCCRAY, EXAMINING ATTORNEY

Int. Cl.: 23

Prior U.S. Cl.: 43

United States Patent and Trademark Office

Reg. No. 3,396,945

Registered Mar. 18, 2008

**TRADEMARK
PRINCIPAL REGISTER**

FARMHOUSE YARNS

FARMHOUSE YARNS, LLC (CONNECTICUT
LTD LIAB CO)
283 MOUNT PARNASSUS ROAD
EAST HADDAM, CT 06423

NO CLAIM IS MADE TO THE EXCLUSIVE
RIGHT TO USE "YARNS", APART FROM THE
MARK AS SHOWN.

FOR: YARN, IN CLASS 23 (U.S. CL. 43).

FIRST USE 7-0-2005; IN COMMERCE 7-0-2005.

SER. NO. 76-679,597, FILED 7-16-2007.

THE MARK CONSISTS OF STANDARD CHAR-
ACTERS WITHOUT CLAIM TO ANY PARTICULAR
FONT, STYLE, SIZE, OR COLOR.

JAMES LOVELACE, EXAMINING ATTORNEY

Int. Cl.: 42

Prior U.S. Cls.: 100 and 101

United States Patent and Trademark Office

Reg. No. 3,396,946

Registered Mar. 18, 2008

**SERVICE MARK
PRINCIPAL REGISTER**

RADON-EASE

RADON-EASE, INC. (VIRGINIA CORPORATION)
1913 MOSELEY ROAD
MOSELEY, VA 23120

FOR: PROVIDING SERVICES IN THE DETECTION OF HAZARDOUS GASES; PROVIDING A PROTECTION PROGRAM, NAMELY, EVALUATING AND TESTING REAL ESTATE FOR THE PRESENCE OF HAZARDOUS GASES, IN CLASS 42 (U.S. CLS. 100 AND 101).

FIRST USE 10-0-1987; IN COMMERCE 10-0-1987.

THE MARK CONSISTS OF STANDARD CHARACTERS WITHOUT CLAIM TO ANY PARTICULAR FONT, STYLE, SIZE, OR COLOR.

SER. NO. 76-679,613, FILED 7-18-2007.

CYNTHIA SLOAN, EXAMINING ATTORNEY

Int. Cl.: 25

Prior U.S. Cls.: 22 and 39

United States Patent and Trademark Office

Reg. No. 3,396,947

Registered Mar. 18, 2008

**TRADEMARK
PRINCIPAL REGISTER**

**CRYSTAL
MONGKEY**

JO, EUN JU (REPUBLIC OF KOREA INDIVIDUAL)
1015 S. CROCKER STREET, #S16
LOS ANGELES, CA 90021

THE MARK CONSISTS OF STANDARD CHARACTERS WITHOUT CLAIM TO ANY PARTICULAR FONT, STYLE, SIZE, OR COLOR.

FOR: WOMEN'S CLOTHING, NAMELY, T-SHIRTS, JEANS, JACKETS, DRESSES, PANTS, HOODED SWEATSHIRTS, SOCKS, HATS, AND UNDERWEAR, IN CLASS 25 (U.S. CLS. 22 AND 39).

SER. NO. 76-679,632, FILED 7-18-2007.

FIRST USE 2-1-2007; IN COMMERCE 2-1-2007.

DORITT L. CARROLL, EXAMINING ATTORNEY

Int. Cl.: 35

Prior U.S. Cls.: 100, 101 and 102

United States Patent and Trademark Office

Reg. No. 3,396,948

Registered Mar. 18, 2008

SERVICE MARK
PRINCIPAL REGISTER



TOFIXIT!, INC. (ARIZONA CORPORATION)
3636 EAST ANNE STREET, SUITE A
PHOENIX, AZ 85040

FOR: PROVIDING CONSUMER INFORMATION ABOUT AND MAKING REFERRALS IN THE FIELDS OF: CONSTRUCTION, REPAIR AND MAINTENANCE OF RESIDENTIAL AND COMMERCIAL PROPERTIES; AUTOMOBILE SERVICE AND REPAIR; FINANCIAL SERVICES; ACCOUNTING AND BOOKKEEPING SERVICES; ESTATE PLANNING SERVICES, FINANCIAL PLANNING SERVICES; INSURANCE SERVICES; INVESTMENT SERVICES; MORTGAGE SERVICES; TAX PREPARATION SERVICES; COMPUTER SERVICES; CONCIERGE AND ERRAND SERVICES; DOG TRAINING SERVICES; PET BOARDING SERVICES; PET GROOMING SERVICES; PRINTING SERVICES; MAID SERVICES; HOME THEATRE AND SATELLITE TELEVISION SALES AND SERVICES; MOVING SERVICES; REALTY SERVICES; PEST

CONTROL SERVICES; AND LANDSCAPING SERVICES, IN CLASS 35 (U.S. CLS. 100, 101 AND 102).

FIRST USE 3-13-2007; IN COMMERCE 3-13-2007.

OWNER OF U.S. REG. NO. 3,104,503.

NO CLAIM IS MADE TO THE EXCLUSIVE RIGHT TO USE "HOME" AND "OFFICE", APART FROM THE MARK AS SHOWN.

THE MARK CONSISTS OF THE PHRASE "TO FIX IT!" IN STYLIZED LETTERS, ABOVE THE WORDS HOME, OFFICE AND LIFE, INSIDE AN OVAL BACKGROUND WITH A DOT AFTER HOME AND AFTER OFFICE. ALL WORDS ARE TO THE RIGHT OF STYLIZED IMAGES OF A HOUSE AND CAR.

SER. NO. 76-679,677, FILED 7-19-2007.

ELISSA GARBER KON, EXAMINING ATTORNEY

Int. Cl.: 35

Prior U.S. Cls.: 100, 101 and 102

United States Patent and Trademark Office

Reg. No. 3,396,949

Registered Mar. 18, 2008

**SERVICE MARK
PRINCIPAL REGISTER**

SOLSTICE SUNGLASS BOUTIQUE

SOLSTICE MARKETING CORPORATION (DELA-
WARE CORPORATION)

801 JEFFERSON ROAD

PARSIPPANY, NJ 07054

FOR: RETAIL STORE SERVICES FEATURING
SUNGLASSES AND PARTS AND ACCESSORIES
THEREFOR, IN CLASS 35 (U.S. CLS. 100, 101 AND
102).

FIRST USE 8-0-2004; IN COMMERCE 8-0-2004.

THE MARK CONSISTS OF STANDARD CHAR-
ACTERS WITHOUT CLAIM TO ANY PARTICULAR
FONT, STYLE, SIZE, OR COLOR.

OWNER OF U.S. REG. NO. 2,404,845.

NO CLAIM IS MADE TO THE EXCLUSIVE
RIGHT TO USE "SUNGLASS BOUTIQUE", APART
FROM THE MARK AS SHOWN.

SER. NO. 76-679,740, FILED 7-20-2007.

BARNEY CHARLON, EXAMINING ATTORNEY

Int. Cl.: 35

Prior U.S. Cls.: 100, 101 and 102

United States Patent and Trademark Office

Reg. No. 3,396,950

Registered Mar. 18, 2008

**SERVICE MARK
PRINCIPAL REGISTER**

WE RECOMMEND THE BEST ..., AND TOSS THE REST!

TOFIXIT!, INC. (ARIZONA CORPORATION)
3636 EAST ANNE STREET, SUITE A
PHOENIX, AZ 85040

FOR: PROVIDING CONSUMER INFORMATION ABOUT AND MAKING REFERRALS IN THE FIELDS OF: CONSTRUCTION, REPAIR AND MAINTENANCE OF RESIDENTIAL AND COMMERCIAL PROPERTIES; AUTOMOBILE SERVICE AND REPAIR; FINANCIAL SERVICES; ACCOUNTING AND BOOKKEEPING SERVICES; ESTATE PLANNING SERVICES, FINANCIAL PLANNING SERVICES; INSURANCE SERVICES; INVESTMENT SERVICES; MORTGAGE SERVICES; TAX PREPARATION SERVICES; COMPUTER SERVICES; CONCIERGE AND ERRAND SERVICES; DOG TRAINING SERVICES; PET BOARDING SERVICES;

PET GROOMING SERVICES; PRINTING SERVICES; MAID SERVICES; HOME THEATRE AND SATELLITE TELEVISION SALES AND SERVICES; MOVING SERVICES; REALTY SERVICES; PEST CONTROL SERVICES; AND LANDSCAPING SERVICES, IN CLASS 35 (U.S. CLS. 100, 101 AND 102).

FIRST USE 3-13-2007; IN COMMERCE 3-13-2007.

THE MARK CONSISTS OF STANDARD CHARACTERS WITHOUT CLAIM TO ANY PARTICULAR FONT, STYLE, SIZE, OR COLOR.

SER. NO. 76-679,745, FILED 7-20-2007.

ELISSA GARBER KON, EXAMINING ATTORNEY

Int. Cl.: 40

Prior U.S. Cls.: 100, 103 and 106

United States Patent and Trademark Office

Reg. No. 3,396,951

Registered Mar. 18, 2008

**SERVICE MARK
PRINCIPAL REGISTER**



LA BELLE TIME (FLORIDA CORPORATION)
15313 NW 33RD PLACE
MIAMI, FL 33154

FOR: CUSTOM IMPRINTING OF PENS, PEN SETS, CLOCKS, CALCULATORS, KEY CHAINS, PORTFOLIOS AND ORGANIZERS, MASSAGERS, WATCHES, DESK CARD CASES, AND GIFT ITEMS WITH DECORATIVE DESIGNS, COMPANY NAMES AND PROMOTIONAL INFORMATION, IN CLASS 40 (U.S. CLS. 100, 103 AND 106).

FIRST USE 10-6-1995; IN COMMERCE 10-6-1995.

NO CLAIM IS MADE TO THE EXCLUSIVE RIGHT TO USE "LINE", APART FROM THE MARK AS SHOWN.

THE MARK CONSISTS OF THE WORD HURRICANE AND THE WORD LINE WHEREIN LINE IS BENEATH THE "CANE" PORTION OF HURRICANE WITH A SEVEN PARALLEL WAVY LINES TO THE LEFT OF THE WORD LINE AND TWO PALM TREES TO THE RIGHT OF BOTH WORDS.

SER. NO. 76-679,929, FILED 7-26-2007.

ZACHARY BELLO, EXAMINING ATTORNEY

Int. Cls.: 37 and 42

Prior U.S. Cls.: 100, 101, 103 and 106

United States Patent and Trademark Office

Reg. No. 3,396,952

Registered Mar. 18, 2008

**SERVICE MARK
PRINCIPAL REGISTER**



PRO ONCALL TECHNOLOGIES, LLC (OHIO LTD
LIAB CO)
4625 RED BANK ROAD
CINCINNATI, OH 45227

FOR: COMPUTER HARDWARE INSTALLATION,
REPAIR AND MAINTENANCE SERVICES; TELE-
PHONE AND INTERCOM INSTALLATION, REPAIR
AND MAINTENANCE SERVICES , IN CLASS 37
(U.S. CLS. 100, 103 AND 106).

FIRST USE 3-15-2007; IN COMMERCE 3-15-2007.

FOR: COMPUTER CONSULTATION IN THE
FIELD OF COMPUTER SECURITY; COMPUTER
NETWORK DESIGN FOR OTHERS; COMPUTER

SITE DESIGN; COMPUTER PROJECT MANAGE-
MENT SERVICES; CUSTOM DESIGN AND ENGI-
NEERING OF TELEPHONY SYSTEMS AND FIBER
OPTICS, IN CLASS 42 (U.S. CLS. 100 AND 101).

FIRST USE 3-15-2007; IN COMMERCE 3-15-2007.

NO CLAIM IS MADE TO THE EXCLUSIVE
RIGHT TO USE "PRO ONCALL" AND "TECHNOL-
OGIES", APART FROM THE MARK AS SHOWN.

SER. NO. 76-679,961, FILED 7-25-2007.

CAROLYN CATALDO, EXAMINING ATTORNEY

Int. Cl.: 9

Prior U.S. Cls.: 21, 23, 26, 36 and 38

United States Patent and Trademark Office

Reg. No. 3,396,953

Registered Mar. 18, 2008

**TRADEMARK
PRINCIPAL REGISTER**



BRAVO, PABLO SOTO (SPAIN INDIVIDUAL)
AVDA. DEL MEDITERRANEO, 24-28007
MADRID, SPAIN

FOR: COMPUTER SOFTWARE; NAMELY, COMPUTER SOFTWARE FOR USE BY PERSONS DOWNLOADING MUSIC AND OTHER FILES FROM THE INTERNET AND PEER TO PEER TRANSFER OF FILES ON THE INTERNET , IN CLASS 9 (U.S. CLS. 21, 23, 26, 36 AND 38).

FIRST USE 3-26-2003; IN COMMERCE 3-26-2003.

NO CLAIM IS MADE TO THE EXCLUSIVE RIGHT TO USE "NETWORKS", APART FROM THE MARK AS SHOWN.

SER. NO. 76-680,584, FILED 8-13-2007.

MICHAEL ENGEL, EXAMINING ATTORNEY

Int. Cl.: 39

Prior U.S. Cls.: 100 and 105

United States Patent and Trademark Office

Reg. No. 3,396,954

Registered Mar. 18, 2008

**SERVICE MARK
PRINCIPAL REGISTER**



BOSTON PARTY TOURS, INC. (MASSACHUSETTS CORPORATION)
386 BOYLSTON STREET
LOWELL, MA 01852

FOR: CONDUCTING SIGHTSEEING TOURS FOR OTHERS; ORGANIZATION, BOOKING AND ARRANGEMENT OF EXCURSIONS, DAY TRIPS AND SIGHTSEEING TOURS; TRANSPORT OF PASSENGERS, IN CLASS 39 (U.S. CLS. 100 AND 105).

FIRST USE 4-17-2005; IN COMMERCE 4-17-2005.

NO CLAIM IS MADE TO THE EXCLUSIVE RIGHT TO USE "BOSTON PARTY TOURS", APART FROM THE MARK AS SHOWN.

THE COLOR(S) MAROON, BLACK, AND WHITE IS/ARE CLAIMED AS A FEATURE OF THE MARK.

THE MARK CONSISTS OF THE WORDS "BOSTON PARTY TOURS" WITH MAROON LETTERS HAVING BLACK OUTLINES SUPERIMPOSED OVER DEPICTIONS OF LANDMARKS WITH EACH LANDMARK HAVING MAROON AS A MAIN BODY COLOR WITH BLACK LINING AND WHITE PORTIONS WITH THE WHITE PORTIONS DISPOSED BETWEEN AND WITHIN THE LANDMARKS AND THE LETTERING.

SER. NO. 77-000,490, FILED 9-15-2006.

BRENDAN REGAN, EXAMINING ATTORNEY

Int. Cl.: 38

Prior U.S. Cls.: 100, 101 and 104

United States Patent and Trademark Office

Reg. No. 3,396,955

Registered Mar. 18, 2008

**SERVICE MARK
PRINCIPAL REGISTER**

KFSH

SALEM COMMUNICATIONS HOLDING COR-
PORATION (DELAWARE CORPORATION)
4880 SANTA ROSA ROAD
CAMARILLO, CA 93012

FOR: RADIO BROADCASTING SERVICES, IN
CLASS 38 (U.S. CLS. 100, 101 AND 104).

FIRST USE 9-21-2000; IN COMMERCE 9-21-2000.

THE MARK CONSISTS OF STANDARD CHAR-
ACTERS WITHOUT CLAIM TO ANY PARTICULAR
FONT, STYLE, SIZE, OR COLOR.

SER. NO. 77-000,591, FILED 9-15-2006.

VIVIAN MICZNIK FIRST, EXAMINING ATTOR-
NEY

Prior U.S. Cl.: A

United States Patent and Trademark Office

Reg. No. 3,396,956

Registered Mar. 18, 2008

**CERTIFICATION MARK
PRINCIPAL REGISTER**



CONSORZIO TUTELA PECORINO TOSCANO
D.O.P. (ITALY CONSORTIUM)
VIA GOFFREDO MAMELI, 17
GROSSETO, ITALY 58100

FOR: CHEESE, IN CLASS A (U.S. CL. A).

FIRST USE 6-17-1986; IN COMMERCE 3-15-1996.

NO CLAIM IS MADE TO THE EXCLUSIVE
RIGHT TO USE "PECORINO" AND "DOP", APART
FROM THE MARK AS SHOWN.

THE MARK CONSISTS OF PECORINO TOSCANO
DOP AND "TP" (PECORINO TOSCANO) STYLIZED.

THE ENGLISH TRANSLATION OF THE WORD
TOSCANO IN THE MARK IS FROM TUSCANY.

THE CERTIFICATION MARK, AS USED BY
AUTHORIZED PERSONS, CERTIFIES THAT THE
CHEESE COMES FROM TUSCANY REGION OF
ITALY AND SATISFIES CERTAIN STANDARDS.

SER. NO. 77-000,683, FILED 9-15-2006.

AMY MCMENAMIN, EXAMINING ATTORNEY

Int. Cl.: 37

Prior U.S. Cls.: 100, 103 and 106

United States Patent and Trademark Office

Reg. No. 3,396,957

Registered Mar. 18, 2008

**SERVICE MARK
PRINCIPAL REGISTER**



USA FRANCHISING LLC (DELAWARE LTD
LIAB CO)
1901 NORTH ROSELLE ROAD
SUITE 740
SCHAUMBURG, IL 60195

FOR: WASTE CONTAINER CLEANING SERVI-
CES, IN CLASS 37 (U.S. CLS. 100, 103 AND 106).

FIRST USE 4-1-2006; IN COMMERCE 4-1-2006.

NO CLAIM IS MADE TO THE EXCLUSIVE
RIGHT TO USE "CLEAN-A-CAN", APART FROM
THE MARK AS SHOWN.

SER. NO. 77-000,708, FILED 9-15-2006.

ROBIN MITTLER, EXAMINING ATTORNEY

Int. Cl.: 36

Prior U.S. Cls.: 100, 101 and 102

United States Patent and Trademark Office

Reg. No. 3,396,958

Registered Mar. 18, 2008

**SERVICE MARK
PRINCIPAL REGISTER**

INTERLUTION

BESSETTE, MATTHEW J. (UNITED STATES INDIVIDUAL), DBA INTERLUTION
3111 W. DR. MLK BLVD, STE. 100
TAMPA, FL 33607

FOR: INVESTMENT SERVICES, NAMELY, ASSET ACQUISITION AND MANAGEMENT SERVICES IN THE FIELD OF INTERNET DOMAIN NAMES, IN CLASS 36 (U.S. CLS. 100, 101 AND 102).

FIRST USE 10-1-1997; IN COMMERCE 10-1-1997.

THE MARK CONSISTS OF STANDARD CHARACTERS WITHOUT CLAIM TO ANY PARTICULAR FONT, STYLE, SIZE, OR COLOR.

OWNER OF U.S. REG. NO. 2,331,735.

SER. NO. 77-001,263, FILED 9-18-2006.

DAWN HAN, EXAMINING ATTORNEY

Int. Cl.: 41

Prior U.S. Cls.: 100, 101 and 107

United States Patent and Trademark Office

Reg. No. 3,396,959

Registered Mar. 18, 2008

**SERVICE MARK
PRINCIPAL REGISTER**



CYBERNET ENTERTAINMENT, LLC (NEW
YORK LTD LIAB CO)
942 MISSION STREET
SAN FRANCISCO, CA 94103

FOR: ENTERTAINMENT SERVICES NAMELY
PROVIDING A WEBSITE FEATURING, PHOTO-
GRAPHIC, AUDIO, VIDEO AND PROSE PRESEN-
TATIONS FEATURING ADULT
ENTERTAINMENT, IN CLASS 41 (U.S. CLS. 100,
101 AND 107).

FIRST USE 1-1-2006; IN COMMERCE 9-18-2006.

THE COLOR(S) RED AND BLACK IS/ARE
CLAIMED AS A FEATURE OF THE MARK.

THE MARK CONSISTS OF THE LETTER "K" IN A
GRAPHICAL FORMAT, WITH THE STEM OF THE
K STYLIZED INTO A POINTED TAIL. THE COLOR
RED APPEARS AS THE STYLIZED LETTER "K"
OVER A BLACK RECTANGLE.

SER. NO. 77-001,274, FILED 9-18-2006.

KATHY DE JONGE, EXAMINING ATTORNEY

Int. Cls.: 35, 39 and 42

Prior U.S. Cls.: 100, 101, 102 and 105

United States Patent and Trademark Office

Reg. No. 3,396,960

Registered Mar. 18, 2008

**SERVICE MARK
PRINCIPAL REGISTER**

WANDRIAN

WANDRIAN, INC. (DELAWARE CORPORATION)
3 BARKER AVENUE
WHITE PLAINS, NY 10601

FOR: BUSINESS CONSULTING SERVICES IN THE FIELD OF RAIL TRAVEL AND E-COMMERCE SOLUTIONS FOR THE TRAVEL INDUSTRY; PROVIDING ASSISTANCE IN THE MARKETING OF RAIL PASSES AND TICKETS; WHOLESALE DISTRIBUTORSHIP SERVICES FEATURING RAIL PASSES AND TICKETS, IN CLASS 35 (U.S. CLS. 100, 101 AND 102).

FIRST USE 1-22-2001; IN COMMERCE 1-22-2001.

FOR: PROVIDING INFORMATION IN THE FIELD OF RAIL TRAVEL, RAIL TRANSPORTATION, TARIFFS, JOURNEYS AND SCHEDULES; PROVIDING AN INTERNET WEBSITE FEATURING INFORMATION IN THE FIELD OF RAIL TRAVEL; DISTRIBUTION SERVICES, NAMELY, DELIVERY OF RAIL PASSES AND TICKETS, IN CLASS 39 (U.S. CLS. 100 AND 105).

FIRST USE 1-22-2001; IN COMMERCE 1-22-2001.

FOR: PROVIDING TECHNOLOGY PRODUCTS, SOLUTIONS AND SERVICES IN THE FIELD OF RAIL TRAVEL AND FOR THE TRAVEL INDUSTRY, NAMELY, COMPUTER CONSULTATION, INFORMATION TECHNOLOGY CONSULTATION, TECHNOLOGY CONSULTATION AND RESEARCH AND CONSULTING SERVICES IN THE FIELD OF DESIGN, SELECTION, IMPLEMENTATION AND USE OF COMPUTER HARDWARE AND SOFTWARE SYSTEMS FOR OTHERS ALL IN THE FIELD OF RAIL TRAVEL AND FOR THE TRAVEL INDUSTRY, IN CLASS 42 (U.S. CLS. 100 AND 101).

FIRST USE 1-22-2001; IN COMMERCE 1-22-2001.

THE MARK CONSISTS OF STANDARD CHARACTERS WITHOUT CLAIM TO ANY PARTICULAR FONT, STYLE, SIZE, OR COLOR.

SER. NO. 77-002,035, FILED 9-19-2006.

BRENDAN MCCAULEY, EXAMINING ATTORNEY

Int. Cl.: 5

Prior U.S. Cls.: 6, 18, 44, 46, 51 and 52

United States Patent and Trademark Office

Reg. No. 3,396,961

Registered Mar. 18, 2008

**TRADEMARK
PRINCIPAL REGISTER**



JOSEPH A. ZAMBITO (UNITED STATES INDIVIDUAL)
41 MUIRFIELD
DOVE CANYON, CA 92679

FOR: PREPARATION FOR THE RELIEF OF PAIN, IN CLASS 5 (U.S. CLS. 6, 18, 44, 46, 51 AND 52).

FIRST USE 8-11-2005; IN COMMERCE 8-11-2005.

NO CLAIM IS MADE TO THE EXCLUSIVE RIGHT TO USE "JOINT LOTION RELIEF", APART FROM THE MARK AS SHOWN.

THE MARK CONSISTS OF THE WORDS "JOINT LOTION" WITH A IMAGE OF A DROP DRIPPING FROM THE LETTER "J" IN THE WORD JOINT AND

THE DROP IS IN THE MIDDLE OF THE LETTER "O" IN THE WORD LOTION. UNDERNEATH THE LETTER "O" IN LOTION IS THE WORD RELIEF. THE WORD RELIEF IS MUCH SMALLER THAN THE WORDS JOINT LOTION AND IS IN A SHAPE THAT CONTOURS THE BOTTOM OF THE LETTER "O". TO THE RIGHT OF THE WORD JOINT LOTION IS AN IMAGE OF A GOLFER SWINGING A GOLF CLUB WITH IMAGES OF SMALL TARGETS ON THE GOLFER'S JOINTS. THE SMALL TARGETS ARE ON THE KNEE, BACK AND ELBOW.

SER. NO. 77-002,837, FILED 9-19-2006.

SUSAN LESLIE DUBOIS, EXAMINING ATTORNEY

Int. Cl.: 36

Prior U.S. Cls.: 100, 101 and 102

United States Patent and Trademark Office

Reg. No. 3,396,962

Registered Mar. 18, 2008

**SERVICE MARK
PRINCIPAL REGISTER**

**...BECAUSE POTENTIAL HAS
NO BOUNDARIES**

STANFORD FINANCIAL GROUP COMPANY
(FLORIDA CORPORATION)
5050 WESTHEIMER
HOUSTON, TX 77056

FOR: FINANCIAL SERVICES, NAMELY, FINANCIAL PLANNING SERVICES, SECURITIES BROKER DEALER SERVICES, MANAGEMENT OF PORTFOLIOS COMPRISING SECURITIES, INVESTMENT ADVISORY, INVESTMENT BANKING, INTERNATIONAL PRIVATE BANKING AND COMMERCIAL BANKING, REAL ESTATE INVESTMENTS, AND INTERNATIONAL INVESTMENT CONSULTATION SERVICES; INVESTMENT SERVICES, NAMELY, ASSET MANAGEMENT SERVICES; INSURANCE AGENCY AND BROKERAGE SERVICES; TRUST SERVICES, NAMELY, INVESTMENT AND TRUST COMPANY SERVICES; ESTATE PLAN-

NING SERVICES; PROVIDING INVESTMENT ADVICE IN THE FIELD OF PRECIOUS METALS AND NUMISMATIC INVESTMENTS; AND BROKERAGE IN THE FIELD OF PRECIOUS METALS AND NUMISMATIC INVESTMENTS, IN CLASS 36 (U.S. CLS. 100, 101 AND 102).

FIRST USE 6-30-2004; IN COMMERCE 6-30-2004.

THE MARK CONSISTS OF STANDARD CHARACTERS WITHOUT CLAIM TO ANY PARTICULAR FONT, STYLE, SIZE, OR COLOR.

SER. NO. 77-003,969, FILED S.R. 9-21-2006 AM. P.R. 5-2-2007.

SUSAN STIGLITZ, EXAMINING ATTORNEY

Int. Cl.: 33

Prior U.S. Cls.: 47 and 49

United States Patent and Trademark Office

Reg. No. 3,396,963

Registered Mar. 18, 2008

**TRADEMARK
PRINCIPAL REGISTER**

ELIZABETH ROSE

NAPA WINE COMPANY, LLC (CALIFORNIA
LTD LIAB CO)
7830 ST. HELENA HIGHWAY
OAKVILLE, CA 94562

THE NAME SHOWN IN THE MARK IDENTIFIES
KENDALL ELIZABETH HOXSEY, ALSO KNOWN
AS ELIZABETH ROSE, WHOSE CONSENT IS OF
RECORD.

FOR: WINE, IN CLASS 33 (U.S. CLS. 47 AND 49).

FIRST USE 5-17-2007; IN COMMERCE 5-17-2007.

SER. NO. 77-004,036, FILED 9-21-2006.

THE MARK CONSISTS OF STANDARD CHAR-
ACTERS WITHOUT CLAIM TO ANY PARTICULAR
FONT, STYLE, SIZE, OR COLOR.

GEORGE LORENZO, EXAMINING ATTORNEY

Int. Cl.: 30

Prior U.S. Cl.: 46

United States Patent and Trademark Office

Reg. No. 3,396,964

Registered Mar. 18, 2008

TRADEMARK
PRINCIPAL REGISTER



MOTHER'S CAKE & COOKIE CO. (CALIFORNIA CORPORATION)
810 81ST AVENUE
OAKLAND, CA 94621

FOR: COOKIES, IN CLASS 30 (U.S. CL. 46).

FIRST USE 12-1-2005; IN COMMERCE 12-1-2005.

OWNER OF U.S. REG. NOS. 1,121,117 AND 1,726,011.

NO CLAIM IS MADE TO THE EXCLUSIVE RIGHT TO USE "BAKERY," "CALIFORNIA ORIGI-

NAL," "SINCE 1914" AND "COOKIES", APART FROM THE MARK AS SHOWN.

THE MARK CONSISTS OF AN OVAL CONTAINING THE WORDING BAKERY WAGON, AND A HORSE DRAWN CARRIAGE WITH A BANNER ON IT DEPICTING THE FACE OF A WOMAN AND THE WORDING "CALIFORNIA ORIGINAL - SINCE 1914 MOTHER'S COOKIES".

SER. NO. 77-005,477, FILED 9-22-2006.

TRICIA SONNEBORN, EXAMINING ATTORNEY

Int. Cls.: 35 and 37

Prior U.S. Cls.: 100, 101, 102, 103 and 106

United States Patent and Trademark Office

Reg. No. 3,396,965

Registered Mar. 18, 2008

**SERVICE MARK
PRINCIPAL REGISTER**

CAPTIVE CHANNEL

CAPTIVE CHANNEL CORPORATION (CANADA CORPORATION)
SUITE 303
100 ALLSTATE PARKWAY
MARKHAM, ONTARIO, CANADA L3R6H3

FOR: ADVERTISING SERVICES FOR OTHERS, NAMELY, ADVERTISING THE WARES AND SERVICES OF OTHERS ON PROPRIETARY DISPLAY SCREENS PLACED IN GROCERY STORES, RETAIL STORES, RETAIL KIOSKS, RECEPTION AREAS, LOBBIES, MANUFACTURING FLOORS, COMMUNITY HALLS, AND IN PUBLIC SPACES, NAMELY, TRANSPORTATION FACILITIES, MUSEUMS, EXHIBIT AREAS, AND PUBLIC GOVERNMENT OFFICES; ADVERTISING SERVICES FOR OTHERS, NAMELY, ADVERTISING ON PROPRIETARY DISPLAY SCREENS IN GROCERY STORES, RETAIL STORES, RETAIL KIOSKS, RECEPTION AREAS, LOBBIES, MANUFACTURING FLOORS, COMMUNITY HALLS, AND IN PUBLIC SPACES THE MESSAGES OF OTHERS, NAMELY, PRICING ADJUSTMENTS, VISITOR GREETING MESSAGES, EVENT SCHEDULES, AMBER ALERTS, IMPORTANT ANNOUNCEMENTS, EMERGENCY ANNOUNCEMENTS, RSS FEEDS FROM DATA AGGREGATORS, PRODUCT AND NEWS ANNOUNCEMENTS AND WEATHER, TRAFFIC, STOCK, AND SPORTS INFORMATION; ADVERTISING AGENCY SERVICES FOR OTHERS, NAMELY,

MEDIA SALES, CREATIVE DESIGN, AND CONTENT PRODUCTION TO SELL, DESIGN AND PREPARE ADVERTISING FOR PROPRIETARY DISPLAY SCREENS; CONSULTING SERVICES WITH RESPECT TO ADVERTISING ON PROPRIETARY DISPLAY SCREENS, IN CLASS 35 (U.S. CLS. 100, 101 AND 102).

FOR: INSTALLATION AND SERVICING OF PROPRIETARY ADVERTISING DISPLAY SCREENS, IN CLASS 37 (U.S. CLS. 100, 103 AND 106).

THE MARK CONSISTS OF STANDARD CHARACTERS WITHOUT CLAIM TO ANY PARTICULAR FONT, STYLE, SIZE, OR COLOR.

PRIORITY CLAIMED UNDER SEC. 44(D) ON CANADA APPLICATION NO. 1317469, FILED 9-21-2006, REG. NO. TMA696939, DATED 9-20-2007, EXPIRES 9-20-2022.

NO CLAIM IS MADE TO THE EXCLUSIVE RIGHT TO USE "CHANNEL", APART FROM THE MARK AS SHOWN.

SER. NO. 77-005,581, FILED 9-22-2006.

WOODROW HARTZOG, EXAMINING ATTORNEY

Int. Cls.: 9, 35 and 38

Prior U.S. Cls.: 21, 23, 26, 36, 38, 100, 101, 102 and 104

United States Patent and Trademark Office

Reg. No. 3,396,966

Registered Mar. 18, 2008

**TRADEMARK
SERVICE MARK
PRINCIPAL REGISTER**

FLOWING CONTENT

FLOWING CONTENT, S.A. (LUXEMBOURG CORPORATION)
19 RUE LUCIEN WERCOLLIER L-8156
BRIDEL, LUXEMBOURG

FOR: DATA PROCESSING EQUIPMENT, NAME-
LY, DATA PROCESSORS AND COMPUTERS IN
THE FIELD OF ENCODING, DECODING AND
TRANSMISSION OF PROTECTED DATA AND IN
THE FIELD OF FOLLOW-UP AND MANAGEMENT
OF THE CIRCULATION OF CONTENTS; TELE-
COMMUNICATION TRANSMITTERS; TRANSMIT-
TERS OF ELECTRONIC SIGNALS, NAMELY,
ELECTRONIC TRANSMITTERS FOR DATA, EN-
CRYPTED DATA, IMAGES AND SOUNDS; MOD-
EMS; RECORDED SOFTWARE PROGRAMS AND
DOWNLOADABLE SOFTWARE FOR THE ENCOD-
ING, DECODING AND TRANSMISSION OF PRO-
TECTED DATA; SOFTWARE AND
DOWNLOADABLE SOFTWARE FOR THE FOL-
LOW-UP AND THE MANAGEMENT OF THE CIR-
CULATION OF CONTENTS, NAMELY, SOFTWARE
FOR THE SECURED TRANSMISSION OF DATA,
IMAGES AND SOUNDS; DOWNLOADABLE ELEC-
TRONIC PUBLICATIONS, NAMELY, DIGITAL
BOOKS, MAGAZINES, MANUALS AND NEWSLET-
TERS FOR USE BY PROFESSIONALS AND INDIVI-
DUALS FOR ENCODING, DECODING AND
TRANSMITTING PROTECTED DATA IN THE
FIELD OF FOLLOW-UP AND MANAGEMENT OF
CIRCULATION OF CONTENTS; MOBILE AND
FIXED DATA RECEIVERS; AUDIO RECEIVERS;
VIDEO RECEIVERS; TELEVISION SETS, IN CLASS
9 (U.S. CLS. 21, 23, 26, 36 AND 38).

FOR: ADVERTISING AND DISSEMINATION OF
ADVERTISING FOR OTHERS RELATED TO SOFT-
WARE FOR THE ENCODING, THE DECODING AND
THE TRANSMISSION OF PROTECTED DATA
AND FOR THE FOLLOW-UP AND MANAGEMENT
OF THE CIRCULATION OF CONTENTS; RENTAL

OF ADVERTISING SPACE AND TIME; ONLINE
ADVERTISING ON A COMPUTER NETWORK FOR
OTHERS IN THE FIELD OF ENCODING, DECOD-
ING AND TRANSMISSION OF PROTECTED DATA
AND IN THE FIELD OF FOLLOW-UP AND MAN-
AGEMENT OF THE CIRCULATION OF CON-
TENTS; SALES PROMOTION CONCERNING
SERVICES OF OTHERS IN THE FIELD OF ENCOD-
ING, DECODING AND TRANSMISSION OF PRO-
TECTED DATA AND IN THE FIELD OF FOLLOW-
UP AND MANAGEMENT OF THE CIRCULATION
OF CONTENTS; BUSINESS MANAGEMENT ASSIS-
TANCE IN THE FIELD OF ENCODING, DECODING
AND TRANSMISSION OF PROTECTED DATA AND
IN THE FIELD OF FOLLOW-UP AND MANAGE-
MENT OF THE CIRCULATION OF CONTENTS;
CLERICAL SERVICES, NAMELY, CLERICAL
WORK IN THE FIELD OF ENCODING, DECODING
AND TRANSMISSION OF PROTECTED DATA AND
IN THE FIELD OF FOLLOW-UP AND MANAGE-
MENT OF THE CIRCULATION OF CONTENTS;
BUSINESS MANAGEMENT CONSULTING IN THE
FIELD OF ENCODING, DECODING AND TRANS-
MISSION OF PROTECTED DATA AND IN THE
FIELD OF FOLLOW-UP AND MANAGEMENT OF
THE CIRCULATION OF CONTENTS; BUSINESS
INFORMATION AND INQUIRIES IN THE FIELD
OF ENCODING, DECODING AND TRANSMISSION
OF PROTECTED DATA AND IN THE FIELD OF
FOLLOW-UP AND MANAGEMENT OF THE CIR-
CULATION OF CONTENTS; ASSISTANCE IN MAN-
AGEMENT OF BUSINESS ACTIVITIES, NAMELY,
ASSISTANCE RELATING TO THE MANAGEMENT
OF COMPANIES AND RELATING TO THE OPTI-
MIZATION AND THE MANAGEMENT OF THE
TRANSMISSION OF DATA, TEXTS, AUDIO OR
VIDEO DOCUMENTS; COMPILATION OF INFOR-
MATION DATA IN A CENTRAL COMPUTER DA-
TABASE; COMPUTERIZED FILE MANAGEMENT
IN THE FIELD OF ENCODING, DECODING AND
TRANSMISSION OF PROTECTED DATA AND IN

THE FIELD OF FOLLOW-UP AND MANAGEMENT OF THE CIRCULATION OF CONTENTS; BUSINESS INFORMATION RESEARCH IN COMPUTER FILES FOR THIRD PARTIES; DRAWING UP OF STATEMENTS OF ACCOUNTS, NAMELY, FINANCIAL STATEMENT PREPARATION AND ANALYSIS FOR BUSINESSES; CHECKING OF ACCOUNTS, NAMELY, ACCOUNT AUDITING, IN CLASS 35 (U.S. CLS. 100, 101 AND 102).

FOR: TELECOMMUNICATION ROUTING AND JUNCTION SERVICES; ELECTRONIC BULLETIN BOARD SERVICES, NAMELY, PROVIDING ON-LINE ELECTRONIC BULLETIN BOARDS FOR TRANSMISSION OF MESSAGES AMONG COMPUTER USERS CONCERNING PROFESSIONAL AND PRIVATE COMMUNICATIONS; COMMUNICATIONS BY COMPUTER TERMINALS; COMMUNICATIONS BY FIBER OPTIC NETWORKS; SATELLITE TRANSMISSION SERVICES; PROVID-

ING MULTIPLE USER ACCESS TO A GLOBAL COMPUTER NETWORK; INFORMATION ABOUT TELECOMMUNICATIONS; COMPUTER-AIDED TRANSMISSION OF MESSAGES AND IMAGES; TELEVISION BROADCASTING, IN CLASS 38 (U.S. CLS. 100, 101 AND 104).

THE MARK CONSISTS OF STANDARD CHARACTERS WITHOUT CLAIM TO ANY PARTICULAR FONT, STYLE, SIZE, OR COLOR.

PRIORITY CLAIMED UNDER SEC. 44(D) ON ERPN CMNTY TM OFC APPLICATION NO. 005165204, FILED 6-28-2006, REG. NO. 005165204, DATED 6-6-2007, EXPIRES 6-28-2016.

SER. NO. 77-005,823, FILED 9-22-2006.

JENNIFER MARTIN, EXAMINING ATTORNEY

Int. Cl.: 9

Prior U.S. Cls.: 21, 23, 26, 36 and 38

United States Patent and Trademark Office

Reg. No. 3,396,967

Registered Mar. 18, 2008

**TRADEMARK
PRINCIPAL REGISTER**

TUTORSYSTEMS

BLS, INC. (DELAWARE CORPORATION)
2219 DOWNING LANE
WILMINGTON, DE 198043651

FOR: EDUCATIONAL COMPUTER SOFTWARE
USED FOR COMPUTER AIDED INSTRUCTION ON
A WIDE VARIETY OF ACADEMIC AND VOCA-
TIONAL TOPICS AND ACCOMPANYING USER
MANUALS SOLD AS A UNIT , IN CLASS 9 (U.S.
CLS. 21, 23, 26, 36 AND 38).

FIRST USE 5-1-1971; IN COMMERCE 5-1-1971.

THE MARK CONSISTS OF STANDARD CHAR-
ACTERS WITHOUT CLAIM TO ANY PARTICULAR
FONT, STYLE, SIZE, OR COLOR.

SER. NO. 77-006,114, FILED 9-24-2006.

MELVIN AXILBUND, EXAMINING ATTORNEY

Int. Cl.: 11

Prior U.S. Cls.: 13, 21, 23, 31 and 34

United States Patent and Trademark Office

Reg. No. 3,396,968

Registered Mar. 18, 2008

**TRADEMARK
PRINCIPAL REGISTER**



SHALOM ZANZURI (ISRAEL INDIVIDUAL)

13013 MOORPARK STREET

STUDIO CITY, CA 91604

FOR: DOMESTIC COOKING OVENS, IN CLASS 11
(U.S. CLS. 13, 21, 23, 31 AND 34).

FIRST USE 6-28-2006; IN COMMERCE 6-28-2006.

NO CLAIM IS MADE TO THE EXCLUSIVE
RIGHT TO USE "OUTDOOR PIZZA OVENS",
APART FROM THE MARK AS SHOWN.

THE MARK CONSISTS OF A CIRCLE WITH A PIE
SHAPE CUTOUT AND THE WORDING "CALIFOR-
NO" AND "OUTDOOR."

SER. NO. 77-006,598, FILED 9-25-2006.

KATHY DE JONGE, EXAMINING ATTORNEY

Int. Cls.: 35 and 42

Prior U.S. Cls.: 100, 101 and 102

United States Patent and Trademark Office

Reg. No. 3,396,969

Registered Mar. 18, 2008

**SERVICE MARK
PRINCIPAL REGISTER**

**THE SCIENCE OF DIGITAL
MARKETING**

24/7 REAL MEDIA, INC. (DELAWARE CORPORATION)
FL 9
132 W. 31ST ST.,
NEW YORK, NY 10001

FOR: BUSINESS SERVICES, NAMELY, ADVERTISEMENT MANAGEMENT BY PROVIDING REPORTS, ADVERTISEMENT TARGETING, AND MANAGEMENT OF ELECTRONICALLY STORED ADVERTISING, FOR USE ON THE GLOBAL COMPUTER NETWORK; ADVERTISING SERVICES AND COMMERCIAL INFORMATION SERVICES, THROUGH THE INTERNET; DISSEMINATION OF ADVERTISING FOR OTHERS, THROUGH THE INTERNET, INCLUDING ADVERTISEMENTS TARGETED BASED ON USER BEHAVIOR; BUSINESS MONITORING SERVICES, NAMELY, ANALYSIS AND REPORTING ON WEBSITE TRAFFIC FOR OTHERS; PROMOTING THE GOODS AND SERVICES OF OTHERS BY PREPARING AND PLACING ON-LINE ADVERTISEMENTS ON A NETWORK OF WEB PAGES ON THE INTERNET, AS WELL AS VIA E-MAIL; PROMOTING THE GOODS AND SERVICES OF OTHERS THROUGH SEARCH ENGINE REFERRAL TRAFFIC ANALYSIS AND REPORTING; AND PROVIDING ADVERTISEMENT REPRESENTATION SERVICES, NAMELY,

REPRESENTING ADVERTISERS IN THE DISSEMINATION OF AND SALES FROM ADVERTISEMENTS ON WEB PAGES; AND CONSULTING IN THE FIELD OF ON-LINE ADVERTISING, IN CLASS 35 (U.S. CLS. 100, 101 AND 102).

FIRST USE 4-1-2006; IN COMMERCE 4-24-2006.

FOR: COMPUTER SERVICES, NAMELY, MAINTAINING A NETWORK OF WEB PAGES ON THE INTERNET FOR OTHERS, IN CLASS 42 (U.S. CLS. 100 AND 101).

FIRST USE 4-1-2006; IN COMMERCE 4-24-2006.

THE MARK CONSISTS OF STANDARD CHARACTERS WITHOUT CLAIM TO ANY PARTICULAR FONT, STYLE, SIZE, OR COLOR.

NO CLAIM IS MADE TO THE EXCLUSIVE RIGHT TO USE "DIGITAL MARKETING", APART FROM THE MARK AS SHOWN.

SER. NO. 77-006,687, FILED 9-25-2006.

KEVIN DINALLO, EXAMINING ATTORNEY

Int. Cl.: 10

Prior U.S. Cls.: 26, 39 and 44

United States Patent and Trademark Office

Reg. No. 3,396,970

Registered Mar. 18, 2008

**TRADEMARK
PRINCIPAL REGISTER**

POTEC

POTEC CO., LTD. (REPUBLIC OF KOREA CORPORATION)
67-14 OHJUNG-DONG, DAEDUCK-GU
DAEJEON-CITY, REPUBLIC OF KOREA

FOR: OPHTHALMOLOGY MEDICAL DEVICES, NAMELY, AUTO REFRACTOMETERS, AUTO LENSMETERS, CHARGE PROJECTORS, MIRROR CHARTS, AUTO KERATOMETERS, SLIT LAMPS, TONOMETERS, RETINAL CAMERAS, AND FUNDUS CAMERAS, IN CLASS 10 (U.S. CLS. 26, 39 AND 44).

FIRST USE 10-24-2003; IN COMMERCE 10-24-2003.

THE MARK CONSISTS OF STANDARD CHARACTERS WITHOUT CLAIM TO ANY PARTICULAR FONT, STYLE, SIZE, OR COLOR.

SER. NO. 77-007,269, FILED 9-26-2006.

RAMONA ORTIGA, EXAMINING ATTORNEY

Int. Cl.: 38

Prior U.S. Cls.: 100, 101 and 104

United States Patent and Trademark Office

Reg. No. 3,396,971

Registered Mar. 18, 2008

**SERVICE MARK
PRINCIPAL REGISTER**

Spot On Networks

SPOT-ON NETWORKS, LLC (DELAWARE LTD
LIAB CO)
SUITE 200
55 CHURCH STREET
NEW HAVEN, CT 06510

FOR: TELECOMMUNICATIONS ACCESS SERVI-
CES, NAMELY, PROVIDING WIRELESS AND
WIRED BROADBAND INTERNET ACCESS, IN
CLASS 38 (U.S. CLS. 100, 101 AND 104).

FIRST USE 6-25-2003; IN COMMERCE 6-25-2003.

THE MARK CONSISTS OF STANDARD CHAR-
ACTERS WITHOUT CLAIM TO ANY PARTICULAR
FONT, STYLE, SIZE, OR COLOR.

NO CLAIM IS MADE TO THE EXCLUSIVE
RIGHT TO USE "NETWORKS", APART FROM
THE MARK AS SHOWN.

SER. NO. 77-007,655, FILED 9-26-2006.

BILL DAWE, EXAMINING ATTORNEY

Int. Cl.: 10

Prior U.S. Cls.: 26, 39 and 44

United States Patent and Trademark Office

Reg. No. 3,396,972

Registered Mar. 18, 2008

**TRADEMARK
PRINCIPAL REGISTER**

DRYVU

CANNUFLOW, INC. (CALIFORNIA CORPORATION)
1190 COLEMAN ROAD, SUITE 250
SAN JOSE, CA 95710

THE MARK CONSISTS OF STANDARD CHARACTERS WITHOUT CLAIM TO ANY PARTICULAR FONT, STYLE, SIZE, OR COLOR.

FOR: SURGICAL INSTRUMENTS FOR USE IN ARTHROSCOPIC SURGERY, IN CLASS 10 (U.S. CLS. 26, 39 AND 44).

SER. NO. 77-009,784, FILED 9-28-2006.

FIRST USE 11-12-2004; IN COMMERCE 11-12-2004.

ALLISON SCHRODY, EXAMINING ATTORNEY

Int. Cl.: 45

Prior U.S. Cls.: 100 and 101

United States Patent and Trademark Office

Reg. No. 3,396,973

Registered Mar. 18, 2008

**SERVICE MARK
PRINCIPAL REGISTER**

THE DOWN TO EARTH DAD

THE DOWN TO EARTH DAD, LLC (IDAHO LTD
LIAB CO)
P.O. BOX 1907
COEUR D'ALENE, ID 83816

FOR: PERSONAL GROWTH AND MOTIVATION
CONSULTING SERVICES; PERSONAL LIFESTYLE
CONSULTING SERVICES, IN CLASS 45 (U.S. CLS.
100 AND 101).

FIRST USE 12-21-1999; IN COMMERCE 12-21-1999.

THE MARK CONSISTS OF STANDARD CHAR-
ACTERS WITHOUT CLAIM TO ANY PARTICULAR
FONT, STYLE, SIZE, OR COLOR.

NO CLAIM IS MADE TO THE EXCLUSIVE
RIGHT TO USE "DAD", APART FROM THE MARK
AS SHOWN.

SER. NO. 77-009,935, FILED 9-28-2006.

SONYA STEPHENS, EXAMINING ATTORNEY

Int. Cl.: 44

Prior U.S. Cls.: 100 and 101

United States Patent and Trademark Office

Reg. No. 3,396,974

Registered Mar. 18, 2008

**SERVICE MARK
PRINCIPAL REGISTER**



HEALTHWAYS

HEALTHWAYS, INC. (DELAWARE CORPORATION)
SUITE 300
3841 GREEN HILLS VILLAGE DRIVE
NASHVILLE, TN 37215

FOR: HEALTHCARE MANAGEMENT SERVICES,
NAMELY, PATIENT CARE MANAGEMENT AND
DISEASE MANAGEMENT, IN CLASS 44 (U.S. CLS.
100 AND 101).

FIRST USE 11-0-2005; IN COMMERCE 11-0-2005.

OWNER OF U.S. REG. NO. 2,654,174.

SER. NO. 77-010,762, FILED 9-29-2006.

KARANENDRA S. CHHINA, EXAMINING ATTORNEY

Int. Cls.: 9, 35 and 42

Prior U.S. Cls.: 21, 23, 26, 36, 38, 100, 101 and 102

United States Patent and Trademark Office

Reg. No. 3,396,975

Registered Mar. 18, 2008

**TRADEMARK
SERVICE MARK
PRINCIPAL REGISTER**

One Simple Move

ONE SIMPLE MOVE, LLC (CALIFORNIA LTD
LIAB CO)
P.O. BOX 5054
SANTA BARBARA, CA 93150

FOR: COMPUTER SOFTWARE FOR USE IN
DATABASE MANAGEMENT IN THE FIELDS OF
MOVING AND RELOCATION SERVICES AND IN-
VENTORY CONTROL AND MANAGEMENT, IN
CLASS 9 (U.S. CLS. 21, 23, 26, 36 AND 38).

FIRST USE 7-17-2006; IN COMMERCE 7-17-2006.

FOR: MOVING AND RELOCATION SERVICES,
NAMELY, PLANNING AND IMPLEMENTING
MOVES OF HOMES; CONSULTATION SERVICES
IN THE FIELD OF RELOCATION SERVICES PRO-
VIDED BY PERSONAL RELOCATION SPECIA-
LISTS; PROVIDING INFORMATION IN THE
FIELD OF RELOCATION SERVICES; BUSINESS
SERVICES, NAMELY, SCREENING AND ORGA-
NIZING THIRD-PARTY VENDORS ON BEHALF OF
OTHERS, NAMELY, MOVERS, REAL ESTATE
AGENTS, AUCTIONEERS, CHARITIES, AND
HEALTH CARE PROVIDERS; PROVIDING A WEB-
SITE FEATURING INFORMATION IN THE FIELD
OF RELOCATION SERVICES; PROVIDING AN ON-
LINE COMPUTER DATABASE IN THE FIELDS OF
RELOCATION SERVICES AND INVENTORY CON-

TROL AND MANAGEMENT; INVENTORY CON-
TROL AND MANAGEMENT, IN CLASS 35 (U.S. CLS.
100, 101 AND 102).

FIRST USE 7-17-2006; IN COMMERCE 7-17-2006.

FOR: DEVELOP, MAINTAIN, UPDATE AND
PROVIDE ONLINE NON-DOWNLOADABLE SOFT-
WARE FOR USE IN DATABASE MANAGEMENT IN
THE FIELDS OF MOVING AND RELOCATION
SERVICES AND INVENTORY CONTROL AND
MANAGEMENT; APPLICATION SERVICE PROVI-
DER (ASP) FEATURING SOFTWARE FOR USE IN
DATABASE MANAGEMENT IN THE FIELDS OF
MOVING AND RELOCATION SERVICES AND IN-
VENTORY CONTROL AND MANAGEMENT, IN
CLASS 42 (U.S. CLS. 100 AND 101).

FIRST USE 7-17-2006; IN COMMERCE 7-17-2006.

THE MARK CONSISTS OF STANDARD CHAR-
ACTERS WITHOUT CLAIM TO ANY PARTICULAR
FONT, STYLE, SIZE, OR COLOR.

SER. NO. 77-011,938, FILED 10-2-2006.

LINDA M. KING, EXAMINING ATTORNEY

Int. Cls.: 7, 9 and 37

**Prior U.S. Cls.: 13, 19, 21, 23, 26, 31, 34, 35, 36, 38,
100, 103 and 106**

Reg. No. 3,396,976

United States Patent and Trademark Office

Registered Mar. 18, 2008

**TRADEMARK
SERVICE MARK
PRINCIPAL REGISTER**

ROBOMOUNT

SCHENCK ROTEC GMBH (FED REP GERMANY
LTD LIAB CO)
LANDWEHRSTRASSE 55
DARMSTADT, FED REP GERMANY D-64293

FOR: MACHINES AND MECHANICAL INSTALLATIONS FOR THE FITTING OF TIRES AND WHEELS, NAMELY, ASSEMBLY MACHINES FOR VEHICLE WHEELS, MACHINES FOR MOUNTING OF VEHICLE TIRES ONTO RIMS, ASSEMBLY LINES FOR VEHICLE WHEELS, PNEUMATICALLY AND/OR ELECTRICALLY OPERATED TIRE INFLATION MACHINES, PARTS FOR THE AFORESAID MACHINES AND INSTALLATIONS, NAMELY, TIRE FITTING TOOLS, RETAINERS, GRIPPING DEVICES, CLAMPING DEVICES, CONVEYORS, CONVEYOR BELTS, TIRE-COATING DEVICES, IN CLASS 7 (U.S. CLS. 13, 19, 21, 23, 31, 34 AND 35).

FOR: BALANCING MACHINES, NAMELY, TIRE-BALANCING MACHINES; VEHICLE TIRE/WHEEL ALIGNMENT DEVICES; SURVEYING, OPTICAL, WEIGHING, MEASURING, SIGNALING AND CHECKING APPARATUS AND INSTRUMENTS, NAMELY, SENSING AND SIGNALING DEVICES FOR MEASUREMENT AND/OR QUALITY CONTROL OF MATERIALS PROCESSING, ELECTRONIC CONTROL SYSTEMS FOR MACHINES, ELECTRIC AND ELECTRONIC MONITORING DE-

VICES, NAMELY, CONTROLLER TO MONITOR AND CONTROL THE FUNCTIONING OF OTHER ELECTRIC DEVICES, DATA PROCESSORS AND COMPUTERS, RECORDED AND DOWNLOADABLE COMPUTER PROGRAMS FOR USE IN CONTROLLING OF MACHINES, IN PARTICULAR FOR CONTROLLING THE MOVEMENTS OF A MACHINE, IN CLASS 9 (U.S. CLS. 21, 23, 26, 36 AND 38).

FOR: INSTALLATION, MAINTENANCE AND REPAIR OF MACHINES AND MECHANICAL INSTALLATIONS FOR THE FITTING OF TIRES AND WHEELS, BALANCING MACHINES, TIRE-BALANCING MACHINES, TIRE-FILLING MACHINES AND TIRE/WHEEL ALIGNMENT DEVICES, IN CLASS 37 (U.S. CLS. 100, 103 AND 106).

THE MARK CONSISTS OF STANDARD CHARACTERS WITHOUT CLAIM TO ANY PARTICULAR FONT, STYLE, SIZE, OR COLOR.

PRIORITY CLAIMED UNDER SEC. 44(D) ON ERPN CMNTY TM OFC APPLICATION NO. 005020491, FILED 4-13-2006, REG. NO. 005020491, DATED 4-12-2007, EXPIRES 4-13-2016.

SER. NO. 77-012,543, FILED 10-3-2006.

LINDA ORNDORFF, EXAMINING ATTORNEY

Int. Cls.: 7, 9 and 37

**Prior U.S. Cls.: 13, 19, 21, 23, 26, 31, 34, 35, 36, 38,
100, 103 and 106**

Reg. No. 3,396,977

United States Patent and Trademark Office

Registered Mar. 18, 2008

**TRADEMARK
SERVICE MARK
PRINCIPAL REGISTER**

ROBMOUNT

SCHENCK ROTEC GMBH (FED REP GERMANY
LTD LIAB CO)
LANDWEHRSTRASSE 55
DARMSTADT, FED REP GERMANY D-64293

FOR: MACHINES AND MECHANICAL INSTALLATIONS FOR THE FITTING OF TIRES AND WHEELS, NAMELY, ASSEMBLY MACHINES FOR VEHICLE WHEELS, MACHINES FOR MOUNTING OF VEHICLE TIRES ONTO RIMS, ASSEMBLY LINES FOR VEHICLE WHEELS, PNEUMATICALLY AND/OR ELECTRICALLY OPERATED TIRE INFLATION MACHINES, PARTS FOR THE AFORESAID MACHINES AND INSTALLATIONS, NAMELY, TIRE FITTING TOOLS, RETAINERS, GRIPPING DEVICES, CLAMPING DEVICES, CONVEYORS, CONVEYOR BELTS, TIRE-COATING DEVICES, IN CLASS 7 (U.S. CLS. 13, 19, 21, 23, 31, 34 AND 35).

FOR: BALANCING MACHINES, NAMELY, TIRE-BALANCING MACHINES; VEHICLE TIRE/WHEEL ALIGNMENT DEVICES; SURVEYING, OPTICAL, WEIGHING, MEASURING, SIGNALING AND CHECKING APPARATUS AND INSTRUMENTS, NAMELY, SENSING AND SIGNALING DEVICES FOR MEASUREMENT AND/OR QUALITY CONTROL OF MATERIALS PROCESSING, ELECTRONIC CONTROL SYSTEMS FOR MACHINES, ELECTRIC AND ELECTRONIC MONITORING DE-

VICES, NAMELY, CONTROLLER TO MONITOR AND CONTROL THE FUNCTIONING OF OTHER ELECTRIC DEVICES, DATA PROCESSORS AND COMPUTERS, RECORDED AND DOWNLOADABLE COMPUTER PROGRAMS FOR USE IN CONTROLLING OF MACHINES, IN PARTICULAR FOR CONTROLLING THE MOVEMENTS OF A MACHINE, IN CLASS 9 (U.S. CLS. 21, 23, 26, 36 AND 38).

FOR: INSTALLATION, MAINTENANCE AND REPAIR OF MACHINES AND MECHANICAL INSTALLATIONS FOR THE FITTING OF TIRES AND WHEELS, BALANCING MACHINES, TIRE-BALANCING MACHINES, TIRE-FILLING MACHINES AND TIRE/WHEEL ALIGNMENT DEVICES, IN CLASS 37 (U.S. CLS. 100, 103 AND 106).

THE MARK CONSISTS OF STANDARD CHARACTERS WITHOUT CLAIM TO ANY PARTICULAR FONT, STYLE, SIZE, OR COLOR.

PRIORITY CLAIMED UNDER SEC. 44(D) ON ERPN CMNTY TM OFC APPLICATION NO. 005020789, FILED 4-13-2006, REG. NO. 005020789, DATED 4-12-2007, EXPIRES 4-13-2016.

SER. NO. 77-012,619, FILED 10-3-2006.

LINDA ORNDORFF, EXAMINING ATTORNEY

Int. Cl.: 5

Prior U.S. Cls.: 6, 18, 44, 46, 51 and 52

Reg. No. 3,396,978

United States Patent and Trademark Office

Registered Mar. 18, 2008

**TRADEMARK
PRINCIPAL REGISTER**

CENFLEX HA+

CENTURION SYSTEMS USA INC. (NEW JERSEY CORPORATION)
105 CAMPUS PLAZA DRIVE
EDISON, NJ 08837

FOR: NUTRITIONAL SUPPLEMENTS FOR HUMANS AND ANIMALS, IN CLASS 5 (U.S. CLS. 6, 18, 44, 46, 51 AND 52).

THE MARK CONSISTS OF STANDARD CHARACTERS WITHOUT CLAIM TO ANY PARTICULAR FONT, STYLE, SIZE, OR COLOR.

PRIORITY CLAIMED UNDER SEC. 44(D) ON CANADA APPLICATION NO. 1299784, FILED 4-11-2006, REG. NO. TMA697991, DATED 10-5-2007, EXPIRES 10-5-2022.

NO CLAIM IS MADE TO THE EXCLUSIVE RIGHT TO USE "HA", APART FROM THE MARK AS SHOWN.

SER. NO. 77-012,686, FILED 10-3-2006.

JAY FLOWERS, EXAMINING ATTORNEY

Int. Cl.: 20

Prior U.S. Cls.: 2, 13, 22, 25, 32 and 50

United States Patent and Trademark Office

Reg. No. 3,396,979

Registered Mar. 18, 2008

**TRADEMARK
PRINCIPAL REGISTER**

BATWING

TRADE GUYS INTERNATIONAL PTY LTD
(AUSTRALIA CORPORATION)
BURLEIGH HEADS 4220
12/8 FORTITUDE CRESENT
QUEENSLAND, AUSTRALIA

FOR: PLASTIC LOCKS FOR USE WITH RECORDED MEDIA PRODUCTS; PLASTIC LOCKS FOR LOCKING DVD'S AND CD'S WITHIN A STORAGE CASE; PLASTIC HUB LOCKS FOR LOCKING DVD'S AND CD'S TO AN INNER WALL OF A MEDIA STORAGE CASE, IN CLASS 20 (U.S. CLS. 2, 13, 22, 25, 32 AND 50).

THE MARK CONSISTS OF STANDARD CHARACTERS WITHOUT CLAIM TO ANY PARTICULAR FONT, STYLE, SIZE, OR COLOR.

PRIORITY CLAIMED UNDER SEC. 44(D) ON AUSTRALIA APPLICATION NO. 1,137,685, FILED 9-26-2006, REG. NO. 1137685, DATED 6-7-2007, EXPIRES 9-26-2016.

SER. NO. 77-012,775, FILED 10-3-2006.

LINDA MICKLEBURGH, EXAMINING ATTORNEY

Int. Cl.: 25

Prior U.S. Cls.: 22 and 39

United States Patent and Trademark Office

Reg. No. 3,396,980

Registered Mar. 18, 2008

**TRADEMARK
PRINCIPAL REGISTER**

[el ei eks]

SHIZUKA MATSUMORI (JAPAN INDIVIDUAL)
553-2-805, URAYASUMINAMI-CHO
OKAYAMA-SHI, JAPAN

THE MARK CONSISTS OF STANDARD CHAR-
ACTERS WITHOUT CLAIM TO ANY PARTICULAR
FONT, STYLE, SIZE, OR COLOR.

FOR: SHIRTS, POLO SHIRTS, T-SHIRTS, BLOU-
SES, JACKETS, PANTS, SKIRTS, DRESSES, HATS,
CAPS AND SHOES, IN CLASS 25 (U.S. CLS. 22 AND
39).

SER. NO. 77-013,032, FILED 10-3-2006.

FIRST USE 5-1-2006; IN COMMERCE 5-1-2006.

CYNTHIA SLOAN, EXAMINING ATTORNEY

Int. Cls.: 16, 41, 42, 43, 44 and 45

Prior U.S. Cls.: 2, 5, 22, 23, 29, 37, 38, 50, 100, 101 and 107

Reg. No. 3,396,981

United States Patent and Trademark Office

Registered Mar. 18, 2008

**TRADEMARK
SERVICE MARK
PRINCIPAL REGISTER**



HELP • HEALING • HOPE

FATHER FLANAGAN'S BOYS' HOME (NEBRASKA CORPORATION)
14100 CRAWFORD STREET
BOYS TOWN, NE 68010

FOR: NEWSLETTERS IN THE FOLLOWING FIELDS: EDUCATIONAL SERVICES, NAMELY, GENERAL CLASSROOM INSTRUCTION FOR BOYS AT THE PRIMARY AND SECONDARY LEVELS, VOCATIONAL INSTRUCTION FOR BOYS, AND INSTRUCTION FOR EDUCATORS, SOCIAL WORKERS AND THE LIKE CONCERNING JUVENILE CARE AND DEVELOPMENT AND JUVENILE CUSTODIAL CARE SERVICES, NAMELY, PROVIDING A HOME FOR HOMELESS, ABANDONED BOYS, RESEARCH SERVICES PERFORMED TO THE ORDER OF OTHERS CONCERNING JUVENILE LIFE PROBLEMS AND COMMUNICATION DISORDERS, AND DEVELOPMENT OF JUVENILE CARE AND EDUCATIONAL PROGRAMS FOR USE BY OTHERS, IN CLASS 16 (U.S. CLS. 2, 5, 22, 23, 29, 37, 38 AND 50).

FIRST USE 8-0-2000; IN COMMERCE 8-0-2000.

FOR: EDUCATIONAL RESEARCH FOR OTHERS CONCERNING TEACHING CHILDREN WITH SOCIAL AND COMMUNICATION DISORDERS; EDUCATIONAL SERVICES, NAMELY, CONDUCTING WORKSHOPS, CONFERENCES, SEMINARS OR CLASSES IN THE FIELDS OF SOCIAL BEHAVIOR, JUVENILE CARE, TEACHING AND PARENTING; CONDUCTING GENERAL CLASSROOM INSTRU-

TION FOR BOYS AND GIRLS AT THE PRIMARY AND SECONDARY LEVELS; RESEARCH, INFORMATION AND CONSULTATION SERVICES IN THE FIELD OF TEACHING; DEVELOPMENT OF EDUCATIONAL PROGRAMS FOR USE BY OTHERS IN THE FIELDS OF SOCIAL BEHAVIOR, JUVENILE CARE, PARENTING AND TEACHING CHILDREN WITH SOCIAL AND COMMUNICATION DISORDERS, IN CLASS 41 (U.S. CLS. 100, 101 AND 107).

FIRST USE 8-0-2000; IN COMMERCE 8-0-2000.

FOR: MEDICAL AND PSYCHOLOGICAL RESEARCH FOR OTHERS CONCERNING JUVENILES WITH SOCIAL AND COMMUNICATION DISORDERS; RESEARCH IN THE FIELD OF SOCIAL BEHAVIOR AND JUVENILE CARE, NAMELY, HEALTH CARE AND PARENTING, IN CLASS 42 (U.S. CLS. 100 AND 101).

FIRST USE 8-0-2000; IN COMMERCE 8-0-2000.

FOR: CHILD CARE SERVICES; JUVENILE CUSTODIAL CARE SERVICES, NAMELY, PROVIDING EMERGENCY SHELTER SERVICES IN THE NATURE OF TEMPORARY HOUSING; DEVELOPMENT OF JUVENILE CARE PROGRAMS FOR OTHERS, IN CLASS 43 (U.S. CLS. 100 AND 101).

FIRST USE 8-0-2000; IN COMMERCE 8-0-2000.

FOR: PSYCHOLOGICAL COUNSELING SERVICES, NAMELY, BEHAVIORAL TREATMENT SER-

VICES FOR YOUTH; INFORMATION AND CONSULTATION SERVICES IN THE FIELDS OF SOCIAL BEHAVIOR AND JUVENILE CARE, NAMELY, HEALTH CARE AND FAMILY COUNSELING; YOUTH AND FAMILY PSYCHOLOGICAL COUNSELING SERVICES, IN CLASS 44 (U.S. CLS. 100 AND 101).

FIRST USE 8-0-2000; IN COMMERCE 8-0-2000.

FOR: FOSTER CARE SERVICES, NAMELY, PROVIDING HOMES FOR CHILDREN, IN CLASS 45 (U.S. CLS. 100 AND 101).

FIRST USE 8-0-2000; IN COMMERCE 8-0-2000.

OWNER OF U.S. REG. NOS. 1,075,701, 1,334,772 AND OTHERS.

"THE NAME(S), PORTRAIT(S), AND/OR SIGNATURE(S) SHOWN IN THE MARK DOES NOT IDENTIFY A PARTICULAR LIVING INDIVIDUAL".

SEC. 2(F) AS TO "BOYS AND GIRLS".

SER. NO. 77-014,448, FILED 10-5-2006.

JULIE WATSON, EXAMINING ATTORNEY

Int. Cl.: 38

Prior U.S. Cls.: 100, 101 and 104

United States Patent and Trademark Office

Reg. No. 3,396,982

Registered Mar. 18, 2008

**SERVICE MARK
PRINCIPAL REGISTER**

KFAX

SALEM COMMUNICATIONS HOLDING COR-
PORATION (CALIFORNIA CORPORATION)
4880 SANTA ROSA ROAD
CAMARILLO, CA 93012

FOR: RADIO BROADCASTING, IN CLASS 38 (U.S.
CLS. 100, 101 AND 104).

FIRST USE 12-31-1959; IN COMMERCE 12-31-1959.

THE MARK CONSISTS OF STANDARD CHAR-
ACTERS WITHOUT CLAIM TO ANY PARTICULAR
FONT, STYLE, SIZE, OR COLOR.

SER. NO. 77-014,602, FILED 10-5-2006.

VIVIAN MICZNIK FIRST, EXAMINING ATTOR-
NEY

Int. Cl.: 41

Prior U.S. Cls.: 100, 101 and 107

United States Patent and Trademark Office

Reg. No. 3,396,983

Registered Mar. 18, 2008

**SERVICE MARK
PRINCIPAL REGISTER**

**"WE BUILD LEADERS, ONE
BLACKBELT AT A TIME."**

AUTHENTIC MARTIAL ARTS INTERNATIONAL, INC. (FLORIDA CORPORATION)
780 N. MISSOURI AVENUE
LARGO, FL 33770

FOR: MARTIAL ARTS INSTRUCTIONS, MARTIAL ARTS TRAINING SERVICES, EDUCATIONAL SERVICES, NAMELY, CONDUCTING CLASSES, SEMINARS AND CONFERENCES IN THE FIELD OF MARTIAL ARTS AND PERSONAL DEVELOPMENT AREAS SUCH AS DISCIPLINE, COURTESY, BEHAVIOR AND SELF CONFIDENCE, CONSULTING SERVICES IN THE FIELD OF MARTIAL ARTS TRAINING AND INSTRUCTION, ENTERTAINMENT SERVICES IN THE NATURE OF MARTIAL ARTS TOURNAMENTS AND MARTIAL ARTS CONTESTS SERVICES, HOSTING AND OPERATING MARTIAL ARTS TOURNAMENTS AND MARTIAL ARTS CONTESTS IN THE NATURE OF THE ARRANGING OF THE TOURNAMENTS AND CON-

TESTS AND OFFICIATING AT THE TOURNAMENTS AND CONTESTS, MARTIAL ARTS SUMMER CAMPS, SUMMER CAMPS; WEAPONS TRAINING SERVICES, INSTRUCTIONAL SERVICES IN THE FIELD OF MARTIAL ARTS; TRAINING SERVICES FOR MARTIAL ARTS INSTRUCTORS AND OPERATING OF MARTIAL ARTS SCHOOLS, IN CLASS 41 (U.S. CLS. 100, 101 AND 107).

FIRST USE 1-1-2003; IN COMMERCE 1-1-2003.

THE MARK CONSISTS OF STANDARD CHARACTERS WITHOUT CLAIM TO ANY PARTICULAR FONT, STYLE, SIZE, OR COLOR.

SER. NO. 77-014,777, FILED 10-5-2006.

LYDIA BELZER, EXAMINING ATTORNEY

Int. Cl.: 38

Prior U.S. Cls.: 100, 101 and 104

United States Patent and Trademark Office

Reg. No. 3,396,984

Registered Mar. 18, 2008

**SERVICE MARK
PRINCIPAL REGISTER**

KFIS

SALEM COMMUNICATIONS HOLDING COR-
PORATION (DELAWARE CORPORATION)
4880 SANTA ROSA ROAD
CAMARILLO, CA 93012

FOR: RADIO BROADCASTING, IN CLASS 38 (U.S.
CLS. 100, 101 AND 104).

FIRST USE 9-1-2001; IN COMMERCE 9-1-2001.

THE MARK CONSISTS OF STANDARD CHAR-
ACTERS WITHOUT CLAIM TO ANY PARTICULAR
FONT, STYLE, SIZE, OR COLOR.

SER. NO. 77-015,099, FILED 10-5-2006.

VIVIAN MICZNIK FIRST, EXAMINING ATTOR-
NEY

Int. Cl.: 35

Prior U.S. Cls.: 100, 101 and 102

United States Patent and Trademark Office

Reg. No. 3,396,985

Registered Mar. 18, 2008

**SERVICE MARK
PRINCIPAL REGISTER**



CONSUMERS UNION OF UNITED STATES, INC.
(NEW YORK NOT-FOR-PROFIT CORPORATION)

101 TRUMAN AVENUE
YONKERS, NY 107031057

FOR: LOBBYING SERVICES, NAMELY, PROMOTING THE INTERESTS OF CONSUMERS IN THE UNITED STATES AS WELL AS ALIGNED INTERESTS OF BUSINESS, NON-PROFITS AND AGENCIES, IN THE FIELDS OF LEGISLATION AND REGULATION, IN CLASS 35 (U.S. CLS. 100, 101 AND 102).

FIRST USE 12-31-2006; IN COMMERCE 12-31-2006.

OWNER OF U.S. REG. NO. 1,901,715.

NO CLAIM IS MADE TO THE EXCLUSIVE RIGHT TO USE "ACTION FUND, INC.", APART FROM THE MARK AS SHOWN.

SEC. 2(F) AS TO "CONSUMERS UNION".

SER. NO. 77-015,557, FILED 10-6-2006.

LYDIA BELZER, EXAMINING ATTORNEY

Int. Cl.: 5

Prior U.S. Cls.: 6, 18, 44, 46, 51 and 52

United States Patent and Trademark Office

Reg. No. 3,396,986

Registered Mar. 18, 2008

**TRADEMARK
PRINCIPAL REGISTER**

Advanced Holistics

PURE ESSENCE LABS (NEVADA CORPORATION)
6155 S SANDHILL RD SUITE 200
LAS VEGAS, NV 89120

FOR: DIETARY AND NUTRITIONAL SUPPLEMENTS, IN CLASS 5 (U.S. CLS. 6, 18, 44, 46, 51 AND 52).

FIRST USE 7-26-2004; IN COMMERCE 7-26-2004.

THE MARK CONSISTS OF STANDARD CHARACTERS WITHOUT CLAIM TO ANY PARTICULAR FONT, STYLE, SIZE, OR COLOR.

NO CLAIM IS MADE TO THE EXCLUSIVE RIGHT TO USE "HOLISTICS", APART FROM THE MARK AS SHOWN.

SER. NO. 77-015,800, FILED 10-6-2006.

ELIZABETH HUGHITT, EXAMINING ATTORNEY

Int. Cl.: 38

Prior U.S. Cls.: 100, 101 and 104

United States Patent and Trademark Office

Reg. No. 3,396,987

Registered Mar. 18, 2008

**SERVICE MARK
PRINCIPAL REGISTER**

KKFS

SALEM COMMUNICATIONS HOLDING COR-
PORATION (DELAWARE CORPORATION)
4880 SANTA ROSA ROAD
CAMARILLO, CA 93012

FOR: RADIO BROADCASTING, IN CLASS 38 (U.S.
CLS. 100, 101 AND 104).

FIRST USE 5-14-2001; IN COMMERCE 5-14-2001.

THE MARK CONSISTS OF STANDARD CHAR-
ACTERS WITHOUT CLAIM TO ANY PARTICULAR
FONT, STYLE, SIZE, OR COLOR.

SER. NO. 77-015,804, FILED 10-6-2006.

VIVIAN MICZNIK FIRST, EXAMINING ATTOR-
NEY

Int. Cl.: 33

Prior U.S. Cls.: 47 and 49

United States Patent and Trademark Office

Reg. No. 3,396,988

Registered Mar. 18, 2008

TRADEMARK
PRINCIPAL REGISTER

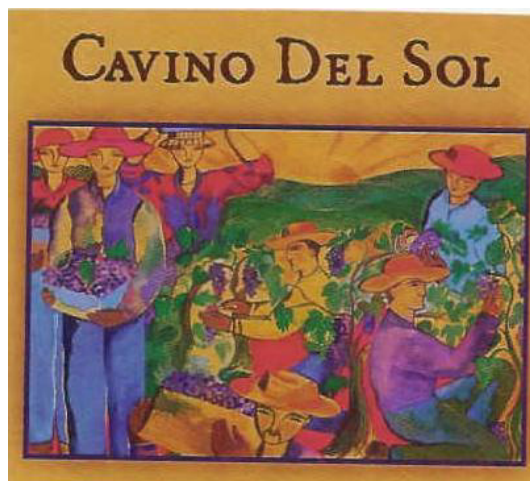

RIO VISTA WINE & SPIRITS, LLC (CALIFORNIA
LTD LIAB CO)
5055 GORDON VALLEY ROAD
FAIRFIELD, CA 94534

FOR: WINE PRODUCTS, NAMELY, SANGRIA, IN
CLASS 33 (U.S. CLS. 47 AND 49).

FIRST USE 2-16-2006; IN COMMERCE 2-16-2006.

THE COLOR(S) BLUE, RED, ORANGE, PURPLE,
BROWN, GREEN AND YELLOW IS/ARE CLAIMED
AS A FEATURE OF THE MARK.

THE MARK CONSISTS OF SEVEN GRAPE PICK-
ERS WEARING BLUE PANTS, THREE WITH RED

HATS AND FOUR WITH ORANGE HATS, PURPLE,
RED AND BLUE SHIRTS, PICKING PURPLE
GRAPES AND/OR HOLDING PURPLE GRAPES
CONTAINED IN A BROWN GRAPE BIN IN A
GREEN VINEYARD IN FRONT OF A YELLOW
SUN AND SKY. THE LETTERS "CAVINO DEL SOL"
AND THE RECTANGULAR BORDER APPEAR IN
BROWN. THE COLOR YELLOW APPEARS IN THE
BACKGROUND.

THE FOREIGN WORDING IN THE MARK
TRANSLATES INTO ENGLISH AS EXTRACTION
OF THE SUN.

SER. NO. 77-016,020, FILED 10-6-2006.

ROBERT STRUCK, EXAMINING ATTORNEY

Int. Cl.: 16

Prior U.S. Cls.: 2, 5, 22, 23, 29, 37, 38 and 50

Reg. No. 3,396,989

United States Patent and Trademark Office

Registered Mar. 18, 2008

**TRADEMARK
PRINCIPAL REGISTER**

ENP

ENPAPER MFG. CO., LTD. (REPUBLIC OF KOREA CORPORATION)
150 NUEUP-DONG, OSAN-SI
GYEONGGI-DO, REPUBLIC OF KOREA

FOR: CORRUGATED CARDBOARDS; PAPER FOR RECORDING MACHINES; ACID-RESISTANT PAPER; NAPKIN PAPER; STATIONERY STENCILS; RICE PAPER; EKG PAPER; LUMINOUS PAPER; WATERPROOF PAPER; OILPROOF PAPER; FIRE-PROOF PAPER; WHITE PAPERBOARD; DUPLICATING PAPER; CARDBOARD MADE FROM PAPER MULBERRY; CELLOPHANE PAPER; NEWSPRINT PAPER; ELECTROCARDIOGRAPH PAPER; ANPEE PAPER (WIKSTROEMIA SIKOKIANA PAPER); WET RECORDING PAPER FOR FISH DETECTOR, NAMELY, PAPER FOR RECORDING MACHINES; FILTER PAPER; PARAFFINED PAPER; OILED PAPER NOT FOR MEDICAL PURPOSES; PRINTING PAPER; HEAT TRANSFER PAPER; HANDKERCHIEFS OF PAPER; TOWELS OF PAPER; FACE TOWELS OF PAPER; CARBON PAPER; PAPER FILTERS FOR COFFEE MAKERS; BLANK PAPER TAPES AND CARDS FOR THE RECORDAL OF COMPUTER PROGRAMS; TYPEWRITING PAPER;

PAPERBOARD; FACSIMILE TRANSMISSION PAPER; POSTCARD PAPER; PACKING PAPER; MILLBOARD; WRITING AND DRAWING PAPER; XUAN PAPER FOR CHINESE PAINTING AND CALLIGRAPHY, NAMELY, ART PAPER; PAPIER MACHE; TOILET PAPER; COSMETIC REMOVING PAPER; TOILET TISSUE; PARCHMENT PAPER; STRAWBOARD, NAMELY CARDBOARD MADE OF STRAW PULP, IN CLASS 16 (U.S. CLS. 2, 5, 22, 23, 29, 37, 38 AND 50).

THE MARK CONSISTS OF STANDARD CHARACTERS WITHOUT CLAIM TO ANY PARTICULAR FONT, STYLE, SIZE, OR COLOR.

PRIORITY CLAIMED UNDER SEC. 44(D) ON REPUBLIC OF KOREA APPLICATION NO. 2006-45493, FILED 9-5-2006, REG. NO. 0716438, DATED 7-9-2007, EXPIRES 7-9-2017.

SER. NO. 77-016,830, FILED 10-9-2006.

JOHN DWYER, EXAMINING ATTORNEY

Int. Cl.: 35

Prior U.S. Cls.: 100, 101 and 102

United States Patent and Trademark Office

Reg. No. 3,396,990

Registered Mar. 18, 2008

**SERVICE MARK
PRINCIPAL REGISTER**



BLUE LINE MEDIA, INC. (VIRGINIA CORPORATION)
PO BOX 17132
ARLINGTON, VA 22216

FOR: PREPARING AND PLACING ADVERTISEMENTS FOR OTHERS; ADVERTISING AND MARKETING SERVICES TO ASSOCIATIONS, MANUFACTURERS AND SERVICE PROVIDERS IN THE FIELDS OF LAW ENFORCEMENT, POLICE, PUBLIC SAFETY, SHERIFF, CORRECTIONS, AND PHYSICAL SECURITY, IN CLASS 35 (U.S. CLS. 100, 101 AND 102).

FIRST USE 9-0-1998; IN COMMERCE 9-0-2001.

NO CLAIM IS MADE TO THE EXCLUSIVE RIGHT TO USE "MARKETING", APART FROM THE MARK AS SHOWN.

THE MARK CONSISTS OF A SHIELD WITH THREE FIVE-POINT STARS POSITIONED AT A SLIGHT ANGLE TO THE RIGHT AT THE TOP OF THE SHIELD AND A LIGHT COLOR LOCATED TO THE LEFT AND RIGHT AND BOTTOM OF THE SHIELD, THE MIDDLE SECTION OF THE SHIELD IS DARK COLORED AND INCLUDES A PARTIAL CRISSCROSS THAT OVERLAPS THE LIGHT COLOR; THE WORDING "MARKETING" IS IN A RECTANGLE CARRIER ABOVE THE SHIELD AND THE SHIELD AND THE RECTANGLE IS SITUATED ABOVE A CIRCULAR DESIGN THAT INCLUDES A PARTIAL FIVE POINT STAR AND THE WORDING "BLUE LINE" ALONG THE TOP PERIMETER OF THE CIRCLE.

SER. NO. 77-017,813, FILED 10-10-2006.

NAKIA HENRY, EXAMINING ATTORNEY

Int. Cl.: 3

Prior U.S. Cls.: 1, 4, 6, 50, 51 and 52

United States Patent and Trademark Office

Reg. No. 3,396,991

Registered Mar. 18, 2008

**TRADEMARK
PRINCIPAL REGISTER**

OLIVEOLOGY

BELLO, ANDREW, JR. (UNITED STATES INDIVIDUAL)
APT 24D
530 EAST 76TH STREET
NEW YORK, NY 10021

FOR: BATH OIL; BODY OIL; FACE AND BODY LOTIONS; HAIR CONDITIONERS; HAND SOAPS; SHAMPOOS; SHAVING PREPARATIONS; SKIN MOISTURIZER , IN CLASS 3 (U.S. CLS. 1, 4, 6, 50, 51 AND 52).

FIRST USE 6-1-2006; IN COMMERCE 7-1-2006.

THE MARK CONSISTS OF STANDARD CHARACTERS WITHOUT CLAIM TO ANY PARTICULAR FONT, STYLE, SIZE, OR COLOR.

SER. NO. 77-018,510, FILED 10-11-2006.

NAKIA HENRY, EXAMINING ATTORNEY

Int. Cls.: 9, 36 and 41

Prior U.S. Cls.: 21, 23, 26, 36, 38, 100, 101, 102 and 107

United States Patent and Trademark Office

Reg. No. 3,396,992

Registered Mar. 18, 2008

**TRADEMARK
SERVICE MARK
PRINCIPAL REGISTER**



MCDOWELL, CHARLES W., III (UNITED STATES INDIVIDUAL)
9635 VENTANA WAY, SUITE 203
ALPHARETTA, VA 30022

FOR: DIGITAL MEDIA IN THE FIELD OF PERSONAL FINANCIAL ENGINEERING AND FINANCIAL ADVICE, TECHNIQUES AND EXERCISES, NAMELY, CD-ROMS, DVDS, DOWNLOADABLE MEDIA, AND PRE-RECORDED AUDIO CDS, IN CLASS 9 (U.S. CLS. 21, 23, 26, 36 AND 38).

FIRST USE 5-0-2002; IN COMMERCE 5-0-2002.

FOR: FINANCIAL SERVICES, NAMELY, PERSONAL FINANCIAL ENGINEERING AND ADVISORY SERVICES; PROVIDING INFORMATION IN THE FIELD OF PERSONAL FINANCIAL ENGINEERING AND FINANCIAL ADVICE, TECHNIQUES AND EXERCISES, ALL VIA THE INTERNET, IN CLASS 36 (U.S. CLS. 100, 101 AND 102).

FIRST USE 5-12-2000; IN COMMERCE 5-12-2000.

FOR: EDUCATIONAL SERVICES, NAMELY, CONDUCTING PROGRAMS IN THE FIELD OF PERSONAL FINANCIAL ENGINEERING AND FINANCIAL ADVICE, TECHNIQUES AND EXERCISES, IN CLASS 41 (U.S. CLS. 100, 101 AND 107).

FIRST USE 5-0-2001; IN COMMERCE 5-0-2001.

OWNER OF U.S. REG. NO. 2,535,957.

NO CLAIM IS MADE TO THE EXCLUSIVE RIGHT TO USE "FINANCIAL", APART FROM THE MARK AS SHOWN.

THE MARK CONSISTS OF THE STYLIZED WORDING THE FINANCIAL INTELLIGENCE EXPERIENCE AND THE DESIGN ABOVE THE WORD EXPERIENCE OF A CIRCLE SHOWING A PORTION OF A TWENTY-DOLLAR BILL.

SER. NO. 77-018,597, FILED 10-11-2006.

DAVID TOOLEY, EXAMINING ATTORNEY

Int. Cl.: 41

Prior U.S. Cls.: 100, 101 and 107

United States Patent and Trademark Office

Reg. No. 3,396,993

Registered Mar. 18, 2008

**SERVICE MARK
PRINCIPAL REGISTER**

**YOUR HEALTH. YOUR LIFE.
YOUR CLUB.**

WEST COAST ATHLETIC CLUBS, INC. (CALI-
FORNIA CORPORATION)
115 W. CANON PERDIDO
SANTA BARBARA, CA 93101

FOR: HEALTH CLUB SERVICES, NAMELY, PRO-
VIDING INSTRUCTION AND EQUIPMENT IN THE
FIELD OF PHYSICAL EXERCISE, IN CLASS 41 (U.S.
CLS. 100, 101 AND 107).

FIRST USE 10-6-2006; IN COMMERCE 10-6-2006.

THE MARK CONSISTS OF STANDARD CHAR-
ACTERS WITHOUT CLAIM TO ANY PARTICULAR
FONT, STYLE, SIZE, OR COLOR.

SER. NO. 77-019,661, FILED 10-12-2006.

GIANCARLO CASTRO, EXAMINING ATTORNEY

Int. Cl.: 35

Prior U.S. Cls.: 100, 101 and 102

United States Patent and Trademark Office

Reg. No. 3,396,994

Registered Mar. 18, 2008

**SERVICE MARK
PRINCIPAL REGISTER**

 **MULTIPARTNER**

MULTIPARTNER S.P.A. (ITALY CORPORATION)
PIAZZA BARBERINI, 45
ROME, ITALY 00187

FOR: PROVIDING OFFICE FUNCTIONS; AD-
VERTISING; BUSINESS MANAGEMENT; BUSI-
NESS ADMINISTRATION, IN CLASS 35 (U.S. CLS.
100, 101 AND 102).

OWNER OF ERPN CMNTY TM OFC REG. NO.
004390043, DATED 3-6-2006, EXPIRES 4-14-2015.

THE MARK CONSISTS OF THE WORD MULTI-
PARTNER STYLIZED AND NINE DOTS FORMING
A SQUARE IN FRONT OF THE WORD WITH AND
ARCH IN FRONT AND OVER THE DOTS CON-
NECTING TO THE M.

SER. NO. 77-020,054, FILED 10-12-2006.

JESSICA FATHY, EXAMINING ATTORNEY

Int. Cl.: 35

Prior U.S. Cls.: 100, 101 and 102

United States Patent and Trademark Office

Reg. No. 3,396,995

Registered Mar. 18, 2008

**SERVICE MARK
PRINCIPAL REGISTER**

OneCart

SHOP.COM (CALIFORNIA CORPORATION)
1 LOWER RAGSDALE, BLDG 1, SUITE 210
MONTEREY, CA 93940

FOR: COMPUTERIZED ONLINE RETAIL STORE
SERVICE FEATURING A WIDE VARIETY OF CON-
SUMER GOODS OF OTHERS AND FEATURING
SINGLE CHECK OUT PROCESS AMONG MULTI-
PLE MERCHANTS SELLING A WIDE VARIETY OF
PRODUCTS, IN CLASS 35 (U.S. CLS. 100, 101 AND
102).

FIRST USE 12-10-2002; IN COMMERCE 8-7-2006.

THE MARK CONSISTS OF STANDARD CHAR-
ACTERS WITHOUT CLAIM TO ANY PARTICULAR
FONT, STYLE, SIZE, OR COLOR.

SEC. 2(F).

SER. NO. 77-020,811, FILED 10-13-2006.

TASNEEM HUSSAIN, EXAMINING ATTORNEY

Int. Cls.: 9 and 18

Prior U.S. Cls.: 1, 2, 3, 21, 22, 23, 26, 36, 38 and 41

United States Patent and Trademark Office

Reg. No. 3,396,996

Registered Mar. 18, 2008

**TRADEMARK
PRINCIPAL REGISTER**



PROJETCLUB (FRANCE SOCIETE ANONYME)
4, BOULEVARD DE MONS
VILLENEUVE D'ASCQ, FRANCE 59650

OWNER OF FRANCE REG. NO. 063423553, DA-
TED 4-14-2006, EXPIRES 4-13-2016.

FOR: PROTECTIVE MASKS; PROTECTIVE HEL-
METS; SPECTACLES, IN CLASS 9 (U.S. CLS. 21, 23,
26, 36 AND 38).

THE MARK CONSISTS OF A STYLIZED VER-
SION OF WED'ZE.

FOR: BACKPACKS; HANDBAGS; WHEELED
BAGS; BAGS FOR CLIMBERS; SPORTS BAGS FOR
CAMPERS; TRAVELLING BAGS; TRUNKS; SUIT-
CASES, IN CLASS 18 (U.S. CLS. 1, 2, 3, 22 AND 41).

SER. NO. 77-021,231, FILED 10-13-2006.

CARYN GLASSER, EXAMINING ATTORNEY

Int. Cl.: 39

Prior U.S. Cls.: 100 and 105

United States Patent and Trademark Office

Reg. No. 3,396,997

Registered Mar. 18, 2008

**SERVICE MARK
PRINCIPAL REGISTER**



CELEBRITY JET CHARTER, LLC (PENNSYLVANIA LTD LIAB CO)
2521 YELLOW SPRINGS ROAD
MALVERN, PA 19355

FOR: TRANSPORTATION SERVICES, NAMELY, CHARTERING JET AIRCRAFT, IN CLASS 39 (U.S. CLS. 100 AND 105).

FIRST USE 8-4-2005; IN COMMERCE 9-1-2006.

NO CLAIM IS MADE TO THE EXCLUSIVE RIGHT TO USE "JET CHARTER", APART FROM THE MARK AS SHOWN.

THE COLOR(S) BLUE, LIGHT BLUE, BLACK AND WHITE IS/ARE CLAIMED AS A FEATURE OF THE MARK.

THE MARK CONSISTS OF BLUE STAR WITH TWO ARCED BLUE AND LIGHT BLUE LINES; STYLIZED LETTERS OR WORDS UNDERLINED AND/OR OVERLINED BY ONE OR MORE STROKES OR LINES; OVERLINED WORDS OR LETTERS; UNDERLINED WORDS OR LETTERS.

SER. NO. 77-022,022, FILED 10-16-2006.

LAURIE MAYES, EXAMINING ATTORNEY

Int. Cls.: 35 and 45

Prior U.S. Cls.: 100, 101 and 102

United States Patent and Trademark Office

Reg. No. 3,396,998

Registered Mar. 18, 2008

**SERVICE MARK
PRINCIPAL REGISTER**

MASCO

MEDICAL ACADEMIC AND SCIENTIFIC COMMUNITY ORGANIZATION, INC. (MASSACHUSETTS CORPORATION)

375 LONGWOOD AVENUE
BOSTON, MA 02215

FOR: PROMOTING ALTERNATIVE COMMUTING METHODS FOR COMMUNITIES, IN CLASS 35 (U.S. CLS. 100, 101 AND 102).

FIRST USE 0-0-1993; IN COMMERCE 0-0-1993.

FOR: CONSULTING REGARDING COMMUNITIES' SECURITY CONCERNS, IN CLASS 45 (U.S. CLS. 100 AND 101).

FIRST USE 0-0-1993; IN COMMERCE 0-0-1993.

THE MARK CONSISTS OF STANDARD CHARACTERS WITHOUT CLAIM TO ANY PARTICULAR FONT, STYLE, SIZE, OR COLOR.

SER. NO. 77-022,432, FILED 10-17-2006.

FRED CARL, EXAMINING ATTORNEY

Int. Cl.: 38

Prior U.S. Cls.: 100, 101 and 104

United States Patent and Trademark Office

Reg. No. 3,396,999

Registered Mar. 18, 2008

**SERVICE MARK
PRINCIPAL REGISTER**

KGU

SALEM COMMUNICATIONS HOLDING COR-
PORATION (DELAWARE CORPORATION)
4880 SANTA ROSA ROAD
CAMARILLO, CA 93012

FOR: RADIO BROADCASTING, IN CLASS 38 (U.S.
CLS. 100, 101 AND 104).

FIRST USE 5-11-1922; IN COMMERCE 5-11-1922.

THE MARK CONSISTS OF STANDARD CHAR-
ACTERS WITHOUT CLAIM TO ANY PARTICULAR
FONT, STYLE, SIZE, OR COLOR.

SER. NO. 77-022,814, FILED 10-17-2006.

VIVIAN MICZNIK FIRST, EXAMINING ATTOR-
NEY

Int. Cl.: 42

Prior U.S. Cls.: 100 and 101

United States Patent and Trademark Office

Reg. No. 3,397,000

Registered Mar. 18, 2008

**SERVICE MARK
PRINCIPAL REGISTER**



SCREEN IMAGING TECHNOLOGY, INC.
(TEXAS CORPORATION)
SUITE 1508
7322 SOUTHWEST FREEWAY
HOUSTON, TX 77074

FOR: SEISMIC IMAGING AND PROCESSING
FOR THE OIL AND GAS INDUSTRY, IN CLASS 42
(U.S. CLS. 100 AND 101).

FIRST USE 6-1-2001; IN COMMERCE 6-1-2001.

THE COLOR(S) LIGHT BLUE (TURQUOISE) AND
DARK BLUE IS/ARE CLAIMED AS A FEATURE OF
THE MARK.

THE MARK CONSISTS OF A LIGHT BLUE OPEN
SQUARE HAVING THREE CURVY LINES IN THE
SQUARE AND HAVING DARK BLUE SHADOW ON
ALL THE LINES.

SER. NO. 77-023,815, FILED 10-18-2006.

CHRISIE B. KING, EXAMINING ATTORNEY

Int. Cl.: 38

Prior U.S. Cls.: 100, 101 and 104

United States Patent and Trademark Office

Reg. No. 3,397,001

Registered Mar. 18, 2008

**SERVICE MARK
PRINCIPAL REGISTER**

KKLA

SALEM COMMUNICATIONS HOLDING COR-
PORATION (DELAWARE CORPORATION)
4880 SANTA ROSA ROAD
CAMARILLO, CA 93012

FOR: RADIO BROADCASTING, IN CLASS 38 (U.S.
CLS. 100, 101 AND 104).

FIRST USE 10-18-1985; IN COMMERCE 10-18-1985.

THE MARK CONSISTS OF STANDARD CHAR-
ACTERS WITHOUT CLAIM TO ANY PARTICULAR
FONT, STYLE, SIZE, OR COLOR.

SER. NO. 77-023,942, FILED 10-18-2006.

VIVIAN MICZNIK FIRST, EXAMINING ATTOR-
NEY

Int. Cl.: 5

Prior U.S. Cls.: 6, 18, 44, 46, 51 and 52

Reg. No. 3,397,002

United States Patent and Trademark Office

Registered Mar. 18, 2008

**TRADEMARK
PRINCIPAL REGISTER**

MULTI+ DAILY GLOW

GENUINE HEALTH INC. (CANADA CORPORATION)
SUITE 501
317 ADELAIDE STREET WEST
TORONTO, CANADA M5V1P9

FOR: VITAMIN, MINERAL AND ANTIOXIDANT
FORMULA FOR SKIN CARE IN POWDER, CAP-
SULE, TABLET OR LIQUID FORM, IN CLASS 5 (U.S.
CLS. 6, 18, 44, 46, 51 AND 52).

THE MARK CONSISTS OF STANDARD CHAR-
ACTERS WITHOUT CLAIM TO ANY PARTICULAR
FONT, STYLE, SIZE, OR COLOR.

PRIORITY CLAIMED UNDER SEC. 44(D) ON
CANADA APPLICATION NO. 1319900, FILED 10-12-
2006, REG. NO. TMA697601, DATED 10-2-2007, EX-
PIRES 10-2-2022.

NO CLAIM IS MADE TO THE EXCLUSIVE
RIGHT TO USE "DAILY", APART FROM THE
MARK AS SHOWN.

SER. NO. 77-024,093, FILED 10-18-2006.

SHANNON TWOHIG, EXAMINING ATTORNEY

Int. Cl.: 39

Prior U.S. Cls.: 100 and 105

United States Patent and Trademark Office

Reg. No. 3,397,003

Registered Mar. 18, 2008

**SERVICE MARK
PRINCIPAL REGISTER**

Encore Aviation

DERRYBERRY, DOUGLAS (UNITED STATES
INDIVIDUAL)
2210 PALOMAR AIRPORT ROAD
CARLSBAD, CA 92011

FOR: AIR TRANSPORTATION, ENCOMPASSING
FEDERAL AVIATION REGULATIONS PARTS 135
AND 91, FRACTIONAL, CLUB MEMBERSHIP AND
FIXED BASE OPERATOR(FBO), IN CLASS 39 (U.S.
CLS. 100 AND 105).

FIRST USE 7-6-2001; IN COMMERCE 7-6-2001.

THE MARK CONSISTS OF STANDARD CHAR-
ACTERS WITHOUT CLAIM TO ANY PARTICULAR
FONT, STYLE, SIZE, OR COLOR.

NO CLAIM IS MADE TO THE EXCLUSIVE
RIGHT TO USE "AVIATION", APART FROM THE
MARK AS SHOWN.

SER. NO. 77-024,167, FILED 10-18-2006.

BENJAMIN OKEKE, EXAMINING ATTORNEY

Int. Cl.: 9

Prior U.S. Cls.: 21, 23, 26, 36 and 38

Reg. No. 3,397,004

United States Patent and Trademark Office

Registered Mar. 18, 2008

**TRADEMARK
PRINCIPAL REGISTER**

TAP TAP

ROYAL SOUNDS ANCA PRODUCTIONS (WA-
SHINGTON PARTNERSHIP)
8309 14TH AVE E
TACOMA, WA 98404

FOR: MUSICAL VIDEO RECORDINGS; A SERIES
OF PRE-RECORDED PHONOGRAPH RECORDS,
COMPACT DISCS, AUDIO TAPES, AUDIO-VIDEO
CASSETTE TAPES AND AUDIO-VIDEO COMPACT
DISCS, ALL FEATURING MUSIC, IN CLASS 9 (U.S.
CLS. 21, 23, 26, 36 AND 38).

FIRST USE 1-1-2005; IN COMMERCE 1-1-2005.

THE MARK CONSISTS OF STANDARD CHAR-
ACTERS WITHOUT CLAIM TO ANY PARTICULAR
FONT, STYLE, SIZE, OR COLOR.

SER. NO. 77-024,456, FILED 10-18-2006.

BILL DAWE, EXAMINING ATTORNEY

Int. Cl.: 35

Prior U.S. Cls.: 100, 101 and 102

United States Patent and Trademark Office

Reg. No. 3,397,005

Registered Mar. 18, 2008

**SERVICE MARK
PRINCIPAL REGISTER**

GimmeGrub

GIMMEGRUB (CALIFORNIA LTD LIAB JT ST
CO)
2671 MILTON AVE
FULLERTON, CA 92831

FOR: ON-LINE ORDERING SERVICES IN THE
FIELD OF RESTAURANT TAKE-OUT AND DELIV-
ERY, IN CLASS 35 (U.S. CLS. 100, 101 AND 102).

FIRST USE 5-1-2006; IN COMMERCE 5-1-2006.

THE MARK CONSISTS OF STANDARD CHAR-
ACTERS WITHOUT CLAIM TO ANY PARTICULAR
FONT, STYLE, SIZE, OR COLOR.

SEC. 2(F).

SER. NO. 77-024,506, FILED 10-19-2006.

JESSICA A. POWERS, EXAMINING ATTORNEY

Int. Cl.: 9

Prior U.S. Cls.: 21, 23, 26, 36 and 38

United States Patent and Trademark Office

Reg. No. 3,397,006

Registered Mar. 18, 2008

**TRADEMARK
PRINCIPAL REGISTER**

MobilityPass

SHARP ROCK TECHNOLOGIES LLC (DELA-
WARE LTD LIAB CO)
16192 COASTAL HIGHWAY
LEWES, DE 19958

THE MARK CONSISTS OF STANDARD CHAR-
ACTERS WITHOUT CLAIM TO ANY PARTICULAR
FONT, STYLE, SIZE, OR COLOR.

FOR: DOWNLOADABLE COMPUTER SOFT-
WARE FOR COMMUNICATION OVER A GLOBAL
COMPUTER NETWORK, IN CLASS 9 (U.S. CLS. 21,
23, 26, 36 AND 38).

SER. NO. 77-024,775, FILED 10-19-2006.

FIRST USE 12-13-2004; IN COMMERCE 12-13-2004.

TINA KUAN, EXAMINING ATTORNEY

Int. Cl.: 36

Prior U.S. Cls.: 100, 101 and 102

United States Patent and Trademark Office

Reg. No. 3,397,007

Registered Mar. 18, 2008

**SERVICE MARK
PRINCIPAL REGISTER**

**California Classic
Financial**

CALIFORNIA CLASSIC PROPERTIES CORP.
(CALIFORNIA CORPORATION)
SUITE 708
4887 E. LA PALMA AVENUE
ANAHEIM, CA 92807

FOR: FINANCIAL MANAGEMENT, IN CLASS 36
(U.S. CLS. 100, 101 AND 102).

FIRST USE 1-23-2005; IN COMMERCE 1-23-2005.

THE MARK CONSISTS OF STANDARD CHARACTERS WITHOUT CLAIM TO ANY PARTICULAR FONT, STYLE, SIZE, OR COLOR.

NO CLAIM IS MADE TO THE EXCLUSIVE RIGHT TO USE "CALIFORNIA" AND "FINANCIAL", APART FROM THE MARK AS SHOWN.

SER. NO. 77-024,871, FILED 10-19-2006.

ALYSSA PALADINO, EXAMINING ATTORNEY

Int. Cl.: 43

Prior U.S. Cls.: 100 and 101

United States Patent and Trademark Office

Reg. No. 3,397,008

Registered Mar. 18, 2008

**SERVICE MARK
PRINCIPAL REGISTER**

Hotel Terra

TERRA PROPERTY MANAGEMENT (WYOM-
ING LTD LIAB CO)
P.O. BOX 417
TETON VILLAGE, WY 83025

FOR: RESORT HOTELS BUT NOT INCLUDING
RESTAURANT SERVICES; HOTEL SERVICES BUT
NOT INCLUDING RESTAURANT SERVICES; HO-
TEL SERVICES FOR PREFERRED CUSTOMERS
BUT NOT INCLUDING RESTAURANT SERVICES;
MAKING HOTEL RESERVATIONS FOR OTHERS;
PROVIDING ON-LINE REVIEWS OF HOTELS; RE-
SERVATION OF HOTEL ROOMS FOR TRAVELERS,
IN CLASS 43 (U.S. CLS. 100 AND 101).

FIRST USE 5-5-2006; IN COMMERCE 6-10-2006.

THE MARK CONSISTS OF STANDARD CHAR-
ACTERS WITHOUT CLAIM TO ANY PARTICULAR
FONT, STYLE, SIZE, OR COLOR.

NO CLAIM IS MADE TO THE EXCLUSIVE
RIGHT TO USE HOTEL, APART FROM THE MARK
AS SHOWN.

SER. NO. 77-025,162, FILED 10-19-2006.

PAUL E. FAHRENKOPF, EXAMINING ATTORNEY

Int. Cl.: 14

Prior U.S. Cls.: 2, 27, 28 and 50

United States Patent and Trademark Office

Reg. No. 3,397,009

Registered Mar. 18, 2008

**TRADEMARK
PRINCIPAL REGISTER**

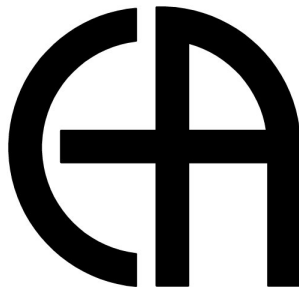

WINSTON STUART ASSOCIATES, LTD. (NEW
YORK CORPORATION)
240 TRACY DRIVE
MORGANVILLE, NJ 07751

THE MARK CONSISTS OF THE STYLIZED LET-
TERS C AND A.

FOR: JEWELRY, IN CLASS 14 (U.S. CLS. 2, 27, 28
AND 50).

SER. NO. 77-025,539, FILED 10-20-2006.

FIRST USE 5-12-2005; IN COMMERCE 5-12-2005.

HANNO RITTNER, EXAMINING ATTORNEY

Int. Cl.: 42

Prior U.S. Cls.: 100 and 101

United States Patent and Trademark Office

Reg. No. 3,397,010

Registered Mar. 18, 2008

**SERVICE MARK
PRINCIPAL REGISTER**



TAXI TECHNOLOGY CORPORATION (DELA-
WARE CORPORATION)
4TH FLOOR
25 ROCKWOOD PLACE
ENGLEWOOD, NJ 07631

FOR: DEVELOPMENT OF NEW TECHNOLOGY
FOR OTHERS IN THE FIELD OF TAXICABS AND
LIVERY VEHICLES, IN CLASS 42 (U.S. CLS. 100 AND
101).

FIRST USE 1-30-2005; IN COMMERCE 1-30-2005.

THE COLOR(S) DARK BLUE, YELLOW AND
WHITE IS/ARE CLAIMED AS A FEATURE OF
THE MARK.

THE MARK CONSISTS OF THE LETTERS "TTC"
IN BLUE SURROUNDED BY A BLUE AND WHITE
AUTOMOBILE WITH YELLOW HEADLIGHTS AND
ROOF LIGHT.

SER. NO. 77-025,874, FILED 10-20-2006.

BRIDGETT SMITH, EXAMINING ATTORNEY

Int. Cl.: 38

Prior U.S. Cls.: 100, 101 and 104

United States Patent and Trademark Office

Reg. No. 3,397,011

Registered Mar. 18, 2008

**SERVICE MARK
PRINCIPAL REGISTER**



HTC HOLDING CO. (ILLINOIS CORPORATION)
213 S. MAIN STREET
WATERLOO, IL 62298

FOR: TELECOMMUNICATIONS AND INFORMATION TECHNOLOGY SERVICES, NAMELY, TRANSMISSION OF VOICE, DATA, IMAGES, AUDIO, VIDEO AND INFORMATION VIA TELEPHONE AND GLOBAL COMMUNICATION NETWORKS AND WIRELESS DEVICES; PERSONAL COMMUNICATIONS SERVICES; ELECTRONIC MAIL SERVICES; VOICE, NUMERIC AND TEXT MESSAGING SERVICES; PROVIDING MULTIPLE-USER ACCESS TO A GLOBAL COMMUNICATIONS NETWORK, IN CLASS 38 (U.S. CLS. 100, 101 AND 104).

FIRST USE 11-0-2000; IN COMMERCE 11-0-2000.

OWNER OF U.S. REG. NOS. 2,423,143, 2,423,144, AND 2,423,147.

NO CLAIM IS MADE TO THE EXCLUSIVE RIGHT TO USE "TECHNOLOGIES", APART FROM THE MARK AS SHOWN.

THE MARK CONSISTS OF THE LETTERS HTC IN STYLIZED FORM ACCOMPANIED BY THE WORD TECHNOLOGIES.

SER. NO. 77-025,999, FILED 10-20-2006.

FRANK LATTUCA, EXAMINING ATTORNEY

Int. Cl.: 9

Prior U.S. Cls.: 21, 23, 26, 36 and 38

Reg. No. 3,397,012

United States Patent and Trademark Office

Registered Mar. 18, 2008

**TRADEMARK
PRINCIPAL REGISTER**

SIMUCAD

SIMUCAD DESIGN AUTOMATION, INC. (DELA-
WARE CORPORATION)
4701 PATRICK HENRY DRIVE, BUILDING 2
SANTA CLARA, CA 95054

FOR: HARDWARE AND SOFTWARE FOR THE
SIMULATION, DESIGN, TESTING, AND MANU-
FACTURING OF INTEGRATED CIRCUITS, SEMI-
CONDUCTORS, AND PRINTED CIRCUIT BOARDS,
IN CLASS 9 (U.S. CLS. 21, 23, 26, 36 AND 38).

FIRST USE 6-0-1984; IN COMMERCE 6-0-1984.

THE MARK CONSISTS OF STANDARD CHAR-
ACTERS WITHOUT CLAIM TO ANY PARTICULAR
FONT, STYLE, SIZE, OR COLOR.

SER. NO. 77-026,109, FILED 10-20-2006.

RAUL CORDOVA, EXAMINING ATTORNEY

Int. Cl.: 25

Prior U.S. Cls.: 22 and 39

United States Patent and Trademark Office

Reg. No. 3,397,013

Registered Mar. 18, 2008

**TRADEMARK
PRINCIPAL REGISTER**

JOHNNY'S \$

JOHNNY'S SPORTSWEAR, INC. (NORTH CAROLINA CORPORATION)
309 DOBY ROAD
MOCKSVILLE, NC 27028

FOR: APPAREL, NAMELY, T-SHIRTS, SWEATSHIRTS, JOGGING SUITS, LEATHER JACKETS, LEATHER VESTS, NIGHTSHIRTS, SWEATERS, JACKETS, SHIRTS, BANDANAS, PANTS AND SHORTS, IN CLASS 25 (U.S. CLS. 22 AND 39).

FIRST USE 10-18-1993; IN COMMERCE 10-18-1993.

OWNER OF U.S. REG. NO. 2,024,099.

"THE MARK CONSISTS OF THE STANDARD CHARACTERS, JOHNNY'S, FOLLOWED BY THE \$ SYMBOL."

SER. NO. 77-026,719, FILED 10-23-2006.

PAUL E. FAHRENKOPF, EXAMINING ATTORNEY

Int. Cl.: 25

Prior U.S. Cls.: 22 and 39

United States Patent and Trademark Office

Reg. No. 3,397,014

Registered Mar. 18, 2008

TRADEMARK
PRINCIPAL REGISTER



JOHNNY'S SPORTSWEAR, INC. (NORTH CAROLINA CORPORATION)
309 DOBY ROAD
MOCKSVILLE, NC 27028

FOR: APPAREL, NAMELY, T-SHIRTS, SWEATSHIRTS, JOGGING SUITS, LEATHER JACKETS, LEATHER VESTS, NIGHTSHIRTS, SWEATERS, JACKETS, SHIRTS, BANDANAS, PANTS AND SHORTS, IN CLASS 25 (U.S. CLS. 22 AND 39).

FIRST USE 10-18-1993; IN COMMERCE 10-18-1993.

OWNER OF U.S. REG. NO. 2,024,099.

"THE MARK CONSISTS OF A STYLIZED \$ SYMBOL OVER A FANCIFUL MULTI-POINTED BACKGROUND SHAPE HAVING A CENTRAL APEX EXTENDING AT THE TOP THEREOF AND MULTIPLE HOOKED CURVATURES EXTENDING AT OPPOSITE SIDES THEREOF, EACH WITH AN INDENTATION IN THE HOOKED CURVATURE. THE STYLIZED WORDING JOHNNY'S APPEARS BENEATH THE STYLIZED \$ SYMBOL."

SER. NO. 77-026,744, FILED 10-23-2006.

PAUL E. FAHRENKOPF, EXAMINING ATTORNEY

Int. Cl.: 38

Prior U.S. Cls.: 100, 101 and 104

United States Patent and Trademark Office

Reg. No. 3,397,015

Registered Mar. 18, 2008

**SERVICE MARK
PRINCIPAL REGISTER**

KCBQ

SALEM COMMUNICATIONS HOLDING COR-
PORATION (DELAWARE CORPORATION)
4880 SANTA ROSA ROAD
CAMARILLO, CA 93012

FOR: RADIO BROADCASTING, IN CLASS 38 (U.S.
CLS. 100, 101 AND 104).

FIRST USE 12-31-1955; IN COMMERCE 12-31-1955.

THE MARK CONSISTS OF STANDARD CHAR-
ACTERS WITHOUT CLAIM TO ANY PARTICULAR
FONT, STYLE, SIZE, OR COLOR.

SER. NO. 77-026,974, FILED 10-23-2006.

VIVIAN MICZNIK FIRST, EXAMINING ATTOR-
NEY

Int. Cl.: 41

Prior U.S. Cls.: 100, 101 and 107

United States Patent and Trademark Office

Reg. No. 3,397,016

Registered Mar. 18, 2008

**SERVICE MARK
PRINCIPAL REGISTER**

PPI

PACIFIC PENSION INSTITUTE, A PUBLIC BENEFIT CORPORATION (CALIFORNIA CORPORATION)
465 CALIFORNIA STREET, SUITE 410
SAN FRANCISCO, CA 94104

FOR: EDUCATIONAL SERVICES, NAMELY, CONDUCTING COURSES, SEMINARS, CONFERENCES AND WORKSHOPS IN THE FIELDS OF INSTITUTIONAL INVESTING AND FIDUCIARY RESPONSIBILITY, IN CLASS 41 (U.S. CLS. 100, 101 AND 107).

FIRST USE 5-0-1994; IN COMMERCE 5-0-1994.

THE MARK CONSISTS OF STANDARD CHARACTERS WITHOUT CLAIM TO ANY PARTICULAR FONT, STYLE, SIZE, OR COLOR.

SER. NO. 77-027,370, FILED 10-23-2006.

CHRISIE B. KING, EXAMINING ATTORNEY

Int. Cl.: 21

Prior U.S. Cls.: 2, 13, 23, 29, 30, 33, 40 and 50

United States Patent and Trademark Office

Reg. No. 3,397,017

Registered Mar. 18, 2008

**TRADEMARK
PRINCIPAL REGISTER**

egg baker

FULTON-MORALES, JULIA A (UNITED STATES
INDIVIDUAL)
2517 WISHBONE CT
CORPUS CHRISTI, TX 78414

FOR: EARTHENWARE FOR EGG BAKING PUR-
POSE, IN CLASS 21 (U.S. CLS. 2, 13, 23, 29, 30, 33, 40
AND 50).

FIRST USE 5-11-1979; IN COMMERCE 10-1-1980.

THE MARK CONSISTS OF STANDARD CHAR-
ACTERS WITHOUT CLAIM TO ANY PARTICULAR
FONT, STYLE, SIZE, OR COLOR.

SEC. 2(F).

SER. NO. 77-027,594, FILED 10-23-2006.

ROSELLE HERRERA, EXAMINING ATTORNEY

Int. Cl.: 9

Prior U.S. Cls.: 21, 23, 26, 36 and 38

United States Patent and Trademark Office

Reg. No. 3,397,018

Registered Mar. 18, 2008

**TRADEMARK
PRINCIPAL REGISTER**



ACS TECHNOLOGIES GROUP, INC. (SOUTH
CAROLINA CORPORATION)
P.O. BOX 202010
FLORENCE, SC 29502

FOR: COMPUTER SOFTWARE FOR USE IN
MANAGEMENT OF ADMINISTRATIVE AND FI-
NANCIAL INFORMATION OF CHURCHES,
SCHOOLS, AND NON-PROFIT ORGANIZATIONS,
IN CLASS 9 (U.S. CLS. 21, 23, 26, 36 AND 38).

FIRST USE 7-0-2005; IN COMMERCE 7-0-2005.

OWNER OF U.S. REG. NOS. 3,167,224 AND
3,209,943.

NO CLAIM IS MADE TO THE EXCLUSIVE
RIGHT TO USE "DATA SYSTEM", APART FROM
THE MARK AS SHOWN.

SEC. 2(F) AS TO "PARISH DATA SYSTEM".

SER. NO. 77-027,777, FILED 10-24-2006.

MORGAN WYNNE, EXAMINING ATTORNEY

Int. Cl.: 16

Prior U.S. Cls.: 2, 5, 22, 23, 29, 37, 38 and 50

United States Patent and Trademark Office

Reg. No. 3,397,019

Registered Mar. 18, 2008

**TRADEMARK
PRINCIPAL REGISTER**

**DIALOGUES IN CLINICAL
PRACTICE**

MESG LLC (MARYLAND LTD LIAB CO)
5523 RESEARCH PARK DRIVE
SUITE 220
BALTIMORE, MD 21228

FOR: WRITTEN ARTICLES AND NEWSLETTERS
IN THE FIELD OF MEDICAL PRACTICE, IN CLASS
16 (U.S. CLS. 2, 5, 22, 23, 29, 37, 38 AND 50).

FIRST USE 6-30-2006; IN COMMERCE 6-30-2006.

THE MARK CONSISTS OF STANDARD CHAR-
ACTERS WITHOUT CLAIM TO ANY PARTICULAR
FONT, STYLE, SIZE, OR COLOR.

NO CLAIM IS MADE TO THE EXCLUSIVE
RIGHT TO USE "CLINICAL PRACTICE", APART
FROM THE MARK AS SHOWN.

SER. NO. 77-027,823, FILED 10-24-2006.

GINA HAYES, EXAMINING ATTORNEY

Int. Cl.: 43

Prior U.S. Cls.: 100 and 101

United States Patent and Trademark Office

Reg. No. 3,397,020

Registered Mar. 18, 2008

SERVICE MARK
PRINCIPAL REGISTER



ROMUALDO LAMBERTI (UNITED STATES IN-
DIVIDUAL)
6 REAR GROVE STREET
CHERRY HILL, NJ 08002

THE FOREIGN WORD TRATTORIA IN THE
MARK TRANSLATES INTO ENGLISH AS RESTAU-
RANT.

FOR: RESTAURANT SERVICES, IN CLASS 43
(U.S. CLS. 100 AND 101).

SEC. 2(F) AS TO "PASTAVINO".

FIRST USE 10-3-1994; IN COMMERCE 10-3-1994.

SER. NO. 77-027,989, FILED 10-24-2006.

NO CLAIM IS MADE TO THE EXCLUSIVE
RIGHT TO USE "TRATTORIA" , APART FROM
THE MARK AS SHOWN.

G. MAYERSCHOFF, EXAMINING ATTORNEY

Int. Cl.: 9

Prior U.S. Cls.: 21, 23, 26, 36 and 38

United States Patent and Trademark Office

Reg. No. 3,397,021

Registered Mar. 18, 2008

**TRADEMARK
PRINCIPAL REGISTER**

APTIXIA

IXIA (CALIFORNIA CORPORATION)
26601 W. AGOURA RD.
CALABASAS, CA 91302

FIRST USE 5-1-2006; IN COMMERCE 5-1-2006.

FOR: COMPUTER SOFTWARE FOR USE IN GENERATING TRAFFIC ACROSS COMMUNICATIONS EQUIPMENT AND NETWORKS; COMPUTER SOFTWARE FOR USE IN TESTING, MONITORING, DIAGNOSING, ANALYZING, AND TROUBLESHOOTING COMPUTER AND EQUIPMENT NETWORK PERFORMANCE, IN CLASS 9 (U.S. CLS. 21, 23, 26, 36 AND 38).

THE MARK CONSISTS OF STANDARD CHARACTERS WITHOUT CLAIM TO ANY PARTICULAR FONT, STYLE, SIZE, OR COLOR.

SER. NO. 77-028,295, FILED 10-24-2006.

KATHRYN COWARD, EXAMINING ATTORNEY

Int. Cls.: 37 and 42

Prior U.S. Cls.: 100, 101, 103 and 106

United States Patent and Trademark Office

Reg. No. 3,397,022

Registered Mar. 18, 2008

**SERVICE MARK
PRINCIPAL REGISTER**



MASTERBUILDER FELLOWSHIP
for
THE BUILT ENVIRONMENT
INCORPORATED

MASTERBUILDER FELLOWSHIP FOR THE
BUILT ENVIRONMENT, INCORPORATED
(NORTH CAROLINA CORPORATION)

433 MAIN STREET
MATTHEWS, NC 28105

FOR: CONSTRUCTION AND RENOVATION OF
RESIDENTIAL AND COMMERCIAL BUILDINGS
AND LANDSCAPES; PLANNING AND LAYING
OUT OF RESIDENTIAL COMMUNITIES, IN CLASS
37 (U.S. CLS. 100, 103 AND 106).

FIRST USE 5-16-2000; IN COMMERCE 5-16-2000.

FOR: DESIGN OF RESIDENTIAL AND COM-
MERCIAL BUILDINGS, IN CLASS 42 (U.S. CLS. 100
AND 101).

FIRST USE 5-16-2000; IN COMMERCE 5-16-2000.

NO CLAIM IS MADE TO THE EXCLUSIVE
RIGHT TO USE "MASTER BUILDER FELLOWSHIP"

AND "INCORPORATED", APART FROM THE
MARK AS SHOWN.

THE COLOR(S) GOLD AND BLACK IS/ARE
CLAIMED AS A FEATURE OF THE MARK.

THE MARK CONSISTS OF A CIRCULAR GOLD
DESIGN WITH THE WORDING MASTERBUILDER
FELLOWSHIP FOR THE BUILT ENVIRONMENT
INCORPORATED CENTERED BENEATH THE DE-
SIGN IN THE MARK. THE COLOR GOLD APPEARS
IN THE DESIGN AND THE COLOR BLACK AP-
PEARS IN THE WORDING BENEATH THE DE-
SIGN.

SER. NO. 77-028,670, FILED 10-25-2006.

STEVEN JACKSON, EXAMINING ATTORNEY

Int. Cl.: 43

Prior U.S. Cls.: 100 and 101

United States Patent and Trademark Office

Reg. No. 3,397,023

Registered Mar. 18, 2008

**SERVICE MARK
PRINCIPAL REGISTER**

**MIKE & C'S FAMILY SPORTS
GRILL**

MICHAEL F. HEALY (UNITED STATES INDIVIDUAL)

107 HOLLY SPRINGS DRIVE

PEACHTREE CITY, GA 30269

FOR: RESTAURANT SERVICES, IN CLASS 43
(U.S. CLS. 100 AND 101).

FIRST USE 3-31-2003; IN COMMERCE 3-31-2003.

THE MARK CONSISTS OF STANDARD CHARACTERS WITHOUT CLAIM TO ANY PARTICULAR FONT, STYLE, SIZE, OR COLOR.

NO CLAIM IS MADE TO THE EXCLUSIVE RIGHT TO USE "FAMILY SPORTS GRILL", APART FROM THE MARK AS SHOWN.

SER. NO. 77-029,355, FILED 10-25-2006.

KELLY CHOE, EXAMINING ATTORNEY

Int. Cls.: 41, 44 and 45

Prior U.S. Cls.: 100, 101 and 107

United States Patent and Trademark Office

Reg. No. 3,397,024

Registered Mar. 18, 2008

**SERVICE MARK
PRINCIPAL REGISTER**

Pine Grove

FORREST GENERAL HOSPITAL (MISSISSIPPI
COMMUNITY HOSPITAL)

6051 U.S. HIGHWAY 49

HATTIESBURG, MS 394017243

FOR: ARRANGING AND CONDUCTING EDUCATIONAL CONFERENCES; ARRANGING OF SEMINARS AND CONFERENCES; ARRANGING PROFESSIONAL WORKSHOP AND TRAINING COURSES; CONDUCTING WORKSHOPS AND SEMINARS IN PERSONAL AWARENESS; CONDUCTING WORKSHOPS AND SEMINARS IN SELF AWARENESS; CONDUCTING WORKSHOPS AND SEMINARS IN ADDICTIONS, PSYCHIATRIC ILLNESSES/DISORDER AND, HEALTHY LIFESTYLES; CONSULTANCY IN THE FIELD OF LEARNING DIFFICULTIES; DEVELOPMENT AND DISSEMINATION OF EDUCATIONAL MATERIALS OF OTHERS IN THE FIELD OF ADDICTION, HEALTHY LIFESTYLES, AND PROFESSIONAL BEHAVIOR; EDUCATION SERVICES, NAMELY, PROVIDING WORKSHOPS IN THE FIELD OF PROFESSIONAL BOUNDARIES AND INTERPERSONAL RELATIONSHIPS; EDUCATION SERVICES, NAMELY, PROVIDING WORKSHOPS IN THE FIELDS OF ADDICTIONS, HEALTHY LIFESTYLES, PROFESSIONAL BEHAVIOR, INTERPERSONAL RELATIONSHIPS, PSYCHIATRIC ILLNESS/DISORDERS AND DISTRIBUTION OF COURSE MATERIALS IN CONNECTION THEREWITH; EDUCATIONAL RESEARCH; EDUCATIONAL SERVICES, NAMELY, DEVELOPING, ARRANGING, AND CONDUCTING EDUCATIONAL CONFERENCES AND PROGRAMS AND PROVIDING COURSES OF INSTRUCTION IN THE FIELD OF ADDICTIONS, HEALTHY LIFESTYLES, PROFESSIONAL BEHAVIOR, INTERPERSONAL RELATIONSHIPS, PSYCHIATRIC ILLNESS/DISORDERS; EDUCATIONAL TESTING; ORGANIZATION OF SEMINARS, WORKING GROUPS, RESEARCH GROUPS AND CONVENTIONS, IN THE FIELD OF MEDICINE; VOCATIONAL GUIDANCE, IN CLASS 41 (U.S. CLS. 100, 101 AND 107).

FIRST USE 3-22-1984; IN COMMERCE 3-2-2005.

FOR: ADDICTION TREATMENT SERVICES; CONSULTING SERVICES IN THE FIELD OF MENTAL FITNESS; DIETARY AND NUTRITIONAL GUIDANCE; DRUG TESTING FOR SUBSTANCE ABUSE; FOOD NUTRITION CONSULTATION; HEALTH CARE; HEALTH CARE SERVICES, NAMELY, DISEASE MANAGEMENT PROGRAMS; HEALTH CARE, NAMELY, ASSISTING INDIVIDUALS TO STOP SMOKING; HYPNOSIS SERVICES; HYPNOTHERAPY SERVICES; MEDICAL ASSISTANCE CONSULTANCY PROVIDED BY DOCTORS AND OTHER SPECIALIZED MEDICAL PERSONNEL; MEDICAL ASSISTANCE SERVICES; MEDICAL CONSULTATIONS; MEDICAL COUNSELING; MEDICAL SERVICES; MENTAL HEALTH COUNSELING AND PSYCHOTHERAPY AS IT RELATES TO RELATIONSHIPS; MENTAL HEALTH SERVICES; PREPARATION AND DISPENSING OF MEDICATIONS; PROVIDING MEDICAL INFORMATION, CONSULTANCY AND ADVISORY SERVICES; PROVIDING SMOKING CESSATION TREATMENT SERVICES; PSYCHIATRIC CONSULTATION; PSYCHIATRIC SERVICES; PSYCHIATRIC TESTING; PSYCHOLOGICAL CONSULTATION; PSYCHOLOGICAL COUNSELING; PSYCHOLOGICAL TESTING SERVICES; PSYCHOLOGICAL TESTS; REHABILITATION OF ALCOHOL ADDICTED PATIENTS; REHABILITATION OF DRUG ADDICTED PATIENTS; REHABILITATION OF NARCOTIC ADDICTED PATIENTS, IN CLASS 44 (U.S. CLS. 100 AND 101).

FIRST USE 3-22-1984; IN COMMERCE 3-2-2005.

FOR: ORGANIZING AND CONDUCTING SUPPORT GROUPS IN THE FIELD OF ADDICTION AND MENTAL ILLNESS, IN CLASS 45 (U.S. CLS. 100 AND 101).

FIRST USE 3-22-1984; IN COMMERCE 3-2-2005.

THE MARK CONSISTS OF STANDARD CHAR-
ACTERS WITHOUT CLAIM TO ANY PARTICULAR
FONT, STYLE, SIZE, OR COLOR.

SER. NO. 77-029,822, FILED 10-26-2006.

MARY CRAWFORD, EXAMINING ATTORNEY

Int. Cls.: 41, 44 and 45

Prior U.S. Cls.: 100, 101 and 107

United States Patent and Trademark Office

Reg. No. 3,397,025

Registered Mar. 18, 2008

**SERVICE MARK
PRINCIPAL REGISTER**



FORREST GENERAL HOSPITAL (MISSISSIPPI
COMMUNITY HOSPITAL)
6051 U.S. HIGHWAY 49
HATTIESBURG, MS 394017243

FOR: ARRANGING AND CONDUCTING EDUCATIONAL CONFERENCES; ARRANGING OF SEMINARS AND CONFERENCES; ARRANGING PROFESSIONAL WORKSHOP AND TRAINING COURSES; CONDUCTING WORKSHOPS AND SEMINARS IN PERSONAL AWARENESS; CONDUCTING WORKSHOPS AND SEMINARS IN SELF AWARENESS; CONDUCTING WORKSHOPS AND SEMINARS IN ADDICTIONS, PSYCHIATRIC ILLNESSES/DISORDERS AND, HEALTHY LIFESTYLES; CONSULTANCY IN THE FIELD OF LEARNING DIFFICULTIES; DEVELOPMENT AND DISSEMINATION OF EDUCATIONAL MATERIALS OF OTHERS IN THE FIELD OF ADDICTION, HEALTHY LIFESTYLES, AND PROFESSIONAL BEHAVIOR; EDUCATION SERVICES, NAMELY, PROVIDING WORKSHOPS IN THE FIELD OF PROFESSIONAL BOUNDARIES AND INTERPERSONAL RELATIONSHIPS; EDUCATION SERVICES, NAMELY, PROVIDING WORKSHOPS IN THE FIELDS OF ADDICTIONS, HEALTHY LIFESTYLES, PROFESSIONAL BEHAVIOR, INTERPERSONAL RELATIONSHIPS, PSYCHIATRIC ILLNESS/DISORDERS AND DISTRIBUTION OF COURSE MATERIALS IN CONNECTION THEREWITH; EDUCATIONAL RESEARCH; EDUCATIONAL SERVICES, NAMELY, DEVELOPING, ARRANGING, AND CONDUCTING EDUCATIONAL CONFERENCES AND PROGRAMS AND PROVIDING COURSES OF INSTRUCTION IN THE FIELD OF ADDICTIONS, HEALTHY LIFESTYLES, PROFESSIONAL BEHAVIOR, INTERPERSONAL RELATIONSHIPS,

PSYCHIATRIC ILLNESS/DISORDERS; EDUCATIONAL TESTING; ORGANIZATION OF SEMINARS, WORKING GROUPS, RESEARCH GROUPS AND CONVENTIONS, IN THE FIELD OF MEDICINE; VOCATIONAL GUIDANCE, IN CLASS 41 (U.S. CLS. 100, 101 AND 107).

FIRST USE 3-22-1984; IN COMMERCE 3-2-2005.

FOR: ADDICTION TREATMENT SERVICES; CONSULTING SERVICES IN THE FIELD OF MENTAL FITNESS; DIETARY AND NUTRITIONAL GUIDANCE; DRUG TESTING FOR SUBSTANCE ABUSE; FOOD NUTRITION CONSULTATION; HEALTH CARE; HEALTH CARE SERVICES, NAMELY, DISEASE MANAGEMENT PROGRAMS; HEALTH CARE, NAMELY, ASSISTING INDIVIDUALS TO STOP SMOKING; HYPNOSIS SERVICES; HYPNOTHERAPY SERVICES; MEDICAL ASSISTANCE CONSULTANCY PROVIDED BY DOCTORS AND OTHER SPECIALIZED MEDICAL PERSONNEL; MEDICAL ASSISTANCE SERVICES; MEDICAL CONSULTATIONS; MEDICAL COUNSELING; MEDICAL SERVICES; MENTAL HEALTH COUNSELING AND PSYCHOTHERAPY AS IT RELATES TO RELATIONSHIPS; MENTAL HEALTH SERVICES; PREPARATION AND DISPENSING OF MEDICATIONS; PROVIDING MEDICAL INFORMATION, CONSULTANCY AND ADVISORY SERVICES; PROVIDING SMOKING CESSATION TREATMENT SERVICES; PSYCHIATRIC CONSULTATION; PSYCHIATRIC SERVICES; PSYCHIATRIC TESTING; PSYCHOLOGICAL CONSULTATION; PSYCHOLOGICAL COUNSELING; PSYCHOLOGICAL TESTING SERVICES; PSYCHOLOGICAL TESTS; REHABILITATION OF ALCOHOL ADDICTED PATIENTS; REHABILITATION OF DRUG AD-

DICTIONED PATIENTS; REHABILITATION OF NARCOTIC ADDICTED PATIENTS, IN CLASS 44 (U.S. CLS. 100 AND 101).

FIRST USE 3-22-1984; IN COMMERCE 3-2-2005.

FOR: ORGANIZING AND CONDUCTING SUPPORT GROUPS IN THE FIELD OF ADDICTION AND MENTAL ILLNESS, IN CLASS 45 (U.S. CLS. 100 AND 101).

FIRST USE 3-22-1984; IN COMMERCE 3-2-2005.

NO CLAIM IS MADE TO THE EXCLUSIVE RIGHT TO USE "BEHAVIORAL HEALTH & ADDICTION SERVICES", APART FROM THE MARK AS SHOWN.

THE COLOR(S) DARK GREEN AND LIGHT GREEN IS/ARE CLAIMED AS A FEATURE OF THE MARK.

THE MARK CONSISTS OF A CLUSTER OF FOUR LIGHT GREEN (PMS COLOR 556C) TREES STANDING ON A PATCH OF LAND ACCOMPANYING THE DARK GREEN (PMS COLOR 554C) LITERAL ELEMENT.

SER. NO. 77-029,844, FILED 10-26-2006.

MARY CRAWFORD, EXAMINING ATTORNEY

Int. Cl.: 38

Prior U.S. Cls.: 100, 101 and 104

United States Patent and Trademark Office

Reg. No. 3,397,026

Registered Mar. 18, 2008

**SERVICE MARK
PRINCIPAL REGISTER**

KRLA

SALEM COMMUNICATIONS HOLDING COR-
PORATION (DELAWARE CORPORATION)
4880 SANTA ROSA ROAD
CAMARILLO, CA 93012

FOR: RADIO BROADCASTING, IN CLASS 38 (U.S.
CLS. 100, 101 AND 104).

FIRST USE 1-1-2001; IN COMMERCE 1-1-2001.

THE MARK CONSISTS OF STANDARD CHAR-
ACTERS WITHOUT CLAIM TO ANY PARTICULAR
FONT, STYLE, SIZE, OR COLOR.

SER. NO. 77-030,115, FILED 10-26-2006.

VIVIAN MICZNIK FIRST, EXAMINING ATTOR-
NEY

Int. Cl.: 29

Prior U.S. Cl.: 46

United States Patent and Trademark Office

Reg. No. 3,397,027

Registered Mar. 18, 2008

**TRADEMARK
PRINCIPAL REGISTER**

COLUCCIO

D. COLUCCIO & SONS, INC. (NEW YORK CORPORATION)

1214-60TH STREET

BROOKLYN, NY 11219

FOR: PROCESSED TOMATOES, IN CLASS 29 (U.S. CL. 46).

FIRST USE 7-31-1998; IN COMMERCE 7-31-1998.

THE MARK CONSISTS OF STANDARD CHARACTERS WITHOUT CLAIM TO ANY PARTICULAR FONT, STYLE, SIZE, OR COLOR.

OWNER OF U.S. REG. NO. 2,429,565.

SEC. 2(F).

SER. NO. 77-030,605, FILED 10-26-2006.

KELLY CHOE, EXAMINING ATTORNEY

Prior U.S. Cl.: A

United States Patent and Trademark Office

Reg. No. 3,397,028

Registered Mar. 18, 2008

**CERTIFICATION MARK
PRINCIPAL REGISTER**



IDAHO-EASTERN OREGON ONION COMMITTEE (IDAHO COMMITTEE ESTABLISHED BY THE U.S. SECRETARY OF AGRICULTURE)
P.O. BOX 909
118 NORTH SECOND STREET
PARMA, ID 83669

FOR: FRESH ONIONS, IN CLASS A (U.S. CL. A).

FIRST USE 9-15-2006; IN COMMERCE 9-15-2006.

OWNER OF U.S. REG. NOS. 1,712,025 AND 2,536,143.

NO CLAIM IS MADE TO THE EXCLUSIVE RIGHT TO USE "SPANISH SWEET ONIONS", APART FROM THE MARK AS SHOWN.

THE MARK CONSISTS OF A DRAWING OF THE STATE OF IDAHO, WITH AN ONION ON THE LEFT, OR "WESTERN" SIDE OF THE STATE. THE DRAWING OF THE STATE IS LARGER THAN A

RECTANGULAR BOX AROUND IT AND THE ONION. THE WORDS "IDAHO EASTERN OREGON" APPEAR IN THE UPPER RIGHT OF THE BOX. THE WORDS "SPANISH SWEET ONIONS" APPEAR ON THE BOTTOM OF THE DRAWING OF THE STATE.

THIS CERTIFICATION MARK AS USED BY PERSONS AUTHORIZED BY THE CERTIFIER, CERTIFIES THAT THE FOOD AND AGRICULTURAL PRODUCTS, NAMELY, ONIONS, PROVIDED ARE GROWN, RAISED OR PROCESSED IN THE STATE OF IDAHO OR MALHEUR COUNTY, OREGON AND THAT THE GOODS MEET THE QUALITY STANDARDS OF THE IDAHO-EASTERN OREGON ONION COMMITTEE.

SER. NO. 77-031,426, FILED 10-27-2006.

WOODROW HARTZOG, EXAMINING ATTORNEY

Int. Cl.: 7

Prior U.S. Cls.: 13, 19, 21, 23, 31, 34 and 35

United States Patent and Trademark Office

Reg. No. 3,397,029

Registered Mar. 18, 2008

**TRADEMARK
PRINCIPAL REGISTER**

GENSMART

LIGHT ENGINEERING (CALIFORNIA CORPORATION)
8158 ZIONSVILLE ROAD
INDIANAPOLIS, IN 46268

THE MARK CONSISTS OF STANDARD CHARACTERS WITHOUT CLAIM TO ANY PARTICULAR FONT, STYLE, SIZE, OR COLOR.

FOR: ELECTRIC MOTORS FOR MACHINES, IN CLASS 7 (U.S. CLS. 13, 19, 21, 23, 31, 34 AND 35).

SER. NO. 77-031,837, FILED 10-30-2006.

FIRST USE 7-1-2004; IN COMMERCE 7-1-2004.

TRACY CROSS, EXAMINING ATTORNEY

Int. Cl.: 7

Prior U.S. Cls.: 13, 19, 21, 23, 31, 34 and 35

United States Patent and Trademark Office

Reg. No. 3,397,030

Registered Mar. 18, 2008

**TRADEMARK
PRINCIPAL REGISTER**

SMARTTORQ

LIGHT ENGINEERING (CALIFORNIA CORPORATION)
8158 ZIONSVILLE ROAD
INDIANAPOLIS, IN 46268

THE MARK CONSISTS OF STANDARD CHARACTERS WITHOUT CLAIM TO ANY PARTICULAR FONT, STYLE, SIZE, OR COLOR.

FOR: ELECTRIC MOTORS FOR MACHINES, IN CLASS 7 (U.S. CLS. 13, 19, 21, 23, 31, 34 AND 35).

SER. NO. 77-031,838, FILED 10-30-2006.

FIRST USE 7-1-2004; IN COMMERCE 7-1-2004.

TRACY CROSS, EXAMINING ATTORNEY

Int. Cl.: 29

Prior U.S. Cl.: 46

United States Patent and Trademark Office

Reg. No. 3,397,031

Registered Mar. 18, 2008

**TRADEMARK
PRINCIPAL REGISTER**

VEGGIE GROWN

PLAINVILLE FARMS, LLC (DELAWARE LTD
LIAB CO)
7830 PLAINVILLE ROAD
PLAINVILLE, NY 13137

FOR: TURKEY; PROCESSED PARTS FROM TUR-
KEY; AND FURTHER PROCESSED TURKEY, IN
CLASS 29 (U.S. CL. 46).

FIRST USE 7-1-1999; IN COMMERCE 7-1-1999.

THE MARK CONSISTS OF STANDARD CHAR-
ACTERS WITHOUT CLAIM TO ANY PARTICULAR
FONT, STYLE, SIZE, OR COLOR.

OWNER OF U.S. REG. NO. 2,505,645.

SEC. 2(F).

SER. NO. 77-031,935, FILED 10-30-2006.

LAURIE MAYES, EXAMINING ATTORNEY

Int. Cls.: 41, 44 and 45

Prior U.S. Cls.: 100, 101 and 107

United States Patent and Trademark Office

Reg. No. 3,397,032

Registered Mar. 18, 2008

**SERVICE MARK
PRINCIPAL REGISTER**

One Place. Many Solutions.

FORREST GENERAL HOSPITAL (MISSISSIPPI
COMMUNITY HOSPITAL)
6051 U.S. HIGHWAY 49
HATTIESBURG, MS 394017243

FOR: EDUCATION SERVICES, NAMELY, PROVIDING WORKSHOPS IN FIELDS OF ADDICTIONS, HEALTHY LIFESTYLES, PROFESSIONAL BEHAVIOR, INTERPERSONAL RELATIONSHIPS, PSYCHIATRIC ILLNESS/DISORDERS AND DISTRIBUTION OF COURSE MATERIALS IN CONNECTION THEREWITH, IN CLASS 41 (U.S. CLS. 100, 101 AND 107).

FIRST USE 8-8-2005; IN COMMERCE 8-8-2005.

FOR: ADDICTION TREATMENT SERVICES; CONSULTING SERVICES IN THE FIELD OF MENTAL FITNESS; DIETARY AND NUTRITIONAL GUIDANCE; DRUG TESTING FOR SUBSTANCE ABUSE; FOOD NUTRITION CONSULTATION; HEALTH CARE; HEALTH CARE SERVICES, NAMELY DISEASE MANAGEMENT PROGRAMS; HEALTH CARE, NAMELY, ASSISTING INDIVIDUALS TO STOP SMOKING; HYPNOSIS SERVICES; HYPNOTHERAPY SERVICES; MEDICAL ASSISTANCE CONSULTANCY PROVIDED BY DOCTORS AND OTHER SPECIALIZED MEDICAL PERSONNEL; MEDICAL ASSISTANCE SERVICES; MEDICAL CONSULTATIONS; MEDICAL COUNSELING; MEDICAL SERVICES; MENTAL HEALTH COUNSELING AND PSYCHOTHERAPY AS IT RELATES TO RELATIONSHIPS; MENTAL HEALTH SERVI-

CES; PREPARATION AND DISPENSING OF MEDICATIONS; PROVIDING MEDICAL INFORMATION, CONSULTANCY AND ADVISORY SERVICES; PROVIDING SMOKING CESSATION TREATMENT SERVICES; PSYCHIATRIC CONSULTATION; PSYCHIATRIC SERVICES; PSYCHIATRIC TESTING; PSYCHOLOGICAL CONSULTATION; PSYCHOLOGICAL COUNSELING; PSYCHOLOGICAL TESTING SERVICES; PSYCHOLOGICAL TESTS; REHABILITATION OF ALCOHOL ADDICTED PATIENTS; REHABILITATION OF DRUG ADDICTED PATIENTS; REHABILITATION OF NARCOTIC ADDICTED PATIENTS, IN CLASS 44 (U.S. CLS. 100 AND 101).

FIRST USE 8-8-2005; IN COMMERCE 8-8-2005.

FOR: ORGANIZING AND CONDUCTING SUPPORT GROUPS IN THE FIELD OF ADDICTION AND MENTAL ILLNESS, IN CLASS 45 (U.S. CLS. 100 AND 101).

FIRST USE 8-8-2005; IN COMMERCE 8-8-2005.

THE MARK CONSISTS OF STANDARD CHARACTERS WITHOUT CLAIM TO ANY PARTICULAR FONT, STYLE, SIZE, OR COLOR.

SER. NO. 77-032,312, FILED 10-30-2006.

MARY CRAWFORD, EXAMINING ATTORNEY

Int. Cls.: 19 and 37

Prior U.S. Cls.: 1, 12, 33, 50, 100, 103 and 106

United States Patent and Trademark Office

Reg. No. 3,397,033

Registered Mar. 18, 2008

**TRADEMARK
SERVICE MARK
PRINCIPAL REGISTER**

TEMGUARD F.R.A.

TEMO, INC. (MICHIGAN CORPORATION)
20400 HALL ROAD
CLINTON TOWNSHIP, MI 48038

FOR: PRODUCTS FOR USE IN THE FIELD OF BUILDING CONSTRUCTION, RENOVATION, AND REMODELING, NAMELY, FABRICATED AND PREFABRICATED WALLS AND PANELS NOT OF METAL, IN CLASS 19 (U.S. CLS. 1, 12, 33 AND 50).

FIRST USE 6-30-2006; IN COMMERCE 6-30-2006.

FOR: INSTALLATION, CONSTRUCTION, RENOVATION, REMODELING, REPAIR, AND CON-

STRUCTION IMPROVEMENTS OF RESIDENTIAL, COMMERCIAL, AND INDUSTRIAL PROPERTIES, SUNROOMS, AND SUBTERRANEAN LIVING SPACES, IN CLASS 37 (U.S. CLS. 100, 103 AND 106).

FIRST USE 6-30-2006; IN COMMERCE 6-30-2006.

THE MARK CONSISTS OF STANDARD CHARACTERS WITHOUT CLAIM TO ANY PARTICULAR FONT, STYLE, SIZE, OR COLOR.

SER. NO. 77-033,258, FILED 10-31-2006.

ELLEN BURNS, EXAMINING ATTORNEY

Int. Cl.: 42

Prior U.S. Cls.: 100 and 101

United States Patent and Trademark Office

Reg. No. 3,397,034

Registered Mar. 18, 2008

**SERVICE MARK
PRINCIPAL REGISTER**

NSIT Technologies

DALLA BETTA, RALPH A. (UNITED STATES
INDIVIDUAL)
865 DOVERTON SQUARE
MOUNTAIN VIEW, CA 94040

FOR: CONSULTING IN THE TECHNICAL AREA
OF CHEMISTRY AND CHEMICAL ENGINEERING,
IN CLASS 42 (U.S. CLS. 100 AND 101).

FIRST USE 10-27-2006; IN COMMERCE 10-27-2006.

THE MARK CONSISTS OF STANDARD CHAR-
ACTERS WITHOUT CLAIM TO ANY PARTICULAR
FONT, STYLE, SIZE, OR COLOR.

NO CLAIM IS MADE TO THE EXCLUSIVE
RIGHT TO USE TECHNOLOGIES, APART FROM
THE MARK AS SHOWN.

SER. NO. 77-033,349, FILED 10-31-2006.

ANNE MADDEN, EXAMINING ATTORNEY

Int. Cl.: 3

Prior U.S. Cls.: 1, 4, 6, 50, 51 and 52

United States Patent and Trademark Office

Reg. No. 3,397,035

Registered Mar. 18, 2008

**TRADEMARK
PRINCIPAL REGISTER**

TOKYO BY KENZO

KENZO S.A. (FRANCE CORPORATION)
1, RUE DU PONT NEUF
75001 PARIS, FRANCE

FOR: TOILET SOAP; PERFUMES; EAU DE TOILETTE; COLOGNE; ESSENTIAL OILS FOR PERSONAL USE; MILKS, LOTIONS, EMULSIONS AND CREAM FOR COSMETIC USE FOR FACE AND BODY; COSMETICS; NON-MEDICATED SUN CARE PREPARATIONS; COSMETIC SUN-PROTECTING PREPARATIONS; COSMETIC CREAMS, GELS AND OILS; BATH SALTS FOR NON MEDICAL USE; TALCUM POWDER FOR TOILET USE; DEODORANTS FOR PERSONAL USE; PRE-SHAVE LOTIONS; AFTER SHAVE LOTIONS; SHAVING CREAMS, GELS AND FOAMS; HAIR PREPARATIONS FOR NON MEDICAL USE, NAMELY, SPRAYS, GELS, CREAMS, BALMS, MOUSSE AND

SHAMPOOS, IN CLASS 3 (U.S. CLS. 1, 4, 6, 50, 51 AND 52).

THE MARK CONSISTS OF STANDARD CHARACTERS WITHOUT CLAIM TO ANY PARTICULAR FONT, STYLE, SIZE, OR COLOR.

PRIORITY CLAIMED UNDER SEC. 44(D) ON FRANCE APPLICATION NO. 063426247, FILED 5-2-2006, REG. NO. 06/3426247, DATED 5-2-2006, EXPIRES 5-2-2016.

OWNER OF U.S. REG. NOS. 1,312,942, 3,106,879 AND OTHERS.

SER. NO. 77-033,364, FILED 10-31-2006.

CIMMERIAN COLEMAN, EXAMINING ATTORNEY

Int. Cl.: 35

Prior U.S. Cls.: 100, 101 and 102

United States Patent and Trademark Office

Reg. No. 3,397,036

Registered Mar. 18, 2008

**SERVICE MARK
PRINCIPAL REGISTER**

Strictly Accounting

DAVID DEVIN (UNITED STATES INDIVIDUAL)
263 MILL ROAD
STAMFORD, CT 06903

FOR: ACCOUNT AUDITING; ACCOUNTANCY SERVICES; ACCOUNTING CONSULTATION; ACCOUNTING SERVICES; ACCOUNTS RECEIVABLE SERVICES; ADMINISTRATION, BILLING AND RECONCILIATION OF ACCOUNTS ON BEHALF OF OTHERS; ADMINISTRATIVE ACCOUNTING; BUSINESS INFORMATION AND ACCOUNTING ADVISORY SERVICES; COMPUTERIZED ACCOUNTING SERVICES; COST ACCOUNTING, IN CLASS 35 (U.S. CLS. 100, 101 AND 102).

FIRST USE 3-1-2002; IN COMMERCE 3-1-2005.

THE MARK CONSISTS OF STANDARD CHARACTERS WITHOUT CLAIM TO ANY PARTICULAR FONT, STYLE, SIZE, OR COLOR.

NO CLAIM IS MADE TO THE EXCLUSIVE RIGHT TO USE "ACCOUNTING", APART FROM THE MARK AS SHOWN.

SER. NO. 77-033,698, FILED 10-31-2006.

KENNETH E. SHARPERSON, EXAMINING ATTORNEY

Int. Cl.: 7

Prior U.S. Cls.: 13, 19, 21, 23, 31, 34 and 35

United States Patent and Trademark Office

Reg. No. 3,397,037

Registered Mar. 18, 2008

**TRADEMARK
PRINCIPAL REGISTER**

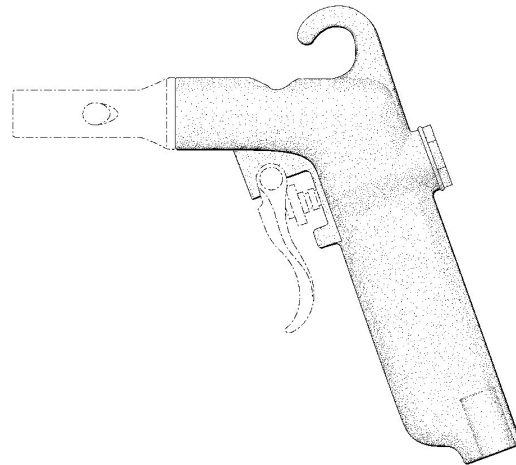

GUARDAIR CORPORATION (MASSACHUSETTS CORPORATION)
54 SECOND AVENUE
CHICOPEE, MA 01020

FOR: PNEUMATIC HAND-OPERATED TOOLS FOR INDUSTRIAL USE, NAMELY, HAND-HELD SAFETY AIR GUNS USED FOR CLEANING AND MAINTENANCE, IN CLASS 7 (U.S. CLS. 13, 19, 21, 23, 31, 34 AND 35).

FIRST USE 10-1-1975; IN COMMERCE 10-1-1975.

THE MARK CONSISTS OF THE CONFIGURATION OF A HAND-HELD SAFETY AIR GUN.

SEC. 2(F).

SER. NO. 77-033,940, FILED 11-1-2006.

JAMES A. RAUEN, EXAMINING ATTORNEY

Int. Cl.: 3

Prior U.S. Cls.: 1, 4, 6, 50, 51 and 52

United States Patent and Trademark Office

Reg. No. 3,397,038

Registered Mar. 18, 2008

TRADEMARK
PRINCIPAL REGISTER



Hope Aesthetics
Skincare

HOPE AESTHETICS COSMECEUTICAL, INC.
(DELAWARE CORPORATION)
SUITE 110
912 S. ANDREASEN DRIVE
ESCONDIDO, CA 92029

FOR: AFTER-SHAVE LOTIONS; AFTER-SUN LOTIONS; AGE RETARDANT GEL; AGE RETARDANT LOTION; ANTI-AGING CREAM; ANTI-WRINKLE CREAM; ANTI-WRINKLE CREAMS; ANTIBACTERIAL SKIN SOAPS; AROMA THERAPY CREAMS; AROMA THERAPY LOTIONS; BEAUTY CREAMS; BEAUTY CREAMS FOR BODY CARE; BEAUTY GELS; BEAUTY LOTIONS; BEAUTY MILKS; BEAUTY SERUMS; BODY AND BEAUTY CARE COSMETICS; BODY AND BEAUTY CARE PREPARATIONS; BODY CREAM; BODY CREAMS; BODY EMULSIONS; BODY LOTION; BODY LOTIONS; BODY MILK; BODY SCRUB; BODY SPRAYS; COSMETIC CREAMS FOR SKIN CARE; COSMETIC OILS; COSMETIC PREPARATIONS AGAINST SUNBURN; COSMETIC PREPARATIONS FOR BODY CARE; COSMETIC PREPARATIONS FOR SKIN RENEWAL; COSMETIC PRODUCTS IN THE FORM OF AEROSOLS FOR SKIN CARE; COSMETIC SOAPS; COSMETIC SUN-PROTECTING PREPARATIONS; COSMETICS; EYE GELS; EYE LOTIONS; EYE MAKE-UP REMOVER; FACE AND BODY BEAUTY CREAMS; FACE AND BODY

CREAMS; FACE AND BODY LOTIONS; FACE CREAMS; FACIAL CLEANSERS; FACIAL CREAM; FACIAL EMULSIONS; FACIAL SCRUBS; HAIR CARE LOTIONS; HAIR CONDITIONERS; HAIR SHAMPOO; HAND LOTIONS; LOTIONS FOR FACE AND BODY CARE; SHAMPOOS; SKIN CARE PREPARATIONS, NAMELY FRUIT ACID PEELS FOR SKIN; SKIN CONDITIONERS; SKIN CREAM; SKIN CREAMS; SKIN EMOLLIENTS; SKIN LOTIONS; SKIN MOISTURIZER; UNDER-EYE ENHANCERS, IN CLASS 3 (U.S. CLS. 1, 4, 6, 50, 51 AND 52).

FIRST USE 1-8-2001; IN COMMERCE 1-8-2001.

OWNER OF U.S. REG. NO. 2,503,804.

NO CLAIM IS MADE TO THE EXCLUSIVE RIGHT TO USE "SKINCARE", APART FROM THE MARK AS SHOWN.

THE MARK CONSISTS OF AN ANGEL STANDING WITHIN A STYLIZED LETTER H AND THE WORDS "HOPE AESTHETIC SKINCARE" BE-NEATH THE H.

SER. NO. 77-034,157, FILED 11-1-2006.

PAUL F. GAST, EXAMINING ATTORNEY

Int. Cl.: 35

Prior U.S. Cls.: 100, 101 and 102

United States Patent and Trademark Office

Reg. No. 3,397,039

Registered Mar. 18, 2008

**SERVICE MARK
PRINCIPAL REGISTER**

BABYSTYLE

ESTYLE, INC. (DELAWARE CORPORATION)
SUITE 2700
865 S. FIGUEROA STREET
LOS ANGELES, CA 90017

FOR: RETAIL STORE SERVICES IN THE FIELD OF MATERNITY, INFANT, AND CHILDREN'S APPAREL, CLOTHING, ACCESSORIES, FOOTWEAR, HALLOWEEN COSTUMES, COSTUMES FOR USE IN ROLE-PLAYING GAMES, AND HEADGEAR, MATERNITY, INFANT, AND CHILDREN'S GEAR AND PRODUCTS, HEALTH AND BEAUTY PRODUCTS, TOYS, GAMES, AND PLAYTHINGS, SEASONAL DECORATIONS, GIFTS, FURNITURE, HOME FURNISHINGS AND HOUSE WARES, BEDDING, BABY BLANKETS, JEWELRY, STATIONERY

AND GREETING CARDS, BOOKS, PRERECORDED MUSIC AND VIDEO, AND PICTURE FRAMES, IN CLASS 35 (U.S. CLS. 100, 101 AND 102).

FIRST USE 2-23-1999; IN COMMERCE 2-23-1999.

THE MARK CONSISTS OF STANDARD CHARACTERS WITHOUT CLAIM TO ANY PARTICULAR FONT, STYLE, SIZE, OR COLOR.

OWNER OF U.S. REG. NOS. 2,391,051, 2,802,620 AND OTHERS.

SER. NO. 77-034,899, FILED 11-2-2006.

YAT SYE, LEE, EXAMINING ATTORNEY

Int. Cls.: 9 and 41

Prior U.S. Cls.: 21, 23, 26, 36, 38, 100, 101 and 107

United States Patent and Trademark Office

Reg. No. 3,397,040

Registered Mar. 18, 2008

**TRADEMARK
SERVICE MARK
PRINCIPAL REGISTER**



SEAREAL PRODUCTIONS, LLC (WASHINGTON
LTD LIAB CO)
700 WEST LEE STREET
SEATTLE, WA 98119

FOR: SOUND RECORDINGS AND COMPACT
DISCS FEATURING MUSIC, IN CLASS 9 (U.S. CLS.
21, 23, 26, 36 AND 38).

FIRST USE 11-0-2003; IN COMMERCE 11-0-2003.

FOR: ENTERTAINMENT SERVICES, NAMELY,
LIVE MUSICAL PERFORMANCES BY A RECORD-
ING ARTIST; PRODUCTION AND DISTRIBUTION

SERVICES FOR OTHERS IN THE FIELD OF SOUND
RECORDINGS; MUSIC PUBLISHING SERVICES, IN
CLASS 41 (U.S. CLS. 100, 101 AND 107).

FIRST USE 11-0-2003; IN COMMERCE 11-0-2003.

THE MARK CONSISTS OF STYLIZED LETTERS
D, U, B AND B.

SER. NO. 77-034,955, FILED 11-2-2006.

H. M. FISHER, EXAMINING ATTORNEY

Int. Cl.: 38

Prior U.S. Cls.: 100, 101 and 104

United States Patent and Trademark Office

Reg. No. 3,397,041

Registered Mar. 18, 2008

**SERVICE MARK
PRINCIPAL REGISTER**

Punky Moms

PUNKY MOMS (VIRGINIA PARTNERSHIP)
6246 PENN DRIVE
BUTLER, PA 16002

FOR: PROVIDING ON-LINE FORUMS FOR
TRANSMISSION OF MESSAGES AMONG COMPU-
TER USERS CONCERNING PARENTING, IN CLASS
38 (U.S. CLS. 100, 101 AND 104).

FIRST USE 1-13-2006; IN COMMERCE 2-1-2006.

THE MARK CONSISTS OF STANDARD CHAR-
ACTERS WITHOUT CLAIM TO ANY PARTICULAR
FONT, STYLE, SIZE, OR COLOR.

NO CLAIM IS MADE TO THE EXCLUSIVE
RIGHT TO USE "MOMS", APART FROM THE
MARK AS SHOWN.

SER. NO. 77-035,088, FILED 11-2-2006.

RAUL CORDOVA, EXAMINING ATTORNEY

Int. Cl.: 31

Prior U.S. Cls.: 1 and 46

United States Patent and Trademark Office

Reg. No. 3,397,042

Registered Mar. 18, 2008

**TRADEMARK
PRINCIPAL REGISTER**

Refuge Partner

COOMER, MICHAEL LEE (UNITED STATES IN-
DIVIDUAL)

12335 ALJEAN DRIVE

MONROEVILLE, IN 46773

FOR: SEEDS FOR AGRICULTURAL PURPOSES,
IN CLASS 31 (U.S. CLS. 1 AND 46).

FIRST USE 8-22-2006; IN COMMERCE 8-22-2006.

THE MARK CONSISTS OF STANDARD CHAR-
ACTERS WITHOUT CLAIM TO ANY PARTICULAR
FONT, STYLE, SIZE, OR COLOR.

NO CLAIM IS MADE TO THE EXCLUSIVE
RIGHT TO USE "REFUGE", APART FROM THE
MARK AS SHOWN.

SER. NO. 77-035,228, FILED 11-2-2006.

HEATHER BIDDULPH, EXAMINING ATTORNEY

Int. Cl.: 9

Prior U.S. Cls.: 21, 23, 26, 36 and 38

United States Patent and Trademark Office

Reg. No. 3,397,043

Registered Mar. 18, 2008

**TRADEMARK
PRINCIPAL REGISTER**



VIVA VISION, INC. (CALIFORNIA CORPORATION)
SUITE 307
10171 PACIFIC MESA BLVD.
SAN DIEGO, CA 92121

FOR: COMPUTER SOFTWARE AND HARDWARE FOR USE IN DELIVERING LIVE STREAMING VIDEO OVER A COMPUTER NETWORK SERVER FOR A GLOBAL INFORMATION NETWORK, OR THROUGH OTHER VIDEO TRANSMISSION VEHICLES, NAMELY, WIRELESS DEVICES, IN CLASS 9 (U.S. CLS. 21, 23, 26, 36 AND 38).

FIRST USE 8-28-2006; IN COMMERCE 8-28-2006.

OWNER OF U.S. REG. NOS. 3,192,845 AND 3,192,846.

THE COLOR(S) WHITE, RED, AND BLACK IS/ARE CLAIMED AS A FEATURE OF THE MARK.

THE MARK CONSISTS OF A WHITE V! IN THE MIDDLE OF A RED CIRCLE WITH BLACK SHADING ON THE BOTTOM HALF OF THE CIRCLE.

SER. NO. 77-036,771, FILED 11-3-2006.

CURTIS FRENCH, EXAMINING ATTORNEY

Int. Cl.: 18

Prior U.S. Cls.: 1, 2, 3, 22 and 41

United States Patent and Trademark Office

Reg. No. 3,397,044

Registered Mar. 18, 2008

TRADEMARK
PRINCIPAL REGISTER



DEWIED INTERNATIONAL, INC. (TEXAS CORPORATION)

5010 EAST INTERSTATE HIGHWAY 10
SAN ANTONIO, TX 782193352

FOR: CASINGS FOR SAUSAGES AND FORMED MEAT PRODUCTS, IN CLASS 18 (U.S. CLS. 1, 2, 3, 22 AND 41).

FIRST USE 1-1-1987; IN COMMERCE 1-1-1987.

HANK BUNDLE DOES NOT IDENTIFY A LIVING INDIVIDUAL.

THE MARK CONSISTS OF A MAN DRESSED IN A SHIRT, APRON AND BOWTIE, HOLDING A LINK SAUSAGE. HE IS WEARING A NAME TAG THAT SAYS HANK BUNDLE.

SER. NO. 77-037,181, FILED 11-6-2006.

MARILYN IZZI, EXAMINING ATTORNEY

Int. Cls.: 9, 35 and 36

Prior U.S. Cls.: 21, 23, 26, 36, 38, 100, 101 and 102

United States Patent and Trademark Office

Reg. No. 3,397,045

Registered Mar. 18, 2008

**TRADEMARK
SERVICE MARK
PRINCIPAL REGISTER**

LOTPRO

ACE TECH INCORPORATED (MICHIGAN CORPORATION)
SUITE 300
2701 TROY CENTER DRIVE
TROY, MI 48084

FOR: COMPUTER SOFTWARE, NAMELY, VEHICLE SALES LEAD MANAGEMENT AND VEHICLE FINANCING MANAGEMENT PROGRAMS. , IN CLASS 9 (U.S. CLS. 21, 23, 26, 36 AND 38).

FIRST USE 2-28-2004; IN COMMERCE 2-28-2004.

FOR: PROVIDING VEHICLE MARKETING SERVICES FOR OTHERS, NAMELY, VEHICLE ADVERTISING SERVICES, VEHICLE CLASSIFIED ADVERTISING SERVICES, NAMELY, PROVIDING A WEB SITE THAT ENABLES USERS TO POST VEHICLES FOR SALE THROUGH ON-LINE CLASSIFIED ADVERTISEMENTS AND PROVIDING AN ON-LINE SEARCHABLE DATABASE FEATURING CLASSIFIED VEHICLE AD LISTINGS, VEHICLE INVENTORY SEARCHING AND LISTING SERVICES, NAMELY, PROVIDING AN ON-LINE SEARCHABLE DATABASE FEATURING VEHICLE INVENTORY AND VEHICLE LISTINGS; PROVIDING BUSINESS AND CONSUMER INFORMATION IN THE FIELD OF MOTOR VEHICLE HISTORY INFORMATION, PROCESSING MANUFACTURER VEHICLE REBATES, CONTESTS AND INCENTIVE AWARD PROGRAMS TO PROMOTE THE SALE OF VEHICLES OF OTHERS, PROVIDING A WEB SITE WHERE USERS CAN POST RATINGS, REVIEWS AND RECOMMENDATIONS ON VEHICLES, PROVIDING BUSINESS AND CONSUMER INFORMATION IN THE FIELD OF MOTOR VEHICLE

RECALL RECORD SERVICES, VEHICLE CRASH TEST AND SAFETY RATING SERVICES, VEHICLE PRICE COMPARISON SERVICES, AND VEHICLE DEALERSHIP INFORMATION SERVICES, MOTOR VEHICLE DEALERSHIP SERVICES, AND VEHICLE REGISTRATION SERVICES; BUSINESS SERVICES, NAMELY, THE PURCHASING FROM OTHERS OF LEADS FOR OTHERS ABOUT POTENTIAL CUSTOMERS IN THE FIELD OF VEHICLES AND VEHICLE FINANCING, AND THE COLLECTION FOR OTHERS OF LEADS ABOUT POTENTIAL CUSTOMERS IN THE FIELD OF VEHICLES AND VEHICLE FINANCING, IN CLASS 35 (U.S. CLS. 100, 101 AND 102).

FIRST USE 2-4-2005; IN COMMERCE 2-4-2005.

FOR: VEHICLE FINANCING SERVICES, NAMELY, VEHICLE CREDIT APPLICATION COLLECTION, PROCESSING, APPROVAL AND PRE-APPROVAL SERVICES, VEHICLE PURCHASER CREDIT REPORT SERVICES, AND VEHICLE PAYMENT COMPUTATION SERVICES; VEHICLE INSURANCE SERVICES, IN CLASS 36 (U.S. CLS. 100, 101 AND 102).

FIRST USE 2-4-2005; IN COMMERCE 2-4-2005.

THE MARK CONSISTS OF STANDARD CHARACTERS WITHOUT CLAIM TO ANY PARTICULAR FONT, STYLE, SIZE, OR COLOR.

SER. NO. 77-037,288, FILED 11-6-2006.

SETH A. RAPPAPORT, EXAMINING ATTORNEY

Int. Cl.: 42

Prior U.S. Cls.: 100 and 101

United States Patent and Trademark Office

Reg. No. 3,397,046

Registered Mar. 18, 2008

**SERVICE MARK
PRINCIPAL REGISTER**

xTrak

USCALIBRATION INCORPORATED (CALIFORNIA CORPORATION)
SUITE P
17922 SKY PARK CIRCLE
IRVINE, CA 92614

FOR: APPLICATION SERVICE PROVIDER (ASP) FEATURING SOFTWARE USED IN THE FIELD OF ASSET MANAGEMENT AND ASSET MANAGEMENT AUTOMATION FOR USE IN MANAGING STEPS IN THE LIFE CYCLE OF AN ASSET, NAMELY, MANAGING THE PROCUREMENT, INSTALLATION, MAINTENANCE, CALIBRATION, REPAIRS, UPGRADES, VALIDATIONS, RETIREMENT, FOR EQUIPMENT, INSTRUMENTS, SOFTWARE, AND OTHER ASSETS THAT ARE USED IN THE FIELDS OF RESEARCH AND DEVELOPMENT, PRODUCTION, QUALITY CONTROL, FACILITIES/ MAINTENANCE OPERATIONS, IT, GENERAL

BUSINESS, AND HOME; APPLICATION SERVICE PROVIDER FEATURING SOFTWARE FOR PROVIDING AN ON-LINE DATABASE IN THE FIELD OF TRANSACTION PROCESSING TO UPLOAD TRANSACTIONAL DATA, PROVIDE STATISTICAL ANALYSIS, AND PRODUCE NOTIFICATIONS AND REPORTS, IN CLASS 42 (U.S. CLS. 100 AND 101).

FIRST USE 10-30-2006; IN COMMERCE 10-30-2006.

THE MARK CONSISTS OF STANDARD CHARACTERS WITHOUT CLAIM TO ANY PARTICULAR FONT, STYLE, SIZE, OR COLOR.

SER. NO. 77-037,544, FILED 11-6-2006.

SHARON MEIER, EXAMINING ATTORNEY

Int. Cl.: 42

Prior U.S. Cls.: 100 and 101

United States Patent and Trademark Office

Reg. No. 3,397,047

Registered Mar. 18, 2008

**SERVICE MARK
PRINCIPAL REGISTER**

"We wrote the book on
it..."

WYATT, AUSTIN & ASSOCIATES, P.C. (OKLA-
HOMA CORPORATION)
2021 ARLINGTON
ADA, OK 74821

THE MARK CONSISTS OF STANDARD CHAR-
ACTERS WITHOUT CLAIM TO ANY PARTICULAR
FONT, STYLE, SIZE, OR COLOR.

FOR: LEGAL SERVICES, IN CLASS 42 (U.S. CLS.
100 AND 101).

SER. NO. 77-037,593, FILED 11-6-2006.

FIRST USE 1-1-1990; IN COMMERCE 1-1-1990.

MICHAEL KEATING, EXAMINING ATTORNEY

Int. Cl.: 42

Prior U.S. Cls.: 100 and 101

United States Patent and Trademark Office

Reg. No. 3,397,048

Registered Mar. 18, 2008

**SERVICE MARK
PRINCIPAL REGISTER**

INTERCOMM

BNY CONVERGEX GROUP, LLC (DELAWARE
LTD LIAB CO)
1633 BROADWAY
NEW YORK, NY 10019

FOR: PROVIDING TEMPORARY USE OF ON-
LINE NON-DOWNLOADABLE FINANCIAL SOFT-
WARE, NAMELY, AN INTERACTIVE
COMMISSION MANAGEMENT PORTAL THAT AL-
LWS CUSTOMERS TO MANAGE THEIR SECURI-
TIES TRANSACTION COMMISSION BALANCES,
APPROVE AND PAY INVOICES FOR SERVICES
RENDERED, OBTAIN ACCOUNT BALANCES FOR
COMMISSION REVENUE, DISPLAY ACCOUNT
STATEMENTS, REVIEW REGULATORY LIBRAR-

IES AND COMMUNICATE VIA ONLINE ELECTRO-
NIC BULLETIN BOARDS, IN CLASS 42 (U.S. CLS. 100
AND 101).

FIRST USE 4-25-2006; IN COMMERCE 4-25-2006.

THE MARK CONSISTS OF STANDARD CHAR-
ACTERS WITHOUT CLAIM TO ANY PARTICULAR
FONT, STYLE, SIZE, OR COLOR.

SER. NO. 77-038,233, FILED 11-7-2006.

AMEETA JORDAN, EXAMINING ATTORNEY

Int. Cls.: 1, 3, 5 and 21

Prior U.S. Cls.: 1, 2, 4, 5, 6, 10, 13, 18, 23, 26, 29, 30, 33, 40, 44, 46, 50, 51 and 52

Reg. No. 3,397,049

United States Patent and Trademark Office

Registered Mar. 18, 2008

**TRADEMARK
PRINCIPAL REGISTER**

APLICARE

APLICARE, INC. (CONNECTICUT CORPORATION)
550 RESEARCH PARKWAY
MERIDEN, CT 06450

FOR: WATER TREATMENT CHEMICALS FOR USE IN WHIRLPOOLS AND OTHER HYDROTHERAPY TANKS, IN CLASS 1 (U.S. CLS. 1, 5, 6, 10, 26 AND 46).

FIRST USE 10-1-2006; IN COMMERCE 10-1-2006.

FOR: NON-MEDICATED, LIQUID PERINEAL WASH; BABY LOTION, BABY SHAMPOO, BABY BATH SOAP, AND BABY OIL; POVIDONE IODINE PERIWASH KITS COMPRISED OF POVIDONE IODINE PERIWASH CONCENTRATE AND DILUTING AND DISPENSING BOTTLE, IN CLASS 3 (U.S. CLS. 1, 4, 6, 50, 51 AND 52).

FIRST USE 8-1-2003; IN COMMERCE 8-1-2003.

FOR: ANTISEPTIC PREPARATIONS AND ANTIBACTERIAL PREPARATIONS, NAMELY LIQUIDS, THICKENED-LIQUIDS, LOTIONS, GELS AND FILMS CONTAINING ANTISEPTIC OR ANTIBACTERIAL ACTIVE INGREDIENTS; ENEMA PREPARATIONS; PRE-PACKAGED CONVENIENCE KITS PRIMARILY CONSISTING OF ANTISEPTICS, GAUZE FOR DRESSINGS, DRESSINGS FOR WOUNDS, BURN DRESSINGS, SURGICAL DRESSINGS, MEDICATED SKIN CARE PREPARATIONS FOR USE WITH MEDICAL DRESSING PROCES-

DURES, AND SURGICAL DRAPES OF PAPER; CLEANING DEVICES COMPRISING A PLASTIC HOUSING FILLED WITH ABSORBENT FOAM AND/OR FIBERS, SATURATED WITH ANTISEPTIC SOLUTION, FOR USE IN CLEANING SKIN, INTRAVENOUS APPARATUS AND COMPONENTS THEREOF, IN CLASS 5 (U.S. CLS. 6, 18, 44, 46, 51 AND 52).

FIRST USE 10-1-1983; IN COMMERCE 10-1-1983.

FOR: DISPENSERS AND PUMPS FOR ANTISEPTIC SOLUTIONS, NAMELY, FOOT OPERATED DISPENSERS, WALL-MOUNTED HAND PUMPS AND HAND PUMPS; DISPENSING BOTTLES FOR POVIDONE IODINE PERIWASH AND OTHER CLEANSERS AND ANTISEPTICS, SOLD EMPTY, IN CLASS 21 (U.S. CLS. 2, 13, 23, 29, 30, 33, 40 AND 50).

FIRST USE 4-7-2005; IN COMMERCE 4-7-2005.

THE MARK CONSISTS OF STANDARD CHARACTERS WITHOUT CLAIM TO ANY PARTICULAR FONT, STYLE, SIZE, OR COLOR.

OWNER OF U.S. REG. NOS. 1,311,964, 3,085,520 AND OTHERS.

SER. NO. 77-039,201, FILED 11-8-2006.

SUNG IN, EXAMINING ATTORNEY

Int. Cl.: 9

Prior U.S. Cls.: 21, 23, 26, 36 and 38

United States Patent and Trademark Office

Reg. No. 3,397,050

Registered Mar. 18, 2008

**TRADEMARK
PRINCIPAL REGISTER**

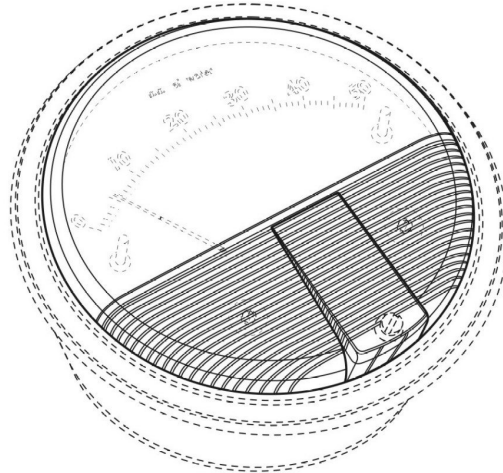

DWYER INSTRUMENTS, INC. (INDIANA CORPORATION)
102 INDIANA HIGHWAY 212
MICHIGAN CITY, IN 46361

FOR: PRESSURE GAGES AND DIFFERENTIAL PRESSURE GAGES, IN CLASS 9 (U.S. CLS. 21, 23, 26, 36 AND 38).

FIRST USE 0-0-1962; IN COMMERCE 0-0-1962.

THE MARK CONSISTS OF A PLURALITY OF HORIZONTAL LINES AND A RAISED RECTANGULAR PORTION ON THE LENS OF A PRESSURE GAUGE.

SEC. 2(F).

SER. NO. 77-039,625, FILED 11-8-2006.

REBECCA SMITH, EXAMINING ATTORNEY

Int. Cls.: 5, 41 and 44

Prior U.S. Cls.: 6, 18, 44, 46, 51, 52, 100, 101 and 107

United States Patent and Trademark Office

Reg. No. 3,397,051

Registered Mar. 18, 2008

**TRADEMARK
SERVICE MARK
PRINCIPAL REGISTER**

BODY IMAGE SOLUTIONS

BODY IMAGE SOLUTIONS, LLC (LOUISIANA
LTD LIAB CO)
7865 JEFFERSON HWY
BATON ROUGE, LA 70809

FOR: DIETARY AND NUTRITIONAL SUPPLE-
MENTS; DIETARY SUPPLEMENTS; NUTRITIONAL
SUPPLEMENTS; STIMULATORY MEDICATIONS
FOR USE IN WEIGHT REDUCTION PROGRAMS,
IN CLASS 5 (U.S. CLS. 6, 18, 44, 46, 51 AND 52).

FIRST USE 6-1-2005; IN COMMERCE 6-1-2005.

FOR: PERSONAL TRAINER SERVICES, IN CLASS
41 (U.S. CLS. 100, 101 AND 107).

FIRST USE 6-1-2005; IN COMMERCE 6-1-2005.

FOR: COSMETIC AND PLASTIC SURGERY;
DIETARY AND NUTRITIONAL GUIDANCE; PRO-

VIDING INFORMATION ABOUT DIETARY SUP-
PLEMENTS AND NUTRITION; WEIGHT
REDUCTION DIET PLANNING AND SUPERVI-
SION, IN CLASS 44 (U.S. CLS. 100 AND 101).

FIRST USE 6-1-2005; IN COMMERCE 6-1-2005.

THE MARK CONSISTS OF STANDARD CHAR-
ACTERS WITHOUT CLAIM TO ANY PARTICULAR
FONT, STYLE, SIZE, OR COLOR.

NO CLAIM IS MADE TO THE EXCLUSIVE
RIGHT TO USE "SOLUTIONS", APART FROM
THE MARK AS SHOWN.

SER. NO. 77-039,758, FILED 11-8-2006.

JAMES LOVELACE, EXAMINING ATTORNEY

Int. Cl.: 25

Prior U.S. Cls.: 22 and 39

United States Patent and Trademark Office

Reg. No. 3,397,052

Registered Mar. 18, 2008

**TRADEMARK
PRINCIPAL REGISTER**

HARD 8

MIZRAHI DESIGN GROUP, INC. (CALIFORNIA
CORPORATION)
1200 SOUTH HOPE STREE
LOS ANGELES, CA 90015

THE MARK CONSISTS OF STANDARD CHAR-
ACTERS WITHOUT CLAIM TO ANY PARTICULAR
FONT, STYLE, SIZE, OR COLOR.

FOR: CLOTHING, NAMELY, MENS T-SHIRTS,
SHIRTS, PANTS, SHORTS, TOPS, JACKETS, SWIM-
WEAR, UNDERWEAR, IN CLASS 25 (U.S. CLS. 22
AND 39).

SER. NO. 77-040,005, FILED 11-8-2006.

FIRST USE 4-1-2003; IN COMMERCE 4-1-2003.

SANJEEV VOHRA, EXAMINING ATTORNEY

Int. Cl.: 9

Prior U.S. Cls.: 21, 23, 26, 36 and 38

United States Patent and Trademark Office

Reg. No. 3,397,053

Registered Mar. 18, 2008

**TRADEMARK
PRINCIPAL REGISTER**

RTD Tango

RTS REALTIME SYSTEMS, INC. (DELAWARE
CORPORATION)
SUITE 1205
29 SOUTH LASALLE STREET
CHICAGO, IL 60603

FOR: COMPUTER SOFTWARE FOR ELECTRO-
NIC TRADING OF FINANCIAL INSTRUMENTS
AND INSTRUCTIONAL MANUALS SOLD AS A
UNIT, IN CLASS 9 (U.S. CLS. 21, 23, 26, 36 AND 38).

FIRST USE 1-10-2006; IN COMMERCE 1-10-2006.

THE MARK CONSISTS OF STANDARD CHAR-
ACTERS WITHOUT CLAIM TO ANY PARTICULAR
FONT, STYLE, SIZE, OR COLOR.

SER. NO. 77-040,373, FILED 11-9-2006.

AMOS T. MATTHEWS, JR., EXAMINING ATTOR-
NEY

Int. Cls.: 9 and 12

Prior U.S. Cls.: 19, 21, 23, 26, 31, 35, 36, 38 and 44

United States Patent and Trademark Office

Reg. No. 3,397,054

Registered Mar. 18, 2008

**TRADEMARK
PRINCIPAL REGISTER**

VERY WELL CONNECTED

GAMBER-JOHNSON LLC (WISCONSIN LTD
LIAB CO)
3001 BORHAM AVENUE
STEVENS POINT, WI 54481

FOR: COMPUTER DOCKING STATIONS FOR
USE IN MOBILE ENVIRONMENTS, NAMELY, MO-
TOR VEHICLES, AIRPLANES AND BOATS; VEHI-
CLE MOUNTING SUPPORTS FOR MOBILE
PHONES, IN CLASS 9 (U.S. CLS. 21, 23, 26, 36 AND 38).

FIRST USE 1-31-2001; IN COMMERCE 1-31-2001.

FOR: VEHICLE CAMERA MOUNTS, IN CLASS 12
(U.S. CLS. 19, 21, 23, 31, 35 AND 44).

FIRST USE 1-31-2001; IN COMMERCE 1-31-2001.

THE MARK CONSISTS OF STANDARD CHAR-
ACTERS WITHOUT CLAIM TO ANY PARTICULAR
FONT, STYLE, SIZE, OR COLOR.

NO CLAIM IS MADE TO THE EXCLUSIVE
RIGHT TO USE "CONNECTED", APART FROM
THE MARK AS SHOWN.

SER. NO. 77-040,462, FILED 11-9-2006.

ELIZABETH KAJUBI, EXAMINING ATTORNEY

Int. Cl.: 36

Prior U.S. Cls.: 100, 101 and 102

United States Patent and Trademark Office

Reg. No. 3,397,055

Registered Mar. 18, 2008

**SERVICE MARK
PRINCIPAL REGISTER**

ACCESSIBLE LIFE

THE WESTERN AND SOUTHERN LIFE INSUR-
ANCE COMPANY (OHIO CORPORATION)
400 BROADWAY, MS 32
CINCINNATI, OH 45202

FOR: INSURANCE UNDERWRITING IN THE
FIELD OF LIFE, IN CLASS 36 (U.S. CLS. 100, 101
AND 102).

FIRST USE 1-1-2001; IN COMMERCE 1-1-2001.

THE MARK CONSISTS OF STANDARD CHAR-
ACTERS WITHOUT CLAIM TO ANY PARTICULAR
FONT, STYLE, SIZE, OR COLOR.

NO CLAIM IS MADE TO THE EXCLUSIVE
RIGHT TO USE "LIFE", APART FROM THE MARK
AS SHOWN.

SER. NO. 77-041,131, FILED 11-10-2006.

DAVID MURRAY, EXAMINING ATTORNEY

Int. Cl.: 42

Prior U.S. Cls.: 100 and 101

United States Patent and Trademark Office

Reg. No. 3,397,056

Registered Mar. 18, 2008

**SERVICE MARK
PRINCIPAL REGISTER**



NEW COOPERATIVE, INC. (IOWA CORPORATION)
2626 FIRST AVE. SOUTH
FORT DODGE, IA 50501

FOR: PROVIDING TEMPORARY USE OF NON-DOWNLOADABLE COMPUTER SOFTWARE WHICH IS USED FOR COMPUTERIZED DATABASE MANAGEMENT, AGRONOMIC RECORD KEEPING, AND TO GENERATE VARIABLE RATE AND NON-VARIABLE RATE RECOMMENDATIONS FOR APPLICATION OF FERTILIZERS, SOIL AMENDMENTS, CROP PROTECTION CHEMICALS, AND SEEDS, ALL FOR USE IN THE FIELD OF AGRICULTURE, IN CLASS 42 (U.S. CLS. 100 AND 101).

FIRST USE 4-9-2003; IN COMMERCE 10-27-2003.

OWNER OF U.S. REG. NO. 2,851,415.

NO CLAIM IS MADE TO THE EXCLUSIVE RIGHT TO USE "MIDWEST AGRONOMIC PROFESSIONAL SERVICES", APART FROM THE MARK AS SHOWN.

THE MARK CONSISTS OF A GLOBE AND THE TERMS MAPS MIDWEST AGRONOMIC PROFESSIONAL SERVICES.

SER. NO. 77-041,218, FILED 11-10-2006.

SUNG IN, EXAMINING ATTORNEY

Int. Cl.: 43

Prior U.S. Cls.: 100 and 101

United States Patent and Trademark Office

Reg. No. 3,397,057

Registered Mar. 18, 2008

**SERVICE MARK
PRINCIPAL REGISTER**

**MAGGIE MOORE'S IRISH PUB &
RESTAURANT**

MOORE, JOHN (UNITED STATES INDIVIDUAL)
607 BENNINGTON LANE
SILVER SPRING, MD 20910

FOR: RESTAURANT AND BAR SERVICES, IN
CLASS 43 (U.S. CLS. 100 AND 101).

FIRST USE 11-1-2004; IN COMMERCE 11-1-2005.

THE MARK CONSISTS OF STANDARD CHAR-
ACTERS WITHOUT CLAIM TO ANY PARTICULAR
FONT, STYLE, SIZE, OR COLOR.

NO CLAIM IS MADE TO THE EXCLUSIVE
RIGHT TO USE "IRISH PUB & RESTAURANT",
APART FROM THE MARK AS SHOWN.

THE NAME SHOWN IN THE MARK IDENTIFIES
MAGGIE MOORE, WHOSE CONSENT TO REGIS-
TER IS SUBMITTED.

SER. NO. 77-041,856, FILED 11-10-2006.

KATHERINE M. DUBRAY, EXAMINING ATTOR-
NEY

Int. Cl.: 36

Prior U.S. Cls.: 100, 101 and 102

United States Patent and Trademark Office

Reg. No. 3,397,058

Registered Mar. 18, 2008

**SERVICE MARK
PRINCIPAL REGISTER**

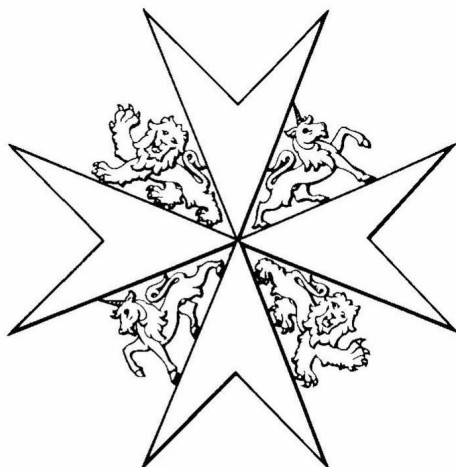

THE MOST VENERABLE ORDER OF THE HOSPITAL OF ST. JOHN OF JERUSALEM (UNITED KINGDOM CORPORATION)
CLERKENWELL
PRIORY HOUSE, 25 ST. JOHN'S LANE
LONDON, UNITED KINGDOM EC1M4PP

FOR: CHARITABLE SERVICES, NAMELY FUNDRAISING FOR AND PROVIDING GRANTS TO DOMESTIC AND INTERNATIONAL HUMANITARIAN, HOSPITALLER, MEDICAL AND RELIGIOUS CAUSES, IN CLASS 36 (U.S. CLS. 100, 101 AND 102).

FIRST USE 5-14-1888; IN COMMERCE 12-26-1957.

THE MARK CONSISTS OF THE DESIGN OF A MALTESE OR AMALFI CROSS COMPRISED OF FOUR ARROWHEADS POINTING INWARD. ALTERNATING IN BETWEEN THE FOUR PRINCIPLE ANGLES ARE A LION PASSANT GUARDANT WITH ITS HEAD TURNED AND FOREARM RAISED AND A UNICORN PASSANT WITH ITS LEG RAISED.

SER. NO. 77-042,028, FILED 11-11-2006.

MAUREEN DALL, EXAMINING ATTORNEY

Int. Cl.: 42

Prior U.S. Cls.: 100 and 101

United States Patent and Trademark Office

Reg. No. 3,397,059

Registered Mar. 18, 2008

**SERVICE MARK
PRINCIPAL REGISTER**

**REDEFINING THE RETAIL
EXPERIENCE**

GFX INTERNATIONAL, INC. (ILLINOIS CORPORATION)
333 BARRON BOULEVARD
GRAYSLAKE, IL 60030

FOR: DESIGN, DEVELOPMENT, IMPLEMENTATION, AND TECHNICAL SUPPORT OF INTERACTIVE AND PASSIVE VISUAL DISPLAY SYSTEMS FOR RETAILERS AND THE DESIGN AND PRODUCTION OF DIGITAL AND PRINT-BASED CONTENT RELATED TO SAID VISUAL DISPLAY SYSTEMS AND TECHNICAL CONSULTING SERVI-

CES IN THE FIELD OF VISUAL DISPLAY SYSTEMS, IN CLASS 42 (U.S. CLS. 100 AND 101).

FIRST USE 5-0-2006; IN COMMERCE 5-0-2006.

THE MARK CONSISTS OF STANDARD CHARACTERS WITHOUT CLAIM TO ANY PARTICULAR FONT, STYLE, SIZE, OR COLOR.

SER. NO. 77-042,271, FILED 11-13-2006.

JASON BLAIR, EXAMINING ATTORNEY

Int. Cls.: 39 and 41

Prior U.S. Cls.: 100, 101, 105 and 107

United States Patent and Trademark Office

Reg. No. 3,397,060

Registered Mar. 18, 2008

**SERVICE MARK
PRINCIPAL REGISTER**



PROJECT R.I.S.E., INC. (MASSACHUSETTS CORPORATION)
745 WASHINGTON STREET
BRAINTREE, MA 02184

FOR: TRAVEL SERVICES, NAMELY, ARRANGING AND CONDUCTING EDUCATIONAL TRIPS, IN CLASS 39 (U.S. CLS. 100 AND 105).

FIRST USE 12-31-1995; IN COMMERCE 12-31-1995.

FOR: EDUCATIONAL SERVICES, NAMELY, PROVIDING LIFE SKILLS TRAINING; MENTORING IN THE FIELDS OF LIFE SKILLS, YOUTH ATHLETIC PROGRAMS, ADULT LITERACY, TEEN PREGNANCY AND EDUCATION; YOUTH ATHLETIC PROGRAMS; ADULT LITERACY PRO-

GRAMS; AND TEEN PREGNANCY PROGRAMS, IN CLASS 41 (U.S. CLS. 100, 101 AND 107).

FIRST USE 12-31-1995; IN COMMERCE 12-31-1995.

NO CLAIM IS MADE TO THE EXCLUSIVE RIGHT TO USE "PROJECT", APART FROM THE MARK AS SHOWN.

THE MARK CONSISTS OF THE WORDS PROJECT AND RISE WITH A PYRAMID SUPERIMPOSED OVER THE WORD RISE.

SER. NO. 77-042,521, FILED 11-13-2006.

PAUL E. FAHRENKOPF, EXAMINING ATTORNEY

Int. Cls.: 29, 31 and 32

Prior U.S. Cls.: 1, 45, 46 and 48

United States Patent and Trademark Office

Reg. No. 3,397,061

Registered Mar. 18, 2008

**TRADEMARK
PRINCIPAL REGISTER**

HIMALANIA

SELECTPRO SALES, INC. (CALIFORNIA CORPORATION)
10853 VENICE BLVD
LOS ANGELES, CA 90034

FOR: CANDIED FRUIT; CANDIED FRUIT SNACKS; CANDIED NUTS; CANNED FRUITS; CANNED OR BOTTLED FRUITS; CANNED OR BOTTLED VEGETABLES; COMPOTES; CRYSTALLIZED FRUIT; CUT FRUITS; CUT VEGETABLES; DEHYDRATED FRUIT SNACKS; DIPS; DRIED FRUIT MIXES; DRIED FRUITS; DRIED VEGETABLES; DRINKING YOGURTS; DRINKS BASED ON YOGHURT; DRY OR AROMATIZED FRUIT; FOOD GLAZING PREPARATIONS COMPRISED PRIMARILY OF FRUIT AND/OR FRUIT PECTIC FOR USE IN COOKING AND BAKING; FOOD PACKAGE COMBINATIONS CONSISTING PRIMARILY OF CHEESE, MEAT AND/OR PROCESSED FRUIT; FROZEN FRUITS; FROZEN VEGETABLES; FRUIT AND SOY BASED SNACK FOOD; FRUIT AND VEGETABLE SALADS; FRUIT CHIPS; FRUIT CONSERVES; FRUIT LEATHERS; FRUIT PASTE; FRUIT PECTIN; FRUIT PEELS; FRUIT PRESERVES; FRUIT PULPS; FRUIT RINDS; FRUIT SALADS; FRUIT TOPPING; FRUIT-BASED FILLING FOR CAKES AND PIES; FRUIT-BASED FOOD BEVERAGE; FRUIT-BASED ORGANIC FOOD BARS; FRUIT-BASED SNACK FOOD; FRUIT-BASED SPREADS; FRUITS PRESERVED IN ALCOHOL; FRUITS, NAMELY, DRIED, CANNED, PRESERVED, PROCESSED GOJI BERRIES; GLAZED FRUITS; JAMS; JELLIES; MILK BASED BEVERAGES CONTAINING FRUIT JUICE; MILK BEVERAGES CONTAINING FRUITS; MILK DRINKS CONTAINING FRUITS; PICKLED FRUITS; PICKLED VEGETABLES; PROCESSED FRUITS; PROCESSED NUTS; PROCESSED ROOTS; PROCESSED VEGETABLES AND FRUITS; PROTEIN BASED, NUTRIENT-DENSE SNACK BARS; PROTEINS BEING FOODSTUFFS FOR HUMAN CONSUMPTION; SNACK DIPS; SNACK MIX CONSISTING PRIMARILY OF PROCESSED

FRUITS, PROCESSED NUTS AND/OR RAISINS; YOGURT-BASED BEVERAGES, IN CLASS 29 (U.S. CL. 46).

FIRST USE 7-0-2005; IN COMMERCE 7-0-2005.

FOR: AGRICULTURAL SEEDS; BEVERAGES FOR ANIMALS; BIRD SEED; DOG BISCUITS; DOG TREATS; DRIED PLANTS; FRESH FRUITS; FRESH NUTS; FRUIT SEEDS; FRUITS, NAMELY, FRESH GOJI BERRIES; LIVING FRUIT PLANTS; PLANT SEEDS; RAW FRUITS; UNPROCESSED FRUITS, IN CLASS 31 (U.S. CLS. 1 AND 46).

FIRST USE 7-0-2005; IN COMMERCE 7-0-2005.

FOR: AERATED FRUIT JUICES; COLAS; CONCENTRATES, SYRUPS OR POWDERS USED IN THE PREPARATION OF SOFT DRINKS; DE-ALCOHOLIZED WINES; ENERGY DRINKS; ESSENCES FOR THE PREPARATION OF MINERAL WATERS; ESSENCES FOR USE IN MAKING SOFT DRINKS; FLAVOURED WATERS; FROZEN FRUIT-BASED BEVERAGES; FRUIT BEVERAGES; FRUIT DRINKS; FRUIT FLAVORED SOFT DRINKS; FRUIT JUICE BASES; FRUIT JUICE CONCENTRATES; FRUIT JUICES; FRUIT JUICES, NAMELY, GOJI BERRY JUICE; FRUIT NECTARS; FRUIT PUNCH; FRUIT-BASED SOFT DRINKS FLAVORED WITH TEA; FRUIT-FLAVORED DRINKS; FRUIT-FLAVOURED BEVERAGES; HERBAL JUICES; HORCHATA; ICED FRUIT BEVERAGES; ISOTONIC DRINKS; JUICE BASE CONCENTRATES; LEMONADE; NON-ALCOHOLIC BEVERAGES CONTAINING FRUIT JUICES; NON-ALCOHOLIC BEVERAGES WITH TEA FLAVOR; NON-ALCOHOLIC BEVERAGES, NAMELY, CARBONATED BEVERAGES; NON-ALCOHOLIC COCKTAIL MIXES; NON-ALCOHOLIC FRUIT EXTRACTS USED IN THE PREPARATION OF BEVERAGES; NON-ALCOHOLIC FRUIT JUICE BEVERAGES; NON-CARBONATED, NON-ALCOHOLIC FROZEN

FLAVORED BEVERAGES; NONALCOHOLIC APERTIFIS; POP; SHERBETS; SMOOTHIES; SOFT DRINKS; SOFT DRINKS FLAVORED WITH TEA; SPORTS DRINKS; SYRUP FOR MAKING LEMONADE; SYRUPS FOR BEVERAGES; SYRUPS FOR MAKING SOFT DRINKS; VEGETABLE JUICES, IN CLASS 32 (U.S. CLS. 45, 46 AND 48).

FIRST USE 7-0-2005; IN COMMERCE 7-0-2005.

THE MARK CONSISTS OF STANDARD CHARACTERS WITHOUT CLAIM TO ANY PARTICULAR FONT, STYLE, SIZE, OR COLOR.

SER. NO. 77-042,705, FILED 11-13-2006.

CHERYL CLAYTON, EXAMINING ATTORNEY

Int. Cls.: 29, 31 and 32

Prior U.S. Cls.: 1, 45, 46 and 48

United States Patent and Trademark Office

Reg. No. 3,397,062

Registered Mar. 18, 2008

**TRADEMARK
PRINCIPAL REGISTER**

TERRAMAZON

SELECTPRO SALES, INC. (CALIFORNIA CORPORATION)
10853 VENICE BLVD
LOS ANGELES, CA 90034

FOR: CANDIED FRUIT; CANDIED FRUIT SNACKS; CANDIED NUTS; CANNED FRUITS; CANNED OR BOTTLED FRUITS; CANNED OR BOTTLED VEGETABLES; COMPOTES; CRYSTALLIZED FRUIT; CUT FRUITS; CUT VEGETABLES; DEHYDRATED FRUIT SNACKS; DIPS; DRIED FRUIT MIXES; DRIED FRUITS; DRIED VEGETABLES; DRINKING YOGURTS; DRINKS BASED ON YOGHURT; DRY OR AROMATIZED FRUIT; FOOD GLAZING PREPARATIONS COMPRISED PRIMARILY OF FRUIT AND/OR FRUIT PECTIC FOR USE IN COOKING AND BAKING; FOOD PACKAGE COMBINATIONS CONSISTING PRIMARILY OF CHEESE, MEAT AND/OR PROCESSED FRUIT; FROZEN FRUITS; FROZEN VEGETABLES; FRUIT AND SOY BASED SNACK FOOD; FRUIT AND VEGETABLE SALADS; FRUIT CHIPS; FRUIT CONSERVES; FRUIT LEATHERS; FRUIT PASTE; FRUIT PECTIN; FRUIT PEELS; FRUIT PRESERVES; FRUIT PULPS; FRUIT RINDS; FRUIT SALADS; FRUIT TOPPING; FRUIT-BASED FILLING FOR CAKES AND PIES; FRUIT-BASED FOOD BEVERAGE; FRUIT-BASED ORGANIC FOOD BARS; FRUIT-BASED SNACK FOOD; FRUIT-BASED SPREADS; FRUITS PRESERVED IN ALCOHOL; FRUITS, NAMELY, DRIED, CANNED, PRESERVED, PROCESSED GOJI BERRIES; GLAZED FRUITS; JAMS; JELLIES; MILK BASED BEVERAGES CONTAINING FRUIT JUICE; MILK BEVERAGES CONTAINING FRUITS; MILK DRINKS CONTAINING FRUITS; PICKLED FRUITS; PICKLED VEGETABLES; PROCESSED FRUITS; PROCESSED NUTS; PROCESSED ROOTS; PROCESSED VEGETABLES AND FRUITS; PROTEIN BASED, NUTRIENT-DENSE SNACK BARS; PROTEINS BEING FOODSTUFFS FOR HUMAN CONSUMPTION; SNACK DIPS; SNACK MIX CONSISTING PRIMARILY OF PROCESSED

FRUITS, PROCESSED NUTS AND/OR RAISINS; YOGURT-BASED BEVERAGES, IN CLASS 29 (U.S. CL. 46).

FIRST USE 7-0-2006; IN COMMERCE 7-0-2006.

FOR: AGRICULTURAL SEEDS; BEVERAGES FOR ANIMALS; BIRD SEED; DOG BISCUITS; DOG TREATS; DRIED PLANTS; FRESH FRUITS; FRESH NUTS; FRUIT SEEDS; FRUITS, NAMELY, FRESH GOJI BERRIES; LIVING FRUIT PLANTS; PLANT SEEDS; RAW FRUITS; UNPROCESSED FRUITS, IN CLASS 31 (U.S. CLS. 1 AND 46).

FIRST USE 7-0-2006; IN COMMERCE 7-0-2006.

FOR: AERATED FRUIT JUICES; COLAS; CONCENTRATES, SYRUPS OR POWDERS USED IN THE PREPARATION OF SOFT DRINKS; DE-ALCOHOLIZED WINES; ENERGY DRINKS; ESSENCES FOR THE PREPARATION OF MINERAL WATERS; ESSENCES FOR USE IN MAKING SOFT DRINKS; FLAVOURED WATERS; FROZEN FRUIT-BASED BEVERAGES; FRUIT BEVERAGES; FRUIT DRINKS; FRUIT FLAVORED SOFT DRINKS; FRUIT JUICE BASES; FRUIT JUICE CONCENTRATES; FRUIT JUICES; FRUIT JUICES, NAMELY, GOJI BERRY JUICE; FRUIT NECTARS; FRUIT PUNCH; FRUIT-BASED SOFT DRINKS FLAVORED WITH TEA; FRUIT-FLAVORED DRINKS; FRUIT-FLAVOURED BEVERAGES; HERBAL JUICES; HORCHATA; ICED FRUIT BEVERAGES; ISOTONIC DRINKS; JUICE BASE CONCENTRATES; LEMONADE; NON-ALCOHOLIC BEVERAGES CONTAINING FRUIT JUICES; NON-ALCOHOLIC BEVERAGES WITH TEA FLAVOR; NON-ALCOHOLIC BEVERAGES, NAMELY, CARBONATED BEVERAGES; NON-ALCOHOLIC COCKTAIL MIXES; NON-ALCOHOLIC FRUIT EXTRACTS USED IN THE PREPARATION OF BEVERAGES; NON-ALCOHOLIC FRUIT JUICE BEVERAGES; NON-CARBONATED, NON-ALCOHOLIC FROZEN

FLAVORED BEVERAGES; NONALCOHOLIC APERTIFIS; POP; SHERBETS; SMOOTHIES; SOFT DRINKS; SOFT DRINKS FLAVORED WITH TEA; SPORTS DRINKS; SYRUP FOR MAKING LEMONADE; SYRUPS FOR BEVERAGES; SYRUPS FOR MAKING SOFT DRINKS; VEGETABLE JUICES, IN CLASS 32 (U.S. CLS. 45, 46 AND 48).

FIRST USE 7-0-2006; IN COMMERCE 7-0-2006.

THE MARK CONSISTS OF STANDARD CHARACTERS WITHOUT CLAIM TO ANY PARTICULAR FONT, STYLE, SIZE, OR COLOR.

SER. NO. 77-042,738, FILED 11-13-2006.

CHERYL CLAYTON, EXAMINING ATTORNEY

Int. Cl.: 43

Prior U.S. Cls.: 100 and 101

United States Patent and Trademark Office

Reg. No. 3,397,063

Registered Mar. 18, 2008

**SERVICE MARK
PRINCIPAL REGISTER**



SAMARA, JAWAD N. (UNITED STATES INDIVIDUAL)
10305 FOX RUN
MUNSTER, IN 46321

FOR: RESTAURANT SERVICES, IN CLASS 43
(U.S. CLS. 100 AND 101).

FIRST USE 0-0-1962; IN COMMERCE 0-0-1962.

OWNER OF U.S. REG. NO. 1,835,781.

THE MARK CONSISTS OF A PARTIALLY SHAD-
DED OVAL .

SEC. 2(F).

SER. NO. 77-042,781, FILED 11-13-2006.

JAMES MACFARLANE, EXAMINING ATTORNEY

Int. Cl.: 9

Prior U.S. Cls.: 21, 23, 26, 36 and 38

United States Patent and Trademark Office

Reg. No. 3,397,064

Registered Mar. 18, 2008

**TRADEMARK
PRINCIPAL REGISTER**

SETTING THE NEW STANDARD

COMPLETECAMPAIGNS.COM, LLC (CALIFORNIA LTD LIAB CO)
SUITE K
610 GATEWAY CENTER WAY
SAN DIEGO, CA 92102

FOR: COMPUTER SOFTWARE FOR CONTACT MANAGEMENT, FUNDRAISING, ACCOUNTING, GOVERNMENT COMPLIANCE REPORTING, WEBSITE MANAGEMENT AND OFFICE MANAGEMENT IN THE FIELD OF BUSINESS MANAGEMENT FOR POLITICAL AND NON-

PROFIT ORGANIZATIONS, IN CLASS 9 (U.S. CLS. 21, 23, 26, 36 AND 38).

FIRST USE 7-14-2006; IN COMMERCE 7-14-2006.

THE MARK CONSISTS OF STANDARD CHARACTERS WITHOUT CLAIM TO ANY PARTICULAR FONT, STYLE, SIZE, OR COLOR.

SER. NO. 77-043,493, FILED 11-14-2006.

MORGAN WYNNE, EXAMINING ATTORNEY

Int. Cls.: 44 and 45

Prior U.S. Cls.: 100 and 101

United States Patent and Trademark Office

Reg. No. 3,397,065

Registered Mar. 18, 2008

**SERVICE MARK
PRINCIPAL REGISTER**

CSSTEST

CSS TEST INC. (NEW JERSEY CORPORATION)
SUITE 102
400 LAUREL OAK ROAD
VOORHEES, NJ 08043

FOR: DRUG TESTING FOR SUBSTANCE ABUSE,
IN CLASS 44 (U.S. CLS. 100 AND 101).

FIRST USE 12-23-2002; IN COMMERCE 12-23-2002.

FOR: PRE-EMPLOYMENT BACKGROUND
SCREENING, IN CLASS 45 (U.S. CLS. 100 AND 101).

FIRST USE 12-23-2002; IN COMMERCE 12-23-2002.

THE MARK CONSISTS OF STANDARD CHAR-
ACTERS WITHOUT CLAIM TO ANY PARTICULAR
FONT, STYLE, SIZE, OR COLOR.

SER. NO. 77-043,857, FILED 11-14-2006.

JESSICA FATHY, EXAMINING ATTORNEY

Int. Cl.: 17

Prior U.S. Cls.: 1, 5, 12, 13, 35 and 50

United States Patent and Trademark Office

Reg. No. 3,397,066

Registered Mar. 18, 2008

**TRADEMARK
PRINCIPAL REGISTER**

HAWG STALKER

SUPREME CORPORATION (NORTH CAROLINA
CORPORATION)
325 SPENCER ROAD
CONOVER, NC 28613

FOR: ELASTIC RUBBER-LIKE MATERIAL FOR
USE IN THE MANUFACTURE OF FISHING PRO-
DUCTS AND ACCESSORIES, IN CLASS 17 (U.S. CLS.
1, 5, 12, 13, 35 AND 50).

FIRST USE 6-1-2006; IN COMMERCE 6-1-2006.

THE MARK CONSISTS OF STANDARD CHAR-
ACTERS WITHOUT CLAIM TO ANY PARTICULAR
FONT, STYLE, SIZE, OR COLOR.

SER. NO. 77-043,984, FILED 11-14-2006.

MELVIN AXILBUND, EXAMINING ATTORNEY

Int. Cl.: 25

Prior U.S. Cls.: 22 and 39

United States Patent and Trademark Office

Reg. No. 3,397,067

Registered Mar. 18, 2008

**TRADEMARK
PRINCIPAL REGISTER**

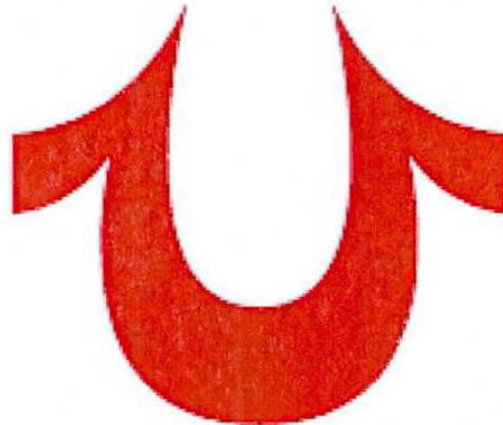

GURU DENIM INC. (CALIFORNIA CORPORATION)
2263 EAST VERNON AVENUE
VERNON, CA 90058

FOR: PANTS, JEANS, SHORTS, OVERALLS, SHIRTS, T-SHIRTS, BLOUSES, VESTS, SKIRTS, JACKETS, COATS, SWEATSHIRTS, SWEATPANTS, IN CLASS 25 (U.S. CLS. 22 AND 39).

FIRST USE 12-0-2002; IN COMMERCE 12-0-2002.

OWNER OF U.S. REG. NO. 3,147,244.

THE COLOR(S) RED IS/ARE CLAIMED AS A FEATURE OF THE MARK.

THE MARK CONSISTS OF A STYLIZED REPRESENTATION OF THE LETTER "U" IN THE COLOR RED.

SER. NO. 77-044,078, FILED 11-14-2006.

LESLIE RICHARDS, EXAMINING ATTORNEY

Int. Cl.: 45

Prior U.S. Cls.: 100 and 101

United States Patent and Trademark Office

Reg. No. 3,397,068

Registered Mar. 18, 2008

**SERVICE MARK
PRINCIPAL REGISTER**

EPISCOPAL CHURCH CENTER

THE EPISCOPAL CHURCH (NEW YORK UNINC.
ASSOCIATION)
815 SECOND AVENUE
NEW YORK, NY 10017

FOR: RELIGIOUS SERVICES, NAMELY, MINIS-
TERIAL, EVANGELICAL, AND MISSIONARY SER-
VICES, IN CLASS 45 (U.S. CLS. 100 AND 101).

FIRST USE 1-1-1961; IN COMMERCE 1-1-1961.

THE MARK CONSISTS OF STANDARD CHAR-
ACTERS WITHOUT CLAIM TO ANY PARTICULAR
FONT, STYLE, SIZE, OR COLOR.

OWNER OF U.S. REG. NOS. 3,195,454 AND
3,195,455.

NO CLAIM IS MADE TO THE EXCLUSIVE
RIGHT TO USE "CHURCH", APART FROM THE
MARK AS SHOWN.

SEC. 2(F).

SER. NO. 77-044,615, FILED 11-15-2006.

STEVEN R. FINE, EXAMINING ATTORNEY

Int. Cls.: 38 and 41

Prior U.S. Cls.: 100, 101, 104 and 107

United States Patent and Trademark Office

Reg. No. 3,397,069

Registered Mar. 18, 2008

**SERVICE MARK
PRINCIPAL REGISTER**

COAST TO COAST

WLF | THE WILLIAMS LAW FIRM, PC (CALIFORNIA CORPORATION)
100 BAYVIEW CIR., SOUTH TOWER, SUITE 330
NEWPORT BEACH, CA 926602984

FOR: RADIO PROGRAM BROADCASTING, AUDIO BROADCASTING, COMMUNICATION BY ELECTRONIC COMPUTER TERMINALS, COMMUNICATION VIA COMPUTER TERMINALS, BY DIGITAL TRANSMISSION, OR BY SATELLITE, PODCASTING SERVICES, PROVIDING ON-LINE COMMUNICATIONS LINKS WHICH TRANSFER THE WEBSITE USER TO OTHER LOCAL AND GLOBAL WEB PAGES, IN CLASS 38 (U.S. CLS. 100, 101 AND 104).

FIRST USE 8-31-2005; IN COMMERCE 8-31-2005.

FOR: ENTERTAINMENT SERVICES, NAMELY, PROVIDING A TALK RADIO PROGRAM IN THE FIELD OF LEGAL ISSUES VIA A GLOBAL COMPUTER NETWORK, IN CLASS 41 (U.S. CLS. 100, 101 AND 107).

FIRST USE 8-31-2005; IN COMMERCE 8-31-2005.

THE MARK CONSISTS OF STANDARD CHARACTERS WITHOUT CLAIM TO ANY PARTICULAR FONT, STYLE, SIZE, OR COLOR.

SEC. 2(F).

SER. NO. 77-045,548, FILED 11-16-2006.

ANTHONY RINKER, EXAMINING ATTORNEY

Int. Cls.: 9, 16 and 41

**Prior U.S. Cls.: 2, 5, 21, 22, 23, 26, 29, 36, 37, 38, 50,
100, 101 and 107**

Reg. No. 3,397,070

United States Patent and Trademark Office

Registered Mar. 18, 2008

**TRADEMARK
SERVICE MARK
PRINCIPAL REGISTER**

Musicmap Series

KOOMZAAL CO., LTD. (REPUBLIC OF KOREA CORPORATION)
7F SAMJUNG BLDG., 33-1 MAPO-DONG
MAPO-GU, SEOUL, REPUBLIC OF KOREA 121-708

FOR: AUDIO TAPES FEATURING MUSIC, VIDEO TAPES FEATURING MUSIC, ELECTRONIC PUBLICATIONS, NAMELY, BOOK, MAGAZINE AND MANUAL FEATURING MUSIC, MUSIC RECORDED ON OPTICAL DISCS AND COMPUTER READABLE MEDIA, NAMELY, COMPACT DISCS (CDS) AND DIGITAL VIDEO DISCS (DVDS), DOWNLOADABLE MUSIC VIA THE INTERNET USING COMPUTER AND WIRELESS DEVICES, IN CLASS 9 (U.S. CLS. 21, 23, 26, 36 AND 38).

FIRST USE 11-8-2006; IN COMMERCE 11-8-2006.

FOR: SONG BOOK, GREETING CARD, BOOKLETS IN THE FIELD OF MUSIC, PICTURE POSTCARD, COMIC BOOK, BOOKS IN THE FIELD OF MUSIC, CATALOGS IN THE FIELD OF MUSIC, PICTURE BOOKS, LETTER CARD FOR STUDYING MUSIC, PRINTED PERIODICALS IN THE FIELD OF MUSIC, PAMPHLETS IN THE FIELD OF MUSIC, THREE DIMENSIONAL MODELS FOR EDUCATIONAL PURPOSES, ENVELOPES, NOTEBOOK PAPER, PRINTED MUSIC BOOKS, WIRE-BOUND NOTEBOOKS, IN CLASS 16 (U.S. CLS. 2, 5, 22, 23, 29, 37, 38 AND 50).

FIRST USE 11-8-2006; IN COMMERCE 11-8-2006.

FOR: INSTRUCTION IN THE FIELD OF MUSIC, EDUCATION SERVICES, NAMELY, PROVIDING LIVE AND ON-LINE MUSIC CLASSES, SEMINARS AND WORKSHOPS, MULTIMEDIA PUBLISHING OF BOOKS, MAGAZINES, JOURNALS, SOFTWARE, GAMES, MUSIC, AND ELECTRONIC PUBLICATIONS, EDUCATIONAL SERVICES, NAMELY, DEVELOPING, ARRANGING, AND CONDUCTING EDUCATIONAL CONFERENCES AND PROGRAMS AND PROVIDING COURSES OF INSTRUCTION IN THE FIELD OF MUSIC, IN CLASS 41 (U.S. CLS. 100, 101 AND 107).

FIRST USE 11-8-2006; IN COMMERCE 11-8-2006.

NO CLAIM IS MADE TO THE EXCLUSIVE RIGHT TO USE "SERIES", APART FROM THE MARK AS SHOWN.

THE COLOR(S) GREEN AND GREY IS/ARE CLAIMED AS A FEATURE OF THE MARK.

THE MARK CONSISTS OF STYLIZED MUSIC-MAP WITH GREEN COLOR AND SERIES WITH GREY COLOR.

SER. NO. 77-045,957, FILED 11-16-2006.

ANNE E. GUSTASON, EXAMINING ATTORNEY

Int. Cl.: 35

Prior U.S. Cls.: 100, 101 and 102

United States Patent and Trademark Office

Reg. No. 3,397,071

Registered Mar. 18, 2008

**SERVICE MARK
PRINCIPAL REGISTER**

FRANCHISE  SERVICES

FRANCHISE SERVICES, INC. (CALIFORNIA CORPORATION)
26722 PLAZA DRIVE
MISSION VIEJO, CA 92691

FOR: BUSINESS MANAGEMENT AND CONSULTATION, IN CLASS 35 (U.S. CLS. 100, 101 AND 102).

FIRST USE 8-9-1996; IN COMMERCE 8-9-1996.

NO CLAIM IS MADE TO THE EXCLUSIVE RIGHT TO USE "FRANCHISE" AND "SERVICES", APART FROM THE MARK AS SHOWN.

THE MARK CONSISTS OF THE LITERAL ELEMENTS "FRANCHISE" AND "SERVICES" WITH A DESIGN BETWEEN THOSE TWO WORDS CONSISTING OF FOUR IRREGULARLY SHAPED AND INCOMPLETE SQUARES, WHICH SQUARES ARE PROGRESSIVELY SHADED FROM LIGHT TO DARK CLOCKWISE AROUND A CIRCULAR CENTER.

SER. NO. 77-046,118, FILED 11-16-2006.

THOMAS MANOR, EXAMINING ATTORNEY

Int. Cl.: 42

Prior U.S. Cls.: 100 and 101

United States Patent and Trademark Office

Reg. No. 3,397,072

Registered Mar. 18, 2008

**SERVICE MARK
PRINCIPAL REGISTER**

ReputationDefender

REPUTATIONDEFENDER, INC. (DELAWARE CORPORATION)
SUITE 132
3723 HAVEN AVE.
MENLO PARK, CA 94025

FOR: COMPUTER SERVICES, NAMELY, CREATING INDEXES OF INFORMATION, SITES AND OTHER RESOURCES AND TRACKING RELEVANT INFORMATION AVAILABLE ON COMPUTER NETWORKS FOR THE PURPOSES OF OFFERING AN ONLINE REPUTATION MANAGEMENT SERVICE, IN CLASS 42 (U.S. CLS. 100 AND 101).

FIRST USE 6-1-2006; IN COMMERCE 10-9-2006.

THE MARK CONSISTS OF STANDARD CHARACTERS WITHOUT CLAIM TO ANY PARTICULAR FONT, STYLE, SIZE, OR COLOR.

SER. NO. 77-046,395, FILED 11-17-2006.

SCOTT SISUN, EXAMINING ATTORNEY

Int. Cl.: 41

Prior U.S. Cls.: 100, 101 and 107

United States Patent and Trademark Office

Reg. No. 3,397,073

Registered Mar. 18, 2008

**SERVICE MARK
PRINCIPAL REGISTER**

**WE'LL SHARE & SAVE & SPEND
SMART TOO!**

LANZA ENTERTAINMENT COMPANY, LLC
(CALIFORNIA LTD LIAB CO)
419 N. LARCHMONT BLVD. #5
LOS ANGELES, CA 90004

FOR: ENTERTAINMENT AND EDUCATION IN THE NATURE OF ON-GOING TELEVISION PROGRAMS IN THE FIELD OF TEACHING CHILDREN ABOUT PERSONAL FINANCE; ENTERTAINMENT AND EDUCATION IN THE NATURE SEMINARS AND CLASSES TEACHING CHILDREN ABOUT PERSONAL FINANCE; ENTERTAINMENT AND EDUCATION SERVICES, NAMELY, AN ONLINE ACTIVITY WHERE YOU CREATE YOUR OWN MUSIC VIDEOS; ENTERTAINMENT SERVICES, NAMELY, PROVIDING A TELEVISION PROGRAM IN THE FIELD OF TEACHING CHILDREN ABOUT PERSONAL FINANCE VIA A GLOBAL COMPUTER INFORMATION NETWORK; ENTERTAINMENT AND EDUCATION SERVICES, NAMELY, PROVIDING A WEB SITE FEATURING MUSICAL PERFORMANCES, MUSICAL VIDEOS, RELATED FILM CLIPS, PHOTOGRAPHS AND OTHER MULTIMEDIA MATERIALS; ENTERTAINMENT AND EDUCATION SERVICES, NAMELY, PROVIDING ON-

LINE COMPUTER GAMES; ENTERTAINMENT AND EDUCATION SERVICES, NAMELY, PROVIDING ENTERTAINMENT INFORMATION, PRODUCTION OF ENTERTAINMENT AND EDUCATION PROGRAMS AND INTERACTIVE ENTERTAINMENT AND EDUCATION PROGRAMS IN THE FIELD OF TEACHING CHILDREN ABOUT PERSONAL FINANCE; ENTERTAINMENT AND EDUCATION SERVICES, NAMELY, PRODUCTION OF ENTERTAINMENT NEWS AND INFORMATION ABOUT PERSONAL FINANCE FOR CHILDREN VIA A GLOBAL COMPUTER INFORMATION NETWORK, IN CLASS 41 (U.S. CLS. 100, 101 AND 107).

FIRST USE 10-1-2005; IN COMMERCE 3-29-2006.

THE MARK CONSISTS OF STANDARD CHARACTERS WITHOUT CLAIM TO ANY PARTICULAR FONT, STYLE, SIZE, OR COLOR.

SER. NO. 77-046,711, FILED 11-17-2006.

JULIE WATSON, EXAMINING ATTORNEY

Int. Cl.: 16

Prior U.S. Cls.: 2, 5, 22, 23, 29, 37, 38 and 50

Reg. No. 3,397,074

United States Patent and Trademark Office

Registered Mar. 18, 2008

**TRADEMARK
PRINCIPAL REGISTER**

ALO Hayati

KENAAN, WAFAA (UNITED STATES INDIVIDUAL)
BLDG. 1
19365 BUSINESS CENTER DRIVE
NORTHRIDGE, CA 91324

FOR: GENERAL FEATURE MAGAZINES, IN CLASS 16 (U.S. CLS. 2, 5, 22, 23, 29, 37, 38 AND 50).

FIRST USE 3-1-2005; IN COMMERCE 3-1-2005.

THE MARK CONSISTS OF STANDARD CHARACTERS WITHOUT CLAIM TO ANY PARTICULAR FONT, STYLE, SIZE, OR COLOR.

THE FOREIGN WORDING IN THE MARK TRANSLATES INTO ENGLISH AS HELLO DARLING OR HELLO MY LIFE.

SER. NO. 77-047,001, FILED 11-17-2006.

DAVID TOOLEY, EXAMINING ATTORNEY

Int. Cl.: 40

Prior U.S. Cls.: 100, 103 and 106

United States Patent and Trademark Office

Reg. No. 3,397,075

Registered Mar. 18, 2008

**SERVICE MARK
PRINCIPAL REGISTER**

GET YOUR FILL

HYALURON, INC. (MASSACHUSETTS CORPORATION)
SUITE 2
99 SOUTH BEDFORD STREET
BURLINGTON, MA 01803

FOR: CONTRACT MANUFACTURING IN THE FIELD OF PHARMACEUTICALS AND BIOPHARMACEUTICALS; CONTRACT MANUFACTURING IN THE FIELD OF ASEPTICALLY FILLED LIQUID PARENTERAL VIALS, SYRINGES, MEDICAL VIALS, AND CONTAINERS; ASSEMBLING OF PRODUCT FOR OTHERS, IN THE NATURE OF FILLING OF VIALS, SYRINGES, AND CUSTOM CONTAINERS FOR OTHERS IN THE FIELD OF PHARMACEUTICAL PRODUCTS OF LIQUID,

SEMI-SOLID, OR SOLID KIND, IN CLASS 40 (U.S. CLS. 100, 103 AND 106).

FIRST USE 5-9-2006; IN COMMERCE 5-9-2006.

THE MARK CONSISTS OF STANDARD CHARACTERS WITHOUT CLAIM TO ANY PARTICULAR FONT, STYLE, SIZE, OR COLOR.

NO CLAIM IS MADE TO THE EXCLUSIVE RIGHT TO USE "FILL", APART FROM THE MARK AS SHOWN.

SER. NO. 77-047,137, FILED 11-17-2006.

DAWN HAN, EXAMINING ATTORNEY

Int. Cl.: 37

Prior U.S. Cls.: 100, 103 and 106

United States Patent and Trademark Office

Reg. No. 3,397,076

Registered Mar. 18, 2008

**SERVICE MARK
PRINCIPAL REGISTER**



MAVCO, INC. (MINNESOTA CORPORATION)
11227 RIVER ROAD NE
HANOVER, MN 55341

FOR: RESIDENTIAL AND COMMERCIAL RE-
STORATION AND REMODELING FOLLOWING
DAMAGE BY FIRE, WATER OR STORM, IN CLASS
37 (U.S. CLS. 100, 103 AND 106).

FIRST USE 1-1-2000; IN COMMERCE 1-1-2000.

NO CLAIM IS MADE TO THE EXCLUSIVE
RIGHT TO USE "CONSTRUCTION COMPANY",
APART FROM THE MARK AS SHOWN.

THE MARK CONSISTS OF MAVERICK CON-
STRUCTION COMPANY WITH HORNS.

SER. NO. 77-047,257, FILED 11-18-2006.

WENDY JUN, EXAMINING ATTORNEY

Int. Cl.: 9

Prior U.S. Cls.: 21, 23, 26, 36 and 38

Reg. No. 3,397,077

United States Patent and Trademark Office

Registered Mar. 18, 2008

**TRADEMARK
PRINCIPAL REGISTER**

MALWAREBOT

C-NETMEDIA INC. (ALABAMA CORPORATION)
590 B SCHILLINGER ROAD SOUTH, SUITE 8
MOBILE, AL 36695

FIRST USE 1-3-2001; IN COMMERCE 3-5-2006.

FOR: COMPUTER SOFTWARE AND DOWN-
LOADABLE COMPUTER SOFTWARE FOR SCAN-
NING COMPUTER DRIVES AND REMOVABLE
STORAGE DEVICES TO DETECT AND REMOVE
UNWANTED PROGRAMS, IN CLASS 9 (U.S. CLS. 21,
23, 26, 36 AND 38).

THE MARK CONSISTS OF STANDARD CHAR-
ACTERS WITHOUT CLAIM TO ANY PARTICULAR
FONT, STYLE, SIZE, OR COLOR.

SER. NO. 77-047,470, FILED 11-20-2006.

KATHERINE CHANG, EXAMINING ATTORNEY

Int. Cl.: 44

Prior U.S. Cls.: 100 and 101

United States Patent and Trademark Office

Reg. No. 3,397,078

Registered Mar. 18, 2008

**SERVICE MARK
PRINCIPAL REGISTER**

RELAXATION & RETREAT

RELAXATION & RETREAT MESSAGES OF
YORK, LLC (PENNSYLVANIA LTD LIAB CO)
924A COLONIAL AVENUE
YORK, PA 17403

THE MARK CONSISTS OF STANDARD CHAR-
ACTERS WITHOUT CLAIM TO ANY PARTICULAR
FONT, STYLE, SIZE, OR COLOR.

FOR: MASSAGE THERAPY, IN CLASS 44 (U.S.
CLS. 100 AND 101).

SER. NO. 77-047,510, FILED 11-20-2006.

FIRST USE 6-22-2004; IN COMMERCE 6-22-2004.

EMILY CHUO, EXAMINING ATTORNEY

Int. Cls.: 41 and 42

Prior U.S. Cls.: 100, 101 and 107

United States Patent and Trademark Office

Reg. No. 3,397,079

Registered Mar. 18, 2008

**SERVICE MARK
PRINCIPAL REGISTER**

The logo for Istec features the word "istec" in a bold, lowercase, sans-serif font. The letter "i" is stylized with a circular dot that is open at the top, resembling a keyhole or a ring. The letters "s", "t", "e", and "c" are solid and connected.

ISTEC, INC. (NEW MEXICO NON-PROFIT ORGANIZATION)
MSC 02-1600, 1 UNIVERSITY OF NEW MEXICO
ALBUQUERQUE, NM 871310001

FOR: EDUCATIONAL SERVICES, NAMELY, CONDUCTING SEMINARS, SYMPOSIA, WORKSHOPS, COURSES, CONFERENCES AND TRAINING IN THE FIELD OF DIGITAL LIBRARIES, INFORMATION MANAGEMENT, COPYRIGHT PROTECTION, PRESERVATION OF DIGITAL AND PHYSICAL INFORMATION RESOURCES, AND USE OF ELECTRONIC AND DIGITAL RESOURCES IN RESEARCH AND EDUCATION; EDUCATIONAL SERVICES, NAMELY, PROVIDING COURSES OF INSTRUCTION AT THE COLLEGE AND GRADUATE LEVEL IN THE FIELD OF DIGITAL LIBRARIES, INFORMATION MANAGEMENT, COPYRIGHT PROTECTION, PRESERVATION OF DIGITAL AND PHYSICAL INFORMATION RESOURCES AND USE OF ELECTRONIC AND DIGITAL RESOURCES IN RESEARCH AND EDUCATION; EDUCATIONAL SERVICES, NAMELY, CONDUCTING DISTANCE LEARNING INSTRUCTION AT THE SECONDARY, COLLEGE AND GRADUATE LEVELS, AS WELL AS, PROVIDING CONTINUING EDUCATION COURSES, ALL IN THE FIELDS OF ENGINEERING AND SOCIAL SCIENCES, TECHNOLOGY IMPLEMENTATION AND TRANSFER, RESEARCH AND DEVELOP-

MENT, ENTREPRENEURSHIP; PROVIDING CONTINUING MEDICAL EDUCATION COURSES, IN CLASS 41 (U.S. CLS. 100, 101 AND 107).

FIRST USE 10-0-2000; IN COMMERCE 10-0-2000.

FOR: ACCREDITATION SERVICES, NAMELY, SETTING AND PROVIDING STANDARDS FOR THE FIELDS OF ENGINEERING AND SOCIAL SCIENCES TECHNOLOGY IMPLEMENTATION, TRANSFER, RESEARCH AND DEVELOPMENT FOR THE PURPOSE OF ACCREDITATION; SCIENTIFIC PROJECT DEVELOPMENT FOR OTHERS IN THE FIELD OF DIGITAL LIBRARIES, INFORMATION MANAGEMENT, COPYRIGHT PROTECTION, PRESERVATION OF DIGITAL AND PHYSICAL INFORMATION RESOURCES, USE OF ELECTRONIC AND DIGITAL RESOURCES IN RESEARCH AND EDUCATION, IN CLASS 42 (U.S. CLS. 100 AND 101).

FIRST USE 12-28-2001; IN COMMERCE 12-28-2001.

THE MARK CONSISTS OF STYLIZED VERSION OF THE WORD ISTEC.

SER. NO. 77-047,869, FILED 11-20-2006.

BERNICE MIDDLETON, EXAMINING ATTORNEY

Int. Cl.: 35

Prior U.S. Cls.: 100, 101 and 102

United States Patent and Trademark Office

Reg. No. 3,397,080

Registered Mar. 18, 2008

**SERVICE MARK
PRINCIPAL REGISTER**

GETQUIK

GETQUIK, INC. (DELAWARE CORPORATION)
16355 CAMELLIA TERRACE
LOS GATOS, CA 95032

THE MARK CONSISTS OF STANDARD CHAR-
ACTERS WITHOUT CLAIM TO ANY PARTICULAR
FONT, STYLE, SIZE, OR COLOR.

FOR: ON-LINE ORDERING SERVICES IN THE
FIELD OF RESTAURANT TAKE-OUT AND DELIV-
ERY VIA A WEBSITE AND MOBILE PHONES, IN
CLASS 35 (U.S. CLS. 100, 101 AND 102).

SER. NO. 77-048,127, FILED 11-20-2006.

FIRST USE 11-3-2006; IN COMMERCE 11-3-2006.

KYLE PEETE, EXAMINING ATTORNEY

Int. Cl.: 12

Prior U.S. Cls.: 19, 21, 23, 31, 35 and 44

United States Patent and Trademark Office

Reg. No. 3,397,081

Registered Mar. 18, 2008

**TRADEMARK
PRINCIPAL REGISTER**

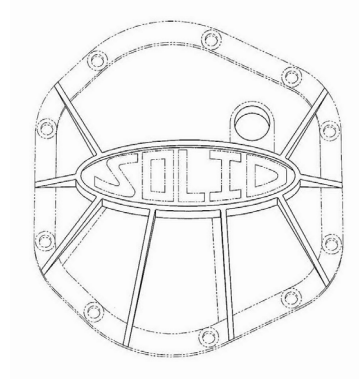

SOLID AXLE INDUSTRIES LLC (OHIO LTD
LIAB CO)
12356 MAHONING AVENUE
NORTH JACKSON, OH 44451

FOR: LAND VEHICLE PARTS, NAMELY, DIF-
FERENTIAL COVERS, IN CLASS 12 (U.S. CLS. 19, 21,
23, 31, 35 AND 44).

FIRST USE 12-0-2003; IN COMMERCE 12-0-2003.

THE MARK CONSISTS OF A THREE-DIMEN-
SIONAL DESIGN USED ON DIFFERENTIAL COV-
ERS CONSISTING OF A RAISED OVAL WITH

EIGHT RIBS RADIATING THEREFROM WITH
TWO RIBS EXTENDING FROM THE BOTTOM OF
THE OVAL AND TWO SETS OF THREE RIBS
EXTENDING FROM EACH LATERAL END OF
THE OVAL AND A CIRCULAR FILL HOLE ABOVE
THE TOP RIGHT OF THE OVAL.

SEC. 2(F).

SER. NO. 77-048,206, FILED 11-20-2006.

JASON TURNER, EXAMINING ATTORNEY

Int. Cl.: 41

Prior U.S. Cls.: 100, 101 and 107

United States Patent and Trademark Office

Reg. No. 3,397,082

Registered Mar. 18, 2008

**SERVICE MARK
PRINCIPAL REGISTER**

EPISCOPAL CHURCH CENTER

THE EPISCOPAL CHURCH (NEW YORK UNINC.
ASSOCIATION)
815 SECOND AVENUE
NEW YORK, NY 10017

FOR: RELIGIOUS INSTRUCTION SERVICES, IN
CLASS 41 (U.S. CLS. 100, 101 AND 107).

FIRST USE 1-1-1961; IN COMMERCE 1-1-1961.

THE MARK CONSISTS OF STANDARD CHAR-
ACTERS WITHOUT CLAIM TO ANY PARTICULAR
FONT, STYLE, SIZE, OR COLOR.

OWNER OF U.S. REG. NOS. 3,195,454 AND
3,195,455.

NO CLAIM IS MADE TO THE EXCLUSIVE
RIGHT TO USE "CHURCH", APART FROM THE
MARK AS SHOWN.

SEC. 2(F).

SER. NO. 77-048,514, FILED 11-21-2006.

STEVEN R. FINE, EXAMINING ATTORNEY

Int. Cl.: 2

Prior U.S. Cls.: 6, 11 and 16

United States Patent and Trademark Office

Reg. No. 3,397,083

Registered Mar. 18, 2008

**TRADEMARK
PRINCIPAL REGISTER**

SNOW SEAL

AMES RESEARCH LABORATORIES, INC. (OREGON CORPORATION)

P.O. BOX 1350

JEFFERSON, OR 97352

FOR: ELASTOMERIC REFLECTIVE ROOF COATING, IN CLASS 2 (U.S. CLS. 6, 11 AND 16).

FIRST USE 7-1-2003; IN COMMERCE 8-6-2003.

THE MARK CONSISTS OF STANDARD CHARACTERS WITHOUT CLAIM TO ANY PARTICULAR FONT, STYLE, SIZE, OR COLOR.

NO CLAIM IS MADE TO THE EXCLUSIVE RIGHT TO USE "SEAL", APART FROM THE MARK AS SHOWN.

SER. NO. 77-049,022, FILED 11-21-2006.

DAVID COLLIER, EXAMINING ATTORNEY

Int. Cl.: 40

Prior U.S. Cls.: 100, 103 and 106

United States Patent and Trademark Office

Reg. No. 3,397,084

Registered Mar. 18, 2008

**SERVICE MARK
PRINCIPAL REGISTER**



ALLSTAR WATER SYSTEMS, INC. (CALIFORNIA CORPORATION)
SUITE A
10360 SORRENTO VALLEY ROAD
SAN DIEGO, CA 92121

FOR: RENTAL OF WATER PURIFYING APPARATUS, IN CLASS 40 (U.S. CLS. 100, 103 AND 106).

FIRST USE 4-1-2006; IN COMMERCE 4-1-2006.

NO CLAIM IS MADE TO THE EXCLUSIVE RIGHT TO USE "FRESH WATER SYSTEMS", APART FROM THE MARK AS SHOWN.

THE COLOR(S) LIGHT BLUE, DARK BLUE, AND WHITE IS/ARE CLAIMED AS A FEATURE OF THE MARK.

THE COLOR DARK BLUE APPEARS IN THE WORDING "ALLSTAR" AND IN THE DESIGN OF THE WATER DROP; LIGHT BLUE APPEARS IN THE WORDING "FRESH WATER SYSTEMS," IN THE HORIZONTAL LINE DIRECTLY ABOVE THIS WORDING, AND IN THE SEVEN THICKER HORIZONTAL STRIPES OF THE SEMICIRCLE DESIGN; WHITE APPEARS IN THE EIGHT POINT STAR WITHIN THE WATER DROP AND IN THE SIX THINNER STRIPES OF THE SEMICIRCLE DESIGN.

SER. NO. 77-049,324, FILED 11-21-2006.

REBECCA POVARCHUK, EXAMINING ATTORNEY

Int. Cl.: 5

Prior U.S. Cls.: 6, 18, 44, 46, 51 and 52

United States Patent and Trademark Office

Reg. No. 3,397,085

Registered Mar. 18, 2008

**TRADEMARK
PRINCIPAL REGISTER**

ALOE ADVANTAGE

RARE VALLEY RESOURCES, INC (ARKANSAS CORPORATION)
11252 RARE VALLEY ROAD
PRAIRIE GROVE, AR 727530567

FOR: AMINO ACIDS FOR MEDICAL OR VETERINARY PURPOSES; ANALGESIC PREPARATIONS; ANTI-INFECTIVE PRODUCTS FOR VETERINARY USE; ANTIBACTERIAL SPRAY; ANTISEPTIC PREPARATIONS; DIETARY AND NUTRITIONAL SUPPLEMENTS; DIETARY SUPPLEMENTS FOR ANIMALS; DRESSINGS FOR WOUNDS; FIRST AID KITS; FLY COMBATING PREPARATIONS; GASTRO-INTESTINAL TREATMENT PREPARATIONS; LINIMENTS; MEDICAL CLEANSERS FOR SKIN AND WOUNDS; MEDICATED GROOMING PREPARATIONS FOR DOGS, CATS, HORSES, GOATS, CATTLE AND OTHER LIVESTOCK, NAMELY, SHAMPOOS, CONDITIONERS, SPRAYS, GELS, LINIMENTS AND MEDICATED HOOF CARE PREPARATIONS; MEDICATED SKIN CARE PREPARATIONS; NUTRACEUTICALS FOR USE AS A DIETARY SUPPLEMENT; PLANT EXTRACTS FOR MEDICAL, VETERINARY AND PHARMACEUTI-

CAL PURPOSES; PREPARATIONS FOR CLEANSING THE SKIN FOR MEDICAL USE; PRODUCTS AND PREPARATIONS FOR CLEANSING THE SKIN FOR MEDICAL USE; TOPICAL FIRST AID GEL; VETERINARY PREPARATIONS FOR DOGS, CATS, HORSES, GOATS, CATTLE AND OTHER LIVESTOCK; NAMELY PHARMACEUTICAL PREPARATIONS FOR WOUND CARE; WOUND DRESSINGS, IN CLASS 5 (U.S. CLS. 6, 18, 44, 46, 51 AND 52).

FIRST USE 2-10-1984; IN COMMERCE 2-10-1984.

THE MARK CONSISTS OF STANDARD CHARACTERS WITHOUT CLAIM TO ANY PARTICULAR FONT, STYLE, SIZE, OR COLOR.

NO CLAIM IS MADE TO THE EXCLUSIVE RIGHT TO USE "ALOE", APART FROM THE MARK AS SHOWN.

SER. NO. 77-049,525, FILED 11-22-2006.

LAURIE KAUFMAN, EXAMINING ATTORNEY

Int. Cl.: 36

Prior U.S. Cls.: 100, 101 and 102

United States Patent and Trademark Office

Reg. No. 3,397,086

Registered Mar. 18, 2008

**SERVICE MARK
PRINCIPAL REGISTER**



RTW, INC. (MINNESOTA CORPORATION)
8500 NORMANDALE BOULEVARD, SUITE 1400
BLOOMINGTON, MN 55437

FOR: CONSULTING SERVICES IN THE FIELD OF WORKER'S COMPENSATION, NAMELY, IDENTIFYING AND MANAGING HIGH-RISK CLAIMS IN WORKERS COMPENSATION, SHORT AND LONG-TERM DISABILITY, SICK LEAVE, PAID TIME-OFF AND FAMILY AND MEDICAL LEAVE ACT (FMLA), EMPLOYING A PROPRIETARY THREE-POINT INTERVIEW PROCESS, PREDICTIVE TECHNOLOGY AND TELEPHONIC AND FIELD CASE MANAGEMENT MODEL TO INTER-

VE NE WITH HIGH-RISK INDIVIDUALS, TO ACHIEVE RESULTS TO DECREASE ABSENCE TIMES, INCREASE PRODUCTIVITY AND LOWER COSTS, IN CLASS 36 (U.S. CLS. 100, 101 AND 102).

FIRST USE 5-1-2006; IN COMMERCE 5-1-2006.

THE MARK CONSISTS OF ALPHA ACIC, LETTER A IS PARTIALLY SURROUNDED BY TWO CURVED LINES ENDING IN AN ARROW.

SER. NO. 77-050,057, FILED 11-22-2006.

HOWARD B. LEVINE, EXAMINING ATTORNEY

Int. Cl.: 36

Prior U.S. Cls.: 100, 101 and 102

United States Patent and Trademark Office

Reg. No. 3,397,087

Registered Mar. 18, 2008

**SERVICE MARK
PRINCIPAL REGISTER**



RTW, INC. (MINNESOTA CORPORATION)
8500 NORMANDALE LAKE BOULEVARD
BLOOMINGTON, MN 55439

FOR: CONSULTING SERVICES IN THE FIELD OF WORKERS COMPENSATION, NAMELY, IDENTIFYING AND MANAGING HIGH-RISK CLAIMS IN WORKERS COMPENSATION, SHORT AND LONG-TERM DISABILITY, SICK LEAVE, PAID TIME-OFF AND FAMILY AND MEDICAL LEAVE ACT (FMLA), EMPLOYING A PROPRIETARY THREE-POINT INTERVIEW PROCESS, PREDICTIVE TECHNOLOGY AND TELEPHONIC AND FIELD CASE MANAGEMENT MODEL TO INTERVENE WITH HIGH-RISK INDIVIDUALS, TO

ACHIEVE RESULTS TO DECREASE ABSENCE TIMES, INCREASE PRODUCTIVITY AND LOWER COSTS, IN CLASS 36 (U.S. CLS. 100, 101 AND 102).

FIRST USE 5-1-2006; IN COMMERCE 5-1-2006.

THE MARK CONSISTS OF LETTERS BCIC WITH TWO CURVED LINES PARTIALLY SURROUNDING THE LETTER B WITH AN ARROW AT THE END OF THE LINES.

SER. NO. 77-050,062, FILED 11-22-2006.

HOWARD B. LEVINE, EXAMINING ATTORNEY

Int. Cl.: 37

Prior U.S. Cls.: 100, 103 and 106

United States Patent and Trademark Office

Reg. No. 3,397,088

Registered Mar. 18, 2008

SERVICE MARK
PRINCIPAL REGISTER



Home Improvement Specialists

PINCUS, ALLAN D (NEW JERSEY LTD LIAB CO)
16 MOUNT BETHEL ROAD, SUITE 149
WARREN, NJ 07059

FOR: HOUSING SERVICES, NAMELY, REPAIR, IMPROVEMENT, AND CONSTRUCTION OF RESIDENTIAL REAL PROPERTY, IN CLASS 37 (U.S. CLS. 100, 103 AND 106).

FIRST USE 9-23-2004; IN COMMERCE 9-23-2004.

NO CLAIM IS MADE TO THE EXCLUSIVE RIGHT TO USE "HOUSE, LLC" AND "HOME IMPROVEMENT SPECIALISTS", APART FROM THE MARK AS SHOWN.

THE COLOR(S) BLACK, YELLOW, BLUE, WHITE IS/ARE CLAIMED AS A FEATURE OF THE MARK.

THE MARK CONSISTS OF A HOUSE DESIGN IN THE MARK APPEARS IN THE COLOR YELLOW, OUTLINED IN BLACK. THE WORDS AROUND YOUR HOUSE, LLC APPEAR IN THE COLOR BLACK, OUTLINED IN BLUE AND WHITE. THE WORDS HOME IMPROVEMENT SPECIALISTS APPEAR IN THE COLOR BLACK.

SER. NO. 77-050,633, FILED 11-25-2006.

GEORGIA CARTY, EXAMINING ATTORNEY

Int. Cl.: 16

Prior U.S. Cls.: 2, 5, 22, 23, 29, 37, 38 and 50

United States Patent and Trademark Office

Reg. No. 3,397,089

Registered Mar. 18, 2008

TRADEMARK
PRINCIPAL REGISTER



HEALTH CARE LOGISTICS, INC. (OHIO CORPORATION)
450 EAST TOWN STREET
CIRCLEVILLE, OH 43113

FOR: CATALOGS IN THE FIELD OF PROFESSIONAL GIFTS FOR THE PHARMART, DENTISTRY, MEDICAL, OPTICAL AND VETERINARY PROFESSIONS, IN CLASS 16 (U.S. CLS. 2, 5, 22, 23, 29, 37, 38 AND 50).

FIRST USE 11-1-2006; IN COMMERCE 11-1-2006.

NO CLAIM IS MADE TO THE EXCLUSIVE RIGHT TO USE "GIFTS FOR MEDICAL PROFESSIONALS MEDICALLY INSPIRED GIFTS AND COLLECTIBLES" AND THE DESIGN OF THE CADUCEUS, APART FROM THE MARK AS SHOWN.

THE COLOR(S) WHITE, BLUE, AND RED IS/ARE CLAIMED AS A FEATURE OF THE MARK.

THE WORD GIFTS AND THE BOW ON THE PACKAGE ARE RED. THE WORDING FOR MEDICAL PROFESSIONALS AND MEDICALLY INSPIRED GIFTS AND COLLECTIBLES IS BLUE. THE BACKGROUND OF THE PACKAGE IS BLUE WITH WHITE CADUCEI.

SER. NO. 77-050,844, FILED S.R. 11-27-2006 AM.
P.R. 9-28-2007.

KIM SAITO, EXAMINING ATTORNEY

Int. Cl.: 33

Prior U.S. Cls.: 47 and 49

United States Patent and Trademark Office

Reg. No. 3,397,090

Registered Mar. 18, 2008

**TRADEMARK
PRINCIPAL REGISTER**

VOLADOR

JAGO USA, INC. (DELAWARE CORPORATION)
800 DELAWARE AVENUE
WILMINGTON, DE 19801

THE FOREIGN WORDING IN THE MARK
TRANSLATES INTO ENGLISH AS "SOMEONE OR
SOMETHING THAT FLIES."

FOR: RUM, IN CLASS 33 (U.S. CLS. 47 AND 49).

FIRST USE 8-21-2006; IN COMMERCE 8-21-2006.

SER. NO. 77-050,948, FILED 11-27-2006.

THE MARK CONSISTS OF STANDARD CHAR-
ACTERS WITHOUT CLAIM TO ANY PARTICULAR
FONT, STYLE, SIZE, OR COLOR.

ANNE MADDEN, EXAMINING ATTORNEY

Int. Cl.: 38

Prior U.S. Cls.: 100, 101 and 104

United States Patent and Trademark Office

Reg. No. 3,397,091

Registered Mar. 18, 2008

**SERVICE MARK
PRINCIPAL REGISTER**

One Simple Connection

US CABLE OF COASTAL TEXAS (NEW JERSEY
LIMITED PARTNERSHIP)
28 WEST GRAND AVENUE
MONTVALE, NJ 076452100

FOR: CABLE TELEVISION TRANSMISSION SERVICES; PAY-PER-VIEW AND PREMIUM SUBSCRIPTION CABLE TELEVISION TRANSMISSION SERVICES; AND PROVIDING HIGH SPEED ACCESS TO A GLOBAL COMMUNICATIONS NETWORK VIA CABLE, IN CLASS 38 (U.S. CLS. 100, 101 AND 104).

FIRST USE 7-31-2000; IN COMMERCE 7-31-2000.

THE MARK CONSISTS OF STANDARD CHARACTERS WITHOUT CLAIM TO ANY PARTICULAR FONT, STYLE, SIZE, OR COLOR.

SER. NO. 77-050,993, FILED 11-27-2006.

KENNETH E. SHARPERSON, EXAMINING ATTORNEY

Int. Cl.: 35

Prior U.S. Cls.: 100, 101 and 102

United States Patent and Trademark Office

Reg. No. 3,397,092

Registered Mar. 18, 2008

**SERVICE MARK
PRINCIPAL REGISTER**



FARMS AND FAMILIES OF NORTH AMERICA
INCORPORATED (CANADA CORPORATION)
318-111 RESEARCH DRIVE
SASKATOON, SASKATCHEWAN, CANADA S7N
3R2

FOR: ASSOCIATION SERVICES, NAMELY, PROMOTING THE INTEREST OF FARMERS, NAMELY, PROVIDING SERVICES TO MEMBER FARMERS TO IMPROVE SALES AND PROFITABILITY OF MEMBERS, NAMELY, NEGOTIATE THE ACCESS TO PRODUCTS DIRECTLY FROM MANUFACTURERS TO PROVIDE ACCESS AND COST REDUCTIONS TO MEMBERS, PURCHASING SERVICES, NAMELY, PURCHASING CROP PROTECTION AND ANIMAL HEALTH PRODUCTS ON BEHALF OF AND FOR MEMBERS, BUSINESS INVESTIGATION SERVICES IN THE FIELD OF SPECIALTY GRAIN MARKETS AND CONDUCTING MARKET RESEARCH TO IDENTIFY WHERE ADDITIONAL

SALES CAN BE MADE BY MEMBERS, PROMOTING THE INTERESTS OF MEMBERS ON INDUSTRY BOARDS, IN CLASS 35 (U.S. CLS. 100, 101 AND 102).

FIRST USE 12-0-2002; IN COMMERCE 12-0-2002.

THE MARK CONSISTS OF THE LETTERS FNA WITH THE RIGHT-HAND PART OF THE LETTER N HAVING THREE (3) PARALLEL LINES FLOWING TOWARD THE LEFT AND SIX (6) PARALLEL LINES UNDER THE LETTERS FNA, THREE (3) FLOWING TOWARD THE LEFT AND THREE (3) TOWARD THE RIGHT.

SER. NO. 77-051,114, FILED 11-27-2006.

GEORGIA CARTY, EXAMINING ATTORNEY

Int. Cl.: 37

Prior U.S. Cls.: 100, 103 and 106

United States Patent and Trademark Office

Reg. No. 3,397,093

Registered Mar. 18, 2008

**SERVICE MARK
PRINCIPAL REGISTER**

WALSH CONSTRUCTION

THE WALSH GROUP LTD. (ILLINOIS CORPORATION)
929 W. ADAMS
CHICAGO, IL 60607

FOR: CONSTRUCTION MANAGEMENT, NAME-
LY, SUPERVISING PRECONSTRUCTION ACTIV-
ITIES AND CONSTRUCTION SERVICES OF
ATHLETIC FACILITIES, HOSPITALS, BRIDGES,
CONDOMINIUMS, OFFICE BUILDINGS, CASINOS,
SCHOOLS, INDUSTRIAL BUILDINGS, ROADS,
CONFERENCE CENTERS, AND OTHER COMMERCIAL
BUILDINGS, IN CLASS 37 (U.S. CLS. 100, 103
AND 106).

FIRST USE 12-1-1977; IN COMMERCE 12-1-1977.

THE MARK CONSISTS OF STANDARD CHAR-
ACTERS WITHOUT CLAIM TO ANY PARTICULAR
FONT, STYLE, SIZE, OR COLOR.

NO CLAIM IS MADE TO THE EXCLUSIVE
RIGHT TO USE "CONSTRUCTION", APART FROM
THE MARK AS SHOWN.

SEC. 2(F) AS TO "WALSH".

SER. NO. 77-051,901, FILED 11-28-2006.

KELLY MCCOY, EXAMINING ATTORNEY

Int. Cl.: 3

Prior U.S. Cls.: 1, 4, 6, 50, 51 and 52

United States Patent and Trademark Office

Reg. No. 3,397,094

Registered Mar. 18, 2008

**TRADEMARK
PRINCIPAL REGISTER**

REDI-GLASS

U.S. NONWOVENS CORPORATION (NEW YORK
CORPORATION)
100 EMJAY BLVD.
BRENTWOOD, NY 11717

FOR: DISPOSABLE WIPES IMPREGNATED
WITH CLEANING COMPOUNDS FOR USE ON
GLASS, IN CLASS 3 (U.S. CLS. 1, 4, 6, 50, 51 AND 52).

FIRST USE 11-22-2006; IN COMMERCE 11-22-2006.

THE MARK CONSISTS OF STANDARD CHAR-
ACTERS WITHOUT CLAIM TO ANY PARTICULAR
FONT, STYLE, SIZE, OR COLOR.

SER. NO. 77-051,958, FILED 11-28-2006.

JANICE L. MCMORROW, EXAMINING ATTOR-
NEY

Int. Cl.: 7

Prior U.S. Cls.: 13, 19, 21, 23, 31, 34 and 35

United States Patent and Trademark Office

Reg. No. 3,397,095

Registered Mar. 18, 2008

**TRADEMARK
PRINCIPAL REGISTER**

ARMORTEC

ASTENJOHNSON, INC. (DELAWARE CORPORATION)
4399 CORPORATE ROAD
CHARLESTON, SC 294057445

THE MARK CONSISTS OF STANDARD CHARACTERS WITHOUT CLAIM TO ANY PARTICULAR FONT, STYLE, SIZE, OR COLOR.

FOR: CONTAMINANT RESISTANT COATED PRESS, DRYER, AND FORMING FABRICS FOR PAPER MAKING MACHINES, IN CLASS 7 (U.S. CLS. 13, 19, 21, 23, 31, 34 AND 35).

SER. NO. 77-052,155, FILED 11-28-2006.

FIRST USE 2-1-2005; IN COMMERCE 2-1-2005.

JORDAN BAKER, EXAMINING ATTORNEY

Int. Cls.: 35 and 36

Prior U.S. Cls.: 100, 101 and 102

United States Patent and Trademark Office

Reg. No. 3,397,096

Registered Mar. 18, 2008

**SERVICE MARK
PRINCIPAL REGISTER**

VALHALLA PARTNERS

WEDNESDAY MANAGEMENT LLC (DELA-
WARE LTD LIAB CO)
8000 TOWERS CRESCENT DRIVE, SUITE 1050
VIENNA, VA 22182

FOR: BUSINESS CONSULTING SERVICES,
NAMELY, ASSISTING OTHERS IN BUILDING
MANAGEMENT TEAMS AND PLANNING STRA-
TEGIC DIRECTION, IN CLASS 35 (U.S. CLS. 100, 101
AND 102).

FIRST USE 4-0-2002; IN COMMERCE 4-0-2002.

FOR: INVESTMENT SERVICES IN THE FIELDS
OF VENTURE CAPITAL AND PRIVATE EQUITY,
IN CLASS 36 (U.S. CLS. 100, 101 AND 102).

FIRST USE 4-0-2002; IN COMMERCE 4-0-2002.

THE MARK CONSISTS OF STANDARD CHAR-
ACTERS WITHOUT CLAIM TO ANY PARTICULAR
FONT, STYLE, SIZE, OR COLOR.

NO CLAIM IS MADE TO THE EXCLUSIVE
RIGHT TO USE "PARTNERS", APART FROM THE
MARK AS SHOWN.

SER. NO. 77-052,216, FILED 11-28-2006.

TINA L. SNAPP, EXAMINING ATTORNEY

Int. Cl.: 41

Prior U.S. Cls.: 100, 101 and 107

United States Patent and Trademark Office

Reg. No. 3,397,097

Registered Mar. 18, 2008

SERVICE MARK
PRINCIPAL REGISTER



GEORGIA EDUCATIONAL TECHNOLOGY CON-
SORTIUM, INC. (GEORGIA CORPORATION)
158 LAKEOVER DRIVE
ATHENS, GA 30607

FOR: EDUCATIONAL SERVICES, NAMELY, OR-
GANIZING AND CONDUCTING CONFERENCES,
SEMINARS, WORKSHOPS, AND STUDENT TECH-
NOLOGY FAIRS IN THE FIELD OF EDUCATIONAL
TECHNOLOGY AND SOFTWARE; PROVIDING AN
ON-LINE ELECTRONIC JOURNAL IN THE FIELD
OF EDUCATIONAL TECHNOLOGY AND SOFT-
WARE; AND, PROVIDING AN ON-LINE COMPU-
TER DATABASE FEATURING INFORMATION
REGARDING EDUCATIONAL TECHNOLOGY
AND SOFTWARE, IN CLASS 41 (U.S. CLS. 100, 101
AND 107).

FIRST USE 4-0-2006; IN COMMERCE 4-0-2006.

NO CLAIM IS MADE TO THE EXCLUSIVE
RIGHT TO USE "EDUCATIONAL TECHNOLOGY

CONSORTIUM, INC.", APART FROM THE MARK
AS SHOWN.

THE COLOR(S) BLUE, DARK BLUE, AND WHITE
IS/ARE CLAIMED AS A FEATURE OF THE MARK.

THE MARK CONSISTS OF A CURVED LINE IN
DARK BLUE EXTENDING OVER AND PARTIAL-
LY AROUND THE WORD "GEORGIA" IN BLUE
LETTERING ON A WHITE BACKGROUND, UN-
DERNEATH WHICH ARE THE WORDS "EDUCA-
TIONAL TECHNOLOGY CONSORTIUM, INC." IN
WHITE LETTERING ON A DARK BLUE RECTAN-
GULAR BACKGROUND.

SEC. 2(F) AS TO "GEORGIA EDUCATIONAL
TECHNOLOGY CONSORTIUM, INC.".

SER. NO. 77-052,576, FILED 11-29-2006.

NAKIA HENRY, EXAMINING ATTORNEY

Int. Cl.: 29

Prior U.S. Cl.: 46

United States Patent and Trademark Office

Reg. No. 3,397,098

Registered Mar. 18, 2008

**TRADEMARK
PRINCIPAL REGISTER**



WIN SOON, INC. (CALIFORNIA CORPORATION), DBA EPOCA
4569 FIRESTONE BLVD.
SOUTH GATE, CA 90280

THE MARK CONSISTS OF THE WORDING YO-COOL IN STYLIZED FORM.

FOR: DAIRY-BASED BEVERAGES, NAMELY, CULTURED DAIRY BEVERAGES AND DRINKABLE YOGURTS, IN CLASS 29 (U.S. CL. 46).

SER. NO. 77-052,579, FILED 11-29-2006.

FIRST USE 4-0-1997; IN COMMERCE 4-0-1997.

MARY BOAGNI, EXAMINING ATTORNEY

Int. Cl.: 35

Prior U.S. Cls.: 100, 101 and 102

United States Patent and Trademark Office

Reg. No. 3,397,099

Registered Mar. 18, 2008

**SERVICE MARK
PRINCIPAL REGISTER**

GHSMART A MODEL FOR HIRING

G.H. SMART & COMPANY INC. (ILLINOIS CORPORATION)
SUITE 2100
203 NORTH LASALLE STREET
CHICAGO, IL 60601

FOR: EMPLOYMENT HIRING SERVICES USING A PROPRIETARY PROCESS WHICH ASSISTS IN HIRING THE MOST HIGHLY QUALIFIED APPLICANTS, IN CLASS 35 (U.S. CLS. 100, 101 AND 102).

FIRST USE 10-20-2006; IN COMMERCE 10-20-2006.

THE MARK CONSISTS OF STANDARD CHARACTERS WITHOUT CLAIM TO ANY PARTICULAR FONT, STYLE, SIZE, OR COLOR.

OWNER OF U.S. REG. NOS. 2,681,289, 2,681,290, AND 2,681,291.

NO CLAIM IS MADE TO THE EXCLUSIVE RIGHT TO USE "HIRING", APART FROM THE MARK AS SHOWN.

SER. NO. 77-052,740, FILED 11-29-2006.

WENDY GOODMAN, EXAMINING ATTORNEY

Int. Cl.: 20

Prior U.S. Cls.: 2, 13, 22, 25, 32 and 50

United States Patent and Trademark Office

Reg. No. 3,397,100

Registered Mar. 18, 2008

**TRADEMARK
PRINCIPAL REGISTER**

EasiKit

HANNECKE DISPLAY SYSTEMS, INC. (NEW
JERSEY CORPORATION)
91 FULTON STREET #3
BOONTON, NJ 07005

FOR: FURNITURE, NAMELY, DISPLAY UNITS
AND POINT OF PURCHASE DISPLAYS COM-
PRISED OF MERCHANDISE CARRIERS, MER-
CHANDISE PURCHASING DISPLAY UNITS FOR
BOOKS, CDS, DVDS, BOX PACKAGES AND
PACKED BOXES, STORAGE AND ARCHIVE SYS-
TEMS FOR MEDIA COMPRISED OF A BASE
PLATE, SHELF PLATES, A HEADER AND DIVI-
DERS, SPINNER AND REVOLVING COLUMNS
SYSTEMS FOR MEDIA, COMPRISED OF A BASE
PLATE, SHELF PLATES, A HEADER AND DIVI-

DERS, COMPONENTS OF THE BEFORE MEN-
TIONED GOODS MADE OF METAL, WOOD OR
PLASTICS, TRAYS FOR STORAGE AND DISPLAY
OF MERCHANDISES, IN CLASS 20 (U.S. CLS. 2, 13,
22, 25, 32 AND 50).

FIRST USE 5-19-2004; IN COMMERCE 6-3-2005.

THE MARK CONSISTS OF STANDARD CHAR-
ACTERS WITHOUT CLAIM TO ANY PARTICULAR
FONT, STYLE, SIZE, OR COLOR.

SER. NO. 77-052,885, FILED 11-29-2006.

MICHAEL ENGEL, EXAMINING ATTORNEY

Int. Cl.: 19

Prior U.S. Cls.: 1, 12, 33 and 50

United States Patent and Trademark Office

Reg. No. 3,397,101

Registered Mar. 18, 2008

**TRADEMARK
PRINCIPAL REGISTER**



FLOORAGE PRODUCTS CORP. (FLORIDA CORPORATION)

17707 NW MIAMI COURT, UNIT 112
MIAMI, FL 33169

FOR: BUILDING MATERIALS, NAMELY, WOOD FLOORING BOARDS; FLOOR BOARDS; NON-METAL FLOORS; PRE-FINISHED WOOD MOLDINGS AND WOOD TRIM FOR WOOD FLOORS; WOODEN FLOORING, IN CLASS 19 (U.S. CLS. 1, 12, 33 AND 50).

FIRST USE 11-1-2005; IN COMMERCE 1-3-2006.

NO CLAIM IS MADE TO THE EXCLUSIVE RIGHT TO USE "WOODFLOORS", APART FROM THE MARK AS SHOWN.

THE COLOR(S) BEIGE, BROWN, LIGHT BROWN, LIGHT ORANGE, LIGHT YELLOW, AND GOLDEN YELLOW IS/ARE CLAIMED AS A FEATURE OF THE MARK.

THE MARK CONSISTS OF A LITERAL ELEMENT "AFRICAN SAFARI WOODFLOORS" WITH A RECTANGLE AND SETTING SUN DESIGN DISPLAYED OVER A BEIGE BACKGROUND. ABOVE THE LEFT SIDE OF THE RECTANGLE THE WORD AFRICAN IS WRITTEN IN BROWN PRINT LETTERS. A SETTING SUN DESIGN IS LOCATED ABOVE THE RIGHT SIDE OF THE RECTANGLE IN LIGHT YELLOW, GOLDEN YELLOW, LIGHT ORANGE AND ORANGE. INSIDE THE RECTANGLE THE WORD SAFARI IS WRITTEN IN BROWN, HIGHLIGHTED IN LIGHT YELLOW AND LIGHT ORANGE. THE RECTANGLE IS BROWN, WITH DARK BROWN BEING ON TOP AND PROGRESSIVELY GETTING LIGHTER TO A LIGHT BROWN ON THE BOTTOM. UNDER THE RECTANGLE THE WORD, WOODFLOORS IS WRITTEN IN BROWN.

SER. NO. 77-052,945, FILED 11-29-2006.

MATTHEW MCDOWELL, EXAMINING ATTORNEY

Int. Cl.: 18

Prior U.S. Cls.: 1, 2, 3, 22 and 41

United States Patent and Trademark Office

Reg. No. 3,397,102

Registered Mar. 18, 2008

**TRADEMARK
PRINCIPAL REGISTER**

COURIER BAG SPECIALIST

NORCO DELIVERY SERVICE, INC. (CALIFORNIA CORPORATION)
851 E. CERRITOS AVENUE
ANAHEIM, CA 92805

FOR: COURIER BAGS, IN CLASS 18 (U.S. CLS. 1, 2, 3, 22 AND 41).

FIRST USE 10-30-1998; IN COMMERCE 10-30-1998.

THE MARK CONSISTS OF STANDARD CHARACTERS WITHOUT CLAIM TO ANY PARTICULAR FONT, STYLE, SIZE, OR COLOR.

OWNER OF U.S. REG. NO. 2,409,584.

NO CLAIM IS MADE TO THE EXCLUSIVE RIGHT TO USE "COURIER BAG", APART FROM THE MARK AS SHOWN.

SEC. 2(F).

SER. NO. 77-053,538, FILED 11-29-2006.

NAPOLEON SHARMA, EXAMINING ATTORNEY

Int. Cl.: 41

Prior U.S. Cls.: 100, 101 and 107

United States Patent and Trademark Office

Reg. No. 3,397,103

Registered Mar. 18, 2008

**SERVICE MARK
PRINCIPAL REGISTER**

**MUSIC CITY CONNECTION;
HEROES BEHIND THE HITS**

NASHVILLE CONVENTION & VISITORS BU-
REAU (TENNESSEE CORPORATION)
150 FOURTH AVENUE, SUITE G-250
NASHVILLE, TN 37219

FOR: ENTERTAINMENT SERVICES IN THE
NATURE OF AN ONGOING RADIO PROGRAM
IN THE FIELD OF MUSIC, IN CLASS 41 (U.S. CLS.
100, 101 AND 107).

FIRST USE 3-31-2006; IN COMMERCE 3-31-2006.

THE MARK CONSISTS OF STANDARD CHAR-
ACTERS WITHOUT CLAIM TO ANY PARTICULAR
FONT, STYLE, SIZE, OR COLOR.

NO CLAIM IS MADE TO THE EXCLUSIVE
RIGHT TO USE "MUSIC CITY", APART FROM
THE MARK AS SHOWN.

SER. NO. 77-053,950, FILED 11-30-2006.

DAWN FELDMAN, EXAMINING ATTORNEY

Int. Cl.: 36

Prior U.S. Cls.: 100, 101 and 102

United States Patent and Trademark Office

Reg. No. 3,397,104

Registered Mar. 18, 2008

**SERVICE MARK
PRINCIPAL REGISTER**

BANKERS INSURANCE CENTER

CORPORATION FOR AMERICAN BANKING
(D.C. CORPORATION)
1120 CONNECTICUT AVENUE, N.W.
WASHINGTON, DC 20036

FOR: PROVIDING HOMEOWNER'S INSURANCE
AND PROPERTY AND CASUALTY INSURANCE
AND FINANCIAL SERVICES, NAMELY, FINAN-
CIAL PLANNING, IN CLASS 36 (U.S. CLS. 100, 101
AND 102).

FIRST USE 8-12-1993; IN COMMERCE 8-12-1993.

THE MARK CONSISTS OF STANDARD CHAR-
ACTERS WITHOUT CLAIM TO ANY PARTICULAR
FONT, STYLE, SIZE, OR COLOR.

OWNER OF U.S. REG. NO. 1,975,485.

NO CLAIM IS MADE TO THE EXCLUSIVE
RIGHT TO USE "INSURANCE CENTER", APART
FROM THE MARK AS SHOWN.

SEC. 2(F).

SER. NO. 77-054,051, FILED 11-30-2006.

CAROLYN GRAY, EXAMINING ATTORNEY

Int. Cls.: 29 and 30

Prior U.S. Cl.: 46

United States Patent and Trademark Office

Reg. No. 3,397,105

Registered Mar. 18, 2008

**TRADEMARK
PRINCIPAL REGISTER**

NOMU

THE TRACY FOULKES AND PAUL RAPHAELY
PARTNERSHIP (SOUTH AFRICA PARTNER-
SHIP)

37 AVIATION CRESCENT
ARPT. CITY BUS. PK, CAPE TOWN INT. ARPT.
CAPE TOWN, SOUTH AFRICA 7490

FOR: MEAT EXTRACTS; JELLIES, JAMS, COM-
POTES; EDIBLE OILS AND FATS; DAIRY-BASED
CHOCOLATE FOOD BEVERAGES; VEGETABLE-
BASED CHOCOLATE FOOD BEVERAGES, IN
CLASS 29 (U.S. CL. 46).

FIRST USE 12-0-2000; IN COMMERCE 10-0-2003.

FOR: COFFEE, TEA, COCOA, INCLUDING CO-
COA POWDER AND BEVERAGES WITH A COCOA
BASE; CHOCOLATE FOOD BEVERAGES NOT DAI-
RY-BASED OR VEGETABLE-BASED; SALT, PEP-
PER; SPICES; MARINADES; VANILLA, NAMELY,
VANILLA EXTRACTS AND VANILLA PASTES, IN
CLASS 30 (U.S. CL. 46).

FIRST USE 12-0-2000; IN COMMERCE 10-0-2003.

SER. NO. 77-054,925, FILED 12-1-2006.

ALICE SUE CARRUTHERS, EXAMINING ATTOR-
NEY

Int. Cl.: 35

Prior U.S. Cls.: 100, 101 and 102

United States Patent and Trademark Office

Reg. No. 3,397,106

Registered Mar. 18, 2008

**SERVICE MARK
PRINCIPAL REGISTER**

**CAMPAIGN TO ELIMINATE
DRUNK DRIVING**

MOTHERS AGAINST DRUNK DRIVING (D.C.
NON-PROFIT CORPORATION)
SUITE 700
511 E. JOHN CARPENTER FREEWAY
IRVING, TX 75062

FOR: ASSOCIATION SERVICES, NAMELY, PROMOTING THE INTERESTS OF INDIVIDUALS OPPOSED TO DRUNK DRIVING, IN CLASS 35 (U.S. CLS. 100, 101 AND 102).

FIRST USE 11-20-2006; IN COMMERCE 11-20-2006.

THE MARK CONSISTS OF STANDARD CHARACTERS WITHOUT CLAIM TO ANY PARTICULAR FONT, STYLE, SIZE, OR COLOR.

SEC. 2(F).

SER. NO. 77-055,021, FILED 12-1-2006.

NATALIE POLZER, EXAMINING ATTORNEY

Int. Cl.: 9

Prior U.S. Cls.: 21, 23, 26, 36 and 38

Reg. No. 3,397,107

United States Patent and Trademark Office

Registered Mar. 18, 2008

**TRADEMARK
PRINCIPAL REGISTER**



TUNG THIH ENTERPRISE CO., LTD. (TAIWAN CORPORATION)
NO. 42, NEI-TSO ST.
LUCHU TOWNSHIP, TAOYUA, TAIWAN 33852

FOR: TIRE PRESSURE GAUGES; TIRE-PRESSURE MEASURERS; REFLECTIVE MIRRORS TO PREVENT ACCIDENTS; PASSIVE KEYFREE ANTI-THEFT SECURITY SYSTEM, NAMELY, THEFT ALARMS; ELECTRIC OR ELECTRONIC SENSORS USED IN AUTOMOBILES FOR SENSING THE PROXIMITY OF OBJECTS WHEN PARKING OR MOVING IN A REVERSE MOTION; LASER, RADAR AND ULTRASONIC OBJECT DETECTORS FOR USE ON VEHICLES; WARNING DEVICES, NAMELY, BELLS FOR VEHICLES TO GIVE AUDIBLE WARNING WHILE VEHICLES ARE MOVING IN REVERSE; CCD CAMERAS FOR USE ON VEHICLES; HEADS UP DISPLAY COMPRISED OF AN OPTICAL PROJECTION UNIT, MOTOR, CIRCUIT BOARD, LENS, COVER AND MIRROR FOR DISPLAYING TEXT, MAPS, AND GRAPHIC IMAGES OF VEHICLE STATUS AND NAVIGATIONAL INFORMATION ON THE WINDSHIELD OF MOTOR VEHICLES; ON SCREEN DISPLAY MODULES COMPRISED OF AN ELECTRONIC CONTROL UNIT WITH VIDEO INPUT AND OUTPUT CONNECTORS TO ADD ADDITIONAL TEXT TO THE INPUT VIDEO AND THEN OUTPUT TO DISPLAY DEVICE; ELECTRIC ACTUATORS; CENTRAL DOOR LOCKING APPARATUS FOR VEHICLES COMPRISED OF AN ELECTRONIC CONTROL UNIT, ACTUATORS, MOTORS AND PLASTIC COV-

ERS; ELECTRIC DOOR LOCKS FOR VEHICLES; ELECTRIC LOCKS FOR VEHICLES; REMOTE CONTROLS FOR OPERATING VEHICLE DOOR LOCKS; PAINTABLE SENSORS FOR VEHICLES COMPRISED OF A PARKING SENSOR AND A BEZEL TO PAINT THE SENSOR, THE BEZEL CAN BE TAKEN OFF WHILE PAINTING AND CAN BE PUT ON LATER; MP3 PLAYERS; AUDIO AND VIDEO CONTROL UNITS FOR VEHICLES COMPRISED OF AN ELECTRONIC CONTROL UNIT, INPUT AND OUTPUT CONNECTORS CONFORMING TO THE RS232 STANDARD TO CONTROL THE CURSOR POSITION OF THE TOUCH PANEL; VEHICLE LOCATING, TRACKING AND SECURITY SYSTEM COMPRISED OF A GPS RECEIVER AND A GLOBAL SYSTEM FOR MOBILE COMMUNICATIONS DEVICE TO BE PLACED IN A VEHICLE TO NOTIFY THE DRIVER OF THE NEARBY FACILITY OR SPOT WITHIN THE PREDEFINED AREA OR TO NOTIFY POLICE OR RESCUE TEAM OF THE LOCATION INFORMATION IN EMERGENCY SITUATIONS; DEVICES FOR HANDS-FREE USE OF MOBILE PHONES; REVERSING SENSOR DISPLAY MODULES FOR USE ON VEHICLES COMPRISED OF CIRCUIT BOARDS AND A REAR-VIEW MIRROR FOR DISPLAYING TEXT AND GRAPHIC IMAGES OF VEHICLE STATUS; APPARATUS FOR DISPLAYING THE PATH FOLLOWED BY A VEHICLE COMPRISED OF AN ELECTRONIC CONTROL UNIT, A MONITOR, A CAMERA AND ON-SCREEN-DISPLAY MODULE; ELECTRICAL APPARATUS FOR FITTING TO VEHICLES COMPRISED OF

LCD OR LCOS DISPLAY DEVICE, A LIGHT REFLECTION FILM TO DISPLAY NAVIGATIONAL OR METER DATA VISUAL INFORMATION; CCD AND CMOS VIDEO CAMERAS ADAPTED TO VEHICLES FOR MONITORING FRONT, LEFT, RIGHT AND BACK SCENE ENVIRONMENT FOR USE DURING PARKING AND WHILE VEHICLE IS MOVING, IN CLASS 9 (U.S. CLS. 21, 23, 26, 36 AND 38).

FIRST USE 6-0-1996; IN COMMERCE 6-0-1996.

OWNER OF U.S. REG. NO. 3,104,388.

THE MARK CONSISTS OF THE LETTERS TTE SET INSIDE A CIRCLE.

SER. NO. 77-055,587, FILED 12-1-2006.

THOMAS MANOR, EXAMINING ATTORNEY

Int. Cl.: 37

Prior U.S. Cls.: 100, 103 and 106

United States Patent and Trademark Office

Reg. No. 3,397,108

Registered Mar. 18, 2008

**SERVICE MARK
PRINCIPAL REGISTER**



VIKING FENCE COMPANY, INC. (TEXAS CORPORATION)
9602 GRAY BLVD.
AUSTIN, TX 78758

FOR: CUSTOM CONSTRUCTION AND INSTALLATION OF ALL TYPES OF FENCING, IN CLASS 37 (U.S. CLS. 100, 103 AND 106).

FIRST USE 7-0-1975; IN COMMERCE 7-0-1975.

NO CLAIM IS MADE TO THE EXCLUSIVE RIGHT TO USE "FENCE CO", APART FROM THE MARK AS SHOWN.

THE MARK CONSISTS OF A BEARDED VIKING WEARING TRADITIONAL HEAD GEAR AND GARB, WITH A SHIELD IN HIS LEFT HAND AND A SWORD IN HIS RIGHT HAND. THE WORD "VIKING" ABOVE THE WORDS "FENCE CO." ARE SUPERIMPOSED ACROSS THE VIKING MASCOT'S LEGS.

SER. NO. 77-056,321, FILED 12-4-2006.

DEZMONA MIZELLE, EXAMINING ATTORNEY

Int. Cl.: 9

Prior U.S. Cls.: 21, 23, 26, 36 and 38

United States Patent and Trademark Office

Reg. No. 3,397,109

Registered Mar. 18, 2008

**TRADEMARK
PRINCIPAL REGISTER**

eXshield

SAMSUNG NETWORKS, INC. (REPUBLIC OF
KOREA CORPORATION)
ASEM TOWER, WORLD TRADE CENTER 159-1
SAMSUNG-DONG, GANGNAM-GU
SEOUL, REPUBLIC OF KOREA

FOR: COMPUTER WORKSTATIONS COMPRIS-
ING CENTRAL PROCESSING UNITS, COMPUTER
NETWORKING HARDWARE, COMMUNICATION
SERVERS, LOCAL AREA NETWORK CONTROL-
LERS, VIDEOGRAPHIC CONTROLLERS, MICRO-
CHIPS, DISK DRIVES, MONITORS, KEYBOARDS,
MOUSE, AND COMPUTER WORKSTATION OPER-
ATING SOFTWARE, IN CLASS 9 (U.S. CLS. 21, 23, 26,
36 AND 38).

THE MARK CONSISTS OF STANDARD CHAR-
ACTERS WITHOUT CLAIM TO ANY PARTICULAR
FONT, STYLE, SIZE, OR COLOR.

PRIORITY CLAIMED UNDER SEC. 44(D) ON
REPUBLIC OF KOREA APPLICATION NO. 2006-
0053996, FILED 10-25-2006, REG. NO. 0718651, DATED
7-27-2007, EXPIRES 7-27-2017.

SER. NO. 77-056,566, FILED 12-4-2006.

CARYN GLASSER, EXAMINING ATTORNEY

Int. Cls.: 9, 37, 41 and 42

**Prior U.S. Cls.: 21, 23, 26, 36, 38, 100, 101, 103, 106
and 107**

Reg. No. 3,397,110

United States Patent and Trademark Office

Registered Mar. 18, 2008

**TRADEMARK
SERVICE MARK
PRINCIPAL REGISTER**

PARTICLE MEASURING SYSTEMS

PARTICLE MEASURING SYSTEMS, INC. (COLORADO CORPORATION)
5475 AIRPORT BOULEVARD
BOULDER, CO 803012339

FOR: COMPUTER SOFTWARE AND HARDWARE FOR USE IN SENSING, MONITORING, AND ANALYZING VARIOUS SOLID, LIQUID AND GASEOUS CONTAMINANTS; SOFTWARE AND HARDWARE FOR COUNTING CONTAMINANT PARTICLES; SOFTWARE AND HARDWARE FOR MONITORING POLISHING AND PLANARIZATION SLURRIES; SOFTWARE AND HARDWARE FOR CONTINUOUS MONITORING OF HYDROGEN PEROXIDE CONCENTRATIONS; CLEANLINESS TESTING STATIONS COMPRISED IN PART OF COMPUTER HARDWARE, COMPUTER SOFTWARE, OR COMPUTER PERIPHERALS, IN CLASS 9 (U.S. CLS. 21, 23, 26, 36 AND 38).

FIRST USE 1-1-1977; IN COMMERCE 1-1-1977.

FOR: INSTALLATION, MAINTENANCE AND REPAIR SERVICES, NAMELY, INSTALLATION, MAINTENANCE AND REPAIR OF COMPUTER HARDWARE FOR: SENSING, MONITORING, AND ANALYZING VARIOUS SOLID, LIQUID AND GASEOUS CONTAMINANTS; SENSING, MONITORING, AND ANALYZING HYDROGEN PEROXIDE CONCENTRATIONS; COUNTING CONTAMINANT PARTICLES; MONITORING POLISHING AND PLANARIZATION SLURRIES; AND CLEANLINESS TESTING, IN CLASS 37 (U.S. CLS. 100, 103 AND 106).

FIRST USE 1-1-1977; IN COMMERCE 1-1-1977.

FOR: EDUCATION AND TRAINING SERVICES, NAMELY, OFFERING TRAINING PROGRAMS AND SEMINARS TAILORED TO THE OPERATION,

MAINTENANCE, REPAIR AND CALIBRATION OF SYSTEMS FOR: SENSING, MONITORING, AND ANALYZING VARIOUS SOLID, LIQUID AND GASEOUS CONTAMINANTS; SENSING, MONITORING, AND ANALYZING HYDROGEN PEROXIDE CONCENTRATIONS; COUNTING CONTAMINANT PARTICLES; MONITORING POLISHING AND PLANARIZATION SLURRIES; AND CLEANLINESS TESTING, IN CLASS 41 (U.S. CLS. 100, 101 AND 107).

FIRST USE 1-1-1977; IN COMMERCE 1-1-1977.

FOR: INSTALLATION, MAINTENANCE AND REPAIR SERVICES, NAMELY, INSTALLATION, MAINTENANCE AND REPAIR OF COMPUTER SOFTWARE FOR: SENSING, MONITORING, AND ANALYZING VARIOUS SOLID, LIQUID AND GASEOUS CONTAMINANTS; SENSING, MONITORING, AND ANALYZING HYDROGEN PEROXIDE CONCENTRATIONS; COUNTING CONTAMINANT PARTICLES; MONITORING POLISHING AND PLANARIZATION SLURRIES; AND CLEANLINESS TESTING; DEVELOPMENT OF COMPUTER PROGRAMS FOR MANUFACTURING PROCESS CHARACTERIZATION AND DESIGN RELATING TO CONTAMINANTS, CLEANLINESS, AND HYDROGEN PEROXIDE CONCENTRATIONS; DEVELOPMENT OF COMPUTER PROGRAMS FOR TROUBLE SHOOTING OF MANUFACTURING PROCESSES RELATING TO CONTAMINANTS, CLEANLINESS, AND HYDROGEN PEROXIDE CONCENTRATIONS; DEVELOPMENT OF COMPUTER PROGRAMS FOR DESIGN OF PRODUCT VALIDITY PROCEDURES, TESTING METHODS AND TECHNIQUES RELATED TO CONTAMINANTS, CLEANLINESS, AND HYDROGEN PEROXIDE CONCENTRATIONS; DEVELOPMENT OF COMPUTER PROGRAMS FOR MANUFACTURING SITE SURVEYS RELATED TO CONTAMINANTS,

CLEANLINESS, AND HYDROGEN PEROXIDE CONCENTRATIONS; DEVELOPMENT OF COMPUTER PROGRAMS FOR ON-SITE TESTING FOR CONTAMINANTS, CLEANLINESS, AND HYDROGEN PEROXIDE CONCENTRATIONS; DEVELOPMENT OF COMPUTER PROGRAMS FOR MICROCONTAMINATION TESTING SERVICES; DEVELOPMENT OF COMPUTER PROGRAMS FOR LABORATORY TESTING FOR CONTAMINANTS, CLEANLINESS AND HYDROGEN PEROXIDE CONCENTRATIONS, IN CLASS 42 (U.S. CLS. 100 AND 101).

FIRST USE 1-1-1977; IN COMMERCE 1-1-1977.

THE MARK CONSISTS OF STANDARD CHARACTERS WITHOUT CLAIM TO ANY PARTICULAR FONT, STYLE, SIZE, OR COLOR.

SEC. 2(F).

SER. NO. 77-056,660, FILED 12-4-2006.

RICHARD A. STRASER, EXAMINING ATTORNEY

Int. Cl.: 9

Prior U.S. Cls.: 21, 23, 26, 36 and 38

Reg. No. 3,397,111

United States Patent and Trademark Office

Registered Mar. 18, 2008

**TRADEMARK
PRINCIPAL REGISTER**

TTE

TUNG THIH ENTERPRISE CO., LTD. (TAIWAN CORPORATION)
LUCHU TOWNSHIP,
NO. 42, NEI-TSO ST.
TAOYUAN COUNTY, TAIWAN 33852

FOR: TIRE PRESSURE GAUGES; TIRE-PRESSURE MEASURERS; REFLECTIVE MIRRORS TO PREVENT ACCIDENTS; PASSIVE KEYFREE ANTI-THEFT SECURITY SYSTEM, NAMELY, THEFT ALARMS; ELECTRIC OR ELECTRONIC SENSORS USED IN AUTOMOBILES FOR SENSING THE PROXIMITY OF OBJECTS WHEN PARKING OR MOVING IN A REVERSE MOTION; LASER, RADAR AND ULTRASONIC OBJECT DETECTORS FOR USE ON VEHICLES; WARNING DEVICES, NAMELY, BELLS FOR VEHICLES TO GIVE AUDIBLE WARNING WHILE VEHICLES ARE MOVING IN REVERSE; CCD CAMERAS FOR USE ON VEHICLES; HEADS UP DISPLAY COMPRISED OF AN OPTICAL PROJECTION UNIT, MOTOR, CIRCUIT BOARD, LENS, COVER AND MIRROR FOR DISPLAYING TEXT, MAPS, AND GRAPHIC IMAGES OF VEHICLE STATUS AND NAVIGATIONAL INFORMATION ON THE WINDSHIELD OF MOTOR VEHICLES; ON SCREEN DISPLAY MODULES COMPRISED OF AN ELECTRONIC CONTROL UNIT WITH VIDEO INPUT AND OUTPUT CONNECTORS TO ADD ADDITIONAL TEXT TO THE INPUT VIDEO AND THEN OUTPUT TO DISPLAY DEVICE; ELECTRIC ACTUATORS; CENTRAL DOOR LOCKING APPARATUS FOR VEHICLES COMPRISED OF AN ELECTRONIC CONTROL UNIT, ACTUATORS, MOTORS AND PLASTIC COVERS; ELECTRIC DOOR LOCKS FOR VEHICLES; ELECTRIC LOCKS FOR VEHICLES; REMOTE CONTROLS FOR OPERATING VEHICLE DOOR LOCKS; PAINTABLE SENSORS FOR VEHICLES COMPRISED OF A PARKING SENSOR AND A BEZEL TO PAINT THE SENSOR, THE BEZEL CAN BE TAKEN OFF WHILE PAINTING AND CAN BE PUT ON LATER; MP3 PLAYERS; AUDIO AND VIDEO

CONTROL UNITS FOR VEHICLES COMPRISED OF AN ELECTRONIC CONTROL UNIT, INPUT AND OUTPUT CONNECTORS CONFORMING TO THE RS232 STANDARD TO CONTROL THE CURSOR POSITION OF THE TOUCH PANEL; VEHICLE LOCATING, TRACKING AND SECURITY SYSTEM COMPRISED OF A GPS RECEIVER AND A GLOBAL SYSTEM FOR MOBILE COMMUNICATIONS DEVICE TO BE PLACED IN A VEHICLE TO NOTIFY THE DRIVER OF THE NEARBY FACILITY OR SPOT WITHIN THE PREDEFINED AREA OR TO NOTIFY POLICE OR RESCUE TEAM OF THE LOCATION INFORMATION IN EMERGENCY SITUATIONS; DEVICES FOR HANDS-FREE USE OF MOBILE PHONES; REVERSING SENSOR DISPLAY MODULES FOR USE ON VEHICLES COMPRISED OF CIRCUIT BOARDS AND A REAR-VIEW MIRROR FOR DISPLAYING TEXT AND GRAPHIC IMAGES OF VEHICLE STATUS; APPARATUS FOR DISPLAYING THE PATH FOLLOWED BY A VEHICLE COMPRISED OF AN ELECTRONIC CONTROL UNIT, A MONITOR, A CAMERA AND ON-SCREEN-DISPLAY MODULE; ELECTRICAL APPARATUS FOR FITTING TO VEHICLES COMPRISED OF LCD OR LCOS DISPLAY DEVICE, A LIGHT REFLECTION FILM TO DISPLAY NAVIGATIONAL OR METER DATA VISUAL INFORMATION; CCD AND CMOS VIDEO CAMERAS ADAPTED TO VEHICLES FOR MONITORING FRONT, LEFT, RIGHT AND BACK SCENE ENVIRONMENT FOR USE DURING PARKING AND WHILE VEHICLE IS MOVING, IN CLASS 9 (U.S. CLS. 21, 23, 26, 36 AND 38).

FIRST USE 6-0-1996; IN COMMERCE 6-0-1996.

THE MARK CONSISTS OF STANDARD CHARACTERS WITHOUT CLAIM TO ANY PARTICULAR FONT, STYLE, SIZE, OR COLOR.

OWNER OF U.S. REG. NO. 3,104,388.

SER. NO. 77-056,788, FILED 12-4-2006.

THOMAS MANOR, EXAMINING ATTORNEY

Int. Cl.: 43

Prior U.S. Cls.: 100 and 101

United States Patent and Trademark Office

Reg. No. 3,397,112

Registered Mar. 18, 2008

**SERVICE MARK
PRINCIPAL REGISTER**



URBAN FARMING, INC. (MICHIGAN CORPORATION)
#537
19785 WEST 12 MILE RD.
SOUTHFIELD, MI 48076

FOR: CHARITABLE SERVICES, NAMELY, PROVIDING FOOD TO NEEDY PERSONS, SCHOOL CHILDREN, AND SENIORS THROUGH THE OPTIMIZATION, GARDENING, AND PRODUCTION OF UNUSED LAND FOR FOOD AND ALTERNATIVE FUEL, IN CLASS 43 (U.S. CLS. 100 AND 101).

FIRST USE 7-20-2005; IN COMMERCE 7-30-2005.

NO CLAIM IS MADE TO THE EXCLUSIVE RIGHT TO USE "URBAN FARMING", APART FROM THE MARK AS SHOWN.

THE COLOR(S) GREEN, YELLOW, AND BLACK IS/ARE CLAIMED AS A FEATURE OF THE MARK.

THE MARK CONSISTS OF THE WORDING "URBAN FARMING" IN GREEN AND BETWEEN THE WORDS APPEARS A DESIGN OF CORN STALK LEAVES IN GREEN WITH GREEN ROOTS AND THE CORN INSIDE WHICH IS COMPRISED OF YELLOW AND BLACK SQUARES THAT REPRESENT A BUILDING WITH LIGHTS ON INSIDE.

SER. NO. 77-057,139, FILED 12-5-2006.

EDWARD NELSON, EXAMINING ATTORNEY

Int. Cl.: 35

Prior U.S. Cls.: 100, 101 and 102

United States Patent and Trademark Office

Reg. No. 3,397,113

Registered Mar. 18, 2008

**SERVICE MARK
PRINCIPAL REGISTER**



CHARLES TUNE (UNITED STATES INDIVIDUAL)

11140 LEO COLLINS

EL PASO, TX 79936

FOR: ACCOUNTING SERVICES, IN CLASS 35
(U.S. CLS. 100, 101 AND 102).

FIRST USE 8-25-2006; IN COMMERCE 8-25-2006.

NO CLAIM IS MADE TO THE EXCLUSIVE
RIGHT TO USE CPA , APART FROM THE MARK
AS SHOWN.

THE MARK CONSISTS OF THE WORDS "A NEW
BREED OF CPA" AND IMAGE OF THE FRONT
HALF OF A GALLOPING HORSE..

SER. NO. 77-057,149, FILED 12-5-2006.

MARK PILARO, EXAMINING ATTORNEY

Int. Cls.: 35 and 36

Prior U.S. Cls.: 100, 101 and 102

United States Patent and Trademark Office

Reg. No. 3,397,114

Registered Mar. 18, 2008

**SERVICE MARK
PRINCIPAL REGISTER**



SUNSTREET MORTGAGE, LLC (ARIZONA LTD
LIAB CO)
6340 N. CAMPBELL AVENUE, #140
TUCSON, AZ 85718

THE COLOR(S) WHITE, GREEN AND BLACK. IS/
ARE CLAIMED AS A FEATURE OF THE MARK.

FOR: MATCHING BORROWERS WITH POTENTIAL LENDERS IN THE FIELD OF CONSUMER AND MORTGAGE LENDING, IN CLASS 35 (U.S. CLS. 100, 101 AND 102).

FIRST USE 7-25-2005; IN COMMERCE 7-25-2005.

FOR: MORTGAGE BANKING SERVICES, NAME-
LY, ORIGINATION, ACQUISITION, SERVICING,
SECURITIZATION AND BROKERAGE OF MORT-
GAGE LOANS; MORTGAGE BROKERAGE; MORT-
GAGE PROCUREMENT FOR OTHERS, IN CLASS 36
(U.S. CLS. 100, 101 AND 102).

FIRST USE 7-25-2005; IN COMMERCE 7-25-2005.

NO CLAIM IS MADE TO THE EXCLUSIVE
RIGHT TO USE "MORTGAGE", APART FROM
THE MARK AS SHOWN.

THE MARK CONSISTS OF WHITE LETTERS
SPELLING "SUNSTREET" IN ALL CAPITAL LET-
TERS ON A RECTANGULAR GREEN FIELD, SUR-
ROUNDED BY A NARROW WHITE
RECTANGULAR BOX, WITH A SLIGHTLY WIDER
RECTAGULAR GREEN BORDER ON THE OUT-
SIDE OF THE NARROW WHITE BOX, WITH
"MORTGAGE" IN ALL CAPITAL BLACK LETTERS
UNDERNEATH THE ABOVE MARK, STARTING
BELOW THE "S" AND ENDING BELOW THE "T" IN
"SUNSTREET".

SER. NO. 77-057,176, FILED 12-5-2006.

PATRICIA EVANKO, EXAMINING ATTORNEY

Int. Cl.: 16

Prior U.S. Cls.: 2, 5, 22, 23, 29, 37, 38 and 50

United States Patent and Trademark Office

Reg. No. 3,397,115

Registered Mar. 18, 2008

TRADEMARK
PRINCIPAL REGISTER



Think outside the book

DIANE THOMAS (CANADA INDIVIDUAL)
R. R. #2
2521 MT. ALBERT ROAD
QUEENSVILLE, CANADA L0G 1R0

FOR: PIN DISPLAY BOARDS FOR COLLECTIBLE ITEMS, SUCH AS NOVELTY ORNAMENTAL PINS, STICKERS, SPORTS TRADING CARDS, COLLECTIBLE CARDS, BASEBALL AND BASKETBALL CARDS, PRINTED EMBLEMS, PHOTOGRAPHS, ENGRAVED PLATES AND PAPER LABELS, IN CLASS 16 (U.S. CLS. 2, 5, 22, 23, 29, 37, 38 AND 50).

FIRST USE 7-16-2003; IN COMMERCE 9-8-2006.

NO CLAIM IS MADE TO THE EXCLUSIVE RIGHT TO USE BOARD, APART FROM THE MARK AS SHOWN.

SER. NO. 77-057,202, FILED S.R. 12-5-2006 AM. P.R. 10-19-2007.

PATRICIA EVANKO, EXAMINING ATTORNEY

Int. Cl.: 9

Prior U.S. Cls.: 21, 23, 26, 36 and 38

Reg. No. 3,397,116

United States Patent and Trademark Office

Registered Mar. 18, 2008

**TRADEMARK
PRINCIPAL REGISTER**

MURF

WADING RIVER HOLDINGS, LLC (DELAWARE
LTD LIAB CO)
P. O. BOX 519
NEW GRETN, NJ 08224

FIRST USE 9-15-2003; IN COMMERCE 9-15-2003.

FOR: ELECTRIC AND ELECTRONIC VIDEO
SURVEILLANCE INSTALLATIONS COMPOSED
OF DIGITAL CAMERAS, COMPUTERS, VIDEO
STORAGE DEVICES, POWER GENERATION
EQUIPMENT AND ENVIRONMENTAL CONTROL
SYSTEMS, ALL INSTALLED IN A VEHICLE, IN
CLASS 9 (U.S. CLS. 21, 23, 26, 36 AND 38).

THE MARK CONSISTS OF STANDARD CHAR-
ACTERS WITHOUT CLAIM TO ANY PARTICULAR
FONT, STYLE, SIZE, OR COLOR.

SER. NO. 77-057,241, FILED 12-5-2006.

APRIL ROACH, EXAMINING ATTORNEY

Int. Cl.: 3

Prior U.S. Cls.: 1, 4, 6, 50, 51 and 52

United States Patent and Trademark Office

Reg. No. 3,397,117

Registered Mar. 18, 2008

**TRADEMARK
PRINCIPAL REGISTER**

STEELMAGIC

U.S. TECHNOLOGY CORPORATION (OHIO
CORPORATION)
1446 TUSCARAWAS STREET, W.
CANTON, OH 447022038

THE MARK CONSISTS OF STANDARD CHAR-
ACTERS WITHOUT CLAIM TO ANY PARTICULAR
FONT, STYLE, SIZE, OR COLOR.

FOR: ABRASIVES FOR USE IN BLAST-CLEAN-
ING, IN CLASS 3 (U.S. CLS. 1, 4, 6, 50, 51 AND 52).

SER. NO. 77-057,422, FILED 12-5-2006.

FIRST USE 9-13-2003; IN COMMERCE 9-13-2003.

LAURA HAMMEL, EXAMINING ATTORNEY

Int. Cl.: 16

Prior U.S. Cls.: 2, 5, 22, 23, 29, 37, 38 and 50

United States Patent and Trademark Office

Reg. No. 3,397,118

Registered Mar. 18, 2008

**TRADEMARK
PRINCIPAL REGISTER**



BURLYMAN ENTERTAINMENT, INC. (ILLINOIS CORPORATION)

C/O LICHTER GROSSMAN NICHOLS & ADLER
9200 SUNSET BLVD., STE. 1200
LOS ANGELES, CA 90069

FOR: COMIC BOOKS, STICKERS, IN CLASS 16
(U.S. CLS. 2, 5, 22, 23, 29, 37, 38 AND 50).

FIRST USE 10-0-2003; IN COMMERCE 10-0-2003.

NO CLAIM IS MADE TO THE EXCLUSIVE RIGHT TO USE "ENTERTAINMENT", APART FROM THE MARK AS SHOWN.

THE MARK CONSISTS OF DRAWING OF A MUSCLEMAN STANDING ABOVE THE WORDS BURLYMAN ENTERTAINMENT.

SER. NO. 77-057,541, FILED 12-5-2006.

CAROLYN GRAY, EXAMINING ATTORNEY

Int. Cl.: 41

Prior U.S. Cls.: 100, 101 and 107

United States Patent and Trademark Office

Reg. No. 3,397,119

Registered Mar. 18, 2008

**SERVICE MARK
PRINCIPAL REGISTER**



GOLFNOW INC. (ARIZONA CORPORATION)
SUITE 1
6615 N. SCOTTSDALE ROAD
SCOTTSDALE, AZ 85250

FOR: COMPUTERIZED ELECTRONIC SERVICES, NAMELY, A WEBSITE THROUGH WHICH GOLFERS RESERVE TEE TIMES AT GOLF COURSES, IN CLASS 41 (U.S. CLS. 100, 101 AND 107).

FIRST USE 12-31-2005; IN COMMERCE 12-31-2005.

THE MARK CONSISTS OF THE STYLIZED LOWERCASE WORDS GOLFNOW.COM, WITH A GOLF BALL APPEARING TO BE BOUNCING OFF OF THE SECOND "O" IN GOLFNOW.COM AND THE "." IN GOLFNOW.COM IN THE DESIGN OF A GOLF BALL LANDING ON A OVAL SHAPED SURFACE; IMMEDIATELY UNDERNEATH GOLFNOW.COM ARE THE STYLIZED WORDS THE POWER TO PLAY MORE.

SER. NO. 77-057,700, FILED 12-5-2006.

ANNE E. GUSTASON, EXAMINING ATTORNEY

Int. Cl.: 14

Prior U.S. Cls.: 2, 27, 28 and 50

United States Patent and Trademark Office

Reg. No. 3,397,120

Registered Mar. 18, 2008

**TRADEMARK
PRINCIPAL REGISTER**

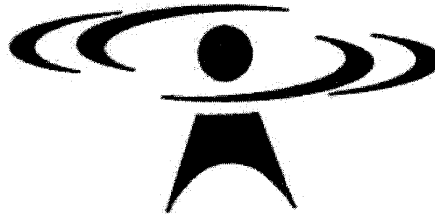

CITIZEN CBM KABUSHIKI KAISHA, ALSO
TRADING AS JAPAN CBM CORPORATION
(JAPAN CORPORATION)
68-10, 5-CHOME, NAKANO
NAKANO-KU, TOKYO, JAPAN

FOR: WATCHES, IN CLASS 14 (U.S. CLS. 2, 27, 28
AND 50).

OWNER OF JAPAN REG. NO. 4714146, DATED 10-
3-2003, EXPIRES 10-3-2013.

THE MARK CONSISTS OF A HIGHLY STYLIZED
DEPICTION OF A MAN WITH FOUR ARCS RE-
PRESENTING ORBITS, TWO TO THE LEFT OF THE
MAN'S HEAD AND TWO TO RIGHT OF THE
MAN'S HEAD.

SER. NO. 77-057,818, FILED 12-6-2006.

MYRIAH HABEEB, EXAMINING ATTORNEY

Int. Cl.: 6

Prior U.S. Cls.: 2, 12, 13, 14, 23, 25 and 50

Reg. No. 3,397,121

United States Patent and Trademark Office

Registered Mar. 18, 2008

**TRADEMARK
PRINCIPAL REGISTER**



LOYAL WROUGHT IRON CO., LTD. (CHINA CORPORATION)
CAOHE INDUSTRY ESTATE, SHAWAN TOWN
PANYU, GUANGZHOU, CHINA

WINDOWS, METAL DOORS AND WINDOW FRAMES, IN CLASS 6 (U.S. CLS. 2, 12, 13, 14, 23, 25 AND 50).

FOR: METAL PALINGS, METAL DOORS, METAL RAILINGS FOR FENCES, IRON WORKS FOR USE IN WINDOWS, NAMELY, WROUGHT IRON DECORATIVE ARTWORK, METAL BUILDING MATERIALS, NAMELY, SOFFITS AND FASCIA, METAL

FIRST USE 11-20-2006; IN COMMERCE 11-20-2006.

SER. NO. 77-057,909, FILED 12-6-2006.

LINDSEY RUBIN, EXAMINING ATTORNEY

Int. Cls.: 9, 16, 41 and 42

**Prior U.S. Cls.: 2, 5, 21, 22, 23, 26, 29, 36, 37, 38, 50,
100, 101 and 107**

Reg. No. 3,397,122

United States Patent and Trademark Office

Registered Mar. 18, 2008

**TRADEMARK
SERVICE MARK
PRINCIPAL REGISTER**

MYSQL

MYSQL AB (SWEDEN AKTIEBOLAG, A LIMITED COMPANY)
BANGÅRD SGATAN 8
UPPSALA, SWEDEN SE-75320

FOR: DOWNLOADABLE ELECTRONIC PUBLICATIONS IN THE NATURE OF BOOKS, ARTICLES, NEWSLETTERS AND COMPUTER MANUALS IN THE FIELD OF COMPUTER SOFTWARE, IN CLASS 9 (U.S. CLS. 21, 23, 26, 36 AND 38).

FIRST USE 11-11-1996; IN COMMERCE 11-11-1996.

FOR: PUBLICATIONS IN THE NATURE OF BOOKS, ARTICLES, NEWSLETTERS AND COMPUTER MANUALS IN THE FIELD OF COMPUTER SOFTWARE, IN CLASS 16 (U.S. CLS. 2, 5, 22, 23, 29, 37, 38 AND 50).

FIRST USE 11-30-1996; IN COMMERCE 11-30-1996.

FOR: PROVIDING NON-DOWNLOADABLE ONLINE PUBLICATIONS IN THE NATURE OF BOOKS, ARTICLES, NEWSLETTERS AND COMPUTER MANUALS IN THE FIELD OF COMPUTER SOFTWARE;

PROVIDING NEWSLETTERS IN THE FIELD OF COMPUTER SOFTWARE VIA EMAIL, IN CLASS 41 (U.S. CLS. 100, 101 AND 107).

FIRST USE 11-11-1996; IN COMMERCE 11-11-1996.

FOR: PROVIDING INFORMATION ONLINE IN THE FIELD OF COMPUTER SOFTWARE, IN CLASS 42 (U.S. CLS. 100 AND 101).

FIRST USE 11-11-1996; IN COMMERCE 11-11-1996.

THE MARK CONSISTS OF STANDARD CHARACTERS WITHOUT CLAIM TO ANY PARTICULAR FONT, STYLE, SIZE, OR COLOR.

OWNER OF U.S. REG. NOS. 2,713,476, 2,948,540 AND OTHERS.

SER. NO. 77-058,039, FILED 12-6-2006.

MARIA-VICTORIA SUAREZ, EXAMINING ATTORNEY

Int. Cl.: 44

Prior U.S. Cls.: 100 and 101

United States Patent and Trademark Office

Reg. No. 3,397,123

Registered Mar. 18, 2008

**SERVICE MARK
PRINCIPAL REGISTER**

**ONE therapist to ONE
patient...ONE at a time.
EVERY TIME!**

PROFITNESS PHYSICAL THERAPY, P.C. (NEW
YORK CORPORATION)
171 EAST 84TH STREET
NEW YORK, NY 10028

FOR: HEALTH CARE SERVICES IN THE NAT-
URE OF SPORTS MEDICINE THERAPY; PHYSICAL
THERAPY SERVICES; PHYSICAL REHABILITA-
TION SERVICES, IN CLASS 44 (U.S. CLS. 100 AND
101).

FIRST USE 10-15-2006; IN COMMERCE 10-15-2006.

THE MARK CONSISTS OF STANDARD CHAR-
ACTERS WITHOUT CLAIM TO ANY PARTICULAR
FONT, STYLE, SIZE, OR COLOR.

SER. NO. 77-058,380, FILED 12-6-2006.

STEVEN PEREZ, EXAMINING ATTORNEY

Int. Cl.: 41

Prior U.S. Cls.: 100, 101 and 107

United States Patent and Trademark Office

Reg. No. 3,397,124

Registered Mar. 18, 2008

**SERVICE MARK
PRINCIPAL REGISTER**

PHILLY'S HOME GAME

GREENWOOD FINANCE, INC. (DELAWARE
CORPORATION)
CORPORATION TRUST CENTER
1209 ORANGE STREET
WILMINGTON, DE 19801

FOR: CASINOS; GAMBLING SERVICES; SLOT
MACHINE SERVICES, NAMELY, PROVIDING
SLOT MACHINE PARLORS, IN CLASS 41 (U.S.
CLS. 100, 101 AND 107).

FIRST USE 11-1-2006; IN COMMERCE 11-1-2006.

THE MARK CONSISTS OF STANDARD CHAR-
ACTERS WITHOUT CLAIM TO ANY PARTICULAR
FONT, STYLE, SIZE, OR COLOR.

NO CLAIM IS MADE TO THE EXCLUSIVE
RIGHT TO USE "PHILLY'S", APART FROM THE
MARK AS SHOWN.

SER. NO. 77-058,400, FILED 12-6-2006.

DAVID MILLER, EXAMINING ATTORNEY

Int. Cls.: 35 and 41

Prior U.S. Cls.: 100, 101, 102 and 107

United States Patent and Trademark Office

Reg. No. 3,397,125

Registered Mar. 18, 2008

**SERVICE MARK
PRINCIPAL REGISTER**

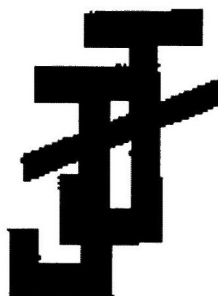

JACK AND JILL OF AMERICA INCORPORATED
(DELAWARE CORPORATION)
1930 17TH STREET N.W.
WASHINGTON, DC 20009

FOR: LOBBYING SERVICES, NAMELY, PROMOTING THE INTERESTS OF CHILDREN IN THE FIELDS OF LEGISLATION AND REGULATION; ASSOCIATION SERVICES, NAMELY, PROMOTING THE INTERESTS OF CHILDREN; PROMOTING PUBLIC AWARENESS OF THE NEED TO IMPROVE CHILDREN'S QUALITY OF LIFE AND RIGHTS; CHARITABLE SERVICES, NAMELY, ORGANIZING AND CONDUCTING VOLUNTEER PROGRAMS AND COMMUNITY SERVICE PROJECTS, IN CLASS 35 (U.S. CLS. 100, 101 AND 102).

FIRST USE 11-10-2006; IN COMMERCE 11-10-2006.

FOR: ARRANGING AND CONDUCTING EDUCATIONAL CONFERENCES; EDUCATIONAL SERVICES, NAMELY, CONDUCTING PROGRAMS, CONFERENCES AND WORKSHOPS IN THE

FIELDS OF CHILD DEVELOPMENT, CHILD GROWTH, CHILD CARE AND THE PROMOTION OF CHILDREN'S RIGHTS; DEVELOPMENT AND DISSEMINATION OF EDUCATIONAL MATERIALS OF OTHERS IN THE FIELD OF CHILD DEVELOPMENT, CHILD GROWTH, CHILD CARE AND THE PROMOTION OF CHILDREN'S RIGHTS; ORGANIZING COMMUNITY CULTURAL EVENTS; CHARITABLE SERVICES, NAMELY, PROVIDING TOYS TO NEEDY CHILDREN, IN CLASS 41 (U.S. CLS. 100, 101 AND 107).

FIRST USE 12-31-1957; IN COMMERCE 12-31-1957.

THE MARK CONSISTS OF THE LETTERS JJ WITH A DIAGONAL LINE INTERSECTING THE LETTERS.

SER. NO. 77-058,518, FILED 12-6-2006.

LESLEY LAMOTHE, EXAMINING ATTORNEY

Int. Cl.: 35

Prior U.S. Cls.: 100, 101 and 102

United States Patent and Trademark Office

Reg. No. 3,397,126

Registered Mar. 18, 2008

**SERVICE MARK
PRINCIPAL REGISTER**

STAKEHOLDER 100

STAKEHOLDER, INC (MARYLAND CORPORATION)
PMB 143, SUTIE L-15
11006 VIERS MILL ROAD
WHEATON, MD 20902

FOR: PROMOTING INTEREST IN EDUCATION, RECOGNITION, CAREER ADVANCEMENT AND LEADERSHIP FOR BUSINESS AND PROFESSIONAL ASSOCIATES IN CORPORATIONS AND PROFESSIONAL SERVICE FIRMS, IN CLASS 35 (U.S. CLS. 100, 101 AND 102).

FIRST USE 6-1-2006; IN COMMERCE 9-1-2006.

THE MARK CONSISTS OF STANDARD CHARACTERS WITHOUT CLAIM TO ANY PARTICULAR FONT, STYLE, SIZE, OR COLOR.

SER. NO. 77-058,560, FILED 12-6-2006.

SANDRA MANIOS, EXAMINING ATTORNEY

Int. Cl.: 35

Prior U.S. Cls.: 100, 101 and 102

United States Patent and Trademark Office

Reg. No. 3,397,127

Registered Mar. 18, 2008

**SERVICE MARK
PRINCIPAL REGISTER**



WATSON ROAD HOLDING CORPORATION,
DBA STUART B. MILLNER & ASSOCIATES
(MISSOURI CORPORATION)
1532 FENPARK DRIVE
FENTON, MO 63026

FOR: INDUSTRIAL ASSET MANAGEMENT SERVICES, NAMELY, AUCTIONING, LIQUIDATING, APPRAISING AND REMARKETING INDUSTRIAL ASSETS, IN CLASS 35 (U.S. CLS. 100, 101 AND 102).

FIRST USE 11-0-2001; IN COMMERCE 11-0-2001.

THE MARK CONSISTS OF THE LETTERS T, P, D, A KEY, A GEAR, AND THE WORDS TOTAL PLANT DEACTIVATION.

SEC. 2(F) AS TO "TOTAL PLANT DEACTIVATION".

SER. NO. 77-059,204, FILED 12-7-2006.

JOHN SCHUYLER YARD, EXAMINING ATTORNEY

Int. Cl.: 18

Prior U.S. Cls.: 1, 2, 3, 22 and 41

United States Patent and Trademark Office

Reg. No. 3,397,128

Registered Mar. 18, 2008

**TRADEMARK
PRINCIPAL REGISTER**

WingPockets

SCOTT P. GIBSON (UNITED STATES INDIVIDUAL)
10 HICKORY HILL
NEW PALTZ, NY 12561

FOR: ACCESSORIES FOR BACKPACKS, SHOULDER BAGS, HIP BELTS, LUGGAGE, CHILD CARRIERS AND WAIST BELTS IN THE NATURE OF SUPPLEMENTAL ZIPPERED POUCHES FOR ATTACHMENT THERETO , IN CLASS 18 (U.S. CLS. 1, 2, 3, 22 AND 41).

FIRST USE 5-31-2004; IN COMMERCE 5-31-2004.

THE MARK CONSISTS OF STANDARD CHARACTERS WITHOUT CLAIM TO ANY PARTICULAR FONT, STYLE, SIZE, OR COLOR.

SER. NO. 77-059,285, FILED 12-7-2006.

HEATHER THOMPSON, EXAMINING ATTORNEY

Int. Cl.: 35

Prior U.S. Cls.: 100, 101 and 102

United States Patent and Trademark Office

Reg. No. 3,397,129

Registered Mar. 18, 2008

**SERVICE MARK
PRINCIPAL REGISTER**

TOTAL PLANT DEACTIVATION

WATSON ROAD HOLDING CORPORATION
(MISSOURI CORPORATION), DBA STUART
B. MILLNER & ASSOCIATES
1532 FENPARK DRIVE
FENTON, MO 63026

FOR: INDUSTRIAL ASSET MANAGEMENT SER-
VICES, NAMELY, AUCTIONING, LIQUIDATING,
APPRAISING AND REMARKETING INDUSTRIAL
ASSETS, IN CLASS 35 (U.S. CLS. 100, 101 AND 102).

FIRST USE 11-0-2001; IN COMMERCE 11-0-2001.

THE MARK CONSISTS OF STANDARD CHAR-
ACTERS WITHOUT CLAIM TO ANY PARTICULAR
FONT, STYLE, SIZE, OR COLOR.

SEC. 2(F).

SER. NO. 77-059,736, FILED 12-8-2006.

JOHN SCHUYLER YARD, EXAMINING ATTOR-
NEY

Int. Cl.: 35

Prior U.S. Cls.: 100, 101 and 102

United States Patent and Trademark Office

Reg. No. 3,397,130

Registered Mar. 18, 2008

**SERVICE MARK
PRINCIPAL REGISTER**



CHINNICI DIRECT, INC. (DELAWARE CORPORATION)
411 LAFAYETTE ST. 3RD FLOOR
NEW YORK, NY 10003

THE MARK CONSISTS OF THE WORDS "COMPANY C", ALONG WITH A STYLIZED LETTER "C" ON ITS SIDE, AS WELL AS THE WORDS "CREATE CONNECT COMPEL".

FOR: ADVERTISING, MARKETING AND PROMOTION SERVICES, IN CLASS 35 (U.S. CLS. 100, 101 AND 102).

SER. NO. 77-060,042, FILED 12-8-2006.

FIRST USE 10-15-2006; IN COMMERCE 10-15-2006.

STEPHEN AQUILA, EXAMINING ATTORNEY

Int. Cl.: 11

Prior U.S. Cls.: 13, 21, 23, 31 and 34

United States Patent and Trademark Office

Reg. No. 3,397,131

Registered Mar. 18, 2008

**TRADEMARK
PRINCIPAL REGISTER**



MIDWEST FILTRATION COMPANY (OHIO CORPORATION)
9775 INTERNATIONAL BLVD.
CINCINNATI, OH 45246

FOR: FIBROUS FILTERING MEDIA FOR GENERAL INDUSTRIAL USE IN THE PURIFICATION OF AIR AND INDUSTRIAL FLUIDS, IN CLASS 11 (U.S. CLS. 13, 21, 23, 31 AND 34).

FIRST USE 10-10-2001; IN COMMERCE 10-10-2001.

NO CLAIM IS MADE TO THE EXCLUSIVE RIGHT TO USE COMPANY, APART FROM THE MARK AS SHOWN.

THE STIPPLING IS A FEATURE OF THE MARK AND DOES NOT INDICATE COLOR.

THE MARK CONSISTS OF "MIDWEST FILTRATION COMPANY" AND STYLIZED IMAGE OF TWO SHAPES OF DIFFERENT TEXTURE WITH WAVE EXTENDING THERETHROUGH.

SEC. 2(F) AS TO "MIDWEST FILTRATION COMPANY".

SER. NO. 77-060,339, FILED 12-8-2006.

JOHN WILKE, EXAMINING ATTORNEY

Int. Cl.: 7

Prior U.S. Cls.: 13, 19, 21, 23, 31, 34 and 35

United States Patent and Trademark Office

Reg. No. 3,397,132

Registered Mar. 18, 2008

**TRADEMARK
PRINCIPAL REGISTER**



DELAWARE CAPITAL FORMATION, INC. (DE-
LAWARE CORPORATION)
SUITE 102
1403 FOULK ROAD
WILMINGTON, DE 19803

FOR: CONNECTING RODS FOR MACHINES,
MOTORS AND ENGINES; CRANKSHAFTS FOR
MACHINES, MOTORS AND ENGINES; MAIN CAPS;
ROTATING ASSEMBLIES; INTERNAL COMBUS-
TION ENGINE PARTS NAMELY, PISTONS; AND
PISTON RINGS, IN CLASS 7 (U.S. CLS. 13, 19, 21, 23,
31, 34 AND 35).

FIRST USE 7-0-2004; IN COMMERCE 7-0-2004.

NO CLAIM IS MADE TO THE EXCLUSIVE
RIGHT TO USE "TECHNOLOGIES", APART FROM
THE MARK AS SHOWN.

THE MARK CONSISTS OF A SQUARE DESIGN
THAT CONTAINS THREE LINES AND A WRENCH
DESIGN. THE WORDING TECHNOLOGIES SITS
UNDERNEATH THE SQUARE DESIGN AND UN-
DERNEATH THE TERM K1 WHICH SITS TO THE
RIGHT OF THE SQUARE DESIGN.

SER. NO. 77-060,379, FILED 12-8-2006.

SETH A. RAPPAPORT, EXAMINING ATTORNEY

Int. Cl.: 25

Prior U.S. Cls.: 22 and 39

United States Patent and Trademark Office

Reg. No. 3,397,133

Registered Mar. 18, 2008

**TRADEMARK
PRINCIPAL REGISTER**

MAZZONI

VALUE CITY OF MICHIGAN, INC. (MICHIGAN CORPORATION)

36901 WARREN ROAD

WESTLAND, MI 48185

FOR: DRESS SHIRTS, KNIT SPORT SHIRTS, SWEATERS, TIES, IN CLASS 25 (U.S. CLS. 22 AND 39).

FIRST USE 3-15-2006; IN COMMERCE 3-15-2006.

THE MARK CONSISTS OF STANDARD CHARACTERS WITHOUT CLAIM TO ANY PARTICULAR FONT, STYLE, SIZE, OR COLOR.

OWNER OF U.S. REG. NOS. 2,263,818 AND 3,069,906.

SEC. 2(F).

SER. NO. 77-061,036, FILED 12-11-2006.

KATHY DE JONGE, EXAMINING ATTORNEY

Int. Cl.: 36

Prior U.S. Cls.: 100, 101 and 102

United States Patent and Trademark Office

Reg. No. 3,397,134

Registered Mar. 18, 2008

**SERVICE MARK
PRINCIPAL REGISTER**

OFFICIALS FOR KIDS

MICHIGAN HIGH SCHOOL ATHLETIC ASSO-
CIATION (MICHIGAN NON-PROFIT COR-
PORATION)
1661 RAMBLEWOOD DRIVE
EAST LANSING, MI 48823

FOR: CHARITABLE FUNDRAISING, IN CLASS
36 (U.S. CLS. 100, 101 AND 102).

FIRST USE 6-1-2004; IN COMMERCE 6-1-2004.

THE MARK CONSISTS OF STANDARD CHAR-
ACTERS WITHOUT CLAIM TO ANY PARTICULAR
FONT, STYLE, SIZE, OR COLOR.

SER. NO. 77-061,130, FILED 12-11-2006.

DAYNA BROWNE, EXAMINING ATTORNEY

Int. Cl.: 7

Prior U.S. Cls.: 13, 19, 21, 23, 31, 34 and 35

Reg. No. 3,397,135

United States Patent and Trademark Office

Registered Mar. 18, 2008

**TRADEMARK
PRINCIPAL REGISTER**



MOBILE HYDRAULICS EQUIPMENT COMPAN-
NY, LLC (MISSOURI LTD LIAB CO)
1544 HOWELL STREET
NORTH KANSAS CITY, MO 64116

FOR: MOBILE HYDRAULIC GENERATORS FEAT-
URING MULTIPLE POWER SOURCES, IN CLASS 7
(U.S. CLS. 13, 19, 21, 23, 31, 34 AND 35).

FIRST USE 10-1-2006; IN COMMERCE 10-1-2006.

NO CLAIM IS MADE TO THE EXCLUSIVE
RIGHT TO USE MULTIPOWER SYSTEMS, APART
FROM THE MARK AS SHOWN.

THE MARK CONSISTS OF THE MARK CONSISTS
OF A TRIANGLE WITH THE WORD HIPPO
ACROSS THE TOP, A HIPPOPOTAMUS IN WORK
CLOTHES IS SUPERIMPOSED OVER THE TRIAN-
GLE WITH ARMS CROSSED OVER A RECTANGLE
DISPLAYING THE WORDS MULTIPOWER SYS-
TEMS, AND POWER TOOLS FILL EACH CORNER
OF THE TRIANGLE .

SER. NO. 77-061,358, FILED 12-11-2006.

ANDREA BUTLER, EXAMINING ATTORNEY

Int. Cls.: 36 and 37

Prior U.S. Cls.: 100, 101, 102, 103 and 106

United States Patent and Trademark Office

Reg. No. 3,397,136

Registered Mar. 18, 2008

**SERVICE MARK
PRINCIPAL REGISTER**

**A CAR DONATED IS A JOB
CREATED**

STEP 13, INC. (COLORADO CORPORATION)
2029 LARIMER STREET
DENVER, CO 80205

FOR: CHARITABLE FUND RAISING SERVICES,
IN CLASS 36 (U.S. CLS. 100, 101 AND 102).

FIRST USE 6-0-2005; IN COMMERCE 6-0-2005.

FOR: VEHICLE DETAILING SERVICES , IN
CLASS 37 (U.S. CLS. 100, 103 AND 106).

FIRST USE 6-0-2005; IN COMMERCE 6-0-2005.

THE MARK CONSISTS OF STANDARD CHAR-
ACTERS WITHOUT CLAIM TO ANY PARTICULAR
FONT, STYLE, SIZE, OR COLOR.

SER. NO. 77-061,407, FILED 12-11-2006.

BRENDAN MCCAULEY, EXAMINING ATTORNEY

Int. Cl.: 35

Prior U.S. Cls.: 100, 101 and 102

United States Patent and Trademark Office

Reg. No. 3,397,137

Registered Mar. 18, 2008

**SERVICE MARK
PRINCIPAL REGISTER**

**UNITED STATES MASTERS
SWIMMING**

UNITED STATES MASTERS SWIMMING, INC.
(OHIO NON-PROFIT CORPORATION)
9 WILEY HILL ROAD
LONDONDERRY, NH 03053

NO CLAIM IS MADE TO THE EXCLUSIVE
RIGHT TO USE "SWIMMING", APART FROM THE
MARK AS SHOWN.

FOR: PROVIDING A WEBSITE THAT PROVIDES
SPORTS LEAGUE MANAGEMENT, IN CLASS 35
(U.S. CLS. 100, 101 AND 102).

SEC. 2(F).

FIRST USE 9-1-1996; IN COMMERCE 9-1-1996.

SER. NO. 77-061,828, FILED 12-11-2006.

THE MARK CONSISTS OF STANDARD CHAR-
ACTERS WITHOUT CLAIM TO ANY PARTICULAR
FONT, STYLE, SIZE, OR COLOR.

RONALD MCMORROW, EXAMINING ATTORNEY

Int. Cls.: 38 and 41

Prior U.S. Cls.: 100, 101, 104 and 107

United States Patent and Trademark Office

Reg. No. 3,397,138

Registered Mar. 18, 2008

**SERVICE MARK
PRINCIPAL REGISTER**

WINNING SPORTS PLAYS

PATRICK, RICHARD V. (UNITED STATES INDIVIDUAL)
16 MAPLE AVENUE
LITTLE SILVER, NJ 07739

FOR: PROVIDING ON-LINE ELECTRONIC BULLETIN BOARDS FOR THE TRANSMISSION OF MESSAGES AMONG COMPUTER USERS CONCERNING THE FIELD OF SPORTS , IN CLASS 38 (U.S. CLS. 100, 101 AND 104).

FIRST USE 10-19-2004; IN COMMERCE 10-19-2004.

FOR: PROVIDING ON-LINE CONTENT IN THE FIELD OF SPORT-RELATED INFORMATION; ENTERTAINMENT IN THE NATURE OF GAMES AND CONTESTS WHICH MAY BE ACCESSED VIA THE

INTERNET BY SUBSCRIBERS, IN CLASS 41 (U.S. CLS. 100, 101 AND 107).

FIRST USE 10-19-2004; IN COMMERCE 10-19-2004.

THE MARK CONSISTS OF STANDARD CHARACTERS WITHOUT CLAIM TO ANY PARTICULAR FONT, STYLE, SIZE, OR COLOR.

NO CLAIM IS MADE TO THE EXCLUSIVE RIGHT TO USE SPORTS PLAYS, APART FROM THE MARK AS SHOWN.

SER. NO. 77-062,186, FILED 12-12-2006.

SHAUNIA CARLYLE, EXAMINING ATTORNEY

Int. Cl.: 33

Prior U.S. Cls.: 47 and 49

United States Patent and Trademark Office

Reg. No. 3,397,139

Registered Mar. 18, 2008

**TRADEMARK
PRINCIPAL REGISTER**

Zinrah

PARMELEE-HILL WINES (CALIFORNIA LTD
LIAB CO)
PO BOX 432
1695 SPERRING RD, SONOMA CA 95476
SONOMA, CA 95476

THE MARK CONSISTS OF STANDARD CHAR-
ACTERS WITHOUT CLAIM TO ANY PARTICULAR
FONT, STYLE, SIZE, OR COLOR.

FOR: PORT WINES; RED WINE; TABLE WINES;
WHITE WINE; WINE; WINES, IN CLASS 33 (U.S.
CLS. 47 AND 49).

SER. NO. 77-062,275, FILED 12-12-2006.

FIRST USE 11-18-2006; IN COMMERCE 11-18-2006.

CHARLOTTE CORWIN, EXAMINING ATTORNEY

Int. Cl.: 42

Prior U.S. Cls.: 100 and 101

United States Patent and Trademark Office

Reg. No. 3,397,140

Registered Mar. 18, 2008

**SERVICE MARK
PRINCIPAL REGISTER**



PGMS, INC. (DELAWARE CORPORATION)
303 SOUTH BROADWAY, SUITE 311
TARRYTOWN, NY 10591

FOR: PROVIDING TEMPORARY USE OF ON-LINE NON-DOWNLOADABLE SOFTWARE FOR THE PURPOSE OF MAINTAINING WEB-BASED ELECTRONIC MEDICAL RECORDS DESIGNED FOR USE BY HOSPITALS AND PHYSICIANS' PRACTICES, IN CLASS 42 (U.S. CLS. 100 AND 101).

FIRST USE 2-1-2003; IN COMMERCE 2-1-2003.

THE COLOR(S) WHITE, YELLOW AND BLUE IS/ARE CLAIMED AS A FEATURE OF THE MARK.

THE MARK CONSISTS OF THE WORDS "PRACTICE" AND "CHARTS" WHICH ARE WRITTEN IN WHITE LOWER CASE TIMES NEW ROMAN LET-

TERS. IN PLACE OF THE LETTER "A" IN BOTH "PRACTICE" AND "CHARTS" IS A YELLOW V-SHAPED SYMBOL THAT CUTS IN BETWEEN BOTH WORDS. THE WORD "PRACTICE" IS ON TOP OF THE WORD "CHART." THERE IS A WHITE DOT LOCATED SLIGHTLY ABOVE THE MIDDLE OF THE V-SHAPED SYMBOL. THERE IS ALSO A SEMI-CIRCULAR WHITE ARCH THAT BEGINS ABOVE THE WORD "PRACTICE," BEGINNING ABOVE THE MID-POINT OF THE LETTER "P" AND ENDING DIRECTLY ABOVE THE LETTER "I" IN "PRACTICE." THE RECTANGULAR BACKGROUND OF THE MARK IS SHADED VERTICALLY FROM DARK BLUE TO LIGHT BLUE AND BACK TO THE SAME SHADE OF DARK BLUE, WITH LIGHT BLUE APPEARING IN THE CENTER.

SER. NO. 77-062,344, FILED 12-12-2006.

ALLISON SCHRODY, EXAMINING ATTORNEY

Int. Cl.: 42

Prior U.S. Cls.: 100 and 101

United States Patent and Trademark Office

Reg. No. 3,397,141

Registered Mar. 18, 2008

**SERVICE MARK
PRINCIPAL REGISTER**

ESN

ENGINEERING SERVICES NETWORK, INC.
(VIRGINIA CORPORATION)
2450 CRYSTAL DRIVE, SUITE 1015
ARLINGTON, VA 222023983

FOR: TECHNICAL AND ENGINEERING CONSULTING SERVICES IN THE FIELDS OF NAVAL OPERATIONS AND AERONAUTICS AND AVIATION; TESTING OR RESEARCH ON MACHINES, APPARATUS AND INSTRUMENTS; MATERIALS TESTING AND EVALUATION; NEW PRODUCT RESEARCH AND DEVELOPMENT FOR OTHERS, DESIGN AND TESTING FOR NEW PRODUCT DEVELOPMENT FOR OTHERS, ALL RELATING TO NAVAL OPERATIONS AND AERONAUTICS AND AVIATION, NAVAL AND AERONAUTICS SYSTEMS AND VEHICLES, ELECTRONIC SYSTEMS, INFORMATION SYSTEMS, ENERGY SYSTEMS, AND MATERIALS TECHNOLOGY; CONSULTING SERVICES IN THE FIELD OF DESIGN, SELECTION, IMPLEMENTATION AND USE OF COMPUTER HARDWARE AND SOFTWARE SYSTEMS FOR OTHERS; COMPUTER CONSULTING SERVICES FOR PLANNING, DESIGN, AND ANALYSIS OF INFORMATION PROCESSES, SYSTEMS, AND BUSINESS REENGINEERING; ANALYSIS AND DESIGN OF COMPUTER SYSTEMS, SOFTWARE AND INFORMATION SYSTEMS FOR OTHERS; DESIGN FOR OTHERS OF WEB SITES AND SOFTWARE APPLICATIONS THEREFORE ON LOCAL AND INTERNAL COMPUTER NET-

WORKS AND THE INTERNET; PROVIDING DESIGN, DEVELOPMENT AND HOST SERVICES FOR OTHERS' INTERNET WEB SITES AND COMPUTER NETWORKS; MAINTENANCE OF SOFTWARE, SOFTWARE SYSTEMS AND INTERNET WEB SITES; INFORMATION TECHNOLOGY CONSULTATION SERVICES; COMPUTER CONSULTATION ON THE COMPUTER-RELATED ASPECTS OF E-COMMERCE AND INFORMATION TECHNOLOGY SECURITY; PROVIDING INFORMATION OVER LOCAL AND INTERNAL COMPUTER NETWORKS AND THE INTERNET ON THE SUBJECTS OF COMPUTER ANALYSIS, COMPUTER SYSTEMS DESIGN SERVICES, AND SOFTWARE AND SOFTWARE DEVELOPMENT; AND PROVIDING INFORMATION VIA THE INTERNET ON THE SUBJECTS OF SOFTWARE DESIGN; INTEGRATION OF COMPUTER SYSTEMS AND NETWORKS, IN CLASS 42 (U.S. CLS. 100 AND 101).

FIRST USE 9-24-1990; IN COMMERCE 9-24-1990.

THE MARK CONSISTS OF STANDARD CHARACTERS WITHOUT CLAIM TO ANY PARTICULAR FONT, STYLE, SIZE, OR COLOR.

SER. NO. 77-062,509, FILED 12-12-2006.

ELLEN PERKINS, EXAMINING ATTORNEY

Int. Cl.: 42

Prior U.S. Cls.: 100 and 101

United States Patent and Trademark Office

Reg. No. 3,397,142

Registered Mar. 18, 2008

**SERVICE MARK
PRINCIPAL REGISTER**

SHOULDER TO SHOULDER

ENGINEERING SERVICES NETWORK, INC.
(VIRGINIA CORPORATION)
2450 CRYSTAL DRIVE, SUITE 1015
ARLINGTON, VA 222023983

FOR: TECHNICAL AND ENGINEERING CONSULTING SERVICES IN THE FIELDS OF NAVAL OPERATIONS AND AERONAUTICS AND AVIATION; TESTING OR RESEARCH ON MACHINES, APPARATUS AND INSTRUMENTS; MATERIALS TESTING AND EVALUATION; NEW PRODUCT RESEARCH AND DEVELOPMENT FOR OTHERS, DESIGN AND TESTING FOR NEW PRODUCT DEVELOPMENT FOR OTHERS, ALL RELATING TO NAVAL OPERATIONS AND AERONAUTICS AND AVIATION, NAVAL AND AERONAUTICS SYSTEMS AND VEHICLES, ELECTRONIC SYSTEMS, INFORMATION SYSTEMS, ENERGY SYSTEMS, AND MATERIALS TECHNOLOGY; CONSULTING SERVICES IN THE FIELD OF DESIGN, SELECTION, IMPLEMENTATION AND USE OF COMPUTER HARDWARE AND SOFTWARE SYSTEMS FOR OTHERS; COMPUTER CONSULTING SERVICES FOR PLANNING, DESIGN, AND ANALYSIS OF INFORMATION PROCESSES, SYSTEMS, AND BUSINESS REENGINEERING; ANALYSIS AND DESIGN OF COMPUTER SYSTEMS, SOFTWARE AND INFORMATION SYSTEMS FOR OTHERS; DESIGN FOR OTHERS OF WEB SITES AND SOFTWARE APPLICATIONS THEREFORE ON LOCAL AND INTERNAL COMPUTER NET-

WORKS AND THE INTERNET; PROVIDING DESIGN, DEVELOPMENT AND HOST SERVICES FOR OTHERS' INTERNET WEB SITES AND COMPUTER NETWORKS; MAINTENANCE OF SOFTWARE, SOFTWARE SYSTEMS AND INTERNET WEB SITES; INFORMATION TECHNOLOGY CONSULTATION SERVICES; COMPUTER CONSULTATION ON THE COMPUTER-RELATED ASPECTS OF E-COMMERCE AND INFORMATION TECHNOLOGY SECURITY; PROVIDING INFORMATION OVER LOCAL AND INTERNAL COMPUTER NETWORKS AND THE INTERNET ON THE SUBJECTS OF COMPUTER ANALYSIS, COMPUTER SYSTEMS DESIGN SERVICES, AND SOFTWARE AND SOFTWARE DEVELOPMENT; AND PROVIDING INFORMATION VIA THE INTERNET ON THE SUBJECTS OF SOFTWARE DESIGN; INTEGRATION OF COMPUTER SYSTEMS AND NETWORKS, IN CLASS 42 (U.S. CLS. 100 AND 101).

FIRST USE 5-1-2006; IN COMMERCE 5-1-2006.

THE MARK CONSISTS OF STANDARD CHARACTERS WITHOUT CLAIM TO ANY PARTICULAR FONT, STYLE, SIZE, OR COLOR.

SER. NO. 77-062,569, FILED 12-12-2006.

ELLEN PERKINS, EXAMINING ATTORNEY

Int. Cl.: 38

Prior U.S. Cls.: 100, 101 and 104

United States Patent and Trademark Office

Reg. No. 3,397,143

Registered Mar. 18, 2008

**SERVICE MARK
PRINCIPAL REGISTER**

The Black Coffee Channel

WELCH, CEDRIC (UNITED STATES INDIVIDUAL)
P.O. BOX 1451
CAMDEN, NJ 08105

FOR: BROADCASTING SERVICES AND PROVISION OF TELECOMMUNICATION ACCESS TO VIDEO AND AUDIO CONTENT PROVIDED VIA A VIDEO-ON-DEMAND SERVICE VIA THE INTERNET, IN CLASS 38 (U.S. CLS. 100, 101 AND 104).

FIRST USE 11-20-2006; IN COMMERCE 11-20-2006.

THE MARK CONSISTS OF STANDARD CHARACTERS WITHOUT CLAIM TO ANY PARTICULAR FONT, STYLE, SIZE, OR COLOR.

NO CLAIM IS MADE TO THE EXCLUSIVE RIGHT TO USE "CHANNEL", APART FROM THE MARK AS SHOWN.

SER. NO. 77-062,976, FILED 12-13-2006.

KATHY DE JONGE, EXAMINING ATTORNEY

Int. Cl.: 36

Prior U.S. Cls.: 100, 101 and 102

United States Patent and Trademark Office

Reg. No. 3,397,144

Registered Mar. 18, 2008

**SERVICE MARK
PRINCIPAL REGISTER**

H-CARD

H-CARD, LLC (DELAWARE LTD LIAB CO)
1125 SOUTH 103RD STREET, SUITE 400
OMAHA, NE 68124

THE MARK CONSISTS OF STANDARD CHAR-
ACTERS WITHOUT CLAIM TO ANY PARTICULAR
FONT, STYLE, SIZE, OR COLOR.

FOR: ELECTRONIC PAYMENT, NAMELY, ELEC-
TRONIC PROCESSING AND TRANSMISSION OF
BILL PAYMENT DATA, IN CLASS 36 (U.S. CLS. 100,
101 AND 102).

SER. NO. 77-063,016, FILED 12-13-2006.

FIRST USE 4-1-2005; IN COMMERCE 4-1-2005.

ANNE E. GUSTASON, EXAMINING ATTORNEY

Int. Cl.: 36

Prior U.S. Cls.: 100, 101 and 102

United States Patent and Trademark Office

Reg. No. 3,397,145

Registered Mar. 18, 2008

**SERVICE MARK
PRINCIPAL REGISTER**



H-CARD, LLC (DELAWARE LTD LIAB CO)
1125 SOUTH 103RD STREET, SUITE 400
OMAHA, NE 68124

THE MARK CONSISTS OF A CAPITAL LETTER
"H", FOLLOWED BY THE UNDERLINED WORD
"CARD".

FOR: ELECTRONIC PAYMENT, NAMELY, ELEC-
TRONIC PROCESSING AND TRANSMISSION OF
BILL PAYMENT DATA, IN CLASS 36 (U.S. CLS. 100,
101 AND 102).

SER. NO. 77-063,034, FILED 12-13-2006.

FIRST USE 4-1-2005; IN COMMERCE 4-1-2005.

ANNE E. GUSTASON, EXAMINING ATTORNEY

Int. Cl.: 9

Prior U.S. Cls.: 21, 23, 26, 36 and 38

United States Patent and Trademark Office

Reg. No. 3,397,146

Registered Mar. 18, 2008

**TRADEMARK
PRINCIPAL REGISTER**

SHEPHERD MEDICAL SOLUTIONS

SHEPHERD MEDICAL SOLUTIONS LLC
(NORTH CAROLINA LTD LIAB CO)
341 BLACK BRANCH ROAD
CANTON, NC 28716

FOR: COMMUNICATIONS SOFTWARE FOR CONNECTING COMPUTER NETWORK USERS; COMPUTER SOFTWARE FOR CONTROLLING AND MANAGING PATIENT MEDICAL INFORMATION; COMPUTER SOFTWARE FOR THE COLLECTION, EDITING, ORGANIZING, MODIFYING, BOOK MARKING, TRANSMISSION, STORAGE AND SHARING OF DATA AND INFORMATION; ENTERPRISE SOFTWARE IN THE NATURE OF A DATABASE FOR NON-TRANSACTIONAL DATA AND A SEARCH ENGINE FOR DATABASE CONTENT, IN CLASS 9 (U.S. CLS. 21, 23, 26, 36 AND 38).

FIRST USE 11-15-2004; IN COMMERCE 3-31-2006.

THE MARK CONSISTS OF STANDARD CHARACTERS WITHOUT CLAIM TO ANY PARTICULAR FONT, STYLE, SIZE, OR COLOR.

NO CLAIM IS MADE TO THE EXCLUSIVE RIGHT TO USE "MEDICAL SOLUTIONS", APART FROM THE MARK AS SHOWN.

SER. NO. 77-063,159, FILED 12-13-2006.

TOBY BULLOFF, EXAMINING ATTORNEY

Int. Cl.: 16

Prior U.S. Cls.: 2, 5, 22, 23, 29, 37, 38 and 50

United States Patent and Trademark Office

Reg. No. 3,397,147

Registered Mar. 18, 2008

**TRADEMARK
PRINCIPAL REGISTER**



THE KRAFTMARK COMPANY (PENNSYLVANIA PARTNERSHIP)
P.O. BOX 84
SPRING CITY, PA 194750084

FOR: MODELING COMPOUND IN THE NATURE OF A GEL, PUTTY OR PASTE FOR USE IN SCULPTING, IN CLASS 16 (U.S. CLS. 2, 5, 22, 23, 29, 37, 38 AND 50).

FIRST USE 4-1-2006; IN COMMERCE 7-1-2006.

NO CLAIM IS MADE TO THE EXCLUSIVE RIGHT TO USE "PC PROCREATE", APART FROM THE MARK AS SHOWN.

THE COLOR(S) BLUE, BLUE, VIOLET, BLACK, WHITE AND GREEN IS/ARE CLAIMED AS A FEATURE OF THE MARK.

THE MARK CONSISTS OF THE COLOR LIGHT BLUE APPEARS IN THE UPPER SHADED BACKGROUND RECTANGLE UPON WHICH THE LETTERS PC ARE SUPERIMPOSED, THE COLORS SHADING FROM BLUE IN THE CENTER THROUGH VIOLET TO BLACK AT THE PERIMETER OF THE RECTANGLE. THE LETTERS PC ARE IN THE DUC DE BERRY FONT STYLE. THE COLOR WHITE APPEARS IN THE WORDING PROCREATE. THE COLOR GREEN APPEARS IN THE LOWER SHADED BACKGROUND RECTANGLE WHICH PROCREATE IS SUPERIMPOSED IS/ARE CLAIMED AS A FEATURE OF THE MARK.

SER. NO. 77-063,292, FILED 12-13-2006.

ALLISON HOLTZ, EXAMINING ATTORNEY

Int. Cl.: 19

Prior U.S. Cls.: 1, 12, 33 and 50

United States Patent and Trademark Office

Reg. No. 3,397,148

Registered Mar. 18, 2008

**TRADEMARK
PRINCIPAL REGISTER**

Gage

SWEETMAN CONST. CO. (SOUTH DAKOTA
CORPORATION)
1201 WEST RUSSELL
SIOUX FALLS, SD 571184140

THE MARK CONSISTS OF STANDARD CHAR-
ACTERS WITHOUT CLAIM TO ANY PARTICULAR
FONT, STYLE, SIZE, OR COLOR.

FOR: CONCRETE MASONRY UNITS, NAMELY,
CONCRETE BLOCKS, IN CLASS 19 (U.S. CLS. 1, 12,
33 AND 50).

SER. NO. 77-063,384, FILED 12-13-2006.

FIRST USE 9-1-2005; IN COMMERCE 9-1-2005.

SALLY SHIH, EXAMINING ATTORNEY

Int. Cl.: 42

Prior U.S. Cls.: 100 and 101

United States Patent and Trademark Office

Reg. No. 3,397,149

Registered Mar. 18, 2008

**SERVICE MARK
PRINCIPAL REGISTER**



SINO GEOPHYSICAL CO., LTD. (CHINA CORPORATION)
ZIZHUYUAN RD., HAIDIAN DIST.
1516, JIA HUI YUAN EPOCH CENTRE NO. 31
BEIJING, CHINA 100089

FOR: ANALYSIS FOR OIL-FIELD EXPLOITATION; GEOLOGICAL SURVEYS; GEOLOGICAL PROSPECTING; OIL-FIELD SURVEYS; OIL PROSPECTING; OIL-FIELD TESTING; GEOLOGICAL

RESEARCH; UNDERWATER EXPLORATION; SURVEYING, IN CLASS 42 (U.S. CLS. 100 AND 101).

FIRST USE 11-15-2003; IN COMMERCE 1-10-2006.

SER. NO. 77-063,684, FILED 12-13-2006.

AMOS T. MATTHEWS, JR., EXAMINING ATTORNEY

Int. Cl.: 43

Prior U.S. Cls.: 100 and 101

United States Patent and Trademark Office

Reg. No. 3,397,150

Registered Mar. 18, 2008

**SERVICE MARK
PRINCIPAL REGISTER**



TOOTSA'S, LLC (OHIO LTD LIAB CO)
P.O. BOX 530, 949 SOUTH MCCORD ROAD
HOLLAND, OH 43528

FOR: COFFEE AND ICE CREAM CAFE SERVICES, IN CLASS 43 (U.S. CLS. 100 AND 101).

FIRST USE 4-30-2007; IN COMMERCE 4-30-2007.

THE COLOR(S) RASPBERRY, BLACK AND WHITE IS/ARE CLAIMED AS A FEATURE OF THE MARK.

THE MARK CONSISTS OF THE WORD TOOTSA'S CONTAINING BLACK LETTERING, AND A WHITE BORDER; THE WORDING IS PLACED IN AN OVAL RASPBERRY COLOR BACKGROUND, WITH BLACK AND WHITE BORDERS.

SER. NO. 77-063,976, FILED 12-14-2006.

HENRY S. ZAK, EXAMINING ATTORNEY

Int. Cl.: 41

Prior U.S. Cls.: 100, 101 and 107

United States Patent and Trademark Office

Reg. No. 3,397,151

Registered Mar. 18, 2008

**SERVICE MARK
PRINCIPAL REGISTER**

SCHMOOZ-A-PALOOZA

SN EVENTS INC. (DELAWARE CORPORATION)
8383 WILSHIRE BOULEVARD
BEVERLY HILLS, CA 90211

THE MARK CONSISTS OF STANDARD CHAR-
ACTERS WITHOUT CLAIM TO ANY PARTICULAR
FONT, STYLE, SIZE, OR COLOR.

FOR: ENTERTAINMENT SERVICES, NAMELY
CONDUCTING PARTIES FOR THE PURPOSE OF
DATING AND PERSONAL RELATIONSHIP INTER-
ACTIONS, IN CLASS 41 (U.S. CLS. 100, 101 AND 107).

SER. NO. 77-064,020, FILED 12-14-2006.

FIRST USE 12-12-1997; IN COMMERCE 12-12-1997.

MICHAEL LITZAU, EXAMINING ATTORNEY

Int. Cl.: 9

Prior U.S. Cls.: 21, 23, 26, 36 and 38

United States Patent and Trademark Office

Reg. No. 3,397,152

Registered Mar. 18, 2008

**TRADEMARK
PRINCIPAL REGISTER**



COM DEV LTD. (CANADA CORPORATION)
155 SHELDON DRIVE
CAMBRIDGE, ONTARIO, CANADA N1R7H6

FOR: HIGH TECHNOLOGY COMMUNICATIONS EQUIPMENT, NAMELY, MICROWAVE/MILLIMETER MULTIPLEXERS, CO-AXIAL AND WAVEGUIDE RF AND MICROWAVE SWITCHES, ELECTRONICS IN THE NATURE OF RF AND MICROWAVE/MILLIMETER-WAVE RECEIVERS, TRANSMITTERS AND SIGNAL PROCESSING ELECTRONICS, SURFACE ACOUSTIC WAVE DEVICES (SAW) DEVICES COMPRISING RF FILTERING RECEIVERS, TRANSMITTERS AND SENSORS, HIGH TECHNOLOGY SCIENTIFIC INSTRUMENTS, SENSORS AND MECHANISMS FOR ASTRONOMICAL, REMOTE SENSING, ENVIRONMENTAL AND CLIMATOLOGY APPLI-

CATIONS FOR THE SPACE, AEROSPACE AND MILITARY MARKETS, NAMELY, OPTICAL AND IR RECEIVERS AND PROCESSING ELECTRONICS, SPECTROMETERS, ION RECEIVING INSTRUMENTS, OPTICAL GUIDANCE SENSORS, AND RADAR TRANSCEIVERS, IN CLASS 9 (U.S. CLS. 21, 23, 26, 36 AND 38).

FIRST USE 1-2-1975; IN COMMERCE 1-2-1975.

THE MARK CONSISTS OF THE STYLIZED LETTERS "C" AND "D" IN THE SHAPE OF A TRIANGLE.

SER. NO. 77-064,025, FILED 12-14-2006.

JENNIFER HETU, EXAMINING ATTORNEY

Int. Cl.: 9

Prior U.S. Cls.: 21, 23, 26, 36 and 38

United States Patent and Trademark Office

Reg. No. 3,397,153

Registered Mar. 18, 2008

**TRADEMARK
PRINCIPAL REGISTER**

Broker Webstation

BWS HOLDING COMPANY (FLORIDA CORPORATION)
5201 BLUE LAGOON DR, SUITE 250
MIAMI, FL 33126

FOR: COMPUTER COMMUNICATIONS SOFTWARE TO ALLOW CUSTOMERS TO ACCESS BANK ACCOUNT INFORMATION AND TRANSACT BANK BUSINESS; COMPUTER E-COMMERCE SOFTWARE TO ALLOW USERS TO PERFORM ELECTRONIC BUSINESS TRANSACTIONS VIA A GLOBAL COMPUTER NETWORK, IN CLASS 9 (U.S. CLS. 21, 23, 26, 36 AND 38).

FIRST USE 12-1-2000; IN COMMERCE 12-1-2000.

THE MARK CONSISTS OF STANDARD CHARACTERS WITHOUT CLAIM TO ANY PARTICULAR FONT, STYLE, SIZE, OR COLOR.

NO CLAIM IS MADE TO THE EXCLUSIVE RIGHT TO USE "BROKER", APART FROM THE MARK AS SHOWN.

SEC. 2(F).

SER. NO. 77-064,113, FILED 12-14-2006.

ADA HAN, EXAMINING ATTORNEY

Int. Cl.: 35

Prior U.S. Cls.: 100, 101 and 102

United States Patent and Trademark Office

Reg. No. 3,397,154

Registered Mar. 18, 2008

**SERVICE MARK
PRINCIPAL REGISTER**

POwRE

ESCH, ARTHUR G. (UNITED STATES INDIVIDUAL)
3631 SE CLUBHOUSE PLACE
STUART, FL 34997

FOR: REAL ESTATE MARKETING SERVICES IN THE FIELD OF RESIDENTIAL AND COMMERCIAL RESIDENCES, CONDOMINIUMS AND PROPERTY VIA A GLOBAL NETWORK, AND NAMELY ONLINE SERVICES FEATURING TOURS OF RESIDENTIAL AND COMMERCIAL REAL ESTATE, IN CLASS 35 (U.S. CLS. 100, 101 AND 102).

FIRST USE 3-1-2005; IN COMMERCE 3-13-2006.

THE MARK CONSISTS OF STANDARD CHARACTERS WITHOUT CLAIM TO ANY PARTICULAR FONT, STYLE, SIZE, OR COLOR.

SER. NO. 77-064,168, FILED 12-14-2006.

CAROLINE WOOD, EXAMINING ATTORNEY

Int. Cl.: 36

Prior U.S. Cls.: 100, 101 and 102

United States Patent and Trademark Office

Reg. No. 3,397,155

Registered Mar. 18, 2008

**SERVICE MARK
PRINCIPAL REGISTER**



EMIGRANT BANK (NEW YORK CORPORATION)
5 EAST 42ND STREET
NEW YORK, NY 10017

FOR: FINANCIAL SERVICES, NAMELY, BANKING, MORTGAGE LENDING, SECURITIES BROKERAGE, MONEY LENDING, TRUST COMPANY SERVICES, AND INSURANCE BROKERAGE, IN CLASS 36 (U.S. CLS. 100, 101 AND 102).

FIRST USE 1-1-1992; IN COMMERCE 1-1-1992.

THE MARK CONSISTS OF THREE STRIPES (NOT WITH ANY BORDERS).

SER. NO. 77-064,324, FILED 12-14-2006.

PETER B. BROMAGHIM, EXAMINING ATTORNEY

Int. Cl.: 41

Prior U.S. Cls.: 100, 101 and 107

United States Patent and Trademark Office

Reg. No. 3,397,156

Registered Mar. 18, 2008

**SERVICE MARK
PRINCIPAL REGISTER**

NUMBTHUMB

NUMBTHUMB.COM LLC (WASHINGTON LTD
LIAB CO)
SUITE D
14727 123 RD AVE
YELM, WA 98597

THE MARK CONSISTS OF STANDARD CHAR-
ACTERS WITHOUT CLAIM TO ANY PARTICULAR
FONT, STYLE, SIZE, OR COLOR.

FOR: RENTAL OF VIDEO GAMES, IN CLASS 41
(U.S. CLS. 100, 101 AND 107).

SER. NO. 77-064,368, FILED 12-14-2006.

FIRST USE 5-1-2002; IN COMMERCE 5-1-2002.

CORY BOONE, EXAMINING ATTORNEY

Int. Cl.: 36

Prior U.S. Cls.: 100, 101 and 102

United States Patent and Trademark Office

Reg. No. 3,397,157

Registered Mar. 18, 2008

**SERVICE MARK
PRINCIPAL REGISTER**

Hope • Help • Here for You

ALS OF MICHIGAN, INC. (MICHIGAN NON-
PROFIT CORPORATION)
SUITE 200
21311 CIVIC CENTER DRIVE
SOUTHFIELD, MI 48076

FOR: CHARITABLE FUND RAISING SERVICES
FOR FUNDING RESEARCH PROGRAMS, PATIENT
SERVICES PROGRAMS, CLINICAL CENTERS, AND
RELATED PROGRAMS AND ACTIVITIES RELAT-
ING TO THE TREATMENT OF AND FINDING A
CURE OF AMYOTROPHIC LATERAL SCLEROSIS;
FINANCIAL SPONSORSHIP OF RESEARCH IN THE

FIELD OF AMYOTROPHIC LATERAL SCLEROSIS,
IN CLASS 36 (U.S. CLS. 100, 101 AND 102).

FIRST USE 7-1-2006; IN COMMERCE 7-1-2006.

THE MARK CONSISTS OF THE WORDS HOPE,
HELP, HERE FOR YOU WITH A BULLET SYMBOL
BETWEEN THE WORDS "HOPE", "HELP" AND
"HERE".

SER. NO. 77-064,391, FILED 12-14-2006.

SUE LAWRENCE, EXAMINING ATTORNEY

Int. Cl.: 44

Prior U.S. Cls.: 100 and 101

United States Patent and Trademark Office

Reg. No. 3,397,158

Registered Mar. 18, 2008

**SERVICE MARK
PRINCIPAL REGISTER**



HERITAGE NEW YORK, IPA INC. (NEW YORK
CORPORATION)
SUITE 100
1225 FRANKLIN AVENUE
GARDEN CITY, NY 115301655

FOR: MANAGED HEALTH CARE SERVICES, IN
CLASS 44 (U.S. CLS. 100 AND 101).

FIRST USE 0-0-1985; IN COMMERCE 0-0-1986.

THE MARK CONSISTS OF A CROSS CONTAIN-
ING A SPIRALED CENTER.

SER. NO. 77-064,420, FILED 12-14-2006.

JAY FLOWERS, EXAMINING ATTORNEY

Int. Cl.: 44

Prior U.S. Cls.: 100 and 101

United States Patent and Trademark Office

Reg. No. 3,397,159

Registered Mar. 18, 2008

**SERVICE MARK
PRINCIPAL REGISTER**

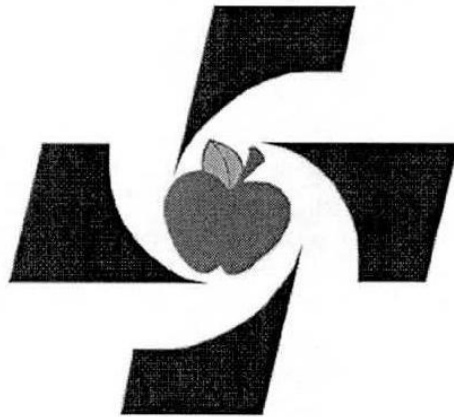

HERITAGE NEW YORK IPA, INC. (NEW YORK CORPORATION)
SUITE 100
1225 FRANKLIN AVENUE
GARDEN CITY, NY 115301655

FOR: MANAGED HEALTH CARE SERVICES, IN CLASS 44 (U.S. CLS. 100 AND 101).

FIRST USE 0-0-1985; IN COMMERCE 0-0-1986.

THE MARK CONSISTS OF A CROSS WITH A SPIRALED CENTER HAVING AN APPLE POSITIONED THEREIN.

SER. NO. 77-064,451, FILED 12-14-2006.

JAY FLOWERS, EXAMINING ATTORNEY

Int. Cl.: 30

Prior U.S. Cl.: 46

United States Patent and Trademark Office

Reg. No. 3,397,160

Registered Mar. 18, 2008

**TRADEMARK
PRINCIPAL REGISTER**

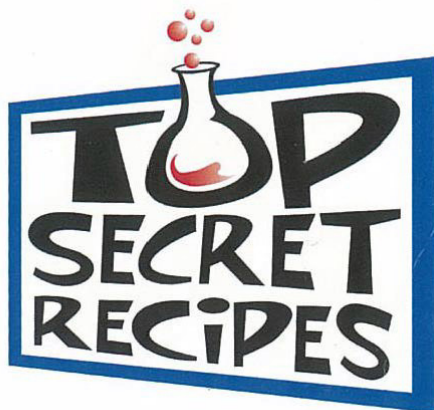

TOP SECRET RECIPES, INC. (NEVADA CORPORATION)
10401 ORKINEY DR.
LAS VEGAS, NV 89144

FOR: BAKING SPICES; BARBECUE DRY RUB; DRY SEASONING MIXES FOR FOOD; SPICE BLENDS; SPICES, IN CLASS 30 (U.S. CL. 46).

FIRST USE 5-31-2001; IN COMMERCE 12-5-2001.

OWNER OF U.S. REG. NO. 2,661,232.

NO CLAIM IS MADE TO THE EXCLUSIVE RIGHT TO USE "RECIPES", APART FROM THE MARK AS SHOWN.

THE COLOR(S) RED, BLACK, BLUE, AND WHITE IS/ARE CLAIMED AS A FEATURE OF THE MARK.

THE MARK CONSISTS OF THE WORDS "TOP SECRET RECIPES", WITH THE REPRESENTATION OF A FLASK WITHIN THE LETTER "O". THE LETTERS IN THE WORDS "TOP SECRET RECIPES" ARE THE COLOR BLACK; THE RECTANGLE BORDER IS BLUE; WHAT APPEARS TO BE FLUID IN THE FLASK IS RED; THE BUBBLES ABOVE THE FLASK ARE RED; AND ALL SPACING WITHIN THE RECTANGLE IS WHITE.

SER. NO. 77-064,641, FILED 12-14-2006.

ROSELLE HERRERA, EXAMINING ATTORNEY

Int. Cl.: 42

Prior U.S. Cls.: 100 and 101

United States Patent and Trademark Office

Reg. No. 3,397,161

Registered Mar. 18, 2008

**SERVICE MARK
PRINCIPAL REGISTER**

360°RF

TESTING CORP. (NEW YORK CORPORATION)
470 NEPPERHAN AVE., STE. 303-321A
YONKERS, NY 10701

FOR: PRODUCT RESEARCH AND DEVELOPMENT FOR WIRELESS CONSUMER AND BUSINESS PRODUCTS; TESTING, ENGINEERING AND DEVELOPMENT OF WIRELESS CONSUMER AND BUSINESS PRODUCTS FOR OTHERS; TESTING, EVALUATION, ANALYSIS AND ENGINEERING OF WIRELESS CONSUMER AND BUSINESS GOODS AND SERVICES FOR OTHERS FOR THE PURPOSE OF PERFORMANCE DETERMINATION AND/OR IMPROVEMENT, OR GOODS AND SER-

VICES DEVELOPMENT, IN CLASS 42 (U.S. CLS. 100 AND 101).

FIRST USE 10-31-2006; IN COMMERCE 10-31-2006.

THE MARK CONSISTS OF STANDARD CHARACTERS WITHOUT CLAIM TO ANY PARTICULAR FONT, STYLE, SIZE, OR COLOR.

SER. NO. 77-064,960, FILED 12-15-2006.

KENNETH E. SHARPERSON, EXAMINING ATTORNEY

Int. Cl.: 5

Prior U.S. Cls.: 6, 18, 44, 46, 51 and 52

United States Patent and Trademark Office

Reg. No. 3,397,162

Registered Mar. 18, 2008

**TRADEMARK
PRINCIPAL REGISTER**

SKIN SMOOTHIE

GOLDSMITH, IVAN (UNITED STATES INDIVIDUAL)
SUITE 110
6787 W. TROPICANA AVE.
LAS VEGAS, NV 89103

FOR: VITAMIN AND MINERAL PREPARATIONS
FOR MEDICAL USE, IN CLASS 5 (U.S. CLS. 6, 18, 44,
46, 51 AND 52).

FIRST USE 12-4-2006; IN COMMERCE 12-4-2006.

THE MARK CONSISTS OF STANDARD CHARACTERS WITHOUT CLAIM TO ANY PARTICULAR FONT, STYLE, SIZE, OR COLOR.

NO CLAIM IS MADE TO THE EXCLUSIVE RIGHT TO USE "SKIN", APART FROM THE MARK AS SHOWN.

SER. NO. 77-065,287, FILED 12-15-2006.

JAMES A. RAUEN, EXAMINING ATTORNEY

Int. Cl.: 25

Prior U.S. Cls.: 22 and 39

United States Patent and Trademark Office

Reg. No. 3,397,163

Registered Mar. 18, 2008

**TRADEMARK
PRINCIPAL REGISTER**

REENIE BEENIE

SILLY ME, INC. (NEW YORK CORPORATION)
530 EAST 88TH STREET
NEW YORK, NY 10128

FOR: NOVELTY HEAD-GEAR, NAMELY, HATS,
SCARVES, HEADBANDS, BANDANAS, BEANIES,
CAPS, EARMUFFS, SKI HATS, AND FLEECE HATS
IN THE SHAPE OF A TIARA, IN CLASS 25 (U.S. CLS.
22 AND 39).

FIRST USE 5-1-2003; IN COMMERCE 5-1-2003.

THE MARK CONSISTS OF STANDARD CHAR-
ACTERS WITHOUT CLAIM TO ANY PARTICULAR
FONT, STYLE, SIZE, OR COLOR.

SER. NO. 77-065,545, FILED 12-15-2006.

MARY BOAGNI, EXAMINING ATTORNEY

Int. Cls.: 3, 9, 18 and 25

**Prior U.S. Cls.: 1, 2, 3, 4, 6, 21, 22, 23, 26, 36, 38, 39,
41, 50, 51 and 52**

Reg. No. 3,397,164

United States Patent and Trademark Office

Registered Mar. 18, 2008

**TRADEMARK
PRINCIPAL REGISTER**

DESIGNED FOR REAL LIFE

REITMANS (CANADA) LIMITED (CANADA CORPORATION)
250 SAUVÉ WEST STREET
MONTREAL, CANADA H3L1Z2

FOR: SKIN CARE PRODUCTS, NAMELY, SOAPS, CLEANSING PREPARATIONS, BATH OILS, BATH SALTS, HERBAL BATH MIXES, AND BATH ADDITIVES; SCRUB MASK PREPARATIONS; CLAY MASK PREPARATIONS; FACIAL AND BODY CREAM LOTIONS; MOISTURIZING FACIAL AND BODY CREAMS AND LOTIONS; HAND CREAMS AND LOTIONS; LIP PROTECTIVE PREPARATIONS, NAMELY, NON-MEDICATED LIP PROTECTOR; BALMS, NAMELY, LIP BALMS; NON-MEDICATED FOOT BALMS; BATH AND BODY OILS; DEPILATORIES; DEPILATORY WAXES; SUN-TANNING PREPARATIONS; SUN-TAN CREAMS, BODY AND SUN-TAN OILS AND LOTIONS; BEAUTY MASKS AND FACIAL PACKS; ASTRINGENT PREPARATIONS FOR COSMETIC PURPOSES; TONING PREPARATIONS, NAMELY, TONING LOTIONS FOR THE FACE, BODY, AND HANDS; MASSAGE PREPARATIONS, NAMELY, OILS; MASSAGE LOTIONS; SHAVING PREPARATIONS; BODY SCRUBBERS, NAMELY, BODY SCRUB; AND PERFUME, IN CLASS 3 (U.S. CLS. 1, 4, 6, 50, 51 AND 52).

FOR: SUNGLASSES, IN CLASS 9 (U.S. CLS. 21, 23, 26, 36 AND 38).

FOR: UMBRELLAS, PURSES, DAYPACKS, FANNY PACKS, DUFFLE BAGS, HANDBAGS, WALLET, BACKPACKS, IN CLASS 18 (U.S. CLS. 1, 2, 3, 22 AND 41).

FOR: WOMEN'S AND YOUNG WOMEN'S CLOTHING, NAMELY, HOSIERY, LINGERIE,

DRESSES, JUMP SUITS, ROMPERS, BATHING SUITS, SKIRTS, SWEATSHIRTS, SWEATPANTS, PANTS, JEANS, OVERALLS, BLOUSES, SHIRTS, SHORTS, T-SHIRTS, SWEATSHIRTS, TANK TOPS, BLAZERS, SWEATERS, SHORTS, BRAS, UNDERWEAR, ROBES; OUTERWEAR, NAMELY JACKETS, COATS, BLAZERS, RAINCOATS, OVERALLS, VESTS, CAPES, SUITS, PONCHOS, SWEATERS, DUFFLE COATS, PARKAS, SKI JACKETS, HATS, AND SCARVES; SLEEPWEAR, NAMELY, BRAS, PANTIES, TEDDIES, CAMISOLES, SLIPS, HALF SLIPS, GARTER BELTS, GARTERS, ROBES, BODY-SUITS, NIGHTGOWNS, NIGHTIES, BABY DOLL PAJAMAS, PAJAMAS, BATHROBES, NEGLIGES, KIMONOS, NIGHT SHIRTS, BATH TERRY CLOTH WRAPS; EXERCISE WEAR, NAMELY, SWEAT TOPS, SWEAT BOTTOMS, JOGGING SUITS, BODY SUITS, LEGGINGS; HOSIERY, NAMELY, LEGGINGS, SOCKS, ANKLE SOCKS, KNEE-HIGH SOCKS, TIGHTS AND PANTY-HOSE; BELTS; GLOVES; FOOTWEAR, NAMELY, THONGS, SHOES, BOOTS, SLIPPERS, SANDALS, AND RUNNING SHOES, IN CLASS 25 (U.S. CLS. 22 AND 39).

THE MARK CONSISTS OF STANDARD CHARACTERS WITHOUT CLAIM TO ANY PARTICULAR FONT, STYLE, SIZE, OR COLOR.

OWNER OF CANADA REG. NO. TMA652,386, DATED 11-8-2005, EXPIRES 11-8-2022.

OWNER OF CANADA REG. NO. TMA652,386, DATED 11-8-2005, EXPIRES 11-8-2020.

SER. NO. 77-065,580, FILED 12-15-2006.

TASHIA BUNCH, EXAMINING ATTORNEY

Int. Cl.: 41

Prior U.S. Cls.: 100, 101 and 107

United States Patent and Trademark Office

Reg. No. 3,397,165

Registered Mar. 18, 2008

**SERVICE MARK
PRINCIPAL REGISTER**

KOKUA FESTIVAL

KOKUA HAWAII FOUNDATION (HAWAII NON-
PROFIT CORPORATION)
C/O PROVIDENT FINANCIAL MANAGEMENT
2020 UNION STREET
SAN FRANCISCO, CA 94123

FOR: ENTERTAINMENT SERVICES FEATUR-
ING LIVE MUSICAL PERFORMANCES, IN CLASS
41 (U.S. CLS. 100, 101 AND 107).

FIRST USE 1-3-2004; IN COMMERCE 1-3-2004.

THE MARK CONSISTS OF STANDARD CHAR-
ACTERS WITHOUT CLAIM TO ANY PARTICULAR
FONT, STYLE, SIZE, OR COLOR.

NO CLAIM IS MADE TO THE EXCLUSIVE
RIGHT TO USE "FESTIVAL", APART FROM THE
MARK AS SHOWN.

"KOKUA" IS A HAWAIIAN WORD THAT
TRANSLATES INTO ENGLISH AS "MUTUALLY
HELP ONE ANOTHER, HELP, AID, ASSIST, RELIEF,
SUPPORT."

SER. NO. 77-065,670, FILED 12-15-2006.

MICHAEL WEBSTER, EXAMINING ATTORNEY

Int. Cl.: 9

Prior U.S. Cls.: 21, 23, 26, 36 and 38

United States Patent and Trademark Office

Reg. No. 3,397,166

Registered Mar. 18, 2008

**TRADEMARK
PRINCIPAL REGISTER**

KOKUA FESTIVAL

KOKUA HAWAII FOUNDATION (HAWAII NON-PROFIT CORPORATION)
C/O PROVIDENT FINANCIAL MANAGEMENT
2020 UNION STREET
SAN FRANCISCO, CA 94123

FOR: DIGITAL VIDEO DISCS AND COMPACT DISCS FEATURING MUSIC AND MUSICAL PERFORMANCES, IN CLASS 9 (U.S. CLS. 21, 23, 26, 36 AND 38).

FIRST USE 1-3-2004; IN COMMERCE 1-3-2004.

THE MARK CONSISTS OF STANDARD CHARACTERS WITHOUT CLAIM TO ANY PARTICULAR FONT, STYLE, SIZE, OR COLOR.

NO CLAIM IS MADE TO THE EXCLUSIVE RIGHT TO USE "FESTIVAL", APART FROM THE MARK AS SHOWN.

'KOKUA" IS A HAWAIIAN WORD THAT TRANSLATES INTO ENGLISH AS "MUTUALLY HELP ONE ANOTHER, HELP, AID, ASSIST, RELIEF, SUPPORT."

SER. NO. 77-065,715, FILED 12-15-2006.

MICHAEL WEBSTER, EXAMINING ATTORNEY

Int. Cls.: 35, 38 and 42

Prior U.S. Cls.: 100, 101, 102 and 104

United States Patent and Trademark Office

Reg. No. 3,397,167

Registered Mar. 18, 2008

**SERVICE MARK
PRINCIPAL REGISTER**

NEXTCAT

NEXTCAT, INC. (DELAWARE CORPORATION)
1205 HANCOCK STREET, SUITE 815
QUINCY, MA 02169

FOR: CAREER NETWORKING SERVICES,
NAMELY, PROVIDING ONLINE JOB LISTINGS
AND RESUMES, IN CLASS 35 (U.S. CLS. 100, 101
AND 102).

FIRST USE 5-1-2006; IN COMMERCE 5-1-2006.

FOR: COMPUTER SERVICES, NAMELY PROVID-
ING AN ONLINE FORUM FOR TRANSMISSION OF
MESSAGES AND OTHER MULTIMEDIA DATA
AMONG COMPUTER USERS ABOUT THE ENTER-
TAINMENT INDUSTRY AND TO FACILITATE
CAREER NETWORKING, IN CLASS 38 (U.S. CLS.
100, 101 AND 104).

FIRST USE 5-1-2006; IN COMMERCE 5-1-2006.

FOR: COMPUTER SERVICES, NAMELY, CREAT-
ING AN ONLINE COMMUNITY FOR MEMBERS
OF THE ENTERTAINMENT INDUSTRY WHO ARE
REGISTERED USERS TO SHOWCASE THEIR
SKILLS, POST THEIR PERSONAL PROFILES, AND
ENGAGE IN SOCIAL NETWORKING, IN CLASS 42
(U.S. CLS. 100 AND 101).

FIRST USE 5-1-2006; IN COMMERCE 5-1-2006.

THE MARK CONSISTS OF STANDARD CHAR-
ACTERS WITHOUT CLAIM TO ANY PARTICULAR
FONT, STYLE, SIZE, OR COLOR.

SER. NO. 77-065,762, FILED 12-15-2006.

MICHAEL LITZAU, EXAMINING ATTORNEY

Int. Cls.: 35, 42 and 45

Prior U.S. Cls.: 100, 101 and 102

United States Patent and Trademark Office

Reg. No. 3,397,168

Registered Mar. 18, 2008

**SERVICE MARK
PRINCIPAL REGISTER**

POPNOGGINS

POPNOGGINS, LLC (FLORIDA LTD LIAB CO)
11100 ASTRONAUT BLVD
ORLANDO, FL 32837

FOR: BUSINESS SERVICES, NAMELY, DISTRIBUTORSHIPS IN THE FIELD OF HARDWARE, COMPUTER SOFTWARE AND ENTERTAINMENT SYSTEMS FOR CREATING CUSTOM DIGITAL VIDEO DISCS; RETAIL STORE SERVICES IN THE FIELD OF HARDWARE, COMPUTER SOFTWARE AND ENTERTAINMENT SYSTEMS FOR CREATING CUSTOM DIGITAL VIDEO DISCS, IN CLASS 35 (U.S. CLS. 100, 101 AND 102).

FIRST USE 11-0-2006; IN COMMERCE 11-0-2006.

FOR: RENTAL OF COMPUTERS AND SOFTWARE FOR CREATING CUSTOM DIGITAL DISCS, IN CLASS 42 (U.S. CLS. 100 AND 101).

FIRST USE 11-0-2006; IN COMMERCE 11-0-2006.

FOR: LICENSING OF COMPUTERS AND SOFTWARE FOR CREATING CUSTOM DIGITAL VIDEO DISCS, IN CLASS 45 (U.S. CLS. 100 AND 101).

FIRST USE 11-0-2006; IN COMMERCE 11-0-2006.

THE MARK CONSISTS OF STANDARD CHARACTERS WITHOUT CLAIM TO ANY PARTICULAR FONT, STYLE, SIZE, OR COLOR.

SER. NO. 77-066,364, FILED 12-18-2006.

MICHAEL ENGEL, EXAMINING ATTORNEY

Int. Cls.: 35 and 44

Prior U.S. Cls.: 100, 101 and 102

United States Patent and Trademark Office

Reg. No. 3,397,169

Registered Mar. 18, 2008

**SERVICE MARK
PRINCIPAL REGISTER**

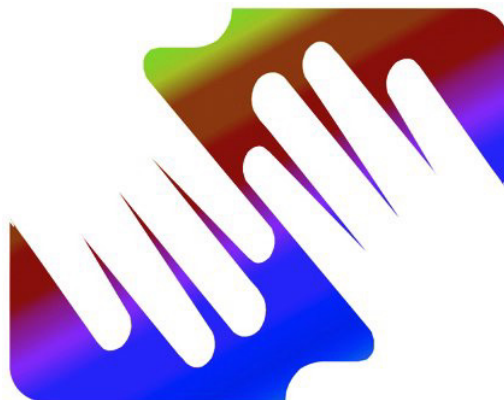

THE BLOOD AND TISSUE CENTER OF CENTRAL TEXAS, (TEXAS CORPORATION)
4300 N LAMAR BLVD.
AUSTIN, TX 78756

FOR: CHARITABLE SERVICES, NAMELY, ORGANIZING AND CONDUCTING VOLUNTEER PROGRAMS AND COMMUNITY SERVICE PROJECTS; PROMOTING THE GOODS AND SERVICES OF OTHERS BY MEANS OF A PREFERRED CUSTOMER PROGRAM FEATURING REWARDS FOR FREQUENCY OF BLOOD DONATION, IN CLASS 35 (U.S. CLS. 100, 101 AND 102).

FIRST USE 10-16-2006; IN COMMERCE 10-16-2006.

FOR: BLOOD BANKS; COLLECTION AND PRESERVATION OF HUMAN BLOOD, IN CLASS 44 (U.S. CLS. 100 AND 101).

FIRST USE 10-16-2006; IN COMMERCE 10-16-2006.

THE COLOR(S) WHITE, BLUE, RED, YELLOW, GREEN, VIOLET, ORANGE IS/ARE CLAIMED AS A FEATURE OF THE MARK.

THE COLOR WHITE APPEARS IN THE HAND DESIGNS; THE COLORS BLUE, RED, YELLOW, GREEN, VIOLET, ORANGE APPEAR IN THE BACKGROUND.

SER. NO. 77-066,721, FILED 12-18-2006.

ADA HAN, EXAMINING ATTORNEY

Int. Cl.: 7

Prior U.S. Cls.: 13, 19, 21, 23, 31, 34 and 35

United States Patent and Trademark Office

Reg. No. 3,397,170

Registered Mar. 18, 2008

**TRADEMARK
PRINCIPAL REGISTER**

EASYCHANGE

CUTSFORTH PRODUCTS, INC. (MINNESOTA
CORPORATION)
37837 ROCK HAVEN ROAD
COHASSET, MN 55721

FOR: ELECTRICAL BRUSH HOLDER SYSTEMS,
BRUSH HOLDER ASSEMBLIES, BRUSH HOLDERS,
AND BRUSHES, USED IN INDUSTRIAL AND
COMMERCIAL ELECTRIC MOTORS AND GEN-
ERATORS , IN CLASS 7 (U.S. CLS. 13, 19, 21, 23, 31, 34
AND 35).

FIRST USE 2-1-2004; IN COMMERCE 2-1-2004.

THE MARK CONSISTS OF STANDARD CHAR-
ACTERS WITHOUT CLAIM TO ANY PARTICULAR
FONT, STYLE, SIZE, OR COLOR.

SER. NO. 77-066,737, FILED 12-18-2006.

JULIE WATSON, EXAMINING ATTORNEY

Int. Cl.: 41

Prior U.S. Cls.: 100, 101 and 107

United States Patent and Trademark Office

Reg. No. 3,397,171

Registered Mar. 18, 2008

**SERVICE MARK
PRINCIPAL REGISTER**

ANSWER-WITHIN SYSTEM

BR CONSULTING, INC. (NEW JERSEY CORPORATION)
340 JORDAN ROAD
SEDONA, AZ 86336

FOR: EDUCATIONAL SERVICES, NAMELY, CONDUCTING CORPORATE TRAINING AND EDUCATION PROGRAMS IN THE FIELD OF PERSONAL AND PROFESSIONAL DEVELOPMENT, IN CLASS 41 (U.S. CLS. 100, 101 AND 107).

FIRST USE 6-1-2006; IN COMMERCE 6-1-2006.

THE MARK CONSISTS OF STANDARD CHARACTERS WITHOUT CLAIM TO ANY PARTICULAR FONT, STYLE, SIZE, OR COLOR.

NO CLAIM IS MADE TO THE EXCLUSIVE RIGHT TO USE "SYSTEM", APART FROM THE MARK AS SHOWN.

SER. NO. 77-066,802, FILED 12-18-2006.

PAUL CROWLEY, EXAMINING ATTORNEY

Int. Cl.: 25

Prior U.S. Cls.: 22 and 39

United States Patent and Trademark Office

Reg. No. 3,397,172

Registered Mar. 18, 2008

TRADEMARK
PRINCIPAL REGISTER

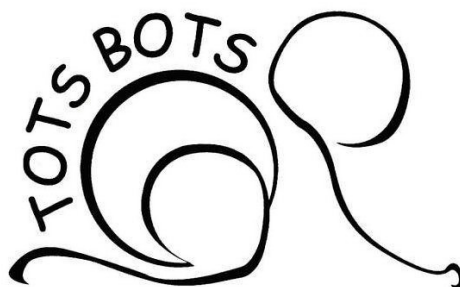

TOTSBOTS LIMITED (UNITED KINGDOM LIMITED COMPANY)
SUITE 214, ABERCROMBY BUSINESS CENTRE
279 ABERCROMBY STREET
GLASGOW, UNITED KINGDOM G402DD

FOR: SHAPED COTTON NAPPIES; TEXTILE NAPPY COVERS MADE OF COTTON, ORGANIC COTTON, BAMBOO FIBER AND POLYESTER FLEECE; TEXTILE NAPPY LINERS MADE OF POLYESTER FLEECE AND CELLULOSE FIBERS; TEXTILE ABSORBENT PADS FOR USE IN NAPPIES MADE OF COTTON, ORGANIC COTTON, BAMBOO FIBER AND POLYESTER FLEECE; CLOTHING, NAMELY, TROUSERS, SHIRTS, T-SHIRTS, DRESSES, BODYSUITS, CARDIGANS, ROMPER SUITS, JUMPERS, SKIRTS, SLEEPWEAR, SHORTS, JEANS, COATS, JACKETS, VESTS, TIGHTS, SOCKS, MATERNITY SLEEPWEAR AND UNDERWEAR FOR BABIES; FOOTWEAR, NAMELY, SHOES, TRAINING SHOES, SANDALS AND BOOTIES; HEADWEAR, NAMELY, CAPS AND HATS; KNITWEAR FOR BABIES, NAMELY, CARDIGANS, DRESSES,

JUMPERS, HATS, SCARVES, PONCHOS, SHAWLS AND BOOTIES; BABIES' ABSORBENT PANTS; CLOTH BABIES' BIBS; BABIES' DIAPERS OF TEXTILES; BABIES' PANTS; BABIES' VESTS; DIAPERS OF TEXTILES; UNDERPANTS FOR BABIES; AND WATERPROOF BABIES' PANTS, IN CLASS 25 (U.S. CLS. 22 AND 39).

OWNER OF ERPN CMNTY TM OFC REG. NO. 005030614, DATED 4-20-2006, EXPIRES 4-20-2016.

NO CLAIM IS MADE TO THE EXCLUSIVE RIGHT TO USE "TOTS", APART FROM THE MARK AS SHOWN.

THE MARK CONSISTS OF FIGURATIVE REPRESENTATION OF A BABY.

SER. NO. 77-067,033, FILED 12-19-2006.

JIM RINGLE, EXAMINING ATTORNEY

Int. Cl.: 16

Prior U.S. Cls.: 2, 5, 22, 23, 29, 37, 38 and 50

United States Patent and Trademark Office

Reg. No. 3,397,173

Registered Mar. 18, 2008

**TRADEMARK
PRINCIPAL REGISTER**



CHENG, JOHNNY T. (UNITED STATES INDIVIDUAL)
PO BOX 1121
ARTESIA, CA 90702

NO CLAIM IS MADE TO THE EXCLUSIVE RIGHT TO USE "STORY" AND "NATURE", APART FROM THE MARK AS SHOWN.

FOR: BOOKS IN THE FIELD OF NATURE AND OUTDOOR RECREATIONS; GUIDE BOOKS FEATURING NATURE AND OUTDOOR RECREATIONS; TRAVEL BOOKS, IN CLASS 16 (U.S. CLS. 2, 5, 22, 23, 29, 37, 38 AND 50).

THE MARK CONSISTS OF STORY NATURE AND A LEAF WITH A PERSON.

SER. NO. 77-067,170, FILED 12-19-2006.

FIRST USE 4-1-2006; IN COMMERCE 10-19-2006.

BENJAMIN OKEKE, EXAMINING ATTORNEY

Int. Cl.: 13

Prior U.S. Cls.: 2 and 9

United States Patent and Trademark Office

Reg. No. 3,397,174

Registered Mar. 18, 2008

**TRADEMARK
PRINCIPAL REGISTER**

MANGONEL

DEFENSE PROCUREMENT MANUFACTURING
SERVICES, INC. (MINNESOTA CORPORATION)
3312 12TH STREET SE
ST. CLOUD, MN 56304

FOR: GUN SIGHTS FOR FIREARMS, IN CLASS 13
(U.S. CLS. 2 AND 9).

FIRST USE 2-5-2003; IN COMMERCE 2-5-2003.

THE MARK CONSISTS OF STANDARD CHARACTERS WITHOUT CLAIM TO ANY PARTICULAR FONT, STYLE, SIZE, OR COLOR.

SER. NO. 77-067,305, FILED 12-19-2006.

REBECCA POVARCHUK, EXAMINING ATTORNEY

Prior U.S. Cl.: A

United States Patent and Trademark Office

Reg. No. 3,397,175

Registered Mar. 18, 2008

**CERTIFICATION MARK
PRINCIPAL REGISTER**



Conforms to
ASTM D 4236

THE ART & CREATIVE MATERIALS INSTITUTE, INC. (NEW YORK NON-PROFIT CORPORATION)

2ND FLOOR
1280 MAIN STREET
HANSON, MA 02341

FOR: ART, CRAFT AND CERAMIC MATERIALS,
IN CLASS A (U.S. CL. A).

FIRST USE 11-24-1998; IN COMMERCE 3-31-1999.

NO CLAIM IS MADE TO THE EXCLUSIVE
RIGHT TO USE "ART & CREATIVE MATERIALS
INSTITUTE CERTIFIED" AND "CONFORMS TO

ASTM D 4236", APART FROM THE MARK AS
SHOWN.

THE CERTIFICATION MARK, AS USED BY AN
AUTHORIZED PERSON, CERTIFIES THAT A TOXICOLOGICAL EVALUATION HAS BEEN DONE BY
A TOXICOLOGICAL OR MEDICAL EXPERT ON
ART MATERIALS FOR ANY KNOWN HEALTH
RISKS AND WITH INFORMATION ON THE SAFE
AND PROPER USE OF THESE MATERIALS.

SER. NO. 77-067,927, FILED 12-19-2006.

BERYL GARDNER, EXAMINING ATTORNEY

Int. Cl.: 36

Prior U.S. Cls.: 100, 101 and 102

United States Patent and Trademark Office

Reg. No. 3,397,176

Registered Mar. 18, 2008

SERVICE MARK
PRINCIPAL REGISTER

Service Net

CAPITALSOURCE FINANCE LLC, AS COLLAT-
ERAL AGENT (DELAWARE LTD LIAB CO)
4445 WILLARD AVENUE
12TH FLOOR
CHEVY CHASE, MD 20815

FOR: PROVIDING EXTENDED WARRANTY
CONTRACTS ON CONSUMER ELECTRONICS,
COMPUTER EQUIPMENT, ELECTRONIC CALCU-
LATORS, PERSONAL COPIERS, FACSIMILE MA-
CHINES, PERSONAL ELECTRONIC ORGANIZERS,
CELLULAR PHONES, ELECTRIC TYPEWRITERS,
WORD PROCESSORS, COMPUTER PERIPHERALS,
HOME APPLIANCES AND HOME AND GARDEN
EQUIPMENT, IN CLASS 36 (U.S. CLS. 100, 101 AND
102).

FIRST USE 6-14-1996; IN COMMERCE 6-14-1996.

THE MARK CONSISTS OF STANDARD CHAR-
ACTERS WITHOUT CLAIM TO ANY PARTICULAR
FONT, STYLE, SIZE, OR COLOR.

OWNER OF U.S. REG. NOS. 2,331,234 AND
2,334,655.

SEC. 2(F).

SER. NO. 77-068,072, FILED 12-20-2006.

GINA FINK, EXAMINING ATTORNEY

Int. Cl.: 5

Prior U.S. Cls.: 6, 18, 44, 46, 51 and 52

United States Patent and Trademark Office

Reg. No. 3,397,177

Registered Mar. 18, 2008

**TRADEMARK
PRINCIPAL REGISTER**

BITE BLOCKER XTREME

HOMS, LLC (NORTH CAROLINA LTD LIAB CO)
P.O. BOX 724
CLAYTON, NC 27528

FOR: PEST REPELLENTS; INSECT REPELLENTS;
ANTI-INSECT SPRAYS, IN CLASS 5 (U.S. CLS. 6, 18,
44, 46, 51 AND 52).

FIRST USE 11-10-2005; IN COMMERCE 12-14-2005.

THE MARK CONSISTS OF STANDARD CHAR-
ACTERS WITHOUT CLAIM TO ANY PARTICULAR
FONT, STYLE, SIZE, OR COLOR.

OWNER OF U.S. REG. NO. 2,824,922.

SER. NO. 77-068,337, FILED 12-20-2006.

LOURDES AYALA, EXAMINING ATTORNEY

Int. Cl.: 42

Prior U.S. Cls.: 100 and 101

United States Patent and Trademark Office

Reg. No. 3,397,178

Registered Mar. 18, 2008

**SERVICE MARK
PRINCIPAL REGISTER**

SITELIFE

PLUCK CORPORATION (DELAWARE CORPORATION)
200 ACADEMY DRIVE, SUITE 120
AUSTIN, TX 78704

FOR: APPLICATION SERVICE PROVIDER (ASP) FEATURING SOFTWARE ENABLING WEB SITE VISITORS TO MAKE, MANAGE AND SHARE DIGITAL CONTENT OVER ELECTRONIC COMMUNICATION NETWORKS; APPLICATION SERVICE PROVIDER (ASP) FEATURING SOFTWARE FOR AGGREGATING AND SYNTHESIZING DIGITAL CONTENT OVER ELECTRONIC COMMUNICATIONS NETWORKS; APPLICATION SERVICE PROVIDER (ASP) FEATURING SOFTWARE FOR USE IN ONLINE PUBLISHING, NAMELY, SOFTWARE ENABLING ONLINE POSTINGS, PHOTOS, MEDIA, COMMENTS AND RATINGS; APPLICATION SERVICE PROVIDER (ASP) FEATURING SOFTWARE

PROVIDING COMMUNICATIONS BETWEEN WEB SITE VISITORS; COMPUTER CONSULTING SERVICES; COMPUTER WEB SITE DESIGN FOR OTHERS; MANAGING WEBSITES AND THEIR DIGITAL CONTENT FOR OTHERS; HOSTING OF DIGITAL CONTENT ON THE INTERNET FOR OTHERS, IN CLASS 42 (U.S. CLS. 100 AND 101).

FIRST USE 2-7-2006; IN COMMERCE 2-7-2006.

THE MARK CONSISTS OF STANDARD CHARACTERS WITHOUT CLAIM TO ANY PARTICULAR FONT, STYLE, SIZE, OR COLOR.

SER. NO. 77-068,404, FILED 12-20-2006.

JUSTINE D. PARKER, EXAMINING ATTORNEY

Int. Cl.: 43

Prior U.S. Cls.: 100 and 101

United States Patent and Trademark Office

Reg. No. 3,397,179

Registered Mar. 18, 2008

**SERVICE MARK
PRINCIPAL REGISTER**

TR'S

MIELE, PATRICK A. (UNITED STATES INDIVIDUAL)
PO BOX 4
OLD WESTBURY, NY 11568

FOR: RESTAURANT SERVICES, IN CLASS 43
(U.S. CLS. 100 AND 101).

FIRST USE 8-31-1981; IN COMMERCE 8-31-1981.

THE MARK CONSISTS OF STANDARD CHARACTERS WITHOUT CLAIM TO ANY PARTICULAR FONT, STYLE, SIZE, OR COLOR.

OWNER OF U.S. REG. NOS. 1,181,640, 3,076,224 AND OTHERS.

SER. NO. 77-068,460, FILED 12-20-2006.

SEAN CROWLEY, EXAMINING ATTORNEY

Int. Cl.: 43

Prior U.S. Cls.: 100 and 101

United States Patent and Trademark Office

Reg. No. 3,397,180

Registered Mar. 18, 2008

**SERVICE MARK
PRINCIPAL REGISTER**



MIELE, PATRICK A. (UNITED STATES INDIVIDUAL)

PO BOX 4

OLD WESTBURY, NY 11568

FOR: RESTAURANT SERVICES, IN CLASS 43
(U.S. CLS. 100 AND 101).

FIRST USE 8-31-1981; IN COMMERCE 8-31-1981.

OWNER OF U.S. REG. NOS. 376,224, 3,070,684 AND OTHERS.

THE MARK CONSISTS OF THE LETTERS "TR'S" AND THE DESIGN OF A MUSTACHE, SPECTACLES, AND HAIR.

SER. NO. 77-068,495, FILED 12-20-2006.

SEAN CROWLEY, EXAMINING ATTORNEY

Int. Cl.: 30

Prior U.S. Cl.: 46

United States Patent and Trademark Office

Reg. No. 3,397,181

Registered Mar. 18, 2008

**TRADEMARK
PRINCIPAL REGISTER**



PLUSH PIPPIN COMPANY, LLC (VIRGINIA LTD
LIAB CO)
50 MAPLEHURST DRIVE
BROWNSBURG, IN 46112

FOR: PIES, IN CLASS 30 (U.S. CL. 46).

FIRST USE 2-0-2003; IN COMMERCE 2-0-2003.

OWNER OF U.S. REG. NOS. 1,747,286 AND
1,986,767.

NO CLAIM IS MADE TO THE EXCLUSIVE
RIGHT TO USE "PIPPIN", APART FROM THE
MARK AS SHOWN.

THE MARK CONSISTS OF THE WORDS PLUSH
PIPPIN SEPARATED BY THE DESIGN OF A CHEF
HOLDING A PIE ON A SQUARE BACKGROUND.

SER. NO. 77-068,504, FILED 12-20-2006.

SEAN CROWLEY, EXAMINING ATTORNEY

Int. Cl.: 12

Prior U.S. Cls.: 19, 21, 23, 31, 35 and 44

United States Patent and Trademark Office

Reg. No. 3,397,182

Registered Mar. 18, 2008

**TRADEMARK
PRINCIPAL REGISTER**

AIRGUIDE

DAIMLERCHRYSLER AG (FED REP GERMANY
CORPORATION)
EPPLESTRASSE 225
D-70567 STUTTGART, FED REP GERMANY

FOR: LAND VEHICLES AND THEIR STRUCTURAL PARTS, NOT INCLUDING AIR SPRINGS AND PNEUMATIC SUSPENSIONS, IN CLASS 12 (U.S. CLS. 19, 21, 23, 31, 35 AND 44).

THE MARK CONSISTS OF STANDARD CHARACTERS WITHOUT CLAIM TO ANY PARTICULAR FONT, STYLE, SIZE, OR COLOR.

PRIORITY CLAIMED UNDER SEC. 44(D) ON FED REP GERMANY APPLICATION NO. 30643294.3/1, FILED 7-12-2006, REG. NO. 30642294, DATED 8-16-2006, EXPIRES 7-31-2016.

SER. NO. 77-068,522, FILED 12-20-2006.

RENEE MCCRAY, EXAMINING ATTORNEY

Int. Cl.: 25

Prior U.S. Cls.: 22 and 39

United States Patent and Trademark Office

Reg. No. 3,397,183

Registered Mar. 18, 2008

**TRADEMARK
PRINCIPAL REGISTER**



RAMSEY MEDIAWORKS LLC (MISSOURI LTD
LIAB CO)
1002 S. BYERS
JOPLIN, MO 64801

FOR: CLOTHING, NAMELY, T-SHIRTS, SWEAT-
SHIRTS, TANKTOPS AND HATS, IN CLASS 25 (U.S.
CLS. 22 AND 39).

FIRST USE 10-7-2005; IN COMMERCE 10-7-2005.

THE MARK CONSISTS OF THE WORD
"DRIVE18" LOCATED WITHIN AN INTERSTATE
SIGN.

SER. NO. 77-068,601, FILED 12-20-2006.

JANICE L. MCMORROW, EXAMINING ATTOR-
NEY

Int. Cl.: 36

Prior U.S. Cls.: 100, 101 and 102

United States Patent and Trademark Office

Reg. No. 3,397,184

Registered Mar. 18, 2008

**SERVICE MARK
PRINCIPAL REGISTER**

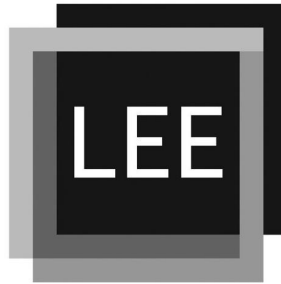

EQUITY PARTNERS

LEE EQUITY PARTNERS, LLC (DELAWARE
LTD LIAB CO)
767 FIFTH AVENUE
NEW YORK, NY 10153

FOR: INVESTMENT AND FINANCIAL MAN-
AGEMENT SERVICES, NAMELY, MAKING AND
MANAGING PRIVATE EQUITY INVESTMENTS, IN
CLASS 36 (U.S. CLS. 100, 101 AND 102).

FIRST USE 9-6-2006; IN COMMERCE 9-6-2006.

NO CLAIM IS MADE TO THE EXCLUSIVE
RIGHT TO USE "EQUITY PARTNERS", APART
FROM THE MARK AS SHOWN.

THE MARK CONSISTS OF DESIGN MARK CON-
SISTING OF FOUR OVERLAPPING SQUARES AND
THE WORDS "LEE EQUITY PARTNERS".

SER. NO. 77-068,668, FILED 12-20-2006.

MYRIAH HABEEB, EXAMINING ATTORNEY

Int. Cls.: 35, 36 and 37

Prior U.S. Cls.: 100, 101, 102, 103 and 106

United States Patent and Trademark Office

Reg. No. 3,397,185

Registered Mar. 18, 2008

**SERVICE MARK
PRINCIPAL REGISTER**

PROJECTQA

PROJECT QUALITY ASSURANCE, LLC (ILLINOIS LTD LIAB CO)
13116 WESTERN AVENUE
SUITE 2
BLUE ISLAND, IL 60406

FOR: BUSINESS CONSULTING, MANAGEMENT, PLANNING AND SUPERVISION; BUSINESS MANAGEMENT ASSISTANCE TO INDUSTRIAL OR COMMERCIAL COMPANIES; COMMERCIAL CONSULTANCY; MANAGEMENT AND BUSINESS CONSULTING SERVICES IN THE FIELD OF CONSTRUCTION, NAMELY, SCOPE MANAGEMENT COST ESTIMATING, IN CLASS 35 (U.S. CLS. 100, 101 AND 102).

FIRST USE 8-0-2004; IN COMMERCE 8-0-2004.

FOR: RISK MANAGEMENT IN THE FIELD OF CONSTRUCTION, IN CLASS 36 (U.S. CLS. 100, 101 AND 102).

FIRST USE 8-0-2004; IN COMMERCE 8-0-2004.

FOR: CONSTRUCTION PLANNING, CONSTRUCTION CONSULTATION, CONSTRUCTION MANAGEMENT AND CONSTRUCTION SUPERVISION, NAMELY, SCOPE DEFINITION, SCHEDULING, PROGRAMMING, DECISION ANALYSIS, PROGRESS MONITORING AND REVIEW OF PROJECT DOCUMENTS, NAMELY, ARCHITECTURAL DRAWINGS, DESIGN AND PERFORMANCE SPECIFICATIONS, CONTRACTS AND SCHEDULES, IN CLASS 37 (U.S. CLS. 100, 103 AND 106).

FIRST USE 8-0-2004; IN COMMERCE 8-0-2004.

THE MARK CONSISTS OF STANDARD CHARACTERS WITHOUT CLAIM TO ANY PARTICULAR FONT, STYLE, SIZE, OR COLOR.

SER. NO. 77-068,787, FILED 12-20-2006.

SHAILA SETTLES, EXAMINING ATTORNEY

Int. Cl.: 11

Prior U.S. Cls.: 13, 21, 23, 31 and 34

United States Patent and Trademark Office

Reg. No. 3,397,186

Registered Mar. 18, 2008

**TRADEMARK
PRINCIPAL REGISTER**

LOV

FRYMASTER LLC (LOUISIANA LTD LIAB CO)
8700 LINE AVENUE
SHREVEPORT, LA 71106

THE MARK CONSISTS OF STANDARD CHAR-
ACTERS WITHOUT CLAIM TO ANY PARTICULAR
FONT, STYLE, SIZE, OR COLOR.

FOR: GAS AND ELECTRIC COMMERCIAL FRY-
ERS, IN CLASS 11 (U.S. CLS. 13, 21, 23, 31 AND 34).

SER. NO. 77-068,793, FILED 12-20-2006.

FIRST USE 10-5-2007; IN COMMERCE 10-5-2007.

BERYL GARDNER, EXAMINING ATTORNEY

Int. Cls.: 35, 36 and 37

Prior U.S. Cls.: 100, 101, 102, 103 and 106

United States Patent and Trademark Office

Reg. No. 3,397,187

Registered Mar. 18, 2008

**SERVICE MARK
PRINCIPAL REGISTER**

**COMMITTED TO PROJECT
SUCCESS**

PROJECT QUALITY ASSURANCE, LLC (ILLINOIS LTD LIAB CO)
13116 WESTERN AVENUE
SUITE 2
BLUE ISLAND, IL 60406

FOR: BUSINESS CONSULTING, MANAGEMENT, PLANNING AND SUPERVISION; BUSINESS MANAGEMENT ASSISTANCE TO INDUSTRIAL OR COMMERCIAL COMPANIES; COMMERCIAL CONSULTANCY; MANAGEMENT AND BUSINESS CONSULTING SERVICES IN THE FIELD OF CONSTRUCTION, NAMELY, SCOPE MANAGEMENT COST ESTIMATING, IN CLASS 35 (U.S. CLS. 100, 101 AND 102).

FIRST USE 8-0-2004; IN COMMERCE 8-0-2004.

FOR: RISK MANAGEMENT IN THE FIELD OF CONSTRUCTION, IN CLASS 36 (U.S. CLS. 100, 101 AND 102).

FIRST USE 8-0-2004; IN COMMERCE 8-0-2004.

FOR: CONSTRUCTION PLANNING, CONSTRUCTION CONSULTATION, CONSTRUCTION MANAGEMENT AND CONSTRUCTION SUPERVISION, NAMELY, SCOPE DEFINITION, SCHEDULING, PROGRAMMING, DECISION ANALYSIS, PROGRESS MONITORING AND REVIEW OF PROJECT DOCUMENTS, NAMELY, ARCHITECTURAL DRAWINGS, DESIGN AND PERFORMANCE SPECIFICATIONS, CONTRACTS AND SCHEDULES, IN CLASS 37 (U.S. CLS. 100, 103 AND 106).

FIRST USE 8-0-2004; IN COMMERCE 8-0-2004.

THE MARK CONSISTS OF STANDARD CHARACTERS WITHOUT CLAIM TO ANY PARTICULAR FONT, STYLE, SIZE, OR COLOR.

SER. NO. 77-068,798, FILED 12-20-2006.

SHAILA SETTLES, EXAMINING ATTORNEY

Int. Cls.: 9 and 41

Prior U.S. Cls.: 21, 23, 26, 36, 38, 100, 101 and 107

United States Patent and Trademark Office

Reg. No. 3,397,188

Registered Mar. 18, 2008

**TRADEMARK
SERVICE MARK
PRINCIPAL REGISTER**



MALEY, MICHAEL (UNITED STATES INDIVIDUAL)
2022 BARLOW STREET
PHILADELPHIA, PA 19116

FOR: PRE-RECORDED CDS, VIDEO TAPES, LASER DISKS AND DVDS FEATURING MUSIC, IN CLASS 9 (U.S. CLS. 21, 23, 26, 36 AND 38).

FIRST USE 1-12-1995; IN COMMERCE 5-23-1997.

FOR: ENTERTAINMENT SERVICES, NAMELY, LIVE, TELEVISED AND MOVIE APPEARANCES BY A PROFESSIONAL ENTERTAINER; ENTERTAIN-

MENT, NAMELY, LIVE MUSIC CONCERTS; ENTERTAINMENT, NAMELY, LIVE PERFORMANCES BY ROCK GROUPS, IN CLASS 41 (U.S. CLS. 100, 101 AND 107).

FIRST USE 1-12-1995; IN COMMERCE 5-23-1997.

THE MARK CONSISTS OF STYLIZED TEXT OF THE WORDING "SIRIS".

SER. NO. 77-068,885, FILED 12-20-2006.

SUNG IN, EXAMINING ATTORNEY

Int. Cl.: 41

Prior U.S. Cls.: 100, 101 and 107

United States Patent and Trademark Office

Reg. No. 3,397,189

Registered Mar. 18, 2008

**SERVICE MARK
PRINCIPAL REGISTER**

**CFC Combat Fighting
Championships**

COMBAT FIGHTING CHAMPIONSHIPS, LLC
(FLORIDA LTD LIAB CO)
2200 NE 36TH AVENUE, BLDG 400
OCALA, FL 34470

FOR: ENTERTAINMENT SERVICES, NAMELY,
ARRANGING AND CONDUCTING OF COMPETI-
TIONS FOR MIXED MARTIAL ARTS, IN CLASS 41
(U.S. CLS. 100, 101 AND 107).

FIRST USE 7-15-2006; IN COMMERCE 7-15-2006.

THE MARK CONSISTS OF STANDARD CHAR-
ACTERS WITHOUT CLAIM TO ANY PARTICULAR
FONT, STYLE, SIZE, OR COLOR.

NO CLAIM IS MADE TO THE EXCLUSIVE
RIGHT TO USE "COMBAT FIGHTING CHAMPION-
SHIPS", APART FROM THE MARK AS SHOWN.

SER. NO. 77-069,014, FILED 12-21-2006.

REBECCA EISINGER, EXAMINING ATTORNEY

Int. Cl.: 41

Prior U.S. Cls.: 100, 101 and 107

United States Patent and Trademark Office

Reg. No. 3,397,190

Registered Mar. 18, 2008

**SERVICE MARK
PRINCIPAL REGISTER**



COMBAT FIGHTING CHAMPIONSHIPS, LLC
(FLORIDA LTD LIAB CO)
2200 NE 36TH AVENUE, BLDG 400
OCALA, FL 34470

FOR: ENTERTAINMENT SERVICES, NAMELY,
ARRANGING AND CONDUCTING OF COMPETI-
TIONS FOR MIXED MARTIAL ARTS, IN CLASS 41
(U.S. CLS. 100, 101 AND 107).

FIRST USE 7-15-2006; IN COMMERCE 7-15-2006.

NO CLAIM IS MADE TO THE EXCLUSIVE
RIGHT TO USE "COMBAT FIGHTING CHAMPION-
SHIPS", APART FROM THE MARK AS SHOWN.

THE MARK CONSISTS OF THE WORDS "COM-
BAT" AND "FIGHTING" SEPARATED BY A SMALL
CIRCLE ABOVE A HORIZONTAL LINE WHICH IN
TURN IS ABOVE THE WORD "CHAMPIONSHIPS"
WHICH IN TURN IS ABOVE THE LETTERS "CFC"
WHEREIN EACH LETTER "C" HAS A RIGHT
HAND GLOVED FIST IN ITS CENTER AND THE
TOP OF THE FIRST LETTER "C" IS CONNECTED
TO THE TOP OF THE LETTER "F".

SER. NO. 77-069,022, FILED 12-21-2006.

CHERYL CLAYTON, EXAMINING ATTORNEY

Int. Cl.: 25

Prior U.S. Cls.: 22 and 39

United States Patent and Trademark Office

Reg. No. 3,397,191

Registered Mar. 18, 2008

TRADEMARK
PRINCIPAL REGISTER

Dolores Cortés

DOLORES FONT CORTES (SPAIN INDIVIDUAL)
PADRE LLUIS M. LLOPEZ # 8
VILLA REAL, SPAIN 12540

FOR: READY MADE CLOTHING FOR INDOOR
AND OUTDOOR WEAR, NAMELY, SHIRTS, PANT
AND COATS; FOOTWEAR, BELTS AND HEAD-
GEAR, NAMELY, HATS, CAPS AND SWIMSUITS,
IN CLASS 25 (U.S. CLS. 22 AND 39).

OWNER OF ERPN CMNTY TM OFC REG. NO.
000127001, DATED 6-10-1998, EXPIRES 6-10-2008.

"THE NAME(S), PORTRAIT(S), AND/OR SIGNA-
TURE(S) SHOWN IN THE MARK IDENTIFIES

DOLORES CORTES, WHOSE CONSENT(S) TO REG-
ISTER IS SUBMITTED."

THE COLOR(S) BLACK AND WHITE IS/ARE
CLAIMED AS A FEATURE OF THE MARK.

THE MARK CONSISTS OF THE NAME OF DO-
LORES CORTES IN COLOR BLACK IN CURSIVE
LETTERS WITH THE BACKGROUND IN WHITE.

SER. NO. 77-069,026, FILED 12-21-2006.

ANDREA BUTLER, EXAMINING ATTORNEY

Int. Cl.: 12

Prior U.S. Cls.: 19, 21, 23, 31, 35 and 44

United States Patent and Trademark Office

Reg. No. 3,397,192

Registered Mar. 18, 2008

**TRADEMARK
PRINCIPAL REGISTER**

AIRSTREAK

ALASKAN BUSHWHEEL INC. (OREGON CORPORATION)
PO BOX 2380, 83496 E. RUSSELL LN.
JOSEPH, OR 97846

THE MARK CONSISTS OF STANDARD CHARACTERS WITHOUT CLAIM TO ANY PARTICULAR FONT, STYLE, SIZE, OR COLOR.

FOR: TIRES FOR LANDING GEAR WHEELS OF AIRCRAFT, IN CLASS 12 (U.S. CLS. 19, 21, 23, 31, 35 AND 44).

SER. NO. 77-069,061, FILED 12-21-2006.

FIRST USE 3-23-2007; IN COMMERCE 3-23-2007.

EDWARD NELSON, EXAMINING ATTORNEY

Int. Cl.: 16

Prior U.S. Cls.: 2, 5, 22, 23, 29, 37, 38 and 50

United States Patent and Trademark Office

Reg. No. 3,397,193

Registered Mar. 18, 2008

**TRADEMARK
PRINCIPAL REGISTER**

NATIONAL CATHOLIC REGISTER

CIRCLE MEDIA, INC. (NEW YORK CORPORATION)
590 COLUMBUS AVE.
THORNWOOD, NY 10594

FOR: NEWSPAPERS; STATIONERY, IN CLASS 16
(U.S. CLS. 2, 5, 22, 23, 29, 37, 38 AND 50).

FIRST USE 8-30-1970; IN COMMERCE 8-30-1970.

THE MARK CONSISTS OF STANDARD CHARACTERS WITHOUT CLAIM TO ANY PARTICULAR FONT, STYLE, SIZE, OR COLOR.

SEC. 2(F).

SER. NO. 77-069,120, FILED 12-21-2006.

TARAH HARDY, EXAMINING ATTORNEY

Int. Cls.: 20 and 42

Prior U.S. Cls.: 2, 13, 22, 25, 32, 50, 100 and 101

United States Patent and Trademark Office

Reg. No. 3,397,194

Registered Mar. 18, 2008

**TRADEMARK
SERVICE MARK
PRINCIPAL REGISTER**

IRPINIA

IRPINIA (CANADA CORPORATION)
278 NEWKIRK ROAD
RICHMOND HILL, CANADA L4C3G7

FOR: KITCHEN CABINETS; CABINET BASE UNITS; CABINETS; CLOSET SYSTEMS COMPRISED OF SHELVES AND DOORS; ENTERTAINMENT CENTERS; BATHROOM CABINERY; DRAWER DIVIDERS; FITTED KITCHENS, NAMELY, FIXED BUILT-IN KITCHEN CABINETS, DRAWERS, PANTRIES, ISLANDS AND COUNTERTOPS AND KITCHEN CUPBOARDS; KITCHEN STORAGE RACKS; OFFICE FURNITURE AND BATHROOM FURNITURE, IN CLASS 20 (U.S. CLS. 2, 13, 22, 25, 32 AND 50).

FIRST USE 6-15-1960; IN COMMERCE 4-12-1989.

FOR: KITCHEN DESIGN AND KITCHEN DESIGN SERVICES; BATHROOM DESIGN AND BATHROOM DESIGN SERVICES; INTERIOR DESIGNING, NAMELY, DESIGN OF KITCHENS, BATHROOMS AND TILE AND STONE SURFACES; DESIGN CONSULTATION SERVICES FOR KITCHENS AND BATHROOMS, IN CLASS 42 (U.S. CLS. 100 AND 101).

FIRST USE 6-15-1960; IN COMMERCE 4-12-1989.

THE MARK CONSISTS OF STANDARD CHARACTERS WITHOUT CLAIM TO ANY PARTICULAR FONT, STYLE, SIZE, OR COLOR.

SER. NO. 77-069,143, FILED 12-21-2006.

DAVID YONTEF, EXAMINING ATTORNEY

Int. Cl.: 9

Prior U.S. Cls.: 21, 23, 26, 36 and 38

United States Patent and Trademark Office

Reg. No. 3,397,195

Registered Mar. 18, 2008

**TRADEMARK
PRINCIPAL REGISTER**

PROTECTA WRAP

PLUM ENTERPRISES, INC. (PENNSYLVANIA
CORPORATION)
500 FREEDOM VIEW LANE
VALLEY FORGE, PA 19481

OWNER OF U.S. REG. NOS. 1,402,263, 2,588,832,
AND 2,588,833.

FOR: PROTECTIVE CLOTHING, IN CLASS 9 (U.S.
CLS. 21, 23, 26, 36 AND 38).

NO CLAIM IS MADE TO THE EXCLUSIVE
RIGHT TO USE "WRAP", APART FROM THE
MARK AS SHOWN.

FIRST USE 8-7-2006; IN COMMERCE 8-7-2006.

SER. NO. 77-069,200, FILED 12-21-2006.

THE MARK CONSISTS OF STANDARD CHAR-
ACTERS WITHOUT CLAIM TO ANY PARTICULAR
FONT, STYLE, SIZE, OR COLOR.

LINDA POWELL, EXAMINING ATTORNEY

Int. Cl.: 44

Prior U.S. Cls.: 100 and 101

United States Patent and Trademark Office

Reg. No. 3,397,196

Registered Mar. 18, 2008

**SERVICE MARK
PRINCIPAL REGISTER**



BECK'S HYBRIDS (INDIANA CORPORATION)
6767 EAST 276TH STREET
ATLANTA, IN 46031

FOR: GREENHOUSE SERVICES WHEREBY
CORN SEED IS GROWN RAPIDLY IN A GREEN-
HOUSE ENVIRONMENT TO ALLOW FOR RAPID
TRAIT INTROGRESSION OF USEFUL INPUT AND
OUTPUT CORN TRAITS, IN CLASS 44 (U.S. CLS. 100
AND 101).

FIRST USE 9-29-2005; IN COMMERCE 9-29-2005.

NO CLAIM IS MADE TO THE EXCLUSIVE
RIGHT TO USE "CONVERSION PROGRAM",
APART FROM THE MARK AS SHOWN.

THE MARK CONSISTS OF THE LETTERS FAS,
WITH A STYLIZED 'T' DRAWN AS A PLANT, THEN
GRO.

SER. NO. 77-069,398, FILED 12-21-2006.

JIM RINGLE, EXAMINING ATTORNEY

Int. Cl.: 33

Prior U.S. Cls.: 47 and 49

United States Patent and Trademark Office

Reg. No. 3,397,197

Registered Mar. 18, 2008

**TRADEMARK
PRINCIPAL REGISTER**

SILVER SPUR

SILVER SPUR PARTNERS, INC. (WASHINGTON
CORPORATION)
313 PRIEST POINT DR. N.W.
MARYSVILLE, WA 98271

THE MARK CONSISTS OF STANDARD CHAR-
ACTERS WITHOUT CLAIM TO ANY PARTICULAR
FONT, STYLE, SIZE, OR COLOR.

FOR: WINE, IN CLASS 33 (U.S. CLS. 47 AND 49).

SER. NO. 77-069,433, FILED 12-21-2006.

FIRST USE 1-4-2004; IN COMMERCE 3-5-2004.

JILL C. ALT, EXAMINING ATTORNEY

Int. Cl.: 16

Prior U.S. Cls.: 2, 5, 22, 23, 29, 37, 38 and 50

United States Patent and Trademark Office

Reg. No. 3,397,198

Registered Mar. 18, 2008

**TRADEMARK
PRINCIPAL REGISTER**

RISC MANAGEMENT PROGRAM

PSP CORPORATION (CANADA CORPORATION)
SUITE 100
245 YORKLAND BOULEVARD
TORONTO, ONTARIO, CANADA M2J4W9

FOR: PAPER GOODS IN THE NATURE OF A
CARDBOARD BOX USED TO COLLECT AND SEG-
REGATE CONFIDENTIAL INFORMATION, IN
CLASS 16 (U.S. CLS. 2, 5, 22, 23, 29, 37, 38 AND 50).

FIRST USE 8-24-2006; IN COMMERCE 8-24-2006.

THE MARK CONSISTS OF STANDARD CHAR-
ACTERS WITHOUT CLAIM TO ANY PARTICULAR
FONT, STYLE, SIZE, OR COLOR.

SER. NO. 77-069,582, FILED 12-21-2006.

BRENDAN MCCAULEY, EXAMINING ATTORNEY

Int. Cl.: 25

Prior U.S. Cls.: 22 and 39

United States Patent and Trademark Office

Reg. No. 3,397,199

Registered Mar. 18, 2008

**TRADEMARK
PRINCIPAL REGISTER**

Apprentice

THE SUFFOLK POINTE SHOE CO.LTD (ENGLAND LIMITED COMPANY)
UNIT 6 CHURCHILL WORKS, HIGHFIELD STREET
EARL SHILTON, LEICESTER, ENGLAND LE97HS

FOR: BALLET SHOES, IN CLASS 25 (U.S. CLS. 22 AND 39).

FIRST USE 11-16-2006; IN COMMERCE 11-16-2006.

THE MARK CONSISTS OF STANDARD CHARACTERS WITHOUT CLAIM TO ANY PARTICULAR FONT, STYLE, SIZE, OR COLOR.

SER. NO. 77-069,750, FILED 12-21-2006.

MATTHEW MCDOWELL, EXAMINING ATTORNEY

Int. Cl.: 41

Prior U.S. Cls.: 100, 101 and 107

United States Patent and Trademark Office

Reg. No. 3,397,200

Registered Mar. 18, 2008

**SERVICE MARK
PRINCIPAL REGISTER**

BANACHEK

BANACHEK, INC. (TEXAS CORPORATION)
1721 WYCLIFFE DR.
HOUSTON, TX 77043

FOR: ENTERTAINMENT SERVICES, NAMELY,
LIVE AND TELEVISED PERFORMANCES BY A
MAGICIAN, MENTALIST AND THEATRICAL PER-
FORMER, IN CLASS 41 (U.S. CLS. 100, 101 AND 107).

FIRST USE 0-0-1997; IN COMMERCE 0-0-1997.

THE MARK CONSISTS OF STANDARD CHAR-
ACTERS WITHOUT CLAIM TO ANY PARTICULAR
FONT, STYLE, SIZE, OR COLOR.

THE NAME(S), PORTRAIT(S), AND/OR SIGNA-
TURE(S) SHOWN IN THE MARK IDENTIFIES
BANACHEK, WHOSE CONSENT(S) TO REGISTER
IS SUBMITTED.

SER. NO. 77-069,949, FILED 12-21-2006.

MATTHEW EINSTEIN, EXAMINING ATTORNEY

Int. Cl.: 16

Prior U.S. Cls.: 2, 5, 22, 23, 29, 37, 38 and 50

Reg. No. 3,397,201

United States Patent and Trademark Office

Registered Mar. 18, 2008

**TRADEMARK
PRINCIPAL REGISTER**

FAITH & FAMILY

CIRCLE MEDIA, INC. (NEW YORK CORPORATION)
590 COLUMBUS AVE.
THORNWOOD, NY 10594

FOR: MAGAZINE PAPER; MAGAZINES FEATURING ARTICLES AND STORIES CONCERNING CATHOLIC FAMILY LIFE, IN CLASS 16 (U.S. CLS. 2, 5, 22, 23, 29, 37, 38 AND 50).

FIRST USE 12-1-2000; IN COMMERCE 12-1-2000.

THE MARK CONSISTS OF STANDARD CHARACTERS WITHOUT CLAIM TO ANY PARTICULAR FONT, STYLE, SIZE, OR COLOR.

SEC. 2(F).

SER. NO. 77-070,168, FILED 12-22-2006.

TARAH HARDY, EXAMINING ATTORNEY

Int. Cl.: 42

Prior U.S. Cls.: 100 and 101

United States Patent and Trademark Office

Reg. No. 3,397,202

Registered Mar. 18, 2008

**SERVICE MARK
PRINCIPAL REGISTER**



ACTION ONLINE, LLC (FLORIDA LTD LIAB
CO)
SUITE 18
767 SOUTH STATE ROAD 7
MARGATE, FL 33068

THE COLOR(S) RED, BLUE AND WHITE IS/ARE
CLAIMED AS A FEATURE OF THE MARK.

FOR: PROVIDING TEMPORARY USE OF ON-
LINE NON-DOWNLOADABLE SOFTWARE FOR
EDITING THE CONTENT OF A WEB PAGE, NOT
INCLUSIVE OF PROVIDING ON-LINE COMPUTER
GAMES THAT ARE PLAYED ON-LINE, IN CLASS 42
(U.S. CLS. 100 AND 101).

THE MARK CONSISTS OF THE COLOR RED IN
THE TEXT EZNET AND THE COLOR BLUE IN THE
TEXT PUBLISH AND THE COLOR BLUE IN A
SPHERE WITH WHITE MERIDIANS AND PARAL-
LELS.

FIRST USE 8-12-2006; IN COMMERCE 8-12-2006.

SER. NO. 77-070,289, FILED 12-22-2006.

NO CLAIM IS MADE TO THE EXCLUSIVE
RIGHT TO USE "PUBLISH", APART FROM THE
MARK AS SHOWN.

JEAN IM, EXAMINING ATTORNEY

Int. Cls.: 5 and 32

Prior U.S. Cls.: 6, 18, 44, 45, 46, 48, 51 and 52

United States Patent and Trademark Office

Reg. No. 3,397,203

Registered Mar. 18, 2008

**TRADEMARK
PRINCIPAL REGISTER**

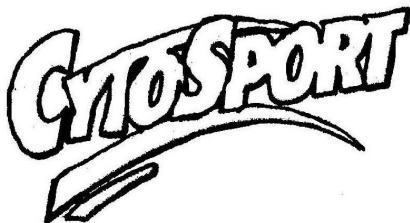

CYTOSPORT, INC. (CALIFORNIA CORPORATION)

4795 INDUSTRIAL WAY

BENICIA, CA 94510

FOR: DIETARY AND NUTRITIONAL SUPPLEMENTS, IN CLASS 5 (U.S. CLS. 6, 18, 44, 46, 51 AND 52).

FIRST USE 8-0-1998; IN COMMERCE 8-0-1998.

FOR: NON-CARBONATED SOFT DRINKS AND SPORTS DRINKS, IN CLASS 32 (U.S. CLS. 45, 46 AND 48).

FIRST USE 8-0-1998; IN COMMERCE 8-0-1998.

THE MARK CONSISTS OF CURVED LINES UNDERNEATH CYTOSPORT.

SER. NO. 77-070,437, FILED 12-22-2006.

ELLEN PERKINS, EXAMINING ATTORNEY

Int. Cls.: 35, 36 and 42

Prior U.S. Cls.: 100, 101 and 102

United States Patent and Trademark Office

Reg. No. 3,397,204

Registered Mar. 18, 2008

**SERVICE MARK
PRINCIPAL REGISTER**

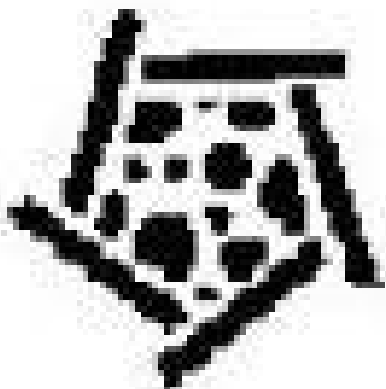

THE SAMUEL WAXMAN CANCER RESEARCH
FOUNDATION (NEW YORK NON-PROFIT
ORGANIZATION)

1150 FIFTH AVENUE
NEW YORK, NY 10128

FOR: PROMOTING PUBLIC AWARENESS OF
THE NEED FOR CANCER RESEARCH, IN CLASS
35 (U.S. CLS. 100, 101 AND 102).

FIRST USE 0-0-1981; IN COMMERCE 0-0-1981.

FOR: CHARITABLE FUNDRAISING SERVICES;
PROVIDING CHARITABLE FUNDING OF CAN-
CER RESEARCH; FINANCIAL SPONSORSHIP OF
CANCER RESEARCH; PROVIDING GRANTS TO

CANCER RESEARCHERS AND PHYSICIANS, IN
CLASS 36 (U.S. CLS. 100, 101 AND 102).

FIRST USE 0-0-1981; IN COMMERCE 0-0-1981.

FOR: CONDUCTING MEDICAL AND SCIENTI-
FIC CANCER RESEARCH, IN CLASS 42 (U.S. CLS.
100 AND 101).

FIRST USE 0-0-1981; IN COMMERCE 0-0-1981.

THE MARK CONSISTS OF STYLIZED CELL DE-
SIGN.

SER. NO. 77-070,498, FILED 12-22-2006.

FRED MANDIR, EXAMINING ATTORNEY

Int. Cls.: 35, 36 and 42

Prior U.S. Cls.: 100, 101 and 102

United States Patent and Trademark Office

Reg. No. 3,397,205

Registered Mar. 18, 2008

**SERVICE MARK
PRINCIPAL REGISTER**

COLLABORATING FOR A CURE

THE SAMUEL WAXMAN CANCER RESEARCH
FOUNDATION (NEW YORK NON-PROFIT
ORGANIZATION)
1150 FIFTH AVENUE
NEW YORK, NY 10128

FOR: PROMOTING PUBLIC AWARENESS OF
THE NEED FOR CANCER RESEARCH, IN CLASS
35 (U.S. CLS. 100, 101 AND 102).

FIRST USE 0-0-1997; IN COMMERCE 0-0-1997.

FOR: CHARITABLE FUNDRAISING SERVICES;
PROVIDING CHARITABLE FUNDING OF CAN-
CER RESEARCH; FINANCIAL SPONSORSHIP OF
CANCER RESEARCH; PROVIDING GRANTS TO
CANCER RESEARCHERS AND PHYSICIANS, IN
CLASS 36 (U.S. CLS. 100, 101 AND 102).

FIRST USE 0-0-1997; IN COMMERCE 0-0-1997.

FOR: CONDUCTING MEDICAL AND SCIENTI-
FIC CANCER RESEARCH, IN CLASS 42 (U.S. CLS.
100 AND 101).

FIRST USE 0-0-1997; IN COMMERCE 0-0-1997.

THE MARK CONSISTS OF STANDARD CHAR-
ACTERS WITHOUT CLAIM TO ANY PARTICULAR
FONT, STYLE, SIZE, OR COLOR.

SER. NO. 77-070,527, FILED 12-22-2006.

FRED MANDIR, EXAMINING ATTORNEY

Int. Cls.: 35, 36 and 42

Prior U.S. Cls.: 100, 101 and 102

United States Patent and Trademark Office

Reg. No. 3,397,206

Registered Mar. 18, 2008

**SERVICE MARK
PRINCIPAL REGISTER**

AN INSTITUTE WITHOUT WALLS

THE SAMUEL WAXMAN CANCER RESEARCH
FOUNDATION (NEW YORK NON-PROFIT
CORPORATION)
1150 FIFTH AVENUE
NEW YORK, NY 10128

FOR: PROMOTING PUBLIC AWARENESS OF
THE NEED FOR CANCER RESEARCH, IN CLASS
35 (U.S. CLS. 100, 101 AND 102).

FIRST USE 0-0-2002; IN COMMERCE 0-0-2002.

FOR: CHARITABLE FUNDRAISING SERVICES;
PROVIDING CHARITABLE FUNDING OF CAN-
CER RESEARCH; FINANCIAL SPONSORSHIP OF
CANCER RESEARCH; PROVIDING GRANTS TO
CANCER RESEARCHERS AND PHYSICIANS, IN
CLASS 36 (U.S. CLS. 100, 101 AND 102).

FIRST USE 0-0-2002; IN COMMERCE 0-0-2002.

FOR: CONDUCTING MEDICAL AND SCIENTI-
FIC CANCER RESEARCH, IN CLASS 42 (U.S. CLS.
100 AND 101).

FIRST USE 0-0-2002; IN COMMERCE 0-0-2002.

THE MARK CONSISTS OF STANDARD CHAR-
ACTERS WITHOUT CLAIM TO ANY PARTICULAR
FONT, STYLE, SIZE, OR COLOR.

SER. NO. 77-070,539, FILED 12-22-2006.

FRED MANDIR, EXAMINING ATTORNEY

Int. Cls.: 35, 36 and 42

Prior U.S. Cls.: 100, 101 and 102

United States Patent and Trademark Office

Reg. No. 3,397,207

Registered Mar. 18, 2008

**SERVICE MARK
PRINCIPAL REGISTER**

**SAMUEL WAXMAN CANCER
RESEARCH FOUNDATION**

THE SAMUEL WAXMAN CANCER RESEARCH
FOUNDATION (NEW YORK NON-PROFIT
CORPORATION)

1150 FIFTH AVENUE
NEW YORK, NY 10128

FOR: PROMOTING PUBLIC AWARENESS OF
THE NEED FOR CANCER RESEARCH, IN CLASS
35 (U.S. CLS. 100, 101 AND 102).

FIRST USE 0-0-1976; IN COMMERCE 0-0-1976.

FOR: CHARITABLE FUNDRAISING SERVICES;
PROVIDING CHARITABLE FUNDING OF CAN-
CER RESEARCH; FINANCIAL SPONSORSHIP OF
CANCER RESEARCH; PROVIDING GRANTS TO
CANCER RESEARCHERS AND PHYSICIANS, IN
CLASS 36 (U.S. CLS. 100, 101 AND 102).

FIRST USE 0-0-1976; IN COMMERCE 0-0-1976.

FOR: CONDUCTING MEDICAL AND SCIENTI-
FIC CANCER RESEARCH, IN CLASS 42 (U.S. CLS.
100 AND 101).

FIRST USE 0-0-1976; IN COMMERCE 0-0-1976.

THE MARK CONSISTS OF STANDARD CHAR-
ACTERS WITHOUT CLAIM TO ANY PARTICULAR
FONT, STYLE, SIZE, OR COLOR.

NO CLAIM IS MADE TO THE EXCLUSIVE
RIGHT TO USE "CANCER RESEARCH FOUNDA-
TION", APART FROM THE MARK AS SHOWN.

THE NAME(S), PORTRAIT(S), AND/OR SIGNA-
TURE(S) SHOWN IN THE MARK IDENTIFIES A
LIVING INDIVIDUAL, WHOSE CONSENT(S) TO
REGISTER IS MADE OF RECORD.

SER. NO. 77-070,565, FILED 12-22-2006.

FRED MANDIR, EXAMINING ATTORNEY

Int. Cls.: 1 and 6

**Prior U.S. Cls.: 1, 2, 5, 6, 10, 12, 13, 14, 23, 25, 26, 46
and 50**

Reg. No. 3,397,208

United States Patent and Trademark Office

Registered Mar. 18, 2008

**TRADEMARK
PRINCIPAL REGISTER**

PROSTAR

PRAXAIR TECHNOLOGY, INC. (DELAWARE
CORPORATION)
55 OLD RIDGEBURY ROAD
DANBURY, CT 06810

FOR: CHEMICAL PREPARATIONS, NAMELY,
ANTI-SPATTER SPRAYS, NOZZLE DIPS AND COM-
POUNDS FOR USE IN WELDING; WELDING CON-
SUMABLES, NAMELY, BRAZING AND
SOLDERING FLUXES, IN CLASS 1 (U.S. CLS. 1, 5,
6, 10, 26 AND 46).

FIRST USE 6-1-1997; IN COMMERCE 6-1-1997.

FOR: WELDING CONSUMABLES, NAMELY,
BRAZING RODS AND HARD AND SOFT SOLDER-

ING ALLOYS, IN CLASS 6 (U.S. CLS. 2, 12, 13, 14, 23,
25 AND 50).

FIRST USE 1-1-2001; IN COMMERCE 1-1-2001.

THE MARK CONSISTS OF STANDARD CHAR-
ACTERS WITHOUT CLAIM TO ANY PARTICULAR
FONT, STYLE, SIZE, OR COLOR.

OWNER OF U.S. REG. NO. 2,184,371.

SER. NO. 77-070,781, FILED 12-22-2006.

AMY HELLA, EXAMINING ATTORNEY

Int. Cl.: 9

Prior U.S. Cls.: 21, 23, 26, 36 and 38

United States Patent and Trademark Office

Reg. No. 3,397,209

Registered Mar. 18, 2008

**TRADEMARK
PRINCIPAL REGISTER**

GIZMOMAX

MAINLINE, INC. (CALIFORNIA CORPORATION)
20917 HIGGINS COURT
TORRANCE, CA 90501

FOR: CABLE TELEVISION EQUIPMENT, NAME-
LY, AMPLIFIERS, TRUNK AMPLIFIERS, LINE EX-
TENDERS, BRIDGE MODULES IN THE FORM OF
INTEGRATED CIRCUIT MODULES, MOTHER-
BOARDS, TOUCH PADS, EQUALIZERS AND
PLUG-IN CONNECTORS, IN CLASS 9 (U.S. CLS. 21,
23, 26, 36 AND 38).

FIRST USE 9-3-2004; IN COMMERCE 9-3-2004.

THE MARK CONSISTS OF STANDARD CHAR-
ACTERS WITHOUT CLAIM TO ANY PARTICULAR
FONT, STYLE, SIZE, OR COLOR.

SER. NO. 77-071,307, FILED 12-26-2006.

INGRID C. EULIN, EXAMINING ATTORNEY

Int. Cl.: 35

Prior U.S. Cls.: 100, 101 and 102

United States Patent and Trademark Office

Reg. No. 3,397,210

Registered Mar. 18, 2008

**SERVICE MARK
PRINCIPAL REGISTER**

ESSENTIAL

QUADRATEC, INC. (PENNSYLVANIA CORPORATION)
1028 SAUNDERS LANE
WESTCHESTER, PA 19380

FOR: MAIL-ORDER CATALOG SERVICES FEATURING VEHICLE ACCESSORIES; ELECTRONIC CATALOG SERVICES FEATURING VEHICLE ACCESSORIES; TELEPHONE CATALOG SERVICES FEATURING VEHICLE ACCESSORIES, IN CLASS 35 (U.S. CLS. 100, 101 AND 102).

FIRST USE 1-29-1999; IN COMMERCE 1-29-1999.

THE MARK CONSISTS OF STANDARD CHARACTERS WITHOUT CLAIM TO ANY PARTICULAR FONT, STYLE, SIZE, OR COLOR.

OWNER OF U.S. REG. NO. 2,325,595.

SER. NO. 77-071,983, FILED 12-27-2006.

JERI J. FICKES, EXAMINING ATTORNEY

Int. Cl.: 33

Prior U.S. Cls.: 47 and 49

United States Patent and Trademark Office

Reg. No. 3,397,211

Registered Mar. 18, 2008

**TRADEMARK
PRINCIPAL REGISTER**

ORANGELA

EMPIRE WINERIES, LLC (FLORIDA LTD LIAB
CO), DBA EMPIRE WINERY AND DISTIL-
LERY
11807 LITTLE ROAD
NEW PORT RICHEY, FL 34656

THE MARK CONSISTS OF STANDARD CHAR-
ACTERS WITHOUT CLAIM TO ANY PARTICULAR
FONT, STYLE, SIZE, OR COLOR.

FOR: LIQUEURS, IN CLASS 33 (U.S. CLS. 47 AND
49).

SER. NO. 77-071,990, FILED 12-27-2006.

FIRST USE 5-22-2005; IN COMMERCE 5-22-2005.

MICHAEL ENGEL, EXAMINING ATTORNEY

Int. Cl.: 9

Prior U.S. Cls.: 21, 23, 26, 36 and 38

Reg. No. 3,397,212

United States Patent and Trademark Office

Registered Mar. 18, 2008

**TRADEMARK
PRINCIPAL REGISTER**

JBL ON STAGE

HARMAN INTERNATIONAL INDUSTRIES, IN-
CORPORATED (DELAWARE CORPORATION)
LAW DEPARTMENT
8500 BALBOA BLVD.
NORTHRIDGE, CA 91329

FOR: AUDIO EQUIPMENT, NAMELY, AMPLIFI-
ERS AND LOUD SPEAKERS, IN CLASS 9 (U.S. CLS.
21, 23, 26, 36 AND 38).

FIRST USE 7-11-2004; IN COMMERCE 7-11-2004.

THE MARK CONSISTS OF STANDARD CHAR-
ACTERS WITHOUT CLAIM TO ANY PARTICULAR
FONT, STYLE, SIZE, OR COLOR.

OWNER OF U.S. REG. NOS. 3,027,602, 3,121,896,
AND 3,175,423.

SER. NO. 77-072,181, FILED 12-27-2006.

ALEX KEAM, EXAMINING ATTORNEY

Int. Cl.: 9

Prior U.S. Cls.: 21, 23, 26, 36 and 38

Reg. No. 3,397,213

United States Patent and Trademark Office

Registered Mar. 18, 2008

**TRADEMARK
PRINCIPAL REGISTER**



HARNISCHFEGER TECHNOLOGIES, INC. (DE-
LAWARE CORPORATION)
2751 CENTERVILLE ROAD, SUITE 342
WILMINGTON, DE 19808

FOR: ELECTRONIC CONTROL SYSTEMS FOR
MACHINES, IN CLASS 9 (U.S. CLS. 21, 23, 26, 36 AND
38).

FIRST USE 11-14-2006; IN COMMERCE 11-14-2006.

OWNER OF U.S. REG. NOS. 409,963 AND 1,058,988.

THE MARK CONSISTS OF A BLACK SHIELD
WITH A HELMET SUPERIMPOSED ON THE
SHIELD ON THE LEFT AND P&H ABOVE AND
CENTURION BELOW SUPERIMPOSED ON THE
SHIELD ON THE RIGHT.

SER. NO. 77-072,426, FILED 12-28-2006.

LESLEY LAMOTHE, EXAMINING ATTORNEY

Int. Cls.: 41, 43 and 44

Prior U.S. Cls.: 100, 101 and 107

United States Patent and Trademark Office

Reg. No. 3,397,214

Registered Mar. 18, 2008

**SERVICE MARK
PRINCIPAL REGISTER**

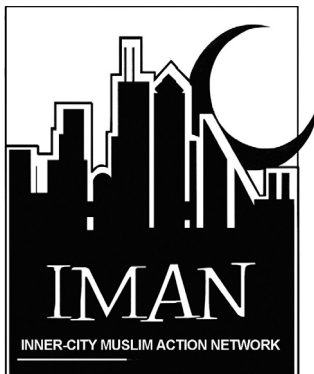

INNER-CITY MUSLIM ACTION NETWORK (IL-
LINOIS NON-PROFIT CORPORATION)
2744 WEST 63RD STREET
CHICAGO, IL 60629

FOR: EDUCATIONAL SERVICES, IN THE NATURE OF SEMINARS AND WORKSHOPS TO MENTOR YOUTH AND ASSIST WITH INTER-RELIGIOUS UNDERSTANDING AND DIALOGUE; EDUCATIONAL SERVICES, NAMELY, CONDUCTING CAREER TRAINING PROGRAMS IN THE FIELD OF HIGH SCHOOL EQUIVALENCY CLASSES AND COMPUTER SKILLS TRAINING; ENTERTAINMENT SERVICES, NAMELY, PROVIDING POETRY EVENTS, ARTS PROGRAMS AND A SERIES OF ONGOING MUSICAL CONCERTS, IN CLASS 41 (U.S. CLS. 100, 101 AND 107).

FIRST USE 0-0-1997; IN COMMERCE 0-0-1997.

FOR: CHARITABLE SERVICES, NAMELY, PROVIDING FOOD TO NEEDY PERSONS, IN CLASS 43 (U.S. CLS. 100 AND 101).

FIRST USE 0-0-1997; IN COMMERCE 0-0-1997.

FOR: PROVIDING MEDICAL SERVICES IN THE NATURE OF A MEDICAL CLINIC AND HEALTH CARE PROGRAMS, IN CLASS 44 (U.S. CLS. 100 AND 101).

FIRST USE 0-0-1997; IN COMMERCE 0-0-1997.

NO CLAIM IS MADE TO THE EXCLUSIVE RIGHT TO USE "IMAN" AND "INNER-CITY MUSLIM ACTION NETWORK", APART FROM THE MARK AS SHOWN.

THE MARK CONSISTS OF AN OUTLINE OF CHICAGO'S DOWNTOWN SKYLINE WITH A CRESCENT MOON LOCATED IN THE UPPER RIGHT SIDE OF THE SKYLINE.

SER. NO. 77-072,454, FILED 12-28-2006.

EDWARD NELSON, EXAMINING ATTORNEY

Int. Cl.: 9

Prior U.S. Cls.: 21, 23, 26, 36 and 38

United States Patent and Trademark Office

Reg. No. 3,397,215

Registered Mar. 18, 2008

TRADEMARK
PRINCIPAL REGISTER



KABUSHIKI KAISHA SQUARE ENIX (ALSO
TRADING AS SQUARE ENIX CO., LTD.)
(JAPAN CORPORATION)
3-22-7 YOYOGI, SHIBUYA-KU
TOKYO, JAPAN

FOR: COMPUTER GAME SOFTWARE; VIDEO
GAME SOFTWARE, IN CLASS 9 (U.S. CLS. 21, 23, 26,
36 AND 38).

FIRST USE 4-3-2007; IN COMMERCE 4-3-2007.

OWNER OF U.S. REG. NOS. 2,518,663, 2,598,292,
AND 2,824,475.

NO CLAIM IS MADE TO THE EXCLUSIVE
RIGHT TO USE "TALES", APART FROM THE
MARK AS SHOWN.

THE COLOR(S) YELLOW, BLUE, ORANGE,
WHITE AND BLACK IS/ARE CLAIMED AS A
FEATURE OF THE MARK.

THE MARK CONSISTS OF THE WORDS CHOCO-
BO TALES IN YELLOW LETTERS OUTLINED IN
BLACK, WITH THE SECOND O IN THE WORD
CHOCOBO BEING REPRESENTED BY THE
ROUND HEAD OF A BIRD WITH BLUE EYES
AND AN ORANGE BEAK, AND A YELLOW AND
WHITE FEATHER OUTLINED IN BLACK FOL-
LOWING THE WORD TALES.

SER. NO. 77-072,468, FILED 12-28-2006.

SALLY SHIH, EXAMINING ATTORNEY

Int. Cl.: 35

Prior U.S. Cls.: 100, 101 and 102

United States Patent and Trademark Office

Reg. No. 3,397,216

Registered Mar. 18, 2008

**SERVICE MARK
PRINCIPAL REGISTER**

JavaPlumcom

SCRIPPS TREASURE COAST PUBLISHING COM-
PANY (FLORIDA CORPORATION)
1939 S. FEDERAL HIGHWAY
STUART, FL 34994

THE MARK CONSISTS OF THE WORD MARKS
JAVAPLUM AND COM, SEPARATED BY A PIC-
TURE OF A PLUM.

FOR: PROVIDING AN ON-LINE COMMERCIAL
INFORMATION DIRECTORY ON THE INTERNET,
IN CLASS 35 (U.S. CLS. 100, 101 AND 102).

SER. NO. 77-072,577, FILED 12-28-2006.

FIRST USE 7-30-2006; IN COMMERCE 7-30-2006.

GEOFFREY FOSDICK, EXAMINING ATTORNEY

Int. Cl.: 36

Prior U.S. Cls.: 100, 101 and 102

United States Patent and Trademark Office

Reg. No. 3,397,217

Registered Mar. 18, 2008

**SERVICE MARK
PRINCIPAL REGISTER**

Real People. Wise Choices.

STERLING LIFE INSURANCE COMPANY (ILLINOIS CORPORATION)
1000 MILWAUKEE AVE. LEGAL DEPT.
GLENVIEW, IL 60025

THE MARK CONSISTS OF STANDARD CHARACTERS WITHOUT CLAIM TO ANY PARTICULAR FONT, STYLE, SIZE, OR COLOR.

FOR: INSURANCE UNDERWRITING IN THE FIELD OF HEALTH AND LIFE, IN CLASS 36 (U.S. CLS. 100, 101 AND 102).

SER. NO. 77-073,021, FILED 12-28-2006.

FIRST USE 10-1-2005; IN COMMERCE 10-15-2005.

DOMINICK J. SALEMI, EXAMINING ATTORNEY

Int. Cl.: 37

Prior U.S. Cls.: 100, 103 and 106

Reg. No. 3,397,218

United States Patent and Trademark Office

Registered Mar. 18, 2008

**SERVICE MARK
PRINCIPAL REGISTER**

WE'LL MAKE IT RIGHT, RIGHT AWAY.

MANHEIM AUCTIONS, INC. (DELAWARE COR-
PORATION)
6205 PEACHTREE DUNWOODY ROAD
ATLANTA, GA 30328

THE MARK CONSISTS OF STANDARD CHAR-
ACTERS WITHOUT CLAIM TO ANY PARTICULAR
FONT, STYLE, SIZE, OR COLOR.

FOR: AUTOMOTIVE REPAIR SERVICES, IN
CLASS 37 (U.S. CLS. 100, 103 AND 106).

SER. NO. 77-073,135, FILED 12-29-2006.

FIRST USE 7-9-2004; IN COMMERCE 7-9-2004.

LINDSEY RUBIN, EXAMINING ATTORNEY

Int. Cls.: 16, 41 and 43

Prior U.S. Cls.: 2, 5, 22, 23, 29, 37, 38, 50, 100, 101 and 107

Reg. No. 3,397,219

United States Patent and Trademark Office

Registered Mar. 18, 2008

**TRADEMARK
SERVICE MARK
PRINCIPAL REGISTER**



PLANET GRAPE LLC (CALIFORNIA LTD LIAB CO)
3826 LAWTON STREET
SAN FRANCISCO, CA 94122

FOR: BOOKS, MAGAZINE COLUMNS AND NEWS BULLETINS IN THE FIELD OF WINE, CHAMPAGNE AND SPARKLING WINE, FOOD, TRAVEL, WINE HISTORY, WINE EDUCATION, WINE AND FOOD PAIRINGS, AND WINE TASTING, IN CLASS 16 (U.S. CLS. 2, 5, 22, 23, 29, 37, 38 AND 50).

FIRST USE 2-1-2002; IN COMMERCE 2-1-2002.

FOR: EDUCATIONAL SERVICES, NAMELY, CONDUCTING LECTURES, CLASSES, SEMINARS AND WORKSHOPS IN THE FIELD OF WINE, WINE AND FOOD PAIRINGS AND WINE TASTING; PROVIDING ON-LINE INFORMATION AND NEWS IN THE FIELDS OF WINE AND FOOD FESTIVALS AND WINE AND FOOD TASTINGS; ENTERTAINMENT SERVICES FOR INDIVIDUALS, ORGANIZATIONS AND BUSINESSES, NAMELY, HOSTING WINE AND FOOD TASTINGS, JUDGING WINE

COMPETITIONS, PERFORMING CHAMPAGNE SABERING; AND PERSONAL APPEARANCES AT LIVE ENTERTAINMENT EVENTS AND ON TELEVISION BY A CELEBRITY SOMMELIER, IN CLASS 41 (U.S. CLS. 100, 101 AND 107).

FIRST USE 2-1-2002; IN COMMERCE 2-1-2002.

FOR: PROVIDING INFORMATION ABOUT WINE CHARACTERISTICS; SOMMELIER SERVICES, NAMELY, PROVIDING ADVICE ON WINE, AND WINE AND FOOD PAIRINGS; WINE BAR SERVICES, IN CLASS 43 (U.S. CLS. 100 AND 101).

FIRST USE 2-1-2002; IN COMMERCE 2-1-2002.

THE MARK CONSISTS OF THE SILHOUETTE OF A GODDESS-LIKE WOMAN WITH ARM EXTENDED OVERHEAD, HOLDING A BUNCH OF GRAPES.

SER. NO. 77-073,687, FILED 12-29-2006.

BARBARA GAYNOR, EXAMINING ATTORNEY

Int. Cl.: 36

Prior U.S. Cls.: 100, 101 and 102

United States Patent and Trademark Office

Reg. No. 3,397,220

Registered Mar. 18, 2008

**SERVICE MARK
PRINCIPAL REGISTER**

The logo for myTruston features the word "myTruston" in a bold, lowercase, sans-serif font. Above the letter "T" in "Truston", there are two short, angled lines that meet at a point, forming a small roof-like shape.

SCAMSAFE, INC. (CALIFORNIA CORPORATION)
402 E GUITIERREZ ST.
SANTA BARBARA, CA 93101

THE MARK CONSISTS OF THE WORD MYTRUSTON, ALONG WITH TWO ANGLED LINES ABOVE THE SECOND T.

FOR: CREDIT MANAGEMENT SERVICES, NAMELY, ASSISTANCE WITH RESTORING CREDIT DAMAGED BY IDENTITY THEFT, IN CLASS 36 (U.S. CLS. 100, 101 AND 102).

SER. NO. 77-073,703, FILED 12-29-2006.

FIRST USE 5-12-2005; IN COMMERCE 11-27-2006.

DAWN FELDMAN, EXAMINING ATTORNEY

Int. Cl.: 36

Prior U.S. Cls.: 100, 101 and 102

United States Patent and Trademark Office

Reg. No. 3,397,221

Registered Mar. 18, 2008

**SERVICE MARK
PRINCIPAL REGISTER**

Safeguard your good name

SCAMSAFE, INC. (CALIFORNIA CORPORATION)
402 E GUITIERREZ ST.
SANTA BARBARA, CA 93101

THE MARK CONSISTS OF STANDARD CHARACTERS WITHOUT CLAIM TO ANY PARTICULAR FONT, STYLE, SIZE, OR COLOR.

FOR: CREDIT MANAGEMENT SERVICES, NAMELY, ASSISTANCE WITH RESTORING CREDIT DAMAGED BY IDENTITY THEFT, IN CLASS 36 (U.S. CLS. 100, 101 AND 102).

SER. NO. 77-073,705, FILED 12-29-2006.

FIRST USE 5-12-2005; IN COMMERCE 11-27-2006.

DAWN FELDMAN, EXAMINING ATTORNEY

Int. Cl.: 36

Prior U.S. Cls.: 100, 101 and 102

United States Patent and Trademark Office

Reg. No. 3,397,222

Registered Mar. 18, 2008

**SERVICE MARK
PRINCIPAL REGISTER**

Truston

SCAMSAFE, INC. (CALIFORNIA CORPORATION)
402 E GUITIERREZ ST.
SANTA BARBARA, CA 93101

THE MARK CONSISTS OF STANDARD CHARACTERS WITHOUT CLAIM TO ANY PARTICULAR FONT, STYLE, SIZE, OR COLOR.

FOR: CREDIT MANAGEMENT SERVICES, NAMELY, ASSISTANCE WITH RESTORING CREDIT DAMAGED BY IDENTITY THEFT, IN CLASS 36 (U.S. CLS. 100, 101 AND 102).

SER. NO. 77-073,706, FILED 12-29-2006.

FIRST USE 5-12-2005; IN COMMERCE 11-27-2006.

DAWN FELDMAN, EXAMINING ATTORNEY

Int. Cl.: 36

Prior U.S. Cls.: 100, 101 and 102

United States Patent and Trademark Office

Reg. No. 3,397,223

Registered Mar. 18, 2008

**SERVICE MARK
PRINCIPAL REGISTER**

The logo for Truston features the word "Truston" in a bold, sans-serif font. Above the letter 'u' in "Truston", there are two short, parallel, upward-pointing diagonal lines that meet at a point, forming a simple roof-like shape.

SCAMSAFE, INC. (CALIFORNIA CORPORATION)
402 E GUITIERREZ ST.
SANTA BARBARA, CA 93101

THE MARK CONSISTS OF THE WORD TRUSTON, WITH TWO ANGLED LINES OVER THE SECOND T.

FOR: CREDIT MANAGEMENT SERVICES, NAMELY, ASSISTANCE WITH RESTORING CREDIT DAMAGED BY IDENTITY THEFT, IN CLASS 36 (U.S. CLS. 100, 101 AND 102).

SER. NO. 77-073,707, FILED 12-29-2006.

FIRST USE 5-12-2005; IN COMMERCE 11-27-2006.

DAWN FELDMAN, EXAMINING ATTORNEY

Int. Cl.: 43

Prior U.S. Cls.: 100 and 101

United States Patent and Trademark Office

Reg. No. 3,397,224

Registered Mar. 18, 2008

**SERVICE MARK
PRINCIPAL REGISTER**

Keating House

SCOTT, DOUGLAS BRYCE (CALIFORNIA PART-
NERSHIP)
2331 SECOND AVENUE
SAN DIEGO, CA 92101 AND
BALTIC, BENJAMIN FRANKLIN (CALIFORNIA
PARTNERSHIP)
2331 SECOND AVENUE
SAN DIEGO, CA 92101

THE MARK CONSISTS OF STANDARD CHAR-
ACTERS WITHOUT CLAIM TO ANY PARTICULAR
FONT, STYLE, SIZE, OR COLOR.

NO CLAIM IS MADE TO THE EXCLUSIVE
RIGHT TO USE "HOUSE", APART FROM THE
MARK AS SHOWN.

FOR: HOTELS, IN CLASS 43 (U.S. CLS. 100 AND
101).

SER. NO. 77-073,971, FILED 12-31-2006.

FIRST USE 8-29-1985; IN COMMERCE 8-29-1985.

AMEETA JORDAN, EXAMINING ATTORNEY

Int. Cl.: 9

Prior U.S. Cls.: 21, 23, 26, 36 and 38

Reg. No. 3,397,225

United States Patent and Trademark Office

Registered Mar. 18, 2008

**TRADEMARK
PRINCIPAL REGISTER**

Insight

PERSYST DEVELOPMENT CORPORATION, INC.
(ARIZONA CORPORATION)
SUITE E2
1060 SANDRETTO DR.
PRESCOTT, AZ 86305

FOR: COMPUTER SOFTWARE FOR INTERPRE-
TATION OF NEURO AND BRAIN SCANS PROVI-
DED BY DIAGNOSTIC IMAGING EQUIPMENT, IN
CLASS 9 (U.S. CLS. 21, 23, 26, 36 AND 38).

FIRST USE 2-1-1996; IN COMMERCE 2-1-1996.

THE MARK CONSISTS OF STANDARD CHAR-
ACTERS WITHOUT CLAIM TO ANY PARTICULAR
FONT, STYLE, SIZE, OR COLOR.

SER. NO. 77-074,022, FILED 1-1-2007.

ODESSA BIBBINS, EXAMINING ATTORNEY

Int. Cl.: 41

Prior U.S. Cls.: 100, 101 and 107

United States Patent and Trademark Office

Reg. No. 3,397,226

Registered Mar. 18, 2008

**SERVICE MARK
PRINCIPAL REGISTER**



AMERICAN SOCCER TENNIS ORGANIZATION,
LLC (CALIFORNIA LTD LIAB CO)
55 SAN SIMEON
LAGUNA NIGUEL, CA 92677

FOR: ENTERTAINMENT IN THE NATURE OF
COMPETITIONS IN THE FIELD OF SOCCER TEN-
NIS, IN CLASS 41 (U.S. CLS. 100, 101 AND 107).

FIRST USE 5-1-2005; IN COMMERCE 11-1-2005.

THE COLOR(S) BLUE, WHITE, RED, BLACK,
AND GREEN IS/ARE CLAIMED AS A FEATURE
OF THE MARK.

THE MARK CONSISTS OF A GREEN SOCCER-
TENNIS FIELD DIVIDED BY A WHITE LINE, A
BLACK NET WITH A WHITE LINE ACROSS THE
TOP, A BLACK AND WHITE SOCCER BALL IN
MID-AIR STANDING BEFORE A RED STAR AND
THE LETTERS "ASTO" WRITTEN IN WHITE
BLOCK LETTERING BEFORE A BLUE SKY, SU-
PERIMPOSED ON A BLACK SHIELD.

SER. NO. 77-074,703, FILED 1-2-2007.

CHRISTINA SOBRAL, EXAMINING ATTORNEY

Int. Cls.: 16, 35 and 36

Prior U.S. Cls.: 2, 5, 22, 23, 29, 37, 38, 50, 100, 101 and 102

Reg. No. 3,397,227

United States Patent and Trademark Office

Registered Mar. 18, 2008

**TRADEMARK
SERVICE MARK
PRINCIPAL REGISTER**

DBLCI

DEUTSCHE BANK AG (FED REP GERMANY CORPORATION)
WINCHESTER HOUSE, 23 GREAT WINCHESTER ST
LONDON, UNITED KINGDOM EC2P2AX

FOR: PRINTED PUBLICATIONS, NAMELY, BOOKS, MAGAZINES, GUIDES, MANUALS, PERIODICALS AND PRINTED INSTRUCTIONAL AND TEACHING MATERIALS, ALL IN THE FIELD OF FINANCIAL SERVICES, IN CLASS 16 (U.S. CLS. 2, 5, 22, 23, 29, 37, 38 AND 50).

FOR: PREPARING FINANCIAL REPORTS FOR OTHERS; PROVIDING FINANCIAL INDICES OF COMMODITIES FUTURES CONTRACTS; ADVISORY AND CONSULTANT SERVICES RELATING TO ALL OF THE AFORESAID SERVICES; AND PROVIDING ALL OF THE AFORESAID SERVICES VIA THE INTERNET, IN CLASS 35 (U.S. CLS. 100, 101 AND 102).

FOR: ARRANGING OF LOANS; BANKING; CAPITAL INVESTMENT CONSULTATION; RAISING OF CAPITAL FOR OTHERS; CASH MANAGEMENT; FINANCIAL CLEARING-HOUSE SERVICES; FINANCIAL CONSULTATIONS; CORPORATE FINANCING; CURRENCY EXCHANGE SERVICES;

FINANCIAL PLANNING; FINANCING OF LOANS; FUND INVESTMENT; INVESTMENT SERVICES, NAMELY, INVESTMENT ADVICE; WORKING CAPITAL INVESTMENT; FINANCIAL SERVICES IN THE FIELD OF SECURED MONEY LENDING; MERCHANT BANKING; INVESTMENT PORTFOLIO MANAGEMENT SERVICES; FINANCIAL INVESTMENT IN THE FIELD OF REAL ESTATE; FINANCIAL INFORMATION SERVICES; FINANCIAL MANAGEMENT SERVICES; FINANCIAL RESEARCH; ADVISORY AND CONSULTANCY SERVICES RELATING TO ALL OF THE AFORESAID SERVICES; AND PROVIDING ALL OF THE AFORESAID SERVICES VIA THE INTERNET, IN CLASS 36 (U.S. CLS. 100, 101 AND 102).

THE MARK CONSISTS OF STANDARD CHARACTERS WITHOUT CLAIM TO ANY PARTICULAR FONT, STYLE, SIZE, OR COLOR.

OWNER OF UNITED KINGDOM REG. NO. 2342492, DATED 9-5-2003, EXPIRES 9-5-2013.

SER. NO. 77-074,942, FILED 1-3-2007.

STEVEN R. FOSTER, EXAMINING ATTORNEY

Int. Cls.: 16, 35 and 36

Prior U.S. Cls.: 2, 5, 22, 23, 29, 37, 38, 50, 100, 101 and 102

Reg. No. 3,397,228

United States Patent and Trademark Office

Registered Mar. 18, 2008

**TRADEMARK
SERVICE MARK
PRINCIPAL REGISTER**

DBLCI-MR

DEUTSCHE BANK AG (FED REP GERMANY CORPORATION)
WINCHESTER HOUSE, 23 GREAT WINCHESTER ST
LONDON, UNITED KINGDOM EC2P2AX

FOR: PRINTED PUBLICATIONS, NAMELY, BOOKS, MAGAZINES, GUIDES, MANUALS, PERIODICALS AND PRINTED INSTRUCTIONAL AND TEACHING MATERIALS, ALL IN THE FIELD OF FINANCIAL SERVICES, IN CLASS 16 (U.S. CLS. 2, 5, 22, 23, 29, 37, 38 AND 50).

FOR: PREPARING FINANCIAL REPORTS FOR OTHERS; PROVIDING FINANCIAL INDICES OF COMMODITIES FUTURES CONTRACTS; ADVISORY AND CONSULTANCY SERVICES RELATING TO ALL OF THE AFORESAID SERVICES; AND PROVIDING ALL OF THE AFORESAID SERVICES VIA THE INTERNET, IN CLASS 35 (U.S. CLS. 100, 101 AND 102).

FOR: ARRANGING OF LOANS; BANKING; CAPITAL INVESTMENT CONSULTATION; RAISING OF CAPITAL FOR OTHERS; CASH MANAGEMENT; FINANCIAL CLEARING-HOUSE SERVICES; FINANCIAL CONSULTATIONS; CORPORATE FINANCING; CURRENCY EXCHANGE SERVICES;

FINANCIAL PLANNING; FINANCING OF LOANS; FUND INVESTMENT; INVESTMENT SERVICES, NAMELY, INVESTMENT ADVICE; WORKING CAPITAL INVESTMENT; FINANCIAL SERVICES IN THE FIELD OF SECURED MONEY LENDING; MERCHANT BANKING; INVESTMENT PORTFOLIO MANAGEMENT SERVICES; FINANCIAL INVESTMENT IN THE FIELD OF REAL ESTATE; FINANCIAL INFORMATION SERVICES; FINANCIAL MANAGEMENT SERVICES; FINANCIAL RESEARCH; ADVISORY AND CONSULTANCY SERVICES RELATING TO ALL OF THE AFORESAID SERVICES; AND PROVIDING ALL OF THE AFORESAID SERVICES VIA THE INTERNET, IN CLASS 36 (U.S. CLS. 100, 101 AND 102).

THE MARK CONSISTS OF STANDARD CHARACTERS WITHOUT CLAIM TO ANY PARTICULAR FONT, STYLE, SIZE, OR COLOR.

OWNER OF UNITED KINGDOM REG. NO. 2342491, DATED 9-5-2003, EXPIRES 9-5-2013.

SER. NO. 77-074,947, FILED 1-3-2007.

STEVEN R. FOSTER, EXAMINING ATTORNEY

Int. Cl.: 41

Prior U.S. Cls.: 100, 101 and 107

United States Patent and Trademark Office

Reg. No. 3,397,229

Registered Mar. 18, 2008

**SERVICE MARK
PRINCIPAL REGISTER**

BizBoxSeries.com

BEE HIVE HEAD PRODUCTIONS, LLC (TEXAS
LTD LIAB CO)
3942 W. ALABAMA, SUITE ONE
HOUSTON, TX 77027

FOR: EDUCATIONAL SERVICES, NAMELY,
CONDUCTING INFORMAL ON-LINE PROGRAMS
IN THE FIELDS OF ENTERTAINMENT, AND PRIN-
TABLE MATERIALS DISTRIBUTED THEREWITH,
IN CLASS 41 (U.S. CLS. 100, 101 AND 107).

FIRST USE 1-1-2002; IN COMMERCE 1-1-2002.

THE MARK CONSISTS OF STANDARD CHAR-
ACTERS WITHOUT CLAIM TO ANY PARTICULAR
FONT, STYLE, SIZE, OR COLOR.

SER. NO. 77-075,480, FILED 1-3-2007.

TAMARA FRAZIER, EXAMINING ATTORNEY

Int. Cl.: 30

Prior U.S. Cl.: 46

United States Patent and Trademark Office

Reg. No. 3,397,230

Registered Mar. 18, 2008

**TRADEMARK
PRINCIPAL REGISTER**

SNO-BAL

TONE PRODUCTS, INC. (ILLINOIS CORPORATION)
2129 N. 15TH AVENUE
MELROSE PARK, IL 60160

THE MARK CONSISTS OF STANDARD CHARACTERS WITHOUT CLAIM TO ANY PARTICULAR FONT, STYLE, SIZE, OR COLOR.

FOR: FLAVORING SYRUP FOR USE IN MAKING SHAVED ICE CONFECTIONS AND ICE CREAM, IN CLASS 30 (U.S. CL. 46).

SER. NO. 77-075,975, FILED 1-4-2007.

FIRST USE 0-0-1975; IN COMMERCE 0-0-1975.

LA TONIA FISHER, EXAMINING ATTORNEY

Int. Cl.: 44

Prior U.S. Cls.: 100 and 101

United States Patent and Trademark Office

Reg. No. 3,397,231

Registered Mar. 18, 2008

**SERVICE MARK
PRINCIPAL REGISTER**



CRITICAL SIGNAL TECHNOLOGIES (DELA-
WARE CORPORATION)
22600 HAGGERTY ROAD
FARMINGTON HILLS, MI 48335

FOR: PERSONAL EMERGENCY MEDICAL RE-
SPONSE SERVICES, IN CLASS 44 (U.S. CLS. 100 AND
101).

FIRST USE 8-1-2006; IN COMMERCE 8-1-2006.

NO CLAIM IS MADE TO THE EXCLUSIVE
RIGHT TO USE "EMERGENCY MEDICAL ALERT
SYSTEM", APART FROM THE MARK AS SHOWN.

THE COLOR(S) WHITE, BLACK AND BLUE IS/
ARE CLAIMED AS A FEATURE OF THE MARK.

THE MARK CONSISTS OF THE STYLIZED
WORDS AND NUMBERS BOB 3600 IN THE COLORS
BLACK AND WHITE BENEATH WHICH APPEAR
THE WORDS EMERGENCY MEDICAL ALERT
SYSTEM IN THE COLOR BLUE.

SER. NO. 77-076,185, FILED 1-4-2007.

JAMES MACFARLANE, EXAMINING ATTORNEY

Int. Cl.: 44

Prior U.S. Cls.: 100 and 101

United States Patent and Trademark Office

Reg. No. 3,397,232

Registered Mar. 18, 2008

SERVICE MARK
PRINCIPAL REGISTER



CRITICAL SIGNAL TECHNOLOGIES (DELA-
WARE CORPORATION)
22600 HAGGERTY ROAD
FARMINGTON HILLS, MI 48335

FOR: PERSONAL EMERGENCY MEDICAL RE-
SPONSE SERVICES, IN CLASS 44 (U.S. CLS. 100 AND
101).

FIRST USE 8-1-2006; IN COMMERCE 8-1-2006.

NO CLAIM IS MADE TO THE EXCLUSIVE
RIGHT TO USE "EMERGENCY MEDICAL ALERT
SYSTEM", APART FROM THE MARK AS SHOWN.

THE COLOR(S) WHITE, BLACK AND BLUE IS/
ARE CLAIMED AS A FEATURE OF THE MARK.

THE MARK CONSISTS OF THE STYLIZED
WORDS AND NUMBERS BOB 4000 IN THE COLORS
BLACK AND WHITE BENEATH WHICH APPEAR
THE WORDS EMERGENCY MEDICAL ALERT
SYSTEM IN THE COLOR BLUE.

SER. NO. 77-076,203, FILED 1-4-2007.

JAMES MACFARLANE, EXAMINING ATTORNEY

Int. Cl.: 25

Prior U.S. Cls.: 22 and 39

United States Patent and Trademark Office

Reg. No. 3,397,233

Registered Mar. 18, 2008

**TRADEMARK
PRINCIPAL REGISTER**

**THIRTEEN-TWENTYFOUR
13★24
CLOTHING**

SOLORIO, ANTHONY (UNITED STATES INDIVIDUAL)
1735 3RD STREET
RIVERSIDE, CA 92507 AND
CUMMINGS, JARED (UNITED STATES INDIVIDUAL)
1735 3RD STREET
RIVERSIDE, CA 92507

FOR: CLOTHING, NAMELY, HATS, T-SHIRTS AND SWEATSHIRTS, IN CLASS 25 (U.S. CLS. 22 AND 39).

FIRST USE 4-0-2004; IN COMMERCE 4-0-2004.

NO CLAIM IS MADE TO THE EXCLUSIVE RIGHT TO USE "CLOTHING", APART FROM THE MARK AS SHOWN.

THE MARK CONSISTS OF THE LETTERS THIRTEEN TWENTYFOUR CLOTHING AND THE NUMBERS 13 AND 24 WITH A STAR DESIGN IN BETWEEN.

SER. NO. 77-076,260, FILED 1-4-2007.

TRACY WHITTAKER-BROWN, EXAMINING ATTORNEY

Int. Cl.: 41

Prior U.S. Cls.: 100, 101 and 107

United States Patent and Trademark Office

Reg. No. 3,397,234

Registered Mar. 18, 2008

**SERVICE MARK
PRINCIPAL REGISTER**

Omaha Theater Company

OMAHA THEATER COMPANY (NEBRASKA
CORPORATION)
2001 FARNAM STREET
OMAHA, NE 68102

NO CLAIM IS MADE TO THE EXCLUSIVE
RIGHT TO USE "THEATER COMPANY", APART
FROM THE MARK AS SHOWN.

FOR: ENTERTAINMENT IN THE NATURE OF
LIVE THEATER PRODUCTIONS, IN CLASS 41 (U.S.
CLS. 100, 101 AND 107).

SEC. 2(F).

FIRST USE 12-31-1995; IN COMMERCE 12-31-1995.

SER. NO. 77-076,330, FILED 1-4-2007.

THE MARK CONSISTS OF STANDARD CHAR-
ACTERS WITHOUT CLAIM TO ANY PARTICULAR
FONT, STYLE, SIZE, OR COLOR.

AMY HELLA, EXAMINING ATTORNEY

Int. Cl.: 28

Prior U.S. Cls.: 22, 23, 38 and 50

United States Patent and Trademark Office

Reg. No. 3,397,235

Registered Mar. 18, 2008

**TRADEMARK
PRINCIPAL REGISTER**



DAVIS, SR. ANTONIO M. (UNITED STATES
INDIVIDUAL)
2030 POCAHONTAS STREET
LYNCHBURG, VA 24501

THE COLOR(S) RED, BLUE, YELLOW, PURPLE,
GREEN AND ORANGE IS/ARE CLAIMED AS A
FEATURE OF THE MARK.

FOR: EDUCATIONAL TOY IN THE NATURE OF
SHOE TYING KIT USED TO TEACH CHILDREN TO
TIE THEIR SHOES COMPRISED OF A LACE,
CLOTH OR FABRIC IN THE SHAPE OF A SHOE
WITH EYELETS FOR SHOELACES AND INSTRUC-
TIONS FOR USING THE KIT TO AID IN LEARNING
HOW TO TIE SHOES, IN CLASS 28 (U.S. CLS. 22, 23,
38 AND 50).

THE MARK CONSISTS OF THE WORD SNEEKS.
THE "S" IN THE MARK APPEARS IN RED, THE "N"
IN BLUE, THE FIRST "E" IN YELLOW, THE SEC-
OND "E" IN PURPLE, THE "K" IN GREEN, AND
THE SECOND "S" IN ORANGE.

SER. NO. 77-076,430, FILED 1-4-2007.

FIRST USE 2-1-2004; IN COMMERCE 2-1-2004.

MARK T. MULLEN, EXAMINING ATTORNEY

Int. Cl.: 16

Prior U.S. Cls.: 2, 5, 22, 23, 29, 37, 38 and 50

United States Patent and Trademark Office

Reg. No. 3,397,236

Registered Mar. 18, 2008

**TRADEMARK
PRINCIPAL REGISTER**

The logo consists of the words "RiverWorks" and "Discovery" stacked vertically. Both words are rendered in a bold, red, sans-serif font with a slightly irregular, hand-drawn appearance. The letters are closely spaced, and the overall color is a vibrant red.

AEP MEMCO LLC (DELAWARE LTD LIAB CO)
10690 SWINGLEY RIDGE ROAD
CHESTERFIELD, MO 63017

FOR: PRINTED INSTRUCTIONAL, EDUCATIONAL, AND TEACHING MATERIALS IN THE FIELD OF CONTEMPORARY RIVER ISSUES, NAMELY, RIVER CAREERS, RIVER ECOLOGY AND CULTURE, IN CLASS 16 (U.S. CLS. 2, 5, 22, 23, 29, 37, 38 AND 50).

FIRST USE 10-5-2006; IN COMMERCE 10-5-2006.

THE COLOR(S) RED IS/ARE CLAIMED AS A FEATURE OF THE MARK.

THE MARK CONSISTS OF THE STYLIZED WORDS "RIVERWORKS DISCOVERY" IN RED LETTERS.

SER. NO. 77-076,636, FILED 1-5-2007.

DAVID YONTEF, EXAMINING ATTORNEY

Int. Cl.: 38

Prior U.S. Cls.: 100, 101 and 104

United States Patent and Trademark Office

Reg. No. 3,397,237

Registered Mar. 18, 2008

**SERVICE MARK
PRINCIPAL REGISTER**



ATSI COMMUNICATIONS, INC. (NEVADA CORPORATION)
3201 CHERRY RIDGE, STE C-300
SAN ANTONIO, TX 78230

THE COLOR(S) RED, BLACK AND WHITE IS/ARE CLAIMED AS A FEATURE OF THE MARK.

FOR: TELECOMMUNICATION SERVICES, NAMELY, LOCAL AND INTERNATIONAL LONG DISTANCE TRANSMISSION OF VOICE, DATA, GRAPHICS BY MEANS OF TELEPHONE, TELEGRAPHIC, CABLE, SATELLITE AND VOICE OVER INTERNET PROTOCOL TRANSMISSIONS, IN CLASS 38 (U.S. CLS. 100, 101 AND 104).

"THE MARK CONSISTS OF TWO RED "ARCS" UPPER LEFT HAND CORNER, THE TWO DOTS ABOVE THE "I'S" ARE IN RED, THE REMAINING LITERAL ELEMENTS ARE IN BLACK AND ALL ELEMENTS ARE ON A WHITE BACKGROUND."

FIRST USE 1-23-2006; IN COMMERCE 1-23-2006.

SER. NO. 77-077,155, FILED 1-5-2007.

NO CLAIM IS MADE TO THE EXCLUSIVE RIGHT TO USE NETWORKS, APART FROM THE MARK AS SHOWN.

ANTHONY RINKER, EXAMINING ATTORNEY

Int. Cl.: 25

Prior U.S. Cls.: 22 and 39

United States Patent and Trademark Office

Reg. No. 3,397,238

Registered Mar. 18, 2008

**TRADEMARK
PRINCIPAL REGISTER**

CALL A ROSE

CHRISTINA ZELJEZNAK (UNITED STATES IN-
DIVIDUAL)
12575 LEAVENWORTH RD
KANSAS CITY, KS 66109

FOR: BLOUSES; COATS FOR MEN AND WO-
MEN; MEN AND WOMEN JACKETS, COATS,
TROUSERS, VESTS; PANTS; SHIRTS; SHORTS;
SKIRTS AND DRESSES; SLACKS; T-SHIRTS; TOPS,
IN CLASS 25 (U.S. CLS. 22 AND 39).

FIRST USE 11-5-2006; IN COMMERCE 1-5-2007.

THE MARK CONSISTS OF STANDARD CHAR-
ACTERS WITHOUT CLAIM TO ANY PARTICULAR
FONT, STYLE, SIZE, OR COLOR.

SER. NO. 77-077,643, FILED 1-7-2007.

JANICE L. MCMORROW, EXAMINING ATTOR-
NEY

Int. Cl.: 41

Prior U.S. Cls.: 100, 101 and 107

United States Patent and Trademark Office

Reg. No. 3,397,239

Registered Mar. 18, 2008

SERVICE MARK
PRINCIPAL REGISTER



CLASSMATE, L.L.C. (TEXAS LTD LIAB CO)
SUITE 215
3535 WESTHEIMER
HOUSTON, TX 77027

THE COLOR(S) BLACK AND RED IS/ARE
CLAIMED AS A FEATURE OF THE MARK.

FOR: ONLINE EDUCATIONAL SERVICES,
NAMELY, PROVIDING INTERNET-BASED, ON DE-
MAND, INDIVIDUALIZED, AND INTERACTIVE
TUTORING AND INSTRUCTION FOR USE BY
STUDENTS IN THE FIELDS OF READING, MATH,
AND SCIENCE, IN CLASS 41 (U.S. CLS. 100, 101 AND
107).

THE MARK CONSISTS OF A DESIGN IN RED
RESEMBLING THE SYMBOL PI HAVING TWO
DOTS ABOVE THE PI SYMBOL AND THE WORD
"YOUR" IN BLACK AND THE WORD "TEACHER"
IN RED BELOW THE DESIGN .

FIRST USE 11-1-2006; IN COMMERCE 11-1-2006.

SER. NO. 77-077,644, FILED 1-7-2007.

NO CLAIM IS MADE TO THE EXCLUSIVE
RIGHT TO USE YOURTEACHER, APART FROM
THE MARK AS SHOWN.

JANICE L. MCMORROW, EXAMINING ATTOR-
NEY

Int. Cl.: 44

Prior U.S. Cls.: 100 and 101

United States Patent and Trademark Office

Reg. No. 3,397,240

Registered Mar. 18, 2008

**SERVICE MARK
PRINCIPAL REGISTER**

HealthTime

UNITED TECHNOLOGIES CORPORATION (DE-
LAWARE CORPORATION)
1 FINANCIAL PLAZA
HARTFORD, CT 06103

FOR: PROVIDING HEALTH CARE SERVICES,
NAMELY, WELLNESS PROGRAMS, ADMINISTRA-
TION OF SHOTS AND HEALTH SCREENING, IN
CLASS 44 (U.S. CLS. 100 AND 101).

FIRST USE 5-15-2003; IN COMMERCE 5-15-2003.

THE MARK CONSISTS OF STANDARD CHAR-
ACTERS WITHOUT CLAIM TO ANY PARTICULAR
FONT, STYLE, SIZE, OR COLOR.

SER. NO. 77-077,908, FILED 1-8-2007.

BARBARA BROWN, EXAMINING ATTORNEY

Int. Cls.: 35, 39 and 43

Prior U.S. Cls.: 100, 101, 102 and 105

United States Patent and Trademark Office

Reg. No. 3,397,241

Registered Mar. 18, 2008

**SERVICE MARK
PRINCIPAL REGISTER**



LAKE NORMAN CONVENTION & VISITORS
BUREAU (NORTH CAROLINA NON-PROFIT
CORPORATION)
SUITE 102
19900 W. CATAWBA AVENUE
CORNELIUS, NC 28031

FOR: VISITOR BUREAU SERVICES, NAMELY, PROMOTING BUSINESS AND TOURISM IN THE REGION SURROUNDING LAKE NORMAN, NORTH CAROLINA; ADVERTISING AND PROMOTION OF TOURISM AND CONVENTION SERVICES IN THE LAKE NORMAN AREA; DESTINATION MARKETING FOR THE LAKE NORMAN AREA IN ORDER TO ATTRACT CONVENTIONS, LEISURE TRAVELERS AND VISITORS; ADVERTISING SERVICES, NAMELY, DISSEMINATING ADVERTISING AND INFORMATION ABOUT THE LAKE NORMAN AREA; RETAIL GIFT SHOPS FEATURING MEMENTOS AND SOUVENIRS OF THE LAKE NORMAN AREA AND THE STATE OF NORTH CAROLINA; MARKETING SERVICES, NAMELY, MARKETING PARTNERSHIPS, LEISURE AND INTERNATIONAL PROGRAMS TO BRING TOURIST TO THE LAKE NORMAN AREA, IN CLASS 35 (U.S. CLS. 100, 101 AND 102).

FIRST USE 8-31-2005; IN COMMERCE 8-31-2005.

FOR: TRAVEL AND TOUR INFORMATION SERVICES PERTAINING TO THE REGION SURROUNDING LAKE NORMAN, NORTH CAROLINA, NAMELY, INFORMATION CENTER SERVICES FOR RESPONDING TO VISITOR AND PROSPECTIVE VISITOR INQUIRIES, IN CLASS 39 (U.S. CLS. 100 AND 105).

FIRST USE 8-31-2005; IN COMMERCE 8-31-2005.

FOR: CONVENTION SERVICES, NAMELY, PROVIDING CONVENTION FACILITIES IN THE LAKE NORMAN AREA, IN CLASS 43 (U.S. CLS. 100 AND 101).

FIRST USE 8-31-2005; IN COMMERCE 8-31-2005.

NO CLAIM IS MADE TO THE EXCLUSIVE RIGHT TO USE "LAKE NORMAN CONVENTION AND VISITORS BUREAU", APART FROM THE MARK AS SHOWN.

SER. NO. 77-078,118, FILED 1-8-2007.

RENEE SERVANCE, EXAMINING ATTORNEY

Int. Cl.: 9

Prior U.S. Cls.: 21, 23, 26, 36 and 38

United States Patent and Trademark Office

Reg. No. 3,397,242

Registered Mar. 18, 2008

**TRADEMARK
PRINCIPAL REGISTER**

CURRENT REPORTS

CURRENT MEDICINE GROUP, LLC (NEW JERSEY LTD LIAB CO)
400 MARKET STREET, SUITE 700
PHILADELPHIA, PA 191062514

FOR: DOWNLOADABLE ELECTRONIC PUBLICATIONS, DELIVERED VIA THE INTERNET, NAMELY, MEDICAL AND PHARMACEUTICAL JOURNALS, MEDICAL CLINICAL MANUALS, MEDICAL ATLASES, PRINTED LECTURES IN THE FIELDS OF MEDICAL, PHARMACEUTICAL, CLINICAL AND HEALTH ISSUES; INTERACTIVE TRAINING TOOLS IN THE NATURE OF ELECTRONIC DOWNLOADABLE PUBLICATIONS FOR USE BY MEDICAL PROFESSIONALS IN THE FIELD OF SCIENCE AND MEDICINE, IN CLASS 9 (U.S. CLS. 21, 23, 26, 36 AND 38).

FIRST USE 12-31-2000; IN COMMERCE 12-31-2000.

THE MARK CONSISTS OF STANDARD CHARACTERS WITHOUT CLAIM TO ANY PARTICULAR FONT, STYLE, SIZE, OR COLOR.

NO CLAIM IS MADE TO THE EXCLUSIVE RIGHT TO USE "REPORTS", APART FROM THE MARK AS SHOWN.

SEC. 2(F).

SER. NO. 77-078,216, FILED 1-8-2007.

BRENDAN MCCAULEY, EXAMINING ATTORNEY

Int. Cl.: 9

Prior U.S. Cls.: 21, 23, 26, 36 and 38

United States Patent and Trademark Office

Reg. No. 3,397,243

Registered Mar. 18, 2008

**TRADEMARK
PRINCIPAL REGISTER**

CURRENT TREATMENT OPTIONS

CURRENT MEDICINE GROUP, LLC (NEW JERSEY LTD LIAB CO)
400 MARKET STREET, SUITE 700
PHILADELPHIA, PA 191062514

FOR: DOWNLOADABLE ELECTRONIC PUBLICATIONS, DELIVERED VIA THE INTERNET, NAMELY, MEDICAL AND PHARMACEUTICAL JOURNALS, MEDICAL CLINICAL MANUALS, MEDICAL ATLASES, PRINTED LECTURES RELATED TO MEDICAL, PHARMACEUTICAL, CLINICAL AND HEALTH ISSUES, MEDICAL AND PHARMACEUTICAL REFERENCE BOOKS, MEDICAL AND PHARMACEUTICAL HANDBOOKS, AND MEDICAL AND PHARMACEUTICAL MANUALS; INTERACTIVE TRAINING TOOLS IN THE NATURE OF ELECTRONIC DOWNLOADABLE

PUBLICATIONS FOR USE BY MEDICAL PROFESSIONALS IN THE FIELD OF SCIENCE AND MEDICINE, IN CLASS 9 (U.S. CLS. 21, 23, 26, 36 AND 38).

FIRST USE 12-31-2000; IN COMMERCE 12-31-2000.

THE MARK CONSISTS OF STANDARD CHARACTERS WITHOUT CLAIM TO ANY PARTICULAR FONT, STYLE, SIZE, OR COLOR.

SEC. 2(F).

SER. NO. 77-078,345, FILED 1-8-2007.

BRENDAN MCCAULEY, EXAMINING ATTORNEY

Int. Cl.: 6

Prior U.S. Cls.: 2, 12, 13, 14, 23, 25 and 50

Reg. No. 3,397,244

United States Patent and Trademark Office

Registered Mar. 18, 2008

**TRADEMARK
PRINCIPAL REGISTER**

METASPACE

SERENUS JOHNSON PORTABLES, LLC (MICHIGAN LTD LIAB CO)
5178 KASEMEYER ROAD
BAY CITY, MI 48706

THE MARK CONSISTS OF STANDARD CHARACTERS WITHOUT CLAIM TO ANY PARTICULAR FONT, STYLE, SIZE, OR COLOR.

FOR: PORTABLE BUILDING MADE PREDOMINATELY OF METAL, IN CLASS 6 (U.S. CLS. 2, 12, 13, 14, 23, 25 AND 50).

SER. NO. 77-078,473, FILED 1-8-2007.

FIRST USE 12-6-2006; IN COMMERCE 12-6-2006.

DANIEL BRODY, EXAMINING ATTORNEY

Int. Cl.: 44

Prior U.S. Cls.: 100 and 101

United States Patent and Trademark Office

Reg. No. 3,397,245

Registered Mar. 18, 2008

**SERVICE MARK
PRINCIPAL REGISTER**

**NATURAL HORIZONS WELLNESS
CENTER**

NATURAL HORIZONS WELLNESS CENTER
(VIRGINIA CORPORATION)
SUITE 300
10640 MAIN STREET
FAIRFOX, VA 22030

FOR: HEALTH CARE SERVICES, NAMELY,
WELLNESS PROGRAMS FEATURING BIOLOGIC
DENTISTRY, NATUROPATHY, HOLISTIC MEDI-
CINE, CONVENTIONAL MEDICINE, CHIROPRACTIC,
ACUPUNCTURE, COLON HYDROTHERAPY,
NUTRITION COUNSELING, AND MASSAGE
THERAPY, IN CLASS 44 (U.S. CLS. 100 AND 101).

FIRST USE 1-1-2000; IN COMMERCE 1-1-2000.

THE MARK CONSISTS OF STANDARD CHAR-
ACTERS WITHOUT CLAIM TO ANY PARTICULAR
FONT, STYLE, SIZE, OR COLOR.

NO CLAIM IS MADE TO THE EXCLUSIVE
RIGHT TO USE "WELLNESS CENTER", APART
FROM THE MARK AS SHOWN.

SER. NO. 77-078,603, FILED 1-9-2007.

KATHERINE CHANG, EXAMINING ATTORNEY

Int. Cl.: 41

Prior U.S. Cls.: 100, 101 and 107

United States Patent and Trademark Office

Reg. No. 3,397,246

Registered Mar. 18, 2008

SERVICE MARK
PRINCIPAL REGISTER



JIMONG CHOE (UNITED STATES INDIVIDUAL)
1802 BELMONT CREEK POINTE
SUWANEE, GA 30024

FOR: MARTIAL ARTS INSTRUCTION, IN CLASS
41 (U.S. CLS. 100, 101 AND 107).

FIRST USE 10-1-2003; IN COMMERCE 5-1-2004.

OWNER OF U.S. REG. NOS. 2,963,196 AND
3,216,223.

NO CLAIM IS MADE TO THE EXCLUSIVE
RIGHT TO USE "EASTERN PHILOSOPHY CEN-
TER", APART FROM THE MARK AS SHOWN.

THE NAME "GRANDMASTER CHOE'S" IDENTI-
FIES A LIVING INDIVIDUAL WHOSE CONSENT IS
OF RECORD.

THE COLOR(S) BLACK, WHITE, RED, YELLOW
AND BLUE IS/ARE CLAIMED AS A FEATURE OF
THE MARK.

THE COLOR BLACK APPEARS IN THE WORD-
ING GRANDMASTER CHOE'S EASTERN PHILO-
SOPHY CENTER AND IN THE MANDARIN
CHINESE CHARACTERS AND THE FORM OF AN
OUTLINE AROUND THE OTHER ELEMENTS IN
THE MARK; THE COLORS BLUE AND RED EACH
FORM ONE HALF OF A SPIRALED CIRCLE; THE
COLOR YELLOW APPEARS IN THE FORM OF A
CIRCLE IN THE CENTER OF THE MARK; THE
COLOR WHITE APPEARS IN THE FORM TWO
STYLIZED VAJRAS THAT ARE CROSSED AND IN
THE BACKGROUND OF THE OUTERMOST CIR-
CLE

THE NON-LATIN CHARACTERS IN THE MARK
TRANSLITERATE TO "CHO KWANJANIM DONG
YANG CHUL HAK WON" AND THIS MEANS
"GRANDMASTER CHOE'S EASTERN PHILOSO-
PHY CENTER" IN ENGLISH.

SER. NO. 77-078,828, FILED 1-9-2007.

SEAN CROWLEY, EXAMINING ATTORNEY

Int. Cl.: 25

Prior U.S. Cls.: 22 and 39

United States Patent and Trademark Office

Reg. No. 3,397,247

Registered Mar. 18, 2008

**TRADEMARK
PRINCIPAL REGISTER**



TRIAD OF NORTH ATLANTA, LLC (GEORGIA
LTD LIAB CO)
471 MANOR OAK LANE
MARIETTA, GA 30067

FOR: DISPOSABLE SLIPPERS USED TO PRO-
TECT FEET AT AIRLINE SECURITY CHECKS
WHEN SHOES MUST BE REMOVED, IN CLASS 25
(U.S. CLS. 22 AND 39).

FIRST USE 8-1-2005; IN COMMERCE 8-1-2005.

NO CLAIM IS MADE TO THE EXCLUSIVE
RIGHT TO USE AIRPORT BOOTIES, APART FROM
THE MARK AS SHOWN.

THE MARK CONSISTS OF A STYLIZED AIR-
PLANE APPEARING TO THE LEFT OF THE
WORDS AIRPORT BOOTIES.

SER. NO. 77-079,457, FILED 1-9-2007.

LAURA KOVALSKY, EXAMINING ATTORNEY

Int. Cl.: 31

Prior U.S. Cls.: 1 and 46

United States Patent and Trademark Office

Reg. No. 3,397,248

Registered Mar. 18, 2008

TRADEMARK
PRINCIPAL REGISTER



ROBERTSON, ANN K. (CONNECTICUT SOLE
PROPRIETORSHIP)
68 VALLEYWOOD RD
COS COB, CT 06807

FOR: LIVE FLOWER ARRANGEMENTS, IN
CLASS 31 (U.S. CLS. 1 AND 46).

FIRST USE 10-5-2003; IN COMMERCE 10-5-2003.

THE COLOR(S) PINK, GREEN, BLUE, BROWN IS/
ARE CLAIMED AS A FEATURE OF THE MARK.

THE MARK CONSISTS OF BLUE SKY AND
BROWN DIRT WITH THE WORD "DIRT" GROW-
ING OUT OF IT THE LETTERS "DIR" ARE BROWN,
THE "T" IS A GREEN STEM TOPPED WITH A PINK
FLOWER.

SER. NO. 77-080,159, FILED 1-10-2007.

CHRISTOPHER BUONGIORNO, EXAMINING AT-
TORNEY

Int. Cls.: 43, 44 and 45

Prior U.S. Cls.: 100 and 101

United States Patent and Trademark Office

Reg. No. 3,397,249

Registered Mar. 18, 2008

**SERVICE MARK
PRINCIPAL REGISTER**

GUIDE PROGRAM

GUIDE PROGRAM, INC. (MARYLAND CORPORATION)
8643 CHERRY LANE
LAUREL, MD 20707

FOR: PROVIDING TEMPORARY ACCOMMODATIONS; PROVIDING COMMUNITY-BASED RESIDENCES AND HOUSING FOR JUVENILE JUSTICE INVOLVED YOUTH, CHILD WELFARE CLIENTS, AND MENTALLY DISABLED ADULTS, IN CLASS 43 (U.S. CLS. 100 AND 101).

FIRST USE 12-31-1968; IN COMMERCE 12-31-1968.

FOR: ADDICTION TREATMENT SERVICES TO PREVENT ADDICTION; MENTAL HEALTH SERVICES; CONSULTING AND COUNSELING SERVICES IN THE FIELD OF MENTAL HEALTH AND MENTAL FITNESS; CONSULTING SERVICES IN THE FIELD OF MENTAL HEALTH AND WELLNESS; MENTAL HEALTH INFORMATION; MENTAL HEALTH COUNSELING AND PSYCHOTHERAPY AS IT RELATES TO PERSONAL RELATIONSHIPS AND ADJUSTMENT; PROVIDING HEALTH INFORMATION; PROVIDING MENTAL REHABILITATION FACILITIES; PSYCHIATRIC CONSULTATION, SERVICES, AND TESTING; PSYCHOLOGICAL CONSULTATION, COUNSELING, AND TESTING; PSYCHOTHERAPY AND PSYCHOTHERAPY COUNSELING FOR CHILDREN, YOUTH, AND ADULTS IN INDIVIDUAL, GROUP, AND FAMILY SESSIONS; TREATMENT AND REHABILITATION OF ALCOHOL, DRUG, AND NARCOTIC ADDICTED PATIENTS; THERAPEUTIC SERVICES FOR AT-RISK CHILDREN, ADOLESCENTS AND THEIR FAMILIES AND MENTALLY

ILL AND MENTALLY DISABLED ADULTS, PRIMARILY IN COMMUNITY AND RESIDENTIAL SETTINGS, IN CLASS 44 (U.S. CLS. 100 AND 101).

FIRST USE 12-31-1968; IN COMMERCE 12-31-1968.

FOR: CASE MANAGEMENT SERVICES, NAMELY, COORDINATION OF NECESSARY LEGAL, SOCIAL, MEDICAL, VOCATIONAL AND PSYCHOLOGICAL SERVICES FOR JUVENILE JUSTICE AND WELFARE CHILDREN, YOUTH, FAMILIES AND DISABLED ADULTS; ORGANIZING AND CONDUCTING SUPPORT GROUPS IN THE FIELD OF MENTAL HEALTH AND SOCIAL SERVICES; PERSONAL GROWTH AND MOTIVATION CONSULTING AND COUNSELING SERVICES; PROVIDING INFORMATION IN THE FIELD OF SELF-IMPROVEMENT, SOCIAL SERVICES AND COMMUNITY SOCIAL SERVICES, IN CLASS 45 (U.S. CLS. 100 AND 101).

FIRST USE 12-31-1968; IN COMMERCE 12-31-1968.

THE MARK CONSISTS OF STANDARD CHARACTERS WITHOUT CLAIM TO ANY PARTICULAR FONT, STYLE, SIZE, OR COLOR.

NO CLAIM IS MADE TO THE EXCLUSIVE RIGHT TO USE "PROGRAM", APART FROM THE MARK AS SHOWN.

SER. NO. 77-080,277, FILED 1-10-2007.

KAPIL BHANOT, EXAMINING ATTORNEY

Int. Cl.: 41

Prior U.S. Cls.: 100, 101 and 107

United States Patent and Trademark Office

Reg. No. 3,397,250

Registered Mar. 18, 2008

**SERVICE MARK
PRINCIPAL REGISTER**

ClinfoSource

CLINFOSOURCE (CALIFORNIA SOLE PROPRIETORSHIP)
1075 CHESHIRE CIRCLE
DANVILLE, CA 94506

FOR: ARRANGING PROFESSIONAL WORKSHOP AND TRAINING COURSES IN THE FIELD OF GOOD CLINICAL PRACTICES IN CLINICAL TRIALS IN THE PHARMACEUTICAL, BIOTECHNOLOGICAL, AND MEDICAL DEVICES INDUSTRY; PROVIDING ON-LINE TRAINING IN THE FORM OF COURSES IN THE FIELD OF GOOD CLINICAL PRACTICES IN CLINICAL TRIALS IN THE FIELD OF PHARMACEUTICAL, BIOTECHNO-

LOGICAL, AND MEDICAL DEVICES INDUSTRY, IN CLASS 41 (U.S. CLS. 100, 101 AND 107).

FIRST USE 12-1-2000; IN COMMERCE 12-11-2001.

THE MARK CONSISTS OF STANDARD CHARACTERS WITHOUT CLAIM TO ANY PARTICULAR FONT, STYLE, SIZE, OR COLOR.

SER. NO. 77-080,335, FILED 1-10-2007.

WENDY GOODMAN, EXAMINING ATTORNEY

Int. Cl.: 9

Prior U.S. Cls.: 21, 23, 26, 36 and 38

United States Patent and Trademark Office

Reg. No. 3,397,251

Registered Mar. 18, 2008

**TRADEMARK
PRINCIPAL REGISTER**

TAHITI MAGIC

ARISTOCRAT TECHNOLOGIES AUSTRALIA
PTY LTD (AUSTRALIA CORPORATION)
71 LONGUEVILLE ROAD
LANE COVE, NSW, AUSTRALIA 2066

FOR: GAMING MACHINES; COMPUTER HARD-
WARE; DOWNLOADABLE GAME SOFTWARE;
ELECTRONIC GAME SOFTWARE, IN CLASS 9
(U.S. CLS. 21, 23, 26, 36 AND 38).

THE MARK CONSISTS OF STANDARD CHAR-
ACTERS WITHOUT CLAIM TO ANY PARTICULAR
FONT, STYLE, SIZE, OR COLOR.

PRIORITY CLAIMED UNDER SEC. 44(D) ON
AUSTRALIA APPLICATION NO. 1128908, FILED 8-
10-2006, REG. NO. 1128908, DATED 4-23-2007, EX-
PIRES 8-10-2016.

SER. NO. 77-080,413, FILED 1-10-2007.

WILLIAM VERHOSEK, EXAMINING ATTORNEY

Int. Cl.: 35

Prior U.S. Cls.: 100, 101 and 102

United States Patent and Trademark Office

Reg. No. 3,397,252

Registered Mar. 18, 2008

**SERVICE MARK
PRINCIPAL REGISTER**

Toolcritic.com

CRITICAL PURSUITS (CALIFORNIA CORPORATION)
946 RODEO RD
FULLERTON, CA 92835

FOR: PROVIDING A WEBSITE FEATURING INFORMATION AND REVIEWS OF PRODUCTS, NAMELY, BOOKS ON TOOLS, HAND TOOLS, AND POWER TOOLS, IN CLASS 35 (U.S. CLS. 100, 101 AND 102).

FIRST USE 2-17-2004; IN COMMERCE 1-31-2005.

THE MARK CONSISTS OF STANDARD CHARACTERS WITHOUT CLAIM TO ANY PARTICULAR FONT, STYLE, SIZE, OR COLOR.

SER. NO. 77-080,854, FILED 1-11-2007.

ANTHONY RINKER, EXAMINING ATTORNEY

Int. Cls.: 30 and 43

Prior U.S. Cls.: 46, 100 and 101

United States Patent and Trademark Office

Reg. No. 3,397,253

Registered Mar. 18, 2008

**TRADEMARK
SERVICE MARK
PRINCIPAL REGISTER**



ROCKET FOODS, LLC (WASHINGTON LTD
LIAB CO)
13343 BEL-RED ROAD
BELLEVUE, WA 980052333

THE COLOR(S) RED, ORANGE, BROWN, TAN,
BLACK AND WHITE IS/ARE CLAIMED AS A
FEATURE OF THE MARK.

FOR: DONUTS, IN CLASS 30 (U.S. CL. 46).

FIRST USE 10-21-2006; IN COMMERCE 10-21-2006.

FOR: RESTAURANTS, IN CLASS 43 (U.S. CLS. 100
AND 101).

FIRST USE 10-21-2006; IN COMMERCE 10-21-2006.

OWNER OF U.S. REG. NO. 3,280,966.

NO CLAIM IS MADE TO THE EXCLUSIVE
RIGHT TO USE "DONUTS", APART FROM THE
MARK AS SHOWN.

THE MARK CONSISTS OF A RED ROCKET,
OUTLINED IN BLACK, WITH ORANGE FINS
AND TAN EXHAUST FLAMES FLYING THROUGH
A BROWN DONUT WITH WHITE STYLIZED LET-
TERS SPELLING "ROCKET DONUTS" AROUND
THE DONUT.

SER. NO. 77-081,148, FILED 1-11-2007.

JULIE GUTTADAURO, EXAMINING ATTORNEY

Int. Cls.: 30 and 43

Prior U.S. Cls.: 46, 100 and 101

United States Patent and Trademark Office

Reg. No. 3,397,254

Registered Mar. 18, 2008

**TRADEMARK
SERVICE MARK
PRINCIPAL REGISTER**

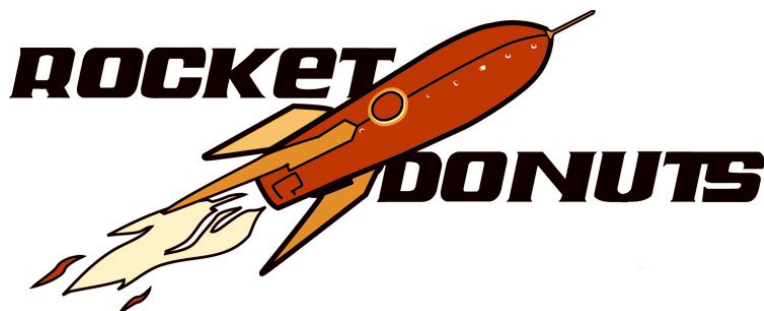

ROCKET FOODS, LLC (WASHINGTON LTD
LIAB CO)
13343 BEL-RED ROAD
BELLEVUE, WA 980052333

THE COLOR(S) RED, ORANGE, TAN, BLACK
AND WHITE IS/ARE CLAIMED AS A FEATURE OF
THE MARK.

FOR: DONUTS, IN CLASS 30 (U.S. CL. 46).

FIRST USE 10-21-2006; IN COMMERCE 10-21-2006.

FOR: RESTAURANTS, IN CLASS 43 (U.S. CLS. 100
AND 101).

FIRST USE 10-21-2006; IN COMMERCE 10-21-2006.

OWNER OF U.S. REG. NO. 3,280,966.

NO CLAIM IS MADE TO THE EXCLUSIVE
RIGHT TO USE "DONUTS", APART FROM THE
MARK AS SHOWN.

THE MARK CONSISTS OF A RED ROCKET,
OUTLINED IN BLACK, WITH ORANGE TAIL FINS,
A CIRCLE OUTLINED IN ORANGE, ORANGE
LIGHTS ON THE SIDE AND TAN AND RED
EXHAUST FLYING BETWEEN BLACK STYLIZED
LETTERS SPELLING ROCKET DONUTS.

SER. NO. 77-081,356, FILED 1-11-2007.

JULIE GUTTADAURO, EXAMINING ATTORNEY

Int. Cls.: 11 and 37

Prior U.S. Cls.: 13, 21, 23, 31, 34, 100, 103 and 106

United States Patent and Trademark Office

Reg. No. 3,397,255

Registered Mar. 18, 2008

**TRADEMARK
SERVICE MARK
PRINCIPAL REGISTER**

H2OCOOL

417394 ALBERTA LTD. (CANADA CORPORATION)
47 GLENSUMMIT CLOSE
COCHRANE, CANADA T4C2K1

FOR: WATER COOLERS, IN CLASS 11 (U.S. CLS. 13, 21, 23, 31 AND 34).

FOR: INSTALLATION, SERVICING AND MAINTENANCE OF WATER COOLERS , IN CLASS 37 (U.S. CLS. 100, 103 AND 106).

THE MARK CONSISTS OF STANDARD CHARACTERS WITHOUT CLAIM TO ANY PARTICULAR FONT, STYLE, SIZE, OR COLOR.

OWNER OF CANADA REG. NO. TMA537840, DATED 11-28-2000, EXPIRES 11-28-2015.

SER. NO. 77-081,747, FILED 1-12-2007.

TARAH HARDY, EXAMINING ATTORNEY

Int. Cl.: 41

Prior U.S. Cls.: 100, 101 and 107

United States Patent and Trademark Office

Reg. No. 3,397,256

Registered Mar. 18, 2008

**SERVICE MARK
PRINCIPAL REGISTER**

**DISNEY'S FAIRY TALE
WEDDINGS**

DISNEY ENTERPRISES, INC. (DELAWARE COR-
PORATION)
500 SOUTH BUENA VISTA STREET
BURBANK, CA 91521

FOR: PROVIDING INFORMATION IN THE
FIELD OF WEDDING PARTY PLANNING, IN
CLASS 41 (U.S. CLS. 100, 101 AND 107).

FIRST USE 11-30-1991; IN COMMERCE 11-30-1991.

THE MARK CONSISTS OF STANDARD CHAR-
ACTERS WITHOUT CLAIM TO ANY PARTICULAR
FONT, STYLE, SIZE, OR COLOR.

NO CLAIM IS MADE TO THE EXCLUSIVE
RIGHT TO USE "WEDDINGS", APART FROM THE
MARK AS SHOWN.

SER. NO. 77-081,972, FILED 1-12-2007.

MICHAEL WEBSTER, EXAMINING ATTORNEY

Int. Cl.: 14

Prior U.S. Cls.: 2, 27, 28 and 50

United States Patent and Trademark Office

Reg. No. 3,397,257

Registered Mar. 18, 2008

TRADEMARK
PRINCIPAL REGISTER

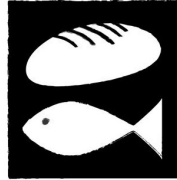

buns & guppies

HARRIS, BERNADETTE M. (UNITED STATES
INDIVIDUAL)
6006 AMELIA TERRACE COURT
SUGARLAND, TX 77479

FOR: JEWELRY, IN CLASS 14 (U.S. CLS. 2, 27, 28
AND 50).

FIRST USE 6-29-2005; IN COMMERCE 6-29-2005.

THE MARK CONSISTS OF THE IMAGE OF A
BUN ABOVE A FISH WITHIN A SHADED SQUARE
WITH THE WORDING "BUNS & GUPPIES" DI-
RECTLY BELOW THE DESIGN ELEMENT.

SER. NO. 77-082,088, FILED 1-12-2007.

ASMAT KHAN, EXAMINING ATTORNEY

Int. Cl.: 36

Prior U.S. Cls.: 100, 101 and 102

United States Patent and Trademark Office

Reg. No. 3,397,258

Registered Mar. 18, 2008

**SERVICE MARK
PRINCIPAL REGISTER**

Simplifying Real Estate

TRAN, ANH HAO (UNITED STATES INDIVIDUAL)
2411 SOUTH FREMONT AVE.
ALHAMBRA, CA 91803

FOR: PROVIDING INFORMATION IN THE FIELD OF REAL ESTATE BY MEANS OF LINKING THE WEB SITE TO OTHER WEB SITES FEATURING REAL ESTATE INFORMATION, IN CLASS 36 (U.S. CLS. 100, 101 AND 102).

FIRST USE 9-1-2006; IN COMMERCE 10-1-2006.

THE MARK CONSISTS OF STANDARD CHARACTERS WITHOUT CLAIM TO ANY PARTICULAR FONT, STYLE, SIZE, OR COLOR.

NO CLAIM IS MADE TO THE EXCLUSIVE RIGHT TO USE REAL ESTATE, APART FROM THE MARK AS SHOWN.

SER. NO. 77-082,570, FILED 1-13-2007.

THEODORE MCBRIDE, EXAMINING ATTORNEY

Int. Cl.: 35

Prior U.S. Cls.: 100, 101 and 102

United States Patent and Trademark Office

Reg. No. 3,397,259

Registered Mar. 18, 2008

**SERVICE MARK
PRINCIPAL REGISTER**

COGWHEEL MARKETING

CAMPBELL MITHUN LLC (DELAWARE LTD
LIAB CO)
222 SOUTH 9TH STREET
MINNEAPOLIS, MN 55402

FOR: ADVERTISING AGENCY AND CONSULT-
ING SERVICES IN THE FIELD OF INTEGRATED
MARKETING, IN CLASS 35 (U.S. CLS. 100, 101 AND
102).

FIRST USE 7-25-2006; IN COMMERCE 7-25-2006.

THE MARK CONSISTS OF STANDARD CHAR-
ACTERS WITHOUT CLAIM TO ANY PARTICULAR
FONT, STYLE, SIZE, OR COLOR.

NO CLAIM IS MADE TO THE EXCLUSIVE
RIGHT TO USE "MARKETING", APART FROM
THE MARK AS SHOWN.

SER. NO. 77-082,683, FILED 1-14-2007.

ANDREA BUTLER, EXAMINING ATTORNEY

Int. Cl.: 5

Prior U.S. Cls.: 6, 18, 44, 46, 51 and 52

United States Patent and Trademark Office

Reg. No. 3,397,260

Registered Mar. 18, 2008

**TRADEMARK
PRINCIPAL REGISTER**

LONGIVAL

BIOFARMA (FRANCE SOCIETE PAR ACTIONS
SIMPLIFEE)
22, RUE GARNIER
NEUILLY-SUR-SEINE, FRANCE 92200

OWNER OF FRANCE REG. NO. 93466098, DATED
4-28-1993, RENEWED AS REG. NO. 93466098, DATED
4-1-2003, EXPIRES 4-1-2013.

FOR: PHARMACEUTICAL PREPARATION FOR
THE TREATMENT OF CARDIOVASCULAR DISEA-
SES, IN CLASS 5 (U.S. CLS. 6, 18, 44, 46, 51 AND 52).

SER. NO. 77-084,100, FILED 1-16-2007.

THE MARK CONSISTS OF STANDARD CHAR-
ACTERS WITHOUT CLAIM TO ANY PARTICULAR
FONT, STYLE, SIZE, OR COLOR.

JENNIFER HETU, EXAMINING ATTORNEY

Int. Cl.: 35

Prior U.S. Cls.: 100, 101 and 102

United States Patent and Trademark Office

Reg. No. 3,397,261

Registered Mar. 18, 2008

**SERVICE MARK
PRINCIPAL REGISTER**

The logo for ModaGo, featuring the word "ModaGo" in a stylized, rounded font. The letters "Moda" are blue and "Go" is green.

MODAGO SHOWROOMS (DELAWARE CORPORATION)

305

452 ALDINE ST
CHICAGO, IL 60657

FOR: PROVIDING AN ON-LINE SHOWROOM FOR THE GOODS OF OTHERS IN THE FIELD OF WHOLESALE FASHION FOOTWEAR, APPAREL AND ACCESSORIES; WHOLESALE ORDERING SERVICES IN THE FIELD OF FASHION FOOTWEAR, APPAREL AND ACCESSORIES, IN CLASS 35 (U.S. CLS. 100, 101 AND 102).

FIRST USE 6-1-2006; IN COMMERCE 6-1-2006.

THE COLOR(S) BLUE AND GREEN IS/ARE CLAIMED AS A FEATURE OF THE MARK.

THE MARK CONSISTS OF THE LETTERS MODA ARE IN BLUE, AND GO IN GREEN.

SER. NO. 77-084,206, FILED 1-16-2007.

MARK SPARACINO, EXAMINING ATTORNEY

Int. Cl.: 35

Prior U.S. Cls.: 100, 101 and 102

United States Patent and Trademark Office

Reg. No. 3,397,262

Registered Mar. 18, 2008

**SERVICE MARK
PRINCIPAL REGISTER**

clearstate

CLEARSTATE (PTE.) LTD. (SINGAPORE LTD
LIAB CO)
9B BERRIMA ROAD
SINGAPORE, SINGAPORE 299928

THE MARK CONSISTS OF THE WORD CLEAR-
STATE IN GREY, ON A WHITE BACKGROUND,
UNDERLINED BY A LIGHT BLUE LINE, INTER-
SECTED HALFWAY BY A DARK BLUE TRIANGLE.

FOR: BUSINESS CONSULTATION SERVICES, IN
CLASS 35 (U.S. CLS. 100, 101 AND 102).

FIRST USE 7-11-2006; IN COMMERCE 7-11-2006.

SER. NO. 77-084,269, FILED 1-17-2007.

THE COLOR(S) WHITE, GREY, LIGHT BLUE
AND DARK BLUE IS/ARE CLAIMED AS A FEAT-
TURE OF THE MARK.

DANIEL CAPSHAW, EXAMINING ATTORNEY

Int. Cl.: 9

Prior U.S. Cls.: 21, 23, 26, 36 and 38

United States Patent and Trademark Office

Reg. No. 3,397,263

Registered Mar. 18, 2008

**TRADEMARK
PRINCIPAL REGISTER**

COHERENCE

PARALLELS SOFTWARE INTERNATIONAL,
INC. (BR.VIRGIN ISLANDS CORPORATION)
C/O DANTRUST LTD.
49 MAIN STREET, P.O. BOX 186
ROAD TOWN, TORTOLA, BR.VIRGIN ISLANDS

FOR: COMPUTER SOFTWARE FOR USE IN
HARDWARE VIRTUALIZATION AND OPERAT-
ING SYSTEM VIRTUALIZATION; COMPUTER
SOFTWARE FOR USE IN HARDWARE EMULA-
TION AND OPERATING SYSTEM EMULATION;
COMPUTER SOFTWARE FOR USE IN SEAMLESS
INTEGRATION OF NON-NATIVE APPLICATIONS;
COMPUTER SOFTWARE FOR USE IN RENDER-
ING DISPLAYS OF ICONS, FILE SYSTEMS AND
APPLICATIONS OF GUEST OPERATING SYSTEMS;
COMPUTER SOFTWARE FOR USE IN INTEGRAT-
ING A VIRTUALIZED OPERATING SYSTEM INTO
A NATIVE OPERATING SYSTEM; COMPUTER
SOFTWARE FOR USE IN INTEGRATING A NA-

TIVE OPERATING SYSTEM INTO A VIRTUALIZED
OPERATING SYSTEM; COMPUTER SOFTWARE
FOR USE IN PROVIDING SERVICES OF ONE
OPERATING SYSTEM INSIDE ANOTHER OPERAT-
ING SYSTEM; COMPUTER SOFTWARE FOR USE
IN ENABLING APPLICATIONS FROM ONE OPER-
ATING SYSTEM TO APPEAR AS NATIVE ON AN-
OTHER OPERATING SYSTEM, IN CLASS 9 (U.S.
CLS. 21, 23, 26, 36 AND 38).

FIRST USE 1-12-2007; IN COMMERCE 1-12-2007.

THE MARK CONSISTS OF STANDARD CHAR-
ACTERS WITHOUT CLAIM TO ANY PARTICULAR
FONT, STYLE, SIZE, OR COLOR.

SER. NO. 77-084,572, FILED 1-17-2007.

KAREN SEVERSON, EXAMINING ATTORNEY

Int. Cl.: 36

Prior U.S. Cls.: 100, 101 and 102

United States Patent and Trademark Office

Reg. No. 3,397,264

Registered Mar. 18, 2008

**SERVICE MARK
PRINCIPAL REGISTER**

TRANSFORM GREEN LISTING

TRANSFORM REAL ESTATE (NEVADA CORPORATION)
4560 S. DECATUR BLVD.
LAS VEGAS, NV 89103

FOR: LEASING OF REAL ESTATE; REAL ESTATE BROKERAGE; REAL ESTATE LISTING, IN CLASS 36 (U.S. CLS. 100, 101 AND 102).

FIRST USE 4-0-2005; IN COMMERCE 4-0-2005.

THE MARK CONSISTS OF STANDARD CHARACTERS WITHOUT CLAIM TO ANY PARTICULAR FONT, STYLE, SIZE, OR COLOR.

NO CLAIM IS MADE TO THE EXCLUSIVE RIGHT TO USE "LISTING", APART FROM THE MARK AS SHOWN.

SER. NO. 77-085,043, FILED 1-17-2007.

JILL C. ALT, EXAMINING ATTORNEY

Int. Cls.: 23, 24 and 25

Prior U.S. Cls.: 22, 39, 42, 43 and 50

United States Patent and Trademark Office

Reg. No. 3,397,265

Registered Mar. 18, 2008

**TRADEMARK
PRINCIPAL REGISTER**



AUSTRALIAN WOOL INNOVATION LIMITED
(AUSTRALIA LTD LIAB CO)
LEVEL 5, 16-20 BARRACK STREET
SYDNEY NEW SOUTH WALES, AUSTRALIA 2000

FOR: YARNS AND THREADS FOR TEXTILE USE
CONTAINING MERINO WOOL, IN CLASS 23 (U.S.
CL. 43).

FOR: TEXTILES AND TEXTILE GOODS, NAME-
LY, WOVEN AND NON-WOVEN TEXTILE FAB-
RICS, ALL CONTAINING MERINO WOOL, IN
CLASS 24 (U.S. CLS. 42 AND 50).

FOR: CLOTHING, NAMELY, TOPS, BOTTOMS;
OUTERWEAR, NAMELY, JACKETS, COATS AND
VESTS; SWIMWEAR; SLEEPWEAR; UNDERWEAR;

HEADWEAR AND FOOTWEAR, ALL CONTAIN-
ING MERINO WOOL, IN CLASS 25 (U.S. CLS. 22
AND 39).

PRIORITY CLAIMED UNDER SEC. 44(D) ON
AUSTRALIA APPLICATION NO. 1137204, FILED 9-
22-2006, REG. NO. 1137204, DATED 9-22-2006, EX-
PIRES 9-22-2016.

NO CLAIM IS MADE TO THE EXCLUSIVE
RIGHT TO USE "AUSTRALIAN MERINO", APART
FROM THE MARK AS SHOWN.

SER. NO. 77-085,498, FILED 1-18-2007.

BENJAMIN OKEKE, EXAMINING ATTORNEY

Int. Cl.: 35

Prior U.S. Cls.: 100, 101 and 102

United States Patent and Trademark Office

Reg. No. 3,397,266

Registered Mar. 18, 2008

**SERVICE MARK
PRINCIPAL REGISTER**



RESTAR ASSOCIATES, LLC (PENNSYLVANIA
LTD LIAB CO)
45 CONTINENTAL DRIVE
VALLEY FORGE, PA 19481

FOR: CONSULTING SERVICES IN THE FIELD
OF RESTAURANT AND FRANCHISE OPERATION
AND MANAGEMENT, IN CLASS 35 (U.S. CLS. 100,
101 AND 102).

FIRST USE 2-1-2007; IN COMMERCE 2-1-2007.

NO CLAIM IS MADE TO THE EXCLUSIVE
RIGHT TO USE "BIZ BUILDERS", APART FROM
THE MARK AS SHOWN.

THE COLOR(S) BLACK, BLUE AND GREEN IS/
ARE CLAIMED AS A FEATURE OF THE MARK.

THE MARK CONSISTS OF THE WORDING BIZ
BUILDERS, WITH THE WORDING BIZ APPEAR-
ING IN BLACK LETTERING, WITH A GREEN
SWIRL OVER THE "I", WITH A BLUE ARROW
COMING FROM THE BOTTOM OF THE "Z", AND
THE WORDING BUILDERS APPEARING BE-
NEATH IN THE COLOR BLUE.

SER. NO. 77-085,755, FILED 1-18-2007.

VIVIAN MICZNIK FIRST, EXAMINING ATTOR-
NEY

Int. Cl.: 16

Prior U.S. Cls.: 2, 5, 22, 23, 29, 37, 38 and 50

Reg. No. 3,397,267

United States Patent and Trademark Office

Registered Mar. 18, 2008

**TRADEMARK
PRINCIPAL REGISTER**



CITY OF DALLAS (TEXAS MUNICIPAL CORPORATION)
ROOM 4A, DALLAS CITY HALL
1500 MARILLA ST.
DALLAS, TX 75201

FIRST USE 6-1-2004; IN COMMERCE 6-1-2004.

OWNER OF U.S. REG. NO. 2,829,512.

SER. NO. 77-085,880, FILED 1-18-2007.

FOR: INFORMATIONAL FLYERS FEATURING TIPS ON HOW TO CONSERVE WATER, IN CLASS 16 (U.S. CLS. 2, 5, 22, 23, 29, 37, 38 AND 50).

LINDA M. KING, EXAMINING ATTORNEY

Int. Cl.: 39

Prior U.S. Cls.: 100 and 105

United States Patent and Trademark Office

Reg. No. 3,397,268

Registered Mar. 18, 2008

**SERVICE MARK
PRINCIPAL REGISTER**

EXCURSION SOCIETY

CARLSON TRAVEL GROUP, INC. (CALIFORNIA
CORPORATION)
CARLSON PARKWAY
PO BOX 59159
MINNEAPOLIS, MN 554598249

FOR: TRAVEL AGENCY SERVICES, NAMELY,
ARRANGING CRUISES AND TRAVEL TOURS, IN
CLASS 39 (U.S. CLS. 100 AND 105).

FIRST USE 1-1-2007; IN COMMERCE 1-1-2007.

THE MARK CONSISTS OF STANDARD CHAR-
ACTERS WITHOUT CLAIM TO ANY PARTICULAR
FONT, STYLE, SIZE, OR COLOR.

NO CLAIM IS MADE TO THE EXCLUSIVE
RIGHT TO USE "EXCURSION", APART FROM
THE MARK AS SHOWN.

SER. NO. 77-086,460, FILED 1-19-2007.

ANDREA BUTLER, EXAMINING ATTORNEY

Int. Cls.: 6, 8, 16 and 21

**Prior U.S. Cls.: 2, 5, 12, 13, 14, 22, 23, 25, 28, 29, 30,
33, 37, 38, 40, 44 and 50**

Reg. No. 3,397,269

United States Patent and Trademark Office

Registered Mar. 18, 2008

**TRADEMARK
PRINCIPAL REGISTER**

BOARDWALK

LAGASSE, INC. (LOUISIANA CORPORATION)
ONE PARKWAY NORTH BLVD.
DEERFIELD, IL 60015

FOR: FOODSERVICE DISPOSABLE LINE, NAME-
LY, ALUMINUM FOIL, IN CLASS 6 (U.S. CLS. 2, 12,
13, 14, 23, 25 AND 50).

FIRST USE 1-31-2000; IN COMMERCE 1-31-2000.

FOR: FOODSERVICE DISPOSABLE LINE, NAME-
LY, PLASTIC CUTLERY, IN CLASS 8 (U.S. CLS. 23, 28
AND 44).

FIRST USE 1-31-2000; IN COMMERCE 1-31-2000.

FOR: FOODSERVICE DISPOSABLE LINE, NAME-
LY, PLASTIC WRAP, IN CLASS 16 (U.S. CLS. 2, 5, 22,
23, 29, 37, 38 AND 50).

FIRST USE 1-31-2000; IN COMMERCE 1-31-2000.

FOR: FOODSERVICE DISPOSABLE LINE, NAME-
LY, PLASTIC CUPS AND PLASTIC PLATES, IN
CLASS 21 (U.S. CLS. 2, 13, 23, 29, 30, 33, 40 AND 50).

FIRST USE 1-31-2000; IN COMMERCE 1-31-2000.

THE MARK CONSISTS OF STANDARD CHAR-
ACTERS WITHOUT CLAIM TO ANY PARTICULAR
FONT, STYLE, SIZE, OR COLOR.

OWNER OF U.S. REG. NO. 2,429,442.

SER. NO. 77-086,775, FILED 1-19-2007.

ALLISON HOLTZ, EXAMINING ATTORNEY

Int. Cl.: 5

Prior U.S. Cls.: 6, 18, 44, 46, 51 and 52

Reg. No. 3,397,270

United States Patent and Trademark Office

Registered Mar. 18, 2008

**TRADEMARK
PRINCIPAL REGISTER**

ENHANCE750

LA WEIGHT LOSS FRANCHISE COMPANY (DE-
LAWARE CORPORATION)
747 DRESHER ROAD SUITE 150
HORSHAM, PA 19044

THE MARK CONSISTS OF STANDARD CHAR-
ACTERS WITHOUT CLAIM TO ANY PARTICULAR
FONT, STYLE, SIZE, OR COLOR.

FOR: DIETARY SUPPLEMENTS, IN CLASS 5 (U.S.
CLS. 6, 18, 44, 46, 51 AND 52).

SER. NO. 77-086,848, FILED 1-19-2007.

FIRST USE 12-31-2006; IN COMMERCE 12-31-2006.

PAULA MAHONEY, EXAMINING ATTORNEY

Int. Cl.: 35

Prior U.S. Cls.: 100, 101 and 102

United States Patent and Trademark Office

Reg. No. 3,397,271

Registered Mar. 18, 2008

SERVICE MARK
PRINCIPAL REGISTER



JULIE QUIGLEY (UNITED STATES INDIVIDUAL)
14138 WILDHORSE ROAD
WEED, CA 96094

FOR: CLERICAL AND ADMINISTRATIVE SUPPORT SERVICES, NAMELY, PROVIDING OFFICE SUPPORT STAFFING SERVICES, RENTAL OF OFFICE MACHINERY AND EQUIPMENT, AND MANAGEMENT AND BUSINESS CONSULTING SERVICES IN THE FIELD OF DISASTER AND EMERGENCY RESPONSE, IN CLASS 35 (U.S. CLS. 100, 101 AND 102).

FIRST USE 12-18-2005; IN COMMERCE 1-30-2006.

THE COLOR(S) RED, BLACK, WHITE, YELLOW, TAN, AND GRAY IS/ARE CLAIMED AS A FEATURE OF THE MARK.

THE MARK CONSISTS OF THE WORDS "FIRE DAWG" IN RED FLAMES WITH BLACK LINES, A WHITE ANTHROPOMORPHIC BULL DOG WITH FOLDED ARMS FEATURING TAN FINGERNAILS, GRAY JOWLS, TAN UPPER LIP AND EYES, AND BLACK NOSE AND FEATURES, A RED FIREMAN'S HAT WITH A YELLOW AND WHITE STRIPED PLATE FEATURING THE BLACK NUMBERS 343, RED SUSPENDERS, AND A BLACK PAW PRINT AND A RED PAW PRINT.

SER. NO. 77-087,187, FILED 1-19-2007.

DAVID C. REIHNER, EXAMINING ATTORNEY

Int. Cl.: 43

Prior U.S. Cls.: 100 and 101

United States Patent and Trademark Office

Reg. No. 3,397,272

Registered Mar. 18, 2008

**SERVICE MARK
PRINCIPAL REGISTER**

OYSTER KING

LANZO, CHARLES P (UNITED STATES INDIVIDUAL)

4220 S. MAIN ST.

ACWORTH, GA 30101

FOR: RESTAURANT SERVICES, IN CLASS 43
(U.S. CLS. 100 AND 101).

FIRST USE 2-3-1983; IN COMMERCE 2-3-1983.

THE MARK CONSISTS OF STANDARD CHARACTERS WITHOUT CLAIM TO ANY PARTICULAR FONT, STYLE, SIZE, OR COLOR.

NO CLAIM IS MADE TO THE EXCLUSIVE RIGHT TO USE "OYSTER", APART FROM THE MARK AS SHOWN.

SER. NO. 77-087,227, FILED 1-19-2007.

JOHN DWYER, EXAMINING ATTORNEY

Int. Cl.: 16

Prior U.S. Cls.: 2, 5, 22, 23, 29, 37, 38 and 50

United States Patent and Trademark Office

Reg. No. 3,397,273

Registered Mar. 18, 2008

**TRADEMARK
PRINCIPAL REGISTER**

**Phonetics First- Focus On
Sounds**

KENNELLY, KIM (UNITED STATES INDIVIDUAL)
313 TAVERNIER DRIVE
OLDSMAR, FL 34677

FOR: PRINTED INSTRUCTIONAL, EDUCATIONAL, AND TEACHING MATERIALS IN THE FIELD OF A READING PROGRAM EMPHASIZING SOUNDS; EDUCATIONAL BOOKS FEATURING A READING PROGRAM WHICH EMPHASIZES SOUNDS FIRST; EDUCATIONAL LEARNING CARDS, NAMELY, CARDS PRINTED WITH LETTERS TO REPRESENT SOUNDS FOR USE IN A READING PROGRAM WHICH IS ORGANIZED BY SOUNDS, IN CLASS 16 (U.S. CLS. 2, 5, 22, 23, 29, 37, 38 AND 50).

FIRST USE 8-16-2006; IN COMMERCE 1-4-2007.

THE MARK CONSISTS OF STANDARD CHARACTERS WITHOUT CLAIM TO ANY PARTICULAR FONT, STYLE, SIZE, OR COLOR.

NO CLAIM IS MADE TO THE EXCLUSIVE RIGHT TO USE "PHONETICS", APART FROM THE MARK AS SHOWN.

SER. NO. 77-087,316, FILED 1-20-2007.

DANIEL BRODY, EXAMINING ATTORNEY

Int. Cl.: 45

Prior U.S. Cls.: 100 and 101

United States Patent and Trademark Office

Reg. No. 3,397,274

Registered Mar. 18, 2008

SERVICE MARK
PRINCIPAL REGISTER



CASH ASSET MANAGEMENT, LLC (NEVADA
LTD LIAB CO)
5 WILD HORSE CANYON DRIVE
SPARKS, NV 89434

FOR: LEGAL PROSTITUTION SERVICES, IN
CLASS 45 (U.S. CLS. 100 AND 101).

FIRST USE 6-7-2002; IN COMMERCE 6-7-2002.

NO CLAIM IS MADE TO THE EXCLUSIVE
RIGHT TO USE "ADULT RESORT" AND "SPA",
APART FROM THE MARK AS SHOWN.

THE MARK CONSISTS OF A WOMAN HUGGING
A HORSE

SER. NO. 77-087,383, FILED 1-20-2007.

ELISSA GARBER KON, EXAMINING ATTORNEY

Int. Cl.: 35

Prior U.S. Cls.: 100, 101 and 102

United States Patent and Trademark Office

Reg. No. 3,397,275

Registered Mar. 18, 2008

**SERVICE MARK
PRINCIPAL REGISTER**

Power Matrix

ITV MARKETING GROUP, INC. (MASSACHU-
SETTS CORPORATION)
55 CHERRY HILL DRIVE
BEVERLY, MA 01915

FOR: ADVERTISING AND MARKETING; AD-
VERTISING, MARKETING AND PROMOTION SER-
VICES; DIRECT MARKETING SERVICES; MULTI-
LEVEL MARKETING BUSINESS SERVICES, IN
CLASS 35 (U.S. CLS. 100, 101 AND 102).

FIRST USE 8-1-2006; IN COMMERCE 8-1-2006.

THE MARK CONSISTS OF STANDARD CHAR-
ACTERS WITHOUT CLAIM TO ANY PARTICULAR
FONT, STYLE, SIZE, OR COLOR.

SER. NO. 77-087,454, FILED 1-21-2007.

TAMARA FRAZIER, EXAMINING ATTORNEY

Int. Cls.: 36 and 41

Prior U.S. Cls.: 100, 101, 102 and 107

United States Patent and Trademark Office

Reg. No. 3,397,276

Registered Mar. 18, 2008

**SERVICE MARK
PRINCIPAL REGISTER**



KELLER COLLEGE SERVICES, LLC (MARY-
LAND LTD LIAB CO)
9401 MELLONBROOK ROAD
COLUMBIA, MD 21045

FOR: FINANCIAL SERVICES, NAMELY TUI-
TION-RELATED FINANCIAL AID PLANNING, IN
CLASS 36 (U.S. CLS. 100, 101 AND 102).

FIRST USE 9-30-2006; IN COMMERCE 10-12-2006.

FOR: EDUCATIONAL SERVICES, NAMELY
CONDUCTING SEMINARS AND WORKSHOPS IN
THE FIELD OF SCHOOL PLACEMENT AND FI-
NANCIAL ASSISTANCE; AND PERSONAL SERVI-
CES, NAMELY ONE-ON-ONE COUNSELING IN
THE FIELD OF EDUCATIONAL INSTITUTION
SELECTION, EDUCATIONAL INSTITUTION AP-
PLICATIONS AND CAREER COUNSELING, IN
CLASS 41 (U.S. CLS. 100, 101 AND 107).

FIRST USE 9-30-2006; IN COMMERCE 10-12-2006.

NO CLAIM IS MADE TO THE EXCLUSIVE
RIGHT TO USE "COLLEGE SERVICES", APART
FROM THE MARK AS SHOWN.

THE COLOR(S) BLACK, ROYAL BLUE AND
WHITE IS/ARE CLAIMED AS A FEATURE OF
THE MARK.

THE MARK CONSISTS OF A WHITE BOX WITH
A ROYAL BLUE BORDER CONTAINING A GRA-
DUATION CAP AND TASSEL IN WHITE WITH
BLACK OUTLINING AND A ROYAL BLUE CEN-
TER, HANGING FROM THE TOP LEFT CORNER
OF THE LETTERS KCS, APPEARING IN ROYAL
BLUE; THE WORDING KELLER COLLEGE SERVI-
CES APPEARS IN WHITE WITHIN A ROYAL BLUE
BAND.

SER. NO. 77-087,645, FILED 1-22-2007.

PAUL E. FAHRENKOPF, EXAMINING ATTORNEY

Int. Cl.: 6

Prior U.S. Cls.: 2, 12, 13, 14, 23, 25 and 50

United States Patent and Trademark Office

Reg. No. 3,397,277

Registered Mar. 18, 2008

**TRADEMARK
PRINCIPAL REGISTER**

SS 15

ALLIED TUBE AND CONDUIT CORPORATION
(DELAWARE CORPORATION)
16100 SOUTH LATHROP AVENUE
HARVEY, IL 60426

THE MARK CONSISTS OF STANDARD CHAR-
ACTERS WITHOUT CLAIM TO ANY PARTICULAR
FONT, STYLE, SIZE, OR COLOR.

FOR: STEEL PIPE, IN CLASS 6 (U.S. CLS. 2, 12, 13,
14, 23, 25 AND 50).

SER. NO. 77-088,141, FILED 1-22-2007.

FIRST USE 9-25-2007; IN COMMERCE 9-25-2007.

YAT SYE, LEE, EXAMINING ATTORNEY

Int. Cls.: 25, 35 and 43

Prior U.S. Cls.: 22, 39, 100, 101 and 102

United States Patent and Trademark Office

Reg. No. 3,397,278

Registered Mar. 18, 2008

**TRADEMARK
SERVICE MARK
PRINCIPAL REGISTER**

GRAMPY'S

CALLAHAN REALTY COMPANY (DELAWARE CORPORATION)
261 LEDYARD STREET
NEW LONDON, CT 06320

FOR: CLOTHING, NAMELY, HATS, CAPS, T-SHIRTS, LONG SLEEVE T-SHIRTS, GOLF SHIRTS AND GOLF WIND RESISTANT PULLOVERS, IN CLASS 25 (U.S. CLS. 22 AND 39).

FIRST USE 0-0-1989; IN COMMERCE 0-0-1989.

FOR: PROVIDING GASOLINE STATION SERVICES, NAMELY, RETAIL STORE SERVICES FEATURING CONVENIENCE STORE ITEMS AND GASOLINE, IN CLASS 35 (U.S. CLS. 100, 101 AND 102).

FIRST USE 11-1-1982; IN COMMERCE 1-5-1983.

FOR: FAST FOOD RESTAURANTS AND CARRY-OUT RESTAURANTS, IN CLASS 43 (U.S. CLS. 100 AND 101).

FIRST USE 11-1-1982; IN COMMERCE 9-5-1983.

THE MARK CONSISTS OF STANDARD CHARACTERS WITHOUT CLAIM TO ANY PARTICULAR FONT, STYLE, SIZE, OR COLOR.

THE NAME GRAMPY'S DOES NOT IDENTIFY A LIVING INDIVIDUAL.

SER. NO. 77-088,330, FILED 1-22-2007.

JAY BESCH, EXAMINING ATTORNEY

Int. Cls.: 25, 35 and 43

Prior U.S. Cls.: 22, 39, 100, 101 and 102

United States Patent and Trademark Office

Reg. No. 3,397,279

Registered Mar. 18, 2008

**TRADEMARK
SERVICE MARK
PRINCIPAL REGISTER**

GRAMPY'S

CALLAHAN REALTY COMPANY (DELAWARE
CORPORATION)
261 LEDYARD STREET
NEW LONDON, CT 06320

FOR: CLOTHING, NAMELY, HATS, CAPS, T-SHIRTS, LONG SLEEVE T-SHIRTS, GOLF SHIRTS AND GOLF WIND RESISTANT PULLOVERS, IN CLASS 25 (U.S. CLS. 22 AND 39).

FIRST USE 0-0-1989; IN COMMERCE 0-0-1989.

FOR: PROVIDING GASOLINE STATION SERVICES, NAMELY, RETAIL STORE SERVICES FEATURING CONVENIENCE STORE ITEMS AND GASOLINE, IN CLASS 35 (U.S. CLS. 100, 101 AND 102).

FIRST USE 11-1-1982; IN COMMERCE 1-5-1983.

FOR: FAST FOOD RESTAURANTS AND CARRY-OUT RESTAURANTS, IN CLASS 43 (U.S. CLS. 100 AND 101).

FIRST USE 11-1-1982; IN COMMERCE 9-5-1983.

THE NAME GRAMPY'S DOES NOT IDENTIFY A LIVING INDIVIDUAL.

SER. NO. 77-088,340, FILED 1-22-2007.

JAY BESCH, EXAMINING ATTORNEY

Int. Cls.: 35, 41 and 42

Prior U.S. Cls.: 100, 101, 102 and 107

United States Patent and Trademark Office

Reg. No. 3,397,280

Registered Mar. 18, 2008

**SERVICE MARK
PRINCIPAL REGISTER**

take a hit. pass it on.

INDIE911, LLC (CALIFORNIA LTD LIAB CO)
SUITE 201
8949 SUNSET BLVD
WEST HOLLYWOOD, CA 90069

FOR: ON-LINE RETAIL STORE SERVICES FEATURING DIGITAL AUDIO AND AUDIOVISUAL RECORDINGS, MULTIMEDIA FILES, IMAGE FILES AND TEXT FILES , IN CLASS 35 (U.S. CLS. 100, 101 AND 102).

FIRST USE 12-1-2006; IN COMMERCE 12-1-2006.

FOR: PROVIDING A WEBSITE OVER A GLOBAL COMPUTER NETWORK FEATURING MUSIC AND ENTERTAINMENT INFORMATION; PROVIDING ONLINE ENTERTAINMENT NAMELY, A WEBSITE FEATURING DIGITAL AUDIO AND AUDIOVISUAL RECORDINGS, MULTIMEDIA FILES, IMAGE FILES AND TEXT FILES, FOR USE ON COMPUTERS, MOBILE PHONES AND PORTABLE MEDIA PLAYERS, IN CLASS 41 (U.S. CLS. 100, 101 AND 107).

FIRST USE 12-1-2006; IN COMMERCE 12-1-2006.

FOR: PROVIDING ON-LINE NON-DOWNLOADABLE SOFTWARE FOR DOWNLOADING,

STREAMING, VIEWING, SHARING, SELLING, PURCHASING, ORGANIZING, PLAYING AND CREATING PLAYLISTS OF DIGITAL AUDIO AND AUDIOVISUAL RECORDINGS, MULTIMEDIA FILES, IMAGE FILES, TEXT FILES, FOR USE ON COMPUTERS, MOBILE PHONES AND PORTABLE MEDIA PLAYERS; PROVIDING A WEBSITE FEATURING TEMPORARY USE OF NON-DOWNLOADABLE SOFTWARE FOR DOWNLOADING, STREAMING, VIEWING, SHARING, SELLING, PURCHASING, ORGANIZING, PLAYING AND CREATING PLAYLISTS OF DIGITAL AUDIO AND AUDIOVISUAL RECORDINGS, MULTIMEDIA FILES, IMAGE FILES, TEXT FILES, FOR USE ON COMPUTERS, MOBILE PHONES AND PORTABLE MEDIA PLAYERS, IN CLASS 42 (U.S. CLS. 100 AND 101).

FIRST USE 12-1-2006; IN COMMERCE 12-1-2006.

THE MARK CONSISTS OF STANDARD CHARACTERS WITHOUT CLAIM TO ANY PARTICULAR FONT, STYLE, SIZE, OR COLOR.

SER. NO. 77-088,476, FILED 1-22-2007.

EDWARD NELSON, EXAMINING ATTORNEY

Int. Cl.: 28

Prior U.S. Cls.: 22, 23, 38 and 50

United States Patent and Trademark Office

Reg. No. 3,397,281

Registered Mar. 18, 2008

**TRADEMARK
PRINCIPAL REGISTER**

ALPHA MIXER

TECHNO SOURCE (HONG KONG CORPORATION)
SILVERCORD BLDG
30 CANTON RD, 4TH FLOOR, TOWER II,
KOWLOON, HONG KONG

FOR: WORD GAME SOFTWARE SOLD AS AN
INTEGRAL COMPONENT OF HAND HELD UNITS
FOR PLAYING ELECTRONIC GAMES, IN CLASS 28
(U.S. CLS. 22, 23, 38 AND 50).

FIRST USE 12-22-2006; IN COMMERCE 4-3-2007.

THE MARK CONSISTS OF STANDARD CHARACTERS WITHOUT CLAIM TO ANY PARTICULAR FONT, STYLE, SIZE, OR COLOR.

SER. NO. 77-088,717, FILED 1-23-2007.

KATHERINE STOIDES, EXAMINING ATTORNEY

Int. Cl.: 41

Prior U.S. Cls.: 100, 101 and 107

United States Patent and Trademark Office

Reg. No. 3,397,282

Registered Mar. 18, 2008

**SERVICE MARK
PRINCIPAL REGISTER**

**YALE-NEW HAVEN TEACHERS
INSTITUTE**

YALE UNIVERSITY (CONNECTICUT NON-
PROFIT CORPORATION)
105 WALL STREET
NEW HAVEN, CT 06520

FOR: EDUCATIONAL SERVICES, NAMELY,
PROVIDING SEMINARS, TALKS AND WORK-
SHOPS FOR PUBLIC SCHOOL TEACHERS TO HELP
INCREASE THEIR PREPARATION IN SUBJECT
AREAS THEY TEACH, AND TO HELP DEVELOP
CURRICULUM UNITS TO TEACH WHAT THEY
HAVE LEARNED TO THEIR OWN PUBLIC
SCHOOL STUDENTS; PUBLICATION OF CURRI-
CULUM JOURNALS, BOOKS, ARTICLES, REPORTS
AND NEWSLETTERS; EDUCATIONAL CONSULT-
ING SERVICES, NAMELY, PROVIDING EDUCA-
TIONAL ADVICE AND ASSISTANCE TO
UNIVERSITY AND GRADE SCHOOL TEACHERS
AND TO COMMUNITY OFFICIALS, IN CLASS 41
(U.S. CLS. 100, 101 AND 107).

FIRST USE 0-0-1978; IN COMMERCE 0-0-1978.

THE MARK CONSISTS OF STANDARD CHAR-
ACTERS WITHOUT CLAIM TO ANY PARTICULAR
FONT, STYLE, SIZE, OR COLOR.

OWNER OF U.S. REG. NOS. 1,391,543, 2,271,288
AND OTHERS.

NO CLAIM IS MADE TO THE EXCLUSIVE
RIGHT TO USE "TEACHERS INSTITUTE", APART
FROM THE MARK AS SHOWN.

SEC. 2(F) AS TO "NEW HAVEN TEACHERS
INSTITUTE".

SER. NO. 77-088,969, FILED 1-23-2007.

BRENDAN MCCAULEY, EXAMINING ATTORNEY

Int. Cl.: 9

Prior U.S. Cls.: 21, 23, 26, 36 and 38

Reg. No. 3,397,283

United States Patent and Trademark Office

Registered Mar. 18, 2008

**TRADEMARK
PRINCIPAL REGISTER**

EVERFINE

EVERFINE PHOTO-E-INFO CO., LTD. (CHINA CORPORATION)
NO. 669 BINKANG ROAD
BINJIANG HI-TECH ZONE
HANGZHOU, CHINA

FOR: COMPUTER SOFTWARE FOR OPTICAL INSTRUMENTS USED FOR ANALYZING AND MANAGING DATA; INTELLIGENT MULTIMETERS; OPTICAL STANDARD LAMPS, NAMELY LIGHT SOURCES USED IN OPTICAL METROLOGY INSPECTION; INTEGRATING SPHERES, NAMELY, LIGHT COLLECTORS USED FOR LUMINANCE AND RADIANCE STANDARDS, LAMP MEASUREMENT, REFLECTANCE AND TRANSMITTANCE MEASUREMENT, LASER AND LED MEASUREMENTS AND UNIFORM CALIBRATION LIGHT SOURCE; OPTICAL DETECTORS, NAMELY, SEN-

SORS OF PHOTOMETERS, COLORIMETERS, RADIOMETERS AND ARRAY DETECTORS; LUMINANCE METERS; SPECTROSCOPES, IN CLASS 9 (U.S. CLS. 21, 23, 26, 36 AND 38).

FIRST USE 12-31-1998; IN COMMERCE 12-31-1999.

THE MARK CONSISTS OF STANDARD CHARACTERS WITHOUT CLAIM TO ANY PARTICULAR FONT, STYLE, SIZE, OR COLOR.

OWNER OF CHINA REG. NO. 3309660, DATED 10-28-2003, EXPIRES 10-27-2013.

SER. NO. 77-089,027, FILED 1-23-2007.

JAMES A. RAUEN, EXAMINING ATTORNEY

Int. Cl.: 28

Prior U.S. Cls.: 22, 23, 38 and 50

United States Patent and Trademark Office

Reg. No. 3,397,284

Registered Mar. 18, 2008

**TRADEMARK
PRINCIPAL REGISTER**

TEXT TUMBLER

TECHNO SOURCE (HONG KONG CORPORATION)
4TH FLOOR
30 CANTON RD, TOWER II, SILVERCORD BLDG
KOWLOON, HONG KONG

FOR: WORD GAME SOFTWARE SOLD AS AN
INTEGRAL COMPONENT OF HAND HELD UNITS
FOR PLAYING ELECTRONIC GAMES, IN CLASS 28
(U.S. CLS. 22, 23, 38 AND 50).

FIRST USE 12-22-2006; IN COMMERCE 4-3-2007.

THE MARK CONSISTS OF STANDARD CHARACTERS WITHOUT CLAIM TO ANY PARTICULAR FONT, STYLE, SIZE, OR COLOR.

SER. NO. 77-089,105, FILED 1-23-2007.

KATHERINE STOIDES, EXAMINING ATTORNEY

Int. Cl.: 41

Prior U.S. Cls.: 100, 101 and 107

United States Patent and Trademark Office

Reg. No. 3,397,285

Registered Mar. 18, 2008

**SERVICE MARK
PRINCIPAL REGISTER**



AMERICAN INSTITUTE OF AERONAUTICS
AND ASTRONAUTICS, INC. (NEW YORK
CORPORATION)
SUITE 500
1801 ALEXANDER BELL DRIVE
RESTON, VA 201914344

FOR: ARRANGING AND CONDUCTING EDU-
CATIONAL COMPETITIONS IN THE FIELDS OF
AVIATION, AERONAUTICS AND ASTRONAUTICS
, IN CLASS 41 (U.S. CLS. 100, 101 AND 107).

FIRST USE 1-17-2007; IN COMMERCE 1-17-2007.

OWNER OF U.S. REG. NOS. 1,856,025 AND
2,902,851.

SEC. 2(F) AS TO "DESIGN BUILD FLY".

SER. NO. 77-089,736, FILED 1-24-2007.

KIMBERLY FRYE, EXAMINING ATTORNEY

Int. Cl.: 33

Prior U.S. Cls.: 47 and 49

United States Patent and Trademark Office

Reg. No. 3,397,286

Registered Mar. 18, 2008

TRADEMARK
PRINCIPAL REGISTER



DIAGEO NORTH AMERICA, INC. (CONNECTI-
CUT CORPORATION)
801 MAIN AVENUE
NORWALK, CT 06851

FOR: ALCOHOLIC BEVERAGES, NAMELY, PRE-
PARED COCKTAILS, IN CLASS 33 (U.S. CLS. 47 AND
49).

FIRST USE 4-30-2007; IN COMMERCE 4-30-2007.

OWNER OF U.S. REG. NOS. 2,873,498, 3,178,155
AND OTHERS.

NO CLAIM IS MADE TO THE EXCLUSIVE
RIGHT TO USE "WORLD CLASS COCKTAILS",
APART FROM THE MARK AS SHOWN.

THE MARK CONSISTS OF A DESIGN OF TWO
EAGLES WEARING CROWNS AT THE TOP OF A
COCKTAIL GLASS, SURROUNDED BY CONCEN-
TRIC CIRCLES AND THE WORDS WORLD CLASS
COCKTAILS.

SER. NO. 77-089,868, FILED 1-24-2007.

DAVID ELTON, EXAMINING ATTORNEY

Int. Cl.: 25

Prior U.S. Cls.: 22 and 39

United States Patent and Trademark Office

Reg. No. 3,397,287

Registered Mar. 18, 2008

**TRADEMARK
PRINCIPAL REGISTER**

RABIA YALCIN

YALCIN, RABIA (TURKEY INDIVIDUAL)
415 NORTH LASALLE
SUITE 504
CHICAGO, IL 60610

FOR: DRESSES, IN CLASS 25 (U.S. CLS. 22 AND 39).

FIRST USE 0-0-2005; IN COMMERCE 0-0-2006.

THE MARK CONSISTS OF STANDARD CHARACTERS WITHOUT CLAIM TO ANY PARTICULAR FONT, STYLE, SIZE, OR COLOR.

"THE NAME(S), PORTRAIT(S), AND/OR SIGNATURE(S) SHOWN IN THE MARK IDENTIFIES RABIA YALCIN, WHOSE CONSENT(S) TO REGISTER IS SUBMITTED."

SER. NO. 77-090,991, FILED 1-25-2007.

LAURA KOVALSKY, EXAMINING ATTORNEY

Int. Cl.: 35

Prior U.S. Cls.: 100, 101 and 102

United States Patent and Trademark Office

Reg. No. 3,397,288

Registered Mar. 18, 2008

SERVICE MARK
PRINCIPAL REGISTER



TURNER EVENTS AND MARKETING, LLC (NEBRASKA LTD LIAB CO)
SUITE 110
15864 LARIMORE PLAZA
OMAHA, NE 68116

FOR: ARRANGING AND CONDUCTING MARKETING PROMOTIONAL EVENTS FOR OTHERS, IN CLASS 35 (U.S. CLS. 100, 101 AND 102).

FIRST USE 11-2-2005; IN COMMERCE 11-2-2005.

NO CLAIM IS MADE TO THE EXCLUSIVE RIGHT TO USE "EVENTS MARKETING", APART FROM THE MARK AS SHOWN.

THE COLOR(S) BLACK, BLUE, TAN, DARK MAUVE AND LIGHT MAUVE IS/ARE CLAIMED AS A FEATURE OF THE MARK.

THE MARK CONSISTS OF THE COLOR BLACK IN ALL WORDING, AS WELL AS THE BOX BETWEEN THE WORDS EVENTS AND MARKETING; THE COLOR BLUE APPEARS IN THE FIRST BOX ON THE LEFT; THE COLOR TAN APPEARS IN THE SECOND BOX FROM THE LEFT; THE COLOR DARK MAUVE APPEARS IN THE THIRD BOX FROM THE LEFT; THE COLOR LIGHT MAUVE APPEARS IN THE BOX ON THE RIGHT.

SER. NO. 77-091,208, FILED 1-25-2007.

STEPHEN AQUILA, EXAMINING ATTORNEY

Int. Cl.: 16

Prior U.S. Cls.: 2, 5, 22, 23, 29, 37, 38 and 50

Reg. No. 3,397,289

United States Patent and Trademark Office

Registered Mar. 18, 2008

**TRADEMARK
PRINCIPAL REGISTER**

**HELPING KIDS GET SMART
ABOUT MONEY**

MONEY SAVVY GENERATION, LLC (ILLINOIS
LTD LIAB CO)
SUITE 1700
910 SHERWOOD DRIVE
LAKE BLUFF, IL 60044

FIRST USE 3-1-2005; IN COMMERCE 3-1-2005.

THE MARK CONSISTS OF STANDARD CHAR-
ACTERS WITHOUT CLAIM TO ANY PARTICULAR
FONT, STYLE, SIZE, OR COLOR.

FOR: PRINTED EDUCATIONAL TEACHING MA-
TERIALS, NAMELY, BOOKS AND HANDBOOKS IN
THE FIELD OF TEACHING FINANCIAL LITERA-
CY TO CHILDREN AND YOUNG ADULTS, IN
CLASS 16 (U.S. CLS. 2, 5, 22, 23, 29, 37, 38 AND 50).

SER. NO. 77-091,299, FILED 1-25-2007.

JANICE L. MCMORROW, EXAMINING ATTOR-
NEY

Int. Cls.: 36 and 41

Prior U.S. Cls.: 100, 101, 102 and 107

United States Patent and Trademark Office

Reg. No. 3,397,290

Registered Mar. 18, 2008

**SERVICE MARK
PRINCIPAL REGISTER**



100 HOMES INC

100 HOMES, INC. (CALIFORNIA CORPORATION)
2275 HUNTINGTON DRIVE, #830
SAN MARINO, CA 91108

FOR: FINANCIAL SERVICES, NAMELY, PROVIDING FINANCIAL CONSULTATION TO LOW INCOME FAMILIES IN POOR NEIGHBORHOODS, ENABLING THEM TO MANAGE FINANCIAL GOALS, SO THAT THEY MAY MOVE INTO BETTER HOUSING, IN CLASS 36 (U.S. CLS. 100, 101 AND 102).

FIRST USE 4-5-2003; IN COMMERCE 4-5-2003.

FOR: EDUCATIONAL SERVICES, NAMELY, PROVIDING INSTRUCTION IN THE FIELD OF DEVELOPING POSITIVE FAMILY VALUES AND

IMPROVING PERSONAL WORK HABITS, PROVIDING LESSONS IN GOOD HEALTH AND NUTRITION, PROVIDING TUTORING TO ADULTS AND TO STUDENTS AT GRADE AND HIGH SCHOOL LEVELS INCLUDING READING, ESL AND COMPUTER SKILLS, IN CLASS 41 (U.S. CLS. 100, 101 AND 107).

FIRST USE 4-5-2003; IN COMMERCE 4-5-2003.

NO CLAIM IS MADE TO THE EXCLUSIVE RIGHT TO USE "INC.", APART FROM THE MARK AS SHOWN.

SER. NO. 77-091,568, FILED 1-25-2007.

PAUL F. GAST, EXAMINING ATTORNEY

Int. Cls.: 1, 2, 4 and 17

**Prior U.S. Cls.: 1, 5, 6, 10, 11, 12, 13, 15, 16, 26, 35, 46
and 50**

Reg. No. 3,397,291

United States Patent and Trademark Office

Registered Mar. 18, 2008

**TRADEMARK
PRINCIPAL REGISTER**

BIOBLEND

MOTOR OIL, INC. (ILLINOIS CORPORATION)
1490 JARVIS AVENUE
ELK GROVE VILLAGE, IL 60007

FOR: HYDRAULIC FLUIDS, IN CLASS 1 (U.S. CLS. 1, 5, 6, 10, 26 AND 46).

FIRST USE 4-6-2001; IN COMMERCE 4-6-2001.

FOR: RUST, OXIDATION AND CORROSION PREVENTING COATINGS, NAMELY, GENERAL PURPOSE FOOD GRADE WIPE DOWN OILS FOR PROTECTING PROCESSING AND PACKAGING EQUIPMENT, IN CLASS 2 (U.S. CLS. 6, 11 AND 16).

FIRST USE 4-6-2001; IN COMMERCE 4-6-2001.

FOR: ALL PURPOSE LUBRICANTS, NAMELY, LUBRICANTS FOR GEARS, WIRE ROPES, CHAINS, CABLES, TRACKS, TROLLEYS, CONVEYORS, SAWS, DRILLS, MACHINES, ENGINES, COMPRESSORS, INDUSTRIAL MACHINERY, MARINE MACHINERY, FOOD INDUSTRY MACHINERY AND EQUIPMENT, FREEZERS, AND TRANSFORMER AND ELECTRICAL SWITCHGEARS; LUBRICATING OILS, NAMELY, LUBRICATING OILS FOR GEARS, WIRE ROPES, CHAINS, CABLES, TRACKS, TROLLEYS, CONVEYORS, SAWS, DRILLS, MACHINES, ENGINES, COMPRESSORS, INDUSTRIAL MACHINERY, MARINE MACHINERY, FOOD INDUSTRY MACHINERY AND EQUIPMENT, FREE-

ZERS, AND TRANSFORMER AND ELECTRICAL SWITCHGEARS; LUBRICATING, INDUSTRIAL, AND GENERAL PURPOSE GREASES FOR GEARS, WIRE ROPES, CHAINS, CABLES, TRACKS, TROLLEYS, CONVEYORS, SAWS, DRILLS, MACHINES, ENGINES, COMPRESSORS, INDUSTRIAL MACHINERY, MARINE MACHINERY, FOOD INDUSTRY MACHINERY AND EQUIPMENT, FREEZERS, AND TRANSFORMER AND ELECTRICAL SWITCHGEARS; HYDRAULIC OILS; PNEUMATIC TOOL LUBRICATING OILS; ALL PURPOSE SILICONE SPRAY LUBRICANTS, NOT FOR USE AS A PERSONAL LUBRICANT, IN CLASS 4 (U.S. CLS. 1, 6 AND 15).

FIRST USE 4-6-2001; IN COMMERCE 4-6-2001.

FOR: PIPE THREAD AND PIPE JOINT COMPOUNDS, IN CLASS 17 (U.S. CLS. 1, 5, 12, 13, 35 AND 50).

FIRST USE 4-6-2001; IN COMMERCE 4-6-2001.

THE MARK CONSISTS OF STANDARD CHARACTERS WITHOUT CLAIM TO ANY PARTICULAR FONT, STYLE, SIZE, OR COLOR.

SER. NO. 77-091,871, FILED 1-26-2007.

JAY BESCH, EXAMINING ATTORNEY

Int. Cl.: 41

Prior U.S. Cls.: 100, 101 and 107

United States Patent and Trademark Office

Reg. No. 3,397,292

Registered Mar. 18, 2008

**SERVICE MARK
PRINCIPAL REGISTER**

T-trax Productions

J7 RECORDS, INC. (LOUISIANA CORPORATION)
9947 EAST GRONER AVENUE
BATON ROUGE, LA 70809

FOR: COMPOSITION OF MUSIC FOR OTHERS; ENTERTAINMENT IN THE NATURE OF THEATER PRODUCTIONS; ENTERTAINMENT IN THE NATURE OF VISUAL AND AUDIO PERFORMANCES, AND MUSICAL, VARIETY, NEWS AND COMEDY SHOWS; ENTERTAINMENT NAMELY, LIVE PERFORMANCES BY A MUSICAL BAND; ENTERTAINMENT SERVICES, NAMELY, PROVIDING A WEB SITE FEATURING MUSICAL PERFORMANCES, MUSICAL VIDEOS, RELATED FILM CLIPS, PHOTOGRAPHS, AND OTHER MULTIMEDIA MATERIALS; ENTERTAINMENT SERVICES, NAMELY, PROVIDING PRERECORDED MUSIC, INFORMATION IN THE FIELD OF MUSIC, AND COMMENTARY AND ARTICLES ABOUT MUSIC, ALL ONLINE VIA A GLOBAL COMPUTER NETWORK; ENTERTAINMENT, NAMELY, LIVE MUSIC CONCERTS; ENTERTAINMENT, NAMELY, LIVE PERFORMANCES BY MUSICAL BANDS; MOBILE MEDIA AND ENTERTAINMENT SERVICES IN THE NATURE OF CONTENT PREPARATION, POST-PRODUCTION; MOTION PICTURE FILM

PRODUCTION; MOTION PICTURE SONG PRODUCTION; MUSIC COMPOSITION FOR OTHERS; MUSIC PRODUCTION SERVICES; MUSIC PUBLISHING SERVICES; PRESENTATION OF MUSICAL PERFORMANCE; PRODUCTION OF SOUND AND MUSIC VIDEO RECORDINGS; PRODUCTION OF VIDEO AND CREATION OF VISUAL EFFECTS FOR OTHERS FOR USE IN DVDS, TELEVISION PROGRAMS AND ON WEBSITES; RECORD MASTER PRODUCTION; RECORD PRODUCTION, IN CLASS 41 (U.S. CLS. 100, 101 AND 107).

FIRST USE 5-14-2003; IN COMMERCE 5-14-2003.

THE MARK CONSISTS OF STANDARD CHARACTERS WITHOUT CLAIM TO ANY PARTICULAR FONT, STYLE, SIZE, OR COLOR.

NO CLAIM IS MADE TO THE EXCLUSIVE RIGHT TO USE "PRODUCTIONS", APART FROM THE MARK AS SHOWN.

SER. NO. 77-093,110, FILED 1-29-2007.

AISHA CLARKE, EXAMINING ATTORNEY

Int. Cls.: 11 and 19

Prior U.S. Cls.: 1, 12, 13, 21, 23, 31, 33, 34 and 50

United States Patent and Trademark Office

Reg. No. 3,397,293

Registered Mar. 18, 2008

**TRADEMARK
PRINCIPAL REGISTER**



HYDROPOOL
self-cleaning hot tubs

HYDROPOOL INDUSTRIES INC. (CANADA
CORPORATION)
40 KING STREET WEST
SUITE 2700
TORONTO, ONTARIO M5H 3Y2

FOR: GAZEBOS NOT PRIMARILY OF METAL, IN
CLASS 19 (U.S. CLS. 1, 12, 33 AND 50).

FIRST USE 7-1-2005; IN COMMERCE 7-1-2005.

FOR: HOT TUBS, SPAS IN THE NATURE OF
HEATED POOLS, WHIRLPOOL BATHS, SPAS IN
THE NATURE OF HEATED POOLS THAT ALLOWS
THE SWIMMER TO SWIM IN PLACE AGAINST AN
ADJUSTABLE CURRENT, SAUNAS; SWIMMING
POOL WATER CLEANING AND FILTERING
UNITS, IN CLASS 11 (U.S. CLS. 13, 21, 23, 31 AND 34).

NO CLAIM IS MADE TO THE EXCLUSIVE
RIGHT TO USE "SELF-CLEANING HOT TUBS",
APART FROM THE MARK AS SHOWN.

SER. NO. 77-094,143, FILED 1-30-2007.

FIRST USE 7-1-2005; IN COMMERCE 7-1-2005.

DAVID HOFFMAN, EXAMINING ATTORNEY

Int. Cls.: 7 and 11

Prior U.S. Cls.: 13, 19, 21, 23, 31, 34 and 35

United States Patent and Trademark Office

Reg. No. 3,397,294

Registered Mar. 18, 2008

**TRADEMARK
PRINCIPAL REGISTER**

CANYON CAPACITY

SEARS BRANDS, LLC (ILLINOIS LTD LIAB CO)
3333 BEVERLY ROAD
HOFFMAN ESTATES, IL 60179

FIRST USE 2-0-2006; IN COMMERCE 2-0-2006.

FOR: WASH DRUM, AS A COMPONENT FEATURE ON CLOTHES WASHING MACHINES, IN CLASS 7 (U.S. CLS. 13, 19, 21, 23, 31, 34 AND 35).

THE MARK CONSISTS OF STANDARD CHARACTERS WITHOUT CLAIM TO ANY PARTICULAR FONT, STYLE, SIZE, OR COLOR.

FIRST USE 2-0-2006; IN COMMERCE 2-0-2006.

SER. NO. 77-094,295, FILED 1-30-2007.

FOR: DRYER DRUM, AS A COMPONENT FEATURE ON CLOTHES DRYERS, IN CLASS 11 (U.S. CLS. 13, 21, 23, 31 AND 34).

AMY HELLA, EXAMINING ATTORNEY

Int. Cl.: 36

Prior U.S. Cls.: 100, 101 and 102

United States Patent and Trademark Office

Reg. No. 3,397,295

Registered Mar. 18, 2008

**SERVICE MARK
PRINCIPAL REGISTER**

Americap Financial, Inc.

AMERICAP FINANCIAL, INC. (NEW JERSEY CORPORATION)
614 HADDONFIELD ROAD
CHERRY HILL, NJ 08002

FOR: MORTGAGE BANKING; MORTGAGE BANKING SERVICES, NAMELY, ORIGINATION, ACQUISITION, SERVICING, SECURITIZATION AND BROKERAGE OF MORTGAGE LOANS; MORTGAGE BROKERAGE; MORTGAGE LENDING; MORTGAGE PROCUREMENT FOR OTHERS, IN CLASS 36 (U.S. CLS. 100, 101 AND 102).

FIRST USE 7-7-1998; IN COMMERCE 7-7-1998.

THE MARK CONSISTS OF STANDARD CHARACTERS WITHOUT CLAIM TO ANY PARTICULAR FONT, STYLE, SIZE, OR COLOR.

NO CLAIM IS MADE TO THE EXCLUSIVE RIGHT TO USE "FINANCIAL, INC.", APART FROM THE MARK AS SHOWN.

SER. NO. 77-094,635, FILED 1-30-2007.

LEE-ANNE BERNS, EXAMINING ATTORNEY

Int. Cl.: 25

Prior U.S. Cls.: 22 and 39

United States Patent and Trademark Office

Reg. No. 3,397,296

Registered Mar. 18, 2008

**TRADEMARK
PRINCIPAL REGISTER**



THE BOARD OF REGENTS OF THE UNIVERSITY OF TEXAS SYSTEM (TEXAS STATE AGENCY)
201 WEST 7TH STREET
AUSTIN, TX 78701

FIRST USE 8-0-2004; IN COMMERCE 8-0-2004.

OWNER OF U.S. REG. NOS. 2,510,053 AND 2,549,679.

FOR: SHIRTS, JACKETS, WARM-UP SUITS, SWEAT SHIRTS, SWEAT PANTS, CAPS, BANDANAS, SHORTS, SCARVES, PONCHOS, RAINCOATS, TANK TOPS, SWEAT BANDS, CLOTH BABY BIBS, BABY PANTIES AND DRESSES, WRIST BANDS, BELTS, SOCKS, WIND SUITS, IN CLASS 25 (U.S. CLS. 22 AND 39).

THE MARK CONSISTS OF A PICK AX.

SER. NO. 77-094,659, FILED 1-30-2007.

RENEE SERVANCE, EXAMINING ATTORNEY

Int. Cl.: 39

Prior U.S. Cls.: 100 and 105

United States Patent and Trademark Office

Reg. No. 3,397,297

Registered Mar. 18, 2008

**SERVICE MARK
PRINCIPAL REGISTER**



DEVON GLENN (CALIFORNIA LTD LIAB CO)
13636 BURBANK BLVD.
SHERMAN OAKS, CA 91401

FOR: PACKING ARTICLES FOR TRANSPORTATION, IN CLASS 39 (U.S. CLS. 100 AND 105).

FIRST USE 9-1-2006; IN COMMERCE 9-1-2006.

NO CLAIM IS MADE TO THE EXCLUSIVE RIGHT TO USE BOXES, APART FROM THE MARK AS SHOWN.

THE COLOR(S) RED, BLACK IS/ARE CLAIMED AS A FEATURE OF THE MARK.

THE MARK CONSISTS OF STYLIZED LETTERS AND WORDS CONSISTING OF THE WORDS ROCKIN BOXES IN RED LOCATED INSIDE A BLACK RECTANGLE. THE WORD ROCKIN APPEARS ABOVE THE WORD BOXES. BOTH THE WORDS ROCKIN AND BOXES ARE AT AN ANGLE GOING UPWARDS FROM LEFT TO RIGHT. THERE IS A 5-POINTED STAR ABOVE THE I IN ROCKIN BOXES..

SER. NO. 77-095,031, FILED 1-30-2007.

INGA ERVIN, EXAMINING ATTORNEY

Int. Cl.: 43

Prior U.S. Cls.: 100 and 101

United States Patent and Trademark Office

Reg. No. 3,397,298

Registered Mar. 18, 2008

**SERVICE MARK
PRINCIPAL REGISTER**



BANNER MANAGEMENT INC. (TEXAS CORPORATION)
4950 KELLER SPRINGS RD. # 220
ADDISON, TX 75001

FOR: RESTAURANTS, IN CLASS 43 (U.S. CLS. 100 AND 101).

FIRST USE 7-11-1994; IN COMMERCE 7-18-1994.

OWNER OF U.S. REG. NO. 1,509,612.

NO CLAIM IS MADE TO THE EXCLUSIVE RIGHT TO USE "MEXICAN CAFE", APART FROM THE MARK AS SHOWN.

THE COLOR(S) RED IS/ARE CLAIMED AS A FEATURE OF THE MARK.

THE MARK CONSISTS OF THE COLOR RED IN CUCOS AND THE COLOR BLACK APPEARS IN THE OUTLINE OF THE WORDING CUCOS AND IN THE WORDING MEXICAN CAFE.

SER. NO. 77-095,287, FILED 1-31-2007.

GIANCARLO CASTRO, EXAMINING ATTORNEY

Int. Cl.: 2

Prior U.S. Cls.: 6, 11 and 16

United States Patent and Trademark Office

Reg. No. 3,397,299

Registered Mar. 18, 2008

**TRADEMARK
PRINCIPAL REGISTER**

Panasonic

MATSUSHITA ELECTRIC INDUSTRIAL CO.,
LTD. (JAPAN CORPORATION)
1006 OAZA KADOMA
KADOMA-SHI OSAKA, JAPAN 571-8501

FOR: TONER CARTRIDGES FOR PHOTO COPY-
ING MACHINES; TONER CARTRIDGES FOR FAC-
SIMILE MACHINES; TONER CARTRIDGES FOR
PRINTERS, IN CLASS 2 (U.S. CLS. 6, 11 AND 16).

FIRST USE 0-0-1955; IN COMMERCE 0-0-1961.

THE MARK CONSISTS OF STANDARD CHAR-
ACTERS WITHOUT CLAIM TO ANY PARTICULAR
FONT, STYLE, SIZE, OR COLOR.

OWNER OF U.S. REG. NOS. 1,859,056, 2,219,862,
AND 3,108,573.

SER. NO. 77-095,866, FILED 1-31-2007.

ANDREA HACK, EXAMINING ATTORNEY

Int. Cls.: 7, 9 and 11

Prior U.S. Cls.: 13, 19, 21, 23, 26, 31, 34, 35, 36 and 38

Reg. No. 3,397,300

United States Patent and Trademark Office

Registered Mar. 18, 2008

**TRADEMARK
PRINCIPAL REGISTER**

Panasonic

MATSUSHITA ELECTRIC INDUSTRIAL CO.,
LTD. (JAPAN CORPORATION)
1006 OAZA KADOMA
KADOMA-SHI OSAKA, JAPAN 571-8501

FOR: AUTOMATIC ASSEMBLY MACHINES FOR PLACING COMPONENTS ON SUBSTRATES, NAMELY, CHIP MOUNTING MACHINES, PLASMA WASHING MACHINES, ELECTRONIC COMPONENT PLACEMENT MACHINES, ELECTRONIC COMPONENT INSERTION MACHINES, SOLDERING PASTE PRINTING MACHINES, ADHESIVE DISPENSING MACHINES FOR ELECTRONIC COMPONENTS, LASER INSPECTION MACHINES FOR INDUSTRIAL PURPOSES, ELECTRONIC COMPONENT FEEDER MACHINES, DIE BONDING MACHINES, WIRE BONDING MACHINES, FLIP CHIP BONDING MACHINES, ASSEMBLY MACHINES FOR FLAT PANEL DISPLAYS, LASER PROCESSING MACHINES; CO2 LASER OSCILLATORS FOR SOLDERING, JOINTING AND PROCESSING; CHUCKS FOR ELECTRICALLY OPERATED NUT DRIVERS; BLADES FOR ELECTRIC SAWS; ELECTRIC SAWS FOR METAL, WOOD, AND A COMBINATION OF METAL AND WOOD; BAND SAWS; CIRCULAR SAWS; ELECTRIC MOTORS FOR MACHINES; REDUCTION GEARS FOR MACHINES; POWER-OPERATED LIFTING APPARATUS FOR MOVING AND PLACING LIGHTING FIXTURES, NAMELY, A SMALL DEVICE THAT IS MOUNTED OR INSTALLED ONTO A CEILING AND USED TO LOWER LIGHT FIXTURES FOR MAINTENANCE AND REPAIR, AND ATTACHED CONTROL PANELS SOLD AS A UNIT; ELECTRIC MEAT GRINDERS FOR HOUSEHOLD PURPOSES; ELECTRIC VACUUM CLEANERS; ELECTRIC STAPLERS; ELECTRIC ARC WELDING MACHINES; DRY ETCHING MACHINES; HAND-HELD ELECTRIC POWER TOOLS, NAMELY, SCREWDRIVERS,

DRILL DRIVERS, HAMMERS, ROTARY SAWS, WRENCHES, DRILLS, SEALING GUNS, RECIPROCATING SAWS; ACCESSORIES FOR HAND-HELD ELECTRIC POWER TOOLS, NAMELY, CHUCKS FOR POWER DRILLS; HEAD ATTACHMENTS FOR HAND-HELD ELECTRIC POWER TOOLS, NAMELY, HEADS FOR ENGAGING SCREWS AND BOLTS, IMPACT SOCKETS, WOOD DRILL BITS, AND METAL DRILL BITS; GAS WELDING MACHINES; ELECTRIC WELDING MACHINES, IN CLASS 7 (U.S. CLS. 13, 19, 21, 23, 31, 34 AND 35).

FIRST USE 0-0-1955; IN COMMERCE 0-0-1961.

FOR: CARRYING CASES FOR POWER TOOLS; ACCESSORIES FOR HAND-HELD ELECTRIC POWER TOOLS, NAMELY, BATTERIES AND BATTERY CHARGERS, IN CLASS 9 (U.S. CLS. 21, 23, 26, 36 AND 38).

FIRST USE 0-0-1955; IN COMMERCE 0-0-1961.

FOR: ELECTRIC ICE CREAM MAKING MACHINES; FLASHLIGHTS, IN CLASS 11 (U.S. CLS. 13, 21, 23, 31 AND 34).

FIRST USE 6-1-2003; IN COMMERCE 6-1-2003.

THE MARK CONSISTS OF STANDARD CHARACTERS WITHOUT CLAIM TO ANY PARTICULAR FONT, STYLE, SIZE, OR COLOR.

OWNER OF U.S. REG. NOS. 1,047,045, 2,219,862, AND 3,108,573.

SER. NO. 77-095,886, FILED 1-31-2007.

ANDREA HACK, EXAMINING ATTORNEY

Int. Cl.: 20

Prior U.S. Cls.: 2, 13, 22, 25, 32 and 50

United States Patent and Trademark Office

Reg. No. 3,397,301

Registered Mar. 18, 2008

**TRADEMARK
PRINCIPAL REGISTER**

Panasonic

MATSUSHITA ELECTRIC INDUSTRIAL CO.,
LTD. (JAPAN CORPORATION)
1006 OAZA KADOMA
KADOMA-SHI OSAKA, JAPAN 571-8501

FOR: TELEVISION RACKS; RACKS FOR AUDIO
VISUAL APPARATUS AND EQUIPMENT, IN CLASS
20 (U.S. CLS. 2, 13, 22, 25, 32 AND 50).

FIRST USE 0-0-1955; IN COMMERCE 0-0-1961.

THE MARK CONSISTS OF STANDARD CHAR-
ACTERS WITHOUT CLAIM TO ANY PARTICULAR
FONT, STYLE, SIZE, OR COLOR.

OWNER OF U.S. REG. NO. 3,154,660.

SER. NO. 77-096,135, FILED 1-31-2007.

ALEXANDER L. POWERS, EXAMINING ATTOR-
NEY

Int. Cl.: 21

Prior U.S. Cls.: 2, 13, 23, 29, 30, 33, 40 and 50

Reg. No. 3,397,302

United States Patent and Trademark Office

Registered Mar. 18, 2008

**TRADEMARK
PRINCIPAL REGISTER**

Panasonic

MATSUSHITA ELECTRIC INDUSTRIAL CO.,
LTD. (JAPAN CORPORATION)
1006 OAZA KADOMA
KADOMA-SHI OSAKA, JAPAN 571-8501

FOR: ELECTRIC TOOTHBRUSHES; REPLACEMENT BRUSHES FOR ELECTRIC TOOTHBRUSHES; WATER APPARATUS FOR CLEANING TEETH AND GUMS; ORAL IRRIGATORS OTHER THAN FOR USE IN DENTISTRY, IN CLASS 21 (U.S. CLS. 2, 13, 23, 29, 30, 33, 40 AND 50).

FIRST USE 0-0-1955; IN COMMERCE 0-0-1961.

THE MARK CONSISTS OF STANDARD CHARACTERS WITHOUT CLAIM TO ANY PARTICULAR FONT, STYLE, SIZE, OR COLOR.

OWNER OF U.S. REG. NOS. 2,219,862, 3,108,573, AND 3,233,843.

SER. NO. 77-096,138, FILED 1-31-2007.

ALEXANDER L. POWERS, EXAMINING ATTORNEY

Int. Cl.: 37

Prior U.S. Cls.: 100, 103 and 106

United States Patent and Trademark Office

Reg. No. 3,397,303

Registered Mar. 18, 2008

SERVICE MARK
PRINCIPAL REGISTER

Panasonic

MATSUSHITA ELECTRIC INDUSTRIAL CO.,
LTD. (JAPAN CORPORATION)
1006 OAZA KADOMA
KADOMA-SHI OSAKA, JAPAN 571-8501

FOR: REPAIR OF RADIO RECEIVERS AND TELEVISION RECEIVERS; REPAIR AND MAINTENANCE OF ELECTRICAL COMMUNICATION APPARATUS AND INSTRUMENTS; INSTALLATION OF ELECTRIC APPLIANCES; REPAIR OF RADIO RECEIVERS AND TELEVISION RECEIVERS; REPAIR AND MAINTENANCE OF ELECTRICAL COMMUNICATION APPARATUS AND INSTRUMENTS; REPAIR AND MAINTENANCE OF HOUSEHOLD ELECTRIC APPLIANCES; REPAIR AND MAINTENANCE OF ELECTRIC LIGHTING APPARATUS; REPAIR AND MAINTENANCE OF MEDICAL APPARATUS AND INSTRUMENTS; REPAIR AND MAINTENANCE OF COOKING APPARATUS FOR COMMERCIAL USE; REPAIR AND MAINTENANCE OF MUSICAL INSTRUMENTS; REPAIR OF TOILET STOOL UNITS WITH WASHING WATER SQUIRTERS; INSTALLATION, MAINTENANCE AND REPAIR OF COMPUTER HARDWARE; RE-

PAIR AND MAINTENANCE OF AIR-CONDITIONING APPARATUS; INSTALLATION, MAINTENANCE AND REPAIR OF OFFICE MACHINES AND EQUIPMENT; REPAIR AND MAINTENANCE OF COMPUTERS; REPAIR AND MAINTENANCE OF ELECTRONIC PRINTERS; TELEPHONE REPAIR; INSTALLATION AND REPAIR OF TELECOMMUNICATION EQUIPMENT, IN CLASS 37 (U.S. CLS. 100, 103 AND 106).

FIRST USE 0-0-1955; IN COMMERCE 0-0-1961.

THE MARK CONSISTS OF STANDARD CHARACTERS WITHOUT CLAIM TO ANY PARTICULAR FONT, STYLE, SIZE, OR COLOR.

OWNER OF U.S. REG. NOS. 1,859,056, 3,233,843 AND OTHERS.

SER. NO. 77-096,157, FILED 1-31-2007.

ALEXANDER L. POWERS, EXAMINING ATTORNEY

Int. Cl.: 44

Prior U.S. Cls.: 100 and 101

United States Patent and Trademark Office

Reg. No. 3,397,304

Registered Mar. 18, 2008

**SERVICE MARK
PRINCIPAL REGISTER**

PCM

GATEWAY HEALTH PLAN L.P. (PENNSYLVANIA LIMITED PARTNERSHIP)
U.S. STEEL TOWER, 40TH FLOOR
600 GRANT STREET
PITTSBURGH, PA 15219

THE MARK CONSISTS OF STANDARD CHARACTERS WITHOUT CLAIM TO ANY PARTICULAR FONT, STYLE, SIZE, OR COLOR.

FOR: PROVIDING MANAGED HEALTH CARE SERVICES FOR MEMBERS, IN CLASS 44 (U.S. CLS. 100 AND 101).

SER. NO. 77-096,487, FILED 2-1-2007.

FIRST USE 10-1-2001; IN COMMERCE 8-1-2002.

BARBARA GAYNOR, EXAMINING ATTORNEY

Int. Cl.: 20

Prior U.S. Cls.: 2, 13, 22, 25, 32 and 50

United States Patent and Trademark Office

Reg. No. 3,397,305

Registered Mar. 18, 2008

**TRADEMARK
PRINCIPAL REGISTER**

XPANDX

MANNA MARKETING & DEVELOPMENT
GROUP, INC. (TEXAS CORPORATION)
9140 PREMIER ROW ROAD
DALLAS, TX 75247

THE MARK CONSISTS OF STANDARD CHAR-
ACTERS WITHOUT CLAIM TO ANY PARTICULAR
FONT, STYLE, SIZE, OR COLOR.

FOR: TABLES USED AS SURFACES FOR CUT-
TING FABRICS IN THE GARMENT INDUSTRY, IN
CLASS 20 (U.S. CLS. 2, 13, 22, 25, 32 AND 50).

SER. NO. 77-096,491, FILED 2-1-2007.

FIRST USE 2-9-1972; IN COMMERCE 2-9-1972.

CARYN GLASSER, EXAMINING ATTORNEY

Int. Cl.: 41

Prior U.S. Cls.: 100, 101 and 107

United States Patent and Trademark Office

Reg. No. 3,397,306

Registered Mar. 18, 2008

**SERVICE MARK
PRINCIPAL REGISTER**

HARBOR ISLES

JELD-WEN, INC. (OREGON CORPORATION)
3250 LAKEPORT BOULEVARD
KLAMATH FALLS, OR 97601

FIRST USE 7-31-1982; IN COMMERCE 7-31-1982.

FOR: PROVIDING SERVICES IN THE NATURE
OF A TENNIS CLUB; PROVIDING SERVICES IN
THE NATURE OF A FITNESS CLUB, NAMELY,
PROVIDING INSTRUCTION AND EQUIPMENT IN
THE FIELD OF PHYSICAL EXERCISE, IN CLASS 41
(U.S. CLS. 100, 101 AND 107).

THE MARK CONSISTS OF STANDARD CHAR-
ACTERS WITHOUT CLAIM TO ANY PARTICULAR
FONT, STYLE, SIZE, OR COLOR.

SER. NO. 77-096,745, FILED 2-1-2007.

KEVIN CORWIN, EXAMINING ATTORNEY

Int. Cl.: 41

Prior U.S. Cls.: 100, 101 and 107

United States Patent and Trademark Office

Reg. No. 3,397,307

Registered Mar. 18, 2008

**SERVICE MARK
PRINCIPAL REGISTER**



JELD-WEN, INC. (OREGON CORPORATION)
3250 LAKEPORT BOULEVARD
KLAMATH FALLS, OR 97601

FOR: PROVIDING SERVICES IN THE NATURE OF A TENNIS CLUB; PROVIDING SERVICES IN THE NATURE OF A FITNESS CLUB, NAMELY, PROVIDING INSTRUCTION AND EQUIPMENT IN THE FIELD OF PHYSICAL EXERCISE, IN CLASS 41 (U.S. CLS. 100, 101 AND 107).

FIRST USE 7-31-2004; IN COMMERCE 7-31-2004.

NO CLAIM IS MADE TO THE EXCLUSIVE RIGHT TO USE "TENNIS & FITNESS CLUB", APART FROM THE MARK AS SHOWN.

THE MARK CONSISTS OF THE WORDS HARBOR ISLES TENNIS & FITNESS CLUB WITH A SEAGULL ABOVE THE MARK.

SER. NO. 77-096,753, FILED 2-1-2007.

KEVIN CORWIN, EXAMINING ATTORNEY

Int. Cl.: 25

Prior U.S. Cls.: 22 and 39

United States Patent and Trademark Office

Reg. No. 3,397,308

Registered Mar. 18, 2008

**TRADEMARK
PRINCIPAL REGISTER**

Skinsulates

DAVID & YOUNG CO (NEW YORK CORPORATION)
GROUND FL
28 WEST 27TH STREET
NEW YORK, NY 10001

THE MARK CONSISTS OF STANDARD CHARACTERS WITHOUT CLAIM TO ANY PARTICULAR FONT, STYLE, SIZE, OR COLOR.

FOR: GLOVES, IN CLASS 25 (U.S. CLS. 22 AND 39).

SER. NO. 77-096,854, FILED 2-1-2007.

FIRST USE 11-1-2006; IN COMMERCE 11-1-2006.

JOHN HWANG, EXAMINING ATTORNEY

Int. Cl.: 44

Prior U.S. Cls.: 100 and 101

United States Patent and Trademark Office

Reg. No. 3,397,309

Registered Mar. 18, 2008

SERVICE MARK
PRINCIPAL REGISTER



FIRST FORENSIC, INCORPORATED (ILLINOIS CORPORATION)
9797 DINWIDDIE CT
CENTERVILLE, OH 45458

FOR: MEDICAL SERVICES, NAMELY, AUTOPSY PATHOLOGY AND FORENSIC MEDICAL SERVICES, IN CLASS 44 (U.S. CLS. 100 AND 101).

FIRST USE 7-25-2002; IN COMMERCE 9-1-2004.

NO CLAIM IS MADE TO THE EXCLUSIVE RIGHT TO USE "FORENSIC", APART FROM THE MARK AS SHOWN.

THE MARK CONSISTS OF THE WORDS "FIRST FORENSIC" AND A DESIGN WHICH INCLUDES TWO SETS OF CONNECTED SQUARES IN THE PATTERN SHOWN ENCOMPASSED BY ARCS ON EITHER END.

SER. NO. 77-097,229, FILED 2-1-2007.

MARK T. MULLEN, EXAMINING ATTORNEY

Int. Cl.: 9

Prior U.S. Cls.: 21, 23, 26, 36 and 38

Reg. No. 3,397,310

United States Patent and Trademark Office

Registered Mar. 18, 2008

**TRADEMARK
PRINCIPAL REGISTER**

DB BLOCKER

CUSTOM PROTECT EAR INC. (CANADA CORPORATION)
SUITE 681
7789 134TH STREET
SURREY, B.C., CANADA V3W9E9

FOR: HEARING PROTECTORS, NAMELY, HEARING PROTECTION EARPIECES AND HEADSETS NOT FOR MEDICAL USE AND EAR PLUGS FOR SOUNDPROOFING , IN CLASS 9 (U.S. CLS. 21, 23, 26, 36 AND 38).

FIRST USE 4-1-1994; IN COMMERCE 4-1-1994.

THE MARK CONSISTS OF STANDARD CHARACTERS WITHOUT CLAIM TO ANY PARTICULAR FONT, STYLE, SIZE, OR COLOR.

NO CLAIM IS MADE TO THE EXCLUSIVE RIGHT TO USE "DB", APART FROM THE MARK AS SHOWN.

SER. NO. 77-097,299, FILED 2-1-2007.

INGRID C. EULIN, EXAMINING ATTORNEY

Int. Cl.: 30

Prior U.S. Cl.: 46

United States Patent and Trademark Office

Reg. No. 3,397,311

Registered Mar. 18, 2008

TRADEMARK
PRINCIPAL REGISTER



SCONEHENGE (CALIFORNIA CORPORATION)
2787 SHATTUCK AVENUE
BERKELEY, CA 94705

FOR: BAKERY DESSERTS; BAKERY GOODS; BAKERY PRODUCTS; BAKERY PRODUCTS, NAMELY SWEET BAKERY GOODS; BAKING POWDER; BAKING POWDERS; BAKING SODA; BAKING SPICES; BARLEY FLOUR; BREAD; BREAD AND BUNS; BREAD CRUMB; BREAD DOUGHS; BREAD MIXES; BREAD ROLLS; BREAD STICKS; BREAD WITH SOY BEAN; BRUSCHETTE-TOPPED BREAD; BUCKWHEAT FLOUR; CAKE MIXES; CONFECTIONERY CHIPS FOR BAKING; COOKIE MIXES; COOKIES; CORN FLOUR; CORN STARCH FLOUR; CREAM OF TARTAR FOR COOKING AND BAKING PURPOSES; DANISH PASTRIES; FLOUR; FLOUR FOR FOOD; FLOUR-BASED CHIPS; FOOD PACKAGE COMBINATIONS CONSISTING PRIMARILY OF BREAD, CRACKERS AND/OR COOKIES; FREEZABLE LIQUID FOR USE IN MAKING FROZEN CONFECTIONS; FRIED DOUGH COOKIES (KARINTOH); FROSTING MIXES; FROZEN

BREADS; FROZEN CONFECTIONS; FROZEN CUSTARDS; FROZEN PIE CRUSTS; ICING MIXES; INSTANT DOUGHNUT MIXES; INSTANT PANCAKE MIXES; INSTANT PUDDING MIXES; MIXES FOR BAKERY GOODS; MUFFIN MIXES; MUFFINS; PANCAKE MIXES; PASTRIES; PASTRY SHELLS FOR MONAKA; PITA BREAD; POTATO FLOUR; RICE FLOUR; ROLLS; SCONES; SNACK MIX CONSISTING PRIMARILY OF CRACKERS, PRETZELS, CANDIED NUTS AND/OR POPPED POPCORN; STUFFING MIXES CONTAINING BREAD; UNLEAVENED BREAD IN THIN SHEETS; WHEAT FLOUR; WHEAT STARCH FLOUR; WHOLEMEAL BREAD, IN CLASS 30 (U.S. CL. 46).

FIRST USE 3-1-1987; IN COMMERCE 3-1-1987.

THE MARK CONSISTS OF SCONEHENGE AND IMAGE OF STONEHENGE.

SER. NO. 77-097,372, FILED 2-1-2007.

JAMES LOVELACE, EXAMINING ATTORNEY

Int. Cls.: 35 and 42

Prior U.S. Cls.: 100, 101 and 102

United States Patent and Trademark Office

Reg. No. 3,397,312

Registered Mar. 18, 2008

**SERVICE MARK
PRINCIPAL REGISTER**

2cast

2CAST, INC. (CALIFORNIA CORPORATION)
7133 WOODED LAKE DR
SAN JOSE, CA 95120

FOR: ADVERTISING AND MARKETING, IN
CLASS 35 (U.S. CLS. 100, 101 AND 102).

FIRST USE 1-31-2007; IN COMMERCE 1-31-2007.

FOR: APPLICATION SERVICE PROVIDER,
NAMELY, PROVIDING, HOSTING, MANAGING,
DEVELOPING, AND MAINTAINING APPLICA-
TIONS, SOFTWARE, WEBSITES, AND DATABASES
IN THE FIELDS OF PERSONAL PRODUCTIVITY,
WIRELESS COMMUNICATION, MOBILE INFOR-

MATION ACCESS, AND REMOTE DATA MANAGE-
MENT FOR WIRELESS DELIVERY OF CONTENT
TO HANDHELD COMPUTERS, LAPTOPS AND MO-
BILE ELECTRONIC DEVICES, IN CLASS 42 (U.S.
CLS. 100 AND 101).

FIRST USE 1-31-2007; IN COMMERCE 1-31-2007.

THE MARK CONSISTS OF STANDARD CHAR-
ACTERS WITHOUT CLAIM TO ANY PARTICULAR
FONT, STYLE, SIZE, OR COLOR.

SER. NO. 77-097,421, FILED 2-1-2007.

AISHA CLARKE, EXAMINING ATTORNEY

Int. Cl.: 3

Prior U.S. Cls.: 1, 4, 6, 50, 51 and 52

United States Patent and Trademark Office

Reg. No. 3,397,313

Registered Mar. 18, 2008

**TRADEMARK
PRINCIPAL REGISTER**

CARBOREX

WASHINGTON MILLS COMPANY (DELAWARE
CORPORATION)
1000 EAST NIAGARA STREET
TONAWANDA, NY 14150

FOR: INDUSTRIAL ABRASIVES FOR USE IN
CERAMICS AND WIRE SAWING APPLICATIONS,
IN CLASS 3 (U.S. CLS. 1, 4, 6, 50, 51 AND 52).

FIRST USE 1-1-1996; IN COMMERCE 1-1-1996.

THE MARK CONSISTS OF STANDARD CHAR-
ACTERS WITHOUT CLAIM TO ANY PARTICULAR
FONT, STYLE, SIZE, OR COLOR.

THE MARK HAS NO SIGNIFICANCE IN THE
ABRASIVE TRADE OR INDUSTRY, NO GEOGRA-
PHICAL SIGNIFICANCE, AND NO MEANING IN A
FOREIGN LANGUAGE.

SER. NO. 77-097,598, FILED 2-2-2007.

ANDREA K. NADELMAN, EXAMINING ATTOR-
NEY

Int. Cl.: 37

Prior U.S. Cls.: 100, 103 and 106

United States Patent and Trademark Office

Reg. No. 3,397,314

Registered Mar. 18, 2008

**SERVICE MARK
PRINCIPAL REGISTER**

CapX

GIBRALTAR CONSTRUCTION CO. (NEBRASKA
CORPORATION)
10040 REGENCY CIRCLE, SUITE 200
OMAHA, NE 68114

THE MARK CONSISTS OF STANDARD CHAR-
ACTERS WITHOUT CLAIM TO ANY PARTICULAR
FONT, STYLE, SIZE, OR COLOR.

FOR: CONSTRUCTION, MAINTENANCE AND
RENOVATION OF PROPERTY, IN CLASS 37 (U.S.
CLS. 100, 103 AND 106).

SER. NO. 77-097,623, FILED 2-2-2007.

FIRST USE 6-15-2006; IN COMMERCE 6-15-2006.

JILL C. ALT, EXAMINING ATTORNEY

Int. Cl.: 43

Prior U.S. Cls.: 100 and 101

United States Patent and Trademark Office

Reg. No. 3,397,315

Registered Mar. 18, 2008

**SERVICE MARK
PRINCIPAL REGISTER**

CRAZY DUTCHMAN

CISCO'S, INC. (SOUTH CAROLINA CORPORATION)
1114 SAM RITTENBERG BOULEVARD
CHARLESTON, SC 29407

FOR: CATERING; CATERING FOR THE PROVISION OF FOOD AND BEVERAGES; CATERING OF FOOD AND DRINKS, IN CLASS 43 (U.S. CLS. 100 AND 101).

FIRST USE 4-6-2006; IN COMMERCE 4-6-2006.

THE MARK CONSISTS OF STANDARD CHARACTERS WITHOUT CLAIM TO ANY PARTICULAR FONT, STYLE, SIZE, OR COLOR.

SER. NO. 77-097,634, FILED 2-2-2007.

SEAN CROWLEY, EXAMINING ATTORNEY

Int. Cls.: 9, 16 and 42

**Prior U.S. Cls.: 2, 5, 21, 22, 23, 26, 29, 36, 37, 38, 50,
100 and 101**

Reg. No. 3,397,316

United States Patent and Trademark Office

Registered Mar. 18, 2008

**TRADEMARK
SERVICE MARK
PRINCIPAL REGISTER**

EyeTV

ELGATO SYSTEMS GMBH (FED REP GERMA-
NY CORPORATION)
NYMPHENBURGER STR. 14
MÜNCHEN, FED REP GERMANY 80335

FOR: (BASED ON USE IN COMMERCE) (BASED ON 44(D) PRIORITY APPLICATION) (BASED ON 44(E)) COMPUTER HARDWARE AND COMPUTER SOFTWARE FOR RECORDING, TRANSMISSION OR REPRODUCTION OF SOUND OR IMAGE, EXCLUDING ELECTRICAL, AUDIO, AND VIDEO SIGNAL TRANSMITTING CABLES AND CONNECTORS FOR CONNECTING A COMPUTER TO A TELEVISION TO WATCH MOVIES; COMPUTER-HARDWARE, COMPUTER-SOFTWARE, IN PARTICULAR FOR TELEVISION RECEPTION AND FOR RECORDING, DIGITIZING, EDITING AND REPRODUCING VIDEO AND SOUND RECORDINGS, IN CLASS 9 (U.S. CLS. 21, 23, 26, 36 AND 38).

FIRST USE 7-18-2002; IN COMMERCE 7-18-2002.

FOR: (BASED ON USE IN COMMERCE) (BASED ON 44(D) PRIORITY APPLICATION) (BASED ON 44(E)) PRINTED MATTER, IN PARTICULAR COMPUTER MAGAZINES AND WRITTEN MATERIAL ACCOMPANYING COMPUTER SOFTWARE, NAMELY, MANUALS, CATALOGUES, OPERAT-

ING INSTRUCTIONS AND WORK INSTRUCTIONS, IN CLASS 16 (U.S. CLS. 2, 5, 22, 23, 29, 37, 38 AND 50).

FIRST USE 7-18-2002; IN COMMERCE 7-18-2002.

FOR: (BASED ON 44(D) PRIORITY APPLICATION) (BASED ON 44(E)) DESIGN AND DEVELOPMENT OF COMPUTER-HARDWARE AND -SOFTWARE, IN PARTICULAR FOR TELEVISION RECEPTION AND FOR RECORDING, DIGITIZING, EDITING AND REPRODUCING VIDEO AND SOUND RECORDINGS, IN CLASS 42 (U.S. CLS. 100 AND 101).

THE MARK CONSISTS OF STANDARD CHARACTERS WITHOUT CLAIM TO ANY PARTICULAR FONT, STYLE, SIZE, OR COLOR.

PRIORITY CLAIMED UNDER SEC. 44(D) ON FED REP GERMANY APPLICATION NO. 30676908.5, FILED 12-14-2006, REG. NO. 30676908, DATED 2-14-2007, EXPIRES 12-31-2016.

SER. NO. 77-097,821, FILED 2-2-2007.

TINA L. SNAPP, EXAMINING ATTORNEY

Int. Cl.: 30

Prior U.S. Cl.: 46

United States Patent and Trademark Office

Reg. No. 3,397,317

Registered Mar. 18, 2008

**TRADEMARK
PRINCIPAL REGISTER**

CINNABON

CINNABON, INC. (WASHINGTON CORPORATION)
SUITE 200
200 GLENRIDGE POINT PARKWAY
ATLANTA, GA 30342

FOR: MICROWAVE POPCORN, POPCORN PRODUCTS, NAMELY, PROCESSED UNPOPPED POPCORN, READY-TO-EAT POPCORN, POPPED POPCORN; SNACK FOODS CONSISTING PRIMARILY OF POPCORN, NAMELY, GLAZED POPCORN BARS AND POPCORN CAKES, IN CLASS 30 (U.S. CL. 46).

FIRST USE 8-25-2003; IN COMMERCE 8-25-2003.

THE MARK CONSISTS OF STANDARD CHARACTERS WITHOUT CLAIM TO ANY PARTICULAR FONT, STYLE, SIZE, OR COLOR.

OWNER OF U.S. REG. NO. 2,953,486.

SER. NO. 77-098,015, FILED 2-2-2007.

MICHAEL WEBSTER, EXAMINING ATTORNEY

Int. Cl.: 41

Prior U.S. Cls.: 100, 101 and 107

United States Patent and Trademark Office

Reg. No. 3,397,318

Registered Mar. 18, 2008

**SERVICE MARK
PRINCIPAL REGISTER**

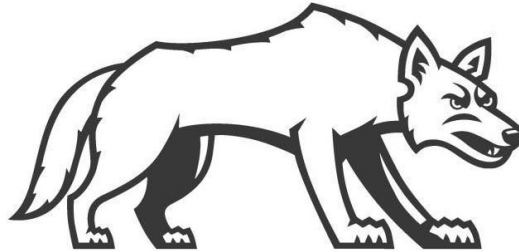

THE UNIVERSITY OF SOUTH DAKOTA (SOUTH
DAKOTA EDUCATIONAL INSTITUTION)
414 E. CLARK STREET
VERMILLION, SD 570692390

FOR: ENTERTAINMENT SERVICES, NAMELY,
ARRANGING AND CONDUCTING ATHLETIC
EVENTS AND COMPETITIONS, IN CLASS 41 (U.S.
CLS. 100, 101 AND 107).

FIRST USE 0-0-2004; IN COMMERCE 0-0-2004.

OWNER OF U.S. REG. NO. 3,110,248.

THE MARK CONSISTS OF A COYOTE.

SER. NO. 77-098,035, FILED 2-2-2007.

ANDREA K. NADELMAN, EXAMINING ATTOR-
NEY

Int. Cl.: 38

Prior U.S. Cls.: 100, 101 and 104

United States Patent and Trademark Office

Reg. No. 3,397,319

Registered Mar. 18, 2008

**SERVICE MARK
PRINCIPAL REGISTER**



CRICKET COMMUNICATIONS, INC. (DELAWARE CORPORATION)
10307 PACIFIC CENTER COURT
SAN DIEGO, CA 92121

FOR: TELECOMMUNICATION SERVICES, NAMELY, PROVIDING LOCAL, LONG DISTANCE AND INTERNATIONAL TRANSMISSION OF VOICE, DATA IMAGES, AUDIO, VIDEO, AND INFORMATION BY MEANS OF WIRELESS TELEPHONE AND THE INTERNET, AND PROVIDING PERSONAL COMMUNICATIONS SERVICES, ELECTRONIC MAIL AND VOICE MESSAGING SERVICES, PROVIDING ACCESS TO DIRECTORY SERVICES BY MEANS OF WIRELESS TELEPHONE AND THE INTERNET, PAGING SERVICES, COMPUTER-AIDED TRANSMISSION OF MESSAGES AND IMAGES, AND TRANSMITTING AND BROADCASTING AUDIO AND AUDIO-VISUAL WORKS, TELEPHONE TELECOMMUNICATIONS SERVICES PROVIDED VIA PREPAID TELEPHONE

CALLING CARDS, IN CLASS 38 (U.S. CLS. 100, 101 AND 104).

FIRST USE 1-31-2007; IN COMMERCE 1-31-2007.

NO CLAIM IS MADE TO THE EXCLUSIVE RIGHT TO USE "MOBILE", APART FROM THE MARK AS SHOWN.

THE MARK CONSISTS OF THE WORD JUMP IN CAPITAL LETTERS WITH THE WORD MOBILE IN SMALLER CAPITAL LETTERS POSITIONED TO SLIGHTLY OVERLAP THE BOTTOM OF THE CAPITAL M IN JUMP AND THE BOTTOM OF THE CAPITAL P IN JUMP.

SER. NO. 77-098,180, FILED 2-2-2007.

ROBERT C. CLARK JR., EXAMINING ATTORNEY

Int. Cls.: 38 and 42

Prior U.S. Cls.: 100, 101 and 104

United States Patent and Trademark Office

Reg. No. 3,397,320

Registered Mar. 18, 2008

**SERVICE MARK
PRINCIPAL REGISTER**



UNITED IMPACT MEDIA (FLORIDA SOLE PROPRIETORSHIP)
1 GARDEN DR.
FT MYERS, FL 33908

FOR: WEB CONFERENCING SERVICES, IN CLASS 38 (U.S. CLS. 100, 101 AND 104).

FIRST USE 9-12-2006; IN COMMERCE 1-14-2007.

FOR: COMPUTER SERVICES IN THE NATURE OF CUSTOMIZED WEB PAGES FEATURING USER-DEFINED INFORMATION, PERSONAL PROFILES AND INFORMATION, IN CLASS 42 (U.S. CLS. 100 AND 101).

FIRST USE 1-14-2007; IN COMMERCE 1-14-2007.

THE COLOR(S) GOLD, BLUE IS/ARE CLAIMED AS A FEATURE OF THE MARK.

THE MARK CONSISTS OF GOLD STAR WITH BLUE NON CAPITALIZED LETTER "I" BLUE LETTERS ISTARLIVE.

SER. NO. 77-098,631, FILED 2-3-2007.

DORITT L. CARROLL, EXAMINING ATTORNEY

Int. Cl.: 18

Prior U.S. Cls.: 1, 2, 3, 22 and 41

United States Patent and Trademark Office

Reg. No. 3,397,321

Registered Mar. 18, 2008

**TRADEMARK
PRINCIPAL REGISTER**

Saraye

YESBERGER, THOMAS (UNITED STATES INDIVIDUAL)
8806 218TH ST SW
EDMONDS, WA 98026

FOR: BRIEFCASE-TYPE PORTFOLIOS; BRIEFCASES; BRIEFCASES; BRIEFCASES; CHAIN MESH PURSES; CHANGE PURSES; CLUTCH PURSES; CLUTCHES; COIN PURSES; COIN PURSES NOT MADE OF PRECIOUS METAL; COIN PURSES, NOT OF PRECIOUS METALS; EVENING HANDBAGS; FOLDING BRIEFCASES; HANDBAG FRAMES; HANDBAGS; HANDBAGS FOR MEN; LEATHER BRIEFCASES; LEATHER HANDBAGS; LEATHER PURSES; MULTI-PURPOSE PURSES; PURSE FRAMES; PURSES; PURSES; PURSES AND WAL-

LETS OF PRECIOUS METAL; SMALL CLUTCH PURSES; SMALL PURSES; STRAPS FOR HANDBAGS; WRIST MOUNTED PURSES, IN CLASS 18 (U.S. CLS. 1, 2, 3, 22 AND 41).

FIRST USE 12-22-2004; IN COMMERCE 3-12-2005.

THE MARK CONSISTS OF STANDARD CHARACTERS WITHOUT CLAIM TO ANY PARTICULAR FONT, STYLE, SIZE, OR COLOR.

SER. NO. 77-098,827, FILED 2-4-2007.

HANNO RITTNER, EXAMINING ATTORNEY

Int. Cl.: 41

Prior U.S. Cls.: 100, 101 and 107

United States Patent and Trademark Office

Reg. No. 3,397,322

Registered Mar. 18, 2008

**SERVICE MARK
PRINCIPAL REGISTER**

REGIONS UNIVERSITY

REGIONS ASSET COMPANY (DELAWARE CORPORATION)
SUITE 209
3501 SILVERSIDE ROAD
WILMINGTON, DE 19810

FOR: EDUCATIONAL SERVICES, NAMELY, EMPLOYEE TRAINING PROGRAMS AND COURSES IN THE FIELD OF BANKING SERVICES, AND DISTRIBUTION OF COURSE MATERIALS IN CONNECTION THEREWITH, IN CLASS 41 (U.S. CLS. 100, 101 AND 107).

FIRST USE 1-0-2005; IN COMMERCE 1-0-2005.

THE MARK CONSISTS OF STANDARD CHARACTERS WITHOUT CLAIM TO ANY PARTICULAR FONT, STYLE, SIZE, OR COLOR.

OWNER OF U.S. REG. NOS. 1,881,600, 1,914,267, AND 3,119,462.

NO CLAIM IS MADE TO THE EXCLUSIVE RIGHT TO USE UNIVERSITY, APART FROM THE MARK AS SHOWN.

SER. NO. 77-098,922, FILED 2-5-2007.

LINDA E. BLOHM, EXAMINING ATTORNEY

Int. Cls.: 3, 17, 28 and 36

Prior U.S. Cls.: 1, 4, 5, 6, 12, 13, 22, 23, 35, 38, 50, 51, 52, 100, 101 and 102

Reg. No. 3,397,323

United States Patent and Trademark Office

Registered Mar. 18, 2008

**TRADEMARK
SERVICE MARK
PRINCIPAL REGISTER**

Panasonic

MATSUSHITA ELECTRIC INDUSTRIAL CO.,
LTD. (JAPAN CORPORATION)
1006 OAZA KADOMA
KADOMA-SHI OSAKA, JAPAN 571-8501

FOR: SOAPS AND DETERGENTS, IN CLASS 3
(U.S. CLS. 1, 4, 6, 50, 51 AND 52).

FIRST USE 0-0-1955; IN COMMERCE 0-0-1961.

FOR: GRAPHITE SHEETS WITH HIGH THERMAL CONDUCTIVITY FOR USE IN HEAT RADIATION MANAGEMENT, IN CLASS 17 (U.S. CLS. 1, 5, 12, 13, 35 AND 50).

FIRST USE 0-0-1955; IN COMMERCE 0-0-1961.

FOR: SPORTS EQUIPMENT, NAMELY, ELECTRIC PERSONAL EXERCISE MACHINES, IN CLASS 28 (U.S. CLS. 22, 23, 38 AND 50).

FIRST USE 0-0-1955; IN COMMERCE 0-0-1961.

FOR: PROVIDING EXTENDED WARRANTIES ON ELECTRONIC PRODUCTS, NAMELY, TELEVISIONS, COMPUTERS, CAMCORDERS, DIGITAL CAMERAS, TELEPHONES, FACSIMILE MACHINES, VIDEO DISC/DVD RECORDERS/PLAYERS AND VIDEO CASSETTE RECORDERS (VCRS), HOME AUDIO RECEIVERS AND SPEAKERS, CAR AUDIO RECEIVERS, PLAYERS, POWER AMPLIFIERS AND SPEAKERS, CAR DVD PLAYERS AND DISPLAY SCREENS AND CAR NAVIGATION SYSTEMS, TURNTABLES, MIXERS AND HEADPHONES, PORTABLE COMPACT DISC (CD) PLAYERS, PORTABLE MP3 PLAYERS, PORTABLE AUDIO RECORDERS, PORTABLE RADIOS, PORTABLE CASSETTE RECORDERS/PLAYERS AND

CLOCK RADIOS, PHOTO PRINTERS, LASER PRINTERS AND PHOTOCOPIERS, COMPUTER NETWORK APPLIANCES, NAMELY, ROUTERS AND CAMERAS CONNECTABLE TO THE INTERNET, HOME APPLIANCES, NAMELY, MICROWAVE OVENS, AIR CONDITIONERS, VACUUM CLEANERS, IRONS, BREAD AND DOUGH MAKERS, PRESSURE COOKERS, RICE COOKERS, TOASTER OVENS, MEAT GRINDERS, ELECTRIC COOKING POTS, OVENS FOR COOKING AND ELECTRIC THERMO POTS, ELECTRIC BUILDING PRODUCTS, NAMELY, VENTILATION FANS, INLET VENTS AND RADIATION DAMPERS, FLUORESCENT LAMPS AND BULBS, ELECTRIC BUILDING TOOLS, NAMELY, CORDLESS DRILLS, DRIVERS, SCREWDRIVERS AND WRENCHES, ELECTRIC SAWS AND FLASHLIGHTS, ELECTRIC HEALTHCARE PRODUCTS, NAMELY, SHAVERS AND HAIR TRIMMERS, BLOOD PRESSURE MONITORS, ELECTRIC TOOTHBRUSHES, HAND-HELD MASSAGERS, MASSAGING CHAIRS AND ELECTRIC PERSONAL EXERCISE MACHINES, IN CLASS 36 (U.S. CLS. 100, 101 AND 102).

FIRST USE 0-0-1955; IN COMMERCE 0-0-1961.

THE MARK CONSISTS OF STANDARD CHARACTERS WITHOUT CLAIM TO ANY PARTICULAR FONT, STYLE, SIZE, OR COLOR.

OWNER OF U.S. REG. NOS. 1,859,056, 2,219,862, AND 3,108,573.

SER. NO. 77-099,043, FILED 2-5-2007.

ALEXANDER L. POWERS, EXAMINING ATTORNEY

Int. Cl.: 25

Prior U.S. Cls.: 22 and 39

United States Patent and Trademark Office

Reg. No. 3,397,324

Registered Mar. 18, 2008

**TRADEMARK
PRINCIPAL REGISTER**



TWINS ENTERPRISE, INC. (MASSACHUSETTS CORPORATION)
480 SPRAGUE STREET
DEDHAM, MA 02026

FOR: HEADGEAR, NAMELY, HATS, CAPS, BASEBALL CAPS, KNITTED HATS, BUCKET HATS AND VISORS; APPAREL, NAMELY, T-SHIRTS, TANK TOPS, SWEAT SHIRTS, GOLF SHIRTS, SPORTS JERSEYS, JACKETS, COATS, PANTS, SHORTS, DRESSES, TIES, UNDERWEAR, BOXER SHORTS, BRAS, SOCKS; RAIN GEAR, NAMELY, RAIN COATS, RAIN SUITS, RAIN BOOTS,

PONCHOS, AND SLICKERS; INFANT AND TODDLER OUTFITS, NAMELY, INFANT AND TODDLER ONE PIECE CLOTHING, INFANT AND TODDLER BOTTOMS, AND INFANT AND TODDLER TOPS; AND CLOTH BIBS, IN CLASS 25 (U.S. CLS. 22 AND 39).

FIRST USE 4-1-2002; IN COMMERCE 4-1-2002.

SER. NO. 77-099,981, FILED 2-6-2007.

BILL DAWE, EXAMINING ATTORNEY

Int. Cl.: 28

Prior U.S. Cls.: 22, 23, 38 and 50

United States Patent and Trademark Office

Reg. No. 3,397,325

Registered Mar. 18, 2008

**TRADEMARK
PRINCIPAL REGISTER**

CHERRY BLAST

MATTEL, INC. (DELAWARE CORPORATION)
MAIL STOP M1-1518
333 CONTINENTAL BOULEVARD
EL SEGUNDO, CA 90245

FOR: TOYS, GAMES AND PLAYTHINGS, NAME-
LY, TOY VEHICLES, TOY FIGURES, AND ACCES-
SORIES FOR ALL OF THE FOREGOING, IN CLASS
28 (U.S. CLS. 22, 23, 38 AND 50).

FIRST USE 9-17-2007; IN COMMERCE 9-17-2007.

THE MARK CONSISTS OF STANDARD CHAR-
ACTERS WITHOUT CLAIM TO ANY PARTICULAR
FONT, STYLE, SIZE, OR COLOR.

SER. NO. 77-100,146, FILED 2-6-2007.

SCOTT SISUN, EXAMINING ATTORNEY

Int. Cl.: 14

Prior U.S. Cls.: 2, 27, 28 and 50

United States Patent and Trademark Office

Reg. No. 3,397,326

Registered Mar. 18, 2008

**TRADEMARK
PRINCIPAL REGISTER**

PoshRocks

BROWN, ERIC M (UNITED STATES INDIVIDUAL)
24 PLEASANT LANE
BOYLSTON, MA 01505

FOR: JEWELRY, IN CLASS 14 (U.S. CLS. 2, 27, 28 AND 50).

FIRST USE 12-2-2002; IN COMMERCE 12-3-2002.

THE MARK CONSISTS OF STANDARD CHARACTERS WITHOUT CLAIM TO ANY PARTICULAR FONT, STYLE, SIZE, OR COLOR.

SEC. 2(F).

SER. NO. 77-100,241, FILED 2-6-2007.

RONALD MCMORROW, EXAMINING ATTORNEY

Int. Cl.: 3

Prior U.S. Cls.: 1, 4, 6, 50, 51 and 52

United States Patent and Trademark Office

Reg. No. 3,397,327

Registered Mar. 18, 2008

TRADEMARK
PRINCIPAL REGISTER



RR Y ASOCIADOS,S.A. (DOMINICAN REP
PARTNERSHIP)
MAX HENRIQUEZ UREÑA #3, LOS PRADOS
SANTO DOMINGO, DOMINICAN REP

THE COLOR(S) BLACK, WHITE AND RED IS/
ARE CLAIMED AS A FEATURE OF THE MARK.

FOR: HAIR BALSAM; HAIR CARE LOTIONS;
HAIR CLEANING PREPARATIONS; HAIR COLOR;
HAIR COLOR REMOVERS; HAIR COLORANTS;
HAIR CONDITIONERS; HAIR DECOLORANTS;
HAIR GELS; HAIR LOTIONS; HAIR NOURISHERS;
HAIR OILS; HAIR SHAMPOO; HAIR STYLING
SPRAY; HYDROGEN PEROXIDE FOR USE ON
THE HAIR; OILS FOR HAIR CONDITIONING, IN
CLASS 3 (U.S. CLS. 1, 4, 6, 50, 51 AND 52).

THE MARK CONSISTS OF THE LETTER "R" IN
REVERSE, TO THE LEFT OF A LARGER LETTER
"R", BOTH IN THE COLOR BLACK, WITH THE
WORD, LINE IN THE COLOR BLACK, UNDER-
SCORED BY A RED LINE, WITH ALL OF THE
FOREGOING ELEMENTS ON A WHITE BACK-
GROUND.

FIRST USE 10-30-2005; IN COMMERCE 11-23-2006.

SER. NO. 77-100,311, FILED 2-6-2007.

NO CLAIM IS MADE TO THE EXCLUSIVE
RIGHT TO USE "LINE", APART FROM THE MARK
AS SHOWN.

ODESSA BIBBINS, EXAMINING ATTORNEY

Int. Cl.: 25

Prior U.S. Cls.: 22 and 39

United States Patent and Trademark Office

Reg. No. 3,397,328

Registered Mar. 18, 2008

**TRADEMARK
PRINCIPAL REGISTER**

You've always had the power

BRINSON, CYNTHIA L. (UNITED STATES INDIVIDUAL)
5004 SUNDANCE COURT
DOYLESTOWN, PA 18902

FOR: HATS; SHIRTS; SHORT-SLEEVED OR LONG-SLEEVED T-SHIRTS; SWEAT SHIRTS; T-SHIRTS, IN CLASS 25 (U.S. CLS. 22 AND 39).

FIRST USE 1-1-2007; IN COMMERCE 2-6-2007.

THE MARK CONSISTS OF STANDARD CHARACTERS WITHOUT CLAIM TO ANY PARTICULAR FONT, STYLE, SIZE, OR COLOR.

SER. NO. 77-100,924, FILED 2-6-2007.

JOHN DWYER, EXAMINING ATTORNEY

Int. Cl.: 16

Prior U.S. Cls.: 2, 5, 22, 23, 29, 37, 38 and 50

United States Patent and Trademark Office

Reg. No. 3,397,329

Registered Mar. 18, 2008

**TRADEMARK
PRINCIPAL REGISTER**

JUST DIVE

NAUI SERVICES GROUP, INC. (FLORIDA CORPORATION)
1232 TECH BLVD.
TAMPA, FL 33619

THE MARK CONSISTS OF STANDARD CHARACTERS WITHOUT CLAIM TO ANY PARTICULAR FONT, STYLE, SIZE, OR COLOR.

FOR: STICKERS, IN CLASS 16 (U.S. CLS. 2, 5, 22, 23, 29, 37, 38 AND 50).

SER. NO. 77-101,100, FILED 2-7-2007.

FIRST USE 2-7-2007; IN COMMERCE 2-7-2007.

ELISSA GARBER KON, EXAMINING ATTORNEY

Int. Cls.: 16 and 41

Prior U.S. Cls.: 2, 5, 22, 23, 29, 37, 38, 50, 100, 101 and 107

United States Patent and Trademark Office

Reg. No. 3,397,330

Registered Mar. 18, 2008

**TRADEMARK
SERVICE MARK
PRINCIPAL REGISTER**

THE UNION

NEVADA COUNTY PUBLISHING CO. (WASHINGTON CORPORATION)
500 DOUBLE EAGLE COURT
RENO, NV 89521

FOR: DAILY NEWSPAPER, IN CLASS 16 (U.S. CLS. 2, 5, 22, 23, 29, 37, 38 AND 50).

FIRST USE 10-26-1864; IN COMMERCE 10-26-1864.

FOR: PROVIDING ON-LINE PUBLICATIONS IN THE NATURE OF DAILY NEWSPAPERS FEATURING CURRENT EVENTS, POLITICS, POLICY, SPORTS, BUSINESS, TECHNOLOGY, ENTERTAINMENT, ARTS, LEISURE, AND TRAVEL; PROVIDING ON-LINE PUBLICATIONS IN THE NATURE OF DAILY NEWSPAPERS FEATURING INFORMA-

TION IN THE FIELDS OF CURRENT EVENTS, POLITICS, POLICY, SPORTS, BUSINESS, TECHNOLOGY, ENTERTAINMENT, ARTS, LEISURE AND TRAVEL VIA ELECTRONIC MAIL, IN CLASS 41 (U.S. CLS. 100, 101 AND 107).

FIRST USE 0-0-2001; IN COMMERCE 0-0-2001.

THE MARK CONSISTS OF STANDARD CHARACTERS WITHOUT CLAIM TO ANY PARTICULAR FONT, STYLE, SIZE, OR COLOR.

SER. NO. 77-101,370, FILED 2-7-2007.

LEIGH CAROLINE CASE, EXAMINING ATTORNEY

Int. Cl.: 41

Prior U.S. Cls.: 100, 101 and 107

United States Patent and Trademark Office

Reg. No. 3,397,331

Registered Mar. 18, 2008

**SERVICE MARK
PRINCIPAL REGISTER**

LIFE'S HEADWATERS

GARY S. STEVENS FOUNDATION (MINNESOTA
NON-PROFIT CORPORATION)
9101 2ND AVENUE SOUTH
BLOOMINGTON, MN 55420

FOR: CHARITABLE SERVICES, NAMELY, PROVIDING GROUP AND PERSONAL EDUCATIONAL SERVICES, NAMELY, CLASSES, LECTURES AND SEMINARS, AND PERSONAL COACHING SERVICES IN PERSON OR BY ELECTRONIC CONNECTION, ALL IN THE FIELD OF LIFE TRANSITION ISSUES, IN CLASS 41 (U.S. CLS. 100, 101 AND 107).

FIRST USE 2-20-2007; IN COMMERCE 2-20-2007.

THE MARK CONSISTS OF STANDARD CHARACTERS WITHOUT CLAIM TO ANY PARTICULAR FONT, STYLE, SIZE, OR COLOR.

SER. NO. 77-101,509, FILED 2-7-2007.

SALLY SHIH, EXAMINING ATTORNEY

Int. Cl.: 9

Prior U.S. Cls.: 21, 23, 26, 36 and 38

United States Patent and Trademark Office

Reg. No. 3,397,332

Registered Mar. 18, 2008

**TRADEMARK
PRINCIPAL REGISTER**

DESERT BLOOM

ARISTOCRAT TECHNOLOGIES AUSTRALIA
PTY LTD (AUSTRALIA CORPORATION)
71 LONGUEVILLE ROAD
LANE COVE, NSW, AUSTRALIA 2066

OWNER OF AUSTRALIA REG. NO. 708731, DATED 5-16-1996, EXPIRES 5-16-2016.

FOR: GAMING MACHINES, IN CLASS 9 (U.S. CLS. 21, 23, 26, 36 AND 38).

SER. NO. 77-101,639, FILED 2-7-2007.

THE MARK CONSISTS OF STANDARD CHARACTERS WITHOUT CLAIM TO ANY PARTICULAR FONT, STYLE, SIZE, OR COLOR.

WILLIAM VERHOSEK, EXAMINING ATTORNEY

Int. Cl.: 41

Prior U.S. Cls.: 100, 101 and 107

United States Patent and Trademark Office

Reg. No. 3,397,333

Registered Mar. 18, 2008

**SERVICE MARK
PRINCIPAL REGISTER**



LIFE'S HEADWATERS

GARY S. STEVENS FOUNDATION (MINNESOTA
NON-PROFIT CORPORATION)
9101 2ND AVENUE SOUTH
BLOOMINGTON, MN 55420

FOR: CHARITABLE SERVICES, NAMELY, PRO-
VIDING GROUP AND PERSONAL EDUCATIONAL
SERVICES, NAMELY, CLASSES, LECTURES AND
SEMINARS, AND PERSONAL COACHING SERVI-
CES IN PERSON OR BY ELECTRONIC CONNEC-

TION, ALL IN THE FIELD OF LIFE TRANSITION
ISSUES, IN CLASS 41 (U.S. CLS. 100, 101 AND 107).

FIRST USE 2-20-2007; IN COMMERCE 2-20-2007.

SER. NO. 77-101,770, FILED 2-7-2007.

SALLY SHIH, EXAMINING ATTORNEY

Int. Cl.: 30

Prior U.S. Cl.: 46

United States Patent and Trademark Office

Reg. No. 3,397,334

Registered Mar. 18, 2008

**TRADEMARK
PRINCIPAL REGISTER**



PINNACLE RESTAURANT GROUP, INC. (COLORADO CORPORATION)
6662 GUNPARK DRIVE EAST, #201
BOULDER, CO 80301

NO CLAIM IS MADE TO THE EXCLUSIVE RIGHT TO USE "DELI", APART FROM THE MARK AS SHOWN.

FOR: SALAD DRESSING, IN CLASS 30 (U.S. CL. 46).

SER. NO. 77-101,898, FILED 2-7-2007.

FIRST USE 6-4-2003; IN COMMERCE 6-4-2003.

ELIZABETH BEYER, EXAMINING ATTORNEY

Int. Cl.: 44

Prior U.S. Cls.: 100 and 101

United States Patent and Trademark Office

Reg. No. 3,397,335

Registered Mar. 18, 2008

**SERVICE MARK
PRINCIPAL REGISTER**

econeutral

ERA ECOSYSTEM RESTORATION ASSOCIATES
INC (CANADA CORPORATION)
10, 340B, 555 BROOKSBANK AVENUE
NORTH VANCOUVER, CANADA V7J3S5

FOR: RESTORATION OF FORESTS TO THEIR
HISTORICAL HEALTH, COMPOSITION AND CAR-
BON SEQUESTRATION THROUGH REMOVING
INVASIVE/NON-NATIVE SPECIES BY HAND AND
THE USE OF BRUSH SAWS, IN CLASS 44 (U.S. CLS.
100 AND 101).

THE MARK CONSISTS OF STANDARD CHAR-
ACTERS WITHOUT CLAIM TO ANY PARTICULAR
FONT, STYLE, SIZE, OR COLOR.

OWNER OF CANADA REG. NO. TMA678291,
DATED 12-8-2006, EXPIRES 12-7-2021.

SER. NO. 77-101,946, FILED 2-7-2007.

SHAUNIA CARLYLE, EXAMINING ATTORNEY

Int. Cl.: 9

Prior U.S. Cls.: 21, 23, 26, 36 and 38

United States Patent and Trademark Office

Reg. No. 3,397,336

Registered Mar. 18, 2008

**TRADEMARK
PRINCIPAL REGISTER**

KING OF ASIA

ARISTOCRAT TECHNOLOGIES AUSTRALIA
PTY LTD (AUSTRALIA CORPORATION)
71 LONGUEVILLE ROAD
LANE COVE, NSW, AUSTRALIA 2066

FOR: GAMING MACHINES; COMPUTER HARD-
WARE; DOWNLOADABLE GAME SOFTWARE;
ELECTRONIC GAME SOFTWARE, IN CLASS 9
(U.S. CLS. 21, 23, 26, 36 AND 38).

THE MARK CONSISTS OF STANDARD CHAR-
ACTERS WITHOUT CLAIM TO ANY PARTICULAR
FONT, STYLE, SIZE, OR COLOR.

OWNER OF AUSTRALIA REG. NO. 944342, DA-
TED 10-14-2003, EXPIRES 2-20-2013.

SER. NO. 77-102,065, FILED 2-7-2007.

WILLIAM VERHOSEK, EXAMINING ATTORNEY

Int. Cl.: 9

Prior U.S. Cls.: 21, 23, 26, 36 and 38

Reg. No. 3,397,337

United States Patent and Trademark Office

Registered Mar. 18, 2008

**TRADEMARK
PRINCIPAL REGISTER**

PRECISIONWEB

ABBOTT LABORATORIES (ILLINOIS CORPORATION)
100 ABBOTT PARK ROAD
ABBOTT PARK, IL 60064

THE MARK CONSISTS OF STANDARD CHARACTERS WITHOUT CLAIM TO ANY PARTICULAR FONT, STYLE, SIZE, OR COLOR.

FOR: SOFTWARE APPLICATION FOR USE IN MANAGING POINT OF CARE DIAGNOSTIC EQUIPMENT, NAMELY ANALYZERS AND METERS, AND RESULTING TEST DATA, IN CLASS 9 (U.S. CLS. 21, 23, 26, 36 AND 38).

OWNER OF U.S. REG. NOS. 2,005,126, 3,097,939 AND OTHERS.

SER. NO. 77-102,690, FILED 2-8-2007.

FIRST USE 12-31-2003; IN COMMERCE 12-31-2003.

TINA KUAN, EXAMINING ATTORNEY

Int. Cl.: 16

Prior U.S. Cls.: 2, 5, 22, 23, 29, 37, 38 and 50

United States Patent and Trademark Office

Reg. No. 3,397,338

Registered Mar. 18, 2008

**TRADEMARK
PRINCIPAL REGISTER**

I PLEDGE ALLEGIANCE TO THE
FLAG

ALL TALK CORPORATION (MASSACHUSETTS
CORPORATION)
1 PHYLMOR DRIVE
WESTBORO, MA 01581

FOR: POSTERS AND GREETING CARDS
GEARED TOWARDS FANS OF THE AUTOMOTIVE
RACING AND MOTOR SPORTS INDUSTRIES, IN
CLASS 16 (U.S. CLS. 2, 5, 22, 23, 29, 37, 38 AND 50).

FIRST USE 12-30-2004; IN COMMERCE 12-30-2004.

THE MARK CONSISTS OF STANDARD CHAR-
ACTERS WITHOUT CLAIM TO ANY PARTICULAR
FONT, STYLE, SIZE, OR COLOR.

OWNER OF U.S. REG. NO. 2,223,614.

SEC. 2(F).

SER. NO. 77-103,295, FILED 2-9-2007.

BRENDAN REGAN, EXAMINING ATTORNEY

Int. Cl.: 44

Prior U.S. Cls.: 100 and 101

United States Patent and Trademark Office

Reg. No. 3,397,339

Registered Mar. 18, 2008

**SERVICE MARK
PRINCIPAL REGISTER**

CODE:HEART

KING'S DAUGHTERS' MEDICAL CENTER (KEN-
TUCKY CORPORATION)
2202 LEXINGTON AVE.
ASHLAND, KY 41101

THE MARK CONSISTS OF STANDARD CHAR-
ACTERS WITHOUT CLAIM TO ANY PARTICULAR
FONT, STYLE, SIZE, OR COLOR.

FOR: HEALTH CARE, IN CLASS 44 (U.S. CLS. 100
AND 101).

SER. NO. 77-103,444, FILED 2-9-2007.

FIRST USE 1-31-2007; IN COMMERCE 1-31-2007.

H. M. FISHER, EXAMINING ATTORNEY

Int. Cl.: 21

Prior U.S. Cls.: 2, 13, 23, 29, 30, 33, 40 and 50

United States Patent and Trademark Office

Reg. No. 3,397,340

Registered Mar. 18, 2008

**TRADEMARK
PRINCIPAL REGISTER**



DIELECTRIC SOLUTIONS, LLC (PENNSYLVANIA LTD LIAB CO)
1655 ORR AVENUE
KITTANNING, PA 16201

FOR: GLASS FIBER FABRIC FOR USE IN ELECTRONICS AND IN COMPOSITE MATERIALS, IN CLASS 21 (U.S. CLS. 2, 13, 23, 29, 30, 33, 40 AND 50).

FIRST USE 1-31-2003; IN COMMERCE 1-31-2003.

NO CLAIM IS MADE TO THE EXCLUSIVE RIGHT TO USE "DIELECTRIC", APART FROM THE MARK AS SHOWN.

THE LINING IS A FEATURE OF THE MARK AND DOES NOT INDICATE COLOR.

SER. NO. 77-103,868, FILED 2-9-2007.

RICHARD A. STRASER, EXAMINING ATTORNEY

Int. Cl.: 15

Prior U.S. Cls.: 2, 21 and 36

United States Patent and Trademark Office

Reg. No. 3,397,341

Registered Mar. 18, 2008

TRADEMARK
PRINCIPAL REGISTER



LPD MUSIC INTERNATIONAL (MICHIGAN CORPORATION)
32575 INDUSTRIAL DRIVE
MADISON HEIGHTS, MI 480715004

FOR: ACOUSTIC GUITARS; BASS GUITARS; CARRYING CASES FOR MUSICAL INSTRUMENTS; DRUMS; ELECTRIC GUITARS; GUITAR PICKS; GUITAR STRAPS; GUITARS, IN CLASS 15 (U.S. CLS. 2, 21 AND 36).

FIRST USE 1-1-2005; IN COMMERCE 7-1-2005.

THE COLOR(S) YELLOW, GOLD, BLUE, PURPLE AND PINK IS/ARE CLAIMED AS A FEATURE OF THE MARK.

THE MARK CONSISTS OF A THREE PRONGED CROWN IN YELLOW AND GOLD WITH A CIRCLE IN EACH PRONG AND A SWIRL ON THE CENTER OF THE CROWN FACE. THE CROWN IS PLACED ABOVE AND TO THE LEFT OF THE LETTER "D" IN THE TERM DARLING DIVAS. IN STYLIZED LETTERING GRADUATING FROM BLUE TO PURPLE TO PINK, AS THE LETTERS ARE READ LEFT TO RIGHT.

SER. NO. 77-104,112, FILED 2-9-2007.

JAMES STEIN, EXAMINING ATTORNEY

Int. Cls.: 35 and 36

Prior U.S. Cls.: 100, 101 and 102

United States Patent and Trademark Office

Reg. No. 3,397,342

Registered Mar. 18, 2008

**SERVICE MARK
PRINCIPAL REGISTER**

GROUNDWORK EQUITY

GROUNDWORK EQUITY, LLC (CALIFORNIA
LTD LIAB CO)
826 CALLE PLANO
CAMARILLO, CA 93012

FOR: BUSINESS MANAGEMENT FOR EARLY-STAGE TECHNOLOGY COMPANIES, NAMELY, FOSTERING ENTREPRENEURSHIP BY CONDUCTING BUSINESS AND MARKET RESEARCH AND ANALYSIS, DEVELOPMENT AND IMPLEMENTATION OF ORGANIZATIONAL DEVELOPMENT, DEVISING CUSTOM BUSINESS STRATEGIES, DEVELOPING AND IDENTIFYING APPROPRIATE PARTNERSHIPS, IN CLASS 35 (U.S. CLS. 100, 101 AND 102).

FIRST USE 1-9-2007; IN COMMERCE 1-9-2007.

FOR: PROCURING ANGEL AND VENTURE CAPITAL, IN CLASS 36 (U.S. CLS. 100, 101 AND 102).

FIRST USE 1-9-2007; IN COMMERCE 1-9-2007.

THE MARK CONSISTS OF STANDARD CHARACTERS WITHOUT CLAIM TO ANY PARTICULAR FONT, STYLE, SIZE, OR COLOR.

NO CLAIM IS MADE TO THE EXCLUSIVE RIGHT TO USE "EQUITY", APART FROM THE MARK AS SHOWN.

SER. NO. 77-104,150, FILED 2-9-2007.

MIDGE BUTLER, EXAMINING ATTORNEY

Int. Cl.: 41

Prior U.S. Cls.: 100, 101 and 107

United States Patent and Trademark Office

Reg. No. 3,397,343

Registered Mar. 18, 2008

**SERVICE MARK
PRINCIPAL REGISTER**

Radiotron

RIVAS, JULIO CESAR (EL SALVADOR INDIVIDUAL)
420 NORTH EVERGREEN AVE, UNIT 323
LOS ANGELES, CA, CA 90033

FOR: DANCE EVENTS; DANCE INSTRUCTION; DANCE SCHOOLS; ENTERTAINMENT IN THE NATURE OF DANCE PERFORMANCES; ENTERTAINMENT IN THE NATURE OF VISUAL AND AUDIO PERFORMANCES, NAMELY, MUSICAL BAND, ROCK GROUP, GYMNASTIC, DANCE, AND BALLET PERFORMANCES; ORGANIZATION OF DANCING EVENTS; ORGANIZING COMMUNITY FESTIVALS FEATURING A VARIETY OF ACTIVITIES, NAMELY SPORTING EVENTS, ART

EXHIBITIONS, FLEA MARKETS, ETHNIC DANCES AND THE LIKE, IN CLASS 41 (U.S. CLS. 100, 101 AND 107).

FIRST USE 2-22-1994; IN COMMERCE 2-22-1994.

THE MARK CONSISTS OF STANDARD CHARACTERS WITHOUT CLAIM TO ANY PARTICULAR FONT, STYLE, SIZE, OR COLOR.

SER. NO. 77-105,648, FILED 2-12-2007.

LEIGH CAROLINE CASE, EXAMINING ATTORNEY

Int. Cl.: 35

Prior U.S. Cls.: 100, 101 and 102

United States Patent and Trademark Office

Reg. No. 3,397,344

Registered Mar. 18, 2008

**SERVICE MARK
PRINCIPAL REGISTER**

AMERICA'S YARN STORE

VALLEY FIBERS CORPORATION (MASSACHU-
SETTS CORPORATION), DBA WEBS
75 SERVICE CENTER ROAD
NORTHAMPTON, MA 01106

FOR: RETAIL STORE SERVICES, ONLINE RE-
TAIL STORE SERVICES AND CATALOG ORDER-
ING SERVICES FEATURING YARNS FOR
KNITTING AND WEAVING, PATTERNS AND IN-
STRUCTIONAL BOOKS, KNITTING AND WEAV-
ING IMPLEMENTS, NAMELY, KNITTING
NEEDLES, STITCH MARKERS, METERS, BLOCK-
ING BOARDS, NEEDLE AND STITCH GAUGES,
STITCH HOLDERS, ROW COUNTERS, CROCHET
HOOKS, BOBBINS AND PIRNS, WARPING
BOARDS, BOAT SHUTTLES, REEDS, TEMPLES,
BOBBIN WINDERS, REED HOOKS AND HEDDLE
HOOKS, IN CLASS 35 (U.S. CLS. 100, 101 AND 102).

FIRST USE 12-31-1983; IN COMMERCE 12-31-1983.

THE MARK CONSISTS OF STANDARD CHAR-
ACTERS WITHOUT CLAIM TO ANY PARTICULAR
FONT, STYLE, SIZE, OR COLOR.

NO CLAIM IS MADE TO THE EXCLUSIVE
RIGHT TO USE "YARN STORE", APART FROM
THE MARK AS SHOWN.

SEC. 2(F).

SER. NO. 77-105,922, FILED 2-13-2007.

ROBERT LAVACHE, EXAMINING ATTORNEY

Int. Cl.: 31

Prior U.S. Cls.: 1 and 46

United States Patent and Trademark Office

Reg. No. 3,397,345

Registered Mar. 18, 2008

**TRADEMARK
PRINCIPAL REGISTER**

SCOPIA

DANZIGER - DAN FLOWER FARM (ISRAEL
CORPORATION)
P.O. BOX 24
MOSHAV MISHMAR HASHIVA 50297
BEIT DAGAN, ISRAEL

THE MARK CONSISTS OF STANDARD CHAR-
ACTERS WITHOUT CLAIM TO ANY PARTICULAR
FONT, STYLE, SIZE, OR COLOR.

FOR: FLOWER SEEDS, LIVE PLANTS AND
FLOWERS, IN CLASS 31 (U.S. CLS. 1 AND 46).

SER. NO. 77-106,218, FILED 2-13-2007.

FIRST USE 4-1-2007; IN COMMERCE 4-1-2007.

GENE MACIOL, EXAMINING ATTORNEY

Int. Cls.: 35 and 42

Prior U.S. Cls.: 100, 101 and 102

United States Patent and Trademark Office

Reg. No. 3,397,346

Registered Mar. 18, 2008

**SERVICE MARK
PRINCIPAL REGISTER**

parts.com
For every part of your life

INTELLIGENTZ CORPORATION (DELAWARE CORPORATION)
SUITE 200
115 E. 5TH STREET
AUSTIN, TX 78701

FOR: MARKETING SERVICES, NAMELY, PROVIDING INFORMATIONAL WEB PAGES DESIGNED TO GENERATE SALES TRAFFIC VIA HYPERLINKS TO OTHER WEB SITES; PROMOTING THE GOODS AND SERVICES OF OTHERS BY PROVIDING HYPERTEXT LINKS TO THE WEBSITES OF OTHERS; PROVIDING A WEBSITE WHICH FEATURES ADVERTISEMENTS FOR THE GOODS AND SERVICES OF OTHERS ON A GLOBAL COMPUTER NETWORK; PROVIDING ON-LINE DIRECTORY INFORMATION SERVICES ALSO FEATURING HYPERLINKS TO OTHER WEBSITES; ONLINE AUCTION SERVICES, IN CLASS 35 (U.S. CLS. 100, 101 AND 102).

FIRST USE 3-30-1999; IN COMMERCE 3-30-1999.

FOR: COMPUTER SERVICES, NAMELY, PROVIDING SOFTWARE INTERFACES AVAILABLE OVER A NETWORK IN ORDER TO CREATE A PERSONALIZED ON-LINE INFORMATION SERVICE; EXTRACTION AND RETRIEVAL OF INFORMATION AND DATA MINING BY MEANS OF GLOBAL COMPUTER NETWORKS; CREATING INDEXES OF INFORMATION, INDEXES OF WEB SITES AND INDEXES OF OTHER INFORMATION SOURCES IN CONNECTION WITH GLOBAL COMPUTER NETWORKS, IN CLASS 42 (U.S. CLS. 100 AND 101).

FIRST USE 3-30-1999; IN COMMERCE 3-30-1999.

NO CLAIM IS MADE TO THE EXCLUSIVE RIGHT TO USE "PARTS.COM", APART FROM THE MARK AS SHOWN.

SER. NO. 77-106,484, FILED 2-13-2007.

KATHERINE E. HALMEN, EXAMINING ATTORNEY

Int. Cl.: 41

Prior U.S. Cls.: 100, 101 and 107

United States Patent and Trademark Office

Reg. No. 3,397,347

Registered Mar. 18, 2008

**SERVICE MARK
PRINCIPAL REGISTER**

FOX SOCCER REPORT

TWENTIETH CENTURY FOX FILM CORPORATION
(DELAWARE CORPORATION)
10201 WEST PICO BOULEVARD
LOS ANGELES, CA 90035

FOR: ENTERTAINMENT SERVICES IN THE
NATURE OF A TELEVISION SERIES FEATURING
SPORTS; PROVIDING ONLINE INFORMATION IN
THE FIELD OF SPORTS AND TELEVISION ENTER-
TAINMENT VIA THE INTERNET, IN CLASS 41 (U.S.
CLS. 100, 101 AND 107).

FIRST USE 1-8-2007; IN COMMERCE 1-8-2007.

THE MARK CONSISTS OF STANDARD CHAR-
ACTERS WITHOUT CLAIM TO ANY PARTICULAR
FONT, STYLE, SIZE, OR COLOR.

OWNER OF U.S. REG. NOS. 3,058,283, 3,094,354,
AND 3,195,046.

NO CLAIM IS MADE TO THE EXCLUSIVE
RIGHT TO USE "SOCCER REPORT", APART FROM
THE MARK AS SHOWN.

SER. NO. 77-106,609, FILED 2-13-2007.

KYLE PEETE, EXAMINING ATTORNEY

Int. Cls.: 16, 41 and 42

Prior U.S. Cls.: 2, 5, 22, 23, 29, 37, 38, 50, 100, 101 and 107

Reg. No. 3,397,348

United States Patent and Trademark Office

Registered Mar. 18, 2008

**TRADEMARK
SERVICE MARK
PRINCIPAL REGISTER**

BLOOMBERG LAWNOTES

BLOOMBERG L.P. (DELAWARE LIMITED PARTNERSHIP)
731 LEXINGTON AVENUE
NEW YORK, NY 10022

FOR: PUBLICATIONS, NAMELY, REPORTS, DIGESTS, DIRECTORIES, CHARTS, BROCHURES, REFERENCE MATERIALS, LEAFLETS, NEWSLETTERS, BOOKLETS, PAMPHLETS, POST CARDS, FLYERS, JOURNALS, MAGAZINE SUPPLEMENTS TO NEWSPAPERS, NEWSPAPERS, NEWSPAPER ARTICLES, MAGAZINES AND TRADE AND PROFESSIONAL BOOKS IN THE FIELDS OF NEWS, RESEARCH, COMPUTERIZED DATABASES AND OTHER INDEXES OF INFORMATION, LAW, GOVERNMENT AND PUBLIC RECORDS, BUSINESS, FINANCE, SECURITIES, SECURITIES MARKETS, POLITICS, CURRENT EVENTS, ENTERTAINMENT, SPORTS, SCIENCE AND TECHNOLOGY, HEALTH, TRAVEL, HUMAN INTEREST STORIES AND THE ENERGY AND ASPHALT INDUSTRIES, IN CLASS 16 (U.S. CLS. 2, 5, 22, 23, 29, 37, 38 AND 50).

FIRST USE 12-15-2005; IN COMMERCE 12-15-2005.

FOR: COMPUTER SERVICES, NAMELY, PROVIDING ON-LINE PUBLICATIONS IN THE NATURE OF REPORTS, DIGESTS, DIRECTORIES, BROCHURES, REFERENCE MATERIALS, LEAFLETS, NEWSLETTERS, NEWSPAPERS, BOOKLETS, PAMPHLETS, POST CARDS, FLYERS, MAGAZINE SUPPLEMENTS TO NEWSPAPERS, MAGAZINES AND TRADE AND PROFESSIONAL BOOKS IN THE FIELDS OF NEWS, RESEARCH, COMPUTERIZED DATABASES AND OTHER INDEXES OF INFORMATION, LAW, GOVERNMENT AND PUBLIC RECORDS, BUSINESS, FINANCE, SECURITIES, SECURITIES MARKETS, POLITICS, CURRENT EVENTS, ENTERTAINMENT, SPORTS, SCIENCE AND TECHNOLOGY, HEALTH, TRAVEL, HUMAN

INTEREST STORIES AND THE ENERGY AND ASPHALT INDUSTRIES; ENTERTAINMENT SERVICES, NAMELY, ONGOING AUDIO AND VISUAL PROGRAMS IN THE FIELDS OF NEWS, RESEARCH, COMPUTERIZED DATABASES AND OTHER INDEXES OF INFORMATION, LAW, GOVERNMENT AND PUBLIC RECORDS, BUSINESS, FINANCE, SECURITIES, SECURITIES MARKETS, POLITICS, CURRENT EVENTS, ENTERTAINMENT, SPORTS, SCIENCE AND TECHNOLOGY, HEALTH, TRAVEL, HUMAN INTEREST STORIES AND THE ENERGY AND ASPHALT INDUSTRIES; ENTERTAINMENT SERVICES, NAMELY, PRODUCTION AND DISTRIBUTION OF ONGOING AUDIO AND VISUAL PROGRAMS IN THE FIELDS OF NEWS, RESEARCH, COMPUTERIZED DATABASES AND OTHER INDEXES OF INFORMATION, LAW, GOVERNMENT AND PUBLIC RECORDS, BUSINESS, FINANCE, SECURITIES, SECURITIES MARKETS, POLITICS, CURRENT EVENTS, ENTERTAINMENT, SPORTS, SCIENCE AND TECHNOLOGY, HEALTH, TRAVEL, HUMAN INTEREST STORIES AND THE ENERGY AND ASPHALT INDUSTRIES; NEWS AGENCIES AND NEWS REPORTING SERVICES, NAMELY, GATHERING AND DISSEMINATION OF NEWS BY COMPUTER, IN CLASS 41 (U.S. CLS. 100, 101 AND 107).

FIRST USE 12-15-2005; IN COMMERCE 12-15-2005.

FOR: LEGAL RESEARCH SERVICES; COMPUTER SERVICES, NAMELY, COMPUTERIZED LEGAL RESEARCH SERVICES OVER, BY OR THROUGH LOCAL OR WIDE AREA COMPUTER NETWORKS, WIRELESS COMMUNICATION NETWORKS, GLOBAL COMPUTER INFORMATION NETWORKS AND OTHER ELECTRONIC COMMUNICATION NETWORKS, IN CLASS 42 (U.S. CLS. 100 AND 101).

FIRST USE 12-15-2005; IN COMMERCE 12-15-2005.

THE MARK CONSISTS OF STANDARD CHARACTERS WITHOUT CLAIM TO ANY PARTICULAR FONT, STYLE, SIZE, OR COLOR.

OWNER OF U.S. REG. NOS. 2,266,559, 2,736,744 AND OTHERS.

NO CLAIM IS MADE TO THE EXCLUSIVE RIGHT TO USE "LAWNOTES", APART FROM THE MARK AS SHOWN.

SEC. 2(F).

SER. NO. 77-106,685, FILED 2-13-2007.

CAROLYN CATALDO, EXAMINING ATTORNEY

Int. Cls.: 35 and 36

Prior U.S. Cls.: 100, 101 and 102

United States Patent and Trademark Office

Reg. No. 3,397,349

Registered Mar. 18, 2008

**SERVICE MARK
PRINCIPAL REGISTER**

GLOBECHARGE

GLOBECHARGE PTY LTD (AUSTRALIA LTD
LIAB CO)
MULGRAVE
88 PETERS AVENUE
VICTORIA, AUSTRALIA 3170

FOR: ELECTRONIC PROCESSING OF ORDERS
FOR OTHERS; ON-LINE ORDER MANAGEMENT
SERVICES, NAMELY, PROCESSING OF ORDERS
ON THE INTERNET , IN CLASS 35 (U.S. CLS. 100, 101
AND 102).

FIRST USE 3-31-1999; IN COMMERCE 3-31-1999.

FOR: PROVIDING ELECTRONIC PROCESSING
OF CREDIT CARD TRANSACTIONS AND OTHER

ELECTRONIC PAYMENTS VIA A GLOBAL COM-
PUTER NETWORK, IN CLASS 36 (U.S. CLS. 100, 101
AND 102).

FIRST USE 3-31-1999; IN COMMERCE 3-31-1999.

THE MARK CONSISTS OF STANDARD CHAR-
ACTERS WITHOUT CLAIM TO ANY PARTICULAR
FONT, STYLE, SIZE, OR COLOR.

SER. NO. 77-107,480, FILED 2-14-2007.

BRENDAN REGAN, EXAMINING ATTORNEY

Int. Cls.: 6 and 19

Prior U.S. Cls.: 1, 2, 12, 13, 14, 23, 25, 33 and 50

United States Patent and Trademark Office

Reg. No. 3,397,350

Registered Mar. 18, 2008

**TRADEMARK
PRINCIPAL REGISTER**

WATER WARDEN

ESSE TRADING, INC. (FLORIDA CORPORATION)
9141 TIVOLI PLACE
BOCA RATON, FL 33434

FOR: SWIMMING POOL SAFETY PRODUCTS, NAMELY, METAL GATES AND FENCES, IN CLASS 6 (U.S. CLS. 2, 12, 13, 14, 23, 25 AND 50).

FIRST USE 1-30-2007; IN COMMERCE 1-30-2007.

FOR: SWIMMING POOL SAFETY PRODUCTS, NAMELY, NON-METAL GATES AND FENCES, IN CLASS 19 (U.S. CLS. 1, 12, 33 AND 50).

FIRST USE 1-30-2007; IN COMMERCE 1-30-2007.

THE MARK CONSISTS OF STANDARD CHARACTERS WITHOUT CLAIM TO ANY PARTICULAR FONT, STYLE, SIZE, OR COLOR.

SER. NO. 77-107,562, FILED 2-14-2007.

RONALD MCMORROW, EXAMINING ATTORNEY

Int. Cl.: 9

Prior U.S. Cls.: 21, 23, 26, 36 and 38

United States Patent and Trademark Office

Reg. No. 3,397,351

Registered Mar. 18, 2008

**TRADEMARK
PRINCIPAL REGISTER**

SLAMLOCK

DIVERSIFIED CONTROL, INC. (NEW YORK CORPORATION)
3333 CALIFORNIA ROAD
ORCHARD PARK, NY 14127

FOR: ELECTRONIC LOCKS, NAMELY, SELF-SECURING ENCLOSURES FOR SIGNAL MANAGEMENT IN THE TELECOMMUNICATION INDUSTRY, AND A SELF-SECURING LATCH-TYPE OF LOCK, IN CLASS 9 (U.S. CLS. 21, 23, 26, 36 AND 38).

FIRST USE 1-13-1994; IN COMMERCE 1-13-1994.

THE MARK CONSISTS OF STANDARD CHARACTERS WITHOUT CLAIM TO ANY PARTICULAR FONT, STYLE, SIZE, OR COLOR.

SER. NO. 77-108,002, FILED 2-15-2007.

BARBARA BROWN, EXAMINING ATTORNEY

Int. Cl.: 42

Prior U.S. Cls.: 100 and 101

United States Patent and Trademark Office

Reg. No. 3,397,352

Registered Mar. 18, 2008

**SERVICE MARK
PRINCIPAL REGISTER**

BCPO

NAPO, INC. D/B/A NATIONAL ASSOCIATION
OF PROFESSIONAL ORGANIZERS (TEXAS
NON-PROFIT CORPORATION)
15000 COMMERCE PARKWAY
SUITE C
MOUNT LAUREL, NJ 08054

FOR: TESTING, ANALYSIS AND EVALUATION
OF THE SERVICES OF OTHERS FOR THE PUR-
POSE OF CERTIFICATION IN THE FIELDS OF
ORGANIZATION AND TIME MANAGEMENT, IN
CLASS 42 (U.S. CLS. 100 AND 101).

FIRST USE 12-31-2006; IN COMMERCE 12-31-2006.

THE MARK CONSISTS OF STANDARD CHAR-
ACTERS WITHOUT CLAIM TO ANY PARTICULAR
FONT, STYLE, SIZE, OR COLOR.

OWNER OF U.S. REG. NO. 3,097,501.

SER. NO. 77-108,555, FILED 2-15-2007.

LYDIA BELZER, EXAMINING ATTORNEY

Int. Cl.: 9

Prior U.S. Cls.: 21, 23, 26, 36 and 38

Reg. No. 3,397,353

United States Patent and Trademark Office

Registered Mar. 18, 2008

**TRADEMARK
PRINCIPAL REGISTER**



MULLIN, GREGORY (UNITED STATES INDIVIDUAL)
PO BOX 11608
ATLANTA, GA 303551608

FIRST USE 6-30-2006; IN COMMERCE 9-13-2006.

FOR: AUDIO RECORDINGS FEATURING MUSIC; VIDEO RECORDINGS FEATURING MUSIC; DOWNLOADABLE AUDIO AND VIDEO RECORDINGS FEATURING MUSIC; PRERECORDED MUSIC ON CD AND DVD, IN CLASS 9 (U.S. CLS. 21, 23, 26, 36 AND 38).

THE MARK CONSISTS OF TWO OPEN PARENTHESIS FOLLOWED BY THE LETTERS DSIR FOLLOWED BY TWO CLOSED PARENTHESIS.

SER. NO. 77-108,763, FILED 2-15-2007.

EMILY CARLSEN, EXAMINING ATTORNEY

Int. Cl.: 41

Prior U.S. Cls.: 100, 101 and 107

United States Patent and Trademark Office

Reg. No. 3,397,354

Registered Mar. 18, 2008

**SERVICE MARK
PRINCIPAL REGISTER**

**SAN FRANCISCO LESBIAN GAY
BISEXUAL TRANSGENDER PRIDE
CELEBRATION COMMITTEE, INC.**

SAN FRANCISCO LESBIAN GAY BISEXUAL
TRANSGENDER PRIDE CELEBRATION COM-
MITTEE, INC. (CALIFORNIA NON-PROFIT
CORPORATION)

PMB #5

1800 MARKET STREET

SAN FRANCISCO, CA 94102

FOR: EDUCATION AND ENTERTAINMENT
SERVICES, NAMELY, ORGANIZING AND CON-
DUCTING COMMUNITY FESTIVALS, DANCE
AND SOCIAL EVENTS, ART EXHIBITS, PARADES,
STREET FAIRS, THEATER PERFORMANCES, MU-
SIC PERFORMANCES, FORUMS, PARTIES AND
RALLIES WHICH FOSTER PRIDE IN A WIDE
VARIETY OF SEXUAL ORIENTATIONS, NAMELY,
LESBIAN, GAY, BISEXUAL AND TRANSGENDER
IDENTITIES, IN CLASS 41 (U.S. CLS. 100, 101 AND
107).

FIRST USE 10-0-1997; IN COMMERCE 1-0-1998.

THE MARK CONSISTS OF STANDARD CHAR-
ACTERS WITHOUT CLAIM TO ANY PARTICULAR
FONT, STYLE, SIZE, OR COLOR.

OWNER OF U.S. REG. NOS. 2,545,913, 2,646,391
AND OTHERS.

NO CLAIM IS MADE TO THE EXCLUSIVE
RIGHT TO USE "CELEBRATION COMMITTEE,
INC.", APART FROM THE MARK AS SHOWN.

SEC. 2(F).

SER. NO. 77-108,932, FILED 2-15-2007.

SARA THOMAS, EXAMINING ATTORNEY

Int. Cl.: 8

Prior U.S. Cls.: 23, 28 and 44

United States Patent and Trademark Office

Reg. No. 3,397,355

Registered Mar. 18, 2008

**TRADEMARK
PRINCIPAL REGISTER**

MULTI-CUT

WAHL CLIPPER CORPORATION (ILLINOIS
CORPORATION)
2900 N. LOCUST STREET
STERLING, IL 610810578

FOR: ELECTRIC HAIR CLIPPERS, IN CLASS 8
(U.S. CLS. 23, 28 AND 44).

FIRST USE 0-0-1949; IN COMMERCE 0-0-1949.

THE MARK CONSISTS OF STANDARD CHAR-
ACTERS WITHOUT CLAIM TO ANY PARTICULAR
FONT, STYLE, SIZE, OR COLOR.

SEC. 2(F).

SER. NO. 77-109,008, FILED 2-16-2007.

SANI KHOURI, EXAMINING ATTORNEY

Int. Cls.: 35 and 42

Prior U.S. Cls.: 100, 101 and 102

United States Patent and Trademark Office

Reg. No. 3,397,356

Registered Mar. 18, 2008

**SERVICE MARK
PRINCIPAL REGISTER**



I360TECHNOLOGIES, INC. (DELAWARE CORPORATION)
SUITE P-120
1800 ALEXANDER BELL DRIVE
RESTON, VA 20191

FOR: BUSINESS MANAGEMENT AND BUSINESS CONSULTING SERVICES IN THE FIELD OF COMPUTER HARDWARE, COMPUTER SOFTWARE, AND COMPUTERIZED DATABASES , IN CLASS 35 (U.S. CLS. 100, 101 AND 102).

FIRST USE 3-1-2005; IN COMMERCE 3-1-2005.

FOR: COMPUTER PROJECT MANAGEMENT SERVICES, IN CLASS 42 (U.S. CLS. 100 AND 101).

FIRST USE 3-1-2005; IN COMMERCE 3-1-2005.

NO CLAIM IS MADE TO THE EXCLUSIVE RIGHT TO USE TECHNOLOGIES, APART FROM THE MARK AS SHOWN.

SER. NO. 77-109,125, FILED 2-16-2007.

JANICE L. MCMORROW, EXAMINING ATTORNEY

Int. Cl.: 35

Prior U.S. Cls.: 100, 101 and 102

United States Patent and Trademark Office

Reg. No. 3,397,357

Registered Mar. 18, 2008

**SERVICE MARK
PRINCIPAL REGISTER**



FINANCIAL INDEPENDENCE GROUP, INC.
(NORTH CAROLINA CORPORATION)
19520 W. CATAWBA AVENUE, SUITE 200
CORNELIUS, NC 28031

FIRST USE 2-27-1997; IN COMMERCE 2-27-1997.

SER. NO. 77-109,451, FILED 2-16-2007.

FOR: PROMOTION OF FINANCIAL AND INSUR-
ANCE SERVICES ON BEHALF OF OTHERS, IN
CLASS 35 (U.S. CLS. 100, 101 AND 102).

AMOS T. MATTHEWS, JR., EXAMINING ATTOR-
NEY

Int. Cl.: 10

Prior U.S. Cls.: 26, 39 and 44

United States Patent and Trademark Office

Reg. No. 3,397,358

Registered Mar. 18, 2008

**TRADEMARK
PRINCIPAL REGISTER**

RADspeed

SHIMADZU CORPORATION (JAPAN CORPORATION)
1, NISHINOKYO-KUWABARACHO, NAKAGYOKU
KYOTO, JAPAN

FOR: MEDICAL RADIOGRAPHIC APPARATUS, NAMELY, MEDICAL X-RAY APPARATUS COMPRISED OF X-RAY HIGH-VOLTAGE GENERATOR, X-RAY TUBE RETENTION CRANE, AND AN X-RAY EXAMINATION STAND AND TABLE, IN CLASS 10 (U.S. CLS. 26, 39 AND 44).

FIRST USE 9-30-2004; IN COMMERCE 9-30-2004.

PRIORITY CLAIMED UNDER SEC. 44(D) ON JAPAN APPLICATION NO. 2007-001372, FILED 1-12-2007.

"THE MARK CONSISTS OF THE WORDING RADSPEED IN STYLIZED CHARACTERS."

SER. NO. 77-109,562, FILED 2-16-2007.

KEVIN CORWIN, EXAMINING ATTORNEY

Int. Cl.: 7

Prior U.S. Cls.: 13, 19, 21, 23, 31, 34 and 35

United States Patent and Trademark Office

Reg. No. 3,397,359

Registered Mar. 18, 2008

**TRADEMARK
PRINCIPAL REGISTER**



ULTRA-DEX TOOLING SYSTEMS (MICHIGAN CORPORATION)
7162 SHERIDAN RD
FLUSHING, MI 48433

THE COLOR(S) RED, BLACK AND WHITE IS/ARE CLAIMED AS A FEATURE OF THE MARK.

FOR: MACHINE TOOL HOLDERS; CHUCKS; CHUCK ADAPTORS AND COLLETS; ALL FOR USE WITH MILLING MACHINES; TOOLS FOR MACHINING, NAMELY, TURNING, FACING, DRILLING, BORING, THREADING, MILLING, GROOVING, REAMING, SHEARING AND CUT-OFF TOOLS; CUTTING INSERTS; HOLDERS FOR DRILLS, IN CLASS 7 (U.S. CLS. 13, 19, 21, 23, 31, 34 AND 35).

THE MARK CONSISTS OF THE LETTERS UTS IN BLACK SURROUNDED BY A RED PARALLELOGRAM WITH ROUNDED EDGES. TO THE RIGHT OF THE PARALLELOGRAM ARE THE WORDS ULTRA-DEX ALSO IN BLACK. DIRECTLY UNDER "ULTRA-DEX" ARE THE WORDS TOOLING SYSTEMS, WHICH APPEARS IN BLACK AS WELL. A RED LINE SEPARATES THE TWO LINES OF TEXT.

FIRST USE 1-1-1989; IN COMMERCE 1-1-1989.

SER. NO. 77-109,615, FILED 2-16-2007.

NO CLAIM IS MADE TO THE EXCLUSIVE RIGHT TO USE "TOOLING SYSTEMS", APART FROM THE MARK AS SHOWN.

MICHELE SWAIN, EXAMINING ATTORNEY

Int. Cl.: 25

Prior U.S. Cls.: 22 and 39

United States Patent and Trademark Office

Reg. No. 3,397,360

Registered Mar. 18, 2008

**TRADEMARK
PRINCIPAL REGISTER**

Locally Grown

SCOTT, FRED M. (UNITED STATES INDIVIDUAL)
129 51ST STREET
DES MOINES, IA 50312

THE MARK CONSISTS OF STANDARD CHARACTERS WITHOUT CLAIM TO ANY PARTICULAR FONT, STYLE, SIZE, OR COLOR.

FOR: SHORT-SLEEVED OR LONG-SLEEVED T-SHIRTS; T-SHIRTS, IN CLASS 25 (U.S. CLS. 22 AND 39).

SER. NO. 77-109,632, FILED 2-16-2007.

FIRST USE 8-15-2006; IN COMMERCE 8-15-2006.

PAULA MAHONEY, EXAMINING ATTORNEY

Int. Cl.: 35

Prior U.S. Cls.: 100, 101 and 102

United States Patent and Trademark Office

Reg. No. 3,397,361

Registered Mar. 18, 2008

**SERVICE MARK
PRINCIPAL REGISTER**

**The Grassroots Outdoor
Alliance**

GRASSROOTS OUTDOOR ALLIANCE, INC.
(TEXAS CORPORATION)
347 KENILWORTH ROAD
ASHEVILLE, NC 28805

FOR: FACILITATING THE GROUP PURCHAS-
ING OF OUTDOOR EQUIPMENT INVENTORY
FOR INDEPENDENT RETAILERS OF OUTDOOR
EQUIPMENT, IN CLASS 35 (U.S. CLS. 100, 101 AND
102).

FIRST USE 11-1-2006; IN COMMERCE 11-1-2006.

THE MARK CONSISTS OF STANDARD CHAR-
ACTERS WITHOUT CLAIM TO ANY PARTICULAR
FONT, STYLE, SIZE, OR COLOR.

SER. NO. 77-110,486, FILED 2-19-2007.

CHERYL CLAYTON, EXAMINING ATTORNEY

Int. Cl.: 44

Prior U.S. Cls.: 100 and 101

United States Patent and Trademark Office

Reg. No. 3,397,362

Registered Mar. 18, 2008

**SERVICE MARK
PRINCIPAL REGISTER**

**Healthy Living Through
Healthy Touch**

CONNECTING TOUCH THERAPY & WELLNESS
CENTER, INC. (OHIO CORPORATION)
960 GRAHAM ROAD
CUYAHOGA FALLS, OH 44221

FOR: INFORMATION RELATING TO MASSAGE;
MASSAGE; MASSAGE AND THERAPEUTIC SHIAT-
SU MASSAGE; SALON SERVICES, NAMELY, FA-
CIALS, MANICURES AND MESSAGES THAT ARE
PROVIDED IN A TRAILER OUTFITTED WITH
CHAIR, TABLE AND SINK ACCESSORIES, IN
CLASS 44 (U.S. CLS. 100 AND 101).

FIRST USE 1-1-2006; IN COMMERCE 1-1-2006.

THE MARK CONSISTS OF STANDARD CHAR-
ACTERS WITHOUT CLAIM TO ANY PARTICULAR
FONT, STYLE, SIZE, OR COLOR.

SER. NO. 77-111,166, FILED 2-20-2007.

JIM RINGLE, EXAMINING ATTORNEY

Int. Cl.: 12

Prior U.S. Cls.: 19, 21, 23, 31, 35 and 44

United States Patent and Trademark Office

Reg. No. 3,397,363

Registered Mar. 18, 2008

**TRADEMARK
PRINCIPAL REGISTER**

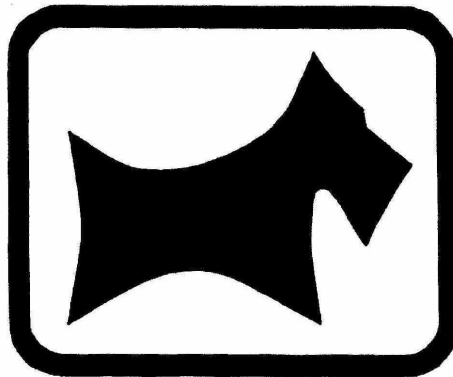

MOBILE CONCEPTS BY SCOTTY (PENNSYLVANIA CORPORATION)
480 BESSEMER ROAD
MT. PLEASANT, PA 15666

THE MARK CONSISTS OF THE DESIGN OF A SCOTTISH TERRIER DOG INSIDE A RECTANGLE.

FOR: TRAILERS, TRAVEL TRAILERS AND EQUIPMENT TRAILERS, IN CLASS 12 (U.S. CLS. 19, 21, 23, 31, 35 AND 44).

SER. NO. 77-111,203, FILED 2-20-2007.

FIRST USE 4-21-1997; IN COMMERCE 4-21-1997.

MAUREEN DALL, EXAMINING ATTORNEY

Int. Cl.: 9

Prior U.S. Cls.: 21, 23, 26, 36 and 38

United States Patent and Trademark Office

Reg. No. 3,397,364

Registered Mar. 18, 2008

**TRADEMARK
PRINCIPAL REGISTER**

Speedalite

FIBER CABLES DIRECT, LLC (CALIFORNIA
LTD LIAB CO)
33 VIA MARGUESA
SANTA MARGUERITA, CA 92688

FOR: FIBER OPTIC CABLES; OPTICAL FIBERS
SOLD AS A COMPONENT OF FIBER OPTICAL
CABLES, IN CLASS 9 (U.S. CLS. 21, 23, 26, 36 AND 38).

FIRST USE 9-1-2006; IN COMMERCE 1-1-2007.

THE MARK CONSISTS OF STANDARD CHAR-
ACTERS WITHOUT CLAIM TO ANY PARTICULAR
FONT, STYLE, SIZE, OR COLOR.

SER. NO. 77-111,438, FILED 2-20-2007.

JOHN SCHUYLER YARD, EXAMINING ATTOR-
NEY

Int. Cl.: 14

Prior U.S. Cls.: 2, 27, 28 and 50

United States Patent and Trademark Office

Reg. No. 3,397,365

Registered Mar. 18, 2008

**TRADEMARK
PRINCIPAL REGISTER**



NEW YORK FOOTBALL GIANTS, INC. (NEW
YORK CORPORATION)
GIANTS STADIUM
EAST RUTHERFORD, NJ 07073

FOR: JEWELRY, WATCHES, CLOCKS, ORNA-
MENTAL PINS, EARRINGS, NECKLACES, BRACE-
LETS, CHARMS, COLLECTIBLE AND
COMMEMORATIVE COINS MADE OF PRECIOUS
METAL AND PENDANTS MADE OF PRECIOUS
METAL, IN CLASS 14 (U.S. CLS. 2, 27, 28 AND 50).

FIRST USE 9-0-2000; IN COMMERCE 9-0-2000.

OWNER OF U.S. REG. NOS. 2,774,776, 2,790,409
AND OTHERS.

THE MARK CONSISTS OF THE LETTERS "N"
AND "Y" STYLIZED.

SEC. 2(F).

SER. NO. 77-111,487, FILED 2-20-2007.

KATHERINE E. HALMEN, EXAMINING ATTOR-
NEY

Int. Cl.: 33

Prior U.S. Cls.: 47 and 49

United States Patent and Trademark Office

Reg. No. 3,397,366

Registered Mar. 18, 2008

**TRADEMARK
PRINCIPAL REGISTER**

SIMPLY RED

FRANCIS S. MILLIER (UNITED STATES INDIVIDUAL)
P.O. BOX 1154
MURPHYS, CA 95247 AND
ELIZABETH J. MILLIER (UNITED STATES INDIVIDUAL)
P.O. BOX 1154
MURPHYS, CA 95247

THE MARK CONSISTS OF STANDARD CHARACTERS WITHOUT CLAIM TO ANY PARTICULAR FONT, STYLE, SIZE, OR COLOR.

NO CLAIM IS MADE TO THE EXCLUSIVE RIGHT TO USE "RED", APART FROM THE MARK AS SHOWN.

FOR: WINES, IN CLASS 33 (U.S. CLS. 47 AND 49).

SER. NO. 77-111,876, FILED 2-20-2007.

FIRST USE 9-1-1992; IN COMMERCE 9-1-1992.

TASHIA BUNCH, EXAMINING ATTORNEY

Int. Cl.: 25

Prior U.S. Cls.: 22 and 39

United States Patent and Trademark Office

Reg. No. 3,397,367

Registered Mar. 18, 2008

**TRADEMARK
PRINCIPAL REGISTER**



HUDSON, ALBION (UNITED STATES INDIVIDUAL)
P.O. BOX 5074
BEVERLY HILLS, CA 90209

THE MARK CONSISTS OF A RED OVAL WITH WHITE LETTERS THAT SPELL CONART.

FOR: SHORT-SLEEVED OR LONG-SLEEVED T-SHIRTS, IN CLASS 25 (U.S. CLS. 22 AND 39).

SER. NO. 77-112,037, FILED 2-21-2007.

FIRST USE 0-0-1989; IN COMMERCE 0-0-1989.

THE COLOR(S) RED AND WHITE IS/ARE CLAIMED AS A FEATURE OF THE MARK.

DOMINIC J. FERRAIUOLO, EXAMINING ATTORNEY

Int. Cls.: 38, 39, 41, 42 and 43

Prior U.S. Cls.: 100, 101, 104, 105 and 107

United States Patent and Trademark Office

Reg. No. 3,397,368

Registered Mar. 18, 2008

**SERVICE MARK
PRINCIPAL REGISTER**

TRAVELPOD

TRIPADVISOR LLC (DELAWARE CORPORATION)
SUITE 304
464 HILLSIDE AVENUE
NEEDHAM, MA 02494

FOR: PROVIDING ON-LINE ELECTRONIC BULLETIN BOARDS AND FORUMS FOR TRANSMISSION OF MESSAGES AND PHOTOS AMONG COMPUTER USERS IN THE FIELD OF TRAVEL, IN CLASS 38 (U.S. CLS. 100, 101 AND 104).

FIRST USE 12-3-1998; IN COMMERCE 12-3-1998.

FOR: TRAVEL INFORMATION SERVICES; PROVIDING AN ON-LINE COMPUTER DATABASE IN THE FIELD OF TRAVEL INFORMATION SERVICES; PROVIDING A WEBSITE CONTAINING REVIEWS OF TRAVEL SERVICE PROVIDERS, TRAVEL DESTINATIONS, AND LOCAL ATTRACTIONS, IN CLASS 39 (U.S. CLS. 100 AND 105).

FIRST USE 12-3-1998; IN COMMERCE 12-3-1998.

FOR: PROVIDING ON-LINE JOURNALS AND BLOGS IN THE FIELD OF TRAVEL, IN CLASS 41 (U.S. CLS. 100, 101 AND 107).

FIRST USE 12-3-1998; IN COMMERCE 12-3-1998.

FOR: COMPUTER SERVICES, NAMELY, PROVIDING SEARCH ENGINES FOR OBTAINING TRAVEL DATA ON A GLOBAL COMPUTER NETWORK; COMPUTER SERVICES, NAMELY, INTERACTIVE HOSTING SERVICES WHICH ALLOW THE USER TO PUBLISH AND SHARE THEIR OWN CONTENT AND IMAGES ONLINE, IN CLASS 42 (U.S. CLS. 100 AND 101).

FIRST USE 12-3-1998; IN COMMERCE 12-3-1998.

FOR: PROVIDING LODGING INFORMATION SERVICES; PROVIDING A WEBSITE CONTAINING REVIEWS OF HOTEL ACCOMMODATIONS, IN CLASS 43 (U.S. CLS. 100 AND 101).

FIRST USE 1-30-2003; IN COMMERCE 1-30-2003.

THE MARK CONSISTS OF STANDARD CHARACTERS WITHOUT CLAIM TO ANY PARTICULAR FONT, STYLE, SIZE, OR COLOR.

SER. NO. 77-112,122, FILED 2-21-2007.

G. MAYERSCHOFF, EXAMINING ATTORNEY

Int. Cl.: 9

Prior U.S. Cls.: 21, 23, 26, 36 and 38

United States Patent and Trademark Office

Reg. No. 3,397,369

Registered Mar. 18, 2008

**TRADEMARK
PRINCIPAL REGISTER**

PAGE TALKERS

GRANT, STEPHEN (AUSTRALIA INDIVIDUAL)
30 CHURCH STREET
TOORAK, VIC. 3142, AUSTRALIA

FOR: APPARATUS FOR RECORDING, TRANSMISSION, OR DISPLAYING SOUND AND IMAGES; COMPUTER SOFTWARE TO RECORD AND STORE VOICES, SOUNDS; COMPUTER HARDWARE; SOUND RECORDERS, DIGITAL RECORDING DEVICES TO RECORD, STORE, DISPLAY AND BROADCAST SOUND; DIGITAL RECORDING DEVICES TO RECORD, STORE, DISPLAY AND BROADCAST SOUND AND IMAGES, NONE OF THE FOREGOING BEING IN RELATION TO MU-

SICAL INSTRUMENTS, IN CLASS 9 (U.S. CLS. 21, 23, 26, 36 AND 38).

THE MARK CONSISTS OF STANDARD CHARACTERS WITHOUT CLAIM TO ANY PARTICULAR FONT, STYLE, SIZE, OR COLOR.

OWNER OF AUSTRALIA REG. NO. 1130865, DATED 8-22-2006, EXPIRES 8-22-2016.

SER. NO. 77-112,589, FILED 2-21-2007.

YAT SYE, LEE, EXAMINING ATTORNEY

Int. Cl.: 20

Prior U.S. Cls.: 2, 13, 22, 25, 32 and 50

United States Patent and Trademark Office

Reg. No. 3,397,370

Registered Mar. 18, 2008

**TRADEMARK
PRINCIPAL REGISTER**

PLAYNIX

BACKYARD ADVENTURES OF COLORADO
(COLORADO LTD LIAB CO)
3540 S LOGAN ST
ENGLEWOOD, CO 80113

THE MARK CONSISTS OF THE WORD PLAY-
NIX.

FOR: FURNITURE, IN CLASS 20 (U.S. CLS. 2, 13,
22, 25, 32 AND 50).

SER. NO. 77-112,732, FILED 2-21-2007.

FIRST USE 7-3-1972; IN COMMERCE 7-3-1972.

JANET LEE, EXAMINING ATTORNEY

Int. Cl.: 42

Prior U.S. Cls.: 100 and 101

United States Patent and Trademark Office

Reg. No. 3,397,371

Registered Mar. 18, 2008

**SERVICE MARK
PRINCIPAL REGISTER**

MyPrivacy

REPUTATIONDEFENDER, INC. (DELAWARE
CORPORATION)
3723 HAVEN AVE., SUITE 132
MENLO PARK, CA 94025

THE MARK CONSISTS OF STANDARD CHAR-
ACTERS WITHOUT CLAIM TO ANY PARTICULAR
FONT, STYLE, SIZE, OR COLOR.

FOR: COMPUTER SERVICES, NAMELY, CREAT-
ING INDEXES OF INFORMATION, SITES AND
OTHER RESOURCES AVAILABLE ON COMPUTER
NETWORKS, IN CLASS 42 (U.S. CLS. 100 AND 101).

SER. NO. 77-112,859, FILED 2-21-2007.

FIRST USE 6-1-2006; IN COMMERCE 1-15-2007.

SCOTT SISUN, EXAMINING ATTORNEY

Int. Cls.: 35 and 42

Prior U.S. Cls.: 100, 101 and 102

United States Patent and Trademark Office

Reg. No. 3,397,372

Registered Mar. 18, 2008

**SERVICE MARK
PRINCIPAL REGISTER**

CORVIDEA

CORVIDEA, LLC (GEORGIA LTD LIAB CO)
5070 TAHOE PINES WAY
ALPHARETTA, GA 30005

FOR: BUSINESS CONSULTING SERVICES, NAME-
LEY, CUSTOMIZING BUSINESS SOLUTIONS TO
INCREASE EFFICIENCY AND MAXIMIZE RE-
SOURCE IN SPECIFIC WORK AREAS, NAME-
LY, RISK MANAGEMENT, OPERATIONS MAINTEN-
ANCE AND E-LEARNING IN THE FIELD OF
COMMERCIAL REAL-ESTATE, IN CLASS 35 (U.S.
CLS. 100, 101 AND 102).

FIRST USE 5-1-2006; IN COMMERCE 5-1-2006.

FOR: APPLICATION SERVICE PROVIDER,
NAME-LEY, PROVIDING, HOSTING, MANAGING,
DEVELOPING, AND MAINTAINING APPLICA-
TIONS, SOFTWARE, WEB SITES, AND DATABASES

IN THE FIELDS OF REAL ESTATE; PROVIDING
ON-LINE NON-DOWNLOADABLE SOFTWARE
FOR ACCESSING PROPERTY MANAGEMENT RE-
SOURCE IN ASSOCIATED REAL ESTATE DA-
TABASES; DOCUMENT DATA TRANSFER FROM
ONE COMPUTER FORMAT TO ANOTHER, NAME-
LY, TRANSFERRING DATA RELATING TO REAL
ESTATE TO AND FROM DATABASES, IN CLASS 42
(U.S. CLS. 100 AND 101).

FIRST USE 5-1-2006; IN COMMERCE 5-1-2006.

THE MARK CONSISTS OF STANDARD CHAR-
ACTERS WITHOUT CLAIM TO ANY PARTICULAR
FONT, STYLE, SIZE, OR COLOR.

SER. NO. 77-113,946, FILED 2-22-2007.

CARYN GLASSER, EXAMINING ATTORNEY

Int. Cl.: 3

Prior U.S. Cls.: 1, 4, 6, 50, 51 and 52

United States Patent and Trademark Office

Reg. No. 3,397,373

Registered Mar. 18, 2008

**TRADEMARK
PRINCIPAL REGISTER**

EXLINEA

PHYSICIAN'S CARE ALLIANCE, LLC (ARIZONA
LTD LIAB CO)
SUITE 150
8501 NORTH SCOTTSDALE ROAD
SCOTTSDALE, AZ 85253

FOR: COSMETIC PREPARATIONS FOR SKIN
RENEWAL; NONMEDICATED SKIN CARE PRE-
PARATIONS; NONMEDICATED SKIN CREAMS;
SKIN CARE PREPARATIONS, NAMELY, CHEMI-
CAL PEELS FOR SKIN; COSMETIC SUN-PROTECT-
ING PREPARATIONS; NON-MEDICATED SUN
CARE PREPARATIONS, IN CLASS 3 (U.S. CLS. 1, 4,
6, 50, 51 AND 52).

FIRST USE 8-23-2004; IN COMMERCE 8-23-2004.

THE MARK CONSISTS OF STANDARD CHAR-
ACTERS WITHOUT CLAIM TO ANY PARTICULAR
FONT, STYLE, SIZE, OR COLOR.

SER. NO. 77-115,544, FILED 2-24-2007.

ANDREA K. NADELMAN, EXAMINING ATTOR-
NEY

Int. Cl.: 7

Prior U.S. Cls.: 13, 19, 21, 23, 31, 34 and 35

United States Patent and Trademark Office

Reg. No. 3,397,374

Registered Mar. 18, 2008

**TRADEMARK
PRINCIPAL REGISTER**

Titan

STEVE CHANDLER (UNITED STATES INDIVIDUAL)
9893 SOUTH HOUSTON WAY
GERMANTOWN, TN 38119

FOR: EXHAUST AIR JACKS, IN CLASS 7 (U.S. CLS. 13, 19, 21, 23, 31, 34 AND 35).

FIRST USE 10-31-2006; IN COMMERCE 10-31-2006.

THE MARK CONSISTS OF STANDARD CHARACTERS WITHOUT CLAIM TO ANY PARTICULAR FONT, STYLE, SIZE, OR COLOR.

SER. NO. 77-115,926, FILED 2-26-2007.

DOMINIC J. FERRAIUOLO, EXAMINING ATTORNEY

Int. Cl.: 1

Prior U.S. Cls.: 1, 5, 6, 10, 26 and 46

United States Patent and Trademark Office

Reg. No. 3,397,375

Registered Mar. 18, 2008

TRADEMARK
PRINCIPAL REGISTER



BIOCELL TECHNOLOGY, LLC (CALIFORNIA
LTD LIAB CO)
4695 MACARTHUR COURT, 11TH FLOOR
NEWPORT BEACH, CA 92660

FOR: PLANT EXTRACTS, NAMELY, EXTRACT
OF THE WASABI JAPONICA PLANT USED IN THE
MANUFACTURE OF DIETARY SUPPLEMENTS,
PHARMACEUTICAL AND COSMETIC APPLICA-
TIONS, IN CLASS 1 (U.S. CLS. 1, 5, 6, 10, 26 AND 46).

FIRST USE 12-12-2006; IN COMMERCE 12-12-2006.

NO CLAIM IS MADE TO THE EXCLUSIVE
RIGHT TO USE "WASABI JAPONICA", APART
FROM THE MARK AS SHOWN.

THE MARK CONSISTS OF THE TERM "I-SABI". A
LONG STEM LEAF EXTENDS FROM ACROSS THE
LAST "I" TO THE FIRST "I" IN "SABI" TO CREATE A
CURVE. THE LEAF HEAD SERVES AS A DOT OF
THE FIRST "I" AND THE END OF THE STEM
SERVES AS A DOT OF THE LAST "I". THE LEAF
HEAD IS A HEART-SHAPED LEAF.

SER. NO. 77-116,377, FILED 2-26-2007.

ROBERT C. CLARK JR., EXAMINING ATTORNEY

Int. Cl.: 25

Prior U.S. Cls.: 22 and 39

United States Patent and Trademark Office

Reg. No. 3,397,376

Registered Mar. 18, 2008

**TRADEMARK
PRINCIPAL REGISTER**



NASHVILLE SOUNDS BASEBALL CLUB LIMITED PARTNERSHIP (TENNESSEE LIMITED PARTNERSHIP)
534 CHESTNUT ST.
NASHVILLE, TN 37203

FOR: CLOTHING; NAMELY, SHIRTS, SHORTS, T-SHIRTS, POLO SHIRTS, GOLF SHIRTS, TANK TOPS, SOCKS, JACKETS, SWEATERS, VESTS, VISORS, HATS, CAPS, SWEATSHIRTS, WRIST BANDS, WIND RESISTANT JACKETS, SWEATPANTS, GYM SUITS, HEAD WEAR, JERSEYS, PULLOVERS, V-NECK SWEATERS AND KNIT SHIRTS, IN CLASS 25 (U.S. CLS. 22 AND 39).

FIRST USE 12-1-1998; IN COMMERCE 12-1-1998.

THE MARK CONSISTS OF THE DESIGN OF A FANCIFUL MUSICAL NOTE CONTAINING A PORTION OF A BASEBALL.

SEC. 2(F).

SER. NO. 77-116,427, FILED 2-26-2007.

DAVID C. REIHNER, EXAMINING ATTORNEY

Int. Cl.: 9

Prior U.S. Cls.: 21, 23, 26, 36 and 38

United States Patent and Trademark Office

Reg. No. 3,397,377

Registered Mar. 18, 2008

TRADEMARK
PRINCIPAL REGISTER

**MAGNUM
MAGNUM**

PETRA INDUSTRIES, INC. (OKLAHOMA COR-
PORATION)
2101 SOUTH KELLEY AVENUE
EDMOND, OK 73013

FIRST USE 5-14-1998; IN COMMERCE 5-14-1998.

SER. NO. 77-116,440, FILED 2-26-2007.

FOR: ELECTRICAL CORDS FOR USE IN CON-
NECTION WITH DRYERS AND ELECTRICAL
RANGES, IN CLASS 9 (U.S. CLS. 21, 23, 26, 36 AND
38).

YAT SYE, LEE, EXAMINING ATTORNEY

Int. Cl.: 16

Prior U.S. Cls.: 2, 5, 22, 23, 29, 37, 38 and 50

Reg. No. 3,397,378

United States Patent and Trademark Office

Registered Mar. 18, 2008

**TRADEMARK
PRINCIPAL REGISTER**



AIDS PROJECT LOS ANGELES (CALIFORNIA
NON-PROFIT CORPORATION)
611 SOUTH KINGSLEY DRIVE
THE DAVID GEFFEN CENTER
LOS ANGELES, CA 90005

OWNER OF U.S. REG. NO. 2,197,182.

FOR: PRINTED PUBLICATIONS, NAMELY, BRO-
CHURES, BOOKLETS, AND TEACHING MATERI-
ALS IN THE FIELD OF HIV AND AIDS
PREVENTION, IN CLASS 16 (U.S. CLS. 2, 5, 22, 23,
29, 37, 38 AND 50).

NO CLAIM IS MADE TO THE EXCLUSIVE
RIGHT TO USE "AIDS PROJECT LOS ANGELES",
APART FROM THE MARK AS SHOWN.

SER. NO. 77-116,457, FILED 2-26-2007.

FIRST USE 1-0-2003; IN COMMERCE 1-0-2003.

TARAH HARDY, EXAMINING ATTORNEY

Int. Cl.: 41

Prior U.S. Cls.: 100, 101 and 107

United States Patent and Trademark Office

Reg. No. 3,397,379

Registered Mar. 18, 2008

**SERVICE MARK
PRINCIPAL REGISTER**



AIDS PROJECT LOS ANGELES (CALIFORNIA
NON-PROFIT CORPORATION)
THE DAVID GEFFEN CENTER
611 SOUTH KINGSLEY DRIVE
LOS ANGELES, CA 90005

FIRST USE 1-0-2003; IN COMMERCE 1-0-2003.

OWNER OF U.S. REG. NO. 2,197,182.

FOR: EDUCATIONAL SERVICES, NAMELY,
PROVIDING CLASSES AND TRAINING IN THE
FIELD OF HIV AND AIDS PREVENTION AND
DISTRIBUTION OF COURSE MATERIAL IN CON-
NECTION THEREWITH; PROVIDING ONLINE
PUBLICATIONS IN THE NATURE OF JOURNALS,
MAGAZINES, PAMPHLETS, AND BROCHURES IN
THE FIELD OF HIV AND AIDS PREVENTION, IN
CLASS 41 (U.S. CLS. 100, 101 AND 107).

NO CLAIM IS MADE TO THE EXCLUSIVE
RIGHT TO USE "AIDS PROJECT LOS ANGELES",
APART FROM THE MARK AS SHOWN.

SER. NO. 77-116,488, FILED 2-26-2007.

TARAH HARDY, EXAMINING ATTORNEY

Int. Cl.: 36

Prior U.S. Cls.: 100, 101 and 102

United States Patent and Trademark Office

Reg. No. 3,397,380

Registered Mar. 18, 2008

**SERVICE MARK
PRINCIPAL REGISTER**



AIDS PROJECT LOS ANGELES (CALIFORNIA
NON-PROFIT CORPORATION)
611 SOUTH KINGSLEY DRIVE
THE DAVID GEFFEN CENTER
LOS ANGELES, CA 90005

OWNER OF U.S. REG. NO. 2,197,182.

NO CLAIM IS MADE TO THE EXCLUSIVE
RIGHT TO USE AIDS PROJECT LOS ANGELES,
APART FROM THE MARK AS SHOWN.

FOR: CHARITABLE FUNDRAISING, IN CLASS
36 (U.S. CLS. 100, 101 AND 102).

SER. NO. 77-116,494, FILED 2-26-2007.

FIRST USE 1-0-2003; IN COMMERCE 1-0-2003.

TARAH HARDY, EXAMINING ATTORNEY

Int. Cls.: 5 and 44

Prior U.S. Cls.: 6, 18, 44, 46, 51, 52, 100 and 101

United States Patent and Trademark Office

Reg. No. 3,397,381

Registered Mar. 18, 2008

**TRADEMARK
SERVICE MARK
PRINCIPAL REGISTER**

Transforming Lives Changing Perceptions



ARES TRADING S.A. (SWITZERLAND SOCIETE
ANONYME)
CH-1170
ZONE INDUSTRIELLE DE L'OURIETTAZ
AUBONNE, SWITZERLAND

FOR: PHARMACEUTICAL PREPARATIONS IN
THE FIELD OF DERMATOLOGY, IN CLASS 5 (U.S.
CLS. 6, 18, 44, 46, 51 AND 52).

FOR: PHARMACEUTICAL AND MEDICAL SER-
VICES IN THE FIELD OF DERMATOLOGY, NAME-
LY, PROVIDING PHARMACEUTICAL AND
MEDICAL INFORMATION AND COUNSELING,
IN CLASS 44 (U.S. CLS. 100 AND 101).

OWNER OF SWITZERLAND REG. NO. 551887,
DATED 11-2-2006, EXPIRES 8-8-2016.

THE MARK CONSISTS OF THE WORDS TRANS-
FORMING LIVES, CHANGING PERCEPTIONS
AND AN IMAGE OF A MAP OF THE WORLD WITH
HUMAN FACES SUPERIMPOSED ON TO IT.

SER. NO. 77-117,488, FILED 2-27-2007.

KIMBERLY FRYE, EXAMINING ATTORNEY

Int. Cl.: 29

Prior U.S. Cl.: 46

United States Patent and Trademark Office

Reg. No. 3,397,382

Registered Mar. 18, 2008

**TRADEMARK
PRINCIPAL REGISTER**

HONGAR FARMS

GOLD STAR BRANDS LLC DBA HONGAR
FARMS GOURMET FOODS (GEORGIA LTD
LIAB CO)
2121 TUCKER INDUSTRIAL ROAD
TUCKER, GA 300847191

FOR: OLIVE OIL, FLAVORED OLIVE OIL, AND
FLAVORED DIPPING OILS MADE PRIMARILY OF
OLIVE OIL, IN CLASS 29 (U.S. CL. 46).

FIRST USE 1-1-1988; IN COMMERCE 1-1-1988.

THE MARK CONSISTS OF STANDARD CHAR-
ACTERS WITHOUT CLAIM TO ANY PARTICULAR
FONT, STYLE, SIZE, OR COLOR.

NO CLAIM IS MADE TO THE EXCLUSIVE
RIGHT TO USE "FARMS", APART FROM THE
MARK AS SHOWN.

SER. NO. 77-118,339, FILED 2-28-2007.

STEVEN PEREZ, EXAMINING ATTORNEY

Int. Cls.: 35, 41 and 44

Prior U.S. Cls.: 100, 101, 102 and 107

United States Patent and Trademark Office

Reg. No. 3,397,383

Registered Mar. 18, 2008

SERVICE MARK
PRINCIPAL REGISTER



CITY OF ALISO VIEJO (CALIFORNIA MUNICIPAL CORPORATION)
SUITE 100
12 JOURNEY
ALISO VIEJO, CA 92656

FOR: PROMOTING PUBLIC AWARENESS OF FAMILY ISSUES, NAMELY, SAFETY AND PERMANENCY IN HOMES AND COMMUNITIES THROUGH PREVENTION EFFORTS AIMED AT CHILD ABUSE, DOMESTIC VIOLENCE, GANG ACTIVITY, AND SUBSTANCE ABUSE, INCREASING ACCESSIBILITY TO HEALTH AND MENTAL HEALTH CARE SERVICES, INCREASING AVAILABILITY AND ACCESSIBILITY OF QUALITY CHILDCARE AND YOUTH PROGRAMS, WAYS TO ASSIST FAMILIES IN OBTAINING ACCESS TO RESOURCES AIMED AT ECONOMIC SELF-SUFFICIENCY, AND STRENGTHENING PARENTING SKILLS; REFERRALS TO COMMUNITY SERVICES AND AGENCIES, IN CLASS 35 (U.S. CLS. 100, 101 AND 102).

FIRST USE 7-1-2002; IN COMMERCE 7-1-2002.

FOR: EDUCATION SERVICES, NAMELY, PROVIDING PARENT EDUCATION CLASSES FOCUSING ON PARENTING SKILLS, CHILD DEVELOPMENT, PREVENTION OF AND RECOVERY FROM CHILD ABUSE, DOMESTIC VIOLENCE, GANG ACTIVITY, AND SUBSTANCE ABUSE; EDUCATION SERVICES, NAMELY, CONDUCTING FIRST-AID, HEALTH, HEALTHCARE, AND NUTRITION CLASSES, ENGLISH AS A SECOND LANGUAGE CLASSES, SCHOOL READINESS CLASSES, HOMEWORK CLUBS FOR TUTORING, AND AFTER-SCHOOL EDUCATIONAL PROGRAMS

FOR CHILDREN AGES 5 TO 12; CHILDREN'S READING GROUPS AND LIBRARY SERVICES; CHARITABLE SERVICES, NAMELY, PROVIDING TRAINING IN THE FIELD OF FILING INSURANCE APPLICATIONS, IN CLASS 41 (U.S. CLS. 100, 101 AND 107).

FIRST USE 7-1-2002; IN COMMERCE 7-1-2002.

FOR: PHYSIOLOGICAL COUNSELING SERVICES IN THE FIELD OF ADOLESCENT ISSUES, NAMELY, BODY IMAGE, SELF-ESTEEM, MOTIVATIONAL TECHNIQUES, AND TEEN PRESSURE PROGRAMS, AND MOTHER-DAUGHTER AND FATHER-SON WORKSHOPS, IN CLASS 44 (U.S. CLS. 100 AND 101).

FIRST USE 7-1-2002; IN COMMERCE 7-1-2002.

NO CLAIM IS MADE TO THE EXCLUSIVE RIGHT TO USE "ALISO VIEJO FAMILY RESOURCE CENTER", APART FROM THE MARK AS SHOWN.

THE MARK CONSISTS OF THE WORDS FAMILY RESOURCE CENTER IN A HORIZONTAL POSITION WITH THE WORDS ALISO VIEJO PLACED ONE ON TOP OF THE OTHER AND ABOVE THE WORD FAMILY; A HEART WITH A CUTOUT OF HANDS AND FOUR PEOPLE APPEARING IN THE MIDDLE IS IN BETWEEN THE WORDS FAMILY AND RESOURCE.

SER. NO. 77-118,756, FILED 2-28-2007.

LINDA MICKLEBURGH, EXAMINING ATTORNEY

Int. Cl.: 19

Prior U.S. Cls.: 1, 12, 33 and 50

United States Patent and Trademark Office

Reg. No. 3,397,384

Registered Mar. 18, 2008

**TRADEMARK
PRINCIPAL REGISTER**

KING'S

KING'S MATERIAL, INC. (IOWA CORPORATION)
355 - 50TH AVENUE DRIVE SW
P.O. BOX 368
CEDAR RAPIDS, IA 52406

FOR: CONCRETE BUILDING MATERIALS,
NAMELY, CONCRETE BLOCK AND BRICKS; CON-
CRETE, IN CLASS 19 (U.S. CLS. 1, 12, 33 AND 50).

FIRST USE 1-1-1982; IN COMMERCE 1-1-1982.

THE MARK CONSISTS OF STANDARD CHAR-
ACTERS WITHOUT CLAIM TO ANY PARTICULAR
FONT, STYLE, SIZE, OR COLOR.

OWNER OF U.S. REG. NOS. 1,951,082, 2,585,030,
AND 2,586,561.

SER. NO. 77-119,334, FILED 3-1-2007.

JENNIFER HETU, EXAMINING ATTORNEY

Int. Cl.: 40

Prior U.S. Cls.: 100, 103 and 106

United States Patent and Trademark Office

Reg. No. 3,397,385

Registered Mar. 18, 2008

**SERVICE MARK
PRINCIPAL REGISTER**



CHUDINA JR, GEORGE J (VIRGINIA CORPORATION)
387 THORNGROVE PIKE
KODAK, TN 37764

FOR: METAL FABRICATION AND FINISHING SERVICES, IN CLASS 40 (U.S. CLS. 100, 103 AND 106).

FIRST USE 8-1-2005; IN COMMERCE 9-19-2005.

NO CLAIM IS MADE TO THE EXCLUSIVE RIGHT TO USE "PRODUCTS", APART FROM THE MARK AS SHOWN.

THE COLOR(S) GREEN, BLACK AND WHITE IS/ ARE CLAIMED AS A FEATURE OF THE MARK.

THE MARK CONSISTS OF OVAL SHAPED BACKGROUND WITH GREEN BORDER TRIMMED IN BLACK, MIDDLE OF OVAL IS BLACK TRIMMED IN LIGHT GREEN, A DESIGN OF WHITE BULL HEAD WITH HORNS, TRIMMED IN BLACK, IS LOCATED IN THE MIDDLE OF THE ENTIRE OVAL WITH WHITE WORDS BULL HEAD, TRIMMED IN BLACK, CENTERED ON EITHER SIDE OF THE BULL HEAD DRAWING, THE WORD PRODUCTS WRITTEN IN WHITE IN THE BOTTOM PORTION OF GREEN OVAL BORDER AND 3 WHITE DOTS IN TOP PORTION OF THE GREEN OVAL BORDER.

SER. NO. 77-119,959, FILED 3-1-2007.

ROBIN CHOSID, EXAMINING ATTORNEY

Int. Cl.: 9

Prior U.S. Cls.: 21, 23, 26, 36 and 38

United States Patent and Trademark Office

Reg. No. 3,397,386

Registered Mar. 18, 2008

**TRADEMARK
PRINCIPAL REGISTER**

VGA SNIFFER

ALTINEX, INC. (CALIFORNIA CORPORATION)
592 APOLLO STREET
BREA, CA 92821

FOR: DIGITAL SIGNAL PROCESSORS, IN CLASS
9 (U.S. CLS. 21, 23, 26, 36 AND 38).

FIRST USE 3-1-2007; IN COMMERCE 3-1-2007.

THE MARK CONSISTS OF STANDARD CHAR-
ACTERS WITHOUT CLAIM TO ANY PARTICULAR
FONT, STYLE, SIZE, OR COLOR.

NO CLAIM IS MADE TO THE EXCLUSIVE
RIGHT TO USE VGA, APART FROM THE MARK
AS SHOWN.

SER. NO. 77-120,224, FILED 3-1-2007.

ELIZABETH KAJUBI, EXAMINING ATTORNEY

Int. Cl.: 9

Prior U.S. Cls.: 21, 23, 26, 36 and 38

Reg. No. 3,397,387

United States Patent and Trademark Office

Registered Mar. 18, 2008

**TRADEMARK
PRINCIPAL REGISTER**

HEART OF VEGAS

ARISTOCRAT TECHNOLOGIES AUSTRALIA
PTY LTD (AUSTRALIA CORPORATION)
71 LONGUEVILLE ROAD
LANE COVE, NSW, AUSTRALIA 2066

PRIORITY CLAIMED UNDER SEC. 44(D) ON
AUSTRALIA APPLICATION NO. 1135575, FILED 9-
14-2006, REG. NO. 1135575, DATED 4-30-2007, EX-
PIRES 9-14-2016.

FOR: GAMING MACHINES; COMPUTER HARD-
WARE; DOWNLOADABLE GAME SOFTWARE;
ELECTRONIC GAME SOFTWARE, IN CLASS 9
(U.S. CLS. 21, 23, 26, 36 AND 38).

SER. NO. 77-120,746, FILED 3-2-2007.

THE MARK CONSISTS OF STANDARD CHAR-
ACTERS WITHOUT CLAIM TO ANY PARTICULAR
FONT, STYLE, SIZE, OR COLOR.

WILLIAM VERHOSEK, EXAMINING ATTORNEY

Int. Cl.: 37

Prior U.S. Cls.: 100, 103 and 106

United States Patent and Trademark Office

Reg. No. 3,397,388

Registered Mar. 18, 2008

**SERVICE MARK
PRINCIPAL REGISTER**



EMERGENCY SERVICES RESTORATION, INC.
(CALIFORNIA CORPORATION)
P. O. BOX 2567
REDONDO BEACH, CA 90278

FOR: RESTORATION SERVICES PROVIDED FOR RESIDENTIAL AND COMMERCIAL STRUCTURES DUE TO WATER DAMAGE, NAMELY, WATER EXTRACTION, CLEAN AND GRAY SEWAGE MITIGATION, NAMELY, CLEANING UP SEWAGE SPILLS OR OVERFLOW, STRUCTURE AND CONTENT DRYING, ODOR REMOVAL, AND EVALUATION OF THE AMOUNT AND TYPE OF RESTORATION SERVICES REQUIRED, IN CLASS 37 (U.S. CLS. 100, 103 AND 106).

FIRST USE 10-1-2006; IN COMMERCE 10-1-2006.

NO CLAIM IS MADE TO THE EXCLUSIVE RIGHT TO USE "EXPERTS IN WATER DAMAGE EMERGENCY SERVICES RESTORATION 100% UNCONDITIONAL GUARANTEE", APART FROM THE MARK AS SHOWN.

THE COLOR(S) RED, BLACK, AND WHITE IS/ ARE CLAIMED AS A FEATURE OF THE MARK.

THE MARK CONSISTS OF A BLACK CROSS WITH RED BACKGROUND SHADING AND WHITE LETTERING.

SER. NO. 77-120,874, FILED 3-2-2007.

NANCY CLARKE, EXAMINING ATTORNEY

Int. Cl.: 14

Prior U.S. Cls.: 2, 27, 28 and 50

United States Patent and Trademark Office

Reg. No. 3,397,389

Registered Mar. 18, 2008

**TRADEMARK
PRINCIPAL REGISTER**

GIANNA

WORLD WIDE IMPORTS, INC. (WASHINGTON
CORPORATION)
5862 SO. 194TH STREET
KENT, WA 98032

THE MARK CONSISTS OF STANDARD CHAR-
ACTERS WITHOUT CLAIM TO ANY PARTICULAR
FONT, STYLE, SIZE, OR COLOR.

FOR: PEARLS, PEARL JEWELRY AND
WATCHES, IN CLASS 14 (U.S. CLS. 2, 27, 28 AND 50).

SER. NO. 77-120,951, FILED 3-2-2007.

FIRST USE 2-25-1984; IN COMMERCE 2-25-1984.

JEFFERY COWARD, EXAMINING ATTORNEY

Int. Cl.: 43

Prior U.S. Cls.: 100 and 101

United States Patent and Trademark Office

Reg. No. 3,397,390

Registered Mar. 18, 2008

**SERVICE MARK
PRINCIPAL REGISTER**

Maison

KOR REALTY GROUP, L.L.C. (CALIFORNIA
LTD LIAB CO)
1212 SOUTH FLOWER STREET
SUITE 500
LOS ANGELES, CA 90015

FOR: HOTEL SERVICES; PROVISION OF GENERAL PURPOSE FACILITIES FOR MEETINGS, CONFERENCES AND EXHIBITIONS; RESERVATION SERVICES FOR OTHERS FOR HOTEL ACCOMMODATIONS; CATERING, PREPARATION

AND SERVING OF FOOD AND BEVERAGES, IN CLASS 43 (U.S. CLS. 100 AND 101).

FIRST USE 8-25-2000; IN COMMERCE 8-25-2000.

THE ENGLISH TRANSLATION OF THE WORD MAISON IN THE MARK IS HOUSE.

SER. NO. 77-121,193, FILED 3-2-2007.

TAMARA FRAZIER, EXAMINING ATTORNEY

Int. Cl.: 25

Prior U.S. Cls.: 22 and 39

United States Patent and Trademark Office

Reg. No. 3,397,391

Registered Mar. 18, 2008

**TRADEMARK
PRINCIPAL REGISTER**

AMALIALAD

ACORN CONCEPTS LLC (NEW YORK LTD LIAB
CO)
264 LEONARD ST. 2ND FLOOR
BROOKLYN, NY 11211

FOR: KNITTED FABRIC GARMENTS, NAMELY,
SWEATERS, TOPS, SHIRTS, TANK TOPS, SKIRTS,
DRESSES, WRAPS, CARDIGANS, VESTS, JACKETS,
COATS, TURTLENECKS AND LOUNGEWEAR, IN
CLASS 25 (U.S. CLS. 22 AND 39).

FIRST USE 1-15-2006; IN COMMERCE 1-15-2006.

THE MARK CONSISTS OF STANDARD CHAR-
ACTERS WITHOUT CLAIM TO ANY PARTICULAR
FONT, STYLE, SIZE, OR COLOR.

THE NAME AMALIALAD DOES NOT IDENTIFY
A LIVING INDIVIDUAL.

SER. NO. 77-122,061, FILED 3-5-2007.

DOMINIC J. FERRAIUOLO, EXAMINING ATTOR-
NEY

Int. Cls.: 35 and 43

Prior U.S. Cls.: 100, 101 and 102

United States Patent and Trademark Office

Reg. No. 3,397,392

Registered Mar. 18, 2008

**SERVICE MARK
PRINCIPAL REGISTER**



OSI RESTAURANT PARTNERS, LLC (DELA-
WARE LTD LIAB CO)
2202 N. WEST SHORE BLVD., 5TH FLOOR
TAMPA, FL 33607

FOR: RESTAURANT MANAGEMENT FOR OTHERS, IN CLASS 35 (U.S. CLS. 100, 101 AND 102).

FIRST USE 2-26-2007; IN COMMERCE 2-26-2007.

FOR: BAR AND RESTAURANT SERVICES, IN CLASS 43 (U.S. CLS. 100 AND 101).

FIRST USE 2-26-2007; IN COMMERCE 2-26-2007.

NO CLAIM IS MADE TO THE EXCLUSIVE RIGHT TO USE "RESTAURANT PARTNERS, LLC", APART FROM THE MARK AS SHOWN.

THE COLOR(S) BLACK AND RED IS/ARE CLAIMED AS A FEATURE OF THE MARK.

THE MARK CONSISTS OF THE LETTERS "OSI" IN A STYLIZED FONT, THE "O" AND "I" IN BLACK AND THE "S" IN RED, AND BELOW, THE WORDS RESTAURANT PARTNERS, INC.

SER. NO. 77-122,344, FILED 3-6-2007.

JILL C. ALT, EXAMINING ATTORNEY

Int. Cls.: 35 and 41

Prior U.S. Cls.: 100, 101, 102 and 107

United States Patent and Trademark Office

Reg. No. 3,397,393

Registered Mar. 18, 2008

**SERVICE MARK
PRINCIPAL REGISTER**

EXTRA INNINGS

EXTRA INNINGS, INC. (MASSACHUSETTS CORPORATION)
264 S. MAIN STREET, ROUTE 114
MIDDLETON, MA 01949

FOR: PRO SHOPS FEATURING BASEBALL AND SOFTBALL EQUIPMENT AND ACCESSORIES, IN CLASS 35 (U.S. CLS. 100, 101 AND 102).

FIRST USE 3-1-1996; IN COMMERCE 3-1-1996.

FOR: BASEBALL AND SOFTBALL TRAINING CENTERS, FEATURING BASEBALL AND SOFTBALL INSTRUCTION, BATTING CAGE AND TUNNEL RENTALS, IN CLASS 41 (U.S. CLS. 100, 101 AND 107).

FIRST USE 3-1-1996; IN COMMERCE 3-1-1996.

THE MARK CONSISTS OF STANDARD CHARACTERS WITHOUT CLAIM TO ANY PARTICULAR FONT, STYLE, SIZE, OR COLOR.

OWNER OF U.S. REG. NO. 3,223,595.

SER. NO. 77-122,609, FILED 3-5-2007.

WARREN L. OLANDRIA, EXAMINING ATTORNEY

Int. Cl.: 5

Prior U.S. Cls.: 6, 18, 44, 46, 51 and 52

United States Patent and Trademark Office

Reg. No. 3,397,394

Registered Mar. 18, 2008

**TRADEMARK
PRINCIPAL REGISTER**

RELIMATIC

GLAXO GROUP LIMITED (UNITED KINGDOM
CORPORATION)
GLAXO WELLCOME HOUSE
BERKELEY AVE.
GREENFORD, MIDDLESEX, UNITED KINGDOM
UB60NN

FOR: PHARMACEUTICAL PREPARATIONS
AND SUBSTANCES FOR THE TREATMENT OF
RESPIRATORY DISORDERS AND INHALERS
CONTAINING MEDICATION FOR THE TREAT-
MENT OF RESPIRATORY DISORDERS, IN CLASS
5 (U.S. CLS. 6, 18, 44, 46, 51 AND 52).

THE MARK CONSISTS OF STANDARD CHAR-
ACTERS WITHOUT CLAIM TO ANY PARTICULAR
FONT, STYLE, SIZE, OR COLOR.

OWNER OF UNITED KINGDOM REG. NO.
2148568, DATED 10-21-1997, EXPIRES 10-21-2017.

SER. NO. 77-123,483, FILED 3-6-2007.

DAVID H. STINE, EXAMINING ATTORNEY

Int. Cls.: 35 and 43

Prior U.S. Cls.: 100, 101 and 102

United States Patent and Trademark Office

Reg. No. 3,397,395

Registered Mar. 18, 2008

**SERVICE MARK
PRINCIPAL REGISTER**



LITTLE CITY KIDS FRANCHISE SERVICES, LLC
(WISCONSIN LTD LIAB CO)
1101 BLUEBIRD TRAIL
WAUNAKEE, WI 53597

FOR: FRANCHISE SERVICES, NAMELY, OFFERING TECHNICAL AND BUSINESS MANAGEMENT ASSISTANCE IN THE ESTABLISHMENT AND OPERATION OF PRESCHOOL AND CHILD DAYCARE CENTERS, IN CLASS 35 (U.S. CLS. 100, 101 AND 102).

FIRST USE 6-1-2004; IN COMMERCE 3-15-2006.

FOR: PRESCHOOLER AND INFANT CARE AT DAYCARE CENTERS, IN CLASS 43 (U.S. CLS. 100 AND 101).

FIRST USE 6-1-2004; IN COMMERCE 6-1-2004.

NO CLAIM IS MADE TO THE EXCLUSIVE RIGHT TO USE "KIDS", APART FROM THE MARK AS SHOWN.

THE COLOR(S) BROWN, GOLD AND GREY IS/ ARE CLAIMED AS A FEATURE OF THE MARK.

THE MARK CONSISTS OF STONE AND BRICK CLOCK TOWER WITH THE HANDS AT THREE O'CLOCK, THE HANDS FORM THE LETTER "L" OF THE WORD "LITTLE", THE CIRCLE OF THE CLOCK FACE FORMS THE LETTER "C" OF THE WORD "CITY" AND THE WORD "KIDS" FOLLOWS BELOW. THE COLORS BROWN, GRAY AND GOLD APPEAR IN THE WORDING "LITTLE, CITY AND KIDS" AND IN THE DESIGNS OF A CLOCK AND A BRICK WALL.

SER. NO. 77-123,656, FILED 3-6-2007.

PAM WILLIS, EXAMINING ATTORNEY

Int. Cl.: 9

Prior U.S. Cls.: 21, 23, 26, 36 and 38

United States Patent and Trademark Office

Reg. No. 3,397,396

Registered Mar. 18, 2008

**TRADEMARK
PRINCIPAL REGISTER**

EasySen

EASYSSEN (INDIANA LTD LIAB CO)
401 NORTH COQUILLARD DRIVE
SOUTH BEND, IN 46617

FOR: INTEGRATED SENSORS ON A PRINTED
CIRCUIT BOARD FOR SENSING PRESSURE, TEM-
PERATURE, HUMIDITY, LIGHT, INFRA-RED,
SOUND, MAGNETIC FIELD, ACCELERATION,
PROXIMITY, AND ABSORPTIVITY , IN CLASS 9
(U.S. CLS. 21, 23, 26, 36 AND 38).

FIRST USE 8-0-2005; IN COMMERCE 7-0-2006.

THE MARK CONSISTS OF STANDARD CHAR-
ACTERS WITHOUT CLAIM TO ANY PARTICULAR
FONT, STYLE, SIZE, OR COLOR.

SER. NO. 77-124,299, FILED 3-7-2007.

LEIGH CAROLINE CASE, EXAMINING ATTOR-
NEY

Int. Cls.: 16 and 40

Prior U.S. Cls.: 2, 5, 22, 23, 29, 37, 38, 50, 100, 103 and 106

United States Patent and Trademark Office

Reg. No. 3,397,397

Registered Mar. 18, 2008

**TRADEMARK
SERVICE MARK
PRINCIPAL REGISTER**

SHUTTERFLY

SHUTTERFLY, INC. (DELAWARE CORPORATION)
SUITE 101
2800 BRIDGE PARKWAY
REDWOOD CITY, CA 94065

FOR: SCRAPBOOKS, SCRAPBOOK PAGES, SCRAPBOOK ALBUMS, PHOTO BOOKS, SNAPBOOKS, AND BOOKS CONTAINING PHOTOS OR IMAGES, IN CLASS 16 (U.S. CLS. 2, 5, 22, 23, 29, 37, 38 AND 50).

FIRST USE 5-1-2001; IN COMMERCE 5-1-2001.

FOR: DIGITAL ON-DEMAND PRINTING SERVICES OF BOOKS AND OTHER DOCUMENTS, DIGITAL PRINTING, VARIABLE PRINTING, NAMELY,

PRINTING MATERIAL PERSONALIZED FOR THE ORDERER, IN CLASS 40 (U.S. CLS. 100, 103 AND 106).

FIRST USE 5-1-2001; IN COMMERCE 5-1-2001.

THE MARK CONSISTS OF STANDARD CHARACTERS WITHOUT CLAIM TO ANY PARTICULAR FONT, STYLE, SIZE, OR COLOR.

OWNER OF U.S. REG. NOS. 2,604,030 AND 2,962,700.

SER. NO. 77-124,316, FILED 3-7-2007.

MELVIN AXILBUND, EXAMINING ATTORNEY

Int. Cls.: 35 and 41

Prior U.S. Cls.: 100, 101, 102 and 107

United States Patent and Trademark Office

Reg. No. 3,397,398

Registered Mar. 18, 2008

**SERVICE MARK
PRINCIPAL REGISTER**

CGFNS QUALIFYING EXAM

COMMISSION ON GRADUATES OF FOREIGN
NURSING SCHOOLS (PENNSYLVANIA NON-
PROFIT CORPORATION)

SUITE 400
3600 MARKET STREET
PHILADELPHIA, PA 191042651

FOR: TESTING OF GRADUATES OF NURSING
SCHOOLS TO DETERMINE EMPLOYMENT
SKILLS, JOB COMPETENCY, AND PROFESSIONAL
COMPETENCY FOR ELIGIBILITY FOR NURSING
PRACTICE, IN CLASS 35 (U.S. CLS. 100, 101 AND
102).

FIRST USE 12-19-1977; IN COMMERCE 12-19-1977.

FOR: STANDARDIZED TESTING OF GRADU-
ATES OF NURSING SCHOOLS TO DETERMINE
ELIGIBILITY FOR NURSING PRACTICE, IN CLASS
41 (U.S. CLS. 100, 101 AND 107).

FIRST USE 12-19-1977; IN COMMERCE 12-19-1977.

THE MARK CONSISTS OF STANDARD CHAR-
ACTERS WITHOUT CLAIM TO ANY PARTICULAR
FONT, STYLE, SIZE, OR COLOR.

OWNER OF U.S. REG. NOS. 2,760,986 AND
3,109,721.

NO CLAIM IS MADE TO THE EXCLUSIVE
RIGHT TO USE "QUALIFYING EXAM", APART
FROM THE MARK AS SHOWN.

SER. NO. 77-125,238, FILED 3-8-2007.

ADA HAN, EXAMINING ATTORNEY

Int. Cl.: 9

Prior U.S. Cls.: 21, 23, 26, 36 and 38

United States Patent and Trademark Office

Reg. No. 3,397,399

Registered Mar. 18, 2008

**TRADEMARK
PRINCIPAL REGISTER**

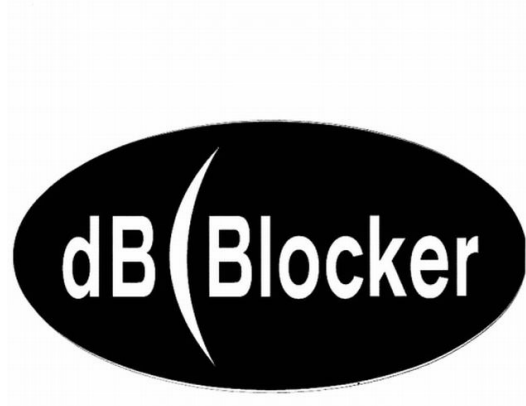

CUSTOM PROTECT EAR INC. (CANADA CORPORATION)
SUITE 681
7789 134TH STREET
SURREY, B.C., CANADA V3W9E9

FOR: HEARING PROTECTORS, NAMELY, HEARING PROTECTION EARPIECES AND HEADSETS NOT FOR MEDICAL USE AND EAR PLUGS FOR SOUNDPROOFING, IN CLASS 9 (U.S. CLS. 21, 23, 26, 36 AND 38).

FIRST USE 0-0-1995; IN COMMERCE 0-0-1995.

NO CLAIM IS MADE TO THE EXCLUSIVE RIGHT TO USE "DB", APART FROM THE MARK AS SHOWN.

SER. NO. 77-125,496, FILED 3-8-2007.

INGRID C. EULIN, EXAMINING ATTORNEY

Int. Cl.: 16

Prior U.S. Cls.: 2, 5, 22, 23, 29, 37, 38 and 50

United States Patent and Trademark Office

Reg. No. 3,397,400

Registered Mar. 18, 2008

**TRADEMARK
PRINCIPAL REGISTER**

LIVING WITH PANACHE

KR U.S.A., INC. (DELAWARE CORPORATION)
2100 Q STREET
SACRAMENTO, CA 95816

THE MARK CONSISTS OF STANDARD CHAR-
ACTERS WITHOUT CLAIM TO ANY PARTICULAR
FONT, STYLE, SIZE, OR COLOR.

FOR: MAGAZINE IN THE FIELD OF GENERAL
UPSCALE LIFESTYLES AND UPSCALE GOODS, IN
CLASS 16 (U.S. CLS. 2, 5, 22, 23, 29, 37, 38 AND 50).

SER. NO. 77-126,128, FILED 3-8-2007.

FIRST USE 1-1-1998; IN COMMERCE 1-1-1998.

GRETTA YAO, EXAMINING ATTORNEY

Int. Cl.: 35

Prior U.S. Cls.: 100, 101 and 102

United States Patent and Trademark Office

Reg. No. 3,397,401

Registered Mar. 18, 2008

**SERVICE MARK
PRINCIPAL REGISTER**



NATIONAL FRANCHISE CENTER, INC. (COL-
ORADO CORPORATION)
100 HOOVER AVE, STE 12-14
MESA, AZ 85210

FOR: FRANCHISE SERVICES, NAMELY, OFFER-
ING TECHNICAL AND BUSINESS MANAGEMENT
ASSISTANCE IN THE ESTABLISHMENT AND OP-
ERATION OF STORES BUYING AND SELLING
CELLULAR PHONES IN THE SECONDARY MAR-
KETS, IN CLASS 35 (U.S. CLS. 100, 101 AND 102).

FIRST USE 9-1-2006; IN COMMERCE 9-1-2006.

THE MARK CONSISTS OF THE LETTER M
WITHIN A BOX ABOVE THE WORDS MRBUY-
BACK.

SER. NO. 77-126,213, FILED 3-8-2007.

ERIN FALK, EXAMINING ATTORNEY

Int. Cl.: 41

Prior U.S. Cls.: 100, 101 and 107

United States Patent and Trademark Office

Reg. No. 3,397,402

Registered Mar. 18, 2008

**SERVICE MARK
PRINCIPAL REGISTER**

ROMANCE: B(U)Y THE BOOK

MICHELLE BUONFIGLIO (UNITED STATES IN-
DIVIDUAL)
7751 WEST 96TH STREET
BLOOMINGTON, MN 55438

FOR: PROVIDING INFORMATION ONLINE,
NAMELY, PROVIDING ONLINE COLUMNS IN
THE FIELD OF ROMANCE LITERATURE; PRO-
VIDING INFORMATION ONLINE RELATING TO
PERSONAL LIVES OF AUTHORS AND NEW
BOOKS, NAMELY, PROVIDING ONLINE BOOK
REVIEWS ABOUT NEW BOOKS BY OTHER AU-
THORS; PROVIDING ONLINE INFORMATION RE-
LATING TO ONLINE INTERVIEWS WITH BOOK
AUTHORS IN THE FIELD OF ROMANCE LITERA-
TURE; ON-LINE JOURNALS, NAMELY, BLOGS
FEATURING INFORMATION RELATING TO AU-

THORS AND BOOKS IN THE FIELD OF ROMANCE
LITERATURE; PROVIDING LINKS TO WEB SITES
OF OTHERS FEATURING BOOKS AND INTER-
VIEWS OF AUTHORS IN THE FIELD OF ROMANCE
LITERATURE, IN CLASS 41 (U.S. CLS. 100, 101 AND
107).

FIRST USE 8-11-2005; IN COMMERCE 8-11-2005.

THE MARK CONSISTS OF STANDARD CHAR-
ACTERS WITHOUT CLAIM TO ANY PARTICULAR
FONT, STYLE, SIZE, OR COLOR.

SER. NO. 77-126,469, FILED 3-9-2007.

SIMON TENG, EXAMINING ATTORNEY

Int. Cl.: 35

Prior U.S. Cls.: 100, 101 and 102

United States Patent and Trademark Office

Reg. No. 3,397,403

Registered Mar. 18, 2008

**SERVICE MARK
PRINCIPAL REGISTER**



EXPONATION, L.L.C. (GEORGIA LTD LIAB CO)
1405 OLD ALABAMA RD., STE 120
ROSWELL, GA 30076

"RETAIL", "HOSPITALITY", "FINANCIAL", AND
"PUBLIC SPACES", APART FROM THE MARK AS
SHOWN.

FOR: ARRANGING AND CONDUCTING TRADE
SHOW EXHIBITIONS IN THE FIELD OF DIGITAL
SIGNAGE FOR VARIOUS INDUSTRIES, INCLUD-
ING RETAIL, HOSPITALITY, FINANCIAL, AND
PUBLIC SPACES , IN CLASS 35 (U.S. CLS. 100, 101
AND 102).

THE MARK CONSISTS OF THE WORDS "DIGI-
TAL SIGNAGE" WITH THE WORD "EXPO" SUPER-
IMPOSED ON A STYLIZED GLOBE SHOWING
ONLY MERIDIAN AND PARALLEL LINES.

FIRST USE 2-1-2007; IN COMMERCE 2-1-2007.

SER. NO. 77-127,109, FILED 3-9-2007.

NO CLAIM IS MADE TO THE EXCLUSIVE
RIGHT TO USE "EXPO", "DIGITAL SIGNAGE",

JANICE L. MCMORROW, EXAMINING ATTOR-
NEY

Int. Cl.: 30

Prior U.S. Cl.: 46

United States Patent and Trademark Office

Reg. No. 3,397,404

Registered Mar. 18, 2008

**TRADEMARK
PRINCIPAL REGISTER**

TRUFFLE PIG

HAGENSBORG CHOCOLATES LTD. (CANADA
CORPORATION)
20384 KENT STREET
MAPLE RIDGE, CANADA V6X1A6

FOR: CHOCOLATE; CHOCOLATE BARS; CHO-
COLATE TRUFFLES, IN CLASS 30 (U.S. CL. 46).

FIRST USE 12-0-2005; IN COMMERCE 12-0-2005.

THE MARK CONSISTS OF STANDARD CHAR-
ACTERS WITHOUT CLAIM TO ANY PARTICULAR
FONT, STYLE, SIZE, OR COLOR.

PRIORITY CLAIMED UNDER SEC. 44(D) ON
CANADA APPLICATION NO. 1338860, FILED 3-9-
2007.

NO CLAIM IS MADE TO THE EXCLUSIVE
RIGHT TO USE "TRUFFLE", APART FROM THE
MARK AS SHOWN.

SER. NO. 77-127,586, FILED 3-9-2007.

KAREN SEVERSON, EXAMINING ATTORNEY

Int. Cl.: 39

Prior U.S. Cls.: 100 and 105

United States Patent and Trademark Office

Reg. No. 3,397,405

Registered Mar. 18, 2008

**SERVICE MARK
PRINCIPAL REGISTER**

DIVERSITY. DELIVERED.

DEHCO, INC. (INDIANA CORPORATION)
58263 CHARLOTTE AVENUE
ELKHART, IN 46515

FIRST USE 10-7-2006; IN COMMERCE 10-7-2006.

FOR: WAREHOUSING AND DISTRIBUTION SERVICES, NAMELY, STORAGE, DISTRIBUTION, PICK-UP, PACKING AND SHIPPING OF BUILDING PRODUCTS AND CONSTRUCTION PRODUCTS, NAMELY, PLUMBING, FAUCETS, ADHESIVES, SINKS, FLOORING, BUTYL TAPES, AND SHUTTERS AND SPECIALTY ELECTRONIC PRODUCTS, NAMELY, HIGH-DEFINITION FLAT SCREEN TELEVISIONS, HOME THEATER SYSTEMS, DVD PLAYERS, SPEAKERS, CAR AUDIO, MARINE AUDIO, AND KITCHEN APPLIANCES, IN CLASS 39 (U.S. CLS. 100 AND 105).

THE MARK CONSISTS OF STANDARD CHARACTERS WITHOUT CLAIM TO ANY PARTICULAR FONT, STYLE, SIZE, OR COLOR.

NO CLAIM IS MADE TO THE EXCLUSIVE RIGHT TO USE "DELIVERED" , APART FROM THE MARK AS SHOWN.

SER. NO. 77-127,694, FILED 3-10-2007.

KEVON CHISOLM, EXAMINING ATTORNEY

Int. Cl.: 28

Prior U.S. Cls.: 22, 23, 38 and 50

United States Patent and Trademark Office

Reg. No. 3,397,406

Registered Mar. 18, 2008

**TRADEMARK
PRINCIPAL REGISTER**

STRIKE SQUAD

MATTEL, INC. (DELAWARE CORPORATION)
M1-1518
333 CONTINENTAL BLVD.
EL SEGUNDO, CA 90245

THE MARK CONSISTS OF STANDARD CHAR-
ACTERS WITHOUT CLAIM TO ANY PARTICULAR
FONT, STYLE, SIZE, OR COLOR.

FOR: TOYS, GAMES AND PLAYTHINGS, NAME-
LY, TOY VEHICLES AND ACCESSORIES THERE-
FOR, IN CLASS 28 (U.S. CLS. 22, 23, 38 AND 50).

SER. NO. 77-128,673, FILED 3-12-2007.

FIRST USE 10-18-2007; IN COMMERCE 10-18-2007.

JAMES A. RAUEN, EXAMINING ATTORNEY

Int. Cl.: 6

Prior U.S. Cls.: 2, 12, 13, 14, 23, 25 and 50

United States Patent and Trademark Office

Reg. No. 3,397,407

Registered Mar. 18, 2008

**TRADEMARK
PRINCIPAL REGISTER**



**PUSH PULL OPEN CLOSE INCORPORATED
(TEXAS CORPORATION)
P.O. BOX 41706
AUSTIN, TX 78704**

FOR: COMMON METAL DRAWER PULLS; METAL BATHROOM HARDWARE, NAMELY, PULLS; METAL PULLS FOR DRAWERS, CABINETS AND FURNITURE; METAL HANDLES FOR DOORS, NAMELY, DOORKNOBS; METAL LATCHES; METAL DOOR TRIM; METAL KNOBS, IN CLASS 6 (U.S. CLS. 2, 12, 13, 14, 23, 25 AND 50).

FIRST USE 9-15-2003; IN COMMERCE 9-15-2003.

THE MARK CONSISTS OF THE LETTERS PPOC APPEARING WITHIN AN OVAL.

SER. NO. 77-129,269, FILED 3-13-2007.

TASHIA BUNCH, EXAMINING ATTORNEY

Int. Cls.: 35 and 36

Prior U.S. Cls.: 100, 101 and 102

United States Patent and Trademark Office

Reg. No. 3,397,408

Registered Mar. 18, 2008

**SERVICE MARK
PRINCIPAL REGISTER**

BILLTRUST

FACTOR SYSTEMS, INC. (DELAWARE CORPORATION)
SUITE 3
1095 CRANBURY - SOUTH RIVER ROAD
JAMESBURG, NJ 08831

FOR: ADMINISTRATION, BILLING AND RECONCILIATION OF ACCOUNTS ON BEHALF OF OTHERS; BILLING SERVICES, NAMELY, ISSUING INVOICES AND BILLS FOR THIRD PARTIES, IN CLASS 35 (U.S. CLS. 100, 101 AND 102).

FIRST USE 1-31-2002; IN COMMERCE 2-28-2002.

FOR: BILL PAYMENT SERVICES; ELECTRONIC PAYMENT SERVICES, NAMELY, ELECTRONIC

PROCESSING AND TRANSMISSION OF BILL PAYMENT DATA, IN CLASS 36 (U.S. CLS. 100, 101 AND 102).

FIRST USE 1-31-2002; IN COMMERCE 2-28-2002.

THE MARK CONSISTS OF STANDARD CHARACTERS WITHOUT CLAIM TO ANY PARTICULAR FONT, STYLE, SIZE, OR COLOR.

SER. NO. 77-129,786, FILED 3-13-2007.

LINDA ESTRADA, EXAMINING ATTORNEY

Int. Cl.: 9

Prior U.S. Cls.: 21, 23, 26, 36 and 38

United States Patent and Trademark Office

Reg. No. 3,397,409

Registered Mar. 18, 2008

TRADEMARK
PRINCIPAL REGISTER



DIGITAL INFO SECURITY CO, INC (COLOR-
ADO CORPORATION)
11030 CIRCLE POINT ROAD, SUITE 100
WESTMINSTER, CO 80020

FOR: COMPUTER SOFTWARE FOR THE COL-
LECTION, EDITING, ORGANIZING, MODIFYING,
BOOK MARKING, TRANSMISSION, STORAGE
AND SHARING OF DATA AND INFORMATION ,
IN CLASS 9 (U.S. CLS. 21, 23, 26, 36 AND 38).

FIRST USE 3-1-2005; IN COMMERCE 3-1-2005.

THE COLOR(S) BLUE, DARK GREY, BLACK IS/
ARE CLAIMED AS A FEATURE OF THE MARK.

THE MARK CONSISTS OF A DINOSAUR, A
TYRANNOSAURUS REX, THAT IS UPRIGHT
AND WALKING WITH ITS MOUTH OPEN. THE

SHAPE OF THE DINOSAUR IS OUTLINED WITH
HEAVY LINES AND THE MIDDLE OF THE DINO-
SAUR IS WHITE (NOT SHADED.) THE WORD
RESTOREREX APPEARS TO THE RIGHT OF THE
DINOSAUR, AND THE WORDS DON'T LET YOUR
DATA BECOME EXTINCT APPEAR BELOW RE-
STOREREX. THE COLORS BLUE, DARK GREY
AND BLACK ARE CLAIMED AS FEATURES OF
THE MARK. THE COLOR BLUE APPEARS ON THE
OUTLINE AND ALL LINES THAT CREATE THE
TYRANNOSAURUS REX DINOSAUR. THE COLOR
DARK GREY APPEARS ON THE TEXT "RESTOR-
EREX." THE COLOR BLACK APPEARS ON THE
TEXT "DON'T LET YOUR DATA BECOME EX-
TINCT."

SER. NO. 77-130,095, FILED 3-13-2007.

ANNE MADDEN, EXAMINING ATTORNEY

Int. Cl.: 41

Prior U.S. Cls.: 100, 101 and 107

United States Patent and Trademark Office

Reg. No. 3,397,410

Registered Mar. 18, 2008

**SERVICE MARK
PRINCIPAL REGISTER**



FRANK D. FAKINOS (UNITED STATES INDIVIDUAL)
12322 DELTA ST
GARDEN GROVE, CA 92840

FOR: ENTERTAINMENT, NAMELY LIVE PERFORMANCES BY MUSICAL BANDS, IN CLASS 41 (U.S. CLS. 100, 101 AND 107).

FIRST USE 1-1-2002; IN COMMERCE 1-1-2002.

THE COLOR(S) GREEN, YELLOW, ORANGE, RED AND PURPLE IS/ARE CLAIMED AS A FEATURE OF THE MARK.

THE MARK CONSISTS OF THE WORDS ISLAND GROOVIN', WITH GREEN PALM TREE LEAVES AT THE TOP OF THE LETTER "I" IN THE WORD ISLAND; EACH LETTER OF THE WORDS HAS GRADIENT COLOR BEGINNING WITH YELLOW AT THE TOP, ORANGE IN THE UPPER CENTER, RED IN THE LOWER CENTER AND PURPLE AT THE BOTTOM.

SER. NO. 77-130,384, FILED 3-14-2007.

TINA BROWN, EXAMINING ATTORNEY

Int. Cls.: 3 and 44

Prior U.S. Cls.: 1, 4, 6, 50, 51, 52, 100 and 101

United States Patent and Trademark Office

Reg. No. 3,397,411

Registered Mar. 18, 2008

**TRADEMARK
SERVICE MARK
PRINCIPAL REGISTER**

MAKE UP STORE

MAKE UP STORE AB (SWEDEN JOINT STOCK COMPANY)
ADOLF FREDRIKS KYRKOGATA 15
STOCKHOLM, SWEDEN SE-11137

FOR: LIPSTICK, LIP GLOSS, EYE SHADOW, EYELINER, MASCARA, NAIL POLISH, NAIL POLISH REMOVER, BLUSH, SKIN POWDER, FOUNDATION, BODY SOAPS, BODY CLEANSERS, FACIAL MASKS, PERFUMES, COSMETICS, COSMETIC CREAMS FOR SKIN CARE, PREPARATIONS FOR SKIN RENEWAL, HAIR CARE PREPARATIONS, IN CLASS 3 (U.S. CLS. 1, 4, 6, 50, 51 AND 52).

FIRST USE 2-0-1991; IN COMMERCE 7-0-2000.

FOR: COSMETOLOGY SERVICES, NAMELY, BEAUTY CARE AND HYGIENIC CARE, IN CLASS 44 (U.S. CLS. 100 AND 101).

FIRST USE 0-0-1996; IN COMMERCE 0-0-2000.

THE MARK CONSISTS OF STANDARD CHARACTERS WITHOUT CLAIM TO ANY PARTICULAR FONT, STYLE, SIZE, OR COLOR.

OWNER OF U.S. REG. NO. 3,268,519.

NO CLAIM IS MADE TO THE EXCLUSIVE RIGHT TO USE "MAKE UP", APART FROM THE MARK AS SHOWN.

SEC. 2(F).

THE 2(F) CLAIM IS RESTRICTED TO CLASS(ES) 44

SER. NO. 77-131,909, FILED 3-15-2007.

BONNIE LUKEN, EXAMINING ATTORNEY

Int. Cls.: 9, 25 and 41

Prior U.S. Cls.: 21, 22, 23, 26, 36, 38, 39, 100, 101 and 107

Reg. No. 3,397,412

United States Patent and Trademark Office

Registered Mar. 18, 2008

**TRADEMARK
SERVICE MARK
PRINCIPAL REGISTER**

NCFC

NORTH COUNTY FIGHT CLUB, LLC (CALIFORNIA LTD LIAB CO)
6992 EL CAMINO REAL , SUITE 104
CARLSBAD, CA 92011

FOR: CINEMATOGRAPHIC FILMS; FILM STRIPS FEATURING MIXED MARTIAL ARTS; MOVIES FEATURING MIXED MARTIAL ARTS; ELECTRONIC PUBLICATIONS, NAMELY, BOOKS, MAGAZINES, MANUALS FEATURING MIXED MARTIAL ARTS RECORDED ON COMPUTER MEDIA; ELECTRONIC GAME PROGRAMS; INTERACTIVE GAME PROGRAMS ADAPTED FOR USE WITH TELEVISION RECEIVERS; COMPUTER SOFTWARE USED FOR INSTRUCTION ON MIXED MARTIAL ARTS; COMPUTER PROGRAMS USED FOR INSTRUCTION ON MIXED MARTIAL ARTS; AUDIO TAPES FEATURING INSTRUCTION ON MIXED MARTIAL ARTS; TAPE CASSETTES FEATURING INSTRUCTION ON MIXED MARTIAL ARTS; VIDEO TAPES FEATURING INSTRUCTION ON MIXED MARTIAL ARTS; LASER DISCS FEATURING INSTRUCTION ON MIXED MARTIAL ARTS; MULTIMEDIA SOFTWARE RECORDED ON COMPACT DISCS AND INTERACTIVE CD ROMS FEATURING INSTRUCTION ON MIXED MARTIAL ARTS; DIGITAL VIDEO DISCS (DVD) FEATURING INSTRUCTION ON MIXED MARTIAL ARTS, IN CLASS 9 (U.S. CLS. 21, 23, 26, 36 AND 38).

FIRST USE 5-1-2004; IN COMMERCE 5-1-2004.

FOR: CLOTHING AND ATHLETIC GEAR NAME-
LY, SHORT SLEEVE T-SHIRTS, LONG SLEEVE T-

SHIRTS, SLEEVELESS T-SHIRTS, ATHLETIC SHIRTS, TANK TOPS, SWEATERS, SWEATSHIRTS, PULLOVERS, HOODED SWEATSHIRT, RASH GUARD JERSEYS AND T-SHIRTS, JERSEYS, JACKETS, COATS, SHORTS, SWEAT PANTS, WARM UP PANTS, AND JACKETS, UNDERWEAR, CAPS, HATS, BEANIES, SKULL CAPS, SUN VISORS, HAND BANDS, SOCKS, BANDANNA, HEAD AND WRIST BANDS, AND FOOTWEAR, IN CLASS 25 (U.S. CLS. 22 AND 39).

FIRST USE 5-1-2004; IN COMMERCE 5-1-2004.

FOR: ENTERTAINMENT SERVICES, NAMELY, ORGANIZING, ARRANGING AND CONDUCTING MIXED MARTIAL ARTS FIGHTING EXHIBITIONS, COMPETITIONS, TOURNAMENTS; MOTION PICTURE FILM AND VIDEOTAPE PRODUCTION SERVICES; EDUCATIONAL SERVICES, NAMELY, PROVIDING TRAINING PROGRAMS, COURSES AND SEMINARS IN THE FIELD OF MIXED MARTIAL ARTS, IN CLASS 41 (U.S. CLS. 100, 101 AND 107).

FIRST USE 5-1-2004; IN COMMERCE 5-1-2004.

THE MARK CONSISTS OF STANDARD CHARACTERS WITHOUT CLAIM TO ANY PARTICULAR FONT, STYLE, SIZE, OR COLOR.

SER. NO. 77-132,123, FILED 3-15-2007.

WENDY GOODMAN, EXAMINING ATTORNEY

Int. Cl.: 5

Prior U.S. Cls.: 6, 18, 44, 46, 51 and 52

United States Patent and Trademark Office

Reg. No. 3,397,413

Registered Mar. 18, 2008

**TRADEMARK
PRINCIPAL REGISTER**

Nutrilina

VASQUEZ, CARLOS (CUBA INDIVIDUAL)
#305
510 S KENMORE
LOS ANGELES, CA 90020

THE MARK CONSISTS OF STANDARD CHARACTERS WITHOUT CLAIM TO ANY PARTICULAR FONT, STYLE, SIZE, OR COLOR.

FOR: NUTRITIONAL SUPPLEMENTS, IN CLASS 5 (U.S. CLS. 6, 18, 44, 46, 51 AND 52).

SER. NO. 77-133,762, FILED 3-17-2007.

FIRST USE 7-1-2006; IN COMMERCE 7-1-2006.

CAROLYN CATALDO, EXAMINING ATTORNEY

Int. Cl.: 44

Prior U.S. Cls.: 100 and 101

United States Patent and Trademark Office

Reg. No. 3,397,414

Registered Mar. 18, 2008

SERVICE MARK
PRINCIPAL REGISTER



WHITE, JEFFEORY H. MD/PC (UNITED STATES
INDIVIDUAL)
SUITE 1
1575 CHATTANOOGA AVENUE
DALTON, GA 30721

FOR: HEALTH CARE; HEALTH CARE SERVICES,
NAMELY, DISEASE MANAGEMENT PROGRAMS;
HEALTH CARE SERVICES, NAMELY, WELLNESS
PROGRAMS, IN CLASS 44 (U.S. CLS. 100 AND 101).

FIRST USE 1-1-2002; IN COMMERCE 1-1-2002.

NO CLAIM IS MADE TO THE EXCLUSIVE
RIGHT TO USE "PEDIATRICS" AND "HEALTH",
APART FROM THE MARK AS SHOWN.

THE COLOR(S) BURGUNDY IS/ARE CLAIMED
AS A FEATURE OF THE MARK.

THE COLOR BURGUNDY APPEARS IN THE
ANGEL FIGURE AND HALO, THE WORDING
WHITE'S PEDIATRIC HALOS FOR HEALTH AND
THE UNDERLINING.

SER. NO. 77-134,462, FILED 3-19-2007.

CYNTHIA SLOAN, EXAMINING ATTORNEY

Int. Cl.: 25

Prior U.S. Cls.: 22 and 39

United States Patent and Trademark Office

Reg. No. 3,397,415

Registered Mar. 18, 2008

**TRADEMARK
PRINCIPAL REGISTER**



SAVINO, DAVID A. (UNITED STATES INDIVIDUAL)
307 LYNNHAVEN PARKWAY
VIRGINIA BEACH, VA 23452

FOR: CLOTHING, NAMELY, SKATEBOARD SHORTS, GYM SHORTS, RUNNING SHORTS, SKI WEAR AND SNOWBOARD WEAR, NAMELY, SKI SUITS, SKI PANTS, SKI TROUSERS, SKI JACKETS, SNOWBOARD PANTS, SNOWBOARD TROUSERS

AND SNOWBOARD JACKETS, SNOW BOOTS, SNOWBOARD BOOTS AND SKI BOOTS, IN CLASS 25 (U.S. CLS. 22 AND 39).

FIRST USE 6-10-2006; IN COMMERCE 3-5-2007.

SER. NO. 77-135,376, FILED S.R. 3-20-2007 AM. P.R. 8-20-2007.

G. MAYERSCHOFF, EXAMINING ATTORNEY

Int. Cl.: 25

Prior U.S. Cls.: 22 and 39

United States Patent and Trademark Office

Reg. No. 3,397,416

Registered Mar. 18, 2008

**TRADEMARK
PRINCIPAL REGISTER**



PRL USA HOLDINGS, INC. (DELAWARE CORPORATION)
103 FOULK ROAD
WILMINGTON, DE 19803

FOR: WEARING APPAREL, NAMELY, SPORT SHIRTS, KNIT SHIRTS, SWEATERS, SWEATSHIRTS, T-SHIRTS, BLOUSES, SHORTS, JACKETS, PANTS, JEANS, OVERALLS, SKIRTS, DRESSES, HATS, SOCKS AND SWIMWEAR, IN CLASS 25 (U.S. CLS. 22 AND 39).

FIRST USE 9-0-2004; IN COMMERCE 9-0-2004.

OWNER OF U.S. REG. NO. 3,175,462.

NO CLAIM IS MADE TO THE EXCLUSIVE RIGHT TO USE "EST. 1978", "DENIM" AND "TRUE

AMERICAN BRAND", APART FROM THE MARK AS SHOWN.

THE MARK CONSISTS OF THE WORDS EST 1978 CHAPS DENIM TRUE AMERICAN BRAND IN A SHAPE OF AN IRREGULAR HEXAGON WITH TWO CURVED FACES, WITH STITCHES ON THE BORDER, THE WORD CHAPS BEING IN THE CENTER OF THE SHAPE ON A STRIPE AND WITH EST. 1978 ABOVE AND DENIM AND TRUE AMERICAN BRAND BELOW ON TWO LINES AND WITH THREE STARS UNDERNEATH.

SER. NO. 77-135,703, FILED 3-20-2007.

KENNETH E. SHARPERSON, EXAMINING ATTORNEY

Int. Cls.: 35 and 42

Prior U.S. Cls.: 100, 101 and 102

United States Patent and Trademark Office

Reg. No. 3,397,417

Registered Mar. 18, 2008

**SERVICE MARK
PRINCIPAL REGISTER**

VSA PARTNERS, INC.

VSA PARTNERS, INC. (ILLINOIS CORPORATION)
1347 SOUTH STATE STREET
CHICAGO, IL 60605

FOR: ADVERTISING SERVICES, NAMELY, CREATING CORPORATE AND BRAND IDENTITY FOR OTHERS; BUSINESS MERCHANDISING POINT-OF-SALE DISPLAY SERVICES; MARKET RESEARCH SERVICES; ADVERTISING SERVICES; NAMELY, PROMOTING AND MARKETING THE GOODS AND SERVICES OF OTHERS THROUGH ALL PUBLIC COMMUNICATION MEANS, IN CLASS 35 (U.S. CLS. 100, 101 AND 102).

FIRST USE 2-11-1991; IN COMMERCE 2-11-1991.

FOR: CREATING PACKAGING DESIGN FOR OTHERS, IN CLASS 42 (U.S. CLS. 100 AND 101).

FIRST USE 2-11-1991; IN COMMERCE 2-11-1991.

THE MARK CONSISTS OF STANDARD CHARACTERS WITHOUT CLAIM TO ANY PARTICULAR FONT, STYLE, SIZE, OR COLOR.

NO CLAIM IS MADE TO THE EXCLUSIVE RIGHT TO USE "PARTNERS, INC.", APART FROM THE MARK AS SHOWN.

SER. NO. 77-135,820, FILED 3-20-2007.

RONALD AIKENS, EXAMINING ATTORNEY

Int. Cls.: 35 and 42

Prior U.S. Cls.: 100, 101 and 102

United States Patent and Trademark Office

Reg. No. 3,397,418

Registered Mar. 18, 2008

**SERVICE MARK
PRINCIPAL REGISTER**

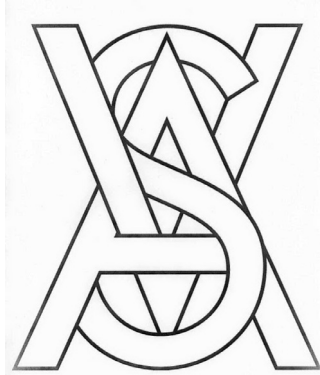

VSA PARTNERS, INC. (ILLINOIS CORPORATION)
1347 SOUTH STATE STREET
CHICAGO, IL 60605

FOR: ADVERTISING SERVICES, NAMELY, CREATING CORPORATE AND BRAND IDENTITY FOR OTHERS; BUSINESS MERCHANDISING POINT-OF-SALE DISPLAY SERVICES; MARKET RESEARCH SERVICES; ADVERTISING SERVICES, NAMELY, PROMOTING AND MARKETING THE GOODS AND SERVICES OF OTHERS THROUGH ALL PUBLIC COMMUNICATION MEANS, IN CLASS 35 (U.S. CLS. 100, 101 AND 102).

FIRST USE 12-31-1997; IN COMMERCE 12-31-1997.

FOR: CREATING PACKAGING DESIGN FOR OTHERS, IN CLASS 42 (U.S. CLS. 100 AND 101).

FIRST USE 12-31-1997; IN COMMERCE 12-31-1997.

THE MARK CONSISTS OF THE LETTERS VSA.

SER. NO. 77-135,934, FILED 3-20-2007.

RONALD AIKENS, EXAMINING ATTORNEY

Int. Cl.: 9

Prior U.S. Cls.: 21, 23, 26, 36 and 38

United States Patent and Trademark Office

Reg. No. 3,397,419

Registered Mar. 18, 2008

**TRADEMARK
PRINCIPAL REGISTER**

SiteVista

PLACEVISION, INC. (ILLINOIS CORPORATION)
2653 N. ST. LOUIS AVENUE
CHICAGO, IL 60647

FOR: DATABASE MANAGEMENT SOFTWARE WHICH COMPILES, PRODUCES, AND DELIVERS GEOGRAPHIC INFORMATION TO A USER UTILIZING THE INTERNET, IN CLASS 9 (U.S. CLS. 21, 23, 26, 36 AND 38).

FIRST USE 12-30-2006; IN COMMERCE 12-30-2006.

THE MARK CONSISTS OF STANDARD CHARACTERS WITHOUT CLAIM TO ANY PARTICULAR FONT, STYLE, SIZE, OR COLOR.

SER. NO. 77-135,976, FILED 3-20-2007.

JOHN DALIER, EXAMINING ATTORNEY

Int. Cl.: 13

Prior U.S. Cls.: 2 and 9

United States Patent and Trademark Office

Reg. No. 3,397,420

Registered Mar. 18, 2008

**TRADEMARK
PRINCIPAL REGISTER**



NICE SHOT INC. (PENNSYLVANIA CORPORATION)
9970 BARNEY RD
ALBION, PA 16401

NO CLAIM IS MADE TO THE EXCLUSIVE RIGHT TO USE "SHOT NON-TOXIC SHOT", APART FROM THE MARK AS SHOWN.

FOR: LEAD-FREE SHOT, IN CLASS 13 (U.S. CLS. 2 AND 9).

SER. NO. 77-136,215, FILED 3-21-2007.

FIRST USE 2-17-2007; IN COMMERCE 2-17-2007.

LYDIA BELZER, EXAMINING ATTORNEY

Int. Cl.: 10

Prior U.S. Cls.: 26, 39 and 44

Reg. No. 3,397,421

United States Patent and Trademark Office

Registered Mar. 18, 2008

**TRADEMARK
PRINCIPAL REGISTER**

VITYAZ

MEDICAL QUANT USA, INC. (OHIO CORPORATION)
6565 COCHRAN ROAD
SOLON, OH 44139

FOR: LIGHT-BASED MEDICAL DEVICES, NAMELY, DEVICES USING LOW LEVEL LASERS, LIGHT EMITTING DIODES, INFRARED LIGHT AND PULSED LIGHT FOR TREATING DISEASES AND PROVIDING THERAPEUTIC APPLICATIONS, NAMELY, MUSCLE, SKELETAL, NERVE AND SKIN THERAPIES, IN CLASS 10 (U.S. CLS. 26, 39 AND 44).

FIRST USE 1-31-1999; IN COMMERCE 1-31-1999.

THE MARK CONSISTS OF STANDARD CHARACTERS WITHOUT CLAIM TO ANY PARTICULAR FONT, STYLE, SIZE, OR COLOR.

THE ENGLISH TRANSLATION OF VITYAZ IN THE MARK IS "WARRIOR" OR "HERO."

SER. NO. 77-136,239, FILED 3-21-2007.

WOODROW HARTZOG, EXAMINING ATTORNEY

Int. Cl.: 3

Prior U.S. Cls.: 1, 4, 6, 50, 51 and 52

United States Patent and Trademark Office

Reg. No. 3,397,422

Registered Mar. 18, 2008

**TRADEMARK
PRINCIPAL REGISTER**

URINE TROUBLE!

INNIVATION, LLC (DELAWARE LTD LIAB CO)
407 VINE STREET, #149
CINCINNATI, OH 45202

FOR: STAIN REMOVERS; PET ODOR REMOV-
ERS, IN CLASS 3 (U.S. CLS. 1, 4, 6, 50, 51 AND 52).

FIRST USE 7-25-2005; IN COMMERCE 7-25-2005.

THE MARK CONSISTS OF STANDARD CHAR-
ACTERS WITHOUT CLAIM TO ANY PARTICULAR
FONT, STYLE, SIZE, OR COLOR.

NO CLAIM IS MADE TO THE EXCLUSIVE
RIGHT TO USE "URINE", APART FROM THE
MARK AS SHOWN.

SER. NO. 77-136,330, FILED 3-21-2007.

RICHARD A. STRASER, EXAMINING ATTORNEY

Int. Cl.: 42

Prior U.S. Cls.: 100 and 101

United States Patent and Trademark Office

Reg. No. 3,397,423

Registered Mar. 18, 2008

**SERVICE MARK
PRINCIPAL REGISTER**

Zingerding

LOWTWAIT, STEVE (UNITED STATES INDIVIDUAL)
3060 17TH STREET
BOULDER, CO 80304

THE MARK CONSISTS OF STANDARD CHARACTERS WITHOUT CLAIM TO ANY PARTICULAR FONT, STYLE, SIZE, OR COLOR.

FOR: HOSTING OF DIGITAL CONTENT ON THE INTERNET, IN CLASS 42 (U.S. CLS. 100 AND 101).

SER. NO. 77-136,492, FILED 3-21-2007.

FIRST USE 2-6-2007; IN COMMERCE 2-6-2007.

MATTHEW EINSTEIN, EXAMINING ATTORNEY

Int. Cl.: 25

Prior U.S. Cls.: 22 and 39

United States Patent and Trademark Office

Reg. No. 3,397,424

Registered Mar. 18, 2008

**TRADEMARK
PRINCIPAL REGISTER**

Dirty Royalty

DIRTY ROYALTY, LLC (FLORIDA LTD LIAB
CO)
3661 SW 163RD AVE
MIRAMAR, FL 33027

FOR: MEN'S, WOMEN'S, YOUNG ADULTS',
CHILDREN'S, AND INFANTS' CLOTHING, APPA-
REL, AND FOOTWEAR, NAMELY, CUSTOM DE-
SIGNER T-SHIRTS, JEANS, PANTS, JERSEYS,
BANDANAS, BELTS, BODY SUITS, BLOUSES, CA-
MISOLES, DRESSES, FOOTWEAR, BOOTS, SNEA-
KERS, SOCKS, BOW TIES, COATS, JACKETS,
SPORTS COATS, SWEATERS WITH HOODS,

GLOVES, HATS, HEAD BANDS, BASEBALL CAPS,
HEADWEAR, IN CLASS 25 (U.S. CLS. 22 AND 39).

FIRST USE 3-13-2007; IN COMMERCE 3-13-2007.

THE MARK CONSISTS OF STANDARD CHAR-
ACTERS WITHOUT CLAIM TO ANY PARTICULAR
FONT, STYLE, SIZE, OR COLOR.

SER. NO. 77-137,145, FILED 3-21-2007.

MARILYN IZZI, EXAMINING ATTORNEY

Int. Cl.: 36

Prior U.S. Cls.: 100, 101 and 102

United States Patent and Trademark Office

Reg. No. 3,397,425

Registered Mar. 18, 2008

SERVICE MARK
PRINCIPAL REGISTER



MARIA LO BIANCO (UNITED STATES INDIVIDUAL)
42902 PARK BROOKE COURT
ASHBURN, VA 20148

FOR: REAL ESTATE SERVICES, NAMELY, REAL ESTATE BROKERAGE, REAL ESTATE MANAGEMENT, AND CONSULTANCY TO REAL ESTATE BUYERS, SELLERS, INVESTORS, BROKERS AND AGENTS, IN CLASS 36 (U.S. CLS. 100, 101 AND 102).

FIRST USE 3-18-2007; IN COMMERCE 3-18-2007.

NO CLAIM IS MADE TO THE EXCLUSIVE RIGHT TO USE "FLEXIBLE REAL ESTATE SOLUTIONS FLEXIBLE FEES AND SERVICES", APART FROM THE MARK AS SHOWN.

THE COLOR(S) ORANGE, MAROON, BLACK, AND WHITE IS/ARE CLAIMED AS A FEATURE OF THE MARK.

THE MARK CONSISTS OF A RECTANGLE DIVIDED INTO THREE STRIPES WITH THE COLOR ORANGE AT THE TOP, FOLLOWED BY THE

SECOND STRIPE WITH A WHITE BACKGROUND WHICH ENCOMPASSES THE STYLIZED TEXT, BENEATH WHICH IS ANOTHER ORANGE STRIPE. THE MARK CONSISTS OF THE WORDS "FLEXIBLE" IN MAROON STYLIZED TEXT UNDERLINED WITH A SOLID BLACK LINE, BENEATH OF WHICH THE WORDS "REAL ESTATE" ARE PRINTED IN BLACK UPPERCASE TEXT, AGAIN UNDERLINED IN PART WITH A BLACK STRIPE; AND BELOW THIS, THE WORD "SOLUTIONS" IN MAROON WITH A STYLIZED TEXT. THE WORD "FLEXABLE" IS PURPOSELY MISSPELLED. THIS TEXT OVERLAYS PART OF THE TOP ORANGE STRIPE. THE WORD "SOLUTIONS" IN MAROON CURSIVE TEXT ALSO HAS A MAROON SOLID LINE EXTENDING FROM EITHER SIDE, WHICH MIMICS THE BLACK LINE SURROUNDING THE WORDS "REAL ESTATE". THE BOTTOM ORANGE STRIPE ALSO ENCOMPASSES THE PHRASE "FLEXIBLE FEES AND SERVICES" IN BLACK UPPERCASE TEXT.

SER. NO. 77-137,250, FILED 3-21-2007.

CORY BOONE, EXAMINING ATTORNEY

Int. Cl.: 41

Prior U.S. Cls.: 100, 101 and 107

United States Patent and Trademark Office

Reg. No. 3,397,426

Registered Mar. 18, 2008

**SERVICE MARK
PRINCIPAL REGISTER**

Amazinflates

RIVERA, RONNIE (UNITED STATES INDIVIDUAL)
PMB#419 809 E. BLOOMINGDALE AVE
BRANDON, FL 335118113

FOR: RENTALS TO CHURCHES, CORPORATIONS, INDIVIDUALS, SCHOOLS, FAIRS OF OUTDOOR AND INDOOR AMUSEMENT INFLATABLE STRUCTURES SUCH AS MOONWALKS/JUMPERS, COMBO UNITS, SLIDES, OBSTACLE COURSES, INFLATABLES GAMES, IN CLASS 41 (U.S. CLS. 100, 101 AND 107).

FIRST USE 1-13-2006; IN COMMERCE 1-13-2006.

THE MARK CONSISTS OF STANDARD CHARACTERS WITHOUT CLAIM TO ANY PARTICULAR FONT, STYLE, SIZE, OR COLOR.

SER. NO. 77-137,618, FILED 3-22-2007.

DOMINICK J. SALEMI, EXAMINING ATTORNEY

Int. Cl.: 39

Prior U.S. Cls.: 100 and 105

United States Patent and Trademark Office

Reg. No. 3,397,427

Registered Mar. 18, 2008

**SERVICE MARK
PRINCIPAL REGISTER**



ULTRA RAYZ, INC. (MISSOURI CORPORATION)
2323 SOUTH OUTER ROAD
JOPLIN, MO 64804

FOR: DELIVERY OF CUSTOMIZED GIFT CERTIFICATES AND CERTIFICATES FOR SPA, HOTEL, LIMOUSINE AND DINING SERVICES, IN CLASS 39 (U.S. CLS. 100 AND 105).

FIRST USE 1-1-2007; IN COMMERCE 1-1-2007.

THE MARK CONSISTS OF A PRESENT ON WHEELS.

SER. NO. 77-137,700, FILED 3-22-2007.

KIM SAITO, EXAMINING ATTORNEY

Int. Cl.: 41

Prior U.S. Cls.: 100, 101 and 107

United States Patent and Trademark Office

Reg. No. 3,397,428

Registered Mar. 18, 2008

**SERVICE MARK
PRINCIPAL REGISTER**



TERCERO RODRIGUEZ, ALDO ERNESTO
(MEXICO INDIVIDUAL)
XALAPA, VERACRUZ 91130
2DA PRIV GUANAJUATO 60-3 COL.PROGRESO
XALAPA, MEXICO

FOR: MULTIMEDIA PUBLISHING OF BOOKS,
MAGAZINES, JOURNALS, SOFTWARE, GAMES,
MUSIC, AND ELECTRONIC PUBLICATIONS, IN
CLASS 41 (U.S. CLS. 100, 101 AND 107).

FIRST USE 9-1-2006; IN COMMERCE 9-1-2006.

NO CLAIM IS MADE TO THE EXCLUSIVE
RIGHT TO USE "SCORES MEXICAN MUSIC",
APART FROM THE MARK AS SHOWN.

THE STIPPLING IS A FEATURE OF THE MARK
AND DOES NOT INDICATE COLOR.

THE MARK CONSISTS OF A LANDSCAPE IN-
SIDE A TRIANGLE, THE TRIANGLE IS FILLED BY
BLACK HORIZONTAL PARALLEL THIN LINES,
ON TOP THE BACKGROUND THE LANDSCAPE
HAS A CIRCLE CLOSE TO THE TOP OF THE
TRIANGLE THAT REPRESENT THE MOON AND
THE SUN, AND THE CIRCLE HAS A LINE FORM-
ING A CLOUD IN FORM OF THE LETTER "S", THE
CIRCLE IS ON THE TOP OF TWO LETTERS "M"
THAT TOGETHER FORM A GEOMETRIC FORM
THAT REPRESENT A BIRD WITH THE SPREAD
WINGS AND/OR TWO MOUNTAINS UNDER-
NEATH THE SUN AND MOON. IN THE LOWER
PART IS THE TEXT "SCORES MEXICAN MUSIC".

SER. NO. 77-138,394, FILED 3-23-2007.

AMY MCMENAMIN, EXAMINING ATTORNEY

Int. Cl.: 43

Prior U.S. Cls.: 100 and 101

United States Patent and Trademark Office

Reg. No. 3,397,429

Registered Mar. 18, 2008

SERVICE MARK
PRINCIPAL REGISTER

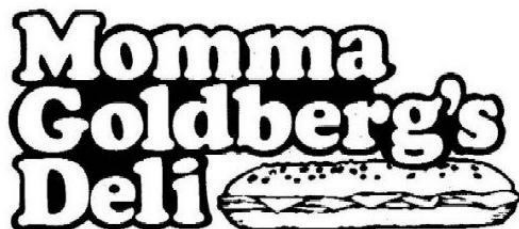

MOMMA GOLDBERG'S DELI, INC. (ALABAMA CORPORATION)
500 WEST MAGNOLIA AVENUE
AUBURN, AL 36830

FOR: RESTAURANT SERVICES, IN CLASS 43 (U.S. CLS. 100 AND 101).

FIRST USE 10-20-1976; IN COMMERCE 10-20-1976.

NO CLAIM IS MADE TO THE EXCLUSIVE RIGHT TO USE DELI, APART FROM THE MARK AS SHOWN.

"THE NAME(S), PORTRAIT(S), AND/OR SIGNATURE(S) SHOWN IN THE MARK DOES NOT IDENTIFY A PARTICULAR LIVING INDIVIDUAL."

THE MARK CONSISTS OF THE WORD MOMMA WITH THE WORD GOLDBERG'S BELOW IT, AND THE WORD DELI BELOW THAT, ALL THE WORDS BEING IN ROUNDED FONT. THE INTERIOR OF THE INDIVIDUAL LETTERS AND THE AREA BETWEEN THE WORDS IS SHADOWED. THERE IS A PICTURE OF A FOOTLONG SANDWICH TO THE LOWER RIGHT AND AFTER THE WORD DELI.

SER. NO. 77-138,417, FILED 3-23-2007.

CURTIS FRENCH, EXAMINING ATTORNEY

Int. Cl.: 41

Prior U.S. Cls.: 100, 101 and 107

United States Patent and Trademark Office

Reg. No. 3,397,430

Registered Mar. 18, 2008

**SERVICE MARK
PRINCIPAL REGISTER**

MOOS FROM THE FARM

FARMS FOR CITY KIDS FOUNDATION, INC.
(NEW YORK CORPORATION)
800 PORT WASHINGTON BOULEVARD
PORT WASHINGTON, NY 11050

FOR: EDUCATIONAL SERVICES, NAMELY,
CONDUCTING EDUCATIONAL PROGRAMS FOR
CHILDREN FEATURING HANDS-ON PRACTICAL
LEARNING EXPERIENCES ON A DAIRY FARM ,
IN CLASS 41 (U.S. CLS. 100, 101 AND 107).

FIRST USE 12-31-1999; IN COMMERCE 12-31-1999.

THE MARK CONSISTS OF STANDARD CHAR-
ACTERS WITHOUT CLAIM TO ANY PARTICULAR
FONT, STYLE, SIZE, OR COLOR.

SER. NO. 77-139,392, FILED 3-23-2007.

AMY MCMENAMIN, EXAMINING ATTORNEY

Int. Cls.: 9 and 41

Prior U.S. Cls.: 21, 23, 26, 36, 38, 100, 101 and 107

Reg. No. 3,397,431

United States Patent and Trademark Office

Registered Mar. 18, 2008

**TRADEMARK
SERVICE MARK
PRINCIPAL REGISTER**

Angelic Abundance

KASPER, CATHERINE M. (UNITED STATES INDIVIDUAL)
P.O. BOX 362
CEDARBURG, WI 530120362

FOR: DOWNLOADABLE ELECTRONIC PUBLICATIONS IN THE NATURE OF BOOKS AND CARDS IN THE FIELD OF SPIRITUALITY, IN CLASS 9 (U.S. CLS. 21, 23, 26, 36 AND 38).

FIRST USE 1-1-1999; IN COMMERCE 8-18-2001.

FOR: EDUCATION SERVICES, NAMELY, PROVIDING LIVE AND ON-LINE CLASSES, SEMINARS, WORKSHOPS, TUTORING AND MENTORING IN

THE FIELD OF SPIRITUALITY; PUBLICATION OF A SERIES OF PRINTED BOOKS, CARDS AND MANUALS IN THE FIELD OF SPIRITUALITY, IN CLASS 41 (U.S. CLS. 100, 101 AND 107).

FIRST USE 1-1-1999; IN COMMERCE 8-18-2001.

THE MARK CONSISTS OF STANDARD CHARACTERS WITHOUT CLAIM TO ANY PARTICULAR FONT, STYLE, SIZE, OR COLOR.

SER. NO. 77-139,596, FILED 3-24-2007.

BARBARA BROWN, EXAMINING ATTORNEY

Int. Cl.: 5

Prior U.S. Cls.: 6, 18, 44, 46, 51 and 52

United States Patent and Trademark Office

Reg. No. 3,397,432

Registered Mar. 18, 2008

**TRADEMARK
PRINCIPAL REGISTER**

ampm flex

H&N HERBS (CALIFORNIA CORPORATION)
19 E NEWMAN AVENUE
ARCADIA, CA 91006

FIRST USE 10-20-2006; IN COMMERCE 10-20-2006.

FOR: DIETARY AND NUTRITIONAL SUPPLEMENTS; DIETARY SUPPLEMENTS; DIETARY SUPPLEMENTS FOR HUMAN CONSUMPTION; HERBAL SUPPLEMENTS; NUTRACEUTICALS FOR USE AS A DIETARY SUPPLEMENT; NUTRITIONAL SUPPLEMENTS, IN CLASS 5 (U.S. CLS. 6, 18, 44, 46, 51 AND 52).

THE MARK CONSISTS OF STANDARD CHARACTERS WITHOUT CLAIM TO ANY PARTICULAR FONT, STYLE, SIZE, OR COLOR.

SER. NO. 77-139,756, FILED 3-25-2007.

KAPIL BHANOT, EXAMINING ATTORNEY

Int. Cl.: 35

Prior U.S. Cls.: 100, 101 and 102

United States Patent and Trademark Office

Reg. No. 3,397,433

Registered Mar. 18, 2008

**SERVICE MARK
PRINCIPAL REGISTER**

**Equipping Leaders for
Greater Service**

CLD CONSULTANTS, INC. (CALIFORNIA CORPORATION)
FOUR SOUTH VISTA DE CATALINA
LAGUNA BEACH, CA 92651

FOR: ASSISTANCE, ADVISORY SERVICES AND CONSULTANCY WITH REGARD TO BUSINESS PLANNING, BUSINESS ANALYSIS, BUSINESS MANAGEMENT, AND BUSINESS ORGANIZATION; BUSINESS CONSULTATION; BUSINESS CONSULTATION SERVICES; BUSINESS CONSULTING, MANAGEMENT, PLANNING AND SUPERVISION; BUSINESS MANAGEMENT AND CONSULTATION; BUSINESS MANAGEMENT CONSULTANCY AND ADVISORY SERVICES; BUSINESS MANAGEMENT CONSULTANCY AS WELL AS DEVELOPMENT OF PROCESSES FOR THE ANALYSIS AND THE IMPLEMENTATION OF STRATEGY PLANS AND MANAGEMENT PROJECTS; BUSINESS MANAGEMENT CONSULTANCY SERVICES; BUSINESS MANAGEMENT CONSULTATION; BUSINESS MANAGEMENT CONSULTATION IN THE FIELD OF EXECUTIVE AND LEADERSHIP DEVELOPMENT; BUSINESS

MANAGEMENT CONSULTING AND ADVISORY SERVICES; BUSINESS ORGANIZATION AND MANAGEMENT CONSULTING SERVICES; BUSINESS ORGANIZATIONAL CONSULTATION; CONSULTANCY SERVICES REGARDING BUSINESS STRATEGIES; CONSULTING SERVICES IN BUSINESS ORGANIZATION AND MANAGEMENT; PROFESSIONAL BUSINESS CONSULTATION; PROVIDING BUSINESS MANAGEMENT INFORMATION IN CONNECTION WITH CONSULTING AND ADVISORY SERVICES IN THE FIELD OF STRATEGIC PLANNING, IN CLASS 35 (U.S. CLS. 100, 101 AND 102).

FIRST USE 1-1-2003; IN COMMERCE 1-1-2003.

THE MARK CONSISTS OF STANDARD CHARACTERS WITHOUT CLAIM TO ANY PARTICULAR FONT, STYLE, SIZE, OR COLOR.

SER. NO. 77-139,758, FILED 3-25-2007.

MARTHA FROMM, EXAMINING ATTORNEY

Int. Cl.: 11

Prior U.S. Cls.: 13, 21, 23, 31 and 34

United States Patent and Trademark Office

Reg. No. 3,397,434

Registered Mar. 18, 2008

**TRADEMARK
PRINCIPAL REGISTER**

EVERLAST

FULL SPECTRUM SOLUTIONS, INC. (MICHIGAN CORPORATION)
712 E. SOUTH ST.
JACKSON, MI 49203

THE MARK CONSISTS OF STANDARD CHARACTERS WITHOUT CLAIM TO ANY PARTICULAR FONT, STYLE, SIZE, OR COLOR.

FOR: LIGHTING FIXTURES THAT INTEGRATE NATURAL DAYLIGHT AND FLUORESCENT LIGHTING INTO THE FIXTURE, IN CLASS 11 (U.S. CLS. 13, 21, 23, 31 AND 34).

SER. NO. 77-140,001, FILED 3-26-2007.

FIRST USE 3-25-2007; IN COMMERCE 3-25-2007.

JENNIFER MARTIN, EXAMINING ATTORNEY

Int. Cl.: 42

Prior U.S. Cls.: 100 and 101

United States Patent and Trademark Office

Reg. No. 3,397,435

Registered Mar. 18, 2008

**SERVICE MARK
PRINCIPAL REGISTER**

Family Pursuit

FAMILY PURSUIT, LC (UTAH LTD LIAB CO)
129 S 700 W
PROVO, UT 84601

FOR: PROVIDING ONLINE GENEALOGY AND FAMILY HISTORY SERVICES IN THE NATURE OF PROVIDING AN ONLINE COMPUTER DATABASE FEATURING INFORMATION REGARDING GENEALOGY AND FAMILY HISTORY; PROVIDING A WEBSITE FEATURING INFORMATION ON GENEALOGY AND GENEALOGICAL RESEARCH; PROVIDING A WEBSITE THAT ALLOWS USERS TO RESEARCH GENEALOGY AND FAMILY HISTORY AND TO CREATE A PEDIGREE AND FAMILY HISTORY; PROVIDING A WEBSITE THAT ALLOWS USERS TO COLLABORATE ON THEIR GENEALOGY AND COORDINATE THEIR GENEALOGICAL

RESEARCH EFFORTS, IN CLASS 42 (U.S. CLS. 100 AND 101).

FIRST USE 10-6-2006; IN COMMERCE 1-24-2007.

THE MARK CONSISTS OF STANDARD CHARACTERS WITHOUT CLAIM TO ANY PARTICULAR FONT, STYLE, SIZE, OR COLOR.

NO CLAIM IS MADE TO THE EXCLUSIVE RIGHT TO USE "FAMILY", APART FROM THE MARK AS SHOWN.

SER. NO. 77-140,770, FILED 3-26-2007.

TINA BROWN, EXAMINING ATTORNEY

Int. Cl.: 30

Prior U.S. Cl.: 46

United States Patent and Trademark Office

Reg. No. 3,397,436

Registered Mar. 18, 2008

TRADEMARK
PRINCIPAL REGISTER



SPANGLER CANDY COMPANY (OHIO CORPORATION)
400 N. PORTLAND STREET
BRYAN, OH 43506

FOR: CANDY, NAMELY, LOLLIPOPS, IN CLASS 30 (U.S. CL. 46).

FIRST USE 5-31-1950; IN COMMERCE 5-31-1950.

THE MARK CONSISTS OF A DESIGN FOR A LOLLIPOP WRAPPER AS IT APPEARS WHEN IN PLACE ON A LOLLIPOP PRODUCT. AS APPLIED TO THE LOLLIPOP, THE TOP THIRD OF A SQUARE PAPER WRAPPER IS FOLDED OVER THE TOP OF

THE LOLLIPOP, EACH SIDE OF THE FOLDED WRAPPER IS IN TURN FOLDED IN, AND THE BOTTOM OF THE WRAPPER IS THEN TWISTED AROUND THE LOLLIPOP STICK TO SECURE THE WRAPPER. THE LOLLIPOP STICK AND THE BOTTOM OF THE WRAPPER TWISTED AROUND THE LOLLIPOP STICK TO SECURE THE WRAPPER ARE NOT CLAIMED AS FEATURES OF THE MARK.

SEC. 2(F).

SER. NO. 77-141,094, FILED 3-27-2007.

COLLEEN DOMBROW, EXAMINING ATTORNEY

Int. Cl.: 5

Prior U.S. Cls.: 6, 18, 44, 46, 51 and 52

United States Patent and Trademark Office

Reg. No. 3,397,437

Registered Mar. 18, 2008

**TRADEMARK
PRINCIPAL REGISTER**

PAVAZEN

TAKEDA PHARMACEUTICAL COMPANY LIM-
ITED (JAPAN CORPORATION)
1-1, DOSHOMACHI 4-CHOME
CHUO-KU, OSAKA, JAPAN

FOR: PHARMACEUTICAL PREPARATIONS FOR
THE TREATMENT AND PREVENTION OF CARDI-
OVASCULAR DISEASES, IN CLASS 5 (U.S. CLS. 6, 18,
44, 46, 51 AND 52).

THE MARK CONSISTS OF STANDARD CHAR-
ACTERS WITHOUT CLAIM TO ANY PARTICULAR
FONT, STYLE, SIZE, OR COLOR.

PRIORITY CLAIMED UNDER SEC. 44(D) ON
JAPAN APPLICATION NO. 2007-015936, FILED 2-26-
2007, REG. NO. 5065194, DATED 7-27-2007, EXPIRES
7-27-2017.

SER. NO. 77-141,418, FILED 3-27-2007.

CHRISTINA SOBRAL, EXAMINING ATTORNEY

Int. Cls.: 24 and 25

Prior U.S. Cls.: 22, 39, 42 and 50

United States Patent and Trademark Office

Reg. No. 3,397,438

Registered Mar. 18, 2008

**TRADEMARK
PRINCIPAL REGISTER**

TORAYAGE

TORAY KABUSHIKI KAISHA (TORAY INDUSTRIES, INC.) (JAPAN CORPORATION)

NO. 1-1, 2-CHOME, NIHONBASHI-MUROMACHI

CHUO-KU, TOKYO, JAPAN

FOR: KNITTED FABRICS, IN CLASS 24 (U.S. CLS. 42 AND 50).

FOR: CLOTHING, NAMELY, UNDERWEAR FOR WOMEN AND MEN, IN CLASS 25 (U.S. CLS. 22 AND 39).

THE MARK CONSISTS OF STANDARD CHARACTERS WITHOUT CLAIM TO ANY PARTICULAR FONT, STYLE, SIZE, OR COLOR.

OWNER OF JAPAN REG. NO. 5079542, DATED 9-21-2007, EXPIRES 9-21-2017.

THE MARK HAS NO KNOWN MEANING IN ANY FOREIGN LANGUAGE.

SER. NO. 77-141,518, FILED 3-27-2007.

LAURA KOVALSKY, EXAMINING ATTORNEY

Int. Cl.: 38

Prior U.S. Cls.: 100, 101 and 104

United States Patent and Trademark Office

Reg. No. 3,397,439

Registered Mar. 18, 2008

**SERVICE MARK
PRINCIPAL REGISTER**

Octopus Open

DEUTSCHE TELEKOM AG (FED REP GERMA-
NY CORPORATION)
FRIEDRICH-EBERT-ALLEE 140
BONN, FED REP GERMANY 53113

FOR: TELECOMMUNICATION AND INFORMATION TECHNOLOGY SERVICES, NAMELY, ELECTRIC, DIGITAL, CELLULAR AND WIRELESS TRANSMISSION OF VOICE, DATA, INFORMATION IMAGES, SIGNALS AND MESSAGES AND TRANSMISSION OF VOICE, DATA, IMAGES, AUDIO, VIDEO AND INFORMATION VIA TELEPHONE, TELEVISION AND GLOBAL COMMUNICATION NETWORKS; PROVIDING TELECOMMUNICATIONS CONNECTIONS OVER A GLOBAL COMMUNICATIONS NETWORK, ELECTRONIC STORE-AND-FORWARD MESSAGING; RENTAL OF TELECOMMUNICATIONS EQUIPMENT, NAMELY, EQUIPMENT FOR ELECTRONIC ACCESS TO GLOBAL TELECOMMUNICATIONS NETWORK, EQUIPMENT FOR TRANSMITTING, RECEIVING, RECORDING AND MONITORING VOICE, DATA, INFORMATION IMAGES, SIGNALS, MESSAGES COMPRISED OF DATA AND WORD PROCESSORS, AND TELECOMMUNICATIONS HARDWARE COMPONENTS AND PERIPHERALS THEREOF FOR USE IN THE TELECOMMUNICATIONS INDUSTRY, AND RENTAL

OF EQUIPMENT FOR TRANSMITTING, RECEIVING, RECORDING AND MONITORING COMPUTER PROGRAMS FOR USE IN OPERATING AND ACCESSING TELECOMMUNICATIONS SYSTEMS; PROVIDING MULTIPLE-USER DIAL-UP AND DEDICATED ACCESS TO THE INTERNET; PERSONAL COMMUNICATIONS SERVICES; PAGER SERVICES; LEASING OF TELECOMMUNICATIONS EQUIPMENT, COMPONENTS AND SYSTEMS; PROVIDING INFORMATION VIA THE TELEPHONE AND THE GLOBAL COMMUNICATION NETWORKS IN THE FIELD OF TELECOMMUNICATIONS; CONSULTING IN THE FIELD OF TELECOMMUNICATIONS, IN CLASS 38 (U.S. CLS. 100, 101 AND 104).

THE MARK CONSISTS OF STANDARD CHARACTERS WITHOUT CLAIM TO ANY PARTICULAR FONT, STYLE, SIZE, OR COLOR.

OWNER OF FED REP GERMANY REG. NO. 30620822, DATED 2-9-2007, EXPIRES 4-30-2016.

SER. NO. 77-141,737, FILED 3-27-2007.

LINDA ORNDORFF, EXAMINING ATTORNEY

Int. Cl.: 9

Prior U.S. Cls.: 21, 23, 26, 36 and 38

Reg. No. 3,397,440

United States Patent and Trademark Office

Registered Mar. 18, 2008

**TRADEMARK
PRINCIPAL REGISTER**

VIETNAM

GERNER, MICHAEL (UNITED STATES INDIVIDUAL)

C/O KEMADO RECORDS

601 WEST 26TH STREET, SUITE 1175

NEW YORK, NY 10001 AND

GRUBB, JOSH (UNITED STATES INDIVIDUAL)

C/O KEMADO RECORDS

601 WEST 26TH STREET, SUITE 1175

NEW YORK, NY 10001 AND

FOSS, MICHAEL (UNITED STATES INDIVIDUAL)

C/O KEMADO RECORDS

601 WEST 26TH STREET, SUITE 1175

NEW YORK, NY 10001 AND

BERKO, IVAN (UNITED STATES INDIVIDUAL)

C/O KEMADO RECORDS

601 WEST 26TH STREET, SUITE 1175

NEW YORK, NY 10001

FOR: CDS CONTAINING MUSICAL SOUND RECORDINGS, IN CLASS 9 (U.S. CLS. 21, 23, 26, 36 AND 38).

FIRST USE 7-13-2004; IN COMMERCE 7-13-2004.

THE MARK CONSISTS OF STANDARD CHARACTERS WITHOUT CLAIM TO ANY PARTICULAR FONT, STYLE, SIZE, OR COLOR.

SER. NO. 77-142,728, FILED 3-28-2007.

TRACY WHITTAKER-BROWN, EXAMINING ATTORNEY

Int. Cl.: 25

Prior U.S. Cls.: 22 and 39

United States Patent and Trademark Office

Reg. No. 3,397,441

Registered Mar. 18, 2008

**TRADEMARK
PRINCIPAL REGISTER**

POTTERY BARN KIDS

WILLIAMS-SONOMA, INC. (CALIFORNIA CORPORATION)
3250 VAN NESS AVENUE
SAN FRANCISCO, CA 94109

FOR: CLOTHING, NAMELY, CLOTH AND PLASTIC BABY BIBS, BABY PANTS, BODY SUITS, BOOTIES, CARDIGANS, CAPS, COATS, DIAPER PANTS FOR HOLDING DIAPERS FOR INFANTS, DRESSES, HATS, INFANT ONE PIECE UNDERWEAR AND OUTERWEAR, NAMELY, SNOW SUITS, JACKETS, JEANS, JUMPERS, LEGGINGS, LEOTARDS, LOUNGEWEAR, MITTENS, OVERALLS, PANTS, POLO SHIRTS, ROBES, INFANT SLEEPERS, SHIRTS, SHORTS, SKIRTS, SLEEPWEAR, SLIPPERS, SMOCKS, SOCKS, SPORT SHIRTS, SWEATERS, SWEATSHIRTS, SWIMWEAR, T-SHIRTS, TIGHTS, UNDERWEAR, AND WARM-UP SUITS, IN CLASS 25 (U.S. CLS. 22 AND 39).

FIRST USE 10-1-1999; IN COMMERCE 10-1-1999.

THE MARK CONSISTS OF STANDARD CHARACTERS WITHOUT CLAIM TO ANY PARTICULAR FONT, STYLE, SIZE, OR COLOR.

OWNER OF U.S. REG. NO. 2,383,910.

NO CLAIM IS MADE TO THE EXCLUSIVE RIGHT TO USE "KIDS", APART FROM THE MARK AS SHOWN.

SER. NO. 77-142,801, FILED 3-28-2007.

CYNTHIA SLOAN, EXAMINING ATTORNEY

Int. Cl.: 9

Prior U.S. Cls.: 21, 23, 26, 36 and 38

Reg. No. 3,397,442

United States Patent and Trademark Office

Registered Mar. 18, 2008

**TRADEMARK
PRINCIPAL REGISTER**

X-CAL

DOUBLE BLACK IMAGING CORPORATION
(COLORADO CORPORATION)
11005 DOVER ST #500
WESTMINSTER, CO 80021

THE MARK CONSISTS OF STANDARD CHAR-
ACTERS WITHOUT CLAIM TO ANY PARTICULAR
FONT, STYLE, SIZE, OR COLOR.

FOR: COMPUTER COMPONENT TESTING AND
CALIBRATING COMPUTER SOFTWARE, IN CLASS
9 (U.S. CLS. 21, 23, 26, 36 AND 38).

SER. NO. 77-143,187, FILED 3-28-2007.

FIRST USE 5-26-2006; IN COMMERCE 11-6-2006.

TEJBIR SINGH, EXAMINING ATTORNEY

Int. Cl.: 35

Prior U.S. Cls.: 100, 101 and 102

United States Patent and Trademark Office

Reg. No. 3,397,443

Registered Mar. 18, 2008

**SERVICE MARK
PRINCIPAL REGISTER**

WILLIAM-NEIL ASSOCIATES

CABELA'S INC. (DELAWARE CORPORATION)
ONE CABELA DRIVE
SIDNEY, NE 69160

FOR: CUSTOMER MAILING LIST PREPARATION; ADVERTISING; COMPILATION AND MANAGEMENT OF COMPUTERIZED CUSTOMER MAILING LIST DATABASES; DISTRIBUTION AND DISSEMINATION OF CUSTOMER MAILING LISTS, IN CLASS 35 (U.S. CLS. 100, 101 AND 102).

FIRST USE 10-1-1981; IN COMMERCE 10-1-1981.

THE MARK CONSISTS OF STANDARD CHARACTERS WITHOUT CLAIM TO ANY PARTICULAR FONT, STYLE, SIZE, OR COLOR.

NO CLAIM IS MADE TO THE EXCLUSIVE RIGHT TO USE "ASSOCIATES", APART FROM THE MARK AS SHOWN.

SER. NO. 77-143,314, FILED 3-29-2007.

DAVID TAYLOR, EXAMINING ATTORNEY

Int. Cls.: 35, 36 and 37

Prior U.S. Cls.: 100, 101, 102, 103 and 106

United States Patent and Trademark Office

Reg. No. 3,397,444

Registered Mar. 18, 2008

**SERVICE MARK
PRINCIPAL REGISTER**



GINN REAL ESTATE COMPANY, LLC (GEORGIA LTD LIAB CO)
SUITE 200
215 CELEBRATION PLACE
CELEBRATION, FL 34747

FOR: REAL ESTATE ADVERTISING SERVICES, NAMELY, MARKETING AND ADVERTISING OF RESORT AND RESIDENTIAL PROPERTIES; OPERATING UPSCALE RESIDENTIAL AND GOLF COMMUNITIES AND RESORTS, IN CLASS 35 (U.S. CLS. 100, 101 AND 102).

FIRST USE 11-30-2006; IN COMMERCE 11-30-2006.

FOR: FINANCIAL SERVICES, NAMELY, MORTGAGE LENDING, IN CLASS 36 (U.S. CLS. 100, 101 AND 102).

FIRST USE 11-30-2006; IN COMMERCE 11-30-2006.

FOR: REAL ESTATE DEVELOPMENT AND CONSTRUCTION SERVICES, NAMELY, DEVELOPING UPSCALE RESIDENTIAL AND GOLF COMMUNITIES AND RESORTS, IN CLASS 37 (U.S. CLS. 100, 103 AND 106).

FIRST USE 11-30-2006; IN COMMERCE 11-30-2006.

OWNER OF U.S. REG. NOS. 2,970,328, 3,221,415 AND OTHERS.

THE MARK CONSISTS OF THE STYLIZED WORD GINN WITH A PARTIAL UNDERLINE.

SEC. 2(F).

SER. NO. 77-144,005, FILED 3-29-2007.

MIDGE BUTLER, EXAMINING ATTORNEY

Int. Cl.: 3

Prior U.S. Cls.: 1, 4, 6, 50, 51 and 52

United States Patent and Trademark Office

Reg. No. 3,397,445

Registered Mar. 18, 2008

TRADEMARK
PRINCIPAL REGISTER



RISLEYCORUM, LEYEA R (UNITED STATES
INDIVIDUAL)
377 BROADWAY #2
SOUTH PORTLAND, ME 04106 AND
CORUM, BENJAMIN M (UNITED STATES INDIVI-
DUAL)
377 BROADWAY #2
SOUTH PORTLAND, ME 04106

FOR: BODY AND BEAUTY CARE COSMETICS;
BABY OILS, IN CLASS 3 (U.S. CLS. 1, 4, 6, 50, 51 AND
52).

FIRST USE 7-0-2005; IN COMMERCE 7-0-2005.

THE COLOR(S) ORANGE, YELLOW AND DARK
RED IS/ARE CLAIMED AS A FEATURE OF THE
MARK.

THE MARK CONSISTS OF A YELLOW LINE
DRAWING OF A DANCING, PREGNANT WOMAN
WHO IS CENTERED WITHIN A CIRCLE. THE
COLOR OF THE CIRCLE CHANGES FROM DARK
RED TO ORANGE AS YOU APPROACH THE CEN-
TER. THE CIRCLE IS CENTERED WITHIN A
SLIGHTLY LARGER SQUARE WITH ROUNDED
CORNERS. THE COLOR OF THE SQUARE IS
ORANGE. BELOW THE SQUARE IS THE TEXT
"HAPPY MAMA ESSENTIALS". THE TEXT COLOR
IS DARK RED.

SER. NO. 77-144,403, FILED 3-30-2007.

PATRICIA EVANKO, EXAMINING ATTORNEY

Int. Cl.: 36

Prior U.S. Cls.: 100, 101 and 102

United States Patent and Trademark Office

Reg. No. 3,397,446

Registered Mar. 18, 2008

**SERVICE MARK
PRINCIPAL REGISTER**



PINK RIBBON ROUND-UP, INC. (PENNSYLVANIA CORPORATION)
1692 GARVIN ROAD
CRANBERRY TOWNSHIP, PA 16066

FOR: CHARITABLE FUND RAISING SERVICES, NAMELY, RAISING MONEY FOR BREAST CANCER DETECTION, TREATMENT, RESEARCH AND AWARENESS, IN CLASS 36 (U.S. CLS. 100, 101 AND 102).

FIRST USE 5-19-2006; IN COMMERCE 9-30-2006.

NO CLAIM IS MADE TO THE EXCLUSIVE RIGHT TO USE "PINK RIBBON", APART FROM THE MARK AS SHOWN.

THE COLOR(S) PINK, BLACK, LIGHT PINK AND WHITE IS/ARE CLAIMED AS A FEATURE OF THE MARK.

THE MARK CONSISTS OF A SILHOUETTE OF A COWBOY ON A HORSE SHADED IN BLACK AND LOCATED WITHIN THE LOOP OF A PINK RIBBON. THE WORDS "PINK RIBBON ROUND UP" IN STYLIZED FONT APPEAR ABOVE THE IMAGE IN THE COLOR BLACK. ALL ELEMENTS APPEAR ON A RECTANGULAR BACKGROUND DESIGN THAT TRANSITIONS IN GRADIENT FASHION FROM THE COLOR LIGHT PINK AT THE TOP-RIGHT TO THE COLOR WHITE AT THE BOTTOM-LEFT.

SER. NO. 77-144,742, FILED 3-30-2007.

KEVIN CORWIN, EXAMINING ATTORNEY

Int. Cl.: 25

Prior U.S. Cls.: 22 and 39

United States Patent and Trademark Office

Reg. No. 3,397,447

Registered Mar. 18, 2008

**TRADEMARK
PRINCIPAL REGISTER**

NYLON PUNK

NYLON PUNK, LTD. (NEW YORK CORPORATION)

#B

464 2ND STREET

PALISADES PARK, NJ 07650

FOR: JACKETS, JEANS, PANTS, SHIRTS, SWEATERS AND T-SHIRTS, IN CLASS 25 (U.S. CLS. 22 AND 39).

FIRST USE 2-4-2005; IN COMMERCE 11-6-2005.

THE MARK CONSISTS OF STANDARD CHARACTERS WITHOUT CLAIM TO ANY PARTICULAR FONT, STYLE, SIZE, OR COLOR.

NO CLAIM IS MADE TO THE EXCLUSIVE RIGHT TO USE "NYLON", APART FROM THE MARK AS SHOWN.

SER. NO. 77-146,121, FILED 4-2-2007.

ROBERT LAVACHE, EXAMINING ATTORNEY

Int. Cl.: 36

Prior U.S. Cls.: 100, 101 and 102

United States Patent and Trademark Office

Reg. No. 3,397,448

Registered Mar. 18, 2008

**SERVICE MARK
PRINCIPAL REGISTER**

S&P CUSTOM INDICES

THE MCGRAW-HILL COMPANIES, INC. (NEW
YORK CORPORATION)
1221 AVENUE OF THE AMERICAS
NEW YORK, NY 10020

OWNER OF U.S. REG. NOS. 1,481,545, 2,475,074
AND OTHERS.

FOR: CALCULATING FINANCIAL INDICES TAI-
LORED TO THE SPECIFICATIONS OF OTHERS, IN
CLASS 36 (U.S. CLS. 100, 101 AND 102).

NO CLAIM IS MADE TO THE EXCLUSIVE
RIGHT TO USE "CUSTOM INDICES", APART
FROM THE MARK AS SHOWN.

FIRST USE 9-0-2006; IN COMMERCE 9-0-2006.

SER. NO. 77-146,517, FILED 4-2-2007.

THE MARK CONSISTS OF STANDARD CHAR-
ACTERS WITHOUT CLAIM TO ANY PARTICULAR
FONT, STYLE, SIZE, OR COLOR.

LINDA M. KING, EXAMINING ATTORNEY

Int. Cl.: 36

Prior U.S. Cls.: 100, 101 and 102

United States Patent and Trademark Office

Reg. No. 3,397,449

Registered Mar. 18, 2008

**SERVICE MARK
PRINCIPAL REGISTER**

S&P CUSTOM INDEX

THE MCGRAW-HILL COMPANIES, INC. (NEW
YORK CORPORATION)
1221 AVENUE OF THE AMERICAS
NEW YORK, NY 10020

OWNER OF U.S. REG. NOS. 1,481,545, 2,475,074
AND OTHERS.

FOR: CALCULATING FINANCIAL INDICES TAI-
LORED TO THE SPECIFICATIONS OF OTHERS, IN
CLASS 36 (U.S. CLS. 100, 101 AND 102).

NO CLAIM IS MADE TO THE EXCLUSIVE
RIGHT TO USE "CUSTOM INDEX", APART FROM
THE MARK AS SHOWN.

FIRST USE 9-0-2006; IN COMMERCE 9-0-2006.

SER. NO. 77-146,530, FILED 4-2-2007.

THE MARK CONSISTS OF STANDARD CHAR-
ACTERS WITHOUT CLAIM TO ANY PARTICULAR
FONT, STYLE, SIZE, OR COLOR.

LINDA M. KING, EXAMINING ATTORNEY

Int. Cl.: 37

Prior U.S. Cls.: 100, 103 and 106

Reg. No. 3,397,450

United States Patent and Trademark Office

Registered Mar. 18, 2008

**SERVICE MARK
PRINCIPAL REGISTER**



YONG I .KIM (UNITED STATES INDIVIDUAL)
513 S. MAIN STREET
SEATTLE, WA 98104

"THE COLOR(S) BLUE IS/ARE CLAIMED AS A
FEATURE OF THE MARK."

FOR: MAID SERVICES, IN CLASS 37 (U.S. CLS.
100, 103 AND 106).

"THE MARK CONSISTS OF THE COLOR BLUE
APPEARS IN ALL WORDING IN THE MARK AND
IN THE FLOWER DESIGN ABOVE THE WORDING
FRIDAYMAID WITH SHADING FROM LIGHT
BLUE TO DARK BLUE IN THE LETTERS AND
THE PETALS OF THE FLOWER."

FIRST USE 10-1-2002; IN COMMERCE 10-1-2002.

NO CLAIM IS MADE TO THE EXCLUSIVE
RIGHT TO USE "FRIDAY MAID" , APART FROM
THE MARK AS SHOWN.

SER. NO. 77-146,931, FILED 4-3-2007.

ELLEN BURNS, EXAMINING ATTORNEY

Int. Cl.: 11

Prior U.S. Cls.: 13, 21, 23, 31 and 34

United States Patent and Trademark Office

Reg. No. 3,397,451

Registered Mar. 18, 2008

**TRADEMARK
PRINCIPAL REGISTER**

ANTILIA

KOHLER CO. (WISCONSIN CORPORATION)
444 HIGHLAND DRIVE
KOHLER, WI 53044

THE MARK CONSISTS OF STANDARD CHAR-
ACTERS WITHOUT CLAIM TO ANY PARTICULAR
FONT, STYLE, SIZE, OR COLOR.

FOR: LAVATORIES, IN CLASS 11 (U.S. CLS. 13, 21,
23, 31 AND 34).

SER. NO. 77-147,699, FILED 4-3-2007.

FIRST USE 5-8-2007; IN COMMERCE 5-8-2007.

NAPOLEON SHARMA, EXAMINING ATTORNEY

Int. Cl.: 10

Prior U.S. Cls.: 26, 39 and 44

United States Patent and Trademark Office

Reg. No. 3,397,452

Registered Mar. 18, 2008

**TRADEMARK
PRINCIPAL REGISTER**

Renovo
Spine System

SPECIALTY SPINE PRODUCTS, LLC (CALIFORNIA LTD LIAB CO)
SUITE 210
1901 W. LUGONIA AVE.
REDLANDS, CA 92374

FOR: MEDICAL AND SURGICAL APPARATUS AND INSTRUMENTS, NAMELY, ORTHOPEDIC FIXATION DEVICE USED IN ORTHOPEDIC TRANSPLANT AND/OR IMPLANT SURGERY , IN CLASS 10 (U.S. CLS. 26, 39 AND 44).

FIRST USE 7-1-2006; IN COMMERCE 7-11-2007.

NO CLAIM IS MADE TO THE EXCLUSIVE RIGHT TO USE "RENOVO SPINE SYSTEM", APART FROM THE MARK AS SHOWN.

THE MARK CONSISTS OF RENOVO SPINE SYSTEM THE 1ST O IN RENOVO IS MADE UP OF A SYMBOL CONSISTING OF OUTER EDGES AND A CENTERED STAR SHAPE. SPINE SYSTEM IS LOCATED BENETH RENOVO.

"THE FOREIGN WORDING IN THE MARK TRANSLATES INTO ENGLISH AS RESTORE/ REPAIR."

SER. NO. 77-148,972, FILED 4-4-2007.

ROBERT C. CLARK JR., EXAMINING ATTORNEY

Int. Cl.: 5

Prior U.S. Cls.: 6, 18, 44, 46, 51 and 52

United States Patent and Trademark Office

Reg. No. 3,397,453

Registered Mar. 18, 2008

**TRADEMARK
PRINCIPAL REGISTER**

ESSIX

RAINTREE ESSIX INC. (DELAWARE CORPORATION)
1209 ORANGE STREET
WILMINGTON, DE 19801

FOR: DENTAL COMPOUNDS, NAMELY, DIE STONE, PUTTY AND BLOCKOUT COMPOUND, DEBUBBLIZER, FLAVORINGS FOR IMPRESSION MATERIALS, AND IMPRESSION MATERIALS, ALL FOR PROFESSIONAL DENTAL USE, IN CLASS 5 (U.S. CLS. 6, 18, 44, 46, 51 AND 52).

FIRST USE 5-15-1993; IN COMMERCE 5-15-1993.

THE MARK CONSISTS OF STANDARD CHARACTERS WITHOUT CLAIM TO ANY PARTICULAR FONT, STYLE, SIZE, OR COLOR.

OWNER OF U.S. REG. NOS. 1,902,595, 3,062,755 AND OTHERS.

SER. NO. 77-149,736, FILED 4-5-2007.

MICHAEL LITZAU, EXAMINING ATTORNEY

Int. Cls.: 42 and 45

Prior U.S. Cls.: 100 and 101

United States Patent and Trademark Office

Reg. No. 3,397,454

Registered Mar. 18, 2008

**SERVICE MARK
PRINCIPAL REGISTER**



BORGIA, WILLIAM (UNITED STATES INDIVIDUAL)
2729 GARDEN LANE
BENSALEM, PA 19020

FOR: DESIGN, CREATION, HOSTING AND MAINTENANCE OF INTERNET SITES FOR THIRD PARTIES; COMPUTER SERVICES, NAMELY, MONITORING, TESTING, ANALYZING, AND REPORTING ON THE INTERNET TRAFFIC CONTROL AND CONTENT CONTROL OF THE WEB SITES OF OTHERS; MAINTENANCE OF DOMAIN NAMES FOR OTHERS, IN CLASS 42 (U.S. CLS. 100 AND 101).

FIRST USE 2-1-2007; IN COMMERCE 2-1-2007.

FOR: COMPUTER SERVICES, NAMELY, REGISTERING DOMAIN NAMES FOR USE ON A GLOBAL COMPUTER NETWORK, IN CLASS 45 (U.S. CLS. 100 AND 101).

FIRST USE 2-1-2007; IN COMMERCE 2-1-2007.

THE MARK CONSISTS OF NIAMOD.

SER. NO. 77-150,338, FILED 4-6-2007.

ROBIN CHOSID, EXAMINING ATTORNEY

Int. Cl.: 7

Prior U.S. Cls.: 13, 19, 21, 23, 31, 34 and 35

United States Patent and Trademark Office

Reg. No. 3,397,455

Registered Mar. 18, 2008

**TRADEMARK
PRINCIPAL REGISTER**

SCORPION PERFORMANCE

SCORPION PERFORMANCE, INC. (FLORIDA CORPORATION)
3000 SW 4TH AVENUE
FORT LAUDERDALE, FL 33315

FOR: HIGH PERFORMANCE AUTOMOTIVE RACING ENGINE PARTS, NAMELY, ROCKER ARMS, IN CLASS 7 (U.S. CLS. 13, 19, 21, 23, 31, 34 AND 35).

FIRST USE 12-17-1999; IN COMMERCE 12-17-1999.

THE MARK CONSISTS OF STANDARD CHARACTERS WITHOUT CLAIM TO ANY PARTICULAR FONT, STYLE, SIZE, OR COLOR.

NO CLAIM IS MADE TO THE EXCLUSIVE RIGHT TO USE PERFORMANCE, APART FROM THE MARK AS SHOWN.

SER. NO. 77-150,396, FILED 4-6-2007.

DANIEL CAPSHAW, EXAMINING ATTORNEY

Int. Cl.: 9

Prior U.S. Cls.: 21, 23, 26, 36 and 38

United States Patent and Trademark Office

Reg. No. 3,397,456

Registered Mar. 18, 2008

**TRADEMARK
PRINCIPAL REGISTER**

Trading Alchemy

ALCHEMY TRADING TECHNOLOGIES, INC.
(COLORADO CORPORATION)
146 COYOTE COURT
BOULDER, CO 80302

FOR: COMPUTER SOFTWARE FOR USE IN
TRADING IN FINANCIAL MARKETS, IN CLASS 9
(U.S. CLS. 21, 23, 26, 36 AND 38).

FIRST USE 4-1-2001; IN COMMERCE 4-1-2001.

THE MARK CONSISTS OF STANDARD CHAR-
ACTERS WITHOUT CLAIM TO ANY PARTICULAR
FONT, STYLE, SIZE, OR COLOR.

NO CLAIM IS MADE TO THE EXCLUSIVE
RIGHT TO USE "TRADING", APART FROM THE
MARK AS SHOWN.

SER. NO. 77-151,409, FILED 4-8-2007.

KEVIN CORWIN, EXAMINING ATTORNEY

Int. Cls.: 16, 36 and 41

**Prior U.S. Cls.: 2, 5, 22, 23, 29, 37, 38, 50, 100, 101, 102
and 107**

Reg. No. 3,397,457

United States Patent and Trademark Office

Registered Mar. 18, 2008

**TRADEMARK
SERVICE MARK
PRINCIPAL REGISTER**

MORTGAGE U

MORTGAGE U, INC. (MICHIGAN CORPORATION)
SUITE 100
30300 TELEGRAPH RD.
BINGHAM FARMS, MI 48025

FOR: EDUCATIONAL PUBLICATIONS, NAME-
LY, WORKBOOKS, MANUALS, AND TEXTBOOKS
IN THE FIELD OF BANKING AND MORTGAGE
BROKERING, SERVICING, AND REGULATION, IN
CLASS 16 (U.S. CLS. 2, 5, 22, 23, 29, 37, 38 AND 50).

FIRST USE 2-1-1996; IN COMMERCE 2-1-1996.

FOR: FINANCIAL CONSULTING SERVICES IN
THE FIELDS OF BANKING AND MORTGAGE
BROKERING, SERVICING, AND REGULATION,
IN CLASS 36 (U.S. CLS. 100, 101 AND 102).

FIRST USE 2-1-1996; IN COMMERCE 2-1-1996.

FOR: EDUCATIONAL SERVICES, NAME-
LY, PROVIDING COURSES, CLASSES, SEMINARS,

AND WORKSHOPS IN THE FIELD OF BANKING
AND MORTGAGE BROKERING, SERVICING, AND
REGULATION; EDUCATIONAL TESTING IN THE
FIELD OF BANKING AND MORTGAGE BROKER-
ING, SERVICING, AND REGULATION, IN CLASS
41 (U.S. CLS. 100, 101 AND 107).

FIRST USE 2-1-1996; IN COMMERCE 2-1-1996.

THE MARK CONSISTS OF STANDARD CHAR-
ACTERS WITHOUT CLAIM TO ANY PARTICULAR
FONT, STYLE, SIZE, OR COLOR.

NO CLAIM IS MADE TO THE EXCLUSIVE
RIGHT TO USE "MORTGAGE", APART FROM
THE MARK AS SHOWN.

SER. NO. 77-151,564, FILED 4-9-2007.

LINDSEY RUBIN, EXAMINING ATTORNEY

Int. Cls.: 35 and 37

Prior U.S. Cls.: 100, 101, 102, 103 and 106

United States Patent and Trademark Office

Reg. No. 3,397,458

Registered Mar. 18, 2008

SERVICE MARK
PRINCIPAL REGISTER



RESORTS

GINN REAL ESTATE COMPANY, LLC (GEORGIA LTD LIAB CO)
SUITE 200
215 CELEBRATION PLACE
CELEBRATION, FL 34747

FOR: REAL ESTATE ADVERTISING SERVICES, NAMELY, MARKETING AND ADVERTISING OF RESORT AND RESIDENTIAL PROPERTIES; OPERATING UPSCALE RESIDENTIAL AND GOLF COMMUNITIES AND RESORTS, IN CLASS 35 (U.S. CLS. 100, 101 AND 102).

FIRST USE 11-30-2006; IN COMMERCE 11-30-2006.

FOR: REAL ESTATE DEVELOPMENT AND CONSTRUCTION SERVICES, NAMELY, DEVELOPING UPSCALE RESIDENTIAL AND GOLF COMMUNITIES AND RESORTS, IN CLASS 37 (U.S. CLS. 100, 103 AND 106).

FIRST USE 11-30-2006; IN COMMERCE 11-30-2006.

OWNER OF U.S. REG. NOS. 2,970,328, 3,221,415 AND OTHERS.

NO CLAIM IS MADE TO THE EXCLUSIVE RIGHT TO USE "RESORTS" , APART FROM THE MARK AS SHOWN.

THE MARK CONSISTS OF STYLIZED GINN SEPARATED BY LINE FROM THE TERM RESORTS.

SEC. 2(F) "GINN HAS BECOME DISTINCTIVE OF THE GOODS/SERVICES AS EVIDENCED BY THE OWNERSHIP ON THE PRINCIPAL REGISTER FOR THE SAME MARK FOR RELATED GOODS OR SERVICES OF U.S. REGISTRATION NO(S)3221415, 2970329, 2970328."

SER. NO. 77-151,766, FILED 4-9-2007.

MIDGE BUTLER, EXAMINING ATTORNEY

Int. Cl.: 41

Prior U.S. Cls.: 100, 101 and 107

United States Patent and Trademark Office

Reg. No. 3,397,459

Registered Mar. 18, 2008

**SERVICE MARK
PRINCIPAL REGISTER**

Juguemos en Español

SUSY DORN PRODUCTIONS, LLC (CALIFORNIA LTD LIAB CO)

1429 SPRUANCE CT.

SAN JOSE, CA 95128

FOR: EDUCATIONAL SERVICES, NAMELY, SPANISH LANGUAGE IMMERSION CLASSES THAT TEACH SPANISH TO CHILDREN THROUGH GAMES, PUPPETS, DRAMA, STORIES, SINGING, PLAYTIME ACTIVITIES , IN CLASS 41 (U.S. CLS. 100, 101 AND 107).

FIRST USE 5-1-2001; IN COMMERCE 5-1-2001.

THE MARK CONSISTS OF STANDARD CHARACTERS WITHOUT CLAIM TO ANY PARTICULAR FONT, STYLE, SIZE, OR COLOR.

NO CLAIM IS MADE TO THE EXCLUSIVE RIGHT TO USE "EN ESPANOL", APART FROM THE MARK AS SHOWN.

THE FOREIGN WORDING IN THE MARK TRANSLATES INTO ENGLISH AS LET'S PLAY IN SPANISH.

SER. NO. 77-152,053, FILED 4-9-2007.

KATHLEEN LORENZO, EXAMINING ATTORNEY

Int. Cls.: 25 and 43

Prior U.S. Cls.: 22, 39, 100 and 101

United States Patent and Trademark Office

Reg. No. 3,397,460

Registered Mar. 18, 2008

TRADEMARK
SERVICE MARK
PRINCIPAL REGISTER



DISCOVER RESTAURANTS, LTD. (TEXAS LIMITED PARTNERSHIP)
2929 MOSSROCK, SUITE 227
SAN ANTONIO, TX 78230

FOR: MEN'S, WOMEN'S AND CHILDREN'S CLOTHING, NAMELY, APRONS, BASEBALL CAPS, BEACHWEAR, BELTS, CAPS, CAP VISORS, CHEF JACKETS, CROP TOPS, DRESS SHIRTS, GOLF SHIRTS, HALTER TOPS, HATS, INFANTWEAR, JACKETS, JERSEYS, KNIT SHIRTS, LOUNGEWEAR, NECKWEAR, POLO SHIRTS, RUGBY TOPS, SCARVES, SHIRTS, SHORTS, SLEEPWEAR, SPORT JERSEYS, SPORT SHIRTS, SOCKS, SWEATSHIRTS, SWIM WEAR, TANK TOPS, TEE SHIRTS, TIES, TOPS, VESTS, IN CLASS 25 (U.S. CLS. 22 AND 39).

FIRST USE 2-2-2007; IN COMMERCE 2-2-2007.

FOR: RESTAURANT AND BAR SERVICES; RESTAURANTS, IN CLASS 43 (U.S. CLS. 100 AND 101).

FIRST USE 2-2-2007; IN COMMERCE 2-2-2007.

NO CLAIM IS MADE TO THE EXCLUSIVE RIGHT TO USE "CABO GRILLE", APART FROM THE MARK AS SHOWN.

THE NAME(S), PORTRAIT(S), AND/OR SIGNATURE(S) SHOWN IN THE MARK DOES NOT IDENTIFY A PARTICULAR LIVING INDIVIDUAL.

THE MARK CONSISTS OF A LITERAL ELEMENT AND A DESIGN ELEMENT. THE LITERAL ELEMENT OF THE MARK IS THE PHRASE "TIAGO'S CABO GRILLE", AND THE DESIGN ELEMENT OF THE MARK IS A FLAME. A FLAME IS LOCATED AT THE TOP OF THE MARK. TWO DESIGNS FIT TOGETHER TO MAKE THE OVERALL FLAME DESIGN. THE FIRST DESIGN WITHIN THE FLAME, WHICH IS LOCATED AT THE LOWER LEFT PORTION, IS A SWIRL THAT ENDS WITH A JAGGED CORNER. THE SECOND DESIGN WITHIN THE FLAME, WHICH IS LOCATED IN THE UPPER-RIGHT PORTION OF THE FLAME, CONSISTS OF TWO JAGGED PEAKS, REPRESENTING THE TOP OF THE FLAME. TOGETHER, THESE TWO DESIGNS FIT TOGETHER TO CREATE THE IMAGE OF A FLAME. THE WORD "TIAGO'S" IS LOCATED BENEATH THE FLAME AND IS WRITTEN IN A LARGE DESIGN SCRIPT. THE PHRASE, "CABO GRILLE", IS LOCATED BENEATH THE WORD "TIAGO'S" AND IS WRITTEN IN SMALLER, CAPITAL LETTERS.

THE FOREIGN WORDING IN THE MARK TRANSLATES INTO ENGLISH AS CAPE.

SER. NO. 77-152,075, FILED 4-9-2007.

SANI KHOURI, EXAMINING ATTORNEY

Int. Cl.: 42

Prior U.S. Cls.: 100 and 101

United States Patent and Trademark Office

Reg. No. 3,397,461

Registered Mar. 18, 2008

SERVICE MARK
PRINCIPAL REGISTER

fsix

BILLINGS, ROGER E. (UNITED STATES INDIVIDUAL)
26900 E. PINK HILL RD.
INDEPENDENCE, MO 64057

FOR: COMPUTER SECURITY SERVICE, NAME-
LY, RESTRICTING ACCESS TO AND BY COM-
PUTER NETWORKS TO AND OF UNDESIRE WEB
SITES, MEDIA AND INDIVIDUALS AND FACIL-
ITIES; DESIGN AND DEVELOPMENT OF NET-
WORKS; DESIGN OF COMPUTER HARDWARE,
INTEGRATED CIRCUITS, COMMUNICATIONS
HARDWARE AND SOFTWARE AND COMPUTER
NETWORKS FOR OTHERS; DEVELOPMENT OF
SOFTWARE FOR SECURE NETWORK OPERA-
TIONS; INTEGRATION OF COMPUTER SYSTEMS
AND NETWORKS; PLANNING, DEVELOPMENT
AND TECHNICAL SUPPORT OF ELECTRONIC
COMMUNICATIONS NETWORKS; TECHNICAL
CONSULTATION IN THE FIELD OF REAL-TIME
RECONFIGURABLE WIRELESS COMMUNICA-
TION HANDSETS AND NETWORK EQUIPMENT
FOR USE IN WIDEBAND COMMUNICATIONS;
TECHNICAL SUPPORT, NAMELY, MONITORING
OF NETWORK SYSTEMS; COMPUTER NETWORK
DESIGN FOR OTHERS; COMPUTER CONSULTA-
TION IN THE FIELD OF COMPUTER SECURITY;
COMPUTER DIAGNOSTIC SERVICES; COMPUTER
MONITORING SERVICE WHICH TRACKS HARD-

WARE PERFORMANCE AND PROCESSES AND
SENDS OUT HISTORICAL REPORTS AND ALERTS;
COMPUTER PROGRAMMING; COMPUTER SER-
VICES, NAMELY, COMPUTER SYSTEM ADMINIS-
TRATION FOR OTHERS; COMPUTER SYSTEMS
ANALYSIS; INSTALLATION OF COMPUTER SOFT-
WARE; MONITORING THE COMPUTER SYSTEMS
OF OTHERS FOR TECHNICAL PURPOSES AND
PROVIDING BACK-UP COMPUTER PROGRAMS
AND FACILITIES; PERIODIC UPGRADING OF
COMPUTER SOFTWARE FOR OTHERS; TECHNICAL
SUPPORT SERVICES, NAMELY, TROUBLE-
SHOOTING OF COMPUTER HARDWARE AND
SOFTWARE PROBLEMS, IN CLASS 42 (U.S. CLS.
100 AND 101).

FIRST USE 11-17-1997; IN COMMERCE 11-17-1997.

THE MARK CONSISTS OF STANDARD CHAR-
ACTERS WITHOUT CLAIM TO ANY PARTICULAR
FONT, STYLE, SIZE, OR COLOR.

OWNER OF U.S. REG. NO. 2,320,541.

SER. NO. 77-152,162, FILED 4-9-2007.

KATHERINE CHANG, EXAMINING ATTORNEY

Int. Cl.: 25

Prior U.S. Cls.: 22 and 39

United States Patent and Trademark Office

Reg. No. 3,397,462

Registered Mar. 18, 2008

**TRADEMARK
PRINCIPAL REGISTER**

A Viking's Joy

RANG, ULLA CAMILLA (UNITED STATES INDIVIDUAL)
159 10TH STREET
DEL MAR, CA 92014

FOR: BASED ON USE IN COMMERCE GOLF SHIRTS; SWEAT SHIRTS; T-SHIRTS; BASED ON INTENT TO USE BUTTON-FRONT ALOHA SHIRTS; CAMP SHIRTS; DRESS SHIRTS; KNIT SHIRTS; NIGHT SHIRTS; OPEN-NECKED SHIRTS; PIQUE SHIRTS; POLO SHIRTS; SHIRT FRONTS; SHIRT YOKES; SHIRTS; SHIRTS FOR SUITS; SHORT-SLEEVED OR LONG-SLEEVED T-SHIRTS; SHORT-SLEEVED SHIRTS; SLEEP SHIRTS; SPORT SHIRTS;

SPORTS SHIRTS; SPORTS SHIRTS WITH SHORT SLEEVES; WIND SHIRTS; YOGA SHIRTS, IN CLASS 25 (U.S. CLS. 22 AND 39).

FIRST USE 4-1-2007; IN COMMERCE 4-1-2007.

THE MARK CONSISTS OF STANDARD CHARACTERS WITHOUT CLAIM TO ANY PARTICULAR FONT, STYLE, SIZE, OR COLOR.

SER. NO. 77-152,377, FILED 4-9-2007.

LOURDES AYALA, EXAMINING ATTORNEY

Int. Cl.: 45

Prior U.S. Cls.: 100 and 101

United States Patent and Trademark Office

Reg. No. 3,397,463

Registered Mar. 18, 2008

**SERVICE MARK
PRINCIPAL REGISTER**

Mocha Moms

MOCHA MOMS, INC. (MARYLAND CORPORATION)
12700 GOODLOES PROMISE DRIVE
BOWIE, MD 20720

FOR: ORGANIZING AND CONDUCTING SUPPORT GROUPS IN THE FIELD OF AT-HOME PARENTING, IN CLASS 45 (U.S. CLS. 100 AND 101).

FIRST USE 4-1-1997; IN COMMERCE 10-1-1997.

THE MARK CONSISTS OF STANDARD CHARACTERS WITHOUT CLAIM TO ANY PARTICULAR FONT, STYLE, SIZE, OR COLOR.

SEC. 2(F) AS TO "MOMS".

SER. NO. 77-153,165, FILED 4-10-2007.

NATALIE POLZER, EXAMINING ATTORNEY

Int. Cl.: 41

Prior U.S. Cls.: 100, 101 and 107

United States Patent and Trademark Office

Reg. No. 3,397,464

Registered Mar. 18, 2008

**SERVICE MARK
PRINCIPAL REGISTER**



NEWPORT EXCHANGE HOLDINGS, INC. (CALIFORNIA CORPORATION)
SUITE 140
18004 SKYPARK CIRCLE
IRVINE, CA 92614

FOR: EDUCATIONAL SERVICES, NAMELY, INSTRUCTION AND TRAINING IN THE FIELD OF SECURITIES TRADING, IN CLASS 41 (U.S. CLS. 100, 101 AND 107).

FIRST USE 3-20-1999; IN COMMERCE 3-20-1999.

OWNER OF U.S. REG. NOS. 2,505,612 AND 3,035,060.

NO CLAIM IS MADE TO THE EXCLUSIVE RIGHT TO USE "ONLINE AND ACADEMY", APART FROM THE MARK AS SHOWN.

THE STIPPLING IS FOR SHADING PURPOSES ONLY.

THE COLOR(S) BLUE, RED, YELLOW, ORANGE, RED AND WHITE IS/ARE CLAIMED AS A FEATURE OF THE MARK.

THE MARK CONSISTS OF A STYLIZED IMAGE OF AN OPEN BOOK WITH AN IMAGE OF THE NORTHERN AND SOUTHERN HEMISPHERE ON THE LEFT PAGE. THREE CURVED LINES EACH APPEARING IN A SPECTRUM FROM YELLOW TO ORANGE TO RED JOIN THE LEFT PAGE TO THE RIGHT PAGE. THE WORDS "ONLINE TRADING ACADEMY" ALL IN CAPITAL LETTERS APPEAR DIRECTLY BELOW THE OPEN BOOK IN BLUE. THE STYLIZED IMAGE AND WORDING APPEAR OVER A WHITE BACKGROUND.

SEC. 2(F) AS TO "ONLINE TRADING ACADEMY".

SER. NO. 77-153,308, FILED 4-10-2007.

STEVEN JACKSON, EXAMINING ATTORNEY

Int. Cl.: 35

Prior U.S. Cls.: 100, 101 and 102

United States Patent and Trademark Office

Reg. No. 3,397,465

Registered Mar. 18, 2008

**SERVICE MARK
PRINCIPAL REGISTER**

WRANGLER WRAPID WRESPONSE

WRANGLER APPAREL CORP. (DELAWARE
CORPORATION)
3411 SILVERSIDE RD.
WILMINGTON, DE 19810

FOR: COMPUTERIZED ON-LINE ORDERING
SERVICES FOR USE BY SUPPLIERS AND RETAILERS
IN THE FIELD OF APPAREL AND APPAREL
ACCESSORIES WHICH IS DESIGNED TO REDUCE
CYCLE TIMES FOR REPLENISHMENT OF PRODUCTS,
IN CLASS 35 (U.S. CLS. 100, 101 AND 102).

FIRST USE 6-6-1997; IN COMMERCE 6-6-1997.

THE MARK CONSISTS OF STANDARD CHARACTERS
WITHOUT CLAIM TO ANY PARTICULAR FONT,
STYLE, SIZE, OR COLOR.

OWNER OF U.S. REG. NOS. 849,477, 3,082,733 AND
OTHERS.

NO CLAIM IS MADE TO THE EXCLUSIVE
RIGHT TO USE "RAPID RESPONSE", APART FROM
THE MARK AS SHOWN.

SER. NO. 77-153,862, FILED 4-11-2007.

RENEE SERVANCE, EXAMINING ATTORNEY

Int. Cl.: 29

Prior U.S. Cl.: 46

United States Patent and Trademark Office

Reg. No. 3,397,466

Registered Mar. 18, 2008

**TRADEMARK
PRINCIPAL REGISTER**

Ki Delicia 

BRAZILIAN SPECIALTY FOODS, INC. (NEW
JERSEY CORPORATION)
8012 GRAND AVE
NORTH BERGEN, NJ 07047

THE MARK CONSISTS OF THE MARK IS THE
NAME KI DELICIA WITH A CHEF HAT ON THE
TOP OF LETTER "A".

FOR: SAUSAGES, IN CLASS 29 (U.S. CL. 46).

THE FOREIGN WORDING IN THE MARK
TRANSLATES INTO ENGLISH AS HOW DELI-
CIOUS.

FIRST USE 1-1-2002; IN COMMERCE 1-1-2002.

OWNER OF U.S. REG. NO. 2,511,660.

SER. NO. 77-154,353, FILED 4-11-2007.

THE COLOR(S) BLUE IS/ARE CLAIMED AS A
FEATURE OF THE MARK.

DANNEAN HETZEL, EXAMINING ATTORNEY

Int. Cl.: 35

Prior U.S. Cls.: 100, 101 and 102

United States Patent and Trademark Office

Reg. No. 3,397,467

Registered Mar. 18, 2008

**SERVICE MARK
PRINCIPAL REGISTER**

MASTERCARE

KAZI, ANWAR (UNITED STATES INDIVIDUAL)
SUITE 410
1314 SOUTH KING STREET
HONOLULU, HI 96814

FOR: PERSONNEL PLACEMENT, NAMELY,
PROVIDING TEMPORARY AND PERMANENT
NURSING PERSONNEL FOR HOSPITAL STAFF-
ING, FOR SENIOR HOME STAFFING AND FOR
HOME HEALTH CARE, IN CLASS 35 (U.S. CLS. 100,
101 AND 102).

FIRST USE 12-31-2005; IN COMMERCE 12-31-2005.

THE MARK CONSISTS OF STANDARD CHAR-
ACTERS WITHOUT CLAIM TO ANY PARTICULAR
FONT, STYLE, SIZE, OR COLOR.

SER. NO. 77-154,593, FILED 4-11-2007.

BRENDAN REGAN, EXAMINING ATTORNEY

Int. Cl.: 43

Prior U.S. Cls.: 100 and 101

United States Patent and Trademark Office

Reg. No. 3,397,468

Registered Mar. 18, 2008

**SERVICE MARK
PRINCIPAL REGISTER**



LOS TOROS MEXICAN RESTAURANT, INC.
(CALIFORNIA CORPORATION)
21743 DEVONSHIRE STREET
CHATSWORTH, CA 91311

FOR: RESTAURANT SERVICES, IN CLASS 43
(U.S. CLS. 100 AND 101).

FIRST USE 12-31-1989; IN COMMERCE 12-31-1989.

THE COLOR(S) GREEN, BLACK AND RED IS/
ARE CLAIMED AS A FEATURE OF THE MARK.

THE MARK CONSISTS OF THE WORDS LOS
TOROS IN BLACK OVER THREE BULLS FACES;
ONE GREEN FACE, ONE BLACK FACE, AND ONE
RED FACE. THE APPEARANCE OF WHITE IN THE
MARK IS MERELY BACKGROUND, AND NOT
PART OF THE MARK.

THE FOREIGN WORDING IN THE MARK
TRANSLATES INTO ENGLISH AS THE BULLS.

SER. NO. 77-154,976, FILED 4-12-2007.

FRANK LATTUCA, EXAMINING ATTORNEY

Int. Cl.: 43

Prior U.S. Cls.: 100 and 101

United States Patent and Trademark Office

Reg. No. 3,397,469

Registered Mar. 18, 2008

**SERVICE MARK
PRINCIPAL REGISTER**

**LOS TOROS MEXICAN
RESTAURANT**

LOS TOROS MEXICAN RESTAURANT, INC.
(CALIFORNIA CORPORATION)
21743 DEVONSHIRE STREET
CHATSWORTH, CA 91311

FOR: RESTAURANT SERVICES, IN CLASS 43
(U.S. CLS. 100 AND 101).

FIRST USE 4-24-1967; IN COMMERCE 4-24-1967.

THE MARK CONSISTS OF STANDARD CHAR-
ACTERS WITHOUT CLAIM TO ANY PARTICULAR
FONT, STYLE, SIZE, OR COLOR.

NO CLAIM IS MADE TO THE EXCLUSIVE
RIGHT TO USE "MEXICAN RESTAURANT",
APART FROM THE MARK AS SHOWN.

THE FOREIGN WORDING IN THE MARK
TRANSLATES INTO ENGLISH AS THE BULLS.

SER. NO. 77-154,982, FILED 4-12-2007.

FRANK LATTUCA, EXAMINING ATTORNEY

Int. Cls.: 35 and 42

Prior U.S. Cls.: 100, 101 and 102

United States Patent and Trademark Office

Reg. No. 3,397,470

Registered Mar. 18, 2008

**SERVICE MARK
PRINCIPAL REGISTER**



VIRTUAL HOMES INCORPORATED (NEW HAMPSHIRE CORPORATION)
55 PONEMAH ROAD
AMHERST, NH 03031

FOR: INTERNET MARKETING SERVICES, NAMELY, ADVERTISING OF REAL ESTATE AND REAL ESTATE RELATED PROFESSIONALS VIA THE INTERNET BY MEANS OF AN ON-LINE ELECTRONIC DATABASE FEATURING REAL ESTATE LISTINGS AND LISTINGS OF REAL ESTATE RELATED PROFESSIONALS, IN CLASS 35 (U.S. CLS. 100, 101 AND 102).

FIRST USE 6-30-1999; IN COMMERCE 9-0-2006.

FOR: MAINTENANCE AND HOSTING OF WEB SITES TO AND FOR THE REAL ESTATE COMMUNITY, HOME BUYERS AND HOME SELLERS; AND PROVIDING TEMPORARY USE OF ON-LINE NON-DOWNLOADABLE COMPUTER SOFTWARE FOR PROVIDING HOMEBUYERS AND HOME SELLERS WITH A VIRTUAL VISIT TO A COMMUNITY UTILIZING PANORAMIC PHOTOGRAPHY OF

THE LANDMARKS, SCHOOLS, NEIGHBORHOODS, BUSINESSES AND RECREATIONAL FACILITIES AS WELL AS INFORMATION RELATED TO SUCH LANDMARKS, SCHOOLS, NEIGHBORHOODS, BUSINESSES AND RECREATIONAL FACILITIES, IN CLASS 42 (U.S. CLS. 100 AND 101).

FIRST USE 6-30-1999; IN COMMERCE 9-0-2006.

NO CLAIM IS MADE TO THE EXCLUSIVE RIGHT TO USE "VIRTUAL HOMES", APART FROM THE MARK AS SHOWN.

THE MARK CONSISTS OF A CIRCLE CONTAINING A HOUSE ROOF, CHIMNEY AND WINDOW CONNECTED TO A COMPUTER MOUSE ALONG SIDE WHICH APPEARS THE WORDS "VIRTUAL HOMES EXPERIENCE THE FUTURE OF REAL ESTATE TODAY."

SER. NO. 77-155,279, FILED 4-12-2007.

ALEX KEAM, EXAMINING ATTORNEY

Int. Cl.: 5

Prior U.S. Cls.: 6, 18, 44, 46, 51 and 52

United States Patent and Trademark Office

Reg. No. 3,397,471

Registered Mar. 18, 2008

TRADEMARK
PRINCIPAL REGISTER

A n t e r c o n l i n s
安 德 康 靈 斯

SUPERMED HEALTH INC. (CALIFORNIA CORPORATION)
3179 W. TEMPLE AVE #100
POMONA, CA 91768

FOR: DIETARY SUPPLEMENTS, IN CLASS 5 (U.S. CLS. 6, 18, 44, 46, 51 AND 52).

FIRST USE 2-3-2000; IN COMMERCE 2-3-2000.

THE COLOR(S) BLUE IS/ARE CLAIMED AS A FEATURE OF THE MARK.

"THE MARK CONSISTS OF THE WORDING "ANTERCONLINS" AND CHINESE CHARACTERS THAT TRANSLITERATE THE WORD "ANTERCONLINS" APPEARING BELOW THIS WORDING. THE COLOR BLUE APPEARS IN THE WORDING

"ANTERCONLINS" AND IN THE CHINESE CHARACTERS THAT TRANSLITERATE THE WORD "ANTERCONLINS". THE COLOR WHITE APPEARS AS BACKGROUND ONLY AND IS NOT CLAIMED AS A FEATURE OF THE MARK".

THE FOREIGN WORDING IN THE MARK TRANSLATES INTO ENGLISH AS ANTERCONLINS.

THE NON-LATIN CHARACTER(S) IN THE MARK TRANSLITERATE INTO ANTERCONLINS, AND THIS MEANS ANTERCONLINS IN ENGLISH.

SER. NO. 77-157,064, FILED 4-15-2007.

LEE-ANNE BERNS, EXAMINING ATTORNEY

Int. Cl.: 28

Prior U.S. Cls.: 22, 23, 38 and 50

United States Patent and Trademark Office

Reg. No. 3,397,472

Registered Mar. 18, 2008

TRADEMARK
PRINCIPAL REGISTER



L-DOT DESIGNS, LLC (MINNESOTA LTD LIAB
CO)

8301 LOWER 208TH ST. W.

LAKEVILLE, MN 55044

FOR: HAND-HELD SEARCH AND FIND GAME
IN THE NATURE OF A MANIPULATIVE GAME, IN
CLASS 28 (U.S. CLS. 22, 23, 38 AND 50).

FIRST USE 1-16-2007; IN COMMERCE 1-16-2007.

NO CLAIM IS MADE TO THE EXCLUSIVE
RIGHT TO USE "BAGS", APART FROM THE MARK
AS SHOWN.

THE MARK CONSISTS OF THE WORDING "FID-
DLIN' BAGS" AND A TEDDY BEAR AND AN
APPLE DESIGN FRAMED BY A POLKA-DOT BOR-
DER.

SER. NO. 77-157,451, FILED 4-16-2007.

LAURA HAMMEL, EXAMINING ATTORNEY

Int. Cl.: 42

Prior U.S. Cls.: 100 and 101

United States Patent and Trademark Office

Reg. No. 3,397,473

Registered Mar. 18, 2008

**SERVICE MARK
PRINCIPAL REGISTER**



OBJECTIVE INTEGRITY, INC. (PENNSYLVANIA
CORPORATION)
1770 E LANCASTER AVENUE, SUITE 15
PAOLI, PA 19301

THE MARK CONSISTS OF CAPITAL LETTERS
DCG WITH THE C INTERTWINED WITH THE D
AND THE G.

FOR: INFORMATION TECHNOLOGY CONSUL-
TATION, IN CLASS 42 (U.S. CLS. 100 AND 101).

SER. NO. 77-158,731, FILED 4-17-2007.

FIRST USE 1-1-2007; IN COMMERCE 1-1-2007.

MATTHEW EINSTEIN, EXAMINING ATTORNEY

Int. Cl.: 42

Prior U.S. Cls.: 100 and 101

United States Patent and Trademark Office

Reg. No. 3,397,474

Registered Mar. 18, 2008

**SERVICE MARK
PRINCIPAL REGISTER**



OBJECTIVE INTEGRITY, INC. (PENNSYLVANIA CORPORATION)
1770 E. LANCASTER AVENUE, SUITE 15
PAOLI, PA 19301

FOR: INFORMATION TECHNOLOGY CONSULTATION, IN CLASS 42 (U.S. CLS. 100 AND 101).

FIRST USE 1-1-2007; IN COMMERCE 1-1-2007.

THE MARK CONSISTS OF CAPITAL LETTERS DCG WITH THE C INTERTWINED WITH THE D AND THE G. UNDERNEATH THE DCG IS A HORIZONTAL LINE WITH ONE VERTICAL LINE ON THE LEFT AND TWO ON THE RIGHT.

SER. NO. 77-159,340, FILED 4-18-2007.

MATTHEW EINSTEIN, EXAMINING ATTORNEY

Int. Cl.: 9

Prior U.S. Cls.: 21, 23, 26, 36 and 38

United States Patent and Trademark Office

Reg. No. 3,397,475

Registered Mar. 18, 2008

**TRADEMARK
PRINCIPAL REGISTER**

PADDS

ZENTECH, INC. (TEXAS CORPORATION)
14800 ST. MARY'S LANE, SUITE 270
HOUSTON, TX 77079

FOR: COMPUTER PROGRAMS FOR ENGINEERING ANALYSIS, DESIGN AND DRAFTING OF OFFSHORE OIL AND GAS EXPLORATION AND PRODUCTION STRUCTURES, IN CLASS 9 (U.S. CLS. 21, 23, 26, 36 AND 38).

FIRST USE 5-1-2006; IN COMMERCE 5-1-2006.

THE MARK CONSISTS OF STANDARD CHARACTERS WITHOUT CLAIM TO ANY PARTICULAR FONT, STYLE, SIZE, OR COLOR.

SER. NO. 77-159,400, FILED 4-18-2007.

JOHN E. MICHOS, EXAMINING ATTORNEY

Int. Cl.: 1

Prior U.S. Cls.: 1, 5, 6, 10, 26 and 46

United States Patent and Trademark Office

Reg. No. 3,397,476

Registered Mar. 18, 2008

**TRADEMARK
PRINCIPAL REGISTER**

BIO1ONE

A.L.E.G., INC. (TEXAS CORPORATION)
5005 SAINT LAWRENCE COURT
PARKER, TX 75094

THE MARK CONSISTS OF STANDARD CHAR-
ACTERS WITHOUT CLAIM TO ANY PARTICULAR
FONT, STYLE, SIZE, OR COLOR.

FOR: FERTILIZERS AND SOIL AMENDMENTS
FOR AGRICULTURAL USE, IN CLASS 1 (U.S. CLS.
1, 5, 6, 10, 26 AND 46).

SER. NO. 77-159,424, FILED 4-18-2007.

FIRST USE 0-0-2004; IN COMMERCE 0-0-2004.

IRA J. GOODSaid, EXAMINING ATTORNEY

Int. Cl.: 18

Prior U.S. Cls.: 1, 2, 3, 22 and 41

United States Patent and Trademark Office

Reg. No. 3,397,477

Registered Mar. 18, 2008

**TRADEMARK
PRINCIPAL REGISTER**

ZAC POSEN

Z SPOKE, LLC (DELAWARE LTD LIAB CO)
13-17 LAIGHT STREET
NEW YORK, NY 10013

FOR: HANDBAGS, IN CLASS 18 (U.S. CLS. 1, 2, 3,
22 AND 41).

FIRST USE 1-15-2003; IN COMMERCE 1-15-2003.

THE MARK CONSISTS OF STANDARD CHAR-
ACTERS WITHOUT CLAIM TO ANY PARTICULAR
FONT, STYLE, SIZE, OR COLOR.

THE NAME(S), PORTRAIT(S), AND/OR SIGNA-
TURE(S) SHOWN IN THE MARK IDENTIFIES ZAC
POSEN , WHOSE CONSENT(S) TO REGISTER IS
SUBMITTED.

SER. NO. 77-159,640, FILED 4-18-2007.

KATHERINE E. HALMEN, EXAMINING ATTOR-
NEY

Int. Cl.: 35

Prior U.S. Cls.: 100, 101 and 102

United States Patent and Trademark Office

Reg. No. 3,397,478

Registered Mar. 18, 2008

**SERVICE MARK
PRINCIPAL REGISTER**

eSP

E-VENTUS CORPORATION (OHIO CORPORATION)
5005 ROCKSIDE ROAD, SUITE 600
CLEVELAND, OH 44131

FOR: PROVIDING REAL TIME, WEB-BASED INFORMATION MANAGEMENT SERVICES, NAMELY, PURCHASE ORDER AND CHANGE ORDER PROCESSING, SHIPMENT AND INVOICE PROCESSING, PREPARING SHIPPING DOCUMENTS, MONITORING AND TRACKING DOCUMENTS, PACKAGES AND FREIGHT OVER COMPUTER

NETWORKS, INTRANETS AND INTERNETS, IN CLASS 35 (U.S. CLS. 100, 101 AND 102).

FIRST USE 1-3-2005; IN COMMERCE 1-3-2005.

THE MARK CONSISTS OF STANDARD CHARACTERS WITHOUT CLAIM TO ANY PARTICULAR FONT, STYLE, SIZE, OR COLOR.

SER. NO. 77-159,715, FILED 4-18-2007.

MARIAM MAHMOUDI, EXAMINING ATTORNEY

Int. Cl.: 44

Prior U.S. Cls.: 100 and 101

United States Patent and Trademark Office

Reg. No. 3,397,479

Registered Mar. 18, 2008

**SERVICE MARK
PRINCIPAL REGISTER**



TEXAS SURGICAL
ASSOCIATES

TEXAS SURGICAL ASSOCIATES, L.L.P. (TEXAS
LIMITED LIABILITY PARTNERSHIP)
SUITE 1402
6560 FANNIN
HOUSTON, TX 77030

FOR: MEDICAL SERVICES, NAMELY, CARDIO-
VASCULAR SURGERY, IN CLASS 44 (U.S. CLS. 100
AND 101).

FIRST USE 7-31-1997; IN COMMERCE 7-31-1997.

NO CLAIM IS MADE TO THE EXCLUSIVE
RIGHT TO USE "TEXAS SURGICAL ASSOCIATES",
APART FROM THE MARK AS SHOWN.

THE MARK CONSISTS OF THE IMAGE OF FIVE
HANDS HOLDING A HEART.

SER. NO. 77-159,969, FILED 4-18-2007.

MICHAEL KAZAZIAN, EXAMINING ATTORNEY

Int. Cl.: 28

Prior U.S. Cls.: 22, 23, 38 and 50

United States Patent and Trademark Office

Reg. No. 3,397,480

Registered Mar. 18, 2008

**TRADEMARK
PRINCIPAL REGISTER**

CLUB DISCO

MATTEL, INC. (DELAWARE CORPORATION)
M1-1518
333 CONTINENTAL BLVD.
EL SEGUNDO, CA 90245

FOR: TOYS, GAMES AND PLAYTHINGS, NAME-
LY, DOLLS, DOLL CLOTHING AND DOLL ACCES-
SORIES, TOY FIGURES AND ACCESSORIES
THEREFOR, IN CLASS 28 (U.S. CLS. 22, 23, 38 AND
50).

FIRST USE 10-16-2007; IN COMMERCE 10-16-2007.

THE MARK CONSISTS OF STANDARD CHAR-
ACTERS WITHOUT CLAIM TO ANY PARTICULAR
FONT, STYLE, SIZE, OR COLOR.

SER. NO. 77-160,368, FILED 4-19-2007.

MATTHEW PAPPAS, EXAMINING ATTORNEY

Int. Cl.: 16

Prior U.S. Cls.: 2, 5, 22, 23, 29, 37, 38 and 50

Reg. No. 3,397,481

United States Patent and Trademark Office

Registered Mar. 18, 2008

**TRADEMARK
PRINCIPAL REGISTER**

Haute Handbags

STAMPINGTON & COMPANY, LLC (CALIFORNIA LTD LIAB CO)
22992 MILL CREEK, STE. B
LAGUNA HILLS, CA 92653

FOR: MAGAZINES IN THE FIELD OF HANDBAGS FEATURING INFORMATION ABOUT MAKING ARTFUL HANDBAGS, ALTERING, EMBELLISHING AND CREATING HANDBAGS , IN CLASS 16 (U.S. CLS. 2, 5, 22, 23, 29, 37, 38 AND 50).

FIRST USE 4-1-2007; IN COMMERCE 4-1-2007.

THE MARK CONSISTS OF STANDARD CHARACTERS WITHOUT CLAIM TO ANY PARTICULAR FONT, STYLE, SIZE, OR COLOR.

NO CLAIM IS MADE TO THE EXCLUSIVE RIGHT TO USE "HANDBAGS", APART FROM THE MARK AS SHOWN.

SER. NO. 77-160,654, FILED 4-19-2007.

VIVIAN MICZNIK FIRST, EXAMINING ATTORNEY

Int. Cl.: 41

Prior U.S. Cls.: 100, 101 and 107

United States Patent and Trademark Office

Reg. No. 3,397,482

Registered Mar. 18, 2008

SERVICE MARK
PRINCIPAL REGISTER



SAN PEDRO, PATRICIA (UNITED STATES INDIVIDUAL)

P.O. BOX 7706

CORAL GABLES, FL 33234

FOR: RECREATIONAL CAMPS, IN CLASS 41 (U.S. CLS. 100, 101 AND 107).

FIRST USE 9-1-2005; IN COMMERCE 9-1-2005.

NO CLAIM IS MADE TO THE EXCLUSIVE RIGHT TO USE "CAMP" , APART FROM THE MARK AS SHOWN.

THE COLOR(S) BLACK, LIGHT ORANGE AND DARK ORANGE IS/ARE CLAIMED AS A FEATURE OF THE MARK.

THE MARK CONSISTS OF THE LEFT HAND CORNER THERE IS A DARK ORANGE OUTLINED LIGHT-ORANGE SUNSET WITH BLACK PINE TREES IN THE FOREFRONT. NEXT TO THAT, ON TWO LINES AND IN BLACK, APPEARS THE CAMP BOMBSHELL WORDS.

SER. NO. 77-161,285, FILED 4-19-2007.

BRENDAN REGAN, EXAMINING ATTORNEY

Int. Cls.: 6, 20 and 21

**Prior U.S. Cls.: 2, 12, 13, 14, 22, 23, 25, 29, 30, 32, 33,
40 and 50**

United States Patent and Trademark Office

Reg. No. 3,397,483

Registered Mar. 18, 2008

**TRADEMARK
PRINCIPAL REGISTER**

GEERPRES

GEERPRES, INC. (MICHIGAN CORPORATION)
P.O. BOX 658
MUSKEGON, MI 49443

FOR: METAL MOP HANDLES; METAL MOP
HANDLE STICKS, IN CLASS 6 (U.S. CLS. 2, 12, 13,
14, 23, 25 AND 50).

FIRST USE 4-15-1937; IN COMMERCE 4-15-1937.

FOR: NON-METAL MOP HANDLES; NON-ME-
TAL MOP HANDLE STICKS, IN CLASS 20 (U.S. CLS.
2, 13, 22, 25, 32 AND 50).

FIRST USE 4-15-1937; IN COMMERCE 4-15-1937.

FOR: MOP WASHER AND MOP WRINGERS
COMPRISED OF BUCKETS, CHASSIS, AND HOLD-
ER FOR SMALL SUPPLY ITEMS; BROOM AND
MOP HANGERS AND HOLDERS; BUCKETS, IN
CLASS 21 (U.S. CLS. 2, 13, 23, 29, 30, 33, 40 AND 50).

FIRST USE 4-15-1937; IN COMMERCE 4-15-1937.

THE MARK CONSISTS OF STANDARD CHAR-
ACTERS WITHOUT CLAIM TO ANY PARTICULAR
FONT, STYLE, SIZE, OR COLOR.

OWNER OF U.S. REG. NO. 827,456.

SER. NO. 77-161,470, FILED 4-20-2007.

RAMONA ORTIGA, EXAMINING ATTORNEY

Int. Cl.: 35

Prior U.S. Cls.: 100, 101 and 102

United States Patent and Trademark Office

Reg. No. 3,397,484

Registered Mar. 18, 2008

**SERVICE MARK
PRINCIPAL REGISTER**

Urban Sole

URBAN SOLE (ILLINOIS LTD LIAB CO)
72 SOUTH LAGRANGE ROAD
LAGRANGE, IL 60525

THE MARK CONSISTS OF STANDARD CHAR-
ACTERS WITHOUT CLAIM TO ANY PARTICULAR
FONT, STYLE, SIZE, OR COLOR.

FOR: RETAIL STORE SERVICES IN THE FIELDS
OF SHOES, BOOTS, SANDALS, SLIPPERS,
SCARVES, JEWELRY, HOSIERY, SOCKS, HATS,
HANDBAGS, WALLETS, LUGGAGE, BELTS, AND
CLOTHING, IN CLASS 35 (U.S. CLS. 100, 101 AND
102).

OWNER OF U.S. REG. NO. 3,050,139.

SER. NO. 77-161,551, FILED 4-20-2007.

FIRST USE 8-21-2004; IN COMMERCE 8-21-2004.

KEVIN CORWIN, EXAMINING ATTORNEY

Int. Cl.: 25

Prior U.S. Cls.: 22 and 39

United States Patent and Trademark Office

Reg. No. 3,397,485

Registered Mar. 18, 2008

**TRADEMARK
PRINCIPAL REGISTER**

Erika Lynn

ERIKA LYNN DESIGNS INC. (NEW YORK CORPORATION)
1400 BROADWAY, FL 21, RM 2111
NEW YORK, NY 10018

FOR: LADIES APPAREL, NAMELY, DRESSES, JACKETS, TOPS AND PANTS, IN CLASS 25 (U.S. CLS. 22 AND 39).

FIRST USE 2-25-2003; IN COMMERCE 2-25-2003.

THE MARK CONSISTS OF STANDARD CHARACTERS WITHOUT CLAIM TO ANY PARTICULAR FONT, STYLE, SIZE, OR COLOR.

"THE NAME(S), PORTRAIT(S), AND/OR SIGNATURE(S) SHOWN IN THE MARK DOES NOT IDENTIFY A PARTICULAR LIVING INDIVIDUAL."

SER. NO. 77-161,657, FILED 4-20-2007.

THOMAS MANOR, EXAMINING ATTORNEY

Int. Cl.: 36

Prior U.S. Cls.: 100, 101 and 102

United States Patent and Trademark Office

Reg. No. 3,397,486

Registered Mar. 18, 2008

**SERVICE MARK
PRINCIPAL REGISTER**



THE MIGRAINE AND PAIN FUND, INC. (NEW YORK CORPORATION)
909 THIRD AVENUE, 5TH FLOOR
NEW YORK, UNITED STATES 10022

FOR: CHARITABLE SERVICES, NAMELY, FUND-RAISING SERVICES TO PROMOTE AND FUND RESEARCH INTO THE CAUSES AND TREATMENTS OF MIGRAINE AND CHRONIC PAIN, IN CLASS 36 (U.S. CLS. 100, 101 AND 102).

FIRST USE 1-22-2007; IN COMMERCE 1-22-2007.

NO CLAIM IS MADE TO THE EXCLUSIVE RIGHT TO USE "THE MIGRAINE AND PAIN FUND", APART FROM THE MARK AS SHOWN.

THE COLOR(S) BLACK, YELLOW AND YELLOW/ORANGE IS/ARE CLAIMED AS A FEATURE OF THE MARK.

THE MARK CONSISTS OF DESIGN OF DOOR IN BLACK HALF OPEN AND BEHIND IT IS A YELLOW AND YELLOW-ORANGE SUN WITH RAYS AND A SEMI-CIRCLE AROUND THE DESIGN WITH THE NAME OF THE COMPANY IN BLACK.

SER. NO. 77-162,957, FILED 4-23-2007.

B. PARADEWELAI, EXAMINING ATTORNEY

Int. Cl.: 37

Prior U.S. Cls.: 100, 103 and 106

United States Patent and Trademark Office

Reg. No. 3,397,487

Registered Mar. 18, 2008

SERVICE MARK
PRINCIPAL REGISTER



PROBITY, LLC (CONNECTICUT LTD LIAB CO)
4 DANIELS FARM ROAD
TRUMBULL, CT 06611

FOR: ROOFING SERVICES, NAMELY, INSTALLATION AND REPAIR SERVICES, IN CLASS 37 (U.S. CLS. 100, 103 AND 106).

FIRST USE 4-7-2000; IN COMMERCE 4-30-2000.

NO CLAIM IS MADE TO THE EXCLUSIVE RIGHT TO USE "SLATE", APART FROM THE MARK AS SHOWN.

THE COLOR(S) BLACK AND LIGHT BLUE IS/ ARE CLAIMED AS A FEATURE OF THE MARK.

THE MARK CONSISTS OF THE STYLIZED WORDING PARAGON SLATE WITHIN A RECTANGULAR DESIGN. THE CENTER PORTION OF THE RECTANGLE CONTAINS THE DESIGN OF THREE TRIANGLES - TWO BEING SOLID AND ONE COMPRISED OF A SERIES OF PARALLEL ANGLED LINES. THE COLOR BLACK APPEARS IN THE WORDING PARAGON SLATE, THE SQUARE BENEATH THE LETTER O AND THE STYLIZED TRIANGLE IN THE CENTER OF THE MARK. THE COLOR LIGHT BLUE APPEARS IN THE TWO SOLID TRIANGLES IN THE CENTER PORTION OF THE MARK AND IN THE HORIZONTAL LINES THAT APPEAR ABOVE AND BENEATH THE WORDING IN THE MARK.

SER. NO. 77-163,405, FILED 4-23-2007.

KAREN BRACEY, EXAMINING ATTORNEY

Int. Cls.: 9 and 16

Prior U.S. Cls.: 2, 5, 21, 22, 23, 26, 29, 36, 37, 38 and 50

United States Patent and Trademark Office

Reg. No. 3,397,488

Registered Mar. 18, 2008

**TRADEMARK
PRINCIPAL REGISTER**



WWW.FINDYOURWHY.COM

JOHN DI LEMME (UNITED STATES INDIVIDUAL)
15104 GLENMOOR DRIVE
WEST PALM BEACH, FL 33409

FOR: PRE-RECORDED CDS, VIDEO TAPES, LASER DISKS AND DVDS FEATURING PERSONAL DEVELOPMENT, MARKETING, BUSINESS STRATEGIES AND MOTIVATION; ELECTRONIC PUBLICATIONS, NAMELY, BOOKS, MAGAZINES, AND BROCHURES FEATURING PERSONAL DEVELOPMENT, MARKETING, MOTIVATION AND BUSINESS STRATEGIES ALL WRITTEN BY JOHN DI LEMME ALL RECORDED ON COMPUTER MEDIA; (CLASS 9), IN CLASS 9 (U.S. CLS. 21, 23, 26, 36 AND 38).

FIRST USE 1-1-2003; IN COMMERCE 1-1-2003.

FOR: A SERIES OF BOOKS, WRITTEN ARTICLES, HANDOUTS AND WORKSHEETS IN THE FIELD OF PERSONAL DEVELOPMENT, MARKETING, BUSINESS STRATEGIES, AND/OR MOTIVATION; BOOKS IN THE FIELD OF PERSONAL DEVELOPMENT, MARKETING, BUSINESS STRATEGIES AND MOTIVATION, IN CLASS 16 (U.S. CLS. 2, 5, 22, 23, 29, 37, 38 AND 50).

FIRST USE 1-1-2003; IN COMMERCE 1-1-2003.

OWNER OF U.S. REG. NO. 3,221,559.

NO CLAIM IS MADE TO THE EXCLUSIVE RIGHT TO USE "DEVELOPMENT GROUP, INC.", APART FROM THE MARK AS SHOWN.

THE COLOR(S) RED, BLUE, BLACK, AND WHITE IS/ARE CLAIMED AS A FEATURE OF THE MARK.

THE MARK CONSISTS OF AN EAGLE WITH A BLACK BREAST, A WHITE HEAD OUTLINED IN BLACK AND A DARKED BLACK EYE. RED, WHITE AND BLUE FLOWING FLAG DESIGN BEHIND EAGLE EXTENDING TO THE RIGHT OF THE EAGLE. LETTERS DDG ARE IN WHITE OUTLINED IN BLUE IN FRONT OF THE EAGLE AND THE FLAG. DI LEMME DEVELOPMENT GROUP, INC. IS IN A WHITE TEXT BOX WITH A DIM BLACK OUTLINE IN RED TO CLARIFY WHAT DDG STANDS FOR. DIRECTLY UNDERNEATH THE ENTIRE DESIGN IS THE COMPANY WEBSITE - WWW.FINDYOURWHY.COM - IN BLACK LETTERS AND CAPITALIZED. THIS ENTIRE DESIGN IS ON A WHITE BACKGROUND.

SER. NO. 77-163,721, FILED 4-23-2007.

CAROLINE WOOD, EXAMINING ATTORNEY

Int. Cl.: 41

Prior U.S. Cls.: 100, 101 and 107

United States Patent and Trademark Office

Reg. No. 3,397,489

Registered Mar. 18, 2008

**SERVICE MARK
PRINCIPAL REGISTER**

PROVISION THEATER

PROVISION THEATER COMPANY (ILLINOIS
NON-PROFIT CORPORATION)

2211 NORTH CLYBORN AVENUE, NO. 2F

CHICAGO, IL 60614

FOR: ENTERTAINMENT IN THE NATURE OF
THEATER PRODUCTIONS, IN CLASS 41 (U.S. CLS.
100, 101 AND 107).

FIRST USE 3-0-2004; IN COMMERCE 3-0-2004.

THE MARK CONSISTS OF STANDARD CHAR-
ACTERS WITHOUT CLAIM TO ANY PARTICULAR
FONT, STYLE, SIZE, OR COLOR.

NO CLAIM IS MADE TO THE EXCLUSIVE
RIGHT TO USE THEATER, APART FROM THE
MARK AS SHOWN.

SER. NO. 77-164,019, FILED 4-24-2007.

ALEXANDER L. POWERS, EXAMINING ATTOR-
NEY

Int. Cl.: 5

Prior U.S. Cls.: 6, 18, 44, 46, 51 and 52

Reg. No. 3,397,490

United States Patent and Trademark Office

Registered Mar. 18, 2008

**TRADEMARK
PRINCIPAL REGISTER**

SIS

NCORE LIMITED (ENGLAND LTD LIAB CO)
SPRING LANE NORTH, MALVERN LINK
WORCESTERSHIRE, ENGLAND WR141BU

FIRST USE 5-24-2004; IN COMMERCE 6-30-2004.

FOR: POULTRY LITTER PREPARATIONS AND TREATMENTS, NAMELY, SANITIZING PREPARATIONS IN THE NATURE OF INTESTINAL FLORA FOR USE AS A POULTRY LITTER TREATMENT TO PREVENT INFECTION AND BACTERIAL COLONIZATION IN BIRDS AND POULTRY, IN CLASS 5 (U.S. CLS. 6, 18, 44, 46, 51 AND 52).

THE MARK CONSISTS OF STANDARD CHARACTERS WITHOUT CLAIM TO ANY PARTICULAR FONT, STYLE, SIZE, OR COLOR.

SER. NO. 77-164,214, FILED 4-24-2007.

BRENDAN MCCAULEY, EXAMINING ATTORNEY

Int. Cls.: 36 and 45

Prior U.S. Cls.: 100, 101 and 102

United States Patent and Trademark Office

Reg. No. 3,397,491

Registered Mar. 18, 2008

**SERVICE MARK
PRINCIPAL REGISTER**



SIR GROOVY INC. (NEW YORK CORPORATION)
172 E BOSTON POST RD. APPT 2W
MAMARONECK, NY 10543

FOR: COLLECTING LICENSE FEES ON BEHALF OF INDEPENDENT WRITERS AND PUBLISHERS AND MAKING PAYMENTS TO THE COPYRIGHT OWNERS OF THE MUSIC, IN CLASS 36 (U.S. CLS. 100, 101 AND 102).

FIRST USE 1-12-2007; IN COMMERCE 1-12-2007.

FOR: INTELLECTUAL PROPERTY LICENSING, IN CLASS 45 (U.S. CLS. 100 AND 101).

FIRST USE 1-12-2007; IN COMMERCE 1-12-2007.

THE COLOR(S) RED, WHITE, YELLOW-ORANGE, ORANGE, BLUE, BLACK, BLUE-VIOLET AND RED-VIOLET IS/ARE CLAIMED AS A FEATURE OF THE MARK.

THE MARK CONSISTS OF THE WORD SIR IN RED CAPITAL LETTERS IS FOLLOWED BY THE HEAD OF A HELMETED SAXOPHONE PLAYING KNIGHT. BLACK MUSICAL NOTES FLOAT IN THE AIR IN FRONT OF AND ABOVE THE SAXOPHONE. THE KNIGHT IS IN FRONT OF A YELLOW-ORANGE CIRCLE WITH A WHITE MULTI-POINTED

CURVED STAR PATTERN WITHIN THE CIRCLE. THE SAXOPHONE AND MUSICAL NOTES EXTEND BEYOND THE CIRCLE. AFTER THE KNIGHT IS THE WORD GROOVY IN RED CAPITAL LETTERS. THE LETTERS, CIRCLE, SAXOPHONE, AND MUSICAL NOTES ARE SURROUNDED BY A WHITE BORDER WHICH FADES TO THE YELLOW-ORANGE OF THE BACKGROUND, WHICH IS A HORIZONTAL YELLOW RECTANGLE. THE LETTERS ALL HAVE BLACK SHADOW BORDERS WITH AN APPARENT LIGHT SOURCE ABOVE AND TO THE RIGHT OF THE LETTERS THEMSELVES. THE KNIGHT HAS A WHITE TOOTHY SMILE, BUT NO OTHER FEATURES OF HIS BODY ARE VISIBLE. HIS HELMET HAS A RED-VIOLET VISOR AND IS OTHERWISE BLUE AND YELLOW. THE INTERIOR CAN BE SEEN ON THE LOWER RIGHT AND APPEARS BLUE-VIOLET DUE TO SHADOW. BLACK LINES ARE USED TO DELINEATE THE EDGE OF THE CIRCLE AND THE EDGES OF FEATURES OF THE KNIGHT'S HELMET AND TEETH AND OF THE SAXOPHONE. THE SAXOPHONE APPEARS SOMEWHAT THREE DIMENSIONAL DUE TO THE SHADOW AND GLARE EFFECT OF COLORING IT WITH SEVERAL SHADES OF ORANGE.

SER. NO. 77-164,798, FILED 4-24-2007.

BRENDAN REGAN, EXAMINING ATTORNEY

Int. Cls.: 25 and 41

Prior U.S. Cls.: 22, 39, 100, 101 and 107

United States Patent and Trademark Office

Reg. No. 3,397,492

Registered Mar. 18, 2008

**TRADEMARK
SERVICE MARK
PRINCIPAL REGISTER**

CORNERSPEED

CORNERSPEED INC. (NORTH CAROLINA CORPORATION)
707 JACKSON AVENUE
CHARLOTTE, NC 28204

FOR: CLOTHING, NAMELY, SHIRTS, T-SHIRTS, PANTS, SHORTS, JACKETS, SUITS, IN CLASS 25 (U.S. CLS. 22 AND 39).

FIRST USE 11-0-1999; IN COMMERCE 11-0-1999.

FOR: EDUCATION SERVICES, NAMELY, CLASSES IN THE FIELDS OF MOTORCYCLE DRIVING, MAINTENANCE, RACING AND REPAIR, AND AUTOMOBILE DRIVING, MAINTENANCE, RA-

CING AND REPAIR; MOTORCYCLE AND AUTOMOBILE DRIVING INSTRUCTION SERVICES, IN CLASS 41 (U.S. CLS. 100, 101 AND 107).

FIRST USE 11-0-1999; IN COMMERCE 11-0-1999.

THE MARK CONSISTS OF STANDARD CHARACTERS WITHOUT CLAIM TO ANY PARTICULAR FONT, STYLE, SIZE, OR COLOR.

SER. NO. 77-165,200, FILED 4-25-2007.

NANCY CLARKE, EXAMINING ATTORNEY

Int. Cl.: 37

Prior U.S. Cls.: 100, 103 and 106

United States Patent and Trademark Office

Reg. No. 3,397,493

Registered Mar. 18, 2008

**SERVICE MARK
PRINCIPAL REGISTER**

**FOR MECHANICS KNOWN FOR
THEIR WORK AND THEIR WORD,
TRUST THE MIDAS TOUCH**

MIDAS INTERNATIONAL CORPORATION (DE-
LAWARE CORPORATION)
1300 ARLINGTON HEIGHTS ROAD
ITASCA, IL 60143

FOR: REPAIR, ADJUSTMENT AND INSTALLA-
TION OF AUTOMOTIVE EXHAUST SYSTEM COM-
PONENTS, BRAKE SYSTEM COMPONENTS,
AUTOMOTIVE SUSPENSION SYSTEM AND
FRONT END PARTS, SHOCK ABSORBERS AND
STRUTS, AUTOMOTIVE BATTERIES, CABLES,
GENERATORS AND ALTERNATORS, POSITIVE
CRANKCASE VALVES AND SYSTEMS; TIRE
MOUNTING, BALANCING AND REPAIR SERVI-
CES; VEHICLE AIR CONDITIONING REPAIR AND
MAINTENANCE SERVICES; VEHICLE OIL
CHANGE AND LUBRICATION SERVICES; VEHI-

CLE MAINTENANCE AND REPAIR SERVICES, IN
CLASS 37 (U.S. CLS. 100, 103 AND 106).

FIRST USE 3-8-2004; IN COMMERCE 3-8-2004.

THE MARK CONSISTS OF STANDARD CHAR-
ACTERS WITHOUT CLAIM TO ANY PARTICULAR
FONT, STYLE, SIZE, OR COLOR.

OWNER OF U.S. REG. NOS. 1,258,822, 3,158,702
AND OTHERS.

SER. NO. 77-165,382, FILED 4-25-2007.

MATTHEW PAPPAS, EXAMINING ATTORNEY

Int. Cl.: 37

Prior U.S. Cls.: 100, 103 and 106

United States Patent and Trademark Office

Reg. No. 3,397,494

Registered Mar. 18, 2008

**SERVICE MARK
PRINCIPAL REGISTER**

**CONFÍA EN LOS QUE SABEN.
MECÁNICOS MIDAS**

MIDAS INTERNATIONAL CORPORATION (DE-
LAWARE CORPORATION)
1300 ARLINGTON HEIGHTS ROAD
ITASCA, IL 60143

FOR: REPAIR, ADJUSTMENT AND INSTALLA-
TION OF AUTOMOTIVE EXHAUST SYSTEM COM-
PONENTS, BRAKE SYSTEM COMPONENTS,
AUTOMOTIVE SUSPENSION SYSTEM AND
FRONT END PARTS, SHOCK ABSORBERS AND
STRUTS, AUTOMOTIVE BATTERIES, CABLES,
GENERATORS AND ALTERNATORS, POSITIVE
CRANKCASE VALVES AND SYSTEMS; TIRE
MOUNTING, BALANCING AND REPAIR SERVI-
CES; VEHICLE AIR CONDITIONING REPAIR AND
MAINTENANCE SERVICES; VEHICLE OIL
CHANGE AND LUBRICATION SERVICES; VEHI-
CLE MAINTENANCE AND REPAIR SERVICES, IN
CLASS 37 (U.S. CLS. 100, 103 AND 106).

FIRST USE 3-31-2005; IN COMMERCE 3-31-2005.

THE MARK CONSISTS OF STANDARD CHAR-
ACTERS WITHOUT CLAIM TO ANY PARTICULAR
FONT, STYLE, SIZE, OR COLOR.

OWNER OF U.S. REG. NOS. 2,455,463, 3,108,815
AND OTHERS.

THE FOREIGN WORDING IN THE MARK
TRANSLATES INTO ENGLISH AS TRUST IN
THOSE WHO KNOW. MIDAS MECHANICS.

SER. NO. 77-165,392, FILED 4-25-2007.

NELSON SNYDER, EXAMINING ATTORNEY

Int. Cl.: 9

Prior U.S. Cls.: 21, 23, 26, 36 and 38

United States Patent and Trademark Office

Reg. No. 3,397,495

Registered Mar. 18, 2008

**TRADEMARK
PRINCIPAL REGISTER**

T-3 Fibs ProTrader

NEXGEN SOFTWARE SERVICES, INC. (TEXAS
CORPORATION)
SUITE B9
3400 RESEARCH FOREST DRIVE
THE WOODLANDS, TX 77381

FOR: DOWNLOADABLE COMPUTER SOFTWARE FOR TECHNICAL ANALYSIS OF FINANCIAL MARKETS, IN CLASS 9 (U.S. CLS. 21, 23, 26, 36 AND 38).

FIRST USE 8-4-1998; IN COMMERCE 8-4-1998.

THE MARK CONSISTS OF STANDARD CHARACTERS WITHOUT CLAIM TO ANY PARTICULAR FONT, STYLE, SIZE, OR COLOR.

NO CLAIM IS MADE TO THE EXCLUSIVE RIGHT TO USE "FIBS PROTRADER", APART FROM THE MARK AS SHOWN.

SER. NO. 77-165,474, FILED 4-25-2007.

SUSAN LESLIE DUBOIS, EXAMINING ATTORNEY

Int. Cl.: 35

Prior U.S. Cls.: 100, 101 and 102

United States Patent and Trademark Office

Reg. No. 3,397,496

Registered Mar. 18, 2008

**SERVICE MARK
PRINCIPAL REGISTER**

PEETNIKS

PEET'S TRADEMARK COMPANY (WASHING-
TON CORPORATION)
1400 PARK AVENUE
EMERYVILLE, CA 946083502

FOR: CUSTOMER LOYALTY INCENTIVE PRO-
GRAM FOR COMMERCIAL PURPOSES WHEREBY
PARTICIPANTS OBTAIN GIFTS, DISCOUNTS,
PRIZE OPPORTUNITIES AND OTHER BENEFITS
FROM PURCHASES, IN CLASS 35 (U.S. CLS. 100, 101
AND 102).

FIRST USE 0-0-1991; IN COMMERCE 0-0-2003.

THE MARK CONSISTS OF STANDARD CHAR-
ACTERS WITHOUT CLAIM TO ANY PARTICULAR
FONT, STYLE, SIZE, OR COLOR.

SER. NO. 77-165,751, FILED 4-25-2007.

ROBERT C. CLARK JR., EXAMINING ATTORNEY

Int. Cl.: 44

Prior U.S. Cls.: 100 and 101

United States Patent and Trademark Office

Reg. No. 3,397,497

Registered Mar. 18, 2008

SERVICE MARK
PRINCIPAL REGISTER



LANHAM, CORP. (KENTUCKY CORPORATION)
1401 WINCHESTER AVENUE, SUITE 502
ASHLAND, KY 41101

FOR: PHYSICIAN SERVICES; CHIROPRACTIC SERVICES; CHIROPRACTICS; CONSULTING SERVICES IN THE FIELD OF MENTAL HEALTH AND WELLNESS; CONSULTING SERVICES IN THE FIELD OF WOMEN'S HEALTH; HEALTH CARE; HEALTH CARE IN THE NATURE OF HEALTH MAINTENANCE ORGANIZATIONS; HEALTH CARE SERVICES, NAMELY, DISEASE MANAGEMENT PROGRAMS; HEALTH CARE SERVICES, NAMELY, WELLNESS PROGRAMS; HEALTH CARE, NAMELY, ASSISTING INDIVIDUALS TO STOP SMOKING; HEALTH SPA SERVICES FOR HEALTH AND WELLNESS OF THE BODY AND SPIRIT OFFERED AT A HEALTH RESORT; HEALTH SPA SERVICES FOR HEALTH AND WELLNESS OF THE MIND, BODY AND SPIRIT OFFERED IN OR FROM A REMOTE, MOBILE OR TEMPORARY ON-SITE LOCATION; HEALTH SPA SERVICES, NAMELY, COSMETIC BODY CARE SERVICES; HOME HEALTH CARE SERVICES; MANAGED HEALTH CARE SERVICES; PROVIDING A WEBSITE FEATURING INFORMATION IN THE FIELD OF MENTAL HEALTH AND WELLNESS; PROVIDING ASSISTANCE, FITNESS EVALUATION AND CONSULTATION TO CORPORATE CLIENTS TO HELP THEIR EMPLOYEES MAKE

HEALTH, WELLNESS AND NUTRITIONAL CHANGES IN THEIR DAILY LIVING TO IMPROVE HEALTH; PROVIDING HEALTH CARE INFORMATION BY TELEPHONE AND THE INTERNET; PROVIDING HEALTH INFORMATION, IN CLASS 44 (U.S. CLS. 100 AND 101).

FIRST USE 1-15-2004; IN COMMERCE 1-15-2004.

NO CLAIM IS MADE TO THE EXCLUSIVE RIGHT TO USE "AMERICAN HEALTH CENTERS, CHIROPRACTIC, FITNESS", AND "REHABILITATION", APART FROM THE MARK AS SHOWN.

THE COLOR(S) RED, WHITE AND GRAY IS/ARE CLAIMED AS A FEATURE OF THE MARK.

THE MARK CONSISTS OF THE WORD "AMERICAN" IN RED, THE WORDS "HEALTH CENTERS" IN GRAY, THE WORDS "CHIROPRACTIC FITNESS REHABILITATION" IN RED LETTERS WITH RED LINES ABOVE AND BELOW, WITH A GRAY AND WHITE HUMAN IMAGE STANDING WITH ARMS OUTSTRETCHED WITH A RED AND GRAY RIBBON CIRCLING THE HUMAN IMAGE.

SER. NO. 77-165,927, FILED 4-25-2007.

PAUL E. FAHRENKOPF, EXAMINING ATTORNEY

Int. Cls.: 2 and 37

Prior U.S. Cls.: 6, 11, 16, 100, 103 and 106

United States Patent and Trademark Office

Reg. No. 3,397,498

Registered Mar. 18, 2008

**TRADEMARK
SERVICE MARK
PRINCIPAL REGISTER**

Auditions

LF, LLC (DELAWARE LTD LIAB CO)
2601 ANNAND DRIVE, SUITE 17
WILMINGTON, DE 19808

FOR: INTERIOR AND EXTERIOR PAINTS, IN
CLASS 2 (U.S. CLS. 6, 11 AND 16).

FIRST USE 7-11-2005; IN COMMERCE 7-11-2005.

FOR: PAINT MIXING SERVICES , IN CLASS 37
(U.S. CLS. 100, 103 AND 106).

FIRST USE 7-11-2005; IN COMMERCE 7-11-2005.

OWNER OF U.S. REG. NO. 3,140,309.

THE MARK CONSISTS OF THE WORD AUDI-
TIONS IN A STYLIZED FORM WITH A CURVED
LINE BENEATH THE WORD.

SER. NO. 77-166,505, FILED 4-26-2007.

HEATHER BIDDULPH, EXAMINING ATTORNEY

Int. Cl.: 16

Prior U.S. Cls.: 2, 5, 22, 23, 29, 37, 38 and 50

United States Patent and Trademark Office

Reg. No. 3,397,499

Registered Mar. 18, 2008

**TRADEMARK
PRINCIPAL REGISTER**

PAGE PAW

COPERNICUS EDUCATIONAL PRODUCTS INC.
(CANADA CORPORATION)

R.R. #3

#8194 HWY 109

ARTHUR, CANADA N0G1A0

FOR: DOCUMENT HOLDER; BOOK AND PAPER
HOLDER, IN CLASS 16 (U.S. CLS. 2, 5, 22, 23, 29, 37, 38
AND 50).

FIRST USE 12-0-2006; IN COMMERCE 12-0-2006.

THE MARK CONSISTS OF STANDARD CHAR-
ACTERS WITHOUT CLAIM TO ANY PARTICULAR
FONT, STYLE, SIZE, OR COLOR.

NO CLAIM IS MADE TO THE EXCLUSIVE
RIGHT TO USE "PAGE", APART FROM THE MARK
AS SHOWN.

SER. NO. 77-166,616, FILED 4-26-2007.

MICHAEL WEBSTER, EXAMINING ATTORNEY

Int. Cls.: 29, 30 and 35

Prior U.S. Cls.: 46, 100, 101 and 102

United States Patent and Trademark Office

Reg. No. 3,397,500

Registered Mar. 18, 2008

**TRADEMARK
SERVICE MARK
PRINCIPAL REGISTER**



REID'S MILKY-WAY DAIRY STORES INC. (CANADA CORPORATION)
UNIT 1
222 BELL BLVD.
BELLEVILLE, ONTARIO, CANADA K8P5L7

FOR: PRE-PACKAGED DELI MEAT; MILK AND CREAM CHEESE; FROZEN, DRIED, SLICED, BAGGED AND CANNED VEGETABLES; FROZEN, DRIED, SLICED, BAGGED AND CANNED FRUITS, IN CLASS 29 (U.S. CL. 46).

FOR: COOKIES; CRACKERS, PIZZA; PREPARED ICE CREAM PRODUCTS, NAMELY, SOFT SERVE ICE CREAM, ICE CREAM CONES, AND MILK SHAKES; DESSERTS, NAMELY, ICE CREAM CAKES, CHEESECAKES, AND PIES, IN CLASS 30 (U.S. CL. 46).

FOR: OPERATION OF A RETAIL OUTLET DEALING WITH FOOD AND FROZEN FOOD PRO-

DUCTS, NAMELY, DAIRY AND PREPARED ICE CREAM PRODUCTS; FRANCHISE SERVICES FOR FRANCHISING RETAIL OUTLET STORES DEALING WITH FOOD AND FROZEN FOOD PRODUCTS, NAMELY, DAIRY AND PREPARED ICE CREAM PRODUCTS, IN CLASS 35 (U.S. CLS. 100, 101 AND 102).

OWNER OF CANADA REG. NO. TMA699,642, DATED 10-29-2007, EXPIRES 10-29-2022.

NO CLAIM IS MADE TO THE EXCLUSIVE RIGHT TO USE "DAIRY & FROZEN FOOD", APART FROM THE MARK AS SHOWN.

SER. NO. 77-166,671, FILED 4-26-2007.

RAUL CORDOVA, EXAMINING ATTORNEY

Int. Cl.: 32

Prior U.S. Cls.: 45, 46 and 48

United States Patent and Trademark Office

Reg. No. 3,397,501

Registered Mar. 18, 2008

TRADEMARK
PRINCIPAL REGISTER

COFE

COFE CO., LTD (THAILAND LIMITED COR-
PORATION)
8/96 M8, CHARANSANITWONG RD
BANG PROM, TALING CHAN
BANGKOK, THAILAND 10170

FOR: CONCENTRATES, SYRUPS OR POWDERS
USED IN THE PREPARATION OF INSTANT
DRINKS, IN CLASS 32 (U.S. CLS. 45, 46 AND 48).

FIRST USE 12-31-1981; IN COMMERCE 10-31-1985.

THE MARK CONSISTS OF STANDARD CHAR-
ACTERS WITHOUT CLAIM TO ANY PARTICULAR
FONT, STYLE, SIZE, OR COLOR.

SEC. 2(F).

SER. NO. 77-166,903, FILED 4-26-2007.

MELVIN AXILBUND, EXAMINING ATTORNEY

Int. Cl.: 41

Prior U.S. Cls.: 100, 101 and 107

United States Patent and Trademark Office

Reg. No. 3,397,502

Registered Mar. 18, 2008

**SERVICE MARK
PRINCIPAL REGISTER**

Yoga 1-2-3 Ready

CHATTERELLI, SHELLY (UNITED STATES INDIVIDUAL)
1162 LOUISA MARIE AVE
MASSILLON, OH 44646 AND
PARKER, ANGELA (UNITED STATES INDIVIDUAL)
1910 AUGUSTA DR. SE
MASSILLON, OH 44646

FOR: EDUCATION SERVICES, NAMELY, PROVIDING TRAINING, CLASSES, WORKSHOPS IN THE FIELD OF EARLY CHILDHOOD DEVELOPMENT AND DISTRIBUTION OF COURSE MATERIALS IN CONNECTION THEREWITH; EDUCATION CONSULTING IN THE FIELD OF PRE-SCHOOL EARLY CHILDHOOD EDUCATION, IN CLASS 41 (U.S. CLS. 100, 101 AND 107).

FIRST USE 1-1-2006; IN COMMERCE 1-1-2006.

THE MARK CONSISTS OF STANDARD CHARACTERS WITHOUT CLAIM TO ANY PARTICULAR FONT, STYLE, SIZE, OR COLOR.

NO CLAIM IS MADE TO THE EXCLUSIVE RIGHT TO USE "YOGA", APART FROM THE MARK AS SHOWN.

SER. NO. 77-167,474, FILED 4-27-2007.

CHARLOTTE CORWIN, EXAMINING ATTORNEY

Int. Cl.: 30

Prior U.S. Cl.: 46

United States Patent and Trademark Office

Reg. No. 3,397,503

Registered Mar. 18, 2008

**TRADEMARK
PRINCIPAL REGISTER**



SUSTAINABLE SOURCING, LLC (MASSACHU-
SETTS LTD LIAB CO)
15 CASTLE HILL AVENUE
GREAT BARRINGTON, MA 01230

NO CLAIM IS MADE TO THE EXCLUSIVE
RIGHT TO USE "SUSTAINABLE", APART FROM
THE MARK AS SHOWN.

FOR: SALT, IN CLASS 30 (U.S. CL. 46).

SER. NO. 77-167,754, FILED 4-27-2007.

FIRST USE 1-1-2006; IN COMMERCE 5-1-2006.

TINA BROWN, EXAMINING ATTORNEY

Int. Cl.: 37

Prior U.S. Cls.: 100, 103 and 106

United States Patent and Trademark Office

Reg. No. 3,397,504

Registered Mar. 18, 2008

**SERVICE MARK
PRINCIPAL REGISTER**

WATCH 9-1-1

KENNETH JAMES PEDERSEN (UNITED STATES
INDIVIDUAL)

8110 S. HOUGHTON ROAD 158-143

TUCSON, AZ 85747

FOR: MAINTENANCE AND/OR REPAIR OF
WATCHES, IN CLASS 37 (U.S. CLS. 100, 103 AND 106).

FIRST USE 7-31-2007; IN COMMERCE 7-31-2007.

THE MARK CONSISTS OF STANDARD CHAR-
ACTERS WITHOUT CLAIM TO ANY PARTICULAR
FONT, STYLE, SIZE, OR COLOR.

NO CLAIM IS MADE TO THE EXCLUSIVE
RIGHT TO USE "WATCH", APART FROM THE
MARK AS SHOWN.

SER. NO. 77-168,157, FILED 4-27-2007.

MICHAEL WIENER, EXAMINING ATTORNEY

Int. Cl.: 5

Prior U.S. Cls.: 6, 18, 44, 46, 51 and 52

United States Patent and Trademark Office

Reg. No. 3,397,505

Registered Mar. 18, 2008

**TRADEMARK
PRINCIPAL REGISTER**

The Beauty Scoop

YAGODA, M.D., MICHELLE R. (UNITED STATES INDIVIDUAL)

SUITE #1B

122 EAST 78TH STREET

NEW YORK, NY 10021 AND

GANS, PH.D., EUGENE H. (UNITED STATES INDIVIDUAL)

514 HARVEST COMMONS

WESTPORT, CT 06880

FOR: NUTRACEUTICALS FOR USE AS A DIETARY SUPPLEMENT, IN CLASS 5 (U.S. CLS. 6, 18, 44, 46, 51 AND 52).

FIRST USE 6-1-2006; IN COMMERCE 6-1-2006.

THE MARK CONSISTS OF STANDARD CHARACTERS WITHOUT CLAIM TO ANY PARTICULAR FONT, STYLE, SIZE, OR COLOR.

SER. NO. 77-168,260, FILED 4-27-2007.

EMILY CHUO, EXAMINING ATTORNEY

Int. Cl.: 15

Prior U.S. Cls.: 2, 21 and 36

United States Patent and Trademark Office

Reg. No. 3,397,506

Registered Mar. 18, 2008

**TRADEMARK
PRINCIPAL REGISTER**

MIKO

OPEN LABS, INC. (TEXAS CORPORATION)
5810 TRADE CENTER DR., SUITE 100
AUSTIN, TX 78744

THE MARK CONSISTS OF STANDARD CHAR-
ACTERS WITHOUT CLAIM TO ANY PARTICULAR
FONT, STYLE, SIZE, OR COLOR.

FOR: MUSICAL INSTRUMENTS, IN CLASS 15
(U.S. CLS. 2, 21 AND 36).

SER. NO. 77-168,358, FILED 4-28-2007.

FIRST USE 4-1-2007; IN COMMERCE 4-1-2007.

CARYN GLASSER, EXAMINING ATTORNEY

Int. Cl.: 36

Prior U.S. Cls.: 100, 101 and 102

United States Patent and Trademark Office

Reg. No. 3,397,507

Registered Mar. 18, 2008

**SERVICE MARK
PRINCIPAL REGISTER**



Argonaut Retail

MEMBER ARGONAUT GROUP

ARGONAUT GROUP, INC. (DELAWARE CORPORATION)
10101 REUNION PLACE
SUITE 500
SAN ANTONIO, TX 78216

FOR: INSURANCE SERVICES, NAMELY, INSURANCE AGENCY AND BROKERAGE SERVICES, UNDERWRITING AND ADMINISTRATION IN THE FIELD OF RETAIL BUSINESSES, SPECIALTY COMMERCIAL PROPERTY AND SPECIALTY COMMERCIAL LIABILITY; INSURANCE CLAIMS MANAGEMENT SERVICES, NAMELY, CLAIM ESTABLISHMENT, EVALUATION, NEGOTIATION AND DISPOSITION; INSURANCE RISK MANAGEMENT AND LOSS CONTROL, IN CLASS 36 (U.S. CLS. 100, 101 AND 102).

FIRST USE 4-5-2007; IN COMMERCE 4-5-2007.

OWNER OF U.S. REG. NOS. 2,856,824, 2,867,823, AND 3,230,419.

NO CLAIM IS MADE TO THE EXCLUSIVE RIGHT TO USE "RETAIL MEMBER" AND "GROUP", APART FROM THE MARK AS SHOWN.

THE COLOR(S) BLUE AND BLACK IS/ARE CLAIMED AS A FEATURE OF THE MARK.

"THE MARK CONSISTS OF A BLUE SAILBOAT INSIDE A BLUE CIRCLE ABOVE THE WORDS "ARGONAUT RETAIL" IN BLACK, ABOVE THE WORDS "MEMBER ARGONAUT GROUP" IN BLUE. THE WHITE CENTER IN THE CIRCLE OF THE DRAWING REPRESENTS BACKGROUND AND IS NOT PART OF THE MARK."

SER. NO. 77-168,536, FILED 4-29-2007.

APRIL ROACH, EXAMINING ATTORNEY

Int. Cl.: 37

Prior U.S. Cls.: 100, 103 and 106

United States Patent and Trademark Office

Reg. No. 3,397,508

Registered Mar. 18, 2008

SERVICE MARK
PRINCIPAL REGISTER



DIRSCHERL, DANIEL D. (ALASKA SOLE PROPRIETORSHIP)
8903 MEADOW PARK CIRCLE
EAGLE RIVER, AK 99577

FOR: CLEANING OF RESIDENTIAL HOUSES, IN CLASS 37 (U.S. CLS. 100, 103 AND 106).

FIRST USE 2-1-2007; IN COMMERCE 2-1-2007.

NO CLAIM IS MADE TO THE EXCLUSIVE RIGHT TO USE "CLEANING SERVICE", APART FROM THE MARK AS SHOWN.

"THE COLOR(S) GREEN, LIGHT BLUE, DARK BLUE, BLACK AND WHITE IS/ARE CLAIMED AS A FEATURE OF THE MARK."

"THE MARK CONSISTS OF THE DESIGN OF THREE BUBBLES OUTLINED IN DARK BLUE WITH THE INTERIOR FADING FROM DARK BLUE TO LIGHT BLUE TO WHITE IN THE CENTER. THE WORD "SCRUBS" IS GREEN AT THE TOP OF EACH LETTER AND GRADUALLY CHANGES TO BLUE AT THE BOTTOM WITH EACH LETTER OUTLINED IN DARK BLUE. THE WORDING "CLEANING SERVICE" IS GREEN OUTLINED IN DARK BLUE WITH LIGHT BLUE SHADOWING. THE FISH DESIGN IS IN BLACK."

SER. NO. 77-169,529, FILED 4-30-2007.

MARY CRAWFORD, EXAMINING ATTORNEY

Int. Cl.: 35

Prior U.S. Cls.: 100, 101 and 102

United States Patent and Trademark Office

Reg. No. 3,397,509

Registered Mar. 18, 2008

**SERVICE MARK
PRINCIPAL REGISTER**

MSPA

MYSTERY SHOPPING PROVIDERS ASSOCIATION (ILLINOIS NON-PROFIT CORPORATION)
SUITE 135
12300 FORD ROAD
DALLAS, TX 75234

FOR: ASSOCIATION SERVICES, NAMELY, PROMOTING, DEVELOPING, MAINTAINING, AND STRENGTHENING THE MYSTERY SHOPPING INDUSTRY GLOBALLY TO IMPROVE AND STIMULATE THE ACCEPTANCE, PERFORMANCE, REPUTATION, AND USE OF MYSTERY SHOPPING SERVICES, BY MEANS OF ESTABLISHING, EDUCATING IN ANNUAL CONFERENCES AND PUB-

LICATIONS, AND ENFORCING A CODE OF STANDARDS AND ETHICS, IN CLASS 35 (U.S. CLS. 100, 101 AND 102).

FIRST USE 5-1-1999; IN COMMERCE 5-1-1999.

THE MARK CONSISTS OF STANDARD CHARACTERS WITHOUT CLAIM TO ANY PARTICULAR FONT, STYLE, SIZE, OR COLOR.

SER. NO. 77-169,646, FILED 5-1-2007.

HEATHER SAPP, EXAMINING ATTORNEY

Int. Cl.: 16

Prior U.S. Cls.: 2, 5, 22, 23, 29, 37, 38 and 50

Reg. No. 3,397,510

United States Patent and Trademark Office

Registered Mar. 18, 2008

**TRADEMARK
PRINCIPAL REGISTER**

FlexEffect

CROWLEY DEBORAH E (UNITED STATES IN-
DIVIDUAL)
1604 H STREET
EUREKA, CA 95501

THE MARK CONSISTS OF STANDARD CHAR-
ACTERS WITHOUT CLAIM TO ANY PARTICULAR
FONT, STYLE, SIZE, OR COLOR.

FOR: EXERCISE BOOKS, IN CLASS 16 (U.S. CLS.
2, 5, 22, 23, 29, 37, 38 AND 50).

SER. NO. 77-170,142, FILED 5-1-2007.

FIRST USE 6-24-1979; IN COMMERCE 10-10-1993.

TARAH HARDY, EXAMINING ATTORNEY

Int. Cl.: 42

Prior U.S. Cls.: 100 and 101

United States Patent and Trademark Office

Reg. No. 3,397,511

Registered Mar. 18, 2008

**SERVICE MARK
PRINCIPAL REGISTER**

E-URBAN

HUMPHREYS & PARTNERS ARCHITECTS, L.P.
(TEXAS LIMITED PARTNERSHIP)
SUITE 300
5339 ALPHA ROAD
DALLAS, TX 75240

THE MARK CONSISTS OF STANDARD CHARACTERS WITHOUT CLAIM TO ANY PARTICULAR FONT, STYLE, SIZE, OR COLOR.

FOR: DESIGN FOR OTHERS IN THE FIELD OF ARCHITECTURE, IN CLASS 42 (U.S. CLS. 100 AND 101).

SER. NO. 77-170,195, FILED 5-1-2007.

FIRST USE 4-30-2007; IN COMMERCE 4-30-2007.

DANNEAN HETZEL, EXAMINING ATTORNEY

Int. Cl.: 28

Prior U.S. Cls.: 22, 23, 38 and 50

United States Patent and Trademark Office

Reg. No. 3,397,512

Registered Mar. 18, 2008

**TRADEMARK
PRINCIPAL REGISTER**

JAZZ DIVA

MATTEL, INC. (DELAWARE CORPORATION)
M1-1518
333 CONTINENTAL BLVD.
EL SEGUNDO, CA 90245

FOR: TOYS, GAMES AND PLAYTHINGS, NAME-
LY, DOLLS, DOLL CLOTHING AND DOLL ACCES-
SORIES, TOY FIGURES AND ACCESSORIES
THEREFOR, IN CLASS 28 (U.S. CLS. 22, 23, 38 AND
50).

FIRST USE 10-9-2007; IN COMMERCE 10-9-2007.

THE MARK CONSISTS OF STANDARD CHAR-
ACTERS WITHOUT CLAIM TO ANY PARTICULAR
FONT, STYLE, SIZE, OR COLOR.

OWNER OF U.S. REG. NOS. 3,024,579, 3,272,387
AND OTHERS.

SER. NO. 77-170,395, FILED 5-1-2007.

DAWN FELDMAN, EXAMINING ATTORNEY

Int. Cl.: 30

Prior U.S. Cl.: 46

United States Patent and Trademark Office

Reg. No. 3,397,513

Registered Mar. 18, 2008

**TRADEMARK
PRINCIPAL REGISTER**

BELLA MARIA

WICKED JOE, LLC (MAINE LTD LIAB CO)
78 WATER STREET
BRUNSWICK, ME 04011

FOR: COFFEE; COFFEE BEANS; GROUND COFFEE BEANS, IN CLASS 30 (U.S. CL. 46).

FIRST USE 4-1-2003; IN COMMERCE 4-1-2003.

THE MARK CONSISTS OF STANDARD CHARACTERS WITHOUT CLAIM TO ANY PARTICULAR FONT, STYLE, SIZE, OR COLOR.

THE ENGLISH TRANSLATION OF THE ITALIAN WORD "BELLA" IS "BEAUTIFUL."

SER. NO. 77-170,849, FILED 5-2-2007.

ROSELLE HERRERA, EXAMINING ATTORNEY

Int. Cl.: 7

Prior U.S. Cls.: 13, 19, 21, 23, 31, 34 and 35

United States Patent and Trademark Office

Reg. No. 3,397,514

Registered Mar. 18, 2008

**TRADEMARK
PRINCIPAL REGISTER**

DeDuster

PELETRON CORPORATION (PENNSYLVANIA
CORPORATION)
SUITE 105
499 RUNNING PUMP ROAD
LANCASTER, PA 176012208

THE MARK CONSISTS OF STANDARD CHAR-
ACTERS WITHOUT CLAIM TO ANY PARTICULAR
FONT, STYLE, SIZE, OR COLOR.

FOR: MACHINES FOR REMOVING DUST AND
DEBRIS FROM PARTICULATE MATERIAL, IN
CLASS 7 (U.S. CLS. 13, 19, 21, 23, 31, 34 AND 35).

SER. NO. 77-173,221, FILED 5-4-2007.

FIRST USE 7-31-1989; IN COMMERCE 7-31-1989.

ROBIN CHOSID, EXAMINING ATTORNEY

Int. Cl.: 36

Prior U.S. Cls.: 100, 101 and 102

United States Patent and Trademark Office

Reg. No. 3,397,515

Registered Mar. 18, 2008

**SERVICE MARK
PRINCIPAL REGISTER**

EXACTRAC

JPMORGAN CHASE & CO. (DELAWARE CORPORATION)
270 PARK AVENUE
NEW YORK, NY 10017

THE MARK CONSISTS OF STANDARD CHARACTERS WITHOUT CLAIM TO ANY PARTICULAR FONT, STYLE, SIZE, OR COLOR.

FOR: BANKING AND RELATED FINANCIAL SERVICES, IN CLASS 36 (U.S. CLS. 100, 101 AND 102).

SER. NO. 77-173,228, FILED 5-4-2007.

FIRST USE 5-24-2005; IN COMMERCE 5-24-2005.

MICHAEL LEWIS, EXAMINING ATTORNEY

Int. Cl.: 36

Prior U.S. Cls.: 100, 101 and 102

United States Patent and Trademark Office

Reg. No. 3,397,516

Registered Mar. 18, 2008

**SERVICE MARK
PRINCIPAL REGISTER**

SUCCESS IN EXCESS

CORPORATE PROPERTY DISPOSITIONS (GEOR-
GIA LTD LIAB CO)
6400 POWERS FERRY RD. #395
ATLANTA, GA 30339

FOR: REAL ESTATE CONSULTATION, REAL
ESTATE LISTING, REAL ESTATE BROKERAGE,
REAL ESTATE VALUATION AND ACQUISITION
SERVICES, IN CLASS 36 (U.S. CLS. 100, 101 AND 102).

FIRST USE 6-1-2005; IN COMMERCE 6-1-2005.

THE MARK CONSISTS OF STANDARD CHAR-
ACTERS WITHOUT CLAIM TO ANY PARTICULAR
FONT, STYLE, SIZE, OR COLOR.

SER. NO. 77-173,307, FILED 5-4-2007.

CARYN GLASSER, EXAMINING ATTORNEY

Int. Cls.: 29, 30 and 31

Prior U.S. Cls.: 1 and 46

United States Patent and Trademark Office

Reg. No. 3,397,517

Registered Mar. 18, 2008

**TRADEMARK
PRINCIPAL REGISTER**

REBEKAH GRACE

REBEKAH GRACE FOOD & SUPPLEMENTS
FOR LIFE, LLC (KENTUCKY LTD LIAB CO)
APT. 3A
501 E. MAIN ST.
HAZARD, KY 41701

FOR: MILK; JAMS; JELLIES, IN CLASS 29 (U.S.
CL. 46).

FIRST USE 7-15-2006; IN COMMERCE 3-18-2007.

FOR: COOKIES , IN CLASS 30 (U.S. CL. 46).

FIRST USE 7-1-2006; IN COMMERCE 8-15-2006.

FOR: AGRICULTURAL PRODUCE, NAMELY,
UNPROCESSED TOMATOES, IN CLASS 31 (U.S.
CLS. 1 AND 46).

FIRST USE 10-1-2006; IN COMMERCE 4-18-2007.

THE MARK CONSISTS OF STANDARD CHAR-
ACTERS WITHOUT CLAIM TO ANY PARTICULAR
FONT, STYLE, SIZE, OR COLOR.

THE NAME(S), PORTRAIT(S), AND/OR SIGNA-
TURE(S) SHOWN IN THE MARK IDENTIFIES
REBEKAH GRACE, WHOSE CONSENT(S) TO REG-
ISTER IS SUBMITTED.

SER. NO. 77-174,100, FILED 5-7-2007.

JASON LOTT, EXAMINING ATTORNEY

Int. Cls.: 16, 35, 36 and 38

**Prior U.S. Cls.: 2, 5, 22, 23, 29, 37, 38, 50, 100, 101, 102
and 104**

Reg. No. 3,397,518

United States Patent and Trademark Office

Registered Mar. 18, 2008

**TRADEMARK
SERVICE MARK
PRINCIPAL REGISTER**

openbank

OPEN BANK SANTANDER CONSUMER, S.A.
(SPAIN CORPORATION)
CIUDAD GRUPO SANTANDER
AV. CANTABRIA S/N 28660
MADRID, SPAIN

FOR: PAPER GOODS AND PRINTED MATTER, NAMELY, NOTEBOOK PAPER, WRITING PAPER, DRAWING PAPER, STATIONERY, WRITING PADS, WRAPPING PAPER, PAPER GIFT BAGS, CALENDARS, NOTE CARDS, ENVELOPES, PHOTOGRAPHS; ADHESIVES FOR STATIONERY OR HOUSEHOLD PURPOSES; ARTISTS' MATERIALS, NAMELY, BRUSHES, PENCILS, PASTELS, PENS, EASELS, AND CANVASES FOR PAINTING; PAINT BRUSHES; TYPEWRITERS AND OFFICE REQUISITES, NAMELY CORRECTING FLUID FOR TYPE, PAPER HOLE PUNCHERS, RUBBER BANDS, STAPLERS, PAPER CLIPS, HIGHLIGHTING MARKERS, DESK FILE TRAYS, STAPLE REMOVERS, PENCIL SHARPENERS, LETTER OPENERS, AND ADHESIVE TAPE DISPENSERS; PRINTED INSTRUCTIONAL AND EDUCATIONAL MATERIAL IN THE FIELD OF MUSIC, ARTS, GAMES AND SPORTS; PRINTERS' TYPE; PRINTING BLOCKS, IN CLASS 16 (U.S. CLS. 2, 5, 22, 23, 29, 37, 38 AND 50).

FOR: ADVERTISING; BUSINESS MANAGEMENT; BUSINESS ADMINISTRATION; OFFICE FUNCTIONS, IN CLASS 35 (U.S. CLS. 100, 101 AND 102).

FOR: INSURANCE UNDERWRITING IN THE FIELDS OF LIFE, HEALTH, ACCIDENT AND FIRE;

FINANCIAL AFFAIRS, NAMELY, INVESTMENT BROKERAGE, LOAN FINANCING, REAL ESTATE AFFAIRS, NAMELY REAL ESTATE BROKERAGE AND REAL ESTATE CONSULTANCY, IN CLASS 36 (U.S. CLS. 100, 101 AND 102).

FOR: TELECOMMUNICATIONS SERVICES, NAMELY, CELLULAR TELEPHONE SERVICES AND ELECTRONIC TRANSMISSION OF VOICE, VIDEO, MESSAGES AND DATA AND PROVIDING MULTIPLE USER ACCESS TO A GLOBAL COMPUTER INFORMATION NETWORK, IN CLASS 38 (U.S. CLS. 100, 101 AND 104).

OWNER OF SPAIN REG. NO. 2656362, DATED 11-17-2005, EXPIRES 6-9-2015.

OWNER OF U.S. REG. NO. 2,590,416.

THE COLOR(S) RED AND BLACK IS/ARE CLAIMED AS A FEATURE OF THE MARK.

THE MARK CONSISTS OF THE WORD OPEN-BANK WRITTEN IN LOWERCASE LETTERS. THE WORD OPEN IS SHOWN IN RED COLOR WHILE THE WORD BANK IS SHOWN IN BLACK COLOR.

SER. NO. 77-174,212, FILED 5-7-2007.

ANDREA K. NADELMAN, EXAMINING ATTORNEY

Int. Cl.: 35

Prior U.S. Cls.: 100, 101 and 102

United States Patent and Trademark Office

Reg. No. 3,397,519

Registered Mar. 18, 2008

**SERVICE MARK
PRINCIPAL REGISTER**

**AMERICAN PERFORMANCE PARTS
WAREHOUSE, INC.**

AMERICAN PERFORMANCE PARTS WAREHOUSE, INC. (GEORGIA CORPORATION)
1799 MARIETTA BOULEVARD NW
ATLANTA, GA 30318

FOR: DISTRIBUTORSHIP SERVICES IN THE FIELD OF HIGH PERFORMANCE AUTOMOBILE PARTS, IN CLASS 35 (U.S. CLS. 100, 101 AND 102).

FIRST USE 10-0-1970; IN COMMERCE 10-0-1970.

THE MARK CONSISTS OF STANDARD CHARACTERS WITHOUT CLAIM TO ANY PARTICULAR FONT, STYLE, SIZE, OR COLOR.

NO CLAIM IS MADE TO THE EXCLUSIVE RIGHT TO USE "PERFORMANCE PARTS WAREHOUSE, INC.", APART FROM THE MARK AS SHOWN.

SEC. 2(F).

SER. NO. 77-174,470, FILED 5-7-2007.

CIMMERIAN COLEMAN, EXAMINING ATTORNEY

Int. Cl.: 35

Prior U.S. Cls.: 100, 101 and 102

United States Patent and Trademark Office

Reg. No. 3,397,520

Registered Mar. 18, 2008

**SERVICE MARK
PRINCIPAL REGISTER**

БЕРЁЗКА

BERIOZKASHOP.COM, INC. (NEW YORK CORPORATION)
4TH FLOOR
304 HUDSON STREET
NEW YORK, NY 10013

FIRST USE 3-27-2007; IN COMMERCE 3-27-2007.

THE MARK CONSISTS OF A RUSSIAN WORD IN CYRILLIC LETTERS.

FOR: ONLINE INTERACTIVE RETAIL STORE SERVICES PROVIDED VIA THE COMPUTER, TELEVISION AND THE INTERNET, FEATURING GENERAL MERCHANDISE; PROVIDING HOME SHOPPING SERVICES IN THE FIELD OF GENERAL MERCHANDISE BY MEANS OF INTERNET, TELEPHONE, AND PORTABLE HANDHELD DIGITAL AND ELECTRONIC DEVICES, IN CLASS 35 (U.S. CLS. 100, 101 AND 102).

THE NON-LATIN CHARACTER(S) IN THE MARK TRANSLITERATE INTO BERIOZKA, AND THIS MEANS BIRCH TREE IN ENGLISH.

SER. NO. 77-174,599, FILED 5-7-2007.

SUSAN LESLIE DUBOIS, EXAMINING ATTORNEY

Int. Cl.: 45

Prior U.S. Cls.: 100 and 101

United States Patent and Trademark Office

Reg. No. 3,397,521

Registered Mar. 18, 2008

**SERVICE MARK
PRINCIPAL REGISTER**

DockuChek

INVESTIGATIVE CONSULTANTS, INC. (ILLINOIS CORPORATION)
SUITE 813
2020 PENNSYLVANIA AVENUE NW
WASHINGTON, DC 20006

FOR: PROVIDING AN ON-LINE COMPUTER DATABASE THAT ALLOWS INTELLIGENCE PROFESSIONALS TO CONDUCT BACKGROUND CHECKS, IN CLASS 45 (U.S. CLS. 100 AND 101).

FIRST USE 5-4-2007; IN COMMERCE 5-4-2007.

THE MARK CONSISTS OF STANDARD CHARACTERS WITHOUT CLAIM TO ANY PARTICULAR FONT, STYLE, SIZE, OR COLOR.

SER. NO. 77-175,399, FILED 5-8-2007.

ALICE SUE CARRUTHERS, EXAMINING ATTORNEY

Int. Cl.: 39

Prior U.S. Cls.: 100 and 105

United States Patent and Trademark Office

Reg. No. 3,397,522

Registered Mar. 18, 2008

**SERVICE MARK
PRINCIPAL REGISTER**

TRIP DOGS TRAVEL

TRIP DOGS TRAVEL SERVICES, LLC (MINNE-
SOTA LTD LIAB CO)
5165 TRENTON LANE
PLYMOUTH, MN 55442

FOR: TRAVEL AGENCY SERVICES, NAMELY,
MAKING RESERVATIONS AND BOOKINGS FOR
TRANSPORTATION, IN CLASS 39 (U.S. CLS. 100
AND 105).

FIRST USE 5-3-2007; IN COMMERCE 5-12-2007.

THE MARK CONSISTS OF STANDARD CHAR-
ACTERS WITHOUT CLAIM TO ANY PARTICULAR
FONT, STYLE, SIZE, OR COLOR.

NO CLAIM IS MADE TO THE EXCLUSIVE
RIGHT TO USE "TRIP" AND "TRAVEL", APART
FROM THE MARK AS SHOWN.

SER. NO. 77-175,509, FILED 5-8-2007.

WENDY JUN, EXAMINING ATTORNEY

Int. Cls.: 35, 36, 37 and 39

Prior U.S. Cls.: 100, 101, 102, 103, 105 and 106

United States Patent and Trademark Office

Reg. No. 3,397,523

Registered Mar. 18, 2008

**SERVICE MARK
PRINCIPAL REGISTER**

FIRST TEAM

AUTOMOTIVE RESOURCES DEVELOPMENT
GROUP, LLC (VIRGINIA LTD LIAB CO)
1919 COMMERCE DRIVE
HAMPTON, VA 23666

FOR: AUTOMOBILE DEALERSHIPS; PROVIDING INFORMATION ABOUT AUTOMOBILES FOR SALE BY MEANS OF THE INTERNET; RETAIL AUTOMOBILE PARTS AND ACCESSORIES STORES, IN CLASS 35 (U.S. CLS. 100, 101 AND 102).

FIRST USE 6-30-1999; IN COMMERCE 6-30-1999.

FOR: FINANCING RELATED TO AUTOMOBILES; UNDERWRITING WARRANTY PROGRAMS IN THE FIELD OF AUTOMOBILES; AUTOMOBILE APPRAISAL, IN CLASS 36 (U.S. CLS. 100, 101 AND 102).

FIRST USE 6-30-1999; IN COMMERCE 6-30-1999.

FOR: AUTOMOBILE REPAIR AND MAINTENANCE; AUTOMOBILE GREASING AND LUBRICATION; REBUILDING OF AUTOMOBILE ENGINES; AUTOMOBILE BODY REPAIR, FINISH-

ING, AND PAINTING FOR OTHERS; AUTOMOBILE UNDERCOATING SERVICES; AUTOMOBILE CLEANING, WASHING, WAXING, POLISHING, AND DETAILING; AUTOMOBILE CUSTOMIZATION SERVICES; AUTOMOBILE PIN STRIPING, IN CLASS 37 (U.S. CLS. 100, 103 AND 106).

FIRST USE 6-30-1999; IN COMMERCE 6-30-1999.

FOR: LEASING OF AUTOMOBILES; PROVIDING INFORMATION ABOUT AUTOMOBILES FOR LEASE BY MEANS OF THE INTERNET; EMERGENCY AUTOMOBILE TOWING, IN CLASS 39 (U.S. CLS. 100 AND 105).

FIRST USE 6-30-1999; IN COMMERCE 6-30-1999.

THE MARK CONSISTS OF STANDARD CHARACTERS WITHOUT CLAIM TO ANY PARTICULAR FONT, STYLE, SIZE, OR COLOR.

SER. NO. 77-175,626, FILED 5-8-2007.

LINDA M. KING, EXAMINING ATTORNEY

Int. Cl.: 41

Prior U.S. Cls.: 100, 101 and 107

United States Patent and Trademark Office

Reg. No. 3,397,524

Registered Mar. 18, 2008

**SERVICE MARK
PRINCIPAL REGISTER**



U-S.S. MEDICAL CORP. (PUERTO RICO CORPORATION)
SUITE 3 GARDENVILLE
BRASIL #50
GUAYNABO, PUERTO RICO 00966

FOR: HEALTH CLUB SERVICES, NAMELY PROVIDING GYMNASTIC INSTRUCTION CLASSES, AND PROVIDING INSTRUCTION AND EQUIPMENT IN THE FIELD OF PHYSICAL EXERCISE AND ATHLETIC CONDITION, IN CLASS 41 (U.S. CLS. 100, 101 AND 107).

FIRST USE 1-1-2007; IN COMMERCE 1-1-2007.

THE COLOR(S) ORANGE IS/ARE CLAIMED AS A FEATURE OF THE MARK.

THE MARK CONSISTS OF AN ORANGE STYLIZED LOWER CASE LETTER "U" ENCLOSED IN A SEMI-CIRCLE.

SER. NO. 77-175,797, FILED 5-8-2007.

AHSEN KHAN, EXAMINING ATTORNEY

Int. Cl.: 28

Prior U.S. Cls.: 22, 23, 38 and 50

United States Patent and Trademark Office

Reg. No. 3,397,525

Registered Mar. 18, 2008

**TRADEMARK
PRINCIPAL REGISTER**

MOVIE DOUBLES

MATTEL, INC. (DELAWARE CORPORATION)
M1-1518
333 CONTINENTAL BLVD.
EL SEGUNDO, CA 90245

THE MARK CONSISTS OF STANDARD CHAR-
ACTERS WITHOUT CLAIM TO ANY PARTICULAR
FONT, STYLE, SIZE, OR COLOR.

FOR: TOYS, GAMES AND PLAYTHINGS, NAME-
LY, TOY VEHICLES AND ACCESSORIES THERE-
FOR, IN CLASS 28 (U.S. CLS. 22, 23, 38 AND 50).

SER. NO. 77-176,202, FILED 5-9-2007.

FIRST USE 10-18-2007; IN COMMERCE 10-18-2007.

KAPIL BHANOT, EXAMINING ATTORNEY

Int. Cl.: 35

Prior U.S. Cls.: 100, 101 and 102

United States Patent and Trademark Office

Reg. No. 3,397,526

Registered Mar. 18, 2008

**SERVICE MARK
PRINCIPAL REGISTER**

...AND WE DELIVER

BAY RIDGE AUTOMOTIVE MANAGEMENT
CORP. (NEW YORK CORPORATION)
6401 SIXTH AVENUE
BROOKLYN, NY 11220

FOR: AUTOMOBILE DEALERSHIPS, IN CLASS 35
(U.S. CLS. 100, 101 AND 102).

FIRST USE 6-0-1983; IN COMMERCE 6-0-1983.

THE MARK CONSISTS OF STANDARD CHAR-
ACTERS WITHOUT CLAIM TO ANY PARTICULAR
FONT, STYLE, SIZE, OR COLOR.

OWNER OF U.S. REG. NO. 2,476,229.

SER. NO. 77-176,488, FILED 5-9-2007.

JAMES LOVELACE, EXAMINING ATTORNEY

Int. Cl.: 19

Prior U.S. Cls.: 1, 12, 33 and 50

United States Patent and Trademark Office

Reg. No. 3,397,527

Registered Mar. 18, 2008

**TRADEMARK
PRINCIPAL REGISTER**

**The Next Generation of
Pool Pebble**

WET EDGE TECHNOLOGIES (ARIZONA LTD
LIAB CO)
4322 S 80TH STREET
MESA, AZ 85212

THE MARK CONSISTS OF STANDARD CHAR-
ACTERS WITHOUT CLAIM TO ANY PARTICULAR
FONT, STYLE, SIZE, OR COLOR.

FOR: AGGREGATE MATERIAL COMPOSED OF
MARBLE, QUARTZ AND CEMENT FOR SWIM-
MING POOL FINISHES, IN CLASS 19 (U.S. CLS. 1, 12,
33 AND 50).

SER. NO. 77-176,793, FILED 5-9-2007.

FIRST USE 5-1-2007; IN COMMERCE 5-1-2007.

ANDREW RHIM, EXAMINING ATTORNEY

Int. Cl.: 7

Prior U.S. Cls.: 13, 19, 21, 23, 31, 34 and 35

United States Patent and Trademark Office

Reg. No. 3,397,528

Registered Mar. 18, 2008

**TRADEMARK
PRINCIPAL REGISTER**

The logo for Hoonved features a stylized, bold letter 'H' on the left, followed by the word 'HOONVED' in a similar bold, sans-serif font. The 'H' is significantly larger and more prominent than the other letters.

HOONVED S.R.L. (ITALY SOCIETA A RESPONSABILITA LIMITATA)
VIA CAMPERIO 9
MILAN, ITALY 20123

INDUSTRIES AND FOR LABORATORY SETTINGS;
MACHINES FOR WASHING UTENSILS, IN CLASS 7
(U.S. CLS. 13, 19, 21, 23, 31, 34 AND 35).

FOR: COMMERCIAL GLASS AND DISHWASHING MACHINES; MACHINES FOR WASHING AND SANITIZING BAKING TRAYS, MEAT TROLLEYS, CHEESE BOARDS AND BASKETS FOR THE FOOD PREPARATION INDUSTRY; AND MACHINES FOR WASHING AND SANITIZING TEST-TUBES, BASKETS AND LABORATORY CONTAINERS FOR THE PHARMACEUTICAL AND DERMOCOSMETIC

OWNER OF ERPN CMNTY TM OFC REG. NO. 3488228, DATED 6-4-2005, EXPIRES 10-3-2013.

OWNER OF U.S. REG. NO. 1,443,876.

SER. NO. 77-177,281, FILED 5-10-2007.

MIDGE BUTLER, EXAMINING ATTORNEY

Int. Cl.: 36

Prior U.S. Cls.: 100, 101 and 102

United States Patent and Trademark Office

Reg. No. 3,397,529

Registered Mar. 18, 2008

**SERVICE MARK
PRINCIPAL REGISTER**

877-FAST-BAIL

ABC BAIL BONDS, INC. (PENNSYLVANIA CORPORATION)
215 WEST BRIDGE STREET
MORRISVILLE, PA 19067

THE MARK CONSISTS OF STANDARD CHARACTERS WITHOUT CLAIM TO ANY PARTICULAR FONT, STYLE, SIZE, OR COLOR.

FOR: BAIL BONDING, FINANCIAL GUARANTEE, AND SURETY SERVICES, IN CLASS 36 (U.S. CLS. 100, 101 AND 102).

SER. NO. 77-177,463, FILED 5-10-2007.

FIRST USE 1-0-2000; IN COMMERCE 1-0-2000.

DAVID HOFFMAN, EXAMINING ATTORNEY

Int. Cl.: 6

Prior U.S. Cls.: 2, 12, 13, 14, 23, 25 and 50

United States Patent and Trademark Office

Reg. No. 3,397,530

Registered Mar. 18, 2008

**TRADEMARK
PRINCIPAL REGISTER**

**QUITE POSSIBLY THE WORLD'S
EASIEST MOUNTS TO INSTALL!**

BELL'O INTERNATIONAL CORP. (DELAWARE
CORPORATION)
711 GINESI DRIVE
MORGANVILLE, NJ 07751

THE MARK CONSISTS OF STANDARD CHAR-
ACTERS WITHOUT CLAIM TO ANY PARTICULAR
FONT, STYLE, SIZE, OR COLOR.

FOR: METAL MOUNTING BRACKETS FOR
AUDIO AND VIDEO EQUIPMENT AND FOR HOME
THEATER SYSTEMS, IN CLASS 6 (U.S. CLS. 2, 12, 13,
14, 23, 25 AND 50).

SER. NO. 77-177,756, FILED 5-10-2007.

FIRST USE 1-8-2007; IN COMMERCE 1-8-2007.

TINA L. SNAPP, EXAMINING ATTORNEY

Int. Cl.: 18

Prior U.S. Cls.: 1, 2, 3, 22 and 41

United States Patent and Trademark Office

Reg. No. 3,397,531

Registered Mar. 18, 2008

**TRADEMARK
PRINCIPAL REGISTER**

SUPER  GRABBER

LOOK! MARKETING INC. (FLORIDA CORPORATION)
4207 SOUTHWEST 55TH CIRCLE
OCALA, FL 34474

FOR: HANDLE GRIPS FOR BAGS AND POUCHES IN THE NATURE OF A WRAP-AROUND COMBINATION GRIP/SHOULDER PAD CONTAINING AN IDENTIFICATION TAG, FOR COMFORT AND SECURE GRABBING OF BAGS, STRAPS, AND HANDLES IN INTERNATIONAL CLASS 18, IN CLASS 18 (U.S. CLS. 1, 2, 3, 22 AND 41).

FIRST USE 9-28-2006; IN COMMERCE 1-3-2007.

NO CLAIM IS MADE TO THE EXCLUSIVE RIGHT TO USE SUPER GRABBER, APART FROM THE MARK AS SHOWN.

"THE MARK CONSISTS OF THE WORDS "SUPER GRABBER" AND A DRAWING OF AN EYE."

SER. NO. 77-177,788, FILED 5-10-2007.

ANDREA K. NADELMAN, EXAMINING ATTORNEY

Int. Cl.: 37

Prior U.S. Cls.: 100, 103 and 106

United States Patent and Trademark Office

Reg. No. 3,397,532

Registered Mar. 18, 2008

SERVICE MARK
PRINCIPAL REGISTER



RESTORATION WINDOWS (CALIFORNIA CORPORATION)
SUITE 4E
215 WEST 98TH STREET
NEW YORK, NY 10025

FOR: RESTORATION IN THE FIELD OF WOOD WINDOWS, IN CLASS 37 (U.S. CLS. 100, 103 AND 106).

FIRST USE 11-1-2002; IN COMMERCE 11-1-2002.

NO CLAIM IS MADE TO THE EXCLUSIVE RIGHT TO USE "RESTORATION WINDOWS.COM" AND "REPLACEMENT WINDOW", APART FROM THE MARK AS SHOWN.

THE COLOR(S) DARK PERIWINKLE, MEDIUM PERIWINKLE, LIGHT PERIWINKLE, BLACK AND WHITE IS/ARE CLAIMED AS A FEATURE OF THE MARK.

THE MARK CONSISTS OF ONE IMAGE AND TWO SEPARATE WORD PHRASES. THE IMAGE IS A CARTOON STYLE RENDERING OF A DOUBLE HUNG WINDOW WITH 6 DIVIDED LIGHTS ON THE TOP AND ONE SINGLE LIGHT ON THE BOTTOM. THE WINDOW IS IN BLACK WITH A GRADIENT BEHIND IT THAT FADES TO LIGHT GREY. THE FIRST WORD PHRASE IS "RESTORATIONWINDOWS.COM". THIS PHRASE IS IN THE FONT "STONE SANS." THIS PHRASE IS IN THREE SHADES OF PERIWINKLE BLUE. "RESTORATION" IS IN DARK PERIWINKLE. "WINDOWS" IS IN MEDIUM PERIWINKLE. ".COM" IS IN LIGHT PERIWINKLE. THE SECOND PHRASE IS "THE REPLACEMENT WINDOW ALTERNATIVE". THIS PHRASE IS IN THE FONT "ARRUS" IN ITALIC. ALL THE WORDS IN THIS PHRASE ARE IN BLACK.

SER. NO. 77-179,539, FILED 5-12-2007.

CHERYL CLAYTON, EXAMINING ATTORNEY

Int. Cls.: 35 and 41

Prior U.S. Cls.: 100, 101, 102 and 107

United States Patent and Trademark Office

Reg. No. 3,397,533

Registered Mar. 18, 2008

**SERVICE MARK
PRINCIPAL REGISTER**



ALNET TRANSPORTATION, INC. (FLORIDA CORPORATION)
SUITE 200
5971 BRICK COURT
WINTER PARK, FL 32792

FOR: ONLINE SCHEDULING OF TRANSPORTATION AND LANGUAGE SERVICES, IN CLASS 35 (U.S. CLS. 100, 101 AND 102).

FIRST USE 0-0-2003; IN COMMERCE 0-0-2003.

FOR: ONLINE LANGUAGE TRANSLATION SERVICES, IN CLASS 41 (U.S. CLS. 100, 101 AND 107).

FIRST USE 0-0-2003; IN COMMERCE 0-0-2003.

NO CLAIM IS MADE TO THE EXCLUSIVE RIGHT TO USE "LANGUAGE & TRANSPORTA-

TION SERVICES", APART FROM THE MARK AS SHOWN.

THE COLOR(S) BLUE, ORANGE, TAN AND BLACK IS/ARE CLAIMED AS A FEATURE OF THE MARK.

THE MARK CONSISTS OF AN ORANGE AND TAN TRIANGLE WITH A BLUE AND ORANGE CIRCLE. THE WORDS ALTRAC II AND ALNET ARE BLUE, ALBERS IS TAN, WITH A BLACK LINE ABOVE THE WORDS LANGUAGE & TRANSPORTATION SERVICES ARE BLACK.

SER. NO. 77-180,948, FILED 5-15-2007.

KATHY DE JONGE, EXAMINING ATTORNEY

Int. Cls.: 9, 41 and 42

Prior U.S. Cls.: 21, 23, 26, 36, 38, 100, 101 and 107

United States Patent and Trademark Office

Reg. No. 3,397,534

Registered Mar. 18, 2008

**TRADEMARK
SERVICE MARK
PRINCIPAL REGISTER**



AVEPOINT, INC. (DELAWARE CORPORATION)
3 SECOND ST., SUITE 202
JERSEY CITY, NJ 07311

FOR: COMPUTER SOFTWARE FOR DATA BACK UP, PROTECTION, ARCHIVING, DISASTER RECOVERY, MIGRATION AND CONTENT MANAGEMENT, IN CLASS 9 (U.S. CLS. 21, 23, 26, 36 AND 38).

FIRST USE 4-1-2001; IN COMMERCE 1-29-2003.

FOR: TRAINING SERVICES IN THE FIELD OF INSTALLING AND USING COMPUTER SOFTWARE, IN CLASS 41 (U.S. CLS. 100, 101 AND 107).

FIRST USE 4-1-2001; IN COMMERCE 4-1-2001.

FOR: COMPUTER CONSULTING SERVICES AND DESIGN AND DEVELOPMENT OF CUSTOMIZED SOFTWARE, ALL IN CONNECTION WITH DATA BACK UP, PROTECTION, ARCHIVING, DISASTER RECOVERY, MIGRATION AND CONTENT MANAGEMENT; AND RELATED TECHNICAL SUPPORT SERVICES, NAMELY, TROUBLESHOOTING OF COMPUTER HARDWARE AND SOFTWARE PROBLEMS, IN CLASS 42 (U.S. CLS. 100 AND 101).

FIRST USE 4-1-2001; IN COMMERCE 4-1-2001.

SER. NO. 77-180,972, FILED 5-15-2007.

SUE LAWRENCE, EXAMINING ATTORNEY

Int. Cl.: 37

Prior U.S. Cls.: 100, 103 and 106

United States Patent and Trademark Office

Reg. No. 3,397,535

Registered Mar. 18, 2008

**SERVICE MARK
PRINCIPAL REGISTER**

**PHOENIX BUILDING
SOLUTIONS, INC.**

PHOENIX BUILDING SOLUTIONS, INC. (OHIO
CORPORATION)

630 HAY AVENUE

BROOKVILLE, OH 45309

FOR: BUILDING CONSTRUCTION, IN CLASS 37
(U.S. CLS. 100, 103 AND 106).

FIRST USE 3-24-2007; IN COMMERCE 3-24-2007.

THE MARK CONSISTS OF STANDARD CHAR-
ACTERS WITHOUT CLAIM TO ANY PARTICULAR
FONT, STYLE, SIZE, OR COLOR.

NO CLAIM IS MADE TO THE EXCLUSIVE
RIGHT TO USE BUILDING AND INC., APART
FROM THE MARK AS SHOWN.

SER. NO. 77-181,009, FILED 5-15-2007.

RENEE MCCRAY, EXAMINING ATTORNEY

Int. Cl.: 35

Prior U.S. Cls.: 100, 101 and 102

United States Patent and Trademark Office

Reg. No. 3,397,536

Registered Mar. 18, 2008

**SERVICE MARK
PRINCIPAL REGISTER**

ETHNIC COMMUNICATIONS

ETHNIC COMMUNICATIONS, INC. (DELA-
WARE CORPORATION)
12327 STANWOOD DRIVE
LOS ANGELES, CA 90066

FOR: MARKETING SERVICES, NAMELY THE
CREATION AND DISTRIBUTION OF PRINT AND
ELECTRONIC CONTENT, TO PROMOTE THE SALE
OF GOODS AND SERVICES OF OTHERS, IN CLASS
35 (U.S. CLS. 100, 101 AND 102).

FIRST USE 12-31-2006; IN COMMERCE 12-31-2006.

THE MARK CONSISTS OF STANDARD CHAR-
ACTERS WITHOUT CLAIM TO ANY PARTICULAR
FONT, STYLE, SIZE, OR COLOR.

NO CLAIM IS MADE TO THE EXCLUSIVE
RIGHT TO USE "COMMUNICATIONS", APART
FROM THE MARK AS SHOWN.

SER. NO. 77-181,080, FILED 5-15-2007.

AHSEN KHAN, EXAMINING ATTORNEY

Int. Cls.: 9, 40 and 42

Prior U.S. Cls.: 21, 23, 26, 36, 38, 100, 101, 103 and 106

United States Patent and Trademark Office

Reg. No. 3,397,537

Registered Mar. 18, 2008

**TRADEMARK
SERVICE MARK
PRINCIPAL REGISTER**

FOCUS ON GEOLOGY

AUSTIN GEOMODELING, INC. (TEXAS CORPORATION)
BUILDING IV, SUITE 205
6500 RIVER PLACE BLVD
AUSTIN, TX 78730

FOR: 3-D GEOLOGICAL INTERPRETATION SOFTWARE, IN CLASS 9 (U.S. CLS. 21, 23, 26, 36 AND 38).

FIRST USE 8-31-1996; IN COMMERCE 8-31-1996.

FOR: CONSULTING SERVICES, NAMELY, CONSULTING ON OIL AND GAS PRODUCTION, IN CLASS 40 (U.S. CLS. 100, 103 AND 106).

FIRST USE 8-31-1996; IN COMMERCE 8-31-1996.

FOR: CONSULTING SERVICES, NAMELY, CONSULTING ON OIL AND GAS EXPLORATION, IN CLASS 42 (U.S. CLS. 100 AND 101).

FIRST USE 8-31-1996; IN COMMERCE 8-31-1996.

THE MARK CONSISTS OF STANDARD CHARACTERS WITHOUT CLAIM TO ANY PARTICULAR FONT, STYLE, SIZE, OR COLOR.

NO CLAIM IS MADE TO THE EXCLUSIVE RIGHT TO USE "GEOLOGY", APART FROM THE MARK AS SHOWN.

SER. NO. 77-181,097, FILED 5-15-2007.

ROSELLE HERRERA, EXAMINING ATTORNEY

Int. Cl.: 36

Prior U.S. Cls.: 100, 101 and 102

United States Patent and Trademark Office

Reg. No. 3,397,538

Registered Mar. 18, 2008

SERVICE MARK
PRINCIPAL REGISTER



VERACITY PAYMENT SOLUTIONS, INC.
(GEORGIA CORPORATION)
8607 ROBERTS DRIVE
SUITE 200
ATLANTA, GA 30350

FOR: PROVIDING ELECTRONIC PROCESSING OF CREDIT CARD TRANSACTIONS AND ELECTRONIC PAYMENTS VIA A GLOBAL COMPUTER NETWORK, IN CLASS 36 (U.S. CLS. 100, 101 AND 102).

FIRST USE 4-30-2007; IN COMMERCE 5-4-2007.

NO CLAIM IS MADE TO THE EXCLUSIVE RIGHT TO USE "PAYMENT SOLUTIONS", APART FROM THE MARK AS SHOWN.

THE COLOR(S) GOLD, BLUE AND BURGUNDY-RED IS/ARE CLAIMED AS A FEATURE OF THE MARK.

THE MARK CONSISTS OF A GOLD CURVED SYMBOL ABOVE THE WORD VERACITY. THE WORD VERACITY IS BLUE. THE WORDS PAYMENT SOLUTIONS ARE BURGUNDY-RED. THE HORIZONTAL LINE BENEATH THE WORDS PAYMENT SOLUTIONS IS BLUE. THE WORDS CONNECTING RELATIONSHIPS TO SUCCESS ARE BLUE.

SER. NO. 77-181,873, FILED 5-15-2007.

TAMARA FRAZIER, EXAMINING ATTORNEY

Int. Cl.: 25

Prior U.S. Cls.: 22 and 39

United States Patent and Trademark Office

Reg. No. 3,397,539

Registered Mar. 18, 2008

TRADEMARK
PRINCIPAL REGISTER



ETHNICITEE (CALIFORNIA LTD LIAB CO)
13844 COMANCHE
TUSTIN, CA 92782

FOR: HATS; JACKETS; PANTS; SHIRTS; T-SHIRTS, IN CLASS 25 (U.S. CLS. 22 AND 39).

FIRST USE 8-1-2006; IN COMMERCE 4-19-2007.

NO CLAIM IS MADE TO THE EXCLUSIVE RIGHT TO USE "AUG 1 2006", APART FROM THE MARK AS SHOWN.

THE MARK CONSISTS OF THE WORDING CELEBRATE RESPECT, AUG 1 2006, AND ETHNICITEE. THE DESIGN OF A STAMP APPEARS BEHIND THE E IN ETHNICITEE, AND THE DESIGN OF A CIRCLE REPRESENTING A POSTMARK APPEARS AROUND THE WORDING CELEBRATE RESPECT AUG 1 2006.

SER. NO. 77-182,360, FILED 5-16-2007.

MARTHA FROMM, EXAMINING ATTORNEY

Int. Cl.: 36

Prior U.S. Cls.: 100, 101 and 102

United States Patent and Trademark Office

Reg. No. 3,397,540

Registered Mar. 18, 2008

**SERVICE MARK
PRINCIPAL REGISTER**



HUGHESWARE COMPUTER SERVICES, L.L.C.
(MICHIGAN LTD LIAB CO)
20926 LANCASTER
HARPER WOODS, MI 48225

FOR: CLEARING AND RECONCILING FINANCIAL TRANSACTIONS VIA A GLOBAL NETWORK; PROVIDING A WIDE VARIETY OF PAYMENT SERVICES, NAMELY, CREDIT CARD AND MERCHANT ACCOUNT BANK TRANSFER PROCESSING; PROVIDING FINANCIAL SERVICES, NAMELY, MERCHANT ACCOUNT SERVICES IN THE NATURE OF ELECTRONIC PROCESSING OF PAYMENT DATA, ADMINISTRATION OF MERCHANT ACCOUNT CREDIT CARD TRANSACTION PROCESSING AND TRANSMISSION OF BILLS PAYMENT DATA, CONDUCTED VIA A GLOBAL

COMPUTER NETWORK, IN CLASS 36 (U.S. CLS. 100, 101 AND 102).

FIRST USE 1-29-2005; IN COMMERCE 1-29-2005.

NO CLAIM IS MADE TO THE EXCLUSIVE RIGHT TO USE "TRANSACTION SERVICES", APART FROM THE MARK AS SHOWN.

THE MARK CONSISTS OF THE LETTERS HTS ARE SUPER-IMPOSED OVER THE CONTINENTS OF THE EARTH.

SER. NO. 77-182,363, FILED 5-16-2007.

ALICE BENMAMAN, EXAMINING ATTORNEY

Int. Cl.: 44

Prior U.S. Cls.: 100 and 101

United States Patent and Trademark Office

Reg. No. 3,397,541

Registered Mar. 18, 2008

**SERVICE MARK
PRINCIPAL REGISTER**



CAPITAL BLUECROSS (PENNSYLVANIA CORPORATION)
MD 2132
2500 ELMERTON AVENUE
HARRISBURG, PA 17177

FOR: COMPREHENSIVE HEALTH CARE PROGRAMS, NAMELY, THOSE RENDERED THROUGH A HEALTH MAINTENANCE ORGANIZATION, NAMELY, PROVIDING PHYSICIAN, DENTIST, HOSPITAL, HOME HEALTH CARE, PREVENTIVE HEALTH CARE TREATMENT, PHYSICAL THERAPY, DISPENSING OF

PHARMACEUTICALS, PHARMACEUTICAL ADVICE, AND AMBULANT MEDICAL CARE SERVICES, IN CLASS 44 (U.S. CLS. 100 AND 101).

FIRST USE 5-15-2007; IN COMMERCE 5-15-2007.

THE MARK CONSISTS OF A STARBURST DESIGN.

SER. NO. 77-182,437, FILED 5-16-2007.

KATHERINE CHANG, EXAMINING ATTORNEY

Int. Cls.: 16 and 25

Prior U.S. Cls.: 2, 5, 22, 23, 29, 37, 38, 39 and 50

United States Patent and Trademark Office

Reg. No. 3,397,542

Registered Mar. 18, 2008

**TRADEMARK
PRINCIPAL REGISTER**

WAY

JSONG INTERNATIONAL INC. (NEW YORK CORPORATION)
2/F SOUTH
499 SEVENTH AVENUE
NEW YORK, NY 10018

FOR: PRINTED PUBLICATION, NAMELY, A PERIODICALLY PUBLISHED MAGAZINE FEATURING WOMEN'S FASHION DESIGNS, PHOTOGRAPHS THEREOF AND WRITTEN ARTICLES RELATING TO FASHION DESIGN, IN CLASS 16 (U.S. CLS. 2, 5, 22, 23, 29, 37, 38 AND 50).

FIRST USE 1-31-2005; IN COMMERCE 1-31-2005.

FOR: LADIES' CLOTHING AND WEARING APPAREL, NAMELY, JACKETS, SKIRTS, PANTS,

PANTSUITS, T-SHIRTS, DRESSES, BLOUSES, TOPS, TWO AND THREE PIECE SUITS, CAMISOLES, VESTS AND DUSTERS, IN CLASS 25 (U.S. CLS. 22 AND 39).

FIRST USE 3-12-2004; IN COMMERCE 3-12-2004.

THE MARK CONSISTS OF STANDARD CHARACTERS WITHOUT CLAIM TO ANY PARTICULAR FONT, STYLE, SIZE, OR COLOR.

SER. NO. 77-182,602, FILED 5-16-2007.

JULIE WATSON, EXAMINING ATTORNEY

Int. Cl.: 41

Prior U.S. Cls.: 100, 101 and 107

United States Patent and Trademark Office

Reg. No. 3,397,543

Registered Mar. 18, 2008

**SERVICE MARK
PRINCIPAL REGISTER**

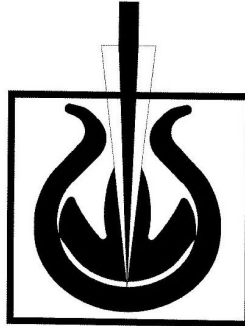

HIGH ENERGY DECISIONS, LLC (MISSOURI
LTD LIAB CO)
9745 LINDLEY DR.
OLIVETTE, MO 63132

FOR: EDUCATIONAL SERVICES, NAMELY
CONDUCTING SEMINARS AND TRAINING PRO-
GRAMS IN THE FIELD OF DECISION-MAKING
AND LEADERSHIP SKILLS, STRESS REDUCTION
TECHNIQUES, MEDITATION AND RELAXATION
TECHNIQUES, PERSONAL AWARENESS CON-
SCIOUSNESS, PERSONAL VALUES, AND PERSO-
NAL WELLNESS; PERSONAL COACHING
SERVICES IN THE FIELD OF DECISION-MAKING
AND LEADERSHIP SKILLS, STRESS REDUCTION
TECHNIQUES, MEDITATION AND RELAXATION

TECHNIQUES, PERSONAL AWARENESS CON-
SCIOUSNESS, PERSONAL VALUES, AND PERSO-
NAL WELLNESS; CONSULTATION SERVICES IN
THE FIELD OF MEDITATION, IN CLASS 41 (U.S.
CLS. 100, 101 AND 107).

FIRST USE 6-0-2005; IN COMMERCE 6-0-2005.

THE MARK CONSISTS OF A BEAM OF LIGHT
SHOOTING UP FROM A FLAME WITHIN A VES-
SEL.

SER. NO. 77-183,854, FILED 5-17-2007.

COLLEEN DOMBROW, EXAMINING ATTORNEY

Int. Cl.: 9

Prior U.S. Cls.: 21, 23, 26, 36 and 38

Reg. No. 3,397,544

United States Patent and Trademark Office

Registered Mar. 18, 2008

**TRADEMARK
PRINCIPAL REGISTER**

SnapShell

CSSN, INC. (CALIFORNIA CORPORATION),
DBA CARD SCANNING SOLUTIONS
SUITE 330
10350 SANTA MONICA BLVD
LOS ANGELES, CA 90025

AND HAND-HELD COMPUTING DEVICES, IN
CLASS 9 (U.S. CLS. 21, 23, 26, 36 AND 38).

FIRST USE 10-6-2004; IN COMMERCE 6-1-2005.

FOR: A SCANNER FOR THE PURPOSE OF
SCANNING, PARSING, AND TRANSLATING OF
GRAPHICAL DATA, USING OPTICAL CHARAC-
TER RECOGNITION TECHNOLOGY, INTO A PER-
SONAL INFORMATION MANAGEMENT
DATABASE AND FOR THE DISPLAY, SYNCHRO-
NIZATION, AND TRANSFER OF SUCH DATA
BETWEEN VARIOUS SOFTWARE APPLICATIONS

THE MARK CONSISTS OF STANDARD CHAR-
ACTERS WITHOUT CLAIM TO ANY PARTICULAR
FONT, STYLE, SIZE, OR COLOR.

SER. NO. 77-184,711, FILED 5-18-2007.

TANYA AMOS, EXAMINING ATTORNEY

Int. Cl.: 45

Prior U.S. Cls.: 100 and 101

United States Patent and Trademark Office

Reg. No. 3,397,545

Registered Mar. 18, 2008

**SERVICE MARK
PRINCIPAL REGISTER**

Archstone Law Group

VAN WERT, ZIMMER & CONLIN, P.C. (MASSACHUSETTS CORPORATION)

245 WINTER STREET, SUITE 400

WALTHAM, MA 024518709

FOR: LEGAL SERVICES, IN CLASS 45 (U.S. CLS. 100 AND 101).

FIRST USE 5-15-2007; IN COMMERCE 5-15-2007.

THE MARK CONSISTS OF STANDARD CHARACTERS WITHOUT CLAIM TO ANY PARTICULAR FONT, STYLE, SIZE, OR COLOR.

NO CLAIM IS MADE TO THE EXCLUSIVE RIGHT TO USE LAW GROUP, APART FROM THE MARK AS SHOWN.

SER. NO. 77-184,926, FILED 5-18-2007.

MARK SPARACINO, EXAMINING ATTORNEY

Int. Cl.: 6

Prior U.S. Cls.: 2, 12, 13, 14, 23, 25 and 50

United States Patent and Trademark Office

Reg. No. 3,397,546

Registered Mar. 18, 2008

**TRADEMARK
PRINCIPAL REGISTER**

VALMICRO

LUPATECH S/A (BRAZIL CORPORATION)
DALTON LAHM DOS REIS Nº 201
CAXIAS DO SUL, BRAZIL

FOR: MANUALLY OPERATED METAL VALVES,
IN CLASS 6 (U.S. CLS. 2, 12, 13, 14, 23, 25 AND 50).

FIRST USE 12-0-1985; IN COMMERCE 8-0-1992.

THE MARK CONSISTS OF STANDARD CHAR-
ACTERS WITHOUT CLAIM TO ANY PARTICULAR
FONT, STYLE, SIZE, OR COLOR.

SER. NO. 77-185,080, FILED 5-18-2007.

JACQUELINE A. LAVINE, EXAMINING ATTOR-
NEY

Int. Cl.: 9

Prior U.S. Cls.: 21, 23, 26, 36 and 38

United States Patent and Trademark Office

Reg. No. 3,397,547

Registered Mar. 18, 2008

TRADEMARK
PRINCIPAL REGISTER

us amps

KIM, EUNJUNG (UNITED STATES INDIVIDUAL)
1995 PEACEFUL HILLS
DIAMOND BAR, CA 91765

FOR: AUDIO EQUIPMENT FOR VEHICLES, NAMELY, STEREOS, SPEAKERS, AMPLIFIERS, EQUALIZERS, CROSSOVERS AND SPEAKER HOUSINGS, IN CLASS 9 (U.S. CLS. 21, 23, 26, 36 AND 38).

FIRST USE 1-1-1987; IN COMMERCE 1-1-1987.

THE MARK CONSISTS OF STANDARD CHARACTERS WITHOUT CLAIM TO ANY PARTICULAR FONT, STYLE, SIZE, OR COLOR.

NO CLAIM IS MADE TO THE EXCLUSIVE RIGHT TO USE "AMPS", APART FROM THE MARK AS SHOWN.

SEC. 2(F).

SER. NO. 77-185,535, FILED 5-20-2007.

ROSELLE HERRERA, EXAMINING ATTORNEY

Int. Cl.: 29

Prior U.S. Cl.: 46

United States Patent and Trademark Office

Reg. No. 3,397,548

Registered Mar. 18, 2008

**TRADEMARK
PRINCIPAL REGISTER**

**TRUFRESH UNIQUE FRESH
FREEZING METHOD**

WINTERLAB LIMITED (DELAWARE CORPORATION)
421 HUDSON STREET
NEW YORK, NY 10014

FOR: FROZEN FISH, BEEF, PORK, LAMB AND FOWL, IN CLASS 29 (U.S. CL. 46).

FIRST USE 5-0-1994; IN COMMERCE 5-0-1994.

THE MARK CONSISTS OF STANDARD CHARACTERS WITHOUT CLAIM TO ANY PARTICULAR FONT, STYLE, SIZE, OR COLOR.

OWNER OF U.S. REG. NOS. 1,964,394 AND 2,063,570.

NO CLAIM IS MADE TO THE EXCLUSIVE RIGHT TO USE UNIQUE FRESH FREEZING METHOD, APART FROM THE MARK AS SHOWN.

SER. NO. 77-185,832, FILED 5-21-2007.

RUDY R. SINGLETON, EXAMINING ATTORNEY

Int. Cl.: 35

Prior U.S. Cls.: 100, 101 and 102

United States Patent and Trademark Office

Reg. No. 3,397,549

Registered Mar. 18, 2008

**SERVICE MARK
PRINCIPAL REGISTER**



WISE COMPONENTS, INC. (CONNECTICUT CORPORATION)
79 HARBOR VIEW AVENUE
STAMFORD, CT 06902

FOR: COMPUTERIZED ON-LINE RETAIL STORE SERVICES IN THE FIELD OF ELECTRONICS AND ELECTRICAL COMPONENTS, PARTS, TOOLS, AND TESTING EQUIPMENT; ON-LINE RETAIL STORE SERVICES FEATURING ELECTRONICS AND ELECTRICAL COMPONENTS, PARTS, TOOLS, AND TESTING EQUIPMENT; RETAIL OUTLETS FEATURING ELECTRONICS AND ELECTRICAL COMPONENTS, PARTS, TOOLS, AND TESTING EQUIPMENT; RETAIL SERVICES BY DIRECT SOLICITATION BY SALES AGENTS IN THE FIELD OF ELECTRONICS AND ELECTRICAL COMPONENTS, PARTS, TOOLS, AND TESTING EQUIPMENT; RETAIL STORE SERVICES FEATURING ELECTRONICS AND ELECTRICAL COMPONENTS, PARTS, TOOLS, AND TESTING EQUIPMENT; RETAIL STORE SERVICES, AVAILABLE THROUGH COMPUTER COMMUNICATIONS AND INTERACTIVE TELEVISION, FEATURING ELECTRONICS AND ELECTRICAL COMPONENTS, PARTS, TOOLS, AND TESTING EQUIPMENT; WHOLESALE DISTRIBUTORSHIPS FEATURING ELECTRONICS AND ELECTRICAL COMPONENTS, PARTS, TOOLS, AND TESTING EQUIPMENT; INDEPENDENT SALES REPRESENTATIVES IN THE FIELD OF ELECTRONICS AND ELECTRICAL COMPONENTS,

PARTS, TOOLS, AND TESTING EQUIPMENT, IN CLASS 35 (U.S. CLS. 100, 101 AND 102).

FIRST USE 1-1-1999; IN COMMERCE 1-1-1999.

NO CLAIM IS MADE TO THE EXCLUSIVE RIGHT TO USE "DATACOMTOOLS.COM" AND "THE WEB'S BEST SOURCE FOR TELECOM TOOLS AND TESTERS", APART FROM THE MARK AS SHOWN.

THE COLOR(S) LIGHT BLUE, BLUE, DARK BLUE, GRAY, AND BLACK IS/ARE CLAIMED AS A FEATURE OF THE MARK.

THE MARK CONSISTS OF A BLUE CIRCLE WITH A LIGHT BLUE CRESCENT AT THE RIGHT SIDE OF CIRCLE, SUPERIMPOSED ON THE CIRCLE ARE TWO TRIANGULAR GEOMETRIC ITEMS, ONE BEING GRAY AND THE OTHER BEING DARK BLUE. THE WORDING DATACOMTOOLS.COM AND UNDERLINE APPEAR IN BLACK. THE WORDING "THE WEB'S BEST SOURCE FOR TELECOM TOOLS AND TESTERS APPEARS IN DARK BLUE.

SER. NO. 77-186,803, FILED 5-22-2007.

KATHERINE CONNOLLY, EXAMINING ATTORNEY

Int. Cl.: 35

Prior U.S. Cls.: 100, 101 and 102

United States Patent and Trademark Office

Reg. No. 3,397,550

Registered Mar. 18, 2008

**SERVICE MARK
PRINCIPAL REGISTER**

LIBERATE YOUR BRAND

THE SPARK AGENCY, INC. (DELAWARE CORPORATION)
SUITE 500
1120 S. SIXTH ST.
ST. LOUIS, MO 63104

FOR: MARKETING AND PROMOTIONAL SERVICES, NAMELY, PLANNING, CONDUCTING, AND ORGANIZING MOBILE MARKETING EXHIBITS, TRADE SHOW EXHIBITS, POINT OF SALE EXHIBITS, AND MARKETING DISPLAYS FOR BUSINESS MEETINGS AND BUSINESS EVENTS FOR ADVERTISING PURPOSES; DESIGN OF ADVERTISING MULTIMEDIA PRESENTATIONS AND THEMED GRAPHICS FOR USE IN MARKETING

CAMPAIGNS FOR OTHERS FOR TRADE SHOWS, BUSINESS MEETINGS, AND BUSINESS TO BUSINESS EVENTS, IN CLASS 35 (U.S. CLS. 100, 101 AND 102).

FIRST USE 4-0-2006; IN COMMERCE 4-0-2006.

THE MARK CONSISTS OF STANDARD CHARACTERS WITHOUT CLAIM TO ANY PARTICULAR FONT, STYLE, SIZE, OR COLOR.

SER. NO. 77-186,819, FILED 5-22-2007.

DANNEAN HETZEL, EXAMINING ATTORNEY

Int. Cls.: 35 and 41

Prior U.S. Cls.: 100, 101, 102 and 107

United States Patent and Trademark Office

Reg. No. 3,397,551

Registered Mar. 18, 2008

**SERVICE MARK
PRINCIPAL REGISTER**

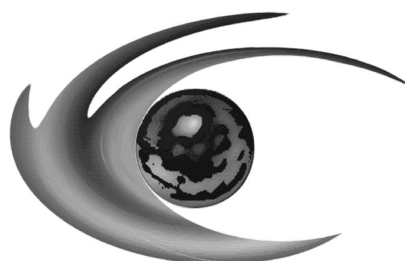

Private Dental Network

CAFOLLA, MARK (UNITED STATES INDIVIDUAL)
SUITE #603, BOX 35
4111 W. ALAMEDA AVENUE
BURBANK, CA 91505

FOR: ADVERTISING SERVICES, NAMELY, PROMOTING THE GOODS AND SERVICES RELATED TO DENTAL AND ORAL HEALTH VIA A WIRELESS BROADBAND NETWORK, IN CLASS 35 (U.S. CLS. 100, 101 AND 102).

FIRST USE 8-30-2003; IN COMMERCE 8-30-2003.

FOR: EDUCATIONAL SERVICES, NAMELY, CONDUCTING INFORMAL ON-LINE PROGRAMS FOR DENTAL PATIENTS IN THE FIELD OF DENTAL AND ORAL HEALTH, VIA A WIRELESS

BROADBAND NETWORK, IN CLASS 41 (U.S. CLS. 100, 101 AND 107).

FIRST USE 8-30-2003; IN COMMERCE 8-30-2003.

NO CLAIM IS MADE TO THE EXCLUSIVE RIGHT TO USE "PRIVATE DENTAL NETWORK", APART FROM THE MARK AS SHOWN.

THE MARK CONSISTS OF THE WORDS "PRIVATE DENTAL NETWORK", A REPRESENTATION OF A GLOBE, AND A STYLIZED SWISH DESIGN.

SER. NO. 77-188,911, FILED 5-23-2007.

CURTIS FRENCH, EXAMINING ATTORNEY

Int. Cl.: 41

Prior U.S. Cls.: 100, 101 and 107

United States Patent and Trademark Office

Reg. No. 3,397,552

Registered Mar. 18, 2008

**SERVICE MARK
PRINCIPAL REGISTER**



MARYLAND PUBLIC SECONDARY SCHOOLS
ATHLETIC ASSOCIATION (MPSSAA) (MARY-
LAND STATE AGENCY)
6TH FLOOR
200 W. BALTIMORE STREET
BALTIMORE, MD 21201

FOR: ARRANGING AND CONDUCTING ATH-
LETIC COMPETITIONS, IN CLASS 41 (U.S. CLS. 100,
101 AND 107).

FIRST USE 12-1-1983; IN COMMERCE 12-1-1983.

NO CLAIM IS MADE TO THE EXCLUSIVE
RIGHT TO USE "MARYLAND ATHLETIC ASSO-
CIATION", "PUBLIC SECONDARY SCHOOLS" AND
THE PICTORIAL REPRESENTATION OF THE
STATE OF MARYLAND, APART FROM THE
MARK AS SHOWN.

THE COLOR(S) BLACK, RED, AND WHITE. IS/
ARE CLAIMED AS A FEATURE OF THE MARK.

THE MARK CONSISTS OF THREE CONCENTRIC
CIRCLES ALL IN RED. THE OUTER TWO CON-
CENTRIC CIRCLES ARE RED PLAIN LINE CIR-
CLES. THE INNER CIRCLE IS A SOLID RED
CIRCLE WITH A WHITE REPRESENTATION OF
THE STATE OF MARYLAND INSIDE. THE WORDS
"MARYLAND ATHLETIC ASSOCIATION" APPEAR
IN BLACK CAPITAL LETTERS TO THE OUTSIDE
OF ALL OF THE CONCENTRIC CIRCLES. THE
WORDS "PUBLIC SECONDARY SCHOOLS" AP-
PEAR IN BLACK ALL CAPITAL LETTERS BE-
TWEEN THE FIRST AND SECOND RED PLAIN
LINE CONCENTRIC CIRCLES..

SER. NO. 77-189,134, FILED 5-24-2007.

MARY CRAWFORD, EXAMINING ATTORNEY

Int. Cl.: 41

Prior U.S. Cls.: 100, 101 and 107

United States Patent and Trademark Office

Reg. No. 3,397,553

Registered Mar. 18, 2008

**SERVICE MARK
PRINCIPAL REGISTER**



LFP IP, LLC (DELAWARE LTD LIAB CO)
SUITE 900
8484 WILSHIRE BLVD.
BEVERLY HILLS, CA 90211

FOR: NIGHT CLUBS, IN CLASS 41 (U.S. CLS. 100,
101 AND 107).

FIRST USE 11-1-2002; IN COMMERCE 11-1-2002.

OWNER OF U.S. REG. NOS. 2,773,372 AND
3,096,427.

THE COLOR(S) BLUE, PURPLE, BROWN, GOLD
AND WHITE IS/ARE CLAIMED AS A FEATURE OF
THE MARK.

THE MARK CONSISTS OF A BEAVER WEARING
A TOP HAT AND A TUXEDO WITH A MONOCLE,
HOLDING A CANE. THE COLOR BLUE APPEARS
IN THE TOP HAT. THE COLOR PURPLE APPEARS
IN THE BAND OF THE HAT AND IN THE TUXEDO.
THE COLOR BROWN APPEARS IN THE BEAVER'S
FACE AND THE CIGAR IN ITS MOUTH. THE
COLOR GOLD APPEARS IN THE BEAVER'S TEETH
AND IN THE CAP ON THE CANE. THE COLOR
WHITE APPEARS IN THE BEAVER'S TEETH,
SHIRT, GLOVES AND SHOES.

SER. NO. 77-189,249, FILED 5-24-2007.

LESLIE RICHARDS, EXAMINING ATTORNEY

Int. Cl.: 41

Prior U.S. Cls.: 100, 101 and 107

United States Patent and Trademark Office

Reg. No. 3,397,554

Registered Mar. 18, 2008

**SERVICE MARK
PRINCIPAL REGISTER**

CONCRETEBEAT

YEE, BENJAMIN (UNITED STATES INDIVIDUAL)
243 WEST 16TH STREET
NEW YORK, NY 10011

FOR: ENTERTAINMENT SERVICES, NAMELY, PROVIDING AN INTERACTIVE WEBSITE FEATURING INTERVIEWS WITH, REVIEWS AND BIOGRAPHIES OF STREET PERFORMERS AND STREET MUSICIANS AND FEATURING DOWNLOADABLE MUSIC AND VIDEO OF STREET PERFORMERS AND STREET MUSICIANS, IN CLASS 41 (U.S. CLS. 100, 101 AND 107).

FIRST USE 2-1-2007; IN COMMERCE 2-1-2007.

THE MARK CONSISTS OF STANDARD CHARACTERS WITHOUT CLAIM TO ANY PARTICULAR FONT, STYLE, SIZE, OR COLOR.

SER. NO. 77-189,331, FILED 5-24-2007.

KYLE PEETE, EXAMINING ATTORNEY

Int. Cl.: 41

Prior U.S. Cls.: 100, 101 and 107

United States Patent and Trademark Office

Reg. No. 3,397,555

Registered Mar. 18, 2008

**SERVICE MARK
PRINCIPAL REGISTER**

KEITH LOCKHART & FRIENDS

BOSTON SYMPHONY ORCHESTRA, INC. (MAS-
SACHUSETTS CORPORATION)
SYMPHONY HALL
301 MASSACHUSETTS AVENUE
BOSTON, MA 02115

FOR: ENTERTAINMENT SERVICES, NAMELY,
LIVE MUSICAL PERFORMANCES, IN CLASS 41
(U.S. CLS. 100, 101 AND 107).

FIRST USE 11-9-2002; IN COMMERCE 11-9-2002.

THE MARK CONSISTS OF STANDARD CHAR-
ACTERS WITHOUT CLAIM TO ANY PARTICULAR
FONT, STYLE, SIZE, OR COLOR.

THE NAME KEITH LOCKHART IDENTIFIES A
LIVING INDIVIDUAL WHOSE CONSENT IS OF
RECORD.

SER. NO. 77-189,428, FILED 5-24-2007.

ALLISON HOLTZ, EXAMINING ATTORNEY

Int. Cl.: 43

Prior U.S. Cls.: 100 and 101

United States Patent and Trademark Office

Reg. No. 3,397,556

Registered Mar. 18, 2008

**SERVICE MARK
PRINCIPAL REGISTER**



BOULDER CREEK PROPERTIES LLC (NEW
YORK LTD LIAB CO)
401 BROADHOLLOW ROAD
MELVILLE, NY 11747

FOR: RESTAURANT AND BAR SERVICES, IN
CLASS 43 (U.S. CLS. 100 AND 101).

FIRST USE 2-0-2006; IN COMMERCE 2-0-2006.

NO CLAIM IS MADE TO THE EXCLUSIVE
RIGHT TO USE STEAKHOUSE & GRILL AND EST.
1907, APART FROM THE MARK AS SHOWN.

THE MARK CONSISTS OF THE WORDS EST. 1907
ROTHMANN'S STEAKHOUSE & GRILL AND THE
STYLIZED LETTERS CR IN A CIRCLE.

SER. NO. 77-189,706, FILED 5-24-2007.

SUE LAWRENCE, EXAMINING ATTORNEY

Int. Cl.: 41

Prior U.S. Cls.: 100, 101 and 107

United States Patent and Trademark Office

Reg. No. 3,397,557

Registered Mar. 18, 2008

**SERVICE MARK
PRINCIPAL REGISTER**

GATEWAY COMMUNITY COLLEGE

MARICOPA COUNTY COMMUNITY COLLEGE
DISTRICT (ARIZONA POLITICAL SUBDIVISION OF THE STATE OF ARIZONA)
2411 W 14TH STREET
TEMPE, AZ 85281

FOR: EDUCATIONAL SERVICES, NAMELY, PROVIDING COURSES OF INSTRUCTION AT THE COLLEGE LEVEL AND DISTRIBUTING COURSE MATERIALS IN CONNECTION THEREWITH; EDUCATIONAL SERVICES, NAMELY, PROVIDING COURSES OF INSTRUCTION AT THE COMMUNITY EDUCATION LEVEL FOR THE PUBLIC AND DISTRIBUTING COURSE MATERIAL THEREWITH; EDUCATIONAL SERVICES, NAMELY, CONDUCTING DISTANCE LEARNING INSTRUCTION AT THE COLLEGE LEVEL AND DISTRIBUTING COURSE MATERIALS IN CONNECTION THEREWITH; ENTERTAINMENT IN THE NATURE OF DANCE PERFORMANCES,

THEATER PRODUCTIONS, LIVE MUSIC CONCERTS, ART EXHIBITIONS AND COMPETITIONS IN THE FIELD OF ATHLETICS, IN CLASS 41 (U.S. CLS. 100, 101 AND 107).

FIRST USE 12-31-1987; IN COMMERCE 12-31-1987.

THE MARK CONSISTS OF STANDARD CHARACTERS WITHOUT CLAIM TO ANY PARTICULAR FONT, STYLE, SIZE, OR COLOR.

NO CLAIM IS MADE TO THE EXCLUSIVE RIGHT TO USE "COMMUNITY COLLEGE", APART FROM THE MARK AS SHOWN.

SER. NO. 77-189,779, FILED 5-24-2007.

JAY FLOWERS, EXAMINING ATTORNEY

Int. Cl.: 16

Prior U.S. Cls.: 2, 5, 22, 23, 29, 37, 38 and 50

United States Patent and Trademark Office

Reg. No. 3,397,558

Registered Mar. 18, 2008

**TRADEMARK
PRINCIPAL REGISTER**



SANCHEZ, MARIA TRESA (UNITED STATES
INDIVIDUAL)
40 JUNIPER VALLEY LANE
TROUTVILLE, VA 24175

FOR: WORKS OF ART, NAMELY, ACRYLIC
DRAWINGS AND PAINTINGS, GRAPHITE POR-
TRAITS, AND PHOTOGRAPHS, IN CLASS 16 (U.S.
CLS. 2, 5, 22, 23, 29, 37, 38 AND 50).

FIRST USE 5-31-1998; IN COMMERCE 12-31-1998.

THE FOREIGN WORDING IN THE MARK
TRANSLATES INTO ENGLISH AS THREE.

SER. NO. 77-191,390, FILED 5-28-2007.

MARK SPARACINO, EXAMINING ATTORNEY

Int. Cl.: 14

Prior U.S. Cls.: 2, 27, 28 and 50

United States Patent and Trademark Office

Reg. No. 3,397,559

Registered Mar. 18, 2008

**TRADEMARK
PRINCIPAL REGISTER**

AANRAKU

CASTALINE, JEFFREY (UNITED STATES INDIVIDUAL)
2323 S. EL CAMINO REAL
SAN MATEO, CA 94403

THE MARK CONSISTS OF STANDARD CHARACTERS WITHOUT CLAIM TO ANY PARTICULAR FONT, STYLE, SIZE, OR COLOR.

FOR: JEWELRY FINDINGS, IN CLASS 14 (U.S. CLS. 2, 27, 28 AND 50).

SER. NO. 77-191,514, FILED 5-28-2007.

FIRST USE 10-1-1997; IN COMMERCE 10-1-1997.

KAPIL BHANOT, EXAMINING ATTORNEY

Int. Cl.: 12

Prior U.S. Cls.: 19, 21, 23, 31, 35 and 44

Reg. No. 3,397,560

United States Patent and Trademark Office

Registered Mar. 18, 2008

**TRADEMARK
PRINCIPAL REGISTER**



CART-RITE, LLC (CONNECTICUT LTD LIAB
CO)
15 JAMES VINCENT DRIVE
CLINTON, CT 06413

FOR: ELECTRIC MOTORIZED CARTS, IN CLASS
12 (U.S. CLS. 19, 21, 23, 31, 35 AND 44).

FIRST USE 9-23-2005; IN COMMERCE 9-23-2005.

THE COLOR(S) RED, SILVER AND GREY IS/ARE
CLAIMED AS A FEATURE OF THE MARK.

THE MARK CONSISTS OF A RED OVAL OUT-
LINED IN SILVER WITH GREY SHADING, AN
INNER SILVER AND GREY ELLIPTICAL CRES-
CENT WITH SILVER AND GREY WORDS "CART-
RITE" IN THE MIDDLE.

SER. NO. 77-191,689, FILED 5-29-2007.

JOHN DWYER, EXAMINING ATTORNEY

Int. Cls.: 9, 25 and 41

Prior U.S. Cls.: 21, 22, 23, 26, 36, 38, 39, 100, 101 and 107

Reg. No. 3,397,561

United States Patent and Trademark Office

Registered Mar. 18, 2008

**TRADEMARK
SERVICE MARK
PRINCIPAL REGISTER**

AVENGED SEVENFOLD PARTNERSHIP (CALIFORNIA PARTNERSHIP)
C/O GELFAND, RENNERT & FELDMAN, LLP
1880 CENTURY PARK EAST, SUITE 1600
LOS ANGELES, CA 90067

FOR: SERIES OF MUSICAL SOUND RECORDINGS, NAMELY, PRERECORDED AUDIO AND VIDEO CASSETTES, TAPES AND DIGITALLY FORMATTED DISCS OR OTHER AUDIO OR VIDEO STORAGE DEVICES FEATURING DRAMATIC AND NON-DRAMATIC PERFORMANCES OF MUSICAL WORKS, IN CLASS 9 (U.S. CLS. 21, 23, 26, 36 AND 38).

FIRST USE 9-0-2000; IN COMMERCE 9-0-2000.

FOR: CLOTHING FOR MEN, WOMEN AND CHILDREN, NAMELY, T-SHIRTS, TANK TOPS,

SWEAT SHIRTS, SWEATERS, JACKETS, HATS, VISORS, HEAD BANDS, SCARVES, SHORTS, WRISTBANDS, BEANIES, AND GLOVES, IN CLASS 25 (U.S. CLS. 22 AND 39).

FIRST USE 9-0-2000; IN COMMERCE 9-0-2000.

FOR: ENTERTAINMENT IN THE NATURE OF LIVE PERFORMANCES BY A MUSICAL GROUP, IN CLASS 41 (U.S. CLS. 100, 101 AND 107).

FIRST USE 9-0-2000; IN COMMERCE 9-0-2000.

SER. NO. 77-192,446, FILED 5-29-2007.

RONALD MCMORROW, EXAMINING ATTORNEY

Int. Cl.: 32

Prior U.S. Cls.: 45, 46 and 48

United States Patent and Trademark Office

Reg. No. 3,397,562

Registered Mar. 18, 2008

**TRADEMARK
PRINCIPAL REGISTER**

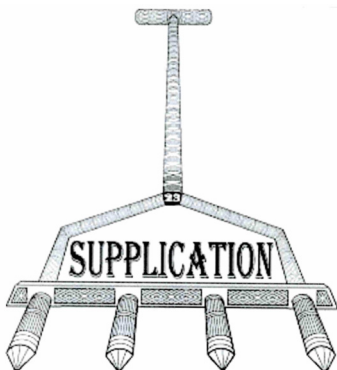

23 BOTTLES OF BEER LLC (CALIFORNIA LTD
LIAB CO)
725 4TH ST.
SANTA ROSA, CA 95404

FOR: BEER, IN CLASS 32 (U.S. CLS. 45, 46 AND 48).

FIRST USE 5-4-2004; IN COMMERCE 5-4-2004.

THE MARK CONSISTS OF AN ARTISTIC DRAW-
ING OF A GRASS AERATOR COLORED IN BLACK
AND WHITE. AT THE TOP OF THE MARK IS
HANDLE WITH A LONG NARROW SHAFT THAT
COMES TO A CROSS ARM THAT HAS THE NUM-

BER 23 IN WHITE WITH A BLACK BACKGROUND.
THE CROSS ARM CONTINUES DOWN THE SIDES
OF THE MARK TO THE BASE HORIZONTAL
CROSS ARM THAT HAS FOUR FORKS COMING
OUT OF IT WHICH ARE BLACK AND WHITE.
ABOVE THE FOUR FORKS IS THE WORD SUPPLI-
CATION WHICH IS COLORED IN BLACK WITH A
SLIGHT WHITE AND BLACK SHADOW.

SER. NO. 77-192,579, FILED 5-29-2007.

KIM SAITO, EXAMINING ATTORNEY

Int. Cl.: 16

Prior U.S. Cls.: 2, 5, 22, 23, 29, 37, 38 and 50

United States Patent and Trademark Office

Reg. No. 3,397,563

Registered Mar. 18, 2008

**TRADEMARK
PRINCIPAL REGISTER**

FORTUNE SMALL BUSINESS

TIME INC. (DELAWARE CORPORATION)
1271 AVENUE OF THE AMERICAS
NEW YORK, NY 10020

OWNER OF U.S. REG. NO. 3,211,052.

FOR: MAGAZINES FEATURING BUSINESS, FINANCE AND TOPICS OF GENERAL INTEREST, IN CLASS 16 (U.S. CLS. 2, 5, 22, 23, 29, 37, 38 AND 50).

NO CLAIM IS MADE TO THE EXCLUSIVE RIGHT TO USE SMALL BUSINESS, APART FROM THE MARK AS SHOWN.

FIRST USE 10-27-1999; IN COMMERCE 10-27-1999.

SER. NO. 77-192,875, FILED 5-30-2007.

THE MARK CONSISTS OF STANDARD CHARACTERS WITHOUT CLAIM TO ANY PARTICULAR FONT, STYLE, SIZE, OR COLOR.

JOHN KELLY, EXAMINING ATTORNEY

Int. Cls.: 35, 38 and 42

Prior U.S. Cls.: 100, 101, 102 and 104

United States Patent and Trademark Office

Reg. No. 3,397,564

Registered Mar. 18, 2008

SERVICE MARK
PRINCIPAL REGISTER



OPENVIEW FORUM (COLORADO CORPORATION)
8770 WEST BRYN MAWR, SUITE 1300
CHICAGO, IL 60631

FOR: PROMOTING THE GOODS AND SERVICES OF OTHERS VIA A GLOBAL COMPUTER NETWORK; PROVIDING A WEB SITE WHICH FEATURES ADVERTISEMENTS FOR THE GOODS AND SERVICES OF OTHERS ON A GLOBAL COMPUTER NETWORK; PROVIDING AN ON-LINE COMPUTER DATABASE FEATURING TRADE INFORMATION IN THE FIELD OF SOFTWARE USER GROUPS; PROVIDING INFORMATION ABOUT COMMERCIAL BUSINESS AND COMMERCIAL INFORMATION VIA THE GLOBAL COMPUTER NETWORK; PROVIDING INFORMATION ABOUT THE GOODS AND SERVICES OF OTHERS VIA THE GLOBAL COMPUTER NETWORK, IN CLASS 35 (U.S. CLS. 100, 101 AND 102).

FIRST USE 3-1-2007; IN COMMERCE 3-1-2007.

FOR: PROVIDING MULTIPLE-USER ACCESS TO A GLOBAL COMPUTER INFORMATION NETWORK; PROVIDING ON-LINE CHAT ROOMS FOR TRANSMISSION OF MESSAGES AMONG COMPUTER USERS CONCERNING SOFTWARE USER GROUPS; PROVIDING ON-LINE ELECTRONIC BULLETIN BOARDS FOR TRANSMISSION OF MESSAGES AMONG COMPUTER USERS CONCERNING SOFTWARE USER GROUPS; PROVIDING ON-LINE FORUMS FOR TRANSMISSION OF MESSAGES AMONG COMPUTER USERS CONCERNING SOFTWARE USER GROUPS; PROVIDING ON-LINE LISTSERVERS FOR TRANSMISSION OF MESSAGES AMONG COMPUTER USERS CONCERNING SOFTWARE USER GROUPS, IN CLASS 38 (U.S. CLS. 100, 101 AND 104).

FIRST USE 3-1-2007; IN COMMERCE 3-1-2007.

FOR: COMPUTER SERVICE, NAMELY, ACTING AS AN APPLICATION SERVICE PROVIDER IN THE FIELD OF KNOWLEDGE MANAGEMENT TO HOST COMPUTER APPLICATION SOFTWARE FOR CREATING SEARCHABLE DATABASES OF INFORMATION AND DATA; COMPUTER SERVICE, NAMELY, ACTING AS AN APPLICATION SERVICE PROVIDER IN THE FIELD OF KNOWLEDGE MANAGEMENT TO HOST COMPUTER APPLICATION SOFTWARE FOR THE COLLECTION, EDITING, ORGANIZING, MODIFYING, BOOK MARKING, TRANSMISSION, STORAGE AND SHARING OF DATA AND INFORMATION, IN CLASS 42 (U.S. CLS. 100 AND 101).

FIRST USE 3-1-2007; IN COMMERCE 3-1-2007.

THE COLOR(S) ORANGE, PINK, AND BLUE IS/ARE CLAIMED AS A FEATURE OF THE MARK.

THE MARK CONSISTS OF SLIVERS OF COLOR ARRANGED IN AN ELLIPTICAL SHAPE FOLLOWED BY THE LETTERS "VIVIT." THE TOP SLIVER OF THE ELLIPTICAL SHAPE IS IN GRADIENTS OF ORANGE, THE RIGHT SLIVER IS IN GRADIENTS OF PINK, AND THE LEFT SLIVER IS IN GRADIENTS OF BLUE. THE COLOR WHITE IS NOT PART OF THE MARK, BUT RATHER IT IS AN INDICATION THAT THE MARK APPEARS ON A TRANSPARENT BACKGROUND. THE LETTERS "VIV" ARE BLUE. THE LETTERS "IT" ARE PINK.

SER. NO. 77-193,229, FILED 5-30-2007.

LA TONIA FISHER, EXAMINING ATTORNEY

Int. Cl.: 32

Prior U.S. Cls.: 45, 46 and 48

United States Patent and Trademark Office

Reg. No. 3,397,565

Registered Mar. 18, 2008

TRADEMARK
PRINCIPAL REGISTER



23 BOTTLES OF BEER LLC (CALIFORNIA LTD
LIAB CO)
725 4TH ST.
SANTA ROSA, CA 95404

FOR: BEER, IN CLASS 32 (U.S. CLS. 45, 46 AND 48).

FIRST USE 3-22-2004; IN COMMERCE 3-22-2004.

NO CLAIM IS MADE TO THE EXCLUSIVE
RIGHT TO USE "BIERE DE SONOMA" , APART
FROM THE MARK AS SHOWN.

THE MARK CONSISTS OF A BLACK AND
WHITE ARTISTIC DRAWING OF A HAND HELD
GARDENING TOOL. THE TOP OF THE MARK

SHOWS A BLADE WITH WHITE AND BLACK
LINES RUNNING VERTICALLY WHICH IS CON-
NECTED TO THE HANDLE WHICH HAS BLACK
AND WHITE LINES RUNNING IN EVERY DIREC-
TION INCLUDING CIRCULAR. AT THE BASE OF
THE MARK IS THE NUMBER 23 COLORED IN
WHITE WITH A BLACK BACK GROUND. THE
LINING IS A FEATURE OF THE MARK..

THE FOREIGN WORDING IN THE MARK
TRANSLATES INTO ENGLISH AS BEER OF.

SER. NO. 77-193,402, FILED 5-30-2007.

KIM SAITO, EXAMINING ATTORNEY

Int. Cl.: 16

Prior U.S. Cls.: 2, 5, 22, 23, 29, 37, 38 and 50

United States Patent and Trademark Office

Reg. No. 3,397,566

Registered Mar. 18, 2008

**TRADEMARK
PRINCIPAL REGISTER**

endura  tex

SIGNWAREHOUSE, INC. (TEXAS CORPORATION)

2614 TEXOMA DRIVE
DENISON, TX 75020

FOR: SIGNAGE SUPPLIES, NAMELY, HEAT APPLIED VINYL TRANSFER SHEETING, IN CLASS 16 (U.S. CLS. 2, 5, 22, 23, 29, 37, 38 AND 50).

FIRST USE 1-1-2005; IN COMMERCE 1-1-2005.

THE COLOR(S) BLACK AND ORANGE IS/ARE CLAIMED AS A FEATURE OF THE MARK.

THE MARK CONSISTS OF THE WORD ENDURA IN BLACK NEXT TO A ORANGE FLAME FOLLOWED BY THE WORD TEX IN BLACK.

SER. NO. 77-193,431, FILED 5-30-2007.

SCOTT SISUN, EXAMINING ATTORNEY

Int. Cl.: 32

Prior U.S. Cls.: 45, 46 and 48

United States Patent and Trademark Office

Reg. No. 3,397,567

Registered Mar. 18, 2008

TRADEMARK
PRINCIPAL REGISTER

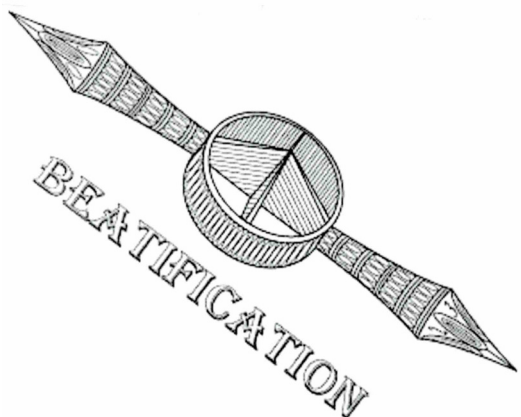

23 BOTTLES OF BEER LLC (CALIFORNIA LTD
LIAB CO)
725 4TH ST.
SANTA ROSA, CA 95404

FOR: BEER, IN CLASS 32 (U.S. CLS. 45, 46 AND 48).

FIRST USE 6-1-2006; IN COMMERCE 6-1-2006.

THE LINING IS A FEATURE OF THE MARK.

THE MARK CONSISTS OF A BLACK AND
WHITE ARTISTIC DRAWING OF A HAND HELD
GARDENING BAMBOO SPLITTER. THE MARK IS
AT AN ANGLE WITH THE CENTER SECTION

BEING ROUND AND HANDLES ON EACH SIDE.
THE TWO HANDLES AND THE CIRCULAR CEN-
TER SECTION HAVE BLACK AND WHITE LINES
RUNNING IN EVERY DIRECTION. AT THE BASE
OF THE RIGHT HANDLE PORTION OF THE MARK
IS THE NUMBER 23 COLORED IN BLACK ON A
WHITE BACKGROUND. THE WORD BEATIFICA-
TION IS TYPED WITH A BLACK OUTLINE WITH
THE INSIDE OF EACH LETTER COLORED IN
WHITE.

SER. NO. 77-193,441, FILED 5-30-2007.

KIM SAITO, EXAMINING ATTORNEY

Int. Cl.: 12

Prior U.S. Cls.: 19, 21, 23, 31, 35 and 44

United States Patent and Trademark Office

Reg. No. 3,397,568

Registered Mar. 18, 2008

**TRADEMARK
PRINCIPAL REGISTER**

HOODLIFT

HOODLIFT LTD (CALIFORNIA CORPORATION)
3109 ALDER WAY
WEST SACRAMENTO, CA 95691

FOR: DEVICE TO BE INSTALLED ON A VEHICLE
THAT WILL ASSIST IN THE RAISING AND LOW-
ERING OF THE HOOD OF THE VEHICLE, IN CLASS
12 (U.S. CLS. 19, 21, 23, 31, 35 AND 44).

FIRST USE 2-1-1998; IN COMMERCE 5-5-1998.

THE MARK CONSISTS OF STANDARD CHAR-
ACTERS WITHOUT CLAIM TO ANY PARTICULAR
FONT, STYLE, SIZE, OR COLOR.

SEC. 2(F).

SER. NO. 77-193,511, FILED 5-30-2007.

DEBRA LEE, EXAMINING ATTORNEY

Int. Cl.: 11

Prior U.S. Cls.: 13, 21, 23, 31 and 34

United States Patent and Trademark Office

Reg. No. 3,397,569

Registered Mar. 18, 2008

**TRADEMARK
PRINCIPAL REGISTER**

JUMP START MANIFOLDS

JUMP START MANIFOLDS, LLC (NEW YORK
LTD LIAB CO)
P.O. BOX 55
6915 ROUTE 55
WINGDALE, NY 12594

FOR: MODULAR MANIFOLD KITS FOR INSTALLING BOILERS FOR HEATING SYSTEMS, CONSISTING ESSENTIALLY OF COPPER PIPES OF VARIOUS SIZES WITH ELBOWS, CAPS, TEES, UNIONS, ADAPTORS, BALL VALVES, PURGE VALVES, BACKFLOW VALVES, A PRESSURE REGULATOR, CIRCULATOR ISOLATION FLANGES AND A POWER VENT CONNECTION FOR FLUE GASES, IN CLASS 11 (U.S. CLS. 13, 21, 23, 31 AND 34).

FIRST USE 5-10-2006; IN COMMERCE 5-10-2006.

THE MARK CONSISTS OF STANDARD CHARACTERS WITHOUT CLAIM TO ANY PARTICULAR FONT, STYLE, SIZE, OR COLOR.

NO CLAIM IS MADE TO THE EXCLUSIVE RIGHT TO USE "MANIFOLDS", APART FROM THE MARK AS SHOWN.

SER. NO. 77-193,893, FILED 5-31-2007.

SANI KHOURI, EXAMINING ATTORNEY

Int. Cl.: 45

Prior U.S. Cls.: 100 and 101

United States Patent and Trademark Office

Reg. No. 3,397,570

Registered Mar. 18, 2008

**SERVICE MARK
PRINCIPAL REGISTER**

CARDWAYS

ARROWEYE SOLUTIONS, INC. (DELAWARE
CORPORATION)
SUITE 200
549 WEST RANDOLPH STREET
CHICAGO, IL 60661

FOR: PROVIDING A SELECTION OF ON-LINE
ELECTRONIC GIFT CARDS AND GREETING
CARDS FOR CUSTOMIZATION, IN CLASS 45 (U.S.
CLS. 100 AND 101).

FIRST USE 9-15-2006; IN COMMERCE 9-15-2006.

THE MARK CONSISTS OF STANDARD CHAR-
ACTERS WITHOUT CLAIM TO ANY PARTICULAR
FONT, STYLE, SIZE, OR COLOR.

SER. NO. 77-194,054, FILED 5-31-2007.

KATHERINE STOIDES, EXAMINING ATTORNEY

Int. Cl.: 36

Prior U.S. Cls.: 100, 101 and 102

United States Patent and Trademark Office

Reg. No. 3,397,571

Registered Mar. 18, 2008

**SERVICE MARK
PRINCIPAL REGISTER**

INSUREHEALTH

BRODY, RONALD F. (UNITED STATES INDIVIDUAL)
46 BRIAN DRIVE
BREWER, ME 04412

FOR: INSURANCE BROKERAGE IN THE FIELD OF INSURANCE AND INSURANCE-RELATED PLANS FOR EMPLOYERS, NAMELY TAX-FAVORED ACCOUNTS SUCH AS DEDICATED SAVINGS AND REIMBURSEMENT ACCOUNTS, DEBIT CARDS, AND THE COMBINATION OF SUCH PLANS AND OPTIONS, FOR THE PURPOSE OF PROVIDING EMPLOYMENT BENEFITS TO FUND MEDICAL CARE, PROMOTE PREVENTIVE CARE

AND ENCOURAGE EMPLOYEE AND DEPENDENT WELLNESS, IN CLASS 36 (U.S. CLS. 100, 101 AND 102).

FIRST USE 5-30-2005; IN COMMERCE 5-30-2005.

THE MARK CONSISTS OF STANDARD CHARACTERS WITHOUT CLAIM TO ANY PARTICULAR FONT, STYLE, SIZE, OR COLOR.

SER. NO. 77-194,098, FILED 5-31-2007.

KYLE PEETE, EXAMINING ATTORNEY

Int. Cl.: 44

Prior U.S. Cls.: 100 and 101

United States Patent and Trademark Office

Reg. No. 3,397,572

Registered Mar. 18, 2008

**SERVICE MARK
PRINCIPAL REGISTER**



**REHABILITATION
& PAIN CENTER**

SURGEON'S MANAGEMENT, INC. (TEXAS
CORPORATION)
PO BOX 924587
HOUSTON, TX 77292

NO CLAIM IS MADE TO THE EXCLUSIVE
RIGHT TO USE "REHABILITATION & PAIN CEN-
TER", APART FROM THE MARK AS SHOWN.

FOR: MEDICAL, PHYSICAL REHABILITATION
AND PHYSICAL THERAPY SERVICES, IN CLASS 44
(U.S. CLS. 100 AND 101).

SER. NO. 77-194,180, FILED 5-31-2007.

FIRST USE 6-1-2001; IN COMMERCE 6-1-2001.

LESLEY LAMOTHE, EXAMINING ATTORNEY

Int. Cl.: 35

Prior U.S. Cls.: 100, 101 and 102

United States Patent and Trademark Office

Reg. No. 3,397,573

Registered Mar. 18, 2008

**SERVICE MARK
PRINCIPAL REGISTER**



ACTION TRAILER DEPOT (NEW MEXICO CORPORATION)
9999 CENTRAL NE
ALBUQUERQUE, NM 87123

FOR: DEALERSHIPS IN THE FIELD OF TRAILERS AND RECREATIONAL VEHICLES, IN CLASS 35 (U.S. CLS. 100, 101 AND 102).

FIRST USE 3-12-2007; IN COMMERCE 3-12-2007.

NO CLAIM IS MADE TO THE EXCLUSIVE RIGHT TO USE "TRAILER DEPOT", APART FROM THE MARK AS SHOWN.

THE MARK CONSISTS OF A TRAILER WITH A WHEEL AND SPOKES RIDING ON A CRESCENT SHAPED ROAD. THE TRAILER IS CARRYING THE WORDS ACTION AND TRAILER WITH THE WORD DEPOT BELOW THE TONGUE OF THE TRAILER.

SER. NO. 77-194,247, FILED 5-31-2007.

AHSEN KHAN, EXAMINING ATTORNEY

Int. Cl.: 20

Prior U.S. Cls.: 2, 13, 22, 25, 32 and 50

Reg. No. 3,397,574

United States Patent and Trademark Office

Registered Mar. 18, 2008

**TRADEMARK
PRINCIPAL REGISTER**



SIGNWAREHOUSE, INC. (TEXAS CORPORATION)
2614 TEXOMA DRIVE
DENISON, TX 75020

FOR: SIGNAGE SUPPLIES, NAMELY, POLY VINYL CHLORIDE (PVC) BANNERS, IN CLASS 20 (U.S. CLS. 2, 13, 22, 25, 32 AND 50).

FIRST USE 1-1-2005; IN COMMERCE 1-1-2005.

NO CLAIM IS MADE TO THE EXCLUSIVE RIGHT TO USE "BANNER", APART FROM THE MARK AS SHOWN.

THE COLOR(S) BLACK, GREY, GREEN, YELLOW, RED, LIGHT BLUE AND ROYAL BLUE IS/ARE CLAIMED AS A FEATURE OF THE MARK.

THE MARK CONSISTS OF THE WORD ENDURA IN BLACK NEXT TO THE WORD BANNER IN GREY WITH A RIGHT ARROW CONTAINING THE COLORS GREEN, YELLOW, RED, BLACK, LIGHT BLUE AND ROYAL BLUE UNDER THE WORD ENDURA.

SER. NO. 77-194,314, FILED 5-31-2007.

SCOTT SISUN, EXAMINING ATTORNEY

Int. Cl.: 41

Prior U.S. Cls.: 100, 101 and 107

United States Patent and Trademark Office

Reg. No. 3,397,575

Registered Mar. 18, 2008

SERVICE MARK
PRINCIPAL REGISTER

WE JOY  ING

WEJOYSING, INC. (OHIO CORPORATION)
5290 LAMBERT ROAD
GROVE CITY, OH 43123

FOR: EDUCATIONAL SERVICES, NAMELY,
PROVIDING CLASSES, SEMINARS, AND WORK-
SHOPS IN THE FIELDS OF EARLY CHILDHOOD
MUSIC AND MOVEMENT BASED LEARNING, IN
CLASS 41 (U.S. CLS. 100, 101 AND 107).

FIRST USE 1-19-1991; IN COMMERCE 10-9-1991.

THE COLOR(S) BLACK AND RED IS/ARE
CLAIMED AS A FEATURE OF THE MARK.

THE COLOR BLACK APPEARS IN THE WORD-
ING 'WEJOYSING' AND THE TREBLE CLEF SYM-
BOL. THE COLOR RED APPEARS IN THE DESIGN
OF THE HEART IN THE CENTER OF THE TREBLE
CLEF SYMBOL.

SER. NO. 77-194,318, FILED 5-31-2007.

YAT SYE, LEE, EXAMINING ATTORNEY

Int. Cl.: 19

Prior U.S. Cls.: 1, 12, 33 and 50

United States Patent and Trademark Office

Reg. No. 3,397,576

Registered Mar. 18, 2008

**TRADEMARK
PRINCIPAL REGISTER**

PANOMUR WALL

BORGERT PRODUCTS, INC. (MINNESOTA CORPORATION)

8646 RIDGEWOOD ROAD

ST. JOSEPH, MN 56374

FOR: CONCRETE RETAINING WALLS, IN CLASS 19 (U.S. CLS. 1, 12, 33 AND 50).

FIRST USE 6-0-2006; IN COMMERCE 6-0-2006.

THE MARK CONSISTS OF STANDARD CHARACTERS WITHOUT CLAIM TO ANY PARTICULAR FONT, STYLE, SIZE, OR COLOR.

NO CLAIM IS MADE TO THE EXCLUSIVE RIGHT TO USE "WALL", APART FROM THE MARK AS SHOWN.

SER. NO. 77-194,352, FILED 5-31-2007.

MARY BOAGNI, EXAMINING ATTORNEY

Int. Cl.: 44

Prior U.S. Cls.: 100 and 101

United States Patent and Trademark Office

Reg. No. 3,397,577

Registered Mar. 18, 2008

**SERVICE MARK
PRINCIPAL REGISTER**



SURGEON'S MANAGEMENT, INC. (TEXAS
CORPORATION)
PO BOX 924587
HOUSTON, TX 77292

FOR: MEDICAL, PHYSICAL REHABILITATION
AND PHYSICAL THERAPY SERVICES, IN CLASS 44
(U.S. CLS. 100 AND 101).

FIRST USE 5-1-2007; IN COMMERCE 5-1-2007.

NO CLAIM IS MADE TO THE EXCLUSIVE
RIGHT TO USE "HAND CENTER", "M.D." AND

"FOUNDER", APART FROM THE MARK AS
SHOWN.

THE NAME MICHAEL G. BROWN IDENTIFIES A
LIVING INDIVIDUAL WHOSE CONSENT IS OF
RECORD.

SER. NO. 77-194,419, FILED 5-31-2007.

LESLEY LAMOTHE, EXAMINING ATTORNEY

Int. Cl.: 41

Prior U.S. Cls.: 100, 101 and 107

United States Patent and Trademark Office

Reg. No. 3,397,578

Registered Mar. 18, 2008

**SERVICE MARK
PRINCIPAL REGISTER**

FAMILY PLUS

BOYS & GIRLS CLUBS OF AMERICA (UNITED STATES CONGRESSIONALLY CHARTERED NONPROFIT ORGANIZATION)
1275 PEACHTREE ST.
ATLANTA, GA 30309

FOR: EDUCATIONAL SERVICES, NAMELY, CLASSES AND TRAINING FOR CAREGIVERS, PARENTS AND CHILDREN TO PROMOTE POSITIVE DEVELOPMENT OF CHILDREN, IN CLASS 41 (U.S. CLS. 100, 101 AND 107).

FIRST USE 6-1-2006; IN COMMERCE 6-1-2006.

THE MARK CONSISTS OF STANDARD CHARACTERS WITHOUT CLAIM TO ANY PARTICULAR FONT, STYLE, SIZE, OR COLOR.

NO CLAIM IS MADE TO THE EXCLUSIVE RIGHT TO USE FAMILY, APART FROM THE MARK AS SHOWN.

SER. NO. 77-195,105, FILED 6-1-2007.

KEVON CHISOLM, EXAMINING ATTORNEY

Int. Cl.: 13

Prior U.S. Cls.: 2 and 9

United States Patent and Trademark Office

Reg. No. 3,397,579

Registered Mar. 18, 2008

**TRADEMARK
PRINCIPAL REGISTER**

NITRO TURKEY

RA BRANDS, L.L.C. (DELAWARE LTD LIAB CO)
870 REMINGTON DRIVE
MADISON, NC 27025

OWNER OF U.S. REG. NOS. 1,086,881 AND
2,041,087.

FOR: AMMUNITION, IN CLASS 13 (U.S. CLS. 2
AND 9).

NO CLAIM IS MADE TO THE EXCLUSIVE
RIGHT TO USE TURKEY, APART FROM THE
MARK AS SHOWN.

FIRST USE 12-31-2005; IN COMMERCE 12-31-2005.

SER. NO. 77-195,123, FILED 6-1-2007.

THE MARK CONSISTS OF STANDARD CHAR-
ACTERS WITHOUT CLAIM TO ANY PARTICULAR
FONT, STYLE, SIZE, OR COLOR.

ANTHONY RINKER, EXAMINING ATTORNEY

Int. Cl.: 13

Prior U.S. Cls.: 2 and 9

United States Patent and Trademark Office

Reg. No. 3,397,580

Registered Mar. 18, 2008

**TRADEMARK
PRINCIPAL REGISTER**

NITRO PHEASANT

RA BRANDS, L.L.C. (DELAWARE LTD LIAB CO)
870 REMINGTON DRIVE
MADISON, NC 27025

OWNER OF U.S. REG. NOS. 1,086,881 AND
2,041,087.

FOR: AMMUNITION, IN CLASS 13 (U.S. CLS. 2
AND 9).

NO CLAIM IS MADE TO THE EXCLUSIVE
RIGHT TO USE PHEASANT, APART FROM THE
MARK AS SHOWN.

FIRST USE 12-31-2005; IN COMMERCE 12-31-2005.

SER. NO. 77-195,129, FILED 6-1-2007.

THE MARK CONSISTS OF STANDARD CHAR-
ACTERS WITHOUT CLAIM TO ANY PARTICULAR
FONT, STYLE, SIZE, OR COLOR.

ANTHONY RINKER, EXAMINING ATTORNEY

Int. Cl.: 9

Prior U.S. Cls.: 21, 23, 26, 36 and 38

United States Patent and Trademark Office

Reg. No. 3,397,581

Registered Mar. 18, 2008

**TRADEMARK
PRINCIPAL REGISTER**

REGISCELL

REGIS TECHNOLOGIES, INC. (ILLINOIS CORPORATION)
8210 NORTH AUSTIN AVENUE
MORTON GROVE, IL 600530519

FOR: COLUMNS PROVIDING A CELL FOR USE
IN LIQUID CHROMATOGRAPHY, IN CLASS 9 (U.S.
CLS. 21, 23, 26, 36 AND 38).

FIRST USE 2-26-2007; IN COMMERCE 2-26-2007.

THE MARK CONSISTS OF STANDARD CHARACTERS WITHOUT CLAIM TO ANY PARTICULAR FONT, STYLE, SIZE, OR COLOR.

OWNER OF U.S. REG. NO. 874,108.

SER. NO. 77-195,431, FILED 6-1-2007.

ANGELA M. MICHELI, EXAMINING ATTORNEY

Int. Cl.: 42

Prior U.S. Cls.: 100 and 101

United States Patent and Trademark Office

Reg. No. 3,397,582

Registered Mar. 18, 2008

**SERVICE MARK
PRINCIPAL REGISTER**

REGISSEP

REGIS TECHNOLOGIES, INC. (ILLINOIS CORPORATION)
8210 NORTH AUSTIN AVENUE
MORTON GROVE, IL 600530519

FOR: LABORATORY SERVICES, NAMELY, CHROMATOGRAPHY SEPARATION SERVICES, IN CLASS 42 (U.S. CLS. 100 AND 101).

FIRST USE 2-13-2007; IN COMMERCE 2-13-2007.

THE MARK CONSISTS OF STANDARD CHARACTERS WITHOUT CLAIM TO ANY PARTICULAR FONT, STYLE, SIZE, OR COLOR.

OWNER OF U.S. REG. NO. 874,108.

SER. NO. 77-195,484, FILED 6-1-2007.

ANGELA M. MICHELI, EXAMINING ATTORNEY

Int. Cl.: 42

Prior U.S. Cls.: 100 and 101

United States Patent and Trademark Office

Reg. No. 3,397,583

Registered Mar. 18, 2008

**SERVICE MARK
PRINCIPAL REGISTER**



Blue Mouse Monkey

JULIA STOOPS (UNITED STATES INDIVIDUAL)
2144 SE 54TH AVENUE
PORTLAND, OR 97215

FOR: MULTIMEDIA DESIGN SERVICES AND DESIGN CONSULTING SERVICES IN THE FIELDS OF GRAPHIC DESIGN, GRAPHIC ART, PRINT, VISUAL AND FINE ART, COMMERCIAL ART, LOGOS, TYPOGRAPHY DESIGN, WEBSITES AND HOME PAGES, ANIMATION, ILLUSTRATION, AND DIGITAL MEDIA; VIDEO DESIGN SERVICES FOR OTHERS; WEBSITE DEVELOPMENT FOR OTHERS; PROVIDING A WEBSITE THAT FEATURES INFORMATION ON VISUAL ARTS DESIGN

AND DEVELOPMENT, WEBSITE CREATION, DEVELOPMENT AND DESIGN, IN CLASS 42 (U.S. CLS. 100 AND 101).

FIRST USE 8-13-1999; IN COMMERCE 10-1-2000.

THE MARK CONSISTS OF A DRAWING OF A MOUSE AND THE WORDS "BLUE MOUSE MONKEY".

SER. NO. 77-195,712, FILED 6-1-2007.

ZACHARY BELLO, EXAMINING ATTORNEY

Int. Cl.: 42

Prior U.S. Cls.: 100 and 101

United States Patent and Trademark Office

Reg. No. 3,397,584

Registered Mar. 18, 2008

**SERVICE MARK
PRINCIPAL REGISTER**

Ecolect

GEBBIA, JOSEPH N. (UNITED STATES INDIVIDUAL)
19 RAUSCH STREET, UNIT C
SAN FRANCISCO, CA 94103 AND
GRIGSBY, MATT (UNITED STATES INDIVIDUAL)
60 VALLEY STREET UNIT 7
PROVIDENCE, RI 02909

FOR: INDUSTRIAL DESIGN, IN CLASS 42 (U.S. CLS. 100 AND 101).

FIRST USE 2-2-2006; IN COMMERCE 9-10-2006.

THE MARK CONSISTS OF STANDARD CHARACTERS WITHOUT CLAIM TO ANY PARTICULAR FONT, STYLE, SIZE, OR COLOR.

SER. NO. 77-196,296, FILED 6-3-2007.

FLORENTINA BLANDU, EXAMINING ATTORNEY

Int. Cl.: 44

Prior U.S. Cls.: 100 and 101

United States Patent and Trademark Office

Reg. No. 3,397,585

Registered Mar. 18, 2008

**SERVICE MARK
PRINCIPAL REGISTER**

Breakthrough Energetics

DRAPER-O'CROTTY, HEATHER D. (WASHINGTON SOLE PROPRIETORSHIP)
732 1/2 S. 231ST ST.
DES MOINES, WA 98198

FOR: HEALTH SPA SERVICES FOR HEALTH AND WELLNESS OF THE BODY AND SPIRIT OFFERED AT A HEALTH RESORT; HYPNOTHERAPY SERVICES; MASSAGE; MASSAGE AND THERAPEUTIC SHIATSU MASSAGE; PROVIDING WELLNESS SERVICES, NAMELY, PERSONAL ASSESSMENTS, PERSONALIZED ROUTINES, MAINTENANCE SCHEDULES, AND COUNSELING; PSYCHOLOGICAL COUNSELING, IN CLASS 44 (U.S. CLS. 100 AND 101).

FIRST USE 4-1-2007; IN COMMERCE 4-1-2007.

THE MARK CONSISTS OF STANDARD CHARACTERS WITHOUT CLAIM TO ANY PARTICULAR FONT, STYLE, SIZE, OR COLOR.

NO CLAIM IS MADE TO THE EXCLUSIVE RIGHT TO USE "ENERGETICS", APART FROM THE MARK AS SHOWN.

SER. NO. 77-196,329, FILED 6-3-2007.

BRIAN PINO, EXAMINING ATTORNEY

Int. Cl.: 43

Prior U.S. Cls.: 100 and 101

United States Patent and Trademark Office

Reg. No. 3,397,586

Registered Mar. 18, 2008

**SERVICE MARK
PRINCIPAL REGISTER**



CHLN, INC. (DELAWARE CORPORATION)
1510 WEST LOOP SOUTH
HOUSTON, TX 77027

FOR: RESTAURANT AND BAR SERVICES, IN
CLASS 43 (U.S. CLS. 100 AND 101).

FIRST USE 2-1-2004; IN COMMERCE 2-1-2004.

OWNER OF U.S. REG. NOS. 1,061,033 AND
2,086,009.

NO CLAIM IS MADE TO THE EXCLUSIVE
RIGHT TO USE "RESTAURANT", APART FROM
THE MARK AS SHOWN.

THE MARK CONSISTS OF CHART HOUSE RES-
TAURANT AND DESIGN (BOX WITH FISH DE-
SIGN).

SER. NO. 77-196,635, FILED 6-4-2007.

WILLIAM VERHOSEK, EXAMINING ATTORNEY

Int. Cls.: 28, 35 and 38

Prior U.S. Cls.: 22, 23, 38, 50, 100, 101, 102 and 104

United States Patent and Trademark Office

Reg. No. 3,397,587

Registered Mar. 18, 2008

**TRADEMARK
SERVICE MARK
PRINCIPAL REGISTER**

WOOT!

WOOT, INC. (TEXAS CORPORATION)
4121 INTERNATIONAL PARKWAY
CARROLLTON, TX 75007

FOR: PLUSH TOYS, IN CLASS 28 (U.S. CLS. 22, 23,
38 AND 50).

FIRST USE 12-8-2006; IN COMMERCE 12-8-2006.

FOR: ON-LINE RETAIL STORE SERVICES IN
THE FIELD OF CONSUMER ELECTRONICS,
HOUSE WARES, HOME FURNISHINGS, HOME
APPLIANCES, WINE, T-SHIRTS, PLUSH TOYS,
COMPUTERS AND COMPUTER ACCESSORIES, IN
CLASS 35 (U.S. CLS. 100, 101 AND 102).

FIRST USE 7-13-2003; IN COMMERCE 7-13-2003.

FOR: COMPUTER SERVICES, NAMELY, PRO-
VIDING ON-LINE FORUMS FOR TRANSMISSION
OF MESSAGES AMONG COMPUTER USERS CON-
CERNING CONSUMER PRODUCTS, AND GENER-
AL INTEREST, IN CLASS 38 (U.S. CLS. 100, 101 AND
104).

FIRST USE 7-13-2003; IN COMMERCE 7-13-2003.

THE MARK CONSISTS OF STANDARD CHAR-
ACTERS WITHOUT CLAIM TO ANY PARTICULAR
FONT, STYLE, SIZE, OR COLOR.

OWNER OF U.S. REG. NO. 3,012,788.

SER. NO. 77-196,788, FILED 6-4-2007.

ANDREA K. NADELMAN, EXAMINING ATTOR-
NEY

Int. Cl.: 41

Prior U.S. Cls.: 100, 101 and 107

United States Patent and Trademark Office

Reg. No. 3,397,588

Registered Mar. 18, 2008

**SERVICE MARK
PRINCIPAL REGISTER**

Pocket Presentation Coach

D'ARCY, JAN T. (UNITED STATES INDIVIDUAL)
533 ALDER STREET A-6
EDMONDS, WA 980203440

FOR: EDUCATION SERVICES NAMELY, ONE-ON-ONE MENTORING IN THE FIELD OF PRESENTATION SKILLS; EDUCATIONAL SERVICES, NAMELY, CONDUCTING INFORMAL ON-LINE PROGRAMS IN THE FIELDS OF PRESENTATION SKILLS, AND PRINTABLE MATERIALS DISTRIBUTED THEREWITH; EDUCATIONAL SERVICES, NAMELY, CONDUCTING PROGRAMS IN THE FIELD OF PRESENTATION SKILLS AND DISTRIBUTION OF COURSE MATERIAL IN CONNECTION THEREWITH, IN CLASS 41 (U.S. CLS. 100, 101 AND 107).

FIRST USE 5-1-2007; IN COMMERCE 5-21-2007.

THE MARK CONSISTS OF STANDARD CHARACTERS WITHOUT CLAIM TO ANY PARTICULAR FONT, STYLE, SIZE, OR COLOR.

NO CLAIM IS MADE TO THE EXCLUSIVE RIGHT TO USE "PRESENTATION COACH", APART FROM THE MARK AS SHOWN.

SER. NO. 77-197,078, FILED 6-4-2007.

APRIL ROACH, EXAMINING ATTORNEY

Int. Cls.: 36, 37 and 42

Prior U.S. Cls.: 100, 101, 102, 103 and 106

United States Patent and Trademark Office

Reg. No. 3,397,589

Registered Mar. 18, 2008

**SERVICE MARK
PRINCIPAL REGISTER**

STOREVAULT

NETWORK APPLIANCE, INC. (DELAWARE CORPORATION)
495 EAST JAVA DRIVE
SUNNYVALE, CA 94089

FOR: PROVIDING WARRANTIES ON COMPUTER HARDWARE AND SOFTWARE FOR STORING, MANAGING, AND SECURING DATA AND FOR MANAGING AND MONITORING NETWORKS, ELECTRONIC DATA STORAGE SYSTEMS AND DATABASES OVER COMPUTER NETWORKS; PROVIDING WARRANTIES ON COMPUTER HARDWARE AND SOFTWARE FOR OPTIMIZING THE ACCESSIBILITY, DELIVERY, BACKUP, RESTORATION AND REPLICATION OF DATA, IN CLASS 36 (U.S. CLS. 100, 101 AND 102).

FIRST USE 6-26-2006; IN COMMERCE 6-26-2006.

FOR: INSTALLATION AND MAINTENANCE OF COMPUTER HARDWARE FOR STORING, MANAGING AND SECURING DATA AND FOR MANAGING AND MONITORING NETWORKS, ELECTRONIC DATA STORAGE SYSTEMS AND DATABASES OVER COMPUTER NETWORKS; INSTALLATION AND MAINTENANCE OF COMPUTER HARDWARE FOR OPTIMIZING THE ACCESSIBILITY, DELIVERY, BACKUP RESTORATION AND REPLICATION OF DATA, IN CLASS 37 (U.S. CLS. 100, 103 AND 106).

FIRST USE 6-26-2006; IN COMMERCE 6-26-2006.

FOR: TECHNICAL SUPPORT SERVICES, NAME-
LY, MONITORING AND TROUBLESHOOTING

FOR PROBLEMS WITH COMPUTER SOFTWARE AND HARDWARE, AND COMPUTER STORAGE NETWORKS, AND PROVIDING BACK-UP COMPUTER PROGRAMS AND FACILITIES; PROVIDING TEMPORARY USE OF ONLINE, NONDOWNLOADABLE SOFTWARE FOR STORAGE HARDWARE USERS TO MANAGE, TROUBLESHOOT, SECURE AND MONITOR NETWORK AND DATA STORAGE SYSTEMS; INSTALLATION AND MAINTENANCE OF COMPUTER SOFTWARE FOR STORING, MANAGING, AND SECURING DATA AND FOR MANAGING AND MONITORING NETWORKS, ELECTRONIC DATA STORAGE SYSTEMS AND DATABASES OVER COMPUTER NETWORKS; INSTALLATION AND MAINTENANCE OF COMPUTER SOFTWARE FOR OPTIMIZING THE ACCESSIBILITY, DELIVERY, BACKUP, RESTORATION AND REPLICATION OF DATA; PROVIDING AN ONLINE DATABASE OF INFORMATION RELATED TO TROUBLESHOOTING FOR PROBLEMS WITH COMPUTER SOFTWARE AND HARDWARE, AND COMPUTER STORAGE NETWORKS, IN CLASS 42 (U.S. CLS. 100 AND 101).

FIRST USE 6-26-2006; IN COMMERCE 6-26-2006.

THE MARK CONSISTS OF STANDARD CHARACTERS WITHOUT CLAIM TO ANY PARTICULAR FONT, STYLE, SIZE, OR COLOR.

SER. NO. 77-197,234, FILED 6-4-2007.

JUSTINE D. PARKER, EXAMINING ATTORNEY

Int. Cl.: 35

Prior U.S. Cls.: 100, 101 and 102

United States Patent and Trademark Office

Reg. No. 3,397,590

Registered Mar. 18, 2008

**SERVICE MARK
PRINCIPAL REGISTER**

HOUSE OF SILK FLOWERS

HOUSE OF SILK FLOWERS, INC. (NORTH CAROLINA CORPORATION)
103 OUTER BANKS DRIVE
HAVELOCK, NC 28532

FOR: WHOLESALE STORE SERVICES FEATURING SILK FLOWERS, RETAIL STORE SERVICES FEATURING SILK FLOWERS; ONLINE RETAIL STORE SERVICES FEATURING SILK FLOWERS , IN CLASS 35 (U.S. CLS. 100, 101 AND 102).

FIRST USE 1-1-1994; IN COMMERCE 1-1-1994.

THE MARK CONSISTS OF STANDARD CHARACTERS WITHOUT CLAIM TO ANY PARTICULAR FONT, STYLE, SIZE, OR COLOR.

NO CLAIM IS MADE TO THE EXCLUSIVE RIGHT TO USE SILK FLOWERS, APART FROM THE MARK AS SHOWN.

SER. NO. 77-197,744, FILED 6-5-2007.

KEVIN CORWIN, EXAMINING ATTORNEY

Int. Cl.: 42

Prior U.S. Cls.: 100 and 101

United States Patent and Trademark Office

Reg. No. 3,397,591

Registered Mar. 18, 2008

SERVICE MARK
PRINCIPAL REGISTER



LERNER, JAIME K. DBA THE GEEK GODDESS
(ILLINOIS SOLE PROPRIETORSHIP)
288 VALLEY FORGE AVENUE
SOUTH ELGIN, IL 60177

FOR: WEBSITE DEVELOPMENT FOR OTHERS,
IN CLASS 42 (U.S. CLS. 100 AND 101).

FIRST USE 1-30-2007; IN COMMERCE 5-11-2007.

THE COLOR(S) PINK, BLACK, GRAY AND
WHITE IS/ARE CLAIMED AS A FEATURE OF
THE MARK.

THE COLOR PINK APPEARS IN THE WORDING
"GEEK GODDESS." THE COLOR BLACK APPEARS
IN THE WORDING "THE" AND AS THE OUTLINE
AND IN THE DESIGN OF A COMPUTER MOUSE
AND CORD. THE COLOR GRAY APPEARS THE
DESIGN OF THE UPPER LEFT BUTTON OF THE
COMPUTER MOUSE. THE COLOR WHITE AP-
PEARS IN THE DESIGN OF THE COMPUTER
MOUSE.

SER. NO. 77-197,903, FILED 6-5-2007.

AMY MCMENAMIN, EXAMINING ATTORNEY

Int. Cl.: 35

Prior U.S. Cls.: 100, 101 and 102

United States Patent and Trademark Office

Reg. No. 3,397,592

Registered Mar. 18, 2008

**SERVICE MARK
PRINCIPAL REGISTER**



NATIONAL FEDERATION OF PARALEGAL ASSOCIATIONS, INC. (DELAWARE CORPORATION)

SUITE 2C, P.O. BOX 2016
23607 HIGHWAY 99
EDMONDS, WA 98020

FOR: ASSOCIATION SERVICES, NAMELY, PROMOTING THE INTERESTS OF PARALEGALS; PROVIDING ON-LINE SEARCHABLE DATABASE FEATURING CLASSIFIED AD LISTINGS AND EMPLOYMENT OPPORTUNITIES; ON-LINE REGISTRATION SERVICES FOR INSTRUCTIONAL CLASSES; ADVERTISING SERVICES, NAMELY, PROMOTING AND MARKETING THE GOODS AND SERVICES OF OTHERS THROUGH ALL PUBLIC COMMUNICATION MEANS, IN CLASS 35 (U.S. CLS. 100, 101 AND 102).

FIRST USE 5-0-2007; IN COMMERCE 5-0-2007.

NO CLAIM IS MADE TO THE EXCLUSIVE RIGHT TO USE "PARALEGAL ASSOCIATION, INC.", APART FROM THE MARK AS SHOWN.

THE MARK CONSISTS OF STARS SURROUNDING THREE PROFILES .

SEC. 2(F).

SER. NO. 77-198,215, FILED 6-5-2007.

DOMINIC J. FERRAIUOLO, EXAMINING ATTORNEY

Int. Cl.: 9

Prior U.S. Cls.: 21, 23, 26, 36 and 38

United States Patent and Trademark Office

Reg. No. 3,397,593

Registered Mar. 18, 2008

TRADEMARK
PRINCIPAL REGISTER



LEIGHTON, JOHN T (UNITED STATES INDIVIDUAL)
1 GAMACHE RD
DERRY, NH 03038

FOR: ELECTRIC FLAT IRONS; ELECTRIC HAIR CRIMPER; ELECTRIC HAIR CURLERS; ELECTRIC HAIR CURLING IRONS; ELECTRIC HAIR STRAIGHTENER; ELECTRIC HAIR STRAIGHTENING IRONS; ELECTRIC HAIR-CURLERS; ELECTRIC HAND-HELD HAIR STYLING IRONS; ELECTRIC IRONS FOR STYLING HAIR, IN CLASS 9 (U.S. CLS. 21, 23, 26, 36 AND 38).

FIRST USE 1-1-2005; IN COMMERCE 1-1-2006.

THE NAME SHOWN IN THE MARK DOES NOT IDENTIFY A PARTICULAR LIVING INDIVIDUAL.

THE MARK CONSISTS OF THE WORDS MELISSA KAYE WRITTEN IN MONOTYPE CORSIVA WITH ACCENTS OVER THE LETTER E ON BOTH WORDS.

SER. NO. 77-198,527, FILED 6-5-2007.

CHARLES L. JENKINS, EXAMINING ATTORNEY

Int. Cl.: 35

Prior U.S. Cls.: 100, 101 and 102

United States Patent and Trademark Office

Reg. No. 3,397,594

Registered Mar. 18, 2008

**SERVICE MARK
PRINCIPAL REGISTER**

ONE DAY, ONE DEAL

WOOT, INC. (TEXAS CORPORATION)
4121 INTERNATIONAL PARKWAY
CARROLLTON, TX 75007

FOR: ON-LINE RETAIL STORE SERVICES IN
THE FIELD OF CONSUMER ELECTRONICS,
HOUSE WARES, HOME FURNISHINGS, HOME
APPLIANCES, WINE, T-SHIRTS, PLUSH TOYS,
COMPUTERS, AND COMPUTER ACCESSORIES,
IN CLASS 35 (U.S. CLS. 100, 101 AND 102).

FIRST USE 10-11-2004; IN COMMERCE 10-11-2004.

THE MARK CONSISTS OF STANDARD CHAR-
ACTERS WITHOUT CLAIM TO ANY PARTICULAR
FONT, STYLE, SIZE, OR COLOR.

SER. NO. 77-198,751, FILED 6-6-2007.

ANDREA K. NADELMAN, EXAMINING ATTOR-
NEY

Int. Cl.: 35

Prior U.S. Cls.: 100, 101 and 102

United States Patent and Trademark Office

Reg. No. 3,397,595

Registered Mar. 18, 2008

**SERVICE MARK
PRINCIPAL REGISTER**

BERIOZKA

BERIOZKASHOP.COM, INC. (NEW YORK CORPORATION)
4TH FLOOR
304 HUDSON STREET
NEW YORK, NY 10013

FOR: ONLINE INTERACTIVE RETAIL STORE SERVICES PROVIDED VIA COMPUTER, TELEVISION AND THE INTERNET, FEATURING GENERAL MERCHANDISE; PROVIDING HOME SHOPPING SERVICES IN THE FIELD OF GENERAL MERCHANDISE BY MEANS OF INTERNET, TELEPHONE, AND PORTABLE HANDHELD DIGITAL AND ELECTRONIC DEVICES, IN CLASS 35 (U.S. CLS. 100, 101 AND 102).

FIRST USE 5-14-2007; IN COMMERCE 5-14-2007.

THE MARK CONSISTS OF STANDARD CHARACTERS WITHOUT CLAIM TO ANY PARTICULAR FONT, STYLE, SIZE, OR COLOR.

THE ENGLISH TRANSLATION OF THE WORD BERIOZKA IN THE MARK IS BIRCH TREE.

SER. NO. 77-198,765, FILED 6-6-2007.

SUSAN LESLIE DUBOIS, EXAMINING ATTORNEY

Int. Cl.: 37

Prior U.S. Cls.: 100, 103 and 106

United States Patent and Trademark Office

Reg. No. 3,397,596

Registered Mar. 18, 2008

**SERVICE MARK
PRINCIPAL REGISTER**



GAHANNA-CREEKSIDE INVESTMENTS LLC
(OHIO LTD LIAB CO)
ATTN: LEGAL DEPARTMENT
147 NORTH HIGH STREET
GAHANNA, OH 43230

FOR: CONSTRUCTION SERVICES, NAMELY,
PLANNING, LAYING OUT AND CUSTOM CON-
STRUCTION OF RESIDENTIAL AND COMMER-
CIAL COMMUNITIES, IN CLASS 37 (U.S. CLS. 100,
103 AND 106).

FIRST USE 6-1-2005; IN COMMERCE 6-1-2005.

THE COLOR(S) BLUE, DARK GREEN, AQUA-
MARINE, AND WHITE IS/ARE CLAIMED AS A
FEATURE OF THE MARK.

THE MARK CONSISTS OF A WHITE-BORDERED
BLUE RIVER FLOWING IN A STYLIZED S-CURVE
FROM THE LOWER LEFT FOREGROUND TO THE
UPPER RIGHT BACKGROUND, THOROUGH
FIELDS OF AQUAMARINE IN THE UPPER BACK-
GROUND, ALL OVERLAYING A THICK SQUARE
BORDER OF DARK GREEN.

SER. NO. 77-198,789, FILED 6-6-2007.

DAWN FELDMAN, EXAMINING ATTORNEY

Int. Cl.: 30

Prior U.S. Cl.: 46

United States Patent and Trademark Office

Reg. No. 3,397,597

Registered Mar. 18, 2008

**TRADEMARK
PRINCIPAL REGISTER**



MALT-O-MEAL COMPANY (MINNESOTA CORPORATION)
2700 IDS CENTER, 80 SOUTH EIGHTH STREET
MINNEAPOLIS, MN 55402

THE MARK CONSISTS OF A KANGAROO WITH GLASSES ON AND A BABY KANGAROO IN ITS POUCH.

FOR: BREAKFAST CEREAL, IN CLASS 30 (U.S. CL. 46).

SER. NO. 77-199,177, FILED 6-6-2007.

FIRST USE 9-0-2003; IN COMMERCE 9-0-2006.

OWNER OF U.S. REG. NO. 2,436,990.

COLLEEN KEARNEY, EXAMINING ATTORNEY

Int. Cl.: 41

Prior U.S. Cls.: 100, 101 and 107

United States Patent and Trademark Office

Reg. No. 3,397,598

Registered Mar. 18, 2008

SERVICE MARK
PRINCIPAL REGISTER



ROGER L. ZAPATA (UNITED STATES INDIVIDUAL)
17506 GLADESWORTH LANE
FAIR OAKS RANCH, CA 91387

FOR: EDUCATIONAL SERVICES, NAMELY, PROVIDING TRAINING FOR PET OWNERS IN THE FIELDS OF PROPER PET FOOD, PET SUPPLIES, PET ACCESSORIES, PET CARE, PET GROOMING, PET BOARDING, PET ADOPTION, AND PET OBEDIENCE; PET OBEDIENCE TRAINING SERVICES; PROVIDING INFORMATION IN THE FIELD OF PET OBEDIENCE TRAINING, IN CLASS 41 (U.S. CLS. 100, 101 AND 107).

FIRST USE 3-1-2007; IN COMMERCE 3-1-2007.

THE COLOR(S) RED, BLUE AND WHITE IS/ARE CLAIMED AS A FEATURE OF THE MARK.

THE MARK CONSISTS OF STYLIZED WORDS "PAW CORNER," OFF CENTERED, WITH THE SYMBOL OF A ANIMAL PAW REPLACING THE LETTER "A", "P" AND "W" IN RED, THE PAW SYMBOL, AND WORD "CORNER" IN BLUE, "PAW CORNER" UNDERScoreD BY A RIBBON LIKE LEASH DRAWING ENDING IN A REPRESENTATION OF A BONE, WITH THE LEASH IN RED WITH WHITE DOTS ON THE COLLAR PORTION AND A BONE IN BLUE OUTLINED IN WHITE; "A CORNER FOR ALL PAWS!" IN SMALLER FONT IN BLUE LETTERING ADORNED WITH TWO PAW SYMBOLS.

SER. NO. 77-199,273, FILED 6-6-2007.

PETER B. BROMAGHIM, EXAMINING ATTORNEY

Int. Cl.: 41

Prior U.S. Cls.: 100, 101 and 107

United States Patent and Trademark Office

Reg. No. 3,397,599

Registered Mar. 18, 2008

**SERVICE MARK
PRINCIPAL REGISTER**

ATMOSPHERE

CUTLIP, CHERYL HEBERT (UNITED STATES
INDIVIDUAL)
393 WEST 49TH STREET #2JJ
NEW YORK, NY 20029

THE MARK CONSISTS OF STANDARD CHAR-
ACTERS WITHOUT CLAIM TO ANY PARTICULAR
FONT, STYLE, SIZE, OR COLOR.

FOR: ENTERTAINMENT IN THE NATURE OF
DANCE PERFORMANCES, IN CLASS 41 (U.S. CLS.
100, 101 AND 107).

SER. NO. 77-200,082, FILED 6-7-2007.

FIRST USE 1-1-2007; IN COMMERCE 1-1-2007.

ANGELA M. MICHELI, EXAMINING ATTORNEY

Int. Cl.: 43

Prior U.S. Cls.: 100 and 101

United States Patent and Trademark Office

Reg. No. 3,397,600

Registered Mar. 18, 2008

**SERVICE MARK
PRINCIPAL REGISTER**

BASE2STAY

BASE2STAY LIMITED (UNITED KINGDOM
CORPORATION)
1 RED PLACE
LONDON, UNITED KINGDOM W1K6PL

FOR: HOTEL AND TEMPORARY ACCOMMO-
DATION SERVICES; RESERVATION AND BOOK-
ING AND RENTAL SERVICES RELATING TO
HOTELS AND TEMPORARY ACCOMMODATION;
RESTAURANT, CATERING AND BAR SERVICES;
INFORMATION, ADVISORY AND CONSULTANCY
SERVICES RELATING TO THE AFORESAID, IN
CLASS 43 (U.S. CLS. 100 AND 101).

FIRST USE 12-14-2005; IN COMMERCE 12-14-2005.

THE MARK CONSISTS OF STANDARD CHAR-
ACTERS WITHOUT CLAIM TO ANY PARTICULAR
FONT, STYLE, SIZE, OR COLOR.

SER. NO. 77-200,384, FILED 6-7-2007.

MARTHA FROMM, EXAMINING ATTORNEY

Int. Cl.: 35

Prior U.S. Cls.: 100, 101 and 102

United States Patent and Trademark Office

Reg. No. 3,397,601

Registered Mar. 18, 2008

**SERVICE MARK
PRINCIPAL REGISTER**

BIRTHDAY CONNECTIONS

CORSICA ENTERPRISES, LTD. (PENNSYLVANIA CORPORATION)
812 WEST CHESTNUT STREET
PERKASIE, PA 18944

FOR: PROMOTING THE GOODS AND SERVICES OF OTHERS THROUGH A DIRECT MAIL PROGRAM TO POTENTIAL CUSTOMERS IN SUBSCRIBER TRADE AREAS, IN CLASS 35 (U.S. CLS. 100, 101 AND 102).

FIRST USE 5-15-2007; IN COMMERCE 6-1-2007.

THE MARK CONSISTS OF STANDARD CHARACTERS WITHOUT CLAIM TO ANY PARTICULAR FONT, STYLE, SIZE, OR COLOR.

NO CLAIM IS MADE TO THE EXCLUSIVE RIGHT TO USE "BIRTHDAY", APART FROM THE MARK AS SHOWN.

SER. NO. 77-200,389, FILED 6-7-2007.

ERNEST SHOSHO, EXAMINING ATTORNEY

Int. Cl.: 35

Prior U.S. Cls.: 100, 101 and 102

United States Patent and Trademark Office

Reg. No. 3,397,602

Registered Mar. 18, 2008

**SERVICE MARK
PRINCIPAL REGISTER**



CORSICA ENTERPRISES, LTD. (PENNSYLVANIA CORPORATION)
812 WEST CHESTNUT STREET
PERKASIE, PA 18944

FOR: PROMOTING THE GOODS AND SERVICES OF OTHERS THROUGH A DIRECT MAIL PROGRAM TO POTENTIAL CUSTOMERS IN SUBSCRIBER TRADE AREAS, IN CLASS 35 (U.S. CLS. 100, 101 AND 102).

FIRST USE 5-15-2007; IN COMMERCE 6-1-2007.

NO CLAIM IS MADE TO THE EXCLUSIVE RIGHT TO USE "BIRTHDAY", APART FROM THE MARK AS SHOWN.

THE COLOR(S) RED, PURPLE AND WHITE IS/ARE CLAIMED AS A FEATURE OF THE MARK.

THE MARK CONSISTS OF THE WORDS BIRTHDAY AND CONNECTIONS IN RED SEPARATED BY PURPLE WAVY LINES; OVER THE WORD BIRTHDAY ARE THREE PURPLE CANDLES WITH RED FLAMES; THE MARK IS ON A WHITE BACKGROUND SURROUNDED BY A PURPLE BORDER.

SER. NO. 77-200,410, FILED 6-7-2007.

ERNEST SHOSHO, EXAMINING ATTORNEY

Int. Cls.: 37 and 45

Prior U.S. Cls.: 100, 101, 103 and 106

United States Patent and Trademark Office

Reg. No. 3,397,603

Registered Mar. 18, 2008

**SERVICE MARK
PRINCIPAL REGISTER**



M. A. MORTENSON COMPANY (MINNESOTA CORPORATION)
700 MEADOW LANE NORTH
MINNEAPOLIS, MN 55422

FOR: REAL ESTATE DEVELOPMENT; CONSTRUCTION SERVICES; NAMELY, EQUIPMENT INSTALLATION AND MAINTENANCE, PLANNING, LAYING OUT, MANAGEMENT SUPERVISION AND CONSTRUCTION OF COMMERCIAL AND INDUSTRIAL FACILITIES, IN CLASS 37 (U.S. CLS. 100, 103 AND 106).

FIRST USE 5-14-2007; IN COMMERCE 5-14-2007.

FOR: SERVICES TO ENSURE COMPLIANCE WITH ZONING LAWS AND REGULATIONS, IN CLASS 45 (U.S. CLS. 100 AND 101).

FIRST USE 5-14-2007; IN COMMERCE 5-14-2007.

OWNER OF U.S. REG. NO. 1,864,948.

SER. NO. 77-200,428, FILED 6-7-2007.

RICHARD WHITE, EXAMINING ATTORNEY

Int. Cl.: 5

Prior U.S. Cls.: 6, 18, 44, 46, 51 and 52

United States Patent and Trademark Office

Reg. No. 3,397,604

Registered Mar. 18, 2008

**TRADEMARK
PRINCIPAL REGISTER**

CUTTER

UNITED INDUSTRIES CORPORATION (DELA-
WARE CORPORATION)
13260 CORPORATE EXCHANGE
ST. LOUIS, MO 63044

FOR: INSECTICIDES; TOPICAL FLEA AND TICK
PREVENTATIVE PREPARATIONS FOR DOGS, IN
CLASS 5 (U.S. CLS. 6, 18, 44, 46, 51 AND 52).

FIRST USE 9-7-1995; IN COMMERCE 9-7-1995.

THE MARK CONSISTS OF STANDARD CHAR-
ACTERS WITHOUT CLAIM TO ANY PARTICULAR
FONT, STYLE, SIZE, OR COLOR.

OWNER OF U.S. REG. NO. 1,341,985.

SER. NO. 77-200,458, FILED 6-7-2007.

KATHLEEN LORENZO, EXAMINING ATTORNEY

Int. Cl.: 43

Prior U.S. Cls.: 100 and 101

United States Patent and Trademark Office

Reg. No. 3,397,605

Registered Mar. 18, 2008

SERVICE MARK
PRINCIPAL REGISTER

Rosa Mexicano

ROSA MEXICANO BRANDS, INC. (NEW YORK CORPORATION)
4TH FLOOR
346 SEVENTH AVENUE
NEW YORK, NY 10019

FOR: RESTAURANT AND BAR SERVICES, IN CLASS 43 (U.S. CLS. 100 AND 101).

FIRST USE 0-0-1984; IN COMMERCE 0-0-1984.

NO CLAIM IS MADE TO THE EXCLUSIVE RIGHT TO USE "MEXICANO", APART FROM THE MARK AS SHOWN.

THE FOREIGN WORDING IN THE MARK TRANSLATES INTO ENGLISH AS "MEXICAN PINK."

SER. NO. 77-200,591, FILED 6-7-2007.

LINDA LAVACHE, EXAMINING ATTORNEY

Int. Cl.: 42

Prior U.S. Cls.: 100 and 101

United States Patent and Trademark Office

Reg. No. 3,397,606

Registered Mar. 18, 2008

**SERVICE MARK
PRINCIPAL REGISTER**

Apropeaux Design

CYNTHIA ERB (UNITED STATES INDIVIDUAL)
17 ST. ANDREWS PLACE, SUITE A
ALAMO, CA 94507

FOR: DESIGN OF SPECIALTY INTERIOR AND
EXTERIOR ENVIRONMENT SETTINGS, IN CLASS
42 (U.S. CLS. 100 AND 101).

FIRST USE 2-7-2007; IN COMMERCE 2-9-2007.

THE MARK CONSISTS OF STANDARD CHAR-
ACTERS WITHOUT CLAIM TO ANY PARTICULAR
FONT, STYLE, SIZE, OR COLOR.

NO CLAIM IS MADE TO THE EXCLUSIVE
RIGHT TO USE "DESIGN", APART FROM THE
MARK AS SHOWN.

SER. NO. 77-200,757, FILED 6-7-2007.

MATTHEW PAPPAS, EXAMINING ATTORNEY

Int. Cl.: 41

Prior U.S. Cls.: 100, 101 and 107

United States Patent and Trademark Office

Reg. No. 3,397,607

Registered Mar. 18, 2008

**SERVICE MARK
PRINCIPAL REGISTER**

Fifth Power Fitness

WARDEN, CHRISTOPHER STEPHEN (UNITED STATES INDIVIDUAL)
31 NAGLE AVENUE, 4L
NEW YORK, NY 10040

FOR: PERSONAL TRAINER SERVICES; PERSONAL TRAINING SERVICES, NAMELY, STRENGTH AND CONDITIONING TRAINING; PHYSICAL FITNESS CONDITIONING CLASSES; PHYSICAL FITNESS CONSULTATION; PHYSICAL FITNESS INSTRUCTION; PROVIDING FITNESS AND EXERCISE FACILITIES; PROVIDING INFORMATION IN THE FIELD OF EXERCISE TRAINING; PROVIDING ON-LINE TRAINING SEMINARS AND PHYSICAL FITNESS CONSULTATION IN THE FIELD OF PERSONAL STRENGTH AND CONDITIONING TRAIN-

ING AND COACHING, IN CLASS 41 (U.S. CLS. 100, 101 AND 107).

FIRST USE 4-13-2007; IN COMMERCE 4-13-2007.

THE MARK CONSISTS OF STANDARD CHARACTERS WITHOUT CLAIM TO ANY PARTICULAR FONT, STYLE, SIZE, OR COLOR.

NO CLAIM IS MADE TO THE EXCLUSIVE RIGHT TO USE "FITNESS", APART FROM THE MARK AS SHOWN.

SER. NO. 77-200,949, FILED 6-7-2007.

ZHALEH DELANEY, EXAMINING ATTORNEY

Int. Cl.: 25

Prior U.S. Cls.: 22 and 39

United States Patent and Trademark Office

Reg. No. 3,397,608

Registered Mar. 18, 2008

TRADEMARK
PRINCIPAL REGISTER



MICHAEL SEILER (UNITED STATES INDIVIDUAL)
642 MOULTON AVE, W2
LOS ANGELES, CA 90031

FOR: COATS OF DENIM; DENIM JACKETS; DENIMS; DOWN JACKETS; FUR COATS AND JACKETS; FUR JACKETS; HEAVY JACKETS; JACKET LINERS; JACKETS; SPORTS JACKETS; STUFF JACKETS; SUEDE JACKETS; T-SHIRTS; WIND RESISTANT JACKETS; WIND-JACKETS; LEATHER JACKETS; LONG JACKETS; MEN AND WOMEN JACKETS, COATS, TROUSERS, VESTS; RAIN JACKETS; SHORT-SLEEVED OR LONG-SLEEVED T-

SHIRTS; SKI JACKETS; SLEEVED OR SLEEVELESS JACKETS; WATERPROOF JACKETS AND PANTS, IN CLASS 25 (U.S. CLS. 22 AND 39).

FIRST USE 12-15-2006; IN COMMERCE 2-20-2007.

THE MARK CONSISTS OF TWO LINKED M LIGHTNING BOLTS WITH VERBIAGE UNDERNEATH.

SER. NO. 77-200,978, FILED 6-8-2007.

LA TONIA FISHER, EXAMINING ATTORNEY

Int. Cl.: 5

Prior U.S. Cls.: 6, 18, 44, 46, 51 and 52

United States Patent and Trademark Office

Reg. No. 3,397,609

Registered Mar. 18, 2008

**TRADEMARK
PRINCIPAL REGISTER**

Powders Plus

BETTY MITCHELL (CALIFORNIA SOLE PROPRIETORSHIP)

1500 W. EL CAMINO, STE. 544
SACRAMENTO, DC 95833

FOR: POWDERED NUTRITIONAL SUPPLEMENT DRINK MIX, IN CLASS 5 (U.S. CLS. 6, 18, 44, 46, 51 AND 52).

FIRST USE 11-1-2005; IN COMMERCE 11-1-2006.

THE MARK CONSISTS OF STANDARD CHARACTERS WITHOUT CLAIM TO ANY PARTICULAR FONT, STYLE, SIZE, OR COLOR.

NO CLAIM IS MADE TO THE EXCLUSIVE RIGHT TO USE "POWDER", APART FROM THE MARK AS SHOWN.

SER. NO. 77-201,070, FILED 6-8-2007.

DORITT L. CARROLL, EXAMINING ATTORNEY

Int. Cl.: 3

Prior U.S. Cls.: 1, 4, 6, 50, 51 and 52

United States Patent and Trademark Office

Reg. No. 3,397,610

Registered Mar. 18, 2008

**TRADEMARK
PRINCIPAL REGISTER**



SWISSCLINICAL S.A. (SWITZERLAND CORPORATION)
C/O FRANCOIS FRAGNIERE
RUE DU CHATEAU 1
1800 VEVEY, SWITZERLAND

PRIORITY CLAIMED UNDER SEC. 44(D) ON SWITZERLAND APPLICATION NO. 01910/2006, FILED 12-15-2006, REG. NO. 555802, DATED 2-22-2007, EXPIRES 12-15-2016.

FOR: COSMETICS, SOAPS, PERFUME, ESSENTIAL OILS; DEODORANTS FOR BODY USE; CREAMS, MILKS, LOTIONS, GELS, POWDER, SERUMS AND MASKS FOR COSMETIC USE FOR BODY AND FACE CARE; NON-MEDICATED SKIN CARE PREPARATIONS, NAMELY, PEELS; TOPICAL LOTIONS, CREAMS AND OILS FOR COSMETIC USE; COSMETIC PREPARATIONS FOR SLIMMING PURPOSES; BATH AND SHOWER FOAM, GELS AND CREAMS; SUN TANNING MILKS, GELS AND OILS; AFTER-SUN LOTIONS; MAKE-UP REMOVER, MAKE-UP REMOVING LOTIONS AND MILKS; DEPILATORIES; HAIR-CARE PRODUCTS, IN PARTICULAR, SHAMPOOS, CREAMS, MASKS, SERUMS, FOAMS; HAIR DYES; DENTIFRICES; ALL AFORESAID PRODUCTS OF SWISS ORIGIN, IN CLASS 3 (U.S. CLS. 1, 4, 6, 50, 51 AND 52).

THE COLOR(S) GRAY AND RED IS/ARE CLAIMED AS A FEATURE OF THE MARK.

"THE MARK CONSISTS OF THE COLOR GRAY APPEARING IN THE WORD SWISSCLINICAL AND IN THE LOWEST HORIZONTAL BAR ABOVE THE FIRST LETTER "C" AND THE COLOR RED APPEARING IN THE TWO UPPER BARS ABOVE THE FIRST LETTER "C."

SER. NO. 77-201,170, FILED 6-8-2007.

ESTHER BELENKER, EXAMINING ATTORNEY

Int. Cl.: 45

Prior U.S. Cls.: 100 and 101

United States Patent and Trademark Office

Reg. No. 3,397,611

Registered Mar. 18, 2008

**SERVICE MARK
PRINCIPAL REGISTER**

**Operating Experience.
Operating Efficiency.**

BEACON LAW ADVISORS, PLLC (WASHING-
TON LTD LIAB CO)
SUITE 614
801 2ND AVENUE
SEATTLE, WA 98104

FOR: LEGAL SERVICES, IN CLASS 45 (U.S. CLS.
100 AND 101).

FIRST USE 12-8-2003; IN COMMERCE 12-8-2003.

THE MARK CONSISTS OF STANDARD CHAR-
ACTERS WITHOUT CLAIM TO ANY PARTICULAR
FONT, STYLE, SIZE, OR COLOR.

NO CLAIM IS MADE TO THE EXCLUSIVE
RIGHT TO USE "EXPERIENCE" AND "EFFICIEN-
CY", APART FROM THE MARK AS SHOWN.

SER. NO. 77-201,390, FILED 6-8-2007.

SUSAN RICHARDS, EXAMINING ATTORNEY

Int. Cl.: 8

Prior U.S. Cls.: 23, 28 and 44

United States Patent and Trademark Office

Reg. No. 3,397,612

Registered Mar. 18, 2008

**TRADEMARK
PRINCIPAL REGISTER**

Spread the Love

KATE ASPEN, INC. (GEORGIA CORPORATION)
3012 ADRIATIC COURT
NORCROSS, GA 30071

THE MARK CONSISTS OF STANDARD CHAR-
ACTERS WITHOUT CLAIM TO ANY PARTICULAR
FONT, STYLE, SIZE, OR COLOR.

FOR: CUTLERY, NAMELY, A BUTTER KNIFE,
IN CLASS 8 (U.S. CLS. 23, 28 AND 44).

SER. NO. 77-201,575, FILED 6-8-2007.

FIRST USE 1-1-2005; IN COMMERCE 1-1-2005.

MARLENE BELL, EXAMINING ATTORNEY

Int. Cl.: 11

Prior U.S. Cls.: 13, 21, 23, 31 and 34

United States Patent and Trademark Office

Reg. No. 3,397,613

Registered Mar. 18, 2008

**TRADEMARK
PRINCIPAL REGISTER**

Hydronika

HYDRONIKA, INC (NEVADA CORPORATION)
1010 MOUNT VERNON ROAD
SHELBYVILLE, CA 40065

FOR: CHILLER, NAMELY, A DEVICE THAT PROVIDES TEMPERATURE CONTROLLED FLUIDS TO VARIOUS APPLICATIONS IN THE HEATING, VENTILION AND AIR CONDITIONING MARKETS; BOILER, NAMELY, A DEVICE THAT PROVIDES TEMPERATURE CONTROLLED FLUIDS TO VARIOUS APPLICATIONS IN THE HEATING, VENTILION AND AIR CONDITIONING MARKETS; CHILLER BOILER, NAMELY, A DEVICE THAT COMBINES THE FUNCTIONALITY OF A CHILLER AND A FURNACE BOILER THAT

PROVIDES BOTH HOT AND COLD TEMPERATURE CONTROLLED FLUIDS TO VARIOUS APPLICATIONS IN THE HEATING VENTILATION AND AIR CONDITIONING MARKETS, IN CLASS 11 (U.S. CLS. 13, 21, 23, 31 AND 34).

FIRST USE 1-1-2006; IN COMMERCE 1-1-2006.

THE MARK CONSISTS OF STANDARD CHARACTERS WITHOUT CLAIM TO ANY PARTICULAR FONT, STYLE, SIZE, OR COLOR.

SER. NO. 77-201,980, FILED 6-8-2007.

RONALD AIKENS, EXAMINING ATTORNEY

Int. Cl.: 18

Prior U.S. Cls.: 1, 2, 3, 22 and 41

United States Patent and Trademark Office

Reg. No. 3,397,614

Registered Mar. 18, 2008

**TRADEMARK
PRINCIPAL REGISTER**

G-bags

GRIFFIN, MARK A. (UNITED STATES INDIVIDUAL)
23 LEWISTON CIR
LANCASTER, PA 17601

THE MARK CONSISTS OF STANDARD CHARACTERS WITHOUT CLAIM TO ANY PARTICULAR FONT, STYLE, SIZE, OR COLOR.

FOR: ALL-PURPOSE CARRYING BAGS, IN CLASS 18 (U.S. CLS. 1, 2, 3, 22 AND 41).

SER. NO. 77-202,060, FILED 6-8-2007.

FIRST USE 5-1-2007; IN COMMERCE 5-1-2007.

FLORENTINA BLANDU, EXAMINING ATTORNEY

Int. Cl.: 9

Prior U.S. Cls.: 21, 23, 26, 36 and 38

United States Patent and Trademark Office

Reg. No. 3,397,615

Registered Mar. 18, 2008

**TRADEMARK
PRINCIPAL REGISTER**

Hineynu

SOLEL SOFTWARE CORPORATION (CALIFORNIA CORPORATION)
5519 CLAIREMONT MESA BLVD. #4419
SAN DIEGO, CA 92117

FOR: COMPUTER SOFTWARE FOR USE IN CUSTOMER RELATIONSHIP MANAGEMENT (CRM), IN CLASS 9 (U.S. CLS. 21, 23, 26, 36 AND 38).

FIRST USE 0-0-2004; IN COMMERCE 0-0-2004.

THE MARK CONSISTS OF STANDARD CHARACTERS WITHOUT CLAIM TO ANY PARTICULAR FONT, STYLE, SIZE, OR COLOR.

THE FOREIGN WORDING IN THE MARK TRANSLATES INTO ENGLISH AS HERE WE ARE.

SER. NO. 77-202,261, FILED 6-10-2007.

AHSEN KHAN, EXAMINING ATTORNEY

Int. Cl.: 35

Prior U.S. Cls.: 100, 101 and 102

United States Patent and Trademark Office

Reg. No. 3,397,616

Registered Mar. 18, 2008

**SERVICE MARK
PRINCIPAL REGISTER**

UniBox

UNIBOX EXPRESS SYSTEMS CORP. (FLORIDA
LTD LIAB CO)
2258 N.W. 82ND AVENUE
MIAMI, FL 33122

THE MARK CONSISTS OF STANDARD CHAR-
ACTERS WITHOUT CLAIM TO ANY PARTICULAR
FONT, STYLE, SIZE, OR COLOR.

FOR: TRANSPORTATION LOGISTICS SERVICES,
NAMELY, ARRANGING THE TRANSPORTATION
OF GOODS FOR OTHERS, IN CLASS 35 (U.S. CLS.
100, 101 AND 102).

SER. NO. 77-202,337, FILED 6-10-2007.

FIRST USE 7-15-2006; IN COMMERCE 7-15-2006.

CAROLYN GRAY, EXAMINING ATTORNEY

Int. Cl.: 29

Prior U.S. Cl.: 46

United States Patent and Trademark Office

Reg. No. 3,397,617

Registered Mar. 18, 2008

**TRADEMARK
PRINCIPAL REGISTER**

ELEGANZA

EDIBLE FOOD GROUP, LLC. (RHODE ISLAND
LTD LIAB CO)
15 JENNIFER CIRCLE
CRANSTON, RI 02921

FOR: VEGETABLE OILS; OLIVE OIL, IN CLASS 29
(U.S. CL. 46).

FIRST USE 7-1-2006; IN COMMERCE 7-1-2006.

THE MARK CONSISTS OF STANDARD CHAR-
ACTERS WITHOUT CLAIM TO ANY PARTICULAR
FONT, STYLE, SIZE, OR COLOR.

"THE FOREIGN WORDING IN THE MARK
TRANSLATES INTO ENGLISH AS ELEGANCE."

SER. NO. 77-202,449, FILED 6-11-2007.

SCOTT SISUN, EXAMINING ATTORNEY

Int. Cls.: 35 and 41

Prior U.S. Cls.: 100, 101, 102 and 107

United States Patent and Trademark Office

Reg. No. 3,397,618

Registered Mar. 18, 2008

**SERVICE MARK
PRINCIPAL REGISTER**



VITALPAINTBALL, LLC. (NORTH CAROLINA
LTD LIAB CO)
224 OLD DOC COURT
LEXINGTON, NC 27295

FOR: RETAIL STORE SERVICES AND ONLINE
RETAIL STORE SERVICES IN THE FIELD OF
PAINTBALL SUPPLIES FEATURING ITEMS SUCH
AS PAINTBALL GUNS, PAINTBALL RIFLES,
PAINTBALL GOGGLES, AND PAINTBALL APPA-
REL, IN CLASS 35 (U.S. CLS. 100, 101 AND 102).

FIRST USE 3-1-2007; IN COMMERCE 3-1-2007.

FOR: ENTERTAINMENT SERVICES, NAMELY,
ORGANIZING AND CONDUCTING PAINTBALL
SPORTING EVENTS, TOURNAMENTS AND EXHI-

BITIONS; CONSULTING SERVICES FOR OTHERS
IN THE FIELD OF ORGANIZING AND CONDUCT-
ING PAINTBALL SPORTING EVENTS, TOURNA-
MENTS AND EXHIBITIONS, IN CLASS 41 (U.S. CLS.
100, 101 AND 107).

FIRST USE 3-1-2007; IN COMMERCE 3-1-2007.

NO CLAIM IS MADE TO THE EXCLUSIVE
RIGHT TO USE "PAINTBALL", APART FROM
THE MARK AS SHOWN.

SER. NO. 77-202,481, FILED 6-11-2007.

KATHERINE CHANG, EXAMINING ATTORNEY

Int. Cl.: 25

Prior U.S. Cls.: 22 and 39

United States Patent and Trademark Office

Reg. No. 3,397,619

Registered Mar. 18, 2008

**TRADEMARK
PRINCIPAL REGISTER**

BRA TENDERS

BRA*TENDERS, INC. (NEW YORK CORPORATION)
SUITE 601
630 NINTH AVENUE
NEW YORK, NY 10036

FOR: WOMEN'S UNDERGARMENTS, IN CLASS
25 (U.S. CLS. 22 AND 39).

FIRST USE 12-0-2000; IN COMMERCE 10-1-2004.

THE MARK CONSISTS OF STANDARD CHARACTERS WITHOUT CLAIM TO ANY PARTICULAR FONT, STYLE, SIZE, OR COLOR.

NO CLAIM IS MADE TO THE EXCLUSIVE RIGHT TO USE BRA, APART FROM THE MARK AS SHOWN.

SER. NO. 77-202,532, FILED 6-11-2007.

KEVON CHISOLM, EXAMINING ATTORNEY

Int. Cl.: 41

Prior U.S. Cls.: 100, 101 and 107

United States Patent and Trademark Office

Reg. No. 3,397,620

Registered Mar. 18, 2008

**SERVICE MARK
PRINCIPAL REGISTER**

GENERAL • COUNSEL • INSTITUTE
PRESENTED BY BAKER DONELSON

BAKER, DONELSON, BEARMAN, CALDWELL &
BERKOWITZ, PC (TENNESSEE CORPORATION)
165 MADISON AVENUE, SUITE 2000
MEMPHIS, TN 38103

FOR: ARRANGING AND CONDUCTING EDUCATIONAL CONFERENCES IN THE FIELDS OF LEGAL AND BUSINESS ISSUES, IN CLASS 41 (U.S. CLS. 100, 101 AND 107).

FIRST USE 9-30-2004; IN COMMERCE 9-30-2004.

OWNER OF U.S. REG. NOS. 2,838,858 AND 3,020,609.

NO CLAIM IS MADE TO THE EXCLUSIVE RIGHT TO USE "GENERAL COUNSEL INSTITUTE" AND "PRESENTED BY", APART FROM THE MARK AS SHOWN.

THE MARK CONSISTS OF THE PHRASE "GENERAL COUNSEL INSTITUTE" IS SEPARATED BY DIAMOND SHAPES, THIS PHRASE IS ABOVE A RECTANGLE WITH THE PHRASE "PRESENT BY BAKER DONELSON" INSIDE OF IT.

SER. NO. 77-202,543, FILED 6-11-2007.

KEVON CHISOLM, EXAMINING ATTORNEY

Int. Cl.: 18

Prior U.S. Cls.: 1, 2, 3, 22 and 41

United States Patent and Trademark Office

Reg. No. 3,397,621

Registered Mar. 18, 2008

**TRADEMARK
PRINCIPAL REGISTER**

TRI ALL 3 SPORTS

TRI ALL 3 SPORTS (CALIFORNIA SOLE PROPRIETORSHIP)
SUITE O
931 CALLE NEGOCIO
SAN CLEMENTE, CA 92673

FOR: TRAVEL CARRYING CASES FOR SPORTS EQUIPMENT, THE SPORTS INDUSTRY AND THE MILITARY, IN CLASS 18 (U.S. CLS. 1, 2, 3, 22 AND 41).

FIRST USE 4-1-1988; IN COMMERCE 4-1-1988.

THE MARK CONSISTS OF STANDARD CHARACTERS WITHOUT CLAIM TO ANY PARTICULAR FONT, STYLE, SIZE, OR COLOR.

SER. NO. 77-202,642, FILED 6-11-2007.

KIMBERLY PERRY, EXAMINING ATTORNEY

Int. Cl.: 11

Prior U.S. Cls.: 13, 21, 23, 31 and 34

United States Patent and Trademark Office

Reg. No. 3,397,622

Registered Mar. 18, 2008

**TRADEMARK
PRINCIPAL REGISTER**

INTELLI-CHECK

KAZ, INCORPORATED (NEW YORK CORPORATION)
10 COLUMBUS CIRCLE
NEW YORK, NY 10019

FOR: FILTER CONDITION MONITORS SOLD AS AN INTEGRAL COMPONENT OF AIR CLEANERS FOR COMMERCIAL AND DOMESTIC USE, IN CLASS 11 (U.S. CLS. 13, 21, 23, 31 AND 34).

FIRST USE 9-28-1998; IN COMMERCE 9-28-1998.

THE MARK CONSISTS OF STANDARD CHARACTERS WITHOUT CLAIM TO ANY PARTICULAR FONT, STYLE, SIZE, OR COLOR.

SER. NO. 77-202,663, FILED 6-11-2007.

JANICE L. MCMORROW, EXAMINING ATTORNEY

Int. Cl.: 43

Prior U.S. Cls.: 100 and 101

United States Patent and Trademark Office

Reg. No. 3,397,623

Registered Mar. 18, 2008

**SERVICE MARK
PRINCIPAL REGISTER**



PIFA ENTERPRISES CORP. (CANADA CORPORATION)
212 OLD ABBEY ROAD
WATERLOO, ONTARIO, CANADA N2K3L5

FOR: RESTAURANT SERVICES, IN CLASS 43
(U.S. CLS. 100 AND 101).

OWNER OF CANADA REG. NO. TMA538517,
DATED 12-11-2000, EXPIRES 12-11-2015.

NO CLAIM IS MADE TO THE EXCLUSIVE
RIGHT TO USE "PITA" AND "A DIVISION OF",
APART FROM THE MARK AS SHOWN.

THE MARK CONSISTS OF THE WORDS PITA
FACTORY A DIVISION OF WRAPP IT UP AND A
MAPLE LEAF APPEARING IN A CIRCLE, SUR-
ROUNDING A DEPICTION OF A MUSTACHIOED
MAN IN A TOGA AND HELMET, HOLDING A PITA
SANDWICH, IN FRONT OF AN ANCIENT TEMPLE
OR MONUMENT.

SER. NO. 77-202,909, FILED 6-11-2007.

FLORENTINA BLANDU, EXAMINING ATTORNEY

Int. Cl.: 3

Prior U.S. Cls.: 1, 4, 6, 50, 51 and 52

Reg. No. 3,397,624

United States Patent and Trademark Office

Registered Mar. 18, 2008

**TRADEMARK
PRINCIPAL REGISTER**

1 2 3

HENKEL CAPITAL, S.A. DE C.V. (MEXICO CORPORATION)
CENTRO URBANO INTERLOMAS
BLVD. MAGNOCENTRO NO. 8 PISO 2
HUIXQUILUCAN, MEXICO C.P.52760

THE MARK CONSISTS OF STANDARD CHARACTERS WITHOUT CLAIM TO ANY PARTICULAR FONT, STYLE, SIZE, OR COLOR.

FOR: FABRIC SOFTENERS FOR LAUNDRY USE; LAUNDRY DETERGENT; LAUNDRY SOAP, IN CLASS 3 (U.S. CLS. 1, 4, 6, 50, 51 AND 52).

SER. NO. 77-203,925, FILED 6-12-2007.

FIRST USE 2-26-2003; IN COMMERCE 2-26-2003.

DORITT L. CARROLL, EXAMINING ATTORNEY

Int. Cls.: 25 and 28

Prior U.S. Cls.: 22, 23, 38, 39 and 50

United States Patent and Trademark Office

Reg. No. 3,397,625

Registered Mar. 18, 2008

**TRADEMARK
PRINCIPAL REGISTER**

DOGWOOD CANYON

BASS PRO TRADEMARKS, L.L.C. (MISSOURI
LTD LIAB CO)
2500 EAST KEARNEY
SPRINGFIELD, MO 65898

FOR: CLOTHING, NAMELY, FISHING VESTS
AND FISHING WADERS, IN CLASS 25 (U.S. CLS.
22 AND 39).

FIRST USE 0-0-1992; IN COMMERCE 0-0-1992.

FOR: FISHING REELS, FISHING RODS, AND
HAND-HELD FISHING NETS, IN CLASS 28 (U.S.
CLS. 22, 23, 38 AND 50).

FIRST USE 0-0-1992; IN COMMERCE 0-0-1992.

THE MARK CONSISTS OF STANDARD CHAR-
ACTERS WITHOUT CLAIM TO ANY PARTICULAR
FONT, STYLE, SIZE, OR COLOR.

SEC. 2(F).

SER. NO. 77-203,941, FILED 6-12-2007.

ROBERT C. CLARK JR., EXAMINING ATTORNEY

Int. Cl.: 41

Prior U.S. Cls.: 100, 101 and 107

United States Patent and Trademark Office

Reg. No. 3,397,626

Registered Mar. 18, 2008

**SERVICE MARK
PRINCIPAL REGISTER**

SLEEPLESS NIGHT

CITY OF MIAMI BEACH (FLORIDA MUNICIPAL CORPORATION)
1700 CONVENTION CENTER DRIVE
MIAMI BEACH, FL 33139

FOR: ORGANIZING COMMUNITY CULTURAL EVENTS, NAMELY, A FREE, CITY-WIDE CULTURAL FESTIVAL FEATURING INDOOR AND OUTDOOR FILMS, ART EXHIBITIONS, INSTALLATIONS IN THE NATURE OF ART PERFORMANCES, DANCE PERFORMANCES, MUSICAL PERFORMANCES, THEATER PERFORMANCES, COMEDY PERFORMANCES, FASHION SHOWS, POETIC PERFORMANCES, ACROBATIC PERFORMANCES, AND GUIDED ARCHITECTURAL TOURS, IN CLASS 41 (U.S. CLS. 100, 101 AND 107).

FIRST USE 12-13-2006; IN COMMERCE 4-25-2007.

THE MARK CONSISTS OF STANDARD CHARACTERS WITHOUT CLAIM TO ANY PARTICULAR FONT, STYLE, SIZE, OR COLOR.

NO CLAIM IS MADE TO THE EXCLUSIVE RIGHT TO USE "NIGHT", APART FROM THE MARK AS SHOWN.

SER. NO. 77-204,297, FILED 6-12-2007.

JAY BESCH, EXAMINING ATTORNEY

Int. Cl.: 42

Prior U.S. Cls.: 100 and 101

United States Patent and Trademark Office

Reg. No. 3,397,627

Registered Mar. 18, 2008

**SERVICE MARK
PRINCIPAL REGISTER**



AIR MOVEMENT AND CONTROL ASSOCIATION, INC. (MICHIGAN CORPORATION)
30 WEST UNIVERSITY DRIVE
ARLINGTON HEIGHTS, IL 60004

FOR: ASSOCIATION SERVICES, NAMELY, PROMOTING THE GENERAL INTERESTS OF THE AIR MOVEMENT AND AIR CONTROLLING EQUIPMENT INDUSTRY AND ENGINEERING SERVICES, NAMELY, DEVELOPING STANDARDS FOR THE PURPOSE OF CERTIFICATION, PROVIDING TECHNICAL AND INDUSTRY INFORMATION AND PERFORMING TESTING FOR MANUFACTURERS OF AIR MOVING EQUIPMENT AND AIR CONTROLLING EQUIPMENT, IN CLASS 42 (U.S. CLS. 100 AND 101).

FIRST USE 12-31-1994; IN COMMERCE 12-31-1994.

OWNER OF U.S. REG. NOS. 838,097, 1,464,065, AND 1,476,293.

NO CLAIM IS MADE TO THE EXCLUSIVE RIGHT TO USE "INTERNATIONAL", APART FROM THE MARK AS SHOWN.

THE COLOR(S) BLACK, WHITE, RED IS/ARE CLAIMED AS A FEATURE OF THE MARK.

THE MARK CONSISTS OF A RED RECTANGLE WITH THE WORDS "AMCA INTERNATIONAL" IN WHITE, WITH A WHITE AND RED STYLIZED GRAPHIC. THE RED RECTANGLE IS SUPERIMPOSED OVER BLACK LATITUDE AND LONGITUDE LINES OF A GLOBE.

SER. NO. 77-204,319, FILED 6-12-2007.

CHARLES L. JENKINS, EXAMINING ATTORNEY

Int. Cl.: 41

Prior U.S. Cls.: 100, 101 and 107

United States Patent and Trademark Office

Reg. No. 3,397,628

Registered Mar. 18, 2008

**SERVICE MARK
PRINCIPAL REGISTER**

Alisha The Active Shark

REGAN, JR., ROLAND J. (UNITED STATES INDIVIDUAL)
11 HATHAWAY ROAD, SUITE 1A
MARBLEHEAD, MA 01945 AND
MULLALY, ROBERT W. (UNITED STATES INDIVIDUAL)
40A CLOUTMAN LANE
MARBLEHEAD, MA 01945

FOR: CHARITABLE SERVICES, NAMELY, PROVIDING TOYS TO NEEDY CHILDREN; CHILDREN'S ENTERTAINMENT AND AMUSEMENT CENTERS, NAMELY, INTERACTIVE PLAY AREAS; EDUCATION SERVICES, NAMELY, A PROGRAM TO PROMOTE THE USE OF PROPER PUNCTUATION TO SCHOOL AGE CHILDREN; ENTERTAINMENT SERVICES IN THE NATURE OF ON-GOING TELEVISION PROGRAMS IN THE FIELD OF CHILDREN'S ENTERTAINMENT; ENTERTAINMENT SERVICES, NAMELY, CONTEST AND INCENTIVE AWARD PROGRAMS DESIGNED TO REWARD

PROGRAM PARTICIPANTS WHO EXERCISE, MAKE HEALTHY EATING CHOICES, AND ENGAGING IN OTHER HEALTH-PROMOTING ACTIVITIES; HEALTH CLUB SERVICES, NAMELY, PROVIDING INSTRUCTION AND EQUIPMENT IN THE FIELD OF PHYSICAL EXERCISE; INFORMATION IN THE FIELD OF PARENTING CONCERNING EDUCATION OF CHILDREN, IN CLASS 41 (U.S. CLS. 100, 101 AND 107).

FIRST USE 6-1-2007; IN COMMERCE 6-1-2007.

THE MARK CONSISTS OF STANDARD CHARACTERS WITHOUT CLAIM TO ANY PARTICULAR FONT, STYLE, SIZE, OR COLOR.

SER. NO. 77-204,531, FILED 6-12-2007.

TINA L. SNAPP, EXAMINING ATTORNEY

Int. Cl.: 9

Prior U.S. Cls.: 21, 23, 26, 36 and 38

Reg. No. 3,397,629

United States Patent and Trademark Office

Registered Mar. 18, 2008

**TRADEMARK
PRINCIPAL REGISTER**

BLUEGRASS UNLIMITED

BLUEGRASS UNLIMITED, INC. (VIRGINIA CORPORATION)
9514 JAMES MADISON HWY.
WARRENTON, VA 20186

FOR: ELECTRONIC PUBLICATIONS, NAMELY, A MAGAZINE FEATURING MUSIC AND MUSICIANS RECORDED ON COMPUTER MEDIA, IN CLASS 9 (U.S. CLS. 21, 23, 26, 36 AND 38).

FIRST USE 9-16-1996; IN COMMERCE 9-16-1996.

THE MARK CONSISTS OF STANDARD CHARACTERS WITHOUT CLAIM TO ANY PARTICULAR FONT, STYLE, SIZE, OR COLOR.

SEC. 2(F).

SER. NO. 77-204,702, FILED 6-13-2007.

ADA HAN, EXAMINING ATTORNEY

Int. Cl.: 30

Prior U.S. Cl.: 46

United States Patent and Trademark Office

Reg. No. 3,397,630

Registered Mar. 18, 2008

**TRADEMARK
PRINCIPAL REGISTER**

VALDIVIA'S SALSA

VALDIVIA'S SALSA, LLC (NEBRASKA LTD
LIAB CO)
1003 W. 19TH STREET
NORTH PLATTE, NE 69101

FOR: SALSAS, ENCHILADAS, BURRITOS AND
TAMALES, IN CLASS 30 (U.S. CL. 46).

FIRST USE 6-10-1978; IN COMMERCE 6-10-1978.

THE MARK CONSISTS OF STANDARD CHAR-
ACTERS WITHOUT CLAIM TO ANY PARTICULAR
FONT, STYLE, SIZE, OR COLOR.

NO CLAIM IS MADE TO THE EXCLUSIVE
RIGHT TO USE SALSA, APART FROM THE MARK
AS SHOWN.

"THE NAME(S), PORTRAIT(S), AND/OR SIGNA-
TURE(S) SHOWN IN THE MARK IDENTIFIES
JAMES F. VALDIVIA, WHOSE CONSENT(S) TO
REGISTER IS SUBMITTED."

SEC. 2(F).

SER. NO. 77-205,453, FILED 6-13-2007.

BARNEY CHARLON, EXAMINING ATTORNEY

Int. Cl.: 21

Prior U.S. Cls.: 2, 13, 23, 29, 30, 33, 40 and 50

United States Patent and Trademark Office

Reg. No. 3,397,631

Registered Mar. 18, 2008

**TRADEMARK
PRINCIPAL REGISTER**

KroniK Chill

KRONIK LLC (MISSOURI LTD LIAB CO)
730 MULLANPHY
FLORISSANT, MO 63031

THE MARK CONSISTS OF STANDARD CHAR-
ACTERS WITHOUT CLAIM TO ANY PARTICULAR
FONT, STYLE, SIZE, OR COLOR.

FOR: PLASTIC CUPS, IN CLASS 21 (U.S. CLS. 2, 13,
23, 29, 30, 33, 40 AND 50).

SER. NO. 77-205,667, FILED 6-13-2007.

FIRST USE 1-18-2002; IN COMMERCE 9-19-2005.

KAREN SEVERSON, EXAMINING ATTORNEY

Int. Cl.: 37

Prior U.S. Cls.: 100, 103 and 106

United States Patent and Trademark Office

Reg. No. 3,397,632

Registered Mar. 18, 2008

**SERVICE MARK
PRINCIPAL REGISTER**



HOLLEY, JAMES M. (UNITED STATES INDIVIDUAL)
2203 KESSLER WOODS COURT
DALLAS, TX 75208

FOR: HOUSE BUILDING AND REPAIR, IN CLASS 37 (U.S. CLS. 100, 103 AND 106).

FIRST USE 1-1-2005; IN COMMERCE 1-1-2005.

THE COLOR(S) BLACK, WHITE AND LIME GREEN IS/ARE CLAIMED AS A FEATURE OF THE MARK.

THE MARK CONSISTS OF A WHITE BACKGROUND, WITH "KESSLER" IN LIME GREEN ON THE LEFT SIDE AND "WOODS" IN BLACK ON THE RIGHT.

SER. NO. 77-206,310, FILED 6-14-2007.

ALEXANDER L. POWERS, EXAMINING ATTORNEY

Int. Cl.: 35

Prior U.S. Cls.: 100, 101 and 102

United States Patent and Trademark Office

Reg. No. 3,397,633

Registered Mar. 18, 2008

**SERVICE MARK
PRINCIPAL REGISTER**

CREATION TECHNOLOGIES

CREATION TECHNOLOGIES (WASHINGTON CORPORATION)
3939 N. FRASER WAY
BURNABY, CANADA V5J5J1

FOR: BUSINESS CONSULTING AND BUSINESS INFORMATION FOR ENTERPRISES; BUSINESS CONSULTING SERVICES RELATING TO PRODUCT DISTRIBUTION, OPERATIONS MANAGEMENT SERVICES, LOGISTICS, REVERSE LOGISTICS, SUPPLY CHAIN, AND PRODUCTION SYSTEMS AND DISTRIBUTION SOLUTIONS; BUSINESS CONSULTING, MANAGEMENT, PLANNING AND SUPERVISION; BUSINESS PLANNING; CONSULTING SERVICES IN BUSINESS ORGANIZATION AND MANAGEMENT; CONSULTANCY SERVICES REGARDING BUSINESS STRATEGIES; COST/PRICE ANALYSIS; DISTRIBUTORSHIPS IN THE FIELD OF ELECTRONICS; EVALUATIONS RELATING TO COMMERCIAL MATTERS; INVENTORY CONTROL; INVENTORY MANAGEMENT IN THE FIELD OF INDUSTRIAL CONTROLS, MEDICINE, TELECOMMUNICATIONS, TRANSPORTATION AND ELECTRONICS; MANAGEMENT AND BUSINESS CONSULTING SERVICES IN THE FIELD OF INDUSTRIAL CONTROLS, MEDICINE, TELECOMMUNICATIONS, TRANSPORTATION AND ELECTRONICS; MANAGEMENT AND OPERATION ASSISTANCE TO COMMERCIAL BUSINESSES; MANUFACTURER REPRESENTATIVES IN THE FIELD OF INDUSTRIAL CONTROLS, MEDI-

CINE, TELECOMMUNICATIONS, TRANSPORTATION AND ELECTRONICS; ORGANIZATIONAL SERVICES FOR BUSINESS PURPOSES; BUSINESS MANAGEMENT SERVICES, NAMELY, MANAGING LOGISTICS, REVERSE LOGISTICS, SUPPLY CHAIN SERVICES, SUPPLY CHAIN VISIBILITY AND SYNCHRONIZATION, SUPPLY AND DEMAND FORECASTING AND PRODUCT DISTRIBUTION PROCESSES FOR OTHERS; TRANSPORTATION LOGISTICS SERVICES, NAMELY, ARRANGING THE TRANSPORTATION OF GOODS FOR OTHERS; TRANSPORTATION LOGISTICS SERVICES, NAMELY, PLANNING AND SCHEDULING SHIPMENTS FOR USERS OF TRANSPORTATION SERVICES, IN CLASS 35 (U.S. CLS. 100, 101 AND 102).

FIRST USE 6-1-2001; IN COMMERCE 6-1-2001.

THE MARK CONSISTS OF STANDARD CHARACTERS WITHOUT CLAIM TO ANY PARTICULAR FONT, STYLE, SIZE, OR COLOR.

NO CLAIM IS MADE TO THE EXCLUSIVE RIGHT TO USE TECHNOLOGIES, APART FROM THE MARK AS SHOWN.

SER. NO. 77-206,691, FILED 6-14-2007.

MONIQUE MILLER, EXAMINING ATTORNEY

Int. Cl.: 39

Prior U.S. Cls.: 100 and 105

United States Patent and Trademark Office

Reg. No. 3,397,634

Registered Mar. 18, 2008

**SERVICE MARK
PRINCIPAL REGISTER**

CREATION TECHNOLOGIES

CREATION TECHNOLOGIES (CANADA CORPORATION)
3939 N. FRASER WAY
BURNABY, CANADA V5J5J1

FOR: DISTRIBUTION SERVICES, NAMELY DELIVERY OF MANUFACTURED ELECTRONICS PRODUCTS; SUPPLY CHAIN, LOGISTICS AND REVERSE LOGISTICS SERVICES, NAMELY, STORAGE, TRANSPORTATION AND DELIVERY OF DOCUMENTS, PACKAGES, RAW MATERIALS, AND OTHER FREIGHT FOR OTHERS BY AIR, RAIL, SHIP OR TRUCK; WAREHOUSING SERVICES; WAREHOUSING SERVICES, NAMELY, STORAGE, DISTRIBUTION, PICK-UP, AND PACKING FOR SHIPMENT OF DOCUMENTS, PACKAGES,

RAW MATERIALS, AND OTHER FREIGHT FOR OTHERS, IN CLASS 39 (U.S. CLS. 100 AND 105).

FIRST USE 6-1-2001; IN COMMERCE 6-1-2001.

THE MARK CONSISTS OF STANDARD CHARACTERS WITHOUT CLAIM TO ANY PARTICULAR FONT, STYLE, SIZE, OR COLOR.

NO CLAIM IS MADE TO THE EXCLUSIVE RIGHT TO USE TECHNOLOGIES, APART FROM THE MARK AS SHOWN.

SER. NO. 77-206,759, FILED 6-14-2007.

MONIQUE MILLER, EXAMINING ATTORNEY

Int. Cl.: 40

Prior U.S. Cls.: 100, 103 and 106

United States Patent and Trademark Office

Reg. No. 3,397,635

Registered Mar. 18, 2008

**SERVICE MARK
PRINCIPAL REGISTER**

CREATION TECHNOLOGIES

CREATION TECHNOLOGIES (CANADA CORPORATION)
3939 N. FRASER WAY
BURNABY, CANADA V5J5J1

FOR: CONTRACT MANUFACTURING IN THE FIELD OF ELECTRONICS; MANUFACTURE OF GENERAL PRODUCT LINES IN THE FIELD OF ELECTRONICS TO THE ORDER AND SPECIFICATION OF OTHERS; MANUFACTURE OF ELECTRONICS TO ORDER AND/OR SPECIFICATION OF OTHERS; MANUFACTURING SERVICES FOR OTHERS IN THE FIELD OF ELECTRONICS, IN CLASS 40 (U.S. CLS. 100, 103 AND 106).

FIRST USE 6-1-2001; IN COMMERCE 6-1-2001.

THE MARK CONSISTS OF STANDARD CHARACTERS WITHOUT CLAIM TO ANY PARTICULAR FONT, STYLE, SIZE, OR COLOR.

NO CLAIM IS MADE TO THE EXCLUSIVE RIGHT TO USE TECHNOLOGIES, APART FROM THE MARK AS SHOWN.

SER. NO. 77-206,764, FILED 6-14-2007.

MONIQUE MILLER, EXAMINING ATTORNEY

Int. Cl.: 42

Prior U.S. Cls.: 100 and 101

United States Patent and Trademark Office

Reg. No. 3,397,636

Registered Mar. 18, 2008

**SERVICE MARK
PRINCIPAL REGISTER**

CREATION TECHNOLOGIES

CREATION TECHNOLOGIES (CANADA CORPORATION)
3939 N. FRASER WAY
BURNABY, CANADA V5J5J1

FOR: DESIGN AND TESTING FOR NEW PRODUCT DEVELOPMENT; DESIGN AND TESTING OF NEW PRODUCTS FOR OTHERS; DESIGN FOR OTHERS IN THE FIELD OF INDUSTRIAL CONTROLS, MEDICINE, TELECOMMUNICATIONS, TRANSPORTATION AND ELECTRONICS; DESIGN FOR OTHERS OF INTEGRATED CIRCUITS AND INTEGRATED CIRCUIT CORES FOR USE IN WIRELESS COMMUNICATIONS AND WIRELESS COMMUNICATION EQUIPMENT AND APPARATI AND DIGITAL SIGNAL PROCESSORS (DSP); DESIGNING OF MACHINES, APPARATUS, INSTRUMENTS OR SYSTEMS COMPOSED OF SUCH MACHINES, APPARATUS AND INSTRUMENTS; DEVELOPMENT OF TECHNOLOGIES FOR THE FABRICATION OF CIRCUITS FOR WIRELESS COMMUNICATION, ELECTRONIC DATA PROCESSING, CONSUMER ELECTRONIC, AUTOMOTIVE ELECTRONICS; MATERIALS TESTING AND ANA-

LYSING; PACKAGING DESIGN FOR OTHERS; PRODUCT DEVELOPMENT; TECHNICAL SUPPORT SERVICES, NAMELY, TROUBLESHOOTING OF COMPUTER HARDWARE AND SOFTWARE PROBLEMS; TECHNICAL SUPPORT SERVICES, NAMELY, TROUBLESHOOTING OF INDUSTRIAL PROCESS CONTROL COMPUTER SOFTWARE PROBLEMS, IN CLASS 42 (U.S. CLS. 100 AND 101).

FIRST USE 6-1-2001; IN COMMERCE 6-1-2001.

THE MARK CONSISTS OF STANDARD CHARACTERS WITHOUT CLAIM TO ANY PARTICULAR FONT, STYLE, SIZE, OR COLOR.

NO CLAIM IS MADE TO THE EXCLUSIVE RIGHT TO USE TECHNOLOGIES, APART FROM THE MARK AS SHOWN.

SER. NO. 77-206,769, FILED 6-14-2007.

MONIQUE MILLER, EXAMINING ATTORNEY

Int. Cl.: 41

Prior U.S. Cls.: 100, 101 and 107

United States Patent and Trademark Office

Reg. No. 3,397,637

Registered Mar. 18, 2008

**SERVICE MARK
PRINCIPAL REGISTER**



GORDON, DWAYNE (UNITED STATES INDIVIDUAL)
SUITE 7
401 PASSAIC STREET
HACKENSACK, NJ 07601

FOR: ENTERTAINMENT SERVICES NAMELY PROVIDING A WEBSITE FEATURING, PHOTOGRAPHIC, AUDIO, VIDEO AND PROSE PRESENTATIONS FEATURING ADULT CONTENT, IN CLASS 41 (U.S. CLS. 100, 101 AND 107).

FIRST USE 8-1-2006; IN COMMERCE 11-1-2006.

NO CLAIM IS MADE TO THE EXCLUSIVE RIGHT TO USE PRODUCTIONS, APART FROM THE MARK AS SHOWN.

SER. NO. 77-207,058, FILED 6-15-2007.

MARIA-VICTORIA SUAREZ, EXAMINING ATTORNEY

Int. Cl.: 40

Prior U.S. Cls.: 100, 103 and 106

United States Patent and Trademark Office

Reg. No. 3,397,638

Registered Mar. 18, 2008

**SERVICE MARK
PRINCIPAL REGISTER**

UNITED CALIFORNIA RETURNS

UNITED CALIFORNIA RETURNS (CALIFORNIA
PARTNERSHIP)

688 S. SANTA FE AVE., SUITE 207

LOS ANGELES, CA 90021

FOR: RECYCLING, IN CLASS 40 (U.S. CLS. 100,
103 AND 106).

FIRST USE 4-20-2007; IN COMMERCE 4-20-2007.

THE MARK CONSISTS OF STANDARD CHAR-
ACTERS WITHOUT CLAIM TO ANY PARTICULAR
FONT, STYLE, SIZE, OR COLOR.

NO CLAIM IS MADE TO THE EXCLUSIVE
RIGHT TO USE CALIFORNIA, APART FROM THE
MARK AS SHOWN.

SER. NO. 77-207,155, FILED 6-15-2007.

MARK T. MULLEN, EXAMINING ATTORNEY

Int. Cl.: 40

Prior U.S. Cls.: 100, 103 and 106

United States Patent and Trademark Office

Reg. No. 3,397,639

Registered Mar. 18, 2008

**SERVICE MARK
PRINCIPAL REGISTER**

THINK BLUE, LIVE GREEN

UNITED CALIFORNIA RETURNS (CALIFORNIA
PARTNERSHIP)
688 S. SANTA FE AVE., SUITE 207
LOS ANGELES, CA 90021

THE MARK CONSISTS OF STANDARD CHAR-
ACTERS WITHOUT CLAIM TO ANY PARTICULAR
FONT, STYLE, SIZE, OR COLOR.

FOR: RECYCLING, IN CLASS 40 (U.S. CLS. 100,
103 AND 106).

SER. NO. 77-207,161, FILED 6-15-2007.

FIRST USE 4-20-2007; IN COMMERCE 4-20-2007.

MARK T. MULLEN, EXAMINING ATTORNEY

Int. Cl.: 40

Prior U.S. Cls.: 100, 103 and 106

United States Patent and Trademark Office

Reg. No. 3,397,640

Registered Mar. 18, 2008

**SERVICE MARK
PRINCIPAL REGISTER**



UNITED CALIFORNIA RETURNS (CALIFORNIA
PARTNERSHIP)
688 S. SANTA FE AVE., SUITE 207
LOS ANGELES, CA 90021

FOR: RECYCLING, IN CLASS 40 (U.S. CLS. 100,
103 AND 106).

FIRST USE 4-20-2007; IN COMMERCE 4-20-2007.

NO CLAIM IS MADE TO THE EXCLUSIVE
RIGHT TO USE THE GEOGRAPHIC DESIGN OF

CALIFORNIA, APART FROM THE MARK AS
SHOWN.

THE MARK CONSISTS OF A TRIANGLE BRO-
KEN INTO THREE PARTS, TWO OF WHICH ARE
FOLDED ARROWS AND THE THIRD OF WHICH IS
A REPRESENTATION OF THE STATE OF CALI-
FORNIA.

SER. NO. 77-207,171, FILED 6-15-2007.

MARK T. MULLEN, EXAMINING ATTORNEY

Int. Cls.: 4, 35, 39 and 42

Prior U.S. Cls.: 1, 6, 15, 100, 101, 102 and 105

United States Patent and Trademark Office

Reg. No. 3,397,641

Registered Mar. 18, 2008

**TRADEMARK
SERVICE MARK
PRINCIPAL REGISTER**

MANSFIELD

MANSFIELD OIL COMPANY OF GAINESVILLE,
INC. (GEORGIA CORPORATION)
1025 AIRPORT PARKWAY
GAINESVILLE, GA 30501

FOR: FUEL FOR MOTOR VEHICLES, NAMELY,
GASOLINE AND DIESEL FUEL, IN CLASS 4 (U.S.
CLS. 1, 6 AND 15).

FIRST USE 1-1-1965; IN COMMERCE 1-1-1965.

FOR: LOGISTICS MANAGEMENT IN THE FIELD
OF FUEL; INVENTORY MANAGEMENT IN THE
FIELD OF FUEL; ADVERTISING SERVICES,
NAMELY, CREATING CORPORATE AND BRAND
IDENTITY FOR OTHERS, IN CLASS 35 (U.S. CLS.
100, 101 AND 102).

FIRST USE 1-1-1985; IN COMMERCE 1-1-1985.

FOR: TRANSPORTATION AND STORAGE OF
FUELS; DISTRIBUTION SERVICES, NAMELY DE-

LIVERY OF FUEL, IN CLASS 39 (U.S. CLS. 100 AND
105).

FIRST USE 1-1-1985; IN COMMERCE 1-1-1985.

FOR: CONSULTING SERVICES IN THE FIELD
OF ENVIRONMENTAL ASSESSMENT, COMPLI-
ANCE AND PLANNING, IN CLASS 42 (U.S. CLS.
100 AND 101).

FIRST USE 1-1-1985; IN COMMERCE 1-1-1985.

THE MARK CONSISTS OF STANDARD CHAR-
ACTERS WITHOUT CLAIM TO ANY PARTICULAR
FONT, STYLE, SIZE, OR COLOR.

SEC. 2(F).

SER. NO. 77-207,336, FILED 6-15-2007.

MICHELE SWAIN, EXAMINING ATTORNEY

Int. Cl.: 37

Prior U.S. Cls.: 100, 103 and 106

United States Patent and Trademark Office

Reg. No. 3,397,642

Registered Mar. 18, 2008

**SERVICE MARK
PRINCIPAL REGISTER**

MANSFIELD

MANSFIELD OIL COMPANY OF GAINESVILLE,
INC. (GEORGIA CORPORATION)
1025 AIRPORT PARKWAY SW
GAINESVILLE, GA 30501

THE MARK CONSISTS OF STANDARD CHAR-
ACTERS WITHOUT CLAIM TO ANY PARTICULAR
FONT, STYLE, SIZE, OR COLOR.

FOR: MANAGEMENT OF COMMERCIAL AND
RETAIL FUEL FACILITIES CONSTRUCTION PRO-
JECTS; SUPERVISION OF THE REPAIR AND MAIN-
TENANCE OF COMMERCIAL AND RETAIL FUEL
EQUIPMENT, IN CLASS 37 (U.S. CLS. 100, 103 AND
106).

SEC. 2(F).

SER. NO. 77-207,342, FILED 6-15-2007.

FIRST USE 1-1-1985; IN COMMERCE 1-1-1985.

MICHELE SWAIN, EXAMINING ATTORNEY

Int. Cl.: 41

Prior U.S. Cls.: 100, 101 and 107

United States Patent and Trademark Office

Reg. No. 3,397,643

Registered Mar. 18, 2008

**SERVICE MARK
PRINCIPAL REGISTER**

THE ART OF WORK, THE WORK
OF ART

GOLDMAN, SUSAN (UNITED STATES INDIVIDUAL)
1507 LINCOLN STREET
BERKELEY, CA 94703 AND
DANA, RICHARD (UNITED STATES INDIVIDUAL)
1507 LINCOLN STREET
BERKELEY, CA 94703 AND
SEGALL, LEWIS (UNITED STATES INDIVIDUAL)
1507 LINCOLN STREET
BERKELEY, CA 94703

FOR: ORGANIZING VISUAL ART EXHIBITIONS WHICH FEATURE PERSONAL PORTRAITS CREATED DURING A LONG TERM PROJECT WHICH PAIRED VISUAL ARTISTS WITH NON-ARTIST PROFESSIONALS IN ORDER TO EXPLORE EACH

OTHERS WORK LIFE, IN CLASS 41 (U.S. CLS. 100, 101 AND 107).

FIRST USE 1-1-1995; IN COMMERCE 1-1-1995.

THE MARK CONSISTS OF STANDARD CHARACTERS WITHOUT CLAIM TO ANY PARTICULAR FONT, STYLE, SIZE, OR COLOR.

OWNER OF U.S. REG. NO. 2,276,168.

SER. NO. 77-207,792, FILED 6-15-2007.

WENDY GOODMAN, EXAMINING ATTORNEY

Int. Cl.: 35

Prior U.S. Cls.: 100, 101 and 102

United States Patent and Trademark Office

Reg. No. 3,397,644

Registered Mar. 18, 2008

**SERVICE MARK
PRINCIPAL REGISTER**

Yalla

VELEZ, BEN (UNITED STATES INDIVIDUAL)
237 POWERS STREET #1
BROOKLYN, NY 11211

FIRST USE 1-1-2007; IN COMMERCE 1-1-2007.

FOR: ADVERTISING, MARKETING AND PROMOTION SERVICES; CREATIVE MARKETING DESIGN SERVICES; PROVIDING MARKETING AND PROMOTION OF SPECIAL EVENTS; MEDIA CONSULTING SERVICES, NAMELY, ADVISING THE CLIENT ON THE CORRECT TIMES AND AMOUNT OF TIME THE CLIENT SHOULD BE PURCHASING FOR ADVERTISING AND THE STATIONS TO ADVERTISE BASED ON MEDIA ANALYSIS OF THE MARKET FOR THAT MEDIA, IN CLASS 35 (U.S. CLS. 100, 101 AND 102).

THE MARK CONSISTS OF STANDARD CHARACTERS WITHOUT CLAIM TO ANY PARTICULAR FONT, STYLE, SIZE, OR COLOR.

THE ENGLISH TRANSLATION OF YALLA IS "HURRY UP" OR "COME ON."

SER. NO. 77-207,884, FILED 6-16-2007.

STEVEN PEREZ, EXAMINING ATTORNEY

Int. Cl.: 42

Prior U.S. Cls.: 100 and 101

United States Patent and Trademark Office

Reg. No. 3,397,645

Registered Mar. 18, 2008

**SERVICE MARK
PRINCIPAL REGISTER**



INTERACTIVE VIEWS INCORPORATED (VIRGINIA CORPORATION)

19909 AUGUSTA VILLAGE PL

ASHBURN, VA 20147

FOR: CONSULTATION SERVICES IN THE FIELDS OF SELECTION, IMPLEMENTATION AND USE OF COMPUTER HARDWARE AND SOFTWARE SYSTEMS FOR OTHERS; DESIGN, DEVELOPMENT AND IMPLEMENTATION OF SOFTWARE; DEVELOPMENT, UPDATING AND MAINTENANCE OF SOFTWARE AND DATA BASES, IN CLASS 42 (U.S. CLS. 100 AND 101).

FIRST USE 4-20-2006; IN COMMERCE 10-2-2006.

NO CLAIM IS MADE TO THE EXCLUSIVE RIGHT TO USE INTERACTIVE, APART FROM THE MARK AS SHOWN.

THE MARK CONSISTS OF A PERSON ON THE LEFT REACHES OUT WITH THE HAND THROUGH AN ELLIPSOID CURVE LINE TO THE SECOND LETTER "I" IN "INTERACTIVE". ALL DOTS IN THE THREE LETTERS "I" CONTAINED IN "INTERACTIVE VIEWS" ARE HIGHLIGHTED IN A DIFFERENT COLOR FROM THE REST OF THE LETTER BODY.

SER. NO. 77-208,438, FILED 6-18-2007.

CIMMERIAN COLEMAN, EXAMINING ATTORNEY

Int. Cl.: 35

Prior U.S. Cls.: 100, 101 and 102

United States Patent and Trademark Office

Reg. No. 3,397,646

Registered Mar. 18, 2008

**SERVICE MARK
PRINCIPAL REGISTER**



LONGHORN CABINETS (ARIZONA CORPORATION)
20118 E. LONGHORN LN.
CORDES LAKES, AZ 86333

FOR: WHOLESALE DISTRIBUTORSHIPS FEATURING CABINETS, CABINET ACCESSORIES, AND CABINET HARDWARE; RETAIL STORE SERVICES FEATURING CABINETS, CABINET ACCESSORIES, AND CABINET HARDWARE, IN CLASS 35 (U.S. CLS. 100, 101 AND 102).

FIRST USE 12-1-2006; IN COMMERCE 1-1-2007.

NO CLAIM IS MADE TO THE EXCLUSIVE RIGHT TO USE "CABINETS", APART FROM THE MARK AS SHOWN.

THE MARK CONSISTS OF A STYLIZED BULL-HEAD WITH HORNS TO THE LEFT OF THE WORDS LONGHORN CABINETS.

SER. NO. 77-208,448, FILED 6-18-2007.

KATHERINE M. DUBRAY, EXAMINING ATTORNEY

Int. Cl.: 45

Prior U.S. Cls.: 100 and 101

United States Patent and Trademark Office

Reg. No. 3,397,647

Registered Mar. 18, 2008

**SERVICE MARK
PRINCIPAL REGISTER**

I WANT U

MANA INTERNET SOLUTIONS (COSTA RICA
CORPORATION)
APDO 152-2120 CALLE BLANCOS
SAN JOSE, COSTA RICA

FOR: INTERNET BASED DATING SERVICES;
WEBSITE SITE SERVICES FEATURING ON-LINE
DATING CLUB, IN CLASS 45 (U.S. CLS. 100 AND
101).

FIRST USE 3-1-1997; IN COMMERCE 3-1-1997.

THE MARK CONSISTS OF STANDARD CHAR-
ACTERS WITHOUT CLAIM TO ANY PARTICULAR
FONT, STYLE, SIZE, OR COLOR.

OWNER OF U.S. REG. NO. 2,471,589.

SEC. 2(F).

SER. NO. 77-208,893, FILED 6-18-2007.

DAVID I, EXAMINING ATTORNEY

Int. Cls.: 38, 41 and 42

Prior U.S. Cls.: 100, 101, 104 and 107

United States Patent and Trademark Office

Reg. No. 3,397,648

Registered Mar. 18, 2008

**SERVICE MARK
PRINCIPAL REGISTER**

SCLAFANI WILLIAMS

WILLIAMS, FREIDA SCLAFANI (UNITED STATES INDIVIDUAL)
SUITE 390
402 S. KENTUCKY AVE
LAKELAND, FL 33809

FOR: PROVIDING FACILITIES AND EQUIPMENT FOR VIDEOCONFERENCING, IN CLASS 38 (U.S. CLS. 100, 101 AND 104).

FIRST USE 10-12-1982; IN COMMERCE 10-12-1982.

FOR: VIDEOTAPING LEGAL DEPOSITIONS, IN CLASS 41 (U.S. CLS. 100, 101 AND 107).

FIRST USE 10-12-1982; IN COMMERCE 10-12-1982.

FOR: COURT REPORTING, IN CLASS 42 (U.S. CLS. 100 AND 101).

FIRST USE 10-12-1982; IN COMMERCE 10-12-1982.

THE MARK CONSISTS OF STANDARD CHARACTERS WITHOUT CLAIM TO ANY PARTICULAR FONT, STYLE, SIZE, OR COLOR.

SER. NO. 77-209,227, FILED S.R. 6-19-2007 AM. P.R. 10-24-2007.

LEIGH CAROLINE CASE, EXAMINING ATTORNEY

Int. Cl.: 18

Prior U.S. Cls.: 1, 2, 3, 22 and 41

United States Patent and Trademark Office

Reg. No. 3,397,649

Registered Mar. 18, 2008

**TRADEMARK
PRINCIPAL REGISTER**

TOUR MASTER

HELMET HOUSE, INC. (CALIFORNIA CORPORATION)
26855 MALIBU HILLS ROAD
CALABASAS, CA 91301

FOR: MOTORISTS LUGGAGE, NAMELY MOTORCYCLE BAGS, SADDLE BAGS, TANK BAGS, TAIL BAGS; HELMET BAGS, BACKPACKS; TRAVEL BAGS, TOOL BAGS SOLD EMPTY, BARREL BAGS, SISSYBAR BAGS, IN CLASS 18 (U.S. CLS. 1, 2, 3, 22 AND 41).

FIRST USE 10-12-1979; IN COMMERCE 10-12-1979.

THE MARK CONSISTS OF STANDARD CHARACTERS WITHOUT CLAIM TO ANY PARTICULAR FONT, STYLE, SIZE, OR COLOR.

SER. NO. 77-209,411, FILED 6-19-2007.

FRANK LATTUCA, EXAMINING ATTORNEY

Int. Cl.: 19

Prior U.S. Cls.: 1, 12, 33 and 50

United States Patent and Trademark Office

Reg. No. 3,397,650

Registered Mar. 18, 2008

**TRADEMARK
PRINCIPAL REGISTER**

Panel Channels

EVERITT, THOMAS J. (UNITED STATES INDIVIDUAL)
4320 OAK STREET
LITTLE RIVER, SC 29566

FOR: PLASTIC EXTRUSIONS, NAMELY, STORM PANEL ATTACHMENTS FOR EXTERIOR USE ON BUILDINGS, IN CLASS 19 (U.S. CLS. 1, 12, 33 AND 50).

FIRST USE 6-1-2007; IN COMMERCE 6-1-2007.

THE MARK CONSISTS OF STANDARD CHARACTERS WITHOUT CLAIM TO ANY PARTICULAR FONT, STYLE, SIZE, OR COLOR.

NO CLAIM IS MADE TO THE EXCLUSIVE RIGHT TO USE PANEL, APART FROM THE MARK AS SHOWN.

SER. NO. 77-209,687, FILED 6-19-2007.

PETER B. BROMAGHIM, EXAMINING ATTORNEY

Int. Cl.: 39

Prior U.S. Cls.: 100 and 105

United States Patent and Trademark Office

Reg. No. 3,397,651

Registered Mar. 18, 2008

**SERVICE MARK
PRINCIPAL REGISTER**

MAIL FOR YOU INC

MAIL FOR YOU INC. (NEVADA CORPORATION)
8635 W SAHARA AVE
LAS VEGAS, NV 89117

FOR: MAIL BOX RENTAL; POSTAL SERVICES, NAMELY, PARCEL DELIVERY, PACKAGING ARTICLES FOR TRANSPORTATION, RENTAL OF MAIL BOXES; RENTAL OF MAIL BOXES, IN CLASS 39 (U.S. CLS. 100 AND 105).

FIRST USE 3-10-1986; IN COMMERCE 3-10-1986.

THE MARK CONSISTS OF STANDARD CHARACTERS WITHOUT CLAIM TO ANY PARTICULAR FONT, STYLE, SIZE, OR COLOR.

NO CLAIM IS MADE TO THE EXCLUSIVE RIGHT TO USE "INC", APART FROM THE MARK AS SHOWN.

SER. NO. 77-210,064, FILED 6-19-2007.

AISHA CLARKE, EXAMINING ATTORNEY

Int. Cl.: 45

Prior U.S. Cls.: 100 and 101

United States Patent and Trademark Office

Reg. No. 3,397,652

Registered Mar. 18, 2008

**SERVICE MARK
PRINCIPAL REGISTER**

Living Life Fully

THOMAS WALSH (UNITED STATES INDIVIDUAL)
PO BOX 569
IDAHO SPRINGS, CO 80452

THE MARK CONSISTS OF STANDARD CHARACTERS WITHOUT CLAIM TO ANY PARTICULAR FONT, STYLE, SIZE, OR COLOR.

FOR: PROVIDING ON-LINE INFORMATION IN THE FIELD OF SPIRITUALITY, SELF-HELP, AND PERSONAL EMPOWERMENT SUBJECT MATTERS, IN CLASS 45 (U.S. CLS. 100 AND 101).

SER. NO. 77-210,233, FILED 6-19-2007.

FIRST USE 2-1-1999; IN COMMERCE 2-1-1999.

LAURA HAMMEL, EXAMINING ATTORNEY

Int. Cl.: 9

Prior U.S. Cls.: 21, 23, 26, 36 and 38

United States Patent and Trademark Office

Reg. No. 3,397,653

Registered Mar. 18, 2008

**TRADEMARK
PRINCIPAL REGISTER**



STAGL, JOHN (UNITED STATES INDIVIDUAL)
4658 LA JOLLA DRIVE
BRADENTON, FL 34210

FOR: COMPUTER SOFTWARE FOR SONO-
GRAPHIC REPORTING AND RELATED PHYSI-
CIAN'S NOTES, IN CLASS 9 (U.S. CLS. 21, 23, 26, 36
AND 38).

FIRST USE 6-0-2005; IN COMMERCE 11-0-2005.

THE STIPPLING IS FOR SHADING PURPOSES
ONLY.

THE MARK CONSISTS OF A BALL TO THE LEFT
WITH LARGE "SONOSOFT" SUPERIMPOSED
OVER A PORTION OF THE BALL. THERE ARE
TWO LINES CIRCLING THE BALL.

SER. NO. 77-210,398, FILED 6-20-2007.

KELLY MCCOY, EXAMINING ATTORNEY

Int. Cl.: 41

Prior U.S. Cls.: 100, 101 and 107

United States Patent and Trademark Office

Reg. No. 3,397,654

Registered Mar. 18, 2008

**SERVICE MARK
PRINCIPAL REGISTER**



LAUNCH MATH LLC (NEW YORK LTD LIAB
CO)
6 WEST 75TH STREET #3B
NEW YORK, NY 10023

FIRST USE 6-12-2007; IN COMMERCE 6-12-2007.

FOR: EDUCATIONAL SERVICES, NAMELY,
CONDUCTING SEMINARS, WORKSHOPS,
HANDS-ON EDUCATIONAL PROGRAMS AND IN-
DIVIDUALIZED LEARNING SESSIONS IN THE
FIELD OF ACADEMIC SUBJECTS RELATED TO
PRIMARY AND SECONDARY EDUCATION, IN
PARTICULAR MATH AND SCIENCE AND DISTRI-
BUTION OF COURSE MATERIAL IN CONNEC-
TION THEREWITH, IN CLASS 41 (U.S. CLS. 100, 101
AND 107).

THE MARK CONSISTS OF THE WORD
"LAUNCH" WRITTEN STYLISTICALLY WITH
THE LETTER "A" SHAPED AS A ROCKETSHIP
AND PLUS SIGNS BELOW THE "A" REPRESENT-
ING THE ROCKET EXHAUST.

SER. NO. 77-210,506, FILED 6-20-2007.

JILL C. ALT, EXAMINING ATTORNEY

Int. Cl.: 9

Prior U.S. Cls.: 21, 23, 26, 36 and 38

United States Patent and Trademark Office

Reg. No. 3,397,655

Registered Mar. 18, 2008

**TRADEMARK
PRINCIPAL REGISTER**



THINK HOLDINGS LLC (FLORIDA LTD LIAB
CO)
SUITE 204
5551 N. UNIVERSITY DRIVE
CORAL SPRINGS, FL 33067

FOR: COMPUTER SOFTWARE USED FOR DE-
VELOPING ASSESSMENT STANDARDS, STRATE-
GIC PLANS, PLANNING BASED BUDGETS, AND
ACCOUNTABILITY GOALS FOR VARIOUS BUSI-
NESS PURPOSES AND INSTITUTIONAL NEEDS, IN
CLASS 9 (U.S. CLS. 21, 23, 26, 36 AND 38).

FIRST USE 3-5-2002; IN COMMERCE 5-8-2005.

NO CLAIM IS MADE TO THE EXCLUSIVE
RIGHT TO USE "STRATEGIC PLANNING ON-
LINE", APART FROM THE MARK AS SHOWN.

THE COLOR(S) GREEN, RED, BLUE, AND YEL-
LOW IS/ARE CLAIMED AS A FEATURE OF THE
MARK.

THE MARK CONSISTS OF GREEN, RED, AND
BLUE ARROWS OVER A YELLOW BALL POINT-
ING TO EACH OTHER, THE WORDS "STRATEGIC
PLANNING ONLINE" ARE IN BLUE WITH A BLUE
LINE UNDERNEATH THE WORDS "STRATEGIC
PLANNING ONLINE".

SER. NO. 77-210,557, FILED 6-20-2007.

LAURIE MAYES, EXAMINING ATTORNEY

Int. Cl.: 6

Prior U.S. Cls.: 2, 12, 13, 14, 23, 25 and 50

Reg. No. 3,397,656

United States Patent and Trademark Office

Registered Mar. 18, 2008

**TRADEMARK
PRINCIPAL REGISTER**

DOPAR

UNIROPE LIMITED (CANADA CORPORATION)
3070 UNIVERSAL DRIVE
MISSISSAUGA, ONTARIO, CANADA L4X2C8

FOR: STEEL WIRE ROPE USED IN LIFTING,
PULLING, LOAD SECUREMENT AND ANCHOR-
ING APPLICATIONS, IN CLASS 6 (U.S. CLS. 2, 12, 13,
14, 23, 25 AND 50).

FIRST USE 0-0-2002; IN COMMERCE 0-0-2002.

THE MARK CONSISTS OF STANDARD CHAR-
ACTERS WITHOUT CLAIM TO ANY PARTICULAR
FONT, STYLE, SIZE, OR COLOR.

PRIORITY CLAIMED UNDER SEC. 44(D) ON
CANADA APPLICATION NO. 1328996, FILED 12-20-
2006.

SER. NO. 77-210,755, FILED 6-20-2007.

JULIE GUTTADAURO, EXAMINING ATTORNEY

Int. Cl.: 9

Prior U.S. Cls.: 21, 23, 26, 36 and 38

Reg. No. 3,397,657

United States Patent and Trademark Office

Registered Mar. 18, 2008

**TRADEMARK
PRINCIPAL REGISTER**

WINGGARD

ACTUANT CORPORATION (WISCONSIN COR-
PORATION)
13000 WEST SILVER SPRING DRIVE
BUTLER, WI 53007

THE MARK CONSISTS OF STANDARD CHAR-
ACTERS WITHOUT CLAIM TO ANY PARTICULAR
FONT, STYLE, SIZE, OR COLOR.

FOR: ELECTRICAL WIRE CONNECTORS, IN
CLASS 9 (U.S. CLS. 21, 23, 26, 36 AND 38).

SER. NO. 77-210,802, FILED 6-20-2007.

FIRST USE 12-31-1979; IN COMMERCE 12-31-1979.

JOHN KELLY, EXAMINING ATTORNEY

Int. Cl.: 9

Prior U.S. Cls.: 21, 23, 26, 36 and 38

Reg. No. 3,397,658

United States Patent and Trademark Office

Registered Mar. 18, 2008

**TRADEMARK
PRINCIPAL REGISTER**

WI-TRAC

CYBER ANGEL SECURITY SOLUTIONS, INC.
(TENNESSEE CORPORATION)
SUITE 104
475 METROPLEX DRIVE
NASHVILLE, TN 37211

FIRST USE 11-1-2006; IN COMMERCE 11-1-2006.

THE MARK CONSISTS OF STANDARD CHARACTERS WITHOUT CLAIM TO ANY PARTICULAR FONT, STYLE, SIZE, OR COLOR.

FOR: COMPUTER SOFTWARE FOR LOCATING AND RECOVERING AN ELECTRONIC DEVICE USING A COMPUTER NETWORK OR WIRELESS SIGNAL, IN CLASS 9 (U.S. CLS. 21, 23, 26, 36 AND 38).

SER. NO. 77-210,954, FILED 6-20-2007.

SCOTT SISUN, EXAMINING ATTORNEY

Int. Cl.: 29

Prior U.S. Cl.: 46

United States Patent and Trademark Office

Reg. No. 3,397,659

Registered Mar. 18, 2008

**TRADEMARK
PRINCIPAL REGISTER**

LEONCINI

LEONCINI S.R.L. (ITALY LTD LIAB CO)
VIA CONFINE 4
COLA'LAZISE (VERONA), ITALY 37017

FOR: SALAMI; SAUSAGES; PORK SAUSAGE;
MORTADELLA; BOLOGNA; BOLOGNA SAUSAGE;
COTECHINO, NAMELY, BOILED PORK SAUSAGE;
WURSTEL, NAMELY, WURSTEL SALAMI; ZAMPONE,
NAMELY, STUFFED PIG'S TROTTER;
CHARCUTERIE; HAM, COOKED HAM, PANCETTA,
BACON; COPPA, NAMELY, CURED NECK OF PORK;
SPECK, NAMELY, A TYPE OF SMOKED HAM;
BRESAOLA, NAMELY, CURED RAW BEEF,
IN CLASS 29 (U.S. CL. 46).

FIRST USE 1-2-1961; IN COMMERCE 3-12-1996.

THE MARK CONSISTS OF STANDARD CHARACTERS
WITHOUT CLAIM TO ANY PARTICULAR FONT,
STYLE, SIZE, OR COLOR.

OWNER OF U.S. REG. NOS. 2,073,506 AND
2,115,207.

THE FOREIGN WORDING IN THE MARK
TRANSLATES INTO ENGLISH AS LITTLE LIONS.

SER. NO. 77-211,025, FILED 6-20-2007.

JOHN KELLY, EXAMINING ATTORNEY

Int. Cl.: 9

Prior U.S. Cls.: 21, 23, 26, 36 and 38

United States Patent and Trademark Office

Reg. No. 3,397,660

Registered Mar. 18, 2008

TRADEMARK
PRINCIPAL REGISTER



OCUSAFE (KANSAS LTD LIAB CO)
27010 W HIGHWAY 24
SAINT MARYS, KS 66536

FOR: COMPUTER SOFTWARE FOR ENABLING
A USER TO ACCESS AN ELECTRONIC CONTROL
PANEL REMOTELY FROM A WEB-BASED INTER-
FACE, FOR THE PURPOSE OF VIEWING AND
CONTROLLING ALARM, SURVEILLANCE, AND
AUTOMATION SYSTEMS, IN CLASS 9 (U.S. CLS. 21,
23, 26, 36 AND 38).

FIRST USE 3-1-2007; IN COMMERCE 3-16-2007.

THE MARK CONSISTS OF THE WORDS "LIVE"
AND "WATCH" TOGETHER, WITH A HOUSE
ROOF OVER "LIVE" AND "WATCH" ITALICIZED.

SER. NO. 77-211,323, FILED 6-20-2007.

CAROLYN CATALDO, EXAMINING ATTORNEY

Int. Cl.: 42

Prior U.S. Cls.: 100 and 101

United States Patent and Trademark Office

Reg. No. 3,397,661

Registered Mar. 18, 2008

**SERVICE MARK
PRINCIPAL REGISTER**

MYTA

THE MYTA CORPORATION (MARYLAND CORPORATION)
11301 HOLLOWSTONE DRIVE
ROCKVILLE, MD 20852

FOR: COMPUTER SOFTWARE DESIGN FOR OTHERS; CONSULTATION SERVICES IN THE FIELDS OF SELECTION, IMPLEMENTATION AND USE OF COMPUTER HARDWARE AND SOFTWARE SYSTEMS FOR OTHERS; CONSULTING SERVICES IN THE FIELD OF DESIGN, SELECTION, IMPLEMENTATION AND USE OF COMPUTER HARDWARE AND SOFTWARE SYSTEMS FOR OTHERS; PERIODIC UPGRADING OF

COMPUTER SOFTWARE FOR OTHERS; UPDATING OF COMPUTER SOFTWARE FOR OTHERS, IN CLASS 42 (U.S. CLS. 100 AND 101).

FIRST USE 7-1-1989; IN COMMERCE 7-1-1989.

THE MARK CONSISTS OF STANDARD CHARACTERS WITHOUT CLAIM TO ANY PARTICULAR FONT, STYLE, SIZE, OR COLOR.

SER. NO. 77-211,609, FILED 6-21-2007.

LESLIE RICHARDS, EXAMINING ATTORNEY

Int. Cl.: 41

Prior U.S. Cls.: 100, 101 and 107

United States Patent and Trademark Office

Reg. No. 3,397,662

Registered Mar. 18, 2008

**SERVICE MARK
PRINCIPAL REGISTER**



**F FITNESS
MAXX**

"I BRING OUT THE RESULTS YOU CAN SEE."

FITNESS MAXX (FLORIDA CORPORATION)
770 CLAUGHTON ISLAND DRIVE #1911
MIAMI, FL 33131

FOR: PROVIDING ASSISTANCE, PERSONAL TRAINING AND PHYSICAL FITNESS CONSULTATION TO INDIVIDUALS TO HELP THEM MAKE PHYSICAL FITNESS, STRENGTH, CONDITIONING, AND EXERCISE IMPROVEMENT IN THEIR DAILY LIVING, IN CLASS 41 (U.S. CLS. 100, 101 AND 107).

FIRST USE 1-1-2006; IN COMMERCE 1-1-2006.

NO CLAIM IS MADE TO THE EXCLUSIVE RIGHT TO USE "FITNESS", APART FROM THE MARK AS SHOWN.

SER. NO. 77-211,642, FILED 6-21-2007.

PETER B. BROMAGHIM, EXAMINING ATTORNEY

Int. Cl.: 38

Prior U.S. Cls.: 100, 101 and 104

United States Patent and Trademark Office

Reg. No. 3,397,663

Registered Mar. 18, 2008

**SERVICE MARK
PRINCIPAL REGISTER**

DCTV

PUBLIC ACCESS CORPORATION OF THE DISTRICT OF COLUMBIA (D.C. CORPORATION)
901 NEWTON ST., NE
WASHINGTON, DC 20017

FOR: TELEVISION BROADCASTING SERVICES RENDERED IN AND DIRECTLY AROUND THE DISTRICT OF COLUMBIA, IN CLASS 38 (U.S. CLS. 100, 101 AND 104).

FIRST USE 8-13-1986; IN COMMERCE 2-1-1987.

THE MARK CONSISTS OF STANDARD CHARACTERS WITHOUT CLAIM TO ANY PARTICULAR FONT, STYLE, SIZE, OR COLOR.

SEC. 2(F).

SER. NO. 77-212,105, FILED 6-21-2007.

SCOTT SISUN, EXAMINING ATTORNEY

Int. Cl.: 14

Prior U.S. Cls.: 2, 27, 28 and 50

United States Patent and Trademark Office

Reg. No. 3,397,664

Registered Mar. 18, 2008

**TRADEMARK
PRINCIPAL REGISTER**

MITALI

B.H.D. INC (CALIFORNIA CORPORATION)
550 SOUTH HILL STREET, SUITE #875
LOS ANGELES, CA 90013

FOR: JEWELRY, IN CLASS 14 (U.S. CLS. 2, 27, 28
AND 50).

FIRST USE 10-1-2005; IN COMMERCE 10-1-2005.

THE MARK CONSISTS OF STANDARD CHAR-
ACTERS WITHOUT CLAIM TO ANY PARTICULAR
FONT, STYLE, SIZE, OR COLOR.

THE ENGLISH TRANSLATION OF MARK IS
"MEDAL."

SER. NO. 77-212,445, FILED 6-21-2007.

DAWN HAN, EXAMINING ATTORNEY

Int. Cl.: 30

Prior U.S. Cl.: 46

United States Patent and Trademark Office

Reg. No. 3,397,665

Registered Mar. 18, 2008

**TRADEMARK
PRINCIPAL REGISTER**

**MONTEREY GOURMET FOODS
FINEST QUALITY ONE STEP
GOURMET**

MONTEREY GOURMET FOODS, INC. (CALI-
FORNIA CORPORATION)
1528 MOFFETT STREET
SALINAS, CA 93905

FOR: PASTA; PREPARED PASTA; FROZEN, PRE-
PARED AND PACKAGED ENTREES CONSISTING
PRIMARILY OF PASTA OR RICE; FROZEN, PRE-
PARED AND PACKAGED MEALS CONSISTING
PRIMARILY OF PASTA OR RICE , IN CLASS 30
(U.S. CL. 46).

FIRST USE 3-1-2005; IN COMMERCE 3-1-2005.

THE MARK CONSISTS OF STANDARD CHAR-
ACTERS WITHOUT CLAIM TO ANY PARTICULAR
FONT, STYLE, SIZE, OR COLOR.

OWNER OF U.S. REG. NOS. 1,953,489 AND
2,203,576.

NO CLAIM IS MADE TO THE EXCLUSIVE
RIGHT TO USE "GOURMET FOODS", "GOUR-
MET", AND "FINEST QUALITY", APART FROM
THE MARK AS SHOWN.

SEC. 2(F) AS TO "MONTEREY".

SER. NO. 77-212,528, FILED 6-21-2007.

ADA HAN, EXAMINING ATTORNEY

Int. Cls.: 37 and 42

Prior U.S. Cls.: 100, 101, 103 and 106

United States Patent and Trademark Office

Reg. No. 3,397,666

Registered Mar. 18, 2008

**SERVICE MARK
PRINCIPAL REGISTER**

K-DIRECT

EVERGREEN ENERGY INC. (DELAWARE CORPORATION)
1225 - 17TH STREET, SUITE 1300
DENVER, CO 80202

FOR: CONSTRUCTION, OPERATION AND MAINTENANCE OF COAL REFINING PLANTS WHICH ARE CO-LOCATED AT FACILITIES OF END USERS OF THE REFINED COAL , IN CLASS 37 (U.S. CLS. 100, 103 AND 106).

FIRST USE 9-30-2006; IN COMMERCE 9-30-2006.

FOR: DESIGN AND ENGINEERING OF COAL REFINING PLANTS WHICH ARE CO-LOCATED AT

FACILITIES OF END USERS OF THE REFINED COAL, IN CLASS 42 (U.S. CLS. 100 AND 101).

FIRST USE 9-30-2006; IN COMMERCE 9-30-2006.

THE MARK CONSISTS OF STANDARD CHARACTERS WITHOUT CLAIM TO ANY PARTICULAR FONT, STYLE, SIZE, OR COLOR.

SER. NO. 77-212,536, FILED 6-21-2007.

SUSAN LESLIE DUBOIS, EXAMINING ATTORNEY

Int. Cl.: 42

Prior U.S. Cls.: 100 and 101

United States Patent and Trademark Office

Reg. No. 3,397,667

Registered Mar. 18, 2008

**SERVICE MARK
PRINCIPAL REGISTER**



DRI MANAGEMENT SYSTEMS, INC. (CALIFORNIA CORPORATION)
SUITE 100
1451 QUAIL STREET
NEWPORT BEACH, CA 92660

FOR: APPLICATION SERVICE PROVIDER (ASP) FEATURING SOFTWARE FOR USE IN LOAN MANAGEMENT, IN CLASS 42 (U.S. CLS. 100 AND 101).

FIRST USE 11-1-2005; IN COMMERCE 11-1-2005.

THE MARK CONSISTS OF A PARTIAL CIRCLE AROUND THE LITERAL ELEMENT OF THE MARK.

SER. NO. 77-212,626, FILED 6-21-2007.

HOWARD SMIGA, EXAMINING ATTORNEY

Int. Cl.: 41

Prior U.S. Cls.: 100, 101 and 107

United States Patent and Trademark Office

Reg. No. 3,397,668

Registered Mar. 18, 2008

**SERVICE MARK
PRINCIPAL REGISTER**



MOUNT SNOW, LTD. (VERMONT CORPORATION)
ATTN: THOMAS J. MONTEMAGNI, LEGAL DEPT.
12 MOUNT SNOW ROAD
WEST DOVER, VT 05356

FOR: SKI RESORT SERVICES, NAMELY, PROVIDING SEASON PASSES, IN CLASS 41 (U.S. CLS. 100, 101 AND 107).

FIRST USE 4-7-2007; IN COMMERCE 4-7-2007.

NO CLAIM IS MADE TO THE EXCLUSIVE RIGHT TO USE "SEASON PASS", APART FROM THE MARK AS SHOWN.

THE COLOR(S) BLUE, GREEN AND WHITE IS/ ARE CLAIMED AS A FEATURE OF THE MARK.

THE MARK CONSISTS OF FIVE POINTS OF A BLUE, GREEN AND WHITE COMPASS WITH THE WORD NOR'EASTER WRITTEN IN BLUE AND THE WORDS SEASON PASS WRITTEN IN GREEN.

SER. NO. 77-213,109, FILED 6-22-2007.

ANNE E. GUSTASON, EXAMINING ATTORNEY

Int. Cl.: 36

Prior U.S. Cls.: 100, 101 and 102

United States Patent and Trademark Office

Reg. No. 3,397,669

Registered Mar. 18, 2008

**SERVICE MARK
PRINCIPAL REGISTER**



COCONUT GROVE BANK

COCONUT GROVE BANK (FLORIDA CORPORATION)
2701 SOUTH BAYSHORE DRIVE
MIAMI, FL 33133

THE MARK CONSISTS OF DESIGN WITHIN A CIRCLE AND THE WORDS COCONUT GROVE BANK.

FOR: COMMERCIAL BANK SERVICES, IN CLASS 36 (U.S. CLS. 100, 101 AND 102).

SEC. 2(F) AS TO "COCONUT GROVE".

FIRST USE 0-0-1974; IN COMMERCE 0-0-1974.

SER. NO. 77-213,126, FILED 6-22-2007.

NO CLAIM IS MADE TO THE EXCLUSIVE RIGHT TO USE "BANK" , APART FROM THE MARK AS SHOWN.

BRIAN CALLAGHAN, EXAMINING ATTORNEY

Int. Cls.: 41 and 45

Prior U.S. Cls.: 100, 101 and 107

United States Patent and Trademark Office

Reg. No. 3,397,670

Registered Mar. 18, 2008

**SERVICE MARK
PRINCIPAL REGISTER**

SWINGTOWNS

STREET INK CORPORATION (FLORIDA CORPORATION)
522 S. HUNT CLUB BLVD #107
APOPKA, FL 32703

FOR: ENTERTAINMENT SERVICES, NAMELY, PROVIDING A WEBSITE FEATURING, PHOTOGRAPHIC, AUDIO, VIDEO AND PROSE PRESENTATIONS FEATURING THE SWINGING LIFESTYLE , IN CLASS 41 (U.S. CLS. 100, 101 AND 107).

FIRST USE 12-21-2000; IN COMMERCE 12-21-2000.

FOR: INTERNET BASED SOCIAL NETWORKING, INTRODUCTION, AND DATING SERVICES, IN CLASS 45 (U.S. CLS. 100 AND 101).

FIRST USE 12-21-2000; IN COMMERCE 12-21-2000.

THE MARK CONSISTS OF STANDARD CHARACTERS WITHOUT CLAIM TO ANY PARTICULAR FONT, STYLE, SIZE, OR COLOR.

SER. NO. 77-213,135, FILED 6-22-2007.

MICHAEL WEBSTER, EXAMINING ATTORNEY

Int. Cl.: 2

Prior U.S. Cls.: 6, 11 and 16

United States Patent and Trademark Office

Reg. No. 3,397,671

Registered Mar. 18, 2008

**TRADEMARK
PRINCIPAL REGISTER**



JOMAX INTERNATIONAL, CORP. (FLORIDA CORPORATION)
20861 JOHNSON STREET BUILDING C UNIT 105
PEMBROKE PINES, FL 33029

NO CLAIM IS MADE TO THE EXCLUSIVE RIGHT TO USE "DESIGNING YOUR HOME", APART FROM THE MARK AS SHOWN.

FOR: INTERIOR PAINT AND EXTERIOR PAINT,
IN CLASS 2 (U.S. CLS. 6, 11 AND 16).

SER. NO. 77-213,386, FILED 6-22-2007.

FIRST USE 11-15-2006; IN COMMERCE 11-15-2006.

H. M. FISHER, EXAMINING ATTORNEY

Int. Cl.: 44

Prior U.S. Cls.: 100 and 101

United States Patent and Trademark Office

Reg. No. 3,397,672

Registered Mar. 18, 2008

**SERVICE MARK
PRINCIPAL REGISTER**

IMWell Health

IMWELL HEALTH, LLC (ARKANSAS LTD LIAB
CO)

1000 FIANNA WAY

FORT SMITH, AR 72919

FOR: MEDICAL CLINICS; HEALTH CARE, IN
CLASS 44 (U.S. CLS. 100 AND 101).

FIRST USE 6-1-2006; IN COMMERCE 6-1-2006.

THE MARK CONSISTS OF STANDARD CHAR-
ACTERS WITHOUT CLAIM TO ANY PARTICULAR
FONT, STYLE, SIZE, OR COLOR.

NO CLAIM IS MADE TO THE EXCLUSIVE
RIGHT TO USE "HEALTH", APART FROM THE
MARK AS SHOWN.

SER. NO. 77-213,421, FILED 6-22-2007.

SKYE YOUNG, EXAMINING ATTORNEY

Int. Cl.: 16

Prior U.S. Cls.: 2, 5, 22, 23, 29, 37, 38 and 50

United States Patent and Trademark Office

Reg. No. 3,397,673

Registered Mar. 18, 2008

**TRADEMARK
PRINCIPAL REGISTER**



FRANK J. SEPE, INC. (NEW YORK CORPORATION)
51 SEATON PLACE
VALLEY STREAM, NY 11580

FOR: MAGAZINES FEATURING HEALTH AND FITNESS, IN CLASS 16 (U.S. CLS. 2, 5, 22, 23, 29, 37, 38 AND 50).

FIRST USE 9-27-2007; IN COMMERCE 9-27-2007.

NO CLAIM IS MADE TO THE EXCLUSIVE RIGHT TO USE "MEN'S ATHLETIC QUARTERLY", APART FROM THE MARK AS SHOWN.

THE MARK CONSISTS OF THE TERM "MEN'S ATHLETIC QUARTERLY" UNDERNEATH THE TERM "MAQ".

SER. NO. 77-213,578, FILED 6-22-2007.

ANNE MADDEN, EXAMINING ATTORNEY

Int. Cl.: 40

Prior U.S. Cls.: 100, 103 and 106

United States Patent and Trademark Office

Reg. No. 3,397,674

Registered Mar. 18, 2008

**SERVICE MARK
PRINCIPAL REGISTER**



FOXFIRE ENTERPRISES, INC. (TEXAS CORPORATION)
173 WILLOW LANE
WEST, TX 766912632

FOR: WATERPROOFING OF ARTICLES OF MASONRY, WOOD AND OTHER BUILDING AND/OR CONSTRUCTION MATERIAL, IN CLASS 40 (U.S. CLS. 100, 103 AND 106).

FIRST USE 12-31-1995; IN COMMERCE 12-31-1995.

NO CLAIM IS MADE TO THE EXCLUSIVE RIGHT TO USE "ENTERPRISES, INC.", APART FROM THE MARK AS SHOWN.

THE COLOR(S) DARK, RED, RED AND WHITE IS/ARE CLAIMED AS A FEATURE OF THE MARK.

THE MARK CONSISTS OF A RED OVAL WITH A FOX HEAD IN THE LEFT OF THE OVAL OUTLINED IN WHITE TURNED SLIGHTLY TO THE RIGHT WITH AN OPEN MOUTH. TO THE RIGHT OF THE FOX HEAD ARE THE WORDS "FOXFIRE ENTERPRISES INC." WITH "FOXFIRE" BEING IN BIGGER FONT ON TOP OF "ENTERPRISES INC." BELOW "FOXFIRE". THE TEXT IS IN WHITE. AT THE BOTTOM AND TO THE RIGHT OF THE OVAL IT IS DARK RED WHILE THE TOP LEFT IS A LIGHTER SHADE OF RED.

SER. NO. 77-213,625, FILED 6-22-2007.

VERNA BETH RIRIE, EXAMINING ATTORNEY

Int. Cl.: 11

Prior U.S. Cls.: 13, 21, 23, 31 and 34

United States Patent and Trademark Office

Reg. No. 3,397,675

Registered Mar. 18, 2008

**TRADEMARK
PRINCIPAL REGISTER**

OPTILED

OPTILED HOLDINGS COMPANY LIMITED
(HONG KONG COMPANY)
6/F, PHOTONICS CENTRE
2 SCIENCE PARK EAST AVENUE, HKSP
SHATIN, HONG KONG

FOR: ELECTRIC LIGHT BULBS AND FIXTURES,
NAMELY, LED LIGHT BULBS AND FIXTURES, IN
CLASS 11 (U.S. CLS. 13, 21, 23, 31 AND 34).

FIRST USE 1-27-2007; IN COMMERCE 1-27-2007.

OWNER OF U.S. REG. NO. 2,861,422.

THE COLOR(S) GREY AND CYAN IS/ARE
CLAIMED AS A FEATURE OF THE MARK.

THE MARK CONSISTS OF A STYLIZED ICON OF
THE HUMAN EYE WHICH REPRESENTS THE
LETTER O AND THE CAPITAL LETTERS
P,T,I,L,E,D WITH THE FIRST FOUR LETTERS OF
THE MARK COLORED GREY AND THE LAST
THREE LETTERS OF THE MARK COLORED
CYAN.

SER. NO. 77-213,800, FILED 6-23-2007.

EUGENIA MARTIN, EXAMINING ATTORNEY

Int. Cls.: 35, 37 and 42

Prior U.S. Cls.: 100, 101, 102, 103 and 106

United States Patent and Trademark Office

Reg. No. 3,397,676

Registered Mar. 18, 2008

SERVICE MARK
PRINCIPAL REGISTER

Atlanta
Kitchen &
Bath

ATLANTA KITCHEN & BATH CABINET OUT-
LET, INC. (GEORGIA CORPORATION)
1562 EAST FORREST AVENUE
EAST POINT, GA 30344

FOR: RETAIL STORE SERVICES AND ONLINE
RETAIL STORE SERVICES IN THE FIELD OF
KITCHEN AND BATH ACCESSORIES IN THE NAT-
URE OF KNOBS, DRAWER PULLS, DRAWER
SLIDES, COUNTERTOPS AND CABINETS, IN
CLASS 35 (U.S. CLS. 100, 101 AND 102).

FIRST USE 10-21-1989; IN COMMERCE 11-1-1989.

FOR: INSTALLATION OF BATH CABINETS,
KITCHEN CABINETS, AND COUNTERTOPS, IN
CLASS 37 (U.S. CLS. 100, 103 AND 106).

FIRST USE 10-21-1989; IN COMMERCE 11-1-1989.

FOR: DESIGN FOR OTHERS IN THE FIELD OF
KITCHENS AND BATHS, IN CLASS 42 (U.S. CLS. 100
AND 101).

FIRST USE 10-21-1989; IN COMMERCE 11-1-1989.

OWNER OF U.S. REG. NO. 3,281,690.

NO CLAIM IS MADE TO THE EXCLUSIVE
RIGHT TO USE "KITCHEN AND BATH", APART
FROM THE MARK AS SHOWN.

SEC. 2(F).

SER. NO. 77-214,396, FILED 6-25-2007.

MARIA-VICTORIA SUAREZ, EXAMINING ATTOR-
NEY

Int. Cl.: 36

Prior U.S. Cls.: 100, 101 and 102

United States Patent and Trademark Office

Reg. No. 3,397,677

Registered Mar. 18, 2008

**SERVICE MARK
PRINCIPAL REGISTER**

ProPay InstantPay

PROPAY USA, INC. (UTAH CORPORATION)
500 TIMPANOGOS CIRCLE
OREM, UT 84097

FOR: FINANCIAL SERVICES, NAMELY, EN-
ABLING ONLINE OR HOME-BASED BUSINESSES
TO MAKE AND RECEIVE PAYMENTS VIA TELE-
PHONE, FACSIMILE, ONLINE AND WIRELESS
APPLICATIONS, IN CLASS 36 (U.S. CLS. 100, 101
AND 102).

FIRST USE 5-15-2007; IN COMMERCE 5-15-2007.

THE MARK CONSISTS OF STANDARD CHAR-
ACTERS WITHOUT CLAIM TO ANY PARTICULAR
FONT, STYLE, SIZE, OR COLOR.

OWNER OF U.S. REG. NO. 3,061,051.

NO CLAIM IS MADE TO THE EXCLUSIVE
RIGHT TO USE "INSTANT PAY", APART FROM
THE MARK AS SHOWN.

SER. NO. 77-214,466, FILED 6-25-2007.

HEATHER BIDDULPH, EXAMINING ATTORNEY

Int. Cl.: 39

Prior U.S. Cls.: 100 and 105

United States Patent and Trademark Office

Reg. No. 3,397,678

Registered Mar. 18, 2008

**SERVICE MARK
PRINCIPAL REGISTER**

COME PLAY YOUR WAY

WASHINGTON COUNTY VISITORS ASSOCIATION (OREGON NON-PROFIT CORPORATION)
5075 SW GRIFFITH DR.
BEAVERTON, OR 97005

FOR: PROVIDING AN ON-LINE COMPUTER DATABASE IN THE FIELD OF TRAVEL INFORMATION SERVICES; PROVIDING LINKS TO WEB SITES OF OTHERS FEATURING TRAVEL; TRAVEL AND TOUR INFORMATION SERVICE; TRAVEL INFORMATION SERVICES, IN CLASS 39 (U.S. CLS. 100 AND 105).

FIRST USE 9-12-2007; IN COMMERCE 9-12-2007.

THE MARK CONSISTS OF STANDARD CHARACTERS WITHOUT CLAIM TO ANY PARTICULAR FONT, STYLE, SIZE, OR COLOR.

SER. NO. 77-214,983, FILED 6-25-2007.

MARLENE BELL, EXAMINING ATTORNEY

Int. Cl.: 16

Prior U.S. Cls.: 2, 5, 22, 23, 29, 37, 38 and 50

United States Patent and Trademark Office

Reg. No. 3,397,679

Registered Mar. 18, 2008

**TRADEMARK
PRINCIPAL REGISTER**

Manage More Calendar

HANNUM, SANDRA RAE (UNITED STATES IN-
DIVIDUAL)

4417 EL CAMINO AVE

SACRAMENTO, CA 95821

FOR: PRINTED CALENDARS, IN CLASS 16 (U.S.
CLS. 2, 5, 22, 23, 29, 37, 38 AND 50).

FIRST USE 6-12-2007; IN COMMERCE 6-12-2007.

THE MARK CONSISTS OF STANDARD CHAR-
ACTERS WITHOUT CLAIM TO ANY PARTICULAR
FONT, STYLE, SIZE, OR COLOR.

NO CLAIM IS MADE TO THE EXCLUSIVE
RIGHT TO USE "CALENDAR", APART FROM
THE MARK AS SHOWN.

SER. NO. 77-215,210, FILED 6-26-2007.

WON TEAK OH, EXAMINING ATTORNEY

Int. Cl.: 40

Prior U.S. Cls.: 100, 103 and 106

United States Patent and Trademark Office

Reg. No. 3,397,680

Registered Mar. 18, 2008

**SERVICE MARK
PRINCIPAL REGISTER**

Gator Machine Shop

BRITT, DONALD C. (UNITED STATES INDIVIDUAL)
9909 46 AVE WEST
BRADENTON, FL 34210

FOR: MACHINE AND JOB SHOPS SERVICES, NAMELY, MACHINING PARTS FOR OTHERS; COMPUTERIZED NUMERIC CONTROL (CNC) TURNING AND MILLING FOR OTHERS; CONTRACT MANUFACTURING, PRECISION TURNED PRODUCT MANUFACTURING, AND PRECISION MILLED PRODUCT MANUFACTURING IN THE FIELD OF GUIDED MISSILE AND SPACE COMPONENTS, NAMELY, FARINGS, GYROCASINGS, FLANGE ADAPTERS, WIRING HARNESSSES; CONTRACT MANUFACTURING, PRECISION TURNED PRODUCT MANUFACTURING, AND PRECISION MILLED PRODUCT MANUFACTURING IN THE FIELD OF MILITARY ARMORED VEHICLES, NAMELY, SIDE DOOR FLANGE, POWER TAKE-OFF ADAPTERS, GUN PINTLES; CONTRACT MANUFACTURING, PRECISION TURNED PRODUCT MANUFACTURING, AND PRECISION MILLED PRODUCT MANUFACTURING IN THE FIELD OF ENGINE COOLING SYSTEM COMPONENTS, NAMELY, RADIATOR BRACKETS, PLUGS; CONTRACT MANUFACTURING, PRECISION TURNED PRODUCT MANUFACTURING, AND PRECISION

MILLED PRODUCT MANUFACTURING IN THE FIELD OF FLUID POWER VALVE AND HOSE FITTINGS, NAMELY, HYDRAULIC DISTRIBUTION BLOCKS, ADAPTER PLUGS, ADAPTER REDUCERS; CONTRACT MANUFACTURING, PRECISION TURNED PRODUCT MANUFACTURING, AND PRECISION MILLED PRODUCT MANUFACTURING IN THE FIELD OF HYDRAULICS, MANIFOLDS, AND VALVES, IN CLASS 40 (U.S. CLS. 100, 103 AND 106).

FIRST USE 1-1-1987; IN COMMERCE 1-1-1987.

THE MARK CONSISTS OF STANDARD CHARACTERS WITHOUT CLAIM TO ANY PARTICULAR FONT, STYLE, SIZE, OR COLOR.

OWNER OF U.S. REG. NO. 3,191,576.

NO CLAIM IS MADE TO THE EXCLUSIVE RIGHT TO USE "MACHINE SHOP", APART FROM THE MARK AS SHOWN.

SER. NO. 77-215,283, FILED 6-26-2007.

SUZANNE BLANE, EXAMINING ATTORNEY

Int. Cl.: 36

Prior U.S. Cls.: 100, 101 and 102

United States Patent and Trademark Office

Reg. No. 3,397,681

Registered Mar. 18, 2008

**SERVICE MARK
PRINCIPAL REGISTER**



CU SERVICE NETWORK, INC. (COLORADO CORPORATION)
355 UNION BLVD., SUITE 301
LAKEWOOD, CO 80228

FOR: CREDIT UNION SERVICES, NAMELY, PROVIDING SHARED BRANCHING SERVICES TO A NETWORK OF PARTICIPATING CREDIT UNIONS AND THEIR MEMBERS, IN CLASS 36 (U.S. CLS. 100, 101 AND 102).

FIRST USE 3-30-2006; IN COMMERCE 3-30-2006.

NO CLAIM IS MADE TO THE EXCLUSIVE RIGHT TO USE "CREDIT UNION SERVICE NETWORK", APART FROM THE MARK AS SHOWN.

THE COLOR(S) BLACK AND BLUE IS/ARE CLAIMED AS A FEATURE OF THE MARK.

THE COLOR BLUE APPEARS ON THE LITERAL ELEMENT OF CUSN AND THE SHARK FIN DESIGN, AND THE COLOR BLACK APPEARS ON THE LITERAL ELEMENT OF CREDIT UNION SERVICE NETWORK.

SER. NO. 77-215,391, FILED 6-26-2007.

ELIZABETH HUGHITT, EXAMINING ATTORNEY

Int. Cl.: 41

Prior U.S. Cls.: 100, 101 and 107

United States Patent and Trademark Office

Reg. No. 3,397,682

Registered Mar. 18, 2008

**SERVICE MARK
PRINCIPAL REGISTER**



SOCIETY FOR THE ARTS IN HEALTHCARE

SOCIETY FOR THE ARTS IN HEALTHCARE
(D.C. CORPORATION)
2437 15TH STREET, NW
WASHINGTON, DC 20009

FOR: CHARITABLE SERVICES, NAMELY, PROVIDING ARTS AND CRAFTS WITHIN HEALTH CARE FACILITIES; PROVIDING EDUCATIONAL SERVICES, NAMELY, WORKSHOPS AND SEMINARS PROVIDED TO HEALTHCARE AND ARTS PROFESSIONALS TO ADVOCATE FOR THE INTEGRATION OF THE ARTS INTO THE ENVIRONMENT OF HEALTHCARE FACILITIES; EDUCATIONAL RESEARCH IN THE FIELD OF THE BENEFICIAL EFFECTS OF THE ARTS IN HEALTHCARE, IN CLASS 41 (U.S. CLS. 100, 101 AND 107).

FIRST USE 7-14-1995; IN COMMERCE 7-14-1995.

NO CLAIM IS MADE TO THE EXCLUSIVE RIGHT TO USE "SOCIETY FOR THE ARTS IN

HEALTHCARE", APART FROM THE MARK AS SHOWN.

THE MARK CONSISTS OF AN OVERALL RECTANGULAR SHAPE THAT IS PARTIALLY SHADED; A SEMI-CIRCLE DOME SHAPE WHICH IS SHADED; MULTIPLE STARS WITH FIVE POINTS, ONE STAR WITH SEVEN OR MORE POINTS, THE STARS BEING GROUPED IN A CIRCLE OR OVAL GEOMETRIC FIGURE; A THEATRICAL MASK TO THE LEFT; A SHADOW OR SILHOUETTE OF A MAN OR HUMAN BEING IN THE CENTER; STYLIZED BIRDS ON THE RIGHT; THE GRAYSCALE SHADING DOES NOT DEPICT ANY PARTICULAR COLOR AND IS ONLY INTENDED TO SHOW THAT THE MARK HAS LIGHTER AND DARKER FEATURES.

SER. NO. 77-215,419, FILED 6-26-2007.

DOMINIC J. FERRAIUOLO, EXAMINING ATTORNEY

Int. Cl.: 33

Prior U.S. Cls.: 47 and 49

United States Patent and Trademark Office

Reg. No. 3,397,683

Registered Mar. 18, 2008

**TRADEMARK
PRINCIPAL REGISTER**

CHATEAU DE RAYNE VIGNEAU

SOCIETE CIVILE DU CHATEAU RAYNE VIG-
NEAU (FRANCE SOCIÉTÉ CIVILE)
CHATEAU RAYNE VIGNEAU
BOMMES, FRANCE 33210

FOR: WINES, IN CLASS 33 (U.S. CLS. 47 AND 49).

THE MARK CONSISTS OF STANDARD CHAR-
ACTERS WITHOUT CLAIM TO ANY PARTICULAR
FONT, STYLE, SIZE, OR COLOR.

OWNER OF FRANCE REG. NO. 1303902, DATED
3-21-1985, EXPIRES 3-20-2015.

NO CLAIM IS MADE TO THE EXCLUSIVE
RIGHT TO USE "CHATEAU", APART FROM THE
MARK AS SHOWN.

"THE NAME(S), PORTRAIT(S), AND/OR SIGNA-
TURE(S) SHOWN IN THE MARK DOES NOT IDEN-
TIFY A PARTICULAR LIVING INDIVIDUAL."

"THE FOREIGN WORDING IN THE MARK
TRANSLATES INTO ENGLISH AS HOUSE OF
RAYNE VIGNEAU."

SER. NO. 77-215,420, FILED 6-26-2007.

DOMINIC J. FERRAIUOLO, EXAMINING ATTOR-
NEY

Int. Cl.: 9

Prior U.S. Cls.: 21, 23, 26, 36 and 38

United States Patent and Trademark Office

Reg. No. 3,397,684

Registered Mar. 18, 2008

**TRADEMARK
PRINCIPAL REGISTER**



AVENTURINE INC. (FLORIDA CORPORATION)
1440 CORAL RIDEG DRIVE #145
CORAL SPRINGS, FL 33071

THE COLOR(S) BLUE AND WHITE IS/ARE
CLAIMED AS A FEATURE OF THE MARK.

FOR: COMPUTER SOFTWARE FOR USE IN
CUSTOMER RELATIONSHIP MANAGEMENT
(CRM); COMPUTER SOFTWARE FOR CREATING
SEARCHABLE DATABASES OF INFORMATION
AND DATA; DATABASE MANAGEMENT SOFT-
WARE FOR GENERAL USE BY MEMBERSHIP
BASED FACILITIES; FACILITIES MANAGEMENT
SOFTWARE, NAMELY, SOFTWARE TO CONTROL
FACILITY ACCESS AND SECURITY SYSTEMS, IN
CLASS 9 (U.S. CLS. 21, 23, 26, 36 AND 38).

THE MARK CONSISTS OF THE TEXT OF THE
WORD QUIKCHEK CENTERED INSIDE THE LET-
TER Q. ALL LETTERING IS IN THE FONT OF
PALATINO LINOTYPE. THE COLOR OF THE
WORD QUIKCHEK IS BLUE WITH A WHITE
BACKGROUND. THE COLOR OF THE LARGE Q
IS BLUE WITH A WHITE BACKGROUND.

SER. NO. 77-215,469, FILED 6-26-2007.

FIRST USE 11-1-2003; IN COMMERCE 11-1-2003.

SHAILA SETTLES, EXAMINING ATTORNEY

Int. Cl.: 37

Prior U.S. Cls.: 100, 103 and 106

United States Patent and Trademark Office

Reg. No. 3,397,685

Registered Mar. 18, 2008

**SERVICE MARK
PRINCIPAL REGISTER**

I'LL BEE THERE

I'LL BEE THERE ANIMAL AND BEE REMOVAL,
INC. (FLORIDA CORPORATION)
201
7420 SW 153RD COURT
MIAMI, FL 33193

FOR: VERMIN EXTERMINATION OTHER THAN FOR AGRICULTURE; EXTERMINATING CONSULTATION; PEST CONTROL; ANIMAL CONTROL SERVICES, NAMELY, LARGE BIRD CONTROL, CAPTURING, AND TRAPPING; ANIMAL CONTAMINATION CLEANING AND DISPOSAL SERVICES; FUMIGATING; INSECTICIDE SPRAYING; REMOVING BIRDS FROM RESIDENTIAL AND COMMERCIAL BUILDINGS; INSTALLATION OF PEST REPELLANTS, PEST CONTROL DEVICES, PEST REMOVAL DEVICES, ANIMAL REPELLANTS, ANIMAL TRAPS, ANIMAL REMOVAL DEVICES, ANIMAL RESCUE DEVICES, BEE REPELLANTS, BEE CONTROL DEVICES, BEE TRAPS, BEE REMOVAL DEVICES, INSECT REPELLANTS, INSECT TRAPS, INSECT REMOVAL DEVICES, APIARIES, OR ZOO EXHIBITS; CLEANING OF BUILDINGS, PROPERTY AND STRUCTURES OF ANIMALS, INSECTS, PESTS AND RODENTS; CONSTRUCTION OF PEST REPELLANTS, PEST CONTROL DEVICES, PEST REMOVAL DEVICES, ANIMAL REPELLANTS, ANIMAL TRAPS, ANIMAL REMOVAL DEVICES, ANIMAL RESCUE DEVICES, BEE REPELLANTS, BEE CONTROL DEVICES, BEE TRAPS, BEE REMOVAL DEVICES, INSECT REPELLANTS, INSECT TRAPS, INSECT REMOVAL DEVICES, APIARIES, OR ZOO EXHIBITS; MAINTENANCE AND/OR REPAIR OF PEST REPELLANTS, PEST CONTROL DEVICES, PEST REMOVAL DEVICES, ANIMAL REPELLANTS,

ANIMAL TRAPS, ANIMAL REMOVAL DEVICES, ANIMAL RESCUE DEVICES, BEE REPELLANTS, BEE CONTROL DEVICES, BEE TRAPS, BEE REMOVAL DEVICES, INSECT REPELLANTS, INSECT TRAPS, INSECT REMOVAL DEVICES, APIARIES, OR ZOO EXHIBITS; CONSULTATION IN THE FIELD OF PHYSICAL MAINTENANCE OF PEST REPELLANTS, PEST CONTROL DEVICES, PEST REMOVAL DEVICES, ANIMAL REPELLANTS, ANIMAL TRAPS, ANIMAL REMOVAL DEVICES, ANIMAL RESCUE DEVICES, BEE REPELLANTS, BEE CONTROL DEVICES, BEE TRAPS, BEE REMOVAL DEVICES, INSECT REPELLANTS, INSECT TRAPS, INSECT REMOVAL DEVICES, APIARIES, OR ZOO EXHIBITS; INSTALLATION, MAINTENANCE AND REPAIR OF PEST REPELLANTS, PEST CONTROL DEVICES, PEST REMOVAL DEVICES, ANIMAL REPELLANTS, ANIMAL TRAPS, ANIMAL REMOVAL DEVICES, ANIMAL RESCUE DEVICES, BEE REPELLANTS, BEE CONTROL DEVICES, BEE TRAPS, BEE REMOVAL DEVICES, INSECT REPELLANTS, INSECT TRAPS, INSECT REMOVAL DEVICES, APIARIES, OR ZOO EXHIBITS, IN CLASS 37 (U.S. CLS. 100, 103 AND 106).

FIRST USE 8-31-2003; IN COMMERCE 8-31-2003.

THE MARK CONSISTS OF STANDARD CHARACTERS WITHOUT CLAIM TO ANY PARTICULAR FONT, STYLE, SIZE, OR COLOR.

SER. NO. 77-215,470, FILED 6-26-2007.

ERNEST SHOSHO, EXAMINING ATTORNEY

Int. Cls.: 24 and 25

Prior U.S. Cls.: 22, 39, 42 and 50

United States Patent and Trademark Office

Reg. No. 3,397,686

Registered Mar. 18, 2008

TRADEMARK
PRINCIPAL REGISTER



OTTO LESQUE LLC (DELAWARE LTD LIAB CO)
225 CENTRAL PARK WEST, SUITE 802
NEW YORK, NY 10024

THE COLOR(S) IVORY AND GREEN IS/ARE
CLAIMED AS A FEATURE OF THE MARK.

FOR: TOWELS, IN CLASS 24 (U.S. CLS. 42 AND 50).

THE MARK CONSISTS OF GREEN LETTERS ON
IVORY BACKGROUND.

FIRST USE 2-1-2007; IN COMMERCE 2-1-2007.

"THE FOREIGN WORDING IN THE MARK
TRANSLATES INTO ENGLISH AS NATURAL SE-
LECTION."

FOR: BATHROBES, IN CLASS 25 (U.S. CLS. 22
AND 39).

SER. NO. 77-215,482, FILED 6-26-2007.

FIRST USE 2-1-2007; IN COMMERCE 2-1-2007.

PAM WILLIS, EXAMINING ATTORNEY

Int. Cl.: 39

Prior U.S. Cls.: 100 and 105

United States Patent and Trademark Office

Reg. No. 3,397,687

Registered Mar. 18, 2008

**SERVICE MARK
PRINCIPAL REGISTER**

Our business is moving

ALL WAYS MOVING & STORAGE (PENNSYLVANIA CORPORATION)
338 WEST MAIDEN STREET
WASHINGTON, PA 15301

FOR: MOVING AND STORAGE OF HOUSEHOLD GOODS, IN CLASS 39 (U.S. CLS. 100 AND 105).

FIRST USE 5-1-2007; IN COMMERCE 5-1-2007.

THE MARK CONSISTS OF STANDARD CHARACTERS WITHOUT CLAIM TO ANY PARTICULAR FONT, STYLE, SIZE, OR COLOR.

SER. NO. 77-215,489, FILED S.R. 6-26-2007 AM. P.R. 11-29-2007.

ALICE SUE CARRUTHERS, EXAMINING ATTORNEY

Int. Cl.: 42

Prior U.S. Cls.: 100 and 101

United States Patent and Trademark Office

Reg. No. 3,397,688

Registered Mar. 18, 2008

**SERVICE MARK
PRINCIPAL REGISTER**



PROCON INC. (TENNESSEE CORPORATION)
STE 125
2035 LAKESIDE CENTRE WAY
KNOXVILLE, TN 37922

FOR: SUBSCRIPTION BASED SERVICES PROVIDED OVER A GLOBAL COMPUTER NETWORK, NAMELY, PROVIDING A WEBSITE FEATURING TEMPORARY USE OF NON-DOWNLOADABLE SOFTWARE FOR TRACKING THE LOCATION OF A WIRELESS COMMUNICATION DEVICE, WHERE THE LOCATION OF THE WIRELESS COMMUNICATION DEVICE IS INDICATED ON A MAP DISPLAYED ON A WEB PAGE, AND FOR PROVIDING ASSISTANCE TO A USER OF THE WIRELESS DEVICE BASED ON REQUESTS COMMUNICATED BY THE USER TO THE SERVICE PROVIDER; SUBSCRIPTION BASED SERVICES PROVIDED OVER A WIRELESS COMMUNICATION SYSTEM, NAMELY, PROVIDING TEMPORARY USE OF NON-DOWNLOADABLE SOFTWARE FOR DETERMIN-

ING THE LOCATION OF A MOBILE ASSET USING A TEXT MESSAGE ENABLED WIRELESS COMMUNICATION DEVICE, AND FOR CONTROLLING FUNCTIONS OF THE MOBILE ASSET USING THE TEXT MESSAGE ENABLED WIRELESS COMMUNICATION DEVICE, IN CLASS 42 (U.S. CLS. 100 AND 101).

FIRST USE 2-18-2004; IN COMMERCE 2-18-2004.

THE COLOR(S) BLACK AND BLUE IS/ARE CLAIMED AS A FEATURE OF THE MARK.

THE MARK CONSISTS OF THE WORD "PROCON" IN BLACK BLOCK LETTERS IN FRONT OF A STYLIZED BLUE ELLIPSE.

SER. NO. 77-215,762, FILED 6-26-2007.

CHARLOTTE CORWIN, EXAMINING ATTORNEY

Int. Cl.: 40

Prior U.S. Cls.: 100, 103 and 106

United States Patent and Trademark Office

Reg. No. 3,397,689

Registered Mar. 18, 2008

**SERVICE MARK
PRINCIPAL REGISTER**

OWEN BIOSCIENCES

OWEN BIOSCIENCES, INC. (LOUISIANA CORPORATION)
7053 REVENUE DRIVE
BATON ROUGE, LA 70809

FOR: MANUFACTURE OF SKINCARE PRODUCTS, NAMELY, SKIN LIGHTNERS, SKIN SUNSCREENS, SKIN CLEANSERS, SKIN TONERS, SKIN EXFOLIANTS, SKIN MOISTURIZERS, SKIN CREAMS, AND SKIN LOTIONS AND ASSOCIATED DELIVERY SYSTEMS, NAMELY, MICROEMULSION AND NANOEMULSION DELIVERY SYSTEMS FOR TOPICAL OR TRANSDERMAL SKINCARE APPLICATIONS, TO ORDER AND/OR SPECIFICATION OF OTHERS, IN CLASS 40 (U.S. CLS. 100, 103 AND 106).

FIRST USE 7-15-2005; IN COMMERCE 7-15-2005.

THE MARK CONSISTS OF STANDARD CHARACTERS WITHOUT CLAIM TO ANY PARTICULAR FONT, STYLE, SIZE, OR COLOR.

OWNER OF U.S. REG. NO. 3,176,428.

NO CLAIM IS MADE TO THE EXCLUSIVE RIGHT TO USE "BIOSCIENCES" , APART FROM THE MARK AS SHOWN.

SER. NO. 77-215,857, FILED 6-26-2007.

YAT SYE, LEE, EXAMINING ATTORNEY

Int. Cl.: 35

Prior U.S. Cls.: 100, 101 and 102

United States Patent and Trademark Office

Reg. No. 3,397,690

Registered Mar. 18, 2008

**SERVICE MARK
PRINCIPAL REGISTER**

**SAFE SECURITY ASSESSMENT
FOR EMPLOYEES**

PREVENT LOSS, LTD. (TEXAS LIMITED PART-
NERSHIP)
1820 PRESTON PARK BLVD. SUITE 2900
PLANO, TX 75093

FOR: PSYCHOLOGICAL TESTING FOR THE
SELECTION OF PERSONNEL, NAMELY, WORK
ETHIC, AND ATTITUDE TESTING, AND TESTING
THE PROPENSITY OF INDIVIDUALS TO ENGAGE
IN COUNTER-PRODUCTIVE BEHAVIORS FOR
PRE-EMPLOYMENT AND PROMOTION CONSID-
ERATIONS, IN CLASS 35 (U.S. CLS. 100, 101 AND
102).

FIRST USE 6-1-2002; IN COMMERCE 6-1-2002.

THE MARK CONSISTS OF STANDARD CHAR-
ACTERS WITHOUT CLAIM TO ANY PARTICULAR
FONT, STYLE, SIZE, OR COLOR.

OWNER OF U.S. REG. NO. 3,049,432.

NO CLAIM IS MADE TO THE EXCLUSIVE
RIGHT TO USE "SECURITY ASSESSMENT FOR
EMPLOYEES", APART FROM THE MARK AS
SHOWN.

SER. NO. 77-215,864, FILED 6-26-2007.

KAREN BRACEY, EXAMINING ATTORNEY

Int. Cl.: 3

Prior U.S. Cls.: 1, 4, 6, 50, 51 and 52

United States Patent and Trademark Office

Reg. No. 3,397,691

Registered Mar. 18, 2008

TRADEMARK
PRINCIPAL REGISTER



KATAI, NOELLE C. (UNITED STATES INDIVIDUAL)
1641 BLOSSOM FIELD WAY
ENCINITAS, CA 92024

FOR: AROMATHERAPY CREAMS; AROMATHERAPY LOTIONS; AROMATHERAPY OILS; ESSENTIAL OILS; NATURAL ESSENTIAL OILS; BATH OILS; BODY OILS; COSMETIC OILS FOR THE EPIDERMIS; ESSENTIAL OILS FOR PERSONAL USE; NUTRITIONAL OILS FOR COSMETIC PURPOSES; SKIN AND BODY TOPICAL LOTIONS, CREAMS AND OILS FOR COSMETIC USE; NON-MEDICATED SKIN CARE PREPARATIONS; SKIN CLEANSERS; SKIN CREAMS; SKIN EMOLLIENTS; SKIN LOTIONS; NON-MEDICATED TOILETRIES, IN CLASS 3 (U.S. CLS. 1, 4, 6, 50, 51 AND 52).

FIRST USE 8-0-2006; IN COMMERCE 9-0-2006.

NO CLAIM IS MADE TO THE EXCLUSIVE RIGHT TO USE "ESSENTIALS", APART FROM THE MARK AS SHOWN.

THE MARK CONSISTS OF THE WORDS "VIM ESSENTIALS", UNDER A STYLIZED DESIGNED VERSION OF THE WORD "VIM."

SER. NO. 77-215,960, FILED 6-26-2007.

KELLY BOULTON, EXAMINING ATTORNEY

Int. Cl.: 24

Prior U.S. Cls.: 42 and 50

United States Patent and Trademark Office

Reg. No. 3,397,692

Registered Mar. 18, 2008

**TRADEMARK
PRINCIPAL REGISTER**

TOWTAB

2608961 CANADA INC. (CANADA CORPORATION)
2500 VIMONT STREET
MONTREAL, QUEBEC, CANADA H1V3L5

FOR: DISPOSAL INSTANT GROW TOWEL TABLETS MADE OF NON-WOVEN RAYON, IN CLASS 24 (U.S. CLS. 42 AND 50).

FIRST USE 2-28-2006; IN COMMERCE 2-28-2006.

THE MARK CONSISTS OF STANDARD CHARACTERS WITHOUT CLAIM TO ANY PARTICULAR FONT, STYLE, SIZE, OR COLOR.

PRIORITY CLAIMED UNDER SEC. 44(D) ON CANADA APPLICATION NO. 1348624, FILED 5-24-2007.

SER. NO. 77-215,994, FILED 6-26-2007.

LINDA MICKLEBURGH, EXAMINING ATTORNEY

Int. Cl.: 35

Prior U.S. Cls.: 100, 101 and 102

United States Patent and Trademark Office

Reg. No. 3,397,693

Registered Mar. 18, 2008

**SERVICE MARK
PRINCIPAL REGISTER**

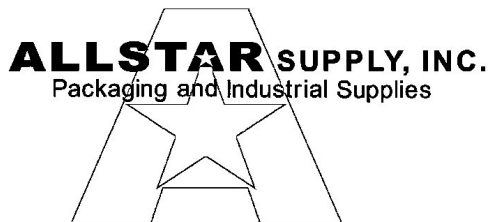

ALLSTAR SUPPLY, INC. (CONNECTICUT CORPORATION)
P.O. BOX 8
COLLINSVILLE, CT 06022

FOR: DISTRIBUTORSHIPS IN THE FIELD OF PACKAGING PRODUCTS, NAMELY, STRETCH WRAP, SHRINK WRAP, TAPES, STAPLES AND PLASTIC BAGS; WHOLESALE DISTRIBUTORSHIPS FEATURING PACKAGING PRODUCTS, NAMELY, STRETCH WRAP, SHRINK WRAP, TAPES, STAPLES AND PLASTIC BAGS, IN CLASS 35 (U.S. CLS. 100, 101 AND 102).

FIRST USE 9-1-1991; IN COMMERCE 9-1-1991.

NO CLAIM IS MADE TO THE EXCLUSIVE RIGHT TO USE "SUPPLY, INC. AND PACKAGING

AND INDUSTRIAL SUPPLIES", APART FROM THE MARK AS SHOWN.

THE MARK CONSISTS OF THE CAPITAL LETTER A WITH THE SPACE FORMING THE CENTER OF THE A BEING A STAR. AN ADDITIONAL STAR FORMS THE TOP OF THE LARGER CENTER STAR AND BECOMES THE CENTER OF THE SECOND A IN THE COMPANY NAME. ALLSTAR SUPPLY, INC. THE WORDS A ALLSTAR SUPPLY, INC. PACKAGING AND INDUSTRIAL SUPPLIES IS IN A STYLIZED TEXT.

SER. NO. 77-216,088, FILED 6-26-2007.

SHARON MEIER, EXAMINING ATTORNEY

Int. Cl.: 42

Prior U.S. Cls.: 100 and 101

United States Patent and Trademark Office

Reg. No. 3,397,694

Registered Mar. 18, 2008

SERVICE MARK
PRINCIPAL REGISTER



BARTLE, CHERYL (UNITED STATES INDIVIDUAL)
3602 CHABLIS DRIVE
BROWNSVILLE, TX 785261131

FOR: CONSULTING SERVICES FOR LOCAL CITY GOVERNMENTS, NAMELY, CONSULTATION SERVICES IN THE FIELD OF MAPPING, URBAN PLANNING AND CITY PLANNING, LAND USE PLANNING SERVICES, PLANNING OF BUILDINGS AND INFRASTRUCTURE SYSTEMS FOR BUILDINGS, PLANNING, DEVELOPMENT AND TECHNICAL SUPPORT OF ELECTRONIC COMMUNICATIONS NETWORKS, PROVIDING PLANNING SERVICES IN THE FIELD OF INFORMATION AND COMMUNICATIONS NETWORKS AND CONSULTING SERVICES IN THE FIELD OF ENVIRONMENTAL ASSESSMENT, COMPLIANCE AND PLANNING, IN CLASS 42 (U.S. CLS. 100 AND 101).

FIRST USE 2-2-2006; IN COMMERCE 2-2-2006.

NO CLAIM IS MADE TO THE EXCLUSIVE RIGHT TO USE "MAPPING", APART FROM THE MARK AS SHOWN.

THE MARK CONSISTS OF A HALF CIRCLE WITH A PALM TREE IN THE CENTER OF THE HALF CIRCLE. THREE COCONUTS ARE PART OF THE DESIGN AND ARE LOCATED AS FOLLOWS: ONE COCONUT IS LOCATED JUST UNDERNEATH

THE PALM TREE LEAVES AND APPEARS TO BE PART OF THE PALM TREE'S TRUNK; ONE COCONUT IS JUST TO THE RIGHT AND SLIGHTLY ABOVE THE COCONUT DESCRIBED ABOVE; THE THIRD COCONUT IS LOCATED TO THE LEFT AND SLIGHTLY LOWER THAN THE FIRST COCONUT DESCRIBED ABOVE BEFORE THE SECOND COCONUT. LOCATED JUST BELOW THE LOWEST PALM TREE LEAF ON THE LEFT AND RUNNING HORIZONTALLY THROUGH THE TRUNK OF THE PALM TREE ARE THREE THIN LINES WHICH BEGIN AT THE LEFT HAND SIDE OF THE HALF CIRCLE AND END AT THE RIGHT HAND SIDE OF THE HALF CIRCLE. BELOW THE ABOVE DESCRIBED GRAPHIC ARE THE WORDS, LA PLAYA SPACED SO THAT THEY ARE CENTERED BENEATH THE ABOVE DESCRIBED GRAPHIC. BELOW THE WORDS, LA PLAYA IS THE WORD, MAPPING SPACED SO THAT THE WORD IS CENTERED BELOW THE WORDS LA PLAYA AND SO THAT THE FIRST LETTER, M IS UNDER THE L IN LA PLAYA AND THE LETTER G IS UNDER THE LAST LETTER A IN LA PLAYA.

THE FOREIGN WORDING IN THE MARK TRANSLATES INTO ENGLISH AS THE BEACH.

SER. NO. 77-216,270, FILED 6-26-2007.

ANDREA BUTLER, EXAMINING ATTORNEY

Int. Cl.: 11

Prior U.S. Cls.: 13, 21, 23, 31 and 34

United States Patent and Trademark Office

Reg. No. 3,397,695

Registered Mar. 18, 2008

**TRADEMARK
PRINCIPAL REGISTER**

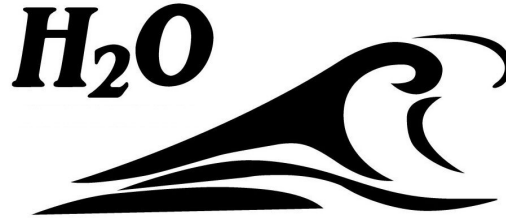

H2O INTERNATIONAL, INC. (FLORIDA CORPORATION)
SUITE C
3001 S.W. 15TH STREET
DEERFIELD BEACH, FL 33442

FOR: WATER FILTERING UNITS AND FILTERS FOR WATER FILTERING UNITS ON POTABLE WATER SUPPLIES FOR DOMESTIC, COMMERCIAL AND INDUSTRIAL USE; WATER FILTERING UNITS FOR USE IN SHOWERS AND BATHS FOR DOMESTIC AND COMMERCIAL USE; WATER DISPENSERS, NAMELY, WATER FILTRATION PITCHERS SOLD EMPTY; ICE MACHINES; AIR FILTERS FOR DOMESTIC USE, IN CLASS 11 (U.S. CLS. 13, 21, 23, 31 AND 34).

FIRST USE 6-30-1993; IN COMMERCE 6-30-1993.

NO CLAIM IS MADE TO THE EXCLUSIVE RIGHT TO USE "H2O", APART FROM THE MARK AS SHOWN.

THE MARK CONSISTS OF H2O AND A STYLIZED WAVE.

SER. NO. 77-216,538, FILED 6-27-2007.

MARTHA FROMM, EXAMINING ATTORNEY

Int. Cls.: 35 and 43

Prior U.S. Cls.: 100, 101 and 102

United States Patent and Trademark Office

Reg. No. 3,397,696

Registered Mar. 18, 2008

**SERVICE MARK
PRINCIPAL REGISTER**



MAX AND SEATTLE CO INC. DBA BUBBLE
ISLAND (WASHINGTON CORPORATION)
SUITE 2200
1420 5TH AVENUE
SEATTLE, WA 98101

FOR: RESTAURANT FRANCHISES; FRANCHISE
SERVICES, NAMELY, OFFERING TECHNICAL
AND BUSINESS MANAGEMENT ASSISTANCE IN
THE ESTABLISHMENT AND OPERATION OF
CAFES AND RESTAURANTS, IN CLASS 35 (U.S.
CLS. 100, 101 AND 102).

FIRST USE 1-0-2006; IN COMMERCE 1-0-2006.

FOR: CAFE-RESTAURANTS; COFFEE-HOUSE
AND SNACK-BAR SERVICES; SERVING OF FOOD
AND DRINK/BEVERAGES; CAFES-RESTAURANT
SERVICES FEATURING THE PREPARATION,
MARKETING AND SALE OF BUBBLE-TEA, IN
CLASS 43 (U.S. CLS. 100 AND 101).

FIRST USE 1-0-2006; IN COMMERCE 1-0-2006.

NO CLAIM IS MADE TO THE EXCLUSIVE
RIGHT TO USE "DELICIOUS & TRADITIONAL
BUBBLE TEA CAFE" , APART FROM THE MARK
AS SHOWN.

THE MARK CONSISTS OF THE STYLIZED
WORDS DELICIOUS & TRADITIONAL BUBBLE
TEA CAFE LOCATED ON THE OUTER UPPER
AND INSIDE PERIMETER OF A CIRCULAR DE-
SIGN; IN THE CENTER OF THE DESIGN ARE
LEAVES; LOCATED IN THE MIDDLE AND TO THE
RIGHT OF THE CIRCULAR DESIGN IS A KOALA
BEAR, HOLDING A CUP.

SER. NO. 77-216,603, FILED 6-27-2007.

TINA BROWN, EXAMINING ATTORNEY

Int. Cl.: 36

Prior U.S. Cls.: 100, 101 and 102

United States Patent and Trademark Office

Reg. No. 3,397,697

Registered Mar. 18, 2008

**SERVICE MARK
PRINCIPAL REGISTER**

**Lubbock's First Name in
Appraisals and Estate Sales**

MADDOX, EDDIE (UNITED STATES INDIVIDUAL)
3509 45TH ST.
LUBBOCK, TX 79413

FOR: ANTIQUE APPRAISAL; APPRAISALS FOR INSURANCE CLAIMS OF PERSONAL PROPERTY; CONSULTATION RELATING TO THE APPRAISAL OF GOODS, IN CLASS 36 (U.S. CLS. 100, 101 AND 102).

FIRST USE 6-27-2007; IN COMMERCE 6-27-2007.

THE MARK CONSISTS OF STANDARD CHARACTERS WITHOUT CLAIM TO ANY PARTICULAR FONT, STYLE, SIZE, OR COLOR.

NO CLAIM IS MADE TO THE EXCLUSIVE RIGHT TO USE "LUBBOCK'S" AND "APPRAISALS AND ESTATE SALES", APART FROM THE MARK AS SHOWN.

SER. NO. 77-216,678, FILED 6-27-2007.

LINDSEY RUBIN, EXAMINING ATTORNEY

Int. Cl.: 35

Prior U.S. Cls.: 100, 101 and 102

United States Patent and Trademark Office

Reg. No. 3,397,698

Registered Mar. 18, 2008

**SERVICE MARK
PRINCIPAL REGISTER**

SPOTVIEWER

DAKOTA VIDEO & POST PRODUCTIONS, L.L.C.
(SOUTH DAKOTA LTD LIAB CO)
196 E. 6TH ST STE 200
SIOUX FALLS, SD 571040112

FOR: PROVIDING A WEB SITE WHICH FEAT-
URES ADVERTISEMENTS FOR THE GOODS AND
SERVICES OF OTHERS ON A GLOBAL COMPUTER
NETWORK, IN CLASS 35 (U.S. CLS. 100, 101 AND
102).

FIRST USE 8-0-2005; IN COMMERCE 8-0-2005.

THE MARK CONSISTS OF STANDARD CHAR-
ACTERS WITHOUT CLAIM TO ANY PARTICULAR
FONT, STYLE, SIZE, OR COLOR.

SER. NO. 77-216,691, FILED 6-27-2007.

TAMARA FRAZIER, EXAMINING ATTORNEY

Int. Cl.: 36

Prior U.S. Cls.: 100, 101 and 102

United States Patent and Trademark Office

Reg. No. 3,397,699

Registered Mar. 18, 2008

**SERVICE MARK
PRINCIPAL REGISTER**

MorQuest

MORQUEST, LLC (FLORIDA LTD LIAB CO)
520 N. ORLANDO AVE., SUITE 1
WINTER PARK, FL 32789

FOR: FINANCIAL SERVICES, NAMELY, MORTGAGE PLANNING; MORTGAGE BANKING; MORTGAGE BANKING SERVICES, NAMELY, ORIGINATION, ACQUISITION, SERVICING, SECURITIZATION AND BROKERAGE OF MORTGAGE LOANS; MORTGAGE BROKERAGE; MORTGAGE LENDING; MORTGAGE PROCUREMENT FOR OTHERS; MORTGAGE SERVICES, NAMELY, BUYER PRE-QUALIFICATION OF MORTGAGES FOR

MORTGAGE BROKERS AND BANKS, IN CLASS 36 (U.S. CLS. 100, 101 AND 102).

FIRST USE 3-16-2005; IN COMMERCE 3-16-2005.

THE MARK CONSISTS OF STANDARD CHARACTERS WITHOUT CLAIM TO ANY PARTICULAR FONT, STYLE, SIZE, OR COLOR.

SER. NO. 77-216,796, FILED 6-27-2007.

LAURIE MAYES, EXAMINING ATTORNEY

Int. Cl.: 5

Prior U.S. Cls.: 6, 18, 44, 46, 51 and 52

Reg. No. 3,397,700

United States Patent and Trademark Office

Registered Mar. 18, 2008

TRADEMARK
PRINCIPAL REGISTER

ONE VISIT. ONE TEST. ONE
TIME.

QUIDEL CORPORATION (DELAWARE COR-
PORATION)
10165 MCKELLAR COURT
SAN DIEGO, CA 92121

THE MARK CONSISTS OF STANDARD CHAR-
ACTERS WITHOUT CLAIM TO ANY PARTICULAR
FONT, STYLE, SIZE, OR COLOR.

FOR: IN VITRO MEDICAL DIAGNOSTIC TEST
KITS PRIMARILY CONTAINING REAGENTS AND
DEVICES FOR DIAGNOSIS OF DISEASE OR CON-
DITION, IN CLASS 5 (U.S. CLS. 6, 18, 44, 46, 51 AND
52).

OWNER OF U.S. REG. NOS. 2,449,466 AND
2,487,904.

SER. NO. 77-216,826, FILED 6-27-2007.

FIRST USE 11-0-1997; IN COMMERCE 11-0-1997.

LINDSEY RUBIN, EXAMINING ATTORNEY

Int. Cl.: 45

Prior U.S. Cls.: 100 and 101

United States Patent and Trademark Office

Reg. No. 3,397,701

Registered Mar. 18, 2008

**SERVICE MARK
PRINCIPAL REGISTER**

The Composed Domain

ROSS, REBECCA (WASHINGTON SOLE PROPRIETORSHIP)
17327 1ST AVE NW
SHORELINE, WA 98177

FOR: ORGANIZATIONAL SERVICES FOR HOME OR PERSONAL PURPOSES, NAMELY, ORGANIZING ROOMS AND HOUSES BY ASSESSING CLUTTER AND IDENTIFYING THE INTENT AND PURPOSE OF THE ROOM OR HOME , IN CLASS 45 (U.S. CLS. 100 AND 101).

FIRST USE 1-1-2000; IN COMMERCE 1-1-2000.

THE MARK CONSISTS OF STANDARD CHARACTERS WITHOUT CLAIM TO ANY PARTICULAR FONT, STYLE, SIZE, OR COLOR.

SER. NO. 77-216,906, FILED 6-27-2007.

APRIL ROACH, EXAMINING ATTORNEY

Int. Cl.: 29

Prior U.S. Cl.: 46

United States Patent and Trademark Office

Reg. No. 3,397,702

Registered Mar. 18, 2008

**TRADEMARK
PRINCIPAL REGISTER**

HEIDI'S OMELET CREATIONS

W3 PARTNERS, LLC (ARKANSAS LTD LIAB CO)
5509 WALSH LANE
ROGERS, AR 72758

FOR: OMELET KITS CONSISTING PRIMARILY
OF LIQUID EGGS, CUT VEGETABLES AND DRIED
MEAT, IN CLASS 29 (U.S. CL. 46).

FIRST USE 10-6-2006; IN COMMERCE 10-6-2006.

THE MARK CONSISTS OF STANDARD CHAR-
ACTERS WITHOUT CLAIM TO ANY PARTICULAR
FONT, STYLE, SIZE, OR COLOR.

NO CLAIM IS MADE TO THE EXCLUSIVE
RIGHT TO USE "OMELET", APART FROM THE
MARK AS SHOWN.

SER. NO. 77-216,947, FILED 6-27-2007.

WARREN L. OLANDRIA, EXAMINING ATTOR-
NEY

Int. Cl.: 29

Prior U.S. Cl.: 46

United States Patent and Trademark Office

Reg. No. 3,397,703

Registered Mar. 18, 2008

**TRADEMARK
PRINCIPAL REGISTER**

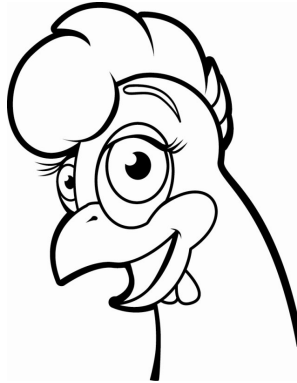

W3 PARTNERS, LLC (ARKANSAS LTD LIAB CO)
5509 WALSH LANE
ROGERS, AR 72758

THE MARK CONSISTS OF THE STYLIZED
DRAWING OF A HEN.

FOR: EGGS; LIQUID EGGS; RING-SHAPED
BREADED CHICKEN; OMELET KITS CONSISTING
PRIMARILY OF LIQUID EGGS, CUT VEGETABLES
AND DRIED MEAT, IN CLASS 29 (U.S. CL. 46).

SER. NO. 77-216,990, FILED 6-27-2007.

FIRST USE 10-6-2006; IN COMMERCE 10-6-2006.

WARREN L. OLANDRIA, EXAMINING ATTOR-
NEY

Int. Cl.: 35

Prior U.S. Cls.: 100, 101 and 102

United States Patent and Trademark Office

Reg. No. 3,397,704

Registered Mar. 18, 2008

**SERVICE MARK
PRINCIPAL REGISTER**



MILLER PRODUCTS COMPANY (WISCONSIN CORPORATION)
3939 WEST HIGHLAND BOULEVARD
MILWAUKEE, WI 53208

FOR: PROMOTING THE PUBLIC AWARENESS FOR THE NEED FOR ALCOHOL AWARENESS AND MODERATION AND RESPONSIBILITY IN DRINKING ALCOHOLIC BEVERAGES, AND ENCOURAGING PARENTS AND OTHER ADULTS TO SUPPORT THE LEGAL DRINKING AGE, IN CLASS 35 (U.S. CLS. 100, 101 AND 102).

FIRST USE 4-11-2005; IN COMMERCE 4-11-2005.

NO CLAIM IS MADE TO THE EXCLUSIVE RIGHT TO USE "21" AND "PREVENTING UNDERAGE ACCESS", APART FROM THE MARK AS SHOWN.

THE MARK CONSISTS OF THE WORD RESPECT AND THE NUMBER 21 IN A DESIGN ELEMENT WITH THE WORDS PREVENTING UNDERAGE ACCESS UNDERNEATH..

SER. NO. 77-216,993, FILED 6-27-2007.

CHRISTINA SOBRAL, EXAMINING ATTORNEY

Int. Cl.: 35

Prior U.S. Cls.: 100, 101 and 102

United States Patent and Trademark Office

Reg. No. 3,397,705

Registered Mar. 18, 2008

**SERVICE MARK
PRINCIPAL REGISTER**

PRO-FRUIT

PRO-FRUIT MARKETING, INC. (NEW JERSEY
CORPORATION)
1 KALISA WAY
PARAMUS, NJ 07652

THE MARK CONSISTS OF STANDARD CHAR-
ACTERS WITHOUT CLAIM TO ANY PARTICULAR
FONT, STYLE, SIZE, OR COLOR.

FOR: DISTRIBUTORSHIP SERVICES IN THE
FIELD OF FRESH FRUIT AND VEGETABLES, IN
CLASS 35 (U.S. CLS. 100, 101 AND 102).

SER. NO. 77-216,994, FILED 6-27-2007.

FIRST USE 9-29-1984; IN COMMERCE 9-29-1984.

JENNIFER MARTIN, EXAMINING ATTORNEY

Int. Cls.: 9 and 41

Prior U.S. Cls.: 21, 23, 26, 36, 38, 100, 101 and 107

United States Patent and Trademark Office

Reg. No. 3,397,706

Registered Mar. 18, 2008

TRADEMARK
SERVICE MARK
PRINCIPAL REGISTER



LAROCCA, JAMES C. (UNITED STATES INDIVIDUAL)
1413 GREEN STREET
METAIRIE, LA 70001

FOR: MUSICAL SOUND RECORDINGS, IN CLASS 9 (U.S. CLS. 21, 23, 26, 36 AND 38).

FIRST USE 9-30-1997; IN COMMERCE 9-30-1997.

FOR: ENTERTAINMENT SERVICES NAMELY LIVE PERFORMANCES BY A MUSICAL BAND, IN CLASS 41 (U.S. CLS. 100, 101 AND 107).

FIRST USE 12-31-1917; IN COMMERCE 12-31-1917.

OWNER OF U.S. REG. NO. 2,161,120.

NO CLAIM IS MADE TO THE EXCLUSIVE RIGHT TO USE DIXIELAND JAZZ BAND, APART FROM THE MARK AS SHOWN.

SEC. 2(F) AS TO "ORIGINAL".

SER. NO. 77-217,305, FILED 6-27-2007.

AHSEN KHAN, EXAMINING ATTORNEY

Int. Cl.: 41

Prior U.S. Cls.: 100, 101 and 107

United States Patent and Trademark Office

Reg. No. 3,397,707

Registered Mar. 18, 2008

**SERVICE MARK
PRINCIPAL REGISTER**

RETIREMENT ENVIRONMENT

REDMOND, ELAINE (UNITED STATES INDIVIDUAL)
103 HOPE TOWN RD.
CAROLINA BEACH, NC 28428 AND
ROWLINGS, SCOTT (UNITED STATES INDIVIDUAL)
103 HOPE TOWN RD.
CAROLINA BEACH, NC 28428

FOR: ENTERTAINMENT SERVICES, NAMELY PROVIDING A RADIO PROGRAM IN THE FIELD OF RETIREMENT PLANNING, IN CLASS 41 (U.S. CLS. 100, 101 AND 107).

FIRST USE 2-1-2006; IN COMMERCE 2-1-2006.

THE MARK CONSISTS OF STANDARD CHARACTERS WITHOUT CLAIM TO ANY PARTICULAR FONT, STYLE, SIZE, OR COLOR.

NO CLAIM IS MADE TO THE EXCLUSIVE RIGHT TO USE "RETIREMENT", APART FROM THE MARK AS SHOWN.

SER. NO. 77-217,704, FILED 6-28-2007.

CHERYL CLAYTON, EXAMINING ATTORNEY

Int. Cl.: 41

Prior U.S. Cls.: 100, 101 and 107

United States Patent and Trademark Office

Reg. No. 3,397,708

Registered Mar. 18, 2008

SERVICE MARK
PRINCIPAL REGISTER

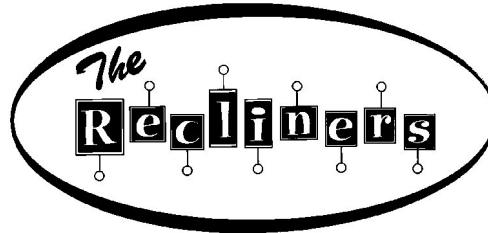

YOUNG, RUSSELL (UNITED STATES INDIVIDUAL)

2142 CERVIN BLVD
AUSTIN, TX 78728

FOR: ENTERTAINMENT IN THE NATURE OF VISUAL AND AUDIO PERFORMANCES, AND MUSICAL, VARIETY, NEWS AND COMEDY SHOWS, ENTERTAINMENT IN THE NATURE OF VISUAL AND AUDIO PERFORMANCES, NAMELY, MUSICAL BAND, ROCK GROUP, GYMNASTIC, DANCE, AND BALLET PERFORMANCES, ENTERTAINMENT IN THE NATURE OF AN ON-GOING SPECIAL VARIETY, NEWS, MUSIC OR COMEDY SHOW FEATURING LOUNGE MUSIC BROADCAST OVER TELEVISION, SATELLITE, AUDIO, AND VIDEO MEDIA, ENTERTAINMENT, NAMELY, LIVE PERFORMANCES BY A MUSICAL BAND, ENTERTAINMENT SERVICES IN THE NATURE OF AN AMUSEMENT PARK SHOW, ENTERTAINMENT SERVICES, NAMELY, PROVIDING A WEB SITE FEATURING MUSICAL PERFORMANCES, MUSICAL VIDEOS, RELATED FILM CLIPS, PHOTOGRAPHS, AND OTHER MULTIMEDIA MATERIALS, ENTERTAINMENT SERVICES, NAMELY, PROVIDING PRERECORDED MUSIC, INFORMATION IN THE FIELD OF MUSIC, AND COMMENTARY AND ARTICLES ABOUT MUSIC, ALL ONLINE VIA A GLOBAL COMPUTER NETWORK, ENTERTAINMENT SERVICES, NAMELY, LIVE, TELEvised AND MOVIE APPEARANCES BY A PROFESSIONAL ENTERTAINER, ENTERTAINMENT SERVICES IN THE NATURE OF ON-GOING TELEVISION PROGRAMS IN THE FIELD OF CHILDREN'S ENTERTAINMENT, ENTERTAINMENT SERVICES, NAMELY, PROVIDING A WEBSITE FEATURING, PHOTOGRAPHIC, AUDIO, VIDEO AND PROSE PRESENTATIONS FEATURING LOUNGE BAND, BAND CALENDAR, MUSIC CLIP OF LOUNGE BAND, BAND PRESS CLIPPINGS, BAND PHOTOGRAPHS, ENTERTAINMENT SERVI-

CES, NAMELY, NON-DOWNLOADABLE RINGTONES, PRE-RECORDED MUSIC, VIDEO AND GRAPHICS PRESENTED TO MOBILE COMMUNICATIONS DEVICES VIA A GLOBAL COMPUTER NETWORK AND WIRELESS NETWORKS, ENTERTAINMENT SERVICES IN THE NATURE OF AN ON-GOING REALITY BASED TELEVISION PROGRAM, ENTERTAINMENT, NAMELY, LIVE PERFORMANCES BY MUSICAL BANDS, ENTERTAINMENT, NAMELY, LIVE MUSIC CONCERTS, ENTERTAINMENT, NAMELY, A CONTINUING VARIETY SHOW, NEWS SHOW, OR COMEDY SHOW BROADCAST OVER TELEVISION, SATELLITE, AUDIO, AND VIDEO MEDIA, MOBILE MEDIA SERVICES IN THE NATURE OF ELECTRONIC TRANSMISSION OF ENTERTAINMENT MEDIA CONTENT, BOOKING OF ENTERTAINMENT HALLS, ENTERTAINMENT IN THE NATURE OF ORCHESTRA PERFORMANCES, ENTERTAINMENT IN THE NATURE OF ON-GOING TELEVISION PROGRAMS IN THE FIELD OF NEWS, COMEDY, AND VARIETY, ENTERTAINMENT IN THE NATURE OF LIVE PERFORMANCES BY THE LOUNGE AND/OR VARIETY BAND, ENTERTAINMENT, NAMELY, LIVE PERFORMANCES BY A MUSICAL BAND, ENTERTAINMENT, NAMELY, LIVE PERFORMANCES BY ROCK GROUPS, LIVE PERFORMANCES FEATURING PRERECORDED VOCAL AND INSTRUMENTAL PERFORMANCES VIEWED ON A BIG SCREEN, PRESENTATION OF LIVE SHOW PERFORMANCES, ELECTRONIC PUBLISHING SERVICES, NAMELY, PUBLICATION OF TEXT AND GRAPHIC WORKS OF OTHERS ON CD, DVD, ON-LINE, IN VIDEO AND FILM FEATURING MUSIC AND PERFORMANCE OF SAID BAND, ENTERTAINMENT SERVICES, NAMELY, PROVIDING A RADIO PROGRAM IN THE FIELD OF LOUNGE MUSIC VIA A GLOBAL COMPUTER NETWORK, MUSIC SELECTION SERVICES FOR USE IN TV, FILM, RADIO AND VIDEO GAMES, OPERATION OF VIDEO

EQUIPMENT OR AUDIO EQUIPMENT ETC. FOR PRODUCTION OF RADIO OR TELEVISION PROGRAMS, PRODUCTION AND DISTRIBUTION OF RADIO PROGRAMS, PRODUCTION OF RADIO AND TELEVISION PROGRAMS, PRODUCTION OF RADIO OR TELEVISION PROGRAMS, RADIO ENTERTAINMENT PRODUCTION, RADIO ENTERTAINMENT SERVICES, NAMELY, RADIO PROGRAMS FEATURING PERFORMANCES BY A LOUNGE BAND, ROCK BAND, ACOUSTIC BAND OR COMBO, RADIO PROGRAM SYNDICATION, MULTIMEDIA ENTERTAINMENT SERVICES IN THE NATURE OF RECORDING, PRODUCTION AND POST-PRODUCTION SERVICES IN THE

FIELDS OF MUSIC, VIDEO, AND FILMS AND POST-PRODUCTION EDITING SERVICES IN THE FIELD OF MUSIC, VIDEOS AND FILMS, IN CLASS 41 (U.S. CLS. 100, 101 AND 107).

FIRST USE 8-1-1994; IN COMMERCE 8-1-1994.

THE MARK CONSISTS OF AN OVAL WITH THE WORDS THE RECLINERS IN A STYLIZED TEXT.

SER. NO. 77-217,801, FILED 6-28-2007.

DEZMONA MIZELLE, EXAMINING ATTORNEY

Int. Cl.: 35

Prior U.S. Cls.: 100, 101 and 102

United States Patent and Trademark Office

Reg. No. 3,397,709

Registered Mar. 18, 2008

**SERVICE MARK
PRINCIPAL REGISTER**



LEVEL ONE PERSONNEL, INC. (MARYLAND CORPORATION)
SUITE 314
10320 LITTLE PATUXENT PARKWAY
COLUMBIA, MD 21044

FOR: EMPLOYMENT AGENCY SERVICES, NAMELY, PLACEMENT AND STAFFING SERVICES FOR TEMPORARY, TEMPORARY-TO-PERMANENT AND PERMANENT OFFICE PERSONNEL , IN CLASS 35 (U.S. CLS. 100, 101 AND 102).

FIRST USE 11-8-1999; IN COMMERCE 11-8-1999.

NO CLAIM IS MADE TO THE EXCLUSIVE RIGHT TO USE "PERSONNEL" OR "STAFFING SOLUTIONS", APART FROM THE MARK AS SHOWN.

THE COLOR(S) RED, WHITE AND BLACK IS/ ARE CLAIMED AS A FEATURE OF THE MARK.

THE MARK CONSISTS OF A LOGO ON A WHITE BACKGROUND INCLUDING A RED TRIANGLE ADJACENT TO A BLACK STYLIZED REPRESENTATION OF THE LETTER L AND THE NUMBER 1 ABOVE THE WORDS LEVEL ONE PERSONNEL IN BLACK LETTERS, WITH A RED DOT BETWEEN THE WORDS LEVEL AND ONE, AND THE ABOVE-NOTED LOGO ON A RED BACKGROUND NEXT TO THE WORDS SUCCESSFUL STAFFING SOLUTIONS . . . BEGIN AT LEVEL ONE IN WHITE LETTERS.

SER. NO. 77-217,853, FILED 6-28-2007.

CARRIE GENOVESE, EXAMINING ATTORNEY

Int. Cl.: 36

Prior U.S. Cls.: 100, 101 and 102

United States Patent and Trademark Office

Reg. No. 3,397,710

Registered Mar. 18, 2008

**SERVICE MARK
PRINCIPAL REGISTER**

TICKETING 2.0

THE TICKET RESERVE, INC. (ILLINOIS CORPORATION)
20 N. WACKER DRIVE, SUITE 1100
CHICAGO, IL 60606

FOR: COMMODITY TRADING SERVICES FOR OTHERS IN CONNECTION WITH EVENT TICKETS, FORWARD CONTRACTS ON EVENT TICKETS, PERSONAL TRAVEL VIA COMMON CARRIER AND PRIVATE CARRIER AIR TRANSPORTATION, FORWARD CONTRACTS FOR HOTEL AND OTHER TEMPORARY ACCOMMODATIONS, IN CLASS 36 (U.S. CLS. 100, 101 AND 102).

FIRST USE 1-0-2007; IN COMMERCE 1-0-2007.

THE MARK CONSISTS OF STANDARD CHARACTERS WITHOUT CLAIM TO ANY PARTICULAR FONT, STYLE, SIZE, OR COLOR.

NO CLAIM IS MADE TO THE EXCLUSIVE RIGHT TO USE "TICKETING", APART FROM THE MARK AS SHOWN.

SER. NO. 77-218,005, FILED 6-28-2007.

MONIQUE MILLER, EXAMINING ATTORNEY

Int. Cl.: 35

Prior U.S. Cls.: 100, 101 and 102

United States Patent and Trademark Office

Reg. No. 3,397,711

Registered Mar. 18, 2008

**SERVICE MARK
PRINCIPAL REGISTER**

BIPs

WIEDEMANN & LOMASNEY, LLC (DELAWARE
LTD LIAB CO)
SUITE 100
1910 S. HIGHLAND AVENUE
LOMBARD, IL 60148

FOR: CREATION OF MARKETING TOOLS AND
INDICATORS DESIGNED TO INCREASE A CLIENT
COMPANY'S KNOWLEDGE OF CUSTOMER
NEEDS, IN CLASS 35 (U.S. CLS. 100, 101 AND 102).

FIRST USE 4-16-2007; IN COMMERCE 5-23-2007.

THE MARK CONSISTS OF STANDARD CHAR-
ACTERS WITHOUT CLAIM TO ANY PARTICULAR
FONT, STYLE, SIZE, OR COLOR.

SER. NO. 77-218,410, FILED 6-28-2007.

JULIE GUTTADAURO, EXAMINING ATTORNEY

Int. Cl.: 41

Prior U.S. Cls.: 100, 101 and 107

United States Patent and Trademark Office

Reg. No. 3,397,712

Registered Mar. 18, 2008

**SERVICE MARK
PRINCIPAL REGISTER**



B.BETTER SUCCESS COACHING AND CONSULTING, LLC (MINNESOTA LTD LIAB CO)
326 BROADWAY AVE. SO.
WAYZATA, MN 55391

FOR: LIFE COACHING SERVICES IN THE FIELD OF PERSONAL ACTUALIZATION AND SUCCESS ACHIEVEMENT, IN CLASS 41 (U.S. CLS. 100, 101 AND 107).

FIRST USE 6-7-2005; IN COMMERCE 6-7-2005.

THE COLOR(S) LIGHT GREEN AND DARK GREEN IS/ARE CLAIMED AS A FEATURE OF THE MARK.

THE COLOR, LIGHT GREEN APPEARS IN THE DESIGN OF TWO INTERSECTING OAK TREES, AND THE COLOR, DARK GREEN APPEARS IN THE WORDING B BETTER CREATING A BETTER WAY OF BEING. THE COLOR WHITE IS NOT CLAIMED AS A FEATURE OF THE MARK BUT MERELY DENOTES A TRANSPARENT BACKGROUND.

SER. NO. 77-218,821, FILED 6-29-2007.

KELLY CHOE, EXAMINING ATTORNEY

Int. Cls.: 35 and 42

Prior U.S. Cls.: 100, 101 and 102

United States Patent and Trademark Office

Reg. No. 3,397,713

Registered Mar. 18, 2008

**SERVICE MARK
PRINCIPAL REGISTER**



Virtutrix

VIRTUTRIX, INC. (MINNESOTA CORPORATION)
2040 17TH AVE E
NORTH ST. PAUL, MN 55109

FOR: PRODUCING AUDIO OR VIDEO INFORMATIONALS; PRODUCING PROMOTIONAL VIDEOTAPES, VIDEO DISCS, AND AUDIO VISUAL RECORDINGS; PROVIDING ADVERTISING, MARKETING AND PROMOTIONAL SERVICES, NAMELY DEVELOPMENT OF ADVERTISING CAMPAIGNS FOR BUSINESSES, COMPANIES; BUSINESS MARKETING SERVICES; CREATION OF MARKETING TOOLS DESIGNED TO INCREASE A CLIENT COMPANY'S KNOWLEDGE OF CUSTOMER NEEDS, AND ITS COMPETITORS' PRODUCTS AND SERVICES, PRICING, ADVERTISING STRATEGY AND SALES STRATEGY; CREATIVE MARKETING DESIGN SERVICES; DEVELOPMENT OF MARKETING STRATEGIES AND CONCEPTS; DIRECT MARKETING SERVICES; GENERAL BUSINESS MERCHANDISING SERVICES, NAMELY, MARKETING; PROMOTING, ADVERTISING AND MARKETING OF THE ON-LINE WEBSITES OF OTHERS; PROMOTION AND MARKETING SERVICES AND RELATED CONSULTING; PROMOTION, ADVERTISING AND MARKETING OF ON-LINE WEBSITES; PROVIDING INFORMATION IN THE FIELD OF MARKETING AND ON-LINE MARKETING MEDIA VIA THE INTERNET; PROVIDING MARKETING AND PROMOTION OF SPECIAL EVENTS; REAL ESTATE MARKETING SERVICES, NAMELY, ON-LINE SERVICES FEATURING TOURS OF RESIDENTIAL AND COMMERCIAL REAL ESTATE; DESIGN OF ADVERTISING MATERIALS FOR OTHERS; DE-

SIGN OF INTERNET ADVERTISING, IN CLASS 35 (U.S. CLS. 100, 101 AND 102).

FIRST USE 2-1-2007; IN COMMERCE 2-1-2007.

FOR: COMPUTER SERVICES, NAMELY, CREATING AND MAINTAINING WEB SITES FOR OTHERS; COMPUTER SERVICES, NAMELY, DESIGNING AND IMPLEMENTING WEB SITES FOR OTHERS; CREATING OR MAINTAINING WEB SITES FOR OTHERS; CREATION AND MAINTENANCE OF WEB SITES FOR OTHERS; DESIGN OF HOMEPAGES AND WEB-SITES; COMPUTER GRAPHICS SERVICES; CONSULTING SERVICES IN THE FIELD OF DESIGN OF NEWSLETTERS; DESIGN OF HOME PAGES; DESIGN OF HOMEPAGES AND WEBSITES; DESIGNING WEBSITES FOR ADVERTISING PURPOSES; GRAPHIC ART DESIGN; GRAPHIC DESIGN SERVICES; VISUAL DESIGN SERVICES IN THE NATURE OF DESIGNING VISUAL ELEMENTS FOR ONLINE, BROADCAST, PRINT, OUTDOOR AND OTHER COMMUNICATION MEDIA, IN CLASS 42 (U.S. CLS. 100 AND 101).

FIRST USE 2-1-2007; IN COMMERCE 2-1-2007.

THE MARK CONSISTS OF WORD VIRTUTRIX WITH STARS ABOVE THE TWO I'S STARTING WITH A BIGGER STAR AND THEN ARCHING SMALLER AND SMALLER IN SIZE TO THE SMALLER STAR OVER THE SECOND I.

SER. NO. 77-218,845, FILED 6-29-2007.

DEZMONA MIZELLE, EXAMINING ATTORNEY

Int. Cl.: 41

Prior U.S. Cls.: 100, 101 and 107

United States Patent and Trademark Office

Reg. No. 3,397,714

Registered Mar. 18, 2008

SERVICE MARK
PRINCIPAL REGISTER



BALLS-N-STRIKES GROUP, INC. (MISSOURI CORPORATION)
732 CROWN INDUSTRIAL COURT
CHESTERFIELD, MO 63005

FOR: SPORTS CAMPS, TRAINING CLINICS AND INSTRUCTION IN THE FIELDS OF SPORTS AND BASEBALL, AND PROVIDING SPORTS AND BASEBALL FACILITIES THEREFOR, IN CLASS 41 (U.S. CLS. 100, 101 AND 107).

FIRST USE 6-0-1999; IN COMMERCE 6-0-1999.

THE MARK CONSISTS OF THE TERMS, BALLS-N-STRIKES, PARTIALLY WITHIN THE DESIGN OF A BASEBALL, WITH THE DESIGN OF A SMALLER BASEBALL IN THE CENTER OF A BASEBALL MITT FORMING THE "I" OF "STRIKES", WHICH IS UNDERLINED, AND MISCELLANEOUS DESIGN.

SER. NO. 77-218,846, FILED 6-29-2007.

BARBARA A. GOLD, EXAMINING ATTORNEY

Int. Cls.: 9 and 35

Prior U.S. Cls.: 21, 23, 26, 36, 38, 100, 101 and 102

United States Patent and Trademark Office

Reg. No. 3,397,715

Registered Mar. 18, 2008

**TRADEMARK
SERVICE MARK
PRINCIPAL REGISTER**



**ADVANCED

INSTRUMENTS

DIVISION**

AGS ADVANCED INSTRUMENTS DIVISION
(NEVADA CORPORATION)
8881 WEST SAHARA AVENUE
LAS VEGAS, NV 89117

FOR: OPTICAL MAGNIFICATION INSTRUMENTS, NAMELY, FOR USING THE ANGULAR SPECTRUM TO MEASURE AND EVALUATE THE OPTICAL PERFORMANCE OF FACETTED GEMSTONES, IN CLASS 9 (U.S. CLS. 21, 23, 26, 36 AND 38).

FIRST USE 4-25-2007; IN COMMERCE 4-25-2007.

FOR: ONLINE WHOLESALE STORES AND RETAIL STORES FEATURING COMPUTER SOFTWARE USED TO EVALUATE THE OPTICAL PERFORMANCE OF FACETTED GEMSTONES AND OPTICAL MAGNIFICATION INSTRUMENTS, IN CLASS 35 (U.S. CLS. 100, 101 AND 102).

FIRST USE 4-25-2007; IN COMMERCE 4-25-2007.

NO CLAIM IS MADE TO THE EXCLUSIVE RIGHT TO USE "ADVANCED INSTRUMENTS DIVISION", APART FROM THE MARK AS SHOWN.

THE MARK CONSISTS OF THE WORDS, ADVANCED INSTRUMENTS DIVISION, WITH THE FIRST TWO WORDS UNDERLINED, ALL BELOW THE FANCIFUL DESIGN OF THE SIDE VIEW OF A RING WITH THREE PRONGS HOLDING THREE GEMSTONES IN THE SHAPE OF ARROWHEADS, WITH A SEMI-CIRCLE OF TRIANGLES OF VARYING SIZES AND SHAPES, REPRESENTING FACETTED GEMSTONES FORMING THE BACKGROUND FOR THE RING DESIGN.

SER. NO. 77-218,857, FILED 6-29-2007.

BARBARA A. GOLD, EXAMINING ATTORNEY

Int. Cl.: 41

Prior U.S. Cls.: 100, 101 and 107

United States Patent and Trademark Office

Reg. No. 3,397,716

Registered Mar. 18, 2008

**SERVICE MARK
PRINCIPAL REGISTER**



Radio Orenovscotia

ST. JAMES, CHARLES (UNITED STATES INDIVIDUAL)
85 VISCOUNT DRIVE, 6-A
MILFORD, CT 06460

FOR: ENTERTAINMENT SERVICES, NAMELY, PROVIDING A RADIO PROGRAM FEATURING MUSIC VIA A GLOBAL COMPUTER NETWORK, IN CLASS 41 (U.S. CLS. 100, 101 AND 107).

FIRST USE 7-0-2005; IN COMMERCE 7-0-2005.

NO CLAIM IS MADE TO THE EXCLUSIVE RIGHT TO USE "RADIO ORENOVSCOTIA", APART FROM THE MARK AS SHOWN.

THE COLOR(S) BROWN, TAN, GRAY, WHITE AND BLACK IS/ARE CLAIMED AS A FEATURE OF THE MARK.

THE MARK CONSISTS OF THE WORDS, RADIO ORENOVSCOTIA, IN BLACK, BELOW A PICTURE OF A CAT LYING ON THE SEAT OF AN ARMCHAIR. THE COLOR WHITE APPEARS ON THE CAT'S CHEST AND PAWS, ON THE BASEBOARD AND HIGHLIGHT SPOT ON THE WALL BEHIND THE CHAIR, AND ON HIGHLIGHTS ON THE CHAIR; THE COLOR LIGHT TAN APPEARS ON THE CHAIR SEAT AND BACK, ON THE ARMS OF THE CHAIR, ON THE CAT'S EARS; THE COLOR BROWN APPEARS ON THE WOOD OF THE CHAIR; THE COLOR BLACK APPEARS ON THE CAT; THE COLOR GRAY APPEARS ON THE CAT AND ON THE WALL BEHIND THE CHAIR.

SER. NO. 77-218,891, FILED 6-29-2007.

BARBARA A. GOLD, EXAMINING ATTORNEY

Int. Cl.: 41

Prior U.S. Cls.: 100, 101 and 107

United States Patent and Trademark Office

Reg. No. 3,397,717

Registered Mar. 18, 2008

**SERVICE MARK
PRINCIPAL REGISTER**

**See your potential. Create
your results.**

TERRY STEVENS, INC. (TEXAS CORPORATION)
SUITE 100
2212 FAIRMOUNT AVE.
FORT WORTH, TX 76110

FOR: EDUCATIONAL SERVICES, NAMELY, PERSONAL AND PROFESSIONAL COACHING, MENTORING, TRAINING, AND CREATING AND CONDUCTING IN-PERSON AND ON-LINE CLASSES, CONFERENCES, INSTRUCTION, LECTURES, PROGRAMS, SEMINARS, AND WORKSHOPS ON THE SUBJECTS OF LIFESTYLE DEVELOPMENT, LIFE SKILLS DEVELOPMENT, LEADERSHIP DEVELOPMENT, AND PERSONAL, PROFESSIONAL, BUSINESS, AND ORGANIZATIONAL DEVELOP-

MENT, AND COURSE MATERIALS IN PRINTED AND ELECTRONIC FORM DISTRIBUTED IN CONNECTION THEREWITH, IN CLASS 41 (U.S. CLS. 100, 101 AND 107).

FIRST USE 11-18-2005; IN COMMERCE 3-20-2006.

THE MARK CONSISTS OF STANDARD CHARACTERS WITHOUT CLAIM TO ANY PARTICULAR FONT, STYLE, SIZE, OR COLOR.

SER. NO. 77-218,968, FILED 6-29-2007.

NANCY CLARKE, EXAMINING ATTORNEY

Int. Cl.: 30

Prior U.S. Cl.: 46

United States Patent and Trademark Office

Reg. No. 3,397,718

Registered Mar. 18, 2008

TRADEMARK
PRINCIPAL REGISTER



SHASTA UNION HIGH SCHOOL DISTRICT (CALIFORNIA EDUCATIONAL INSTITUTION)
2200 EUREKA WAY, SUITE B
REDDING, CA 96001

FOR: PIZZAS; FRESH PIZZA; PIZZA CRUST; PIZZA DOUGH; PIZZA SAUCE; PIZZA, IN CLASS 30 (U.S. CL. 46).

FIRST USE 5-7-2007; IN COMMERCE 6-6-2007.

NO CLAIM IS MADE TO THE EXCLUSIVE RIGHT TO USE "PIZZA", APART FROM THE MARK AS SHOWN.

THE COLOR(S) RED, PEACH, BLACK, AND WHITE IS/ARE CLAIMED AS A FEATURE OF THE MARK.

THE MARK CONSISTS OF A RED PENTAGON RESEMBLING A RECTANGLE WITH A TRIANGLE ATTACHED IMMEDIATELY ABOVE THAT RECTANGLE. THE TOP CORNERS OF THE RECTANGLE ARE EVEN WITH THE BOTTOM CORNERS OF THE TRIANGLE. WITHIN THE RECTANGLE AREA OF THE PENTAGON IS THE WORD PIZZA IN PEACH STYLIZED BLOCK LETTERING ALL CAPITAL LETTERS. EACH LETTER HAS SEVERAL INDIVIDUAL HOLES IN IT MADE TO RESEMBLE INDIVIDUAL PEPPERONI SLICES. BELOW PIZZA IN SMALLER BLACK STYLIZED LETTERS IS THE

PHRASE THE EDUCATED CHOICE. IMMEDIATELY ABOVE THE RED PENTAGON IS A BLACK ROOF CONSISTING OF TWO TRAPEZOIDS JOINED ON ONE SIDE IMMEDIATELY ABOVE THE HIGHEST POINT OF THE RED PENTAGON. THE TWO TRAPEZOIDS DESCEND ON EACH SIDE TO BE PARALLEL TO THE TRIANGLE PORTION OF THE RED PENTAGON, EXTENDING SLIGHTLY PAST THE TRIANGLE PORTION OF THE PENTAGON TO FORM EAVES OF THE ROOF. THE WORD SCHOOLHOUSE IS WRITTEN IN STYLIZED WHITE BLOCK LETTERING (WITH FAINT BLACK AND RED OUTLINE) AT THE BOTTOM OF THE TRIANGLE PORTION OF THE RED PENTAGON WITH THE S AND THE E EXTENDING BEYOND THE RED PENTAGON AND ROOF. ABOVE THE ROOF IS A BELL TOWER CONSISTING OF AN IRREGULAR RED POLYGON IMMEDIATELY ABOVE THE BLACK ROOF. INSIDE THE RED POLYGON IS A WHITE SQUARE THAT IS PARTIALLY OVERLAPPED AT ITS BASE BY THE BLACK ROOF OF THE SCHOOLHOUSE. INSIDE THE SQUARE IS A BLACK AND WHITE BELL LEANING TO THE LEFT. ABOVE THE RED POLYGON IS A BLACK ROOF TO THE BELL TOWER CONSISTING OF TWO TRAPEZOIDS THAT RUN PARALLEL TO THE SCHOOLHOUSE ROOF.

SER. NO. 77-219,092, FILED 6-29-2007.

ELIZABETH KAJUBI, EXAMINING ATTORNEY

Int. Cl.: 29

Prior U.S. Cl.: 46

United States Patent and Trademark Office

Reg. No. 3,397,719

Registered Mar. 18, 2008

**TRADEMARK
PRINCIPAL REGISTER**

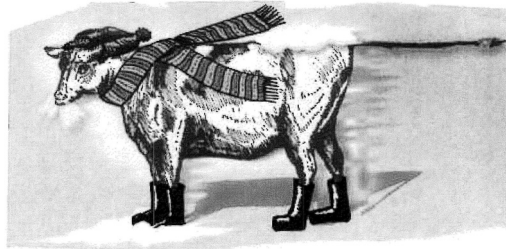

SANDRIDGE FOOD CORPORATION (OHIO
CORPORATION)
133 COMMERCE DRIVE
MEDINA, OH 44256

THE MARK CONSISTS OF A DEPICTION OF A
COW WITH HAIR, A SCARF, AND BOOTS STAND-
ING IN A COLD CLIMATE.

FOR: PREPARED SOUPS, NAMELY, CHILI WITH
BEANS, IN CLASS 29 (U.S. CL. 46).

SER. NO. 77-219,111, FILED 6-29-2007.

FIRST USE 3-7-2005; IN COMMERCE 3-7-2005.

KATHLEEN LORENZO, EXAMINING ATTORNEY

Int. Cl.: 6

Prior U.S. Cls.: 2, 12, 13, 14, 23, 25 and 50

Reg. No. 3,397,720

United States Patent and Trademark Office

Registered Mar. 18, 2008

**TRADEMARK
PRINCIPAL REGISTER**

RMI

RMI TITANIUM COMPANY (OHIO CORPORATION)
1000 WARREN AVENUE
NILES, OH 444461168

THE MARK CONSISTS OF STANDARD CHARACTERS WITHOUT CLAIM TO ANY PARTICULAR FONT, STYLE, SIZE, OR COLOR.

FOR: TITANIUM AND TITANIUM ALLOYS IN THE FORM OF SHEETS, PLATES, BARS, RODS AND OTHER SHAPES FOR USE IN MANUFACTURING, IN CLASS 6 (U.S. CLS. 2, 12, 13, 14, 23, 25 AND 50).

OWNER OF U.S. REG. NO. 1,418,148.

SER. NO. 77-219,194, FILED 6-29-2007.

FIRST USE 10-31-1964; IN COMMERCE 1-31-1995.

ELIZABETH KAJUBI, EXAMINING ATTORNEY

Int. Cl.: 33

Prior U.S. Cls.: 47 and 49

United States Patent and Trademark Office

Reg. No. 3,397,721

Registered Mar. 18, 2008

**TRADEMARK
PRINCIPAL REGISTER**

GILBEY'S

DIAGEO BRANDS B.V. (NETHERLANDS PRIVATE LIMITED COMPANY)

MOLENWERF 10-12

AMSTERDAM 1014 BG, NETHERLANDS

FOR: DISTILLED SPIRITS, IN CLASS 33 (U.S. CLS. 47 AND 49).

FIRST USE 0-0-1857; IN COMMERCE 0-0-1857.

THE MARK CONSISTS OF STANDARD CHARACTERS WITHOUT CLAIM TO ANY PARTICULAR FONT, STYLE, SIZE, OR COLOR.

OWNER OF U.S. REG. NO. 3,040,004.

SEC. 2(F).

SER. NO. 77-219,247, FILED 6-29-2007.

NAKIA HENRY, EXAMINING ATTORNEY

Int. Cls.: 38 and 41

Prior U.S. Cls.: 100, 101, 104 and 107

United States Patent and Trademark Office

Reg. No. 3,397,722

Registered Mar. 18, 2008

**SERVICE MARK
PRINCIPAL REGISTER**



TELEVISION DE LAS AMERICAS, LLC (CALIFORNIA LTD LIAB CO)
500 SOUTH CHINOWTH ROAD
VISALIA, CA 93277

FOR: TELEVISION BROADCASTING, IN CLASS 38 (U.S. CLS. 100, 101 AND 104).

FIRST USE 7-7-2007; IN COMMERCE 7-7-2007.

FOR: TELEVISION PROGRAMMING, NAMELY NAMELY PRODUCING TELEVISION NEWS SHOWS, ENTERTAINMENT IN THE NATURE OF ON-GOING TELEVISION PROGRAMS IN THE FIELDS OF NEWS, COMEDY, VARIETY, AND PUBLIC SERVICE PROGRAMS, IN CLASS 41 (U.S. CLS. 100, 101 AND 107).

FIRST USE 7-7-2007; IN COMMERCE 7-7-2007.

THE COLOR(S) BLACK, YELLOW GREEN, BLUE AND RED IS/ARE CLAIMED AS A FEATURE OF THE MARK.

THE WORDING IS BLACK; THE SMALL UPPER LEFT SIDE PORTION OF THE BANNER DESIGN IS YELLOW, THE LARGER LEFT SIDE PORTION IS GREEN, THE LARGER RIGHT SIDE PORTION IS BLUE AND THE SMALLER LOWER RIGHT SIDE PORTION IS RED.

THE FOREIGN WORDING IN THE MARK TRANSLATES INTO ENGLISH AS YOUR VISION.

SER. NO. 77-219,299, FILED 6-29-2007.

RONALD MCMORROW, EXAMINING ATTORNEY

Int. Cl.: 33

Prior U.S. Cls.: 47 and 49

United States Patent and Trademark Office

Reg. No. 3,397,723

Registered Mar. 18, 2008

**TRADEMARK
PRINCIPAL REGISTER**



DIAGEO BRANDS B.V. (NETHERLANDS PRIVATE LIMITED COMPANY)
MOLENWERF 10-12
AMSTERDAM 1014 BG, NETHERLANDS

FOR: DISTILLED SPIRITS, IN CLASS 33 (U.S. CLS. 47 AND 49).

FIRST USE 0-0-1769; IN COMMERCE 0-0-1769.

OWNER OF U.S. REG. NO. 2,865,218.

THE MARK CONSISTS OF A STYLIZED DESIGN OF A BOAR'S HEAD.

SER. NO. 77-219,328, FILED 6-29-2007.

ANN E. SAPPENFIELD, EXAMINING ATTORNEY

Int. Cl.: 9

Prior U.S. Cls.: 21, 23, 26, 36 and 38

United States Patent and Trademark Office

Reg. No. 3,397,724

Registered Mar. 18, 2008

**TRADEMARK
PRINCIPAL REGISTER**

salontec

SALONTEC, INC. (FLORIDA CORPORATION)
522 SANDY HOOK ROAD
TREASURE ISLAND, FL 33706

FOR: COMPUTER SOFTWARE FOR USE IN
CREATING MARKETING ADVERTISEMENTS,
FOR MANAGING INVENTORY AND FINANCIAL-
LY TRACKING SALES, FOR USE IN PROCESSING
POINT OF SALE FINANCIAL TRANSACTIONS,
AND FOR USE IN APPOINTMENT SCHEDULING,
ALL FOR USE BY THE PROFESSIONAL HAIR

SALON AND SPA INDUSTRY, IN CLASS 9 (U.S.
CLS. 21, 23, 26, 36 AND 38).

FIRST USE 2-1-1987; IN COMMERCE 4-14-1988.

THE MARK CONSISTS OF STANDARD CHAR-
ACTERS WITHOUT CLAIM TO ANY PARTICULAR
FONT, STYLE, SIZE, OR COLOR.

SER. NO. 77-219,545, FILED 6-29-2007.

MAUREEN DALL, EXAMINING ATTORNEY

Int. Cl.: 35

Prior U.S. Cls.: 100, 101 and 102

United States Patent and Trademark Office

Reg. No. 3,397,725

Registered Mar. 18, 2008

**SERVICE MARK
PRINCIPAL REGISTER**



HEAVENLY COUTURE (CALIFORNIA CORPORATION)
2436 CLEAR CREEK LANE
DIAMOND BAR, CA 91765

NO CLAIM IS MADE TO THE EXCLUSIVE
RIGHT TO USE COUTURE , APART FROM THE
MARK AS SHOWN.

FOR: RETAIL CLOTHING STORES, IN CLASS 35
(U.S. CLS. 100, 101 AND 102).

SER. NO. 77-219,704, FILED 6-29-2007.

FIRST USE 4-4-2007; IN COMMERCE 4-4-2007.

TASHIA BUNCH, EXAMINING ATTORNEY

Int. Cls.: 25 and 41

Prior U.S. Cls.: 22, 39, 100, 101 and 107

United States Patent and Trademark Office

Reg. No. 3,397,726

Registered Mar. 18, 2008

TRADEMARK
SERVICE MARK
PRINCIPAL REGISTER



GUARINO, JERRY C (UNITED STATES INDIVIDUAL)
SUITE 4
4 WEST MAIN STREET
BAY SHORE, NY 11706

FOR: SHIRTS, SHORT-SLEEVED OR LONG-SLEEVED T-SHIRTS, HATS, CAPS, BANDANAS, SWEAT PANTS, SWEAT BANDS/WRIST BANDS, IN CLASS 25 (U.S. CLS. 22 AND 39).

FIRST USE 3-28-2007; IN COMMERCE 3-28-2007.

FOR: ENTERTAINMENT, NAMELY, LIVE PERFORMANCES BY A MUSICAL BAND, IN CLASS 41 (U.S. CLS. 100, 101 AND 107).

FIRST USE 3-28-2007; IN COMMERCE 3-28-2007.

THE COLOR(S) BLUE, BLACK, WHITE, SILVER, ORANGE, YELLOW, GREEN AND RED IS/ARE CLAIMED AS A FEATURE OF THE MARK.

THE MARK CONSISTS OF A WHITE SKULL WITH A BLACK, WHITE AND BLUE HAT, SILVER PISTOLS WITH ORANGE HANDLES, A YELLOW BANNER WITH THE WORDS NOVEMBER RAIN IN BLACK, RED ROSE AND BLOOD DRIPPING WITH GREEN LEAVES, AND BLACK BARB WIRE ALL AROUND.

SER. NO. 77-219,822, FILED 6-30-2007.

ZACHARY BELLO, EXAMINING ATTORNEY

Int. Cl.: 35

Prior U.S. Cls.: 100, 101 and 102

United States Patent and Trademark Office

Reg. No. 3,397,727

Registered Mar. 18, 2008

**SERVICE MARK
PRINCIPAL REGISTER**

Racing Against Diabetes

RACING AGAINST DIABETES FOUNDATION,
INC. (CALIFORNIA CORPORATION)
6211 SOLEDAD MTN. RD.
LA JOLLA, CA 920377018

FOR: PUBLIC ADVOCACY TO PROMOTE
AWARENESS OF DIABETES, IN CLASS 35 (U.S.
CLS. 100, 101 AND 102).

FIRST USE 11-5-2005; IN COMMERCE 11-5-2005.

THE MARK CONSISTS OF STANDARD CHAR-
ACTERS WITHOUT CLAIM TO ANY PARTICULAR
FONT, STYLE, SIZE, OR COLOR.

NO CLAIM IS MADE TO THE EXCLUSIVE
RIGHT TO USE "DIABETES", APART FROM THE
MARK AS SHOWN.

SER. NO. 77-219,832, FILED 6-30-2007.

KAPIL BHANOT, EXAMINING ATTORNEY

Int. Cl.: 44

Prior U.S. Cls.: 100 and 101

United States Patent and Trademark Office

Reg. No. 3,397,728

Registered Mar. 18, 2008

**SERVICE MARK
PRINCIPAL REGISTER**

MIO

PHYSICAL ENTERPRISES INC. (CANADA CORPORATION)
3323 DUNBAR STREET
VANCOUVER, CANADA V6S2B9

FOR: HEALTH CARE; HEALTH CARE SERVICES, NAMELY WELLNESS PROGRAMS; PROVIDING ASSISTANCE, FITNESS EVALUATION AND CONSULTATION TO CORPORATE CLIENTS TO HELP THEIR EMPLOYEES MAKE HEALTH, WELLNESS AND NUTRITIONAL CHANGES IN THEIR DAILY LIVING TO IMPROVE HEALTH; PROVIDING HEALTH CARE INFORMATION BY TELEPHONE AND THE INTERNET; PROVIDING HEALTH INFORMATION; PROVIDING WELLNESS SERVICES, NAMELY, PERSONAL ASSESSMENTS, PERSONALIZED ROUTINES, MAINTENANCE SCHEDULES, AND COUNSELING; REMOTE MONITORING OF DATA INDICATIVE OF THE HEALTH OR CONDI-

TION OF AN INDIVIDUAL OR GROUP OF INDIVIDUALS, IN CLASS 44 (U.S. CLS. 100 AND 101).

FIRST USE 3-10-2001; IN COMMERCE 3-10-2001.

THE MARK CONSISTS OF STANDARD CHARACTERS WITHOUT CLAIM TO ANY PARTICULAR FONT, STYLE, SIZE, OR COLOR.

OWNER OF U.S. REG. NO. 2,970,869.

THE FOREIGN WORDING IN THE MARK TRANSLATES INTO ENGLISH AS MINE.

SER. NO. 77-220,013, FILED 7-1-2007.

THOMAS MANOR, EXAMINING ATTORNEY

Int. Cl.: 20

Prior U.S. Cls.: 2, 13, 22, 25, 32 and 50

United States Patent and Trademark Office

Reg. No. 3,397,729

Registered Mar. 18, 2008

**TRADEMARK
PRINCIPAL REGISTER**



PES INC. (VIRGINIA CORPORATION)
3912 PACIFIC AVE. #202
VIRGINIA BEACH, VA 23451

FOR: OUTDOOR FURNITURE; SEATS; STONE
FURNITURE; TABLES, IN CLASS 20 (U.S. CLS. 2, 13,
22, 25, 32 AND 50).

FIRST USE 1-1-1996; IN COMMERCE 1-1-1998.

THE COLOR(S) PINK, PURPLE, DARK YELLOW,
RUST, YELLOW, LIGHT BLUE, ROYAL BLUE,
GREEN, ORANGE, RED, AND BLACK. IS/ARE
CLAIMED AS A FEATURE OF THE MARK.

THE MARK CONSISTS OF THE WORD KALEI-
DOSKOP IN BLACK LETTERING. ON THE LEFT
SIDE OF THE K IS A 3/4 STAR OF RAINBOW
COLORS, STARTING WITH THE TOP PART OF THE
K AND MOVING AROUND COUNTER-CLOCK-
WISE IT IS PINK, PURPLE, DARK YELLOW, RUST,
YELLOW, LIGHT BLUE, ROYAL BLUE, GREEN,
ORANGE AND RED.

SER. NO. 77-220,122, FILED 7-2-2007.

KRISTINA MORRIS, EXAMINING ATTORNEY

Int. Cl.: 45

Prior U.S. Cls.: 100 and 101

United States Patent and Trademark Office

Reg. No. 3,397,730

Registered Mar. 18, 2008

**SERVICE MARK
PRINCIPAL REGISTER**



AN EXTRA PAIR OF HANDS, LLC (MARYLAND
LTD LIAB CO)

4624 SHERWOOD MILLS ROAD
OWINGS MILLS, MD 21117

FOR: PERSONAL CONCIERGE SERVICES FOR OTHERS COMPRISING MAKING REQUESTED PERSONAL ARRANGEMENTS AND RESERVATIONS, RUNNING ERRANDS AND PROVIDING CUSTOMER SPECIFIC INFORMATION TO MEET INDIVIDUAL NEEDS, ALL RENDERED IN BUSINESS ESTABLISHMENTS, OFFICE BUILDINGS, HOTELS, RESIDENTIAL COMPLEXES AND HOMES, IN CLASS 45 (U.S. CLS. 100 AND 101).

FIRST USE 7-27-2006; IN COMMERCE 8-2-2006.

NO CLAIM IS MADE TO THE EXCLUSIVE RIGHT TO USE "LLC", APART FROM THE MARK AS SHOWN.

THE MARK CONSISTS OF THE WORDS "AN EXTRA PAIR OF HANDS", WITH LLC BELOW THE LETTER "S" IN HANDS, SEMI-ENCLOSED BY A SICKLE SHAPED CURVE, COMBINED WITH A SILHOUETTE OF A HUMANOID FORM WITH OUTSTRETCHED ARMS STANDING ON THE PALMS OF TWO HANDS ENCLOSED BY A FANCY CIRCLE TO THE LEFTMOST SECTION OF THE MARK, WITH A SHADOW OF THE BASE OF THE CIRCLE, AT THE BOTTOM OF THE CIRCLE.

SER. NO. 77-220,362, FILED 7-2-2007.

ODESSA BIBBINS, EXAMINING ATTORNEY

Int. Cl.: 16

Prior U.S. Cls.: 2, 5, 22, 23, 29, 37, 38 and 50

United States Patent and Trademark Office

Reg. No. 3,397,731

Registered Mar. 18, 2008

**TRADEMARK
PRINCIPAL REGISTER**

**STAR KEY ASTROLOGY CARD
SYSTEM**

JANIS E WHITE (UNITED STATES INDIVIDUAL)
1550 VAN BUREN STREET
HOLLYWOOD, FL 33020

FOR: PRINTED INFORMATIONAL CARDS IN
THE FIELD OF ASTROLOGY, IN CLASS 16 (U.S.
CLS. 2, 5, 22, 23, 29, 37, 38 AND 50).

FIRST USE 6-1-2007; IN COMMERCE 6-1-2007.

THE MARK CONSISTS OF STANDARD CHAR-
ACTERS WITHOUT CLAIM TO ANY PARTICULAR
FONT, STYLE, SIZE, OR COLOR.

NO CLAIM IS MADE TO THE EXCLUSIVE
RIGHT TO USE "ASTROLOGY CARD SYSTEM",
APART FROM THE MARK AS SHOWN.

SER. NO. 77-220,367, FILED 7-2-2007.

ANDREA K. NADELMAN, EXAMINING ATTOR-
NEY

Int. Cl.: 41

Prior U.S. Cls.: 100, 101 and 107

United States Patent and Trademark Office

Reg. No. 3,397,732

Registered Mar. 18, 2008

**SERVICE MARK
PRINCIPAL REGISTER**

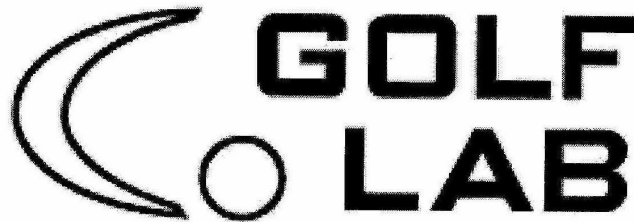

GOLF LAB, LLC (UTAH LTD LIAB CO)
925 SOUTH WEST TEMPLE
SALT LAKE CITY, UT 84101

FOR: FITTING OF GOLF CLUBS TO INDIVIDUAL USERS; GOLF INSTRUCTION, IN CLASS 41 (U.S. CLS. 100, 101 AND 107).

FIRST USE 10-19-2005; IN COMMERCE 10-19-2005.

OWNER OF U.S. REG. NO. 2,573,304.

NO CLAIM IS MADE TO THE EXCLUSIVE RIGHT TO USE "GOLF", APART FROM THE MARK AS SHOWN.

THE MARK CONSISTS OF A CRESCENT, ADJACENT TO A CIRCLE, ADJACENT TO THE WORDS GOLF LAB..

SER. NO. 77-220,870, FILED 7-2-2007.

ADA HAN, EXAMINING ATTORNEY

Int. Cl.: 28

Prior U.S. Cls.: 22, 23, 38 and 50

United States Patent and Trademark Office

Reg. No. 3,397,733

Registered Mar. 18, 2008

**TRADEMARK
PRINCIPAL REGISTER**

RIP BAT

ENOR CORPORATION (NEW JERSEY CORPORATION)

245 LIVINGSTON STREET

NORTHVALE, NJ 07647

FOR: BASEBALL BATS, IN CLASS 28 (U.S. CLS. 22, 23, 38 AND 50).

FIRST USE 6-1-2006; IN COMMERCE 6-1-2006.

THE MARK CONSISTS OF STANDARD CHARACTERS WITHOUT CLAIM TO ANY PARTICULAR FONT, STYLE, SIZE, OR COLOR.

NO CLAIM IS MADE TO THE EXCLUSIVE RIGHT TO USE "BAT", APART FROM THE MARK AS SHOWN.

SER. NO. 77-221,108, FILED 7-3-2007.

JOHN DWYER, EXAMINING ATTORNEY

Int. Cl.: 25

Prior U.S. Cls.: 22 and 39

United States Patent and Trademark Office

Reg. No. 3,397,734

Registered Mar. 18, 2008

**TRADEMARK
PRINCIPAL REGISTER**

BENECCI

BENECCI CORPORATION (CALIFORNIA CORPORATION)
SUITE 600
2400 E. KATELLA AVENUE
ANAHEIM, CA 928060000

FOR: SUITS; JACKETS; PANTS, IN CLASS 25 (U.S. CLS. 22 AND 39).

FIRST USE 1-5-1995; IN COMMERCE 1-5-1995.

THE MARK CONSISTS OF STANDARD CHARACTERS WITHOUT CLAIM TO ANY PARTICULAR FONT, STYLE, SIZE, OR COLOR.

THE MARK HAS NO MEANING IN A FOREIGN LANGUAGE.

SER. NO. 77-221,155, FILED 7-3-2007.

RAUL CORDOVA, EXAMINING ATTORNEY

Int. Cl.: 37

Prior U.S. Cls.: 100, 103 and 106

United States Patent and Trademark Office

Reg. No. 3,397,735

Registered Mar. 18, 2008

**SERVICE MARK
PRINCIPAL REGISTER**



TONY FORT SERVICES, LLC (KENTUCKY LTD
LIAB CO)

2929 BROADWAY

PADUCAH, KY 42086

FOR: BUILDING RESTORATION; BUILDING
REPAIR, IN CLASS 37 (U.S. CLS. 100, 103 AND 106).

FIRST USE 6-0-2007; IN COMMERCE 6-0-2007.

NO CLAIM IS MADE TO THE EXCLUSIVE
RIGHT TO USE SERVICES, APART FROM THE
MARK AS SHOWN.

THE MARK CONSISTS OF THE WORDS "FORT
SERVICES" AND A STYLIZED DRAWING OF A
FORT..

SER. NO. 77-221,203, FILED 7-3-2007.

SARA THOMAS, EXAMINING ATTORNEY

Int. Cl.: 25

Prior U.S. Cls.: 22 and 39

United States Patent and Trademark Office

Reg. No. 3,397,736

Registered Mar. 18, 2008

**TRADEMARK
PRINCIPAL REGISTER**

Nantucket Brand

NANTUCKET BRAND, LLC (FLORIDA LTD
LIAB CO)
8787 BAY COLONY DR., STE 904
NAPLES, FL 24108

FOR: UNDERWEAR; BELTS; CAPS; JERSEYS;
TIES; DRESS SHIRTS; GOLF SHIRTS; SHIRTS; KNIT
SHIRTS; POLO SHIRTS; PANTS; JACKETS; BLOU-
SES; SKIRTS; SKIRTS AND DRESSES; COATS;
SPORT COATS; WIND COATS; SOCKS; SOCKS
AND STOCKINGS, IN CLASS 25 (U.S. CLS. 22 AND
39).

FIRST USE 10-1-2005; IN COMMERCE 10-1-2005.

THE MARK CONSISTS OF STANDARD CHAR-
ACTERS WITHOUT CLAIM TO ANY PARTICULAR
FONT, STYLE, SIZE, OR COLOR.

NO CLAIM IS MADE TO THE EXCLUSIVE
RIGHT TO USE "BRAND", APART FROM THE
MARK AS SHOWN.

SER. NO. 77-221,238, FILED 7-3-2007.

TARAH HARDY, EXAMINING ATTORNEY

Int. Cl.: 25

Prior U.S. Cls.: 22 and 39

United States Patent and Trademark Office

Reg. No. 3,397,737

Registered Mar. 18, 2008

**TRADEMARK
PRINCIPAL REGISTER**

ILLINOIS TECH

ILLINOIS INSTITUTE OF TECHNOLOGY (ILLI-
NOIS CORPORATION)
10 W. 33RD ST. ROOM 224
CHICAGO, IL 60616

FOR: SWEAT SHIRTS; T-SHIRTS; HATS, IN
CLASS 25 (U.S. CLS. 22 AND 39).

FIRST USE 9-1-1946; IN COMMERCE 8-15-2000.

THE MARK CONSISTS OF STANDARD CHAR-
ACTERS WITHOUT CLAIM TO ANY PARTICULAR
FONT, STYLE, SIZE, OR COLOR.

SEC. 2(F).

SER. NO. 77-221,455, FILED 7-3-2007.

PAUL E. FAHRENKOPF, EXAMINING ATTORNEY

Int. Cl.: 39

Prior U.S. Cls.: 100 and 105

United States Patent and Trademark Office

Reg. No. 3,397,738

Registered Mar. 18, 2008

**SERVICE MARK
PRINCIPAL REGISTER**



WAYNE C. HENDERSON (UNITED STATES IN-
DIVIDUAL)
220 WINDSOR WAY
DOYLESTOWN, PA 189012661

FOR: PRIVATE AIR TRANSPORTATION, IN
CLASS 39 (U.S. CLS. 100 AND 105).

FIRST USE 5-6-2007; IN COMMERCE 5-6-2007.

OWNER OF U.S. REG. NO. 3,298,900.

THE COLOR(S) BURGUNDY, ORANGE, YEL-
LOW AND GRAY IS/ARE CLAIMED AS A FEAT-
URE OF THE MARK.

THE MARK CONSISTS OF A MODIFIED OVAL
SHAPE WITH THE WORD "JETTHERE" APPEAR-
ING UNDERNEATH, WITH AN IMAGE OF A JET
DEPARTING FROM THE RIGHT SIDE OF THE
OVAL. THE COLORS IN THE OVAL APPEAR IN
BURGUNDY, ORANGE, YELLOW AND GRAY,
BLENDING FROM LEFT TO RIGHT. THE WORD
"JET" IS IN BURGUNDY AND THE WORD
"THERE" IS IN GRAY. THE OUTLINE OF THE
IMAGE OF THE JET IS IN BURGUNDY.

SER. NO. 77-221,518, FILED 7-3-2007.

CARYN GLASSER, EXAMINING ATTORNEY

Int. Cl.: 35

Prior U.S. Cls.: 100, 101 and 102

United States Patent and Trademark Office

Reg. No. 3,397,739

Registered Mar. 18, 2008

**SERVICE MARK
PRINCIPAL REGISTER**

Trek Bicycle Store

TREK BICYCLE CORPORATION (WISCONSIN CORPORATION)
801 WEST MADISON ST
WATERLOO, WI 53594

FOR: RETAIL STORES FEATURING BICYCLES,
IN CLASS 35 (U.S. CLS. 100, 101 AND 102).

FIRST USE 9-1-1996; IN COMMERCE 9-1-1996.

THE MARK CONSISTS OF STANDARD CHARACTERS WITHOUT CLAIM TO ANY PARTICULAR FONT, STYLE, SIZE, OR COLOR.

OWNER OF U.S. REG. NOS. 1,994,479 AND 2,742,116.

NO CLAIM IS MADE TO THE EXCLUSIVE RIGHT TO USE "BICYCLE STORE", APART FROM THE MARK AS SHOWN.

SER. NO. 77-221,529, FILED 7-3-2007.

CHRISTOPHER BUONGIORNO, EXAMINING ATTORNEY

Int. Cl.: 41

Prior U.S. Cls.: 100, 101 and 107

United States Patent and Trademark Office

Reg. No. 3,397,740

Registered Mar. 18, 2008

**SERVICE MARK
PRINCIPAL REGISTER**

**CHEER-BLING TUMBLING: THE
BLING IN CHEERLEADING**

CHEER-BLING, LLC (KENTUCKY LTD LIAB
CO)
865 JOHNSON HOLLOW ROAD
SHEPHERDSVILLE, KY 40165

FOR: INSTRUCTION IN THE FIELD OF CHEER-
LEADING AND TUMBLING, IN CLASS 41 (U.S. CLS.
100, 101 AND 107).

FIRST USE 3-1-2006; IN COMMERCE 8-21-2006.

THE MARK CONSISTS OF STANDARD CHAR-
ACTERS WITHOUT CLAIM TO ANY PARTICULAR
FONT, STYLE, SIZE, OR COLOR.

NO CLAIM IS MADE TO THE EXCLUSIVE
RIGHT TO USE TUMBLING, APART FROM THE
MARK AS SHOWN.

SER. NO. 77-221,688, FILED 7-3-2007.

JAY FLOWERS, EXAMINING ATTORNEY

Int. Cls.: 30 and 43

Prior U.S. Cls.: 46, 100 and 101

United States Patent and Trademark Office

Reg. No. 3,397,741

Registered Mar. 18, 2008

TRADEMARK
SERVICE MARK
PRINCIPAL REGISTER



B&G CREPE LLC (TEXAS LTD LIAB CO)
8811 BURGANDY
SAN ANTONIO, TX 78240

NO CLAIM IS MADE TO THE EXCLUSIVE
RIGHT TO USE CREPES, APART FROM THE
MARK AS SHOWN.

FOR: CREPES, IN CLASS 30 (U.S. CL. 46).

FIRST USE 12-25-2006; IN COMMERCE 3-18-2007.

FOR: RESTAURANTS, IN CLASS 43 (U.S. CLS. 100
AND 101).

FIRST USE 12-25-2006; IN COMMERCE 3-18-2007.

THE MARK CONSISTS OF AN ANIMATED PIC-
TURE OF A BOY AND GIRL ON A CREPE CONE
BEHIND THE LETTERING "B&G CREPES".

SER. NO. 77-221,944, FILED 7-3-2007.

STEVEN R. FINE, EXAMINING ATTORNEY

Int. Cl.: 25

Prior U.S. Cls.: 22 and 39

United States Patent and Trademark Office

Reg. No. 3,397,742

Registered Mar. 18, 2008

TRADEMARK
PRINCIPAL REGISTER



HOPE FOR YOU! CORPORATION (COLORADO CORPORATION)
P.O. BOX 5894
COLORADO SPRINGS, CO 80931

FOR: CLOTHING, NAMELY, T-SHIRTS, SHIRTS, TOPS, PANTS, DRESSES, MEN'S AND WOMEN'S SUITS, GLOVES, MITTENS, JACKETS, JEANS, JERSEYS, EAR MUFFS, SCARVES, BELTS, SOCKS, LEG WARMERS, PAJAMAS, NECK BANDS, NECKTIES, SUSPENDERS, CUFFS, SHORT SETS, COVERALLS, COATS, HOUSECOATS, BATHROBES, COSTUMES FOR USE IN ROLE-PLAYING GAMES, JOGGING SUITS, ATHLETIC UNIFORMS, SCHOOL UNIFORMS, UNIFORMS, BEACHWEAR, LOUNGEWEAR, SLEEPWEAR, RAINWEAR, SWIMWEAR, BODYSUITS, SUNSUITS, JUMPSUITS, FLIGHT SUITS, SURFWEAR, SKI WEAR, SNOW SUITS, INFANTWEAR, LINGERIE, UNDERWEAR, NURSING CLOTHING, NAMELY, NURSE DRESSES, NURSE OVERALLS AND NURSE PANTS; FOOTWEAR; HEADGEAR, NAMELY, HATS, CAPS, DO RAGS, SHAWLS, BERETS, HEADBANDS, TURBANS, SHOWER CAPS, HEADWEAR, HEAD-SCARVES AND BANDANAS, IN CLASS 25 (U.S. CLS. 22 AND 39).

FIRST USE 8-22-2001; IN COMMERCE 6-19-2007.

OWNER OF U.S. REG. NOS. 3,031,759, 3,217,601 AND OTHERS.

THE COLOR(S) BLACK, RED, CHROME AND WHITE. IS/ARE CLAIMED AS A FEATURE OF THE MARK.

THE COLOR BLACK APPEARS IN THE "HOPE" LETTERING IN THE MARK AND IN THE SHADING OF THE RED RUBY PENDANT, THE COLOR RED APPEARS IN THE HEART SHAPED DESIGN OF THE LETTER "O" IN THE MARK AND IN THE LETTERING "FOR YOU!", THE COLOR CHROME APPEARS IN THE OUTLINE OF THE HEART SHAPED LETTER "O" IN THE MARK, THE COLOR WHITE APPEARS IN THE OUTLINE OF THE HEART SHAPED LETTER "O" DESIGN IN THE MARK. THE MARK APPEARS ON A TRANSPARENT BACKGROUND AND NO OTHER COLORS ARE CLAIMED.

SER. NO. 77-222,124, FILED 7-5-2007.

GINA FINK, EXAMINING ATTORNEY

Int. Cl.: 9

Prior U.S. Cls.: 21, 23, 26, 36 and 38

United States Patent and Trademark Office

Reg. No. 3,397,743

Registered Mar. 18, 2008

**TRADEMARK
PRINCIPAL REGISTER**

TABLATURE

AZTEC SYSTEMS, INC. (TEXAS CORPORATION)
SUITE 301
1345 VALWOOD PARKWAY
CARROLLTON, TX 75006

FOR: SOFTWARE, NAMELY, SOFTWARE FOR
THE SCANNING AND ORGANIZATION OF DOCU-
MENTS INTO A CENTRALIZED DATABASE AC-
CESSIBLE FROM LOCAL AND WIDE AREA
COMPUTER NETWORKS, IN CLASS 9 (U.S. CLS.
21, 23, 26, 36 AND 38).

FIRST USE 10-0-2005; IN COMMERCE 10-0-2005.

THE MARK CONSISTS OF STANDARD CHAR-
ACTERS WITHOUT CLAIM TO ANY PARTICULAR
FONT, STYLE, SIZE, OR COLOR.

SER. NO. 77-222,277, FILED 7-5-2007.

PAUL E. FAHRENKOPF, EXAMINING ATTORNEY

Int. Cl.: 45

Prior U.S. Cls.: 100 and 101

United States Patent and Trademark Office

Reg. No. 3,397,744

Registered Mar. 18, 2008

**SERVICE MARK
PRINCIPAL REGISTER**

Connect America

CONNECTAMERICA.COM, LLC (DELAWARE
LTD LIAB CO)
2193 WEST CHESTER PIKE
BROOMALL, PA 19008

FOR: MONITORING TELEPHONE CALLS FROM
SUBSCRIBERS AND NOTIFYING EMERGENCY
FACILITIES, IN CLASS 45 (U.S. CLS. 100 AND 101).

FIRST USE 11-1-2003; IN COMMERCE 11-1-2003.

THE MARK CONSISTS OF STANDARD CHAR-
ACTERS WITHOUT CLAIM TO ANY PARTICULAR
FONT, STYLE, SIZE, OR COLOR.

NO CLAIM IS MADE TO THE EXCLUSIVE
RIGHT TO USE AMERICA, APART FROM THE
MARK AS SHOWN.

SER. NO. 77-222,331, FILED 7-5-2007.

AISHA SALEM, EXAMINING ATTORNEY

Int. Cl.: 42

Prior U.S. Cls.: 100 and 101

United States Patent and Trademark Office

Reg. No. 3,397,745

Registered Mar. 18, 2008

**SERVICE MARK
PRINCIPAL REGISTER**

COTTONBLEND

TICKETMASTER CORPORATION (ILLINOIS
CORPORATION)
6TH FLOOR
8800 SUNSET BOULEVARD
WEST HOLLYWOOD, CA 90069

FOR: WEB SITE DESIGN AND DEVELOPMENT
FOR OTHERS, IN CLASS 42 (U.S. CLS. 100 AND 101).

FIRST USE 11-9-2005; IN COMMERCE 11-9-2005.

THE MARK CONSISTS OF STANDARD CHAR-
ACTERS WITHOUT CLAIM TO ANY PARTICULAR
FONT, STYLE, SIZE, OR COLOR.

OWNER OF U.S. REG. NOS. 3,185,015 AND
3,235,403.

SER. NO. 77-222,470, FILED 7-5-2007.

LEIGH CAROLINE CASE, EXAMINING ATTOR-
NEY

Int. Cl.: 42

Prior U.S. Cls.: 100 and 101

United States Patent and Trademark Office

Reg. No. 3,397,746

Registered Mar. 18, 2008

SERVICE MARK
PRINCIPAL REGISTER



TICKETMASTER CORPORATION (ILLINOIS
CORPORATION)
6TH FLOOR
8800 SUNSET BOULEVARD
WEST HOLLYWOOD, CA 90069

FOR: WEB SITE DESIGN AND DEVELOPMENT
FOR OTHERS, IN CLASS 42 (U.S. CLS. 100 AND 101).

FIRST USE 11-22-2005; IN COMMERCE 11-22-2005.

OWNER OF U.S. REG. NOS. 3,185,015 AND
3,235,403.

THE MARK CONSISTS OF THE WORDING COT-
TONBLEND AND THE STYLIZED RENDITION OF
A RABBIT.

SER. NO. 77-222,482, FILED 7-5-2007.

LEIGH CAROLINE CASE, EXAMINING ATTOR-
NEY

Int. Cl.: 41

Prior U.S. Cls.: 100, 101 and 107

United States Patent and Trademark Office

Reg. No. 3,397,747

Registered Mar. 18, 2008

**SERVICE MARK
PRINCIPAL REGISTER**

DARK EDGE ENTERTAINMENT

JAGELS, DANIEL (UNITED STATES INDIVIDUAL)
817 SALISBURY ROAD
LA CANADA, CA 91011

FOR: MOTION PICTURE FILM PRODUCTION;
TELEVISION PRODUCTION, IN CLASS 41 (U.S. CLS.
100, 101 AND 107).

FIRST USE 6-18-2007; IN COMMERCE 6-18-2007.

THE MARK CONSISTS OF STANDARD CHARACTERS WITHOUT CLAIM TO ANY PARTICULAR FONT, STYLE, SIZE, OR COLOR.

NO CLAIM IS MADE TO THE EXCLUSIVE RIGHT TO USE ENTERTAINMENT, APART FROM THE MARK AS SHOWN.

SER. NO. 77-222,580, FILED 7-5-2007.

DAVID TOOLEY, EXAMINING ATTORNEY

Int. Cl.: 42

Prior U.S. Cls.: 100 and 101

United States Patent and Trademark Office

Reg. No. 3,397,748

Registered Mar. 18, 2008

**SERVICE MARK
PRINCIPAL REGISTER**



XL ACADEMICS, INC. (ILLINOIS CORPORATION)

843 CRANE DR., APT. 805
DEKALB, IL 60115

FOR: HOSTING AN ONLINE EDUCATIONAL COMMUNITY WEBSITE FEATURING MENTORING IN THE FIELD OF BUSINESS, HEALTH AND HUMAN SCIENCES, EDUCATION, ENGINEERING, ENGINEERING TECHNOLOGY, VISUAL AND PERFORMING ARTS, LIBERAL ARTS AND SCIENCES, IN CLASS 42 (U.S. CLS. 100 AND 101).

FIRST USE 2-16-2006; IN COMMERCE 2-16-2006.

NO CLAIM IS MADE TO THE EXCLUSIVE RIGHT TO USE "XL", APART FROM THE MARK AS SHOWN.

THE COLOR(S) LIGHT BLUE AND DARK BLUE IS/ARE CLAIMED AS A FEATURE OF THE MARK.

THE MARK CONSISTS OF A CAPITAL LETTER X, WHICH IS DARK BLUE, AND ONE STEM OF THE X EXTENDS AROUND LIKE A SEMI CIRCLE. A CAPITAL LETTER L, WHICH IS LIGHT BLUE, AND ONE STEM OF THE L EXTENDS AROUND LIKE A SEMI CIRCLE. THE OVERALL DESIGN IS A PARTIAL CIRCLE, ROUGHLY 300 DEGREES, WITH THE LETTERS XL ON THE INSIDE OF THE PARTIAL CIRCLE.

SEC. 2(F).

SER. NO. 77-222,639, FILED 7-5-2007.

MARK SPARACINO, EXAMINING ATTORNEY

Int. Cl.: 25

Prior U.S. Cls.: 22 and 39

United States Patent and Trademark Office

Reg. No. 3,397,749

Registered Mar. 18, 2008

**TRADEMARK
PRINCIPAL REGISTER**

Down to the Bonz

SILVA, CHRISTINE LEONORA (UNITED STATES
INDIVIDUAL)
144 LONG POND ROAD
PLYMOUTH, MA 02360

FOR: CLOTHING, NAMELY, TEE SHIRTS,
SHIRTS, JACKETS, TANK TOPS, SWEATERS,
COATS, SHORTS, NECKWEAR, BOXER SHORTS,
ROBES, UNDERWEAR, OVERCOATS, SWEAT-
PANTS, SWEATSHIRTS, SKIRTS, DRESSES, SOCKS,
HATS, CAPS, NIGHTWEAR, SCARVES, BLOUSES,
PANTS, JEANS, GLOVES, SWIMWEAR, HEAD-

WEAR, PAJAMAS, FOOTWEAR, HATS, VESTS,
AND BELTS, IN CLASS 25 (U.S. CLS. 22 AND 39).

FIRST USE 2-10-2007; IN COMMERCE 2-10-2007.

THE MARK CONSISTS OF STANDARD CHAR-
ACTERS WITHOUT CLAIM TO ANY PARTICULAR
FONT, STYLE, SIZE, OR COLOR.

SER. NO. 77-222,665, FILED 7-5-2007.

CORY BOONE, EXAMINING ATTORNEY

Int. Cls.: 9, 40 and 42

Prior U.S. Cls.: 21, 23, 26, 36, 38, 100, 101, 103 and 106

United States Patent and Trademark Office

Reg. No. 3,397,750

Registered Mar. 18, 2008

**TRADEMARK
SERVICE MARK
PRINCIPAL REGISTER**



GRAHAM GROUP INTERNATIONAL, INC. (CANADA CORPORATION)
1455 32ND AVE.
LACHINE, QUEBEC, CANADA H8T3J1

FOR: ELECTRONIC/FUNCTIONAL MEMBRANE SWITCHES, NAMELY, TOUCH SENSITIVE, NON-TOUCH SENSITIVE, FULL AND SHORT TRAVEL, MULTI-DIRECTIONAL AND/OR ROTARY SWITCHES; INTERFACE ASSEMBLIES IN THE NATURE OF ELECTRONIC/FUNCTIONAL CONTROL PANELS INCORPORATING A SELECTION OF PRINTED CIRCUIT BOARDS, POLYESTER CIRCUITS, POLYIMIDE CIRCUITS, KEYPADS OF SILICONE RUBBER, LIQUID CRYSTAL DISPLAYS, ACTIVE AND PASSIVE COMPONENTS, SWITCHING OPTIONS, GRAPHIC OVERLAYS, FIBER OPTICS BACKLIGHTING, ELECTROLUMINESCENT BACKLIGHTING AND LIGHT EMITTING DIODE (LED) BACKLIGHTING, IN CLASS 9 (U.S. CLS. 21, 23, 26, 36 AND 38).

FIRST USE 6-29-2007; IN COMMERCE 6-29-2007.

FOR: CUSTOM MANUFACTURE FOR OTHERS OF INTERFACE ASSEMBLIES INCORPORATING MEMBRANE SWITCHES IN THE FIELDS OF ELECTRONIC, MEDICAL, TRANSPORT, INDUSTRIAL EQUIPMENT, AEROSPACE, MILITARY, TELECOMMUNICATIONS AND INSTRUMENTATION, IN CLASS 40 (U.S. CLS. 100, 103 AND 106).

FIRST USE 6-29-2007; IN COMMERCE 6-29-2007.

FOR: CUSTOM DESIGN FOR OTHERS OF INTERFACE ASSEMBLIES INCORPORATING MEMBRANE SWITCHES IN THE FIELDS OF ELECTRONIC, MEDICAL, TRANSPORT, INDUSTRIAL EQUIPMENT, AEROSPACE, MILITARY, TELECOMMUNICATIONS AND INSTRUMENTATION, IN CLASS 42 (U.S. CLS. 100 AND 101).

FIRST USE 6-29-2007; IN COMMERCE 6-29-2007.

OWNER OF U.S. REG. NO. 3,301,805.

NO CLAIM IS MADE TO THE EXCLUSIVE RIGHT TO USE "INTERNATIONAL", APART FROM THE MARK AS SHOWN.

THE COLOR(S) GRAY AND BLUE IS/ARE CLAIMED AS A FEATURE OF THE MARK.

THE MARK CONSISTS OF THE LETTERS GGI WRITTEN IN GRAY, WITH THE WORD INTERNATIONAL BELOW AND SIX SQUARES TO THE RIGHT, BOTH IN BLUE.

SER. NO. 77-222,677, FILED 7-5-2007.

CORY BOONE, EXAMINING ATTORNEY

Int. Cl.: 1

Prior U.S. Cls.: 1, 5, 6, 10, 26 and 46

United States Patent and Trademark Office

Reg. No. 3,397,751

Registered Mar. 18, 2008

**TRADEMARK
PRINCIPAL REGISTER**

EXTREME GREEN

J.R. SIMPLOT COMPANY (NEVADA CORPORATION)
P.O. BOX 27
BOISE, ID 83707

FOR: FERTILIZERS, IN CLASS 1 (U.S. CLS. 1, 5, 6, 10, 26 AND 46).

FIRST USE 6-14-2004; IN COMMERCE 6-14-2004.

THE MARK CONSISTS OF STANDARD CHARACTERS WITHOUT CLAIM TO ANY PARTICULAR FONT, STYLE, SIZE, OR COLOR.

OWNER OF U.S. REG. NOS. 3,220,203 AND 3,220,216.

SER. NO. 77-222,774, FILED 7-5-2007.

EMILY CHUO, EXAMINING ATTORNEY

Int. Cl.: 35

Prior U.S. Cls.: 100, 101 and 102

United States Patent and Trademark Office

Reg. No. 3,397,752

Registered Mar. 18, 2008

**SERVICE MARK
PRINCIPAL REGISTER**

RIA INCUBATOR

MARKETCOUNSEL, LLC (NEW JERSEY LTD
LIAB CO)
61 WEST PALISADE AVENUE
ENGLEWOOD, NJ 07631

FOR: BUSINESS CONSULTATION SERVICES IN
THE FIELD OF SECURITIES COMPLIANCE AND
REGULATORY MATTERS, IN CLASS 35 (U.S. CLS.
100, 101 AND 102).

FIRST USE 8-1-2000; IN COMMERCE 8-1-2000.

THE MARK CONSISTS OF STANDARD CHAR-
ACTERS WITHOUT CLAIM TO ANY PARTICULAR
FONT, STYLE, SIZE, OR COLOR.

NO CLAIM IS MADE TO THE EXCLUSIVE
RIGHT TO USE "RIA", APART FROM THE MARK
AS SHOWN.

SER. NO. 77-223,020, FILED 7-5-2007.

BRENDAN REGAN, EXAMINING ATTORNEY

Int. Cl.: 36

Prior U.S. Cls.: 100, 101 and 102

United States Patent and Trademark Office

Reg. No. 3,397,753

Registered Mar. 18, 2008

**SERVICE MARK
PRINCIPAL REGISTER**



OPTIMUM SYNERGY ENTERPRISES (CALIFORNIA CORPORATION)
SUITE #301
10604 VALLEY SPRING LANE
TOLUCA LAKE, CA 91602

FOR: REAL ESTATE BROKERAGE; REAL ESTATE LENDING SERVICES, IN CLASS 36 (U.S. CLS. 100, 101 AND 102).

FIRST USE 4-15-2007; IN COMMERCE 5-1-2007.

NO CLAIM IS MADE TO THE EXCLUSIVE RIGHT TO USE "INNOVATIVE LENDING GROUP", APART FROM THE MARK AS SHOWN.

THE STIPLING IS FOR SHADING PURPOSES ONLY.

THE MARK CONSISTS OF AN ABSTRACT DESIGN WITH THE STYLIZED TEXT "INNOVATIVE LENDING GROUP".

SER. NO. 77-223,051, FILED 7-5-2007.

RUSS HERMAN, EXAMINING ATTORNEY

Int. Cl.: 5

Prior U.S. Cls.: 6, 18, 44, 46, 51 and 52

United States Patent and Trademark Office

Reg. No. 3,397,754

Registered Mar. 18, 2008

**TRADEMARK
PRINCIPAL REGISTER**



SEAGATE

FIRST FISHERY DEVELOPMENT SERVICES
INC. (CALIFORNIA CORPORATION)
11097 VIA TEMPRANO
SAN DIEGO, CA 92124

THE MARK CONSISTS OF SEAGATE AND A
STYLIZED SET OF EIGHT TRIANGLES FORMING
INTO THE APPEARANCE OF 4 FISH.

FOR: DIETARY FOOD SUPPLEMENTS; DIETE-
TIC FOODS ADAPTED FOR MEDICAL USE; FOOD
SUPPLEMENTS, IN CLASS 5 (U.S. CLS. 6, 18, 44, 46, 51
AND 52).

SER. NO. 77-223,087, FILED 7-5-2007.

FIRST USE 12-1-1981; IN COMMERCE 12-1-1981.

JORDAN BAKER, EXAMINING ATTORNEY

Int. Cl.: 14

Prior U.S. Cls.: 2, 27, 28 and 50

United States Patent and Trademark Office

Reg. No. 3,397,755

Registered Mar. 18, 2008

TRADEMARK
PRINCIPAL REGISTER



IMAGES APPLIED LLC (DELAWARE LTD LIAB
CO)
1031 SANTA LUCIA DRIVE
PLEASANT HILL, CA 94523

FOR: JEWEL CHAINS; JEWEL PENDANTS; AN-
KLE BRACELETS; BRACELETS; BRACELETS OF
PRECIOUS METAL; WATCH BRACELETS; RINGS;
RINGS BEING JEWELRY; NECKLACES; CHOKERS;
EARRINGS, IN CLASS 14 (U.S. CLS. 2, 27, 28 AND 50).

FIRST USE 1-1-2007; IN COMMERCE 3-1-2007.

NO CLAIM IS MADE TO THE EXCLUSIVE
RIGHT TO USE JEWELS, APART FROM THE
MARK AS SHOWN.

THE MARK CONSISTS OF STRING "JOOWELS"
REPRESENTING JEWELS, THE "O"S ARE SPIRALS..

SER. NO. 77-223,215, FILED 7-6-2007.

JOHN DALIER, EXAMINING ATTORNEY

Int. Cl.: 43

Prior U.S. Cls.: 100 and 101

United States Patent and Trademark Office

Reg. No. 3,397,756

Registered Mar. 18, 2008

SERVICE MARK
PRINCIPAL REGISTER



SINELLI, JEFFREY (UNITED STATES INDIVIDUAL)
1310 ELM STREET
SUITE 180
DALLAS, TX 75202

FOR: RESTAURANT SERVICES, IN CLASS 43
(U.S. CLS. 100 AND 101).

FIRST USE 12-1-2003; IN COMMERCE 12-1-2003.

NO CLAIM IS MADE TO THE EXCLUSIVE
RIGHT TO USE "SUPERIOR SANDWICHES",
APART FROM THE MARK AS SHOWN.

THE COLOR(S) YELLOW, BLACK AND WHITE
IS/ARE CLAIMED AS A FEATURE OF THE MARK.

THE MARK CONSISTS OF STYLIZED LETTERING FOR THE WORDS "WHICH WICH" THAT APPEAR IN YELLOW WITH BLACK OUTLINES. A YELLOW BREAD "BUN", OUTLINED IN BLACK, APPEARS AT THE BOTTOM OF THE "W" IN THE WORD "WICH". A BLACK QUESTION MARK APPEARS WITHIN A YELLOW CIRCLE, OUTLINED IN BLACK, AFTER THE WORD "WICH". THE WORDS "SUPERIOR SANDWICHES" APPEAR IN BLACK WITHIN A HORIZONTAL WHITE OVAL THAT IS OUTLINED IN BLACK. THE BACKGROUND IS WHITE, WITH THE OVERALL RECTANGULAR DESIGN OUTLINED IN BLACK.

SER. NO. 77-223,247, FILED 7-6-2007.

BRENDAN REGAN, EXAMINING ATTORNEY

Int. Cl.: 41

Prior U.S. Cls.: 100, 101 and 107

United States Patent and Trademark Office

Reg. No. 3,397,757

Registered Mar. 18, 2008

**SERVICE MARK
PRINCIPAL REGISTER**

**Paramount Educational
Seminars**

PARAMOUNT EDUCATIONAL SEMINARS, LLC
(NEBRASKA LTD LIAB CO)
6609 NORTH 150 ST.
OMAHA, NE 68116

FOR: ARRANGING OF EXHIBITIONS, SEMINARS AND CONFERENCES; ARRANGING OF SEMINARS; ARRANGING OF SEMINARS AND CONFERENCES; CONDUCTING WORKSHOPS AND SEMINARS IN HUMAN RESOURCES, EMPLOYMENT AND LABOR LAW, ACCOUNTING, TAX, CONSTRUCTION, MEDICINE, REAL ESTATE, EDUCATION, INSURANCE, LEGAL, FINANCE, LAW ENFORCEMENT, SOCIAL WORK AND BANKING; EDUCATION SERVICES, NAMELY, PROVIDING LIVE AND ON-LINE SEMINARS IN THE FIELD OF HUMAN RESOURCES, EMPLOYMENT AND LABOR LAW, ACCOUNTING, TAX, CONSTRUCTION, MEDICINE, REAL ESTATE, EDUCATION, INSURANCE, LEGAL, FINANCE, LAW ENFORCEMENT, SOCIAL WORK AND BANKING; EDUCATION SERVICES, NAMELY, PROVIDING SEMINARS IN THE FIELD OF HUMAN RESOURCES, EMPLOYMENT AND LABOR LAW, ACCOUNTING, TAX, CONSTRUCTION, MEDICINE, REAL ESTATE, EDUCATION, INSURANCE, LEGAL, FINANCE, LAW ENFORCEMENT, SOCIAL WORK AND BANKING AND DISTRIBUTION OF COURSE MATERIAL THEREWITH; EDUCATION SERVICES, NAMELY, PROVIDING TELECONFERENCES AND SEMINARS IN THE FIELDS OF HUMAN RESOURCES, EMPLOYMENT AND LABOR LAW, ACCOUNTING, TAX, CONSTRUCTION, MEDICINE, REAL ESTATE, EDUCATION, INSURANCE, LEGAL, FINANCE, LAW ENFORCEMENT, SOCIAL WORK AND BANKING; EDUCATIONAL SERVICES, NAMELY, CONDUCTING SEMINARS IN THE FIELD OF HUMAN RESOURCES, EMPLOYMENT AND LABOR LAW,

ACCOUNTING, TAX, CONSTRUCTION, MEDICINE, REAL ESTATE, EDUCATION, INSURANCE, LEGAL, FINANCE, LAW ENFORCEMENT, SOCIAL WORK AND BANKING AND DISTRIBUTION OF COURSE MATERIAL IN CONNECTION THEREWITH; EDUCATIONAL SERVICES, NAMELY, CONDUCTING SEMINARS AND WORKSHOPS IN THE FIELD OF HUMAN RESOURCES, EMPLOYMENT AND LABOR LAW, ACCOUNTING, TAX, CONSTRUCTION, MEDICINE, REAL ESTATE, EDUCATION, INSURANCE, LEGAL, FINANCE, LAW ENFORCEMENT, SOCIAL WORK AND BANKING; MEETING AND SEMINAR ARRANGING; ORGANIZATION OF SEMINARS, WORKING GROUPS, RESEARCH GROUPS AND CONVENTIONS, IN THE FIELD OF MEDICINE; PROVIDING ON-LINE TRAINING AND SEMINARS IN THE FIELD OF HUMAN RESOURCES, EMPLOYMENT AND LABOR LAW, ACCOUNTING, TAX, CONSTRUCTION, MEDICINE, REAL ESTATE, EDUCATION, INSURANCE, LEGAL, FINANCE, LAW ENFORCEMENT, SOCIAL WORK AND BANKING, IN CLASS 41 (U.S. CLS. 100, 101 AND 107).

FIRST USE 7-5-2007; IN COMMERCE 7-5-2007.

THE MARK CONSISTS OF STANDARD CHARACTERS WITHOUT CLAIM TO ANY PARTICULAR FONT, STYLE, SIZE, OR COLOR.

NO CLAIM IS MADE TO THE EXCLUSIVE RIGHT TO USE "EDUCATIONAL SEMINARS", APART FROM THE MARK AS SHOWN.

SER. NO. 77-223,263, FILED 7-6-2007.

MARK PILARO, EXAMINING ATTORNEY

Int. Cl.: 43

Prior U.S. Cls.: 100 and 101

United States Patent and Trademark Office

Reg. No. 3,397,758

Registered Mar. 18, 2008

**SERVICE MARK
PRINCIPAL REGISTER**



SINELLI, JEFFREY (UNITED STATES INDIVIDUAL)
1310 ELM STREET
SUITE 180
DALLAS, TX 75202

FOR: RESTAURANT SERVICES, IN CLASS 43
(U.S. CLS. 100 AND 101).

FIRST USE 12-1-2003; IN COMMERCE 12-1-2003.

THE COLOR(S) YELLOW, BLACK AND GRAY IS/
ARE CLAIMED AS A FEATURE OF THE MARK.

THE MARK CONSISTS OF AN OVAL YELLOW BREAD BUN THAT IS OUTLINED IN BLACK, WITH THREE BLACK INVERTED TRIANGULAR-SHAPED POINTS ACROSS THE TOP OF THE BUN. THE LOWER EDGE OF THE BUN IS OUTLINED WITH A GREY BORDER TO SIMULATE SHADOWING.

SER. NO. 77-223,285, FILED 7-6-2007.

BRENDAN REGAN, EXAMINING ATTORNEY

Int. Cls.: 36 and 37

Prior U.S. Cls.: 100, 101, 102, 103 and 106

United States Patent and Trademark Office

Reg. No. 3,397,759

Registered Mar. 18, 2008

**SERVICE MARK
PRINCIPAL REGISTER**

THE BEST OF URBAN LIVING

SAAMAN DEVELOPMENT LLC (MISSOURI LTD
LIAB CO)
7925 FORSYTH BLVD.
CLAYTON, MO 63105

FOR: REAL ESTATE AGENCIES, IN CLASS 36
(U.S. CLS. 100, 101 AND 102).

FIRST USE 7-1-2007; IN COMMERCE 7-1-2007.

FOR: REAL ESTATE DEVELOPMENT , IN CLASS
37 (U.S. CLS. 100, 103 AND 106).

FIRST USE 7-1-2007; IN COMMERCE 7-1-2007.

THE MARK CONSISTS OF STANDARD CHAR-
ACTERS WITHOUT CLAIM TO ANY PARTICULAR
FONT, STYLE, SIZE, OR COLOR.

SER. NO. 77-223,290, FILED 7-6-2007.

RICHARD A. STRASER, EXAMINING ATTORNEY

Int. Cl.: 38

Prior U.S. Cls.: 100, 101 and 104

United States Patent and Trademark Office

Reg. No. 3,397,760

Registered Mar. 18, 2008

**SERVICE MARK
PRINCIPAL REGISTER**

NO LINE LEFT BEHIND

ERNEST COMMUNICATIONS, INC. (GEORGIA
CORPORATION)
5275 TRIANGLE PARKWAY, SUITE 150
NORCROSS, GA 30092

THE MARK CONSISTS OF STANDARD CHAR-
ACTERS WITHOUT CLAIM TO ANY PARTICULAR
FONT, STYLE, SIZE, OR COLOR.

FOR: INTERSTATE TELEPHONE SERVICES; IN-
TRASTATE TELEPHONE SERVICES; LOCAL AND
LONG DISTANCE TELEPHONE SERVICES, IN
CLASS 38 (U.S. CLS. 100, 101 AND 104).

SER. NO. 77-223,303, FILED 7-6-2007.

FIRST USE 12-1-2005; IN COMMERCE 12-1-2005.

KELLEY WELLS, EXAMINING ATTORNEY

Int. Cls.: 11 and 20

Prior U.S. Cls.: 2, 13, 21, 22, 23, 25, 31, 32, 34 and 50

United States Patent and Trademark Office

Reg. No. 3,397,761

Registered Mar. 18, 2008

**TRADEMARK
PRINCIPAL REGISTER**

GRUPO T DIFFUSION

VIBIA, INC. (CALIFORNIA CORPORATION)
272 FERNWOOD AVENUE
EDISON, NJ 08837

FOR: ELECTRIC LIGHT BULBS; ELECTRIC LIGHTING FIXTURES; ELECTRIC TRACK LIGHTING UNITS; FLUORESCENT LIGHTING TUBES; LED AND HID LIGHT FIXTURES; LIGHT DIFFUSERS; LIGHTING FIXTURES; SCONCE LIGHTING FIXTURES, IN CLASS 11 (U.S. CLS. 13, 21, 23, 31 AND 34).

FIRST USE 1-15-1999; IN COMMERCE 1-15-1999.

FOR: FURNITURE; OFFICE FURNITURE; SEAT CUSHIONS; SEATING FURNITURE, IN CLASS 20 (U.S. CLS. 2, 13, 22, 25, 32 AND 50).

FIRST USE 1-15-1999; IN COMMERCE 1-15-1999.

THE MARK CONSISTS OF STANDARD CHARACTERS WITHOUT CLAIM TO ANY PARTICULAR FONT, STYLE, SIZE, OR COLOR.

NO CLAIM IS MADE TO THE EXCLUSIVE RIGHT TO USE "GRUPO" OR "DIFFUSION" , APART FROM THE MARK AS SHOWN.

THE FOREIGN WORDING "GRUPO" IN THE MARK TRANSLATES INTO ENGLISH AS "GROUP."

SER. NO. 77-223,332, FILED 7-6-2007.

CARRIE GENOVESE, EXAMINING ATTORNEY

Int. Cl.: 10

Prior U.S. Cls.: 26, 39 and 44

United States Patent and Trademark Office

Reg. No. 3,397,762

Registered Mar. 18, 2008

**TRADEMARK
PRINCIPAL REGISTER**

A LITTLE EASIER RECOVERY

MCGRATH, CATHERINE E. (UNITED STATES
INDIVIDUAL)
247 BRIDGES LANE
NORTH ANDOVER, MA 10845

FOR: MEDICAL TREATMENT AND RECOVERY
GARMENTS, NAMELY, HOSPITAL JACKETS,
SHIRTS AND PANTS; MEDICAL TREATMENT
AND RECOVERY GARMENTS, NAMELY, HOSPI-
TAL JACKETS, SHIRTS AND PANTS FOR CANCER
PATIENTS; SPECIALTY GARMENTS FOR USE BY
SURGICAL AND NON-SURGICAL CANCER PA-
TIENTS, NAMELY, JACKETS, SHIRTS, AND
PANTS; HOSPITAL JACKETS, SHIRTS AND PANTS
WITH INSIDE POCKET FOR HOLDING SURGICAL
DRAINS OR CATHETER BAGS; HOSPITAL JACK-

ETS, SHIRTS AND PANTS FOR EASE OF DRESSING
AND ACCESSIBILITY IN MEDICAL EXAMINA-
TIONS, IN CLASS 10 (U.S. CLS. 26, 39 AND 44).

FIRST USE 2-15-2007; IN COMMERCE 2-15-2007.

THE MARK CONSISTS OF STANDARD CHAR-
ACTERS WITHOUT CLAIM TO ANY PARTICULAR
FONT, STYLE, SIZE, OR COLOR.

OWNER OF U.S. REG. NO. 3,013,652.

SER. NO. 77-223,887, FILED 7-6-2007.

REBECCA SMITH, EXAMINING ATTORNEY

Int. Cl.: 39

Prior U.S. Cls.: 100 and 105

United States Patent and Trademark Office

Reg. No. 3,397,763

Registered Mar. 18, 2008

**SERVICE MARK
PRINCIPAL REGISTER**

TRAVELICIOUS

MACK, NICHOLAS (UNITED STATES INDIVIDUAL)

#14

3438 E. COLLINS
ORANGE, CA 92867

FOR: PROVIDING LINKS TO WEB SITES OF OTHERS FEATURING TRAVEL; TRAVEL GUIDE SERVICES; TRAVEL INFORMATION SERVICES, IN CLASS 39 (U.S. CLS. 100 AND 105).

FIRST USE 4-0-2006; IN COMMERCE 4-0-2006.

THE MARK CONSISTS OF STANDARD CHARACTERS WITHOUT CLAIM TO ANY PARTICULAR FONT, STYLE, SIZE, OR COLOR.

SER. NO. 77-223,896, FILED 7-6-2007.

TARAH HARDY, EXAMINING ATTORNEY

Int. Cl.: 16

Prior U.S. Cls.: 2, 5, 22, 23, 29, 37, 38 and 50

United States Patent and Trademark Office

Reg. No. 3,397,764

Registered Mar. 18, 2008

**TRADEMARK
PRINCIPAL REGISTER**

FANCY CUTS

CABIN CREEK, LLC (UTAH LTD LIAB CO)
1199 W 700 SOUTH
PLEASANT GROVE, UT 84062

FOR: DIE-CUT PAPER FOR EMBELLISHING
SCRAPBOOKS, PHOTOGRAPH ALBUMS, GREET-
ING CARDS, OCCASION CARDS AND JOURNALS,
IN CLASS 16 (U.S. CLS. 2, 5, 22, 23, 29, 37, 38 AND 50).

FIRST USE 6-0-2004; IN COMMERCE 6-0-2004.

THE MARK CONSISTS OF STANDARD CHAR-
ACTERS WITHOUT CLAIM TO ANY PARTICULAR
FONT, STYLE, SIZE, OR COLOR.

NO CLAIM IS MADE TO THE EXCLUSIVE
RIGHT TO USE "CUTS", APART FROM THE MARK
AS SHOWN.

SER. NO. 77-223,905, FILED 7-6-2007.

AMOS T. MATTHEWS, JR., EXAMINING ATTOR-
NEY

Int. Cl.: 36

Prior U.S. Cls.: 100, 101 and 102

United States Patent and Trademark Office

Reg. No. 3,397,765

Registered Mar. 18, 2008

**SERVICE MARK
PRINCIPAL REGISTER**

Bridgebay

BRIDGEBAY FINANCIAL, INC. (CALIFORNIA CORPORATION)
STE. 202
3548 ASHBOURNE CIRCLE
SAN RAMON, CA 945836014

FOR: ADVICE RELATING TO INVESTMENTS; FINANCIAL CONSULTATION; FINANCIAL SERVICES, NAMELY ASSISTING OTHERS WITH THE COMPLETION OF FINANCIAL TRANSACTIONS FOR STOCKS, BONDS, SECURITIES AND EQUITIES; FUND INVESTMENT CONSULTATION; FUNDS INVESTMENT; INVESTMENT ADVICE; INVESTMENT ADVISORY SERVICES; INVESTMENT

CONSULTATION; INVESTMENT OF FUNDS FOR OTHERS; MUTUAL FUND INVESTMENT, IN CLASS 36 (U.S. CLS. 100, 101 AND 102).

FIRST USE 12-4-1987; IN COMMERCE 12-4-1987.

THE MARK CONSISTS OF STANDARD CHARACTERS WITHOUT CLAIM TO ANY PARTICULAR FONT, STYLE, SIZE, OR COLOR.

SER. NO. 77-224,125, FILED 7-7-2007.

LINDSEY RUBIN, EXAMINING ATTORNEY

Int. Cl.: 37

Prior U.S. Cls.: 100, 103 and 106

United States Patent and Trademark Office

Reg. No. 3,397,766

Registered Mar. 18, 2008

**SERVICE MARK
PRINCIPAL REGISTER**

GO FROM GRAY TO GREAT

COMFORT WINDOW CO., INC. (NEW YORK
CORPORATION)
60 JOHN GLENN BOULEVARD
SYRACUSE, NY 13209

THE MARK CONSISTS OF STANDARD CHAR-
ACTERS WITHOUT CLAIM TO ANY PARTICULAR
FONT, STYLE, SIZE, OR COLOR.

FOR: BASEMENT REFINISHING SERVICES, IN
CLASS 37 (U.S. CLS. 100, 103 AND 106).

SER. NO. 77-224,368, FILED 7-9-2007.

FIRST USE 5-30-2007; IN COMMERCE 5-30-2007.

ELLEN PERKINS, EXAMINING ATTORNEY

Int. Cl.: 9

Prior U.S. Cls.: 21, 23, 26, 36 and 38

United States Patent and Trademark Office

Reg. No. 3,397,767

Registered Mar. 18, 2008

**TRADEMARK
PRINCIPAL REGISTER**

Acuité

VERO SYSTEMS INC. (NEW JERSEY CORPORATION)
11 PIEDMONT CENTER, SUITE 302
3495 PIEDMONT ROAD NE
ATLANTA, GA 30305

FOR: COMPUTER SOFTWARE USED BY COMMUNICATION SERVICE PROVIDERS, APPLICATION SERVICE PROVIDERS, DATA AND/OR VOICE NETWORK OPERATORS, AND OTHER BUSINESSES INVOLVED IN MANAGING VOICE, DATA AND ELECTRONIC INFORMATION SERVICES TO GENERATE OPTIMIZED NETWORK ROUTING PLANS, BUSINESS ANALYTICS REPORTS, TRAFFIC RATING GUIDELINES AND AU-

TOMATES THE SWITCH UPDATE PROCESS, IN CLASS 9 (U.S. CLS. 21, 23, 26, 36 AND 38).

FIRST USE 1-1-2004; IN COMMERCE 1-1-2004.

THE MARK CONSISTS OF STANDARD CHARACTERS WITHOUT CLAIM TO ANY PARTICULAR FONT, STYLE, SIZE, OR COLOR.

THE FOREIGN WORDING IN THE MARK TRANSLATES INTO ENGLISH AS ACUITY.

SER. NO. 77-224,453, FILED 7-9-2007.

SUSAN LESLIE DUBOIS, EXAMINING ATTORNEY

Int. Cl.: 36

Prior U.S. Cls.: 100, 101 and 102

United States Patent and Trademark Office

Reg. No. 3,397,768

Registered Mar. 18, 2008

**SERVICE MARK
PRINCIPAL REGISTER**

INFUND

FIRST INSURANCE FUNDING CORP. (ILLINOIS
CORPORATION)
450 SKOKIE BLVD, SUITE 1000
NORTHBROOK, IL 60062

THE MARK CONSISTS OF STANDARD CHAR-
ACTERS WITHOUT CLAIM TO ANY PARTICULAR
FONT, STYLE, SIZE, OR COLOR.

FOR: COMMERCIAL INSURANCE PREMIUM
FINANCING, IN CLASS 36 (U.S. CLS. 100, 101 AND
102).

SER. NO. 77-224,481, FILED 7-9-2007.

FIRST USE 6-25-2005; IN COMMERCE 6-25-2005.

KAREN SEVERSON, EXAMINING ATTORNEY

Int. Cl.: 36

Prior U.S. Cls.: 100, 101 and 102

United States Patent and Trademark Office

Reg. No. 3,397,769

Registered Mar. 18, 2008

**SERVICE MARK
PRINCIPAL REGISTER**

FIRST FUNDING SOLUTIONS

FIRST INSURANCE FUNDING CORP. (ILLINOIS
CORPORATION)
SUITE 1000
450 SKOKIE BLVD
NORTHBROOK, IL 60062

FOR: COMMERCIAL INSURANCE PREMIUM
FINANCING, IN CLASS 36 (U.S. CLS. 100, 101 AND
102).

FIRST USE 5-0-1997; IN COMMERCE 5-0-1997.

THE MARK CONSISTS OF STANDARD CHAR-
ACTERS WITHOUT CLAIM TO ANY PARTICULAR
FONT, STYLE, SIZE, OR COLOR.

NO CLAIM IS MADE TO THE EXCLUSIVE
RIGHT TO USE "FUNDING SOLUTIONS", APART
FROM THE MARK AS SHOWN.

SER. NO. 77-224,517, FILED 7-9-2007.

KAREN SEVERSON, EXAMINING ATTORNEY

Int. Cl.: 35

Prior U.S. Cls.: 100, 101 and 102

United States Patent and Trademark Office

Reg. No. 3,397,770

Registered Mar. 18, 2008

**SERVICE MARK
PRINCIPAL REGISTER**



REMWES MEDICAL, LLC (ILLINOIS LTD LIAB
CO)
105 SOUTH AMOS
SPRINGFIELD, IL 62704

FOR: PROVIDING AN ONLINE DIRECTORY
INFORMATION SERVICE FEATURING INFORMA-
TION REGARDING NURSING HOME FACILITIES
IN THE UNITED STATES, IN CLASS 35 (U.S. CLS.
100, 101 AND 102).

FIRST USE 6-16-2007; IN COMMERCE 6-16-2007.

NO CLAIM IS MADE TO THE EXCLUSIVE
RIGHT TO USE "NURSINGHOMERANK.COM",
APART FROM THE MARK AS SHOWN.

THE MARK CONSISTS OF AN ARCHWAY WITH
SUN RAYS WITH THE WORDS NURSINGHOMER-
ANK.COM IN THE FOREFRONT.

SER. NO. 77-224,539, FILED 7-9-2007.

AHSEN KHAN, EXAMINING ATTORNEY

Int. Cls.: 19 and 40

Prior U.S. Cls.: 1, 12, 33, 50, 100, 103 and 106

United States Patent and Trademark Office

Reg. No. 3,397,771

Registered Mar. 18, 2008

**TRADEMARK
SERVICE MARK
PRINCIPAL REGISTER**

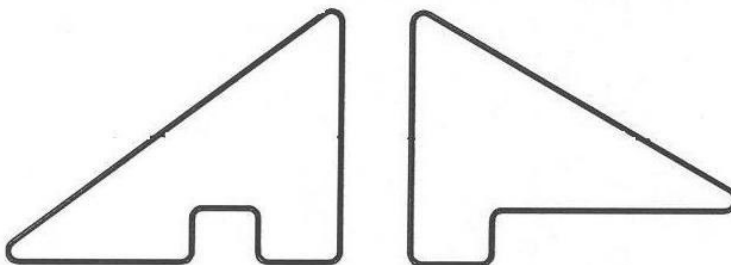

ARCHITECTURAL POLYMERS, INC. (PENNSYLVANIA CORPORATION)
1220 LITTLE GAP ROAD
PALMERTON, PA 18071

FOR: BRICKS; CONCRETE BUILDING MATERIALS, NAMELY, PANELS, SLABS, BLOCKS; CONSTRUCTION MATERIALS, NAMELY, NON-METAL EXTERIOR PANELS; NON-METAL CASTING FORMS FOR CONCRETE AND BRICK-LAYING, IN CLASS 19 (U.S. CLS. 1, 12, 33 AND 50).

FIRST USE 8-0-2006; IN COMMERCE 8-0-2006.

FOR: CUSTOM MANUFACTURE OF NON-METAL EXTERIOR WALL PANELS TO THE ORDER AND SPECIFICATION OF OTHERS, IN CLASS 40 (U.S. CLS. 100, 103 AND 106).

FIRST USE 8-0-2006; IN COMMERCE 8-0-2006.

THE MARK CONSISTS OF THE STYLIZED LETTERS AP.

SER. NO. 77-224,643, FILED 7-9-2007.

SALLY SHIH, EXAMINING ATTORNEY

Int. Cl.: 5

Prior U.S. Cls.: 6, 18, 44, 46, 51 and 52

United States Patent and Trademark Office

Reg. No. 3,397,772

Registered Mar. 18, 2008

**TRADEMARK
PRINCIPAL REGISTER**

SILOSPHERES

MCGRAW, THOMAS L. (UNITED STATES INDIVIDUAL)
UNIT 5C
1440 S. OCEAN BLVD.
POMPANO BEACH, FL 33062

FOR: DRUG DELIVERY AGENTS CONSISTING OF COMPOUNDS THAT FACILITATE DELIVERY OF A WIDE RANGE OF PHARMACEUTICALS, IN CLASS 5 (U.S. CLS. 6, 18, 44, 46, 51 AND 52).

FIRST USE 11-2-2006; IN COMMERCE 11-2-2006.

THE MARK CONSISTS OF STANDARD CHARACTERS WITHOUT CLAIM TO ANY PARTICULAR FONT, STYLE, SIZE, OR COLOR.

SER. NO. 77-224,704, FILED 7-9-2007.

JOHN DWYER, EXAMINING ATTORNEY

Int. Cl.: 30

Prior U.S. Cl.: 46

United States Patent and Trademark Office

Reg. No. 3,397,773

Registered Mar. 18, 2008

**TRADEMARK
PRINCIPAL REGISTER**

PIZZAROLI

FUNK FOODS, INC. (GEORGIA CORPORATION)
PO BOX 362
TIFTON, GA 31793

THE MARK CONSISTS OF STANDARD CHAR-
ACTERS WITHOUT CLAIM TO ANY PARTICULAR
FONT, STYLE, SIZE, OR COLOR.

FOR: DOUGH-BASED WRAPS FILLED WITH
CHEESE AND/OR MEATS AND/OR VEGETABLES,
IN CLASS 30 (U.S. CL. 46).

SER. NO. 77-224,720, FILED 7-9-2007.

FIRST USE 1-1-1987; IN COMMERCE 1-1-1987.

JOHN DWYER, EXAMINING ATTORNEY

Int. Cl.: 9

Prior U.S. Cls.: 21, 23, 26, 36 and 38

United States Patent and Trademark Office

Reg. No. 3,397,774

Registered Mar. 18, 2008

**TRADEMARK
PRINCIPAL REGISTER**

SAFFRON ATLAS

SAFFRON TECHNOLOGY, INC. (DELAWARE CORPORATION)
SUITE 300
1600 PERIMETER PARK DRIVE
MORRISVILLE, NC 27560

FOR: COMPUTER SOFTWARE FOR AMASSING, SORTING, ANALYZING AND IDENTIFYING MASS QUANTITIES OF DATA FOR PROBABILITY ANALYSIS, DISCOVERY OF ASSOCIATED OR SIMILAR ENTITIES, DISCERNING OF PATTERNS, PREDICTING OF OUTCOMES AND MAKING OF RECOMMENDATIONS FOR APPLICATIONS IN VARIOUS FIELDS, INCLUDING MILITARY LOGISTICS, AVIATION, SECURITY, DEFENSE AND INTELLIGENCE, IN CLASS 9 (U.S. CLS. 21, 23, 26, 36 AND 38).

FIRST USE 7-9-2007; IN COMMERCE 7-9-2007.

THE MARK CONSISTS OF STANDARD CHARACTERS WITHOUT CLAIM TO ANY PARTICULAR FONT, STYLE, SIZE, OR COLOR.

OWNER OF U.S. REG. NOS. 2,870,776, 3,018,866 AND OTHERS.

SER. NO. 77-224,768, FILED 7-9-2007.

KARANENDRA S. CHHINA, EXAMINING ATTORNEY

Int. Cl.: 35

Prior U.S. Cls.: 100, 101 and 102

United States Patent and Trademark Office

Reg. No. 3,397,775

Registered Mar. 18, 2008

**SERVICE MARK
PRINCIPAL REGISTER**



PENNWELL CORPORATION (OKLAHOMA CORPORATION)
1421 SOUTH SHERIDAN ROAD
TULSA, OK 74112

FOR: ARRANGING AND CONDUCTING BUSINESS CONFERENCES AND EXHIBITIONS IN THE FIELD OF WATER AND WASTEWATER TREATMENT, IN CLASS 35 (U.S. CLS. 100, 101 AND 102).

FIRST USE 6-30-2007; IN COMMERCE 6-30-2007.

NO CLAIM IS MADE TO THE EXCLUSIVE RIGHT TO USE "URBAN WATER MANAGEMENT", APART FROM THE MARK AS SHOWN.

SER. NO. 77-224,828, FILED 7-9-2007.

MICHAEL WIENER, EXAMINING ATTORNEY

Int. Cl.: 11

Prior U.S. Cls.: 13, 21, 23, 31 and 34

United States Patent and Trademark Office

Reg. No. 3,397,776

Registered Mar. 18, 2008

**TRADEMARK
PRINCIPAL REGISTER**

RAIL-LOCK

SUREFIRE, LLC (CALIFORNIA LTD LIAB CO)
18300 MOUNT BALDY CIRCLE
FOUNTAIN VALLEY, CA 92708

THE MARK CONSISTS OF STANDARD CHAR-
ACTERS WITHOUT CLAIM TO ANY PARTICULAR
FONT, STYLE, SIZE, OR COLOR.

FOR: FIREARM LIGHT FASTENING MECHAN-
ISM, SOLD AS A COMPONENT OF THE FIREARM
LIGHT, IN CLASS 11 (U.S. CLS. 13, 21, 23, 31 AND 34).

SER. NO. 77-224,993, FILED 7-9-2007.

FIRST USE 2-1-2007; IN COMMERCE 2-1-2007.

HENRY S. ZAK, EXAMINING ATTORNEY

Int. Cl.: 19

Prior U.S. Cls.: 1, 12, 33 and 50

United States Patent and Trademark Office

Reg. No. 3,397,777

Registered Mar. 18, 2008

**TRADEMARK
PRINCIPAL REGISTER**

PROCELL

AZEK BUILDING PRODUCTS, INC. (DELA-
WARE CORPORATION)
801 COREY STREET
SCRANTON, PA 18505

THE MARK CONSISTS OF STANDARD CHAR-
ACTERS WITHOUT CLAIM TO ANY PARTICULAR
FONT, STYLE, SIZE, OR COLOR.

FOR: BUILDING MATERIALS, NAMELY, DECK-
ING BOARDS, IN CLASS 19 (U.S. CLS. 1, 12, 33 AND
50).

SER. NO. 77-225,010, FILED 7-9-2007.

FIRST USE 1-1-2003; IN COMMERCE 1-1-2003.

HENRY S. ZAK, EXAMINING ATTORNEY

Int. Cl.: 41

Prior U.S. Cls.: 100, 101 and 107

United States Patent and Trademark Office

Reg. No. 3,397,778

Registered Mar. 18, 2008

**SERVICE MARK
PRINCIPAL REGISTER**

**2 FOR 10 WITH MELISSA.
CHEAP. EASY. TASTY.**

BUTTERY MOON MEDIA LLC (NEW JERSEY
LTD LIAB CO)
141 HIGHVIEW DRIVE
WOODBIDGE, NJ 07095

FOR: EDUCATION AND ENTERTAINMENT
SERVICES IN THE NATURE OF PRE-RECORDED
ONGOING VIDEO PROGRAMS FEATURING
COOKING INSTRUCTION AND RECIPES FOR
BROADCAST ON TELEVISION AND/OR THE IN-
TERNET, IN CLASS 41 (U.S. CLS. 100, 101 AND 107).

FIRST USE 9-15-2006; IN COMMERCE 9-15-2006.

THE MARK CONSISTS OF STANDARD CHAR-
ACTERS WITHOUT CLAIM TO ANY PARTICULAR
FONT, STYLE, SIZE, OR COLOR.

SER. NO. 77-225,068, FILED 7-9-2007.

TOBY BULLOFF, EXAMINING ATTORNEY

Int. Cl.: 35

Prior U.S. Cls.: 100, 101 and 102

United States Patent and Trademark Office

Reg. No. 3,397,779

Registered Mar. 18, 2008

**SERVICE MARK
PRINCIPAL REGISTER**



TRUE NORTH, LLC (TENNESSEE LTD LIAB CO)
1015 FOXWOOD DRIVE
NASHVILLE, TN 37215

FIRST USE 6-25-2007; IN COMMERCE 6-25-2007.

FOR: ENTERTAINMENT MARKETING SERVICES, NAMELY, MARKETING AND PROMOTING MUSIC TO RADIO AND SATELLITE CARRIERS ON BEHALF OF MUSICIANS, ENTERTAINERS, RECORD LABELS, AND MANAGERS , IN CLASS 35 (U.S. CLS. 100, 101 AND 102).

NO CLAIM IS MADE TO THE EXCLUSIVE RIGHT TO USE "RECORDS", APART FROM THE MARK AS SHOWN.

SER. NO. 77-225,080, FILED 7-9-2007.

VERNA BETH RIRIE, EXAMINING ATTORNEY

Int. Cl.: 9

Prior U.S. Cls.: 21, 23, 26, 36 and 38

Reg. No. 3,397,780

United States Patent and Trademark Office

Registered Mar. 18, 2008

**TRADEMARK
PRINCIPAL REGISTER**

**THE VERMILLION PARTNERSHIP
SYSTEM**

VERMILLION CONSULTING, INC. (ILLINOIS
CORPORATION)
SUITE 202
480 W. CENTER STREET
GRAYSLAKE, IL 60030

FOR: PRE-RECORDED VIDEOS, DVDS AND
COMPACT DISCS IN THE FIELD OF SALES AND
MARKETING SKILLS FOR MORTGAGE AND
HOME EQUITY LOANS , IN CLASS 9 (U.S. CLS. 21,
23, 26, 36 AND 38).

FIRST USE 4-24-2007; IN COMMERCE 4-24-2007.

THE MARK CONSISTS OF STANDARD CHAR-
ACTERS WITHOUT CLAIM TO ANY PARTICULAR
FONT, STYLE, SIZE, OR COLOR.

NO CLAIM IS MADE TO THE EXCLUSIVE
RIGHT TO USE "PARTNERSHIP SYSTEM", APART
FROM THE MARK AS SHOWN.

SER. NO. 77-225,124, FILED 7-9-2007.

AMY MCMENAMIN, EXAMINING ATTORNEY

Int. Cl.: 44

Prior U.S. Cls.: 100 and 101

United States Patent and Trademark Office

Reg. No. 3,397,781

Registered Mar. 18, 2008

**SERVICE MARK
PRINCIPAL REGISTER**

ANAD

NATIONAL ASSOCIATION OF ANOREXIA NERVOSA AND ASSOCIATED DISORDERS (ILLINOIS CORPORATION)
P.O. BOX 7
HIHGLAND PARK, IL 60035

FOR: PROVIDING INFORMATION AND COUNSELING SERVICES REGARDING EATING DISORDERS TO THE GENERAL PUBLIC, IN CLASS 44 (U.S. CLS. 100 AND 101).

FIRST USE 6-9-1979; IN COMMERCE 6-9-1979.

THE MARK CONSISTS OF STANDARD CHARACTERS WITHOUT CLAIM TO ANY PARTICULAR FONT, STYLE, SIZE, OR COLOR.

SER. NO. 77-225,127, FILED 7-9-2007.

DAWN HAN, EXAMINING ATTORNEY

Int. Cl.: 28

Prior U.S. Cls.: 22, 23, 38 and 50

United States Patent and Trademark Office

Reg. No. 3,397,782

Registered Mar. 18, 2008

**TRADEMARK
PRINCIPAL REGISTER**

CQBBs

PYRAMYD AIR (OHIO PARTNERSHIP)
UNIT #L
26800 FARGO AVENUE
BEDFORD HTS, OH 44146

THE MARK CONSISTS OF STANDARD CHAR-
ACTERS WITHOUT CLAIM TO ANY PARTICULAR
FONT, STYLE, SIZE, OR COLOR.

FOR: PLASTIC BBS FOR USE IN TOY AIR GUNS,
IN CLASS 28 (U.S. CLS. 22, 23, 38 AND 50).

SER. NO. 77-225,319, FILED 7-9-2007.

FIRST USE 6-1-2007; IN COMMERCE 6-1-2007.

RICHARD WHITE, EXAMINING ATTORNEY

Int. Cl.: 36

Prior U.S. Cls.: 100, 101 and 102

United States Patent and Trademark Office

Reg. No. 3,397,783

Registered Mar. 18, 2008

**SERVICE MARK
PRINCIPAL REGISTER**

PEMBROKE POINTE

PEMBROKE POINT PHASE I LLC (NORTH CAROLINA LTD LIAB CO)
SUITE 115
7901 STRICKLAND ROAD
RALEIGH, NC 27615

THE MARK CONSISTS OF STANDARD CHARACTERS WITHOUT CLAIM TO ANY PARTICULAR FONT, STYLE, SIZE, OR COLOR.

FOR: APARTMENT HOUSE MANAGEMENT; LEASING OF APARTMENTS; RENTAL OF APARTMENTS, IN CLASS 36 (U.S. CLS. 100, 101 AND 102).

SER. NO. 77-225,392, FILED 7-10-2007.

FIRST USE 12-31-2003; IN COMMERCE 12-31-2003.

RENEE MCCRAY, EXAMINING ATTORNEY

Int. Cls.: 35, 42 and 45

Prior U.S. Cls.: 100, 101 and 102

United States Patent and Trademark Office

Reg. No. 3,397,784

Registered Mar. 18, 2008

**SERVICE MARK
PRINCIPAL REGISTER**

Zelky

ZELKY, INC. (DELAWARE CORPORATION)
972 VASCO DA GAMA LANE
FOSTER CITY, CA 94404

FOR: ADMINISTRATION OF COMMUNITY RECREATIONAL SPORTS LEAGUES; COORDINATION OF RECREATIONAL SPORTING OPPORTUNITIES FOR INDIVIDUALS WHO WISH TO PARTICIPATE IN TEAM LEAGUE SPORTS; PROMOTING SPORTS COMPETITIONS AND/OR EVENTS OF OTHERS; PROMOTING THE GOODS AND SERVICES OF OTHERS BY ARRANGING FOR SPONSORS TO AFFILIATE THEIR GOODS AND SERVICES WITH AN AWARDS PROGRAM, A SPORTS COMPETITION AND SPORTING ACTIVITIES; PROMOTING THE INTERESTS OF PEOPLE INVOLVED AND CONCERNED WITH YOUTH SPORTS; PROVIDING A WEBSITE THAT PROVIDES SPORTS LEAGUE MANAGEMENT, IN CLASS 35 (U.S. CLS. 100, 101 AND 102).

FIRST USE 5-15-2007; IN COMMERCE 5-15-2007.

FOR: COMPUTER SERVICES, NAMELY, CREATING AN ONLINE COMMUNITY FOR REGISTERED USERS TO PARTICIPATE IN COMPETITIONS, SHOWCASE THEIR SKILLS, GET FEEDBACK FROM THEIR PEERS, FORM VIRTUAL COMMUNITIES, ENGAGE IN SOCIAL NETWORKING AND IMPROVE THEIR TALENT; COMPUTER SERVICES,

NAMELY, HOSTING AND MAINTAINING AN ONLINE WEBSITE FOR OTHERS TO TRACK PERSONAL WORKOUTS AND FITNESS GOALS; COMPUTER SERVICES, NAMELY, HOSTING ONLINE WEB FACILITIES FOR OTHERS FOR ORGANIZING AND CONDUCTING ONLINE MEETINGS, GATHERINGS, AND INTERACTIVE DISCUSSIONS, IN CLASS 42 (U.S. CLS. 100 AND 101).

FIRST USE 5-15-2007; IN COMMERCE 5-15-2007.

FOR: PROVIDING AN INTERACTIVE WEBSITE FOR PERSONS TO LOCATE OTHER INDIVIDUALS WITH SIMILAR INTERESTS TO PARTICIPATE WITH THEM IN, OR ACCOMPANY THEM TO, EVENTS AND ACTIVITIES; ONLINE SOCIAL NETWORKING SERVICES, IN CLASS 45 (U.S. CLS. 100 AND 101).

FIRST USE 5-15-2007; IN COMMERCE 5-15-2007.

THE MARK CONSISTS OF STANDARD CHARACTERS WITHOUT CLAIM TO ANY PARTICULAR FONT, STYLE, SIZE, OR COLOR.

SER. NO. 77-225,399, FILED 7-10-2007.

MATTHEW MCDOWELL, EXAMINING ATTORNEY

Int. Cl.: 41

Prior U.S. Cls.: 100, 101 and 107

United States Patent and Trademark Office

Reg. No. 3,397,785

Registered Mar. 18, 2008

**SERVICE MARK
PRINCIPAL REGISTER**

Quantum Violet Focus

STRICKLAND, KAREN (UNITED STATES INDIVIDUAL)
8308 COPPERNAIL WAY
WEST CHESTER, OH 45069

FOR: EDUCATION SERVICES, NAMELY, PROVIDING SEMINARS IN THE FIELD OF ALTERNATIVE MEDICINE, IN CLASS 41 (U.S. CLS. 100, 101 AND 107).

FIRST USE 3-3-2006; IN COMMERCE 3-3-2006.

THE MARK CONSISTS OF STANDARD CHARACTERS WITHOUT CLAIM TO ANY PARTICULAR FONT, STYLE, SIZE, OR COLOR.

SER. NO. 77-225,435, FILED 7-10-2007.

NAAKWAMA ANKRAH, EXAMINING ATTORNEY

Int. Cl.: 20

Prior U.S. Cls.: 2, 13, 22, 25, 32 and 50

United States Patent and Trademark Office

Reg. No. 3,397,786

Registered Mar. 18, 2008

TRADEMARK
PRINCIPAL REGISTER



DIMCOGRAY CORPORATION (OHIO CORPORATION)
900 DIMCO WAY
CENTERVILLE, OH 45458

FOR: PLASTIC KNOBS, PLASTIC HANDLES FOR MEDICAL EQUIPMENT, FARM AND CONSTRUCTION MACHINERY, MECHANICAL CONTROLS, SPECIALTY FURNITURE, FITNESS EQUIPMENT, FOOD SERVICE EQUIPMENT, COMMERCIAL LIGHTING, THEATRE LIGHTING, INDUSTRIAL EQUIPMENT, HEATING, VENTILATING AND AIR-CONDITIONING (HVAC) EQUIPMENT, IN CLASS 20 (U.S. CLS. 2, 13, 22, 25, 32 AND 50).

FIRST USE 2-28-2006; IN COMMERCE 7-27-2006.

THE MARK CONSISTS OF A LOGO CONTAINING A STYLIZED "D" AND "G" TO THE LEFT OF THE WORD "DIMCOGRAY" WITH THE WORDS "SOLUTIONS AT HAND" POSITIONED UNDER THE WORD "GRAY".

SER. NO. 77-225,490, FILED 7-10-2007.

KAPIL BHANOT, EXAMINING ATTORNEY

Int. Cl.: 16

Prior U.S. Cls.: 2, 5, 22, 23, 29, 37, 38 and 50

United States Patent and Trademark Office

Reg. No. 3,397,787

Registered Mar. 18, 2008

**TRADEMARK
PRINCIPAL REGISTER**

CREATE A PLATE

MAKIT PRODUCTS, INC. (TEXAS CORPORATION)
4510 DUNCANVILLE RD.
DALLAS, TX 75236

FOR: KITS PRIMARILY CONTAINING SPECIAL PAPER FOR USE IN MAKING DRAWINGS TO BE MOLDED IN DINNERWARE, IN CLASS 16 (U.S. CLS. 2, 5, 22, 23, 29, 37, 38 AND 50).

FIRST USE 7-1-2002; IN COMMERCE 7-1-2002.

THE MARK CONSISTS OF STANDARD CHARACTERS WITHOUT CLAIM TO ANY PARTICULAR FONT, STYLE, SIZE, OR COLOR.

OWNER OF U.S. REG. NO. 2,770,491.

SEC. 2(F).

SER. NO. 77-225,515, FILED 7-10-2007.

LINDA POWELL, EXAMINING ATTORNEY

Int. Cl.: 16

Prior U.S. Cls.: 2, 5, 22, 23, 29, 37, 38 and 50

Reg. No. 3,397,788

United States Patent and Trademark Office

Registered Mar. 18, 2008

**TRADEMARK
PRINCIPAL REGISTER**

AUTOGRAPH PARTY PLATE!

MAKIT PRODUCTS, INC. (TEXAS CORPORATION)
4510 DUNCANVILLE RD.
DALLAS, TX 75236

FOR: KITS PRIMARILY CONTAINING SPECIAL PAPER FOR USE IN MAKING DRAWINGS TO BE MOLDED IN DINNERWARE, IN CLASS 16 (U.S. CLS. 2, 5, 22, 23, 29, 37, 38 AND 50).

FIRST USE 7-1-2002; IN COMMERCE 7-1-2002.

THE MARK CONSISTS OF STANDARD CHARACTERS WITHOUT CLAIM TO ANY PARTICULAR FONT, STYLE, SIZE, OR COLOR.

OWNER OF U.S. REG. NO. 2,833,436.

SEC. 2(F).

SER. NO. 77-225,518, FILED 7-10-2007.

LINDA POWELL, EXAMINING ATTORNEY

Int. Cl.: 44

Prior U.S. Cls.: 100 and 101

United States Patent and Trademark Office

Reg. No. 3,397,789

Registered Mar. 18, 2008

**SERVICE MARK
PRINCIPAL REGISTER**

ShapeFit

SHAPEFIT, LLC (FLORIDA LTD LIAB CO)
12055 GANDY BLVD NORTH UNIT 265
SAINT PETERSBURG, FL 33702

FOR: PROVIDING INFORMATION ABOUT DIETARY SUPPLEMENTS AND NUTRITION; DIETARY AND NUTRITIONAL GUIDANCE; FOOD NUTRITION CONSULTATION; NUTRITION COUNSELING; PROVIDING A WEBSITE FEATURING EDUCATIONAL INFORMATION REGARDING NUTRITION AND GENETICS; PROVIDING A WEBSITE THAT FEATURES INFORMATION ON CHILDREN'S NUTRITION; WEIGHT REDUCTION DIET PLANNING AND SUPERVISION; CONSULTING TO INDIVIDUALS AND COMMUNITIES ENGAGED IN GROUP WEIGHT LOSS PROGRAMS; PROVIDING A WEBSITE FEATURING INFORMA-

TION IN THE FIELD OF MENTAL HEALTH AND WELLNESS; VITAMIN THERAPY, IN CLASS 44 (U.S. CLS. 100 AND 101).

FIRST USE 7-24-2001; IN COMMERCE 9-7-2003.

THE MARK CONSISTS OF STANDARD CHARACTERS WITHOUT CLAIM TO ANY PARTICULAR FONT, STYLE, SIZE, OR COLOR.

OWNER OF U.S. REG. NO. 3,120,075.

SER. NO. 77-225,548, FILED 7-10-2007.

AMOS T. MATTHEWS, JR., EXAMINING ATTORNEY

Int. Cl.: 36

Prior U.S. Cls.: 100, 101 and 102

United States Patent and Trademark Office

Reg. No. 3,397,790

Registered Mar. 18, 2008

**SERVICE MARK
PRINCIPAL REGISTER**

ARCH RE FACULTATIVE

ARCH CAPITAL GROUP (U.S.) INC. (DELA-
WARE CORPORATION)
53RD FLOOR
ONE LIBERTY PLAZA
NEW YORK, NY 10006

FOR: REINSURANCE UNDERWRITING, IN
CLASS 36 (U.S. CLS. 100, 101 AND 102).

FIRST USE 6-25-2007; IN COMMERCE 6-25-2007.

THE MARK CONSISTS OF STANDARD CHAR-
ACTERS WITHOUT CLAIM TO ANY PARTICULAR
FONT, STYLE, SIZE, OR COLOR.

OWNER OF U.S. REG. NOS. 3,116,625 AND
3,123,046.

NO CLAIM IS MADE TO THE EXCLUSIVE
RIGHT TO USE "RE FACULTATIVE", APART
FROM THE MARK AS SHOWN.

SER. NO. 77-225,582, FILED 7-10-2007.

BILL DAWE, EXAMINING ATTORNEY

Int. Cl.: 45

Prior U.S. Cls.: 100 and 101

United States Patent and Trademark Office

Reg. No. 3,397,791

Registered Mar. 18, 2008

**SERVICE MARK
PRINCIPAL REGISTER**

**PROVIDING CREATIVE AND
PRACTICAL SOLUTIONS AT
UNSURPASSED VALUE**

SHOOK, HARDY & BACON L.L.P. (MISSOURI
LIMITED LIABILITY PARTNERSHIP)
2555 GRAND BLVD.
KANSAS CITY, MO 64108

THE MARK CONSISTS OF STANDARD CHAR-
ACTERS WITHOUT CLAIM TO ANY PARTICULAR
FONT, STYLE, SIZE, OR COLOR.

FOR: LEGAL SERVICES, IN CLASS 45 (U.S. CLS.
100 AND 101).

SER. NO. 77-225,625, FILED 7-10-2007.

FIRST USE 5-28-2004; IN COMMERCE 8-1-2005.

GILBERT SWIFT, EXAMINING ATTORNEY

Int. Cl.: 9

Prior U.S. Cls.: 21, 23, 26, 36 and 38

Reg. No. 3,397,792

United States Patent and Trademark Office

Registered Mar. 18, 2008

**TRADEMARK
PRINCIPAL REGISTER**

MODERN TIMES

MODERN OPTICAL INTERNATIONAL, LTD.
(ILLINOIS CORPORATION)
585 CONGRESS CIRCLE NORTH
ROSELLE, IL 60172

THE MARK CONSISTS OF STANDARD CHAR-
ACTERS WITHOUT CLAIM TO ANY PARTICULAR
FONT, STYLE, SIZE, OR COLOR.

FOR: EYEWEAR, NAMELY, SUNGLASSES, EYE-
GLASSES AND OPHTHALMIC FRAMES; AND CASES
THEREFOR, IN CLASS 9 (U.S. CLS. 21, 23, 26, 36 AND
38).

SER. NO. 77-225,712, FILED 7-10-2007.

FIRST USE 12-0-1996; IN COMMERCE 1-1-1997.

JENNIFER MARTIN, EXAMINING ATTORNEY

Int. Cl.: 9

Prior U.S. Cls.: 21, 23, 26, 36 and 38

United States Patent and Trademark Office

Reg. No. 3,397,793

Registered Mar. 18, 2008

**TRADEMARK
PRINCIPAL REGISTER**

GOSTEREO

PRICE POINT ACCESSORIES LLC (NEW JERSEY
LTD LIAB CO)
3500 SUNSET AVENUE
ASBURY PARK, NJ 07712

FOR: AUDIO EQUIPMENT FOR VEHICLES, NAMELY, STEREOS, SPEAKERS, AMPLIFIERS, EQUALIZERS, CROSSOVERS AND SPEAKER HOUSINGS; AUDIO SPEAKERS; LOUD SPEAKER SYSTEMS; HEADPHONES; PORTABLE RADIOS; RADIOS; SATELLITE RADIOS; TWO-WAY RADIOS; PERSONAL STEREOS; STEREO AMPLIFIERS; STEREO CABLES; STEREO TUNERS; MP3 PLAYERS; PORTABLE LISTENING DEVICES, NAMELY, MP3 PLAYERS; CD CASES; CASES FOR ELECTRONIC DIARIES; CASES FOR MOBILE PHONES; CASES FOR TELEPHONES; COMPUTER CARRYING CASES; DVD CASES; LAPTOP CARRYING CASES; PROTECTIVE CARRYING CASES FOR PORTABLE MUSIC PLAYERS NAMELY MP3 PLAYERS; PRO-

TECTIVE CARRYING CASES SPECIALLY ADAPTED FOR GLOBAL POSITIONING SYSTEM (GPS) APPARATUS; PROTECTIVE CARRYING CASES SPECIALLY ADAPTED FOR PERSONAL DIGITAL ASSISTANTS (PDA); UPI (UNIVERSAL PERIPHERAL INTERFACE) HARDWARE; CONNECTION CABLES; POWER CABLES; PORTABLE DVD PLAYERS; PORTABLE MEDIA PLAYERS, IN CLASS 9 (U.S. CLS. 21, 23, 26, 36 AND 38).

FIRST USE 9-1-2005; IN COMMERCE 9-1-2005.

THE MARK CONSISTS OF STANDARD CHARACTERS WITHOUT CLAIM TO ANY PARTICULAR FONT, STYLE, SIZE, OR COLOR.

SER. NO. 77-225,807, FILED 7-10-2007.

MICHAEL KAZAZIAN, EXAMINING ATTORNEY

Int. Cl.: 41

Prior U.S. Cls.: 100, 101 and 107

United States Patent and Trademark Office

Reg. No. 3,397,794

Registered Mar. 18, 2008

**SERVICE MARK
PRINCIPAL REGISTER**

LITTLE RACQUETS

LITTLE RACQUETS, LLC (OHIO LTD LIAB CO)
6750 RIDGECLIFF DRIVE
SOLON, OH 44139

FOR: TENNIS INSTRUCTION, IN CLASS 41 (U.S.
CLS. 100, 101 AND 107).

FIRST USE 4-30-2007; IN COMMERCE 4-30-2007.

THE MARK CONSISTS OF STANDARD CHAR-
ACTERS WITHOUT CLAIM TO ANY PARTICULAR
FONT, STYLE, SIZE, OR COLOR.

NO CLAIM IS MADE TO THE EXCLUSIVE
RIGHT TO USE "RACQUETS", APART FROM THE
MARK AS SHOWN.

SER. NO. 77-225,829, FILED 7-10-2007.

ZACHARY BELLO, EXAMINING ATTORNEY

Int. Cl.: 41

Prior U.S. Cls.: 100, 101 and 107

United States Patent and Trademark Office

Reg. No. 3,397,795

Registered Mar. 18, 2008

**SERVICE MARK
PRINCIPAL REGISTER**



ATWORK! (WASHINGTON CORPORATION)
690 NW JUNIPER STREET
ISSAQUAH, WA 98027

FOR: JOB TRAINING SERVICES FOR THE DIS-
ABLED, IN CLASS 41 (U.S. CLS. 100, 101 AND 107).

FIRST USE 4-0-2007; IN COMMERCE 4-0-2007.

OWNER OF U.S. REG. NO. 2,563,213.

THE MARK CONSISTS OF THE TEXT "ATWORK!
CHANGING THE FACE OF EMPLOYMENT" OVER-
LAPPING A SQUARE POSITIONED AT AN ANGLE.

SER. NO. 77-225,896, FILED 7-10-2007.

CHRIS WELLS, EXAMINING ATTORNEY

Int. Cls.: 41, 43 and 44

Prior U.S. Cls.: 100, 101 and 107

United States Patent and Trademark Office

Reg. No. 3,397,796

Registered Mar. 18, 2008

**SERVICE MARK
PRINCIPAL REGISTER**



HOMEBASE YOUTH SERVICES, INC. (ARIZONA CORPORATION)
931 EAST DEVONSHIRE AVENUE
PHOENIX, AZ 85014

FOR: CHARITABLE SERVICES, NAMELY, PROVIDING EDUCATIONAL AND VOCATIONAL COUNSELING TO HOMELESS AND RUNAWAY TEENS, IN CLASS 41 (U.S. CLS. 100, 101 AND 107).

FIRST USE 12-31-1991; IN COMMERCE 12-31-1991.

FOR: CHARITABLE SERVICES, NAMELY, PROVIDING SHORT-AND LONG-TERM RESIDENTIAL SERVICES TO HOMELESS AND RUNAWAY TEENS, IN CLASS 43 (U.S. CLS. 100 AND 101).

FIRST USE 12-31-1991; IN COMMERCE 12-31-1991.

FOR: CHARITABLE SERVICES, NAMELY, PROVIDING PSYCHOLOGICAL AND MEDICAL COUNSELING FOR HOMELESS AND RUNAWAY TEENS, IN CLASS 44 (U.S. CLS. 100 AND 101).

FIRST USE 12-31-1991; IN COMMERCE 12-31-1991.

THE MARK CONSISTS OF A STYLIZED DRAWING OF A BASEBALL HOME PLATE.

SER. NO. 77-225,939, FILED 7-10-2007.

CIMMERIAN COLEMAN, EXAMINING ATTORNEY

Int. Cl.: 37

Prior U.S. Cls.: 100, 103 and 106

United States Patent and Trademark Office

Reg. No. 3,397,797

Registered Mar. 18, 2008

**SERVICE MARK
PRINCIPAL REGISTER**



EDIFICE, INC. (NORTH CAROLINA CORPORATION)
1401 WEST MOREHEAD STREET
CHARLOTTE, NC 28208

FOR: GENERAL CONSTRUCTION CONTRACTING, IN CLASS 37 (U.S. CLS. 100, 103 AND 106).

FIRST USE 4-1-2007; IN COMMERCE 4-1-2007.

THE MARK CONSISTS OF TWO INTERLOCKING PIECES WHICH TOGETHER FORM THE

SHAPE OF A BASEBALL DIAMOND. THE FIRST PIECE IS A STYLIZED LETTER E AND SECOND PIECE, SMALLER THAN THE FIRST PIECE, IS TO THE RIGHT OF THE FIRST PIECE, IS IN THE SHAPE OF THE LETTER L ROTATED 180 DEGREES ON THE VERTICAL AXIS AND SLIGHTLY COUNTER-CLOCKWISE.

SER. NO. 77-226,029, FILED 7-10-2007.

REBECCA SMITH, EXAMINING ATTORNEY

Int. Cl.: 45

Prior U.S. Cls.: 100 and 101

United States Patent and Trademark Office

Reg. No. 3,397,798

Registered Mar. 18, 2008

**SERVICE MARK
PRINCIPAL REGISTER**

AGING AT HOME

AGING AT HOME, LTD. (NEW YORK LTD LIAB
CO)
89 MINEOLA BLVD.
MINEOLA, NY 11501

THE MARK CONSISTS OF STANDARD CHAR-
ACTERS WITHOUT CLAIM TO ANY PARTICULAR
FONT, STYLE, SIZE, OR COLOR.

FOR: PLACING COMPANIONS WITH SENIOR
CITIZENS, IN CLASS 45 (U.S. CLS. 100 AND 101).

SER. NO. 77-226,084, FILED 7-10-2007.

FIRST USE 1-5-1995; IN COMMERCE 1-5-1995.

JEAN IM, EXAMINING ATTORNEY

Int. Cl.: 35

Prior U.S. Cls.: 100, 101 and 102

United States Patent and Trademark Office

Reg. No. 3,397,799

Registered Mar. 18, 2008

**SERVICE MARK
PRINCIPAL REGISTER**



KIPLING APPAREL CORP. (DELAWARE CORPORATION)
3411 SILVERSIDE ROAD
WILMINGTON, DE 19810

FOR: RETAIL STORE AND WHOLESALE STORE SERVICES IN THE FIELD OF HANDBAGS, LUGGAGE AND RELATED ACCESSORIES; PROVIDING CONSUMER PRODUCT AND DEALER INFORMATION VIA THE INTERNET, IN CLASS 35 (U.S. CLS. 100, 101 AND 102).

FIRST USE 7-29-2005; IN COMMERCE 7-29-2005.

OWNER OF U.S. REG. NOS. 1,952,994, 2,945,417 AND OTHERS.

THE MARK CONSISTS OF THE WORD KIPLING FOLLOWED BY A STYLIZED MONKEY DESIGN CONSISTING OF THE SILHOUETTE OF A LONG-TAILED MONKEY WALKING FROM LEFT TO RIGHT ON ALL FOUR LEGS. THE TAIL OF THE MONKEY CURLS OVER THE WORD ELEMENT AND ENDS IN DOTTING THE LETTER 'I' IN THE WORD.

SER. NO. 77-226,170, FILED 7-10-2007.

MYRIAH HABEEB, EXAMINING ATTORNEY

Int. Cl.: 41

Prior U.S. Cls.: 100, 101 and 107

United States Patent and Trademark Office

Reg. No. 3,397,800

Registered Mar. 18, 2008

**SERVICE MARK
PRINCIPAL REGISTER**

**For how you train...so
shall you fight**

KFD TRAINING & CONSULTATION, LLC (CON-
NECTICUT LTD LIAB CO)
48 MARSHALL'S MEADOW
WETHERSFIELD, CT 06109

THE MARK CONSISTS OF STANDARD CHAR-
ACTERS WITHOUT CLAIM TO ANY PARTICULAR
FONT, STYLE, SIZE, OR COLOR.

FOR: TRAINING SERVICES IN THE FIELD OF
RISK MANAGEMENT FOR POLICE COMBAT AND
RELATED ARREST AND CONTROL TECHNIQUES,
IN CLASS 41 (U.S. CLS. 100, 101 AND 107).

SER. NO. 77-226,190, FILED 7-10-2007.

FIRST USE 12-15-1999; IN COMMERCE 12-15-1999.

RICHARD WHITE, EXAMINING ATTORNEY

Int. Cl.: 41

Prior U.S. Cls.: 100, 101 and 107

United States Patent and Trademark Office

Reg. No. 3,397,801

Registered Mar. 18, 2008

**SERVICE MARK
PRINCIPAL REGISTER**

Gemeanii

GEMENY, STEVEN E. (UNITED STATES INDIVIDUAL)
8606 DELCRIS DR.
MONTGOMERY VILLAGE, MD 20886

THE MARK CONSISTS OF STANDARD CHARACTERS WITHOUT CLAIM TO ANY PARTICULAR FONT, STYLE, SIZE, OR COLOR.

FOR: CONDUCTING ENTERTAINMENT EXHIBITIONS IN THE NATURE OF MAGIC AND SIDESHOW, IN CLASS 41 (U.S. CLS. 100, 101 AND 107).

SER. NO. 77-226,223, FILED 7-10-2007.

FIRST USE 10-8-2004; IN COMMERCE 10-8-2004.

MICHAEL KAZAZIAN, EXAMINING ATTORNEY

Int. Cl.: 35

Prior U.S. Cls.: 100, 101 and 102

United States Patent and Trademark Office

Reg. No. 3,397,802

Registered Mar. 18, 2008

**SERVICE MARK
PRINCIPAL REGISTER**

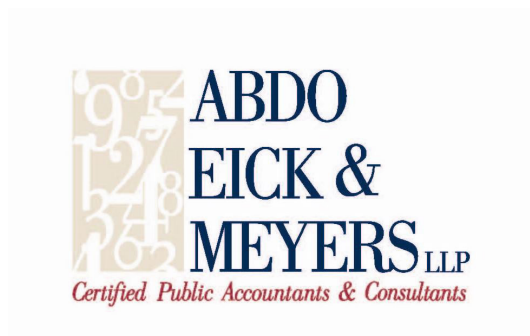

ABDO, EICK & MEYERS LLP (MINNESOTA
LIMITED PARTNERSHIP)
SUITE 370
5201 EDEN AVENUE
EDINA, MN 55436

FOR: ACCOUNTING CONSULTATION; AC-
COUNTING SERVICES, IN CLASS 35 (U.S. CLS. 100,
101 AND 102).

FIRST USE 6-0-1998; IN COMMERCE 6-0-1998.

NO CLAIM IS MADE TO THE EXCLUSIVE
RIGHT TO USE "LLP CERTIFIED PUBLIC AC-
COUNTANTS & CONSULTANTS", APART FROM
THE MARK AS SHOWN.

THE COLOR(S) BLUE, RED, BEIGE AND WHITE
IS/ARE CLAIMED AS A FEATURE OF THE MARK.

THE MARK CONSISTS OF THE WORDS ABDO
EICK & MEYERS LLP IS IN THE COLOR BLUE
WHICH IS ABOVE THE WORDS CERTIFIED PUB-
LIC ACCOUNTANTS & CONSULTANTS IS IN THE
COLOR RED WHICH IS LOCATED TO THE RIGHT
OF AND BELOW A SQUARE IN THE COLOR BEIGE
WITH A SERIES OF RANDOM OVERLAPPING
NUMBERS IN THE COLOR WHITE.

SER. NO. 77-226,238, FILED 7-10-2007.

EDWARD FENNESSY, EXAMINING ATTORNEY

Int. Cl.: 9

Prior U.S. Cls.: 21, 23, 26, 36 and 38

Reg. No. 3,397,803

United States Patent and Trademark Office

Registered Mar. 18, 2008

**TRADEMARK
PRINCIPAL REGISTER**

VS PRO

VIEWTECH INCORPORATED (CALIFORNIA
CORPORATION)
3038 OCEANIC DRIVE #409
OCEANSIDE, CA 92056

THE MARK CONSISTS OF STANDARD CHAR-
ACTERS WITHOUT CLAIM TO ANY PARTICULAR
FONT, STYLE, SIZE, OR COLOR.

FOR: SATELLITE RECEIVERS, IN CLASS 9 (U.S.
CLS. 21, 23, 26, 36 AND 38).

SER. NO. 77-226,248, FILED 7-10-2007.

FIRST USE 7-10-2007; IN COMMERCE 7-10-2007.

CHARISMA HAMPTON, EXAMINING ATTORNEY

Int. Cl.: 43

Prior U.S. Cls.: 100 and 101

United States Patent and Trademark Office

Reg. No. 3,397,804

Registered Mar. 18, 2008

**SERVICE MARK
PRINCIPAL REGISTER**

CBGB

KRISTAL, HILLEL (UNITED STATES INDIVIDUAL)
87 EAST 3RD STREET
NEW YORK, NY 10003

THE MARK CONSISTS OF STANDARD CHARACTERS WITHOUT CLAIM TO ANY PARTICULAR FONT, STYLE, SIZE, OR COLOR.

FOR: RESTAURANT AND BAR SERVICES, IN CLASS 43 (U.S. CLS. 100 AND 101).

SER. NO. 77-226,252, FILED 7-10-2007.

FIRST USE 3-15-1976; IN COMMERCE 3-15-1976.

THEODORE MCBRIDE, EXAMINING ATTORNEY

Int. Cl.: 42

Prior U.S. Cls.: 100 and 101

United States Patent and Trademark Office

Reg. No. 3,397,805

Registered Mar. 18, 2008

**SERVICE MARK
PRINCIPAL REGISTER**



WAGNER, STEVE (UNITED STATES INDIVIDUAL)
1015 CALLE AMANECER
SAN CLEMENTE, CA 92673

FOR: PROVIDING ON-LINE NON-DOWNLOADABLE SOFTWARE FOR BENCHMARKING SIGNIFICANT ASPECTS OF THE REVENUE AND OPERATING COSTS OF A BUSINESS, WHICH WOULD INCLUDE HYPOTHETICAL MODELS OF SERVICE AND PRODUCT MIX, IN CLASS 42 (U.S. CLS. 100 AND 101).

FIRST USE 2-1-2006; IN COMMERCE 2-1-2006.

THE MARK CONSISTS OF STYLIZED QUESTION MARK WITH THE PERIOD AT THE BOTTOM OF THE QUESTION MARK AS A \$.

SER. NO. 77-226,255, FILED 7-10-2007.

BENJAMIN ALLEN, EXAMINING ATTORNEY

Int. Cls.: 35 and 42

Prior U.S. Cls.: 100, 101 and 102

United States Patent and Trademark Office

Reg. No. 3,397,806

Registered Mar. 18, 2008

**SERVICE MARK
PRINCIPAL REGISTER**

CHERRYSTONEIT

CHERRYSTONEIT, INC. (CALIFORNIA CORPORATION)
7632 WOODWIND DRIVE, #101
HUNTINGTON BEACH, CA 92647

FOR: RETAIL AND ON-LINE RETAIL STORE SERVICES FEATURING NEW, PRE-OWNED, AND REFURBISHED COMPUTERS FOR SALE OR TRADE; RETAIL AND ON-LINE RETAIL STORE SERVICES FEATURING NEW, PRE-OWNED, AND REFURBISHED I.T. EQUIPMENT, NAMELY, WORKSTATIONS, SERVERS, MODULES, STORAGE DEVICES, MEMORY UPGRADES, HARDWARE, PERIPHERALS, PROCESSORS, ADAPTERS, TAPE, TAPE LIBRARIES, SUBSYSTEMS, DISK SUBSYSTEMS, EXTERNAL STORAGE DEVICES, ROUTERS, SWITCHES, CATALYST SWITCHES, FIREWALLS, VPNS, CABLES, AND BACK-UP STORAGE DEVICES FOR SALE OR TRADE; WHOLESALE SERVICES FEATURING COMPUTER HARDWARE, IN CLASS 35 (U.S. CLS. 100, 101 AND 102).

FIRST USE 8-0-2007; IN COMMERCE 8-0-2007.

FOR: RENTAL OF COMPUTERS; RENTAL OF I.T. EQUIPMENT, NAMELY, WORKSTATIONS, SERVERS, MODULES, STORAGE DEVICES, MEMORY UPGRADES, HARDWARE, PERIPHERALS, PROCESSORS, ADAPTERS, TAPE, TAPE LIBRARIES, SUBSYSTEMS, DISK SUBSYSTEMS, EXTERNAL STORAGE DEVICES, ROUTERS, SWITCHES, CATALYST SWITCHES, FIREWALLS, VPNS, CABLES, AND BACK-UP STORAGE DEVICES; LEASING OF COMPUTER HARDWARE, IN CLASS 42 (U.S. CLS. 100 AND 101).

FIRST USE 8-0-2007; IN COMMERCE 8-0-2007.

THE MARK CONSISTS OF STANDARD CHARACTERS WITHOUT CLAIM TO ANY PARTICULAR FONT, STYLE, SIZE, OR COLOR.

SER. NO. 77-226,273, FILED 7-10-2007.

THEODORE MCBRIDE, EXAMINING ATTORNEY

Int. Cl.: 12

Prior U.S. Cls.: 19, 21, 23, 31, 35 and 44

United States Patent and Trademark Office

Reg. No. 3,397,807

Registered Mar. 18, 2008

**TRADEMARK
PRINCIPAL REGISTER**



HUBEI AVIATION PRECISION MACHINERY
TECHNOLOGY CO., LTD. (CHINA CORPORATION)
XIANGFAN
NO. 8, ZHUIRI ROAD, HIGH TECH ZONE
HUBEI, CHINA

FOR: VEHICLE SEATS; SEAT BELTS FOR USE IN
VEHICLES; GEARBOXES FOR MOTOR CARS;
GEARBOXES; CLUTCHES FOR LAND VEHICLES;
CLUTCH LININGS FOR LAND VEHICLES; TRANSMISSION
MECHANISMS FOR LAND VEHICLES;
TORSION BARS FOR MOTOR CARS; TORQUE
CONVERTERS FOR LAND VEHICLES; LAND VEHICLE
TRANSMISSIONS AND REPLACEMENT

PARTS THEREOF; CABLE CARS; SUSPENSION
ARMS FOR CABLE CARS, IN CLASS 12 (U.S. CLS.
19, 21, 23, 31, 35 AND 44).

FIRST USE 2-1-2005; IN COMMERCE 9-1-2006.

THE MARK CONSISTS OF THE WORD HAPM IN
A STYLIZED FORMAT.

SER. NO. 77-226,288, FILED 7-10-2007.

AMOS T. MATTHEWS, JR., EXAMINING ATTORNEY

Int. Cl.: 35

Prior U.S. Cls.: 100, 101 and 102

United States Patent and Trademark Office

Reg. No. 3,397,808

Registered Mar. 18, 2008

**SERVICE MARK
PRINCIPAL REGISTER**



WHITEPAGES.COM, INC. (DELAWARE CORPORATION)
1301 FIFTH AVENUE, SUITE 1600
SEATTLE, WA 98101

FOR: PROVIDING ONLINE TELEPHONE AND ADDRESS DIRECTORY INFORMATION; SUPPLYING AND RENTING ONLINE ADVERTISING SPACE, IN CLASS 35 (U.S. CLS. 100, 101 AND 102).

FIRST USE 5-17-2007; IN COMMERCE 5-17-2007.

OWNER OF U.S. REG. NO. 2,535,021.

THE MARK CONSISTS OF A STYLIZED "ADDRESS.COM" WITH A "@" REPLACING THE "A".

SER. NO. 77-226,331, FILED 7-10-2007.

NANCY CLARKE, EXAMINING ATTORNEY

Int. Cls.: 39 and 40

Prior U.S. Cls.: 100, 103, 105 and 106

United States Patent and Trademark Office

Reg. No. 3,397,809

Registered Mar. 18, 2008

**SERVICE MARK
PRINCIPAL REGISTER**



UAP DISTRIBUTION, INC. (DELAWARE CORPORATION)
7251 W. 4TH STREET
GREELEY, CO 80634

FOR: WAREHOUSING SERVICES, NAMELY, STORAGE, HANDLING, DISTRIBUTION, PICK-UP, PACKING, AND SHIPPING OF AGRICULTURAL CHEMICALS; RENTAL OF WAREHOUSE SPACE; PACKAGING GOODS FOR TRANSPORTATION; TRANSPORTATION OF GOODS BY TRUCK, IN CLASS 39 (U.S. CLS. 100 AND 105).

FIRST USE 3-24-1995; IN COMMERCE 3-24-1995.

FOR: MANUFACTURING SERVICES FOR OTHERS IN THE FIELD OF AGRICULTURAL CHEMICALS, IN CLASS 40 (U.S. CLS. 100, 103 AND 106).

FIRST USE 3-24-1995; IN COMMERCE 3-24-1995.

NO CLAIM IS MADE TO THE EXCLUSIVE RIGHT TO USE "DEPOT", APART FROM THE MARK AS SHOWN.

THE MARK CONSISTS OF THE TERMS AG DEPOT IN FRONT OF THE LETTER D WITH A FLOWER BETWEEN THE TERMS AG AND DEPOT.

SER. NO. 77-226,343, FILED 7-10-2007.

MARGERY A. TIERNEY, EXAMINING ATTORNEY

Int. Cl.: 24

Prior U.S. Cls.: 42 and 50

United States Patent and Trademark Office

Reg. No. 3,397,810

Registered Mar. 18, 2008

**TRADEMARK
PRINCIPAL REGISTER**



REST MY CASE INCORPORATED (CALIFORNIA CORPORATION)
28055 LIANA LANE
VALENCIA, CA 91354

FOR: BED LINEN; PILLOW CASES; PILLOW COVERS; PILLOW SHAMS; PILLOWCASES, IN CLASS 24 (U.S. CLS. 42 AND 50).

FIRST USE 6-1-2007; IN COMMERCE 6-28-2007.

THE MARK CONSISTS OF A CHILD SLEEPING WITH ARMS WRAPPED ABOUT A PILLOW WHICH IS SYMBOLIZED BY THE ROUND PORTION OF THE LETTER "R", WITH THE REST OF THE LETTERS SPELLING "EST MY CASE."

SER. NO. 77-226,359, FILED 7-10-2007.

BENJAMIN ALLEN, EXAMINING ATTORNEY

Int. Cl.: 44

Prior U.S. Cls.: 100 and 101

United States Patent and Trademark Office

Reg. No. 3,397,811

Registered Mar. 18, 2008

**SERVICE MARK
PRINCIPAL REGISTER**

THE MALLOW CENTER

GARY W. MALLOW, M.D., P.A. (FLORIDA CORPORATION)
SUITE 1
9633 WEST BROWARD BOULEVARD
PLANTATION, FL 33324

FOR: WEIGHT REDUCTION DIET PLANNING AND SUPERVISION; PHYSICIAN SERVICES; MEDICAL TESTING SERVICES, NAMELY, FITNESS EVALUATION; LASER AND IPL (INTENSE PULSE LIGHT) SKIN ENHANCEMENT PROCEDURES; MICRODERMABRASION, NAMELY, A TOPICAL SKIN TREATMENT INVOLVING ABRASION OF THE SKIN WITH A HIGH-PRESSURE FLOW OF CRYSTALS; SKIN TREATMENT, NAMELY, THE INJECTION OF DERMAL FILLERS TO REDUCE THE APPEARANCE OF FACIAL FINE LINES; PROVIDING LASER THERAPY FOR TREATING MEDICAL CONDITIONS; PROVIDING MEDICAL

INFORMATION; PROVIDING MEDICAL INFORMATION, CONSULTANCY AND ADVISORY SERVICES, IN CLASS 44 (U.S. CLS. 100 AND 101).

FIRST USE 5-1-2005; IN COMMERCE 5-1-2005.

THE MARK CONSISTS OF STANDARD CHARACTERS WITHOUT CLAIM TO ANY PARTICULAR FONT, STYLE, SIZE, OR COLOR.

NO CLAIM IS MADE TO THE EXCLUSIVE RIGHT TO USE "CENTER", APART FROM THE MARK AS SHOWN.

SER. NO. 77-226,420, FILED 7-10-2007.

KATHERINE CHANG, EXAMINING ATTORNEY

Int. Cls.: 9 and 38

Prior U.S. Cls.: 21, 23, 26, 36, 38, 100, 101 and 104

United States Patent and Trademark Office

Reg. No. 3,397,812

Registered Mar. 18, 2008

**TRADEMARK
SERVICE MARK
PRINCIPAL REGISTER**

iComment

QUALITY PROGRAMMING CORPORATION
(FLORIDA CORPORATION)
6002 NW 73RD COURT
PARKLAND, FL 33067

FOR: COMPUTER DATABASE MANAGEMENT SOFTWARE FOR USE IN PERSONALIZING THE CONTENT OF EMAIL COMMUNICATIONS; COMPUTER E-COMMERCE SOFTWARE TO ALLOW USERS TO PERFORM ELECTRONIC BUSINESS TRANSACTIONS VIA A GLOBAL COMPUTER NETWORK; COMPUTER SEARCH ENGINE SOFTWARE; COMPUTER SOFTWARE FOR ACCESSING INFORMATION DIRECTORIES THAT MAY BE DOWNLOADED FROM THE GLOBAL COMPUTER NETWORK; COMPUTER SOFTWARE FOR CREATING SEARCHABLE DATABASES OF INFORMATION AND DATA; COMPUTER SOFTWARE FOR THE COLLECTION, EDITING, ORGANIZING, MODIFYING, BOOK MARKING, TRANSMISSION, STORAGE AND SHARING OF DATA AND INFORMATION; DATABASE MANAGEMENT SOFTWARE FOR ONLINE FORUMS, WEB PAGE POSTS, WEB

PAGE COMMENTS, WEB PAGE OPINIONS, WEB PAGE VOTES, WEB PAGE RATINGS; GRAPHICAL USER INTERFACE SOFTWARE, IN CLASS 9 (U.S. CLS. 21, 23, 26, 36 AND 38).

FIRST USE 2-21-2002; IN COMMERCE 2-21-2002.

FOR: PROVIDING ON-LINE FORUMS FOR TRANSMISSION OF MESSAGES AMONG COMPUTER USERS IN THE FIELD OF GENERAL INTEREST, IN CLASS 38 (U.S. CLS. 100, 101 AND 104).

FIRST USE 2-21-2002; IN COMMERCE 2-21-2002.

THE MARK CONSISTS OF STANDARD CHARACTERS WITHOUT CLAIM TO ANY PARTICULAR FONT, STYLE, SIZE, OR COLOR.

SER. NO. 77-226,506, FILED 7-11-2007.

NELSON SNYDER, EXAMINING ATTORNEY

Int. Cl.: 14

Prior U.S. Cls.: 2, 27, 28 and 50

United States Patent and Trademark Office

Reg. No. 3,397,813

Registered Mar. 18, 2008

**TRADEMARK
PRINCIPAL REGISTER**

QCHARM

QCHARM, LLC (MARYLAND LTD LIAB CO)
7101 WISCONSIN AVENUE, SUITE 108
BETHESDA, MD 20814

THE MARK CONSISTS OF STANDARD CHAR-
ACTERS WITHOUT CLAIM TO ANY PARTICULAR
FONT, STYLE, SIZE, OR COLOR.

FOR: WRIST BANDS IN THE NATURE OF
CHARM BRACELETS FOR CUEING AUTISTIC
CHILDREN, IN CLASS 14 (U.S. CLS. 2, 27, 28 AND 50).

SER. NO. 77-226,555, FILED 7-11-2007.

FIRST USE 10-1-2006; IN COMMERCE 10-1-2006.

ROBIN CHOSID, EXAMINING ATTORNEY

Int. Cl.: 35

Prior U.S. Cls.: 100, 101 and 102

United States Patent and Trademark Office

Reg. No. 3,397,814

Registered Mar. 18, 2008

**SERVICE MARK
PRINCIPAL REGISTER**

NAVMAP

APEX, LLC (RHODE ISLAND LTD LIAB CO)
100 MAIN STREET
PAWTUCKET, RI 02860

FOR: PROMOTING THE GOODS AND SERVICES OF OTHERS BY PREPARING AND PLACING ADVERTISEMENTS IN AN ELECTRONIC MAGAZINE ACCESSED THROUGH A GLOBAL COMPUTER NETWORK; PROMOTING THE GOODS AND SERVICES OF OTHERS THROUGH ON-LINE ORDERING AND CATALOGING OF THOSE GOODS AND SERVICES; PROMOTING THE GOODS AND SERVICES OF OTHERS VIA A GLOBAL COMPUTER NETWORK; PROMOTING THE GOODS AND SERVICES OF OTHERS BY MEANS OF OPERATING AN ON-LINE SHOPPING MALL WITH LINKS TO THE RETAIL WEB SITES OF OTHERS; PROVIDING A WEB SITE WHICH FEATURES ADVERTISEMENTS FOR THE GOODS AND SERVICES OF OTHERS ON A GLOBAL COMPUTER NETWORK; PROVIDING INFORMATION ABOUT THE GOODS AND SERVICES OF OTHERS VIA THE GLOBAL COMPUTER

NETWORK; COMPUTERIZED ON-LINE ORDERING FEATURING GENERAL MERCHANDISE AND GENERAL CONSUMER GOODS; COMPUTERIZED ON-LINE RETAIL STORE SERVICES IN THE FIELD OF GENERAL MERCHANDISE AND GENERAL CONSUMER GOODS; BUSINESS SERVICES, NAMELY, PROVIDING COMPUTER DATABASES REGARDING THE PURCHASE AND SALE OF A WIDE VARIETY OF PRODUCTS AND SERVICES OF OTHERS, IN CLASS 35 (U.S. CLS. 100, 101 AND 102).

FIRST USE 7-5-2007; IN COMMERCE 7-5-2007.

THE MARK CONSISTS OF STANDARD CHARACTERS WITHOUT CLAIM TO ANY PARTICULAR FONT, STYLE, SIZE, OR COLOR.

SER. NO. 77-226,619, FILED 7-11-2007.

CHRISTINA SOBRAL, EXAMINING ATTORNEY

Int. Cl.: 42

Prior U.S. Cls.: 100 and 101

United States Patent and Trademark Office

Reg. No. 3,397,815

Registered Mar. 18, 2008

**SERVICE MARK
PRINCIPAL REGISTER**



CHRISTOPHER TECHNOLOGIES, LLC (OHIO
LTD LIAB CO)

7908 CINCINNATI DAYTON RD., SUITE M

WEST CHESTER, OH 45069

FOR: DESIGN AND DEVELOPMENT OF ON-
LINE COMPUTER SOFTWARE SYSTEMS, IN
CLASS 42 (U.S. CLS. 100 AND 101).

FIRST USE 1-31-2007; IN COMMERCE 3-31-2007.

NO CLAIM IS MADE TO THE EXCLUSIVE
RIGHT TO USE "TECHNOLOGIES", APART FROM
THE MARK AS SHOWN.

THE MARK CONSISTS OF A LOGO COMPRIS-
ING OF A STYLIZED "C" AND A STYLIZED "T,"
AND THE WORDS "CHRISTOPHER TECHNOLO-
GIES."

SER. NO. 77-226,620, FILED 7-11-2007.

ROBIN CHOSID, EXAMINING ATTORNEY

Int. Cl.: 9

Prior U.S. Cls.: 21, 23, 26, 36 and 38

Reg. No. 3,397,816

United States Patent and Trademark Office

Registered Mar. 18, 2008

**TRADEMARK
PRINCIPAL REGISTER**

SIECLEAR

SIEMENS MEDICAL SOLUTIONS USA, INC.
(DELAWARE CORPORATION)
51 VALLEY STREAM PARKWAY
MALVERN, PA 19355

THE MARK CONSISTS OF STANDARD CHARACTERS WITHOUT CLAIM TO ANY PARTICULAR FONT, STYLE, SIZE, OR COLOR.

FOR: IMAGE ENHANCEMENT AND PROCESSING SOFTWARE FOR MEDICAL DIAGNOSTIC IMAGING, PARTICULARLY, ULTRASOUND IMAGING, IN CLASS 9 (U.S. CLS. 21, 23, 26, 36 AND 38).

SER. NO. 77-226,658, FILED 7-11-2007.

FIRST USE 11-0-2000; IN COMMERCE 11-0-2000.

DAVID COLLIER, EXAMINING ATTORNEY

Int. Cl.: 41

Prior U.S. Cls.: 100, 101 and 107

United States Patent and Trademark Office

Reg. No. 3,397,817

Registered Mar. 18, 2008

**SERVICE MARK
PRINCIPAL REGISTER**

VIRGINIA RENAISSANCE FAIRE

OUT OF THE WOODWORK PRODUCTIONS,
INC. (VIRGINIA CORPORATION)
5436 LOMAX WAY
WOODBIDGE, VA 221393559

FOR: ENTERTAINMENT IN THE NATURE OF A
RENAISSANCE-STYLE HISTORICAL FESTIVAL IN-
CLUDING LIVE THEATER AND MUSICAL PER-
FORMANCES, IN CLASS 41 (U.S. CLS. 100, 101 AND
107).

FIRST USE 12-0-2001; IN COMMERCE 12-0-2001.

THE MARK CONSISTS OF STANDARD CHAR-
ACTERS WITHOUT CLAIM TO ANY PARTICULAR
FONT, STYLE, SIZE, OR COLOR.

OWNER OF U.S. REG. NO. 3,030,805.

NO CLAIM IS MADE TO THE EXCLUSIVE
RIGHT TO USE "RENAISSANCE FAIRE", APART
FROM THE MARK AS SHOWN.

SEC. 2(F).

SER. NO. 77-226,739, FILED 7-11-2007.

ELLEN B. AWRICH, EXAMINING ATTORNEY

Int. Cl.: 9

Prior U.S. Cls.: 21, 23, 26, 36 and 38

United States Patent and Trademark Office

Reg. No. 3,397,818

Registered Mar. 18, 2008

**TRADEMARK
PRINCIPAL REGISTER**

MegaRAD

THERMO CIDTEC (NEW YORK CORPORATION)
101 COMMERCE BLVD.
LIVERPOOL, NY 13088

THE MARK CONSISTS OF STANDARD CHAR-
ACTERS WITHOUT CLAIM TO ANY PARTICULAR
FONT, STYLE, SIZE, OR COLOR.

FOR: A SOLID STATE VIDEO CAMERA FOR USE
IN RADIATION ENVIRONMENTS, IN CLASS 9 (U.S.
CLS. 21, 23, 26, 36 AND 38).

SER. NO. 77-226,781, FILED 7-11-2007.

FIRST USE 6-1-1995; IN COMMERCE 6-1-1995.

JAY FLOWERS, EXAMINING ATTORNEY

Int. Cl.: 41

Prior U.S. Cls.: 100, 101 and 107

United States Patent and Trademark Office

Reg. No. 3,397,819

Registered Mar. 18, 2008

**SERVICE MARK
PRINCIPAL REGISTER**

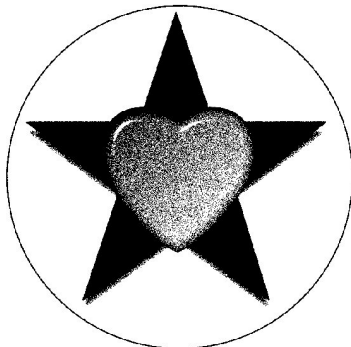

HEARTLAND, LLC (ALABAMA LTD LIAB CO)
482 MT. ZION RD.
MADISON, AL 35757

FOR: ENTERTAINMENT IN THE NATURE OF LIVE PERFORMANCES BY A MUSICAL BAND; ENTERTAINMENT SERVICES, NAMELY, PERSONAL APPEARANCES BY A MUSICAL BAND; ENTERTAINMENT SERVICES, NAMELY, PROVIDING A WEB SITE FEATURING MUSICAL PERFORMANCES, MUSICAL VIDEOS, RELATED FILM CLIPS, PHOTOGRAPHS, AND OTHER MULTIMEDIA MATERIALS, IN CLASS 41 (U.S. CLS. 100, 101 AND 107).

FIRST USE 9-0-2006; IN COMMERCE 1-0-2007.

THE STIPPLING IS FOR SHADING PURPOSES.

THE MARK CONSISTS OF A CIRCLE ENCOMPASSING A SLIGHTLY RAISED HEART IN THE MIDDLE OF A FIVE POINT STAR.

SER. NO. 77-226,788, FILED 7-11-2007.

REBECCA EISINGER, EXAMINING ATTORNEY

Int. Cl.: 37

Prior U.S. Cls.: 100, 103 and 106

United States Patent and Trademark Office

Reg. No. 3,397,820

Registered Mar. 18, 2008

**SERVICE MARK
PRINCIPAL REGISTER**

InneReam

NOWAK PIPE REAMING, INC. (KANSAS CORPORATION)
200 SOUTH GODDARD RD
GODDARD, KS 67052

FOR: CONSTRUCTION OF IN GROUND PIPING SYSTEMS VIA TRENCHLESS PIPE REPLACEMENT METHODS, IN CLASS 37 (U.S. CLS. 100, 103 AND 106).

FIRST USE 1-30-1997; IN COMMERCE 1-30-1997.

THE MARK CONSISTS OF STANDARD CHARACTERS WITHOUT CLAIM TO ANY PARTICULAR FONT, STYLE, SIZE, OR COLOR.

OWNER OF U.S. REG. NO. 2,125,784.

SER. NO. 77-226,801, FILED 7-11-2007.

AMY GEARIN, EXAMINING ATTORNEY

Int. Cls.: 9 and 42

Prior U.S. Cls.: 21, 23, 26, 36, 38, 100 and 101

Reg. No. 3,397,821

United States Patent and Trademark Office

Registered Mar. 18, 2008

**TRADEMARK
SERVICE MARK
PRINCIPAL REGISTER**

rēkon

REKON TECHNOLOGIES (CALIFORNIA CORPORATION)
SUITE 203
23 E. COLORADO BLVD.
PASADENA, CA 91105

FOR: DOWNLOADABLE SOFTWARE FOR CREATING, PREPARING AND PROCESSING OF RELEASE AND ASSIGNMENT DOCUMENTS IN THE FIELD OF REAL ESTATE , IN CLASS 9 (U.S. CLS. 21, 23, 26, 36 AND 38).

FIRST USE 5-2-1994; IN COMMERCE 5-23-1994.

FOR: PROVIDING ONLINE NON-DOWNLOADABLE SOFTWARE FOR CREATING, PREPARING, AND PROCESSING RELEASE AND ASSIGNMENT DOCUMENTS IN THE FIELD OF REAL ESTATE; COMPUTER SOFTWARE DEVELOPMENT, IN CLASS 42 (U.S. CLS. 100 AND 101).

FIRST USE 5-2-1994; IN COMMERCE 5-23-1994.

SER. NO. 77-226,820, FILED 7-11-2007.

CHRISTINA SOBRAL, EXAMINING ATTORNEY

Int. Cl.: 35

Prior U.S. Cls.: 100, 101 and 102

United States Patent and Trademark Office

Reg. No. 3,397,822

Registered Mar. 18, 2008

**SERVICE MARK
PRINCIPAL REGISTER**

MAPNAV

APEX, LLC (RHODE ISLAND LTD LIAB CO)
100 MAIN STREET
PAWTUCKET, RI 02860

FOR: PROMOTING THE GOODS AND SERVICES OF OTHERS BY PREPARING AND PLACING ADVERTISEMENTS IN AN ELECTRONIC MAGAZINE ACCESSED THROUGH A GLOBAL COMPUTER NETWORK; PROMOTING THE GOODS AND SERVICES OF OTHERS THROUGH ON-LINE ORDERING AND CATALOGING OF THOSE GOODS AND SERVICES; PROMOTING THE GOODS AND SERVICES OF OTHERS VIA A GLOBAL COMPUTER NETWORK; PROMOTING THE GOODS AND SERVICES OF OTHERS BY MEANS OF OPERATING AN ON-LINE SHOPPING MALL WITH LINKS TO THE RETAIL WEB SITES OF OTHERS; PROVIDING A WEB SITE WHICH FEATURES ADVERTISEMENTS FOR THE GOODS AND SERVICES OF OTHERS ON A GLOBAL COMPUTER NETWORK; PROVIDING INFORMATION ABOUT THE GOODS AND SERVICES OF OTHERS VIA THE GLOBAL COMPUTER

NETWORK; COMPUTERIZED ON-LINE ORDERING FEATURING GENERAL MERCHANDISE AND GENERAL CONSUMER GOODS; COMPUTERIZED ON-LINE RETAIL STORE SERVICES IN THE FIELD OF GENERAL MERCHANDISE AND GENERAL CONSUMER GOODS; BUSINESS SERVICES, NAMELY, PROVIDING COMPUTER DATABASES REGARDING THE PURCHASE AND SALE OF A WIDE VARIETY OF PRODUCTS AND SERVICES OF OTHERS, IN CLASS 35 (U.S. CLS. 100, 101 AND 102).

FIRST USE 1-1-2001; IN COMMERCE 1-1-2001.

THE MARK CONSISTS OF STANDARD CHARACTERS WITHOUT CLAIM TO ANY PARTICULAR FONT, STYLE, SIZE, OR COLOR.

SER. NO. 77-226,828, FILED 7-11-2007.

CHRISTINA SOBRAL, EXAMINING ATTORNEY

Int. Cl.: 41

Prior U.S. Cls.: 100, 101 and 107

United States Patent and Trademark Office

Reg. No. 3,397,823

Registered Mar. 18, 2008

**SERVICE MARK
PRINCIPAL REGISTER**



EDUCATIONAL ADVANTAGE, INC. (UTAH CORPORATION)

#60

2700 HOMESTEAD RD.
PARK CITY, UT 84098

FOR: EDUCATIONAL SERVICES, NAMELY, PROVIDING COURSES OF INSTRUCTION AT THE PRE-SCHOOL, PRIMARY AND SECONDARY LEVEL; EDUCATION SERVICES, NAMELY, PROVIDING TUTORING IN THE FIELDS OF PRE-SCHOOL, PRIMARY AND SECONDARY LEVELS OF EDUCATION; EDUCATIONAL SERVICES, NAMELY, PROVIDING COURSES IN THE FIELDS OF STANDARDIZED TEST PREPARATION AND PREPARATION OF APPLICATIONS FOR HIGHER EDUCATION, IN CLASS 41 (U.S. CLS. 100, 101 AND 107).

FIRST USE 7-1-2006; IN COMMERCE 7-1-2006.

NO CLAIM IS MADE TO THE EXCLUSIVE RIGHT TO USE "EDUCATIONAL" AND "INC.", APART FROM THE MARK AS SHOWN.

THE MARK CONSISTS OF GEOMETRIC SHAPES FORMING A GENERAL SHAPE OF A PERSON AND THE WORDING "EDUCATIONAL ADVANTAGE, INC."

SER. NO. 77-226,851, FILED 7-11-2007.

JENNY PARK, EXAMINING ATTORNEY

Int. Cl.: 41

Prior U.S. Cls.: 100, 101 and 107

United States Patent and Trademark Office

Reg. No. 3,397,824

Registered Mar. 18, 2008

**SERVICE MARK
PRINCIPAL REGISTER**

Nobody Smiling.com

NOBODYSMILING INC (NEW YORK CORPORATION)
3400 SNYDER AVE, #5B
BROOKLYN, NY 11203

FOR: ENTERTAINMENT SERVICES NAMELY PROVIDING A WEBSITE FEATURING, PHOTOGRAPHIC, AUDIO, VIDEO AND PROSE PRESENTATIONS FEATURING MUSIC, NEWS, EVENTS, REVIEWS, INTERVIEWS, MUSIC VIDEOS, AND RELATED ENTERTAINMENT INFORMATION IN THE MUSIC INDUSTRY, IN CLASS 41 (U.S. CLS. 100, 101 AND 107).

FIRST USE 1-1-2003; IN COMMERCE 1-1-2003.

THE MARK CONSISTS OF STANDARD CHARACTERS WITHOUT CLAIM TO ANY PARTICULAR FONT, STYLE, SIZE, OR COLOR.

SER. NO. 77-226,872, FILED 7-11-2007.

JAMES LOVELACE, EXAMINING ATTORNEY

Int. Cl.: 3

Prior U.S. Cls.: 1, 4, 6, 50, 51 and 52

United States Patent and Trademark Office

Reg. No. 3,397,825

Registered Mar. 18, 2008

**TRADEMARK
PRINCIPAL REGISTER**

Wipekins

CYNTHIA S FERRARO (UNITED STATES INDIVIDUAL)
20 JANNEY LANE
SPRINGBORO, OH 45066

FOR: BABY WIPES; DISPOSABLE WIPES IMPREGNATED WITH CLEANSING COMPOUNDS FOR USE ON BABIES, CHILDREN, AND ADULTS, IN CLASS 3 (U.S. CLS. 1, 4, 6, 50, 51 AND 52).

FIRST USE 7-2-2007; IN COMMERCE 7-2-2007.

THE MARK CONSISTS OF STANDARD CHARACTERS WITHOUT CLAIM TO ANY PARTICULAR FONT, STYLE, SIZE, OR COLOR.

SER. NO. 77-226,916, FILED 7-11-2007.

THEODORE MCBRIDE, EXAMINING ATTORNEY

Int. Cl.: 9

Prior U.S. Cls.: 21, 23, 26, 36 and 38

Reg. No. 3,397,826

United States Patent and Trademark Office

Registered Mar. 18, 2008

**TRADEMARK
PRINCIPAL REGISTER**

ROBOT MONSTER RECORDS

BERGERON, ANTHONY (UNITED STATES IN-
DIVIDUAL)
1669 JUNO AVENUE
SAINT PAUL, MN 55116

FOR: PRE-RECORDED ELECTRONIC MEDIA
FEATURING MUSIC, IN CLASS 9 (U.S. CLS. 21, 23,
26, 36 AND 38).

FIRST USE 10-0-2000; IN COMMERCE 10-0-2001.

THE MARK CONSISTS OF STANDARD CHAR-
ACTERS WITHOUT CLAIM TO ANY PARTICULAR
FONT, STYLE, SIZE, OR COLOR.

NO CLAIM IS MADE TO THE EXCLUSIVE
RIGHT TO USE "RECORDS", APART FROM THE
MARK AS SHOWN.

SER. NO. 77-226,944, FILED 7-11-2007.

KATHY DE JONGE, EXAMINING ATTORNEY

Int. Cls.: 36 and 41

Prior U.S. Cls.: 100, 101, 102 and 107

United States Patent and Trademark Office

Reg. No. 3,397,827

Registered Mar. 18, 2008

**SERVICE MARK
PRINCIPAL REGISTER**



SCHWARTZ, JEREMY S. (UNITED STATES INDIVIDUAL)

APARTMENT 1716
60 WEST 23RD STREET
NEW YORK, NY 10010 AND

RUBY, ETHAN (UNITED STATES INDIVIDUAL)

APARTMENT 1716
60 WEST 23RD STREET
NEW YORK, NY 10010

FOR: CHARITABLE FUND RAISING SERVICES
BY MEANS OF POKER TOURNAMENTS, IN CLASS
36 (U.S. CLS. 100, 101 AND 102).

FIRST USE 6-22-2006; IN COMMERCE 6-22-2006.

FOR: PROVIDING A WEBSITE FEATURING INFORMATION ABOUT CHARITY POKER TOURNAMENTS AND THE BENEFICIARIES, IN CLASS 41 (U.S. CLS. 100, 101 AND 107).

FIRST USE 3-27-2006; IN COMMERCE 3-27-2006.

SER. NO. 77-226,986, FILED 7-11-2007.

DANNEAN HETZEL, EXAMINING ATTORNEY

Int. Cl.: 1

Prior U.S. Cls.: 1, 5, 6, 10, 26 and 46

United States Patent and Trademark Office

Reg. No. 3,397,828

Registered Mar. 18, 2008

**TRADEMARK
PRINCIPAL REGISTER**

TRIPLE EIGHT

GLOBAL ORGANICS, LLC (ARIZONA LTD LIAB
CO)
16121 W. EDDIE ALBERT WAY
GOODYEAR, AZ 85338

FOR: SOIL CONDITIONERS FOR AGRICULTURAL,
DOMESTIC AND HORTICULTURAL USE; FERTILIZERS;
FERTILIZERS FOR AGRICULTURAL USE; FERTILIZERS
FOR DOMESTIC USE, IN CLASS 1 (U.S. CLS. 1, 5, 6, 10,
26 AND 46).

FIRST USE 1-0-1996; IN COMMERCE 1-0-1996.

THE MARK CONSISTS OF STANDARD CHARACTERS
WITHOUT CLAIM TO ANY PARTICULAR FONT, STYLE,
SIZE, OR COLOR.

SER. NO. 77-227,142, FILED 7-11-2007.

GEORGE LORENZO, EXAMINING ATTORNEY

Int. Cl.: 35

Prior U.S. Cls.: 100, 101 and 102

United States Patent and Trademark Office

Reg. No. 3,397,829

Registered Mar. 18, 2008

**SERVICE MARK
PRINCIPAL REGISTER**



TREE OF LIFE, INC. (FLORIDA CORPORATION)
405 GOLFWAY WEST DRIVE
ST. AUGUSTINE, FL 32095

FOR: ADVERTISING AND PROMOTION SERVICES AND RELATED CONSULTING; ADVERTISING CONSULTATION; ADVERTISING, MARKETING AND PROMOTION SERVICES; BUSINESS MARKETING CONSULTING SERVICES; BUSINESS MARKETING SERVICES; MARKETING CONSULTATION IN THE FIELD OF FOOD, BEVERAGE AND NUTRITIONAL SUPPLEMENTS, IN CLASS 35 (U.S. CLS. 100, 101 AND 102).

FIRST USE 6-28-2006; IN COMMERCE 6-28-2006.

NO CLAIM IS MADE TO THE EXCLUSIVE RIGHT TO USE "PROGRAM", APART FROM THE MARK AS SHOWN.

THE COLOR(S) BLACK, WHITE, RED AND AQUA BLUE IS/ARE CLAIMED AS A FEATURE OF THE MARK.

THE MARK CONSISTS OF A BULLSEYE PARTIALLY COVERING AN AQUA BLUE SQUARE, THE BULLSEYE IS BLACK AND WHITE WITH A RED CENTER AND A RED ARROW OUTLINED IN WHITE POINTING AT THE CENTER AND THE WORDS "SMART ASSORTMENT" IN BLACK AND THE WORDS "A TREE OF LIFE PROGRAM" IN RED CAPITAL LETTERS UNDER THE WORD "ASSORTMENT".

SER. NO. 77-227,144, FILED 7-11-2007.

KATHERINE M. DUBRAY, EXAMINING ATTORNEY

Int. Cl.: 1

Prior U.S. Cls.: 1, 5, 6, 10, 26 and 46

United States Patent and Trademark Office

Reg. No. 3,397,830

Registered Mar. 18, 2008

**TRADEMARK
PRINCIPAL REGISTER**

CHICKEN NUGGETS

GLOBAL ORGANICS, LLC (ARIZONA LTD LIAB
CO)
16121 W. EDDIE ALBERT WAY
GOODYEAR, AZ 85338

FOR: SOIL CONDITIONERS FOR AGRICULTURAL,
DOMESTIC AND HORTICULTURAL USE; FERTILIZERS;
FERTILIZERS FOR AGRICULTURAL USE; FERTILIZERS
FOR DOMESTIC USE, IN CLASS 1 (U.S. CLS. 1, 5, 6, 10,
26 AND 46).

FIRST USE 1-0-2001; IN COMMERCE 1-0-2001.

THE MARK CONSISTS OF STANDARD CHARACTERS
WITHOUT CLAIM TO ANY PARTICULAR FONT, STYLE,
SIZE, OR COLOR.

SER. NO. 77-227,171, FILED 7-11-2007.

GEORGE LORENZO, EXAMINING ATTORNEY

Int. Cl.: 1

Prior U.S. Cls.: 1, 5, 6, 10, 26 and 46

United States Patent and Trademark Office

Reg. No. 3,397,831

Registered Mar. 18, 2008

**TRADEMARK
PRINCIPAL REGISTER**

MEGATURF

GLOBAL ORGANICS, LLC (ARIZONA LTD LIAB
CO)
16121 W. EDDIE ALBERT WAY
GOODYEAR, AZ 85338

FOR: SOIL CONDITIONERS FOR AGRICULTURAL,
DOMESTIC AND HORTICULTURAL USE; FERTILIZERS;
FERTILIZERS FOR AGRICULTURAL USE; FERTILIZERS
FOR DOMESTIC USE, IN CLASS 1 (U.S. CLS. 1, 5, 6, 10,
26 AND 46).

FIRST USE 1-0-1996; IN COMMERCE 1-0-1996.

THE MARK CONSISTS OF STANDARD CHARACTERS
WITHOUT CLAIM TO ANY PARTICULAR FONT, STYLE,
SIZE, OR COLOR.

SER. NO. 77-227,214, FILED 7-11-2007.

GEORGE LORENZO, EXAMINING ATTORNEY

Int. Cl.: 9

Prior U.S. Cls.: 21, 23, 26, 36 and 38

United States Patent and Trademark Office

Reg. No. 3,397,832

Registered Mar. 18, 2008

**TRADEMARK
PRINCIPAL REGISTER**

BellySonic

SLEEPSONIC, LLC (WASHINGTON LTD LIAB
CO)
11605 DAN COOK RD.
YELM, WA 98597

FOR: ABDOMINAL BELT CONTAINING BUILT-
IN SPEAKERS FOR PURPOSES OF TRANSMIT-
TING MUSIC/SOUNDS/EDUCATIONAL MATERI-
AL TO A FETUS AND A BUILT-IN POCKETS IN
WHICH TO CARRY AUDIO TRANSMITTERS , IN
CLASS 9 (U.S. CLS. 21, 23, 26, 36 AND 38).

FIRST USE 3-1-2007; IN COMMERCE 3-1-2007.

THE MARK CONSISTS OF STANDARD CHAR-
ACTERS WITHOUT CLAIM TO ANY PARTICULAR
FONT, STYLE, SIZE, OR COLOR.

SER. NO. 77-227,218, FILED 7-11-2007.

BILL DAWE, EXAMINING ATTORNEY

Int. Cl.: 43

Prior U.S. Cls.: 100 and 101

United States Patent and Trademark Office

Reg. No. 3,397,833

Registered Mar. 18, 2008

**SERVICE MARK
PRINCIPAL REGISTER**



AMERICAN HOUSE LICENSING LLC (MICHIGAN LTD LIAB CO)
6755 TELEGRAPH ROAD, SUITE 330
BLOOMFIELD HILLS, MI 48301

THE MARK CONSISTS OF THE WORDS AMERICAN HOUSE TO THE LEFT OF A STYLIZED FLAG DESIGN.

FOR: RETIREMENT RESIDENCE SERVICES, IN CLASS 43 (U.S. CLS. 100 AND 101).

SER. NO. 77-227,233, FILED 7-11-2007.

FIRST USE 6-0-2005; IN COMMERCE 6-0-2005.

NATALIE POLZER, EXAMINING ATTORNEY

Int. Cl.: 1

Prior U.S. Cls.: 1, 5, 6, 10, 26 and 46

United States Patent and Trademark Office

Reg. No. 3,397,834

Registered Mar. 18, 2008

**TRADEMARK
PRINCIPAL REGISTER**

MEGACAL

GLOBAL ORGANICS, LLC (ARIZONA LTD LIAB
CO)
16121 W. EDDIE ALBERT WAY
GOODYEAR, AZ 85338

FOR: SOIL CONDITIONERS FOR AGRICULTURAL,
DOMESTIC AND HORTICULTURAL USE; FERTILIZERS;
FERTILIZERS FOR AGRICULTURAL USE; FERTILIZERS
FOR DOMESTIC USE, IN CLASS 1 (U.S. CLS. 1, 5, 6, 10,
26 AND 46).

FIRST USE 1-0-1996; IN COMMERCE 1-0-1996.

THE MARK CONSISTS OF STANDARD CHARACTERS
WITHOUT CLAIM TO ANY PARTICULAR FONT, STYLE,
SIZE, OR COLOR.

SER. NO. 77-227,242, FILED 7-11-2007.

GEORGE LORENZO, EXAMINING ATTORNEY

Int. Cl.: 33

Prior U.S. Cls.: 47 and 49

United States Patent and Trademark Office

Reg. No. 3,397,835

Registered Mar. 18, 2008

**TRADEMARK
PRINCIPAL REGISTER**

PARAJAXX

DUCKHORN WINE COMPANY (CALIFORNIA
CORPORATION)
1000 LODI LANE
ST. HELENA, CA 94574

THE MARK CONSISTS OF STANDARD CHAR-
ACTERS WITHOUT CLAIM TO ANY PARTICULAR
FONT, STYLE, SIZE, OR COLOR.

FOR: WINES, IN CLASS 33 (U.S. CLS. 47 AND 49).

SER. NO. 77-227,246, FILED 7-11-2007.

FIRST USE 7-1-2007; IN COMMERCE 7-9-2007.

CAROLYN CATALDO, EXAMINING ATTORNEY

Int. Cl.: 31

Prior U.S. Cls.: 1 and 46

United States Patent and Trademark Office

Reg. No. 3,397,836

Registered Mar. 18, 2008

**TRADEMARK
PRINCIPAL REGISTER**

**CHICKEN SOUP FOR THE CAT
LOVER'S SOUL**

CANFIELD, JOHN T. (UNITED STATES INDIVIDUAL)
SUITE D2
711 W. 17TH STREET
COSTA MESA, CA 92627 AND
HANSEN & HANSEN LLC (CALIFORNIA LTD LIABILITY)
SUITE D2
711 W. 17TH STREET
COSTA MESA, CA 92627

FOR: PET FOOD; EDIBLE PET TREATS, IN CLASS
31 (U.S. CLS. 1 AND 46).

FIRST USE 6-30-2003; IN COMMERCE 6-30-2003.

THE MARK CONSISTS OF STANDARD CHARACTERS WITHOUT CLAIM TO ANY PARTICULAR FONT, STYLE, SIZE, OR COLOR.

OWNER OF U.S. REG. NOS. 2,048,194, 3,085,947 AND OTHERS.

SER. NO. 77-227,256, FILED 7-11-2007.

JASON BLAIR, EXAMINING ATTORNEY

Int. Cl.: 1

Prior U.S. Cls.: 1, 5, 6, 10, 26 and 46

United States Patent and Trademark Office

Reg. No. 3,397,837

Registered Mar. 18, 2008

**TRADEMARK
PRINCIPAL REGISTER**

MEGA-K

GLOBAL ORGANICS, LLC (ARIZONA LTD LIAB
CO)
16121 W. EDDIE ALBERT WAY
GOODYEAR, AZ 85338

FOR: SOIL CONDITIONERS FOR AGRICULTURAL,
DOMESTIC AND HORTICULTURAL USE; FERTILIZERS;
FERTILIZERS FOR AGRICULTURAL USE; FERTILIZERS
FOR DOMESTIC USE, IN CLASS 1 (U.S. CLS. 1, 5, 6, 10,
26 AND 46).

FIRST USE 1-0-1996; IN COMMERCE 1-0-1996.

THE MARK CONSISTS OF STANDARD CHARACTERS
WITHOUT CLAIM TO ANY PARTICULAR FONT, STYLE,
SIZE, OR COLOR.

SER. NO. 77-227,260, FILED 7-11-2007.

GEORGE LORENZO, EXAMINING ATTORNEY

Int. Cl.: 41

Prior U.S. Cls.: 100, 101 and 107

United States Patent and Trademark Office

Reg. No. 3,397,838

Registered Mar. 18, 2008

**SERVICE MARK
PRINCIPAL REGISTER**

BEAUTY AND THE BLOG

SEPHORA USA, INC. (DELAWARE CORPORATION)
32ND FLOOR
525 MARKET STREET
SAN FRANCISCO, CA 94105

FOR: ON-LINE JOURNALS, NAMELY, BLOGS FEATURING INFORMATION IN THE FIELDS OF COSMETICS, MAKEUP, FRAGRANCES, HAIR CARE PRODUCTS, HEALTH AND WELLNESS, BEAUTY NEWS, BEAUTY TRENDS, AND BEAUTY GOSSIP, IN CLASS 41 (U.S. CLS. 100, 101 AND 107).

FIRST USE 9-0-2006; IN COMMERCE 9-0-2006.

THE MARK CONSISTS OF STANDARD CHARACTERS WITHOUT CLAIM TO ANY PARTICULAR FONT, STYLE, SIZE, OR COLOR.

SER. NO. 77-227,281, FILED 7-11-2007.

TIMOTHY FINNEGAN, EXAMINING ATTORNEY

Int. Cl.: 31

Prior U.S. Cls.: 1 and 46

United States Patent and Trademark Office

Reg. No. 3,397,839

Registered Mar. 18, 2008

**TRADEMARK
PRINCIPAL REGISTER**

**CHICKEN SOUP FOR THE DOG
LOVER'S SOUL**

CANFIELD, JOHN T. (UNITED STATES INDIVIDUAL)
SUITE D2
711 W. 17TH STREET
COSTA MESA, CA 92627 AND
HANSEN & HANSEN, LLC (CALIFORNIA LTD
LIAB CO)
SUITE D2
711 W. 17TH STREET
COSTA MESA, CA 92627

FOR: PET FOOD; EDIBLE PET TREATS, IN CLASS
31 (U.S. CLS. 1 AND 46).

FIRST USE 6-30-2003; IN COMMERCE 6-30-2003.

THE MARK CONSISTS OF STANDARD CHARACTERS WITHOUT CLAIM TO ANY PARTICULAR FONT, STYLE, SIZE, OR COLOR.

OWNER OF U.S. REG. NOS. 2,048,194, 3,085,947 AND OTHERS.

SER. NO. 77-227,291, FILED 7-11-2007.

JASON BLAIR, EXAMINING ATTORNEY

Int. Cl.: 1

Prior U.S. Cls.: 1, 5, 6, 10, 26 and 46

Reg. No. 3,397,840

United States Patent and Trademark Office

Registered Mar. 18, 2008

**TRADEMARK
PRINCIPAL REGISTER**

FULVEX

GLOBAL ORGANICS, LLC (ARIZONA LTD LIAB
CO)
16121 W. EDDIE ALBERT WAY
GOODYEAR, AZ 85338

FOR: SOIL CONDITIONERS FOR AGRICULTURAL,
DOMESTIC AND HORTICULTURAL USE; FERTILIZERS;
FERTILIZERS FOR AGRICULTURAL USE; FERTILIZERS
FOR DOMESTIC USE, IN CLASS 1 (U.S. CLS. 1, 5, 6, 10,
26 AND 46).

FIRST USE 1-0-2006; IN COMMERCE 1-0-2006.

THE MARK CONSISTS OF STANDARD CHARACTERS
WITHOUT CLAIM TO ANY PARTICULAR FONT, STYLE,
SIZE, OR COLOR.

SER. NO. 77-227,292, FILED 7-11-2007.

GEORGE LORENZO, EXAMINING ATTORNEY

Int. Cl.: 31

Prior U.S. Cls.: 1 and 46

United States Patent and Trademark Office

Reg. No. 3,397,841

Registered Mar. 18, 2008

**TRADEMARK
PRINCIPAL REGISTER**

**CHICKEN SOUP FOR THE
KITTEN LOVER'S SOUL**

CANFIELD, JOHN T. (UNITED STATES INDIVIDUAL)
SUITE D2
711 W. 17TH STREET
COSTA MESA, CA 92627 AND
HANSEN & HANSEN, LLC (CALIFORNIA LTD
LIAB CO)
SUITE D2
711 W. 17TH STREET
COSTA MESA, CA 92627

FOR: PET FOOD; EDIBLE PET TREATS, IN CLASS
31 (U.S. CLS. 1 AND 46).

FIRST USE 12-31-2006; IN COMMERCE 12-31-2006.

THE MARK CONSISTS OF STANDARD CHARACTERS WITHOUT CLAIM TO ANY PARTICULAR FONT, STYLE, SIZE, OR COLOR.

OWNER OF U.S. REG. NOS. 2,048,194, 3,085,947 AND OTHERS.

SER. NO. 77-227,314, FILED 7-11-2007.

JASON BLAIR, EXAMINING ATTORNEY

Int. Cl.: 1

Prior U.S. Cls.: 1, 5, 6, 10, 26 and 46

Reg. No. 3,397,842

United States Patent and Trademark Office

Registered Mar. 18, 2008

**TRADEMARK
PRINCIPAL REGISTER**

DYNAMEGA

GLOBAL ORGANICS, LLC (ARIZONA LTD LIAB
CO)
16121 W. EDDIE ALBERT WAY
GOODYEAR, AZ 85338

FOR: SOIL CONDITIONERS FOR AGRICULTURAL,
DOMESTIC AND HORTICULTURAL USE; FERTILIZERS;
FERTILIZERS FOR AGRICULTURAL USE; FERTILIZERS
FOR DOMESTIC USE, IN CLASS 1 (U.S. CLS. 1, 5, 6, 10,
26 AND 46).

FIRST USE 1-0-2004; IN COMMERCE 1-0-2004.

THE MARK CONSISTS OF STANDARD CHARACTERS
WITHOUT CLAIM TO ANY PARTICULAR FONT, STYLE,
SIZE, OR COLOR.

SER. NO. 77-227,315, FILED 7-11-2007.

GEORGE LORENZO, EXAMINING ATTORNEY

Int. Cls.: 16 and 43

Prior U.S. Cls.: 2, 5, 22, 23, 29, 37, 38, 50, 100 and 101

United States Patent and Trademark Office

Reg. No. 3,397,843

Registered Mar. 18, 2008

**TRADEMARK
SERVICE MARK
PRINCIPAL REGISTER**

AMERICAN HOUSE

AMERICAN HOUSE LICENSING LLC (MICHIGAN LTD LIAB CO)
6755 TELEGRAPH ROAD, SUITE 330
BLOOMFIELD HILLS, MI 48301

FOR: PRINTED PUBLICATIONS, NAMELY NEWSPAPERS, MAGAZINES, NEWSLETTERS, JOURNALS, PERIODICALS, BULLETINS AND BROCHURES IN THE FIELDS OF RETIREMENT, MATURE OR RETIRED LIFESTYLES, FINANCE, HEALTH, INSURANCE, MEDICINE, TRAVEL, VOLUNTEER ACTIVITIES, AGING AND FAMILY RELATIONSHIPS, IN CLASS 16 (U.S. CLS. 2, 5, 22, 23, 29, 37, 38 AND 50).

FIRST USE 7-0-2002; IN COMMERCE 7-0-2002.

FOR: RETIREMENT RESIDENCE SERVICES, IN CLASS 43 (U.S. CLS. 100 AND 101).

FIRST USE 12-31-1980; IN COMMERCE 12-31-1980.

THE MARK CONSISTS OF STANDARD CHARACTERS WITHOUT CLAIM TO ANY PARTICULAR FONT, STYLE, SIZE, OR COLOR.

SER. NO. 77-227,333, FILED 7-11-2007.

NATALIE POLZER, EXAMINING ATTORNEY

Int. Cl.: 1

Prior U.S. Cls.: 1, 5, 6, 10, 26 and 46

United States Patent and Trademark Office

Reg. No. 3,397,844

Registered Mar. 18, 2008

**TRADEMARK
PRINCIPAL REGISTER**

CRUMBLES

GLOBAL ORGANICS, LLC (ARIZONA LTD LIAB
CO)
16121 W. EDDIE ALBERT WAY
GOODYEAR, AZ 85338

FOR: SOIL CONDITIONERS FOR AGRICULTURAL,
DOMESTIC AND HORTICULTURAL USE; FERTILIZERS;
FERTILIZERS FOR AGRICULTURAL USE; FERTILIZERS
FOR DOMESTIC USE, IN CLASS 1 (U.S. CLS. 1, 5, 6, 10,
26 AND 46).

FIRST USE 1-0-2006; IN COMMERCE 1-0-2006.

THE MARK CONSISTS OF STANDARD CHARACTERS
WITHOUT CLAIM TO ANY PARTICULAR FONT, STYLE,
SIZE, OR COLOR.

SER. NO. 77-227,336, FILED 7-11-2007.

GEORGE LORENZO, EXAMINING ATTORNEY

Int. Cl.: 31

Prior U.S. Cls.: 1 and 46

United States Patent and Trademark Office

Reg. No. 3,397,845

Registered Mar. 18, 2008

**TRADEMARK
PRINCIPAL REGISTER**

**CHICKEN SOUP FOR THE PUPPY
LOVER'S SOUL**

CANFIELD, JOHN T. (UNITED STATES INDIVIDUAL)
SUITE D2
711 W. 17TH STREET
COSTA MESA, CA 92627 AND
HANSEN & HANSEN, LLC (CALIFORNIA LTD
LIAB CO)
SUITE D2
711 W. 17TH STREET
COSTA MESA, CA 92627

FOR: PET FOOD; EDIBLE PET TREATS, IN CLASS
31 (U.S. CLS. 1 AND 46).

FIRST USE 12-31-2006; IN COMMERCE 12-31-2006.

THE MARK CONSISTS OF STANDARD CHARACTERS WITHOUT CLAIM TO ANY PARTICULAR FONT, STYLE, SIZE, OR COLOR.

OWNER OF U.S. REG. NOS. 2,048,194, 3,085,947 AND OTHERS.

SER. NO. 77-227,339, FILED 7-11-2007.

JASON BLAIR, EXAMINING ATTORNEY

Int. Cl.: 16

Prior U.S. Cls.: 2, 5, 22, 23, 29, 37, 38 and 50

Reg. No. 3,397,846

United States Patent and Trademark Office

Registered Mar. 18, 2008

**TRADEMARK
PRINCIPAL REGISTER**

THE SENIOR BANNER

AMERICAN HOUSE LICENSING LLC (MICHIGAN LTD LIAB CO)
6755 TELEGRAPH ROAD, SUITE 330
BLOOMFIELD HILLS, MI 48301

FOR: PRINTED PUBLICATIONS, NAMELY NEWSPAPERS, MAGAZINES, NEWSLETTERS, JOURNALS, PERIODICALS, BULLETINS AND BROCHURES IN THE FIELDS OF RETIREMENT, MATURE OR RETIRED LIFESTYLES, FINANCE, HEALTH, INSURANCE, MEDICINE, TRAVEL, VOLUNTEER ACTIVITIES, AGING AND FAMILY RELATIONSHIPS, IN CLASS 16 (U.S. CLS. 2, 5, 22, 23, 29, 37, 38 AND 50).

FIRST USE 7-0-2002; IN COMMERCE 7-0-2002.

THE MARK CONSISTS OF STANDARD CHARACTERS WITHOUT CLAIM TO ANY PARTICULAR FONT, STYLE, SIZE, OR COLOR.

NO CLAIM IS MADE TO THE EXCLUSIVE RIGHT TO USE "SENIOR", APART FROM THE MARK AS SHOWN.

SER. NO. 77-227,348, FILED 7-11-2007.

NATALIE POLZER, EXAMINING ATTORNEY

Int. Cl.: 35

Prior U.S. Cls.: 100, 101 and 102

United States Patent and Trademark Office

Reg. No. 3,397,847

Registered Mar. 18, 2008

**SERVICE MARK
PRINCIPAL REGISTER**

VISION & VIBE

MODY, MIHIR (UNITED STATES INDIVIDUAL)
6808 HORNWOOD DRIVE
HOUSTON, TX 77074

FIRST USE 2-0-2004; IN COMMERCE 2-0-2004.

FOR: RETAIL STORE AND ON-LINE RETAIL STORE SERVICES FEATURING HOME THEATER SYSTEMS AND DESIGNS, AND HOME ENTERTAINMENT CENTERS; PRE-PAID GIFT CARD SERVICES, NAMELY, ISSUING GIFT CARD CERTIFICATES THAT MAY BE REDEEMED FOR GOODS OR SERVICES, IN CLASS 35 (U.S. CLS. 100, 101 AND 102).

THE MARK CONSISTS OF STANDARD CHARACTERS WITHOUT CLAIM TO ANY PARTICULAR FONT, STYLE, SIZE, OR COLOR.

SER. NO. 77-227,427, FILED 7-11-2007.

KAPIL BHANOT, EXAMINING ATTORNEY

Int. Cl.: 3

Prior U.S. Cls.: 1, 4, 6, 50, 51 and 52

United States Patent and Trademark Office

Reg. No. 3,397,848

Registered Mar. 18, 2008

TRADEMARK
PRINCIPAL REGISTER

Recycled
princess

SARA ELIZABETH WALTHER (CALIFORNIA
SOLE PROPRIETORSHIP)
281 MALLORCA WAY
SAN FRANCISCO, CA 94123

THE MARK CONSISTS OF THE WORD RECY-
CLED ABOVE AND TO THE LEFT OF THE ITALI-
CIZED WORD PRINCESS IN LOWERCASE.

FOR: AROMATHERAPY PILLOWS THAT MAY
BE USED TO FRESHEN CLOTHING OR LAY OVER
THE EYES, IN CLASS 3 (U.S. CLS. 1, 4, 6, 50, 51 AND
52).

SER. NO. 77-227,434, FILED 7-11-2007.

FIRST USE 5-0-2007; IN COMMERCE 6-0-2007.

KARANENDRA S. CHHINA, EXAMINING ATTOR-
NEY

Int. Cls.: 7 and 9

Prior U.S. Cls.: 13, 19, 21, 23, 26, 31, 34, 35, 36 and 38

United States Patent and Trademark Office

Reg. No. 3,397,849

Registered Mar. 18, 2008

**TRADEMARK
PRINCIPAL REGISTER**

SIMPLE. RELIABLE. SECURE.

HY-SECURITY GATE, INC. (WASHINGTON CORPORATION)
6623 S. 228TH
KENT, WA 98032

FOR: HYDRAULIC GATE OPERATORS, IN CLASS 7 (U.S. CLS. 13, 19, 21, 23, 31, 34 AND 35).

FIRST USE 1-30-2003; IN COMMERCE 1-30-2003.

FOR: ELECTRIC GATE OPERATORS; BATTERY OPERATED GATE OPERATORS, IN CLASS 9 (U.S. CLS. 21, 23, 26, 36 AND 38).

FIRST USE 1-30-2003; IN COMMERCE 1-30-2003.

THE MARK CONSISTS OF STANDARD CHARACTERS WITHOUT CLAIM TO ANY PARTICULAR FONT, STYLE, SIZE, OR COLOR.

SER. NO. 77-227,462, FILED 7-11-2007.

NAAKWAMA ANKRAH, EXAMINING ATTORNEY

Int. Cl.: 12

Prior U.S. Cls.: 19, 21, 23, 31, 35 and 44

Reg. No. 3,397,850

United States Patent and Trademark Office

Registered Mar. 18, 2008

**TRADEMARK
PRINCIPAL REGISTER**

IS

TOYOTA JIDOSHA KABUSHIKI KAISHA, T/A
TOYOTA MOTOR CORPORATION (JAPAN
CORPORATION)
TOYOTA-SHI
1, TOYOTA-CHO
AICHI-KEN, JAPAN

FOR: AUTOMOBILES AND STRUCTURAL
PARTS THEREOF, IN CLASS 12 (U.S. CLS. 19, 21,
23, 31, 35 AND 44).

FIRST USE 6-8-2000; IN COMMERCE 6-8-2000.

THE MARK CONSISTS OF STANDARD CHAR-
ACTERS WITHOUT CLAIM TO ANY PARTICULAR
FONT, STYLE, SIZE, OR COLOR.

OWNER OF U.S. REG. NO. 2,500,758.

SER. NO. 77-227,484, FILED 7-11-2007.

GEORGE LORENZO, EXAMINING ATTORNEY

Int. Cl.: 9

Prior U.S. Cls.: 21, 23, 26, 36 and 38

Reg. No. 3,397,851

United States Patent and Trademark Office

Registered Mar. 18, 2008

**TRADEMARK
PRINCIPAL REGISTER**

**WELLS FARGO BUSINESS
BANKING ROUNDUP**

WELLS FARGO & COMPANY (DELAWARE
CORPORATION)
1700 WELLS FARGO CENTER, MAC N9305-176
SIXTH AND MARQUETTE
MINNEAPOLIS, MN 55479

FOR: ELECTRONIC PUBLICATIONS IN THE
NATURE OF NEWSLETTERS DELIVERED VIA
ELECTRONIC MAIL FEATURING BANKING, FI-
NANCIAL AND INSURANCE INFORMATION, IN
CLASS 9 (U.S. CLS. 21, 23, 26, 36 AND 38).

FIRST USE 3-23-2004; IN COMMERCE 3-23-2004.

THE MARK CONSISTS OF STANDARD CHAR-
ACTERS WITHOUT CLAIM TO ANY PARTICULAR
FONT, STYLE, SIZE, OR COLOR.

OWNER OF U.S. REG. NO. 2,569,737.

NO CLAIM IS MADE TO THE EXCLUSIVE
RIGHT TO USE BUSINESS BANKING ROUNDUP,
APART FROM THE MARK AS SHOWN.

SER. NO. 77-227,489, FILED 7-11-2007.

EDWARD FENNESSY, EXAMINING ATTORNEY

Int. Cl.: 35

Prior U.S. Cls.: 100, 101 and 102

United States Patent and Trademark Office

Reg. No. 3,397,852

Registered Mar. 18, 2008

**SERVICE MARK
PRINCIPAL REGISTER**

BabyShowerDepot.com

BABYSHOWERDEPOT.COM LLC (NEW JERSEY
LTD LIAB CO)
32 HORIZON DRIVE
EDISON, NJ 08817

FOR: ON-LINE RETAIL STORE SERVICES FEATURING BABY SHOWER FAVORS, BABY SHOWER GAMES, BABY GIFTS, NEW DADDY GIFTS, INVITATIONS, PLUSH ANIMALS, DIAPER CAKES AND EBOOKS, IN CLASS 35 (U.S. CLS. 100, 101 AND 102).

FIRST USE 4-16-2007; IN COMMERCE 4-16-2007.

THE MARK CONSISTS OF STANDARD CHARACTERS WITHOUT CLAIM TO ANY PARTICULAR FONT, STYLE, SIZE, OR COLOR.

SER. NO. 77-227,542, FILED 7-11-2007.

KELLY MCCOY, EXAMINING ATTORNEY

Int. Cl.: 42

Prior U.S. Cls.: 100 and 101

United States Patent and Trademark Office

Reg. No. 3,397,853

Registered Mar. 18, 2008

**SERVICE MARK
PRINCIPAL REGISTER**

ACHPPE

PAYMENT SYSTEMS GROUP, INC. (MISSOURI
CORPORATION)
5988 MID RIVERS MALL DR.
ST. CHARLES, MO 63304

THE MARK CONSISTS OF STANDARD CHAR-
ACTERS WITHOUT CLAIM TO ANY PARTICULAR
FONT, STYLE, SIZE, OR COLOR.

FOR: COMPUTER SOFTWARE DEVELOPMENT,
IN CLASS 42 (U.S. CLS. 100 AND 101).

SER. NO. 77-227,591, FILED 7-11-2007.

FIRST USE 11-24-2004; IN COMMERCE 11-24-2004.

JAY FLOWERS, EXAMINING ATTORNEY

Int. Cl.: 42

Prior U.S. Cls.: 100 and 101

United States Patent and Trademark Office

Reg. No. 3,397,854

Registered Mar. 18, 2008

**SERVICE MARK
PRINCIPAL REGISTER**

CCPPE

PAYMENT SYSTEMS GROUP, INC. (MISSOURI
CORPORATION)
5988 MID RIVERS MALL DR.
ST. CHARLES, MO 63304

THE MARK CONSISTS OF STANDARD CHAR-
ACTERS WITHOUT CLAIM TO ANY PARTICULAR
FONT, STYLE, SIZE, OR COLOR.

FOR: COMPUTER SOFTWARE DEVELOPMENT,
IN CLASS 42 (U.S. CLS. 100 AND 101).

SER. NO. 77-227,592, FILED 7-12-2007.

FIRST USE 4-4-2007; IN COMMERCE 4-4-2007.

JAY FLOWERS, EXAMINING ATTORNEY

Int. Cl.: 10

Prior U.S. Cls.: 26, 39 and 44

United States Patent and Trademark Office

Reg. No. 3,397,855

Registered Mar. 18, 2008

**TRADEMARK
PRINCIPAL REGISTER**

Tantra

FORERUNNERS TECHNOLOGY, INC. (CALI-
FORNIA CORPORATION)
FORERUNNERS@MSN.COM
1875 EAST 43RD STREET
LOS ANGELES, CA 90058

THE MARK CONSISTS OF STANDARD CHAR-
ACTERS WITHOUT CLAIM TO ANY PARTICULAR
FONT, STYLE, SIZE, OR COLOR.

FOR: ELECTRIC MASSAGE APPLIANCES,
NAMELY, ELECTRIC VIBRATING MASSAGER, IN
CLASS 10 (U.S. CLS. 26, 39 AND 44).

SER. NO. 77-227,597, FILED 7-12-2007.

FIRST USE 6-1-2007; IN COMMERCE 6-1-2007.

JOHN E. MICHOS, EXAMINING ATTORNEY

Int. Cl.: 14

Prior U.S. Cls.: 2, 27, 28 and 50

United States Patent and Trademark Office

Reg. No. 3,397,856

Registered Mar. 18, 2008

**TRADEMARK
PRINCIPAL REGISTER**

The image shows the stylized letters 'RGM' in a bold, serif font. The 'R' and 'G' are connected at the top, and the 'M' is positioned to the right of the 'G'. The letters are black and set against a white background.

MURPHY, ROLAND (UNITED STATES INDIVIDUAL)
801 WEST MAIN STREET
MOUNT JOY, PA 17552

THE MARK CONSISTS OF THE STYLIZED LETTERS R, G AND M.

FOR: (BASED ON USE IN COMMERCE)
WATCHES, IN CLASS 14 (U.S. CLS. 2, 27, 28 AND 50).

SER. NO. 77-227,671, FILED 7-12-2007.

FIRST USE 1-10-1993; IN COMMERCE 4-20-1993.

COLLEEN DOMBROW, EXAMINING ATTORNEY

Int. Cl.: 42

Prior U.S. Cls.: 100 and 101

United States Patent and Trademark Office

Reg. No. 3,397,857

Registered Mar. 18, 2008

**SERVICE MARK
PRINCIPAL REGISTER**

**A More Successful Practice
By Design**

HEALTHCARE FACILITIES SOLUTIONS, INC.
(DELAWARE CORPORATION)
1605 E. AYRE STREET
NEWPORT, DE 19804

THE MARK CONSISTS OF STANDARD CHAR-
ACTERS WITHOUT CLAIM TO ANY PARTICULAR
FONT, STYLE, SIZE, OR COLOR.

FOR: ARCHITECTURAL DESIGN, IN CLASS 42
(U.S. CLS. 100 AND 101).

SER. NO. 77-227,741, FILED 7-12-2007.

FIRST USE 7-2-2007; IN COMMERCE 7-2-2007.

BRIAN PINO, EXAMINING ATTORNEY

Int. Cl.: 41

Prior U.S. Cls.: 100, 101 and 107

United States Patent and Trademark Office

Reg. No. 3,397,858

Registered Mar. 18, 2008

**SERVICE MARK
PRINCIPAL REGISTER**

Pianafiddle

DEGRAFF, ADAM J. (UNITED STATES INDIVIDUAL)
174-A DAVIS STUART RD.
LEWISBURG, WV 24901

THE MARK CONSISTS OF STANDARD CHARACTERS WITHOUT CLAIM TO ANY PARTICULAR FONT, STYLE, SIZE, OR COLOR.

FOR: ENTERTAINMENT IN THE NATURE OF VISUAL AND AUDIO PERFORMANCES, AND MUSICAL, VARIETY, NEWS AND COMEDY SHOWS, IN CLASS 41 (U.S. CLS. 100, 101 AND 107).

SER. NO. 77-227,764, FILED 7-12-2007.

FIRST USE 2-26-2005; IN COMMERCE 2-26-2005.

CYNTHIA SLOAN, EXAMINING ATTORNEY

Int. Cl.: 41

Prior U.S. Cls.: 100, 101 and 107

United States Patent and Trademark Office

Reg. No. 3,397,859

Registered Mar. 18, 2008

**SERVICE MARK
PRINCIPAL REGISTER**

SHAMU ROCKS

SEA WORLD, INC. (DELAWARE CORPORATION)
202-6
ONE BUSCH PLACE
ST. LOUIS, MO 63118

FOR: ENTERTAINMENT SERVICES IN THE NATURE OF AN AMUSEMENT PARK SHOW, IN CLASS 41 (U.S. CLS. 100, 101 AND 107).

FIRST USE 5-30-2007; IN COMMERCE 5-30-2007.

THE MARK CONSISTS OF STANDARD CHARACTERS WITHOUT CLAIM TO ANY PARTICULAR FONT, STYLE, SIZE, OR COLOR.

OWNER OF U.S. REG. NOS. 1,261,685, 2,165,751 AND OTHERS.

SER. NO. 77-227,778, FILED 7-12-2007.

CAROLINE WOOD, EXAMINING ATTORNEY

Int. Cl.: 3

Prior U.S. Cls.: 1, 4, 6, 50, 51 and 52

Reg. No. 3,397,860

United States Patent and Trademark Office

Registered Mar. 18, 2008

**TRADEMARK
PRINCIPAL REGISTER**

FRAGRANCE STUDIO

COUSIN CORPORATION OF AMERICA (FLOR-
IDA CORPORATION)

12333 ENTERPRISE BLVD

LARGO, FL 33773

FOR: ROOM FRAGRANCES, IN CLASS 3 (U.S.
CLS. 1, 4, 6, 50, 51 AND 52).

FIRST USE 7-10-2007; IN COMMERCE 7-10-2007.

THE MARK CONSISTS OF STANDARD CHAR-
ACTERS WITHOUT CLAIM TO ANY PARTICULAR
FONT, STYLE, SIZE, OR COLOR.

NO CLAIM IS MADE TO THE EXCLUSIVE
RIGHT TO USE "FRAGRANCE", APART FROM
THE MARK AS SHOWN.

SER. NO. 77-227,784, FILED 7-12-2007.

BRIAN CALLAGHAN, EXAMINING ATTORNEY

Int. Cl.: 30

Prior U.S. Cl.: 46

United States Patent and Trademark Office

Reg. No. 3,397,861

Registered Mar. 18, 2008

TRADEMARK
PRINCIPAL REGISTER



KITTRIDGE & FREDRICKSON, LTD. (OREGON CORPORATION)
14664 S.W. PINOT COURT
TIGARD, OR 97224

THE ENGLISH TRANSLATION OF THE WORDING BELLA SELVA IN THE MARK IS BEAUTIFUL JUNGLE.

FOR: COFFEE, IN CLASS 30 (U.S. CL. 46).

SER. NO. 77-227,796, FILED 7-12-2007.

FIRST USE 6-14-2007; IN COMMERCE 6-14-2007.

MARCIE MILONE, EXAMINING ATTORNEY

Int. Cl.: 30

Prior U.S. Cl.: 46

United States Patent and Trademark Office

Reg. No. 3,397,862

Registered Mar. 18, 2008

**TRADEMARK
PRINCIPAL REGISTER**

GOOD FOR OUR PLANET SINCE
1983

KITTRIDGE & FREDRICKSON, LTD. (OREGON
CORPORATION)
14664 S.W. PINOT COURT
TIGARD, OR 97224

NO CLAIM IS MADE TO THE EXCLUSIVE
RIGHT TO USE "SINCE 1983", APART FROM THE
MARK AS SHOWN.

FOR: COFFEE, IN CLASS 30 (U.S. CL. 46).

SER. NO. 77-227,799, FILED 7-12-2007.

FIRST USE 6-14-2007; IN COMMERCE 6-14-2007.

THE MARK CONSISTS OF STANDARD CHAR-
ACTERS WITHOUT CLAIM TO ANY PARTICULAR
FONT, STYLE, SIZE, OR COLOR.

NORA BUCHANAN WILL, EXAMINING ATTOR-
NEY

Int. Cl.: 5

Prior U.S. Cls.: 6, 18, 44, 46, 51 and 52

United States Patent and Trademark Office

Reg. No. 3,397,863

Registered Mar. 18, 2008

**TRADEMARK
PRINCIPAL REGISTER**

CartiaXT

ANDRX PHARMACEUTICALS, INC. (FLORIDA CORPORATION), DBA WATSON LABORATORIES - FLORIDA
4955 ORANGE DRIVE
DAVIE, FL 33314

FOR: CARDIOVASCULAR PHARMACEUTICALS; CARDIOVASCULAR TREATMENT PREPARATIONS, IN CLASS 5 (U.S. CLS. 6, 18, 44, 46, 51 AND 52).

FIRST USE 6-23-1999; IN COMMERCE 6-23-1999.

THE MARK CONSISTS OF STANDARD CHARACTERS WITHOUT CLAIM TO ANY PARTICULAR FONT, STYLE, SIZE, OR COLOR.

SER. NO. 77-227,830, FILED 7-12-2007.

MARK SPARACINO, EXAMINING ATTORNEY

Int. Cl.: 37

Prior U.S. Cls.: 100, 103 and 106

United States Patent and Trademark Office

Reg. No. 3,397,864

Registered Mar. 18, 2008

**SERVICE MARK
PRINCIPAL REGISTER**

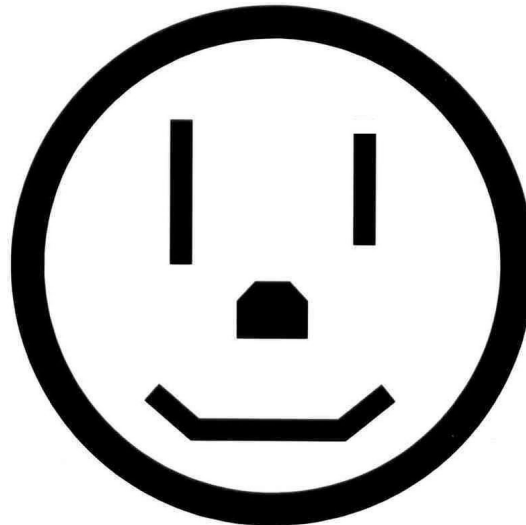

CUSHING, EDWIN A. (WASHINGTON SOLE
PROPRIETORSHIP)
28413 NW 66TH AVE.
RIDGEFIELD, WA 986429397

THE MARK CONSISTS OF A STANDARD ELEC-
TRICAL OUTLET WITH A SMILE TO CREATE A
FACE.

FOR: ELECTRICAL CONTRACTOR SERVICES,
IN CLASS 37 (U.S. CLS. 100, 103 AND 106).

SER. NO. 77-227,851, FILED 7-12-2007.

FIRST USE 5-27-2007; IN COMMERCE 6-10-2007.

KRISTINA MORRIS, EXAMINING ATTORNEY

Int. Cl.: 31

Prior U.S. Cls.: 1 and 46

United States Patent and Trademark Office

Reg. No. 3,397,865

Registered Mar. 18, 2008

**TRADEMARK
PRINCIPAL REGISTER**

HI-GEST

CAL/WEST SEEDS (CALIFORNIA CORPORATION)
38001 COUNTY ROAD 27
WOODLAND, CA 95695

THE MARK CONSISTS OF STANDARD CHARACTERS WITHOUT CLAIM TO ANY PARTICULAR FONT, STYLE, SIZE, OR COLOR.

FOR: AGRICULTURAL SEEDS, IN CLASS 31 (U.S. CLS. 1 AND 46).

SER. NO. 77-227,862, FILED 7-12-2007.

FIRST USE 1-24-2007; IN COMMERCE 1-24-2007.

ASMAT KHAN, EXAMINING ATTORNEY

Int. Cls.: 25 and 35

Prior U.S. Cls.: 22, 39, 100, 101 and 102

United States Patent and Trademark Office

Reg. No. 3,397,866

Registered Mar. 18, 2008

**TRADEMARK
SERVICE MARK
PRINCIPAL REGISTER**

MAGICAL CHILD

BRICE, MERI (UNITED STATES INDIVIDUAL)
250 POINSETTIA
VISTA, CA 92083 AND
BRICE, DAVID (UNITED STATES INDIVIDUAL)
250 POINSETTIA AVE.
VISTA, CA 92083

FOR: WOMEN'S, CHILDREN'S AND INFANTS
SHIRTS, T-SHIRTS, BELTS, UNDERWEAR, SWEA-
TERS, COATS, JEANS, SHORTS, HOSIERY, TANK
TOPS, HALTER TOPS, NIGHTGOWNS, NIGHT
SHIRTS, PAJAMAS, PANTS, SWEATSHIRTS,
SWEATPANTS, APRONS, LINGERIE, SWIMSUITS,
SKIRTS, CHILDREN'S CLOTH EATING BIBS, BABY
BIBS NOT OF PAPER, FOOTWEAR, HATS, IN
CLASS 25 (U.S. CLS. 22 AND 39).

FIRST USE 1-1-2007; IN COMMERCE 1-1-2007.

FOR: ONLINE RETAIL STORE SERVICES AND
RETAIL STORE SERVICES FEATURING WO-
MEN'S, CHILDREN'S AND INFANT'S CLOTHING,

BATH PRODUCTS, BATH TEXTILES, CANDLES,
TOYS, GAMES, PAPER GOODS NAMELY GREET-
ING CARDS, CALENDARS, POSTERS, STICKERS
AND BOOK MARKS, CHILDREN'S ACCESSORIES,
STROLLERS, BODY LOTION, BODY SCRUB, HOME
ACCESSORIES, BOOKS, HOLIDAY AND SEASO-
NAL GIFTS, IN CLASS 35 (U.S. CLS. 100, 101 AND
102).

FIRST USE 1-1-1997; IN COMMERCE 1-10-1997.

THE MARK CONSISTS OF STANDARD CHAR-
ACTERS WITHOUT CLAIM TO ANY PARTICULAR
FONT, STYLE, SIZE, OR COLOR.

NO CLAIM IS MADE TO THE EXCLUSIVE
RIGHT TO USE "CHILD", APART FROM THE
MARK AS SHOWN.

SER. NO. 77-227,890, FILED 7-12-2007.

APRIL ROACH, EXAMINING ATTORNEY

Int. Cl.: 11

Prior U.S. Cls.: 13, 21, 23, 31 and 34

United States Patent and Trademark Office

Reg. No. 3,397,867

Registered Mar. 18, 2008

**TRADEMARK
PRINCIPAL REGISTER**

TRULY-MAGIC

PINEDA, MANUEL (UNITED STATES INDIVIDUAL)
575 E. ST. JOHN STREET
SAN JOSE, CA 95112

THE MARK CONSISTS OF STANDARD CHARACTERS WITHOUT CLAIM TO ANY PARTICULAR FONT, STYLE, SIZE, OR COLOR.

FOR: WATER TREATMENT SYSTEMS, NAMELY, CARTRIDGE FILTRATION UNITS, IN CLASS 11 (U.S. CLS. 13, 21, 23, 31 AND 34).

SER. NO. 77-227,892, FILED 7-12-2007.

FIRST USE 11-30-2001; IN COMMERCE 11-30-2001.

MICHAEL LEWIS, EXAMINING ATTORNEY

Int. Cl.: 41

Prior U.S. Cls.: 100, 101 and 107

United States Patent and Trademark Office

Reg. No. 3,397,868

Registered Mar. 18, 2008

**SERVICE MARK
PRINCIPAL REGISTER**

Uncover The Stashed Cash

YONKERS RACING CORPORATION (NEW
YORK CORPORATION)
810 CENTRAL AVENUE
YONKERS, NY 10704

FOR: ENTERTAINMENT SERVICES, NAMELY,
PRODUCTION AND DISTRIBUTION OF A GAME
SHOW; ENTERTAINMENT IN THE NATURE OF
LIVE GAME SHOWS AND VARIETY SHOWS, IN
CLASS 41 (U.S. CLS. 100, 101 AND 107).

FIRST USE 3-29-2007; IN COMMERCE 3-29-2007.

THE MARK CONSISTS OF STANDARD CHAR-
ACTERS WITHOUT CLAIM TO ANY PARTICULAR
FONT, STYLE, SIZE, OR COLOR.

SER. NO. 77-227,912, FILED 7-12-2007.

MICHAEL LEWIS, EXAMINING ATTORNEY

Int. Cl.: 35

Prior U.S. Cls.: 100, 101 and 102

United States Patent and Trademark Office

Reg. No. 3,397,869

Registered Mar. 18, 2008

**SERVICE MARK
PRINCIPAL REGISTER**

PAVEMENT DEPOT

PAVEMENT DEPOT OF MARYLAND, LLC
(MARYLAND LTD LIAB CO)
UNIT B-2
95 MONOCACY BLVD.
FREDERICK, MD 21701

FOR: RETAIL STORE SERVICES FEATURING
ASPHALT MAINTENANCE PRODUCTS, IN CLASS
35 (U.S. CLS. 100, 101 AND 102).

FIRST USE 4-1-2006; IN COMMERCE 4-1-2006.

THE MARK CONSISTS OF STANDARD CHAR-
ACTERS WITHOUT CLAIM TO ANY PARTICULAR
FONT, STYLE, SIZE, OR COLOR.

NO CLAIM IS MADE TO THE EXCLUSIVE
RIGHT TO USE "PAVEMENT", APART FROM THE
MARK AS SHOWN.

SER. NO. 77-227,914, FILED 7-12-2007.

MICHAEL LEWIS, EXAMINING ATTORNEY

Int. Cl.: 42

Prior U.S. Cls.: 100 and 101

United States Patent and Trademark Office

Reg. No. 3,397,870

Registered Mar. 18, 2008

**SERVICE MARK
PRINCIPAL REGISTER**

ALCYONE TECHNOLOGIES

ROSA MARIA BOLIVAR GARCIA (VENEZUELA
INDIVIDUAL)
108 BELMONT PLACE
BOYNTON BEACH, FL 33436

FOR: CONSULTING SERVICES IN THE FIELD OF DESIGN, SELECTION, IMPLEMENTATION AND USE OF COMPUTER HARDWARE AND SOFTWARE SYSTEMS FOR OTHERS; COMPUTER SOFTWARE DESIGN FOR OTHERS; COMPUTER SOFTWARE DESIGN, COMPUTER PROGRAMMING, OR MAINTENANCE OF COMPUTER SOFTWARE; CONSULTANCY IN THE FIELD OF SOFTWARE DESIGN; DESIGN AND DEVELOPMENT OF ON-LINE COMPUTER SOFTWARE SYSTEMS; DESIGN OF HOME PAGES, COMPUTER SOFTWARE AND WEB SITES; DESIGN, DEVELOPMENT AND IMPLEMENTATION OF SOFTWARE; DEVELOPMENT, UPDATING AND MAINTENANCE OF SOFTWARE AND DATA BASES; DE-

VELOPMENT OF SOFTWARE FOR SECURE NETWORK OPERATIONS; PLANNING, DEVELOPMENT AND TECHNICAL SUPPORT OF ELECTRONIC COMMUNICATIONS NETWORKS , IN CLASS 42 (U.S. CLS. 100 AND 101).

FIRST USE 6-1-2006; IN COMMERCE 6-1-2006.

THE MARK CONSISTS OF STANDARD CHARACTERS WITHOUT CLAIM TO ANY PARTICULAR FONT, STYLE, SIZE, OR COLOR.

NO CLAIM IS MADE TO THE EXCLUSIVE RIGHT TO USE "TECHNOLOGIES", APART FROM THE MARK AS SHOWN.

SER. NO. 77-227,924, FILED 7-12-2007.

JILL C. ALT, EXAMINING ATTORNEY

Int. Cl.: 37

Prior U.S. Cls.: 100, 103 and 106

United States Patent and Trademark Office

Reg. No. 3,397,871

Registered Mar. 18, 2008

**SERVICE MARK
PRINCIPAL REGISTER**

The Solarminiums

HARE, KENNETH E. (UNITED STATES INDIVIDUAL)
P. O. BOX 1420
CHICAGO, IL 60690

FOR: (BASED ON USE IN COMMERCE) HOUSING SERVICES, NAMELY, DEVELOPMENT OF REAL PROPERTY, NAMELY, REPAIR, IMPROVEMENT, AND NEW CONSTRUCTION, IN CLASS 37 (U.S. CLS. 100, 103 AND 106).

FIRST USE 9-27-2004; IN COMMERCE 1-6-2007.

THE MARK CONSISTS OF STANDARD CHARACTERS WITHOUT CLAIM TO ANY PARTICULAR FONT, STYLE, SIZE, OR COLOR.

SER. NO. 77-227,926, FILED 7-12-2007.

MATTHEW PAPPAS, EXAMINING ATTORNEY

Int. Cl.: 35

Prior U.S. Cls.: 100, 101 and 102

United States Patent and Trademark Office

Reg. No. 3,397,872

Registered Mar. 18, 2008

**SERVICE MARK
PRINCIPAL REGISTER**

**OPPORTUNITY DOESN'T
KNOCK... IT CALLS!**

VOICESTAR, INC. (PENNSYLVANIA CORPORATION)
SUITE 1352
1315 WALNUT STREET
PHILADELPHIA, PA 19107

FOR: GENERAL BUSINESS NETWORKING SERVICES, NAMELY, PROMOTING THE GOODS AND SERVICES OF OTHERS BY PASSING BUSINESS LEADS AND INFORMATION AMONG GROUP MEMBERS VIA TELEPHONE; BUSINESS MARKETING CONSULTING SERVICES; MARKET RESEARCH SERVICES, NAMELY, MARKET ANALYSIS AND COMPILATION; MARKET DATA RESEARCH SERVICES, NAMELY, AD RESPONSE TRACKING AND MONITORING SERVICES WHICH AUTOMATICALLY TRACKS TELEPHONE CALLS BY TELEPHONE NUMBER, CALLER, LOCATION AND RELATED MARKETING DATA BACK TO A SPECIFIC ADVERTISING SOURCE;

INTERACTIVE BUSINESS MARKETING SERVICES, NAMELY, PROVIDING USER CUSTOMIZABLE REPORTS WHICH MANAGE, TRACK AND REPORT CALL-RELATED DATA, NAMELY, CUSTOMER PROFILES AND CONTACT INFORMATION, TO TRACK ADVERTISING EFFECTIVENESS, IMPROVE SALES AND PROVIDE CALL AND CONTACT CENTER SERVICE EVALUATIONS, IN CLASS 35 (U.S. CLS. 100, 101 AND 102).

FIRST USE 8-1-2004; IN COMMERCE 8-1-2004.

THE MARK CONSISTS OF STANDARD CHARACTERS WITHOUT CLAIM TO ANY PARTICULAR FONT, STYLE, SIZE, OR COLOR.

SER. NO. 77-227,927, FILED 7-12-2007.

KAREN BRACEY, EXAMINING ATTORNEY

Int. Cl.: 41

Prior U.S. Cls.: 100, 101 and 107

United States Patent and Trademark Office

Reg. No. 3,397,873

Registered Mar. 18, 2008

**SERVICE MARK
PRINCIPAL REGISTER**

BEING BLISS YOGA

MILLER, JANE E. (UNITED STATES INDIVIDUAL)
2510 TORREY PINES ROAD, APT. 220
LA JOLLA, CA 92037

FOR: EDUCATIONAL SERVICES, NAMELY CONDUCTING PROGRAMS, CLASSES AND SEMINARS AND INSTRUCTION IN THE FIELD OF YOGA, IN CLASS 41 (U.S. CLS. 100, 101 AND 107).

FIRST USE 1-1-2007; IN COMMERCE 1-1-2007.

THE MARK CONSISTS OF STANDARD CHARACTERS WITHOUT CLAIM TO ANY PARTICULAR FONT, STYLE, SIZE, OR COLOR.

NO CLAIM IS MADE TO THE EXCLUSIVE RIGHT TO USE "BLISS YOGA", APART FROM THE MARK AS SHOWN.

SER. NO. 77-227,951, FILED 7-12-2007.

YAT SYE, LEE, EXAMINING ATTORNEY

Int. Cl.: 31

Prior U.S. Cls.: 1 and 46

United States Patent and Trademark Office

Reg. No. 3,397,874

Registered Mar. 18, 2008

**TRADEMARK
PRINCIPAL REGISTER**



CAL/WEST SEEDS (CALIFORNIA CORPORATION)
38001 COUNTY ROAD 27
WOODLAND, CA 95695

THE MARK CONSISTS OF THE WORD HI-GEST AND A LOGO COMPRISING A CURVED RIBBON HAVING UPPER AND LOWER BAND SEGMENTS PASSING THROUGH THE LETTER "G".

FOR: AGRICULTURAL SEEDS, IN CLASS 31 (U.S. CLS. 1 AND 46).

SER. NO. 77-227,984, FILED 7-12-2007.

FIRST USE 1-24-2007; IN COMMERCE 1-24-2007.

ASMAT KHAN, EXAMINING ATTORNEY

Int. Cl.: 41

Prior U.S. Cls.: 100, 101 and 107

United States Patent and Trademark Office

Reg. No. 3,397,875

Registered Mar. 18, 2008

**SERVICE MARK
PRINCIPAL REGISTER**

SEDUCED BY A COUGAR

LA TOURAINNE, INC. (NEVADA CORPORATION)
625 BROADWAY STREET, #700
SAN DIEGO, CA 92101

FOR: PROVIDING AN ONLINE INTERACTIVE
WEB SITE FEATURING ADULT ENTERTAIN-
MENT SUBJECT MATTER, IN CLASS 41 (U.S. CLS.
100, 101 AND 107).

FIRST USE 11-9-2006; IN COMMERCE 11-9-2006.

THE MARK CONSISTS OF STANDARD CHAR-
ACTERS WITHOUT CLAIM TO ANY PARTICULAR
FONT, STYLE, SIZE, OR COLOR.

SER. NO. 77-227,986, FILED 7-12-2007.

MORGAN WYNNE, EXAMINING ATTORNEY

Int. Cl.: 41

Prior U.S. Cls.: 100, 101 and 107

United States Patent and Trademark Office

Reg. No. 3,397,876

Registered Mar. 18, 2008

**SERVICE MARK
PRINCIPAL REGISTER**

GETTING FULLY ENGAGED

LGE PERFORMANCE SYSTEMS, INC. DBA HUMAN PERFORMANCE INSTITUTE (FLORIDA CORPORATION)
9757 LAKE NONA ROAD
ORLANDO, FL 32827

FOR: EDUCATIONAL SERVICES, NAMELY, CONDUCTING SEMINARS, WORKSHOPS, CONFERENCES, SPEECHES, TRAINING AND PERSONAL COACHING, ALL IN THE FIELDS OF IMPROVING PERSONAL AND BUSINESS SKILLS, ABILITIES AND PERFORMANCE, IN CLASS 41 (U.S. CLS. 100, 101 AND 107).

FIRST USE 12-31-2002; IN COMMERCE 12-31-2002.

THE MARK CONSISTS OF STANDARD CHARACTERS WITHOUT CLAIM TO ANY PARTICULAR FONT, STYLE, SIZE, OR COLOR.

OWNER OF U.S. REG. NOS. 2,777,719, 2,779,352 AND OTHERS.

SER. NO. 77-228,014, FILED 7-12-2007.

BARBARA GAYNOR, EXAMINING ATTORNEY

Int. Cl.: 9

Prior U.S. Cls.: 21, 23, 26, 36 and 38

United States Patent and Trademark Office

Reg. No. 3,397,877

Registered Mar. 18, 2008

**TRADEMARK
PRINCIPAL REGISTER**

SIONEX

SIONEX CORPORATION (DELAWARE CORPORATION)
8-A PRESTON COURT
BEDFORD, MA 01730

FOR: SENSORS, DETECTORS, MONITORS, SPECTROMETERS, ION FILTERS AND ION SEPARATORS, ALL FOR THE DETECTION, ANALYSIS, SEPARATION AND USE OF CHEMICALS, INCLUDING BIOCHEMICALS, WHERE THE DETECTION, ANALYSIS, SEPARATION, AND USE IS PERFORMED IN THE NON-LIQUID PHASE, IN CLASS 9 (U.S. CLS. 21, 23, 26, 36 AND 38).

FIRST USE 12-12-2002; IN COMMERCE 12-12-2002.

THE MARK CONSISTS OF STANDARD CHARACTERS WITHOUT CLAIM TO ANY PARTICULAR FONT, STYLE, SIZE, OR COLOR.

OWNER OF U.S. REG. NO. 3,195,411.

SER. NO. 77-228,024, FILED 7-12-2007.

SCOTT BIBB, EXAMINING ATTORNEY

Int. Cls.: 9 and 45

Prior U.S. Cls.: 21, 23, 26, 36, 38, 100 and 101

United States Patent and Trademark Office

Reg. No. 3,397,878

Registered Mar. 18, 2008

**TRADEMARK
SERVICE MARK
PRINCIPAL REGISTER**

EVERTECH

DUMANOGULLARI, SEMIH (TURKEY INDIVIDUAL)
576 VALLEY BROOK AVENUE
LYNDHURST, NJ 07071

FOR: ACCESS CONTROL AND ALARM MONITORING SYSTEMS; BUILDING SECURITY SYSTEMS COMPRISING SOFTWARE AND HARDWARE FOR PROVIDING PICTURE, VIDEO, ALARM STATUS, BUILDING PLANS, AND OTHER INFORMATION TO A REMOTE STATION; CABLES FOR ELECTRICAL AND OPTICAL SIGNAL TRANSMISSION SYSTEMS; ELECTRIC AND ELECTRONIC VIDEO SURVEILLANCE INSTALLATIONS; ELECTRICAL DISTRIBUTION SYSTEMS, NAMELY, POWER DISTRIBUTION PANELS; FIRE-EXTINGUISHING SYSTEMS; HOME AND OFFICE AUTOMATION SYSTEMS COMPRISING WIRELESS AND WIRED CONTROLLERS, CONTROLLED DEVICES, AND SOFTWARE FOR LIGHTING, HVAC, SECURITY, SAFETY AND OTHER HOME AND OFFICE MONITORING AND CONTROL APPLICATIONS; AUTOMATED SELF CONTAINED ELECTRONIC SURVEILLANCE DEVICES THAT CAN BE DEPLOYED TO GATHER EVIDENCE OR INTELLIGENCE IN REMOTE LOCATIONS; ELECTRONIC DOOR CLOSING SYSTEMS; KEYLESS ENTRY SYSTEM AND KEYLESS IGNITION SWITCH SYSTEM FOR AUTOMOTIVE VEHICLES COMPRISED OF A MICROPROCESSOR, ELECTRONIC SIGNAL RECEIVER, AND KEYFOB WITH ELECTRONIC SIGNAL TRANSPONDER; PATTERN RECOGNITION

SYSTEMS COMPOSED OF COMPUTER CHIPS, COMPUTER HARDWARE AND SOFTWARE; PROGRAMMABLE LOCKING SYSTEMS, CONSISTING OF ELECTRONIC CYLINDRICAL LOCKSETS AND KEYPADS; SECURITY LIGHTING SYSTEM FOR VEHICLES USING RADIO FREQUENCY DEVICE; SYSTEM BOARDS (MOTHER CARDS) AND PROCESSORS, IN CLASS 9 (U.S. CLS. 21, 23, 26, 36 AND 38).

FIRST USE 10-1-1999; IN COMMERCE 10-1-1999.

FOR: CONTROL OF BUILDING ENVIRONMENTAL ACCESS AND SECURITY SYSTEMS; MONITORING OF COMPUTER SYSTEMS FOR SECURITY PURPOSES; MONITORING SECURITY SYSTEMS; INVESTIGATION OR SURVEILLANCE ON BACKGROUND PROFILES, IN CLASS 45 (U.S. CLS. 100 AND 101).

FIRST USE 10-1-1999; IN COMMERCE 10-1-1999.

THE MARK CONSISTS OF STANDARD CHARACTERS WITHOUT CLAIM TO ANY PARTICULAR FONT, STYLE, SIZE, OR COLOR.

SER. NO. 77-228,028, FILED 7-12-2007.

ALEXANDER L. POWERS, EXAMINING ATTORNEY

Int. Cl.: 30

Prior U.S. Cl.: 46

United States Patent and Trademark Office

Reg. No. 3,397,879

Registered Mar. 18, 2008

**TRADEMARK
PRINCIPAL REGISTER**

MRS. APPLETREE

DISTINCT INDULGENCE, INC. (CALIFORNIA
CORPORATION)
740 SALEM STREET
GLENDALE, CA 91203

THE LIKENESS (OR, "PORTRAIT") IN THE
MARK DOES NOT IDENTIFY A LIVING INDIVI-
DUAL.

FOR: BAKERY GOODS, IN CLASS 30 (U.S. CL. 46).

FIRST USE 12-31-1991; IN COMMERCE 12-31-1991.

SER. NO. 77-228,029, FILED 7-12-2007.

THE MARK CONSISTS OF STANDARD CHAR-
ACTERS WITHOUT CLAIM TO ANY PARTICULAR
FONT, STYLE, SIZE, OR COLOR.

ANDREA HACK, EXAMINING ATTORNEY

Int. Cl.: 41

Prior U.S. Cls.: 100, 101 and 107

United States Patent and Trademark Office

Reg. No. 3,397,880

Registered Mar. 18, 2008

**SERVICE MARK
PRINCIPAL REGISTER**

ASIAN 1 ON 1

LA TOURAINÉ, INC. (NEVADA CORPORATION)
625 BROADWAY STREET, #700
SAN DIEGO, CA 92101

FOR: PROVIDING AN ONLINE INTERACTIVE
WEB SITE FEATURING ADULT ENTERTAIN-
MENT SUBJECT MATTER, IN CLASS 41 (U.S. CLS.
100, 101 AND 107).

FIRST USE 8-24-2006; IN COMMERCE 8-24-2006.

THE MARK CONSISTS OF STANDARD CHAR-
ACTERS WITHOUT CLAIM TO ANY PARTICULAR
FONT, STYLE, SIZE, OR COLOR.

NO CLAIM IS MADE TO THE EXCLUSIVE
RIGHT TO USE "ASIAN", APART FROM THE
MARK AS SHOWN.

SER. NO. 77-228,071, FILED 7-12-2007.

MORGAN WYNNE, EXAMINING ATTORNEY

Int. Cl.: 30

Prior U.S. Cl.: 46

United States Patent and Trademark Office

Reg. No. 3,397,881

Registered Mar. 18, 2008

**TRADEMARK
PRINCIPAL REGISTER**



DISTINCT INDULGENCE, INC. (CALIFORNIA CORPORATION)
740 SALEM STREET
GLENDALE, CA 91203

FOR: BAKERY GOODS, IN CLASS 30 (U.S. CL. 46).

FIRST USE 1-15-2007; IN COMMERCE 1-15-2007.

"MRS. APPLETREE" DOES NOT IDENTIFY A LIVING INDIVIDUAL.

THE MARK CONSISTS OF TWO GIRLS SITTING IN THE CENTER OF THE IMAGE, WITH THE

YOUNGER GIRL SITTING IN THE LAP OF THE OLDER GIRL, THE YOUNGER GIRL IS POINTING TO A LOAF OF BREAD WITH A SLICE REMOVED, A JAR OF FLOUR AND A BOWL OF APPLES. BEHIND THE GIRLS ARE THREE MUFFINS AND A JAR OF HONEY WITH BEES FLYING ABOVE THE JAR. BELOW THE GIRLS ARE THE WORDS MRS. APPLETREE LOCATED WITHIN A DOUBLE EDGED RECTANGLE.

SER. NO. 77-228,087, FILED 7-12-2007.

ANDREA HACK, EXAMINING ATTORNEY

Int. Cl.: 3

Prior U.S. Cls.: 1, 4, 6, 50, 51 and 52

Reg. No. 3,397,882

United States Patent and Trademark Office

Registered Mar. 18, 2008

**TRADEMARK
PRINCIPAL REGISTER**

THE STAIN REMEDY

FOREVER NEW INTERNATIONAL, INC. (MIN-
NESOTA CORPORATION)
4701 NORTH FOURTH AVENUE
SIOUX FALLS, SD 571040403

OWNER OF U.S. REG. NO. 2,572,387.

FOR: CLEANING PREPARATIONS FOR FAB-
RICS, IN CLASS 3 (U.S. CLS. 1, 4, 6, 50, 51 AND 52).

NO CLAIM IS MADE TO THE EXCLUSIVE
RIGHT TO USE "STAIN", APART FROM THE
MARK AS SHOWN.

FIRST USE 4-25-2001; IN COMMERCE 4-25-2001.

SER. NO. 77-228,089, FILED 7-12-2007.

THE MARK CONSISTS OF STANDARD CHAR-
ACTERS WITHOUT CLAIM TO ANY PARTICULAR
FONT, STYLE, SIZE, OR COLOR.

JEFF DEFORD, EXAMINING ATTORNEY

Int. Cl.: 41

Prior U.S. Cls.: 100, 101 and 107

United States Patent and Trademark Office

Reg. No. 3,397,883

Registered Mar. 18, 2008

**SERVICE MARK
PRINCIPAL REGISTER**

DIARY OF A NANNY

LA TOURAINNE, INC. (NEVADA CORPORATION)
625 BROADWAY STREET, #700
SAN DIEGO, CA 92101

FOR: PROVIDING AN ONLINE INTERACTIVE
WEB SITE FEATURING ADULT ENTERTAIN-
MENT SUBJECT MATTER, IN CLASS 41 (U.S. CLS.
100, 101 AND 107).

FIRST USE 2-0-2007; IN COMMERCE 2-0-2007.

THE MARK CONSISTS OF STANDARD CHAR-
ACTERS WITHOUT CLAIM TO ANY PARTICULAR
FONT, STYLE, SIZE, OR COLOR.

SER. NO. 77-228,116, FILED 7-12-2007.

MORGAN WYNNE, EXAMINING ATTORNEY

Int. Cl.: 41

Prior U.S. Cls.: 100, 101 and 107

United States Patent and Trademark Office

Reg. No. 3,397,884

Registered Mar. 18, 2008

**SERVICE MARK
PRINCIPAL REGISTER**

NAUGHTY FLIPSIDE

LA TOURAINÉ, INC. (NEVADA CORPORATION)
625 BROADWAY STREET, #700
SAN DIEGO, CA 92101

THE MARK CONSISTS OF STANDARD CHARACTERS WITHOUT CLAIM TO ANY PARTICULAR FONT, STYLE, SIZE, OR COLOR.

FOR: PROVIDING AN ONLINE INTERACTIVE WEB SITE FEATURING ADULT ENTERTAINMENT SUBJECT MATTER, IN CLASS 41 (U.S. CLS. 100, 101 AND 107).

SER. NO. 77-228,127, FILED 7-12-2007.

FIRST USE 1-28-2007; IN COMMERCE 1-28-2007.

MORGAN WYNNE, EXAMINING ATTORNEY

Int. Cl.: 16

Prior U.S. Cls.: 2, 5, 22, 23, 29, 37, 38 and 50

United States Patent and Trademark Office

Reg. No. 3,397,885

Registered Mar. 18, 2008

**TRADEMARK
PRINCIPAL REGISTER**

WILDCAT OPAQUE

FRASER PAPERS LIMITED (MAINE CORPORATION)

82 BRIDGE AVENUE

MADAWASKA, ME 04756

FOR: PRINTING AND WRITING PAPERS, IN CLASS 16 (U.S. CLS. 2, 5, 22, 23, 29, 37, 38 AND 50).

FIRST USE 12-31-2004; IN COMMERCE 12-31-2004.

THE MARK CONSISTS OF STANDARD CHARACTERS WITHOUT CLAIM TO ANY PARTICULAR FONT, STYLE, SIZE, OR COLOR.

NO CLAIM IS MADE TO THE EXCLUSIVE RIGHT TO USE "OPAQUE", APART FROM THE MARK AS SHOWN.

SER. NO. 77-228,161, FILED 7-12-2007.

MICHAEL GAAFAR, EXAMINING ATTORNEY

Int. Cls.: 31 and 35

Prior U.S. Cls.: 1, 46, 100, 101 and 102

United States Patent and Trademark Office

Reg. No. 3,397,886

Registered Mar. 18, 2008

**TRADEMARK
SERVICE MARK
PRINCIPAL REGISTER**

PRODUCING LIFETIME LAWNS

PATTEN SEED COMPANY (GEORGIA CORPORATION)
P.O. BOX 217
LAKELAND, GA 31635

FOR: GRASS SEEDS; SOD, IN CLASS 31 (U.S. CLS. 1 AND 46).

FIRST USE 1-31-2002; IN COMMERCE 1-31-2002.

FOR: ON-LINE RETAIL STORE SERVICES FEATURING GRASS SEEDS, IN CLASS 35 (U.S. CLS. 100, 101 AND 102).

FIRST USE 5-31-2006; IN COMMERCE 5-31-2006.

THE MARK CONSISTS OF STANDARD CHARACTERS WITHOUT CLAIM TO ANY PARTICULAR FONT, STYLE, SIZE, OR COLOR.

SER. NO. 77-228,170, FILED 7-12-2007.

ELIZABETH KAJUBI, EXAMINING ATTORNEY

Int. Cl.: 19

Prior U.S. Cls.: 1, 12, 33 and 50

United States Patent and Trademark Office

Reg. No. 3,397,887

Registered Mar. 18, 2008

**TRADEMARK
PRINCIPAL REGISTER**

MacTube

MACCAFERRI, INC. (MARYLAND CORPORATION)
10303 GOVERNOR LANE BLVD
WILLIAMSPORT, MD 21795

THE COLOR(S) GREEN IS/ARE CLAIMED AS A
FEATURE OF THE MARK.

FOR: GEOTEXTILES FOR THE PURPOSES OF
DRAINAGE, STABILIZING INCLINES, RECULTI-
VATION, PLANT SUPPORT, ABSORPTION, FIL-
TRATION, SEPARATION, STABILIZATION AND
REINFORCEMENT OF THE SOIL, IN CLASS 19
(U.S. CLS. 1, 12, 33 AND 50).

THE MARK CONSISTS OF THE WORDING
MACTUBE IN GREEN.

SER. NO. 77-228,249, FILED 7-12-2007.

FIRST USE 6-1-2007; IN COMMERCE 6-1-2007.

KRISTIN DAHLING, EXAMINING ATTORNEY

Int. Cl.: 41

Prior U.S. Cls.: 100, 101 and 107

United States Patent and Trademark Office

Reg. No. 3,397,888

Registered Mar. 18, 2008

**SERVICE MARK
PRINCIPAL REGISTER**

WORK-ABLE

AUCTION INN CORPORATION (DELAWARE
CORPORATION)
241 WEST LEMON STREET
LANCASTER, PA 17603

THE MARK CONSISTS OF STANDARD CHAR-
ACTERS WITHOUT CLAIM TO ANY PARTICULAR
FONT, STYLE, SIZE, OR COLOR.

FOR: JOB SKILLS TRAINING PROGRAM, IN
CLASS 41 (U.S. CLS. 100, 101 AND 107).

SER. NO. 77-228,299, FILED 7-12-2007.

FIRST USE 6-0-2004; IN COMMERCE 6-0-2004.

SHARON MEIER, EXAMINING ATTORNEY

Int. Cl.: 41

Prior U.S. Cls.: 100, 101 and 107

United States Patent and Trademark Office

Reg. No. 3,397,889

Registered Mar. 18, 2008

**SERVICE MARK
PRINCIPAL REGISTER**

Poppy-Laced

SIDIGU, ANNAH O. (UNITED STATES INDIVIDUAL)
45 EAST MUMMA AVENUE
DAYTON, OH 45405

FOR: ENTERTAINMENT IN THE NATURE OF VISUAL AND AUDIO PERFORMANCES, AND MUSICAL, VARIETY, NEWS AND COMEDY SHOWS; ENTERTAINMENT IN THE NATURE OF VISUAL AND AUDIO PERFORMANCES, NAMELY, MUSICAL BAND, ROCK GROUP, GYMNASTIC, DANCE, AND BALLET PERFORMANCES; ENTERTAINMENT NAMELY, LIVE PERFORMANCES BY A MUSICAL BAND; ENTERTAINMENT SERVICES, NAMELY, AN ONLINE ACTIVITY WHERE YOU CREATE YOUR OWN MUSIC VIDEOS; ENTERTAINMENT SERVICES, NAMELY, PROVIDING A WEB SITE FEATURING MUSICAL PERFORMANCES, MUSICAL VIDEOS, RELATED FILM CLIPS, PHOTOGRAPHS, AND OTHER MULTIMEDIA MATERIALS; ENTERTAINMENT SERVICES, NAMELY, PROVIDING PRERECORDED MUSIC, INFORMATION IN THE FIELD OF MUSIC, AND COMMENTARY AND ARTICLES ABOUT MUSIC, ALL ON-LINE VIA A GLOBAL COMPUTER NET-

WORK; ENTERTAINMENT, NAMELY LIVE MUSIC CONCERTS; ENTERTAINMENT, NAMELY LIVE PERFORMANCES BY MUSICAL BANDS; ENTERTAINMENT, NAMELY, LIVE PERFORMANCES BY ROCK GROUPS; LIVE PERFORMANCES FEATURING PRERECORDED VOCAL AND INSTRUMENTAL PERFORMANCES VIEWED ON A BIG SCREEN; COMPOSITION OF MUSIC FOR OTHERS; MUSIC COMPOSITION AND TRANSCRIPTION FOR OTHERS; MUSIC COMPOSITION FOR OTHERS; PRESENTATION OF LIVE SHOW PERFORMANCES; PRESENTATION OF MUSICAL PERFORMANCE, IN CLASS 41 (U.S. CLS. 100, 101 AND 107).

FIRST USE 6-29-2007; IN COMMERCE 6-29-2007.

THE MARK CONSISTS OF STANDARD CHARACTERS WITHOUT CLAIM TO ANY PARTICULAR FONT, STYLE, SIZE, OR COLOR.

SER. NO. 77-228,329, FILED 7-12-2007.

AMY HELLA, EXAMINING ATTORNEY

Int. Cl.: 35

Prior U.S. Cls.: 100, 101 and 102

United States Patent and Trademark Office

Reg. No. 3,397,890

Registered Mar. 18, 2008

**SERVICE MARK
PRINCIPAL REGISTER**



PRODISO, LLC (FLORIDA LTD LIAB CO)
3250 NW 77TH CT.
MIAMI, FL 33122

FOR: IMPORT AND EXPORT AGENCIES;
WHOLESALE DISTRIBUTORSHIPS AND RETAIL
STORE SERVICES FEATURING FURNITURE AND
CABINETS, IN CLASS 35 (U.S. CLS. 100, 101 AND
102).

FIRST USE 7-5-2007; IN COMMERCE 7-5-2007.

THE MARK CONSISTS OF SEVEN STYLIZED
LETTERS READING PRODISO UNDERNEATH
FOUR TILTED BARS.

SER. NO. 77-228,333, FILED 7-12-2007.

AMY HELLA, EXAMINING ATTORNEY

Int. Cls.: 37 and 41

Prior U.S. Cls.: 100, 101, 103, 106 and 107

United States Patent and Trademark Office

Reg. No. 3,397,891

Registered Mar. 18, 2008

**SERVICE MARK
PRINCIPAL REGISTER**

Encore

W.H. PAIGE AND CO., INC. (INDIANA CORPORATION)
5282 EAST 65TH STREET
INDIANAPOLIS, IN 46220

FOR: REPAIR OF MUSICAL INSTRUMENTS, IN CLASS 37 (U.S. CLS. 100, 103 AND 106).

FIRST USE 6-1-2006; IN COMMERCE 6-1-2006.

FOR: RENTAL OF MUSICAL INSTRUMENTS, IN CLASS 41 (U.S. CLS. 100, 101 AND 107).

FIRST USE 6-1-2006; IN COMMERCE 6-1-2006.

THE MARK CONSISTS OF STANDARD CHARACTERS WITHOUT CLAIM TO ANY PARTICULAR FONT, STYLE, SIZE, OR COLOR.

SER. NO. 77-228,362, FILED 7-12-2007.

ANNE E. GUSTASON, EXAMINING ATTORNEY

Int. Cl.: 37

Prior U.S. Cls.: 100, 103 and 106

United States Patent and Trademark Office

Reg. No. 3,397,892

Registered Mar. 18, 2008

**SERVICE MARK
PRINCIPAL REGISTER**

ACTUALLY CLEAN

JASON BAILEY (UNITED STATES INDIVIDUAL)
P.O. BOX 11212
CEDAR RAPIDS, IA 52410

FOR: BUILDING RESTORATION; FURNITURE RESTORATION CONSULTATION; FURNITURE RESTORATION, REPAIR AND MAINTENANCE; RESTORATION IN THE FIELD OF WATER DAMAGE, ODOR DECONTAMINATION, STAIN REMOVAL, UPHOLSTERY; CARPET CLEANING, IN CLASS 37 (U.S. CLS. 100, 103 AND 106).

FIRST USE 12-31-2001; IN COMMERCE 12-31-2001.

THE MARK CONSISTS OF STANDARD CHARACTERS WITHOUT CLAIM TO ANY PARTICULAR FONT, STYLE, SIZE, OR COLOR.

NO CLAIM IS MADE TO THE EXCLUSIVE RIGHT TO USE "CLEAN", APART FROM THE MARK AS SHOWN.

SER. NO. 77-228,368, FILED 7-12-2007.

JOHN WILKE, EXAMINING ATTORNEY

Int. Cl.: 35

Prior U.S. Cls.: 100, 101 and 102

United States Patent and Trademark Office

Reg. No. 3,397,893

Registered Mar. 18, 2008

**SERVICE MARK
PRINCIPAL REGISTER**

ANTARRA

LOGICAL PERCEPTIONS, INC. (CALIFORNIA
CORPORATION)
SUITE D13
11602 KNOTT STREET
GARDEN GROVE, CA 92841

THE MARK CONSISTS OF STANDARD CHAR-
ACTERS WITHOUT CLAIM TO ANY PARTICULAR
FONT, STYLE, SIZE, OR COLOR.

FOR: PUBLIC RELATIONS, ADVERTISING AND
MARKETING SERVICES, IN CLASS 35 (U.S. CLS.
100, 101 AND 102).

SER. NO. 77-228,495, FILED 7-12-2007.

FIRST USE 4-2-2001; IN COMMERCE 4-2-2001.

LA TONIA FISHER, EXAMINING ATTORNEY

Int. Cl.: 20

Prior U.S. Cls.: 2, 13, 22, 25, 32 and 50

United States Patent and Trademark Office

Reg. No. 3,397,894

Registered Mar. 18, 2008

**TRADEMARK
PRINCIPAL REGISTER**



NATURE INSPIRES MANUFACTURE, INC.
(NEW YORK CORPORATION)
17TH FLOOR
90 PARK AVENUE
NEW YORK, NY 10016

FIRST USE 7-9-2007; IN COMMERCE 7-9-2007.

SER. NO. 77-228,546, FILED 7-12-2007.

FOR: FURNITURE, IN CLASS 20 (U.S. CLS. 2, 13,
22, 25, 32 AND 50).

MELVIN AXILBUND, EXAMINING ATTORNEY

Int. Cl.: 41

Prior U.S. Cls.: 100, 101 and 107

United States Patent and Trademark Office

Reg. No. 3,397,895

Registered Mar. 18, 2008

**SERVICE MARK
PRINCIPAL REGISTER**

THE YARD

THE YARD, INC. (MASSACHUSETTS NON-
PROFIT CORPORATION)
P.O. BOX 405
CHILMARK, MA 02535

FOR: EDUCATIONAL SERVICES, NAMELY,
WORKSHOPS AND RESIDENCIES IN THE FIELD
OF DANCE AND CHOREOGRAPHY; ENTERTAIN-
MENT SERVICES, NAMELY, LIVE PERFORMAN-
CES FEATURING DANCE, FILM, MUSIC,
THEATER AND VISUAL ARTS, IN CLASS 41 (U.S.
CLS. 100, 101 AND 107).

FIRST USE 0-0-1973; IN COMMERCE 0-0-1973.

THE MARK CONSISTS OF STANDARD CHAR-
ACTERS WITHOUT CLAIM TO ANY PARTICULAR
FONT, STYLE, SIZE, OR COLOR.

SER. NO. 77-228,555, FILED 7-12-2007.

APRIL ROACH, EXAMINING ATTORNEY

Int. Cl.: 36

Prior U.S. Cls.: 100, 101 and 102

United States Patent and Trademark Office

Reg. No. 3,397,896

Registered Mar. 18, 2008

**SERVICE MARK
PRINCIPAL REGISTER**

Nation's Choice Realty

WILLIAMS, DEBRA JEAN (UNITED STATES INDIVIDUAL)
11340 EAGLE DRIVE, SUITE 3
BAYTOWN, TX 77520

FOR: LAND ACQUISITION, NAMELY, REAL ESTATE BROKERAGE; LEASING OF REAL ESTATE; LEASING OF REAL PROPERTY; PROVIDING INFORMATION IN THE FIELD OF REAL ESTATE BY MEANS OF LINKING THE WEB SITE TO OTHER WEB SITES FEATURING REAL ESTATE INFORMATION; PROVIDING INFORMATION IN THE FIELD OF REAL ESTATE VIA THE INTERNET; PROVIDING REAL ESTATE LISTINGS AND REAL ESTATE INFORMATION VIA THE INTERNET; REAL ESTATE ACQUISITION SERVICES; REAL ESTATE AGENCIES; REAL ESTATE BROKERAGE; REAL ESTATE CONSULTANCY; REAL ESTATE CONSULTATION; REAL ESTATE INVESTMENT SERVICES IN THE NATURE OF PURCHASING

AND SELLING OF REAL ESTATE FOR OTHERS; REAL ESTATE LISTING; REAL ESTATE MANAGEMENT; REAL ESTATE MANAGEMENT CONSULTATION; REAL ESTATE PROCUREMENT FOR OTHERS, IN CLASS 36 (U.S. CLS. 100, 101 AND 102).

FIRST USE 6-1-2006; IN COMMERCE 7-1-2006.

THE MARK CONSISTS OF STANDARD CHARACTERS WITHOUT CLAIM TO ANY PARTICULAR FONT, STYLE, SIZE, OR COLOR.

NO CLAIM IS MADE TO THE EXCLUSIVE RIGHT TO USE "REALTY", APART FROM THE MARK AS SHOWN.

SER. NO. 77-228,637, FILED 7-12-2007.

ESTHER A. BORSUK, EXAMINING ATTORNEY

Int. Cl.: 44

Prior U.S. Cls.: 100 and 101

United States Patent and Trademark Office

Reg. No. 3,397,897

Registered Mar. 18, 2008

SERVICE MARK
PRINCIPAL REGISTER



EXECUTIVE TURF MANAGEMENT, INC.
(GEORGIA CORPORATION)
6235 STERLING DRIVE
SUWANEE, GA 30024

FOR: LANDSCAPE DESIGN; LANDSCAPE GARDENING; LAWN CARE, IN CLASS 44 (U.S. CLS. 100 AND 101).

FIRST USE 4-1-2006; IN COMMERCE 4-1-2006.

NO CLAIM IS MADE TO THE EXCLUSIVE RIGHT TO USE "TURF MANAGEMENT, INC.", APART FROM THE MARK AS SHOWN.

THE MARK CONSISTS OF THE WORDS EXECUTIVE TURF MANAGEMENT, INC. IN A STYLIZED TEXT WITH A STEM AND LEAF.

SER. NO. 77-228,665, FILED 7-12-2007.

JOHN WILKE, EXAMINING ATTORNEY

Int. Cl.: 25

Prior U.S. Cls.: 22 and 39

United States Patent and Trademark Office

Reg. No. 3,397,898

Registered Mar. 18, 2008

TRADEMARK
PRINCIPAL REGISTER



MEREDITH GARRETT (UNITED STATES INDIVIDUAL)
SUITE 307
501 NORTH ROSSMORE AVENUE
LOS ANGELES, CA 90004

FOR: ANKLE SOCKS; BANDANAS; BEACH FOOTWEAR; BEACHWEAR; BELTS; BIKINIS; BLOUSES; BODY SUITS; BOXER SHORTS; BRAS; CAPRIS; CHEMISETTES; COVERUPS; DRESSES; FLEECE PULLOVERS; FLEECE SHORTS; FLIP FLOPS; FOOTWEAR; GARTERS; GLOVES; HALTER TOPS; HATS; HOSIERY; JEANS; KNIT SHIRTS; LADIES' UNDERWEAR; LONG JACKETS; MINISKIRTS; NIGHT SHIRTS; NIGHTDRESSES; PAJAMAS; PANTS; ROBES; SHIRTS; SHOES; SHORT-SLEEVED OR LONG-SLEEVED T-SHIRTS; SHORTS;

SLEEPWEAR; SLIPPERS; SNEAKERS; SPORTS BRA; SWEAT PANTS; SWEAT SHIRTS; SWEATERS; SWIM WEAR; TANK TOPS; THERMAL UNDERWEAR, IN CLASS 25 (U.S. CLS. 22 AND 39).

FIRST USE 4-1-2005; IN COMMERCE 1-30-2006.

THE MARK CONSISTS OF THE MARK CONSISTS OF THE LETTER "S" SURROUNDED BY WINGS APPEARING AT THE UPPER PORTION OF THE MARK.

SER. NO. 77-228,670, FILED 7-12-2007.

LA TONIA FISHER, EXAMINING ATTORNEY

Int. Cl.: 35

Prior U.S. Cls.: 100, 101 and 102

United States Patent and Trademark Office

Reg. No. 3,397,899

Registered Mar. 18, 2008

**SERVICE MARK
PRINCIPAL REGISTER**

PROJECTGROUND

PROJECTGROUND, INC. (VIRGINIA CORPORATION)
11084 PELHAM MANOR PLACE
RESTON, VA 20194

FOR: BUSINESS SERVICES, NAMELY, PROVIDING AN ONLINE MARKETPLACE FOR BUYERS AND SELLERS OF GOODS AND/OR SERVICES ON A GLOBAL COMPUTER NETWORK; ADVERTISING THE GOODS AND SERVICES OF OTHERS VIA A WEBSITE ON A GLOBAL COMPUTER NETWORK, IN CLASS 35 (U.S. CLS. 100, 101 AND 102).

FIRST USE 7-0-2007; IN COMMERCE 7-0-2007.

THE MARK CONSISTS OF STANDARD CHARACTERS WITHOUT CLAIM TO ANY PARTICULAR FONT, STYLE, SIZE, OR COLOR.

SER. NO. 77-228,735, FILED 7-12-2007.

SHARON MEIER, EXAMINING ATTORNEY

Int. Cl.: 9

Prior U.S. Cls.: 21, 23, 26, 36 and 38

Reg. No. 3,397,900

United States Patent and Trademark Office

Registered Mar. 18, 2008

**TRADEMARK
PRINCIPAL REGISTER**

3 Bad Brothaz

PAYES, AARON T (GEORGIA LTD LIAB CO)
116 BRADSHAW PARK DR.
WOODSTOCK, GA 30188

FOR: COMPACT DISC PLAYERS; DOWNLOADABLE MP3 FILES, MP3 RECORDINGS, ONLINE DISCUSSION BOARDS, WEB CASTS, POD CASTS FEATURING MUSIC, AUDIO BOOKS AND NEWS BROADCASTS; DOWNLOADABLE MUSICAL SOUND RECORDINGS; DOWNLOADABLE RING TONES, GRAPHICS AND MUSIC VIA A GLOBAL COMPUTER NETWORK AND WIRELESS DEVICES; DOWNLOADABLE VIDEO RECORDINGS FEATURING MUSIC CONSISTING OF MUSIC VIDEOS FILMS VIDEO PODCASTS; DOWNLOADABLE MUSIC CONSISTING OF MP3S PODCASTS VIA THE INTERNET AND WIRELESS DEVICES; MUSIC RECORDINGS SOLD AS A KIT WITH A MASK; MUSICAL SOUND RECORDINGS; MUSICAL VIDEO RECORDINGS; PROTECTIVE CARRYING

CASES FOR PORTABLE MUSIC PLAYERS NAMELY MP3 PLAYERS; SOUND RECORDINGS FEATURING MUSIC CONSISTING OF VINYL RECORDINGS CASSETTES COMPACT DISCS MP3 DOWNLOADS; VIDEO RECORDINGS FEATURING MUSIC CONSISTING OF MUSIC VIDEOS FILMS VIDEO PODCASTS, IN CLASS 9 (U.S. CLS. 21, 23, 26, 36 AND 38).

FIRST USE 1-1-2002; IN COMMERCE 5-1-2003.

THE MARK CONSISTS OF STANDARD CHARACTERS WITHOUT CLAIM TO ANY PARTICULAR FONT, STYLE, SIZE, OR COLOR.

SER. NO. 77-228,756, FILED 7-12-2007.

WARREN L. OLANDRIA, EXAMINING ATTORNEY

Int. Cl.: 41

Prior U.S. Cls.: 100, 101 and 107

United States Patent and Trademark Office

Reg. No. 3,397,901

Registered Mar. 18, 2008

**SERVICE MARK
PRINCIPAL REGISTER**

The Bay State

THE BAY STATE (MAINE JOINT VENTURE)
93 HONEYMAN AVE.
MIDDLETOWN, RI 02842

FIRST USE 10-21-2004; IN COMMERCE 3-3-2005.

FOR: ENTERTAINMENT IN THE NATURE OF VISUAL AND AUDIO PERFORMANCES, NAMELY, MUSICAL BAND, ROCK GROUP, GYMNASTIC, DANCE, AND BALLET PERFORMANCES; ENTERTAINMENT NAMELY, LIVE PERFORMANCES BY A MUSICAL BAND, IN CLASS 41 (U.S. CLS. 100, 101 AND 107).

THE MARK CONSISTS OF STANDARD CHARACTERS WITHOUT CLAIM TO ANY PARTICULAR FONT, STYLE, SIZE, OR COLOR.

SER. NO. 77-228,760, FILED 7-13-2007.

TINA KUAN, EXAMINING ATTORNEY

Int. Cl.: 40

Prior U.S. Cls.: 100, 103 and 106

United States Patent and Trademark Office

Reg. No. 3,397,902

Registered Mar. 18, 2008

**SERVICE MARK
PRINCIPAL REGISTER**

STOP-N-GO LINE

GOLDEN APPLIXX CO., INC. (CALIFORNIA
CORPORATION)
128 BRENT CIRCLE
INDUSTRY, CA 91789

THE MARK CONSISTS OF STANDARD CHAR-
ACTERS WITHOUT CLAIM TO ANY PARTICULAR
FONT, STYLE, SIZE, OR COLOR.

FOR: CUSTOMIZED PRINTING OF COMPANY
NAMES AND LOGOS FOR PROMOTIONAL AND
ADVERTISING PURPOSES ON THE GOODS OF
OTHERS, IN CLASS 40 (U.S. CLS. 100, 103 AND 106).

SER. NO. 77-228,767, FILED 7-13-2007.

FIRST USE 1-1-2002; IN COMMERCE 1-1-2002.

DEIRDRE ROBERTSON, EXAMINING ATTORNEY

Int. Cl.: 28

Prior U.S. Cls.: 22, 23, 38 and 50

United States Patent and Trademark Office

Reg. No. 3,397,903

Registered Mar. 18, 2008

**TRADEMARK
PRINCIPAL REGISTER**

BrickArms

BRICKARMS LLC (WASHINGTON LTD LIAB
CO)
10816 158TH CT NE
REDMOND, WA 98052

THE MARK CONSISTS OF STANDARD CHAR-
ACTERS WITHOUT CLAIM TO ANY PARTICULAR
FONT, STYLE, SIZE, OR COLOR.

FOR: TOY ACTION FIGURES AND ACCESSOR-
IES THEREFOR, IN CLASS 28 (U.S. CLS. 22, 23, 38
AND 50).

SER. NO. 77-228,775, FILED 7-13-2007.

FIRST USE 6-1-2006; IN COMMERCE 6-1-2006.

DEIRDRE ROBERTSON, EXAMINING ATTORNEY

Int. Cl.: 9

Prior U.S. Cls.: 21, 23, 26, 36 and 38

Reg. No. 3,397,904

United States Patent and Trademark Office

Registered Mar. 18, 2008

**TRADEMARK
PRINCIPAL REGISTER**

Toilet Tunes

GREEN, LEWIS A (UNITED STATES INDIVIDUAL)
SUITE 913
3300 NE 192 STREET
AVENTURA, FL 33180

FOR: ELECTRONIC DEVICE THAT WILL AUTOMATICALLY PLAY PLEASING OR NATURE SOUNDS WHENEVER A CONSUMER USES HIS/HER TOILET, IN CLASS 9 (U.S. CLS. 21, 23, 26, 36 AND 38).

FIRST USE 1-4-2007; IN COMMERCE 6-26-2007.

THE MARK CONSISTS OF STANDARD CHARACTERS WITHOUT CLAIM TO ANY PARTICULAR FONT, STYLE, SIZE, OR COLOR.

NO CLAIM IS MADE TO THE EXCLUSIVE RIGHT TO USE "TOILET", APART FROM THE MARK AS SHOWN.

SER. NO. 77-228,778, FILED 7-13-2007.

DEIRDRE ROBERTSON, EXAMINING ATTORNEY

Int. Cl.: 42

Prior U.S. Cls.: 100 and 101

United States Patent and Trademark Office

Reg. No. 3,397,905

Registered Mar. 18, 2008

**SERVICE MARK
PRINCIPAL REGISTER**

UtiliTeam

ZAPDOT INTERACTIVE, LLC (DELAWARE LTD
LIAB CO)
ONE TANGLEWOOD ROAD
NORTH SMITHFIELD, RI 02896

FOR: COMPUTER SERVICES, NAMELY, HOSTING AND MAINTAINING AN INTERNET WEBSITE TO BE USED BY OTHERS TO MANAGE ONLINE COMPETITIVE VIDEO GAMING TEAMS; PROVIDING ONLINE NON-DOWNLOADABLE SOFTWARE FOR THOSE WHO PARTICIPATE IN VIDEO GAMES ONLINE IN A COMPETITIVE TEAM ENVIRONMENT, IN CLASS 42 (U.S. CLS. 100 AND 101).

FIRST USE 11-22-2006; IN COMMERCE 5-14-2007.

THE MARK CONSISTS OF STANDARD CHARACTERS WITHOUT CLAIM TO ANY PARTICULAR FONT, STYLE, SIZE, OR COLOR.

SER. NO. 77-228,804, FILED 7-13-2007.

GINA HAYES, EXAMINING ATTORNEY

Int. Cl.: 42

Prior U.S. Cls.: 100 and 101

United States Patent and Trademark Office

Reg. No. 3,397,906

Registered Mar. 18, 2008

**SERVICE MARK
PRINCIPAL REGISTER**

Focus On Your Game

ZAPDOT INTERACTIVE, LLC (DELAWARE LTD
LIAB CO)
ONE TANGLEWOOD ROAD
NORTH SMITHFIELD, RI 02896

FOR: COMPUTER SERVICES, NAMELY, HOSTING AND MAINTAINING AN INTERNET WEBSITE TO BE USED BY OTHERS TO MANAGE ONLINE COMPETITIVE VIDEO GAMING TEAMS; PROVIDING ONLINE NON-DOWNLOADABLE SOFTWARE FOR THOSE WHO PARTICIPATE IN VIDEO GAMES ONLINE IN A COMPETITIVE TEAM ENVIRONMENT, IN CLASS 42 (U.S. CLS. 100 AND 101).

FIRST USE 11-22-2006; IN COMMERCE 5-14-2007.

THE MARK CONSISTS OF STANDARD CHARACTERS WITHOUT CLAIM TO ANY PARTICULAR FONT, STYLE, SIZE, OR COLOR.

SER. NO. 77-228,819, FILED 7-13-2007.

GINA HAYES, EXAMINING ATTORNEY

Int. Cl.: 19

Prior U.S. Cls.: 1, 12, 33 and 50

United States Patent and Trademark Office

Reg. No. 3,397,907

Registered Mar. 18, 2008

**TRADEMARK
PRINCIPAL REGISTER**

MacBag

MACCAFERRI, INC. (MARYLAND CORPORATION)
10303 GOVERNOR LAND BLVD.
WILLIAMSPORT, MD 21795

THE COLOR(S) GREEN IS/ARE CLAIMED AS A FEATURE OF THE MARK.

FOR: GEOTEXTILES FOR THE PURPOSES OF DRAINAGE, STABILIZING INCLINES, RECULTIVATION, PLANT SUPPORT, ABSORPTION, FILTRATION, SEPARATION, STABILIZATION AND REINFORCEMENT OF THE SOIL, IN CLASS 19 (U.S. CLS. 1, 12, 33 AND 50).

THE MARK CONSISTS OF THE WORDING MACBAG IN GREEN.

SER. NO. 77-228,830, FILED 7-13-2007.

FIRST USE 6-1-2007; IN COMMERCE 6-1-2007.

KRISTIN DAHLING, EXAMINING ATTORNEY

Int. Cl.: 33

Prior U.S. Cls.: 47 and 49

United States Patent and Trademark Office

Reg. No. 3,397,908

Registered Mar. 18, 2008

**TRADEMARK
PRINCIPAL REGISTER**

MOOSE VALLEY VINEYARD

STEPHENS & COMPANY (CALIFORNIA CORPORATION), DBA D.R. STEPHENS ESTATE
1860 HOWELL MOUNTAIN ROAD
ST. HELENA, CA 94574

NO CLAIM IS MADE TO THE EXCLUSIVE RIGHT TO USE "VINEYARD", APART FROM THE MARK AS SHOWN.

FOR: WINES, IN CLASS 33 (U.S. CLS. 47 AND 49).

FIRST USE 1-12-2004; IN COMMERCE 1-12-2004.

SER. NO. 77-228,836, FILED 7-13-2007.

THE MARK CONSISTS OF STANDARD CHARACTERS WITHOUT CLAIM TO ANY PARTICULAR FONT, STYLE, SIZE, OR COLOR.

ELLEN PERKINS, EXAMINING ATTORNEY

Int. Cl.: 42

Prior U.S. Cls.: 100 and 101

United States Patent and Trademark Office

Reg. No. 3,397,909

Registered Mar. 18, 2008

**SERVICE MARK
PRINCIPAL REGISTER**

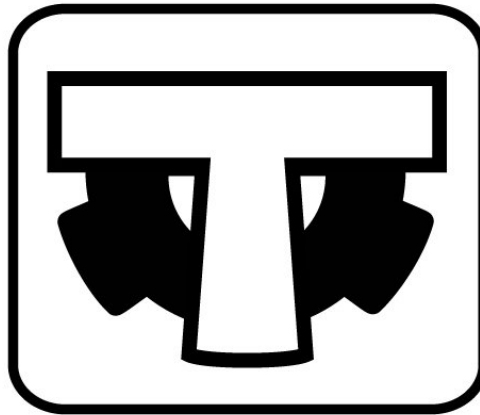

ZAPDOT INTERACTIVE, LLC (DELAWARE LTD
LIAB CO)
ONE TANGLEWOOD ROAD
NORTH SMITHFIELD, RI 02896

FOR: COMPUTER SERVICES, NAMELY, HOST-
ING AND MAINTAINING AN INTERNET WEBSITE
TO BE USED BY OTHERS TO MANAGE ONLINE
COMPETITIVE VIDEO GAMING TEAMS; PROVID-
ING ONLINE NON-DOWNLOADABLE SOFTWARE
FOR THOSE WHO PARTICIPATE IN VIDEO GAMES

ONLINE IN A COMPETITIVE TEAM ENVIRON-
MENT, IN CLASS 42 (U.S. CLS. 100 AND 101).

FIRST USE 5-15-2005; IN COMMERCE 5-14-2007.

THE MARK CONSISTS OF A STYLIZED LETTER
T.

SER. NO. 77-228,843, FILED 7-13-2007.

GINA HAYES, EXAMINING ATTORNEY

Int. Cl.: 42

Prior U.S. Cls.: 100 and 101

United States Patent and Trademark Office

Reg. No. 3,397,910

Registered Mar. 18, 2008

**SERVICE MARK
PRINCIPAL REGISTER**

Glam Squad Decorators

FULLER, CHEVON (UNITED STATES INDIVIDUAL)
321 DOVER WAY CT.
ELLISVILLE, MO 63021

FOR: DESIGN OF SPECIALTY INTERIOR AND EXTERIOR ENVIRONMENT SETTINGS, IN CLASS 42 (U.S. CLS. 100 AND 101).

FIRST USE 7-13-2007; IN COMMERCE 7-13-2007.

THE MARK CONSISTS OF STANDARD CHARACTERS WITHOUT CLAIM TO ANY PARTICULAR FONT, STYLE, SIZE, OR COLOR.

NO CLAIM IS MADE TO THE EXCLUSIVE RIGHT TO USE "DECORATORS", APART FROM THE MARK AS SHOWN.

SER. NO. 77-228,859, FILED 7-13-2007.

MICHAEL TANNER, EXAMINING ATTORNEY

Int. Cl.: 5

Prior U.S. Cls.: 6, 18, 44, 46, 51 and 52

Reg. No. 3,397,911

United States Patent and Trademark Office

Registered Mar. 18, 2008

**TRADEMARK
PRINCIPAL REGISTER**

HONGOCHAN

CACERES, AUGUSTO B. (CALIFORNIA SOLE
PROPRIETORSHIP), DBA ABC BEAUTY
WHOLESALE
3139 WEST 178TH STREET
TORRANCE, CA 90504

THE MARK CONSISTS OF STANDARD CHAR-
ACTERS WITHOUT CLAIM TO ANY PARTICULAR
FONT, STYLE, SIZE, OR COLOR.

FOR: ANTI-FUNGAL MATERIAL, NAMELY,
ANTI-FUNGAL MEDICATION, IN CLASS 5 (U.S.
CLS. 6, 18, 44, 46, 51 AND 52).

SER. NO. 77-228,883, FILED 7-13-2007.

FIRST USE 2-0-2004; IN COMMERCE 2-0-2004.

MICHAEL TANNER, EXAMINING ATTORNEY

Int. Cl.: 35

Prior U.S. Cls.: 100, 101 and 102

United States Patent and Trademark Office

Reg. No. 3,397,912

Registered Mar. 18, 2008

**SERVICE MARK
PRINCIPAL REGISTER**



THREESIXTY SOURCING LTD. (BR.VIRGIN ISLANDS CORPORATION)
C/O CRAIGMUIR CHAMBERS
P.O. BOX 71 ROAD TOWN
TORTOLA, BR.VIRGIN ISLANDS

FOR: GLOBAL SOURCING SERVICES, NAMELY, LOCATING AND PROCURING FOR OTHERS BUYER-SPECIFIED PRODUCTS ON A FULLY OUT-SOURCED BASIS FOR CONSUMER-BRANDED HARD GOODS COMPANIES, IN CLASS 35 (U.S. CLS. 100, 101 AND 102).

FIRST USE 8-0-2003; IN COMMERCE 8-0-2003.

OWNER OF U.S. REG. NO. 3,101,168.

NO CLAIM IS MADE TO THE EXCLUSIVE RIGHT TO USE "SOURCING", APART FROM THE MARK AS SHOWN.

THE MARK CONSISTS OF THE WORDS "THREESIXTY SOURCING" ENCLOSED BY TWO CIRCLES.

SER. NO. 77-228,887, FILED 7-13-2007.

SUNG IN, EXAMINING ATTORNEY

Int. Cl.: 30

Prior U.S. Cl.: 46

United States Patent and Trademark Office

Reg. No. 3,397,913

Registered Mar. 18, 2008

**TRADEMARK
PRINCIPAL REGISTER**

CIN-A-MOLLY'S

TAMOLLY'S MEXICAN RESTAURANT OF
AMERICA, LTD. (TEXAS CORPORATION)
P.O. BOX 5751
TEXARKANA, TX 75503

FOR: BAKERY DESSERT, IN CLASS 30 (U.S. CL.
46).

FIRST USE 2-20-2006; IN COMMERCE 2-20-2006.

THE MARK CONSISTS OF STANDARD CHAR-
ACTERS WITHOUT CLAIM TO ANY PARTICULAR
FONT, STYLE, SIZE, OR COLOR.

SER. NO. 77-228,897, FILED 7-13-2007.

CHRISTOPHER BUONGIORNO, EXAMINING AT-
TORNEY

Int. Cl.: 36

Prior U.S. Cls.: 100, 101 and 102

United States Patent and Trademark Office

Reg. No. 3,397,914

Registered Mar. 18, 2008

**SERVICE MARK
PRINCIPAL REGISTER**

NATIONAL PROBATE RESCUE

NATIONAL PROBATE RESCUE, INC. (FLORIDA CORPORATION)
222 S. CANDLER AVENUE
ORLANDO, FL 32856

FOR: FINANCIAL INVESTMENT IN THE FIELD OF REAL ESTATE; REAL ESTATE CONSULTANCY; REAL ESTATE CONSULTATION; REAL ESTATE INVESTMENT; FINANCIAL SERVICES, NAMELY ESTATE SETTLEMENT SERVICES; FINANCIAL VALUATION OF PERSONAL PROPERTY AND REAL ESTATE; LAND ACQUISITION, NAMELY, REAL ESTATE BROKERAGE; REAL ESTATE ACQUISITION SERVICES, IN CLASS 36 (U.S. CLS. 100, 101 AND 102).

FIRST USE 3-8-2006; IN COMMERCE 3-8-2006.

THE MARK CONSISTS OF STANDARD CHARACTERS WITHOUT CLAIM TO ANY PARTICULAR FONT, STYLE, SIZE, OR COLOR.

NO CLAIM IS MADE TO THE EXCLUSIVE RIGHT TO USE "NATIONAL PROBATE", APART FROM THE MARK AS SHOWN.

SER. NO. 77-228,908, FILED 7-13-2007.

FRED MANDIR, EXAMINING ATTORNEY

Int. Cl.: 36

Prior U.S. Cls.: 100, 101 and 102

United States Patent and Trademark Office

Reg. No. 3,397,915

Registered Mar. 18, 2008

**SERVICE MARK
PRINCIPAL REGISTER**

PROBATE RESCUE

NATIONAL PROBATE RESCUE, INC. (FLORIDA CORPORATION)
222 S. CANDLER AVENUE
ORLANDO, FL 32856

FOR: FINANCIAL INVESTMENT IN THE FIELD OF REAL ESTATE; FINANCIAL SERVICES, NAMELY ESTATE SETTLEMENT SERVICES; FINANCIAL VALUATION OF PERSONAL PROPERTY AND REAL ESTATE; LAND ACQUISITION, NAMELY, REAL ESTATE BROKERAGE; REAL ESTATE ACQUISITION SERVICES; REAL ESTATE CONSULTANCY; REAL ESTATE CONSULTATION; REAL ESTATE INVESTMENT, IN CLASS 36 (U.S. CLS. 100, 101 AND 102).

FIRST USE 3-8-2006; IN COMMERCE 3-8-2006.

THE MARK CONSISTS OF STANDARD CHARACTERS WITHOUT CLAIM TO ANY PARTICULAR FONT, STYLE, SIZE, OR COLOR.

NO CLAIM IS MADE TO THE EXCLUSIVE RIGHT TO USE "PROBATE", APART FROM THE MARK AS SHOWN.

SER. NO. 77-228,923, FILED 7-13-2007.

FRED MANDIR, EXAMINING ATTORNEY

Int. Cl.: 12

Prior U.S. Cls.: 19, 21, 23, 31, 35 and 44

Reg. No. 3,397,916

United States Patent and Trademark Office

Registered Mar. 18, 2008

**TRADEMARK
PRINCIPAL REGISTER**

RISK RACING

BISS PRODUCT DEVELOPMENT LLC (NORTH
CAROLINA LTD LIAB CO)
200 OVERHILL DR. SUITE C
MOORESVILLE, NC 28117

FOR: (BASED ON USE IN COMMERCE) MOTOR-
CYCLE KICKSTANDS, IN CLASS 12 (U.S. CLS. 19, 21,
23, 31, 35 AND 44).

FIRST USE 1-15-2000; IN COMMERCE 2-1-2000.

THE MARK CONSISTS OF STANDARD CHAR-
ACTERS WITHOUT CLAIM TO ANY PARTICULAR
FONT, STYLE, SIZE, OR COLOR.

NO CLAIM IS MADE TO THE EXCLUSIVE
RIGHT TO USE "RACING", APART FROM THE
MARK AS SHOWN.

SER. NO. 77-228,931, FILED 7-13-2007.

FRED MANDIR, EXAMINING ATTORNEY

Int. Cl.: 9

Prior U.S. Cls.: 21, 23, 26, 36 and 38

United States Patent and Trademark Office

Reg. No. 3,397,917

Registered Mar. 18, 2008

**TRADEMARK
PRINCIPAL REGISTER**

CHANGEGEAR

SUNVIEW SOFTWARE, INC. (FLORIDA CORPORATION)
SUITE 115
18302 HIGHWOODS PRESERVE PARKWAY
TAMPA, FL 33647

FOR: COMPUTER SOFTWARE THAT AUTOMATES, TRACKS, MANAGES AND CONTROLS CHANGES TO IT INFRASTRUCTURES, IN CLASS 9 (U.S. CLS. 21, 23, 26, 36 AND 38).

FIRST USE 7-19-2004; IN COMMERCE 7-19-2004.

THE MARK CONSISTS OF STANDARD CHARACTERS WITHOUT CLAIM TO ANY PARTICULAR FONT, STYLE, SIZE, OR COLOR.

SER. NO. 77-228,949, FILED 7-13-2007.

BARBARA GAYNOR, EXAMINING ATTORNEY

Int. Cls.: 40 and 42

Prior U.S. Cls.: 100, 101, 103 and 106

United States Patent and Trademark Office

Reg. No. 3,397,918

Registered Mar. 18, 2008

**SERVICE MARK
PRINCIPAL REGISTER**

JABIL

JABIL CIRCUIT, INC. (DELAWARE CORPORATION)
10800 ROOSEVELT BOULEVARD
ST. PETERSBURG, FL 33716

FOR: CUSTOM MANUFACTURE OF ELECTRONIC CIRCUIT BOARDS AND SYSTEMS FOR THE COMMUNICATIONS, PERSONAL COMPUTER, COMPUTER PERIPHERAL, AUTOMOTIVE AND CONSUMER PRODUCT MARKETS, IN CLASS 40 (U.S. CLS. 100, 103 AND 106).

FIRST USE 7-0-2006; IN COMMERCE 7-0-2006.

FOR: DESIGN AND DEVELOPMENT FOR OTHERS OF ELECTRONIC CIRCUIT BOARDS AND SYSTEMS FOR THE COMMUNICATIONS, PERSONAL COMPUTER, COMPUTER PERIPHERAL, AU-

TOMOTIVE AND CONSUMER PRODUCT MARKETS, IN CLASS 42 (U.S. CLS. 100 AND 101).

FIRST USE 7-0-2006; IN COMMERCE 7-0-2006.

OWNER OF U.S. REG. NOS. 2,350,738 AND 2,582,575.

THE MARK CONSISTS OF THE WORD JABIL IN STYLIZED LETTERS, WITH THE HORIZONTAL PORTION OF THE LETTER A SHOWN AS A TRIANGULAR SHAPE WHICH EXTENDS RIGHTWARD TOWARD THE LETTER B.

SER. NO. 77-228,952, FILED 7-13-2007.

BARBARA GAYNOR, EXAMINING ATTORNEY

Int. Cl.: 35

Prior U.S. Cls.: 100, 101 and 102

United States Patent and Trademark Office

Reg. No. 3,397,919

Registered Mar. 18, 2008

**SERVICE MARK
PRINCIPAL REGISTER**

**RITZCAMERA.COM &
ELECTRONICS**

RITZ CAMERA CENTERS, INC. (DELAWARE CORPORATION)

6711 RITZ WAY

BELTSVILLE, MD 20705

FOR: ON-LINE RETAIL STORE SERVICES FEATURING COMPUTER AND ELECTRONIC GOODS, PHOTOGRAPHIC EQUIPMENT, AND PHOTOGRAPHIC SUPPLIES, IN CLASS 35 (U.S. CLS. 100, 101 AND 102).

FIRST USE 3-16-2007; IN COMMERCE 3-16-2007.

THE MARK CONSISTS OF STANDARD CHARACTERS WITHOUT CLAIM TO ANY PARTICULAR FONT, STYLE, SIZE, OR COLOR.

OWNER OF U.S. REG. NOS. 1,594,588, 2,509,769, AND 3,114,215.

NO CLAIM IS MADE TO THE EXCLUSIVE RIGHT TO USE "ELECTRONICS", APART FROM THE MARK AS SHOWN.

SER. NO. 77-228,960, FILED 7-13-2007.

MICHAEL SOUDERS, EXAMINING ATTORNEY

Int. Cl.: 45

Prior U.S. Cls.: 100 and 101

United States Patent and Trademark Office

Reg. No. 3,397,920

Registered Mar. 18, 2008

**SERVICE MARK
PRINCIPAL REGISTER**

**We Don't Just Answer the
Questions . . . We
Question the Answers**

OVED & OVED LLP (NEW YORK LIMITED
PARTNERSHIP)
15TH FLOOR
101 AVENUE OF THE AMERICAS
NEW YORK, NY 10013

THE MARK CONSISTS OF STANDARD CHAR-
ACTERS WITHOUT CLAIM TO ANY PARTICULAR
FONT, STYLE, SIZE, OR COLOR.

FOR: LEGAL SERVICES, IN CLASS 45 (U.S. CLS.
100 AND 101).

SER. NO. 77-228,963, FILED 7-13-2007.

FIRST USE 2-1-2003; IN COMMERCE 2-1-2003.

ATTIYA MALIK, EXAMINING ATTORNEY

Int. Cl.: 45

Prior U.S. Cls.: 100 and 101

United States Patent and Trademark Office

Reg. No. 3,397,921

Registered Mar. 18, 2008

**SERVICE MARK
PRINCIPAL REGISTER**

NAM

NATIONAL ARBITRATION AND MEDIATION,
INC. (NEW YORK CORPORATION)
990 STEWART AVENUE
GARDEN CITY, NY 11530

FOR: ALTERNATIVE DISPUTE RESOLUTION;
MEDIATION; LEGAL SERVICES, IN CLASS 45
(U.S. CLS. 100 AND 101).

FIRST USE 1-0-1994; IN COMMERCE 1-0-1994.

THE MARK CONSISTS OF STANDARD CHAR-
ACTERS WITHOUT CLAIM TO ANY PARTICULAR
FONT, STYLE, SIZE, OR COLOR.

OWNER OF U.S. REG. NOS. 2,106,199, 2,123,952,
AND 2,145,599.

SER. NO. 77-228,990, FILED 7-13-2007.

LA TONIA FISHER, EXAMINING ATTORNEY

Int. Cl.: 9

Prior U.S. Cls.: 21, 23, 26, 36 and 38

Reg. No. 3,397,922

United States Patent and Trademark Office

Registered Mar. 18, 2008

**TRADEMARK
PRINCIPAL REGISTER**

QoVision

QOMO HITEVISION (MICHIGAN LTD LIAB CO)
900 WILSHIRE DRIVE, SUITE 202
TROY, MI 48084

THE MARK CONSISTS OF STANDARD CHAR-
ACTERS WITHOUT CLAIM TO ANY PARTICULAR
FONT, STYLE, SIZE, OR COLOR.

FOR: COMPUTER SOFTWARE FOR CREATING,
MANAGING AND PLAYING INTERACTIVE MUL-
TIMEDIA PRESENTATIONS, IN CLASS 9 (U.S. CLS.
21, 23, 26, 36 AND 38).

SER. NO. 77-228,999, FILED 7-13-2007.

FIRST USE 12-7-2006; IN COMMERCE 12-7-2006.

LYDIA BELZER, EXAMINING ATTORNEY

Int. Cl.: 41

Prior U.S. Cls.: 100, 101 and 107

United States Patent and Trademark Office

Reg. No. 3,397,923

Registered Mar. 18, 2008

**SERVICE MARK
PRINCIPAL REGISTER**

Gateway Dog Training

GATEWAY DOG TRAINING, INC. (TEXAS CORPORATION)

1120 MEADOW RIDGE ROAD

DRIPPING SPRINGS, TX 78620

FOR: DOG TRAINING, IN CLASS 41 (U.S. CLS. 100, 101 AND 107).

FIRST USE 4-1-2004; IN COMMERCE 4-12-2004.

THE MARK CONSISTS OF STANDARD CHARACTERS WITHOUT CLAIM TO ANY PARTICULAR FONT, STYLE, SIZE, OR COLOR.

NO CLAIM IS MADE TO THE EXCLUSIVE RIGHT TO USE "DOG TRAINING", APART FROM THE MARK AS SHOWN.

SER. NO. 77-229,000, FILED 7-13-2007.

LYDIA BELZER, EXAMINING ATTORNEY

Int. Cl.: 9

Prior U.S. Cls.: 21, 23, 26, 36 and 38

Reg. No. 3,397,924

United States Patent and Trademark Office

Registered Mar. 18, 2008

**TRADEMARK
PRINCIPAL REGISTER**

BED READY

NEW AGE SYSTEMS, INC. (INDIANA COR-
PORATION)
207 OLIVE DRIVE
PRINCETON, IN 47670

THE MARK CONSISTS OF STANDARD CHAR-
ACTERS WITHOUT CLAIM TO ANY PARTICULAR
FONT, STYLE, SIZE, OR COLOR.

FOR: COMPUTER SOFTWARE FOR HOSPITAL
BED CAPACITY MANAGEMENT, IN CLASS 9 (U.S.
CLS. 21, 23, 26, 36 AND 38).

SER. NO. 77-229,022, FILED 7-13-2007.

FIRST USE 1-3-2006; IN COMMERCE 1-3-2006.

THOMAS MANOR, EXAMINING ATTORNEY

Int. Cl.: 30

Prior U.S. Cl.: 46

United States Patent and Trademark Office

Reg. No. 3,397,925

Registered Mar. 18, 2008

**TRADEMARK
PRINCIPAL REGISTER**

NOI CAFFE

WAKE UP AMERICA GROUP (FLORIDA LTD
LIAB CO)

SUITE 1

2950 GLADE CIRCLE

WESTON, FL 33327

FOR: COFFEE; COFFEE BEANS; GROUND COFFEE BEANS; ROASTED COFFEE BEANS; FRUIT TEAS; GREEN TEA; HERBAL TEA; JAPANESE GREEN TEA; TEA; TEA BAGS, IN CLASS 30 (U.S. CL. 46).

FIRST USE 1-1-2006; IN COMMERCE 1-1-2006.

THE MARK CONSISTS OF STANDARD CHARACTERS WITHOUT CLAIM TO ANY PARTICULAR FONT, STYLE, SIZE, OR COLOR.

NO CLAIM IS MADE TO THE EXCLUSIVE RIGHT TO USE "CAFFE", APART FROM THE MARK AS SHOWN.

THE FOREIGN WORDING IN THE MARK TRANSLATES INTO ENGLISH AS WE, OUR COFFEE.

SER. NO. 77-229,024, FILED 7-13-2007.

THOMAS MANOR, EXAMINING ATTORNEY

Int. Cl.: 36

Prior U.S. Cls.: 100, 101 and 102

United States Patent and Trademark Office

Reg. No. 3,397,926

Registered Mar. 18, 2008

**SERVICE MARK
PRINCIPAL REGISTER**



CLAYTON SERVICES, INC. (DELAWARE CORPORATION)
2 CORPORATE DRIVE
SHELTON, CT 06484

FOR: FINANCIAL SERVICES, NAMELY, PROVIDING LOAN AND LOAN PORTFOLIO CONSULTATION, ANALYSIS AND DUE DILIGENCE SERVICES; PROVIDING INFORMATION, EVALUATION AND ASSESSMENT OF THE COMPOSITION, PERFORMANCE, VALUE AND CREDIT AND OPERATIONAL RISKS OF LOANS AND LOAN PORTFOLIOS, IN CLASS 36 (U.S. CLS. 100, 101 AND 102).

FIRST USE 3-20-2007; IN COMMERCE 4-1-2007.

THE MARK CONSISTS OF THE WORD CLARITY IN STYLIZED FORMAT ABOVE THE WORDING SIMPLIFY. STRATIFY. PREDICT. IN SIMPLE TYPEFACE.

SER. NO. 77-229,030, FILED 7-13-2007.

THOMAS MANOR, EXAMINING ATTORNEY

Int. Cls.: 36 and 37

Prior U.S. Cls.: 100, 101, 102, 103 and 106

United States Patent and Trademark Office

Reg. No. 3,397,927

Registered Mar. 18, 2008

**SERVICE MARK
PRINCIPAL REGISTER**



OLIVERMCMILLAN, LLC (CALIFORNIA LTD
LIAB CO)
733 8TH AVENUE
SAN DIEGO, CA 92101

FOR: LEASING OF REAL PROPERTY; REAL
ESTATE INVESTMENT; REAL ESTATE MANAGE-
MENT, IN CLASS 36 (U.S. CLS. 100, 101 AND 102).

FIRST USE 5-21-2007; IN COMMERCE 5-21-2007.

FOR: REAL ESTATE DEVELOPMENT; CON-
STRUCTION SERVICES, NAMELY, PLANNING,
LAYING OUT, IMPROVEMENT, AND CONSTRUC-

TION OF RESIDENTIAL AND COMMERCIAL
REAL PROPERTIES, IN CLASS 37 (U.S. CLS. 100,
103 AND 106).

FIRST USE 5-21-2007; IN COMMERCE 5-21-2007.

NO CLAIM IS MADE TO THE EXCLUSIVE
RIGHT TO USE "HISTORIC GUASTI DISTRICT",
APART FROM THE MARK AS SHOWN.

SER. NO. 77-229,050, FILED 7-13-2007.

RENEE MCCRAY, EXAMINING ATTORNEY

Int. Cl.: 9

Prior U.S. Cls.: 21, 23, 26, 36 and 38

Reg. No. 3,397,928

United States Patent and Trademark Office

Registered Mar. 18, 2008

**TRADEMARK
PRINCIPAL REGISTER**

UltraLite ALS

CAO GROUP, INC. (UTAH CORPORATION)
4628 W SKYHAKW DRIVE
WEST JORDAN, UT 84084

FOR: SEMICONDUCTOR LIGHTS FOR THE DE-
TECTION OF FORENSIC EVIDENCE, IN CLASS 9
(U.S. CLS. 21, 23, 26, 36 AND 38).

FIRST USE 1-1-2005; IN COMMERCE 1-1-2005.

THE MARK CONSISTS OF STANDARD CHAR-
ACTERS WITHOUT CLAIM TO ANY PARTICULAR
FONT, STYLE, SIZE, OR COLOR.

NO CLAIM IS MADE TO THE EXCLUSIVE
RIGHT TO USE "ALS", APART FROM THE MARK
AS SHOWN.

SER. NO. 77-229,051, FILED 7-13-2007.

ESTHER A. BORSUK, EXAMINING ATTORNEY

Int. Cl.: 36

Prior U.S. Cls.: 100, 101 and 102

United States Patent and Trademark Office

Reg. No. 3,397,929

Registered Mar. 18, 2008

**SERVICE MARK
PRINCIPAL REGISTER**

TVALLEY

SALLS, ALAN (UNITED STATES INDIVIDUAL)
1380 RIO RANCHO DRIVE #283
RIO RANCHO, NM 87124

THE MARK CONSISTS OF STANDARD CHAR-
ACTERS WITHOUT CLAIM TO ANY PARTICULAR
FONT, STYLE, SIZE, OR COLOR.

FOR: COLLECTION AGENCIES; COLLECTION
OF DEBTS; DEBT RECOVERY AND COLLECTION
AGENCIES, IN CLASS 36 (U.S. CLS. 100, 101 AND
102).

SER. NO. 77-229,075, FILED 7-13-2007.

FIRST USE 4-1-2001; IN COMMERCE 4-1-2001.

TEJBIR SINGH, EXAMINING ATTORNEY

Int. Cl.: 35

Prior U.S. Cls.: 100, 101 and 102

United States Patent and Trademark Office

Reg. No. 3,397,930

Registered Mar. 18, 2008

**SERVICE MARK
PRINCIPAL REGISTER**

3 DEUCE BRANDING

THREE DEUCE BRANDING, LLC (OHIO LTD
LIAB CO)
3318 WALWORTH AVENUE
CINCINNATI, OH 45226

FOR: DEVELOPMENT OF MARKETING STRA-
TEGIES AND CONCEPTS, IN CLASS 35 (U.S. CLS.
100, 101 AND 102).

FIRST USE 5-18-2007; IN COMMERCE 5-18-2007.

THE MARK CONSISTS OF STANDARD CHAR-
ACTERS WITHOUT CLAIM TO ANY PARTICULAR
FONT, STYLE, SIZE, OR COLOR.

NO CLAIM IS MADE TO THE EXCLUSIVE
RIGHT TO USE "BRANDING", APART FROM THE
MARK AS SHOWN.

SER. NO. 77-229,084, FILED 7-13-2007.

MATTHEW EINSTEIN, EXAMINING ATTORNEY

Int. Cl.: 45

Prior U.S. Cls.: 100 and 101

United States Patent and Trademark Office

Reg. No. 3,397,931

Registered Mar. 18, 2008

**SERVICE MARK
PRINCIPAL REGISTER**

IPRACTICE

PROSKAUER ROSE LLP (NEW YORK LIMITED
LIABILITY PARTNERSHIP)
1585 BROADWAY
NEW YORK, NY 100368299

FOR: PROVISION OF LEGAL SERVICES IN THE
AREAS OF TECHNOLOGY, NEW MEDIA, LICEN-
SING, AND INTELLECTUAL PROPERTY CONSUL-
TATION, IN CLASS 45 (U.S. CLS. 100 AND 101).

FIRST USE 9-27-1999; IN COMMERCE 9-27-1999.

THE MARK CONSISTS OF STANDARD CHAR-
ACTERS WITHOUT CLAIM TO ANY PARTICULAR
FONT, STYLE, SIZE, OR COLOR.

OWNER OF U.S. REG. NO. 2,538,682.

SEC. 2(F).

SER. NO. 77-229,092, FILED 7-13-2007.

MICHAEL KEATING, EXAMINING ATTORNEY

Int. Cl.: 3

Prior U.S. Cls.: 1, 4, 6, 50, 51 and 52

United States Patent and Trademark Office

Reg. No. 3,397,932

Registered Mar. 18, 2008

**TRADEMARK
PRINCIPAL REGISTER**

allgone

EARTH FRIENDLY CHEMICALS, INC. (VIRGINIA CORPORATION)
977 CENTERVILLE TURNPIKE SHB 202
VIRGINIA BEACH, VA 23463

FOR: EMULSIONS FOR GENERAL PURPOSE CLEANING AND GRAFFITI REMOVAL, IN CLASS 3 (U.S. CLS. 1, 4, 6, 50, 51 AND 52).

FIRST USE 6-30-2007; IN COMMERCE 6-30-2007.

THE MARK CONSISTS OF STANDARD CHARACTERS WITHOUT CLAIM TO ANY PARTICULAR FONT, STYLE, SIZE, OR COLOR.

SER. NO. 77-229,105, FILED 7-13-2007.

AMOS T. MATTHEWS, JR., EXAMINING ATTORNEY

Int. Cl.: 9

Prior U.S. Cls.: 21, 23, 26, 36 and 38

United States Patent and Trademark Office

Reg. No. 3,397,933

Registered Mar. 18, 2008

**TRADEMARK
PRINCIPAL REGISTER**

DYNASTY

CAO GROUP, INC. (UTAH CORPORATION)
4628 W SKYHAWK DRIVE
WEST JORDAN, UT 84084

THE MARK CONSISTS OF STANDARD CHAR-
ACTERS WITHOUT CLAIM TO ANY PARTICULAR
FONT, STYLE, SIZE, OR COLOR.

FOR: LIGHT EMITTING DIODES (LEDS), IN
CLASS 9 (U.S. CLS. 21, 23, 26, 36 AND 38).

SER. NO. 77-229,113, FILED 7-13-2007.

FIRST USE 1-1-2006; IN COMMERCE 1-1-2006.

ESTHER A. BORSUK, EXAMINING ATTORNEY

Int. Cl.: 37

Prior U.S. Cls.: 100, 103 and 106

United States Patent and Trademark Office

Reg. No. 3,397,934

Registered Mar. 18, 2008

**SERVICE MARK
PRINCIPAL REGISTER**



CALLAHAN CONSTRUCTION, INC. (OKLAHOMA CORPORATION)
448 EAST STATE HIGHWAY 152
MUSTANG, OK 73064

NO CLAIM IS MADE TO THE EXCLUSIVE RIGHT TO USE "CONSTRUCTION", APART FROM THE MARK AS SHOWN.

FOR: RESIDENTIAL AND COMMERCIAL BUILDING CONSTRUCTION, IN CLASS 37 (U.S. CLS. 100, 103 AND 106).

SER. NO. 77-229,134, FILED 7-13-2007.

FIRST USE 12-0-1995; IN COMMERCE 12-0-1995.

YAT SYE, LEE, EXAMINING ATTORNEY

Int. Cl.: 35

Prior U.S. Cls.: 100, 101 and 102

Reg. No. 3,397,935

United States Patent and Trademark Office

Registered Mar. 18, 2008

**SERVICE MARK
PRINCIPAL REGISTER**

**CLEAR BRAND VISION - BOLD
BRAND IDEAS - A WINNING
HAND**

THREE DEUCE BRANDING, LLC (OHIO LTD
LIAB CO)
3318 WALWORTH AVENUE
CINCINNATI, OH 45226

THE MARK CONSISTS OF STANDARD CHAR-
ACTERS WITHOUT CLAIM TO ANY PARTICULAR
FONT, STYLE, SIZE, OR COLOR.

FOR: DEVELOPMENT OF MARKETING STRA-
TEGIES AND CONCEPTS, IN CLASS 35 (U.S. CLS.
100, 101 AND 102).

SER. NO. 77-229,143, FILED 7-13-2007.

FIRST USE 5-18-2007; IN COMMERCE 5-18-2007.

MATTHEW EINSTEIN, EXAMINING ATTORNEY

Int. Cl.: 9

Prior U.S. Cls.: 21, 23, 26, 36 and 38

United States Patent and Trademark Office

Reg. No. 3,397,936

Registered Mar. 18, 2008

**TRADEMARK
PRINCIPAL REGISTER**

MediaVista

CAO GROUP, INC. (UTAH CORPORATION)
4628 W SKYHAWK DRIVE
WEST JORDAN, UT 84084

THE MARK CONSISTS OF STANDARD CHAR-
ACTERS WITHOUT CLAIM TO ANY PARTICULAR
FONT, STYLE, SIZE, OR COLOR.

FOR: LIGHT EMITTING DIODES (LEDS), IN
CLASS 9 (U.S. CLS. 21, 23, 26, 36 AND 38).

SER. NO. 77-229,146, FILED 7-13-2007.

FIRST USE 2-1-2007; IN COMMERCE 2-1-2007.

ESTHER A. BORSUK, EXAMINING ATTORNEY

Int. Cl.: 44

Prior U.S. Cls.: 100 and 101

United States Patent and Trademark Office

Reg. No. 3,397,937

Registered Mar. 18, 2008

**SERVICE MARK
PRINCIPAL REGISTER**

PHYSICAL CAPACITY PROFILE

OCCUPATIONAL PERFORMANCE CENTER,
INC. (KANSAS CORPORATION)
519 S. SANTA FE
SALINA, KS 67401

FOR: STRENGTH TESTING AND EVALUATION
OF EMPLOYEES USING MEDICAL REVIEW,
WEIGHTS AND STRENGTH MEASURING EQUIP-
MENT TO DETERMINE JOB SUITABILITY FOR
ALL OCCUPATIONS TOGETHER WITH PROVID-
ING REPORTS THEREOF, IN CLASS 44 (U.S. CLS.
100 AND 101).

FIRST USE 6-19-2000; IN COMMERCE 6-19-2000.

THE MARK CONSISTS OF STANDARD CHAR-
ACTERS WITHOUT CLAIM TO ANY PARTICULAR
FONT, STYLE, SIZE, OR COLOR.

OWNER OF U.S. REG. NO. 2,574,715.

NO CLAIM IS MADE TO THE EXCLUSIVE
RIGHT TO USE "PROFILE", APART FROM THE
MARK AS SHOWN.

SEC. 2(F).

SER. NO. 77-229,153, FILED 7-13-2007.

MARK T. MULLEN, EXAMINING ATTORNEY

Int. Cl.: 9

Prior U.S. Cls.: 21, 23, 26, 36 and 38

United States Patent and Trademark Office

Reg. No. 3,397,938

Registered Mar. 18, 2008

**TRADEMARK
PRINCIPAL REGISTER**

MVADS

BILLY AZBELL ELECTRONICS, INC. (TEXAS
CORPORATION)
P.O. BOX 5992
FT. HOOD, TX 76544

THE MARK CONSISTS OF STANDARD CHAR-
ACTERS WITHOUT CLAIM TO ANY PARTICULAR
FONT, STYLE, SIZE, OR COLOR.

FOR: ELECTRONIC DEVICES, NAMELY, CUS-
TOMIZED COMPUTER NETWORKING HARD-
WARE AND RADIO REMOTE CONTROLS, IN
CLASS 9 (U.S. CLS. 21, 23, 26, 36 AND 38).

SER. NO. 77-229,180, FILED 7-13-2007.

FIRST USE 1-1-2000; IN COMMERCE 1-1-2000.

TEJBIR SINGH, EXAMINING ATTORNEY

Int. Cl.: 32

Prior U.S. Cls.: 45, 46 and 48

United States Patent and Trademark Office

Reg. No. 3,397,939

Registered Mar. 18, 2008

**TRADEMARK
PRINCIPAL REGISTER**

BOLT

206 MACOPIN CORP (NEW JERSEY CORPORATION)
206 MACOPIN RD
BLOOMINGDALE, NJ 07403

FOR: ENERGY DRINKS, IN CLASS 32 (U.S. CLS. 45, 46 AND 48).

FIRST USE 10-6-2006; IN COMMERCE 10-6-2006.

THE MARK CONSISTS OF STANDARD CHARACTERS WITHOUT CLAIM TO ANY PARTICULAR FONT, STYLE, SIZE, OR COLOR.

OWNER OF U.S. REG. NOS. 1,627,946, 3,139,201 AND OTHERS.

SER. NO. 77-229,215, FILED 7-13-2007.

MICHELE SWAIN, EXAMINING ATTORNEY

Int. Cl.: 36

Prior U.S. Cls.: 100, 101 and 102

United States Patent and Trademark Office

Reg. No. 3,397,940

Registered Mar. 18, 2008

SERVICE MARK
PRINCIPAL REGISTER



PACIFICRATE
MORTGAGE INC

PACIFIC RATE MORTGAGE, INC. (CALIFORNIA CORPORATION)

16 CAMBRIDGE CT.

TRABUCO CANYON, CA 92679

FOR: MORTGAGE BANKING SERVICES, NAME-
LY, ORIGINATION, ACQUISITION, SERVICING,
SECURITIZATION AND BROKERAGE OF MORT-
GAGE LOANS, IN CLASS 36 (U.S. CLS. 100, 101 AND
102).

FIRST USE 4-19-2007; IN COMMERCE 4-19-2007.

NO CLAIM IS MADE TO THE EXCLUSIVE
RIGHT TO USE "MORTGAGE INC", APART FROM
THE MARK AS SHOWN.

THE MARK CONSISTS OF THE WORDS PACIFI-
CRATE MORTGAGE INC IN A STYLIZED TEXT
WITH A CIRCLE WITH THE TOP PART SEPER-
ATED FROM THE BOTTOM. THE TOP IS THE SKY,
AND THE BOTTOM SECTION IS A HOUSE AND
LAWN WITH A DOOR.

SER. NO. 77-229,243, FILED 7-13-2007.

STEVEN R. FINE, EXAMINING ATTORNEY

Int. Cl.: 30

Prior U.S. Cl.: 46

United States Patent and Trademark Office

Reg. No. 3,397,941

Registered Mar. 18, 2008

**TRADEMARK
PRINCIPAL REGISTER**

TRULY SUGAR FREE

LANDIES CANDIES CO., INC. (NEW YORK
CORPORATION)
SUITE 350
2495 MAIN STREET
BUFFALO, NY 14214

FOR: COOKIES; CHOCOLATES; CHOCOLATE
COVERED NUTS; AND CHOCOLATE COVERED
PRETZELS, IN CLASS 30 (U.S. CL. 46).

FIRST USE 4-18-1994; IN COMMERCE 4-18-1994.

THE MARK CONSISTS OF STANDARD CHAR-
ACTERS WITHOUT CLAIM TO ANY PARTICULAR
FONT, STYLE, SIZE, OR COLOR.

OWNER OF U.S. REG. NO. 1,911,626.

NO CLAIM IS MADE TO THE EXCLUSIVE
RIGHT TO USE "SUGAR FREE", APART FROM
THE MARK AS SHOWN.

SER. NO. 77-229,246, FILED 7-13-2007.

BONNIE LUKEN, EXAMINING ATTORNEY

Int. Cl.: 3

Prior U.S. Cls.: 1, 4, 6, 50, 51 and 52

Reg. No. 3,397,942

United States Patent and Trademark Office

Registered Mar. 18, 2008

**TRADEMARK
PRINCIPAL REGISTER**

ERMINIA ESSENCE

CASTANEDA, ERMINIA (UNITED STATES IN-
DIVIDUAL)
5115 WEST 129TH STREET
HAWTHORNE, CA 90250

FOR: CONCEALERS; COSMETIC CREAMS; COS-
METIC CREAMS FOR SKIN CARE; COSMETIC
PENCILS; MAKE-UP KITS COMPRISED OF LIP-
STICK, MASCARA, EYE SHADOWS, FOUNDA-
TION, MAKE-UP PENCILS, AND COSMETIC
BRUSHES, ALL SOLD TOGETHER AS A UNIT, IN
CLASS 3 (U.S. CLS. 1, 4, 6, 50, 51 AND 52).

FIRST USE 2-3-2007; IN COMMERCE 4-1-2007.

THE MARK CONSISTS OF STANDARD CHAR-
ACTERS WITHOUT CLAIM TO ANY PARTICULAR
FONT, STYLE, SIZE, OR COLOR.

NO CLAIM IS MADE TO THE EXCLUSIVE
RIGHT TO USE "ESSENCE", APART FROM THE
MARK AS SHOWN.

SER. NO. 77-229,292, FILED 7-13-2007.

SHARON MEIER, EXAMINING ATTORNEY

Int. Cl.: 11

Prior U.S. Cls.: 13, 21, 23, 31 and 34

United States Patent and Trademark Office

Reg. No. 3,397,943

Registered Mar. 18, 2008

**TRADEMARK
PRINCIPAL REGISTER**

PRESIDENTIAL II

CRAFTMADE INTERNATIONAL, INC. (DELA-
WARE CORPORATION)

650 S. ROYAL LANE

COPPELL, TX 75019

FOR: (BASED ON USE IN COMMERCE) CEILING
FANS, IN CLASS 11 (U.S. CLS. 13, 21, 23, 31 AND 34).

FIRST USE 0-0-1995; IN COMMERCE 0-0-1995.

THE MARK CONSISTS OF STANDARD CHAR-
ACTERS WITHOUT CLAIM TO ANY PARTICULAR
FONT, STYLE, SIZE, OR COLOR.

NO CLAIM IS MADE TO THE EXCLUSIVE
RIGHT TO USE "II", APART FROM THE MARK
AS SHOWN.

SER. NO. 77-229,295, FILED 7-13-2007.

MARILYN IZZI, EXAMINING ATTORNEY

Int. Cl.: 35

Prior U.S. Cls.: 100, 101 and 102

United States Patent and Trademark Office

Reg. No. 3,397,944

Registered Mar. 18, 2008

**SERVICE MARK
PRINCIPAL REGISTER**

**ProSource Mortgage
Marketing**

PROSOURCE MORTGAGE MARKETING, INC.
(OREGON CORPORATION)
5000 SW MEADOWS DRIVE, SUITE 440
LAKE OSWEGO, OR 97035

FOR: PROMOTION AND MARKETING SERVICES AND RELATED CONSULTING, IN CLASS 35 (U.S. CLS. 100, 101 AND 102).

FIRST USE 5-8-2006; IN COMMERCE 5-8-2006.

THE MARK CONSISTS OF STANDARD CHARACTERS WITHOUT CLAIM TO ANY PARTICULAR FONT, STYLE, SIZE, OR COLOR.

NO CLAIM IS MADE TO THE EXCLUSIVE RIGHT TO USE "MORTGAGE MARKETING", APART FROM THE MARK AS SHOWN.

SER. NO. 77-229,307, FILED 7-13-2007.

LAURA HAMMEL, EXAMINING ATTORNEY

Int. Cl.: 25

Prior U.S. Cls.: 22 and 39

United States Patent and Trademark Office

Reg. No. 3,397,945

Registered Mar. 18, 2008

**TRADEMARK
PRINCIPAL REGISTER**

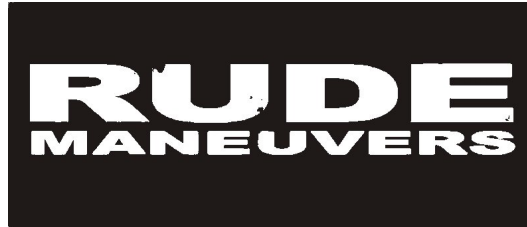

RUDE MANEUVERS INDUSTRIES, L.L.C. (ARIZONA LTD LIAB CO)
5075 N. LA CANADA DR., STE 157-229
TUCSON, AZ 85704

FOR: SHORT-SLEEVED OR LONG-SLEEVED T-SHIRTS, IN CLASS 25 (U.S. CLS. 22 AND 39).

FIRST USE 6-1-2007; IN COMMERCE 6-1-2007.

THE MARK CONSISTS OF STYLIZED WORDS "RUDE" AND "MANEUVERS" WITH THE WORD "RUDE" LARGER THAN THE WORD "MANEUVERS" ABOVE THE WORD "MANEUVERS" SUCH THAT THE WORD "RUDE" IS ROUGHLY THE SAME LENGTH AS THE WORD "MANEUVERS".

SER. NO. 77-229,335, FILED 7-13-2007.

ZACHARY BELLO, EXAMINING ATTORNEY

Int. Cl.: 44

Prior U.S. Cls.: 100 and 101

United States Patent and Trademark Office

Reg. No. 3,397,946

Registered Mar. 18, 2008

**SERVICE MARK
PRINCIPAL REGISTER**

PRECISION NUTRIENTS

DR. JIMMY, INC. (FLORIDA CORPORATION)
SUITE B
205 N. GARDEN AVENUE
CLEARWATER, FL 33755

FOR: PROVIDING HEALTH AND HEALTH PRO-
DUCT INFORMATION IN REGARD TO HEALTH
SUPPLEMENTS AND NUTRITION, IN CLASS 44
(U.S. CLS. 100 AND 101).

FIRST USE 11-12-2002; IN COMMERCE 11-12-2002.

THE MARK CONSISTS OF STANDARD CHAR-
ACTERS WITHOUT CLAIM TO ANY PARTICULAR
FONT, STYLE, SIZE, OR COLOR.

NO CLAIM IS MADE TO THE EXCLUSIVE
RIGHT TO USE "NUTRIENTS", APART FROM
THE MARK AS SHOWN.

SER. NO. 77-229,359, FILED 7-13-2007.

CARYN GLASSER, EXAMINING ATTORNEY

Int. Cl.: 11

Prior U.S. Cls.: 13, 21, 23, 31 and 34

United States Patent and Trademark Office

Reg. No. 3,397,947

Registered Mar. 18, 2008

**TRADEMARK
PRINCIPAL REGISTER**



COOL AIR INTERNATIONAL, INC. (MINNESOTA CORPORATION)
9124 GRAND AVE. S.
BLOOMINGTON, MN 554203636

FOR: (BASED ON USE IN COMMERCE) AIR CONDITIONERS, IN CLASS 11 (U.S. CLS. 13, 21, 23, 31 AND 34).

FIRST USE 1-31-2007; IN COMMERCE 1-31-2007.

THE COLOR(S) BLUE AND RED IS/ARE CLAIMED AS A FEATURE OF THE MARK.

THE MARK CONSISTS OF THE WORD AMERICAIRE WITH STARS FOR DOTS ON BOTH "I'S WITH WAVING BAND OF STRIPES ABOVE IT. THE "AMERIC" IS IN RED LETTERS AND THE "AIRE" IS IN BLUE LETTERS. BOTH STARS ARE BLUE. THE STAR ABOVE THE "I" IN "AMERIC" IS IN THE MIDDLE OF THE BAND OF WAVING STRIPES, WITH A SINGLE BLUE STRIPE TO THE LEFT OF THE STAR AND TWO SEPARATE RED STRIPES TO THE RIGHT OF THE STAR.

SER. NO. 77-229,385, FILED 7-13-2007.

STEPHEN AQUILA, EXAMINING ATTORNEY

Int. Cl.: 35

Prior U.S. Cls.: 100, 101 and 102

United States Patent and Trademark Office

Reg. No. 3,397,948

Registered Mar. 18, 2008

**SERVICE MARK
PRINCIPAL REGISTER**

GREEN MONSTER

BOSTON RED SOX BASEBALL CLUB LIMITED
PARTNERSHIP (MASSACHUSETTS LIMITED
PARTNERSHIP)
FENWAY PARK
4 YAWKEY WAY
BOSTON, MA 02215

FOR: CONCESSION STANDS FEATURING FOOD
AND BEVERAGES, IN CLASS 35 (U.S. CLS. 100, 101
AND 102).

FIRST USE 4-30-2003; IN COMMERCE 4-30-2003.

THE MARK CONSISTS OF STANDARD CHAR-
ACTERS WITHOUT CLAIM TO ANY PARTICULAR
FONT, STYLE, SIZE, OR COLOR.

OWNER OF U.S. REG. NO. 1,742,345.

SER. NO. 77-229,387, FILED 7-13-2007.

STEPHEN AQUILA, EXAMINING ATTORNEY

Int. Cl.: 10

Prior U.S. Cls.: 26, 39 and 44

United States Patent and Trademark Office

Reg. No. 3,397,949

Registered Mar. 18, 2008

**TRADEMARK
PRINCIPAL REGISTER**

RAMP

ST. JUDE MEDICAL ATRIAL FIBRILLATION
DIVISION, INC. (MINNESOTA CORPORATION)
14901 DEVEAU PLACE
MINNETONKA, MN 553452126

THE MARK CONSISTS OF STANDARD CHARACTERS WITHOUT CLAIM TO ANY PARTICULAR FONT, STYLE, SIZE, OR COLOR.

FOR: CARDIAC CATHETER GUIDING INTRODUCERS, IN CLASS 10 (U.S. CLS. 26, 39 AND 44).

SER. NO. 77-229,409, FILED 7-13-2007.

FIRST USE 6-30-1999; IN COMMERCE 6-30-1999.

DAWN FELDMAN, EXAMINING ATTORNEY

Int. Cl.: 10

Prior U.S. Cls.: 26, 39 and 44

United States Patent and Trademark Office

Reg. No. 3,397,950

Registered Mar. 18, 2008

**TRADEMARK
PRINCIPAL REGISTER**

RAMP-1

ST. JUDE MEDICAL ATRIAL FIBRILLATION
DIVISION, INC. (MINNESOTA CORPORATION)
14901 DEVEAU PLACE
MINNETONKA, MN 553452126

THE MARK CONSISTS OF STANDARD CHARACTERS WITHOUT CLAIM TO ANY PARTICULAR FONT, STYLE, SIZE, OR COLOR.

FOR: CARDIAC CATHETER GUIDING INTRODUCERS, IN CLASS 10 (U.S. CLS. 26, 39 AND 44).

SER. NO. 77-229,415, FILED 7-13-2007.

FIRST USE 6-10-2002; IN COMMERCE 6-10-2002.

DAWN FELDMAN, EXAMINING ATTORNEY

Int. Cl.: 42

Prior U.S. Cls.: 100 and 101

United States Patent and Trademark Office

Reg. No. 3,397,951

Registered Mar. 18, 2008

**SERVICE MARK
PRINCIPAL REGISTER**

ResearchTrail

RESEARCHTRAIL LTD. (ISRAEL LTD LIAB CO)
78 SHIMEON ST. #1
MOD'IN, ISRAEL 71724

FIRST USE 5-1-2007; IN COMMERCE 7-1-2007.

FOR: COMPUTER SERVICES, NAMELY, HOSTING AND MAINTAINING AN ONLINE WEBSITE FOR OTHERS TO SHOWCASE THEIR SEARCH SKILLS, GET FEEDBACK ON SEARCH STRATEGIES, AND IMPROVE THEIR ABILITY TO FORMULATE STRATEGIES FOR SEARCHING FOR INFORMATION ONLINE, IN CLASS 42 (U.S. CLS. 100 AND 101).

THE MARK CONSISTS OF STANDARD CHARACTERS WITHOUT CLAIM TO ANY PARTICULAR FONT, STYLE, SIZE, OR COLOR.

SER. NO. 77-229,469, FILED 7-13-2007.

MARGERY A. TIERNEY, EXAMINING ATTORNEY

Int. Cl.: 9

Prior U.S. Cls.: 21, 23, 26, 36 and 38

United States Patent and Trademark Office

Reg. No. 3,397,952

Registered Mar. 18, 2008

**TRADEMARK
PRINCIPAL REGISTER**

JIMM-ENEWS

JIMMY JOHN ENTERPRISES, LLC (DELAWARE
LTD LIAB CO)
2212 FOX DRIVE
CHAMPAIGN, IL 61820

THE MARK CONSISTS OF STANDARD CHAR-
ACTERS WITHOUT CLAIM TO ANY PARTICULAR
FONT, STYLE, SIZE, OR COLOR.

FOR: PROVIDING DOWNLOADABLE ELECTRO-
NIC NEWSLETTERS IN THE FIELD OF RESTAU-
RANTS, IN CLASS 9 (U.S. CLS. 21, 23, 26, 36 AND 38).

SER. NO. 77-229,477, FILED 7-13-2007.

FIRST USE 7-9-2007; IN COMMERCE 7-9-2007.

JIM RINGLE, EXAMINING ATTORNEY

Int. Cl.: 30

Prior U.S. Cl.: 46

United States Patent and Trademark Office

Reg. No. 3,397,953

Registered Mar. 18, 2008

TRADEMARK
PRINCIPAL REGISTER



HAMPTON BAKE CO. INC. (NEW YORK COR-
PORATION)
32 MONTAUK HIGHWAY
SOUTHAMPTON, NY 11968

FIRST USE 1-22-2007; IN COMMERCE 1-22-2007.

SER. NO. 77-229,501, FILED 7-13-2007.

FOR: COOKIES, PASTRIES, BROWNIES AND
CAKES, IN CLASS 30 (U.S. CL. 46).

EMILY CHUO, EXAMINING ATTORNEY

Int. Cl.: 32

Prior U.S. Cls.: 45, 46 and 48

United States Patent and Trademark Office

Reg. No. 3,397,954

Registered Mar. 18, 2008

**TRADEMARK
PRINCIPAL REGISTER**

ROLYIER

SUPERIOR BRANDS, INC. (DELAWARE CORPORATION)
13006 SATICOY STREET, #4
NORTH HOLLYWOOD, CA 91605

FOR: SOFT DRINK, IN CLASS 32 (U.S. CLS. 45, 46 AND 48).

FIRST USE 1-1-1999; IN COMMERCE 1-1-2006.

THE MARK CONSISTS OF STANDARD CHARACTERS WITHOUT CLAIM TO ANY PARTICULAR FONT, STYLE, SIZE, OR COLOR.

SER. NO. 77-229,503, FILED 7-13-2007.

ALEXANDER L. POWERS, EXAMINING ATTORNEY

Int. Cl.: 17

Prior U.S. Cls.: 1, 5, 12, 13, 35 and 50

United States Patent and Trademark Office

Reg. No. 3,397,955

Registered Mar. 18, 2008

**TRADEMARK
PRINCIPAL REGISTER**

FIBER BRITE

U.S. HIGHWAY PRODUCTS, INC. (CONNECTI-
CUT CORPORATION)
500 BOSTWICK AVENUE
BRIDGEPORT, CT 06605

THE MARK CONSISTS OF STANDARD CHAR-
ACTERS WITHOUT CLAIM TO ANY PARTICULAR
FONT, STYLE, SIZE, OR COLOR.

FOR: PLASTIC IN SHEET FORM FOR USE IN
THE MANUFACTURE OF OUTDOOR SIGNS, IN
CLASS 17 (U.S. CLS. 1, 5, 12, 13, 35 AND 50).

SER. NO. 77-229,510, FILED 7-13-2007.

FIRST USE 12-9-1988; IN COMMERCE 12-9-1988.

LINDA MICKLEBURGH, EXAMINING ATTORNEY

Int. Cl.: 38

Prior U.S. Cls.: 100, 101 and 104

United States Patent and Trademark Office

Reg. No. 3,397,956

Registered Mar. 18, 2008

**SERVICE MARK
PRINCIPAL REGISTER**

DAILY DOSE

LIMELIFE, INC. (CALIFORNIA CORPORATION)
4300 BOHANNON DRIVE SUITE 230
MENLO PARK, CA 94025

FOR: WIRELESS DIGITAL MESSAGING SERVICES CONTAINING TEXT, NUMBERS, VIDEO, AUDIO AND/OR GRAPHICAL IMAGES, IN CLASS 38 (U.S. CLS. 100, 101 AND 104).

FIRST USE 5-12-2006; IN COMMERCE 5-12-2006.

THE MARK CONSISTS OF STANDARD CHARACTERS WITHOUT CLAIM TO ANY PARTICULAR FONT, STYLE, SIZE, OR COLOR.

NO CLAIM IS MADE TO THE EXCLUSIVE RIGHT TO USE "DAILY", APART FROM THE MARK AS SHOWN.

SER. NO. 77-229,513, FILED 7-13-2007.

KATHERINE CONNOLLY, EXAMINING ATTORNEY

Int. Cl.: 25

Prior U.S. Cls.: 22 and 39

United States Patent and Trademark Office

Reg. No. 3,397,957

Registered Mar. 18, 2008

**TRADEMARK
PRINCIPAL REGISTER**

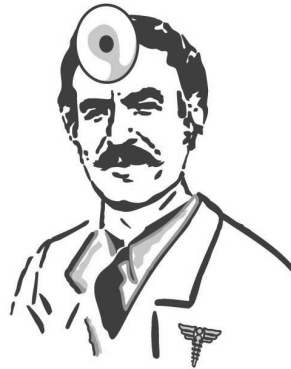

VALIANT GROUP, INC. (CALIFORNIA CORPORATION)
133 E. DE LA GUERRA, #G
SANTA BARBARA, CA 93101

FOR: CLOTHING, NAMELY, SHIRTS, TANK-TOPS, T-SHIRTS, NAMELY, LONG SLEEVE AND SHORT SLEEVE T-SHIRTS, POLO SHIRTS; HEAD WEAR, NAMELY, CAPS, HATS, AND VISORS, IN CLASS 25 (U.S. CLS. 22 AND 39).

FIRST USE 3-21-2007; IN COMMERCE 3-21-2007.

THE MARK CONSISTS OF A PICTURE OF A DOCTOR.

SER. NO. 77-229,522, FILED 7-13-2007.

LINDA M. KING, EXAMINING ATTORNEY

Int. Cls.: 36 and 37

Prior U.S. Cls.: 100, 101, 102, 103 and 106

United States Patent and Trademark Office

Reg. No. 3,397,958

Registered Mar. 18, 2008

**SERVICE MARK
PRINCIPAL REGISTER**

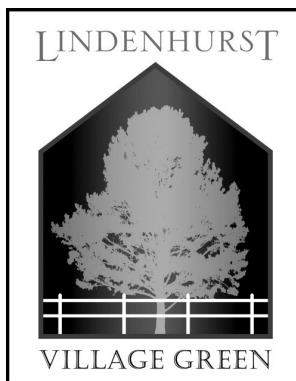

OLIVERMCMILLAN, LLC (CALIFORNIA LTD
LIAB CO)
733 8TH AVENUE
SAN DIEGO, CA 92101

FOR: REAL ESTATE INVESTMENT, REAL ES-
TATE MANAGEMENT, IN CLASS 36 (U.S. CLS. 100,
101 AND 102).

FIRST USE 5-21-2007; IN COMMERCE 5-21-2007.

FOR: REAL ESTATE DEVELOPMENT; CON-
STRUCTION SERVICES, NAMELY, PLANNING,

LAYING OUT, IMPROVEMENT, AND CONSTRU-
TION OF RESIDENTIAL AND COMMERCIAL
REAL PROPERTIES, IN CLASS 37 (U.S. CLS. 100,
103 AND 106).

FIRST USE 5-21-2007; IN COMMERCE 5-21-2007.

SER. NO. 77-229,564, FILED 7-13-2007.

RENEE MCCRAY, EXAMINING ATTORNEY

Int. Cl.: 39

Prior U.S. Cls.: 100 and 105

United States Patent and Trademark Office

Reg. No. 3,397,959

Registered Mar. 18, 2008

**SERVICE MARK
PRINCIPAL REGISTER**



BROWN BAG NATURALS (CALIFORNIA CORPORATION)
20651 SEABOARD RD
MALIBU, CA 90265

FOR: FOOD DELIVERY, IN CLASS 39 (U.S. CLS. 100 AND 105).

FIRST USE 8-1-2005; IN COMMERCE 11-5-2005.

THE COLOR(S) BROWN ORANGE LIME WHITE IS/ARE CLAIMED AS A FEATURE OF THE MARK.

THE MARK CONSISTS OF A DARK BROWN RECTANGLE WITH A WHITE CUTOUT OF A PIECE OF TOAST CONTAINING AN ORANGE AND LIME APPLE. COMPANY NAME IS CONTAINED IN THE RECTANGLE IN WHITE AND GREEN.

SER. NO. 77-229,585, FILED 7-13-2007.

DOMINICK J. SALEMI, EXAMINING ATTORNEY

Int. Cls.: 36 and 37

Prior U.S. Cls.: 100, 101, 102, 103 and 106

United States Patent and Trademark Office

Reg. No. 3,397,960

Registered Mar. 18, 2008

**SERVICE MARK
PRINCIPAL REGISTER**



OLIVERMCMILLAN, LLC (CALIFORNIA LTD
LIAB CO)
733 8TH AVENUE
SAN DIEGO, CA 92101

FOR: LEASING OF REAL PROPERTY; REAL
ESTATE INVESTMENT; REAL ESTATE MANAGE-
MENT, IN CLASS 36 (U.S. CLS. 100, 101 AND 102).

FIRST USE 5-21-2007; IN COMMERCE 5-21-2007.

FOR: REAL ESTATE DEVELOPMENT; CON-
STRUCTION SERVICES, NAMELY, PLANNING,
LAYING OUT, IMPROVEMENT, AND CONSTRUC-

TION OF RESIDENTIAL AND COMMERCIAL
REAL PROPERTIES, IN CLASS 37 (U.S. CLS. 100,
103 AND 106).

FIRST USE 5-21-2007; IN COMMERCE 5-21-2007.

NO CLAIM IS MADE TO THE EXCLUSIVE
RIGHT TO USE "RIVERFRONT", APART FROM
THE MARK AS SHOWN.

SER. NO. 77-229,595, FILED 7-13-2007.

RENEE MCCRAY, EXAMINING ATTORNEY

Int. Cl.: 35

Prior U.S. Cls.: 100, 101 and 102

United States Patent and Trademark Office

Reg. No. 3,397,961

Registered Mar. 18, 2008

**SERVICE MARK
PRINCIPAL REGISTER**

SMRP

SOCIETY FOR MAINTENANCE AND RELIABILITY PROFESSIONALS (ILLINOIS NON-PROFIT CORPORATION)
8201 GREENSBORO DR., 3RD FLOOR
MCLEAN, VA 22102

FOR: ASSOCIATION SERVICES, NAMELY, PROMOTING THE INTERESTS OF THOSE INVOLVED WITH UPKEEP AND REPAIR OF EQUIPMENT USED IN SERVICE AND MANUFACTURING AREAS, IN CLASS 35 (U.S. CLS. 100, 101 AND 102).

FIRST USE 0-0-1991; IN COMMERCE 0-0-1991.

THE MARK CONSISTS OF STANDARD CHARACTERS WITHOUT CLAIM TO ANY PARTICULAR FONT, STYLE, SIZE, OR COLOR.

OWNER OF U.S. REG. NOS. 1,985,400 AND 2,985,459.

SER. NO. 77-229,632, FILED 7-13-2007.

REBECCA SMITH, EXAMINING ATTORNEY

Int. Cl.: 11

Prior U.S. Cls.: 13, 21, 23, 31 and 34

United States Patent and Trademark Office

Reg. No. 3,397,962

Registered Mar. 18, 2008

**TRADEMARK
PRINCIPAL REGISTER**

LUXEMBRIGHT

CAO GROUP, INC. (UTAH CORPORATION)
4628 W SKYHAWK DRIVE
WEST JORDAN, UT 84084

THE MARK CONSISTS OF STANDARD CHAR-
ACTERS WITHOUT CLAIM TO ANY PARTICULAR
FONT, STYLE, SIZE, OR COLOR.

FOR: LED LIGHTING UNITS FOR USE IN
CHANNEL LETTER AND BACK-LIT SIGNAGE, IN
CLASS 11 (U.S. CLS. 13, 21, 23, 31 AND 34).

SER. NO. 77-229,633, FILED 7-13-2007.

FIRST USE 1-1-2006; IN COMMERCE 1-1-2006.

ESTHER A. BORSUK, EXAMINING ATTORNEY

Int. Cl.: 31

Prior U.S. Cls.: 1 and 46

United States Patent and Trademark Office

Reg. No. 3,397,963

Registered Mar. 18, 2008

**TRADEMARK
PRINCIPAL REGISTER**

**Working With You To
Achieve Profitable
Nutrition**

POET, LLC (SOUTH DAKOTA LTD LIAB CO)
4615 N. LEWIS AVENUE
SIOUX FALLS, SD 57104

THE MARK CONSISTS OF STANDARD CHAR-
ACTERS WITHOUT CLAIM TO ANY PARTICULAR
FONT, STYLE, SIZE, OR COLOR.

FOR: ANIMAL FEED, IN CLASS 31 (U.S. CLS. 1
AND 46).

SER. NO. 77-229,636, FILED 7-13-2007.

FIRST USE 12-0-2005; IN COMMERCE 12-0-2005.

BENJAMIN ALLEN, EXAMINING ATTORNEY

Int. Cl.: 35

Prior U.S. Cls.: 100, 101 and 102

United States Patent and Trademark Office

Reg. No. 3,397,964

Registered Mar. 18, 2008

**SERVICE MARK
PRINCIPAL REGISTER**

StratStaff

STRATSTAFF, LLC (COLORADO LTD LIAB CO)
#605
1888 SHERMAN ST.
DENVER, CO 80203

THE MARK CONSISTS OF STANDARD CHAR-
ACTERS WITHOUT CLAIM TO ANY PARTICULAR
FONT, STYLE, SIZE, OR COLOR.

FOR: PERSONNEL PLACEMENT AND RE-
CRUITMENT, IN CLASS 35 (U.S. CLS. 100, 101 AND
102).

SER. NO. 77-229,647, FILED 7-13-2007.

FIRST USE 11-1-2005; IN COMMERCE 11-12-2005.

SOPHIA S. KIM, EXAMINING ATTORNEY

Int. Cl.: 5

Prior U.S. Cls.: 6, 18, 44, 46, 51 and 52

United States Patent and Trademark Office

Reg. No. 3,397,965

Registered Mar. 18, 2008

**TRADEMARK
PRINCIPAL REGISTER**

QH-ABSORB

JARROW FORMULAS, INC. (CALIFORNIA CORPORATION)
1824 SOUTH ROBERTSON BLVD.
LOS ANGELES, CA 900354317

FOR: DIETARY AND NUTRITIONAL SUPPLEMENTS, IN CLASS 5 (U.S. CLS. 6, 18, 44, 46, 51 AND 52).

FIRST USE 2-26-2007; IN COMMERCE 2-26-2007.

THE MARK CONSISTS OF STANDARD CHARACTERS WITHOUT CLAIM TO ANY PARTICULAR FONT, STYLE, SIZE, OR COLOR.

OWNER OF U.S. REG. NOS. 3,249,403 AND 3,260,761.

SER. NO. 77-229,648, FILED 7-13-2007.

SOPHIA S. KIM, EXAMINING ATTORNEY

Int. Cl.: 28

Prior U.S. Cls.: 22, 23, 38 and 50

United States Patent and Trademark Office

Reg. No. 3,397,966

Registered Mar. 18, 2008

**TRADEMARK
PRINCIPAL REGISTER**

MAD RATS

WOLF, MARSHALL JON (UNITED STATES IN-
DIVIDUAL)
171 PIER AVE #229
SANTA MONICA, CA 90405

THE MARK CONSISTS OF STANDARD CHAR-
ACTERS WITHOUT CLAIM TO ANY PARTICULAR
FONT, STYLE, SIZE, OR COLOR.

FOR: SKATEBOARD HIP PADS, IN CLASS 28 (U.S.
CLS. 22, 23, 38 AND 50).

SER. NO. 77-229,652, FILED 7-13-2007.

FIRST USE 6-15-2007; IN COMMERCE 7-13-2007.

SOPHIA S. KIM, EXAMINING ATTORNEY

Int. Cl.: 41

Prior U.S. Cls.: 100, 101 and 107

United States Patent and Trademark Office

Reg. No. 3,397,967

Registered Mar. 18, 2008

**SERVICE MARK
PRINCIPAL REGISTER**

STD FILMS

ZINK, JASON W. (UNITED STATES INDIVIDUAL)
6903 WEST 159TH AVE
LOWELL, IN 46356

FOR: MOTION PICTURE FILM PRODUCTION; PRODUCTION AND DISTRIBUTION OF INDEPENDENT MOTION PICTURES; PRODUCTION AND DISTRIBUTION OF MOTION PICTURES, IN CLASS 41 (U.S. CLS. 100, 101 AND 107).

FIRST USE 0-0-2001; IN COMMERCE 0-0-2001.

THE MARK CONSISTS OF STANDARD CHARACTERS WITHOUT CLAIM TO ANY PARTICULAR FONT, STYLE, SIZE, OR COLOR.

NO CLAIM IS MADE TO THE EXCLUSIVE RIGHT TO USE "FILMS", APART FROM THE MARK AS SHOWN.

SER. NO. 77-229,655, FILED 7-13-2007.

SOPHIA S. KIM, EXAMINING ATTORNEY

Int. Cl.: 5

Prior U.S. Cls.: 6, 18, 44, 46, 51 and 52

United States Patent and Trademark Office

Reg. No. 3,397,968

Registered Mar. 18, 2008

**TRADEMARK
PRINCIPAL REGISTER**

Q-ABSORB

JARROW FORMULAS, INC. (CALIFORNIA CORPORATION)
1824 SOUTH ROBERTSON BLVD.
LOS ANGELES, CA 900354317

FOR: DIETARY AND NUTRITIONAL SUPPLEMENTS, IN CLASS 5 (U.S. CLS. 6, 18, 44, 46, 51 AND 52).

FIRST USE 6-14-1999; IN COMMERCE 6-14-1999.

THE MARK CONSISTS OF STANDARD CHARACTERS WITHOUT CLAIM TO ANY PARTICULAR FONT, STYLE, SIZE, OR COLOR.

OWNER OF U.S. REG. NOS. 3,249,403 AND 3,260,761.

SER. NO. 77-229,657, FILED 7-13-2007.

SOPHIA S. KIM, EXAMINING ATTORNEY

Int. Cl.: 45

Prior U.S. Cls.: 100 and 101

United States Patent and Trademark Office

Reg. No. 3,397,969

Registered Mar. 18, 2008

**SERVICE MARK
PRINCIPAL REGISTER**

**PowerScreen Hiring and
Risk Management Tools**

INFORMATIVE SOLUTIONS (NEVADA COR-
PORATION)

13030 EUCLID ST.

GARDEN GROVE, CA 92843

FOR: EMPLOYMENT AND TENANT BACK-
GROUND SCREENING SERVICES, IN CLASS 45
(U.S. CLS. 100 AND 101).

FIRST USE 3-5-2007; IN COMMERCE 3-5-2007.

THE MARK CONSISTS OF STANDARD CHAR-
ACTERS WITHOUT CLAIM TO ANY PARTICULAR
FONT, STYLE, SIZE, OR COLOR.

NO CLAIM IS MADE TO THE EXCLUSIVE
RIGHT TO USE "HIRING AND RISK MANAGE-
MENT TOOLS", APART FROM THE MARK AS
SHOWN.

SER. NO. 77-229,712, FILED 7-13-2007.

MELISSA VALLILLO, EXAMINING ATTORNEY

Int. Cl.: 28

Prior U.S. Cls.: 22, 23, 38 and 50

United States Patent and Trademark Office

Reg. No. 3,397,970

Registered Mar. 18, 2008

**TRADEMARK
PRINCIPAL REGISTER**



U.S. CHINA TRADING CORP. (ILLINOIS CORPORATION)
7884 QUINCY STREET
WILLOWBROOK, IL 60521

OWNER OF U.S. REG. NO. 3,085,155.

FOR: BARBELLS, DUMB-BELLS, WEIGHT LIFTING BENCHES AND BENCH ACCESSORIES, IN CLASS 28 (U.S. CLS. 22, 23, 38 AND 50).

THE MARK CONSISTS OF AN OVAL CONTAINING THE WORD "HAMPTON"..

SER. NO. 77-229,756, FILED 7-13-2007.

FIRST USE 11-1-2000; IN COMMERCE 11-1-2000.

SARA THOMAS, EXAMINING ATTORNEY

Int. Cl.: 39

Prior U.S. Cls.: 100 and 105

United States Patent and Trademark Office

Reg. No. 3,397,971

Registered Mar. 18, 2008

**SERVICE MARK
PRINCIPAL REGISTER**

**BACKUP
FREEDOM**

RC GENERAL ENTERPRISES, INC. (NEW YORK CORPORATION)
1254 HOLLYWOOD AVE. #2
BRONX, NY 10461

FOR: REMOTE COMPUTER DATA BACKUP SERVICES, NAMELY, STORAGE SERVICE FOR ARCHIVING DATABASES, IMAGES AND OTHER ELECTRONIC DATA, IN CLASS 39 (U.S. CLS. 100 AND 105).

FIRST USE 5-15-2006; IN COMMERCE 5-15-2006.

NO CLAIM IS MADE TO THE EXCLUSIVE RIGHT TO USE "BACKUP", APART FROM THE MARK AS SHOWN.

SER. NO. 77-229,769, FILED 7-13-2007.

DEIRDRE ROBERTSON, EXAMINING ATTORNEY

Int. Cl.: 15

Prior U.S. Cls.: 2, 21 and 36

United States Patent and Trademark Office

Reg. No. 3,397,972

Registered Mar. 18, 2008

**TRADEMARK
PRINCIPAL REGISTER**



STEWART, RICK (NORTH CAROLINA SOLE PROPRIETORSHIP), DBA VENGEANCE GUITARS AND GRAPHIX
SUITE F-1
44 BUCK SHOALS ROAD
ARDEN, NC 28704

FOR: ELECTRIC GUITARS, IN CLASS 15 (U.S. CLS. 2, 21 AND 36).

FIRST USE 2-23-2003; IN COMMERCE 2-23-2003.

NO CLAIM IS MADE TO THE EXCLUSIVE RIGHT TO USE "GUITARS & GRAPHICS", APART FROM THE MARK AS SHOWN.

THE COLOR(S) PURPLE, GOLD AND BLACK IS/ ARE CLAIMED AS A FEATURE OF THE MARK.

THE MARK CONSISTS OF PURPLE "V" GOLD STONHENGE FONT LETTERING AND UNDERLINING AND BLACK BACKGROUND. THE PURPLE V IS OUTLINED IN GOLD AND HAS GOLD AND BLACK ACCENTS.

SER. NO. 77-229,814, FILED 7-14-2007.

KATHLEEN M. VANSTON, EXAMINING ATTORNEY

Int. Cl.: 35

Prior U.S. Cls.: 100, 101 and 102

United States Patent and Trademark Office

Reg. No. 3,397,973

Registered Mar. 18, 2008

**SERVICE MARK
PRINCIPAL REGISTER**

BOX-O-BOX

BOX-O-BOX, LLC (NEW JERSEY LTD LIAB CO)
145 SOUTH STREET
FREEHOLD, NJ 07728

MEDICINE, LAUNDRY SUPPLIES AND HOLIDAY
SUPPLIES, IN CLASS 35 (U.S. CLS. 100, 101 AND 102).

FIRST USE 6-1-2006; IN COMMERCE 6-1-2006.

FOR: ON-LINE RETAIL STORE SERVICES, RE-
TAIL STORE SERVICES, MAIL ORDER CATALOG
SERVICES FEATURING PRE-MADE KITS AND
CARE-PACKAGES CONTAINING FOOD, GIFTS,
NOVELTIES, TOYS, STUDY SUPPLIES AND MATE-
RIALS, BOOKS AND MAGAZINES, CONSUMER
ELECTRONICS, VIDEOS, CDS, MUSIC, BED AND
BATH LINENS AND SUPPLIES, CLOTHING, COS-
METICS, SPA SUPPLIES, NON-PRESCRIPTION

THE MARK CONSISTS OF STANDARD CHAR-
ACTERS WITHOUT CLAIM TO ANY PARTICULAR
FONT, STYLE, SIZE, OR COLOR.

SER. NO. 77-229,857, FILED 7-14-2007.

G. MAYERSCHOFF, EXAMINING ATTORNEY

Int. Cl.: 35

Prior U.S. Cls.: 100, 101 and 102

United States Patent and Trademark Office

Reg. No. 3,397,974

Registered Mar. 18, 2008

**SERVICE MARK
PRINCIPAL REGISTER**

**To Simply Give is the
Sweetest Gift**

RICHARD, RACHELLE (UNITED STATES INDIVIDUAL)
10 W. MINNEZONA AVE. #1070
PHOENIZ, AZ 85013

FOR: ONLINE RETAIL STORE SERVICES FEATURING PET TOY BOXES, PICTURE FRAMES, POSTERS, CARDS AND OTHER RELATED MERCHANDISE, IN CLASS 35 (U.S. CLS. 100, 101 AND 102).

FIRST USE 4-1-2007; IN COMMERCE 4-1-2007.

THE MARK CONSISTS OF STANDARD CHARACTERS WITHOUT CLAIM TO ANY PARTICULAR FONT, STYLE, SIZE, OR COLOR.

SER. NO. 77-229,859, FILED 7-14-2007.

DAVID TAYLOR, EXAMINING ATTORNEY

Int. Cl.: 42

Prior U.S. Cls.: 100 and 101

United States Patent and Trademark Office

Reg. No. 3,397,975

Registered Mar. 18, 2008

**SERVICE MARK
PRINCIPAL REGISTER**

Heavenly Birthday

HEAVENLY BIRTHDAY, L.L.C. (ALABAMA LTD
LIAB CO)
P.O. BOX 26737
BIRMINGHAM, AL 352600737

FOR: COMPUTER SERVICES, NAMELY, HOST-
ING AND MAINTAINING AN ONLINE WEBSITE
FOR OTHERS TO CREATE MEMORIALS FEATUR-
ING PHOTOGRAPHS, TEXT, AUDIO AND AUDIO
VISUAL CLIPS, VIA A GLOBAL COMPUTER NET-
WORK, LOCAL AREA NETWORK OR STAND
ALONE COMPUTER, IN CLASS 42 (U.S. CLS. 100
AND 101).

FIRST USE 7-11-2007; IN COMMERCE 7-11-2007.

THE MARK CONSISTS OF STANDARD CHAR-
ACTERS WITHOUT CLAIM TO ANY PARTICULAR
FONT, STYLE, SIZE, OR COLOR.

NO CLAIM IS MADE TO THE EXCLUSIVE
RIGHT TO USE "BIRTHDAY", APART FROM THE
MARK AS SHOWN.

SER. NO. 77-229,876, FILED 7-14-2007.

KATHY DE JONGE, EXAMINING ATTORNEY

Int. Cl.: 9

Prior U.S. Cls.: 21, 23, 26, 36 and 38

United States Patent and Trademark Office

Reg. No. 3,397,976

Registered Mar. 18, 2008

**TRADEMARK
PRINCIPAL REGISTER**

Smoke Free Wisdom

ROBERT J. REINA (UNITED STATES INDIVIDUAL)
164 LAKEVIEW DRIVE # 102
WESTON, FL 33326

FOR: COMPUTER SCREEN SAVER SOFTWARE,
IN CLASS 9 (U.S. CLS. 21, 23, 26, 36 AND 38).

FIRST USE 4-25-2005; IN COMMERCE 5-1-2006.

THE MARK CONSISTS OF STANDARD CHARACTERS WITHOUT CLAIM TO ANY PARTICULAR FONT, STYLE, SIZE, OR COLOR.

OWNER OF U.S. REG. NOS. 3,129,596 AND 3,129,597.

NO CLAIM IS MADE TO THE EXCLUSIVE RIGHT TO USE "SMOKE FREE", APART FROM THE MARK AS SHOWN.

SER. NO. 77-229,878, FILED 7-14-2007.

CARYN GLASSER, EXAMINING ATTORNEY

Int. Cl.: 30

Prior U.S. Cl.: 46

United States Patent and Trademark Office

Reg. No. 3,397,977

Registered Mar. 18, 2008

**TRADEMARK
PRINCIPAL REGISTER**

CREATED BY HAND, INSPIRED
BY ART

MY FAVORITE COMPANY, INC. (FLORIDA
CORPORATION)
PO BOX 69977
LOS ANGELES, CA 90069

THE MARK CONSISTS OF STANDARD CHAR-
ACTERS WITHOUT CLAIM TO ANY PARTICULAR
FONT, STYLE, SIZE, OR COLOR.

FOR: CHOCOLATE; CHOCOLATE BARS; CHO-
COLATE CANDIES; CANDY, IN CLASS 30 (U.S. CL.
46).

SER. NO. 77-229,879, FILED 7-14-2007.

FIRST USE 7-9-2007; IN COMMERCE 7-9-2007.

PRISCILLA MILTON, EXAMINING ATTORNEY

Int. Cl.: 41

Prior U.S. Cls.: 100, 101 and 107

United States Patent and Trademark Office

Reg. No. 3,397,978

Registered Mar. 18, 2008

SERVICE MARK
PRINCIPAL REGISTER

never quit

MCCUE, MATT, J (UNITED STATES INDIVIDUAL), DBA MCCUE TRAINING
40 HARTFORD STREET
WESTWOOD, MA 02090

FOR: PROVIDING ASSISTANCE, PERSONAL TRAINING AND PHYSICAL FITNESS CONSULTATION TO INDIVIDUALS TO HELP THEM MAKE PHYSICAL FITNESS, STRENGTH, CONDITIONING, AND EXERCISE IMPROVEMENT IN THEIR

DAILY LIVING, IN CLASS 41 (U.S. CLS. 100, 101 AND 107).

FIRST USE 7-1-2006; IN COMMERCE 7-1-2006.

THE MARK CONSISTS OF STYLIZED WORDS.

SER. NO. 77-229,885, FILED 7-14-2007.

PRISCILLA MILTON, EXAMINING ATTORNEY

Int. Cl.: 41

Prior U.S. Cls.: 100, 101 and 107

United States Patent and Trademark Office

Reg. No. 3,397,979

Registered Mar. 18, 2008

**SERVICE MARK
PRINCIPAL REGISTER**

Bad Data

JAMES ROGER NELSON BLUE (UNITED STATES INDIVIDUAL), DBA JIMMY BLUE
P.O. BOX 91153
7005 WEST MANCHESTER AVE.
LOS ANGELES, CA 90045

FOR: ENTERTAINMENT, NAMELY, LIVE PERFORMANCES BY MUSICAL BANDS; ENTERTAINMENT, NAMELY, LIVE PERFORMANCES BY ROCK GROUPS, IN CLASS 41 (U.S. CLS. 100, 101 AND 107).

FIRST USE 12-15-2004; IN COMMERCE 1-15-2005.

THE MARK CONSISTS OF STANDARD CHARACTERS WITHOUT CLAIM TO ANY PARTICULAR FONT, STYLE, SIZE, OR COLOR.

SER. NO. 77-229,886, FILED 7-14-2007.

PRISCILLA MILTON, EXAMINING ATTORNEY

Int. Cl.: 41

Prior U.S. Cls.: 100, 101 and 107

United States Patent and Trademark Office

Reg. No. 3,397,980

Registered Mar. 18, 2008

**SERVICE MARK
PRINCIPAL REGISTER**

Hot For Words

COMO, CHARLES T. (UNITED STATES INDIVIDUAL)
1409 WILSHIRE BOULEVARD
SANTA MONICA, CA 90403

FOR: EDUCATIONAL AND ENTERTAINMENT SERVICES, NAMELY, A CONTINUING PROGRAM ABOUT THE ORIGIN OF WORDS ACCESSIBLE BY RADIO, TELEVISION, SATELLITE, AUDIO, VIDEO AND COMPUTER NETWORKS, IN CLASS 41 (U.S. CLS. 100, 101 AND 107).

FIRST USE 2-26-2007; IN COMMERCE 2-26-2007.

THE MARK CONSISTS OF STANDARD CHARACTERS WITHOUT CLAIM TO ANY PARTICULAR FONT, STYLE, SIZE, OR COLOR.

NO CLAIM IS MADE TO THE EXCLUSIVE RIGHT TO USE "WORDS", APART FROM THE MARK AS SHOWN.

SER. NO. 77-229,891, FILED 7-14-2007.

JAY FLOWERS, EXAMINING ATTORNEY

Int. Cl.: 9

Prior U.S. Cls.: 21, 23, 26, 36 and 38

Reg. No. 3,397,981

United States Patent and Trademark Office

Registered Mar. 18, 2008

**TRADEMARK
PRINCIPAL REGISTER**

STUDIO DEVIL

GALLO, MARC N. (NEW YORK SOLE PROPRIETORSHIP), DBA GALLO ENGINEERING, PLLC

56-20 203RD STREET
BAYSIDE, NY 11364

FOR: SOFTWARE TO PROCESS AUDIO SIGNALS AND MUSICAL INSTRUMENTS, IN CLASS 9 (U.S. CLS. 21, 23, 26, 36 AND 38).

FIRST USE 3-6-2001; IN COMMERCE 10-24-2006.

THE MARK CONSISTS OF STANDARD CHARACTERS WITHOUT CLAIM TO ANY PARTICULAR FONT, STYLE, SIZE, OR COLOR.

NO CLAIM IS MADE TO THE EXCLUSIVE RIGHT TO USE "STUDIO", APART FROM THE MARK AS SHOWN.

SER. NO. 77-229,934, FILED 7-15-2007.

MICHAEL KEATING, EXAMINING ATTORNEY

Int. Cl.: 37

Prior U.S. Cls.: 100, 103 and 106

United States Patent and Trademark Office

Reg. No. 3,397,982

Registered Mar. 18, 2008

**SERVICE MARK
PRINCIPAL REGISTER**

**THE NAME YOU KNOW, THE
PEOPLE YOU TRUST**

COMFORT WINDOW CO., INC. (NEW YORK CORPORATION)
60 JOHN GLENN BOULEVARD
SYRACUSE, NY 13209

FOR: (BASED ON USE IN COMMERCE) INSTALLATION OF DOORS AND WINDOWS; INSTALLATION OF INSULATING MATERIALS; INSTALLING DRYWALL PANELS; INSTALLING SIDING; INSTALLING WALLBOARD; CONSTRUCTING SUNROOMS; CARPENTRY CONTRACTOR SERVICES; DRYWALL CONTRACTOR SERVICES; ELECTRICAL CONTRACTOR SERVICES; FRAMING CONTRACTOR SERVICES; HVAC CONTRACTOR SERVICES; PAINTING CONTRACTOR SERVICES;

PLASTERING CONTRACTOR SERVICES; PLUMBING CONTRACTOR SERVICES, IN CLASS 37 (U.S. CLS. 100, 103 AND 106).

FIRST USE 5-31-2007; IN COMMERCE 5-31-2007.

THE MARK CONSISTS OF STANDARD CHARACTERS WITHOUT CLAIM TO ANY PARTICULAR FONT, STYLE, SIZE, OR COLOR.

SER. NO. 77-229,981, FILED 7-15-2007.

ELLEN PERKINS, EXAMINING ATTORNEY

Int. Cl.: 8

Prior U.S. Cls.: 23, 28 and 44

United States Patent and Trademark Office

Reg. No. 3,397,983

Registered Mar. 18, 2008

**TRADEMARK
PRINCIPAL REGISTER**

Pacific

FILO AMERICA (CANADA CORPORATION)
UNIT B
2701 SOUTH SANTA FE AVE
VERNON, CA 90058

THE MARK CONSISTS OF STANDARD CHAR-
ACTERS WITHOUT CLAIM TO ANY PARTICULAR
FONT, STYLE, SIZE, OR COLOR.

FOR: NON-ELECTRIC RAZORS, RAZOR
BLADES, RAZORS AND STRAIGHT RAZORS, IN
CLASS 8 (U.S. CLS. 23, 28 AND 44).

SER. NO. 77-230,004, FILED 7-15-2007.

FIRST USE 7-18-2005; IN COMMERCE 7-18-2005.

MATTHEW PAPPAS, EXAMINING ATTORNEY

Int. Cl.: 5

Prior U.S. Cls.: 6, 18, 44, 46, 51 and 52

Reg. No. 3,397,984

United States Patent and Trademark Office

Registered Mar. 18, 2008

**TRADEMARK
PRINCIPAL REGISTER**

virx

FILO AMERICA (CANADA CORPORATION)
UNIT B
2701 SOUTH SANTA FE AVE
VERNON, CA 90058

THE MARK CONSISTS OF STANDARD CHAR-
ACTERS WITHOUT CLAIM TO ANY PARTICULAR
FONT, STYLE, SIZE, OR COLOR.

FOR: ANTIBACTERIAL ALCOHOL SKIN SANI-
TIZER GEL AND SANITIZERS FOR HOUSEHOLD
USE, IN CLASS 5 (U.S. CLS. 6, 18, 44, 46, 51 AND 52).

SER. NO. 77-230,009, FILED 7-15-2007.

FIRST USE 3-13-2007; IN COMMERCE 3-13-2007.

MATTHEW PAPPAS, EXAMINING ATTORNEY

Int. Cl.: 44

Prior U.S. Cls.: 100 and 101

United States Patent and Trademark Office

Reg. No. 3,397,985

Registered Mar. 18, 2008

**SERVICE MARK
PRINCIPAL REGISTER**

Slim Diamond

FAITH HOLISTIC HEALTHCARE (ARIZONA
LTD LIAB CO)
16051 E. VENETIAN LANE
FOUNTAIN HILLS, AZ 85268

FOR: DESIGNING AND IMPLEMENTING OF
PROGRAMS AND ADVICE AND PROVIDING CON-
SULTATION FOR OTHERS IN THE FIELD OF
WEIGHT MANAGEMENT, OBESITY MANAGE-
MENT, DIET, HEALTH AND NUTRITION, HEALTH
CARE; WEIGHT REDUCTION DIET PLANNING
AND SUPERVISION, IN CLASS 44 (U.S. CLS. 100
AND 101).

FIRST USE 1-2-2007; IN COMMERCE 3-11-2007.

THE MARK CONSISTS OF STANDARD CHAR-
ACTERS WITHOUT CLAIM TO ANY PARTICULAR
FONT, STYLE, SIZE, OR COLOR.

SER. NO. 77-230,066, FILED 7-16-2007.

RONALD MCMORROW, EXAMINING ATTORNEY

Int. Cls.: 38 and 42

Prior U.S. Cls.: 100, 101 and 104

United States Patent and Trademark Office

Reg. No. 3,397,986

Registered Mar. 18, 2008

**SERVICE MARK
PRINCIPAL REGISTER**

Philip

ATZEMOGLOU, GEORGIOS FILIPPOS (GREECE
INDIVIDUAL), DBA ATZEMOGLOU,
GEORGE PHILIP
DIMOKRITOU 20 KAI ELEFSINION
NEO IRAKLIO, GREECE 14122

FOR: PROVIDING E-MAIL SERVICES, IN CLASS
38 (U.S. CLS. 100, 101 AND 104).

FIRST USE 6-0-1995; IN COMMERCE 0-0-1999.

FOR: DESIGN OF HOMEPAGES AND WEBSITES,
IN CLASS 42 (U.S. CLS. 100 AND 101).

FIRST USE 6-0-1995; IN COMMERCE 0-0-1999.

THE MARK CONSISTS OF STANDARD CHAR-
ACTERS WITHOUT CLAIM TO ANY PARTICULAR
FONT, STYLE, SIZE, OR COLOR.

SER. NO. 77-230,077, FILED 7-16-2007.

ANN E. SAPPENFIELD, EXAMINING ATTORNEY

Int. Cl.: 41

Prior U.S. Cls.: 100, 101 and 107

United States Patent and Trademark Office

Reg. No. 3,397,987

Registered Mar. 18, 2008

**SERVICE MARK
PRINCIPAL REGISTER**

SPACE LIBRARY

SPACE EXPLORERS, INC. (WISCONSIN CORPORATION)
1825 NIMITZ DRIVE
DE PERE, WI 54115

FOR: EDUCATIONAL SERVICES, NAMELY, SPACE-RELATED INTERACTIVE EDUCATION PROGRAM AND CURRICULUM DELIVERED VIA THE INTERNET, IN CLASS 41 (U.S. CLS. 100, 101 AND 107).

FIRST USE 8-30-1998; IN COMMERCE 8-30-1998.

THE MARK CONSISTS OF STANDARD CHARACTERS WITHOUT CLAIM TO ANY PARTICULAR FONT, STYLE, SIZE, OR COLOR.

OWNER OF U.S. REG. NO. 2,586,884.

NO CLAIM IS MADE TO THE EXCLUSIVE RIGHT TO USE "LIBRARY", APART FROM THE MARK AS SHOWN.

SEC. 2(F).

SER. NO. 77-230,107, FILED 7-16-2007.

PAUL F. GAST, EXAMINING ATTORNEY

Int. Cl.: 35

Prior U.S. Cls.: 100, 101 and 102

United States Patent and Trademark Office

Reg. No. 3,397,988

Registered Mar. 18, 2008

**SERVICE MARK
PRINCIPAL REGISTER**

GLOBAL GIG

GLOBAL GIG, INC. (FLORIDA CORPORATION)
3589 S. OCEAN BLVD #809
PALM BEACH, FL 33480

FOR: BUSINESS MANAGEMENT CONSULTING WITH RELATION TO STRATEGY, MARKETING, PRODUCTION, PERSONNEL AND RETAIL SALE MATTERS; BUSINESS MARKETING CONSULTING SERVICES; MARKETING CONSULTING; ADVERTISING SERVICES, PUBLIC RELATIONS AND MARKETING SERVICES, NAMELY, PROMOTING AND MARKETING THE GOODS AND SERVICES OF OTHERS THROUGH ALL PUBLIC COMMUNICATION MEANS; ADVISORY AND CONSULTANCY SERVICES RELATING TO EXPORT, EXPORT SERVICES, EXPORT PROMOTION INFORMATION AND SERVICES; EXPORT AND IMPORT AGEN-

CIES; WRITING OF PUBLICITY TEXTS, IN CLASS 35 (U.S. CLS. 100, 101 AND 102).

FIRST USE 6-29-2007; IN COMMERCE 7-11-2007.

THE MARK CONSISTS OF STANDARD CHARACTERS WITHOUT CLAIM TO ANY PARTICULAR FONT, STYLE, SIZE, OR COLOR.

NO CLAIM IS MADE TO THE EXCLUSIVE RIGHT TO USE "GLOBAL", APART FROM THE MARK AS SHOWN.

SER. NO. 77-230,127, FILED 7-16-2007.

CHARISMA HAMPTON, EXAMINING ATTORNEY

Int. Cl.: 37

Prior U.S. Cls.: 100, 103 and 106

United States Patent and Trademark Office

Reg. No. 3,397,989

Registered Mar. 18, 2008

**SERVICE MARK
PRINCIPAL REGISTER**

PPE SafetyCare Services

GEAR WASH LLC (WISCONSIN LTD LIAB CO)
657 S. 72ND STREET
MILWAUKEE, WI 53214

FOR: MAINTENANCE AND/OR REPAIR OF PERSONAL PROTECTIVE EQUIPMENT, IN CLASS 37 (U.S. CLS. 100, 103 AND 106).

FIRST USE 6-1-2007; IN COMMERCE 6-1-2007.

THE MARK CONSISTS OF STANDARD CHARACTERS WITHOUT CLAIM TO ANY PARTICULAR FONT, STYLE, SIZE, OR COLOR.

NO CLAIM IS MADE TO THE EXCLUSIVE RIGHT TO USE "PPE" AND "SERVICES", APART FROM THE MARK AS SHOWN.

SER. NO. 77-230,200, FILED 7-16-2007.

RICHARD A. STRASER, EXAMINING ATTORNEY

Int. Cl.: 33

Prior U.S. Cls.: 47 and 49

United States Patent and Trademark Office

Reg. No. 3,397,990

Registered Mar. 18, 2008

**TRADEMARK
PRINCIPAL REGISTER**

Hats Off

WENTE BROS. (CALIFORNIA CORPORATION)
5565 TESLA ROAD
LIVERMORE, CA 94550

THE MARK CONSISTS OF STANDARD CHAR-
ACTERS WITHOUT CLAIM TO ANY PARTICULAR
FONT, STYLE, SIZE, OR COLOR.

FOR: WINE, IN CLASS 33 (U.S. CLS. 47 AND 49).

SER. NO. 77-230,261, FILED 7-16-2007.

FIRST USE 7-12-2005; IN COMMERCE 8-5-2005.

ROSELLE HERRERA, EXAMINING ATTORNEY

Int. Cl.: 33

Prior U.S. Cls.: 47 and 49

United States Patent and Trademark Office

Reg. No. 3,397,991

Registered Mar. 18, 2008

**TRADEMARK
PRINCIPAL REGISTER**

In the Saddle

WENTE BROS. (CALIFORNIA CORPORATION)
5565 TESLA ROAD
LIVERMORE, CA 94550

THE MARK CONSISTS OF STANDARD CHAR-
ACTERS WITHOUT CLAIM TO ANY PARTICULAR
FONT, STYLE, SIZE, OR COLOR.

FOR: WINE, IN CLASS 33 (U.S. CLS. 47 AND 49).

SER. NO. 77-230,275, FILED 7-16-2007.

FIRST USE 10-3-2005; IN COMMERCE 10-28-2005.

ROSELLE HERRERA, EXAMINING ATTORNEY

Int. Cl.: 3

Prior U.S. Cls.: 1, 4, 6, 50, 51 and 52

United States Patent and Trademark Office

Reg. No. 3,397,992

Registered Mar. 18, 2008

**TRADEMARK
PRINCIPAL REGISTER**

Hair Foundation

MARK ADAMS (CANADA INDIVIDUAL)
108 CINDY AVENUE
CAMBRIDGE, CANADA N3C3J2

FOR: HAIR CARE PREPARATIONS, IN CLASS 3
(U.S. CLS. 1, 4, 6, 50, 51 AND 52).

FIRST USE 9-9-2006; IN COMMERCE 5-7-2007.

THE MARK CONSISTS OF STANDARD CHARACTERS WITHOUT CLAIM TO ANY PARTICULAR FONT, STYLE, SIZE, OR COLOR.

NO CLAIM IS MADE TO THE EXCLUSIVE RIGHT TO USE "HAIR", APART FROM THE MARK AS SHOWN.

SER. NO. 77-230,276, FILED 7-16-2007.

JAY FLOWERS, EXAMINING ATTORNEY

Int. Cl.: 33

Prior U.S. Cls.: 47 and 49

United States Patent and Trademark Office

Reg. No. 3,397,993

Registered Mar. 18, 2008

**TRADEMARK
PRINCIPAL REGISTER**

Best Foot Forward

WENTE BROS. (CALIFORNIA CORPORATION)
5565 TESLA ROAD
LIVERMORE, CA 94550

THE MARK CONSISTS OF STANDARD CHAR-
ACTERS WITHOUT CLAIM TO ANY PARTICULAR
FONT, STYLE, SIZE, OR COLOR.

FOR: WINE, IN CLASS 33 (U.S. CLS. 47 AND 49).

SER. NO. 77-230,289, FILED 7-16-2007.

FIRST USE 10-4-2005; IN COMMERCE 10-26-2005.

ROSELLE HERRERA, EXAMINING ATTORNEY

Int. Cl.: 33

Prior U.S. Cls.: 47 and 49

United States Patent and Trademark Office

Reg. No. 3,397,994

Registered Mar. 18, 2008

**TRADEMARK
PRINCIPAL REGISTER**

Lucky Horseshoe

WENTE BROS. (CALIFORNIA CORPORATION)
5565 TESLA ROAD
LIVERMORE, CA 94550

THE MARK CONSISTS OF STANDARD CHAR-
ACTERS WITHOUT CLAIM TO ANY PARTICULAR
FONT, STYLE, SIZE, OR COLOR.

FOR: WINE, IN CLASS 33 (U.S. CLS. 47 AND 49).

SER. NO. 77-230,298, FILED 7-16-2007.

FIRST USE 10-3-2005; IN COMMERCE 10-28-2005.

ROSELLE HERRERA, EXAMINING ATTORNEY

Int. Cl.: 41

Prior U.S. Cls.: 100, 101 and 107

United States Patent and Trademark Office

Reg. No. 3,397,995

Registered Mar. 18, 2008

**SERVICE MARK
PRINCIPAL REGISTER**

HEALTHCORPS

HEALTHCORPS (NEW YORK NON-PROFIT ORGANIZATION)
30 WALL STREET, 6TH FLOOR
NEW YORK, NY 10005

FOR: CHARITABLE SERVICES, NAMELY, EDUCATING YOUTH, PARENTS AND THE COMMUNITY ABOUT THE WORKINGS AND WONDERS OF THEIR BODIES THROUGH SCHOOL SEMINARS ON DIET, NUTRITION AND EXERCISE, IN CLASS 41 (U.S. CLS. 100, 101 AND 107).

FIRST USE 1-1-2007; IN COMMERCE 1-1-2007.

THE MARK CONSISTS OF STANDARD CHARACTERS WITHOUT CLAIM TO ANY PARTICULAR FONT, STYLE, SIZE, OR COLOR.

SER. NO. 77-230,301, FILED 7-16-2007.

VIVIAN MICZNIK FIRST, EXAMINING ATTORNEY

Int. Cl.: 35

Prior U.S. Cls.: 100, 101 and 102

United States Patent and Trademark Office

Reg. No. 3,397,996

Registered Mar. 18, 2008

**SERVICE MARK
PRINCIPAL REGISTER**

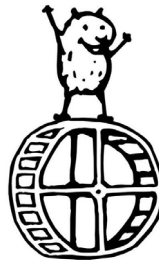

SCHALLERT, JON (UNITED STATES INDIVIDUAL)
SUITE 100
2117 EMERALD DRIVE
LONGMONT, CO 80504 AND
SCHALLERT, MARGARET (UNITED STATES INDIVIDUAL)
SUITE 100
2117 EMERALD DRIVE
LONGMONT, CO 80504

PRODUCTION, PERSONNEL AND RETAIL SALE MATTERS, IN CLASS 35 (U.S. CLS. 100, 101 AND 102).

FIRST USE 8-16-2005; IN COMMERCE 8-16-2005.

THE MARK CONSISTS OF A HAMSTER RUNNING WHEEL WITH A TRIUMPHANT HAMSTER STANDING ON TOP OF IT

SER. NO. 77-230,312, FILED 7-16-2007.

FOR: BUSINESS MANAGEMENT CONSULTING WITH RELATION TO STRATEGY, MARKETING,

RENEE MCCRAY, EXAMINING ATTORNEY

Int. Cl.: 36

Prior U.S. Cls.: 100, 101 and 102

United States Patent and Trademark Office

Reg. No. 3,397,997

Registered Mar. 18, 2008

**SERVICE MARK
PRINCIPAL REGISTER**

**WEST COAST MERCHANT
SERVICES**

WEST COAST BANCORP (OREGON CORPORATION)
SUITE 201
5335 MEADOWS ROAD
LAKE OSWEGO, OR 97035

FOR: BANKING AND RELATED FINANCIAL SERVICES, NAMELY, CREDIT CARD, DEBIT CARD AND STORED VALUE CARD TRANSACTION PROCESSING SERVICES, IN CLASS 36 (U.S. CLS. 100, 101 AND 102).

FIRST USE 6-3-2002; IN COMMERCE 6-3-2002.

THE MARK CONSISTS OF STANDARD CHARACTERS WITHOUT CLAIM TO ANY PARTICULAR FONT, STYLE, SIZE, OR COLOR.

NO CLAIM IS MADE TO THE EXCLUSIVE RIGHT TO USE "MERCHANT SERVICES", APART FROM THE MARK AS SHOWN.

SEC. 2(F).

SER. NO. 77-230,315, FILED 7-16-2007.

KAREN K. BUSH, EXAMINING ATTORNEY

Int. Cl.: 29

Prior U.S. Cl.: 46

United States Patent and Trademark Office

Reg. No. 3,397,998

Registered Mar. 18, 2008

**TRADEMARK
PRINCIPAL REGISTER**

Otter Creek Organic Farm

LOCAL CHOICE MARKETING, LLC (WISCONSIN LTD LIAB CO)
9255 UNION VALLEY ROAD
BLACK EARTH, WI 53515

NO CLAIM IS MADE TO THE EXCLUSIVE RIGHT TO USE "ORGANIC FARM", APART FROM THE MARK AS SHOWN.

FOR: CHEESE, IN CLASS 29 (U.S. CL. 46).

FIRST USE 6-1-2006; IN COMMERCE 6-1-2006.

SER. NO. 77-230,333, FILED 7-16-2007.

THE MARK CONSISTS OF STANDARD CHARACTERS WITHOUT CLAIM TO ANY PARTICULAR FONT, STYLE, SIZE, OR COLOR.

KATHLEEN LORENZO, EXAMINING ATTORNEY

Int. Cl.: 7

Prior U.S. Cls.: 13, 19, 21, 23, 31, 34 and 35

United States Patent and Trademark Office

Reg. No. 3,397,999

Registered Mar. 18, 2008

**TRADEMARK
PRINCIPAL REGISTER**

SERVAPUMP

SERVA CORPORATION (TEXAS CORPORATION)
POST OFFICE BOX 8121
WICHITA FALLS, TX 76307

FOR: OILFIELD EQUIPMENT, NAMELY, PLUNGER PUMPS AND CENTRIFUGAL PUMPS FOR USE IN THE OIL AND GAS INDUSTRY, IN CLASS 7 (U.S. CLS. 13, 19, 21, 23, 31, 34 AND 35).

FIRST USE 6-1-1997; IN COMMERCE 6-1-1997.

THE MARK CONSISTS OF STANDARD CHARACTERS WITHOUT CLAIM TO ANY PARTICULAR FONT, STYLE, SIZE, OR COLOR.

SER. NO. 77-230,372, FILED 7-16-2007.

TOBY BULLOFF, EXAMINING ATTORNEY

Int. Cl.: 41

Prior U.S. Cls.: 100, 101 and 107

United States Patent and Trademark Office

Reg. No. 3,398,000

Registered Mar. 18, 2008

**SERVICE MARK
PRINCIPAL REGISTER**

DESTINATION UNIVERSITY

THE SCHALLERT GROUP, INC. (COLORADO CORPORATION)
SUITE 100
2117 EMERALD DRIVE
LONGMONT, CO 80504

FOR: EDUCATION SERVICES, NAMELY, PROVIDING LIVE AND ON-LINE PROGRAMS, SEMINARS, TUTORIALS AND WORKSHOPS IN THE FIELD OF MARKETING, BUSINESS MANAGEMENT AND ADVERTISING, IN CLASS 41 (U.S. CLS. 100, 101 AND 107).

FIRST USE 3-26-2007; IN COMMERCE 3-26-2007.

THE MARK CONSISTS OF STANDARD CHARACTERS WITHOUT CLAIM TO ANY PARTICULAR FONT, STYLE, SIZE, OR COLOR.

NO CLAIM IS MADE TO THE EXCLUSIVE RIGHT TO USE "UNIVERSITY", APART FROM THE MARK AS SHOWN.

SER. NO. 77-230,388, FILED 7-16-2007.

MELISSA VALLILLO, EXAMINING ATTORNEY

Int. Cl.: 3

Prior U.S. Cls.: 1, 4, 6, 50, 51 and 52

United States Patent and Trademark Office

Reg. No. 3,398,001

Registered Mar. 18, 2008

**TRADEMARK
PRINCIPAL REGISTER**

ZIM'S

PERFECTA PRODUCTS, INC. (OHIO CORPORATION)
131 W. SOUTH RANGE ROAD
NORTH LIMA, OH 44452

FOR: SKIN CREAMS, IN CLASS 3 (U.S. CLS. 1, 4, 6,
50, 51 AND 52).

FIRST USE 6-29-1994; IN COMMERCE 7-30-1994.

THE MARK CONSISTS OF STANDARD CHARACTERS WITHOUT CLAIM TO ANY PARTICULAR FONT, STYLE, SIZE, OR COLOR.

SEC. 2(F).

SER. NO. 77-230,391, FILED 7-16-2007.

GISELLE AGOSTO, EXAMINING ATTORNEY

Int. Cl.: 40

Prior U.S. Cls.: 100, 103 and 106

United States Patent and Trademark Office

Reg. No. 3,398,002

Registered Mar. 18, 2008

**SERVICE MARK
PRINCIPAL REGISTER**

GEOPLASMA

GEOPLASMA, LLC (GEORGIA LTD LIAB CO)
171 17TH STREET NW, SUITE 1550
ATLANTA, GA 30363

THE MARK CONSISTS OF STANDARD CHAR-
ACTERS WITHOUT CLAIM TO ANY PARTICULAR
FONT, STYLE, SIZE, OR COLOR.

FOR: WASTE-TO-ENERGY GENERATION SER-
VICES, IN CLASS 40 (U.S. CLS. 100, 103 AND 106).

SER. NO. 77-230,402, FILED 7-16-2007.

FIRST USE 3-13-2003; IN COMMERCE 7-31-2003.

THEODORE MCBRIDE, EXAMINING ATTORNEY

Int. Cl.: 3

Prior U.S. Cls.: 1, 4, 6, 50, 51 and 52

United States Patent and Trademark Office

Reg. No. 3,398,003

Registered Mar. 18, 2008

**TRADEMARK
PRINCIPAL REGISTER**

PROLIPOSOME

PROSTRONG, INC. (CONNECTICUT CORPORATION)
20 MAIN STREET
OAKVILLE, CT 06779

THE MARK CONSISTS OF STANDARD CHARACTERS WITHOUT CLAIM TO ANY PARTICULAR FONT, STYLE, SIZE, OR COLOR.

FOR: NAIL CARE PREPARATIONS; NAIL-POLISH REMOVERS, IN CLASS 3 (U.S. CLS. 1, 4, 6, 50, 51 AND 52).

SER. NO. 77-230,405, FILED 7-16-2007.

FIRST USE 9-23-1995; IN COMMERCE 9-23-1995.

THEODORE MCBRIDE, EXAMINING ATTORNEY

Int. Cl.: 9

Prior U.S. Cls.: 21, 23, 26, 36 and 38

United States Patent and Trademark Office

Reg. No. 3,398,004

Registered Mar. 18, 2008

**TRADEMARK
PRINCIPAL REGISTER**

Newsmakers In Medicine 
Where Breaking Research Speaks to the Clinician

PROJECTS IN KNOWLEDGE, INC. (NEW YORK CORPORATION)
10TH FLOOR
150 CLOVE ROAD
LITTLE FALLS, NJ 07424

FOR: DOWNLOADABLE PODCASTS IN THE FIELD OF MEDICINE, IN CLASS 9 (U.S. CLS. 21, 23, 26, 36 AND 38).

FIRST USE 5-12-2006; IN COMMERCE 5-12-2006.

OWNER OF U.S. REG. NO. 3,293,143.

NO CLAIM IS MADE TO THE EXCLUSIVE RIGHT TO USE "MEDICINE", APART FROM THE MARK AS SHOWN.

THE MARK CONSISTS OF WORDS AND A PICTURE OF AN MP3 PLAYER.

SER. NO. 77-230,433, FILED 7-16-2007.

CYNTHIA SLOAN, EXAMINING ATTORNEY

Int. Cl.: 6

Prior U.S. Cls.: 2, 12, 13, 14, 23, 25 and 50

United States Patent and Trademark Office

Reg. No. 3,398,005

Registered Mar. 18, 2008

**TRADEMARK
PRINCIPAL REGISTER**

SERVAFRAC

SERVA CORPORATION (TEXAS CORPORATION)
POST OFFICE BOX 8121
WICHITA FALLS, TX 76307

THE MARK CONSISTS OF STANDARD CHARACTERS WITHOUT CLAIM TO ANY PARTICULAR FONT, STYLE, SIZE, OR COLOR.

FOR: OIL FIELD STORAGE EQUIPMENT, NAMELY, METAL FLUID FRACTURING TANKS, IN CLASS 6 (U.S. CLS. 2, 12, 13, 14, 23, 25 AND 50).

SER. NO. 77-230,435, FILED 7-16-2007.

FIRST USE 6-1-1997; IN COMMERCE 6-1-1997.

TOBY BULLOFF, EXAMINING ATTORNEY

Int. Cl.: 41

Prior U.S. Cls.: 100, 101 and 107

United States Patent and Trademark Office

Reg. No. 3,398,006

Registered Mar. 18, 2008

**SERVICE MARK
PRINCIPAL REGISTER**



THE SCHALLERT GROUP, INC. (COLORADO CORPORATION)
SUITE 100
2117 EMERALD DRIVE
LONGMONT, CO 80504

FOR: EDUCATION SERVICES, NAMELY, PROVIDING LIVE AND ON-LINE PROGRAMS, SEMINARS, TUTORIALS AND WORKSHOPS IN THE FIELD OF MARKETING, BUSINESS MANAGEMENT AND ADVERTISING, IN CLASS 41 (U.S. CLS. 100, 101 AND 107).

FIRST USE 3-26-2007; IN COMMERCE 3-26-2007.

THE COLOR(S) GREEN, WHITE, BROWN, TAN, BLUE, ORANGE, YELLOW AND GRAY IS/ARE CLAIMED AS A FEATURE OF THE MARK.

THE MARK CONSISTS OF A SCENE SHOWING A BROWN AND TAN HIGH RISE CITYSCAPE IN THE BACKGROUND, WITH A WHITE AND GRAY ROAD WINDING THROUGH MULTIPLE GREEN ROLLING HILLS, DOTTED WITH DARKER GREEN TREES, IN THE FOREGROUND, AND WITH ORANGE AND YELLOW SUN RAYS SPREADING ACROSS THE BLUE AND WHITE CLOUDED SKY IN THE BACKGROUND, EMANATING FROM BEHIND THE CENTER OF THE CITYSCAPE

SER. NO. 77-230,449, FILED 7-16-2007.

MELISSA VALLILLO, EXAMINING ATTORNEY

Int. Cl.: 35

Prior U.S. Cls.: 100, 101 and 102

United States Patent and Trademark Office

Reg. No. 3,398,007

Registered Mar. 18, 2008

**SERVICE MARK
PRINCIPAL REGISTER**

**DESTINATION BUSINESS
BOOTCAMP**

THE SCHALLERT GROUP, INC. (COLORADO
CORPORATION)
SUITE 100
2117 EMERALD DRIVE
LONGMONT, CO 80504

FOR: BUSINESS MANAGEMENT CONSULTING
WITH RELATION TO STRATEGY, MARKETING,
PRODUCTION, PERSONNEL AND RETAIL SALE
MATTERS, IN CLASS 35 (U.S. CLS. 100, 101 AND 102).

FIRST USE 8-16-2005; IN COMMERCE 8-16-2005.

THE MARK CONSISTS OF STANDARD CHAR-
ACTERS WITHOUT CLAIM TO ANY PARTICULAR
FONT, STYLE, SIZE, OR COLOR.

NO CLAIM IS MADE TO THE EXCLUSIVE
RIGHT TO USE "BUSINESS", APART FROM THE
MARK AS SHOWN.

SER. NO. 77-230,467, FILED 7-16-2007.

MELISSA VALLILLO, EXAMINING ATTORNEY

Int. Cl.: 33

Prior U.S. Cls.: 47 and 49

United States Patent and Trademark Office

Reg. No. 3,398,008

Registered Mar. 18, 2008

**TRADEMARK
PRINCIPAL REGISTER**

GOLD STRIPE

VENTANA VINTNERS, LLC (CALIFORNIA LTD
LIAB CO)
2999 MONTEREY-SALINAS HIGHWAY, #10
MONTEREY, CA 93940

THE MARK CONSISTS OF STANDARD CHAR-
ACTERS WITHOUT CLAIM TO ANY PARTICULAR
FONT, STYLE, SIZE, OR COLOR.

FOR: WINE, IN CLASS 33 (U.S. CLS. 47 AND 49).

SER. NO. 77-230,468, FILED 7-16-2007.

FIRST USE 0-0-1985; IN COMMERCE 0-0-1985.

ATTIYA MALIK, EXAMINING ATTORNEY

Int. Cl.: 9

Prior U.S. Cls.: 21, 23, 26, 36 and 38

Reg. No. 3,398,009

United States Patent and Trademark Office

Registered Mar. 18, 2008

**TRADEMARK
PRINCIPAL REGISTER**

WEIGH SHARK

MCR TECHNOLOGIES GROUP, INC. (ILLINOIS
CORPORATION)
13420 GALT ROAD
STERLING,, IL 61081

FOR: WEIGHING EQUIPMENT, NAMELY,
SCALES AND BALANCES, IN CLASS 9 (U.S. CLS.
21, 23, 26, 36 AND 38).

FIRST USE 1-1-2005; IN COMMERCE 1-1-2005.

THE MARK CONSISTS OF STANDARD CHAR-
ACTERS WITHOUT CLAIM TO ANY PARTICULAR
FONT, STYLE, SIZE, OR COLOR.

NO CLAIM IS MADE TO THE EXCLUSIVE
RIGHT TO USE "WEIGH", APART FROM THE
MARK AS SHOWN.

SER. NO. 77-230,472, FILED 7-16-2007.

CHRISTINA SOBRAL, EXAMINING ATTORNEY

Int. Cl.: 1

Prior U.S. Cls.: 1, 5, 6, 10, 26 and 46

United States Patent and Trademark Office

Reg. No. 3,398,010

Registered Mar. 18, 2008

**TRADEMARK
PRINCIPAL REGISTER**

HAFNIUM OXIMET

GENERAL SCIENCES, INC. (PENNSYLVANIA
CORPORATION)

205 SCHOOLHOUSE ROAD

SOUDERTON, PA 18964

FOR: CHEMICAL MIXTURES OF OXIDANTS
AND METALS, INCLUDING HAFNIUM, FOR USE
IN THE MANUFACTURE OF REACTIVE PROJEC-
TILES, IN CLASS 1 (U.S. CLS. 1, 5, 6, 10, 26 AND 46).

FIRST USE 9-7-2006; IN COMMERCE 9-7-2006.

THE MARK CONSISTS OF STANDARD CHAR-
ACTERS WITHOUT CLAIM TO ANY PARTICULAR
FONT, STYLE, SIZE, OR COLOR.

OWNER OF U.S. REG. NO. 2,555,226.

NO CLAIM IS MADE TO THE EXCLUSIVE
RIGHT TO USE "HAFNIUM", APART FROM THE
MARK AS SHOWN.

SER. NO. 77-230,473, FILED 7-16-2007.

LINDA LAVACHE, EXAMINING ATTORNEY

Int. Cl.: 15

Prior U.S. Cls.: 2, 21 and 36

United States Patent and Trademark Office

Reg. No. 3,398,011

Registered Mar. 18, 2008

**TRADEMARK
PRINCIPAL REGISTER**

JAMES TYLER

TYLER, JAMES (UNITED STATES INDIVIDUAL)
6166 SEPULVEDA BLVD.
VAN NUYS, CA 91411

FOR: BASS GUITARS; ELECTRIC GUITARS;
GUITARS, IN CLASS 15 (U.S. CLS. 2, 21 AND 36).

FIRST USE 6-1-1987; IN COMMERCE 12-31-1991.

THE MARK CONSISTS OF STANDARD CHAR-
ACTERS WITHOUT CLAIM TO ANY PARTICULAR
FONT, STYLE, SIZE, OR COLOR.

THE NAME(S), PORTRAIT(S), AND/OR SIGNA-
TURE(S) SHOWN IN THE MARK IDENTIFIES
JAMES TYLER, WHOSE CONSENT(S) TO REGIS-
TER IS MADE OF RECORD.

SER. NO. 77-230,482, FILED 7-16-2007.

SANDRA MANIOS, EXAMINING ATTORNEY

Int. Cl.: 36

Prior U.S. Cls.: 100, 101 and 102

United States Patent and Trademark Office

Reg. No. 3,398,012

Registered Mar. 18, 2008

**SERVICE MARK
PRINCIPAL REGISTER**

CETALUS

CETALUS LLC (MASSACHUSETTS LTD LIAB
CO)
SUITE 300, 25 BURLINGTON MALL ROAD
BURLINGTON, MA 01803

FOR: BUSINESS BROKERAGE, IN CLASS 36 (U.S.
CLS. 100, 101 AND 102).

FIRST USE 5-31-2007; IN COMMERCE 5-31-2007.

THE MARK CONSISTS OF STANDARD CHAR-
ACTERS WITHOUT CLAIM TO ANY PARTICULAR
FONT, STYLE, SIZE, OR COLOR.

OWNER OF U.S. REG. NO. 3,296,642.

SER. NO. 77-230,485, FILED 7-16-2007.

REBECCA EISINGER, EXAMINING ATTORNEY

Int. Cl.: 35

Prior U.S. Cls.: 100, 101 and 102

United States Patent and Trademark Office

Reg. No. 3,398,013

Registered Mar. 18, 2008

**SERVICE MARK
PRINCIPAL REGISTER**

CE CRAFTS ETC!

CRAFTS, ETC!, LTD. (OKLAHOMA CORPORATION)
7707 SOUTHWEST 44TH STREET
OKLAHOMA CITY, OK 73179

FOR: DISTRIBUTORSHIPS IN THE FIELD OF ART, CRAFT, HOBBY, AND FLORAL SUPPLIES; MAIL ORDER SERVICES FEATURING ART, CRAFT, HOBBY, AND FLORAL SUPPLIES; ELECTRONIC CATALOG SERVICES FEATURING ART, CRAFT, HOBBY, AND FLORAL SUPPLIES, IN CLASS 35 (U.S. CLS. 100, 101 AND 102).

FIRST USE 11-1-1996; IN COMMERCE 11-1-1996.

THE MARK CONSISTS OF STANDARD CHARACTERS WITHOUT CLAIM TO ANY PARTICULAR FONT, STYLE, SIZE, OR COLOR.

OWNER OF U.S. REG. NOS. 1,244,866, 2,422,465 AND OTHERS.

NO CLAIM IS MADE TO THE EXCLUSIVE RIGHT TO USE "CRAFTS", APART FROM THE MARK AS SHOWN.

SER. NO. 77-230,509, FILED 7-16-2007.

BRENDAN REGAN, EXAMINING ATTORNEY

Int. Cl.: 25

Prior U.S. Cls.: 22 and 39

United States Patent and Trademark Office

Reg. No. 3,398,014

Registered Mar. 18, 2008

TRADEMARK
PRINCIPAL REGISTER

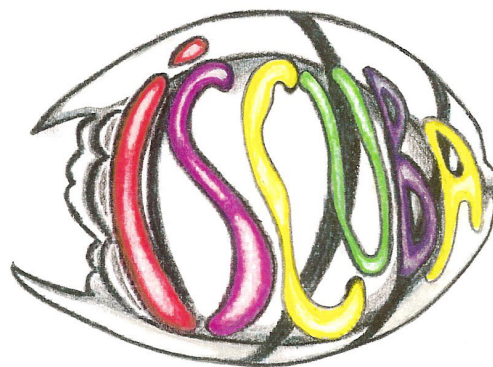

COLLEEN QUIGLEY (FLORIDA SOLE PROPRIETORSHIP), DBA ISCUBA
37 BIG BEAR PATH
ORMOND BEACH, FL 32174

FOR: SHORT-SLEEVED OR LONG-SLEEVED T-SHIRTS, IN CLASS 25 (U.S. CLS. 22 AND 39).

FIRST USE 4-23-2007; IN COMMERCE 4-23-2007.

THE COLOR(S) RED IS USED FOR "I", PINK IS FOR "S", YELLOW IS FOR "C", GREEN IS FOR "U", PURPLE IS FOR "B", YELLOW IS USED AGAIN FOR "A", SURROUNDED BY A WHITE FISH WITH BLACK STRIPES IS/ARE CLAIMED AS A FEATURE OF THE MARK.

THE MARK CONSISTS OF AN IMAGE OF A BANDED BUTTERFLY FISH - WHITE WITH BLACK STRIPES WITH STYLIZED CHARACTERS - THAT IS LETTERS THAT HAVE A LIQUID QUALITY, AS IF THEY ARE MADE FROM DROPS OF COLORED WATER. WRITTEN ACROSS THE BODY OF THE FISH, ARE COLORED LETTERS SPELLING OUT THE "ISCUBA" LOGO. THE COLORED LETTERS ARE AS FOLLOWS: "I" IS RED, "S" IS PINK, "C" IS YELLOW, "U" IS GREEN, "B" IS PURPLE, "A" IS YELLOW .

SER. NO. 77-230,524, FILED 7-16-2007.

RICHARD A. STRASER, EXAMINING ATTORNEY

Int. Cl.: 27

Prior U.S. Cls.: 19, 20, 37, 42 and 50

Reg. No. 3,398,015

United States Patent and Trademark Office

Registered Mar. 18, 2008

**TRADEMARK
PRINCIPAL REGISTER**

SISKIYOU

FIBREWORKS CORPORATION (KENTUCKY
CORPORATION)
2417 DATA DRIVE
LOUISVILLE, KY 40299

THE MARK CONSISTS OF STANDARD CHAR-
ACTERS WITHOUT CLAIM TO ANY PARTICULAR
FONT, STYLE, SIZE, OR COLOR.

FOR: CARPETS; RUGS, IN CLASS 27 (U.S. CLS. 19,
20, 37, 42 AND 50).

SER. NO. 77-230,535, FILED 7-16-2007.

FIRST USE 1-31-2004; IN COMMERCE 1-31-2004.

EDWARD NELSON, EXAMINING ATTORNEY

Int. Cl.: 6

Prior U.S. Cls.: 2, 12, 13, 14, 23, 25 and 50

Reg. No. 3,398,016

United States Patent and Trademark Office

Registered Mar. 18, 2008

**TRADEMARK
PRINCIPAL REGISTER**

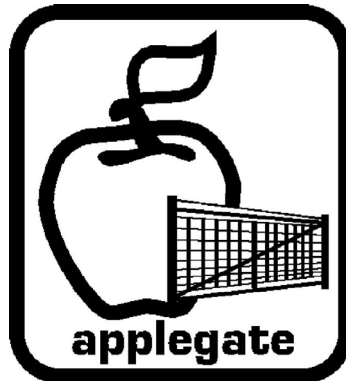

R.G. APPELATE STEEL COMPANY, INC. (IN-
DIANA CORPORATION)
201 OWENS STREET
SARATOGA, IN 47382

FOR: METAL LIVESTOCK AND FARM ANIMAL
RETENTION AND FEEDING EQUIPMENT, NAME-
LY, GATES, CORRALS, WATERING TANKS AND
EARTH ANCHORS, IN CLASS 6 (U.S. CLS. 2, 12, 13,
14, 23, 25 AND 50).

FIRST USE 6-30-1961; IN COMMERCE 6-30-1961.

THE MARK CONSISTS OF A LINE DRAWING OF
AN APPLE WITH A DRAWING OF A GATE SUPER-
IMPOSED ON THE LOWER RIGHT QUADRANT
OF THE APPLE, SET OVER THE WORD APPEL-
GATE RENDERED IN LOWER CASE LETTERS.

SER. NO. 77-230,543, FILED 7-16-2007.

DANIEL BRODY, EXAMINING ATTORNEY

Int. Cl.: 12

Prior U.S. Cls.: 19, 21, 23, 31, 35 and 44

Reg. No. 3,398,017

United States Patent and Trademark Office

Registered Mar. 18, 2008

**TRADEMARK
PRINCIPAL REGISTER**

ALLSET

ALLSET RV SYSTEMS, LLC (ARIZONA LTD
LIAB CO)
300 N. BUDWEISER CIRCLE
PAYSON, AZ 85541

THE MARK CONSISTS OF STANDARD CHAR-
ACTERS WITHOUT CLAIM TO ANY PARTICULAR
FONT, STYLE, SIZE, OR COLOR.

FOR: RECREATIONAL VEHICLE ACCESSORIES,
NAMELY, AWNING HOLD DOWNS, IN CLASS 12
(U.S. CLS. 19, 21, 23, 31, 35 AND 44).

SER. NO. 77-230,549, FILED 7-16-2007.

FIRST USE 3-19-2003; IN COMMERCE 3-19-2003.

JOHN DWYER, EXAMINING ATTORNEY

Int. Cl.: 44

Prior U.S. Cls.: 100 and 101

United States Patent and Trademark Office

Reg. No. 3,398,018

Registered Mar. 18, 2008

**SERVICE MARK
PRINCIPAL REGISTER**

LifeStar Network

LIFESTAR NETWORK, LLC (UTAH LTD LIAB
CO)
SUITE 204
151 EAST 5600 SOUTH
MURRAY, UT 84107

FOR: COUNSELING IN THE FIELD OF SEXUAL
ADDICTIONS, IN CLASS 44 (U.S. CLS. 100 AND 101).

FIRST USE 2-0-2005; IN COMMERCE 2-0-2005.

THE MARK CONSISTS OF STANDARD CHAR-
ACTERS WITHOUT CLAIM TO ANY PARTICULAR
FONT, STYLE, SIZE, OR COLOR.

NO CLAIM IS MADE TO THE EXCLUSIVE
RIGHT TO USE "NETWORK", APART FROM THE
MARK AS SHOWN.

SER. NO. 77-230,578, FILED 7-16-2007.

STEVEN JACKSON, EXAMINING ATTORNEY

Int. Cl.: 6

Prior U.S. Cls.: 2, 12, 13, 14, 23, 25 and 50

Reg. No. 3,398,019

United States Patent and Trademark Office

Registered Mar. 18, 2008

**TRADEMARK
PRINCIPAL REGISTER**



R.G. APPLGATE STEEL COMPANY, INC. (IN-
DIANA CORPORATION)
201 OWENS STREET
SARATOGA, IN 47382

FOR: METAL LIVESTOCK AND FARM ANIMAL
RETENTION AND FEEDING EQUIPMENT, NAME-
LY, GATES, CORRALS, WATERING TANKS AND
EARTH ANCHORS, IN CLASS 6 (U.S. CLS. 2, 12, 13,
14, 23, 25 AND 50).

FIRST USE 9-1-2000; IN COMMERCE 9-1-2000.

THE MARK CONSISTS OF A LINE DRAWING OF
AN APPLE WITH THE WORD APPLGATE, REN-
DERED IN LOWER CASE LETTERS, SUPERIM-
POSED ON THE DRAWING AND EXTENDING TO
THE RIGHT OF THE DRAWING.

SER. NO. 77-230,589, FILED 7-16-2007.

DANIEL BRODY, EXAMINING ATTORNEY

Int. Cl.: 41

Prior U.S. Cls.: 100, 101 and 107

United States Patent and Trademark Office

Reg. No. 3,398,020

Registered Mar. 18, 2008

**SERVICE MARK
PRINCIPAL REGISTER**



HEALTHCORPS (NEW YORK NON-PROFIT ORGANIZATION)
191 SEVENTH AVENUE #4N
NEW YORK, NY 10011

FOR: CHARITABLE SERVICES, NAMELY, EDUCATING YOUTH, PARENTS AND THE COMMUNITY ABOUT THE WORKINGS AND WONDERS OF THEIR BODIES THROUGH SCHOOL SEMINARS ON DIET, NUTRITION AND EXERCISE, IN CLASS 41 (U.S. CLS. 100, 101 AND 107).

FIRST USE 1-1-2007; IN COMMERCE 1-1-2007.

NO CLAIM IS MADE TO THE EXCLUSIVE RIGHT TO USE "HEALTH", APART FROM THE MARK AS SHOWN.

THE MARK CONSISTS, IN PART, OF A HEART-SHAPED APPLE WITH STEM AND LEAF.

SER. NO. 77-230,601, FILED 7-16-2007.

VIVIAN MICZNIK FIRST, EXAMINING ATTORNEY

Int. Cl.: 36

Prior U.S. Cls.: 100, 101 and 102

United States Patent and Trademark Office

Reg. No. 3,398,021

Registered Mar. 18, 2008

**SERVICE MARK
PRINCIPAL REGISTER**

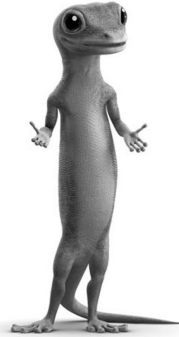

GOVERNMENT EMPLOYEES INSURANCE
COMPANY (MARYLAND CORPORATION)
ONE GEICO PLAZA
WASHINGTON, DC 20076

FOR: INSURANCE BROKERAGE; INSURANCE
UNDERWRITING SERVICES FOR ALL TYPES OF
INSURANCE, INSURANCE CLAIMS PROCESSING,
INSURANCE CLAIMS ADMINISTRATION, AND
PROVIDING INFORMATION ABOUT INSURANCE

VIA THE INTERNET, IN CLASS 36 (U.S. CLS. 100, 101
AND 102).

FIRST USE 5-14-2002; IN COMMERCE 5-14-2002.

SER. NO. 77-230,612, FILED 7-16-2007.

KATHLEEN LORENZO, EXAMINING ATTORNEY

Int. Cl.: 41

Prior U.S. Cls.: 100, 101 and 107

United States Patent and Trademark Office

Reg. No. 3,398,022

Registered Mar. 18, 2008

**SERVICE MARK
PRINCIPAL REGISTER**

CYPRESS STRING QUARTET

CYPRESS PERFORMING ARTS ASSOCIATION
(CALIFORNIA NON-PROFIT CORPORATION)
912 COLE STREET, PMB 137
SAN FRANCISCO, CA 94117

FOR: ENTERTAINMENT, NAMELY, LIVE MUSIC CONCERTS, IN CLASS 41 (U.S. CLS. 100, 101 AND 107).

FIRST USE 7-0-1996; IN COMMERCE 7-0-1996.

THE MARK CONSISTS OF STANDARD CHARACTERS WITHOUT CLAIM TO ANY PARTICULAR FONT, STYLE, SIZE, OR COLOR.

NO CLAIM IS MADE TO THE EXCLUSIVE RIGHT TO USE "STRING QUARTET", APART FROM THE MARK AS SHOWN.

SER. NO. 77-230,618, FILED 7-16-2007.

KATHLEEN LORENZO, EXAMINING ATTORNEY

Int. Cl.: 41

Prior U.S. Cls.: 100, 101 and 107

United States Patent and Trademark Office

Reg. No. 3,398,023

Registered Mar. 18, 2008

**SERVICE MARK
PRINCIPAL REGISTER**



HEALTHCORPS (NEW YORK NON-PROFIT ORGANIZATION)
191 SEVENTH AVENUE #4N
NEW YORK, NY 10011

FOR: CHARITABLE SERVICES, NAMELY, EDUCATING YOUTH, PARENTS AND THE COMMUNITY ABOUT THE WORKINGS AND WONDERS OF THEIR BODIES THROUGH SCHOOL SEMINARS ON DIET, NUTRITION AND EXERCISE, IN CLASS 41 (U.S. CLS. 100, 101 AND 107).

FIRST USE 1-1-2007; IN COMMERCE 1-1-2007.

NO CLAIM IS MADE TO THE EXCLUSIVE RIGHT TO USE "HEALTH", APART FROM THE MARK AS SHOWN.

THE COLOR(S) BLACK, RED, GREEN IS/ARE CLAIMED AS A FEATURE OF THE MARK.

THE MARK CONSISTS OF RED HEART-SHAPED APPLE WITH BLACK STEM AND GREEN LEAF; THE LETTERS CORPS IS IN RED; AND THE WORDS HEALTH AND EDUCATING THE STUDENT BODY IN BLACK.

SER. NO. 77-230,662, FILED 7-16-2007.

VIVIAN MICZNIK FIRST, EXAMINING ATTORNEY

Int. Cl.: 43

Prior U.S. Cls.: 100 and 101

United States Patent and Trademark Office

Reg. No. 3,398,024

Registered Mar. 18, 2008

**SERVICE MARK
PRINCIPAL REGISTER**



GREEN ISLAND ASSOCIATES (NEW YORK
PARTNERSHIP)
SUITE 1200
ONE INDEPENDENCE MALL
PHILADELPHIA, PA 19106

THE MARK CONSISTS OF STYLIZED MARK,
THE SAGAMORE, INCLUDING UNDERLINING.

FOR: RESORT HOTELS, IN CLASS 43 (U.S. CLS.
100 AND 101).

SER. NO. 77-230,672, FILED 7-16-2007.

FIRST USE 1-1-1984; IN COMMERCE 1-1-1984.

KATHERINE STOIDES, EXAMINING ATTORNEY

Int. Cl.: 9

Prior U.S. Cls.: 21, 23, 26, 36 and 38

Reg. No. 3,398,025

United States Patent and Trademark Office

Registered Mar. 18, 2008

**TRADEMARK
PRINCIPAL REGISTER**

JFT

CDM TECHNOLOGIES, INC. (CALIFORNIA
CORPORATION)
2975 MCMILLAN AVE., SUITE 272
SAN LUIS OBISPO, CA 93401

THE MARK CONSISTS OF STANDARD CHAR-
ACTERS WITHOUT CLAIM TO ANY PARTICULAR
FONT, STYLE, SIZE, OR COLOR.

FOR: COMPUTER SOFTWARE FOR MILITARY
FORCE PROJECTION AND LOGISTICS PLAN-
NING, IN CLASS 9 (U.S. CLS. 21, 23, 26, 36 AND 38).

SER. NO. 77-230,710, FILED 7-16-2007.

FIRST USE 4-30-2007; IN COMMERCE 4-30-2007.

MATTHEW PAPPAS, EXAMINING ATTORNEY

Int. Cl.: 41

Prior U.S. Cls.: 100, 101 and 107

United States Patent and Trademark Office

Reg. No. 3,398,026

Registered Mar. 18, 2008

**SERVICE MARK
PRINCIPAL REGISTER**

WHITEDINGO

HOLLIDAY II, DAVID (UNITED STATES INDIVIDUAL)
8021 E OSBORN RD, 201B
SCOTTSDALE, AZ 85251

FOR: ENTERTAINMENT SERVICES, NAMELY, LIVE, TELEVISED AND MOVIE APPEARANCES BY A PROFESSIONAL ENTERTAINER; ENTERTAINMENT, NAMELY, LIVE MUSIC CONCERTS; ENTERTAINMENT, NAMELY, LIVE PERFORMANCES BY A MUSICAL BAND; ENTERTAINMENT SERVICES, NAMELY, PERSONAL APPEARANCES BY A MUSICAL BAND; ENTERTAINMENT SERVICES, NAMELY, PROVIDING A WEB SITE FEATURING MUSICAL PERFOR-

MANCES, MUSICAL VIDEOS, RELATED FILM CLIPS, PHOTOGRAPHS, AND OTHER MULTIMEDIA MATERIALS, IN CLASS 41 (U.S. CLS. 100, 101 AND 107).

FIRST USE 2-2-2003; IN COMMERCE 4-21-2004.

THE MARK CONSISTS OF STANDARD CHARACTERS WITHOUT CLAIM TO ANY PARTICULAR FONT, STYLE, SIZE, OR COLOR.

SER. NO. 77-230,715, FILED 7-16-2007.

WANDA KAY PRICE, EXAMINING ATTORNEY

Int. Cl.: 36

Prior U.S. Cls.: 100, 101 and 102

United States Patent and Trademark Office

Reg. No. 3,398,027

Registered Mar. 18, 2008

**SERVICE MARK
PRINCIPAL REGISTER**



PLANET HOLLYWOOD (REGION IV), INC.
(MINNESOTA CORPORATION)
7598 W. SAND LAKE ROAD
ORLANDO, FL 32819

FOR: VACATION REAL ESTATE TIMESHARE
SERVICES, NAMELY, FINANCING, MANAGE-
MENT, BROKERAGE AND LEASING OF TIME-
SHARE PROPERTIES, IN CLASS 36 (U.S. CLS. 100,
101 AND 102).

FIRST USE 12-1-2006; IN COMMERCE 12-1-2006.

THE MARK CONSISTS OF TWO LOWER CASE
LETTERS, PH, THAT ARE PLACED WITHIN TWO
SEMI-CIRCLES OF DIFFERENT DIAMETERS.

SER. NO. 77-230,744, FILED 7-16-2007.

JOHN HWANG, EXAMINING ATTORNEY

Int. Cl.: 7

Prior U.S. Cls.: 13, 19, 21, 23, 31, 34 and 35

United States Patent and Trademark Office

Reg. No. 3,398,028

Registered Mar. 18, 2008

**TRADEMARK
PRINCIPAL REGISTER**

MULTIPRO

CREDO TECHNOLOGY CORPORATION (DELA-
WARE CORPORATION)
2800 SOUTH 25TH AVENUE
BROADVIEW, IL 60155

FOR: (BASED ON USE IN COMMERCE) POWER
TOOLS, NAMELY, ROTARY TOOLS AND ROTARY
TOOL KITS, COMPRISING ACCESSORY PARTS
THEREFOR, NAMELY, DRILL BITS, ENGRAVING
CUTTERS, MANDRELS, BRISTLE BRUSHES,
DRUM SANDERS, SANDING BANDS, SANDING
DISKS, FELT POLISHING TIPS, AND SPEED CON-
TROLS; AND STORAGE CASES, SOLD AS A UNIT,
IN CLASS 7 (U.S. CLS. 13, 19, 21, 23, 31, 34 AND 35).

FIRST USE 2-22-1995; IN COMMERCE 2-22-1995.

THE MARK CONSISTS OF STANDARD CHAR-
ACTERS WITHOUT CLAIM TO ANY PARTICULAR
FONT, STYLE, SIZE, OR COLOR.

SEC. 2(F).

SER. NO. 77-230,752, FILED 7-16-2007.

RICHARD WHITE, EXAMINING ATTORNEY

Int. Cl.: 41

Prior U.S. Cls.: 100, 101 and 107

United States Patent and Trademark Office

Reg. No. 3,398,029

Registered Mar. 18, 2008

**SERVICE MARK
PRINCIPAL REGISTER**

THE WEDDING BUREAU

THE WEDDING BUREAU, INC. (GEORGIA CORPORATION)
SUITE 201
532 SE BELMONT STREET
PORTLAND, OR 97214

FOR: PHOTOGRAPHY SERVICES, IN CLASS 41
(U.S. CLS. 100, 101 AND 107).

FIRST USE 1-8-1999; IN COMMERCE 1-8-1999.

THE MARK CONSISTS OF STANDARD CHARACTERS WITHOUT CLAIM TO ANY PARTICULAR FONT, STYLE, SIZE, OR COLOR.

NO CLAIM IS MADE TO THE EXCLUSIVE RIGHT TO USE WEDDING, APART FROM THE MARK AS SHOWN.

SER. NO. 77-230,760, FILED 7-16-2007.

FRANK LATTUCA, EXAMINING ATTORNEY

Int. Cl.: 41

Prior U.S. Cls.: 100, 101 and 107

United States Patent and Trademark Office

Reg. No. 3,398,030

Registered Mar. 18, 2008

**SERVICE MARK
PRINCIPAL REGISTER**

DEEP

TYCOON DYNASTY, INC. (NEW YORK CORPORATION)

ATTN: CMW BUSINESS MANAGEMENT, INC.
57 WEST 38TH STREET - SUITE 600
NEW YORK, NY 10018

FOR: ENTERTAINMENT IN THE NATURE OF
LIVE PERFORMANCES BY AN RANDB/SOUL
SINGING GROUP, IN CLASS 41 (U.S. CLS. 100, 101
AND 107).

FIRST USE 3-15-2005; IN COMMERCE 3-15-2005.

THE MARK CONSISTS OF STANDARD CHARACTERS WITHOUT CLAIM TO ANY PARTICULAR FONT, STYLE, SIZE, OR COLOR.

SER. NO. 77-230,764, FILED 7-16-2007.

FRANK LATTUCA, EXAMINING ATTORNEY

Int. Cl.: 41

Prior U.S. Cls.: 100, 101 and 107

United States Patent and Trademark Office

Reg. No. 3,398,031

Registered Mar. 18, 2008

**SERVICE MARK
PRINCIPAL REGISTER**

**LET A PHOTOJOURNALIST'S
EYE CAPTURE YOUR HEART**

THE WEDDING BUREAU, INC. (GEORGIA COR-
PORATION)
SUITE 201
532 SE BELMONT STREET
PORTLAND, OR 97214

FOR: PHOTOGRAPHY SERVICES, IN CLASS 41
(U.S. CLS. 100, 101 AND 107).

FIRST USE 1-8-1999; IN COMMERCE 1-8-1999.

THE MARK CONSISTS OF STANDARD CHAR-
ACTERS WITHOUT CLAIM TO ANY PARTICULAR
FONT, STYLE, SIZE, OR COLOR.

SER. NO. 77-230,765, FILED 7-16-2007.

FRANK LATTUCA, EXAMINING ATTORNEY

Int. Cl.: 35

Prior U.S. Cls.: 100, 101 and 102

United States Patent and Trademark Office

Reg. No. 3,398,032

Registered Mar. 18, 2008

**SERVICE MARK
PRINCIPAL REGISTER**

BARKWORKS

CHIEN ET. CHAT, INC. (CALIFORNIA CORPORATION)
19159 E. HINSDALE LANE
CENTENNIAL, CO 80016

THE MARK CONSISTS OF STANDARD CHARACTERS WITHOUT CLAIM TO ANY PARTICULAR FONT, STYLE, SIZE, OR COLOR.

FOR: RETAIL STORE SERVICES AND ON-LINE RETAIL STORE SERVICES FEATURING PETS AND PET SUPPLIES, IN CLASS 35 (U.S. CLS. 100, 101 AND 102).

SER. NO. 77-230,778, FILED 7-16-2007.

FIRST USE 3-15-2007; IN COMMERCE 3-15-2007.

KATHY DE JONGE, EXAMINING ATTORNEY

Int. Cl.: 44

Prior U.S. Cls.: 100 and 101

United States Patent and Trademark Office

Reg. No. 3,398,033

Registered Mar. 18, 2008

**SERVICE MARK
PRINCIPAL REGISTER**

HEAVEN SCENT

GONTOWSKI, RENEE A. (UNITED STATES IN-
DIVIDUAL)
11 KILBURN COURT
CHERRY HILL, NJ 08003

THE MARK CONSISTS OF STANDARD CHAR-
ACTERS WITHOUT CLAIM TO ANY PARTICULAR
FONT, STYLE, SIZE, OR COLOR.

FOR: MASSAGE, IN CLASS 44 (U.S. CLS. 100 AND
101).

SER. NO. 77-230,784, FILED 7-16-2007.

FIRST USE 7-12-2007; IN COMMERCE 7-12-2007.

CYNTHIA SLOAN, EXAMINING ATTORNEY

Int. Cl.: 22

Prior U.S. Cls.: 1, 2, 7, 19, 22, 42 and 50

Reg. No. 3,398,034

United States Patent and Trademark Office

Registered Mar. 18, 2008

**TRADEMARK
PRINCIPAL REGISTER**

Anchor Buddy

TUGGY PRODUCTS INC. (OREGON CORPORATION)

5743 MCLOUGHLIN DR.

CENTRAL POINT, OR 97502

FOR: ANCHORING ROPES, IN CLASS 22 (U.S. CLS. 1, 2, 7, 19, 22, 42 AND 50).

FIRST USE 7-8-1993; IN COMMERCE 7-8-1993.

THE MARK CONSISTS OF STANDARD CHARACTERS WITHOUT CLAIM TO ANY PARTICULAR FONT, STYLE, SIZE, OR COLOR.

NO CLAIM IS MADE TO THE EXCLUSIVE RIGHT TO USE "ANCHOR", APART FROM THE MARK AS SHOWN.

SER. NO. 77-230,809, FILED 7-16-2007.

CAROLINE WOOD, EXAMINING ATTORNEY

Int. Cl.: 42

Prior U.S. Cls.: 100 and 101

United States Patent and Trademark Office

Reg. No. 3,398,035

Registered Mar. 18, 2008

**SERVICE MARK
PRINCIPAL REGISTER**

The Inspired Room

MICHAELS, MELISSA (UNITED STATES INDIVIDUAL), DBA THE INSPIRED ROOM
654 SW BURLINGAME TER
PORTLAND, OR 97239

FOR: INTERIOR DECORATING; INTERIOR DECORATION CONSULTATION; INTERIOR DESIGN SERVICES; TEMPORARY INTERIOR AND EXTERIOR HOME DECORATION CONSULTATION, NAMELY, HOME STAGING CONSULTATION FOR THE PURPOSE OF MAKING HOMES MORE APPEALING TO PROSPECTIVE BUYERS; HOME STAGING CONSULTATION, NAMELY, TEMPORARY INTERIOR AND EXTERIOR HOME DECORATION CONSULTATION FOR THE PUR-

POSE OF MAKING HOMES MORE APPEALING TO PROSPECTIVE BUYERS, IN CLASS 42 (U.S. CLS. 100 AND 101).

FIRST USE 3-1-2007; IN COMMERCE 3-1-2007.

THE MARK CONSISTS OF STANDARD CHARACTERS WITHOUT CLAIM TO ANY PARTICULAR FONT, STYLE, SIZE, OR COLOR.

SER. NO. 77-230,822, FILED 7-16-2007.

MARTHA FROMM, EXAMINING ATTORNEY

Int. Cl.: 35

Prior U.S. Cls.: 100, 101 and 102

United States Patent and Trademark Office

Reg. No. 3,398,036

Registered Mar. 18, 2008

**SERVICE MARK
PRINCIPAL REGISTER**

IONIC OASIS

IONIC OASIS, LLC (NEBRASKA LTD LIAB CO)
2455 SOUTH 8TH STREET
LINCOLN, NE 68502

FOR: ON-LINE RETAIL STORE SERVICES FEATURING IONIC FOOT BATHS AND SPAS; RETAIL STORE SERVICES FEATURING IONIC FOOT BATHS AND SPAS, IN CLASS 35 (U.S. CLS. 100, 101 AND 102).

FIRST USE 12-28-2006; IN COMMERCE 12-28-2006.

THE MARK CONSISTS OF STANDARD CHARACTERS WITHOUT CLAIM TO ANY PARTICULAR FONT, STYLE, SIZE, OR COLOR.

NO CLAIM IS MADE TO THE EXCLUSIVE RIGHT TO USE "IONIC", APART FROM THE MARK AS SHOWN.

SER. NO. 77-230,839, FILED 7-16-2007.

IRA J. GOODSaid, EXAMINING ATTORNEY

Int. Cl.: 36

Prior U.S. Cls.: 100, 101 and 102

United States Patent and Trademark Office

Reg. No. 3,398,037

Registered Mar. 18, 2008

**SERVICE MARK
PRINCIPAL REGISTER**

e3Financial
Founded by entrepreneurs for entrepreneurs

E3 FINANCIAL, INC. (CALIFORNIA CORPORATION)
SUITE 650
4100 NEWPORT PLACE
NEWPORT BEACH, CA 92660

FOR: CONSULTING SERVICES, NAMELY, PROVIDING INFORMATION TO ORGANIZATIONS AND INDIVIDUALS IN THE AREAS OF INSURANCE PLANS AND EMPLOYEE BENEFITS, AND AGENT AND BROKERING SERVICES FOR INSURANCE AND EMPLOYEE BENEFITS, IN CLASS 36 (U.S. CLS. 100, 101 AND 102).

FIRST USE 2-28-2000; IN COMMERCE 2-28-2000.

OWNER OF U.S. REG. NO. 2,460,417.

THE MARK CONSISTS OF A STYLIZED LOWER CASE LETTER "E", A STYLIZED NUMBER "3", AND THE WORD "FINANCIAL" IN STYLIZED LETTERS, OVER THE TERM "FOUNDED BY ENTREPRENEURS FOR ENTREPRENEURS" IN STYLIZED LETTERS.

SER. NO. 77-230,844, FILED 7-16-2007.

JENNIFER MARTIN, EXAMINING ATTORNEY

Int. Cl.: 28

Prior U.S. Cls.: 22, 23, 38 and 50

United States Patent and Trademark Office

Reg. No. 3,398,038

Registered Mar. 18, 2008

**TRADEMARK
PRINCIPAL REGISTER**

STINGER

GOLFSMITH INTERNATIONAL, INC. (DELA-
WARE CORPORATION)
11000 NORTH IH-35
AUSTIN, TX 78753

THE MARK CONSISTS OF STANDARD CHAR-
ACTERS WITHOUT CLAIM TO ANY PARTICULAR
FONT, STYLE, SIZE, OR COLOR.

FOR: GOLF CLUBS AND GOLF TEES, IN CLASS
28 (U.S. CLS. 22, 23, 38 AND 50).

SER. NO. 77-230,845, FILED 7-16-2007.

FIRST USE 1-11-1999; IN COMMERCE 1-11-1999.

THEODORE MCBRIDE, EXAMINING ATTORNEY

Int. Cl.: 35

Prior U.S. Cls.: 100, 101 and 102

United States Patent and Trademark Office

Reg. No. 3,398,039

Registered Mar. 18, 2008

**SERVICE MARK
PRINCIPAL REGISTER**

WHAT DOES YOUR BRAND SOUND
LIKE?

RUMBLEFISH, INC. (OREGON CORPORATION)
SUITE 300
919 SW TAYLOR ST
PORTLAND, OR 97205

FOR: ADVERTISING SERVICES, NAMELY,
CREATING CORPORATE AND BRAND IDENTITY
FOR OTHERS, IN CLASS 35 (U.S. CLS. 100, 101 AND
102).

FIRST USE 6-14-2006; IN COMMERCE 6-14-2006.

THE MARK CONSISTS OF STANDARD CHAR-
ACTERS WITHOUT CLAIM TO ANY PARTICULAR
FONT, STYLE, SIZE, OR COLOR.

SER. NO. 77-230,860, FILED 7-16-2007.

WILLIAM P. SHANAHAN, EXAMINING ATTOR-
NEY

Int. Cl.: 9

Prior U.S. Cls.: 21, 23, 26, 36 and 38

United States Patent and Trademark Office

Reg. No. 3,398,040

Registered Mar. 18, 2008

**TRADEMARK
PRINCIPAL REGISTER**

IMT

CDM TECHNOLOGIES, INC. (CALIFORNIA
CORPORATION)
2975 MCMILLAN AVE., SUITE 272
SAN LUIS OBISPO, CA 93401

THE MARK CONSISTS OF STANDARD CHAR-
ACTERS WITHOUT CLAIM TO ANY PARTICULAR
FONT, STYLE, SIZE, OR COLOR.

FOR: COMPUTER SOFTWARE FOR CREATING
SEMANTIC MAPS BETWEEN DATABASES, IN
CLASS 9 (U.S. CLS. 21, 23, 26, 36 AND 38).

SER. NO. 77-230,865, FILED 7-16-2007.

FIRST USE 12-31-2006; IN COMMERCE 12-31-2006.

MATTHEW PAPPAS, EXAMINING ATTORNEY

Int. Cl.: 35

Prior U.S. Cls.: 100, 101 and 102

United States Patent and Trademark Office

Reg. No. 3,398,041

Registered Mar. 18, 2008

**SERVICE MARK
PRINCIPAL REGISTER**

GLOBAL REACH - LOCAL TOUCH

EVENTPRO STRATEGIES, INC. (NORTH CAROLINA CORPORATION)
SUITE 3011
1111 W. UNIVERSITY DR.
TEMPE, AZ 85281

FOR: ADVERTISING, MARKETING AND PROMOTION SERVICES; ARRANGING AND CONDUCTING MARKETING AND PROMOTIONAL EVENTS FOR OTHERS; PROVIDING MARKETING AND PROMOTION OF SPECIAL EVENTS, NAMELY, PROVIDING EVENT STAFFING, EVENT LOGISTICS, EVENT EXECUTION, AND EVENT MANAGEMENT SERVICES; PROMOTIONAL MODELING AND CASTING SERVICES FOR ADVERTIS-

ING AND SALES PROMOTION; MANAGEMENT AND COMPILATION OF COMPUTERIZED DATABASES, IN CLASS 35 (U.S. CLS. 100, 101 AND 102).

FIRST USE 5-31-2003; IN COMMERCE 5-31-2003.

THE MARK CONSISTS OF STANDARD CHARACTERS WITHOUT CLAIM TO ANY PARTICULAR FONT, STYLE, SIZE, OR COLOR.

SER. NO. 77-230,887, FILED 7-16-2007.

KAREN BRACEY, EXAMINING ATTORNEY

Int. Cl.: 44

Prior U.S. Cls.: 100 and 101

United States Patent and Trademark Office

Reg. No. 3,398,042

Registered Mar. 18, 2008

**SERVICE MARK
PRINCIPAL REGISTER**

petaholics

PETAHOLICS LLC (NEW YORK LTD LIAB CO)
APT 8F
320 EAST 54TH STREET
NEW YORK, NY 10022

FOR: DOG WALKING SERVICES; PET CARE SERVICES, NAMELY, DOG WALKING, DOG BATHING AND NON-MEDICATED PET GROOMING; PET CARE SERVICES, NAMELY, DOG WALKING, DOG BATHING, NON-MEDICATED PET GROOMING AND IN-HOME MEDICAL CARE, IN CLASS 44 (U.S. CLS. 100 AND 101).

FIRST USE 6-1-2001; IN COMMERCE 6-1-2001.

THE MARK CONSISTS OF STANDARD CHARACTERS WITHOUT CLAIM TO ANY PARTICULAR FONT, STYLE, SIZE, OR COLOR.

SER. NO. 77-230,893, FILED 7-16-2007.

JENNIFER MARTIN, EXAMINING ATTORNEY

Int. Cl.: 41

Prior U.S. Cls.: 100, 101 and 107

United States Patent and Trademark Office

Reg. No. 3,398,043

Registered Mar. 18, 2008

**SERVICE MARK
PRINCIPAL REGISTER**

Wu-Yin Yan-Jing

MILES SR, RAY (UNITED STATES INDIVIDUAL)
2078 OLD HOLLOW RD
BUCHANAN, VA 240664877

FOR: EDUCATION SERVICES, NAMELY, PROVIDING CLASSES, SEMINARS, AND WORKSHOPS IN THE FIELDS OF MARTIAL ARTS, IN CLASS 41 (U.S. CLS. 100, 101 AND 107).

FIRST USE 7-15-1975; IN COMMERCE 3-3-2007.

THE MARK CONSISTS OF STANDARD CHARACTERS WITHOUT CLAIM TO ANY PARTICULAR FONT, STYLE, SIZE, OR COLOR.

THE FOREIGN WORDING IN THE MARK TRANSLATES INTO ENGLISH AS "DECEPTIVE EYE."

SER. NO. 77-230,934, FILED 7-16-2007.

MATTHEW PAPPAS, EXAMINING ATTORNEY

Int. Cl.: 44

Prior U.S. Cls.: 100 and 101

United States Patent and Trademark Office

Reg. No. 3,398,044

Registered Mar. 18, 2008

**SERVICE MARK
PRINCIPAL REGISTER**

MARY SCHOOK

BEAUTY BY MARY SCHOOK, LLC. (NEW YORK
LTD LIAB CO)

36 EAST 23RD STREET, FLOOR 4

NEW YORK, NY 10010

FOR: NON-INVASIVE COSMETIC PROCEDURES,
IN CLASS 44 (U.S. CLS. 100 AND 101).

FIRST USE 1-0-1997; IN COMMERCE 2-1-2005.

THE MARK CONSISTS OF STANDARD CHAR-
ACTERS WITHOUT CLAIM TO ANY PARTICULAR
FONT, STYLE, SIZE, OR COLOR.

THE NAME MARY SCHOOK IDENTIFIES A
LIVING INDIVIDUAL WHOSE CONSENT IS OF
RECORD.

SER. NO. 77-230,940, FILED 7-16-2007.

HENRY S. ZAK, EXAMINING ATTORNEY

Int. Cl.: 5

Prior U.S. Cls.: 6, 18, 44, 46, 51 and 52

United States Patent and Trademark Office

Reg. No. 3,398,045

Registered Mar. 18, 2008

**TRADEMARK
PRINCIPAL REGISTER**

FLORAJEN

AMERICAN LIFELINE, INC (WISCONSIN CORPORATION)
138 1ST ST.
BARABOO, WI 53913

FOR: DIETARY AND NUTRITIONAL SUPPLEMENTS, IN CLASS 5 (U.S. CLS. 6, 18, 44, 46, 51 AND 52).

FIRST USE 8-21-1992; IN COMMERCE 8-21-1992.

THE MARK CONSISTS OF STANDARD CHARACTERS WITHOUT CLAIM TO ANY PARTICULAR FONT, STYLE, SIZE, OR COLOR.

OWNER OF U.S. REG. NO. 1,776,217.

SER. NO. 77-230,946, FILED 7-16-2007.

MARY MUNSON, EXAMINING ATTORNEY

Int. Cl.: 5

Prior U.S. Cls.: 6, 18, 44, 46, 51 and 52

United States Patent and Trademark Office

Reg. No. 3,398,046

Registered Mar. 18, 2008

**TRADEMARK
PRINCIPAL REGISTER**

FLORAJEN3

AMERICAN LIFELINE, INC (WISCONSIN CORPORATION)
138 1ST ST.
BARABOO, WI 53913

FOR: DIETARY AND NUTRITIONAL SUPPLEMENTS, IN CLASS 5 (U.S. CLS. 6, 18, 44, 46, 51 AND 52).

FIRST USE 5-24-1995; IN COMMERCE 5-24-1995.

THE MARK CONSISTS OF STANDARD CHARACTERS WITHOUT CLAIM TO ANY PARTICULAR FONT, STYLE, SIZE, OR COLOR.

OWNER OF U.S. REG. NO. 1,776,217.

SER. NO. 77-230,963, FILED 7-16-2007.

MARY MUNSON, EXAMINING ATTORNEY

Int. Cl.: 30

Prior U.S. Cl.: 46

United States Patent and Trademark Office

Reg. No. 3,398,047

Registered Mar. 18, 2008

**TRADEMARK
PRINCIPAL REGISTER**

Pastries With A Purpose!

EMILY'S EDIBLES, LLC (NEW YORK LTD LIAB
CO)
33A NASSAU DRIVE
GREAT NECK, NY 11021

THE MARK CONSISTS OF STANDARD CHAR-
ACTERS WITHOUT CLAIM TO ANY PARTICULAR
FONT, STYLE, SIZE, OR COLOR.

FOR: BAKERY GOODS, IN CLASS 30 (U.S. CL. 46).

SER. NO. 77-230,965, FILED 7-16-2007.

FIRST USE 3-15-2007; IN COMMERCE 3-15-2007.

JAMES MACFARLANE, EXAMINING ATTORNEY

Int. Cl.: 9

Prior U.S. Cls.: 21, 23, 26, 36 and 38

Reg. No. 3,398,048

United States Patent and Trademark Office

Registered Mar. 18, 2008

**TRADEMARK
PRINCIPAL REGISTER**

RFgen Software

THE DATAMAX SOFTWARE GROUP, INC. (CALIFORNIA CORPORATION)
5049 RJ MATHEWS PARKWAY
SUITE 100
EL DORADO HILLS, CA 95762

THE MARK CONSISTS OF A COMBINATION OF UPPER CASE AND LOWER CASE LETTERS, WITH THE LETTERS "RF" FOLLOWED BY THE LETTERS "GEN" AND THE WORD "SOFTWARE" HORIZONTALLY DISPOSED ABOVE THE LETTERS "GEN".

FOR: DATA COLLECTION SOFTWARE, IN CLASS 9 (U.S. CLS. 21, 23, 26, 36 AND 38).

FIRST USE 8-18-1997; IN COMMERCE 8-19-1998.

SER. NO. 77-230,974, FILED 7-16-2007.

NO CLAIM IS MADE TO THE EXCLUSIVE RIGHT TO USE "SOFTWARE", APART FROM THE MARK AS SHOWN.

DAVID COLLIER, EXAMINING ATTORNEY

Int. Cl.: 30

Prior U.S. Cl.: 46

United States Patent and Trademark Office

Reg. No. 3,398,049

Registered Mar. 18, 2008

**TRADEMARK
PRINCIPAL REGISTER**

Rex's Outrageous

REX'S OUTRAGEOUS, LLC (VERMONT LTD
LIAB CO)
15 RIDGE ROAD
JERICHO, VT 05465

THE MARK CONSISTS OF STANDARD CHAR-
ACTERS WITHOUT CLAIM TO ANY PARTICULAR
FONT, STYLE, SIZE, OR COLOR.

FOR: CEREAL BASED SNACK FOOD; CHOCO-
LATE, IN CLASS 30 (U.S. CL. 46).

SER. NO. 77-231,005, FILED 7-16-2007.

FIRST USE 12-0-2005; IN COMMERCE 12-0-2005.

ERIN FALK, EXAMINING ATTORNEY

Int. Cl.: 30

Prior U.S. Cl.: 46

United States Patent and Trademark Office

Reg. No. 3,398,050

Registered Mar. 18, 2008

**TRADEMARK
PRINCIPAL REGISTER**

PRECIOUS WHITE PEACH

TEAVANA CORPORATION (GEORGIA CORPORATION)

SUITE 860

3475 LENOX ROAD

ATLANTA, GA 30326

FOR: TEA, IN CLASS 30 (U.S. CL. 46).

FIRST USE 6-0-2004; IN COMMERCE 6-0-2004.

THE MARK CONSISTS OF STANDARD CHARACTERS WITHOUT CLAIM TO ANY PARTICULAR FONT, STYLE, SIZE, OR COLOR.

NO CLAIM IS MADE TO THE EXCLUSIVE RIGHT TO USE "WHITE PEACH", APART FROM THE MARK AS SHOWN.

SER. NO. 77-231,051, FILED 7-17-2007.

DEBRA LEE, EXAMINING ATTORNEY

Int. Cl.: 30

Prior U.S. Cl.: 46

United States Patent and Trademark Office

Reg. No. 3,398,051

Registered Mar. 18, 2008

**TRADEMARK
PRINCIPAL REGISTER**

SIX SUMMITS OOLONG

TEAVANA CORPORATION (GEORGIA CORPORATION)

SUITE 860

3475 LENOX ROAD

ATLANTA, GA 30326

FOR: TEA, IN CLASS 30 (U.S. CL. 46).

FIRST USE 6-0-2005; IN COMMERCE 6-0-2005.

THE MARK CONSISTS OF STANDARD CHARACTERS WITHOUT CLAIM TO ANY PARTICULAR FONT, STYLE, SIZE, OR COLOR.

NO CLAIM IS MADE TO THE EXCLUSIVE RIGHT TO USE "OOLONG", APART FROM THE MARK AS SHOWN.

SER. NO. 77-231,057, FILED 7-17-2007.

DEBRA LEE, EXAMINING ATTORNEY

Int. Cl.: 30

Prior U.S. Cl.: 46

United States Patent and Trademark Office

Reg. No. 3,398,052

Registered Mar. 18, 2008

**TRADEMARK
PRINCIPAL REGISTER**

BANANA CALYPSO

TEAVANA CORPORATION (GEORGIA CORPORATION)

SUITE 860

3475 LENOX ROAD

ATLANTA, GA 30326

FOR: TEA, IN CLASS 30 (U.S. CL. 46).

FIRST USE 6-0-2005; IN COMMERCE 6-0-2005.

THE MARK CONSISTS OF STANDARD CHARACTERS WITHOUT CLAIM TO ANY PARTICULAR FONT, STYLE, SIZE, OR COLOR.

NO CLAIM IS MADE TO THE EXCLUSIVE RIGHT TO USE "BANANA", APART FROM THE MARK AS SHOWN.

SER. NO. 77-231,067, FILED 7-17-2007.

DEBRA LEE, EXAMINING ATTORNEY

Int. Cl.: 40

Prior U.S. Cls.: 100, 103 and 106

United States Patent and Trademark Office

Reg. No. 3,398,053

Registered Mar. 18, 2008

SERVICE MARK
PRINCIPAL REGISTER

SONOCO
RECYCLING

SPC RESOURCES, INC. (DELAWARE CORPORATION)
125 WEST HOME AVENUE
HARTSVILLE, SC 29550

FOR: RECYCLING SERVICES, CONSULTING SERVICES RELATING TO RECYCLING, PAPER TREATMENT SERVICES, WASTE MANAGEMENT SERVICES, RECLAMATION SERVICES FOR PAPER, PLASTIC, METAL, AND WOOD, AND PROVIDING MATERIAL TREATMENT INFORMATION, IN CLASS 40 (U.S. CLS. 100, 103 AND 106).

FIRST USE 6-11-2007; IN COMMERCE 7-11-2007.

OWNER OF U.S. REG. NOS. 552,840, 2,218,311 AND OTHERS.

NO CLAIM IS MADE TO THE EXCLUSIVE RIGHT TO USE "RECYCLING", APART FROM THE MARK AS SHOWN.

THE MARK CONSISTS OF THE WORD SONOCO ABOVE THE WORD RECYCLING, EACH WRITTEN IN BOLD CAPITAL LETTERS AND EACH HAVE A STRAIGHT LINE UNDERNEATH.

SER. NO. 77-231,091, FILED 7-17-2007.

CHARLOTTE CORWIN, EXAMINING ATTORNEY

Int. Cl.: 30

Prior U.S. Cl.: 46

United States Patent and Trademark Office

Reg. No. 3,398,054

Registered Mar. 18, 2008

**TRADEMARK
PRINCIPAL REGISTER**

AZTECA FIRE

TEAVANA CORPORATION (GEORGIA COR-
PORATION)
SUITE 860
3475 LENOX ROAD
ATLANTA, GA 30326

THE MARK CONSISTS OF STANDARD CHAR-
ACTERS WITHOUT CLAIM TO ANY PARTICULAR
FONT, STYLE, SIZE, OR COLOR.

FOR: TEA, IN CLASS 30 (U.S. CL. 46).

SER. NO. 77-231,100, FILED 7-17-2007.

FIRST USE 6-0-2005; IN COMMERCE 6-0-2005.

DEBRA LEE, EXAMINING ATTORNEY

Int. Cl.: 36

Prior U.S. Cls.: 100, 101 and 102

United States Patent and Trademark Office

Reg. No. 3,398,055

Registered Mar. 18, 2008

**SERVICE MARK
PRINCIPAL REGISTER**

Oakleaf Financial Services

STURGIS BANK & TRUST COMPANY (MICHIGAN CHARTERED BANK)
113-125 EAST CHICAGO RD.
STURGIS, MI 49091

FOR: FINANCIAL SERVICES, NAMELY, BROKERAGE SERVICES IN THE FIELDS OF STOCKS, BONDS, OPTIONS, COMMODITIES, FUTURES AND OTHER SECURITIES, FINANCIAL PLANNING, FINANCIAL MANAGEMENT, INVESTMENT PORTFOLIO ANALYSIS, FINANCIAL PORTFOLIO MANAGEMENT, INVESTMENT MANAGEMENT, FINANCIAL ASSET MANAGEMENT SERVICES, FINANCIAL RETIREMENT PLANNING, COLLEGE FUNDING PLANNING, INVESTMENT ADVISORY SERVICES, MUTUAL FUNDS INVESTMENT SERVICES, LIFE AND DISABILITY INSURANCE UNDERWRITING SERVICES, ANNU-

ITY UNDERWRITING, IN CLASS 36 (U.S. CLS. 100, 101 AND 102).

FIRST USE 1-13-2000; IN COMMERCE 1-13-2000.

THE MARK CONSISTS OF STANDARD CHARACTERS WITHOUT CLAIM TO ANY PARTICULAR FONT, STYLE, SIZE, OR COLOR.

NO CLAIM IS MADE TO THE EXCLUSIVE RIGHT TO USE FINANCIAL SERVICES, APART FROM THE MARK AS SHOWN.

SER. NO. 77-231,133, FILED 7-17-2007.

JOHN WILKE, EXAMINING ATTORNEY

Int. Cl.: 36

Prior U.S. Cls.: 100, 101 and 102

United States Patent and Trademark Office

Reg. No. 3,398,056

Registered Mar. 18, 2008

**SERVICE MARK
PRINCIPAL REGISTER**

ARCIS

ISNARD, ARNAUD (FRANCE INDIVIDUAL)
54 REDCLIFFE SQUARE #6
LONDON, UNITED KINGDOM SW109HQ

FOR: INSURANCE, FINANCIAL AND MONE-
TARY CONSULTATION SERVICES; FINANCIAL,
ADVISORY AND INVESTMENT SERVICES IN THE
FIELD OF EQUITY AND PRIVATE EQUITY, IN
CLASS 36 (U.S. CLS. 100, 101 AND 102).

FIRST USE 0-0-1999; IN COMMERCE 0-0-1999.

THE MARK CONSISTS OF STANDARD CHAR-
ACTERS WITHOUT CLAIM TO ANY PARTICULAR
FONT, STYLE, SIZE, OR COLOR.

OWNER OF U.S. REG. NO. 2,328,412.

SER. NO. 77-231,146, FILED 7-17-2007.

HANNO RITTNER, EXAMINING ATTORNEY

Int. Cl.: 35

Prior U.S. Cls.: 100, 101 and 102

United States Patent and Trademark Office

Reg. No. 3,398,057

Registered Mar. 18, 2008

**SERVICE MARK
PRINCIPAL REGISTER**

INSOUND

INSOUND LLC (NEW YORK LTD LIAB CO)
221 WEST 17TH STREET, 5TH FLOOR
NEW YORK, NY 10011

THE MARK CONSISTS OF STANDARD CHAR-
ACTERS WITHOUT CLAIM TO ANY PARTICULAR
FONT, STYLE, SIZE, OR COLOR.

FOR: COMPUTERIZED ON-LINE ORDERING
SERVICES IN THE FIELD OF RECORDS AND
ASSOCIATED MERCHANDISE, IN CLASS 35 (U.S.
CLS. 100, 101 AND 102).

SER. NO. 77-231,165, FILED 7-17-2007.

FIRST USE 9-1-1998; IN COMMERCE 10-1-1998.

JAMES LOVELACE, EXAMINING ATTORNEY

Int. Cl.: 42

Prior U.S. Cls.: 100 and 101

United States Patent and Trademark Office

Reg. No. 3,398,058

Registered Mar. 18, 2008

**SERVICE MARK
PRINCIPAL REGISTER**

Clusterblogs

IDEUM INC. (NEW MEXICO CORPORATION)
4895 1/2 CORRALES ROAD
CORRALES, NM 87048

FOR: COMPUTER SERVICES, NAMELY, PROVIDING SEARCH ENGINES FOR OBTAINING DATA ON A GLOBAL COMPUTER NETWORK, IN CLASS 42 (U.S. CLS. 100 AND 101).

THE MARK CONSISTS OF STANDARD CHARACTERS WITHOUT CLAIM TO ANY PARTICULAR FONT, STYLE, SIZE, OR COLOR.

SER. NO. 77-231,201, FILED 7-17-2007.

FIRST USE 7-14-2007; IN COMMERCE 7-14-2007.

JAMES A. RAUEN, EXAMINING ATTORNEY

Int. Cl.: 41

Prior U.S. Cls.: 100, 101 and 107

United States Patent and Trademark Office

Reg. No. 3,398,059

Registered Mar. 18, 2008

**SERVICE MARK
PRINCIPAL REGISTER**



DIDIER, ANTHONY G (UNITED STATES INDIVIDUAL)
1010 SUNSET LAKE COVE
FORT WAYNE, IN 46845

FOR: DIRECTION OF MAKING RADIO OR TELEVISION PROGRAMS; DISTRIBUTION OF RADIO PROGRAMS FOR OTHERS; EDUCATIONAL AND ENTERTAINMENT SERVICES, NAMELY, A CONTINUING PROGRAM ABOUT "BABY BOOMER" MUSIC, FILM, TELEVISION, AND CULTURE ACCESSIBLE BY RADIO, TELEVISION, SATELLITE, AUDIO, VIDEO AND COMPUTER NETWORKS; ENTERTAINMENT SERVICES, NAMELY, PROVIDING A RADIO PROGRAM IN THE FIELD OF "BABY BOOMER" MUSIC, FILM, TELEVISION, AND CULTURE VIA A GLOBAL COMPUTER NETWORK; MUSIC SELECTION SERVICES FOR USE IN TV, FILM, RADIO AND VIDEO GAMES; PRODUCTION AND DISTRIBUTION OF RADIO PROGRAMS; PRODUCTION OF RADIO AND TELEVISION PROGRAMS; PRODUCTION OF RADIO OR TELEVISION PROGRAMS; RADIO ENTERTAINMENT PRODUCTION; RADIO ENTERTAINMENT SERVICES, NAMELY RADIO PROGRAMS FEATURING PERFORMANCES BY A "BABY BOOMER" MUSIC, FILM, TELEVISION, AND CULTURE; RADIO PRO-

GRAM SYNDICATION; RADIO PROGRAMMING; TELEVISION AND RADIO PROGRAMMING, IN CLASS 41 (U.S. CLS. 100, 101 AND 107).

FIRST USE 3-1-2006; IN COMMERCE 3-1-2006.

NO CLAIM IS MADE TO THE EXCLUSIVE RIGHT TO USE "RADIO", APART FROM THE MARK AS SHOWN.

THE MARK CONSISTS OF TEXT CONSISTING OF "HIPPIE RADIO", "HIPPIE" PORTION OF LOGO WRITTEN IN THICK CALLIGRAPHY-STYLE FONT, WITH THE INITIAL "H", CONTAINING A CARTOON SIX-PETALED FLOWER DESIGN IN THE LOWER-LEFT-HAND PRONG, PRECEDES "IPPIE" IN LETTERS ABOUT TWO-THIRDS THE SIZE OF THE INITIAL "H". "RADIO", WRITTEN IN ALL LOWER-CASE BLOCK FONT, DIRECTLY BENEATH THE "PIE" PORTION OF "HIPPIE". FINAL "O" IN "RADIO" INCLUDES A PEACE SYMBOL IN THE CENTER.

SER. NO. 77-231,222, FILED 7-17-2007.

MICHAEL KEATING, EXAMINING ATTORNEY

Int. Cl.: 37

Prior U.S. Cls.: 100, 103 and 106

United States Patent and Trademark Office

Reg. No. 3,398,060

Registered Mar. 18, 2008

**SERVICE MARK
PRINCIPAL REGISTER**

GroundZero Services

GROUND ZERO SERVICES, LLC (MINNESOTA
LTD LIAB CO)

312 FOURTH STREET

COURTLAND, MN 56021

FOR: MAINTENANCE AND/OR REPAIR OF
PARKING LOTS, IN CLASS 37 (U.S. CLS. 100, 103
AND 106).

FIRST USE 1-1-1999; IN COMMERCE 1-1-1999.

THE MARK CONSISTS OF STANDARD CHAR-
ACTERS WITHOUT CLAIM TO ANY PARTICULAR
FONT, STYLE, SIZE, OR COLOR.

NO CLAIM IS MADE TO THE EXCLUSIVE
RIGHT TO USE "SERVICES", APART FROM THE
MARK AS SHOWN.

SER. NO. 77-231,230, FILED 7-17-2007.

KATHLEEN M. VANSTON, EXAMINING ATTOR-
NEY

Int. Cl.: 35

Prior U.S. Cls.: 100, 101 and 102

United States Patent and Trademark Office

Reg. No. 3,398,061

Registered Mar. 18, 2008

SERVICE MARK
PRINCIPAL REGISTER



INTELLIDYN CORP. (DELAWARE CORPORATION)
175 DERBY STREET, UNIT 40
HINGHAM, MA 02043

FOR: DATA MANAGEMENT SERVICES FOR USE IN DEBT COLLECTION, NAMELY, ELECTRONIC DATA COLLECTION AND ONLINE CLAIMS MANAGEMENT, IN CLASS 35 (U.S. CLS. 100, 101 AND 102).

FIRST USE 7-10-2007; IN COMMERCE 7-10-2007.

THE MARK CONSISTS OF THE STYLIZED DRAWING OF A STALKING WOLF ABOVE THE TERM "IWOLF" WITH THE TERMS "DYNAMIC INTELLIGENCE DELIVERED" DISPOSED BELOW THE "IWOLF" TERM.

SER. NO. 77-231,243, FILED 7-17-2007.

JOHN DALIER, EXAMINING ATTORNEY

Int. Cl.: 36

Prior U.S. Cls.: 100, 101 and 102

United States Patent and Trademark Office

Reg. No. 3,398,062

Registered Mar. 18, 2008

**SERVICE MARK
PRINCIPAL REGISTER**

**Helping You Win The
Battles of Life**

LIBERTY ASSURANCE GROUP (MISSISSIPPI
CORPORATION), DBA LIBERTY ASSURANCE
GROUP
4604 PARADISE ROAD
BENTONIA, MS 39040

THE MARK CONSISTS OF STANDARD CHAR-
ACTERS WITHOUT CLAIM TO ANY PARTICULAR
FONT, STYLE, SIZE, OR COLOR.

FOR: (BASED ON USE IN COMMERCE) INSUR-
ANCE AGENCY AND BROKERAGE, IN CLASS 36
(U.S. CLS. 100, 101 AND 102).

SER. NO. 77-231,246, FILED 7-17-2007.

FIRST USE 9-1-2006; IN COMMERCE 9-1-2006.

DAVID MURRAY, EXAMINING ATTORNEY

Int. Cl.: 41

Prior U.S. Cls.: 100, 101 and 107

United States Patent and Trademark Office

Reg. No. 3,398,063

Registered Mar. 18, 2008

**SERVICE MARK
PRINCIPAL REGISTER**

NO PROGRESS

LANDERS, KEVIN (UNITED STATES INDIVIDUAL)
609 BENDERMERE AVE
INTERLAKEN, NJ 07712

FOR: ENTERTAINMENT, NAMELY, LIVE MUSIC CONCERTS; ENTERTAINMENT SERVICES, NAMELY, PERSONAL APPEARANCES BY A MUSICAL BAND; ENTERTAINMENT, NAMELY, LIVE PERFORMANCES BY MUSICAL BANDS, IN CLASS 41 (U.S. CLS. 100, 101 AND 107).

FIRST USE 1-3-1982; IN COMMERCE 8-12-2007.

THE MARK CONSISTS OF STANDARD CHARACTERS WITHOUT CLAIM TO ANY PARTICULAR FONT, STYLE, SIZE, OR COLOR.

SER. NO. 77-231,291, FILED 7-17-2007.

BRIAN NEVILLE, EXAMINING ATTORNEY

Int. Cl.: 44

Prior U.S. Cls.: 100 and 101

United States Patent and Trademark Office

Reg. No. 3,398,064

Registered Mar. 18, 2008

SERVICE MARK
PRINCIPAL REGISTER



JONES MANAGEMENT SERVICES, LLC (TEN-
NESSEE LTD LIAB CO)
SUITE 80
201 KEITH STREET
CLEVELAND, TN 37311

FOR: BEAUTY SALONS, IN CLASS 44 (U.S. CLS.
100 AND 101).

FIRST USE 4-17-2007; IN COMMERCE 5-2-2007.

OWNER OF U.S. REG. NOS. 3,053,543 AND
3,053,545.

THE MARK CONSISTS OF THE WORDS "THE
VILLAGE BARBER-ETTES". THE "I" IN "VILLAGE"
CONSISTS OF A BARBERSHOP POLE. THE WORDS
ARE FOLLOWED BY A PAIR OF LIPS.

SER. NO. 77-231,296, FILED 7-17-2007.

JOHN WILKE, EXAMINING ATTORNEY

Int. Cl.: 41

Prior U.S. Cls.: 100, 101 and 107

United States Patent and Trademark Office

Reg. No. 3,398,065

Registered Mar. 18, 2008

**SERVICE MARK
PRINCIPAL REGISTER**

SOUL PROPRIETOR

MARTELLO, KEN (UNITED STATES INDIVIDUAL)
108 E. WALTON
SPOKANE, WA 99207

THE MARK CONSISTS OF STANDARD CHARACTERS WITHOUT CLAIM TO ANY PARTICULAR FONT, STYLE, SIZE, OR COLOR.

FOR: ENTERTAINMENT, NAMELY, LIVE PERFORMANCES OF MUSIC, IN CLASS 41 (U.S. CLS. 100, 101 AND 107).

SER. NO. 77-231,298, FILED 7-17-2007.

FIRST USE 7-1-1995; IN COMMERCE 8-1-1998.

JOHN WILKE, EXAMINING ATTORNEY

Int. Cl.: 9

Prior U.S. Cls.: 21, 23, 26, 36 and 38

Reg. No. 3,398,066

United States Patent and Trademark Office

Registered Mar. 18, 2008

**TRADEMARK
PRINCIPAL REGISTER**



MUSIC STAR PRODUCTIONS (CALIFORNIA
PARTNERSHIP)
SUITE 100
1430 BARBIS WAY
CONCORD, CA 94518

FOR: PRE-RECORDED CDS, VIDEO TAPES, LA-
SER DISKS AND DVDS FEATURING MUSIC, IN
CLASS 9 (U.S. CLS. 21, 23, 26, 36 AND 38).

FIRST USE 6-1-2004; IN COMMERCE 6-1-2004.

NO CLAIM IS MADE TO THE EXCLUSIVE
RIGHT TO USE "ROCK", APART FROM THE
MARK AS SHOWN.

THE MARK CONSISTS OF ICONS OF ROCK
LETTERING WITH A STAR BEHIND THE "OF".

SER. NO. 77-231,303, FILED 7-17-2007.

MIDGE BUTLER, EXAMINING ATTORNEY

Int. Cl.: 39

Prior U.S. Cls.: 100 and 105

United States Patent and Trademark Office

Reg. No. 3,398,067

Registered Mar. 18, 2008

**SERVICE MARK
PRINCIPAL REGISTER**

DUMPMATCH

DUMPMATCH, LLC (FLORIDA LTD LIAB CO)
1513 PINEDALE MEADOWS CT.
PLANT CITY, FL 33563

THE MARK CONSISTS OF STANDARD CHAR-
ACTERS WITHOUT CLAIM TO ANY PARTICULAR
FONT, STYLE, SIZE, OR COLOR.

FOR: ONLINE FREIGHT MATCHING SERVICE
FOR THE DUMP TRUCK AND TRAILER INDUS-
TRY, IN CLASS 39 (U.S. CLS. 100 AND 105).

SER. NO. 77-231,323, FILED 7-17-2007.

FIRST USE 12-20-2006; IN COMMERCE 5-1-2007.

ESTHER A. BORSUK, EXAMINING ATTORNEY

Int. Cl.: 42

Prior U.S. Cls.: 100 and 101

United States Patent and Trademark Office

Reg. No. 3,398,068

Registered Mar. 18, 2008

**SERVICE MARK
PRINCIPAL REGISTER**

nüregime

PEREZ, JORGE (UNITED STATES INDIVIDUAL)
871 HAROLD PLACE SUITE 103
CHULA VISTA, CA 91914

THE MARK CONSISTS OF STANDARD CHAR-
ACTERS WITHOUT CLAIM TO ANY PARTICULAR
FONT, STYLE, SIZE, OR COLOR.

FOR: DESIGN OF HOMEPAGES AND WEBSITES;
GRAPHIC DESIGN SERVICES, IN CLASS 42 (U.S.
CLS. 100 AND 101).

SER. NO. 77-231,330, FILED 7-17-2007.

FIRST USE 1-1-2000; IN COMMERCE 5-20-2003.

JOHN DALIER, EXAMINING ATTORNEY

Int. Cl.: 35

Prior U.S. Cls.: 100, 101 and 102

United States Patent and Trademark Office

Reg. No. 3,398,069

Registered Mar. 18, 2008

**SERVICE MARK
PRINCIPAL REGISTER**

**DIVERSIFIED FLEET SERVICES
INTERNATIONAL**

AUTOMOTIVE RENTALS, INC. (NEW JERSEY CORPORATION)
9000 MIDLANTIC DRIVE
MOUNT LAUREL, NJ 08054

FOR: MANAGEMENT AND BUSINESS CONSULTING SERVICES IN THE FIELD OF AUTOMOTIVE FLEETS; PROVIDING AN ONLINE COMPUTER DATABASE FOR THE REPORTING AND TRACKING OF VEHICLE FLEETS; PROCUREMENT, NAMELY, PURCHASING VEHICLES FOR OTHERS, IN CLASS 35 (U.S. CLS. 100, 101 AND 102).

FIRST USE 12-31-1997; IN COMMERCE 12-31-1997.

THE MARK CONSISTS OF STANDARD CHARACTERS WITHOUT CLAIM TO ANY PARTICULAR FONT, STYLE, SIZE, OR COLOR.

OWNER OF U.S. REG. NO. 2,493,638.

NO CLAIM IS MADE TO THE EXCLUSIVE RIGHT TO USE "SERVICES INTERNATIONAL", APART FROM THE MARK AS SHOWN.

SEC. 2(F).

SER. NO. 77-231,384, FILED 7-17-2007.

ATTIYA MALIK, EXAMINING ATTORNEY

Int. Cls.: 35 and 39

Prior U.S. Cls.: 100, 101, 102 and 105

United States Patent and Trademark Office

Reg. No. 3,398,070

Registered Mar. 18, 2008

**SERVICE MARK
PRINCIPAL REGISTER**

**DIVERSIFIED FLEET SERVICES
INTERNATIONAL**

AUTOMOTIVE RENTALS, INC. (NEW JERSEY CORPORATION)
9000 MIDLANTIC DRIVE
MOUNT LAUREL, NJ 08054

FOR: REFERRAL SERVICES, NAMELY, RECOMMENDING VEHICLE VENDORS; CONSULTATION SERVICES IN THE FIELD OF FLEET VEHICLES, IN CLASS 35 (U.S. CLS. 100, 101 AND 102).

FIRST USE 12-31-1997; IN COMMERCE 12-31-1997.

FOR: SHIPPING AND DELIVERY SERVICES, NAMELY, ARRANGING THE PICKUP, TRANSPORTATION AND DELIVERY OF VEHICLES; AUTOMOBILE SALVAGE, NAMELY, ARRANGING FOR VEHICLE DISPOSAL FOR OTHERS; LEASING OF VEHICLES, IN CLASS 39 (U.S. CLS. 100 AND 105).

FIRST USE 12-31-1997; IN COMMERCE 12-31-1997.

THE MARK CONSISTS OF STANDARD CHARACTERS WITHOUT CLAIM TO ANY PARTICULAR FONT, STYLE, SIZE, OR COLOR.

OWNER OF U.S. REG. NO. 2,493,638.

NO CLAIM IS MADE TO THE EXCLUSIVE RIGHT TO USE SERVICES INTERNATIONAL, APART FROM THE MARK AS SHOWN.

SEC. 2(F).

SER. NO. 77-231,388, FILED 7-17-2007.

ATTIYA MALIK, EXAMINING ATTORNEY

Int. Cl.: 3

Prior U.S. Cls.: 1, 4, 6, 50, 51 and 52

United States Patent and Trademark Office

Reg. No. 3,398,071

Registered Mar. 18, 2008

**TRADEMARK
PRINCIPAL REGISTER**

PROCOAT

PROSTRONG, INC. (CONNECTICUT CORPORATION)
20 MAIN STREET
OAKVILLE, CT 06779

THE MARK CONSISTS OF STANDARD CHARACTERS WITHOUT CLAIM TO ANY PARTICULAR FONT, STYLE, SIZE, OR COLOR.

FOR: NAIL POLISH; NAIL POLISH BASE COAT; NAIL POLISH TOP COAT, IN CLASS 3 (U.S. CLS. 1, 4, 6, 50, 51 AND 52).

SER. NO. 77-231,396, FILED 7-17-2007.

FIRST USE 9-23-1995; IN COMMERCE 9-23-1995.

THEODORE MCBRIDE, EXAMINING ATTORNEY

Int. Cl.: 35

Prior U.S. Cls.: 100, 101 and 102

United States Patent and Trademark Office

Reg. No. 3,398,072

Registered Mar. 18, 2008

**SERVICE MARK
PRINCIPAL REGISTER**

Dr. Schick's Dermaceuticals

DERMFX, P.C. (GEORGIA CORPORATION)
280 SOUTH ATLANTA STREET
ROSWELL, GA 30075

FOR: ONLINE ORDERING SERVICES USING A GLOBAL COMPUTER NETWORK, TELEPHONE ORDERING SERVICES, AND MAIL ORDER SERVICES FEATURING PET SUPPLIES, PET NUTRITIONAL PRODUCTS, AND VETERINARY PHARMACEUTICALS FOR PETS, IN CLASS 35 (U.S. CLS. 100, 101 AND 102).

FIRST USE 12-28-2006; IN COMMERCE 12-28-2006.

THE MARK CONSISTS OF STANDARD CHARACTERS WITHOUT CLAIM TO ANY PARTICULAR FONT, STYLE, SIZE, OR COLOR.

NO CLAIM IS MADE TO THE EXCLUSIVE RIGHT TO USE "DERMACEUTICALS", APART FROM THE MARK AS SHOWN.

THE NAME(S), PORTRAIT(S), AND/OR SIGNATURE(S) SHOWN IN THE MARK IDENTIFIES DR. SCHICK, WHOSE CONSENT(S) TO REGISTER IS MADE OF RECORD.

SER. NO. 77-231,400, FILED 7-17-2007.

JOHN HWANG, EXAMINING ATTORNEY

Int. Cl.: 3

Prior U.S. Cls.: 1, 4, 6, 50, 51 and 52

United States Patent and Trademark Office

Reg. No. 3,398,073

Registered Mar. 18, 2008

**TRADEMARK
PRINCIPAL REGISTER**

PROACCELERATOR

PROSTRONG, INC. (CONNECTICUT CORPORATION)
20 MAIN STREET
OAKVILLE, CT 06779

THE MARK CONSISTS OF STANDARD CHARACTERS WITHOUT CLAIM TO ANY PARTICULAR FONT, STYLE, SIZE, OR COLOR.

FOR: NAIL CARE PREPARATIONS; NAIL HARDENERS, IN CLASS 3 (U.S. CLS. 1, 4, 6, 50, 51 AND 52).

SER. NO. 77-231,428, FILED 7-17-2007.

FIRST USE 9-23-1995; IN COMMERCE 9-23-1995.

THEODORE MCBRIDE, EXAMINING ATTORNEY

Int. Cl.: 42

Prior U.S. Cls.: 100 and 101

United States Patent and Trademark Office

Reg. No. 3,398,074

Registered Mar. 18, 2008

**SERVICE MARK
PRINCIPAL REGISTER**

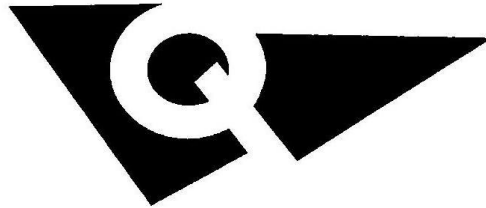

TEAM QUALITY SERVICES, INC. (INDIANA
CORPORATION)
SUITE B
4483 COUNTY ROAD 19
AUBURN, IN 46706

THE MARK CONSISTS OF STYLIZED TRIAN-
GLE WITH LETTER "Q" INSIDE THE TRIANGLE .

FOR: QUALITY CONTROL FOR OTHERS, IN
CLASS 42 (U.S. CLS. 100 AND 101).

SER. NO. 77-231,459, FILED 7-17-2007.

FIRST USE 7-1-2005; IN COMMERCE 7-1-2005.

JAY FLOWERS, EXAMINING ATTORNEY

Int. Cl.: 41

Prior U.S. Cls.: 100, 101 and 107

United States Patent and Trademark Office

Reg. No. 3,398,075

Registered Mar. 18, 2008

**SERVICE MARK
PRINCIPAL REGISTER**

**SHIFT YOUR
PERSPECTIVE**

MUSEUM OF CONTEMPORARY ART JACKSON-
VILLE, INC. (FLORIDA CORPORATION)
333 NORTH LAURA STREET
JACKSONVILLE, FL 32202

FIRST USE 12-12-2006; IN COMMERCE 12-12-2006.

SER. NO. 77-231,483, FILED 7-17-2007.

FOR: MUSEUMS, IN CLASS 41 (U.S. CLS. 100, 101
AND 107).

JORDAN BAKER, EXAMINING ATTORNEY

Int. Cl.: 9

Prior U.S. Cls.: 21, 23, 26, 36 and 38

United States Patent and Trademark Office

Reg. No. 3,398,076

Registered Mar. 18, 2008

**TRADEMARK
PRINCIPAL REGISTER**

HANDI-LENS

ULTRA-OPTIX, INC. (CONNECTICUT CORPORATION)
P O BOX 120627
17 COMMERCE STREET
EAST HAVEN, CT 06512

FOR: MAGNIFYING GLASSES AND MAGNIFYING LENSES, IN CLASS 9 (U.S. CLS. 21, 23, 26, 36 AND 38).

FIRST USE 5-18-1984; IN COMMERCE 5-18-1984.

THE MARK CONSISTS OF STANDARD CHARACTERS WITHOUT CLAIM TO ANY PARTICULAR FONT, STYLE, SIZE, OR COLOR.

SER. NO. 77-231,501, FILED 7-17-2007.

KATHLEEN M. VANSTON, EXAMINING ATTORNEY

Int. Cl.: 30

Prior U.S. Cl.: 46

United States Patent and Trademark Office

Reg. No. 3,398,077

Registered Mar. 18, 2008

**TRADEMARK
PRINCIPAL REGISTER**

EPILOGUE

DC3 ENTERTAINMENT, LLC (WASHINGTON
LTD LIAB CO)
210 THIRD AVENUE, SUITE 5D
SEATTLE, WA 98104

THE MARK CONSISTS OF STANDARD CHAR-
ACTERS WITHOUT CLAIM TO ANY PARTICULAR
FONT, STYLE, SIZE, OR COLOR.

FOR: GROUND COFFEE BEANS; COFFEE
BEANS, IN CLASS 30 (U.S. CL. 46).

SER. NO. 77-231,512, FILED 7-17-2007.

FIRST USE 11-2-2006; IN COMMERCE 11-2-2006.

MARK RADEMACHER, EXAMINING ATTORNEY

Int. Cl.: 42

Prior U.S. Cls.: 100 and 101

United States Patent and Trademark Office

Reg. No. 3,398,078

Registered Mar. 18, 2008

**SERVICE MARK
PRINCIPAL REGISTER**

ResQ

THE ARC GROUP, LLC. (TEXAS LTD LIAB CO)
PMB 502-387
4815 W. BRAKER LANE
AUSTIN, TX 78759

FOR: ANALYSIS OF OIL FIELDS, IN CLASS 42
(U.S. CLS. 100 AND 101).

FIRST USE 7-6-2007; IN COMMERCE 7-6-2007.

THE MARK CONSISTS OF STANDARD CHAR-
ACTERS WITHOUT CLAIM TO ANY PARTICULAR
FONT, STYLE, SIZE, OR COLOR.

SER. NO. 77-231,514, FILED 7-17-2007.

VIVIAN MICZNIK FIRST, EXAMINING ATTOR-
NEY

Int. Cl.: 45

Prior U.S. Cls.: 100 and 101

United States Patent and Trademark Office

Reg. No. 3,398,079

Registered Mar. 18, 2008

**SERVICE MARK
PRINCIPAL REGISTER**

INTUITIVE GIFTS

HALL, SARAH K. (UNITED STATES INDIVIDUAL)
4804 GRANITE DR., SUITE F-3, 160
ROCKLIN, CA 95677 AND
KAGETA, MARIA L. (UNITED STATES INDIVIDUAL)
4804 GRANITE DR., SUITE F-3, 160
ROCKLIN, CA 95677

FOR: PREPARATION OF CUSTOMIZED GIFT BASKETS WITH SELECTED ITEMS REGARDING A PARTICULAR OCCASION OR THEME, IN CLASS 45 (U.S. CLS. 100 AND 101).

FIRST USE 1-1-2007; IN COMMERCE 1-1-2007.

THE MARK CONSISTS OF STANDARD CHARACTERS WITHOUT CLAIM TO ANY PARTICULAR FONT, STYLE, SIZE, OR COLOR.

NO CLAIM IS MADE TO THE EXCLUSIVE RIGHT TO USE "GIFTS", APART FROM THE MARK AS SHOWN.

SER. NO. 77-231,520, FILED 7-17-2007.

KATHLEEN M. VANSTON, EXAMINING ATTORNEY

Int. Cl.: 30

Prior U.S. Cl.: 46

United States Patent and Trademark Office

Reg. No. 3,398,080

Registered Mar. 18, 2008

**TRADEMARK
PRINCIPAL REGISTER**

PROLOGUE

DC3 ENTERTAINMENT, LLC (WASHINGTON
LTD LIAB CO)
210 THIRD AVENUE, SUITE 5D
SEATTLE, WA 98104

THE MARK CONSISTS OF STANDARD CHAR-
ACTERS WITHOUT CLAIM TO ANY PARTICULAR
FONT, STYLE, SIZE, OR COLOR.

FOR: GROUND COFFEE BEANS; COFFEE
BEANS, IN CLASS 30 (U.S. CL. 46).

SER. NO. 77-231,528, FILED 7-17-2007.

FIRST USE 11-2-2006; IN COMMERCE 11-2-2006.

MARK RADEMACHER, EXAMINING ATTORNEY

Int. Cl.: 32

Prior U.S. Cls.: 45, 46 and 48

Reg. No. 3,398,081

United States Patent and Trademark Office

Registered Mar. 18, 2008

TRADEMARK
PRINCIPAL REGISTER



ARBOR BREWING COMPANY, LLC (MICHIGAN
LTD LIAB CO)
114 E. WASHINGTON
ANN ARBOR, MI 48104

FOR: BEER, IN CLASS 32 (U.S. CLS. 45, 46 AND 48).

FIRST USE 10-31-2006; IN COMMERCE 10-31-2006.

OWNER OF U.S. REG. NO. 2,075,695.

NO CLAIM IS MADE TO THE EXCLUSIVE
RIGHT TO USE "BREWING COMPANY" OR "SINCE

1995" OR "BREAKFAST STOUT", APART FROM
THE MARK AS SHOWN.

THE MARK CONSISTS OF THE LITERAL ELE-
MENT, A DESIGN OF A TREE, A COFFEE CUP AND
SAUCER WITH A LIPSTICK KISS, AND STEAM
RISING FROM THE CUP.

SER. NO. 77-231,558, FILED 7-17-2007.

AMY GEARIN, EXAMINING ATTORNEY

Int. Cl.: 35

Prior U.S. Cls.: 100, 101 and 102

United States Patent and Trademark Office

Reg. No. 3,398,082

Registered Mar. 18, 2008

**SERVICE MARK
PRINCIPAL REGISTER**

RelightNY

RELIGHTNY (NEW YORK NON-PROFIT ASSO-
CIATION)
C/O AVERY HAIRSTON
175 EAST 72ND STREET
NEW YORK, NY 10021

FOR: PROMOTING THE AWARENESS OF EN-
VIRONMENTAL AND CONSERVATION ISSUES,
INCLUDING THE ENVIRONMENTAL BENEFITS
OF ENERGY-EFFICIENT LIGHT BULBS, AMONG
CITIZENS, IN CLASS 35 (U.S. CLS. 100, 101 AND 102).

FIRST USE 2-4-2007; IN COMMERCE 2-4-2007.

THE MARK CONSISTS OF STANDARD CHAR-
ACTERS WITHOUT CLAIM TO ANY PARTICULAR
FONT, STYLE, SIZE, OR COLOR.

SER. NO. 77-231,571, FILED 7-17-2007.

MATTHEW MCDOWELL, EXAMINING ATTOR-
NEY

Int. Cl.: 41

Prior U.S. Cls.: 100, 101 and 107

United States Patent and Trademark Office

Reg. No. 3,398,083

Registered Mar. 18, 2008

**SERVICE MARK
PRINCIPAL REGISTER**

COOLFIRE MEDIA

COOLFIRE MEDIA, LLC (MISSOURI LTD LIAB
CO)
3RD FLOOR
415 N. 10TH STREET
ST. LOUIS, MO 63101

FOR: AUDIO AND VIDEO RECORDING, PRODUCTION, AND POST-PRODUCTION SERVICES; OPERATION OF VIDEO EQUIPMENT, AUDIO EQUIPMENT AND OTHER EQUIPMENT FOR PRODUCTION OF RADIO COMMERCIALS, TELEVISION PROGRAMS, AND VIDEOS; MUSIC PRODUCTION SERVICES; COMPOSITION OF MUSIC FOR OTHERS; MUSIC SELECTION SERVICES FOR USE IN TELEVISION AND RADIO; PRODUCTION AND DUPLICATION OF AUDIO AND VIDEO CASSETTES AND VIDEO DISCS; ANIMATION PRODUCTION SERVICES; CREATION OF VISUAL EFFECTS FOR OTHERS FOR USE IN DVDS, TELEVISION PROGRAMS, AND WEBSITES; CUSTOM SCRIPT WRITING SERVICES; ENTERTAINMENT, NAMELY A CONTINUING VARIETY SHOW BROADCAST OVER TELEVISION, SATELLITE, AUDIO, OR VIDEO MEDIA; PRODUCTION OF

CABLE TELEVISION PROGRAMS; ENTERTAINMENT SERVICES, NAMELY, PROVIDING ENTERTAINMENT CONTENT, NAMELY, FILMS, PHOTOGRAPHS AND OTHER MULTIMEDIA MATERIALS FOR ACCESS VIA MOBILE MEDIA DEVICES; PLANNING, ORGANIZING AND PRODUCING SPORTING AND OTHER SPECIAL EVENTS, IN CLASS 41 (U.S. CLS. 100, 101 AND 107).

FIRST USE 2-15-2002; IN COMMERCE 2-15-2002.

THE MARK CONSISTS OF STANDARD CHARACTERS WITHOUT CLAIM TO ANY PARTICULAR FONT, STYLE, SIZE, OR COLOR.

NO CLAIM IS MADE TO THE EXCLUSIVE RIGHT TO USE "MEDIA", APART FROM THE MARK AS SHOWN.

SER. NO. 77-231,623, FILED 7-17-2007.

JULIE WATSON, EXAMINING ATTORNEY

Int. Cl.: 33

Prior U.S. Cls.: 47 and 49

United States Patent and Trademark Office

Reg. No. 3,398,084

Registered Mar. 18, 2008

**TRADEMARK
PRINCIPAL REGISTER**



FAST FORWARD BRANDS, LLC (DELAWARE
LTD LIAB CO)
SUITE 1000
44 COOK STREET
DENVER, CO 80206

FOR: VODKA; DISTILLED SPIRITS, IN CLASS 33
(U.S. CLS. 47 AND 49).

FIRST USE 12-0-2006; IN COMMERCE 12-0-2006.

NO CLAIM IS MADE TO THE EXCLUSIVE
RIGHT TO USE "5" , APART FROM THE MARK
AS SHOWN.

THE MARK CONSISTS OF THE NUMBER 5
INSIDE A STYLIZED V .

SER. NO. 77-231,630, FILED 7-17-2007.

EVELYN BRADLEY, EXAMINING ATTORNEY

Int. Cl.: 41

Prior U.S. Cls.: 100, 101 and 107

United States Patent and Trademark Office

Reg. No. 3,398,085

Registered Mar. 18, 2008

**SERVICE MARK
PRINCIPAL REGISTER**

IU IS RED HOT

THE TRUSTEES OF INDIANA UNIVERSITY (IN-
DIANA BODY POLITIC AND CORPORATE)
ROOM M005 INDIANA MEMORIAL UNION
900 EAST SEVENTH STREET
BLOOMINGTON, IN 474057103

FOR: EDUCATIONAL SERVICES, NAMELY,
PROVIDING COURSES OF INSTRUCTION AT
THE UNIVERSITY AND GRADUATE STUDIES
LEVEL, IN CLASS 41 (U.S. CLS. 100, 101 AND 107).

FIRST USE 8-15-2005; IN COMMERCE 8-15-2005.

THE MARK CONSISTS OF STANDARD CHAR-
ACTERS WITHOUT CLAIM TO ANY PARTICULAR
FONT, STYLE, SIZE, OR COLOR.

OWNER OF U.S. REG. NO. 1,752,963.

SER. NO. 77-231,639, FILED 7-17-2007.

DAVID COLLIER, EXAMINING ATTORNEY

Int. Cl.: 5

Prior U.S. Cls.: 6, 18, 44, 46, 51 and 52

Reg. No. 3,398,086

United States Patent and Trademark Office

Registered Mar. 18, 2008

**TRADEMARK
PRINCIPAL REGISTER**

3V

IVX ANIMAL HEALTH, INC. (DELAWARE CORPORATION)
3915 SOUTH 48TH STREET TERRACE
ST. JOSEPH, MO 64503

THE MARK CONSISTS OF STANDARD CHARACTERS WITHOUT CLAIM TO ANY PARTICULAR FONT, STYLE, SIZE, OR COLOR.

FOR: VETERINARY NUTRITIONAL SUPPLEMENTS FOR DOMESTIC ANIMALS, IN CLASS 5 (U.S. CLS. 6, 18, 44, 46, 51 AND 52).

SER. NO. 77-231,675, FILED 7-17-2007.

FIRST USE 3-22-1995; IN COMMERCE 3-22-1995.

CHRISTINE COOPER, EXAMINING ATTORNEY

Int. Cls.: 38 and 41

Prior U.S. Cls.: 100, 101, 104 and 107

United States Patent and Trademark Office

Reg. No. 3,398,087

Registered Mar. 18, 2008

**SERVICE MARK
PRINCIPAL REGISTER**



THE OUTDOOR CHANNEL, INC. (NEVADA CORPORATION)
SUITE 103
43445 BUSINESS PARK DRIVE
TEMECULA, CA 92590

FOR: TELEVISION BROADCASTING SERVICES, IN CLASS 38 (U.S. CLS. 100, 101 AND 104).

FIRST USE 3-0-2007; IN COMMERCE 3-0-2007.

FOR: TELEVISION PRODUCTION; TELEVISION SCHEDULING OF PROGRAMS, ENTERTAINMENT SERVICES IN THE NATURE OF ONGOING TELEVISION PROGRAMS FEATURING OUTDOOR LIFESTYLES, ADVENTURE, SPORTS, AND RECREATION ACTIVITIES AND PROVIDING A WEBSITE FEATURING PHOTOGRAPHIC, AUDIO, VIDEO, AND PROSE PRESENTATIONS FEATURING OUTDOOR LIFESTYLES, ADVENTURE, SPORTS AND RECREATION ACTIVITIES, IN CLASS 41 (U.S. CLS. 100, 101 AND 107).

FIRST USE 3-0-2007; IN COMMERCE 3-0-2007.

OWNER OF U.S. REG. NOS. 2,053,733 AND 3,144,319.

NO CLAIM IS MADE TO THE EXCLUSIVE RIGHT TO USE "CHANNEL", APART FROM THE MARK AS SHOWN.

THE MARK CONSISTS OF THE WORDS OUTDOOR CHANNEL WITH A MOUNTAIN DESIGN THE WORDS.

SEC. 2(F) OUTDOOR CHANNEL.

SER. NO. 77-231,686, FILED 7-17-2007.

PATRICIA EVANKO, EXAMINING ATTORNEY

Int. Cl.: 5

Prior U.S. Cls.: 6, 18, 44, 46, 51 and 52

Reg. No. 3,398,088

United States Patent and Trademark Office

Registered Mar. 18, 2008

**TRADEMARK
PRINCIPAL REGISTER**

URIXIN

BIOADVANTECH PHARMA INC. (CANADA CORPORATION)
1280 COURTNEYPARK DRIVE EAST
MISSISSAUGA, ONTARIO, CANADA L5T1N6

THE MARK CONSISTS OF STANDARD CHARACTERS WITHOUT CLAIM TO ANY PARTICULAR FONT, STYLE, SIZE, OR COLOR.

FOR: VITAMINS; HERBAL SUPPLEMENTS; MINERAL SUPPLEMENTS; NUTRITIONAL SUPPLEMENTS, IN CLASS 5 (U.S. CLS. 6, 18, 44, 46, 51 AND 52).

SER. NO. 77-231,711, FILED 7-17-2007.

FIRST USE 6-30-2001; IN COMMERCE 6-30-2001.

GEORGE LORENZO, EXAMINING ATTORNEY

Int. Cls.: 9 and 11

Prior U.S. Cls.: 13, 21, 23, 26, 31, 34, 36 and 38

United States Patent and Trademark Office

Reg. No. 3,398,089

Registered Mar. 18, 2008

**TRADEMARK
PRINCIPAL REGISTER**



TPI CORPORATION (TENNESSEE CORPORATION)
P.O. BOX 4973
JOHNSON CITY, TN 376024973

FOR: CONTROLS FOR ELECTRIC HEATERS, NAMELY, THERMOSTATS, HUMIDISTATS AND ELECTRIC RELAYS, IN CLASS 9 (U.S. CLS. 21, 23, 26, 36 AND 38).

FIRST USE 12-31-2004; IN COMMERCE 12-31-2004.

FOR: BUILT IN ELECTRIC CONVECTION, WALL, CABINET, BASEBOARD AND CEILING HEATERS; PORTABLE ELECTRIC HEATERS; ELECTRIC DUCT HEATERS; ELECTRIC PLENUM HEATERS; ELECTRIC INFRA-RED HEATERS; VENTILATORS, NAMELY, WALL EXHAUST FANS AND ROOF VENTILATORS; ELECTRIC MACHINE TOOL LIGHTS, PORTABLE UTILITY LIGHTS AND

DOCK LIGHTS, IN CLASS 11 (U.S. CLS. 13, 21, 23, 31 AND 34).

FIRST USE 12-31-2004; IN COMMERCE 12-31-2004.

OWNER OF U.S. REG. NO. 1,004,750.

NO CLAIM IS MADE TO THE EXCLUSIVE RIGHT TO USE "INDUSTRIAL", APART FROM THE MARK AS SHOWN.

THE MARK CONSISTS OF CIRCLE CONTAINING THE WORDS "TPI INDUSTRIAL" AND THE TPI LOGO.

SER. NO. 77-231,712, FILED 7-17-2007.

ELLEN B. AWRICH, EXAMINING ATTORNEY

Int. Cl.: 5

Prior U.S. Cls.: 6, 18, 44, 46, 51 and 52

Reg. No. 3,398,090

United States Patent and Trademark Office

Registered Mar. 18, 2008

**TRADEMARK
PRINCIPAL REGISTER**

ProVantex

BIOADVANTEX PHARMA INC. (CANADA CORPORATION)
1280 COURTNEYPARK DRIVE EAST
MISSISSAUGA, ONTARIO, CANADA L5T1N6

THE MARK CONSISTS OF STANDARD CHARACTERS WITHOUT CLAIM TO ANY PARTICULAR FONT, STYLE, SIZE, OR COLOR.

FOR: VITAMINS; HERBAL SUPPLEMENTS; MINERAL SUPPLEMENTS; NUTRITIONAL SUPPLEMENTS, IN CLASS 5 (U.S. CLS. 6, 18, 44, 46, 51 AND 52).

SER. NO. 77-231,717, FILED 7-17-2007.

FIRST USE 6-30-2001; IN COMMERCE 6-30-2001.

GEORGE LORENZO, EXAMINING ATTORNEY

Int. Cl.: 35

Prior U.S. Cls.: 100, 101 and 102

United States Patent and Trademark Office

Reg. No. 3,398,091

Registered Mar. 18, 2008

**SERVICE MARK
PRINCIPAL REGISTER**



EVENTPRO STRATEGIES, INC. (NORTH CAROLINA CORPORATION)
SUITE 3011
1111 W. UNIVERSITY DR.
TEMPE, AZ 85281

FOR: ADVERTISING, MARKETING AND PROMOTION SERVICES; ARRANGING AND CONDUCTING MARKETING AND PROMOTIONAL EVENTS FOR OTHERS; PROVIDING MARKETING AND PROMOTION OF SPECIAL EVENTS, NAMELY, PROVIDING EVENT STAFFING, EVENT LOGISTICS, EVENT EXECUTION, AND EVENT MANAGEMENT SERVICES; PROMOTIONAL MODELING AND CASTING SERVICES FOR ADVERTIS-

ING AND SALES PROMOTION; MANAGEMENT AND COMPILATION OF COMPUTERIZED DATABASES, IN CLASS 35 (U.S. CLS. 100, 101 AND 102).

FIRST USE 5-31-2003; IN COMMERCE 5-31-2003.

THE MARK CONSISTS OF A PORTION OF A SPHERICAL GLOBE SHAPE, WITH THE SURFACE BEING DEFINED BY GENERALLY CIRCULAR SHAPES..

SER. NO. 77-231,720, FILED 7-17-2007.

KAREN BRACEY, EXAMINING ATTORNEY

Int. Cl.: 35

Prior U.S. Cls.: 100, 101 and 102

United States Patent and Trademark Office

Reg. No. 3,398,092

Registered Mar. 18, 2008

**SERVICE MARK
PRINCIPAL REGISTER**

JUDGING AMERICA'S BEST

AMERICAN CULINARY CHEFSBEST, INC. (NE-
VADA CORPORATION)
LEVI'S PLAZA
1255 BATTERY STREET
SAN FRANCISCO, CA 94111

FOR: PROMOTING THE GOODS AND SERVICES
OF OTHERS BY PROVIDING RECOGNITION,
AWARDS AND INCENTIVES IN THE FIELDS OF
FOOD AND BEVERAGE PRODUCTS AND SERVI-
CES, COMMERCIAL FOODSERVICE-RELATED
DURABLE PRODUCTS, CONSUMER FOOD AND
BEVERAGE RELATED DURABLE PRODUCTS,
AND FOODSERVICE PRODUCTS; BUSINESS NET-
WORKING; CONDUCTING MARKETING STUDIES
ACTIVITIES, NAMELY, STUDIES REGARDING

CHEFS, RESTAURANTEURS AND CONSUMERS,
IN CLASS 35 (U.S. CLS. 100, 101 AND 102).

FIRST USE 1-0-2005; IN COMMERCE 1-0-2005.

THE MARK CONSISTS OF STANDARD CHAR-
ACTERS WITHOUT CLAIM TO ANY PARTICULAR
FONT, STYLE, SIZE, OR COLOR.

OWNER OF U.S. REG. NO. 3,238,196.

SER. NO. 77-231,758, FILED 7-17-2007.

TIMOTHY FINNEGAN, EXAMINING ATTORNEY

Int. Cl.: 25

Prior U.S. Cls.: 22 and 39

United States Patent and Trademark Office

Reg. No. 3,398,093

Registered Mar. 18, 2008

**TRADEMARK
PRINCIPAL REGISTER**

SIGMA CHI

SIGMA CHI CORPORATION (ILLINOIS CORPORATION)
1714 HINMAN AVENUE
P.O. BOX 469
EVANSTON, IL 602040469

FOR: GYM SHORTS; HATS; JACKETS; SHIRTS;
SHORTS; SWEAT PANTS; SWEAT SHIRTS; T-
SHIRTS, IN CLASS 25 (U.S. CLS. 22 AND 39).

FIRST USE 0-0-1960; IN COMMERCE 0-0-1960.

THE MARK CONSISTS OF STANDARD CHARACTERS WITHOUT CLAIM TO ANY PARTICULAR FONT, STYLE, SIZE, OR COLOR.

OWNER OF U.S. REG. NOS. 218,796, 1,167,884 AND OTHERS.

SER. NO. 77-231,771, FILED 7-17-2007.

MICHAEL GAAFAR, EXAMINING ATTORNEY

Int. Cl.: 35

Prior U.S. Cls.: 100, 101 and 102

United States Patent and Trademark Office

Reg. No. 3,398,094

Registered Mar. 18, 2008

**SERVICE MARK
PRINCIPAL REGISTER**



RELIGHTNY (NEW YORK NON-PROFIT ASSO-
CIATION)

C/O AVERY HAIRSTON
265 EAST 72ND STREET
NEW YORK, NY 10021

FOR: PROMOTING THE AWARENESS OF EN-
VIRONMENTAL AND CONSERVATION ISSUES,
INCLUDING THE ENVIRONMENTAL BENEFITS
OF ENERGY-EFFICIENT LIGHT BULBS, AMONG
CITIZENS, IN CLASS 35 (U.S. CLS. 100, 101 AND 102).

FIRST USE 2-4-2007; IN COMMERCE 2-4-2007.

NO CLAIM IS MADE TO THE EXCLUSIVE
RIGHT TO USE "NY", APART FROM THE MARK
AS SHOWN.

THE MARK CONSISTS OF THE WORD RE-
LIGHTNY WITH THE DESIGN OF A COMPACT
FLUORESCENT LIGHTBULB ABOVE AND CON-
NECTING THE WORDS RELIGHT AND NY.

SER. NO. 77-231,801, FILED 7-17-2007.

SAIMA MAKHDOOM, EXAMINING ATTORNEY

Int. Cl.: 41

Prior U.S. Cls.: 100, 101 and 107

United States Patent and Trademark Office

Reg. No. 3,398,095

Registered Mar. 18, 2008

**SERVICE MARK
PRINCIPAL REGISTER**



THE 67 GROUP, LLC (NEVADA LTD LIAB CO),
DBA ANGEL MUSIC GROUP
SUITE 110N
3773 HOWARD HUGHES PARKWAY
LAS VEGAS, NV 89169

FOR: ENTERTAINMENT SERVICES, NAMELY,
NIGHT CLUB SERVICES FEATURING LIVE DJ
PERFORMANCES WITH AUDIO AND OR VIDEO
RECORDINGS, IN CLASS 41 (U.S. CLS. 100, 101 AND
107).

FIRST USE 7-26-2004; IN COMMERCE 7-26-2004.

THE COLOR(S) RED AND BLACK IS/ARE
CLAIMED AS A FEATURE OF THE MARK.

THE MARK CONSISTS OF THE WORDS ROK
BOX IN BLACK LETTERS AND TWO BLOCK
LINES, ONE ABOVE AND ONE BELOW THE
WORDS, COLORED IN RED..

SER. NO. 77-231,811, FILED 7-17-2007.

JAMES A. RAUEN, EXAMINING ATTORNEY

Int. Cl.: 10

Prior U.S. Cls.: 26, 39 and 44

United States Patent and Trademark Office

Reg. No. 3,398,096

Registered Mar. 18, 2008

**TRADEMARK
PRINCIPAL REGISTER**

White Silk

SENTRY MEDICAL PRODUCTS, INC. (WISCONSIN CORPORATION)

795 CORONIS WAY

GREEN BAY, WI 54304

FOR: GLOVES FOR MEDICAL USE, IN CLASS 10 (U.S. CLS. 26, 39 AND 44).

FIRST USE 4-11-2006; IN COMMERCE 6-14-2006.

THE MARK CONSISTS OF STANDARD CHARACTERS WITHOUT CLAIM TO ANY PARTICULAR FONT, STYLE, SIZE, OR COLOR.

NO CLAIM IS MADE TO THE EXCLUSIVE RIGHT TO USE "WHITE", APART FROM THE MARK AS SHOWN.

SER. NO. 77-231,815, FILED 7-17-2007.

SUSAN STIGLITZ, EXAMINING ATTORNEY

Int. Cl.: 36

Prior U.S. Cls.: 100, 101 and 102

United States Patent and Trademark Office

Reg. No. 3,398,097

Registered Mar. 18, 2008

**SERVICE MARK
PRINCIPAL REGISTER**

**THE STATE LIFE INSURANCE
COMPANY**

THE STATE LIFE INSURANCE COMPANY (IN-
DIANA CORPORATION)
P.O. BOX 368
ONE AMERICAN SQUARE
INDIANAPOLIS, IN 462060368

FOR: INSURANCE UNDERWRITING IN THE
FIELD OF LONG-TERM CARE AND LIFE INSUR-
ANCE; ANNUITY UNDERWRITING; ISSUANCE
AND ADMINISTRATION OF ANNUITIES; INSUR-
ANCE ADMINISTRATION IN THE FIELD OF
LONG-TERM CARE AND LIFE INSURANCE, IN
CLASS 36 (U.S. CLS. 100, 101 AND 102).

FIRST USE 0-0-1948; IN COMMERCE 0-0-1948.

THE MARK CONSISTS OF STANDARD CHAR-
ACTERS WITHOUT CLAIM TO ANY PARTICULAR
FONT, STYLE, SIZE, OR COLOR.

OWNER OF U.S. REG. NO. 1,555,044.

NO CLAIM IS MADE TO THE EXCLUSIVE
RIGHT TO USE "LIFE INSURANCE COMPANY",
APART FROM THE MARK AS SHOWN.

SER. NO. 77-231,844, FILED 7-17-2007.

ANDREA K. NADELMAN, EXAMINING ATTOR-
NEY

Int. Cl.: 1

Prior U.S. Cls.: 1, 5, 6, 10, 26 and 46

United States Patent and Trademark Office

Reg. No. 3,398,098

Registered Mar. 18, 2008

**TRADEMARK
PRINCIPAL REGISTER**



BIO-PURE PRODUCTS, INC. (CALIFORNIA CORPORATION)
2280 GRASS VALLEY HWY. #148
AUBURN, CA 95603

FOR: BACTERIA FOR WASTE WATER TREATMENT; BIOLOGICALLY ACTIVE ENZYMES AND MICROORGANISMS THAT ARE AIMED AT SANITISING WATER ENVIRONMENTS AND TO TREAT THE ACTIVATION AND OPTIMISATION OF BIOLOGICAL FILTER SYSTEMS, IN CLASS 1 (U.S. CLS. 1, 5, 6, 10, 26 AND 46).

FIRST USE 5-8-2007; IN COMMERCE 6-15-2007.

NO CLAIM IS MADE TO THE EXCLUSIVE RIGHT TO USE "BIO", APART FROM THE MARK AS SHOWN.

THE COLOR(S) BLACK, WHITE, BLUE IS/ARE CLAIMED AS A FEATURE OF THE MARK.

THE COLOR WHITE APPEARS IN THE WORDS "BIO PURE," THE DESIGN OF THE WATER DROP, AND AS THE OUTLINE OF THE MARK'S BACKGROUND. THE COLOR BLUE APPEARS IN THE DESIGN OF THE WATER DROP. THE COLOR BLACK APPEARS AS THE BACKGROUND OF THE MARK AND IN THE LETTERS "B" OF THE WORD "BIO," AND THE "P" OF THE WORD "PURE."

SER. NO. 77-231,854, FILED 7-17-2007.

AHSEN KHAN, EXAMINING ATTORNEY

Int. Cl.: 16

Prior U.S. Cls.: 2, 5, 22, 23, 29, 37, 38 and 50

United States Patent and Trademark Office

Reg. No. 3,398,099

Registered Mar. 18, 2008

**TRADEMARK
PRINCIPAL REGISTER**

LANWORTH

LANWORTH, INC. (DELAWARE CORPORATION)
300 PARK BOULEVARD, SUITE 425
ITASCA, IL 60143

THE MARK CONSISTS OF STANDARD CHARACTERS WITHOUT CLAIM TO ANY PARTICULAR FONT, STYLE, SIZE, OR COLOR.

FOR: MAPS, PHOTOGRAPHS, PHOTOGRAPHIC PRINTS AND PICTURES, IN CLASS 16 (U.S. CLS. 2, 5, 22, 23, 29, 37, 38 AND 50).

SER. NO. 77-231,857, FILED 7-17-2007.

FIRST USE 5-29-2007; IN COMMERCE 5-29-2007.

PATRICIA EVANKO, EXAMINING ATTORNEY

Int. Cl.: 10

Prior U.S. Cls.: 26, 39 and 44

United States Patent and Trademark Office

Reg. No. 3,398,100

Registered Mar. 18, 2008

**TRADEMARK
PRINCIPAL REGISTER**

Super Flex

SENTRY MEDICAL PRODUCTS, INC. (WISCONSIN CORPORATION)
795 CORONIS WAY
GREEN BAY, WI 54304

THE MARK CONSISTS OF STANDARD CHARACTERS WITHOUT CLAIM TO ANY PARTICULAR FONT, STYLE, SIZE, OR COLOR.

FOR: GLOVES FOR MEDICAL USE, IN CLASS 10 (U.S. CLS. 26, 39 AND 44).

SER. NO. 77-231,859, FILED 7-17-2007.

FIRST USE 9-16-2005; IN COMMERCE 11-2-2005.

SUSAN STIGLITZ, EXAMINING ATTORNEY

Int. Cl.: 41

Prior U.S. Cls.: 100, 101 and 107

United States Patent and Trademark Office

Reg. No. 3,398,101

Registered Mar. 18, 2008

**SERVICE MARK
PRINCIPAL REGISTER**

**COLORS OF THE RAINBOW TEAM
MATCH**

AMERICAN BALLROOM THEATER COMPANY,
INC. (NEW JERSEY CORPORATION)
FOURTH FLOOR
25 W. 31ST STREET
NEW YORK, NY 10001

FOR: EDUCATIONAL AND ENTERTAINMENT
SERVICES, NAMELY CONDUCTING COURSES IN
DANCE AND DANCE HISTORY, CONDUCTING
DANCE COMPETITIONS, PRESENTING DANCE
EXHIBITIONS AND DANCE PERFORMANCES, IN
CLASS 41 (U.S. CLS. 100, 101 AND 107).

FIRST USE 6-0-1997; IN COMMERCE 6-0-1997.

THE MARK CONSISTS OF STANDARD CHAR-
ACTERS WITHOUT CLAIM TO ANY PARTICULAR
FONT, STYLE, SIZE, OR COLOR.

NO CLAIM IS MADE TO THE EXCLUSIVE
RIGHT TO USE "TEAM MATCH", APART FROM
THE MARK AS SHOWN.

SER. NO. 77-231,863, FILED 7-17-2007.

BRIAN CALLAGHAN, EXAMINING ATTORNEY

Int. Cls.: 35 and 41

Prior U.S. Cls.: 100, 101, 102 and 107

United States Patent and Trademark Office

Reg. No. 3,398,102

Registered Mar. 18, 2008

**SERVICE MARK
PRINCIPAL REGISTER**

Grow yourself to grow your
business

EMERSON, MELINDA F. (UNITED STATES IN-
DIVIDUAL)
6703 GERMANTOWN AVENUE, SUITE 200
C/O TME LAW
PHILADELPHIA, PA 19119

FOR: BUSINESS CONSULTATION SERVICES, IN
CLASS 35 (U.S. CLS. 100, 101 AND 102).

FIRST USE 5-21-2007; IN COMMERCE 5-21-2007.

FOR: WORKSHOPS AND SEMINARS IN THE
FIELD OF SMALL BUSINESS DEVELOPMENT, IN
CLASS 41 (U.S. CLS. 100, 101 AND 107).

FIRST USE 5-21-2007; IN COMMERCE 5-21-2007.

THE MARK CONSISTS OF STANDARD CHAR-
ACTERS WITHOUT CLAIM TO ANY PARTICULAR
FONT, STYLE, SIZE, OR COLOR.

SER. NO. 77-231,893, FILED 7-17-2007.

LANA PHAM, EXAMINING ATTORNEY

Int. Cl.: 16

Prior U.S. Cls.: 2, 5, 22, 23, 29, 37, 38 and 50

United States Patent and Trademark Office

Reg. No. 3,398,103

Registered Mar. 18, 2008

**TRADEMARK
PRINCIPAL REGISTER**

THE PIC THAT STICKS

3M COMPANY (DELAWARE CORPORATION)
3M CENTER, 2501 HUDSON ROAD
ST. PAUL, MN 55144

THE MARK CONSISTS OF STANDARD CHAR-
ACTERS WITHOUT CLAIM TO ANY PARTICULAR
FONT, STYLE, SIZE, OR COLOR.

FOR: PRINTING PAPER, IN CLASS 16 (U.S. CLS. 2,
5, 22, 23, 29, 37, 38 AND 50).

SER. NO. 77-231,896, FILED 7-17-2007.

FIRST USE 3-0-2006; IN COMMERCE 3-0-2006.

TARAH HARDY, EXAMINING ATTORNEY

Int. Cl.: 25

Prior U.S. Cls.: 22 and 39

United States Patent and Trademark Office

Reg. No. 3,398,104

Registered Mar. 18, 2008

**TRADEMARK
PRINCIPAL REGISTER**

ERIN FETHERSTON

FETHERSTON DESIGN GROUP (NEVADA CORPORATION)
P.O. BOX 235
GLENBROOK, NV 89413

FOR: (BASED ON USE IN COMMERCE) BLOUSES; COATS; DRESSES; JACKETS; PANTS; SHORTS; SKIRTS; TOPS; SHIRTS; GOWNS, IN CLASS 25 (U.S. CLS. 22 AND 39).

FIRST USE 3-30-2006; IN COMMERCE 3-30-2006.

THE MARK CONSISTS OF STANDARD CHARACTERS WITHOUT CLAIM TO ANY PARTICULAR FONT, STYLE, SIZE, OR COLOR.

OWNER OF U.S. REG. NO. 3,232,940.

SER. NO. 77-231,900, FILED 7-17-2007.

SUSAN LESLIE DUBOIS, EXAMINING ATTORNEY

Int. Cl.: 35

Prior U.S. Cls.: 100, 101 and 102

United States Patent and Trademark Office

Reg. No. 3,398,105

Registered Mar. 18, 2008

**SERVICE MARK
PRINCIPAL REGISTER**



URBANIMAL, LLC (ILLINOIS LTD LIAB CO)
1425 WEST FULLERTON
CHICAGO, IL 60614

FOR: RETAIL STORE SERVICES FEATURING
NATURAL PET FOOD, IN CLASS 35 (U.S. CLS. 100,
101 AND 102).

FIRST USE 7-9-2007; IN COMMERCE 7-9-2007.

THE MARK CONSISTS OF THE STYLIZED RE-
PRESENTATION OF AN ARROW CURVING
DOWNWARD ABOVE THE WORD URBANIMAL
WHICH IN TURN IS ABOVE THE STYLIZED RE-
PRESENTATION OF AN ARROW CURVING UP-
WARD.

SER. NO. 77-231,954, FILED 7-17-2007.

LINDA MICKLEBURGH, EXAMINING ATTORNEY

Int. Cl.: 3

Prior U.S. Cls.: 1, 4, 6, 50, 51 and 52

Reg. No. 3,398,106

United States Patent and Trademark Office

Registered Mar. 18, 2008

**TRADEMARK
PRINCIPAL REGISTER**

L A B O R A T O I R E
R E M È D E

BLISS WORLD LLC (DELAWARE LTD LIAB CO)
75 VARICK STREET
NEW YORK, NY 10013

FOR: COSMETICS, IN CLASS 3 (U.S. CLS. 1, 4, 6, 50,
51 AND 52).

FIRST USE 12-0-2004; IN COMMERCE 12-0-2004.

OWNER OF U.S. REG. NOS. 2,489,360, 2,618,674,
AND 2,635,744.

THE MARK CONSISTS OF THE TERMS LABOR-
ATOIRE AND REMEDE WITH A LINE BETWEEN
THEM.

THE ENGLISH TRANSLATION OF THE WORDS
LABORATIORE REMEDE IS LABORATORY REME-
DY.

SER. NO. 77-231,981, FILED 7-17-2007.

JOHN WILKE, EXAMINING ATTORNEY

Int. Cl.: 18

Prior U.S. Cls.: 1, 2, 3, 22 and 41

United States Patent and Trademark Office

Reg. No. 3,398,107

Registered Mar. 18, 2008

**TRADEMARK
PRINCIPAL REGISTER**

310 MOTORING

310 GLOBAL BRANDS, INC. (DELAWARE CORPORATION)
225 SOUTH SEPULVEDA BOULEVARD
MANHATTAN BEACH, CA 90266

FOR: TOTE BAGS, DUFFEL BAGS, ROLLING BAGS, MESSENGER BAGS, BACKPACKS AND LUGGAGE, IN CLASS 18 (U.S. CLS. 1, 2, 3, 22 AND 41).

FIRST USE 1-31-2005; IN COMMERCE 1-31-2005.

THE MARK CONSISTS OF STANDARD CHARACTERS WITHOUT CLAIM TO ANY PARTICULAR FONT, STYLE, SIZE, OR COLOR.

OWNER OF U.S. REG. NOS. 2,565,085, 2,571,277 AND OTHERS.

SER. NO. 77-231,992, FILED 7-17-2007.

TARAH HARDY, EXAMINING ATTORNEY

Int. Cl.: 43

Prior U.S. Cls.: 100 and 101

United States Patent and Trademark Office

Reg. No. 3,398,108

Registered Mar. 18, 2008

**SERVICE MARK
PRINCIPAL REGISTER**



ROVER RETREAT FRANCHISING, LLC (COL-
ORADO LTD LIAB CO)
4597 MAROON CIRCLE
BROOMFIELD, CO 80023

THE MARK CONSISTS OF CIRCLE WITH THE
WORDS ROVER RETREAT CONTAINING A STY-
LIZED DOG.

FOR: KENNEL SERVICES, IN CLASS 43 (U.S. CLS.
100 AND 101).

SER. NO. 77-231,996, FILED 7-17-2007.

FIRST USE 2-1-2007; IN COMMERCE 2-1-2007.

MIDGE BUTLER, EXAMINING ATTORNEY

Int. Cl.: 41

Prior U.S. Cls.: 100, 101 and 107

United States Patent and Trademark Office

Reg. No. 3,398,109

Registered Mar. 18, 2008

**SERVICE MARK
PRINCIPAL REGISTER**

OPERATION PAINTBALL ISLAND
ONE WEEK. ONE ISLAND. ONE
MILLION DOLLARS.

MAHONEY JR., MICHAEL (UNITED STATES
INDIVIDUAL)
18212 OAKDALE ROAD
ODESSA, FL 33556

THE MARK CONSISTS OF STANDARD CHAR-
ACTERS WITHOUT CLAIM TO ANY PARTICULAR
FONT, STYLE, SIZE, OR COLOR.

FOR: ENTERTAINMENT IN THE NATURE OF
PAINTBALL TOURNAMENTS, IN CLASS 41 (U.S.
CLS. 100, 101 AND 107).

SER. NO. 77-232,000, FILED 7-17-2007.

FIRST USE 1-31-2007; IN COMMERCE 1-31-2007.

HANNO RITTNER, EXAMINING ATTORNEY

Int. Cl.: 43

Prior U.S. Cls.: 100 and 101

United States Patent and Trademark Office

Reg. No. 3,398,110

Registered Mar. 18, 2008

**SERVICE MARK
PRINCIPAL REGISTER**

SEOUL BROS.

SEOUL BROS. GROUP, INC. (CALIFORNIA CORPORATION)

#250

700 N. CENTRAL AVE.

GLENDALE, CA 91203

FOR: RESTAURANT SERVICES, IN CLASS 43
(U.S. CLS. 100 AND 101).

FIRST USE 5-31-2006; IN COMMERCE 7-11-2007.

THE MARK CONSISTS OF STANDARD CHARACTERS WITHOUT CLAIM TO ANY PARTICULAR FONT, STYLE, SIZE, OR COLOR.

SER. NO. 77-232,021, FILED 7-17-2007.

NAAKWAMA ANKRAH, EXAMINING ATTORNEY

Int. Cl.: 36

Prior U.S. Cls.: 100, 101 and 102

United States Patent and Trademark Office

Reg. No. 3,398,111

Registered Mar. 18, 2008

**SERVICE MARK
PRINCIPAL REGISTER**

suwanabee

HART, BEVERLY (UNITED STATES INDIVIDUAL)
3859 LAKE RUBY LANE
SUWANEE, GA 30024

THE MARK CONSISTS OF STANDARD CHARACTERS WITHOUT CLAIM TO ANY PARTICULAR FONT, STYLE, SIZE, OR COLOR.

FOR: REAL ESTATE CONSULTATION, IN CLASS 36 (U.S. CLS. 100, 101 AND 102).

SER. NO. 77-232,036, FILED 7-17-2007.

FIRST USE 7-17-2006; IN COMMERCE 7-17-2006.

DAVID TOOLEY, EXAMINING ATTORNEY

Int. Cl.: 12

Prior U.S. Cls.: 19, 21, 23, 31, 35 and 44

Reg. No. 3,398,112

United States Patent and Trademark Office

Registered Mar. 18, 2008

**TRADEMARK
PRINCIPAL REGISTER**



ANHUI JIANGHUAI AUTOMOBILE GROUP CO.,
LTD. (CHINA CORPORATION)
NO. 176 DONGLIU ROAD, BAOHE DISTRICT
HEFEI CITY, CHINA

TIRES; THREE-WHEELED MOTOR VEHICLES;
TWO-WHEELED MOTOR VEHICLES; TWO-
WHEELED MOTORIZED VEHICLES, IN CLASS 12
(U.S. CLS. 19, 21, 23, 31, 35 AND 44).

FOR: COACHES; BUSES; LIGHT TRUCKS; PICK-
UP TRUCKS; PICKUP TRUCKS; AUTOMOBILES;
AUTOMOBILES AND STRUCTURAL PARTS
THEREFOR; SPORTS UTILITY VEHICLES; VANS
AND STRUCTURAL PARTS THEREFOR; MOTOR-
CYCLES AND STRUCTURAL PARTS THEREFOR;

FIRST USE 1-15-2007; IN COMMERCE 1-15-2007.

SER. NO. 77-232,053, FILED 7-17-2007.

JASON BLAIR, EXAMINING ATTORNEY

Int. Cl.: 33

Prior U.S. Cls.: 47 and 49

United States Patent and Trademark Office

Reg. No. 3,398,113

Registered Mar. 18, 2008

**TRADEMARK
PRINCIPAL REGISTER**

HEALDSBURG RANCHES

HAMBRECHT WINE GROUP, LP (CALIFORNIA
LIMITED PARTNERSHIP)
4035 WESTSIDE ROAD
HEALDSBURG, CA 95448

FOR: WINE, IN CLASS 33 (U.S. CLS. 47 AND 49).

FIRST USE 0-0-2000; IN COMMERCE 0-0-2000.

THE MARK CONSISTS OF STANDARD CHAR-
ACTERS WITHOUT CLAIM TO ANY PARTICULAR
FONT, STYLE, SIZE, OR COLOR.

SEC. 2(F).

SER. NO. 77-232,076, FILED 7-17-2007.

SUSAN LESLIE DUBOIS, EXAMINING ATTORNEY

Int. Cl.: 42

Prior U.S. Cls.: 100 and 101

United States Patent and Trademark Office

Reg. No. 3,398,114

Registered Mar. 18, 2008

**SERVICE MARK
PRINCIPAL REGISTER**

WEBSITES UNDER YOUR CONTROL

SHOLAR, WILLIAM (UNITED STATES INDIVIDUAL)
11818 EASTPARK LN.
FRISCO, TX 75034

FOR: DESIGN, CREATION, HOSTING, MAINTENANCE OF WEBSITES FOR OTHERS, IN CLASS 42 (U.S. CLS. 100 AND 101).

FIRST USE 4-0-2007; IN COMMERCE 4-0-2007.

THE MARK CONSISTS OF STANDARD CHARACTERS WITHOUT CLAIM TO ANY PARTICULAR FONT, STYLE, SIZE, OR COLOR.

NO CLAIM IS MADE TO THE EXCLUSIVE RIGHT TO USE "WEBSITES", APART FROM THE MARK AS SHOWN.

SER. NO. 77-232,082, FILED 7-17-2007.

NAAKWAMA ANKRAH, EXAMINING ATTORNEY

Int. Cl.: 43

Prior U.S. Cls.: 100 and 101

United States Patent and Trademark Office

Reg. No. 3,398,115

Registered Mar. 18, 2008

**SERVICE MARK
PRINCIPAL REGISTER**



SEUL BROS. GROUP, INC. (CALIFORNIA CORPORATION)

#250
700 N. CENTRAL AVE.
GLENDALE, CA 91203

FOR: RESTAURANT SERVICES, IN CLASS 43
(U.S. CLS. 100 AND 101).

FIRST USE 5-31-2006; IN COMMERCE 7-11-2007.

THE MARK CONSISTS OF STYLIZED SEUL BROS. WITHIN A SQUARE SHAPE SURROUNDED WITH BORDERS.

SER. NO. 77-232,087, FILED 7-17-2007.

NAKWAMA ANKRAH, EXAMINING ATTORNEY

Int. Cl.: 33

Prior U.S. Cls.: 47 and 49

United States Patent and Trademark Office

Reg. No. 3,398,116

Registered Mar. 18, 2008

**TRADEMARK
PRINCIPAL REGISTER**

LE POUSSEUR

BONNY DOON WINERY, INC. (CALIFORNIA
CORPORATION)

P. O. BOX 8376

SANTA CRUZ, CA 95061

FOR: WINE, IN CLASS 33 (U.S. CLS. 47 AND 49).

FIRST USE 10-1-2003; IN COMMERCE 10-1-2003.

THE MARK CONSISTS OF STANDARD CHAR-
ACTERS WITHOUT CLAIM TO ANY PARTICULAR
FONT, STYLE, SIZE, OR COLOR.

THE FOREIGN WORDING IN THE MARK
TRANSLATES INTO ENGLISH AS THE PUSHER.

SER. NO. 77-232,129, FILED 7-17-2007.

ATTIYA MALIK, EXAMINING ATTORNEY

Int. Cl.: 35

Prior U.S. Cls.: 100, 101 and 102

United States Patent and Trademark Office

Reg. No. 3,398,117

Registered Mar. 18, 2008

**SERVICE MARK
PRINCIPAL REGISTER**

The Bell Tree

DCM ALLIANCE, LLC (NEW JERSEY LTD LIAB
CO)
8A KNIGHTS BRIDGE DRIVE
RANDOLPH, NJ 07869

THE MARK CONSISTS OF STANDARD CHAR-
ACTERS WITHOUT CLAIM TO ANY PARTICULAR
FONT, STYLE, SIZE, OR COLOR.

FOR: RESTAURANT FRANCHISING, IN CLASS
35 (U.S. CLS. 100, 101 AND 102).

SER. NO. 77-232,135, FILED 7-17-2007.

FIRST USE 3-1-2007; IN COMMERCE 3-1-2007.

BARBARA BROWN, EXAMINING ATTORNEY

Int. Cl.: 35

Prior U.S. Cls.: 100, 101 and 102

United States Patent and Trademark Office

Reg. No. 3,398,118

Registered Mar. 18, 2008

**SERVICE MARK
PRINCIPAL REGISTER**

TUFF BLOCKS

HIGH TECH BLOCKS LLC (NEVADA LTD LIAB
CO)
P.O BOX 7397
REDLANDS, CA 92375

THE MARK CONSISTS OF STANDARD CHAR-
ACTERS WITHOUT CLAIM TO ANY PARTICULAR
FONT, STYLE, SIZE, OR COLOR.

FOR: ADVERTISING SERVICES, IN CLASS 35
(U.S. CLS. 100, 101 AND 102).

SER. NO. 77-232,141, FILED 7-17-2007.

FIRST USE 1-7-2007; IN COMMERCE 2-7-2007.

RENEE MCCRAY, EXAMINING ATTORNEY

Int. Cl.: 41

Prior U.S. Cls.: 100, 101 and 107

United States Patent and Trademark Office

Reg. No. 3,398,119

Registered Mar. 18, 2008

**SERVICE MARK
PRINCIPAL REGISTER**

KickSwish

SHERMAN, MICHAEL D (UNITED STATES IN-
DIVIDUAL)
19360 RINALDI ST., SUITE 257
NORTHRIDGE, CA 91326

THE MARK CONSISTS OF STANDARD CHAR-
ACTERS WITHOUT CLAIM TO ANY PARTICULAR
FONT, STYLE, SIZE, OR COLOR.

FOR: ENTERTAINMENT SERVICES IN THE
NATURE OF FANTASY SPORTS LEAGUES, IN
CLASS 41 (U.S. CLS. 100, 101 AND 107).

SER. NO. 77-232,150, FILED 7-17-2007.

FIRST USE 1-5-2007; IN COMMERCE 7-3-2007.

MORGAN WYNNE, EXAMINING ATTORNEY

Int. Cl.: 36

Prior U.S. Cls.: 100, 101 and 102

United States Patent and Trademark Office

Reg. No. 3,398,120

Registered Mar. 18, 2008

**SERVICE MARK
PRINCIPAL REGISTER**

SECURITYCHOICE

WELLPOINT, INC. (INDIANA CORPORATION)
120 MONUMENT CIRCLE
INDIANAPOLIS, IN 46204

FOR: INSURANCE SERVICES, NAMELY, UNDERWRITING, ADMINISTRATION OF HEALTH CARE PLANS, PRESCRIPTION DRUG AND PHARMACY BENEFIT CLAIMS PROCESSING SERVICES, IN CLASS 36 (U.S. CLS. 100, 101 AND 102).

FIRST USE 3-1-2003; IN COMMERCE 3-1-2003.

THE MARK CONSISTS OF STANDARD CHARACTERS WITHOUT CLAIM TO ANY PARTICULAR FONT, STYLE, SIZE, OR COLOR.

SER. NO. 77-232,160, FILED 7-17-2007.

SALLY SHIH, EXAMINING ATTORNEY

Int. Cl.: 36

Prior U.S. Cls.: 100, 101 and 102

United States Patent and Trademark Office

Reg. No. 3,398,121

Registered Mar. 18, 2008

**SERVICE MARK
PRINCIPAL REGISTER**

SMARTVALUE

WELLPOINT, INC. (INDIANA CORPORATION)
120 MONUMENT CIRCLE
INDIANAPOLIS, IN 46204

FOR: INSURANCE SERVICES, NAMELY, UNDERWRITING AND ADMINISTRATION OF HEALTH CARE PLANS, PRESCRIPTION DRUG AND PHARMACY BENEFIT CLAIMS PROCESSING SERVICES, IN CLASS 36 (U.S. CLS. 100, 101 AND 102).

FIRST USE 10-1-2004; IN COMMERCE 10-1-2004.

THE MARK CONSISTS OF STANDARD CHARACTERS WITHOUT CLAIM TO ANY PARTICULAR FONT, STYLE, SIZE, OR COLOR.

SER. NO. 77-232,161, FILED 7-17-2007.

SALLY SHIH, EXAMINING ATTORNEY

Int. Cl.: 41

Prior U.S. Cls.: 100, 101 and 107

United States Patent and Trademark Office

Reg. No. 3,398,122

Registered Mar. 18, 2008

**SERVICE MARK
PRINCIPAL REGISTER**



JENSEN, JAY L. (UNITED STATES INDIVIDUAL)
10044 RICHARD CIRCLE
FORNEY, TX 75126

FOR: ENTERTAINMENT SERVICES, NAMELY, PROVIDING A WEBSITE FEATURING, PHOTOGRAPHIC, AUDIO, VIDEO AND PROSE PRESENTATIONS FEATURING A MUSICAL GROUP; ENTERTAINMENT IN THE NATURE OF LIVE PERFORMANCES BY A MUSICAL GROUP; ENTERTAINMENT IN THE NATURE OF VISUAL AND AUDIO PERFORMANCES, NAMELY, MUSICAL BAND, ROCK GROUP, GYMNASTIC, DANCE,

AND BALLET PERFORMANCES, IN CLASS 41 (U.S. CLS. 100, 101 AND 107).

FIRST USE 6-0-2007; IN COMMERCE 6-0-2007.

THE MARK CONSISTS OF STYLIZED FONT WITH THE FIRST LETTER BEING CAPITAL WITH THE OTHER LETTERS BEING LOWER CASE.

SER. NO. 77-232,175, FILED 7-18-2007.

RONALD AIKENS, EXAMINING ATTORNEY

Int. Cls.: 41 and 45

Prior U.S. Cls.: 100, 101 and 107

United States Patent and Trademark Office

Reg. No. 3,398,123

Registered Mar. 18, 2008

**SERVICE MARK
PRINCIPAL REGISTER**

HOUR-ZERO

HOUR-ZERO CRISIS CONSULTING LTD. (CANADA CORPORATION)
9914 86 AVENUE
EDMONTON, CANADA T6E2L7

FOR: PROVIDING ON-LINE TRAINING, NAMELY, COURSES AND WORKSHOPS IN THE FIELD OF EMERGENCY PREPAREDNESS, EMERGENCY RESPONSE, CRISIS RESPONSE AND RESCUE; EDUCATIONAL SERVICES, NAMELY, CONDUCTING SEMINARS, WORKSHOPS AND CONFERENCES IN THE FIELDS OF EMERGENCY PREPAREDNESS, EMERGENCY RESPONSE, CRISIS RESPONSE AND RESCUE, IN CLASS 41 (U.S. CLS. 100, 101 AND 107).

FIRST USE 6-30-2007; IN COMMERCE 6-30-2007.

FOR: PROVIDING CONSULTATION AND INFORMATION IN THE FIELD OF EMERGENCY RESPONSE PROGRAM DEVELOPMENT, EMERGENCY PREPAREDNESS, AND SAFETY PLANNING, IN CLASS 45 (U.S. CLS. 100 AND 101).

FIRST USE 6-30-2007; IN COMMERCE 6-30-2007.

THE MARK CONSISTS OF STANDARD CHARACTERS WITHOUT CLAIM TO ANY PARTICULAR FONT, STYLE, SIZE, OR COLOR.

SER. NO. 77-232,180, FILED 7-18-2007.

RONALD AIKENS, EXAMINING ATTORNEY

Int. Cl.: 30

Prior U.S. Cl.: 46

United States Patent and Trademark Office

Reg. No. 3,398,124

Registered Mar. 18, 2008

**TRADEMARK
PRINCIPAL REGISTER**

PLUM HARVEST

TEAVANA CORPORATION (GEORGIA COR-
PORATION)

SUITE 860

3475 LENOX ROAD

ATLANTA, GA 30326

FOR: TEA, IN CLASS 30 (U.S. CL. 46).

FIRST USE 1-0-2003; IN COMMERCE 1-0-2003.

THE MARK CONSISTS OF STANDARD CHAR-
ACTERS WITHOUT CLAIM TO ANY PARTICULAR
FONT, STYLE, SIZE, OR COLOR.

NO CLAIM IS MADE TO THE EXCLUSIVE
RIGHT TO USE "PLUM", APART FROM THE
MARK AS SHOWN.

SER. NO. 77-232,188, FILED 7-18-2007.

DEBRA LEE, EXAMINING ATTORNEY

Int. Cl.: 25

Prior U.S. Cls.: 22 and 39

United States Patent and Trademark Office

Reg. No. 3,398,125

Registered Mar. 18, 2008

**TRADEMARK
PRINCIPAL REGISTER**



SIGMA CHI CORPORATION (ILLINOIS CORPORATION)
1714 HINMAN AVENUE, P.O. BOX 469
EVANSTON, IL 602040469

FOR: GYM SHORTS; HATS; JACKETS; SHIRTS;
SHORTS; SWEAT PANTS; SWEAT SHIRTS; T-
SHIRTS, IN CLASS 25 (U.S. CLS. 22 AND 39).

FIRST USE 0-0-1960; IN COMMERCE 0-0-1960.

OWNER OF U.S. REG. NOS. 218,796, 1,167,884 AND
OTHERS.

THE MARK CONSISTS OF THE GREEK LETTERS
"SIGMA" AND "CHI".

SER. NO. 77-232,224, FILED 7-18-2007.

MICHAEL GAAFAR, EXAMINING ATTORNEY

Int. Cl.: 35

Prior U.S. Cls.: 100, 101 and 102

United States Patent and Trademark Office

Reg. No. 3,398,126

Registered Mar. 18, 2008

**SERVICE MARK
PRINCIPAL REGISTER**

BRADLEY-MORRIS

BRADLEY-MORRIS, INC. (GEORGIA CORPORATION)
1825 BARRETT LAKES BLVD., SUITE 300
KENNESAW, GA 30144

THE MARK CONSISTS OF STANDARD CHARACTERS WITHOUT CLAIM TO ANY PARTICULAR FONT, STYLE, SIZE, OR COLOR.

FOR: JOB AND PERSONNEL PLACEMENT, IN CLASS 35 (U.S. CLS. 100, 101 AND 102).

SER. NO. 77-232,264, FILED 7-18-2007.

FIRST USE 7-7-1991; IN COMMERCE 7-7-1991.

JORDAN BAKER, EXAMINING ATTORNEY

Int. Cl.: 20

Prior U.S. Cls.: 2, 13, 22, 25, 32 and 50

United States Patent and Trademark Office

Reg. No. 3,398,127

Registered Mar. 18, 2008

**TRADEMARK
PRINCIPAL REGISTER**

CHROMALUXE

UNIVERSAL WOODS, INCORPORATED (KEN-
TUCKY CORPORATION)
2600 GRASSLAND DRIVE
LOUISVILLE, KY 40299

THE MARK CONSISTS OF STANDARD CHAR-
ACTERS WITHOUT CLAIM TO ANY PARTICULAR
FONT, STYLE, SIZE, OR COLOR.

FOR: PHOTO PANELS FOR USE IN DYE-SUBLI-
MATION PRINTING, IN CLASS 20 (U.S. CLS. 2, 13,
22, 25, 32 AND 50).

SER. NO. 77-232,284, FILED 7-18-2007.

FIRST USE 4-12-2007; IN COMMERCE 4-12-2007.

KEVON CHISOLM, EXAMINING ATTORNEY

Int. Cl.: 35

Prior U.S. Cls.: 100, 101 and 102

United States Patent and Trademark Office

Reg. No. 3,398,128

Registered Mar. 18, 2008

**SERVICE MARK
PRINCIPAL REGISTER**

PowerHire

BRADLEY-MORRIS, INC. (GEORGIA CORPORATION)
1825 BARRETT LAKES BLVD., SUITE 300
KENNESAW, GA 30144

THE MARK CONSISTS OF STANDARD CHARACTERS WITHOUT CLAIM TO ANY PARTICULAR FONT, STYLE, SIZE, OR COLOR.

FOR: JOB AND PERSONNEL PLACEMENT, IN CLASS 35 (U.S. CLS. 100, 101 AND 102).

SER. NO. 77-232,289, FILED 7-18-2007.

FIRST USE 3-6-2006; IN COMMERCE 3-6-2006.

JORDAN BAKER, EXAMINING ATTORNEY

Int. Cl.: 30

Prior U.S. Cl.: 46

United States Patent and Trademark Office

Reg. No. 3,398,129

Registered Mar. 18, 2008

**TRADEMARK
PRINCIPAL REGISTER**

SWEETWISTS

FARLEY'S AND SATHERS CANDY COMPANY,
INC. (DELAWARE CORPORATION)
ONE SATHER PLAZA
P.O. BOX 28
ROUND LAKE, MN 56167

THE MARK CONSISTS OF STANDARD CHAR-
ACTERS WITHOUT CLAIM TO ANY PARTICULAR
FONT, STYLE, SIZE, OR COLOR.

SEC. 2(F).

FOR: CANDY, IN CLASS 30 (U.S. CL. 46).

SER. NO. 77-232,297, FILED 7-18-2007.

FIRST USE 0-0-1992; IN COMMERCE 0-0-1992.

DAVID C. REIHNER, EXAMINING ATTORNEY

Int. Cl.: 3

Prior U.S. Cls.: 1, 4, 6, 50, 51 and 52

United States Patent and Trademark Office

Reg. No. 3,398,130

Registered Mar. 18, 2008

**TRADEMARK
PRINCIPAL REGISTER**

DKNY RED DELICIOUS

GABRIELLE STUDIO, INC. (NEW YORK CORPORATION)
550 SEVENTH AVENUE
NEW YORK, NY 10018

FOR: COSMETICS, IN CLASS 3 (U.S. CLS. 1, 4, 6, 50, 51 AND 52).

FIRST USE 2-1-2006; IN COMMERCE 2-1-2006.

THE MARK CONSISTS OF STANDARD CHARACTERS WITHOUT CLAIM TO ANY PARTICULAR FONT, STYLE, SIZE, OR COLOR.

OWNER OF U.S. REG. NOS. 2,203,071, 2,601,327 AND OTHERS.

SER. NO. 77-232,327, FILED 7-18-2007.

MICHAEL ENGEL, EXAMINING ATTORNEY

Int. Cl.: 37

Prior U.S. Cls.: 100, 103 and 106

United States Patent and Trademark Office

Reg. No. 3,398,131

Registered Mar. 18, 2008

**SERVICE MARK
PRINCIPAL REGISTER**

FLOORS-2-LOVE

LIQUID SOLID SURFACE FRANCHISING, LTD.
(OHIO LTD LIAB CO)
800 VISTA AVENUE
MASSILLON, OH 44646

FOR: FLOOR INSTALLATION, REFINISHING,
RESURFACING AND REPAIR SERVICES, IN
CLASS 37 (U.S. CLS. 100, 103 AND 106).

FIRST USE 9-0-2004; IN COMMERCE 3-0-2005.

THE MARK CONSISTS OF STANDARD CHAR-
ACTERS WITHOUT CLAIM TO ANY PARTICULAR
FONT, STYLE, SIZE, OR COLOR.

OWNER OF U.S. REG. NO. 2,988,978.

SER. NO. 77-232,339, FILED 7-18-2007.

VIVIAN MICZNIK FIRST, EXAMINING ATTOR-
NEY

Int. Cls.: 35 and 41

Prior U.S. Cls.: 100, 101, 102 and 107

United States Patent and Trademark Office

Reg. No. 3,398,132

Registered Mar. 18, 2008

**SERVICE MARK
PRINCIPAL REGISTER**

GHISALLO

GHISALLO HOLDINGS, LLC (MISSOURI LTD
LIAB CO)
161 LONG ROAD, SUITE 103
CHESTERFIELD, MO 63005

FOR: RETAIL STORE SERVICES FEATURING
BICYCLES, BICYCLE PARTS, AND CLOTHING,
GEAR AND ACCESSORIES FOR CYCLING, SWIM-
MING, RUNNING, TRIATHLON AND GENERAL
FITNESS, IN CLASS 35 (U.S. CLS. 100, 101 AND 102).

FIRST USE 2-28-2004; IN COMMERCE 2-28-2004.

FOR: ARRANGING AND CONDUCTING ATH-
LETIC COMPETITIONS, NAMELY, RUNNING

EVENTS, CYCLING EVENTS AND TRIATHLONS,
IN CLASS 41 (U.S. CLS. 100, 101 AND 107).

FIRST USE 2-28-2004; IN COMMERCE 2-28-2004.

THE MARK CONSISTS OF STANDARD CHAR-
ACTERS WITHOUT CLAIM TO ANY PARTICULAR
FONT, STYLE, SIZE, OR COLOR.

SER. NO. 77-232,357, FILED 7-18-2007.

CHRIS WELLS, EXAMINING ATTORNEY

Int. Cl.: 25

Prior U.S. Cls.: 22 and 39

United States Patent and Trademark Office

Reg. No. 3,398,133

Registered Mar. 18, 2008

**TRADEMARK
PRINCIPAL REGISTER**



BRICE, MERI (UNITED STATES INDIVIDUAL)
250 POINSETTIA
VISTA, CA 92083 AND
BRICE, DAVID (UNITED STATES INDIVIDUAL)
250 POINSETTIA
VISTA, CA 92083

FOR: WOMEN'S, CHILDREN'S AND INFANTS
SHIRTS, T-SHIRTS, BELTS, UNDERWEAR, SWEA-
TERS, COATS, JEANS, SHORTS, HOSIERY, TANK
TOPS, HALTER TOPS, NIGHTGOWNS, NIGHT

SHIRTS, PAJAMAS, PANTS, SWEATSHIRTS,
SWEATPANTS, APRONS, LINGERIE, SWIMSUITS,
SKIRTS, CHILDREN'S CLOTH EATING BIBS, BABY
BIBS NOT OF PAPER, FOOTWEAR, HATS, IN
CLASS 25 (U.S. CLS. 22 AND 39).

FIRST USE 1-1-2007; IN COMMERCE 1-1-2007.

SER. NO. 77-232,408, FILED 7-18-2007.

APRIL ROACH, EXAMINING ATTORNEY

Int. Cl.: 35

Prior U.S. Cls.: 100, 101 and 102

United States Patent and Trademark Office

Reg. No. 3,398,134

Registered Mar. 18, 2008

**SERVICE MARK
PRINCIPAL REGISTER**

Accidental Pren-her

REID, SUSAN LEE (UNITED STATES INDIVIDUAL)
112 FRIDLEY COURT
MCGAHEYSVILLE, VA 22840

THE MARK CONSISTS OF STANDARD CHARACTERS WITHOUT CLAIM TO ANY PARTICULAR FONT, STYLE, SIZE, OR COLOR.

FOR: SMALL BUSINESS CONSULTATION SERVICES, IN CLASS 35 (U.S. CLS. 100, 101 AND 102).

SER. NO. 77-232,422, FILED 7-18-2007.

FIRST USE 11-0-2006; IN COMMERCE 11-0-2006.

MARGERY A. TIERNEY, EXAMINING ATTORNEY

Int. Cl.: 35

Prior U.S. Cls.: 100, 101 and 102

United States Patent and Trademark Office

Reg. No. 3,398,135

Registered Mar. 18, 2008

**SERVICE MARK
PRINCIPAL REGISTER**

**The Best Brands in the
Industry All have the Same
Address**

RETAIL STORE NETWORKS, INC. (VIRGINIA
CORPORATION), DBA WHOLESALPET.COM
2016 MONUMENT AVENUE
RICHMOND, VA 23220

THE MARK CONSISTS OF STANDARD CHAR-
ACTERS WITHOUT CLAIM TO ANY PARTICULAR
FONT, STYLE, SIZE, OR COLOR.

FOR: ONLINE WHOLESALE STORE SERVICES
FEATURING PET SUPPLIES, IN CLASS 35 (U.S. CLS.
100, 101 AND 102).

SER. NO. 77-232,444, FILED 7-18-2007.

FIRST USE 4-30-2003; IN COMMERCE 4-30-2003.

STEPHANIE ALI, EXAMINING ATTORNEY

Int. Cl.: 45

Prior U.S. Cls.: 100 and 101

United States Patent and Trademark Office

Reg. No. 3,398,136

Registered Mar. 18, 2008

**SERVICE MARK
PRINCIPAL REGISTER**

SHABEAR

SHABEAR INC. (NEVADA CORPORATION)
9200 YAAK RIVER RD
TROY, MT 59935

FIRST USE 12-26-2000; IN COMMERCE 12-26-2000.

FOR: PSYCHIC READING SERVICES; RELIGIOUS AND SPIRITUAL SERVICES, NAMELY, PROVIDING GATHERINGS AND RETREATS TO DEVELOP AND ENHANCE THE SPIRITUAL LIVES OF INDIVIDUALS, IN CLASS 45 (U.S. CLS. 100 AND 101).

THE MARK CONSISTS OF STANDARD CHARACTERS WITHOUT CLAIM TO ANY PARTICULAR FONT, STYLE, SIZE, OR COLOR.

SER. NO. 77-232,445, FILED 7-18-2007.

KAREN BRACEY, EXAMINING ATTORNEY

Int. Cl.: 35

Prior U.S. Cls.: 100, 101 and 102

United States Patent and Trademark Office

Reg. No. 3,398,137

Registered Mar. 18, 2008

**SERVICE MARK
PRINCIPAL REGISTER**



BIRTHDAY SCENES, INC. (ILLINOIS CORPORATION)
3211 FARMGATE DRIVE
NAPERVILLE, IL 60564

FOR: ON-LINE RETAIL STORE SERVICES FEATURING PARTY GOODS, NAMELY, DECORATIONS, TABLEWARE, AND PARTY GAMES PACKAGED AS A THEME, IN CLASS 35 (U.S. CLS. 100, 101 AND 102).

FIRST USE 1-16-2007; IN COMMERCE 1-16-2007.

THE MARK CONSISTS OF THE WORDS " BIRTHDAYSCENES.COM BIRTHDAY SCENES" IN A STYLIZED TEXT WITH A CANDLE REPRESENTING THE "I" IN BIRTHDAY AND A MOVIE REEL CIRCLING THE BEGINNING OF THE WORDS.

SER. NO. 77-232,448, FILED 7-18-2007.

DORITT L. CARROLL, EXAMINING ATTORNEY

Int. Cl.: 30

Prior U.S. Cl.: 46

United States Patent and Trademark Office

Reg. No. 3,398,138

Registered Mar. 18, 2008

**TRADEMARK
PRINCIPAL REGISTER**

Peerless Coffee & Tea

PEERLESS COFFEE & TEA (CALIFORNIA CORPORATION), DBA PEERLESS COFFEE COMPANY

260 OAK ST.

OAKLAND, CA 94607

FOR: COFFEE; TEA, IN CLASS 30 (U.S. CL. 46).

FIRST USE 11-1-1924; IN COMMERCE 11-1-1924.

THE MARK CONSISTS OF STANDARD CHARACTERS WITHOUT CLAIM TO ANY PARTICULAR FONT, STYLE, SIZE, OR COLOR.

NO CLAIM IS MADE TO THE EXCLUSIVE RIGHT TO USE "COFFEE & TEA", APART FROM THE MARK AS SHOWN.

SER. NO. 77-232,465, FILED 7-18-2007.

DAWN FELDMAN, EXAMINING ATTORNEY

Int. Cl.: 35

Prior U.S. Cls.: 100, 101 and 102

United States Patent and Trademark Office

Reg. No. 3,398,139

Registered Mar. 18, 2008

**SERVICE MARK
PRINCIPAL REGISTER**

UNIVERSAL

UNIVERSAL DATA CORPORATION (CALIFORNIA CORPORATION)
11271 VENTURA BOULEVARD #502
STUDIO CITY, CA 91604

FOR: DIRECT MARKETING SERVICES, NAME-
LY, PROVIDING SALES LEADS, PREPARING
MAILING LISTS AND PROVIDING BUSINESS
AND CONSUMER MARKETING INFORMATION
FOR DIRECT MARKETING CAMPAIGNS; BUSI-
NESS MARKETING AND DIRECT MAIL CON-
SULTING SERVICES; MANAGEMENT AND
COMPILATION OF COMPUTERIZED DATABASES;
PROVIDING BUSINESS INFORMATION IN THE
FIELD OF COMPANY PROFILES, COMPANY AND
CONTACT NAMES, TELEPHONE NUMBERS, AND
ADDRESSES VIA A GLOBAL COMPUTER NET-
WORK; PROVIDING SALES AND MARKET RE-
PORTS TO THE ORDER AND/OR SPECIFICATION
OF OTHERS; PROVIDING GENERAL BUSINESS

INFORMATION CONCERNING SALES, SIZE AND
POSITION; PROVIDING BUSINESS INFORMATION
SERVICES PERTAINING TO MARKETING, DEMO-
GRAPHICS AND STATISTICAL FIELDS; SUPPLY-
ING SALES AND MARKETING INFORMATION
CONCERNING THE BUSINESS COMMUNITY AC-
CORDING TO THE REQUIREMENT OF CUSTO-
MERS, MAILING LISTS PREPARATION SERVICES,
IN CLASS 35 (U.S. CLS. 100, 101 AND 102).

FIRST USE 3-1-2006; IN COMMERCE 3-1-2006.

THE MARK CONSISTS OF STANDARD CHAR-
ACTERS WITHOUT CLAIM TO ANY PARTICULAR
FONT, STYLE, SIZE, OR COLOR.

SER. NO. 77-232,471, FILED 7-18-2007.

DAVID H. STINE, EXAMINING ATTORNEY

Int. Cl.: 41

Prior U.S. Cls.: 100, 101 and 107

United States Patent and Trademark Office

Reg. No. 3,398,140

Registered Mar. 18, 2008

**SERVICE MARK
PRINCIPAL REGISTER**



UNIVERSITY OF MARKETING, LA, INC. (CALIFORNIA CORPORATION)
30101 AGOURA COURT
SUITE 220
AGOURA HILLS, CA 91301

FOR: EDUCATION SERVICES, NAMELY, PROVIDING CLASSES IN THE FIELDS OF MARKETING AND SALES, IN CLASS 41 (U.S. CLS. 100, 101 AND 107).

FIRST USE 4-14-2006; IN COMMERCE 4-14-2006.

NO CLAIM IS MADE TO THE EXCLUSIVE RIGHT TO USE "UNIVERSITY OF MARKETING

LOS ANGELES", APART FROM THE MARK AS SHOWN.

THE MARK CONSISTS OF THE LETTERS "UMLA" SURROUNDED BY A SKYLINE OF LOS ANGELES, ENCLOSED IN A RING WITH THE WORDING "UNIVERSITY OF MARKETING LOS ANGELES".

SER. NO. 77-232,473, FILED 7-18-2007.

AHSEN KHAN, EXAMINING ATTORNEY

Int. Cl.: 36

Prior U.S. Cls.: 100, 101 and 102

United States Patent and Trademark Office

Reg. No. 3,398,141

Registered Mar. 18, 2008

**SERVICE MARK
PRINCIPAL REGISTER**

GUARANTEEDWEATHER

MSI GUARANTEEDWEATHER, LLC (KANSAS
LTD LIAB CO)
8400 WEST 110TH STREET
OVERLAND PARK, KS 66210

FOR: FINANCIAL RISK MANAGEMENT IN THE
FIELD OF WEATHER RISK MANAGEMENT; FI-
NANCIAL SERVICES, NAMELY, PROVIDING IN-
FORMATION IN THE FIELD OF FINANCIAL
DERIVATIVES; DERIVATIVE TRADING AND IN-
VESTING SERVICES FOR OTHERS, IN CLASS 36
(U.S. CLS. 100, 101 AND 102).

FIRST USE 5-1-1997; IN COMMERCE 5-1-1997.

THE MARK CONSISTS OF STANDARD CHAR-
ACTERS WITHOUT CLAIM TO ANY PARTICULAR
FONT, STYLE, SIZE, OR COLOR.

SER. NO. 77-232,475, FILED 7-18-2007.

ALICE SUE CARRUTHERS, EXAMINING ATTOR-
NEY

Int. Cl.: 41

Prior U.S. Cls.: 100, 101 and 107

United States Patent and Trademark Office

Reg. No. 3,398,142

Registered Mar. 18, 2008

**SERVICE MARK
PRINCIPAL REGISTER**

CUENTE CON NOSOTROS

ENTRAVISION COMMUNICATIONS CORPORATION (DELAWARE CORPORATION)
SUITE 6000 WEST
2425 OLYMPIC BOULEVARD
SANTA MONICA, CA 90404

FOR: ENTERTAINMENT IN THE NATURE OF TELEVISION NEWS SHOWS, IN CLASS 41 (U.S. CLS. 100, 101 AND 107).

FIRST USE 10-31-2005; IN COMMERCE 10-31-2005.

THE MARK CONSISTS OF STANDARD CHARACTERS WITHOUT CLAIM TO ANY PARTICULAR FONT, STYLE, SIZE, OR COLOR.

THE FOREIGN WORDING IN THE MARK TRANSLATES INTO ENGLISH AS COUNT ON US.

SER. NO. 77-232,499, FILED 7-18-2007.

STEPHANIE ALI, EXAMINING ATTORNEY

Int. Cl.: 25

Prior U.S. Cls.: 22 and 39

United States Patent and Trademark Office

Reg. No. 3,398,143

Registered Mar. 18, 2008

**TRADEMARK
PRINCIPAL REGISTER**

COLDPRUF

INDERA MILLS COMPANY (NORTH CAROLINA
CORPORATION)
P.O. BOX 309
350 WEST MAPLE STREET
YADKINVILLE, NC 27055

FOR: UNDERWEAR, IN CLASS 25 (U.S. CLS. 22
AND 39).

FIRST USE 12-21-1921; IN COMMERCE 12-21-1921.

THE MARK CONSISTS OF STANDARD CHAR-
ACTERS WITHOUT CLAIM TO ANY PARTICULAR
FONT, STYLE, SIZE, OR COLOR.

SEC. 2(F).

SER. NO. 77-232,514, FILED 7-18-2007.

KRISTIN DAHLING, EXAMINING ATTORNEY

Int. Cl.: 43

Prior U.S. Cls.: 100 and 101

United States Patent and Trademark Office

Reg. No. 3,398,144

Registered Mar. 18, 2008

**SERVICE MARK
PRINCIPAL REGISTER**



CUPCAFE NY, LLC (NEW YORK LTD LIAB CO),
DBA MOCCA LOUNGE
78TH READE STREET
NEW YORK, NY 10007

FOR: RESTAURANT AND BAR SERVICES;
COCKTAIL LOUNGES; CAFE-RESTAURANTS;
TAKE-OUT RESTAURANT SERVICES, IN CLASS
43 (U.S. CLS. 100 AND 101).

FIRST USE 4-1-2006; IN COMMERCE 4-1-2006.

NO CLAIM IS MADE TO THE EXCLUSIVE
RIGHT TO USE "RESTAURANT, LOUNGE,
ESPRESSO BAR MOCCA", APART FROM THE
MARK AS SHOWN.

THE COLOR(S) RED, GREEN, WHITE AND
BLACK IS/ARE CLAIMED AS A FEATURE OF
THE MARK.

THE MARK CONSISTS OF WORD "MOCCA"
OVER RED CIRCLE WITH ADDITIONAL CLEAR
RED STRIPES, AN ADDITIONAL EXTERIOR CIR-
CUMFERENCE IN GREEN INCLUDES THE WHITE
WORDING "RESTAURANT - LOUNGE - ESPRESSO
BAR- WWW.MOCCALOUNGE.COM".

SER. NO. 77-232,554, FILED 7-18-2007.

JOHN WILKE, EXAMINING ATTORNEY

Int. Cl.: 14

Prior U.S. Cls.: 2, 27, 28 and 50

United States Patent and Trademark Office

Reg. No. 3,398,145

Registered Mar. 18, 2008

**TRADEMARK
PRINCIPAL REGISTER**

Landmark

WATCH WINDER STORE (CALIFORNIA SOLE
PROPRIETORSHIP)
1950 BIRCH BEND COURT
CHINO HILLS, CA 91709

THE MARK CONSISTS OF STANDARD CHAR-
ACTERS WITHOUT CLAIM TO ANY PARTICULAR
FONT, STYLE, SIZE, OR COLOR.

FOR: WATCH WINDERS, IN CLASS 14 (U.S. CLS.
2, 27, 28 AND 50).

SER. NO. 77-232,576, FILED 7-18-2007.

FIRST USE 4-11-2006; IN COMMERCE 4-11-2006.

EDWARD NELSON, EXAMINING ATTORNEY

Int. Cl.: 36

Prior U.S. Cls.: 100, 101 and 102

United States Patent and Trademark Office

Reg. No. 3,398,146

Registered Mar. 18, 2008

**SERVICE MARK
PRINCIPAL REGISTER**

Better World Mortgage

TOTAL SUCCESS TECHNOLOGIES, INC. (OREGON CORPORATION)
25 NW 23RD PLACE, #290
PORTLAND, OR 97210

FOR: MORTGAGE SERVICES, NAMELY, BUYER PRE-QUALIFICATION OF MORTGAGES FOR MORTGAGE BROKERS AND BANKS; MORTGAGE BROKERAGE, IN CLASS 36 (U.S. CLS. 100, 101 AND 102).

FIRST USE 9-1-2005; IN COMMERCE 6-4-2006.

THE MARK CONSISTS OF STANDARD CHARACTERS WITHOUT CLAIM TO ANY PARTICULAR FONT, STYLE, SIZE, OR COLOR.

NO CLAIM IS MADE TO THE EXCLUSIVE RIGHT TO USE "MORTGAGE", APART FROM THE MARK AS SHOWN.

SER. NO. 77-232,596, FILED 7-18-2007.

LOURDES AYALA, EXAMINING ATTORNEY

Int. Cl.: 20

Prior U.S. Cls.: 2, 13, 22, 25, 32 and 50

United States Patent and Trademark Office

Reg. No. 3,398,147

Registered Mar. 18, 2008

**TRADEMARK
PRINCIPAL REGISTER**

SUMMER LEGENDS

PATIO ENCLOSURES, INC. (OHIO CORPORATION)
750 EAST HIGHLAND ROAD
MACEDONIA, OH 44056

THE MARK CONSISTS OF STANDARD CHARACTERS WITHOUT CLAIM TO ANY PARTICULAR FONT, STYLE, SIZE, OR COLOR.

FOR: FURNITURE, IN CLASS 20 (U.S. CLS. 2, 13, 22, 25, 32 AND 50).

SER. NO. 77-232,623, FILED 7-18-2007.

FIRST USE 2-28-2005; IN COMMERCE 2-28-2005.

DOMINIC FATHY, EXAMINING ATTORNEY

Int. Cl.: 3

Prior U.S. Cls.: 1, 4, 6, 50, 51 and 52

United States Patent and Trademark Office

Reg. No. 3,398,148

Registered Mar. 18, 2008

**TRADEMARK
PRINCIPAL REGISTER**

SWAGAT

R. EXPO (WASHINGTON CORPORATION)
1112 SOUTH 344TH STEET
FEDERAL WAY, WA 98003

FOR: INCENSE, IN CLASS 3 (U.S. CLS. 1, 4, 6, 50, 51
AND 52).

FIRST USE 12-1-1988; IN COMMERCE 12-1-1988.

THE MARK CONSISTS OF STANDARD CHAR-
ACTERS WITHOUT CLAIM TO ANY PARTICULAR
FONT, STYLE, SIZE, OR COLOR.

THE ENGLISH TRANSLATION OF THE WORD
"SWAGAT" IN THE MARK IS "WELCOME."

SER. NO. 77-232,631, FILED 7-18-2007.

DAVID COLLIER, EXAMINING ATTORNEY

Int. Cl.: 37

Prior U.S. Cls.: 100, 103 and 106

United States Patent and Trademark Office

Reg. No. 3,398,149

Registered Mar. 18, 2008

**SERVICE MARK
PRINCIPAL REGISTER**

WHEREVER YOU WALK

LIQUID SOLID SURFACE FRANCHISING, LTD.
(OHIO LTD LIAB CO)
800 VISTA AVENUE
MASSILLON, OH 44646

THE MARK CONSISTS OF STANDARD CHARACTERS WITHOUT CLAIM TO ANY PARTICULAR FONT, STYLE, SIZE, OR COLOR.

FOR: FLOOR INSTALLATION, REFINISHING, RESURFACING AND REPAIR SERVICES, IN CLASS 37 (U.S. CLS. 100, 103 AND 106).

SER. NO. 77-232,649, FILED 7-18-2007.

FIRST USE 12-0-2006; IN COMMERCE 3-0-2007.

VIVIAN MICZNIK FIRST, EXAMINING ATTORNEY

Int. Cl.: 28

Prior U.S. Cls.: 22, 23, 38 and 50

United States Patent and Trademark Office

Reg. No. 3,398,150

Registered Mar. 18, 2008

**TRADEMARK
PRINCIPAL REGISTER**

ROAD CANNIBAL

MATTEL, INC. (DELAWARE CORPORATION)
M1-1518
333 CONTINENTAL BLVD.
EL SEGUNDO, CA 90245

THE MARK CONSISTS OF STANDARD CHAR-
ACTERS WITHOUT CLAIM TO ANY PARTICULAR
FONT, STYLE, SIZE, OR COLOR.

FOR: TOYS, GAMES AND PLAYTHINGS, NAME-
LY, TOY VEHICLES AND ACCESSORIES THERE-
FOR, IN CLASS 28 (U.S. CLS. 22, 23, 38 AND 50).

SER. NO. 77-232,653, FILED 7-18-2007.

FIRST USE 12-0-1999; IN COMMERCE 12-0-1999.

GEOFFREY FOSDICK, EXAMINING ATTORNEY

Int. Cl.: 14

Prior U.S. Cls.: 2, 27, 28 and 50

United States Patent and Trademark Office

Reg. No. 3,398,151

Registered Mar. 18, 2008

TRADEMARK
PRINCIPAL REGISTER



SIGMA CHI CORPORATION (ILLINOIS CORPORATION)
1714 HINMAN AVENUE
P.O. BOX 469
EVANSTON, IL 602040469

FOR: JEWELRY, IN CLASS 14 (U.S. CLS. 2, 27, 28 AND 50).

FIRST USE 0-0-1855; IN COMMERCE 0-0-1855.

OWNER OF U.S. REG. NOS. 218,796, 1,152,026 AND OTHERS.

THE MARK CONSISTS OF A CROSS DESIGN WITH CHAINS CONNECTING THE TOP PORTION

OF THE CROSS WITH THE SIDE BRANCHES, WITH THE TOP PORTION OF THE CROSS BEARING CROSSED KEYS, THE SIDE BRANCHES BEARING AN EAGLE'S HEAD AND A SCROLL, THE LOWER PORTION BEARING CLASPED HANDS AND SEVEN STARS WITH AN OVAL IN THE CONVERGENCE OF THE BRANCHES OF THE CROSS BEARING THE GREEK LETTERS "SIGMA" AND "CHI."

SER. NO. 77-232,699, FILED 7-18-2007.

MICHAEL GAAFAR, EXAMINING ATTORNEY

Int. Cls.: 35 and 36

Prior U.S. Cls.: 100, 101 and 102

United States Patent and Trademark Office

Reg. No. 3,398,152

Registered Mar. 18, 2008

**SERVICE MARK
PRINCIPAL REGISTER**

ANCHIN

ANCHIN, BLOCK & ANCHIN LLP (NEW YORK
LIMITED LIABILITY PARTNERSHIP)
1375 BROADWAY
NEW YORK, NY 10018

FOR: ACCOUNTING SERVICES; BUSINESS INFORMATION AND ACCOUNTING ADVISORY SERVICES; ACCOUNTING CONSULTATION; BUSINESS AUDITING SERVICES; FINANCIAL SERVICES, NAMELY, FINANCIAL RECORDS MANAGEMENT, PREPARING FINANCIAL REPORTS FOR OTHERS; FINANCIAL STATEMENT PREPARATION AND ANALYSIS FOR BUSINESSES; TAX PLANNING AND COMPLIANCE SERVICES; TAX AND TAXATION PLANNING, ADVICE, INFORMATION AND CONSULTANCY SERVICES; FORENSIC ACCOUNTING SERVICES; BUSINESS MANAGEMENT AND SUCCESSION ADVISORY SERVICES; BUSINESS DEVELOPMENT SERVICES, NAMELY, PROMOTING ECONOMIC AND BUSINESS DEVELOPMENT IN THE UNITED STATES; PROCURING FEDERAL, STATE AND LOCAL TAX INCENTIVES FOR BUSINESSES; ACQUISITION AND MERGER CONSULTATION SERVICES, IN CLASS 35 (U.S. CLS. 100, 101 AND 102).

FIRST USE 12-31-1923; IN COMMERCE 12-31-1923.

FOR: FINANCIAL SERVICES, NAMELY, FINANCIAL MANAGEMENT, FINANCIAL PLANNING; FINANCIAL CONSULTING SERVICES; WEALTH MANAGEMENT, NAMELY, INVESTMENT ADVICE AND CONSULTATION, BUSINESS VALUATION SERVICES; BUSINESS VALUATION CONSULTING AND ADVISORY SERVICES, IN CLASS 36 (U.S. CLS. 100, 101 AND 102).

FIRST USE 12-31-1923; IN COMMERCE 12-31-1923.

THE MARK CONSISTS OF STANDARD CHARACTERS WITHOUT CLAIM TO ANY PARTICULAR FONT, STYLE, SIZE, OR COLOR.

SEC. 2(F).

SER. NO. 77-232,708, FILED 7-18-2007.

ALICIA COLLINS, EXAMINING ATTORNEY

Int. Cl.: 37

Prior U.S. Cls.: 100, 103 and 106

United States Patent and Trademark Office

Reg. No. 3,398,153

Registered Mar. 18, 2008

**SERVICE MARK
PRINCIPAL REGISTER**

EDGE-TO-EDGE ADVANTAGE

PATIO ENCLOSURES, INC. (OHIO CORPORATION)
750 EAST HIGHLAND ROAD
MACEDONIA, OH 44056

THE MARK CONSISTS OF STANDARD CHARACTERS WITHOUT CLAIM TO ANY PARTICULAR FONT, STYLE, SIZE, OR COLOR.

FOR: CONSTRUCTING SUNROOMS, IN CLASS 37 (U.S. CLS. 100, 103 AND 106).

SER. NO. 77-232,728, FILED 7-18-2007.

FIRST USE 2-28-2007; IN COMMERCE 2-28-2007.

DOMINIC FATHY, EXAMINING ATTORNEY

Int. Cl.: 36

Prior U.S. Cls.: 100, 101 and 102

United States Patent and Trademark Office

Reg. No. 3,398,154

Registered Mar. 18, 2008

**SERVICE MARK
PRINCIPAL REGISTER**

NETSFORLIFE

EPISCOPAL RELIEF AND DEVELOPMENT
(NEW YORK NON-PROFIT CORPORATION)
815 SECOND AVENUE
NEW YORK, NY 10017

FOR: CHARITABLE FUND RAISING SERVICES,
NAMELY, RAISING FUNDS FOR USE IN CONNEC-
TION WITH ADVICE, EDUCATION AND PRO-
DUCTS FOR THE PREVENTION OF MALARIA ,
IN CLASS 36 (U.S. CLS. 100, 101 AND 102).

FIRST USE 5-22-2006; IN COMMERCE 5-22-2006.

THE MARK CONSISTS OF STANDARD CHAR-
ACTERS WITHOUT CLAIM TO ANY PARTICULAR
FONT, STYLE, SIZE, OR COLOR.

SER. NO. 77-232,733, FILED 7-18-2007.

TINA BROWN, EXAMINING ATTORNEY

Int. Cl.: 35

Prior U.S. Cls.: 100, 101 and 102

United States Patent and Trademark Office

Reg. No. 3,398,155

Registered Mar. 18, 2008

**SERVICE MARK
PRINCIPAL REGISTER**

FlexMAX

THE REHMANN GROUP (MICHIGAN LTD LIAB
CO)
STE. 201
5800 GRATIOT AVE.
SAGINAW, MI 48683

THE MARK CONSISTS OF STANDARD CHAR-
ACTERS WITHOUT CLAIM TO ANY PARTICULAR
FONT, STYLE, SIZE, OR COLOR.

FOR: HUMAN RESOURCES MANAGEMENT, IN
CLASS 35 (U.S. CLS. 100, 101 AND 102).

SER. NO. 77-232,740, FILED 7-18-2007.

FIRST USE 1-3-2007; IN COMMERCE 1-3-2007.

ZACHARY BELLO, EXAMINING ATTORNEY

Int. Cl.: 43

Prior U.S. Cls.: 100 and 101

United States Patent and Trademark Office

Reg. No. 3,398,156

Registered Mar. 18, 2008

**SERVICE MARK
PRINCIPAL REGISTER**

QUENCH YOUR CRUNCH!

K & S ENTERPRISES (NEW HAMPSHIRE COR-
PORATION)
19 TECHNOLOGY WAY
NASHUA, NH 03060

THE MARK CONSISTS OF STANDARD CHAR-
ACTERS WITHOUT CLAIM TO ANY PARTICULAR
FONT, STYLE, SIZE, OR COLOR.

FOR: RESTAURANT SERVICES, IN CLASS 43
(U.S. CLS. 100 AND 101).

SER. NO. 77-232,748, FILED 7-18-2007.

FIRST USE 4-26-2007; IN COMMERCE 4-26-2007.

DAVID COLLIER, EXAMINING ATTORNEY

Int. Cl.: 35

Prior U.S. Cls.: 100, 101 and 102

United States Patent and Trademark Office

Reg. No. 3,398,157

Registered Mar. 18, 2008

**SERVICE MARK
PRINCIPAL REGISTER**



COUNTY OF CHESTERFIELD, VIRGINIA (VIRGINIA BODY POLITIC AND CORPORATE)
SUITE 503
9901 LORI ROAD
CHESTERFIELD, VA 23832

FOR: PROMOTING THE ECONOMIC DEVELOPMENT IN THE COUNTY OF CHESTERFIELD, VIRGINIA, IN CLASS 35 (U.S. CLS. 100, 101 AND 102).

FIRST USE 5-15-2007; IN COMMERCE 5-15-2007.

NO CLAIM IS MADE TO THE EXCLUSIVE RIGHT TO USE "CHESTERFIELD ECONOMIC DEVELOPMENT", APART FROM THE MARK AS SHOWN.

THE COLOR(S) YELLOW, ORANGE, RED AND BLACK IS/ARE CLAIMED AS A FEATURE OF THE MARK.

THE MARK CONSISTS OF THE WORD "CHESTERFIELD" AND IS PRECEDED BY THREE SEMI-CIRCLES-FIRST ONE IN YELLOW, SECOND ONE IN ORANGE, THIRD IN RED, WHICH ACCENT THE LETTER "C" IN CHESTERFIELD; THEN, "ECONOMIC DEVELOPMENT" IS PRINTED BENEATH "CHESTERFIELD"; THEN "BUSINESS STARTS HERE" IS PRINTED BENEATH "ECONOMIC DEVELOPMENT". ALL OF THE WORDS IN THE MARK APPEAR IN THE COLOR BLACK.

SER. NO. 77-232,754, FILED 7-18-2007.

DAVID COLLIER, EXAMINING ATTORNEY

Int. Cl.: 3

Prior U.S. Cls.: 1, 4, 6, 50, 51 and 52

Reg. No. 3,398,158

United States Patent and Trademark Office

Registered Mar. 18, 2008

**TRADEMARK
PRINCIPAL REGISTER**

ZODIAC

R. EXPO (WASHINGTON CORPORATION)
1112 SOUTH 344TH STREET
FEDERAL WAY, WA 98003

THE MARK CONSISTS OF STANDARD CHAR-
ACTERS WITHOUT CLAIM TO ANY PARTICULAR
FONT, STYLE, SIZE, OR COLOR.

FOR: INCENSE, IN CLASS 3 (U.S. CLS. 1, 4, 6, 50, 51
AND 52).

SER. NO. 77-232,755, FILED 7-18-2007.

FIRST USE 12-1-1988; IN COMMERCE 12-1-1988.

DAVID COLLIER, EXAMINING ATTORNEY

Int. Cl.: 3

Prior U.S. Cls.: 1, 4, 6, 50, 51 and 52

United States Patent and Trademark Office

Reg. No. 3,398,159

Registered Mar. 18, 2008

**TRADEMARK
PRINCIPAL REGISTER**

IFRENEL

MATIAS, JONATHAN R. (UNITED STATES IN-
DIVIDUAL)
89-26 205 STREET
HOLLIS, NY 11423

THE MARK CONSISTS OF STANDARD CHAR-
ACTERS WITHOUT CLAIM TO ANY PARTICULAR
FONT, STYLE, SIZE, OR COLOR.

FOR: COSMETICS, IN CLASS 3 (U.S. CLS. 1, 4, 6, 50,
51 AND 52).

SER. NO. 77-232,759, FILED 7-18-2007.

FIRST USE 6-12-2007; IN COMMERCE 6-12-2007.

SHAUNIA CARLYLE, EXAMINING ATTORNEY

Int. Cl.: 33

Prior U.S. Cls.: 47 and 49

United States Patent and Trademark Office

Reg. No. 3,398,160

Registered Mar. 18, 2008

**TRADEMARK
PRINCIPAL REGISTER**



MACHAT, MICHAEL (UNITED STATES INDIVIDUAL)
9107 WILSHIRE BLVD., STE 425
BEVERLY HILLS, CA 90210

FOR: WINES, IN CLASS 33 (U.S. CLS. 47 AND 49).

FIRST USE 9-30-1997; IN COMMERCE 9-30-1997.

OWNER OF U.S. REG. NOS. 2,263,907, 3,082,097,
AND 3,196,399.

THE MARK CONSISTS OF THE WORD "VAMPIRE", WITH A DROP OF BLOOD DESCENDING FROM THE LETTER "V" (IN "VAMPIRE").

SER. NO. 77-232,783, FILED 7-18-2007.

SUSAN LESLIE DUBOIS, EXAMINING ATTORNEY

Int. Cl.: 37

Prior U.S. Cls.: 100, 103 and 106

United States Patent and Trademark Office

Reg. No. 3,398,161

Registered Mar. 18, 2008

**SERVICE MARK
PRINCIPAL REGISTER**

**YOU DON'T JUST NEED A
PLUMBER.... YOU NEED A
LITTLE TLC**

TLC COMPANY INC. (NEW MEXICO CORPORATION)
5000 EDITH BLVD., NE
ALBUQUERQUE, NM 87107

THE MARK CONSISTS OF STANDARD CHARACTERS WITHOUT CLAIM TO ANY PARTICULAR FONT, STYLE, SIZE, OR COLOR.

FOR: PLUMBING CONTRACTOR SERVICES, IN CLASS 37 (U.S. CLS. 100, 103 AND 106).

SER. NO. 77-232,815, FILED 7-18-2007.

FIRST USE 0-0-1997; IN COMMERCE 0-0-1997.

KAREN K. BUSH, EXAMINING ATTORNEY

Int. Cl.: 41

Prior U.S. Cls.: 100, 101 and 107

United States Patent and Trademark Office

Reg. No. 3,398,162

Registered Mar. 18, 2008

**SERVICE MARK
PRINCIPAL REGISTER**

NEUSPORT FOOTBALL CLUB

NEUSPORT FOOTBALL CLUB (NEVADA NON-
PROFIT CORPORATION)

SUITE C

2801 N. TENYA WAY

LAS VEGAS, NV 89128

FOR: INSTRUCTION SERVICES, NAMELY,
COACHING IN THE FIELD OF SOCCER; CON-
DUCTING SPORTS CAMPS IN THE FIELD OF
SOCCER; ENTERTAINMENT SERVICES, NAMELY,
ORGANIZING AND CONDUCTING SOCCER
TOURNAMENTS; REFEREEING AND OFFICIAT-
ING IN THE FIELD OF SOCCER, IN CLASS 41 (U.S.
CLS. 100, 101 AND 107).

FIRST USE 7-1-2006; IN COMMERCE 7-1-2006.

THE MARK CONSISTS OF STANDARD CHAR-
ACTERS WITHOUT CLAIM TO ANY PARTICULAR
FONT, STYLE, SIZE, OR COLOR.

NO CLAIM IS MADE TO THE EXCLUSIVE
RIGHT TO USE "FOOTBALL CLUB", APART FROM
THE MARK AS SHOWN.

SER. NO. 77-232,830, FILED 7-18-2007.

MELISSA VALLILLO, EXAMINING ATTORNEY

Int. Cl.: 42

Prior U.S. Cls.: 100 and 101

United States Patent and Trademark Office

Reg. No. 3,398,163

Registered Mar. 18, 2008

**SERVICE MARK
PRINCIPAL REGISTER**

SimplePort

SIMPLE BUSINESS SYSTEMS, INC. (CALIFORNIA CORPORATION)
SUITE 1603
216-G MOUNT HERMON ROAD
SCOTTS VALLEY, CA 95066

FOR: APPLICATION SERVICE PROVIDER (ASP) FEATURING SOFTWARE FOR USE UPLOADING TRANSACTIONAL DATA AND CONVERSION THEREOF TO DATA FORMATS THAT MAY BE USED WITH CONSUMER FINANCIAL SOFTWARE PROGRAMS, IN CLASS 42 (U.S. CLS. 100 AND 101).

FIRST USE 7-13-2007; IN COMMERCE 7-13-2007.

THE MARK CONSISTS OF STANDARD CHARACTERS WITHOUT CLAIM TO ANY PARTICULAR FONT, STYLE, SIZE, OR COLOR.

SER. NO. 77-232,868, FILED 7-18-2007.

PAUL CROWLEY, EXAMINING ATTORNEY

Int. Cl.: 37

Prior U.S. Cls.: 100, 103 and 106

United States Patent and Trademark Office

Reg. No. 3,398,164

Registered Mar. 18, 2008

**SERVICE MARK
PRINCIPAL REGISTER**

Serviceworks

THE MATWORKS COMPANY, LLC (DELAWARE
LTD LIAB CO)
11900 OLD BALTIMORE PIKE
BELTSVILLE, MD 20705

FOR: INSTALLATION, REPAIR AND MAINTENANCE OF FLOORING PRODUCTS, NAMELY, CARPETS, RUGS, TILES, VINYL FLOORING AND CONCRETE, IN COMMERCIAL ESTABLISHMENTS, IN CLASS 37 (U.S. CLS. 100, 103 AND 106).

FIRST USE 12-18-2006; IN COMMERCE 12-18-2006.

THE MARK CONSISTS OF STANDARD CHARACTERS WITHOUT CLAIM TO ANY PARTICULAR FONT, STYLE, SIZE, OR COLOR.

SER. NO. 77-232,899, FILED 7-18-2007.

TAMARA FRAZIER, EXAMINING ATTORNEY

Int. Cl.: 41

Prior U.S. Cls.: 100, 101 and 107

United States Patent and Trademark Office

Reg. No. 3,398,165

Registered Mar. 18, 2008

**SERVICE MARK
PRINCIPAL REGISTER**

WHITE ORCHID

A WHITE ORCHID WEDDING, INC. (HAWAII
CORPORATION)
P.O. BOX 2696
WAILUKU, HI 96793

THE MARK CONSISTS OF STANDARD CHAR-
ACTERS WITHOUT CLAIM TO ANY PARTICULAR
FONT, STYLE, SIZE, OR COLOR.

FOR: EVENT PLANNING CONSULTATION,
NAMELY, WEDDING PLANNING CONSULTA-
TION, IN CLASS 41 (U.S. CLS. 100, 101 AND 107).

SER. NO. 77-232,947, FILED 7-18-2007.

FIRST USE 1-1-1991; IN COMMERCE 1-1-1991.

MELISSA VALLILLO, EXAMINING ATTORNEY

Int. Cl.: 39

Prior U.S. Cls.: 100 and 105

United States Patent and Trademark Office

Reg. No. 3,398,166

Registered Mar. 18, 2008

**SERVICE MARK
PRINCIPAL REGISTER**

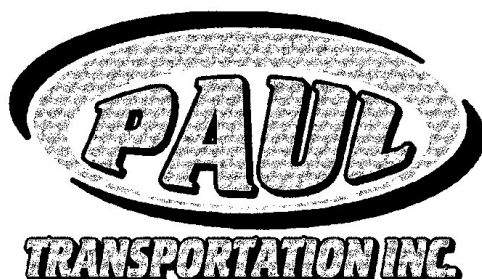

PAUL TRANSPORTATION, INC. (OKLAHOMA CORPORATION)
SUITE 110
300 WEST CHEROKEE
ENID, OK 73701

FOR: SHIPPING AND DELIVERY SERVICES, NAMELY, PICKUP, TRANSPORTATION, AND DELIVERY OF PACKAGES AND LETTERS BY VARIOUS MODES OF TRANSPORTATION, IN CLASS 39 (U.S. CLS. 100 AND 105).

FIRST USE 1-1-2004; IN COMMERCE 1-1-2004.

NO CLAIM IS MADE TO THE EXCLUSIVE RIGHT TO USE "TRANSPORTATION INC.", APART FROM THE MARK AS SHOWN.

THE STIPPLING IS FOR SHADING PURPOSES ONLY.

THE NAME "PAUL" DOES NOT IDENTIFY A KNOWN PARTICULAR LIVING INDIVIDUAL.

THE MARK CONSISTS OF THE WORDING "PAUL" INSIDE AN INCOMPLETE OVAL AND THE WORDING "TRANSPORTATION INC."

SER. NO. 77-232,948, FILED 7-18-2007.

DAVID C. REIHNER, EXAMINING ATTORNEY

Int. Cl.: 5

Prior U.S. Cls.: 6, 18, 44, 46, 51 and 52

United States Patent and Trademark Office

Reg. No. 3,398,167

Registered Mar. 18, 2008

**TRADEMARK
PRINCIPAL REGISTER**

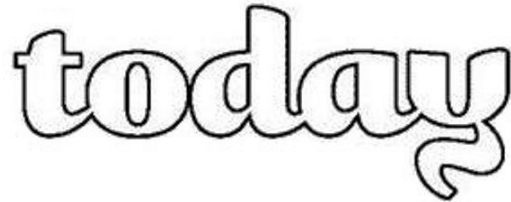

TODAYS WOMENCARE COMPANY (DELA-
WARE CORPORATION)
SUITE 6010
1400 N. PROVIDENCE ROAD
MEDIA, PA 19063

OWNER OF U.S. REG. NOS. 1,387,999, 3,146,959
AND OTHERS.

FOR: CONTRACEPTIVE SPONGES, IN CLASS 5
(U.S. CLS. 6, 18, 44, 46, 51 AND 52).

SER. NO. 77-232,969, FILED 7-18-2007.

FIRST USE 6-29-2007; IN COMMERCE 6-29-2007.

MELISSA VALLILLO, EXAMINING ATTORNEY

Int. Cl.: 37

Prior U.S. Cls.: 100, 103 and 106

United States Patent and Trademark Office

Reg. No. 3,398,168

Registered Mar. 18, 2008

**SERVICE MARK
PRINCIPAL REGISTER**

BUG BITES

CENTEX CORPORATION (NEVADA CORPORATION)
2728 N. HARWOOD STREET
DALLAS, TX 752011516

THE MARK CONSISTS OF STANDARD CHARACTERS WITHOUT CLAIM TO ANY PARTICULAR FONT, STYLE, SIZE, OR COLOR.

FOR: TERMITE AND PEST CONTROL SERVICES, INSTALLATION SERVICES IN THE FIELD OF TERMITE AND PEST CONTROL SYSTEMS, IN CLASS 37 (U.S. CLS. 100, 103 AND 106).

SER. NO. 77-232,976, FILED 7-18-2007.

FIRST USE 7-2-2007; IN COMMERCE 7-2-2007.

LINDA MICKLEBURGH, EXAMINING ATTORNEY

Int. Cl.: 28

Prior U.S. Cls.: 22, 23, 38 and 50

United States Patent and Trademark Office

Reg. No. 3,398,169

Registered Mar. 18, 2008

**TRADEMARK
PRINCIPAL REGISTER**

Who's Talking

BROQUEVILLE, PAULETTE RENEE (UNITED STATES INDIVIDUAL)
1260 LOGAN AVE. SUITE B3
COSTA MESA, CA 92626

THE MARK CONSISTS OF STANDARD CHARACTERS WITHOUT CLAIM TO ANY PARTICULAR FONT, STYLE, SIZE, OR COLOR.

FOR: CARD GAMES, IN CLASS 28 (U.S. CLS. 22, 23, 38 AND 50).

SER. NO. 77-232,994, FILED 7-18-2007.

FIRST USE 5-1-2007; IN COMMERCE 5-1-2007.

PAUL F. GAST, EXAMINING ATTORNEY

Int. Cl.: 7

Prior U.S. Cls.: 13, 19, 21, 23, 31, 34 and 35

United States Patent and Trademark Office

Reg. No. 3,398,170

Registered Mar. 18, 2008

**TRADEMARK
PRINCIPAL REGISTER**

STRETCH-O-MATIC

A.M. MACHINERY INC. (CANADA CORPORATION)
200, CHEMIN LAMARTINE EST
SAINT-EUGENE DE L'ISLE, CANADA G0R1X0

FOR: AGRICULTURAL MACHINES, NAMELY,
BALE WRAPPERS, IN CLASS 7 (U.S. CLS. 13, 19, 21,
23, 31, 34 AND 35).

FIRST USE 9-0-1992; IN COMMERCE 4-0-1994.

THE MARK CONSISTS OF STANDARD CHARACTERS WITHOUT CLAIM TO ANY PARTICULAR FONT, STYLE, SIZE, OR COLOR.

SER. NO. 77-233,004, FILED 7-18-2007.

TARAH HARDY, EXAMINING ATTORNEY

Int. Cl.: 17

Prior U.S. Cls.: 1, 5, 12, 13, 35 and 50

United States Patent and Trademark Office

Reg. No. 3,398,171

Registered Mar. 18, 2008

**TRADEMARK
PRINCIPAL REGISTER**

ACCUFLEX

KURIYAMA OF AMERICA, INC. (ILLINOIS
CORPORATION)
360 E. STATE PARKWAY
SCHAUMBURG, IL 60173

THE MARK CONSISTS OF STANDARD CHAR-
ACTERS WITHOUT CLAIM TO ANY PARTICULAR
FONT, STYLE, SIZE, OR COLOR.

FOR: POLYVINYLCHLORIDE HOSES FOR USE
IN BEVERAGE DISPENSING MACHINES, IN CLASS
17 (U.S. CLS. 1, 5, 12, 13, 35 AND 50).

SER. NO. 77-233,015, FILED 7-18-2007.

FIRST USE 4-1-1977; IN COMMERCE 11-1-1980.

INGA ERVIN, EXAMINING ATTORNEY

Int. Cl.: 33

Prior U.S. Cls.: 47 and 49

United States Patent and Trademark Office

Reg. No. 3,398,172

Registered Mar. 18, 2008

**TRADEMARK
PRINCIPAL REGISTER**



MOLECA

MOLECA, LLC (FLORIDA LTD LIAB CO)
156 GIRALDA AVENUE
CORAL GABLES, FL 33134

FOR: DISTILLED BRAZILIAN SUGAR CANE
SPIRIT; CACHAÇA; ALCOHOLIC BEVERAGES
MADE FROM CACHAÇA, IN CLASS 33 (U.S. CLS.
47 AND 49).

FIRST USE 12-1-2006; IN COMMERCE 5-1-2007.

THE MARK CONSISTS OF DRAWING OF A
YOUNG GIRL HOLDING AN URN WITH THE
WORD MOLECA UNDERNEATH..

THE FOREIGN WORDING IN THE MARK
TRANSLATES INTO ENGLISH AS YOUNGSTER
GIRL.

SER. NO. 77-233,039, FILED 7-18-2007.

TARAH HARDY, EXAMINING ATTORNEY

Int. Cl.: 3

Prior U.S. Cls.: 1, 4, 6, 50, 51 and 52

United States Patent and Trademark Office

Reg. No. 3,398,173

Registered Mar. 18, 2008

**TRADEMARK
PRINCIPAL REGISTER**

POOF!

POOF, LLC (CALIFORNIA LTD LIAB CO)
11100 SANTA MONICA BLVD., STE. 560
LOS ANGELES, CA 90025

THE MARK CONSISTS OF STANDARD CHAR-
ACTERS WITHOUT CLAIM TO ANY PARTICULAR
FONT, STYLE, SIZE, OR COLOR.

FOR: ALL PURPOSE CLEANING PREPARATION
AND SPOT REMOVER FOR HOUSEHOLD AND
INDUSTRIAL CLEANING, IN CLASS 3 (U.S. CLS. 1,
4, 6, 50, 51 AND 52).

SER. NO. 77-233,143, FILED 7-18-2007.

FIRST USE 11-1-1991; IN COMMERCE 11-1-1991.

WILLIAM P. SHANAHAN, EXAMINING ATTOR-
NEY

Int. Cl.: 44

Prior U.S. Cls.: 100 and 101

United States Patent and Trademark Office

Reg. No. 3,398,174

Registered Mar. 18, 2008

SERVICE MARK
PRINCIPAL REGISTER



WRIGHT, JAMES P DDS (UNITED STATES INDIVIDUAL)
8855 WEST FLAMINGO SUITE 101
LAS VEGAS, NV 89147

FOR: DENTIST SERVICES; DENTAL HYGIENIST SERVICES, IN CLASS 44 (U.S. CLS. 100 AND 101).

FIRST USE 6-1-2004; IN COMMERCE 6-1-2004.

THE COLOR(S) DARK BLUE, MEDIUM BLUE, YELLOW, LIGHT GREEN, RED ORANGE IS/ARE CLAIMED AS A FEATURE OF THE MARK.

THE MARK CONSISTS OF A DARK BLUE STYLIZED TREE TRUNK WITH FOUR DARK BLUE STYLIZED CURLING BRANCHES, POSITIONED IN RELATION TO THE TRUNK AS FOLLOWS: AT 9

O'CLOCK A DARK BLUE STYLIZED BRANCH CURLING LEFTWARD AND DOWNWARD SUPERIMPOSED OVER A MEDIUM BLUE LEAF; AT 11 O'CLOCK A DARK BLUE STYLIZED BRANCH CURLING LEFTWARD, UPWARD AND DOWNWARD SUPERIMPOSED OVER A YELLOW LEAF; AT 1 O'CLOCK A DARK BLUE STYLIZED BRANCH CURLING UPWARD, RIGHTWARD AND DOWNWARD SUPERIMPOSED OVER A LIGHT GREEN LEAF; AT 3 O'CLOCK A DARK BLUE STYLIZED BRANCH CURLING RIGHTWARD AND DOWNWARD SUPERIMPOSED OVER A RED/ORANGE LEAF.

SER. NO. 77-233,167, FILED 7-18-2007.

CHRISTOPHER BUONGIORNO, EXAMINING ATTORNEY

Int. Cl.: 20

Prior U.S. Cls.: 2, 13, 22, 25, 32 and 50

United States Patent and Trademark Office

Reg. No. 3,398,175

Registered Mar. 18, 2008

**TRADEMARK
PRINCIPAL REGISTER**

THE INCREDIBEDS

THE INCREDIBEDS CORPORATION (FLORIDA
CORPORATION)
3601 ST. MORITZ STREET
BELLE ISLE, FL 32812

FOR: (BASED ON USE IN COMMERCE) BEDS, IN
CLASS 20 (U.S. CLS. 2, 13, 22, 25, 32 AND 50).

FIRST USE 7-15-2006; IN COMMERCE 5-26-2007.

THE MARK CONSISTS OF STANDARD CHAR-
ACTERS WITHOUT CLAIM TO ANY PARTICULAR
FONT, STYLE, SIZE, OR COLOR.

SER. NO. 77-233,168, FILED 7-18-2007.

CHRISTOPHER BUONGIORNO, EXAMINING AT-
TORNEY

Int. Cl.: 35

Prior U.S. Cls.: 100, 101 and 102

United States Patent and Trademark Office

Reg. No. 3,398,176

Registered Mar. 18, 2008

**SERVICE MARK
PRINCIPAL REGISTER**

Outsource Your Life

METRO ENTERPRISES, INC. (CALIFORNIA CORPORATION), DBA DOMYSTUFF.COM
SUITE 525
9454 WILSHIRE BLVD.
BEVERLY HILLS, CA 90212

FOR: AUCTION MANAGEMENT SERVICES PROVIDED TO OTHERS OVER AN ON-LINE WEB SITE ACCESSED THROUGH A GLOBAL COMPUTER NETWORK; ONLINE AUCTION SERVICES; OUTSOURCING IN THE FIELD OF DOMESTIC SERVICES, IN CLASS 35 (U.S. CLS. 100, 101 AND 102).

FIRST USE 2-1-2007; IN COMMERCE 3-21-2007.

THE MARK CONSISTS OF STANDARD CHARACTERS WITHOUT CLAIM TO ANY PARTICULAR FONT, STYLE, SIZE, OR COLOR.

SER. NO. 77-233,180, FILED 7-18-2007.

ALICIA COLLINS, EXAMINING ATTORNEY

Int. Cl.: 30

Prior U.S. Cl.: 46

United States Patent and Trademark Office

Reg. No. 3,398,177

Registered Mar. 18, 2008

**TRADEMARK
PRINCIPAL REGISTER**

MATE'VANA

TEAVANA CORPORATION (GEORGIA COR-
PORATION)
SUITE 860
3475 LENOX ROAD
ATLANTA, GA 30308

THE MARK CONSISTS OF STANDARD CHAR-
ACTERS WITHOUT CLAIM TO ANY PARTICULAR
FONT, STYLE, SIZE, OR COLOR.

FOR: TEA, IN CLASS 30 (U.S. CL. 46).

SER. NO. 77-233,250, FILED 7-19-2007.

FIRST USE 8-0-2000; IN COMMERCE 8-0-2000.

DEBRA LEE, EXAMINING ATTORNEY

Int. Cl.: 3

Prior U.S. Cls.: 1, 4, 6, 50, 51 and 52

United States Patent and Trademark Office

Reg. No. 3,398,178

Registered Mar. 18, 2008

**TRADEMARK
PRINCIPAL REGISTER**

SUKICOLOR

SUKI, INC. (MASSACHUSETTS CORPORATION)
99 INDUSTRIAL DRIVE
NORTHAMPTON, MA 01060

FOR: COSMETICS, IN CLASS 3 (U.S. CLS. 1, 4, 6, 50,
51 AND 52).

FIRST USE 7-15-2007; IN COMMERCE 7-15-2007.

THE MARK CONSISTS OF STANDARD CHAR-
ACTERS WITHOUT CLAIM TO ANY PARTICULAR
FONT, STYLE, SIZE, OR COLOR.

OWNER OF U.S. REG. NO. 2,810,547.

SER. NO. 77-233,312, FILED 7-19-2007.

MICHAEL WEBSTER, EXAMINING ATTORNEY

Int. Cl.: 10

Prior U.S. Cls.: 26, 39 and 44

United States Patent and Trademark Office

Reg. No. 3,398,179

Registered Mar. 18, 2008

**TRADEMARK
PRINCIPAL REGISTER**

PINNACLE

B. BRAUN MEDICAL INC. (PENNSYLVANIA
CORPORATION)
824 TWELFTH AVENUE
BETHLEHEM, PA 18018

FOR: MEDICAL APPARATUS, NAMELY, COM-
POUNDER CONTROL PANEL AND PUMP MOD-
ULE TO BE USED WITH SOLUTION CONTAINERS
IN THE PREPARATION OF TOTAL PARENTERAL
NUTRITION PRESCRIPTIONS BY PHARMACISTS,
IN CLASS 10 (U.S. CLS. 26, 39 AND 44).

FIRST USE 11-28-2006; IN COMMERCE 11-28-2006.

THE MARK CONSISTS OF STANDARD CHAR-
ACTERS WITHOUT CLAIM TO ANY PARTICULAR
FONT, STYLE, SIZE, OR COLOR.

SER. NO. 77-233,314, FILED 7-19-2007.

MICHAEL WEBSTER, EXAMINING ATTORNEY

Int. Cl.: 32

Prior U.S. Cls.: 45, 46 and 48

United States Patent and Trademark Office

Reg. No. 3,398,180

Registered Mar. 18, 2008

TRADEMARK
PRINCIPAL REGISTER



ARBOR BREWING COMPANY, LLC (MICHIGAN
LTD LIAB CO)
114 E. WASHINGTON
ANN ARBOR, MI 48104

NO CLAIM IS MADE TO THE EXCLUSIVE
RIGHT TO USE "BREWING COMPANY" OR "SINCE
1995" OR "AMBER ALE", APART FROM THE MARK
AS SHOWN.

FOR: BEER, IN CLASS 32 (U.S. CLS. 45, 46 AND 48).

THE MARK CONSISTS OF LITERAL ELEMENT,
A DESIGN OF A TREE, AND A FISH.

FIRST USE 10-31-2006; IN COMMERCE 10-31-2006.

SER. NO. 77-233,372, FILED 7-19-2007.

OWNER OF U.S. REG. NO. 2,075,695.

AMY GEARIN, EXAMINING ATTORNEY

Int. Cl.: 36

Prior U.S. Cls.: 100, 101 and 102

United States Patent and Trademark Office

Reg. No. 3,398,181

Registered Mar. 18, 2008

**SERVICE MARK
PRINCIPAL REGISTER**

CREDIT GENIE

CREDIT GENIE FRANCHISING, LLC (ALABA-
MA LTD LIAB CO), DBA CREDIT GENIE
SUITE B
2200 US HIGHWAY 98
DAPHNE, AL 36526

FOR: CREDIT AND FINANCIAL CONSULTA-
TION; EVALUATION OF CREDIT BUREAU DATA,
IN CLASS 36 (U.S. CLS. 100, 101 AND 102).

FIRST USE 7-9-2007; IN COMMERCE 7-9-2007.

THE MARK CONSISTS OF STANDARD CHAR-
ACTERS WITHOUT CLAIM TO ANY PARTICULAR
FONT, STYLE, SIZE, OR COLOR.

NO CLAIM IS MADE TO THE EXCLUSIVE
RIGHT TO USE "CREDIT", APART FROM THE
MARK AS SHOWN.

SER. NO. 77-233,424, FILED 7-19-2007.

CHRISTINA SOBRAL, EXAMINING ATTORNEY

Int. Cl.: 36

Prior U.S. Cls.: 100, 101 and 102

United States Patent and Trademark Office

Reg. No. 3,398,182

Registered Mar. 18, 2008

**SERVICE MARK
PRINCIPAL REGISTER**

THE INCOME GENERATOR

ARLEN CORPORATION (RHODE ISLAND CORPORATION)

121 SOUTH MAIN STREET, SEVENTH FLOOR

PROVIDENCE, RI 02903

FOR: CUSTOMIZED STRATEGIC INVESTMENT AND FINANCIAL PLANNING SERVICES FOR OTHERS, IN CLASS 36 (U.S. CLS. 100, 101 AND 102).

FIRST USE 3-0-1998; IN COMMERCE 3-0-1998.

THE MARK CONSISTS OF STANDARD CHARACTERS WITHOUT CLAIM TO ANY PARTICULAR FONT, STYLE, SIZE, OR COLOR.

OWNER OF U.S. REG. NO. 2,583,938.

SEC. 2(F).

SER. NO. 77-233,454, FILED 7-19-2007.

LEIGH CAROLINE CASE, EXAMINING ATTORNEY

Int. Cls.: 35 and 41

Prior U.S. Cls.: 100, 101, 102 and 107

United States Patent and Trademark Office

Reg. No. 3,398,183

Registered Mar. 18, 2008

**SERVICE MARK
PRINCIPAL REGISTER**

WE MAKE TALENT WORK

PARTNERS IN HUMAN RESOURCES INTERNATIONAL, INC. (NEW JERSEY CORPORATION)
9 EAST 37TH STREET
NEW YORK CITY, NY 10016

FOR: CONSULTING SERVICES IN THE FIELD OF HUMAN RESOURCES DEVELOPMENT, NAMELY, FOR THE PROMOTION OF EMPLOYEE RETENTION, CAREER GROWTH, AND INCREASED PRODUCTIVITY FOR EMPLOYEES AND EMPLOYERS; EMPLOYMENT HIRING, RECRUITING, PLACEMENT, STAFFING AND CAREER NETWORKING SERVICES; EMPLOYMENT OUTPLACEMENT SERVICES, IN CLASS 35 (U.S. CLS. 100, 101 AND 102).

FIRST USE 1-1-2007; IN COMMERCE 1-1-2007.

FOR: CAREER COUNSELING, IN CLASS 41 (U.S. CLS. 100, 101 AND 107).

FIRST USE 1-1-2007; IN COMMERCE 1-1-2007.

THE MARK CONSISTS OF STANDARD CHARACTERS WITHOUT CLAIM TO ANY PARTICULAR FONT, STYLE, SIZE, OR COLOR.

SER. NO. 77-233,455, FILED 7-19-2007.

CHARLES L. JENKINS, EXAMINING ATTORNEY

Int. Cl.: 35

Prior U.S. Cls.: 100, 101 and 102

United States Patent and Trademark Office

Reg. No. 3,398,184

Registered Mar. 18, 2008

**SERVICE MARK
PRINCIPAL REGISTER**

DOBLIN

DOBLIN INC. (ILLINOIS CORPORATION)
SUITE 1300
330 NORTH WABASH AVENUE
CHICAGO, IL 60611

THE MARK CONSISTS OF STANDARD CHAR-
ACTERS WITHOUT CLAIM TO ANY PARTICULAR
FONT, STYLE, SIZE, OR COLOR.

FOR: BUSINESS CONSULTING SERVICES, IN
CLASS 35 (U.S. CLS. 100, 101 AND 102).

SER. NO. 77-233,464, FILED 7-19-2007.

FIRST USE 4-30-1996; IN COMMERCE 4-30-1996.

MARK SPARACINO, EXAMINING ATTORNEY

Int. Cl.: 36

Prior U.S. Cls.: 100, 101 and 102

United States Patent and Trademark Office

Reg. No. 3,398,185

Registered Mar. 18, 2008

**SERVICE MARK
PRINCIPAL REGISTER**

**YOUR FIRST STEP TO BETTER
CREDIT**

CREDIT GENIE FRANCHISING, LLC (ALABA-
MA LTD LIAB CO), DBA CREDIT GENIE
SUITE B
2200 US HIGHWAY 98
DAPHNE, AL 36526

FOR: CREDIT AND FINANCIAL CONSULTA-
TION; EVALUATION OF CREDIT BUREAU DATA,
IN CLASS 36 (U.S. CLS. 100, 101 AND 102).

FIRST USE 7-9-2007; IN COMMERCE 7-9-2007.

THE MARK CONSISTS OF STANDARD CHAR-
ACTERS WITHOUT CLAIM TO ANY PARTICULAR
FONT, STYLE, SIZE, OR COLOR.

NO CLAIM IS MADE TO THE EXCLUSIVE
RIGHT TO USE "CREDIT", APART FROM THE
MARK AS SHOWN.

SER. NO. 77-233,475, FILED 7-19-2007.

CHRISTINA SOBRAL, EXAMINING ATTORNEY

Int. Cl.: 41

Prior U.S. Cls.: 100, 101 and 107

United States Patent and Trademark Office

Reg. No. 3,398,186

Registered Mar. 18, 2008

**SERVICE MARK
PRINCIPAL REGISTER**

ANDLAB-EDU

PARK, SUNOOK (UNITED STATES INDIVIDUAL)

303

600 MOULTON AVE

LOS ANGELES, CA 90031

FOR: EDUCATIONAL SERVICES, NAMELY, CONDUCTING CLASSES IN THE FIELD OF ART AND DESIGN AND DISTRIBUTION OF COURSE MATERIAL IN CONNECTION THEREWITH; EDUCATIONAL RESEARCH, IN CLASS 41 (U.S. CLS. 100, 101 AND 107).

FIRST USE 1-1-2002; IN COMMERCE 1-1-2002.

THE MARK CONSISTS OF STANDARD CHARACTERS WITHOUT CLAIM TO ANY PARTICULAR FONT, STYLE, SIZE, OR COLOR.

SER. NO. 77-233,479, FILED 7-19-2007.

MARK SPARACINO, EXAMINING ATTORNEY

Int. Cl.: 44

Prior U.S. Cls.: 100 and 101

United States Patent and Trademark Office

Reg. No. 3,398,187

Registered Mar. 18, 2008

**SERVICE MARK
PRINCIPAL REGISTER**

EARLY OPTIONS

JOAN FLEISCHMAN MD PC (NEW YORK CORPORATION)
188 MONTAGUE STREET, #404
BROOKLYN, NY 11201

FOR: HEALTH CARE AND MEDICAL SERVICES, NAMELY, PROVIDING INFORMATION, COUNSELING AND TREATMENT IN THE FIELD OF REPRODUCTIVE HEALTH TO WOMEN, INCLUDING THE TERMINATION OF PREGNANCIES, IN CLASS 44 (U.S. CLS. 100 AND 101).

FIRST USE 9-1-2001; IN COMMERCE 9-1-2001.

THE MARK CONSISTS OF STANDARD CHARACTERS WITHOUT CLAIM TO ANY PARTICULAR FONT, STYLE, SIZE, OR COLOR.

SER. NO. 77-233,513, FILED 7-19-2007.

CARYN GLASSER, EXAMINING ATTORNEY

Int. Cl.: 33

Prior U.S. Cls.: 47 and 49

United States Patent and Trademark Office

Reg. No. 3,398,188

Registered Mar. 18, 2008

**TRADEMARK
PRINCIPAL REGISTER**

Zinfandoodle

SCHERRER, FRED C., A CITIZEN OF THE
UNITED STATES (CALIFORNIA SOLE PRO-
PRIETORSHIP), DBA SCHERRER WINERY
966 TILLER LANE
SEBASTOPOL, CA 95472

THE MARK CONSISTS OF STANDARD CHAR-
ACTERS WITHOUT CLAIM TO ANY PARTICULAR
FONT, STYLE, SIZE, OR COLOR.

FOR: GRAPE WINE; TABLE WINES; WINE, IN
CLASS 33 (U.S. CLS. 47 AND 49).

SER. NO. 77-233,518, FILED 7-19-2007.

FIRST USE 10-1-2005; IN COMMERCE 10-1-2005.

MIDGE BUTLER, EXAMINING ATTORNEY

Int. Cl.: 20

Prior U.S. Cls.: 2, 13, 22, 25, 32 and 50

Reg. No. 3,398,189

United States Patent and Trademark Office

Registered Mar. 18, 2008

**TRADEMARK
PRINCIPAL REGISTER**

BUDDIES

FRANKENSTEIN, GRETCHEN E (UNITED STATES INDIVIDUAL)
5440 18TH AVE SW
SEATTLE, WA 98106 AND
KESSNER, THOMAS D (UNITED STATES INDIVIDUAL)
3236 SW AVALON WAY, #301
SEATTLE, WA 98126

GANIZER, IN CLASS 20 (U.S. CLS. 2, 13, 22, 25, 32 AND 50).

FIRST USE 6-9-2006; IN COMMERCE 9-17-2006.

SER. NO. 77-233,522, FILED 7-19-2007.

FOR: NON-METAL FABRIC HANGING ORGANIZER; NON-METAL FABRIC STORAGE BIN OR-

SHANNON TWOHIG, EXAMINING ATTORNEY

Int. Cl.: 37

Prior U.S. Cls.: 100, 103 and 106

United States Patent and Trademark Office

Reg. No. 3,398,190

Registered Mar. 18, 2008

**SERVICE MARK
PRINCIPAL REGISTER**

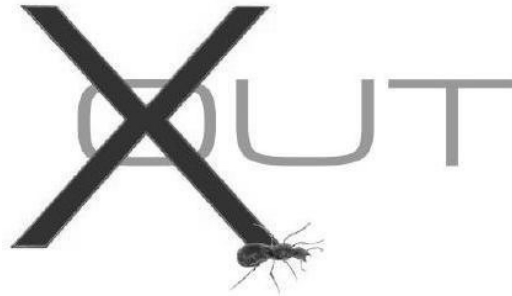

X-OUT PEST SERVICES, LLC (TEXAS LTD LIAB
CO)
SUITE 72, PMB 253
120 E. FM 544
MURPHY, TX 75094

FOR: PEST CONTROL, IN CLASS 37 (U.S. CLS. 100,
103 AND 106).

FIRST USE 3-9-2007; IN COMMERCE 3-9-2007.

THE MARK CONSISTS OF STYLIZED DESIGN.

SER. NO. 77-233,527, FILED 7-19-2007.

RUSS HERMAN, EXAMINING ATTORNEY

Int. Cl.: 37

Prior U.S. Cls.: 100, 103 and 106

United States Patent and Trademark Office

Reg. No. 3,398,191

Registered Mar. 18, 2008

**SERVICE MARK
PRINCIPAL REGISTER**

X OUT

X-OUT PEST SERVICES, LLC (TEXAS LTD LIAB
CO)
SUITE 72, PMB 253
120 E. FM 544
MURPHY, TX 75094

THE MARK CONSISTS OF STANDARD CHAR-
ACTERS WITHOUT CLAIM TO ANY PARTICULAR
FONT, STYLE, SIZE, OR COLOR.

FOR: PEST CONTROL, IN CLASS 37 (U.S. CLS. 100,
103 AND 106).

SER. NO. 77-233,535, FILED 7-19-2007.

FIRST USE 3-9-2007; IN COMMERCE 3-9-2007.

RUSS HERMAN, EXAMINING ATTORNEY

Int. Cl.: 32

Prior U.S. Cls.: 45, 46 and 48

United States Patent and Trademark Office

Reg. No. 3,398,192

Registered Mar. 18, 2008

**TRADEMARK
PRINCIPAL REGISTER**

DARK CORNER ALE

ARBOR BREWING COMPANY, LLC (MICHIGAN
LTD LIAB CO)
114 E. WASHINGTON
ANN ARBOR, MI 48104

NO CLAIM IS MADE TO THE EXCLUSIVE
RIGHT TO USE "ALE", APART FROM THE MARK
AS SHOWN.

FOR: BEER, IN CLASS 32 (U.S. CLS. 45, 46 AND 48).

FIRST USE 6-30-2007; IN COMMERCE 6-30-2007.

SER. NO. 77-233,537, FILED 7-19-2007.

THE MARK CONSISTS OF STANDARD CHAR-
ACTERS WITHOUT CLAIM TO ANY PARTICULAR
FONT, STYLE, SIZE, OR COLOR.

AMY GEARIN, EXAMINING ATTORNEY

Int. Cl.: 7

Prior U.S. Cls.: 13, 19, 21, 23, 31, 34 and 35

United States Patent and Trademark Office

Reg. No. 3,398,193

Registered Mar. 18, 2008

**TRADEMARK
PRINCIPAL REGISTER**



FPT HOLDING S.A. (LUXEMBOURG CORPORATION)
18, RUE DE L'EAU, 1449 LUXEMBOURG R.C.
LUXEMBOURG, LUXEMBOURG B53084

FOR: MILLING MACHINES, MILLING-BORING
MACHINES AND PARTS THEREFOR, IN CLASS 7
(U.S. CLS. 13, 19, 21, 23, 31, 34 AND 35).

FIRST USE 6-0-1994; IN COMMERCE 6-0-1994.

OWNER OF U.S. REG. NO. 2,115,767.

THE MARK CONSISTS OF THE LETTERS FPT
WHICH INTERSECT AN OVAL AT VARIOUS
POINTS.

SER. NO. 77-233,551, FILED 7-19-2007.

RUSS HERMAN, EXAMINING ATTORNEY

Int. Cl.: 3

Prior U.S. Cls.: 1, 4, 6, 50, 51 and 52

United States Patent and Trademark Office

Reg. No. 3,398,194

Registered Mar. 18, 2008

**TRADEMARK
PRINCIPAL REGISTER**

SEPTICON

ALOPECIL CORPORATION, C. X. A. (DOMINI-
CAN REP CORPORATION)
R. I. 17590 / R. S. 6460
SANTO DOMINGO, DOMINICAN REP

THE MARK CONSISTS OF STANDARD CHAR-
ACTERS WITHOUT CLAIM TO ANY PARTICULAR
FONT, STYLE, SIZE, OR COLOR.

FOR: NON-MEDICATED MOUTHWASH AND
GARGLE, IN CLASS 3 (U.S. CLS. 1, 4, 6, 50, 51 AND
52).

SER. NO. 77-233,617, FILED 7-19-2007.

FIRST USE 0-0-1988; IN COMMERCE 0-0-1988.

LEE-ANNE BERNS, EXAMINING ATTORNEY

Int. Cl.: 20

Prior U.S. Cls.: 2, 13, 22, 25, 32 and 50

United States Patent and Trademark Office

Reg. No. 3,398,195

Registered Mar. 18, 2008

**TRADEMARK
PRINCIPAL REGISTER**

INNER SOULS

HIDE 'N SEEK CHILDREN'S FOUNDATION
(CALIFORNIA CORPORATION)
P.O. BOX 2450
SALINAS, CA 93902

FOR: CLEAR PLASTIC HOLDERS, TO BE
PLACED INSIDE OF SHOES, THAT HOLD A RE-
PLACEABLE CARD CONTAINING BIBLE VERSES,
QUOTATIONS, AND SAYINGS , IN CLASS 20 (U.S.
CLS. 2, 13, 22, 25, 32 AND 50).

FIRST USE 5-1-2007; IN COMMERCE 5-2-2007.

THE MARK CONSISTS OF STANDARD CHAR-
ACTERS WITHOUT CLAIM TO ANY PARTICULAR
FONT, STYLE, SIZE, OR COLOR.

SER. NO. 77-233,624, FILED 7-19-2007.

CARYN GLASSER, EXAMINING ATTORNEY

Int. Cl.: 35

Prior U.S. Cls.: 100, 101 and 102

United States Patent and Trademark Office

Reg. No. 3,398,196

Registered Mar. 18, 2008

**SERVICE MARK
PRINCIPAL REGISTER**



DANIELS WHOLESALE SIGN & PLASTICS, INC.
(FLORIDA CORPORATION)
1856 PATTERSON AVE.
DELAND, FL 32724

FOR: GOODS OR SERVICES PRICE QUOTATIONS, EXCLUDING TRAVEL SERVICES, IN CLASS 35 (U.S. CLS. 100, 101 AND 102).

FIRST USE 7-12-2007; IN COMMERCE 7-12-2007.

THE COLOR(S) BLACK, RED AND GRAY IS/ARE CLAIMED AS A FEATURE OF THE MARK.

THE COLORS BLACK, RED AND GRAY ARE CLAIMED AS A FEATURE OF THE MARK. THE COLOR BLACK APPEARS IN THE WORD "JET". THE COLOR RED APPEARS IN THE WORD "QUOTE" AND THE COLOR GRAY APPEARS IN THE DESIGN OF THE JET AND IN THE LINE CROSSING THE WORDING "JETQUOTE".

SER. NO. 77-233,793, FILED 7-19-2007.

LEE-ANNE BERNS, EXAMINING ATTORNEY

Int. Cl.: 6

Prior U.S. Cls.: 2, 12, 13, 14, 23, 25 and 50

Reg. No. 3,398,197

United States Patent and Trademark Office

Registered Mar. 18, 2008

**TRADEMARK
PRINCIPAL REGISTER**

EAGLE SHIELD

VICTORY BOLT & SPECIALTY, INC. (NORTH
CAROLINA CORPORATION)
4812 UNIONVILLE-INDIAN TRAIL ROAD
INDIAN TRAIL, NC 28079

THE MARK CONSISTS OF STANDARD CHAR-
ACTERS WITHOUT CLAIM TO ANY PARTICULAR
FONT, STYLE, SIZE, OR COLOR.

FOR: METAL FASTENERS, INCLUDING
CHROME OVER FASTENERS, IN CLASS 6 (U.S.
CLS. 2, 12, 13, 14, 23, 25 AND 50).

SER. NO. 77-233,804, FILED 7-19-2007.

FIRST USE 7-19-2007; IN COMMERCE 7-19-2007.

ANNE MADDEN, EXAMINING ATTORNEY

Int. Cl.: 31

Prior U.S. Cls.: 1 and 46

United States Patent and Trademark Office

Reg. No. 3,398,198

Registered Mar. 18, 2008

**TRADEMARK
PRINCIPAL REGISTER**



BRANCH PROPERTIES, INC. (FLORIDA CORPORATION), DBA SEMINOLE STORES
335 N.E. WATULA AVENUE
OCALA, FL 34470

FOR: ANIMAL FEED, IN CLASS 31 (U.S. CLS. 1 AND 46).

FIRST USE 12-1-1934; IN COMMERCE 1-1-1947.

THE NAME(S), PORTRAIT(S), AND/OR SIGNATURE(S) SHOWN IN THE MARK DOES NOT IDENTIFY A PARTICULAR LIVING INDIVIDUAL.

THE MARK CONSISTS OF THE HEAD OF A PERSON.

SER. NO. 77-233,810, FILED 7-19-2007.

PRISCILLA MILTON, EXAMINING ATTORNEY

Int. Cl.: 33

Prior U.S. Cls.: 47 and 49

United States Patent and Trademark Office

Reg. No. 3,398,199

Registered Mar. 18, 2008

**TRADEMARK
PRINCIPAL REGISTER**

MCWILLIAM'S

M & G BRANDS, LIMITED (CAYMAN ISLANDS
CORPORATION)
P. O. BOX 309 G.T.
UGLAND HOUSE
GRAND CAYMAN, CAYMAN ISLANDS

OWNER OF U.S. REG. NOS. 2,765,123 AND
3,032,801.

FOR: WINES, IN CLASS 33 (U.S. CLS. 47 AND 49).

SEC. 2(F).

FIRST USE 6-1-2002; IN COMMERCE 6-1-2002.

SER. NO. 77-233,824, FILED 7-19-2007.

THE MARK CONSISTS OF STANDARD CHAR-
ACTERS WITHOUT CLAIM TO ANY PARTICULAR
FONT, STYLE, SIZE, OR COLOR.

PAUL E. FAHRENKOPF, EXAMINING ATTORNEY

Int. Cls.: 31 and 44

Prior U.S. Cls.: 1, 46, 100 and 101

United States Patent and Trademark Office

Reg. No. 3,398,200

Registered Mar. 18, 2008

TRADEMARK
SERVICE MARK
PRINCIPAL REGISTER



THE FARM, INC. (FLORIDA CORPORATION)
24120 SW 119 AVENUE
MIAMI, FL 33032

THE COLOR(S) YELLOW, BLACK, BROWN, ORANGE, AND GREEN IS/ARE CLAIMED AS A FEATURE OF THE MARK.

FOR: LIVING PALMS, TREES, SHRUBS, BUSHES, PLANTS, AND FLOWERS; SOD, TOP SOIL, MULCH, PEAT MOSS, WOOD CHIPS FOR GROUND COVER, LAWN TURF; SEEDS AND BULBS; SEEDLINGS AND SAPLINGS; LIVESTOCK, NAMELY, CATTLE, IN CLASS 31 (U.S. CLS. 1 AND 46).

FIRST USE 6-21-1997; IN COMMERCE 6-21-1997.

FOR: LANDSCAPE GARDENING AND DESIGN, IN CLASS 44 (U.S. CLS. 100 AND 101).

FIRST USE 6-21-1997; IN COMMERCE 6-21-1997.

NO CLAIM IS MADE TO THE EXCLUSIVE RIGHT TO USE "INC." AND "TREE COMPANY", APART FROM THE MARK AS SHOWN.

THE MARK CONSISTS OF A YELLOW RECTANGLE OUTLINED IN BLACK IN WHICH THE WORDS THE FARM INC. IN BLACK LETTERS ARE CENTERED ABOVE A YELLOW OVAL OUTLINED IN BLACK. THE YELLOW OVAL CONTAINS THE WORDS A TREE COMPANY IN BLACK LETTERS CENTERED ABOVE A ROAD, WITH PALM TREES ON BOTH SIDES, AND THE SUN AT THE HORIZON. THE ROAD IS BROWN, ORANGE AND YELLOW. THE PALM TREES ARE BROWN, BLACK, GREEN AND YELLOW. THE SUN AND SKY ARE ORANGE AND YELLOW.

SEC. 2(F).

SER. NO. 77-233,830, FILED 7-19-2007.

JOHN HWANG, EXAMINING ATTORNEY

Int. Cl.: 10

Prior U.S. Cls.: 26, 39 and 44

United States Patent and Trademark Office

Reg. No. 3,398,201

Registered Mar. 18, 2008

**TRADEMARK
PRINCIPAL REGISTER**



HOSPIRA, INC. (DELAWARE CORPORATION)
NLEG, HI
275 NORTH FIELD DRIVE
LAKE FOREST, IL 600452579

FOR: MEDICAL DEVICE, NAMELY, AN INFUSION PUMP AND TUBING SETS FOR DRUG AND NUTRITIONAL DELIVERY, IN CLASS 10 (U.S. CLS. 26, 39 AND 44).

FIRST USE 6-1-2000; IN COMMERCE 6-1-2000.

OWNER OF U.S. REG. NOS. 1,546,296, 2,451,275 AND OTHERS.

THE MARK CONSISTS OF A PLUM AND A LEAF WHEREIN THE OUTLINE OF THE PLUM EXTENDS THROUGH THE WORD PLUM AND THE LETTER A. A PLUS SYMBOL FOLLOWS THE LETTER A.

SER. NO. 77-233,838, FILED 7-19-2007.

PAUL F. GAST, EXAMINING ATTORNEY

Int. Cl.: 45

Prior U.S. Cls.: 100 and 101

United States Patent and Trademark Office

Reg. No. 3,398,202

Registered Mar. 18, 2008

**SERVICE MARK
PRINCIPAL REGISTER**

**Legal insight. Trusted
counsel.**

MCGRATH NORTH MULLIN & KRATZ, PC LLO
(NEBRASKA PROFESSIONAL CORPORATION)
SUITE 3700 FIRST NATIONAL TOWER
1601 DODGE STREET
OMAHA, NE 68102

FOR: LEGAL SERVICES, IN CLASS 45 (U.S. CLS.
100 AND 101).

FIRST USE 5-23-2007; IN COMMERCE 5-23-2007.

THE MARK CONSISTS OF STANDARD CHAR-
ACTERS WITHOUT CLAIM TO ANY PARTICULAR
FONT, STYLE, SIZE, OR COLOR.

SER. NO. 77-233,843, FILED 7-19-2007.

DEIRDRE ROBERTSON, EXAMINING ATTORNEY

Int. Cl.: 41

Prior U.S. Cls.: 100, 101 and 107

United States Patent and Trademark Office

Reg. No. 3,398,203

Registered Mar. 18, 2008

**SERVICE MARK
PRINCIPAL REGISTER**



COVIDIEN AG (SWITZERLAND CORPORATION)
VICTOR VON BRUNS-STRASSE 19
NEUHAUSEN AM RHEINFALL, SWITZERLAND
8212

FOR: EDUCATIONAL SERVICES, NAMELY, DEVELOPING, ARRANGING, AND CONDUCTING EDUCATIONAL CONFERENCES AND PROGRAMS AND PROVIDING COURSES OF INSTRUCTION IN THE FIELDS OF HUMAN HEALTH, HEALTHCARE, PHARMACEUTICALS, MEDICAL DEVICES, MEDICAL RESEARCH, SURGERY, MEDICAL SCIENCE AND MEDICINE; DISTRIBUTION OF COURSE MATERIALS IN CONNECTION THEREWITH, IN CLASS 41 (U.S. CLS. 100, 101 AND 107).

PRIORITY CLAIMED UNDER SEC. 44(D) ON SWITZERLAND APPLICATION NO. 50832/2007, FILED 1-23-2007, REG. NO. 555921, DATED 1-23-2007, EXPIRES 1-23-2017.

THE MARK CONSISTS OF TWO BLOCK LETTER CS, WITH ONE REVERSED SO THEY ARE FACING EACH OTHER, COMBINED WITH THE DESIGNATION COVIDIEN.

SER. NO. 77-233,857, FILED 7-19-2007.

DANIEL CAPSHAW, EXAMINING ATTORNEY

Int. Cl.: 27

Prior U.S. Cls.: 19, 20, 37, 42 and 50

United States Patent and Trademark Office

Reg. No. 3,398,204

Registered Mar. 18, 2008

**TRADEMARK
PRINCIPAL REGISTER**

HEXOMAT

INTRO-TECH AUTOMOTIVE, INC. (CALIFORNIA CORPORATION)
3961 SCHAEFER AVENUE
CHINO, CA 91710

FOR: VEHICLE FLOORMATS, IN CLASS 27 (U.S. CLS. 19, 20, 37, 42 AND 50).

FIRST USE 6-1-2004; IN COMMERCE 6-1-2004.

THE MARK CONSISTS OF STANDARD CHARACTERS WITHOUT CLAIM TO ANY PARTICULAR FONT, STYLE, SIZE, OR COLOR.

SER. NO. 77-233,926, FILED 7-19-2007.

WARREN L. OLANDRIA, EXAMINING ATTORNEY

Int. Cl.: 42

Prior U.S. Cls.: 100 and 101

United States Patent and Trademark Office

Reg. No. 3,398,205

Registered Mar. 18, 2008

**SERVICE MARK
PRINCIPAL REGISTER**

CableWISE

UTILX CORPORATION (DELAWARE CORPORATION)
22820 RUSSELL ROAD
KENT, WA 98032

FOR: MAINTENANCE ASSESSMENT OF THE PERFORMANCE AND RELIABILITY OF ELECTRICAL SYSTEMS AND CABLE DIAGNOSTIC SERVICES, IN CLASS 42 (U.S. CLS. 100 AND 101).

FIRST USE 0-0-2000; IN COMMERCE 0-0-2000.

THE MARK CONSISTS OF STANDARD CHARACTERS WITHOUT CLAIM TO ANY PARTICULAR FONT, STYLE, SIZE, OR COLOR.

OWNER OF U.S. REG. NOS. 1,760,683, 1,827,730, AND 1,831,785.

SER. NO. 77-233,935, FILED 7-19-2007.

JEAN IM, EXAMINING ATTORNEY

Int. Cl.: 27

Prior U.S. Cls.: 19, 20, 37, 42 and 50

United States Patent and Trademark Office

Reg. No. 3,398,206

Registered Mar. 18, 2008

**TRADEMARK
PRINCIPAL REGISTER**

Protect-A-Mat

INTRO-TECH AUTOMOTIVE, INC. (CALIFORNIA CORPORATION)
3961 SCHAEFER AVENUE
CHINO, CA 91710

FOR: VEHICLE FLOORMAT, IN CLASS 27 (U.S. CLS. 19, 20, 37, 42 AND 50).

FIRST USE 6-1-2001; IN COMMERCE 6-1-2001.

THE MARK CONSISTS OF STANDARD CHARACTERS WITHOUT CLAIM TO ANY PARTICULAR FONT, STYLE, SIZE, OR COLOR.

SER. NO. 77-233,939, FILED 7-19-2007.

WARREN L. OLANDRIA, EXAMINING ATTORNEY

Int. Cl.: 41

Prior U.S. Cls.: 100, 101 and 107

United States Patent and Trademark Office

Reg. No. 3,398,207

Registered Mar. 18, 2008

**SERVICE MARK
PRINCIPAL REGISTER**

Evenings Under the Stars

SOUTH SHORE CONSERVATORY OF MUSIC,
INC. (MASSACHUSETTS NON-PROFIT COR-
PORATION)
ONE CONSERVATORY DRIVE
HINGHAM, MA 02043

FOR: ENTERTAINMENT, NAMELY, LIVE MU-
SIC CONCERTS; ENTERTAINMENT IN THE NAT-
URE OF ORCHESTRA PERFORMANCES;
ENTERTAINMENT IN THE NATURE OF SYMPH-
ONY ORCHESTRA PERFORMANCES; ENTER-
TAINMENT IN THE NATURE OF VISUAL AND
AUDIO PERFORMANCES, AND MUSICAL, VARI-

ETY, NEWS AND COMEDY SHOWS, IN CLASS 41
(U.S. CLS. 100, 101 AND 107).

FIRST USE 3-1-1997; IN COMMERCE 3-1-1997.

THE MARK CONSISTS OF STANDARD CHAR-
ACTERS WITHOUT CLAIM TO ANY PARTICULAR
FONT, STYLE, SIZE, OR COLOR.

SER. NO. 77-233,950, FILED 7-19-2007.

PAUL F. GAST, EXAMINING ATTORNEY

Int. Cl.: 3

Prior U.S. Cls.: 1, 4, 6, 50, 51 and 52

United States Patent and Trademark Office

Reg. No. 3,398,208

Registered Mar. 18, 2008

**TRADEMARK
PRINCIPAL REGISTER**

ECO-PH

GORS, DON (UNITED STATES INDIVIDUAL)
6015 N RIDGE AVE
CHICAGO, IL 606602328

THE MARK CONSISTS OF STANDARD CHAR-
ACTERS WITHOUT CLAIM TO ANY PARTICULAR
FONT, STYLE, SIZE, OR COLOR.

FOR: ALL-PURPOSE CLEANERS, IN CLASS 3
(U.S. CLS. 1, 4, 6, 50, 51 AND 52).

SER. NO. 77-233,972, FILED 7-19-2007.

FIRST USE 7-5-2006; IN COMMERCE 7-5-2006.

ESTHER A. BORSUK, EXAMINING ATTORNEY

Int. Cl.: 9

Prior U.S. Cls.: 21, 23, 26, 36 and 38

Reg. No. 3,398,209

United States Patent and Trademark Office

Registered Mar. 18, 2008

**TRADEMARK
PRINCIPAL REGISTER**

POWER MOS 8

MICROSEMI CORPORATION (DELAWARE CORPORATION)
405 S.W. COLUMBIA STREET
BEND, OR 97702

OWNER OF U.S. REG. NOS. 2,166,537, 2,552,197
AND OTHERS.

FOR: SOLID STATE POWER SWITCHES, IN
CLASS 9 (U.S. CLS. 21, 23, 26, 36 AND 38).

SEC. 2(F) AS TO POWER MOS.

FIRST USE 10-3-2006; IN COMMERCE 12-4-2006.

SER. NO. 77-233,976, FILED 7-19-2007.

THE MARK CONSISTS OF STANDARD CHARACTERS WITHOUT CLAIM TO ANY PARTICULAR FONT, STYLE, SIZE, OR COLOR.

MIDGE BUTLER, EXAMINING ATTORNEY

Int. Cl.: 36

Prior U.S. Cls.: 100, 101 and 102

United States Patent and Trademark Office

Reg. No. 3,398,210

Registered Mar. 18, 2008

**SERVICE MARK
PRINCIPAL REGISTER**

**From Bayshore to the
Beaches We Sell
Tampa Bay!**

ZITO, DEBORAH J. (UNITED STATES INDIVIDUAL)
2803 SHORE BREEZE DRIVE
TAMPA, FL 33611

FOR: PROVIDING INFORMATION IN THE FIELD OF REAL ESTATE VIA THE INTERNET; REAL ESTATE AGENCIES, IN CLASS 36 (U.S. CLS. 100, 101 AND 102).

FIRST USE 6-1-2002; IN COMMERCE 6-1-2002.

THE MARK CONSISTS OF STANDARD CHARACTERS WITHOUT CLAIM TO ANY PARTICULAR FONT, STYLE, SIZE, OR COLOR.

SER. NO. 77-234,038, FILED 7-19-2007.

MATTHEW MCDOWELL, EXAMINING ATTORNEY

Int. Cl.: 9

Prior U.S. Cls.: 21, 23, 26, 36 and 38

United States Patent and Trademark Office

Reg. No. 3,398,211

Registered Mar. 18, 2008

**TRADEMARK
PRINCIPAL REGISTER**

PIPENET VISION

SUNRISE SYSTEMS LIMITED (UNITED KING-
DOM CORPORATION)
ELY ROAD
SUNRISE BUSINESS PARK
WATERBEACH, CAMBRIDGE, ENGLAND
CB259QZ

FOR: COMPUTER PROGRAMS, NAMELY, SOFT-
WARE USED TO CALCULATE FLUID FLOW ANA-
LYSIS IN PIPE AND DUCT NETWORKS FOR USE
BY THE PROCESS, NUCLEAR, SHIPBUILDING
AND POWER GENERATION INDUSTRIES, AND
INSTRUCTIONAL MANUAL PROVIDED AS A

UNIT THEREWITH, IN CLASS 9 (U.S. CLS. 21, 23,
26, 36 AND 38).

FIRST USE 1-31-2006; IN COMMERCE 1-31-2006.

THE MARK CONSISTS OF STANDARD CHAR-
ACTERS WITHOUT CLAIM TO ANY PARTICULAR
FONT, STYLE, SIZE, OR COLOR.

SER. NO. 77-234,120, FILED 7-19-2007.

ELI HELLMAN, EXAMINING ATTORNEY

Int. Cl.: 33

Prior U.S. Cls.: 47 and 49

United States Patent and Trademark Office

Reg. No. 3,398,212

Registered Mar. 18, 2008

**TRADEMARK
PRINCIPAL REGISTER**

TOROSOL

SOMO, INC. (DELAWARE CORPORATION)
152 NORTH HARBOR CITY BLVD.
MELBOURNE, FL 32902

THE MARK CONSISTS OF STANDARD CHAR-
ACTERS WITHOUT CLAIM TO ANY PARTICULAR
FONT, STYLE, SIZE, OR COLOR.

FOR: WINE, IN CLASS 33 (U.S. CLS. 47 AND 49).

SER. NO. 77-234,139, FILED 7-19-2007.

FIRST USE 2-28-2007; IN COMMERCE 4-27-2007.

DAVID COLLIER, EXAMINING ATTORNEY

Int. Cls.: 9, 16 and 41

Prior U.S. Cls.: 2, 5, 21, 22, 23, 26, 29, 36, 37, 38, 50,
100, 101 and 107

Reg. No. 3,398,213

United States Patent and Trademark Office

Registered Mar. 18, 2008

TRADEMARK
SERVICE MARK
PRINCIPAL REGISTER



LINGOLYNX, LLC (COLORADO LTD LIAB CO)
314 SOUTH SAN JUAN AVE.
BUENA VISTA, CO 81211

FOR: EDUCATIONAL SOFTWARE FEATURING INSTRUCTION IN LEARNING SPANISH; PRE-RECORDED AUDIO CDS FEATURING FOREIGN LANGUAGE LEARNING MATERIALS FOR SPANISH; DIGITAL MATERIALS, NAMELY, PRERECORDED CD-ROMS AND AUDIO COMPACT DISCS FEATURING INSTRUCTION ON LEARNING SPANISH AS A FOREIGN LANGUAGE, IN CLASS 9 (U.S. CLS. 21, 23, 26, 36 AND 38).

FIRST USE 12-1-2006; IN COMMERCE 12-1-2006.

FOR: EDUCATIONAL PUBLICATIONS, NAMELY, TRAINING MANUALS IN THE FIELD OF LEARNING SPANISH AS A FOREIGN LANGUAGE, CONSISTING OF A WORKBOOK AND PRACTICE READING BOOK; PRINTED INSTRUCTIONAL, EDUCATIONAL, AND TEACHING MATERIALS IN THE FIELD OF LEARNING SPANISH AS A FOREIGN LANGUAGE, CONSISTING OF OUR PRINTED TEXTBOOKS AND WORKBOOKS, IN CLASS 16 (U.S. CLS. 2, 5, 22, 23, 29, 37, 38 AND 50).

FIRST USE 12-1-2006; IN COMMERCE 12-1-2006.

FOR: EDUCATION SERVICES, NAMELY, PROVIDING CLASSES, SEMINARS AND WORKSHOPS FOR ADULTS IN THE FIELD OF SPANISH LANGUAGE LEARNING; EDUCATION SERVICES, NAMELY, PROVIDING CLASSES, SEMINARS

AND WORKSHOPS IN THE FIELDS OF SPANISH AS A FOREIGN LANGUAGE, IN CLASS 41 (U.S. CLS. 100, 101 AND 107).

FIRST USE 12-1-2006; IN COMMERCE 12-1-2006.

OWNER OF U.S. REG. NO. 3,268,068.

NO CLAIM IS MADE TO THE EXCLUSIVE RIGHT TO USE "ENGLISH", APART FROM THE MARK AS SHOWN.

THE COLOR(S) TAN, BLACK GRAY AND TEAL IS/ARE CLAIMED AS A FEATURE OF THE MARK.

THE MARK CONSISTS OF A LYNX CAT WEARING A SOMBRERO ABOVE THE TEAL WORDS, REALITY ENGLISH, SURROUNDED BY SHADOWING. THE COLOR TEAL APPEARS IN THE WORDING REALITY ENGLISH. THE COLOR TAN APPEARS IN THE INTERIOR OF THE LYNX'S SOMBRERO TOP. THE COLOR BLACK APPEARS IN THE SIDES OF THE SOMBRERO, THE OUTLINE OF THE TOP PART OF THE SOMBRERO, AND THE DETAILS OF THE LYNX'S EARS, EYES, NOSE MOUTH, AND WHISKERS. THE COLOR GRAY APPEARS IN THE SHADOWING OF THE WORDING REALITY ENGLISH.

SER. NO. 77-234,142, FILED 7-19-2007.

DAVID COLLIER, EXAMINING ATTORNEY

Int. Cl.: 45

Prior U.S. Cls.: 100 and 101

United States Patent and Trademark Office

Reg. No. 3,398,214

Registered Mar. 18, 2008

**SERVICE MARK
PRINCIPAL REGISTER**

RUNNINGBEAR

HOSKET, GARY W. (UNITED STATES INDIVIDUAL)
9200 YAAK RIVER RD
TROY, MT 59935

FOR: PSYCHIC READING SERVICES; RELIGIOUS AND SPIRITUAL SERVICES, NAMELY, PROVIDING GATHERINGS AND RETREATS TO DEVELOP AND ENHANCE THE SPIRITUAL LIVES OF INDIVIDUALS, IN CLASS 45 (U.S. CLS. 100 AND 101).

FIRST USE 6-11-1996; IN COMMERCE 3-1-2001.

THE MARK CONSISTS OF STANDARD CHARACTERS WITHOUT CLAIM TO ANY PARTICULAR FONT, STYLE, SIZE, OR COLOR.

SER. NO. 77-234,148, FILED 7-19-2007.

DAVID COLLIER, EXAMINING ATTORNEY

Int. Cl.: 41

Prior U.S. Cls.: 100, 101 and 107

United States Patent and Trademark Office

Reg. No. 3,398,215

Registered Mar. 18, 2008

**SERVICE MARK
PRINCIPAL REGISTER**

MOMCARE

BROWN, NEIL (UNITED STATES INDIVIDUAL)
11905 HIGHWAY 92
WOODSTOCK, GA 30188

THE MARK CONSISTS OF STANDARD CHAR-
ACTERS WITHOUT CLAIM TO ANY PARTICULAR
FONT, STYLE, SIZE, OR COLOR.

FOR: EDUCATION SERVICES, NAMELY, PRO-
VIDING CLASSES IN THE FIELDS OF BIBLICAL
STUDIES FOR YOUNG MOTHERS, IN CLASS 41
(U.S. CLS. 100, 101 AND 107).

SER. NO. 77-234,175, FILED 7-19-2007.

FIRST USE 7-1-2007; IN COMMERCE 7-1-2007.

DAVID I, EXAMINING ATTORNEY

Int. Cl.: 25

Prior U.S. Cls.: 22 and 39

United States Patent and Trademark Office

Reg. No. 3,398,216

Registered Mar. 18, 2008

**TRADEMARK
PRINCIPAL REGISTER**

STPL

STAPLE DESIGN STUDIO INC. (NEW YORK
CORPORATION)
156 ALLEN STREET
NEW YORK, NY 10002

FOR: PANTS; SHIRTS; CAPS; HEADWEAR;
FOOTWEAR; SNEAKERS; JACKETS; BELTS;
COATS; SWEATERS; JEANS; SWEAT PANTS;
SWEAT SHIRTS; SWEAT SUITS; T-SHIRTS; HATS;
SCARVES; SOCKS , IN CLASS 25 (U.S. CLS. 22 AND
39).

FIRST USE 1-0-2001; IN COMMERCE 1-0-2001.

THE MARK CONSISTS OF STANDARD CHAR-
ACTERS WITHOUT CLAIM TO ANY PARTICULAR
FONT, STYLE, SIZE, OR COLOR.

SER. NO. 77-234,209, FILED 7-19-2007.

JAMES MACFARLANE, EXAMINING ATTORNEY

Int. Cl.: 39

Prior U.S. Cls.: 100 and 105

United States Patent and Trademark Office

Reg. No. 3,398,217

Registered Mar. 18, 2008

**SERVICE MARK
PRINCIPAL REGISTER**



SAN FRANCISCO BAY BOAT CRUISES, LLC
(CALIFORNIA LTD LIAB CO)
20 PARK RIDGE DRIVE
SAN FRANCISCO, CA 94131

FOR: PLEASURE BOAT CRUISES, IN CLASS 39
(U.S. CLS. 100 AND 105).

FIRST USE 5-8-2007; IN COMMERCE 5-8-2007.

NO CLAIM IS MADE TO THE EXCLUSIVE
RIGHT TO USE "CRUISE", APART FROM THE
MARK AS SHOWN.

THE MARK CONSISTS OF AN IMAGE OF A
MERMAID AND THE GOLDEN GATE BRIDGE.

SER. NO. 77-234,210, FILED 7-19-2007.

HEATHER SAPP, EXAMINING ATTORNEY

Int. Cl.: 42

Prior U.S. Cls.: 100 and 101

United States Patent and Trademark Office

Reg. No. 3,398,218

Registered Mar. 18, 2008

**SERVICE MARK
PRINCIPAL REGISTER**

STAPLE DESIGN

STAPLE DESIGN STUDIO INC. (NEW YORK CORPORATION)
156 ALLEN STREET
NEW YORK, NY 10002

FOR: GRAPHIC DESIGN SERVICES; VISUAL DESIGN SERVICES IN THE NATURE OF DESIGNING VISUAL ELEMENTS FOR ONLINE, BROADCAST, PRINT, OUTDOOR AND OTHER COMMUNICATION MEDIA; DESIGN OF HOMEPAGES AND WEBSITES; INDUSTRIAL DESIGN, IN CLASS 42 (U.S. CLS. 100 AND 101).

FIRST USE 3-0-1997; IN COMMERCE 3-0-1997.

THE MARK CONSISTS OF STANDARD CHARACTERS WITHOUT CLAIM TO ANY PARTICULAR FONT, STYLE, SIZE, OR COLOR.

NO CLAIM IS MADE TO THE EXCLUSIVE RIGHT TO USE "DESIGN", APART FROM THE MARK AS SHOWN.

SER. NO. 77-234,219, FILED 7-19-2007.

JAMES MACFARLANE, EXAMINING ATTORNEY

Int. Cl.: 9

Prior U.S. Cls.: 21, 23, 26, 36 and 38

Reg. No. 3,398,219

United States Patent and Trademark Office

Registered Mar. 18, 2008

**TRADEMARK
PRINCIPAL REGISTER**

Bock Audio

BOCK, DAVID (UNITED STATES INDIVIDUAL)
1219 BERKELEY DR
GLENDALE, CA 91205

FOR: PRE-AMPLIFIERS; AUDIO PROCESSING
EQUIPMENT, NAMELY, LIMITERS AND COM-
PRESSORS; AUDIO EQUALIZERS; MICROPHONES,
IN CLASS 9 (U.S. CLS. 21, 23, 26, 36 AND 38).

FIRST USE 1-28-2000; IN COMMERCE 5-1-2003.

THE MARK CONSISTS OF STANDARD CHAR-
ACTERS WITHOUT CLAIM TO ANY PARTICULAR
FONT, STYLE, SIZE, OR COLOR.

NO CLAIM IS MADE TO THE EXCLUSIVE
RIGHT TO USE "AUDIO", APART FROM THE
MARK AS SHOWN.

SER. NO. 77-234,244, FILED 7-19-2007.

JOHN WILKE, EXAMINING ATTORNEY

Int. Cl.: 32

Prior U.S. Cls.: 45, 46 and 48

United States Patent and Trademark Office

Reg. No. 3,398,220

Registered Mar. 18, 2008

TRADEMARK
PRINCIPAL REGISTER



KEEP ROCKIN', LLC (WASHINGTON LTD LIAB
CO)
1508 O STREET, SW #105
AUBURN, WA 98001

THE MARK CONSISTS OF A FEMALE FIGURE
WEARING HORNS, HOLDING A TRIDENT AND
LOOKING THROUGH AN OVAL PORTHOLE, AND
A WINGED DRAGON SITTING ON TOP OF IT.

FOR: BEER; ALE, IN CLASS 32 (U.S. CLS. 45, 46
AND 48).

FIRST USE 2-0-2002; IN COMMERCE 2-0-2002.

SER. NO. 77-234,275, FILED 7-19-2007.

NO CLAIM IS MADE TO THE EXCLUSIVE
RIGHT TO USE "VERY PALE LOW CAL ALE" ,
APART FROM THE MARK AS SHOWN.

DAVID I, EXAMINING ATTORNEY

Int. Cl.: 32

Prior U.S. Cls.: 45, 46 and 48

United States Patent and Trademark Office

Reg. No. 3,398,221

Registered Mar. 18, 2008

TRADEMARK
PRINCIPAL REGISTER



KEEP ROCKIN', LLC (WASHINGTON LTD LIAB
CO)
1508 O STREET, SW #105
AUBURN, WA 98001

FOR: BEER; ALE, IN CLASS 32 (U.S. CLS. 45, 46
AND 48).

FIRST USE 8-0-1996; IN COMMERCE 8-0-1996.

NO CLAIM IS MADE TO THE EXCLUSIVE
RIGHT TO USE "RED", APART FROM THE MARK
AS SHOWN.

THE MARK CONSISTS OF A GEAR-LIKE WRIST-
WATCH FACE DESIGN ON AN OBLONG BASE
AND WITH A HAZARDOUS MATERIALS SYMBOL
IN THE CENTER.

SER. NO. 77-234,282, FILED 7-19-2007.

DAVID I, EXAMINING ATTORNEY

Int. Cl.: 36

Prior U.S. Cls.: 100, 101 and 102

United States Patent and Trademark Office

Reg. No. 3,398,222

Registered Mar. 18, 2008

**SERVICE MARK
PRINCIPAL REGISTER**

TEAMLEGAL

PROFESSIONAL LAW ENFORCEMENT ASSO-
CIATION, INC. (MICHIGAN CORPORATION)
P.O. BOX 1197
TROY, MI 480991197

FOR: FINANCIAL SERVICES, NAMELY, ADMIN-
ISTRATION OF SELF-FUNDED AND PREPAID
LEGAL SERVICES BENEFITS PLANS, IN CLASS 36
(U.S. CLS. 100, 101 AND 102).

FIRST USE 10-0-1996; IN COMMERCE 10-0-1996.

THE MARK CONSISTS OF STANDARD CHAR-
ACTERS WITHOUT CLAIM TO ANY PARTICULAR
FONT, STYLE, SIZE, OR COLOR.

OWNER OF U.S. REG. NO. 2,888,352.

SEC. 2(F).

SER. NO. 77-234,395, FILED 7-20-2007.

KEVIN DINALLO, EXAMINING ATTORNEY

Int. Cl.: 16

Prior U.S. Cls.: 2, 5, 22, 23, 29, 37, 38 and 50

United States Patent and Trademark Office

Reg. No. 3,398,223

Registered Mar. 18, 2008

**TRADEMARK
PRINCIPAL REGISTER**

HEAD OF THE CLASS

LAND O'LAKES, INC. (MINNESOTA CORPORATION)
MS 2500
4001 LEXINGTON AVENUE NORTH
ARDEN HILLS, MN 55126

FOR: NEWSLETTERS IN THE FIELD OF SCHOOL
FOOD SERVICE, IN CLASS 16 (U.S. CLS. 2, 5, 22, 23,
29, 37, 38 AND 50).

FIRST USE 6-1-2001; IN COMMERCE 6-1-2001.

THE MARK CONSISTS OF STANDARD CHARACTERS WITHOUT CLAIM TO ANY PARTICULAR FONT, STYLE, SIZE, OR COLOR.

OWNER OF U.S. REG. NO. 2,538,189.

SER. NO. 77-234,408, FILED 7-20-2007.

JOHN WILKE, EXAMINING ATTORNEY

Int. Cl.: 5

Prior U.S. Cls.: 6, 18, 44, 46, 51 and 52

United States Patent and Trademark Office

Reg. No. 3,398,224

Registered Mar. 18, 2008

**TRADEMARK
PRINCIPAL REGISTER**

CHIGGER-TOX

SCHERER LABORATORIES, INC. (TEXAS CORPORATION)
28161 N. KEITH DRIVE
LAKE FOREST, IL 60044

FOR: MEDICATED SKIN PREPARATION FOR USE IN TREATING INSECT BITES, IN CLASS 5 (U.S. CLS. 6, 18, 44, 46, 51 AND 52).

FIRST USE 5-19-1949; IN COMMERCE 5-19-1949.

THE MARK CONSISTS OF STANDARD CHARACTERS WITHOUT CLAIM TO ANY PARTICULAR FONT, STYLE, SIZE, OR COLOR.

OWNER OF U.S. REG. NO. 1,742,691.

SER. NO. 77-234,521, FILED 7-20-2007.

AMY GEARIN, EXAMINING ATTORNEY

Int. Cl.: 41

Prior U.S. Cls.: 100, 101 and 107

United States Patent and Trademark Office

Reg. No. 3,398,225

Registered Mar. 18, 2008

**SERVICE MARK
PRINCIPAL REGISTER**

MINIMAL ART

MINIMAL ART (PENNSYLVANIA PARTNER-
SHIP)
453 JENNY DRIVE
GIBSONIA, PA 15044

FOR: ENTERTAINMENT, NAMELY, LIVE MU-
SIC CONCERTS; ENTERTAINMENT, NAMELY,
LIVE PERFORMANCES BY MUSICAL BANDS, IN
CLASS 41 (U.S. CLS. 100, 101 AND 107).

FIRST USE 4-1-2007; IN COMMERCE 4-1-2007.

THE MARK CONSISTS OF STANDARD CHAR-
ACTERS WITHOUT CLAIM TO ANY PARTICULAR
FONT, STYLE, SIZE, OR COLOR.

SER. NO. 77-234,547, FILED 7-20-2007.

RICHARD A. STRASER, EXAMINING ATTORNEY

Int. Cl.: 25

Prior U.S. Cls.: 22 and 39

United States Patent and Trademark Office

Reg. No. 3,398,226

Registered Mar. 18, 2008

**TRADEMARK
PRINCIPAL REGISTER**



LIQUID MILITIA, LLC (CALIFORNIA LTD LIAB
CO)
PO BOX 60921
SANTA BARBARA, CA 93160

THE MARK CONSISTS OF A RECTANGULAR
SHAPE, WITH INSIDE SWIRLS THAT ROTATE IN A
CLOCK WISE DIRECTION, REPRESENTING AN
OCEAN WAVE.

FOR: BANDANAS; BASEBALL CAPS; BEANIES;
PANTS; SANDALS; SHORTS; PANTIES; SOCKS;
SWEAT PANTS; RASH GUARDS; T-SHIRTS; JACK-
ETS, IN CLASS 25 (U.S. CLS. 22 AND 39).

SER. NO. 77-234,563, FILED 7-20-2007.

FIRST USE 1-1-2005; IN COMMERCE 10-1-2006.

EVELYN BRADLEY, EXAMINING ATTORNEY

Int. Cl.: 5

Prior U.S. Cls.: 6, 18, 44, 46, 51 and 52

United States Patent and Trademark Office

Reg. No. 3,398,227

Registered Mar. 18, 2008

**TRADEMARK
PRINCIPAL REGISTER**

4Joint Health Plus

GENESIS TODAY, INC. (TEXAS CORPORATION)
JACKIE WEIGEL
14101 W. HWY. 290, BLDG. 1900
AUSTIN, TX 78737

OWNER OF U.S. REG. NO. 3,257,226.

FOR: HERBAL SUPPLEMENTS, IN CLASS 5 (U.S. CLS. 6, 18, 44, 46, 51 AND 52).

NO CLAIM IS MADE TO THE EXCLUSIVE RIGHT TO USE FOR JOINT HEALTH, APART FROM THE MARK AS SHOWN.

FIRST USE 8-1-2005; IN COMMERCE 8-1-2005.

SER. NO. 77-234,577, FILED 7-20-2007.

THE MARK CONSISTS OF STANDARD CHARACTERS WITHOUT CLAIM TO ANY PARTICULAR FONT, STYLE, SIZE, OR COLOR.

ESTHER BELENKER, EXAMINING ATTORNEY

Int. Cl.: 36

Prior U.S. Cls.: 100, 101 and 102

United States Patent and Trademark Office

Reg. No. 3,398,228

Registered Mar. 18, 2008

**SERVICE MARK
PRINCIPAL REGISTER**



BUSINESS ACQUISITIONS_{LTD.}

BUSINESS ACQUISITIONS, LTD. (COLORADO CORPORATION)
3900 EAST MEXICO AVE., SUITE 970
DENVER, CO 80210

THE MARK CONSISTS OF THE LETTERS AND WORDS OF BA BUSINESS ACQUISITIONS, LTD. IN A STYLIZED TEXT.

FOR: BUSINESS BROKERAGE, IN CLASS 36 (U.S. CLS. 100, 101 AND 102).

SER. NO. 77-234,578, FILED 7-20-2007.

FIRST USE 9-21-1986; IN COMMERCE 9-21-1986.

NO CLAIM IS MADE TO THE EXCLUSIVE RIGHT TO USE "BUSINESS ACQUISITIONS LTD.", APART FROM THE MARK AS SHOWN.

MATTHEW MCDOWELL, EXAMINING ATTORNEY

Int. Cl.: 3

Prior U.S. Cls.: 1, 4, 6, 50, 51 and 52

United States Patent and Trademark Office

Reg. No. 3,398,229

Registered Mar. 18, 2008

**TRADEMARK
PRINCIPAL REGISTER**

SCENTPAK

INTELLISCENTS, LLC (CALIFORNIA LTD LIAB
CO)
2 TOWNSEND STREET, #2-608
SAN FRANCISCO, CA 94107

FOR: PACKET MADE OF PLASTIC CONTAIN-
ING A SCENT EMITTING MATERIAL, NAMELY,
FRAGRANCE FOR DISPENSING THE SCENT,
WHEN THE PACKET IS SQUEEZED, ALL SOLD
AS A UNIT, IN CLASS 3 (U.S. CLS. 1, 4, 6, 50, 51 AND
52).

FIRST USE 1-29-2007; IN COMMERCE 1-29-2007.

THE MARK CONSISTS OF STANDARD CHAR-
ACTERS WITHOUT CLAIM TO ANY PARTICULAR
FONT, STYLE, SIZE, OR COLOR.

SER. NO. 77-234,585, FILED 7-20-2007.

MARK T. MULLEN, EXAMINING ATTORNEY

Int. Cl.: 3

Prior U.S. Cls.: 1, 4, 6, 50, 51 and 52

United States Patent and Trademark Office

Reg. No. 3,398,230

Registered Mar. 18, 2008

**TRADEMARK
PRINCIPAL REGISTER**

DEMOSCENTER

INTELLISCENTS, LLC (CALIFORNIA LTD LIAB
CO)
2 TOWNSEND STREET, #2-608
SAN FRANCISCO, CA 94107

FOR: PACKET MADE OF PLASTIC CONTAIN-
ING A SCENT EMITTING MATERIAL, NAMELY,
FRAGRANCE FOR DISPENSING THE SCENT,
WHEN THE PACKET IS SQUEEZED, ALL SOLD
AS A UNIT, IN CLASS 3 (U.S. CLS. 1, 4, 6, 50, 51 AND
52).

FIRST USE 1-29-2007; IN COMMERCE 1-29-2007.

THE MARK CONSISTS OF STANDARD CHAR-
ACTERS WITHOUT CLAIM TO ANY PARTICULAR
FONT, STYLE, SIZE, OR COLOR.

SER. NO. 77-234,587, FILED 7-20-2007.

MARK T. MULLEN, EXAMINING ATTORNEY

Int. Cl.: 5

Prior U.S. Cls.: 6, 18, 44, 46, 51 and 52

United States Patent and Trademark Office

Reg. No. 3,398,231

Registered Mar. 18, 2008

**TRADEMARK
PRINCIPAL REGISTER**

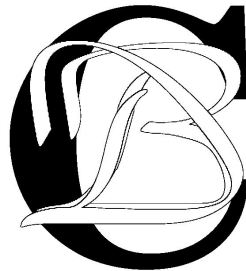

HEALING POWER INC. (NEW YORK CORPORATION)
5515 CANOGA AVE, UNIT 326
WOODLAND HLS, CA 91367

FOR: HERBAL SUPPLEMENTS, IN CLASS 5 (U.S. CLS. 6, 18, 44, 46, 51 AND 52).

FIRST USE 2-27-2006; IN COMMERCE 2-27-2006.

OWNER OF U.S. REG. NO. 3,321,549.

THE MARK CONSISTS OF THE STYLIZED TEXT "DBC".

SER. NO. 77-234,614, FILED 7-20-2007.

DORITT L. CARROLL, EXAMINING ATTORNEY

Int. Cl.: 44

Prior U.S. Cls.: 100 and 101

United States Patent and Trademark Office

Reg. No. 3,398,232

Registered Mar. 18, 2008

**SERVICE MARK
PRINCIPAL REGISTER**

BABY SOUND CHECK

JOHN TRACY CLINIC (CALIFORNIA CORPORATION)
806 WEST ADAMS BOULEVARD
LOS ANGELES, CA 900072505

FOR: PROVIDING HEARING SCREENINGS TO NEWBORNS AND TODDLERS, IN CLASS 44 (U.S. CLS. 100 AND 101).

FIRST USE 5-11-2007; IN COMMERCE 5-11-2007.

THE MARK CONSISTS OF STANDARD CHARACTERS WITHOUT CLAIM TO ANY PARTICULAR FONT, STYLE, SIZE, OR COLOR.

NO CLAIM IS MADE TO THE EXCLUSIVE RIGHT TO USE "BABY", APART FROM THE MARK AS SHOWN.

SER. NO. 77-234,618, FILED 7-20-2007.

DOMINIC FATHY, EXAMINING ATTORNEY

Int. Cl.: 9

Prior U.S. Cls.: 21, 23, 26, 36 and 38

United States Patent and Trademark Office

Reg. No. 3,398,233

Registered Mar. 18, 2008

**TRADEMARK
PRINCIPAL REGISTER**

HYPERFEA

COLLIER RESEARCH & DEVELOPMENT CORP.
(VIRGINIA CORPORATION)
45 DIAMOND HILL ROAD
HAMPTON, VA 236666016

FOR: COMPUTER SOFTWARE FOR ENGINEER-
ING STRUCTURAL DESIGN AND ANALYSIS, IN
CLASS 9 (U.S. CLS. 21, 23, 26, 36 AND 38).

FIRST USE 8-0-2006; IN COMMERCE 8-0-2006.

THE MARK CONSISTS OF STANDARD CHAR-
ACTERS WITHOUT CLAIM TO ANY PARTICULAR
FONT, STYLE, SIZE, OR COLOR.

OWNER OF U.S. REG. NO. 2,273,464.

SER. NO. 77-234,622, FILED 7-20-2007.

DORITT L. CARROLL, EXAMINING ATTORNEY

Int. Cl.: 35

Prior U.S. Cls.: 100, 101 and 102

United States Patent and Trademark Office

Reg. No. 3,398,234

Registered Mar. 18, 2008

**SERVICE MARK
PRINCIPAL REGISTER**

WAA

WISCONSIN ARBORIST ASSOCIATION, INC.
(WISCONSIN CORPORATION)
345 SOUTH JEFFERSON STREET
GREEN BAY, WI 54301

THE MARK CONSISTS OF STANDARD CHAR-
ACTERS WITHOUT CLAIM TO ANY PARTICULAR
FONT, STYLE, SIZE, OR COLOR.

FOR: ASSOCIATION SERVICES, NAMELY, PRO-
MOTING THE INTERESTS OF ARBORISTS, IN CLASS
35 (U.S. CLS. 100, 101 AND 102).

SER. NO. 77-234,678, FILED 7-20-2007.

FIRST USE 1-26-1965; IN COMMERCE 1-26-1965.

ALEX KEAM, EXAMINING ATTORNEY

Int. Cl.: 9

Prior U.S. Cls.: 21, 23, 26, 36 and 38

United States Patent and Trademark Office

Reg. No. 3,398,235

Registered Mar. 18, 2008

**TRADEMARK
PRINCIPAL REGISTER**

SecurityTitan

TITAN SAFETY PRODUCTS, INC. (CALIFORNIA CORPORATION), DBA TAG INOVENTIONS, INC.
2901 TECH CENTER DR.
SANTA ANA, CA 92705

FOR: HOME AND OFFICE AUTOMATION SYSTEMS COMPRISING WIRELESS AND WIRED CONTROLLERS, CONTROLLED DEVICES, AND SOFTWARE FOR LIGHTING, HVAC, SECURITY, SAFETY AND OTHER HOME AND OFFICE MONITORING AND CONTROL APPLICATIONS, IN CLASS 9 (U.S. CLS. 21, 23, 26, 36 AND 38).

FIRST USE 5-15-2007; IN COMMERCE 6-12-2007.

THE MARK CONSISTS OF STANDARD CHARACTERS WITHOUT CLAIM TO ANY PARTICULAR FONT, STYLE, SIZE, OR COLOR.

SER. NO. 77-234,712, FILED 7-20-2007.

INGA ERVIN, EXAMINING ATTORNEY

Int. Cl.: 9

Prior U.S. Cls.: 21, 23, 26, 36 and 38

United States Patent and Trademark Office

Reg. No. 3,398,236

Registered Mar. 18, 2008

**TRADEMARK
PRINCIPAL REGISTER**



STEC, INC. (CALIFORNIA CORPORATION)
3001 DAIMLER STREET
SANTA ANA, CA 92705

FOR: COMPUTER HARDWARE; COMPUTER SOFTWARE FOR OPERATING MEMORY UPGRADES FOR COMPUTERS, FOR DETERMINING THE TYPE OF MEMORY OR FLASH CARD PRODUCTS TO BE USED IN COMPUTERS, CELLULAR PHONES, CAMERAS, PDAS, AND PORTABLE AND HANDHELD DIGITAL ELECTRONIC DEVICES, FOR DETERMINING MEMORY CAPABILITY AND COMPATIBLE MEMORY PARTS FOR ASSEMBLE-TO-ORDER COMPUTERS; COMPUTER PRINTERS; COMPUTER WORKSTATIONS COMPRISING COMPUTERS, COMPUTER PRINTERS, EXPANSION BOARDS, HARD DRIVE PC CARDS, MEMORY MODULES, MEMORY CARDS, COMMUNICATION CARDS FOR COMPUTER, FLASH CARDS, SRAM CARDS, HARD DRIVES, ETHERNET ADAPTERS, SCSI ADAPTERS, SCSI PORTS, AND INTERNAL DESKTOP PC CARD DRIVES; COMPUTER EXPANSION BOARDS; ETHERNET ADAPTER; BLANK HARD DRIVES

FOR COMPUTERS; FLASH MEMORY CARD; MEMORY CARDS; RAM (RANDOM ACCESS MEMORY) CARD; COMPUTER STORAGE DEVICES, NAME- LY, FLASH DRIVES; COMPUTER MEMORY HARD- WARE, IN CLASS 9 (U.S. CLS. 21, 23, 26, 36 AND 38).

FIRST USE 2-9-2007; IN COMMERCE 2-9-2007.

THE COLOR(S) BLUE, AND RED IS/ARE CLAIMED AS A FEATURE OF THE MARK.

THE MARK CONSISTS OF A SWOOPING BLUE CURVED LINE LIKE A HALF CIRCLE THAT STARTS OUT THIN AT ONE END AND EXPANDS IN THICKNESS TO THE OTHER END, UNDER WHICH IS A SLIGHTLY CURVED RED LINE THAT SUBSTANTIALLY MATCHES THE CURVATURE OF THE LOWER HALF OF THE BLUE CURVED LINE ABOVE IT.

SER. NO. 77-234,894, FILED 7-20-2007.

MARK SPARACINO, EXAMINING ATTORNEY

Int. Cl.: 29

Prior U.S. Cl.: 46

United States Patent and Trademark Office

Reg. No. 3,398,237

Registered Mar. 18, 2008

TRADEMARK
PRINCIPAL REGISTER



PPC MARKETING, LTD. (TEXAS LIMITED
PARTNERSHIP)
4845 US HIGHWAY 271 NORTH
PITTSBURG, TX 75686

FOR: POULTRY; POULTRY PRODUCTS, NAME-
LY, DICED CHICKEN, IN CLASS 29 (U.S. CL. 46).

FIRST USE 1-1-2007; IN COMMERCE 1-1-2007.

OWNER OF U.S. REG. NOS. 764,028, 2,733,111 AND
OTHERS.

NO CLAIM IS MADE TO THE EXCLUSIVE
RIGHT TO USE "CHICKEN", APART FROM THE
MARK AS SHOWN.

THE MARK CONSISTS OF A STYLIZED "P" TO
THE LEFT OF STYLIZED "PIERCE CHICKEN,"
BOTH OF WHICH ARE ABOVE STYLIZED "MAS-
TER PIECES," ALL OF WHICH ARE CONTAINED
IN TWO SHADED RECTANGULAR FORMS.

SER. NO. 77-235,028, FILED 7-20-2007.

MARTHA FROMM, EXAMINING ATTORNEY

Int. Cl.: 25

Prior U.S. Cls.: 22 and 39

United States Patent and Trademark Office

Reg. No. 3,398,238

Registered Mar. 18, 2008

TRADEMARK
PRINCIPAL REGISTER



TRUEBLOOD, SAMUEL E. (UNITED STATES
INDIVIDUAL)
9258 PENNINSULA DRIVE
DALLAS, TX 75218

FOR: SPORTS BRA; SPORTS JERSEYS; SPORTS
SHIRTS; JOGGING OUTFITS; JOGGING PANTS;
JOGGING SUITS; CAPS; GOLF CAPS; BASEBALL
CAPS; HATS; SOCKS, IN CLASS 25 (U.S. CLS. 22 AND
39).

FIRST USE 5-1-2007; IN COMMERCE 5-1-2007.

THE MARK CONSISTS OF THE WORD ZEN
RUNNER WITH A HALF SUN DIRECTLY ABOVE
THE Z.

SER. NO. 77-235,553, FILED 7-22-2007.

FRED MANDIR, EXAMINING ATTORNEY

Int. Cl.: 43

Prior U.S. Cls.: 100 and 101

United States Patent and Trademark Office

Reg. No. 3,398,239

Registered Mar. 18, 2008

**SERVICE MARK
PRINCIPAL REGISTER**



BRIGHT HORIZONS LIMITED PARTNERSHIP
(MASSACHUSETTS LIMITED PARTNERSHIP)
200 TALCOTT AVENUE SOUTH
WATERTOWN, MA 02472

FOR: CHILD CARE SERVICES, IN CLASS 43 (U.S.
CLS. 100 AND 101).

FIRST USE 3-1-2006; IN COMMERCE 3-1-2006.

THE COLOR(S) PINK, ORANGE, BEIGE, BLACK,
WHITE, FLESH, BLUISH PURPLE IS/ARE
CLAIMED AS A FEATURE OF THE MARK.

THE MARK CONSISTS OF FOUR STYLIZED
FIGURES. THE FIGURE ON THE RIGHT IS CO-

LORED PINK AND OUTLINED IN BLACK. THE
FIGURE ON THE RIGHT IS HOLDING A STYLIZED
BLUISH PURPLE UMBRELLA. THE FIGURE ON
THE LEFT IS BEIGE AND OUTLINED IN BLACK,
AND IS CRADLING A FLESH COLORED BABY
WRAPPED IN A WHITE BLANKET OUTLINED IN
BLACK IN ITS RIGHT ARM. THE FIGURE ON THE
LEFT IS HOLDING HANDS WITH A SMALLER
BEIGE FIGURE WHICH IS OUTLINED IN BLACK.
THERE IS A STYLIZED ORANGE SUN ABOVE THE
FIGURE ON THE RIGHT.

SER. NO. 77-236,197, FILED 7-23-2007.

CHRISTINA SOBRAL, EXAMINING ATTORNEY

Int. Cl.: 36

Prior U.S. Cls.: 100, 101 and 102

United States Patent and Trademark Office

Reg. No. 3,398,240

Registered Mar. 18, 2008

**SERVICE MARK
PRINCIPAL REGISTER**

GREAT-WEST

GREAT-WEST LIFE & ANNUITY INSURANCE
COMPANY (COLORADO CORPORATION)
8515 EAST ORCHARD ROAD
GREENWOOD VILLAGE, CA 80111

FOR: INSURANCE UNDERWRITING AND ADMINISTRATION IN THE AREAS OF MEDICAL, DENTAL, VISION, LIFE, DISABILITY AND HEALTH CARE PLAN SERVICES, INCLUDING PREPAID HEALTH CARE PLANS AND REINSURANCE, ALL PROVIDED TO GROUPS AND INDIVIDUALS; UNDERWRITING AND ADMINISTRATION OF INDIVIDUAL AND GROUP ANNUITIES; ADMINISTRATION AND RECORD KEEPING OF RETIREMENT PLANS AND GROUP PENSIONS, IN CLASS 36 (U.S. CLS. 100, 101 AND 102).

FIRST USE 8-28-1891; IN COMMERCE 3-1-1920.

THE MARK CONSISTS OF STANDARD CHARACTERS WITHOUT CLAIM TO ANY PARTICULAR FONT, STYLE, SIZE, OR COLOR.

OWNER OF U.S. REG. NOS. 1,466,557, 2,964,565 AND OTHERS.

SER. NO. 77-236,443, FILED 7-23-2007.

MICHAEL KEATING, EXAMINING ATTORNEY

Int. Cl.: 36

Prior U.S. Cls.: 100, 101 and 102

United States Patent and Trademark Office

Reg. No. 3,398,241

Registered Mar. 18, 2008

**SERVICE MARK
PRINCIPAL REGISTER**



GREAT-WEST LIFE & ANNUITY INSURANCE
COMPANY (COLORADO CORPORATION)
8515 EAST ORCHARD ROAD
GREENWOOD VILLAGE, CO 80111

FOR: INSURANCE UNDERWRITING AND ADMINISTRATION IN THE AREAS OF MEDICAL, DENTAL, VISION, LIFE, DISABILITY AND HEALTH CARE PLAN SERVICES, INCLUDING PREPAID HEALTH CARE PLANS AND REINSURANCE, ALL PROVIDED TO GROUPS AND INDIVIDUALS; UNDERWRITING AND ADMINISTRATION OF INDIVIDUAL AND GROUP ANNUITIES; ADMINISTRATION AND RECORD KEEPING OF RETIREMENT PLANS AND GROUP PENSIONS, IN CLASS 36 (U.S. CLS. 100, 101 AND 102).

FIRST USE 8-26-1986; IN COMMERCE 8-26-1986.

OWNER OF U.S. REG. NOS. 1,683,217 AND 1,714,127.

THE MARK CONSISTS OF THE MARK COMPRISES A KEY WITH THE LETTERS "G" AND "W" BEING REPRESENTED BY PARTS OF THE KEY..

SER. NO. 77-236,519, FILED 7-23-2007.

MICHAEL KEATING, EXAMINING ATTORNEY

Int. Cl.: 9

Prior U.S. Cls.: 21, 23, 26, 36 and 38

United States Patent and Trademark Office

Reg. No. 3,398,242

Registered Mar. 18, 2008

**TRADEMARK
PRINCIPAL REGISTER**

ITUNES

APPLE INC. (CALIFORNIA CORPORATION)
1 INFINITE LOOP
CUPERTINO, CA 95014

FOR: COMPUTER SOFTWARE FOR USE IN AUTHORIZING, DOWNLOADING, TRANSMITTING, RECEIVING, EDITING, EXTRACTING, ENCODING, DECODING, PLAYING, STORING AND ORGANIZING TEXT, DATA, IMAGES, AUDIO FILES, VIDEO FILES AND ELECTRONIC GAMES; COMPUTER SOFTWARE FOR PERSONAL INFORMATION MANAGEMENT; COMPUTER SOFTWARE FOR USE IN RECORDING, ORGANIZING, TRANSMITTING, MANIPULATING, AND REVIEWING TEXT, DATA, AUDIO FILES, VIDEO FILES AND ELECTRONIC GAMES IN CONNECTION WITH COMPUTERS, TELEVISION SET-TOP BOXES, MUSIC PLAYERS, VIDEO PLAYERS, MEDIA PLAYERS, CELLULAR PHONES, AND PORTABLE AND HANDHELD DIGITAL ELECTRONIC DEVICES; COMPUTER SOFTWARE FOR ACCESSING, BROWSING AND SEARCHING ONLINE DATABASES; COMPUTER SOFTWARE TO ENABLE USERS TO PROGRAM AND DISTRIBUTE AUDIO, VIDEO, TEXT AND OTHER MULTIMEDIA CONTENT, INCLUDING MUSIC, CONCERTS, VIDEOS, RADIO,

TELEVISION, NEWS, SPORTS, GAMES, CULTURAL EVENTS, AND ENTERTAINMENT-RELATED AND EDUCATIONAL PROGRAMS VIA COMMUNICATIONS NETWORKS; COMPUTER SOFTWARE FOR IDENTIFYING, LOCATING, GROUPING, DISTRIBUTING, AND MANAGING DATA AND LINKS BETWEEN COMPUTER SERVERS AND USERS CONNECTED TO ELECTRONIC COMMUNICATIONS NETWORKS, IN CLASS 9 (U.S. CLS. 21, 23, 26, 36 AND 38).

FIRST USE 1-9-2001; IN COMMERCE 1-9-2001.

THE MARK CONSISTS OF STANDARD CHARACTERS WITHOUT CLAIM TO ANY PARTICULAR FONT, STYLE, SIZE, OR COLOR.

OWNER OF U.S. REG. NOS. 2,653,465, 2,828,093, AND 2,993,227.

SEC. 2(F).

SER. NO. 77-236,568, FILED 7-23-2007.

APRIL ROACH, EXAMINING ATTORNEY

Int. Cl.: 16

Prior U.S. Cls.: 2, 5, 22, 23, 29, 37, 38 and 50

United States Patent and Trademark Office

Reg. No. 3,398,243

Registered Mar. 18, 2008

**TRADEMARK
PRINCIPAL REGISTER**

**CORE CLINICAL OUTCOME
RESOURCE ESSENTIALS**

PSS WORLD MEDICAL, INC. (FLORIDA CORPORATION)
4345 SOUTHPOINT BOULEVARD
JACKSONVILLE, FL 32216

FOR: PRINTED MATERIALS, NAMELY, BOOKLETS FOR USE BY HOME HEALTHCARE PROVIDERS CONTAINING A FORMULARY OF HOME HEALTH PRODUCTS, ESTIMATED CALCULATIONS FOR NECESSARY PRODUCT INVENTORY IN MULTIPLE HOME HEALTH SITUATIONS, DECISION TOOLS FOR IDENTIFYING A DISEASE STATE, UNDERSTANDING WHAT IS NEEDED FOR TREATMENT AND IDENTIFYING APPROPRIATE MEDICAL PRODUCTS FOR TREATING PARTICULAR DISEASES, IN CLASS 16 (U.S. CLS. 2, 5, 22, 23, 29, 37, 38 AND 50).

FIRST USE 6-4-2007; IN COMMERCE 6-4-2007.

THE MARK CONSISTS OF STANDARD CHARACTERS WITHOUT CLAIM TO ANY PARTICULAR FONT, STYLE, SIZE, OR COLOR.

NO CLAIM IS MADE TO THE EXCLUSIVE RIGHT TO USE "CLINICAL OUTCOME RESOURCE", APART FROM THE MARK AS SHOWN.

SER. NO. 77-236,885, FILED 7-24-2007.

AMY HELLA, EXAMINING ATTORNEY

Int. Cl.: 16

Prior U.S. Cls.: 2, 5, 22, 23, 29, 37, 38 and 50

United States Patent and Trademark Office

Reg. No. 3,398,244

Registered Mar. 18, 2008

**TRADEMARK
PRINCIPAL REGISTER**

The logo for 'InStyle' is displayed in a bold, white, sans-serif font against a solid black rectangular background. The letters are closely spaced, and the overall design is clean and modern.

TIME INC. (DELAWARE CORPORATION)
1271 AVENUE OF THE AMERICAS
NEW YORK, NY 10020

FOR: GENERAL FEATURE MAGAZINES; MAGAZINES FEATURING CELEBRITY LIFESTYLES AND EVENTS, ENTERTAINMENT NEWS, FASHION, BEAUTY AND CULTURE, IN CLASS 16 (U.S. CLS. 2, 5, 22, 23, 29, 37, 38 AND 50).

FIRST USE 1-31-2002; IN COMMERCE 1-31-2002.

OWNER OF U.S. REG. NOS. 1,851,469, 3,194,185 AND OTHERS.

SER. NO. 77-236,993, FILED 7-24-2007.

MARK SPARACINO, EXAMINING ATTORNEY

Int. Cl.: 3

Prior U.S. Cls.: 1, 4, 6, 50, 51 and 52

United States Patent and Trademark Office

Reg. No. 3,398,245

Registered Mar. 18, 2008

**TRADEMARK
PRINCIPAL REGISTER**

BEAUTIFUL FLOORS MADE EASY

RECKITT BENCKISER INC. (DELAWARE CORPORATION)
399 INTERPACE PARKWAY
PARSIPPANY, NJ 07054

FOR: FLOOR POLISH AND CLEANER; PREPARATIONS FOR CLEANING, POLISHING AND WAXING FLOORS, CABINETS AND OTHER HOUSEHOLD SURFACES, IN CLASS 3 (U.S. CLS. 1, 4, 6, 50, 51 AND 52).

FIRST USE 6-1-2007; IN COMMERCE 6-5-2007.

THE MARK CONSISTS OF STANDARD CHARACTERS WITHOUT CLAIM TO ANY PARTICULAR FONT, STYLE, SIZE, OR COLOR.

SER. NO. 77-237,048, FILED 7-24-2007.

JAMES LOVELACE, EXAMINING ATTORNEY

Int. Cl.: 35

Prior U.S. Cls.: 100, 101 and 102

United States Patent and Trademark Office

Reg. No. 3,398,246

Registered Mar. 18, 2008

**SERVICE MARK
PRINCIPAL REGISTER**

Draft Day

THE CHRIS DRAFT FAMILY FOUNDATION
(GEORGIA FOUNDATION)
SUITE 240-A
165 COURTLAND STREET
ATLANTA, GA 30303

FOR: CHARITABLE SERVICES, NAMELY, ORGANIZING AND CONDUCTING VOLUNTEER PROGRAMS AND COMMUNITY SERVICE PROJECTS, IN CLASS 35 (U.S. CLS. 100, 101 AND 102).

FIRST USE 7-8-2006; IN COMMERCE 7-8-2006.

THE MARK CONSISTS OF STANDARD CHARACTERS WITHOUT CLAIM TO ANY PARTICULAR FONT, STYLE, SIZE, OR COLOR.

SER. NO. 77-237,091, FILED 7-24-2007.

TEJBIR SINGH, EXAMINING ATTORNEY

Int. Cl.: 36

Prior U.S. Cls.: 100, 101 and 102

United States Patent and Trademark Office

Reg. No. 3,398,247

Registered Mar. 18, 2008

**SERVICE MARK
PRINCIPAL REGISTER**

VIRGIN

VIRGIN ENTERPRISES LIMITED (UNITED
KINGDOM LIMITED COMPANY)
120 CAMPDEN HILL ROAD
LONDON, UNITED KINGDOM W87AR

FOR: BANKING SERVICES; LOAN SERVICES,
NAMELY, OFFERING LOANS TO OTHERS; CRED-
IT CARD SERVICES; CONSUMER FINANCING;
ELECTRONIC FUNDS TRANSFER , IN CLASS 36
(U.S. CLS. 100, 101 AND 102).

FIRST USE 1-0-2002; IN COMMERCE 1-0-2002.

THE MARK CONSISTS OF STANDARD CHAR-
ACTERS WITHOUT CLAIM TO ANY PARTICULAR
FONT, STYLE, SIZE, OR COLOR.

OWNER OF U.S. REG. NOS. 2,622,510, 3,298,421
AND OTHERS.

SER. NO. 77-237,167, FILED 7-24-2007.

MARILYN IZZI, EXAMINING ATTORNEY

Int. Cl.: 36

Prior U.S. Cls.: 100, 101 and 102

United States Patent and Trademark Office

Reg. No. 3,398,248

Registered Mar. 18, 2008

SERVICE MARK
PRINCIPAL REGISTER



VIRGIN ENTERPRISES LIMITED (UNITED
KINGDOM LIMITED COMPANY)
120 CAMPDEN HILL ROAD
LONDON, UNITED KINGDOM W87AR

FOR: BANKING SERVICES; LOAN SERVICES,
NAMELY, OFFERING LOANS TO OTHERS; CRED-
IT CARD SERVICES; CONSUMER FINANCING;
ELECTRONIC FUNDS TRANSFER , IN CLASS 36
(U.S. CLS. 100, 101 AND 102).

FIRST USE 1-0-2002; IN COMMERCE 1-0-2002.

OWNER OF U.S. REG. NOS. 2,622,510, 3,298,421
AND OTHERS.

THE MARK CONSISTS OF THE WORD "VIRGIN"
IN A STYLIZED FORM.

SER. NO. 77-237,172, FILED 7-24-2007.

SHARON MEIER, EXAMINING ATTORNEY

Int. Cl.: 25

Prior U.S. Cls.: 22 and 39

United States Patent and Trademark Office

Reg. No. 3,398,249

Registered Mar. 18, 2008

**TRADEMARK
PRINCIPAL REGISTER**

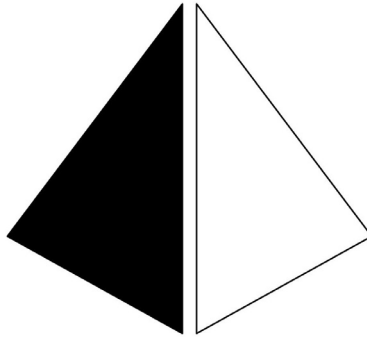

INDERA MILLS COMPANY (NORTH CAROLINA
CORPORATION)
P.O. BOX 309
350 WEST MAPLE STREET
YADKINVILLE, NC 27055

FOR: UNDERWEAR, IN CLASS 25 (U.S. CLS. 22
AND 39).

FIRST USE 1-1-2006; IN COMMERCE 1-1-2006.

THE MARK CONSISTS OF TWO TRIANGLES.

SER. NO. 77-237,981, FILED 7-25-2007.

KRISTIN DAHLING, EXAMINING ATTORNEY

Int. Cl.: 30

Prior U.S. Cl.: 46

United States Patent and Trademark Office

Reg. No. 3,398,250

Registered Mar. 18, 2008

**TRADEMARK
PRINCIPAL REGISTER**

GOLD-N-RAISE

THE PILLSBURY COMPANY (DELAWARE COR-
PORATION)
NUMBER ONE GENERAL MILLS BOULEVARD
MINNEAPOLIS, MN 55426

FOR: BAKING MIX, IN CLASS 30 (U.S. CL. 46).

FIRST USE 0-0-1952; IN COMMERCE 0-0-1952.

THE MARK CONSISTS OF STANDARD CHAR-
ACTERS WITHOUT CLAIM TO ANY PARTICULAR
FONT, STYLE, SIZE, OR COLOR.

SER. NO. 77-238,079, FILED 7-25-2007.

CARYN GLASSER, EXAMINING ATTORNEY

Int. Cl.: 16

Prior U.S. Cls.: 2, 5, 22, 23, 29, 37, 38 and 50

United States Patent and Trademark Office

Reg. No. 3,398,251

Registered Mar. 18, 2008

**TRADEMARK
PRINCIPAL REGISTER**

Down East

DOWN EAST ENTERPRISE, INC. (MAINE CORPORATION)
PO 679
CAMDEN, ME 04843

FOR: GENERAL FEATURE MAGAZINES;
BOOKS IN THE FIELD OF PREDOMINANTLY
NEW ENGLAND THEMES, IN CLASS 16 (U.S. CLS.
2, 5, 22, 23, 29, 37, 38 AND 50).

FIRST USE 8-1-1954; IN COMMERCE 8-1-1954.

OWNER OF U.S. REG. NO. 2,496,426.

THE MARK CONSISTS OF THE STYLIZED
WORDS "DOWN EAST."

SEC. 2(F).

SER. NO. 77-238,121, FILED 7-25-2007.

ELLEN PERKINS, EXAMINING ATTORNEY

Int. Cl.: 29

Prior U.S. Cl.: 46

United States Patent and Trademark Office

Reg. No. 3,398,252

Registered Mar. 18, 2008

**TRADEMARK
PRINCIPAL REGISTER**

BEST'S KOSHER

SARA LEE FOODS, LLC (DELAWARE LTD LIAB
CO)
11370 REED HARTMAN HWY
BLUE ASH, OH 60608

FOR: PROCESSED MEAT, IN CLASS 29 (U.S. CL.
46).

FIRST USE 8-1-1994; IN COMMERCE 8-1-1994.

THE MARK CONSISTS OF STANDARD CHAR-
ACTERS WITHOUT CLAIM TO ANY PARTICULAR
FONT, STYLE, SIZE, OR COLOR.

OWNER OF U.S. REG. NOS. 724,564 AND 1,993,821.

NO CLAIM IS MADE TO THE EXCLUSIVE
RIGHT TO USE "KOSHER", APART FROM THE
MARK AS SHOWN.

SER. NO. 77-238,618, FILED 7-25-2007.

CHRISTOPHER BUONGIORNO, EXAMINING AT-
TORNEY

Int. Cl.: 36

Prior U.S. Cls.: 100, 101 and 102

United States Patent and Trademark Office

Reg. No. 3,398,253

Registered Mar. 18, 2008

**SERVICE MARK
PRINCIPAL REGISTER**



ARCH CAPITAL GROUP (U.S.) INC. (DELA-
WARE CORPORATION)
53RD FLOOR, ONE LIBERTY PLAZA
NEW YORK, NY 10006

FOR: REINSURANCE UNDERWRITING, IN
CLASS 36 (U.S. CLS. 100, 101 AND 102).

FIRST USE 6-25-2007; IN COMMERCE 6-25-2007.

OWNER OF U.S. REG. NOS. 3,116,625, 3,116,628,
AND 3,123,046.

NO CLAIM IS MADE TO THE EXCLUSIVE
RIGHT TO USE "RE FACULTATIVE", APART
FROM THE MARK AS SHOWN.

THE MARK CONSISTS OF A DESIGN OF A STAR
WHICH IS FORMED BY SEVEN CHECK MARKS
ARRANGED IN A CIRCLE, NEXT TO THE WORDS
"ARCH RE" AND DIRECTLY UNDER THE WORDS
"ARCH RE" IS THE WORD "FACULTATIVE".

SER. NO. 77-239,214, FILED 7-26-2007.

BILL DAWE, EXAMINING ATTORNEY

Int. Cl.: 43

Prior U.S. Cls.: 100 and 101

United States Patent and Trademark Office

Reg. No. 3,398,254

Registered Mar. 18, 2008

**SERVICE MARK
PRINCIPAL REGISTER**



CELEBREE HOLDINGS, INC. (MARYLAND CORPORATION)
2111B LAUREL BUSH ROAD
BEL AIR, MD 21015

NO CLAIM IS MADE TO THE EXCLUSIVE RIGHT TO USE "LEARNING CENTERS", APART FROM THE MARK AS SHOWN.

FOR: CHILD CARE CENTERS, IN CLASS 43 (U.S. CLS. 100 AND 101).

SER. NO. 77-239,299, FILED 7-26-2007.

FIRST USE 8-1-2005; IN COMMERCE 8-1-2005.

OWNER OF U.S. REG. NO. 2,918,160.

LINDSEY RUBIN, EXAMINING ATTORNEY

Int. Cl.: 9

Prior U.S. Cls.: 21, 23, 26, 36 and 38

United States Patent and Trademark Office

Reg. No. 3,398,255

Registered Mar. 18, 2008

**TRADEMARK
PRINCIPAL REGISTER**

PROJECTS IN KNOWLEDGE

PROJECTS IN KNOWLEDGE, INC. (NEW YORK CORPORATION)
10TH FLOOR
150 CLOVE ROAD
LITTLE FALLS, NJ 07424

FOR: (BASED ON USE IN COMMERCE) DOWNLOADABLE PODCASTS IN THE FIELD OF MEDICINE; DOWNLOADABLE WEBCASTS IN THE FIELD OF MEDICINE; PROVIDING DOWNLOADABLE ELECTRONIC NEWSLETTERS IN THE FIELD OF MEDICINE, IN CLASS 9 (U.S. CLS. 21, 23, 26, 36 AND 38).

FIRST USE 0-0-1981; IN COMMERCE 0-0-1981.

THE MARK CONSISTS OF STANDARD CHARACTERS WITHOUT CLAIM TO ANY PARTICULAR FONT, STYLE, SIZE, OR COLOR.

SER. NO. 77-241,001, FILED 7-27-2007.

CYNTHIA SLOAN, EXAMINING ATTORNEY

Int. Cl.: 3

Prior U.S. Cls.: 1, 4, 6, 50, 51 and 52

United States Patent and Trademark Office

Reg. No. 3,398,256

Registered Mar. 18, 2008

**TRADEMARK
PRINCIPAL REGISTER**

Voci Della Mora

BLOOMWORKS SOAP COMPANY, LC (VIRGINIA LTD LIAB CO)
117 MARCY DRIVE
YORKTOWN, VA 23693

FOR: PERSONAL CARE PRODUCTS, NAMELY, BAR SOAPS, SOAP FOR THE FACE, SOAP FOR THE HANDS, BODY SCRUBS, BUBBLE BATH, BODY WASH, BODY LOTIONS, BODY BUTTER, CREAM FOR THE BODY, BODY SPRAY, BODY SPLASH, COLOGNE, PERFUMES, FRAGRANCED BODY MIST, ESSENTIAL OILS FOR PERSONAL USE, HAIR CONDITIONER, HAIR SHAMPOO, HOUSEHOLD FRAGRANCES FOR PERSONAL USE AND HOUSEHOLD FRAGRANCES FOR ROOM USE, IN CLASS 3 (U.S. CLS. 1, 4, 6, 50, 51 AND 52).

FIRST USE 8-13-2006; IN COMMERCE 8-13-2006.

THE MARK CONSISTS OF STANDARD CHARACTERS WITHOUT CLAIM TO ANY PARTICULAR FONT, STYLE, SIZE, OR COLOR.

NO CLAIM IS MADE TO THE EXCLUSIVE RIGHT TO USE MORA, APART FROM THE MARK AS SHOWN.

THE FOREIGN WORDING IN THE MARK TRANSLATES INTO ENGLISH AS RUMOR OF BLACKBERRY.

SER. NO. 77-241,471, FILED 7-29-2007.

DAVID MURRAY, EXAMINING ATTORNEY

Int. Cl.: 16

Prior U.S. Cls.: 2, 5, 22, 23, 29, 37, 38 and 50

United States Patent and Trademark Office

Reg. No. 3,398,257

Registered Mar. 18, 2008

**TRADEMARK
PRINCIPAL REGISTER**

GO DIEGO GO!

VIACOM INTERNATIONAL INC. (DELAWARE CORPORATION)
1515 BROADWAY
NEW YORK, NY 10036

FOR: PRINTED MATTER, NAMELY, SERIES OF FICTION BOOKS, STICKERS, TRADING CARDS, CALENDARS, NOTEBOOKS, CRAFT BOOKS; SCHOOL SUPPLIES, NAMELY, PENCILS, PENS, PEN AND PENCIL CASES AND HOLDERS, ERASERS, PENCIL SHARPENERS, MARKERS, AND DRAWING RULERS; GIFT WRAPPING PAPER; PAPER PARTY DECORATIONS; PARTY PAPER BAGS, IN CLASS 16 (U.S. CLS. 2, 5, 22, 23, 29, 37, 38 AND 50).

FIRST USE 11-1-2006; IN COMMERCE 11-1-2006.

THE MARK CONSISTS OF STANDARD CHARACTERS WITHOUT CLAIM TO ANY PARTICULAR FONT, STYLE, SIZE, OR COLOR.

OWNER OF U.S. REG. NO. 3,259,274.

SER. NO. 77-241,705, FILED 7-30-2007.

COLLEEN DOMBROW, EXAMINING ATTORNEY

Int. Cl.: 18

Prior U.S. Cls.: 1, 2, 3, 22 and 41

United States Patent and Trademark Office

Reg. No. 3,398,258

Registered Mar. 18, 2008

**TRADEMARK
PRINCIPAL REGISTER**

GO DIEGO GO!

VIACOM INTERNATIONAL INC. (DELAWARE CORPORATION)
1515 BROADWAY
NEW YORK, NY 10036

THE MARK CONSISTS OF STANDARD CHARACTERS WITHOUT CLAIM TO ANY PARTICULAR FONT, STYLE, SIZE, OR COLOR.

FOR: UMBRELLAS, BAGS, NAMELY, BACKPACKS, MESSENGER BAGS, HANDBAGS, WALLETS AND PURSES, ATHLETIC BAGS, GARMENT BAGS FOR TRAVEL, KNAPSACKS, CHANGE PURSES, DUFFLE BAGS, BEACH BAGS , IN CLASS 18 (U.S. CLS. 1, 2, 3, 22 AND 41).

OWNER OF U.S. REG. NO. 3,259,274.

SER. NO. 77-241,715, FILED 7-30-2007.

FIRST USE 8-11-2006; IN COMMERCE 8-11-2006.

COLLEEN DOMBROW, EXAMINING ATTORNEY

Int. Cl.: 25

Prior U.S. Cls.: 22 and 39

United States Patent and Trademark Office

Reg. No. 3,398,259

Registered Mar. 18, 2008

**TRADEMARK
PRINCIPAL REGISTER**

GO DIEGO GO!

VIACOM INTERNATIONAL INC. (DELAWARE CORPORATION)
1515 BROADWAY
NEW YORK, NY 10036

FOR: CLOTHING, NAMELY, BATHING SUITS, BELTS, COATS, SOCKS, FOOTWEAR, BANDANNAS, GLOVES, GYM SHORTS, NECK WEAR, JACKETS, PAJAMAS, PANTS, SHIRTS, SHORTS, SKI WEAR, HATS, SUSPENDERS, SWEATERS, UNDERCLOTHES, HEADWEAR, BATHROBES, BEACHWEAR, IN CLASS 25 (U.S. CLS. 22 AND 39).

FIRST USE 8-11-2006; IN COMMERCE 8-11-2006.

THE MARK CONSISTS OF STANDARD CHARACTERS WITHOUT CLAIM TO ANY PARTICULAR FONT, STYLE, SIZE, OR COLOR.

OWNER OF U.S. REG. NO. 3,259,274.

SER. NO. 77-241,717, FILED 7-30-2007.

COLLEEN DOMBROW, EXAMINING ATTORNEY

Int. Cl.: 28

Prior U.S. Cls.: 22, 23, 38 and 50

Reg. No. 3,398,260

United States Patent and Trademark Office

Registered Mar. 18, 2008

**TRADEMARK
PRINCIPAL REGISTER**

GO DIEGO GO!

VIACOM INTERNATIONAL INC. (DELAWARE CORPORATION)
1515 BROADWAY
NEW YORK, NY 10036

FOR: GAMES AND PLAYTHINGS, NAMELY, CARD GAMES, PLAYING CARDS, DOLLS; ACTION FIGURES AND ACCESSORIES THEREOF; STAND ALONE VIDEO GAME MACHINES UTILIZING CD ROM'S, STAND ALONE VIDEO GAME MACHINES, STAND ALONE AUDIO OUTPUT GAME MACHINES, AND BOARD GAMES; SPORTING ARTICLES, NAMELY, BASEBALLS, BASEBALL BATS; FOOTBALLS, SOCCER BALLS; DECORATIONS

FOR CHRISTMAS TREES, IN CLASS 28 (U.S. CLS. 22, 23, 38 AND 50).

FIRST USE 8-11-2006; IN COMMERCE 8-11-2006.

THE MARK CONSISTS OF STANDARD CHARACTERS WITHOUT CLAIM TO ANY PARTICULAR FONT, STYLE, SIZE, OR COLOR.

OWNER OF U.S. REG. NO. 3,259,274.

SER. NO. 77-241,720, FILED 7-30-2007.

COLLEEN DOMBROW, EXAMINING ATTORNEY

Int. Cl.: 41

Prior U.S. Cls.: 100, 101 and 107

United States Patent and Trademark Office

Reg. No. 3,398,261

Registered Mar. 18, 2008

**SERVICE MARK
PRINCIPAL REGISTER**

GO DIEGO GO!

VIACOM INTERNATIONAL INC. (DELAWARE
CORPORATION)
1515 BROADWAY
NEW YORK, NY 10036

FOR: ENTERTAINMENT, IN THE NATURE OF
AN INTERACTIVE ONLINE COMPUTER GAME, IN
CLASS 41 (U.S. CLS. 100, 101 AND 107).

FIRST USE 11-1-2006; IN COMMERCE 11-1-2006.

THE MARK CONSISTS OF STANDARD CHAR-
ACTERS WITHOUT CLAIM TO ANY PARTICULAR
FONT, STYLE, SIZE, OR COLOR.

OWNER OF U.S. REG. NO. 3,259,274.

SER. NO. 77-241,722, FILED 7-30-2007.

COLLEEN DOMBROW, EXAMINING ATTORNEY

Int. Cl.: 3

Prior U.S. Cls.: 1, 4, 6, 50, 51 and 52

United States Patent and Trademark Office

Reg. No. 3,398,262

Registered Mar. 18, 2008

**TRADEMARK
PRINCIPAL REGISTER**

PERFECT-IT

3M COMPANY (DELAWARE CORPORATION)
3M CENTER, 2501 HUDSON ROAD
ST. PAUL, MN 55144

FOR: PREPARATIONS FOR CLEANING, POLISH-
ING, GLAZING, WAXING, RESTORING OR PRE-
SERVING FINISHED SURFACES OF MOTORIZED
VEHICLES, IN CLASS 3 (U.S. CLS. 1, 4, 6, 50, 51 AND
52).

FIRST USE 11-28-1995; IN COMMERCE 11-28-1995.

THE MARK CONSISTS OF STANDARD CHAR-
ACTERS WITHOUT CLAIM TO ANY PARTICULAR
FONT, STYLE, SIZE, OR COLOR.

OWNER OF U.S. REG. NO. 1,749,723.

SER. NO. 77-241,751, FILED 7-30-2007.

TARAH HARDY, EXAMINING ATTORNEY

Int. Cl.: 41

Prior U.S. Cls.: 100, 101 and 107

United States Patent and Trademark Office

Reg. No. 3,398,263

Registered Mar. 18, 2008

**SERVICE MARK
PRINCIPAL REGISTER**

LAS VEGAS TURKEY SHOOT

NEUSPORT FOOTBALL CLUB (NEVADA NON-
PROFIT CORPORATION)
SUITE C
2801 N. TENAYA WAY
LAS VEGAS, NV 89128

FOR: ENTERTAINMENT IN THE NATURE OF
SOCCER GAMES; ORGANIZATION OF SPORTS
EVENTS IN THE FIELD OF SOCCER, IN CLASS 41
(U.S. CLS. 100, 101 AND 107).

FIRST USE 9-0-1982; IN COMMERCE 9-0-1982.

THE MARK CONSISTS OF STANDARD CHAR-
ACTERS WITHOUT CLAIM TO ANY PARTICULAR
FONT, STYLE, SIZE, OR COLOR.

NO CLAIM IS MADE TO THE EXCLUSIVE
RIGHT TO USE "LAS VEGAS", APART FROM THE
MARK AS SHOWN.

SER. NO. 77-242,516, FILED 7-30-2007.

MELISSA VALLILLO, EXAMINING ATTORNEY

Int. Cl.: 35

Prior U.S. Cls.: 100, 101 and 102

United States Patent and Trademark Office

Reg. No. 3,398,264

Registered Mar. 18, 2008

**SERVICE MARK
PRINCIPAL REGISTER**

WHERE THE PEOPLE ARE

TACODA, INC. (DELAWARE CORPORATION)
345 SEVENTH AVE., 8TH FLOOR
NEW YORK, NY 10001

THE MARK CONSISTS OF STANDARD CHAR-
ACTERS WITHOUT CLAIM TO ANY PARTICULAR
FONT, STYLE, SIZE, OR COLOR.

FOR: ON-LINE ADVERTISING SERVICES, IN
CLASS 35 (U.S. CLS. 100, 101 AND 102).

SER. NO. 77-242,980, FILED 7-31-2007.

FIRST USE 3-31-2006; IN COMMERCE 3-31-2006.

KAPIL BHANOT, EXAMINING ATTORNEY

Int. Cl.: 9

Prior U.S. Cls.: 21, 23, 26, 36 and 38

United States Patent and Trademark Office

Reg. No. 3,398,265

Registered Mar. 18, 2008

**TRADEMARK
PRINCIPAL REGISTER**

ACS SCIENCE ELEMENTS

AMERICAN CHEMICAL SOCIETY (DELAWARE
CORPORATION)
1155 SIXTEENTH ST., NW
WASHINGTON, DC 20036

FOR: DOWNLOADABLE PODCASTS IN THE
FIELD OF SCIENCE, IN CLASS 9 (U.S. CLS. 21, 23,
26, 36 AND 38).

FIRST USE 5-2-2007; IN COMMERCE 5-2-2007.

THE MARK CONSISTS OF STANDARD CHAR-
ACTERS WITHOUT CLAIM TO ANY PARTICULAR
FONT, STYLE, SIZE, OR COLOR.

NO CLAIM IS MADE TO THE EXCLUSIVE
RIGHT TO USE "SCIENCE ELEMENTS", APART
FROM THE MARK AS SHOWN.

SER. NO. 77-243,067, FILED 7-31-2007.

TIMOTHY FINNEGAN, EXAMINING ATTORNEY

Int. Cl.: 31

Prior U.S. Cls.: 1 and 46

United States Patent and Trademark Office

Reg. No. 3,398,266

Registered Mar. 18, 2008

**TRADEMARK
PRINCIPAL REGISTER**



DEVONE LAWSON, INCORPORATED (CALI-
FORNIA CORPORATION)
13428 MAXELLA AVENUE
NUMBER 507
MARINA DEL REY, CA 90292

FOR: ANIMAL BEVERAGES; BEVERAGES FOR
ANIMALS; PET BEVERAGES; DRINKING WATER
FOR DOGS, IN CLASS 31 (U.S. CLS. 1 AND 46).

FIRST USE 6-1-2006; IN COMMERCE 6-1-2006.

NO CLAIM IS MADE TO THE EXCLUSIVE
RIGHT TO USE "PET H2O", APART FROM THE
MARK AS SHOWN.

THE COLOR(S) BLUE AND WHITE IS/ARE
CLAIMED AS A FEATURE OF THE MARK.

THE MARK CONSISTS OF A LARGE BLUE
WATER BUBBLE THAT CONTAINS THE PHRASE
"PET H2O" WITH AN OVERLAPPING WATER
BUBBLE CONTAINING THE WHITE NUMBER 2;
THE TERM PET IS IN WHITE, AND THE H AND O
IN H2O ARE LIGHT BLUE; AND TWO ADDITION-
AL SEPARATE WATER BUBBLES UNDERNEATH
THE MAIN WATER BUBBLE, ALL OF THE BUB-
BLES RANGE IN SHADE FROM LIGHT TO DARK
BLUE.

SER. NO. 77-243,277, FILED 7-31-2007.

LINDA MICKLEBURGH, EXAMINING ATTORNEY

Int. Cl.: 9

Prior U.S. Cls.: 21, 23, 26, 36 and 38

United States Patent and Trademark Office

Reg. No. 3,398,267

Registered Mar. 18, 2008

**TRADEMARK
PRINCIPAL REGISTER**

E-Hop

PAYES, AARON T (GEORGIA LTD LIAB CO),
DBA LIVE WIRE EMPIRE
116 BRADSHAW PARK DR.
WOODSTOCK, GA 30188 AND
MONICA, STEPHEN M (GEORGIA LTD LIAB CO),
DBA LIVE WIRE EMPIRE
116 BRADSHAW PARK DR.
WOODSTOCK, GA 30188

FOR: DOWNLOADABLE MP3 FILES, MP3 RECORDINGS, ONLINE DISCUSSION BOARDS, WEBCASTS, PODCASTS FEATURING MUSIC, AUDIO BOOKS AND NEWS BROADCASTS; DOWNLOADABLE MUSICAL SOUND RECORDINGS; DOWNLOADABLE RING TONES, GRAPHICS AND MUSIC VIA A GLOBAL COMPUTER NETWORK AND WIRELESS DEVICES; DOWNLOADABLE VIDEO RECORDINGS FEATURING MUSIC; DOWNLOADABLE MUSIC VIA THE INTERNET AND WIRELESS

DEVICES; MUSICAL SOUND RECORDINGS; MUSICAL VIDEO RECORDINGS; SOUND RECORDINGS FEATURING MUSIC; VIDEO RECORDINGS FEATURING MUSIC; VISUAL RECORDINGS AND AUDIO VISUAL RECORDINGS FEATURING MUSIC AND ANIMATION, IN CLASS 9 (U.S. CLS. 21, 23, 26, 36 AND 38).

FIRST USE 6-1-2004; IN COMMERCE 6-1-2004.

THE MARK CONSISTS OF STANDARD CHARACTERS WITHOUT CLAIM TO ANY PARTICULAR FONT, STYLE, SIZE, OR COLOR.

SER. NO. 77-243,806, FILED 8-1-2007.

WARREN L. OLANDRIA, EXAMINING ATTORNEY

Int. Cl.: 43

Prior U.S. Cls.: 100 and 101

United States Patent and Trademark Office

Reg. No. 3,398,268

Registered Mar. 18, 2008

**SERVICE MARK
PRINCIPAL REGISTER**

LUCA PIZZA DI ROMA

PIZZA DI ROMA INTERNATIONAL, INC. (IN-
DIANA CORPORATION)
8809 SOUTH MERIDIAN STREET
INDIANAPOLIS, IN 46217

FOR: RESTAURANT SERVICES, IN CLASS 43
(U.S. CLS. 100 AND 101).

FIRST USE 10-0-1998; IN COMMERCE 10-0-1998.

THE MARK CONSISTS OF STANDARD CHAR-
ACTERS WITHOUT CLAIM TO ANY PARTICULAR
FONT, STYLE, SIZE, OR COLOR.

OWNER OF U.S. REG. NO. 3,249,643.

NO CLAIM IS MADE TO THE EXCLUSIVE
RIGHT TO USE "PIZZA DI ROMA", APART FROM
THE MARK AS SHOWN.

THE ENGLISH TRANSLATION OF THE WORD
DI ROMA IN THE MARK IS OF OR FROM ROME.

SER. NO. 77-244,022, FILED 8-1-2007.

LOURDES AYALA, EXAMINING ATTORNEY

Int. Cl.: 3

Prior U.S. Cls.: 1, 4, 6, 50, 51 and 52

United States Patent and Trademark Office

Reg. No. 3,398,269

Registered Mar. 18, 2008

**TRADEMARK
PRINCIPAL REGISTER**

Guinefyr's Tryst

BLOOMWORKS SOAP COMPANY, LC (VIRGINIA LTD LIAB CO)
117 MARCY DRIVE
YORKTOWN, VA 23693

FOR: PERSONAL CARE PRODUCTS, NAMELY, BAR SOAPS, SOAP FOR THE FACE, SOAP FOR THE HANDS, BODY SCRUBS, BUBBLE BATH, BODY WASH, BODY LOTIONS, BODY BUTTER, CREAM FOR THE BODY, BODY SPRAY, BODY SPLASH, COLOGNE, PERFUMES, FRAGRANCED BODY MIST, ESSENTIAL OILS FOR PERSONAL USE, HAIR CONDITIONER, HAIR SHAMPOO, HOUSEHOLD FRAGRANCES FOR PERSONAL USE AND

HOUSEHOLD FRAGRANCES FOR ROOM USE, IN CLASS 3 (U.S. CLS. 1, 4, 6, 50, 51 AND 52).

FIRST USE 3-15-2005; IN COMMERCE 3-15-2005.

THE MARK CONSISTS OF STANDARD CHARACTERS WITHOUT CLAIM TO ANY PARTICULAR FONT, STYLE, SIZE, OR COLOR.

SER. NO. 77-244,299, FILED 8-1-2007.

DAVID MURRAY, EXAMINING ATTORNEY

Int. Cl.: 3

Prior U.S. Cls.: 1, 4, 6, 50, 51 and 52

United States Patent and Trademark Office

Reg. No. 3,398,270

Registered Mar. 18, 2008

**TRADEMARK
PRINCIPAL REGISTER**

Cadeberry Moss

BLOOMWORKS SOAP COMPANY, LC (VIRGINIA LTD LIAB CO)
117 MARCY DRIVE
YORKTOWN, VA 23693

FOR: PERSONAL CARE PRODUCTS, NAMELY, BAR SOAPS, SOAP FOR THE FACE, SOAP FOR THE HANDS, BODY SCRUBS, BUBBLE BATH, BODY WASH, BODY LOTIONS, BODY BUTTER, CREAM FOR THE BODY, BODY SPRAY, BODY SPLASH, COLOGNE, PERFUMES, FRAGRANCED BODY MIST, ESSENTIAL OILS FOR PERSONAL USE, HAIR CONDITIONER, HAIR SHAMPOO, HOUSEHOLD FRAGRANCES FOR PERSONAL USE AND

HOUSEHOLD FRAGRANCES FOR ROOM USE, IN CLASS 3 (U.S. CLS. 1, 4, 6, 50, 51 AND 52).

FIRST USE 2-4-2005; IN COMMERCE 2-4-2005.

THE MARK CONSISTS OF STANDARD CHARACTERS WITHOUT CLAIM TO ANY PARTICULAR FONT, STYLE, SIZE, OR COLOR.

SER. NO. 77-244,314, FILED 8-1-2007.

DAVID MURRAY, EXAMINING ATTORNEY

Int. Cl.: 45

Prior U.S. Cls.: 100 and 101

United States Patent and Trademark Office

Reg. No. 3,398,271

Registered Mar. 18, 2008

**SERVICE MARK
PRINCIPAL REGISTER**



COLORADO STATE PATROL (COLORADO
STATE AGENCY)
700 KIPLING STREET
SUITE 3000
DENVER, CO 80215

FOR: POLICE AND CIVIL PROTECTION SERVICES, IN CLASS 45 (U.S. CLS. 100 AND 101).

FIRST USE 5-1-1999; IN COMMERCE 5-1-1999.

NO CLAIM IS MADE TO THE EXCLUSIVE RIGHT TO USE "STATE PATROL", APART FROM THE MARK AS SHOWN.

THE MARK CONSISTS OF A SHIELD SHAPED DESIGN WITH THE WORD "COLORADO" AT THE TOP, "STATE PATROL" AT THE BOTTOM AND IN THE MIDDLE OF THE SHIELD ARE MOUNTAINS, WINGS AND A SPOKED MOTORCYCLE WHEEL WITH TREAD DETAIL AND THE WORDS "STATE PATROL" AND "COLORADO" CONTAINED WITHIN BANNERS.

SEC. 2(F) "COLORADO".

SER. NO. 77-244,464, FILED 8-1-2007.

TRICIA SONNEBORN, EXAMINING ATTORNEY

Int. Cl.: 3

Prior U.S. Cls.: 1, 4, 6, 50, 51 and 52

United States Patent and Trademark Office

Reg. No. 3,398,272

Registered Mar. 18, 2008

**TRADEMARK
PRINCIPAL REGISTER**

MIDNIGHT

R. EXPO (USA) LTD., INC. (WASHINGTON COR-
PORATION)
1112 S. 344TH ST. #309
FEDERAL WAY, WA 98033

THE MARK CONSISTS OF STANDARD CHAR-
ACTERS WITHOUT CLAIM TO ANY PARTICULAR
FONT, STYLE, SIZE, OR COLOR.

FOR: INCENSE, IN CLASS 3 (U.S. CLS. 1, 4, 6, 50, 51
AND 52).

SER. NO. 77-244,754, FILED 8-1-2007.

FIRST USE 3-2-2007; IN COMMERCE 3-2-2007.

ROBIN CHOSID, EXAMINING ATTORNEY

Int. Cl.: 8

Prior U.S. Cls.: 23, 28 and 44

United States Patent and Trademark Office

Reg. No. 3,398,273

Registered Mar. 18, 2008

**TRADEMARK
PRINCIPAL REGISTER**

**THE RIGHT TOOL FOR YOUR
GOATEE**

WAHL CLIPPER CORPORATION (ILLINOIS
CORPORATION)
2900 N. LOCUST ST.
STERLING, IL 610810578

THE MARK CONSISTS OF STANDARD CHAR-
ACTERS WITHOUT CLAIM TO ANY PARTICULAR
FONT, STYLE, SIZE, OR COLOR.

FOR: ELECTRIC HAIR TRIMMERS, IN CLASS 8
(U.S. CLS. 23, 28 AND 44).

SER. NO. 77-245,174, FILED 8-2-2007.

FIRST USE 6-0-2006; IN COMMERCE 6-0-2006.

CHARISMA HAMPTON, EXAMINING ATTORNEY

Int. Cl.: 8

Prior U.S. Cls.: 23, 28 and 44

United States Patent and Trademark Office

Reg. No. 3,398,274

Registered Mar. 18, 2008

**TRADEMARK
PRINCIPAL REGISTER**

**THE RIGHT TOOL FOR YOUR
MUSTACHE**

WAHL CLIPPER CORPORATION (ILLINOIS
CORPORATION)
2900 N. LOCUST ST.
STERLING, IL 610810578

THE MARK CONSISTS OF STANDARD CHAR-
ACTERS WITHOUT CLAIM TO ANY PARTICULAR
FONT, STYLE, SIZE, OR COLOR.

FOR: ELECTRIC HAIR TRIMMERS, IN CLASS 8
(U.S. CLS. 23, 28 AND 44).

SER. NO. 77-245,201, FILED 8-2-2007.

FIRST USE 7-0-2006; IN COMMERCE 7-0-2006.

CHARISMA HAMPTON, EXAMINING ATTORNEY

Int. Cl.: 42

Prior U.S. Cls.: 100 and 101

United States Patent and Trademark Office

Reg. No. 3,398,275

Registered Mar. 18, 2008

**SERVICE MARK
PRINCIPAL REGISTER**

FREEWHEEL

AUTODESK, INC. (DELAWARE CORPORATION)
111 MCINNIS PARKWAY
SAN RAFAEL, CA 94903

FOR: COMPUTER SERVICES, NAMELY, HOST-
ING AND MAINTAINING AN ONLINE WEBSITE
FOR OTHERS TO VIEW AND SHARE 2D AND 3D
DESIGNS AND IMAGES, IN CLASS 42 (U.S. CLS. 100
AND 101).

FIRST USE 7-4-2006; IN COMMERCE 4-10-2007.

THE MARK CONSISTS OF STANDARD CHAR-
ACTERS WITHOUT CLAIM TO ANY PARTICULAR
FONT, STYLE, SIZE, OR COLOR.

SER. NO. 77-245,284, FILED 8-2-2007.

THEODORE MCBRIDE, EXAMINING ATTORNEY

Int. Cl.: 30

Prior U.S. Cl.: 46

United States Patent and Trademark Office

Reg. No. 3,398,276

Registered Mar. 18, 2008

**TRADEMARK
PRINCIPAL REGISTER**

DOLLY

INTERSTATE BAKERIES CORPORATION (DE-
LAWARE CORPORATION)

12 EAST ARMOUR BOULEVARD

KANSAS CITY, MO 64111

FOR: BAKERY GOODS, IN CLASS 30 (U.S. CL. 46).

FIRST USE 8-22-2000; IN COMMERCE 8-22-2000.

THE MARK CONSISTS OF STANDARD CHAR-
ACTERS WITHOUT CLAIM TO ANY PARTICULAR
FONT, STYLE, SIZE, OR COLOR.

OWNER OF U.S. REG. NOS. 375,163, 2,700,741 AND
OTHERS.

SER. NO. 77-245,657, FILED 8-2-2007.

STEPHANIE ALI, EXAMINING ATTORNEY

Int. Cl.: 5

Prior U.S. Cls.: 6, 18, 44, 46, 51 and 52

United States Patent and Trademark Office

Reg. No. 3,398,277

Registered Mar. 18, 2008

**TRADEMARK
PRINCIPAL REGISTER**

SmartFlex

SMARTPAK EQUINE, LLC. (DELAWARE LTD
LIAB CO)
SUITE 500
40 GRISSOM ROAD
PLYMOUTH, MA 02360

THE MARK CONSISTS OF STANDARD CHAR-
ACTERS WITHOUT CLAIM TO ANY PARTICULAR
FONT, STYLE, SIZE, OR COLOR.

FOR: FEED SUPPLEMENTS FOR HORSES, IN
CLASS 5 (U.S. CLS. 6, 18, 44, 46, 51 AND 52).

SER. NO. 77-245,674, FILED 8-2-2007.

FIRST USE 10-0-2005; IN COMMERCE 12-0-2006.

ANDREW RHIM, EXAMINING ATTORNEY

Int. Cl.: 30

Prior U.S. Cl.: 46

United States Patent and Trademark Office

Reg. No. 3,398,278

Registered Mar. 18, 2008

**TRADEMARK
PRINCIPAL REGISTER**

**GIVE 'EM WHAT THEY LOVE...
WONDER!**

INTERSTATE BAKERIES CORPORATION (DE-
LAWARE CORPORATION)

12 EAST ARMOUR BOULEVARD

KANSAS CITY, MO 64111

FOR: BAKERY GOODS, IN CLASS 30 (U.S. CL. 46).

FIRST USE 1-0-2006; IN COMMERCE 1-0-2006.

THE MARK CONSISTS OF STANDARD CHAR-
ACTERS WITHOUT CLAIM TO ANY PARTICULAR
FONT, STYLE, SIZE, OR COLOR.

OWNER OF U.S. REG. NOS. 215,188, 776,291 AND
OTHERS.

SER. NO. 77-245,840, FILED 8-2-2007.

STEPHANIE ALI, EXAMINING ATTORNEY

Int. Cl.: 35

Prior U.S. Cls.: 100, 101 and 102

United States Patent and Trademark Office

Reg. No. 3,398,279

Registered Mar. 18, 2008

**SERVICE MARK
PRINCIPAL REGISTER**



1 SPORT LLC (FLORIDA LTD LIAB CO)
1670 BAY ROAD N 6-B
MIAMI BEACH, FL 33139

NO CLAIM IS MADE TO THE EXCLUSIVE
RIGHT TO USE "ATHLETES", APART FROM THE
MARK AS SHOWN.

FOR: ONLINE ADVERTISING ON A COMPUTER
NETWORK; MANAGEMENT OF COMPUTERIZED
FILES; RENTAL OF ADVERTISING SPACE, IN
CLASS 35 (U.S. CLS. 100, 101 AND 102).

SER. NO. 77-246,412, FILED 8-3-2007.

FIRST USE 7-24-2006; IN COMMERCE 7-24-2006.

TASNEEM HUSSAIN, EXAMINING ATTORNEY

Int. Cl.: 6

Prior U.S. Cls.: 2, 12, 13, 14, 23, 25 and 50

Reg. No. 3,398,280

United States Patent and Trademark Office

Registered Mar. 18, 2008

**TRADEMARK
PRINCIPAL REGISTER**

QWEST

QWEST COMMUNICATIONS INTERNATIONAL
INC. (DELAWARE CORPORATION)
1801 CALIFORNIA STREET
DENVER, CO 80202

FOR: METAL LOCKS FOR LUGGAGE; METAL
KEY CHAINS, IN CLASS 6 (U.S. CLS. 2, 12, 13, 14, 23,
25 AND 50).

FIRST USE 10-31-2000; IN COMMERCE 10-31-2000.

THE MARK CONSISTS OF STANDARD CHAR-
ACTERS WITHOUT CLAIM TO ANY PARTICULAR
FONT, STYLE, SIZE, OR COLOR.

OWNER OF U.S. REG. NO. 3,109,003.

SER. NO. 77-246,747, FILED 8-3-2007.

TRACY WHITTAKER-BROWN, EXAMINING AT-
TORNEY

Int. Cl.: 25

Prior U.S. Cls.: 22 and 39

United States Patent and Trademark Office

Reg. No. 3,398,281

Registered Mar. 18, 2008

**TRADEMARK
PRINCIPAL REGISTER**

EZYWALKER

ARORA GULSHAN (INDIA INDIVIDUAL)
2117 SW 151ST PLACE
MIAMI, FL 33185 AND
ARORA RAJINDER (INDIA INDIVIDUAL)
2117 SW 151ST PLACE
MIAMI, FL 33185

FOR: ATHLETIC FOOTWEAR; BEACH FOOTWEAR; FLIP FLOPS; FOOTWEAR; FOOTWEAR; FOOTWEAR FOR MEN; FOOTWEAR FOR MEN AND WOMEN; FOOTWEAR FOR TRACK AND FIELD ATHLETICS; FOOTWEAR FOR WOMEN; FOOTWEAR MADE OF WOOD; FOOTWEAR NOT FOR SPORTS; FOOTWEAR, NAMELY, PUMPS; FOOTWEAR, NAMELY, RUBBERS; JAPANESE

FOOTWEAR OF RICE STRAW (WARAJI); JAPANESE SPLIT-TOED WORK FOOTWEAR (JIKATABI), IN CLASS 25 (U.S. CLS. 22 AND 39).

FIRST USE 3-3-1987; IN COMMERCE 3-3-1987.

THE MARK CONSISTS OF STANDARD CHARACTERS WITHOUT CLAIM TO ANY PARTICULAR FONT, STYLE, SIZE, OR COLOR.

SER. NO. 77-247,377, FILED 8-5-2007.

NORA BUCHANAN WILL, EXAMINING ATTORNEY

Int. Cl.: 9

Prior U.S. Cls.: 21, 23, 26, 36 and 38

United States Patent and Trademark Office

Reg. No. 3,398,282

Registered Mar. 18, 2008

**TRADEMARK
PRINCIPAL REGISTER**



Projects In Knowledge

Medical Education Activities for Clinicians Since 1980

PROJECTS IN KNOWLEDGE, INC. (NEW YORK CORPORATION)
10TH FLOOR
150 CLOVE ROAD
LITTLE FALLS, NJ 07424

FOR: PROVIDING DOWNLOADABLE ELECTRONIC NEWSLETTERS IN THE FIELD OF MEDICINE; DOWNLOADABLE PODCASTS IN THE FIELD OF MEDICINE; DOWNLOADABLE WEBCASTS IN THE FIELD OF MEDICINE, IN CLASS 9 (U.S. CLS. 21, 23, 26, 36 AND 38).

FIRST USE 5-0-2003; IN COMMERCE 5-0-2003.

NO CLAIM IS MADE TO THE EXCLUSIVE RIGHT TO USE "MEDICAL EDUCATION ACTIV-

ITIES FOR CLINICIANS SINCE 1980", APART FROM THE MARK AS SHOWN.

THE COLOR(S) RED AND BLACK IS/ARE CLAIMED AS A FEATURE OF THE MARK.

THE MARK CONSISTS OF A TREE IN RED PARTIALLY SURROUNDED BY A BLACK BORDER. THE WORDING IN THE MARK IS IN THE COLOR BLACK.

SER. NO. 77-247,755, FILED 8-6-2007.

CYNTHIA SLOAN, EXAMINING ATTORNEY

Int. Cl.: 8

Prior U.S. Cls.: 23, 28 and 44

United States Patent and Trademark Office

Reg. No. 3,398,283

Registered Mar. 18, 2008

**TRADEMARK
PRINCIPAL REGISTER**

**THE RIGHT TOOL FOR YOUR
BEARD**

WAHL CLIPPER CORPORATION (ILLINOIS
CORPORATION)
2900 N. LOCUST STREET
STERLING, IL 610810578

THE MARK CONSISTS OF STANDARD CHAR-
ACTERS WITHOUT CLAIM TO ANY PARTICULAR
FONT, STYLE, SIZE, OR COLOR.

FOR: ELECTRIC HAIR TRIMMERS, IN CLASS 8
(U.S. CLS. 23, 28 AND 44).

SER. NO. 77-247,761, FILED 8-6-2007.

FIRST USE 6-0-2006; IN COMMERCE 6-0-2006.

CHARISMA HAMPTON, EXAMINING ATTORNEY

Int. Cl.: 44

Prior U.S. Cls.: 100 and 101

United States Patent and Trademark Office

Reg. No. 3,398,284

Registered Mar. 18, 2008

**SERVICE MARK
PRINCIPAL REGISTER**



ORGANIC LAWNS (SOUTH CAROLINA LTD
LIAB CO)
340 SAND PAVER WAY
FORT MILL, SC 29708

FOR: ORGANIC LAWN CARE SERVICES, IN
CLASS 44 (U.S. CLS. 100 AND 101).

FIRST USE 1-1-2007; IN COMMERCE 1-1-2007.

NO CLAIM IS MADE TO THE EXCLUSIVE
RIGHT TO USE "ORGANIC LAWNS" , APART
FROM THE MARK AS SHOWN.

THE MARK CONSISTS, IN PART, OF WAVY
LINES WITH GRASS BLADES EXTENDING INTO
THE TOP OF THE BACKGROUND

SER. NO. 77-248,001, FILED 8-6-2007.

EDWARD NELSON, EXAMINING ATTORNEY

Int. Cl.: 43

Prior U.S. Cls.: 100 and 101

United States Patent and Trademark Office

Reg. No. 3,398,285

Registered Mar. 18, 2008

**SERVICE MARK
PRINCIPAL REGISTER**



VALIANT GROUP, INC. (CALIFORNIA CORPORATION)
133 E. DE LA GUERRA, #G
SANTA BARBARA, CA 93101

FOR: RESTAURANT SERVICES AND CARRY OUT FOOD SERVICES, IN CLASS 43 (U.S. CLS. 100 AND 101).

FIRST USE 2-14-2007; IN COMMERCE 2-14-2007.

THE MARK CONSISTS OF A CADUCEUS.

SER. NO. 77-248,513, FILED 8-6-2007.

LINDA M. KING, EXAMINING ATTORNEY

Int. Cl.: 36

Prior U.S. Cls.: 100, 101 and 102

United States Patent and Trademark Office

Reg. No. 3,398,286

Registered Mar. 18, 2008

**SERVICE MARK
PRINCIPAL REGISTER**

FIRST CITIZENS DIRECT

FIRST CITIZENS BANCSHARES, INC. (DELA-
WARE CORPORATION)
4300 SIX FORKS ROAD
RALEIGH, NC 27609

FOR: BANKING SERVICES FEATURING BANK-
ING TRANSACTIONS VIA TELEPHONE, INTER-
NET AND AUTOMATED TELLER MACHINES, IN
CLASS 36 (U.S. CLS. 100, 101 AND 102).

FIRST USE 5-1-1996; IN COMMERCE 5-1-1996.

THE MARK CONSISTS OF STANDARD CHAR-
ACTERS WITHOUT CLAIM TO ANY PARTICULAR
FONT, STYLE, SIZE, OR COLOR.

OWNER OF U.S. REG. NOS. 1,728,084, 2,321,270
AND OTHERS.

SER. NO. 77-248,867, FILED 8-7-2007.

MATTHEW MCDOWELL, EXAMINING ATTOR-
NEY

Int. Cl.: 45

Prior U.S. Cls.: 100 and 101

United States Patent and Trademark Office

Reg. No. 3,398,287

Registered Mar. 18, 2008

**SERVICE MARK
PRINCIPAL REGISTER**

BEHIND THE BEAN

LYMABEAN, LLC (CALIFORNIA LTD LIAB CO)
5462 OCEANUS DRIVE, SUITE G
HUNTINGTON BEACH, CA 92649

FOR: ONLINE SOCIAL NETWORKING SERVICES, IN CLASS 45 (U.S. CLS. 100 AND 101).

FIRST USE 6-1-2007; IN COMMERCE 8-5-2007.

THE MARK CONSISTS OF STANDARD CHARACTERS WITHOUT CLAIM TO ANY PARTICULAR FONT, STYLE, SIZE, OR COLOR.

SER. NO. 77-249,152, FILED 8-7-2007.

GEORGE LORENZO, EXAMINING ATTORNEY

Int. Cl.: 41

Prior U.S. Cls.: 100, 101 and 107

United States Patent and Trademark Office

Reg. No. 3,398,288

Registered Mar. 18, 2008

**SERVICE MARK
PRINCIPAL REGISTER**

Down East

DOWN EAST ENTERPRISE, INC. (MAINE CORPORATION)
PO BOX 679
CAMDEN, ME 04843

FOR: PUBLISHING OF BOOKS, MAGAZINES;
PUBLISHING OF WEB MAGAZINES, IN CLASS 41
(U.S. CLS. 100, 101 AND 107).

FIRST USE 7-31-1954; IN COMMERCE 7-31-1954.

OWNER OF U.S. REG. NO. 2,496,426.

THE MARK CONSISTS OF THE SYLIZED
WORDS DOWN EAST..

SEC. 2(F).

SER. NO. 77-249,700, FILED 8-8-2007.

ELLEN PERKINS, EXAMINING ATTORNEY

Int. Cl.: 5

Prior U.S. Cls.: 6, 18, 44, 46, 51 and 52

United States Patent and Trademark Office

Reg. No. 3,398,289

Registered Mar. 18, 2008

**TRADEMARK
PRINCIPAL REGISTER**

STICK TOGETHER

T-MOBILE USA, INC. (DELAWARE CORPORATION)
12920 S.E. 38TH STREET
BELLEVUE, WA 98006

THE MARK CONSISTS OF STANDARD CHARACTERS WITHOUT CLAIM TO ANY PARTICULAR FONT, STYLE, SIZE, OR COLOR.

FOR: FIRST AID KITS; ANTIBACTERIAL SANITIZER SPRAY, IN CLASS 5 (U.S. CLS. 6, 18, 44, 46, 51 AND 52).

SER. NO. 77-249,917, FILED 8-8-2007.

FIRST USE 9-20-2006; IN COMMERCE 9-20-2006.

CORY BOONE, EXAMINING ATTORNEY

Int. Cl.: 35

Prior U.S. Cls.: 100, 101 and 102

United States Patent and Trademark Office

Reg. No. 3,398,290

Registered Mar. 18, 2008

**SERVICE MARK
PRINCIPAL REGISTER**

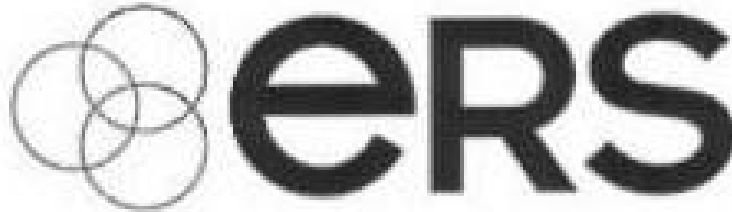

ENVIRONMENTAL RESOURCE SERVICES, INC.
(GEORGIA CORPORATION)
SUITE D
2320 VIRGINIA PLACE N.E.
ATLANTA, GA 303054237

FIRST USE 10-9-2006; IN COMMERCE 10-9-2006.

THE MARK CONSISTS OF THREE INTERSECTING CIRCLES.

FOR: CONSULTING SERVICES IN THE FIELD OF SOCIALLY RESPONSIBLE BUSINESS PRACTICES; BUSINESS CONSULTING, MANAGEMENT AND PLANNING , IN CLASS 35 (U.S. CLS. 100, 101 AND 102).

SER. NO. 77-250,152, FILED 8-8-2007.

JESSICA FATHY, EXAMINING ATTORNEY

Int. Cl.: 35

Prior U.S. Cls.: 100, 101 and 102

United States Patent and Trademark Office

Reg. No. 3,398,291

Registered Mar. 18, 2008

**SERVICE MARK
PRINCIPAL REGISTER**



USHORSE.BIZ, INC. (NEVADA CORPORATION)
1030 HILLCROFT ROAD
GLENDALE, CA 91207

FOR: BUSINESS SERVICES, NAMELY, PROVIDING COMPUTER DATABASES REGARDING THE PURCHASE AND SALE OF A WIDE VARIETY OF PRODUCTS AND SERVICES OF OTHERS, IN CLASS 35 (U.S. CLS. 100, 101 AND 102).

FIRST USE 10-1-2006; IN COMMERCE 8-8-2007.

NO CLAIM IS MADE TO THE EXCLUSIVE RIGHT TO USE "USHORSE.BIZ", APART FROM THE MARK AS SHOWN.

THE COLOR(S) BROWN, GREEN, GRAY, BLACK, WHITE EGG WHITE AND DIFFERENT SHADES OF YELLOW IS/ARE CLAIMED AS A FEATURE OF THE MARK.

THE MARK CONSISTS OF THE WORDS USHORSE.BIZ WITH "US" AND "BIZ" IN WHITE AND "HORSE." IN BLACK AND A RECTANGULAR BACKGROUND FIELD IN DIFFERENT SHADES OF YELLOW AND BROWN WITH ROAMING HORSES IN BROWN, GREEN, GRAY AND EGG WHITE.

SER. NO. 77-250,281, FILED 8-8-2007.

RAUL CORDOVA, EXAMINING ATTORNEY

Int. Cl.: 28

Prior U.S. Cls.: 22, 23, 38 and 50

United States Patent and Trademark Office

Reg. No. 3,398,292

Registered Mar. 18, 2008

**TRADEMARK
PRINCIPAL REGISTER**

STICK TOGETHER

T-MOBILE USA, INC. (DELAWARE CORPORATION)
12920 S.E. 38TH STREET
BELLEVUE, WA 98006

FOR: BALLOONS; FLYING DISCS; GOLF BALLS;
INFLATABLE TOYS, NAMELY INFLATABLE
NOISE STICKS, IN CLASS 28 (U.S. CLS. 22, 23, 38
AND 50).

FIRST USE 9-20-2006; IN COMMERCE 9-20-2006.

THE MARK CONSISTS OF STANDARD CHARACTERS WITHOUT CLAIM TO ANY PARTICULAR FONT, STYLE, SIZE, OR COLOR.

SER. NO. 77-250,320, FILED 8-8-2007.

CORY BOONE, EXAMINING ATTORNEY

Int. Cl.: 30

Prior U.S. Cl.: 46

United States Patent and Trademark Office

Reg. No. 3,398,293

Registered Mar. 18, 2008

**TRADEMARK
PRINCIPAL REGISTER**

STICK TOGETHER

T-MOBILE USA, INC. (DELAWARE CORPORATION)
12920 S.E. 38TH STREET
BELLEVUE, WA 98006

THE MARK CONSISTS OF STANDARD CHARACTERS WITHOUT CLAIM TO ANY PARTICULAR FONT, STYLE, SIZE, OR COLOR.

FOR: CANDY, CHEWING GUM, CANDY MINTS, POPCORN, IN CLASS 30 (U.S. CL. 46).

SER. NO. 77-250,354, FILED 8-8-2007.

FIRST USE 9-20-2006; IN COMMERCE 9-20-2006.

CORY BOONE, EXAMINING ATTORNEY

Int. Cl.: 11

Prior U.S. Cls.: 13, 21, 23, 31 and 34

United States Patent and Trademark Office

Reg. No. 3,398,294

Registered Mar. 18, 2008

**TRADEMARK
PRINCIPAL REGISTER**

STICK TOGETHER

T-MOBILE USA, INC. (DELAWARE CORPORATION)
12920 S.E. 38TH STREET
BELLEVUE, WA 98006

THE MARK CONSISTS OF STANDARD CHARACTERS WITHOUT CLAIM TO ANY PARTICULAR FONT, STYLE, SIZE, OR COLOR.

FOR: FLASHLIGHTS, IN CLASS 11 (U.S. CLS. 13, 21, 23, 31 AND 34).

SER. NO. 77-250,373, FILED 8-8-2007.

FIRST USE 9-20-2006; IN COMMERCE 9-20-2006.

CORY BOONE, EXAMINING ATTORNEY

Int. Cl.: 25

Prior U.S. Cls.: 22 and 39

United States Patent and Trademark Office

Reg. No. 3,398,295

Registered Mar. 18, 2008

**TRADEMARK
PRINCIPAL REGISTER**

STICK TOGETHER

T-MOBILE USA, INC. (DELAWARE CORPORATION)
12920 S.E. 38TH STREET
BELLEVUE, WA 98006

FOR: APRONS, SHIRTS, DRESS SHIRTS, POLO SHIRTS, T-SHIRTS, BLOUSES, SWEAT SHIRTS, VESTS, JACKETS, IN CLASS 25 (U.S. CLS. 22 AND 39).

FIRST USE 9-20-2006; IN COMMERCE 9-20-2006.

THE MARK CONSISTS OF STANDARD CHARACTERS WITHOUT CLAIM TO ANY PARTICULAR FONT, STYLE, SIZE, OR COLOR.

SER. NO. 77-250,419, FILED 8-8-2007.

CORY BOONE, EXAMINING ATTORNEY

Int. Cl.: 6

Prior U.S. Cls.: 2, 12, 13, 14, 23, 25 and 50

United States Patent and Trademark Office

Reg. No. 3,398,296

Registered Mar. 18, 2008

**TRADEMARK
PRINCIPAL REGISTER**

STICK TOGETHER

T-MOBILE USA, INC. (DELAWARE CORPORATION)
12920 S.E. 38TH STREET
BELLEVUE, WA 98006

THE MARK CONSISTS OF STANDARD CHARACTERS WITHOUT CLAIM TO ANY PARTICULAR FONT, STYLE, SIZE, OR COLOR.

FOR: METAL KEY RINGS, IN CLASS 6 (U.S. CLS. 2, 12, 13, 14, 23, 25 AND 50).

SER. NO. 77-250,610, FILED 8-8-2007.

FIRST USE 9-20-2006; IN COMMERCE 9-20-2006.

CORY BOONE, EXAMINING ATTORNEY

Int. Cl.: 35

Prior U.S. Cls.: 100, 101 and 102

United States Patent and Trademark Office

Reg. No. 3,398,297

Registered Mar. 18, 2008

**SERVICE MARK
PRINCIPAL REGISTER**

RADIANCE

BOSA DEVELOPMENT CALIFORNIA II INC.
(CALIFORNIA CORPORATION)
560 FIRST AVENUE
SAN DIEGO, CA 92101

THE MARK CONSISTS OF STANDARD CHAR-
ACTERS WITHOUT CLAIM TO ANY PARTICULAR
FONT, STYLE, SIZE, OR COLOR.

FOR: REAL ESTATE SALES MANAGEMENT, IN
CLASS 35 (U.S. CLS. 100, 101 AND 102).

SER. NO. 77-250,623, FILED 8-8-2007.

FIRST USE 3-31-2007; IN COMMERCE 3-31-2007.

MICHAEL ENGEL, EXAMINING ATTORNEY

Int. Cl.: 9

Prior U.S. Cls.: 21, 23, 26, 36 and 38

Reg. No. 3,398,298

United States Patent and Trademark Office

Registered Mar. 18, 2008

**TRADEMARK
PRINCIPAL REGISTER**



NICHOLSON, HAL L (NEW YORK JOINT VENTURE), AKA KING PAPS
18 ROCKLAND ST
APT 1
HAVERSTRAW, NY 10927 AND
NICHOLSON, STEVIE O. (NEW YORK JOINT VENTURE), AKA STEVIE PRIEST
18 ROCKLAND ST
APT 1
HAVERSTRAW, NY 10927

FOR: AUDIO RECORDINGS FEATURING MUSICAL ARTISTS; DOWNLOADABLE MUSICAL SOUND RECORDINGS; DOWNLOADABLE RING TONES, GRAPHICS AND MUSIC VIA A GLOBAL COMPUTER NETWORK AND WIRELESS DEVICES; DOWNLOADABLE VIDEO RECORDINGS FEATURING MUSICAL ARTISTS; JUKE BOXES; MUSICAL SOUND RECORDINGS; MUSICAL VIDEO RECORDINGS; PROTECTIVE CARRYING CASES FOR PORTABLE MUSIC PLAYERS, NAMELY, MP3 PLAYERS; SOUND RECORDINGS FEATURING

MUSICAL ARTISTS; VIDEO RECORDINGS FEATURING MUSICAL ARTISTS; VISUAL RECORDINGS AND AUDIO VISUAL RECORDINGS FEATURING MUSIC AND ANIMATION, IN CLASS 9 (U.S. CLS. 21, 23, 26, 36 AND 38).

FIRST USE 8-21-2007; IN COMMERCE 8-21-2007.

THE COLOR(S) BLACK, WHITE, RED AND SILVER IS/ARE CLAIMED AS A FEATURE OF THE MARK.

THE MARK CONSISTS OF THE LOS ONES IN RED LETTERING. THE CROSS THAT STANDS FOR THE T IN LOST IS SILVER.

SER. NO. 77-250,703, FILED 8-8-2007.

RICHARD A. STRASER, EXAMINING ATTORNEY

Int. Cl.: 30

Prior U.S. Cl.: 46

United States Patent and Trademark Office

Reg. No. 3,398,299

Registered Mar. 18, 2008

**TRADEMARK
PRINCIPAL REGISTER**

FLATTBOY

ROR COMPANY, LLC (CONNECTICUT LTD
LIAB CO)
19 MAIN STREET
NEWTOWN, CT 06470

THE MARK CONSISTS OF STANDARD CHAR-
ACTERS WITHOUT CLAIM TO ANY PARTICULAR
FONT, STYLE, SIZE, OR COLOR.

FOR: SANDWICHES, IN CLASS 30 (U.S. CL. 46).

SER. NO. 77-251,154, FILED 8-9-2007.

FIRST USE 2-0-2003; IN COMMERCE 2-0-2003.

KAREN SEVERSON, EXAMINING ATTORNEY

Int. Cl.: 41

Prior U.S. Cls.: 100, 101 and 107

United States Patent and Trademark Office

Reg. No. 3,398,300

Registered Mar. 18, 2008

**SERVICE MARK
PRINCIPAL REGISTER**

MACON'S HOME PAGE

MCCLATCHY U.S.A., INC. (DELAWARE CORPORATION)
2100 Q STREET
SACRAMENTO, CA 95816

FOR: COMPUTER SERVICES, NAMELY, PROVIDING AN ON-LINE NEWSPAPER FEATURING A WIDE VARIETY OF CURRENT NEWS AND INFORMATION, IN CLASS 41 (U.S. CLS. 100, 101 AND 107).

FIRST USE 6-0-2000; IN COMMERCE 6-0-2000.

THE MARK CONSISTS OF STANDARD CHARACTERS WITHOUT CLAIM TO ANY PARTICULAR FONT, STYLE, SIZE, OR COLOR.

OWNER OF U.S. REG. NO. 2,596,231.

NO CLAIM IS MADE TO THE EXCLUSIVE RIGHT TO USE "HOME PAGE", APART FROM THE MARK AS SHOWN.

SEC. 2(F).

SER. NO. 77-251,523, FILED 8-9-2007.

DEZMONA MIZELLE, EXAMINING ATTORNEY

Int. Cl.: 41

Prior U.S. Cls.: 100, 101 and 107

United States Patent and Trademark Office

Reg. No. 3,398,301

Registered Mar. 18, 2008

**SERVICE MARK
PRINCIPAL REGISTER**

Salsamore

LE, VIET N. (UNITED STATES INDIVIDUAL),
DBA SALSAMORE
5512 MAKATI CIR.
SAN JOSE, CA 951236231

THE MARK CONSISTS OF STANDARD CHAR-
ACTERS WITHOUT CLAIM TO ANY PARTICULAR
FONT, STYLE, SIZE, OR COLOR.

FOR: DANCE INSTRUCTION, IN CLASS 41 (U.S.
CLS. 100, 101 AND 107).

SER. NO. 77-251,530, FILED 8-9-2007.

FIRST USE 12-30-2003; IN COMMERCE 8-4-2007.

LAURA KOVALSKY, EXAMINING ATTORNEY

Int. Cls.: 25 and 30

Prior U.S. Cls.: 22, 39 and 46

United States Patent and Trademark Office

Reg. No. 3,398,302

Registered Mar. 18, 2008

TRADEMARK
PRINCIPAL REGISTER



CONDIMENTMAN, LLC (NEW JERSEY LTD
LIAB CO)
47 HILLSIDE TERRACE
SKILLMAN, NJ 08558

FOR: CLOTHING, NAMELY, HATS, TEE SHIRTS,
SWEATSHIRTS, SWEATPANTS, SHORTS AND
APRONS, IN CLASS 25 (U.S. CLS. 22 AND 39).

FIRST USE 8-6-2007; IN COMMERCE 8-6-2007.

FOR: BARBECUE SAUCE, CHILI SAUCE, HOT
SAUCE, SAUCES, SAUCES FOR BARBECUED

MEAT, KETCHUP, MUSTARD, RELISH, MARI-
NADES, SALSA, SPICES, IN CLASS 30 (U.S. CL. 46).

FIRST USE 5-8-2007; IN COMMERCE 5-8-2007.

THE MARK CONSISTS OF A STYLIZED REPRESENTATION OF THE BUST OF THE HEAD OF A MALE CHARACTER WEARING A NECKLACE CONTAINING THE LETTERS CM.

SER. NO. 77-251,829, FILED 8-9-2007.

LINDA E. BLOHM, EXAMINING ATTORNEY

Int. Cl.: 29

Prior U.S. Cl.: 46

United States Patent and Trademark Office

Reg. No. 3,398,303

Registered Mar. 18, 2008

TRADEMARK
PRINCIPAL REGISTER



LUIS G. BONOMI Y CÍA. S.A. (URUGUAY CORPORATION)
AV. SAN MARTÍN 4751
MONTEVIDEO, URUGUAY

FOR: SOUPS, IN CLASS 29 (U.S. CL. 46).

FIRST USE 12-31-1870; IN COMMERCE 7-31-2007.

OWNER OF U.S. REG. NO. 2,870,227.

NO CLAIM IS MADE TO THE EXCLUSIVE RIGHT TO USE "1876", APART FROM THE MARK AS SHOWN.

THE COLOR(S) GREEN, BEIGE, WHITE, RED AND BROWN IS/ARE CLAIMED AS A FEATURE OF THE MARK.

THE MARK CONSISTS OF A RED HORIZONTALLY POSITIONED RECTANGLE WITH A SEMI

CIRCLE EXTENDING UPWARDS FROM THE CENTER OF ITS UPPER SIDE COVERED WITH BROWN SPOTS. INSIDE IT BUT CLOSE TO THE EDGES THERE IS A BEIGE BORDER THAT FOLLOWS AND FORMS THE SAME SHAPE. INSIDE THE SEMICIRCLE AREA APPEARS THE NUMBER 1876 AND THE DRAWING OF A BEIGE AND GREEN BOWL. ON EITHER SIDE OF THE BASE OF THE BOWL APPEAR BEIGE HORIZONTAL LINES. BELOW THE HORIZONTAL LINES AND THE BOWL APPEAR THE WORDS MONTE CUDINE IN STYLIZED BEIGE LETTERS.

THE FOREIGN WORDING IN THE MARK TRANSLATES INTO ENGLISH AS MOUNTAIN.

SER. NO. 77-251,928, FILED 8-10-2007.

NATALIE POLZER, EXAMINING ATTORNEY

Int. Cl.: 25

Prior U.S. Cls.: 22 and 39

United States Patent and Trademark Office

Reg. No. 3,398,304

Registered Mar. 18, 2008

**TRADEMARK
PRINCIPAL REGISTER**



YACABUCCI, ANTHONY (UNITED STATES IN-
DIVIDUAL)
4 PINE BROOK LOOP
HOPEWELL JUNCTION, NY 12533

FOR: SPORT SHIRTS, IN CLASS 25 (U.S. CLS. 22
AND 39).

FIRST USE 4-1-2007; IN COMMERCE 4-1-2007.

OWNER OF U.S. REG. NO. 3,127,636.

THE MARK CONSISTS OF A STYLIZED IMAGE
OF A FEMALE FASTPITCH SOFTBALL PLAYER
DELIVERING A PITCH.

SER. NO. 77-251,971, FILED 8-10-2007.

HANNO RITTNER, EXAMINING ATTORNEY

Int. Cl.: 35

Prior U.S. Cls.: 100, 101 and 102

United States Patent and Trademark Office

Reg. No. 3,398,305

Registered Mar. 18, 2008

**SERVICE MARK
PRINCIPAL REGISTER**

Down East

DOWN EAST ENTERPRISE, INC. (MAINE CORPORATION)
PO 679
CAMDEN, ME 04843

FOR: OPERATING AN ONLINE SHOPPING SITE IN THE FIELD OF BOOKS, MAGAZINES, COMPACT DISKS AND VIDEOS, IN CLASS 35 (U.S. CLS. 100, 101 AND 102).

FIRST USE 1-16-1998; IN COMMERCE 1-16-1998.

OWNER OF U.S. REG. NO. 2,496,426.

THE MARK CONSISTS OF THE STYLIZED WORD DOWN EAST.

SEC. 2(F).

SER. NO. 77-252,380, FILED 8-10-2007.

ELLEN PERKINS, EXAMINING ATTORNEY

Int. Cl.: 41

Prior U.S. Cls.: 100, 101 and 107

United States Patent and Trademark Office

Reg. No. 3,398,306

Registered Mar. 18, 2008

**SERVICE MARK
PRINCIPAL REGISTER**



OVERSEAS MEDIA INC (DELAWARE CORPORATION)
304 HUDSON ST 4TH FL
NEW YORK, NY 10013

FOR: ENTERTAINMENT SERVICES, NAMELY, PROVIDING A WEB SITE FEATURING MUSICAL PERFORMANCES, MUSICAL VIDEOS, RELATED FILM CLIPS, PHOTOGRAPHS AND OTHER MULTIMEDIA MATERIALS, IN CLASS 41 (U.S. CLS. 100, 101 AND 107).

FIRST USE 11-0-2005; IN COMMERCE 11-0-2005.

THE COLOR(S) BLACK, RED AND LIGHT VIOLET IS/ARE CLAIMED AS A FEATURE OF THE MARK.

THE MARK CONSISTS OF THE FIVE LETTERS "RTViM" ARRANGED HORIZONTALLY IN A LINE IN STYLIZED FONT. THE COLOR BLACK APPEARS ON THE LETTER "R" WITH A RED SQUARE FORMING THE LEFT LEG OF THE "R." THE COLOR BLACK APPEARS ON THE LETTERS TV. THE COLOR BLACK APPEARS AS THE LINE IN A LOWER CASE LETTER "i" DOTTED WITH A RED SQUARE. THE COLOR LIGHT VIOLET APPEARS ON THE LETTER "M" IN STYLIZED FONT. THE COLOR WHITE APPEARS AS BACKGROUND BEHIND THE LETTERING IN THE MARK AND THE STYLIZED "R" AND IS NOT PART OF THE MARK.

SER. NO. 77-252,507, FILED 8-10-2007.

SANDRA MANIOS, EXAMINING ATTORNEY

Int. Cls.: 35 and 41

Prior U.S. Cls.: 100, 101, 102 and 107

United States Patent and Trademark Office

Reg. No. 3,398,307

Registered Mar. 18, 2008

**SERVICE MARK
PRINCIPAL REGISTER**

INDIA SPLENDOR

TRUSTEE OF MGLOBAL TRUST (MAURITIUS TRUST)
ST. JAMES COURT, ST. DENNIS STREET
SUITE G 12 GROUND FLOOR
PORT LOUIS, MAURITIUS

FOR: ARRANGING AND CONDUCTING OF FAIRS AND EXHIBITIONS FOR BUSINESS AND ADVERTISING PURPOSES; CONDUCTING TRADE SHOWS IN THE FIELD OF SPIRITUALITY, ART, BUSINESS, CUISINE, BOOKS, MUSIC, FILMS, DANCE AND FASHION; FASHION SHOW EXHIBITIONS FOR COMMERCIAL PURPOSES; FOREIGN TRADE INFORMATION AND CONSULTATION; ORGANISATION AND HOLDING OF FAIRS FOR COMMERCIAL OR ADVERTISING PURPOSES; ORGANISING EXHIBITIONS FOR COMMERCIAL OR ADVERTISING PURPOSES; PROMOTING THE ECONOMIC DEVELOPMENT IN THE COUNTRY OF INDIA; PROMOTING THE GOODS AND SERVICES OF OTHERS BY ARRANGING FOR SPONSORS TO AFFILIATE THEIR GOODS AND SERVICES WITH AN AWARDS PROGRAM, A SPORTS COMPETITION AND SPORTING ACTIVITIES; PROMOTING THE SALE OF CREDIT CARD ACCOUNTS THROUGH THE ADMINISTRATION OF INCENTIVE AWARD PROGRAMS; PROMOTING THE SALE OF GOODS AND SERVICES OF OTHERS BY AWARDED PURCHASE POINTS FOR CREDIT CARD USE, IN CLASS 35 (U.S. CLS. 100, 101 AND 102).

FIRST USE 8-10-2007; IN COMMERCE 8-10-2007.

FOR: ARRANGING AND CONDUCTING EDUCATIONAL CONFERENCES; ARRANGING OF EX-

HIBITIONS, SEMINARS AND CONFERENCES; ART EXHIBITIONS; CONDUCTING ENTERTAINMENT EXHIBITIONS IN THE NATURE OF AN ETHNIC FESTIVAL FEATURING FASHIONS OF INDIA, PANEL DISCUSSIONS, DANCE AND MOTION PICTURES; DANCE EVENTS; ENTERTAINMENT IN THE NATURE OF DANCE PERFORMANCES; ENTERTAINMENT IN THE NATURE OF FASHION SHOWS; ENTERTAINMENT IN THE NATURE OF AN ETHNIC FESTIVAL FEATURING FASHION SHOWS, DANCE PERFORMANCES, PANEL DISCUSSIONS, ART EXHIBITIONS AND MOTION PICTURES.; ENTERTAINMENT SERVICES, NAMELY, PLANNING AND CONDUCTING A SERIES OF FILM FESTIVALS; ORGANIZING COMMUNITY FESTIVALS FEATURING A VARIETY OF ACTIVITIES, NAMELY, ART EXHIBITIONS, HERITAGE MARKETS, ETHNIC DANCES, AND THE LIKE, IN CLASS 41 (U.S. CLS. 100, 101 AND 107).

FIRST USE 8-10-2007; IN COMMERCE 8-10-2007.

THE MARK CONSISTS OF STANDARD CHARACTERS WITHOUT CLAIM TO ANY PARTICULAR FONT, STYLE, SIZE, OR COLOR.

NO CLAIM IS MADE TO THE EXCLUSIVE RIGHT TO USE "INDIA", APART FROM THE MARK AS SHOWN.

SER. NO. 77-252,949, FILED 8-10-2007.

JAY BESCH, EXAMINING ATTORNEY

Int. Cl.: 28

Prior U.S. Cls.: 22, 23, 38 and 50

United States Patent and Trademark Office

Reg. No. 3,398,308

Registered Mar. 18, 2008

**TRADEMARK
PRINCIPAL REGISTER**

BANAPUP

DOLE FOOD COMPANY, INC. (DELAWARE
CORPORATION)
ONE DOLE DRIVE
WESTLAKE VILLAGE, CA 91362

THE MARK CONSISTS OF STANDARD CHAR-
ACTERS WITHOUT CLAIM TO ANY PARTICULAR
FONT, STYLE, SIZE, OR COLOR.

FOR: STUFFED TOY ANIMALS, IN CLASS 28
(U.S. CLS. 22, 23, 38 AND 50).

SER. NO. 77-252,968, FILED 8-10-2007.

FIRST USE 8-1-2007; IN COMMERCE 8-1-2007.

ELISSA GARBER KON, EXAMINING ATTORNEY

Int. Cl.: 28

Prior U.S. Cls.: 22, 23, 38 and 50

Reg. No. 3,398,309

United States Patent and Trademark Office

Registered Mar. 18, 2008

**TRADEMARK
PRINCIPAL REGISTER**

PINEANIMAL

DOLE FOOD COMPANY, INC. (DELAWARE
CORPORATION)
ONE DOLE DRIVE
WESTLAKE VILLAGE, CA 91362

THE MARK CONSISTS OF STANDARD CHAR-
ACTERS WITHOUT CLAIM TO ANY PARTICULAR
FONT, STYLE, SIZE, OR COLOR.

FOR: STUFFED TOY ANIMALS, IN CLASS 28
(U.S. CLS. 22, 23, 38 AND 50).

SER. NO. 77-252,972, FILED 8-10-2007.

FIRST USE 8-1-2007; IN COMMERCE 8-1-2007.

ELISSA GARBER KON, EXAMINING ATTORNEY

Int. Cl.: 28

Prior U.S. Cls.: 22, 23, 38 and 50

United States Patent and Trademark Office

Reg. No. 3,398,310

Registered Mar. 18, 2008

**TRADEMARK
PRINCIPAL REGISTER**

PINEOSAURUS

DOLE FOOD COMPANY, INC. (DELAWARE
CORPORATION)
ONE DOLE DRIVE
WESTLAKE VILLAGE, CA 91362

THE MARK CONSISTS OF STANDARD CHAR-
ACTERS WITHOUT CLAIM TO ANY PARTICULAR
FONT, STYLE, SIZE, OR COLOR.

FOR: STUFFED TOY ANIMALS, IN CLASS 28
(U.S. CLS. 22, 23, 38 AND 50).

SER. NO. 77-252,974, FILED 8-10-2007.

FIRST USE 8-1-2007; IN COMMERCE 8-1-2007.

ELISSA GARBER KON, EXAMINING ATTORNEY

Int. Cls.: 9, 16 and 25

**Prior U.S. Cls.: 2, 5, 21, 22, 23, 26, 29, 36, 37, 38, 39
and 50**

Reg. No. 3,398,311

United States Patent and Trademark Office

Registered Mar. 18, 2008

**TRADEMARK
PRINCIPAL REGISTER**

ACTIVISION

ACTIVISION PUBLISHING, INC. (DELAWARE CORPORATION)
3100 OCEAN PARK BOULEVARD
SANTA MONICA, CA 90405

FOR: COMPUTER GAME SOFTWARE; DOWNLOADABLE SOFTWARE FOR USE IN CONNECTION WITH COMPUTER GAMES; DOWNLOADABLE COMPUTER GAME SOFTWARE AND ENTERTAINMENT SOFTWARE, NAMELY, RING TONES, GRAPHICS AND DIGITAL AUDIO FILES FOR USE WITH MOBILE AND CELLULAR PHONES AND OTHER WIRELESS DEVICES; ELECTRONIC PUBLICATIONS, NAMELY, COMPUTER GAME STRATEGY GUIDES, IN CLASS 9 (U.S. CLS. 21, 23, 26, 36 AND 38).

FIRST USE 0-0-1980; IN COMMERCE 0-0-1980.

FOR: PRINTED COMPUTER GAME STRATEGY GUIDES, IN CLASS 16 (U.S. CLS. 2, 5, 22, 23, 29, 37, 38 AND 50).

FIRST USE 0-0-1994; IN COMMERCE 0-0-1994.

FOR: CLOTHING, NAMELY, SHIRTS, HATS AND JACKETS, IN CLASS 25 (U.S. CLS. 22 AND 39).

FIRST USE 0-0-1995; IN COMMERCE 0-0-1995.

THE MARK CONSISTS OF STANDARD CHARACTERS WITHOUT CLAIM TO ANY PARTICULAR FONT, STYLE, SIZE, OR COLOR.

OWNER OF U.S. REG. NOS. 1,183,958, 1,207,377, AND 1,350,487.

SER. NO. 77-254,263, FILED 8-13-2007.

BENJAMIN ALLEN, EXAMINING ATTORNEY

Int. Cl.: 1

Prior U.S. Cls.: 1, 5, 6, 10, 26 and 46

United States Patent and Trademark Office

Reg. No. 3,398,312

Registered Mar. 18, 2008

**TRADEMARK
PRINCIPAL REGISTER**

bio FRESH-END

ADVANCED BIOLOGICAL MARKETING (DELA-
WARE CORPORATION)
375 BONNEWITZ AVENUE
VAN WERT, OH 45891

THE MARK CONSISTS OF STANDARD CHAR-
ACTERS WITHOUT CLAIM TO ANY PARTICULAR
FONT, STYLE, SIZE, OR COLOR.

FOR: BACTERIA FOR WASTE WATER TREAT-
MENT, IN CLASS 1 (U.S. CLS. 1, 5, 6, 10, 26 AND 46).

SER. NO. 77-254,384, FILED 8-14-2007.

FIRST USE 5-7-2007; IN COMMERCE 5-14-2007.

MARK PILARO, EXAMINING ATTORNEY

Int. Cl.: 1

Prior U.S. Cls.: 1, 5, 6, 10, 26 and 46

United States Patent and Trademark Office

Reg. No. 3,398,313

Registered Mar. 18, 2008

**TRADEMARK
PRINCIPAL REGISTER**

Septic-eeze

ADVANCED BIOLOGICAL MARKETING (DELA-
WARE CORPORATION)
375 BONNEWITZ AVENUE
VAN WERT, OH 45891

THE MARK CONSISTS OF STANDARD CHAR-
ACTERS WITHOUT CLAIM TO ANY PARTICULAR
FONT, STYLE, SIZE, OR COLOR.

FOR: BACTERIA FOR WASTE WATER TREAT-
MENT, IN CLASS 1 (U.S. CLS. 1, 5, 6, 10, 26 AND 46).

SER. NO. 77-254,410, FILED 8-14-2007.

FIRST USE 5-7-2007; IN COMMERCE 5-14-2007.

MARK PILARO, EXAMINING ATTORNEY

Int. Cl.: 9

Prior U.S. Cls.: 21, 23, 26, 36 and 38

Reg. No. 3,398,314

United States Patent and Trademark Office

Registered Mar. 18, 2008

**TRADEMARK
PRINCIPAL REGISTER**

CEDAR

CEDAR AUDIO, LTD. (UNITED KINGDOM
CORPORATION)
43 DEERFIELD ROAD
PORTLAND, ME 04101

FOR: AUDIO COMPONENTS, NAMELY, AUDIO
RECORDING EQUIPMENT FOR USE IN REMOV-
ING UNWANTED SOUNDS IN RECORDINGS, LIVE
BROADCASTS, AND LIVE PERFORMANCES AND
FOR USE IN LIVE SOUND AND FORENSIC AUDIO
INVESTIGATIONS AND ARCHIVING AND RE-
STORATION OF DAMAGED AUDIO FOR RELEASE

AND/OR BROADCAST, IN CLASS 9 (U.S. CLS. 21, 23,
26, 36 AND 38).

FIRST USE 12-31-1988; IN COMMERCE 8-9-1989.

THE MARK CONSISTS OF STANDARD CHAR-
ACTERS WITHOUT CLAIM TO ANY PARTICULAR
FONT, STYLE, SIZE, OR COLOR.

SER. NO. 77-254,523, FILED 8-14-2007.

KELLY CHOE, EXAMINING ATTORNEY

Int. Cl.: 44

Prior U.S. Cls.: 100 and 101

United States Patent and Trademark Office

Reg. No. 3,398,315

Registered Mar. 18, 2008

**SERVICE MARK
PRINCIPAL REGISTER**



IT'S ALL GOOD-HEALTH, INC. (NORTH CAROLINA CORPORATION)
175 FOLKSTONE ROAD
MOORESVILLE, NC 28117

FOR: CHIROPRACTIC SERVICES, IN CLASS 44
(U.S. CLS. 100 AND 101).

FIRST USE 3-1-2000; IN COMMERCE 3-1-2000.

THE MARK CONSISTS OF A DRAWING OF A HUMAN SPINE IN BLACK WITH A DRAWING OF A CHECKERED BLACK AND WHITE FLAG ATTACHED TO THE SPINE..

SER. NO. 77-254,699, FILED 8-14-2007.

JOHN WILKE, EXAMINING ATTORNEY

Int. Cl.: 32

Prior U.S. Cls.: 45, 46 and 48

United States Patent and Trademark Office

Reg. No. 3,398,316

Registered Mar. 18, 2008

**TRADEMARK
PRINCIPAL REGISTER**



SAPOREITALIANO IMPORTING CO., INC. (NEW
JERSEY CORPORATION)
SUITE 401 A
2125 CENTER AVENUE
FORT LEE, NJ 07024

FOR: MINERAL WATER, CARBONATED MI-
NERAL WATER, NON-CARBONATED MINERAL
WATER, SPRING WATER, NATURAL SPRING WA-
TER, CARBONATED SPRING WATER, SPARK-
LING SPRING WATER, NON-SPARKLING
SPRING WATER, NON-CARBONATED SPRING

WATER; FLAVORED WATERS, IN CLASS 32 (U.S.
CLS. 45, 46 AND 48).

FIRST USE 7-31-2007; IN COMMERCE 7-31-2007.

THE MARK CONSISTS OF THE WORD PANGEA
ABOVE A DRAWING OF A DROP OF WATER
LANDING ON WATER AND CREATING RIPPLES.

SER. NO. 77-254,875, FILED 8-14-2007.

RICHARD A. STRASER, EXAMINING ATTORNEY

Int. Cl.: 41

Prior U.S. Cls.: 100, 101 and 107

United States Patent and Trademark Office

Reg. No. 3,398,317

Registered Mar. 18, 2008

**SERVICE MARK
PRINCIPAL REGISTER**

**GENERATION GIVING IRA
WORKSHOP**

COVENANT RELIANCE PRODUCERS, LLC
(TENNESSEE LTD LIAB CO)
SUITE 301
26 CENTURY PLACE
NASHVILLE, TN 37214

FOR: EDUCATIONAL SERVICES, NAMELY,
CONDUCTING SEMINARS AND WORKSHOPS IN
THE FIELD OF ESTATE PLANNING, INSURANCE
AND ANNUITIES AND DISTRIBUTION OF
COURSE MATERIAL IN CONNECTION THERE-
WITH, IN CLASS 41 (U.S. CLS. 100, 101 AND 107).

FIRST USE 3-20-2007; IN COMMERCE 3-20-2007.

THE MARK CONSISTS OF STANDARD CHAR-
ACTERS WITHOUT CLAIM TO ANY PARTICULAR
FONT, STYLE, SIZE, OR COLOR.

NO CLAIM IS MADE TO THE EXCLUSIVE
RIGHT TO USE "IRA WORKSHOP", APART FROM
THE MARK AS SHOWN.

SER. NO. 77-255,061, FILED 8-14-2007.

BRIAN NEVILLE, EXAMINING ATTORNEY

Int. Cl.: 20

Prior U.S. Cls.: 2, 13, 22, 25, 32 and 50

Reg. No. 3,398,318

United States Patent and Trademark Office

Registered Mar. 18, 2008

**TRADEMARK
PRINCIPAL REGISTER**



ART DREAMS HOME, INC. (CALIFORNIA CORPORATION)
2433 EASTMAN AVE.
VENTURA, CA 93003

"THE NAME(S), PORTRAIT(S), AND/OR SIGNATURE(S) SHOWN IN THE MARK IDENTIFIES KATHLEEN KOSZYK, WHOSE CONSENT(S) TO REGISTER IS SUBMITTED."

FOR: SMALL FURNITURE, PEDESTALS, MIRRORS, SHADOWBOXES, AND FIREPLACE SCREENS, IN CLASS 20 (U.S. CLS. 2, 13, 22, 25, 32 AND 50).

SER. NO. 77-255,303, FILED 8-14-2007.

FIRST USE 7-1-2007; IN COMMERCE 7-1-2007.

JENNY PARK, EXAMINING ATTORNEY

Int. Cl.: 35

Prior U.S. Cls.: 100, 101 and 102

United States Patent and Trademark Office

Reg. No. 3,398,319

Registered Mar. 18, 2008

**SERVICE MARK
PRINCIPAL REGISTER**



EAGLE TAX SERVICES GROUP, INC. (PENNSYLVANIA CORPORATION)
325 CHESTNUT STREET, SUITE 3000
PHILADELPHIA, PA 19106

FOR: INCOME TAX CONSULTATION; INCOME TAX PREPARATION; TAX AND TAXATION PLANNING, ADVICE, INFORMATION AND CONSULTANCY SERVICES; TAX CONSULTATION; TAX FILING SERVICES; TAX PREPARATION, IN CLASS 35 (U.S. CLS. 100, 101 AND 102).

FIRST USE 4-20-2007; IN COMMERCE 4-20-2007.

OWNER OF U.S. REG. NO. 1,482,673.

THE COLOR(S) GREEN, BLUE AND WHITE IS/ARE CLAIMED AS A FEATURE OF THE MARK.

THE COLORS GREEN, BLUE AND WHITE ARE CLAIMED AS A FEATURE OF THE MARK. THE MARK CONSISTS OF THE WORD EAGLE IN THE COLOR GREEN, THE WORD TAX IN THE COLOR BLUE AND A DESIGN OF AN EAGLE IN THE COLORS BLUE AND WHITE INSIDE A GREEN CIRCLE DESIGN.

SER. NO. 77-255,657, FILED 8-15-2007.

VERNA BETH RIRIE, EXAMINING ATTORNEY

Int. Cl.: 35

Prior U.S. Cls.: 100, 101 and 102

United States Patent and Trademark Office

Reg. No. 3,398,320

Registered Mar. 18, 2008

**SERVICE MARK
PRINCIPAL REGISTER**



EAGLE TAX SERVICES GROUP, INC. (PENNSYLVANIA CORPORATION)
325 CHESTNUT STREET, SUITE 3000
PHILADELPHIA, PA 19106

FOR: TAX ADVISORY SERVICES; TAX AND TAXATION PLANNING, ADVICE, INFORMATION AND CONSULTANCY SERVICES; TAX CONSULTATION; TAX FILING SERVICES; TAX PREPARATION, IN CLASS 35 (U.S. CLS. 100, 101 AND 102).

FIRST USE 4-20-2007; IN COMMERCE 4-20-2007.

OWNER OF U.S. REG. NO. 1,482,673.

THE MARK CONSISTS OF WORDS EAGLETAX WITH OVAL CONTAINING EAGLE HEAD.

SER. NO. 77-255,678, FILED 8-15-2007.

VERNA BETH RIRIE, EXAMINING ATTORNEY

Int. Cl.: 25

Prior U.S. Cls.: 22 and 39

United States Patent and Trademark Office

Reg. No. 3,398,321

Registered Mar. 18, 2008

**TRADEMARK
PRINCIPAL REGISTER**

LN LIV NEKED

SAINI, KIRPAL (UNITED STATES INDIVIDUAL)
PO BOX 2034
RANCHO CORDOVA, CA 95741

FOR: BABY BOTTOMS; BABY TOPS; CAMI-
SOLES; HALTER TOPS; HEADGEAR, NAMELY,
FITTED HATS, FLEXIBLE FITTED HATS, BEANIES,
CAPS; INFANT AND TODDLER ONE PIECE
CLOTHING; LONG-SLEEVED SHIRTS; LOUNGE
PANTS; PANTIES; POLO SHIRTS; SHIRTS; SWEAT
SHIRTS; T-SHIRTS; TANK TOPS; THONGS; TOPS;

UNDERWEAR; WRISTBANDS, IN CLASS 25 (U.S.
CLS. 22 AND 39).

FIRST USE 1-1-2007; IN COMMERCE 2-10-2007.

THE MARK CONSISTS OF STANDARD CHAR-
ACTERS WITHOUT CLAIM TO ANY PARTICULAR
FONT, STYLE, SIZE, OR COLOR.

SER. NO. 77-255,892, FILED 8-15-2007.

BENJAMIN OKEKE, EXAMINING ATTORNEY

Int. Cl.: 42

Prior U.S. Cls.: 100 and 101

United States Patent and Trademark Office

Reg. No. 3,398,322

Registered Mar. 18, 2008

**SERVICE MARK
PRINCIPAL REGISTER**



HOWSTUFFWORKS, INC. (DELAWARE CORPORATION)
SUITE 1500
ONE CAPITAL CITY PLZA; 3350 PEACHTREE RD
ATLANTA, GA 30326

FOR: INFORMATION SERVICES, NAMELY, PROVIDING A WIDE RANGE OF INFORMATION IN THE FIELDS OF SCIENCE AND TECHNOLOGY VIA A GLOBAL COMPUTER NETWORK, CABLE TELEVISION, BROADCAST TELEVISION, BROAD-

CAST RADIO, AND DIGITAL MEDIA, IN CLASS 42 (U.S. CLS. 100 AND 101).

FIRST USE 7-27-2007; IN COMMERCE 7-27-2007.

THE MARK CONSISTS OF A STYLIZED HEAD WITH A GLOBE ON TOP.

SER. NO. 77-256,061, FILED 8-15-2007.

STEVEN JACKSON, EXAMINING ATTORNEY

Int. Cl.: 27

Prior U.S. Cls.: 19, 20, 37, 42 and 50

United States Patent and Trademark Office

Reg. No. 3,398,323

Registered Mar. 18, 2008

**TRADEMARK
PRINCIPAL REGISTER**

**EVERYTHING YOU KNOW ABOUT
ASTROTURF IS HISTORY**

TEXTILE MANAGEMENT ASSOCIATES, INC.
(GEORGIA CORPORATION)
1906 SOUTH HAMILTON STREET
DALTON, GA 30720

FOR: ARTIFICIAL TURF, IN CLASS 27 (U.S. CLS.
19, 20, 37, 42 AND 50).

FIRST USE 12-12-2006; IN COMMERCE 12-12-2006.

THE MARK CONSISTS OF STANDARD CHAR-
ACTERS WITHOUT CLAIM TO ANY PARTICULAR
FONT, STYLE, SIZE, OR COLOR.

OWNER OF U.S. REG. NOS. 830,657, 1,003,222 AND
OTHERS.

SER. NO. 77-256,169, FILED 8-15-2007.

ESTHER A. BORSUK, EXAMINING ATTORNEY

Int. Cl.: 27

Prior U.S. Cls.: 19, 20, 37, 42 and 50

United States Patent and Trademark Office

Reg. No. 3,398,324

Registered Mar. 18, 2008

**TRADEMARK
PRINCIPAL REGISTER**

PUREGRASS PORTABLE

TEXTILE MANAGEMENT ASSOCIATES, INC.
(GEORGIA CORPORATION)
1906 SOUTH HAMILTON STREET
DALTON, GA 30720

FOR: ARTIFICIAL TURF, IN CLASS 27 (U.S. CLS.
19, 20, 37, 42 AND 50).

FIRST USE 12-12-2006; IN COMMERCE 12-12-2006.

THE MARK CONSISTS OF STANDARD CHAR-
ACTERS WITHOUT CLAIM TO ANY PARTICULAR
FONT, STYLE, SIZE, OR COLOR.

OWNER OF U.S. REG. NO. 3,107,607.

NO CLAIM IS MADE TO THE EXCLUSIVE
RIGHT TO USE "PORTABLE", APART FROM THE
MARK AS SHOWN.

SER. NO. 77-256,198, FILED 8-15-2007.

ESTHER A. BORSUK, EXAMINING ATTORNEY

Int. Cl.: 32

Prior U.S. Cls.: 45, 46 and 48

United States Patent and Trademark Office

Reg. No. 3,398,325

Registered Mar. 18, 2008

**TRADEMARK
PRINCIPAL REGISTER**



GAGE ROADS BREWING CO. LTD (AUSTRALIA
PRIVATE LIMITED COMPANY)
14 ABSOLON STREET
PALMYRA, WA, AUSTRALIA 6957

FOR: BEER, IN CLASS 32 (U.S. CLS. 45, 46 AND 48).

FIRST USE 1-10-2001; IN COMMERCE 1-10-2001.

THE MARK CONSISTS OF TOP HALF OF A
MYTHICAL FIGURE HOLDING A THREE-PRON-
GED FORK.

SER. NO. 77-256,563, FILED 8-16-2007.

JANICE L. MCMORROW, EXAMINING ATTOR-
NEY

Int. Cl.: 41

Prior U.S. Cls.: 100, 101 and 107

United States Patent and Trademark Office

Reg. No. 3,398,326

Registered Mar. 18, 2008

**SERVICE MARK
PRINCIPAL REGISTER**

**TIMELESS FITNESS 24 HOUR
ACCESS**

POWERSHOP GYM, INC. (SOUTH DAKOTA
CORPORATION)
514 MAIN AVENUE
BROOKINGS, SD 57006

FOR: PROVIDING FITNESS AND EXERCISE
FACILITIES, IN CLASS 41 (U.S. CLS. 100, 101 AND
107).

FIRST USE 3-1-2005; IN COMMERCE 3-1-2005.

THE MARK CONSISTS OF STANDARD CHAR-
ACTERS WITHOUT CLAIM TO ANY PARTICULAR
FONT, STYLE, SIZE, OR COLOR.

NO CLAIM IS MADE TO THE EXCLUSIVE
RIGHT TO USE "FITNESS" AND "24 HOUR AC-
CESS", APART FROM THE MARK AS SHOWN.

SER. NO. 77-257,131, FILED 8-16-2007.

AMY HELLA, EXAMINING ATTORNEY

Int. Cl.: 36

Prior U.S. Cls.: 100, 101 and 102

United States Patent and Trademark Office

Reg. No. 3,398,327

Registered Mar. 18, 2008

**SERVICE MARK
PRINCIPAL REGISTER**

**In-Synch With Your Growing
Business**

THE TRAVELERS INDEMNITY COMPANY
(CONNECTICUT CORPORATION)
ONE TOWER SQUARE
HARTFORD, CT 06183

FOR: PROPERTY AND CASUALTY INSURANCE
UNDERWRITING SERVICES, IN CLASS 36 (U.S.
CLS. 100, 101 AND 102).

FIRST USE 7-10-2006; IN COMMERCE 7-10-2006.

THE MARK CONSISTS OF STANDARD CHAR-
ACTERS WITHOUT CLAIM TO ANY PARTICULAR
FONT, STYLE, SIZE, OR COLOR.

OWNER OF U.S. REG. NO. 1,825,111.

SER. NO. 77-257,282, FILED 8-16-2007.

AHSEN KHAN, EXAMINING ATTORNEY

Int. Cl.: 29

Prior U.S. Cl.: 46

United States Patent and Trademark Office

Reg. No. 3,398,328

Registered Mar. 18, 2008

**TRADEMARK
PRINCIPAL REGISTER**

COUPOLE

VERMONT BUTTER AND CHEESE COMPANY,
INC. (VERMONT CORPORATION)

40 PITMAN ROAD

WEBSTERVILLE, VT 05678

FOR: CHEESE, IN CLASS 29 (U.S. CL. 46).

FIRST USE 5-0-2006; IN COMMERCE 5-0-2006.

THE MARK CONSISTS OF STANDARD CHAR-
ACTERS WITHOUT CLAIM TO ANY PARTICULAR
FONT, STYLE, SIZE, OR COLOR.

THE WORDING COUPOLE, IN FRENCH, IS AN
ARCHITECTURAL ELEMENT, NAMELY, A DOME.

SER. NO. 77-257,297, FILED 8-16-2007.

ESTHER A. BORSUK, EXAMINING ATTORNEY

Int. Cls.: 9 and 10

Prior U.S. Cls.: 21, 23, 26, 36, 38, 39 and 44

Reg. No. 3,398,329

United States Patent and Trademark Office

Registered Mar. 18, 2008

**TRADEMARK
PRINCIPAL REGISTER**

3M

3M COMPANY (DELAWARE CORPORATION)
3M CENTER, 220-9E-01
2501 HUDSON ROAD
ST. PAUL, MN 55144

FOR: FULL LINE OF PARTICULATE, OZONE, GAS, VAPOR, CHEMICAL, BIOHAZARD AND OTHER RESPIRATORS, INCLUDING FILTERING FACE-PIECE RESPIRATORS AND ELASTOMERIC FACE-PIECE RESPIRATORS, OTHER THAN FOR ARTIFICIAL RESPIRATION; FULL LINE OF SELF-RESCUE AND PROTECTION APPARATUS, NAME- LY, OXYGEN BREATHING UNITS, SUPPLIED-AIR RESPIRATORS, AND POWERED AIR-PURIFYING SYSTEMS (PAPRS) RESPIRATORS; CARTRIDGES, FILTERS, AIR TANKS AND OTHER COMPONENT PARTS FOR RESPIRATORS AND BREATHING UNITS; DUST MASKS; FULL LINE OF PROTEC- TIVE EYEWEAR, NAMELY, SAFETY GOGGLES, EYEGASSES AND EYE SHIELDS; FACE-PROTEC- TION SHIELDS; EAR PLUGS AND EAR MUFFS TO ATTENUATE SOUND AND PROTECT HEARING; HARD HATS AND OTHER PROTECTIVE HEL- METS; WELDING HELMETS; AIR MONITORING DEVICES AND SENSORS FOR MEASURING GASES AND VAPOR CONCENTRATION LEVELS; GAS DETECTORS FOR DETECTING THE PRESENCE OF CARBON MONOXIDE AND OTHER GASES; THERMAL-IMAGING CAMERAS FOR USE BY FIREFIGHTERS AND FOR SEARCH AND RESCUE; ENVIRONMENTAL SAMPLING AND TESTING IN- STRUMENTS AND EQUIPMENT, NAMELY, ELEC- TRONIC LUMINOMETERS, AND RELATED SOFTWARE, DOCKING STATIONS AND BATTER- IES, FOR DETECTING, MEASURING AND ANA- LYZING CHEMICALS, BIOLOGICAL SUBSTANCES, FOOD RESIDUES AND MICROBES; MICROBIOLOGICAL AND CONTAMINANT-TEST- ING INSTRUMENTS AND EQUIPMENT, AND SOFTWARE RELATED THERETO, FOR DETECT- ING, MEASURING AND ANALYZING BACTERIA, INCLUDING PATHOGENS SUCH SALMONELLA

AND LISTERIA, ALLERGENS, TOXINS, VITAMINS, ANTIBIOTICS, AND OTHER ORGANISMS AND SUBSTANCES; DIAGNOSTIC APPARATUS FOR TESTING FOOD; LABORATORY EQUIPMENT AND SUPPLIES, NAMELY, TEST TUBES, TEST TUBE CAPS, DIP STICKS, RACKS, MICROTITRE PLATES AND TRAYS; SECURITY SCANNERS AND READERS FOR USE IN READING PASSPORTS AND OTHER FORMS OF IDENTIFICATION; ANTI-THEFT AND LIBRARY MATERIAL CHECK- OUT SECURITY SYSTEMS; RADIO FREQUENCY IDENTIFICATION (RFID) TAGS AND READERS; COMPUTER SOFTWARE FOR SUPPLY CHAIN MANAGEMENT FROM SOURCE TO CONSUMP- TION, NAMELY, FOR COLLECTING, STORING AND MANAGING DATA, AND REPORTING, EX- ECUTING AND TRACKING, IN CONNECTION WITH ENTERPRISE RESOURCE PLANNING, SUP- PLIER ENABLEMENT, MANUFACTURING, IN- VENTORY CONTROL AND WAREHOUSING, ORDER FULFILLMENT, SHIPPING, TRANSPOR- TATION AND DELIVERY; COMPUTER SOFT- WARE FOR USE IN THE MEDICAL AND HEALTH CARE FIELDS FOR PROCESSING CLAIMS FOR REIMBURSEMENT, MAINTAINING PATIENT AND MEDICAL RECORDS, CODING AND GROUP- ING DATA USED FOR MEDICAL AND HEALTH CARE RESEARCH, AND FOR REPORTING HEALTH TRENDS AND OTHER MEDICAL DATA; AND MEDICAL IMAGING SCANNERS AND RE- LATED SOFTWARE FOR CAPTURING IMAGES OF THE MOUTH AND TEETH FOR USE IN DENTIS- TRY, IN CLASS 9 (U.S. CLS. 21, 23, 26, 36 AND 38).

FIRST USE 0-0-1960; IN COMMERCE 0-0-1960.

FOR: FULL LINE OF SURGICAL AND MEDICAL MASKS, RESPIRATORS AND FACE AND EYE SHIELDS FOR MEDICAL AND HEALTH-CARE RELATED PERSONNEL; FULL LINE OF ORTHO- PEDIC CASTINGS TAPES, SPLINTS, REINFORCING STRIPS, ELASTIC BANDAGES, AND SUPPORT

BANDAGES AND COMPRESSION WRAPS; COMPOSITE FABRICS CONTAINING FIBERGLASS AND RESINS FOR USE IN MAKING CASTS; PADDING FOR ORTHOPEDIC CASTS; ORTHOPEDIC CASTING TOOLS; FULL LINE OF STETHOSCOPES; FULL LINE OF SURGICAL MASKS, FACE SHIELDS, AND RESPIRATORY MASKS FOR MEDICAL PURPOSES; FULL LINE OF SURGICAL AND MEDICAL PROCEDURE DRAPES AND SHEETS; PATIENT ISOLATION DRAPES; MEDICAL-EQUIPMENT ISOLATION DRAPES; NON-ADHERENT SHEETING FOR BEDS, STRETCHERS AND EXAM TABLES; SURGICAL GOWNS; COMPRESSION BANDAGES; SURGICAL COMPRESSES; MEDICAL THERMOMETERS; FULL LINE OF MEDICAL ELECTRODES WITH OR WITHOUT CHEMICAL CONDUCTORS AND WET GELS FOR USE IN CARDIAC, ELECTROCARDIOGRAPH, ELECTROENCEPHALOGRAPH AND OTHER TYPES OF PATIENT MONITORING; LEADS AND CONNECTORS FOR USE WITH MEDICAL ELECTRODES; DEFIBRILLATION PADS; ELECTROSURGICAL PADS, PLATES AND ADAPTERS TO REMOVE RF CURRENT FROM A PATIENT'S BODY DURING ELECTROSURGERY; THERMAL COLD AND HOT PACKS FOR FIRST AID AND THERAPEUTIC PURPOSES; EYE PATCHES FOR MEDICAL USE; PADDING FOR USE BETWEEN MEDICAL EQUIPMENT AND PATIENTS OR FOR ELEVATING OR POSITIONING LIMBS; POUCHES FOR HOLDING SURGICAL AND MEDICAL INSTRUMENTS; ISOLATION POUCHES AND BAGS FOR STORING ORGANS, TISSUE AND OTHER BODY PARTS FOR TRANSPLANTS AND LABORATORY TESTING; FULL LINE OF STERILIZED AND NON-STERILIZED FASTENING AND COMPRESSION SURGI-

CAL WRAPS; AUTOCLAVES FOR MEDICAL USE; ORTHODONTIC APPLIANCES; DENTAL APPARATUS, NAMELY, INTRA-ORAL LIGHT SYSTEMS FOR CURING DENTAL MATERIALS, CERAMIC USED IN MAKING DENTAL CROWNS, BRIDGES AND OTHER RESTORATIVES; DENTAL INSTRUMENTS AND KITS COMPRISED OF SUCH INSTRUMENTS, NAMELY, MANDRELS, BURS, DISCS, CUPS, WHEELS, POINTS, BRUSHES AND ABRASIVE STRIPS USED TO GRIND, POLISH OR FINISH DENTAL RESTORATIVES; DENTAL INSTRUMENTS, NAMELY, SCISSORS, CRIMPING PLIERS, CONTOURING PLIERS AND IMPRESSION TRAYS; ELECTRONIC MIXERS FOR DENTAL COMPOUNDS; APPLICATORS AND DISPENSERS FOR DENTAL PRIMERS, CEMENTS, ADHESIVES, IMPRESSION MATERIALS AND RESTORATIVE MATERIALS; GLASS-FIBER POSTS USED IN DENTAL RESTORATIVE PROCEDURES; AND DENTAL PROPHYLAXIS ANGLES AND DENTAL PROPHYLAXIS CUPS FOR USE IN CLEANING TEETH AND DENTAL HYGIENE PROCEDURES, IN CLASS 10 (U.S. CLS. 26, 39 AND 44).

FIRST USE 0-0-1960; IN COMMERCE 0-0-1960.

THE MARK CONSISTS OF STANDARD CHARACTERS WITHOUT CLAIM TO ANY PARTICULAR FONT, STYLE, SIZE, OR COLOR.

OWNER OF U.S. REG. NOS. 1,237,168, 2,793,534 AND OTHERS.

SER. NO. 77-257,496, FILED 8-16-2007.

TARAH HARDY, EXAMINING ATTORNEY

Int. Cls.: 12, 35, 36, 37, 39 and 42

Prior U.S. Cls.: 19, 21, 23, 31, 35, 44, 100, 101, 102, 103, 105 and 106

Reg. No. 3,398,330

United States Patent and Trademark Office

Registered Mar. 18, 2008

**TRADEMARK
SERVICE MARK
PRINCIPAL REGISTER**



BAYERISCHE MOTOREN WERKE AKTIENGESELLSCHAFT (FED REP GERMANY AKTIENGESELLSCHAFT)
PETUELRING 130
MUNICH, FED REP GERMANY 80809

FOR: AUTOMOBILES, SPORTS UTILITY VEHICLES AND LIGHT TRUCKS, IN CLASS 12 (U.S. CLS. 19, 21, 23, 31, 35 AND 44).

FIRST USE 4-7-1998; IN COMMERCE 4-7-1998.

FOR: RATING THE CONDITION OF PRE-OWNED CARS FOR BUYERS PRIOR TO PURCHASE TO VERIFY THAT PRE-OWNED CARS HAVE BEEN RECONDITIONED AND ARE IN GOOD WORKING ORDER; DEALERSHIPS IN THE FIELD OF PRE-OWNED MOTOR VEHICLES, IN CLASS 35 (U.S. CLS. 100, 101 AND 102).

FIRST USE 4-7-1998; IN COMMERCE 4-7-1998.

FOR: FINANCING RELATING TO MOTOR VEHICLES; PROVIDING EXTENDED WARRANTIES ON MOTOR VEHICLES; WARRANTY CLAIMS ADMINISTRATION SERVICES, NAMELY, PROCESSING WARRANTY CLAIMS FOR MOTOR VEHICLES, IN CLASS 36 (U.S. CLS. 100, 101 AND 102).

FIRST USE 4-7-1998; IN COMMERCE 4-7-1998.

FOR: REPAIR AND MAINTENANCE OF MOTOR VEHICLES; EMERGENCY ROADSIDE ASSISTANCE SERVICES, NAMELY, RESPONDING TO CALLS FOR ROADSIDE ASSISTANCE, FLAT TIRE CHANGING, EMERGENCY FUEL SUPPLYING,

AND BATTERY JUMP STARTING, IN CLASS 37 (U.S. CLS. 100, 103 AND 106).

FIRST USE 4-7-1998; IN COMMERCE 4-7-1998.

FOR: LEASING OF MOTOR VEHICLES; VEHICLE TOWING; EMERGENCY MOTOR VEHICLE TOWING, IN CLASS 39 (U.S. CLS. 100 AND 105).

FIRST USE 4-7-1998; IN COMMERCE 4-7-1998.

FOR: ANALYZING AND EVALUATING THE CONDITION OF PRE-OWNED CARS FOR BUYERS PRIOR TO PURCHASE TO VERIFY THAT PRE-OWNED CARS HAVE BEEN RECONDITIONED AND ARE IN GOOD WORKING ORDER; TESTING, ANALYSIS AND EVALUATION OF THE GOODS AND SERVICES OF OTHERS FOR THE PURPOSE OF CERTIFICATION; INSPECTION SERVICES FOR NEW AND USED VEHICLES FOR PERSONS BUYING OR SELLING THEIR VEHICLES; INSPECTIONS OF MOTOR VEHICLES, IN CLASS 42 (U.S. CLS. 100 AND 101).

FIRST USE 4-7-1998; IN COMMERCE 4-7-1998.

OWNER OF U.S. REG. NOS. 611,710, 1,164,922 AND OTHERS.

NO CLAIM IS MADE TO THE EXCLUSIVE RIGHT TO USE "CERTIFIED PRE-OWNED", APART FROM THE MARK AS SHOWN.

SER. NO. 77-257,728, FILED 8-17-2007.

CARRIE GENOVESE, EXAMINING ATTORNEY

Int. Cl.: 32

Prior U.S. Cls.: 45, 46 and 48

Reg. No. 3,398,331

United States Patent and Trademark Office

Registered Mar. 18, 2008

**TRADEMARK
PRINCIPAL REGISTER**

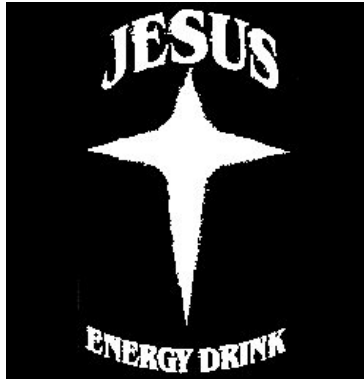

ZARNEKEE, JERRY (UNITED STATES INDIVIDUAL)
11274 EVERGREEN LOOP
CORONA, CA 92883

NO CLAIM IS MADE TO THE EXCLUSIVE RIGHT TO USE "ENERGY DRINK", APART FROM THE MARK AS SHOWN.

FOR: COFFEE-FLAVORED SOFT DRINK; COLAS; COFFEE FLAVORED ENERGY DRINK; TEA FLAVORED ENERGY DRINK; ENERGY DRINKS; FRUIT FLAVORED SOFT DRINKS; POP; SOFT DRINKS; SOFT DRINKS FLAVORED WITH TEA; FRUIT AND FRUIT FLAVORED SOFT DRINKS, IN CLASS 32 (U.S. CLS. 45, 46 AND 48).

THE MARK CONSISTS OF AN ABSTRACT DESIGN IN THE FORM OF A CROSS, WITH THE STYLIZED TEXT "JESUS ENERGY DRINK".

SER. NO. 77-258,547, FILED 8-17-2007.

FIRST USE 5-20-2007; IN COMMERCE 8-16-2007.

ALEX KEAM, EXAMINING ATTORNEY

Int. Cl.: 3

Prior U.S. Cls.: 1, 4, 6, 50, 51 and 52

Reg. No. 3,398,332

United States Patent and Trademark Office

Registered Mar. 18, 2008

TRADEMARK
PRINCIPAL REGISTER

Bodytique

BLOOMWORKS SOAP COMPANY, LC (VIRGINIA LTD LIAB CO), DBA BLOOMWORKS SOAP COMPANY, LC

117 MARCY DRIVE
YORKTOWN, VA 23693

FOR: PERSONAL CARE PRODUCTS, NAMELY, AFTER SHAVE LOTIONS, AFTER SHAVE BALM, AGE SPOT SKIN LIGHTENER, ANTIPERSPIRANT, AROMATIC SHOWER STEAM CREAMS, ASTRINGENT FOR THE FACE AND SKIN FOR COSMETIC PURPOSES, BATH BEADS, BATH GEL, BATH SALTS IN CUBES, FIZZY BATH SALTS, BATH FOAM, BATH MILK, BATH OIL, BATH SALTS, BATH PEARLS, CONCEALER, CONCEALER IN A STICK FORM, BODY BAR SOAP, BODY BUTTER CREAM, BODY CREAM, ESSENTIAL OILS FOR PERSONAL USE, BODY GEL, BODY GLITTER, BODY LOTION, BODY MASK, BODY SPRAY, BODY OIL, BODY POWDER, BODY SCRUB, BODY SMOOTHING CREAM, BODY SOAP, BODY WASH, BUBBLE BATH, COLOGNE, CREAM BODY WASH, CREAM SKIN CLEANSER, CUTICLE CREAM, CUTICLE CREAM IN THE SHAPE OF A STICK, CUTICLE CREAM IN THE SHAPE OF A PEN, DEODORANT FOR PERSONAL USE, EXFOLIATOR FOR THE FEET, EYE CREAM, EYE GEL, NON-MEDICATED FACE BALM, SUN BLOCK FOR THE FACE, FACIAL CLEANSER, FACE CREAM, FACE GEL, FACE LOTION, FACE MASK, FACIAL MOISTURIZER, FACE POWDER, FACIAL SCRUB, FACE SOAP, FACIAL WASH, TOPICAL HERBAL CREAM FOR FIRING AND ENHANCING BREASTS, FOAM BATH, NON-MEDICATED FOOT CREAM, NON-MEDICATED FOOT POWDER, NON-MEDICATED FOOT SOAK, FOOT DEODORANT SPRAY, FACIAL WASHES IN GEL FORM, GLYCERIN SOAP, HAIR CONDITIONER, HAIR DYE, HAIR GEL, HAIR MASCARA, HAIR MIST, HAIR POMADE, HAIR REMOVING CREAM, HAIR RINSE, HAIR SHAMPOO, HAIR SHINE SERUM, HAIR SPRAY, HAIR STRAIGHTENING PREPARATIONS,

HAIR STYLING MOUSSE, HAND BALM, HAND CLEANSERS IN SPRAY FORM, HAND CREAM, HAND EXFOLIATOR, HAND LOTION, COSMETIC PREPARATIONS FOR SKIN RENEWAL OF THE HAND, HAND SOAP, NON-MEDICATED HAND WASH, TANNING CREAM FOR THE LEG, ANTI-WRINKLE CREAM, ANTI-WRINKLE BEAUTY SERUM, WRINKLE RESISTANT CREAM, WRINKLE RESISTANT BEAUTY SERUM, LIP BALM, NON-MEDICATED LIP PROTECTOR, LIP GLOSS, LIP PAINT FOR COSMETIC PURPOSES, LIP POLISHER, MASSAGE CREAM, MASSAGE LOTION, MASSAGE OIL, MINERAL SALT IN THE NATURE OF BATH SALTS NOT FOR MEDICAL PURPOSES, MOOD ENHANCING MASSAGE OINTMENT, MOOD ENHANCING BODY SPRAY, MOOD ENHANCING SKIN CREAM, NAIL CREAM, NAIL POLISH, NAIL POLISH REMOVER, NIGHT EYE CREAM, NIGHT NOURISHING SKIN CREAM, COSMETIC FACIAL OIL BLOTTING SHEETS, BODY SPRAY CONTAINING OIL, PERFUME, PERFUME OILS, HOUSEHOLD FRAGRANCES FOR PERSONAL USE, SCENTED ROOM SPRAY FOR THE PILLOW, POST-SUNTANNING LOTION FOR THE BODY, POTPOURRI, PRE-SUNTANNING LOTION FOR THE BODY, PUMICE STONES FOR PERSONAL USE, ROOM FRAGRANCES, ROOM FRAGRANCE SPRAY, SACHETS, SALT BODY SCRUB, SEA SALT SKIN EXFOLIATOR, SELF TANNING PREPARATION, SHAVING CREAM, BUTTER HAND CREAM, SHOWER FOAM, SHOWER GEL, BODY SCRUB FOR THE SHOWER, SKIN TANNING CREAM, PRE-MOISTENED COSMETIC WIPES FOR SKIN CLEANSING, SKIN CREAM, SKIN EXFOLIATOR, SKIN LOTION, SKIN MOISTURIZER, BEAUTY SERUM, FRAGRANCED AROMATHERAPY OIL, SOAP, SUN SCREEN, SUNBLOCK FOR THE BODY, SUNBLOCK FOR THE FACE, SELF-TANNING CREAM, SELF-TANNING LOTION FOR THE BODY, SELF-TANNING LOTION FOR THE FACE, SUNTAN LOTION FOR THE BODY, SUNTAN LOTION FOR THE FACE, TALCUM POWDER, PAT-

CHES CONTAINING SUN SCREEN AND SUN
BLOCK FOR USE ON THE SKIN UNDER THE EYES
AND NON-MEDICATED OINTMENTS FOR THE
PREVENTION AND TREATMENT OF SUNBURN,
IN CLASS 3 (U.S. CLS. 1, 4, 6, 50, 51 AND 52).

FIRST USE 4-15-2006; IN COMMERCE 7-26-2006.

THE MARK CONSISTS OF STANDARD CHAR-
ACTERS WITHOUT CLAIM TO ANY PARTICULAR
FONT, STYLE, SIZE, OR COLOR.

SER. NO. 77-258,566, FILED 8-17-2007.

DAVID MURRAY, EXAMINING ATTORNEY

Int. Cl.: 36

Prior U.S. Cls.: 100, 101 and 102

United States Patent and Trademark Office

Reg. No. 3,398,333

Registered Mar. 18, 2008

**SERVICE MARK
PRINCIPAL REGISTER**



SUTTON GREEN, LLC (COLORADO LTD LIAB
CO)
79 COMSTOCK PLACE
CASTLE ROCK, CO 80104

FOR: VENTURE CAPITAL SERVICES, NAMELY,
PROVIDING FINANCING TO EMERGING AND
START-UP COMPANIES; FINANCIAL CONSULTA-
TION IN THE FIELD OF VENTURE CAPITAL
FINANCING; PROVIDING EQUITY, VENTURE CA-
PITAL AND FINANCING FOR INVESTMENTS
AND ONLINE FINANCIAL INFORMATION, IN
CLASS 36 (U.S. CLS. 100, 101 AND 102).

FIRST USE 1-0-2006; IN COMMERCE 1-0-2006.

OWNER OF U.S. REG. NO. 2,433,600.

NO CLAIM IS MADE TO THE EXCLUSIVE
RIGHT TO USE EQUITY, APART FROM THE
MARK AS SHOWN.

THE COLOR(S) BLUE, RED, YELLOW, GREEN
AND BLACK IS/ARE CLAIMED AS A FEATURE OF
THE MARK.

THE MARK CONSISTS OF FOUR (4) OVERLAP-
PING RECTANGLES EACH OF THE FOUR IN ITS
OWN COLOR, NAMELY, BLUE, RED, YELLOW
AND GREEN ABOVE THE WORDS EQUITY
STREET IN THE COLOR BLACK..

SER. NO. 77-260,871, FILED 8-21-2007.

KEVIN DINALLO, EXAMINING ATTORNEY

Int. Cl.: 16

Prior U.S. Cls.: 2, 5, 22, 23, 29, 37, 38 and 50

Reg. No. 3,398,334

United States Patent and Trademark Office

Registered Mar. 18, 2008

**TRADEMARK
PRINCIPAL REGISTER**

YIELDMAKER

MONSANTO TECHNOLOGY LLC (DELAWARE
LTD LIAB CO)
E2NA
800 NORTH LINDBERGH BLVD.
SAINT LOUIS, MO 63167

FOR: PUBLICATIONS, NAMELY, BROCHURES
AND BOOKLETS ABOUT AGRICULTURAL SEED
PRODUCTS INCLUDING HYBRID YIELD INFOR-
MATION, IN CLASS 16 (U.S. CLS. 2, 5, 22, 23, 29, 37, 38
AND 50).

FIRST USE 6-30-2005; IN COMMERCE 6-30-2005.

THE MARK CONSISTS OF STANDARD CHAR-
ACTERS WITHOUT CLAIM TO ANY PARTICULAR
FONT, STYLE, SIZE, OR COLOR.

SER. NO. 77-261,775, FILED 8-22-2007.

BARBARA RUTLAND, EXAMINING ATTORNEY

Int. Cl.: 30

Prior U.S. Cl.: 46

United States Patent and Trademark Office

Reg. No. 3,398,335

Registered Mar. 18, 2008

**TRADEMARK
PRINCIPAL REGISTER**



KELLOGG NORTH AMERICA COMPANY (DE-
LAWARE CORPORATION)
ONE KELLOGG SQUARE, PO BOX 3599
BATTLE CREEK, MI 490163599

FOR: KITS FOR MAKING COOKIES, IN CLASS 30
(U.S. CL. 46).

FIRST USE 7-15-2006; IN COMMERCE 7-15-2006.

OWNER OF U.S. REG. NOS. 844,688 AND 977,788.

THE COLOR(S) RED, BLACK AND WHITE IS/
ARE CLAIMED AS A FEATURE OF THE MARK.

THE MARK CONSISTS OF THE WORD KEEBLER
IN WHITE LETTERS OUTLINED IN BLACK DIS-
PLAYED ON A WHITE SHIELD OUTLINED IN
BLACK WITH A RED BACKGROUND.

SER. NO. 77-262,717, FILED 8-23-2007.

KELLY MCCOY, EXAMINING ATTORNEY

Int. Cl.: 24

Prior U.S. Cls.: 42 and 50

United States Patent and Trademark Office

Reg. No. 3,398,336

Registered Mar. 18, 2008

**TRADEMARK
PRINCIPAL REGISTER**

FAN SOCKS

WESTINGHOUSE LIGHTING CORPORATION
(PENNSYLVANIA CORPORATION)

12401 MCNULTY ROAD

PHILADELPHIA, PA 19154

FOR: FABRIC COVERING FOR CEILING FAN
BLADE, IN CLASS 24 (U.S. CLS. 42 AND 50).

FIRST USE 7-0-2007; IN COMMERCE 7-0-2007.

THE MARK CONSISTS OF STANDARD CHAR-
ACTERS WITHOUT CLAIM TO ANY PARTICULAR
FONT, STYLE, SIZE, OR COLOR.

NO CLAIM IS MADE TO THE EXCLUSIVE
RIGHT TO USE "FAN", APART FROM THE MARK
AS SHOWN.

SER. NO. 77-263,460, FILED 8-24-2007.

FLORENTINA BLANDU, EXAMINING ATTORNEY

Int. Cl.: 9

Prior U.S. Cls.: 21, 23, 26, 36 and 38

United States Patent and Trademark Office

Reg. No. 3,398,337

Registered Mar. 18, 2008

**TRADEMARK
PRINCIPAL REGISTER**

BARON

COLEMAN CABLE, INC. (DELAWARE CORPORATION)
1530 SHIELDS DRIVE
WAUKEGAN, IL 60085

FOR: ELECTRICAL AND LOW VOLTAGE SIGNALING WIRE FOR THERMOSTATS; ELECTRICAL AND LOW VOLTAGE SIGNALING WIRE FOR IRRIGATION SYSTEMS; ELECTRICAL WHIPS FOR AIR CONDITIONERS; LOW VOLTAGE WIRES AND CABLES; ELECTRICAL WIRES AND CABLES, IN CLASS 9 (U.S. CLS. 21, 23, 26, 36 AND 38).

FIRST USE 9-0-1991; IN COMMERCE 9-0-1991.

THE MARK CONSISTS OF STANDARD CHARACTERS WITHOUT CLAIM TO ANY PARTICULAR FONT, STYLE, SIZE, OR COLOR.

SER. NO. 77-267,015, FILED 8-29-2007.

BARBARA GAYNOR, EXAMINING ATTORNEY

Int. Cl.: 3

Prior U.S. Cls.: 1, 4, 6, 50, 51 and 52

United States Patent and Trademark Office

Reg. No. 3,398,338

Registered Mar. 18, 2008

**TRADEMARK
PRINCIPAL REGISTER**

IDENTOIL

SYMRISE GMBH & CO. KG (FED REP GERMA-
NY LIMITED PARTNERSHIP)
MUHLENFELDSTRASSE 1
HOLZMINDEN, FED REP GERMANY 37603

FOR: ESSENTIAL OILS, IN CLASS 3 (U.S. CLS. 1, 4,
6, 50, 51 AND 52).

THE MARK CONSISTS OF STANDARD CHAR-
ACTERS WITHOUT CLAIM TO ANY PARTICULAR
FONT, STYLE, SIZE, OR COLOR.

OWNER OF FED REP GERMANY REG. NO.
906910, DATED 7-3-1973, EXPIRES 4-30-2012.

OWNER OF U.S. REG. NO. 2,078,838.

SER. NO. 77-269,302, FILED 8-31-2007.

DAVID H. STINE, EXAMINING ATTORNEY

Int. Cl.: 35

Prior U.S. Cls.: 100, 101 and 102

United States Patent and Trademark Office

Reg. No. 3,398,339

Registered Mar. 18, 2008

**SERVICE MARK
PRINCIPAL REGISTER**

FORE! DAD

GOLFSMITH INTERNATIONAL, INC. (DELA-
WARE CORPORATION)
11000 NORTH IH-35
AUSTIN, TX 78753

FOR: RETAIL STORE SERVICES, MAIL ORDER
CATALOG SERVICES, AND ONLINE RETAIL SER-
VICES, ALL IN THE FIELDS OF SPORTING GOODS
AND CLOTHING, IN CLASS 35 (U.S. CLS. 100, 101
AND 102).

FIRST USE 5-31-2006; IN COMMERCE 5-31-2006.

THE MARK CONSISTS OF STANDARD CHAR-
ACTERS WITHOUT CLAIM TO ANY PARTICULAR
FONT, STYLE, SIZE, OR COLOR.

SER. NO. 77-269,727, FILED 8-31-2007.

THEODORE MCBRIDE, EXAMINING ATTORNEY

Int. Cl.: 9

Prior U.S. Cls.: 21, 23, 26, 36 and 38

United States Patent and Trademark Office

Reg. No. 3,398,340

Registered Mar. 18, 2008

**TRADEMARK
PRINCIPAL REGISTER**

SOUNDSATIONAL

COLEMAN CABLE, INC. (DELAWARE CORPORATION)
1530 SHIELDS DRIVE
WAUKEGAN, IL 60085

THE MARK CONSISTS OF STANDARD CHARACTERS WITHOUT CLAIM TO ANY PARTICULAR FONT, STYLE, SIZE, OR COLOR.

FOR: SPEAKER CABLE, IN CLASS 9 (U.S. CLS. 21, 23, 26, 36 AND 38).

SER. NO. 77-270,877, FILED 9-4-2007.

FIRST USE 0-0-2000; IN COMMERCE 0-0-2000.

BARBARA GAYNOR, EXAMINING ATTORNEY

Int. Cl.: 42

Prior U.S. Cls.: 100 and 101

United States Patent and Trademark Office

Reg. No. 3,398,341

Registered Mar. 18, 2008

**SERVICE MARK
PRINCIPAL REGISTER**

twisthink
DESIGN TECHNOLOGY STRATEGY

TWISTHINK, LLC (MICHIGAN LTD LIAB CO)
SUITE 400
130 CENTRAL AVENUE
HOLLAND, MI 49423

FOR: CONSULTATION SERVICES IN THE FIELD
OF PRODUCT DEVELOPMENT, PRODUCT PRO-
CESS AND PRODUCT CONCEPTS, IN CLASS 42
(U.S. CLS. 100 AND 101).

FIRST USE 11-1-2004; IN COMMERCE 11-1-2004.

OWNER OF U.S. REG. NOS. 2,580,236, 2,580,237,
AND 2,580,238.

NO CLAIM IS MADE TO THE EXCLUSIVE
RIGHT TO USE "DESIGN TECHNOLOGY", APART
FROM THE MARK AS SHOWN.

"THE MARK CONSISTS OF THE WORD 'TWS-
THINK' IN LOWER CASE ABOVE THE UPPER
CASE WORDING 'DESIGN TECHNOLOGY STRAT-
EGY'."

SER. NO. 77-271,669, FILED 9-5-2007.

EDWARD FENNESSY, EXAMINING ATTORNEY

Int. Cl.: 3

Prior U.S. Cls.: 1, 4, 6, 50, 51 and 52

United States Patent and Trademark Office

Reg. No. 3,398,342

Registered Mar. 18, 2008

**TRADEMARK
PRINCIPAL REGISTER**

BODACIOUS

BLOOMWORKS SOAP COMPANY, LC (VIRGINIA LTD LIAB CO)
117 MARCY DRIVE
YORKTOWN, VA 23693

FOR: PERSONAL CARE PRODUCTS, NAMELY, BAR SOAPS, SOAP FOR THE FACE, BAR SOAP FOR THE HANDS, GLYCERIN SOAP, SHOWER GEL, BATH GEL, BUBBLE BATH, BODY WASH, BODY SCRUBS, BODY SCRUB FOR THE SHOWER, BODY LOTIONS, BODY BUTTER, CREAM FOR THE BODY, SKIN CREAM, SKIN EXFOLIATOR, SKIN LOTION, SKIN MOISTURIZER, BODY SPRAY, BODY SPLASH, COLOGNE, PERFUMES, FRAGRANCED BODY MIST, ESSENTIAL OILS FOR PERSONAL USE, HAIR CONDITIONER, HAIR SHAMPOO, FACIAL CLEANSER, FACE CREAM, FACE GEL, FACE LOTION, FACE MASK, FACE MOISTURIZER, FACIAL SCRUB, FACE SOAP, FACIAL WASH, HAND CREAM, HAND EXFOLIATOR, HAND LOTION, COSMETIC PREPARATIONS FOR SKIN RENEWAL OF THE HAND, HAND SOAP,

NON-MEDICATED HAND WASH, NON-MEDICATED FOOT CREAM, NON-MEDICATED FOOT POWDER, NON-MEDICATED FOOT SOAK, FOOT DEODORANT SPRAY, SELF TANNING PREPARATION, SELF-TANNING CREAM, SELF-TANNING LOTION FOR THE BODY, SELF-TANNING LOTION FOR THE FACE, HOUSEHOLD FRAGRANCES FOR PERSONAL USE AND HOUSEHOLD FRAGRANCES FOR ROOM USE, IN CLASS 3 (U.S. CLS. 1, 4, 6, 50, 51 AND 52).

FIRST USE 6-7-2007; IN COMMERCE 6-21-2007.

THE MARK CONSISTS OF STANDARD CHARACTERS WITHOUT CLAIM TO ANY PARTICULAR FONT, STYLE, SIZE, OR COLOR.

SER. NO. 77-274,849, FILED 9-7-2007.

DAVID MURRAY, EXAMINING ATTORNEY

Int. Cl.: 28

Prior U.S. Cls.: 22, 23, 38 and 50

United States Patent and Trademark Office

Reg. No. 3,398,343

Registered Mar. 18, 2008

**TRADEMARK
PRINCIPAL REGISTER**



NIKE, INC. (OREGON CORPORATION)
ONE BOWERMAN DRIVE
BEAVERTON, OR 97005

OWNER OF U.S. REG. NOS. 2,024,437, 2,522,877,
AND 3,218,672.

FOR: GOLF CLUBS, GOLF BAGS, IN CLASS 28
(U.S. CLS. 22, 23, 38 AND 50).

SER. NO. 77-277,161, FILED 9-11-2007.

FIRST USE 11-1-2005; IN COMMERCE 11-1-2005.

LINDA ORNDORFF, EXAMINING ATTORNEY

Int. Cl.: 37

Prior U.S. Cls.: 100, 103 and 106

United States Patent and Trademark Office

Reg. No. 3,398,344

Registered Mar. 18, 2008

**SERVICE MARK
PRINCIPAL REGISTER**

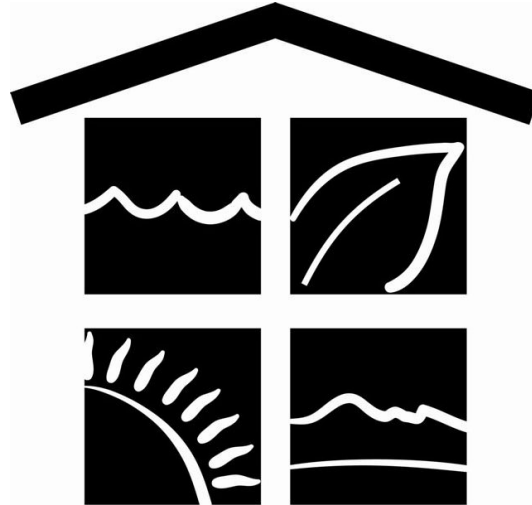

**CENTEX CORPORATION (NEVADA CORPORATION)
2728 N. HARWOOD STREET
DALLAS, TX 752011516**

**FOR: CONSTRUCTION SERVICES, NAMELY,
PLANNING, LAYING OUT AND CONSTRUCTION
OF RESIDENTIAL AND COMMERCIAL COMMU-
NITIES, IN CLASS 37 (U.S. CLS. 100, 103 AND 106).**

FIRST USE 4-1-2007; IN COMMERCE 4-1-2007.

**THE MARK CONSISTS OF OF A SQUARE HOUSE
WITH A ROOF DIVIDED INTO FOUR SQUARES;
THE UPPER RIGHT IMAGE IS OF A SINGLE LEAF;
THE UPPER LEFT IMAGE IS OF WATER WAVES;
THE BOTTOM RIGHT IMAGE IS OF LAND/MOUN-
TAINS; AND THE BOTTOM LEFT IMAGE IS OF
THE SUN.**

SER. NO. 77-279,088, FILED 9-13-2007.

LINDA MICKLEBURGH, EXAMINING ATTORNEY

Int. Cl.: 37

Prior U.S. Cls.: 100, 103 and 106

United States Patent and Trademark Office

Reg. No. 3,398,345

Registered Mar. 18, 2008

**SERVICE MARK
PRINCIPAL REGISTER**

EFFICIENT-C

CENTEX CORPORATION (NEVADA CORPORATION)
2728 N. HARWOOD STREET
DALLAS, TX 752011516

THE MARK CONSISTS OF STANDARD CHARACTERS WITHOUT CLAIM TO ANY PARTICULAR FONT, STYLE, SIZE, OR COLOR.

FOR: CONSTRUCTION SERVICES, NAMELY, PLANNING, LAYING OUT AND CONSTRUCTION OF RESIDENTIAL AND COMMERCIAL COMMUNITIES, IN CLASS 37 (U.S. CLS. 100, 103 AND 106).

SER. NO. 77-279,091, FILED 9-13-2007.

FIRST USE 4-1-2007; IN COMMERCE 4-1-2007.

LINDA MICKLEBURGH, EXAMINING ATTORNEY

Int. Cl.: 3

Prior U.S. Cls.: 1, 4, 6, 50, 51 and 52

United States Patent and Trademark Office

Reg. No. 3,398,346

Registered Mar. 18, 2008

**TRADEMARK
PRINCIPAL REGISTER**

FACETIOUS

BLOOMWORKS SOAP COMPANY, LC (VIRGINIA LTD LIAB CO)
117 MARCY DRIVE
YORKTOWN, VA 23693

FOR: PERSONAL CARE PRODUCTS, NAMELY, BAR SOAPS, SOAP FOR THE FACE, NON-MEDICATED FACIAL SERUMS; FACIAL MOISTURIZER; NON-MEDICATED SKIN MOISTURIZER, SKIN CLEANSER, FACE CLEANSER, NON-MEDICATED FACE CLEANSER, FACE TONERS; FACE LOTIONS, FACE CREAM, ANTI-WRINKLE CREAMS, FACE GEL, FACE MASK, FACIAL SCRUB, FACE SOAP, FACIAL WASH, NON-MEDICATED LIP BALMS, SKIN CLEANSERS, BATH FOAM, BODY WASH AND BODY SOAP, BODY SCRUBS, SKIN MOIST-

URIZERS, SKIN CREAMS AND SKIN LOTIONS, BODY OIL, PRE-MOISTENED COSMETIC CLEANSING WIPES AND PADS FOR THE SKIN, SKIN TONERS, IN CLASS 3 (U.S. CLS. 1, 4, 6, 50, 51 AND 52).

FIRST USE 2-14-2007; IN COMMERCE 2-14-2007.

THE MARK CONSISTS OF STANDARD CHARACTERS WITHOUT CLAIM TO ANY PARTICULAR FONT, STYLE, SIZE, OR COLOR.

SER. NO. 77-280,394, FILED 9-14-2007.

DAVID MURRAY, EXAMINING ATTORNEY

Int. Cls.: 35, 36 and 45

Prior U.S. Cls.: 100, 101 and 102

United States Patent and Trademark Office

Reg. No. 3,398,347

Registered Mar. 18, 2008

**SERVICE MARK
PRINCIPAL REGISTER**

ACCOUNTNOW

ACCOUNTNOW, INC. (DELAWARE CORPORATION)
2603 CAMINO RAMON, SUITE 200
SAN RAMON, CA 94583

FOR: ADVERTISING THE GOODS AND SERVICES OF OTHERS VIA THE INTERNET; TRANSACTION AUTHORIZATION AND SETTLEMENT SERVICES, NAMELY, NEGOTIATION AND SETTLEMENT OF COMMERCIAL TRANSACTIONS FOR THIRD PARTIES, IN CLASS 35 (U.S. CLS. 100, 101 AND 102).

FIRST USE 2-20-2005; IN COMMERCE 2-20-2005.

FOR: FINANCIAL SERVICES, NAMELY, FINANCIAL ANALYSIS AND CONSULTATION, FINANCIAL MANAGEMENT AND FINANCIAL PLANNING; PREPAID CREDIT CARD, DEBIT CARD AND ONLINE CASH ACCOUNT SERVICES; DISTRIBUTION AND ISSUING OF PREPAID CREDIT AND DEBIT CARDS; ELECTRONIC ACCOUNT SERVICES, NAMELY, PROVIDING ON-LINE STORED VALUE ACCOUNTS IN AN ELECTRONIC ENVIRONMENT; FINANCIAL TRANSACTION SERVICES INVOLVING PAYMENTS TO ONLINE AND OFFLINE RETAILERS AND MERCHANTS USING CASH ACCOUNT INFORMATION STORED

IN A CENTRALIZED DATABASE, NAMELY, BILL PAYMENT SERVICES; ELECTRONIC FUNDS AND CURRENCY TRANSFER SERVICES; TRANSACTION AUTHORIZATION AND SETTLEMENT SERVICES, NAMELY, CREDIT CARD TRANSACTION PROCESSING SERVICES, IN CLASS 36 (U.S. CLS. 100, 101 AND 102).

FIRST USE 2-20-2005; IN COMMERCE 2-20-2005.

FOR: TRANSACTION AUTHORIZATION AND SETTLEMENT SERVICES, NAMELY, PROVIDING USER AUTHENTICATION SERVICES IN E-COMMERCE TRANSACTIONS, IN CLASS 45 (U.S. CLS. 100 AND 101).

FIRST USE 2-20-2005; IN COMMERCE 2-20-2005.

THE MARK CONSISTS OF STANDARD CHARACTERS WITHOUT CLAIM TO ANY PARTICULAR FONT, STYLE, SIZE, OR COLOR.

OWNER OF U.S. REG. NO. 3,175,043.

SER. NO. 77-296,747, FILED 10-4-2007.

KRISTIN DAHLING, EXAMINING ATTORNEY

Int. Cl.: 9

Prior U.S. Cls.: 21, 23, 26, 36 and 38

United States Patent and Trademark Office

Reg. No. 3,398,348

Registered Mar. 18, 2008

**TRADEMARK
PRINCIPAL REGISTER**

JAMES TYLER ELECTRIC

TYLER, JAMES (UNITED STATES INDIVIDUAL)
6166 SEPULVEDA BLVD
VAN NUYS, CA 91411

FOR: ELECTRONIC SOUND PICKUP FOR GUITARS AND BASSES; GUITAR AMPLIFIERS; GUITAR CABLES; GUITAR EFFECTS PROCESSORS; GUITAR PEDALS; MUSICAL INSTRUMENT ADAPTORS; MUSICAL INSTRUMENT CONNECTORS, IN CLASS 9 (U.S. CLS. 21, 23, 26, 36 AND 38).

FIRST USE 7-1-2007; IN COMMERCE 7-1-2007.

THE MARK CONSISTS OF STANDARD CHARACTERS WITHOUT CLAIM TO ANY PARTICULAR FONT, STYLE, SIZE, OR COLOR.

NO CLAIM IS MADE TO THE EXCLUSIVE RIGHT TO USE "ELECTRIC", APART FROM THE MARK AS SHOWN.

THE NAME(S), PORTRAIT(S), AND/OR SIGNATURE(S) SHOWN IN THE MARK IDENTIFIES JAMES TYLER, WHOSE CONSENT(S) TO REGISTER IS MADE OF RECORD.

SER. NO. 77-297,325, FILED 10-5-2007.

SANDRA MANIOS, EXAMINING ATTORNEY

Int. Cls.: 9, 35, 38, 41 and 42

**Prior U.S. Cls.: 21, 23, 26, 36, 38, 100, 101, 102, 104
and 107**

Reg. No. 3,398,349

United States Patent and Trademark Office

Registered Mar. 18, 2008

**TRADEMARK
SERVICE MARK
PRINCIPAL REGISTER**



3-PLUS HF. (ICELAND PUBLIC COMPANY)
MYRARGOTU 2-8
REYKJAVIK, ICELAND 107

FOR: SCIENTIFIC, ELECTRICAL, CINEMATOGRAPHIC, SIGNALING, SUPERVISION, TEACHING APPARATUS AND INSTRUMENTS, NAMELY, HANDHELD DEVICE FOR DVD-PLAYERS TO ENABLE CHILDREN TO CONTROL AND INTERACT WITH SPECIALLY DESIGNED CONTENT, DVD-PLAYERS, TELEVISION, COMPUTERS, REMOTE CONTROLS FOR DVD-PLAYERS, TELEVISIONS, AND COMPUTERS THAT USES MULTIMEDIA IN PROVIDING EDUCATIONAL AND ENTERTAINMENT CONTENT FOR CHILDREN; APPARATUS FOR RECORDING, TRANSMISSION OR REPRODUCTION OF SOUND OR IMAGES, NAMELY A DVD MACHINE WITH A SPECIFICALLY EQUIPPED DEVICE TO ENABLE YOUNG CHILDREN TO CONTROL AND INTERACT WITH THE MACHINE USING SPECIALLY DESIGNED CONTENT, VIDEO TAPE DECKS, AUDIO TAPE DECKS, CD PLAYERS, DVD PLAYERS, STEREO TUNERS; PRE-RECORDED MAGNETIC DATA CARRIERS WITH EDUCATIONAL AND ENTERTAINMENT CONTENT SPECIALLY DESIGNED FOR CHILDREN, VIDEO CASSETTE RECORDERS, RADIO RECEIVING SETS, RECORDING BLANK DVD-DISCS; DATA PROCESSORS FOR USE IN THE FIELD OF MULTIMEDIA, COMPUTERS, COMPUTER SOFTWARE FOR CHILDREN'S EDUCATION AND ENTERTAINMENT, COMPUTER HARD-

WARE, COMPUTER CHIPS AND MICROPROCESSORS, HAND HELD COMPUTERS, LAPTOP COMPUTERS, COMPUTER TERMINALS, KEYBOARDS, JOYSTICKS, MONITORS, DEVICES FOR PROCESSING COMPUTER GAMES, NAMELY, SPECIAL DEVICES FOR DVD-PLAYERS, COMPUTER GAME SOFTWARE, SENSOR CARDS (K-CARDS) FOR USE BY CHILDREN AND TO ALLOW CHILDREN EASILY TO INTERACT WITH THE SPECIALLY-FORMATTED DVD-PROGRAMMING, AND COMPUTER PARTS AND FITTINGS SOLD AS A UNIT THEREFORE, ELECTRICAL PLUGS, REMOTE CONTROLS FOR DVD-MACHINES, TELEVISIONS, COMPUTERS FOR USE BY CHILDREN; PRERECORDED PROGRAMS RECORDED ON DVD'S FOR ENTERTAINMENT AND TEACHING OF CHILDREN, DVD-MACHINES, DVD-DISCS PRERECORDED WITH MATTER SPECIFICALLY DESIGNED FOR CHILDREN, INTERACTIVE TV-CARDS, NAMELY, SENSOR CARDS THAT USES MULTIMEDIA IN PROVIDING EDUCATIONAL AND ENTERTAINMENT CONTENT FOR CHILDREN; COMPUTER HARDWARE DEVICES THAT USE SOFTWARE THAT PROVIDES VISUAL PRESENTATIONS OF MESSAGES AND COMMANDS ON VIDEO DISPLAYS THAT USE MULTIMEDIA IN PROVIDING EDUCATIONAL AND ENTERTAINMENT CONTENT FOR CHILDREN; DOWNLOADABLE ELECTRONIC PUBLICATIONS IN THE NATURE OF MAGAZINES, NEWSLETTERS FEATURING MATTER FOR CHILDREN ON A GLOBAL COMPUTER NETWORK AND RECORDED ON

DVD-DISCS AND SENSOR CARDS; MECHANISMS FOR COIN-OPERATED APPARATUS, NAMELY, VIDEO GAMES, PINBALL MACHINES, DVD-MACHINES THAT USES MULTIMEDIA IN PROVIDING EDUCATIONAL AND ENTERTAINMENT CONTENT FOR CHILDREN, IN CLASS 9 (U.S. CLS. 21, 23, 26, 36 AND 38).

FOR: RETAIL STORE SERVICES IN THE FIELD OF MULTIMEDIA EQUIPMENT, NAMELY A SPECIFICALLY EQUIPPED DEVICE TO ENABLE YOUNG CHILDREN TO CONTROL AND INTERACT WITH DVD PLAYERS WITH SPECIALLY DESIGNED CONTENT, BLANK AND PRERECORDED DVD-DISCS, SENSOR CARDS; RETAIL MAIL ORDER SERVICES IN THE FIELD OF MULTIMEDIA EQUIPMENT, NAMELY, A SPECIFICALLY EQUIPPED DEVICE TO ENABLE YOUNG CHILDREN TO CONTROL AND INTERACT WITH DVD PLAYERS WITH SPECIALLY DESIGNED CONTENT, BLANK AND PRERECORDED DVD DISCS, SENSOR CARDS, RETAIL ON-LINE ORDERING SERVICES IN THE FIELD OF MULTIMEDIA EQUIPMENT, NAMELY, A SPECIFICALLY EQUIPPED DEVICE TO ENABLE YOUNG CHILDREN TO CONTROL AND INTERACT WITH DVD PLAYERS WITH SPECIALLY DESIGNED CONTENT, BLANK AND PRERECORDED DVD DISCS, SENSOR CARDS, IN CLASS 35 (U.S. CLS. 100, 101 AND 102).

FOR: ELECTRONIC TRANSMISSION OF MESSAGES, IMAGES AND SOUND; MULTIMEDIA SERVICES, NAMELY, BROADCASTING PROGRAMS VIA A GLOBAL COMPUTER NETWORK, INTERACTIVE TELEVISION SERVICES IN THE FIELD OF ENTERTAINMENT AND EDUCATION FOR CHILDREN, COMPUTER-AIDED TRANSMISSION OF MESSAGES, INFORMATION, DATA AND IMAGES; DIGITAL TRANSMISSION OF VOICE, DATA, IMAGES, SIGNALS AND MESSAGES IN MULTIMEDIA FORM, IN CLASS 38 (U.S. CLS. 100, 101 AND 104).

FOR: PROVISION OF INFORMATION AND DATA, IN ELECTRONIC FORM, BY MEANS OF WEB PAGE ON A GLOBAL COMPUTER NETWORK THAT USES MULTIMEDIA IN PROVIDING EDUCATIONAL AND ENTERTAINMENT CONTENT FOR CHILDREN; EDUCATIONAL SERVICES,

NAMELY, PROVIDING TRAINING FOR CHILDREN IN THE USE OF MULTIMEDIA EQUIPMENT; PROVIDING TRAINING IN THE USE OF MULTIMEDIA EQUIPMENT; ENTERTAINMENT, NAMELY, PROVIDING TELEVISION COMEDY SERIES, FESTIVALS FOR CHILDREN USING MULTIMEDIA; ORGANIZING COMMUNITY SPORTING AND CULTURAL ACTIVITIES; ELECTRONIC PUBLISHING SERVICES, NAMELY, PUBLICATION OF DATA IN THE FORM OF TEXT OF OTHERS ON CD-ROMS FEATURING ENTERTAINMENT AND EDUCATION MATTER FOR CHILDREN AND PUBLICATION OF COMPUTER GAMES ON CD ROMS FOR OTHERS; PROVISION OF COMPUTER GAMES ACCESSIBLE VIA A GLOBAL COMPUTER NETWORK; PROVIDING INTERACTIVE COMPUTER GAMES VIA A GLOBAL COMPUTER NETWORK, PROVIDING INTERACTIVE COMPUTER GAMES VIA A GLOBAL COMPUTER NETWORK, PROVIDING INTERACTIVE TRAINING AND TEACHING SESSIONS IN THE USE OF MULTIMEDIA EQUIPMENT, IN CLASS 41 (U.S. CLS. 100, 101 AND 107).

FOR: COMPUTER SERVICES, NAMELY, SOFTWARE DEVELOPMENT FOR OTHERS, COMPUTER PROGRAMMING FOR OTHERS, UPDATING AND MAINTENANCE OF COMPUTER SOFTWARE FOR OTHERS; PROVIDING INFORMATION OBTAINABLE FROM A WEB PAGE VIA A GLOBAL COMPUTER NETWORK ON THE SUBJECT OF DVD-TECHNOLOGY, COMPUTERS, COMPUTER HARDWARE, COMPUTER SOFTWARE, COMPUTER GAME DEVICES, COMPUTER GAMES, AND PARTS AND FITTINGS, IN CLASS 42 (U.S. CLS. 100 AND 101).

PRIORITY CLAIMED UNDER SEC. 44(D) ON ICELAND APPLICATION NO. 239/2001, FILED 1-17-2001, REG. NO. 947, DATED 10-3-2001, EXPIRES 10-3-2011.

NO CLAIM IS MADE TO THE EXCLUSIVE RIGHT TO USE "DVD" AND "KIDS", APART FROM THE MARK AS SHOWN.

SER. NO. 78-073,784, FILED 7-13-2001.

AMY HELLA, EXAMINING ATTORNEY

Int. Cl.: 36

Prior U.S. Cls.: 100, 101 and 102

United States Patent and Trademark Office

Reg. No. 3,398,350

Registered Mar. 18, 2008

**SERVICE MARK
PRINCIPAL REGISTER**

ALPHAGEN

GARTMORE INVESTMENT MANAGEMENT
PLC (UNITED KINGDOM BRITISH INVEST-
MENT COMPANY)
GARTMORE HOUSE
8 FENCHURCH PLACE
LONDON, ENGLAND, UNITED KINGDOM EC3M
4PH

FOR: FINANCIAL SERVICE SIN THE NATURE
OF FINANCIAL CONSULTATION AND INVEST-
MENT PLANNING AND FINANCIAL SERVICES IN
THE NATURE OF FINANCIAL CONSULTATION
AND INVESTMENT PLANNING PROVIDED
THROUGH A GLOBAL NETWORK; FINANCIAL
AFFAIRS, NAMELY SERVICES IN THE AREA OF
PORTFOLIO MANAGEMENT; MONETARY AF-
FAIRS, NAMELY COMMERCIAL AND PERSONAL
LOANS; BANKING SERVICES; FINANCIAL SERVI-
CES IN THE NATURE OF AN INVESTMENT SE-
CURITY; SAVINGS ACCOUNT SERVICES; FUND

ASSET, UNIT TRUST AND INVESTMENT TRUST
MANAGEMENT; FINANCIAL ANALYSIS AND
CONSULTATION RELATING TO INVESTMENT,
SAVINGS AND PENSIONS, PROVIDED ONLINE
FROM A COMPUTER DATABASE OR VIA THE
INTERNET OR EXTRANETS; FUND INVESTMENT
COLLECTION, IN CLASS 36 (U.S. CLS. 100, 101 AND
102).

PRIORITY CLAIMED UNDER SEC. 44(D) ON
UNITED KINGDOM APPLICATION NO. 2279292,
FILED 8-30-2001, REG. NO. 2279292, DATED 2-15-
2002, EXPIRES 8-30-2011.

SER. NO. 78-087,757, FILED 10-10-2001.

CIMMERIAN COLEMAN, EXAMINING ATTOR-
NEY

Int. Cl.: 7

Prior U.S. Cls.: 13, 19, 21, 23, 31, 34 and 35

United States Patent and Trademark Office

Reg. No. 3,398,351

Registered Mar. 18, 2008

**TRADEMARK
PRINCIPAL REGISTER**

The logo for "StairEasy" features the word "Stair" in a bold, sans-serif font and "Easy" in a bold, italicized serif font. The text is white and set against a solid black rectangular background.

ACCESS INTERNATIONAL, INC. (PENNSYLVANIA CORPORATION), DBA ACCESS-ABILITY, INC.

151 WEST 4TH STREET
BETHLEHEM, PA 180151695

FIRST USE 12-0-1998; IN COMMERCE 12-0-1998.

SER. NO. 78-110,907, FILED 2-25-2002.

FOR: STAIRWAY LIFTS AND ELEVATOR LIFTS,
IN CLASS 7 (U.S. CLS. 13, 19, 21, 23, 31, 34 AND 35).

KELLY BOULTON, EXAMINING ATTORNEY

Int. Cl.: 29

Prior U.S. Cl.: 46

United States Patent and Trademark Office

Reg. No. 3,398,352

Registered Mar. 18, 2008

**TRADEMARK
PRINCIPAL REGISTER**



OCEANIC BEVERAGES CO., LTD. (TAIWAN CORPORATION)
10F 99 SEC 3, CHUNG-YANG ROAD
SAN-CHUNG CITY
TAIPEI HSIEN, TAIWAN

FOR: BUTTERCREAM; CHEESE; DAIRY PRODUCTS, NAMELY CREAM; PRESERVED FRUIT; FRUIT SALAD; JAMS; JELLIES FOR FOOD; MILK; RENNET; WHEY; YOGURT; MILK PROTEIN, NAMELY CASEIN FOR FOOD PURPOSES; NON-ALCOHOLIC, FERMENTED MARE OR CAMEL MILK, NAMELY KOUMISS; NON-ALCOHOLIC

MILK-BASED BEVERAGES, IN CLASS 29 (U.S. CL. 46).

FIRST USE 1-1-2002; IN COMMERCE 2-1-2002.

THE MARK CONSISTS OF A RED APPLE WITH GREEN LEAVES, CROSSED BY A GREEN BANNER WITH WHITE LETTERS.

SER. NO. 78-116,616, FILED 3-21-2002.

ZHALEH DELANEY, EXAMINING ATTORNEY

Int. Cl.: 32

Prior U.S. Cls.: 45, 46 and 48

United States Patent and Trademark Office

Reg. No. 3,398,353

Registered Mar. 18, 2008

**TRADEMARK
PRINCIPAL REGISTER**



OCEANIC BEVERAGES CO., LTD. (TAIWAN CORPORATION)
10F 99 SEC 3, CHUNG-YANG ROAD
SAN-CHUNG CITY
TAIPEI HSIEN, TAIWAN

FOR: SOFT DRINKS, FRUIT JUICE, VEGETABLE JUICE, BOTTLED WATER FOR DRINKING, BEER, NON-ALCOHOLIC FRUIT JUICE-BASED BEVERAGES, SODA WATER, SYRUPS FOR MAKING FRUIT DRINKS AND WHEY-BASED BEVERAGES, IN CLASS 32 (U.S. CLS. 45, 46 AND 48).

FIRST USE 1-1-2002; IN COMMERCE 2-1-2002.

THE MARK CONSISTS OF A RED APPLE WITH GREEN LEAVES, CROSSED BY A GREEN BANNER WITH WHITE LETTERS.

SER. NO. 78-116,814, FILED 3-22-2002.

ZHALEH DELANEY, EXAMINING ATTORNEY

Int. Cls.: 9, 35, 38 and 42

Prior U.S. Cls.: 21, 23, 26, 36, 38, 100, 101, 102 and 104

United States Patent and Trademark Office

Reg. No. 3,398,354

Registered Mar. 18, 2008

**TRADEMARK
SERVICE MARK
PRINCIPAL REGISTER**



BIOMNI LIMITED (UNITED KINGDOM CORPORATION)
THANET HOUSE
231-232 THE STRAND
LONDON, UNITED KINGDOM WC2R 1DA

FOR: COMPUTER HARDWARE; COMPUTER SOFTWARE FOR DATABASE MANAGEMENT IN THE FIELD OF PROCUREMENT, NAMELY, REQUESTING THE PURCHASE OF THE GOODS AND SERVICES NECESSARY FOR EMPLOYEES TO DO THEIR JOBS, MAKING RESERVATIONS FOR BUSINESS TRAVEL, MAKING A DEPARTMENTAL CROSS-CHARGE OR MONITORING BUDGETS AND FOR USE IN MANAGING, TRACKING, RETRIEVING, DELIVERING AND SHARING OF DATA RELATED TO PROCUREMENT, BUYING, SELLING, TENDERING, JOB AND PROJECT BIDDING INFORMATION AND OPPORTUNITIES; COMPUTER OPERATING SOFTWARE FOR WEB-BASED PROCUREMENT SYSTEMS; COMPUTER OPERATING SOFTWARE FOR OUT-SOURCED, CALL CENTER SALES SYSTEMS; BUSINESS MANAGEMENT SOFTWARE, NAMELY, SOFTWARE FOR THE COLLECTION, EDITING, ORGANIZING, MODIFYING, BOOK MARKING, TRANSMISSION STORAGE AND SHARING OF BUSINESS DATA AND INFORMATION; COMPUTER E-COMMERCE SOFTWARE TO ALLOW USERS TO PERFORM ELECTRONIC BUSINESS TRANSACTIONS VIA A GLOBAL COMPUTER NETWORK, NAMELY, ONLINE BIDDING AND PAYMENT TENDERING; COMPUTER SOFTWARE TO ALLOW USERS TO PERFORM ELECTRONIC BUSINESS TRANSACTIONS, NAMELY, BILL PAYMENTS; COMPUTER NETWORK SECURITY SOFTWARE, NAMELY, PROGRAMS FOR ENCRYPTING AND AUTHENTICATING DATA, MONITORING ENCRYPTION

AND AUTHENTICATION OF DATA; COMPUTER SOFTWARE FOR AUTOMATING THE EMPLOYEE REQUEST PROCESS FOR INTERNAL SERVICES SUCH AS HOLIDAY REQUESTS, BOOKING MEETING ROOMS, CATERING SERVICES AND HIRING INTERNAL RESOURCES; COMPUTER SOFTWARE FOR PROVIDING ACCESS TO PRODUCT CATALOGUES FROM MANY DIFFERENT SUPPLIERS INTEGRATED INTO THE TRADING HUB; COMPUTER SOFTWARE FOR CUSTOMIZING THE REQUISITION PROCESS BY CREATING SEARCHABLE DATABASES OF INFORMATION AND DATA RELATED TO REQUISITION PURCHASE ORDERS, CREATING FLEXIBLE ORDER AUTHORIZATION, ORDER ACKNOWLEDGEMENT AND TRACKING, PROCESSING INVOICE PAYMENTS AND RECEIPTS, PURCHASING SUPPORT, NAMELY PROVIDING STRICT MANAGEMENT OF PURCHASE REQUESTS, REPORTS AND AUTHORIZATION, PRODUCT COMPARISONS, AND SEARCHING CATALOGUES OF THIRD PARTIES, IN CLASS 9 (U.S. CLS. 21, 23, 26, 36 AND 38).

FOR: ADVERTISING AND BUSINESS SERVICES, NAMELY DISSEMINATION OF ADVERTISING FOR OTHERS VIA THE INTERNET AS WELL AS DIRECT MAIL ADVERTISING AND DISTRIBUTION OF SAMPLES OF GOODS FOR OTHERS; BUSINESS MARKETING CONSULTATION SERVICES; OFFICE FUNCTIONS SERVICES, NAMELY, PROFESSIONAL SECRETARIAL AND CLERICAL SERVICES; PROVIDING BUSINESS INFORMATION RELATING TO GOODS AND SERVICES USED IN OFFICES AND BUSINESSES IN THE FIELDS OF PROCUREMENT, TENDER AND SUPPLY CHAIN MANAGEMENT; PROVIDING BUSINESS INFORMATION RELATING TO AUTOMATING THE EMPLOYEE REQUEST PROCESS FOR INTERNAL

SERVICES SUCH AS HOLIDAY REQUESTS, BOOKING MEETING ROOMS, CATERING SERVICES AND HIRING INTERNAL RESOURCES; PROVIDING BUSINESS INFORMATION RELATING TO CUSTOMIZING THE REQUISITION PROCESS, CREATING FLEXIBLE ORDER AUTHORIZATION, ORDER ACKNOWLEDGEMENT AND TRACKING, INVOICE PAYMENT AND RECEIPT, PURCHASING SUPPORT, PRODUCT COMPARISONS, AND SEARCHING CATALOGUE OF THIRD PARTIES; PROVIDING BUSINESS INFORMATION RELATING TO REQUESTING THE PURCHASE OF THE GOODS AND SERVICES NECESSARY FOR EMPLOYEES TO DO THEIR JOBS, RESERVE BUSINESS TRAVEL, MAKE A DEPARTMENTAL CROSS-CHARGE OR TO MONITOR BUDGETS; PROVIDING BUSINESS MARKETING INFORMATION IN THE FIELDS OF PROCUREMENT, TENDER AND SUPPLY CHAIN MANAGEMENT; BUSINESS MANAGEMENT SERVICES, NAMELY, REQUEST MANAGEMENT AND MANAGING ELECTRONIC PROCUREMENT TRANSACTIONS BETWEEN BUSINESSES TO ASSIST THIRD PARTIES TO TRACK PRODUCT AND SERVICES SALES AND PURCHASES, TO SELECT PRODUCTS AND SERVICES, TO TENDER OFFERS AND TO PLACE ORDERS, TO CONTROL APPROVAL PROCESSES AND TO STREAMLINE ADMINISTRATION; PROVIDING BUSINESS MANAGEMENT REPORTING SERVICES, NAMELY, PROVIDING REPORTS ON ELECTRONIC PROCUREMENT TRANSACTIONS AND PRODUCT AND SERVICES SALES AND PURCHASES, SELECTION, ORDERING AND APPROVAL; MARKET ANALYSIS SERVICES IN THE NATURE OF PROVIDING SERVICES THAT TRACK AND IDENTIFY PURCHASING TRENDS IN BUSINESS AND COMPANIES; BUSINESS CONSULTANCY SERVICE PROVIDED USING THE INTERNET AND OTHER COMMUNICATIONS NETWORKS OR USING INFORMATION PROVIDED ON THE INTERNET AND OTHER COMMUNICATIONS NETWORKS IN ORDER TO PROVIDE ANALYSIS AND ADVICE RELATING TO BUSINESS, COMPANIES, ADVERTISING, OFFICE FUNCTIONS, ACCOUNTING, EMPLOYMENT, IMPORT-EXPORT OF GOODS, MANAGEMENT, PERSONNEL, PUBLIC RELATIONS OR TRADE FAIRS; BUSINESS CONSULTANCY, NAMELY PROVIDING BUSINESS INFORMATION SERVICES, ANALYSIS AND ADVICE RELATING TO BUSINESS ADVERTISING; PROVIDING BUSINESS INFORMATION SERVICES, ANALYSIS AND ADVICE RELATING TO PROMOTION WITHIN BUSINESS; PROVIDING BUSINESS INFORMATION SERVICES ANALYSIS AND ADVICE RELATING TO BUSINESS PROVIDED ON OR RELATING TO THE INTERNET AND OTHER COMMUNICATIONS NETWORKS; ARRANGING AND CONDUCTING TRADE SHOWS, AND EXHIBITIONS RELATING TO THE INTERNET AND/OR OTHER COMMUNICATIONS NETWORKS; ORGANIZING EXHIBITIONS TO PROMOTE THE GOODS AND SERVICES OF OTHERS; REQUEST MANAGEMENT AND MARKET RESEARCH INFORMATION SERVICES; PROVISION OF LINKS TO THE WEBSITES AND COMPUTER DATABASES OF OTHERS FEATURING BUSINESS INFORMATION IN THE NATURE OF MANAGING, TRACKING, RETRIEV-

ING, DELIVERING AND SHARING OF PROCUREMENT, BUYING, SELLING, TENDERING, JOB AND PROJECT BIDDING INFORMATION AND OPPORTUNITIES; BUSINESS CONSULTANCY INFORMATION AND/OR ADVICE RELATING TO MANAGING, TRACKING, RETRIEVING, DELIVERING AND SHARING OF PROCUREMENT, BUYING, SELLING, TENDERING, AND JOB AND PROJECT BIDDING INFORMATION AND OPPORTUNITIES; BUSINESS CONSULTANCY INFORMATION AND/OR ADVICE RELATING TO MANAGING, TRACKING, RETRIEVING, DELIVERING AND SHARING OF PROCUREMENT, BUYING, SELLING, TENDERING, JOB AND PROJECT BIDDING INFORMATION AND OPPORTUNITIES UTILIZING THE INTERNET; BUSINESS INFORMATION AND/OR ADVICE RELATING TO TELECOMMUNICATIONS, THE INTERNET AND COMMUNICATION NETWORKS IN THE FIELDS OF MANAGING, TRACKING, RETRIEVING, DELIVERING AND SHARING OF PROCUREMENT, BUYING, SELLING, TENDERING, JOB AND PROJECT BIDDING INFORMATION AND OPPORTUNITIES; BUSINESS INFORMATION PROVIDED VIA TELECOMMUNICATIONS NETWORKS AND THE INTERNET IN THE FIELDS OF PROCUREMENT, NAMELY, MANAGING, TRACKING, RETRIEVING, DELIVERING AND SHARING OF PROCUREMENT, BUYING, SELLING, TENDERING, JOB AND PROJECT BIDDING INFORMATION AND OPPORTUNITIES; BUSINESS INFORMATION AND/OR ADVICE RELATING TO AUTOMATING THE EMPLOYEE REQUEST PROCESS FOR INTERNAL SERVICES SUCH AS HOLIDAY REQUESTS, BOOKING MEETING ROOMS, CATERING SERVICES AND HIRING INTERNAL RESOURCES; BUSINESS INFORMATION AND/OR ADVICE RELATING TO CUSTOMIZING THE REQUISITION PROCESS, CREATING FLEXIBLE ORDER AUTHORIZATION, ORDER ACKNOWLEDGEMENT AND TRACKING, INVOICE PAYMENT AND RECEIPT, PURCHASING SUPPORT, PRODUCT COMPARISONS, AND SEARCHING CATALOGUE OF THIRD PARTIES; BUSINESS INFORMATION AND/OR ADVICE RELATING TO REQUESTING THE PURCHASE OF THE GOODS AND SERVICES NECESSARY FOR EMPLOYEES TO DO THEIR JOBS, RESERVE BUSINESS TRAVEL, MAKE A DEPARTMENTAL CROSS-CHARGE OR TO MONITOR BUDGETS PROVIDED ONLINE FROM THE INTERNET AND OTHER COMMUNICATION NETWORKS; BUSINESS RESEARCH SERVICES RELATING TO THE INTERNET AND OTHER COMMUNICATIONS NETWORKS; BUSINESS RESEARCH SERVICES RELATING TO INFORMATION PROVIDED ON THE INTERNET AND OTHER COMMUNICATIONS NETWORKS IN THE FIELD OF COMPUTERS, COMPUTER DATABASES AND SOFTWARE, IN CLASS 35 (U.S. CLS. 100, 101 AND 102).

FOR: ELECTRONIC TRANSMISSION OF DATA, IMAGES AND DOCUMENTS VIA COMPUTER TERMINALS AND NETWORKS; ELECTRONIC MAIL SERVICES; PROVIDING ACCESS TO ONLINE MARKETPLACES FOR THE CONDUCTING OF BUSINESS TO BUSINESS ELECTRONIC COMMERCE PROVIDING ACCESS TO THE INTERNET

AND OTHER COMMUNICATIONS NETWORKS; WEB MESSAGING UTILIZING THE INTERNET AND OTHER COMMUNICATIONS NETWORKS; PROVIDING ACCESS TO THE INTERNET AND OTHER COMMUNICATIONS NETWORKS; PROVIDING INTERACTIVE TELECOMMUNICATIONS CONNECTIONS TO THE INTERNET AND LOCAL, NATIONWIDE AND INTERNATIONAL COMPUTER NETWORKS THROUGH THE SUBSCRIBER'S TELEVISION, COMPUTER AND MOBILE TELEPHONE; ELECTRONIC MAIL SERVICES UTILIZING THE INTERNET AND OTHER COMMUNICATIONS NETWORKS; ELECTRONIC TRANSMISSION OF MESSAGES, DATA, INFORMATION, COMPUTER PROGRAMS, WEB PAGES, IMAGES AND/OR DOCUMENTS UTILIZING THE INTERNET AND OTHER COMMUNICATIONS NETWORKS; ELECTRONIC TRANSMISSION OF DATA AND VOICE COMMUNICATIONS UTILIZING THE INTERNET AND OTHER COMMUNICATIONS NETWORKS; PROVIDING ACCESS VIA THE INTERNET AND OTHER COMMUNICATIONS NETWORKS TO ON-LINE INFORMATION AND COMMUNICATION SERVICES; PROVISION OF TELECOMMUNICATION ACCESS TO WEBSITES AND COMPUTER DATABASES OF OTHERS IN THE FIELDS OF MANAGING, TRACKING, RETRIEVING, DELIVERING AND SHARING OF PROCUREMENT, BUYING, SELLING, TENDERING, JOB AND PROJECT BIDDING INFORMATION AND OPPORTUNITIES AND REQUEST MANAGEMENT; TELECOMMUNICATIONS CONSULTANCY IN THE FIELD OF MANAGING, TRACKING, RETRIEVING, DELIVERING AND SHARING OF PROCUREMENT, BUYING, SELLING, TENDERING, JOB AND PROJECT BIDDING INFORMATION AND OPPORTUNITIES AND REQUEST MANAGEMENT VIA THE INTERNET; PROVIDING ON-LINE CHAT ROOMS AND ACCESS TO TELECOMMUNICATIONS NETWORKS FOR TRANSMISSION OF

MESSAGES AMONG COMPUTER USERS CONCERNING MANAGING, TRACKING, RETRIEVING, DELIVERING AND SHARING OF PROCUREMENT, BUYING, SELLING, TENDERING, JOB AND PROJECT BIDDING INFORMATION AND OPPORTUNITIES, IN CLASS 38 (U.S. CLS. 100, 101 AND 104).

FOR: COMPUTER SERVICES, NAMELY, CREATING, DESIGNING, DRAWING, COMMISSIONED WRITING AND/OR MAINTAINING WEB-SITES; INSTALLATION AND MAINTENANCE OF COMPUTER SOFTWARE RELATING TO THE INTERNET AND OTHER COMMUNICATIONS NETWORKS; PROVIDING INFORMATION AND ADVICE RELATING TO LEGAL SERVICES, SCIENTIFIC AND INDUSTRIAL RESEARCH, COMPUTERS, COMPUTER PROGRAMMING, COMPUTER LEASING AND COMPUTER RENTAL PROVIDED ON-LINE FROM THE INTERNET AND OTHER COMMUNICATION NETWORKS; AND COMPUTER SERVICES, NAMELY DESIGN AND IMPLEMENTATION OF ON-LINE MARKETPLACES FOR THE CONDUCTING OF BUSINESS TO BUSINESS ELECTRONIC COMMERCE; TECHNOLOGY CONSULTATION IN THE FIELD OF MANAGING, TRACKING, RETRIEVING, DELIVERING AND SHARING OF PROCUREMENT, BUYING, SELLING, TENDERING, JOB AND PROJECT BIDDING INFORMATION AND OPPORTUNITIES AND REQUEST MANAGEMENT UTILIZING THE INTERNET, IN CLASS 42 (U.S. CLS. 100 AND 101).

OWNER OF ERPN CMNTY TM OFC REG. NO. 002336675, DATED 5-17-2004, EXPIRES 8-10-2011.

SER. NO. 78-145,988, FILED 7-21-2002.

MARILYN IZZI, EXAMINING ATTORNEY

Int. Cl.: 44

Prior U.S. Cls.: 100 and 101

United States Patent and Trademark Office

Reg. No. 3,398,355

Registered Mar. 18, 2008

**SERVICE MARK
PRINCIPAL REGISTER**

HEALTH SOLUTIONS

HEALTH SOLUTIONS OF MORTON, LLC (ILLI-
NOIS LIMITED LIABILITY CORPORATION)
11 CURRENCY DRIVE
SUITE 201
BLOOMINGTON, IL 61704

FOR: CHIROPRACTIC SERVICES, IN CLASS 44
(U.S. CLS. 100 AND 101).

FIRST USE 2-1-2002; IN COMMERCE 2-1-2002.

NO CLAIM IS MADE TO THE EXCLUSIVE
RIGHT TO USE "HEALTH", APART FROM THE
MARK AS SHOWN.

SER. NO. 78-156,540, FILED 8-21-2002.

THEODORE MCBRIDE, EXAMINING ATTORNEY

Int. Cls.: 9 and 42

Prior U.S. Cls.: 21, 23, 26, 36, 38, 100 and 101

United States Patent and Trademark Office

Reg. No. 3,398,356

Registered Mar. 18, 2008

**TRADEMARK
SERVICE MARK
PRINCIPAL REGISTER**

SC3D

BRAINTECH CANADA, INC. (CANADA CORPORATION)

102 - 930 WEST 1ST STREET

NORTH VANCOUVER, BRITISH COLUMBIA, CANADA V7P 3N4

FOR: ROBOTIC GUIDANCE SYSTEMS COMPRISING ROBOTS AND CONTROLLERS, VIDEO CAMERAS AND LENSES, PERSONAL COMPUTERS, LIGHTING AND CABLING FOR USE IN PARTS AND MATERIAL HANDLING; COMPUTER OPERATING SYSTEM SOFTWARE FOR VISION-GUIDED ROBOTICS, IN CLASS 9 (U.S. CLS. 21, 23, 26, 36 AND 38).

FOR: TECHNICAL CONSULTATION, ENGINEERING, DEVELOPMENT, RESEARCH, AND COMPUTER PROGRAMMING FOR OTHERS IN THE FIELD OF VISION-GUIDED ROBOTICS, IN CLASS 42 (U.S. CLS. 100 AND 101).

PRIORITY CLAIMED UNDER SEC. 44(D) ON CANADA APPLICATION NO. 1134578, FILED 3-15-2002, REG. NO. TMA601039, DATED 1-30-2004, EXPIRES 1-30-2019.

SER. NO. 78-164,494, FILED 9-16-2002.

NORA BUCHANAN WILL, EXAMINING ATTORNEY

Int. Cl.: 33

Prior U.S. Cls.: 47 and 49

United States Patent and Trademark Office

Reg. No. 3,398,357

Registered Mar. 18, 2008

**TRADEMARK
PRINCIPAL REGISTER**

CAPITAN

BARTON BRANDS, LTD. (DELAWARE COR-
PORATION)
SUITE 1700
1 SOUTH DEARBORN
CHICAGO, IL 60603

FOR: TEQUILA, IN CLASS 33 (U.S. CLS. 47 AND
49).

FIRST USE 5-27-1987; IN COMMERCE 5-27-1987.

THE ENGLISH TRANSLATION OF CAPITAN IS
CAPTAIN.

SER. NO. 78-206,145, FILED 1-22-2003.

KATHLEEN M. VANSTON, EXAMINING ATTOR-
NEY

Int. Cl.: 10

Prior U.S. Cls.: 26, 39 and 44

United States Patent and Trademark Office

Reg. No. 3,398,358

Registered Mar. 18, 2008

**TRADEMARK
PRINCIPAL REGISTER**

ULTRAFLEX

MEDTRONIC, INC. (MINNESOTA CORPORATION)
710 MEDTRONIC PARKWAY
MINNEAPOLIS, MN 55449

FIRST USE 12-31-1990; IN COMMERCE 12-31-1990.

SER. NO. 78-218,268, FILED 2-24-2003.

FOR: MEDICAL DEVICES, NAMELY, CANNULAE, IN CLASS 10 (U.S. CLS. 26, 39 AND 44).

GEORGIA CARTY, EXAMINING ATTORNEY

Int. Cls.: 10 and 12

Prior U.S. Cls.: 19, 21, 23, 26, 31, 35, 39 and 44

United States Patent and Trademark Office

Reg. No. 3,398,359

Registered Mar. 18, 2008

**TRADEMARK
PRINCIPAL REGISTER**

STRIDER

DAYS HEALTHCARE U.K. LIMITED (UNITED KINGDOM PRIVATE LIMITED COMPANY)
NORTH ROAD, BRIDGEND INDUSTRIAL ESTATE
BRIDGEND, MID GLAMORGAN, UNITED KINGDOM CF31 3TP

FOR: INVALID HOISTS; INVALID LIFTS; INVALID WALKERS, IN CLASS 10 (U.S. CLS. 26, 39 AND 44).

FOR: WHEELCHAIRS; MOTORIZED WHEELCHAIRS; MOTORIZED SCOOTERS, IN CLASS 12 (U.S. CLS. 19, 21, 23, 31, 35 AND 44).

PRIORITY CLAIMED UNDER SEC. 44(D) ON ERPNTY TM OFC APPLICATION NO. 3163151, FILED 4-1-2003, REG. NO. 003163151, DATED 4-19-2006, EXPIRES 4-1-2013.

SER. NO. 78-278,121, FILED 7-24-2003.

SOPHIA S. KIM, EXAMINING ATTORNEY

Int. Cls.: 7 and 37

Prior U.S. Cls.: 13, 19, 21, 23, 31, 34, 35, 100, 103 and 106

United States Patent and Trademark Office

Reg. No. 3,398,360

Registered Mar. 18, 2008

**TRADEMARK
SERVICE MARK
PRINCIPAL REGISTER**

AJAY

AJAY EQUIPMENT CORPORATION (CALIFORNIA CORPORATION)
712 S. RICHFIELD ROAD
PLACENTIA, CA 928706760

FOR: FREIGHT ELEVATORS, VERTICAL RECIPROCATING CONVEYOR; STORAGE ELEVATORS, CONSTRUCTION MATERIALS ELEVATORS , IN CLASS 7 (U.S. CLS. 13, 19, 21, 23, 31, 34 AND 35).

FIRST USE 10-0-1983; IN COMMERCE 10-0-1983.

FOR: INSTALLATION AND MAINTENANCE OF VERTICAL RECIPROCATING CONVEYORS, FREIGHT LIFTS, STORAGE LIFTS, AND MATERIAL LIFTS, IN CLASS 37 (U.S. CLS. 100, 103 AND 106).

FIRST USE 10-0-1983; IN COMMERCE 10-0-1983.

SER. NO. 78-286,704, FILED 8-13-2003.

TIMOTHY FINNEGAN, EXAMINING ATTORNEY

Int. Cls.: 9 and 16

Prior U.S. Cls.: 2, 5, 21, 22, 23, 26, 29, 36, 37, 38 and 50

Reg. No. 3,398,361

United States Patent and Trademark Office

Registered Mar. 18, 2008

**TRADEMARK
PRINCIPAL REGISTER**

QUIZMAS

GORDON PAPE ENTERPRISES LTD. (CANADA CORPORATION)
372 WOODSWORTH ROAD
TORONTO, ONTARIO, CANADA M2L 2T6

FOR: COMPUTER GAME SOFTWARE AND VIDEO GAME SOFTWARE, IN CLASS 9 (U.S. CLS. 21, 23, 26, 36 AND 38).

FOR: BOOKS ON THE SUBJECT OF CHRISTMAS-RELATED TRIVIA AND MEMOIRS, SERIES OF NON-FICTION BOOKS ON THE SUBJECT OF CHRISTMAS-RELATED TRIVIA AND MEMOIRS,

GREETING CARDS, IN CLASS 16 (U.S. CLS. 2, 5, 22, 23, 29, 37, 38 AND 50).

PRIORITY CLAIMED UNDER SEC. 44(D) ON CANADA APPLICATION NO. 1172220, FILED 4-14-2003, REG. NO. TMA680,857, DATED 2-1-2007, EXPIRES 2-1-2022.

SER. NO. 78-308,356, FILED 10-2-2003.

MIDGE BUTLER, EXAMINING ATTORNEY

Int. Cl.: 5

Prior U.S. Cls.: 6, 18, 44, 46, 51 and 52

United States Patent and Trademark Office

Reg. No. 3,398,362

Registered Mar. 18, 2008

**TRADEMARK
PRINCIPAL REGISTER**

ALLER 24

CONFIDENCE INC. (NEW YORK CORPORATION)
138 HAVEN AVE., #101
PORT WASHINGTON, NY 11050

NO CLAIM IS MADE TO THE EXCLUSIVE
RIGHT TO USE "24", APART FROM THE MARK
AS SHOWN.

FOR: HERBAL AND VITAMIN SUPPLEMENTS,
IN CLASS 5 (U.S. CLS. 6, 18, 44, 46, 51 AND 52).

SER. NO. 78-310,193, FILED 10-7-2003.

FIRST USE 5-1-2002; IN COMMERCE 5-1-2002.

LINDA ESTRADA, EXAMINING ATTORNEY

Int. Cl.: 3

Prior U.S. Cls.: 1, 4, 6, 50, 51 and 52

Reg. No. 3,398,363

United States Patent and Trademark Office

Registered Mar. 18, 2008

**TRADEMARK
PRINCIPAL REGISTER**

Tribal Ink

DIXON, MARK A (UNITED STATES INDIVIDUAL)

315 3RD STREET UNIT M

HUNTINGTON BEACH, CA 92648

FOR: BODY PAINTS, IN CLASS 3 (U.S. CLS. 1, 4, 6, 50, 51 AND 52).

FIRST USE 8-1-2002; IN COMMERCE 8-1-2002.

THE MARK CONSISTS OF STANDARD CHARACTERS WITHOUT CLAIM TO ANY PARTICULAR FONT, STYLE, SIZE, OR COLOR.

NO CLAIM IS MADE TO THE EXCLUSIVE RIGHT TO USE "INK", APART FROM THE MARK AS SHOWN.

SER. NO. 78-349,120, FILED 1-7-2004.

MICHAEL SOUDERS, EXAMINING ATTORNEY

Int. Cl.: 40

Prior U.S. Cls.: 100, 103 and 106

United States Patent and Trademark Office

Reg. No. 3,398,364

Registered Mar. 18, 2008

**SERVICE MARK
PRINCIPAL REGISTER**

Rapid Casting

RAPID PRODUCT DEVELOPMENT GROUP,
INC. (CALIFORNIA CORPORATION)
2565 SUMMIT DRIVE
ESCONDIDO, CA 92025

FOR: CUSTOM MANUFACTURE OF PLASTIC,
WAX, AND ELASTOMERIC PARTS IN SILICONE
RUBBER MOLDS, IN CLASS 40 (U.S. CLS. 100, 103
AND 106).

FIRST USE 11-15-2003; IN COMMERCE 11-15-2003.

THE MARK CONSISTS OF STANDARD CHAR-
ACTERS WITHOUT CLAIM TO ANY PARTICULAR
FONT, STYLE, SIZE, OR COLOR.

NO CLAIM IS MADE TO THE EXCLUSIVE
RIGHT TO USE "CASTING", APART FROM THE
MARK AS SHOWN.

SER. NO. 78-370,795, FILED 2-19-2004.

ALICE BENMAMAN, EXAMINING ATTORNEY

Int. Cl.: 35

Prior U.S. Cls.: 100, 101 and 102

United States Patent and Trademark Office

Reg. No. 3,398,365

Registered Mar. 18, 2008

**SERVICE MARK
PRINCIPAL REGISTER**

**BESTCHOICEVACUUMS.
COM**

IAN DESIGN, INC. (DELAWARE CORPORATION)
92 ORCHID COURT
TOMS RIVER, NJ 08753

THE MARK CONSISTS OF STANDARD CHARACTERS WITHOUT CLAIM TO ANY PARTICULAR FONT, STYLE, SIZE, OR COLOR.

FOR: ONLINE RETAIL STORE SERVICES FEATURING VACUUM CLEANERS, IN CLASS 35 (U.S. CLS. 100, 101 AND 102).

SER. NO. 78-377,462, FILED 3-3-2004.

FIRST USE 2-24-2004; IN COMMERCE 2-24-2004.

KATHRYN COWARD, EXAMINING ATTORNEY

Int. Cl.: 30

Prior U.S. Cl.: 46

United States Patent and Trademark Office

Reg. No. 3,398,366

Registered Mar. 18, 2008

TRADEMARK
PRINCIPAL REGISTER

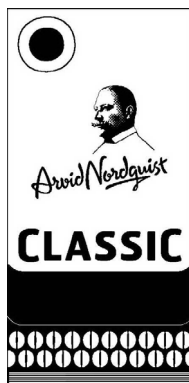

ARVID NORDQUIST HAB (SWEDEN JOINT
STOCK COMPANY)
BOX 1285
SOLNA, SWEDEN S-171 25

FOR: COFFEE AND ARTIFICIAL COFFEE, IN
CLASS 30 (U.S. CL. 46).

PRIORITY CLAIMED UNDER SEC. 44(D) ON
SWEDEN APPLICATION NO. 200307418, FILED 12-
10-2003, REG. NO. 390866, DATED 8-31-2007, EX-
PIRES 8-31-2017.

NO CLAIM IS MADE TO THE EXCLUSIVE
RIGHT TO USE "CLASSIC", APART FROM THE
MARK AS SHOWN.

THE NAME(S), PORTRAIT(S), AND/OR SIGNA-
TURE(S) SHOWN IN THE MARK DOES NOT IDEN-
TIFY A PARTICULAR LIVING INDIVIDUAL.

THE BACKGROUND CONSISTS OF THREE SEC-
TIONS. THE LOWER AND UPPER SECTIONS OF
THE BACKGROUND ARE COMPOSED OF PAIRS
OF SEMI CIRCULAR FIGURES RESEMBLING
OVALS. THE MIDDLE SECTION OF THE BACK-
GROUND IS BLACK. THE UPPER SECTION IS
COMPRISED OF A CIRCLE ENCIRCLING A CIR-
CLE IN THE UPPER LEFT CORNER; A MALE BUST
IN THE CENTER WITH THE STYLIZED WORDS
"ARVID NORDQUIST" IMMEDIATELY UNDER-
NEATH; AND THE WORD "CLASSIC" AT THE
BOTTOM OF THAT SECTION.

SER. NO. 78-395,762, FILED 4-2-2004.

STEVEN R. FINE, EXAMINING ATTORNEY

Int. Cl.: 11

Prior U.S. Cls.: 13, 21, 23, 31 and 34

United States Patent and Trademark Office

Reg. No. 3,398,367

Registered Mar. 18, 2008

**TRADEMARK
PRINCIPAL REGISTER**

PLUGG

PLUGG LTD (UNITED KINGDOM COMPANY)
11 CHALCOT ROAD
LONDON, UNITED KINGDOM NW1 8LH

FOR: APPARATUS FOR LIGHTING, NAMELY, LASER LIGHT PROJECTORS; DECORATIVE LAMPS; LASER LAMPS; LAMPS WHICH PROJECT LIGHT USING LASERS; LAMPS WHICH PROJECT LIGHT USING LEDS (LIGHT EMITTING DIODES), LAMPS WHICH PROJECT LIGHT USING CRYSTALS, AND LAMPS WHICH PROJECT LIGHT USING HOLOGRAPHS; LAMPS AND LIGHTS WHICH GENERATE LASER EFFECTS; LIGHT DIFFUSERS; PARTS AND FITTINGS FOR ALL THE

AFORESAID GOODS, IN CLASS 11 (U.S. CLS. 13, 21, 23, 31 AND 34).

THE MARK CONSISTS OF STANDARD CHARACTERS WITHOUT CLAIM TO ANY PARTICULAR FONT, STYLE, SIZE, OR COLOR.

PRIORITY CLAIMED UNDER SEC. 44(D) ON ERPN CMNTY TM OFC APPLICATION NO. 3755725, FILED 4-6-2004, REG. NO. 3755725, DATED 4-6-2004, EXPIRES 4-6-2014.

SER. NO. 78-397,685, FILED 4-7-2004.

KATHRYN COWARD, EXAMINING ATTORNEY

Int. Cl.: 9

Prior U.S. Cls.: 21, 23, 26, 36 and 38

Reg. No. 3,398,368

United States Patent and Trademark Office

Registered Mar. 18, 2008

**TRADEMARK
PRINCIPAL REGISTER**



SPAM CUBE, INC (DELAWARE CORPORATION), DBA SPAM CUBE
305 W BROADWAY #315
NEW YORK, NY 10013

FIRST USE 5-1-2002; IN COMMERCE 6-1-2002.

NO CLAIM IS MADE TO THE EXCLUSIVE RIGHT TO USE "SPAM CUBE", APART FROM THE MARK AS SHOWN.

FOR: COMPUTER HARDWARE, NAMELY A COMPUTER NETWORK PERIPHERAL FOR PCS FOR PROCESSING INCOMING E-MAIL AND FILTERING JUNK E-MAIL, IN CLASS 9 (U.S. CLS. 21, 23, 26, 36 AND 38).

SER. NO. 78-411,511, FILED 4-30-2004.

ANDREA BUTLER, EXAMINING ATTORNEY

Int. Cl.: 29

Prior U.S. Cl.: 46

United States Patent and Trademark Office

Reg. No. 3,398,369

Registered Mar. 18, 2008

TRADEMARK
PRINCIPAL REGISTER



UNITED FOOD IMPORT (NEW JERSEY CORPORATION)
3 CHRIS COURT
SUITE K
DAYTON, NJ 08810

FOR: FROZEN FRUIT AND VEGETABLES, NAMELY, OKRA, MOLOKHIA, ARTICHOKE, GREEN PEAS, GREEN BEANS, MIXED VEGETABLES, CAULIFLOWER, COLCASSIA, ALSO KNOWN AS TARO ROOT, GREEN SPINACH, BROAD BEANS VINE LEAVES ALSO KNOWN AS GRAPE LEAVES, FALAFEL, BROCCOLI, STRAWBERRIES, SWEET CORN, CARROTS, CORIANDER, GARLIC, POTATOES, IN CLASS 29 (U.S. CL. 46).

FIRST USE 1-1-1998; IN COMMERCE 1-1-1998.

NO CLAIM IS MADE TO THE EXCLUSIVE RIGHT TO USE "GREEN MOLOKHIA" AND THE "PHOTOGRAPH OF GREEN LEAFY VEGETABLES" AND "400G", APART FROM THE MARK AS SHOWN.

THE COLOR(S) GREEN, RED AND YELLOW IS/ARE CLAIMED AS A FEATURE OF THE MARK.

THE LEAVES APPEAR IN GREEN. THE WRITING ON THE PACKAGING APPEARS IN RED. THE BORDER, OVAL AND RIBBON DESIGNS APPEAR IN YELLOW.

THE FOREIGN WORDING IN THE MARK TRANSLATES INTO ENGLISH AS SMILE.

THE NON-LATIN CHARACTER(S) IN THE MARK TRANSLITERATES INTO BASMA, AND THIS MEANS SMILE IN ENGLISH.

SER. NO. 78-421,214, FILED 5-19-2004.

INGA ERVIN, EXAMINING ATTORNEY

Int. Cl.: 35

Prior U.S. Cls.: 100, 101 and 102

United States Patent and Trademark Office

Reg. No. 3,398,370

Registered Mar. 18, 2008

SERVICE MARK
PRINCIPAL REGISTER



QUALITY TONNES, LLC (CALIFORNIA CORPORATION)
1358 GIRARD ST., N.W.
WASHINGTON, DC, DC 20009

FOR: DEVELOPING, DESIGNING AND IMPLEMENTING ENERGY EFFICIENCY PROJECTS FEATURING CARBON OFFSETS, IN CLASS 35 (U.S. CLS. 100, 101 AND 102).

FIRST USE 3-24-2003; IN COMMERCE 4-1-2004.

NO CLAIM IS MADE TO THE EXCLUSIVE RIGHT TO USE "QUALITY" AND "TONNES", APART FROM THE MARK AS SHOWN.

THE MARK CONSISTS OF A LARGE, STYLIZED LETTER "Q," IN THE MIDDLE OF WHICH MAY BE FOUND THE TEXT, "QUALITY TONNES CARBON REDUCTION WITH A SOCIAL BENEFIT".

SER. NO. 78-424,530, FILED 5-25-2004.

RONALD AIKENS, EXAMINING ATTORNEY

Int. Cls.: 14, 35, 36 and 37

Prior U.S. Cls.: 2, 27, 28, 50, 100, 101, 102, 103 and 106

United States Patent and Trademark Office

Reg. No. 3,398,371

Registered Mar. 18, 2008

**TRADEMARK
SERVICE MARK
PRINCIPAL REGISTER**

WATCH BANK

YAFRIRO INTERNATIONAL PTE LTD (SINGAPORE CORPORATION)
290 ORCHARD ROAD
#01-29 PARAGON, SINGAPORE 238859

FOR: PRECIOUS METALS AND THEIR ALLOYS AND GOODS IN PRECIOUS METALS OR COATED THEREWITH, NAMELY, JEWELRY, PRECIOUS STONES; HOROLOGICAL AND CHRONOMETRIC INSTRUMENTS; WATCHES, WRISTWATCHES, MECHANICAL WATCHES, CHRONOGRAPHS, CHRONOMETERS; CLOCK HANDS, WATCH CASES, DIALS, WATCH BANDS, WATCH SPRINGS, MOVEMENTS FOR CLOCKS AND WATCHES, BARRELS, WATCH CHAINS, WATCH GLASSES; CASES FOR WATCHES, IN CLASS 14 (U.S. CLS. 2, 27, 28 AND 50).

FOR: ADVERTISING; BUSINESS MANAGEMENT; BUSINESS ADMINISTRATION; RETAIL STORE SERVICES FEATURING HOROLOGICAL PRODUCTS, WATCHES, JEWELRY; ONLINE RETAIL STORE SERVICES FEATURING HOROLOGICAL PRODUCTS, WATCHES, JEWELRY; RETAIL MAIL ORDER SERVICES FEATURING HOROLOGICAL PRODUCTS, WATCHES, JEWELRY, IN CLASS 35 (U.S. CLS. 100, 101 AND 102).

FOR: SAFE DEPOSIT BOX SERVICES; JEWELRY, WATCH AND CLOCK APPRAISAL, IN CLASS 36 (U.S. CLS. 100, 101 AND 102).

FOR: REPAIR AND MAINTENANCE OF CLOCKS, WATCHES, CHRONOMETERS AND

CHRONOGRAPHS, IN CLASS 37 (U.S. CLS. 100, 103 AND 106).

THE MARK CONSISTS OF STANDARD CHARACTERS WITHOUT CLAIM TO ANY PARTICULAR FONT, STYLE, SIZE, OR COLOR.

PRIORITY CLAIMED UNDER SEC. 44(D) ON SINGAPORE APPLICATION NO. T03/19206A, FILED 11-28-2003, REG. NO. T03/19206A, DATED 11-28-2003, EXPIRES 11-28-2013.

PRIORITY CLAIMED UNDER SEC. 44(D) ON SINGAPORE APPLICATION NO. T04/05693E, FILED 4-8-2004, REG. NO. T04/05693E, DATED 4-8-2004, EXPIRES 4-8-2014.

PRIORITY CLAIMED UNDER SEC. 44(D) ON SINGAPORE APPLICATION NO. T03/19207Z, FILED 11-28-2003, REG. NO. T03/19207Z, DATED 11-28-2003, EXPIRES 11-28-2013.

PRIORITY CLAIMED UNDER SEC. 44(D) ON SINGAPORE APPLICATION NO. T03/19205C, FILED 11-28-2003, REG. NO. T03/19205C, DATED 11-28-2003, EXPIRES 11-28-2013.

NO CLAIM IS MADE TO THE EXCLUSIVE RIGHT TO USE "WATCH", APART FROM THE MARK AS SHOWN.

SER. NO. 78-426,284, FILED 5-27-2004.

ALICE SUE CARRUTHERS, EXAMINING ATTORNEY

Int. Cl.: 29

Prior U.S. Cl.: 46

United States Patent and Trademark Office

Reg. No. 3,398,372

Registered Mar. 18, 2008

**TRADEMARK
PRINCIPAL REGISTER**

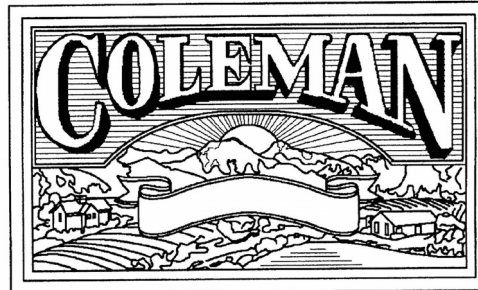

COLEMAN NATURAL PRODUCTS, INC. (DELA-
WARE CORPORATION)
SUITE 200
1767 DENVER WEST MARRIOTT ROAD
GOLDEN, CO 80401

FOR: FRESH, FROZEN AND PROCESSED
MEATS, IN CLASS 29 (U.S. CL. 46).

FIRST USE 5-0-2003; IN COMMERCE 5-0-2003.

OWNER OF U.S. REG. NOS. 1,484,448, 2,463,451
AND OTHERS.

THE LINING IN THE DRAWING IS A FEATURE
OF THE MARK.

SER. NO. 78-429,021, FILED 6-2-2004.

ANGELA M. MICHELI, EXAMINING ATTORNEY

Int. Cl.: 29

Prior U.S. Cl.: 46

United States Patent and Trademark Office

Reg. No. 3,398,373

Registered Mar. 18, 2008

**TRADEMARK
PRINCIPAL REGISTER**

**HIGH SCHOOL
SPECIAL**

MARINI, GIUSEPPE (UNITED STATES INDIVIDUAL)
153 BEACH ROAD
POUGHQUAG, NY 125705142

OWNER OF U.S. REG. NOS. 2,781,400 AND 3,274,131.

FOR: COMBINATION MEAL CONSISTING OF CHICKEN PIECES, FRENCH FRIES AND A BEVERAGE, IN CLASS 29 (U.S. CL. 46).

NO CLAIM IS MADE TO THE EXCLUSIVE RIGHT TO USE "SPECIAL", APART FROM THE MARK AS SHOWN.

FIRST USE 8-27-2004; IN COMMERCE 2-4-2005.

SER. NO. 78-429,850, FILED 6-4-2004.

THE MARK CONSISTS OF STANDARD CHARACTERS WITHOUT CLAIM TO ANY PARTICULAR FONT, STYLE, SIZE, OR COLOR.

DOMINICK J. SALEMI, EXAMINING ATTORNEY

Int. Cls.: 9, 18, 25 and 28

Prior U.S. Cls.: 1, 2, 3, 21, 22, 23, 26, 36, 38, 39, 41 and 50

Reg. No. 3,398,374

United States Patent and Trademark Office

Registered Mar. 18, 2008

**TRADEMARK
PRINCIPAL REGISTER**

MARK TODD

WESTGATE EFI LIMITED (UNITED KINGDOM CORPORATION)
ROSS HOUSE, THE SQUARE, STOW ON THE WORLD
CHELTENHAM, GLOUCESTERSHIRE, UNITED KINGDOM GL54 1AF

FOR: PROTECTIVE CLOTHING, IN CLASS 9 (U.S. CLS. 21, 23, 26, 36 AND 38).

FOR: ARTICLES OF LEATHER AND IMITATION LEATHER ALL BEING FOR EQUESTRIAN USE, NAMELY, BRIDLES, SADDLES, HEADCOLLARS, GIRTHS, LEATHER STIRRUPS, WHIPS, DRESSAGE WHIPS, SADDLEPADS, SADDLEPADS FOR DRESSAGE; NUMNAHS, SADDLERY, HORSE BRIDLES, STIRRUPS, HORSE CLOTHING, BREASTPLATES, HEADCOLLARS, LEAD ROPES, NECK COVERS FOR STABLES, NECK COVERS FOR TURNOUTS, HIND AND FRONT LEG BOOTS, TURNOUT RUGS, STABLE RUGS, RUGS, FLY RUGS SHEETS, EXERCISE SHEETS, BLANKETS, SHEETS, EQUESTRIAN COOLERS ALL OF THE AFOREMENTIONED GOODS FOR USE ON HORSES; NOSE BAGS; HORSE CLOTHS, COLLARS, COVERS, AND BLANKETS; HORSE LEG PROTECTORS AND BOOTS; WHIPS AND CROPS, IN CLASS 18 (U.S. CLS. 1, 2, 3, 22 AND 41).

FOR: ARTICLES OF CLOTHING, NAMELY, SOCKS, UNDERGARMENTS, JODHPURS, TROU-

SERS, SHORTS, SHOWSHIRTS, OUTERWEAR, NAMELY, JACKETS AND CHAPS, SHOWING JACKETS, RIDERS JACKETS, FOOTWEAR AND HEADGEAR, NAMELY, HATS, CAPS, RIDER HATS; RIDING COATS, JACKETS, BOOTS, GLOVES, AND RIDING BOOTS; BREECHES, CHAPS, WAISTCOATS, SCARVES AND TIES, IN CLASS 25 (U.S. CLS. 22 AND 39).

FOR: BODY PROTECTORS FOR EQUESTRIAN USE, IN CLASS 28 (U.S. CLS. 22, 23, 38 AND 50).

THE MARK CONSISTS OF STANDARD CHARACTERS WITHOUT CLAIM TO ANY PARTICULAR FONT, STYLE, SIZE, OR COLOR.

PRIORITY CLAIMED UNDER SEC. 44(D) ON ERPN CMNTY TM OFC APPLICATION NO. 003677671, FILED 2-19-2004, REG. NO. 003677671, DATED 8-19-2005, EXPIRES 2-19-2014.

THE NAME "MARK TODD" IDENTIFIES A PARTICULAR LIVING INDIVIDUAL WHOSE CONSENT IS OF RECORD.

SER. NO. 78-436,922, FILED 6-17-2004.

DARRYL SPRUILL, EXAMINING ATTORNEY

Int. Cls.: 4 and 34

Prior U.S. Cls.: 1, 2, 6, 8, 9, 15 and 17

United States Patent and Trademark Office

Reg. No. 3,398,375

Registered Mar. 18, 2008

**TRADEMARK
PRINCIPAL REGISTER**

SWIFT-LITE

SWIFT-LITE CHARCOAL COMPANY LTD. (UNI-
TED KINGDOM LTD LIAB CO)
MARLEY LANE
BATTLE EAST SUSSEX, UNITED KINGDOM TN33
043

FOR: CHARCOAL TABLETS FOR USE AS A FUEL
FOR BURNING INCENSE, IN CLASS 4 (U.S. CLS. 1, 6
AND 15).

FIRST USE 0-0-1992; IN COMMERCE 0-0-1992.

FOR: CHARCOAL TABLETS FOR USE IN SMOK-
ING HOOKAH PIPES, IN CLASS 34 (U.S. CLS. 2, 8, 9
AND 17).

FIRST USE 0-0-1992; IN COMMERCE 0-0-1992.

THE MARK CONSISTS OF STANDARD CHAR-
ACTERS WITHOUT CLAIM TO ANY PARTICULAR
FONT, STYLE, SIZE, OR COLOR.

OWNER OF U.S. REG. NO. 3,131,839.

SER. NO. 78-458,355, FILED 7-28-2004.

GEORGE LORENZO, EXAMINING ATTORNEY

Int. Cl.: 25

Prior U.S. Cls.: 22 and 39

United States Patent and Trademark Office

Reg. No. 3,398,376

Registered Mar. 18, 2008

**TRADEMARK
PRINCIPAL REGISTER**

SHROOMERY

MIND MEDIA, INC. (CALIFORNIA CORPORATION)
SUITE C, PMB 187
849 ALMAR AVE
SANTA CRUZ, CA 95060

FOR: CLOTHING, NAMELY, HOODED SWEATSHIRTS, SWEATSHIRTS, LONG AND SHORT-SLEEVE T-SHIRTS, CAPS AND HATS, AND BOXERS AND THONGS, IN CLASS 25 (U.S. CLS. 22 AND 39).

FIRST USE 8-1-1997; IN COMMERCE 5-1-2004.

THE MARK CONSISTS OF STANDARD CHARACTERS WITHOUT CLAIM TO ANY PARTICULAR FONT, STYLE, SIZE, OR COLOR.

SER. NO. 78-467,507, FILED 8-13-2004.

STEVEN JACKSON, EXAMINING ATTORNEY

Int. Cl.: 26

Prior U.S. Cls.: 37, 39, 40, 42 and 50

United States Patent and Trademark Office

Reg. No. 3,398,377

Registered Mar. 18, 2008

**TRADEMARK
PRINCIPAL REGISTER**

The logo consists of the word "HAIRXTEND" written in a bold, black, slasher-style font. The letters are highly stylized with sharp, angular edges and some internal cutouts, giving it a modern, edgy appearance.

HAIRXTEND INC. (VIRGINIA CORPORATION)
130 MAPLE AVENUE WEST
VIENNA, VA 22180

FIRST USE 2-4-2001; IN COMMERCE 2-4-2002.

THE MARK CONSISTS OF SLASHER STYLE
FONT.

SEC. 2(F).

SER. NO. 78-491,483, FILED 9-29-2004.

FOR: HAIR EXTENSION KIT COMPRISED OF
HUMAN HAIR AND HAIR EXTENSIONS SOLD
TOGETHER WITH A TRAVEL BAG, APPLICATORS,
SILICON PADS, PLIERS, REMOVAL FLUID, COLOR
SELECTION RING, DRAWING CARDS, BRUSH,
BONDING RESIN, INSTRUCTION MANUAL; HU-
MAN HAIR AND HAIR EXTENSIONS, IN CLASS 26
(U.S. CLS. 37, 39, 40, 42 AND 50).

EUGENIA MARTIN, EXAMINING ATTORNEY

Int. Cl.: 9

Prior U.S. Cls.: 21, 23, 26, 36 and 38

United States Patent and Trademark Office

Reg. No. 3,398,378

Registered Mar. 18, 2008

**TRADEMARK
PRINCIPAL REGISTER**



SU-KAM COMMUNICATION SYSTEMS LTD.
(INDIA CORPORATION)
WZ-1401/2, NANGAL RAYA
NEW DELHI 110046, INDIA

OWNER OF INDIA REG. NO. 821727, DATED 10-5-1998, EXPIRES 10-5-2008.

FOR: INVERTERS; LINE INTERACTIVE UPS
(UNINTERRUPTIBLE POWER SUPPLIES); ONLINE
UPS; BATTERIES; AND BATTERY CHARGERS, IN
CLASS 9 (U.S. CLS. 21, 23, 26, 36 AND 38).

SER. NO. 78-499,014, FILED 10-13-2004.

SUNG IN, EXAMINING ATTORNEY

Int. Cl.: 42

Prior U.S. Cls.: 100 and 101

United States Patent and Trademark Office

Reg. No. 3,398,379

Registered Mar. 18, 2008

**SERVICE MARK
PRINCIPAL REGISTER**

ASSAY DESIGNS

ASSAY DESIGNS, INC. (GEORGIA CORPORATION)
800 TECHNOLOGY DRIVE
ANN ARBOR, MI 48108

FOR: SCIENTIFIC RESEARCH; RESEARCH AND DEVELOPMENT OF NEW PRODUCTS FOR OTHERS IN THE BIOMEDICAL, PHARMACEUTICAL, AND SCIENTIFIC RESEARCH FIELD; CUSTOM DESIGN SERVICES IN THE FIELD OF BIOMEDICAL PRODUCTS, PHARMACEUTICAL PRODUCTS, AND SCIENTIFIC RESEARCH PRODUCTS, IN CLASS 42 (U.S. CLS. 100 AND 101).

FIRST USE 0-0-1995; IN COMMERCE 0-0-1995.

THE MARK CONSISTS OF STANDARD CHARACTERS WITHOUT CLAIM TO ANY PARTICULAR FONT, STYLE, SIZE, OR COLOR.

NO CLAIM IS MADE TO THE EXCLUSIVE RIGHT TO USE "DESIGNS", APART FROM THE MARK AS SHOWN.

SER. NO. 78-499,819, FILED 10-14-2004.

TEJBIR SINGH, EXAMINING ATTORNEY

Int. Cls.: 16 and 21

**Prior U.S. Cls.: 2, 5, 13, 22, 23, 29, 30, 33, 37, 38, 40
and 50**

Reg. No. 3,398,380

United States Patent and Trademark Office

Registered Mar. 18, 2008

**TRADEMARK
PRINCIPAL REGISTER**



CARTE BLANCHE GREETINGS LIMITED (UNITED KINGDOM CORPORATION)
P.O. BOX 500
CHICHESTER, UNITED KINGDOM PO20 2XZ

FOR: NOTEBOOKS, AUTOGRAPH BOOKS, EXERCISE BOOKS, EDUCATIONAL PICTURE BOOKS FOR CHILDREN, CHILDREN'S ACTIVITY BOOKS, COLORING BOOKS, CHILDREN'S BOOKS; STATIONERY; PUBLICATIONS AND PRINTED MATERIALS, NAMELY, BROCHURES RELATING TO GIFTWARE AND SOFT TOYS; SCRAPBOOKS, ADDRESS BOOKS; PHOTO ALBUMS, DIARIES AND SECRET BOOKS; PHOTOGRAPHS, PICTURES AND POSTERS; DRAWING RULERS, UNGRADUATED RULERS; ERASERS, PENS, PENCILS, CRAYONS, PAINTS, PEN AND PENCIL STANDS; PEN AND PENCIL HOLDERS AND CASES; ADHESIVES FOR STATIONERY OR HOUSEHOLD USE; ARTISTS MATERIALS, NAMELY, ARTISTS' BRUSHES, ARTISTS' PENCILS; PAINT BRUSHES; GREETING CARDS; STICKERS, WRAPPING PAPER, BUSINESS CARDS, PAPER AND CARDBOARD BOWS FOR GIFTWRAP; PAPER AND CARDBOARD GIFT RIBBONS; ENVELOPES, PRINTED PAPER SIGNS; STICKERS; DECORATIVE STICKERS FOR CARS; TABLE LINEN OF PAPER; TABLECLOTHS OF

PAPER; TABLE NAPKINS OF PAPER; TRASH BAGS; PAPER CLIPS, IN CLASS 16 (U.S. CLS. 2, 5, 22, 23, 29, 37, 38 AND 50).

FOR: FIGURINES OF CHINA, CRYSTAL, EARTHENWARE, GLASS, PORCELAIN AND TERRA COTTA; HAIRBRUSHES AND COMBS; HAIR BRUSH AND COMB CASES; CANDLE-HOLDERS; MUGS, BEVERAGE GLASSWARE; CHINA ORNAMENTS, PORCELAIN, GLASSWARE AND EARTHENWARE, NAMELY, MUGS, PLATES, BOWLS, ORNAMENTS AND FIGURINES; CONTAINERS FOR HOUSEHOLD OR KITCHEN USE; CLOTHES PINS, IN CLASS 21 (U.S. CLS. 2, 13, 23, 29, 30, 33, 40 AND 50).

OWNER OF ERPN CMNTY TM OFC REG. NO. 2552172, DATED 1-28-2002, EXPIRES 1-28-2012.

NO CLAIM IS MADE TO THE EXCLUSIVE RIGHT TO USE "GREETINGS LTD.", APART FROM THE MARK AS SHOWN.

SER. NO. 78-507,187, FILED 10-28-2004.

MICHAEL SOUDERS, EXAMINING ATTORNEY

Int. Cls.: 35, 36, 37, 39, 42 and 43

Prior U.S. Cls.: 100, 101, 102, 103, 105 and 106

United States Patent and Trademark Office

Reg. No. 3,398,381

Registered Mar. 18, 2008

**SERVICE MARK
PRINCIPAL REGISTER**

ON YOU GO

CALIFORNIA STATE AUTOMOBILE ASSOCIATION (CALIFORNIA MUTUAL BENEFIT CORPORATION)

100 VAN NESS AVENUE
SAN FRANCISCO, CA 94102

FOR: AUTOMOBILE CLUB SERVICES, NAMELY PROMOTING THE INTERESTS OF MOTOR VEHICLE OWNERS AND USERS, PROMOTING PUBLIC AWARENESS OF THE NEED FOR HIGHWAY AND PEDESTRIAN SAFETY PROGRAMS, ARRANGING DISCOUNTS FOR MEMBERS OF AN AUTOMOBILE CLUB FROM VENDORS OF AUTOMOTIVE SERVICES, HOTEL CHAINS, TOURIST ATTRACTIONS, RESTAURANTS AND RETAIL OUTLETS, REFERRAL SERVICES IN THE FIELD OF VEHICLE PRICING AND PURCHASING, IN CLASS 35 (U.S. CLS. 100, 101 AND 102).

FIRST USE 9-20-2004; IN COMMERCE 9-20-2004.

FOR: INSURANCE AGENCY SERVICES, NAMELY, INSURANCE UNDERWRITING IN THE FIELDS OF AUTOMOBILE, HOMEOWNERS, RENTERS, FLOOD, PERSONAL LIABILITY, MOBILE HOME, LIFE AND EARTHQUAKE INSURANCE, INSURANCE CLAIMS AND PAYMENTS ADMINISTRATION; ONLINE INSURANCE QUOTATIONS, IN CLASS 36 (U.S. CLS. 100, 101 AND 102).

FIRST USE 9-20-2004; IN COMMERCE 9-20-2004.

FOR: EMERGENCY ROAD SIDE SERVICES; EMERGENCY ROAD SIDE SERVICE FEATURING

DISPATCHING EMERGENCY ROAD SERVICE VEHICLES VIA THE INTERNET; AUTOMOBILE REPAIR AND MAINTENANCE SERVICES, IN CLASS 37 (U.S. CLS. 100, 103 AND 106).

FIRST USE 9-20-2004; IN COMMERCE 9-20-2004.

FOR: TRAVEL BOOKING AGENCY SERVICES, NAMELY, ARRANGING AND BOOKING TRAVEL TOURS; TRAVEL CLUB SERVICES, NAMELY, PROVIDING MEMBERS WITH TRAVEL INFORMATION ABOUT TRIP PLANNING AND TOURING, AND PROVIDING MAPS AND ROUTE INFORMATION; MAKING RESERVATIONS AND BOOKINGS FOR TRANSPORTATION; PROVIDING CUSTOMIZED TRAVEL ROUTINGS VIA THE INTERNET; PROVIDING TRAFFIC CONDITIONS INFORMATION VIA THE INTERNET, IN CLASS 39 (U.S. CLS. 100 AND 105).

FIRST USE 9-20-2004; IN COMMERCE 9-20-2004.

FOR: AUTOMOBILE ENGINE AND TRANSMISSION DIAGNOSTIC SERVICES; AUTOMOTIVE DIAGNOSTIC SERVICES FEATURING COMPUTER SOFTWARE FOR USE BY INDEPENDENT AUTOMOTIVE REPAIR PERSONNEL, IN CLASS 42 (U.S. CLS. 100 AND 101).

FIRST USE 9-20-2004; IN COMMERCE 9-20-2004.

FOR: TRAVEL AGENCY SERVICES, NAMELY, MAKING HOTEL AND OTHER TEMPORARY LOD-

GING RESERVATIONS, IN CLASS 43 (U.S. CLS. 100 AND 101).

THE MARK CONSISTS OF STANDARD CHARACTERS WITHOUT CLAIM TO ANY PARTICULAR FONT, STYLE, SIZE, OR COLOR.

SER. NO. 78-508,661, FILED 10-29-2004.

FIRST USE 9-20-2004; IN COMMERCE 9-20-2004.

ESTHER BELENKER, EXAMINING ATTORNEY

Int. Cl.: 7

Prior U.S. Cls.: 13, 19, 21, 23, 31, 34 and 35

Reg. No. 3,398,382

United States Patent and Trademark Office

Registered Mar. 18, 2008

**TRADEMARK
PRINCIPAL REGISTER**

WHISPER TECH

WHISPER TECH LTD. (NEW ZEALAND CORPORATION)
224 ARMAGH STREET
CHRISTCHURCH, NEW ZEALAND

FOR: ELECTRIC GENERATORS FOR USE WITH AN EXTERNAL COMBUSTION ENGINE, AND PARTS AND FITTINGS THEREFOR, NAMELY YOKES AND BURNERS, FOR GENERATION OF ELECTRICITY, HEATING, AND/OR COOLING IN HOUSEHOLD AND COMMERCIAL ESTABLISHMENTS AND ELECTRIC GENERATORS FOR USE WITH AN EXTERNAL COMBUSTION ENGINE IN SYSTEMS AND APPARATUS FOR GENERATION OF ELECTRICITY, HEATING AND/OR COOLING, NAMELY IN HOUSEHOLD AND COMMERCIAL APPLICATIONS, IN CLASS 7 (U.S. CLS. 13, 19, 21, 23, 31, 34 AND 35).

THE MARK CONSISTS OF STANDARD CHARACTERS WITHOUT CLAIM TO ANY PARTICULAR FONT, STYLE, SIZE, OR COLOR.

OWNER OF NEW ZEALAND REG. NO. 288258, DATED 7-22-1999, EXPIRES 2-9-2015.

OWNER OF NEW ZEALAND REG. NO. 288257, DATED 9-30-1998, EXPIRES 2-9-2015.

NO CLAIM IS MADE TO THE EXCLUSIVE RIGHT TO USE "TECH", APART FROM THE MARK AS SHOWN.

SER. NO. 78-512,280, FILED 11-5-2004.

ALLISON HOLTZ, EXAMINING ATTORNEY

Int. Cls.: 37 and 40

Prior U.S. Cls.: 100, 103 and 106

United States Patent and Trademark Office

Reg. No. 3,398,383

Registered Mar. 18, 2008

**SERVICE MARK
PRINCIPAL REGISTER**

CONTECH

CONTECH CONSTRUCTION PRODUCTS INC.
(OHIO CORPORATION)
1001 GROVE STREET
MIDDLETOWN, OH 45044

FOR: PROVIDING TECHNICAL INFORMATION CONCERNING THE INSTALLATION OF CONCRETE ARCH STRUCTURES, PREFABRICATED STEEL TRUSS BRIDGES, STRUCTURAL METAL PLATE, BRIDGE PLANKS, METALLIC DRAINAGE PIPES, PLASTIC DRAINAGE PIPES, STORM WATER DETENTION STRUCTURES, STORM WATER TREATMENT UNITS, STORM WATER FILTRATION UNITS, RETAINING WALL SYSTEMS AND BLOCK, GEOGRIDS, GEOTEXTILES AND HARD ARMOR PRODUCTS TO CIVIL ENGINEERS, DESIGN/BUILD PROFESSIONALS AND CONTRACTORS IN THE FIELDS OF BRIDGES, DRAINAGE, EROSION CONTROL, GRADE CHANGE, PAVEMENT, REHABILITATION, SANITARY SEWER, SOIL STABILIZATION, STORM WATER MANAGEMENT AND TUNNELING, VIA A COMPUTER NETWORK, IN CLASS 37 (U.S. CLS. 100, 103 AND 106).

FIRST USE 0-0-1986; IN COMMERCE 0-0-1986.

FOR: PROVIDING TECHNICAL INFORMATION CONCERNING THE MANUFACTURE OF CON-

CRETE ARCH STRUCTURES, PREFABRICATED STEEL TRUSS BRIDGES, STRUCTURAL METAL PLATE, BRIDGE PLANKS, METALLIC DRAINAGE PIPES, PLASTIC DRAINAGE PIPES, STORM WATER DETENTION STRUCTURES, STORM WATER TREATMENT UNITS, STORM WATER FILTRATION UNITS, RETAINING WALL SYSTEMS AND BLOCK, GEOGRIDS, GEOTEXTILES AND HARD ARMOR PRODUCTS TO CIVIL ENGINEERS, DESIGN/BUILD PROFESSIONALS AND CONTRACTORS IN THE FIELDS OF BRIDGES, DRAINAGE, EROSION CONTROL, GRADE CHANGE, PAVEMENT, REHABILITATION, SANITARY SEWER, SOIL STABILIZATION, STORM WATER MANAGEMENT AND TUNNELING, VIA A COMPUTER NETWORK, IN CLASS 40 (U.S. CLS. 100, 103 AND 106).

FIRST USE 0-0-1986; IN COMMERCE 0-0-1986.

THE MARK CONSISTS OF STANDARD CHARACTERS WITHOUT CLAIM TO ANY PARTICULAR FONT, STYLE, SIZE, OR COLOR.

SER. NO. 78-521,296, FILED 11-22-2004.

WENDY GOODMAN, EXAMINING ATTORNEY

Int. Cls.: 14, 35, 37, 40 and 42

Prior U.S. Cls.: 2, 27, 28, 50, 100, 101, 102, 103 and 106

Reg. No. 3,398,384

United States Patent and Trademark Office

Registered Mar. 18, 2008

**TRADEMARK
SERVICE MARK
PRINCIPAL REGISTER**

NATURE'S ORIGINALS

NATURAL DIAMOND COMPANY LIMITED
(UNITED KINGDOM CORPORATION)
KLEINWORT BENSON HOUSE, WESTS CENTRE
ST. HELIER, JERSEY JE4 8PQ

FOR: DIAMONDS, PRECIOUS GEMS AND GEMSTONES, AND SEMI-PRECIOUS GEMS AND GEMSTONES; JEWELLERY CONTAINING DIAMONDS, PRECIOUS GEMS AND GEMSTONES, AND SEMI-PRECIOUS GEMS AND GEMSTONES, NAMELY, BRACELETS, RINGS, NECKLACES, PENDANTS, CHAINS, ANKLETS, EARRINGS, BROOCHES, TIE PINS, TIE CLIPS, CUFFLINKS; AND TIMEPIECES CONTAINING DIAMONDS, PRECIOUS GEMS AND GEMSTONES, AND SEMI-PRECIOUS GEMS AND GEMSTONES, NAMELY, WATCHES, STOP WATCHES, CHRONOMETERS, AND CLOCKS, IN CLASS 14 (U.S. CLS. 2, 27, 28 AND 50).

FOR: RETAIL STORE AND WHOLESALE DISTRIBUTORSHIP SERVICES IN THE FIELD OF DIAMONDS, GEMS OR GEMSTONES, JEWELLERY CONTAINING DIAMONDS, GEMS OR GEMSTONES, AND TIMEPIECES CONTAINING DIAMONDS, GEMS OR GEMSTONES; ON-LINE RETAIL STORE SERVICES, AVAILABLE VIA GLOBAL COMPUTER NETWORK, IN THE FIELD OF DIAMONDS, GEMS OR GEMSTONES, JEWELLERY CONTAINING DIAMONDS, GEMS OR GEMSTONES, AND TIMEPIECES CONTAINING DIAMONDS, GEMS OR GEMSTONES; COMPUTERIZED TRACKING AND TRACING SERVICES, NAMELY, PROVIDING TRACKING SERVICES TO OTHERS WHEREBY THE MOVEMENT, LOCATION, DISTRIBUTION, AND PROCESSING OF DIAMONDS, GEMS, AND GEMSTONES IS MONITORED AND TRACKED, IN CLASS 35 (U.S. CLS. 100, 101 AND 102).

FOR: MINING EXTRACTION OF DIAMONDS, PRECIOUS GEMS AND GEMSTONES, AND SEMI-PRECIOUS GEMS AND GEMSTONES, IN CLASS 37 (U.S. CLS. 100, 103 AND 106).

FOR: LASER SCRIBING OF DIAMONDS AND GEMSTONES, IN CLASS 40 (U.S. CLS. 100, 103 AND 106).

FOR: AUTHENTICATION SERVICES, NAMELY, VERIFYING AND CERTIFYING DIAMONDS, GEMS, AND GEMSTONES, IN RESPECT OF CHARACTER AND QUALITY, METHODS OF PRODUCTION, PROCESSING, AND FINISHING, MINE OR COUNTRY OF ORIGIN IN WHICH ITEM WAS MINED, AND CHAIN OF PROCESSING AND DISTRIBUTION BETWEEN MINE AND WHOLESALE AND RETAIL OUTLETS; AND GEMOLOGICAL SERVICES AND GRADING DIAMONDS, PRECIOUS GEMS AND GEMSTONES, AND SEMI-PRECIOUS GEMS AND GEMSTONES ON BEHALF OF OTHERS; MINING EXPLORATION FOR DIAMONDS, PRECIOUS GEMS AND GEMSTONES, AND SEMI-PRECIOUS GEMS AND GEMSTONES, IN CLASS 42 (U.S. CLS. 100 AND 101).

THE MARK CONSISTS OF STANDARD CHARACTERS WITHOUT CLAIM TO ANY PARTICULAR FONT, STYLE, SIZE, OR COLOR.

PRIORITY CLAIMED UNDER SEC. 44(D) ON ERPN CMNTY TM OFC APPLICATION NO. 004022191, FILED 9-14-2004, REG. NO. 004022191, DATED 11-27-2006, EXPIRES 9-14-2014.

SER. NO. 78-536,537, FILED 12-21-2004.

KATHLEEN M. VANSTON, EXAMINING ATTORNEY

Int. Cls.: 18, 21, 25, 36, 43, 44 and 45

Prior U.S. Cls.: 1, 2, 3, 13, 22, 23, 29, 30, 33, 39, 40, 41, 50, 100, 101 and 102

Reg. No. 3,398,385

United States Patent and Trademark Office

Registered Mar. 18, 2008

**TRADEMARK
SERVICE MARK
PRINCIPAL REGISTER**

MCARTHUR GLEN

MCARTHUR/GLEN EUROPE HOLDINGS LIMITED, LLC (DELAWARE LTD LIAB CO)
CORPORATION TRUST CENTER
1209 ORANGE STREET
WILMINGTON, DE 19801

FOR: ARTICLES MADE FROM LEATHER OR IMITATION LEATHER, NAMELY, BAGS, TRUNKS AND TRAVELING BAGS; LUGGAGE; UMBRELLAS; PARASOLS; WALKING STICKS; PARTS FOR ALL THE AFORESAID GOODS, IN CLASS 18 (U.S. CLS. 1, 2, 3, 22 AND 41).

FOR: HOUSEHOLD OR KITCHEN UTENSILS, NAMELY, GRILLS, GRILL COVERS, WIRE BASKETS, GRATERS, SIEVES, SPATULAS, STRAINERS, TURNERS, POT AND PAN SCRAPERS, ROLLING PINS, WHISKS, CONTAINERS FOR HOUSEHOLD OR KITCHEN USE; COMBS; CLEANING SPONGES; BRUSHES, NAMELY, DISHWASHING, DUSTING, POT CLEANING, SCRUBBING, SCOURING; ARTICLES FOR CLEANING PURPOSES, NAMELY, HOUSEHOLD GLOVES FOR GENERAL USE, DUSTING CLOTHS; GLASSWARE, NAMELY, BEVERAGE GLASSES, BAKING DISHES, GLASS CONTAINERS FOR HOUSEHOLD USE; PORCELAIN ITEMS, NAMELY, DINNERWARE, MUGS, DOORKNOBS, CONTAINERS FOR HOUSEHOLD USE, FIGURINES; EARTHENWARE ITEMS, NAMELY, DINNERWARE, MUGS, DOORKNOBS, CONTAINERS FOR HOUSEHOLD USE, FIGURINES; SHOE HORNS; PARTS FOR ALL THE AFORESAID ITEMS, IN CLASS 21 (U.S. CLS. 2, 13, 23, 29, 30, 33, 40 AND 50).

FOR: ARTICLES OF CLOTHING, NAMELY, SHIRTS, POLO SHIRTS, T-SHIRTS, SPORTS SHIRTS, DRESS SHIRTS, SWEAT SHIRTS, SKIRTS, DRESSES,

PANTS, DENIMS, SWEAT PANTS, SOCKS, UNDERPANTS, LINGERIE; FOOTWEAR; HEADGEAR, NAMELY, HATS, CAPS, HEADBANDS; BELTS; SHOES, TIES AND SCARVES, IN CLASS 25 (U.S. CLS. 22 AND 39).

FOR: REAL ESTATE MANAGEMENT; LEASING OF REAL ESTATE; LEASING OF RETAIL OUTLET UNITS, MANUFACTURER'S OUTLET UNITS AND SPACE FOR THE PROVISION OF RESTAURANT, SAFE, CRECHE, NURSERY AND BANKING FACILITIES; BANKING SERVICES; MONETARY EXCHANGE SERVICES, IN CLASS 36 (U.S. CLS. 100, 101 AND 102).

FOR: RESTAURANT SERVICES; CAFETERIA AND SNACK BAR SERVICES; PROVIDING FACILITIES FOR EXHIBITIONS; PROVISION OF CRECHE AND NURSERY FACILITIES, IN CLASS 43 (U.S. CLS. 100 AND 101).

FOR: LANDSCAPE GARDENING; OPTICIAN'S SERVICES, IN CLASS 44 (U.S. CLS. 100 AND 101).

FOR: PROVISION OF SECURITY FOR RETAIL OUTLETS AND SHOPPING MALLS, IN CLASS 45 (U.S. CLS. 100 AND 101).

THE MARK CONSISTS OF STANDARD CHARACTERS WITHOUT CLAIM TO ANY PARTICULAR FONT, STYLE, SIZE, OR COLOR.

OWNER OF ERPN CMNTY TM OFC REG. NO. EC001079219, DATED 10-18-2000, EXPIRES 10-18-2010.

SER. NO. 78-537,627, FILED 12-23-2004.

ELLEN BURNS, EXAMINING ATTORNEY

Int. Cls.: 18, 21, 25, 36, 43, 44 and 45

Prior U.S. Cls.: 1, 2, 3, 13, 22, 23, 29, 30, 33, 39, 40, 41, 50, 100, 101 and 102

Reg. No. 3,398,386

United States Patent and Trademark Office

Registered Mar. 18, 2008

**TRADEMARK
SERVICE MARK
PRINCIPAL REGISTER**



MCARTHUR/GLEN EUROPE HOLDINGS LIMITED, LLC (DELAWARE LTD LIAB CO)
CORPORATION TRUST CENTER
1209 ORANGE STREET
WILMINGTON, DE 19801

FOR: ARTICLES MADE FROM LEATHER OR IMITATION LEATHER, NAMELY, BAGS, TRUNKS AND TRAVELING BAGS; LUGGAGE; UMBRELLAS; PARASOLS; WALKING STICKS; PARTS FOR ALL THE AFORESAID GOODS, IN CLASS 18 (U.S. CLS. 1, 2, 3, 22 AND 41).

FOR: HOUSEHOLD OR KITCHEN UTENSILS, NAMELY, GRILLS, GRILL COVERS, WIRE BASKETS, GRATERS, SIEVES, SPATULAS, STRAINERS, TURNERS, POT AND PAN SCRAPERS, ROLLING PINS, WHISKS, CONTAINERS FOR HOUSEHOLD OR KITCHEN USE; COMBS; CLEANING SPONGES; BRUSHES, NAMELY, DISHWASHING, DUSTING, POT CLEANING, SCRUBBING, SCOURING; ARTICLES FOR CLEANING PURPOSES, NAMELY, HOUSEHOLD GLOVES FOR GENERAL USE, DUSTING CLOTHS; GLASSWARE, NAMELY, BEVERAGE GLASSES, BAKING DISHES, GLASS CONTAINERS FOR HOUSEHOLD USE; PORCELAIN ITEMS, NAMELY, DINNERWARE, MUGS, DOORKNOBS, CONTAINERS FOR HOUSEHOLD USE, FIGURINES; EARTHENWARE ITEMS, NAMELY, DINNERWARE, MUGS, DOORKNOBS, CONTAINERS FOR HOUSEHOLD USE, FIGURINES; SHOE HORNS; PARTS FOR ALL THE AFORESAID ITEMS, IN CLASS 21 (U.S. CLS. 2, 13, 23, 29, 30, 33, 40 AND 50).

FOR: ARTICLES OF CLOTHING, NAMELY, SHIRTS, POLO SHIRTS, T-SHIRTS, SPORTS SHIRTS, DRESS SHIRTS, SWEAT SHIRTS, SKIRTS, DRESSES, PANTS, DENIMS, SWEAT PANTS, SOCKS, UNDER-

PANTS, LINGERIE; FOOTWEAR; HEADGEAR, NAMELY, HATS, CAPS, HEADBANDS; BELTS; SHOES, TIES AND SCARVES, IN CLASS 25 (U.S. CLS. 22 AND 39).

FOR: REAL ESTATE MANAGEMENT; LEASING OF REAL ESTATE; LEASING OF RETAIL OUTLET UNITS, MANUFACTURER'S OUTLET UNITS AND SPACE FOR THE PROVISION OF RESTAURANT, SAFE, CRECHE, NURSERY AND BANKING FACILITIES; BANKING SERVICES; MONETARY EXCHANGE SERVICES, IN CLASS 36 (U.S. CLS. 100, 101 AND 102).

FOR: RESTAURANT SERVICES; CAFETERIA AND SNACK BAR SERVICES; PROVIDING FACILITIES FOR EXHIBITIONS; PROVISION OF CRECHE AND NURSERY FACILITIES, IN CLASS 43 (U.S. CLS. 100 AND 101).

FOR: LANDSCAPE GARDENING; OPTICIAN'S SERVICES, IN CLASS 44 (U.S. CLS. 100 AND 101).

FOR: PROVISION OF SECURITY FOR RETAIL OUTLETS AND SHOPPING MALLS, IN CLASS 45 (U.S. CLS. 100 AND 101).

OWNER OF ERPN CMNTY TM OFC REG. NO. EC11017136, DATED 6-5-2002, EXPIRES 6-5-2012.

NO CLAIM IS MADE TO THE EXCLUSIVE RIGHT TO USE "DESIGNER OUTLET", APART FROM THE MARK AS SHOWN.

SER. NO. 78-537,696, FILED 12-23-2004.

ELLEN BURNS, EXAMINING ATTORNEY

Int. Cls.: 9 and 42

Prior U.S. Cls.: 21, 23, 26, 36, 38, 100 and 101

United States Patent and Trademark Office

Reg. No. 3,398,387

Registered Mar. 18, 2008

**TRADEMARK
SERVICE MARK
PRINCIPAL REGISTER**

K2

SOURCECODE TECHNOLOGY HOLDINGS, INC.
(DELAWARE CORPORATION)
148TH AVENUE NE
REDMOND, WA 98052

FOR: COMPUTER SOFTWARE FOR USE IN COMPUTERS TO PROVIDE SERVICE ACTIVATION, PROVIDE CUSTOMER CARE AND PROVIDE CUSTOMER SERVICE SOLUTIONS IN THE TELECOMMUNICATIONS INDUSTRY, IN CLASS 9 (U.S. CLS. 21, 23, 26, 36 AND 38).

FIRST USE 11-15-1989; IN COMMERCE 11-15-1989.

FOR: APPLICATION SERVICE PROVIDER FEATURING COMPUTER SOFTWARE THAT PRO-

VIDES SERVICE ACTIVATION, PROVIDES CUSTOMER CARE AND PROVIDES CUSTOMER SERVICE SOLUTIONS IN THE TELECOMMUNICATIONS INDUSTRY, IN CLASS 42 (U.S. CLS. 100 AND 101).

FIRST USE 11-15-1989; IN COMMERCE 11-15-1989.

THE MARK CONSISTS OF STANDARD CHARACTERS WITHOUT CLAIM TO ANY PARTICULAR FONT, STYLE, SIZE, OR COLOR.

SER. NO. 78-537,896, FILED 12-23-2004.

SEAN CROWLEY, EXAMINING ATTORNEY

Int. Cl.: 11

Prior U.S. Cls.: 13, 21, 23, 31 and 34

United States Patent and Trademark Office

Reg. No. 3,398,388

Registered Mar. 18, 2008

**TRADEMARK
PRINCIPAL REGISTER**

FORCE

KOOTENAY GROWER'S SUPPLY LTD. (CANADA CORPORATION)

2722 HIGHWAY 3A

NELSON, BRITISH COLUMBIA, CANADA V1L 6L6

FOR: ELECTRIC FANS, ELECTRIC BLOWERS, AND ELECTRIC HEATERS, ALL FOR COMMERCIAL AND INDUSTRIAL USE, IN CLASS 11 (U.S. CLS. 13, 21, 23, 31 AND 34).

THE MARK CONSISTS OF STANDARD CHARACTERS WITHOUT CLAIM TO ANY PARTICULAR FONT, STYLE, SIZE, OR COLOR.

PRIORITY CLAIMED UNDER SEC. 44(D) ON CANADA APPLICATION NO. 1222855, FILED 7-7-2004, REG. NO. TMA693041, DATED 7-31-2007, EXPIRES 7-31-2022.

SER. NO. 78-544,252, FILED 1-7-2005.

MARK SPARACINO, EXAMINING ATTORNEY

Int. Cls.: 9 and 28

Prior U.S. Cls.: 21, 22, 23, 26, 36, 38 and 50

Reg. No. 3,398,389

United States Patent and Trademark Office

Registered Mar. 18, 2008

**TRADEMARK
PRINCIPAL REGISTER**

TIGER AND DRAGON

ATRONIC INTERNATIONAL GMBH (FED REP
GERMANY CORPORATION)
BORSIGSTR. 26
32312 LÜBBECKE, FED REP GERMANY

FOR: ELECTRIC AND ELECTRONIC APPARATUS, INSTRUMENTS, DEVICES AND MACHINES NAMELY, GAMING AND GAMBLING MACHINES; COIN OPERATED MACHINES AND MACHINES OPERABLE WITH BILLS, MAGNETIC CARDS, COMPUTER CHIPS, MICRO-PROCESSOR DEVICES AND TOKENS; MECHANISMS FOR COIN OPERATED AND COIN CONTROLLED MACHINES, NAMELY MECHANICAL UNITS FOR DISPENSING COINS, NAMELY COIN HOPPERS; COIN, CURRENCY AND TOKEN-CONTROLLED GAMING MACHINES; APPARATUSES FOR BILLING OPERATIONS OF COIN-OPERATED MACHINES, NAMELY COMPUTERS AND COMPUTER SOFTWARE USED TO GENERATE BILLS IN CONNECTION WITH COIN OPERATED GAMING MACHINES; AUTOMATED DATA STORAGE MACHINES IN THE NATURE OF COMPUTERS, COMPUTER DATA PRINTER FOR DISPLAYING TOTAL WINNINGS IN FRONT OF GAMING MACHINES; ELECTRONIC PRINTED CIRCUIT BOARDS; COIN CHANGERS; VENDING MACHINES WHICH PROVIDE TOKENS, COUPONS AND GAME CARDS; ELECTRIC AND ELECTRONIC MACHINES AND APPARATUSES FOR GAMES, AMUSEMENT, ENTERTAINMENT AND GAMING, NAMELY, SLOT MACHINES, GAMING EQUIPMENT, NAMELY GAMING MACHINES, VIDEO SLOT MACHINES; CASINO GAMBLING DEVICES, NAMELY SLOT MACHINES AND PARTS THEREFOR, GAME SYMBOL CYLINDERS FOR SLOT MACHINES; DROP-DOWN CAROUSELS FOR SLOT MACHINES AND GAMING MACHINES; TV MONITORS, LCD-DISPLAY MONITORS, ALL FOR GAMBLING MACHINES; ELECTRONIC CASINO GAME MACHINES; ELECTRIC AND ELECTRONIC GAM-

ING AND GAMBLING MACHINES; MACHINES FOR PLAYING GAMES OF CHANCE; COMPUTER GAME CASSETTES AND CARTRIDGES FOR ELECTRONIC POCKET GAMES VIDEO GAME MACHINES FOR USE WITH TELEVISION; PRERECORDED DATA CARRIERS PROGRAMMED FOR ELECTRONIC VIDEO AND AUDIO DISPLAY FOR PLAYING ELECTRONIC GAMES, IN CLASS 9 (U.S. CLS. 21, 23, 26, 36 AND 38).

FOR: ELECTRIC AND ELECTRONIC STAND ALONE VIDEO MACHINES FEATURING GAMES, AMUSEMENT, SPORTS AND ENTERTAINMENT ALL FOR USE INDIVIDUALLY OR AS A NETWORK, COIN-OPERATED STAND ALONE COMPACT VIDEO GAME SPORTS MACHINES; HANDHELD UNIT FOR PLAYING ELECTRONIC GAMES NAMELY COMPACT SPORTS MACHINES FOR PLAYING IN SMALL AREAS, NAMELY, DARTS, TABLE SOCCER, POOL-BILLIARD, SNOOKER, SHOOTING GALLERIES, PINBALL GAMES; HANDHELD CONSOLES FOR ELECTRONIC GAMES, ELECTRONIC PARLOR GAMES, VIDEO GAMES AND INSTRUMENTS, NAMELY HANDHELD UNIT FOR PLAYING VIDEO GAMES, STAND ALONE VIDEO GAME MACHINES, IN CLASS 28 (U.S. CLS. 22, 23, 38 AND 50).

THE MARK CONSISTS OF STANDARD CHARACTERS WITHOUT CLAIM TO ANY PARTICULAR FONT, STYLE, SIZE, OR COLOR.

PRIORITY CLAIMED UNDER SEC. 44(D) ON FED REP GERMANY APPLICATION NO. 004170403, FILED 12-16-2004, REG. NO. 004170403, DATED 2-23-2006, EXPIRES 12-16-2014.

SER. NO. 78-546,914, FILED 1-13-2005.

DEZMONA MIZELLE, EXAMINING ATTORNEY

Int. Cl.: 28

Prior U.S. Cls.: 22, 23, 38 and 50

United States Patent and Trademark Office

Reg. No. 3,398,390

Registered Mar. 18, 2008

**TRADEMARK
PRINCIPAL REGISTER**



MILLER, ANGELES A. (SPAIN INDIVIDUAL)
1270 EAST 2000 NORTH
PROVO, UT 84604

FOR: SNOWBOARDS, SKIS, AND SNOWBOARD
BINDINGS, IN CLASS 28 (U.S. CLS. 22, 23, 38 AND
50).

FIRST USE 7-8-2003; IN COMMERCE 7-8-2003.

THE MARK CONSISTS OF A SNOWBOARD,
BLADE, OR SKI BETWEEN "WINGS," OR "WAKES"
THAT COME OUT ON EACH SIDE, OR AROUND
EACH SIDE.

SER. NO. 78-547,304, FILED 1-13-2005.

PRISCILLA MILTON, EXAMINING ATTORNEY

Int. Cl.: 36

Prior U.S. Cls.: 100, 101 and 102

United States Patent and Trademark Office

Reg. No. 3,398,391

Registered Mar. 18, 2008

**SERVICE MARK
PRINCIPAL REGISTER**

MARCHEDESPARTENAIRESMONDIAUX.COM

AGA KHAN FOUNDATION CANADA (CANADA CORPORATION)
CONSTITUTION SQUARE
1220 - 360 RUE ALBERT STREET
ONTARIO OTTAWA, CANADA K1R 7X7

FOR: CHARITABLE FUND RAISING SERVICES,
IN CLASS 36 (U.S. CLS. 100, 101 AND 102).

THE MARK CONSISTS OF STANDARD CHARACTERS WITHOUT CLAIM TO ANY PARTICULAR FONT, STYLE, SIZE, OR COLOR.

PRIORITY CLAIMED UNDER SEC. 44(D) ON CANADA APPLICATION NO. 1,241,269, FILED 12-14-2004, REG. NO. TMA679564, DATED 1-17-2007, EXPIRES 1-17-2022.

THE ENGLISH TRANSLATION OF MARCHEDESPARTENAIRESMONDIAUX IS "WORLD PARTNERSHIP WALK".

SER. NO. 78-547,666, FILED 1-14-2005.

KARANENDRA S. CHHINA, EXAMINING ATTORNEY

Int. Cl.: 41

Prior U.S. Cls.: 100, 101 and 107

United States Patent and Trademark Office

Reg. No. 3,398,392

Registered Mar. 18, 2008

**SERVICE MARK
PRINCIPAL REGISTER**

**BIG SCREEN
CLASSROOM**

REGAL CINEMEDIA CORPORATION (VIRGINIA CORPORATION)
9110 EAST NICHOLS AVENUE, SUITE 200
ENGLEWOOD, CO 80112

FOR: EDUCATIONAL AND ENTERTAINMENT SERVICES, NAMELY, PROVIDING MOVIE THEATERS FOR EDUCATIONAL WORKSHOPS, PROGRAMS AND EVENTS, IN CLASS 41 (U.S. CLS. 100, 101 AND 107).

FIRST USE 11-22-2004; IN COMMERCE 11-22-2004.

THE MARK CONSISTS OF STANDARD CHARACTERS WITHOUT CLAIM TO ANY PARTICULAR FONT, STYLE, SIZE, OR COLOR.

NO CLAIM IS MADE TO THE EXCLUSIVE RIGHT TO USE "BIG SCREEN", APART FROM THE MARK AS SHOWN.

SER. NO. 78-548,003, FILED 1-14-2005.

DAYNA BROWNE, EXAMINING ATTORNEY

Int. Cl.: 36

Prior U.S. Cls.: 100, 101 and 102

United States Patent and Trademark Office

Reg. No. 3,398,393

Registered Mar. 18, 2008

**SERVICE MARK
PRINCIPAL REGISTER**

**SECOND CHANCE
CHECKING**

WOODFOREST NATIONAL BANK (UNITED STATES CHARTERED BANK)
1330 LAKE ROBBINS DRIVE
SUITE 100
THE WOODLANDS, TX 77380

FOR: BANKING SERVICES, NAMELY OFFERING CHECK WRITING ACCOUNTS FOR CUSTOMERS WHO HAVE EXPERIENCED PREVIOUS CREDIT OR BANK ACCOUNT OBSTACLES , IN CLASS 36 (U.S. CLS. 100, 101 AND 102).

FIRST USE 7-1-2004; IN COMMERCE 7-1-2004.

THE MARK CONSISTS OF STANDARD CHARACTERS WITHOUT CLAIM TO ANY PARTICULAR FONT, STYLE, SIZE, OR COLOR.

NO CLAIM IS MADE TO THE EXCLUSIVE RIGHT TO USE CHECKING, APART FROM THE MARK AS SHOWN.

SER. NO. 78-548,014, FILED 1-14-2005.

COLLEEN DOMBROW, EXAMINING ATTORNEY

Int. Cl.: 43

Prior U.S. Cls.: 100 and 101

United States Patent and Trademark Office

Reg. No. 3,398,394

Registered Mar. 18, 2008

**SERVICE MARK
PRINCIPAL REGISTER**

ROSIE O'GRADY'S

TREL RESTAURANT INC. (NEW YORK CORPORATION)

800 SEVENTH AVENUE

NEW YORK, NY 10013

FOR: RESTAURANT, BAR AND CATERING SERVICES, IN CLASS 43 (U.S. CLS. 100 AND 101).

FIRST USE 0-0-1972; IN COMMERCE 0-0-1972.

THE MARK CONSISTS OF STANDARD CHARACTERS WITHOUT CLAIM TO ANY PARTICULAR FONT, STYLE, SIZE, OR COLOR.

THE NAME(S), PORTRAIT(S), AND/OR SIGNATURE(S) SHOWN IN THE MARK DOES NOT IDENTIFY A PARTICULAR LIVING INDIVIDUAL.

SER. NO. 78-556,633, FILED 1-31-2005.

ELIZABETH HUGHITT, EXAMINING ATTORNEY

Int. Cl.: 35

Prior U.S. Cls.: 100, 101 and 102

United States Patent and Trademark Office

Reg. No. 3,398,395

Registered Mar. 18, 2008

**SERVICE MARK
PRINCIPAL REGISTER**

Flowerkisses

ESCALANTE, THOMAS ANTHONY (UNITED STATES INDIVIDUAL)
79 DAILY DR., #302
CAMARILLO, CA 93010

THE MARK CONSISTS OF STANDARD CHARACTERS WITHOUT CLAIM TO ANY PARTICULAR FONT, STYLE, SIZE, OR COLOR.

FOR: RETAIL FLORAL SHOP SERVICE; ONLINE RETAIL FLORAL SHOP SERVICE, IN CLASS 35 (U.S. CLS. 100, 101 AND 102).

SER. NO. 78-560,227, FILED 2-3-2005.

FIRST USE 2-1-2002; IN COMMERCE 2-1-2002.

CHARISMA HAMPTON, EXAMINING ATTORNEY

Int. Cls.: 9, 35, 41 and 42

Prior U.S. Cls.: 21, 23, 26, 36, 38, 100, 101, 102 and 107

United States Patent and Trademark Office

Reg. No. 3,398,396

Registered Mar. 18, 2008

**TRADEMARK
SERVICE MARK
PRINCIPAL REGISTER**

**QUOTATION
LIFECYCLE
MANAGEMENT**

QSTRAT INC. (CANADA CORPORATION)
1709 BLOOR STREET WEST, SUITE 200
TORONTO, ONTARIO, CANADA M6P 4E5

FOR: COMPUTER SOFTWARE, NAMELY, SOFTWARE FOR MANUFACTURERS IN THE AUTOMOTIVE, TRANSPORTATION, AEROSPACE, ELECTRONICS AND OTHER DISCRETE MANUFACTURING MARKETS TO MODEL AND AUTOMATE A BUSINESS PROCESS IN WHOLE OR PART, IN WHICH QUOTES, PRICES, COSTS, ESTIMATES, REQUESTS FOR PROPOSAL, REQUESTS FOR QUOTATION OR QUOTATIONS, OF PRODUCTS, PARTS, COMPONENTS OR ASSEMBLIES ARE PASSED FROM ONE PARTICIPANT TO ANOTHER FOR ACTION, COLLABORATION, INFORMATION EXCHANGE, APPROVAL, REPORTING, ANALYSIS OR TRANSACTION PROCESSING, IN CLASS 9 (U.S. CLS. 21, 23, 26, 36 AND 38).

FOR: CONSULTING SERVICES FOR MANUFACTURERS IN THE AUTOMOTIVE, TRANSPORTATION, AEROSPACE, ELECTRONICS AND OTHER DISCRETE MANUFACTURING MARKETS IN THE FIELD OF GOODS AND SERVICES PRICE QUOTATIONS, COST MODELING, QUOTATION PROCESSES, AND QUOTATION MANAGEMENT, IN CLASS 35 (U.S. CLS. 100, 101 AND 102).

FOR: TRAINING IN THE FIELD OF QUOTING, COSTING, COST MODELING, QUOTATION PROCESSES, QUOTATION MANAGEMENT SYSTEMS AND SOFTWARE APPLICATIONS FOR DISCRETE MANUFACTURING MARKETS, IN CLASS 41 (U.S. CLS. 100, 101 AND 107).

FOR: COMPUTER CONSULTING SERVICES FOR OTHERS, NAMELY, FOR MANUFACTURERS IN THE AUTOMOTIVE, TRANSPORTATION, AEROSPACE, ELECTRONICS AND OTHER DISCRETE MANUFACTURING MARKETS WITH RESPECT TO SETTING UP COMPUTER AND COMPUTER SOFTWARE SYSTEMS FOR QUOTING, COSTING, COST MODELING, QUOTATION PROCESSES, AND QUOTATION MANAGEMENT SYSTEMS AND SOFTWARE APPLICATIONS; TECHNICAL SUPPORT, NAMELY, MONITORING OF NETWORK SYSTEMS, PROVIDING BACK-UP COMPUTER PROGRAM AND FACILITIES AND TROUBLESHOOTING OF COMPUTER HARDWARE AND SOFTWARE PROBLEMS, AND MAINTENANCE RELATED TO THE AFOREMENTIONED SOFTWARE, IN CLASS 42 (U.S. CLS. 100 AND 101).

THE MARK CONSISTS OF STANDARD CHARACTERS WITHOUT CLAIM TO ANY PARTICULAR FONT, STYLE, SIZE, OR COLOR.

PRIORITY CLAIMED UNDER SEC. 44(D) ON CANADA APPLICATION NO. 1229814, FILED 9-2-2004, REG. NO. TMA679,763, DATED 1-19-2007, EXPIRES 1-19-2022.

NO CLAIM IS MADE TO THE EXCLUSIVE RIGHT TO USE "QUOTATION" AND "MANAGEMENT", APART FROM THE MARK AS SHOWN.

SER. NO. 78-578,303, FILED 3-2-2005.

LINDA ESTRADA, EXAMINING ATTORNEY

Int. Cls.: 9 and 28

Prior U.S. Cls.: 21, 22, 23, 26, 36, 38 and 50

Reg. No. 3,398,397

United States Patent and Trademark Office

Registered Mar. 18, 2008

**TRADEMARK
PRINCIPAL REGISTER**

CRYSTAL LAKE

ATRONIC INTERNATIONAL GMBH (FED REP
GERMANY CORPORATION)
BORSIGSTRASSE 26
32312 LÜBBECKE, FED REP GERMANY

FOR: ELECTRIC AND ELECTRONIC APPARATUS, INSTRUMENTS, DEVICES AND MACHINES NAMELY, COIN AND NON-COIN OPERATED GAMING AND GAMBLING MACHINES, COIN CHANGERS; MECHANISMS FOR COIN OPERATED AND COIN CONTROLLED MACHINES, NAMELY MECHANICAL UNITS FOR DISPENSING COINS, APPARATUS FOR BILLING OPERATIONS OF COIN-OPERATED MACHINES, NAMELY COMPUTER HARDWARE AND SOFTWARE USED TO GENERATE BILLS IN CONNECTION WITH COIN OPERATED GAMING MACHINES; AUTOMATED DATA STORAGE MACHINES IN THE NATURE OF COMPUTERS, COMPUTER DATA PRINTERS FOR DISPLAYING TOTAL WINNINGS IN FRONT OF GAMING MACHINES; ELECTRONIC PRINTED CIRCUIT BOARDS; COIN COUNTING AND SORTING MACHINES; VENDING MACHINES WHICH PROVIDE TOKENS, COUPONS AND GAME CARDS; ELECTRIC AND ELECTRONIC MACHINES AND APPARATUS FOR GAMES, AMUSEMENT, ENTERTAINMENT AND GAMING; NAMELY, SLOT MACHINES, GAMING EQUIPMENT, NAMELY GAMING MACHINES, VIDEO SLOT MACHINES; CASINO GAMBLING DEVICES, NAMELY SLOT MACHINES AND STRUCTURAL PARTS THEREFOR; GAME SYMBOL CYLINDERS FOR SLOT MACHINES; DROP-DOWN CAROUSELS FOR SLOT MACHINES AND GAMING MACHINES; TV MONITORS AND LCD-DISPLAY MONITORS FOR GAMBLING MACHINES; ELECTRONIC CASINO GAME MACHINES; ELECTRIC AND ELECTRONIC GAMING AND GAM-

BLING MACHINES; BETTING MACHINES FOR BETTING ON JACKPOTS—COMPUTER GAME CASSETTES AND CARTRIDGES FOR ELECTRONIC POCKET GAMES, VIDEO GAME MACHINES FOR USE WITH TELEVISION; PRERECORDED MAGNETIC DATA CARRIERS FEATURING PROGRAMS FOR ELECTRONIC VIDEO AND AUDIO DISPLAY FOR PLAYING ELECTRONIC GAMES, IN CLASS 9 (U.S. CLS. 21, 23, 26, 36 AND 38).

FOR: ELECTRIC AND ELECTRONIC STAND ALONE VIDEO GAME MACHINES FEATURING GAMES-, AMUSEMENT AND SPORTS-AND ENTERTAINMENT FOR USE INDIVIDUALLY OR AS A NETWORK; COIN-OPERATED STAND ALONE COMPACT VIDEO GAME MACHINES FEATURING SPORTS ENTERTAINMENT; HANDHELD UNITS FOR PLAYING ELECTRONIC PARLOR GAMES; COMPACT SPORTS MACHINES FOR PLAYING IN SMALL AREAS, NAMELY, DARTS, TABLE SOCCER; POOL-BILLIARD; SNOOKER; SHOOTING GALLERIES, PINBALL GAMES; VIDEO GAMES AND INSTRUMENTS, NAMELY HAND-HELD UNITS FOR PLAYING VIDEO GAMES; STAND ALONE VIDEO GAME MACHINES, IN CLASS 28 (U.S. CLS. 22, 23, 38 AND 50).

THE MARK CONSISTS OF STANDARD CHARACTERS WITHOUT CLAIM TO ANY PARTICULAR FONT, STYLE, SIZE, OR COLOR.

PRIORITY CLAIMED UNDER SEC. 44(D) ON ERPN CMNTY TM OFC APPLICATION NO. 004238903, FILED 2-17-2005, REG. NO. 004238903, DATED 4-13-2006, EXPIRES 2-17-2015.

SER. NO. 78-579,424, FILED 3-3-2005.

STEPHANIE ALI, EXAMINING ATTORNEY

Int. Cl.: 11

Prior U.S. Cls.: 13, 21, 23, 31 and 34

United States Patent and Trademark Office

Reg. No. 3,398,398

Registered Mar. 18, 2008

**TRADEMARK
PRINCIPAL REGISTER**

EQUINOX

EQUINOX PRODUCTS, L.L.C. (MICHIGAN LTD
LIAB CO)
1409 G-1 ALLEN DRIVE
TROY, MI 48083

THE MARK CONSISTS OF STANDARD CHAR-
ACTERS WITHOUT CLAIM TO ANY PARTICULAR
FONT, STYLE, SIZE, OR COLOR.

FOR: COMMERCIAL AND DOMESTIC AIR AND
WATER FILTRATION UNITS, IN CLASS 11 (U.S.
CLS. 13, 21, 23, 31 AND 34).

SER. NO. 78-585,616, FILED 3-11-2005.

FIRST USE 7-12-2001; IN COMMERCE 7-12-2001.

CAROLYN GRAY, EXAMINING ATTORNEY

Int. Cl.: 11

Prior U.S. Cls.: 13, 21, 23, 31 and 34

United States Patent and Trademark Office

Reg. No. 3,398,399

Registered Mar. 18, 2008

**TRADEMARK
PRINCIPAL REGISTER**

EQ-300

EQUINOX PRODUCTS L.L.C. (MICHIGAN LTD
LIAB CO)
1409 G-1 ALLEN DRIVE
TROY, MI 48083

FOR: COMMERCIAL AND DOMESTIC WHOLE
HOUSE WATER FILTRATION SYSTEMS CONSIST-
ING OF PURIFICATION TANKS, AND WATER
FILTRATION MEDIA, IN CLASS 11 (U.S. CLS. 13,
21, 23, 31 AND 34).

FIRST USE 7-12-2001; IN COMMERCE 7-12-2001.

THE MARK CONSISTS OF STANDARD CHAR-
ACTERS WITHOUT CLAIM TO ANY PARTICULAR
FONT, STYLE, SIZE, OR COLOR.

SER. NO. 78-585,751, FILED 3-11-2005.

ANDREA SAUNDERS, EXAMINING ATTORNEY

Int. Cl.: 33

Prior U.S. Cls.: 47 and 49

United States Patent and Trademark Office

Reg. No. 3,398,400

Registered Mar. 18, 2008

**TRADEMARK
PRINCIPAL REGISTER**

CASA RITA

EL CHICO RESTAURANTS, INC. (TEXAS CORPORATION)
SUITE 100
12200 STEMMONS FREEWAY
DALLAS, TX 75234

FOR: PREPARED ALCOHOLIC COCKTAILS, IN CLASS 33 (U.S. CLS. 47 AND 49).

FIRST USE 7-0-2002; IN COMMERCE 6-29-2004.

THE MARK CONSISTS OF STANDARD CHARACTERS WITHOUT CLAIM TO ANY PARTICULAR FONT, STYLE, SIZE, OR COLOR.

NO CLAIM IS MADE TO THE EXCLUSIVE RIGHT TO USE "RITA", APART FROM THE MARK AS SHOWN.

THE FOREIGN WORDING IN THE MARK TRANSLATES INTO ENGLISH AS RITA HOUSE.

SER. NO. 78-587,727, FILED 3-15-2005.

MICHAEL GAAFAR, EXAMINING ATTORNEY

Int. Cl.: 14

Prior U.S. Cls.: 2, 27, 28 and 50

United States Patent and Trademark Office

Reg. No. 3,398,401

Registered Mar. 18, 2008

**TRADEMARK
PRINCIPAL REGISTER**

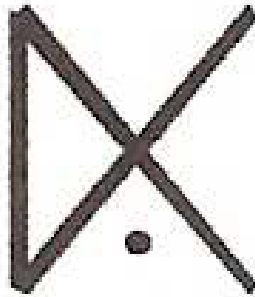

CASELLA, DAVID ADAM (UNITED STATES IN-
DIVIDUAL)
2250 21ST AVENUE
SAN FRANCISCO, CA 94116

THE MARK CONSISTS OF MARK IS A STYLIZED
RENDITION OF APPLICANT'S INITIALS - D A C.

FOR: SCULPTURES MADE OF PRECIOUS ME-
TAL; JEWELRY, IN CLASS 14 (U.S. CLS. 2, 27, 28
AND 50).

SER. NO. 78-590,900, FILED 3-18-2005.

FIRST USE 1-1-1995; IN COMMERCE 1-1-1995.

MARK SPARACINO, EXAMINING ATTORNEY

Int. Cl.: 3

Prior U.S. Cls.: 1, 4, 6, 50, 51 and 52

United States Patent and Trademark Office

Reg. No. 3,398,402

Registered Mar. 18, 2008

**TRADEMARK
PRINCIPAL REGISTER**

SPAZZSTICK

HOLSCHEN, RICHARD (UNITED STATES INDIVIDUAL)
P.O. BOX 77
KAKTOVIK, AK 99747

THE MARK CONSISTS OF STANDARD CHARACTERS WITHOUT CLAIM TO ANY PARTICULAR FONT, STYLE, SIZE, OR COLOR.

FOR: NON-MEDICATED SKIN PROTECTANT AND MOISTURIZER, NAMELY LIP BALM, IN CLASS 3 (U.S. CLS. 1, 4, 6, 50, 51 AND 52).

SER. NO. 78-591,347, FILED 3-21-2005.

FIRST USE 12-7-2004; IN COMMERCE 12-7-2004.

ALLISON HOLTZ, EXAMINING ATTORNEY

Int. Cl.: 9

Prior U.S. Cls.: 21, 23, 26, 36 and 38

United States Patent and Trademark Office

Reg. No. 3,398,403

Registered Mar. 18, 2008

**TRADEMARK
PRINCIPAL REGISTER**

CLMEI

CYBERLINK CORPORATION (TAIWAN CORPORATION)
15FL., NO.100
MINGCHIUAN RD., SHINDIAN CITY
TAIPEI, TAIWAN 231

FOR: COMPUTER SOFTWARE FOR AUDIO AND VIDEO PRODUCING, PLAYING AND RECORDING; COMPACT DISCS AND FLOPPY DISCS RECORDED WITH COMPUTER PROGRAMS FOR USE IN AUDIO AND VIDEO PRODUCING, PLAYING AND RECORDING, IN CLASS 9 (U.S. CLS. 21, 23, 26, 36 AND 38).

FIRST USE 9-1-2003; IN COMMERCE 9-1-2003.

THE MARK CONSISTS OF STANDARD CHARACTERS WITHOUT CLAIM TO ANY PARTICULAR FONT, STYLE, SIZE, OR COLOR.

OWNER OF TAIWAN REG. NO. 01076425, DATED 12-1-2003, EXPIRES 11-30-2013.

SER. NO. 78-596,705, FILED 3-29-2005.

MELISSA VALLILLO, EXAMINING ATTORNEY

Int. Cl.: 44

Prior U.S. Cls.: 100 and 101

United States Patent and Trademark Office

Reg. No. 3,398,404

Registered Mar. 18, 2008

**SERVICE MARK
PRINCIPAL REGISTER**

PACIFIC SUN

PACIFIC SUN, L.A. (CALIFORNIA LIMITED
LIABILITY CORPORATION)
14670 VENTURA BL
SHERMAN OAKS, CA 91403

FOR: TANNING SALONS AND SPAS PROVIDING
COSMETIC BODY CARE SERVICES, IN CLASS 44
(U.S. CLS. 100 AND 101).

FIRST USE 1-31-1994; IN COMMERCE 1-3-2002.

THE MARK CONSISTS OF STANDARD CHAR-
ACTERS WITHOUT CLAIM TO ANY PARTICULAR
FONT, STYLE, SIZE, OR COLOR.

SER. NO. 78-600,262, FILED 4-1-2005.

DOMINICK J. SALEMI, EXAMINING ATTORNEY

Int. Cls.: 9, 11 and 17

**Prior U.S. Cls.: 1, 5, 12, 13, 21, 23, 26, 31, 34, 35, 36, 38
and 50**

Reg. No. 3,398,405

United States Patent and Trademark Office

Registered Mar. 18, 2008

**TRADEMARK
PRINCIPAL REGISTER**

Warmup

WARMUP PLC (UNITED KINGDOM CORPORATION)

702 TUDOR ESTATE, ABBEY ROAD
LONDON, UNITED KINGDOM NW10 7UW

FOR: HEAT REGULATING APPARATUS, NAME-
LY, TEMPERATURE SENSORS; THERMOSTATS;
ELECTRONIC TIMERS; ELECTRONIC SENSORS
FOR SENSING TEMPERATURE; ELECTRIC
CABLES, WIRES AND SWITCHES FOR HEATING
APPARATUS AND INSTALLATIONS, IN CLASS 9
(U.S. CLS. 21, 23, 26, 36 AND 38).

FOR: APPARATUS FOR HEATING PURPOSES,
NAMELY, KITS FOR INSTALLING UNDERFLOOR
HEATING CONSISTING PRIMARILY OF ELECTRI-
CALLY HEATED WIRES, THERMAL PRIMER FOR
APPLICATION TO THE FLOOR AREA, ADHESIVE
TAPE FOR SECURING THE HEATER WIRE IN
PLACE AND A THERMOSTAT; APPARATUS FOR
HEATING PURPOSES, NAMELY, KITS FOR IN-
STALLING UNDERFLOOR HEATING CONSIST-
ING PRIMARILY OF FIBREGLASS MATS OR
MATTING INCORPORATING ELECTRICALLY HE-
ATED WIRES; APPARATUS FOR HEATING PUR-
POSES, NAMELY, KITS FOR INSTALLING
UNDERFLOOR HEATING CONSISTING PRIMAR-
ILY OF PANELS INCORPORATING CARBON
HEATING ELEMENTS; APPARATUS FOR HEAT-
ING PURPOSES, NAMELY, ELECTRICALLY HE-
ATED MATS AND MATTING; APPARATUS FOR
HEATING PURPOSES, NAMELY, ELECTRIC RA-
DIATORS FOR HEATING ROOMS AND HEATED
TOWEL RAILS; APPARATUS FOR HEATING PUR-
POSES, NAMELY, MIRROR DEMISTERS; APPARA-
TUS FOR HEATING PURPOSES, NAMELY, TUBES,
PIPES AND PRE-ASSEMBLED MANIFOLDS FOR
TRANSPORTING WARM WATER FOR HEATING
PURPOSES; APPARATUS FOR HEATING PURPO-
SES, NAMELY, HEAT PUMPS AND TEMPERA-
TURE CONTROLS FOR USE IN RELATION TO A
HEATING SYSTEM COMPOSED PRIMARILY OF

TUBES, PIPES AND PRE-ASSEMBLED MANIFOLDS
THROUGH WHICH WARM WATER CIRCULATES;
APPARATUS FOR HEATING PURPOSES, NAMELY,
WATER PUMPS AND WATER FLOW CONTROLS
OR USE IN RELATION TO A HEATING SYSTEM
COMPOSED PRIMARILY OF TUBES, PIPES AND
PRE-ASSEMBLED MANIFOLDS THROUGH
WHICH WARM WATER CIRCULATES; ELECTRIC
HEATING APPARATUS FOR HEATING BUILD-
INGS, FLOORS AND WALLS; UNDER FLOOR
AND UNDER TILE HEATING APPARATUS AND
INSTALLATIONS FOR HEATING PURPOSES COM-
POSED PRIMARILY OF ELECTRICALLY HEATED
WIRES OR CARBON ELEMENTS; UNDER FLOOR
AND UNDER TILE HEATING APPARATUS AND
INSTALLATIONS FOR HEATING PURPOSES COM-
POSED PRIMARILY OF TUBES, PIPES AND PRE-
ASSEMBLED MANIFOLDS THROUGH WHICH
WARM WATER CIRCULATES; ELECTRICAL
MATS AND MATTING FOR UNDERFLOOR HEAT-
ING; ELECTRICAL MATS AND MATTING FOR
HEATING FLOORS AND WALLS; HEATING ELE-
MENTS COMPOSED OF FLEXIBLE WIRES OR
CARBON ELEMENTS FOR UNDERFLOOR HEAT-
ING, IN CLASS 11 (U.S. CLS. 13, 21, 23, 31 AND 34).

FOR: INSULATING MATERIALS, NAMELY,
POLYSTYRENE INSULATING BOARDS, THER-
MAL PRIMER FOR APPLICATION TO FLOORS;
INSULATING MATERIALS FOR APPLICATION TO
FLOORS, WALLS, CEILINGS AND ROOFS NAME-
LY, POLYSTYRENE INSULATING BOARDS, POLY-
STYRENE INSULATING BOARDS LAMINATED
WITH ALUMINUM FOIL, POLYSTYRENE INSU-
LATING BOARDS LAMINATED WITH ENCAPSU-
LATED GAS BUBBLES, POLYSTYRENE
INSULATING BOARDS LAMINATED WITH CE-
MENT COATINGS, POLYSTYRENE INSULATING
BOARDS LAMINATED WITH NATURAL INSU-
LATING FIBRES; INSULATING MATERIALS FOR
APPLICATION TO FLOORS, WALLS CEILINGS
AND ROOFS, NAMELY VACUUM INSULATION

PANELS, GAS FILLED INSULATION PANELS,
NATURAL INSULATING FIBRES; INSULATION
BOARDS FOR FLOORS, IN CLASS 17 (U.S. CLS. 1,
5, 12, 13, 35 AND 50).

PRIORITY CLAIMED UNDER SEC. 44(D) ON
ERPNTY TM OFC APPLICATION NO.

4409926, FILED 4-20-2005, REG. NO. 4409926, DATED
6-14-2006, EXPIRES 4-20-2015.

OWNER OF U.S. REG. NO. 2,675,905.

SER. NO. 78-613,507, FILED 4-21-2005.

AMY HELLA, EXAMINING ATTORNEY

Int. Cl.: 33

Prior U.S. Cls.: 47 and 49

United States Patent and Trademark Office

Reg. No. 3,398,406

Registered Mar. 18, 2008

**TRADEMARK
PRINCIPAL REGISTER**

SATOMI

ANTOGNOLLI, ANTONIO S. (AUSTRALIA INDIVIDUAL)
CARLOS PELLEGRINI
MENDOZA, ARGENTINA 1141-7

THE MARK CONSISTS OF STANDARD CHARACTERS WITHOUT CLAIM TO ANY PARTICULAR FONT, STYLE, SIZE, OR COLOR.

FOR: WINES, IN CLASS 33 (U.S. CLS. 47 AND 49).

SER. NO. 78-622,737, FILED 5-4-2005.

FIRST USE 8-0-2005; IN COMMERCE 8-0-2005.

GISELLE AGOSTO, EXAMINING ATTORNEY

Int. Cls.: 9, 35, 41 and 42

Prior U.S. Cls.: 21, 23, 26, 36, 38, 100, 101, 102 and 107

United States Patent and Trademark Office

Reg. No. 3,398,407

Registered Mar. 18, 2008

**TRADEMARK
SERVICE MARK
PRINCIPAL REGISTER**



OUTSYSTEMS, SOFTWARE EM REDE, S.A.
(PORTUGAL CORPORATION)
RUA CENTRAL PARK ED. 6 2 A
LINDA-A-VELHA, PORTUGAL 2795-242

FOR: SOFTWARE FOR COMPUTERS AND COMPUTER NETWORKS, NAMELY, APPLICATIONS AND PROGRAMS FOR USE AS DEVELOPMENT TOOLS FOR IMPLEMENTATION, INTEGRATION, TESTING AND DEPLOYMENT OF SOFTWARE SOLUTIONS BY ENTERPRISES FOR PORTALS, TRANSACTIONAL SYSTEMS, WORKFLOWS, DATABASE CENTRIC APPLICATIONS, INTEGRATION SYSTEMS, CONTAINING WEB, EMAIL AND MOBILE INTERFACES, THAT MAY BE DOWNLOADED FROM A GLOBAL COMPUTER NETWORK, IN CLASS 9 (U.S. CLS. 21, 23, 26, 36 AND 38).

FOR: DISTRIBUTORSHIPS IN THE FIELD OF COMPUTER SOFTWARE, IN CLASS 35 (U.S. CLS. 100, 101 AND 102).

FOR: TECHNICAL TRAINING IN INFORMATION TECHNOLOGY, NAMELY, TECHNICAL TRAINING FOR THE DEVELOPMENT OF WEB AND MOBILE ENTERPRISE APPLICATIONS THAT INCLUDE TRANSACTIONAL CAPABILITIES, DATA BASE CENTRIC PROCESSING, INTEGRATION WITH EXISTING INFORMATION SYSTEMS AND CREATION OF WORKFLOW BASED APPLICATIONS, SYSTEMS AND SOLUTIONS; TRAINING ON THE OPERATION OF APPLICATIONS, TRAINING ON SOFTWARE DEVELOPMENT, TOOLS AND METHODOLOGIES, PROJECT MANAGEMENT OF AGILE AND DISTRIBUTED DEVELOPMENT

TEAMS AND AGILE METHODOLOGIES, IN CLASS 41 (U.S. CLS. 100, 101 AND 107).

FOR: CONSULTANCY IN THE FIELD OF SOFTWARE DESIGN, ANALYSIS, IMPLEMENTATION AND PROGRAMMING OF COMPUTER SOFTWARE FOR ENTERPRISE APPLICATIONS; TECHNICAL RESEARCH IN THE FIELD OF APPLICATIONS DEVELOPMENT, MAINTENANCE AND CHANGE MANAGEMENT, APPLICATIONS DEPLOYMENT AND OPERATIONS; INSTALLATION AND MAINTENANCE OF COMPUTER SOFTWARE; DATA CONVERSION FOR COMPUTER PROGRAMS AND OTHER SOFTWARE; CREATION AND MAINTENANCE OF ENTERPRISE APPLICATIONS, NAMELY, WEBSITES, WEB APPLICATIONS, TRANSACTIONAL APPLICATIONS, WORKFLOW APPLICATIONS AND MOBILE APPLICATIONS FOR THIRD PARTIES, IN CLASS 42 (U.S. CLS. 100 AND 101).

PRIORITY CLAIMED UNDER SEC. 44(D) ON ERPN CMNTY TM OFC APPLICATION NO. 004371911, FILED 3-31-2005, REG. NO. 4.371.911, DATED 5-2-2006, EXPIRES 3-31-2015.

NO CLAIM IS MADE TO THE EXCLUSIVE RIGHT TO USE "SYSTEMS", APART FROM THE MARK AS SHOWN.

SER. NO. 78-628,416, FILED 5-12-2005.

SCOTT SISUN, EXAMINING ATTORNEY

Int. Cl.: 28

Prior U.S. Cls.: 22, 23, 38 and 50

United States Patent and Trademark Office

Reg. No. 3,398,408

Registered Mar. 18, 2008

**TRADEMARK
PRINCIPAL REGISTER**

METRO

BRUNSWICK BOWLING & BILLIARDS COR-
PORATION (DELAWARE CORPORATION)
1 N. FIELD COURT
LAKE FOREST, IL 600454811

THE MARK CONSISTS OF STANDARD CHAR-
ACTERS WITHOUT CLAIM TO ANY PARTICULAR
FONT, STYLE, SIZE, OR COLOR.

FOR: BILLIARD TABLES AND CUE RACKS, IN
CLASS 28 (U.S. CLS. 22, 23, 38 AND 50).

SER. NO. 78-629,496, FILED 5-13-2005.

FIRST USE 5-30-2004; IN COMMERCE 5-30-2004.

TRACY CROSS, EXAMINING ATTORNEY

Int. Cl.: 19

Prior U.S. Cls.: 1, 12, 33 and 50

United States Patent and Trademark Office

Reg. No. 3,398,409

Registered Mar. 18, 2008

**TRADEMARK
PRINCIPAL REGISTER**

EASYTEAR

HBP ACQUISITION LLC (DELAWARE LTD LIAB
CO)
1361 ALPS ROAD
WAYNE, NJ 07470

THE MARK CONSISTS OF STANDARD CHAR-
ACTERS WITHOUT CLAIM TO ANY PARTICULAR
FONT, STYLE, SIZE, OR COLOR.

FOR: FEATURE OF NON-METAL VENTILATING
DUCTS FOR ATTICS, NAMELY, A CUSTOMIZ-
ABLE LENGTH INSTALLATION FEATURE, IN
CLASS 19 (U.S. CLS. 1, 12, 33 AND 50).

SER. NO. 78-637,224, FILED 5-25-2005.

FIRST USE 4-6-2007; IN COMMERCE 4-6-2007.

KATHERINE CHANG, EXAMINING ATTORNEY

Int. Cls.: 38 and 41

Prior U.S. Cls.: 100, 101, 104 and 107

United States Patent and Trademark Office

Reg. No. 3,398,410

Registered Mar. 18, 2008

**SERVICE MARK
PRINCIPAL REGISTER**

JC-TV

TRINITY CHRISTIAN CENTER OF SANTA ANA,
INC. (CALIFORNIA CORPORATION)
2442 MICHELLE DRIVE
SANTA ANA, CA 92680

FOR: TELEVISION BROADCASTING; CABLE TELEVISION BROADCASTING; DIGITAL TELEVISION BROADCASTING; PROVIDING ONLINE CHAT ROOMS FOR TRANSMISSION OF MESSAGES AMONG COMPUTER USERS CONCERNING RELIGION, MUSIC, HEALTH, COMEDY, POLITICS AND NEWS; PROVIDING ONLINE CHAT ROOMS AND ELECTRONIC BULLETIN BOARDS FOR TRANSMISSION OF MESSAGES AMONG USERS IN THE FIELD OF GENERAL INTEREST; AND STREAMING OF AUDIO AND VIDEO MATERIAL ON THE INTERNET, IN CLASS 38 (U.S. CLS. 100, 101 AND 104).

FIRST USE 9-0-2003; IN COMMERCE 9-0-2003.

FOR: ENTERTAINMENT, NAMELY, TELEVISION NEWS SHOWS; PRODUCTION OF CABLE TELEVISION PROGRAMS; PRODUCTION OF CLOSED CAPTION TELEVISION PROGRAMS; PRODUCTION OF RADIO AND TELEVISION PROGRAMS; TELEVISION PRODUCTION; TELEVISION PROGRAM SYNDICATION; TELEVISION SHOW PRODUCTION; BROADCASTING PROGRAMS VIA A GLOBAL COMPUTER NETWORK; RADIO BROADCASTING OF INFORMATION AND OTHER PROGRAMS; RADIO PROGRAM BROADCASTING; ENTERTAINMENT IN THE NATURE OF ON-GOING TELEVISION PROGRAMS IN THE FIELD OF NEWS, COMEDY, VARIETY, RELIGION, HEALTH, MUSIC AND YOUTH, ADULT AND CHILDREN SPECIFIC TOPICS; ENTERTAINMENT SERVICES, NAMELY, PROVIDING A RADIO PROGRAM IN THE FIELD OF NEWS, RELIGION, HEALTH, VARIETY, MUSIC, COMEDY AND YOUTH, ADULT AND CHILDREN SPECIFIC TOPICS VIA A GLOBAL COMPUTER

NETWORK; ENTERTAINMENT SERVICES, NAMELY, PROVIDING A TELEVISION PROGRAM IN THE FIELD OF NEWS, RELIGION, HEALTH, VARIETY, MUSIC, COMEDY AND YOUTH, ADULT AND CHILDREN SPECIFIC TOPICS VIA A GLOBAL COMPUTER NETWORK; ENTERTAINMENT SERVICES IN THE NATURE OF ON-GOING TELEVISION PROGRAMS IN THE FIELD OF CHILDREN'S ENTERTAINMENT; PRODUCTION OF CABLE TELEVISION PROGRAMS; PRODUCTION OF RADIO OR TELEVISION PROGRAMS; RADIO ENTERTAINMENT SERVICES, NAMELY, RADIO PROGRAMS FEATURING PERFORMANCES BY A RADIO PERSONALITY; ENTERTAINMENT, NAMELY, PRODUCTION OF TELEVISION SHOWS AND GAME SHOWS; ENTERTAINMENT SERVICES, NAMELY, PRODUCTION AND DISTRIBUTION OF A GAME SHOW; PRODUCTION OF VIDEO CASSETTES; RADIO ENTERTAINMENT PRODUCTION; TELEVISION PRODUCTION; TELEVISION SHOW PRODUCTION; VIDEOTAPE PRODUCTION; ENTERTAINMENT SERVICES, NAMELY, PROVIDING A WEB SITE FEATURING MUSICAL PERFORMANCES, MUSICAL VIDEOS, RELATED FILM CLIPS, PHOTOGRAPHS, AND OTHER MULTIMEDIA MATERIALS; ENTERTAINMENT SERVICES, NAMELY, AN ONLINE ACTIVITY WHERE USERS CREATE THEIR OWN MUSIC VIDEOS; ENTERTAINMENT, NAMELY, A CONTINUING NEWS, COMEDY, VARIETY, HEALTH, MUSIC OR RELIGIOUS SHOW BROADCAST OVER TELEVISION, SATELLITE, AUDIO, AND VIDEO MEDIA, IN CLASS 41 (U.S. CLS. 100, 101 AND 107).

FIRST USE 9-0-2003; IN COMMERCE 9-0-2003.

THE MARK CONSISTS OF STANDARD CHARACTERS WITHOUT CLAIM TO ANY PARTICULAR FONT, STYLE, SIZE, OR COLOR.

SEC. 2(F).

SER. NO. 78-641,329, FILED 6-1-2005.

STEVEN JACKSON, EXAMINING ATTORNEY

Int. Cls.: 10 and 42

Prior U.S. Cls.: 26, 39, 44, 100 and 101

United States Patent and Trademark Office

Reg. No. 3,398,411

Registered Mar. 18, 2008

**TRADEMARK
SERVICE MARK
PRINCIPAL REGISTER**

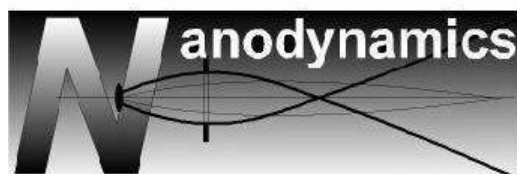

NANODYNAMICS, INC. (DELAWARE CORPORATION)
34 EAST 29TH STREET
NEW YORK, NY 10016

FOR: MEDICAL SOLID STATE DEVICES, NAME-
LY, X-RAY MICROSCOPES FOR VIEWING ACTIV-
ITIES AT NANO-SCALE, NAMELY, MOLECULAR,
ATOMIC AND MACROMOLECULAR LEVELS , IN
CLASS 10 (U.S. CLS. 26, 39 AND 44).

FIRST USE 8-8-1988; IN COMMERCE 8-8-1988.

FOR: TESTING AND RESEARCH ON MEDICAL
APPLICATIONS OF THE USE OF SOLID STATE
DEVICES, NAMELY, X-RAY MICROSCOPES FOR
VIEWING ACTIVITIES AT NANO-SCALE, NAME-
LY, MOLECULAR, ATOMIC AND MACROMOLE-
CULAR LEVELS, IN CLASS 42 (U.S. CLS. 100 AND
101).

FIRST USE 8-8-1988; IN COMMERCE 8-8-1988.

THE COLOR(S) BLACK, WHITE AND GRAY IS/
ARE CLAIMED AS A FEATURE OF THE MARK.

THE MARK CONSISTS OF THE CAPITAL LET-
TER "N" SHOWN IN SHADES OF GRAY WITH
LOWER CASE LETTERING OF "ANAODYNAMICS"
IN WHITE SUPERIMPOSED ON BACKGROUND
SHOWING VARIOUS SHADES OF GREY; DESIGN
ELEMENTS IN BLACK.

SEC. 2(F).

SER. NO. 78-642,575, FILED 6-2-2005.

ARETHA SOMERVILLE, EXAMINING ATTORNEY

Int. Cl.: 28

Prior U.S. Cls.: 22, 23, 38 and 50

Reg. No. 3,398,412

United States Patent and Trademark Office

Registered Mar. 18, 2008

TRADEMARK
PRINCIPAL REGISTER

APOS

APOS - SPORTS AND MEDICAL TECHNOLOGIES LTD. (ISRAEL CORPORATION)
11 HAPISGA STREET
DIMONA, ISRAEL

FOR: EXERCISING EQUIPMENT, NAMELY, BIO-MECHANICAL APPARATUS THAT TRAIN AND ENHANCE NEUROMUSCULAR CONTROL TO PREVENT AND REHABILITATE INJURIES AND IMPROVE MOVEMENT, BALANCE AND SPORTS PERFORMANCE; GAMES, NAMELY, ACTION SKILL GAMES, ACTION-TYPE TARGET GAMES, AERODYNAMIC DISK FOR USE IN PLAYING CATCHING GAMES, TARGET GAMES; TOYS, NAMELY, DISC TOSS TOYS; SPORTS DEVICES, NAMELY, ANKLE AND WRIST WEIGHTS FOR EXERCISE, AQUATIC CANINE TREADMILL, AEROBIC STEP MACHINES, AEROBIC STEPS, ARCHERY EQUIPMENT, NAMELY, ARM GUARDS, ARROW FLETCHING DEVICES, ARROWS, ARROW POINTS, BOW STRINGS, BOWS, OPEN BOW SIGHTS, NON-TELESCOPIC BOW SIGHTS, FINGER TABS, QUIVERS, TARGETS; ATHLETIC EQUIPMENT, NAMELY, MOUTH GUARDS, CHIN GUARDS, NOSE GUARDS, EYE GUARDS, STRIKING SHIELDS, STRIKING BAGS, HAND WRAPS, SUPPORTERS, TAPE, WRIST AND JOINT SUPPORTS; ATHLETIC TRAINING DEVICES, NAMELY, WEIGHTED INSERTS FOR FOOTWEAR, BADMINTON FLOOR PLATES, BADMINTON GAME PLAYING EQUIPMENT, NAMELY, RACKET STRINGS, RACKETS FOR BADMINTON, BADMINTON SETS, BADMINTON SHUTTLECOCKS, BADMINTON UPRIGHTS, GYMNASTIC BALANCE BEAMS, BALL PITCHING MACHINES, BASEBALL BATTING CAGES, BARBELLS FOR WEIGHTLIFTING, BASEBALL BASES, BASEBALL BATS, BASEBALLS, BATTING GLOVES, BASEBALL BATTING TEES, BASEBALL MITTS, BASEBALL PITCHING SCREENS, BASKETBALLS, BASKETBALL GOAL SETS, BASKETBALL HOOPS, BASKETBALL NETS, BASKETBALLS, BEACH BALLS; BILLIARD GAME

PLAYING EQUIPMENT, NAMELY, BALLS, CUE STICKS, BRIDGES, BUMPERS, CHALK, CUE RACKS, CUES, CUSHIONS, NETS, TABLES, TALLY BALLS, TIPS, TRIANGLES; BINDINGS FOR ALPINE SKIS, DOWNHILL SKIS, AND SNOWBOARDS, BOARDS USED IN THE PRACTICE OF WATER SPORTS, BOCCE BALLS, BODY BOARDS, SURFBOARDS, KNEE BOARDS, BOOMERANGS, BOXING BAGS, CATCHERS' MITTS, CLIMBERS' HARNESSES, CRICKET BATS AND BALLS; CROQUET SETS, COMPOSED OF CROQUET MALLETS, BALLS, AND WICKETS; DART EQUIPMENT, NAMELY, DARTS, DARTBOARDS, DART FLIGHTS, SHAFTS, STEMS; DISCUSES FOR FIELD SPORTS; DUMBBELL SETS, COMPOSED OF DUMBBELLS, DUMBBELLS SHAFTS FOR WEIGHTLIFTING, ELBOW GUARDS AND ELBOW PADS; ELLIPTICAL EXERCISE MACHINES, EXERCISE BARS, EXERCISE BENCHES, DOORWAY GYM BARS, EQUIPMENT FOR LATERAL MOVEMENT IN A SKATING MOTION, MANUALLY OPERATED JOGGING MACHINES, MANUALLY OPERATED ROWING MACHINES, STAIR-STEPPING MACHINES, STATIONARY CYCLES, ABDOMINAL BOARDS, CHEST EXPANDERS, CHEST PULLS, ROTARY ABDOMINAL BOARDS, SHOULDER STRETCHER USING RESISTANCE CABLES, EXERCISE PLATFORMS, EXERCISE TABLES, TRAMPOLINES, EXERCISE TREADMILLS, EXERCISE WEIGHT CUFFS, EXERCISE WEIGHTS, EXERCISE PULLEYS, WEIGHT-LIFTING MACHINES, POWERED TREADMILLS FOR RUNNING, FENCING EQUIPMENT, NAMELY, FOILS, GAUNTLETS, MASKS, FIELD HOCKEY BALLS, STICKS, GOALIE STICKS, FLYING DISCS AND SAUCERS; FOOTBALL EQUIPMENT, NAMELY, FOOTBALLS, BODY PROTECTORS, CHEST PADS, ELBOW PADS, GIRDLES, KNEE PADS, LEG PADS, SHOULDER PADS, GOALS; GOLF BALLS, GOLF CLUBS; GYMNASTIC APPARATUS, NAMELY, HORIZONTAL BARS, PARALLEL BARS, TRAINING STOOLS, VAULTING HORSES; HANDBALL EQUIPMENT, NAMELY,

RACQUETS AND BALLS; IN-LINE AND ICE HOCKEY EQUIPMENT, NAMELY, STICKS, PUCKS, CHEST PROTECTORS, ELBOW PROTECTORS, SHIN PROTECTORS, SKATES, SKATE BLADES, SKATE WHEELS, GLOVES, NETS, GOALIE STICKS, IRON SHOTS SPECIFICALLY FOR USE IN SHOT PUT COMPETITION; JAVELINS FOR FIELD SPORTS, JOCK STRAPS, JUMP ROPES; KARATE GEAR, NAMELY, GLOVES, HEAD GUARDS, KICK PADS, SHIN PADS, TARGET PADS; LACROSSE EQUIPMENT, NAMELY, STICKS, BALLS, CHEST PROTECTORS, ELBOW PROTECTORS, SHIN PROTECTORS, GLOVES, NETS, GOALIE STICKS; MOUNTAINEERING EQUIPMENT, NAMELY, BINDING STRAPS, HOOK AND RING COMBINATIONS, HOOKS; PADDLE BALL GAMES EQUIPMENT, NAMELY, PADDLE BOARDS, BALLS; PERSONAL EXERCISE MATS, PUTTING PRACTICE MATS; RACQUETBALL EQUIPMENT, NAMELY, GLOVES, NETS, RACKET STRINGS, RACQUETS, BALLS; RING BUOYS FOR RECREATIONAL USE, ROLLER SKATES, ROSIN USED BY ATHLETES, RUGBY BALLS, FENCING WEAPON, NAMELY, SABRES, SCUBA FINS, SCUBA FLIPPERS, SKATEBOARDS, DOWNHILL AND CROSS-COUNTRY SKI EQUIPMENT, NAMELY, BINDINGS AND PARTS THEREFORE, POLES, BRAKES, EDGES, ROPES; SKIPPING ROPES, SLINGSHOTS, SNOWBOARDS AND SNOWBOARD BINDINGS, SNOWSHOES; SOCCER EQUIPMENT, NAMELY, BALLS, GOAL NETS, KNEE PADS; SPORTING GOODS AND EQUIPMENT FOR SPEED TRAINING, NAMELY, RINGS, CONES, SPEED LADDERS, COACHING STICKS, TRAINING ARCHES, ANKLE

BANDS, RESISTANCE CHUTES, HURDLES; SPORTS EQUIPMENT, NAMELY, LOWER BODY ALIGNMENT APPARATUS, SPRING BAR TENSION SETS FOR USE IN EXERCISING, SPRING BOARDS; SQUASH EQUIPMENT, NAMELY, BALLS AND RACQUETS; STATIONARY EXERCISE BICYCLES, STRESS RELIEF BALLS FOR HAND EXERCISE, SWIM BOARDS AND FLOATS FOR RECREATIONAL USE; TABLE TENNIS EQUIPMENT, NAMELY, BATS, NETS, PADDLES, POST SETS, RACQUETS, BALLS, TABLES, TARGETS; TEEBALL SETS; TENNIS EQUIPMENT, NAMELY, RACQUETS, BALLS, NETS, UPRIGHTS; TOSSING DISC TOYS, TRAMPOLINES; VOLLEYBALL EQUIPMENT, NAMELY, BALLS, NETS, FLOOR PLATES, STANDARDS, UPRIGHTS; WEIGHTLIFTING EQUIPMENT, NAMELY, BELTS, BENCHES AND BENCH ACCESSORIES, GLOVES; WRIST AND ANKLE WEIGHTS FOR EXERCISE, YOGA MATS, IN CLASS 28 (U.S. CLS. 22, 23, 38 AND 50).

THE MARK CONSISTS OF STANDARD CHARACTERS WITHOUT CLAIM TO ANY PARTICULAR FONT, STYLE, SIZE, OR COLOR.

PRIORITY CLAIMED UNDER SEC. 44(D) ON ISRAEL APPLICATION NO. 176799, FILED 12-7-2004, REG. NO. 176799, DATED 10-23-2006, EXPIRES 12-7-2011.

SER. NO. 78-645,536, FILED 6-7-2005.

ALYSSA PALADINO, EXAMINING ATTORNEY

Int. Cl.: 37

Prior U.S. Cls.: 100, 103 and 106

United States Patent and Trademark Office

Reg. No. 3,398,413

Registered Mar. 18, 2008

**SERVICE MARK
PRINCIPAL REGISTER**



DYCOM IDENTITY, LLC (DELAWARE LTD
LIAB CO)
SUITE 101E
11770 US HIGHWAY 1
PALM BEACH GARDENS, FL 33408

FIRST USE 10-1-2000; IN COMMERCE 10-1-2000.

NO CLAIM IS MADE TO THE EXCLUSIVE
RIGHT TO USE "DIGITAL, LLC", APART FROM
THE MARK AS SHOWN.

FOR: INSTALLATION AND MAINTENANCE OF
POWER, CABLE, FIBER OPTIC, AND VARIOUS
OTHER TELECOMMUNICATION SYSTEMS OF
OTHERS, IN CLASS 37 (U.S. CLS. 100, 103 AND 106).

SER. NO. 78-665,531, FILED 7-7-2005.

DAVID YONTEF, EXAMINING ATTORNEY

Int. Cl.: 37

Prior U.S. Cls.: 100, 103 and 106

United States Patent and Trademark Office

Reg. No. 3,398,414

Registered Mar. 18, 2008

**SERVICE MARK
PRINCIPAL REGISTER**

APEX DIGITAL

DYCOM IDENTITY, LLC (DELAWARE LTD
LIAB CO)
SUITE 101E
11770 US HIGHWAY 1
PALM BEACH GARDENS, FL 33408

FOR: INSTALLATION AND MAINTENANCE OF
POWER, CABLE, FIBER OPTIC, AND VARIOUS
OTHER TELECOMMUNICATION SYSTEMS OF
OTHERS, IN CLASS 37 (U.S. CLS. 100, 103 AND 106).

FIRST USE 10-1-2000; IN COMMERCE 10-1-2000.

THE MARK CONSISTS OF STANDARD CHAR-
ACTERS WITHOUT CLAIM TO ANY PARTICULAR
FONT, STYLE, SIZE, OR COLOR.

NO CLAIM IS MADE TO THE EXCLUSIVE
RIGHT TO USE "DIGITAL", APART FROM THE
MARK AS SHOWN.

SER. NO. 78-665,536, FILED 7-7-2005.

DAVID YONTEF, EXAMINING ATTORNEY

Int. Cl.: 37

Prior U.S. Cls.: 100, 103 and 106

United States Patent and Trademark Office

Reg. No. 3,398,415

Registered Mar. 18, 2008

**SERVICE MARK
PRINCIPAL REGISTER**

APEX

DYCOM IDENTITY, LLC (DELAWARE LTD
LIAB CO)
SUITE 101E
11770 US HIGHWAY 1
PALM BEACH GARDENS, FL 33408

FOR: INSTALLATION AND MAINTENANCE OF
POWER, CABLE, FIBER OPTIC, AND VARIOUS
OTHER TELECOMMUNICATION SYSTEMS OF
OTHERS, IN CLASS 37 (U.S. CLS. 100, 103 AND 106).

FIRST USE 10-1-2000; IN COMMERCE 10-1-2000.

THE MARK CONSISTS OF STANDARD CHAR-
ACTERS WITHOUT CLAIM TO ANY PARTICULAR
FONT, STYLE, SIZE, OR COLOR.

SER. NO. 78-665,688, FILED 7-7-2005.

DAVID YONTEF, EXAMINING ATTORNEY

Int. Cl.: 39

Prior U.S. Cls.: 100 and 105

United States Patent and Trademark Office

Reg. No. 3,398,416

Registered Mar. 18, 2008

**SERVICE MARK
PRINCIPAL REGISTER**



DEUTSCHE TELEKOM AG (FED REP GERMA-
NY CORPORATION)
FRIEDRICH-EBERT-ALLEE 140
BONN, FED REP GERMANY 53113

FOR: WAREHOUSE STORAGE OF GOODS; STO-
RAGE OF TELECOMMUNICATIONS, COMPUTERS
AND OTHER INFORMATION TECHNOLOGY DE-
VICES; TRANSPORTATION OF GOODS BY TRUCK,
SHIP, RAILWAY AND PLANE; ELECTRONIC STO-
RAGE OF INFORMATION IN THE NATURE OF
FILES AND DOCUMENTS; MANAGEMENT OF
VEHICULAR TRAFFIC FLOW THROUGH AD-
VANCED COMMUNICATIONS NETWORKS AND
TECHNOLOGY; AIR TRAFFIC CONTROL SERVI-
CES; TRAFFIC INFORMATION SERVICES PROVI-
DED BY TELEPHONE, CELLULAR TELEPHONE,
RADIO, COMPUTER OVER A GLOBAL COMPU-
TER NETWORK; TRAVEL AGENCY SERVICES,
NAMELY, MAKING RESERVATIONS AND BOOK-
INGS FOR TRANSPORTATION; ARRANGING
TRAVEL TOURS AND CRUISES, IN CLASS 39 (U.S.
CLS. 100 AND 105).

OWNER OF FED REP GERMANY REG. NO.
39722098, DATED 8-6-1997, EXPIRES 5-31-2017.

OWNER OF U.S. REG. NOS. 2,436,053, 2,508,277
AND OTHERS.

NO CLAIM IS MADE TO THE EXCLUSIVE
RIGHT TO USE "DEUTSCHE TELEKOM", APART
FROM THE MARK AS SHOWN.

THE COLOR(S) MAGENTA AND GREY IS/ARE
CLAIMED AS A FEATURE OF THE MARK.

THE MARK CONSISTS OF THE COLOR MAGEN-
TA APPEARS IN THE LETTER "T", AND THE
COLOR GREY APPEARS IN THE THREE SQUARES
THAT ARE SET TO THE LEFT OF THE LETTER "T"
AND THE ONE SQUARE SET TO THE RIGHT OF
THE LETTER "T" AND IN THE WORDS
"DEUTSCHE TELEKOM" WHICH IS POSITIONED
ON THE RIGHT-HAND SIDE OF THE SQUARES
AND THE LETTER "T".

THE FOREIGN WORDING IN THE MARK
TRANSLATES INTO ENGLISH AS GERMAN TELE-
COM.

SER. NO. 78-667,232, FILED 7-11-2005.

JULIE GUTTADAURO, EXAMINING ATTORNEY

Int. Cl.: 41

Prior U.S. Cls.: 100, 101 and 107

United States Patent and Trademark Office

Reg. No. 3,398,417

Registered Mar. 18, 2008

**SERVICE MARK
PRINCIPAL REGISTER**

THE TTABLOG

JOHN L. WELCH (UNITED STATES INDIVIDUAL)
79 SAINT BOTOLPH STREET, UNIT 1
BOSTON, MA 021166404

FOR: AN ONLINE BLOG FEATURING COMMENTARY AND INFORMATION IN THE FIELD OF TRADEMARKS; AN ONLINE BLOG FEATURING COMMENTARY AND INFORMATION REGARDING DECISIONS OF THE TRADEMARK TRIAL AND APPEAL BOARD AND THE COURTS RELATING TO TRADEMARK LAW, IN CLASS 41 (U.S. CLS. 100, 101 AND 107).

FIRST USE 11-9-2004; IN COMMERCE 11-9-2004.

THE MARK CONSISTS OF STANDARD CHARACTERS WITHOUT CLAIM TO ANY PARTICULAR FONT, STYLE, SIZE, OR COLOR.

SEC. 2(F).

SER. NO. 78-669,946, FILED 7-13-2005.

DANNEAN HETZEL, EXAMINING ATTORNEY

Int. Cls.: 42 and 44

Prior U.S. Cls.: 100 and 101

United States Patent and Trademark Office

Reg. No. 3,398,418

Registered Mar. 18, 2008

**SERVICE MARK
PRINCIPAL REGISTER**

HARBORVIEW

HARBORVIEW MEDICAL CENTER (WASHINGTON A WASHINGTON GOVERNMENTAL ENTITY, NAMELY, A HOSPITAL OF THE MUNICIPALITY)
325 NINTH AVENUE
SEATTLE, WA 98104

FOR: MEDICAL RESEARCH SERVICES, IN CLASS 42 (U.S. CLS. 100 AND 101).

FIRST USE 0-0-1985; IN COMMERCE 0-0-1985.

FOR: HEALTHCARE SERVICES, NAMELY, HOSPITAL SERVICES, INPATIENT AND OUTPATIENT HEALTHCARE SERVICES, MEDICAL CLINICAL

SERVICES AND PHYSICIAN SERVICES, IN CLASS 44 (U.S. CLS. 100 AND 101).

FIRST USE 12-31-1932; IN COMMERCE 12-31-1932.

THE MARK CONSISTS OF STANDARD CHARACTERS WITHOUT CLAIM TO ANY PARTICULAR FONT, STYLE, SIZE, OR COLOR.

OWNER OF U.S. REG. NO. 2,339,744.

SER. NO. 78-673,209, FILED 7-19-2005.

JENNIFER VASQUEZ, EXAMINING ATTORNEY

Int. Cl.: 30

Prior U.S. Cl.: 46

United States Patent and Trademark Office

Reg. No. 3,398,419

Registered Mar. 18, 2008

**TRADEMARK
PRINCIPAL REGISTER**



GENERAL MILLS IP HOLDINGS II, LLC (DELA-
WARE LTD LIAB CO)
NUMBER ONE GENERAL MILLS BLVD.
MINNEAPOLIS, MN 55426

FOR: PROCESSED CEREAL-DERIVED FOOD
PRODUCT TO BE USED AS A BREAKFAST FOOD,
SNACK FOOD OR INGREDIENT FOR MAKING
FOOD, IN CLASS 30 (U.S. CL. 46).

FIRST USE 0-0-1960, THE MARK WAS FIRST
USED ANYWHERE IN A DIFFERENT FORM
OTHER THAN THAT SOUGHT TO BE
REGISTERED ON 00/00/1951.; IN COMMERCE
0-0-1960, THE MARK WAS FIRST USED IN
COMMERCE IN A DIFFERENT FORM OTHER
THAN THAT SOUGHT TO BE REGISTERED ON
00/00/1951..

OWNER OF U.S. REG. NOS. 199,448, 2,667,272 AND
OTHERS.

THE COLOR(S) ORANGE, WHITE AND BLUE IS/
ARE CLAIMED AS A FEATURE OF THE MARK.

THE MARK CONSISTS OF A RECTANGULAR
ORANGE BACKGROUND WITH THE WORD
"WHEATIES" IN WHITE BLOCK LETTERING THAT
GRADUALLY INCREASES IN HEIGHT, THE LET-
TERS INCLUDING BLUE AND ORANGE HIGH-
LIGHTING.

SER. NO. 78-675,500, FILED 7-21-2005.

STEVEN JACKSON, EXAMINING ATTORNEY

Int. Cl.: 36

Prior U.S. Cls.: 100, 101 and 102

United States Patent and Trademark Office

Reg. No. 3,398,420

Registered Mar. 18, 2008

**SERVICE MARK
PRINCIPAL REGISTER**



DARWIN PROFESSIONAL UNDERWRITERS,
INC. (DELAWARE CORPORATION)
9 FARM SPRINGS ROAD
FARMINGTON, CT 06032

FOR: INSURANCE SERVICES, NAMELY, UNDERWRITING PROFESSIONAL LIABILITY INSURANCE, UNDERWRITING FIDUCIARY INSURANCE, UNDERWRITING FIDELITY INSURANCE, UNDERWRITING PROPERTY AND CASUALTY INSURANCE, UNDERWRITING EMPLOYMENT PRACTICES INSURANCE; INSURANCE ADMINISTRATION SERVICES; INSURANCE AGENCY SERVICES; RISK MANAGEMENT SERVICES, IN CLASS 36 (U.S. CLS. 100, 101 AND 102).

FIRST USE 7-18-2004; IN COMMERCE 7-18-2004.

THE COLOR(S) YELLOW IS/ARE CLAIMED AS A FEATURE OF THE MARK.

THE MARK COMPRISES A YELLOW ARC, LIGHTER ON THE FRINGES AND DARKER IN THE CENTER.

SER. NO. 78-678,172, FILED 7-26-2005.

ATTIYA MALIK, EXAMINING ATTORNEY

Int. Cls.: 37 and 42

Prior U.S. Cls.: 100, 101, 103 and 106

United States Patent and Trademark Office

Reg. No. 3,398,421

Registered Mar. 18, 2008

**SERVICE MARK
PRINCIPAL REGISTER**

NORMENT

NORMENT SECURITY GROUP, INC. (DELA-
WARE CORPORATION)
3224 MOBILE HIGHWAY
MONTGOMERY, AL 36108

FOR: INSTALLATION OF SECURITY SYSTEMS;
INSTALLATION OF ELECTRONIC SECURITY SYS-
TEMS, IN CLASS 37 (U.S. CLS. 100, 103 AND 106).

FIRST USE 1-1-1986; IN COMMERCE 1-1-1986.

FOR: DESIGN FOR OTHERS IN THE FIELD OF
SECURITY SYSTEMS; DESIGN FOR OTHERS IN
THE FIELD OF ELECTRONIC SECURITY SYS-
TEMS; PRODUCT DEVELOPMENT IN THE FIELD
OF SECURITY SYSTEMS; PRODUCT DEVELOP-

MENT IN THE FIELD OF ELECTRONIC SECURITY
SYSTEMS, IN CLASS 42 (U.S. CLS. 100 AND 101).

FIRST USE 1-1-1986; IN COMMERCE 1-1-1986.

THE MARK CONSISTS OF STANDARD CHAR-
ACTERS WITHOUT CLAIM TO ANY PARTICULAR
FONT, STYLE, SIZE, OR COLOR.

SEC. 2(F).

SER. NO. 78-679,901, FILED 7-27-2005.

LAURA HAMMEL, EXAMINING ATTORNEY

Int. Cl.: 42

Prior U.S. Cls.: 100 and 101

United States Patent and Trademark Office

Reg. No. 3,398,422

Registered Mar. 18, 2008

**SERVICE MARK
PRINCIPAL REGISTER**



SMITH ENGINEERING CONSULTANTS, INC.
(ILLINOIS CORPORATION)
4500 PRIME PARKWAY
MCHENRY, IL 60050

THE COLOR(S) GREEN, WHITE BLUE IS/ARE
CLAIMED AS A FEATURE OF THE MARK.

FOR: ENGINEERING; ENGINEERING SERVICES
FOR THE CONSTRUCTION OF WATER TREAT-
MENT AND PURIFICATION PLANTS, SOLID
WASTE TREATMENT PLANTS AND OTHER MU-
NICIPAL INFRASTRUCTURE FACILITIES; ME-
CHANICAL ENGINEERING; SURVEYING AND
ENGINEERING, IN CLASS 42 (U.S. CLS. 100 AND
101).

THE MARK CONSISTS OF A DESIGN PLUS
WORDS. THE DESIGN IS OF A RECTANGLE WITH
A STYLIZED LETTER S IN THE RECTANGLE.
LEFT OF THE S IS THE COLOR GREEN, THE
STYLIZED S IS WHITE, AND RIGHT OF THE S IS
THE COLOR BLUE. THE WORDS "SMITH ENGI-
NEERING" ARE CENTERED UNDERNEATH THE
DESIGN.

FIRST USE 3-31-1986; IN COMMERCE 1-1-2001.

SER. NO. 78-682,521, FILED 8-1-2005.

NO CLAIM IS MADE TO THE EXCLUSIVE
RIGHT TO USE "ENGINEERING", APART FROM
THE MARK AS SHOWN.

SHAUNIA CARLYLE, EXAMINING ATTORNEY

Int. Cl.: 9

Prior U.S. Cls.: 21, 23, 26, 36 and 38

United States Patent and Trademark Office

Reg. No. 3,398,423

Registered Mar. 18, 2008

**TRADEMARK
PRINCIPAL REGISTER**

SPAMFIGHTER

SPAMFIGHTER APS (DENMARK CORPORATION)
ROVSINGSGADE 88, 2
COPENHAGEN N, DENMARK 2200

FOR: COMPUTER SOFTWARE FOR ELIMINATING UNSOLICITED COMMERCIAL ELECTRONIC MAIL; COMPUTER SOFTWARE FOR ENSURING THE SECURITY OF ELECTRONIC MAIL; COMPUTER SOFTWARE FOR ELIMINATING UNSOLICITED ELECTRONIC MAIL THAT MAY BE DOWNLOADED FROM A GLOBAL COMPUTER

NETWORK, IN CLASS 9 (U.S. CLS. 21, 23, 26, 36 AND 38).

FIRST USE 11-1-2002; IN COMMERCE 11-1-2002.

THE MARK CONSISTS OF STANDARD CHARACTERS WITHOUT CLAIM TO ANY PARTICULAR FONT, STYLE, SIZE, OR COLOR.

SER. NO. 78-691,344, FILED 8-12-2005.

MIDGE BUTLER, EXAMINING ATTORNEY

Int. Cl.: 25

Prior U.S. Cls.: 22 and 39

United States Patent and Trademark Office

Reg. No. 3,398,424

Registered Mar. 18, 2008

TRADEMARK
PRINCIPAL REGISTER

Groovy Goddess

WAYSHAK, CORINNE (UNITED STATES INDIVIDUAL)
1721 HOLT AVENUE
LOS ALTOS, CA 94024

FOR: LINE OF CLOTHING WITH FEMALE ORIENTED SAYINGS OR DRAWINGS, NAMELY, ANKLETS, SOCKS, APRONS, ATHLETIC FOOTWEAR AND SHOES, BABY BIBS NOT OF PAPER, BABY BUNTING, BABY DOLL PAJAMAS, CAPS, CAPS WITH VISORS, BATHROBES, BLAZERS, BLOUSES, BODY SUITS, BOTTOMS, UNDERWEAR BRIEFS, CAMISOLE SHIRTS, CHEMISES, CLOTH BIBS, COATS, DENIM JACKETS, DENIM PANTS, SHIRTS, FISHERMEN'S JACKETS AND VESTS, PULLOVERS, HATS, FOOTWEAR FOR MEN AND WOMEN, HALTER TOPS, HEAD WEAR, INFANT AND TODDLER ONE PIECE CLOTHING, INFANTWEAR, JACKETS, JEANS, JERSEYS, TANK TOPS, JOGGING PANTS AND SUITS, LEOTARDS, LOUNGEWEAR, NIGHTDRESSES, OPEN-NECKED

SHIRTS, OVERALLS, PAJAMAS, PANTS, PULLOVERS, ROBES, SCARVES, SHIRTS, SHORTS, SHORT-SLEEVED OR LONG-SLEEVED T-SHIRTS, SKIRTS AND DRESSES, SKORTS, SLEEPING GARMENTS, SPORTS SHIRTS, SWEAT PANTS, SWEAT SHIRTS, TANK-TOPS, AND TOPS, NONE OF THE AFORESAID GOODS COMPRISING LINQERIE, HOSIERY, BEACHWEAR OR SWIMWEAR, IN CLASS 25 (U.S. CLS. 22 AND 39).

FIRST USE 8-1-2005; IN COMMERCE 9-22-2005.

THE MARK CONSISTS OF STANDARD CHARACTERS WITHOUT CLAIM TO ANY PARTICULAR FONT, STYLE, SIZE, OR COLOR.

SER. NO. 78-693,168, FILED 8-16-2005.

HEATHER THOMPSON, EXAMINING ATTORNEY

Int. Cls.: 35 and 45

Prior U.S. Cls.: 100, 101 and 102

United States Patent and Trademark Office

Reg. No. 3,398,425

Registered Mar. 18, 2008

**SERVICE MARK
PRINCIPAL REGISTER**



DELAWARE RIVER MARITIME ENTERPRISE
COUNCIL (PENNSYLVANIA CORPORATION)
2 NESHAMINY INTERPLEX SUITE 208
TREVOSE, PA 19053

FOR: TRANSPORTATION MANAGEMENT SERVICES, NAMELY, MONITORING, TRACKING AND COORDINATION OF ROAD, RAIL, SHIP AND AIR TRANSPORTATION SYSTEMS AND FACILITIES, IN CLASS 35 (U.S. CLS. 100, 101 AND 102).

FIRST USE 10-1-2004; IN COMMERCE 10-1-2004.

FOR: MONITORING, TRACKING AND COORDINATION SERVICES FOR SECURITY PURPOSES IN THE FIELD OF TRANSPORTATION BY ROAD, RAIL, SHIP, AIR OR A COMBINATION THEREOF AND FACILITIES RELATED THERETO, IN CLASS 45 (U.S. CLS. 100 AND 101).

FIRST USE 10-1-2004; IN COMMERCE 10-1-2004.

OWNER OF U.S. REG. NOS. 2,793,028, 2,793,029, AND 2,793,030.

NO CLAIM IS MADE TO THE EXCLUSIVE RIGHT TO USE "SYSTEM" AND "REGIONAL AGILE PORT INTERMODAL DISTRIBUTION", APART FROM THE MARK AS SHOWN.

THE COLOR(S) GREEN AND BLUE IS/ARE CLAIMED AS A FEATURE OF THE MARK.

THE MARK CONSISTS OF TWO GRAPHIC ELEMENTS TOGETHER WITH THE WORDS RAPID SYSTEMS IN GREEN, THE FIRST WORD BEING ALL CAPITALS AND THE SECOND A COMBINATION OF CAPITALS AND ORDINALS, TOGETHER WITH THE WORDS REGIONAL AGILE PORT INTERMODAL DISTRIBUTION IN SMALLER TYPE IN BLUE. THE FIRST LETTER OF EACH COMBINING TO FORM THE WORD RAPID.

SER. NO. 78-695,530, FILED 8-18-2005.

MIDGE BUTLER, EXAMINING ATTORNEY

Int. Cl.: 3

Prior U.S. Cls.: 1, 4, 6, 50, 51 and 52

United States Patent and Trademark Office

Reg. No. 3,398,426

Registered Mar. 18, 2008

**TRADEMARK
PRINCIPAL REGISTER**

DermaSwim

PRO LOTIONS, LLC (NEW JERSEY CORPORATION)
40 SHREWSBURY AVE
RED BANK, NJ 07701

THE MARK CONSISTS OF STANDARD CHARACTERS WITHOUT CLAIM TO ANY PARTICULAR FONT, STYLE, SIZE, OR COLOR.

FOR: BODY LOTIONS, IN CLASS 3 (U.S. CLS. 1, 4, 6, 50, 51 AND 52).

SER. NO. 78-696,171, FILED 8-19-2005.

FIRST USE 6-1-2003; IN COMMERCE 9-1-2003.

CHARLES L. JENKINS, EXAMINING ATTORNEY

Int. Cl.: 16

Prior U.S. Cls.: 2, 5, 22, 23, 29, 37, 38 and 50

Reg. No. 3,398,427

United States Patent and Trademark Office

Registered Mar. 18, 2008

**TRADEMARK
PRINCIPAL REGISTER**

SMART PAK

SMART PAPERS HOLDINGS LLC (DELAWARE
LTD LIAB CO)
601 NORTH B STREET
HAMILTON, OH 45013

FOR: PAPER PRODUCTS PROVIDED IN SMALL
LOTS FOR HIGH END USES, NAMELY, PREMIUM
GRADE PAPERS FOR PRINTING, PUBLICATION
AND REPRODUCTION, IN CLASS 16 (U.S. CLS. 2, 5,
22, 23, 29, 37, 38 AND 50).

FIRST USE 5-1-2005; IN COMMERCE 5-1-2005.

THE MARK CONSISTS OF STANDARD CHAR-
ACTERS WITHOUT CLAIM TO ANY PARTICULAR
FONT, STYLE, SIZE, OR COLOR.

NO CLAIM IS MADE TO THE EXCLUSIVE
RIGHT TO USE "PACK", APART FROM THE MARK
AS SHOWN.

SER. NO. 78-697,341, FILED 8-22-2005.

KATHERINE STOIDES, EXAMINING ATTORNEY

Int. Cl.: 13

Prior U.S. Cls.: 2 and 9

United States Patent and Trademark Office

Reg. No. 3,398,428

Registered Mar. 18, 2008

**TRADEMARK
PRINCIPAL REGISTER**

POLY TECHNOLOGIES, INC.

KENG'S FIREARMS SPECIALTY, INC. (GEORGIA CORPORATION)
875 WHARTON DRIVE, S.W. P.O. BOX 44405
ATLANTA, GA 30336

FOR: FIREARM COMPONENTS AND ACCESSORIES, NAMELY, MAGAZINE CLAMPS, IN CLASS 13 (U.S. CLS. 2 AND 9).

FIRST USE 1-1-1987; IN COMMERCE 1-1-1987.

THE MARK CONSISTS OF STANDARD CHARACTERS WITHOUT CLAIM TO ANY PARTICULAR FONT, STYLE, SIZE, OR COLOR.

NO CLAIM IS MADE TO THE EXCLUSIVE RIGHT TO USE "TECHNOLOGIES, INC.", APART FROM THE MARK AS SHOWN.

SER. NO. 78-698,813, FILED 8-23-2005.

LINDA LAVACHE, EXAMINING ATTORNEY

Int. Cls.: 7 and 9

Prior U.S. Cls.: 13, 19, 21, 23, 26, 31, 34, 35, 36 and 38

United States Patent and Trademark Office

Reg. No. 3,398,429

Registered Mar. 18, 2008

**TRADEMARK
PRINCIPAL REGISTER**

UNIVEX

UNIVEX CORPORATION (DELAWARE CORPORATION)
3 OLD ROCKINGHAM ROAD
SALEM, NH 03079

FOR: FOOD SLICING MACHINES, FOOD CUTTING MACHINES, VEGETABLE PEELING MACHINES, ELECTRIC FOOD MIXERS; ATTACHMENTS FOR ELECTRIC FOOD MIXERS, NAMELY, MEAT AND FOOD CHOPPERS, FRUIT AND VEGETABLE SLICERS, KNIFE AND TOOL SHARPENERS, BEATERS, KNIVES, DOUGH HOOKS, OIL AND LIQUID DISPENSERS, JUICE EXTRACTORS, AND TRAY SUPPORTS IN THE NATURE OF HOLDERS FOR HOLDING THE AFOREMENTIONED ELECTRIC FOOD MIXER ATTACHMENTS ONTO ELECTRONIC FOOD MIXERS; AND FOOD MACHINE SUPPORTING STANDS, IN CLASS 7 (U.S. CLS. 13, 19, 21, 23, 31, 34 AND 35).

FIRST USE 10-0-1948; IN COMMERCE 10-0-1948.

FOR: FOOD FAT CONTENT ANALYZERS, IN CLASS 9 (U.S. CLS. 21, 23, 26, 36 AND 38).

FIRST USE 12-0-1967; IN COMMERCE 12-0-1967.

THE MARK CONSISTS OF STANDARD CHARACTERS WITHOUT CLAIM TO ANY PARTICULAR FONT, STYLE, SIZE, OR COLOR.

OWNER OF U.S. REG. NO. 629,913.

SER. NO. 78-703,237, FILED 8-30-2005.

MAUREEN DALL, EXAMINING ATTORNEY

Int. Cls.: 5 and 10

Prior U.S. Cls.: 6, 18, 26, 39, 44, 46, 51 and 52

United States Patent and Trademark Office

Reg. No. 3,398,430

Registered Mar. 18, 2008

**TRADEMARK
PRINCIPAL REGISTER**

XAWEX

WIELAND DENTAL + TECHNIK GMBH & CO.
KG (FED REP GERMANY CORPORATION)
SCHWENNINGER STRASSE 13
PFORZHEIM, FED REP GERMANY 75179

FOR: MATERIALS FOR DENTAL PROSTHESIS, INCLUDED IN THIS CLASS, NAMELY, MATERIALS FOR CROWNS AND BRIDGES FOR DENTAL USE AND FOR ORAL PROPHYLAXIS, IN PARTICULAR DISCS MADE FROM CERAMICS, FROM METALS OR METAL ALLOYS OR FROM PLASTICS AS BLANKS FOR THE FABRICATION OF DENTAL RESTORATIONS; MATERIALS FOR FACING ARTIFICIAL TEETH AND TEETH PROSTHESIS, IN PARTICULAR METAL CERAMICS, DENTAL CERAMICS AND DENTAL RESTORATION COMPOUNDS OF PLASTIC; DENTAL RESTORATION COMPOUNDS OF METAL, PRECIOUS METALS AND DENTAL ALLOYS THEREOF AS WELL AS CERAMIC MASSES AND PLASTICS FOR DENTAL RESTORATION USE; DENTAL FILLERS FOR TEETH, DENTAL FILLING MATERIALS, MATERIALS FOR SEALING TEETH AND VENEERING MATERIALS FOR DENTAL USE, COMPOSITE MATERIALS FOR MODEL PREPARATION AND MODEL PROCESSING COMPOSITE MATERIALS FOR DENTAL USE; MODELING MATERIALS, IN PARTICULAR WAXES FOR DENTAL USE; DENTAL IMPRESSION MATERIALS, DUPLICATING MATERIALS, NAMELY, ORTHODONTIC ALGINATE

FOR DENTAL IMPRESSIONS; INVESTMENT MATERIALS, NAMELY, MATERIALS FOR REPAIRING DENTAL CROWNS AND BRIDGES AND FIXING MATERIALS FOR DENTAL USE, NAMELY, MATERIAL FOR REPAIRING TEETH , IN CLASS 5 (U.S. CLS. 6, 18, 44, 46, 51 AND 52).

FOR: DENTAL APPARATUS AND INSTRUMENTS FOR THE HANDLING, APPLICATION AND USE OF DENTAL CERAMIC MASSES, NAMELY, PROSTHETIC INSTRUMENTS FOR DENTAL PURPOSES, AND DENTAL IMPLANTS; ARTIFICIAL TEETH, DENTURES, DENTAL CROWNS, DENTAL BRIDGES, IN CLASS 10 (U.S. CLS. 26, 39 AND 44).

THE MARK CONSISTS OF STANDARD CHARACTERS WITHOUT CLAIM TO ANY PARTICULAR FONT, STYLE, SIZE, OR COLOR.

PRIORITY CLAIMED UNDER SEC. 44(D) ON ERPN CMNTY TM OFC APPLICATION NO. 004415501, FILED 4-29-2005, REG. NO. 004415501, DATED 3-7-2006, EXPIRES 4-29-2015.

SER. NO. 78-710,830, FILED 9-12-2005.

JOHN DALIER, EXAMINING ATTORNEY

Int. Cl.: 10

Prior U.S. Cls.: 26, 39 and 44

United States Patent and Trademark Office

Reg. No. 3,398,431

Registered Mar. 18, 2008

**TRADEMARK
PRINCIPAL REGISTER**



BECTON, DICKINSON AND COMPANY (NEW JERSEY CORPORATION)
1 BECTON DRIVE, MC 090
FRANKLIN LAKES, NJ 07417

FOR: SURGICAL INSTRUMENTS AND APPARATUS, NAMELY, CANNULAS, ANTERIOR CHAMBER MAINTAINERS, DRAPES, SYRINGES, KNIVES, CATHETERS, CYSTOTOMES, FLUID COLLECTION BAGS, FLUID ADMINISTRATION SETS CONSISTING OF TUBES AND MICRO-FILTERS, IRIS RETRACTORS, IRIS HOOKS, NUCLEUS CHOPPERS, NUCLEUS ROTATORS, NUCLEUS SPATULAS, IRRIGATING VECTIS, EYE SPECULUMS, SURGICAL GLIDES, AND ACCESSORIES THEREFOR, NAMELY, REPOSITIONERS, HANDLES, SPATULAS, EYE DRAINS AND SHIELDS, MARKING PADS AND SPEARS; EYE PROTECTION PRODUCTS FOR POST-SURGERY EYE PROTECTION,

NAMELY, EYE SHIELDS AND PATCHES; VITRECTOMY KITS CONSISTING OF A HAND PIECE, CONTROL AND BATTERY POWER UNIT, POWER CORD, SCREW DRIVER, STORAGE CONTAINER, BATTERIES, BIOPSY PROBES, SYRINGES, STOPCOCKS, GUILLOTINE AND MVR KNIVES, ALL USED TO PERFORM MICROSURGERY IN THE FIELD OF OPHTHALMOLOGY, IN CLASS 10 (U.S. CLS. 26, 39 AND 44).

FIRST USE 8-31-2002; IN COMMERCE 8-31-2002.

OWNER OF U.S. REG. NOS. 442,281, 2,996,913 AND OTHERS.

SER. NO. 78-711,172, FILED 9-12-2005.

MARK RADEMACHER, EXAMINING ATTORNEY

Int. Cl.: 30

Prior U.S. Cl.: 46

United States Patent and Trademark Office

Reg. No. 3,398,432

Registered Mar. 18, 2008

**TRADEMARK
PRINCIPAL REGISTER**



WING HING LUNG LTD. (CANADA CORPORATION)
50 TORLAKE CRESCENT
TORONTO, CANADA M8Z 1B8

FOR: SAUCES FOR DIPPING; SALAD DRESSINGS; CONDIMENTS, NAMELY, MUSTARD, KETCHUP, VINEGAR, RELISH, MAYONNAISE, SALT, PEPPER, HORSERADISH, VINAIGRETTE, PEPPER SAUCES, PICKLED GINGER, PIMIENTO; SPICES; GLAZES, NAMELY, MEAT GLAZES, DESERT GLAZES, BAKED GOOD GLAZES; SAUCES;

MARINADES; NOODLES; PASTA; COOKIES; AND BAKERY GOODS, IN CLASS 30 (U.S. CL. 46).

PRIORITY CLAIMED UNDER SEC. 44(D) ON CANADA APPLICATION NO. 1250836, FILED 3-14-2005, REG. NO. TMA673,917, DATED 10-3-2006, EXPIRES 10-3-2021.

SER. NO. 78-711,361, FILED 9-12-2005.

ANNE E. GUSTASON, EXAMINING ATTORNEY

Int. Cl.: 30

Prior U.S. Cl.: 46

United States Patent and Trademark Office

Reg. No. 3,398,433

Registered Mar. 18, 2008

**TRADEMARK
PRINCIPAL REGISTER**



WING HING LUNG LTD. (CANADA CORPORATION)
50 TORLAKE CRESCENT
TORONTO, CANADA M8Z 1B8

FOR: SAUCES FOR DIPPING; SALAD DRESSINGS; CONDIMENTS, NAMELY, MUSTARD, KETCHUP, VINEGAR, RELISH, MAYONNAISE, SALT, PEPPER, HORSERADISH, VINAIGRETTE, PEPPER SAUCES, PICKLED GINGER, PIMIENTO; SPICES; GLAZES, NAMELY, MEAT GLAZES, DESERT GLAZES, BAKED GOOD GLAZES; SAUCES;

MARINADES; NOODLES; PASTA; COOKIES; AND BAKERY GOODS, IN CLASS 30 (U.S. CL. 46).

PRIORITY CLAIMED UNDER SEC. 44(D) ON CANADA APPLICATION NO. 1250836, FILED 3-14-2005, REG. NO. TMA711370, DATED 10-3-2006, EXPIRES 10-3-2021.

SER. NO. 78-711,370, FILED 9-12-2005.

ANNE E. GUSTASON, EXAMINING ATTORNEY

Int. Cl.: 39

Prior U.S. Cls.: 100 and 105

United States Patent and Trademark Office

Reg. No. 3,398,434

Registered Mar. 18, 2008

**SERVICE MARK
PRINCIPAL REGISTER**



When Quality and Trust Counts

AIR AMBULANCE SPECIALISTS, INC. (COLOR-
ADO CORPORATION)
8001 SOUTH INTERPORT BOULEVARD
SUITE 250
ENGLEWOOD, CO 80112

FOR: AIR TRANSPORT, IN CLASS 39 (U.S. CLS.
100 AND 105).

FIRST USE 5-31-2002; IN COMMERCE 5-31-2002.

NO CLAIM IS MADE TO THE EXCLUSIVE
RIGHT TO USE "INC.", APART FROM THE MARK
AS SHOWN.

THE MARK CONSISTS OF A PORTION OF A
GLOBE DESIGN THAT IS PARTIALLY SHADED,
AN AIRPLANE, AND THREE SWEEPING LINES.

SEC. 2(F) AS TO "AIR AMBULANCE SPECIA-
LISTS".

SER. NO. 78-713,227, FILED 9-14-2005.

CARRIE GENOVESE, EXAMINING ATTORNEY

Int. Cls.: 16, 35 and 41

Prior U.S. Cls.: 2, 5, 22, 23, 29, 37, 38, 50, 100, 101, 102
and 107

Reg. No. 3,398,435

United States Patent and Trademark Office

Registered Mar. 18, 2008

TRADEMARK
SERVICE MARK
PRINCIPAL REGISTER



FLYING FINGERS, INC. (NEW YORK CORPORATION)
15 MAIN STREET
TARRYTOWN, NY 10591

FOR: NEWSLETTERS IN THE FIELD OF ARTS AND CRAFTS, IN CLASS 16 (U.S. CLS. 2, 5, 22, 23, 29, 37, 38 AND 50).

FIRST USE 9-1-2002; IN COMMERCE 9-1-2002.

FOR: ISSUING GIFT CERTIFICATES REDEEMABLE FOR GOODS AND SERVICES; RETAIL STORES FEATURING ARTS AND CRAFTS ITEMS; ONLINE RETAIL STORE SERVICES FEATURING ARTS AND CRAFTS ITEMS; ONLINE ORDERING SERVICES FEATURING ARTS AND CRAFTS ITEMS; ELECTRONIC CATALOG SERVICES FEATURING ARTS AND CRAFTS, IN CLASS 35 (U.S. CLS. 100, 101 AND 102).

FIRST USE 9-1-2002; IN COMMERCE 9-1-2002.

FOR: EDUCATIONAL SERVICES, NAMELY, ARRANGING AND CONDUCTING WORKSHOPS,

SEMINARS, AND INSTRUCTIONAL CLASSES IN THE FIELD OF ARTS AND CRAFTS, AND DISTRIBUTING COURSE MATERIALS FOR USE IN CONNECTION THEREWITH ; PROVIDING NEWSLETTERS IN THE FIELD OF ARTS AND CRAFTS VIA EMAIL, IN CLASS 41 (U.S. CLS. 100, 101 AND 107).

FIRST USE 9-1-2002; IN COMMERCE 9-1-2002.

NO CLAIM IS MADE TO THE EXCLUSIVE RIGHT TO USE "YARN SHOP", APART FROM THE MARK AS SHOWN.

THE MARK CONSISTS OF TWO BALLS OF YARN, SUPPORTING TWO NEEDLES WITH ATTACHED WINGS, BELOW FLYING FINGERS AND A BANNER CONTAINING YARN SHOP.

SER. NO. 78-715,372, FILED 9-19-2005.

SUE LAWRENCE, EXAMINING ATTORNEY

Int. Cl.: 7

Prior U.S. Cls.: 13, 19, 21, 23, 31, 34 and 35

United States Patent and Trademark Office

Reg. No. 3,398,436

Registered Mar. 18, 2008

**TRADEMARK
PRINCIPAL REGISTER**

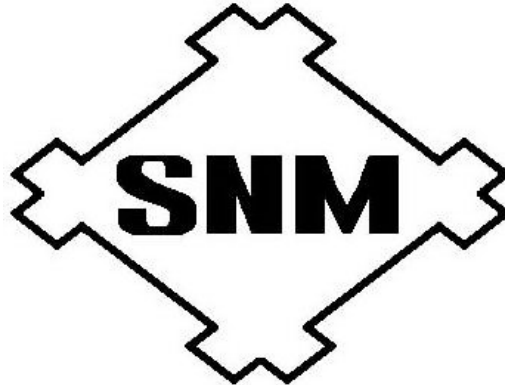

SHIN NIPPON MACHINERY CO., LTD. (JAPAN CORPORATION)
1-1, OSAKI 2-CHOME, SHINAGAWA-KU
THINKPARK TOWER
TOKYO, JAPAN 1416025

UNITS; VACUUM PUMPS; CENTRIFUGAL PUMPS; SUMP PUMPS; PROCESS PUMPS FOR PETROLEUM REFINING AND PETROCHEMISTRY, IN CLASS 7 (U.S. CLS. 13, 19, 21, 23, 31, 34 AND 35).

FOR: TURBINES NOT FOR LAND VEHICLES; PUMPS, NAMELY, WATER PUMPS FOR IRRIGATION, RAIN WATER DRAINING, RAIN TREATMENT, SEWAGE DRAINING, DOCK DRAINING, INDUSTRIAL WATER DRAINING, INDUSTRIAL WATER TREATMENT, SLUDGE TREATMENT, SLUDGE DRAINING AND WATER FILTERING

OWNER OF JAPAN REG. NO. 2194382, DATED 12-25-1989, EXPIRES 12-25-2009.

SER. NO. 78-717,812, FILED 9-21-2005.

SHANNON TWOHIG, EXAMINING ATTORNEY

Int. Cls.: 16 and 35

Prior U.S. Cls.: 2, 5, 22, 23, 29, 37, 38, 50, 100, 101 and 102

United States Patent and Trademark Office

Reg. No. 3,398,437

Registered Mar. 18, 2008

**TRADEMARK
SERVICE MARK
PRINCIPAL REGISTER**

IT'S A JUNGLE UP THERE

ZULUWORKS, LLC (DELAWARE LIMITED LIABILITY COMPANY)
2404 DIVISADERO STREET
SAN FRANCISCO, CA 94115

FOR: CLIPBOARDS, PERSONAL ORGANIZERS, KNEE BOARDS IN THE NATURE OF PERSONAL ORGANIZERS THAT ARE STRAPPED TO A PILOT'S LEG AND USED DURING FLIGHT, NOTE PADS, PRINTED AVIATION INFORMATION CARDS AND OTHER PRINTED MATERIAL, NAMELY, INSTRUCTIONAL MATERIALS FOR AVIATION-SPECIFIC CODES AND TERMINOLOGY, IN CLASS 16 (U.S. CLS. 2, 5, 22, 23, 29, 37, 38 AND 50).

FIRST USE 7-0-2003; IN COMMERCE 7-0-2003.

FOR: ONLINE RETAIL STORE SERVICES IN THE FIELD OF PILOT AND FLYING ACCESSORIES, IN CLASS 35 (U.S. CLS. 100, 101 AND 102).

FIRST USE 7-0-2003; IN COMMERCE 7-0-2003.

THE MARK CONSISTS OF STANDARD CHARACTERS WITHOUT CLAIM TO ANY PARTICULAR FONT, STYLE, SIZE, OR COLOR.

SER. NO. 78-717,838, FILED 9-21-2005.

CARRIE GENOVESE, EXAMINING ATTORNEY

Int. Cls.: 9 and 42

Prior U.S. Cls.: 21, 23, 26, 36, 38, 100 and 101

United States Patent and Trademark Office

Reg. No. 3,398,438

Registered Mar. 18, 2008

**TRADEMARK
SERVICE MARK
PRINCIPAL REGISTER**

SURFCONTROL RISKFILTER

SURFCONTROL PLC (UNITED KINGDOM PUBLIC LIMITED COMPANY (PLC))
RIVERSIDE MOUNTBATTEN WAY
CONGLETON, UNITED KINGDOM CW12 1DY

FOR: COMPUTER SOFTWARE AND COMPUTER HARDWARE FOR MONITORING OR FILTERING OF ELECTRIC COMMUNICATIONS INCLUDING TEXT MESSAGES, E-MAILS, INSTANT MESSAGES OR WEB ACCESS; COMPUTER COMMUNICATIONS FILTERING SOFTWARE AND HARDWARE; COMPUTER SOFTWARE AND COMPUTER HARDWARE FOR FILTERING CONTENT FOR USE IN A LOCAL AREA NETWORK, A WIDE AREA NETWORK OR A WIRELESS COMMUNICATIONS NETWORK, IN CLASS 9 (U.S. CLS. 21, 23, 26, 36 AND 38).

FOR: COMPUTER CONSULTANCY SERVICES, NAMELY, CONSULTANCY IN THE FIELD OF MONITORING OR FILTERING OF TEXT MESSAGES, E-MAILS, INSTANT MESSAGES OR WEB

ACCESS, AND IN THE FILTERING OF ELECTRONIC COMMUNICATIONS; PROVIDING DATABASES OF INFORMATION FOR USE IN CONTENT FILTERING, IN CLASS 42 (U.S. CLS. 100 AND 101).

THE MARK CONSISTS OF STANDARD CHARACTERS WITHOUT CLAIM TO ANY PARTICULAR FONT, STYLE, SIZE, OR COLOR.

PRIORITY CLAIMED UNDER SEC. 44(D) ON ERPN CMNTY TM OFC APPLICATION NO. 4413308, FILED 4-28-2005, REG. NO. 004413308, DATED 7-24-2006, EXPIRES 4-28-2015.

OWNER OF U.S. REG. NOS. 2,128,321, 3,028,838 AND OTHERS.

SER. NO. 78-720,532, FILED 9-26-2005.

SANI KHOURI, EXAMINING ATTORNEY

Int. Cl.: 12

Prior U.S. Cls.: 19, 21, 23, 31, 35 and 44

United States Patent and Trademark Office

Reg. No. 3,398,439

Registered Mar. 18, 2008

**TRADEMARK
PRINCIPAL REGISTER**

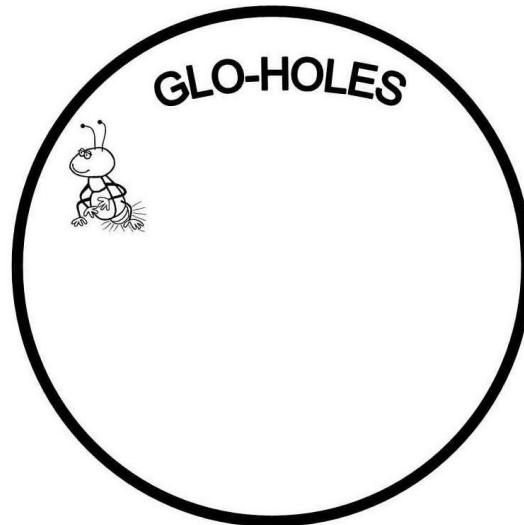

SW CREATIONS (TEXAS SOLE PROPRIETOR-
SHIP)
133 CONEJOS DRIVE
NOCONA, TX 762558905

FOR: GLOW-IN-THE-DARK STICKERS SOLD AS
AN INTEGRAL COMPONENT OF CUP HOLDERS
FOR USE IN VEHICLES, IN CLASS 12 (U.S. CLS. 19,
21, 23, 31, 35 AND 44).

FIRST USE 8-8-2005; IN COMMERCE 8-8-2005.

THE MARK CONSISTS OF GLO-HOLES (TEXT)
AND GRAPHIC OF LIGHTNING BUG.

SER. NO. 78-722,043, FILED 9-28-2005.

CURTIS FRENCH, EXAMINING ATTORNEY

Int. Cls.: 36 and 37

Prior U.S. Cls.: 100, 101, 102, 103 and 106

United States Patent and Trademark Office

Reg. No. 3,398,440

Registered Mar. 18, 2008

**SERVICE MARK
PRINCIPAL REGISTER**

BLUEGREEN RESORTS

BLUEGREEN CORPORATION (MASSACHU-
SETTS CORPORATION)
4960 CONFERENCE WAY NORTH, SUITE 100
BOCA RATON, FL 33431

FOR: VACATION REAL ESTATE TIME-SHAR-
ING SERVICES; MANAGEMENT OF RESORT AND
TIMESHARE PROPERTIES; VACATION REAL ES-
TATE TIMESHARE SERVICES FEATURING IN-
CENTIVE AWARD PROGRAMS; ACQUIRING
LAND FOR RESIDENTIAL, TIMESHARE, RESORT
AND OTHER LIVING AND RECREATIONAL USES,
IN CLASS 36 (U.S. CLS. 100, 101 AND 102).

FIRST USE 11-0-2004; IN COMMERCE 11-0-2004.

FOR: LAND DEVELOPMENT SERVICES, NAME-
LY, PLANNING AND LAYING OUT LAND FOR
RESIDENTIAL, TIMESHARE, RESORT AND

OTHER LIVING AND RECREATIONAL USES, IN
CLASS 37 (U.S. CLS. 100, 103 AND 106).

FIRST USE 11-0-2004; IN COMMERCE 11-0-2004.

THE MARK CONSISTS OF STANDARD CHAR-
ACTERS WITHOUT CLAIM TO ANY PARTICULAR
FONT, STYLE, SIZE, OR COLOR.

OWNER OF U.S. REG. NOS. 2,088,758, 2,857,874
AND OTHERS.

NO CLAIM IS MADE TO THE EXCLUSIVE
RIGHT TO USE "RESORTS", APART FROM THE
MARK AS SHOWN.

SER. NO. 78-723,337, FILED 9-29-2005.

KAREN K. BUSH, EXAMINING ATTORNEY

Int. Cl.: 35

Prior U.S. Cls.: 100, 101 and 102

United States Patent and Trademark Office

Reg. No. 3,398,441

Registered Mar. 18, 2008

SERVICE MARK
PRINCIPAL REGISTER



the **eyes** of the customer ■ the **ears** of management

SERVICE EVALUATION CONCEPTS, INC. (NEW YORK CORPORATION)
210 CROSSWAYS PARK DRIVE
WOODBURY, NY 11797

FOR: SHOPPING BY RESEARCHERS OR USING SERVICES BY RESEARCHERS WHO POSE AS CUSTOMERS TO EVALUATE THE QUALITY OF SERVICES DELIVERED, IN CLASS 35 (U.S. CLS. 100, 101 AND 102).

FIRST USE 1-1-1998; IN COMMERCE 1-1-1998.

NO CLAIM IS MADE TO THE EXCLUSIVE RIGHT TO USE "SERVICE EVALUATION", APART FROM THE MARK AS SHOWN.

SER. NO. 78-726,553, FILED 10-4-2005.

DORITT L. CARROLL, EXAMINING ATTORNEY

Int. Cl.: 35

Prior U.S. Cls.: 100, 101 and 102

United States Patent and Trademark Office

Reg. No. 3,398,442

Registered Mar. 18, 2008

**SERVICE MARK
PRINCIPAL REGISTER**

**BUILD YOUR OWN DIAMOND
PENDANT**

BLUE NILE, INC. (DELAWARE CORPORATION)
705 FIFTH AVENUE SOUTH
SEATTLE, WA 98104

NO CLAIM IS MADE TO THE EXCLUSIVE
RIGHT TO USE "DIAMOND PENDANT", APART
FROM THE MARK AS SHOWN.

FOR: ONLINE RETAIL STORE SERVICES IN THE
FIELD OF JEWELRY, IN CLASS 35 (U.S. CLS. 100, 101
AND 102).

SEC. 2(F).

FIRST USE 1-24-2002; IN COMMERCE 1-24-2002.

SER. NO. 78-730,266, FILED 10-10-2005.

THE MARK CONSISTS OF STANDARD CHAR-
ACTERS WITHOUT CLAIM TO ANY PARTICULAR
FONT, STYLE, SIZE, OR COLOR.

LINDA POWELL, EXAMINING ATTORNEY

Int. Cls.: 35, 38, 39 and 41

Prior U.S. Cls.: 100, 101, 102, 104, 105 and 107

United States Patent and Trademark Office

Reg. No. 3,398,443

Registered Mar. 18, 2008

**SERVICE MARK
PRINCIPAL REGISTER**

GOLFCHIX

MTT MEDIAWORKS (CALIFORNIA PARTNER-
SHIP)
1301 MONTANA AVENUE
SANTA MONICA, CA 904031772

FOR: ON-LINE RETAIL SERVICES FEATURING SPORTING GOODS, CLOTHING AND ACCESSORIES AND MULTIMEDIA PRODUCTS; PUBLIC RELATIONS, NAMELY, SPORTS MARKETING; PROMOTION OF SPORTS COMPETITIONS AND EVENTS OF OTHERS; ARRANGING FOR SPONSORS TO AFFILIATE THEIR GOODS AND SERVICES WITH A WIDE VARIETY OF SPORTING COMPETITIONS AND EVENTS, IN CLASS 35 (U.S. CLS. 100, 101 AND 102).

FIRST USE 3-0-2000; IN COMMERCE 3-0-2000.

FOR: BROADCASTING PROGRAMS BY ENCODING, TRANSMITTING AND RECEIVING OF PICTURES, VIDEO, TEXT AND/OR AUDIO OVER LOCAL AND GLOBAL NETWORKS, NAMELY RADIO, WEBCASTING AND TELEVISION BROADCASTING, IN CLASS 38 (U.S. CLS. 100, 101 AND 104).

FIRST USE 3-0-2000; IN COMMERCE 3-0-2000.

FOR: PROVIDING ON-LINE INFORMATION RELATING TO TRAVEL AND ADVENTURE TOURS

VIA A GLOBAL COMPUTER INFORMATION NETWORK, IN CLASS 39 (U.S. CLS. 100 AND 105).

FIRST USE 3-0-2000; IN COMMERCE 3-0-2000.

FOR: PROVIDING ON-LINE INFORMATION RELATING TO SPORTS AND FITNESS, VIA A GLOBAL COMPUTER INFORMATION NETWORK; PRODUCTION OF VIDEO PROGRAMS FOR TRANSMISSION OVER TELEVISION AND GLOBAL COMPUTER NETWORKS; ARRANGING AND CONDUCTING ATHLETIC COMPETITIONS; ORGANIZING ATHLETIC EVENTS AND EXHIBITIONS OF OTHERS, IN CLASS 41 (U.S. CLS. 100, 101 AND 107).

FIRST USE 3-0-2000; IN COMMERCE 3-0-2000.

THE MARK CONSISTS OF STANDARD CHARACTERS WITHOUT CLAIM TO ANY PARTICULAR FONT, STYLE, SIZE, OR COLOR.

SER. NO. 78-735,178, FILED 10-18-2005.

JANICE L. MCMORROW, EXAMINING ATTORNEY

Int. Cls.: 9, 11 and 17

**Prior U.S. Cls.: 1, 5, 12, 13, 21, 23, 26, 31, 34, 35, 36, 38
and 50**

Reg. No. 3,398,444

United States Patent and Trademark Office

Registered Mar. 18, 2008

**TRADEMARK
PRINCIPAL REGISTER**

WARMUP

WARMUP PLC (UNITED KINGDOM CORPORATION)
702 TUDOR ESTATE ABBEY ROAD
LONDON, UNITED KINGDOM NW10 7UW

FOR: HEAT REGULATING APPARATUS, NAME-
LY, TEMPERATURE SENSORS; THERMOSTATS;
ELECTRONIC TIMERS; ELECTRONIC SENSORS
FOR SENSING TEMPERATURE; ELECTRIC
CABLES, WIRES AND SWITCHES FOR HEATING
APPARATUS AND INSTALLATIONS, IN CLASS 9
(U.S. CLS. 21, 23, 26, 36 AND 38).

FIRST USE 4-10-2003; IN COMMERCE 4-10-2003.

FOR: APPARATUS FOR HEATING PURPOSES,
NAMELY, KITS FOR INSTALLING UNDERFLOOR
HEATING CONSISTING PRIMARILY OF ELECTRI-
CALLY HEATED WIRES, THERMAL PRIMER FOR
APPLICATION TO THE FLOOR AREA, ADHESIVE
TAPE FOR SECURING THE HEATER WIRE IN
PLACE AND A THERMOSTAT; APPARATUS FOR
HEATING PURPOSES, NAMELY, KITS FOR IN-
STALLING UNDERFLOOR HEATING CONSIST-
ING PRIMARILY OF FIBREGLASS MATS OR
MATTING INCORPORATING ELECTRICALLY HE-
ATED WIRES; APPARATUS FOR HEATING PUR-
POSES, NAMELY, KITS FOR INSTALLING
UNDERFLOOR HEATING CONSISTING PRIMAR-
ILY OF PANELS INCORPORATING CARBON
HEATING ELEMENTS; APPARATUS FOR HEAT-
ING PURPOSES, NAMELY, ELECTRICALLY HE-
ATED MATS AND MATTING; APPARATUS FOR
HEATING PURPOSES, NAMELY, ELECTRIC RA-
DIATORS FOR HEATING ROOMS AND HEATED
TOWEL RAILS; APPARATUS FOR HEATING PUR-
POSES, NAMELY, MIRROR DEMISTERS; APPARA-
TUS FOR HEATING PURPOSES, NAMELY, TUBES,
PIPES AND PRE-ASSEMBLED MANIFOLDS FOR
TRANSPORTING WARM WATER FOR HEATING
PURPOSES; APPARATUS FOR HEATING PURPO-

SES, NAMELY, HEAT PUMPS AND TEMPERA-
TURE CONTROLS FOR USE IN RELATION TO A
HEATING SYSTEM COMPOSED PRIMARILY OF
TUBES, PIPES AND PRE-ASSEMBLED MANIFOLDS
THROUGH WHICH WARM WATER CIRCULATES;
APPARATUS FOR HEATING PURPOSES, NAMELY,
WATER PUMPS AND WATER FLOW CONTROLS
FOR USE IN RELATION TO A HEATING SYSTEM
COMPOSED PRIMARILY OF TUBES, PIPES AND
PRE-ASSEMBLED MANIFOLDS THROUGH
WHICH WARM WATER CIRCULATES; ELECTRIC
HEATING APPARATUS FOR HEATING BUILD-
INGS, FLOORS AND WALLS; UNDER FLOOR
AND UNDER TILE HEATING APPARATUS AND
INSTALLATIONS FOR HEATING PURPOSES COM-
POSED PRIMARILY OF ELECTRICALLY HEATED
WIRES OR CARBON ELEMENTS; UNDER FLOOR
AND UNDER TILE HEATING APPARATUS AND
INSTALLATIONS FOR HEATING PURPOSES COM-
POSED PRIMARILY OF TUBES, PIPES AND PRE-
ASSEMBLED MANIFOLDS THROUGH WHICH
WARM WATER CIRCULATES; ELECTRICAL
MATS AND MATTING FOR UNDERFLOOR HEAT-
ING; ELECTRICAL MATS AND MATTING FOR
HEATING FLOORS AND WALLS; HEATING ELE-
MENTS COMPOSED OF FLEXIBLE WIRES OR
CARBON ELEMENTS FOR UNDERFLOOR HEAT-
ING, IN CLASS 11 (U.S. CLS. 13, 21, 23, 31 AND 34).

FIRST USE 4-10-2003; IN COMMERCE 4-10-2003.

FOR: (BASED ON 44(E)) INSULATING MATERI-
ALS, NAMELY, POLYSTYRENE INSULATING
BOARDS, INSULATING MATERIALS FOR APPLI-
CATION TO FLOORS, WALLS, CEILINGS AND
ROOFS, NAMELY, POLYSTYRENE INSULATING
BOARDS, POLYSTYRENE INSULATING BOARDS
LAMINATED WITH ALUMINUM FOIL, POLY-
STYRENE INSULATING BOARDS LAMINATED
WITH ENCAPSULATED GAS BUBBLES, POLY-
STYRENE INSULATING BOARDS LAMINATED

WITH CEMENT COATINGS, POLYSTYRENE INSULATING BOARDS LAMINATED WITH NATURAL INSULATING FIBRES; INSULATING MATERIALS FOR APPLICATION TO FLOORS, WALLS CEILINGS AND ROOFS, NAMELY, VACUUM INSULATION PANELS, GAS FILLED INSULATION PANELS, NATURAL INSULATING FIBRES; INSULATION BOARDS FOR FLOORS;(BASED ON USE IN COMMERCE) (BASED ON 44(E)) THERMAL PRIMER FOR APPLICATION TO FLOORS, IN CLASS 17 (U.S. CLS. 1, 5, 12, 13, 35 AND 50).

FIRST USE 4-10-2003; IN COMMERCE 4-10-2003.

THE MARK CONSISTS OF STANDARD CHARACTERS WITHOUT CLAIM TO ANY PARTICULAR FONT, STYLE, SIZE, OR COLOR.

PRIORITY CLAIMED UNDER SEC. 44(D) ON ERPN CMNTY TM OFC APPLICATION NO. 4409934, FILED 4-20-2005, REG. NO. 4409934, DATED 3-9-2007, EXPIRES 4-20-2015.

OWNER OF U.S. REG. NO. 2,675,905.

SER. NO. 78-735,264, FILED 10-18-2005.

AMY HELLA, EXAMINING ATTORNEY

Int. Cl.: 29

Prior U.S. Cl.: 46

United States Patent and Trademark Office

Reg. No. 3,398,445

Registered Mar. 18, 2008

**TRADEMARK
PRINCIPAL REGISTER**

EL PORTEZUELO DE LOLOL

BUDGE, CRISTIAN VIAL (CHILE INDIVIDUAL)
RUTA H-30 #3024 DONIHUE
RANCAGUA, CHILE

PRIORITY CLAIMED UNDER SEC. 44(D) ON
CHILE APPLICATION NO. 706673, FILED 10-11-
2005, REG. NO. 751400, DATED 2-21-2006, EXPIRES
2-21-2016.

FOR: OLIVE OIL, IN CLASS 29 (U.S. CL. 46).

THE TERM "PORTEZUELO" TRANSLATES INTO
ENGLISH AS "PORT" OR "HARBOR."

THE MARK CONSISTS OF STANDARD CHAR-
ACTERS WITHOUT CLAIM TO ANY PARTICULAR
FONT, STYLE, SIZE, OR COLOR.

SER. NO. 78-740,835, FILED 10-26-2005.

RICHARD A. STRASER, EXAMINING ATTORNEY

Int. Cl.: 30

Prior U.S. Cl.: 46

United States Patent and Trademark Office

Reg. No. 3,398,446

Registered Mar. 18, 2008

TRADEMARK
PRINCIPAL REGISTER

The trademark consists of the words "Wine Glacé" written in a stylized, handwritten font. The letters are thick and slightly irregular, with a grainy texture. The word "Wine" is on the left and "Glacé" is on the right, with a small accent over the 'e' in "Glacé".

WINE.A.RITA LLC (TEXAS LTD LIAB CO)
31 KNOTTY PINE
TEXARKANA, TX 75503

FOR: POWDER FOR FLAVORING WINE, IN
CLASS 30 (U.S. CL. 46).

FIRST USE 1-1-2004; IN COMMERCE 1-1-2004.

NO CLAIM IS MADE TO THE EXCLUSIVE
RIGHT TO USE WINE, APART FROM THE MARK
AS SHOWN.

"THE FOREIGN WORDING IN THE MARK
TRANSLATES INTO ENGLISH AS FROZEN."

SER. NO. 78-747,921, FILED 11-5-2005.

ANTHONY RINKER, EXAMINING ATTORNEY

Int. Cl.: 12

Prior U.S. Cls.: 19, 21, 23, 31, 35 and 44

United States Patent and Trademark Office

Reg. No. 3,398,447

Registered Mar. 18, 2008

**TRADEMARK
PRINCIPAL REGISTER**

Coronado

CORONADO RUNABOUTS INC, (OKLAHOMA CORPORATION)
308 PALISADE
EUREKA SPRINGS, AR 72631

FOR: WATERCRAFT, NAMELY, BOATS, IN CLASS 12 (U.S. CLS. 19, 21, 23, 31, 35 AND 44).

FIRST USE 1-1-1954; IN COMMERCE 1-1-1954.

THE MARK CONSISTS OF STANDARD CHARACTERS WITHOUT CLAIM TO ANY PARTICULAR FONT, STYLE, SIZE, OR COLOR.

THE WORDING CORONADO TRANSLATES INTO ENGLISH AS CROWNED.

SER. NO. 78-748,271, FILED 11-7-2005.

MELISSA VALLILLO, EXAMINING ATTORNEY

Int. Cl.: 30

Prior U.S. Cl.: 46

United States Patent and Trademark Office

Reg. No. 3,398,448

Registered Mar. 18, 2008

TRADEMARK
PRINCIPAL REGISTER



HEART'S DELIGHT BAKERY, INC. (MASSACHUSETTS CORPORATION)
28 ELDRED STREET
LEXINGTON, MA 024201431

FOR: BAKERY DESSERTS; BAKERY GOODS; BAKERY PRODUCTS; BAKERY PRODUCTS, NAMELY, SWEET BAKERY GOODS; MIXES FOR BAKERY GOODS, IN CLASS 30 (U.S. CL. 46).

FIRST USE 11-2-2005; IN COMMERCE 11-2-2005.

NO CLAIM IS MADE TO THE EXCLUSIVE RIGHT TO USE "BAKERY", APART FROM THE MARK AS SHOWN.

THE COLOR(S) RED, WHITE AND BLACK IS/ARE CLAIMED AS A FEATURE OF THE MARK.

THE MARK CONSISTS OF THE WORDS "HEARTS" AND "DELIGHT" IN RED, ALL CAPITALS WITH A BLACK OPEN HEART BETWEEN THE WORDS "HEARTS" AND "DELIGHT" THE WORD "BAKERY" IS WRITTEN BELOW IN SMALLER BLACK LETTERS, ALL CAPITALS.

SER. NO. 78-749,765, FILED 11-8-2005.

WON TEAK OH, EXAMINING ATTORNEY

Int. Cl.: 16

Prior U.S. Cls.: 2, 5, 22, 23, 29, 37, 38 and 50

United States Patent and Trademark Office

Reg. No. 3,398,449

Registered Mar. 18, 2008

**TRADEMARK
PRINCIPAL REGISTER**



MORRIS VISITOR PUBLICATIONS, LLC (GEORGIA LTD LIAB CO)
725 BROAD STREET
AUGUSTA, GA 30901

FOR: GUIDE BOOKS FEATURING AN ADVENTURE NOVEL AS WELL AS INSIDER'S TIPS, ECONOMICAL ACCOMMODATIONS, HISTORICAL SITES, GPS COORDINATES AND SUGGESTED ITINERARIES FOR TRAVELERS TO EUROPE, IN CLASS 16 (U.S. CLS. 2, 5, 22, 23, 29, 37, 38 AND 50).

FIRST USE 9-1-2000; IN COMMERCE 8-15-2003.

OWNER OF U.S. REG. NO. 3,277,504.

THE MARK CONSISTS OF THE WORDS YOUR TRAVELING COMPANION WRAPPED IN A SEMI-CIRCLE AROUND ITS ACRONYM, YTC.

SER. NO. 78-751,780, FILED 11-10-2005.

KAREN K. BUSH, EXAMINING ATTORNEY

Int. Cl.: 41

Prior U.S. Cls.: 100, 101 and 107

United States Patent and Trademark Office

Reg. No. 3,398,450

Registered Mar. 18, 2008

**SERVICE MARK
PRINCIPAL REGISTER**



THE CONNECTICUT AUDUBON SOCIETY, INC.
(CONNECTICUT CORPORATION)
2325 BURR STREET
FAIRFIELD, CT 06824

OWNER OF U.S. REG. NO. 2,713,169.

FOR: EDUCATION AND ENTERTAINMENT SERVICES, NAMELY, CONDUCTING COURSES AND SEMINARS IN THE FIELD OF WILDLIFE, CONSERVATION, AND THE ENVIRONMENT; AND ORGANIZING FESTIVALS FEATURING A VARIETY OF ACTIVITIES IN THE FIELD OF BIRD MIGRATION, IN CLASS 41 (U.S. CLS. 100, 101 AND 107).

NO CLAIM IS MADE TO THE EXCLUSIVE RIGHT TO USE "ON THE CONNECTICUT RIVER NEW ENGLAND'S PREMIER", APART FROM THE MARK AS SHOWN.

SEC. 2(F) AS TO "CONNECTICUT AUDUBON SOCIETY" AND "EAGLE FESTIVAL".

SER. NO. 78-753,881, FILED 11-15-2005.

FIRST USE 9-0-2004; IN COMMERCE 9-0-2004.

TARAH HARDY, EXAMINING ATTORNEY

Int. Cl.: 36

Prior U.S. Cls.: 100, 101 and 102

United States Patent and Trademark Office

Reg. No. 3,398,451

Registered Mar. 18, 2008

**SERVICE MARK
PRINCIPAL REGISTER**



COHEN, DOUGLAS A. (UNITED STATES INDIVIDUAL)
500 N. STATE COLLEGE BLVD, SUITE 550
ORANGE, CA 92868

FOR: QUOTING, UNDERWRITING, AND WRITING OF INSURANCE, NAMELY PROPERTY AND CASUALTY, LIFE, HEALTH, LIABILITY, COMMERCIAL, TITLE, SURPLUS, FIDELITY, MARINE FIRE, SURETY, DISABILITY, PLATE GLASS, WORKER'S COMPENSATION, COMMON CARRIER LIABILITY, BROILER AND MACHINERY, BURGLARY, CREDIT, SPRINKLER, TEAM AND VEHICLE, MORTGAGE, AIRCRAFT, MORTGAGE GUARANTY, LEGAL INSURANCE, FINANCIAL GUARANTEE; CLAIMS ADMINISTRATION, CLAIMS ADJUSTMENT, BROKERAGE, FINANCIAL PLANNING, CONSULTATION AND RESEARCH IN THE FIELDS OF INSURANCE AND FINANCIAL PLANNING, IN CLASS 36 (U.S. CLS. 100, 101 AND 102).

FIRST USE 10-0-1998; IN COMMERCE 10-0-1998.

NO CLAIM IS MADE TO THE EXCLUSIVE RIGHT TO USE "INSURANCE.COM", APART FROM THE MARK AS SHOWN.

THE COLORS BLUE AND GREEN ARE CLAIMED AS A FEATURE OF THE MARK.

THE MARK CONSISTS OF THE LARGE STYLIZED "E" IS GREEN WITH BLUE TRIM AND THE WORDING "ENSURANCE.COM" IS BLUE.

SER. NO. 78-754,127, FILED 11-15-2005.

RONALD MCMORROW, EXAMINING ATTORNEY

Int. Cl.: 3

Prior U.S. Cls.: 1, 4, 6, 50, 51 and 52

Reg. No. 3,398,452

United States Patent and Trademark Office

Registered Mar. 18, 2008

TRADEMARK
PRINCIPAL REGISTER

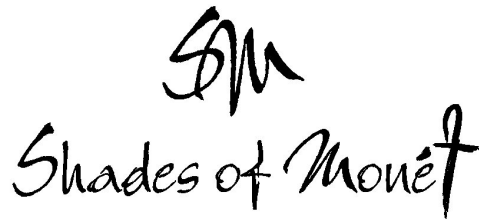

SM
Shades of Monet

COLBERT, MONIQUE (UNITED STATES INDIVIDUAL)
8637 NW 50TH DR
CORAL SPRINGS, FL 33071

FOR: COSMETICS, NAMELY, EYE SHADOWS, LIPSTICKS, EYELINER PENCILS, LIP GLOSS, BLUSH, NAIL POLISH, FOUNDATION, AND LIP LINER PENCILS; COSMETICS; NON-MEDICATED SKIN CARE PREPARATIONS; FACIAL SCRUBS;

SKIN MOISTURIZER; SKIN TONERS, IN CLASS 3 (U.S. CLS. 1, 4, 6, 50, 51 AND 52).

FIRST USE 3-1-2004; IN COMMERCE 3-1-2004.

SER. NO. 78-755,062, FILED 11-16-2005.

ELISSA GARBER KON, EXAMINING ATTORNEY

Int. Cls.: 14, 18, 21, 24, 25 and 28

Prior U.S. Cls.: 1, 2, 3, 13, 22, 23, 27, 28, 29, 30, 33, 38, 39, 40, 41, 42 and 50

Reg. No. 3,398,453

United States Patent and Trademark Office

Registered Mar. 18, 2008

**TRADEMARK
PRINCIPAL REGISTER**

SIMMS

SIMMS FISHING PRODUCTS LLC (DELAWARE LTD LIAB CO)
101 EVERGREEN DRIVE
BOZEMAN, MT 59715

FOR: WRIST WATCHES MADE FOR AND MARKETED TO THE FISHING INDUSTRY, IN CLASS 14 (U.S. CLS. 2, 27, 28 AND 50).

FIRST USE 1-31-2005; IN COMMERCE 1-31-2005.

FOR: BAGS AND PACKS MADE FOR AND MARKETED TO THE FISHING INDUSTRY, NAMELY, CHEST PACKS, BACKPACKS, FANNY PACKS, ALL-PURPOSE SPORT BAGS, ALL-PURPOSE ATHLETIC BAGS, ALL-PURPOSE CARRYING BAGS, TRAVEL BAGS, DUFFEL BAGS, ROLL BAGS, LUGGAGE, AND WADER BAGS MADE OF POLYURETHANE NYLON, POLYESTER MESH, AND/OR POLYURETHANE-COATED PACK-CLOTH FOR STORING FISHING GEAR; FISHING WADING STAFF, IN CLASS 18 (U.S. CLS. 1, 2, 3, 22 AND 41).

FIRST USE 1-31-2005; IN COMMERCE 1-31-2005.

FOR: BOTTLE OPENERS, IN CLASS 21 (U.S. CLS. 2, 13, 23, 29, 30, 33, 40 AND 50).

FIRST USE 1-31-2005; IN COMMERCE 1-31-2005.

FOR: BOAT AND VEST TOWELS, IN CLASS 24 (U.S. CLS. 42 AND 50).

FIRST USE 2-28-2005; IN COMMERCE 2-28-2005.

FOR: CLOTHING MADE FOR AND MARKETED TO THE FISHING INDUSTRY, NAMELY, SHIRTS, TOPS, PANTS, BIBS, SHORTS, JACKETS, VESTS, RAINWEAR, SOCKS, GLOVES, UNDERWEAR, FLEECE TOPS AND BOTTOMS, HATS, CAPS, BALACLAVAS, AND BELTS; GAITERS; FOOTWEAR, NAMELY WADING BOOTS AND SANDALS, IN CLASS 25 (U.S. CLS. 22 AND 39).

FIRST USE 7-31-1982; IN COMMERCE 7-31-1982.

FOR: CHRISTMAS TREE ORNAMENTS, NAMELY, WADERS AND VESTS AS ORNAMENTS, IN CLASS 28 (U.S. CLS. 22, 23, 38 AND 50).

FIRST USE 1-31-2000; IN COMMERCE 1-31-2000.

THE MARK CONSISTS OF STANDARD CHARACTERS WITHOUT CLAIM TO ANY PARTICULAR FONT, STYLE, SIZE, OR COLOR.

OWNER OF U.S. REG. NOS. 1,778,709 AND 1,778,945.

SEC. 2(F).

SER. NO. 78-758,814, FILED 11-21-2005.

JASON TURNER, EXAMINING ATTORNEY

Int. Cls.: 16 and 19

Prior U.S. Cls.: 1, 2, 5, 12, 22, 23, 29, 33, 37, 38 and 50

United States Patent and Trademark Office

Reg. No. 3,398,454

Registered Mar. 18, 2008

**TRADEMARK
PRINCIPAL REGISTER**



GRAPHICS 2000, INC. (CONNECTICUT CORPORATION)
#12 32 PINE STREET
NORWALK, CT 06854

FOR: ART ETCHINGS; ART PICTURES; ART PRINTS; GRAPHIC ART REPRODUCTIONS, IN CLASS 16 (U.S. CLS. 2, 5, 22, 23, 29, 37, 38 AND 50).

FIRST USE 12-31-1998; IN COMMERCE 12-31-2000.

FOR: SCULPTURES OF CONCRETE, CEMENT, STONE, MARBLE, AND GRANITE, IN CLASS 19 (U.S. CLS. 1, 12, 33 AND 50).

FIRST USE 12-31-1998; IN COMMERCE 12-31-2000.

THE MARK CONSISTS OF A POINT OF SALE DISPLAY IN THE FORM OF A THREE DIMENSIONAL REPRESENTATION OF A PLURALITY OF FINGERPRINTS ONE ATOP ANOTHER LIKE A TOTEM POLE.

SER. NO. 78-760,539, FILED 11-23-2005.

BARBARA A. GOLD, EXAMINING ATTORNEY

Int. Cl.: 39

Prior U.S. Cls.: 100 and 105

United States Patent and Trademark Office

Reg. No. 3,398,455

Registered Mar. 18, 2008

**SERVICE MARK
PRINCIPAL REGISTER**



TARGA RESOURCES, INC. (DELAWARE CORPORATION)
SUITE 4700
1000 LOUISIANA
HOUSTON, TX 77002

FIRST USE 12-1-2005; IN COMMERCE 12-1-2005.

FOR: TRANSPORTATION AND STORAGE OF NATURAL GAS AND NATURAL GAS LIQUIDS FOR OTHERS; GATHERING OF NATURAL GAS AND NATURAL GAS LIQUIDS FOR OTHERS, NAMELY, CONNECTING TO NATURAL GAS SOURCES FOR THE PURPOSE OF SUPPLYING AND DISTRIBUTING NATURAL GAS, IN CLASS 39 (U.S. CLS. 100 AND 105).

"THE FOREIGN WORDING IN THE MARK TRANSLATES INTO ENGLISH AS SHIELD OR A COMMERATIVE INSCRIBED TABLET AFFIXED TO OR SET INTO A WALL."

SER. NO. 78-765,091, FILED 12-1-2005.

MARY CRAWFORD, EXAMINING ATTORNEY

Int. Cl.: 9

Prior U.S. Cls.: 21, 23, 26, 36 and 38

Reg. No. 3,398,456

United States Patent and Trademark Office

Registered Mar. 18, 2008

**TRADEMARK
PRINCIPAL REGISTER**

VANGONOTES

PEARSON EDUCATION, INC. (DELAWARE
CORPORATION)
ONE LAKE STREET
UPPER SADDLE RIVER, NJ 07458

FOR: PROVIDING ONLINE DOWNLOADABLE
ELECTRONIC PUBLICATIONS IN THE NATURE
OF STUDY GUIDES FEATURING INSTRUCTION
IN ANTHROPOLOGY, ART HISTORY, BUSINESS,
COMPUTING, EDUCATION, ENGLISH, HEALTH
EDUCATION, HEALTH PROFESSIONS, HISTORY,
HOSPITALITY, LAW, PSYCHOLOGY, SCIENCE,
SOCIOLOGY, AND GENERAL STUDY SKILLS
FOR UNDERGRADUATE, GRADUATE, POST-

GRADUATE AND PROFESSIONAL CURRICU-
LUM, IN CLASS 9 (U.S. CLS. 21, 23, 26, 36 AND 38).

FIRST USE 3-8-2006; IN COMMERCE 3-8-2006.

THE MARK CONSISTS OF STANDARD CHAR-
ACTERS WITHOUT CLAIM TO ANY PARTICULAR
FONT, STYLE, SIZE, OR COLOR.

SER. NO. 78-765,309, FILED 12-2-2005.

GILBERT SWIFT, EXAMINING ATTORNEY

Int. Cls.: 29 and 30

Prior U.S. Cl.: 46

United States Patent and Trademark Office

Reg. No. 3,398,457

Registered Mar. 18, 2008

**TRADEMARK
PRINCIPAL REGISTER**

CAROLINA

EXCELLENT, LESLIE F. (UNITED STATES INDIVIDUAL)
173 RUE DU CENTRE
PORT-AU-PRINCE, HAITI AND
EXCELLENT, ROBERT (UNITED STATES INDIVIDUAL)
173 RUE DU CENTRE
PORT-AU-PRINCE, HAITI

FOR: BAKED BEANS; BUTTER; DRIED BEANS; PROCESSED BEANS; TOMATO PASTE; VEGETABLE PASTE; VEGETABLE-BASED FOOD BEVERAGES; VEGETABLE-BASED SPREADS; INTENDED FOR SALE IN SPECIALTY STORES FEATURING CARIBBEAN FOODS, IN CLASS 29 (U.S. CL. 46).

FIRST USE 6-1-1996; IN COMMERCE 6-1-1996.

FOR: KETCHUP; MAYONNAISE; INTENDED FOR SALE IN SPECIALTY STORES FEATURING CARIBBEAN FOODS, IN CLASS 30 (U.S. CL. 46).

FIRST USE 12-1-1995; IN COMMERCE 12-1-1995.

THE MARK CONSISTS OF STANDARD CHARACTERS WITHOUT CLAIM TO ANY PARTICULAR FONT, STYLE, SIZE, OR COLOR.

SER. NO. 78-768,453, FILED 12-7-2005.

NICHOLAS ALTREE, EXAMINING ATTORNEY

Int. Cls.: 35, 37, 38 and 42

Prior U.S. Cls.: 100, 101, 102, 103, 104 and 106

United States Patent and Trademark Office

Reg. No. 3,398,458

Registered Mar. 18, 2008

**SERVICE MARK
PRINCIPAL REGISTER**



INDUSTRIAL TOWER AND WIRELESS, LLC
(DELAWARE LTD LIAB CO)
40 LONE STREET
MARSHFIELD, MA 02050

FOR: OPERATION AND MANAGEMENT OF TELECOMMUNICATION TOWERS; MANAGING WIRELESS TELECOMMUNICATION TOWERS AND TOWER SPACE, IN CLASS 35 (U.S. CLS. 100, 101 AND 102).

FIRST USE 12-0-1991; IN COMMERCE 12-0-1991.

FOR: CONSTRUCTION, INSTALLATION, REPAIR AND MAINTENANCE OF WIRELESS TELECOMMUNICATION TOWERS AND WIRELESS TOWER SYSTEMS; SITE DEVELOPMENT, NAMELY, PHYSICAL DEVELOPMENT OF WIRELESS TELECOMMUNICATION TOWERS, IN CLASS 37 (U.S. CLS. 100, 103 AND 106).

FIRST USE 12-0-1991; IN COMMERCE 12-0-1991.

FOR: LEASING OF WIRELESS TELECOMMUNICATION TOWERS, TOWER SPACE, ANTENNAS AND TELECOMMUNICATION INFRASTRUCTURE IN CONNECTION WITH WIRELESS TELECOMMUNICATION NETWORKS; AND MOBILE RADIO AND TELEPHONE COMMUNICATION

SERVICES; LEASING EQUIPMENT SPACE IN COMMUNICATION TOWERS, IN CLASS 38 (U.S. CLS. 100, 101 AND 104).

FIRST USE 12-0-1991; IN COMMERCE 12-0-1991.

FOR: ENGINEERING AND DESIGN SERVICES IN THE FIELD OF WIRELESS TELECOMMUNICATION TOWERS AND TOWER SYSTEMS; CONSULTING SERVICES FOR THE DESIGN OF WIRELESS TELECOMMUNICATION TOWERS; ZONING REVIEW AND APPROVAL IN CONNECTION WITH WIRELESS TELECOMMUNICATION TOWERS, TOWER SPACE AND INFRASTRUCTURE; RADIO FREQUENCY (RF) ENGINEERING AND DESIGN IN CONNECTION WITH WIRELESS TELECOMMUNICATIONS; REVIEWING STANDARDS AND PRACTICES TO ASSURE COMPLIANCE WITH STATE AND FEDERAL WIRELESS TELECOMMUNICATION TOWERS, TOWER SPACE AND INFRASTRUCTURE, IN CLASS 42 (U.S. CLS. 100 AND 101).

FIRST USE 12-0-1991; IN COMMERCE 12-0-1991.

SER. NO. 78-769,135, FILED 12-8-2005.

GEORGIA CARTY, EXAMINING ATTORNEY

Int. Cl.: 9

Prior U.S. Cls.: 21, 23, 26, 36 and 38

United States Patent and Trademark Office

Reg. No. 3,398,459

Registered Mar. 18, 2008

**TRADEMARK
PRINCIPAL REGISTER**

Single Copy Delivery System

AUTOMATED SOLUTIONS CORPORATION
(OHIO CORPORATION)
3401 BRECKSVILLE ROAD
RICHFIELD, OH 44286

FOR: COMPUTER SOFTWARE FOR IMPROVING EFFICIENCY AND ACCURACY OF PLANNING, DISTRIBUTION, COLLECTION, AND ELECTRONIC SIGNATURE CAPTURE OF DELIVERABLE ITEMS, NAMELY, PERIODICAL PUBLICATIONS AND SUPPLIES; SOFTWARE FOR MOBILE, CLIENT, AND SERVER COMPUTERS TO ALLOW ACCESSING, CREATING, EDITING, MANAGING AND PROCESSING SALES AND FIELD SERVICE DATA; COMMUNICATIONS SOFTWARE, NAMELY, SYSTEM APPLICATIONS AND OPERATING SOFTWARE FOR TRANSFERRING DATA TO AND FROM DATABASES, COMPUTER PROGRAMS, AND COMPUTER FILES VIA PUBLIC AND PRIVATE TELECOMMUNICATIONS AND COMPUTER NETWORKS; SOFTWARE INTERFACES FOR AUTOMATICALLY EXCHANGING DATA WITH CIRCULATION MANAGEMENT AND ACCOUNTING SOFTWARE; SOFTWARE FOR MANAGING SECURITY OF ELECTRONIC COMMUNICATION; SOFTWARE TO AUTOMATE LOGISTICS, ANALYZE, AND PRESENT SALES AND FIELD SERVICE DATA; COMPUTER DEVICES IN THE NATURE OF MOBILE COMPUTERS, SERVERS, WORKSTATIONS, AND NETWORKING EQUIPMENT, COM-

PUTER PERIPHERALS, AND ACCESSORIES IN THE NATURE OF DATA INPUT DEVICES, MEMORY, STORAGE EQUIPMENT, DOCKS, CHARGERS, MOUNTS, AND PROTECTIVE GEAR USED IN THE FIELD OF SALES; COMPUTER SOFTWARE FOR ADMINISTRATION OF SALES AND FIELD SERVICE DATA THAT MAY BE DOWNLOADED FROM A GLOBAL COMPUTER NETWORK; DOWNLOADABLE COMPUTER PROGRAMS FOR USE IN DISTRIBUTING MARKETING AND TRAINING MATERIALS IN THE FIELD OF SALES, IN CLASS 9 (U.S. CLS. 21, 23, 26, 36 AND 38).

FIRST USE 4-30-2001; IN COMMERCE 4-30-2001.

THE MARK CONSISTS OF STANDARD CHARACTERS WITHOUT CLAIM TO ANY PARTICULAR FONT, STYLE, SIZE, OR COLOR.

NO CLAIM IS MADE TO THE EXCLUSIVE RIGHT TO USE "SINGLE COPY", APART FROM THE MARK AS SHOWN.

SEC. 2(F).

SER. NO. 78-770,396, FILED 12-9-2005.

BRIDGETT SMITH, EXAMINING ATTORNEY

Int. Cl.: 41

Prior U.S. Cls.: 100, 101 and 107

United States Patent and Trademark Office

Reg. No. 3,398,460

Registered Mar. 18, 2008

**SERVICE MARK
PRINCIPAL REGISTER**

APEX

ROBERT A. TOIGO FOUNDATION (CALIFORNIA CORPORATION)
1230 PRESERVATION PARK WAY
OAKLAND, CA 94612

FOR: EDUCATIONAL SERVICES FOR MINORITY STUDENTS IN UNIVERSITY BUSINESS SCHOOL PROGRAMS, NAMELY, ARRANGING AND CONDUCTING EDUCATIONAL SEMINARS, LECTURES, WORKSHOPS, PRESENTATIONS, RETREATS AND TUTORIAL SESSIONS IN THE FIELD OF FINANCE AND PROMOTING CAREERS WITHIN THE FIELD OF FINANCE FOR SUCH STUDENTS; DEVELOPING AND DISTRIBUTING

COURSE MATERIALS IN CONNECTION THEREWITH, IN CLASS 41 (U.S. CLS. 100, 101 AND 107).

FIRST USE 10-0-2005; IN COMMERCE 10-0-2005.

THE MARK CONSISTS OF STANDARD CHARACTERS WITHOUT CLAIM TO ANY PARTICULAR FONT, STYLE, SIZE, OR COLOR.

SER. NO. 78-779,272, FILED 12-22-2005.

KATHERINE M. DUBRAY, EXAMINING ATTORNEY

Int. Cl.: 25

Prior U.S. Cls.: 22 and 39

United States Patent and Trademark Office

Reg. No. 3,398,461

Registered Mar. 18, 2008

**TRADEMARK
PRINCIPAL REGISTER**

TUSCAN

MWM CREATIONS, INC. (FLORIDA CORPORATION)
2061 BROOKSIDE DRIVE
SAFETY HARBOR, FL 34695

THE MARK CONSISTS OF STANDARD CHARACTERS WITHOUT CLAIM TO ANY PARTICULAR FONT, STYLE, SIZE, OR COLOR.

FOR: CLOTHING AND SPORTSWEAR, NAMELY, SHIRTS AND SWEATERS, IN CLASS 25 (U.S. CLS. 22 AND 39).

SER. NO. 78-779,309, FILED 12-22-2005.

FIRST USE 8-19-2003; IN COMMERCE 8-19-2003.

MELVIN AXILBUND, EXAMINING ATTORNEY

Int. Cl.: 16

Prior U.S. Cls.: 2, 5, 22, 23, 29, 37, 38 and 50

United States Patent and Trademark Office

Reg. No. 3,398,462

Registered Mar. 18, 2008

**TRADEMARK
PRINCIPAL REGISTER**

CELEBRATE LIFE

KI MEMORIES, INC. (TEXAS CORPORATION)
3720 ARAPAHO ROAD
ADDISON, TX 75001

FOR: SCRAPBOOK ALBUMS, PRINTED PAPERS
FOR USE AS SCRAPBOOK PAGES, SCRAPBOOK
STICKERS, SCRAPBOOK RIBBONS, BOOKS OF
IDEAS FOR SCRAPBOOKING PROJECTS, IN CLASS
16 (U.S. CLS. 2, 5, 22, 23, 29, 37, 38 AND 50).

FIRST USE 1-30-2004; IN COMMERCE 1-30-2004.

THE MARK CONSISTS OF STANDARD CHAR-
ACTERS WITHOUT CLAIM TO ANY PARTICULAR
FONT, STYLE, SIZE, OR COLOR.

SER. NO. 78-781,665, FILED 12-28-2005.

SIMON TENG, EXAMINING ATTORNEY

Int. Cl.: 14

Prior U.S. Cls.: 2, 27, 28 and 50

United States Patent and Trademark Office

Reg. No. 3,398,463

Registered Mar. 18, 2008

**TRADEMARK
PRINCIPAL REGISTER**

LUCKY LEAF

GERSHI, YEHUDA (ISRAEL INDIVIDUAL)
68 HAZON ISH STREET
BNEI BRAK, ISRAEL

OWNER OF ISRAEL REG. NO. 180121, DATED 5-8-
2005, EXPIRES 5-8-2015.

FOR: JEWELRY, DIAMONDS, PRECIOUS
STONES, IN CLASS 14 (U.S. CLS. 2, 27, 28 AND 50).

SER. NO. 78-785,056, FILED 1-4-2006.

THE MARK CONSISTS OF STANDARD CHAR-
ACTERS WITHOUT CLAIM TO ANY PARTICULAR
FONT, STYLE, SIZE, OR COLOR.

GRETTA YAO, EXAMINING ATTORNEY

Int. Cls.: 16, 39 and 43

Prior U.S. Cls.: 2, 5, 22, 23, 29, 37, 38, 50, 100, 101 and 105

Reg. No. 3,398,464

United States Patent and Trademark Office

Registered Mar. 18, 2008

**TRADEMARK
SERVICE MARK
PRINCIPAL REGISTER**

**THE GREAT GAME TRAVEL
COMPANY**

THE GREAT GAME TRAVEL COMPANY LIMITED (UNITED KINGDOM CORPORATION)
16 MALONE VIEW PARK
BELFAST, UNITED KINGDOM BT9 5PN

FOR: PRINTED MATTER, NAMELY, PHOTOGRAPHS, STATIONERY, CATALOGUES, BROCHURES, LEAFLETS, PERIODICALS, MAGAZINES AND INSTRUCTIONAL MATERIALS IN THE FIELDS OF TRAVEL, EXPEDITIONS, TOURISM, HISTORY, CULTURE, GEOGRAPHY AND NATURE; MAPS; PRINTED FORMS AND INSTRUCTIONS FOR THE SECURING OF PERMITS AND VISAS, IN CLASS 16 (U.S. CLS. 2, 5, 22, 23, 29, 37, 38 AND 50).

FOR: TRANSPORT OF GOODS; PACKAGING OF ARTICLES FOR TRANSPORTATION; STORAGE OF GOODS; TRAVEL ARRANGEMENT, TRAVEL AGENCY SERVICES, NAMELY, MAKING RESERVATIONS AND BOOKINGS FOR TRANSPORTATION; TRAVEL TICKET RESERVATION SERVICES; AND TRAVEL INFORMATION SERVICES; BOOKING OF FLIGHTS FOR OTHERS; PROVISION AND ARRANGEMENT OF TRAVEL PERMITS FOR TOURISTS; PROVISION OF ARRANGEMENT OF VISA FOR TRAVELLERS AND TOURISTS; ADVICE AND CONSULTANCY SERVICES IN RELATION TO TRANSPORTATION, TRAVEL, TRAVEL PERMITS AND TRAVEL VISAS; PROVISION OF TOURS, TREKS AND EXPEDITIONS, BY LAND, FOOT, WATER AND ANIMAL; ARRANGING AND CONDUCTING MOUNTAINEERING EXPEDITIONS AND HIKING EXPEDITIONS; PROVISION OF ONLINE TRAVEL RESERVATION AND INFORMATION SERVICES; ONLINE FLIGHT BOOKING

SERVICES; PROVISION OF ONLINE VISA INFORMATION FOR TRAVELLERS AND TOURISTS; PROVISION OF ONLINE INFORMATION FOR TRAVELLERS AND TOURISTS IN THE FIELD OF TRAVEL AND TRANSPORTATION, IN CLASS 39 (U.S. CLS. 100 AND 105).

FOR: SERVING FOOD AND DRINKS; PROVIDING TEMPORARY ACCOMMODATION; PROVISION, BOOKING AND ARRANGING OF ACCOMMODATION FOR OTHERS; PROVISION AND RENTAL OF CAMPING FACILITIES; PROVIDING INFORMATION AND ADVICE IN RELATION TO ACCOMMODATION FOR TRAVELLERS AND TOURISTS; PROVIDING ONLINE INFORMATION AND ADVICE FOR TRAVELLERS AND TOURISTS ON THE SUBJECT OF ACCOMMODATIONS, RESTAURANTS, CAFES, BARS AND OTHERS LOCATIONS THAT SERVE FOOD AND DRINK, IN CLASS 43 (U.S. CLS. 100 AND 101).

THE MARK CONSISTS OF STANDARD CHARACTERS WITHOUT CLAIM TO ANY PARTICULAR FONT, STYLE, SIZE, OR COLOR.

OWNER OF ERPN CMNTY TM OFC REG. NO. 004532041, DATED 7-27-2006, EXPIRES 7-8-2015.

NO CLAIM IS MADE TO THE EXCLUSIVE RIGHT TO USE "TRAVEL COMPANY" , APART FROM THE MARK AS SHOWN.

SER. NO. 78-789,434, FILED 1-11-2006.

RONALD MCMORROW, EXAMINING ATTORNEY

Int. Cl.: 11

Prior U.S. Cls.: 13, 21, 23, 31 and 34

United States Patent and Trademark Office

Reg. No. 3,398,465

Registered Mar. 18, 2008

**TRADEMARK
PRINCIPAL REGISTER**

SAMSUNG ELECTRONICS CO., LTD. (REPUBLIC OF KOREA CORPORATION)
416, MAETAN-DONG, YEONGTONG-GU, SUWON-SI
GYEONGGI-DO, REPUBLIC OF KOREA

FOR: REFRIGERATORS; REFRIGERATING SHOWCASES; HUMIDIFIERS; AIR CONDITIONING UNITS, NAMELY, ROOM COOLERS FOR HOUSEHOLD PURPOSES; AIR CONDITIONERS; ELECTRIC FANS; ELECTRIC STOVES; CLOTHES DRYERS; ELECTRIC PRESSURE COOKERS; ELECTRIC DEEP FRYERS; ELECTRIC COFFEE POTS; ELECTRIC COOKERS; ELECTRIC TOASTERS; MICROWAVE OVENS; DENTAL OVENS; HOUSEHOLD WATER PURIFIERS; GAS RANGES; ELECTRIC COOKING OVENS FOR HOUSEHOLD PURPOSES; GAS STOVES; RADIATORS; ELECTRICAL BOILERS FOR HOUSEHOLD PURPOSES; GAS REFRIGERATORS; GAS LAMPS; ELECTRIC LIGHT

BULBS; BIDETS; HOUSEHOLD AIR CLEANERS, IN CLASS 11 (U.S. CLS. 13, 21, 23, 31 AND 34).

PRIORITY CLAIMED UNDER SEC. 44(D) ON REPUBLIC OF KOREA APPLICATION NO. 402006000190, FILED 1-12-2006, REG. NO. 0698571, DATED 2-15-2007, EXPIRES 2-15-2017.

NO CLAIM IS MADE TO THE EXCLUSIVE RIGHT TO USE "SMART INVERTER", APART FROM THE MARK AS SHOWN.

THE MARK CONSISTS OF THE WORDS "SMART" AND "INVERTER," WITH THE "I" STYLIZED INTO AN ELLIPSE DESIGN.

SER. NO. 78-791,543, FILED 1-13-2006.

DAVID MILLER, EXAMINING ATTORNEY

Int. Cls.: 9, 38 and 41

Prior U.S. Cls.: 21, 23, 26, 36, 38, 100, 101, 104 and 107

Reg. No. 3,398,466

United States Patent and Trademark Office

Registered Mar. 18, 2008

**TRADEMARK
SERVICE MARK
PRINCIPAL REGISTER**

GRASS VALLEY

THOMSON (FRANCE SOCIETE ANONYME)
46 QUAI ALPHONSE LE GALLO
BOULOGNE-BILLANCOURT, FRANCE 92100

FOR: APPARATUS AND INSTRUMENTS FOR GENERATING, SWITCHING, EDITING AND ROUTING TELEVISION, VIDEO, AND AUDIO SIGNALS, NAMELY, CAMERAS, CAMCORDERS, ROUTERS, SWITCHERS, MULTIPLEXERS, DEMULTIPLEXERS, INTELLIGENT VIDEO DIGITAL RECORDERS, MASTER CONTROL SYSTEMS FOR USE IN TELEVISION BROADCASTING COMPRISED OF VIDEO PROCESSORS, AUDIO PROCESSORS, SERIAL PORTS, FILE SERVERS, PRODUCTION SWITCHERS, ROUTING SWITCHERS, VIDEO TAPE RECORDERS, CONTROL CONSOLE, CONTROL PANELS, SOFTWARE FOR CONTROL OF ROUTERS AND VIDEOTAPE RECORDERS, SOFTWARE FOR CREATING DIGITAL VIDEO EFFECTS, SOFTWARE FOR BRANDING VIDEO CONTENT, REDUNDANT POWER SUPPLIES AND EMERGENCY BACKUP SWITCHERS; DISTRIBUTION AMPLIFIERS, GENERATORS, OSCILLATORS, ACQUISITION CIRCUITS, SIGNAL CONVERTERS, TELEVISION AND AUDIO-VIDEO TRANSMITTERS AND RECEIVERS; SERVERS, NAMELY, MEDIA SERVERS, VIDEO SERVERS, AND BROADCASTING SERVERS; MEDIA STORAGE DEVICES, NAMELY, MEDIA SERVERS, SOLID-STATE MEDIA RECORDERS, AND REMOVABLE MEDIA DRIVES AND DISKS; APPARATUS FOR GENERATING, CONTROLLING, AND REPRODUCING VIDEO SPECIAL EFFECTS FOR TELEVISION, VIDEO PRODUCTION, AND THE MOVIES; POSTPRODUCTION EQUIPMENT AND APPARATUS, NAMELY, SCANNERS, TELECINES USED TO TRANSFER MOTION PICTURE FILMS TO A DIGITAL FORMAT, SOLID-STATE RECORDERS, SOFTWARE IN THE FIELD OF POST PRODUCTION, CONVERTERS; VIDEO COMPRESSION AND NETWORKING APPARATUS AND INSTRU-

MENTS, NAMELY, ENCODERS, DECODERS, NETWORK ADAPTORS; COMPUTER PROGRAMS FOR THE PRODUCTION AND EDITING OF PROGRAMS AND TELEVISION SIGNALS AND AUDIO-VIDEO SIGNALS; MOVIE APPARATUS, NAMELY, CINEMATOGRAPHIC CAMERAS, SOLID-STATE RECORDERS, SCANNERS, TELECINES USED TO TRANSFER MOTION PICTURE FILMS TO A DIGITAL FORMAT, SOFTWARE IN THE FIELD OF POST PRODUCTION, COLOR SPACE CONVERTER FOR USE IN COLOR GRADING AND COLOR CORRECTION, AND GRAIN REDUCTION HARDWARE AND SOFTWARE, IN CLASS 9 (U.S. CLS. 21, 23, 26, 36 AND 38).

FOR: TELECOMMUNICATIONS SERVICES IN THE TELEVISION AND MOVIE INDUSTRIES, NAMELY, ELECTRONIC TRANSMISSION OF DATA AND MESSAGES, TELEVISION BROADCASTING, RADIO BROADCASTING, AUDIO AND VIDEO BROADCASTING, CABLE AND SATELLITE TELEVISION, COMMUNICATIONS BY COMPUTER TERMINALS, IN CLASS 38 (U.S. CLS. 100, 101 AND 104).

FOR: ENTERTAINMENT SERVICES, NAMELY, EDITING OF RADIO AND TELEVISION PROGRAMS, AND LEASE OF AUDIOVISUAL APPARATUS; MOTION PICTURE FILM PRODUCTION, RADIO AND TELEVISION PROGRAM PRODUCTION, RECORDING STUDIO SERVICES, MOVIE STUDIOS, IN CLASS 41 (U.S. CLS. 100, 101 AND 107).

THE MARK CONSISTS OF STANDARD CHARACTERS WITHOUT CLAIM TO ANY PARTICULAR FONT, STYLE, SIZE, OR COLOR.

PRIORITY CLAIMED UNDER SEC. 44(D) ON FRANCE APPLICATION NO. 053371250, FILED 7-20-2005, REG. NO. 053371250, DATED 7-20-2005, EXPIRES 7-20-2015.

SER. NO. 78-794,194, FILED 1-18-2006.

GIANCARLO CASTRO, EXAMINING ATTORNEY

Int. Cl.: 9

Prior U.S. Cls.: 21, 23, 26, 36 and 38

Reg. No. 3,398,467

United States Patent and Trademark Office

Registered Mar. 18, 2008

**TRADEMARK
PRINCIPAL REGISTER**

CLIO

ENDOWMENT CAPITAL GROUP, L.P. (DELA-
WARE LIMITED PARTNERSHIP)
1515 MARKET STREET, SUITE 2000
PHILADELPHIA, PA 19102

THE MARK CONSISTS OF STANDARD CHAR-
ACTERS WITHOUT CLAIM TO ANY PARTICULAR
FONT, STYLE, SIZE, OR COLOR.

FOR: COMPUTER SOFTWARE USED FOR CON-
TACT AND RELATIONSHIP MANAGEMENT IN
THE FIELD OF INVESTMENT MANAGEMENT, IN
CLASS 9 (U.S. CLS. 21, 23, 26, 36 AND 38).

SER. NO. 78-795,463, FILED 1-20-2006.

FIRST USE 7-14-2005; IN COMMERCE 7-14-2005.

MARY MUNSON, EXAMINING ATTORNEY

Int. Cl.: 35

Prior U.S. Cls.: 100, 101 and 102

United States Patent and Trademark Office

Reg. No. 3,398,468

Registered Mar. 18, 2008

**SERVICE MARK
PRINCIPAL REGISTER**

OPTICA ITALEE

ITALEE OPTICS, INC. (CALIFORNIA CORPORATION)
2641 W. OLYMPIC BLVD.
LOS ANGELES, CA 90006

FOR: RETAIL SHOPS FEATURING EYEGLASSES, EYEGLASS FRAMES, EYEGLASS LENSES, CONTACT LENSES, SUNGLASSES, AND EYEGLASS ACCESSORIES, NAMELY, EYEGLASS CASES, EYEGLASS CLEANING CLOTHS, EYEGLASS CLEANING SOLUTIONS, CONTACT LENS CASES, CONTACT LENS CLEANING SOLUTIONS, EYEGLASS CHAINS, IN CLASS 35 (U.S. CLS. 100, 101 AND 102).

FIRST USE 0-0-1979; IN COMMERCE 0-0-1979.

THE MARK CONSISTS OF STANDARD CHARACTERS WITHOUT CLAIM TO ANY PARTICULAR FONT, STYLE, SIZE, OR COLOR.

OWNER OF U.S. REG. NOS. 2,370,041, 2,370,042, AND 2,931,310.

SEC. 2(F).

SER. NO. 78-796,168, FILED 1-20-2006.

JAMES STEIN, EXAMINING ATTORNEY

Int. Cl.: 41

Prior U.S. Cls.: 100, 101 and 107

United States Patent and Trademark Office

Reg. No. 3,398,469

Registered Mar. 18, 2008

**SERVICE MARK
PRINCIPAL REGISTER**

RHYTHM HOUSE

FARRINGTON PRODUCTIONS, INC. (NEVADA
CORPORATION)
4350 S. ARVILLE, STE. 15
LAS VEGAS, NV 89103

FOR: ENTERTAINMENT SERVICES, NAMELY, A
LIVE THEATRICAL PRODUCTION TROUPE CON-
SISTING OF PERFORMERS AND ACROBATS, PER-
FORMING WITH THE APPROPRIATE COSTUMES,
PROPS, SCENERY, MUSIC, CHOREOGRAPHY,
LIGHTING AND SOUND, IN CLASS 41 (U.S. CLS.
100, 101 AND 107).

FIRST USE 6-30-2006; IN COMMERCE 9-10-2006.

THE MARK CONSISTS OF STANDARD CHAR-
ACTERS WITHOUT CLAIM TO ANY PARTICULAR
FONT, STYLE, SIZE, OR COLOR.

SER. NO. 78-797,008, FILED 1-23-2006.

SANDRA MANIOS, EXAMINING ATTORNEY

Int. Cl.: 35

Prior U.S. Cls.: 100, 101 and 102

United States Patent and Trademark Office

Reg. No. 3,398,470

Registered Mar. 18, 2008

SERVICE MARK
PRINCIPAL REGISTER



DIRECT SUPPLY, INC. (WISCONSIN CORPORATION)
6767 NORTH INDUSTRIAL ROAD
MILWAUKEE, WI 53223

FOR: BUSINESS MANAGEMENT, NAMELY, PROVIDING PROJECT MANAGEMENT SERVICES, EQUIPMENT PLANNING SERVICES, LIFETIME SUPPORT SERVICES FOR LONG-TERM CARE FACILITIES; LOGISTICS MANAGEMENT SERVICES FOR LONG TERM CARE FACILITIES, IN CLASS 35 (U.S. CLS. 100, 101 AND 102).

FIRST USE 1-1-2003; IN COMMERCE 1-1-2003.

OWNER OF U.S. REG. NOS. 1,948,126, 2,844,206 AND OTHERS.

NO CLAIM IS MADE TO THE EXCLUSIVE RIGHT TO USE "ELDERCARE", APART FROM THE MARK AS SHOWN.

SEC. 2(F) AS TO "DIRECT SUPPLY".

SER. NO. 78-798,155, FILED 1-24-2006.

KATHERINE E. HALMEN, EXAMINING ATTORNEY

Int. Cls.: 9, 35 and 42

Prior U.S. Cls.: 21, 23, 26, 36, 38, 100, 101 and 102

Reg. No. 3,398,471

United States Patent and Trademark Office

Registered Mar. 18, 2008

**TRADEMARK
SERVICE MARK
PRINCIPAL REGISTER**

U&U

NIHON UNISYS, LTD. (JAPAN CORPORATION)
KOTO-KU
1-1 TOYOSU 1-CHOME
TOKYO, JAPAN

FOR: (BASED ON 44(E) 4947336) CASH REGISTERS, COIN CALCULATING OR SORTING MACHINES, JOB RECORDING MACHINES, NAMELY, COMPUTERS, DIGITAL PENS, VIDEO CAMERAS, AND AUDIO RECORDERS, PHOTOCOPYING MACHINES, MANUALLY OPERATED COMPUTING MACHINES, NAMELY CALCULATORS, DRAWING OR DRAFTING MACHINES AND INSTRUMENTS, NAMELY, COMPUTERS AND PRINTERS, TIME STAMPING MACHINES, TIME RECORDERS, NAMELY CHRONOGRAPHS FOR USE AS SPECIALIZED TIME RECORDING APPARATUSES AND TIME CLOCKS, PUNCH CARD SYSTEM MACHINES, VOTE NUMBER COMPUTING MACHINES, BILLING MACHINES, POSTAGE STAMP PASTING CHECKING MACHINES; ELECTRICAL DISTRIBUTION OR CONTROL MACHINES AND INSTRUMENTS, ROTARY CONVERTERS, PHASE MODIFIERS; BATTERIES AND ELECTRICAL CELLS; INSTRUMENTS FOR MEASURING ELECTRICAL AND MAGNETIC STRENGTH; ELECTRIC WIRES AND CABLES; ELECTRIC IRONS, ELECTRIC HAIR CURLERS, ELECTRIC BUZZERS; ELECTRICAL COMMUNICATION MACHINES AND INSTRUMENTS FOR TELECOMMUNICATIONS NAMELY, RADIO FREQUENCY IDENTIFICATION (RFID) TAGS, RFID READERS, COMPUTER NETWORK HUBS, SWITCHES AND ROUTERS, GATEWAY ROUTERS IN THE NATURE OF COMPUTER HARDWARE, WIRELESS COMMUNICATIONS DEVICES, TELEPHONES, WALKIE-TALKIES; PORTABLE RADIO COMMUNICATION MACHINES AND APPARATUS, NAVIGATION APPARATUS FOR VEHICLES (ON-BOARD COMPUTERS); COMPUTER PROGRAMS AND COMPUTER SOFTWARE, BOTH FOR WEB SERVICES, NAMELY, CONNECTING TO

THE INTERNET, GATHERING BUSINESS INTELLIGENCE, ACCESSING INTERNET AND INTRANET PORTALS, DATA WAREHOUSING, ONLINE EQUITIES TRADING, AND CONDUCTING WIRELESS COMMUNICATIONS; COMPUTER HARDWARE AND COMPUTER SOFTWARE APPLICATION IN THE FIELDS OF HEALTH CARE, NAMELY, DATA PROCESSING, IN THE FIELD OF EDUCATION, NAMELY, E-LEARNING SYSTEMS, IN THE FIELD OF CUSTOMER SERVICE, NAMELY, CONDUCTING CONSUMER SURVEYS AND PROCESSING CREDIT CARD TRANSACTIONS, IN THE FIELD OF SALES, NAMELY, CONSUMER DATA PROCESSING, IN THE FIELD OF MARKETING, NAMELY, FOR GENERATING SALES LEADS AND FOR CONDUCTING SALES ANALYSIS, IN THE FIELD OF HUMAN RESOURCES, NAMELY, MAINTAINING EMPLOYEE RECORDS, IN THE FIELD OF COMMUNICATIONS, NAMELY, FOR ACCESSING THE INTERNET, IN THE FIELD OF MANAGEMENT OF SUPPLY CHAINS, ASSETS, MANUFACTURING, ENTERPRISE AND RESOURCE PLANNING, IN THE FIELD OF FINANCE, NAMELY, FOR FINANCIAL ANALYSIS AND FOR FINANCIAL DATA MANAGEMENT, IN THE FIELDS OF ACCOUNT MANAGEMENT AND CASH MANAGEMENT, IN THE FIELD OF SECURITY, NAMELY, MONITORING COMPUTER NETWORKS, IN THE FIELDS OF SUPPLIER RELATIONSHIP MANAGEMENT (SRM), CUSTOMER RELATIONSHIP MANAGEMENT AND ENTERPRISE INFORMATION PORTAL, IN THE FIELD OF BUSINESS FINANCIAL ACTIVITY MONITORING, AND IN THE FIELDS OF CAD/CAM, AND DATA STORAGE USING RAID (REDUNDANT ARRAY OF INDEPENDENT DISKS); AND ALL OTHER ELECTRONIC MACHINES AND INSTRUMENTS AND THEIR PARTS AND FITTINGS, NAMELY, COMPUTERS, AUDIO MIXERS, BARCODE SCANNERS; MAGNETIC CORES, RESISTANCE WIRES,

AND ELECTRODES, IN CLASS 9 (U.S. CLS. 21, 23, 26, 36 AND 38).

FOR: (BASED ON 44(E) 4947336) ADVERTISING AND PUBLICITY; BUSINESS MANAGEMENT ANALYSIS OR BUSINESS CONSULTANCY; MARKETING RESEARCH; PROVISION OF INFORMATION ABOUT SALE OF GOODS; EMPLOYMENT AGENCY OR BROKERAGE FOR CLERICAL WORK IN RELATION TO SALE OF GOODS VIA THE INTERNET; BUSINESS INTERMEDIATION FOR OTHERS FOR CONTRACT FOR SALES OF COMMODITIES; AUCTIONEERING BY USING COMMUNICATION VIA COMPUTER TERMINALS; DOCUMENT REPRODUCTION; CLERICAL SERVICES, NAMELY, FILING OF DOCUMENTS OR MAGNETIC TAPES; OFFICE FUNCTIONS, NAMELY, OPERATION OF COMPUTERS, TYPEWRITERS OR SIMILAR OFFICE MACHINES; ACTING AS AGENTS FOR CARRYING OUT OF FILING PROCEDURES FOR OBTAINING THE INTERNET DOMAIN NAMES; COMPUTERIZED DATA AND WORD PROCESSING, IN CLASS 35 (U.S. CLS. 100, 101 AND 102).

FOR: (BASED ON 44(E) 3221978) ARCHITECTURAL DESIGN; COMPUTER SOFTWARE DESIGN, COMPUTER PROGRAMMING, OR MAINTENANCE OF COMPUTER SOFTWARE; RENTAL OF COMPUTERS INCLUDING CPU, AND ELECTRO-

NIC CIRCUITS, MAGNETIC DISCS, MAGNETIC TAPES ON WHICH COMPUTER PROGRAMS ARE RECORDED, AND OTHER PERIPHERALS; OPERATIONAL MANAGEMENT OF COMPUTER SYSTEM OPERATION; PROVIDING INFORMATION AND CONSULTANCY IN THE FIELD OF OPERATIONAL MANAGEMENT OF COMPUTER SYSTEM OPERATION; OPERATIONAL MANAGEMENT IN THE FIELD OF OPERATION OF COMPUTERS OR COMPUTER INFORMATION NETWORK, IN CLASS 42 (U.S. CLS. 100 AND 101).

THE MARK CONSISTS OF STANDARD CHARACTERS WITHOUT CLAIM TO ANY PARTICULAR FONT, STYLE, SIZE, OR COLOR.

PRIORITY CLAIMED UNDER SEC. 44(D) ON JAPAN APPLICATION NO. 2005-71183, FILED 8-1-2005, REG. NO. 4947336, DATED 4-21-2006, EXPIRES 4-21-2016.

OWNER OF JAPAN REG. NO. 3221978, DATED 11-29-1996, RENEWED AS REG. NO. 3221978, DATED 11-21-2006, EXPIRES 11-21-2016.

SER. NO. 78-804,148, FILED 2-1-2006.

KARANENDRA S. CHHINA, EXAMINING ATTORNEY

Int. Cls.: 41 and 43

Prior U.S. Cls.: 100, 101 and 107

United States Patent and Trademark Office

Reg. No. 3,398,472

Registered Mar. 18, 2008

**SERVICE MARK
PRINCIPAL REGISTER**

Lotus

LULU'S, LLC (NEW YORK LTD LIAB CO)
C/O 3SIXTY HOSPITALITY LLC
411 WEST 14TH STREET, 4TH FLOOR
NEW YORK, NY 10014

FOR: ENTERTAINMENT SERVICES, NAMELY,
CONDUCTING PARTIES; NIGHT CLUBS; SPECIAL
EVENT PLANNING, IN CLASS 41 (U.S. CLS. 100, 101
AND 107).

FIRST USE 5-1-2000; IN COMMERCE 5-1-2000.

FOR: PROVIDING BANQUET AND SOCIAL
FUNCTION FACILITIES FOR SPECIAL OCCA-

SIONS; RESTAURANT AND BAR SERVICES, IN
CLASS 43 (U.S. CLS. 100 AND 101).

FIRST USE 5-1-2000; IN COMMERCE 5-1-2000.

THE MARK CONSISTS OF STANDARD CHAR-
ACTERS WITHOUT CLAIM TO ANY PARTICULAR
FONT, STYLE, SIZE, OR COLOR.

SER. NO. 78-804,342, FILED 2-1-2006.

SANDRA MANIOS, EXAMINING ATTORNEY

Int. Cl.: 36

Prior U.S. Cls.: 100, 101 and 102

United States Patent and Trademark Office

Reg. No. 3,398,473

Registered Mar. 18, 2008

**SERVICE MARK
PRINCIPAL REGISTER**



CAPITAL AUTOMOTIVE LLC (DELAWARE LTD
LIAB CO)
8270 GREENSBORO DRIVE, SUITE 950
MCLEAN, VA 22102

FOR: FINANCIAL SERVICES PROVIDED TO THE
AUTOMOTIVE RETAIL INDUSTRY, NAMELY,
PROVIDING AUTOMOTIVE DEALERS WITH REAL
ESTATE INVESTMENT TRUST SERVICES, REAL
ESTATE INVESTMENT SERVICES AND FINAN-

CIAL SERVICES IN THE FIELD OF MONEY LEND-
ING, IN CLASS 36 (U.S. CLS. 100, 101 AND 102).

FIRST USE 2-12-1998; IN COMMERCE 2-12-1998.

SER. NO. 78-806,269, FILED 2-3-2006.

ELLEN BURNS, EXAMINING ATTORNEY

Int. Cl.: 42

Prior U.S. Cls.: 100 and 101

United States Patent and Trademark Office

Reg. No. 3,398,474

Registered Mar. 18, 2008

**SERVICE MARK
PRINCIPAL REGISTER**



COUPONS, INC. (CALIFORNIA CORPORATION)
520 SAN ANTONIO ROAD
MOUNTAIN VIEW, CA 94040

OWNER OF U.S. REG. NO. 2,992,533.

FOR: PROVIDING ONLINE, NON-DOWNLOAD-
ABLE SOFTWARE FOR USE IN DISPLAYING IN-
FORMATION AND ADVERTISEMENTS OF
OTHERS THAT ARE LINKED TO KEYWORDS,
PHRASES OR ICONS, IN CLASS 42 (U.S. CLS. 100
AND 101).

NO CLAIM IS MADE TO THE EXCLUSIVE
RIGHT TO USE "COUPONS INC.", APART FROM
THE MARK AS SHOWN.

SER. NO. 78-807,889, FILED 2-6-2006.

FIRST USE 9-25-2005; IN COMMERCE 9-25-2005.

AMY MCMENAMIN, EXAMINING ATTORNEY

Int. Cl.: 41

Prior U.S. Cls.: 100, 101 and 107

United States Patent and Trademark Office

Reg. No. 3,398,475

Registered Mar. 18, 2008

**SERVICE MARK
PRINCIPAL REGISTER**

Prep Camp Excel

EDUCATION UNLIMITED, INC. (CALIFORNIA CORPORATION)

1681 SHATTUCK AVE, SUITE E

BERKELEY, CA 94709

FOR: SUMMER CAMPS, IN CLASS 41 (U.S. CLS. 100, 101 AND 107).

FIRST USE 11-1-1999; IN COMMERCE 11-1-1999.

THE MARK CONSISTS OF STANDARD CHARACTERS WITHOUT CLAIM TO ANY PARTICULAR FONT, STYLE, SIZE, OR COLOR.

NO CLAIM IS MADE TO THE EXCLUSIVE RIGHT TO USE "PREP CAMP", APART FROM THE MARK AS SHOWN.

SER. NO. 78-809,843, FILED 2-8-2006.

JOHN WILKE, EXAMINING ATTORNEY

Int. Cls.: 10 and 28

Prior U.S. Cls.: 22, 23, 26, 38, 39, 44 and 50

United States Patent and Trademark Office

Reg. No. 3,398,476

Registered Mar. 18, 2008

**TRADEMARK
PRINCIPAL REGISTER**

LIFE CARE

MUELLER SPORTS MEDICINE, INC. (WISCONSIN CORPORATION)
ONE QUENCH DRIVE, P.O. BOX 99
PRAIRIE DU SAC, WI 53578

FOR: ATHLETIC ANKLE BRACES FOR MEDICAL USE; BRACES FOR LIMBS AND JOINTS, FOR MEDICAL USE; MEDICAL BRACES FOR KNEE, ANKLE, WRIST, ELBOW, BACK; ORTHOPEDIC BRACES; SUPPORTS FOR KNEE, ANKLE, WRIST, ELBOW, BACK FOR MEDICAL USE, IN CLASS 10 (U.S. CLS. 26, 39 AND 44).

FIRST USE 10-9-2007; IN COMMERCE 10-9-2007.

FOR: ATHLETIC SPORTING GOODS, NAMELY, ATHLETIC WRIST AND JOINT SUPPORTS, IN CLASS 28 (U.S. CLS. 22, 23, 38 AND 50).

FIRST USE 10-9-2007; IN COMMERCE 10-9-2007.

THE MARK CONSISTS OF STANDARD CHARACTERS WITHOUT CLAIM TO ANY PARTICULAR FONT, STYLE, SIZE, OR COLOR.

SER. NO. 78-810,590, FILED 2-8-2006.

MICHAEL W. BAIRD, EXAMINING ATTORNEY

Int. Cl.: 35

Prior U.S. Cls.: 100, 101 and 102

United States Patent and Trademark Office

Reg. No. 3,398,477

Registered Mar. 18, 2008

**SERVICE MARK
PRINCIPAL REGISTER**

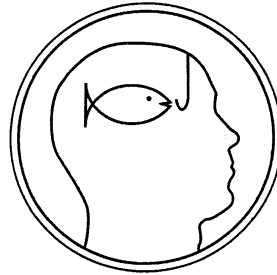

O.C.F.
Obsessive Compulsive Fishing

ELY CHAMBER OF COMMERCE (MINNESOTA CORPORATION)
1600 E SHERIDAN
ELY, MN 55731

FOR: CHAMBER OF COMMERCE SERVICES, NAMELY, PROMOTING BUSINESS IN THE ELY, MINNESOTA AREA, IN CLASS 35 (U.S. CLS. 100, 101 AND 102).

FIRST USE 1-2-2006; IN COMMERCE 1-2-2006.

THE MARK CONSISTS OF OUTLINE OF A MAN'S HEAD IN A CIRCLE WITH SIMPLE OUTLINE OF FISH AND HOOK INSIDE OF THE HEAD.

SER. NO. 78-813,636, FILED 2-13-2006.

LINDA LAVACHE, EXAMINING ATTORNEY

Int. Cls.: 9, 41 and 43

Prior U.S. Cls.: 21, 23, 26, 36, 38, 100, 101 and 107

United States Patent and Trademark Office

Reg. No. 3,398,478

Registered Mar. 18, 2008

**TRADEMARK
SERVICE MARK
PRINCIPAL REGISTER**

SOUL KITCHEN

MALNIK, SHAREEF (UNITED STATES INDIVIDUAL)
432 41ST STREET
MIAMI BEACH, FL 33140

FOR: PRE-RECORDED CD'S FEATURING MUSIC, IN CLASS 9 (U.S. CLS. 21, 23, 26, 36 AND 38).

FIRST USE 1-29-2006; IN COMMERCE 2-25-2007.

FOR: NIGHT CLUB SERVICES, IN CLASS 41 (U.S. CLS. 100, 101 AND 107).

FIRST USE 11-17-2005; IN COMMERCE 11-17-2005.

FOR: RESTAURANT SERVICES, NAMELY, PROVIDING AND SERVING OF FOOD AND DRINKS AT WEEKLY DINNER EVENTS, IN CLASS 43 (U.S. CLS. 100 AND 101).

FIRST USE 11-17-2005; IN COMMERCE 11-17-2005.

THE MARK CONSISTS OF STANDARD CHARACTERS WITHOUT CLAIM TO ANY PARTICULAR FONT, STYLE, SIZE, OR COLOR.

NO CLAIM IS MADE TO THE EXCLUSIVE RIGHT TO USE "SOUL" IN CLASSES 09 AND 41 ON THE PRINCIPAL REGISTER AND "SOUL" IN CLASS 43 UNDER SECTION 2(F) ON THE PRINCIPAL REGISTER, APART FROM THE MARK AS SHOWN.

SEC. 2(F).

SER. NO. 78-815,159, FILED 2-15-2006.

WILLIAM VERHOSEK, EXAMINING ATTORNEY

Int. Cl.: 41

Prior U.S. Cls.: 100, 101 and 107

United States Patent and Trademark Office

Reg. No. 3,398,479

Registered Mar. 18, 2008

**SERVICE MARK
PRINCIPAL REGISTER**

NO DRAWING-SENSORY MARK

TIVO BRANDS LLC (DELAWARE LTD LIAB CO)
2160 GOLD STREET
ALVISO, CA 95002

FOR: ENTERTAINMENT SERVICES, NAMELY, PERSONALIZED AND INTERACTIVE ENTERTAINMENT SERVICES IN THE NATURE OF PROVIDING PERSONALIZED TELEVISION PROGRAMMING, AND INTERACTIVE TELEVISION PROGRAMMING AND GAMES, AND ENTERTAINMENT INFORMATION, NAMELY, AN ONLINE GUIDE TO PERSONALIZED AND INTERACTIVE TELEVISION PROGRAMMING, IN CLASS 41 (U.S. CLS. 100, 101 AND 107).

FIRST USE 3-31-1999; IN COMMERCE 3-31-1999.

OWNER OF U.S. REG. NOS. 2,993,862 AND 2,996,654.

THE MARK CONSISTS OF A SEQUENCE OF TWO WOODBLOCK TONES IN INCREASING PITCH, PLAYING THE MUSICAL NOTE F-SHARP FOLLOWED BY THE MUSICAL NOTE G, JUST ABOVE F-SHARP.

SEC. 2(F).

SER. NO. 78-815,914, FILED 2-15-2006.

JASON BLAIR, EXAMINING ATTORNEY

Int. Cl.: 41

Prior U.S. Cls.: 100, 101 and 107

United States Patent and Trademark Office

Reg. No. 3,398,480

Registered Mar. 18, 2008

**SERVICE MARK
PRINCIPAL REGISTER**

NO DRAWING-SENSORY MARK

TIVO BRANDS LLC (DELAWARE LTD LIAB CO)
2160 GOLD STREET
ALVISO, CA 95002

FOR: ENTERTAINMENT SERVICES, NAMELY, PERSONALIZED AND INTERACTIVE ENTERTAINMENT SERVICES IN THE NATURE OF PROVIDING PERSONALIZED TELEVISION PROGRAMMING, AND INTERACTIVE TELEVISION PROGRAMMING AND GAMES, AND ENTERTAINMENT INFORMATION, NAMELY, AN ONLINE GUIDE TO PERSONALIZED AND INTERACTIVE TELEVISION PROGRAMMING, IN CLASS 41 (U.S. CLS. 100, 101 AND 107).

FIRST USE 3-31-1999; IN COMMERCE 3-31-1999.

OWNER OF U.S. REG. NOS. 2,993,862 AND 2,996,654.

THE MARK CONSISTS OF A SEQUENCE OF TWO WOODBLOCK TONES IN INCREASING PITCH, PLAYING THE MUSICAL NOTE G FOLLOWED BY THE MUSICAL NOTE A, JUST ABOVE G.

SEC. 2(F).

SER. NO. 78-815,932, FILED 2-15-2006.

JASON BLAIR, EXAMINING ATTORNEY

Int. Cl.: 41

Prior U.S. Cls.: 100, 101 and 107

United States Patent and Trademark Office

Reg. No. 3,398,481

Registered Mar. 18, 2008

**SERVICE MARK
PRINCIPAL REGISTER**

NO DRAWING-SENSORY MARK

TIVO BRANDS LLC (DELAWARE LTD LIAB CO)
2160 GOLD STREET
ALVISO, CA 95002

OWNER OF U.S. REG. NOS. 2,993,862 AND
2,996,654.

FOR: ENTERTAINMENT SERVICES, NAMELY,
PERSONALIZED AND INTERACTIVE ENTERTAINMENT SERVICES IN THE NATURE OF PROVIDING PERSONALIZED TELEVISION PROGRAMMING, AND INTERACTIVE TELEVISION PROGRAMMING AND GAMES, AND ENTERTAINMENT INFORMATION, NAMELY, AN ONLINE GUIDE TO PERSONALIZED AND INTERACTIVE TELEVISION PROGRAMMING, IN CLASS 41 (U.S. CLS. 100, 101 AND 107).

THE MARK CONSISTS OF A SEQUENCE OF TWO WOODBLOCK TONES IN INCREASING PITCH, PLAYING THE MUSICAL NOTE D FOLLOWED BY THE MUSICAL NOTE F, JUST ABOVE D.

SEC. 2(F).

SER. NO. 78-815,952, FILED 2-15-2006.

FIRST USE 3-31-1999; IN COMMERCE 3-31-1999.

JASON BLAIR, EXAMINING ATTORNEY

Int. Cls.: 10 and 44

Prior U.S. Cls.: 26, 39, 44, 100 and 101

United States Patent and Trademark Office

Reg. No. 3,398,482

Registered Mar. 18, 2008

**TRADEMARK
SERVICE MARK
PRINCIPAL REGISTER**

EAR-TRONICS

EAR-TRONICS, INC. (FLORIDA CORPORATION)
7181 COLLEGE PARKWAY, #14
FORT MYERS, FL 33907

FOR: HEARING AIDS, IN CLASS 10 (U.S. CLS. 26,
39 AND 44).

FIRST USE 1-1-1982; IN COMMERCE 1-1-1982.

FOR: HEARING AID SERVICES , IN CLASS 44
(U.S. CLS. 100 AND 101).

FIRST USE 1-1-1986; IN COMMERCE 1-1-1986.

THE MARK CONSISTS OF STANDARD CHAR-
ACTERS WITHOUT CLAIM TO ANY PARTICULAR
FONT, STYLE, SIZE, OR COLOR.

OWNER OF U.S. REG. NO. 3,194,050.

SER. NO. 78-821,669, FILED 2-23-2006.

SHANNON TWOHIG, EXAMINING ATTORNEY

Int. Cl.: 3

Prior U.S. Cls.: 1, 4, 6, 50, 51 and 52

United States Patent and Trademark Office

Reg. No. 3,398,483

Registered Mar. 18, 2008

**TRADEMARK
PRINCIPAL REGISTER**

LA POUDRE C'EST MOI

GUERLAIN S.A. (FRANCE CORPORATION)
68, AVENUE DES CHAMPS-ELYSEES
75008 PARIS, FRANCE

FOR: COSMETICS, IN CLASS 3 (U.S. CLS. 1, 4, 6, 50,
51 AND 52).

THE MARK CONSISTS OF STANDARD CHAR-
ACTERS WITHOUT CLAIM TO ANY PARTICULAR
FONT, STYLE, SIZE, OR COLOR.

OWNER OF FRANCE REG. NO. 98742841, DATED
7-13-1998, EXPIRES 7-13-2008.

NO CLAIM IS MADE TO THE EXCLUSIVE
RIGHT TO USE "LA POUDRE", APART FROM
THE MARK AS SHOWN.

THE FOREIGN WORDING IN THE MARK
TRANSLATES INTO ENGLISH AS "I AM THE
POWDER" OR "THE POWDER, IT IS ME"

SER. NO. 78-821,920, FILED 2-23-2006.

MICHAEL GAAFAR, EXAMINING ATTORNEY

Int. Cl.: 36

Prior U.S. Cls.: 100, 101 and 102

United States Patent and Trademark Office

Reg. No. 3,398,484

Registered Mar. 18, 2008

**SERVICE MARK
PRINCIPAL REGISTER**



BIOXESS CORPORATION (CALIFORNIA CORPORATION)
65 ENTERPRISE
ALISO VIEJO, CA 92656

FOR: ELECTRONIC CASH TRANSACTIONS, ELECTRONIC CREDIT CARD TRANSACTIONS, ELECTRONIC DEBIT TRANSACTIONS, ELECTRONIC FUNDS TRANSFER, ELECTRONIC FUNDS TRANSFER BY TELECOMMUNICATIONS, ELECTRONIC TRANSFERS OF MONEY, IN CLASS 36 (U.S. CLS. 100, 101 AND 102).

FIRST USE 2-6-2006; IN COMMERCE 2-6-2006.

THE COLOR(S) PURPLE, GRAY, GREEN, AND BLACK IS/ARE CLAIMED AS A FEATURE OF THE MARK.

THE MARK CONSISTS OF AN IMAGE OF A PURPLE LAPTOP COMPUTER WITH A GRAY SCREEN AND GRAY BUTTONS, OPEN AND LEANING AT AN ANGLE AGAINST A PURPLE RECTANGLE NEXT TO AN IMAGE OF A CURVED, TWO PIECE GREEN \$100 DOLLAR BILL AND BOTH IMAGES ARE ABOVE THE BLOCK LETTERS OF THE COMPOUND WORD KUSHCASH, THE FIRST HALF OF THE WORD IN BLACK AND THE SECOND HALF IN GREEN.

SER. NO. 78-822,294, FILED 2-23-2006.

NANCY CLARKE, EXAMINING ATTORNEY

Int. Cls.: 35, 38 and 41

Prior U.S. Cls.: 100, 101, 102, 104 and 107

United States Patent and Trademark Office

Reg. No. 3,398,485

Registered Mar. 18, 2008

**SERVICE MARK
PRINCIPAL REGISTER**



WOMEN IN CONSULTING (CALIFORNIA CORPORATION)
PO BOX 36255
SAN JOSE, CA 95158

FOR: ASSOCIATION SERVICES, NAMELY, PROMOTING THE INTERESTS OF GENERAL AND SPECIALIZED CONSULTANTS; PROVIDING A WEB SITE FEATURING BUSINESS INFORMATION RELATING TO GENERAL AND SPECIALIZED CONSULTING SERVICES, IN CLASS 35 (U.S. CLS. 100, 101 AND 102).

FIRST USE 1-31-2003; IN COMMERCE 1-31-2003.

FOR: PROVIDING ON-LINE ELECTRONIC BULLETIN BOARDS IN THE NATURE OF E-MAIL LISTS FOR THE TRANSMISSION OF MESSAGES AMONG USERS IN THE FIELD OF GENERAL AND SPECIALIZED CONSULTING SERVICES, IN CLASS 38 (U.S. CLS. 100, 101 AND 104).

FIRST USE 1-31-2003; IN COMMERCE 1-31-2003.

FOR: PROVIDING ONLINE NON-DOWNLOADABLE NEWSLETTERS AND OTHER MATERIALS IN THE NATURE OF INFORMATIONAL BROCHURES AND BOOKLETS RELATING TO GENERAL AND SPECIALIZED CONSULTING SERVICES OFFERED BY MEMBERS, IN CLASS 41 (U.S. CLS. 100, 101 AND 107).

FIRST USE 1-31-2003; IN COMMERCE 1-31-2003.

NO CLAIM IS MADE TO THE EXCLUSIVE RIGHT TO USE "WOMEN IN CONSULTING", APART FROM THE MARK AS SHOWN.

THE MARK CONSISTS OF THE LETTER "W" IN A SHADED BOX, FOLLOWED BY THE WORDS WOMEN IN CONSULTING, ALL ON THE SAME LINE.

SER. NO. 78-823,364, FILED 2-25-2006.

KATHERINE CONNOLLY, EXAMINING ATTORNEY

Int. Cl.: 6

Prior U.S. Cls.: 2, 12, 13, 14, 23, 25 and 50

Reg. No. 3,398,486

United States Patent and Trademark Office

Registered Mar. 18, 2008

**TRADEMARK
PRINCIPAL REGISTER**

TUBULAR USA

TUBULAR USA, INC. (MISSOURI CORPORATION)
830 WESTWOOD INDUSTRIAL PARK DRIVE
WELDON SPRING, MO 63304

FOR: METAL BUILDING MATERIALS, NAME-
LY, STEEL PIPES AND TUBING, IN CLASS 6 (U.S.
CLS. 2, 12, 13, 14, 23, 25 AND 50).

FIRST USE 7-2-1998; IN COMMERCE 7-2-1998.

THE MARK CONSISTS OF STANDARD CHAR-
ACTERS WITHOUT CLAIM TO ANY PARTICULAR
FONT, STYLE, SIZE, OR COLOR.

OWNER OF U.S. REG. NO. 2,358,836.

NO CLAIM IS MADE TO THE EXCLUSIVE
RIGHT TO USE "TUBULAR", APART FROM THE
MARK AS SHOWN.

SEC. 2(F).

SER. NO. 78-823,802, FILED 2-27-2006.

WOODROW HARTZOG, EXAMINING ATTORNEY

Int. Cl.: 31

Prior U.S. Cls.: 1 and 46

United States Patent and Trademark Office

Reg. No. 3,398,487

Registered Mar. 18, 2008

**TRADEMARK
PRINCIPAL REGISTER**

AXO-MAMA

THE LITTLE POTATO COMPANY LTD (CANADA CORPORATION)
11720-170 STREET
EDMONTON, ALBERTA, CANADA T5S1J7

FOR: FRESH POTATOES; RAW POTATOES; UNPROCESSED POTATOES, IN CLASS 31 (U.S. CLS. 1 AND 46).

THE MARK CONSISTS OF STANDARD CHARACTERS WITHOUT CLAIM TO ANY PARTICULAR FONT, STYLE, SIZE, OR COLOR.

PRIORITY CLAIMED UNDER SEC. 44(D) ON CANADA APPLICATION NO. 1273966, FILED 9-29-2005, REG. NO. TMA691326, DATED 7-4-2007, EXPIRES 7-4-2022.

SER. NO. 78-826,447, FILED 3-1-2006.

SUSAN RICHARDS, EXAMINING ATTORNEY

Int. Cls.: 37 and 42

Prior U.S. Cls.: 100, 101, 103 and 106

United States Patent and Trademark Office

Reg. No. 3,398,488

Registered Mar. 18, 2008

**SERVICE MARK
PRINCIPAL REGISTER**

**Bringing the Power of
Tomorrow to Business Today**

OSAM DOCUMENT SOLUTIONS INC (ARIZONA CORPORATION)
3520 NORTH 16TH STREET
PHOENIX, AZ 85016

FOR: REPAIR AND MAINTENANCE OF DIGITAL SCANNER, MICROFILM AND MICROFICHE READERS AND PRINTERS, AND MULTI-FUNCTION NETWORK PRINTER/SCANNER/COPIERS , IN CLASS 37 (U.S. CLS. 100, 103 AND 106).

FIRST USE 4-13-2005; IN COMMERCE 4-13-2005.

FOR: TECHNICAL SUPPORT SERVICES, NAME- LY, TROUBLESHOOTING OF ELECTRONIC DATA MANAGEMENT SOFTWARE PROBLEMS; DATA CONVERSION OF COMPUTER PROGRAMS AND

DATA FROM HARD-COPY TO DIGITAL, DIGITAL- TO-DIGITAL, MICROFILM AND MICROFICHE TO DIGITAL, HARD-COPY TO MICROFILM TO MI- CROFICHE, AND HARD-COPY, DIGITAL, MICRO- FILM, AND MICROFICHE TO APERTURE CARD, IN CLASS 42 (U.S. CLS. 100 AND 101).

FIRST USE 4-13-2005; IN COMMERCE 4-13-2005.

THE MARK CONSISTS OF STANDARD CHAR- ACTERS WITHOUT CLAIM TO ANY PARTICULAR FONT, STYLE, SIZE, OR COLOR.

SER. NO. 78-826,760, FILED 3-1-2006.

HOWARD B. LEVINE, EXAMINING ATTORNEY

Int. Cl.: 19

Prior U.S. Cls.: 1, 12, 33 and 50

United States Patent and Trademark Office

Reg. No. 3,398,489

Registered Mar. 18, 2008

**TRADEMARK
PRINCIPAL REGISTER**

GORILLAGRID

CHECKMATE GEOSYNTHETICS INC. (CANADA CORPORATION)
28 - 6014 VEDDER ROAD
CHILLIWACK, BRITISH COLUMBIA, CANADA
V2R 5M4

FOR: PLASTIC GEOSYNTHETIC REINFORCEMENT GRIDS FOR USE IN ROAD CONSTRUCTION, IN CLASS 19 (U.S. CLS. 1, 12, 33 AND 50).

THE MARK CONSISTS OF STANDARD CHARACTERS WITHOUT CLAIM TO ANY PARTICULAR FONT, STYLE, SIZE, OR COLOR.

PRIORITY CLAIMED UNDER SEC. 44(D) ON CANADA APPLICATION NO. 1271178, FILED 9-7-2005, REG. NO. TMA682,440, DATED 2-27-2007, EXPIRES 2-27-2022.

SER. NO. 78-830,388, FILED 3-6-2006.

KELLY BOULTON, EXAMINING ATTORNEY

Int. Cl.: 44

Prior U.S. Cls.: 100 and 101

United States Patent and Trademark Office

Reg. No. 3,398,490

Registered Mar. 18, 2008

**SERVICE MARK
PRINCIPAL REGISTER**

**THE TRILOGY OF OPTIMAL
HEALTH**

JASON ENTERPRISES, INC. (TEXAS CORPORATION)
6116 N. CENTRAL EXPRESSWAY, SUITE 304B
DALLAS, TX 75206

FOR: HEALTH CARE SERVICES, NAMELY, DISEASE MANAGEMENT AND WELLNESS PROGRAMS FOR THE PURPOSE OF DISEASE, WEIGHT, WELLNESS AND HEALTH MANAGEMENT; WEIGHT REDUCTION DIET PLANNING AND SUPERVISION FOR THE PURPOSE OF DISEASE, WEIGHT, WELLNESS AND HEALTH MANAGEMENT, IN CLASS 44 (U.S. CLS. 100 AND 101).

FIRST USE 12-31-2004; IN COMMERCE 12-31-2004.

THE MARK CONSISTS OF STANDARD CHARACTERS WITHOUT CLAIM TO ANY PARTICULAR FONT, STYLE, SIZE, OR COLOR.

NO CLAIM IS MADE TO THE EXCLUSIVE RIGHT TO USE "HEALTH", APART FROM THE MARK AS SHOWN.

SER. NO. 78-832,229, FILED 3-8-2006.

H. M. FISHER, EXAMINING ATTORNEY

Int. Cl.: 35

Prior U.S. Cls.: 100, 101 and 102

United States Patent and Trademark Office

Reg. No. 3,398,491

Registered Mar. 18, 2008

**SERVICE MARK
PRINCIPAL REGISTER**

COLLEGIATE SUPERSTORE

BARNES & NOBLE COLLEGE BOOKSELLERS,
INC. (NEW YORK CORPORATION)
120 MOUNTAIN VIEW BOULEVARD
BASKING RIDGE, NJ 07920

FOR: RETAIL AND ONLINE RETAIL BOOK-
STORE SERVICES FEATURING NEW AND USED
TEXTBOOKS, BOOKS, MAGAZINES, NEWSPA-
PERS, CLOTHING, SCHOOL SUPPLIES, SOFT-
WARE, GAMES, DVDS, PRE-RECORDED MUSIC
ON CD AND CASSETTE, GENERAL GIFTWARE
ITEMS, FOOD AND BEVERAGES, IN CLASS 35 (U.S.
CLS. 100, 101 AND 102).

FIRST USE 12-31-1995; IN COMMERCE 12-31-1995.

THE MARK CONSISTS OF STANDARD CHAR-
ACTERS WITHOUT CLAIM TO ANY PARTICULAR
FONT, STYLE, SIZE, OR COLOR.

NO CLAIM IS MADE TO THE EXCLUSIVE
RIGHT TO USE "SUPERSTORE", APART FROM
THE MARK AS SHOWN.

SEC. 2(F).

SER. NO. 78-836,339, FILED 3-14-2006.

KAPIL BHANOT, EXAMINING ATTORNEY

Int. Cl.: 9

Prior U.S. Cls.: 21, 23, 26, 36 and 38

United States Patent and Trademark Office

Reg. No. 3,398,492

Registered Mar. 18, 2008

**TRADEMARK
PRINCIPAL REGISTER**

CRITERION

CRI SYSTEMS, INC. (MARYLAND CORPORATION)
6671-H SANTA BARBARA ROAD
ELKRIDGE, MD 21075

FOR: LOAN ORIGATION, CROSS SELLING
AND WORK FLOW SOFTWARE PROGRAMS FOR
USE BY FINANCIAL INSTITUTIONS, IN CLASS 9
(U.S. CLS. 21, 23, 26, 36 AND 38).

FIRST USE 11-15-1992; IN COMMERCE 11-15-1992.

THE MARK CONSISTS OF STANDARD CHARACTERS WITHOUT CLAIM TO ANY PARTICULAR FONT, STYLE, SIZE, OR COLOR.

SER. NO. 78-838,857, FILED 3-16-2006.

AISHA SALEM, EXAMINING ATTORNEY

Int. Cl.: 42

Prior U.S. Cls.: 100 and 101

United States Patent and Trademark Office

Reg. No. 3,398,493

Registered Mar. 18, 2008

**SERVICE MARK
PRINCIPAL REGISTER**

**THE PHARMACEUTICAL VALUE
INDEX**

CENTER FOR VALUE-BASED MEDICINE, LLC
(PENNSYLVANIA LTD LIAB CO)
P.O. BOX 335
FLOURTOWN, PA 19031

FOR: PROVIDING DATABASES FEATURING INFORMATION IN THE FIELD OF HEALTH CARE ECONOMICS, NAMELY, THE STUDY OF THE DISTRIBUTION OF HEALTH CARE SERVICES TO PATIENTS AND HEALTH CARE UTILIZATION AND REVIEW SERVICES; PROVIDING DATABASES FEATURING INFORMATION IN THE FIELD OF PATIENT BENEFIT QUANTIFICATION, NAMELY, DATA COMPILING AND ANALYZING IN THE FIELD OF INSURANCE; PROVIDING ECONOMIC ANALYSIS SERVICES IN THE FIELD OF THE DISTRIBUTION OF HEALTH CARE SERVICES TO PATIENTS; AND PROVIDING ECONOMIC ANALY-

SIS SERVICES IN THE FIELD OF HEALTH CARE PATIENTS' DISABILITIES AS THEY RELATE TO CALCULATING HEALTH CARE BENEFITS, IN CLASS 42 (U.S. CLS. 100 AND 101).

FIRST USE 10-0-2002; IN COMMERCE 10-0-2002.

THE MARK CONSISTS OF STANDARD CHARACTERS WITHOUT CLAIM TO ANY PARTICULAR FONT, STYLE, SIZE, OR COLOR.

SEC. 2(F).

SER. NO. 78-840,873, FILED 3-20-2006.

AISHA CLARKE, EXAMINING ATTORNEY

Int. Cl.: 9

Prior U.S. Cls.: 21, 23, 26, 36 and 38

Reg. No. 3,398,494

United States Patent and Trademark Office

Registered Mar. 18, 2008

**TRADEMARK
PRINCIPAL REGISTER**

OMOX

SEMICONDUCTOR ENERGY LABORATORY
CO., LTD. (JAPAN CORPORATION)
398 HASE, ATSUGI-SHI
KANAGAWA-KEN, JAPAN 243-0036

FOR: PHYSICAL AND CHEMICAL MACHINES OR APPARATUS, NAMELY, HAND-HELD DEVICES COMPRISED OF CHEMICAL AND HEAT SENSORS FOR THE DETECTION OF EXPLOSIVES; PLATES, GLASS SLIDES OR CHIPS HAVING MULTI-WELL ARRAYS THAT CAN BE USED IN CHEMICAL ANALYSIS, BIOLOGICAL ANALYSIS OR PATTERNING FOR SCIENTIFIC, LABORATORY OR MEDICAL RESEARCH USE; MEASURING MACHINES OR APPARATUS, NAMELY, INSTRUMENTS FOR MEASURING LENGTH, FLUOROMETERS, RESISTANCE MEASURING INSTRUMENTS; ELECTRONIC MAGNETOMETER; PHOTOGRAPH MACHINES OR APPARATUS, NAMELY, PHOTOGRAPHIC CAMERAS, PHOTOGRAPHIC FILTERS; MOTION-PICTURE MACHINES OR APPARATUS, NAMELY, MOTION PICTURE CAMERAS, COLOR FILTERS FOR MOTION PICTURE FILM CAMERAS; OPTICAL MACHINES OR APPARATUS, NAMELY, FILTERS FOR OPTICAL DEVICES, OPTICAL CABLES, BLANK OPTICAL DISCS; TELEVISION TELEPHONES, NAMELY, VIDEO-TELEPHONES; ELECTRICAL COMMUNICATION MACHINES OR APPARATUS FOR TELEVISION CONFERENCE SYSTEM, NAMELY, VIDEO CAMERAS, VIDEO MONITORS, SPEAKERS; MOBILE TELEPHONES; DIGITAL CAMERAS; DIGITAL VIDEO CAMERAS; ELECTRICAL COMMUNICATION MACHINES OR APPARATUS, NAMELY, TELECOMMUNICATIONS AND DATA NETWORKING HARDWARE, NAMELY, DEVICES FOR TRANSPORTING AND AGGREGATING VOICE, DATA AND VIDEO COMMUNICATIONS ACROSS MULTIPLE NETWORK INFRASTRUCTURES AND COMMUNICATIONS PROTOCOLS, COMMUNICATION HUBS; TELEVISION GAME MACHINES FOR COMMER-

CIAL USE, NAMELY, VIDEO GAME MACHINES FOR USE WITH TELEVISIONS, VIDEO OUTPUT GAME MACHINES FOR USE WITH TELEVISIONS; SIMULATORS FOR TRAINING EXERCISES, NAMELY, FLIGHT SIMULATORS; SIMULATORS FOR TRAINING FOR DRIVING A VEHICLE; TRIANGLE SIGNS FOR ALERTING VEHICLES ABOUT AN ACCIDENT, NAMELY, LUMINOUS OR MECHANICAL SIGNS; FLASH OR MECHANICAL TRAFFIC SIGNS, NAMELY, LUMINOUS OR MECHANICAL ROAD SIGNS; APPARATUS FOR A FILLING STATION, NAMELY, ELECTRONIC VALVES FOR CONTROLLING GAS OR FLUIDS, METERED GASOLINE PUMPS; VENDING MACHINES; GATE OPERATED BY COINS FOR PARKING, NAMELY, COIN OPERATED GATES FOR CAR PARKING FACILITIES; MACHINES FOR COUNTING OR SORTING COINS; PHOTOCOPIERS; ELECTRONIC CALCULATORS; CALCULATORS FOR VOTES; TELEVISION GAMES FOR HOME USE, NAMELY, VIDEO GAME CARTRIDGES, VIDEO-GAME SOFTWARE; SEMICONDUCTOR ELEMENTS, NAMELY, SEMICONDUCTOR SWITCHING ELEMENTS, SEMICONDUCTOR SENSORS, SEMICONDUCTOR ELEMENTS CONSTITUTING A CIRCUIT; NAVIGATION SYSTEM FOR CAR, NAMELY, CAR NAVIGATION COMPUTERS; FLAT PANEL DISPLAYS, NAMELY, SCREENS, LIQUID CRYSTAL DISPLAY (LCD), LIGHT EMITTING DIODE DISPLAY (LED), ELECTROLUMINESCENT DISPLAY, VACUUM FLUORESCENT DISPLAY, PLASMA DISPLAY PANELS; EL DISPLAY DEVICES, NAMELY, ELECTROLUMINESCENT DISPLAY PANELS; HEAD MOUNTED MONITOR WHICH ENABLES VIEWING AND HEARING VIDEO AND VOICE BY CONNECTING VIDEO DEVICE HAVING VIDEO INPUT; MOBILE COMPUTERS; BODY MOUNTED ELECTRONIC CALCULATORS; ELECTRONIC STILL CAMERAS; TABLET COMPUTERS, NAMELY, THIN LIGHT-WEIGHT DISPLAY DEVICES IN WHICH A SUBSTRATE HAVING INFORMATION PROCESSING

FUNCTIONS IS EMBEDDED, IN CLASS 9 (U.S. CLS. 21, 23, 26, 36 AND 38).

THE MARK CONSISTS OF STANDARD CHARACTERS WITHOUT CLAIM TO ANY PARTICULAR FONT, STYLE, SIZE, OR COLOR.

PRIORITY CLAIMED UNDER SEC. 44(D) ON JAPAN APPLICATION NO. 2005-095981, FILED 10-

14-2005, REG. NO. 4983577, DATED 9-1-2006, EXPIRES 9-1-2016.

SER. NO. 78-842,068, FILED 3-21-2006.

KATHERINE M. DUBRAY, EXAMINING ATTORNEY

Int. Cl.: 9

Prior U.S. Cls.: 21, 23, 26, 36 and 38

United States Patent and Trademark Office

Reg. No. 3,398,495

Registered Mar. 18, 2008

**TRADEMARK
PRINCIPAL REGISTER**

I-Lighting

SUNPLUS TECHNOLOGY CO., LTD. (TAIWAN CORPORATION)
SCIENCE-BASED INDUSTRIAL PARK
19, INNOVATION ROAD 1
HSIN-CHU, TAIWAN

FOR: DIGITAL STILL CAMERA; PC CAMERA; ELECTRONIC INTEGRATED CIRCUITS; ELECTRONIC CAMERA CHIPS FOR USE IN CELLULAR PHONE; CAMERA MODULES FOR USE IN CELLULAR PHONE, IN CLASS 9 (U.S. CLS. 21, 23, 26, 36 AND 38).

THE MARK CONSISTS OF STANDARD CHARACTERS WITHOUT CLAIM TO ANY PARTICULAR FONT, STYLE, SIZE, OR COLOR.

OWNER OF TAIWAN REG. NO. 01248787, DATED 2-1-2007, EXPIRES 1-31-2017.

SER. NO. 78-843,045, FILED 3-22-2006.

SETH A. RAPPAPORT, EXAMINING ATTORNEY

Int. Cl.: 43

Prior U.S. Cls.: 100 and 101

United States Patent and Trademark Office

Reg. No. 3,398,496

Registered Mar. 18, 2008

SERVICE MARK
PRINCIPAL REGISTER



SARAH SALIM SORATHIA INC (FLORIDA CORPORATION)

7617 TERRACE RIVER DR

TAMPA, FL 33637

FOR: RESTAURANT, IN CLASS 43 (U.S. CLS. 100 AND 101).

FIRST USE 8-1-2005; IN COMMERCE 8-1-2005.

NO CLAIM IS MADE TO THE EXCLUSIVE RIGHT TO USE "PHILLYSTEAK & GYROS" AND "WINGS", APART FROM THE MARK AS SHOWN.

SLIM ORLANDO'S DOES NOT IDENTIFY A LIVING INDIVIDUAL.

SER. NO. 78-843,805, FILED 3-22-2006.

KATHERINE CONNOLLY, EXAMINING ATTORNEY

Int. Cl.: 14

Prior U.S. Cls.: 2, 27, 28 and 50

United States Patent and Trademark Office

Reg. No. 3,398,497

Registered Mar. 18, 2008

**TRADEMARK
PRINCIPAL REGISTER**

Lucello

LUCCELLO, INC. (NEW YORK CORPORATION)
2 W. 46TH ST., #808
NEW YORK, NY 10036

FOR: ANKLE BRACELETS; BRACELETS; BRACELETS OF PRECIOUS METAL; EAR STUDS; EARRINGS; IDENTIFICATION BRACELETS; JEWEL PENDANTS; JEWELRY; JEWELRY CHAINS; JEWELRY FOR THE HEAD; JEWELRY, NAMELY, AMULETS; JEWELRY, NAMELY, CROSSES; KEY RINGS OF PRECIOUS METAL; NECKLACES; PENDANTS; PET JEWELRY; PINS BEING JEWELRY; RINGS; RINGS BEING JEWELRY; RUBBER OR SILICON WRISTBANDS IN THE NATURE OF A

BRACELET; WATCH BOXES, IN CLASS 14 (U.S. CLS. 2, 27, 28 AND 50).

FIRST USE 8-23-1993; IN COMMERCE 8-23-1993.

THE MARK CONSISTS OF STANDARD CHARACTERS WITHOUT CLAIM TO ANY PARTICULAR FONT, STYLE, SIZE, OR COLOR.

THE FOREIGN WORDING IN THE MARK TRANSLATES INTO ENGLISH AS "THE BIRD."

SER. NO. 78-844,434, FILED 3-23-2006.

MARLENE BELL, EXAMINING ATTORNEY

Int. Cl.: 19

Prior U.S. Cls.: 1, 12, 33 and 50

United States Patent and Trademark Office

Reg. No. 3,398,498

Registered Mar. 18, 2008

**TRADEMARK
PRINCIPAL REGISTER**

CAPRIZI

SAROYAN LUMBER CO. (CALIFORNIA CORPORATION)
6230 SOUTH ALAMEDA STREET
HUNTINGTON PARK, CA 902553503

THE MARK CONSISTS OF STANDARD CHARACTERS WITHOUT CLAIM TO ANY PARTICULAR FONT, STYLE, SIZE, OR COLOR.

FOR: FLOOR BOARDS; WOODEN FLOORING,
IN CLASS 19 (U.S. CLS. 1, 12, 33 AND 50).

SER. NO. 78-844,461, FILED 3-23-2006.

FIRST USE 1-26-2006; IN COMMERCE 1-26-2006.

PRISCILLA MILTON, EXAMINING ATTORNEY

Int. Cls.: 9 and 41

Prior U.S. Cls.: 21, 23, 26, 36, 38, 100, 101 and 107

United States Patent and Trademark Office

Reg. No. 3,398,499

Registered Mar. 18, 2008

**TRADEMARK
SERVICE MARK
PRINCIPAL REGISTER**

DOUBLE BASS

DOUBLE BASS PRODUCTIONS (CALIFORNIA
SOLE PROPRIETORSHIP)
13500 HAYNES STREET
VAN NUYS, CA 91401

FOR: VIDEO RECORDINGS FEATURING
DANCE PERFORMANCES, IN CLASS 9 (U.S. CLS.
21, 23, 26, 36 AND 38).

FIRST USE 9-0-2004; IN COMMERCE 9-0-2004.

FOR: ENTERTAINMENT IN THE NATURE OF
DANCE PERFORMANCES, IN CLASS 41 (U.S. CLS.
100, 101 AND 107).

FIRST USE 9-0-2004; IN COMMERCE 9-0-2004.

THE MARK CONSISTS OF STANDARD CHAR-
ACTERS WITHOUT CLAIM TO ANY PARTICULAR
FONT, STYLE, SIZE, OR COLOR.

SER. NO. 78-844,907, FILED 3-23-2006.

ROBERT C. CLARK JR., EXAMINING ATTORNEY

Int. Cl.: 41

Prior U.S. Cls.: 100, 101 and 107

United States Patent and Trademark Office

Reg. No. 3,398,500

Registered Mar. 18, 2008

**SERVICE MARK
PRINCIPAL REGISTER**

Easton Gym Co.

JOHNSON & SHADLE LLC (CALIFORNIA LTD
LIAB CO)
8053 BEVERLY BLVD.
LOS ANGELES, CA 90048

FOR: HEALTH CLUB SERVICES, NAMELY, PRO-
VIDING INSTRUCTION AND EQUIPMENT IN THE
FIELD OF PHYSICAL EXERCISE, IN CLASS 41 (U.S.
CLS. 100, 101 AND 107).

FIRST USE 3-11-2005; IN COMMERCE 3-11-2005.

THE MARK CONSISTS OF STANDARD CHAR-
ACTERS WITHOUT CLAIM TO ANY PARTICULAR
FONT, STYLE, SIZE, OR COLOR.

NO CLAIM IS MADE TO THE EXCLUSIVE
RIGHT TO USE "GYM CO.", APART FROM THE
MARK AS SHOWN.

THE NAME(S), PORTRAIT(S), AND/OR SIGNA-
TURE(S) SHOWN IN THE MARK DOES NOT IDENT-
TIFY A PARTICULAR LIVING INDIVIDUAL.

SER. NO. 78-846,087, FILED 3-24-2006.

DAVID I, EXAMINING ATTORNEY

Int. Cl.: 35

Prior U.S. Cls.: 100, 101 and 102

United States Patent and Trademark Office

Reg. No. 3,398,501

Registered Mar. 18, 2008

**SERVICE MARK
PRINCIPAL REGISTER**



VEROS SOFTWARE INC. (CALIFORNIA CORPORATION)
2333 N. BROADWAY SUITE 350
SANTA ANA, CA 92706

FOR: PROVIDING DATA ANALYSIS SERVICES FOR DECISION MANAGEMENT THROUGH THE USE OF COMPUTER SOFTWARE AND PROVIDED TO THE MORTGAGE, INSURANCE, ENGINEERING, AND FINANCIAL INVESTMENTS INDUSTRIES, IN CLASS 35 (U.S. CLS. 100, 101 AND 102).

FIRST USE 5-1-2001; IN COMMERCE 9-1-2002.

THE COLOR(S) BLUE AND BLACK IS/ARE CLAIMED AS A FEATURE OF THE MARK.

THE MARK CONSISTS OF THE COLOR BLUE APPEARING ON A CURVED "V" SHAPED BAND DESIGN AND THE COLOR BLACK APPEARING ON THE WORDING VEROS. THE COLOR WHITE APPEARS AS A BACKGROUND OR TRANSPARENT AREA AND IS NOT A PART OF THE MARK.

SER. NO. 78-846,743, FILED 3-27-2006.

LINDA ESTRADA, EXAMINING ATTORNEY

Int. Cl.: 41

Prior U.S. Cls.: 100, 101 and 107

Reg. No. 3,398,502

United States Patent and Trademark Office

Registered Mar. 18, 2008

**SERVICE MARK
PRINCIPAL REGISTER**



MILWAUKEE COUNTY DEPARTMENT OF
AGING (WISCONSIN STATE AGENCY)
SUITE 3300
310 W. WISCONSIN AVENUE
MILWAUKEE, WI 53203

FOR: EDUCATIONAL SERVICES IN THE FIELD
OF LONG TERM CARE, NAMELY, PROVIDING
TRAINING IN THE FIELD OF LONG TERM CARE;
PUBLICATION OF ON-LINE BROCHURES, PRIN-
TED MATERIALS, AND AUDIO-VISUAL MEDIA IN
THE FIELD OF LONG TERM CARE; ARRANGING
AND CONDUCTING EDUCATIONAL CONFEREN-

CES, WORKSHOPS, AND SEMINARS IN THE FIELD
OF LONG TERM CARE; DEVELOPING AND DIS-
SEMINATING EDUCATIONAL MATERIALS FOR
OTHERS IN THE FIELD OF LONG TERM CARE, IN
CLASS 41 (U.S. CLS. 100, 101 AND 107).

FIRST USE 9-23-2005; IN COMMERCE 9-23-2005.

SER. NO. 78-847,144, FILED 3-27-2006.

DORITT L. CARROLL, EXAMINING ATTORNEY

Int. Cl.: 41

Prior U.S. Cls.: 100, 101 and 107

United States Patent and Trademark Office

Reg. No. 3,398,503

Registered Mar. 18, 2008

**SERVICE MARK
PRINCIPAL REGISTER**

LTC: LET'S TAKE CARE

MILWAUKEE COUNTY DEPARTMENT OF
AGING (WISCONSIN STATE AGENCY)
SUITE 3300
310 W. WISCONSIN AVENUE
MILWAUKEE, WI 53203

FOR: EDUCATIONAL SERVICES IN THE FIELD OF LONG TERM CARE, NAMELY, PROVIDING TRAINING IN THE FIELD OF LONG TERM CARE; PUBLICATION OF ON-LINE BROCHURES, PRINTED MATERIALS, AND AUDIO-VISUAL MEDIA IN THE FIELD OF LONG TERM CARE; ARRANGING AND CONDUCTING EDUCATIONAL CONFERENCES, WORKSHOPS, AND SEMINARS IN THE FIELD OF LONG TERM CARE; DEVELOPING AND DISSEMINATING EDUCATIONAL MATERIALS FOR

OTHERS IN THE FIELD OF LONG TERM CARE, IN CLASS 41 (U.S. CLS. 100, 101 AND 107).

FIRST USE 9-23-2005; IN COMMERCE 9-23-2005.

THE MARK CONSISTS OF STANDARD CHARACTERS WITHOUT CLAIM TO ANY PARTICULAR FONT, STYLE, SIZE, OR COLOR.

NO CLAIM IS MADE TO THE EXCLUSIVE RIGHT TO USE "LTC", APART FROM THE MARK AS SHOWN.

SER. NO. 78-847,162, FILED 3-27-2006.

DORITT L. CARROLL, EXAMINING ATTORNEY

Int. Cl.: 9

Prior U.S. Cls.: 21, 23, 26, 36 and 38

Reg. No. 3,398,504

United States Patent and Trademark Office

Registered Mar. 18, 2008

**TRADEMARK
PRINCIPAL REGISTER**

SG

INFRARED FIBER SYSTEMS, INC. (DELAWARE
CORPORATION)
2301-A BROADBIRCH DR.
SILVER SPRING, MD 20904

FOR: INFRARED FLUORIDE GLASS FIBER FOR
USE IN INDUSTRIAL AND SCIENTIFIC SENSORS,
IN CLASS 9 (U.S. CLS. 21, 23, 26, 36 AND 38).

FIRST USE 3-29-1996; IN COMMERCE 5-3-1996.

THE MARK CONSISTS OF STANDARD CHAR-
ACTERS WITHOUT CLAIM TO ANY PARTICULAR
FONT, STYLE, SIZE, OR COLOR.

SEC. 2(F).

SER. NO. 78-848,589, FILED 3-29-2006.

JEAN IM, EXAMINING ATTORNEY

Int. Cl.: 42

Prior U.S. Cls.: 100 and 101

United States Patent and Trademark Office

Reg. No. 3,398,505

Registered Mar. 18, 2008

**SERVICE MARK
PRINCIPAL REGISTER**



GLANCE NETWORKS, INC. (DELAWARE CORPORATION)

1167 MASSACHUSETTS AVE.
ARLINGTON, MA 02476

FOR: PROVIDING TEMPORARY USE OF NON-DOWNLOADABLE COMPUTER SOFTWARE FOR ENABLING USERS TO REMOTELY VIEW OTHER USER ON-SCREEN APPLICATIONS VIA THE INTERNET., IN CLASS 42 (U.S. CLS. 100 AND 101).

FIRST USE 12-11-2005; IN COMMERCE 12-11-2005.

THE COLOR(S) BLUE, BLACK, AND GRAY IS/ARE CLAIMED AS A FEATURE OF THE MARK.

THE MARK CONSISTS OF A RECTANGLE SURROUNDING THE WORD GLANCE. THE COLOR BLUE APPEARS AS THE BACKGROUND COLOR THAT FADES FROM THE BOTTOM OF THE RECTANGLE TO THE TOP. THE COLOR BLACK APPEARS AS THE LETTERS GL NCE. THE LETTER A IS FORMED FROM A DARK BLUE DOT WITH A BLACK CURVED BAND FORMING THE UPPER PART OF THE A. BLACK ALSO FORMS THE BORDER OF THE MARK. THE COLOR GRAY APPEARS AS THE SHADOW EFFECT TO THE MARK.

SER. NO. 78-848,650, FILED 3-29-2006.

LYDIA BELZER, EXAMINING ATTORNEY

Int. Cl.: 40

Prior U.S. Cls.: 100, 103 and 106

United States Patent and Trademark Office

Reg. No. 3,398,506

Registered Mar. 18, 2008

**SERVICE MARK
PRINCIPAL REGISTER**

HAYNES

R AND J CORPORATION (OHIO CORPORATION), DBA HAYNES MANUFACTURING COMPANY
24142 DETROIT ROAD
WESTLAKE, OH 44145

FOR: MANUFACTURING TO THE ORDER AND SPECIFICATION OF OTHERS OF LUBRICANTS FOR USE ON FOOD PROCESSING EQUIPMENT, LUBRICANTS FOR NON-FOOD CONTACT APPLICATIONS, AND NON-METALLIC GASKETS AND SEALS, IN CLASS 40 (U.S. CLS. 100, 103 AND 106).

FIRST USE 12-0-1937; IN COMMERCE 12-0-1937.

THE MARK CONSISTS OF STANDARD CHARACTERS WITHOUT CLAIM TO ANY PARTICULAR FONT, STYLE, SIZE, OR COLOR.

SEC. 2(F).

SER. NO. 78-849,053, FILED 3-29-2006.

DOMINIC J. FERRAIUOLO, EXAMINING ATTORNEY

Int. Cl.: 25

Prior U.S. Cls.: 22 and 39

United States Patent and Trademark Office

Reg. No. 3,398,507

Registered Mar. 18, 2008

**TRADEMARK
PRINCIPAL REGISTER**



HIGH SPEED PRODUCTIONS, INC. (CALIFORNIA CORPORATION)
1303 UNDERWOOD AVENUE
SAN FRANCISCO, CA 94124

FOR: HATS; SWEAT SHIRTS; T-SHIRTS, IN CLASS 25 (U.S. CLS. 22 AND 39).

FIRST USE 9-30-2002; IN COMMERCE 9-30-2002.

OWNER OF U.S. REG. NOS. 1,447,232 AND 1,593,990.

THE MARK CONSISTS OF A PENTAGRAM, GOAT AND WHEELS.

SER. NO. 78-849,568, FILED 3-29-2006.

NICHOLAS ALTREE, EXAMINING ATTORNEY

Int. Cls.: 35 and 41

Prior U.S. Cls.: 100, 101, 102 and 107

United States Patent and Trademark Office

Reg. No. 3,398,508

Registered Mar. 18, 2008

**SERVICE MARK
PRINCIPAL REGISTER**



ONE STOP WEDDING SHOP, L.L.C. (ILLINOIS
LTD LIAB CO)
5732 E. RIVERSIDE BOULEVARD
LOVES PARK, IL 61111

FOR: RETAIL STORE SERVICES FEATURING
WEDDING GOWNS, GARMENTS, AND ACCES-
SORIES AND WEDDING RELATED GOODS, IN
CLASS 35 (U.S. CLS. 100, 101 AND 102).

FIRST USE 6-30-2004; IN COMMERCE 2-28-2005.

FOR: SPECIAL EVENT PLANNING, NAMELY,
WEDDING PLANNING, MANAGEMENT, COORDI-
NATION AND CONSULTATION, IN CLASS 41 (U.S.
CLS. 100, 101 AND 107).

FIRST USE 6-30-2004; IN COMMERCE 2-28-2005.

NO CLAIM IS MADE TO THE EXCLUSIVE
RIGHT TO USE "WEDDING SHOP", APART FROM
THE MARK AS SHOWN.

THE MARK CONSISTS OF THE INTERIOR OF
THE CIRCLE AROUND THE LITERAL ELEMENTS
1 STOP.

SER. NO. 78-850,337, FILED 3-30-2006.

DAVID I, EXAMINING ATTORNEY

Int. Cl.: 44

Prior U.S. Cls.: 100 and 101

United States Patent and Trademark Office

Reg. No. 3,398,509

Registered Mar. 18, 2008

**SERVICE MARK
PRINCIPAL REGISTER**



**EAST CAROLINA
HEART INSTITUTE**

PITT COUNTY MEMORIAL HOSPITAL, INCORPORATED (NORTH CAROLINA CORPORATION)

PO BOX 6028

GREENVILLE, NC 278356028 AND

EAST CAROLINA UNIVERSITY (NORTH CAROLINA EDUCATIONAL INSTITUTION)

SPILMAN 105

210 SPILMAN BUILDING

GREENVILLE, NC 278584353

FOR: HEALTH CARE SERVICES, IN CLASS 44 (U.S. CLS. 100 AND 101).

FIRST USE 4-2-2006; IN COMMERCE 4-2-2006.

NO CLAIM IS MADE TO THE EXCLUSIVE RIGHT TO USE "EAST CAROLINA HEART INSTITUTE", APART FROM THE MARK AS SHOWN.

THE COLOR(S) BLACK, PURPLE, AND TEAL IS/ ARE CLAIMED AS A FEATURE OF THE MARK.

THE MARK CONSISTS OF THE WORDS EAST CAROLINA HEART INSTITUTE RENDERED IN BLACK, AND TWO INTERLOCKING ELLIPSES, WHERE THE UPPER PORTION OF EACH ELLIPSE IS RENDERED IN PURPLE AND THE LOWER PORTION OF EACH ELLIPSE IS RENDERED IN TEAL.

SER. NO. 78-850,470, FILED 3-30-2006.

CURTIS FRENCH, EXAMINING ATTORNEY

Int. Cl.: 20

Prior U.S. Cls.: 2, 13, 22, 25, 32 and 50

United States Patent and Trademark Office

Reg. No. 3,398,510

Registered Mar. 18, 2008

**TRADEMARK
PRINCIPAL REGISTER**



ACORN KITCHENS (CANADA LIMITED PART-
NERSHIP)
56 TRILLIUM PARK PLACE
KITCHENER, ONTARIO, CANADA M5H 3Y2

FOR: KITCHEN CABINETS, BATHROOM CABI-
NETS AND ENTERTAINMENT CENTERS, IN
CLASS 20 (U.S. CLS. 2, 13, 22, 25, 32 AND 50).

FIRST USE 0-0-1990; IN COMMERCE 0-0-1990.

PRIORITY CLAIMED UNDER SEC. 44(D) ON
CANADA APPLICATION NO. 1279366, FILED 11-14-
2005, REG. NO. TMA681817, DATED 2-16-2007, EX-
PIRES 2-16-2022.

SER. NO. 78-851,697, FILED 3-31-2006.

KATHLEEN LORENZO, EXAMINING ATTORNEY

Int. Cl.: 22

Prior U.S. Cls.: 1, 2, 7, 19, 22, 42 and 50

Reg. No. 3,398,511

United States Patent and Trademark Office

Registered Mar. 18, 2008

**TRADEMARK
PRINCIPAL REGISTER**

ALL AMERICAN

PLYMKRAFT, INC. (DELAWARE CORPORATION)
479 EXPORT CIRCLE
NEWPORT NEWS, VA 23601

THE MARK CONSISTS OF STANDARD CHARACTERS WITHOUT CLAIM TO ANY PARTICULAR FONT, STYLE, SIZE, OR COLOR.

FOR: ROPE; ARBORIST ROPE, IN CLASS 22 (U.S. CLS. 1, 2, 7, 19, 22, 42 AND 50).

SER. NO. 78-853,437, FILED 4-4-2006.

FIRST USE 5-31-2003; IN COMMERCE 5-31-2003.

MARY MUNSON, EXAMINING ATTORNEY

Int. Cl.: 43

Prior U.S. Cls.: 100 and 101

United States Patent and Trademark Office

Reg. No. 3,398,512

Registered Mar. 18, 2008

SERVICE MARK
PRINCIPAL REGISTER



KATHLEEN HANSEN (UNITED STATES INDIVIDUAL)
1888 E. RODEO LANE
KUNA, ID 83634

FOR: BAR SERVICES, RESTAURANT AND BAR SERVICES, TAVERN SERVICES, IN CLASS 43 (U.S. CLS. 100 AND 101).

FIRST USE 8-1-2005; IN COMMERCE 1-6-2006.

NO CLAIM IS MADE TO THE EXCLUSIVE RIGHT TO USE "SALOON & TEQUILARIA", APART FROM THE MARK AS SHOWN.

THE MARK CONSISTS OF COWGIRL PICTURE AND SALOON & TEQUILARIA TEXT.

SER. NO. 78-853,842, FILED 4-4-2006.

DOMINIC J. FERRAIUOLO, EXAMINING ATTORNEY

Int. Cl.: 41

Prior U.S. Cls.: 100, 101 and 107

United States Patent and Trademark Office

Reg. No. 3,398,513

Registered Mar. 18, 2008

**SERVICE MARK
PRINCIPAL REGISTER**

EPIC MEDIA GROUP

EPIC MEDIA GROUP LLC (NEVADA LTD LIAB
CO)
605 S. DOUGLAS STREET
EL SEGUNDO, CA 90245

FOR: SPECIAL EVENT PLANNING, IN CLASS 41
(U.S. CLS. 100, 101 AND 107).

FIRST USE 12-31-2005; IN COMMERCE 12-31-2005.

THE MARK CONSISTS OF STANDARD CHAR-
ACTERS WITHOUT CLAIM TO ANY PARTICULAR
FONT, STYLE, SIZE, OR COLOR.

OWNER OF U.S. REG. NO. 3,023,944.

NO CLAIM IS MADE TO THE EXCLUSIVE
RIGHT TO USE "MEDIA GROUP", APART FROM
THE MARK AS SHOWN.

SER. NO. 78-858,348, FILED 4-10-2006.

CARYN GLASSER, EXAMINING ATTORNEY

Int. Cls.: 35 and 41

Prior U.S. Cls.: 100, 101, 102 and 107

United States Patent and Trademark Office

Reg. No. 3,398,514

Registered Mar. 18, 2008

**SERVICE MARK
PRINCIPAL REGISTER**



WOVI, INC. (TEXAS CORPORATION)
P.O. BOX 803144
DALLAS, TX 753803144

FOR: PROVIDING INFORMATION ABOUT WOMEN IN BUSINESS, IN CLASS 35 (U.S. CLS. 100, 101 AND 102).

FIRST USE 1-18-2004; IN COMMERCE 1-8-2004.

FOR: EDUCATIONAL SERVICES FOR WOMEN, NAMELY, SEMINARS, CONFERENCES, AND WORKSHOPS IN THE FIELD OF PROFESSIONAL

WOMEN AND WOMEN IN BUSINESS AND DISTRIBUTING EDUCATIONAL AND SUPPORT MATERIALS IN CONNECTION THEREWITH; CHARITABLE SERVICES, NAMELY, PROVIDING TRAINING IN THE FIELD OF PROFESSIONAL WOMEN AND BUSINESS, IN CLASS 41 (U.S. CLS. 100, 101 AND 107).

FIRST USE 1-18-2004; IN COMMERCE 1-18-2004.

SER. NO. 78-858,571, FILED 4-11-2006.

SHANNON TWOHIG, EXAMINING ATTORNEY

Int. Cl.: 30

Prior U.S. Cl.: 46

United States Patent and Trademark Office

Reg. No. 3,398,515

Registered Mar. 18, 2008

TRADEMARK
PRINCIPAL REGISTER



FABRICA DE ESPECIAS Y PRODUCTOS EL REY
S.A. (COLOMBIA CORPORATION)
CALLE 40 SUR NO. 68D - 55
7700500 BOGOTA, COLOMBIA

FOR: SPICES; PROCESSED HERBS; CONDIMENTS, NAMELY, ROASTED AND GROUND SESAME SEEDS; MINCED, POWDERED OR PROCESSED SPICES; SEASONINGS AND SEASONING PASTES; CONDIMENTS, NAMELY, GARLIC SAUCE, HOT CHILI SAUCE, SOY SAUCE, BLACK SAUCE, WORCESTERSHIRE SAUCE, ONION SAUCE AND BASIL SAUCE, IN CLASS 30 (U.S. CL. 46).

FIRST USE 1-21-1994; IN COMMERCE 5-11-2000.

THE COLOR(S) RED, YELLOW, WHITE, GOLD, GREEN, BLACK, BLUE AND PEACH IS/ARE CLAIMED AS A FEATURE OF THE MARK.

THE MARK CONSISTS OF THE COLOR RED APPEARS ON THE WORDING EL REY AND ON THE OUTER SQUARE SHAPE WITH CURVED CORNERS AND ON THE RECTANGULAR SHAPE SURROUNDING THE WORDING EL REY. THE

COLOR WHITE APPEARS BEHIND THE WORDING EL REY AND BETWEEN THE INNER AND OUTER SQUARES WITH CURVED CORNERS; THE COLOR PEACH APPEARS ON THE SKIN OF THE STYLIZED KING; THE COLOR WHITE APPEARS ON THE HAIR, BEARD AND MUSTACHE OF THE STYLIZED KING; THE COLORS BLACK, WHITE, AND RED APPEAR ON THE KING'S ROBE; THE COLOR YELLOW APPEARS ON THE KING'S SHIRT; THE COLORS RED, WHITE, GOLD, AND BLUE APPEAR ON THE NECKLACE; THE COLORS GOLD AND GREEN APPEAR ON THE CROWN; THE COLOR BLACK APPEARS ON THE KING'S EYEBROWS, EYES, AND SHADING BENEATH THE KING'S NOSE; THE COLOR YELLOW APPEARS ON THE BACKGROUND BEHIND THE KING; THE COLOR RED APPEARS ON THE INNER SQUARE WITH CURVED CORNERS SURROUNDING THE KING.

THE FOREIGN WORDING IN THE MARK TRANSLATES INTO ENGLISH AS THE KING.

SER. NO. 78-860,672, FILED 4-13-2006.

COLLEEN DOMBROW, EXAMINING ATTORNEY

Int. Cl.: 32

Prior U.S. Cls.: 45, 46 and 48

United States Patent and Trademark Office

Reg. No. 3,398,516

Registered Mar. 18, 2008

**TRADEMARK
PRINCIPAL REGISTER**

ROCKSTAR

WEINER, RUSSELL G. (UNITED STATES INDIVIDUAL)

P.O. BOX 27740

101 CONVENTION CENTER DRIVE, SUITE 777

LAS VEGAS, NV 89126

FOR: SPORTS DRINKS, NAMELY, ENERGY DRINKS, IN CLASS 32 (U.S. CLS. 45, 46 AND 48).

FIRST USE 8-19-1999; IN COMMERCE 8-19-1999.

THE MARK CONSISTS OF STANDARD CHARACTERS WITHOUT CLAIM TO ANY PARTICULAR FONT, STYLE, SIZE, OR COLOR.

OWNER OF U.S. REG. NOS. 2,545,247, 2,613,067, AND 2,784,403.

SER. NO. 78-862,808, FILED 4-17-2006.

CHRISTOPHER BUONGIORNO, EXAMINING ATTORNEY

Int. Cl.: 18

Prior U.S. Cls.: 1, 2, 3, 22 and 41

United States Patent and Trademark Office

Reg. No. 3,398,517

Registered Mar. 18, 2008

**TRADEMARK
PRINCIPAL REGISTER**

PADDINGTON

CHLOE S.A.S. (FRANCE CORPORATION)
5-7 AVENUE PERCIER
75008 PARIS, FRANCE

FOR: HANDBAGS, PURSES, WALLETS NOT INTENDED FOR CHILDREN, IN CLASS 18 (U.S. CLS. 1, 2, 3, 22 AND 41).

THE MARK CONSISTS OF STANDARD CHARACTERS WITHOUT CLAIM TO ANY PARTICULAR FONT, STYLE, SIZE, OR COLOR.

PRIORITY CLAIMED UNDER SEC. 44(D) ON ERPN CMNTY TM OFC APPLICATION NO. 5006853, FILED 4-7-2006, REG. NO. 005006853, DATED 7-17-2007, EXPIRES 4-7-2016.

SER. NO. 78-863,562, FILED 4-18-2006.

COLLEEN KEARNEY, EXAMINING ATTORNEY

Int. Cls.: 5 and 35

Prior U.S. Cls.: 6, 18, 44, 46, 51, 52, 100, 101 and 102

Reg. No. 3,398,518

United States Patent and Trademark Office

Registered Mar. 18, 2008

**TRADEMARK
SERVICE MARK
PRINCIPAL REGISTER**

creomed

CREOMED, INC. (DELAWARE CORPORATION)
4840 SYCAMORE DRIVE
NAPLES, FL 34119

FOR: NUTRITIONAL PRODUCTS AND NATURAL HEALTH PRODUCTS, NAMELY, VITAMIN AND MINERAL SUPPLEMENTS, HERBAL SUPPLEMENTS, AND NUTRITIONAL AND DIETARY SUPPLEMENTS; MINERAL-DERIVED PRODUCTS, NAMELY, MINERAL NUTRITIONAL SUPPLEMENTS, MINERAL SUPPLEMENTS; PLANT-DERIVED PRODUCTS, NAMELY, PLANT EXTRACTS FOR USE AS NUTRITIONAL SUPPLEMENTS; VITAMIN AND MINERAL PREPARATIONS FOR MEDICAL USE; NUTRACEUTICALS FOR THE MANAGEMENT OF HEALTH AND FOR USE AS A DIETARY SUPPLEMENT, IN CLASS 5 (U.S. CLS. 6, 18, 44, 46, 51 AND 52).

FIRST USE 9-3-2004; IN COMMERCE 9-3-2004.

FOR: IMPORT AGENCIES FEATURING NUTRITIONAL PRODUCTS AND NATURAL HEALTH PRODUCTS, IN PARTICULAR VITAMIN AND MINERAL SUPPLEMENTS, HERBAL SUPPLEMENTS, NUTRITIONAL AND DIETARY SUPPLEMENTS,

MINERAL-DERIVED PRODUCTS, PLANT-DERIVED PRODUCTS, VITAMINS, MINERALS AND PREPARATIONS AND COMPOUNDS THEREOF; DISTRIBUTORSHIP SERVICES IN THE FIELD OF NUTRITIONAL PRODUCTS AND NATURAL HEALTH PRODUCTS, IN PARTICULAR VITAMIN AND MINERAL SUPPLEMENTS, HERBAL SUPPLEMENTS, NUTRITIONAL AND DIETARY SUPPLEMENTS, MINERAL-DERIVED PRODUCTS, PLANT-DERIVED PRODUCTS, VITAMINS, MINERALS AND PREPARATIONS AND COMPOUNDS THEREOF; BUSINESS CONSULTING SERVICES FOR THE PHARMACEUTICAL, NUTRACEUTICAL, DIETARY SUPPLEMENT, AND MEDICAL DEVICE INDUSTRIES, IN CLASS 35 (U.S. CLS. 100, 101 AND 102).

FIRST USE 9-3-2004; IN COMMERCE 9-3-2004.

THE MARK CONSISTS OF STANDARD CHARACTERS WITHOUT CLAIM TO ANY PARTICULAR FONT, STYLE, SIZE, OR COLOR.

SER. NO. 78-863,623, FILED 4-18-2006.

JENNY PARK, EXAMINING ATTORNEY

Int. Cls.: 8, 11, 19, 20, 21, 24 and 27

Prior U.S. Cls.: 1, 2, 12, 13, 19, 20, 21, 22, 23, 25, 28,
29, 30, 31, 32, 33, 34, 37, 40, 42, 44 and 50

Reg. No. 3,398,519

United States Patent and Trademark Office

Registered Mar. 18, 2008

TRADEMARK
PRINCIPAL REGISTER

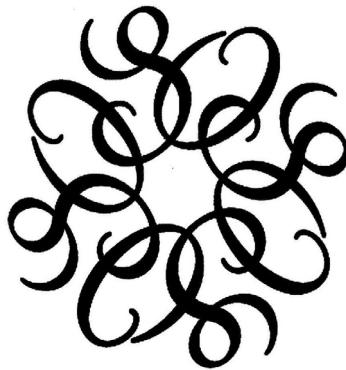

ODEGARD, INC. (NEW YORK CORPORATION)
200 LEXINGTON AVENUE
NEW YORK, NY 10016

FOR: SPOONS, IN CLASS 8 (U.S. CLS. 23, 28 AND 44).

FIRST USE 12-12-2002; IN COMMERCE 12-12-2002.

FOR: LIGHTING, NAMELY, LAMPS, CHANDELIERS, SCENCE LIGHTING FIXTURES, AND PENDANT LIGHTS; AND FOUNTAINS FOR HOME DECORATIVE USE, IN CLASS 11 (U.S. CLS. 13, 21, 23, 31 AND 34).

FIRST USE 12-12-2002; IN COMMERCE 12-12-2002.

FOR: NON-METALIC ARCHITECTURAL PRODUCTS, NAMELY, DOORS, SHUTTERS, LINTELS, AND DECORATIVE WALL PANELS OF WOOD AND MARBLE, IN CLASS 19 (U.S. CLS. 1, 12, 33 AND 50).

FIRST USE 12-12-2002; IN COMMERCE 12-12-2002.

FOR: FURNITURE, NAMELY, DINING TABLES, COFFEE TABLES, SIDE TABLES, CUPBOARDS, BENCHES, DECORATIVE HOUSEHOLD MIRRORS, DRESSERS, ARMOIRES, CHAISE LOUNGES, DAY-

BEDS, CREDENZAS, AND PILLOWS, IN CLASS 20 (U.S. CLS. 2, 13, 22, 25, 32 AND 50).

FIRST USE 12-12-2002; IN COMMERCE 12-12-2002.

FOR: SERVICE BOWLS, GOBLETS, URNS, CANDLESTICKS NOT OF PRECIOUS METAL, TRAYS, PLATES, VASES, AND POTS; SERVING PLATTERS NOT OF PRECIOUS METAL; AND PLANTERS FOR FLOWERS AND PLANTS, IN CLASS 21 (U.S. CLS. 2, 13, 23, 29, 30, 33, 40 AND 50).

FIRST USE 12-12-2002; IN COMMERCE 12-12-2002.

FOR: DECORATIVE THROW BLANKETS, IN CLASS 24 (U.S. CLS. 42 AND 50).

FIRST USE 12-12-2002; IN COMMERCE 12-12-2002.

FOR: RUGS, IN CLASS 27 (U.S. CLS. 19, 20, 37, 42 AND 50).

FIRST USE 12-12-2002; IN COMMERCE 12-12-2002.

THE MARK CONSISTS OF A FANCIFUL DESIGN.

SER. NO. 78-864,752, FILED 4-19-2006.

GEORGE LORENZO, EXAMINING ATTORNEY

Int. Cls.: 35 and 40

Prior U.S. Cls.: 100, 101, 102, 103 and 106

United States Patent and Trademark Office

Reg. No. 3,398,520

Registered Mar. 18, 2008

**SERVICE MARK
PRINCIPAL REGISTER**

PRECISION CONVERTING

HIS COMPANY, INC. (TEXAS CORPORATION)
6650 CONCORD PARK DRIVE
HOUSTON, TX 77040

FOR: CUSTOM PACKAGING SERVICES TO THE
DESIGN AND SPECIFICATIONS OF OTHERS, IN
CLASS 35 (U.S. CLS. 100, 101 AND 102).

FIRST USE 3-0-1987; IN COMMERCE 3-0-1987.

FOR: CUSTOM FABRICATION OF FILMS, FOILS,
PAPER, ADHESIVES AND FABRICS, IN CLASS 40
(U.S. CLS. 100, 103 AND 106).

FIRST USE 3-0-1987; IN COMMERCE 3-0-1987.

THE MARK CONSISTS OF STANDARD CHAR-
ACTERS WITHOUT CLAIM TO ANY PARTICULAR
FONT, STYLE, SIZE, OR COLOR.

SEC. 2(F).

SER. NO. 78-866,368, FILED 4-20-2006.

ALYSSA PALADINO, EXAMINING ATTORNEY

Int. Cls.: 9 and 41

Prior U.S. Cls.: 21, 23, 26, 36, 38, 100, 101 and 107

United States Patent and Trademark Office

Reg. No. 3,398,521

Registered Mar. 18, 2008

**TRADEMARK
SERVICE MARK
PRINCIPAL REGISTER**

Global Communicator

GLOBAL LANGUAGE SOLUTIONS, INC. (CALIFORNIA CORPORATION)
1101 DOVE STREET
SUITE 250
NEWPORT BEACH, CA 92660

FOR: ELECTRONIC PERIODIC PUBLICATIONS, NAMELY, AN E-NEWSLETTER FEATURING A VARIETY OF ISSUES RELATING TO INTERNATIONAL COMMUNICATION, MARKETING, LANGUAGE TRANSLATION AND LOCALIZATION, INTERNATIONAL COMMERCE AND TRADE RECORDED ON COMPUTER MEDIA, IN CLASS 9 (U.S. CLS. 21, 23, 26, 36 AND 38).

FIRST USE 4-0-2000; IN COMMERCE 4-0-2000.

FOR: PROVIDING ON-LINE PERIODIC PUBLICATIONS IN THE NATURE OF E-NEWSLETTERS

FEATURING A VARIETY OF ISSUES RELATING TO INTERNATIONAL COMMUNICATION, MARKETING, LANGUAGE TRANSLATION AND LOCALIZATION, INTERNATIONAL COMMERCE AND TRADE, IN CLASS 41 (U.S. CLS. 100, 101 AND 107).

FIRST USE 1-1-2000; IN COMMERCE 1-1-2000.

THE MARK CONSISTS OF STANDARD CHARACTERS WITHOUT CLAIM TO ANY PARTICULAR FONT, STYLE, SIZE, OR COLOR.

SEC. 2(F).

SER. NO. 78-866,999, FILED 4-21-2006.

ALICE BENMAMAN, EXAMINING ATTORNEY

Int. Cl.: 41

Prior U.S. Cls.: 100, 101 and 107

United States Patent and Trademark Office

Reg. No. 3,398,522

Registered Mar. 18, 2008

**SERVICE MARK
PRINCIPAL REGISTER**

COLDSTREAMS

COLDSTREAMS GROUP (WASHINGTON PART-
NERSHIP)
7717 E. PRINCETON AVE
SPOKANE, WA 99212

FOR: AUDIO PRODUCTION; PRODUCTION OF
VIDEO RECORDINGS FOR STREAMING ON THE
INTERNET; AUDIO AND VIDEO EDITING; DIS-
TRIBUTION OF FILMS AND TELEVISION PRO-
GRAMS AND OF FILMS CREATED FOR
PODCASTING, IN CLASS 41 (U.S. CLS. 100, 101
AND 107).

FIRST USE 12-26-2005; IN COMMERCE 12-26-2005.

THE MARK CONSISTS OF STANDARD CHAR-
ACTERS WITHOUT CLAIM TO ANY PARTICULAR
FONT, STYLE, SIZE, OR COLOR.

SER. NO. 78-867,277, FILED 4-21-2006.

DEBRA LEE, EXAMINING ATTORNEY

Int. Cl.: 6

Prior U.S. Cls.: 2, 12, 13, 14, 23, 25 and 50

Reg. No. 3,398,523

United States Patent and Trademark Office

Registered Mar. 18, 2008

**TRADEMARK
PRINCIPAL REGISTER**



PACIFIC LOCK COMPANY (CALIFORNIA CORPORATION)
21618 MARILLA STREET
CHATSWORTH, CA 91311

FOR: METAL LOCKS, IN CLASS 6 (U.S. CLS. 2, 12, 13, 14, 23, 25 AND 50).

FIRST USE 10-1-2005; IN COMMERCE 10-1-2005.

NO CLAIM IS MADE TO THE EXCLUSIVE RIGHT TO USE "LOCK", APART FROM THE MARK AS SHOWN.

THE MARK CONSISTS OF STYLIZED "P" ON A LOCK NEXT TO THE WORDS "PACIFIC LOCK".

SER. NO. 78-868,574, FILED 4-24-2006.

EUGENIA MARTIN, EXAMINING ATTORNEY

Int. Cl.: 9

Prior U.S. Cls.: 21, 23, 26, 36 and 38

United States Patent and Trademark Office

Reg. No. 3,398,524

Registered Mar. 18, 2008

**TRADEMARK
PRINCIPAL REGISTER**

OEMV

NOVATEL INC. (CANADA CORPORATION)
1120 68TH AVENUE N.E.
CALGARY, CANADA T2E 8S5

FIRST USE 9-14-2005; IN COMMERCE 9-14-2005.

FOR: COMPONENTS FOR USE IN GLOBAL POSITIONING AND NAVIGATION SYSTEMS AND DEVICES, NAMELY, RECEIVERS; SOFTWARE FOR USE IN GLOBAL POSITIONING AND NAVIGATION SYSTEMS AND DEVICES; GLOBAL POSITIONING AND NAVIGATION SYSTEM RECEIVERS, IN CLASS 9 (U.S. CLS. 21, 23, 26, 36 AND 38).

THE MARK CONSISTS OF STANDARD CHARACTERS WITHOUT CLAIM TO ANY PARTICULAR FONT, STYLE, SIZE, OR COLOR.

SER. NO. 78-869,042, FILED 4-25-2006.

LINDA LAVACHE, EXAMINING ATTORNEY

Int. Cls.: 7, 9 and 12

Prior U.S. Cls.: 13, 19, 21, 23, 26, 31, 34, 35, 36, 38 and 44

Reg. No. 3,398,525

United States Patent and Trademark Office

Registered Mar. 18, 2008

**TRADEMARK
PRINCIPAL REGISTER**

WHITE HYDRAULICS

WHITE DRIVE PRODUCTS, INC. (KENTUCKY CORPORATION)

110 BILL BRYAN BLVD.

HOPKINSVILLE, KY 42241

FOR: MACHINE PARTS, NAMELY, HYDRAULIC PUMPS, PLANETARY GEARBOXES, RIGHT-ANGLE GEARBOXES, HELICAL GEARBOXES, WORM DRIVE GEARBOXES, HYDRAULIC VALVES FOR INDUSTRIAL MACHINES, HYDRO-ELECTRICAL MANIFOLD BLOCKS AND VALVING, MECHANICAL OR DRUM BRAKES, HYDRAULIC FLOW DIVIDERS, HYDRAULIC MOTORS, HYDRAULIC BRAKES, HYDRAULIC BRAKE AND MOTORS INTEGRATED INTO ONE PACKAGE, FLOW DIVIDERS, SHOCK VALVES, AND COMPONENT PARTS FOR HYDRAULIC PUMPS, PLANETARY GEARBOXES, RIGHT-ANGLE GEARBOXES, HELICAL GEARBOXES, WORM DRIVE GEARBOXES, HYDRAULIC VALVES FOR INDUSTRIAL MACHINES, HYDRO-ELECTRICAL MANIFOLD BLOCKS AND VALVING MECHANICAL OR DRUM BRAKES, HYDRAULIC FLOW DIVIDERS, HYDRAULIC MOTORS, HYDRAULIC BRAKES, HYDRAULIC BRAKE AND MOTORS INTEGRATED INTO ONE PACKAGE, FLOW DIVIDERS, AND SHOCK VALVES; HYDRAULIC PUMPS FOR LAND VEHICLES; LAND VEHICLE PARTS, NAMELY, HYDRO-ELECTRICAL MANIFOLD BLOCKS AND VALVES; LAND VEHICLE PARTS, NAMELY, HYDRAULIC FLOW DIVIDERS AND FLOW DIVIDERS; LAND VEHICLE COMPONENT PARTS FOR HYDRAULIC PUMPS, HYDRO-ELECTRICAL MANIFOLD BLOCKS AND VALVES, HYDRAULIC FLOW DIVIDERS AND FLOW DIVIDERS, IN CLASS 7 (U.S. CLS. 13, 19, 21, 23, 31, 34 AND 35).

FIRST USE 3-1-1977; IN COMMERCE 3-1-1977.

FOR: ELECTRONIC SPEED SENSORS FOR HYDRAULIC MOTORS, IN CLASS 9 (U.S. CLS. 21, 23, 26, 36 AND 38).

FIRST USE 3-1-1977; IN COMMERCE 3-1-1977.

FOR: PARTS FOR LAND VEHICLES, NAMELY, PLANETARY GEARBOXES, RIGHT-ANGLE GEARBOXES, HELICAL GEARBOXES, WORM DRIVE GEARBOXES, MECHANICAL OR DRUM BRAKES, HYDRAULIC FLOW DIVIDERS, HYDRAULIC MOTORS, HYDRAULIC BRAKES, HYDRAULIC BRAKE AND MOTORS INTEGRATED INTO ONE PACKAGE, HYDRAULIC STEERING UNITS, AND COMPONENT PARTS FOR PLANETARY GEARBOXES, RIGHT-ANGLE GEARBOXES, HELICAL GEARBOXES, WORM DRIVE GEARBOXES, MECHANICAL OR DRUM BRAKES, HYDRAULIC MOTORS, HYDRAULIC BRAKES, HYDRAULIC BRAKE AND MOTORS INTEGRATED INTO ONE PACKAGE, AND HYDRAULIC STEERING UNITS; STEERING VALVES AS PARTS OF STEERING UNITS, AND COMPONENT PARTS THEREOF; LAND VEHICLE PARTS, NAMELY, SHOCK VALVES AND COMPONENT PARTS THEREOF, IN CLASS 12 (U.S. CLS. 19, 21, 23, 31, 35 AND 44).

FIRST USE 3-1-1977; IN COMMERCE 3-1-1977.

THE MARK CONSISTS OF STANDARD CHARACTERS WITHOUT CLAIM TO ANY PARTICULAR FONT, STYLE, SIZE, OR COLOR.

NO CLAIM IS MADE TO THE EXCLUSIVE RIGHT TO USE "HYDRAULICS", APART FROM THE MARK AS SHOWN.

SER. NO. 78-869,682, FILED 4-26-2006.

JOHN GARTNER, EXAMINING ATTORNEY

Int. Cls.: 6, 9 and 20

**Prior U.S. Cls.: 2, 12, 13, 14, 21, 22, 23, 25, 26, 32, 36,
38 and 50**

Reg. No. 3,398,526

United States Patent and Trademark Office

Registered Mar. 18, 2008

**TRADEMARK
PRINCIPAL REGISTER**



QUEST MANUFACTURING CORP (FLORIDA CORPORATION)
11200 NW 138TH ST
MEDLEY, FL 33178

FOR: METAL SHELF BRACKETS, IN CLASS 6 (U.S. CLS. 2, 12, 13, 14, 23, 25 AND 50).

FIRST USE 8-6-2003; IN COMMERCE 8-6-2003.

FOR: WALL AND FLOOR MOUNTED METAL ENCLOSURES FOR MOUNTING ELECTRONIC EQUIPMENT; AND MOUNTING RACKS FOR COMPUTER HARDWARE, IN CLASS 9 (U.S. CLS. 21, 23, 26, 36 AND 38).

FIRST USE 8-6-2003; IN COMMERCE 8-6-2003.

FOR: METAL SHELVES, IN CLASS 20 (U.S. CLS. 2, 13, 22, 25, 32 AND 50).

FIRST USE 8-6-2003; IN COMMERCE 8-6-2003.

NO CLAIM IS MADE TO THE EXCLUSIVE RIGHT TO USE "MANUFACTURING CO.", APART FROM THE MARK AS SHOWN.

THE COLOR(S) RED, BLACK, GRAY AND WHITE IS/ARE CLAIMED AS A FEATURE OF THE MARK.

THE MARK CONSISTS OF THE STYLIZED RED LETTER Q FOLLOWED BY THE LETTERS UEST IN BLOCK RED LETTERS WITH A SHADOW OUTLINE IN WHITE AND GRAY OVER AN OVAL SHAPE IN GRAY WITH A RED OVAL-SHAPED LINE WITHIN THE GRAY OVAL. THE WORDS "MANUFACTURING CO." IN BLACK APPEAR BELOW THE WORD QUEST.

SER. NO. 78-870,953, FILED 4-27-2006.

JAMES LOVELACE, EXAMINING ATTORNEY

Int. Cls.: 35 and 36

Prior U.S. Cls.: 100, 101 and 102

United States Patent and Trademark Office

Reg. No. 3,398,527

Registered Mar. 18, 2008

**SERVICE MARK
PRINCIPAL REGISTER**

Preferred Moves

CAPARO REAL ESTATE (PENNSYLVANIA CORPORATION), DBA COLDWELL BANKER PREFERRED

1207 FAYETTE STREET
CONSHOHOCKEN, PA 19428

FOR: PROMOTING THE REAL ESTATE AND FINANCIAL SERVICES OF OTHERS BY MEANS OF AN AFFINITY PROGRAM PROVIDED TO EMPLOYERS TO ASSIST EMPLOYEES THAT FEATURE DISCOUNTS AND REBATES FOR PREFERRED CUSTOMERS IN THE SALE, RENTAL AND PURCHASE OF REAL ESTATE, HOME MAINTENANCE AND REFERRALS IN THE FIELD OF HOME REPAIR AND MORTGAGES, IN CLASS 35 (U.S. CLS. 100, 101 AND 102).

FIRST USE 6-1-2004; IN COMMERCE 6-1-2004.

FOR: REAL ESTATE SERVICES, NAMELY, ASSISTING PREFERRED CUSTOMERS WITH MORTGAGE PLANNING, AND THE SELLING, RENTING, PURCHASING, OF REAL ESTATE, IN CLASS 36 (U.S. CLS. 100, 101 AND 102).

FIRST USE 6-1-2004; IN COMMERCE 6-1-2004.

THE MARK CONSISTS OF STANDARD CHARACTERS WITHOUT CLAIM TO ANY PARTICULAR FONT, STYLE, SIZE, OR COLOR.

NO CLAIM IS MADE TO THE EXCLUSIVE RIGHT TO USE "MOVES", APART FROM THE MARK AS SHOWN.

SER. NO. 78-871,795, FILED 4-28-2006.

SIMON TENG, EXAMINING ATTORNEY

Int. Cls.: 39 and 43

Prior U.S. Cls.: 100, 101 and 105

United States Patent and Trademark Office

Reg. No. 3,398,528

Registered Mar. 18, 2008

**SERVICE MARK
PRINCIPAL REGISTER**



RMLL INC (MICHIGAN CORPORATION)
142 WINSLOW CIRCLE
COMMERCE TOWNSHIP, MI 48390

THE COLOR(S) RED, GREEN, BLACK AND WHITE IS/ARE CLAIMED AS A FEATURE OF THE MARK.

FOR: DELIVERY OF FOOD BY RESTAURANTS, IN CLASS 39 (U.S. CLS. 100 AND 105).

FIRST USE 3-22-2005; IN COMMERCE 3-22-2005.

FOR: RESTAURANTS, IN CLASS 43 (U.S. CLS. 100 AND 101).

FIRST USE 3-22-2005; IN COMMERCE 3-22-2005.

NO CLAIM IS MADE TO THE EXCLUSIVE RIGHT TO USE "PIZZA", APART FROM THE MARK AS SHOWN.

THE MARK CONSISTS OF AN OVAL-SHAPED IMAGE WITH A RED, BLACK AND GREEN STRIPE WITHIN THE OVAL SHAPE. A WHITE OVAL BORDER SURROUNDS THE OVAL-SHAPED IMAGE AND A GREEN OVAL BORDER SURROUNDS THE WHITE BORDER. THE WORDS DE VINO'S APPEARS AGAINST THE RED BACKGROUND STRIPE AND THE WORD PIZZA APPEARS AGAINST THE BLACK BACKGROUND STRIPE. THE WORDS DE VINO'S APPEAR IN THE COLOR WHITE.

SER. NO. 78-874,028, FILED 5-2-2006.

AMY GEARIN, EXAMINING ATTORNEY

Prior U.S. Cl.: B

United States Patent and Trademark Office

Reg. No. 3,398,529

Registered Mar. 18, 2008

CERTIFICATION MARK
PRINCIPAL REGISTER



JOHNSON FRANCHISE CONSULTING, INC.
(NEBRASKA CORPORATION)
2330 SOUTH 75TH STREET
LINCOLN, NE 68506

FOR: FRANCHISE SERVICES, NAMELY, OFFERING BUSINESS MANAGEMENT ASSISTANCE IN THE ESTABLISHMENT AND OPERATION OF FRANCHISES, IN CLASS B (U.S. CL. B).

FIRST USE 11-1-2004; IN COMMERCE 11-1-2004.

OWNER OF U.S. REG. NO. 2,932,513.

NO CLAIM IS MADE TO THE EXCLUSIVE RIGHT TO USE "FRANCHISE RESEARCH INSTITUTE" AND "FRANCHISEE APPROVED", APART FROM THE MARK AS SHOWN.

THE COLOR(S) WHITE, BLACK, YELLOW, DARK RED AND PINK IS/ARE CLAIMED AS A FEATURE OF THE MARK.

THE MARK CONSISTS OF A CIRCLE WHOSE NARROW OUTER RIM IS BLACK. OUTSIDE OF THE CIRCLE BUT DETACHED, ARE THIRTEEN DARK RED TRIANGLES SURROUNDING THE CIRCLE. ON THE INSIDE OF THE CIRCLE, NEXT TO THE BLACK RIM IS A WIDER DARK RED

BAND WITH THE WORDS FRANCHISE RESEARCH INSTITUTE IN CAPITALIZED WHITE BLOCK LETTERING IN A SEMI-CIRCLE COVERING THE UPPER TWO-THIRDS OF THE CIRCLE. ON THE INSIDE OF THE WIDE DARK RED BAND IS A VERY NARROW BLACK BAND. ON THE INSIDE OF THAT NARROW BLACK BAND IS A WHITE NARROW BAND. ON THE INSIDE OF THAT WHITE NARROW BAND IS A WIDER BLACK BAND WHICH FADES INTO DARK RED, RED AND THEN PINK WITH THE VERY INSIDE OF THE CIRCLE IN WHITE. INSIDE THE VERY CENTER OF THE MARK IS A LARGE BLACK CHECKMARK WHOSE TAIL IS SUPERIMPOSED THROUGH ALL OF THE LEVELS OF THE MARK ON THE UPPER RIGHT SIDE. SUPERIMPOSED OVER THE BOTTOM CENTER OF THE MARK ARE THE WORDS FRANCHISEE APPROVED IN CAPITALIZED YELLOW BLOCK LETTERS.

"THE CERTIFICATION MARK, AS DISPLAYED BY PERSONS AUTHORIZED BY THE CERTIFIER, CERTIFIES THAT THE FRANCHISORS DEMONSTRATE A DOCUMENTED COMMITMENT TO SUPPORTING AND ASSISTING FRANCHISEES."

SER. NO. 78-875,147, FILED 5-3-2006.

DANIEL BRODY, EXAMINING ATTORNEY

Int. Cl.: 9

Prior U.S. Cls.: 21, 23, 26, 36 and 38

United States Patent and Trademark Office

Reg. No. 3,398,530

Registered Mar. 18, 2008

TRADEMARK
PRINCIPAL REGISTER



MOBILITY BUSINESS SOLUTIONS, INC. (TEXAS CORPORATION)
4709 BULL RUN DRIVE
PLANO, TX 75093

FOR: MOBILE COMPUTING AND OPERATING PLATFORMS CONSISTING OF DATA TRANSCEIVERS, WIRELESS NETWORKS AND GATEWAYS FOR COLLECTION AND MANAGEMENT OF DATA, IN CLASS 9 (U.S. CLS. 21, 23, 26, 36 AND 38).

FIRST USE 7-28-2004; IN COMMERCE 9-1-2004.

NO CLAIM IS MADE TO THE EXCLUSIVE RIGHT TO USE "MOBILITY BUSINESS SOLUTIONS", APART FROM THE MARK AS SHOWN.

THE COLOR(S) BLUE, RED, YELLOW, BLACK AND GREEN IS/ARE CLAIMED AS A FEATURE OF THE MARK.

THE MARK CONSISTS OF THE WORD "MOBILITY" IS SPELLED IN BLUE, RED, YELLOW AND GREEN LETTERS WITH THE LETTERS "M", "I" AND "Y" IN BLUE COLOR, THE LETTERS "O" AND "L" IN RED COLOR, THE LETTER "B" IN YELLOW COLOR, AND THE LETTERS "L" AND "T" IN THE GREEN COLOR. DIRECTLY ABOVE THE WORD "MOBILITY," FIVE DOTS OF BLUE, RED, YELLOW, GREEN AND BLUE COLORS IN A STRAIGHT LINE ARE EVENLY SPACED AND CONNECTED BY BLACK LINES. THE WORDS "BUSINESS SOLUTIONS" ARE OF A SMALLER FONT SIZE AND EVENLY SPACED TO FIT DIRECTLY UNDER THE WORD "MOBILITY." ALL LETTERS COMPRISING THE WORDS "BUSINESS SOLUTIONS" ARE BLUE COLORED LETTERS.

SER. NO. 78-875,956, FILED 5-3-2006.

ERNEST SHOSHO, EXAMINING ATTORNEY

Int. Cl.: 45

Prior U.S. Cls.: 100 and 101

United States Patent and Trademark Office

Reg. No. 3,398,531

Registered Mar. 18, 2008

**SERVICE MARK
PRINCIPAL REGISTER**

GOTHICMATCH.COM

SUCCESSFULMATCH.COM, INC. (CALIFORNIA CORPORATION)
800 WEST EL CAMINO REAL, #180
SAN FRANCISCO, CA 94040

FOR: COMPUTER DATING AND INTRODUCTION SERVICES; INTERNET BASED SOCIAL NETWORKING, INTRODUCTION, AND DATING SERVICES, NAMELY, PROVIDING AN ON-LINE DATABASE OF PERSONAL ADS TO FACILITATE ON-LINE DATING AND INTRODUCTIONS AND PROVIDING INFORMATION REGARDING, AND IN THE NATURE OF, ON-LINE PERSONALS, SOCIAL INTRODUCTIONS AND SOCIAL NETWORK-

ING ACTIVITIES AND SERVICES, IN CLASS 45 (U.S. CLS. 100 AND 101).

FIRST USE 9-22-2002; IN COMMERCE 9-22-2002.

THE MARK CONSISTS OF STANDARD CHARACTERS WITHOUT CLAIM TO ANY PARTICULAR FONT, STYLE, SIZE, OR COLOR.

SEC. 2(F).

SER. NO. 78-876,468, FILED 5-4-2006.

ERNEST SHOSHO, EXAMINING ATTORNEY

Int. Cl.: 45

Prior U.S. Cls.: 100 and 101

United States Patent and Trademark Office

Reg. No. 3,398,532

Registered Mar. 18, 2008

**SERVICE MARK
PRINCIPAL REGISTER**

AGEMATCH.COM

SUCCESSFULMATCH.COM, INC. (CALIFORNIA CORPORATION)
800 WEST EL CAMINO REAL, #180
MOUNTAIN VIEW, CA 94040

FOR: COMPUTER DATING AND INTRODUCTION SERVICES; INTERNET BASED SOCIAL NETWORKING, INTRODUCTION, AND DATING SERVICES, NAMELY, PROVIDING AN ON-LINE DATABASE OF PERSONAL ADS TO FACILITATE ON-LINE DATING AND INTRODUCTIONS AND PROVIDING INFORMATION REGARDING, AND IN THE NATURE OF, ON-LINE PERSONALS, SOCIAL INTRODUCTIONS AND SOCIAL NETWORK-

ING ACTIVITIES AND SERVICES, IN CLASS 45 (U.S. CLS. 100 AND 101).

FIRST USE 8-17-2002; IN COMMERCE 8-17-2002.

THE MARK CONSISTS OF STANDARD CHARACTERS WITHOUT CLAIM TO ANY PARTICULAR FONT, STYLE, SIZE, OR COLOR.

SEC. 2(F).

SER. NO. 78-876,491, FILED 5-4-2006.

ERNEST SHOSHO, EXAMINING ATTORNEY

Int. Cl.: 45

Prior U.S. Cls.: 100 and 101

United States Patent and Trademark Office

Reg. No. 3,398,533

Registered Mar. 18, 2008

**SERVICE MARK
PRINCIPAL REGISTER**

INTERRACIALMATCH.COM

SUCCESSFULMATCH.COM, INC. (CALIFORNIA CORPORATION)
800 WEST EL CAMINO REAL, #180
MOUNTAIN VIEW, CA 94040

FOR: COMPUTER DATING AND INTRODUCTION SERVICES; INTERNET BASED SOCIAL NETWORKING, INTRODUCTION, AND DATING SERVICES, NAMELY, PROVIDING AN ON-LINE DATABASE OF PERSONAL ADS TO FACILITATE ON-LINE DATING AND INTRODUCTIONS AND PROVIDING INFORMATION REGARDING, AND IN THE NATURE OF, ON-LINE PERSONALS, SOCIAL INTRODUCTIONS AND SOCIAL NETWORK-

ING ACTIVITIES AND SERVICES, IN CLASS 45 (U.S. CLS. 100 AND 101).

FIRST USE 9-27-2002; IN COMMERCE 9-27-2002.

THE MARK CONSISTS OF STANDARD CHARACTERS WITHOUT CLAIM TO ANY PARTICULAR FONT, STYLE, SIZE, OR COLOR.

SEC. 2(F).

SER. NO. 78-876,494, FILED 5-4-2006.

ERNEST SHOSHO, EXAMINING ATTORNEY

Int. Cl.: 7

Prior U.S. Cls.: 13, 19, 21, 23, 31, 34 and 35

United States Patent and Trademark Office

Reg. No. 3,398,534

Registered Mar. 18, 2008

**TRADEMARK
PRINCIPAL REGISTER**

NEXUS

BROWN, JOHNNIE W. (UNITED STATES INDIVIDUAL)
2 INDUSTRIAL PARK, P.O. BOX 37
COMANCHE, OK 73529

FOR: CAR WASH SYSTEM COMPRISED OF CAR WASHING MACHINES, POWER-OPERATED SPRAY EQUIPMENT FOR SPRAYING WATER, POWER OPERATED SOAP APPLICATORS, POWER-OPERATED DRYERS, UNDER CARRIAGE SPRAYS, CLEANING AGENT APPLICATORS, HIGH-PRESSURE RINSERS, SIGN PACKAGES

AND REPLACEMENT PARTS THEREFORE, IN CLASS 7 (U.S. CLS. 13, 19, 21, 23, 31, 34 AND 35).

FIRST USE 3-5-2002; IN COMMERCE 3-5-2002.

THE MARK CONSISTS OF STANDARD CHARACTERS WITHOUT CLAIM TO ANY PARTICULAR FONT, STYLE, SIZE, OR COLOR.

SER. NO. 78-879,112, FILED 5-8-2006.

MARY MUNSON, EXAMINING ATTORNEY

Int. Cls.: 9 and 11

Prior U.S. Cls.: 13, 21, 23, 26, 31, 34, 36 and 38

United States Patent and Trademark Office

Reg. No. 3,398,535

Registered Mar. 18, 2008

**TRADEMARK
PRINCIPAL REGISTER**

VENTZONE SYSTEMS

AMERICAN ALDES VENTILATION CORPORATION (FLORIDA CORPORATION)
4537 NORTHGATE COURT
SARASOTA, FL 342342124

FOR: VENTILATION SYSTEMS COMPRISING VENTILATION CONTROL DEVICES; AND ZONE CLIMATE CONTROL SYSTEMS CONSISTING OF VENTILATION CONTROL DEVICES, IN CLASS 9 (U.S. CLS. 21, 23, 26, 36 AND 38).

FIRST USE 1-31-2006; IN COMMERCE 1-31-2006.

FOR: VENTILATION SYSTEMS COMPRISING ZONE RETURN/EXHAUST TERMINALS, FLOW REGULATORS, DAMPERS AND VENTILATION FANS, ALL FOR RESIDENTIAL AND COMMER-

CIAL USE, IN CLASS 11 (U.S. CLS. 13, 21, 23, 31 AND 34).

FIRST USE 1-31-2006; IN COMMERCE 1-31-2006.

THE MARK CONSISTS OF STANDARD CHARACTERS WITHOUT CLAIM TO ANY PARTICULAR FONT, STYLE, SIZE, OR COLOR.

NO CLAIM IS MADE TO THE EXCLUSIVE RIGHT TO USE "SYSTEMS", APART FROM THE MARK AS SHOWN.

SER. NO. 78-879,433, FILED 5-9-2006.

LINDA ORNDORFF, EXAMINING ATTORNEY

Int. Cl.: 5

Prior U.S. Cls.: 6, 18, 44, 46, 51 and 52

Reg. No. 3,398,536

United States Patent and Trademark Office

Registered Mar. 18, 2008

**TRADEMARK
PRINCIPAL REGISTER**

READYCHEM

READYCHEM INC. (FLORIDA CORPORATION)
701 D CORNWALL ROAD
SANFORD, FL 32773

FOR: AIR DEODORANT; AIR DEODORIZER;
AIR FRESHENERS; AIR FRESHENING PREPARA-
TIONS; ALL PURPOSE DISINFECTANTS; ALL PUR-
POSE DISINFECTING AND DEODORIZING
PREPARATIONS; ANTIBACTERIAL CLEANERS;
ANTIBACTERIAL HANDWASH; ANTIBACTERIAL
SPRAY; ANTIBIOTIC HANDWASH; ANTIBIOTIC
PREPARATIONS; CAR DEODORANT; CAR DEO-
DORIZER; CARPET DEODORIZERS; CARPET
FRESHENERS AND ODOR ELIMINATORS; CHE-
MICAL PREPARATIONS FOR SANITARY PURPO-
SES; CHEMICAL PREPARATIONS FOR SANITARY
USE; DEODORIZERS FOR AUTOMOBILES; DISIN-
FECTANT BATHROOM CLEANERS; DISINFEC-
TANT TOILET BOWL CLEANERS;
DISINFECTANTS FOR HYGIENIC PURPOSES; DIS-
INFECTANTS FOR SANITARY PURPOSES; DISIN-

FECTING HANDWASH; GARBAGE DISPOSER
FRESHENERS; HOUSEHOLD DEODORANT;
HOUSEHOLD DEODORIZER; ODOR NEUTRALIZ-
ING PREPARATIONS FOR USE ON CARPETS AND
RESTROOMS; PREPARATIONS TO DESTROY MIL-
DEW; ROOM DEODORANTS; ROOM DEODORIZ-
ING COMPOSITIONS; ROOM FRESHENERS;
SANITIZERS FOR HOSPITAL USE; SANITIZERS
FOR HOUSEHOLD USE; SANITIZERS FOR USE IN
INSTITUTIONAL AND INDUSTRIAL AREAS, IN
CLASS 5 (U.S. CLS. 6, 18, 44, 46, 51 AND 52).

FIRST USE 8-25-2004; IN COMMERCE 8-25-2004.

THE MARK CONSISTS OF STANDARD CHAR-
ACTERS WITHOUT CLAIM TO ANY PARTICULAR
FONT, STYLE, SIZE, OR COLOR.

SER. NO. 78-881,351, FILED 5-11-2006.

SANDRA MANIOS, EXAMINING ATTORNEY

Int. Cl.: 17

Prior U.S. Cls.: 1, 5, 12, 13, 35 and 50

United States Patent and Trademark Office

Reg. No. 3,398,537

Registered Mar. 18, 2008

**TRADEMARK
PRINCIPAL REGISTER**

GRIPTOUCH

PYN, S.A. DE C.V. (MEXICO CORPORATION)
NO. 8 FRACC. INDUSTRIAL ALCE BLANCO
CALLE 9
NAUCALPAN, MEXICO 53370

FOR: ADHESIVE-COATED PLASTIC SHEETS
FOR LINING SHELVES, TABLES, DRAWERS AND
BATHS, IN CLASS 17 (U.S. CLS. 1, 5, 12, 13, 35 AND
50).

THE MARK CONSISTS OF STANDARD CHAR-
ACTERS WITHOUT CLAIM TO ANY PARTICULAR
FONT, STYLE, SIZE, OR COLOR.

OWNER OF MEXICO REG. NO. 808759, DATED
10-8-2003, EXPIRES 9-11-2013.

SER. NO. 78-881,752, FILED 5-11-2006.

GEORGE LORENZO, EXAMINING ATTORNEY

Int. Cl.: 20

Prior U.S. Cls.: 2, 13, 22, 25, 32 and 50

United States Patent and Trademark Office

Reg. No. 3,398,538

Registered Mar. 18, 2008

TRADEMARK
PRINCIPAL REGISTER



Thinking Inside the Box

WESTRIM, INC. (DELAWARE CORPORATION)
7855 HAYVENHURST AVENUE
VAN NUYS, CA 91406

FOR: BOOK CASES FOR SCRAPBOOKS, PHOTO ALBUMS AND ACCESSORIES; DESKS FOR SCRAPBOOKS, PHOTO ALBUMS AND ACCESSORIES; CUBES FOR HOLDING AND STORING SCRAP BOOKING AND PHOTO SUPPLIES AND ACCESSORIES; AND FURNITURE FOR HOLDING SCRAP BOOKING AND PHOTO ALBUM SUPPLIES AND ACCESSORIES - ALL OF SAID GOODS BEING MARKETED AND DISTRIBUTED EXCLUSIVELY

THROUGH SCRAP BOOKING AND PHOTO ALBUM CHANNELS OF TRADE, IN CLASS 20 (U.S. CLS. 2, 13, 22, 25, 32 AND 50).

FIRST USE 2-15-2005; IN COMMERCE 2-15-2005.

OWNER OF U.S. REG. NOS. 2,972,455, 3,132,252, AND 3,247,065.

SER. NO. 78-882,860, FILED 5-12-2006.

KAREN K. BUSH, EXAMINING ATTORNEY

Int. Cl.: 41

Prior U.S. Cls.: 100, 101 and 107

United States Patent and Trademark Office

Reg. No. 3,398,539

Registered Mar. 18, 2008

**SERVICE MARK
PRINCIPAL REGISTER**



NATIONAL HOLISTIC INSTITUTE (CALIFORNIA CORPORATION)
5900 HOLLIS STREET, SUITE Q
EMERYVILLE, CA 946082008

FOR: EDUCATIONAL SERVICES, NAMELY, CONDUCTING VOCATIONAL TRAINING CLASSES IN THE FIELD OF MASSAGE THERAPY, IN CLASS 41 (U.S. CLS. 100, 101 AND 107).

FIRST USE 5-15-2005; IN COMMERCE 5-15-2005.

OWNER OF U.S. REG. NO. 2,013,316.

NO CLAIM IS MADE TO THE EXCLUSIVE RIGHT TO USE "NATIONAL" AND "INSTITUTE", APART FROM THE MARK AS SHOWN.

THE MARK CONSISTS OF ENCLOSED ARCH CONTAINING 2 HANDS FORMED IN A CIRCLE WITH THE WORDS, NATIONAL HOLISTIC INSTITUTE.

SEC. 2(F).

SER. NO. 78-883,584, FILED 5-15-2006.

GINA HAYES, EXAMINING ATTORNEY

Int. Cl.: 41

Prior U.S. Cls.: 100, 101 and 107

United States Patent and Trademark Office

Reg. No. 3,398,540

Registered Mar. 18, 2008

**SERVICE MARK
PRINCIPAL REGISTER**



INTERNATIONAL FELLOWSHIP OF
CHRISTIANS AND JEWS

INTERNATIONAL FELLOWSHIP OF CHRIS-
TIAN AND JEWS, INC. (ILLINOIS NON-
PROFIT CORPORATION)
30 N. LASALLE ST., SUITE 2600
CHICAGO, IL 60602

FIRST USE 12-0-2001; IN COMMERCE 7-25-2005.

OWNER OF U.S. REG. NO. 2,491,797.

FOR: RELIGIOUS EDUCATIONAL SERVICES,
NAMELY, CONDUCTING SEMINARS, MEETINGS
AND HOLDING CONFERENCES, ALL TO PRO-
MOTE GREATER UNDERSTANDING AND COOP-
ERATION BETWEEN CHRISTIANS AND JEWS,
AND DISTRIBUTING COURSE MATERIALS IN
CONNECTION THEREWITH, NAMELY, TAPES,
NEWSLETTERS, BOOKS, PAMPHLETS, AND LEAF-
LETS, IN CLASS 41 (U.S. CLS. 100, 101 AND 107).

SEC. 2(F) AS TO "INTERNATIONAL FELLOWSHIP OF CHRISTIANS AND JEWS".

SER. NO. 78-885,660, FILED 5-17-2006.

ANDREA K. NADELMAN, EXAMINING ATTORNEY

Int. Cl.: 41

Prior U.S. Cls.: 100, 101 and 107

United States Patent and Trademark Office

Reg. No. 3,398,541

Registered Mar. 18, 2008

**SERVICE MARK
PRINCIPAL REGISTER**

THIS MUSIC

THIS MUSIC, LLC (TENNESSEE LTD LIAB CO)
20 MUSIC SQUARE EAST
NASHVILLE, TN 37203

FOR: ENTERTAINMENT AND RECORD COMPANY SERVICES, NAMELY, PRODUCTION OF AUDIO AND VIDEO RECORDINGS FEATURING MUSIC AND ENTERTAINMENT, SOUND RECORDING STUDIO SERVICES; RECORDING STUDIO SERVICES; MUSIC PUBLISHING SERVICES; SPECIAL EVENT PLANNING SERVICES; AND CONCERT BOOKING SERVICES., IN CLASS 41 (U.S. CLS. 100, 101 AND 107).

FIRST USE 1-1-2006; IN COMMERCE 1-1-2006.

THE MARK CONSISTS OF STANDARD CHARACTERS WITHOUT CLAIM TO ANY PARTICULAR FONT, STYLE, SIZE, OR COLOR.

NO CLAIM IS MADE TO THE EXCLUSIVE RIGHT TO USE "MUSIC", APART FROM THE MARK AS SHOWN.

SER. NO. 78-886,477, FILED 5-18-2006.

GEORGIA CARTY, EXAMINING ATTORNEY

Int. Cl.: 5

Prior U.S. Cls.: 6, 18, 44, 46, 51 and 52

United States Patent and Trademark Office

Reg. No. 3,398,542

Registered Mar. 18, 2008

**TRADEMARK
PRINCIPAL REGISTER**

Rhumatol

VANG, TONG BRUCE (UNITED STATES INDIVIDUAL)
APT. 9D
2872 MARSHALL AVE SE
GRAND RAPIDS, MI 49508

THE MARK CONSISTS OF STANDARD CHARACTERS WITHOUT CLAIM TO ANY PARTICULAR FONT, STYLE, SIZE, OR COLOR.

FOR: DIETARY SUPPLEMENTS, IN CLASS 5 (U.S. CLS. 6, 18, 44, 46, 51 AND 52).

SER. NO. 78-899,057, FILED 6-2-2006.

FIRST USE 2-1-2006; IN COMMERCE 6-1-2006.

KIMBERLY PERRY, EXAMINING ATTORNEY

Int. Cl.: 36

Prior U.S. Cls.: 100, 101 and 102

United States Patent and Trademark Office

Reg. No. 3,398,543

Registered Mar. 18, 2008

**SERVICE MARK
PRINCIPAL REGISTER**

FOR THE IF IN LIFE

METROPOLITAN LIFE INSURANCE COMPANY
(NEW YORK CORPORATION)
LAW DEPARTMENT
1METLIFE PLAZA, 27-01 QUEENS PLAZA NORTH
LONG ISLAND CITY, NY 11101

FOR: PROVIDING UNDERWRITING AND ADMINISTRATION SERVICES FOR INDIVIDUAL AND GROUP LIFE, HEALTH, HOMEOWNERS, AND AUTOMOBILE INSURANCE, ANNUITIES, AND PENSION FUNDS; RESIDENTIAL AND COMMERCIAL MORTGAGE LENDING SERVICES; REAL ESTATE BROKERAGE AND MANAGEMENT SERVICES; MUTUAL FUND BROKERAGE, BANK-

ING AND INVESTMENT SERVICES, NAMELY, INVESTMENT ADVISORY SERVICES, IN CLASS 36 (U.S. CLS. 100, 101 AND 102).

FIRST USE 6-16-2006; IN COMMERCE 6-16-2006.

THE MARK CONSISTS OF STANDARD CHARACTERS WITHOUT CLAIM TO ANY PARTICULAR FONT, STYLE, SIZE, OR COLOR.

SER. NO. 78-899,479, FILED 6-2-2006.

ALICE BENMAMAN, EXAMINING ATTORNEY

Int. Cls.: 30 and 35

Prior U.S. Cls.: 46, 100, 101 and 102

United States Patent and Trademark Office

Reg. No. 3,398,544

Registered Mar. 18, 2008

**TRADEMARK
SERVICE MARK
PRINCIPAL REGISTER**

EQUICAFE

ALTERNATIVA 3, SOCIEDAD COOPERATIVA
CATALANA LIMITADA (SPAIN CORPORATION)
CARRETERA DE CASTELLAR, 526
TERRASSA, BARCELONA, SPAIN 08227

FOR: COFFEE, IN CLASS 30 (U.S. CL. 46).

FOR: ADVERTISING SERVICES; AGENCY REPRESENTATION FOR ADVERTISING TIME AND SPACE; IMPORT AND EXPORT AGENCIES; RETAIL SERVICES IN SHOPS AND BY MEANS OF WORLDWIDE COMPUTER NETWORKS OF FOODSTUFFS, IN CLASS 35 (U.S. CLS. 100, 101 AND 102).

THE MARK CONSISTS OF STANDARD CHARACTERS WITHOUT CLAIM TO ANY PARTICULAR FONT, STYLE, SIZE, OR COLOR.

PRIORITY CLAIMED UNDER SEC. 44(D) ON SPAIN APPLICATION NO. 2.705.832, FILED 4-11-2006, REG. NO. 2705832, DATED 12-5-2006, EXPIRES 4-11-2016.

SER. NO. 78-900,284, FILED 6-5-2006.

JANICE L. MCMORROW, EXAMINING ATTORNEY

Int. Cl.: 9

Prior U.S. Cls.: 21, 23, 26, 36 and 38

United States Patent and Trademark Office

Reg. No. 3,398,545

Registered Mar. 18, 2008

TRADEMARK
PRINCIPAL REGISTER

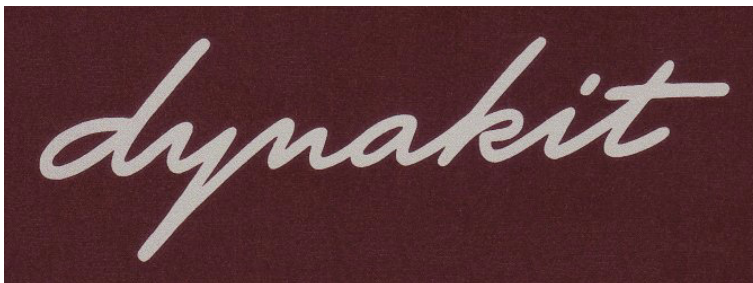

AUTOMATED FLEXIBLE CONVEYOR, INC.
(NEW JERSEY CORPORATION)
55 WALMAN AVENUE
CLIFTON, NJ 07011

FOR: TUBE AMPLIFIERS FOR AUDIO SOUND REPRODUCTION USED IN CONJUNCTION WITH STEREO EQUIPMENT, FULLY ASSEMBLED AND UNASSEMBLED; TUBE AMPLIFIERS FOR AUDIO SOUND REPRODUCTION USED IN CONJUNCTION WITH GUITAR EQUIPMENT, FULLY ASSEMBLED AND UNASSEMBLED, IN CLASS 9 (U.S. CLS. 21, 23, 26, 36 AND 38).

FIRST USE 4-20-2004; IN COMMERCE 4-20-2004.

OWNER OF U.S. REG. NO. 3,058,994.

THE COLOR(S) BROWN AND SILVER IS/ARE CLAIMED AS A FEATURE OF THE MARK.

THE MARK CONSISTS OF THE TERM "DYNAKIT" IN SILVER SCRIPT ON A BROWN BACKGROUND.

SER. NO. 78-900,882, FILED 6-6-2006.

FRANK LATTUCA, EXAMINING ATTORNEY

Int. Cl.: 29

Prior U.S. Cl.: 46

United States Patent and Trademark Office

Reg. No. 3,398,546

Registered Mar. 18, 2008

**TRADEMARK
PRINCIPAL REGISTER**

ECOLIVE

VALLE DE OLIVOS S.A. (CHILE CORPORATION)
4TH FLOOR, PROVIDENCIA
AV. SANTA MARIA 2880
SANTIAGO, CHILE

FOR: EDIBLE OLIVE OIL, IN CLASS 29 (U.S. CL.
46).

THE MARK CONSISTS OF STANDARD CHAR-
ACTERS WITHOUT CLAIM TO ANY PARTICULAR
FONT, STYLE, SIZE, OR COLOR.

OWNER OF CHILE REG. NO. 785455, DATED 4-27-
2007, EXPIRES 4-27-2017.

SER. NO. 78-901,565, FILED 6-6-2006.

CHRISTINA SOBRAL, EXAMINING ATTORNEY

Int. Cl.: 34

Prior U.S. Cls.: 2, 8, 9 and 17

United States Patent and Trademark Office

Reg. No. 3,398,547

Registered Mar. 18, 2008

**TRADEMARK
PRINCIPAL REGISTER**



N.V. SUMATRA TOBACCO TRADING COMPANY (INDONESIA CORPORATION)
JALAN PATTIMURA NO. 3 PEMATANG SIANTAR
SUMATERA UTARA, INDONESIA

FOR: CIGARETTES, IN CLASS 34 (U.S. CLS. 2, 8, 9 AND 17).

OWNER OF INDONESIA REG. NO. 404681, DATED 11-12-1997, RENEWED AS REG. NO. 404681, DATED 2-18-2007, EXPIRES 2-18-2017.

NO CLAIM IS MADE TO THE EXCLUSIVE RIGHT TO USE "GOLD BLEND," "FILTER KINGS" AND "CIGARETTES", APART FROM THE MARK AS SHOWN.

THE COLOR(S) GOLD, YELLOW, BLACK AND WHITE IS/ARE CLAIMED AS A FEATURE OF THE MARK.

THE MARK CONSISTS OF THE COLOR BLACK THAT APPEARS IN THE WORDING GOLD BLEND FILTER KINGS THAT APPEARS AT THE TOP OF THE MARK AND IN THE WORDING CIGARETTES THAT APPEARS UNDER THE WORD JET. THE COLOR GOLD APPEARS IN A RECTANGULAR SHAPE AT THE TOP OF THE MARK, IN THE LIONS HEAD, IN THE WORDING JET AND IN ONE HORIZONTAL LINE AT THE BOTTOM OF THE MARK. THE COLOR WHITE APPEARS INSIDE THE LIONS HEAD AS BACKGROUND OF THE MARK, WHICH APPEARS AS A PACK OF CIGARETTES. THE COLOR YELLOW APPEARS AS A HORIZONTAL LINE AT THE BOTTOM OF THE MARK.

SER. NO. 78-901,913, FILED 6-6-2006.

WILLIAM ROSSMAN, EXAMINING ATTORNEY

Int. Cl.: 9

Prior U.S. Cls.: 21, 23, 26, 36 and 38

United States Patent and Trademark Office

Reg. No. 3,398,548

Registered Mar. 18, 2008

**TRADEMARK
PRINCIPAL REGISTER**

**THE FASTEST WAY TO LEARN A
LANGUAGE. GUARANTEED.**

ROSETTA STONE LTD. (VIRGINIA CORPORATION)
135 WEST MARKET STREET
HARRISONBURG, VA 22801

FOR: COMPUTER SOFTWARE FOR TEACHING
FOREIGN LANGUAGES; COMPUTER SOFTWARE
FOR LEARNING FOREIGN LANGUAGES, IN
CLASS 9 (U.S. CLS. 21, 23, 26, 36 AND 38).

FIRST USE 7-0-2002; IN COMMERCE 7-0-2002.

THE MARK CONSISTS OF STANDARD CHARACTERS WITHOUT CLAIM TO ANY PARTICULAR FONT, STYLE, SIZE, OR COLOR.

SEC. 2(F).

SER. NO. 78-902,748, FILED 6-7-2006.

NAKIA HENRY, EXAMINING ATTORNEY

Int. Cl.: 16

Prior U.S. Cls.: 2, 5, 22, 23, 29, 37, 38 and 50

United States Patent and Trademark Office

Reg. No. 3,398,549

Registered Mar. 18, 2008

**TRADEMARK
PRINCIPAL REGISTER**

MOKA

CASCADES CANADA INC. (CANADA CORPORATION)
SUITE 100
772 SHERBROOKE STREET WEST
MONTREAL, QUEBEC, CANADA H3A 1G1

FOR: PAPER TOWELS, PAPER HAND TOWELS, PAPER NAPKINS, IN CLASS 16 (U.S. CLS. 2, 5, 22, 23, 29, 37, 38 AND 50).

THE MARK CONSISTS OF STANDARD CHARACTERS WITHOUT CLAIM TO ANY PARTICULAR FONT, STYLE, SIZE, OR COLOR.

PRIORITY CLAIMED UNDER SEC. 44(D) ON CANADA APPLICATION NO. 1302824, FILED 5-25-

2006, REG. NO. 691304, DATED 7-4-2007, EXPIRES 7-4-2022.

OWNER OF U.S. REG. NOS. 2,399,124 AND 2,401,365.

THE ENGLISH TRANSLATION OF THE WORD "MOKA" IN THE MARK IS "A KIND OF COFFEE OR CAKE" IN FRENCH.

SER. NO. 78-903,032, FILED 6-7-2006.

RICHARD A. STRASER, EXAMINING ATTORNEY

Int. Cl.: 41

Prior U.S. Cls.: 100, 101 and 107

United States Patent and Trademark Office

Reg. No. 3,398,550

Registered Mar. 18, 2008

**SERVICE MARK
PRINCIPAL REGISTER**

DESIGN NOTES

DESIGN WITHIN REACH, INC. (CALIFORNIA CORPORATION)
225 BUSH STREET, 20TH FLOOR
SAN FRANCISCO, CA 94104

FOR: ONLINE NEWSLETTERS IN THE FIELDS OF FURNITURE, HOUSEWARES, ARCHITECTURE AND RELATED PRODUCTS, IN CLASS 41 (U.S. CLS. 100, 101 AND 107).

FIRST USE 12-28-2000; IN COMMERCE 12-28-2000.

THE MARK CONSISTS OF STANDARD CHARACTERS WITHOUT CLAIM TO ANY PARTICULAR FONT, STYLE, SIZE, OR COLOR.

OWNER OF U.S. REG. NOS. 2,493,177, 2,699,748, AND 3,009,987.

NO CLAIM IS MADE TO THE EXCLUSIVE RIGHT TO USE "NOTES", APART FROM THE MARK AS SHOWN.

SEC. 2(F).

SER. NO. 78-904,750, FILED 6-9-2006.

SUSAN RICHARDS, EXAMINING ATTORNEY

Int. Cl.: 25

Prior U.S. Cls.: 22 and 39

United States Patent and Trademark Office

Reg. No. 3,398,551

Registered Mar. 18, 2008

**TRADEMARK
PRINCIPAL REGISTER**

Century Link

WU, BOJIAN (CHINA INDIVIDUAL)
2315 QIXING ROAD ROOM 603-54
SHANGHAI, CHINA 201101 AND
LIU, YANLING (CHINA INDIVIDUAL)
YI GUO XIN CUN, YUN HE ZHEN
PIZHOU, CHINA 221300

FOR: COATS; DRESSES; INFANT AND TOD-
DLER ONE PIECE CLOTHING; KNIT SHIRTS;
LEATHER COATS; NECKTIES; SHIRTS; SKIRTS; T-
SHIRTS; UNDERWEAR, IN CLASS 25 (U.S. CLS. 22
AND 39).

OWNER OF CHINA REG. NO. 3617317, DATED 12-
14-2005, EXPIRES 12-13-2015.

THE MARK CONSISTS OF THE WORD "CENTU-
RY" WITH ITS INITIAL CAPITALIZED, AND THE
WORD "LINK" WITH ITS INITIAL CAPITALIZED.

SER. NO. 78-905,668, FILED 6-12-2006.

CAROLINE WOOD, EXAMINING ATTORNEY

Int. Cl.: 35

Prior U.S. Cls.: 100, 101 and 102

United States Patent and Trademark Office

Reg. No. 3,398,552

Registered Mar. 18, 2008

**SERVICE MARK
PRINCIPAL REGISTER**

The Meredith Group, Inc.

THE MEREDITH GROUP, INC. (GEORGIA CORPORATION)
8 SANDY POINT RD.
SAVANNAH, GA 31404

FOR: PUBLIC RELATIONS; ADVERTISING, MARKETING AND PROMOTION SERVICES; MARKETING CONSULTING; BUSINESS MARKETING CONSULTING SERVICES, IN CLASS 35 (U.S. CLS. 100, 101 AND 102).

FIRST USE 7-5-2005; IN COMMERCE 7-5-2005.

THE MARK CONSISTS OF STANDARD CHARACTERS WITHOUT CLAIM TO ANY PARTICULAR FONT, STYLE, SIZE, OR COLOR.

NO CLAIM IS MADE TO THE EXCLUSIVE RIGHT TO USE "GROUP, INC.", APART FROM THE MARK AS SHOWN.

SER. NO. 78-905,932, FILED 6-12-2006.

VERNA BETH RIRIE, EXAMINING ATTORNEY

Int. Cl.: 14

Prior U.S. Cls.: 2, 27, 28 and 50

United States Patent and Trademark Office

Reg. No. 3,398,553

Registered Mar. 18, 2008

**TRADEMARK
PRINCIPAL REGISTER**

CHARMED ATTITUDES

CHARMED ATTITUDES (CALIFORNIA SOLE
PROPRIETORSHIP)
2217 HARBOR BLVD #E7
COSTA MESA, CA 92627

THE MARK CONSISTS OF STANDARD CHAR-
ACTERS WITHOUT CLAIM TO ANY PARTICULAR
FONT, STYLE, SIZE, OR COLOR.

FOR: JEWELRY, IN CLASS 14 (U.S. CLS. 2, 27, 28
AND 50).

SER. NO. 78-906,162, FILED 6-12-2006.

FIRST USE 6-1-2005; IN COMMERCE 6-1-2005.

REBECCA EISINGER, EXAMINING ATTORNEY

Int. Cl.: 35

Prior U.S. Cls.: 100, 101 and 102

United States Patent and Trademark Office

Reg. No. 3,398,554

Registered Mar. 18, 2008

**SERVICE MARK
PRINCIPAL REGISTER**



EVEREST COLD STORAGE LIMITED (CANADA
CORPORATION)
SUITE 602
4110 YONGE STREET
TORONTO, CANADA M2P 2B7

FOR: BUSINESS MANAGEMENT SERVICES,
NAMELY, MANAGING LOGISTICS, REVERSE LO-
GISTICS, SUPPLY CHAIN SERVICES, SUPPLY
CHAIN VISIBILITY AND SYNCHRONIZATION,
SUPPLY AND DEMAND FORECASTING AND PRO-
DUCT DISTRIBUTION PROCESSES FOR OTHERS,
IN CLASS 35 (U.S. CLS. 100, 101 AND 102).

PRIORITY CLAIMED UNDER SEC. 44(D) ON
CANADA APPLICATION NO. 1296702, FILED 4-5-
2006, REG. NO. TMA690,009, DATED 6-15-2007, EX-
PIRES 6-15-2022.

NO CLAIM IS MADE TO THE EXCLUSIVE
RIGHT TO USE "COLD STORAGE", APART FROM
THE MARK AS SHOWN.

SER. NO. 78-908,835, FILED 6-15-2006.

SARA THOMAS, EXAMINING ATTORNEY

Int. Cls.: 35, 37, 40 and 42

Prior U.S. Cls.: 100, 101, 102, 103 and 106

United States Patent and Trademark Office

Reg. No. 3,398,555

Registered Mar. 18, 2008

**SERVICE MARK
PRINCIPAL REGISTER**

UNIMIN

UNIMIN CORPORATION (DELAWARE CORPORATION)
258 ELM STREET
NEW CANAAN, CT 06840

FOR: DISTRIBUTORSHIP SERVICES IN THE FIELD OF PROCESSED MINERALS FOR INDUSTRIAL AND COMMERCIAL APPLICATION, IN CLASS 35 (U.S. CLS. 100, 101 AND 102).

FIRST USE 3-31-1979; IN COMMERCE 3-31-1979.

FOR: MINING EXTRACTION SERVICES, IN CLASS 37 (U.S. CLS. 100, 103 AND 106).

FIRST USE 3-31-1979; IN COMMERCE 3-31-1979.

FOR: BENEFICIATING OF MINERALS, NAMELY, PROCESSING OF MINERALS, SEPARATING OF MINERALS, AND SIZING OF MINERALS; BLENDING OF MINERALS, IN CLASS 40 (U.S. CLS. 100, 103 AND 106).

FIRST USE 3-31-1979; IN COMMERCE 3-31-1979.

FOR: RESEARCH AND DEVELOPMENT IN THE FIELD OF MINERALS; TECHNICAL CONSULTING SERVICES DIRECTED TO END-USE APPLICATIONS OF MINERALS, IN CLASS 42 (U.S. CLS. 100 AND 101).

FIRST USE 3-31-1979; IN COMMERCE 3-31-1979.

THE MARK CONSISTS OF STANDARD CHARACTERS WITHOUT CLAIM TO ANY PARTICULAR FONT, STYLE, SIZE, OR COLOR.

OWNER OF U.S. REG. NO. 1,604,208.

SER. NO. 78-910,036, FILED 6-16-2006.

BARNEY CHARLON, EXAMINING ATTORNEY

Int. Cl.: 30

Prior U.S. Cl.: 46

United States Patent and Trademark Office

Reg. No. 3,398,556

Registered Mar. 18, 2008

**TRADEMARK
PRINCIPAL REGISTER**

The logo features the word "DaVinci" in a large, elegant, cursive script. Below it, the word "GOURMET" is written in a smaller, bold, sans-serif, all-caps font.

KERRY GROUP SERVICES INTERNATIONAL,
LTD. (IRELAND CORPORATION)
ATTN: BRIAN DURRAN
PRINCE'S STREET
TRALEE, COUNTY KERRY, IRELAND

NO CLAIM IS MADE TO THE EXCLUSIVE
RIGHT TO USE "GOURMET", APART FROM THE
MARK AS SHOWN.

FOR: FLAVORING SYRUPS, SAUCES AND CON-
FECTIONS, NAMELY, CANDY, IN CLASS 30 (U.S.
CL. 46).

SER. NO. 78-910,492, FILED 6-16-2006.

FIRST USE 2-1-2006; IN COMMERCE 2-1-2006.

HEATHER BIDDULPH, EXAMINING ATTORNEY

Int. Cls.: 35, 36, 41 and 44

Prior U.S. Cls.: 100, 101, 102 and 107

United States Patent and Trademark Office

Reg. No. 3,398,557

Registered Mar. 18, 2008

**SERVICE MARK
PRINCIPAL REGISTER**

CAREMORE

CAREMORE HEALTH PLAN (CALIFORNIA CORPORATION)

12900 PARK PLAZA DR. SUITE 150
CERRITOS, CA 90703

FOR: PHYSICIAN REFERRAL SERVICES; ADMINISTRATION OF INSURANCE CLAIMS FOR HMO AND PPO HEALTHCARE PROVIDERS; HEALTH CARE UTILIZATION, REVIEW AND COST CONTAINMENT SERVICES, ALL IN THE HEALTHCARE FIELD; MEDICAL COST MANAGEMENT AND COST MANAGEMENT FOR HEALTH BENEFIT PLANS OF OTHERS; ADMINISTRATION OF ACUTE MEDICAL CARE PROGRAMS AND SERVICES PROVIDED TO MEDICARE BENEFICIARIES AND OTHERS WHO LIVE IN NURSING HOMES, HOSPICES AND CONVALESCENT HOMES; DIRECT PHYSICIAN REFERRAL SERVICES, IN CLASS 35 (U.S. CLS. 100, 101 AND 102).

FIRST USE 6-1-1993; IN COMMERCE 6-1-1993.

FOR: UNDERWRITING MEDICAL INSURANCE SERVICES IN THE NATURE OF HMOS AND PPOS; ADMINISTRATION OF HEALTH BENEFIT PLANS OF OTHERS; ADMINISTRATION OF PRESCRIPTION DRUG BENEFIT PLANS OF OTHERS; ADMINISTRATION OF HEALTH BENEFIT PLANS COVERING PRESCRIPTION DRUG BENEFITS, DENTAL CARE, VISION AND HEARING CARE, DISCOUNT EYEGLASSES AND MEDICAL TRANSPORTATION, NAMELY, COSTS ASSOCIATED WITH AMBULANCE AND MEDICAL EVACUATION TRANSPORTATION AND CARE, HOSPICE AND CONVALESCENT CARE; ADMINISTRATION OF HEALTH INSURANCE PLANS FOR ELIGIBLE MEDICARE BENEFICIARIES, IN CLASS 36 (U.S. CLS. 100, 101 AND 102).

FIRST USE 6-1-1993; IN COMMERCE 6-1-1993.

FOR: STRENGTH TRAINING PROGRAMS, NAMELY, STRENGTH AND CONDITIONING TRAINING, IN CLASS 41 (U.S. CLS. 100, 101 AND 107).

FIRST USE 6-1-1993; IN COMMERCE 6-1-1993.

FOR: MANAGED HEALTHCARE SERVICES, MEDICAL SERVICES, NAMELY, PHYSICIAN GROUPS OFFERING PRIMARY MEDICAL CARE SERVICES VIA HMO AND PPO MEDICAL PROGRAMS; CHRONIC CARE MEDICAL SERVICES; MEDICAL CLINICS, PRE-SURGICAL EVALUATION CLINICS, COMPREHENSIVE CARE CLINICS, DIABETES AND WOUND CLINICS, ANTICOAGULATION CLINICS, PODIATRY SERVICES; HOSPITALS; PROVIDING IN-HOME AND OUT-PATIENT PHYSICIAN AND NURSING CARE SERVICES; EMERGENCY MEDICAL RESPONSE SERVICES; MEDICAL EVALUATION SERVICES, NAMELY, FUNCTIONAL ASSESSMENT PROGRAMS FOR PATIENTS RECEIVING MEDICAL REHABILITATION SERVICES FOR PURPOSES OF GUIDING TREATMENT AND ASSESSING PROGRAM EFFECTIVENESS; PROVIDING HOSPICE AND CONVALESCENT HOME CARE SERVICES; HOSPITALIST PROGRAMS, NAMELY, PROVIDING PHYSICIAN SERVICES BY PHYSICIANS WHO SPECIALIZE IN TREATING THE HOSPITALIZED PATIENTS OF OTHER PHYSICIANS, IN CLASS 44 (U.S. CLS. 100 AND 101).

FIRST USE 6-1-1993; IN COMMERCE 6-1-1993.

THE MARK CONSISTS OF STANDARD CHARACTERS WITHOUT CLAIM TO ANY PARTICULAR FONT, STYLE, SIZE, OR COLOR.

OWNER OF U.S. REG. NOS. 2,895,387 AND 2,897,163.

SER. NO. 78-911,545, FILED 6-19-2006.

RUSS HERMAN, EXAMINING ATTORNEY

Int. Cl.: 35

Prior U.S. Cls.: 100, 101 and 102

United States Patent and Trademark Office

Reg. No. 3,398,558

Registered Mar. 18, 2008

**SERVICE MARK
PRINCIPAL REGISTER**

THE FAIR TAX

AMERICANS FOR FAIR TAXATION (TEXAS CORPORATION)

SUITE 230

4200 WESTHEIMER

HOUSTON, TX 77027

FOR: PROMOTING PUBLIC AWARENESS OF THE NEED FOR TAX REFORM; AND PROVIDING INFORMATION REGARDING POLITICAL ISSUES, NAMELY, TAXATION AND TAX REFORM, IN CLASS 35 (U.S. CLS. 100, 101 AND 102).

FIRST USE 11-1-1995; IN COMMERCE 11-1-1995.

THE MARK CONSISTS OF STANDARD CHARACTERS WITHOUT CLAIM TO ANY PARTICULAR FONT, STYLE, SIZE, OR COLOR.

OWNER OF U.S. REG. NO. 3,152,630.

NO CLAIM IS MADE TO THE EXCLUSIVE RIGHT TO USE "TAX", APART FROM THE MARK AS SHOWN.

SEC. 2(F).

SER. NO. 78-915,815, FILED 6-23-2006.

COLLEEN DOMBROW, EXAMINING ATTORNEY

Int. Cl.: 36

Prior U.S. Cls.: 100, 101 and 102

United States Patent and Trademark Office

Reg. No. 3,398,559

Registered Mar. 18, 2008

**SERVICE MARK
PRINCIPAL REGISTER**

NETAGENT

ALL CITIES REALTY, INC. (CALIFORNIA CORPORATION)
2576 NEWPORT BOULEVARD, #A
COSTA MESA, CA 92627

THE MARK CONSISTS OF STANDARD CHARACTERS WITHOUT CLAIM TO ANY PARTICULAR FONT, STYLE, SIZE, OR COLOR.

FOR: REAL ESTATE AGENCY SERVICES, IN CLASS 36 (U.S. CLS. 100, 101 AND 102).

SER. NO. 78-916,262, FILED 6-24-2006.

FIRST USE 12-0-1996; IN COMMERCE 10-6-2005.

KEVIN DINALLO, EXAMINING ATTORNEY

Int. Cls.: 9 and 37

Prior U.S. Cls.: 21, 23, 26, 36, 38, 100, 103 and 106

Reg. No. 3,398,560

United States Patent and Trademark Office

Registered Mar. 18, 2008

**TRADEMARK
SERVICE MARK
PRINCIPAL REGISTER**

SILVERTECH

ICS TRIPLEX TECHNOLOGY LTD. (UNITED KINGDOM CORPORATION)
HALL ROAD
MALDON, UNITED KINGDOM CM9 4LA

FOR: INDUSTRIAL PROCESS CONTROL AND MONITORING APPARATUS AND INSTRUMENTS, NAMELY, AUTOMATIC, MANUAL AND COMPUTER COMPATIBLE ELECTRONIC PROCESS CONTROLLERS AND MONITORS; SAFETY, FIRE AND GAS MONITORING APPARATUS, NAMELY MONITORS FOR MONITORING STATUS OF SMOKE, FIRE OR FLAME TOGETHER WITH CONTROLLERS TO CONTROL AND ALARM OR EXTINGUISHANT RELEASE; ALARM SYSTEMS COMPRISED OF MONITORS FOR MONITORING STATUS OF ELECTRICAL, HYDRAULIC OR PNEUMATIC EQUIPMENT, SMOKE, FIRE OR FLAME AND ALARMS FOR INDICATING WHEN OPERATIONAL PARAMETERS ARE EXCEEDED; EMERGENCY SHUTDOWN SYSTEMS COMPRISED OF MONITORS FOR MONITORING STATUS OF ELECTRICAL, HYDRAULIC OR PNEUMATIC EQUIPMENT, SMOKE, FIRE OR FLAME, ALARMS FOR INDICATING WHEN OPERATIONAL PARAMETERS ARE EXCEEDED, AND CONTROLLERS FOR SHUTTING DOWN PROCESSES AND EQUIPMENT WHEN OPERATIONAL PARAMETERS ARE EXCEEDED; COMPUTER HARDWARE AND SOFTWARE FOR DISPLAY OF STATUS OF AUTOMATIC, MANUAL AND COMPUTER COMPATIBLE ELECTRONIC PROCESS CONTROLLERS AND MONITORS; COMPUTER SOFTWARE USED TO OPERATE INDUSTRIAL PROCESS CONTROL AND MONITORING APPARATUS AND INSTRUMENTS, NAMELY, AUTOMATIC, MANUAL AND COMPUTER COMPATIBLE ELECTRONIC PROCESS CONTROLLERS AND MONITORS; COMPUTER SOFTWARE USED TO OPERATE SAFETY, FIRE AND GAS MONITORING APPARATUS, NAMELY MONITORS FOR MONITORING STATUS

OF ELECTRICAL, HYDRAULIC OR PNEUMATIC EQUIPMENT, SMOKE, FIRE OR FLAME TOGETHER WITH CONTROLLERS TO CONTROL AND ALARM OR EXTINGUISHANT RELEASE; COMPUTER SOFTWARE USED TO OPERATE ALARM SYSTEMS COMPRISED OF MONITORS FOR MONITORING STATUS OF ELECTRICAL, HYDRAULIC OR PNEUMATIC EQUIPMENT, SMOKE, FIRE OR FLAME AND ALARMS FOR INDICATING WHEN OPERATIONAL PARAMETERS ARE EXCEEDED; COMPUTER SOFTWARE USED TO OPERATE EMERGENCY SHUTDOWN SYSTEMS COMPRISED OF MONITORS FOR MONITORING STATUS OF ELECTRICAL, HYDRAULIC OR PNEUMATIC EQUIPMENT, SMOKE, FIRE OR FLAME, ALARMS FOR INDICATING WHEN OPERATIONAL PARAMETERS ARE EXCEEDED, AND CONTROLLERS FOR SHUTTING DOWN PROCESSES AND EQUIPMENT WHEN OPERATIONAL PARAMETERS ARE EXCEEDED; COMPUTER SOFTWARE USED TO OPERATE COMPUTER HARDWARE AND SOFTWARE FOR DISPLAY OF STATUS OF AUTOMATIC, MANUAL AND COMPUTER COMPATIBLE ELECTRONIC PROCESS CONTROLLERS AND MONITORS; PARTS FOR INDUSTRIAL PROCESS CONTROL AND MONITORING APPARATUS AND INSTRUMENTS, NAMELY, AUTOMATIC, MANUAL AND COMPUTER COMPATIBLE ELECTRONIC PROCESS CONTROLLERS AND MONITORS; PARTS FOR SAFETY, FIRE AND GAS MONITORING APPARATUS, NAMELY MONITORS FOR MONITORING STATUS OF ELECTRICAL, HYDRAULIC OR PNEUMATIC EQUIPMENT, SMOKE, FIRE OR FLAME TOGETHER WITH CONTROLLERS TO CONTROL AND ALARM OR EXTINGUISHANT RELEASE; PARTS FOR ALARM SYSTEMS COMPRISED OF MONITORS FOR MONITORING STATUS OF ELECTRICAL, HYDRAULIC OR PNEUMATIC EQUIPMENT, SMOKE, FIRE OR FLAME AND ALARMS FOR INDICATING WHEN OPERATIONAL PARAMETERS ARE EXCEEDED;

PARTS FOR EMERGENCY SHUTDOWN SYSTEMS COMPRISED OF MONITORS FOR MONITORING STATUS OF ELECTRICAL, HYDRAULIC OR PNEUMATIC EQUIPMENT, SMOKE, FIRE OR FLAME, ALARMS FOR INDICATING WHEN OPERATIONAL PARAMETERS ARE EXCEEDED, AND CONTROLLERS FOR SHUTTING DOWN PROCESSES AND EQUIPMENT WHEN OPERATIONAL PARAMETERS ARE EXCEEDED; AND PARTS FOR COMPUTER HARDWARE AND SOFTWARE FOR DISPLAY OF STATUS OF AUTOMATIC, MANUAL AND COMPUTER COMPATIBLE ELECTRONIC PROCESS CONTROLLERS AND MONITORS, IN CLASS 9 (U.S. CLS. 21, 23, 26, 36 AND 38).

FOR: INSTALLATION, REPAIR AND MAINTENANCE OF FIRE ALARM SYSTEMS, FIRE SAFETY SYSTEMS, GAS ALARM SYSTEMS, GAS SAFETY SYSTEMS, EMERGENCY SHUTDOWN SYSTEMS

FOR ELECTRICAL, HYDRAULIC OR PNEUMATIC EQUIPMENT AND INDUSTRIAL PROCESS CONTROL SYSTEMS FOR ELECTRICAL, HYDRAULIC OR PNEUMATIC EQUIPMENT , IN CLASS 37 (U.S. CLS. 100, 103 AND 106).

THE MARK CONSISTS OF STANDARD CHARACTERS WITHOUT CLAIM TO ANY PARTICULAR FONT, STYLE, SIZE, OR COLOR.

PRIORITY CLAIMED UNDER SEC. 44(D) ON ERPN CMNTY TM OFC APPLICATION NO. 005161781, FILED 6-26-2006, REG. NO. 005161781, DATED 3-29-2007, EXPIRES 6-26-2016.

SER. NO. 78-916,679, FILED 6-26-2006.

LINDA ORNDORFF, EXAMINING ATTORNEY

Int. Cl.: 25

Prior U.S. Cls.: 22 and 39

United States Patent and Trademark Office

Reg. No. 3,398,561

Registered Mar. 18, 2008

**TRADEMARK
PRINCIPAL REGISTER**



SEVERE, EMANUEL J. (UNITED STATES INDIVIDUAL)
8531 NW 54TH STREET
LAUDERHILL, FL 33351

FOR: BASEBALL CAPS; JACKETS; PANTS; SHIRTS; SWEATERS; T-SHIRTS, IN CLASS 25 (U.S. CLS. 22 AND 39).

FIRST USE 6-12-2006; IN COMMERCE 6-12-2006.

THE COLOR(S) BLUE, GREY, BLACK, AND WHITE IS/ARE CLAIMED AS A FEATURE OF THE MARK.

THE MARK CONSISTS OF A STYLIZED LETTER S.

SER. NO. 78-917,447, FILED 6-27-2006.

SUE LAWRENCE, EXAMINING ATTORNEY

Int. Cl.: 29

Prior U.S. Cl.: 46

United States Patent and Trademark Office

Reg. No. 3,398,562

Registered Mar. 18, 2008

TRADEMARK
PRINCIPAL REGISTER



AZAR NUT COMPANY, LLC (TEXAS LTD LIAB
CO)
1800 NORTHWESTERN DR.
EL PASO, TX 79912

NO CLAIM IS MADE TO THE EXCLUSIVE
RIGHT TO USE "SINCE 1914", APART FROM THE
MARK AS SHOWN.

FOR: PROCESSED EDIBLE NUTS AND PROCES-
SED EDIBLE SUNFLOWER SEEDS, IN CLASS 29
(U.S. CL. 46).

SER. NO. 78-920,859, FILED 6-30-2006.

FIRST USE 1-3-2006; IN COMMERCE 1-3-2006.

KATHLEEN M. VANSTON, EXAMINING ATTOR-
NEY

Int. Cl.: 21

Prior U.S. Cls.: 2, 13, 23, 29, 30, 33, 40 and 50

United States Patent and Trademark Office

Reg. No. 3,398,563

Registered Mar. 18, 2008

**TRADEMARK
PRINCIPAL REGISTER**

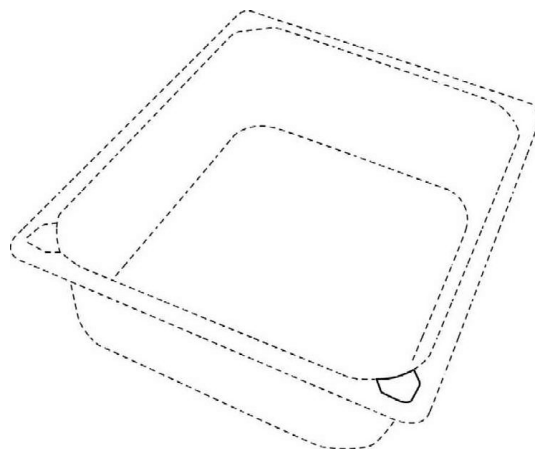

THE VOLLRATH COMPANY, L.L.C. (WISCONSIN LTD LIAB CO)
1236 N. 18TH STREET P.O. BOX 611
SHEBOYGAN, WI 53082

FOR: COOKWARE AND SERVINGWARE PRODUCTS, NAMELY, STEAM TABLE PANS MADE OF METAL OR PLASTIC; METAL BAKING, COOKING, AND SERVING PANS AND COVERS THEREFORE, IN CLASS 21 (U.S. CLS. 2, 13, 23, 29, 30, 33, 40 AND 50).

FIRST USE 1-22-1990; IN COMMERCE 1-22-1990.

THE MARK CONSISTS OF A FIVE-SIDED DESIGN IN AT LEAST ONE CORNER OF A PAN. THE BROKEN LINES ARE INTENDED ONLY TO SHOW THE POSITION OF THE MARK AND DO NOT FORM PART OF THE MARK.

SEC. 2(F).

SER. NO. 78-921,153, FILED 6-30-2006.

ALICE BENMAMAN, EXAMINING ATTORNEY

Int. Cl.: 39

Prior U.S. Cls.: 100 and 105

United States Patent and Trademark Office

Reg. No. 3,398,564

Registered Mar. 18, 2008

**SERVICE MARK
PRINCIPAL REGISTER**

MR. PORTER

PORTER AVIATION HOLDINGS INC. (CANADA CORPORATION)
TORONTO CITY CENTRE AIRPORT
TORONTO, CANADA M5V 1A1

FOR: THE OPERATION OF AN AIRLINE AND AIR TRANSPORTATION SERVICES OF PASSENGERS, BAGGAGE AND OTHER FREIGHT SERVICES, IN CLASS 39 (U.S. CLS. 100 AND 105).

THE MARK CONSISTS OF STANDARD CHARACTERS WITHOUT CLAIM TO ANY PARTICULAR FONT, STYLE, SIZE, OR COLOR.

PRIORITY CLAIMED UNDER SEC. 44(D) ON CANADA APPLICATION NO. 1307144, FILED 6-26-2006, REG. NO. TMA692,868, DATED 7-27-2007, EXPIRES 7-27-2022.

SER. NO. 78-922,513, FILED 7-5-2006.

CAROLYN CATALDO, EXAMINING ATTORNEY

Int. Cl.: 27

Prior U.S. Cls.: 19, 20, 37, 42 and 50

United States Patent and Trademark Office

Reg. No. 3,398,565

Registered Mar. 18, 2008

**TRADEMARK
PRINCIPAL REGISTER**

FIBERESSENCE

BEAULIEU GROUP, LLC (GEORGIA LTD LIAB
CO)
1502 CORONET DRIVE
DALTON, GA 30720

THE MARK CONSISTS OF STANDARD CHAR-
ACTERS WITHOUT CLAIM TO ANY PARTICULAR
FONT, STYLE, SIZE, OR COLOR.

FOR: CARPET BACKING; CARPETS, IN CLASS 27
(U.S. CLS. 19, 20, 37, 42 AND 50).

SER. NO. 78-922,915, FILED 7-5-2006.

FIRST USE 1-4-2005; IN COMMERCE 1-4-2005.

MICHAEL GAAFAR, EXAMINING ATTORNEY

Int. Cls.: 41 and 42

Prior U.S. Cls.: 100, 101 and 107

United States Patent and Trademark Office

Reg. No. 3,398,566

Registered Mar. 18, 2008

**SERVICE MARK
PRINCIPAL REGISTER**

GREENHOUSE

AOL LLC (DELAWARE LTD LIAB CO)
22000 AOL WAY
DULLES, VA 20166

FOR: ONLINE JOURNALS, NAMELY, BLOGS IN THE FIELD OF COMPUTERS, COMPUTER SOFTWARE, COMPUTER APPLICATIONS, INTERACTIVE ONLINE COMPUTER SERVICES, TELECOMMUNICATIONS SERVICES, AND NEW TECHNOLOGY INNOVATION, TESTING, RESEARCH, INCUBATION, AND DEVELOPMENT, IN CLASS 41 (U.S. CLS. 100, 101 AND 107).

FIRST USE 5-10-2006; IN COMMERCE 5-10-2006.

FOR: PROVIDING INFORMATION VIA COMPUTER NETWORKS IN THE FIELD OF NEW TECHNOLOGY INNOVATION, TESTING, INCUBATION, RESEARCH, AND DEVELOPMENT PERTAINING TO COMPUTERS, COMPUTER SOFTWARE, COMPUTER APPLICATIONS, INTERACTIVE ONLINE COMPUTER SERVICES, AND TELECOMMUNICA-

TIONS SERVICES; RESEARCH AND PRODUCT DEVELOPMENT SERVICES IN THE FIELD OF COMPUTER SOFTWARE, COMPUTER APPLICATIONS, INTERACTIVE ONLINE COMPUTER SERVICES, AND TELECOMMUNICATIONS SERVICES; PROVIDING A WEBSITE THAT ALLOWS USERS TO TEST NEW COMPUTER SOFTWARE, COMPUTER APPLICATIONS, INTERACTIVE ONLINE COMPUTER SERVICES, AND TELECOMMUNICATIONS SERVICES AND PROVIDE FEEDBACK ON USABILITY, IN CLASS 42 (U.S. CLS. 100 AND 101).

FIRST USE 5-10-2006; IN COMMERCE 5-10-2006.

THE MARK CONSISTS OF STANDARD CHARACTERS WITHOUT CLAIM TO ANY PARTICULAR FONT, STYLE, SIZE, OR COLOR.

SER. NO. 78-923,231, FILED 7-6-2006.

PATRICIA EVANKO, EXAMINING ATTORNEY

Int. Cl.: 3

Prior U.S. Cls.: 1, 4, 6, 50, 51 and 52

Reg. No. 3,398,567

United States Patent and Trademark Office

Registered Mar. 18, 2008

**TRADEMARK
PRINCIPAL REGISTER**

ORIBE

ORIBE LLC (DELAWARE LTD LIAB CO)
C/O REAVIS PARENT LEHRER LLP
41 MADISON AVENUE 41ST FLOOR
NEW YORK, NY 10010

FIRST USE 10-1-1994; IN COMMERCE 10-1-1994.

THE MARK CONSISTS OF STANDARD CHARACTERS WITHOUT CLAIM TO ANY PARTICULAR FONT, STYLE, SIZE, OR COLOR.

FOR: HAIR CARE CREAMS; HAIR CARE LOTIONS; HAIR CARE PREPARATIONS; HAIR COLORANTS; HAIR COLORING PREPARATIONS; HAIR CREAMS; HAIR GEL; HAIR GELS; HAIR LOTIONS; HAIR MOUSSE; HAIR MOUSSES; HAIR POMADES; HAIR RELAXERS; HAIR RELAXING PREPARATIONS; HAIR SPRAY; HAIR STYLING GEL; HAIR STYLING PREPARATIONS; HAIR STYLING SPRAY; STYLING GELS, IN CLASS 3 (U.S. CLS. 1, 4, 6, 50, 51 AND 52).

OWNER OF U.S. REG. NOS. 2,166,871 AND 3,252,308.

SER. NO. 78-923,798, FILED 7-6-2006.

SOPHIA S. KIM, EXAMINING ATTORNEY

Int. Cl.: 44

Prior U.S. Cls.: 100 and 101

United States Patent and Trademark Office

Reg. No. 3,398,568

Registered Mar. 18, 2008

**SERVICE MARK
PRINCIPAL REGISTER**

**BOOTHE EYE CARE & LASER
CENTER**

BOOTHE, WILLIAM A., MD (UNITED STATES
INDIVIDUAL)

3900 WEST 15TH STREET, SUITE 102

PLANO, TX 75075

FOR: MEDICAL SERVICES, NAMELY, TREAT-
MENT OF EYE DISEASES AND CONDITIONS AND
LASER VISION SURGERY, IN CLASS 44 (U.S. CLS.
100 AND 101).

FIRST USE 12-31-1999; IN COMMERCE 12-31-1999.

THE MARK CONSISTS OF STANDARD CHAR-
ACTERS WITHOUT CLAIM TO ANY PARTICULAR
FONT, STYLE, SIZE, OR COLOR.

NO CLAIM IS MADE TO THE EXCLUSIVE
RIGHT TO USE "EYE CARE & LASER CENTER",
APART FROM THE MARK AS SHOWN.

SEC. 2(F).

SER. NO. 78-925,363, FILED 7-10-2006.

DAVID MURRAY, EXAMINING ATTORNEY

Prior U.S. Cl.: B

United States Patent and Trademark Office

Reg. No. 3,398,569

Registered Mar. 18, 2008

**CERTIFICATION MARK
PRINCIPAL REGISTER**

ECOCERTIFIED

ECOQUEST INTERNATIONAL, INC. (TENNESSEE CORPORATION)

310 T. ELMER COX DRIVE

KNOXVILLE, TN 37743

FOR: MARK CERTIFIES THAT A RESIDENTIAL STRUCTURE HAS MET THE CERTIFIER'S QUALITY STANDARDS FOR WATER AND AIR PURIFICATION THROUGH THE USE AND INSTALLATION OF CERTAIN WATER AND AIR PURIFICATION PRODUCTS, IN CLASS B (U.S. CL. B).

FIRST USE 11-29-2005; IN COMMERCE 11-29-2005.

THE MARK CONSISTS OF STANDARD CHARACTERS WITHOUT CLAIM TO ANY PARTICULAR FONT, STYLE, SIZE, OR COLOR.

MARK CERTIFIES THAT A RESIDENTIAL STRUCTURE HAS MET THE CERTIFIER'S QUALITY STANDARDS FOR WATER AND AIR PURIFICATION THROUGH THE USE AND INSTALLATION OF CERTAIN WATER AND AIR PURIFICATION PRODUCTS.

SER. NO. 78-926,857, FILED 7-11-2006.

NORA BUCHANAN WILL, EXAMINING ATTORNEY

Int. Cl.: 35

Prior U.S. Cls.: 100, 101 and 102

United States Patent and Trademark Office

Reg. No. 3,398,570

Registered Mar. 18, 2008

**SERVICE MARK
PRINCIPAL REGISTER**



RAZORPAGES, INC. (DELAWARE CORPORATION)
321 MISSISSIPPI STREET
SAN FRANCISCO, CA 94107

THE COLOR(S) WHITE, BROWN AND ORANGE IS/ARE CLAIMED AS A FEATURE OF THE MARK.

FOR: MARKETING, ADVERTISING AND PROMOTIONAL SERVICES, NAMELY, PROVIDING INFORMATIONAL WEB PAGES DESIGNED TO PROMOTE AUTHORS AND THEIR BOOKS, IN CLASS 35 (U.S. CLS. 100, 101 AND 102).

THE WORD RAZOR IS IN THE COLOR WHITE. THE WORD PAGES IS IN THE COLOR ORANGE. THE BACKGROUND IS IN THE COLOR BROWN.

FIRST USE 3-1-2006; IN COMMERCE 3-1-2006.

SER. NO. 78-927,495, FILED 7-12-2006.

NO CLAIM IS MADE TO THE EXCLUSIVE RIGHT TO USE "PAGES", APART FROM THE MARK AS SHOWN.

DAVID TAYLOR, EXAMINING ATTORNEY

Int. Cls.: 35 and 43

Prior U.S. Cls.: 100, 101 and 102

United States Patent and Trademark Office

Reg. No. 3,398,571

Registered Mar. 18, 2008

**SERVICE MARK
PRINCIPAL REGISTER**

THELMA AND LOUISE

THELMA AND LOUISE CLUB LIMITED (UNITED KINGDOM LTD LIAB CO)
58-60 BERNERS STREET
LONDON, UNITED KINGDOM W1T 3JS

FOR: ACCOMMODATION SERVICES, NAMELY, RATING ACCOMMODATIONS; PROVIDING INFORMATION ABOUT THE RATING OF ACCOMMODATIONS, IN CLASS 35 (U.S. CLS. 100, 101 AND 102).

FOR: ACCOMMODATION SERVICES, NAMELY, ARRANGING TEMPORARY HOUSING ACCOMMODATIONS, PROVIDING TEMPORARY HOUSING ACCOMMODATIONS, PROVIDING TEMPORARY ACCOMMODATION, AND PROVIDING TEMPORARY LODGING SERVICES IN THE NATURE OF A CONDOMINIUM HOTEL; MAKING HOTEL RESERVATIONS FOR OTHERS; SERVICES FOR THE RESERVATION OF ROOMS; RESORT HOTELS; RESORT LODGING SERVICES; RENTAL OF TENTS; RENTAL OF TEMPORARY AND HOLIDAY ACCOMMODATION, NAMELY, RENTAL OF ROOMS; PROVIDING FOOD AND DRINK FOR GUESTS; BAR AND RESTAURANT SERVICES; CAFÉS, CATERING, PUBS, AND COCKTAIL LOUNGE SERVICES; COFFEE SHOPS; WINE BARS; OPERATION OF TOURIST HOME; SPA SERVICES, NAMELY, PROVIDING TEMPORARY ACCOMMODATIONS AND MEALS TO CLIENTS OF A HEALTH OR BEAUTY SPA; PROVIDING INFORMATION

ABOUT THE FOREGOING; SERVICES GENERALLY PERTAINING TO ACCOMMODATION SERVICES, HOTELS, FOOD AND DRINKING ESTABLISHMENTS AND SERVICES, NAMELY, PRIVATE RESIDENCE CLUB SERVICES IN THE NATURE OF THE PROVISION TO CLUB MEMBERS OF TEMPORARY ACCOMMODATIONS IN COMPANY OWNED OR LEASED PRIVATE RESIDENCES, PROVIDING TRAVEL LODGING INFORMATION SERVICES AND TRAVEL LODGING BOOKING AGENCY SERVICES FOR TRAVELERS, CONTRACT FOOD SERVICES, PREPARATION OF FOOD AND BEVERAGES, GUESTHOUSES, HOSTELS, OPERATION OF TOURIST HOMES, PROVIDING ADVICE TO TOURISTS AND BUSINESS TRAVELERS ON HOTEL AND RESTAURANT DESTINATIONS, PROVIDING ONLINE REVIEWS OF RESTAURANTS AND HOTELS, IN CLASS 43 (U.S. CLS. 100 AND 101).

THE MARK CONSISTS OF STANDARD CHARACTERS WITHOUT CLAIM TO ANY PARTICULAR FONT, STYLE, SIZE, OR COLOR.

OWNER OF UNITED KINGDOM REG. NO. 2362900, DATED 4-22-2005, EXPIRES 5-11-2014.

SER. NO. 78-929,043, FILED 7-13-2006.

JOHN DWYER, EXAMINING ATTORNEY

Int. Cl.: 35

Prior U.S. Cls.: 100, 101 and 102

United States Patent and Trademark Office

Reg. No. 3,398,572

Registered Mar. 18, 2008

SERVICE MARK
PRINCIPAL REGISTER



SIGNATURE CELEBRITIES, INC. (NEVADA CORPORATION)
5808 SUMMITVIEW AVE SUITE A #165
YAKIMA, WA 98908

FOR: ELECTRONIC AUCTION WEBSITE, IN CLASS 35 (U.S. CLS. 100, 101 AND 102).

FIRST USE 10-1-2005; IN COMMERCE 2-1-2006.

THE COLOR(S) PINK, GOLD, SILVER AND BLACK IS/ARE CLAIMED AS A FEATURE OF THE MARK.

THE MARK CONSISTS OF THE COLOR SILVER THAT APPEARS IN ".COM," AND IN THE TRIM OR BORDER OF THE FLAG; THE COLOR PINK APPEARS IN THE WORDING CELEBRITIES, WHILE THE COLOR GOLD APPEARS IN THE WORD SIGNATURE. THE COLOR BLACK APPEARS IN THE BACKGROUND OF THE FLAG.

SER. NO. 78-930,254, FILED S.R. 7-14-2006 AM. P.R. 7-24-2007.

INGA ERVIN, EXAMINING ATTORNEY

Int. Cls.: 39, 41, 43 and 44

Prior U.S. Cls.: 100, 101, 105 and 107

United States Patent and Trademark Office

Reg. No. 3,398,573

Registered Mar. 18, 2008

**SERVICE MARK
PRINCIPAL REGISTER**

VIATOR

VIATOR, INC. (DELAWARE CORPORATION)
SUITE 120E
600 TOWNSEND STREET
SAN FRANCISCO, CA 94103

FOR: TRAVEL AGENCY SERVICES, NAMELY, MAKING RESERVATIONS AND BOOKINGS FOR TRANSPORTATION; TRAVEL AGENCY SERVICES, NAMELY, MAKING RESERVATIONS AND BOOKINGS FOR SIGHTSEEING CRUISES, SIGHTSEEING GARDEN TOURS AND SIGHTSEEING HISTORICAL TOURS; MAKING RESERVATIONS AND BOOKINGS FOR AIRPORT SHUTTLES, CARRIAGE RIDES, HELICOPTER RIDES, ANTIQUE MILITARY PLANE RIDES, BOAT RIDES, WATER TAXI RIDES, LIMOUSINE RIDES, AND TOWN CAR RIDES; MAKING PARKING ARRANGEMENTS; MAKING ARRANGEMENTS FOR ADVENTURE EXCURSIONS IN THE NATURE OF ALL TERRAIN VEHICLE RIDES; RESERVING TOURISM PACKAGES IN THE NATURE OF A CITY CARD GIVING ACCESS TO MULTIPLE SIGHTSEEING ACTIVITIES FOR ONE PRICE; MAKING RESERVATIONS AND BOOKINGS FOR WINE TASTING TOURS, DIVING TOURS, AND SNORKELING TOURS; MAKING ARRANGEMENTS FOR SHOPPING EXCURSIONS; TRAVEL INFORMATION SERVICES; TRAVEL AGENCY SERVICES, NAMELY, MAKING RESERVATIONS AND BOOKINGS FOR RENTAL CARS, IN CLASS 39 (U.S. CLS. 100 AND 105).

FIRST USE 11-0-1999; IN COMMERCE 11-0-1999.

FOR: MAKING TICKET RESERVATIONS FOR SPORTING EVENTS, PLAYS, MOVIES, CONCERTS, MUSEUMS, AQUARIUMS, ZOOS, AMUSEMENT PARKS, GALLERIES, HISTORICAL EXHIBITS, SKI LIFTS, WHALE WATCHING, DOLPHIN WATCHING, SWIMMING WITH WHALES, AND SWIMMING WITH DOLPHINS; MAKING RESERVATIONS AND BOOKINGS FOR LESSONS FOR COOKING, HORSEBACK RIDING, SURFING,

SCUBA DIVING, RACE CAR DRIVING, HANG GLIDING, SAILING, SKIING, TENNIS, AND GOLF; RESERVING TOURISM PACKAGES IN THE NATURE OF A CITY CARD GIVING ACCESS TO MULTIPLE SPORTS AND ENTERTAINMENT ACTIVITIES FOR ONE PRICE; ARRANGING FOR NIGHTCLUB PASSES ; TRAVEL AGENCY SERVICES, NAMELY, MAKING RESERVATIONS AND BOOKINGS FOR GOLF, TENNIS, AND HORSEBACK RIDING; MAKING RESERVATIONS AND BOOKINGS FOR THE RENTAL OF SPORTING EQUIPMENT; ARRANGING FOR HEALTH CLUB PASSES; MAKING ARRANGEMENTS FOR ADVENTURE EXCURSIONS IN THE NATURE OF RACE CAR SIMULATIONS; MAKING RESERVATIONS FOR DVD RENTALS DURING FLIGHTS, IN CLASS 41 (U.S. CLS. 100, 101 AND 107).

FIRST USE 6-0-2000; IN COMMERCE 6-0-2000.

FOR: TRAVEL AGENCY SERVICES, NAMELY, MAKING RESERVATIONS AND BOOKINGS FOR RESTAURANTS; TRAVEL AGENCY SERVICES, NAMELY, MAKING RESERVATIONS AND BOOKINGS FOR TEMPORARY LODGING; MAKING RESERVATIONS FOR MEAL PURCHASES DURING FLIGHTS; TRAVEL AGENCY SERVICES, NAMELY, MAKING RESERVATIONS AND BOOKINGS FOR SPA SERVICES, NAMELY, FOR PROVIDING TEMPORARY ACCOMMODATIONS AND MEALS TO CLIENTS OF A HEALTH OR BEAUTY SPA, IN CLASS 43 (U.S. CLS. 100 AND 101).

FIRST USE 6-0-2004; IN COMMERCE 6-0-2004.

FOR: TRAVEL AGENCY SERVICES, NAMELY, MAKING RESERVATIONS AND BOOKINGS FOR SPA SERVICES, NAMELY, FOR HEALTH AND WELLNESS OF BODY AND SPIRIT OFFERED AT A HEALTH RESORT; TRAVEL AGENCY SERVICES, NAMELY, MAKING RESERVATIONS AND BOOKINGS FOR SPA SERVICES, NAMELY, FOR COS-

METIC BODY CARE SERVICES, IN CLASS 44 (U.S. CLS. 100 AND 101).

SER. NO. 78-931,291, FILED 7-17-2006.

FIRST USE 7-0-2001; IN COMMERCE 7-0-2001.

THE MARK CONSISTS OF STANDARD CHARACTERS WITHOUT CLAIM TO ANY PARTICULAR FONT, STYLE, SIZE, OR COLOR.

KATHLEEN M. VANSTON, EXAMINING ATTORNEY

Int. Cl.: 16

Prior U.S. Cls.: 2, 5, 22, 23, 29, 37, 38 and 50

United States Patent and Trademark Office

Reg. No. 3,398,574

Registered Mar. 18, 2008

**TRADEMARK
PRINCIPAL REGISTER**

**COMPETITIVE INTELLIGENCE
FOUNDATION**

SOCIETY OF COMPETITIVE INTELLIGENCE
PROFESSIONALS (D.C. CORPORATION)
SUITE 600
1700 DIAGONAL ROAD
ALEXANDRIA, VA 22314

FOR: PRINTED PUBLICATIONS, NAMELY,
BOOKS, HANDBOOKS, STUDIES AND SURVEY
REPORTS IN THE FIELD OF COMPETITIVE IN-
TELLIGENCE, IN CLASS 16 (U.S. CLS. 2, 5, 22, 23, 29,
37, 38 AND 50).

FIRST USE 1-0-2006; IN COMMERCE 1-0-2006.

THE MARK CONSISTS OF STANDARD CHAR-
ACTERS WITHOUT CLAIM TO ANY PARTICULAR
FONT, STYLE, SIZE, OR COLOR.

OWNER OF U.S. REG. NOS. 2,235,548 AND
2,440,242.

NO CLAIM IS MADE TO THE EXCLUSIVE
RIGHT TO USE "COMPETITIVE INTELLIGENCE",
APART FROM THE MARK AS SHOWN.

SER. NO. 78-931,559, FILED 7-18-2006.

SCOTT BIBB, EXAMINING ATTORNEY

Int. Cl.: 18

Prior U.S. Cls.: 1, 2, 3, 22 and 41

United States Patent and Trademark Office

Reg. No. 3,398,575

Registered Mar. 18, 2008

**TRADEMARK
PRINCIPAL REGISTER**

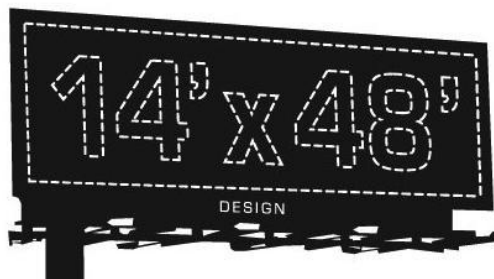

14 X 48 DESIGN, INC. (ILLINOIS CORPORATION)
535 B CHICAGO AVENUE
EVANSTON, IL 60202

FOR: SHOULDER BAG, MESSENGER BAG, SPORT BAG, CARRYALL BAG, IN CLASS 18 (U.S. CLS. 1, 2, 3, 22 AND 41).

FIRST USE 2-26-2006; IN COMMERCE 2-26-2006.

NO CLAIM IS MADE TO THE EXCLUSIVE RIGHT TO USE "DESIGN", APART FROM THE MARK AS SHOWN.

THE MARK CONSISTS OF A RECTANGULAR FIELD, UPON WHICH IS A PARALLELOGRAM DRAWN TO APPEAR AS A PERSPECTIVE DRAWING OF A ROADSIDE BILLBOARD; CENTERED IN THE PARALLELOGRAM AND SURROUNDED BY

A BORDER ARE THE NUMBERS AND SYMBOLS "14' X 48' "; THE NUMBERS, SYMBOLS AND THE BORDER ARE DRAWN WITH A BROKEN LINE SO AS TO APPEAR TO BE STITCHED; THE WORD "DESIGN" IS CENTERED AT THE BOTTOM OF THE PARALLELOGRAM, BELOW THE BROKEN LINE SURROUNDING THE NUMBERS AND SYMBOLS; CONNECTING TO THE LOWER LEFT CORNER OF THE PARALLELOGRAM IS A RECTANGLE DRAWN TO APPEAR TO BE THE LEG OF THE BILLBOARD; IMMEDIATELY BENEATH THE PARALLELOGRAM ARE LINES AND SHAPES DRAWN TO APPEAR TO BE BACKGROUND SCENERY BEHIND THE BILLBOARD.

SER. NO. 78-935,819, FILED 7-24-2006.

LINDA M. KING, EXAMINING ATTORNEY

Int. Cl.: 9

Prior U.S. Cls.: 21, 23, 26, 36 and 38

Reg. No. 3,398,576

United States Patent and Trademark Office

Registered Mar. 18, 2008

**TRADEMARK
PRINCIPAL REGISTER**

rockers

BLUE SUN FILM COMPANY (NEW YORK CORPORATION)
145 EAST 27TH STREET, PH G
NEW YORK, NY 10016

FOR: SERIES OF AUDIO RECORDINGS FEATURING REGGAE MUSIC; SERIES OF DOWNLOADABLE VIDEO RECORDINGS FEATURING REGGAE MUSIC; SERIES OF MUSIC-COMPOSITION SOFTWARE OF REGGAE MUSIC; SERIES OF REGGAE MUSICAL SOUND RECORDINGS; SERIES OF REGGAE MUSICAL VIDEO RECORDINGS; SERIES OF PRE-RECORDED CD'S OF REGGAE MUSIC, VIDEO TAPES, LASER DISKS AND

DVD'S FEATURING REGGAE MUSIC; SERIES OF SOUND RECORDINGS FEATURING REGGAE MUSIC, IN CLASS 9 (U.S. CLS. 21, 23, 26, 36 AND 38).

FIRST USE 1-1-1977; IN COMMERCE 1-1-1978.

THE MARK CONSISTS OF STANDARD CHARACTERS WITHOUT CLAIM TO ANY PARTICULAR FONT, STYLE, SIZE, OR COLOR.

SER. NO. 78-935,991, FILED 7-24-2006.

ELLEN PERKINS, EXAMINING ATTORNEY

Int. Cl.: 43

Prior U.S. Cls.: 100 and 101

United States Patent and Trademark Office

Reg. No. 3,398,577

Registered Mar. 18, 2008

**SERVICE MARK
PRINCIPAL REGISTER**

electronic
beats 

DEUTSCHE TELEKOM AG (FED REP GERMA-
NY CORPORATION)
FRIEDRICH-EBERT-ALLEE 140
BONN, FED REP GERMANY 53113

FOR: RESTAURANT SERVICES; PROVIDING
TEMPORARY ACCOMMODATION, IN CLASS 43
(U.S. CLS. 100 AND 101).

PRIORITY CLAIMED UNDER SEC. 44(D) ON FED
REP GERMANY APPLICATION NO. 30605755709,
FILED 1-27-2006, REG. NO. 30605755, DATED 8-9-
2007, EXPIRES 1-31-2016.

THE COLOR(S) GRAY AND MAGENTA IS/ARE
CLAIMED AS A FEATURE OF THE MARK.

THE COLOR MAGENTA APPEARS IN A SINGLE
LINE THAT FORMS THE DESIGN OF THE "E" AND
"B". THE COLOR GRAY IS USED ON THE LETTERS
SPELLING "ELECTRONIC" AND "BEATS" AND
THE LITTLE SQUARE INSIDE THE "EB" DESIGN.

SER. NO. 78-936,021, FILED 7-24-2006.

DAWN FELDMAN, EXAMINING ATTORNEY

Int. Cl.: 41

Prior U.S. Cls.: 100, 101 and 107

United States Patent and Trademark Office

Reg. No. 3,398,578

Registered Mar. 18, 2008

SERVICE MARK
PRINCIPAL REGISTER



AOL LLC (DELAWARE LTD LIAB CO)
22000 AOL WAY
DULLES, VA 20166

FOR: ENTERTAINMENT SERVICES, NAMELY,
CONDUCTING A TALENT SEARCH CONTEST VIA
COMPUTER NETWORKS, IN CLASS 41 (U.S. CLS.
100, 101 AND 107).

FIRST USE 7-10-2006; IN COMMERCE 7-10-2006.

THE COLOR(S) BLACK, WHITE AND RED IS/
ARE CLAIMED AS A FEATURE OF THE MARK.

THE WORDING BE A STAR IS IN BLACK. THE
WORD RED IS IN RED. THE SUNGLASSES ARE
BLACK WITH WHITE REFLECTIVE SPOTS IN THE
LENSES.

SER. NO. 78-936,659, FILED 7-25-2006.

TOBY BULLOFF, EXAMINING ATTORNEY

Int. Cl.: 40

Prior U.S. Cls.: 100, 103 and 106

United States Patent and Trademark Office

Reg. No. 3,398,579

Registered Mar. 18, 2008

**SERVICE MARK
PRINCIPAL REGISTER**

ALL BIOLOGY NEEDS A LITTLE
CHEMISTRY

THERMO FISHER SCIENTIFIC (MILWAUKEE)
LLC (DELAWARE LTD LIAB CO)
2202 N. BARTLETT AVENUE
MILWAUKEE, WI 53202

THE MARK CONSISTS OF STANDARD CHAR-
ACTERS WITHOUT CLAIM TO ANY PARTICULAR
FONT, STYLE, SIZE, OR COLOR.

FOR: CHEMICAL SYNTHESIS SERVICES, NAME-
LY, CUSTOM SYNTHESIS OF CHEMICALS FOR
OTHERS, IN CLASS 40 (U.S. CLS. 100, 103 AND 106).

SER. NO. 78-937,220, FILED 7-25-2006.

FIRST USE 10-0-2003; IN COMMERCE 10-0-2003.

ESTHER BELENKER, EXAMINING ATTORNEY

Int. Cl.: 40

Prior U.S. Cls.: 100, 103 and 106

United States Patent and Trademark Office

Reg. No. 3,398,580

Registered Mar. 18, 2008

**SERVICE MARK
PRINCIPAL REGISTER**

YOU IMAGINE IT. WE CREATE
IT.

THERMO FISHER SCIENTIFIC (MILWAUKEE)
LLC (DELAWARE LTD LIAB CO)
2202 N. BARTLETT AVENUE
MILWAUKEE, WI 53202

THE MARK CONSISTS OF STANDARD CHAR-
ACTERS WITHOUT CLAIM TO ANY PARTICULAR
FONT, STYLE, SIZE, OR COLOR.

FOR: CHEMICAL SYNTHESIS SERVICES, NAME-
LY, CUSTOM SYNTHESIS OF CHEMICALS FOR
OTHERS, IN CLASS 40 (U.S. CLS. 100, 103 AND 106).

SER. NO. 78-937,236, FILED 7-25-2006.

FIRST USE 10-0-2003; IN COMMERCE 10-0-2003.

ESTHER BELENKER, EXAMINING ATTORNEY

Int. Cl.: 41

Prior U.S. Cls.: 100, 101 and 107

United States Patent and Trademark Office

Reg. No. 3,398,581

Registered Mar. 18, 2008

**SERVICE MARK
PRINCIPAL REGISTER**

AMERICAN MINUTE

AMERISEARCH, INC. (MISSOURI CORPORATION)
P.O. BOX 20163
ST. LOUIS, MO 63123

FOR: ENTERTAINMENT IN THE NATURE OF ON-GOING RADIO AND TELEVISION PROGRAMS IN THE FIELD OF HISTORY; AND EDUCATIONAL SERVICES, NAMELY, PROVIDING HISTORICAL INFORMATION VIA AN INTERNET WEBSITE, IN CLASS 41 (U.S. CLS. 100, 101 AND 107).

FIRST USE 1-1-2000; IN COMMERCE 1-1-2000.

THE MARK CONSISTS OF STANDARD CHARACTERS WITHOUT CLAIM TO ANY PARTICULAR FONT, STYLE, SIZE, OR COLOR.

SER. NO. 78-939,642, FILED 7-28-2006.

TRACY CROSS, EXAMINING ATTORNEY

Int. Cls.: 35, 37, 40 and 42

Prior U.S. Cls.: 100, 101, 102, 103 and 106

United States Patent and Trademark Office

Reg. No. 3,398,582

Registered Mar. 18, 2008

**SERVICE MARK
PRINCIPAL REGISTER**

CHRITTO

MUELLER, DITTMAR (FED REP GERMANY
INDIVIDUAL)
MALTESERWEG 18
BERGISCH GLADBACH, FED REP GERMANY
51465

FOR: PERSONNEL PLACEMENT FOR PREPARING AND CONDUCTING TRADE FAIR AND PRESENTATION EVENTS, IN PARTICULAR PROVIDING OF TECHNICIANS, CRAFTSPEOPLE, HOSTESSES, OFFICE PERSONNEL, TELEPHONE OPERATORS INITIATIVES AND DISSEMINATION OF ADVERTISING FOR FIRMS ON THE INTERNET AND OTHER MEDIA; ADVERTISING CONSULTING SERVICES, NAMELY, MEDIA CONSULTANCY WITH REGARD TO THE PRESENTATION OF FIRMS ON THE INTERNET AND OTHER MEDIA; BUSINESS MARKETING SERVICES AND BUSINESS MARKETING CONSULTING SERVICES, INCLUDING TELEMARKETING, DIRECT MARKETING, TRADE AND EVENT MARKETING, CUSTOMER RELATIONSHIP MARKETING AND MARKETING FOR OTHERS ON DIGITAL NETWORKS; PLANNING, DEVISING AND CONDUCTING OF ADVERTISING INITIATIVES OF ALL KINDS; PROVIDING A WEBSITE THAT GATHERS AND PROCESSES INFORMATION, TEXTS, DRAWINGS AND IMAGES ABOUT EXHIBITIONS AND TRADE FAIRS FOR COMMERCIAL AND ADVERTISING PURPOSES VIA A WEBSITE; E-COMMERCE SERVICES, NAMELY, THE ARRANGING AND CONCLUDING OF COMMERCIAL TRANSACTIONS FOR THIRD PARTIES ONLINE; ARRANGING AND CONDUCTING OF TRADE FAIRS AND EXHIBITIONS FOR COMMERCIAL OR ADVERTISING PURPOSES; MARKETING PLAN DEVELOPMENT AND CONDUCTING OF TWO-DIMENSIONAL AND THREE-DIMENSIONAL MARKETING FOR EVENTS, PRESENTATIONS AND TRADE FAIRS; ARRANGING OF PARTICIPATION OF EXHIBITORS IN TRADE FAIRS AND EXHIBITIONS FOR BUSINESS AND ADVERTISING

PURPOSES; ORGANIZATIONAL PLANNING AND CONDUCTING OF MARKETING AND PROMOTIONAL EVENTS WITHIN THE FRAMEWORK OF PRESENTATIONS AND TRADE FAIRS, FOR COMMERCIAL AND ADVERTISING PURPOSES; RENTAL AND LEASING OF EXHIBITION STANDS, EXHIBITION CONSTRUCTION ELEMENTS AND STAND FIXTURES AND FITTINGS FOR TRADE FAIR AND COMMERCIAL PRESENTATION EVENTS, IN CLASS 35 (U.S. CLS. 100, 101 AND 102).

FIRST USE 12-31-1980; IN COMMERCE 5-13-2000.

FOR: MAINTENANCE AND REPAIR OF EXHIBITION STANDS, EXHIBITION CONSTRUCTION ELEMENTS AND STAND FIXTURES AND FITTINGS FOR TRADE FAIR AND PRESENTATION EVENTS; ASSEMBLY AND DISASSEMBLY OF EXHIBITION STANDS, EXHIBITION CONSTRUCTION ELEMENTS AND STAND FIXTURES AND FITTINGS FOR TRADE FAIR AND PRESENTATION EVENTS; CONSTRUCTION AND ASSEMBLY OF EXHIBITION BOOTHS FOR OTHERS; TECHNICAL CUSTOM BUILDING AND CONSTRUCTING PLANNING AND CONSULTANCY IN THE FIELD OF TRADE FAIR AND EXHIBITION BOOTHS AND SHOP COUNTERS, IN CLASS 37 (U.S. CLS. 100, 103 AND 106).

FIRST USE 12-31-1980; IN COMMERCE 5-13-2000.

FOR: CUSTOM FABRICATION OF EXHIBITION BOOTHS FOR OTHERS, IN CLASS 40 (U.S. CLS. 100, 103 AND 106).

FIRST USE 12-31-1980; IN COMMERCE 5-13-2000.

FOR: TRADE FAIR, EXHIBITION, SHOP, COUNTER AND INTERIOR DESIGN SERVICES, INCLUDING THE ASSOCIATED SKILLED SERVICES, NAMELY, DESIGN OF EXHIBITION BOOTHS; DATABASE-BASED INTERNET SERVICES, NAMELY,

THE CREATING AND INSTALLATION OF INTERNET WEB SITES FOR OTHERS; CONSULTANCY WITH REGARD TO THE DESIGN OF HOMEPAGES AND INTERNET PAGES; E-COMMERCE SERVICES, NAMELY, HOSTING INTERNET WEBSITES FOR OTHERS, IN CLASS 42 (U.S. CLS. 100 AND 101).

FIRST USE 12-31-1980; IN COMMERCE 5-13-2000.

THE MARK CONSISTS OF STANDARD CHARACTERS WITHOUT CLAIM TO ANY PARTICULAR FONT, STYLE, SIZE, OR COLOR.

OWNER OF FED REP GERMANY REG. NO. 30253242, DATED 5-8-2003, EXPIRES 10-30-2012.

THE TERM CHRITTO HAS NO MEANING IN A FOREIGN LANGUAGE.

SER. NO. 78-942,347, FILED 8-1-2006.

AMY HELLA, EXAMINING ATTORNEY

Int. Cl.: 41

Prior U.S. Cls.: 100, 101 and 107

United States Patent and Trademark Office

Reg. No. 3,398,583

Registered Mar. 18, 2008

**SERVICE MARK
PRINCIPAL REGISTER**

THE FACES OF FLU

R&R HEALTHCARE COMMUNICATIONS, INC.
(FLORIDA CORPORATION)
SUITE 300
630 BROOKER CREEK BLVD.
OLDSMAR, FL 34677

THE MARK CONSISTS OF STANDARD CHAR-
ACTERS WITHOUT CLAIM TO ANY PARTICULAR
FONT, STYLE, SIZE, OR COLOR.

FOR: PROVIDING CONTINUING MEDICAL
EDUCATION COURSES, IN CLASS 41 (U.S. CLS.
100, 101 AND 107).

SER. NO. 78-949,737, FILED 8-10-2006.

FIRST USE 7-20-2006; IN COMMERCE 7-20-2006.

JENNIFER VASQUEZ, EXAMINING ATTORNEY

Int. Cl.: 8

Prior U.S. Cls.: 23, 28 and 44

United States Patent and Trademark Office

Reg. No. 3,398,584

Registered Mar. 18, 2008

**TRADEMARK
PRINCIPAL REGISTER**

Handozer

GROSBERG MIKE THOMAS (UNITED STATES
INDIVIDUAL)
2954 HWY 32 STE 1300
CHICO, CA 95973

FOR: GROUND MAINTENANCE EQUIPMENT,
NAMELY, A HAND PULLED GROOMING IMPLE-
MENT IN THE NATURE OF A RAKE LIKE DEVICE
FOR USE ON GROUND SURFACES SUCH AS
BASEBALL INFIELDS AND DRAG HORSE ARE-
NAS, IN CLASS 8 (U.S. CLS. 23, 28 AND 44).

FIRST USE 6-1-2003; IN COMMERCE 6-1-2003.

THE MARK CONSISTS OF STANDARD CHAR-
ACTERS WITHOUT CLAIM TO ANY PARTICULAR
FONT, STYLE, SIZE, OR COLOR.

SER. NO. 78-952,926, FILED 8-15-2006.

MIDGE BUTLER, EXAMINING ATTORNEY

Int. Cl.: 40

Prior U.S. Cls.: 100, 103 and 106

United States Patent and Trademark Office

Reg. No. 3,398,585

Registered Mar. 18, 2008

**SERVICE MARK
PRINCIPAL REGISTER**

**ACCIONA PIONEERS IN
DEVELOPMENT AND
SUSTAINABILITY**

ACCIONA, S.A. (SPAIN CORPORATION)
AVENIDA DE EUROPA, 18
ALCOBENDAS (MADRID), SPAIN 28100

FOR: TREATMENT OF MATERIALS, NAMELY,
OIL AND GAS WELL TREATMENT, NUCLEAR
WASTE TREATMENT, WATER TREATMENT,
TREATMENT OF WATER USED IN NUCLEAR
REACTORS, TREATMENT OF METAL; PRODUC-
TION OF ENERGY; REFINING SERVICES, NAME-
LY, FUEL REFINING, OIL REFINING, IN CLASS 40
(U.S. CLS. 100, 103 AND 106).

THE MARK CONSISTS OF STANDARD CHAR-
ACTERS WITHOUT CLAIM TO ANY PARTICULAR
FONT, STYLE, SIZE, OR COLOR.

PRIORITY CLAIMED UNDER SEC. 44(D) ON
ERPNTM OFC APPLICATION NO.
5238217, FILED 8-3-2006, REG. NO. 005238217, DATED
6-28-2007, EXPIRES 8-3-2016.

THE ENGLISH TRANSLATION OF THE WORD
ACCIONA IS "TO OPERATE" OR "MOVE."

SER. NO. 78-953,671, FILED 8-16-2006.

REBECCA POVARCHUK, EXAMINING ATTOR-
NEY

Int. Cl.: 13

Prior U.S. Cls.: 2 and 9

United States Patent and Trademark Office

Reg. No. 3,398,586

Registered Mar. 18, 2008

**TRADEMARK
PRINCIPAL REGISTER**

TEXAS BRUSH POPPER

CIMARRON FIREARMS COMPANY, INC.
(TEXAS CORPORATION)

105 WINDING OAKS

FREDERICKSBURG, TX 78624

FOR: FIREARMS, IN CLASS 13 (U.S. CLS. 2 AND
9).

FIRST USE 1-30-2006; IN COMMERCE 1-30-2006.

THE MARK CONSISTS OF STANDARD CHAR-
ACTERS WITHOUT CLAIM TO ANY PARTICULAR
FONT, STYLE, SIZE, OR COLOR.

NO CLAIM IS MADE TO THE EXCLUSIVE
RIGHT TO USE "TEXAS", APART FROM THE
MARK AS SHOWN.

SER. NO. 78-953,859, FILED 8-16-2006.

SARA THOMAS, EXAMINING ATTORNEY

Int. Cl.: 41

Prior U.S. Cls.: 100, 101 and 107

United States Patent and Trademark Office

Reg. No. 3,398,587

Registered Mar. 18, 2008

**SERVICE MARK
PRINCIPAL REGISTER**

GEOGRAPHY ALIVE!

TEACHERS' CURRICULUM INSTITUTE, INC.
(CALIFORNIA CORPORATION)
4009 MIRANDA AVENUE, SUITE 100
PALO ALTO, CA 94304

FOR: EDUCATIONAL SERVICES, NAMELY, CONDUCTING WORKSHOPS, LIVE PROGRAMS, VIDEO AND AUDIO TAPE PROGRAMS, AND SLIDE LECTURES IN THE FIELD OF GEOGRAPHY; DEVELOPING EDUCATIONAL MANUALS IN THE FORM OF BOOKS, PAMPHLETS, COMPACT DISCS, FOR OTHERS IN THE FIELD OF GEOGRAPHY; AND PROVIDING INFORMATION ABOUT EDUCATION, NAMELY, PROVIDING TEACHING INFORMATION, EDUCATIONAL COURSE TRAINING AND INSTRUCTIONAL COURSE INFORMA-

TION IN THE FIELD OF GEOGRAPHY, IN CLASS 41 (U.S. CLS. 100, 101 AND 107).

FIRST USE 11-20-2005; IN COMMERCE 11-20-2005.

THE MARK CONSISTS OF STANDARD CHARACTERS WITHOUT CLAIM TO ANY PARTICULAR FONT, STYLE, SIZE, OR COLOR.

NO CLAIM IS MADE TO THE EXCLUSIVE RIGHT TO USE "GEOGRAPHY", APART FROM THE MARK AS SHOWN.

SER. NO. 78-955,362, FILED 8-18-2006.

MARK SPARACINO, EXAMINING ATTORNEY

Int. Cl.: 14

Prior U.S. Cls.: 2, 27, 28 and 50

United States Patent and Trademark Office

Reg. No. 3,398,588

Registered Mar. 18, 2008

**TRADEMARK
PRINCIPAL REGISTER**

Gemfire Diamonds

SUTHERLAND, STEVE S. (UNITED STATES IN-
DIVIDUAL)
PO BOX 530
MANASSA, CO 81141 AND
SUTHERLAND, CHRISTINA (UNITED STATES IN-
DIVIDUAL)
PO BOX 530
MANASSA, CO 81141

FOR: FINE JEWELRY, DIAMONDS, GEM-
STONES, IN CLASS 14 (U.S. CLS. 2, 27, 28 AND 50).

FIRST USE 11-15-2003; IN COMMERCE 2-7-2004.

THE MARK CONSISTS OF STANDARD CHAR-
ACTERS WITHOUT CLAIM TO ANY PARTICULAR
FONT, STYLE, SIZE, OR COLOR.

NO CLAIM IS MADE TO THE EXCLUSIVE
RIGHT TO USE "DIAMONDS", APART FROM THE
MARK AS SHOWN.

SER. NO. 78-955,711, FILED 8-18-2006.

DAVID TOOLEY, EXAMINING ATTORNEY

Int. Cl.: 25

Prior U.S. Cls.: 22 and 39

United States Patent and Trademark Office

Reg. No. 3,398,589

Registered Mar. 18, 2008

**TRADEMARK
PRINCIPAL REGISTER**

Peeler

PEELER, LLC (CALIFORNIA LTD LIAB CO)
SUITE #1846
6404 WILSHIRE BLVD.
LOS ANGELES, CA 90048

SHOES, SANDALS AND SOCKS, IN CLASS 25 (U.S.
CLS. 22 AND 39).

FIRST USE 1-18-2005; IN COMMERCE 11-21-2005.

THE MARK CONSISTS OF STANDARD CHAR-
ACTERS WITHOUT CLAIM TO ANY PARTICULAR
FONT, STYLE, SIZE, OR COLOR.

SER. NO. 78-955,949, FILED 8-19-2006.

FOR: MEN'S, WOMEN'S, AND CHILDREN'S
CLOTHING AND HEADGEAR, NAMELY, T-
SHIRTS, JEANS, PANTS, JACKETS, HATS, SHIRTS,
SWEATSHIRTS, UNDERWEAR, SWEATPANTS,
COATS, SHORTS AND VESTS; MEN'S WOMEN'S,
AND CHILDREN'S FOOTWEAR, NAMELY, BOOTS,

RICHARD A. STRASER, EXAMINING ATTORNEY

Int. Cls.: 35, 37 and 42

Prior U.S. Cls.: 100, 101, 102, 103 and 106

United States Patent and Trademark Office

Reg. No. 3,398,590

Registered Mar. 18, 2008

SERVICE MARK
PRINCIPAL REGISTER

The logo for "dimension" features the word in a bold, lowercase, sans-serif font. A thick, black, curved line arches over the letters, starting above the 'd' and ending above the 'n', creating a stylized, dynamic shape.

DESIGN

M. ROGERS DESIGN, INC. (ILLINOIS CORPORATION)
1907 JANKE DRIVE
NORTHBROOK, IL 60062

FOR: RENTAL OF PROMOTIONAL AND INFORMATIONAL STRUCTURES, NAMELY, TENSIONED FABRIC STRUCTURES FOR THE TRADESHOW INDUSTRY, IN CLASS 35 (U.S. CLS. 100, 101 AND 102).

FIRST USE 1-31-2002; IN COMMERCE 1-31-2002.

FOR: CONSTRUCTION OF PROMOTIONAL AND INFORMATIONAL STRUCTURES, NAMELY, TENSIONED FABRIC STRUCTURES FOR THE TRADESHOW INDUSTRY, IN CLASS 37 (U.S. CLS. 100, 103 AND 106).

FIRST USE 1-31-2002; IN COMMERCE 1-31-2002.

FOR: DESIGN OF PROMOTIONAL AND INFORMATIONAL STRUCTURES, NAMELY, TENSIONED FABRIC STRUCTURES FOR THE TRADESHOW INDUSTRY, IN CLASS 42 (U.S. CLS. 100 AND 101).

FIRST USE 1-31-2002; IN COMMERCE 1-31-2002.

NO CLAIM IS MADE TO THE EXCLUSIVE RIGHT TO USE "DESIGN", APART FROM THE MARK AS SHOWN.

SER. NO. 78-956,728, FILED 8-21-2006.

MARY CRAWFORD, EXAMINING ATTORNEY

Int. Cl.: 33

Prior U.S. Cls.: 47 and 49

United States Patent and Trademark Office

Reg. No. 3,398,591

Registered Mar. 18, 2008

**TRADEMARK
PRINCIPAL REGISTER**

BULLE DE BLANQUETTE

LES VIGNERONS DU SIEUR D'ARQUES SOCI-
ETE COOPERATIVE AGRICOLE (FRANCE
CORPORATION)
AVENUE DU MAUZAC
LIMOUX, FRANCE 11300

FOR: WINES, WINES WITH GUARANTEED LA-
BEL OF ORIGIN, SPARKLING WINES, NATURAL
SWEET WINES; APERITIFS; LIQUEURS AND SPIR-
ITS, NAMELY, BRANDY SPIRITS, DISTILLED SPIR-
ITS, IN CLASS 33 (U.S. CLS. 47 AND 49).

THE MARK CONSISTS OF STANDARD CHAR-
ACTERS WITHOUT CLAIM TO ANY PARTICULAR
FONT, STYLE, SIZE, OR COLOR.

OWNER OF FRANCE REG. NO. 063410943, DA-
TED 2-17-2006, EXPIRES 2-17-2016.

NO CLAIM IS MADE TO THE EXCLUSIVE
RIGHT TO USE "BLANQUETTE", APART FROM
THE MARK AS SHOWN.

THE FOREIGN WORDING IN THE MARK
TRANSLATES INTO ENGLISH AS BUBBLE OF
BLANQUETTE.

SER. NO. 78-956,916, FILED 8-21-2006.

REBECCA POVARCHUK, EXAMINING ATTOR-
NEY

Int. Cl.: 9

Prior U.S. Cls.: 21, 23, 26, 36 and 38

Reg. No. 3,398,592

United States Patent and Trademark Office

Registered Mar. 18, 2008

**TRADEMARK
PRINCIPAL REGISTER**

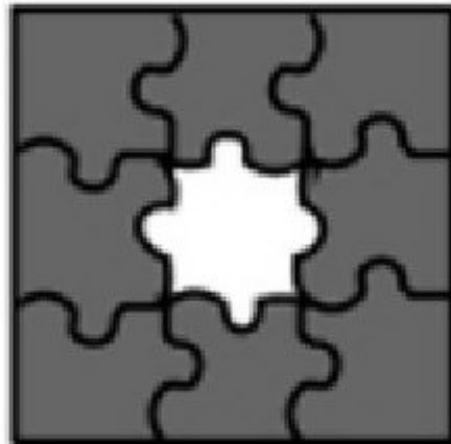

**OBJECTWORLD COMMUNICATIONS CORP.
(CANADA CORPORATION)
308 LEGGET DRIVE
KANATA, CANADA K2K 1Y6**

**FOR: COMPUTER SOFTWARE FOR VOICE,
DATA AND VIDEO COMMUNICATIONS, NAME-
LY, FOR CONNECTING COMPUTER NETWORK
USERS AND GLOBAL COMPUTER NETWORKS,
COMPUTER SOFTWARE FOR MESSAGING,
NAMELY, FOR HANDLING VOICE, DATA AND
VIDEO MESSAGES, COMPUTER SOFTWARE FOR
OFFICE COMMUNICATIONS, NAMELY, FOR
CONNECTING COMPUTER NETWORK USERS**

**AND GLOBAL COMPUTER NETWORKS, IN CLASS
9 (U.S. CLS. 21, 23, 26, 36 AND 38).**

**PRIORITY CLAIMED UNDER SEC. 44(D) ON
CANADA APPLICATION NO. 1291867, FILED 2-28-
2006, REG. NO. TMA697,819, DATED 10-3-2007, EX-
PIRES 10-3-2022.**

THE MARK CONSISTS OF A PUZZLE.

SER. NO. 78-957,683, FILED 8-22-2006.

AMY MCMENAMIN, EXAMINING ATTORNEY

Int. Cl.: 9

Prior U.S. Cls.: 21, 23, 26, 36 and 38

Reg. No. 3,398,593

United States Patent and Trademark Office

Registered Mar. 18, 2008

**TRADEMARK
PRINCIPAL REGISTER**

AWIS

ADE CORPORATION (MASSACHUSETTS CORPORATION)
80 WILSON WAY
WESTWOOD, MA 02090

FOR: EVALUATION MACHINES AND ASSOCIATED OPERATING SOFTWARE FOR SEMICONDUCTOR-BASED PRODUCTS, ALL FOR EVALUATING SURFACE CHARACTERISTICS, CONDITIONS AND DEFECTS, IN CLASS 9 (U.S. CLS. 21, 23, 26, 36 AND 38).

FIRST USE 6-30-2003; IN COMMERCE 6-30-2003.

THE MARK CONSISTS OF STANDARD CHARACTERS WITHOUT CLAIM TO ANY PARTICULAR FONT, STYLE, SIZE, OR COLOR.

OWNER OF U.S. REG. NO. 2,379,493.

SER. NO. 78-958,139, FILED 8-22-2006.

REBECCA POVARCHUK, EXAMINING ATTORNEY

Int. Cl.: 11

Prior U.S. Cls.: 13, 21, 23, 31 and 34

United States Patent and Trademark Office

Reg. No. 3,398,594

Registered Mar. 18, 2008

**TRADEMARK
PRINCIPAL REGISTER**

ENERHEAT

NU-AIR VENTILATION SYSTEMS INC. (CANADA CORPORATION)
16 NELSON STREET
WINDSOR, CANADA B0N 2T0

FOR: HEAT RECOVERY VENTILATORS; COMBINATION FURNACE, HOT WATER TANK, AIR CLEANER, AND HEAT EXCHANGER; AIR CONDITIONERS, IN CLASS 11 (U.S. CLS. 13, 21, 23, 31 AND 34).

FIRST USE 5-10-2007; IN COMMERCE 5-10-2007.

THE MARK CONSISTS OF STANDARD CHARACTERS WITHOUT CLAIM TO ANY PARTICULAR FONT, STYLE, SIZE, OR COLOR.

PRIORITY CLAIMED UNDER SEC. 44(D) ON CANADA APPLICATION NO. 1,312,586, FILED 8-11-2006.

SER. NO. 78-958,329, FILED 8-23-2006.

SETH A. RAPPAPORT, EXAMINING ATTORNEY

Int. Cls.: 35, 36, 41 and 44

Prior U.S. Cls.: 100, 101, 102 and 107

United States Patent and Trademark Office

Reg. No. 3,398,595

Registered Mar. 18, 2008

**SERVICE MARK
PRINCIPAL REGISTER**

BELIEVE IT

CAREMORE HEALTH PLAN (CALIFORNIA CORPORATION)
12900 PARK PLAZA DR. SUITE 150
CERRITOS, CA 90703

FOR: PHYSICIAN REFERRAL SERVICES; ADMINISTRATION OF INSURANCE CLAIMS FOR HMO AND PPO HEALTHCARE PROVIDERS; HEALTH CARE UTILIZATION, REVIEW AND COST CONTAINMENT SERVICES, ALL IN THE HEALTHCARE FIELD; MEDICAL COST MANAGEMENT AND COST MANAGEMENT FOR HEALTH BENEFIT PLANS OF OTHERS; ADMINISTRATION OF ACUTE MEDICAL CARE PROGRAMS AND SERVICES PROVIDED TO MEDICARE BENEFICIARIES AND OTHERS WHO LIVE IN NURSING HOMES, HOSPICES AND CONVALESCENT HOMES; DIRECT PHYSICIAN REFERRAL SERVICES, IN CLASS 35 (U.S. CLS. 100, 101 AND 102).

FIRST USE 3-0-2006; IN COMMERCE 3-0-2006.

FOR: UNDERWRITING MEDICAL INSURANCE SERVICES IN THE NATURE OF HMOS AND PPOS; ADMINISTRATION OF HEALTH BENEFIT PLANS OF OTHERS; ADMINISTRATION OF PRESCRIPTION DRUG BENEFIT PLANS OF OTHERS; ADMINISTRATION OF HEALTH BENEFIT PLANS COVERING PRESCRIPTION DRUG BENEFITS, DENTAL CARE, VISION AND HEARING CARE, DISCOUNT EYEGLASSES AND MEDICAL TRANSPORTATION, NAMELY COSTS ASSOCIATED WITH AMBULANCE AND MEDICAL EVACUATION TRANSPORTATION AND CARE, HOSPICE AND CONVALESCENT CARE; ADMINISTRATION OF HEALTH INSURANCE PLANS FOR ELIGIBLE MEDICARE BENEFICIARIES, IN CLASS 36 (U.S. CLS. 100, 101 AND 102).

FIRST USE 3-0-2006; IN COMMERCE 3-0-2006.

FOR: STRENGTH TRAINING PROGRAMS, NAMELY, STRENGTH AND CONDITIONING TRAINING, IN CLASS 41 (U.S. CLS. 100, 101 AND 107).

FIRST USE 3-0-2006; IN COMMERCE 3-0-2006.

FOR: MEDICAL SERVICES, NAMELY, PHYSICIAN GROUPS OFFERING PRIMARY MEDICAL CARE SERVICES VIA HMO AND PPO MEDICAL PROGRAMS; CHRONIC CARE MEDICAL SERVICES; MEDICAL CLINICS, PRE-SURGICAL EVALUATION CLINICS, COMPREHENSIVE CARE CLINICS, DIABETES AND WOUND CLINICS, ANTICOAGULATION CLINICS, PODIATRY SERVICES; HOSPITALS; PROVIDING IN-HOME AND OUT-PATIENT PHYSICIAN AND NURSING CARE SERVICES; EMERGENCY MEDICAL RESPONSE SERVICES; MEDICAL EVALUATION SERVICES, NAMELY, FUNCTIONAL ASSESSMENT PROGRAMS FOR PATIENTS RECEIVING MEDICAL REHABILITATION SERVICES FOR PURPOSES OF GUIDING TREATMENT AND ASSESSING PROGRAM EFFECTIVENESS; PROVIDING HOSPICE AND CONVALESCENT HOME CARE SERVICES; HOSPITALIST PROGRAMS, NAMELY, PROVIDING PHYSICIAN SERVICES BY PHYSICIANS WHO SPECIALIZE IN TREATING THE HOSPITALIZED PATIENTS OF OTHER PHYSICIANS, IN CLASS 44 (U.S. CLS. 100 AND 101).

FIRST USE 3-0-2006; IN COMMERCE 3-0-2006.

THE MARK CONSISTS OF STANDARD CHARACTERS WITHOUT CLAIM TO ANY PARTICULAR FONT, STYLE, SIZE, OR COLOR.

SER. NO. 78-959,984, FILED 8-24-2006.

RUSS HERMAN, EXAMINING ATTORNEY

Int. Cl.: 9

Prior U.S. Cls.: 21, 23, 26, 36 and 38

United States Patent and Trademark Office

Reg. No. 3,398,596

Registered Mar. 18, 2008

**TRADEMARK
PRINCIPAL REGISTER**

XMES

PERFORMIX INC. (TEXAS CORPORATION)
9720 BEECHNUT SUITE 114
HOUSTON, TX 77036

FOR: COMPUTER SOFTWARE FOR DESIGNED TO INITIATE, GUIDE, COLLECT AND MANAGE ACTIVITIES IN THE PRODUCTION AREAS OF MANUFACTURING ORGANIZATIONS TO PROVIDE TRACEABILITY AND GENEALOGY OF PRODUCED GOODS, PROVIDE VISIBILITY AND TRACKING OF PRODUCTION WHILE ENSURING

COMPLIANCE WITH APPLICABLE LAW, IN CLASS 9 (U.S. CLS. 21, 23, 26, 36 AND 38).

FIRST USE 8-15-2006; IN COMMERCE 8-15-2006.

THE MARK CONSISTS OF STANDARD CHARACTERS WITHOUT CLAIM TO ANY PARTICULAR FONT, STYLE, SIZE, OR COLOR.

SER. NO. 78-960,173, FILED 8-24-2006.

PAM WILLIS, EXAMINING ATTORNEY

Int. Cl.: 29

Prior U.S. Cl.: 46

United States Patent and Trademark Office

Reg. No. 3,398,597

Registered Mar. 18, 2008

**TRADEMARK
PRINCIPAL REGISTER**



J&B WHOLESALE DISTRIBUTING, INC. (MINNESOTA CORPORATION)

13200 43RD STREET NE

P.O. BOX 212

ST. MICHAEL, MN 55376

FOR: FISH AND SEAFOOD, IN CLASS 29 (U.S. CL. 46).

FIRST USE 11-1-2005; IN COMMERCE 11-1-2005.

NO CLAIM IS MADE TO THE EXCLUSIVE RIGHT TO USE "SEAFOOD COMPANY", APART FROM THE MARK AS SHOWN.

THE COLOR(S) BLUE, WHITE, BLACK AND GREEN IS/ARE CLAIMED AS A FEATURE OF THE MARK.

THE MARK CONSISTS OF THE TERM BLUEWAVE, SHOWN IN THE COLOR BLUE, ABOVE A WAVY BLUE LINE, AND THE WORDS SEAFOOD COMPANY, SHOWN IN THE COLOR GREEN, AND A PICTURE OF AN ANCHOR, SHOWN IN THE COLOR BLACK, ALL SET AGAINST A WHITE BACKGROUND.

SER. NO. 78-961,902, FILED 8-28-2006.

LINDA POWELL, EXAMINING ATTORNEY

Int. Cls.: 10, 20, 21 and 28

Prior U.S. Cls.: 2, 13, 22, 23, 25, 26, 29, 30, 32, 33, 38, 39, 40, 44 and 50

Reg. No. 3,398,598

United States Patent and Trademark Office

Registered Mar. 18, 2008

**TRADEMARK
PRINCIPAL REGISTER**



KIDS II, INC. (GEORGIA CORPORATION)
555 NORTH POINT CENTER EAST, SUITE 600
ALPHARETTA, GA 30022

FOR: TEETHING RINGS, IN CLASS 10 (U.S. CLS. 26, 39 AND 44).

FIRST USE 6-5-2006; IN COMMERCE 6-5-2006.

FOR: BABY BOUNCER SEATS, BOOSTER SEATS, STOOLS, IN CLASS 20 (U.S. CLS. 2, 13, 22, 25, 32 AND 50).

FIRST USE 6-1-2006; IN COMMERCE 6-1-2006.

FOR: INFANT FOAM BATH SPONGE PADS WITH SPONGES FOR PLACING BABIES ON DURING OR AFTER A BATH; TOILET TRAINING DEVICES, NAMELY, POTTIES FOR INFANTS, IN CLASS 21 (U.S. CLS. 2, 13, 23, 29, 30, 33, 40 AND 50).

FIRST USE 6-15-2006; IN COMMERCE 6-15-2006.

FOR: BABY MULTIPLE EXERCISER TOYS; EXERCISER TOYS, NAMELY, FABRIC TEETHING TOYS, BATHTUB TOYS, CRIB MOBILES, PLAY GYMS, PLAY MATS CONTAINING INFANT TOYS, PLASTIC CHARACTER TOYS, MULTIPLE TOY MIRRORS FOR INFANTS, IN CLASS 28 (U.S. CLS. 22, 23, 38 AND 50).

FIRST USE 6-5-2006; IN COMMERCE 6-5-2006.

OWNER OF U.S. REG. NOS. 1,804,601 AND 2,473,856.

THE MARK CONSISTS OF PICTURE OF UPPER HALF OF THE SUN WITH THE WORDS BRIGHT STARTS UNDERNEATH.

SER. NO. 78-963,662, FILED 8-30-2006.

WILLIAM VERHOSEK, EXAMINING ATTORNEY

Int. Cl.: 9

Prior U.S. Cls.: 21, 23, 26, 36 and 38

Reg. No. 3,398,599

United States Patent and Trademark Office

Registered Mar. 18, 2008

**TRADEMARK
PRINCIPAL REGISTER**

IITPortf

INFANGER INVESTMENT TECHNOLOGY, LLC
(CALIFORNIA LTD LIAB CO)
2680 BAYSHORE PARKWAY,SUITE 206
MOUNTAIN VIEW, CA 94043

FIRST USE 4-1-1999; IN COMMERCE 4-1-1999.

FOR: COMPUTER SOFTWARE USED TO OPTIMIZE INVESTMENT ASSETS PORTFOLIOS FOR SOLVING LARGE-SCALE EQUITY PORTFOLIO OPTIMIZATION PROBLEMS IN THE FIELD OF ASSET MANAGEMENT, IN CLASS 9 (U.S. CLS. 21, 23, 26, 36 AND 38).

THE MARK CONSISTS OF STANDARD CHARACTERS WITHOUT CLAIM TO ANY PARTICULAR FONT, STYLE, SIZE, OR COLOR.

SER. NO. 78-964,141, FILED 8-30-2006.

CYNTHIA SLOAN, EXAMINING ATTORNEY

Int. Cls.: 3, 9, 14, 16, 20, 25, 35, 36, 37, 43 and 45

Prior U.S. Cls.: 1, 2, 4, 5, 6, 13, 21, 22, 23, 25, 26, 27, 28, 29, 32, 36, 37, 38, 39, 50, 51, 52, 100, 101, 102, 103 and 106

Reg. No. 3,398,600

United States Patent and Trademark Office

Registered Mar. 18, 2008

**TRADEMARK
SERVICE MARK
PRINCIPAL REGISTER**



MATA AMRITANANDAMAYI CENTER (CALIFORNIA CORPORATION)

10200 CROW CANYON ROAD
CASTRO VALLEY, CA 94552

FOR: COSMETICS, NAMELY, BODY CARE, FACE CARE AND HAND CARE PRODUCTS IN THE FORM OF NOURISHING, CONDITIONING AND MOISTURIZING LIQUIDS FOR FACE AND BODY CARE, CREAMS, MASKS, AMPOULES CONTAINING NOURISHING, CONDITIONING AND MOISTURIZING LIQUIDS FOR FACE AND BODY CARE; NOURISHING, CONDITIONING AND MOISTURIZING GELS AND EMULSIONS FOR FACE AND BODY CARE; BODY OIL; SHOWER GEL; BATH GEL; FACE LOTION; BODY LOTION; HAIR OIL; SOAPS FOR BODY CARE; HAIR AND BODY SHAMPOOS; HAIR CONDITIONERS; HAIR GELS; HAIR DYES; HAIR SPRAYS; PERSONAL DEODORANTS; PERSONAL ANTIPERSPIRANTS; ESSENTIAL OILS FOR PERSONAL USE; COSMETICS, NAMELY, FACIAL MAKEUP, FOUNDATIONS, SKIN CLEANSING LOTIONS, CLEANING, SOOTHING AND REFRESHING TONICS FOR FACE CARE, NAMELY, SKIN TONERS, NON-MEDICATED ACNE PREPARATIONS, LIP LINER, MASCARA, EYELINERS, FACE POWDER, FACE CREAMS, NAIL CARE PREPARATIONS, SUN PROTECTION PREPARATIONS, NAMELY, SUN BLOCK; PERFUME; PERFUME OILS; INCENSE, IN CLASS 3 (U.S. CLS. 1, 4, 6, 50, 51 AND 52).

FIRST USE 12-31-2003; IN COMMERCE 12-31-2003.

FOR: DECORATIVE MAGNETS; PRE-RECORDED AUDIO CASSETTES FEATURING MUSIC, DISCOURSES, INSPIRATIONAL TALKS, INFORMATION OR A COMBINATION THEREOF ON AT LEAST ONE AMONG THE TOPICS OF HAPPINESS, SPIRITUALITY, RELIGION, SELF-HELP, PERSONAL EMPOWERMENT, HEALTH AND WELL-BEING, HEALING ARTS, RELIGIOUS CEREMONIES, CHANTING, STRESS MANAGEMENT, AYURVEDIC AND HOLISTIC HEALING OR A COMBINATION THEREOF; PRE-RECORDED VIDEO CASSETTES FEATURING MUSIC, DISCOURSES, INSPIRATIONAL TALKS, INFORMATION OR A COMBINATION THEREOF ON AT LEAST ONE AMONG THE TOPICS OF HAPPINESS, SPIRITUALITY, RELIGION, SELF-HELP, PERSONAL EMPOWERMENT, HEALTH AND WELL-BEING, HEALING ARTS, RELIGIOUS CEREMONIES, CHANTING, STRESS MANAGEMENT, AYURVEDIC AND HOLISTIC HEALING OR A COMBINATION THEREOF; PRE-RECORDED CD'S FEATURING MUSIC, DISCOURSES, INSPIRATIONAL TALKS, IMAGES, INFORMATION OR A COMBINATION THEREOF ON AT LEAST ONE AMONG THE TOPICS OF HAPPINESS, SPIRITUALITY, RELIGION, SELF-HELP, PERSONAL EMPOWERMENT, HEALTH AND WELL-BEING, HEALING ARTS, RELIGIOUS CEREMONIES, CHANTING, STRESS MANAGEMENT, AYURVEDIC AND HOLISTIC HEALING OR A COMBINATION THEREOF; PRE-RECORDED

DVD'S FEATURING MUSIC, DISCOURSES, INSPIRATIONAL TALKS, IMAGES, INFORMATION OR A COMBINATION THEREOF ON AT LEAST ONE AMONG THE TOPICS OF HAPPINESS, SPIRITUALITY, RELIGION, SELF-HELP, PERSONAL EMPOWERMENT, HEALTH AND WELL-BEING, HEALING ARTS, RELIGIOUS CEREMONIES, CHANTING, STRESS MANAGEMENT, AYURVEDIC AND HOLISTIC HEALING OR A COMBINATION THEREOF, IN CLASS 9 (U.S. CLS. 21, 23, 26, 36 AND 38).

FIRST USE 12-31-2003; IN COMMERCE 12-31-2003.

FOR: JEWELRY CHAINS; PENDANTS; JEWELRY PINS; BROOCHES; JEWELRY CHARMS; EARRINGS; JEWELRY RINGS AND TOE RINGS; BRACELETS; NECKLACES; AMULETS; JEWELRY BOXES NOT OF METAL, IN CLASS 14 (U.S. CLS. 2, 27, 28 AND 50).

FIRST USE 12-31-2003; IN COMMERCE 12-31-2003.

FOR: MOUNTED PHOTOGRAPHS; UNMOUNTED PHOTOGRAPHS; MOUNTED POSTERS; UNMOUNTED POSTERS; CALENDARS; GREETING CARDS; STICKERS; BLANK PERSONAL JOURNALS; BOOKS, BOOKLETS MAGAZINES, PAMPHLETS AND NEWSLETTERS IN THE FIELD OF HAPPINESS, SPIRITUALITY, RELIGION, SELF-HELP, PERSONAL EMPOWERMENT, HEALTH AND WELL-BEING, HEALING ARTS, RELIGIOUS CEREMONIES, CHANTING, STRESS MANAGEMENT, AYURVEDIC AND HOLISTIC HEALING, IN CLASS 16 (U.S. CLS. 2, 5, 22, 23, 29, 37, 38 AND 50).

FIRST USE 12-31-2003; IN COMMERCE 12-31-2003.

FOR: CUSHIONS; FLOOR CUSHIONS; PILLOWS; BACK RESTS AND PORTABLE BACK SUPPORTS FOR USE FOR SITTING OR IN PLACE OF CHAIRS; CHAIRS, IN CLASS 20 (U.S. CLS. 2, 13, 22, 25, 32 AND 50).

FIRST USE 12-31-2003; IN COMMERCE 12-31-2003.

FOR: T-SHIRTS; PANTS; SWEATSHIRTS; SWEATPANTS; TOPS; PULLOVERS; JACKETS; SARIS; SALWARS, NAMELY, A WOMAN'S DRESS-LIKE GARMENT; SARONGS; BLOUSES; SHAWLS; VESTS; POLO SHIRTS; SHORTS; TIGHTS; PAJAMAS; SPORTS SHIRTS; SCARVES, IN CLASS 25 (U.S. CLS. 22 AND 39).

FIRST USE 12-31-2003; IN COMMERCE 12-31-2003.

FOR: CATALOG ORDERING SERVICES, MAIL ORDER SERVICES AND COMPUTERIZED ONLINE RETAIL STORE SERVICES ALL FEATURING CLOTHING, PURSES, BAGS, SADDLE BAGS, TOTE BAGS, JEWELRY, COSMETICS, BODY CARE PRODUCTS, FACIAL MAKEUP, BOOKS, MAGAZINES, BROCHURES, PAMPHLETS, POSTERS, PHOTOGRAPHS, STICKERS, CUSHIONS, BACKRESTS,

PILLOWS, DOLLS, CALENDARS, GREETING CARDS, PRE-RECORDED AUDIO CASSETTES, PRE-RECORDED VIDEO CASSETTES, PRE-RECORDED CD'S, PRE-RECORDED DVD'S, OR A COMBINATION THEREOF; CHARITABLE SERVICES, NAMELY, ORGANIZING AND CONDUCTING VOLUNTEER PROGRAMS AND COMMUNITY SERVICE PROJECTS; DISASTER RECOVERY SERVICES, NAMELY, BUSINESS PLANNING AND BUSINESS CONTINUITY CONSULTING; DEVELOPING AND COORDINATING VOLUNTEER PROJECTS FOR CHARITABLE ORGANIZATIONS, IN CLASS 35 (U.S. CLS. 100, 101 AND 102).

FIRST USE 12-31-2003; IN COMMERCE 12-31-2003.

FOR: ACCEPTING AND ADMINISTERING MONETARY CHARITABLE CONTRIBUTIONS; CHARITABLE FUNDRAISING, IN CLASS 36 (U.S. CLS. 100, 101 AND 102).

FIRST USE 12-31-2003; IN COMMERCE 12-31-2003.

FOR: CHARITABLE SERVICES, NAMELY, RENOVATING AND CONSTRUCTING HOMES FOR LOW INCOME PEOPLE, IN CLASS 37 (U.S. CLS. 100, 103 AND 106).

FIRST USE 12-31-2003; IN COMMERCE 12-31-2003.

FOR: CHARITABLE SERVICES, NAMELY, PROVIDING FOOD TO NEEDY PERSONS AND DISASTER VICTIMS, IN CLASS 43 (U.S. CLS. 100 AND 101).

FIRST USE 12-31-2003; IN COMMERCE 12-31-2003.

FOR: CHARITABLE SERVICES, NAMELY, PROVIDING CLOTHING TO THE NEEDY PERSONS AND DISASTER VICTIMS, IN CLASS 45 (U.S. CLS. 100 AND 101).

FIRST USE 12-31-2003; IN COMMERCE 12-31-2003.

OWNER OF U.S. REG. NOS. 2,163,631 AND 2,883,239.

THE NAME(S), PORTRAIT(S), AND/OR SIGNATURE(S) SHOWN IN THE MARK IDENTIFIES MATA AMRITANANDAMAYI, WHOSE CONSENT(S) TO REGISTER IS SUBMITTED.

THE MARK CONSISTS OF A TWO-DIMENSIONAL GRAPHIC DESIGN HAVING A WOMAN WITH A HEART DESIGN EMBRACING ANOTHER PERSON REPRESENTED BY A CIRCLE DESIGN AND THE WORD "AMMA" APPEAR WITHIN A BANNER DESIGN THEREUNDER

THE FOREIGN WORDING IN THE MARK TRANSLATES INTO ENGLISH AS MOTHER.

SER. NO. 78-964,245, FILED 8-30-2006.

JENNIFER MARTIN, EXAMINING ATTORNEY

Int. Cl.: 44

Prior U.S. Cls.: 100 and 101

United States Patent and Trademark Office

Reg. No. 3,398,601

Registered Mar. 18, 2008

**SERVICE MARK
PRINCIPAL REGISTER**



RICHLAND ANIMAL HOSPITAL (MICHIGAN CORPORATION)
8421 N 32ND STREET
RICHLAND, MI 49083

FOR: VETERINARY SERVICES, IN CLASS 44 (U.S. CLS. 100 AND 101).

FIRST USE 11-1-2001; IN COMMERCE 11-1-2001.

NO CLAIM IS MADE TO THE EXCLUSIVE RIGHT TO USE "RICHLAND ANIMAL HOSPITAL", APART FROM THE MARK AS SHOWN.

"THE COLOR(S) RED IS/ARE CLAIMED AS A FEATURE OF THE MARK."

THE MARK CONSISTS OF RED BOX WITH A CAT AND DOG GRAPHIC ON THE RIGHT SIDE OF A RED BOX. THE TAIL FROM THE ANIMALS HANGS DOWN FROM THE BOX. THE LITERAL ELEMENT "RICHLAND ANIMAL HOSPITAL" IS SITUATED INSIDE THE RED BOX TO THE LEFT OF THE ANIMAL GRAPHIC. THE COLOR WHITE IS NOT PART OF THE MARK AND IS MERELY THE BACKGROUND.

SER. NO. 78-965,146, FILED 8-31-2006.

LINDA ORNDORFF, EXAMINING ATTORNEY

Int. Cl.: 25

Prior U.S. Cls.: 22 and 39

United States Patent and Trademark Office

Reg. No. 3,398,602

Registered Mar. 18, 2008

**TRADEMARK
PRINCIPAL REGISTER**

TRELISE

TRELISE COOPER LIMITED (NEW ZEALAND
COMPANY)
8 LION PLACE, NEWMARKET
AUCKLAND, NEW ZEALAND

FOR: CLOTHING NAMELY PANTS, SHIRTS, T-
SHIRTS, SWEATSHIRTS, SHORTS, SKIRTS, SUITS,
TROUSERS, DRESSES, BELTS IN THIS CLASS,
SWEATSHIRTS, SCARVES, SHAWLS, GLOVES,
SWIMSUITS, JUMPSUITS, COATS, JACKETS, TOPS,
SWEATERS, BLOUSES, VESTS, HOSIERY, BRAS,
NIGHTGOWNS, DRESSING GOWNS, PYJAMAS;
LINGERIE; FOOTWEAR; HEADWEAR, IN CLASS
25 (U.S. CLS. 22 AND 39).

THE MARK CONSISTS OF STANDARD CHAR-
ACTERS WITHOUT CLAIM TO ANY PARTICULAR
FONT, STYLE, SIZE, OR COLOR.

OWNER OF NEW ZEALAND REG. NO. 739885,
DATED 12-5-2005, EXPIRES 12-5-2015.

SER. NO. 78-965,466, FILED 8-31-2006.

ROBERT LAVACHE, EXAMINING ATTORNEY

Int. Cl.: 44

Prior U.S. Cls.: 100 and 101

United States Patent and Trademark Office

Reg. No. 3,398,603

Registered Mar. 18, 2008

**SERVICE MARK
PRINCIPAL REGISTER**

HEALING BRILLIANTLY

LASERCARE THERAPEUTICS INC. (CANADA
CORPORATION)
4041 - 200TH STREET
LANGLEY, CANADA V3A1K8

FOR: PROVIDING LASER THERAPY FOR
TREATING MEDICAL CONDITIONS, IN CLASS 44
(U.S. CLS. 100 AND 101).

THE MARK CONSISTS OF STANDARD CHAR-
ACTERS WITHOUT CLAIM TO ANY PARTICULAR
FONT, STYLE, SIZE, OR COLOR.

PRIORITY CLAIMED UNDER SEC. 44(D) ON
CANADA APPLICATION NO. 1294813, FILED 3-22-
2006, REG. NO. TMA696,781, DATED 9-18-2007, EX-
PIRES 9-18-2022.

SER. NO. 78-967,114, FILED 9-5-2006.

MARGERY A. TIERNEY, EXAMINING ATTORNEY

Int. Cls.: 8, 9 and 11

Prior U.S. Cls.: 13, 21, 23, 26, 28, 31, 34, 36, 38 and 44

United States Patent and Trademark Office

Reg. No. 3,398,604

Registered Mar. 18, 2008

**TRADEMARK
PRINCIPAL REGISTER**



XTREME TOOLS INTERNATIONAL, INC.
(FLORIDA CORPORATION)
5440 N.W. 161ST STREET
HIALEAH, FL 33014

FOR: ELECTRIC MANICURE SETS; MANICURE IMPLEMENTS, NAMELY NAIL FILES, NAIL CLIPPERS, CUTICLE PUSHERS, TWEEZERS, AND MANICURE SETS, IN CLASS 8 (U.S. CLS. 23, 28 AND 44).

FIRST USE 5-13-2003; IN COMMERCE 5-13-2003.

FOR: ELECTRIC HAIR STRAIGHTENERS; ELECTRIC HAIR CURLING IRONS; ELECTRIC HAIR CRIMPERS, IN CLASS 9 (U.S. CLS. 21, 23, 26, 36 AND 38).

FIRST USE 5-13-2003; IN COMMERCE 5-13-2003.

FOR: ELECTRIC HOT AIR HAND DRYERS; HAND-HELD ELECTRIC HAIR DRYERS, IN CLASS 11 (U.S. CLS. 13, 21, 23, 31 AND 34).

FIRST USE 5-13-2003; IN COMMERCE 5-13-2003.

NO CLAIM IS MADE TO THE EXCLUSIVE RIGHT TO USE "TOOLS", APART FROM THE MARK AS SHOWN.

THE MARK CONSISTS OF LARGE X WITH "XTREME" ON TOP LINE AND "TOOLS" ON BOTTOM LINE.

SER. NO. 78-967,390, FILED 9-5-2006.

SOPHIA S. KIM, EXAMINING ATTORNEY

Int. Cls.: 9, 16, 35 and 41

**Prior U.S. Cls.: 2, 5, 21, 22, 23, 26, 29, 36, 37, 38, 50,
100, 101, 102 and 107**

Reg. No. 3,398,605

United States Patent and Trademark Office

Registered Mar. 18, 2008

**TRADEMARK
SERVICE MARK
PRINCIPAL REGISTER**

COMMUNICAID

COMMUNICAID GROUP LIMITED (UNITED KINGDOM CORPORATION)
5TH FLOOR, HOLLAND HOUSE
1 - 4 BURY STREET
LONDON EC3A 5AW, UNITED KINGDOM

FOR: DOWNLOADABLE ELECTRONIC PUBLICATIONS IN THE NATURE TEXTBOOKS, BOOKS, WORKBOOKS, MAGAZINES, JOURNALS, BROCHURES, PAMPHLETS, SLIDE PRESENTATIONS, COURSE OUTLINES AND E-LEARNING DEMONSTRATIONS IN THE FIELD OF LANGUAGE, ACCENT REDUCTION, ELOCUTION, CULTURAL AWARENESS, REPORT WRITING, PROFESSIONAL WRITING, SPEAKING SKILLS, NEGOTIATING SKILLS, COMMUNICATION SKILLS AND PRESENTATIONAL SKILLS, TEACHING, COMPREHENSION, ANALYSIS, TRANSLATION AND MANIPULATION OF LANGUAGES; VIDEOCASSETTES, DVDS, CDS AND CD-ROMS, ALL FEATURING INFORMATION IN THE FIELD OF LANGUAGE, ACCENT REDUCTION, ELOCUTION, CULTURAL AWARENESS, REPORT WRITING, PROFESSIONAL WRITING, SPEAKING SKILLS, NEGOTIATING SKILLS, COMMUNICATION SKILLS AND PRESENTATIONAL SKILLS, TEACHING, COMPREHENSION, ANALYSIS, TRANSLATION AND MANIPULATION OF LANGUAGES, IN CLASS 9 (U.S. CLS. 21, 23, 26, 36 AND 38).

FOR: PRINTED MATTER AND PUBLICATIONS, NAMELY, TEXTBOOKS, BOOKS, WORKBOOKS, MAGAZINES, JOURNALS, BROCHURES, PAMPHLETS, SLIDE PRESENTATIONS, COURSE OUTLINES AND PRINTED E-LEARNING DEMONSTRATIONS, ALL IN THE FIELD OF LANGUAGE, ACCENT REDUCTION, ELOCUTION, CULTURAL AWARENESS, REPORT WRITING, PROFESSIONAL WRITING, SPEAKING SKILLS, NEGOTIATING SKILLS, COMMUNICATION

SKILLS AND PRESENTATIONAL SKILLS, TEACHING, COMPREHENSION, ANALYSIS, TRANSLATION AND MANIPULATION OF LANGUAGES; PRINTED TEACHING MATERIALS IN THE FIELDS OF LANGUAGE, ACCENT REDUCTION, ELOCUTION, CULTURAL AWARENESS, REPORT WRITING, PROFESSIONAL WRITING, SPEAKING SKILLS, NEGOTIATING SKILLS, COMMUNICATION SKILLS AND PRESENTATIONAL SKILLS, TEACHING, COMPREHENSION, ANALYSIS, TRANSLATION AND MANIPULATION OF LANGUAGES, IN CLASS 16 (U.S. CLS. 2, 5, 22, 23, 29, 37, 38 AND 50).

FOR: BUSINESS CONSULTANCY, ADVISORY AND INFORMATION SERVICES, ALL IN THE FIELD OF EFFECTIVE INTERNAL BUSINESS COMMUNICATION AND EFFECTIVE COMMUNICATION WITH OTHER BUSINESSES, NONE OF THE AFORESAID BEING RELATED TO, OR FOR THE PURPOSES OF, MARKETING, IN CLASS 35 (U.S. CLS. 100, 101 AND 102).

FOR: EDUCATION AND TRAINING SERVICES, NAMELY, COURSES, SEMINARS, WORKSHOPS AND E-LEARNING DEMONSTRATIONS IN THE FIELDS OF LANGUAGE, ACCENT REDUCTION, ELOCUTION, CULTURAL AWARENESS, REPORT WRITING, PROFESSIONAL WRITING, SPEAKING SKILLS, NEGOTIATING SKILLS, COMMUNICATION SKILLS AND PRESENTATIONAL SKILLS, TEACHING, COMPREHENSION, ANALYSIS, TRANSLATION AND MANIPULATION OF LANGUAGES; PUBLICATION OF TEXTBOOKS, BOOKS, WORKBOOKS, MAGAZINES, JOURNALS, BROCHURES, PAMPHLETS, SLIDE PRESENTATIONS, COURSE OUTLINES AND E-LEARNING DEMONSTRATIONS; CONSULTING, ADVISORY SERVICES AND PROVIDING INFORMATION, ALL IN THE

FIELDS OF PROVIDING EDUCATION AND TRAINING SERVICES, IN CLASS 41 (U.S. CLS. 100, 101 AND 107).

THE MARK CONSISTS OF STANDARD CHARACTERS WITHOUT CLAIM TO ANY PARTICULAR FONT, STYLE, SIZE, OR COLOR.

PRIORITY CLAIMED UNDER SEC. 44(D) ON ERPN CMNTY TM OFC APPLICATION NO. 004940813, FILED 3-6-2006, REG. NO. 004940813, DATED 4-12-2007, EXPIRES 3-6-2016.

SER. NO. 78-967,858, FILED 9-6-2006.

BONNIE LUKEN, EXAMINING ATTORNEY

Int. Cls.: 9, 16 and 25

**Prior U.S. Cls.: 2, 5, 21, 22, 23, 26, 29, 36, 37, 38, 39
and 50**

Reg. No. 3,398,606

United States Patent and Trademark Office

Registered Mar. 18, 2008

**TRADEMARK
PRINCIPAL REGISTER**



SABRE VISION PTY LTD (AUSTRALIA CORPORATION)
53 RIDLEY STREET
CHARLESTOWN, AUSTRALIA 2290

FOR: ANTI-GLARE GLASSES; CASES FOR SPECTACLES AND SUNGLASSES; EYEGGLASS CASES; GOGGLES FOR SPORTS; PROTECTIVE CLOTHING; PROTECTIVE EYEWEAR; PROTECTIVE GLASSES; PROTECTIVE HELMETS; PROTECTIVE HELMETS FOR SPORTS; PROTECTIVE INDUSTRIAL BOOTS; PROTECTIVE INDUSTRIAL SHOES; PROTECTIVE SPECTACLES; SAFETY EYEWEAR; SAFETY GOGGLES; SAFETY HELMETS; SAFETY PRODUCTS, NAMELY, REFLECTIVE SAFETY BANDS TO BE WORN ON THE BODY; SPECTACLE CASES; SPECTACLES; SPORTS EYEWEAR; SPORTS GLASSES; SPORTS' GLASSES; SUNGLASSES, IN CLASS 9 (U.S. CLS. 21, 23, 26, 36 AND 38).

FOR: PEN CASES; PENCIL CASES; STICKERS, IN CLASS 16 (U.S. CLS. 2, 5, 22, 23, 29, 37, 38 AND 50).

FOR: ATHLETIC SHOES; BELTS; BOOTS; CAPS; CAPS WITH VISORS; FOOTWEAR; FOOTWEAR

NOT FOR SPORTS; GLOVES; GYMNASTIC SHOES; HEADBANDS; HEADGEAR, NAMELY, CAPS; HOODS; JACKETS; JERSEYS; JOGGING OUTFITS; JOGGING PANTS; JOGGING SUITS; LIGHT-REFLECTING JACKETS; MONEY BELTS; MUFFS; PANTS; PROTECTIVE METAL MEMBERS FOR SHOES AND BOOTS; RUNNING SHOES; SHIRTS; SHOES; SHORT-SLEEVED OR LONG-SLEEVED T-SHIRTS; SKI BOOTS; SKI JACKETS; SKI PANTS; SKI SUITS; SKI WEAR; SKULL CAPS; SNOWBOARD BOOTS; SNOWBOARD PANTS; SPORTS JERSEYS; SWEAT PANTS; T-SHIRTS; TRACK PANTS; WATERPROOF JACKETS AND PANTS; WORK SHOES AND BOOTS; WRISTBANDS, IN CLASS 25 (U.S. CLS. 22 AND 39).

PRIORITY CLAIMED UNDER SEC. 44(D) ON AUSTRALIA APPLICATION NO. 1125579, FILED 7-25-2006, REG. NO. 1125579, DATED 5-25-2007, EXPIRES 8-7-2016.

SER. NO. 78-968,060, FILED 9-6-2006.

SUNG IN, EXAMINING ATTORNEY

Int. Cl.: 35

Prior U.S. Cls.: 100, 101 and 102

United States Patent and Trademark Office

Reg. No. 3,398,607

Registered Mar. 18, 2008

**SERVICE MARK
PRINCIPAL REGISTER**

MotherTalk

MOTHERTALK, INC (PENNSYLVANIA CORPORATION)
PO BOX 4344
PHILADELPHIA, PA 19118

THE MARK CONSISTS OF STANDARD CHARACTERS WITHOUT CLAIM TO ANY PARTICULAR FONT, STYLE, SIZE, OR COLOR.

FOR: ADVERTISING, MARKETING AND PROMOTION SERVICES, IN CLASS 35 (U.S. CLS. 100, 101 AND 102).

SER. NO. 78-969,821, FILED 9-8-2006.

FIRST USE 2-17-2005; IN COMMERCE 8-1-2006.

RAMONA ORTIGA, EXAMINING ATTORNEY

Int. Cls.: 39, 42 and 43

Prior U.S. Cls.: 100, 101 and 105

United States Patent and Trademark Office

Reg. No. 3,398,608

Registered Mar. 18, 2008

**SERVICE MARK
PRINCIPAL REGISTER**

**YOUR WINDOW TO THE MAYAN
RIVIERA**

LATIN AMERICAN ONLINE SERVICES, INC.
(PANAMA CORPORATION)
ED.ST.GEORGE BANK PISO 15Y16 CALLE 50Y74
PANAMA, PANAMA

FOR: TOURIST AGENCY SERVICES, IN CLASS 39
(U.S. CLS. 100 AND 105).

FIRST USE 5-2-1999; IN COMMERCE 5-2-1999.

FOR: COMPUTER SERVICES, NAMELY, DE-
SIGNING AND IMPLEMENTING NETWORK WEB
PAGES FOR OTHERS, IN CLASS 42 (U.S. CLS. 100
AND 101).

FIRST USE 6-2-2006; IN COMMERCE 6-2-2006.

FOR: PROVIDING ONLINE RESERVATIONS TO
RESORTS, AND HOTELS VIA A GLOBAL COMPU-
TER NETWORK, IN CLASS 43 (U.S. CLS. 100 AND
101).

FIRST USE 5-2-1999; IN COMMERCE 5-2-1999.

THE MARK CONSISTS OF STANDARD CHAR-
ACTERS WITHOUT CLAIM TO ANY PARTICULAR
FONT, STYLE, SIZE, OR COLOR.

SER. NO. 78-970,445, FILED 9-8-2006.

BARNEY CHARLON, EXAMINING ATTORNEY

Int. Cl.: 16

Prior U.S. Cls.: 2, 5, 22, 23, 29, 37, 38 and 50

United States Patent and Trademark Office

Reg. No. 3,398,609

Registered Mar. 18, 2008

**TRADEMARK
PRINCIPAL REGISTER**

RE: PORTER

PORTER AVIATION HOLDINGS INC. (CANADA
CORPORATION)
TORONTO CITY, CENTRE AIRPORT
TORONTO, ONTARIO, CANADA M5V 1A1

FOR: INFLIGHT MAGAZINES, IN CLASS 16 (U.S.
CLS. 2, 5, 22, 23, 29, 37, 38 AND 50).

THE MARK CONSISTS OF STANDARD CHAR-
ACTERS WITHOUT CLAIM TO ANY PARTICULAR
FONT, STYLE, SIZE, OR COLOR.

PRIORITY CLAIMED UNDER SEC. 44(D) ON
CANADA APPLICATION NO. 1315571, FILED 9-6-
2006, REG. NO. TMA692,929, DATED 7-30-2007, EX-
PIRES 7-30-2022.

SER. NO. 78-971,372, FILED 9-11-2006.

CAROLYN CATALDO, EXAMINING ATTORNEY

Int. Cl.: 43

Prior U.S. Cls.: 100 and 101

United States Patent and Trademark Office

Reg. No. 3,398,610

Registered Mar. 18, 2008

**SERVICE MARK
PRINCIPAL REGISTER**

DISH GOURMET

DISH, LLC (COLORADO LTD LIAB CO)
1918 PEARL STREET
BOULDER, CO 80302

FOR: RESTAURANT SERVICES, IN CLASS 43
(U.S. CLS. 100 AND 101).

FIRST USE 5-8-2006; IN COMMERCE 5-8-2006.

THE MARK CONSISTS OF STANDARD CHARACTERS WITHOUT CLAIM TO ANY PARTICULAR FONT, STYLE, SIZE, OR COLOR.

NO CLAIM IS MADE TO THE EXCLUSIVE RIGHT TO USE "GOURMET", APART FROM THE MARK AS SHOWN.

SER. NO. 78-972,794, FILED 9-12-2006.

ARETHA SOMERVILLE, EXAMINING ATTORNEY

Int. Cl.: 41

Prior U.S. Cls.: 100, 101 and 107

United States Patent and Trademark Office

Reg. No. 3,398,611

Registered Mar. 18, 2008

**SERVICE MARK
PRINCIPAL REGISTER**

Catz

UBISOFT INC. (CALIFORNIA CORPORATION)
625, THIRD STREET
THIRD FLOOR
SAN FRANCISCO, CA 94107

FOR: ENTERTAINMENT SERVICES, NAMELY,
PROVIDING INFORMATION ON-LINE RELATING
TO COMPUTER GAMES AND VIDEO GAMES, IN
CLASS 41 (U.S. CLS. 100, 101 AND 107).

FIRST USE 6-0-1996; IN COMMERCE 6-0-1996.

THE MARK CONSISTS OF STANDARD CHAR-
ACTERS WITHOUT CLAIM TO ANY PARTICULAR
FONT, STYLE, SIZE, OR COLOR.

SEC. 2(F).

SER. NO. 78-973,167, FILED 9-13-2006.

DANNEAN HETZEL, EXAMINING ATTORNEY

Int. Cl.: 9

Prior U.S. Cls.: 21, 23, 26, 36 and 38

United States Patent and Trademark Office

Reg. No. 3,398,612

Registered Mar. 18, 2008

**TRADEMARK
PRINCIPAL REGISTER**

EXPEED

NIKON CORPORATION (JAPAN CORPORATION)
2-3, MARUNOUCHI 3-CHOME, CHIYODA-KU
TOKYO, JAPAN 100

FOR: COMPUTER SOFTWARE AND RECORDED MEDIA, NAMELY, CD-ROMS, OPTICAL DISCS, MAGNETIC DISCS, MAGNETIC OPTICAL DISCS, ALL CONTAINING SOFTWARE FOR IMAGE ORGANIZATION AND EDITING, ALL FOR USE IN DIGITAL PHOTOGRAPHY; APPLICATION-SPECIFIC INTEGRATED CIRCUITS CONTAINING SOFTWARE FOR IMAGE ORGANIZATION AND EDITING, ALL FOR USE IN DIGITAL PHOTOGRAPHY; DIGITAL STILL CAMERAS, IN CLASS 9 (U.S. CLS. 21, 23, 26, 36 AND 38).

THE MARK CONSISTS OF STANDARD CHARACTERS WITHOUT CLAIM TO ANY PARTICULAR FONT, STYLE, SIZE, OR COLOR.

PRIORITY CLAIMED UNDER SEC. 44(D) ON JAPAN APPLICATION NO. 2006-038954, FILED 4-27-2006, REG. NO. 5012632, DATED 12-22-2006, EXPIRES 12-22-2016.

SER. NO. 78-973,219, FILED 9-13-2006.

SUNG IN, EXAMINING ATTORNEY

Int. Cls.: 3, 35 and 41

Prior U.S. Cls.: 1, 4, 6, 50, 51, 52, 100, 101, 102 and 107

United States Patent and Trademark Office

Reg. No. 3,398,613

Registered Mar. 18, 2008

TRADEMARK
SERVICE MARK
PRINCIPAL REGISTER



NGUYEN, JULIE MONG (UNITED STATES INDIVIDUAL)
2131 CHANDLER DRIVE
TUSTIN, CA 92782

FOR: ADHESIVES FOR AFFIXING FALSE EYELASHES, ARTIFICIAL EYELASHES; COSMETIC PREPARATION FOR EYELASHES, IN CLASS 3 (U.S. CLS. 1, 4, 6, 50, 51 AND 52).

FIRST USE 11-1-2005; IN COMMERCE 11-1-2005.

FOR: ON-LINE RETAIL STORE SERVICES FEATURING EYELASH EXTENSIONS, ARTIFICIAL EYELASHES; PROMOTING THE GOODS AND SERVICES OF OTHERS BY ARRANGING FOR SPONSORS TO AFFILIATE THEIR GOODS AND SERVICES WITH AN AWARDS PROGRAM, A SPORTS COMPETITION AND SPORTING ACTIVITIES; PROVIDING CONSUMER INFORMATION IN THE FIELD OF EYELASH EXTENSIONS, ARTIFICIAL EYELASHES, IN CLASS 35 (U.S. CLS. 100, 101 AND 102).

FIRST USE 11-1-2005; IN COMMERCE 11-1-2005.

FOR: ARRANGING PROFESSIONAL WORKSHOPS, TRAINING COURSES AND TRAINING SERVICES IN THE FIELD OF EYELASH EXTENSIONS, INDIVIDUAL AND STRIP ARTIFICIAL EYELASHES, ADHESIVES AND REMOVERS FOR

ATTACHING AND REMOVING ARTIFICIAL EYELASHES, COATING, IMPLEMENTS AND APPLICATION FOR EYELASH EXTENSIONS; PROVIDING ON-LINE EDUCATIONAL WORKSHOPS AND TRAINING COURSES IN THE FIELD OF EYELASH EXTENSIONS, IN CLASS 41 (U.S. CLS. 100, 101 AND 107).

FIRST USE 11-1-2005; IN COMMERCE 11-1-2005.

NO CLAIM IS MADE TO THE EXCLUSIVE RIGHT TO USE "LASH", APART FROM THE MARK AS SHOWN.

THE COLOR(S) BLUE, BLACK, AND WHITE IS/ARE CLAIMED AS A FEATURE OF THE MARK.

THE MARK CONSISTS OF THE WORDS "SASSY LASH" IN BLACK LOCATED INSIDE A BLUE AND WHITE CURVED BANNER. ABOVE THE WORDS, LOCATED A BLACK CIRCLE, FLANKED ON BOTH SIDES WITH BLACK CURLED LASHES EXTENDING FROM NEAR TOP OF THE CIRCLE DOWN TO HALFWAY OF THE CIRCLE.

SER. NO. 78-973,318, FILED 9-13-2006.

CAROLYN CATALDO, EXAMINING ATTORNEY

Int. Cls.: 9, 35, 38, 41 and 42

**Prior U.S. Cls.: 21, 23, 26, 36, 38, 100, 101, 102, 104
and 107**

Reg. No. 3,398,614

United States Patent and Trademark Office

Registered Mar. 18, 2008

**TRADEMARK
SERVICE MARK
PRINCIPAL REGISTER**

DISSENT

TONY HAWK, INC. (CALIFORNIA CORPORATION)
1611-A SOUTH MELROSE DR., #362
VISTA, CA 92081

FOR: DOWNLOADABLE RINGTONES, MUSICAL SOUND RECORDINGS, VOICE RECORDINGS, AND OTHER AUDIO RECORDINGS FEATURING MUSIC, SPORTS, TALK, NEWS AND ENTERTAINMENT, AND DOWNLOADABLE VIDEO CONTENT FEATURING GRAPHICS, IMAGES, WALLPAPER GRAPHICS, VIDEO AND AUDIO MESSAGES, AND OTHER DATA COMMUNICATIONS, ALL FOR USE VIA THE INTERNET, SATELLITE AND GLOBAL COMMUNICATIONS NETWORKS TO WIRED AND WIRELESS COMMUNICATION DEVICES, NAMELY, CELL PHONES, PERSONAL DIGITAL ASSISTANTS, COMPUTERS, AND WIRELESS HANDHELDS, IN CLASS 9 (U.S. CLS. 21, 23, 26, 36 AND 38).

FIRST USE 9-12-2006; IN COMMERCE 9-12-2006.

FOR: SUBSCRIPTION MANAGEMENT SERVICES, NAMELY, ORDERING, RENEWING AND REPORTING SUBSCRIPTIONS TO AUDIO CONTENT, VIDEO CONTENT, MESSAGING, AND JOURNALS; ON-LINE RETAIL STORE SERVICES FEATURING DOWNLOADABLE PRE-RECORDED AUDIO CONTENT, NAMELY, RINGTONES, MUSICAL SOUND RECORDINGS, VOICE RECORDINGS, AND OTHER AUDIO RECORDINGS FEATURING MUSIC, SPORTS, TALK, NEWS AND ENTERTAINMENT, AND VIDEO CONTENT, NAMELY, GRAPHICS, IMAGES, WALLPAPER, ALL FOR USE VIA THE INTERNET, SATELLITE AND GLOBAL COMMUNICATIONS NETWORKS VIA WIRED AND WIRELESS COMMUNICATION DEVICES, NAMELY, CELL PHONES, PERSONAL DIGITAL ASSISTANTS, COMPUTERS, AND WIRELESS

HANDHELDS; ON-LINE RETAIL STORE SERVICES FEATURING DOWNLOADABLE PRE-RECORDED MUSIC AND VIDEO, IN CLASS 35 (U.S. CLS. 100, 101 AND 102).

FIRST USE 9-12-2006; IN COMMERCE 9-12-2006.

FOR: TELECOMMUNICATIONS SERVICES, NAMELY, TRANSMISSION OF TEXT, GRAPHICS, IMAGES, WALLPAPERS, VIDEO CONTENT, RINGTONES, MUSICAL RECORDINGS, VOICE AND OTHER AUDIO CONTENT, AND OTHER DATA COMMUNICATIONS VIA THE INTERNET, SATELLITE AND GLOBAL COMMUNICATIONS NETWORKS TO WIRED AND WIRELESS COMMUNICATION DEVICES, NAMELY, CELL PHONES, PERSONAL DIGITAL ASSISTANTS, COMPUTERS, AND WIRELESS HANDHELDS; PROVIDING MULTIPLE USER ACCESS TO A GLOBAL INFORMATION NETWORK FOR THE TRANSFER AND DISSEMINATION OF A WIDE RANGE OF INFORMATION AND CONTENT; BROADCASTING STREAMING AND ON-DEMAND AUDIO, VISUAL AND INTERACTIVE CONTENT AND PROGRAMS VIA THE INTERNET, SATELLITE AND GLOBAL COMMUNICATION NETWORKS TO WIRED AND WIRELESS COMMUNICATION DEVICES, NAMELY, CELL PHONES, PERSONAL DIGITAL ASSISTANTS, COMPUTERS, AND WIRELESS HANDHELDS; PROVIDING CONTENT FORWARDING SERVICES FOR WIRELESS DEVICES, NAMELY, E-MAIL FORWARDING AND WEB SITE FORWARDING SERVICES, IN CLASS 38 (U.S. CLS. 100, 101 AND 104).

FIRST USE 9-12-2006; IN COMMERCE 9-12-2006.

FOR: PROVIDING NON-DOWNLOADABLE AUDIO AND VIDEO PROGRAMS VIA AN AUDIO

AND VIDEO-ON-DEMAND SERVICE; ENTERTAINMENT SERVICES, NAMELY, PROVIDING NON-DOWNLOADABLE AUDIO CONTENT, NAMELY, RINGTONES, MUSICAL SOUND RECORDINGS, VOICE RECORDINGS, AND OTHER AUDIO RECORDINGS FEATURING MUSIC, SPORTS, TALK, NEWS AND ENTERTAINMENT, AND VIDEO CONTENT, NAMELY, GRAPHICS, IMAGES AND WALLPAPER, ALL FOR USE VIA THE INTERNET, SATELLITE AND GLOBAL COMMUNICATIONS NETWORKS VIA WIRED AND WIRELESS COMMUNICATION DEVICES, NAMELY, CELL PHONES, PERSONAL DIGITAL ASSISTANTS, COMPUTERS, AND WIRELESS HANDHELDS VIA AN AUDIO AND VIDEO-ON-DEMAND SERVICE, IN CLASS 41 (U.S. CLS. 100, 101 AND 107).

FIRST USE 9-12-2006; IN COMMERCE 9-12-2006.

FOR: PROVIDING TEMPORARY USE OF NON-DOWNLOADABLE CONTENT IMAGE EDITING SOFTWARE; PROVIDING TEMPORARY USE OF NON-DOWNLOADABLE SOFTWARE FOR THE VIEWING AND LISTENING OF AUDIO CONTENT, NAMELY, RINGTONES, MUSICAL SOUND RECORDINGS, VOICE RECORDINGS, AND OTHER AUDIO RECORDINGS FEATURING MUSIC, SPORTS, TALK, NEWS AND ENTERTAINMENT, AND VIDEO CONTENT, NAMELY, GRAPHICS, IMAGES, WALLPAPER AND, ALL FOR USE VIA

THE INTERNET, SATELLITE AND GLOBAL COMMUNICATIONS NETWORKS VIA WIRED AND WIRELESS COMMUNICATION DEVICES, NAMELY, CELL PHONES, PERSONAL DIGITAL ASSISTANTS, COMPUTERS, AND WIRELESS HANDHELDS; PROVIDING TEMPORARY USE OF NON-DOWNLOADABLE SOFTWARE FOR VIEWING AND LISTENING TO AUDIO CONTENT, NAMELY, RINGTONES, MUSICAL SOUND RECORDINGS, VOICE RECORDINGS, AND OTHER AUDIO RECORDINGS FEATURING MUSIC, SPORTS, TALK, NEWS AND ENTERTAINMENT, AND VIDEO CONTENT, NAMELY, GRAPHICS, IMAGES AND WALLPAPER, ALL FOR USE VIA THE INTERNET, SATELLITE AND GLOBAL COMMUNICATIONS NETWORKS VIA WIRED AND WIRELESS COMMUNICATION DEVICES, NAMELY, CELL PHONES, PERSONAL DIGITAL ASSISTANTS, COMPUTERS, AND WIRELESS HANDHELDS, IN CLASS 42 (U.S. CLS. 100 AND 101).

FIRST USE 9-12-2006; IN COMMERCE 9-12-2006.

THE MARK CONSISTS OF STANDARD CHARACTERS WITHOUT CLAIM TO ANY PARTICULAR FONT, STYLE, SIZE, OR COLOR.

SER. NO. 78-974,419, FILED 9-14-2006.

SCOTT SISUN, EXAMINING ATTORNEY

Int. Cl.: 9

Prior U.S. Cls.: 21, 23, 26, 36 and 38

United States Patent and Trademark Office

Reg. No. 3,398,615

Registered Mar. 18, 2008

**TRADEMARK
PRINCIPAL REGISTER**



PSION TEKLOGIX INC. (CANADA CORPORATION)
2100 MEADOWVALE BOULEVARD
MISSISSAUGA, CANADA L5N 7J9

FOR: CLIENT/SERVER-BASED COMMUNICATIONS SYSTEM COMPRISED OF SERVER SOFTWARE AND CLIENT-DEVICE SOFTWARE TO ALLOW USERS AND DEVICES TO COMMUNICATE WITH EACH OTHER OVER WIRED OR WIRELESS NETWORKS BY REAL TIME PUSH TO TALK STYLE VOICE OVER IP, TEXT MESSAGING, HANDWRITTEN MESSAGING, PICTURE MESSAGING WITH INTEGRATED EDITING CAPABILITIES, VOICE MESSAGING, BROADCAST VOICE

MESSAGING, AND E-MAIL, IN CLASS 9 (U.S. CLS. 21, 23, 26, 36 AND 38).

FIRST USE 5-0-2006; IN COMMERCE 5-0-2006.

PRIORITY CLAIMED UNDER SEC. 44(D) ON CANADA APPLICATION NO. 1297211, FILED 4-10-2006, REG. NO. TMA699093, DATED 10-22-2007, EXPIRES 10-22-2022.

SER. NO. 78-974,501, FILED 9-14-2006.

BRIAN NEVILLE, EXAMINING ATTORNEY

Int. Cls.: 5 and 13

Prior U.S. Cls.: 2, 6, 9, 18, 44, 46, 51 and 52

United States Patent and Trademark Office

Reg. No. 3,398,616

Registered Mar. 18, 2008

**TRADEMARK
PRINCIPAL REGISTER**

VETCAP

VETERINARY ENCAPSULATION BIOSCIENCES
PTY LTD (AUSTRALIA CORPORATION)
150 STANLEY TERRACE
TARINGA QLD, AUSTRALIA 4068

FOR: VETERINARY PREPARATIONS, NAMELY,
BIOLOGICAL AND CHEMICAL PREPARATIONS
AND REAGENTS FOR MEDICAL OR VETERIN-
ARY USE, EXCLUDING CAPSULES FOR INTER-
NAL ADMINISTRATION TO ANIMALS, IN CLASS 5
(U.S. CLS. 6, 18, 44, 46, 51 AND 52).

FOR: HAND-OPERATED GUNS, IN CLASS 13
(U.S. CLS. 2 AND 9).

PRIORITY CLAIMED UNDER SEC. 44(D) ON
AUSTRALIA APPLICATION NO. 1103819, FILED 3-
15-2006, REG. NO. 1103819, DATED 7-16-2007, EX-
PIRES 3-15-2016.

SER. NO. 78-974,949, FILED 9-14-2006.

BARBARA RUTLAND, EXAMINING ATTORNEY

Int. Cl.: 16

Prior U.S. Cls.: 2, 5, 22, 23, 29, 37, 38 and 50

United States Patent and Trademark Office

Reg. No. 3,398,617

Registered Mar. 18, 2008

**TRADEMARK
PRINCIPAL REGISTER**

ON THE WRONG END OF THE PENIS

JANICE WALKER (AUSTRALIA INDIVIDUAL)
PO BOX 786
CARINGBAH NSW 1495, AUSTRALIA

OWNER OF INTERNATIONAL REGISTRATION
0835722 DATED 8-25-2004, EXPIRES 8-25-2014.

FOR: PRINTED MATTER, NAMELY, CALENDARS, IN CLASS 16 (U.S. CLS. 2, 5, 22, 23, 29, 37, 38 AND 50).

SER. NO. 79-006,209, FILED 8-25-2004.

THE MARK CONSISTS OF STANDARD CHARACTERS WITHOUT CLAIM TO ANY PARTICULAR FONT, STYLE, SIZE, OR COLOR.

JASON BLAIR, EXAMINING ATTORNEY

Int. Cl.: 42

Prior U.S. Cls.: 100 and 101

United States Patent and Trademark Office

Reg. No. 3,398,618

Registered Mar. 18, 2008

**SERVICE MARK
PRINCIPAL REGISTER**

ADO *it*

BOC ASSET MANAGEMENT GMBH (AUSTRIA
LTD LIAB CO)
BÄCKERSTRASSE 5
A-1010 WIEN
AUSTRIA

OWNER OF INTERNATIONAL REGISTRATION
0792093 DATED 10-23-2002, EXPIRES 10-23-2012.

FOR: DESIGN, MAINTENANCE AND RENTAL
OF COMPUTER SOFTWARE THAT IMPLEMENTS
AND INTEGRATES BEST PRACTICE BUSINESS
STANDARDS FOR OTHERS, IN CLASS 42 (U.S.
CLS. 100 AND 101).

SER. NO. 79-007,151, FILED 11-3-2004.

AMY HELLA, EXAMINING ATTORNEY

Int. Cls.: 7, 16 and 39

**Prior U.S. Cls.: 2, 5, 13, 19, 21, 22, 23, 29, 31, 34, 35,
37, 38, 50, 100 and 105**

Reg. No. 3,398,619

United States Patent and Trademark Office

Registered Mar. 18, 2008

**TRADEMARK
SERVICE MARK
PRINCIPAL REGISTER**

TwinStar

CFS GERMANY GMBH (FED REP GERMANY
GMBH)
IM RUTTERT
35216 BIEDENKOPF
FED REP GERMANY

FOR: WRAPPING MACHINES FOR THE MANU-
FACTURING OF SYNTHETIC PLASTIC PACKA-
GING, NAMELY, FOR FOODS , IN CLASS 7 (U.S.
CLS. 13, 19, 21, 23, 31, 34 AND 35).

FOR: PACKAGING, NAMELY, BAGS MADE OF
SYNTHETIC PLASTIC; FOOD WRAPPING PLASTIC
FILM FOR HOUSEHOLD USE, IN CLASS 16 (U.S.
CLS. 2, 5, 22, 23, 29, 37, 38 AND 50).

FOR: PACKAGING AND WRAPPING OF GOODS
FOR TRANSPORTATION, IN CLASS 39 (U.S. CLS.
100 AND 105).

THE MARK CONSISTS OF STANDARD CHAR-
ACTERS WITHOUT CLAIM TO ANY PARTICULAR
FONT, STYLE, SIZE, OR COLOR.

PRIORITY DATE OF 3-12-2004 IS CLAIMED.

OWNER OF INTERNATIONAL REGISTRATION
0840414 DATED 9-9-2004, EXPIRES 9-9-2014.

SER. NO. 79-007,898, FILED 9-9-2004.

ALYSSA PALADINO, EXAMINING ATTORNEY

Int. Cls.: 9, 10, 22, 24 and 25

Prior U.S. Cls.: 1, 2, 7, 19, 21, 22, 23, 26, 36, 38, 39, 42, 44 and 50

Reg. No. 3,398,620

United States Patent and Trademark Office

Registered Mar. 18, 2008

**TRADEMARK
PRINCIPAL REGISTER**

ITEX

TEN CATE ADVANCED TEXTILES B.V. (NETHERLANDS LIMITED COMPANY)
CAMPBELLWEG 30 NL-7443 PV NIJVERDAL
NIJVERDAL, NETHERLANDS 7443 PV

FOR: PROTECTIVE CLOTHING, NAMELY, CLOTHING FOR PROTECTION AGAINST ACCIDENTS, IRRADIATION, FIRE AND BACTERIA, IN CLASS 9 (U.S. CLS. 21, 23, 26, 36 AND 38).

FOR: SURGICAL SCRUB SUITS; MEDICAL SHOES FOR USE DURING SURGERY; MEDICAL EXAMINATION SUITS AND GOWNS, SHIRTS, PANTS, TUNICS, AND JACKETS FOR USE DURING PATIENT EXAMINATION, IN CLASS 10 (U.S. CLS. 26, 39 AND 44).

FOR: STRING, TEXTILE FIBERS, COMMERCIAL NETS, SACKS OR BAGS FOR THE TRANSPORTATION OR STORAGE OF MATERIALS IN BULK; PADDING AND STUFFING MATERIALS NOT OF RUBBER OR PLASTIC; RAW FIBROUS TEXTILE MATERIALS, IN CLASS 22 (U.S. CLS. 1, 2, 7, 19, 22, 42 AND 50).

FOR: TEXTILE FABRICS FOR HOME AND COMMERCIAL INTERIORS; TEXTILE FABRICS FOR THE MANUFACTURE OF CLOTHING, SHOES, PROTECTIVE CLOTHING, SAFETY GLOVES, MEDICAL CLOTHING AND HEADGEAR, NAMELY, CAPS AND HATS; LABELS OF TEXTILE; TOWELS OF TEXTILE AND BATH LINEN; TEXTILE FABRICS FOR THE MANUFACTURE OF BED AND TABLE COVERS, NAMELY, BED SPREADS, DUVETS AND TABLE CLOTHS NOT OF PAPER; TEXTILE FABRICS FOR THE MANUFACTURE OF MEDICATED BLANKETS, DUVETS AND SHEETS; TEXTILE CLOTHS FOR USE IN MANUFACTUR-

ING IN THE AUTOMOTIVE, AIRCRAFT AND SPACECRAFT INDUSTRIES; TEXTILE LININGS FOR STRENGTHENING GARMENTS, SHOES, HATS, HELMETS, BLINDS, AWNINGS, PARASOLS, AND FOR STRENGTHENING APPLICATIONS IN THE AUTOMOTIVE, AIRCRAFT AND SPACECRAFT INDUSTRIES; TEXTILE CLOTH FOR THE USE IN THE MANUFACTURE OF BLINDS, AWNINGS, PARASOLS, TENTS, COMMERCIAL NETS, AND SACKS AND BAGS FOR THE TRANSPORTATION OR STORAGE OF MATERIALS IN BULK, IN CLASS 24 (U.S. CLS. 42 AND 50).

FOR: CLOTHING, NAMELY, SHIRTS, BLOUSES, TOPS, GLOVES, MITTENS, SHAWLS, SCARVES, TIES, KNOTTED TIES, SWEATERS, PANTS, SHORTS, SKIRTS, DRESSES, SUITS, COATS, JACKETS, UNDERWEAR, SOCKS, STOCKINGS; HEADGEAR, NAMELY, CAPS AND HATS; OUTER MATERIALS FOR SHOES, NAMELY, SHOE UPERS, INTERNAL AND EXTERNAL SHOE SOLES AND FRONT AND REAR SOLE ENDS, IN CLASS 25 (U.S. CLS. 22 AND 39).

THE MARK CONSISTS OF STANDARD CHARACTERS WITHOUT CLAIM TO ANY PARTICULAR FONT, STYLE, SIZE, OR COLOR.

PRIORITY DATE OF 12-15-2004 IS CLAIMED.

OWNER OF INTERNATIONAL REGISTRATION 0849214 DATED 3-1-2005, EXPIRES 3-1-2015.

SER. NO. 79-010,775, FILED 3-1-2005.

JEFFERY COWARD, EXAMINING ATTORNEY

Int. Cls.: 9, 16 and 38

**Prior U.S. Cls.: 2, 5, 21, 22, 23, 26, 29, 36, 37, 38, 50,
100, 101 and 104**

Reg. No. 3,398,621

United States Patent and Trademark Office

Registered Mar. 18, 2008

**TRADEMARK
SERVICE MARK
PRINCIPAL REGISTER**

The logo for FEEDINFO NEWS SERVICE. The word "FEEDINFO" is written in a large, bold, sans-serif font. Above the letter "I" in "FEEDINFO", there is a horizontal line with a diagonal hatching pattern. Below "FEEDINFO", the words "NEWS SERVICE" are written in a smaller, all-caps, sans-serif font.

DAVID FEELEY (IRELAND INDIVIDUAL)
GLADSTONE HOUSE
50 MERCHANTS QUAY
WATERFORD, IRELAND

FOR: DOWNLOADABLE ELECTRONIC PUBLICATIONS IN THE NATURE OF ARTICLES, REPORTS AND ABSTRACTS IN THE FIELD OF SCIENTIFIC INFORMATION AND NEWS FOR THE FOOD, AGRICULTURAL AND BIOTECHNOLOGY INDUSTRIES, IN CLASS 9 (U.S. CLS. 21, 23, 26, 36 AND 38).

FOR: PRINTED MATTER AND PUBLICATIONS, NAMELY, ARTICLES, REPORTS AND ABSTRACTS IN THE FIELD OF SCIENTIFIC INFORMATION AND NEWS FOR THE FOOD, AGRICULTURAL AND BIOTECHNOLOGY INDUSTRIES, IN CLASS 16 (U.S. CLS. 2, 5, 22, 23, 29, 37, 38 AND 50).

FOR: TRANSMISSION OF REAL TIME BUSINESS AND SCIENTIFIC NEWS FOCUSED ON GLOBAL CORPORATIONS ACTIVE IN THE FOOD, AGRICULTURAL AND BIOTECHNOLOGY SECTORS, IN CLASS 38 (U.S. CLS. 100, 101 AND 104).

OWNER OF INTERNATIONAL REGISTRATION
0854692 DATED 1-4-2005, EXPIRES 1-4-2015.

NO CLAIM IS MADE TO THE EXCLUSIVE RIGHT TO USE "NEWS SERVICE", APART FROM THE MARK AS SHOWN.

THE MARK IS NOT IN COLOR.

SEC. 2(F) AS TO "FEEDINFO".

SER. NO. 79-012,587, FILED 1-4-2005.

MARY CRAWFORD, EXAMINING ATTORNEY

Int. Cls.: 35 and 41

Prior U.S. Cls.: 100, 101, 102 and 107

United States Patent and Trademark Office

Reg. No. 3,398,622

Registered Mar. 18, 2008

**SERVICE MARK
PRINCIPAL REGISTER**

Type Face

JULIA TODOROW (FED REP GERMANY INDIVIDUAL)

GOLTZSTRASSE 13A

10963 BERLIN

FED REP GERMANY

FOR: SERVICES OF A MODEL CASTING AGENCY AND ACTORS AGENCY, NAMELY, SCHEDULING ORGANIZATION AND DESIGN OF ADVERTISING ACTIVITIES FOR THIRD PARTIES, MANNEQUIN SERVICES FOR ADVERTISING AND PROMOTIONAL PURPOSES, IN CLASS 35 (U.S. CLS. 100, 101 AND 102).

FOR: ENTERTAINMENT SERVICES, NAMELY, CONDUCTING CONTESTS, IN CLASS 41 (U.S. CLS. 100, 101 AND 107).

THE MARK CONSISTS OF STANDARD CHARACTERS WITHOUT CLAIM TO ANY PARTICULAR FONT, STYLE, SIZE, OR COLOR.

OWNER OF INTERNATIONAL REGISTRATION 0860870 DATED 3-18-2005, EXPIRES 3-18-2015.

SER. NO. 79-014,880, FILED 3-18-2005.

SHANNON TWOHIG, EXAMINING ATTORNEY

Int. Cl.: 5

Prior U.S. Cls.: 6, 18, 44, 46, 51 and 52

United States Patent and Trademark Office

Reg. No. 3,398,623

Registered Mar. 18, 2008

TRADEMARK
PRINCIPAL REGISTER



NOVARTIS AG (SWITZERLAND AKTIENGESELLSCHAFT)
CH-4002 BASEL
SWITZERLAND

FOR: DIETETIC SUBSTANCES ADAPTED FOR MEDICAL USE, NAMELY, DIETARY FIBER, IN CLASS 5 (U.S. CLS. 6, 18, 44, 46, 51 AND 52).

OWNER OF INTERNATIONAL REGISTRATION 0863288 DATED 8-4-2005, EXPIRES 8-4-2015.

NO CLAIM IS MADE TO THE EXCLUSIVE RIGHT TO USE "FIBER SUPPLEMENT", APART FROM THE MARK AS SHOWN.

THE MARK CONSISTS OF THE DESIGN OF A CYLINDRICAL BOTTLE, THE BOTTLE HAVING TAPERED SIDES NEAR THE TOP OF THE BOTTLE, AND ON THE BOTTLE, A CIRCULAR BANNER FEATURING THE WORDING "BENEFIBER" AND "FIBER SUPPLEMENT", THE DESIGN OF SPOON CONTAINING POWDER, AND CURVED LINES INDICATING MOTION. THE BROKEN LINING INDICATING A LID IS NOT PART OF THE MARK BUT IS MERELY INTENDED TO SHOW THE POSITION OF THE MARK.

SEC. 2(F) AS TO "THE BOTTLE DESIGN".

SER. NO. 79-015,742, FILED 8-4-2005.

DAVID C. REIHNER, EXAMINING ATTORNEY

Int. Cl.: 9

Prior U.S. Cls.: 21, 23, 26, 36 and 38

United States Patent and Trademark Office

Reg. No. 3,398,624

Registered Mar. 18, 2008

TRADEMARK
PRINCIPAL REGISTER

Çanakkale Seramik

KALESERAMIK ÇANAKKALE KALEBODUR
SERAMIK SANAYI ANONİM ŞİRKETİ (TUR-
KEY JOINT STOCK COMPANY)
BÜYÜKDERE CADDESİ KARESERAMIK
BINASI LEVENT; ISTANBUL, TURKEY

FOR: ELECTRICAL INSULATORS WITH LOW
AND HIGH TENSION, IN CLASS 9 (U.S. CLS. 21, 23,
26, 36 AND 38).

OWNER OF INTERNATIONAL REGISTRATION
0865608 DATED 5-27-2005, EXPIRES 5-27-2015.

NO CLAIM IS MADE TO THE EXCLUSIVE
RIGHT TO USE "SERAMIK", APART FROM THE
MARK AS SHOWN.

THE ENGLISH TRANSLATION OF THE WORD
SERAMIK IN THE MARK IS CERAMIC.

SER. NO. 79-016,488, FILED 5-27-2005.

ANGELA M. MICHELI, EXAMINING ATTORNEY

Int. Cl.: 20

Prior U.S. Cls.: 2, 13, 22, 25, 32 and 50

United States Patent and Trademark Office

Reg. No. 3,398,625

Registered Mar. 18, 2008

**TRADEMARK
PRINCIPAL REGISTER**

MALERBA

MOBILI MALERBA SNC DI MALERBA NUNZIO
& C. (ITALY UNLIMITED PARTNERSHIP)
VIA CAIRO, 81
I-61024 MOMBAROCIO (PU)
ITALY

OWNER OF INTERNATIONAL REGISTRATION
0865011 DATED 5-26-2005, EXPIRES 5-26-2015.

FOR: FURNITURE IN PARTICULAR CHESTS OF
DRAWERS, WARDROBES, BOOKCASES, CABI-
NETS, BESIDE TABLES, BEDS, AND TABLES, FUR-
NITURE PARTS, NAMELY, CORBELS AND DOORS
FOR FURNITURE, IN CLASS 20 (U.S. CLS. 2, 13, 22,
25, 32 AND 50).

THE ENGLISH TRANSLATION OF MALERBA IS
WEED.

SER. NO. 79-016,580, FILED 5-26-2005.

PRIORITY DATE OF 4-15-2005 IS CLAIMED.

TINA L. SNAPP, EXAMINING ATTORNEY

Int. Cl.: 9

Prior U.S. Cls.: 21, 23, 26, 36 and 38

Reg. No. 3,398,626

United States Patent and Trademark Office

Registered Mar. 18, 2008

TRADEMARK
PRINCIPAL REGISTER

KARPOS

MICRONTEL S.P.A. (ITALY JOINT STOCK COMPANY)
VIA UMBRIA, 13
REGIONE PESCARITO; I-10099 SAN MAURO T.SE
(TO)
ITALY

FOR: ELECTRONIC TERMINALS FOR DATA COLLECTING, NAMELY, COMPUTER TERMINALS FOR TIME AND ATTENDANCE DATA SURVEYING AND COLLECTION; COMPUTER TERMINALS FOR SHOP FLOOR DATA COLLECTION; COMPUTER TERMINALS FOR BUILDING AND ACCESS AREAS ACCESS CONTROL; HARDWARE, NAMELY, COMPUTER HARDWARE, COMPUTER INTERFACES BOARDS, COMPUTER DISPLAY PANELS AND FUNCTION KEYPADS, COMPUTER PRINTERS, COMPUTER SCANNERS, COMPUTER MEMORIES, COMPUTER MICROPROCESSOR UNITS, MAGNETIC CARD AND CARD PROXIMITY READERS, ELECTRONIC CARDS IN THE NATURE OF ELECTRONIC CIRCUIT CARDS, ELECTRONIC AND MAGNETIC FINGERPRINT AUTHENTICATION CARDS, MAGNETIC BADGES IN THE NATURE OF MAGNETIC IDENTIFYING CARDS; SOFTWARE FOR DATA COLLECTION, STORAGE AND RETRIEVAL FOR CONTROLLING

AND HANDLING OF DATA, NAMELY, EMPLOYEE AND WORKER TIME AND ATTENDANCE DATA, BUILDING, WORKING AND PROTECTED ACCESS AREAS ACCESS DATA, AND SHOP FLOOR DATA, NAMELY, PRODUCTION PROGRESS AND EFFECTIVENESS, WAREHOUSE STATUS, SALE TRANSACTIONS AND RELATED STATISTICS; AUDIO AND VISUAL SOFTWARE FOR PERSONAL RECOGNITION AND IDENTIFICATION OF USERS ACCESS BUILDING, WORKING AND PROTECTED ACCESS AREAS; ALL THE AFOREMENTIONED COMPUTER HARDWARE AND SOFTWARE FOR USE WITH THE FOREGOING TERMINALS, IN CLASS 9 (U.S. CLS. 21, 23, 26, 36 AND 38).

THE MARK CONSISTS OF STANDARD CHARACTERS WITHOUT CLAIM TO ANY PARTICULAR FONT, STYLE, SIZE, OR COLOR.

OWNER OF INTERNATIONAL REGISTRATION
0869461 DATED 9-28-2005, EXPIRES 9-28-2015.

SER. NO. 79-018,134, FILED 9-28-2005.

KRISTINA MORRIS, EXAMINING ATTORNEY

Int. Cl.: 12

Prior U.S. Cls.: 19, 21, 23, 31, 35 and 44

United States Patent and Trademark Office

Reg. No. 3,398,627

Registered Mar. 18, 2008

**TRADEMARK
PRINCIPAL REGISTER**

KTM

KTM-SPORTMOTORCYCLE AG (AUSTRIA
STOCK CORPORATION)
STALLHOFNER STRABE 3
A-5230 MATTIGHOFEN, AUSTRIA

PRIORITY DATE OF 3-18-2005 IS CLAIMED.

FOR: MOTORIZED TWO- OR MULTI-AXLE VE-
HICLES, NAMELY, MOTORCYCLES, MOTOR-
BIKES, MOPEDS, ALL TERRAIN VEHICLES, AND
QUADS, NAMELY, FOUR-WHEELED MOTOR-
CYCLES , IN CLASS 12 (U.S. CLS. 19, 21, 23, 31, 35
AND 44).

OWNER OF INTERNATIONAL REGISTRATION
0870029 DATED 7-27-2005, EXPIRES 7-27-2015.

SER. NO. 79-018,370, FILED 7-27-2005.

THE MARK CONSISTS OF STANDARD CHAR-
ACTERS WITHOUT CLAIM TO ANY PARTICULAR
FONT, STYLE, SIZE, OR COLOR.

DAYNA BROWNE, EXAMINING ATTORNEY

Int. Cl.: 9

Prior U.S. Cls.: 21, 23, 26, 36 and 38

Reg. No. 3,398,628

United States Patent and Trademark Office

Registered Mar. 18, 2008

**TRADEMARK
PRINCIPAL REGISTER**



KSR KUEBLER NIVEAU-MESSTECHNIK AKTIENGESELLSCHAFT (FED REP GERMANY AKTIENGESELLSCHAFT)
17, IM KOHLSTATTERFELD,
69439 ZWINGENBERG
FED REP GERMANY

FOR: ELECTRICAL SWITCHES, IN PARTICULAR MAGNETIC SWITCHES WHICH CAN BE OPERATED WITHOUT CONTACT, INDUCTIVELY AND CAPACITIVELY OPERABLE SWITCHES; ELECTRICAL SWITCHES DESIGNED AS FLOAT SWITCHES, AS OPERATION MONITORS, AS INDICATORS FOR THE PRESENCE OF METALS; ELECTRICAL SWITCHING DEVICES FOR MONITORING LIQUID LEVELS ON THE BASIS OF THE ELECTRICAL CONDUCTIVITY OF THE RELEVANT LIQUID; ELECTRICAL AND ELECTRONIC CONTROLLERS FOR ROTATIONAL SPEED MEASUREMENT, RO-

TATIONAL SPEED REGULATION, MONITORING THAT A MACHINE IS AT REST, ROTATION DIRECTION MONITORING, FILLING LEVEL INDICATION, LIMIT VALUE MONITORING, PHASE-GATING CONTROL, MACHINE CONTROL AND FOR MACHINE MONITORING; ELECTRICAL AND ELECTRONIC CONTROLLERS AS A PHASE FAILURE RELAYS AND AS TIMING RELAYS, IN CLASS 9 (U.S. CLS. 21, 23, 26, 36 AND 38).

OWNER OF INTERNATIONAL REGISTRATION 0870472 DATED 10-18-2005, EXPIRES 10-18-2015.

SER. NO. 79-018,538, FILED 10-18-2005.

DANIEL BRODY, EXAMINING ATTORNEY

Int. Cl.: 25

Prior U.S. Cls.: 22 and 39

United States Patent and Trademark Office

Reg. No. 3,398,629

Registered Mar. 18, 2008

TRADEMARK
PRINCIPAL REGISTER

Racing Green

RACING GREEN LIMITED (UNITED KINGDOM
COMPANY INCORPORATED IN UNITED
KINGDOM)

SRG HOUSE, UNIT 4 CHESTER ROAD
BOREHAMWOOD; HERTFORDSHIRE WD6 1LT
UNITED KINGDOM

FOR: CLOTHING, NAMELY, SUITS, TROUSERS,
JEANS, COATS, JACKETS, SKIRTS, KILTS, SHORTS,
SHIRTS, BLOUSES, SWEATERS, PULLOVERS, JER-
SEYS, CARDIGANS, WAISTCOATS, DRESSES, PAR-
KAS, LOUNGE WEAR, TUXEDOS AND COCKTAIL
DRESSES, RAINWEAR, PAJAMA'S, NIGHTWEAR,
BATHROBES, LINGERIE, UNDERWEAR, VESTS,
BRIEFS, PANTS, CAMISOLES, CORSETS, PETTI-
COATS, SUSPENDERS, SUSPENDER BELTS, GAR-
TERS, SOCKS, TIGHTS, STOCKINGS, GLOVES,

SCARVES, CRAVATS, CUMMERBUNDS, BRACES,
TIES, SHAWLS, STOLE, PASHMINAS, BOAS,
VEILS, ATHLETIC UNIFORMS, T-SHIRTS, SWEAT-
SHIRTS, TRACK SUITS, SWIMWEAR, POLO
SHIRTS, BATHING SUITS, BEACHWEAR, SWEAT
SUITS, BELTS, BELTS FOR CLOTHING; FOOT-
WEAR; HEADWEAR, HATS, IN CLASS 25 (U.S.
CLS. 22 AND 39).

OWNER OF INTERNATIONAL REGISTRATION
0875162 DATED 7-25-2005, EXPIRES 7-25-2015.

SER. NO. 79-020,282, FILED 7-25-2005.

COLLEEN KEARNEY, EXAMINING ATTORNEY

Int. Cls.: 6, 7 and 8

**Prior U.S. Cls.: 2, 12, 13, 14, 19, 21, 23, 25, 28, 31, 34,
35, 44 and 50**

Reg. No. 3,398,630

United States Patent and Trademark Office

Registered Mar. 18, 2008

**TRADEMARK
PRINCIPAL REGISTER**



HUGO BENZING GMBH & CO. KG (FED REP
GERMANY GMBH & CO. KG)

DAIMLERSTRASSE 49-53

70825 KORNTAL-MÜNCHINGEN, FED REP GER-
MANY

FOR: GOODS AND HARDWARE MADE FROM
COMMON METALS AND THEIR ALLOYS, NAME-
LY, RETAINING RINGS, CIRCLIPS, FASTENERS,
NAMESLY, RING ASSEMBLIES, BOLTS, NUTS,
SCREWS, BRACKETS, CLAMPS, CLIPS AND RIV-
ETS, SNAP RINGS, METAL SPRINGS, WASHERS,
VALVES, IN CLASS 6 (U.S. CLS. 2, 12, 13, 14, 23, 25
AND 50).

FOR: MACHINE TOOLS AND ASSEMBLY TOOLS
FOR METAL-WORKING, CUTTING ASSEMBLING
MACHINING, AND FORMING MATERIALS,
NAMESLY, RETAINING RINGS, CIRCLIPS, FAS-
TENERS, SNAP RINGS, METAL SPRINGS, WASH-
ERS, VALVES, STEERING DAMPERS, SCREWS;
MACHINE TOOLS AND ASSEMBLY TOOLS,
NAMESLY, AUTOMATED MACHINES FOR THE
PRODUCTION OF CUSTOMER SPECIFIED RE-
TAINING RINGS, CIRCLIPS, FASTENERS, SNAP
RINGS, METAL SPRINGS, WASHERS, VALVES,
STEERING DAMPERS, SCREWS, IN CLASS 7 (U.S.
CLS. 13, 19, 21, 23, 31, 34 AND 35).

FOR: HAND OPERATED TOOLS AND EQUIP-
MENT FOR MACHINE, APPARATUS AND VEHI-
CLE CONSTRUCTIONS AS WELL AS FOR
BUILDING ENGINEERING, NAMESLY, FOR USE
WITH FOR METAL-WORKING, CUTTING, ASSEM-
BLING, MACHINING, AND FORMING MATERI-
ALS IN THE NATURE OF RETAINING RINGS,
CIRCLIPS, WASHER AND SPRING ASSEMBLY
LINE FEEDERS, NAMESLY, METAL-PUNCHING
TOOLS, METAL-BENDING TOOLS, METAL-WIND-
ING TOOLS, TOOLS FOR INSTALLING METAL
RINGS, CIRCLIPS, FASTENERS, SNAP RINGS, ME-
TAL SPRINGS, WASHERS, VALVES, STEERING
DAMPERS, SCREWS, IN CLASS 8 (U.S. CLS. 23, 28
AND 44).

OWNER OF INTERNATIONAL REGISTRATION
0875301 DATED 11-25-2005, EXPIRES 11-25-2015.

THE MARK CONSISTS OF THREE RING-
SHAPED OBJECTS APPEARING ABOVE THE
WORD BENZING. TWO SOLID RECTANGULAR
BOXES APPEAR ON EACH SIDE OF THE WORD
BENZING.

SER. NO. 79-020,342, FILED 11-25-2005.

DEBRA LEE, EXAMINING ATTORNEY

Int. Cls.: 12 and 26

Prior U.S. Cls.: 19, 21, 23, 31, 35, 37, 39, 40, 42, 44 and 50

Reg. No. 3,398,631

United States Patent and Trademark Office

Registered Mar. 18, 2008

**TRADEMARK
PRINCIPAL REGISTER**



GA MODEFINE S.A. (SWITZERLAND CORPORATION)
VIA PENATE 4
CH-6850 MENDRISIO, SWITZERLAND

OWNER OF INTERNATIONAL REGISTRATION
0875886 DATED 1-24-2006, EXPIRES 1-24-2016.

FOR: APPARATUS FOR LOCOMOTION BY LAND, AIR OR WATER, NAMELY, AUTOMOBILES, TRUCKS, MOTORIZED AND NON-MOTORIZED SCOOTERS, BICYCLES, BOATS, AIRCRAFT, IN CLASS 12 (U.S. CLS. 19, 21, 23, 31, 35 AND 44).

OWNER OF U.S. REG. NOS. 2,644,977 AND 3,055,615.

FOR: LACE AND EMBROIDERY, RIBBONS AND BRAID, BUTTONS FOR CLOTHING, HOOKS AND EYES, PINS, NAMELY, BOBBY PINS, BONNET PINS, CURLING PINS, HAIR PINS, MARKING PINS, ORIENTAL PINS, ORNAMENTAL NOVELTY PINS, PINS WITH GLASS HEADS, SAFETY PINS, SETTING PINS, SEWING PINS, AND WAVING PINS FOR THE HAIR, NEEDLES, AND ARTIFICIAL FLOWERS, IN CLASS 26 (U.S. CLS. 37, 39, 40, 42 AND 50).

THE MARK CONSISTS OF "EMPORIO ARMANI" AND DESIGN REPRESENTATION OF AN EAGLE AND THE LETTERS "GA". THE LINING IN THE DRAWING REPRESENTS SHADING AND DESIGN FEATURES OF THE MARK AND DOES NOT REPRESENT COLOR.

THE ENGLISH TRANSLATION OF THE WORD EMPORIO IN THE MARK IS EMPORIUM.

SER. NO. 79-020,511, FILED 1-24-2006.

PRIORITY DATE OF 12-1-2005 IS CLAIMED.

ALEX KEAM, EXAMINING ATTORNEY

Int. Cls.: 14, 18 and 25

Prior U.S. Cls.: 1, 2, 3, 22, 27, 28, 39, 41 and 50

United States Patent and Trademark Office

Reg. No. 3,398,632

Registered Mar. 18, 2008

TRADEMARK
PRINCIPAL REGISTER



VITA BELLA TRADING COMPANY SAS (ITALY
LIMITED PARTNERSHIP SOCIETY)
VIA ANTEO, 63
ROMA
ITALY

FOR: GOODS MADE OF AND COATED WITH
PRECIOUS METALS AND THEIR ALLOYS NAME-
LY, DECORATIVE BOXES, CRUETS, FANCY KEY
RINGS, FIGURES, HAT PINS, RINGS, BRACELETS,
NECKLACES, NECKLACE, EARRINGS, BELT
BUCKLES, BROOCHES, IN CLASS 14 (U.S. CLS. 2,
27, 28 AND 50).

FOR: GOODS MADE OF LEATHER AND IMITA-
TION LEATHER, NAMELY, BRIEFCASES HAND-
BAGS, POUCHES, WALLETS, BRIEFCASE
PORTFOLIO, TRAVELLING BAGS, SPORTS BAGS,
KEY CASES, WALLETS, IN CLASS 18 (U.S. CLS. 1, 2,
3, 22 AND 41).

FOR: CLOTHING, NAMELY, SUITS DRESSES,
COATS, OVERCOATS AND COATS, JACKETS, LEA-
THER JACKETS, OUTDOOR JACKETS, TROUSERS,
SHORTS, SKIRTS, DIVIDED SKIRTS, RAINCOATS,
PARKAS, PULLOVERS, SHIRTS, TEE-SHIRTS,
SPORT-COATS, SWEATERS, UNDERWEAR, PAJA-
MAS, SWIMMING SUITS, BATHING SUITS,
SCARVES, GLOVES; HEADGEAR, NAMELY HATS,

CAPS, SUN VISOR, IN CLASS 25 (U.S. CLS. 22 AND
39).

PRIORITY DATE OF 6-10-2005 IS CLAIMED.

OWNER OF INTERNATIONAL REGISTRATION
0876543 DATED 7-22-2005, EXPIRES 7-22-2015.

THE TRADEMARK CONSISTS OF THE WORDS
"EIGHT SIN", THE LETTER "E" WRITTEN IN LOW-
ERCASE AND THE OTHERS IN UPPERCASE, A
SMALL SPHERE ABOVE EACH OF THE TWO "I'S".
THE COMPOSITION OF THE LETTERS IS ARRAN-
GED SO AS TO APPEAR TO BE WRITTEN IN A
SPHERE WITH A THICK BORDER, TAPERED AT
THE RIGHT SIDE AND ENDING AT A POINTED
TIP CLOSING OFF THE SPHERE. AT THE RIGHT
SIDE, BELOW THE TIP CLOSING OFF THE
SPHERE, THERE IS A THICK ARROW, SHAPED
LIKE AN "S". AT THE UPPER RIGHT SIDE OF THE
SPHERE THERE ARE TWO HORNS OF DIFFERENT
SIZES TURNED UPWARDS.

SER. NO. 79-020,811, FILED 7-22-2005.

KATHLEEN LORENZO, EXAMINING ATTORNEY

Int. Cl.: 9

Prior U.S. Cls.: 21, 23, 26, 36 and 38

Reg. No. 3,398,633

United States Patent and Trademark Office

Registered Mar. 18, 2008

**TRADEMARK
PRINCIPAL REGISTER**

Klein + Hummel

SENNHEISER ELECTRONIC GMBH & CO. KG
(FED REP GERMANY LIMITED LIABILITY
CORPORATION (GMBH & CO. KG))

AM LABOR 1
30900 WEDEMARK
FED REP GERMANY

FOR: AUDIO APPARATUS AND INSTRUMENTS, NAMELY, LIMITERS, COMPRESSORS, ALSO FOR SOUND STUDIOS AND STRUCTURALLY DEFINED COMPONENTS THEREFORE; APPARATUS AND INSTRUMENTS, NAMELY, DIGITAL VIDEO RECORDERS; MEASURING APPARATUS AND INSTRUMENTS, NAMELY, ELECTRIC APPARATUS AND INSTRUMENTS FOR ELECTRO ACOUSTICS AND PARTS THEREFORE, NAMELY, ANTENNA PARAMETER MEASURING APPARATUS, DERIVED-UNIT MEASURING MACHINES AND APPARATUS, MEASURING INSTRUMENTATION AND APPARATUS, NAMELY, DIGITIZERS; SCIENTIFIC APPARATUS AND INSTRUMENTS, NAMELY, SENSING AND SIGNALING DEVICES FOR ELECTRO ACOUSTICAL PURPOSES FOR MEASUREMENT AND QUALITY CONTROL OF ELECTRO ACOUSTICAL APPARATUS, CONTROLLING APPARATUS AND INSTRUMENTS, NAMELY, APPARATUS FOR SURVEYING, NAMELY, ELECTRIC AND ELECTRONIC VIDEO SURVEYING INSTALLATIONS, TEACHING APPARATUS AND INSTRUMENTS, NAMELY, APPARATUS FOR USE IN ELECTRO ACOUSTICS, NAMELY, COMPUTERS AND INSTRUCTIONAL MANUALS SOLD AS UNIT, OPTICAL APPARATUS AND INSTRUMENTS, NAMELY, LIMITERS, COMPRESSORS; ELECTRONIC APPARATUS AND INSTRUMENTS, NAMELY, APPARATUS AND INSTRUMENTS FOR RECORDING AUDIO SIGNALS, AND PARTS THEREFORE; APPARATUS AND INSTRUMENTS FOR RECORDING, TRANSMISSION AND REPRODUCTION OF SOUND AND IMAGE, NAMELY, HIGH FREQUENCY SOUND TRANSMITTING APPARATUS AND

SOUND TRANSMITTING TECHNOLOGY APPARATUS, TRANSMITTING DEVICES, NAMELY, POCKET TRANSMITTERS, NAMELY, RADIO AND TELEPHONE TRANSMITTERS, POCKET UHF AND VHF TRANSMITTERS AND PARTS AND FITTINGS FOR THE AFORESAID GOODS, NAMELY, AERIALS, BATTERY PACKS, ACCUMULATOR PACKS, PLUG-IN MICROPHONES, MINIMODULE SYSTEMS, NAMELY, RECTIFIER MODULES, MEMORY EXPANSION MODULES, TRANSMITTER CONTAINERS, CORKSCREW AERIALS, QUICK-CHARGING ACCUMULATORS, POWER SUPPLY UNITS FOR CHARGING APPARATUS, AUTOMATIC CHARGING APPARATUS, NAMELY, CHARGING APPLIANCES FOR RECHARGEABLE EQUIPMENT, MAGNETIC DATA CARRIERS, NAMELY, BLANK MAGNETIC DATA CARRIERS AND PRE-RECORDED MAGNETIC DATA CARRIERS FEATURING ELECTRO ACOUSTICS THEMES, NAMELY, MUSIC AND SOUNDS; RECORDING DISCS, NAMELY, BLANK CDS AND DVDS FOR SOUND AND VIDEO RECORDING AND PRERECORDED CDS AND DVDS FEATURING ELECTRO ACOUSTIC THEMES, NAMELY, MUSIC AND SOUNDS AND CDS, NAMELY, BLANK MAGNETIC CDS AND PRERECORDED CDS FEATURING ELECTRO ACOUSTIC THEMES, NAMELY, MUSIC AND SOUND; SOUND RECORDINGS FEATURING MUSIC ENTERTAINMENT; DATA PROCESSING INSTRUMENTS, NAMELY, INTERFACE CARDS FOR DATA PROCESSING EQUIPMENT IN THE FORM OF PRINTED CIRCUIT AND INSTRUCTIONAL MANUALS SOLD AS A UNIT; COMPUTER BUFFERS AND PERSONAL COMPUTERS; DATA CARRIERS CONTAINING PROGRAMS AND SOFTWARE ON FLOPPY DISKS, TAPES AND DISCS FOR USE IN DATABASE MANAGEMENT, USE AS A SPREADSHEET, WORD PROCESSING AND SOFTWARE IN THE FIELD OF ELECTRO ACOUSTICS; COMPUTER HARDWARE; COMPUTER PERIPH-

ERAL APPARATUS; DIGITAL COMMUNICATIONS HARDWARE AND SOFTWARE FOR ELECTRO ACOUSTICS; FOR USE IN DATABASE MANAGEMENT, USE AS A SPREADSHEET, WORD PROCESSING; SOUND PROCESSING APPARATUS, NAMELY, SOUND AMPLIFIERS, RECEIVERS; SOUND RECORDING APPARATUS FOR USE IN VEHICLES, HI-FI SOUND EQUIPMENT, NAMELY, SPEAKERS, MICROPHONES, HEADSETS AND HI-FI VIDEO EQUIPMENT, NAMELY, TELEVISION SETS; STEREO RECORDING APPARATUS; SPEAKING APPARATUS AND PANS; COMPUTER SOUND SYSTEMS, NAMELY, MIXERS AND COMPUTER OPERATING SYSTEMS; LOUDSPEAKER SYSTEMS; LOUDSPEAKERS; LOW FREQUENCY LOUDSPEAKERS; LOWEST FREQUENCY LOUDSPEAKERS; TWEETER LOUDSPEAKERS; RANGE LOUDSPEAKERS; LOUDSPEAKERS FOR MUSICAL INSTRUMENTS; CROSS-OVER NETS; FREQUENCY SEPARATING NETS FOR LOUDSPEAKER SYSTEMS, LOUDSPEAKER SCREENS, CASES, STANDS AND BOXES FOR LOUDSPEAKERS AND HI-FI EQUIPMENT; PASSIVE ANTENNAS FOR STEREO CASES; TRANSFORMERS; HI FREQUENCY TRANSFORMERS; ACOUSTIC LENSES FOR LOUDSPEAKER FUNNELS; DRIVER FOR LOUDSPEAKERS; STEREO AMPLIFIERS; RADIO EQUIPMENT, NAMELY, RADIO TRANSMITTERS, RADIO RECEIVERS; HI-FI SOUND APPARATUS AND INSTRUMENTS FOR CARS, NAMELY, CAR CASSETTE PLAYERS; SIGNAL PROCESSING EQUIPMENT, NAMELY, EMERGENCY SIGNAL TRANSMITTERS, DIGITAL SIGNAL PROCESSING EQUIPMENT, NAMELY, DIGITAL SIGNAL PROCESSORS, DIGITAL SPEECH SIGNAL PROCESSORS; SOUND PROCESSORS; AMPLIFIER MODULES FOR INSTALLATION IN LOUDSPEAKER CASES; ACTIVE FREQUENCY DIVIDERS; INTERFACES AND ANALOG INTERFACES, NAMELY, INTERFACES WITHIN ELECTRO ACOUSTICS; DIGITAL TRANSFORMERS FOR RE-

CORDING OF DIGITAL AUDIO SIGNALS; AMPLIFIERS, PRE-AMPLIFIERS, POWER AMPLIFIERS, RECEIVERS, RECEIVING APPARATUS FOR SOUND AND IMAGE, NAMELY, COMPACT RECEIVERS AND UHF RECEIVERS; TUNERS FOR CARS AND STEREOS; HOME VIDEO PROCESSORS; DVD AND CD-PLAYERS; REMOTE CONTROL FOR RADIOS, TELEVISION, STEREOS; MICROPHONES, HEADSETS FOR TELEPHONES AND COMPUTERS FOR USE IN AEROPLANES, BUSES, TRAINS; SOUND SYSTEMS COMPRISED OF AMPLIFIERS, LOUDSPEAKER SYSTEMS AND COMPONENTS THEREOF; TELEVISION SETS; VIDEO MONITORS, HOME VIDEO SYSTEMS COMPRISED OF SPEAKERS, VIDEO DISC PLAYERS; AUDIO CONTROL SYSTEMS FOR LANGUAGE-CONTROLLED AND MULTIMEDIA PURPOSES CONSISTING OF SOUND MIXING APPARATUS, AUDIO PROCESSING EQUIPMENT, NAMELY, EQUALIZERS, ANTENNAS, FILTERS, MICROPHONES, HEADSETS, HEADPHONES; CABLES, NAMELY, ADAPTER CABLES, CO-AXIAL CABLES, CONNECTION CABLES, HEADPHONE CABLES, ALL GOODS AS MENTIONED HEREIN SOLD WITH INSTRUCTIONAL MANUALS AS A UNIT, IN CLASS 9 (U.S. CLS. 21, 23, 26, 36 AND 38).

THE MARK CONSISTS OF STANDARD CHARACTERS WITHOUT CLAIM TO ANY PARTICULAR FONT, STYLE, SIZE, OR COLOR.

PRIORITY DATE OF 7-5-2005 IS CLAIMED.

OWNER OF INTERNATIONAL REGISTRATION 0878380 DATED 11-15-2005, EXPIRES 11-15-2015.

SER. NO. 79-021,423, FILED 11-15-2005.

SCOTT SISUN, EXAMINING ATTORNEY

Int. Cl.: 9

Prior U.S. Cls.: 21, 23, 26, 36 and 38

Reg. No. 3,398,634

United States Patent and Trademark Office

Registered Mar. 18, 2008

**TRADEMARK
PRINCIPAL REGISTER**

3ivx

3IVX TECHNOLOGIES PTY LTD (AUSTRALIA
COMPANY)
36 WATKINS ROAD
AVALON NSW 2107
AUSTRALIA

FOR: COMPUTER SOFTWARE FOR COMPRES-
SION, STORAGE, TRANSMISSION AND REPRO-
DUCTION OF SOUND AND IMAGES, IN CLASS 9
(U.S. CLS. 21, 23, 26, 36 AND 38).

THE MARK CONSISTS OF STANDARD CHAR-
ACTERS WITHOUT CLAIM TO ANY PARTICULAR
FONT, STYLE, SIZE, OR COLOR.

PRIORITY DATE OF 8-23-2005 IS CLAIMED.

OWNER OF INTERNATIONAL REGISTRATION
0881121 DATED 2-23-2006, EXPIRES 2-23-2016.

SER. NO. 79-022,418, FILED 2-23-2006.

FLORENTINA BLANDU, EXAMINING ATTORNEY

Int. Cls.: 16, 28 and 30

Prior U.S. Cls.: 2, 5, 22, 23, 29, 37, 38, 46 and 50

United States Patent and Trademark Office

Reg. No. 3,398,635

Registered Mar. 18, 2008

**TRADEMARK
PRINCIPAL REGISTER**



KRYPTYX ENTERTAINMENT PTY LTD (AUSTRALIA PROPRIETARY LIMITED COMPANY (P/L OR PTY. LTD.))
6 BRAE STREET
BRONTE, AUSTRALIA NSW 2024

FOR: BOXES OF PAPER OR CARDBOARD; PAPER AND CARDBOARD; PRINTED MATTER, NAMELY, DIARIES; CALENDARS; POSTERS; GREETING CARDS; STICKERS; ALBUMS FOR STICKERS; STATIONERY; DECALS; ALBUM FOR HOLDING TRADING CARDS; PLASTIC PAGES FOR HOLDING TRADING CARDS; GENERAL FEATURE MAGAZINES; MAGAZINES AND PRINTED PERIODICALS IN THE FIELD OF SCIENCE; TRADING CARDS; TRADING CARD DISKS OF PAPER OR CARDBOARD; COMIC BOOKS; ILLUSTRATED PUBLICATIONS, NAMELY, GRAPHIC NOVELS; BOOKS, NAMELY, AS CHILDREN'S BOOKS; CHILDREN'S ACTIVITY BOOKS; CHILDREN'S INTERACTIVE EDUCATIONAL BOOKS; CARDBOARD PACKAGING, PLASTIC BUBBLE PACKS FOR WRAPPING OR PACKAGING AND PLASTIC AND PAPER BAGS FOR PACKAGING, IN CLASS 16 (U.S. CLS. 2, 5, 22, 23, 29, 37, 38 AND 50).

FOR: GAMES AND PLAYTHINGS, NAMELY, NON-POSITIONABLE COLLECTIBLE TOY FIG-

URES, MECHANICAL TOYS, PLUSH TOYS, ELECTRONIC LEARNING TOYS, CARD GAMES AND ACTION SKILL GAMES; CHILDREN'S AMUSEMENTS AND INTERACTIVE CHILDREN'S GAMES, NAMELY, HANDHELD UNITS FOR PLAYING ELECTRONIC GAMES AND ELECTRONIC EDUCATIONAL GAME MACHINES FOR CHILDREN, IN CLASS 28 (U.S. CLS. 22, 23, 38 AND 50).

FOR: CANDY AND CONFECTIONARY, NAMELY, CHEWING GUM; BUBBLE GUM; GUM SWEETS; FLAVOURED AND SWEETENED GELATIN; CANDY; CANDY BARS; CHOCOLATE; CHOCOLATE BARS; CHOCOLATE CANDIES; LOLLIPOPS; ICE CANDIES; ICE CREAM; ICE BLOCKS; PASTILLES; CRYSTAL SUGAR PIECES; FRUIT JELLIES, IN CLASS 30 (U.S. CL. 46).

OWNER OF INTERNATIONAL REGISTRATION
0881314 DATED 8-31-2005, EXPIRES 8-31-2015.

SER. NO. 79-022,476, FILED 8-31-2005.

CHRISIE B. KING, EXAMINING ATTORNEY

Int. Cls.: 9, 16 and 35

**Prior U.S. Cls.: 2, 5, 21, 22, 23, 26, 29, 36, 37, 38, 50,
100, 101 and 102**

Reg. No. 3,398,636

United States Patent and Trademark Office

Registered Mar. 18, 2008

**TRADEMARK
SERVICE MARK
PRINCIPAL REGISTER**

LIFE IS NOTHING WITHOUT CONNECTIONS

PIRELLI & C. S.P.A. (ITALY JOINT STOCK
COMPANY)
VIA G. NEGRI, 10
I-20123 MILANO, ITALY

FOR: ACCESS AND HOME NETWORKS AND SYSTEMS COMPRISED OF COMPUTERS, COMMUNICATION SERVERS, ASYMMETRIC DIGITAL SUBSCRIBER LINE, ROUTERS, MODULAR AND INTEGRATED ACCESS GATEWAYS, SET TOP BOXES, DATA SMART CARDS, MODEMS, MULTIPLEXERS, TERMINALS, RECEIVERS, TRANSMITTERS, DECODERS, AND TRANSCEIVERS CAPABLE OF PROCESSING BROADCAST, SATELLITE, FACSIMILE, TELEVISION, TELECOMMUNICATION, NETWORK, INFRARED, AND COMPUTER DATA SIGNALS AND FOR TRANSMISSION, REPRODUCING OR RECEIVING OF SOUND, IMAGES, VIDEO, MULTIMEDIA OR DATA AND FIBER ETHERNET ACCESSES, NAMELY, SWITCHES, WIRELESS LOCAL AREA NETWORKS (LAN) PRODUCTS, NAMELY, MOBILE COMPUTER, SERVERS, ROUTERS, MODULAR AND INTEGRATED ACCESS GATEWAYS, SET TOP BOXES, DATA SMART CARDS, MODEMS, MULTIPLEXERS, TERMINALS, RECEIVERS, TRANSMITTERS, DECODERS, AND TRANSCEIVERS, WIRELESS ETHERNET DUAL ACCESS POINTS, WIRELESS ETHERNET ACCESS POINTS AND STARTER KITS COMPRISING INSTALLATION CD ROM; EQUIPMENT AND DEVICES FOR USE IN HOME COMMUNICATIONS AND ENTERTAINMENT SYSTEMS, NAMELY, MODULAR AND INTEGRATED ACCESS GATEWAYS FOR HOME NETWORKING, SET TOP BOXES FOR HOME ENTERTAINMENT AND MANAGEMENT SYSTEM COMPRISED OF RADIO TRANSMITTERS AND RECEIVERS FOR REMOTE CONTROL; OPTICAL COMMUNICATIONS APPARATUS, NAMELY, SIGNAL DISTRIBUTION NETWORKS AND SYSTEMS COMPRISED OF COMPUTER HARDWARE AND SOFTWARE, TRANSMITTERS AND RECEIVERS FEATURING SDH (SYNCHRONOUS DIGITAL HIERARCHY), PDH (PLESIOCHRONOUS DIGITAL HIERARCHY), PON (PASSIVE OPTICAL NETWORK), AND WDM (WAVELENGTH DIVISION

MULTIPLEXING); OPTICAL MODEMS, NAMELY, OPTICAL TRANSCEIVER; DATA PROCESSING APPARATUS, NAMELY, ROUTERS, SWITCHES, AND INTEGRATED ACCESS PLATFORMS IN THE NATURE OF COMPUTER SOFTWARE FOR USE IN ACCESSING COMPUTER NETWORKS; EQUIPMENT AND DEVICES FOR USE IN ACCESS AND HOME NETWORKS AND SYSTEMS, NAMELY, MOBILE COMPUTER SERVERS, ROUTERS, MODULAR AND INTEGRATED ACCESS GATEWAYS, SET TOP BOXES, DATA SMART CARDS, MODEMS, MULTIPLEXERS, TERMINALS, RECEIVERS, TRANSMITTERS, DECODERS, AND TRANSCEIVERS, WIRELESS ETHERNET DUAL ACCESS POINTS FOR CONNECTING NETWORKS COMPUTER USERS, WIRELESS ETHERNET ACCESS POINTS FOR CONNECTING NETWORKS COMPUTER USERS AND STARTER KITS COMPRISING INSTALLATION CD ROM AND INSTRUCTIONAL MANUALS SOLD AS A UNIT THEREWITH, WIRELESS GATEWAY ROUTERS IN THE NATURE OF COMPUTER CONTROL HARDWARE FOR HOME AND BUSINESS APPLICATIONS, WIRELESS MODULES IN THE NATURE OF TRANSMITTERS AND RECEIVERS FOR HANDHELDS, NAMELY, COMPUTERS, WIRELESS LAN ANTENNAS, WIRELESS LAN POWER INJECTORS, DOMESTIC APPLIANCES, NAMELY, SET TOP BOXES, VIDEO STATIONS COMPRISED OF MONITORS AND CAMERAS, REMOTELY CONTROLLED HOME APPLIANCES REGULATORS IN THE NATURE OF THERMOSTATS, ELECTRIC LIGHT DIMMER AND SWITCHES, SET TOP BOXES FOR USE IN VIDEO-CONFERRING, DATA PROCESSING APPARATUS, NAMELY, ROUTERS SWITCHES AND INTEGRATED ACCESS PLATFORMS IN THE NATURE OF COMPUTER SOFTWARE FOR USE IN COMPUTER NETWORK ACCESS; CUSTOMER PREMISE EQUIPMENT (CPE) IN THE NATURE OF SET TOP BOXES, INTEGRATED ACCESS DEVICES (IAD) IN THE NATURE OF MODEMS, CAMERAS FOR USE IN TRANSMITTING IMAGES VIA A COMPUTER NETWORK, DIGITAL SUBSCRIBER LINE (DSL) ENABLED CUSTOMER ELECTRONIC GOODS, NAMELY, MODEMS, ALARM SYSTEMS,

NAMELY, ACCESS CONTROL AND ALARM MONITORING SYSTEMS; HOME NETWORKING APPLIANCES, NAMELY, VIDEO PHONES, SET-TOP-BOXES (STB), INTERNET PROTOCOL TELEVISION (IPTV) SET TOP-BOXES, INTEGRATED ACCESS DEVICES (IAD), WEBCAMS, XDSL ENABLED CONSUMER ELECTRONICS GOODS, NAMELY, MODEMS AND ALARM SYSTEMS; DIGITAL SUBSCRIBER LINE (DSL) TERMINATIONS AND DISTRIBUTION, NAMELY, TERMINALS AND EQUIPMENT AND DEVICES FOR USE IN THE ABOVE BROADBAND ACCESS SYSTEMS, NAMELY, MODEMS, SWITCHES, ROUTERS, HUBS, VOIP (VOICE OVER IP), WIRELESS LOCAL AREA NETWORK ACCESS POINTS FOR CONNECTING NETWORK COMPUTER USERS, REPEATERS AND ADAPTERS; PASSIVE OPTICAL NETWORK (PON) COMPRISED OF COMPUTER HARDWARE FOR USE IN LOCAL AREA NETWORK (LAN), COMPUTER NETWORK SWITCHES AND ROUTERS, NAMELY, OPTICAL NETWORK UNIT (ONU) AND OPTICAL LINE TERMINATION (OLT) SWITCHES/ROUTERS FOR METRO AREA NETWORKS, PDH (PLESIOCHRONOUS DIGITAL HIERARCHY) ACCESS MULTIPLEXERS, DSL MULTIPLEXERS; LAST MILE TELECOMMUNICATION EQUIPMENT, NAMELY, MEDIA CONVERTERS, MODEMS, GATEWAY HARDWARE AND SOFTWARE, SWITCHES, ROUTERS, MULTIPLEXERS, TELECOMMUNICATIONS EXCHANGERS; MEDIA CONVERTERS, MODEMS, GATEWAYS FOR RESIDENTIAL AND VIRTUAL PRIVATE NETWORK USE, NAMELY, COMPUTER HARDWARE AND SOFTWARE FOR TRANSMITTING INFORMATION BETWEEN COMPUTERS AND NETWORKS, VPN ROUTERS (VIRTUAL PRIVATE NETWORK ROUTERS), COMPUTER SOFTWARE FOR THE CREATION OF FIREWALLS FOR PERSONAL COMPUTER, GATEWAYS ROUTERS IN THE NATURE OF COMPUTER CONTROL HARDWARE; TELECOMMUNICATIONS AND ELECTRIC SWITCHES, ROUTERS, NAMELY, VPN ROUTERS (VIRTUAL PRIVATE NETWORK ROUTERS), WIRELESS GAMING ROUTERS, DSL ROUTERS (DIGITAL SUBSCRIBER LINE ROUTERS), WIRELESS DSL ROUTERS (WIRELESS DIGITAL SUBSCRIBER LINE ROUTERS), ADSL ROUTERS (ASYMMETRIC DIGITAL SUBSCRIBER LINE ROUTERS), ISDN ROUTERS (INTEGRATED SERVICE DIGITAL NETWORK ROUTERS), ISDN TERMINAL ROUTERS (INTEGRATED SERVICE DIGITAL NETWORK TERMINAL ADAPTERS); MULTIPLEXERS; HOME NETWORKING APPLIANCES, NAMELY, VIDEO CASSETTE RECORDERS, CABLE BOXES IN THE NATURE OF CABLE TELEVISION CONVERTERS, SET TOP BOXES (STB), VIDEO STATIONS FEATURING CAMERAS AND MONITORS AND LIQUID CRYSTAL DISPLAYS; MODEMS, AMPLIFIERS FOR WIRELESS COMMUNICATIONS; SET-TOP BOXES; DIGITAL SUBSCRIBER LINE (XDSL) EQUIPMENT, NAMELY, COMPUTER HARDWARE THAT ENABLES VIDEO COMMUNICATIONS, VOICE COMMUNICATIONS, VOICE-OVER INTERNET PROTOCOL COMMUNICATIONS, VIDEO-OVER INTERNET PROTOCOL COMMUNICATIONS, ONLINE COMMUNICATIONS, VOICE-OVER-DIGITAL-SUBSCRIBER LINE COMMUNICATIONS,

VIDEO-OVER-DIGITAL-SUBSCRIBER LINE COMMUNICATIONS, VOICE MAIL, VIDEO MAIL, CALL FORWARDING, CALLER ID, CONFERENCING, CUSTOMIZED PHONE NUMBER DIRECTORIES, CALL ROUTING SERVICES AND VOICE-OVER DIGITAL LINE COMMUNICATIONS; COMPUTER SOFTWARE THAT ENABLES VIDEO COMMUNICATIONS, VOICE COMMUNICATIONS, VOICE-OVER INTERNET PROTOCOL COMMUNICATIONS, VIDEO-OVER INTERNET PROTOCOL COMMUNICATIONS, ONLINE COMMUNICATIONS, VOICE-OVER-DIGITAL-SUBSCRIBER LINE COMMUNICATIONS, VIDEO-OVER-DIGITAL-SUBSCRIBER LINE COMMUNICATIONS, VOICE MAIL, VIDEO MAIL, CALL FORWARDING, CALLER ID, CONFERENCING, CUSTOMIZED PHONE NUMBER DIRECTORIES, CALL ROUTING SERVICES AND VOICE-OVER DIGITAL LINE COMMUNICATIONS; COMPONENTS FOR USE IN THE ABOVE DEVICES, NAMELY, DSL MODEMS, CABLE MODEMS AND SATELLITE MODEMS THAT INTERFACE DIRECTLY WITH DIGITAL SUBSCRIBER LINE OTHERWISE KNOWN AS DSL, SATELLITE DATA OR CABLE BROADBAND DATA SERVICES AND RELATED SOFTWARE AS A UNIT THEREWITH; COMPONENTS FOR USE IN THE ABOVE DEVICES, NAMELY, OPTICAL TELEPHONE AND ELECTRICAL CONNECTORS, POWER SUPPLIERS, FAN-OUT FOR SEPARATING INDIVIDUAL FIBERS OR BUFFER TUBES OF A FIBER-OPTIC CABLE FOR THE PURPOSE OF SPLICING OR INSTALLING OPTICAL CONNECTORS, SPLICES FOR ELECTRICAL TRANSMISSION LINES, OPTICAL NETWORKING SPLITTERS; END-TO-END VIDEO SOLUTION, NAMELY, VIDEO ENCODERS, VIDEO SERVERS, SET TOP BOXES, VIDEO CAMERAS, VIDEO ENCODERS AND SOFTWARE, NAMELY, FOR COMPLETE IP VIDEO BROADCASTING, OPTICAL CABLES, ELECTRICAL CABLES, COAXIAL CABLES, TELECOMMUNICATION NETWORK CABLES; VIDEO ENCODERS AND RELATED SOFTWARE SOLD AS A UNIT; TELECOMMUNICATIONS SYSTEMS AND LINES, NAMELY, TERMINALS FOR TRANSMITTING DATA, AUDIO, VOICE, VIDEO AND TELEPHONE SIGNALS AND TRANSMISSION WIRES, TELECOMMUNICATIONS CABLES; OPTICAL TELECOMMUNICATIONS SYSTEMS COMPRISED PRIMARILY OF SWITCHES AND TRANSMITTERS AND TELECOMMUNICATION CABLES; APPARATUS FOR GENERATING OR CONVERTING AN OPTICAL SIGNAL FOR USE IN OPTICAL TELECOMMUNICATIONS, OPTICAL CABLES, APPARATUS FOR RECEIVING AN OPTICAL TELECOMMUNICATION SIGNAL AND TRANSMITTING SAID SIGNAL IN OPTICAL OR ELECTRICAL FORM, OPTICAL AMPLIFIERS, OPTICAL REPEATERS, OPTICAL FILTERS, SIGNAL PROCESSING APPARATUS BOTH ELECTRONIC AND OPTICAL, ELECTRONIC APPARATUS FOR GENERATING, RECEIVING, PROCESSING, CONTROLLING, SWITCHING AND FORWARDING SIGNAL PROCESSING OPERATIONS FOR USE IN OPTICAL TELECOMMUNICATION AND TRANSMISSION LINES, TELECOMMUNICATION SWITCHES AND FIBER OPTIC CABLES AND SOFTWARE, NAMELY, COMPUTER PROGRAMS FOR

USE IN OPERATING OPTICAL TELECOMMUNICATION AND TRANSMISSION LINES, TELECOMMUNICATION SWITCHES AND FIBER OPTIC CABLES AND COMPUTER MANUALS, DIAGRAMS AND OPERATING INSTRUCTIONS SOLD AS A UNIT THEREWITH, OPTICAL TELECOMMUNICATIONS SYSTEMS AND LINES WITH WAVELENGTH MULTIPLEXING, NAMELY, TRANSMITTING APPARATUS, CABLES, RECEIVING APPARATUS, AMPLIFIERS, REPEATERS, FILTERS, SIGNAL PROCESSING APPARATUS, TELECOMMUNICATIONS SWITCHES; VIDEO, VOICE AND DATA TRANSMISSION SYSTEMS AND LINES, NAMELY, THE COMBINATION OF ONE OR MORE TRANSMITTERS AND A TRANSMISSION CABLE, OPERATIVE TO TRANSMIT VIDEO, VOICE AND/OR DATA OF OTHER KIND FROM A TRANSMITTER TO ONE OR MORE RECEIVERS, NAMELY, RADIO TRANSMISSION SYSTEMS, TELEPHONE NETWORK OR SYSTEMS FOR THE TRANSMISSION OF DATA, TELECOMMUNICATIONS TRANSMITTERS, FIBER OPTIC CABLES; DISTRIBUTION SYSTEMS AND LINES FOR INTERACTIVE SYSTEMS, NAMELY, OPTOELECTRONIC SYSTEMS, NAMELY, TRANSMISSION/RECEPTION APPARATUS AND TRANSMISSION DISTRIBUTION APPARATUS FOR CONVERSION BETWEEN ELECTRICAL AND OPTICAL SIGNALS AND VICE VERSA; APPARATUS FOR THE TRANSMISSION OF OPTICAL SIGNALS WITHOUT AMPLIFICATION, NAMELY, FIBER OPTICS, FIBER OPTIC PASSIVE NETWORKS PRINCIPALLY COMPRISING TRANSMITTERS, CABLES, RECEIVERS, AMPLIFIERS, REPEATERS, FILTERS, SIGNAL PROCESSOR AND SWITCHES, AND PASSIVE OPTICAL CABLES; OPTICAL GENERATORS, NAMELY, RECEIVERS, AMPLIFIERS, REPEATERS, FILTERS, SIGNAL PROCESSOR AND SWITCHES, OPTICAL RECEIVERS, OPTICAL TRANSMITTERS, OPTICAL REGENERATORS, NAMELY, RECEIVERS, AMPLIFIERS, REPEATERS, FILTERS, SIGNAL PROCESSOR AND SWITCHES; OPTICAL AMPLIFIERS, OPTICAL COUPLERS AND OPTICAL SWITCHES; DEVICES FOR THE TRANSMISSION OF OPTICAL SIGNALS WITHOUT AMPLIFICATION, NAMELY, OPTICAL FIBERS AND OPTICAL FIBER PASSIVE NETWORKS DEVICES FOR THE TRANSMISSION OF OPTICAL SIGNALS WITHOUT AMPLIFICATION, NAMELY, FIBER OPTIC AND FIBER OPTIC PASSIVE NETWORKS PRINCIPALLY COMPRISING TRANSMITTERS, CABLES, RECEIVERS, AMPLIFIERS, REPEATERS, FILTERS, SIGNAL PROCESSOR AND SWITCHES, AND PASSIVE OPTICAL LINES; DEVICES FOR GENERATING, SWITCHING, COMBINING, AMPLIFYING, REGENERATING, TRANSMITTING AND RECEIVING OPTICAL SIGNALS, NAMELY, OPTICAL FIBERS, OPTICAL FIBER PASSIVE NETWORKS PRINCIPALLY COMPRISING TRANSMITTERS, CABLES, RECEIVERS, AMPLIFIERS, REPEATERS, FILTERS, SIGNAL PROCESSOR AND SWITCHES; DEVICES FOR CABLE TELEVISION, NAMELY, CABLE TV TRANSMITTERS, CABLE TV DISTRIBUTION NETWORKS COMPRISED OF COMPUTER HARDWARE AND SOFTWARE, CABLE TV MODULATORS, CABLE TV AMPLIFIERS AND CABLE TV RECEIVERS; OPTICAL DE-

VICES, NAMELY, OPTICAL SPLITTERS, OPTICAL MODULATORS, OPTICAL FILTERS, SWITCHES; LASERS NOT FOR MEDICAL USE, IN CLASS 9 (U.S. CLS. 21, 23, 26, 36 AND 38).

FOR: WRITING, PRINTING AND ART PAPER; CARDBOARD AND GOODS MADE FROM PAPER AND CARDBOARD, NOT INCLUDED IN OTHER CLASSES, NAMELY, PAPER BAGS, PAPER BOXES, ENVELOPES, WRITING PAPER, BLANK PAPER AND PAPER CARDS FOR THE RECORDAL OF COMPUTER PROGRAMS AND DATA, TYPING PAPER, COPY PAPER, CARBON PAPER, COMPUTER PAPER, GIFT WRAPPING PAPER, GIFT BOXES MADE FROM PAPER, NOTE PAPER, DRAWING PAPER, PAPER FLAGS, PAPER DIVIDERS FOR BOXES, PAPER TUBES, PAPER FILING TRAYS, PACKAGING MATERIALS, NAMELY, PAPER MAILING TUBES, PLAIN WRAPPING PAPER, NOTE CARDS, NON-MAGNETICALLY ENCODED CREDIT CARDS, INDEX CARDS PAPER, PAPER TABLECLOTHS, PAPER BANNERS, PAPER FOLDERS, STICKERS, ADDING MACHINE PAPER, ALUMINUM FOIL LAMINATED PAPER FOR PRINTING PURPOSES, ART PAPER, BLANK PAPER COMPUTER TAPES, BLOTTING PAPER, BOND PAPER, CARRYING CASES MADE OF PAPER, CLEANING AND POLISHING PAPER, COASTERS MADE OF PAPER, CONSTRUCTION PAPER, CORRUGATED PAPER, CRAFT PAPER, CREPE PAPER, DECORATIVE PAPER CENTERPIECES, ELECTROCARDIOGRAPH PAPER, ELECTROSTATIC PAPER, FACSIMILE TRANSMISSION PAPER, FIBER PAPER, FILLER PAPER, FILTER PAPER, FLUORESCENT PAPER, GROCERY PAPER, ILLUSTRATION PAPER, GUMMED PAPER, LAMINATED PAPER, LASER PRINTING PAPER, LINING PAPER, LOOSE LEAF PAPER, LUMINOUS PAPER, MAGNETIC PAPER, MANIFOLD PAPER, MASKING PAPER, METALLIC GIFT WRAPPING PAPER, NEWSPRINT PAPER, NOTEBOOK PAPER, PACKING PAPER, PAPER BADGES, PAPER BOARDS, PAPER BOWS FOR GIFT WRAP, PAPER CLIPS, PAPER CLIP HOLDERS, PAPER CLOSURES FOR SEALING CONTAINERS, PAPER CONTAINERS, PAPER CUTTERS, PAPER DISPLAY BOXES, PAPER EMBLEMS, PAPER CARTONS FOR DELIVERING GOODS, PAPER EXPANDING FILES, PAPER FOR RECORDING MACHINES, PAPER FOR WRAPPING AND PACKAGING, PAPER GIFT BAGS, PAPER HANDKERCHIEFS, PAPER IDENTIFICATION TAGS, PAPER ILLUSTRATION BOARDS, PAPER LABELS, PAPER PARTY DECORATIONS, PAPER RACKS, PAPER STAPLES, PAPER STOCK, PAPER TAGS, PAPER TAPE, PAPER TOWELS, PRINTING PAPER, REPRODUCTION PAPER, PUBLICATION PAPER, SYNTHETIC PAPER, STORAGE CONTAINERS MADE OF PAPER, TRACING PAPER, WRAPPING PAPER, POSTCARDS, PAPER NAME TAGS, FOLDERS FOR LETTERS, CARDBOARD BAGS, CARDBOARD BOXES, GIFT WRAPPING CARDBOARD, GIFT BOXES MADE FROM CARDBOARD, CARDBOARD CARTONS, CARDBOARD CONTAINERS, CARDBOARD MAILING TUBES, CARDBOARD DIVIDERS FOR BOXES, CARDBOARD TUBES, CARDBOARD FILING TRAYS, CARDBOARD FOLDERS, CARRYING CASES MADE OF CARD-

BOARD, STORAGE CONTAINERS MADE OF CARDBOARD, CARDBOARD CARTONS FOR DELIVERING GOODS, CARDBOARD CUT-OUT FIGURES AND DECORATIONS, NAMELY, CARDBOARD PARTY DECORATIONS; PRINTED MATTER, NAMELY, PAMPHLETS, BROCHURES, MANUALS, NEWSPAPERS, BOOKLETS, INFORMATIONAL FLYERS, MAGAZINE INSERTS, NEWSLETTERS, JOURNALS, MAGAZINES, POSTERS AND CALENDARS IN THE FIELD OF MUSIC, EDUCATION, CURRENT EVENTS, TRANSPORT, PHILATELY, STAMPS, HERITAGE, HISTORY, GEOGRAPHY, POLITICS, EDUCATION, BUSINESS, FINANCE, INSURANCE, COMMERCE, AGRICULTURE, INDUSTRY, RELIGION, THE HOME, FAMILY, CHILDCARE, CRAFTS, RECREATION, TRAVEL, SCIENCE, ELECTRONIC TECHNOLOGY, COMMUNICATIONS, THE MEDIA, GOVERNMENT, PEOPLE, GAMES, SPORTS, WEATHER, ENTERTAINMENT, HEALTH, LIFESTYLE, FASHION, LEISURE AND SHOPPING, COLLECTION BOOKS, NAMELY, ALBUM FOR COINS AND STAMPS, STAMP ALBUMS, PRINTED MONEY ORDER FORMS, ORDER FORMS FOR ORDERS REQUIRING SPECIAL HANDLING, MAPS, ANNOUNCEMENT CARDS, FLASH CARDS, POSTERS, PRINTED EMBLEMS, PRINTED INVITATIONS, DICTIONARIES, INSTRUCTION SHEETS, PRINTED POSTCARDS AND GREETING CARDS, PRINTED TICKETS; BOOKBINDING MATERIAL, NAMELY, BOOKBINDING LINEN; BOOKBINDING FABRIC; PHOTOGRAPHS; STATIONERY; ADHESIVES FOR STATIONERY OR HOUSEHOLD PURPOSES; ARTISTS' MATERIALS, NAMELY, CANVAS FOR PAINTING, PAINTBRUSHES, PAINTERS' EASELS, PALETES FOR PAINTERS, PASTELS; PAINT BRUSHES; TYPEWRITERS AND OFFICE REQUISITES, NAMELY, BULLETIN BOARDS, CHALK BOARDS FOR HOME AND SCHOOL USE, DESK TOP PLANNERS, DESK SETS, DESK PADS, DESK TOP ORGANIZERS, AGENDAS, TELEPHONE NUMBER

BOOKS, MEMORANDUM BOARDS AND BOOKS, FILING TRAYS, STAMP DISPENSERS, BLANK PAPER LABELS, BLANK ADDRESS BOOKS, BLANK ADDRESS CARDS AND CARD FILES, PAPER HOLE PUNCHES, RUBBER BANDS, STAPLERS, STAPLE REMOVERS, ADHESIVE TAPE DISPENSERS FOR HOUSEHOLD OR STATIONARY USE, STUDENT CALENDARS, CHILDREN'S PLAY BOOKS AND ACTIVITY BOOKS, BLACKBOARDS; PRINTED INSTRUCTIONAL AND TEACHING MATERIAL IN THE FIELD OF ENERGY, SCIENCE, SOCIOLOGY, INDUSTRY, LAW, CHEMICAL, DATA PROCESSING, ENGINEERING, MEDICAL, BIOLOGICAL, ALIMENTARY, VETERINARY, AGRICULTURAL, INDUSTRIAL AND INTELLECTUAL PROPERTY; PLASTIC MATERIALS FOR PACKAGING NOT INCLUDED IN OTHER CLASSES, NAMELY, BUBBLE PACKS, BAGS, ENVELOPES AND POUCHES; PRINTERS' TYPE; PRINTING BLOCKS, IN CLASS 16 (U.S. CLS. 2, 5, 22, 23, 29, 37, 38 AND 50).

FOR: ADVERTISING; BUSINESS MANAGEMENT; BUSINESS ADMINISTRATION; OFFICE FUNCTIONS, IN CLASS 35 (U.S. CLS. 100, 101 AND 102).

THE MARK CONSISTS OF STANDARD CHARACTERS WITHOUT CLAIM TO ANY PARTICULAR FONT, STYLE, SIZE, OR COLOR.

PRIORITY DATE OF 7-29-2005 IS CLAIMED.

OWNER OF INTERNATIONAL REGISTRATION 0881788 DATED 10-3-2005, EXPIRES 10-3-2015.

SER. NO. 79-022,643, FILED 10-3-2005.

MARTHA FROMM, EXAMINING ATTORNEY

Int. Cls.: 9, 16, 35, 38, 41 and 42

**Prior U.S. Cls.: 2, 5, 21, 22, 23, 26, 29, 36, 37, 38, 50,
100, 101, 102, 104 and 107**

Reg. No. 3,398,637

United States Patent and Trademark Office

Registered Mar. 18, 2008

**TRADEMARK
SERVICE MARK
PRINCIPAL REGISTER**



PROSIEBENSAT.1 MEDIA AG (FED REP GER-
MANY AKTIENGESELLSCHAFT (JOINT
STOCK COMPANY))
MEDIENALLEE 7
85774 UNTERFÖHRING
FED REP GERMANY

FOR: APPARATUS FOR RECORDING, TRANSMISSION, OR REPRODUCTION OF SOUND, VIDEO, OR DATA IMAGES; SOUND, IMAGE, AND DATA CARRIERS OF ALL KINDS, NAMELY, BLANK AUDIO CASSETTE TAPES, BLANK VIDEO TAPES, BLANK DVD'S, BLANK COMPACT DISCS, BLANK RECORDS, BLANK AUDIO AND VIDEO CARTRIDGES, AND DIGITAL AUDIO AND VIDEO COMPRESSION SOFTWARE FILES, NAMELY, MP3'S, MP4'S, DIGITAL IMAGE FILES, DIGITAL VIDEO FILES, MOTION PICTURE FILMS, AND DVD'S, ALL FEATURING INSTRUCTION, ENTERTAINMENT, EDUCATION AND INFORMATION RELATING TO RECREATIONAL ACTIVITIES, INTERIOR DECORATING, MUSIC, DRAMA, FILM, ART, ANTIQUES, MOTORING, COMEDY, NEWS, EXERCISE, GARDENING, COOKING, SPORTS, HISTORY, SCIENCE, AND TECHNOLOGY; PRE-RECORDED DATA CARRIERS, NAMELY, RECORDS, DISCS, CD-ROM'S, TAPES, AUDIO CASSETTES, AUDIO AND VIDEO CARTRIDGES, VIDEO GAME CARTRIDGES, COMPUTER GAME CARTRIDGES, DIGITAL AUDIO AND VIDEO COMPRESSION SOFTWARE FILES, NAMELY, MP3'S, MP4'S, JPEG'S, DIGITAL IMAGE FILES, DIGITAL VIDEO FILES, MOTION PICTURE FILMS, AND DVD'S, ALL FEATURING INSTRUCTION, ENTERTAINMENT, EDUCATION AND INFORMATION RELATING TO RECREATIONAL ACTIVITIES, INTERIOR DECORATING, MUSIC, DRAMA, FILM, ART, ANTIQUES, MOTORING, COMEDY, NEWS, EXERCISE, GARDENING, COOKING, SPORTS, HISTORY, SCIENCE, AND TECHNOLOGY; CASH REG-

ISTERS; CALCULATORS, ADDING MACHINES; DATA PROCESSING EQUIPMENT, NAMELY, TELEVISION AND RADIO SIGNAL TRANSMITTERS AND RECEIVERS FOR USE IN RECORDING, PRODUCING, PRESENTING, BROADCASTING, TRANSMITTING, RECEIVING, PROCESSING, REPRODUCING, ENCODING AND DECODING OF RADIO AND TELEVISION PROGRAMMES, INFORMATION AND DATA RELATING TO SAID RADIO AND TELEVISION PROGRAMMES, AND FOR USE IN AUDIO AND VIDEO STREAMING VIA THE INTERNET, AND PARTS THEREFOR; COMPUTERS AND COMPUTER HARDWARE; MOUSE PADS; OPTICAL APPARATUS AND INSTRUMENTS, NAMELY, SPECTACLES, SPECTACLE LENSES, SPECTACLE FRAMES; COMPUTER SOFTWARE FOR USE IN ACCESSING AND ORGANIZING DOWNLOADABLE ELECTRONIC PUBLICATIONS PROVIDED ON-LINE FROM DATABASES OR THE INTERNET; COMPUTER AND VIDEO GAME PROGRAMMES; COMPUTER SOFTWARE FOR USE IN DELIVERING AND RECEIVING VIDEO ON-DEMAND SERVICES; COMPUTER SOFTWARE ENABLING THE USER TO DOWNLOAD AN AUDIO AND VIDEO STREAMS FROM THE INTERNET; COMPUTER SOFTWARE FOR USE IN ORGANIZATION OF DATA FOR MUSIC PUBLISHING; COMPUTER SOFTWARE FOR USE IN ACCESSING THE INTERNET; ELECTRONIC GAMES, NAMELY, VIDEO GAME MACHINES FOR USE WITH TELEVISIONS; COMPUTER GAME EQUIPMENT CONTAINING MEMORY DEVICES, NAMELY, DISCS; INTERACTIVE COMPUTER GAME DISCS; AUTOMATIC VENDING MACHINES; FIRE EXTINGUISHING SYSTEMS; MAGNETICALLY ENCODED PRE-PAID TELEPHONE CALLING CARDS, NON-MAGNETICALLY-ENCODED PRE-PAID TELEPHONE CALLING CARDS; MAGNETICALLY ENCODED CREDIT CARDS;

MAGNETICALLY ENCODED DEBIT CARDS, NON MAGNETICALLY-ENCODED DEBIT CARDS; BLANK ELECTRONIC CHIP CARDS; CHIP CARD READERS, IN CLASS 9 (U.S. CLS. 21, 23, 26, 36 AND 38).

FOR: PAPER BAGS, PLASTIC BAGS FOR PACKING; PRINTED MATERIALS, NAMELY A SERIES OF BOOKS FEATURING INSTRUCTION, ENTERTAINMENT, EDUCATION AND INFORMATION RELATING TO RECREATIONAL ACTIVITIES, INTERIOR DECORATING, MUSIC, DRAMA, FILM, ART, ANTIQUES, MOTORING, COMEDY, NEWS, EXERCISE, GARDENING, COOKING, SPORTS, HISTORY, SCIENCE, AND TECHNOLOGY; PRINTED PUBLICATIONS AND PERIODICAL PUBLICATIONS, NAMELY, MAGAZINES, PRINTED INFORMATIONAL BROCHURES, PAMPHLETS, BOOKLETS, CATALOGUES, AND GUIDES, ALL FEATURING INSTRUCTION, ENTERTAINMENT, EDUCATION AND INFORMATION RELATING TO RECREATIONAL ACTIVITIES, INTERIOR DECORATING, MUSIC, DRAMA, FILM, ART, ANTIQUES, MOTORING, COMEDY, NEWS, EXERCISE, GARDENING, COOKING, SPORTS, HISTORY, SCIENCE, AND TECHNOLOGY; POSTERS; PHOTOGRAPHS; PHOTOGRAPH ALBUMS; STATIONERY; DIARIES; CALENDARS; DRAWINGS; ADHESIVES FOR STATIONERY OR HOUSEHOLD PURPOSES; STICKERS; WRITING INSTRUMENTS, NAMELY, PENS, PENCILS, CRAYONS, ERASERS; PAINT BRUSHES; TYPEWRITERS; PLASTIC BAGS AND PLASTIC BUBBLE PACKS FOR PACKAGING; PRINTERS TYPE; PRINTING BLOCKS, IN CLASS 16 (U.S. CLS. 2, 5, 22, 23, 29, 37, 38 AND 50).

FOR: BUSINESS MANAGEMENT; BUSINESS ADMINISTRATION AND OFFICE WORK; MARKETING CONSULTANCY; MARKET RESEARCH; MARKET ANALYSIS; BUSINESS ORGANIZATION CONSULTING SERVICES; NEGOTIATION, SETTLEMENT, AND CONCLUSION OF COMMERCIAL TRANSACTIONS FOR THIRD PARTIES; MARKET OPINION POLLING STUDIES, PUBLIC OPINION POLLING; ADVERTISING RESEARCH, NAMELY, MARKETING RESEARCH STUDIES; DISTRIBUTION OF GOODS FOR ADVERTISING PURPOSES; PUBLICITY AGENTS, PUBLICITY CONSULTATION; PROVIDING RADIO, TELEVISION, CINEMA, PRINT, VIDEO TEXT, AND TELETEXT ADVERTISING FOR OTHERS; PREPARATION OF ADVERTISEMENTS FOR OTHERS IN THE NATURE OF PUBLICITY FILMS; RENTAL OF ADVERTISEMENT SPACE AND ADVERTISING MATERIAL IN THE NATURE OF PUBLICITY FILMS; TELEPHONE ORDER TAKING SERVICES FOR OTHERS IN THE FIELD OF TEleshopping; PRODUCTION OF TELEVISION COMMERCIALS IN THE NATURE OF TEleshopping PROGRAMMES; DISTRIBUTION OF TELEVISION AND RADIO COMMERCIALS; PROVIDING BUSINESS INFORMATION CONCERNING AUDIO, CABLE TELEVISION, SUBSCRIPTION TELEVISION, INTERACTIVE TELEVISION, VIDEO, AND RADIO BROADCASTING BY MEANS OF AN INTERACTIVE COMPUTER DATABASE IN THE FIELD OF RECREATIONAL ACTIVITIES, INTERIOR DECORATING, MUSIC, DRAMA,

FILM, ART, ANTIQUES, MOTORING, COMEDY, NEWS, EXERCISE, GARDENING, COOKING, SPORTS, HISTORY, SCIENCE, AND TECHNOLOGY, IN CLASS 35 (U.S. CLS. 100, 101 AND 102).

FOR: TELECOMMUNICATION SERVICES, NAMELY, LOCAL AND LONG DISTANCE TRANSMISSION OF INFORMATION, TEXT, SOUND, IMAGES AND DATA BY MEANS OF TELEPHONE, CABLE AND SATELLITE TRANSMISSIONS; TELECOMMUNICATIONS GATEWAY SERVICES FOR ACCESS TO A COMMUNICATION OR COMPUTER NETWORK; PROVIDING MULTIPLE USER ACCESS TO INFORMATION, TEXT, SOUND, IMAGES AND DATA VIA COMPUTER NETWORKS; PROVIDING INFORMATION AND ADVICE IN THE FIELD OF TELECOMMUNICATIONS; BROADCASTING SERVICES AND PROVISION OF TELECOMMUNICATION ACCESS TO FILMS AND TV PROGRAMMES PROVIDED VIA TELEPHONE, CABLE AND SATELLITE TRANSMISSION; AUDIO BROADCASTING; CABLE TELEVISION BROADCASTING; SUBSCRIPTION TELEVISION BROADCASTING; TELEVISION BROADCASTING; INTERACTIVE TELEVISION BROADCASTING, VIDEO BROADCASTING; RADIO BROADCASTING; NEWS AGENCIES, NAMELY, TRANSMISSION OF NEWS TO THIRD PARTIES; SATELLITE, CABLE, NETWORK, AND ISDN TRANSMISSION OF SOUNDS, IMAGES, SIGNALS AND DATA; ELECTRONIC MAIL SERVICES; TELETEXT SERVICES AND INACTIVE VIDEO TEXT SERVICES; MESSAGE SENDING, NAMELY, DELIVERY OF MESSAGES BY ELECTRONIC TRANSMISSION; COMMUNICATIONS VIA COMPUTER TERMINALS, NAMELY, ELECTRONIC TRANSMISSION OF DATA AND DOCUMENTS VIA COMPUTER TERMINALS, IN CLASS 38 (U.S. CLS. 100, 101 AND 104).

FOR: EDUCATION SERVICES, NAMELY, PROVIDING INTERACTIVE ON-LINE TUTORIAL SESSIONS, INTERACTIVE ON-LINE COURSES, ALL RELATING TO RECREATIONAL ACTIVITIES, INTERIOR DECORATING, MUSIC, DRAMA, FILM, ART, ANTIQUES, MOTORING, COMEDY, NEWS, EXERCISE, GARDENING, COOKING, SPORTS, HISTORY, SCIENCE, AND TECHNOLOGY; EDUCATIONAL SERVICES, NAMELY, LANGUAGE TEACHING SEMINARS, WORKSHOPS, CLASSES, AND ONLINE SEMINARS, WORKSHOPS, CLASSES, AND LANGUAGE TEACHING SEMINARS, AND PROVIDING TEXT BOOKS, STUDY GUIDES, PRE-RECORDED AUDIO CASSETTES, PRE-RECORDED VIDEO CASSETTES, PRE-RECORDED CD'S, PRE-RECORDED CD-ROM'S, PRE-RECORDED DVD'S, PRE-RECORDED DVD-ROM'S, PRE-RECORDED INTERACTIVE CD'S, PRE-RECORDED INTERACTIVE CD-ROM'S, PRE-RECORDED INTERACTIVE DVD'S AND PRE-RECORDED INTERACTIVE DVD-ROM'S IN CONNECTION THEREWITH, ALL RELATING TO THE FIELD OF RECREATIONAL ACTIVITIES, INTERIOR DECORATING, MUSIC, DRAMA, FILM, ART, ANTIQUES, MOTORING, COMEDY, NEWS, EXERCISE, GARDENING, COOKING, SPORTS, HISTORY, SCIENCE, AND TECHNOLOGY; ENTERTAINMENT SERVICES, NAMELY, PROVIDING RADIO AND TELEVISION

PROGRAMS IN THE FIELD OF RECREATIONAL ACTIVITIES, INTERIOR DECORATING, MUSIC, DRAMA, FILM, ART, ANTIQUES, MOTORING, COMEDY, NEWS, EXERCISE, GARDENING, COOKING, SPORTS, HISTORY, SCIENCE, AND TECHNOLOGY, IN CLASS 41 (U.S. CLS. 100, 101 AND 107).

FOR: DEVELOPMENT OF COMPUTER SOFTWARE FOR USE AS ELECTRONIC TELEVISION GUIDES; PROVIDING AN INTERACTIVE COMPUTER DATABASE IN THE FIELD OF SCIENCE AND TECHNOLOGY; COMPUTER PROGRAMMING FOR OTHERS; DESIGN AND DEVELOPMENT OF COMPUTER HARDWARE AND SOFTWARE FOR OTHERS; SCIENTIFIC AND TECHNOLOGICAL RESEARCH AND DEVELOPMENT, IN CLASS 42 (U.S. CLS. 100 AND 101).

PRIORITY DATE OF 8-6-2004 IS CLAIMED.

OWNER OF INTERNATIONAL REGISTRATION 0883160 DATED 2-3-2005, EXPIRES 2-3-2015.

THE COLOR(S) RED, BLACK IS/ARE CLAIMED AS A FEATURE OF THE MARK.

THE MARK CONSISTS OF THE COLOR BLACK APPEARING IN THE WORDING PROSIEBENSAT.1 WELT AND THE COLOR RED APPEARING IN THE DESIGN OF THE ARROW AND THE DESIGN OF THE CIRCLE.

THE FOREIGN WORDING IN THE MARK TRANSLATES INTO ENGLISH AS 'WORLD' (WELT).

SER. NO. 79-023,186, FILED 2-3-2005.

SUSAN RICHARDS, EXAMINING ATTORNEY

Int. Cls.: 3 and 8

Prior U.S. Cls.: 1, 4, 6, 23, 28, 44, 50, 51 and 52

United States Patent and Trademark Office

Reg. No. 3,398,638

Registered Mar. 18, 2008

**TRADEMARK
PRINCIPAL REGISTER**

Pulsonic

BRAUN GMBH (FED REP GERMANY LTD LIAB
CO)
FRANKFURTER STRASSE 145
61476 KRONBERG
FED REP GERMANY

FOR: CARTRIDGES FILLED WITH CLEANING
FLUIDS FOR USE IN APPLIANCES THAT CLEAN
ELECTRIC SHAVERS, IN CLASS 3 (U.S. CLS. 1, 4, 6,
50, 51 AND 52).

FOR: ELECTRICALLY OPERATED SHAVER
AND HAIR CUTTING APPLIANCES, NAMELY,
ELECTRIC HAIR CLIPPERS AND TRIMMERS, AS
WELL AS CLEANING AND/OR CHARGING AC-
CESSORY FOR THE AFORESAID APPLIANCES;
ADAPTED CASES AND WALL HOLDERS FOR
THE AFORESAID APPLIANCES; PARTS OF THE
AFORESAID APPLIANCES, NAMELY, SHEAR

FOILS, CUTTER BLOCKS, AND SHEAR HEADS,
IN CLASS 8 (U.S. CLS. 23, 28 AND 44).

THE MARK CONSISTS OF STANDARD CHAR-
ACTERS WITHOUT CLAIM TO ANY PARTICULAR
FONT, STYLE, SIZE, OR COLOR.

PRIORITY DATE OF 6-23-2005 IS CLAIMED.

OWNER OF INTERNATIONAL REGISTRATION
0884411 DATED 12-19-2005, EXPIRES 12-19-2015.

SER. NO. 79-023,419, FILED 12-19-2005.

MONIQUE MILLER, EXAMINING ATTORNEY

Int. Cl.: 34

Prior U.S. Cls.: 2, 8, 9 and 17

United States Patent and Trademark Office

Reg. No. 3,398,639

Registered Mar. 18, 2008

**TRADEMARK
PRINCIPAL REGISTER**



JAPAN TOBACCO INC. (JAPAN CORPORATION)
2-2-1 TORANOMON
MINATO-KU; TOKYO
JAPAN

OWNER OF INTERNATIONAL REGISTRATION
0884981 DATED 5-4-2006, EXPIRES 5-4-2016.

OWNER OF U.S. REG. NOS. 1,068,686 AND
2,178,795.

FOR: CIGARETTES; RAW OR MANUFACTURED
TOBACCO; SMOKERS' ARTICLES, NAMELY, CI-
GARETTE PAPER, CIGARETTE FILTERS, CIGAR-
ETTE CASES NOT OF PRECIOUS METAL,
CIGARETTE HOLDERS NOT OF PRECIOUS ME-
TAL, ASHTRAYS, NOT OF PRECIOUS METAL;
MATCHES, IN CLASS 34 (U.S. CLS. 2, 8, 9 AND 17).

THE MARK COMPRISES A RECTANGLE DE-
SIGN WITH A THIN LINE IN WHITE AND THE
REST OF THE RECTANGLE IS BLACK WITH
WAVES OF WATER IN THE BACKGROUND
SHOWING "WAVE" AND "W" IN A DESIGN OF A
CIRCLE BELOW THE WORDING.

SER. NO. 79-023,863, FILED 5-4-2006.

PRIORITY DATE OF 2-10-2006 IS CLAIMED.

KELLY CHOE, EXAMINING ATTORNEY

Int. Cl.: 18

Prior U.S. Cls.: 1, 2, 3, 22 and 41

United States Patent and Trademark Office

Reg. No. 3,398,640

Registered Mar. 18, 2008

**TRADEMARK
PRINCIPAL REGISTER**

RICHTER

FERDINAND RICHTER GMBH (AUSTRIA LTD
LIAB CO)
SCHÄRDINGER STRASSE 1
A-4061 PASCHING, AUSTRIA

FOR: LEATHER AND IMITATION LEATHER
GOODS, NAMELY, HANDBAGS AND CASES, SUIT-
CASES AND TRAVELING BAGS, SCHOOL SATCH-
ELS, SHOPPING BAGS, BRIEFCASES, SPORTS
BAGS, BAGS FOR COSMETICS SOLD EMPTY
AND BABY CHANGING BAGS, WALLETS AND
PURSES, RUCKSACKS, UMBRELLAS AND PARA-
SOLS, IN CLASS 18 (U.S. CLS. 1, 2, 3, 22 AND 41).

THE MARK CONSISTS OF STANDARD CHAR-
ACTERS WITHOUT CLAIM TO ANY PARTICULAR
FONT, STYLE, SIZE, OR COLOR.

PRIORITY DATE OF 10-10-2005 IS CLAIMED.

OWNER OF INTERNATIONAL REGISTRATION
0884986 DATED 3-13-2006, EXPIRES 3-13-2016.

THE ENGLISH TRANSLATION OF RICHTER IS
JUDGE.

SER. NO. 79-023,864, FILED 3-13-2006.

KAREN K. BUSH, EXAMINING ATTORNEY

Int. Cls.: 35 and 41

Prior U.S. Cls.: 100, 101, 102 and 107

United States Patent and Trademark Office

Reg. No. 3,398,641

Registered Mar. 18, 2008

**SERVICE MARK
PRINCIPAL REGISTER**

CRYSTAL WORLDS

SWAROVSKI AKTIENGESELLSCHAFT (LIECHTENSTEIN JOINT STOCK COMPANY)
DRÖSCHSTRASSE 15
FL-9495 TRIESEN
LIECHTENSTEIN

FOR: RETAIL STORE SERVICES FEATURING SPECTACLES, BAGS, CLOTHING, FURNITURE, DRINKS AND FOOD; BUSINESS MANAGEMENT AND ORGANIZATION CONSULTANCY; WINDOW DRESSING AND DISPLAY ARRANGEMENT SERVICES; ORGANIZATION AND ARRANGEMENT OF EXHIBITIONS IN THE FIELD OF CRYSTAL GLASS AND OBJECTS DECORATED WITH CRYSTAL GLASS, NAMELY, SPECTACLES, BAGS, CLOTHING, PERFUME ARTICLES, LIGHTING EQUIPMENT AND FURNITURE FOR COMMERCIAL OR ADVERTISING PURPOSES; PUBLIC RELATIONS; SALES PROMOTION FOR OTHERS; ADVERTISING SERVICES, NAMELY, THE PRESENTATION OF GOODS FOR ADVERTISING PURPOSES, IN CLASS 35 (U.S. CLS. 100, 101 AND 102).

FOR: ENTERTAINMENT, CULTURAL AND EDUCATION SERVICES, NAMELY, ORGANIZATION AND ARRANGEMENT OF SEMINARS, WORKSHOPS, CONFERENCES, SYMPOSIUMS AND CONGRESSES IN THE FIELD OF CRYSTAL GLASS AND OBJECTS DECORATED WITH CRYSTAL

TAL GLASS, NAMELY, SPECTACLES, BAGS, CLOTHING, PERFUME ARTICLES, LIGHTING EQUIPMENT, AND FURNITURE; ORGANIZATION OF EXHIBITIONS FOR CULTURAL OR EDUCATIONAL PURPOSES, ORGANIZATION OF ENTERTAINMENT SHOWS, NAMELY, FASHION SHOWS, AND PRESENTATION OF LIVE SHOW PERFORMANCES AND MUSICAL PERFORMANCES, IN CLASS 41 (U.S. CLS. 100, 101 AND 107).

THE MARK CONSISTS OF STANDARD CHARACTERS WITHOUT CLAIM TO ANY PARTICULAR FONT, STYLE, SIZE, OR COLOR.

PRIORITY DATE OF 11-16-2005 IS CLAIMED.

OWNER OF INTERNATIONAL REGISTRATION 0886444 DATED 3-9-2006, EXPIRES 3-9-2016.

NO CLAIM IS MADE TO THE EXCLUSIVE RIGHT TO USE "CRYSTAL", APART FROM THE MARK AS SHOWN.

SER. NO. 79-024,448, FILED 3-9-2006.

ATTIYA MALIK, EXAMINING ATTORNEY

Int. Cl.: 9

Prior U.S. Cls.: 21, 23, 26, 36 and 38

United States Patent and Trademark Office

Reg. No. 3,398,642

Registered Mar. 18, 2008

**TRADEMARK
PRINCIPAL REGISTER**

CHEMI-CON

NIPPON CHEMI-CON CORPORATION (JAPAN
CORPORATION)
6-4, OSAKI 5-CHOME
SHINAGAWA-KU; TOKYO 141-8605
JAPAN

FOR: CAPACITORS FOR TELECOMMUNICA-
TION MACHINES AND APPARATUS; ELECTRIC
COILS FOR TELECOMMUNICATIONS MACHINES,
AND APPARATUS; ELECTRIC RESISTORS FOR
TELECOMMUNICATION MACHINES AND APPA-
RATUS, IN CLASS 9 (U.S. CLS. 21, 23, 26, 36 AND 38).

OWNER OF INTERNATIONAL REGISTRATION
0887573 DATED 5-19-2006, EXPIRES 5-19-2016.

OWNER OF U.S. REG. NO. 1,172,056.

SER. NO. 79-024,862, FILED 5-19-2006.

TINA BROWN, EXAMINING ATTORNEY

Int. Cl.: 34

Prior U.S. Cls.: 2, 8, 9 and 17

United States Patent and Trademark Office

Reg. No. 3,398,643

Registered Mar. 18, 2008

**TRADEMARK
PRINCIPAL REGISTER**

XAXO

REINDL, GERHARD, (FED REP GERMANY IN-
DIVIDUAL)
DROSSELWEG 7
54329 KONZ, FED REP GERMANY

FOR: CIGARETTES, CIGARS, CIGARILLOS,
SHREDDED TOBACCO, PIPE TOBACCO, ROLL
YOUR OWN SHREDDED TOBACCO; SMOKING
PRODUCTS, NAMELY, READY-ROLLED TOBAC-
CO IN STICK FORM, READY-MADE TOBACCO IN
STRING FORM, READY-ROILED TOBACCO IN
STICK FORM TO BE FITTED INTO CIGARETTE
TUBES; SELF-STUFFING CIGARETTES, CIGAR-
ETTE TUBES, TOBACCO FILTER TIPS, CIGARETTE
TUBES INCLUDING FILTER TIPS; PRODUCTS FOR
SMOKERS, NAMELY, CIGAR AND CIGARETTE
CUTTERS, CUTTERS FOR READY-ROLLED TO-
BACCO IN STICK FORM, CIGARETTE ROLLING
PAPER, MACHINES ALLOWING SMOKERS TO

MAKE CIGARETTES BY THEMSELVES BY FILL-
ING TOBACCO INTO CIGARETTE TUBES, CIGAR-
ETTE ROLLING MACHINES, POCKET
APPARATUS FOR ROLLING CIGARETTES , IN
CLASS 34 (U.S. CLS. 2, 8, 9 AND 17).

THE MARK CONSISTS OF STANDARD CHAR-
ACTERS WITHOUT CLAIM TO ANY PARTICULAR
FONT, STYLE, SIZE, OR COLOR.

OWNER OF INTERNATIONAL REGISTRATION
0887622 DATED 4-13-2006, EXPIRES 4-13-2016.

SER. NO. 79-024,879, FILED 4-13-2006.

ELI HELLMAN, EXAMINING ATTORNEY

Int. Cl.: 6

Prior U.S. Cls.: 2, 12, 13, 14, 23, 25 and 50

Reg. No. 3,398,644

United States Patent and Trademark Office

Registered Mar. 18, 2008

**TRADEMARK
PRINCIPAL REGISTER**

XYLX

NINGBO ZHENHAI XINGYI; FASTENERS CO.,
LTD; (NINGBOSHI ZHENHAI XINGYI JINGU-
JIAN; ZHIZAO YOUXIAN GONGSI) (CHINA
CORPORATION)
GONGYE KAIFANG, XIEPU
ZHENHAI,; NINGBO CITY; ZHEJIANG 315204
CHINA

METAL SCREWS FOR VEHICLE FIXING, IN CLASS
6 (U.S. CLS. 2, 12, 13, 14, 23, 25 AND 50).

OWNER OF INTERNATIONAL REGISTRATION
0887718 DATED 3-27-2006, EXPIRES 3-27-2016.

FOR: BOLTS OF METAL; PEGS OF METAL;
SCREWS OF METAL; EYE BOLTS; SCREW RINGS
OF METAL; NUTS OF METAL; METAL BOLTS;

SER. NO. 79-024,914, FILED 3-27-2006.

TINA BROWN, EXAMINING ATTORNEY

Int. Cls.: 6 and 20

Prior U.S. Cls.: 2, 12, 13, 14, 22, 23, 25, 32 and 50

United States Patent and Trademark Office

Reg. No. 3,398,645

Registered Mar. 18, 2008

**TRADEMARK
PRINCIPAL REGISTER**

NORDPLAN

NORD-PLAN A/S (DENMARK CORPORATION)
NYBYVEJ 13
DK-4390 VIPPERØD
DENMARK

THE MARK CONSISTS OF STANDARD CHARACTERS WITHOUT CLAIM TO ANY PARTICULAR FONT, STYLE, SIZE, OR COLOR.

FOR: GENERAL PURPOSE METAL STORAGE BINS, GENERAL PURPOSE METAL STORAGE CONTAINERS, GENERAL PURPOSE METAL STORAGE UNITS, METAL CONTAINERS FOR THE STORAGE AND TRANSPORTATION OF GOODS, METAL STORAGE SHEDS, METAL STORAGE SHELTERS, STORAGE PALLETS OF METAL, IN CLASS 6 (U.S. CLS. 2, 12, 13, 14, 23, 25 AND 50).

PRIORITY DATE OF 10-18-2005 IS CLAIMED.

OWNER OF INTERNATIONAL REGISTRATION 0888380 DATED 2-17-2006, EXPIRES 2-17-2016.

FOR: NON-METAL FLUID STORAGE TANKS AND NON-METAL STORAGE TANKS AND ROOFS THEREFOR, IN CLASS 20 (U.S. CLS. 2, 13, 22, 25, 32 AND 50).

SER. NO. 79-025,173, FILED 2-17-2006.

CHRISTOPHER BUONGIORNO, EXAMINING ATTORNEY

Int. Cls.: 16, 35 and 43

Prior U.S. Cls.: 2, 5, 22, 23, 29, 37, 38, 50, 100, 101 and 102

United States Patent and Trademark Office

Reg. No. 3,398,646

Registered Mar. 18, 2008

**TRADEMARK
SERVICE MARK
PRINCIPAL REGISTER**



SSP - creating a better experience

SSP FINANCING UK LIMITED (UNITED KINGDOM PUBLIC LIMITED COMPANY)

1 THE HEIGHTS BROOKLANDS
WEYBRIDGE SURREY KT13 0NY
UNITED KINGDOM

FOR: PAPER, CARDBOARD AND GOODS MADE FROM PAPER AND CARDBOARD, NAMELY, WRITING PAPER, WRITING PADS AND CARDBOARD BOXES; PAPER CARRIER BAGS; PRINTED MATTER, NAMELY, MAGAZINES, BOOKS, DIRECTORIES AND PAMPHLETS IN THE FIELD OF CATERING; BOOK BINDING MATERIAL, NAMELY, CARDBOARD BACKING FOR BOOK BINDINGS; MOUNTED AND UNMOUNTED PHOTOGRAPHS; STATIONERY; ADHESIVES FOR STATIONERY AND HOUSEHOLD PURPOSES; PAINT BRUSHES; PRINTED INSTRUCTIONAL AND TEACHING MATERIAL, NAMELY, PAMPHLETS ON THE SUBJECT OF HYGIENE RULES, AND PAMPHLETS ON THE SUBJECT OF COMMERCIAL TRAINING FOR CATERING GOODS; PLASTIC MATERIALS FOR PACKAGING, NAMELY, PLASTIC CARRIER BAGS FOR SHOPPING; PRINTERS' TYPE; PRINTING BLOCKS; ENVELOPES AND POUCHES OF PAPER FOR PACKAGING; PAPER TABLECLOTHS, PAPER MATS, PAPER TOWELS, PAPER NAPKINS, TABLE LINEN OF PAPER AND CARDBOARD; TISSUES OF PAPER, IN CLASS 16 (U.S. CLS. 2, 5, 22, 23, 29, 37, 38 AND 50).

FOR: ADVERTISING SERVICES FOR OTHERS; CATERING BUSINESS MANAGEMENT; BUSINESS ADMINISTRATION; OFFICE FUNCTIONS; BUSINESS MANAGEMENT AND ORGANIZATION ASSISTANCE AND CONSULTANCY; PUBLICATION OF PUBLICITY MATERIALS IN THE FIELD OF CATERING; ARRANGING AND CONDUCTING

TRADE SHOWS AND EXHIBITIONS FOR BUSINESS PURPOSES AND FOR COMMERCIAL PURPOSES IN THE FIELD OF THE PROVISION OF FOOD AND BEVERAGES; ADVERTISING OF FOOD AND BEVERAGES FOR OTHERS; PROVIDING BUSINESS INFORMATION RELATING TO THE SUPPLY AND/OR PROVISION OF FOOD AND BEVERAGES; BUSINESS INFORMATION AND ADVISORY SERVICES RELATING TO BUSINESS ELECTRONIC PROCUREMENT SYSTEMS FOR USE IN CATERING BUSINESS MANAGEMENT; ADVERTISING SERVICES PROVIDED ON OR RELATING TO THE INTERNET AND/OR OTHER COMMUNICATION NETWORKS; PROMOTION SERVICES PROVIDED ON THE INTERNET AND OTHER COMMUNICATION NETWORKS; PROCUREMENT OF FOOD AND BEVERAGES FOR THIRD PARTIES; THE PROVISION OF CONTRACT STAFF FOR AND MANAGEMENT OF SUPPORT SERVICES IN OFFICES AND INDUSTRIAL, COMMERCIAL AND RETAIL PREMISES; RENTAL OF OFFICE EQUIPMENT; RECEPTIONIST SERVICES; COMMISSIONAIRE SERVICES, NAMELY, PROVIDING PERSONNEL IN THE NATURE OF PROVISION AND MANAGEMENT OF DOORMEN, PORTERS, RECEPTION STAFF, SECURITY STAFF; THE BRINGING TOGETHER, FOR THE BENEFIT OF OTHERS OF A VARIETY OF FOODSTUFFS AND BEVERAGES, ENABLING CUSTOMERS TO CONVENIENTLY VIEW AND PURCHASE THOSE GOODS IN A RETAIL OUTLET; RENTAL OF VENDING MACHINES, IN CLASS 35 (U.S. CLS. 100, 101 AND 102).

FOR: SERVING FOOD AND DRINK; PROVIDING TEMPORARY ACCOMMODATION; CATERING SERVICES; PROVISION OF FOOD AND DRINK FOR PATIENTS AND GUESTS; RESTAURANT,

BAR, BISTRO, CAFÉ, CAFETERIA AND CANTEEN SERVICES; SNACK-BAR SERVICES; COFFEE-SHOP SERVICES; PREPARATION OF FOODSTUFFS AND MEALS AND BEVERAGES FOR CONSUMPTION ON OR OFF THE PREMISES; CONSULTATION RELATING TO THE SERVING AND PREPARATION OF FOOD AND DRINK, CATERING, RESTAURANT AND CAFETERIA SERVICES; CONTRACT FOOD SERVICES; PROVIDING FOOD AND DRINK THROUGH VENDING MACHINES, IN CLASS 43 (U.S. CLS. 100 AND 101).

PRIORITY DATE OF 4-21-2005 IS CLAIMED.

OWNER OF INTERNATIONAL REGISTRATION 0888522 DATED 6-22-2005, EXPIRES 6-22-2015.

OWNER OF U.S. REG. NOS. 2,736,622 AND 2,736,623.

SER. NO. 79-025,218, FILED 6-22-2005.

KRISTINA MORRIS, EXAMINING ATTORNEY

Int. Cl.: 9

Prior U.S. Cls.: 21, 23, 26, 36 and 38

United States Patent and Trademark Office

Reg. No. 3,398,647

Registered Mar. 18, 2008

**TRADEMARK
PRINCIPAL REGISTER**

FISCHER LUC

FISCHER CONNECTORS HOLDING S.A. (SWITZERLAND SOCIÉTÉ ANONYME)
ROUTE DE PAMPIGNY
CH-1143 APPLES, SWITZERLAND

FOR: CONNECTORS AND COMPONENT PARTS, NAMELY, CONNECTORS FOR ELECTRIC AND ELECTRONIC APPARATUS AND INSTRUMENTS, NAMELY, ELECTRICAL CONNECTORS, ELECTRIC CONNECTORS FOR ELECTRIC AND ELECTRONIC APPARATUS, ELECTRICAL POWER CONNECTORS, FIBER OPTIC CONNECTORS FOR HDTV AND DIGITAL CAMERAS; ELECTRICAL CABLES; ELECTRIC CONTACTS; COVERS FOR ELECTRIC CONTACTS; FIBER OPTIC CABLES; PROTECTIVE SHEATHS FOR ELECTRIC CABLES, IN CLASS 9 (U.S. CLS. 21, 23, 26, 36 AND 38).

THE MARK CONSISTS OF STANDARD CHARACTERS WITHOUT CLAIM TO ANY PARTICULAR FONT, STYLE, SIZE, OR COLOR.

PRIORITY DATE OF 2-11-2006 IS CLAIMED.

OWNER OF INTERNATIONAL REGISTRATION 0888760 DATED 5-31-2006, EXPIRES 5-31-2016.

OWNER OF U.S. REG. NOS. 1,732,667, 2,749,222 AND OTHERS.

SER. NO. 79-025,318, FILED 5-31-2006.

ALYSSA PALADINO, EXAMINING ATTORNEY

Int. Cls.: 9 and 42

Prior U.S. Cls.: 21, 23, 26, 36, 38, 100 and 101

United States Patent and Trademark Office

Reg. No. 3,398,648

Registered Mar. 18, 2008

**TRADEMARK
SERVICE MARK
PRINCIPAL REGISTER**



ECO-SOLUTION (FRANCE SOCIÉTÉ ANONYME)
PARC BIOCITECH,
102, ROUTE DE NOISY; F-93230 ROMAINVILLE
FRANCE

FOR: COMPUTER EQUIPMENT, NAMELY, COMPUTERS, SOFTWARE AND DATABASE FOR MANAGEMENT AND MONITORING OF BIOCONVERSION TREATMENT OF INDUSTRIAL WASTE PROCEDURES; ELECTRONIC DATABASES RECORDED ON COMPUTER MEDIA IN THE FIELD OF MANAGEMENT AND MONITORING OF BIOCONVERSION TREATMENT OF INDUSTRIAL WASTE PROCEDURES, IN CLASS 9 (U.S. CLS. 21, 23, 26, 36 AND 38).

FOR: TECHNOLOGY SUPERVISION, NAMELY, REMOTE SUPERVISION OF BIOCONVERSION PROCEDURES FOR INDUSTRIAL WASTES AND WASTE WATERS OF ALL TYPES USING COMPU-

TER TERMINALS AND TELECOMMUNICATIONS NETWORKS, IN CLASS 42 (U.S. CLS. 100 AND 101).

OWNER OF INTERNATIONAL REGISTRATION 0889811 DATED 2-24-2006, EXPIRES 2-24-2016.

THE COLOR(S) GREEN, WHITE AND BLUE IS/ARE CLAIMED AS A FEATURE OF THE MARK.

THE COLOR GREEN APPEARS IN THE RECTANGLE BEHIND THE TERMS ECO, THE TERMS ECO ARE IN WHITE AND BLUE APPEARS IN THE HYPHEN BETWEEN THE TERM ECO AND SET AND IN THE TERM SET.

SER. NO. 79-025,678, FILED 2-24-2006.

CAROLINE WOOD, EXAMINING ATTORNEY

Int. Cls.: 9, 16 and 35

**Prior U.S. Cls.: 2, 5, 21, 22, 23, 26, 29, 36, 37, 38, 50,
100, 101 and 102**

Reg. No. 3,398,649

United States Patent and Trademark Office

Registered Mar. 18, 2008

**TRADEMARK
SERVICE MARK
PRINCIPAL REGISTER**



ORIGINIZE IP AG; C/O INCO CONSULTING AG
(SWITZERLAND CORPORATION)
INDUSTRIESTRASSE 16
CH-6300 ZUG, SWITZERLAND

FOR: ELECTRIC, ELECTRONIC, OPTICAL, MEASURING, SIGNALING AND CONTROL APPARATUS AND INSTRUMENTS, NAMELY, ELECTRONIC DETECTING MACHINES FOR DETECTING COUNTERFEIT SECURITY OR ANTI-PIRACY LABELS, STICKERS, PACKAGING, CHIPS, AND CHIP CARDS; OPTICAL CHARACTER RECOGNITION APPARATUS, OPTICAL FILTERS AND SCANNERS, AND ENCODED AND NON-ENCODED CARD, LABEL AND STICKER EQUIPMENT, NAMELY, COMPUTER PRINTERS FOR PRINTING ENCODED CARDS, LABELS AND STICKERS, ELECTRONIC CARD READERS, AND MAGNETIC CODED CARD READERS, ALL OF THE ABOVE FOR PROTECTION AGAINST FALSIFICATION OF GOODS; MACHINE-READABLE DATA MEDIA, NAMELY, SOFTWARE FOR VERIFICATION AND TRACKING OF ORIGINAL PRODUCTS AND ANTI-COUNTERFEIT SOFTWARE; OPTICAL DATA MEDIA, NAMELY, COMPUTER CHIPS IN THE NATURE OF READ/WRITE CHIPS, AND ENCODED LABELS AND STICKERS TO BE USED FOR LOGISTIC CONTROL, AND FOR IDENTIFICATION AND DETECTION OF COUNTERFEIT PRODUCTS; ELECTRONICALLY AND OPTICALLY ENCODED SECURITY LABELS FOR USE IN LABELING OF GOODS FOR COUNTERFEIT PROTECTION; ENCODED COMPUTER CHIPS FOR IDENTIFICATION OF ORIGINALS; ENCODED ELECTRONIC CHIP CARDS FOR THE IDENTIFICATION OF ORIGINALS AND MAGNETIC CARDS, IN CLASS 9 (U.S. CLS. 21, 23, 26, 36 AND 38).

FOR: GOODS OF PAPER AND CARDBOARD, NOT INCLUDED IN OTHER CLASSES, NAMELY, NON-ENCODED PAPER AND CARDBOARD STICKERS AND LABELS, STAMPED AND/OR PRINTED CARDS, NAMELY, ANTI-COUNTERFEIT STICKERS, LABELS, AND CARDS; PRINTED LABELS AND STICKERS BEARING GRAPHIC REPRESENTATIONS IN THE NATURE OF OPTICAL VARIABLE EFFECTS FOR PROTECTION AGAINST REPRODUCTION AND FALSIFICATION AND FOR VERIFICATION AND TRACKING OF ORIGINAL PRODUCTS, IN CLASS 16 (U.S. CLS. 2, 5, 22, 23, 29, 37, 38 AND 50).

FOR: CONSULTING SERVICES FOR BUSINESS MANAGEMENT, IN PARTICULAR IN CONNECTION WITH THE DESIGN AND PRODUCTION OF SYSTEMS FOR PROTECTION AGAINST FALSIFICATION OF GOODS, IN CLASS 35 (U.S. CLS. 100, 101 AND 102).

PRIORITY DATE OF 1-11-2006 IS CLAIMED.

OWNER OF INTERNATIONAL REGISTRATION
0890182 DATED 4-27-2006, EXPIRES 4-27-2016.

NO CLAIM IS MADE TO THE EXCLUSIVE RIGHT TO USE THE REPRESENTATION OF THE R IN A CIRCLE AS THE FEDERAL REGISTRATION SYMBOL, APART FROM THE MARK AS SHOWN.

SER. NO. 79-025,803, FILED 4-27-2006.

TRICIA SONNEBORN, EXAMINING ATTORNEY

Int. Cl.: 5

Prior U.S. Cls.: 6, 18, 44, 46, 51 and 52

United States Patent and Trademark Office

Reg. No. 3,398,650

Registered Mar. 18, 2008

**TRADEMARK
PRINCIPAL REGISTER**

LuxaPost

ERNST MÜHLBAUER GMBH & CO. KG (FED
REP GERMANY KOMMANDITGESELL-
SCHAFT)

KOOGSTRAAT 4

25870 NORDERFRIEDRICHSKOOG

FED REP GERMANY

FOR: DENTAL MATERIAL FOR FASTENING,
NAMELY, COMPOSITE FIBER POST FOR AN-
CHORING LARGE FILLINGS AND RESTORA-
TIONS IN TEETH OR ARTIFICIAL TEETH, IN
CLASS 5 (U.S. CLS. 6, 18, 44, 46, 51 AND 52).

THE MARK CONSISTS OF STANDARD CHAR-
ACTERS WITHOUT CLAIM TO ANY PARTICULAR
FONT, STYLE, SIZE, OR COLOR.

PRIORITY DATE OF 11-19-2005 IS CLAIMED.

OWNER OF INTERNATIONAL REGISTRATION
0890251 DATED 5-5-2006, EXPIRES 5-5-2016.

SER. NO. 79-025,823, FILED 5-5-2006.

ELI HELLMAN, EXAMINING ATTORNEY

Int. Cl.: 9

Prior U.S. Cls.: 21, 23, 26, 36 and 38

United States Patent and Trademark Office

Reg. No. 3,398,651

Registered Mar. 18, 2008

**TRADEMARK
PRINCIPAL REGISTER**

QUANTAX

BRUKER AXS MICROANALYSIS GMBH (FED
REP GERMANY LTD LIAB CO)
SCHWARZSCHILDSTR. 12
12489 BERLIN, FED REP GERMANY

FOR: X-RAY SPECTROMETERS NOT FOR MEDICAL USE, BEING LABORATORY EQUIPMENT; COMPUTER SOFTWARE FOR USE IN CALCULATING DATA, PRODUCING REPORTS OF READINGS, SCIENTIFIC ANALYSIS OF MINERALS, ALLOYS, SEMICONDUCTORS, DUST PARTICLES, SOLIDS PARTICLES AND ALL SAMPLES ANALYZABLE IN VACUUM FOR X-RAY SPECTROMETERS; DOWNLOADABLE COMPUTER SOFTWARE FOR USE IN CALCULATING DATA, PRODUCING REPORTS OF READINGS, SCIENTIFIC ANALYSIS OF MINERALS, ALLOYS, SEMICONDUCTORS, DUST PARTICLES, SOLIDS PARTICLES AND ALL SAMPLES ANALYZABLE IN VACUUM FOR X-RAY

SPECTROMETERS, IN CLASS 9 (U.S. CLS. 21, 23, 26, 36 AND 38).

THE MARK CONSISTS OF STANDARD CHARACTERS WITHOUT CLAIM TO ANY PARTICULAR FONT, STYLE, SIZE, OR COLOR.

PRIORITY DATE OF 11-28-2005 IS CLAIMED.

OWNER OF INTERNATIONAL REGISTRATION
0891173 DATED 5-16-2006, EXPIRES 5-16-2016.

SER. NO. 79-026,161, FILED 5-16-2006.

LEIGH LOWRY, EXAMINING ATTORNEY

Int. Cl.: 9

Prior U.S. Cls.: 21, 23, 26, 36 and 38

United States Patent and Trademark Office

Reg. No. 3,398,652

Registered Mar. 18, 2008

**TRADEMARK
PRINCIPAL REGISTER**

LUC

FISCHER CONNECTORS HOLDING S.A. (SWITZERLAND SOCIÉTÉ ANONYME)
ROUTE DE PAMPIGNY
CH-1143 APPLES, SWITZERLAND

FOR: CONNECTORS AND COMPONENT PARTS, NAMELY, CONNECTORS FOR ELECTRIC AND ELECTRONIC APPARATUS AND INSTRUMENTS, NAMELY, ELECTRICAL CONNECTORS, ELECTRIC CONNECTORS FOR ELECTRIC AND ELECTRONIC APPARATUS, ELECTRICAL POWER CONNECTORS, FIBER OPTIC CONNECTORS FOR HDTV AND DIGITAL CAMERAS; ELECTRICAL CABLES; ELECTRIC CONTACTS; COVERS FOR ELECTRIC CONTACTS; FIBER OPTIC CABLES; PROTECTIVE SHEATHS FOR ELECTRIC CABLES, IN CLASS 9 (U.S. CLS. 21, 23, 26, 36 AND 38).

THE MARK CONSISTS OF STANDARD CHARACTERS WITHOUT CLAIM TO ANY PARTICULAR FONT, STYLE, SIZE, OR COLOR.

PRIORITY DATE OF 2-18-2006 IS CLAIMED.

OWNER OF INTERNATIONAL REGISTRATION 0891440 DATED 6-14-2006, EXPIRES 6-14-2016.

SER. NO. 79-026,259, FILED 6-14-2006.

ALYSSA PALADINO, EXAMINING ATTORNEY

Int. Cls.: 9, 37 and 42

Prior U.S. Cls.: 21, 23, 26, 36, 38, 100, 101, 103 and 106

United States Patent and Trademark Office

Reg. No. 3,398,653

Registered Mar. 18, 2008

**TRADEMARK
SERVICE MARK
PRINCIPAL REGISTER**

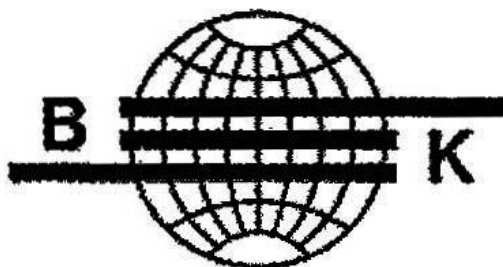

BRÜEL & KJÆR SOUND & VIBRATION; MEASUREMENT A/S (DENMARK CORPORATION)
SKODSBORGVEJ 307
DK-2850 NÆRUM
DENMARK

FOR: APPARATUS FOR VIBRATION MEASUREMENT, MONITORING AND DIAGNOSIS, NAMELY, VIBRATION METERS, ELECTRO-TECHNICAL VIBRATION METERS, SOUND AND VIBRATION ANALYZERS, ACOUSTIC ANALYZERS, ELECTRO-ACOUSTIC ANALYZERS, STRUCTURAL DYNAMICS ANALYZERS, DATA ACQUISITION AMPLIFIERS, CONDITIONING AMPLIFIERS, HAND-HELD VIBRATION ANALYZERS, SOUND LEVEL METERS, NOISE DOSE METERS, NOISE MONITORING TERMINALS, ACOUSTIC TRANSDUCERS, MICROPHONES, HYDROPHONES, VIBRATION TRANSDUCERS, ACCELEROMETERS, CALIBRATION SYSTEMS FOR MONITORING AND DIAGNOSIS OF SOUND VOLUME, QUALITY AND FREQUENCY AND FOR MONITORING AND DIAGNOSIS OF VIBRATION; ELECTRICAL AND ELECTRONIC APPARATUS AND INSTRUMENTS FOR MEASURING, CONTROLLING, TESTING, REGULATING AND CHECKING SOUND AND VIBRATION; ELECTRICAL APPARATUS FOR MACHINE MONITORING AND DIAGNOSIS OF SOUND VOLUME, QUALITY, FREQUENCY AND VIBRATION; ELECTRICAL REPLACEMENT PARTS USED IN THE MANUFACTURE AND OPERATION OF THE AFORESAID GOODS; APPARATUS FOR RECORDING, TRANSMISSION OR REPRODUCTION OF SOUND OR IMAGES; DATA PROCESSING EQUIPMENT, NAMELY, DATA PROCESSORS AND COMPUTER OPERATING SOFTWARE THEREFOR; AND PERSONAL COMPUTERS, IN INTERNATION-

AL CLASS 9, IN CLASS 9 (U.S. CLS. 21, 23, 26, 36 AND 38).

FOR: INSTALLATION, MAINTENANCE AND REPAIR SERVICES OF ELECTRICAL AND ELECTRONIC APPARATUS AND INSTRUMENTS FOR MEASURING, CONTROLLING, TESTING, REGULATING, CHECKING AND SUPERVISING SOUND AND VIBRATION., IN CLASS 37 (U.S. CLS. 100, 103 AND 106).

FOR: SCIENTIFIC AND TECHNOLOGICAL SERVICES, NAMELY, CALIBRATION SERVICES, RENTAL OF EQUIPMENT FOR RESEARCH AND DESIGN RELATED TO ENVIRONMENTAL NOISE MEASUREMENT AND NOISE MONITORING; SCIENTIFIC ANALYSIS RESEARCH SERVICES IN THE FIELD OF ENVIRONMENTAL NOISE MEASUREMENT AND NOISE MONITORING; DESIGN AND DEVELOPMENT OF COMPUTER HARDWARE AND SOFTWARE; ENGINEERING; TECHNICAL CONSULTANCY SERVICES IN THE FIELD OF ENVIRONMENTAL NOISE MEASUREMENT AND NOISE MONITORING, IN INTERNATIONAL CLASS 42, IN CLASS 42 (U.S. CLS. 100 AND 101).

OWNER OF INTERNATIONAL REGISTRATION
0892465 DATED 3-28-2006, EXPIRES 3-28-2016.

THE MARK CONSISTS OF A GLOBE WITH THREE HORIZONTAL LINES AND THE LETTER B ON THE LEFT SIDE AND THE LETTER K ON THE RIGHT SIDE.

SER. NO. 79-026,589, FILED 3-28-2006.

HANNO RITTNER, EXAMINING ATTORNEY

Int. Cl.: 9

Prior U.S. Cls.: 21, 23, 26, 36 and 38

United States Patent and Trademark Office

Reg. No. 3,398,654

Registered Mar. 18, 2008

**TRADEMARK
PRINCIPAL REGISTER**

Lasertec

LASERTEC CORPORATION (JAPAN CORPORATION)
4-10-4, TSUNASHIMA HIGASHI
KOHOKU-KU.; YOKOHAMA-SHI; KANAGAWA-
KEN 223-8551
JAPAN

FOR: CONFOCAL SCANNING MICROSCOPES;
OPTICAL INSPECTION APPARATUS FOR INDUSTRIAL USE, NAMELY, PHOTOMASK AND RETICLE INSPECTION APPARATUS, LCD COLOR FILTER INSPECTION SYSTEM FOR SILICON WAFERS AND MASK BLANKS, AND THIN FILM TRANSISTER INSPECTION APPARATUS; LCD COLOR FILTER AND TFT DEFECT REPAIR SYSTEMS CONSISTING PRIMARILY OF TAPE GRINDING AND FILM THERMAL TRANSFER APPARATUS; PHASE-SHIFT MASK MEASUREMENT SYSTEMS FOR PHOTOMASK COMPRISING

ELECTRONIC-BASED INSTRUMENTS FOR MEASURING PHASE SHIFT, IN CLASS 9 (U.S. CLS. 21, 23, 26, 36 AND 38).

PRIORITY DATE OF 11-2-2005 IS CLAIMED.

OWNER OF INTERNATIONAL REGISTRATION 0892672 DATED 2-8-2006, EXPIRES 2-8-2016.

OWNER OF U.S. REG. NO. 2,749,832.

SER. NO. 79-026,660, FILED 2-8-2006.

MATTHEW MCDOWELL, EXAMINING ATTORNEY

Int. Cls.: 7 and 11

Prior U.S. Cls.: 13, 19, 21, 23, 31, 34 and 35

Reg. No. 3,398,655

United States Patent and Trademark Office

Registered Mar. 18, 2008

**TRADEMARK
PRINCIPAL REGISTER**

WOLVERINE PROCTOR

WOLVERINE PROCTOR & SCHWARTZ LTD
(UNITED KINGDOM COMPANY)
3 LANGLANDS AVENUE
KELVIN SOUTH BUSINESS PARK; EAST KILBRIDE
GLASGOW G75 OYG, UNITED KINGDOM

FOR: MACHINES, NAMELY, WEB PROCESSING EQUIPMENT USED IN CONNECTION WITH CONTINUOUS WEBS OF PAPER, TEXTILES, PACKAGING MATERIALS; CONVEYOR DRYERS FOR THE FOOD, CHEMICAL, PHARMACEUTICAL AND TOBACCO PROCESSING INDUSTRIES; BELT CONVEYORS; INDUSTRIAL DRYING MACHINERY, NAMELY, MACHINERY FOR DRYING FABRICS, FOODS, CHEMICALS, PHARMACEUTICALS, NATURAL FIBERS, SYNTHETIC FIBERS, TOBACCO, WOOD, VENEER, TEXTILES, LEATHER, HAY, CHARCOAL BRIQUETTES, SCOURING PADS, CERAMICS, VEGETABLES AND RUBBER; INDUSTRIAL HEAT TREATING AND CURING MACHINERY, NAMELY, MACHINERY FOR HEAT TREATING AND CURING TEXTILES, RUBBER, HOSIERY, AND SYNTHETIC PRODUCTS; GARNETT MACHINES., IN CLASS 7 (U.S. CLS. 13, 19, 21, 23, 31, 34 AND 35).

FOR: PROPANE GAS, NATURAL GAS OR BUTANE GAS ROASTING MACHINES; ROASTERS FOR COFFEE BEANS, NUTS, AND SEEDS; HEAT RECOVERY APPARATUS, NAMELY, FINNED

HEAT EXCHANGERS FOR RECOVERING AND PROCESSING WASTE HEAT FROM PROCESS EXHAUST AIR STREAMS; INDUSTRIAL BAKING OVENS FOR THE FOOD INDUSTRY; INDUSTRIAL INCINERATORS; INDUSTRIAL GASEOUS FLUID DRYERS AND OVENS; LIQUEFIED GAS TYPE OVENS FOR FOOD OR BEVERAGE PROCESSING; FOOD AND BEVERAGE PROCESSING MACHINES AND APPARATUS, NAMELY, GRILLS, MELTERS, TOASTERS, PUFFERS, NAMELY, INDUSTRIAL COOKING OVENS FOR PUFFING FOOD PRODUCTS, COOLERS, IN CLASS 11 (U.S. CLS. 13, 21, 23, 31 AND 34).

THE MARK CONSISTS OF STANDARD CHARACTERS WITHOUT CLAIM TO ANY PARTICULAR FONT, STYLE, SIZE, OR COLOR.

PRIORITY DATE OF 1-23-2006 IS CLAIMED.

OWNER OF INTERNATIONAL REGISTRATION 0892838 DATED 2-8-2006, EXPIRES 2-8-2016.

SER. NO. 79-026,710, FILED 2-8-2006.

COLLEEN DOMBROW, EXAMINING ATTORNEY

Int. Cls.: 7 and 11

Prior U.S. Cls.: 13, 19, 21, 23, 31, 34 and 35

Reg. No. 3,398,656

United States Patent and Trademark Office

Registered Mar. 18, 2008

**TRADEMARK
PRINCIPAL REGISTER**

PROCTOR & SCHWARTZ

WOLVERINE PROCTOR & SCHWARTZ LTD
(UNITED KINGDOM COMPANY)
3 LANGLANDS AVENUE
KELVIN SOUTH BUSINESS PARK; EAST KIL-
BRIDE, GLASGOW G75 OYG
UNITED KINGDOM

FOR: DRYING MACHINES, NAMELY, WEB PRO-
CESSING EQUIPMENT USED IN CONNECTION
WITH CONTINUOUS WEBS OF PAPER, TEXTILES,
PACKAGING MATERIALS; CONVEYOR DRYERS
FOR THE FOOD, CHEMICAL, PHARMACEUTICAL
AND TOBACCO PROCESSING INDUSTRIES; BELT
CONVEYORS; INDUSTRIAL DRYING MACHIN-
ERY, NAMELY, MACHINERY FOR DRYING FAB-
RICS, FOODS, CHEMICALS, PHARMACEUTICALS,
NATURAL FIBERS, SYNTHETIC FIBERS, TOBAC-
CO, WOOD, VENEER, TEXTILES, LEATHER, HAY,
CHARCOAL BRIQUETTES, SCOURING PADS,
CERAMICS, VEGETABLES AND RUBBER; INDUS-
TRIAL HEAT TREATING AND CURING MACHIN-
ERY, NAMELY, MACHINERY FOR HEAT
TREATING AND CURING TEXTILES, RUBBER,
HOSIERY, AND SYNTHETIC PRODUCTS; GAR-
NETT MACHINES, IN CLASS 7 (U.S. CLS. 13, 19, 21,
23, 31, 34 AND 35).

FOR: PROPANE GAS, NATURAL GAS OR BU-
TANE GAS ROASTING MACHINES; ROASTERS
FOR COFFEE BEANS, NUTS, AND SEEDS; HEAT

RECOVERY APPARATUS, NAMELY, FINNED
HEAT EXCHANGERS FOR RECOVERING AND
PROCESSING WASTE HEAT FROM PROCESS EX-
HAUST AIR STREAMS; INDUSTRIAL BAKING
OVENS FOR THE FOOD INDUSTRY; INDUSTRIAL
INCINERATORS; INDUSTRIAL GASEOUS FLUID
DRYERS AND OVENS; LIQUEFIED GAS TYPE
OVENS FOR FOOD OR BEVERAGE PROCESSING;
FOOD AND BEVERAGE PROCESSING MACHINES
AND APPARATUS, NAMELY, GRILLS, MELTERS,
TOASTERS, PUFFERS, NAMELY, INDUSTRIAL
COOKING OVENS FOR PUFFING FOOD PRO-
DUCTS, COOLERS, IN CLASS 11 (U.S. CLS. 13, 21,
23, 31 AND 34).

THE MARK CONSISTS OF STANDARD CHAR-
ACTERS WITHOUT CLAIM TO ANY PARTICULAR
FONT, STYLE, SIZE, OR COLOR.

PRIORITY DATE OF 1-23-2006 IS CLAIMED.

OWNER OF INTERNATIONAL REGISTRATION
0892839 DATED 2-8-2006, EXPIRES 2-8-2016.

SER. NO. 79-026,711, FILED 2-8-2006.

SAIMA MAKHDOOM, EXAMINING ATTORNEY

Int. Cls.: 9, 16 and 42

**Prior U.S. Cls.: 2, 5, 21, 22, 23, 26, 29, 36, 37, 38, 50,
100 and 101**

Reg. No. 3,398,657

United States Patent and Trademark Office

Registered Mar. 18, 2008

**TRADEMARK
SERVICE MARK
PRINCIPAL REGISTER**

Certess

CERTESS S.A. (FRANCE SOCIÉTÉ ANONYME)
340, RUE DE L'EYGALA
F-38430 MOIRANS
FRANCE

FOR: COMPUTER SOFTWARE FOR USE IN PRODUCT AND/OR SYSTEM TEST PLANNING, TEST CASE DESIGN, TEST EXECUTION, TEST AUTOMATION, DEFECT ANALYSIS AND DOCUMENTATION, AND TEST RESULT TRACKING AND REPORTING RELATING TO THE DEVELOPMENT AND VERIFICATION OF MICROELECTRONICS, IN CLASS 9 (U.S. CLS. 21, 23, 26, 36 AND 38).

FOR: PRINTED INSTRUCTIONAL MANUALS, BROCHURES AND LEAFLETS IN THE FIELD OF COMPUTER PROGRAMS, DATA AND SOFTWARE PERTAINING TO THE DEVELOPMENT AND VERIFICATION OF MICROELECTRONICS, IN CLASS 16 (U.S. CLS. 2, 5, 22, 23, 29, 37, 38 AND 50).

FOR: DESIGN FOR OTHERS OF COMPUTER HARDWARE, COMPUTER SOFTWARE AND COM-

PUTER PROGRAMS ALL IN THE FIELD OF THE DEVELOPMENT AND VERIFICATION OF MICROELECTRONICS; TECHNOLOGICAL CONSULTATION AND ADVISORY SERVICES IN THE FIELD OF MICROELECTRONICS AS IT RELATES TO VERIFICATION TECHNOLOGY; INFORMATION TECHNOLOGY CONSULTATION IN THE FIELD OF MICROELECTRONICS, IN CLASS 42 (U.S. CLS. 100 AND 101).

THE MARK CONSISTS OF STANDARD CHARACTERS WITHOUT CLAIM TO ANY PARTICULAR FONT, STYLE, SIZE, OR COLOR.

OWNER OF INTERNATIONAL REGISTRATION 0893400 DATED 5-17-2006, EXPIRES 5-17-2016.

SER. NO. 79-026,923, FILED 5-17-2006.

COLLEEN KEARNEY, EXAMINING ATTORNEY

Int. Cls.: 18, 25 and 28

Prior U.S. Cls.: 1, 2, 3, 22, 23, 38, 39, 41 and 50

United States Patent and Trademark Office

Reg. No. 3,398,658

Registered Mar. 18, 2008

**TRADEMARK
PRINCIPAL REGISTER**

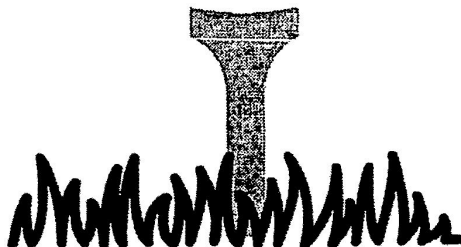

BACK TEE TRADITION A/S (DENMARK CORPORATION)
SØNDERSKOVVEJ 8
DK-8362 HØRNING
DENMARK

FOR: GOODS MADE OF LEATHER AND IMITATION LEATHER, NAMELY, WALLETS, TRAVEL CASES, AND UMBRELLAS, IN CLASS 18 (U.S. CLS. 1, 2, 3, 22 AND 41).

FOR: CLOTHING, NAMELY, TROUSERS, BLOUSES, T-SHIRTS, SWEATSHIRTS, TIES, POLO-SHIRTS, OUTDOOR JACKETS, OUTDOOR PANTS, COATS, VESTS, SKIRTS, SHORTS, GLOVES, SCARVES, BELTS, PULLOVERS, SHIRTS, SOCKS, STOCKINGS, WATER-PROOF CLOTHING, NAMELY, JACKETS AND PANTS; RAINWEAR; HEADGEAR, NAMELY, HATS, HEADSCARVES, PEAKED CAPS, CAPS, HEADBANDS; AND FOOTWEAR,

SPORTS SHOES, GOLF SHOES, SHOES, SANDALS, IN CLASS 25 (U.S. CLS. 22 AND 39).

FOR: GAMES, PLAYTHINGS, GYMNASTIC AND SPORTING ARTICLES, NAMELY, GOLF BALLS, GOLF CLUBS, GOLF GLOVES, GOLF BAGS, NON-MOTORIZED GOLF CARTS, DIVOT REPAIR TOOLS FOR GOLF USE, GOLF CASES, IN CLASS 28 (U.S. CLS. 22, 23, 38 AND 50).

PRIORITY DATE OF 6-12-2006 IS CLAIMED.

OWNER OF INTERNATIONAL REGISTRATION 0895971 DATED 6-20-2006, EXPIRES 6-20-2016.

SER. NO. 79-027,911, FILED 6-20-2006.

TASNEEM HUSSAIN, EXAMINING ATTORNEY

Int. Cls.: 9, 35, 38, 41 and 42

**Prior U.S. Cls.: 21, 23, 26, 36, 38, 100, 101, 102, 104
and 107**

Reg. No. 3,398,659

United States Patent and Trademark Office

Registered Mar. 18, 2008

**TRADEMARK
SERVICE MARK
PRINCIPAL REGISTER**

NUTRAINGREDIENTS

DECISION NEWS MEDIA SAS
LE BELEM -
355 RUE VENDÉMIAIREF-34000 MONTPELLIER
FRANCE

FOR: COMPUTER PROGRAMS AND SOFTWARE FOR CREATING, PUBLISHING AND MANAGING ONLINE CONTENT IN THE FORM OF MESSAGES, DATA, TEXTS, IMAGES AND VIDEOS AND RELATING TO THE PUBLICATION OF INFORMATION FOR PROFESSIONALS IN THE NUTRACEUTICAL PRODUCTS AND FUNCTIONAL FOODS INDUSTRY, DOWNLOADABLE FROM AN EXTERNAL COMPUTER NETWORK OR FROM THE INTERNET; DOWNLOADABLE ELECTRONIC PUBLICATIONS, NAMELY, NEWSLETTERS, MAGAZINES, JOURNALS, NEWS ARTICLES, TECHNICAL PAPERS, RESEARCH ANALYSES, PRODUCT PRESENTATIONS, MARKET REPORTS, BUYERS GUIDES, EVENTS CALENDARS, INTERVIEWS, WHITE PAPERS, PRODUCT BROCHURES AND BUSINESS REVIEWS, IN THE FIELD OF FOOD SUPPLEMENTS, NUTRITION AND HEALTHY FOODS IN ELECTRONIC FORM SUPPLIED FROM A DATABASE OR FROM THE INTERNET, IN CLASS 9 (U.S. CLS. 21, 23, 26, 36 AND 38).

FOR: ADVERTISING; BUSINESS PROMOTION AND BUSINESS INFORMATION SERVICES THROUGH THE INTERNET, NAMELY, PROVIDING COMMERCIAL INFORMATION ON THE NUTRITION AND FOOD BUSINESS; COMPILING BUSINESS ADVERTISEMENTS FOR THIRD PARTIES, NAMELY, PROMOTING THE GOODS AND SERVICES OF OTHERS BY PREPARING AND PLACING ADVERTISEMENTS IN AN ELECTRONIC NEWSLETTER ACCESSED THROUGH A GLOBAL COMPUTER NETWORK; RENTAL OF ADVERTISING SPACE ONLINE FOR PROMOTING GOODS AND SERVICES BETWEEN PROFESSIONALS, IN CLASS 35 (U.S. CLS. 100, 101 AND 102).

FOR: TELECOMMUNICATION SERVICES, NAMELY, ELECTRONIC MESSAGING VIA THE

INTERNET FOR TECHNICAL, SCIENTIFIC, AND INDUSTRIAL NEWS AND INFORMATION ABOUT NUTRACEUTICAL PRODUCTS AND FUNCTIONAL FOODS; TRANSMISSION OF MESSAGES, DATA, TEXTS AND IMAGES BY ELECTRONIC MEANS; COMMUNICATIONS BY COMPUTER TERMINALS; TRANSMISSION OF INFORMATION VIA EMAIL HELD IN A DATABASE OR ON THE INTERNET, IN CLASS 38 (U.S. CLS. 100, 101 AND 104).

FOR: PUBLISHING SERVICES FOR NEWS ARTICLES, NEWSLETTER, MAGAZINES, AND ELECTRONIC PUBLICATIONS FEATURING SCIENTIFIC, INDUSTRIAL AND TECHNICAL INFORMATION AND NEWS FOR PROFESSIONALS IN THE NUTRACEUTICAL PRODUCTS AND FUNCTIONAL FOODS INDUSTRY, IN CLASS 41 (U.S. CLS. 100, 101 AND 107).

FOR: DESIGN AND DEVELOPMENT OF WEBSITES FOR OTHERS; COMPILATION FOR OTHERS OF WEB PAGES ON THE INTERNET, NAMELY, MAINTAINING WEB PAGES FOR OTHERS; RENTAL OF A DATABASE SERVER TO THIRD PARTIES, IN CLASS 42 (U.S. CLS. 100 AND 101).

THE MARK CONSISTS OF STANDARD CHARACTERS WITHOUT CLAIM TO ANY PARTICULAR FONT, STYLE, SIZE, OR COLOR.

PRIORITY DATE OF 9-26-2005 IS CLAIMED.

OWNER OF INTERNATIONAL REGISTRATION 0897394 DATED 3-24-2006, EXPIRES 3-24-2016.

SER. NO. 79-028,461, FILED 3-24-2006.

REBECCA POVARCHUK, EXAMINING ATTORNEY

Int. Cls.: 9, 35, 38, 41 and 42

**Prior U.S. Cls.: 21, 23, 26, 36, 38, 100, 101, 102, 104
and 107**

Reg. No. 3,398,660

United States Patent and Trademark Office

Registered Mar. 18, 2008

**TRADEMARK
SERVICE MARK
PRINCIPAL REGISTER**

DECISION NEWS

DECISION NEWS MEDIA SAS
LE BELEM -
355 RUE VENDÉMIAIREF-34000 MONTPELLIER
FRANCE

FOR: COMPUTER PROGRAMS AND SOFTWARE FOR CREATING, PUBLISHING AND MANAGING ONLINE CONTENT IN THE FORM OF MESSAGES, DATA, TEXTS, IMAGES AND VIDEOS AND RELATING TO THE PUBLICATION OF SCIENTIFIC, TECHNICAL, AND INDUSTRIAL INFORMATION, DOWNLOADABLE FROM AN EXTERNAL COMPUTER NETWORK OR FROM THE INTERNET; DOWNLOADABLE ELECTRONIC PUBLICATIONS, NAMELY, NEWSLETTERS, MAGAZINES, JOURNALS, NEWS ARTICLES, TECHNICAL PAPERS, RESEARCH ANALYSES, PRODUCT PRESENTATIONS, MARKET REPORTS, BUYERS GUIDES, EVENTS CALENDARS, INTERVIEWS, WHITE PAPERS, PRODUCT BROCHURES AND BUSINESS REVIEWS, IN THE FIELD OF SCIENCE, PHARMACEUTICAL, COSMETIC, AND FOOD INDUSTRIES, IN ELECTRONIC FORM SUPPLIED FROM A DATABASE OR FROM THE INTERNET, IN CLASS 9 (U.S. CLS. 21, 23, 26, 36 AND 38).

FOR: ADVERTISING; BUSINESS PROMOTION AND INFORMATION SERVICES THROUGH THE INTERNET, NAMELY, PROVIDING COMMERCIAL INFORMATION ON THE NUTRITION, FOOD, PHARMACEUTICALS, COSMETICS AND FOOD BUSINESS; COMPILING BUSINESS ADVERTISEMENTS FOR THIRD PARTIES, NAMELY, PROMOTING THE GOODS AND SERVICES OF OTHERS BY PREPARING AND PLACING ADVERTISEMENTS IN AN ELECTRONIC NEWSLETTER ACCESSED THROUGH A GLOBAL COMPUTER NETWORK; RENTAL OF ADVERTISING SPACE ONLINE FOR PROMOTING GOODS AND SERVICES BETWEEN PROFESSIONALS, IN CLASS 35 (U.S. CLS. 100, 101 AND 102).

FOR: TELECOMMUNICATION SERVICES, NAMELY, ELECTRONIC MESSAGING VIA THE

INTERNET FOR TECHNICAL, SCIENTIFIC, AND INDUSTRIAL NEWS AND INFORMATION ABOUT NUTRACEUTICAL PRODUCTS AND FUNCTIONAL FOODS; TRANSMISSION OF MESSAGES, DATA, TEXTS AND IMAGES BY ELECTRONIC MEANS; COMMUNICATIONS BY COMPUTER TERMINALS; TRANSMISSION OF INFORMATION VIA EMAIL HELD IN A DATABASE OR ON THE INTERNET, IN CLASS 38 (U.S. CLS. 100, 101 AND 104).

FOR: PUBLISHING SERVICES FOR NEWS ARTICLES, NEWSLETTER, MAGAZINES, AND ELECTRONIC PUBLICATIONS FEATURING SCIENTIFIC, INDUSTRIAL AND TECHNICAL INFORMATION AND NEWS FOR PROFESSIONALS, IN CLASS 41 (U.S. CLS. 100, 101 AND 107).

FOR: DESIGN AND DEVELOPMENT OF WEBSITES FOR OTHERS; COMPILATION FOR OTHERS OF WEB PAGES ON THE INTERNET, NAMELY, MAINTAINING WEB PAGES FOR OTHERS; RENTAL OF A DATABASE SERVER TO THIRD PARTIES, IN CLASS 42 (U.S. CLS. 100 AND 101).

THE MARK CONSISTS OF STANDARD CHARACTERS WITHOUT CLAIM TO ANY PARTICULAR FONT, STYLE, SIZE, OR COLOR.

PRIORITY DATE OF 9-26-2005 IS CLAIMED.

OWNER OF INTERNATIONAL REGISTRATION 0897395 DATED 3-24-2006, EXPIRES 3-24-2016.

NO CLAIM IS MADE TO THE EXCLUSIVE RIGHT TO USE "NEWS" IN CLASSES 9, 35, 38, AND 41, APART FROM THE MARK AS SHOWN.

SER. NO. 79-028,462, FILED 3-24-2006.

REBECCA POVARCHUK, EXAMINING ATTORNEY

Int. Cl.: 35

Prior U.S. Cls.: 100, 101 and 102

United States Patent and Trademark Office

Reg. No. 3,398,661

Registered Mar. 18, 2008

SERVICE MARK
PRINCIPAL REGISTER



UWE ZIRBES (FED REP GERMANY INDIVIDUAL)
FRIEDRICH-EBERT-STRASSE 4
67346 SPEYER, FED REP GERMANY

FOR: EMPLOYMENT AGENCIES, PERSONNEL RECRUITMENT, PERSONNEL MANAGEMENT CONSULTANCY, BUSINESS CONSULTANCY, BUSINESS MANAGEMENT CONSULTANCY, IN CLASS 35 (U.S. CLS. 100, 101 AND 102).

OWNER OF INTERNATIONAL REGISTRATION 0897741 DATED 7-12-2006, EXPIRES 7-12-2016.

NO CLAIM IS MADE TO THE EXCLUSIVE RIGHT TO USE "BERATUNGSINSTITUT FÜR DIE BESETZUNG VON FACH- UND FÜHRUNGSPPOSITIONEN", APART FROM THE MARK AS SHOWN.

THE ENGLISH TRANSLATION OF THE WORD BERATUNGSINSTITUT FÜR DIE BESETZUNG VON FACH- UND FÜHRUNGSPPOSITIONEN IN THE MARK IS CONSULTANTS FOR FILLING OF SPECIALIST AND EXECUTIVE POSITIONS.

SER. NO. 79-028,567, FILED 7-12-2006.

ARETHA SOMERVILLE, EXAMINING ATTORNEY

Int. Cls.: 16 and 41

Prior U.S. Cls.: 2, 5, 22, 23, 29, 37, 38, 50, 100, 101 and 107

Reg. No. 3,398,662

United States Patent and Trademark Office

Registered Mar. 18, 2008

**TRADEMARK
SERVICE MARK
PRINCIPAL REGISTER**

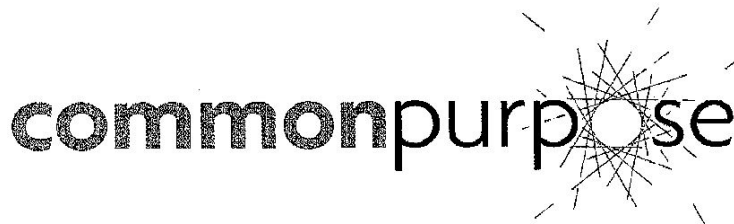

THE COMMON PURPOSE CHARITABLE TRUST
(UNITED KINGDOM TRUST)
DISCOVERY HOUSE
28-42 BANNER STREET
LONDON, UNITED KINGDOM EC1Y 8QE

FOR: PRINTED MATERIALS, NAMELY, BOOKS AND PERIODICALS CONCERNING EDUCATION, HEALTH, HOUSING, TRANSPORT, THE ARTS, EQUAL OPPORTUNITIES, THE ECONOMY, EMPLOYMENT, GOVERNMENT AND POLITICS, CRIME, THE LAW, THE ENVIRONMENT AND METROPOLITAN OR CIVIC AFFAIRS; PRINTED INSTRUCTIONAL AND TEACHING MATERIAL IN THE FIELDS OF HEALTH, HOUSING, TRANSPORT, THE ARTS, EQUAL OPPORTUNITIES, THE ECONOMY, EMPLOYMENT, GOVERNMENT AND POLITICS, CRIME, THE LAW, THE ENVIRONMENT AND METROPOLITAN OR CIVIC AFFAIRS; NEWSPAPERS, IN CLASS 16 (U.S. CLS. 2, 5, 22, 23, 29, 37, 38 AND 50).

FOR: EDUCATIONAL SERVICES, NAMELY, CONDUCTING OF CLASSES, SEMINARS, TUTORIALS, LECTURES AND COURSES RELATING TO HEALTH, HOUSING, TRANSPORT, THE ARTS, EQUAL OPPORTUNITIES, THE ECONOMY, EMPLOYMENT, GOVERNMENT AND POLITICS, CRIME, THE LAW, THE ENVIRONMENT AND METROPOLITAN AND CIVIC AFFAIRS, IN CLASS 41 (U.S. CLS. 100, 101 AND 107).

OWNER OF INTERNATIONAL REGISTRATION
0897954 DATED 8-21-2006, EXPIRES 8-21-2016.

SER. NO. 79-028,643, FILED 8-21-2006.

CORY BOONE, EXAMINING ATTORNEY

Int. Cls.: 9 and 42

Prior U.S. Cls.: 21, 23, 26, 36, 38, 100 and 101

United States Patent and Trademark Office

Reg. No. 3,398,663

Registered Mar. 18, 2008

**TRADEMARK
SERVICE MARK
PRINCIPAL REGISTER**



RECIVA LIMITED (UNITED KINGDOM CORPORATION)
509 COLDHAMS LANE
CAMBRIDGE CB1 3JS
UNITED KINGDOM

FOR: PERSONAL COMPUTERS; INTERNET RADIOS; WIRELESS INTERNET RADIOS; DIGITAL AUDIO PLAYERS AND RECORDERS; COMPUTER HARDWARE AND FIRMWARE FOR THE STREAMING OF AUDIO AND VIDEO OVER THE INTERNET; DOWNLOADABLE COMPUTER SOFTWARE FROM A GLOBAL COMPUTER NETWORK FOR THE STREAMING OF AUDIO AND VIDEO OVER THE INTERNET; COMPUTER SOFTWARE FOR THE STREAMING OF AUDIO AND VIDEO OVER THE INTERNET; TELECOMMUNICATIONS APPARATUS AND DATA NETWORKING HARDWARE, NAMELY, DEVICES FOR TRANSPORTING AND AGGREGATING VOICE, DATA AND VIDEO COMMUNICATIONS ACROSS MULTIPLE NET-

WORK INFRASTRUCTURES AND COMMUNICATIONS PROTOCOLS; DIGITAL AUDIO AND VIDEO RECORDERS; SET-TOP BOXES, IN CLASS 9 (U.S. CLS. 21, 23, 26, 36 AND 38).

FOR: COMPUTER SERVICES, NAMELY, CREATING INTERNET RADIO STATION AUDIO AND VIDEO DATABASE PROGRAMS FOR OTHERS; HOSTING INTERNET WEBSITES FEATURING DIGITAL CONTENT, NAMELY, INTERNET RADIO STATION AUDIO AND VIDEO DATABASES FOR OTHERS, IN CLASS 42 (U.S. CLS. 100 AND 101).

OWNER OF INTERNATIONAL REGISTRATION
0898189 DATED 2-7-2006, EXPIRES 2-7-2016.

SER. NO. 79-028,774, FILED 2-7-2006.

ANTHONY RINKER, EXAMINING ATTORNEY

Int. Cls.: 9 and 11

Prior U.S. Cls.: 13, 21, 23, 26, 31, 34, 36 and 38

United States Patent and Trademark Office

Reg. No. 3,398,664

Registered Mar. 18, 2008

**TRADEMARK
PRINCIPAL REGISTER**

SMARTSPARK

HAMWORTHY COMBUSTION ENGINEERING;
LIMITED (UNITED KINGDOM LTD LIAB CO)
FLEETS CORNER
POOLE, DORSET BH17 0LA
UNITED KINGDOM

FOR: IGNITION SPARK DETECTORS AND
SPARK PLUG WEAR INDICATORS, IN CLASS 9
(U.S. CLS. 21, 23, 26, 36 AND 38).

FOR: SPARK IGNITERS FOR GAS APPLIANCES
AND IGNITION EXCITERS, IN CLASS 11 (U.S. CLS.
13, 21, 23, 31 AND 34).

THE MARK CONSISTS OF STANDARD CHAR-
ACTERS WITHOUT CLAIM TO ANY PARTICULAR
FONT, STYLE, SIZE, OR COLOR.

PRIORITY DATE OF 11-10-2005 IS CLAIMED.

OWNER OF INTERNATIONAL REGISTRATION
0898313 DATED 5-6-2006, EXPIRES 5-6-2016.

SER. NO. 79-028,829, FILED 5-6-2006.

GIANCARLO CASTRO, EXAMINING ATTORNEY

Int. Cl.: 21

Prior U.S. Cls.: 2, 13, 23, 29, 30, 33, 40 and 50

United States Patent and Trademark Office

Reg. No. 3,398,665

Registered Mar. 18, 2008

**TRADEMARK
PRINCIPAL REGISTER**



ZHEJIANG BAOKANG; HOUSEHOLD APPLI-
ANCE., LTD. (CHINA CORPORATION)
NO. 150 WU YONG RD
QUANXI TOWN, WUYI, ZHEJIANG 321200, CHINA

FOR: COOKING POT SETS, NAMELY, COOKING
POTS AND COOKING PANS; POT LIDS; NON-
ELECTRIC PRESSURE COOKERS; GLASSWARE,
NAMELY, GLASS MUGS AND GLASS PANS;
HOMELY USED PORCELAIN, NAMELY, PORCE-
LAIN MUGS; HOMELY USED CERAMICS, NAME-
LY, CERAMIC POTS AND CERAMIC VESSELS;
BEER MUGS; NON-ELECTRIC COFFEE POTS,
NOT OF PRECIOUS METAL; VACUUM BOTTLES;
HEAT-INSULATED VESSELS, IN CLASS 21 (U.S.
CLS. 2, 13, 23, 29, 30, 33, 40 AND 50).

OWNER OF INTERNATIONAL REGISTRATION
0898481 DATED 9-5-2006, EXPIRES 9-5-2016.

THE COLOR(S) RED, WHITE AND BLACK IS/
ARE CLAIMED AS A FEATURE OF THE MARK.

THE MARK CONSISTS OF A RED SQUARE WITH
A WHITE LOOPING THROUGH IT ON THE LEFT
SIDE, NEXT TO THE WORD "POWCAN" OF BLACK
COLOR ON THE RIGHT SIDE.

THE NON-LATIN CHARACTER(S) IN THE
MARK TRANSLITERATES INTO POWCAN, AND
THIS DOES NOT MEAN ANYTHING IN ENGLISH.

SER. NO. 79-028,891, FILED 9-5-2006.

FRANK LATTUCA, EXAMINING ATTORNEY

Int. Cl.: 9

Prior U.S. Cls.: 21, 23, 26, 36 and 38

United States Patent and Trademark Office

Reg. No. 3,398,666

Registered Mar. 18, 2008

**TRADEMARK
PRINCIPAL REGISTER**

Optiarc

SONY NEC OPTIARC INC. (JAPAN CORPORATION)
GATE CITY OSAKI WEST TOWER
1-11-1 OSAKI; SHINAGAWA-KU, TOKYO 141-0032
JAPAN

FOR: OPTICAL DISC DRIVES, OPTICAL MAGNETIC DISC DRIVES, MAGNETIC DISC DRIVES, PERSONAL COMPUTERS, TELEVISION SETS, LIQUID CRYSTAL DISPLAY TELEVISION SETS, PLASMA DISPLAY PANEL TELEVISION SETS, PROJECTION TELEVISION SETS, DIGITAL VERSATILE DISC PLAYERS, DIGITAL VERSATILE DISC RECORDERS, COMPACT DISC PLAYERS, COMPACT DISC RECORDERS, VIDEO CAMERAS, DIGITAL CAMERAS, CONSUMER VIDEO GAME MACHINES FOR USE WITH TELEVISIONS, IN CLASS 9 (U.S. CLS. 21, 23, 26, 36 AND 38).

THE MARK CONSISTS OF STANDARD CHARACTERS WITHOUT CLAIM TO ANY PARTICULAR FONT, STYLE, SIZE, OR COLOR.

PRIORITY DATE OF 1-27-2006 IS CLAIMED.

OWNER OF INTERNATIONAL REGISTRATION 0899086 DATED 7-24-2006, EXPIRES 7-24-2016.

SER. NO. 79-029,125, FILED 7-24-2006.

LEIGH LOWRY, EXAMINING ATTORNEY

Int. Cl.: 30

Prior U.S. Cl.: 46

United States Patent and Trademark Office

Reg. No. 3,398,667

Registered Mar. 18, 2008

TRADEMARK
PRINCIPAL REGISTER

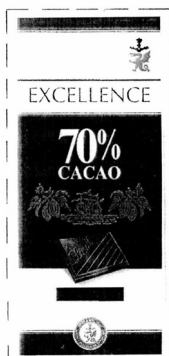

CHOCOLAFABRIKEN; LINDT & SPRÜNGLI
AG (SWITZERLAND CORPORATION)
SEESTRASSE 204
CH-8802 KILCHBERG ZH
SWITZERLAND

FOR: CHOCOLATE, IN CLASS 30 (U.S. CL. 46).

PRIORITY DATE OF 3-13-2006 IS CLAIMED.

OWNER OF INTERNATIONAL REGISTRATION
0899919 DATED 9-12-2006, EXPIRES 9-12-2016.

OWNER OF U.S. REG. NOS. 87,306, 2,031,928 AND
OTHERS.

NO CLAIM IS MADE TO THE EXCLUSIVE
RIGHT TO USE "EXCELLENCE 70% CACAO",
APART FROM THE MARK AS SHOWN.

"THE MARK CONSISTS OF WORDING AND SEVERAL DESIGNS. AN EMBLEM OF A DRAGON AND A HELMET CREST APPEAR IN THE UPPER RIGHT PORTION OF THE MARK. THE WORD "EXCELLENCE" APPEARS ACROSS THE TOP OF THE MARK, BELOW THE DRAGON. BELOW THAT WORDING, THE WORDING 70% APPEARS JUST ABOVE THE WORD "CACAO." BELOW THAT WORDING, IMAGES OF TWO CACAO BRANCHES APPEAR IN THE CENTER OF THE DRAWING. THE BRANCHES FLANK AN IMAGE OF A SHIP ON THE OCEAN. BELOW THE IMAGE OF THE SHIP, THERE IS A PICTURE OF A PIECE OF CHOCOLATE WITH THE WORD "LINDT" IMPRESSED ON IT. THERE IS A SEAL AT THE BOTTOM OF THE MARK. THE BACKGROUND OF THE MARK CONSISTS OF ALTERNATING BANDS OF LIGHT AND DARK."

SER. NO. 79-029,466, FILED 9-12-2006.

CORY BOONE, EXAMINING ATTORNEY

Int. Cl.: 5

Prior U.S. Cls.: 6, 18, 44, 46, 51 and 52

United States Patent and Trademark Office

Reg. No. 3,398,668

Registered Mar. 18, 2008

**TRADEMARK
PRINCIPAL REGISTER**



NOVARTIS AG (SWITZERLAND CORPORATION)
CH-4002 BASEL, SWITZERLAND

OWNER OF INTERNATIONAL REGISTRATION
0899924 DATED 9-14-2006, EXPIRES 9-14-2016.

FOR: VETERINARY ANTHELMINTIC PREPARATIONS, IN CLASS 5 (U.S. CLS. 6, 18, 44, 46, 51 AND 52).

SER. NO. 79-029,469, FILED 9-14-2006.

PRIORITY DATE OF 8-9-2006 IS CLAIMED.

ELI HELLMAN, EXAMINING ATTORNEY

Int. Cl.: 30

Prior U.S. Cl.: 46

United States Patent and Trademark Office

Reg. No. 3,398,669

Registered Mar. 18, 2008

TRADEMARK
PRINCIPAL REGISTER



JUTRZENKA S.A. (POLAND JOINT STOCK COMPANY)
UL. KOSCIUSZKI 53
PL-85-079 BYDGOSZCZ, POLAND

FOR: CHOCOLATE, HARD CHOCOLATE, FILLED CHOCOLATE, CHOCOLATES, PRALINES; CHOCOLATE CONFECTIONERY, NAMELY, CHOCOLATE CHIPS FOR BAKING; CHOCOLATE CONFECTIONERY SOLD IN BOXES AND SETS CONSISTING ENTIRELY OF CHOCOLATE BARS AND CHOCOLATE CANDIES; CANDY; CHOCOLATE PASTRIES AND CHOCOLATE WAFFLES, BEVERAGES MADE OF COFFEE; CHOCOLATE BAKERY DESSERTS AND CHOCOLATE DESSERT TOPPING; CHOCOLATE FOOD BEVERAGES NOT BEING DAIRY-BASED OR VEGETABLE BASED; BAKERY DESSERTS AND TOPPING SYRUP, IN CLASS 30 (U.S. CL. 46).

PRIORITY DATE OF 7-22-2006 IS CLAIMED.

OWNER OF INTERNATIONAL REGISTRATION 0899983 DATED 9-20-2006, EXPIRES 9-20-2016.

NO CLAIM IS MADE TO THE EXCLUSIVE RIGHT TO USE THE IMAGE OF THE SQUARES OF CHOCOLATE, APART FROM THE MARK AS SHOWN.

THE COLOR(S) BLACK, WHITE, GRAY, YELLOW, GOLD, RED, BEIGE, LIGHT BROWN AND DARK BROWN IS/ARE CLAIMED AS A FEATURE OF THE MARK.

THE MARK CONSISTS OF A RECTANGLE FEATURING THE WORDS CHOPIN FREDERICK, A SIGNATURE OF F. CHOPIN AND A BUST IN THE LIKENESS OF THE COMPOSER FREDERIC CHOPIN. THE BACKGROUND OF THE BACK CONTAINS SHEET MUSIC AND THERE IS AN OVAL SURROUNDING THE BUST IMAGE. NEAR THE CENTER OF THE RECTANGLE ARE TWO CHOCOLATE PIECES. THE COLOR BLACK APPEARS IN THE SIGNATURE, F. CHOPIN, IN THE IMAGE OF THE BUST, AND IN THE MUSICAL NOTATION APPEARING IN THE BACKGROUND OF THE MARK. THE COLOR WHITE APPEARS IN THE BUST AND AS OUTLINING OF THE SIGNATURE AND IN THE WRITING ON THE CHOCOLATE PIECES. THE COLOR YELLOW APPEARS IN THE WORDING CHOPIN FREDERIC AND THE OVAL SURROUNDING THE BUST. THE COLOR GRAY APPEARS IN THE BACKGROUND OF THE BUST AND AS SHADING IN THE BUST. THE COLOR GOLD APPEARS IN THE CURVED LINES SURROUNDING THE CHOCOLATE PIECES. THE COLOR RED APPEARS AROUND THE CURVED LINES SURROUNDING THE CHOCOLATE PIECES. THE COLOR BEIGE APPEARS IN THE BACKGROUND OF THE OVAL SURROUNDING THE BUST. THE COLOR LIGHT BROWN APPEARS IN THE BACKGROUND RECTANGLE UPON WHICH THE MARK AS A WHOLE APPEARS. THE COLOR DARK BROWN APPEARS IN THE BACKGROUND RECTANGLE. THE SHADES OF BROWN ARE MIXED THROUGHOUT THE BACKGROUND.

SER. NO. 79-029,751, FILED 9-20-2006.

COLLEEN KEARNEY, EXAMINING ATTORNEY

Int. Cls.: 35 and 41

Prior U.S. Cls.: 100, 101, 102 and 107

United States Patent and Trademark Office

Reg. No. 3,398,670

Registered Mar. 18, 2008

**SERVICE MARK
PRINCIPAL REGISTER**



NEULAND & PARTNER

NEULAND & PARTNER BERATENDE; DIPLOM-
KAUFFRAU DIPLOM-DESIGNER; MODERA-
TOREN UND SEMINARTRAINER (FED REP
GERMANY PARTNERSHIP)
VON-SCHILDECK-STRASSE 12-14
36043 FULDA
FED REP GERMANY

FOR: BUSINESS DEVELOPMENT, NAMELY,
PROVIDING START-UP SUPPORT FOR BUSINES-
SES OF OTHERS AND BUSINESS MANAGEMENT
CONSULTATION SERVICES, IN CLASS 35 (U.S. CLS.
100, 101 AND 102).

FOR: ADULT EDUCATIONAL SERVICES,
NAMELY, CONDUCTING CLASSES, WORKSHOPS
AND SEMINARS IN THE FIELD OF MANAGING

AND DEVELOPING COMPANIES, IN CLASS 41 (U.S.
CLS. 100, 101 AND 107).

OWNER OF INTERNATIONAL REGISTRATION
0901476 DATED 9-9-2006, EXPIRES 9-9-2016.

OWNER OF U.S. REG. NO. 2,342,550.

NO CLAIM IS MADE TO THE EXCLUSIVE
RIGHT TO USE "PARTNER" , APART FROM THE
MARK AS SHOWN.

SER. NO. 79-030,074, FILED 9-9-2006.

AMOS T. MATTHEWS, JR., EXAMINING ATTOR-
NEY

Int. Cl.: 10

Prior U.S. Cls.: 26, 39 and 44

United States Patent and Trademark Office

Reg. No. 3,398,671

Registered Mar. 18, 2008

**TRADEMARK
PRINCIPAL REGISTER**



HANGZHOU SHI TONGLU YILIAO; GUANG-
XUEYIQI ZONGCHANG (CHINA CORPORA-
TION)
SHENAO, TONGLUXIAN
ZHEJIANG, CHINA

FOR: SURGICAL APPARATUS AND INSTRU-
MENTS FOR USE IN GENERAL SURGERY; SUR-
GICAL APPARATUS AND INSTRUMENTS FOR
USE IN OTORHINOLARYNGOLOGICAL SUR-
GERY , IN CLASS 10 (U.S. CLS. 26, 39 AND 44).

OWNER OF INTERNATIONAL REGISTRATION
0901546 DATED 5-15-2006, EXPIRES 5-15-2016.

THE MARK CONSISTS OF AN OVAL WITH THE
WORD FA IN THE MIDDLE. THE TOP PART OF
THE F IS ABOVE THE OVAL AND THE BOTTOM
PART OF THE F AND A ARE BELOW THE OVAL.
ON EITHER SIDE OF THE WORD FA ARE CHINESE
CHARACTERS.

THE CHINESE CHARACTERS IN THE MARK
TRANSLITERATE TO "FU AO," AND THIS MEANS
"FELICITY BAY" IN ENGLISH.

SER. NO. 79-030,106, FILED 5-15-2006.

CHARISMA HAMPTON, EXAMINING ATTORNEY

Int. Cl.: 11

Prior U.S. Cls.: 13, 21, 23, 31 and 34

United States Patent and Trademark Office

Reg. No. 3,398,672

Registered Mar. 18, 2008

**TRADEMARK
PRINCIPAL REGISTER**

Restingwell

STEFAN GERLEMAN (SWEDEN INDIVIDUAL)
KRÄNGSHULT, NYBYGGEL
SE-567 91 VAGGERYD
SWEDEN

OWNER OF INTERNATIONAL REGISTRATION
0901731 DATED 2-13-2006, EXPIRES 2-13-2016.

FOR: SPAS IN THE NATURE OF FLOATATION
TANKS, IN CLASS 11 (U.S. CLS. 13, 21, 23, 31 AND 34).

SER. NO. 79-030,160, FILED 2-13-2006.

THE MARK CONSISTS OF STANDARD CHAR-
ACTERS WITHOUT CLAIM TO ANY PARTICULAR
FONT, STYLE, SIZE, OR COLOR.

DOMINIC FATHY, EXAMINING ATTORNEY

Int. Cls.: 5 and 29

Prior U.S. Cls.: 6, 18, 44, 46, 51 and 52

United States Patent and Trademark Office

Reg. No. 3,398,673

Registered Mar. 18, 2008

**TRADEMARK
PRINCIPAL REGISTER**

BioGaia

BIOGAIA AB (SWEDEN LTD LIAB CO)
BOX 3242
SE-103 64 STOCKHOLM
SWEDEN

FOR: PHARMACEUTICAL PREPARATIONS FOR USE IN TREATING GASTRIC DISEASE AND DISTURBANCES, BABY FOOD; MEDIA BACTERIOLOGICAL CULTURES, BACTERIA AND PREPARATIONS OF BACTERIA IN THE NATURE OF PROBIOTICS FOR MEDICAL USE AND HEALTHCARE; MEDICAL DENTAL CARE PREPARATIONS, NAMELY, CHEWING GUM, LOZENGES, PASTILLES AND MOUTHWASH FOR MEDICAL PURPOSES; ALL OF THE FOREGOING EXCLUDING LIQUID HERBAL EXTRACTS, LIQUID HERBAL EXTRACTS IN VEGETABLE-BASED CAPSULES, AND SOLID HERBAL EXTRACTS, IN CLASS 5 (U.S. CLS. 6, 18, 44, 46, 51 AND 52).

FOR: MILK, MILK BASED DRINKS, NAMELY, DRINKING YOGHURT, MILK PRODUCTS, NAMELY, EATING YOGHURT AND DAIRY PRODUCTS CONTAINING LACTIC ACID BACTERIA, EXCLUDING ICE CREAM, ICE MILK, AND FROZEN YOGHURT, IN CLASS 29 (U.S. CL. 46).

THE MARK CONSISTS OF STANDARD CHARACTERS WITHOUT CLAIM TO ANY PARTICULAR FONT, STYLE, SIZE, OR COLOR.

PRIORITY DATE OF 7-4-2006 IS CLAIMED.

OWNER OF INTERNATIONAL REGISTRATION 0901864 DATED 8-11-2006, EXPIRES 8-11-2016.

SER. NO. 79-030,227, FILED 8-11-2006.

LAURIE KAUFMAN, EXAMINING ATTORNEY

Int. Cls.: 6, 11, 17, 19 and 42

Prior U.S. Cls.: 1, 2, 5, 12, 13, 14, 21, 23, 25, 31, 33, 34, 35, 50, 100 and 101

Reg. No. 3,398,674

United States Patent and Trademark Office

Registered Mar. 18, 2008

**TRADEMARK
SERVICE MARK
PRINCIPAL REGISTER**

VACONO

VACONO ALUMINIUM COVERS GMBH (FED
REP GERMANY GMBH)
FRIEDRICHSTRASSE 80
POSTFACH 1165; 79601 RHEINFELDEN
FED REP GERMANY

FOR: METAL FLOATING COVERS AND METAL
FLOATING COVERS CONSISTING IN PART OF
PLASTIC AND WOOD, ALL FOR COVERING LI-
QUIDS IN OPEN OR CLOSED RECEPTACLES,
NAMELY, TANKS FOR STORAGE OR TRANSPOR-
TATION, CISTERNS, SILOS, POOLS AT TREAT-
MENT PLANTS AND DITCHES; METAL COVERS
CONSISTING IN PART OF PLASTIC AND WOOD,
FOR COVERING LIQUIDS IN OPEN OR CLOSED
RECEPTACLES, NAMELY, TANKS FOR STORAGE
OR TRANSPORTATION, CISTERNS, SILOS; METAL
COVERS CONSISTING IN PART OF PLASTIC AND
WOOD, TO SHADE AND LAG RECEPTACLES,
NAMELY, TANKS FOR STORAGE OR TRANSPOR-
TATION, CISTERNS AND SILOS, IN CLASS 6 (U.S.
CLS. 2, 12, 13, 14, 23, 25 AND 50).

FOR: GAS RECOVERY INSTALLATIONS, NAME-
LY, INSTALLATIONS FOR TREATING AIR CON-
CENTRATED IN ORGANIC VAPOURS SUCH AS
PETROL VAPOUR, BY RECOVERING ORGANIC
LIQUIDS, FUEL TANK INSTALLATIONS WITH
GAS RETURN PIPE, FOR REFUELLING MOTOR
VEHICLES, IN CLASS 11 (U.S. CLS. 13, 21, 23, 31 AND
34).

FOR: PLASTIC SEALS AND PLASTIC PACKINGS
MADE IN PART OF METAL, ALL FOR SEALING
COVERS OR INTERNAL FLOATING COVERS, EX-
PANSION JOINTS FOR INSULATION FOR TANKS
FOR LIQUID GAS, IN CLASS 17 (U.S. CLS. 1, 5, 12, 13,
35 AND 50).

FOR: BUILDING MATERIALS, NAMELY, FIT-
TED COVERINGS MADE OF PLASTIC OR WOOD
ALSO COMPRISING METAL OR A COMBINATION
THEREOF, FOR COVERING LIQUIDS IN OPEN OR
CLOSED RECEPTACLES, NAMELY, SWIMMING
POOLS, POOLS; BUILDING MATERIALS, NAME-
LY, FITTED FLOATING COVERS AND FITTED
FLOATING COVERS MADE OF PLASTIC OR
WOOD ALSO COMPRISING METAL OR A COMBI-
NATION THEREOF, FOR COVERING LIQUIDS IN
OPEN OR CLOSED RECEPTACLES, NAMELY,
SWIMMING POOLS, POOLS, IN CLASS 19 (U.S.
CLS. 1, 12, 33 AND 50).

FOR: RESEARCH AND INSPECTION PROJECTS
RELATING TO MANUFACTURING OF INSTALLA-
TIONS AND FACILITIES FOR OTHERS TO RE-
DUCE EMISSIONS OF, AND TO RECOVER
HYDROCARBONS AND VOLATILE CHEMICAL
PRODUCTS IN REFINERIES AND FUEL TANKS,
IN CLASS 42 (U.S. CLS. 100 AND 101).

THE MARK CONSISTS OF STANDARD CHAR-
ACTERS WITHOUT CLAIM TO ANY PARTICULAR
FONT, STYLE, SIZE, OR COLOR.

OWNER OF INTERNATIONAL REGISTRATION
0717129 DATED 3-8-1999, EXPIRES 3-8-2009.

SER. NO. 79-030,270, FILED 5-26-2006.

WARREN L. OLANDRIA, EXAMINING ATTOR-
NEY

Int. Cls.: 8, 14, 20, 21, 28 and 35

**Prior U.S. Cls.: 2, 13, 22, 23, 25, 27, 28, 29, 30, 32, 33,
38, 40, 44, 50, 100, 101 and 102**

Reg. No. 3,398,675

United States Patent and Trademark Office

Registered Mar. 18, 2008

**TRADEMARK
SERVICE MARK
PRINCIPAL REGISTER**



KAY BOJESEN

SUSANNE BOJESEN ROSENQVIST (DENMARK
INDIVIDUAL)
ASGÅRDSVEJ 9
DK-1811 FREDERIKSBERG C, DENMARK

FOR: INDUSTRIAL ART OBJECTS IN THE FORM
OF CUTLERY, NAMELY, KNIVES, FORKS AND
SPOONS, IN CLASS 8 (U.S. CLS. 23, 28 AND 44).

FOR: INDUSTRIAL ART OBJECTS OF PRECIOUS
METAL, NAMELY, FIGURINES, SERVING DISHES,
COFFEE SETS AND JEWELRY, IN CLASS 14 (U.S.
CLS. 2, 27, 28 AND 50).

FOR: INDUSTRIAL ART OBJECTS OF WOOD,
NAMELY, FIGURINES, IN CLASS 20 (U.S. CLS. 2, 13,
22, 25, 32 AND 50).

FOR: INDUSTRIAL ART OBJECTS IN THE FORM
OF HOLLOWWARE OF STEEL, NAMELY, SERVING
DISHES; SMALL HOUSEHOLD APPLIANCES AND
KITCHEN EQUIPMENT OF WOOD, NAMELY,
WOOD CHOPPING BOARDS, WOOD BOWLS,
WOOD SERVING DISHES, WOOD SALT AND PEP-
PER MILLS, IN CLASS 21 (U.S. CLS. 2, 13, 23, 29, 30, 33,
40 AND 50).

FOR: TOYS, NAMELY, WOODEN TOY ANI-
MALS, DOLLS, WOODEN TOY FIGURES, WOODEN
TOY CARS, ROCKING HORSES, IN CLASS 28 (U.S.
CLS. 22, 23, 38 AND 50).

FOR: WHOLESALE TRADE, NAMELY, WHOLE-
SALE DISTRIBUTORSHIPS FEATURING INDUS-
TRIAL ART OBJECTS AND TOYS, IN CLASS 35 (U.S.
CLS. 100, 101 AND 102).

PRIORITY DATE OF 10-5-2006 IS CLAIMED.

OWNER OF INTERNATIONAL REGISTRATION
0901959 DATED 10-11-2006, EXPIRES 10-11-2016.

THE NAME "KAY BOJESEN" DOES NOT IDEN-
TIFY A LIVING INDIVIDUAL.

SER. NO. 79-030,313, FILED 10-11-2006.

DOMINIC FATHY, EXAMINING ATTORNEY

Int. Cl.: 25

Prior U.S. Cls.: 22 and 39

United States Patent and Trademark Office

Reg. No. 3,398,676

Registered Mar. 18, 2008

**TRADEMARK
PRINCIPAL REGISTER**

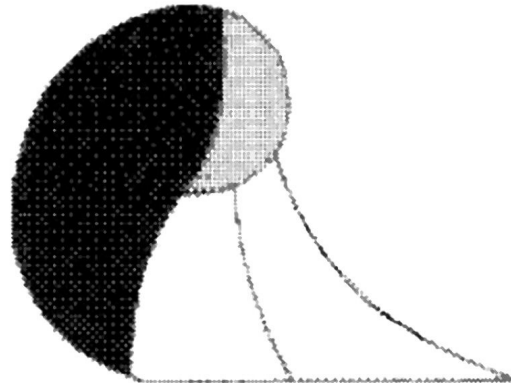

UEMORI SABURO (JAPAN INDIVIDUAL)
NO. 1110 5-2, SHOFUDAI 2-CHOME,
TARUMI-KU.; KOBE-SHI; HYOGO 655-0871
JAPAN

FOR: SUN VISORS; CAPS (HEADWEAR); HATS;
SCARVES, IN CLASS 25 (U.S. CLS. 22 AND 39).

OWNER OF INTERNATIONAL REGISTRATION
0901965 DATED 9-26-2006, EXPIRES 9-26-2016.

SER. NO. 79-030,316, FILED 9-26-2006.

CHRISTINA SOBRAL, EXAMINING ATTORNEY

Int. Cl.: 12

Prior U.S. Cls.: 19, 21, 23, 31, 35 and 44

Reg. No. 3,398,677

United States Patent and Trademark Office

Registered Mar. 18, 2008

**TRADEMARK
PRINCIPAL REGISTER**

BRITPART

BORDER HOLDINGS (UK) LIMITED (UNITED KINGDOM CORPORATION)
THE GROVE CRAVEN ARMS
SHROPSHIRE, UNITED KINGDOM SY7 8DB

FOR: AUTOMOBILE AND TRUCK PARTS, NAMELY, INTERNAL COMBUSTION ENGINES AND PARTS THEREOF, NAMELY, CYLINDER BLOCKS, CYLINDER HEADS, MANIFOLDS, VALVES, VALVE LIFTERS, WATER PUMPS, FUEL PUMPS, OIL PUMPS, STARTER MOTORS, CRANKING MOTORS, FLYWHEELS, AIR CLEANERS, OIL FILTERS, RADIATORS, FANS, FUEL TANKS, EXHAUST PIPES, MUFFLERS, CATALYTIC CONVERTERS, BUMPERS, GRILLES, HOODS, FENDERS, DOOR PANELS, MANUAL AND POWER STEERING UNITS, STEERING WHEELS AND COLUMNS, SHOCK ABSORBERS, TIE RODS, BALL JOINTS, WHEELS, WHEEL COVERS, MANUAL AND POWER BRAKES, BRAKE PUMPS, BRAKE SHOES, BRAKE DRUMS, BRAKE LININGS, MANUAL AND AUTOMATIC TRANSMISSIONS, CLUTCHES, DRIVE AXLES, INSTRUMENT PANELS, SEAT BELTS, WINDSHIELD WIPERS AND BLADES, WINDSHIELD WASHERS, CAR SEATS; BRAKING SYSTEMS FOR VEHICLES AND PARTS THEREOF; CONNECTING RODS FOR LAND VEHICLES OTHER THAN PARTS OF MOTORS AND ENGINES; HOOD SHIELDS AS STRUCTURAL PARTS OF VEHICLES; LAND VEHICLE CONSOLE PARTS, NAMELY, WIRING HARNESES FOR CONTROL, MONITORING AND PROTECTION OF INDUSTRIAL GASOLINE AND DIESEL ENGINES; LAND VEHICLE PARTS, NAMELY, TIRE SNOW CHAINS, TIRE CHAINS, TRANSMISSIONS, WINDSHIELDS,

DIFFERENTIALS, FENDER FLARES, DRIVE BELTS, DRIVE GEARS, MUD GUARDS, RUNNING BOARDS; LAND VEHICLE SUSPENSION PARTS, NAMELY, TORSION/SWAY BARS, COIL SPRINGS, LEAF SPRINGS, EQUALIZERS, AXLES; LAND VEHICLE TRANSMISSIONS AND REPLACEMENT PARTS THEREOF; LAND VEHICLES AND STRUCTURAL PARTS THEREFOR; METAL PARTS FOR VEHICLES, NAMELY, AUTOMOTIVE EXTERIOR AND INTERIOR METAL DECORATIVE AND PROTECTIVE TRIM; MUD FLAP BRACKETS AS STRUCTURAL PARTS OF VEHICLES; PLASTIC PARTS FOR VEHICLES, NAMELY, AUTOMOTIVE EXTERIOR AND INTERIOR PLASTIC EXTRUDED DECORATIVE AND PROTECTIVE TRIM; STEERING UNITS FOR LAND VEHICLES AND PARTS THEREOF. VEHICLE PARTS, NAMELY, REAR-VIEW MIRRORS, CONSTANT VELOCITY JOINTS, SUSPENSION STRUTS, IDLER ARMS, SUN VISORS, WINDSHIELD VISORS, IN CLASS 12 (U.S. CLS. 19, 21, 23, 31, 35 AND 44).

THE MARK CONSISTS OF STANDARD CHARACTERS WITHOUT CLAIM TO ANY PARTICULAR FONT, STYLE, SIZE, OR COLOR.

OWNER OF INTERNATIONAL REGISTRATION
0902168 DATED 10-17-2006, EXPIRES 10-17-2016.

SER. NO. 79-030,382, FILED 10-17-2006.

PAULA MAHONEY, EXAMINING ATTORNEY

Int. Cl.: 11

Prior U.S. Cls.: 13, 21, 23, 31 and 34

United States Patent and Trademark Office

Reg. No. 3,398,678

Registered Mar. 18, 2008

**TRADEMARK
PRINCIPAL REGISTER**

GEMDRYER

N.V. BEKAERT S.A. (BELGIUM CORPORATION)
BEKAERTSTRAAT 2
B-8550 ZWEVEGEM
BELGIUM

FOR: INDUSTRIAL DRYING APPARATUS FOR PAPER AND BOARDS; INDUSTRIAL GAS INFRARED RADIATION INSTALLATIONS FOR DRYING PAPER AND BOARDS; INDUSTRIAL GAS BURNERS FOR GAS INSTALLATIONS; INDUSTRIAL GAS BURNERS FOR INFRARED DRYING INSTALLATIONS; INDUSTRIAL GAS INFRARED DRYING INSTALLATIONS FOR PAPER AND BOARD, IN CLASS 11 (U.S. CLS. 13, 21, 23, 31 AND 34).

THE MARK CONSISTS OF STANDARD CHARACTERS WITHOUT CLAIM TO ANY PARTICULAR FONT, STYLE, SIZE, OR COLOR.

PRIORITY DATE OF 6-22-2006 IS CLAIMED.

OWNER OF INTERNATIONAL REGISTRATION 0902636 DATED 9-8-2006, EXPIRES 9-8-2016.

SER. NO. 79-030,564, FILED 9-8-2006.

BARNEY CHARLON, EXAMINING ATTORNEY

Int. Cl.: 9

Prior U.S. Cls.: 21, 23, 26, 36 and 38

United States Patent and Trademark Office

Reg. No. 3,398,679

Registered Mar. 18, 2008

TRADEMARK
PRINCIPAL REGISTER



FAR EAST CABLE FACTORY (CHINA CORPORATION)
NO.8, FAR EAST ROAD
FANDAO, GAOCHENG TOWN,; YIXING; JIANG-SU214257
CHINA

FOR: COMPUTERS; PHOTOGRAPHIC, ELECTROSTATIC, AND THERMIC PHOTOCOPIERS; WEIGHING MACHINES, NAMELY SCALES AND BALANCES; AMUSEMENT APPARATUS ADAPTED FOR USE WITH TELEVISION RECEIVERS ONLY, NAMELY, ELECTRONIC CIRCUITS RECORDING PROGRAMS FOR AMUSEMENT APPARATUS FOR USE WITH LIQUID CRYSTAL SCREENS; NETWORK COMMUNICATION DEVICES, NAMELY, COMPUTER NETWORK ROUTERS; MEASURES, NAMELY MEASURING BUCKETS, CUPS, RULES, TAPES, SPOONS; SEMICONDUCTOR POWER ELEMENTS; ELECTRICAL WIRE AND ELECTRICAL CABLES; ELECTROPLATING MACHINE; ELECTROLYSERS; INSULATED COPPER WIRE; COAXIAL CABLES, IN CLASS 9 (U.S. CLS. 21, 23, 26, 36 AND 38).

OWNER OF INTERNATIONAL REGISTRATION
0903340 DATED 8-7-2006, EXPIRES 8-7-2016.

NO CLAIM IS MADE TO THE EXCLUSIVE RIGHT TO USE "FAR EAST CABLE" OR THE NON-LATIN CHARACTERS THAT MEAN "FAR EAST CABLE", APART FROM THE MARK AS SHOWN.

THE FIRST CHINESE CHARACTER WHOSE TRANSLITERATION IS "YUAN" MEANS "FAR"; THE SECOND CHINESE CHARACTER WHOSE TRANSLITERATION IS "DONG" MEANS "EAST"; THE THIRD CHINESE CHARACTER WHOSE TRANSLITERATION IS "DIAN" MEANS "ELECTRICITY"; THE LAST CHINESE CHARACTER WHOSE TRANSLITERATION IS "LAN" MEANS "CABLE"; THE COMBINATION OF THE FOUR CHINESE CHARACTERS MEANS "FAR EAST CABLE".

THE TRANSLITERATION OF THE NON-LATIN CHARACTERS IN THE MARK IS: YUAN DONG DIAN LAN.

SER. NO. 79-030,872, FILED 8-7-2006.

KATHRYN COWARD, EXAMINING ATTORNEY

Int. Cl.: 16

Prior U.S. Cls.: 2, 5, 22, 23, 29, 37, 38 and 50

United States Patent and Trademark Office

Reg. No. 3,398,680

Registered Mar. 18, 2008

**TRADEMARK
PRINCIPAL REGISTER**



NINGBO BIG WINDMILL; EDUCATIONAL MATERIALS CO., LTD. (CHINA CORPORATION)
NO. 1, HUAMEI RD.
INDUSTRIAL DEVELOPMENT ZONE; ZHANGTING TOWN
YUYAO, ZHEJIANG, CHINA

FOR: WALL MAPS FOR TEACHING, IN CLASS 16
(U.S. CLS. 2, 5, 22, 23, 29, 37, 38 AND 50).

OWNER OF INTERNATIONAL REGISTRATION
0904344 DATED 11-6-2006, EXPIRES 11-6-2016.

THE MEANING OF "DA" IS "BIG"; THE MEANING OF "FENG" IS "WIND", THE MEANING OF "CHE" IS "VEHICLE"; THE WHOLE MEANING OF "DA FENG CHE" IS "BIG WINDMILL".

THE TRANSLITERATION OF THE NON-LATIN CHARACTERS IN THE MARK IS: DA FENG CHE.

SER. NO. 79-031,252, FILED 11-6-2006.

SHARON MEIER, EXAMINING ATTORNEY

Int. Cl.: 5

Prior U.S. Cls.: 6, 18, 44, 46, 51 and 52

United States Patent and Trademark Office

Reg. No. 3,398,681

Registered Mar. 18, 2008

**TRADEMARK
PRINCIPAL REGISTER**



NOVARTIS AG (SWITZERLAND CORPORATION)
CH-4002 BASEL, SWITZERLAND

OWNER OF INTERNATIONAL REGISTRATION
0904590 DATED 10-11-2006, EXPIRES 10-11-2016.

FOR: PHARMACEUTICAL PREPARATIONS
AVAILABLE ON PRESCRIPTION ONLY FOR USE
IN ONCOLOGY OR IN THE FIELD OF ONCOLOGY,
IN CLASS 5 (U.S. CLS. 6, 18, 44, 46, 51 AND 52).

SER. NO. 79-031,344, FILED 10-11-2006.

PRIORITY DATE OF 9-5-2006 IS CLAIMED.

RAUL CORDOVA, EXAMINING ATTORNEY

Int. Cl.: 25

Prior U.S. Cls.: 22 and 39

United States Patent and Trademark Office

Reg. No. 3,398,682

Registered Mar. 18, 2008

**TRADEMARK
PRINCIPAL REGISTER**



ECCO SKO A/S (DENMARK CORPORATION)
INDUSTRIVEJ 5
DK-6261 BREDEBRO
DENMARK

FOR: FOOTWEAR, NAMELY, SHOES, BOOTS,
SANDALS, SLIPPERS AND INSOLES FOR FOOT-
WEAR, IN CLASS 25 (U.S. CLS. 22 AND 39).

PRIORITY DATE OF 6-7-2006 IS CLAIMED.

OWNER OF INTERNATIONAL REGISTRATION
0904595 DATED 10-30-2006, EXPIRES 10-30-2016.

NO CLAIM IS MADE TO THE EXCLUSIVE
RIGHT TO USE "YAK", APART FROM THE MARK
AS SHOWN.

SER. NO. 79-031,347, FILED 10-30-2006.

BARNEY CHARLON, EXAMINING ATTORNEY

Int. Cl.: 30

Prior U.S. Cl.: 46

Reg. No. 3,398,683

United States Patent and Trademark Office

Registered Mar. 18, 2008

**TRADEMARK
PRINCIPAL REGISTER**



FUJIAN HUIKANG FOODS; INDUSTRY CO.,
LTD (CHINA CORPORATION)
NO. 41, HOULIN GONGYEXIQU
LUOSHAN TOWN,; JINJIANG CITY; FUJIAN PRO-
VINCE 362200
CHINA

FOR: SWEETMEATS; CHOCOLATE; PASTRIES;
BISCUITS; PUDDINGS, IN CLASS 30 (U.S. CL. 46).

OWNER OF INTERNATIONAL REGISTRATION
0904848 DATED 11-6-2006, EXPIRES 11-6-2016.

THE FIRST CHINESE CHARACTER WHOSE
TRANSLITERATION IS "HUI" MEANS "BENEFIT";
THE SECOND CHINESE CHARACTER WHOSE

TRANSLITERATION IS "KANG" MEANS
"HEALTH"; THE COMBINATION OF THE TWO
CHINESE CHARACTERS HAS NO SIGNIFICANCE
IN THE RELEVANT TRADE OR INDUSTRY, AND
HAS NO GEOGRAPHICAL SIGNIFICANCE, AND
HAS NO MEANING IN A FOREIGN LANGUAGE,
AND HAS NO SIGNIFICANCE AS APPLIED TO THE
GOODS.

THE TRANSLITERATION OF THE NON-LATIN
CHARACTERS IN THE MARK IS: HUI KANG.

SER. NO. 79-031,442, FILED 11-6-2006.

SHARON MEIER, EXAMINING ATTORNEY

Int. Cls.: 7, 9, 11, 35, 37 and 42

**Prior U.S. Cls.: 13, 19, 21, 23, 26, 31, 34, 35, 36, 38,
100, 101, 102, 103 and 106**

Reg. No. 3,398,684

United States Patent and Trademark Office

Registered Mar. 18, 2008

**TRADEMARK
SERVICE MARK
PRINCIPAL REGISTER**



CONSEIL EUROPEEN DE LA CONSTRUCTION;
D'APPAREILS DOMESTIQUES; AISBL EN
ABRÉGÉ CECED (BELGIUM ASSOCIATION
INTERNATIONALE SANS BUT LUCRATIF)

80, BOULEVARD AUGUSTE REYERS
B-1030 BRUXELLES, BELGIUM

SMOKE ALARMS, MOTION DETECTOR ALARMS;
ELECTRIC CELLS AND BATTERIES, ELECTRONIC
CONTROL DEVICES, NAMELY, ELECTRIC CON-
TROL PANELS, ELECTRIC POWER SUPPLIES, IN
CLASS 9 (U.S. CLS. 21, 23, 26, 36 AND 38).

FOR: DISHWASHERS, VACUUM CLEANERS
AND WASHING MACHINES, ALL THESE GOODS
FOR HOUSEHOLD PURPOSES; ELECTRIC KNIVES,
IN CLASS 7 (U.S. CLS. 13, 19, 21, 23, 31, 34 AND 35).

FOR: ELECTRIC VIDEO SURVEILLANCE IN-
STALLATIONS, ELECTRICAL CONTROL DEVICES
FOR MANAGING HEATING AND ENERGY USE,
ELECTRIC CONTROL PANELS, ELECTRIC DOOR-
OPENERS, ELECTRIC FENCES, ELECTRIC IRONS,
ELECTRIC GATE-OPENERS; ELECTRIC LIGHT
DATERS, NAMELY, ELECTRIC LIGHT DIMMERS;
ELECTRIC LIGHT SWITCHES, ELECTRIC LUMI-
NESCENT DISPLAY SCREENS, ELECTRIC PLUGS,
ELECTRIC RESISTANCES FOR TELECOMMUNI-
CATIONS APPARATUS, COMPUTER DEVICE FOR
DESIGNING THE LAYOUT OF ELECTRONIC CIR-
CUITS, E-COMMERCE SOFTWARE FOR ALLOW-
ING USERS TO CARRY OUT ELECTRONIC
COMMERCIAL TRANSACTIONS VIA A GLOBAL
COMPUTER NETWORK, ELECTRIC AND ELEC-
TRONIC VIDEO SURVEILLANCE INSTALLA-
TIONS, ELECTRONIC DOOR CLOSING SYSTEMS,
ELECTRONIC DOOR-OPENERS; ELECTRONIC
SAFETY AND SECURITY SOUND ALARMS,
NAMELY, ANTI-INTRUSION ALARMS, FIRE
ALARMS, AND PERSONAL SECURITY ALARMS,

FOR: LAUNDRY DRYERS, LAUNDRY DRYERS
FOR HOUSEHOLD AND INDUSTRIAL USE, ELEC-
TRIC OVENS; ELECTRIC COOKING CONTAINERS,
NAMELY, COOKING POTS; ELECTRIC STEAM
COOKERS, ELECTRIC PLATE WARMERS, ELEC-
TRIC COOKTOPS, MICRO-WAVE OVENS FOR
COOKING, GAS OVENS FOR HOUSEHOLD PUR-
POSES, GAS COOKTOPS, GAS COOKERS, VENTI-
LATION HOODS FOR OVENS, VENTILATION
HOODS FOR COOKERS, VENTILATION HOODS,
ELECTRIC FREEZERS, ELECTRIC REFRIGERA-
TORS, REFRIGERATORS FOR HOUSEHOLD AND
INDUSTRIAL USE, FREEZERS FOR HOUSEHOLD
AND INDUSTRIAL USE, GAS REFRIGERATORS,
COOLING MEANS, NAMELY, FOOD AND BEVER-
AGE REFRIGERATION UNITS, ELECTRIC COF-
FEE MACHINES, ELECTRIC COOKING
APPLIANCES, NAMELY, GRILLS AND ROASTERS,
HOBBS, WOK BURNERS, ELECTRIC DEEP FRYERS,
ELECTRIC EGG BOILERS, ELECTRIC EXPRESSO
MACHINES, ELECTRIC FANS, ELECTRIC KET-
TLES, ELECTRIC BREAD MACHINES, ELECTRIC
TOASTERS, RADIATION HEATING APPARATUS,
NAMELY, ELECTRIC RADIATORS FOR HEATING
BUILDINGS, ELECTRIC FOOT-WARMERS, ELEC-
TRIC SPACE COOLING APPARATUS FOR PREMI-
SES, PORTABLE ELECTRIC HEATING SYSTEMS,

NAMELY, PORTABLE ELECTRIC HEATERS, GAS HEATING APPARATUS FOR HOUSEHOLD AND INDUSTRIAL USE, NAMELY, GAS RADIATORS FOR HEATING BUILDINGS, GAS WATER HEATERS, IN CLASS 11 (U.S. CLS. 13, 21, 23, 31 AND 34).

FOR: ELECTRICITY METER READING; ELECTRICITY CONSUMPTION READING BY THIRD PARTIES FOR SUPPLIERS OF ELECTRICITY, IN CLASS 35 (U.S. CLS. 100, 101 AND 102).

FOR: MAINTENANCE AND REPAIR OF ELECTRIC, ELECTRONIC AND ELECTRICAL APPLIANCES, IN CLASS 37 (U.S. CLS. 100, 103 AND 106).

FOR: CREATION OF CONTROL PROGRAMS FOR CONTROLLING ELECTRIC OPERATION SYSTEMS AND CONTROL MODULES; TECHNICAL ANALYSIS OF ELECTRIC AND GAS METER DATA; TECHNICAL ANALYSIS OF ELECTRICITY CONSUMPTION; CHECKING ELECTRICITY CONSUMPTION BY THIRD PARTIES FOR SUPPLIERS

OF ELECTRICITY; DEVELOPMENT FOR OTHERS OF TECHNOLOGIES FOR MANUFACTURING CIRCUITS FOR WIRELESS CONSUMPTION, ELECTRONIC DATA PROCESSING, GENERAL PUBLIC ELECTRONICS, MOTOR CAR ELECTRONICS; TESTING, ANALYSIS AND EVALUATION OF THE GOODS AND SERVICES OF OTHERS IN THE FIELD OF TECHNICAL CONFORMITY OF HOUSEHOLD ELECTRICAL APPLIANCES AS REGARDS THE SELECTED COMMUNICATION PROTOCOL, IN CLASS 42 (U.S. CLS. 100 AND 101).

PRIORITY DATE OF 1-10-2006 IS CLAIMED.

OWNER OF INTERNATIONAL REGISTRATION 0904914 DATED 6-8-2006, EXPIRES 6-8-2016.

SER. NO. 79-031,466, FILED 6-8-2006.

KRISTINA MORRIS, EXAMINING ATTORNEY

Int. Cl.: 25

Prior U.S. Cls.: 22 and 39

United States Patent and Trademark Office

Reg. No. 3,398,685

Registered Mar. 18, 2008

**TRADEMARK
PRINCIPAL REGISTER**



RENO SCHUHCENTRUM GMBH (FED REP
GERMANY LTD LIAB CO)
INDUSTRIEGEBIET WEST
66987 THALEISCHWEILER-FRÖSCHEN
FED REP GERMANY

FOR: CLOTHING, NAMELY, PANTS, SHORTS,
SHIRTS, SKIRTS, DRESSES, COATS, SUITS, TROU-
SERS, JUMPERS, JACKETS, JERSEYS, SWEATERS,
PARKAS, PAJAMAS, SWIM SUITS, UNDERWEAR,
SOCKS, STOCKINGS, TIES, BELTS, FOULARDS,
SCARVES, MUFFLERS, GLOVES, CAPS, FOOT-
WEAR, AND HEADWEAR, IN CLASS 25 (U.S. CLS.
22 AND 39).

OWNER OF INTERNATIONAL REGISTRATION
0838749 DATED 9-7-2004, EXPIRES 9-7-2014.

THE COLOR(S) RED, ORANGE IS/ARE CLAIMED
AS A FEATURE OF THE MARK.

THE COLOR RED APPEARS IN THE WORD
RENO; THE COLOR ORANGE APPEARS IN THE
CURVED BAND.

SER. NO. 79-031,535, FILED 4-19-2006.

LEIGH LOWRY, EXAMINING ATTORNEY

Int. Cls.: 9, 38, 39, 41, 42 and 45

**Prior U.S. Cls.: 21, 23, 26, 36, 38, 100, 101, 104, 105
and 107**

Reg. No. 3,398,686

United States Patent and Trademark Office

Registered Mar. 18, 2008

**TRADEMARK
SERVICE MARK
PRINCIPAL REGISTER**



TOMTOM INTERNATIONAL B.V. (NETHERLANDS CORPORATION)
REMBRANDTPLEIN 35
NL-1017 CT AMSTERDAM
NETHERLANDS

FOR: COMPUTER HARDWARE; COMPUTER SOFTWARE FOR USE WITH SATELLITE AND FOR USE WITH SATELLITE AND/OR GPS NAVIGATION SYSTEMS FOR NAVIGATION, ROUTE AND TRIP PLANNING, AND ELECTRONIC MAPPING; COMPUTER SOFTWARE FOR TRAVEL INFORMATION SYSTEMS FOR THE PROVISION OR RENDERING OF TRAVEL ADVICE AND/OR INFORMATION CONCERNING SERVICE STATIONS, CAR PARKS, MULTI-STOREY CAR PARKS, RESTAURANTS, CAR DEALERS AND OTHER INFORMATION REGARDING TRAVEL AND TRANSPORT; HARDWARE AND SOFTWARE FOR INFORMATION MANAGEMENT FOR THE TRANSPORT AND TRAFFIC INDUSTRIES; COMPUTER SOFTWARE TO BE USED FOR VIEWING AND DOWNLOADING ELECTRONIC MAPS; SOFTWARE FOR OPERATING ROUTE PLANNERS; ROUTE PLANNERS IN THE NATURE OF HAND-HELD PERSONAL COMPUTERS; SOFTWARE FOR OPERATING DIGITAL DICTIONARIES; ELECTRONIC DIGITAL DICTIONARIES; LOCATION, ORIENTATION, AND NAVIGATION SENSORS, TRANSMITTERS, ACTUATORS, CAMERAS AND

GLOBAL POSITIONING SYSTEMS, NAMELY, GPS COMPRISING COMPUTERS, COMPUTER SOFTWARE, TRANSMITTERS, GPS AND SATELLITE RECEIVERS, NETWORK INTERFACE DEVICES, CONNECTING CABLES, AND PARTS AND FITTINGS THEREOF; HOLDERS FOR POCKET PERSONAL COMPUTERS, NAMELY, PROTECTIVE CARRYING CASES SPECIALLY ADAPTED FOR PERSONAL DIGITAL ASSISTANTS (PDA); SATELLITE AND RADIO TRANSMISSION PROCESSORS AND RECEIVERS; TELECOMMUNICATION INSTALLATIONS, NETWORKS AND APPARATUS, NAMELY, MOUNTING RACKS FOR TELECOMMUNICATIONS HARDWARE, TELECOMMUNICATIONS SWITCHES; COMPUTER TERMINALS TO BE USED WITH NAVIGATION SYSTEMS, ROUTE PLANNERS AND DIGITAL MAPS; BLANK MAGNETIC DATA CARRIERS AND BLANK RECORDING DISCS; AUDIO AND VIDEO APPARATUS, NAMELY, AUDIO AND VIDEO RECEIVERS AND PROCESSORS; HAND-HELD PERSONAL COMPUTERS; PERSONAL DIGITAL ASSISTANTS; ELECTRIC AND ELECTRONIC INSTRUMENTS FOR PROVIDING INFORMATION REGARDING MAPS, NAVIGATION, TRAFFIC, WEATHER AND INTERESTING LOCATIONS; ALARM APPARATUS AND INSTRUMENTS TO BE USED FOR TRACKING AND TRACING VEHICLES, NAMELY, VEHICLE LOCATING AND TRACKING SYSTEMS COMPRISED OF COMPUTERS, COMPUTER SOFT-

WARE, TRANSCEIVERS, TRANSPONDERS, GLOBAL POSITIONING SATELLITE RECEIVERS AND ANTENNAS, IN CLASS 9 (U.S. CLS. 21, 23, 26, 36 AND 38).

FOR: SECURED OR NOT SECURED TELECOMMUNICATION SERVICES, NAMELY, TRANSMISSION, STORAGE AND DELIVERY OF DIGITAL DATA, LIGHT FILES, SOUND FILES, DATA, INFORMATION AND IMAGE SIGNALS, BY MEANS OF COMPUTER, CABLE, RADIO AND SATELLITE NETWORKS, ALL IN PARTICULAR FOR NAVIGATION SYSTEMS, ROUTE PLANNERS AND THE USE OF ELECTRONIC MAPS; WIRELESS TRANSMISSION OF DATA BY MEANS OF VIDEOTEXT, THE INTERNET, GSM AND WAP; WIRELESS TRANSMISSION OF DIGITAL DATA; COMMUNICATION BY WAY OF COMPUTER TERMINALS; TELECOMMUNICATION SERVICES FOR THE COMMUNICATION WITH MEANS OF TRANSPORT, NAMELY, TRANSMISSION OF DIGITAL DATA, LIGHT FILES, SOUND FILES, DATA, INFORMATION AND IMAGE SIGNALS, BY MEANS OF WIRELESS AND SATELLITE NETWORKS; RENTAL OF TELECOMMUNICATION EQUIPMENT; TECHNICAL TELECOMMUNICATIONS CONSULTATION CONCERNING ALL SERVICES MENTIONED ABOVE, IN CLASS 38 (U.S. CLS. 100, 101 AND 104).

FOR: NAVIGATIONAL SERVICES, NAMELY, PROVIDING NAVIGATIONAL INFORMATION FOR USE IN PILOTING LAND VEHICLES, PROVIDING GLOBAL POSITIONING AND NAVIGATION INFORMATION VIA MOBILE TELEPHONE, WIRELESS AND SATELLITE NETWORKS; INFORMATION SERVICES REGARDING TRAFFIC AND TRAFFIC CONGESTION; PROVISION OF INFORMATION REGARDING TRAVEL; PROVISION OF INFORMATION TO TRAVELLERS REGARDING FARES, TIME TABLES AND MEANS OF PUBLIC TRANSPORT; SERVICES OF A TRAVEL AGENCY, NAMELY, BOOKING OF RENTAL CARS, BOATS AND OTHER VEHICLES; ALL OF THE AFORESAID SERVICES ALSO PROVIDED VIA A COMMUNICATIONS NETWORK OR A MOBILE TELEPHONE OR A WIRELESS NAVIGATION DEVICE, IN CLASS 39 (U.S. CLS. 100 AND 105).

FOR: EDUCATION SERVICES, NAMELY, PROVIDING CLASSES AND SEMINARS REGARDING THE USE OF NAVIGATION SYSTEMS; TRAINING SERVICES IN THE FIELD OF NAVIGATION SYSTEMS; ENTERTAINMENT, NAMELY, THE PRODUCTION OF RADIO PROGRAMS AND TELEVISION PROGRAMS; ORGANIZING COMMUNITY CULTURAL ACTIVITIES AND SPORTING ACTIVITIES, IN CLASS 41 (U.S. CLS. 100, 101 AND 107).

FOR: DEVELOPMENT AND DESIGN OF NAVIGATION SYSTEMS, ROUTE PLANNERS, ELECTRONIC MAPS AND DIGITAL DICTIONARIES FOR OTHERS; COMPUTER SOFTWARE AND HARDWARE DESIGN; DEVELOPMENT AND DESIGN OF SOFTWARE FOR USE WITH NAVIGATION SYSTEMS, ROUTE PLANNERS, ELECTRONIC MAPS AND DIGITAL DICTIONARIES; DEVELOPMENT AND DESIGN OF TELECOMMUNICATION AND DATA COMMUNICATION NETWORKS; PROVIDING TEMPORARY USE OF NON-DOWNLOADABLE SOFTWARE FOR TRACKING AND TRACING GOODS AND VEHICLES VIA COMPUTER NETWORKS, INTRANETS AND THE INTERNET, IN CLASS 42 (U.S. CLS. 100 AND 101).

FOR: SECURITY SERVICES FOR THE PROTECTION OF PROPERTY AND INDIVIDUALS, NAMELY, THE TRACKING AND TRACING OF GOODS AND INDIVIDUALS IN THE CONTEXT OF SECURITY, IN CLASS 45 (U.S. CLS. 100 AND 101).

PRIORITY DATE OF 4-13-2006 IS CLAIMED.

OWNER OF INTERNATIONAL REGISTRATION 0905069 DATED 5-4-2006, EXPIRES 5-4-2016.

OWNER OF U.S. REG. NO. 3,187,849.

SER. NO. 79-031,569, FILED 5-4-2006.

MYRIAH HABEEB, EXAMINING ATTORNEY

Int. Cl.: 19

Prior U.S. Cls.: 1, 12, 33 and 50

United States Patent and Trademark Office

Reg. No. 3,398,687

Registered Mar. 18, 2008

**TRADEMARK
PRINCIPAL REGISTER**



RI-WAL CERAMICHE S.P.A. (ITALY JOINT
STOCK COMPANY)
VIA GHIAROLA NUOVA, 101
I-41042 FIORANO MODENESE (MODENA)
ITALY

FOR: BUILDING STONE; GRANITE; MARBLE;
ARTIFICIAL STONE; BUILDING STONE; NON-ME-
TAL FLOOR TILES; PAVING TILES; TILES, NOT OF
METAL FOR BUILDING; STONE MOSAICS FOR
BUILDINGS; BUILDING TILES, NOT OF METAL;
FLOOR TILES, NOT OF METAL; PAVING SLABS,
NOT OF METAL; PAVING BLOCKS, NOT OF ME-
TAL, IN CLASS 19 (U.S. CLS. 1, 12, 33 AND 50).

PRIORITY DATE OF 4-12-2006 IS CLAIMED.

OWNER OF INTERNATIONAL REGISTRATION
0905277 DATED 9-6-2006, EXPIRES 9-6-2016.

OWNER OF U.S. REG. NO. 2,692,108.

THE MARK CONSISTS OF A SIGN DEPICTING
THE WORDING SAIME IN FANCY CHARACTERS,
THE LETTER I BEING SURMOUNTED BY A
SMALL SEMI-CIRCULAR FIGURE, THE UPPER
PART OF WHICH IS CONSTITUTED BY THREE
POINTS HAVING SLANTING SIDES.

SER. NO. 79-031,633, FILED 9-6-2006.

LINDA M. KING, EXAMINING ATTORNEY

Int. Cls.: 6 and 15

Prior U.S. Cls.: 2, 12, 13, 14, 21, 23, 25, 36 and 50

United States Patent and Trademark Office

Reg. No. 3,398,688

Registered Mar. 18, 2008

**TRADEMARK
PRINCIPAL REGISTER**



PACCARD FONDERIE (FRANCE SOCIÉTÉ À
RESPONSABILITÉ LIMITÉE)

ROUTE DES SAINTIERS - LAC D'ANNECY

F-74320 SEVRIER

FRANCE

FOR: CAST BRONZE BELLS, IN CLASS 6 (U.S.
CLS. 2, 12, 13, 14, 23, 25 AND 50).

FOR: MUSICAL INSTRUMENTS CONTAINING
BRONZE BELLS, IN CLASS 15 (U.S. CLS. 2, 21 AND
36).

PRIORITY DATE OF 5-17-2006 IS CLAIMED.

OWNER OF INTERNATIONAL REGISTRATION
0905335 DATED 10-30-2006, EXPIRES 10-30-2016.

THE COLOR(S) GRAY, YELLOW, ORANGE AND
WHITE IS/ARE CLAIMED AS A FEATURE OF THE
MARK.

THE MARK CONSISTS OF A YELLOW BELL
BENDING ON THE RIGHT IN ORDER TO EVOKE
MOVEMENT, DYNAMISM, OR ACTION. AROUND
THE BELL, YELLOW AND WHITE SOUND WAVES
ARE SPREADING THROUGH SPACE. ALL OF THIS
APPEARS ON AN ORANGE BACKGROUND. ON
THE RIGHT OF THE DESIGN, THE SOUND WAVES
ARE VANISHING INTO A WHITE AREA, REPRESENTING
LIGHT. BELOW THE DESIGN, THE
TERM "ARS" APPEARS IN ORANGE, AND THE
TERM "SONORA" APPEARS IN GRAY.

SER. NO. 79-031,654, FILED 10-30-2006.

CAROL SPILS, EXAMINING ATTORNEY

Int. Cl.: 33

Prior U.S. Cls.: 47 and 49

United States Patent and Trademark Office

Reg. No. 3,398,689

Registered Mar. 18, 2008

TRADEMARK
PRINCIPAL REGISTER



CHATEAU LAROSE TRINTAUDON (FRANCE
SOCIÉTÉ ANONYME)
CHÂTEAU LAROSE TRINTAUDON
F-33112 SAINT LAURENT DU MEDOC
FRANCE

FOR: WINES OF GUARANTEED LABEL OF
ORIGIN, SPECIFICALLY, AOC WINES FROM THE
WINE-MAKING ESTATE CALLED CHÂTEAU LAR-
OSE TRINTAUDON, IN CLASS 33 (U.S. CLS. 47 AND
49).

PRIORITY DATE OF 3-16-2006 IS CLAIMED.

OWNER OF INTERNATIONAL REGISTRATION
0905450 DATED 9-15-2006, EXPIRES 9-15-2016.

NO CLAIM IS MADE TO THE EXCLUSIVE
RIGHT TO USE "MIS EN BOUTEILLE AU CHA-
TEAU," "HAUT-MEDOC," "CRU BOURGEOIS"
AND "SUPERIEUR", APART FROM THE MARK
AS SHOWN.

THE COLOR(S) RED AND YELLOW IS/ARE
CLAIMED AS A FEATURE OF THE MARK.

THE COLOR YELLOW APPEARS IN THE WORD-
ING "MIS EN BOUTEILLE AU CHATEAU, CHA-
TEAU, LAROSE-TRINTAUDON, HAUT-MEDOC,
CRU BOURGEOIS AND SUPERIEUR. THE COLOR
YELLOW ALSO APPEARS IN THE DOUBLE-LINED
BORDER AROUND THE PERIMETER OF THE
SQUARE BACKGROUND, THE OUTLINE OF THE
DEPICTION OF THE CHATEAU AND IN THE
FLEUR-DE-LIS DESIGNS IN EACH CORNER OF
THE SQUARE. THE COLOR RED APPEARS IN THE
SQUARE BACKGROUND OF THE ENTIRE MARK.

THE ENGLISH TRANSLATION OF THE WORD-
ING "MIS EN BOUTEILLE AU CHATEAU" IN THE
MARK IS "BOTTLED IN THE ESTATE." THE EN-
GLISH TRANSLATION OF THE WORDING "CRU
BOURGEOIS" IN THE MARK IS "MIDDLE CLASS
VINTAGE." THE ENGLISH TRANSLATION OF THE
WORDING "SUPERIEUR" IN THE MARK IS "SU-
PERIOR." THE WORDING "LAROSE-TRINTAU-
DON" HAS NO MEANING IN A FOREIGN
LANGUAGE.

SER. NO. 79-031,704, FILED 9-15-2006.

TINA BROWN, EXAMINING ATTORNEY

Int. Cl.: 9

Prior U.S. Cls.: 21, 23, 26, 36 and 38

Reg. No. 3,398,690

United States Patent and Trademark Office

Registered Mar. 18, 2008

**TRADEMARK
PRINCIPAL REGISTER**



FAR EAST CABLE FACTORY (CHINA CORPORATION)
NO 8, FAR EAST ROAD
FANDAO, GAOCHENG TOWN,; YIXING
JIANGSU, CHINA 214257

POWER ELEMENTS; ELECTRICAL WIRE AND ELECTRICAL CABLES; ELECTROPLATING MACHINE; ELECTROLYSERS; INSULATED COPPER WIRE; COAXIAL CABLES, IN CLASS 9 (U.S. CLS. 21, 23, 26, 36 AND 38).

FOR: COMPUTERS; PHOTOGRAPHIC, ELECTROSTATIC, AND THERMIC PHOTOCOPIERS; WEIGHING MACHINES, NAMELY, SCALES AND BALANCES; AMUSEMENT APPARATUS ADAPTED FOR USE WITH TELEVISION RECEIVERS ONLY, NAMELY, ELECTRONIC CIRCUITS RECORDING PROGRAMS FOR AMUSEMENT APPARATUS FOR USE WITH LIQUID CRYSTAL SCREENS; NETWORK COMMUNICATION DEVICES, NAMELY, COMPUTER NETWORK ROUTERS; MEASURES, NAMELY, MEASURING BUCKETS, CUPS, RULES, TAPES, SPOONS; SEMICONDUCTOR

OWNER OF INTERNATIONAL REGISTRATION
0905459 DATED 8-7-2006, EXPIRES 8-7-2016.

NO CLAIM IS MADE TO THE EXCLUSIVE RIGHT TO USE "FAR EAST CABLE", APART FROM THE MARK AS SHOWN.

SER. NO. 79-031,706, FILED 8-7-2006.

KATHRYN COWARD, EXAMINING ATTORNEY

Int. Cl.: 33

Prior U.S. Cls.: 47 and 49

United States Patent and Trademark Office

Reg. No. 3,398,691

Registered Mar. 18, 2008

TRADEMARK
PRINCIPAL REGISTER



VERPOORTEN GMBH & CO. KG (FED REP
GERMANY GMBH & CO. KG)

POTSDAMER PLATZ 1

53119 BONN

FED REP GERMANY

FOR: LIQUOR AND LIQUEUR BEVERAGES,
NAMELY, EGG LIQUOR, ADVOCAT, IN CLASS
33 (U.S. CLS. 47 AND 49).

PRIORITY DATE OF 5-4-2006 IS CLAIMED.

OWNER OF INTERNATIONAL REGISTRATION
0905636 DATED 11-3-2006, EXPIRES 11-3-2016.

THE COLOR(S) GOLD, RED, BLUE, BLACK, AND
WHITE IS/ARE CLAIMED AS A FEATURE OF THE
MARK.

THE COLOR GOLD APPEARS IN THE WORDING
VERPOORTEN IN THE OUTER CIRCLE, HIGH-
LIGHTS THE WORD VERPOORTEN IN THE INNER
CIRCLE, IN THE CREST DESIGN IN THE INNER
CIRCLE AND AS A LIGHTLY SHADED DESIGN IN
THE INNER CIRCLE. THE COLOR RED APPEARS
AS THE OUTER OF TWO HIGHLIGHTS TO BOTH
THE OUTER AND INNER CIRCLE, IN THE CREST
DESIGN IN THE INNER CIRCLE AND AS AN
UNDERLINE EFFECT OF VERPOORTEN IN THE
INNER CIRCLE. THE COLOR BLUE APPEARS AS
THE INNER OF TWO HIGHLIGHTS TO BOTH THE
OUTER AND INNER CIRCLE AND IN THE CREST
DESIGN IN THE INNER CIRCLE. THE COLOR
BLACK APPEARS IN THE WORDING VERPOOR-
TEN IN THE INNER CIRCLE AND IN THE OUTER
CIRCLE DESIGN. THE COLOR WHITE APPEARS IN
THE INNER CIRCLE DESIGN.

SER. NO. 79-031,765, FILED 11-3-2006.

KATHERINE E. HALMEN, EXAMINING ATTOR-
NEY

Int. Cl.: 32

Prior U.S. Cls.: 45, 46 and 48

United States Patent and Trademark Office

Reg. No. 3,398,692

Registered Mar. 18, 2008

TRADEMARK
PRINCIPAL REGISTER



HEINZ WEYERMANN; RÖSTMALZBIER-
BRAUEREI BAMBERG GMBH (FED REP
GERMANY GMBH (LIMITED LIABILITY
COMPANY))

BRENNERSTRASSE 17/19
96052 BAMBERG
FED REP GERMANY

FOR: ROASTED MALT BEER, MALT BEER,
MALT WORT, BEER WORT, BEER AND EXTRACTS
FOR PRODUCING BEER, NAMELY, ROASTED
MALT BEER EXTRACT, MALT BEER EXTRACT,
MALT WORT EXTRACT, BEER WORT EXTRACT,
BEER EXTRACT, HOP EXTRACT, IN CLASS 32 (U.S.
CLS. 45, 46 AND 48).

OWNER OF INTERNATIONAL REGISTRATION
0905982 DATED 10-26-2006, EXPIRES 10-26-2016.

THE MARK CONSISTS OF THE WORD "WEYER-
MANN" IN STYLIZED LETTERS ABOVE THE DE-
SIGN OF A CHIMNEY SWEEP WEARING A TOP
HAT AND CARRYING A LADDER AND A BRUSH.

SER. NO. 79-031,816, FILED 10-26-2006.

PRIORITY DATE OF 7-5-2006 IS CLAIMED.

SCOTT BIBB, EXAMINING ATTORNEY

Int. Cls.: 39 and 43

Prior U.S. Cls.: 100, 101 and 105

United States Patent and Trademark Office

Reg. No. 3,398,693

Registered Mar. 18, 2008

**SERVICE MARK
PRINCIPAL REGISTER**

UPGRADE TO BRITISH AIRWAYS

BRITISH AIRWAYS PLC (UNITED KINGDOM CORPORATION)
WATERSIDE, (HB A3) PO BOX 365,
HARMONDSWORTH; WEST DRAYTON UB7 0GB
UNITED KINGDOM

FOR: TRANSPORT BY AIR AND CAR; PACKAGING ARTICLES FOR TRANSPORTATION; WAREHOUSE STORAGE OF GOODS; TRAVEL ARRANGEMENT; AIRLINE TRANSPORTATION SERVICES; TRAVEL SERVICES, NAMELY, TRAVEL GUIDE SERVICES AND TRAVEL INFORMATION SERVICES; TRAVEL AGENCY SERVICES, NAMELY, MAKING RESERVATIONS AND BOOKINGS FOR TRANSPORTATION; TOURIST AGENCY SERVICES FOR ARRANGING TRAVEL; TRAVEL BOOKING AGENCIES; TRAVEL AND TOUR TICKET RESERVATION SERVICES; VEHICLE RENTAL SERVICES; VEHICLE PARKING SERVICES; CHAUFFEUR SERVICES; COURIER SERVICES; TRAVEL GUIDE SERVICES; GUARDED TRUCK TRANSPORT OF VALUABLES; PASSENGER TRANSPORT SERVICES; CARGO HANDLING; CARGO UNLOADING; AIRCRAFT CHARTERING SERVICES; WAREHOUSING SERVICES; ORGANIZATION OF EXCURSIONS, SIGHTSEEING TOURS, HOLIDAYS, TOURS AND TRAVEL; BOOKING AND RESERVATION SERVICES FOR TOURS AND HOLIDAYS; PROVIDING INFORMATION IN THE FIELD

OF TRAVEL, TRANSPORTATION, AND STORAGE, IN CLASS 39 (U.S. CLS. 100 AND 105).

FOR: SERVING OF FOOD AND DRINKS; CATERING OF FOOD AND DRINKS; RESTAURANTS; PROVIDING TEMPORARY ACCOMMODATION; TRAVEL AGENCY SERVICES, NAMELY, MAKING RESERVATIONS AND BOOKING FOR TEMPORARY LODGING, HOTEL ROOMS, AND RESTAURANTS; BAR, SNACK-BAR, AND RESTAURANT SERVICES; CAFÉS; COCKTAIL LOUNGES, IN CLASS 43 (U.S. CLS. 100 AND 101).

THE MARK CONSISTS OF STANDARD CHARACTERS WITHOUT CLAIM TO ANY PARTICULAR FONT, STYLE, SIZE, OR COLOR.

OWNER OF INTERNATIONAL REGISTRATION 0906322 DATED 11-15-2006, EXPIRES 11-15-2016.

OWNER OF U.S. REG. NOS. 1,408,939, 1,802,476 AND OTHERS.

SER. NO. 79-032,033, FILED 11-15-2006.

JENNIFER VASQUEZ, EXAMINING ATTORNEY

Int. Cls.: 5 and 30

Prior U.S. Cls.: 6, 18, 44, 46, 51 and 52

United States Patent and Trademark Office

Reg. No. 3,398,694

Registered Mar. 18, 2008

**TRADEMARK
PRINCIPAL REGISTER**

XYLYCYST

BIOHIT OYJ (FINLAND PUBLIC JOINT STOCK
COMPANY)
LAIPPATIE 1
FI-00880 HELSINKI
FINLAND

FOR: MEDICATED CHEWING GUM, CONFECTIONERY, NAMELY, PASTILLES, MEDICATED LOZENGES, AND MEDICATED CANDIES, ALL FOR MEDICINAL PURPOSES, IN CLASS 5 (U.S. CLS. 6, 18, 44, 46, 51 AND 52).

FOR: CHEWING GUM, CONFECTIONERY, NAMELY, PASTILLES, NON-MEDICATED LOZENGES, AND CANDIES, IN CLASS 30 (U.S. CL. 46).

THE MARK CONSISTS OF STANDARD CHARACTERS WITHOUT CLAIM TO ANY PARTICULAR FONT, STYLE, SIZE, OR COLOR.

PRIORITY DATE OF 5-12-2006 IS CLAIMED.

OWNER OF INTERNATIONAL REGISTRATION
0906521 DATED 11-8-2006, EXPIRES 11-8-2016.

SER. NO. 79-032,108, FILED 11-8-2006.

SETH A. RAPPAPORT, EXAMINING ATTORNEY

Int. Cl.: 9

Prior U.S. Cls.: 21, 23, 26, 36 and 38

Reg. No. 3,398,695

United States Patent and Trademark Office

Registered Mar. 18, 2008

**TRADEMARK
PRINCIPAL REGISTER**

VOXTER

TOPSYSTEM SYSTEMHAUS GMBH (FED REP
GERMANY CORPORATION)
EUROPAPARK A2
ADENAUERSTRASSE 20; 52146 WÜRSELEN
FED REP GERMANY

FOR: ELECTRICAL APPARATUS AND INSTRUMENTS, NAMELY, COMPUTER BASED APPARATUS FOR RECORDING, ENTERING, PROCESSING, TRANSFERRING AND REPLAYING OF SPEECH, SOUND AND PICTURE DATA IN THE AREA OF TRANSPORTATION AND LOGISTICS; SCANNERS; DATA PROCESSING APPARATUS, NAMELY, COMPUTERS AND COMPUTER REPLACEMENT PARTS; SOFTWARE ALLOWING USERS TO ENTER PERFORMANCE AND MASS DATA INTO A DATABASE, WITH THE DATA RELATING TO PERSONNEL, APPARATUS, PRODUCTS AND PRODUCTION, ADMINISTRATING GOODS AND SPACE, FOR DISPATCH HANDLING, FOR CLEARING SERVICES FOR CUSTOMERS, FOR CLEARING AND ADMINISTRATING OF ORGANIZATIONS; INFORMATION SYSTEMS CONSISTING OF COMPUTER HARDWARE AND SOFTWARE FOR TRACKING TRANSPORTATION AND LOGISTICS, INVENTORY MANAGEMENT, FLOW OF GOODS,

AND ONLINE-TRACING OF GOODS, TO BE USED IN TRADING HOUSES, CENTERS OF STOCK TURNOVER, CENTERS OF DISTRIBUTION AND AT ENTERPRISES RENDERING LOGISTICAL SERVICES AS WELL AS FOR THE DISPOSITION OF MATERIAL, APPARATUS AND PERSONNEL; ALL AFOREMENTIONED GOODS NOT FOR MOTORCARS, IN CLASS 9 (U.S. CLS. 21, 23, 26, 36 AND 38).

THE MARK CONSISTS OF STANDARD CHARACTERS WITHOUT CLAIM TO ANY PARTICULAR FONT, STYLE, SIZE, OR COLOR.

PRIORITY DATE OF 5-19-2006 IS CLAIMED.

OWNER OF INTERNATIONAL REGISTRATION
0906843 DATED 10-23-2006, EXPIRES 10-23-2016.

SER. NO. 79-032,241, FILED 10-23-2006.

REBECCA POVARCHUK, EXAMINING ATTORNEY

Int. Cls.: 7, 40 and 42

**Prior U.S. Cls.: 13, 19, 21, 23, 31, 34, 35, 100, 101, 103
and 106**

Reg. No. 3,398,696

United States Patent and Trademark Office

Registered Mar. 18, 2008

**TRADEMARK
SERVICE MARK
PRINCIPAL REGISTER**

VSF

OUTOTEC OYJ (FINLAND LIMITED LIABILITY
CORPORATION)
RIIHITONTUNTIE 7 C
FI-02200 ESPOO
FINLAND

FOR: MACHINES AND DEVICES FOR TREATMENT OF MATERIALS, NAMELY, SOLVENT EXTRACTION MACHINES FOR PUMPING, MIXING AND SETTLING OF IMMISCIBLE LIQUIDS, AQUEOUS AND ORGANIC SOLUTIONS AND PARTS THEREFOR, NAMELY, MIXING REACTORS, SETTLERS, MIXERS AND PUMPS, IN CLASS 7 (U.S. CLS. 13, 19, 21, 23, 31, 34 AND 35).

FOR: TREATMENT OF MATERIALS, NAMELY, METALS, ORES, CONCENTRATES, CHEMICALS, LIQUIDS, SOLUTIONS AND GASES THROUGH A SOLVENT EXTRACTION PROCESS UTILIZING PUMPING, MIXING AND SETTLING OF IMMISCIBLE LIQUIDS, AQUEOUS AND ORGANIC SOLUTIONS, IN CLASS 40 (U.S. CLS. 100, 103 AND 106).

FOR: RESEARCH AND TECHNICAL CONSULTANCY IN BUILDING AND USAGE OF SOLVENT

EXTRACTION PROCESSES AND OF APPARATUS AND DEVICES FOR USE IN SOLVENT EXTRACTION PROCESSES; DESIGN OF METALLURGICAL PLANTS; PROCESS ENGINEERING CONSULTANCY RELATING TO THE BUILDING OF METALLURGICAL PLANTS, IN CLASS 42 (U.S. CLS. 100 AND 101).

THE MARK CONSISTS OF STANDARD CHARACTERS WITHOUT CLAIM TO ANY PARTICULAR FONT, STYLE, SIZE, OR COLOR.

PRIORITY DATE OF 2-27-2006 IS CLAIMED.

OWNER OF INTERNATIONAL REGISTRATION
0906937 DATED 6-28-2006, EXPIRES 6-28-2016.

SER. NO. 79-032,287, FILED 6-28-2006.

KATHERINE STOIDES, EXAMINING ATTORNEY

Int. Cls.: 9, 35 and 42

Prior U.S. Cls.: 21, 23, 26, 36, 38, 100, 101 and 102

Reg. No. 3,398,697

United States Patent and Trademark Office

Registered Mar. 18, 2008

**TRADEMARK
SERVICE MARK
PRINCIPAL REGISTER**

ESSENSIUM

SENSIUM NV (BELGIUM CORPORATION)
KAPELDREEF 75
B-3001 LEUVEN, BELGIUM

FOR: DEVICES AND APPARATUS FOR SENSING, MONITORING, RECORDING AND TRANSMITTING SIGNALS AND INFORMATION, NAMELY, BIOSENSORS THAT DETECT POISON, CONTAMINANTS, POLLUTANTS, BACTERIA, PESTICIDES, HERBICIDES AND FUNGICIDE, CHEMICAL SENSORS THAT DETECT OXIDES, PHOSPHATES, CARBONATES, SODIUM, GLUCOSE, CHLORINES AND HYDROGEN, ELECTRICAL SENSORS THAT DETECT TEMPERATURE POSITIONS, DISTANCE, HUMIDITY, SOUND, MOTION, ACCELERATION, VOLTAGE AND CURRENT, OPTICAL SENSORS THAT DETECT LIGHT, BODY WEARABLE OR IMPLANTABLE SENSORS THAT DETECT PHYSICAL AND NEUROLOGICAL ACTIVITY; SOC/SIP SENSOR DEVICES THAT DETECT CURRENT, VOLTAGE AND FREQUENCY; NETWORKS THAT ARE WIRELESS CONNECTED TO EACH OTHER AND THAT INTERACT WITH EACH OTHER IN ORDER TO TRANSMIT THE DATA GENERATED BY THE SENSORS, NAMELY, ELECTRONIC DATA RELAYS FOR SENSORS; WIRELESS SENSOR NETWORK PRODUCTS, NAMELY, WIRELESS CONTROLLER TO MONITOR AND CONTROL THE FUNCTIONING OF OTHER ELECTRONIC DEVICES; WIRELESS COMMUNICATION DEVICES, NAMELY, RADIO IDENTIFICATION TAGS AND TWO WAY RADIOS; RECEIVING AND PROCESSING APPARATUS FOR WIRELESS SENSOR NETWORK PRODUCTS, NAMELY, MOBILE COMPUTING AND OPERATING PLATFORMS CONSISTING OF DATA TRANSCIEVERS, WIRELESS NETWORKS AND GATEWAYS FOR THE COLLECTION AND MANAGEMENT OF DATA USED FOR VEHICLE LOCATING, TRACKING AND SECURITY SYSTEMS; SENSOR NODES IN THE NATURE OF COMPUTER TERMINALS, GATEWAY NODES IN THE NATURE OF COMPUTER NETWORK ROUTERS AND DATA PROCESSORS HOSTS IN THE NATURE OF MAINFRAME COMPUTERS FOR WIRELESS SENSOR

NODES; EMBEDDED AND NON-EMBEDDED COMPUTER SOFTWARE FOR USE IN DATA PROCESSING FOR WIRELESS SENSOR NETWORK PRODUCTS, NAMELY, FOR USE WITH INTERFACE DRIVERS AND REAL-TIME OPERATING SYSTEMS; COMPUTER SOFTWARE FOR USE IN DATA PROCESSING AND FOR THE TRANSMISSION OF DATA AND INFORMATION; COMPUTER SOFTWARE FOR THE DEVELOPMENT OF COMMUNICATION DEVICES IN WIRELESS SENSOR NETWORKS, FOR DATABASE INTEGRATION AND FOR USE IN DATABASE MANAGEMENT; COMPUTER SOFTWARE FOR EVALUATING COMMUNICATION DEVICES USED WITH WIRELESS SENSOR NETWORKS THAT ARE WIRELESSLY CONNECTED TO EACH OTHER AND THAT INTERACT WITH EACH OTHER IN ORDER TO TRANSMIT THE DATA GENERATED BY THE SENSORS, IN CLASS 9 (U.S. CLS. 21, 23, 26, 36 AND 38).

FOR: COMPILATION AND MANAGEMENT OF COMPUTERIZED DATABASES IN THE FIELD OF WIRELESS SENSOR NETWORKS; BUSINESS RESEARCH SERVICES, NAMELY, PROVIDING ANALYSIS OF BUSINESS AND OPERATIONAL DATA IN THE FIELD OF WIRELESS NETWORKS THAT INTERACT WITH EACH OTHER IN ORDER TO TRANSMIT DATA GENERATED BY SENSORS; BUSINESS INFORMATION, ADVICE AND CONSULTANCY IN THE FIELDS OF DATA PROCESSING AND DATABASE MANAGEMENT, IN CLASS 35 (U.S. CLS. 100, 101 AND 102).

FOR: CUSTOM DESIGN AND DEVELOPMENT OF CHEMICAL REAGENTS AND BIOCHEMICAL ASSAYS FOR SENSING, MONITORING, RECORDING AND TRANSMITTING SIGNALS AND INFORMATION, NAMELY, BIOSENSORS, CHEMICAL SENSORS, ELECTRICAL SENSORS, OPTICAL SENSORS, BODY WEARABLE OR IMPLANTABLE SENSORS AND SOC/SIP SENSOR DEVICES; RESEARCH SERVICES, NAMELY, RESEARCH OF NEW PRODUCTS FOR OTHERS; CONSULTATION IN THE FIELD OF PRODUCT DEVELOPMENT, NAMELY,

NEW PRODUCTS FOR OTHERS; TECHNICAL SUPPORT SERVICES, NAMELY, TROUBLE SHOOTING OF HARDWARE AND SOFTWARE PROBLEMS FOR WIRELESS NETWORKS SYSTEMS THAT INTERACT WITH EACH OTHER IN ORDER TO TRANSMIT THE DATA GENERATED BY THE SENSORS, IN CLASS 42 (U.S. CLS. 100 AND 101).

THE MARK CONSISTS OF STANDARD CHARACTERS WITHOUT CLAIM TO ANY PARTICULAR FONT, STYLE, SIZE, OR COLOR.

PRIORITY DATE OF 11-7-2005 IS CLAIMED.

OWNER OF INTERNATIONAL REGISTRATION 0907017 DATED 5-3-2006, EXPIRES 5-3-2016.

SER. NO. 79-032,321, FILED 5-3-2006.

CHARISMA HAMPTON, EXAMINING ATTORNEY

Int. Cls.: 35, 36 and 39

Prior U.S. Cls.: 100, 101, 102 and 105

United States Patent and Trademark Office

Reg. No. 3,398,698

Registered Mar. 18, 2008

**SERVICE MARK
PRINCIPAL REGISTER**



EUROPEAN COMMODITY CLEARING AG (FED
REP GERMANY CORPORATION ("AKTIEN-
GESELLSCHAFT"))

NEUMARKT 19-19
04109 LEIPZIG
FED REP GERMANY

FOR: COMPILATION AND SYSTEMATIZATION OF INFORMATION AND DATA INTO COMPUTER DATA BASES; MEDIATION OF TRADING TRANSACTIONS FOR OTHERS; MEDIATION OF CONTRACTS FOR THE PURCHASE AND SALE OF GOODS AND ENERGY; MEDIATION OF SERVICE CONTRACTS FOR THIRD PARTIES; COMPILING STATISTICS; BUSINESS MARKETING; MARKET RESEARCH; MARKET ANALYSIS, NAMELY, CREATION OF BUSINESS EXPERTISES INVESTIGATING MARKET CONDITIONS AND MARKETING OPPORTUNITIES, IN CLASS 35 (U.S. CLS. 100, 101 AND 102).

FOR: FINANCIAL AFFAIRS, NAMELY, ORGANIZATION OF A STOCK EXCHANGE AND OF AN ELECTRONIC STOCK EXCHANGE FOR THE BENEFIT OF THE TRADE OF STOCKS AND OTHER FINANCIAL VALUES; SERVICES OF A BLANK, NAMELY, PROVIDING CLEARING SERVICES FOR COMMODITIES AND COMMODITY DERIVATIVES; SERVICES OF A CLEARING HOUSE, NAMELY, FINANCIAL AND PHYSICAL CLEARING HOUSE SERVICES; SERVICES OF A STOCK AND/OR FINANCIAL BROKER, NAMELY, COMMODITY BROKERAGE, BROKERAGE OF SHARES AND

STOCKS; STOCK EXCHANGE PRICE QUOTATIONS; COMMODITY EXCHANGE SERVICES, NAMELY, ASCERTAINING, CALCULATION AND PUBLICATION OF INDICES IN CONNECTION WITH STOCK EXCHANGE-TRADED SECURITIES AND OPTIONS AND FUTURE CONTRACTS; PROVIDING STOCK/SECURITIES MARKET INFORMATION, NAMELY, PROVIDING INFORMATION SERVICES RELATING TO FINANCE AND THE STOCK EXCHANGE PROVIDED ONLINE FROM COMPUTER DATABASES OR THE INTERNET, IN CLASS 36 (U.S. CLS. 100, 101 AND 102).

FOR: POWER SUPPLY SERVICES, NAMELY, LEASING THE USE OF POWER LINES TO THIRD PARTIES FOR THE TRANSMISSION OF ELECTRICITY; PUBLIC UTILITY SERVICES, NAMELY, DISTRIBUTION OF POWER, ELECTRICITY, GAS, COAL, HEAT AND WATER, IN CLASS 39 (U.S. CLS. 100 AND 105).

PRIORITY DATE OF 4-7-2006 IS CLAIMED.

OWNER OF INTERNATIONAL REGISTRATION
0907548 DATED 9-28-2006, EXPIRES 9-28-2016.

NO CLAIM IS MADE TO THE EXCLUSIVE RIGHT TO USE "EUROPEAN COMMODITY CLEARING", APART FROM THE MARK AS SHOWN.

SER. NO. 79-032,512, FILED 9-28-2006.

CHARISMA HAMPTON, EXAMINING ATTORNEY

Int. Cls.: 9, 11 and 24

Prior U.S. Cls.: 13, 21, 23, 26, 31, 34, 36, 38, 42 and 50

United States Patent and Trademark Office

Reg. No. 3,398,699

Registered Mar. 18, 2008

**TRADEMARK
PRINCIPAL REGISTER**

DE-SCENT

BLÜCHER GMBH (FED REP GERMANY PRIVATE LIMITED COMPANY (LTD.))
METTMANNER STRABE 25
40699 ERKRATH
FED REP GERMANY

FOR: FILTERS FOR RESPIRATORY MASKS AND FILTERS FOR RESPIRATORY PROTECTIVE MASKS; RESPIRATORY MASKS AND RESPIRATORY PROTECTIVE MASKS OTHER THAN FOR ARTIFICIAL RESPIRATION, FOR NON-MEDICAL PURPOSES, IN CLASS 9 (U.S. CLS. 21, 23, 26, 36 AND 38).

FOR: CHEMICALLY ADSORPTIVE AIR FILTERS FOR INDUSTRIAL USE FOR THE ADSORPTION OF ODORS AND NOXIOUS MATTERS, AIR FILTERS FOR INDUSTRIAL INSTALLATIONS FOR THE ADSORPTION OF ODORS AND NOXIOUS MATTERS, CHEMICALLY ADSORPTIVE AIR FILTERS FOR AIR CONDITIONING UNITS FOR INDUSTRIAL USE FOR THE ADSORPTION OF ODORS AND NOXIOUS MATTERS; CHEMICALLY ADSORPTIVE FILTERING INSTALLATIONS IN THE NATURE OF AIR CLEANING UNITS FOR INDUSTRIAL USE FOR THE ADSORPTION OF ODORS AND NOXIOUS MATTERS; CHEMICALLY ADSORPTIVE FILTERING INSTALLATIONS IN THE NATURE OF AIR PURIFICATION UNITS FOR INDUSTRIAL USE FOR THE ADSORPTION OF ODORS AND NOXIOUS MATTERS; CHEMICALLY ADSORPTIVE FILTERING INSTALLATIONS IN THE NATURE OF AIR CONDITIONING UNITS FOR INDUSTRIAL USE FOR THE ADSORP-

TION OF ODORS AND NOXIOUS MATTERS, IN CLASS 11 (U.S. CLS. 13, 21, 23, 31 AND 34).

FOR: TEXTILE MATERIALS, NAMELY, TEXTILE FABRICS FOR THE MANUFACTURE OF CLOTHING AND TEXTILE FABRICS FOR USE IN THE FURTHER MANUFACTURE OF AIR FILTERS FOR THE ADSORPTION OF ODORS AND NOXIOUS MATTERS, WOVEN MATERIALS, NAMELY, WOVEN FABRICS, WOVEN FELTS AND MESH-WOVEN FABRICS FOR USE IN THE MANUFACTURE OF CLOTHING; WOVEN MATERIALS, NAMELY, WOVEN FABRICS, WOVEN FELTS AND MESH-WOVEN FABRICS FOR USE IN THE FURTHER MANUFACTURE OF AIR FILTERS FOR THE ADSORPTION OF ODORS AND NOXIOUS MATTERS, IN CLASS 24 (U.S. CLS. 42 AND 50).

THE MARK CONSISTS OF STANDARD CHARACTERS WITHOUT CLAIM TO ANY PARTICULAR FONT, STYLE, SIZE, OR COLOR.

PRIORITY DATE OF 5-19-2006 IS CLAIMED.

OWNER OF INTERNATIONAL REGISTRATION 0907577 DATED 11-13-2006, EXPIRES 11-13-2016.

SER. NO. 79-032,532, FILED 11-13-2006.

JAMES MACFARLANE, EXAMINING ATTORNEY

Int. Cl.: 10

Prior U.S. Cls.: 26, 39 and 44

United States Patent and Trademark Office

Reg. No. 3,398,700

Registered Mar. 18, 2008

**TRADEMARK
PRINCIPAL REGISTER**

EXPLORENT

GYRUS MEDICAL GMBH (FED REP GERMANY
CORPORATION)
GOTENSTRASSE 3
78532 TUTTLINGEN, BADEN-WÜRTTEMBERG
FED REP GERMANY

PRIORITY DATE OF 9-1-2006 IS CLAIMED.

FOR: SURGICAL AND MEDICAL APPARATUS
AND INSTRUMENTS USED IN THE EXAMINA-
TION, TREATMENT AND SURGERY OF THE EAR,
NOSE AND THROAT, AND PARTS AND FITTINGS
THEREFOR, IN CLASS 10 (U.S. CLS. 26, 39 AND 44).

OWNER OF INTERNATIONAL REGISTRATION
0907969 DATED 11-28-2006, EXPIRES 11-28-2016.

SER. NO. 79-032,673, FILED 11-28-2006.

THE MARK CONSISTS OF STANDARD CHAR-
ACTERS WITHOUT CLAIM TO ANY PARTICULAR
FONT, STYLE, SIZE, OR COLOR.

CHERYL CLAYTON, EXAMINING ATTORNEY

Int. Cls.: 9, 35, 38 and 42

Prior U.S. Cls.: 21, 23, 26, 36, 38, 100, 101, 102 and 104

United States Patent and Trademark Office

Reg. No. 3,398,701

Registered Mar. 18, 2008

**TRADEMARK
SERVICE MARK
PRINCIPAL REGISTER**

METNEXT

METEO FRANCE (FRANCE (ETS PUBLIC ADMINISTRATIF SOUS LA TUTELLE DU MINISTÈRECHARGÉ DES TRANSPORTS))

1 QUAI BRANLY
F-75340 PARIS CEDEX 07
FRANCE

FOR: COMPUTER SOFTWARE FOR USE IN METEOROLOGY, NAMELY COMPUTER SOFTWARE FOR TRACKING AND FORECASTING WEATHER AND STORM PATTERNS, AND FOR COLLECTING AND ANALYZING METEOROLOGICAL DATA; DATA PROCESSORS, IN CLASS 9 (U.S. CLS. 21, 23, 26, 36 AND 38).

FOR: MANAGEMENT OF COMPUTERIZED FILES; DISSEMINATION OF ADVERTISEMENTS, IN CLASS 35 (U.S. CLS. 100, 101 AND 102).

FOR: COMMUNICATIONS BY COMPUTER TERMINALS; TELEPHONE COMMUNICATION SERVICES, COMPUTER AIDED TRANSMISSION OF INFORMATION AND IMAGES IN THE NAT-

URE OF MESSAGES AND METEOROLOGICAL MAPS, IN CLASS 38 (U.S. CLS. 100, 101 AND 104).

FOR: ENGINEERING SERVICES; COMPUTER PROGRAMMING IN CONNECTION WITH METEOROLOGY AND METEOROLOGICAL DATA, METEOROLOGICAL INFORMATION PROVIDED TO USERS, IN CLASS 42 (U.S. CLS. 100 AND 101).

THE MARK CONSISTS OF STANDARD CHARACTERS WITHOUT CLAIM TO ANY PARTICULAR FONT, STYLE, SIZE, OR COLOR.

PRIORITY DATE OF 6-1-2006 IS CLAIMED.

OWNER OF INTERNATIONAL REGISTRATION 0908066 DATED 11-10-2006, EXPIRES 11-10-2016.

SER. NO. 79-032,708, FILED 11-10-2006.

JAMES MACFARLANE, EXAMINING ATTORNEY

Int. Cl.: 9

Prior U.S. Cls.: 21, 23, 26, 36 and 38

Reg. No. 3,398,702

United States Patent and Trademark Office

Registered Mar. 18, 2008

**TRADEMARK
PRINCIPAL REGISTER**



CHEN JIAN QING (CHINA INDIVIDUAL)
ROOM 304, NO.7 BUILDING,
TONG XIN LING XIN CUN; SHENZHEN
CHINA

FOR: EARPHONES FOR MOBILE TELEPHONES;
EARPHONES; ELECTRICAL PICKUPS FOR USE
WITH MUSICAL INSTRUMENTS; ELECTRONIC
SOUND PICKUP FOR GUITARS AND BASSES;
PICKUPS; ACOUSTIC CONDUITS; ACOUSTIC
MEMBRANES; ACOUSTIC COUPLING DEVICES;
BLANK AUDIO CASSETTES; BLANK CD-ROMS
FOR SOUND RECORDING; BLANK DIGITAL
AUDIO TAPES; BLANK RECORD DISKS; BLANK
RECORDABLE DVDS; BLANK RECORDABLE OP-
TICAL DISC; MEDIA PLAYERS; APPARATUS FOR

TRANSMITTING SOUND; ACOUSTIC COUPLERS;
ELECTRO-DYNAMIC APPARATUS FOR THE RE-
MOTE CONTROL OF DIGITAL SIGNALS; TELE-
PHONE TRANSMITTERS; PERSONAL STEREOS, IN
CLASS 9 (U.S. CLS. 21, 23, 26, 36 AND 38).

OWNER OF INTERNATIONAL REGISTRATION
0908233 DATED 11-28-2006, EXPIRES 11-28-2016.

THE MARK CONSISTS OF ENGLISH WORDS "I"
"D" "N" "A".

SER. NO. 79-032,772, FILED 11-28-2006.

ANDREA BUTLER, EXAMINING ATTORNEY

Int. Cls.: 3, 14, 18, 25 and 26

Prior U.S. Cls.: 1, 2, 3, 4, 6, 22, 27, 28, 37, 39, 40, 41, 42, 50, 51 and 52

Reg. No. 3,398,703

United States Patent and Trademark Office Registered Mar. 18, 2008

**TRADEMARK
PRINCIPAL REGISTER**

A.D.A.D.DITIONAL.JAPAN

MACK DADDY CO., LTD. (JAPAN LIMITED-LIABILITY COMPANY)
HARAJUKU OHKI BLDG,
2-19-12 JINGUMAE,; SHIBUYA-KU; TOKYO 150-0001
JAPAN

FOR: DE-GREASING PREPARATIONS FOR HOUSEHOLD PURPOSES; RUST REMOVING PREPARATIONS; STAIN REMOVING BENZINE; FABRIC SOFTENERS FOR LAUNDRY USE; LAUNDRY BLEACH; ADHESIVES FOR AFFIXING FALSE HAIR; ADHESIVES FOR AFFIXING FALSE EYELASHES; LAUNDRY STARCH; PAINT STRIPPING PREPARATIONS; SHOE AND BOOT CREAM; POLISHING PREPARATIONS; SOAPS AND DETERGENTS; DENTIFRICES; ABRASIVE CLOTH; ABRASIVE SAND; ARTIFICIAL PUMICE STONE; POLISHING PAPER; POLISHING CLOTH; FALSE NAILS; FALSE EYELASHES, IN CLASS 3 (U.S. CLS. 1, 4, 6, 50, 51 AND 52).

FOR: PRECIOUS METALS; NUTCRACKERS, PEPPER POTS, SUGAR BOWLS, SALT SHAKERS, EGG CUPS, NAPKIN HOLDERS, NAPKIN RINGS, TOOTHPICK HOLDERS OF PRECIOUS METAL; BOXES OF PRECIOUS METAL FOR NEEDLES; CANDLE EXTINGUISHERS AND CANDLESTICKS OF PRECIOUS METAL; FLOWER VASES AND BOWLS OF PRECIOUS METAL; COMMEMORATIVE SHIELDS; PERSONAL ORNAMENTS, NAMELY, RINGS, NECKLACES, BRACELETS, ANKLETS, PIERCED EARRINGS; PURSES AND WALLETS OF PRECIOUS METAL; UNWROUGHT AND SEMI-WROUGHT PRECIOUS STONES AND THEIR IMITATIONS; POWDER COMPACTS OF PRECIOUS METAL; SHOE ORNAMENTS OF PRECIOUS METAL; CLOCKS AND WATCHES, IN CLASS 14 (U.S. CLS. 2, 27, 28 AND 50).

FOR: HANDBAG FRAMES; PURSE FRAMES; INDUSTRIAL PACKAGING CONTAINERS OF LEATHER; CLOTHING FOR DOMESTIC PETS; BAGS, NAMELY, HANDBAGS, TOTE BAGS, CLUTCH BAGS AND BOSTON BAGS; POUCHES OF CLOTH, NAMELY, LEATHER AND FELT POUCHES; UMBRELLAS AND THEIR PARTS; WALKING STICKS; CANES; METAL PARTS OF CANES AND WALK-

ING-STICKS; HANDLES OF CANES AND WALKING-STICKS; SADDLERY; LEATHER, UNWORKED OR SEMI-WORKED, IN CLASS 18 (U.S. CLS. 1, 2, 3, 22 AND 41).

FOR: CLOTHING, NAMELY, SHIRTS, DRESSES, SKIRTS, PANTS, COATS, JACKETS, AND PARKAS; SOCK SUSPENDERS; WAISTBANDS; BELTS FOR CLOTHING; FOOTWEAR; MASQUERADE COSTUMES, IN CLASS 25 (U.S. CLS. 22 AND 39).

FOR: SHUTTLES FOR MAKING FISHING NETS; HOSIERY LOOM NEEDLES; NEEDLES; EYELETS FOR CLOTHING; RIBBONS; KNITTED RASCHEL LACE FABRICS; EMBROIDERY LACE FABRICS; TUFTS AND TASSELS, SEMI-FINISHED; BRAIDS; KNITTING NEEDLES; SEWING BOXES; SEWING THIMBLES; PIN AND NEEDLE CUSHIONS; NEEDLE CASES, NOT OF PRECIOUS METAL; INSIGNIAS FOR WEAR, NOT OF PRECIOUS METAL; BROOCHES FOR CLOTHING; BONNET PINS, NOT OF PRECIOUS METAL; HEAT ADHESIVE STICKERS FOR DECORATION OF TEXTILE ARTICLES; BRASSARDS; HAIR ORNAMENTS; BUTTONS FOR CLOTHING OR SHIRTS; ARTIFICIAL FLOWERS; FALSE BEARDS; FALSE MOUSTACHES; HAIR CURLERS, NON-ELECTRIC; SHOE ORNAMENTS, NOT OF PRECIOUS METAL; SHOE EYELETS; SHOE LACES; METAL FASTENERS FOR SHOES AND BOOTS, IN CLASS 26 (U.S. CLS. 37, 39, 40, 42 AND 50).

THE MARK CONSISTS OF STANDARD CHARACTERS WITHOUT CLAIM TO ANY PARTICULAR FONT, STYLE, SIZE, OR COLOR.

PRIORITY DATE OF 2-20-2006 IS CLAIMED.

OWNER OF INTERNATIONAL REGISTRATION 0908331 DATED 7-5-2006, EXPIRES 7-5-2016.

NO CLAIM IS MADE TO THE EXCLUSIVE RIGHT TO USE "JAPAN", APART FROM THE MARK AS SHOWN.

SER. NO. 79-032,826, FILED 7-5-2006.

NAKIA HENRY, EXAMINING ATTORNEY

Int. Cl.: 1

Prior U.S. Cls.: 1, 5, 6, 10, 26 and 46

United States Patent and Trademark Office

Reg. No. 3,398,704

Registered Mar. 18, 2008

TRADEMARK
PRINCIPAL REGISTER

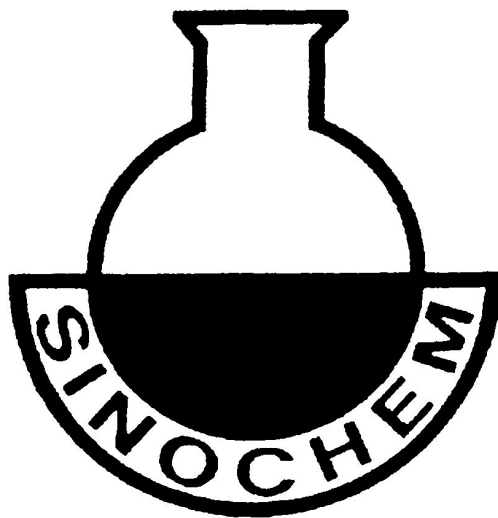

SINOCEM CORPORATION (CHINA CORPORATION)
SINOCEM TOWER
A2 FUXINGMENWAI DAJIE; BEIJING
CHINA

FOR: REFRIGERANTS, NAMELY, REFRIGERANTS FOR COMPRESSOR OF AIR CONDITIONERS AND MEDICAL EQUIPMENT; CHEMICALS FOR INDUSTRIAL PURPOSES; ACIDS, NAMELY, PHOSPHORIC ACID; ALKALIES; BASES FOR CHEMICAL PREPARATIONS, NAMELY, WATER SOLUBLE BASES FOR USE IN CHEMICAL PREPARATIONS; SALTS FROM EARTH METALS FOR CHEMICAL PREPARATIONS; CITRIC ACID FOR INDUSTRIAL PURPOSES; BENZENE DERIVATIVES FOR USE AS PRESERVATIVES IN CHEMICAL PREPARATIONS; PROPYL ALCOHOL; FURFURAL RESIDUE FROM CORN COBS, NAMELY, CELLULOSE BYPRODUCTS DERIVED FROM THE MANUFACTURE OF FURFURAL AND USED IN THE MANUFACTURE OF PLYWOOD; METHYL ESTERS, NAMELY, PHENYLACETATE, ETHYL ESTER, PROPYL ESTER, VINYL ACETATE, ACRYLIC ESTER, OXALATE, SEBACATE, LACTATE, TARTRATE,

CITRATE; GLUCONATE, DIMETHYL PHOSPHITE, DIETHYLPHOSPHITE, TRIMETHYL PHOSPHITE, TRIETHYL PHOSPHATE, NON-METALLIC INORGANIC ACID ESTER, LYSINE ESTER, AMINO ACID, PHOSPHO-AMINOLIPID, MEPROBAMATE, THIOCARBAMATE; SURFACE-ACTIVE CHEMICAL AGENTS FOR SCIENTIFIC AND CHEMICAL PREPARATIONS; KETONES; ANILINE; CAPROLACTAM FOR USE IN SCIENTIFIC AND CHEMICAL PREPARATIONS, IN CLASS 1 (U.S. CLS. 1, 5, 6, 10, 26 AND 46).

PRIORITY DATE OF 7-12-2006 IS CLAIMED.

OWNER OF INTERNATIONAL REGISTRATION
0908486 DATED 12-11-2006, EXPIRES 12-11-2016.

OWNER OF U.S. REG. NO. 3,120,986.

SER. NO. 79-032,883, FILED 12-11-2006.

KAPIL BHANOT, EXAMINING ATTORNEY

Int. Cls.: 3, 5, 35 and 44

Prior U.S. Cls.: 1, 4, 6, 18, 44, 46, 50, 51, 52, 100, 101 and 102

Reg. No. 3,398,705

United States Patent and Trademark Office

Registered Mar. 18, 2008

**TRADEMARK
SERVICE MARK
PRINCIPAL REGISTER**



INSTANT HAIR REMOVAL CLINIC PTY LTD;
ACN 095 241 884 (AUSTRALIA COMPANY)
LEVEL 6, SUITE 607
1 PRINCESS STREET; KEW VIC
AUSTRALIA

NAMELY, SERVICES PROVIDED WITH LASERS
FOR PROVIDING LASER THERAPY FOR TREAT-
ING MEDICAL CONDITIONS, IN CLASS 44 (U.S.
CLS. 100 AND 101).

PRIORITY DATE OF 1-16-2006 IS CLAIMED.

OWNER OF INTERNATIONAL REGISTRATION
0908489 DATED 7-5-2006, EXPIRES 7-5-2016.

FOR: SOAPS, NAMELY, BATH SOAPS IN LIQUID,
SOLID OR GEL FORM, BODY CREAM SOAP,
COSMETIC SOAPS, PERFUMED SOAPS, SOAPS
FOR BODY CARE, HAND SOAPS; PERFUMERY;
ESSENTIAL OILS; COSMETICS; NON-MEDICATED
SKIN CARE PREPARATIONS, IN CLASS 3 (U.S. CLS.
1, 4, 6, 50, 51 AND 52).

NO CLAIM IS MADE TO THE EXCLUSIVE
RIGHT TO USE "COSMETIC" AND "COM.AU",
APART FROM THE MARK AS SHOWN.

FOR: MEDICATED SKIN CARE, MEDICATED
COSMETIC PREPARATIONS, NAMELY, PHARMA-
CEUTICAL PREPARATIONS FOR TREATING SKIN
DISORDERS, PHARMACEUTICAL SKIN LOTIONS;
ANTIMICROBIAL PRESERVATIVES FOR COSMET-
ICS, IN CLASS 5 (U.S. CLS. 6, 18, 44, 46, 51 AND 52).

THE COLOR(S) DARK BLUE, LIGHT BLUE, AND
WHITE IS/ARE CLAIMED AS A FEATURE OF THE
MARK.

FOR: ADVERTISING, BUSINESS MANAGE-
MENT; BUSINESS ADMINISTRATION; PROVID-
ING OFFICE FUNCTIONS, IN CLASS 35 (U.S. CLS.
100, 101 AND 102).

THE COLORS DARK BLUE REPRESENTS
THREE OF THE POLYGONS AND THE WORDING
"COSMETIC CHOICE", THE COLOR LIGHT BLUE
REPRESENTS TWO OF THE POLYGONS, WHICH
ARE SITUATED BETWEEN THE DARK BLUE
POLYGONS, THE COLOR LIGHT BLUE IS SHADED
ABOVE THE ENTIRE DESIGN AND WHITE FILLS
IN THE LOWER HALF OF THE MARK.

FOR: MEDICAL SERVICES; SURGICAL SERVI-
CES, NAMELY, COSMETIC AND PLASTIC SUR-
GERY; HYGIENIC AND BEAUTY CARE FOR
HUMAN BEINGS, NAMELY, PROVIDING INFOR-
MATION ABOUT HYGIENE AND BEAUTY CARE;
HAIR REMOVAL SERVICES, NAMELY, ELECTRO-
LYSIS AND LASER HAIR REMOVAL; HYGIENIC
AND BEAUTY SERVICES FOR THE CARE AND
TREATMENT OF THE SKIN AND SKIN CARE,

SER. NO. 79-032,885, FILED 7-5-2006.

NAKIA HENRY, EXAMINING ATTORNEY

Int. Cls.: 6, 11 and 17

**Prior U.S. Cls.: 1, 2, 5, 12, 13, 14, 21, 23, 25, 31, 34, 35
and 50**

Reg. No. 3,398,706

United States Patent and Trademark Office

Registered Mar. 18, 2008

**TRADEMARK
PRINCIPAL REGISTER**



ALANOD; ALUMINIUM-VEREDLUNG GMBH &
CO. KG (FED REP GERMANY LIMITED
PARTNERSHIP)
EGERSTRASSE 12
58256 ENNEPETAL, FED REP GERMANY

FOR: TAPES, STRIPS, BLANKS AND SHEETS OF
METAL, ALL HAVING A COATING FOR ABSORB-
ING LIGHT AND THERMAL RADIATION, FOR
USE IN FURTHER MANUFACTURE, IN CLASS 6
(U.S. CLS. 2, 12, 13, 14, 23, 25 AND 50).

FOR: THERMAL SOLAR COLLECTORS, IN
CLASS 11 (U.S. CLS. 13, 21, 23, 31 AND 34).

FOR: NON-METAL TAPES, STRIPS AND
BLANKS, ALL HAVING A METALLIC COATING
FOR ABSORBING LIGHT AND THERMAL RADIA-

TION, FOR USE IN FURTHER MANUFACTURE, IN
CLASS 17 (U.S. CLS. 1, 5, 12, 13, 35 AND 50).

PRIORITY DATE OF 5-15-2006 IS CLAIMED.

OWNER OF INTERNATIONAL REGISTRATION
0908549 DATED 11-14-2006, EXPIRES 11-14-2016.

OWNER OF U.S. REG. NOS. 2,162,287, 2,814,480,
AND 3,087,911.

SER. NO. 79-032,910, FILED 11-14-2006.

HOWARD FRIEDMAN, EXAMINING ATTORNEY

Int. Cl.: 25

Prior U.S. Cls.: 22 and 39

United States Patent and Trademark Office

Reg. No. 3,398,707

Registered Mar. 18, 2008

TRADEMARK
PRINCIPAL REGISTER

Natural • Nine

WUXI NATURAL TEXTILE INDUSTRIAL; COM-
PANY LTD. (CHINA CORPORATION)
NO. 8, TIANSHAN ROAD,
GUOJIA GAOXIN JISHU CHANYE; KAIFAQU OF
WUXI; JIANGSU
CHINA

FOR: CLOTHING, NAMELY, SUITS, OVER-
COATS, JACKETS, SHIRTS, T-SHIRTS, TROUSERS,
SKIRTS, DOWN JACKETS, SWEATERS, UNDER-
WEAR, SHOES; LAYETTES; HOSIERY; GLOVES
(CLOTHING); NECKTIES; SCARVES; MANTILLAS;
VEILS (CLOTHING); HATS AND CAPS; CLOTHING

FOR GYMNASTICS, NAMELY, GYMNASTICS
SHOES, SHORTS, JACKETS, VESTS, IN CLASS 25
(U.S. CLS. 22 AND 39).

OWNER OF INTERNATIONAL REGISTRATION
0908703 DATED 12-11-2006, EXPIRES 12-11-2016.

SER. NO. 79-032,964, FILED 12-11-2006.

KIMBERLY FRYE, EXAMINING ATTORNEY

Int. Cl.: 25

Prior U.S. Cls.: 22 and 39

United States Patent and Trademark Office

Reg. No. 3,398,708

Registered Mar. 18, 2008

**TRADEMARK
PRINCIPAL REGISTER**

Nature • Nine

WUXI NATURAL TEXTILE INDUSTRIAL; COMPANY LTD. (CHINA CORPORATION)
NO. 8, TIANSHAN ROAD,
GUOJIA GAOXIN JISHU CHANYE; KAIFANG OF
WUXI; JIANGSU
CHINA

FOR: CLOTHING, NAMELY, SUITS, OVER-
COATS, JACKETS, SHIRTS, T-SHIRTS, TROUSERS,
SKIRTS, DOWN JACKETS, SWEATERS, UNDER-
WEAR, SHOES; LAYETTES; HOSIERY; GLOVES
(CLOTHING); NECKTIES; SCARVES; MANTILLAS;
VEILS (CLOTHING); HATS AND CAPS; CLOTHING

FOR GYMNASTICS, NAMELY, GYMNASTICS
SHOES, SHORTS, JACKETS, VESTS, IN CLASS 25
(U.S. CLS. 22 AND 39).

OWNER OF INTERNATIONAL REGISTRATION
0908704 DATED 12-11-2006, EXPIRES 12-11-2016.

SER. NO. 79-032,965, FILED 12-11-2006.

KIMBERLY FRYE, EXAMINING ATTORNEY

Int. Cls.: 9, 38 and 45

Prior U.S. Cls.: 21, 23, 26, 36, 38, 100, 101 and 104

Reg. No. 3,398,709

United States Patent and Trademark Office

Registered Mar. 18, 2008

**TRADEMARK
SERVICE MARK
PRINCIPAL REGISTER**

BLIGHTER

PLEXTEK LIMITED (UNITED KINGDOM LIMITED CORPORATION)
LONDON ROAD
GREAT CHESTERFORD, ESSEX CB10 1NY
UNITED KINGDOM

FOR: ELECTRICAL AND ELECTRONIC EQUIPMENT FOR TRANSMITTING AND RECEIVING SIGNALS, NAMELY, RADIO FREQUENCY TRANSMITTERS, BATTERY-OPERATED RADIO TRANSMITTERS, WAVEFORM GENERATORS, ANTENNAS; ELECTRONIC SCAN ANTENNAS; MECHANICALLY ROTATED ANTENNAS; RADAR APPARATUS; GROUND RADAR APPARATUS; RADAR APPARATUS FOR NAUTICAL, MARITIME AND AVIONIC USE; RADAR APPARATUS FOR IDENTIFYING AND TRACKING TARGETS, SIGNAL TRANSMISSION OR SIGNAL PROCESSING, PARTICULARLY BATTERY-POWERED RADAR APPARATUS; RADAR APPARATUS FOR USE IN SURVEILLANCE SYSTEMS; RADAR APPARATUS FOR USE IN BORDER, PERIMETER, AREA, PIPELINE AND ASSET SURVEILLANCE SYSTEMS; COMPUTER PROGRAMS FOR ORGANIZING, MODIFYING AND SHARING DATA AND INFORMATION; COMPUTER PROGRAMS FOR MAPPING AND AUTOMATIC SURVEILLANCE CAMERA CONTROL; COMPUTER HARDWARE AND COMPUTER PROGRAMS FOR USE IN POSITION-FIXING, TARGET-LOCATING, TARGET-IDENTIFYING, SIGNAL TRANSMISSION OR SIGNAL PROCESSING; IMAGE GATHERING APPARATUS, NAMELY, THERMAL IMAGING DEVICES AND IMAGE INTENSIFIERS FOR USE IN SURVEILLANCE SYSTEMS; VIDEO CAMERAS; IMAGE PROCESSING APPARATUS AND COMPUTER PROGRAMS FOR CONTROLLING, RECORDING, STORAGE, TRANSMISSION, RETRIEVAL, PROCESSING, DISPLAY AND ANALYSIS OF DATA IN GRAPHIC AND/OR DIGITAL FORMAT; VISUAL

DISPLAY UNITS, NAMELY, FLAT PANEL DISPLAY SCREENS AND COMPUTER MONITORS; PARTS AND FITTINGS FOR ALL THE AFORESAID GOODS, IN CLASS 9 (U.S. CLS. 21, 23, 26, 36 AND 38).

FOR: DATA TRANSMISSION, NAMELY, DATA TRANSMISSION AND RECEPTION SERVICES VIA TELECOMMUNICATION MEANS; REMOTE TRANSMISSION OF DATA BY MEANS OF COMMUNICATIONS APPARATUS, NAMELY, REMOTE ELECTRONIC, ELECTRIC AND DIGITAL TRANSMISSION OF VOICE, DATA, IMAGES, SIGNALS AND MESSAGES, IN CLASS 38 (U.S. CLS. 100, 101 AND 104).

FOR: SERVICES FOR TRACKING, LOCATING AND MONITORING OF ASSETS AND PEOPLE, NAMELY, ELECTRONIC MONITORING SERVICES FOR SECURITY PURPOSES OF ASSETS AND PEOPLE; SERVICES FOR TRACKING, LOCATING AND MONITORING OF GROUND VEHICLES, NAUTICAL AND MARITIME VESSELS, NAMELY, ELECTRONIC MONITORING SERVICES FOR SECURITY PURPOSES OF GROUND VEHICLES, NAUTICAL AND MARITIME VESSELS, ALL OF THE AFORESAID SERVICES PROVIDED VIA A COMMUNICATIONS NETWORK, IN CLASS 45 (U.S. CLS. 100 AND 101).

PRIORITY DATE OF 9-30-2005 IS CLAIMED.

OWNER OF INTERNATIONAL REGISTRATION 0908863 DATED 3-30-2006, EXPIRES 3-30-2016.

SER. NO. 79-033,033, FILED 3-30-2006.

DAYNA BROWNE, EXAMINING ATTORNEY

Int. Cl.: 1

Prior U.S. Cls.: 1, 5, 6, 10, 26 and 46

Reg. No. 3,398,710

United States Patent and Trademark Office

Registered Mar. 18, 2008

**TRADEMARK
PRINCIPAL REGISTER**

SINOCHEM

SINOCHEM CORPORATION (CHINA CORPORATION)
SINOCHEM TOWER,
A2 FUXINGMENWAI DAJIE; BEIJING
CHINA

FOR: REFRIGERANTS, NAMELY, REFRIGERANTS FOR COMPRESSOR OF AIR CONDITIONERS AND MEDICAL EQUIPMENT; CHEMICALS FOR INDUSTRIAL PURPOSES; ACIDS, NAMELY, PHOSPHORIC ACID; ALKALIES; BASES FOR CHEMICAL PREPARATIONS, NAMELY, WATER SOLUBLE BASES FOR USE IN CHEMICAL PREPARATIONS; SALTS FROM EARTH METALS FOR CHEMICAL PREPARATIONS; CITRIC ACID FOR INDUSTRIAL PURPOSES; BENZENE DERIVATIVES FOR USE AS PRESERVATIVES IN CHEMICAL PREPARATIONS; PROPYL ALCOHOL; FURFURAL RESIDUE FROM CORN COBS, NAMELY, CELLULOSE BYPRODUCTS DERIVED FROM THE MANUFACTURE OF FURFURAL AND USED IN THE MANUFACTURE OF PLYWOOD; METHYL ESTERS, NAMELY, PHENYLACETATE, ETHYLESTER, PROPYL ESTER, VINYL ACETATE, ACRYLIC ESTER, OXALATE, SEBACATE, LACTATE, TARTRATE,

CITRATE; GLUCONATE, DIMETHYL PHOSPHITE, DIETHYLPHOSPHITE, TRIMETHYL PHOSPHITE, TRIETHYL PHOSPHATE, NON-METALLIC INORGANIC ACID ESTER, LYSINE ESTER, AMINO ACID, PHOSPHO-AMINOLIPID, MEPROBAMATE, THIOCARBAMATE; SURFACE-ACTIVE CHEMICAL AGENTS FOR SCIENTIFIC AND CHEMICAL PREPARATIONS; KETONES; ANILINE; CAPROLACTAM FOR USE IN SCIENTIFIC AND CHEMICAL PREPARATIONS, IN CLASS 1 (U.S. CLS. 1, 5, 6, 10, 26 AND 46).

PRIORITY DATE OF 7-12-2006 IS CLAIMED.

OWNER OF INTERNATIONAL REGISTRATION
0909174 DATED 12-11-2006, EXPIRES 12-11-2016.

OWNER OF U.S. REG. NO. 3,120,986.

SER. NO. 79-033,162, FILED 12-11-2006.

KAPIL BHANOT, EXAMINING ATTORNEY

Int. Cls.: 9, 35, 36, 38, 42 and 45

Prior U.S. Cls.: 21, 23, 26, 36, 38, 100, 101, 102 and 104

United States Patent and Trademark Office

Reg. No. 3,398,711

Registered Mar. 18, 2008

**TRADEMARK
SERVICE MARK
PRINCIPAL REGISTER**



WISEKEY SA (SWITZERLAND CORPORATION)
29 ROUTE DE PRÉ-BOIS
CP 885; CH-1215 GENÈVE
SWITZERLAND

FOR: DATA PROCESSORS AND COMPUTER EQUIPMENT, NAMELY, COMPUTER HARDWARE AND COMPUTER PERIPHERALS, IN CLASS 9 (U.S. CLS. 21, 23, 26, 36 AND 38).

FOR: ADVERTISING SERVICES, NAMELY, CREATION OF ADVERTISING CONCEPTS FOR OTHERS, PUBLICATION OF PUBLICITY TEXTS FOR OTHERS, PLACEMENT OF ADVERTISING FOR OTHERS IN THE NATURE OF ADVERTISING TEXTS AND PRESS RELEASES, DEVELOPMENT AND DISSEMINATION OF ADVERTISING MATERIAL FOR OTHERS, PUBLIC RELATIONS SERVICES RELATING TO PRESS AGENCIES, BUSINESS MANAGEMENT, NAMELY, ASSISTANCE TO OTHERS IN THE MANAGEMENT OF BUSINESS IN THE FIELDS OF DIGITAL CERTIFICATION AND SECURITY RELATED TECHNOLOGY, IN CLASS 35 (U.S. CLS. 100, 101 AND 102).

FOR: FINANCIAL AFFAIRS, NAMELY, ELECTRONIC FUNDS TRANSFER, CHARITABLE FUND RAISING FOR CREATING INFORMATION SECURITY INFRASTRUCTURES FOR NEEDY ORGANIZATIONS, IN CLASS 36 (U.S. CLS. 100, 101 AND 102).

FOR: PROVIDING TELECOMMUNICATION CONNECTIONS TO A GLOBAL COMPUTER NETWORK, IN CLASS 38 (U.S. CLS. 100, 101 AND 104).

FOR: SCIENTIFIC AND INDUSTRIAL RESEARCH, NAMELY, RESEARCH IN THE FIELD OF CERTIFICATION TECHNOLOGY AND RESEARCH FOR THE PURPOSE OF SECURING ELECTRONIC TRANSACTIONS, DEVELOPING SECURITY STANDARDS AND DEVELOPING INTEROPERABILITY BETWEEN SECURE COMMUNICATION PRODUCTS AND SERVICE PROVIDERS; COMPUTER PROGRAMMING SERVICES FOR OTHERS, PROFESSIONAL SERVICES FOR ENSURING THE SECURITY OF TRANSACTIONS THROUGH THE INTERNET, NAMELY, COMPUTER SOFTWARE DESIGN FOR OTHERS, AND COMPUTER CONSULTATION FOR OTHERS FOCUSING ON THE ISSUANCE AND MANAGEMENT OF DIGITAL CERTIFICATES AND ON THE SECURING OF ELECTRONIC TRANSACTIONS, AND PROVIDING COMPUTER INFORMATION SERVICES RELATING TO DIGITAL CERTIFICATES AND PUBLIC KEY INFRASTRUCTURES; COMPUTER SECURITY SERVICES, NAMELY, MONITORING SECURE ACCESS TO COMPUTER NETWORKS FOR BUSINESSES; DEVELOPMENT FOR OTHERS OF SECURITY-RELATED HARDWARE AND SOFTWARE; DESIGN FOR OTHERS OF COMPUTER INFORMATION SECURITY INFRASTRUCTURES; LEGAL SERVICES IN THE NATURE OF DRAFTING LIABILITY INSURANCE POLICY CONTRACTS, IN CLASS 42 (U.S. CLS. 100 AND 101).

FOR: CONSULTANCY SERVICES IN THE FIELD OF MAINTAINING THE SECURITY AND INTEGRITY OF DATABASES AND PREVENTING DATA AND IDENTITY THEFT; SECURITY SERVICES

FOR THE PROTECTION OF PROPERTY AND INDIVIDUALS; PROVIDING ACCESS TO PROPERTIES VIA A REMOTE LOCKING DEVICE; ANTI-INTRUSION ALARM SURVEILLANCE; MONITORING OF COMPUTER SYSTEMS FOR SECURITY PURPOSES, MONITORING SECURITY SYSTEMS, IN CLASS 45 (U.S. CLS. 100 AND 101).

OWNER OF INTERNATIONAL REGISTRATION 0910334 DATED 11-24-2006, EXPIRES 11-24-2016.

NO CLAIM IS MADE TO THE EXCLUSIVE RIGHT TO USE "CERTIFY ID", APART FROM THE MARK AS SHOWN.

SER. NO. 79-033,564, FILED 11-24-2006.

REBECCA POVARCHUK, EXAMINING ATTORNEY

Int. Cl.: 1

Prior U.S. Cls.: 1, 5, 6, 10, 26 and 46

United States Patent and Trademark Office

Reg. No. 3,398,712

Registered Mar. 18, 2008

**TRADEMARK
PRINCIPAL REGISTER**

DAIRYGOX

DANISCO A/S (DENMARK CORPORATION)
LANGEBROGADE 1
P.O. BOX 17
DK-1001 COPENHAGEN K, DENMARK

PRIORITY DATE OF 6-12-2006 IS CLAIMED.

FOR: ENZYMES FOR USE IN THE FOOD INDUSTRY, IN CLASS 1 (U.S. CLS. 1, 5, 6, 10, 26 AND 46).

OWNER OF INTERNATIONAL REGISTRATION
0910758 DATED 12-9-2006, EXPIRES 12-9-2016.

THE MARK CONSISTS OF STANDARD CHARACTERS WITHOUT CLAIM TO ANY PARTICULAR FONT, STYLE, SIZE, OR COLOR.

SER. NO. 79-033,610, FILED 12-9-2006.

ALYSSA PALADINO, EXAMINING ATTORNEY

Int. Cl.: 1

Prior U.S. Cls.: 1, 5, 6, 10, 26 and 46

United States Patent and Trademark Office

Reg. No. 3,398,713

Registered Mar. 18, 2008

**TRADEMARK
PRINCIPAL REGISTER**

DAIRYCAT

DANISCO A/S (DENMARK CORPORATION)
LANGEBROGADE 1
P.O. BOX 17
DK-1001 COPENHAGEN K, DENMARK

FOR: ENZYMES FOR USE IN FOOD INDUSTRY,
IN CLASS 1 (U.S. CLS. 1, 5, 6, 10, 26 AND 46).

THE MARK CONSISTS OF STANDARD CHAR-
ACTERS WITHOUT CLAIM TO ANY PARTICULAR
FONT, STYLE, SIZE, OR COLOR.

PRIORITY DATE OF 6-14-2006 IS CLAIMED.

OWNER OF INTERNATIONAL REGISTRATION
0910755 DATED 12-8-2006, EXPIRES 12-8-2016.

SER. NO. 79-033,626, FILED 12-8-2006.

ALYSSA PALADINO, EXAMINING ATTORNEY

Int. Cls.: 25, 30 and 43

Prior U.S. Cls.: 22, 39, 46, 100 and 101

United States Patent and Trademark Office

Reg. No. 3,398,714

Registered Mar. 18, 2008

**TRADEMARK
SERVICE MARK
PRINCIPAL REGISTER**



GAGGOHAAS GMBH (SWITZERLAND SOCIÉTÉ
À RESPONSABILITÉ LIMITÉE (SARL))
BINNINGERSTRASSE 15
CH-4051 BASEL
SWITZERLAND

FOR: CLOTHING, NAMELY, SHIRTS, SUITS, SPORT JACKETS, TOPCOATS, DRESSES, PANTS, TROUSERS, COATS, JUMPSUITS, JUMPERS, VESTS, OVERALLS, JEANS, BLAZERS, BLOUSONS, SUSPENDERS, RAINCOATS, PONCHOS, CAFTANS, BLOUSES, SWEAT PANTS, JERSEYS, TUNICS, SKIRTS, ASCOTS, ATHLETIC CLOTHING, NAMELY, UNIFORMS, SWEATERS, T-SHIRTS, SWEATSHIRTS, BATHING SUITS, JOGGING OUTFITS, SNOWSUITS, SKI JACKETS, SKI PANTS, SKI SUITS, ROBES, NIGHTWEAR, NIGHTGOWNS, BABY DOLL PAJAMAS, PAJAMAS, BATHROBES, NEGLIGÉES, KIMONOS, UNDERWEAR AND LINGERIE, TEDDIES, CAMISOLES, PANTYHOSE, LEOTARDS AND TIGHTS FOR WOMEN, MEN AND CHILDREN OF NYLON, NIGHT SHIRTS, BATH TERRY WRAPS, BODYSUITS, LEGGINGS, SOCKS, TIGHTS, SHORTS, STOCKINGS, HOSIERY, PANTIES, SLIPS, BRASSIERES, GIRDLES, GARTER BELTS, GARTERS, GLOVES, MITTENS, SCARVES, BELTS, TIES,

BOWTIES; FOOTWEAR, NAMELY, SHOES, BOOTS, LOAFERS, WALKING SHOES, RUNNING SHOES, ATHLETIC SHOES, SANDALS AND SLIPPERS; HEADGEAR, NAMELY, HATS, CAPS, AND TOQUES, IN CLASS 25 (U.S. CLS. 22 AND 39).

FOR: PREPARED COCOA AND COCOA BASED BEVERAGES; AND COCOA BEVERAGES WITH MILK, IN CLASS 30 (U.S. CL. 46).

FOR: SERVING FOOD AND DRINKS FOR GUESTS; PROVIDING TEMPORARY ACCOMMODATION OF GUESTS, IN CLASS 43 (U.S. CLS. 100 AND 101).

PRIORITY DATE OF 6-27-2006 IS CLAIMED.

OWNER OF INTERNATIONAL REGISTRATION
0911177 DATED 12-15-2006, EXPIRES 12-15-2016.

SER. NO. 79-033,834, FILED 12-15-2006.

CARRIE GENOVESE, EXAMINING ATTORNEY

Int. Cls.: 10, 11 and 37

**Prior U.S. Cls.: 13, 21, 23, 26, 31, 34, 39, 44, 100, 103
and 106**

Reg. No. 3,398,715

United States Patent and Trademark Office

Registered Mar. 18, 2008

**TRADEMARK
SERVICE MARK
PRINCIPAL REGISTER**



GERMITEC (FRANCE SOCIÉTÉ PAR ACTIONS
SIMPLIFIÉE)
45 RUE PIERRE CHARRON
F-75008 PARIS, FRANCE

OWNER OF INTERNATIONAL REGISTRATION
0911285 DATED 12-8-2006, EXPIRES 12-8-2016.

FOR: MEDICAL APPARATUS AND INSTRUMENTS, NAMELY, STERILIZATION AND DISINFECTION UNITS FOR MEDICAL PURPOSES, STERILIZATION AND DISINFECTION UNITS FOR MEDICAL INSTRUMENTS AND PROBES; ULTRASONIC MEDICAL DIAGNOSTIC APPARATUS, ULTRASOUND DIAGNOSTIC APPARATUS, MEDICAL ULTRASOUND APPARATUS, MEDICAL DIAGNOSTIC IMAGING APPARATUS, IN CLASS 10 (U.S. CLS. 26, 39 AND 44).

THE COLOR(S) WHITE, DARK BLUE, BLUE AND LIGHT BLUE IS/ARE CLAIMED AS A FEATURE OF THE MARK.

FOR: STERILIZERS, NOT FOR MEDICAL PURPOSES; DISINFECTANT APPARATUS FOR INDUSTRIAL PURPOSES AND FOR WATER, AIR OR DISH TREATMENT, IN CLASS 11 (U.S. CLS. 13, 21, 23, 31 AND 34).

THE MARK CONSISTS OF THE COLOR WHITE APPEARS IN THE LETTER "G", THE COLOR DARK BLUE APPEARS IN THE LETTERS "ERMITEC", THE COLOR DARK BLUE APPEARS IN THE DESIGN OF THE TRIANGLE THAT BORDERS THE LETTER "G", THE COLOR BLUE AND LIGHT BLUE APPEAR ON THE TWO CORRESPONDING TRIANGLES THAT ARE SUPERIMPOSED AND TO THE LEFT OF THE FIRST TRIANGLE DESIGN.

FOR: DISINFECTION SERVICES, NAMELY, DISINFECTION OF SURGICAL INSTRUMENTS AND PROBES, IN CLASS 37 (U.S. CLS. 100, 103 AND 106).

SER. NO. 79-033,865, FILED 12-8-2006.

PRIORITY DATE OF 7-4-2006 IS CLAIMED.

MICHAEL LEWIS, EXAMINING ATTORNEY

Int. Cls.: 7, 12 and 35

**Prior U.S. Cls.: 13, 19, 21, 23, 31, 34, 35, 44, 100, 101
and 102**

United States Patent and Trademark Office

Reg. No. 3,398,716

Registered Mar. 18, 2008

**TRADEMARK
SERVICE MARK
PRINCIPAL REGISTER**

ROTER

ROTER HUNGARY LIMITED (HUNGARY LIMITED COMPANY)
BÉCSI ÚT 3-5
H-1023 BUDAPEST
HUNGARY

FOR: EARTH MOVING MACHINES, NAMELY, EXCAVATORS AND LOADERS; EXCAVATORS, BULLDOZERS LOADING MACHINES, AND PARTS THEREOF, NAMELY, ROLLERS, IDLER WHEELS, CHAINS AND GEARS; CHASSIS FOR EARTHMOVING MACHINES, NAMELY, EXCAVATORS, BULLDOZERS AND LOADING MACHINES, IN CLASS 7 (U.S. CLS. 13, 19, 21, 23, 31, 34 AND 35).

FOR: TRACTORS; CHASSIS FOR TRACTORS, IN CLASS 12 (U.S. CLS. 19, 21, 23, 31, 35 AND 44).

FOR: GOODS IMPORT-EXPORT AGENCIES; RETAIL STORES AND WHOLESALE STORES FEATURING

TURING EARTH-MOVING MACHINES, TRACTORS, EXCAVATORS, BULLDOZERS AND LOADING MACHINES, AND PARTS FOR THE AFORESAID MACHINES, NAMELY, ROLLERS, IDLER WHEELS, CHAINS AND GEARS, AND CHASSIS FOR EARTH-MOVING MACHINES, TRACTORS, EXCAVATORS, BULLDOZERS AND LOADING MACHINES, IN CLASS 35 (U.S. CLS. 100, 101 AND 102).

OWNER OF INTERNATIONAL REGISTRATION 0911431 DATED 9-6-2006, EXPIRES 9-6-2016.

SER. NO. 79-033,916, FILED 9-6-2006.

REBECCA EISINGER, EXAMINING ATTORNEY

Int. Cls.: 9, 16, 35, 38, 39 and 42

**Prior U.S. Cls.: 2, 5, 21, 22, 23, 26, 29, 36, 37, 38, 50,
100, 101, 102, 104 and 105**

Reg. No. 3,398,717

United States Patent and Trademark Office

Registered Mar. 18, 2008

**TRADEMARK
SERVICE MARK
PRINCIPAL REGISTER**

SUPPLYCHAIN HEALTHCHECK

A.P. MØLLER A/S - MÆRSK A/S (DENMARK
PUBLIC LIMITED COMPANY)
ESPLANADEN 50
DK-1098 COPENHAGEN K
DENMARK

FOR: COMPUTER SOFTWARE FOR USE IN
PLANNING, MANAGING AND TRACKING DELIV-
ERY AND SHIPMENT OF GOODS IN CONNEX-
ION WITH LOGISTICS SERVICES, IN CLASS 9
(U.S. CLS. 21, 23, 26, 36 AND 38).

FOR: PRINTED MATTER, NAMELY, BRO-
CHURES AND MAGAZINES IN THE FIELD OF
BUSINESS MANAGEMENT, LOGISTICS AND TRAVEL;
PRINTED PAPER LABELS; BUSINESS AND
BLANK FORMS, NAMELY, DELIVERY NOTES,
CUSTOMS FORMS, AND TRANSPORTATION PA-
PERS FOR USE IN THE TRANSPORTATION OF
GOODS, ALL RELATING TO OR FOR USE IN THE
FIELD OF LOGISTICS SERVICES, IN CLASS 16 (U.S.
CLS. 2, 5, 22, 23, 29, 37, 38 AND 50).

FOR: BUSINESS ADMINISTRATION AND LOCA-
LIZATION OF FREIGHT AND GOODS, NAMELY,
TRANSPORTATION LOGISTICS SERVICES IN THE
NATURE OF COMPUTERIZED TRACKING AND
TRACING OF PACKAGES IN TRANSIT, IN CLASS
35 (U.S. CLS. 100, 101 AND 102).

FOR: DATA AND TELECOMMUNICATIONS
SERVICES, NAMELY, TRANSMISSION AND
TRANSFER OF IMAGES, INFORMATION AND E-
MAILS VIA DATA, CELLULAR AND TELECOM-
MUNICATION NETWORKS, ALL FOR USE IN THE
FIELD OF LOGISTICS SERVICES, IN CLASS 38 (U.S.
CLS. 100, 101 AND 104).

FOR: PACKAGING ARTICLES FOR TRANSPORTATION;
STORAGE OF GOODS FOR OTHERS;
LOGISTICS SERVICES, NAMELY, CONSULTATION
IN THE FIELD OF TRANSPORTATION OF GOODS
RELATED TO THE ISSUING OF TRANSPORTATION
AND CUSTOMS PAPERS, CERTIFICATES,
BILLS OF LADING AND DOCUMENTS FOR
GOODS; LOGISTICS SERVICES, NAMELY, TRANSPORT
BROKERAGE, FREIGHT BROKERAGE,
FREIGHT FORWARDING; LOGISTICS INFORMATION
SERVICES, NAMELY, INFORMATION REGARDING
TRANSPORTATION AND STORAGE OF
GOODS, IN CLASS 39 (U.S. CLS. 100 AND 105).

FOR: DEVELOPMENT, MAINTENANCE, REPAIR,
INSTALLATION AND IMPLEMENTATION
OF COMPUTER SOFTWARE, IN CLASS 42 (U.S. CLS.
100 AND 101).

THE MARK CONSISTS OF STANDARD CHARACTERS
WITHOUT CLAIM TO ANY PARTICULAR
FONT, STYLE, SIZE, OR COLOR.

PRIORITY DATE OF 4-27-2006 IS CLAIMED.

OWNER OF INTERNATIONAL REGISTRATION
0911600 DATED 9-5-2006, EXPIRES 9-5-2016.

SER. NO. 79-033,956, FILED 9-5-2006.

ANDREA BUTLER, EXAMINING ATTORNEY

Int. Cls.: 3, 5, 29, 30 and 31

Prior U.S. Cls.: 1, 4, 6, 18, 44, 46, 50, 51 and 52

United States Patent and Trademark Office

Reg. No. 3,398,718

Registered Mar. 18, 2008

**TRADEMARK
PRINCIPAL REGISTER**



GECCO IMPORT-EXPORT; HANDELSGESELLSCHAFT MBH (AUSTRIA PRIVATE LIMITED COMPANY)

FILLGRADERGASSE 5
A-1060 WIEN, AUSTRIA

FOR: BLEACHING PREPARATIONS AND OTHER SUBSTANCES FOR LAUNDRY USE, NAMELY, FABRIC SOFTENERS, LAUNDRY BLEACH, LAUNDRY DETERGENT, LAUNDRY PRE-SOAK, LAUNDRY SOAP, AND LAUNDRY STARCH; GENERAL PURPOSE CLEANING, POLISHING, AND ABRASIVE LIQUIDS AND POWDERS; SOAPS; PERFUMES; ESSENTIAL OILS; COSMETICS; HAIR LOTIONS; DENTIFRICES, IN CLASS 3 (U.S. CLS. 1, 4, 6, 50, 51 AND 52).

FOR: DIETETIC FOODS ADAPTED FOR MEDICAL USE; FOOD FOR BABIES; MEDICAL AND VETERINARY PLASTERS; MATERIALS FOR DRESSINGS, NAMELY, GAUZES AND BANDAGES; PREPARATIONS FOR DESTROYING VERMIN; FUNGICIDES; HERBICIDES, IN CLASS 5 (U.S. CLS. 6, 18, 44, 46, 51 AND 52).

FOR: MEAT, FISH, POULTRY AND GAME; MEAT EXTRACTS; PRESERVED, DRIED AND COOKED FRUITS AND VEGETABLES; JELLIES, JAMS, COMPOTES; EGGS, MILK PRODUCTS EXCLUDING ICE CREAM, ICE MILK AND FROZEN YOGURT; EDIBLE OILS AND FATS, IN CLASS 29 (U.S. CL. 46).

FOR: COFFEE, TEA, COCOA, SUGAR, RICE, TAPIOCA, SAGO, INSTANT COFFEE; FLOUR AND PREPARATIONS MADE FROM CEREALS, BREAD, PASTRY AND CONFECTIONERY, NAME-

LY, FOOD BARS, ICE CREAM; HONEY, TABLE SYRUP, TREACLE; YEAST, BAKING-POWDER; SALT, MUSTARD; VINEGAR, SAUCES AS CONDIMENTS; SPICES; EDIBLE FRUIT ICES, IN CLASS 30 (U.S. CL. 46).

FOR: AGRICULTURAL, HORTICULTURAL AND FORESTRY PRODUCTS AND GRAINS NOT INCLUDED IN OTHER CLASSES, NAMELY, AGRICULTURAL GRAINS FOR PLANTING, AND UNPROCESSED GRAINS FOR EATING; LIVE ANIMALS; FRESH FRUITS AND VEGETABLES; SEEDS FOR HORTICULTURAL PURPOSES, LIVE PLANTS AND FLOWERS; FOODSTUFFS FOR ANIMALS; MALT FOR BREWING AND DISTILLING, IN CLASS 31 (U.S. CLS. 1 AND 46).

OWNER OF INTERNATIONAL REGISTRATION
0849024 DATED 10-27-2004, EXPIRES 10-27-2014.

THE COLOR(S) DARK BLUE, BLUE AND LIGHT BLUE IS/ARE CLAIMED AS A FEATURE OF THE MARK.

THE MARK CONSISTS OF THE COLOR DARK BLUE APPEARING IN THE WORDING VIVASAN; THE COLOR BLUE APPEARING IN THE WAVY DESIGN TO THE LEFT OF THE WORDING; AND THE COLOR LIGHT BLUE APPEARING IN THE WAVY DESIGN BELOW THE WORDING.

SER. NO. 79-034,002, FILED 11-29-2006.

DOMINIC FATHY, EXAMINING ATTORNEY

Int. Cls.: 10, 11 and 37

**Prior U.S. Cls.: 13, 21, 23, 26, 31, 34, 39, 44, 100, 103
and 106**

Reg. No. 3,398,719

United States Patent and Trademark Office

Registered Mar. 18, 2008

**TRADEMARK
SERVICE MARK
PRINCIPAL REGISTER**



GERMITEC (FRANCE SOCIÉTÉ PAR ACTIONS
SIMPLIFIÉE)
45 RUE PIERRE CHARRON
F-75008 PARIS, FRANCE

PRIORITY DATE OF 7-4-2006 IS CLAIMED.

FOR: MEDICAL APPARATUS AND INSTRUMENTS, NAMELY, STERILIZATION AND DISINFECTION UNITS FOR MEDICAL PURPOSES, STERILIZATION AND DISINFECTION UNITS FOR MEDICAL INSTRUMENTS AND PROBES; ULTRASONIC MEDICAL DIAGNOSTIC APPARATUS, ULTRASOUND DIAGNOSTIC APPARATUS, MEDICAL ULTRASOUND APPARATUS, MEDICAL DIAGNOSTIC IMAGING APPARATUS, IN CLASS 10 (U.S. CLS. 26, 39 AND 44).

OWNER OF INTERNATIONAL REGISTRATION
0911806 DATED 12-8-2006, EXPIRES 12-8-2016.

THE COLOR(S) WHITE, DARK BLUE, BLUE AND LIGHT BLUE IS/ARE CLAIMED AS A FEATURE OF THE MARK.

FOR: STERILIZERS, NOT FOR MEDICAL PURPOSES; DISINFECTANT APPARATUS FOR INDUSTRIAL PURPOSES AND FOR WATER, AIR OR DISH TREATMENT, IN CLASS 11 (U.S. CLS. 13, 21, 23, 31 AND 34).

THE MARK CONSISTS OF THE COLOR WHITE APPEARS IN THE LETTER "G", THE COLOR DARK BLUE APPEARS IN THE DESIGN OF THE TRIANGLE THAT BORDERS THE LETTER "G", THE COLOR BLUE AND LIGHT BLUE APPEAR ON THE TWO CORRESPONDING TRIANGLES THAT ARE SUPERIMPOSED AND TO THE LEFT OF THE FIRST TRIANGLE DESIGN.

FOR: DISINFECTION SERVICES, NAMELY, DISINFECTION OF SURGICAL INSTRUMENTS AND PROBES, IN CLASS 37 (U.S. CLS. 100, 103 AND 106).

SER. NO. 79-034,035, FILED 12-8-2006.

MICHAEL LEWIS, EXAMINING ATTORNEY

Int. Cl.: 5

Prior U.S. Cls.: 6, 18, 44, 46, 51 and 52

United States Patent and Trademark Office

Reg. No. 3,398,720

Registered Mar. 18, 2008

**TRADEMARK
PRINCIPAL REGISTER**

ANI MARINE

LABORATOIRE MOUTIERS MARINE, S.A.R.L.
(FRANCE SOCIETE A RESPONSABILITE LIM-
ITEE)

58, BIS ROUTE DE LA BERNERIE
MOULIN DES TRÉANS
F-44760 LES MOUTIERS-EN-RETZ, FRANCE

FOR: PREPARATIONS, LOTIONS AND MEDI-
CINES FOR THERAPEUTIC VETERINARY USE,
NAMELY, SEA MUD, OINTMENT, HEALING
BALM, ANTI CRACKING CREAM, CONDITIONER
FOR TAILS AND MANES, SHAMPOO; PLASTERS
FOR THERAPEUTIC USE, BANDAGES AND GAU-
ZES FOR DRESSINGS, ALL PURPOSE DISINFEC-
TANTS FOR ANIMALS; DIETETIC FOODS FOR
ANIMALS AIMED AT IMPROVING THEIR VITAL-
ITY, MOBILITY AND DIGESTIVE COMFORT, VI-
TAMIN SUPPLEMENTS, ANIMAL FEED
SUPPLEMENTS INCLUDED IN THIS CLASS; PRE-
PARATIONS FOR DESTROYING VERMIN AND

INSECT REPELLENTS, IN CLASS 5 (U.S. CLS. 6, 18,
44, 46, 51 AND 52).

PRIORITY DATE OF 10-17-2006 IS CLAIMED.

OWNER OF INTERNATIONAL REGISTRATION
0912163 DATED 12-7-2006, EXPIRES 12-7-2016.

NO CLAIM IS MADE TO THE EXCLUSIVE
RIGHT TO USE "MARINE", APART FROM THE
MARK AS SHOWN.

THE ENGLISH TRANSLATION OF THE FOR-
EIGN WORD(S) IN THE MARK IS MARINE.

SER. NO. 79-034,139, FILED 12-7-2006.

BARBARA RUTLAND, EXAMINING ATTORNEY

Int. Cl.: 28

Prior U.S. Cls.: 22, 23, 38 and 50

United States Patent and Trademark Office

Reg. No. 3,398,721

Registered Mar. 18, 2008

**TRADEMARK
PRINCIPAL REGISTER**

TUONO

PIAGGIO & C. S.P.A. (ITALY CORPORATION)
VIALE RINALDO PIAGGIO, 25
I-56025 PONTEDERA (PISA)
ITALY

FOR: TOY SCALE MODEL VEHICLES, TOY VEHICLES, ELECTRONICALLY OPERATED TOY MOTOR VEHICLES, RADIO-CONTROLLED TOY VEHICLES, CASES FOR TOY VEHICLES, TOY SCOOTERS, CARD GAMES, HAND HELD UNIT FOR PLAYING VIDEO GAMES; ARCADE-TYPE ELECTRONIC VIDEO GAMES, IN CLASS 28 (U.S. CLS. 22, 23, 38 AND 50).

THE MARK CONSISTS OF STANDARD CHARACTERS WITHOUT CLAIM TO ANY PARTICULAR FONT, STYLE, SIZE, OR COLOR.

PRIORITY DATE OF 8-30-2006 IS CLAIMED.

OWNER OF INTERNATIONAL REGISTRATION
0912258 DATED 11-23-2006, EXPIRES 11-23-2016.

OWNER OF U.S. REG. NOS. 1,284,198, 2,806,579
AND OTHERS.

THE FOREIGN WORDING IN THE MARK
TRANSLATES INTO ENGLISH AS THUNDER.

SER. NO. 79-034,172, FILED 11-23-2006.

SUNG IN, EXAMINING ATTORNEY

Int. Cl.: 33

Prior U.S. Cls.: 47 and 49

United States Patent and Trademark Office

Reg. No. 3,398,722

Registered Mar. 18, 2008

**TRADEMARK
PRINCIPAL REGISTER**

PASTOR FRITZ

HAHN BAROSSA VINEYARDS (SA) PTY LTD
(AUSTRALIA COMPANY)
PO BOX 64
STOCKWELL SA 5355
AUSTRALIA

OWNER OF INTERNATIONAL REGISTRATION
0912822 DATED 1-3-2007, EXPIRES 1-3-2017.

FOR: ALCOHOLIC BEVERAGES, NAMELY,
WINES, IN CLASS 33 (U.S. CLS. 47 AND 49).

THE NAME PASTOR FRITZ DOES NOT IDENTIFY
A LIVING INDIVIDUAL.

THE MARK CONSISTS OF STANDARD CHAR-
ACTERS WITHOUT CLAIM TO ANY PARTICULAR
FONT, STYLE, SIZE, OR COLOR.

SER. NO. 79-034,364, FILED 1-3-2007.

PRIORITY DATE OF 9-4-2006 IS CLAIMED.

MICHAEL TANNER, EXAMINING ATTORNEY

Int. Cls.: 19 and 37

Prior U.S. Cls.: 1, 12, 33, 50, 100, 103 and 106

United States Patent and Trademark Office

Reg. No. 3,398,723

Registered Mar. 18, 2008

**TRADEMARK
SERVICE MARK
PRINCIPAL REGISTER**

VEGECOL

COLAS (FRANCE CORPORATION)
7, PLACE RENÉ CLAIR
F-92100 BOULOGNE BILLANCOURT
FRANCE

FOR: NON-METALLIC GOODS FOR BUILDING, MAINTAINING, STABILISING, RESURFACING ROADS, ROAD AND MOTORWAY SURFACES AND OTHER ROAD SURFACES, NAMELY, PATHS FOR BICYCLES AND SIMILAR TRAFFIC, NAMELY, A PLANT-BASED BINDER; NON-METALLIC BUILDING MATERIALS CONTAINING A PLANT-BASED BINDER FOR ROAD CONSTRUCTION, ROAD AND MOTORWAY SURFACES AND OTHER ROAD SURFACES NAMELY PATHS FOR BICYCLES AND SIMILAR TRAFFIC, IN CLASS 19 (U.S. CLS. 1, 12, 33 AND 50).

FOR: BUILDING, REPAIRING, MAINTAINING, RESURFACING AND RENEWING ROADS, ROAD

AND MOTORWAY SURFACES AND OTHER ROAD SURFACES, NAMELY, PATHS FOR BICYCLES AND SIMILAR TRAFFIC; BUILDING, REPAIRING, MAINTAINING RESURFACING AND RENEWING PUBLIC ROAD WORKS, IN CLASS 37 (U.S. CLS. 100, 103 AND 106).

THE MARK CONSISTS OF STANDARD CHARACTERS WITHOUT CLAIM TO ANY PARTICULAR FONT, STYLE, SIZE, OR COLOR.

OWNER OF INTERNATIONAL REGISTRATION
0893993 DATED 4-12-2006, EXPIRES 4-12-2016.

SER. NO. 79-034,457, FILED 12-1-2006.

DOMINIC J. FERRAIUOLO, EXAMINING ATTORNEY

Int. Cl.: 1

Prior U.S. Cls.: 1, 5, 6, 10, 26 and 46

United States Patent and Trademark Office

Reg. No. 3,398,724

Registered Mar. 18, 2008

**TRADEMARK
PRINCIPAL REGISTER**

L I N E A L E N E

IDEMITSU KOSAN CO., LTD. (JAPAN CORPORATION)

1-1, 3-CHOME, MARUNOUCHI

CHIYODA-KU; TOKYO 100-8321

JAPAN

FOR: CHEMICALS FOR USE IN INDUSTRY AND SCIENCE; ALPHA OLEFINS FOR USE IN INDUSTRY AND SCIENCE; PLASTICIZERS; NON-AROMATIC SOLVENTS FOR INDUSTRIAL AND SCIENTIFIC PURPOSES, IN CLASS 1 (U.S. CLS. 1, 5, 6, 10, 26 AND 46).

THE MARK CONSISTS OF STANDARD CHARACTERS WITHOUT CLAIM TO ANY PARTICULAR FONT, STYLE, SIZE, OR COLOR.

PRIORITY DATE OF 9-6-2006 IS CLAIMED.

OWNER OF INTERNATIONAL REGISTRATION 0913123 DATED 1-9-2007, EXPIRES 1-9-2017.

SER. NO. 79-034,484, FILED 1-9-2007.

JOHN KELLY, EXAMINING ATTORNEY

Int. Cl.: 33

Prior U.S. Cls.: 47 and 49

United States Patent and Trademark Office

Reg. No. 3,398,725

Registered Mar. 18, 2008

**TRADEMARK
PRINCIPAL REGISTER**

MARQUES DE TOSOS

BODEGAS SAN VALERO, S. COOP. (SPAIN SO-
CIEDAD COOPERATIVA)
CTRA. NACIONAL 330, KM. 450
E-50400 CARIÑENA (ZARAGOZA), SPAIN

FOR: WINES, DISTILLED SPIRITS AND LI-
QUEURS, IN CLASS 33 (U.S. CLS. 47 AND 49).

OWNER OF INTERNATIONAL REGISTRATION
0913635 DATED 12-1-2006, EXPIRES 12-1-2016.

THE NAME "MARQUIS DE TOSOS" DOES NOT
IDENTIFY A LIVING INDIVIDUAL.

THE ENGLISH TRANSLATION OF "MARQUES
DE TOSOS" IN THE MARK IS "MARQUIS OF
TOSOS".

SER. NO. 79-034,625, FILED 12-1-2006.

DOMINIC J. FERRAIUOLO, EXAMINING ATTOR-
NEY

Int. Cl.: 33

Prior U.S. Cls.: 47 and 49

United States Patent and Trademark Office

Reg. No. 3,398,726

Registered Mar. 18, 2008

TRADEMARK
PRINCIPAL REGISTER

PONTAC

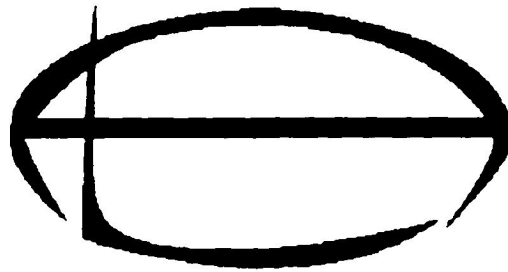

BODEGAS LUIS ALEGRE, S.A. (SPAIN SOCIE-
DAD ANONIMA)

CTRA. NAVARIDAS S/N

E-01300 LAGUARDIA (ALAVA)

SPAIN

OWNER OF INTERNATIONAL REGISTRATION
0913642 DATED 12-20-2006, EXPIRES 12-20-2016.

NO CLAIM IS MADE TO THE EXCLUSIVE
RIGHT TO USE "PONTAC", APART FROM THE
MARK AS SHOWN.

FOR: WINE, IN CLASS 33 (U.S. CLS. 47 AND 49).

SER. NO. 79-034,630, FILED 12-20-2006.

PRIORITY DATE OF 8-9-2006 IS CLAIMED.

ROBERT LAVACHE, EXAMINING ATTORNEY

Int. Cls.: 24 and 25

Prior U.S. Cls.: 22, 39, 42 and 50

United States Patent and Trademark Office

Reg. No. 3,398,727

Registered Mar. 18, 2008

**TRADEMARK
PRINCIPAL REGISTER**



LUCZAK JERZY; PRZEDSIĘBIORSTWO; PRO-
DUKCYJNO-HANDLOWO-USŁUGOWE; LOR-
IN (POLAND SOLE PROPRIETORSHIP)
UL. LEGIONÓW 3A
PL-34-120 ANDRYCHÓW
POLAND

FOR: HOUSEHOLD LINEN; BATH LINEN NOT
INCLUDING CLOTHING; DIAPERED LINEN,
NAMELY, LINEN WITH A DISTINCTIVE PATTERN
OF SMALL REPEATED DIAMOND-SHAPED FIG-
URES, IN CLASS 24 (U.S. CLS. 42 AND 50).

FOR: UNDERCLOTHING; UNDERWEAR; BRAS-
SIERES; SMOCKS; BODIES, NAMELY, BODY SHA-
PERS, BODY STOCKINGS, AND BODY SUITS;
CORSETS IN THE NATURE OF UNDERCLOTH-
ING; GIRDLES; SLIPS IN THE NATURE OF UN-
DERGARMENTS; BATHING SUITS; BATHING
TRUNKS; PANTS; CLOTHING, NAMELY, BATH-
ROBES, BELTS, BLAZERS, BLOUSES, BOW TIES,
BOXER SHORTS, BRAS, BRIEFS, CAPS, COATS,
DENIMS, DRESS SHIRTS, DRESS SUITS, GLOVES,
HATS, HEADWEAR, HOSIERY, JACKETS, JEANS,
JERSEYS, JOGGING SUITS, NIGHTWEAR, OVER-
COATS, PAJAMAS, PANTIES, POLO SHIRTS, PULL-
OVERS, RAINWEAR, RAIN COATS, SCARVES,
SHIRTS, SKIRTS, SHORTS, SKI WEAR, SLACKS,
SNOWBOARD PANTS, SOCKS, SPORTS JERSEYS;
SUITS, SWEATERS, TIES, TROUSERS, UNIFORMS,
AND T-SHIRTS; OUTERCLOTHING, NAMELY,
COATS, DRESSES, COVERALLS, FUR COATS,
FUR JACKETS, FUR HATS, JACKETS, JERSEYS,

JUMPSUITS, SUITS, OVERALLS, PARKAS, PULL-
OVERS, TOP COATS, VESTS; BEACH CLOTHES,
NAMELY, BATHING CAPS, BATHING COSTUMES,
BATHING TRUNKS, BEACH COVER-UPS, BEACH-
WEAR, CAPS WITH VISORS, SUNSUITS, SURF
WEAR, SUN SLEEVES, SUN VISORS, TRUNKS;
GARTERS; ANTI-SWEAT UNDERCLOTHING,
NAMELY, UNDER GARMENTS, UNDERCLOTHES,
UNDERPANTS, UNDERSHIRTS, UNDERSKIRTS,
UNDERWEAR; UNDERPANTS; SHORTS; DRES-
SING GOWNS; TEE-SHIRTS; SUITS, IN CLASS 25
(U.S. CLS. 22 AND 39).

OWNER OF INTERNATIONAL REGISTRATION
0838179 DATED 7-19-2004, EXPIRES 7-19-2014.

THE COLOR(S) BLACK AND RED IS/ARE
CLAIMED AS A FEATURE OF THE MARK.

THE MARK CONSISTS OF THE STYLIZED
WORDING LORIN IN THE COLOR BLACK, A
STRAIGHT LINE UNDERLINING THE WORDING
LORIN IN THE COLOR BLACK, AND A WAVE
LINE IN THE BACKGROUND OF THE WORDING
LORIN IN THE COLOR RED; THE ENTIRE MARK
IS SURROUNDED BY A BLACK RECTANGLE.

SER. NO. 79-034,645, FILED 12-29-2006.

SHAILA SETTLES, EXAMINING ATTORNEY

Int. Cls.: 14, 18, 25 and 26

Prior U.S. Cls.: 1, 2, 3, 22, 27, 28, 37, 39, 40, 41, 42 and 50

Reg. No. 3,398,728

United States Patent and Trademark Office

Registered Mar. 18, 2008

**TRADEMARK
PRINCIPAL REGISTER**

SELVAFONTE

KIKUCHI, YOICHI (JAPAN INDIVIDUAL)
3-1-22-308, HIROO
SHIBUYA-KU; TOKYO, JAPAN

FOR: PURSES OF PRECIOUS METAL, WALL CLOCK, STOPWATCHES, SHOE ORNAMENTS OF PRECIOUS METAL, MASTER CLOCKS, KEY RINGS OF PRECIOUS METAL; KEY TRINKETS, NAMELY, CHARMS FOR KEY RINGS; WATCH FOBS; WATCH CASES; CLOCKWORKS FOR CLOCK AND WATCH MAKING, NAMELY, MOVEMENTS FOR CLOCKS AND WATCHES, WATCH SPRINGS, DIALS, CLOCK HANDS, WATCH GLASSES, ANCHORS, WATCH STRAPS, PENDULUMS AND BARRELS; AUTOMOBILE CLOCKS, ATOMIC CLOCKS, ALARM CLOCKS, ELECTRIC CLOCKS AND WATCHES, ELECTRONIC CLOCKS AND WATCHES, CONTROL CLOCKS, MASTER CLOCKS, CHRONOGRAPHS FOR USE AS TIMEPIECES, WATCHES, CHRONOMETERS, CHRONOSCOPES, TABLE CLOCKS, WRISTWATCHES, SUNDIALS, POCKET WATCHES; ZIRCONIUM JEWELRY; CRYSTAL JEWELRY; JEWELRY; ORNAMENTAL PINS; PASTE JEWELRY; COSTUME JEWELRY; EARRINGS, TURQUOISE JEWELRY, CUFF LINKS; TIGER-EYE JEWELRY; TIE PINS; MEDALS; YELLOW JADE JEWELRY; TIE CLIPS; HAT ORNAMENTS OF PRECIOUS METALS; BADGES OF PRECIOUS METAL; BUCKLES OF PRECIOUS METAL; BELT ORNAMENTS OF PRECIOUS METALS; ORNAMENTAL JEWELRY PINS; JEWELRY, NAMELY, NECKLACES, RINGS, ANKLETS, AMULETS; BROOCHES; CHARMS AND BRACELETS, IN CLASS 14 (U.S. CLS. 2, 27, 28 AND 50).

FOR: FUR; ANIMAL SKINS; RAW SKINS; RAW-HIDES; TANNED LEATHER; SPONGE LEATHER; IMITATION LEATHER PAPER; ARTIFICIAL FUR; IMITATION LEATHER MADE OF POLYURETHANE; BAGS FOR COOKING STOVE, LEATHER KEY CASES; LEATHER WARE, NAMELY, BRIEFCASES AND TRAVELING BAGS; DIAPER BAGS; RUCKSACKS; SCHOOL SATCHELS; LEATHER CARD CASES FOR BUSINESS CARDS; BACKPACKS; BOSTON BAGS; PURSES NOT OF PRECIOUS METAL; BEACH BAGS; BRIEFCASES; CARD

CASES FOR CHECKS; SUITCASES; CARD CASES FOR COMMUTER TICKETS; LEATHER CARD CASES FOR CREDIT CARDS; TRAVELING BAGS; TRAVELING TRUNKS; OPERA BAGS; LEATHER CARD CASES FOR PASSPORTS; LEATHER ENVELOPES BAGS AND POUCHES FOR PACKAGING; HANDBAGS; BEACH UMBRELLAS; BEACH PARASOLS; UMBRELLAS; UMBRELLA OR PARASOL RIBS; FRAMES FOR UMBRELLA OR PARASOLS; UMBRELLA STICKS; UMBRELLA HANDLES; UMBRELLA RINGS; METAL PARTS OF UMBRELLAS; UMBRELLA COVERS; PAPER UMBRELLAS, IN CLASS 18 (U.S. CLS. 1, 2, 3, 22 AND 41).

FOR: MONEY BELTS USED AS CLOTHING, LEATHER SHOES, RUBBER SHOES, GALOSHES, GOLF SHOES, SHOE SOLES, WOODEN SHOES, ANGLERS' SHOES, BASKETBALL SHOES, SHOES, HEELS, MOUNTAINEERING BOOTS, RUGBY SHOES, LACE BOOTS, BATH SANDALS, BATH SLIPPERS, HALF-BOOTS, WINTER BOOTS, BOXING SHOES, BOOTS, VINYL SHOES, BEACH SHOES, SANDALS, SKI BOOTS, SLIPPERS, INNER SOLES, SOLES FOR FOOTWEAR, FOOTWEAR UPPERS, HEELPIECES FOR BOOTS AND SHOES, NON-SLIPPING DEVICES FOR BOOTS AND SHOES, NAMELY, HEEL PIECES; TIPS FOR FOOTWEAR, FITTINGS OF METAL FOR SHOES AND BOOTS, TRAINING SHOES, BASEBALL SHOES, ESPARTO SHOES OR SANDALS, FOOTWEAR FOR TRACK AND FIELD ATHLETICS, OVERSHOES, RAIN BOOTS, WORK SHOES AND BOOTS, LONG BOOTS, STRAW SANDALS, GYMNAS TIC SHOES, FOOTBALL SHOES, LACE BOOTS, FIELD HOCKEY SHOES, HANDBALL SHOES, KOREAN FENCING SUITS, CYCLISTS' CLOTHING, NAMELY, JERSEYS, SHORTS, SHOES; WET SUITS FOR WATER-SKIING, SPORTS ANORAKS, AEROBIC SWEAT SUITS, JUDO SUITS, CLOTHING FOR GYMNAS TICS, NAMELY, SHIRTS, PANTS, TIGHTS, SHOES; TAEKWONDO SUITS, BREECHES FOR WEAR, RIDING BOOTS, MASQUERADE COSTUMES, SCHOOL UNIFORMS, RAINCOATS, LIVERIES, CLOTHING IN THE NATURE OF MANTLES, NAMELY, KNEE-LENGTH TROUSERS, MID-LENGTH COATS,

BLOUSONS, SARIS, SAFARIS SUITS, SMOCKS, SKIRTS, SLACKS, MEN'S SUITS, ANORAKS NOT FOR EXERCISE, CHILDREN'S CLOTHING, NAME- LY, TROUSERS, CEREMONIAL DRESSES, OVER- ALLS, OVERCOATS, DRESSES; INFANTS' ONE- PIECE CLOTHING; EVENING DRESSES, JACKETS; WORK CLOTHING, NAMELY, SHIRTS AND OVER- ALLS; JUMPERS; SHIRT FRONTS; PAPER CLOTH- ING, NAMELY, HATS AND SHOES; CHASUBLES; BLUE JEANS; CAPES, CLOTHING COMBINA- TIONS; TOPCOATS; TUXEDOS; TOGAS, SUITS, TUNICS, PARKAS, PELISSES, FROCKS, GIRDLES, NIGHTGOWNS, ALOHA SHIRTS, NEGLIGEEES, DRESSING GOWNS, ROMPERS, LEOTARDS, MAN- TILLAS, BATH ROBES, LINGERIE BODICES, BODY SHIRTS, BRASSIERES, BLOUSES, SHOWER CAPS, SHIRT YOKES, SHIRT FRONTS, UNDERWEAR, CLOTHING DRAWERS, UNDERSHIRTS, UNDER- PANTS, BATHING CAPS, SWIMSUITS, BATHING TRUNKS, CHEMISETTES, SHIRT FRONTS, CHEMI- SES, SWEATERS, SWEAT SHIRTS, SWEAT PANTS, SPORTS SHIRTS, UNDERGARMENTS IN THE NAT- URE OF SLIPS, DRESS SHIRT, EXERCISE CLOTH- ING, NAMELY, SWEAT SHIRTS, SWEAT PANTS, SHORTS, TIGHTS, LEOTARDS; UNITARDS, CLOTHING COLLARS; NIGHTWEAR, JERSEYS; VESTS, CARDIGANS, COLLAR PROTECTORS, COLLAR CUFFS, CAMISOLES, UNDERCLOTHING IN THE NATURE OF CORSETS, NAMELY, UNDER- GARMENTS; CORSELETS, LEATHER BELTS USED AS CLOTHING; UNDERGARMENT COMBINA- TIONS; TANK TOPS, UNDERGARMENTS IN THE NATURE OF TEDDIES; TRACKSUITS, PAJAMAS, PANTYHOSE, PETTICOATS, POLO SHIRTS, PULL- OVERS, TEE-SHIRTS, SPATS, NECKTIES, SWEAT- ABSORBENT STOCKINGS, LEGWARMERS, LEG- GINGS, MUFFS, MUFFLERS, BANDANAS, NECK- ERCHIEFS, EAR MUFFS, WINTER GLOVES, KOREAN SOCKS, KOREAN SOCK COVERS, MIT- TENS, VEILS, NECKLETS IN THE NATURE OF BOAS, SHOULDER WRAPS, FOOT MUFFS NOT ELECTRICALLY HEATED, SHAWLS, WIMPLES, MANIPLES, SCARVES, STOCKINGS, HEELPIECES FOR STOCKINGS, STOLES, ASCOTS, SOCKS, SOCK COVERS, POCKET SQUARES, APRONS, STOCK- INGS FOR USE WHILE EXERCISING; BABIES' DIAPERS OF TEXTILE; POCKETS FOR CLOTHING, TIGHTS, PELERINES, KOREAN TRADITIONAL

HATS; NIGHT CAPS; KOREAN TRADITIONAL WINTER CAPS IN THE NATURE OF NANBAWIS; KOREAN HEADBANDS MADE OF HORSEHAIR IN THE NATURE OF MANGGONS; CAPS IN THE NATURE OF HEADWEAR; SUN VISORS, BERETS, MITERS IN THE NATURE OF HATS; HOODS; TURBANS, TOP HATS, GAITERS, KOREAN ANKLE BANDS IN THE NATURE OF DAENIM; STOCKING SUSPENDERS; SOCK SUSPENDERS; BRACES FOR CLOTHING IN THE NATURE OF SUSPENDERS, IN CLASS 25 (U.S. CLS. 22 AND 39).

FOR: METAL FASTENERS FOR SHOES; SHOE FASTENING HOOKS; SHOE LACES, SHOE BUCK- LES, SHOE ORNAMENTS NOT OF PRECIOUS ME- TAL, SHOE EYELETS, FALSE HAIR IN THE NATURE OF TOUPEES; PIGTAIL RIBBONS FOR KOREAN SHOE LACES EXCEPT EMBROIDERY LACES; HAIR RIBBONS, HAIR NETS; ARTS AND CRAFTS FINDINGS, NAMELY, POMPOMS; HAIR SUPPORTERS, NAMELY, HAIR PINS; ORNAMEN- TAL NOVELTY BADGES FOR WEAR, NOT OF PRECIOUS METAL; HAIR BARRETTES; HAIR GRIPS; BELT ORNAMENTS NOT OF PRECIOUS METAL, NAMELY, ORNAMENTAL CHARMS FOR BELTS; PINS OTHER THAN JEWELRY, NAMELY, BOBBY PINS, HAIR PINS, CURLING PINS; MICA SPANGLES; BRASSARDS; ORNAMENTAL CLOTH- ING ACCESSORIES IN THE NATURE OF, BIRDS' FEATHERS; DECORATIVE CORDS FOR TRIM- MING FOR CLOTHING; HUMAN HAIR FOR CON- STRUCTING WIGS, HAIRPIECES AND ADD-INS AND ADD-ON HAIR ACCESSORIES; HAIR BANDS; PRIZE RIBBONS; EMBROIDERED EMBLEMS; BUT- TONS FOR CLOTHING; HOOK AND PILE FASTEN- ING TAPES; SLIDE FASTENERS IN THE NATURE OF ZIPPERS; EYELETS FOR CLOTHING, HOOKS FOR CLOTHING, PRESS BUTTONS FOR USE IN DRESSMAKING, IN CLASS 26 (U.S. CLS. 37, 39, 40, 42 AND 50).

OWNER OF INTERNATIONAL REGISTRATION 0913885 DATED 9-29-2006, EXPIRES 9-29-2016.

SER. NO. 79-034,682, FILED 9-29-2006.

RUSS HERMAN, EXAMINING ATTORNEY

Int. Cl.: 1

Prior U.S. Cls.: 1, 5, 6, 10, 26 and 46

United States Patent and Trademark Office

Reg. No. 3,398,729

Registered Mar. 18, 2008

TRADEMARK
PRINCIPAL REGISTER

中化

SINOCEM CORPORATION (CHINA CORPORATION)
SINOCEM TOWER
A2 FUXINGMENWAI DAJIE; BEIJING
CHINA

FOR: REFRIGERANTS, NAMELY, REFRIGERANTS FOR COMPRESSOR OF AIR CONDITIONERS AND MEDICAL EQUIPMENT; CHEMICALS FOR INDUSTRIAL PURPOSES; ACIDS, NAMELY, PHOSPHORIC ACID; ALKALIES; BASES FOR CHEMICAL PREPARATIONS, NAMELY, WATER SOLUBLE BASES FOR USE IN CHEMICAL PREPARATIONS; SALTS FROM EARTH METALS FOR CHEMICAL PREPARATIONS; CITRIC ACID FOR INDUSTRIAL PURPOSES; BENZENE DERIVATIVES FOR USE AS PRESERVATIVES IN CHEMICAL PREPARATIONS; PROPYL ALCOHOL; FURFURAL RESIDUE FROM CORN COBS, NAMELY, CELLULOSE BYPRODUCTS DERIVED FROM THE MANUFACTURER OF FURFURAL AND USED IN THE MANUFACTURE OF PLYWOOD; METHYL ESTERS, NAMELY, PHENYLACETATE, ETHYL ESTER, PROPYL ESTER, VINYL ACETATE, ACRYLIC ESTER, OXALATE, SEBACATE, LACTATE, TARTRATE, CITRATE; GLUCONATE, DIMETHYL PHOSPHITE, DIETHYL PHOSPHITE, TRIMETHYL PHOSPHITE, TRIETHYL PHOSPHATE, NON-METALLIC INORGANIC ACID ESTER, LYSINE ESTER, AMINO ACID, PHOSPHO-AMINOLIPID, MEPROBAMATE,

THIOCARBAMATE; SURFACE-ACTIVE CHEMICAL AGENTS FOR SCIENTIFIC AND CHEMICAL PREPARATIONS; KETONES; ANILINE; CAPROLACTAM FOR USE IN SCIENTIFIC AND CHEMICAL PREPARATIONS, IN CLASS 1 (U.S. CLS. 1, 5, 6, 10, 26 AND 46).

PRIORITY DATE OF 7-12-2006 IS CLAIMED.

OWNER OF INTERNATIONAL REGISTRATION
0913964 DATED 12-15-2006, EXPIRES 12-15-2016.

THE MARK CONSISTS OF CHINESE CHARACTERS.

THE CHINESE CHARACTERS MEAN "MIDDLE" AND "CHANGE" IN ENGLISH; THE TWO CHINESE CHARACTERS COMBINED AS A WHOLE HAVE NO DIRECT MEANING IN ENGLISH.

THE TRANSLITERATION OF THE CHINESE CHARACTERS IS "ZHONG HUA".

SER. NO. 79-034,703, FILED 12-15-2006.

KAPIL BHANOT, EXAMINING ATTORNEY

Int. Cl.: 7

Prior U.S. Cls.: 13, 19, 21, 23, 31, 34 and 35

United States Patent and Trademark Office

Reg. No. 3,398,730

Registered Mar. 18, 2008

**TRADEMARK
PRINCIPAL REGISTER**



DEMAIN TECHNOLOGY PTY LTD (AUSTRALIA
COMPANY)
UNIT 2
11-13 LAKEWOOD BOULEVARD
BRAESIDE VIC 3195, AUSTRALIA

FOR: ELECTRIC POWER TOOLS, HAND-HELD POWER TOOLS AND BATTERY OPERATED POWER TOOLS, NAMELY, ELECTRIC HAND DRILLS AND DRIVERS; POWER TOOLS, NAMELY, ROTARY HAMMER DRILLS; GRINDERS INCLUDING ANGLE GRINDERS; POWER SAWS, INCLUDING CIRCULAR, RECIPROCATING AND JIG SAWS, MITRE SAWS INCLUDING COMPOUND MITRE SAWS; POWER TOOLS, NAMELY, POWER SAW BENCHES; POWER SAW BLADES; POWER ELECTRIC SANDERS, INCLUDING FINISHING, ORBITAL, RANDOM, DELTA AND BELT SANDERS; ELECTRIC PLANERS; POWER TOOLS, NAMELY, ROUTERS AND BENCH DRILL PRESSES, IN CLASS 7 (U.S. CLS. 13, 19, 21, 23, 31, 34 AND 35).

OWNER OF INTERNATIONAL REGISTRATION
0914162 DATED 1-9-2007, EXPIRES 1-9-2017.

NO CLAIM IS MADE TO THE EXCLUSIVE RIGHT TO USE "AIR", APART FROM THE MARK AS SHOWN.

THE COLOR(S) BLUE, GRAY, AND WHITE IS/ ARE CLAIMED AS A FEATURE OF THE MARK.

THE COLOR BLUE APPEARS IN THE OUTLINE OF THE STYLIZED ARROW AND THE OUTLINE OF THE WORDING "AIR" AND "THRU". THE COLOR GRAY APPEARS IN THE SHADED PORTION OF THE OVAL IN THE BACKGROUND. THE COLOR WHITE APPEARS IN THE INTERIOR PORTIONS OF THE ARROW AND WORDING.

SER. NO. 79-034,708, FILED 1-9-2007.

JOHN KELLY, EXAMINING ATTORNEY

Int. Cl.: 25

Prior U.S. Cls.: 22 and 39

United States Patent and Trademark Office

Reg. No. 3,398,731

Registered Mar. 18, 2008

TRADEMARK
PRINCIPAL REGISTER

Francis Montesinos

MADE IN MONTESINOS, S.L. (SPAIN SOCIEDAD
LIMITADA)
TRINITARIOS, 12 BAJO
E-46003 VALENCIA
SPAIN

FOR: CLOTHING, NAMELY, BEACHWEAR,
BELTS, BERMUDA SHORTS, BLOUSES, PANTS,
JEANS, GLOVES, DRESSES, SHIRTS, NECKTIES,
PULLOVERS, SOCKS, SKIRTS, T-SHIRTS, JACKETS,
UNDERWEAR; FOOTWEAR EXCEPT ORTHOPE-
DIC FOOTWEAR; HEADWEAR, IN CLASS 25 (U.S.
CLS. 22 AND 39).

PRIORITY DATE OF 7-28-2006 IS CLAIMED.

OWNER OF INTERNATIONAL REGISTRATION
0913927 DATED 7-31-2006, EXPIRES 7-31-2016.

THE NAME(S), PORTRAIT(S), AND/OR SIGNA-
TURE(S) SHOWN IN THE MARK IDENTIFIES
"FRANCIS MONTESINOS", WHOSE CONSENT(S)
TO REGISTER IS SUBMITTED.

SER. NO. 79-034,742, FILED 7-31-2006.

COLLEEN KEARNEY, EXAMINING ATTORNEY

Int. Cls.: 7, 9 and 16

**Prior U.S. Cls.: 2, 5, 13, 19, 21, 22, 23, 26, 29, 31, 34,
35, 36, 37, 38 and 50**

Reg. No. 3,398,732

United States Patent and Trademark Office

Registered Mar. 18, 2008

**TRADEMARK
PRINCIPAL REGISTER**



ROTOTYPE S.P.A. (ITALY JOINT-STOCK COM-
PANY (S.P.A.))
VIA F. BESSI, 15
I-50041 CALENZANO FI
ITALY

FOR: FLEXOGRAPHIC, INTAGLIO, OR PLANO-
GRAPHIC PRINTING MACHINES, NAMELY MA-
CHINES FOR PERSONALIZED CHECKS
PROCESSING; CHECK BOOK DISPENSERS;
FLEXOGRAPHIC, INTAGLIO, OR PLANOGRAPHIC
PRINTING MACHINES, NAMELY AUTOMATIC
MACHINES FOR DATING, NUMBERING, SIGN-
ING DOCUMENTS AND CHECKS; AUTOMATIC
LETTER OPENERS, IN CLASS 7 (U.S. CLS. 13, 19, 21,
23, 31, 34 AND 35).

FOR: DATA PROCESSORS, NAMELY CHECK,
DOCUMENT AND IMAGE PROCESSING MA-

CHINES; SCANNERS; AUTOMATIC TELLER MA-
CHINES (ATM), NAMELY TERMINALS FOR
CHECK DEPOSIT; PRINTERS, NAMELY CONTIN-
UOUS FORMS AND SINGLE SHEET PRINTERS, IN
CLASS 9 (U.S. CLS. 21, 23, 26, 36 AND 38).

FOR: MANUAL LETTER OPENERS; INK ROLL-
ERS FOR OFFICE MACHINES; INK RIBBONS, IN
CLASS 16 (U.S. CLS. 2, 5, 22, 23, 29, 37, 38 AND 50).

OWNER OF INTERNATIONAL REGISTRATION
0914025 DATED 10-6-2006, EXPIRES 10-6-2016.

SER. NO. 79-034,747, FILED 10-6-2006.

KATHERINE E. HALMEN, EXAMINING ATTOR-
NEY

Int. Cls.: 7, 17, 24 and 25

**Prior U.S. Cls.: 1, 5, 12, 13, 19, 21, 22, 23, 31, 34, 35,
39, 42 and 50**

Reg. No. 3,398,733

United States Patent and Trademark Office

Registered Mar. 18, 2008

**TRADEMARK
PRINCIPAL REGISTER**

Blue Mauritius Label by DORNIER

LINDAUER DORNIER GESELLSCHAFT; MIT
BESCHRÄNKTER HAFTUNG. (FED REP
GERMANY LTD LIAB CO)
RICKENBACHER STR. 119
88129 LINDAU
FED REP GERMANY

FOR: WEAVING MACHINES, NAMELY, RAPIER
WEAVING MACHINES AND AIR JET WEAVING
MACHINES, WEAVING MACHINES WITH NAME-
SELVEDGE JACQUARDS, PARTS OF WEAVING
MACHINES, NAMELY, SELVEDGE TUCKING DE-
VICES, IN CLASS 7 (U.S. CLS. 13, 19, 21, 23, 31, 34 AND
35).

FOR: FABRIC, NAMELY, ASBESTOS FABRIC,
INSULATING FABRIC, AND GLASS FIBER FABRIC
FOR USE IN BUILDING INSULATION, IN CLASS 17
(U.S. CLS. 1, 5, 12, 13, 35 AND 50).

FOR: CLOTH AND FABRIC FOR TEXTILE USE
HAVING A LABEL SELVEDGE AS A PART THERE-
OF, IN CLASS 24 (U.S. CLS. 42 AND 50).

FOR: CLOTHING, NAMELY, TROUSERS, JACK-
ETS, SHIRTS, AND BLOUSES, IN CLASS 25 (U.S.
CLS. 22 AND 39).

THE MARK CONSISTS OF STANDARD CHAR-
ACTERS WITHOUT CLAIM TO ANY PARTICULAR
FONT, STYLE, SIZE, OR COLOR.

PRIORITY DATE OF 4-19-2006 IS CLAIMED.

OWNER OF INTERNATIONAL REGISTRATION
0914142 DATED 9-8-2006, EXPIRES 9-8-2016.

NO CLAIM IS MADE TO THE EXCLUSIVE
RIGHT TO USE "LABEL", APART FROM THE
MARK AS SHOWN.

SER. NO. 79-034,755, FILED 9-8-2006.

RUSS HERMAN, EXAMINING ATTORNEY

Int. Cls.: 7 and 37

Prior U.S. Cls.: 13, 19, 21, 23, 31, 34, 35, 100, 103 and 106

United States Patent and Trademark Office

Reg. No. 3,398,734

Registered Mar. 18, 2008

**TRADEMARK
SERVICE MARK
PRINCIPAL REGISTER**



CEMDAG MAKINA; SANAYI VE TICARET LIMITED SIRKETI (TURKEY LIMITED COMPANY)

129/7 SK. NO.2 4.SANAYI
SITESI BORNOVA; IZMIR
TURKEY

FOR: COMPRESSORS FOR REFRIGERATORS; COMPRESSORS FOR MACHINES; AIR TURBO COMPRESSORS; VEHICLE PNEUMATIC AND HYDRAULIC COMPRESSORS; ELECTRIC COMPRESSORS; COMPRESSORS FOR AIR CONDITIONERS, IN CLASS 7 (U.S. CLS. 13, 19, 21, 23, 31, 34 AND 35).

FOR: INSTALLATION, MAINTENANCE AND REPAIR SERVICES OF COMPRESSORS, IN CLASS 37 (U.S. CLS. 100, 103 AND 106).

OWNER OF INTERNATIONAL REGISTRATION 0914246 DATED 12-28-2006, EXPIRES 12-28-2016.

THE COLOR(S) RED AND WHITE IS/ARE CLAIMED AS A FEATURE OF THE MARK.

THE MARK CONSIST OF THE COLOR RED APPEARS IN THE ENTIRE MARK. THE TERM ARCOM IS IN RED ON A WHITE BACKGROUND WITH A RED RECTANGULAR DESIGN ABOVE AND BELOW ARCOM.

SER. NO. 79-034,798, FILED 12-28-2006.

ANDREA BUTLER, EXAMINING ATTORNEY

Int. Cls.: 7, 36, 37, 38 and 42

Prior U.S. Cls.: 13, 19, 21, 23, 31, 34, 35, 100, 101, 102, 103, 104 and 106

Reg. No. 3,398,735

United States Patent and Trademark Office

Registered Mar. 18, 2008

**TRADEMARK
SERVICE MARK
PRINCIPAL REGISTER**

WOLFFCRANE

WOLFFKRAN GMBH (FED REP GERMANY
LTD LIAB CO)
AUSTRASSE 72
74076 HEILBRONN
FED REP GERMANY

FOR: MACHINES FOR THE VERTICAL AND HORIZONTAL TRANSPORT OF GOODS, NAMELY, CRANES, IN PARTICULAR BUILDING CRANES, SLEWING CRANES, OVERHEAD CRANES, CONTAINER CRANES, LEVEL LUFFING CRANES, PORTAL CRANES; DETACHABLE CRANE COMPONENTS, NAMELY, TOWER SECTIONS, MAST SECTIONS, CROSS FRAMES, FOUNDATION ANCHORS, CLIMBING GEAR, JIBS, COUNTER JIBS, JIB EXTENSIONS, JIB SECTIONS, JIB WEIGHTS, TOWER TIES, TIE FRAMES, TIE RODS, UNDER-CARRIAGES, PORTALS; SPARE PARTS FOR CRANES, IN CLASS 7 (U.S. CLS. 13, 19, 21, 23, 31, 34 AND 35).

FOR: LEASING OF CRANES, IN CLASS 36 (U.S. CLS. 100, 101 AND 102).

FOR: RENTING OF CONSTRUCTION EQUIPMENT, NAMELY, CRANES; MAINTENANCE AND REPAIR OF MACHINES FOR THE VERTICAL AND HORIZONTAL TRANSPORT OF GOODS, NAMELY, CRANES, IN CLASS 37 (U.S. CLS. 100, 103 AND 106).

FOR: TRANSMISSION OF NEWS VIA TELECOMMUNICATION AND PROVISION OF ACCESS TO DATABASES FOR THE PURPOSE OF SURVEILLANCE, MAINTENANCE, DIAGNOSIS, PROCUREMENT OF SPARE PARTS AND SERVICING OF CRANES, IN CLASS 38 (U.S. CLS. 100, 101 AND 104).

FOR: APPLICATION SERVICE PROVIDER, NAMELY, HOSTING COMPUTER SOFTWARE APPLICATIONS OF OTHERS FOR THE SALE, RENTING AND LEASING OF CRANES, IN CLASS 42 (U.S. CLS. 100 AND 101).

THE MARK CONSISTS OF STANDARD CHARACTERS WITHOUT CLAIM TO ANY PARTICULAR FONT, STYLE, SIZE, OR COLOR.

PRIORITY DATE OF 1-11-2006 IS CLAIMED.

OWNER OF INTERNATIONAL REGISTRATION
0914306 DATED 7-11-2006, EXPIRES 7-11-2016.

SER. NO. 79-034,811, FILED 7-11-2006.

JENNY PARK, EXAMINING ATTORNEY

Int. Cl.: 36

Prior U.S. Cls.: 100, 101 and 102

United States Patent and Trademark Office

Reg. No. 3,398,736

Registered Mar. 18, 2008

**SERVICE MARK
PRINCIPAL REGISTER**



EDIZIONE HOLDING S.P.A. (ITALY JOINT STOCK COMPANY)
CALMAGGIORE, 23
I-31100 TREVISO, ITALY

FOR: FINANCIAL AFFAIRS OF A HOLDING COMPANY, NAMELY, INVESTMENT CONSULTATION AND ASSET ACQUISITION; FINANCIAL EVALUATIONS, NAMELY, FINANCIAL EVALUATIONS FOR INSURANCE PURPOSES, FISCAL ASSESSMENT AND EVALUATION, EVALUATION OF REAL PROPERTY, EVALUATION OF THE CREDIT WORTHINESS OF COMPANIES AND PRIVATE INDIVIDUALS; FINANCIAL ANALYSIS, NAMELY, FINANCIAL AND RATE-OF-RETURN ANALYSIS WITH A VIEW TO PURCHASING SHARES IN COMPANIES OF ALL KINDS; VENTURE CAPITAL FUNDING SERVICES TO EMERGING AND START-UP COMPANIES; EQUITY CAPITAL INVESTMENT; FUNDS INVESTMENTS; INVESTMENT SERVICES, NAMELY, FINANCIAL ASSET ACQUISITION OF SHAREHOLDINGS WITHIN COMPANIES THAT HAVE BEEN CREATED AND COMPANIES TO BE CREATED FOR EQUITY CAPITAL INVESTMENT; INVESTMENT SERVICES, NAMELY, ACQUISITION, MANAGEMENT AND TRANSFER OF ASSETS IN THE NATURE OF COMPANY STAKES; MANAGEMENT OF FINANCIAL, SECURITIES AND REAL-ESTATE PORTFOLIOS; STOCK EXCHANGE OPERATIONS, NAMELY, BROKERAGE OF SHARES OR STOCKS AND OTHER SECURITIES, PROVIDING STOCK MARKET INFORMATION, STOCK EXCHANGE PRICE QUOTATIONS, AND ASSISTING OTHERS WITH THE COMPLE-

TION OF FINANCIAL TRANSACTIONS FOR STOCKS, BONDS, SECURITIES AND EQUITIES; FINANCIAL CONSULTING IN THE FIELD OF VENTURE-CAPITAL, INVESTMENT-CAPITAL AND RISK-CAPITAL; REAL ESTATE AFFAIRS OF A HOLDING COMPANY, NAMELY, REAL ESTATE VALUATIONS, REAL ESTATE MANAGEMENT, REAL ESTATE INVESTMENT, REAL ESTATE ACQUISITION SERVICES; REAL ESTATE BROKERAGE, IN CLASS 36 (U.S. CLS. 100, 101 AND 102).

PRIORITY DATE OF 10-27-2006 IS CLAIMED.

OWNER OF INTERNATIONAL REGISTRATION 0914309 DATED 12-18-2006, EXPIRES 12-18-2016.

THE MARK CONSISTS OF THE STYLIZED WORDING "SINTONIA" AND THE DESIGN OF NINE CIRCLES IN THE GENERAL SHAPE OF A SQUARE TO THE RIGHT OF THE WORDING, EACH CIRCLE HAVING A LINE HORIZONTALLY BISECTING THE CIRCLE AND A LINE VERTICALLY BISECTING THE CIRCLE.

THE FOREIGN WORDING "SINTONIA" IN THE MARK TRANSLATES INTO ENGLISH AS "TUNING".

SER. NO. 79-034,812, FILED 12-18-2006.

JAY BESCH, EXAMINING ATTORNEY

Int. Cl.: 10

Prior U.S. Cls.: 26, 39 and 44

United States Patent and Trademark Office

Reg. No. 3,398,737

Registered Mar. 18, 2008

**TRADEMARK
PRINCIPAL REGISTER**

REVOLNERV

ORTHOMED (FRANCE SOCIÉTÉ ANONYME)
ZAC DE SAINT-ESTÈVE
F-06640 SAINT-JEANNET
FRANCE

PRISING ARTIFICIAL MATERIAL, IN CLASS 10
(U.S. CLS. 26, 39 AND 44).

PRIORITY DATE OF 7-3-2006 IS CLAIMED.

FOR: ORTHOPEDIC ARTICLES AND IMPLANTS
CONSISTING OF ARTIFICIAL MATERIALS,
NAMELY, IMPLANTS FOR NERVES COMPRISING
ARTIFICIAL MATERIAL; SUTURES; SURGICAL
IMPLANTS COMPRISING ARTIFICIAL MATERI-
AL; IMPLANTS CONSISTING OF ARTIFICIAL MA-
TERIALS FOR NERVE REGENERATION AND
COLLAGEN-BASED SURGICAL IMPLANTS COM-

OWNER OF INTERNATIONAL REGISTRATION
0914589 DATED 12-14-2006, EXPIRES 12-14-2016.

SER. NO. 79-034,914, FILED 12-14-2006.

SHARON MEIER, EXAMINING ATTORNEY

Int. Cl.: 9

Prior U.S. Cls.: 21, 23, 26, 36 and 38

United States Patent and Trademark Office

Reg. No. 3,398,738

Registered Mar. 18, 2008

**TRADEMARK
PRINCIPAL REGISTER**

SHORAR

OERLIKON CONTRAVES AG (SWITZERLAND
SOCIÉTÉ ANONYME)
BIRCHSTRASSE 155
CH-8050 ZÜRICH
SWITZERLAND

FOR: SURVEILLANCE AND TARGET ACQUISITION RADAR FOR USE WITH FIRE CONTROL EQUIPMENT, IN CLASS 9 (U.S. CLS. 21, 23, 26, 36 AND 38).

THE MARK CONSISTS OF STANDARD CHARACTERS WITHOUT CLAIM TO ANY PARTICULAR FONT, STYLE, SIZE, OR COLOR.

PRIORITY DATE OF 7-24-2006 IS CLAIMED.

OWNER OF INTERNATIONAL REGISTRATION
0914689 DATED 12-11-2006, EXPIRES 12-11-2016.

THE WORDING SHORAR HAS NO MEANING IN ENGLISH.

SER. NO. 79-034,940, FILED 12-11-2006.

LYDIA BELZER, EXAMINING ATTORNEY

Int. Cl.: 11

Prior U.S. Cls.: 13, 21, 23, 31 and 34

United States Patent and Trademark Office

Reg. No. 3,398,739

Registered Mar. 18, 2008

**TRADEMARK
PRINCIPAL REGISTER**

I-CHILLING

FRIGINOX (FRANCE SOCIÉTÉ PAR ACTIONS
SIMPLIFIÉE)
LES BORDS DE L'YONNE
F-89330 VILLEVALLIER
FRANCE

FOR: DEEP FREEZERS; COMPARTMENTS FOR COOLING AND DEEP-FREEZING, NAMELY, BLAST CHILLERS, BLAST FREEZERS AND COMBINED BLAST CHILLERS AND CABINETS TO CONTROL TEMPERATURE AND HUMIDITY FOR CHILLING AND FREEZING FOOD PRODUCTS; DEEP-FREEZE PRESERVERS, NAMELY, DEEP-FREEZERS AND CABINETS TO CONTROL TEMPERATURE AND HUMIDITY FOR CHILLING AND FREEZING FOOD PRODUCTS; FREEZER COMPARTMENTS, NAMELY, REACH-IN BLAST CHILLERS OR BLAST FREEZERS AND ROLL-IN BLAST CHILLERS OR BLAST FREEZERS; COOLERS,

NAMELY, REFRIGERATED COUNTERS, IN CLASS 11 (U.S. CLS. 13, 21, 23, 31 AND 34).

THE MARK CONSISTS OF STANDARD CHARACTERS WITHOUT CLAIM TO ANY PARTICULAR FONT, STYLE, SIZE, OR COLOR.

PRIORITY DATE OF 8-2-2006 IS CLAIMED.

OWNER OF INTERNATIONAL REGISTRATION 0914897 DATED 1-25-2007, EXPIRES 1-25-2017.

SER. NO. 79-035,014, FILED 1-25-2007.

LYDIA BELZER, EXAMINING ATTORNEY

Int. Cl.: 5

Prior U.S. Cls.: 6, 18, 44, 46, 51 and 52

United States Patent and Trademark Office

Reg. No. 3,398,740

Registered Mar. 18, 2008

**TRADEMARK
PRINCIPAL REGISTER**

TERGANZO

ASTRAZENECA AB (SWEDEN LTD LIAB CO)
SE-151 85 SÖDERTÄLJE
SWEDEN

FOR: PHARMACEUTICAL PREPARATIONS FOR THE TREATMENT AND PREVENTION OF ONCOLOGICAL DISORDERS, CARDIOVASCULAR DISEASES, RESPIRATORY DISEASES, INFLAMMATION/INFECTION, GASTROINTESTINAL DISEASES AND CENTRAL NERVOUS SYSTEM DISEASES, IN CLASS 5 (U.S. CLS. 6, 18, 44, 46, 51 AND 52).

THE MARK CONSISTS OF STANDARD CHARACTERS WITHOUT CLAIM TO ANY PARTICULAR FONT, STYLE, SIZE, OR COLOR.

OWNER OF INTERNATIONAL REGISTRATION 0914993 DATED 12-19-2006, EXPIRES 12-19-2016.

SER. NO. 79-035,045, FILED 12-19-2006.

WILLIAM VERHOSEK, EXAMINING ATTORNEY

Int. Cl.: 5

Prior U.S. Cls.: 6, 18, 44, 46, 51 and 52

United States Patent and Trademark Office

Reg. No. 3,398,741

Registered Mar. 18, 2008

**TRADEMARK
PRINCIPAL REGISTER**

IGZURO

ASTRAZENECA AB (SWEDEN LTD LIAB CO)
SE-151 85 SÖDERTÄLJE
SWEDEN

FOR: PHARMACEUTICAL PREPARATIONS FOR THE TREATMENT AND PREVENTION OF ONCOLOGICAL DISORDERS, CARDIOVASCULAR DISEASES, RESPIRATORY DISEASES, INFLAMMATION/INFECTION, GASTROINTESTINAL DISEASES AND CENTRAL NERVOUS SYSTEM DISEASES, IN CLASS 5 (U.S. CLS. 6, 18, 44, 46, 51 AND 52).

THE MARK CONSISTS OF STANDARD CHARACTERS WITHOUT CLAIM TO ANY PARTICULAR FONT, STYLE, SIZE, OR COLOR.

OWNER OF INTERNATIONAL REGISTRATION
0914999 DATED 12-19-2006, EXPIRES 12-19-2016.

SER. NO. 79-035,047, FILED 12-19-2006.

WILLIAM VERHOSEK, EXAMINING ATTORNEY

Int. Cl.: 5

Prior U.S. Cls.: 6, 18, 44, 46, 51 and 52

United States Patent and Trademark Office

Reg. No. 3,398,742

Registered Mar. 18, 2008

**TRADEMARK
PRINCIPAL REGISTER**

FETRUSCO

ASTRAZENECA AB (SWEDEN LTD LIAB CO)
SE-151 85 SÖDERTÄLJE
SWEDEN

FOR: PHARMACEUTICAL PREPARATIONS FOR
THE TREATMENT AND PREVENTION OF ONCO-
LOGICAL DISORDERS, CARDIOVASCULAR DIS-
EASES, RESPIRATORY DISEASES,
INFLAMMATION/INFECTION, GASTROINTEST-
INAL DISEASES AND CENTRAL NERVOUS SYS-
TEM DISEASES, IN CLASS 5 (U.S. CLS. 6, 18, 44, 46, 51
AND 52).

THE MARK CONSISTS OF STANDARD CHAR-
ACTERS WITHOUT CLAIM TO ANY PARTICULAR
FONT, STYLE, SIZE, OR COLOR.

OWNER OF INTERNATIONAL REGISTRATION
0915001 DATED 12-19-2006, EXPIRES 12-19-2016.

SER. NO. 79-035,049, FILED 12-19-2006.

WILLIAM VERHOSEK, EXAMINING ATTORNEY

Int. Cl.: 5

Prior U.S. Cls.: 6, 18, 44, 46, 51 and 52

United States Patent and Trademark Office

Reg. No. 3,398,743

Registered Mar. 18, 2008

**TRADEMARK
PRINCIPAL REGISTER**

FORGRELIS

ASTRAZENECA AB (SWEDEN LTD LIAB CO)
SE-151 85 SÖDERTÄLJE
SWEDEN

FOR: PHARMACEUTICAL PREPARATIONS FOR THE TREATMENT AND PREVENTION OF ONCOLOGICAL DISORDERS, CARDIOVASCULAR DISEASES, RESPIRATORY DISEASES, INFLAMMATION/INFECTION, GASTROINTESTINAL DISEASES AND CENTRAL NERVOUS SYSTEM DISEASES, IN CLASS 5 (U.S. CLS. 6, 18, 44, 46, 51 AND 52).

THE MARK CONSISTS OF STANDARD CHARACTERS WITHOUT CLAIM TO ANY PARTICULAR FONT, STYLE, SIZE, OR COLOR.

OWNER OF INTERNATIONAL REGISTRATION
0915004 DATED 12-19-2006, EXPIRES 12-19-2016.

SER. NO. 79-035,051, FILED 12-19-2006.

WILLIAM VERHOSEK, EXAMINING ATTORNEY

Int. Cl.: 7

Prior U.S. Cls.: 13, 19, 21, 23, 31, 34 and 35

United States Patent and Trademark Office

Reg. No. 3,398,744

Registered Mar. 18, 2008

**TRADEMARK
PRINCIPAL REGISTER**

T M B

ZHEJIANG TIANMA BEARING CO., LTD (CHI-
NA CORPORATION)
NO. 208, SHIXIANG ROAD
HANGZHOU; ZHEJIANG PROVINCE
CHINA

FOR: BEARINGS BEING PARTS OF MACHINES,
NAMELY, BALL-BEARINGS, ROLLER BEARINGS,
BALL RINGS FOR BEARINGS, BEARINGS FOR
TRANSMISSION SHAFTS, BALL RINGS FOR BEAR-
INGS, IN CLASS 7 (U.S. CLS. 13, 19, 21, 23, 31, 34 AND
35).

THE MARK CONSISTS OF STANDARD CHAR-
ACTERS WITHOUT CLAIM TO ANY PARTICULAR
FONT, STYLE, SIZE, OR COLOR.

OWNER OF INTERNATIONAL REGISTRATION
0915145 DATED 1-19-2007, EXPIRES 1-19-2017.

SER. NO. 79-035,100, FILED 1-19-2007.

JENNIFER HETU, EXAMINING ATTORNEY

Int. Cl.: 32

Prior U.S. Cls.: 45, 46 and 48

United States Patent and Trademark Office

Reg. No. 3,398,745

Registered Mar. 18, 2008

**TRADEMARK
PRINCIPAL REGISTER**

DOLOMIA

SORGENTE VALCIMOLIANA S.R.L. (ITALY LTD
LIAB CO)
VIA VITTORIO EMANUELE II, 37
I-33080 CIMOLAIS (PN), ITALY

FOR: BEER, MINERAL AND AERATED WA-
TERS, NON-ALCOHOLIC BEVERAGES, NAMELY,
CARBONATED BEVERAGES AND SOFT DRINKS;
FRUIT DRINKS AND FRUIT JUICES; SYRUPS,
CONCENTRATES AND OTHER PREPARATIONS
FOR MAKING SOFT DRINKS, IN CLASS 32 (U.S.
CLS. 45, 46 AND 48).

THE MARK CONSISTS OF STANDARD CHAR-
ACTERS WITHOUT CLAIM TO ANY PARTICULAR
FONT, STYLE, SIZE, OR COLOR.

OWNER OF INTERNATIONAL REGISTRATION
0915202 DATED 12-6-2006, EXPIRES 12-6-2016.

SER. NO. 79-035,130, FILED 12-6-2006.

SUE LAWRENCE, EXAMINING ATTORNEY

Int. Cl.: 9

Prior U.S. Cls.: 21, 23, 26, 36 and 38

Reg. No. 3,398,746

United States Patent and Trademark Office

Registered Mar. 18, 2008

**TRADEMARK
PRINCIPAL REGISTER**

PuzzleCommerce

TOBIAS RÜCKERT (FED REP GERMANY INDIVIDUAL)
IM LEHENBACH 23
73650 WINTERBACH, FED REP GERMANY

FOR: COMPUTER PROGRAMS, NAMELY, FOR USE IN DOCUMENT MANAGEMENT, FOR USE IN COMPUTER SYSTEM AND APPLICATION DEVELOPMENT, DEPLOYMENT AND MANAGEMENT, FOR USE IN CUSTOMER RELATIONSHIP MANAGEMENT (CRM), FOR USE IN BUSINESS MANAGEMENT PLANNING, FOR USE IN WEBSITE DEVELOPMENT, FOR USE IN SOFTWARE DEVELOPMENT TOOLS, FOR USE IN THE INTEGRATION OF TEXT, AUDIO, GRAPHICS, STILL IMAGES AND MOVING PICTURES INTO AN INTERACTIVE DELIVERY FOR USE IN MULTIMEDIA APPLICATIONS, FOR USE IN COMPUTER SEARCH ENGINE OPERATION, FOR USE IN APPLICATION AND DATABASE INTEGRATION, FOR USE IN ACCESSING INFORMATION DIRECTORIES THAT MAY BE DOWNLOADED FROM THE GLOBAL

COMPUTER NETWORK, FOR USE IN ON-LINE ORDERING FEATURING GENERAL MERCHANDISE AND GENERAL CONSUMER GOODS; COMPUTER OPERATING SYSTEMS; DATA PROCESSING APPARATUS, NAMELY, DATA PROCESSORS; COMPUTER HARDWARE; COMPUTER PERIPHERAL DEVICES, IN CLASS 9 (U.S. CLS. 21, 23, 26, 36 AND 38).

THE MARK CONSISTS OF STANDARD CHARACTERS WITHOUT CLAIM TO ANY PARTICULAR FONT, STYLE, SIZE, OR COLOR.

OWNER OF INTERNATIONAL REGISTRATION 0915233 DATED 12-20-2006, EXPIRES 12-20-2016.

SER. NO. 79-035,143, FILED 12-20-2006.

ALICE BENMAMAN, EXAMINING ATTORNEY

Int. Cl.: 9

Prior U.S. Cls.: 21, 23, 26, 36 and 38

United States Patent and Trademark Office

Reg. No. 3,398,747

Registered Mar. 18, 2008

**TRADEMARK
PRINCIPAL REGISTER**



KONINKLIJKE PHILIPS ELECTRONICS N.V.
(NETHERLANDS LTD LIAB CO)
GROENEWOUDSEWEG 1
NL-5621 BA EINDHOVEN
NETHERLANDS

PRIORITY DATE OF 8-11-2006 IS CLAIMED.

OWNER OF INTERNATIONAL REGISTRATION
0915409 DATED 1-22-2007, EXPIRES 1-22-2017.

FOR: APPARATUS, INSTRUMENTS AND SOFTWARE FOR RECORDING, TRANSMITTING, PROCESSING AND REPRODUCING SOUND OR IMAGE, NAMELY, DICTATION AND TRANSCRIPTION APPARATUS, NAMELY, DICTATION RECORDERS AND DICTATION MACHINES, TRANSCRIBERS; AND SOFTWARE FOR COMPRESSION, MANAGING, TRANSCRIPTION AND PROCESSING OF AUDIO FILES AND DIGITIZED SPEECH, IN CLASS 9 (U.S. CLS. 21, 23, 26, 36 AND 38).

NO CLAIM IS MADE TO THE EXCLUSIVE RIGHT TO USE "DIGITAL SPEECH STANDARD", APART FROM THE MARK AS SHOWN.

SER. NO. 79-035,195, FILED 1-22-2007.

CAROLYN CATALDO, EXAMINING ATTORNEY

Int. Cls.: 7, 9, 12 and 41

**Prior U.S. Cls.: 13, 19, 21, 23, 26, 31, 34, 35, 36, 38, 44,
100, 101 and 107**

Reg. No. 3,398,748

United States Patent and Trademark Office

Registered Mar. 18, 2008

**TRADEMARK
SERVICE MARK
PRINCIPAL REGISTER**

TimberLink

DEERE & COMPANY (DELAWARE CORPORATION)
ONE JOHN DEERE PLACE
MOLINE, IL 612658098

FOR: FOREST MACHINES, NAMELY, CUT-TO-LENGTH TREE HARVESTING MACHINES, FULL TREE FOREST HARVESTING MACHINES; FOREST MACHINE PARTS, NAMELY, HARVESTER HEADS, IN CLASS 7 (U.S. CLS. 13, 19, 21, 23, 31, 34 AND 35).

FOR: ELECTRONIC CONTROL SYSTEMS FOR MACHINES, NAMELY, FOR CONTROLLING MACHINE PERFORMANCE, CONDITION MONITORING SYSTEMS, AND MEASURING SYSTEMS; SOFTWARE, IN PARTICULAR COMPUTER PROGRAMS FOR USE IN DATABASES; ELECTRONIC HARDWARE, IN PARTICULAR COMPUTERS, VIDEO DISPLAY, ELECTRIC SENSORS FOR TIMBER DENSITY, KEYBOARDS, COMPUTER INTERFACE BOARDS, ELECTRIC CONTROL SYSTEMS FOR MACHINES, BLANK MAGNETIC DATA CARRI-

ERS, BLANK FLOPPY DISKS, ELECTRONIC CONTROL MODULES FOR MACHINES, IN CLASS 9 (U.S. CLS. 21, 23, 26, 36 AND 38).

FOR: SKIDDERS, IN CLASS 12 (U.S. CLS. 19, 21, 23, 31, 35 AND 44).

FOR: TRAINING OF MACHINES OPERATORS, IN CLASS 41 (U.S. CLS. 100, 101 AND 107).

PRIORITY DATE OF 2-3-2006 IS CLAIMED.

OWNER OF INTERNATIONAL REGISTRATION 0915434 DATED 8-3-2006, EXPIRES 8-3-2016.

SER. NO. 79-035,201, FILED 8-3-2006.

NORA BUCHANAN WILL, EXAMINING ATTORNEY

Int. Cls.: 3, 9, 18, 24 and 25

**Prior U.S. Cls.: 1, 2, 3, 4, 6, 21, 22, 23, 26, 36, 38, 39,
41, 42, 50, 51 and 52**

Reg. No. 3,398,749

United States Patent and Trademark Office

Registered Mar. 18, 2008

**TRADEMARK
PRINCIPAL REGISTER**

BODY BY UNIQLO

KABUSHIKI KAISHA FAST RETAILING (JAPAN CORPORATION)
717-1, OAZA SAYAMA
YAMAGUCHI-SHI; YAMAGUCHI 754-0894
JAPAN

FOR: BATH SALT; COSMETICS; SKIN SOAP; DENTIFRICES; PERFUMERY; ANTI-STATIC SPRAY FOR CLOTHING; DEGREASING PREPARATIONS FOR HOUSEHOLD PURPOSES; RUST REMOVING PREPARATIONS; STAIN REMOVERS WITH BENZENE; FABRIC SOFTENERS FOR LAUNDRY USE; LAUNDRY BLEACH; SHOE AND BOOT CREAM; SHOE POLISH; POLISHING PREPARATIONS; PUMICE STONES FOR PERSONAL USE; FALSE NAILS; FALSE EYELASHES, IN CLASS 3 (U.S. CLS. 1, 4, 6, 50, 51 AND 52).

FOR: EYEGLASSES, SPECTACLES AND SUNGLASSES; STRAPS FOR MOBILE PHONES, IN CLASS 9 (U.S. CLS. 21, 23, 26, 36 AND 38).

FOR: BAGS, NAMELY, SPORTS BAGS, BABY CARRYING BAGS, BEACH BAGS, BELT BAGS, BOOK BAGS, BOSTON BAGS, CARRY-ALL BAGS, CARRY-ON BAGS, COSMETIC BAGS SOLD EMPTY, DIAPER BAGS, DUFFEL BAGS, HIKING BAGS, GARMENT BAGS FOR TRAVEL, AND LEATHER AND IMITATION LEATHER BAGS; POUCHES, NAMELY, FELT POUCHES, POUCHES MADE OF COTTON, POUCHES OF LEATHER, AND DRAWSTRING POUCHES; VANITY CASES SOLD EMPTY; UMBRELLAS; PARASOLS; CLOTHING FOR DOMESTIC PETS; SLING BAGS FOR BABIES; CARRYING BAGS FOR BABIES; LEATHER BAGS FOR MERCHANDISE; LEATHER, IN CLASS 18 (U.S. CLS. 1, 2, 3, 22 AND 41).

FOR: BED BLANKETS; BEDSHEETS; QUILTS; UNFITTED LINEN FUTON AND QUILT COVERS; UNFITTED FUTON TICK COVERS NOT OF PAPER; PILLOWCASES; PERSONAL ARTICLES OF WOVEN TEXTILES NOT FOR WEAR, NAMELY, FACE TOWELS, NAPKINS, AND QUILTS; FABRICS, NAMELY, WOVEN FABRICS, CHEMICAL FIBER FABRIC, COTTON BASE MIXED FABRIC, COTTON FABRIC,

CURTAIN FABRIC, ELASTIC FABRIC FOR CLOTHING, ELASTIC YARN MIXED FABRIC, FABRIC FOR BOOTS AND SHOES, FABRIC OF IMITATION ANIMAL SKIN, FIBERGLASS FABRIC, GAUZE FABRIC, HEMP BASE MIXED FABRIC, JEANS FABRIC, JERSEY FABRIC, LINEN FABRICS, MESH-WOVEN FABRICS, MIXED FIBER FABRIC, AND NYLON FABRIC; KNITTED FABRIC; FELT AND NON-WOVEN TEXTILE FABRICS; PRESS FELT, WOVEN FELT; FILTERING CHEESE CLOTH; OILCLOTH; GUMMED WATER PROOF CLOTH; VINYL COATED CLOTH FOR USE AS PLACE-MATS, AND FOR USE IN MANUFACTURING CLOTHING, HOME AND COMMERCIAL INTERIORS; RUBBERIZED CLOTH; TABLE NAPKINS OF TEXTILE; DISH CLOTHS; UNFITTED FABRIC CHAIR COVERS; WALL HANGINGS OF TEXTILE; CURTAINS; SHOWER CURTAINS; TABLE CLOTHS NOT OF PAPER; TOILET SEAT COVERS OF TEXTILE; LABELS OF CLOTH; BILLIARD CLOTH, IN CLASS 24 (U.S. CLS. 42 AND 50).

FOR: CLOTHING, NAMELY, SHIRTS, T-SHIRTS, PANTS, JEANS, JACKETS, COATS, DRESSES, SKIRTS, SOCKS, TIGHTS, GLOVES, VESTS, UNDERWEAR, ANORAKS, RAINWEAR, WIND RESISTANT JACKETS, SWEATSHIRTS, TANK TOPS, PULLOVERS, SWEATERS, KNIT SHIRTS, CARDIGANS, BELTS, PARKAS, MUFFLERS, FLEECE PULLOVERS, AND HEADWEAR; GARTERS; SOCK SUSPENDERS; SUSPENDERS; WAISTBANDS; BELTS FOR CLOTHING; FOOTWEAR; MASQUERADE COSTUMES; SPORTS CLOTHING, NAMELY, PANTS, OVERUNIFORMS, JERSEYS, SHIRTS, COATS, AND JACKETS; BOOTS FOR SPORTS, IN CLASS 25 (U.S. CLS. 22 AND 39).

THE MARK CONSISTS OF STANDARD CHARACTERS WITHOUT CLAIM TO ANY PARTICULAR FONT, STYLE, SIZE, OR COLOR.

OWNER OF INTERNATIONAL REGISTRATION
0915451 DATED 6-30-2006, EXPIRES 6-30-2016.

OWNER OF U.S. REG. NOS. 2,720,331, 2,815,984
AND OTHERS.

SER. NO. 79-035,205, FILED 6-30-2006.

VERNA BETH RIRIE, EXAMINING ATTORNEY

Int. Cl.: 7

Prior U.S. Cls.: 13, 19, 21, 23, 31, 34 and 35

United States Patent and Trademark Office

Reg. No. 3,398,750

Registered Mar. 18, 2008

**TRADEMARK
PRINCIPAL REGISTER**

JUROUND

ERWIN JUNKER.; BROUSÍČI TECHNIKA MEL-
NÍK A.S. (CZECH REPUBLIC CORPORATION)
RIPSKÁ 863
CZ-276 01 MELNÍK
CZECH REPUBLIC

OWNER OF INTERNATIONAL REGISTRATION
0915574 DATED 12-21-2006, EXPIRES 12-21-2016.

FOR: MACHINE TOOLS, IN PARTICULAR
GRINDING MACHINES, IN CLASS 7 (U.S. CLS. 13,
19, 21, 23, 31, 34 AND 35).

THE WORDING "JUROUND" HAS NO MEAN-
ING IN A FOREIGN LANGUAGE.

THE MARK CONSISTS OF STANDARD CHAR-
ACTERS WITHOUT CLAIM TO ANY PARTICULAR
FONT, STYLE, SIZE, OR COLOR.

SER. NO. 79-035,250, FILED 12-21-2006.

PRIORITY DATE OF 6-21-2006 IS CLAIMED.

TINA BROWN, EXAMINING ATTORNEY

Int. Cls.: 9, 16, 41 and 45

**Prior U.S. Cls.: 2, 5, 21, 22, 23, 26, 29, 36, 37, 38, 50,
100, 101 and 107**

Reg. No. 3,398,751

United States Patent and Trademark Office

Registered Mar. 18, 2008

**TRADEMARK
SERVICE MARK
PRINCIPAL REGISTER**



FULL FLAME GMBH (FED REP GERMANY
GESELLSCHAFT MIT BESCHRÄNKTER HAF-
TUNG (GMBH))
MELSUNGER STABE 1
60389 FRANKFURT AM MAIN
FED REP GERMANY

CHRISTIAN ENVANGELISATION; PROVIDING
EDUCATIONAL INFORMATION ON CHRISTIAN
DOCTRINE; AND PROVIDING EDUCATIONAL
SEMINARS FEATURING RELIGIOUS INSTRUC-
TION IN THE FIELD OF SPREADING THE CHRIS-
TIAN GOSPEL, IN CLASS 41 (U.S. CLS. 100, 101 AND
107).

FOR: PRE-RECORDED VIDEO CASSETTES,
COMPACT DISCS, MAGNETIC DATA CARRIERS,
AND LASER DATA CARRIERS FEATURING RELI-
GIOUS INSTRUCTION; VIDEO CASSETTES, COM-
PACT DISCS, MAGNETIC DATA CARRIERS, AND
LASER DATA CARRIERS FEATURING TEACHING
AND INSTRUCTIONAL MATERIALS IN THE
FIELD OF RELIGIOUS INSTRUCTION, IN CLASS
9 (U.S. CLS. 21, 23, 26, 36 AND 38).

FOR: PERSONAL AND SOCIAL SERVICES REN-
DERED BY OTHERS TO MEET THE NEEDS OF
INDIVIDUALS, NAMELY, COUNSELING SERVI-
CES IN THE FIELD OF CHRISTIAN CONDUCT IN
PERSONAL RELATIONSHIPS, PERSONAL
GROWTH AND MOTIVATION CONSULTING SER-
VICES, AND ONLINE SOCIAL NETWORKING SER-
VICES; SECURITY GUARD SERVICES FOR THE
PROTECTION OF PROPERTY AND INDIVIDUALS;
AND ORGANIZATION OF RELIGIOUS EVENTS,
NAMELY, ORGANIZING RELIGIOUS MINISTER-
IAL AND EVANGELISTIC SERVICES, IN CLASS 45
(U.S. CLS. 100 AND 101).

FOR: PRINTED MATTER, NAMELY, BOOKS,
PERIODICALS, NEWSPAPERS, PROSPECTUSES,
AND TEACHING AND INSTRUCTIONAL MATERI-
AL IN THE FORM OF BOOKS, NEWSPAPERS,
PERIODICALS, AND LOOSE-LEAF PUBLICA-
TIONS, ALL IN THE FIELD OF RELIGIOUS IN-
STRUCTION; AND PHOTOGRAPHS, IN CLASS 16
(U.S. CLS. 2, 5, 22, 23, 29, 37, 38 AND 50).

OWNER OF INTERNATIONAL REGISTRATION
0915586 DATED 1-11-2007, EXPIRES 1-11-2017.

FOR: PROVIDING EDUCATION SERVICES,
NAMELY, PROVIDING SEMINARS AND WORK-
SHOPS IN THE FIELD OF CHRISTIAN EVANGELI-
SATION AND PROVIDING TRAINING FOR

NO CLAIM IS MADE TO THE EXCLUSIVE
RIGHT TO USE "PRODUCTIONS" AND "EVANGE-
LISTIC RESOURCES", APART FROM THE MARK
AS SHOWN.

THE COLOR(S) RED, ORANGE, YELLOW AND BLACK IS/ARE CLAIMED AS A FEATURE OF THE MARK.

THE MARK CONSISTS OF E R PRODUCTIONS EVANGELISTIC RESOURCES IN THE COLOR BACK AND TWO SINGLE FLAME DESIGNS BE-

TWEEN THE LETTERS E AND R IN THE COLORS RED, ORANGE, AND YELLOW. TWO BLACK HORIZONTAL LINES SEPARATE E AND R FROM THE REMAINING WORDING BELOW.

SER. NO. 79-035,255, FILED 1-11-2007.

KEVIN DINALLO, EXAMINING ATTORNEY

Int. Cls.: 29, 30 and 35

Prior U.S. Cls.: 46, 100, 101 and 102

Reg. No. 3,398,752

United States Patent and Trademark Office

Registered Mar. 18, 2008

**TRADEMARK
SERVICE MARK
PRINCIPAL REGISTER**

The logo for 'Alfesca' is rendered in a bold, black, sans-serif font. The letter 'A' is stylized with a diagonal slash through it. The letters are closely spaced and have a slightly irregular, hand-drawn appearance.

ALFESCA HF. (ICELAND A PUBLIC LIMITED LIABILITY COMPANY)
FORNUBUDUM 5
IS-222 HAFNARFJORDUR
ICELAND

FOR: MEAT; FISH, NOT LIVE; FISH PRODUCTS, FRESH AND FROZEN, NAMELY, FISH SALTED, SMOKED, CANNED, MARINATED, DRIED, JELLED, OR COOKED; SHELLFISH AND CRUSTACEANS, NOT LIVE, NAMELY, PRAWNS, SHRIMP, LOBSTER, AND CRAWFISH; POULTRY AND GAME; MEAT EXTRACTS; FOIE GRAS; PRESERVED, DRIED AND COOKED FRUITS AND VEGETABLES; JELLIES, JAMS, COMPOTES; EGGS, MILK AND MILK PRODUCTS EXCLUDING ICE CREAM, ICE MILK AND FROZEN YOGURT; EDIBLE OILS AND FATS, IN CLASS 29 (U.S. CL. 46).

FOR: COFFEE, TEA, COCOA, SUGAR, RICE, TAPIOCA, SAGO, ARTIFICIAL COFFEE; FLOUR AND PREPARATIONS MADE FROM CEREALS, NAMELY, BLINIS, BREAD, PASTRY; CONFEC-

TIONERY, NAMELY, CHOCOLATES, CANDIES, SWEETS; HONEY, TREACLE; YEAST, BAKING-POWDER; SALT, MUSTARD; VINEGAR, SAUCES BEING CONDIMENTS; SPICES; ICE, IN CLASS 30 (U.S. CL. 46).

FOR: ADVERTISING; BUSINESS MANAGEMENT; BUSINESS ADMINISTRATION; OFFICE FUNCTIONS, IN CLASS 35 (U.S. CLS. 100, 101 AND 102).

PRIORITY DATE OF 2-16-2006 IS CLAIMED.

OWNER OF INTERNATIONAL REGISTRATION 0915779 DATED 6-2-2006, EXPIRES 6-2-2016.

SER. NO. 79-035,346, FILED 6-2-2006.

KIMBERLY FRYE, EXAMINING ATTORNEY

Int. Cls.: 1, 6, 17 and 40

**Prior U.S. Cls.: 1, 2, 5, 6, 10, 12, 13, 14, 23, 25, 26, 35,
46, 50, 100, 103 and 106**

Reg. No. 3,398,753

United States Patent and Trademark Office

Registered Mar. 18, 2008

**TRADEMARK
SERVICE MARK
PRINCIPAL REGISTER**

BEKAERT

N.V. BEKAERT S.A. (BELGIUM PUBLIC LIMITED COMPANY)
BEKAERTSTRAAT 2
B-8550 ZWEVEGEM
BELGIUM

FOR: UNPROCESSED ARTIFICIAL RESINS AS BASIC MATERIAL USED AS COATING, SUCH AS COATINGS BASED ON PLASTIC SYNTHETIC RESINS, DIAMOND-LIKE LAYERS OF PROTECTION OR LAYERS CONTAINING CARBON AND CERAMIC MATERIAL FOR IMPROVING HARDNESS, RESISTANCE FOR USE, FRICTION COEFFICIENT, ELASTICITY AND CHEMICAL INERTIA OF WORKPIECES, MACHINES PARTS, TOOLS, ENGINE PARTS, CASTING MOULDS, IN CLASS 1 (U.S. CLS. 1, 5, 6, 10, 26 AND 46).

FOR: CHROME-COATED STEEL SHEETS FOR IMPROVING HARDNESS, RESISTANCE FOR USE, FRICTION COEFFICIENT, ELASTICITY AND CHEMICAL INERTIA OF WORKPIECES, MACHINE PARTS, TOOLS, ENGINE PARTS, AND CASTING MOULDS, IN CLASS 6 (U.S. CLS. 2, 12, 13, 14, 23, 25 AND 50).

FOR: SEMI-PROCESSED PLASTIC IN THE FORM OF FILMS, SHEETS, TUBES, BARS, OR RODS FOR IMPROVING HARDNESS, RESISTANCE FOR USE, FRICTION COEFFICIENT, ELASTICITY AND CHEMICAL INERTIA OF WORKPIECES, MACHINE

PARTS, TOOLS, ENGINE PARTS, AND CASTING MOULDS, IN CLASS 17 (U.S. CLS. 1, 5, 12, 13, 35 AND 50).

FOR: MATERIAL TREATMENT, NAMELY, APPLICATION OF PROTECTIVE COATINGS, FILMS AND LAYERS OF METALLIC AND NON-METALLIC MATERIAL FOR OBTAINING WEAR RESISTANT AND CORROSION RESISTANT SURFACES, SUCH AS BY SPUTTERING, THERMAL SPRAYING, VACUUM VAPOUR COATING, PLASMA SPRAYING, IN CLASS 40 (U.S. CLS. 100, 103 AND 106).

THE MARK CONSISTS OF STANDARD CHARACTERS WITHOUT CLAIM TO ANY PARTICULAR FONT, STYLE, SIZE, OR COLOR.

OWNER OF INTERNATIONAL REGISTRATION 0915806 DATED 8-25-2006, EXPIRES 8-25-2016.

OWNER OF U.S. REG. NOS. 3,100,986, 3,220,242 AND OTHERS.

SEC. 2(F).

SER. NO. 79-035,355, FILED 8-25-2006.

JENNIFER MARTIN, EXAMINING ATTORNEY

Int. Cls.: 18, 25 and 35

Prior U.S. Cls.: 1, 2, 3, 22, 39, 41, 100, 101 and 102

United States Patent and Trademark Office

Reg. No. 3,398,754

Registered Mar. 18, 2008

TRADEMARK
SERVICE MARK
PRINCIPAL REGISTER



PALMROTH INTERNATIONAL B.V. (NETHERLANDS LTD LIAB CO)
EIKENLAAN 34
NL-5143 CW WAALWIJK
NETHERLANDS

FOR: LEATHER AND IMITATION LEATHER; GOODS MADE OF LEATHER AND IMITATION LEATHER, NAMELY, CARRYALL BAGS, DUFFLE BAGS, HANDBAGS, EVENING BAGS, SLING BAGS, BACKPACKS, SHOULDER BAGS, MESSENGER BAGS, SUITCASES, TRUNKS, TRAVELLING BAGS; UMBRELLAS, PARASOLS AND WALKING STICKS; WHIPS, HARNESSES AND SADDLERY; ANIMAL SKINS AND HIDES, IN CLASS 18 (U.S. CLS. 1, 2, 3, 22 AND 41).

FOR: CLOTHING, NAMELY, JACKETS, COATS, SHIRTS, BLOUSES, TROUSERS, SKIRTS, DRESSES, T-SHIRTS, SWEATSHIRTS, SOCKS, UNDERWEAR, UNDERSHIRTS, PAJAMAS, PANTS; FOOTWEAR; SPORT SHOES, HEADWEAR, NAMELY, HATS AND CAPS, IN CLASS 25 (U.S. CLS. 22 AND 39).

FOR: BUSINESS INTERMEDIARY SERVICES IN THE FIELD OF SELLING PRODUCTS AND RENDERING SERVICES, NAMELY, BUSINESS INTERMEDIARY SERVICES FOR THE WHOLESALE AND RETAIL SERVICES RELATING TO LEATHER AND IMITATIONS OF LEATHER, AND GOODS MADE

OF THESE MATERIALS, ANIMAL SKINS, HIDES, TRUNKS AND TRAVELLING BAGS, UMBRELLAS, PARASOLS AND WALKING STICKS, WHIPS, HARNESS AND SADDLERY, CLOTHING, FOOTWEAR, SPORT SHOES AND HEADGEAR, IN CLASS 35 (U.S. CLS. 100, 101 AND 102).

PRIORITY DATE OF 11-2-2006 IS CLAIMED.

OWNER OF INTERNATIONAL REGISTRATION 0916323 DATED 11-27-2006, EXPIRES 11-27-2016.

OWNER OF U.S. REG. NO. 1,631,620.

THE NAME AND/OR SIGNATURE SHOWN IN THE MARK IDENTIFIES A LIVING INDIVIDUAL, WHOSE CONSENT IS OF RECORD.

THE NON-LATIN CHARACTERS IN THE MARK TRANSLITERATE TO "PERTTI PALMROTH".

SER. NO. 79-035,511, FILED 11-27-2006.

KATHERINE E. HALMEN, EXAMINING ATTORNEY

Int. Cls.: 3, 35 and 44

Prior U.S. Cls.: 1, 4, 6, 50, 51, 52, 100, 101 and 102

United States Patent and Trademark Office

Reg. No. 3,398,755

Registered Mar. 18, 2008

**TRADEMARK
SERVICE MARK
PRINCIPAL REGISTER**

NO NAME NAILS

PETER TROSKA (FED REP GERMANY INDIVIDUAL)
LINZER STRASSE 10
40789 MONHEIM AM RHEIN
FED REP GERMANY

FOR: PERFUMERY; COSMETICS, NAMELY, COSMETIC CREAMS, NAIL VARNISH AND NAIL POLISH REMOVER, IN CLASS 3 (U.S. CLS. 1, 4, 6, 50, 51 AND 52).

FOR: MARKETING RESEARCH; BUSINESS ORGANIZATION CONSULTANCY; PROFESSIONAL BUSINESS CONSULTANCY, IN CLASS 35 (U.S. CLS. 100, 101 AND 102).

FOR: HYGIENIC AND BEAUTY CARE FOR HUMAN BEINGS, NAMELY, BEAUTY SALONS, NAIL CARE SALONS, HAIRDRESSING SALONS, SKIN

CARE SALONS, IN CLASS 44 (U.S. CLS. 100 AND 101).

THE MARK CONSISTS OF STANDARD CHARACTERS WITHOUT CLAIM TO ANY PARTICULAR FONT, STYLE, SIZE, OR COLOR.

OWNER OF INTERNATIONAL REGISTRATION 0916500 DATED 11-27-2006, EXPIRES 11-27-2016.

NO CLAIM IS MADE TO THE EXCLUSIVE RIGHT TO USE "NAILS", APART FROM THE MARK AS SHOWN.

SER. NO. 79-035,579, FILED 11-27-2006.

KATHERINE E. HALMEN, EXAMINING ATTORNEY

Int. Cl.: 33

Prior U.S. Cls.: 47 and 49

United States Patent and Trademark Office

Reg. No. 3,398,756

Registered Mar. 18, 2008

TRADEMARK
PRINCIPAL REGISTER



Istituto del vino
italiano di qualità

ISTITUTO DEL VINO ITALIANO; DI QUALITA' -
GRANDI MARCHI S.R.L.; CONSORTILE (ITA-
LY LTD LIAB CO)
VIA SAVAL, 21
I-37124 VERONA, ITALY

FOR: WINES, DISTILLED SPIRITS, AND LI-
QUEURS, IN CLASS 33 (U.S. CLS. 47 AND 49).

PRIORITY DATE OF 11-30-2006 IS CLAIMED.

OWNER OF INTERNATIONAL REGISTRATION
0916663 DATED 1-8-2007, EXPIRES 1-8-2017.

NO CLAIM IS MADE TO THE EXCLUSIVE
RIGHT TO USE "ISTITUTO DEL VINO ITALIANO

DI QUALITA'", APART FROM THE MARK AS
SHOWN.

THE MARK IS CONSTITUTED BY A GRAPHIC
COMPOSITION INCLUDING THE WORDING "IS-
TITUTO DEL VINO ITALIANO DI QUALITÀ"
WRITTEN IN SMALL LETTERS UNDERLINED,
PLACED BELOW THE FIGURE OF A STYLIZED
GLASS.

THE FOREIGN WORDING IN THE MARK
TRANSLATES INTO ENGLISH AS INSTITUTE OF
ITALIAN WINE OF QUALITY.

SER. NO. 79-035,649, FILED 1-8-2007.

SUE LAWRENCE, EXAMINING ATTORNEY

Int. Cls.: 1 and 4

Prior U.S. Cls.: 1, 5, 6, 10, 15, 26 and 46

United States Patent and Trademark Office

Reg. No. 3,398,757

Registered Mar. 18, 2008

**TRADEMARK
PRINCIPAL REGISTER**

BASONETIC

BASF AKTIENGESELLSCHAFT (FED REP GER-
MANY AKTIENGESELLSCHAFT)
CARL-BOSCH-STRASSE 38
67063 LUDWIGSHAFEN AM RHEIN
FED REP GERMANY

FOR: CHEMICALS FOR USE IN INDUSTRY;
CHEMICALS FOR USE IN INDUSTRY, NAMELY,
MAGNETORHEOLOGICAL FLUIDS , IN CLASS 1
(U.S. CLS. 1, 5, 6, 10, 26 AND 46).

FOR: TECHNICAL OILS AND FATS FOR USE IN
THE MANUFACTURE OF OTHER PRODUCTS;
TECHNICAL OILS AND FATS FOR USE IN THE
MANUFACTURE OF ELECTRONICALLY TUNE-
ABLE FORCE-TRANSMITTING OR DAMPING DE-
VICES BASED ON THE MAGNETORHEOLOGICAL-
EFFECT; LUBRICANTS, NAMELY, INDUSTRIAL
LUBRICANTS; AND LUBRICANTS, NAMELY, IN-
DUSTRIAL LUBRICANTS FOR THE MANUFAC-

TURE OF ELECTRONICALLY TUNEABLE FORCE-
TRANSMITTING OR DAMPING DEVICES BASED
ON THE MAGNETORHEOLOGICAL-EFFECT, IN
CLASS 4 (U.S. CLS. 1, 6 AND 15).

THE MARK CONSISTS OF STANDARD CHAR-
ACTERS WITHOUT CLAIM TO ANY PARTICULAR
FONT, STYLE, SIZE, OR COLOR.

PRIORITY DATE OF 10-6-2006 IS CLAIMED.

OWNER OF INTERNATIONAL REGISTRATION
0916713 DATED 1-5-2007, EXPIRES 1-5-2017.

SER. NO. 79-035,661, FILED 1-5-2007.

CARYN GLASSER, EXAMINING ATTORNEY

Int. Cls.: 11, 35, 42 and 44

Prior U.S. Cls.: 13, 21, 23, 31, 34, 100, 101 and 102

United States Patent and Trademark Office

Reg. No. 3,398,758

Registered Mar. 18, 2008

**TRADEMARK
SERVICE MARK
PRINCIPAL REGISTER**

HORTILED

HORTILUX SCHRÉDER B.V. (NETHERLANDS
BESLOTEN VENNOOTSCHAP (B.V.))
VLOTLAAN 412
NL-2681 TV MONSTER
NETHERLANDS

FOR: LIGHTING ARTICLES AND LIGHTING PRODUCTS, NAMELY, LIGHT BULBS, LIGHTING FIXTURES, PEN LIGHTS, LIGHTING TRACKS, FLUORESCENT LIGHTING TUBES, AND LIGHT ROPES FOR THE PURPOSE OF AGRICULTURE, POULTRY, AND CATTLE BREEDING, IN CLASS 11 (U.S. CLS. 13, 21, 23, 31 AND 34).

FOR: PUBLICITY SERVICES, NAMELY, PUBLICITY CONSULTATION, PUBLICITY AND SALES PROMOTION SERVICES, PUBLICITY AGENTS, ADVERTISING AND PUBLICITY SERVICES; BUSINESS MANAGEMENT; BUSINESS ADMINISTRATION AND MANAGEMENT; PROVIDING OFFICE FUNCTIONS, IN CLASS 35 (U.S. CLS. 100, 101 AND 102).

FOR: SCIENTIFIC SERVICES, NAMELY, SCIENTIFIC RESEARCH AND DEVELOPMENT, SCIENTIFIC INVESTIGATIONS FOR AGRICULTURAL AND POULTRY AND CATTLE BREEDING PURPOSES; TECHNOLOGICAL SERVICES, NAMELY, INFORMATION TECHNOLOGY CONSULTATION, DEVELOPMENT OF NEW TECHNOLOGY FOR OTHERS IN THE FIELD OF GENOMICS AND BIOTECHNOLOGY; TECHNOLOGICAL CONSULTATION IN THE TECHNOLOGY FIELD OF COMPUTER HARDWARE SYSTEMS TO OPERATE LIGHTING SYSTEMS FOR AGRICULTURE, POULTRY, AND CATTLE BREEDING AND WELFARE; TECHNOLOGY SUPERVISION AND INSPECTION

IN THE FIELD OF LIGHTING SYSTEMS FOR AGRICULTURE, POULTRY, AND CATTLE BREEDING AND WELFARE; SCIENTIFIC RESEARCH AND TECHNOLOGY CONSULTATION IN THE FIELD OF LIGHTING SYSTEMS FOR AGRICULTURE, POULTRY, AND CATTLE BREEDING AND WELFARE; SCIENTIFIC AND TECHNOLOGICAL DESIGN FOR OTHERS IN THE FIELD OF LIGHTING SYSTEMS FOR AGRICULTURE, POULTRY, AND CATTLE BREEDING AND WELFARE, IN CLASS 42 (U.S. CLS. 100 AND 101).

FOR: AGRICULTURAL ADVICE, NAMELY, ADVICE WITH REGARD TO THE OPTIMAL CULTIVATION RESULTS OBTAINED BY USING THE CORRECT ASSIMILATION LIGHTING AND WITH REGARD TO LIGHTING ARTICLES AND LIGHTING PRODUCTS FOR AGRICULTURAL PURPOSES, IN CLASS 44 (U.S. CLS. 100 AND 101).

THE MARK CONSISTS OF STANDARD CHARACTERS WITHOUT CLAIM TO ANY PARTICULAR FONT, STYLE, SIZE, OR COLOR.

PRIORITY DATE OF 6-12-2006 IS CLAIMED.

OWNER OF INTERNATIONAL REGISTRATION
0916927 DATED 12-7-2006, EXPIRES 12-7-2016.

SER. NO. 79-035,749, FILED 12-7-2006.

KATHERINE E. HALMEN, EXAMINING ATTORNEY

Int. Cls.: 11, 35, 42 and 44

Prior U.S. Cls.: 13, 21, 23, 31, 34, 100, 101 and 102

United States Patent and Trademark Office

Reg. No. 3,398,759

Registered Mar. 18, 2008

**TRADEMARK
SERVICE MARK
PRINCIPAL REGISTER**

AGRILED

HORTILUX SCHRÉDER B.V. (NETHERLANDS
BESLOTEN VENNOOTSCHAP (B.V.))
VLOTLAAN 412
NL-2681 TV MONSTER
NETHERLANDS

FOR: LIGHTING ARTICLES AND LIGHTING PRODUCTS, NAMELY, LIGHT BULBS, LIGHTING FIXTURES, PEN LIGHTS, LIGHTING TRACKS, FLUORESCENT LIGHTING TUBES, AND LIGHT ROPES FOR THE PURPOSE OF AGRICULTURE, POULTRY, AND CATTLE BREEDING, IN CLASS 11 (U.S. CLS. 13, 21, 23, 31 AND 34).

FOR: PUBLICITY SERVICES, NAMELY, PUBLICITY CONSULTATION, PUBLICITY AND SALES PROMOTION SERVICES, PUBLICITY AGENTS, ADVERTISING AND PUBLICITY SERVICES; BUSINESS MANAGEMENT; BUSINESS ADMINISTRATION AND MANAGEMENT; PROVIDING OFFICE FUNCTIONS, IN CLASS 35 (U.S. CLS. 100, 101 AND 102).

FOR: SCIENTIFIC SERVICES, NAMELY, SCIENTIFIC RESEARCH AND DEVELOPMENT, SCIENTIFIC INVESTIGATIONS FOR AGRICULTURAL AND POULTRY AND CATTLE BREEDING PURPOSES; TECHNOLOGICAL SERVICES, NAMELY, INFORMATION TECHNOLOGY CONSULTATION, DEVELOPMENT OF NEW TECHNOLOGY FOR OTHERS IN THE FIELD OF GENOMICS AND BIOTECHNOLOGY; TECHNOLOGICAL CONSULTATION IN THE TECHNOLOGY FIELD OF COMPUTER HARDWARE SYSTEMS TO OPERATE LIGHTING SYSTEMS FOR AGRICULTURE, POULTRY, AND CATTLE BREEDING AND WELFARE; TECHNOLOGY SUPERVISION AND INSPECTION

IN THE FIELD OF LIGHTING SYSTEMS FOR AGRICULTURE, POULTRY, AND CATTLE BREEDING AND WELFARE; SCIENTIFIC RESEARCH AND TECHNOLOGY CONSULTATION IN THE FIELD OF LIGHTING SYSTEMS FOR AGRICULTURE, POULTRY, AND CATTLE BREEDING AND WELFARE; SCIENTIFIC AND TECHNOLOGICAL DESIGN FOR OTHERS IN THE FIELD OF LIGHTING SYSTEMS FOR AGRICULTURE, POULTRY, AND CATTLE BREEDING AND WELFARE, IN CLASS 42 (U.S. CLS. 100 AND 101).

FOR: AGRICULTURAL ADVICE, NAMELY, ADVICE WITH REGARD TO THE OPTIMAL CULTIVATION RESULTS OBTAINED BY USING THE CORRECT ASSIMILATION LIGHTING AND WITH REGARD TO LIGHTING ARTICLES AND LIGHTING PRODUCTS FOR AGRICULTURAL PURPOSES, IN CLASS 44 (U.S. CLS. 100 AND 101).

THE MARK CONSISTS OF STANDARD CHARACTERS WITHOUT CLAIM TO ANY PARTICULAR FONT, STYLE, SIZE, OR COLOR.

PRIORITY DATE OF 6-12-2006 IS CLAIMED.

OWNER OF INTERNATIONAL REGISTRATION 0916928 DATED 12-7-2006, EXPIRES 12-7-2016.

SER. NO. 79-035,750, FILED 12-7-2006.

KATHERINE E. HALMEN, EXAMINING ATTORNEY

Int. Cls.: 9, 37 and 42

Prior U.S. Cls.: 21, 23, 26, 36, 38, 100, 101, 103 and 106

United States Patent and Trademark Office

Reg. No. 3,398,760

Registered Mar. 18, 2008

**TRADEMARK
SERVICE MARK
PRINCIPAL REGISTER**

VECTRON

VECTRON SYSTEMS AG (FED REP GERMANY
JOINT STOCK COMPANY)
WILLY-BRANDT-WEG 41
48155 MÜNSTER
FED REP GERMANY

FOR: COMPUTER PROGRAMS RECORDED ON DATA CARRIERS AND DATA STORAGE DEVICES FOR ELECTRONIC CASH REGISTERS AND POINT-OF-SALE TERMINALS; DATA PROCESSING APPARATUS, NAMELY, ELECTRONIC CASH REGISTERS AND POINT-OF-SALE TERMINALS; COMPUTERS AND DATA PROCESSING INSTALLATIONS CONSISTING OF THE AFORESAID DEVICES, NAMELY, ELECTRONIC CASH REGISTERS AND POINT-OF-SALE TERMINALS, IN CLASS 9 (U.S. CLS. 21, 23, 26, 36 AND 38).

FOR: INSTALLATION AND MAINTENANCE OF DATA PROCESSING INSTALLATIONS, NAMELY, INSTALLATION AND MAINTENANCE OF PERSONAL

COMPUTERS, ELECTRONIC CASH REGISTERS, AND POINT-OF-SALE TERMINALS, IN CLASS 37 (U.S. CLS. 100, 103 AND 106).

FOR: DEVELOPMENT, PREPARATION, INSTALLATION AND MAINTENANCE OF DATA PROCESSING PROGRAMMES, IN CLASS 42 (U.S. CLS. 100 AND 101).

THE MARK CONSISTS OF STANDARD CHARACTERS WITHOUT CLAIM TO ANY PARTICULAR FONT, STYLE, SIZE, OR COLOR.

OWNER OF INTERNATIONAL REGISTRATION 0917022 DATED 11-23-2006, EXPIRES 11-23-2016.

SER. NO. 79-035,789, FILED 11-23-2006.

DAYNA BROWNE, EXAMINING ATTORNEY

Int. Cls.: 35, 36 and 38

Prior U.S. Cls.: 100, 101, 102 and 104

United States Patent and Trademark Office

Reg. No. 3,398,761

Registered Mar. 18, 2008

**SERVICE MARK
PRINCIPAL REGISTER**

wdeal

WENGO (FRANCE SOCIÉTÉ PAR ACTIONS SIMPLIFIÉE)
40/42 QUAI DU POINT DU JOUR
F-92100 BOULOGNE BILLANCOURT
FRANCE

FOR: ADVERTISING; COMPUTER FILE MANAGEMENT; ONLINE ADVERTISING ON A COMPUTER NETWORK; RENTAL OF ACCESS TIME TO COMMUNICATION MEANS OF ALL KINDS FOR ADVERTISING; PUBLICATION OF ADVERTISING TEXTS; RENTAL OF ADVERTISING SPACE; DISSEMINATION OF ADVERTISEMENTS, IN CLASS 35 (U.S. CLS. 100, 101 AND 102).

FOR: FINANCIAL AFFAIRS, NAMELY, FINANCIAL ANALYSIS AND CONSULTATION, FINANCIAL EXCHANGE, FINANCIAL PLANNING AND FINANCIAL MANAGEMENT; MONETARY AFFAIRS, NAMELY, MONETARY EXCHANGE AND PHILANTHROPIC SERVICES CONCERNING MONETARY DONATIONS; DIRECT BANKING, IN CLASS 36 (U.S. CLS. 100, 101 AND 102).

FOR: TELECOMMUNICATIONS, NAMELY, COMMUNICATIONS VIA WORLD-WIDE TELE-

COMMUNICATION NETWORKS AND TELECOMMUNICATION ACCESS SERVICES; COMMUNICATIONS VIA COMPUTER TERMINALS OR VIA FIBER-OPTIC NETWORKS; RADIO OR TELEPHONE COMMUNICATIONS; MOBILE RADIOTELEPHONY SERVICES; CONNECTION BY TELECOMMUNICATIONS TO A GLOBAL COMPUTER NETWORK; RADIO BROADCASTING; TELEVISION BROADCASTING; AUDIO AND VIDEO TELECONFERENCING SERVICES; ELECTRONIC MESSAGING SERVICES, IN CLASS 38 (U.S. CLS. 100, 101 AND 104).

PRIORITY DATE OF 7-6-2006 IS CLAIMED.

OWNER OF INTERNATIONAL REGISTRATION
0917064 DATED 1-3-2007, EXPIRES 1-3-2017.

SER. NO. 79-035,812, FILED 1-3-2007.

BRENDAN MCCAULEY, EXAMINING ATTORNEY

Int. Cl.: 13

Prior U.S. Cls.: 2 and 9

United States Patent and Trademark Office

Reg. No. 3,398,762

Registered Mar. 18, 2008

**TRADEMARK
PRINCIPAL REGISTER**

Millennium

OERLIKON CONTRAVES AG (SWITZERLAND
SOCIÉTÉ ANONYME)
BIRCHSTRASSE 155
CH-8050 ZÜRICH
SWITZERLAND

FOR: WEAPON INSTALLATIONS DESIGNED TO
BE INTEGRATED ON A SHIP, NAMELY, CANNONS
AND AUTOMATIC GUNS, IN CLASS 13 (U.S. CLS. 2
AND 9).

THE MARK CONSISTS OF STANDARD CHAR-
ACTERS WITHOUT CLAIM TO ANY PARTICULAR
FONT, STYLE, SIZE, OR COLOR.

PRIORITY DATE OF 7-24-2006 IS CLAIMED.

OWNER OF INTERNATIONAL REGISTRATION
0917141 DATED 12-11-2006, EXPIRES 12-11-2016.

SER. NO. 79-035,837, FILED 12-11-2006.

KATHERINE E. HALMEN, EXAMINING ATTOR-
NEY

Int. Cls.: 7 and 42

Prior U.S. Cls.: 13, 19, 21, 23, 31, 34, 35, 100 and 101

United States Patent and Trademark Office

Reg. No. 3,398,763

Registered Mar. 18, 2008

**TRADEMARK
SERVICE MARK
PRINCIPAL REGISTER**

Condor

AMAZONEN-WERKE H. DREYER GMBH & CO.
KG (FED REP GERMANY LIMITED PART-
NERSHIP WITH LIMITED COMPANY AS
GENERAL PARTNER)

9-13, AM AMAZONENWERK,
49205 HASBERGEN
FED REP GERMANY

FOR: AGRICULTURAL MACHINES AND MECHANICAL AGRICULTURAL APPARATUS FOR THE DISTRIBUTION OF MATERIAL, FERTILIZATION, PEST CONTROL, SOIL WORKING, REAPING, SWEEPING, NAMELY, PLOWS, MOLD BOARD PLOWS, DISK PLOWS, BED PLOWS, ROTARY PLOWS, ALTERNATING PLOWS, PLOW SHARES, HARROWS, TIME HARROWS, DISC HARROWS, WHEAT COMBS CULTIVATORS, GRUBBER, CHOPPING MACHINES, ROTAVATOR ROLLS, PACKERS, SOIL LOOSENERS, APPARATUS FOR THE PREPARATION OF SEED BEDS IN THE NATURE OF TILLERS, AIRPLANTERS, ROLLERS FOR SEED PLACEMENT AND SOIL DEPTH GUIDANCE, SEED DRILLS; ROOT CROP MACHINES AND MECHANICAL APPARATUS FOR ROOT CROP HARVEST, NAMELY, BEET CHOPPING MACHINES AND BEET HARVESTING MACHINES; MACHINES FOR PEST CONTROL AND FERTILIZATION, NAMELY, FERTILIZER SPLASHING SPRINKLING AND SPRAYING MACHINES AND FERTILIZER DISTRIBUTOR MACHINES; AGRICULTURAL MACHINES FOR SOWING AND PLANTING, NAMELY, SEEDERS, SINGLE GRAIN SEEDERS, PLANTING MACHINES, AND PLANT CLEARING MACHINES; AGRICULTURAL MACHINES AND MECHANICAL AGRICULTURAL APPARATUS, NOT PROPELLED, PROPELLED, OR SELF-PROPELLED FOR SOIL WORKING, NAMELY, TILLERS, ROLLERS FOR SOIL COMPACTION,

ROLLERS FOR SEED PLACEMENT, SEED DRILLS; PARTS OF MACHINES FOR ATTACHMENT TO TRACTORS, NAMELY, TILLERS, ROLLERS FOR SOIL COMPACTION, ROLLERS FOR SEED PLACEMENT, ROLLERS FOR SOIL DEPTH GUIDANCE, SPRAYERS FOR FERTILIZER AND PEST CONTROL, SPREADERS, AIRPLANTERS; REPLACEMENT PARTS AND FITTINGS FOR THE AFOREMENTIONED GOODS, IN CLASS 7 (U.S. CLS. 13, 19, 21, 23, 31, 34 AND 35).

FOR: TECHNICAL ANALYSES AND TECHNICAL AND SCIENTIFIC CONSULTATION IN CONNECTION WITH THE DISTRIBUTION OF LIQUID, GRAINED OR PULVERIZED MATERIAL ON AGRICULTURAL AREAS; RENTAL OF DATABASE SERVERS AND COMPUTERS TO THIRD PARTIES IN CONNECTION WITH THE DISTRIBUTION OF LIQUID, GRAINED OR PULVERIZED MATERIAL ON AGRICULTURAL AREAS, IN CLASS 42 (U.S. CLS. 100 AND 101).

THE MARK CONSISTS OF STANDARD CHARACTERS WITHOUT CLAIM TO ANY PARTICULAR FONT, STYLE, SIZE, OR COLOR.

PRIORITY DATE OF 3-28-2006 IS CLAIMED.

OWNER OF INTERNATIONAL REGISTRATION
0917378 DATED 9-27-2006, EXPIRES 9-27-2016.

SER. NO. 79-035,936, FILED 9-27-2006.

EMILY CHUO, EXAMINING ATTORNEY

Int. Cls.: 4, 6, 12, 14, 16, 20, 24, 25, 28, 34, 35, 37 and 39

Prior U.S. Cls.: 1, 2, 5, 6, 8, 9, 12, 13, 14, 15, 17, 19, 21, 22, 23, 25, 27, 28, 29, 31, 32, 35, 37, 38, 39, 42, 44, 50, 100, 101, 102, 103, 105 and 106

Reg. No. 3,398,764

United States Patent and Trademark Office

Registered Mar. 18, 2008

**TRADEMARK
SERVICE MARK
PRINCIPAL REGISTER**



OTKRYTOE AKTSIONERNOE OBCHTCHESTVO;
"NEFTYANAYA KOMPANIYA "LUKOIL"
(RUSSIAN FED. CORPORATION)
11, SRETENSKY BOULVAR
RU-101000 MOSKVA
RUSSIAN FED.

FOR: FUELS, NAMELY, FUELS FOR MOTORS
AND ENGINES, IN CLASS 4 (U.S. CLS. 1, 6 AND 15).

FOR: METAL CONTAINERS FOR TRANSPORT;
METAL CONTAINERS FOR COMPRESSED GAS;
METAL CONTAINERS FOR LIQUID FUEL; METAL
PIPES; METAL SIGN HOLDERS, IN CLASS 6 (U.S.
CLS. 2, 12, 13, 14, 23, 25 AND 50).

FOR: VEHICLES, NAMELY, CARS, TRUCKS
AND VANS; VEHICLES FOR LOCOMOTION BY
LAND, AIR AND WATER, NAMELY AUTOMO-
BILES, AIRPLANES, BOATS, IN CLASS 12 (U.S. CLS.
19, 21, 23, 31, 35 AND 44).

FOR: CHARMS, IN CLASS 14 (U.S. CLS. 2, 27, 28
AND 50).

FOR: WRITING SETS COMPRISED OF INK-
STANDS, PENS, PENCIL HOLDERS; PENS; CALEN-
DARS; CATALOGS IN THE FIELD OF PETROLEUM
PRODUCTS AND PETROCHEMICALS; PRINTED
PROSPECTUSES; PRINTED MATTER, NAMELY,
BOOKLETS IN THE FIELD OF PETROLEUM PRO-
DUCTS AND PETROCHEMICALS, NEWSLETTERS

IN THE FIELD OF PETROLEUM PRODUCTS AND
PETROCHEMICALS, TEAR-OFF CALENDARS,
POSTERS; STICKERS; PAPER AND CARDBOARD
SIGNBOARDS; PAPER PENNANTS; NON-TEXTILE
PAPER LABELS; PAPER AND PLASTIC PACKA-
GING BAGS; ADVERTISEMENT POSTER BOARDS
OF PAPER AND CARDBOARD, IN CLASS 16 (U.S.
CLS. 2, 5, 22, 23, 29, 37, 38 AND 50).

FOR: CONTAINERS FOR CONSERVING AND
TRANSPORTING LIQUID FUELS, NAMELY, NON-
METAL AND NON-MASONRY FLEXIBLE AND
PORTABLE PLASTIC BAG FOR CARRYING GASO-
LINE OR OTHER LIQUID PETROLEUM FUELS, IN
CLASS 20 (U.S. CLS. 2, 13, 22, 25, 32 AND 50).

FOR: CLOTH PENNANTS, LABELS OF CLOTH,
IN CLASS 24 (U.S. CLS. 42 AND 50).

FOR: CLOTHING, NAMELY, COMBINATIONS,
JACKETS, T-SHIRTS, OUTERCLOTHING, NAME-
LY, RAINWEAR, UNIFORMS, WATERPROOF
JACKETS AND PANTS; HATS, IN CLASS 25 (U.S.
CLS. 22 AND 39).

FOR: TOYS, NAMELY, TOY VEHICLES; PLAY
BALLOONS, IN CLASS 28 (U.S. CLS. 22, 23, 38 AND
50).

FOR: LIGHTERS FOR SMOKERS, IN CLASS 34
(U.S. CLS. 2, 8, 9 AND 17).

FOR: ADVERTISING AGENCIES; ORGANIZATION OF EXHIBITIONS FOR EXPLORATION AND PRODUCTION OF OIL AND GAS, PRODUCTION OF PETROLEUM PRODUCTS AND PETROCHEMICALS, FOR COMMERCIAL AND ADVERTISING PURPOSES; PUBLICATION OF ADVERTISING TEXTS; RADIO ADVERTISING; DISSEMINATION OF ADVERTISING MATERIAL; ONLINE ADVERTISING ON A COMPUTER NETWORK; TELEVISION ADVERTISING; ADVERTISING, NAMELY, PLACING ADVERTISING ON VEHICLES, NAMELY, MOTOR BUSES, TROLLEY BUSES, TRAMCARS, MOTOR CARS, TAXIS; CONDUCTING MARKETING STUDIES; MARKET RESEARCH; UPDATING OF ADVERTISING TEXTS; PREPARING AND PLACING OUTDOOR ADVERTISEMENTS FOR OTHERS, IN CLASS 35 (U.S. CLS. 100, 101 AND 102).

FOR: VEHICLE SERVICE STATIONS; BREAK-DOWN ASSISTANCE, NAMELY, REPAIR AND MAINTENANCE OF MOTOR VEHICLES, WASHING OF MOTOR VEHICLES, IN CLASS 37 (U.S. CLS. 100, 103 AND 106).

FOR: TRANSPORT OF FUELS BY BOAT, RAIL, CAR; STORAGE OF FUELS; TRANSPORT OF OIL AND GAS THROUGH PIPELINE, IN CLASS 39 (U.S. CLS. 100 AND 105).

PRIORITY DATE OF 5-22-2006 IS CLAIMED.

OWNER OF INTERNATIONAL REGISTRATION 0917488 DATED 11-21-2006, EXPIRES 11-21-2016.

THE COLOR(S) BLUE AND WHITE IS/ARE CLAIMED AS A FEATURE OF THE MARK.

THE MARK CONSISTS OF THE FOLLOWING: THE COLOR BLUE APPEARS IN THE DESIGN OF THE BUBBLES; THE COLOR WHITE APPEARS IN THE BACKGROUND AND IN THE DESIGN OF THE BUBBLES.

SER. NO. 79-036,010, FILED 11-21-2006.

TASNEEM HUSSAIN, EXAMINING ATTORNEY

Int. Cls.: 35 and 42

Prior U.S. Cls.: 100, 101 and 102

United States Patent and Trademark Office

Reg. No. 3,398,765

Registered Mar. 18, 2008

**SERVICE MARK
PRINCIPAL REGISTER**

BIOTRIAL

BIOTRIAL (FRANCE SOCIÉTÉ PAR ACTIONS
SIMPLIFIÉE)
RUE JEAN-LOUIS BERTRAND -
ZAC ATALANTE VILLEJAN
F-35000 RENNES, FRANCE

FOR: COORDINATION OF CLINICAL TRIALS,
NAMELY, COMPILATION OF STATISTICS AND
DATA MANAGEMENT SERVICES FOR CLINICAL
TRIALS, IN CLASS 35 (U.S. CLS. 100, 101 AND 102).

FOR: PHARMACEUTICAL PRODUCT EVALUA-
TION; MEDICAL RESEARCH SERVICES IN PHAR-
MACOLOGY; CLINICAL PHARMACOLOGY
SERVICES, NAMELY, CONDUCTING CLINICAL
TRIALS; CONDUCTING CLINICAL TRIALS FOR
MEDICAL RESEARCH PURPOSES; PHARMACEU-
TICAL RESEARCH SERVICES, NAMELY, MEDI-
CINE I N T E R A C T I O N S T U D I E S ;
PHARMACOLOGICAL MEDICAL RESEARCH;
PRECLINICAL PHARMACOLOGY MEDICAL RE-
SEARCH AND STUDIES, NAMELY, EXPERIMEN-
TAL TESTING IN PHARMACOLOGY FOR THE
EVALUATION OF SYNTHETIC OR NATURALLY-
OCCURRING MOLECULES, IN THE FIELD OF
CARDIOVASCULAR PHARMACOLOGY, PHAR-
MACOLOGY OF THE CENTRAL NERVOUS SYS-
TEM, RESPIRATORY PHARMACOLOGY AND
RENAL PHARMACOLOGY; MEDICAL RESEARCH,
PHARMACEUTICAL RESEARCH AND PARA-
PHARMACEUTICAL RESEARCH CONSULTING,
TESTING, EXAMINATIONS AND MEDICAL RE-
SEARCH, IN CONNECTION WITH PHARMACODY-
NAMICS, NAMELY, STUDIES IN CONNECTION
WITH THE EFFECTS OF MEDICINES ON PRI-
MARY PHYSIOLOGICAL FUNCTIONS, NAMELY,
THE CENTRAL NERVOUS SYSTEM, CARDIOVAS-
CULAR, GASTROINTESTINAL AND LIVER, RE-

SPIRATORY, RENAL, OPHTHALMOLOGICAL
FUNCTIONS; MEDICAL, PHARMACEUTICAL
AND PARAPHARMACEUTICAL MEDICAL RE-
SEARCH SERVICES IN THE FIELD OF PHARMA-
COLOGY AND CARRIED OUT IN THE
FOLLOWING THERAPEUTIC FIELDS, NAMELY,
ALLERGOLOGY AND IMMUNOLOGY, CARDIO-
VASCULAR SYSTEM, CENTRAL NERVOUS SYS-
TEM, DERMATOLOGY, ENDOCRINOLOGY,
METABOLISM, GASTROENTEROLOGY, HEMA-
TOLOGY, RESPIRATORY DISEASES, INFECTIOUS
DISEASES, ONCOLOGY; MEDICAL RESEARCH,
PHARMACEUTICAL RESEARCH AND PARA-
PHARMACEUTICAL RESEARCH CONSULTING,
TESTING, EXAMINATIONS AND MEDICAL RE-
SEARCH, IN CONNECTION WITH PHARMACOKI-
NETICS; CLINICAL MEDICAL RESEARCH
SERVICES IN ONCOLOGY; CLINICAL MEDICAL
RESEARCH SERVICES IN CONNECTION WITH
ANTI-CANCER MEDICINES; DATA WAREHOUS-
ING, IN CLASS 42 (U.S. CLS. 100 AND 101).

THE MARK CONSISTS OF STANDARD CHAR-
ACTERS WITHOUT CLAIM TO ANY PARTICULAR
FONT, STYLE, SIZE, OR COLOR.

PRIORITY DATE OF 2-10-2006 IS CLAIMED.

OWNER OF INTERNATIONAL REGISTRATION
0917582 DATED 8-8-2006, EXPIRES 8-8-2016.

SER. NO. 79-036,053, FILED 8-8-2006.

DOMINIC FATHY, EXAMINING ATTORNEY

Int. Cl.: 33

Prior U.S. Cls.: 47 and 49

United States Patent and Trademark Office

Reg. No. 3,398,766

Registered Mar. 18, 2008

TRADEMARK
PRINCIPAL REGISTER



CARPENÈ MALVOLTÌ S.P.A. (ITALY SOCIETE
PAR ACTIONS)
VIA ANTONIO CARPENE', 1
I-31014 CONEGLIANO (TV)
ITALY

FOR: SPARKLING WINES, ALCOHOLIC BEV-
ERAGES, EXCEPT BEERS, NAMELY, GRAPPA,
BRANDY, WINE BRANDY, IN CLASS 33 (U.S. CLS.
47 AND 49).

PRIORITY DATE OF 6-14-2006 IS CLAIMED.

OWNER OF INTERNATIONAL REGISTRATION
0917835 DATED 9-19-2006, EXPIRES 9-19-2016.

OWNER OF U.S. REG. NO. 1,287,171.

THE COLOR(S) BLACK, RED, GOLD IS/ARE
CLAIMED AS A FEATURE OF THE MARK.

THE MARK CONSISTS OF THE COLOR RED
APPEARING IN THE LETTERS "C" AND "M" AND
THE COLOR BLACK APPEARS IN THE REMAIN-
ING LETTERS OF THE WORDING "CARPENE
MALVOLTÌ", THE COLOR GOLD APPEARS IN
THE CROWN DESIGN AND THE BORDER.

SER. NO. 79-036,141, FILED 9-19-2006.

KATHERINE E. HALMEN, EXAMINING ATTOR-
NEY

Int. Cl.: 36

Prior U.S. Cls.: 100, 101 and 102

United States Patent and Trademark Office

Reg. No. 3,398,767

Registered Mar. 18, 2008

**SERVICE MARK
PRINCIPAL REGISTER**

LOBNEK WEALTH MANAGEMENT

LOBNEK WEALTH MANAGEMENT SA; C/O
SERCOFIN, SOCIÉTÉ DE SERVICES; COMPT-
ABLES ET FINANCIERS SA (SWITZERLAND
SOCIÉTÉ ANONYME)
RUE CHARLES-BONNET 4
GENÈVE, SWITZERLAND CH1206

OWNER OF INTERNATIONAL REGISTRATION
0917840 DATED 1-25-2007, EXPIRES 1-25-2017.

FOR: FINANCIAL SERVICES, NAMELY, INVEST-
MENT FUND TRANSFER AND TRANSACTION
SERVICES, IN CLASS 36 (U.S. CLS. 100, 101 AND 102).

NO CLAIM IS MADE TO THE EXCLUSIVE
RIGHT TO USE "WEALTH MANAGEMENT",
APART FROM THE MARK AS SHOWN.

THE MARK CONSISTS OF STANDARD CHAR-
ACTERS WITHOUT CLAIM TO ANY PARTICULAR
FONT, STYLE, SIZE, OR COLOR.

SER. NO. 79-036,142, FILED 1-25-2007.

PRIORITY DATE OF 11-21-2006 IS CLAIMED.

LINDA E. BLOHM, EXAMINING ATTORNEY

Int. Cl.: 1

Prior U.S. Cls.: 1, 5, 6, 10, 26 and 46

Reg. No. 3,398,768

United States Patent and Trademark Office

Registered Mar. 18, 2008

**TRADEMARK
PRINCIPAL REGISTER**

SOLACOR

OXONICA MATERIALS LIMITED (UNITED KINGDOM LIMITED LIABILITY COMPANY)
7 BEGBROKE SCIENCE PARK
SANDY LANE, YARNTON
KIDLINGTON, OXFORDSHIRE, UNITED KINGDOM OX5 1PF

FOR: CHEMICAL ADDITIVES FOR USE IN THE MANUFACTURE OF FIBRES, TEXTILES, NETTING, CLOTHING, PAPER, WINDOWS, GLASS, SHEETS, FILMS, GELS, FOAM, FOAMED ARTICLES, PLASTICS, PLASTIC EXTRUSIONS, PLASTIC MOULDINGS, PLASTIC ARTICLES, POLYMERS, RESINS, RUBBER, INK, DYE, PIGMENTS, PAINTS, VARNISHES, GELCOAT, PLASTICISED COATINGS, POLISHES, LACQUERS, WAXES AND CREAMS; CHEMICAL ADDITIVES TO IMPROVE RESISTANCE OF POLYMERIC MATERIALS AND PRODUCTS MADE FROM OR COATED WITH THOSE MATERIALS TO DAMAGE FROM ULTRAVIOLET LIGHT; ULTRAVIOLET ABSORBING CHEMICAL AGENTS; UV RESISTANT CHEMICAL PRODUCTS FOR APPLICATION TO AND CHEMICAL ADDITIVES FOR INCORPORATION INTO FIBRES, TEXTILES, NETTING, CLOTHING, PAPER, WINDOWS, GLASS, SHEETS, FILMS, GELS, FOAM, FOAMED ARTICLES, PLASTICS, PLASTIC EXTRUSIONS,

PLASTIC MOULDINGS, PLASTIC ARTICLES, POLYMERS, RESINS, RUBBER, INK, DYE, PIGMENTS, PAINTS, VARNISHES, GELCOAT, PLASTICISED COATINGS, POLISHES, LACQUERS, WAXES AND CREAMS; SMALL PARTICULATE PREPARATIONS COMPRISED OF METAL AND METAL COMPOUNDS FOR USE IN THE MANUFACTURE OF COSMETICS, PHARMACEUTICALS, FUEL ADDITIVES, ELECTRONIC DEVICES, PAINTS, VARNISHES AND COATING COMPOSITIONS; UNPROCESSED PLASTIC AND POLYMERIC COMPOSITIONS; UV RESISTANT UNPROCESSED PLASTIC; UNEXPOSED PHOTOGRAPHIC FILM, IN CLASS 1 (U.S. CLS. 1, 5, 6, 10, 26 AND 46).

THE MARK CONSISTS OF STANDARD CHARACTERS WITHOUT CLAIM TO ANY PARTICULAR FONT, STYLE, SIZE, OR COLOR.

OWNER OF INTERNATIONAL REGISTRATION 0918447 DATED 11-13-2006, EXPIRES 11-13-2016.

SER. NO. 79-036,374, FILED 11-13-2006.

PAULA MAHONEY, EXAMINING ATTORNEY

Int. Cl.: 41

Prior U.S. Cls.: 100, 101 and 107

United States Patent and Trademark Office

Reg. No. 3,398,769

Registered Mar. 18, 2008

**SERVICE MARK
PRINCIPAL REGISTER**

eql eqteq

MARK MCKENZIE (AUSTRALIA INDIVIDUAL)
341 SEASPRAY ROAD
LONGFORD VIC 3851
AUSTRALIA

FOR: CULTURAL SERVICES, NAMELY, ORGANIZING COMMUNITY FESTIVALS FEATURING A VARIETY OF ACTIVITIES, NAMELY, ART EXHIBITIONS, WORKSHOPS AND SEMINARS IN THE FIELD OF ART, INSTRUCTION IN THE FIELD OF ARTWORK, AND THE LIKE, IN CLASS 41 (U.S. CLS. 100, 101 AND 107).

THE MARK CONSISTS OF STANDARD CHARACTERS WITHOUT CLAIM TO ANY PARTICULAR FONT, STYLE, SIZE, OR COLOR.

OWNER OF INTERNATIONAL REGISTRATION
0918564 DATED 2-22-2007, EXPIRES 2-22-2017.

SER. NO. 79-036,422, FILED 2-22-2007.

DANIEL BRODY, EXAMINING ATTORNEY

Int. Cls.: 9 and 10

Prior U.S. Cls.: 21, 23, 26, 36, 38, 39 and 44

United States Patent and Trademark Office

Reg. No. 3,398,770

Registered Mar. 18, 2008

**TRADEMARK
PRINCIPAL REGISTER**

CAREZZA

OTTO BOCK HEALTHCARE GMBH (FED REP
GERMANY LIMITED COMPANY)
MAX-NÄDER-STRASSE 15
37115 DUDERSTADT
FED REP GERMANY

FOR: ELECTRICAL CONTROLLERS FOR OR-
THOSIS FOR LIMBS AND JOINTS; ELECTRICAL
CONTROLLERS FOR ARTIFICIAL LIMBS AND
JOINTS THAT SENSE PRESSURE AND BODY PO-
TENTIAL AND MEASURE UNITS OF PRESSURE,
BODY POTENTIAL AND POSITIONING FOR ARTI-
FICIAL LIMBS AND JOINTS; DATA PROCESSING
PROGRAMS FOR USE IN ORTHOSIS FOR LIMBS
AND JOINTS, IN CLASS 9 (U.S. CLS. 21, 23, 26, 36
AND 38).

FOR: ORTHOPEDIC ORTHESES, NAMELY OR-
THOPEDIC BELTS, ORTHOPEDIC BRACES, OR-
THOPEDIC SUPPORTS, IN CLASS 10 (U.S. CLS. 26,
39 AND 44).

THE MARK CONSISTS OF STANDARD CHAR-
ACTERS WITHOUT CLAIM TO ANY PARTICULAR
FONT, STYLE, SIZE, OR COLOR.

PRIORITY DATE OF 9-28-2006 IS CLAIMED.

OWNER OF INTERNATIONAL REGISTRATION
0918773 DATED 2-15-2007, EXPIRES 2-15-2017.

THE FOREIGN WORDING IN THE MARK
TRANSLATES INTO ENGLISH AS CARESS.

SER. NO. 79-036,481, FILED 2-15-2007.

MARCIE MILONE, EXAMINING ATTORNEY

Int. Cls.: 9 and 10

Prior U.S. Cls.: 21, 23, 26, 36, 38, 39 and 44

United States Patent and Trademark Office

Reg. No. 3,398,771

Registered Mar. 18, 2008

**TRADEMARK
PRINCIPAL REGISTER**

LENIA

OTTO BOCK HEALTHCARE GMBH (FED REP
GERMANY LIMITED COMPANY)
MAX-NÄDER-STRASSE 15
37115 DUDERSTADT
FED REP GERMANY

FOR: ELECTRICAL CONTROLLERS FOR OR-
THOSIS FOR LIMBS AND JOINTS; ELECTRICAL
CONTROLLERS FOR ARTIFICIAL LIMBS AND
JOINTS THAT SENSE PRESSURE AND BODY PO-
TENTIAL AND MEASURE UNITS OF PRESSURE,
BODY POTENTIAL AND POSITIONING FOR ARTI-
FICIAL LIMBS AND JOINTS; DATA PROCESSING
PROGRAMS FOR USE IN ORTHOSIS FOR LIMBS
AND JOINTS, IN CLASS 9 (U.S. CLS. 21, 23, 26, 36
AND 38).

FOR: ORTHOPEDIC ORTHESES, NAMELY, OR-
THOPEDIC BELTS, ORTHOPEDIC BRACES, OR-

THOPEDIC SUPPORTS, IN CLASS 10 (U.S. CLS. 26,
39 AND 44).

THE MARK CONSISTS OF STANDARD CHAR-
ACTERS WITHOUT CLAIM TO ANY PARTICULAR
FONT, STYLE, SIZE, OR COLOR.

PRIORITY DATE OF 9-28-2006 IS CLAIMED.

OWNER OF INTERNATIONAL REGISTRATION
0918775 DATED 2-15-2007, EXPIRES 2-15-2017.

SER. NO. 79-036,483, FILED 2-15-2007.

MARCIE MILONE, EXAMINING ATTORNEY

Int. Cls.: 9 and 10

Prior U.S. Cls.: 21, 23, 26, 36, 38, 39 and 44

United States Patent and Trademark Office

Reg. No. 3,398,772

Registered Mar. 18, 2008

**TRADEMARK
PRINCIPAL REGISTER**

AREXA

OTTO BOCK HEALTHCARE GMBH (FED REP
GERMANY LIMITED COMPANY)
MAX-NÄDER-STRASSE 15
37115 DUDERSTADT
FED REP GERMANY

FOR: ELECTRICAL CONTROLLERS FOR OR-
THOSIS FOR LIMBS AND JOINTS; ELECTRICAL
CONTROLLERS FOR ARTIFICIAL LIMBS AND
JOINTS THAT SENSE PRESSURE AND BODY PO-
TENTIAL AND MEASURE UNITS OF PRESSURE,
BODY POTENTIAL AND POSITIONING FOR ARTI-
FICIAL LIMBS AND JOINTS; DATA PROCESSING
PROGRAMS FOR USE IN ORTHOSIS FOR LIMBS
AND JOINTS, IN CLASS 9 (U.S. CLS. 21, 23, 26, 36
AND 38).

FOR: ORTHOPEDIC ORTHESES, NAMELY, OR-
THOPEDIC BELTS, ORTHOPEDIC BRACES, OR-

THOPEDIC SUPPORTS, IN CLASS 10 (U.S. CLS. 26,
39 AND 44).

THE MARK CONSISTS OF STANDARD CHAR-
ACTERS WITHOUT CLAIM TO ANY PARTICULAR
FONT, STYLE, SIZE, OR COLOR.

PRIORITY DATE OF 9-28-2006 IS CLAIMED.

OWNER OF INTERNATIONAL REGISTRATION
0918777 DATED 2-15-2007, EXPIRES 2-15-2017.

SER. NO. 79-036,485, FILED 2-15-2007.

MARCIE MILONE, EXAMINING ATTORNEY

Int. Cl.: 33

Prior U.S. Cls.: 47 and 49

United States Patent and Trademark Office

Reg. No. 3,398,773

Registered Mar. 18, 2008

**TRADEMARK
PRINCIPAL REGISTER**

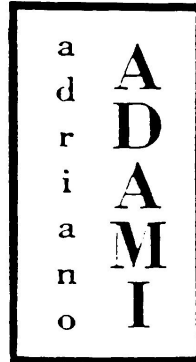

ADAMI S.R.L. (ITALY S.R.L.)
VIA ROVEDE, 21
I-31020 COLBERTALDO DI VIDOR (TV)
ITALY

"THE NAME(S), PORTRAIT(S), AND/OR SIGNATURE(S) SHOWN IN THE MARK DOES NOT IDENTIFY A PARTICULAR LIVING INDIVIDUAL."

FOR: WINES, IN CLASS 33 (U.S. CLS. 47 AND 49).

SER. NO. 79-036,486, FILED 3-29-2007.

OWNER OF INTERNATIONAL REGISTRATION
0918782 DATED 3-29-2007, EXPIRES 3-29-2017.

SARA THOMAS, EXAMINING ATTORNEY

Int. Cls.: 5 and 9

Prior U.S. Cls.: 6, 18, 21, 23, 26, 36, 38, 44, 46, 51 and 52

Reg. No. 3,398,774

United States Patent and Trademark Office

Registered Mar. 18, 2008

**TRADEMARK
PRINCIPAL REGISTER**

TWO CELLS

TWO CELLS CO. LTD. (JAPAN JOINT STOCK COMPANY)
5-17-501, DANBARA 4-CHOME
MINAMI-KU; HIROSHIMA-SHI, HIROSHIMA 732-0811
JAPAN

FOR: MICROORGANISMS FOR MEDICAL PURPOSES; CULTURE BACTERIA FOR MEDICAL PURPOSES; CULTURE MEDIUM FOR MEDICAL PURPOSES; AGENTS FOR CELL CULTURES; GENE EXPRESSION PATTERN ANALYSIS REAGENTS FOR MEDICAL OR VETERINARY PURPOSES; GENE AND PROTEIN REAGENTS FOR MEDICAL OR DIAGNOSTIC PURPOSES; MEDICAL OR DIAGNOSTIC REAGENTS OF GENE ARRAY OR CHIP; GENE THERAPY VECTOR; TRANSGENIC AGENTS; GENE EXPRESSION REGULATION AGENTS; CULTURE MEDIUM, CELLS AND CELL CULTURES FOR GENE THERAPY; TRANSGENIC CELLS AND CELL STRAINS FOR MEDICAL DIAGNOSIS; TRANSGENIC CELLS AND CELL STRAINS

FOR DISEASE TREATMENT; TRANSGENIC CELLS AND CELL STRAINS FOR IMPLANTATION; BIOLOGICAL TISSUE ADHESIVES FOR MEDICAL PURPOSES, IN CLASS 5 (U.S. CLS. 6, 18, 44, 46, 51 AND 52).

FOR: LABORATORY EQUIPMENT, NAMELY, INCUBATORS FOR BACTERIA OR CELLS, IN CLASS 9 (U.S. CLS. 21, 23, 26, 36 AND 38).

THE MARK CONSISTS OF STANDARD CHARACTERS WITHOUT CLAIM TO ANY PARTICULAR FONT, STYLE, SIZE, OR COLOR.

OWNER OF INTERNATIONAL REGISTRATION 0919280 DATED 2-8-2007, EXPIRES 2-8-2017.

SER. NO. 79-036,651, FILED 2-8-2007.

FRED CARL, EXAMINING ATTORNEY

Int. Cls.: 9, 10, 35 and 36

Prior U.S. Cls.: 21, 23, 26, 36, 38, 39, 44, 100, 101 and 102

United States Patent and Trademark Office

Reg. No. 3,398,775

Registered Mar. 18, 2008

**TRADEMARK
SERVICE MARK
PRINCIPAL REGISTER**



BSE HOLDINGS CO., LTD. (REPUBLIC OF KOREA LIMITED COMPANY)
58B-4L, 626-3, GOZAN-DONG,
NAMDONG-GU; INCHON-SI 405-817
REPUBLIC OF KOREA

FOR: SOUND RECORDING APPARATUS AND INSTRUMENTS FOR CINEMATOGRAPHIC PURPOSES, ELECTRIC BATTERIES, VIDEO PHONES, INTERPHONES, TELEPHONE SETS, APPARATUS FOR TRANSMISSION OF COMMUNICATION FOR VEHICLES; PORTABLE APPARATUS FOR TRANSMISSION OF COMMUNICATION, SOUND RECORDING APPARATUS, VOICE RECORDING AND REPRODUCING APPARATUS, DVD PLAYERS, MP 3 PLAYERS, RECORD PLAYERS, VIDEO DISK PLAYER, VIDEO RECORDERS FOR VIDEO TAPE AND VIDEO CASSETTE; SOUND TRANSMITTING APPARATUS, AUDIO CASSETTE PLAYERS, COMPACT DISC PLAYERS, HEADPHONES, NOTEBOOK COMPUTERS, LAPTOP COMPUTERS, DESKTOP COMPUTERS, AMUSEMENT APPARATUS ADAPTED FOR USE WITH TELEVISION RECEIVERS ONLY, PERSONAL DIGITAL ASSISTANTS (PDA), ELECTRONIC POCKET TRANSLATORS, IN CLASS 9 (U.S. CLS. 21, 23, 26, 36 AND 38).

FOR: MEDICAL APPARATUS FOR THE TREATMENT OF DEAFNESS, IN CLASS 10 (U.S. CLS. 26, 39 AND 44).

FOR: IMPORT-EXPORT AGENCIES, ONLINE RETAIL STORE SERVICES AND RETAIL STORES SERVICES FEATURING ACOUSTIC APPARATUS AND INSTRUMENTS, IN CLASS 35 (U.S. CLS. 100, 101 AND 102).

FOR: TRADE BROKERAGE SERVICES IN THE FIELD OF ACOUSTIC APPARATUS AND INSTRUMENTS, MICROPHONES, SPEAKERS, BATTERIES, PRODUCT BROKERAGE SERVICES RELATING TO ACOUSTIC APPARATUS AND INSTRUMENTS, PRODUCT BROKERAGE SERVICES RELATING TO BATTERIES, REAL ESTATE MANAGEMENT, LEASING OF REAL ESTATE, IN CLASS 36 (U.S. CLS. 100, 101 AND 102).

OWNER OF INTERNATIONAL REGISTRATION 0919315 DATED 11-10-2006, EXPIRES 11-10-2016.

THE COLOR(S) GREEN AND WHITE IS/ARE CLAIMED AS A FEATURE OF THE MARK.

THE MARK CONSISTS OF A SPHERE WITH A SWIRL RUNNING THROUGH IT. THE COLOR GREEN APPEARS IN THE SPHERE DESIGN AND THE COLOR WHITE APPEARS IN THE SWIRL DESIGN THAT RUNS THROUGH THE SPHERE.

SER. NO. 79-036,664, FILED 11-10-2006.

DAVID HOFFMAN, EXAMINING ATTORNEY

Int. Cl.: 24

Prior U.S. Cls.: 42 and 50

United States Patent and Trademark Office

Reg. No. 3,398,776

Registered Mar. 18, 2008

**TRADEMARK
PRINCIPAL REGISTER**

ECOLACE

SUOMINEN KUITUKANKAAT OY (FINLAND
FINNISH JOINT STOCK COMPANY)
SUOMISENTIE 11
FI-29250 NAKKILA, FINLAND

FOR: NON-WOVEN FABRICS OF MIXED FIBERS FROM RENEWABLE RAW MATERIALS; FINISHED NON-WOVEN FABRICS OF MIXED FIBERS FROM RENEWABLE RAW MATERIALS; COATED NON-WOVEN FABRICS OF MIXED FIBERS FROM RENEWABLE RAW MATERIALS; NON-WOVEN FABRIC COMPOSITES OF MIXED FIBERS FROM RENEWABLE RAW MATERIALS; PRINTED NON-WOVEN FABRICS OF MIXED FIBERS FROM RENEWABLE RAW MATERIALS, IN CLASS 24 (U.S. CLS. 42 AND 50).

THE MARK CONSISTS OF STANDARD CHARACTERS WITHOUT CLAIM TO ANY PARTICULAR FONT, STYLE, SIZE, OR COLOR.

PRIORITY DATE OF 3-5-2007 IS CLAIMED.

OWNER OF INTERNATIONAL REGISTRATION 0919729 DATED 3-23-2007, EXPIRES 3-23-2017.

SER. NO. 79-036,775, FILED 3-23-2007.

DOMINIC FATHY, EXAMINING ATTORNEY

Int. Cl.: 24

Prior U.S. Cls.: 42 and 50

United States Patent and Trademark Office

Reg. No. 3,398,777

Registered Mar. 18, 2008

**TRADEMARK
PRINCIPAL REGISTER**

BIOLACE

SUOMINEN KUITUKANKAAT OY (FINLAND
FINNISH JOINT STOCK COMPANY)
SUOMISENTIE 11
FI-29250 NAKKILA, FINLAND

FOR: NON-WOVEN FABRICS OF MIXED FIBERS FROM RENEWABLE RAW MATERIALS; FINISHED NON-WOVEN FABRICS OF MIXED FIBERS FROM RENEWABLE RAW MATERIALS; COATED NON-WOVEN FABRICS OF MIXED FIBERS FROM RENEWABLE RAW MATERIALS; NON-WOVEN FABRIC COMPOSITES OF MIXED FIBERS FROM RENEWABLE RAW MATERIALS; PRINTED NON-WOVEN FABRICS OF MIXED FIBERS FROM RENEWABLE RAW MATERIALS, IN CLASS 24 (U.S. CLS. 42 AND 50).

THE MARK CONSISTS OF STANDARD CHARACTERS WITHOUT CLAIM TO ANY PARTICULAR FONT, STYLE, SIZE, OR COLOR.

PRIORITY DATE OF 3-5-2007 IS CLAIMED.

OWNER OF INTERNATIONAL REGISTRATION 0919730 DATED 3-23-2007, EXPIRES 3-23-2017.

SER. NO. 79-036,776, FILED 3-23-2007.

DOMINIC FATHY, EXAMINING ATTORNEY

Int. Cls.: 35 and 36

Prior U.S. Cls.: 100, 101 and 102

United States Patent and Trademark Office

Reg. No. 3,398,778

Registered Mar. 18, 2008

**SERVICE MARK
PRINCIPAL REGISTER**

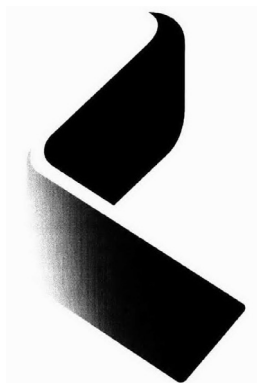

CHINA JIANYIN INVESTMENT LIMITED (CHINA CORPORATION)
25 FINANCIAL STREET
XICHENG DISTRICT; BEIJING
CHINA

FOR: ADVERTISING; COMMERCIAL AND INDUSTRIAL MANAGEMENT ASSISTANCE; BUSINESS APPRAISAL; PROFESSIONAL BUSINESS MANAGEMENT CONSULTING; BUSINESS RESEARCH; MARKETING ANALYSIS; ECONOMIC FORECASTING; BUSINESS MANAGEMENT OF HOTELS FOR OTHERS; PRICE COMPARING SERVICES; IMPORT AND EXPORT AGENCIES; SALES PROMOTION FOR OTHERS PROVIDED THROUGH THE DISTRIBUTION AND THE ADMINISTRATION OF PRIVILEGED USER CARDS; PROCUREMENT SERVICES, NAMELY, PURCHASING BUSINESS FINANCE FOR OTHERS; PERSONNEL MANAGEMENT CONSULTANCY; SYSTEMATIZATION OF INFORMATION INTO COMPUTER DATABASE, NAMELY, PROVIDING AN ON-LINE COMPUTER DATABASE FEATURING TRADE INFORMATION IN THE FIELD OF FINANCIAL MANAGEMENT; ACCOUNT AUDITING, BUSINESS AUDITING, IN CLASS 35 (U.S. CLS. 100, 101 AND 102).

FOR: FINANCIAL SERVICES, NAMELY, FINANCIAL CONSULTANCY, FINANCIAL ANALYSIS, FINANCIAL EVALUATION FOR THE PURPOSES OF INSURANCE, BANKING OR REAL ESTATE, FINANCIAL INFORMATION PROCESSING, FINANCIAL MANAGEMENT, FINANCING SERVI-

CES, BROKERAGE HOUSES IN THE FIELD OF FUTURES, CAPITAL INVESTMENT, NAMELY, CAPITAL INVESTMENT CONSULTATION, MANAGEMENT OF CAPITAL INVESTMENT FUND, FUND INVESTMENT, DEBT COLLECTION AGENCIES, ISSUE OF TOKENS OF VALUE, NAMELY, SECURITIES BROKERAGE, BUSINESS LIQUIDATION SERVICES, DEPOSITS OF VALUABLES, NAMELY, SAFE DEPOSIT BOX SERVICES, STOCK EXCHANGE PRICE QUOTATIONS, FINANCIAL CLEARING HOUSES; INSURANCE AGENCIES, INSURANCE BROKERAGE; INSURANCE CONSULTANCY; JEWELRY APPRAISAL; REAL ESTATE SERVICES, NAMELY, REAL ESTATE APPRAISAL, REAL ESTATE MANAGEMENT, APARTMENT HOUSE MANAGEMENT, RENTAL OF OFFICES; INVESTMENT, MORTGAGE AND SECURITIES BROKERAGE; GUARANTEES, NAMELY, FINANCIAL GUARANTEE AND SURETY, GUARANTEE ASSURANCE UNDERWRITING; CHARITABLE FUND RAISING; FIDUCIARY REPRESENTATIVE; TRUSTEESHIP REPRESENTATIVES; FACTORING AGENCY; MORTGAGE LENDING, MORTGAGE BANKING, IN CLASS 36 (U.S. CLS. 100, 101 AND 102).

OWNER OF INTERNATIONAL REGISTRATION
0919896 DATED 2-13-2007, EXPIRES 2-13-2017.

SER. NO. 79-036,849, FILED 2-13-2007.

CHRISIE B. KING, EXAMINING ATTORNEY

Int. Cl.: 6

Prior U.S. Cls.: 2, 12, 13, 14, 23, 25 and 50

United States Patent and Trademark Office

Reg. No. 3,398,779

Registered Mar. 18, 2008

TRADEMARK
PRINCIPAL REGISTER



WUHAN IRON AND STEEL (GROUP) CO. (CHINA CORPORATION)
CHANGQIAN, QINGSHAN DISTRICT,
WUHAN CITY; HUBEI PROVINCE
CHINA

FOR: UNWROUGHT AND SEMI-WROUGHT IRON; CAST STEEL; STEEL BLOOMS FOR METALLURGY PURPOSES; STEEL SHEETS; STEEL STRIP; STEEL POSTS; SILICON IRON ALLOY; METAL POWDERS FOR USE IN MANUFACTURING; ALLOYS OF COMMON METAL, NAMELY, ALUMINUM ALLOY; STEEL ALLOYS, IN CLASS 6 (U.S. CLS. 2, 12, 13, 14, 23, 25 AND 50).

OWNER OF INTERNATIONAL REGISTRATION
0920211 DATED 2-21-2007, EXPIRES 2-21-2017.

NO CLAIM IS MADE TO THE EXCLUSIVE RIGHT TO USE THE NON-LATIN CHARACTERS THAT MEAN WUHAN IRON AND STEEL, APART FROM THE MARK AS SHOWN.

THE NON-LATIN CHARACTERS IN THE MARK TRANSLITERATE INTO "WU GANG", AND THIS MEANS "WUHAN IRON AND STEEL" IN ENGLISH

SER. NO. 79-036,987, FILED 2-21-2007.

ELI HELLMAN, EXAMINING ATTORNEY

Int. Cls.: 9 and 10

Prior U.S. Cls.: 21, 23, 26, 36, 38, 39 and 44

United States Patent and Trademark Office

Reg. No. 3,398,780

Registered Mar. 18, 2008

**TRADEMARK
PRINCIPAL REGISTER**

CELLAVISTA

INNOVATIS AG (FED REP GERMANY AG)
MEISENSTRASSE 96
33607 BIELEFELD
FED REP GERMANY

FOR: SCIENTIFIC AND MEASURING APPARATUS AND INSTRUMENTS, NAMELY, CELL ANALYZERS, IN CLASS 9 (U.S. CLS. 21, 23, 26, 36 AND 38).

FOR: MEDICAL INSTRUMENTS AND APPARATUS, NAMELY, CELL ANALYZERS, IN CLASS 10 (U.S. CLS. 26, 39 AND 44).

THE MARK CONSISTS OF STANDARD CHARACTERS WITHOUT CLAIM TO ANY PARTICULAR FONT, STYLE, SIZE, OR COLOR.

PRIORITY DATE OF 9-6-2006 IS CLAIMED.

OWNER OF INTERNATIONAL REGISTRATION 0920475 DATED 2-22-2007, EXPIRES 2-22-2017.

SER. NO. 79-037,107, FILED 2-22-2007.

TINA BROWN, EXAMINING ATTORNEY

Int. Cl.: 9

Prior U.S. Cls.: 21, 23, 26, 36 and 38

Reg. No. 3,398,781

United States Patent and Trademark Office

Registered Mar. 18, 2008

**TRADEMARK
PRINCIPAL REGISTER**



TECNICAS DE ELECTRONICA; Y AUTOMATIS-
MOS, S.A. (SPAIN SOCIEDAD ANONIMA)
C/ ESPRONCEDA, 176-180
E-08018 BARCELONA
SPAIN

FOR: WEIGHING SYSTEM COMPONENTS,
NAMELY, LOAD CELLS; SCIENTIFIC, NAUTICAL,
ELECTRIC, WEIGHING AND MEASURING APPA-
RATUS AND INSTRUMENTS FOR MEASURING
AND MONITORING FORCE, TORQUE, TENSION
AND COMPRESSION; TEACHING APPARATUS
AND INSTRUMENTS, NAMELY, COMPUTER

HARDWARE AND SOFTWARE FOR MEASURING
AND MONITORING FORCE, TORQUE, TENSION
AND COMPRESSION; AND COMPUTERS, IN
CLASS 9 (U.S. CLS. 21, 23, 26, 36 AND 38).

OWNER OF INTERNATIONAL REGISTRATION
0920519 DATED 1-30-2007, EXPIRES 1-30-2017.

SER. NO. 79-037,124, FILED 1-30-2007.

NAPOLEON SHARMA, EXAMINING ATTORNEY

Int. Cl.: 7

Prior U.S. Cls.: 13, 19, 21, 23, 31, 34 and 35

United States Patent and Trademark Office

Reg. No. 3,398,782

Registered Mar. 18, 2008

**TRADEMARK
PRINCIPAL REGISTER**

HOSEKI

ZHEJIANG GEMSY; SEWING MACHINE CO.,
LTD. (CHINA CORPORATION)
NO. 638 DONGHUAN ROAD
TAIZHOU ECONOMIC DEVELOPMENT ZONE,;
318000 ZHEJIANG PROVINCE
CHINA

FOR: SEWING MACHINES; HEMMING MA-
CHINES; IRONING MACHINES; PACKING-SEW-
ING MACHINES; BUTTON LOCKING MACHINES;
CLOTH CUTTING MACHINES; STITCHING MA-
CHINES; SEWING MACHINE TABLES FOR INDUS-
TRIAL PURPOSES; PEDAL DRIVES FOR SEWING

MACHINES; ALL THE ABOVE GOODS FOR THE
SEWING INDUSTRY, IN CLASS 7 (U.S. CLS. 13, 19,
21, 23, 31, 34 AND 35).

OWNER OF INTERNATIONAL REGISTRATION
0920849 DATED 3-22-2007, EXPIRES 3-22-2017.

SER. NO. 79-037,233, FILED 3-22-2007.

LAURIE KAUFMAN, EXAMINING ATTORNEY

Int. Cl.: 38

Prior U.S. Cls.: 100, 101 and 104

United States Patent and Trademark Office

Reg. No. 3,398,783

Registered Mar. 18, 2008

**SERVICE MARK
PRINCIPAL REGISTER**

GOMEDIA

MOMAC B.V. (NETHERLANDS BESLOTEN VEN-
NOOTSCHAP)
RIVIUM 1E STRAAT 9
NL-2909 LE CAPELLE AAN DEN IJSSEL
NETHERLANDS

FOR: TELECOMMUNICATIONS, NAMELY, PRO-
VIDING MULTIPLE-USER ACCESS TO THE INTER-
NET, SATELLITE TRANSMISSION SERVICES,
MOBILE INTERNET SITES, NAMELY, PROVIDING
REMOTE INTERNET ACCESS AND MOBILE TELE-
PHONE COMMUNICATIONS SERVICES; ELEC-
TRONIC TRANSMISSION OF DATA AND
INFORMATION VIA THE INTERNET, MOBILE
TELEPHONES AND REMOTE INTERNET SITES;
PROVIDING INTERNET ACCESS TO MOBILE IN-
TERNET SITES; ELECTRONIC TRANSMISSION OF
IMAGE, SOUND AND OTHER DATA AMONG
COMPUTER USERS; INTERNET SERVICE PROVIDER SERVICES; PROVIDING INTERNET ACCESS
TO DATABASES, MOBILE INTERNET SITES AND

OTHER NETWORKS; E-MAIL SERVICES; PROVID-
ING TELECOMMUNICATIONS CONSULTATION
AND INFORMATION, IN CLASS 38 (U.S. CLS. 100,
101 AND 104).

THE MARK CONSISTS OF STANDARD CHAR-
ACTERS WITHOUT CLAIM TO ANY PARTICULAR
FONT, STYLE, SIZE, OR COLOR.

PRIORITY DATE OF 2-12-2007 IS CLAIMED.

OWNER OF INTERNATIONAL REGISTRATION
0921040 DATED 2-26-2007, EXPIRES 2-26-2017.

SER. NO. 79-037,297, FILED 2-26-2007.

MICHELE SWAIN, EXAMINING ATTORNEY

Int. Cls.: 9, 35 and 41

Prior U.S. Cls.: 21, 23, 26, 36, 38, 100, 101, 102 and 107

Reg. No. 3,398,784

United States Patent and Trademark Office

Registered Mar. 18, 2008

TRADEMARK
SERVICE MARK
PRINCIPAL REGISTER

WANTOK

CORINNE DAMAS-SANDIFORD (FRANCE INDIVIDUAL)
9, RUE DU MARÉCHAL JUIN
F-94700 MAISONS ALFORT
FRANCE

FOR: CINEMATOGRAPHIC APPARATUS; APPARATUS FOR RECORDING, TRANSMISSION OR REPRODUCTION OF SOUND AND IMAGES; MAGNETIC AND DIGITAL MEDIA, NAMELY, CD'S, DVD'S, DOWNLOADABLE AUDIO AND VIDEO FILES ON THE SUBJECT OF SOCIAL, ANTHROPOLOGICAL AND EDUCATIONAL; COMPUTER SOFTWARE FOR FILM EDITING, FOR WORD PROCESSING, FOR SOUND DESIGN AND FOR GRAPHICAL VISUAL ON SOCIAL AND EDUCATIONAL FILMS RECORDED ON VIDEO TAPE AND DVD'S ON THE SUBJECTS OF ANTHROPOLOGY, ETHNOGRAPHY, LANGUAGES AND SOCIAL KNOWLEDGE, IN CLASS 9 (U.S. CLS. 21, 23, 26, 36 AND 38).

FOR: ADVERTISING; BUSINESS MANAGEMENT; BUSINESS ADMINISTRATION; DIRECT MAIL ADVERTISING; DOCUMENT REPRODUCTION., IN CLASS 35 (U.S. CLS. 100, 101 AND 102).

FOR: VIDEOTAPE FILM PRODUCTION; RENTAL OF MOTION PICTURES; RENTAL OF SOUND RECORDINGS; VIDEOTAPE EDITING; EDUCATION SERVICES IN THE NATURE OF SEMINARS AND WORKSHOPS ON THE SUBJECT OF ANTHROPOLOGY, ETHNOGRAPHY, LANGUAGES, AND DOCUMENTARIES FEATURING CORPORATE LIFE, DAILY HUMAN LIFE AND SOCIAL KNOWLEDGE; TRAINING ON THE PRODUCTION OF ANTHROPOLOGICAL CINEMA AND DOCU-

MENTARY FILMING AND EDITING; EDUCATIONAL AND ENTERTAINMENT SERVICES, NAMELY, A CONTINUING PROGRAM ABOUT ANTHROPOLOGY, ETHNOGRAPHY, LANGUAGES, AND DOCUMENTARIES FEATURING CORPORATE LIFE, DAILY HUMAN LIFE AND SOCIAL KNOWLEDGE ACCESSIBLE BY RADIO, TELEVISION, SATELLITE, AUDIO, VIDEO AND COMPUTER NETWORKS; ORGANIZING COMMUNITY SPORTING AND CULTURAL ACTIVITIES; ORGANIZATION OF EXHIBITIONS FOR CULTURAL AND EDUCATIONAL PURPOSES FOR ANTHROPOLOGY RESEARCH AND READING SKILLS; ELECTRONIC PUBLISHING OF ONLINE BOOKS AND PERIODICALS FEATURING ANTHROPOLOGICAL, ETHNOGRAPHIC AND SOCIAL RESEARCH CONTENT; DESKTOP PUBLISHING FOR OTHERS, IN CLASS 41 (U.S. CLS. 100, 101 AND 107).

THE MARK CONSISTS OF STANDARD CHARACTERS WITHOUT CLAIM TO ANY PARTICULAR FONT, STYLE, SIZE, OR COLOR.

OWNER OF INTERNATIONAL REGISTRATION 0921676 DATED 2-12-2007, EXPIRES 2-12-2017.

THE FOREIGN WORDING IN THE MARK TRANSLATES INTO ENGLISH AS WE TALK THE SAME LANGUAGE AND WE ARE ON THE SAME WAVELENGTHS.

SER. NO. 79-037,578, FILED 2-12-2007.

LAURA KOVALSKY, EXAMINING ATTORNEY

Int. Cl.: 39

Prior U.S. Cls.: 100 and 105

United States Patent and Trademark Office

Reg. No. 3,398,785

Registered Mar. 18, 2008

**SERVICE MARK
PRINCIPAL REGISTER**

Keolis

Moving further together

KEOLIS (FRANCE SOCIÉTÉ ANONYME)
9, RUE CAUMARTIN
PARIS, FRANCE F75009

OWNER OF INTERNATIONAL REGISTRATION
0923233 DATED 3-23-2007, EXPIRES 3-23-2017.

FOR: TRANSPORT OF PEOPLE; INFORMATION
RELATING TO THE TRANSPORT OF PEOPLE;
RESERVATIONS FOR THE TRANSPORT OF PEOP
LE; ARRANGING THE TRANSPORT OF PEOPLE
AND SYSTEMS FOR THE TRANSPORT OF PEOPLE
, IN CLASS 39 (U.S. CLS. 100 AND 105).

OWNER OF U.S. REG. NOS. 2,750,252 AND
2,769,167.

SER. NO. 79-038,169, FILED 3-23-2007.

PRIORITY DATE OF 10-17-2006 IS CLAIMED.

ROBIN CHOSID, EXAMINING ATTORNEY

Int. Cl.: 5

Prior U.S. Cls.: 6, 18, 44, 46, 51 and 52

United States Patent and Trademark Office

Reg. No. 3,398,786

Registered Mar. 18, 2008

**TRADEMARK
PRINCIPAL REGISTER**

RIKKELTA

UCB, SOCIÉTÉ ANONYME (BELGIUM SOCIÉTÉ
ANONYME DE DROIT BELGE)
ALLÉE DE LA RECHERCHE 60
B-1070 BRUXELLES
BELGIUM

FOR: PHARMACEUTICAL PREPARATIONS
ACTING ON THE CENTRAL NERVOUS SYSTEM,
IN CLASS 5 (U.S. CLS. 6, 18, 44, 46, 51 AND 52).

THE MARK CONSISTS OF STANDARD CHAR-
ACTERS WITHOUT CLAIM TO ANY PARTICULAR
FONT, STYLE, SIZE, OR COLOR.

PRIORITY DATE OF 10-10-2006 IS CLAIMED.

OWNER OF INTERNATIONAL REGISTRATION
0923385 DATED 4-10-2007, EXPIRES 4-10-2017.

SER. NO. 79-038,210, FILED 4-10-2007.

KIMBERLY FRYE, EXAMINING ATTORNEY

Int. Cl.: 9

Prior U.S. Cls.: 21, 23, 26, 36 and 38

United States Patent and Trademark Office

Reg. No. 3,398,787

Registered Mar. 18, 2008

**TRADEMARK
PRINCIPAL REGISTER**

ANDELI

ANDELI GROUP CO., LTD. (CHINA CORPORATION)
LIUSHI FOREIGN INDUSTRY ZONE YUEQING
ZHEJIANG
CHINA

FOR: INTEGRATED CIRCUITS; CAPACITORS;
ELECTRIC SWITCHES; CIRCUIT BREAKERS;
ELECTRIC RELAYS; ELECTRIC LIGHT DIMMERS;
ELECTRIC CONNECTIONS, NAMELY, ELECTRIC
PLUGS, ELECTRIC SOCKETS AND OTHER CON-
TACTS, NAMELY, SAFETY CONTACT PLUGS;

JUMP START CABLES; ELECTRICAL DISTRIBUTION BOXES, IN CLASS 9 (U.S. CLS. 21, 23, 26, 36 AND 38).

OWNER OF INTERNATIONAL REGISTRATION
0923436 DATED 4-10-2007, EXPIRES 4-10-2017.

SER. NO. 79-038,225, FILED 4-10-2007.

MICHELE SWAIN, EXAMINING ATTORNEY

Int. Cl.: 10

Prior U.S. Cls.: 26, 39 and 44

United States Patent and Trademark Office

Reg. No. 3,398,788

Registered Mar. 18, 2008

**TRADEMARK
PRINCIPAL REGISTER**

NOSEVOLE

KEITH STEWART (GREAT BRITAIN INDIVIDUAL)
47 LINKS VIEW,
PORT SETON; EAST LOTHIAN EH32 0EZ
UNITED KINGDOM

FOR: MEDICAL DEVICES, NAMELY, APPARATUS FOR USE IN BREATHING; APPARATUS FOR USE IN THE PREVENTION OF SNORING, IN CLASS 10 (U.S. CLS. 26, 39 AND 44).

THE MARK CONSISTS OF STANDARD CHARACTERS WITHOUT CLAIM TO ANY PARTICULAR FONT, STYLE, SIZE, OR COLOR.

PRIORITY DATE OF 7-11-2006 IS CLAIMED.

OWNER OF INTERNATIONAL REGISTRATION
0923890 DATED 1-10-2007, EXPIRES 1-10-2017.

SER. NO. 79-038,389, FILED 1-10-2007.

ALLISON HOLTZ, EXAMINING ATTORNEY

Int. Cls.: 3 and 14

Prior U.S. Cls.: 1, 2, 4, 6, 27, 28, 50, 51 and 52

United States Patent and Trademark Office

Reg. No. 3,398,789

Registered Mar. 18, 2008

**TRADEMARK
PRINCIPAL REGISTER**

CAROLINA BUCCI 

FERDINANDO BUCCI S.R.L. (ITALY S.R.L. LIMITED LIABILITY COMPANY)
PIAZZA SANTO STEFANO, 1
I-50122 FIRENZE
ITALY

FOR: SOAPS, PERFUMERY, ESSENTIAL OILS, COSMETICS, HAIR LOTIONS, IN CLASS 3 (U.S. CLS. 1, 4, 6, 50, 51 AND 52).

FOR: PRECIOUS METALS AND THEIR ALLOYS; GOODS IN PRECIOUS METALS OR COATED THEREWITH, NAMELY, JEWELRY; JEWELRY, PRECIOUS STONES, WATCHES, HOROLOGICAL AND CHRONOMETRIC INSTRUMENTS, IN CLASS 14 (U.S. CLS. 2, 27, 28 AND 50).

OWNER OF INTERNATIONAL REGISTRATION
0924106 DATED 10-25-2006, EXPIRES 10-25-2016.

CAROLINA BUCCI DOES NOT IDENTIFY A LIVING INDIVIDUAL.

THE MARK CONSISTS OF THE CURSIVE SIGNATURE WRITING FOLLOWED BY A BEE.

SER. NO. 79-038,455, FILED 10-25-2006.

MATTHEW MCDOWELL, EXAMINING ATTORNEY

Int. Cls.: 36, 42 and 45

Prior U.S. Cls.: 100, 101 and 102

United States Patent and Trademark Office

Reg. No. 3,398,790

Registered Mar. 18, 2008

**SERVICE MARK
PRINCIPAL REGISTER**

Allianz Global Corporate & Specialty

ALLIANZ SE (FED REP GERMANY SE)
KÖNIGINSTRASSE 28
80802 MÜNCHEN
FED REP GERMANY

FOR: INSURANCE SERVICES, NAMELY, FULL LINE OF INSURANCE AND REINSURANCE SERVICES IN THE FIELDS OF LIFE INSURANCE, MARINE INSURANCE, ACCIDENT INSURANCE, FINANCIAL LOSS INSURANCE, VEHICLE INSURANCE, FIRE INSURANCE, GUARANTEE INSURANCE, LIABILITY INSURANCE, THEFT INSURANCE, SPORTS INJURY INSURANCE, SURTYSHIP INSURANCE, ERECTION ALL RISK INSURANCE, CONSTRUCTION ALL RISK INSURANCE, AVIATION INSURANCE, TRANSPORTATION INSURANCE, MACHINERY BREAKDOWN INSURANCE, AND ASSISTANCE INSURANCE, NAMELY, ALTERNATIVE RISK TRANSFER, CAPTIVE INSURANCE CONSULTING, CAPTIVE INSURANCE MANAGEMENT, ANNUITY UNDERWRITING AND INVESTMENT MANAGEMENT OF AND DISTRIBUTION OF ANNUITIES, INSURANCE BROKERAGE, INSURANCE ADMINISTRATION, INSURANCE ACTUARIAL SERVICES, APPRAISAL FOR INSURANCE CLAIMS OF PERSONAL PROPERTY, REAL ESTATE, AND ASSETS, INSURANCE AND REINSURANCE CLAIMS PROCESSING AND ADJUSTMENT, INSURANCE AND REINSURANCE CONSULTATION, INSURANCE SUBROGATION AND SALVAGE, INSURANCE UNDERWRITING SERVICES FOR ALL TYPES OF INSURANCE, REINSURANCE UNDERWRITING, INSURANCE ESTIMATION, INSURANCE AMOUNT ASSESSMENT, IN CLASS 36 (U.S. CLS. 100, 101 AND 102).

FOR: SCIENTIFIC AND TECHNOLOGICAL SERVICES AND RESEARCH AND DESIGN RELATING THERETO, IN THE FIELD OF INSURANCE CLAIMS AND UNDERWRITING; INDUSTRIAL ANALYSIS, NAMELY, ANALYSIS IN THE FIELD OF INSURANCE CLAIMS AND UNDERWRITING AND INDUSTRIAL RESEARCH SERVICES, CONSULTING IN THE FIELD OF ENGINEERING AND INDUSTRIAL RESEARCH; ENGINEERING SERVICES, IN CLASS 42 (U.S. CLS. 100 AND 101).

FOR: LEGAL SERVICES RELATED TO INSURANCE SERVICES, IN CLASS 45 (U.S. CLS. 100 AND 101).

THE MARK CONSISTS OF STANDARD CHARACTERS WITHOUT CLAIM TO ANY PARTICULAR FONT, STYLE, SIZE, OR COLOR.

OWNER OF INTERNATIONAL REGISTRATION 0924113 DATED 1-4-2007, EXPIRES 1-4-2017.

OWNER OF U.S. REG. NOS. 2,145,557, 2,392,939 AND OTHERS.

NO CLAIM IS MADE TO THE EXCLUSIVE RIGHT TO USE GLOBAL CORPORATE & SPECIALTY, APART FROM THE MARK AS SHOWN.

"THE FOREIGN WORDING IN THE MARK TRANSLATES INTO ENGLISH AS ALLIANCE."

SER. NO. 79-038,458, FILED 1-4-2007.

SUZANNE BLANE, EXAMINING ATTORNEY

Int. Cls.: 16, 35 and 45

Prior U.S. Cls.: 2, 5, 22, 23, 29, 37, 38, 50, 100, 101 and 102

Reg. No. 3,398,791

United States Patent and Trademark Office

Registered Mar. 18, 2008

**TRADEMARK
SERVICE MARK
PRINCIPAL REGISTER**

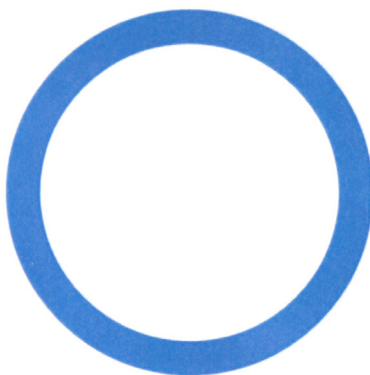

INTERNATIONAL DIABETES FEDERATION; OU
FÉDÉRATION INTERNATIONALE DU DIA-
BÈTE; ÉGALEMENT DENOMMÉE IDF OU
FID.; ASSOCIATION INTERNATIONALE
SANS BUT LUCRATIF (BELGIUM NON-
PROFIT INTERNATIONAL ASSOCIATION)

AVENUE EMILE DE MOT 19
B-1000 BRUXELLES, BELGIUM

FOR: PAPER, CARDBOARD AND GOODS MADE FROM THESE MATERIALS NOT INCLUDED IN OTHER CLASSES, NAMELY, ART PAPER, LASER PRINTING PAPER, COPY PAPER, DRAWING PAPER, CARDBOARD HANG TAGS, CARDBOARD BOXES, CARDBOARD CONTAINERS, PAPER BAGS, PAPER BANNERS, PAPER BOXES, OFFICE STATIONERY, BUSINESS CARDS, ENVELOPES, PAPER OR CARDBOARD ENVELOPES FOR USE IN PACKAGING CD'S, PINS, BALLOONS, FLYING DISCS, AND FLAGS; PRINTED MATTER, NAMELY, PRINTED BOOKS, GUIDES, PAMPHLETS, BOOKLETS, MAGAZINES, POSTERS AND PRESS KIT RELEASES IN THE FIELD OF DIABETES CARE, DIABETES PREVENTION, DIABETES ADVOCACY, AND DIABETES EDUCATION; BOOKBINDING MATERIAL, NAMELY, BOOKBINDING WIRE, BOOKBINDING TAPE, CLOTH AND LEATHER FOR BOOKBINDING, BOOKBINDINGS; PHOTOGRAPHS; WRITING MATERIALS, NAMELY, WRITING INSTRUMENTS, WRITING IMPLEMENTS, WRITING PAPER PADS, WRITING TABLETS, WRITING PAPER, PENS; INSTRUCTIONAL AND TEACHING MATERIAL, NAMELY, PRINTED INSTRUCTIONAL, EDUCATIONAL AND

TEACHING MATERIALS IN THE FIELD OF DIABETES EDUCATION, DIABETES CARE, DIABETES PREVENTION, AND DIABETES ADVOCACY; PLASTIC MATERIALS FOR PACKAGING, NAMELY, PLASTIC BAGS FOR PACKAGING, PLASTIC BUBBLE PACKS FOR WRAPPING OR PACKAGING, PLASTIC BAGS IN THE FORM OF ENVELOPES AND POUCHES FOR MERCHANDISE PACKAGING, PLASTIC WRAP FOR USE IN PACKAGING, IN CLASS 16 (U.S. CLS. 2, 5, 22, 23, 29, 37, 38 AND 50).

FOR: SERVICES OF COMMERCIAL PRESSURE GROUPS, NAMELY, PUBLIC ADVOCACY TO PROMOTE AWARENESS OF DIABETES, DIABETES EDUCATION, DIABETES CARE, DIABETES PREVENTION AND A DIABETES CURE; ADVERTISING AND PROMOTIONAL ACTIVITIES, NAMELY, PROMOTING PUBLIC AWARENESS OF DIABETES, DIABETES EDUCATION, DIABETES CARE, DIABETES PREVENTION AND A DIABETES CURE; ADVERTISING SERVICES IN THE NATURE OF PRODUCTION OF TELEVISION COMMERCIALS AND PUBLIC SERVICE ANNOUNCEMENTS; PROMOTING THE GOODS AND SERVICES OF OTHERS BY ARRANGING FOR SPONSORS TO AFFILIATE THEIR GOODS AND SERVICES WITH AN AWARDS PROGRAM, A SPORTS COMPETITION AND SPORTING ACTIVITIES, IN CLASS 35 (U.S. CLS. 100, 101 AND 102).

FOR: SERVICES OF PRESSURE GROUPS OTHER THAN FOR COMMERCIAL PURPOSES, NAMELY, ORGANIZING AND CONDUCTING SUPPORT

GROUPS IN THE FIELD OF THE DIABETES, PERSONAL CARE ASSISTANCE OF ACTIVITIES OF DAILY LIVING, SUCH AS BATHING, GROOMING AND PERSONAL MOBILITY FOR MENTALLY OR PHYSICALLY CHALLENGED PEOPLE, PROVIDING PATIENT ADVOCATE SERVICES TO HOSPITAL PATIENTS AND PATIENTS IN LONG TERM CARE FACILITIES, PROVIDING PERSONAL SUPPORT SERVICES FOR FAMILIES OF PATIENTS WITH LIFE THREATENING DISORDERS, NAMELY, COMPANIONSHIP, HELP WITH MEDICAL FORMS, COUNSELING AND EMOTIONAL SUPPORT, IN CLASS 45 (U.S. CLS. 100 AND 101).

OWNER OF INTERNATIONAL REGISTRATION 0924217 DATED 2-27-2007, EXPIRES 2-27-2017.

THE COLOR(S) BLUE IS/ARE CLAIMED AS A FEATURE OF THE MARK.

THE COLOR BLUE APPEARS ON THE DEPICTION OF CIRCULAR RING.

SER. NO. 79-038,498, FILED 2-27-2007.

MICHAEL TANNER, EXAMINING ATTORNEY

Int. Cl.: 1

Prior U.S. Cls.: 1, 5, 6, 10, 26 and 46

United States Patent and Trademark Office

Reg. No. 3,398,792

Registered Mar. 18, 2008

TRADEMARK
PRINCIPAL REGISTER



SICHUAN GUO GUANG; AGROCHEMICAL CO.,
LTD (CHINA CORPORATION)
PINGQUAN TOWN,
JIANYANG CITY; SICHUAN PROVINCE
CHINA

FOR: CHEMICAL SUBSTANCES, NAMELY, CHEMICAL PRESERVATIVES FOR USE IN MANUFACTURING AND FOR PRESERVING FOODSTUFFS; PLANT GROWTH REGULATING PREPARATIONS; HORMONES, NAMELY, PLANT HORMONES FOR HASTENING THE RIPENING OF FRUIT; HORMONES, NAMELY, PLANT HORMONES FOR HASTENING THE GROWTH OF FRUIT; ARTIFICIAL SWEETENERS, CHEMICAL PREPARATIONS FOR USE IN AGRICULTURE, NAMELY, CHEMICAL PREPARATIONS FOR THE TREATMENT OF SEEDS; ANTI-SPROUTING CHEMICAL PREPARA-

TIONS FOR VEGETABLES; COMPOST, IN CLASS 1 (U.S. CLS. 1, 5, 6, 10, 26 AND 46).

OWNER OF INTERNATIONAL REGISTRATION
0924323 DATED 4-3-2007, EXPIRES 4-3-2017.

THE ENGLISH TRANSLATION OF THE FOREIGN WORD(S) IN THE MARK IS: "GUO" MEANS "COUNTRY", "GUANG" MEANS "LIGHT".

THE TRANSLITERATION OF THE NON-LATIN CHARACTERS IN THE MARK IS: GUO GUANG.

SER. NO. 79-038,531, FILED 4-3-2007.

MARLENE BELL, EXAMINING ATTORNEY

Int. Cl.: 14

Prior U.S. Cls.: 2, 27, 28 and 50

United States Patent and Trademark Office

Reg. No. 3,398,793

Registered Mar. 18, 2008

**TRADEMARK
PRINCIPAL REGISTER**

Li Antra St Aile

VALBEX SA (SWITZERLAND SOCIÉTÉ ANON-
YME)
C/O MN TRUST, RUE DE SAINT-LÉGER 8
CH-1205 GENÈVE
SWITZERLAND

OWNER OF INTERNATIONAL REGISTRATION
0925148 DATED 3-19-2007, EXPIRES 3-19-2017.

FOR: PRECIOUS METALS AND THEIR ALLOYS
SOLD IN BULK; JEWELRY; PRECIOUS STONES;
TIMEPIECES AND CHRONOMETRIC INSTRU-
MENTS, NAMELY, WATCHES, WRISTWATCHES,
CHRONOMETERS, CLOCKS, TABLE CLOCKS, IN
CLASS 14 (U.S. CLS. 2, 27, 28 AND 50).

THE WORDS CONTAINED IN THE MARK HAVE
NO MEANING AND, THEREFORE, CANNOT BE
TRANSLATED.

SER. NO. 79-038,866, FILED 3-19-2007.

PRIORITY DATE OF 12-8-2006 IS CLAIMED.

PATRICIA EVANKO, EXAMINING ATTORNEY

Int. Cl.: 33

Prior U.S. Cls.: 47 and 49

United States Patent and Trademark Office

Reg. No. 3,398,794

Registered Mar. 18, 2008

**TRADEMARK
PRINCIPAL REGISTER**



MONTSECONDO

SILVIO MESSANA (ITALY INDIVIDUAL)
VIA PER CERBAIA, 18
I-50020 SAN CASCIANO VAL DI PESA (FIRENZE)
ITALY

FOR: WINES, SPARKLING WINES, DISTILLED
LIQUORS, DISTILLED SPIRITS, IN CLASS 33 (U.S.
CLS. 47 AND 49).

PRIORITY DATE OF 2-23-2007 IS CLAIMED.

OWNER OF INTERNATIONAL REGISTRATION
0925884 DATED 4-3-2007, EXPIRES 4-3-2017.

THE ENGLISH TRANSLATION OF THE FOR-
EIGN WORD(S) IN THE MARK IS: SECOND MOUN-
TAIN.

SER. NO. 79-039,175, FILED 4-3-2007.

ELLEN BURNS, EXAMINING ATTORNEY

Int. Cls.: 12, 37 and 39

Prior U.S. Cls.: 19, 21, 23, 31, 35, 44, 100, 103, 105 and 106

United States Patent and Trademark Office

Reg. No. 3,398,795

Registered Mar. 18, 2008

**TRADEMARK
SERVICE MARK
PRINCIPAL REGISTER**

AQUAMARINE

WILLI KUSSBERGER (FED REP GERMANY IN-
DIVIDUAL)
ERLENGRUNDSTRASSE 30
90571 NURNBERG
FED REP GERMANY

FOR: BOATS, YACHTS AND THEIR STRUCTUR-
AL PARTS, IN CLASS 12 (U.S. CLS. 19, 21, 23, 31, 35
AND 44).

FOR: MAINTENANCE AND REPAIR OF BOATS,
CONSTRUCTION OF BOATS, IN CLASS 37 (U.S.
CLS. 100, 103 AND 106).

FOR: BOAT RENTAL PLEASURE BOAT TRANS-
PORT, IN CLASS 39 (U.S. CLS. 100 AND 105).

OWNER OF INTERNATIONAL REGISTRATION
0653435 DATED 3-12-1996, EXPIRES 3-12-2016.

SER. NO. 79-039,189, FILED 12-8-2006.

KIMBERLY FRYE, EXAMINING ATTORNEY

Int. Cl.: 14

Prior U.S. Cls.: 2, 27, 28 and 50

United States Patent and Trademark Office

Reg. No. 3,398,796

Registered Mar. 18, 2008

**TRADEMARK
PRINCIPAL REGISTER**



ZHANG ZHOU SHI HENG LI DIAN; ZI YOU
XIAN GONG SI (CHINA CORPORATION)
LONGWEN GONGYE KAIFANG NEI
ZHANGZHOU SHI; 363000 FUJIAN
CHINA

FOR: CLOCK HANDS FOR CLOCK AND
WATCHMAKING; CLOCKS; SPEAKER CLOCKS;
WRISTWATCHES; DIALS FOR CLOCK AND
WATCHMAKING; CLOCKWORK CLOCKS; ELEC-
TRIC CLOCKS AND WATCHES; MASTER CON-
TROL CLOCKS; PRESENTATION CASES FOR
WATCHES, IN CLASS 14 (U.S. CLS. 2, 27, 28 AND 50).

OWNER OF INTERNATIONAL REGISTRATION
0927003 DATED 3-21-2007, EXPIRES 3-21-2017.

THE MARK CONSISTS OF A STYLIZED DESIGN
OF A TIMEPIECE AND THE WORDING MOVEB-
EST.

SER. NO. 79-039,634, FILED 3-21-2007.

KEVIN CORWIN, EXAMINING ATTORNEY

Int. Cl.: 33

Prior U.S. Cls.: 47 and 49

United States Patent and Trademark Office

Reg. No. 3,398,797

Registered Mar. 18, 2008

**TRADEMARK
PRINCIPAL REGISTER**

WHISPERING ANGEL

CHATEAU D'ESCLANS; DOMAINES SACHA LI-
CHINE (FRANCE SOCIÉTÉ PAR ACTIONS
SIMPLIFIÉE)

CHATEAU D'ESCLANS
F-83920 LA MOTTE
FRANCE

PRIORITY DATE OF 10-24-2006 IS CLAIMED.

OWNER OF INTERNATIONAL REGISTRATION
0927191 DATED 4-23-2007, EXPIRES 4-23-2017.

FOR: WINE, IN CLASS 33 (U.S. CLS. 47 AND 49).

THE MARK CONSISTS OF STANDARD CHAR-
ACTERS WITHOUT CLAIM TO ANY PARTICULAR
FONT, STYLE, SIZE, OR COLOR.

SER. NO. 79-039,705, FILED 4-23-2007.

ESTHER A. BORSUK, EXAMINING ATTORNEY

Int. Cl.: 24

Prior U.S. Cls.: 42 and 50

United States Patent and Trademark Office

Reg. No. 3,398,798

Registered Mar. 18, 2008

**TRADEMARK
PRINCIPAL REGISTER**

MOONDREAM

BRUNSWICK ET FILS SA (FRANCE SOCIÉTÉ
ANONYME)
16 RUE DE LA BANQUE
F-75002 PARIS
FRANCE

FOR: FABRICS FOR TEXTILE USE, HOUSEHOLD
LINEN, TEXTILES, NAMELY, TEXTILES FOR USE
IN THE MANUFACTURE OF CLOTHING, TEXTILE
USED AS LINING FOR CLOTHING, IN CLASS 24
(U.S. CLS. 42 AND 50).

THE MARK CONSISTS OF STANDARD CHAR-
ACTERS WITHOUT CLAIM TO ANY PARTICULAR
FONT, STYLE, SIZE, OR COLOR.

OWNER OF INTERNATIONAL REGISTRATION
0927239 DATED 5-7-2007, EXPIRES 5-7-2017.

SER. NO. 79-039,718, FILED 5-7-2007.

GISELLE AGOSTO, EXAMINING ATTORNEY

Int. Cl.: 1

Prior U.S. Cls.: 1, 5, 6, 10, 26 and 46

United States Patent and Trademark Office

Reg. No. 3,398,799

Registered Mar. 18, 2008

**TRADEMARK
PRINCIPAL REGISTER**

EMCOL

EMSLAND-STÄRKE GMBH (FED REP GERMA-
NY GMBH)
EMSLANDSTR. 58
49820 EMLICHHEIM
FED REP GERMANY

OWNER OF INTERNATIONAL REGISTRATION
0482759 DATED 2-7-1984, EXPIRES 2-7-2014.

FOR: GLUES FOR MANUFACTURING CORRUGATED
CARDBOARD, PAPER BAGS AND GLUING
PAPER; GLUE FOR WALL PAPER; GLUE FOR
TEXTILE PRINTING, IN CLASS 1 (U.S. CLS. 1, 5, 6,
10, 26 AND 46).

SER. NO. 79-039,866, FILED 5-24-2007.

KIMBERLY FRYE, EXAMINING ATTORNEY

Int. Cls.: 7, 17 and 20

**Prior U.S. Cls.: 1, 2, 5, 12, 13, 19, 21, 22, 23, 25, 31, 32,
34, 35 and 50**

United States Patent and Trademark Office

Reg. No. 3,398,800

Registered Mar. 18, 2008

**TRADEMARK
PRINCIPAL REGISTER**

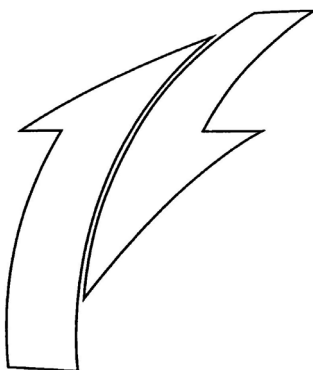

BUCCHI S.R.L. (ITALY SOCIETE A RESPONSABILITE LIMITEE)
VIA BONSI S.N.C.
I-48022 LUGO (RA)
ITALY

FOR: TAPS AND VALVES MADE OF METAL AND MADE OF PLASTICS BEING PARTS OF MACHINES AND EQUIPMENT USED FOR CIRCULATION OF WATER AND OTHER LIQUIDS, IN CLASS 7 (U.S. CLS. 13, 19, 21, 23, 31, 34 AND 35).

FOR: FLEXIBLE PLASTIC PIPES, PLASTIC CONNECTORS FOR PIPES; PLASTIC SEALS FOR PIPES; PLASTIC COUPLINGS FOR PIPES, IN CLASS 17 (U.S. CLS. 1, 5, 12, 13, 35 AND 50).

FOR: WATER-PIPE VALVES OF PLASTIC, IN CLASS 20 (U.S. CLS. 2, 13, 22, 25, 32 AND 50).

PRIORITY DATE OF 3-14-2007 IS CLAIMED.

OWNER OF INTERNATIONAL REGISTRATION
0927764 DATED 4-6-2007, EXPIRES 4-6-2017.

THE MARK CONSISTS OF A GRAPHIC COMPOSITION OF TWO HIGHLY STYLISED, INTERCONNECTED ARROWS, ONE POINTING UPWARDS AND THE OTHER DOWNWARDS, SUGGESTING ROTARY MOTION.

SER. NO. 79-039,895, FILED 4-6-2007.

JAMES GRIFFIN, EXAMINING ATTORNEY

Int. Cl.: 30

Prior U.S. Cl.: 46

United States Patent and Trademark Office

Reg. No. 3,398,801

Registered Mar. 18, 2008

TRADEMARK
PRINCIPAL REGISTER

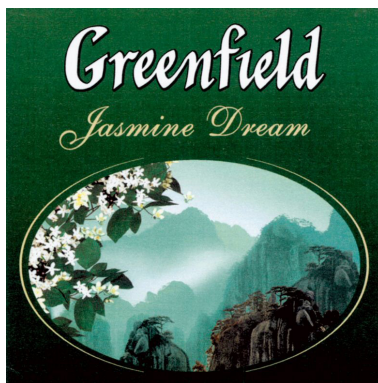

COMPANY "KARAVAN" LTD. (RUSSIAN FED. LIMITED COMPANY)
D.12, FAVORSKOGO STREET
RU-195220 SAINT-PETERSBURG
RUSSIAN FED.

FOR: TEA, ICED TEA, TEA-BASED BEVERAGES,
IN CLASS 30 (U.S. CL. 46).

OWNER OF INTERNATIONAL REGISTRATION
0928053 DATED 5-8-2007, EXPIRES 5-8-2017.

OWNER OF U.S. REG. NO. 3,095,841.

NO CLAIM IS MADE TO THE EXCLUSIVE
RIGHT TO USE "JASMINE", APART FROM THE
MARK AS SHOWN.

THE COLOR(S) GREEN, DARK GREEN, EMERALD GREEN, YELLOW, LIGHT YELLOW, WHITE AND BLACK IS/ARE CLAIMED AS A FEATURE OF THE MARK.

THE MARK CONSISTS OF THE FOLLOWING:
THE GREEN COLOR APPEARS IN THE UPPER

PART OF THE MARK, THE DARK GREEN COLOR APPEARS IN THE LOWER PART OF THE MARK, THE EMERALD GREEN COLOR APPEARS IN THE IMAGE OF THE MOUNTAIN LANDSCAPE IN CENTRAL PART OF THE MARK, THE YELLOW COLOR APPEARS IN THE INSCRIPTION JASMINE DREAM IN THE UPPER PART OF THE MARK, IN TWO OVAL LINES IN THE CENTRAL PART AS CONTOURS OF THE MOUNTAIN LANDSCAPE INSERTED INTO OVAL. THE LIGHT YELLOW COLOR APPEARS IN THE IMAGE OF JASMINE FLOWERS IN THE CENTRAL PART OF THE MARK. THE WHITE COLOR APPEARS IN THE INSCRIPTION GREENFIELD IN THE UPPER PART OF THE MARK AND PARTLY IN THE CENTRAL PART OF THE MARK IN/BETWEEN THE MOUNTAIN LANDSCAPE AND JASMINE FLOWERS IMAGES. THE BLACK COLOR APPEARS IN THE CONTOURS OF THE INSCRIPTION GREENFIELD IN THE UPPER PART OF THE MARK AND PARTLY IN/BETWEEN THE MOUNTAIN LANDSCAPE IMAGE IN THE CENTRAL PART OF THE MARK.

SER. NO. 79-039,978, FILED 5-8-2007.

REGINA DRUMMOND, EXAMINING ATTORNEY

Int. Cl.: 30

Prior U.S. Cl.: 46

United States Patent and Trademark Office

Reg. No. 3,398,802

Registered Mar. 18, 2008

TRADEMARK
PRINCIPAL REGISTER

厨邦

GUANGDONG MEIWEIXIAN FLAVORING;
FOODS CO., LTD. (CHINA CORPORATION)
QIGANG ROAD, WEST SECTION
ZHONGSHAN, GUANGDONG 528400
CHINA

FOR: SAUCE; VINEGAR; CEREAL PREPARA-
TIONS, NAMELY, NOODLES, RICE NOODLES,
OATMEAL; SEASONINGS; INSTANT NOODLE; OY-
STER SAUCE; STARCH SYRUP FOR FOOD; FLA-
VORING SAUCE; COFFEE-BASED BEVERAGES;
COFFEE; TEA; SUGAR; CANDY; SOYA-BEAN
MILK ESSENCE; ICE CREAM; BAKING POWDER;
RELISH, IN CLASS 30 (U.S. CL. 46).

OWNER OF INTERNATIONAL REGISTRATION
0928169 DATED 12-7-2006, EXPIRES 12-7-2016.

THE NON-LATIN CHARACTER(S) IN THE
MARK TRANSLITERATES INTO CHU BANG,
AND THIS MEANS THE KITCHENER'S BEST HELP-
ER IN ENGLISH.

SER. NO. 79-040,003, FILED 12-7-2006.

KAREN K. BUSH, EXAMINING ATTORNEY

Int. Cl.: 17

Prior U.S. Cls.: 1, 5, 12, 13, 35 and 50

United States Patent and Trademark Office

Reg. No. 3,398,803

Registered Mar. 18, 2008

**TRADEMARK
PRINCIPAL REGISTER**

Sarnatherm

SIKA AG (SWITZERLAND CORPORATION)
ZUGERSTRASSE 50
CH-6341 BAAR, SWITZERLAND

OWNER OF INTERNATIONAL REGISTRATION
0466342 DATED 12-15-1981, EXPIRES 12-15-2011.

FOR: THERMAL INSULATION MATERIALS IN
THE FORM OF PLATES FOR USE IN BUILDING
CONSTRUCTION, IN CLASS 17 (U.S. CLS. 1, 5, 12, 13,
35 AND 50).

SER. NO. 79-040,068, FILED 6-4-2007.

FLORENTINA BLANDU, EXAMINING ATTORNEY

Int. Cls.: 35, 40, 41 and 42

Prior U.S. Cls.: 100, 101, 102, 103, 106 and 107

United States Patent and Trademark Office

Reg. No. 3,398,804

Registered Mar. 18, 2008

**SERVICE MARK
PRINCIPAL REGISTER**

FAMIPIX

SKWORTSOW KOSTER MEDIA GROEP (SKMG)
B.V. (NETHERLANDS PUBLIC LIABILITY OR
CORPORATION)
OOSTDAM 5
NL-3441 EM WOERDEN
NETHERLANDS

FOR: MANAGEMENT OF COMPUTER DATABASES AND COMPUTER FILES, ESPECIALLY CONTAINING PHOTOS AND VIDEOS, FOR THIRD PARTIES, IN CLASS 35 (U.S. CLS. 100, 101 AND 102).

FOR: PROCESSING AND PRINTING OF PHOTOS; PROCESSING OF NEGATIVES, FILMS AND VIDEOS, IN CLASS 40 (U.S. CLS. 100, 103 AND 106).

FOR: ONLINE ELECTRONIC PUBLISHING SERVICES, NAMELY, PUBLICATION OF TEXT AND GRAPHIC WORKS OF OTHERS, FEATURING PHOTOS, FILMS AND OTHER PICTORIAL MATERIALS; PHOTO EDITING, WHETHER COMPUTER AIDED OR NOT, IN CLASS 41 (U.S. CLS. 100, 101 AND 107).

FOR: COMPUTER SERVICE, NAMELY, ACTING AS AN APPLICATION SERVICE PROVIDER IN THE

FIELD OF KNOWLEDGE MANAGEMENT TO HOST COMPUTER APPLICATION SOFTWARE FOR THE COLLECTION, EDITING, ORGANIZING, MODIFYING, BOOK MARKING, TRANSMISSION, STORAGE, AND SHARING OF PHOTOS AND VIDEOS ON THE INTERNET IN ORDER THAT THE USER CAN SHARE THEM WITH SELECTED FRIEND AND FAMILY CONTACTS, IN CLASS 42 (U.S. CLS. 100 AND 101).

THE MARK CONSISTS OF STANDARD CHARACTERS WITHOUT CLAIM TO ANY PARTICULAR FONT, STYLE, SIZE, OR COLOR.

PRIORITY DATE OF 7-17-2006 IS CLAIMED.

OWNER OF INTERNATIONAL REGISTRATION 0928572 DATED 12-19-2006, EXPIRES 12-19-2016.

SER. NO. 79-040,155, FILED 12-19-2006.

ALLISON HOLTZ, EXAMINING ATTORNEY

Int. Cl.: 33

Prior U.S. Cls.: 47 and 49

United States Patent and Trademark Office

Reg. No. 3,398,805

Registered Mar. 18, 2008

**TRADEMARK
PRINCIPAL REGISTER**

René Lalou

G.H. MUMM & CIE, SOCIÉTÉ VINICOLE; DE
CHAMPAGNE, SUCCESSEUR.; SOCIÉTÉ
ANONYME (FRANCE SOCIÉTÉ ANONYME)
29, RUE DU CHAMP DE MARS,
F-51100 REIMS
FRANCE

FOR: WINES, SPARKLING WINES, WINES OF
FRENCH ORIGIN, NAMELY, CHAMPAGNE,
HARD CIDERS, APERITIFS AND LIQUEURS , IN
CLASS 33 (U.S. CLS. 47 AND 49).

OWNER OF INTERNATIONAL REGISTRATION
0426891 DATED 10-26-1976, EXPIRES 10-26-2016.

THE NAME(S), PORTRAIT(S), AND/OR SIGNA-
TURE(S) SHOWN IN THE MARK DOES NOT IDEN-
TIFY A PARTICULAR LIVING INDIVIDUAL.

SER. NO. 79-040,295, FILED 1-19-2007.

ALLISON HOLTZ, EXAMINING ATTORNEY

Int. Cl.: 7

Prior U.S. Cls.: 13, 19, 21, 23, 31, 34 and 35

United States Patent and Trademark Office

Reg. No. 3,398,806

Registered Mar. 18, 2008

**TRADEMARK
PRINCIPAL REGISTER**

**AUTO
ADAPT**

GRUNDFOS MANAGEMENT A/S (DENMARK
CORPORATION)
POUL DUE JENSENS VEJ 7
DK-8850 BJERRINGBRO
DENMARK 8850

OWNER OF INTERNATIONAL REGISTRATION
0929354 DATED 6-6-2007, EXPIRES 6-6-2017.

FOR: PUMPS FOR HEATING AND PUMPS FOR
AIR CONDITIONING AND THEIR PARTS IN THE
FORM OF INTELLIGENT REGULATING DEVICES,
IN CLASS 7 (U.S. CLS. 13, 19, 21, 23, 31, 34 AND 35).

SER. NO. 79-040,479, FILED 6-6-2007.

PRIORITY DATE OF 3-2-2007 IS CLAIMED.

ALLISON HOLTZ, EXAMINING ATTORNEY

Int. Cls.: 32 and 33

Prior U.S. Cls.: 45, 46, 47, 48 and 49

Reg. No. 3,398,807

United States Patent and Trademark Office

Registered Mar. 18, 2008

**TRADEMARK
PRINCIPAL REGISTER**

GLAMOUR

OTKRYTOYE AKTSIONERNOYE OBCHTCHEST-
VO; "SYNERGIYA KAPITAL" (RUSSIAN FED.
LTD LIAB CO)

STR. 2, D. 7, PER. KHLEBNIKOV
RU-107020 MOSCOW
RUSSIAN FED.

FOR: BEERS, MINERAL AND AERATED WA-
TERS, FLAVORED WATER, NON-ALCOHOLIC
APERITIFS, NONALCOHOLIC BEVERAGES,
NAMELY, DRINKING WATER, PURE WATER,
SPRING WATER, SYRUPS FOR BEVERAGES,
FRUIT CONCENTRATES AND PUREES USED AS
INGREDIENTS OF BEVERAGES, ESSENCES FOR
THE MANUFACTURE OF LIQUEURS, FRUIT

DRINKS AND FRUIT JUICES, IN CLASS 32 (U.S.
CLS. 45, 46 AND 48).

FOR: APERITIFS, WINES, VODKA, GIN, ALCO-
HOLIC COCKTAIL MIXES, ALCOHOLIC BITTERS,
IN CLASS 33 (U.S. CLS. 47 AND 49).

OWNER OF INTERNATIONAL REGISTRATION
0929431 DATED 5-17-2007, EXPIRES 5-17-2017.

SER. NO. 79-040,509, FILED 5-17-2007.

CHRISTINA SOBRAL, EXAMINING ATTORNEY

Int. Cl.: 20

Prior U.S. Cls.: 2, 13, 22, 25, 32 and 50

United States Patent and Trademark Office

Reg. No. 3,398,808

Registered Mar. 18, 2008

**TRADEMARK
PRINCIPAL REGISTER**

USMDISPLAY

USM HOLDING AG (SWITZERLAND SOCIÉTÉ
ANONYME (SA))
SCHLOSSGUTWEG 39
CH-3073 GÜMLIGEN
SWITZERLAND

OWNER OF INTERNATIONAL REGISTRATION
0640282 DATED 5-18-1995, EXPIRES 5-18-2015.

FOR: FURNITURE, SHELVES SUCH AS SHELVES
FOR ARCHIVES, ROOM DIVIDERS, DISPLAY
BOARDS; CABINETS, ARCHIVE CABINETS, TA-
BLES, CHAIRS, MOBILE DRAWER UNITS, INDEX
CABINETS; FURNITURE, NAMELY, FURNITURE
SYSTEMS COMPRISING ELEMENTS WHICH CAN
BE COMBINED, IN CLASS 20 (U.S. CLS. 2, 13, 22, 25,
32 AND 50).

OWNER OF U.S. REG. NOS. 2,514,218 AND
2,636,228.

SER. NO. 79-040,596, FILED 2-1-2007.

CHRISIE B. KING, EXAMINING ATTORNEY

Int. Cls.: 18 and 25

Prior U.S. Cls.: 1, 2, 3, 22, 39 and 41

United States Patent and Trademark Office

Reg. No. 3,398,809

Registered Mar. 18, 2008

**TRADEMARK
PRINCIPAL REGISTER**

COR.MAR S.A.S; DI CORVARI MARINO & C.
(ITALY LIMITED PARTNERSHIP COMPANY)
STRADA PROVINCIALE MEZZINA SNC
I-63014 MONTEGRANARO (AP)
ITALY

OWNER OF INTERNATIONAL REGISTRATION
0929773 DATED 4-6-2007, EXPIRES 4-6-2017.

FOR: GOODS MADE OF LEATHER, SKINS AND
IMITATIONS OF LEATHER AND SKINS, NAMELY,
BAGS, HANDBAGS, TRAVELLING BAGS, WAL-
LETS AND PURSES, UMBRELLAS, IN CLASS 18
(U.S. CLS. 1, 2, 3, 22 AND 41).

THE MARK CONSISTS OF THE GRAPHIC ELA-
BORATION OF THE FANCIFUL NAME DICO IN
STYLIZED CHARACTERS WHERE THE ACCENT
PLACED UPON THE FINAL LETTER O IS REPRE-
SENTED BY A PORTION OF A STRAIGHT LINE
ENTIRELY OVERTOPPING THE ABOVE-MEN-
TIONED LETTER.

FOR: CLOTHING, NAMELY, DRESSES, SKIRTS,
JACKETS, TROUSERS, SHIRTS, SPORTS JERSEYS,
OVERCOATS, UNDERWEAR, SWIMSUITS, HEAD-
SCARVES, NECKTIES, GLOVES, HATS, BELTS FOR
CLOTHING, SHOES, BOOTS, CLOGS AND SLIP-
PERS, IN CLASS 25 (U.S. CLS. 22 AND 39).

THE FOREIGN WORDING IN THE MARK
TRANSLATES INTO ENGLISH AS, " I SAY".

PRIORITY DATE OF 3-14-2007 IS CLAIMED.

SER. NO. 79-040,670, FILED 4-6-2007.

JOHN DWYER, EXAMINING ATTORNEY

Int. Cls.: 9, 35 and 36

Prior U.S. Cls.: 21, 23, 26, 36, 38, 100, 101 and 102

United States Patent and Trademark Office

Reg. No. 3,398,810

Registered Mar. 18, 2008

**TRADEMARK
SERVICE MARK
PRINCIPAL REGISTER**

UBS TRADER

UBS AG (SWITZERLAND SOCIÉTÉ ANONYME
(SA))
BAHNHOFSTRASSE 45
CH-8001 ZÜRICH, SWITZERLAND

FOR: COMPUTER SOFTWARE PLATFORMS
FOR USE IN TRANSACTIONAL DEALING AND
BROKERAGE IN THE FIELDS OF CURRENCY
EXCHANGE, SECURITIES AND OTHER FINAN-
CIAL INSTRUMENTS, IN CLASS 9 (U.S. CLS. 21, 23,
26, 36 AND 38).

FOR: COMPILATION AND SYSTEMATIZATION
OF INFORMATION ABOUT FOREIGN EX-
CHANGE, SECURITIES AND OTHER FINANCIAL
INSTRUMENTS, IN CLASS 35 (U.S. CLS. 100, 101
AND 102).

FOR: FINANCIAL AND BANKING SERVICES,
NAMELY, BROKERAGE IN THE FIELDS OF CUR-
RENCY EXCHANGE, SECURITIES AND OTHER
FINANCIAL INSTRUMENTS; ANALYSIS AND
PROVISION OF INFORMATION ON FOREIGN
CURRENCIES, SECURITIES AND OTHER FINAN-
CIAL INSTRUMENTS; PROVISION OF INFORMA-
TION RELATING TO THE PRICE OR VALUE OF
FOREIGN CURRENCIES, SECURITIES AND

OTHER FINANCIAL INSTRUMENTS VIA AN IN-
TERACTIVE GLOBAL COMPUTER NETWORK, IN
CLASS 36 (U.S. CLS. 100, 101 AND 102).

THE MARK CONSISTS OF STANDARD CHAR-
ACTERS WITHOUT CLAIM TO ANY PARTICULAR
FONT, STYLE, SIZE, OR COLOR.

PRIORITY DATE OF 1-24-2007 IS CLAIMED.

OWNER OF INTERNATIONAL REGISTRATION
0930205 DATED 5-23-2007, EXPIRES 5-23-2017.

OWNER OF U.S. REG. NOS. 1,573,828, 3,006,891
AND OTHERS.

NO CLAIM IS MADE TO THE EXCLUSIVE
RIGHT TO USE "TRADER", APART FROM THE
MARK AS SHOWN.

SER. NO. 79-040,819, FILED 5-23-2007.

BRIAN PINO, EXAMINING ATTORNEY

Int. Cl.: 10

Prior U.S. Cls.: 26, 39 and 44

United States Patent and Trademark Office

Reg. No. 3,398,811

Registered Mar. 18, 2008

**TRADEMARK
PRINCIPAL REGISTER**

Echidna Pin

IAN GRIGGS (AUSTRALIA INDIVIDUAL)
78 BRICE AVENUE
MOOROOLBARK VIC 3188
AUSTRALIA

OWNER OF INTERNATIONAL REGISTRATION
0930275 DATED 7-2-2007, EXPIRES 7-2-2017.

FOR: ORTHOPAEDIC DEVICES, NAMELY, IN-
TRAMEDULLARY BONE PINNING DEVICE, IN
CLASS 10 (U.S. CLS. 26, 39 AND 44).

NO CLAIM IS MADE TO THE EXCLUSIVE
RIGHT TO USE PIN, APART FROM THE MARK
AS SHOWN.

THE MARK CONSISTS OF STANDARD CHAR-
ACTERS WITHOUT CLAIM TO ANY PARTICULAR
FONT, STYLE, SIZE, OR COLOR.

SER. NO. 79-040,846, FILED 7-2-2007.

TARAH HARDY, EXAMINING ATTORNEY

Int. Cls.: 6, 7 and 12

**Prior U.S. Cls.: 2, 12, 13, 14, 19, 21, 23, 25, 31, 34, 35,
44 and 50**

Reg. No. 3,398,812

United States Patent and Trademark Office

Registered Mar. 18, 2008

**TRADEMARK
PRINCIPAL REGISTER**

POLY CHAIN

THE GATES CORPORATION (DELAWARE CORPORATION)
1551 WEWATTA STREET
DENVER, COLORADO 80202
UNITED STATES

FOR: METAL SPROCKETS AND PULLEYS OF METAL OTHER THAN FOR MACHINES, IN CLASS 6 (U.S. CLS. 2, 12, 13, 14, 23, 25 AND 50).

FOR: POWER TRANSMISSION BELTS FOR LAND VEHICLE ENGINES AND LAND VEHICLES; TIMING BELTS FOR ENGINES FOR LAND VEHICLES; POWER TRANSMISSION BELTS FOR MACHINES, MOTORS AND ENGINES USED IN INDUSTRIAL APPLICATIONS; TIMING BELTS FOR MACHINES, MOTORS AND ENGINES USED IN INDUSTRIAL APPLICATIONS; SPROCKETS AND PULLEYS, BEING PARTS OF ENGINES, MACHINES OR MOTORS, IN CLASS 7 (U.S. CLS. 13, 19, 21, 23, 31, 34 AND 35).

FOR: TRANSMISSION BELTS FOR LAND VEHICLES AND POWER TRANSMISSION APPARATUS BEING A LAND VEHICLE PART; LAND VEHICLE

PARTS, NAMELY, DRIVE BELT SYSTEMS COMPRISED OF DRIVE BELTS, TENSIONERS, SPROCKETS AND PULLEYS; ENGINE TRANSMISSION BELTS FOR LAND VEHICLES, IN CLASS 12 (U.S. CLS. 19, 21, 23, 31, 35 AND 44).

THE MARK CONSISTS OF STANDARD CHARACTERS WITHOUT CLAIM TO ANY PARTICULAR FONT, STYLE, SIZE, OR COLOR.

OWNER OF INTERNATIONAL REGISTRATION 0789084 DATED 8-7-2002, EXPIRES 8-7-2012.

OWNER OF U.S. REG. NO. 985,961.

NO CLAIM IS MADE TO THE EXCLUSIVE RIGHT TO USE "CHAIN", APART FROM THE MARK AS SHOWN.

SER. NO. 79-040,932, FILED 4-16-2007.

GINA FINK, EXAMINING ATTORNEY

Int. Cls.: 9, 35 and 38

Prior U.S. Cls.: 21, 23, 26, 36, 38, 100, 101, 102 and 104

United States Patent and Trademark Office

Reg. No. 3,398,813

Registered Mar. 18, 2008

**TRADEMARK
SERVICE MARK
PRINCIPAL REGISTER**

ADITON

ADITON LIMITED (UNITED KINGDOM LIMITED COMPANY)
123 BUCKINGHAM PALACE ROAD
LONDON SW1W 9SR
UNITED KINGDOM

FOR: SOFTWARE FOR USE WITH MOBILE TELEPHONES AND MOBILE TELECOMMUNICATIONS APPARATUS; SOFTWARE FOR FACILITATING TRANSMISSION OF ADVERTISING MATERIAL TO MOBILE TELEPHONES AND MOBILE TELECOMMUNICATIONS APPARATUS; TELECOMMUNICATIONS APPARATUS AND MOBILE TELECOMMUNICATIONS APPARATUS, NAMELY DATA PROCESSORS AND RADIO TRANSMITTERS FOR TRANSMISSION OF ADVERTISING MATERIAL OR OTHER CONTENT TO MOBILE TELEPHONES AND OTHER MOBILE DEVICES VIA A TELECOMMUNICATIONS NETWORK, MOBILE TELEPHONES, IN CLASS 9 (U.S. CLS. 21, 23, 26, 36 AND 38).

FOR: ADVERTISING SERVICES; ADVERTISING SERVICES PROVIDED BY A MOBILE TELECOMMUNICATIONS NETWORK; ADVISORY AND CONSULTANCY SERVICES IN RELATION TO ADVERTISING SERVICES; DISSEMINATION OF AD-

VERTISING MATERIAL VIA A TELECOMMUNICATIONS OR MOBILE TELECOMMUNICATIONS NETWORK, IN CLASS 35 (U.S. CLS. 100, 101 AND 102).

FOR: TELECOMMUNICATIONS SERVICES AND MOBILE TELECOMMUNICATIONS SERVICES NAMELY, TRANSMISSION OF ADVERTISING MATERIAL OR OTHER CONTENT TO MOBILE TELEPHONES AND OTHER MOBILE DEVICES VIA A TELECOMMUNICATIONS NETWORK; ADVISORY AND CONSULTANCY SERVICES IN RELATION TO TELECOMMUNICATIONS AND MOBILE TELECOMMUNICATIONS, IN CLASS 38 (U.S. CLS. 100, 101 AND 104).

PRIORITY DATE OF 10-11-2006 IS CLAIMED.

OWNER OF INTERNATIONAL REGISTRATION 0930705 DATED 4-10-2007, EXPIRES 4-10-2017.

SER. NO. 79-041,082, FILED 4-10-2007.

DAVID HOFFMAN, EXAMINING ATTORNEY

Int. Cls.: 1, 2, 5 and 30

Prior U.S. Cls.: 1, 5, 6, 10, 11, 16, 18, 26, 44, 46, 51 and 52

United States Patent and Trademark Office

Reg. No. 3,398,814

Registered Mar. 18, 2008

**TRADEMARK
PRINCIPAL REGISTER**

EMGRANULE

EMSLAND-STÄRKE GMBH (FED REP GERMA-
NY GMBH)
EMSLANDSTR. 58
49824 EMLICHHEIM, FED REP GERMANY

FOR: CHEMICALS USED IN INDUSTRY, IN PARTICULAR STARCH PRODUCTS BEING TEXTILE AUXILIARIES, NAMELY, SIZE FOR YARNS, FINISHING PREPARATIONS; EMULSIFYING AGENTS FOR TECHNICAL PURPOSES, NAMELY, FOR THE MANUFACTURE OF ADHESIVES USED IN INDUSTRY, IN PARTICULAR DEXTRINE; GLUE FOR INDUSTRIAL PURPOSES; CHEMICALS USED IN INDUSTRY WITH A STARCH BASE BEING PAPER-MAKING AUXILIARIES, IN PARTICULAR FOR THE INTERNAL SIZING AND SURFACE TREATMENT OF PAPER; CHEMICALS USED IN INDUSTRY WITH A STARCH BASE BEING BINDING AGENTS FOR THE MANUFACTURE OF MINERAL FIBREBOARD AND PLASTERBOARD, IN CLASS 1 (U.S. CLS. 1, 5, 6, 10, 26 AND 46).

FOR: BINDING AND THICKENING AGENTS FOR PAINTS AND LACQUERS, IN CLASS 2 (U.S. CLS. 6, 11 AND 16).

FOR: DIETETIC STARCH AND STARCH PRODUCTS FOR MEDICAL PURPOSES, NAMELY, STARCH FOR USE IN THE MAKING OF PHARMACEUTICALS, IN CLASS 5 (U.S. CLS. 6, 18, 44, 46, 51 AND 52).

FOR: FOOD STARCH AND STARCH PRODUCTS FOR FOODSTUFFS AND LUXURY FOOD ITEMS ON THE BASIS OF STARCH, NAMELY, CORN STARCH, POTATO STARCH, WHEAT STARCH FLOUR, STABILIZING AGENTS USED IN THE MANUFACTURE OF FILLINGS FOR CAKES AND PASTRIES, IN CLASS 30 (U.S. CL. 46).

OWNER OF INTERNATIONAL REGISTRATION
0930737 DATED 5-16-2007, EXPIRES 5-16-2017.

SER. NO. 79-041,095, FILED 5-16-2007.

KIMBERLY FRYE, EXAMINING ATTORNEY

Int. Cls.: 1, 2, 5 and 30

Prior U.S. Cls.: 1, 5, 6, 10, 11, 16, 18, 26, 44, 46, 51 and 52

Reg. No. 3,398,815

United States Patent and Trademark Office

Registered Mar. 18, 2008

**TRADEMARK
PRINCIPAL REGISTER**

EMFLAKE

EMSLAND-STÄRKE GMBH (FED REP GERMA-
NY GMBH (LIMITED LIABILITY COMPANY))
EMSLANDSTR. 58
49824 EMLICHHEIM, FED REP GERMANY

FOR: CHEMICALS USED IN INDUSTRY, IN PARTICULAR STARCH PRODUCTS BEING TEXTILE AUXILIARIES, NAMELY, SIZE FOR YARNS, FINISHING PREPARATIONS; EMULSIFYING AGENTS FOR TECHNICAL PURPOSES, NAMELY, FOR THE MANUFACTURE OF ADHESIVES USED IN INDUSTRY, IN PARTICULAR DEXTRINE; GLUE FOR INDUSTRIAL PURPOSES; CHEMICALS USED IN INDUSTRY WITH A STARCH BASE BEING PAPER-MAKING AUXILIARIES, IN PARTICULAR FOR THE INTERNAL SIZING AND SURFACE TREATMENT OF PAPER; CHEMICALS USED IN INDUSTRY WITH A STARCH BASE BEING BINDING AGENTS FOR THE MANUFACTURE OF MINERAL FIBREBOARD AND PLASTERBOARD, IN CLASS 1 (U.S. CLS. 1, 5, 6, 10, 26 AND 46).

FOR: BINDING AND THICKENING AGENTS FOR PAINTS AND LACQUERS, IN CLASS 2 (U.S. CLS. 6, 11 AND 16).

FOR: DIETETIC STARCH AND STARCH PRODUCTS FOR MEDICAL PURPOSES, NAMELY, STARCH FOR USE IN THE MAKING OF PHARMACEUTICALS, IN CLASS 5 (U.S. CLS. 6, 18, 44, 46, 51 AND 52).

FOR: FOOD STARCH AND STARCH PRODUCTS FOR FOODSTUFFS AND LUXURY FOOD ITEMS ON THE BASIS OF STARCH, NAMELY, CORN STARCH, POTATO STARCH, WHEAT STARCH FLOUR, STABILIZING AGENTS USED IN THE MANUFACTURE OF FILLINGS FOR CAKES AND PASTRIES, IN CLASS 30 (U.S. CL. 46).

OWNER OF INTERNATIONAL REGISTRATION
0930738 DATED 5-16-2007, EXPIRES 5-16-2017.

SER. NO. 79-041,096, FILED 5-16-2007.

KIMBERLY FRYE, EXAMINING ATTORNEY

Int. Cl.: 7

Prior U.S. Cls.: 13, 19, 21, 23, 31, 34 and 35

United States Patent and Trademark Office

Reg. No. 3,398,816

Registered Mar. 18, 2008

**TRADEMARK
PRINCIPAL REGISTER**

AUTO ADAPT

GRUNDFOS MANAGEMENT A/S (DENMARK
CORPORATION)
POUL DUE JENSENS VEJ 7
DK-8850 BJERRINGBRO
DENMARK

FOR: PUMPS FOR HEATING AND PUMPS FOR
AIR CONDITIONING AND THEIR PARTS IN THE
FORM OF INTELLIGENT REGULATING DEVICES,
IN CLASS 7 (U.S. CLS. 13, 19, 21, 23, 31, 34 AND 35).

THE MARK CONSISTS OF STANDARD CHAR-
ACTERS WITHOUT CLAIM TO ANY PARTICULAR
FONT, STYLE, SIZE, OR COLOR.

PRIORITY DATE OF 3-2-2007 IS CLAIMED.

OWNER OF INTERNATIONAL REGISTRATION
0931060 DATED 6-6-2007, EXPIRES 6-6-2017.

SER. NO. 79-041,171, FILED 6-6-2007.

ALLISON HOLTZ, EXAMINING ATTORNEY

Int. Cl.: 3

Prior U.S. Cls.: 1, 4, 6, 50, 51 and 52

United States Patent and Trademark Office

Reg. No. 3,398,817

Registered Mar. 18, 2008

**TRADEMARK
PRINCIPAL REGISTER**

INCANTO HEAVEN

SALVATORE FERRAGAMO ITALIA S.P.A. (ITALY JOINT STOCK COMPANY)
VIA DEI TORNABUONI, 2
I-50123 FIRENZE (FI)
ITALY

FOR: PERFUMES, EAU DE PARFUM, COLOGNE, TOILET WATER, ESSENTIAL OILS, COLD CREAMS, DEODORANTS FOR PERSONAL USE, ANTIPERSPIRANTS, SKIN CLEANSING LOTIONS, SKIN MOISTURIZER, BODY OIL, SKIN EMOLLIENT, SOAPS, BATH SOAPS IN LIQUID, SOLID OR GEL FORM, BATH AND SHOWER GEL, BODY LOTIONS, SKIN LOTIONS, IN CLASS 3 (U.S. CLS. 1, 4, 6, 50, 51 AND 52).

THE MARK CONSISTS OF STANDARD CHARACTERS WITHOUT CLAIM TO ANY PARTICULAR FONT, STYLE, SIZE, OR COLOR.

PRIORITY DATE OF 4-6-2007 IS CLAIMED.

OWNER OF INTERNATIONAL REGISTRATION 0931116 DATED 6-8-2007, EXPIRES 6-8-2017.

OWNER OF U.S. REG. NOS. 3,085,656, 3,286,644 AND OTHERS.

THE ENGLISH TRANSLATION OF THE FOREIGN WORD(S) IN THE MARK IS: ENCHANTMENT HEAVEN.

SER. NO. 79-041,187, FILED 6-8-2007.

BERNICE MIDDLETON, EXAMINING ATTORNEY

Int. Cl.: 7

Prior U.S. Cls.: 13, 19, 21, 23, 31, 34 and 35

United States Patent and Trademark Office

Reg. No. 3,398,818

Registered Mar. 18, 2008

TRADEMARK
PRINCIPAL REGISTER



SUGIYAMA SAW MFG. CO., LTD. (JAPAN
CORPORATION)
128 HIGASHI MISONO
HAMAKITA-KU, HAMAMATSU-SHI; SHIZUOKA-
KEN434-0026
JAPAN

OWNER OF INTERNATIONAL REGISTRATION
0931675 DATED 7-10-2007, EXPIRES 7-10-2017.

SER. NO. 79-041,409, FILED 7-10-2007.

FOR: CIRCULAR SAWS FOR WOOD WORKING,
IN CLASS 7 (U.S. CLS. 13, 19, 21, 23, 31, 34 AND 35).

WENDY JUN, EXAMINING ATTORNEY

Int. Cl.: 10

Prior U.S. Cls.: 26, 39 and 44

United States Patent and Trademark Office

Reg. No. 3,398,819

Registered Mar. 18, 2008

TRADEMARK
PRINCIPAL REGISTER



LANAFORM LANA ALLPEAK S.A., EN ABRÉGÉ
LANA S.A. (BELGIUM JOINT STOCK COM-
PANY)
ZONING DE CORNÉMONT
RUE DE LA LÉGENDE 55; B-4141 LOUVEIGNE
BELGIUM

FOR: APPARATUS AND INSTRUMENTS FOR
MASSAGE, NAMELY, ELECTRIC MASSAGE APPA-
RATUS FOR HOUSEHOLD USE; FITNESS EQUIP-
MENT FOR MEDICAL USE, NAMELY,
APPARATUS FOR PHYSICAL TRAINING, EXER-
CISE MACHINES FOR THERAPEUTIC PURPOSES,
VIBRATING APPARATUS FOR STRENGTHENING
THE MUSCLES, IN CLASS 10 (U.S. CLS. 26, 39 AND
44).

PRIORITY DATE OF 11-17-2006 IS CLAIMED.

OWNER OF INTERNATIONAL REGISTRATION
0931783 DATED 5-15-2007, EXPIRES 5-15-2017.

NO CLAIM IS MADE TO THE EXCLUSIVE
RIGHT TO USE POWER, APART FROM THE MARK
AS SHOWN.

THE COLOR(S) DARK BLUE, LIGHT BLUE AND
GREEN IS/ARE CLAIMED AS A FEATURE OF THE
MARK.

THE COLOR GREEN APPEARS IN THE WORD-
ING TX AND IN THE ARC ABOVE THE WORDING;
THE COLOR DARK BLUE APPEARS IN THE
WORDING POWER AND IN THE OUTER PORTION
OF THE CIRCLE; THE COLOR LIGHT BLUE AP-
PEARS AS THE INNER PORTION OF THE CIRCLE.

SER. NO. 79-041,465, FILED 5-15-2007.

KATHERINE E. HALMEN, EXAMINING ATTOR-
NEY

Int. Cl.: 6

Prior U.S. Cls.: 2, 12, 13, 14, 23, 25 and 50

Reg. No. 3,398,820

United States Patent and Trademark Office

Registered Mar. 18, 2008

**TRADEMARK
PRINCIPAL REGISTER**

CABIN

ZHEJIANG PUJIANG PLUM-BLOSSOM; LOCK
INDUSTRY GROUP CO., LTD (CHINA COR-
PORATION)
JIANGNAN DEVELOPMENT ZONE
ZHENGZHAI TOWN.; PUJIANG; 322200 ZHEJIANG
CHINA

FOR: METAL PADLOCKS; METAL KEYS FOR
LOCKS; LOCKS OF METAL, OTHER THAN ELEC-
TRIC; METAL SPRING LOCKS; LOCKS OF METAL
FOR VEHICLES NOT POWER OPERATED; LOCKS
OF METAL FOR BAGS; CHAINS OF METAL; HIN-
GES OF METAL; DOOR HANDLES OF METAL;

HARDWARE OF METAL, NAMELY, NUTS,
SPRINGS, WASHERS, DOOR BOLTS OF METAL,
IN CLASS 6 (U.S. CLS. 2, 12, 13, 14, 23, 25 AND 50).

OWNER OF INTERNATIONAL REGISTRATION
0932048 DATED 5-9-2007, EXPIRES 5-9-2017.

SER. NO. 79-041,586, FILED 5-9-2007.

CARRIE GENOVESE, EXAMINING ATTORNEY

Int. Cl.: 9

Prior U.S. Cls.: 21, 23, 26, 36 and 38

United States Patent and Trademark Office

Reg. No. 3,398,821

Registered Mar. 18, 2008

**TRADEMARK
PRINCIPAL REGISTER**

LUXIS

SOMFY SAS (FRANCE SOCIÉTÉ PAR ACTIONS
SIMPLIFIÉE)
50 AVENUE DU NOUVEAU MONDE
F-74300 CLUSES
FRANCE

FOR: ILLUMINATION DETECTOR, NAMELY,
LUMINANCE SENSORS AND ILLUMINANCE SEN-
SORS FOR CONTROLLING BLINDS, SHUTTERS,
AWNINGS, WINDOWS, SCREENS AND CURTAINS,
THE AFORESAID PRODUCT NOT INTENDED FOR
INSTALLATION OR USE AS A PART OF LIGHTING
APPLIANCES, IN CLASS 9 (U.S. CLS. 21, 23, 26, 36
AND 38).

THE MARK CONSISTS OF STANDARD CHAR-
ACTERS WITHOUT CLAIM TO ANY PARTICULAR
FONT, STYLE, SIZE, OR COLOR.

PRIORITY DATE OF 11-28-2006 IS CLAIMED.

OWNER OF INTERNATIONAL REGISTRATION
0932794 DATED 5-24-2007, EXPIRES 5-24-2017.

SER. NO. 79-041,907, FILED 5-24-2007.

BERNICE MIDDLETON, EXAMINING ATTORNEY

Int. Cls.: 9, 35, 38 and 41

**Prior U.S. Cls.: 21, 23, 26, 36, 38, 100, 101, 102, 104
and 107**

Reg. No. 3,398,822

United States Patent and Trademark Office

Registered Mar. 18, 2008

**TRADEMARK
SERVICE MARK
PRINCIPAL REGISTER**

AUDIOSCROBBLER

AUDIOSCROBBLER LIMITED (UNITED KING-
DOM LTD LIAB CO)
86C GREENFIELD ROAD
LONDON E1 1EJ
UNITED KINGDOM

FOR: DIGITAL MUSIC, DOWNLOADABLE FROM THE INTERNET AND VIA OTHER COMMUNICATIONS NETWORKS; DOWNLOADABLE TELEPHONE RING TONES VIA THE INTERNET AND WIRELESS DEVICE; MUSICAL SOUND RECORDINGS; ELECTRONIC PUBLICATIONS IN THE NATURE OF MAGAZINES, MANUALS AND BOOKS IN THE FIELD OF MUSIC AND ART, DOWNLOADABLE FROM THE INTERNET, IN CLASS 9 (U.S. CLS. 21, 23, 26, 36 AND 38).

FOR: PROVISION OF ADVERTISING SPACE ON INTERNET WEBSITES; RADIO ADVERTISING; THE BRINGING TOGETHER, FOR THE BENEFIT OF OTHERS, OF A VARIETY OF MUSIC RELATED GOODS, INCLUDING MUSICAL RECORDINGS, ENABLING CUSTOMERS TO CONVENIENTLY VIEW AND PURCHASE THOSE GOODS FROM A GENERAL MERCHANDISE CATALOG BY MAIL ORDER, BY MEANS OF TELECOMMUNICATIONS SYSTEMS, FROM AN INTERNET WEBSITE, FROM A GENERAL MERCHANDISE RETAIL STORE, AND FROM A RETAIL OUTLET SPECIALIZING IN MUSIC, IN CLASS 35 (U.S. CLS. 100, 101 AND 102).

FOR: PROVIDING ACCESS TO ELECTRONIC SITES FEATURING DIGITAL MUSIC, AND ELECTRONIC DELIVERY OF DIGITAL MUSIC VIA THE INTERNET; ELECTRONIC DELIVERY OF DIGITAL MUSIC BY TELECOMMUNICATION NETWORKS AND WIRELESS RADIO COMMUNICATIONS SYSTEMS; AUDIO BROADCASTING FEATURING MU-

SIC; DIGITAL RADIO BROADCASTING, IN CLASS 38 (U.S. CLS. 100, 101 AND 104).

FOR: PROVISION OF NON-DOWNLOADABLE DIGITAL MUSIC VIA THE INTERNET AND OTHER COMMUNICATIONS NETWORKS; PRODUCTION AND DISTRIBUTION OF RADIO PROGRAMS; ENTERTAINMENT BY MEANS OF RADIO, NAMELY, RADIO ENTERTAINMENT PRODUCTION, RADIO PROGRAM SYNDICATION, RADIO PROGRAMMING; PROVISION OF MUSICAL ENTERTAINMENT, NAMELY, PROVIDING PRERECORDED MUSIC, INFORMATION IN THE FIELD OF MUSIC, AND COMMENTARY AND ARTICLES ABOUT MUSIC AND LIVE MUSICAL PERFORMANCES BY MUSICAL BANDS, DISC JOCKEYS AND INDIVIDUALS, ALL ON-LINE VIA A GLOBAL COMPUTER NETWORK; PROVISION OF MUSICAL ENTERTAINMENT, NAMELY, LIVE MUSICAL PERFORMANCES BY MUSICAL BANDS, DISC JOCKEYS AND INDIVIDUALS; MUSIC LIBRARY SERVICES, IN CLASS 41 (U.S. CLS. 100, 101 AND 107).

THE MARK CONSISTS OF STANDARD CHARACTERS WITHOUT CLAIM TO ANY PARTICULAR FONT, STYLE, SIZE, OR COLOR.

PRIORITY DATE OF 12-18-2006 IS CLAIMED.

OWNER OF INTERNATIONAL REGISTRATION 0932951 DATED 6-18-2007, EXPIRES 6-18-2017.

SER. NO. 79-041,971, FILED 6-18-2007.

TINA KUAN, EXAMINING ATTORNEY

Int. Cl.: 30

Prior U.S. Cl.: 46

United States Patent and Trademark Office

Reg. No. 3,398,823

Registered Mar. 18, 2008

TRADEMARK
PRINCIPAL REGISTER

Cellini

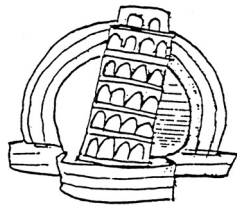

EKAF INDUSTRIA NAZIONALE; DEL CAFFÈ
SPA (ITALY S.P.A.)
LUNGOTORRENTE SECCA, 3R
I-16163 GENOVA
ITALY

FOR: COFFEE, COFFEE PRODUCTS, NAMELY,
COFFEE BEANS AND GROUND COFFEE, IN
CLASS 30 (U.S. CL. 46).

OWNER OF INTERNATIONAL REGISTRATION
0670390 DATED 3-10-1997, EXPIRES 3-10-2017.

OWNER OF U.S. REG. NOS. 2,512,513 AND
3,177,190.

THE MARK CONSISTS OF THE FANCY WORD
"CELLINI" WITH A STYLISED REPRESENTATION
OF A LEANING TOWER.

SER. NO. 79-042,507, FILED 4-3-2007.

REBECCA POVARCHUK, EXAMINING ATTOR-
NEY

Int. Cl.: 32

Prior U.S. Cls.: 45, 46 and 48

United States Patent and Trademark Office

Reg. No. 3,398,824

Registered Mar. 18, 2008

**TRADEMARK
PRINCIPAL REGISTER**

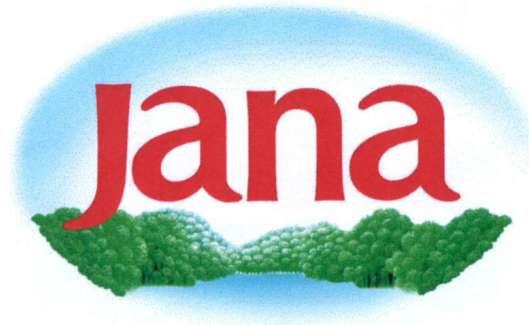

JAMNICA D.D. (CROATIA CORPORATION)
GETALDICEVA 3
HR-10000 ZAGREB
CROATIA

FOR: MINERAL, SPRING AND AERATED WATERS AND OTHER NON-ALCOHOLIC BEVERAGES, NAMELY, BOTTLED DRINKING WATER, ENERGY DRINKS; FRUIT DRINKS AND FRUIT JUICES; SYRUPS FOR MAKING BEVERAGES, IN CLASS 32 (U.S. CLS. 45, 46 AND 48).

OWNER OF INTERNATIONAL REGISTRATION
0803640 DATED 4-17-2003, EXPIRES 4-17-2013.

OWNER OF U.S. REG. NO. 3,116,076.

THE COLOR(S) BLUE, GREEN, WHITE AND RED IS/ARE CLAIMED AS A FEATURE OF THE MARK.

THE MARK CONSISTS OF A WHITE BACKGROUND WITH THE WORD JANA IN RED AND FEATURING A BLUE SKYLINE ALONG WITH GREEN TREES AND BLUE WATER.

THE WORDING JANA HAS NO MEANING IN A FOREIGN LANGUAGE.

SER. NO. 79-042,516, FILED 2-7-2007.

BERNICE MIDDLETON, EXAMINING ATTORNEY

Int. Cl.: 11

Prior U.S. Cls.: 13, 21, 23, 31 and 34

United States Patent and Trademark Office

Reg. No. 3,398,825

Registered Mar. 18, 2008

**TRADEMARK
PRINCIPAL REGISTER**

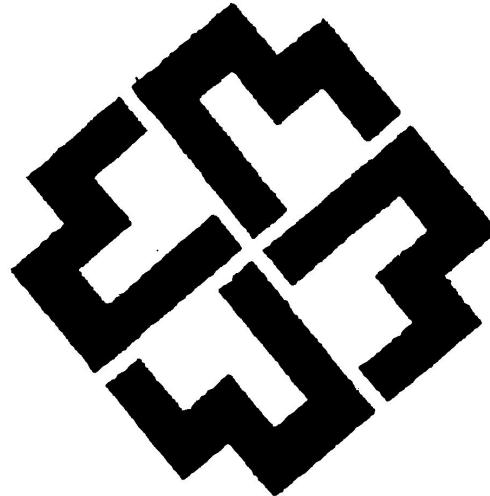

ZHEJIANG HEART & HEART; ELECTRIC CO.,
LTD (CHINA CORPORATION)
XINPU INDUSTRIAL ZONE
XINPU TOWN; 315322 CIXI CITY, ZHEJIANG PRO-
VINCE
CHINA

ATED CARPETS; DRINKING FOUNTAINS, IN
CLASS 11 (U.S. CLS. 13, 21, 23, 31 AND 34).

OWNER OF INTERNATIONAL REGISTRATION
0934745 DATED 7-13-2007, EXPIRES 7-13-2017.

FOR: ELECTRIC KETTLES; AIR CONDITIONING
UNITS; WATER PURIFICATION UNITS; PORTA-
BLE ELECTRIC HEATER; ELECTRICALLY HE-

SER. NO. 79-042,684, FILED 7-13-2007.

PAUL F. GAST, EXAMINING ATTORNEY

Int. Cl.: 33

Prior U.S. Cls.: 47 and 49

United States Patent and Trademark Office

Reg. No. 3,398,826

Registered Mar. 18, 2008

**TRADEMARK
PRINCIPAL REGISTER**



FAZI BATTAGLIA S.P.A. O CON SIGLA; "F & B
S.P.A." (ITALY JOINT STOCK COMPANY)
VIA ROMA, 117
I-60032 CASTELPLANIO (ANCONA)
ITALY

FANCY IMAGE OF AN ETRUSCAN FACE RE-
PRESENTING THE GODDESS CUPRA IN FRON-
TAL VIEW, WITH THE HAIR GATHERED UP ON
THE SIDES, THE FACE IS OVERLAPPED BY A SET
OF DECORATIONS DISPOSED IN A SEMICIRCLE.

FOR: WINES, SPARKLING WINES AND GRAP-
PAS, IN CLASS 33 (U.S. CLS. 47 AND 49).

PRIORITY DATE OF 5-28-2007 IS CLAIMED.

SER. NO. 79-042,799, FILED 7-10-2007.

OWNER OF INTERNATIONAL REGISTRATION
0935143 DATED 7-10-2007, EXPIRES 7-10-2017.

WENDY JUN, EXAMINING ATTORNEY

Int. Cl.: 7

Prior U.S. Cls.: 13, 19, 21, 23, 31, 34 and 35

United States Patent and Trademark Office

Reg. No. 3,398,827

Registered Mar. 18, 2008

**TRADEMARK
PRINCIPAL REGISTER**

LM 3000

SATA GMBH & CO. KG (FED REP GERMANY
GMBH & CO. KG)
DOMERTALSTRASSE 20
70806 KORNWESTHEIM, FED REP GERMANY

PRIORITY DATE OF 4-20-2007 IS CLAIMED.

FOR: PAINT SPRAY GUNS AND PARTS THERE-
OF, IN PARTICULAR NOZZLES AND NOZZLE
SETS FOR PAINT SPRAY GUNS AND PAINT CUPS
FOR PAINT SPRAY GUNS, IN CLASS 7 (U.S. CLS. 13,
19, 21, 23, 31, 34 AND 35).

OWNER OF INTERNATIONAL REGISTRATION
0935237 DATED 7-13-2007, EXPIRES 7-13-2017.

THE MARK CONSISTS OF STANDARD CHAR-
ACTERS WITHOUT CLAIM TO ANY PARTICULAR
FONT, STYLE, SIZE, OR COLOR.

SER. NO. 79-042,909, FILED 7-13-2007.

BARBARA BROWN, EXAMINING ATTORNEY

Int. Cl.: 9

Prior U.S. Cls.: 21, 23, 26, 36 and 38

United States Patent and Trademark Office

Reg. No. 3,398,828

Registered Mar. 18, 2008

**TRADEMARK
PRINCIPAL REGISTER**

SIWO-SCREEN

NEXANS (FRANCE SOCIÉTÉ ANONYME)
16, RUE DE MONCEAU
F-75008 PARIS
FRANCE

FOR: SILICONE INSULATED AND RESISTANT
COPPER POWER AND TELECOMMUNICATION
CABLES, IN CLASS 9 (U.S. CLS. 21, 23, 26, 36 AND 38).

THE MARK CONSISTS OF STANDARD CHAR-
ACTERS WITHOUT CLAIM TO ANY PARTICULAR
FONT, STYLE, SIZE, OR COLOR.

PRIORITY DATE OF 2-23-2007 IS CLAIMED.

OWNER OF INTERNATIONAL REGISTRATION
0935872 DATED 7-27-2007, EXPIRES 7-27-2017.

SER. NO. 79-043,141, FILED 7-27-2007.

JANICE L. MCMORROW, EXAMINING ATTOR-
NEY

Int. Cl.: 9

Prior U.S. Cls.: 21, 23, 26, 36 and 38

United States Patent and Trademark Office

Reg. No. 3,398,829

Registered Mar. 18, 2008

**TRADEMARK
PRINCIPAL REGISTER**

SIWO-CUL

NEXANS (FRANCE SOCIÉTÉ ANONYME)
16, RUE DE MONCEAU
F-75008 PARIS
FRANCE

FOR: SILICONE INSULATED AND RESISTANT
COPPER POWER AND TELECOMMUNICATION
CABLES, IN CLASS 9 (U.S. CLS. 21, 23, 26, 36 AND 38).

THE MARK CONSISTS OF STANDARD CHAR-
ACTERS WITHOUT CLAIM TO ANY PARTICULAR
FONT, STYLE, SIZE, OR COLOR.

PRIORITY DATE OF 2-23-2007 IS CLAIMED.

OWNER OF INTERNATIONAL REGISTRATION
0935873 DATED 7-27-2007, EXPIRES 7-27-2017.

SER. NO. 79-043,142, FILED 7-27-2007.

JANICE L. MCMORROW, EXAMINING ATTOR-
NEY

Int. Cl.: 20

Prior U.S. Cls.: 2, 13, 22, 25, 32 and 50

United States Patent and Trademark Office

Reg. No. 3,398,830

Registered Mar. 18, 2008

**TRADEMARK
PRINCIPAL REGISTER**

TOLIX

TOLIX STEEL DESIGN (FRANCE SOCIÉTÉ PAR
ACTIONS SIMPLIFIÉE)
BOULEVARD DE L'INDUSTRIE,
ZONE INDUSTRIELLE SAINT ANDOCHE; F-
71400AUTUN
FRANCE

FOR: SEATS, ARMCHAIRS, STOOLS AND FUR-
NITURE OF METAL, IN CLASS 20 (U.S. CLS. 2, 13, 22,
25, 32 AND 50).

OWNER OF INTERNATIONAL REGISTRATION
0935911 DATED 7-13-2007, EXPIRES 7-13-2017.

SER. NO. 79-043,161, FILED 7-13-2007.

ZHALEH DELANEY, EXAMINING ATTORNEY

Int. Cl.: 24

Prior U.S. Cls.: 42 and 50

United States Patent and Trademark Office

Reg. No. 3,398,831

Registered Mar. 18, 2008

TRADEMARK
PRINCIPAL REGISTER



ÇALIK DENİM

GAP GÜNEYDOĞU TEKSTİL; SANAYİ VE Tİ-
CARET ANONİM ŞİRKETİ (TURKEY JOINT
STOCK VENTURE)

KERESTECİLER SİTESİ

FATİH CAD. SELVİ SOK. NO: 18; GÜNGÖREN;-
MERTER - İSTANBUL
TURKEY

FOR: WOVEN AND NON-WOVEN DENİM FAB-
RICS FOR USE IN THE MANUFACTURE OF
CLOTHING; CURTAINS OF TEXTILE; SHOWER
CURTAINS OF TEXTILE; TABLE LINEN, BED
LINEN, HOUSEHOLD LINEN; FABRICS FOR FUR-
NITURE UPHOLSTERY AND LUGGAGE; TEXTILE
LININGS, NAMELY, TEXTILE LININGS FOR GAR-
MENTS, TEXTILE USED AS LINING FOR CLOTH-
ING; HOUSEHOLD LINEN; OILCLOTH FOR USE
AS TABLE CLOTHS; TABLE CLOTHS NOT OF
PAPER; BED COVERS, NAMELY, BED BLANKETS,
BED SHEETS, BEDSPREADS, BED LINEN, DIA-
PERED LINEN, PILLOWCASES; FURNITURE COV-
ERINGS OF TEXTILE, NAMELY, UNFITTED
FABRIC FURNITURE COVERS; LOOSE COVERS
FOR FURNITURE, NAMELY, UNFITTED FABRIC

FURNITURE COVERS; UPHOLSTERY FABRICS;
TABLE NAPKINS OF TEXTILE; BED COVERS OF
PAPER, BUNDLES OF TEXTILE, QUILTS OF TEX-
TILE, TAPESTRIES OF TEXTILE; BED BLANKETS;
BATH LINEN; FLANNEL; HAND TOWELS NOT OF
PAPER; FACE TOWELS OF TEXTILE; BATHING
TOWELS, NAMELY, BATH TOWELS; HAND-
KERCHIEFS OF TEXTILE; BANNERS OF TEXTILE,
NAMELY, CLOTH BANNERS; FLAGS NOT OF
PAPER, NAMELY, CLOTH FLAGS, FABRIC FLAGS;
CLOTH LABELS; TRAVELING RUGS, NAMELY,
LAP RUGS, IN CLASS 24 (U.S. CLS. 42 AND 50).

OWNER OF INTERNATIONAL REGISTRATION
0936627 DATED 3-2-2007, EXPIRES 3-2-2017.

NO CLAIM IS MADE TO THE EXCLUSIVE
RIGHT TO USE "DENİM", APART FROM THE
MARK AS SHOWN.

SER. NO. 79-043,500, FILED 3-2-2007.

CURTIS FRENCH, EXAMINING ATTORNEY

Int. Cls.: 20 and 37

Prior U.S. Cls.: 2, 13, 22, 25, 32, 50, 100, 103 and 106

United States Patent and Trademark Office

Reg. No. 3,398,832

Registered Mar. 18, 2008

**TRADEMARK
SERVICE MARK
PRINCIPAL REGISTER**

3Dpillow

PATRICK DUDERSTADT (FED REP GERMANY
INDIVIDUAL)
HOHE STR. 2A
39397 GRÖNINGEN
FED REP GERMANY

FOR: UPHOLSTERED FURNITURE, CHAIRS,
SOFAS, ARMCHAIRS; BEDS, CUSHION; MATTRESSES,
PILLOW , IN CLASS 20 (U.S. CLS. 2, 13, 22, 25, 32
AND 50).

FOR: UPHOLSTERING, IN CLASS 37 (U.S. CLS.
100, 103 AND 106).

THE MARK CONSISTS OF STANDARD CHARACTERS
WITHOUT CLAIM TO ANY PARTICULAR FONT,
STYLE, SIZE, OR COLOR.

OWNER OF INTERNATIONAL REGISTRATION
0936658 DATED 4-5-2007, EXPIRES 4-5-2017.

SER. NO. 79-043,518, FILED 4-5-2007.

CURTIS FRENCH, EXAMINING ATTORNEY

Int. Cl.: 7

Prior U.S. Cls.: 13, 19, 21, 23, 31, 34 and 35

United States Patent and Trademark Office

Reg. No. 3,398,833

Registered Mar. 18, 2008

**TRADEMARK
PRINCIPAL REGISTER**

FLOATFORCE

OUTOTEC OYJ (FINLAND JOINT STOCK COMPANY)
RIIHITONTUNTIE 7 C
FI-02200 ESPOO
FINLAND

FOR: FLOTATION MACHINES, NAMELY, SEPARATOR COMBINING FLOTATION AND MECHANICAL SEPARATION FOR USE IN MINERAL PROCESSING AND PARTICLE SEPARATION AND PARTS THEREFORE, SUCH AS TANK AND FLOW INDUCING COMPONENTS, IN CLASS 7 (U.S. CLS. 13, 19, 21, 23, 31, 34 AND 35).

THE MARK CONSISTS OF STANDARD CHARACTERS WITHOUT CLAIM TO ANY PARTICULAR FONT, STYLE, SIZE, OR COLOR.

PRIORITY DATE OF 1-25-2007 IS CLAIMED.

OWNER OF INTERNATIONAL REGISTRATION 0937190 DATED 7-10-2007, EXPIRES 7-10-2017.

SER. NO. 79-043,737, FILED 7-10-2007.

VERNA BETH RIRIE, EXAMINING ATTORNEY

Int. Cl.: 5

Prior U.S. Cls.: 6, 18, 44, 46, 51 and 52

United States Patent and Trademark Office

Reg. No. 3,398,834

Registered Mar. 18, 2008

**TRADEMARK
PRINCIPAL REGISTER**

BRAMITOB

CHIESI FARMACEUTICI S.P.A. (ITALY JOINT
STOCK COMPANY)

VIA PALERMO, 26/A

I-43100 PARMA (PR)

ITALY

THE MARK CONSISTS OF STANDARD CHAR-
ACTERS WITHOUT CLAIM TO ANY PARTICULAR
FONT, STYLE, SIZE, OR COLOR.

OWNER OF INTERNATIONAL REGISTRATION
0843077 DATED 11-5-2004, EXPIRES 11-5-2014.

FOR: PHARMACEUTICAL PREPARATIONS FOR
THE TREATMENT OF RESPIRATORY DISEASES,
IN CLASS 5 (U.S. CLS. 6, 18, 44, 46, 51 AND 52).

SER. NO. 79-043,807, FILED 11-9-2006.

ROBIN CHOSID, EXAMINING ATTORNEY

Int. Cl.: 13

Prior U.S. Cls.: 2 and 9

United States Patent and Trademark Office

Reg. No. 3,398,835

Registered Mar. 18, 2008

TRADEMARK
PRINCIPAL REGISTER



FIOCCHI MUNIZIONI S.P.A. (ITALY JOINT
STOCK COMPANY)

VIA S. BARBARA, 4

I-23900 LECCO

ITALY

FOR: MUNITIONS, HUNTING AND SHOOTING
BULLETS AND SHOTS, IN CLASS 13 (U.S. CLS. 2
AND 9).

PRIORITY DATE OF 6-12-2007 IS CLAIMED.

OWNER OF INTERNATIONAL REGISTRATION
0937446 DATED 7-16-2007, EXPIRES 7-16-2017.

THE TRADEMARK IS CONSTITUTED BY THE
DENOMINATION "BLACK MAMBA" ASSOCIATED
TO THE DEVICE OF A SNAKE HEAD, BEING THE
FIRST WORD COMPONENT "BLACK" PLACED
OVER THE SECOND ONE "MAMBA."

SER. NO. 79-043,843, FILED 7-16-2007.

ZACHARY BELLO, EXAMINING ATTORNEY

Int. Cls.: 3, 16, and 24

**Prior U.S. Cls.: 1, 2, 4, 5, 6, 22, 23, 29, 37, 38, 42, 50,
51, and 52**

Reg. No. 3,398,836

United States Patent and Trademark Office

Registered Mar. 18, 2008

**TRADEMARK
PRINCIPAL REGISTER**

YAHOO!

YAHOO! INC. (DELAWARE CORPORATION)
701 FIRST AVENUE
SUNNYVALE, CA 94089

FOR: SUN BLOCK, IN CLASS 3 (U.S. CLS. 1, 4, 6, 50,
51 AND 52).

FIRST USE 6-30-2007; IN COMMERCE 6-30-2007.

FOR: PAPER AND STATIONERY ITEMS, NAME-
LY, PAPER POSTCARDS, PERSONAL DIARIES,
AND DECORATIVE PENCIL TOP ORNAMENTS,
IN CLASS 16 (U.S. CLS. 2, 5, 22, 23, 29, 37, 38 AND 50).

FIRST USE 2-28-1998; IN COMMERCE 2-28-1998.

FOR: THROW BLANKETS, IN CLASS 24 (U.S. CLS.
42 AND 50).

FIRST USE 10-31-2007; IN COMMERCE 10-31-2007.

OWNER OF U.S. REG. NOS. 1,572,204, 2,040,222,
AND OTHERS.

SN 75-300,217, FILED 5-28-1997.

CHRISIE B. KING, EXAMINING ATTORNEY

Int. Cl.: 33

Prior U.S. Cls.: 47 and 49

United States Patent and Trademark Office

Reg. No. 3,398,837

Registered Mar. 18, 2008

**TRADEMARK
PRINCIPAL REGISTER**

ABUELO

VARELA HERMANOS, S.A. (PANAMA COR-
PORATION)
CALLE A, URBANIZACION INDUSTRIAL
JUAN DIAZ
CUIDAD DE PANAMA, PANAMA

FIRST USE 12-31-1959; IN COMMERCE 12-31-1990.

SN 75-885,939, FILED 1-4-2000.

FOR: RUM, IN CLASS 33 (U.S. CLS. 47 AND 49).

DAWN FELDMAN, EXAMINING ATTORNEY

Int. Cl.: 18

Prior U.S. Cls.: 1, 2, 3, 22, and 41

United States Patent and Trademark Office

Reg. No. 3,398,838

Registered Mar. 18, 2008

**TRADEMARK
PRINCIPAL REGISTER**

HUNGRY DOG

HEREFORD BI-PRODUCTS, INC. (TEXAS COR-
PORATION)
EAST HIGHWAY 60 @ FM 2943
P.O. BOX 2257
HEREFORD, TX 79045

NO CLAIM IS MADE TO THE EXCLUSIVE
RIGHT TO USE "DOG", APART FROM THE MARK
AS SHOWN.

FOR: RAWHIDE CHEWS, IN CLASS 18 (U.S. CLS.
1, 2, 3, 22 AND 41).

SN 75-983,606, FILED 2-24-2000.

FIRST USE 7-0-2000; IN COMMERCE 7-0-2000.

RAUL CORDOVA, EXAMINING ATTORNEY

Int. Cl.: 9

Prior U.S. Cls.: 21, 23, 26, 36, and 38

United States Patent and Trademark Office

Reg. No. 3,398,839

Registered Mar. 18, 2008

**TRADEMARK
PRINCIPAL REGISTER**

BULLSEYE WEB

BULLSEYE TELECOM, INC. (MICHIGAN CORPORATION)
26935 NORTHWESTERN HWY. #520
SOUTHFIELD, MI 48034

NO CLAIM IS MADE TO THE EXCLUSIVE RIGHT TO USE "WEB", APART FROM THE MARK AS SHOWN.

FOR: COMPUTER SOFTWARE BUILDING AND CUSTOMIZING WEBSITE APPLICATIONS, IN CLASS 9 (U.S. CLS. 21, 23, 26, 36 AND 38).

SN 76-061,515, FILED 6-2-2000.

FIRST USE 1-31-2000; IN COMMERCE 1-31-2000.

ANNE MADDEN, EXAMINING ATTORNEY

Int. Cl.: 25

Prior U.S. Cls.: 22 and 39

United States Patent and Trademark Office

Reg. No. 3,398,840

Registered Mar. 18, 2008

**TRADEMARK
PRINCIPAL REGISTER**

KANNAPOLIS INTIMIDATORS

EARNHARDT, TERESA H (UNITED STATES
ESTATE OF RALPH DALE EARNHARDT
WHO DIED ON FEBRUARY 18, 2001)
C/O DALE EARNHARDT, INC.
1675 DALE EARNHARDT HIGHWAY, NO. 3
MOORESVILLE, NC 28115

OWNER OF U.S. REG. NO. 2,092,602.

NO CLAIM IS MADE TO THE EXCLUSIVE
RIGHT TO USE "KANNAPOLIS", APART FROM
THE MARK AS SHOWN.

FOR: CLOTHING, NAMELY, SWEATSHIRTS,
SHIRTS, SPORT SHIRT, GOLF SHIRTS, T-SHIRTS,
JERSEYS, JACKETS, COATS, HATS, CAPS AND
WRIST BANDS, IN CLASS 25 (U.S. CLS. 22 AND 39).

SN 76-145,863, FILED 10-12-2000.

FIRST USE 4-15-2001; IN COMMERCE 4-15-2001.

DAVID I, EXAMINING ATTORNEY

Int. Cl.: 25

Prior U.S. Cls.: 22 and 39

United States Patent and Trademark Office

Reg. No. 3,398,841

Registered Mar. 18, 2008

**TRADEMARK
PRINCIPAL REGISTER**

QUIKWEAR

PRINTMARK INDUSTRIES, INC. (PENNSYLVANIA CORPORATION)
600 SOUTH POPLAR STREET
HAZLETON, PA 182017725

UNDERWEAR, LINGERIE, FOOTWEAR, IN CLASS 25 (U.S. CLS. 22 AND 39).

FIRST USE 7-20-2001; IN COMMERCE 7-20-2001.

FOR: APPAREL AND OUTERWEAR, NAMELY, HATS, CAPS, GLOVES, SCARVES, SWEATERS, SWEATSHIRTS, JACKETS, SHIRTS, BLOUSES, SKIRTS, PANTS, TROUSERS, SHORTS, T-SHIRTS,

SN 76-285,471, FILED 7-16-2001.

CHRISIE B. KING, EXAMINING ATTORNEY

Int. Cls.: 25 and 26

Prior U.S. Cls.: 22, 37, 39, 40, 42, and 50

United States Patent and Trademark Office

Reg. No. 3,398,842

Registered Mar. 18, 2008

**TRADEMARK
PRINCIPAL REGISTER**



E J ACQUISITION LLC (DELAWARE LTD LIAB
CO)
1375 BROADWAY
NEW YROK, NY 10018

FOR: BELTS, IN CLASS 25 (U.S. CLS. 22 AND 39).

FIRST USE 5-30-2007; IN COMMERCE 5-30-2007.

FOR: BELT BUCKLES NOT OF PRECIOUS ME-
TAL, IN CLASS 26 (U.S. CLS. 37, 39, 40, 42 AND 50).

FIRST USE 5-30-2007; IN COMMERCE 5-30-2007.

SN 76-301,442, FILED 8-16-2001.

ANGELA M. MICHELI, EXAMINING ATTORNEY

Int. Cls.: 16, 25, and 28

Prior U.S. Cls.: 2, 5, 22, 23, 29, 37, 38, 39, and 50

United States Patent and Trademark Office

Reg. No. 3,398,843

Registered Mar. 18, 2008

**TRADEMARK
PRINCIPAL REGISTER**

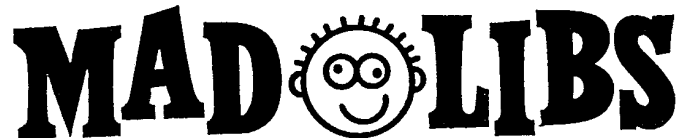

PENGUIN GROUP (USA) INC. (DELAWARE CORPORATION)
375 HUDSON STREET
NEW YORK, NY 10014

FOR: GREETING CARDS, PAPER PARTY FAVORS, IN CLASS 16 (U.S. CLS. 2, 5, 22, 23, 29, 37, 38 AND 50).

FIRST USE 6-24-2005; IN COMMERCE 6-24-2005.

FOR: T-SHIRTS, IN CLASS 25 (U.S. CLS. 22 AND 39).

FIRST USE 12-0-2005; IN COMMERCE 12-0-2005.

FOR: CARD GAMES; HAND HELD UNIT FOR PLAYING ELECTRONIC GAMES, IN CLASS 28 (U.S. CLS. 22, 23, 38 AND 50).

FIRST USE 5-0-2002; IN COMMERCE 5-0-2002.

OWNER OF U.S. REG. NOS. 1,018,812 AND 2,333,753.

SN 76-320,692, FILED 10-3-2001.

MARY BOAGNI, EXAMINING ATTORNEY

Int. Cls.: 9 and 16

Prior U.S. Cls.: 2, 5, 21, 22, 23, 26, 29, 36, 37, 38, and 50

United States Patent and Trademark Office

Reg. No. 3,398,844

Registered Mar. 18, 2008

**TRADEMARK
PRINCIPAL REGISTER**

TEMENOS eMerge

TEMENOS HEADQUARTERS SA (SWITZERLAND CORPORATION)
PLACE DES PHILOSOPHES 18
1205 GENEVA, SWITZERLAND

FOR: COMPUTER SOFTWARE FOR USE IN TRADING, ACCOUNTING, REPORTING AND OPERATIONAL FACILITIES MANAGEMENT BY FINANCIAL INSTITUTIONS; COMPUTER PROGRAMS FOR USE IN TRADING, ACCOUNTING, REPORTING AND OPERATIONAL FACILITIES MANAGEMENT BY FINANCIAL INSTITUTIONS, IN CLASS 9 (U.S. CLS. 21, 23, 26, 36 AND 38).

FIRST USE 1-3-2003; IN COMMERCE 1-3-2003.

FOR: BOOKLETS DESCRIBING THE FUNCTIONALITY AND FEATURES OF COMPUTER SOFTWARE SYSTEMS FOR USE IN FINANCIAL

INSTITUTIONS, PRINTED TEACHING MATERIALS ON HOW TO USE COMPUTER SOFTWARE SYSTEMS FOR USE IN FINANCIAL INSTITUTIONS; EDUCATIONAL PUBLICATIONS, NAMELY, TRAINING MANUALS IN THE FIELD OF COMPUTER SOFTWARE SYSTEMS FOR USE IN FINANCIAL INSTITUTIONS, IN CLASS 16 (U.S. CLS. 2, 5, 22, 23, 29, 37, 38 AND 50).

FIRST USE 1-3-2003; IN COMMERCE 1-3-2003.

PRIORITY CLAIMED UNDER SEC. 44(D) ON SWITZERLAND APPLICATION NO. 05679/2001, FILED 6-7-2001.

SN 76-320,792, FILED 10-2-2001.

YONG KIM, EXAMINING ATTORNEY

Int. Cls.: 35 and 36

Prior U.S. Cls.: 100, 101, and 102

United States Patent and Trademark Office

Reg. No. 3,398,845

Registered Mar. 18, 2008

**SERVICE MARK
PRINCIPAL REGISTER**

FLAGSHIP VENTURES

FLAGSHIP VENTURES MANAGEMENT, INC.
(DELAWARE CORPORATION)
ONE MEMORIAL DRIVE
7TH FLOOR
CAMBRIDGE, MA 02142

FOR: NEW BUSINESS VENTURE PLANNING,
MANAGEMENT AND CONSULTATION, IN CLASS
35 (U.S. CLS. 100, 101 AND 102).

FIRST USE 4-30-2001; IN COMMERCE 4-30-2001.

FOR: FINANCIAL INVESTMENT IN NEW BUSI-
NESS VENTURES; INVESTMENT SERVICES IN
THE FIELDS OF VENTURE CAPITAL AND PRI-

VATE EQUITY, IN CLASS 36 (U.S. CLS. 100, 101 AND
102).

FIRST USE 4-30-2001; IN COMMERCE 4-30-2001.

NO CLAIM IS MADE TO THE EXCLUSIVE
RIGHT TO USE "VENTURES", APART FROM THE
MARK AS SHOWN.

SN 76-328,914, FILED 10-23-2001.

SAMUEL E. SHARPER JR., EXAMINING ATTOR-
NEY

Int. Cl.: 35

Prior U.S. Cls.: 100, 101, and 102

United States Patent and Trademark Office

Reg. No. 3,398,846

Registered Mar. 18, 2008

**SERVICE MARK
PRINCIPAL REGISTER**

CHANGEWIRELESS.COM

LEE, DAVID P. (UNITED STATES INDIVIDUAL)
PSC 2 BOX 11309
APO, NJ 09012

FOR: DIRECT MARKETING ADVERTISING FOR
OTHERS, NAMELY, PROVIDING WIRELESS CEL-
LULAR TELEPHONE SUBSCRIPTION MARKET-
ING SERVICES VIA THE GLOBAL COMPUTER

NETWORK, IN CLASS 35 (U.S. CLS. 100, 101 AND
102).

FIRST USE 10-27-2007; IN COMMERCE 10-27-2007.

SN 76-352,312, FILED 12-26-2001.

ROBERT C. CLARK JR., EXAMINING ATTORNEY

Int. Cls.: 1, 5, and 10

Prior U.S. Cls.: 1, 5, 6, 10, 18, 26, 39, 44, 46, 51, and 52

United States Patent and Trademark Office

Reg. No. 3,398,847

Registered Mar. 18, 2008

**TRADEMARK
PRINCIPAL REGISTER**

The logo for Pritest features the word "Pritest" in a bold, sans-serif font. The letter "i" is stylized with a dot above it and a curved line extending from the top of the letter, resembling a stylized eye or a sensor. The "P" is also stylized with a curved line above it, suggesting a lens or a light source.

PRITEST, INC. (DELAWARE CORPORATION)
2897 152ND AVENUE NE
REDMOND, WA 98052

FOR: DIAGNOSTIC REAGENTS FOR SCIENTIFIC AND RESEARCH APPLICATIONS, IN CLASS 1 (U.S. CLS. 1, 5, 6, 10, 26 AND 46).

FIRST USE 11-22-2005; IN COMMERCE 11-22-2005.

FOR: DIAGNOSTIC REAGENTS FOR MEDICAL APPLICATIONS, IN CLASS 5 (U.S. CLS. 6, 18, 44, 46, 51 AND 52).

FIRST USE 11-22-2005; IN COMMERCE 11-22-2005.

FOR: MEDICAL DEVICES, NAMELY, OPTICAL CHEMICAL SENSOR FOR MEDICAL TESTING AND DIAGNOSTIC USE, IN CLASS 10 (U.S. CLS. 26, 39 AND 44).

FIRST USE 4-13-2006; IN COMMERCE 4-13-2006.

SN 76-383,026, FILED 3-18-2002.

WOODROW HARTZOG, EXAMINING ATTORNEY

Int. Cl.: 11

Prior U.S. Cls.: 13, 21, 23, 31, and 34

Reg. No. 3,398,848

United States Patent and Trademark Office

Registered Mar. 18, 2008

TRADEMARK
PRINCIPAL REGISTER

AMTROL
WaterSoft 

AMTROL INC. (RHODE ISLAND CORPORATION)
1400 DIVISION ROAD
WEST WARWICK, RI 02893

THEREIN, IN CLASS 11 (U.S. CLS. 13, 21, 23, 31 AND 34).

FIRST USE 12-15-2001; IN COMMERCE 12-15-2001.

FOR: EQUIPMENT FOR USE IN RESIDENTIAL AND COMMERCIAL WATER TREATMENT APPLICATIONS, NAMELY, ION EXCHANGE UNITS, CARTRIDGE FILTRATION UNITS, IRON REMOVAL UNITS, CHEMICAL STERILIZATION UNITS, REVERSE OSMOSIS FILTRATION UNITS, ULTRA VIOLET STERILIZATION UNITS, AND ALL STRUCTURAL COMPONENTS CONTAINED

OWNER OF U.S. REG. NOS. 1,264,849, 1,326,576, AND 2,604,069.

SN 76-421,964, FILED 6-17-2002.

BARBARA GAYNOR, EXAMINING ATTORNEY

Int. Cl.: 30

Prior U.S. Cl.: 46

United States Patent and Trademark Office

Reg. No. 3,398,849

Registered Mar. 18, 2008

**TRADEMARK
PRINCIPAL REGISTER**



MARUKOME KABUSHIKI KAISHA (JAPAN
CORPORATION)
883, OHAZA AMORI, NAGANO CITY
NAGANO PREFECTURE, JAPAN

FIRST USE 4-0-2007; IN COMMERCE 4-0-2007.

SN 76-449,239, FILED 9-11-2002.

FOR: JAPANESE MISO-BEAN PASTE; SEASON-
INGS, IN CLASS 30 (U.S. CL. 46).

ZACHARY BELLO, EXAMINING ATTORNEY

Int. Cls.: 9, 35, 38, and 45

Prior U.S. Cls.: 21, 23, 26, 36, 38, 100, 101, 102, and 104

Reg. No. 3,398,850

United States Patent and Trademark Office

Registered Mar. 18, 2008

**TRADEMARK
SERVICE MARK
PRINCIPAL REGISTER**

STARSAT

STARSAT, LLC (KENTUCKY LTD LIAB CO)
3413 COLLINS LANE
LOUISVILLE, KY 40245

FOR: SECURITY AND SURVEILLANCE SYSTEMS COMPRISED PRIMARILY OF COMPUTER EQUIPMENT, NAMELY, DESKTOP COMPUTERS, POINTER DEVICES, MONITORS, KVM SWITCHES, NETWORK HUBS, MOTION SENSORS, DIGITAL CAMERAS AND SOFTWARE; ELECTRONIC DELIVERY SYSTEMS FOR RETAILER SPECIFIC ADVERTISEMENTS AND PROMOTIONS COMPRISED PRIMARILY OF COMPUTER EQUIPMENT, NAMELY, DIGITAL SIGNBOARDS, MONITORS, DIGITAL CAMERAS AND SOFTWARE, AND NETWORKING EQUIPMENT, NAMELY, ROUTERS, HUBS, AND SWITCHES, AND SOFTWARE; DATA COLLECTION SYSTEMS FOR INVENTORY TRACKING AND MANAGEMENT SYSTEMS COMPRISED PRIMARILY OF COMPUTER EQUIPMENT, NAMELY, DESKTOP COMPUTERS, POINTER DEVICES, MONITORS, TOUCHSCREEN MONITORS, INPUT TERMINALS, AND SCANNERS, DIGITAL CAMERAS AND SOFTWARE, AND NETWORKING EQUIPMENT, NAMELY, NETWORK ROUTERS, HUBS, SWITCHES AND SOFTWARE, IN CLASS 9 (U.S. CLS. 21, 23, 26, 36 AND 38).

FIRST USE 7-7-2004; IN COMMERCE 7-7-2004.

FOR: PROVIDING INVENTORY TRACKING AND MANAGEMENT SERVICES FOR OTHERS IN THE FIELDS OF RETAIL SERVICES, GOVERNMENTAL TRANSACTIONS, RESTAURANTS, AND PUBLIC ACCOMMODATIONS, BY WAY OF COM-

MUNICATIONS, TELECOMMUNICATIONS AND COMPUTER EQUIPMENT; PROVIDING INVENTORY TRACKING AND MANAGEMENT SERVICES INFORMATION OVER THE INTERNET, IN CLASS 35 (U.S. CLS. 100, 101 AND 102).

FIRST USE 7-7-2004; IN COMMERCE 7-7-2004.

FOR: ONLINE DOCUMENT DELIVERY VIA A GLOBAL COMPUTER NETWORK, NAMELY, DELIVERY OF RETAILER SPECIFIC ADVERTISEMENTS AND PROMOTIONS BY WAY OF COMMUNICATIONS, TELECOMMUNICATIONS, COMPUTER AND EQUIPMENT, IN CLASS 38 (U.S. CLS. 100, 101 AND 104).

FIRST USE 7-7-2004; IN COMMERCE 7-7-2004.

FOR: PROVIDING SECURITY AND SURVEILLANCE SERVICES FOR OTHERS, NAMELY, MONITORING RETAIL TRANSACTIONS, GOVERNMENTAL TRANSACTIONS, RESTAURANT TRANSACTIONS AND PUBLIC ACCOMMODATION TRANSACTIONS, UTILIZING COMPUTERS, SOFTWARE, DIGITAL CAMERAS; PROVIDING SECURITY AND SURVEILLANCE INFORMATION OVER THE INTERNET, IN CLASS 45 (U.S. CLS. 100 AND 101).

FIRST USE 7-7-2004; IN COMMERCE 7-7-2004.

SN 76-450,375, FILED 9-16-2002.

CAROLYN CATALDO, EXAMINING ATTORNEY

Int. Cl.: 33

Prior U.S. Cls.: 47 and 49

United States Patent and Trademark Office

Reg. No. 3,398,851

Registered Mar. 18, 2008

**TRADEMARK
PRINCIPAL REGISTER**

MACKMYRA SWEDISH WHISKY

MACKMYRA SVENSK WHISKY AB (SWEDEN
CORPORATION)
BRUKSGATAN 4
SE-81832 VALBO, SWEDEN

NO CLAIM IS MADE TO THE EXCLUSIVE
RIGHT TO USE "SWEDISH WHISKY" , APART
FROM THE MARK AS SHOWN.

FOR: WHISKY, IN CLASS 33 (U.S. CLS. 47 AND
49).

SN 76-469,794, FILED 11-26-2002.

FIRST USE 7-12-2006; IN COMMERCE 7-12-2006.

DAWN FELDMAN, EXAMINING ATTORNEY

Int. Cl.: 25

Prior U.S. Cls.: 22 and 39

United States Patent and Trademark Office

Reg. No. 3,398,852

Registered Mar. 18, 2008

**TRADEMARK
PRINCIPAL REGISTER**

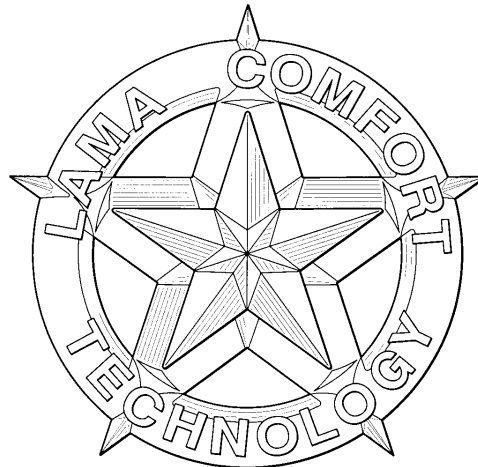

BOOT ROYALTY COMPANY, L.P. (DELAWARE
LIMITED PARTNERSHIP)
610 WEST DAGGETT AVENUE
FORT WORTH, TX 76104

NO CLAIM IS MADE TO THE EXCLUSIVE
RIGHT TO USE "COMFORT TECHNOLOGY",
APART FROM THE MARK AS SHOWN.

FOR: FOOTWEAR, NAMELY, BOOTS AND EX-
CLUDING ATHLETIC FOOTWEAR, IN CLASS 25
(U.S. CLS. 22 AND 39).

THE LINING IS A FEATURE OF THE MARK
AND DOES NOT INDICATE COLOR.

FIRST USE 1-0-2005; IN COMMERCE 1-0-2005.

SN 76-471,682, FILED 11-27-2002.

OWNER OF U.S. REG. NOS. 525,522, 913,819, AND
2,274,989.

MICHAEL KAZAZIAN, EXAMINING ATTORNEY

Int. Cl.: 25

Prior U.S. Cls.: 22 and 39

United States Patent and Trademark Office

Reg. No. 3,398,853

Registered Mar. 18, 2008

TRADEMARK
PRINCIPAL REGISTER



EDDIE BAUER, INC. (DELAWARE CORPORATION)
SUITE 500
10401 NE 8TH STREET
BELLEVUE, WA 98004

FOR: CLOTHING, NAMELY, SHIRTS, IN CLASS
25 (U.S. CLS. 22 AND 39).

FIRST USE 4-13-2007; IN COMMERCE 4-13-2007.

OWNER OF U.S. REG. NOS. 880,279, 2,325,813,
AND OTHERS.

NO CLAIM IS MADE TO THE EXCLUSIVE
RIGHT TO USE "SPORT SHOP" OR "SEATTLE",
APART FROM THE MARK AS SHOWN.

THE NAME "EDDIE BAUER" DOES NOT IDENTIFY
A PARTICULAR LIVING INDIVIDUAL.

SN 76-475,072, FILED 12-13-2002.

ELIZABETH HUGHITT, EXAMINING ATTORNEY

Int. Cls.: 8, 9, 11, 12, 14, 16, 18, 20, 21, 22, 24, 25, 26, and 28

Prior U.S. Cls.: 1, 2, 3, 5, 7, 13, 19, 21, 22, 23, 25, 26, 27, 28, 29, 30, 31, 32, 33, 34, 35, 36, 37, 38, 39, 40, 41, 42, 44, and 50

Reg. No. 3,398,854

United States Patent and Trademark Office

Registered Mar. 18, 2008

**TRADEMARK
PRINCIPAL REGISTER**



UNION PACIFIC RAILROAD COMPANY (DELAWARE CORPORATION)
1416 DODGE STREET
OMAHA, NE 68179

FOR: HAND TOOLS, NAMELY, WRENCHES; HAND TOOLS, NAMELY, SOCKET SETS; HAND TOOLS, NAMELY, SOCKET AND SCREWDRIVER SETS; HAND TOOLS, NAMELY, SETS OF SCREWDRIVERS, PLIERS, WRENCHES AND TAPE MEASURES; MULTI-FUNCTION HAND TOOLS COMPRISED OF SCREWDRIVERS, KNIVES, PLIERS, FILES AND CAN OPENERS; MULTI-FUNCTION HAND TOOLS COMPRISED OF SCISSORS, FILES AND KNIVES; POCKET KNIVES; HUNTING KNIVES; HAND TOOLS, NAMELY, AUTOMOTIVE ICE SCRAPERS; TRAVEL KITS CONSISTING OF SCISSORS AND MANICURE IMPLEMENTS, NAMELY, NAIL FILES AND NAIL CLIPPERS, IN CLASS 8 (U.S. CLS. 23, 28 AND 44).

FIRST USE 0-0-1990; IN COMMERCE 0-0-1990.

FOR: VIDEO TAPES FEATURING RAILROAD RELATED TOPICS; PERSONAL RADIOS; DISPOSABLE CAMERAS; PERSONAL CD PLAYERS; LASER POINTERS; DECORATIVE MAGNETS; COMPUTER PERIPHERAL MOUSE PADS; PERSONAL SECURITY ALARMS; MODEM CABLES; TELEPHONE CABLES; THERMOMETERS NOT FOR MEDICAL USE; EYEGLOSS SECURITY CHAINS; TAPE MEASURES; TIRE PRESSURE GAUGES; LEATHER AND LEATHER-LIKE CD CASES, IN CLASS 9 (U.S. CLS. 21, 23, 26, 36 AND 38).

FIRST USE 0-0-1993; IN COMMERCE 0-0-1993.

FOR: ELECTRIC INDOOR GRILLS; FLASHLIGHTS; ELECTRIC LANTERNS; OIL LANTERNS; AND LAMPS, IN CLASS 11 (U.S. CLS. 13, 21, 23, 31 AND 34).

FIRST USE 0-0-1990; IN COMMERCE 0-0-1990.

FOR: LICENSE PLATE HOLDERS, IN CLASS 12 (U.S. CLS. 19, 21, 23, 31, 35 AND 44).

FIRST USE 0-0-1996; IN COMMERCE 0-0-1996.

FOR: DESK CLOCKS; WALL CLOCKS; AND MEDALLIONS OF PRECIOUS METALS, IN CLASS 14 (U.S. CLS. 2, 27, 28 AND 50).

FIRST USE 0-0-1980; IN COMMERCE 0-0-1980.

FOR: PAPERWEIGHTS; LEATHER AND LEATHER-LIKE PHOTO ALBUMS; LEATHER AND LEATHER-LIKE CHECKBOOK COVERS; LEATHER AND LEATHER-LIKE STATIONARY-TYPE PORTFOLIOS; LEATHER AND LEATHER-LIKE TRAVEL DOCUMENT HOLDERS; CARDBOARD COASTERS, DESKTOP BUSINESS CARD HOLDERS; STICKERS; AND MAPS, IN CLASS 16 (U.S. CLS. 2, 5, 22, 23, 29, 37, 38 AND 50).

FIRST USE 0-0-1930; IN COMMERCE 0-0-1930.

FOR: LUGGAGE; LEATHER AND LEATHER-LIKE BRIEFCASES; HANGING LUGGAGE BAGS; SUITCASES; GYM BAGS; BACKPACKS; SADDLES; UMBRELLAS; LEATHER AND LEATHER-LIKE WALLETS; LEATHER AND LEATHER-LIKE CLUTCH PURSE; TRAVEL KITS SOLD EMPTY; LEATHER AND LEATHER-LIKE BRIEFCASE-TYPE PORTFOLIOS; LEATHER AND LEATHER-LIKE BUSINESS CARD CASES; LEATHER AND LEATHER-LIKE KEY-CHAINS; LEATHER AND LEATHER-LIKE LUGGAGE TAGS; CHILDREN'S BACKPACKS; FANNY PACKS, IN CLASS 18 (U.S. CLS. 1, 2, 3, 22 AND 41).

FIRST USE 0-0-1990; IN COMMERCE 0-0-1990.

FOR: PICTURE FRAMES; CLIP HOLDERS FOR BADGES; NON-ELECTRIC FANS FOR PERSONAL USE; HAND HELD PAPER FANS, IN CLASS 20 (U.S. CLS. 2, 13, 22, 25, 32 AND 50).

FIRST USE 0-0-1993; IN COMMERCE 0-0-1993.

FOR: WIND CHIMES; LEATHER AND LEATHER-LIKE COASTERS; BARWARE OF CRYSTAL AND GLASS, NAMELY, DRINKING GLASSES; PLASTIC WATER BOTTLES SOLD EMPTY; CANDY DISHES OF CRYSTAL OR GLASS; THERMAL INSULATED CONTAINERS FOR BEVERAGES; THERMAL INSULATED WRAPS FOR CANS AND BOTTLES; KITCHEN UTENSILS, NAMELY, ICE CREAM SCOOPS; CUTTING BOARDS OF WOOD AND PLASTIC; BARBECUE TOOL SETS OF FORK, SPATULA AND TONGS; AND INSULATED LUNCH BAGS, IN CLASS 21 (U.S. CLS. 2, 13, 23, 29, 30, 33, 40 AND 50).

FIRST USE 0-0-1993; IN COMMERCE 0-0-1993.

FOR: LANYARDS FOR HOLDING BADGES, IN CLASS 22 (U.S. CLS. 1, 2, 7, 19, 22, 42 AND 50).

FIRST USE 0-0-1999; IN COMMERCE 0-0-1999.

FOR: BED BLANKETS; AFGHANS; CLOTH FLAGS; BEACH TOWELS; AND PLASTIC PLACE MATS, IN CLASS 24 (U.S. CLS. 42 AND 50).

FIRST USE 0-0-1990; IN COMMERCE 0-0-1990.

FOR: LEATHER AND LEATHER-LIKE JACKETS; CHILDREN'S ROMPERS; CHILDREN'S OVERALLS; T-SHIRTS; SWEATERS; EARMUFFS; AND VISORS, IN CLASS 25 (U.S. CLS. 22 AND 39).

FIRST USE 0-0-1975; IN COMMERCE 0-0-1975.

FOR: CLOTH PATCHES FOR CLOTHING, IN CLASS 26 (U.S. CLS. 37, 39, 40, 42 AND 50).

FIRST USE 0-0-1960; IN COMMERCE 0-0-1960.

FOR: SCALE MODEL TRAINS, BATTERY OPERATED TOY TRAINS, WIND-UP TOY TRAINS, SOFT SCULPTURE PLUSH TOYS, BEAN-BAG TOYS, WOODEN TOY TRAINS, YO-YOS, DOMINOES, GOLF CLUBS, SPORT BALLS, SNOW GLOBES, SPORTING GOODS, NAMELY, TOSS DISCS, CHILDREN'S WIRE CONSTRUCTION ACTIVITY TOYS, BUBBLE MAKING TOYS, MUSICAL TOYS AND TOY WHISTLES, IN CLASS 28 (U.S. CLS. 22, 23, 38 AND 50).

FIRST USE 0-0-1990; IN COMMERCE 0-0-1990.

SN 76-479,579, FILED 12-31-2002.

KARANENDRA S. CHHINA, EXAMINING ATTORNEY

Int. Cl.: 18

Prior U.S. Cls.: 1, 2, 3, 22, and 41

United States Patent and Trademark Office

Reg. No. 3,398,855

Registered Mar. 18, 2008

**TRADEMARK
PRINCIPAL REGISTER**



SCRATCH MEDIA PRODUCTIONS, LLC (NEW
YORK LTD LIAB CO)
434 6TH AVE, 2ND FL
NEW YORK, NY 10011

FIRST USE 7-15-2007; IN COMMERCE 7-15-2007.

SN 76-483,663, FILED 1-21-2003.

FOR: BACKPACKS, BOOK BAGS AND SHOULD-
ER BAGS, IN CLASS 18 (U.S. CLS. 1, 2, 3, 22 AND 41).

LINDA M. KING, EXAMINING ATTORNEY

Int. Cl.: 9

Prior U.S. Cls.: 21, 23, 26, 36, and 38

United States Patent and Trademark Office

Reg. No. 3,398,856

Registered Mar. 18, 2008

**TRADEMARK
PRINCIPAL REGISTER**

SSC

VECTOR PRODUCTS, INC. (FLORIDA CORPORATION)
4140 S.W. 28TH WAY
FT. LAUDERDALE, FL 33312

FIRST USE 6-10-2004; IN COMMERCE 6-10-2004.

SN 76-488,618, FILED 2-10-2003.

FOR: AUTOMOTIVE AND MARINE BATTERY
JUMP STARTERS, IN CLASS 9 (U.S. CLS. 21, 23, 26, 36
AND 38).

JANET LEE, EXAMINING ATTORNEY

Int. Cl.: 41

Prior U.S. Cls.: 100, 101, and 107

United States Patent and Trademark Office

Reg. No. 3,398,857

Registered Mar. 18, 2008

**SERVICE MARK
PRINCIPAL REGISTER**

GRAVITY Studio

ENGINEERING FITNESS INTERNATIONAL
CORP. (CALIFORNIA CORPORATION), DBA
TOTAL GYM, DBA EFI AND DBA EFI MED-
ICAL SYSTEMS,
7755 ARJONS DRIVE
SAN DIEGO, CA 92126

FOR: EXERCISE SERVICES, NAMELY, PERSONAL TRAINER SERVICES, PHYSICAL FITNESS CONSULTATION, PHYSICAL FITNESS INSTRUCTION, PHYSICAL FITNESS TRAINING, EXERCISE TRAINING SERVICES, IN CLASS 41 (U.S. CLS. 100, 101 AND 107).

FIRST USE 9-12-2007; IN COMMERCE 9-12-2007.

NO CLAIM IS MADE TO THE EXCLUSIVE RIGHT TO USE "STUDIO", APART FROM THE MARK AS SHOWN.

SN 76-494,906, FILED 3-6-2003.

LESLIE RICHARDS, EXAMINING ATTORNEY

Int. Cl.: 25

Prior U.S. Cls.: 22 and 39

United States Patent and Trademark Office

Reg. No. 3,398,858

Registered Mar. 18, 2008

**TRADEMARK
PRINCIPAL REGISTER**

IN GOD I TRUST

DUPUIS, MICHAEL J. (UNITED STATES INDIVIDUAL)
601 UNIVERSITY AVE STE.278
SACRAMENTO, CA 95825

WEAR, BOXER SHORTS, FOOTWEAR AND HEADWEAR, IN CLASS 25 (U.S. CLS. 22 AND 39).

FIRST USE 12-22-2007; IN COMMERCE 12-22-2007.

FOR: CLOTHING, NAMELY, T-SHIRTS, JACKETS, PANTS, SHORTS, SHIRTS, COATS, SWEATSHIRTS, FASHION ACCESSORIES, NAMELY, BELTS, TIES, GLOVES, SOCKS, HOSIERY, UNDER-

SN 76-497,895, FILED 3-17-2003.

LINDA POWELL, EXAMINING ATTORNEY

Int. Cl.: 16

Prior U.S. Cls.: 2, 5, 22, 23, 29, 37, 38, and 50

Reg. No. 3,398,859

United States Patent and Trademark Office

Registered Mar. 18, 2008

**TRADEMARK
PRINCIPAL REGISTER**

**SETS SPIRITUALLY
ENLIGHTENING THOUGHTS**

MUSE IMAGERY, LLC (NEVADA LTD LIAB CO)
9811 W. CHARLESTON, SUITE 2390
LAS VEGAS, NV 89117

ADDRESS BOOKS, POSTERS, PHOTOGRAPHIC
PRINTS, CHILDREN'S ACTIVITY BOOK, IN CLASS
16 (U.S. CLS. 2, 5, 22, 23, 29, 37, 38 AND 50).

FOR: BOOKS ON RELIGION, PERSONAL
GROWTH AND SELF-MOTIVATION, MAGAZINES
ON RELIGION, PERSONAL GROWTH AND SELF-
MOTIVATION, PERIODICALS ON RELIGION, PER-
SONAL GROWTH AND SELF-MOTIVATION, PRIN-
TED MATERIALS, NAMELY, WORKBOOKS,
OUTLINES, AND JOURNALS ON RELIGION, PER-
SONAL GROWTH AND SELF-MOTIVATION, STA-
TIONERY, NOTE CARDS, NOTE PADS, NOTE
PAPER, CALENDARS, APPOINTMENTS BOOKS,

FIRST USE 11-0-2003; IN COMMERCE 11-0-2003.

THE MARK CONSISTS OF STANDARD CHAR-
ACTERS WITHOUT CLAIM TO ANY PARTICULAR
FONT, STYLE, SIZE, OR COLOR.

SN 76-505,627, FILED 4-10-2003.

DARRYL SPRUILL, EXAMINING ATTORNEY

Int. Cl.: 16

Prior U.S. Cls.: 2, 5, 22, 23, 29, 37, 38, and 50

United States Patent and Trademark Office

Reg. No. 3,398,860

Registered Mar. 18, 2008

**TRADEMARK
PRINCIPAL REGISTER**

BIBLE IN A NUTSHELL

J.S. ENGLISH CO. (OHIO CORPORATION)
17800 CHILLICOTHE ROAD
CHAGRIN FALLS, OH 44023

NO CLAIM IS MADE TO THE EXCLUSIVE
RIGHT TO USE "BIBLE", APART FROM THE
MARK AS SHOWN.

FOR: PRINTED BIBLE SUMMARIES, STORIES
AND READINGS CONTAINED IN NUT-SHAPED
CONTAINERS, IN CLASS 16 (U.S. CLS. 2, 5, 22, 23, 29,
37, 38 AND 50).

SN 76-507,491, FILED 4-17-2003.

FIRST USE 11-8-2007; IN COMMERCE 11-8-2007.

HOWARD B. LEVINE, EXAMINING ATTORNEY

Int. Cl.: 10

Prior U.S. Cls.: 26, 39, and 44

United States Patent and Trademark Office

Reg. No. 3,398,861

Registered Mar. 18, 2008

**TRADEMARK
PRINCIPAL REGISTER**

AMAIRICA

GRAY TEK, INC. (DELAWARE CORPORATION)
100 DAYETT MILLS ROAD
NEWARK, DE 19702

FIRST USE 2-25-2003; IN COMMERCE 2-25-2003.

FOR: INFLATABLE STRUCTURES IN THE NATURE OF INFLATABLE MATTRESSES FOR MOVING LOADS, FOR USE IN LOAD TRANSFERRING AND MEDICAL INDUSTRIES, IN CLASS 10 (U.S. CLS. 26, 39 AND 44).

SN 76-509,317, FILED 4-25-2003.

AMOS T. MATTHEWS, JR., EXAMINING ATTORNEY

Int. Cl.: 25

Prior U.S. Cls.: 22 and 39

United States Patent and Trademark Office

Reg. No. 3,398,862

Registered Mar. 18, 2008

**TRADEMARK
PRINCIPAL REGISTER**

SPOILED ROTTEN

SPOILED ROTTEN U.S.A. (NEW YORK CORPORATION)
304 EAST 140TH STREET
BRONX, NY 10454

FOR: MENS, WOMENS AND CHILDREN'S
SPORTSWEAR AND APPAREL, NAMELY, SHORTS,
PANTS, SHIRTS, HATS AND JACKETS, IN CLASS 25
(U.S. CLS. 22 AND 39).

FIRST USE 8-1-2007; IN COMMERCE 8-1-2007.

OWNER OF U.S. REG. NOS. 1,524,584 AND
2,369,768.

SN 76-515,313, FILED 5-19-2003.

KAREN BRACEY, EXAMINING ATTORNEY

Int. Cl.: 4

Prior U.S. Cls.: 1, 6, and 15

United States Patent and Trademark Office

Reg. No. 3,398,863

Registered Mar. 18, 2008

**TRADEMARK
PRINCIPAL REGISTER**

GREEN D

WILLIAMS, GARY (UNITED STATES INDIVIDUAL)
1061 FREMONT STREET
SANTA CLARA, CA 95050

FOR: BIODIESEL FUELS AND NON-CHEMICAL
ENGINE TREATMENTS AND ADDITIVES FOR
ENGINE OILS, GASOLINE AND DIESEL FUELS,

TRANSMISSION FLUIDS AND COOLING SYSTEMS, IN CLASS 4 (U.S. CLS. 1, 6 AND 15).

FIRST USE 7-0-2007; IN COMMERCE 9-0-2007.

SN 76-518,856, FILED 5-8-2003.

ROBERT C. CLARK JR., EXAMINING ATTORNEY

Int. Cl.: 41

Prior U.S. Cls.: 100, 101, and 107

United States Patent and Trademark Office

Reg. No. 3,398,864

Registered Mar. 18, 2008

**SERVICE MARK
PRINCIPAL REGISTER**

AFAA SHAPE-UP CENTER

AEROBICS AND FITNESS ASSOCIATION OF
AMERICA (CALIFORNIA CORPORATION)
15250 VENTURA BLVD., SUITE 200
SHERMAN OAKS, CA 91403

FOR: INSTRUCTIONAL SERVICES, NAMELY,
CONDUCTING WORKSHOPS, SEMINARS AND
CLASSES ON THE SUBJECTS OF EXERCISE AND
FITNESS, AND PROVIDING INFORMATION, AD-
VICE AND INSTRUCTION OVER A GLOBAL COM-
PUTER NETWORK ON THE SUBJECTS OF
EXERCISE AND FITNESS, IN CLASS 41 (U.S. CLS.
100, 101 AND 107).

FIRST USE 12-1-2007; IN COMMERCE 12-1-2007.

OWNER OF U.S. REG. NOS. 1,430,614 AND
2,595,711.

NO CLAIM IS MADE TO THE EXCLUSIVE
RIGHT TO USE "SHAPE-UP CENTER", APART
FROM THE MARK AS SHOWN.

SN 76-535,245, FILED 7-24-2003.

JOHN GARTNER, EXAMINING ATTORNEY

Int. Cl.: 12

Prior U.S. Cls.: 19, 21, 23, 31, 35, and 44

United States Patent and Trademark Office

Reg. No. 3,398,865

Registered Mar. 18, 2008

TRADEMARK
PRINCIPAL REGISTER

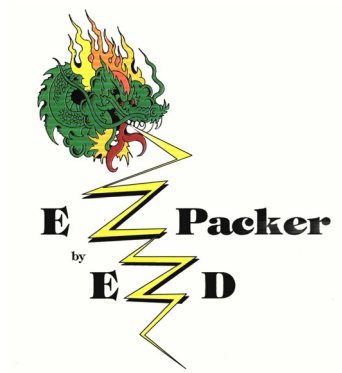

EDWARD L. PAXTON AND LLOYD M. PAXTON
PARTNERSHIP, THE (UTAH PARTNERSHIP)
556 N. 320 E.
SALEM, UT 84653

FOR: INFLATABLE POONTOON BOAT ACCESSORIES, NAMELY, CARRIERS ATTACHED TO THE BACK OF VEHICLES AND WHEELS TO MOVE AROUND ON LAND BY HAND, IN CLASS 12 (U.S. CLS. 19, 21, 23, 31, 35 AND 44).

FIRST USE 5-21-2003; IN COMMERCE 5-21-2003.

THE COLOR(S) ARE YELLOW, GREEN, RED, AND BLACK IS/ARE CLAIMED AS A FEATURE OF THE MARK.

THE MARK CONSISTS OF THE HEAD OF THE DRAGON HAS YELLOW, GREEN, RED WITH YELLOW LIGHTING BOLT COMING FROM MOUTH TO FROM THE LETTER "Z" IN YELLOW BACKED IN BLACK WITH THE LETTERS "E Z PACKER BY E Z D" IN BLACK THE "Z" YELLOW WITH BLACK BACKING.

SN 76-543,072, FILED 8-20-2003.

PAM WILLIS, EXAMINING ATTORNEY

Int. Cl.: 33

Prior U.S. Cls.: 47 and 49

United States Patent and Trademark Office

Reg. No. 3,398,866

Registered Mar. 18, 2008

**TRADEMARK
PRINCIPAL REGISTER**



TEQUILA DON JULIO, S.A. DE C.V. (MEXICO CORPORATION)
PORFIRIO DIAZ NO. 17
COLONIA CHICHIMECO, 47750
ATOTONILCO EL ALTO, JALISCO, MEXICO

THE MARK CONSISTS OF A THREE-DIMENSIONAL CONFIGURATION OF A BOTTLE FOR CONTAINING THE GOODS, SUCH BOTTLE FEATURING EMBOSSED DESIGNS OF PORTIONS OF STYLIZED AGAVE LEAVES.

FOR: BEVERAGE ALCOHOL, NAMELY, DISTILLED SPIRITS, IN CLASS 33 (U.S. CLS. 47 AND 49).

SN 76-543,415, FILED 9-8-2003.

FIRST USE 12-28-2001; IN COMMERCE 12-28-2001.

TANYA AMOS, EXAMINING ATTORNEY

Int. Cl.: 9

Prior U.S. Cls.: 21, 23, 26, 36, and 38

Reg. No. 3,398,867

United States Patent and Trademark Office

Registered Mar. 18, 2008

**TRADEMARK
PRINCIPAL REGISTER**

NISSAN

NISSAN JIDOSHA KABUSHIKI KAISHA (JAPAN CORPORATION), TA NISSAN MOTOR CO., LTD.,
NO. 2 TAKARACHO, KANAGAWA-KU
YOKOHAMA-SHI, KANAGAWA-KEN, JAPAN

ERS/ RECORDERS, IN CLASS 9 (U.S. CLS. 21, 23, 26, 36 AND 38).

FIRST USE 6-1-2006; IN COMMERCE 6-1-2006.

FOR: CONSUMER ELECTRONICS PRODUCTS,
NAMELY AUDIO AND VIDEO PLAYERS/ RECORDERS;
HEADPHONES, PORTABLE AUDIO PLAY-

SN 76-548,123, FILED 9-12-2003.

DAVID H. STINE, EXAMINING ATTORNEY

Int. Cls.: 9, 16, and 25

**Prior U.S. Cls.: 2, 5, 21, 22, 23, 26, 29, 36, 37, 38, 39,
and 50**

Reg. No. 3,398,868

United States Patent and Trademark Office

Registered Mar. 18, 2008

**TRADEMARK
PRINCIPAL REGISTER**

JOSEPH CAMPBELL

JOSEPH CAMPBELL FOUNDATION (HAWAII
CORPORATION)
180 DE BURGH DRIVE
SAN ANSELMO, CA 94960

FOR: PRE-RECORDED AUDIO AND VIDEO CAS-
SETTES AND CDS FEATURING LECTURES IN THE
FIELD OF MYTHOLOGY AND COMPARATIVE
RELIGION , IN CLASS 9 (U.S. CLS. 21, 23, 26, 36
AND 38).

FIRST USE 0-0-1988; IN COMMERCE 0-0-1988.

FOR: BOOKS ON THE SUBJECTS OF MYTHOL-
OGY AND COMPARATIVE RELIGION, NOTE
CARDS AND BOOKMARKS, IN CLASS 16 (U.S.
CLS. 2, 5, 22, 23, 29, 37, 38 AND 50).

FIRST USE 5-0-1988; IN COMMERCE 5-0-1988.

FOR: T-SHIRTS, IN CLASS 25 (U.S. CLS. 22 AND
39).

FIRST USE 7-0-1992; IN COMMERCE 6-0-2006.

THE NAME "JOSEPH CAMPBELL" DOES NOT
IDENTIFY A LIVING INDIVIDUAL.

SN 76-550,611, FILED 10-9-2003.

LANA PHAM, EXAMINING ATTORNEY

Int. Cl.: 21

Prior U.S. Cls.: 2, 13, 23, 29, 30, 33, 40, and 50

United States Patent and Trademark Office

Reg. No. 3,398,869

Registered Mar. 18, 2008

**TRADEMARK
PRINCIPAL REGISTER**



BONGIOVI, JOHN (UNITED STATES INDIVIDUAL)
C/O EDELSTEIN, LAIRD & SOBEL, LLP
9255 SUNSET BOULEVARD, SUITE 800
LOS ANGELES, CA 90069

FIRST USE 1-28-2004; IN COMMERCE 1-28-2004.

THE MARK CONSISTS OF A STYLIZED WINGED FOOTBALL.

FOR: MUGS; BEVERAGE GLASSWARE; PORTABLE BEVERAGE DISPENSERS; PLASTIC CUPS; DECORATIVE CUPS; COMMEMORATIVE PLATES, IN CLASS 21 (U.S. CLS. 2, 13, 23, 29, 30, 33, 40 AND 50).

SN 76-551,255, FILED 9-24-2003.

NELSON SNYDER, EXAMINING ATTORNEY

Int. Cl.: 24

Prior U.S. Cls.: 42 and 50

United States Patent and Trademark Office

Reg. No. 3,398,870

Registered Mar. 18, 2008

**TRADEMARK
PRINCIPAL REGISTER**



BONGIOVI, JOHN (UNITED STATES INDIVIDUAL)
C/O EDELSTEIN, LAIRD & SOBEL, LLP
9255 SUNSET BOULEVARD, SUITE 800
LOS ANGELES, CA 90069

FOR: BATH TOWELS; BEACH TOWELS; BEDDING, NAMELY, BED BLANKETS, COMFORTERS, BED SPREADS AND BED LINEN; BATH LINEN, HOUSEHOLD LINENS, CLOTH COASTERS, PLASTIC PLACE MATS, TEXTILE PLACE MATS, VINYL PLACE MATS, TEXTILE NAPKINS, POT HOLDERS, CLOTH PENNANTS, FELT PENNANTS AND TEX-

TILE WALL HANGINGS, IN CLASS 24 (U.S. CLS. 42 AND 50).

FIRST USE 1-28-2004; IN COMMERCE 1-28-2004.

THE MARK CONSISTS OF A STYLIZED WINGED FOOTBALL.

SN 76-551,256, FILED 9-24-2003.

NELSON SNYDER, EXAMINING ATTORNEY

Int. Cl.: 25

Prior U.S. Cls.: 22 and 39

United States Patent and Trademark Office

Reg. No. 3,398,871

Registered Mar. 18, 2008

**TRADEMARK
PRINCIPAL REGISTER**



BONGIOVI, JOHN (UNITED STATES INDIVIDUAL)
C/O EDELSTEIN, LAIRD & SOBEL, LLP
9255 SUNSET BOULEVARD, SUITE 800
LOS ANGELES, CA 90069

FOR: MEN'S, WOMEN'S AND CHILDREN'S WEARING APPAREL, NAMELY, PANTS, SHIRTS, SLACKS, DRESSES, SKIRTS AND BLOUSES; HEADWEAR, FOOTWEAR; SPORTSWEAR, NAMELY, SWEAT SHIRTS, SWEAT PANTS, WARM-UP SUITS, T-SHIRTS, SHORTS, SPORT SHIRTS, SPORT COATS AND POLO SHIRTS; SWIMWEAR AND BEACHWEAR, NAMELY, BATHING SUITS, ROBES AND

COVER-UPS; AND OUTERWEAR, NAMELY, JACKETS, SWEATERS, COATS AND VESTS, IN CLASS 25 (U.S. CLS. 22 AND 39).

FIRST USE 1-28-2004; IN COMMERCE 1-28-2004.

THE MARK CONSISTS OF A STYLIZED WINGED FOOTBALL.

SN 76-551,257, FILED 9-24-2003.

NELSON SNYDER, EXAMINING ATTORNEY

Int. Cl.: 28

Prior U.S. Cls.: 22, 23, 38, and 50

United States Patent and Trademark Office

Reg. No. 3,398,872

Registered Mar. 18, 2008

**TRADEMARK
PRINCIPAL REGISTER**

NELLIE O'MALLEY

AMERICAN GIRL, LLC (DELAWARE LTD LIAB
CO)
333 CONTINENTAL BOULEVARD
EL SEGUNDO, CA 90245

FOR: DOLLS, DOLL CLOTHING, AND DOLL
ACCESSORIES, IN CLASS 28 (U.S. CLS. 22, 23, 38
AND 50).

FIRST USE 10-15-2007; IN COMMERCE 10-15-2007.

THE MARK CONSISTS OF STANDARD CHAR-
ACTERS WITHOUT CLAIM TO ANY PARTICULAR
FONT, STYLE, SIZE, OR COLOR.

THE NAME SHOWN IN THE MARK DOES NOT
IDENTIFY A LIVING INDIVIDUAL.

SN 76-554,347, FILED 10-8-2003.

IRA J. GOODSaid, EXAMINING ATTORNEY

Int. Cls.: 35 and 44

Prior U.S. Cls.: 100, 101, and 102

United States Patent and Trademark Office

Reg. No. 3,398,873

Registered Mar. 18, 2008

**SERVICE MARK
PRINCIPAL REGISTER**

CONSONUS

F&W ASSOCIATES, INC. (OREGON CORPORATION)
4560 SE INTERNATIONAL WAY
MILWAUKIE, OR 97222

FOR: PHARMACY SERVICES; TEMPORARY STAFFING SERVICES IN THE HEALTHCARE FIELD; PERSONNEL RECRUITMENT SERVICES IN THE FIELD OF HEALTHCARE , IN CLASS 35 (U.S. CLS. 100, 101 AND 102).

FIRST USE 11-1-2003; IN COMMERCE 11-1-2003.

FOR: HEALTHCARE CONSULTATION SERVICES; HEALTHCARE SERVICES; PHYSICAL REHA-

BILITATION SERVICES; HOME HEALTHCARE SERVICES; PHARMACEUTICAL ADVISORY SERVICES; PHYSICAL, OCCUPATIONAL, AND SPEECH THERAPY SERVICES; LONG TERM HEALTHCARE SERVICES, IN CLASS 44 (U.S. CLS. 100 AND 101).

FIRST USE 11-1-2003; IN COMMERCE 11-1-2003.

THE FOREIGN WORDING IN THE MARK TRANSLATES INTO ENGLISH AS HARMONIOUS.

SN 76-559,955, FILED 10-27-2003.

RICHARD A. STRASER, EXAMINING ATTORNEY

Int. Cl.: 11

Prior U.S. Cls.: 13, 21, 23, 31, and 34

United States Patent and Trademark Office

Reg. No. 3,398,874

Registered Mar. 18, 2008

**TRADEMARK
PRINCIPAL REGISTER**

ULTRA-VENT

STUDOR, INC. (FLORIDA CORPORATION)
2030 MAIN STREET
DUNEDIN, FL 34698

THE MARK CONSISTS OF STANDARD CHARACTERS WITHOUT CLAIM TO ANY PARTICULAR FONT, STYLE, SIZE, OR COLOR.

FOR: AIR ADMITTANCE VALVES USED TO VENTILATE A TOILET WATER TRAP SEAL, IN CLASS 11 (U.S. CLS. 13, 21, 23, 31 AND 34).

SN 76-564,860, FILED 12-12-2003.

FIRST USE 11-1-2007; IN COMMERCE 11-1-2007.

TINA L. SNAPP, EXAMINING ATTORNEY

Int. Cl.: 18

Prior U.S. Cls.: 1, 2, 3, 22, and 41

United States Patent and Trademark Office

Reg. No. 3,398,875

Registered Mar. 18, 2008

**TRADEMARK
PRINCIPAL REGISTER**

PHI

SUSAN DELL, INC. (TEXAS CORPORATION)
76 NINTH AVENUE, 16TH FLOOR
NEW YORK, NY 10011

THE MARK CONSISTS OF STANDARD CHAR-
ACTERS WITHOUT CLAIM TO ANY PARTICULAR
FONT, STYLE, SIZE, OR COLOR.

FOR: BAGS, NAMELY, ATHLETIC BAGS, BEACH
BAGS, DUFFEL BAGS, HANDBAGS AND LEA-
THER SHOPPING BAGS, IN CLASS 18 (U.S. CLS. 1,
2, 3, 22 AND 41).

SN 76-565,100, FILED 12-4-2003.

FIRST USE 11-11-2004; IN COMMERCE 11-11-2004.

KATHY DE JONGE, EXAMINING ATTORNEY

Int. Cl.: 28

Prior U.S. Cls.: 22, 23, 38, and 50

United States Patent and Trademark Office

Reg. No. 3,398,876

Registered Mar. 18, 2008

**TRADEMARK
PRINCIPAL REGISTER**

KIDS WITH POSSIBILITIES

DESROSIER, LAURIE M. (UNITED STATES IN-
DIVIDUAL)
6 BREEZY POINT
ACTON, MA 01720

THE MARK CONSISTS OF STANDARD CHAR-
ACTERS WITHOUT CLAIM TO ANY PARTICULAR
FONT, STYLE, SIZE, OR COLOR.

FOR: DOLLS, IN CLASS 28 (U.S. CLS. 22, 23, 38
AND 50).

SN 76-573,686, FILED 1-28-2004.

FIRST USE 11-17-2007; IN COMMERCE 11-17-2007.

IRA J. GOODSaid, EXAMINING ATTORNEY

Int. Cl.: 29

Prior U.S. Cl.: 46

United States Patent and Trademark Office

Reg. No. 3,398,877

Registered Mar. 18, 2008

**TRADEMARK
PRINCIPAL REGISTER**

CATTLE DRIVE GOLD

BUMBLE BEE FOODS, LLC (DELAWARE LTD
LIAB CO)
9655 GRANITE RIDGE DRIVE
SUITE 100
SAN DIEGO, CA 92123

THE MARK CONSISTS OF STANDARD CHAR-
ACTERS WITHOUT CLAIM TO ANY PARTICULAR
FONT, STYLE, SIZE, OR COLOR.

SN 76-575,133, FILED 2-11-2004.

FOR: CHILI, IN CLASS 29 (U.S. CL. 46).

FIRST USE 11-21-2007; IN COMMERCE 11-21-2007.

DAWN FELDMAN, EXAMINING ATTORNEY

Int. Cl.: 10

Prior U.S. Cls.: 26, 39, and 44

United States Patent and Trademark Office

Reg. No. 3,398,878

Registered Mar. 18, 2008

**TRADEMARK
PRINCIPAL REGISTER**

ISCIENCE SURGICAL

ISCIENCE INTERVENTIONAL CORPORATION
(DELAWARE CORPORATION)
4055 CAMPBELL AVENUE
MENLO PARK, CA 94025

FOR: ACCOUSTICAL AND ELECTROMAGNETIC MEDICAL DIAGNOSTIC IMAGING APPARATUS AND COMPONENTS THEREOF FOR USE IN OPHTHALMIC DIAGNOSIS AND RELATED MEDICAL PROCEDURES; SURGICAL INSTRUMENTS FOR USE IN OPHTHALMIC SURGERY; AND OPHTHALMIC IMPLANTS, NAMELY, STENTS AND SUTURE CLIPS, IN CLASS 10 (U.S. CLS. 26, 39 AND 44).

FIRST USE 10-9-2006; IN COMMERCE 10-9-2006.

THE MARK CONSISTS OF STANDARD CHARACTERS WITHOUT CLAIM TO ANY PARTICULAR FONT, STYLE, SIZE, OR COLOR.

NO CLAIM IS MADE TO THE EXCLUSIVE RIGHT TO USE "SURGICAL", APART FROM THE MARK AS SHOWN.

SN 76-578,075, FILED 2-27-2004.

ANNE MADDEN, EXAMINING ATTORNEY

Int. Cls.: 37 and 40

Prior U.S. Cls.: 100, 103, and 106

United States Patent and Trademark Office

Reg. No. 3,398,879

Registered Mar. 18, 2008

**SERVICE MARK
PRINCIPAL REGISTER**



GEORGE ZIMMER 1988 LIVING TRUST, COMPRISING JAMES ZIMMER, LAURIE ECKSTEIN, DAVID EDWAB AND CHARLES BRESLER ALL U.S. CITIZEN. (CALIFORNIA TRUST)

40650 ENCYCLOPEDIA CIRCLE
FREMONT, CA 94538

FOR: DRY CLEANING AND LAUNDRY SERVICES, IN CLASS 37 (U.S. CLS. 100, 103 AND 106).

FIRST USE 3-0-2005; IN COMMERCE 3-0-2005.

FOR: TAILORING AND CLOTHING ALTERATION, IN CLASS 40 (U.S. CLS. 100, 103 AND 106).

FIRST USE 3-0-2005; IN COMMERCE 3-0-2005.

OWNER OF U.S. REG. NO. 2,655,808.

THE STIPPLING IS A FEATURE OF THE MARK AND DOES NOT INDICATE COLOR.

THE LIKENESS (OR, "PORTRAIT") IN THE MARK IDENTIFIES A LIVING INDIVIDUAL WHOSE CONSENT IS OF RECORD.

THE MARK CONSISTS OF A LIKENESS (OR, "PORTRAIT") OF "GEORGE ZIMMER'S" FACE.

SN 76-586,192, FILED 4-12-2004.

JOHN DALIER, EXAMINING ATTORNEY

Int. Cls.: 28 and 35

Prior U.S. Cls.: 22, 23, 38, 50, 100, 101, and 102

United States Patent and Trademark Office

Reg. No. 3,398,880

Registered Mar. 18, 2008

**TRADEMARK
SERVICE MARK
PRINCIPAL REGISTER**

FLYING LURE

LANGER, ALEXANDER G. (UNITED STATES
INDIVIDUAL)
94 SAINT ROSE STREET
BOSTON, MA 02130

FOR: FISHING LURES AND FISHING EQUIP-
MENT, NAMELY, WEIGHTS, FISHING RODS,
REELS, IN CLASS 28 (U.S. CLS. 22, 23, 38 AND 50).

FIRST USE 2-0-1989; IN COMMERCE 2-0-1989.

FOR: DIRECT RESPONSE RETAIL SERVICES BY
MEANS OF INFOMERCIALS IN THE FIELD OF

FISHING LURES AND FISHING RODS, IN CLASS 35
(U.S. CLS. 100, 101 AND 102).

FIRST USE 2-0-1989; IN COMMERCE 2-0-1989.

THE MARK CONSISTS OF STANDARD CHAR-
ACTERS WITHOUT CLAIM TO ANY PARTICULAR
FONT, STYLE, SIZE, OR COLOR.

SN 76-597,527, FILED 6-14-2004.

DAWN FELDMAN, EXAMINING ATTORNEY

Int. Cl.: 7

Prior U.S. Cls.: 13, 19, 21, 23, 31, 34, and 35

United States Patent and Trademark Office

Reg. No. 3,398,881

Registered Mar. 18, 2008

**TRADEMARK
PRINCIPAL REGISTER**

ANACONDA

FRANK'S INTERNATIONAL, INC. (TEXAS CORPORATION)
11700 OLD KATY ROAD, SUITE 300
HOUSTON, TX 77027

FOR: MACHINE PARTS FOR OILFIELD EQUIPMENT, NAMELY, LOAD LIFT RINGS, AND THREAD PROTECTORS FOR USE ON OILFIELD CASING BEFORE SUCH CASING IS RUN INTO AN

EARTH WELL BORE, IN CLASS 7 (U.S. CLS. 13, 19, 21, 23, 31, 34 AND 35).

FIRST USE 5-3-2004; IN COMMERCE 5-3-2004.

SN 76-599,870, FILED 6-28-2004.

SUSAN LESLIE DUBOIS, EXAMINING ATTORNEY

Int. Cl.: 28

Prior U.S. Cls.: 22, 23, 38, and 50

United States Patent and Trademark Office

Reg. No. 3,398,882

Registered Mar. 18, 2008

**TRADEMARK
PRINCIPAL REGISTER**

HERBIE'S ONE-PUTT WEDGE

HYMAN, HERBERT B. (UNITED STATES INDIVIDUAL)
535 VIA CON DIOS
CAMARILLO, CA 93010

FOR: GOLF CLUBS; HEADS FOR GOLF CLUBS,
IN CLASS 28 (U.S. CLS. 22, 23, 38 AND 50).

FIRST USE 12-3-2007; IN COMMERCE 12-3-2007.

THE MARK CONSISTS OF STANDARD CHARACTERS WITHOUT CLAIM TO ANY PARTICULAR FONT, STYLE, SIZE, OR COLOR.

NO CLAIM IS MADE TO THE EXCLUSIVE RIGHT TO USE "WEDGE", APART FROM THE MARK AS SHOWN.

SN 76-601,799, FILED 7-12-2004.

JOHN DALIER, EXAMINING ATTORNEY

Int. Cls.: 38 and 41

Prior U.S. Cls.: 100, 101, 104, and 107

Reg. No. 3,398,883

United States Patent and Trademark Office

Registered Mar. 18, 2008

**SERVICE MARK
PRINCIPAL REGISTER**

i-Guide

TV GUIDE MAGAZINE GROUP, INC. (DELAWARE CORPORATION)
6922 HOLLYWOOD BOULEVARD
LOS ANGELES, CA 90028

FOR: COMMUNICATIONS SERVICES, NAMELY, THE TRANSMISSION AND DELIVERY OF PROMOTIONAL, INFORMATIONAL, AND INTERACTIVE TELEVISION PROGRAMMING SERVICES VIA BROADCAST, CABLE, SATELLITE AND ON-LINE ELECTRONIC COMMUNICATIONS NETWORKS LIMITED TO THE FOLLOWING SUBJECT MATTER: (1) VIDEO PROGRAM LISTINGS; (2) TELEVISION LISTINGS; (3) INFORMATION ON VIDEO PROGRAMMING; (4) INFORMATION ON TELEVISION PROGRAMMING; OR (5) INTERACTIVE OR ELECTRONIC PROGRAM GUIDES RELATED TO TELEVISION OR VIDEO PROGRAMMING. SUCH SERVICES SHALL SPECIFICALLY EXCLUDE SEARCH ENGINE SERVICES AND ALL OTHER SERVICES ON, OVER OR UTILIZING THE INTERNET OTHER THAN THE DISPLAY OF A PROGRAM GUIDE FOR TELEVISION, VIDEO OR AUDIO PROGRAMS AND THE ADVERTISING OF THE SAME ON THIRD-PARTY WEB SITES OR ONE OF ITS OWN WEB SITES, IN CLASS 38 (U.S. CLS. 100, 101 AND 104).

FIRST USE 7-31-2004; IN COMMERCE 7-31-2004.

FOR: ENTERTAINMENT SERVICES, NAMELY, THE PRODUCTION AND DISTRIBUTION OF PRO-

MOTIONAL, INFORMATIONAL, AND INTERACTIVE TELEVISION PROGRAMMING SERVICES VIA BROADCAST, CABLE, SATELLITE AND ON-LINE ELECTRONIC COMMUNICATIONS NETWORKS LIMITED TO FOLLOWING SUBJECT MATTER: (1) VIDEO PROGRAM LISTINGS; (2) TELEVISION LISTINGS; (3) INFORMATION ON VIDEO PROGRAMMING; (4) INFORMATION ON TELEVISION PROGRAMMING; OR (5) INTERACTIVE OR ELECTRONIC PROGRAM GUIDES RELATED TO TELEVISION OR VIDEO PROGRAMMING. SUCH SERVICES SHALL SPECIFICALLY EXCLUDE SEARCH ENGINE SERVICES AND ALL OTHER SERVICES ON, OVER OR UTILIZING THE INTERNET OTHER THAN THE DISPLAY OF A PROGRAM GUIDE FOR TELEVISION, VIDEO OR AUDIO PROGRAMS AND THE ADVERTISING OF THE SAME ON THIRD-PARTY WEB SITES OR ONE OF ITS OWN WEB SITES, IN CLASS 41 (U.S. CLS. 100, 101 AND 107).

FIRST USE 7-31-2004; IN COMMERCE 7-31-2004.

OWNER OF U.S. REG. NOS. 650,942, 2,833,591, AND OTHERS.

SN 76-602,006, FILED 7-14-2004.

HOWARD B. LEVINE, EXAMINING ATTORNEY

Int. Cl.: 33

Prior U.S. Cls.: 47 and 49

United States Patent and Trademark Office

Reg. No. 3,398,884

Registered Mar. 18, 2008

**TRADEMARK
PRINCIPAL REGISTER**

CALIFORNIO

H DE V, LLC (CALIFORNIA LTD LIAB CO)
1101 SHERMAN AVENUE
HOOD RIVER, OR 97031

THE MARK CONSISTS OF STANDARD CHAR-
ACTERS WITHOUT CLAIM TO ANY PARTICULAR
FONT, STYLE, SIZE, OR COLOR.

FOR: WINE ORIGINATING IN CALIFORNIA, IN
CLASS 33 (U.S. CLS. 47 AND 49).

SN 76-604,924, FILED 7-30-2004.

FIRST USE 8-1-2007; IN COMMERCE 8-1-2007.

TRACY FLETCHER, EXAMINING ATTORNEY

Int. Cls.: 9, 25, and 41

Prior U.S. Cls.: 21, 22, 23, 26, 36, 38, 39, 100, 101, and 107

Reg. No. 3,398,885

United States Patent and Trademark Office

Registered Mar. 18, 2008

**TRADEMARK
SERVICE MARK
PRINCIPAL REGISTER**

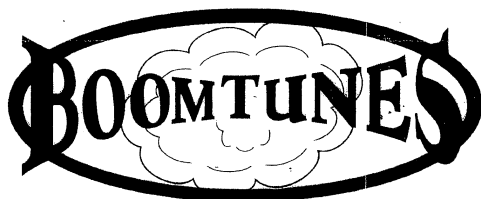

SALAAM REMI MUSIC, LLC (FLORIDA LIMITED LIABILITY CORPORATION)
555 NE 15TH STREET, SUITE 7719
MIAMI, FL 33132

FOR: PRE-RECORDED SOUND RECORDINGS AND AUDIO DEVICES, NAMELY, COMPACT DISCS, VIDEO DISCS, PHONOGRAPH RECORDS, VIDEO AND AUDIO CASSETTE TAPES AND MOTION PICTURES FEATURING MUSIC AND VOCAL PERFORMANCES, IN CLASS 9 (U.S. CLS. 21, 23, 26, 36 AND 38).

FIRST USE 7-17-2003; IN COMMERCE 2-27-2005.

FOR: HATS, T-SHIRTS, SWEAT SHIRTS, SWEAT PANTS, SWEATERS, WRIST BANDS, HEADBANDS, JACKETS, SOCKS, SHOES AND LINGERIE, IN CLASS 25 (U.S. CLS. 22 AND 39).

FIRST USE 8-14-2007; IN COMMERCE 9-14-2007.

FOR: LIVE MUSIC AND VOCAL PERFORMANCES, SONGWRITING, MUSIC PRODUCTION, AUDIO RECORDING AND CASSETTE AND DVD VIDEO PRODUCTION SERVICES FOR OTHERS, LIVE PERFORMANCES BY MUSICAL GROUPS, RECORDING STUDIOS, IN CLASS 41 (U.S. CLS. 100, 101 AND 107).

FIRST USE 9-27-2002; IN COMMERCE 9-27-2002.

SN 76-608,191, FILED 8-18-2004.

WILLIAM BRECKENFELD, EXAMINING ATTORNEY

Int. Cls.: 9, 25, and 41

Prior U.S. Cls.: 21, 22, 23, 26, 36, 38, 39, 100, 101, and 107

Reg. No. 3,398,886

United States Patent and Trademark Office

Registered Mar. 18, 2008

**TRADEMARK
SERVICE MARK
PRINCIPAL REGISTER**

BOOMTUNES

SALAAM REMI MUSIC, LLC (FLORIDA LIMITED LIABILITY CORPORATION)
555 NE 15TH STREET, SUITE 7719
MIAMI, FL 33132

FOR: PRE-RECORDED SOUND RECORDINGS AND AUDIO DEVICES, NAMELY, COMPACT DISCS, VIDEO DISCS, PHONOGRAPH RECORDS, VIDEO AND AUDIO CASSETTE TAPES AND MOTION PICTURES FEATURING MUSIC AND VOCAL PERFORMANCES, IN CLASS 9 (U.S. CLS. 21, 23, 26, 36 AND 38).

FIRST USE 7-17-2003; IN COMMERCE 2-27-2005.

FOR: HATS, T-SHIRTS, SWEAT SHIRTS, SWEAT PANTS, SWEATERS, WRISTS BANDS, HEAD-BANDS, JACKETS, SOCKS, SHOES AND LINGERIE, IN CLASS 25 (U.S. CLS. 22 AND 39).

FIRST USE 5-14-2007; IN COMMERCE 9-14-2007.

FOR: LIVE MUSIC AND VOCAL PERFORMANCES, SONGWRITING, MUSIC PRODUCTION, AUDIO RECORDING AND CASSETTE AND DVD VIDEO PRODUCTION SERVICES FOR OTHERS, LIVE PERFORMANCES BY MUSICAL GROUPS, RECORDING STUDIOS, IN CLASS 41 (U.S. CLS. 100, 101 AND 107).

FIRST USE 9-27-2002; IN COMMERCE 9-27-2002.

THE MARK CONSISTS OF STANDARD CHARACTERS WITHOUT CLAIM TO ANY PARTICULAR FONT, STYLE, SIZE, OR COLOR.

SN 76-608,192, FILED 8-18-2004.

WILLIAM BRECKENFELD, EXAMINING ATTORNEY

Int. Cls.: 5 and 44

Prior U.S. Cls.: 6, 18, 44, 46, 51, 52, 100, and 101

United States Patent and Trademark Office

Reg. No. 3,398,887

Registered Mar. 18, 2008

**TRADEMARK
SERVICE MARK
PRINCIPAL REGISTER**

THE GYM WMD, INC. (NEW JERSEY LTD LIAB
CO)
2 CHESTNUT RIDGE ROAD
MONTVALE, NJ 07645

FOR: VITAMIN SUPPLEMENTS, IN CLASS 5 (U.S.
CLS. 6, 18, 44, 46, 51 AND 52).

FIRST USE 12-14-2005; IN COMMERCE 12-14-2006.

FOR: WEIGHT REDUCTION DIET PLANNING
AND SUPERVISION FEATURING EXERCISE PRO-
GRAMS, IN CLASS 44 (U.S. CLS. 100 AND 101).

FIRST USE 12-14-2005; IN COMMERCE 12-14-2006.

THE MARK CONSISTS OF STANDARD CHAR-
ACTERS WITHOUT CLAIM TO ANY PARTICULAR
FONT, STYLE, SIZE, OR COLOR.

SN 76-608,451, FILED 8-24-2004.

WILLIAM BRECKENFELD, EXAMINING ATTOR-
NEY

Int. Cl.: 9

Prior U.S. Cls.: 21, 23, 26, 36, and 38

United States Patent and Trademark Office

Reg. No. 3,398,888

Registered Mar. 18, 2008

**TRADEMARK
PRINCIPAL REGISTER**

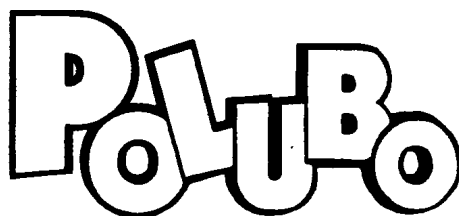

LUXPRO CORPORATION (TAIWAN CORPORATION)
3F., NO. 39, ALLEY 20, LANE 407
SEC. 2, TIDING BLVD.
NEIHU DISTRICT, TAIPEI CITY, TAIWAN 114

FOR: LANGUAGE LEARNING MACHINES, NAMELY, DIGITAL AUDIO PLAYERS CONTAINING STORAGE DEVICE SUCH AS MEMORIES OR HARD DISKS; PORTABLE LISTENING DEVICES, NAMELY, MP3 PLAYERS; ELECTRONIC POCKET DICTIONARIES; ELECTRONIC POCKET TRANSLATORS; ELECTRONIC PERSONAL ORGANIZERS; DIGITAL VIDEO DISC PLAYERS; VCD MACHINES; MUSICAL JUKE BOXES; ELECTRONIC PUBLICATIONS, NAMELY, BOOKS, MAGAZINES AND

MANUALS FEATURING LANGUAGE LEARNING, TRAVELLING, NOVELS AND COOKING RECORDED ON COMPUTER MEDIA; STEREO AMPLIFIERS; STEREO RECEIVERS; STEREO TUNERS; TELEVISION SETS; AUDIO CASSETTE RECORDERS; AUDIO TAPE RECORDERS; DIGITAL AUDIO PLAYERS; RADIOS; DIGITAL VIDEO RECORDERS; LOUDSPEAKERS; MICROPHONES, IN CLASS 9 (U.S. CLS. 21, 23, 26, 36 AND 38).

FIRST USE 8-14-2007; IN COMMERCE 8-14-2007.

SN 76-613,987, FILED 9-30-2004.

ALICE BENMAMAN, EXAMINING ATTORNEY

Int. Cl.: 5

Prior U.S. Cls.: 6, 18, 44, 46, 51, and 52

United States Patent and Trademark Office

Reg. No. 3,398,889

Registered Mar. 18, 2008

TRADEMARK
PRINCIPAL REGISTER



NATURE FRIEND, INC. (CALIFORNIA CORPORATION)
2211 S. HACIENDA BLVD., #208
HACIENDA HEIGHTS, CA 91745

FOR: SANITARY PADS, PANTY LINERS; ADULT DIAPERS; ALLERGY MEDICATIONS; BABY FOOD; BREAST PADS; CAFFEINE PREPARATIONS FOR STIMULATIVE USE; COUGH LOZENGES; COD LIVER OIL; AND CHOLESTEROL REDUCERS, IN CLASS 5 (U.S. CLS. 6, 18, 44, 46, 51 AND 52).

FIRST USE 10-31-2007; IN COMMERCE 10-31-2007.

OWNER OF U.S. REG. NOS. 2,594,168 AND 2,778,944.

THE MARK CONSISTS OF "NATURE FRIEND" AND DESIGN, WHEREIN THE DESIGN COMPRISES OF A MISCELLANEOUS DESIGN IS PLACED BESIDE THE STYLIZED WORDINGS "NATURE FRIEND," WHEREIN THE DESIGN COMPRISES A THE STYLIZED LETTERS "NHF".

SN 76-614,023, FILED 9-27-2004.

MARY ROSSMAN, EXAMINING ATTORNEY

Int. Cl.: 6

Prior U.S. Cls.: 2, 12, 13, 14, 23, 25, and 50

Reg. No. 3,398,890

United States Patent and Trademark Office

Registered Mar. 18, 2008

**TRADEMARK
PRINCIPAL REGISTER**

NuGroove

NUAIR MANUFACTURING COMPANY (FLOR-
IDA CORPORATION)
8105 ANDERSON ROAD
TAMPA, FL 33684

FOR: METAL WINDOWS AND WINDOW COM-
PONENTS, NAMELY, ADD-ON DECORATIVE
GRIDS, IN CLASS 6 (U.S. CLS. 2, 12, 13, 14, 23, 25
AND 50).

FIRST USE 1-1-2006; IN COMMERCE 1-1-2006.

THE MARK CONSISTS OF STANDARD CHAR-
ACTERS WITHOUT CLAIM TO ANY PARTICULAR
FONT, STYLE, SIZE, OR COLOR.

OWNER OF U.S. REG. NOS. 1,748,508, 2,778,506,
AND OTHERS.

SN 76-616,731, FILED 10-19-2004.

KEVIN DINALLO, EXAMINING ATTORNEY

Int. Cl.: 7

Prior U.S. Cls.: 13, 19, 21, 23, 31, 34, and 35

Reg. No. 3,398,891

United States Patent and Trademark Office

Registered Mar. 18, 2008

**TRADEMARK
PRINCIPAL REGISTER**

COUNT ON IT

THE GORMAN-RUPP COMPANY (OHIO CORPORATION)
305 BOWMAN STREET
MANSFIELD, OH 44903

FOR: INDUSTRIAL PUMPS, PUMPING APPARATUS, AND ACCESSORIES AND PARTS THEREFORE, NAMELY, CENTRIFUGAL PUMPS, SELF-PRIMING CENTRIFUGAL PUMPS, STRAIGHT CENTRIFUGAL PUMPS, REFUELLER PUMPS, SUBMERSIBLE PUMPS, DIAPHRAGM PUMPS, ROTARY GEAR PUMPS, SELF PRIMING GEAR PUMPS, POWER TAKE OFF PUMPS, IRRIGATION PUMPS, MULTI-STAGE HIGH PRESSURE PUMPS, SELF-PRIMING PETROLEUM PUMPS, AGRICULTURAL PUMPS, FIRE PUMPS, OSCILLATING PUMPS, ENGINE-DRIVEN PUMPS; SEWAGE PUMPING SYSTEMS, COMPRISING SELF-PRIMING CENTRIFUGAL SOLIDS HANDLING PUMPS,

MOTORS, CONTROLS, PIPING AND STATION ENCLOSURES FOR SEWAGE PUMPING SYSTEMS; PRESSURE BOOSTING PUMPING STATIONS, COMPRISING PUMPS, MOTORS, CONTROLS, PIPING, VALVES, AND ENCLOSURES FOR PUMPING STATIONS AND REPAIR PARTS FOR ALL OF THE ABOVE, IN CLASS 7 (U.S. CLS. 13, 19, 21, 23, 31, 34 AND 35).

FIRST USE 7-1-2006; IN COMMERCE 11-22-2006.

THE MARK CONSISTS OF STANDARD CHARACTERS WITHOUT CLAIM TO ANY PARTICULAR FONT, STYLE, SIZE, OR COLOR.

SN 76-617,633, FILED 10-26-2004.

IRA J. GOODSaid, EXAMINING ATTORNEY

Int. Cl.: 27

Prior U.S. Cls.: 19, 20, 37, 42, and 50

United States Patent and Trademark Office

Reg. No. 3,398,892

Registered Mar. 18, 2008

**TRADEMARK
PRINCIPAL REGISTER**

FREE LAY

TEXTILE RUBBER & CHEMICAL COMPANY,
INC. (GEORGIA CORPORATION)
1300 TIARCO DRIVE
DALTON, GA 30720

THE MARK CONSISTS OF STANDARD CHAR-
ACTERS WITHOUT CLAIM TO ANY PARTICULAR
FONT, STYLE, SIZE, OR COLOR.

FOR: CARPET AND FLOOR COVERINGS, IN
CLASS 27 (U.S. CLS. 19, 20, 37, 42 AND 50).

SN 76-619,654, FILED 11-8-2004.

FIRST USE 6-1-2007; IN COMMERCE 6-1-2007.

AMY GEARIN, EXAMINING ATTORNEY

Int. Cl.: 41

Prior U.S. Cls.: 100, 101, and 107

United States Patent and Trademark Office

Reg. No. 3,398,893

Registered Mar. 18, 2008

**SERVICE MARK
PRINCIPAL REGISTER**

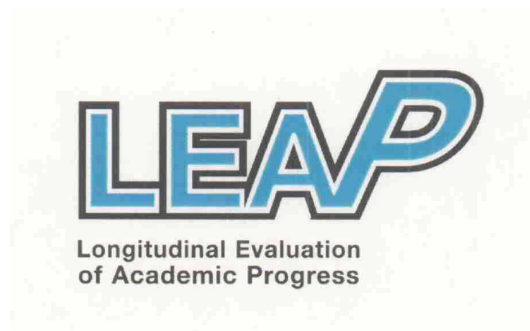

CONNECTIONS ACADEMY, LLC (DELAWARE
LTD LIAB CO)
1000 LANCASTER STREET
BALTIMORE, MD 21202

FOR: EDUCATIONAL SERVICES, NAMELY,
PROVIDING WEB-BASED EDUCATIONAL LEVEL
ASSESSMENT SERVICES, PROVIDING CUSTOMIZED
EDUCATIONAL PROGRAMS TO AID IN
THE INSTRUCTING OF STUDENTS AND CHILDREN
IN CONNECTION WITH CORE SCHOLASTIC
SUBJECTS SUCH AS READING, WRITING
AND MATH; PROVIDING AND ADMINISTERING
EDUCATIONAL ASSESSMENT TESTS AND ON-
LINE EDUCATIONAL ASSESSMENT TESTS TO
STUDENTS AND CHILDREN, IN CLASS 41 (U.S.
CLS. 100, 101 AND 107).

FIRST USE 11-0-2004; IN COMMERCE 11-0-2004.

NO CLAIM IS MADE TO THE EXCLUSIVE
RIGHT TO USE "EVALUATION OF ACADEMIC
PROGRESS", APART FROM THE MARK AS
SHOWN.

THE COLORS BLUE AND BLACK ARE
CLAIMED AS A FEATURE OF THE MARK.

THE COLOR BLUE APPEARS WITHIN THE
WORDING DESIGN OF "LEAP" OF THE MARK;
THE COLOR BLACK APPEARS IN THE OUTLINE
OF THE WORDING DESIGN OF "LEAP" AND IN
THE WORDING "LONGITUDINAL EVALUATION
OF ACADEMIC PROGRESS" OF THE MARK.

SN 76-622,655, FILED 11-30-2004.

DAWN HAN, EXAMINING ATTORNEY

Int. Cl.: 29

Prior U.S. Cl.: 46

United States Patent and Trademark Office

Reg. No. 3,398,894

Registered Mar. 18, 2008

TRADEMARK
PRINCIPAL REGISTER



SOL STIX, LLC (GEORGIA A LIMITED LIABILITY COMPANY)
P.O. BOX 119
MARBLE HILL, GA 30148

FOR: PREPARED MEALS CONSISTING PRIMARILY OF MEAT, FISH, POULTRY AND VEGETABLES, IN CLASS 29 (U.S. CL. 46).

FIRST USE 12-31-2005; IN COMMERCE 12-31-2005.

NO CLAIM IS MADE TO THE EXCLUSIVE RIGHT TO USE "GRILLED FOOD ON A STICK", APART FROM THE MARK AS SHOWN.

THE COLORS GRAY, BLACK, WHITE, PURPLE, YELLOW, RED, AND GREEN ARE CLAIMED AS A FEATURE OF THE MARK.

THE COLOR PURPLE APPEARS IN THE BACKGROUND OVAL. THE COLORS YELLOW, RED AND GREEN APPEAR IN THE STICKS. THE COLOR YELLOW APPEARS IN THE TERM "JUSTIX". THE COLOR WHITE APPEARS IN THE WORDS, "GRILLED FOOD ON A STICK". THE COLOR GRAY APPEARS AS A SHADOW OF THE LETTERS IN THE WORD "JUSTIX". THE COLOR BLACK APPEARS AS AN OUTLINE OF THE OVAL.

SN 76-623,668, FILED 12-8-2004.

DAYNA BROWNE, EXAMINING ATTORNEY

Int. Cl.: 28

Prior U.S. Cls.: 22, 23, 38, and 50

United States Patent and Trademark Office

Reg. No. 3,398,895

Registered Mar. 18, 2008

**TRADEMARK
PRINCIPAL REGISTER**

LOCK N LOAD

NALLEY, MARK (UNITED STATES INDIVIDUAL)
41373 AVENIDA DELORES
MURRIETA, CA 92562

THE MARK CONSISTS OF STANDARD CHARACTERS WITHOUT CLAIM TO ANY PARTICULAR FONT, STYLE, SIZE, OR COLOR.

FOR: PHYSICAL FITNESS EQUIPMENT, NAMELY, WEIGHT PLATES FOR WEIGHT LIFTING MACHINES, IN CLASS 28 (U.S. CLS. 22, 23, 38 AND 50).

SN 76-624,667, FILED 12-13-2004.

FIRST USE 5-4-2007; IN COMMERCE 5-4-2007.

RUDY R. SINGLETON, EXAMINING ATTORNEY

Int. Cl.: 12

Prior U.S. Cls.: 19, 21, 23, 31, 35, and 44

United States Patent and Trademark Office

Reg. No. 3,398,896

Registered Mar. 18, 2008

**TRADEMARK
PRINCIPAL REGISTER**

SOUTHSIDE CHOPPERS

LYONS, ROBERT L., III (UNITED STATES INDIVIDUAL)
14900 S. KOSTNER
MIDLOTHIAN, IL 60445

FOR: CUSTOM BUILT MOTORCYCLES; MOTORCYCLE STRUCTURAL PARTS, NAMELY, FRAMES, BRAKE PEDALS, KICK STANDS, FILLER PANELS, BELT GUARDS, RISERS, RISER CAPS, FRONT ENDS, ROLLING CHASSIS, PRIMARY DRIVE COVERS, MOTORCYCLE HANDLEBARS; MOTORCYCLE GAS TANKS; MOTORCYCLE FENDERS; MOTORCYCLE FORKS; AND MOTORCYCLE WHEEL RIMS, IN CLASS 12 (U.S. CLS. 19, 21, 23, 31, 35 AND 44).

FIRST USE 11-1-2004; IN COMMERCE 11-1-2004.

THE MARK CONSISTS OF STANDARD CHARACTERS WITHOUT CLAIM TO ANY PARTICULAR FONT, STYLE, SIZE, OR COLOR.

NO CLAIM IS MADE TO THE EXCLUSIVE RIGHT TO USE "CHOPPERS", APART FROM THE MARK AS SHOWN.

SN 76-628,759, FILED 1-21-2005.

DOMINICK J. SALEMI, EXAMINING ATTORNEY

Int. Cl.: 44

Prior U.S. Cls.: 100 and 101

United States Patent and Trademark Office

Reg. No. 3,398,897

Registered Mar. 18, 2008

**SERVICE MARK
PRINCIPAL REGISTER**

M-R ALPACAS RANCH, INC.

M-R-ALPACAS RANCH, INC (OHIO CORPORATION)

6431 STATE ROUTE 20

WAKEMAN, OH 44889

FOR: ALPACA BREEDING SERVICES, IN CLASS
44 (U.S. CLS. 100 AND 101).

FIRST USE 5-5-2006; IN COMMERCE 5-5-2006.

THE MARK CONSISTS OF STANDARD CHARACTERS WITHOUT CLAIM TO ANY PARTICULAR FONT, STYLE, SIZE, OR COLOR.

NO CLAIM IS MADE TO THE EXCLUSIVE RIGHT TO USE "ALPACAS RANCH, INC.", APART FROM THE MARK AS SHOWN.

SN 76-636,019, FILED 4-14-2005.

STEVEN R. FINE, EXAMINING ATTORNEY

Int. Cl.: 10

Prior U.S. Cls.: 26, 39, and 44

United States Patent and Trademark Office

Reg. No. 3,398,898

Registered Mar. 18, 2008

**TRADEMARK
PRINCIPAL REGISTER**

TRUFILL DCS ORBIT

CORDIS CORPORATION (FLORIDA CORPORATION)

14201 N.W. 60TH AVENUE

MIAMI LAKES, FL 33014

FOR: ARTIFICIAL MEDICAL EMBOLIZATION DEVICES, NAMELY, DETACHABLE COILS, IN CLASS 10 (U.S. CLS. 26, 39 AND 44).

FIRST USE 10-21-2003; IN COMMERCE 10-21-2003.

THE MARK CONSISTS OF STANDARD CHARACTERS WITHOUT CLAIM TO ANY PARTICULAR FONT, STYLE, SIZE, OR COLOR.

NO CLAIM IS MADE TO THE EXCLUSIVE RIGHT TO USE "DCS", APART FROM THE MARK AS SHOWN.

SN 76-637,115, FILED 4-26-2005.

MICHAEL LEWIS, EXAMINING ATTORNEY

Int. Cl.: 9

Prior U.S. Cls.: 21, 23, 26, 36, and 38

Reg. No. 3,398,899

United States Patent and Trademark Office

Registered Mar. 18, 2008

**TRADEMARK
PRINCIPAL REGISTER**

LAFFLINK

ENTERTAINMENT PROPERTIES HOLDINGS,
LTD. (FLORIDA CORPORATION)
13 HUDSON AVENUE
OCEAN RIDGE, FL 33435

FOR: DVD'S AND COMPUTER DIGITAL FILES
DOWNLOADABLE FROM A WEBSITE FEATUR-
ING PRERECORDED COMEDIC PERFORMANCES,
COMEDIC VIDEOS, JOKES, FUNNY COMMENTS
BY FAMOUS PEOPLE, FUNNY STORIES AND
COMEDY INDUSTRY NEWS, IN CLASS 9 (U.S.
CLS. 21, 23, 26, 36 AND 38).

FIRST USE 8-30-1999; IN COMMERCE 8-30-1999.

THE MARK CONSISTS OF STANDARD CHAR-
ACTERS WITHOUT CLAIM TO ANY PARTICULAR
FONT, STYLE, SIZE, OR COLOR.

SN 76-641,280, FILED 6-20-2005.

RICHARD A. STRASER, EXAMINING ATTORNEY

Int. Cls.: 20, 25, and 35

Prior U.S. Cls.: 2, 13, 22, 25, 32, 39, 50, 100, 101, and 102

United States Patent and Trademark Office

Reg. No. 3,398,900

Registered Mar. 18, 2008

**TRADEMARK
SERVICE MARK
PRINCIPAL REGISTER**

EQUUSTYLE

EQUUSTYLE, INC. (COLORADO CORPORATION)
400 CORPORATE CIRCLE, SUITE B
GOLDEN, CO 80401

FOR: PICTURE FRAMES AND PILLOWS, IN CLASS 20 (U.S. CLS. 2, 13, 22, 25, 32 AND 50).

FIRST USE 5-16-2007; IN COMMERCE 5-16-2007.

FOR: CLOTHING FOR MEN, WOMEN AND CHILDREN, NAMELY T-SHIRTS, SWEATSHIRTS, VESTS, SLEEPWEAR, HATS, CAPS, AND VISORS, IN CLASS 25 (U.S. CLS. 22 AND 39).

FIRST USE 5-16-2007; IN COMMERCE 5-16-2007.

FOR: RETAIL STORE SERVICES AND WHOLESALE STORES, FEATURING HOME FURNISHINGS, HOUSEWARES, FURNITURE, LEATHER GOODS, CLOTHING, CLOTHING ACCESSORIES, HEADWEAR, LUGGAGE, BAGS, ARTWORK, AND PRINTED MATTER, IN CLASS 35 (U.S. CLS. 100, 101 AND 102).

FIRST USE 5-8-2007; IN COMMERCE 5-24-2007.

THE MARK CONSISTS OF STANDARD CHARACTERS WITHOUT CLAIM TO ANY PARTICULAR FONT, STYLE, SIZE, OR COLOR.

SN 76-641,736, FILED 6-27-2005.

MATTHEW PAPPAS, EXAMINING ATTORNEY

Int. Cl.: 12

Prior U.S. Cls.: 19, 21, 23, 31, 35, and 44

Reg. No. 3,398,901

United States Patent and Trademark Office

Registered Mar. 18, 2008

**TRADEMARK
PRINCIPAL REGISTER**

The logo for F.tech features a stylized 'F' on the left, composed of a solid black vertical bar and a white triangle pointing left. To the right of the 'F' is a period, followed by the word 'tech' in a bold, lowercase, sans-serif font.

F.TECH INCORPORATION (JAPAN CORPORATION)
19, SHOWANUMA, SHOBU-MACHI
MINAMI-SAITAMA-GUN
SAITAMA, JAPAN

SHOCK ABSORBERS, SUSPENSIONS, SHOCK ABSORBING SPRINGS, SUSPENSION SPRINGS, AXLE SHAFTS, CLUTCHES, BRAKES, AND ACCELERATOR PEDALS, IN CLASS 12 (U.S. CLS. 19, 21, 23, 31, 35 AND 44).

FOR: AUTOMOBILES AND STRUCTURAL PARTS THEREFORE; TWO-WHEELED MOTOR VEHICLES AND THEIR STRUCTURAL PARTS THEREFORE; BICYCLES AND THEIR STRUCTURAL PARTS THEREFORE; MACHINE ELEMENTS FOR LAND VEHICLES, NAMELY, BODIES, CHASSIS, TORSION BARS, BUMPERS, COUPLINGS,

FIRST USE 6-5-2005; IN COMMERCE 6-5-2007.

SN 76-642,254, FILED 7-6-2005.

LOURDES AYALA, EXAMINING ATTORNEY

Int. Cl.: 7

Prior U.S. Cls.: 13, 19, 21, 23, 31, 34, and 35

Reg. No. 3,398,902

United States Patent and Trademark Office

Registered Mar. 18, 2008

**TRADEMARK
PRINCIPAL REGISTER**

ROAD BURNER

DG PERFORMANCE SPECIALTIES, INC (CALIFORNIA CORPORATION)
1230 LA LOMA CIRCLE
ANAHEIM, CA 92806

THE MARK CONSISTS OF STANDARD CHARACTERS WITHOUT CLAIM TO ANY PARTICULAR FONT, STYLE, SIZE, OR COLOR.

FOR: MOTORCYCLE EXHAUST SYSTEMS COMPRISED OF ENGINE MUFFLERS, EXHAUST PIPES, EXHAUST TIPS AND MOUNTING HARDWARE THEREFOR, IN CLASS 7 (U.S. CLS. 13, 19, 21, 23, 31, 34 AND 35).

OWNER OF U.S. REG. NO. 2,560,324.

SN 76-642,416, FILED 7-7-2005.

FIRST USE 4-30-2005; IN COMMERCE 3-8-2006.

ELLEN PERKINS, EXAMINING ATTORNEY

Int. Cls.: 9 and 28

Prior U.S. Cls.: 21, 22, 23, 26, 36, 38, and 50

United States Patent and Trademark Office

Reg. No. 3,398,903

Registered Mar. 18, 2008

**TRADEMARK
PRINCIPAL REGISTER**

GAPLUS

NAMCO BANDAI GAMES INC. (JAPAN CORPORATION)
2-1-21 YAGUCHI, OTA-KU
TOKYO, JAPAN 1468655

FOR: VIDEO GAME CARTRIDGES AND COMPUTER GAME PROGRAMS, IN CLASS 9 (U.S. CLS. 21, 23, 26, 36 AND 38).

FIRST USE 10-22-1996; IN COMMERCE 10-22-1996.

FOR: COIN-OPERATED AMUSEMENT GAME MACHINES, IN CLASS 28 (U.S. CLS. 22, 23, 38 AND 50).

FIRST USE 10-22-1996; IN COMMERCE 10-22-1996.

THE MARK CONSISTS OF STANDARD CHARACTERS WITHOUT CLAIM TO ANY PARTICULAR FONT, STYLE, SIZE, OR COLOR.

SN 76-644,246, FILED 8-4-2005.

MORGAN WYNNE, EXAMINING ATTORNEY

Int. Cl.: 30

Prior U.S. Cl.: 46

United States Patent and Trademark Office

Reg. No. 3,398,904

Registered Mar. 18, 2008

**TRADEMARK
PRINCIPAL REGISTER**

TODINNO GRAN ALMENDRADO

TODINNO S.A.C. (PERU CORPORATION)
AV. CIRCUNVALACION NO. 580
URB. LA CAPITANA HUACHIPA
LIMA 15, PERU

NO CLAIM IS MADE TO THE EXCLUSIVE
RIGHT TO USE "GRAN ALMENDRADO", APART
FROM THE MARK AS SHOWN.

FOR: PRODUCTS DERIVED FROM FLOUR,
NAMELY, SLICED LOAF OF BREAD IN ALL ITS
VARIETIES, SPONGE CAKES AS FRUIT ROLL
BREADS, IN CLASS 30 (U.S. CL. 46).

THE FOREIGN WORDING IN THE MARK
TRANSLATES INTO ENGLISH AS "GREAT AL-
MOND SHAPED".

FIRST USE 10-22-2007; IN COMMERCE 10-22-2007.

SN 76-645,107, FILED 8-17-2005.

THE MARK CONSISTS OF STANDARD CHAR-
ACTERS WITHOUT CLAIM TO ANY PARTICULAR
FONT, STYLE, SIZE, OR COLOR.

MATTHEW EINSTEIN, EXAMINING ATTORNEY

Int. Cl.: 16

Prior U.S. Cls.: 2, 5, 22, 23, 29, 37, 38, and 50

Reg. No. 3,398,905

United States Patent and Trademark Office

Registered Mar. 18, 2008

**TRADEMARK
PRINCIPAL REGISTER**

WOODESSEN

WOODESSEN, INC. (CALIFORNIA CORPORATION)
15121 GRAHAM STREET #103
HUNTINGTON BEACH, CA 92649

FOR: DESK SETS, NAMELY, PAPER HOLDERS, STATIONERY HOLDERS, TRAYS, TIDY IN THE NATURE OF A DESKTOP ORGANIZER, CALENDAR HOLDERS, PENHOLDERS AND GLOBES, IN CLASS 16 (U.S. CLS. 2, 5, 22, 23, 29, 37, 38 AND 50).

FIRST USE 1-13-2006; IN COMMERCE 3-15-2006.

THE MARK CONSISTS OF STANDARD CHARACTERS WITHOUT CLAIM TO ANY PARTICULAR FONT, STYLE, SIZE, OR COLOR.

SN 76-645,809, FILED 8-29-2005.

WILLIAM ROSSMAN, EXAMINING ATTORNEY

Int. Cl.: 29

Prior U.S. Cl.: 46

United States Patent and Trademark Office

Reg. No. 3,398,906

Registered Mar. 18, 2008

**TRADEMARK
PRINCIPAL REGISTER**

FEEDING AMERICA AND THE WORLD

CAPITOL WHOLESALE MEATS CORPORATION
(ILLINOIS CORPORATION)
911 WEST 37TH PLACE
CHICAGO, IL 60609

FOR: SAUSAGE, IN CLASS 29 (U.S. CL. 46).

FIRST USE 1-0-2006; IN COMMERCE 1-0-2006.

THE MARK CONSISTS OF STANDARD CHARACTERS WITHOUT CLAIM TO ANY PARTICULAR FONT, STYLE, SIZE, OR COLOR.

SN 76-646,358, FILED 9-7-2005.

WILLIAM BRECKENFELD, EXAMINING ATTORNEY

Int. Cl.: 11

Prior U.S. Cls.: 13, 21, 23, 31, and 34

United States Patent and Trademark Office

Reg. No. 3,398,907

Registered Mar. 18, 2008

**TRADEMARK
PRINCIPAL REGISTER**

XERICURE

THE DIAGNOSTIC GROUP, INC. (WISCONSIN CORPORATION)
2461 PROGRESS COURT
NEENAH, WI 549570412

THE MARK CONSISTS OF STANDARD CHARACTERS WITHOUT CLAIM TO ANY PARTICULAR FONT, STYLE, SIZE, OR COLOR.

FOR: DRYERS FOR EVAPORATING LIQUIDS FROM COATINGS, INKS AND SUBSTRATES ON MOVING PAPER, FILM AND FOIL FOR INDUSTRIAL USE, IN CLASS 11 (U.S. CLS. 13, 21, 23, 31 AND 34).

OWNER OF U.S. REG. NO. 1,729,154.

SN 76-646,579, FILED 9-12-2005.

FIRST USE 4-30-2007; IN COMMERCE 4-30-2007.

KIMBERLY FRYE, EXAMINING ATTORNEY

Int. Cl.: 9

Prior U.S. Cls.: 21, 23, 26, 36, and 38

United States Patent and Trademark Office

Reg. No. 3,398,908

Registered Mar. 18, 2008

**TRADEMARK
PRINCIPAL REGISTER**

WHITETAIL PRO LOG

WEEKEND WARRIOR PRODUCTIONS L.L.C.
(LOUISIANA LTD LIAB CO)
1476 WILLOW OAK
DENHAM SPRINGS, LA 70726

FOR: COMPUTER SOFTWARE FOR USE IN
MANAGEMENT OF WILDLIFE AND GAME, IN
CLASS 9 (U.S. CLS. 21, 23, 26, 36 AND 38).

FIRST USE 8-5-2006; IN COMMERCE 8-5-2006.

THE MARK CONSISTS OF STANDARD CHAR-
ACTERS WITHOUT CLAIM TO ANY PARTICULAR
FONT, STYLE, SIZE, OR COLOR.

NO CLAIM IS MADE TO THE EXCLUSIVE
RIGHT TO USE WHITETAIL AND LOG, APART
FROM THE MARK AS SHOWN.

SN 76-649,478, FILED 10-31-2005.

COLLEEN KEARNEY, EXAMINING ATTORNEY

Int. Cl.: 41

Prior U.S. Cls.: 100, 101, and 107

United States Patent and Trademark Office

Reg. No. 3,398,909

Registered Mar. 18, 2008

SERVICE MARK
PRINCIPAL REGISTER

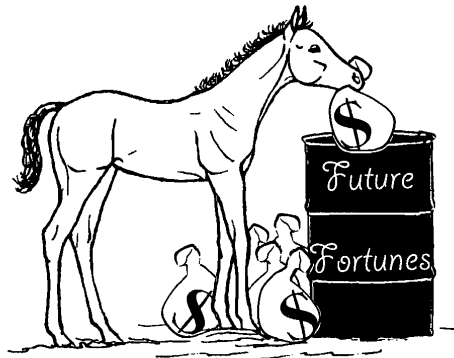

FUTURE FORTUNES, INC. (OHIO CORPORATION)
3116 GALLIPOLIS ROAD
OAK HILL, OH 45656

FOR: EQUINE INCENTIVE PROGRAMS, NAME-
LY, PROVIDING RECOGNITION AND AWARDS
TO REGISTERED FOALS AND STALLIONS AND
THEIR RIDERS, BREEDERS AND OWNERS TO
DEMONSTRATE EXCELLENCE IN THE FIELD OF

HORSE BREEDING AND PERFORMANCE, IN
CLASS 41 (U.S. CLS. 100, 101 AND 107).

FIRST USE 2-1-2003; IN COMMERCE 2-1-2003.

SN 76-649,584, FILED 11-1-2005.

PAUL F. GAST, EXAMINING ATTORNEY

Int. Cl.: 37

Prior U.S. Cls.: 100, 103, and 106

United States Patent and Trademark Office

Reg. No. 3,398,910

Registered Mar. 18, 2008

**SERVICE MARK
PRINCIPAL REGISTER**

800DILIGENT.com

DILIGENT ENVIRONMENTAL SERVICES, INC.
(FLORIDA CORPORATION)
3100 NW BOCA RATON BLVD.
SUITE 106
BOCA RATON, FL 33431

FOR: PEST AND TERMITE CONTROL SERVICES,
NAMELY RIDDING PROPERTY AND STRUC-
TURES OF TERMITES AND PESTS AND CON-
TROLLING AND PROTECTING SUCH PROPERTY
AND STRUCTURES AGAINST INFESTATION AND
RE-INFESTATION THROUGH THE USE OF CHE-

MICALS, GASES, TRAPS, AND OTHER DEVICES,
IN CLASS 37 (U.S. CLS. 100, 103 AND 106).

FIRST USE 9-10-2005; IN COMMERCE 1-14-2006.

THE MARK CONSISTS OF STANDARD CHAR-
ACTERS WITHOUT CLAIM TO ANY PARTICULAR
FONT, STYLE, SIZE, OR COLOR.

SN 76-650,413, FILED 11-16-2005.

BRIAN NEVILLE, EXAMINING ATTORNEY

Int. Cl.: 10

Prior U.S. Cls.: 26, 39, and 44

United States Patent and Trademark Office

Reg. No. 3,398,911

Registered Mar. 18, 2008

**TRADEMARK
PRINCIPAL REGISTER**

FCR CARBON

FUJIFILM CORPORATION (JAPAN CORPORATION)
26-30, NISHIAZABU 2-CHOME, MINATO-KU
TOKYO, JAPAN

FOR: MEDICAL DIAGNOSTIC APPARATUS,
NAMELY, DIGITAL X-RAY SYSTEMS FOR READING,
PROCESSING AND RECORDING DIAGNOSTIC IMAGES
BY RADIOGRAPHY, IN CLASS 10 (U.S. CLS. 26, 39 AND 44).

FIRST USE 11-0-2005; IN COMMERCE 11-0-2005.

THE MARK CONSISTS OF STANDARD CHARACTERS
WITHOUT CLAIM TO ANY PARTICULAR FONT,
STYLE, SIZE, OR COLOR.

SN 76-651,933, FILED 12-15-2005.

TEJBIR SINGH, EXAMINING ATTORNEY

Int. Cl.: 9

Prior U.S. Cls.: 21, 23, 26, 36, and 38

Reg. No. 3,398,912

United States Patent and Trademark Office

Registered Mar. 18, 2008

**TRADEMARK
PRINCIPAL REGISTER**



DIABLOSPORT, LLC (FLORIDA LTD LIAB CO)
3500 NW BOCA RATON BLVD
SUITE 504
BOCA RATON, FL 33431

FORCED INDUCTION TUNING AND OTHER EN-
GINE AND TRANSMISSION VEHICLE PARAME-
TERS, IN CLASS 9 (U.S. CLS. 21, 23, 26, 36 AND 38).

FIRST USE 8-22-2005; IN COMMERCE 8-0-2007.

OWNER OF U.S. REG. NO. 2,947,507.

SN 76-652,856, FILED 1-4-2006.

FOR: ELECTRONIC APPARATUS FOR USE
WITH A VEHICLE, NAMELY, AN ELECTRONIC
MASS AIR FLOW SENSOR INTERFACE ADAPTER
THAT ALLOWS RECALIBRATION AND CONTROL
OF OUTPUT SIGNALS FROM THE MASS AIR
FLOW SENSOR TO ADJUST AND SUPPORT

ALYSSA PALADINO, EXAMINING ATTORNEY

Int. Cl.: 21

Prior U.S. Cls.: 2, 13, 23, 29, 30, 33, 40, and 50

United States Patent and Trademark Office

Reg. No. 3,398,913

Registered Mar. 18, 2008

**TRADEMARK
PRINCIPAL REGISTER**

STAY FRESH

RESOURCEFUL PRODUCTS, INC. (THE RPI
GROUP) (DELAWARE CORPORATION)
31225 BAINBRIDGE ROAD, SUITE A
SOLON, OH 44139

THE MARK CONSISTS OF STANDARD CHAR-
ACTERS WITHOUT CLAIM TO ANY PARTICULAR
FONT, STYLE, SIZE, OR COLOR.

FOR: PLASTIC FOOD STORAGE CONTAINERS
FOR DOMESTIC USE, EXCLUDING PACKAGING
FOR MEAT AND POULTRY PRODUCTS, IN CLASS
21 (U.S. CLS. 2, 13, 23, 29, 30, 33, 40 AND 50).

SN 76-652,916, FILED 1-5-2006.

FIRST USE 1-5-2006; IN COMMERCE 1-5-2006.

DAVID COLLIER, EXAMINING ATTORNEY

Int. Cl.: 39

Prior U.S. Cls.: 100 and 105

United States Patent and Trademark Office

Reg. No. 3,398,914

Registered Mar. 18, 2008

**SERVICE MARK
PRINCIPAL REGISTER**



LONG, ANNE (UNITED STATES INDIVIDUAL)
9300 FITZ FOLLY DRIVE
GREAT FALLS, VA 22066

FOR: VALET PARKING; CAR PARKING; VEHICLE PARKING; PARKING GARAGE SERVICES; PARKING LOT SERVICES, IN CLASS 39 (U.S. CLS. 100 AND 105).

FIRST USE 4-1-2006; IN COMMERCE 4-1-2006.

NO CLAIM IS MADE TO THE EXCLUSIVE RIGHT TO USE "PARKING & TRANSPORTATION, CONVENIENCE AND EXCELLENCE", APART FROM THE MARK AS SHOWN.

THE MARK CONSISTS, IN PART, OF A DESIGN OF A STYLIZED SUN WITHIN A SHADED CIRCLE.

SN 76-653,278, FILED 1-12-2006.

ZHALEH DELANEY, EXAMINING ATTORNEY

Int. Cl.: 35

Prior U.S. Cls.: 100, 101, and 102

United States Patent and Trademark Office

Reg. No. 3,398,915

Registered Mar. 18, 2008

SERVICE MARK
PRINCIPAL REGISTER



LONG, ANNE (UNITED STATES INDIVIDUAL)
9300 FITZ FOLLY DRIVE
GREAT FALLS, VA 22066

FOR: BUSINESS OPERATION, BUSINESS ADMINISTRATION AND OFFICE FUNCTIONS; PROCUREMENT, NAMELY, PURCHASING OFFICE REQUISITES FOR INDUSTRIAL AND COMMERCIAL ENTERPRISES; RENTAL OF OFFICE EQUIPMENT FOR INDUSTRIAL AND COMMERCIAL ENTERPRISES; BUSINESS MANAGEMENT CONSULTING SERVICES RELATING TO SUPPLY CHAIN SOLUTIONS FOR INDUSTRIAL AND COMMERCIAL ENTERPRISES IN THE FIELD OF OFFICE REQUISITES, IN CLASS 35 (U.S. CLS. 100, 101 AND 102).

FIRST USE 4-1-2006; IN COMMERCE 4-1-2006.

NO CLAIM IS MADE TO THE EXCLUSIVE RIGHT TO USE "PARKING & TRANSPORTATION, CONVENIENCE AND EXCELLENCE", APART FROM THE MARK AS SHOWN.

THE MARK CONSISTS, IN PART, OF A DESIGN OF A STYLIZED SUN WITHIN A SHADED CIRCLE.

SN 76-653,280, FILED 1-12-2006.

ZHALEH DELANEY, EXAMINING ATTORNEY

Int. Cl.: 45

Prior U.S. Cls.: 100 and 101

United States Patent and Trademark Office

Reg. No. 3,398,916

Registered Mar. 18, 2008

SERVICE MARK
PRINCIPAL REGISTER



LONG, ANNE (UNITED STATES INDIVIDUAL)
9300 FITZ FOLLY DRIVE
GREAT FALLS, VA 22066

FOR: CONCIERGE SERVICES FOR OTHERS COMPRISING MAKING REQUESTED PERSONAL ARRANGEMENTS AND RESERVATIONS AND PROVIDING CUSTOMER-SPECIFIC INFORMATION TO MEET INDIVIDUAL NEEDS RENDERED TOGETHER IN AN APARTMENT COMPLEX, BUSINESS CONFERENCE, SHOPPING CENTER; HOTEL CONCIERGE SERVICES; CONTROL OF BUILDING ENVIRONMENTAL ACCESS AND SECURITY SYSTEMS; MONITORING BURGLAR AND SECURITY ALARMS; MONITORING OF COMPUTER SYSTEMS FOR SECURITY PURPOSES; MONITORING SECURITY SYSTEMS; SECURITY GUARD SERVI-

CES; SECURITY GUARDING FOR FACILITIES; SECURITY INSPECTION SERVICES FOR OTHERS, IN CLASS 45 (U.S. CLS. 100 AND 101).

FIRST USE 4-1-2006; IN COMMERCE 4-1-2006.

NO CLAIM IS MADE TO THE EXCLUSIVE RIGHT TO USE "PARKING & TRANSPORTATION, CONVENIENCE AND EXCELLENCE", APART FROM THE MARK AS SHOWN.

THE MARK CONSISTS, IN PART, OF A DESIGN OF A STYLIZED SUN WITHIN A SHADED CIRCLE.

SN 76-653,281, FILED 1-12-2006.

ZHALEH DELANEY, EXAMINING ATTORNEY

Int. Cl.: 35

Prior U.S. Cls.: 100, 101, and 102

United States Patent and Trademark Office

Reg. No. 3,398,917

Registered Mar. 18, 2008

**SERVICE MARK
PRINCIPAL REGISTER**



PARAMOUNT AUTOMOTIVE GROUP, LLC
(FLORIDA LTD LIAB CO), DBA TRUCK HEAVEN USA,
2452 ALAQUA DRIVE
LONGWOOD, FL 32779

NO CLAIM IS MADE TO THE EXCLUSIVE
RIGHT TO USE "TRUCK," "USA," AND "THE DE-
SIGN OF THE TRUCK", APART FROM THE MARK
AS SHOWN.

FOR: AUTOMOBILE DEALERSHIPS FEATUR-
ING TRUCKS AND AUTOMOBILES, IN CLASS 35
(U.S. CLS. 100, 101 AND 102).

SN 76-653,662, FILED 1-19-2006.

FIRST USE 2-0-2006; IN COMMERCE 2-0-2006.

MICHAEL LEWIS, EXAMINING ATTORNEY

Int. Cl.: 36

Prior U.S. Cls.: 100, 101, and 102

United States Patent and Trademark Office

Reg. No. 3,398,918

Registered Mar. 18, 2008

**SERVICE MARK
PRINCIPAL REGISTER**

TRUST ADMINISTRATIVE ADVANTAGE

MERRILL LYNCH & CO., INC. (DELAWARE CORPORATION)
4 WORLD FINANCIAL CENTER
NEW YORK, NY 10080

FOR: FINANCIAL SERVICES, NAMELY, THE OFFERING OF A TRUST ACCOUNT PROVIDING INVESTMENT SERVICES AND ADMINISTRATIVE ASSISTANCE TO INDIVIDUAL TRUSTEES, IN CLASS 36 (U.S. CLS. 100, 101 AND 102).

FIRST USE 4-1-2006; IN COMMERCE 4-1-2006.

THE MARK CONSISTS OF STANDARD CHARACTERS WITHOUT CLAIM TO ANY PARTICULAR FONT, STYLE, SIZE, OR COLOR.

NO CLAIM IS MADE TO THE EXCLUSIVE RIGHT TO USE "TRUST ADMINISTRATIVE", APART FROM THE MARK AS SHOWN.

SN 76-655,245, FILED 2-13-2006.

MYRIAH HABEEB, EXAMINING ATTORNEY

Int. Cl.: 16

Prior U.S. Cls.: 2, 5, 22, 23, 29, 37, 38, and 50

United States Patent and Trademark Office

Reg. No. 3,398,919

Registered Mar. 18, 2008

**TRADEMARK
PRINCIPAL REGISTER**

TRIFIT

KOTOBUKI & CO., LTD. (JAPAN CORPORATION)
OAZA KUJIRAI-138, KAWAGOE-SHI
SAITAMA-KEN, JAPAN

THE MARK CONSISTS OF STANDARD CHARACTERS WITHOUT CLAIM TO ANY PARTICULAR FONT, STYLE, SIZE, OR COLOR.

FOR: WRITING INSTRUMENTS, IN CLASS 16
(U.S. CLS. 2, 5, 22, 23, 29, 37, 38 AND 50).

SN 76-656,458, FILED 3-13-2006.

FIRST USE 10-23-2001; IN COMMERCE 1-21-2002.

JAMES A. RAUEN, EXAMINING ATTORNEY

Int. Cls.: 3 and 5

Prior U.S. Cls.: 1, 4, 6, 18, 44, 46, 50, 51, and 52

United States Patent and Trademark Office

Reg. No. 3,398,920

Registered Mar. 18, 2008

**TRADEMARK
PRINCIPAL REGISTER**

HEAL THYSELF

NOAH'S NATURALS, LLC (CALIFORNIA CORPORATION)
11400 W. OLYMPIC BLVD.
STE. 425
LOS ANGELES, CA 90064

FOR: AROMATHERAPY BODY CARE PRODUCTS, NAMELY, BODY LOTION, SHOWER GEL, CUTICLE CREAM, SHAMPOO, CONDITIONER, NON-MEDICATED LIP BALM, SOAP, BODY POLISH, BODY AND FOOT SCRUB AND NON-MEDICATED FOOT CREAM, IN CLASS 3 (U.S. CLS. 1, 4, 6, 50, 51 AND 52).

FIRST USE 10-1-2006; IN COMMERCE 10-1-2006.

FOR: ANALGESIC BALMS, IN CLASS 5 (U.S. CLS. 6, 18, 44, 46, 51 AND 52).

FIRST USE 10-1-2006; IN COMMERCE 10-1-2006.

SN 76-658,918, FILED 4-24-2006.

LA TONIA FISHER, EXAMINING ATTORNEY

Int. Cl.: 9

Prior U.S. Cls.: 21, 23, 26, 36, and 38

United States Patent and Trademark Office

Reg. No. 3,398,921

Registered Mar. 18, 2008

**TRADEMARK
PRINCIPAL REGISTER**

SENSORDAQ

VERNIER SOFTWARE & TECHNOLOGY LLC
(OREGON LTD LIAB CO)
13979 SW MILLIKAN WAY
BEAVERTON, OR 97005

FOR: USB INTERFACE DEVICE TO CONNECT PROBES, SENSORS, METERS, CONTROL UNITS, COUNTERS, AMPLIFIERS, MONITORING DEVICES, ELECTRODES, MOTION DETECTORS, BALANCE DEVICES, AND PHOTOGATES TO A COMPUTER TO RECORD DATA FOR USE IN ELEMENTARY, JUNIOR HIGH SCHOOL, HIGH SCHOOL, AND COLLEGE CLASSROOMS AND LA-

BORATORIES, IN CLASS 9 (U.S. CLS. 21, 23, 26, 36 AND 38).

FIRST USE 6-1-2006; IN COMMERCE 2-16-2007.

THE MARK CONSISTS OF STANDARD CHARACTERS WITHOUT CLAIM TO ANY PARTICULAR FONT, STYLE, SIZE, OR COLOR.

SN 76-659,313, FILED 5-1-2006.

MICHAEL ENGEL, EXAMINING ATTORNEY

Int. Cl.: 36

Prior U.S. Cls.: 100, 101, and 102

United States Patent and Trademark Office

Reg. No. 3,398,922

Registered Mar. 18, 2008

**SERVICE MARK
PRINCIPAL REGISTER**

FLORIDA LEISURE

FLORIDA LEISURE, INC (FLORIDA CORPORATION)

4920 W IRLO BRONSON MEMORIAL HIGHWAY
KISSIMMEE, FL 34746

FOR: REAL ESTATE SERVICES, NAMELY, REAL ESTATE MANAGEMENT, IN CLASS 36 (U.S. CLS. 100, 101 AND 102).

FIRST USE 1-1-2007; IN COMMERCE 1-1-2007.

THE MARK CONSISTS OF STANDARD CHARACTERS WITHOUT CLAIM TO ANY PARTICULAR FONT, STYLE, SIZE, OR COLOR.

NO CLAIM IS MADE TO THE EXCLUSIVE RIGHT TO USE "FLORIDA", APART FROM THE MARK AS SHOWN.

SN 76-659,353, FILED 5-1-2006.

ELLEN B. AWRICH, EXAMINING ATTORNEY

Int. Cls.: 29 and 32

Prior U.S. Cls.: 45, 46, and 48

United States Patent and Trademark Office

Reg. No. 3,398,923

Registered Mar. 18, 2008

TRADEMARK
PRINCIPAL REGISTER



TIM & ANDY LLC (PENNSYLVANIA LTD LIAB
CO)
1701 CAMP ROAD
MANHEIM, PA 17545

FOR: FRUIT-BASED FOOD BEVERAGES, IN
CLASS 29 (U.S. CL. 46).

FIRST USE 7-6-2006; IN COMMERCE 7-6-2006.

FOR: FROZEN FRUIT BEVERAGES; ICED FRUIT
BEVERAGES, IN CLASS 32 (U.S. CLS. 45, 46 AND 48).

FIRST USE 7-6-2006; IN COMMERCE 7-6-2006.

NO CLAIM IS MADE TO THE EXCLUSIVE
RIGHT TO USE "PURE FRUIT", APART FROM
THE MARK AS SHOWN.

THE COLOR(S) BLUE, WHITE, ORANGE, YEL-
LOW, RED, BLACK, GREEN, BROWN, AND PUR-

PLE IS/ARE CLAIMED AS A FEATURE OF THE
MARK.

THE COLOR BLUE APPEARS IN THE WORDS
"ORCHARD FREEZE". BETWEEN THE VERTICAL
ARRANGEMENT OF "ORCHARD FREEZE" IS AN
ORANGE SLICE THAT IS ORANGE AND YELLOW,
A RED APPLE WITH A BROWN STEM AND GREEN
LEAF THAT IS OUTLINED IN BLACK, AND PUR-
PLE GRAPES THAT ARE OUTLINED IN BLACK.
BEHIND THE WORDS "ORCHARD FREEZE" AND
FRUIT GRAPHIC IS A BLUE AND WHITE SNOW-
FLAKE. BENEATH THE SNOWFLAKE ARE THE
WORDS "PURE FRUIT. NATURALLY DELICIOUS".
WHICH ARE IN BLUE.

SN 76-659,717, FILED 5-8-2006.

ALYSSA PALADINO, EXAMINING ATTORNEY

Int. Cl.: 35

Prior U.S. Cls.: 100, 101, and 102

United States Patent and Trademark Office

Reg. No. 3,398,924

Registered Mar. 18, 2008

**SERVICE MARK
PRINCIPAL REGISTER**

MIGHTYDECK

AELERA CONSULTING CORPORATION (GEORGIA CORPORATION)
1005 ALDERMAN DRIVE, SUITE 205
ALPHARETTA, GA 30005

FOR: CONSULTING AND PROVIDING INFORMATION IN THE FIELDS OF MARKETING, BUSINESS OPERATIONS, BUSINESS DEVELOPMENT, BUSINESS NETWORKING AND BUSINESS COLLABORATION; INFORMATION GATHERING FOR BUSINESS AND TRADE PRACTICES AND ANALYSIS THEREOF, IN CLASS 35 (U.S. CLS. 100, 101 AND 102).

FIRST USE 6-12-2007; IN COMMERCE 6-12-2007.

THE MARK CONSISTS OF STANDARD CHARACTERS WITHOUT CLAIM TO ANY PARTICULAR FONT, STYLE, SIZE, OR COLOR.

SN 76-660,317, FILED 5-19-2006.

LESLEY LAMOTHE, EXAMINING ATTORNEY

Int. Cl.: 25

Prior U.S. Cls.: 22 and 39

United States Patent and Trademark Office

Reg. No. 3,398,925

Registered Mar. 18, 2008

**TRADEMARK
PRINCIPAL REGISTER**



PATTON, VALENE (UNITED STATES INDIVIDUAL)
2006 8TH AVE SE
PUYALLUP, WA 98372

FOR: PANTS, T-SHIRTS, IN CLASS 25 (U.S. CLS. 22 AND 39).

FIRST USE 9-19-2007; IN COMMERCE 9-19-2007.

THE COLOR(S) LIGHT BLUE, BLUE, BLACK, AND WHITE IS/ARE CLAIMED AS A FEATURE OF THE MARK.

THE COLOR LIGHT BLUE APPEARS IN PART OF THE BELLBOTTOM JEANS AND THE BELT LOOPS OF THE JEANS WHICH IS A REPRESENTATION OF

THE LETTER "A"; THE COLOR BLUE APPEARS IN THE FLARE OF THE BOTTOM OF THE BELLBOTTOM JEANS, WHICH REPRESENTS THE LETTER "A"; THE COLOR WHITE APPEARS AS DECORATIVE STARS IN THE FLARE OF THE BELLBOTTOMS WHICH REPRESENTS THE LETTER "A" AND AS THE BELT BUCKLE OF THE BELT; AND THE CORE BLACK APPEARS IN THE BELT OF THE JEANS WHICH IS REPRESENTED AS THE LETTER "A", IN THE SHOES, AND IN THE LETTERS V AND LENE.

SN 76-661,594, FILED 6-15-2006.

CARYN GLASSER, EXAMINING ATTORNEY

Int. Cl.: 12

Prior U.S. Cls.: 19, 21, 23, 31, 35, and 44

Reg. No. 3,398,926

United States Patent and Trademark Office

Registered Mar. 18, 2008

**TRADEMARK
PRINCIPAL REGISTER**



HT tires

QINGDAO HUATIAN HAND TRUCK LTD., LLC
(CHINA LTD LIAB CO)
YINZHU INDUSTRIAL ZONE, JIAONAN
QINGDAO, CHINA 266431

NO CLAIM IS MADE TO THE EXCLUSIVE
RIGHT TO USE "TIRES", APART FROM THE
MARK AS SHOWN.

FOR: WHEELS FOR WHEELBARROWS, GAR-
DEN CARTS, HANDTRUCKS AND LAWN MOW-
ERS, IN CLASS 12 (U.S. CLS. 19, 21, 23, 31, 35 AND 44).

SN 76-661,625, FILED 6-15-2006.

FIRST USE 11-30-2007; IN COMMERCE 11-30-2007.

BILL DAWE, EXAMINING ATTORNEY

Int. Cls.: 16 and 25

Prior U.S. Cls.: 2, 5, 22, 23, 29, 37, 38, 39, and 50

United States Patent and Trademark Office

Reg. No. 3,398,927

Registered Mar. 18, 2008

**TRADEMARK
PRINCIPAL REGISTER**



NORTH DAKOTA STATE UNIVERSITY OF
AGRICULTURE AND APPLIED SCIENCE
(NORTH DAKOTA STATE AGENCY)
OFFICE OF THE PRESIDENT
OLD MAIN 102, BOX 5167
FARGO, ND 581055167

FOR: EVENT PROGRAMS, GREETING CARDS,
LETTERHEAD PAPER, STATIONERY, STICKERS,
DECALS, BUMPER STICKERS, IN CLASS 16 (U.S.
CLS. 2, 5, 22, 23, 29, 37, 38 AND 50).

FIRST USE 7-11-2006; IN COMMERCE 7-11-2006.

FOR: PANTS, SHIRTS, SHORT-SLEEVED OR
LONG-SLEEVED T-SHIRTS, SWEAT SHIRTS, JACK-
ETS, HEADGEAR, NAMELY, HATS AND CAPS, IN
CLASS 25 (U.S. CLS. 22 AND 39).

FIRST USE 7-11-2006; IN COMMERCE 7-11-2006.

THE COLOR(S) GREEN, YELLOW, AND WHITE
IS/ARE CLAIMED AS A FEATURE OF THE MARK.

THE COLOR GREEN (PMS 343 GREEN) APPEARS
IN THE OUTLINES OF THE MARK. THE COLOR
YELLOW (PMS 123 YELLOW) APPEARS IN THE
FUR AREA OF THE HEAD. THE COLOR WHITE
APPEARS IN THE HORNS AND WHITES OF THE
EYES. (PMS = PANTONE MATCHING SYSTEM)

SN 76-661,895, FILED 6-16-2006.

CHRISTOPHER BUONGIORNO, EXAMINING AT-
TORNEY

Int. Cl.: 20

Prior U.S. Cls.: 2, 13, 22, 25, 32, and 50

United States Patent and Trademark Office

Reg. No. 3,398,928

Registered Mar. 18, 2008

**TRADEMARK
PRINCIPAL REGISTER**

ENERGY HEALTH SOLUTIONS

ADVANCED SLEEP CONCEPTS, INC. (DELA-
WARE CORPORATION)
195 CHATILLION DRIVE
ROME, GA 30163

THE MARK CONSISTS OF STANDARD CHAR-
ACTERS WITHOUT CLAIM TO ANY PARTICULAR
FONT, STYLE, SIZE, OR COLOR.

FOR: MATTRESSES, IN CLASS 20 (U.S. CLS. 2, 13,
22, 25, 32 AND 50).

SN 76-662,209, FILED 6-27-2006.

FIRST USE 2-0-2007; IN COMMERCE 2-0-2007.

REGINA DRUMMOND, EXAMINING ATTORNEY

Int. Cl.: 25

Prior U.S. Cls.: 22 and 39

United States Patent and Trademark Office

Reg. No. 3,398,929

Registered Mar. 18, 2008

**TRADEMARK
PRINCIPAL REGISTER**

PURE CARE

HOLT HOSIERY MILLS, INC. (NORTH CAROLINA CORPORATION)
P.O. BOX 1757
BURLINGTON, NC 272161757

THE MARK CONSISTS OF STANDARD CHARACTERS WITHOUT CLAIM TO ANY PARTICULAR FONT, STYLE, SIZE, OR COLOR.

FOR: HOSIERY PRODUCTS, NAMELY, MEN'S AND WOMEN'S SOCKS, PANTYHOSE, TIGHTS, KNEE HIGHS, THIGH HIGHS AND TROUSER SOCKS, IN CLASS 25 (U.S. CLS. 22 AND 39).

SN 76-662,777, FILED 7-10-2006.

FIRST USE 8-1-2006; IN COMMERCE 8-1-2006.

TRACY CROSS, EXAMINING ATTORNEY

Int. Cl.: 9

Prior U.S. Cls.: 21, 23, 26, 36, and 38

United States Patent and Trademark Office

Reg. No. 3,398,930

Registered Mar. 18, 2008

**TRADEMARK
PRINCIPAL REGISTER**

X MARKS THE SPOT

TROXLER ELECTRONIC LABORATORIES, INC.
(NORTH CAROLINA CORPORATION)
3008 CORNWALLIS ROAD
RESEARCH TRIANGLE PARK, NC 27709

FOR: ELECTRONIC INSTRUMENTS, NAMELY,
ELECTRONIC GAUGES FOR NONDESTRUCTIVE
TESTING OF SOIL, ASPHALT, AND CONCRETE;
ELECTRONIC INSTRUMENTS, NAMELY, ELEC-
TRONIC GAUGES FOR TESTING SOIL MOISTURE;
ELECTRONIC INSTRUMENTS, NAMELY, ELEC-
TRONIC GAUGES FOR TESTING ASPHALT AND

CONCRETE DENSITY, IN CLASS 9 (U.S. CLS. 21, 23,
26, 36 AND 38).

FIRST USE 12-18-2007; IN COMMERCE 12-18-2007.

THE MARK CONSISTS OF STANDARD CHAR-
ACTERS WITHOUT CLAIM TO ANY PARTICULAR
FONT, STYLE, SIZE, OR COLOR.

SN 76-663,961, FILED 8-1-2006.

MICHAEL WEBSTER, EXAMINING ATTORNEY

Int. Cl.: 35

Prior U.S. Cls.: 100, 101, and 102

United States Patent and Trademark Office

Reg. No. 3,398,931

Registered Mar. 18, 2008

**SERVICE MARK
PRINCIPAL REGISTER**

PHILADELPHIAATHOME

VERTASOURCE, LLC (NEW YORK LTD LIAB
CO)
403 MAIN STREET
SUITE 250
BUFFALO, NY 14203

FOR: PROVIDING ADVERTISING AND PUBLICITY SERVICES FOR OTHERS FEATURING INFORMATION ABOUT THE GOODS, SERVICES, EVENTS, ACTIVITIES, AND ATTRACTIONS OF OTHERS, IN A PARTICULAR GEOGRAPHIC REGION, NAMELY, PHILADELPHIA, PENNSYLVANIA, VIA A WEBSITE ON A GLOBAL COMPUTER

NETWORK, IN CLASS 35 (U.S. CLS. 100, 101 AND 102).

FIRST USE 8-20-2006; IN COMMERCE 8-20-2006.

THE MARK CONSISTS OF STANDARD CHARACTERS WITHOUT CLAIM TO ANY PARTICULAR FONT, STYLE, SIZE, OR COLOR.

SN 76-664,057, FILED 8-3-2006.

ODESSA BIBBINS, EXAMINING ATTORNEY

Int. Cl.: 35

Prior U.S. Cls.: 100, 101, and 102

United States Patent and Trademark Office

Reg. No. 3,398,932

Registered Mar. 18, 2008

**SERVICE MARK
PRINCIPAL REGISTER**

CHICAGOATHOME

VERTASOURCE, LLC (NEW YORK LTD LIAB
CO)
403 MAIN STREET
SUITE 250
BUFFALO, NY 14203

FOR: PROVIDING ADVERTISING AND PUBLICITY SERVICES FOR OTHERS FEATURING INFORMATION ABOUT THE GOODS, SERVICES, EVENTS, ACTIVITIES, AND ATTRACTIONS OF OTHERS, IN A PARTICULAR GEOGRAPHIC REGION, NAMELY, CHICAGO, ILLINOIS, VIA A WEB-

SITE ON A GLOBAL COMPUTER NETWORK, IN CLASS 35 (U.S. CLS. 100, 101 AND 102).

FIRST USE 7-17-2006; IN COMMERCE 7-17-2006.

THE MARK CONSISTS OF STANDARD CHARACTERS WITHOUT CLAIM TO ANY PARTICULAR FONT, STYLE, SIZE, OR COLOR.

SN 76-664,059, FILED 8-3-2006.

JOHN DALIER, EXAMINING ATTORNEY

Int. Cl.: 30

Prior U.S. Cl.: 46

United States Patent and Trademark Office

Reg. No. 3,398,933

Registered Mar. 18, 2008

TRADEMARK
PRINCIPAL REGISTER



TWIN HENS, INC. (NEW JERSEY CORPORATION)
P.O. BOX 543
PRINCETON, NJ 08542

FOR: POT PIES, IN CLASS 30 (U.S. CL. 46).

FIRST USE 8-0-2006; IN COMMERCE 8-0-2006.

OWNER OF U.S. REG. NO. 2,882,394.

NO CLAIM IS MADE TO THE EXCLUSIVE RIGHT TO USE "WHOLESOME & DELICIOUS POT PIES", APART FROM THE MARK AS SHOWN.

THE MARK CONSISTS OF THE WORDS "TWIN HENS WHOLESOME" & "DELICIOUS POT PIES FROM OUR KITCHEN TO YOURS" AND THE DEPICTION OF TWO CHICKENS.

SN 76-664,172, FILED 8-3-2006.

WANDA KAY PRICE, EXAMINING ATTORNEY

Int. Cl.: 5

Prior U.S. Cls.: 6, 18, 44, 46, 51, and 52

United States Patent and Trademark Office

Reg. No. 3,398,934

Registered Mar. 18, 2008

**TRADEMARK
PRINCIPAL REGISTER**

PETAMINS

PURE N.R.G. PRODUCTS, INC. (NEW JERSEY
CORPORATION)
10 STATION STREET
MANALAPAN, NJ 07726

THE MARK CONSISTS OF STANDARD CHAR-
ACTERS WITHOUT CLAIM TO ANY PARTICULAR
FONT, STYLE, SIZE, OR COLOR.

FOR: DOG AND CAT VITAMINS, MINERALS
AND FOOD SUPPLEMENTS, IN CLASS 5 (U.S. CLS.
6, 18, 44, 46, 51 AND 52).

SN 76-664,244, FILED 8-7-2006.

FIRST USE 6-1-2007; IN COMMERCE 6-1-2007.

MARY ROSSMAN, EXAMINING ATTORNEY

Int. Cl.: 16

Prior U.S. Cls.: 2, 5, 22, 23, 29, 37, 38, and 50

United States Patent and Trademark Office

Reg. No. 3,398,935

Registered Mar. 18, 2008

**TRADEMARK
PRINCIPAL REGISTER**

PRISM OF CONSCIOUSNESS

BEYOND MASK, INC. (DELAWARE CORPORATION)
336 RANDOLPH PLACE, NE
WASHINGTON, DC 20002

FOR: PRINTED EDUCATIONAL MATERIALS, NAMELY, ARTICLES, PRINTED INSTRUCTIONAL MATERIALS AND CHECKLISTS ON THE SUBJECT OF IDENTIFYING THE LEVEL OF CONSCIOUSNESS OF PERSONS PARTICIPATING IN CREATIVE ARTS AND CREATIVE ARTS THERAPY TRAINING FOR THE ENHANCEMENT OF INTEGRATION,

PERSONAL AND SPIRITUAL GROWTH, IN CLASS 16 (U.S. CLS. 2, 5, 22, 23, 29, 37, 38 AND 50).

FIRST USE 12-14-2007; IN COMMERCE 12-14-2007.

THE MARK CONSISTS OF STANDARD CHARACTERS WITHOUT CLAIM TO ANY PARTICULAR FONT, STYLE, SIZE, OR COLOR.

SN 76-664,542, FILED 8-14-2006.

DANNEAN HETZEL, EXAMINING ATTORNEY

Int. Cl.: 35

Prior U.S. Cls.: 100, 101, and 102

United States Patent and Trademark Office

Reg. No. 3,398,936

Registered Mar. 18, 2008

**SERVICE MARK
PRINCIPAL REGISTER**

BUYER HUNT

HAGUE, GREGORY D. (UNITED STATES INDIVIDUAL)
4656 E. FOOTHILLS DRIVE
PARADISE VALLEY, AZ 85253

FOR: DATA COMPILING, NAMELY, COMPILING A LISTING OF BUYER'S REQUIREMENTS WHICH IS THEN MADE AVAILABLE TO POTENTIAL PROPERTY SELLERS, IN CLASS 35 (U.S. CLS. 100, 101 AND 102).

FIRST USE 10-6-2007; IN COMMERCE 10-6-2007.

THE MARK CONSISTS OF STANDARD CHARACTERS WITHOUT CLAIM TO ANY PARTICULAR FONT, STYLE, SIZE, OR COLOR.

NO CLAIM IS MADE TO THE EXCLUSIVE RIGHT TO USE "BUYER", APART FROM THE MARK AS SHOWN.

SN 76-664,724, FILED 8-16-2006.

BRENDAN REGAN, EXAMINING ATTORNEY

Int. Cl.: 35

Prior U.S. Cls.: 100, 101, and 102

United States Patent and Trademark Office

Reg. No. 3,398,937

Registered Mar. 18, 2008

SERVICE MARK
PRINCIPAL REGISTER

NoBootLeg

THE TRUSTEES OF THE RODNEY A. HAMIL-
TON LIVING TRUST A CALIFORNIA TRUST,
COMPRISING RODNEY A. HAMILTON, A
UNITED STATES C (CALIFORNIA TRUST)
5250 W. CENTURY BLVD.
SUITE 315
LOS ANGELES, CA 90045

FOR: PROMOTING THE GOODS AND SERVICES
OF OTHERS THROUGH ON-LINE ORDERING
AND CATALOGING OF THOSE GOODS AND SER-
VICES, NAMELY, GENERAL MERCHANDISE, FI-
NANCE, MUSIC RECORDINGS, FOOD, MOVIES,
DVD'S, MULTI MEDIA PRODUCTS AND COMPU-

TER SOFTWARE, IN CLASS 35 (U.S. CLS. 100, 101
AND 102).

FIRST USE 10-30-2007; IN COMMERCE 10-30-2007.

THE MARK CONSISTS OF STANDARD CHAR-
ACTERS WITHOUT CLAIM TO ANY PARTICULAR
FONT, STYLE, SIZE, OR COLOR.

SN 76-664,844, FILED 8-18-2006.

BILL DAWE, EXAMINING ATTORNEY

Int. Cl.: 20

Prior U.S. Cls.: 2, 13, 22, 25, 32, and 50

Reg. No. 3,398,938

United States Patent and Trademark Office

Registered Mar. 18, 2008

**TRADEMARK
PRINCIPAL REGISTER**



LEE SNIJDERS DESIGNS (CALIFORNIA CORPORATION)
19933 ELM PLACE
PORTER RANCH, CA 91326

THE NAME LEE SNIJDERS IDENTIFIES A LIVING INDIVIDUAL WHOSE CONSENT IS OF RECORD.

FOR: FURNITURE, IN CLASS 20 (U.S. CLS. 2, 13, 22, 25, 32 AND 50).

SN 76-664,869, FILED 8-21-2006.

FIRST USE 3-15-2007; IN COMMERCE 3-15-2007.

MATTHEW EINSTEIN, EXAMINING ATTORNEY

Int. Cl.: 20

Prior U.S. Cls.: 2, 13, 22, 25, 32, and 50

United States Patent and Trademark Office

Reg. No. 3,398,939

Registered Mar. 18, 2008

**TRADEMARK
PRINCIPAL REGISTER**

LEE SNIJDERS DESIGNS

LEE SNIJDERS DESIGNS (CALIFORNIA CORPORATION)
19933 ELM PLACE
PORTER RANCH, CA 91326

NO CLAIM IS MADE TO THE EXCLUSIVE RIGHT TO USE "DESIGNS", APART FROM THE MARK AS SHOWN.

FOR: FURNITURE, IN CLASS 20 (U.S. CLS. 2, 13, 22, 25, 32 AND 50).

THE NAME "LEE SNIJDERS" IDENTIFIES A LIVING INDIVIDUAL WHOSE CONSENT IS OF RECORD.

FIRST USE 3-15-2007; IN COMMERCE 3-15-2007.

SN 76-665,718, FILED 9-7-2006.

THE MARK CONSISTS OF STANDARD CHARACTERS WITHOUT CLAIM TO ANY PARTICULAR FONT, STYLE, SIZE, OR COLOR.

MATTHEW EINSTEIN, EXAMINING ATTORNEY

Int. Cl.: 22

Prior U.S. Cls.: 1, 2, 7, 19, 22, 42, and 50

Reg. No. 3,398,940

United States Patent and Trademark Office

Registered Mar. 18, 2008

**TRADEMARK
PRINCIPAL REGISTER**

SAVAWN

KELLEY ORNAMENTAL IRON, LLC (ILLINOIS
LTD LIAB CO), DBA PEORIA AWNING,
3307 W. FARMINGTON RD.
PEORIA, IL 61604

FOR: WINDOW AWNINGS, IN CLASS 22 (U.S.
CLS. 1, 2, 7, 19, 22, 42 AND 50).

FIRST USE 6-15-2007; IN COMMERCE 6-15-2007.

THE MARK CONSISTS OF STANDARD CHAR-
ACTERS WITHOUT CLAIM TO ANY PARTICULAR
FONT, STYLE, SIZE, OR COLOR.

SN 76-665,851, FILED 9-11-2006.

REBECCA POVARCHUK, EXAMINING ATTOR-
NEY

Int. Cl.: 36

Prior U.S. Cls.: 100, 101, and 102

United States Patent and Trademark Office

Reg. No. 3,398,941

Registered Mar. 18, 2008

**SERVICE MARK
PRINCIPAL REGISTER**

CHELSEA STRATUS

735 AVENUE OF THE AMERICAS LLC (DELA-
WARE LTD LIAB CO)
100 BERWYN PARK
BERWYN, PA 19312

FOR: REAL ESTATE SERVICES, NAMELY, CON-
DOMINIUM BROKERAGE, IN CLASS 36 (U.S. CLS.
100, 101 AND 102).

FIRST USE 3-1-2007; IN COMMERCE 3-1-2007.

THE MARK CONSISTS OF STANDARD CHAR-
ACTERS WITHOUT CLAIM TO ANY PARTICULAR
FONT, STYLE, SIZE, OR COLOR.

NO CLAIM IS MADE TO THE EXCLUSIVE
RIGHT TO USE "CHELSEA", APART FROM THE
MARK AS SHOWN.

SN 76-666,287, FILED 9-19-2006.

BARBARA GAYNOR, EXAMINING ATTORNEY

Int. Cl.: 20

Prior U.S. Cls.: 2, 13, 22, 25, 32, and 50

Reg. No. 3,398,942

United States Patent and Trademark Office

Registered Mar. 18, 2008

**TRADEMARK
PRINCIPAL REGISTER**

MORNING STAR

L&P PROPERTY MANAGEMENT COMPANY
(DELAWARE CORPORATION)
4095 FIRESTONE BOULEVARD
SOUTH GATE, CA 90280

THE MARK CONSISTS OF STANDARD CHAR-
ACTERS WITHOUT CLAIM TO ANY PARTICULAR
FONT, STYLE, SIZE, OR COLOR.

FOR: SEATING FURNITURE, MATTRESSES
AND BOX SPRINGS, IN CLASS 20 (U.S. CLS. 2, 13,
22, 25, 32 AND 50).

SN 76-666,380, FILED 9-21-2006.

FIRST USE 7-11-2006; IN COMMERCE 7-11-2006.

KATHERINE CHANG, EXAMINING ATTORNEY

Int. Cl.: 20

Prior U.S. Cls.: 2, 13, 22, 25, 32, and 50

Reg. No. 3,398,943

United States Patent and Trademark Office

Registered Mar. 18, 2008

**TRADEMARK
PRINCIPAL REGISTER**

FIRST LIGHT

L&P PROPERTY MANAGEMENT COMPANY
(DELAWARE CORPORATION)
4095 FIRESTONE BOULEVARD
SOUTH GATE, CA 90280

THE MARK CONSISTS OF STANDARD CHAR-
ACTERS WITHOUT CLAIM TO ANY PARTICULAR
FONT, STYLE, SIZE, OR COLOR.

FOR: SEATING FURNITURE, MATTRESSES
AND BOX SPRINGS, IN CLASS 20 (U.S. CLS. 2, 13,
22, 25, 32 AND 50).

SN 76-666,381, FILED 9-21-2006.

FIRST USE 6-15-2006; IN COMMERCE 6-15-2006.

KATHERINE CHANG, EXAMINING ATTORNEY

Int. Cl.: 9

Prior U.S. Cls.: 21, 23, 26, 36, and 38

Reg. No. 3,398,944

United States Patent and Trademark Office

Registered Mar. 18, 2008

**TRADEMARK
PRINCIPAL REGISTER**

Hyper NA SMI

LITEL INSTRUMENTS (CALIFORNIA CORPORATION)
6142 NANCY RIDGE DRIVE, SUITE 102
SAN DIEGO, CA 92121

FOR: COMPONENTS OF OPTICAL INSTRUMENTS FOR USE IN THE SEMICONDUCTOR INDUSTRY, NAMELY, APPARATUS COMPRISED OF COMPUTER SOFTWARE FOR USE IN ANALYZING DATA RECEIVED FROM AN IMAGE CAPTURE TOOL AND IN-SITU IMAGING OBJECTIVES OF THE PINHOLE, REFRACTIVE OR REFLECTIVE KIND, IN THE SAME FORM FACTOR AS A STANDARD RETICLE FOR USE IN EXPOSING PHOTOGRAPHICALLY PREPARED PATTERNS ON PROJECTION IMAGING SYSTEMS THAT POTENTIALLY OPERATE AT NUMERICAL APERTURES

ABOVE ONE, AND IMAGES THAT ARE USED FOR MEASURING AND AIMING TO THE SURFACES OF WAFERS FOR USE IN MANUFACTURING OF INTEGRATED CIRCUITS, IN CLASS 9 (U.S. CLS. 21, 23, 26, 36 AND 38).

FIRST USE 1-1-2005; IN COMMERCE 6-1-2005.

THE MARK CONSISTS OF STANDARD CHARACTERS WITHOUT CLAIM TO ANY PARTICULAR FONT, STYLE, SIZE, OR COLOR.

SN 76-666,540, FILED 9-22-2006.

REBECCA GILBERT, EXAMINING ATTORNEY

Int. Cl.: 5

Prior U.S. Cls.: 6, 18, 44, 46, 51, and 52

Reg. No. 3,398,945

United States Patent and Trademark Office

Registered Mar. 18, 2008

**TRADEMARK
PRINCIPAL REGISTER**



SILVERADE LLC (NEW JERSEY LTD LIAB CO)
2 ELLISON AVENUE
EAST BRUNSWICK, NJ 08816

NO CLAIM IS MADE TO THE EXCLUSIVE
RIGHT TO USE "AG", APART FROM THE MARK
AS SHOWN.

FOR: COLLOIDAL SILVER MINERAL SUPPLE-
MENT, IN CLASS 5 (U.S. CLS. 6, 18, 44, 46, 51 AND 52).

SN 76-667,119, FILED 10-10-2006.

FIRST USE 5-1-2007; IN COMMERCE 5-1-2007.

BRENDAN MCCAULEY, EXAMINING ATTORNEY

Int. Cl.: 5

Prior U.S. Cls.: 6, 18, 44, 46, 51, and 52

United States Patent and Trademark Office

Reg. No. 3,398,946

Registered Mar. 18, 2008

**TRADEMARK
PRINCIPAL REGISTER**

SILVERADE

SILVERADE LLC (NEW JERSEY LTD LIAB CO)
2 ELLISON AVENUE
EAST BRUNSWICK, NJ 08816

THE MARK CONSISTS OF STANDARD CHARACTERS WITHOUT CLAIM TO ANY PARTICULAR FONT, STYLE, SIZE, OR COLOR.

FOR: COLLOIDAL SILVER MINERAL SUPPLEMENT, IN CLASS 5 (U.S. CLS. 6, 18, 44, 46, 51 AND 52).

SN 76-667,333, FILED 10-10-2006.

FIRST USE 5-1-2007; IN COMMERCE 5-1-2007.

BRENDAN MCCAULEY, EXAMINING ATTORNEY

Int. Cl.: 9

Prior U.S. Cls.: 21, 23, 26, 36, and 38

United States Patent and Trademark Office

Reg. No. 3,398,947

Registered Mar. 18, 2008

**TRADEMARK
PRINCIPAL REGISTER**

VISTA HRMS

PERSONNEL DATA SYSTEMS, INC. (PENNSYLVANIA CORPORATION), DBA PDS,
650 SENTRY PARKWAY, SUITE 200
BLUE BELL, PA 194222320

FOR: COMPUTER SOFTWARE FOR USE IN HUMAN RESOURCE MANAGEMENT, NAMELY, IN MAINTAINING PERSONNEL AND BENEFITS RECORDS AND IN PROCESSING PAYROLLS, IN CLASS 9 (U.S. CLS. 21, 23, 26, 36 AND 38).

FIRST USE 10-31-2007; IN COMMERCE 10-31-2007.

THE MARK CONSISTS OF STANDARD CHARACTERS WITHOUT CLAIM TO ANY PARTICULAR FONT, STYLE, SIZE, OR COLOR.

NO CLAIM IS MADE TO THE EXCLUSIVE RIGHT TO USE "HRMS", APART FROM THE MARK AS SHOWN.

SN 76-667,558, FILED 10-16-2006.

MARGERY A. TIERNEY, EXAMINING ATTORNEY

Int. Cl.: 19

Prior U.S. Cls.: 1, 12, 33, and 50

United States Patent and Trademark Office

Reg. No. 3,398,948

Registered Mar. 18, 2008

**TRADEMARK
PRINCIPAL REGISTER**

STAKWEL

BILCO COMPANY, THE (CONNECTICUT CORPORATION)
37 WATER STREET
WEST HAVEN, CT 06516

THE MARK CONSISTS OF STANDARD CHARACTERS WITHOUT CLAIM TO ANY PARTICULAR FONT, STYLE, SIZE, OR COLOR.

FOR: NON-METAL WINDOW WELLS, IN CLASS 19 (U.S. CLS. 1, 12, 33 AND 50).

SN 76-667,623, FILED 10-13-2006.

FIRST USE 4-2-2007; IN COMMERCE 4-2-2007.

MARGERY A. TIERNEY, EXAMINING ATTORNEY

Int. Cl.: 12

Prior U.S. Cls.: 19, 21, 23, 31, 35, and 44

United States Patent and Trademark Office

Reg. No. 3,398,949

Registered Mar. 18, 2008

**TRADEMARK
PRINCIPAL REGISTER**

LADDER LUGGER

AT CONCEPTS, INC. (ILLINOIS CORPORATION)
13254 HIAWATHA DRIVE
HOMER GLEN, IL 60491

NO CLAIM IS MADE TO THE EXCLUSIVE
RIGHT TO USE "LADDER", APART FROM THE
MARK AS SHOWN.

FOR: MON-MOTORIZED WHEELED CART
USED OF TRANSPORTING LONG OR OVERSIZED
OBJECTS, IN CLASS 12 (U.S. CLS. 19, 21, 23, 31, 35
AND 44).

SN 76-668,356, FILED 11-1-2006.

FIRST USE 10-10-2006; IN COMMERCE 10-10-2006.

KAREN BRACEY, EXAMINING ATTORNEY

Int. Cls.: 14 and 20

Prior U.S. Cls.: 2, 13, 22, 25, 27, 28, 32, and 50

United States Patent and Trademark Office

Reg. No. 3,398,950

Registered Mar. 18, 2008

**TRADEMARK
PRINCIPAL REGISTER**

HEROES CROSS

NINA CUSANELLI LLC (UNITED STATES LTD
LIAB CO)
14013 BIG BRANCH DRIVE
DAYTON, MD 21036

FOR: JEWELRY, NAMELY, NECKLACES AND
LAPEL PINS THAT ARE IN THE SHAPE OF
CROSSES AND THAT ARE REPRESENTATIONS
OF VARIOUS HEROES, IN CLASS 14 (U.S. CLS. 2, 27,
28 AND 50).

FIRST USE 1-1-2007; IN COMMERCE 1-1-2007.

FOR: SOFT, DECORATIVE WALL SCULPTURES
IN THE SHAPE OF CROSSES THAT REPRESENT
VARIOUS HEROES, AND DECORATIVE WALL
PLACQUES IN THE SHAPE OF CROSSES THAT

REPRESENT VARIOUS HEROES, IN CLASS 20 (U.S.
CLS. 2, 13, 22, 25, 32 AND 50).

FIRST USE 7-26-2007; IN COMMERCE 7-26-2007.

THE MARK CONSISTS OF STANDARD CHAR-
ACTERS WITHOUT CLAIM TO ANY PARTICULAR
FONT, STYLE, SIZE, OR COLOR.

NO CLAIM IS MADE TO THE EXCLUSIVE
RIGHT TO USE "CROSS", APART FROM THE
MARK AS SHOWN.

SN 76-668,823, FILED 11-13-2006.

INGA ERVIN, EXAMINING ATTORNEY

Int. Cl.: 28

Prior U.S. Cls.: 22, 23, 38, and 50

United States Patent and Trademark Office

Reg. No. 3,398,951

Registered Mar. 18, 2008

**TRADEMARK
PRINCIPAL REGISTER**

DAY TO DREAM SOOTHER

HASBRO, INC. (RHODE ISLAND CORPORATION)
1027 NEWPORT AVENUE
PAWTUCKET, RI 02862

THE MARK CONSISTS OF STANDARD CHARACTERS WITHOUT CLAIM TO ANY PARTICULAR FONT, STYLE, SIZE, OR COLOR.

FOR: INFANT MUSICAL CRIB TOYS, IN CLASS 28 (U.S. CLS. 22, 23, 38 AND 50).

SN 76-668,827, FILED 11-13-2006.

FIRST USE 7-13-2007; IN COMMERCE 7-13-2007.

TINA L. SNAPP, EXAMINING ATTORNEY

Int. Cl.: 37

Prior U.S. Cls.: 100, 103, and 106

United States Patent and Trademark Office

Reg. No. 3,398,952

Registered Mar. 18, 2008

**SERVICE MARK
PRINCIPAL REGISTER**

ROOTER 1

NORTH AMERICAN SERVICE GROUP, LLC
(MICHIGAN LTD LIAB CO)
37654 AMRHEIN ROAD
LIVONIA, MI 48150

FOR: MUNICIPAL, COMMERCIAL, INDUSTRIAL, AND RESIDENTIAL PLUMBING, SEWER, GREASE TRAP, AND DRAIN CLEANING SERVICES; SEWER LINE REPAIRS, IN CLASS 37 (U.S. CLS. 100, 103 AND 106).

FIRST USE 10-8-2007; IN COMMERCE 10-8-2007.

THE MARK CONSISTS OF STANDARD CHARACTERS WITHOUT CLAIM TO ANY PARTICULAR FONT, STYLE, SIZE, OR COLOR.

NO CLAIM IS MADE TO THE EXCLUSIVE RIGHT TO USE "ROOTER", APART FROM THE MARK AS SHOWN.

SN 76-670,677, FILED 12-22-2006.

SHAUNIA CARLYLE, EXAMINING ATTORNEY

Int. Cl.: 19

Prior U.S. Cls.: 1, 12, 33, and 50

United States Patent and Trademark Office

Reg. No. 3,398,953

Registered Mar. 18, 2008

**TRADEMARK
PRINCIPAL REGISTER**

DEFINITIONS

AWI LICENSING COMPANY (DELAWARE CORPORATION)
802 WEST STREET
WILMINGTON, DE 19801

THE MARK CONSISTS OF STANDARD CHARACTERS WITHOUT CLAIM TO ANY PARTICULAR FONT, STYLE, SIZE, OR COLOR.

FOR: NON-METAL DECORATIVE ROOM DIVIDER PANEL HUNG FROM THE CEILING PLANE, IN CLASS 19 (U.S. CLS. 1, 12, 33 AND 50).

SN 76-671,659, FILED 1-22-2007.

FIRST USE 2-0-2007; IN COMMERCE 6-0-2007.

ARETHA SOMERVILLE, EXAMINING ATTORNEY

Int. Cl.: 25

Prior U.S. Cls.: 22 and 39

United States Patent and Trademark Office

Reg. No. 3,398,954

Registered Mar. 18, 2008

**TRADEMARK
PRINCIPAL REGISTER**

HARDWATER WARE BY STRIKEMASTER

STRIKEMASTER CORPORATION (MINNESOTA
CORPORATION)
POST OFFICE BOX 567
BIG LAKE, MN 55309

OWNER OF U.S. REG. NO. 2,121,312.

FOR: OUTERWEAR CLOTHING, NAMELY,
HATS, VESTS AND JACKETS, IN CLASS 25 (U.S.
CLS. 22 AND 39).

NO CLAIM IS MADE TO THE EXCLUSIVE
RIGHT TO USE "WARE", APART FROM THE
MARK AS SHOWN.

FIRST USE 4-1-2007; IN COMMERCE 4-1-2007.

SN 76-672,370, FILED 2-7-2007.

THE MARK CONSISTS OF STANDARD CHAR-
ACTERS WITHOUT CLAIM TO ANY PARTICULAR
FONT, STYLE, SIZE, OR COLOR.

MICHELE SWAIN, EXAMINING ATTORNEY

Int. Cl.: 40

Prior U.S. Cls.: 100, 103, and 106

United States Patent and Trademark Office

Reg. No. 3,398,955

Registered Mar. 18, 2008

**SERVICE MARK
PRINCIPAL REGISTER**

CHILLTECH

CALIFORNIA CUSTOM FRUITS AND FLAVORS,
INC. (CALIFORNIA CORPORATION)
15800 TAPIA ST.
IRWINDALE, CA 91706

FIRST USE 6-18-2007; IN COMMERCE 6-18-2007.

FOR: CUSTOM MANUFACTURE OF FOOD PRODUCTS TO THE ORDER AND SPECIFICATION OF OTHERS, NAMELY, PROCESSED FRUIT BASES FOR THE DAIRY AND BAKERY INDUSTRIES MANUFACTURED BY COOLING FRUIT BASES FOR PURPOSES OF MAINTAINING FRUIT IDENTITY AND EXTENDING SHELF LIFE, IN CLASS 40 (U.S. CLS. 100, 103 AND 106).

THE MARK CONSISTS OF STANDARD CHARACTERS WITHOUT CLAIM TO ANY PARTICULAR FONT, STYLE, SIZE, OR COLOR.

SN 76-672,482, FILED 2-9-2007.

LEE-ANNE BERNS, EXAMINING ATTORNEY

Int. Cl.: 37

Prior U.S. Cls.: 100, 103, and 106

United States Patent and Trademark Office

Reg. No. 3,398,956

Registered Mar. 18, 2008

**SERVICE MARK
PRINCIPAL REGISTER**



CLEAN COMMANDO, LLC (TEXAS LTD LIAB
CO)
3209 DOLPHIN DRIVE
AUSTIN, TX 78704

FOR: CLEANING OF RESIDENTIAL HOUSES, IN
CLASS 37 (U.S. CLS. 100, 103 AND 106).

FIRST USE 1-1-2007; IN COMMERCE 1-1-2007.

THE MARK CONSISTS OF THE WORDS CLEAN
COMMANDO FIGHT DIRTY IN A STYLIZED FONT
BENEATH THE STYLIZED REPRESENTATION OF
A MAN HOLDING A BROOM AND FOUR SOAP
BUBBLES.

SN 76-673,444, FILED 3-1-2007.

ANTHONY RINKER, EXAMINING ATTORNEY

Int. Cl.: 14

Prior U.S. Cls.: 2, 27, 28, and 50

United States Patent and Trademark Office

Reg. No. 3,398,957

Registered Mar. 18, 2008

**TRADEMARK
PRINCIPAL REGISTER**

THE PURE CRYSTAL COLLECTION

WALGREEN CO. (ILLINOIS CORPORATION)

200 WILMOT ROAD

DEERFIELD, IL 60015

FOR: JEWELRY, IN CLASS 14 (U.S. CLS. 2, 27, 28
AND 50).

FIRST USE 9-12-2007; IN COMMERCE 9-12-2007.

THE MARK CONSISTS OF STANDARD CHAR-
ACTERS WITHOUT CLAIM TO ANY PARTICULAR
FONT, STYLE, SIZE, OR COLOR.

NO CLAIM IS MADE TO THE EXCLUSIVE
RIGHT TO USE "CRYSTAL COLLECTION", APART
FROM THE MARK AS SHOWN.

SN 76-673,661, FILED 3-6-2007.

JENNIFER MARTIN, EXAMINING ATTORNEY

Int. Cl.: 9

Prior U.S. Cls.: 21, 23, 26, 36, and 38

Reg. No. 3,398,958

United States Patent and Trademark Office

Registered Mar. 18, 2008

**TRADEMARK
PRINCIPAL REGISTER**

VisiLock

KING TECHNOLOGY OF MISSOURI, INC. (MISSOURI CORPORATION)
3801 LLOYD KING DRIVE
O'FALLON, MO 63368

THE MARK CONSISTS OF STANDARD CHARACTERS WITHOUT CLAIM TO ANY PARTICULAR FONT, STYLE, SIZE, OR COLOR.

FOR: WATERPROOF ELECTRICAL WIRE CONNECTION SPLICE BOX PRE-FILLED WITH WATERPROOFING SEALANT GEL, IN CLASS 9 (U.S. CLS. 21, 23, 26, 36 AND 38).

SN 76-673,998, FILED 3-13-2007.

FIRST USE 4-12-2007; IN COMMERCE 4-12-2007.

MARY CRAWFORD, EXAMINING ATTORNEY

Int. Cl.: 25

Prior U.S. Cls.: 22 and 39

United States Patent and Trademark Office

Reg. No. 3,398,959

Registered Mar. 18, 2008

**TRADEMARK
PRINCIPAL REGISTER**



TARA GRINNA, INC. (SOUTH CAROLINA CORPORATION)
2910 HIGHWAY 501 W
CONWAY, SC 29526

FOR: SWIMWEAR, T-SHIRTS, SKIRTS, SHORTS AND BELTS, IN CLASS 25 (U.S. CLS. 22 AND 39).

FIRST USE 8-1-2005; IN COMMERCE 8-1-2005.

NO CLAIM IS MADE TO THE EXCLUSIVE RIGHT TO USE "BIKINIS", APART FROM THE MARK AS SHOWN.

THE NAME KIRSTI GRINNA IDENTIFIES A LIVING INDIVIDUAL WHOSE CONSENT IS OF RECORD.

THE LITERAL PORTION OF THE MARK IS ENTIRELY OF THE ENGLISH LANGUAGE AND CONSISTS OF THE STYLIZED WORDING "KIRSTI GRINNA BIKINIS KGB".

SN 76-978,701, FILED 6-7-2004.

DANIEL CAPSHAW, EXAMINING ATTORNEY

Int. Cls.: 16 and 25

Prior U.S. Cls.: 2, 5, 22, 23, 29, 37, 38, 39, and 50

United States Patent and Trademark Office

Reg. No. 3,398,960

Registered Mar. 18, 2008

TRADEMARK
PRINCIPAL REGISTER



PROFESSIONAL BULL RIDERS, INC. (COLOR-
ADO CORPORATION)
6 SOUTH TEJON STREET
SUITE 700
COLORADO SPRINGS, CO 80903

FOR: PRINTED MATTER, NAMELY, POSTERS
AND BROCHURES ABOUT BULL RIDING, DEC-
ALS, BUMPER STICKERS, CALENDARS, PENS
AND NEWSPAPERS AND MAGAZINES ABOUT
BULL RIDING, IN CLASS 16 (U.S. CLS. 2, 5, 22, 23,
29, 37, 38 AND 50).

FIRST USE 7-31-2006; IN COMMERCE 7-31-2006.

FOR: CLOTHING FOR MEN AND WOMEN,
NAMELY, SHIRTS, SWEATSHIRTS, BASEBALL

STYLE CAPS AND JACKETS, IN CLASS 25 (U.S.
CLS. 22 AND 39).

FIRST USE 10-31-2006; IN COMMERCE 10-31-2006.

NO CLAIM IS MADE TO THE EXCLUSIVE
RIGHT TO USE "8 SECOND" FOR "TRADING
CARD GAMES" IN INTERNATIONAL CLASSES 28
AND 41 ONLY, APART FROM THE MARK AS
SHOWN.

THE STIPPLING IS FOR SHADING PURPOSES.

SN 76-978,735, FILED 6-3-2005.

JULIE GUTTADAURO, EXAMINING ATTORNEY

Int. Cls.: 29 and 30

Prior U.S. Cl.: 46

United States Patent and Trademark Office

Reg. No. 3,398,961

Registered Mar. 18, 2008

**TRADEMARK
PRINCIPAL REGISTER**

CREATE AN OCCASION

TRADEMARK MANAGEMENT COMPANY (DE-
LAWARE CORPORATION)
2541 NORTH STOKESBERRY PLACE, SUITE 100
MERIDIAN, ID 83642

FOR: APPETIZERS AND HORS D'OEUVRES
CONSISTING OF MEATS, POULTRY, FISH,
FRUITS, VEGETABLES, MUSHROOMS AND
CHEESE, IN CLASS 29 (U.S. CL. 46).

FIRST USE 9-15-2007; IN COMMERCE 9-15-2007.

FOR: APPETIZERS AND HORS D'OEUVRES
CONSISTING OF PASTRY, BREAD AND DOUGH;

BAKERY DESSERTS; DESSERT MOUSSE, PUD-
DINGS, AND SOUFFLES, IN CLASS 30 (U.S. CL. 46).

FIRST USE 7-30-2007; IN COMMERCE 7-30-2007.

THE MARK CONSISTS OF STANDARD CHAR-
ACTERS WITHOUT CLAIM TO ANY PARTICULAR
FONT, STYLE, SIZE, OR COLOR.

SN 77-000,092, FILED 9-15-2006.

FRANK LATTUCA, EXAMINING ATTORNEY

Int. Cl.: 25

Prior U.S. Cls.: 22 and 39

United States Patent and Trademark Office

Reg. No. 3,398,962

Registered Mar. 18, 2008

TRADEMARK
PRINCIPAL REGISTER



CHERISE, LLC (CONNECTICUT LTD LIAB CO)
458 ROCK RIMMON ROAD
STAMFORD, CT 06903

FOR: CLOTHING, NAMELY, BERETS, BERMUDA SHORTS, BLOUSES, BOLEROS, BOTTOMS, CAPES, CARDIGANS, COATS, COVERALLS, DRESSES, FROCKS, GLOVES, HALTER TOPS, HEAD WEAR, JACKETS, JEANS, JOGGING SUITS, JUMPERS, JUMPSUITS, LEGGINGS, MITTENS, MUFFLERS, OVERALLS, PANTIES, PANTS, PEDAL PUSHERS, PONCHOS, PULLOVERS, VESTS, ROMPERS, SARONGS, SCARVES, SHIRTS, SHORTALLS, SHORTS, SKIRTS, SKORTS, JOGGING SUITS, PAN-

TIES, SWEAT SUITS, SUSPENDERS, SWEAT PANTS, SWEAT SHORTS, SWEAT SHIRTS, SWEATERS, TIGHTS, UNDERWEAR, UNDERSHIRTS, UNDERGARMENTS; FOOTWEAR, IN CLASS 25 (U.S. CLS. 22 AND 39).

FIRST USE 3-7-2007; IN COMMERCE 3-7-2007.

THE MARK CONSISTS OF THE WORD CHERISE & DESIGN.

SN 77-000,746, FILED 9-15-2006.

ATTIYA MALIK, EXAMINING ATTORNEY

Int. Cl.: 10

Prior U.S. Cls.: 26, 39, and 44

United States Patent and Trademark Office

Reg. No. 3,398,963

Registered Mar. 18, 2008

**TRADEMARK
PRINCIPAL REGISTER**

SILIQUE

REGENCY INTERNATIONAL MARKETING,
LLC (NEVADA LTD LIAB CO)
800 N. RAINBOW BLVD., STE. 174
LAS VEGAS, NV 89107

THE MARK CONSISTS OF STANDARD CHAR-
ACTERS WITHOUT CLAIM TO ANY PARTICULAR
FONT, STYLE, SIZE, OR COLOR.

FOR: BREAST PROSTHESES, IN CLASS 10 (U.S.
CLS. 26, 39 AND 44).

SN 77-000,956, FILED 9-15-2006.

FIRST USE 5-8-2007; IN COMMERCE 5-8-2007.

ANNE E. GUSTASON, EXAMINING ATTORNEY

Int. Cl.: 10

Prior U.S. Cls.: 26, 39, and 44

United States Patent and Trademark Office

Reg. No. 3,398,964

Registered Mar. 18, 2008

TRADEMARK
PRINCIPAL REGISTER

Silique
designed for a new you

REGENCY INTERNATIONAL MARKETING,
LLC (NEVADA LTD LIAB CO)
800 N. RAINBOW BLVD., STE. 174
LAS VEGAS, NV 89107

THE MARK CONSISTS OF SILIQUE DESIGNED
FOR A NEW YOU WITH HEART DESIGN.

FOR: BREAST PROSTHESES, IN CLASS 10 (U.S.
CLS. 26, 39 AND 44).

SN 77-000,968, FILED 9-15-2006.

FIRST USE 5-8-2007; IN COMMERCE 5-8-2007.

ANNE E. GUSTASON, EXAMINING ATTORNEY

Int. Cl.: 17

Prior U.S. Cls.: 1, 5, 12, 13, 35, and 50

United States Patent and Trademark Office

Reg. No. 3,398,965

Registered Mar. 18, 2008

**TRADEMARK
PRINCIPAL REGISTER**

INR

REINOSO-RODRIGUEZ, CESAR TULIO (CO-
LOMBIA INDIVIDUAL)
CARRERA 27 NO. 65-39
BOGOTÁ DC, COLOMBIA

FOR: CONNECTING HOSES FOR VEHICLE RA-
DIATORS; FLEXIBLE PLASTIC HOSES FOR USE IN
VENTILATION; FLOATING ANTI-POLLUTION
BARRIERS; HOSES FOR AIR CONDITIONERS
MADE OF RUBBER OR PLASTIC; INSULATING
PAINT; NON-METAL TUBING AND TUBING COU-
PLINGS FOR JOINING AND TERMINATING PIPES;
RUBBER TUBES AND PIPES; SEMI-PROCESSED
PLASTIC IN THE FORM OF FILMS, SHEETS,

TUBES, BARS, OR RODS; VEHICLE RADIATOR
CONNECTING HOSES, IN CLASS 17 (U.S. CLS. 1, 5,
12, 13, 35 AND 50).

FIRST USE 12-31-1996; IN COMMERCE 12-31-2004.

THE MARK CONSISTS OF STANDARD CHAR-
ACTERS WITHOUT CLAIM TO ANY PARTICULAR
FONT, STYLE, SIZE, OR COLOR.

SN 77-001,246, FILED 9-18-2006.

KATHERINE CHANG, EXAMINING ATTORNEY

Int. Cl.: 9

Prior U.S. Cls.: 21, 23, 26, 36, and 38

United States Patent and Trademark Office

Reg. No. 3,398,966

Registered Mar. 18, 2008

**TRADEMARK
PRINCIPAL REGISTER**

LOKNLITE

HI-TECH ELECTRONIC DISPLAYS, INC. (FLOR-
IDA CORPORATION)
13900 US HWY 19 NORTH
CLEARWATER, FL 33764

THE MARK CONSISTS OF STANDARD CHAR-
ACTERS WITHOUT CLAIM TO ANY PARTICULAR
FONT, STYLE, SIZE, OR COLOR.

FOR: LIGHT EMITTING DIODE DISPLAYS, IN
CLASS 9 (U.S. CLS. 21, 23, 26, 36 AND 38).

SN 77-001,969, FILED 9-19-2006.

FIRST USE 7-17-2007; IN COMMERCE 7-17-2007.

BRENDAN MCCAULEY, EXAMINING ATTORNEY

Int. Cl.: 32

Prior U.S. Cls.: 45, 46, and 48

United States Patent and Trademark Office

Reg. No. 3,398,967

Registered Mar. 18, 2008

TRADEMARK
PRINCIPAL REGISTER



HURRICANE JUICE COMPANY, LLC (DELA-
WARE LTD LIAB CO)
3947 CLARK ROAD
SARASOTA, FL 34233

THE MARK CONSISTS OF STYLIZED EQ OFF-
SET FROM EACH OTHER WITH THE WORDS
THIRST EQUALIZER UNDER THE STYLIZED E.

FOR: FRUIT DRINKS; FRUIT-FLAVORED
DRINKS; SPORTS DRINKS, IN CLASS 32 (U.S. CLS.
45, 46 AND 48).

SN 77-002,155, FILED 9-19-2006.

FIRST USE 1-10-2007; IN COMMERCE 1-10-2007.

KAREN BRACEY, EXAMINING ATTORNEY

Int. Cl.: 7

Prior U.S. Cls.: 13, 19, 21, 23, 31, 34, and 35

Reg. No. 3,398,968

United States Patent and Trademark Office

Registered Mar. 18, 2008

**TRADEMARK
PRINCIPAL REGISTER**

SOFTLINE

WASHTEC HOLDING GMBH (FED REP GER-
MANY CORPORATION)
ARGONSTRABE 7
AUGSBURG, FED REP GERMANY 86153

FOR: CAR WASHING EQUIPMENT, NAMELY,
AUTOMATIC TUNNEL AND CONVEYOR-STYLE
MACHINES FOR WASHING, WAXING AND DRY-
ING THE EXTERIOR SURFACE OF AN AUTOMO-
TIVE VEHICLE AND VACUUMING THE INTERIOR
OF SUCH VEHICLE, AND COMPONENT PARTS
THEREOF, IN CLASS 7 (U.S. CLS. 13, 19, 21, 23, 31, 34
AND 35).

FIRST USE 10-9-2007; IN COMMERCE 10-23-2007.

THE MARK CONSISTS OF STANDARD CHAR-
ACTERS WITHOUT CLAIM TO ANY PARTICULAR
FONT, STYLE, SIZE, OR COLOR.

SN 77-002,929, FILED 9-20-2006.

SCOTT SISUN, EXAMINING ATTORNEY

Int. Cl.: 41

Prior U.S. Cls.: 100, 101, and 107

United States Patent and Trademark Office

Reg. No. 3,398,969

Registered Mar. 18, 2008

**SERVICE MARK
PRINCIPAL REGISTER**

ONE PUNK UNDER GOD

SUNDANCE CHANNEL, LLC (DELAWARE LTD
LIAB CO)
1633 BROADWAY
NEW YORK, NY 10020

FOR: ENTERTAINMENT SERVICES IN THE
NATURE OF A DOCUMENTARY TELEVISION
SERIES; ENTERTAINMENT SERVICES, NAMELY,
PROVIDING INFORMATION RELATED TO A DOC-
UMENTARY SERIES VIA THE GLOBAL COMPU-
TER NETWORK, IN CLASS 41 (U.S. CLS. 100, 101
AND 107).

FIRST USE 12-13-2006; IN COMMERCE 12-13-2006.

THE MARK CONSISTS OF STANDARD CHAR-
ACTERS WITHOUT CLAIM TO ANY PARTICULAR
FONT, STYLE, SIZE, OR COLOR.

SN 77-003,638, FILED 9-20-2006.

JUSTINE D. PARKER, EXAMINING ATTORNEY

Int. Cl.: 28

Prior U.S. Cls.: 22, 23, 38, and 50

United States Patent and Trademark Office

Reg. No. 3,398,970

Registered Mar. 18, 2008

**TRADEMARK
PRINCIPAL REGISTER**

BIGFOOT

SOLARI GOLF, INC. (CALIFORNIA CORPORATION)
101 MONTREAL STREET
MARINA DEL REY, CA 90293

THE MARK CONSISTS OF STANDARD CHARACTERS WITHOUT CLAIM TO ANY PARTICULAR FONT, STYLE, SIZE, OR COLOR.

FOR: GOLF CLUB ACCESSORIES, NAMELY, GOLF PUTTERS, IN CLASS 28 (U.S. CLS. 22, 23, 38 AND 50).

SN 77-003,762, FILED 9-20-2006.

FIRST USE 1-31-2006; IN COMMERCE 1-31-2006.

ODESSA BIBBINS, EXAMINING ATTORNEY

Int. Cl.: 25

Prior U.S. Cls.: 22 and 39

United States Patent and Trademark Office

Reg. No. 3,398,971

Registered Mar. 18, 2008

**TRADEMARK
PRINCIPAL REGISTER**

ROCK & ROLL COWGIRL

WESTMOOR MFG. CO. (MINNESOTA COR-
PORATION)
4901 N. FREEWAY
P.O. BOX 162749
FT. WORT, TX 761612749

THE MARK CONSISTS OF STANDARD CHAR-
ACTERS WITHOUT CLAIM TO ANY PARTICULAR
FONT, STYLE, SIZE, OR COLOR.

FOR: BLOUSES; BOTTOMS; COATS; FOOTWEAR;
HEAD WEAR; PANTS; SHIRTS; SHORTS; SKIRTS; T-
SHIRTS; TOPS, IN CLASS 25 (U.S. CLS. 22 AND 39).

SN 77-004,035, FILED 9-21-2006.

FIRST USE 12-0-2006; IN COMMERCE 12-0-2006.

DAVID C. REIHNER, EXAMINING ATTORNEY

Int. Cl.: 25

Prior U.S. Cls.: 22 and 39

United States Patent and Trademark Office

Reg. No. 3,398,972

Registered Mar. 18, 2008

**TRADEMARK
PRINCIPAL REGISTER**

ROCK & ROLL COWBOY

WESTMOOR MFG. CO. (MINNESOTA COR-
PORATION)
4901 N. FREEWAY
P.O. BOX 162749
FT. WORT, TX 761612749

FOR: COATS; HEAD WEAR; SHIRTS; T-SHIRTS;
TOPS, IN CLASS 25 (U.S. CLS. 22 AND 39).

FIRST USE 12-0-2006; IN COMMERCE 12-0-2006.

THE MARK CONSISTS OF STANDARD CHAR-
ACTERS WITHOUT CLAIM TO ANY PARTICULAR
FONT, STYLE, SIZE, OR COLOR.

OWNER OF U.S. REG. NO. 1,958,194.

SN 77-004,042, FILED 9-21-2006.

DAVID C. REIHNER, EXAMINING ATTORNEY

Int. Cl.: 5

Prior U.S. Cls.: 6, 18, 44, 46, 51, and 52

United States Patent and Trademark Office

Reg. No. 3,398,973

Registered Mar. 18, 2008

**TRADEMARK
PRINCIPAL REGISTER**

EQUINE ADVANTAGE

THE LIFE VESSEL CORPORATION (DELAWARE
CORPORATION)
34 ALAMOS
COTTONWOOD, AZ 86326

FOR: ANIMAL FEED ADDITIVE FOR USE AS A
NUTRITIONAL SUPPLEMENT FOR MEDICAL
PURPOSES; DIETARY SUPPLEMENTS FOR ANI-
MALS, IN CLASS 5 (U.S. CLS. 6, 18, 44, 46, 51 AND 52).

FIRST USE 9-0-2006; IN COMMERCE 4-0-2007.

THE MARK CONSISTS OF STANDARD CHAR-
ACTERS WITHOUT CLAIM TO ANY PARTICULAR
FONT, STYLE, SIZE, OR COLOR.

NO CLAIM IS MADE TO THE EXCLUSIVE
RIGHT TO USE "EQUINE", APART FROM THE
MARK AS SHOWN.

SN 77-004,364, FILED 9-21-2006.

KEVON CHISOLM, EXAMINING ATTORNEY

Int. Cl.: 9

Prior U.S. Cls.: 21, 23, 26, 36, and 38

United States Patent and Trademark Office

Reg. No. 3,398,974

Registered Mar. 18, 2008

**TRADEMARK
PRINCIPAL REGISTER**



WEBROOT SOFTWARE, INC. (DELAWARE CORPORATION)
2650 55TH STREET
BOULDER, CO 80301

OWNER OF U.S. REG. NO. 2,753,274.

FOR: COMPUTER SOFTWARE FOR MONITORING THE ACTIVITIES OF A COMPUTER USER, PREVENTING THE EXECUTION OF UNAUTHORIZED PROGRAMS, AND DETERRING ACCESS TO OFFENSIVE CONTENT ON THE INTERNET, IN CLASS 9 (U.S. CLS. 21, 23, 26, 36 AND 38).

THE MARK CONSISTS OF STYLIZED MAN, WOMAN AND CHILD FIGURES WITH THE MAN AND WOMAN PROTECTING THE CHILD, ALL INSIDE A CIRCLE.

SN 77-004,530, FILED 9-21-2006.

FIRST USE 9-15-2006; IN COMMERCE 1-30-2007.

CHARLOTTE CORWIN, EXAMINING ATTORNEY

Int. Cl.: 25

Prior U.S. Cls.: 22 and 39

United States Patent and Trademark Office

Reg. No. 3,398,975

Registered Mar. 18, 2008

TRADEMARK
PRINCIPAL REGISTER

The trademark is the word "Cali Ten" written in a cursive, handwritten style. The letters are connected, with a large, decorative flourish at the end of the word "Ten".

GRANT, ANGELA (CANADA INDIVIDUAL)
1110 ALDER TREE WAY
#308
SACRAMENTO, CA 95831

FIRST USE 2-12-2007; IN COMMERCE 5-18-2007.

THE MARK CONSISTS OF STYLIZED TEXT OF
THE WORDS, "CALI TEN".

FOR: CAPRIS; DENIMS; JEANS; PULLOVERS;
PUMPS; SANDALS; SHIRTS; SHOES; SKIRTS; T-
SHIRTS; TANK TOPS; TROUSERS, IN CLASS 25 (U.S.
CLS. 22 AND 39).

SN 77-004,647, FILED 9-21-2006.

LINDA E. BLOHM, EXAMINING ATTORNEY

Prior U.S. Cl.: B

United States Patent and Trademark Office

Reg. No. 3,398,976

Registered Mar. 18, 2008

**CERTIFICATION MARK
SERVICES
PRINCIPAL REGISTER**

ANGEL THERAPIST

ANGEL THERAPY, INC. (CALIFORNIA CORPORATION)
P.O. BOX 217
LAGUNA BEACH, CA 92652

FOR: TRAINING SERVICES FOR PRACTITIONERS IN THE FIELD OF SPIRITUALITY AND PSYCHOLOGY UTILIZING CERTIFIER'S PROGRAM FOR SPIRITUAL AND EMOTIONAL WELL-BEING, IN CLASS B (U.S. CL. B).

FIRST USE 10-1-2007; IN COMMERCE 10-1-2007.

THE MARK CONSISTS OF STANDARD CHARACTERS WITHOUT CLAIM TO ANY PARTICULAR FONT, STYLE, SIZE, OR COLOR.

OWNER OF U.S. REG. NOS. 2,775,008, 2,883,867, AND 3,072,471.

NO CLAIM IS MADE TO THE EXCLUSIVE RIGHT TO USE "THERAPIST", APART FROM THE MARK AS SHOWN.

THE CERTIFICATION MARK, AS USED BY AUTHORIZED PERSONS, CERTIFIES COMPLETION OF TRAINING COURSES IN THE PRACTICE OF CERTIFIER'S METHOD OF SPIRITUAL HEALING.

SN 77-004,846, FILED 9-21-2006.

EDWARD FENNESSY, EXAMINING ATTORNEY

Int. Cl.: 32

Prior U.S. Cls.: 45, 46, and 48

Reg. No. 3,398,977

United States Patent and Trademark Office

Registered Mar. 18, 2008

**TRADEMARK
PRINCIPAL REGISTER**



UPLIFT NUTRITION, INC. (NEVADA CORPORATION)
P.O. BOX 474
ROY, UT 84067

THE MARK CONSISTS OF THE WORDS "ACTIVE UPLIFT" BORDERED BY A PAIR OF WINGS AND WITH A HALO ABOVE THE WORDING.

FOR: ENERGY DRINK MIXES, IN CLASS 32 (U.S. CLS. 45, 46 AND 48).

SN 77-005,227, FILED 9-22-2006.

FIRST USE 1-5-2007; IN COMMERCE 3-15-2007.

TERESA M. RUPP, EXAMINING ATTORNEY

Int. Cl.: 45

Prior U.S. Cls.: 100 and 101

United States Patent and Trademark Office

Reg. No. 3,398,978

Registered Mar. 18, 2008

**SERVICE MARK
PRINCIPAL REGISTER**

MYFRAUDDOG

INSTANT CREDIT CARD SECURITY SYSTEMS,
INC. (CALIFORNIA CORPORATION)
784 OLIVE AVENUE
FREMONT, CA 94539

FOR: CREDIT CARD FRAUD PREVENTION SERVICES, NAMELY, PROVIDING AUTHENTICATION OF PERSONAL IDENTIFICATION INFORMATION; FRAUD DETECTION SERVICES IN THE FIELD OF CREDIT CARDS FOR ON-LINE PURCHASING; CONSULTATION IN THE FIELD OF DATA THEFT AND IDENTITY THEFT; FINANCIAL IDENTITY MONITORING SERVICE; REAL-TIME REPORTING OF FINANCIAL TRANSAC-

TIONS IN CONJUNCTION WITH CREDIT CARD SECURITY AND IDENTITY THEFT, IN CLASS 45 (U.S. CLS. 100 AND 101).

FIRST USE 11-1-2006; IN COMMERCE 11-1-2006.

THE MARK CONSISTS OF STANDARD CHARACTERS WITHOUT CLAIM TO ANY PARTICULAR FONT, STYLE, SIZE, OR COLOR.

SN 77-005,914, FILED 9-23-2006.

ELLEN PERKINS, EXAMINING ATTORNEY

Int. Cl.: 6

Prior U.S. Cls.: 2, 12, 13, 14, 23, 25, and 50

United States Patent and Trademark Office

Reg. No. 3,398,979

Registered Mar. 18, 2008

**TRADEMARK
PRINCIPAL REGISTER**



MORSE, WILLIAM N. (UNITED STATES INDIVIDUAL)
2111 OAK FOREST DRIVE
ELLCOTT CITY, MD 21043

NO CLAIM IS MADE TO THE EXCLUSIVE RIGHT TO USE "PARKING", APART FROM THE MARK AS SHOWN.

FOR: NON-LUMINOUS AND NON-MECHANICAL METAL SIGNS, IN CLASS 6 (U.S. CLS. 2, 12, 13, 14, 23, 25 AND 50).

SN 77-006,345, FILED 9-25-2006.

FIRST USE 11-30-2003; IN COMMERCE 10-26-2006.

LINDA ORNDORFF, EXAMINING ATTORNEY

Int. Cl.: 30

Prior U.S. Cl.: 46

United States Patent and Trademark Office

Reg. No. 3,398,980

Registered Mar. 18, 2008

**TRADEMARK
PRINCIPAL REGISTER**

NECTARAVE

MATA, ARIEL ALEJANDRO (MEXICO INDIVIDUAL)
PRIVADA MONTANAS #101
TLAJOMULCO DE ZUNIGA, JALISCO, MEXICO
45650

FOR: HONEY AND HONEY SUBSTITUTES, IN
CLASS 30 (U.S. CL. 46).

FIRST USE 2-20-2007; IN COMMERCE 2-20-2007.

THE MARK CONSISTS OF STANDARD CHARACTERS WITHOUT CLAIM TO ANY PARTICULAR FONT, STYLE, SIZE, OR COLOR.

SN 77-006,927, FILED 9-25-2006.

LESLEY LAMOTHE, EXAMINING ATTORNEY

Int. Cl.: 9

Prior U.S. Cls.: 21, 23, 26, 36, and 38

United States Patent and Trademark Office

Reg. No. 3,398,981

Registered Mar. 18, 2008

**TRADEMARK
PRINCIPAL REGISTER**

RUINS OF GOLD

KONAMI GAMING, INC. (NEVADA CORPORATION)
585 TRADE CENTER DRIVE
LAS VEGAS, NV 89119

FOR: ELECTRONIC GAME PROGRAMS; GAMING EQUIPMENT, NAMELY, SLOT MACHINES WITH OR WITHOUT VIDEO OUTPUT; GAMING MACHINES; MACHINES FOR PLAYING GAMES OF CHANCE; SLOT MACHINES, IN CLASS 9 (U.S. CLS. 21, 23, 26, 36 AND 38).

FIRST USE 6-3-2005; IN COMMERCE 6-3-2005.

THE MARK CONSISTS OF STANDARD CHARACTERS WITHOUT CLAIM TO ANY PARTICULAR FONT, STYLE, SIZE, OR COLOR.

OWNER OF U.S. REG. NOS. 2,502,228, 2,973,855, AND OTHERS.

SN 77-007,170, FILED 9-25-2006.

MYRIAH HABEEB, EXAMINING ATTORNEY

Int. Cl.: 9

Prior U.S. Cls.: 21, 23, 26, 36, and 38

United States Patent and Trademark Office

Reg. No. 3,398,982

Registered Mar. 18, 2008

**TRADEMARK
PRINCIPAL REGISTER**

SUPER RUINS OF GOLD

KONAMI GAMING, INC. (NEVADA CORPORATION)
585 TRADE CENTER DRIVE
LAS VEGAS, NV 89119

FOR: ELECTRONIC GAME PROGRAMS; GAMING EQUIPMENT, NAMELY, SLOT MACHINES WITH OR WITHOUT VIDEO OUTPUT; GAMING MACHINES; MACHINES FOR PLAYING GAMES OF CHANCE; SLOT MACHINES, IN CLASS 9 (U.S. CLS. 21, 23, 26, 36 AND 38).

FIRST USE 10-27-2005; IN COMMERCE 10-27-2005.

THE MARK CONSISTS OF STANDARD CHARACTERS WITHOUT CLAIM TO ANY PARTICULAR FONT, STYLE, SIZE, OR COLOR.

OWNER OF U.S. REG. NOS. 2,502,228, 2,973,855, AND OTHERS.

SN 77-007,171, FILED 9-25-2006.

MYRIAH HABEEB, EXAMINING ATTORNEY

Int. Cl.: 9

Prior U.S. Cls.: 21, 23, 26, 36, and 38

Reg. No. 3,398,983

United States Patent and Trademark Office

Registered Mar. 18, 2008

**TRADEMARK
PRINCIPAL REGISTER**

PRIZE CATCH

KONAMI GAMING, INC. (NEVADA CORPORATION)
585 TRADE CENTER DRIVE
LAS VEGAS, NV 89119

FOR: ELECTRONIC GAME PROGRAMS; GAMING EQUIPMENT, NAMELY, SLOT MACHINES WITH OR WITHOUT VIDEO OUTPUT; GAMING MACHINES; MACHINES FOR PLAYING GAMES OF CHANCE; SLOT MACHINES, IN CLASS 9 (U.S. CLS. 21, 23, 26, 36 AND 38).

FIRST USE 12-9-2005; IN COMMERCE 12-9-2005.

THE MARK CONSISTS OF STANDARD CHARACTERS WITHOUT CLAIM TO ANY PARTICULAR FONT, STYLE, SIZE, OR COLOR.

SN 77-007,172, FILED 9-26-2006.

MYRIAH HABEEB, EXAMINING ATTORNEY

Int. Cls.: 3 and 5

Prior U.S. Cls.: 1, 4, 6, 18, 44, 46, 50, 51, and 52

United States Patent and Trademark Office

Reg. No. 3,398,984

Registered Mar. 18, 2008

**TRADEMARK
PRINCIPAL REGISTER**



FOREMOST DENTAL LLC (DELAWARE LTD
LIAB CO)
242 SOUTH DEAN STREET
ENGLEWOOD, NJ 07631

FOR: DENTAL PRODUCTS, NAMELY, PROPHY
PASTE, IN CLASS 3 (U.S. CLS. 1, 4, 6, 50, 51 AND 52).

FIRST USE 12-28-2006; IN COMMERCE 12-28-2006.

FOR: DENTAL PRODUCTS, NAMELY, FLUOR-
IDE GEL AND FLUORIDE FOAM FOR USE IN
PREVENTIVE DENTISTRY; TOPICAL ANESTHET-
ICS, IN CLASS 5 (U.S. CLS. 6, 18, 44, 46, 51 AND 52).

FIRST USE 12-27-2006; IN COMMERCE 12-27-2006.

OWNER OF U.S. REG. NOS. 1,414,695 AND
2,621,765.

NO CLAIM IS MADE TO THE EXCLUSIVE
RIGHT TO USE "DENTAL", APART FROM THE
MARK AS SHOWN.

THE COLOR GRAY IS INTENDED TO INDICATE
SHADING OR CONTRAST ONLY AND COLOR IS
NOT CLAIMED AS A FEATURE OF THE MARK.

SN 77-007,428, FILED 9-26-2006.

RUSS HERMAN, EXAMINING ATTORNEY

Int. Cl.: 29

Prior U.S. Cl.: 46

United States Patent and Trademark Office

Reg. No. 3,398,985

Registered Mar. 18, 2008

**TRADEMARK
PRINCIPAL REGISTER**

THE VEGETABLE WITH MORE

BBI, INC. (DELAWARE CORPORATION)
SUITE 900, 300 DELAWARE AVENUE
WILMINGTON, DE 19801

FOR: PROCESSED, CANNED, DRIED AND FROZEN VEGETABLES, IN CLASS 29 (U.S. CL. 46).

FIRST USE 5-0-2006; IN COMMERCE 11-0-2006.

THE MARK CONSISTS OF STANDARD CHARACTERS WITHOUT CLAIM TO ANY PARTICULAR FONT, STYLE, SIZE, OR COLOR.

NO CLAIM IS MADE TO THE EXCLUSIVE RIGHT TO USE "VEGETABLE", APART FROM THE MARK AS SHOWN.

SN 77-007,479, FILED 9-26-2006.

DAVID YONTEF, EXAMINING ATTORNEY

Int. Cl.: 29

Prior U.S. Cl.: 46

United States Patent and Trademark Office

Reg. No. 3,398,986

Registered Mar. 18, 2008

**TRADEMARK
PRINCIPAL REGISTER**

THE VEGGIE WITH MORE

BBI, INC. (DELAWARE CORPORATION)
SUITE 900, 300 DELAWARE AVENUE
WILMINGTON, DE 19801

FOR: PROCESSED, CANNED, DRIED AND FROZEN VEGETABLES, IN CLASS 29 (U.S. CL. 46).

FIRST USE 11-0-2006; IN COMMERCE 11-0-2006.

THE MARK CONSISTS OF STANDARD CHARACTERS WITHOUT CLAIM TO ANY PARTICULAR FONT, STYLE, SIZE, OR COLOR.

NO CLAIM IS MADE TO THE EXCLUSIVE RIGHT TO USE "VEGGIE", APART FROM THE MARK AS SHOWN.

SN 77-007,487, FILED 9-26-2006.

DAVID YONTEF, EXAMINING ATTORNEY

Int. Cl.: 3

Prior U.S. Cls.: 1, 4, 6, 50, 51, and 52

United States Patent and Trademark Office

Reg. No. 3,398,987

Registered Mar. 18, 2008

**TRADEMARK
PRINCIPAL REGISTER**

OCEAN BLU

KAMSUT, INC. (CALIFORNIA CORPORATION)
2151 ANCHOR COURT
THOUSAND OAKS, CA 91302

THE MARK CONSISTS OF STANDARD CHAR-
ACTERS WITHOUT CLAIM TO ANY PARTICULAR
FONT, STYLE, SIZE, OR COLOR.

FOR: BODY SOAP, IN CLASS 3 (U.S. CLS. 1, 4, 6, 50,
51 AND 52).

SN 77-007,632, FILED 9-26-2006.

FIRST USE 7-31-2006; IN COMMERCE 7-31-2006.

ALEX KEAM, EXAMINING ATTORNEY

Int. Cl.: 18

Prior U.S. Cls.: 1, 2, 3, 22, and 41

United States Patent and Trademark Office

Reg. No. 3,398,988

Registered Mar. 18, 2008

**TRADEMARK
PRINCIPAL REGISTER**

FOOGO

THERMOS L.L.C. (DELAWARE LTD LIAB CO)
2550 WEST GOLF ROAD, SUITE 800
ROLLING MEADOWS, IL 60008

THE MARK CONSISTS OF STANDARD CHAR-
ACTERS WITHOUT CLAIM TO ANY PARTICULAR
FONT, STYLE, SIZE, OR COLOR.

FOR: INSULATED DIAPER BAGS, BAGS FOR
CARRYING BABY ACCESSORIES, IN CLASS 18
(U.S. CLS. 1, 2, 3, 22 AND 41).

SN 77-007,704, FILED 9-26-2006.

FIRST USE 8-2-2007; IN COMMERCE 8-2-2007.

LINDA POWELL, EXAMINING ATTORNEY

Int. Cl.: 44

Prior U.S. Cls.: 100 and 101

United States Patent and Trademark Office

Reg. No. 3,398,989

Registered Mar. 18, 2008

**SERVICE MARK
PRINCIPAL REGISTER**



**GOLDEN GATE ANCILLARY LLC (DELAWARE
LTD LIAB CO)**

1000 BEVERLY WAY

FORT SMITH, AR 72919

**FOR: MANAGED HEALTH CARE SERVICES, IN
CLASS 44 (U.S. CLS. 100 AND 101).**

FIRST USE 9-1-2006; IN COMMERCE 9-1-2006.

**THE COLOR(S) GOLD IS/ARE CLAIMED AS A
FEATURE OF THE MARK.**

**THE MARK CONSISTS OF A HALF GOLDEN
CIRCLE ON LEFT AND A HALF GOLDEN CIRCLE
ON RIGHT BUT NOT JOINING.**

SN 77-007,939, FILED 9-26-2006.

CHRIS WELLS, EXAMINING ATTORNEY

Int. Cl.: 16

Prior U.S. Cls.: 2, 5, 22, 23, 29, 37, 38, and 50

Reg. No. 3,398,990

United States Patent and Trademark Office

Registered Mar. 18, 2008

**TRADEMARK
PRINCIPAL REGISTER**

well-souled

SHAH, MITAL MAHESH (UNITED STATES IN-
DIVIDUAL)
7 APPLEWOOD DRIVE
WESTFORD, MA 01886

THE MARK CONSISTS OF STANDARD CHAR-
ACTERS WITHOUT CLAIM TO ANY PARTICULAR
FONT, STYLE, SIZE, OR COLOR.

FOR: COFFEE TABLE BOOKS FEATURING
FASHION, STYLE, CULTURE, TOURISM AND
SPORTING, IN CLASS 16 (U.S. CLS. 2, 5, 22, 23, 29,
37, 38 AND 50).

SN 77-008,217, FILED 9-27-2006.

FIRST USE 9-1-2007; IN COMMERCE 9-12-2007.

ELIZABETH KAJUBI, EXAMINING ATTORNEY

Int. Cl.: 33

Prior U.S. Cls.: 47 and 49

United States Patent and Trademark Office

Reg. No. 3,398,991

Registered Mar. 18, 2008

**TRADEMARK
PRINCIPAL REGISTER**

ERALES

ERAL BRAVO S.A. (ARGENTINA CORPORATION)
EMILIO CIVIT 567
MENDOZA, ARGENTINA 5500

THE MARK CONSISTS OF STANDARD CHARACTERS WITHOUT CLAIM TO ANY PARTICULAR FONT, STYLE, SIZE, OR COLOR.

FOR: WINES, IN CLASS 33 (U.S. CLS. 47 AND 49).

SN 77-008,292, FILED 9-27-2006.

FIRST USE 10-17-2006; IN COMMERCE 10-17-2006.

JASON BLAIR, EXAMINING ATTORNEY

Int. Cl.: 28

Prior U.S. Cls.: 22, 23, 38, and 50

United States Patent and Trademark Office

Reg. No. 3,398,992

Registered Mar. 18, 2008

**TRADEMARK
PRINCIPAL REGISTER**

DIPPER

NOMACO, INC. (NORTH CAROLINA CORPORATION)
501 NMC DRIVE
ZEBULON, NC 27597

FIRST USE 12-1-2006; IN COMMERCE 12-1-2006.

FOR: TOYS IN THE NATURE OF FLEXIBLE FOAM RODS FOR RECREATIONAL USE, FLEXIBLE FOAM FLOATATION TOYS CONTAINING CONNECTORS SPECIFICALLY DESIGNS FOR JOINING FOAM TOY RODS, SOLD AS A UNIT, FLEXIBLE FOAM CONSTRUCTION TOYS, AND FLEXIBLE FOAM FLOATATION TOYS, IN CLASS 28 (U.S. CLS. 22, 23, 38 AND 50).

THE MARK CONSISTS OF STANDARD CHARACTERS WITHOUT CLAIM TO ANY PARTICULAR FONT, STYLE, SIZE, OR COLOR.

SN 77-008,666, FILED 9-27-2006.

CHRISTINA SOBRAL, EXAMINING ATTORNEY

Int. Cl.: 28

Prior U.S. Cls.: 22, 23, 38, and 50

United States Patent and Trademark Office

Reg. No. 3,398,993

Registered Mar. 18, 2008

**TRADEMARK
PRINCIPAL REGISTER**

LITTLE DIPPER

NOMACO, INC. (NORTH CAROLINA CORPORATION)
501 NMC DRIVE
ZEBULON, NC 27597

FOR: TOYS IN THE NATURE OF FLEXIBLE FOAM RODS FOR RECREATIONAL USE, FLEXIBLE FOAM FLOATATION TOYS CONTAINING CONNECTORS SPECIFICALLY DESIGNS FOR JOINING FOAM TOY RODS, SOLD AS A UNIT, FLEXIBLE FOAM CONSTRUCTION TOYS, AND FLEXIBLE FOAM FLOATATION TOYS, IN CLASS 28 (U.S. CLS. 22, 23, 38 AND 50).

FIRST USE 12-1-2006; IN COMMERCE 12-1-2006.

THE MARK CONSISTS OF STANDARD CHARACTERS WITHOUT CLAIM TO ANY PARTICULAR FONT, STYLE, SIZE, OR COLOR.

SN 77-008,685, FILED 9-27-2006.

CHRISTINA SOBRAL, EXAMINING ATTORNEY

Int. Cl.: 28

Prior U.S. Cls.: 22, 23, 38, and 50

United States Patent and Trademark Office

Reg. No. 3,398,994

Registered Mar. 18, 2008

**TRADEMARK
PRINCIPAL REGISTER**

BIG DIPPER

NOMACO, INC. (NORTH CAROLINA CORPORATION)
501 NMC DRIVE
ZEBULON, NC 27597

FOR: TOYS IN THE NATURE OF FLEXIBLE FOAM RODS FOR RECREATIONAL USE, FLEXIBLE FOAM FLOATATION TOYS CONTAINING CONNECTORS SPECIFICALLY DESIGNS FOR JOINING FOAM TOY RODS, SOLD AS A UNIT, FLEXIBLE FOAM CONSTRUCTION TOYS, AND FLEXIBLE FOAM FLOATATION TOYS, IN CLASS 28 (U.S. CLS. 22, 23, 38 AND 50).

FIRST USE 12-1-2006; IN COMMERCE 12-1-2006.

THE MARK CONSISTS OF STANDARD CHARACTERS WITHOUT CLAIM TO ANY PARTICULAR FONT, STYLE, SIZE, OR COLOR.

SN 77-008,699, FILED 9-27-2006.

CHRISTINA SOBRAL, EXAMINING ATTORNEY

Int. Cl.: 45

Prior U.S. Cls.: 100 and 101

United States Patent and Trademark Office

Reg. No. 3,398,995

Registered Mar. 18, 2008

**SERVICE MARK
PRINCIPAL REGISTER**

SAFEZONE

MOORE SYNDICATION, INC. (ALABAMA CORPORATION)
3701 1ST AVENUE NORTH
BIRMINGHAM, AL 35222

FOR: PROVIDING INFORMATION ABOUT SAFETY ISSUES ASSOCIATED WITH NATURAL GAS LINES, ELECTRIC POWER LINES AND OTHER NATURAL GAS AND ELECTRIC POWER SITES, FOR CONTRACTORS AND OTHER BUSINESSES, CUSTOMERS, AND THE GENERAL PUBLIC, IN CLASS 45 (U.S. CLS. 100 AND 101).

FIRST USE 5-1-2007; IN COMMERCE 5-1-2007.

THE MARK CONSISTS OF STANDARD CHARACTERS WITHOUT CLAIM TO ANY PARTICULAR FONT, STYLE, SIZE, OR COLOR.

SN 77-008,802, FILED 9-27-2006.

MYRIAH HABEEB, EXAMINING ATTORNEY

Int. Cl.: 9

Prior U.S. Cls.: 21, 23, 26, 36, and 38

United States Patent and Trademark Office

Reg. No. 3,398,996

Registered Mar. 18, 2008

**TRADEMARK
PRINCIPAL REGISTER**

NLIGHT

SENSOR SWITCH, INC. (CONNECTICUT CORPORATION)
900 NORTROP ROAD
WALLINGFORD, CT 06492

THE MARK CONSISTS OF STANDARD CHARACTERS WITHOUT CLAIM TO ANY PARTICULAR FONT, STYLE, SIZE, OR COLOR.

FOR: ELECTRONIC SYSTEM FOR CONTROLLING SENSOR AND LIGHTING CONTROL DEVICES, IN CLASS 9 (U.S. CLS. 21, 23, 26, 36 AND 38).

SN 77-009,600, FILED 9-28-2006.

FIRST USE 5-8-2007; IN COMMERCE 5-8-2007.

DAVID TOOLEY, EXAMINING ATTORNEY

Int. Cl.: 14

Prior U.S. Cls.: 2, 27, 28, and 50

United States Patent and Trademark Office

Reg. No. 3,398,997

Registered Mar. 18, 2008

**TRADEMARK
PRINCIPAL REGISTER**

TECHNOFIBER

INVICTA WATCH COMPANY OF AMERICA,
INC. (FLORIDA CORPORATION)
3069 TAFT STREET
HOLLYWOOD, FL 33021

THE MARK CONSISTS OF STANDARD CHAR-
ACTERS WITHOUT CLAIM TO ANY PARTICULAR
FONT, STYLE, SIZE, OR COLOR.

FOR: WATCH BANDS AND STRAPS; WATCHES,
IN CLASS 14 (U.S. CLS. 2, 27, 28 AND 50).

SN 77-009,797, FILED 9-28-2006.

FIRST USE 2-15-2007; IN COMMERCE 2-15-2007.

DAVID MURRAY, EXAMINING ATTORNEY

Int. Cls.: 38 and 41

Prior U.S. Cls.: 100, 101, 104, and 107

United States Patent and Trademark Office

Reg. No. 3,398,998

Registered Mar. 18, 2008

**SERVICE MARK
PRINCIPAL REGISTER**

CSN

COMCAST SPORTSNET PHILADELPHIA, L.P.
(PENNSYLVANIA LTD LIAB CO)
3601 BROAD STREET
PHILADELPHIA, PA 19103

FOR: TELEVISION BROADCASTING SERVICES,
IN CLASS 38 (U.S. CLS. 100, 101 AND 104).

FIRST USE 10-1-1997; IN COMMERCE 10-1-1997.

FOR: ENTERTAINMENT SERVICES, NAMELY,
PRODUCTION OF A SERIES OF SPORTS-RELATED

TELEVISION PROGRAMS, IN CLASS 41 (U.S. CLS.
100, 101 AND 107).

FIRST USE 10-1-1997; IN COMMERCE 10-1-1997.

THE MARK CONSISTS OF STANDARD CHAR-
ACTERS WITHOUT CLAIM TO ANY PARTICULAR
FONT, STYLE, SIZE, OR COLOR.

SN 77-010,844, FILED 9-29-2006.

ZACHARY BELLO, EXAMINING ATTORNEY

Int. Cl.: 38

Prior U.S. Cls.: 100, 101, and 104

United States Patent and Trademark Office

Reg. No. 3,398,999

Registered Mar. 18, 2008

**SERVICE MARK
PRINCIPAL REGISTER**



ZEACOM GROUP LIMITED (NEW ZEALAND CORPORATION)
SUITE 200
2485 MCCABE WAY
IRVINE, CA 92614

FOR: WIRELESS VOICE MAIL SERVICES, IN CLASS 38 (U.S. CLS. 100, 101 AND 104).

FIRST USE 9-27-2006; IN COMMERCE 9-27-2006.

THE COLOR(S) ORANGE AND BLACK IS/ARE CLAIMED AS A FEATURE OF THE MARK.

THE MARK CONSISTS OF THE LETTERS "YOU-MAIL" FOLLOWED BY A COLON AND THEN THREE RIGHT-SIDE PARENTHESES INCREASING IN SIZE FROM LEFT TO RIGHT. THE COLON AND THE LETTERS YOU ARE ORANGE IN COLOR. THE PARENTHESES AND THE LETTERS "MAIL" ARE BLACK IN COLOR.

SN 77-010,949, FILED 9-29-2006.

KELLY BOULTON, EXAMINING ATTORNEY

Int. Cl.: 42

Prior U.S. Cls.: 100 and 101

United States Patent and Trademark Office

Reg. No. 3,399,000

Registered Mar. 18, 2008

**SERVICE MARK
PRINCIPAL REGISTER**

XPOFAIRS

MEERA SANTORO AND LUCIO SANTORO
PARTNERSHIP, THE (UNITED KINGDOM
PARTNERSHIP), DBA SANTORO LICENSING,
ROTUNDA POINT
11 HARTFIELD CRESCENT, WIMBLEDON
LONDON, UNITED KINGDOM SW193RL

FOR: DEVELOPMENT OF SOFTWARE FOR ON-
LINE 3D ENVIRONMENTS , IN CLASS 42 (U.S. CLS.
100 AND 101).

FIRST USE 12-1-2005; IN COMMERCE 1-1-2007.

THE MARK CONSISTS OF STANDARD CHAR-
ACTERS WITHOUT CLAIM TO ANY PARTICULAR
FONT, STYLE, SIZE, OR COLOR.

SN 77-011,459, FILED 10-2-2006.

JAMES MACFARLANE, EXAMINING ATTORNEY

Int. Cl.: 25

Prior U.S. Cls.: 22 and 39

United States Patent and Trademark Office

Reg. No. 3,399,001

Registered Mar. 18, 2008

TRADEMARK
PRINCIPAL REGISTER

XTREME YOUR DREAM

ADAMS, SHAWN MAURICE (UNITED STATES
INDIVIDUAL)
106 LAKE AVE # 2
YONKERS, NY 10703

FOR: CLOTHING, NAMELY, ADHESIVE BRAS, AFTER SKI BOOTS, ALBS, ANGLERS' SHOES, ANKLE BOOTS, ANKLE GARTERS, ANKLE SOCKS, ANKLET SOCKS, ANORAKS PARKAS, ANTI-PERSPIRANT SOCKS, APRES-SKI SHOES, APRONS, ASCOTS, ATHLETIC FOOTWEAR, ATHLETICS SHOES, ATHLETICS UNIFORMS, BABUSHKAS, BABY BIBS NOT OF PAPER, BABY BUNTING, BABY DOLL PAJAMAS, BALACLAVAS, BALLET SHOES, BALLET SLIPPERS, BALLOON PANTS, BANDANAS, BANDEAUX, BASEBALL CAPS, BASEBALL SHOES, BASKETBALL SNEAKERS, BATH SLIPPERS, BATHING CAPS, BATHING COSTUMES, BATHING COSTUMES FOR WOMEN, BATHING SUITS, BATHING SUITS FOR MEN, BATHING TRUNKS, BATHROBES, BEACH COVERUPS, BEACH FOOTWEAR, BEACH SHOES, BEACHWEAR, BEANIES, BED JACKETS, BELTS, BELTS MADE OF LEATHER, BELTS OF TEXTILE, BERETS, BERMUDA SHORTS, BIB OVERALLS, BIBS NOT OF CLOTH OR PAPER, BICYCLE GLOVES, BICYCLING GLOVES, BIKINIS, BLAZERS, BLOOMERS, BLOUSES, BLOUSONS, BOARD SHORTS, BOARD SHORTS, BOAS, BODY SHAPERS, BODY SUITS, BOLEROS, BOLO TIES, BONNETS, BOOTIES, BOOTS, BOTTOMS, BOW TIES, BOWLING SHOES, BOXER BRIEFS, BOXER SHORTS, BOXING SHOES, BRALETTES, BRAS, BRASSIERES, BREECHES, BRIEFS, UNDERWEAR BRIEFS, BUSTIERS, BUSTLE HOLDER BANDS FOR OBI (OBIAGE), BUSTLES FOR OBI-KNOTS (OBIAGE-SHIN), BUTTON-FRONT ALOHA SHIRTS, CAFTANS, CAMISETTES, CAMISOLES, CAMP SHIRTS, CANVAS SHOES, CAP VISORS, CAPELETS, CAPES, CAPRI PANTS, CAPRIS, CLOTHING CAPS, CAPS WITH VISORS, CARDIGANS, CARGO PANTS, CASSOCKS, CHAPS, CHASUBLES, CHEF'S HATS, CHEMISES, CHEMISETTES, CHILDREN'S AND INFANTS' CLOTH BIBS, CHILDREN'S CLOTH EATING BIBS, CHILDREN'S HEADWEAR, CHOIR ROBES, CLAM DIGGERS, CLEATS FOR ATTACHMENT TO SPORTS

SHOES, CLIMBING BOOTS, MOUNTAINEERING BOOTS, CLOGS, CLOTH BIBS, CLOTH BIBS FOR ADULT DINERS, CLOTH BIBS FOR USE BY SENIOR CITIZENS OR PHYSICALLY- OR MENTALLY- CHALLENGED PERSONS, CLOTH DIAPERS, CLOTHING FOR WEAR IN JUDO PRACTICES, CLOTHING FOR WEAR IN WRESTLING GAMES, CLOTHING, NAMELY, ARM WARMERS, CLOTHING, NAMELY, FOLK COSTUMES, CLOTHING, NAMELY, KNEE WARMERS, CLOTHING, NAMELY, NECK TUBES, CLOTHING, NAMELY, WRAP AROUND, COATS, COATS FOR MEN AND WOMEN, COATS MADE OF COTTON, COATS OF DENIM, COBBLERS' APRONS, COLLAR PROTECTORS, COLLARS, COMBINATIONS, COMPETITORS' NUMBERS OF TEXTILE, CORSELETS, CORSETS COSTUMES FOR USE IN ROLE-PLAYING GAMES, COVERALLS, COVERUPS, CRAVATES, CRAVATS, CREEPERS, CROP TOPS, CUFFS, CULOTTES, CUMMERBUNDS, CYCLING SHOES, CYCLISTS' JERSEYS, DANCE COSTUMES, DECK-SHOES, DENIM JACKETS, DENIM PANTS, DETACHABLE NECKPIECES FOR KIMONOS (HANERI), DICKIES, DISPOSABLE SLIPPERS, DISPOSABLE UNDERWEAR, DO RAGS, DOWN JACKETS, DRESS SHIELDS, DRESS SHIRTS, DRESS SUITS, DRESSES, DRESSES MADE FROM SKINS, DRESSING GOWNS, DRY SUITS, DUNGAREES, DUST COATS, CLOTHING, NAMELY, DUSTERS, EAR MUFFS, EARBANDS, EMBOSSED SOLES AND HEELS OF RUBBER OR OF PLASTIC MATERIALS, ESPADRILLES, EVENING DRESSES, EVENING GOWNS, FABRIC BELTS, FINISHED TEXTILES LININGS FOR GARMENTS, FISHERMANS' JACKETS, FISHING VESTS, FISHING WADERS, FITTED SWIMMING COSTUMES WITH BRA CUPS, FLEECE PULLOVERS, FLEECE SHORTS, FLIGHT SUITS, FLIP FLOP FOOTWEAR, FOAM PEDICURE SLIPPERS, FOOTBALL BOOTS AND STUDS THEREFOR, FOOTBALL SHOES, FOOTWEAR, FOOTWEAR FOR MEN, FOOTWEAR FOR MEN AND WOMEN, FOOTWEAR FOR TRACK AND FIELD ATHLETICS, FOOTWEAR FOR WOMEN, FOOTWEAR MADE OF WOOD, FOOTWEAR NOT FOR SPORTS, FOOTWEAR FOR SPORTS, FOOTWEAR, NAMELY, PUMPS, FOOTWEAR, NAMELY, RUBBERS, FOUL

WEATHER GEAR, FOULARDS, FOUNDATION GARMENTS, FROCKS, FULL LENGTH KIMONOS (NAGAGI), FUR CLOAKS, FUR COATS, FUR COATS AND JACKETS, FUR HATS, FUR JACKETS, FUR MUFFS, FUR STOLE, GABERDINES, GAITERS, GALOSHES, GARTER BELTS, GAUCHOS, GIRDLES, GLOVES, GLOVES FOR PERSONAL HAND CONDITIONING USE, GLOVES INCLUDING THOSE MADE OF SKIN, HIDE OR FUR, GOLF CAPS, GOLF CLEATS, GOLF SHIRTS, GOLF SHOES, GOLF SPIKES, GOLF TROUSERS, GOWNS, GREAT-COATS, GYM SHORTS, GYM SUITS, GYMNASIATIC SHOES, G-STRINGS, HALLOWEEN COSTUMES, HALLOWEEN COSTUMES AND MASKS SOLD IN CONNECTION THEREWITH, HALTER TOPS, HANDBALL SHOES, HAT BANDS, HATS, HEAD SCARVES, HEAD SWEATBANDS, HEAD WEAR, HEADBANDS, HEADBANDS AGAINST SWEATING, HEADWEAR, HEAVY JACKETS, HEEL INSERTS, HEEL PIECES FOR SHOES, HEELS, HIGH RAIN CLOGS (ASHIDA), HIKING BOOTS, HIP-GUARDS ESPECIALLY MADE FOR FISHING, HOCKEY SHOES, HOODS, HOODS, HORSE-RIDING BOOTS, HOSIERY, HOUSECOATS, HUNTING BOOT BAGS, HUNTING VESTS, INFANT AND TODDLER ONE PIECE CLOTHING, INFANT CLOTH DIAPERS, TEXTILE INFANT DIAPER COVER, INFANT SLEEPERS, INFANTS' SHOES AND BOOTS, INFANT TROUSERS, INFANTWEAR, INNER SOLES, INSOLES, INSOLES FOR SHOES AND BOOTS, JACKETS LINERS, JACKETS, JAPANESE FOOTWEAR OF RICE STRAW (WARAJI), JAPANESE SLEEPING ROBES (NEMAKI), JAPANESE SPLIT-TOED WORK FOOTWEAR (JIKATABI), JAPANESE STYLE CLOGS AND SANDALS, JAPANESE STYLE SANDALS OF FELT, JAPANESE STYLE SANDALS (ZORI), JAPANESE STYLE SANDALS OF LEATHER, JAPANESE STYLE SOCKS (TABI COVERS), JAPANESE STYLE SOCKS (TABI), JAPANESE STYLE WOODEN CLOGS (GETA), JAPANESE TOE-STRAP SANDALS (ASAURA-ZORI), JEANS, JERKINS, JERSEYS, JODHPURS, JOGGING OUTFITS, JOGGING PANTS, JOGGING SUITS, JUDO SUITS, JUMPERS, JUMPSUITS, KARATE SUITS, KENDO OUTFITS, KERCHIEFS, KILTS, KIMONOS, KNEE HIGHS, KNEE-HIGH STOCKINGS, KNICKERS, KNIT SHIRTS, KNITTED CAPS, KNITTED UNDERWEAR, LAB COATS, LACE BOOTS, LADIES' BOOTS, LADIES' SUITS, LADIES' UNDERWEAR, LAYETTES, LEATHER BELTS, LEATHER COATS, LEATHER HEADWEAR, LEATHER JACKETS, LEATHER PANTS, LEATHER SHOES, LEATHER SLIPPERS, LEG SHAPERS, LEG WARMERS, LEGGINGS, LEG-WARMERS, LEOTARDS, LEOTARDS AND TIGHTS FOR WOMEN, MEN AND CHILDREN OF NYLON, COTTON OR OTHER TEXTILE FIBERS, LIGHT-REFLECTING COATS, LIGHT-REFLECTING JACKETS, LINGERIE, LIVERIES, LONG JACKETS, LONG SLEEVED VESTS, LOUNGEWEAR, LOW WOODEN CLOGS (HIYORI-GETA), LOW WOODEN CLOGS (KOMA-GETA), MAILLOTS, MANTILLAS, MANTLES, MARTIAL ARTS UNIFORMS, MASQUERADE COSTUMES, MASQUERADE COSTUMES AND MASKS SOLD IN CONNECTION THEREWITH, MATERNITY SLEEPWEAR, MEN AND WOMEN JACKETS, COATS, TROUSERS, VESTS, MEN'S SOCKS, MEN'S SUITS,

MEN'S SUITS, WOMEN'S SUITS, METAL FITTINGS FOR JAPANESE STYLE WOODEN CLOGS, MINISKIRTS, MITTENS, MOCCASINS, MOCK TURTLE-NECK SWEATERS, MONEY BELTS, MORNING COATS, MOTORCYCLE GLOVES, MOTORCYCLIST BOOTS, MUFFLERS, MUFFLERS, MUFFS, MUKLUKS, MULES, MUSCLE TOPS, MUU MUUS, NECK BANDS, NECK GAITERS, NECKERCHIEFS, NECKERCHIEFS, NECKTIES, NECKWEAR, NEGLIGES, NIGHT GOWNS, NIGHT SHIRTS, NIGHTCAPS, NIGHTDRESSES, NIGHTIES, NIGHTWEAR, NON-DISPOSABLE CLOTH TRAINING PANTS, NOVELTY HEADWEAR WITH ATTACHED WIGS, NURSE DRESSES, NURSE OVERALLS, NURSE PANTS, NURSE'S ONE PIECE GARMENT FOR INFANTS AND TODDLERS, OPEN-NECKED SHIRTS, OVER COATS, OVERALLS, OVERSHOES, OVER-TROUSERS, PAJAMAS, PANTALOONS, PANTIES, SHORTS AND BRIEFS, PANTS, PANTSUITS, PANTYHOSE, PAPER HATS FOR USE OF CLOTHING ITEMS, PARAMENTS, PAREOS, PAREU, PAREUS, PARKAS, PARTS OF CLOTHING, NAMELY, GUSSETS FOR TIGHTS, GUSSETS FOR STOCKINGS, GUSSETS FOR BATHING SUITS, GUSSETS FOR UNDERWEAR, GUSSETS FOR LEOTARDS AND GUSSETS FOR FOOTLETS, PEDAL PUSHERS, PEDICURE SANDALS, PEDICURE SLIPPERS, PEIGNOIRS, PELERINES, PELISSES, PERSPIRATION ABSORBENT UNDERWEAR PETTICOATS, PETTI-PANTS, PINAFORES, PIQUE SHIRTS, PLASTIC BABY BIBS, PLAY SUITS, PLEATED SKIRTS FOR FORMAL KIMONOS (HAKAMA), PLUS FOURS, POCKET KERCHIEFS POKET SQUARES, POLO SHIRTS, PONCHOS, PROTECTIVE METAL MEMBERS FOR SHOES AND BOOTS, PULLOVERS, PUMPS, PUTTEES AND GAITERS, PAJAMAS, QUILTED VESTS, RAIN BOOTS, RAIN COATS, RAIN JACKETS, RAIN SLICKERS, RAIN SUITS, RAIN TROUSERS, RAINCOATS, RAINPROOF JACKETS, RAINWEAR, RASH GUARDS, REMOVABLE COLLARS, RIDING BOOTS, RIDING COATS, RIDING GLOVES, ROBES, ROMPERS, RUBBER SHOES, RUBBER SOLES FOR JIKATABI, RUBBERS, RUGBY SHOES, RUGBY SHORTS, RUGBY TOPS, RUNNING SHOES, SABOTS, SANDALS, SANDAL-CLOGS, SARIS, SARONGS, SASH BANDS FOR KIMONO (OBI), SASHES, SCARVES, SCHOOL UNIFORMS, SCRUBS NOT FOR MEDICAL PURPOSES, SEDGE HATS (SUGE-GASA), SERAPES, SHAMPOO CAPES, SHAWLS, SHAWLS AND HEADSCARVES, SHAWLS AND STOLE, SHIRTS, SHIRT FRONTS, SHIRT YOKES, SHIRTS, SHIRTS FOR SUITS, SHOE DOWELS, SHOE INSERTS PRIMARILY NON-ORTHOPEDIC PURPOSES, SHOE PEGS, SHOE SOLES, SHOES, SHOE SOLES FOR REPAIR, SHORT OVERCOAT FOR KIMONO (HAORI), SHORT PETTICOATS, SHORT SETS, SHORT TROUSERS, SHORTALLS, SHORTS, SHORT-SLEEVED OR LONG-SLEEVED T-SHIRTS, SHORT-SLEEVED SHIRTS, SHOULDER PADS FOR CLOTHING, SHOULDER SCARVES, SHOULDER WRAPS, SHOWER CAPS, SHRUGS, SILK SCARVES, SINGLETS, SKATING OUTFITS, SKI AND SNOWBOARD SHOES AND PARTS THEREOF, SKI BIBS, SKI BOOTS BAGS, SKI BOOTS, SKI GLOVES, SKI JACKETS, SKI MASKS, SKI PANTS, SKI SUITS, SKI SUITS FOR COMPETITION, SKI WEAR, SKIING SHOES,

SKIRT SUITS, SKIRTS, SKIRTS AND DRESSES, SKORTS, SKULL CAPS, HEADWEAR, NAMELY, SKULLIES, SLACKS, SLEEP MASKS, SLEEP SHIRTS, SLEEPING GARMENTS, SLEEPWEAR, SLEEVED OR SLEEVELESS JACKETS, SLEEVELESS JERSEYS, SLIDING SHORTS, SLIPPER SOLES, SLIPPERS, SLIPS, SMALL HATS, SMOCKS, SMOKING JACKETS, SNEAKERS, SNOW BOARDING SUITS, SNOW PANTS, SNOW SUITS, SNOWBOARDING BOOTS, SNOWBOARDING GLOVES, SNOWBOARDING PANTS, SOCCER BOOTS, SOCCER SHOES, SOCK SUSPENDERS, SOCKS, SOCKS AND STOCKINGS, INNER SOLES, SOLES FOR JAPANESE STYLE SANDALS, SPORT COATS, SPORT SHIRTS, SPORTS BRA, SPORTS JACKETS, SPORTS JERSEYS, SPORTS JERSEYS AND BREECHES FOR SPORTS, SPORTS OVER UNIFORMS, SPORTS SHIRTS, SPORTS SHIRTS WITH SHORT SLEEVES, STOCKINGS, SWEAT-ABSORBENT STOCKINGS, STOLE, STRAPLESS BRAS, STRAPS FOR BRAS, STRING FASTENERS FOR HAORI (HAORI-HIMO), STUFF JACKETS, SUEDE JACKETS, SUIT COATS, SUITS, SUITS OF LEATHER, SUN SLEEVES, SUN VISORS, SUNSUITS, SURF WEAR, SUSPENDER BELTS FOR WOMEN, SUSPENDERS, SWADDLING CLOTHES, SWEAT BANDS, SWEAT PANTS, SWEAT SHIRTS, SWEAT SHORTS, SWEAT SUITS, SWEAT-BANDS, SWEATERS, SWEAT SOCKS, SWIM CAPS, SWIM TRUNKS, SWIM WEAR, SWIM WEAR FOR GENTLEMEN AND LADIES, SWIMMING CAPS, SWIMMING COSTUMES, SWIMMING TRUNKS, SWIMSUITS, TAILLEURS, TANK TOPS, TANKINIS, TANK-TOPS, TAP PANTS, TAP SHOES, TEDDIES, TENNIS SHOES, TENNIS WEAR, TEXTILE DIAPERS, TEXTILE NAPPIES, THERMAL SOCKS, THERMAL UNDERWEAR, FOOTWEAR, NAMELY, THONGS, UNDERWEAR, NAMELY, THONGS TIES, TIGHTENING-UP STRINGS FOR KIMONOS(DATEJIME), TIGHTS, TIPS FOR FOOTWEAR, TOBOGGAN HATS, PANTS AND CAPS, TOE BOXES, TOE CAPS, TOE STRAPS FOR JAPANESE STYLE WOODEN CLOGS, TOE STRAPS FOR JAPANESE STYLE SANDALS ZORI, TOGAS, TONGUE OR PULLSTRAP FOR SHOES AND BOOTS, TOP COATS, TOPS, TOQUES, TRACK AND FIELD SHOES, TRACK PANTS, TRACK SUITS, TRAINING SHOES, TRAINING SUITS, TRENCH COATS, TROUSERS, TROU-

SERS FOR SWEATING, TROUSERS OF LEATHER, TRUNKS, TUNICS, TUQUES, TURBANS, TURTLE-NECK SWEATERS, TURTLENECKS, TUXEDO BELTS, TUXEDOS, TWIN SETS, T-SHIRTS, UNDER GARMENTS, UNDERARM CLOTHING SHIELDS, UNDERCLOTHES, UNDERGARMENTS, UNDERPANTS, UNDERSHIRTS, UNDERSHIRTS FOR KIMONOS (JUBAN), UNDERSHIRTS FOR KIMONOS (KOSHIMAKI), UNDERSKIRTS, UNDERWEAR, UNIFORMS, UNITARDS, UPPERS FOR JAPANESE STYLE SANDALS, UPPERS OF WOVEN RATTAN FOR JAPANESE STYLE SANDALS, VEILS, VEST EXTENDERS, VESTED SUITS, VESTS, VISORS, VOLLEYBALL SHOES, V-NECK SWEATERS, WAIST BELTS, WAIST STRINGS FOR KIMONOS (KOSHIMIMO), WAISTBANDS, WAISTCOATS, WALKING SHORTS, WARM UP SUITS, WATER SOCKS, WATERPROOF JACKETS AND PANTS, WEDDING DRESSES, WEDDING GOWNS, WET SUIT GLOVES, WET SUITS, WET SUITS FOR WATER-SKIING AND SUB-AQUA, WIND COATS, WIND RESISTANT JACKETS, WIND SHIRTS, WIND VESTS, WIND-CHEATERS, WINDJAMMERS, WINDSHIRTS, WIND-JACKETS, WINTER BOOTS, WOMEN'S CEREMONIAL DRESSES, WOMEN'S SHOES, WOMEN'S UNDERWEAR, WOODEN MAIN BODIES OF JAPANESE STYLE WOODEN CLOGS, WOODEN SUPPORTS OF JAPANESE STYLE WOODEN CLOGS, WOOLEN SOCKS, WOOLLY HATS, WORK SHOES AND BOOTS, WORKING OVERALLS, WOVEN OR KNITTED UNDERWEAR, WRAP BELTS FOR KIMONOS (DATEMAKI), WRAPS (CLOTHING), WRIST BANDS, WRISTBANDS CONTAINING A COOLING SUBSTANCE TO COOL WEATHER, YASHMAGHS, ZOOT SUITS, ZORI, IN CLASS 25 (U.S. CLS. 22 AND 39).

FIRST USE 12-14-2007; IN COMMERCE 12-20-2007.

THE MARK CONSISTS OF STANDARD CHARACTERS WITHOUT CLAIM TO ANY PARTICULAR FONT, STYLE, SIZE, OR COLOR.

SN 77-011,620, FILED 10-2-2006.

JULIE WATSON, EXAMINING ATTORNEY

Int. Cl.: 16

Prior U.S. Cls.: 2, 5, 22, 23, 29, 37, 38, and 50

United States Patent and Trademark Office

Reg. No. 3,399,002

Registered Mar. 18, 2008

**TRADEMARK
PRINCIPAL REGISTER**

ALWAYS COOL

ROARING SPRING BLANK BOOK CO. (PENNSYLVANIA CORPORATION)
740 SPANG STREET
ROARING SPRING, PA 16673

THE MARK CONSISTS OF STANDARD CHARACTERS WITHOUT CLAIM TO ANY PARTICULAR FONT, STYLE, SIZE, OR COLOR.

FOR: NOTEBOOKS, IN CLASS 16 (U.S. CLS. 2, 5, 22, 23, 29, 37, 38 AND 50).

SN 77-012,503, FILED 10-3-2006.

FIRST USE 1-0-2007; IN COMMERCE 1-0-2007.

REBECCA EISINGER, EXAMINING ATTORNEY

Int. Cl.: 35

Prior U.S. Cls.: 100, 101, and 102

United States Patent and Trademark Office

Reg. No. 3,399,003

Registered Mar. 18, 2008

**SERVICE MARK
PRINCIPAL REGISTER**



POOLPARTY.COM, LLC (ILLINOIS LTD LIAB
CO)
840 N. LAKE SHORE DRIVE #402
CHICAGO, IL 60611

FIRST USE 5-1-2006; IN COMMERCE 9-1-2006.

SN 77-013,410, FILED 10-4-2006.

FOR: ON-LINE ADVERTISING AND MARKET-
ING SERVICES FEATURING FAMOUS QUOTES IN
THE FIELD OF ENTERTAINMENT, IN CLASS 35
(U.S. CLS. 100, 101 AND 102).

NAPOLEON SHARMA, EXAMINING ATTORNEY

Int. Cl.: 33

Prior U.S. Cls.: 47 and 49

United States Patent and Trademark Office

Reg. No. 3,399,004

Registered Mar. 18, 2008

**TRADEMARK
PRINCIPAL REGISTER**

AMADO SUR

TRIVENTO BODEGAS Y VINEDOS S.A. (ARGENTINA CORPORATION)
CANAL PESCARA 9347, RUSSELL
MAIPU MENDOZA, ARGENTINA

THE FOREIGN WORDING IN THE MARK
TRANSLATES INTO ENGLISH AS "BELOVED
SOUTH".

FOR: WINES, IN CLASS 33 (U.S. CLS. 47 AND 49).

FIRST USE 10-31-2006; IN COMMERCE 10-30-2007.

SN 77-013,617, FILED 10-4-2006.

THE MARK CONSISTS OF STANDARD CHARACTERS WITHOUT CLAIM TO ANY PARTICULAR FONT, STYLE, SIZE, OR COLOR.

FRED CARL, EXAMINING ATTORNEY

Int. Cl.: 9

Prior U.S. Cls.: 21, 23, 26, 36, and 38

United States Patent and Trademark Office

Reg. No. 3,399,005

Registered Mar. 18, 2008

**TRADEMARK
PRINCIPAL REGISTER**

OUTLOUD

SDI TECHNOLOGIES, INC. (DELAWARE CORPORATION)
1299 MAIN STREET
RAHWAY, NJ 076050901

THE MARK CONSISTS OF STANDARD CHARACTERS WITHOUT CLAIM TO ANY PARTICULAR FONT, STYLE, SIZE, OR COLOR.

FOR: AUDIO SPEAKER SYSTEMS COMPRISED OF AUDIO SPEAKERS AND AMPLIFIERS, IN CLASS 9 (U.S. CLS. 21, 23, 26, 36 AND 38).

SN 77-014,272, FILED 10-5-2006.

FIRST USE 3-0-2007; IN COMMERCE 3-0-2007.

ROBERT STRUCK, EXAMINING ATTORNEY

Int. Cl.: 43

Prior U.S. Cls.: 100 and 101

United States Patent and Trademark Office

Reg. No. 3,399,006

Registered Mar. 18, 2008

**SERVICE MARK
PRINCIPAL REGISTER**

VININO

LIVE! HOLDINGS, LLC (MARYLAND LTD LIAB
CO)
6TH FLOOR
601 EAST PRATT STREET
BALTIMORE, MD 21202

THE MARK CONSISTS OF STANDARD CHAR-
ACTERS WITHOUT CLAIM TO ANY PARTICULAR
FONT, STYLE, SIZE, OR COLOR.

FOR: RESTAURANT AND BAR SERVICES, IN
CLASS 43 (U.S. CLS. 100 AND 101).

SN 77-014,326, FILED 10-5-2006.

FIRST USE 11-16-2007; IN COMMERCE 11-16-2007.

ELIZABETH KAJUBI, EXAMINING ATTORNEY

Int. Cl.: 30

Prior U.S. Cl.: 46

United States Patent and Trademark Office

Reg. No. 3,399,007

Registered Mar. 18, 2008

**TRADEMARK
PRINCIPAL REGISTER**

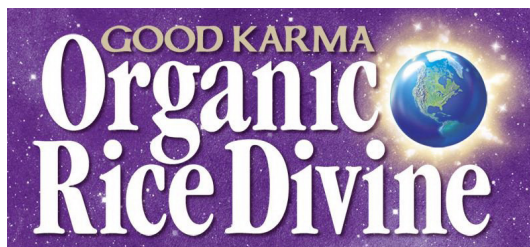

GOOD KARMA FOOD TECHNOLOGIES, INC.
(CALIFORNIA CORPORATION)
SUITE 100
529 HAHN AVENUE
GLENDALE, CA 91203

FOR: FROZEN CONFECTIONS AND ICE CREAM
SUBSTITUTES ALL CONTAINING ORGANIC RICE,
IN CLASS 30 (U.S. CL. 46).

FIRST USE 12-11-2006; IN COMMERCE 12-11-2006.

OWNER OF U.S. REG. NO. 3,195,270.

NO CLAIM IS MADE TO THE EXCLUSIVE
RIGHT TO USE "ORGANIC RICE DIVINE", APART
FROM THE MARK AS SHOWN.

THE COLOR(S) WHITE, GOLD, PURPLE, BLUE,
AND GREEN IS/ARE CLAIMED AS A FEATURE OF
THE MARK.

THE MARK CONSISTS OF THE WORDS "GOOD
KARMA" IN GOLD AND THE WORDS "ORGANIC
RICE DIVINE" IN WHITE SUPERIMPOSED OVER A
PURPLE FIELD OF WHITE STARS WITH THE
BLUE AND GREEN PLANET EARTH IN THE
RIGHT HAND CORNER. THE EARTH IS SUR-
ROUNDED BY A GOLD GLOW.

SN 77-017,247, FILED 10-9-2006.

DAVID COLLIER, EXAMINING ATTORNEY

Int. Cls.: 17, 25, and 28

Prior U.S. Cls.: 1, 5, 12, 13, 22, 23, 35, 38, 39, and 50

United States Patent and Trademark Office

Reg. No. 3,399,008

Registered Mar. 18, 2008

**TRADEMARK
PRINCIPAL REGISTER**

ZECTRON

WHAM-O, INC. (DELAWARE CORPORATION)
5903 CHRISTIE AVENUE
EMERYVILLE, CA 94608

FOR: COMPOSITIONS NAMELY, SYNTHETIC RUBBER USED IN THE MANUFACTURE OF SPORT AND TOY BALLS; FEATURES OF SPORT AND TOY BALLS NAMELY, SYNTHETIC RUBBER; COMPOSITIONS NAMELY, SYNTHETIC RUBBER USED IN THE MANUFACTURE OF FOOTWEAR, IN CLASS 17 (U.S. CLS. 1, 5, 12, 13, 35 AND 50).

FIRST USE 6-0-1965; IN COMMERCE 6-0-1965.

FOR: FOOTWEAR; FEATURE OF FOOTWEAR NAMELY, A SOLE WITH MULTIDIRECTIONAL TRACTION, IN CLASS 25 (U.S. CLS. 22 AND 39).

FIRST USE 8-0-2006; IN COMMERCE 8-0-2006.

FOR: SPORT AND TOY BALLS, IN CLASS 28 (U.S. CLS. 22, 23, 38 AND 50).

FIRST USE 6-0-1965; IN COMMERCE 6-0-1965.

THE MARK CONSISTS OF STANDARD CHARACTERS WITHOUT CLAIM TO ANY PARTICULAR FONT, STYLE, SIZE, OR COLOR.

SN 77-017,248, FILED 10-9-2006.

RICHARD WHITE, EXAMINING ATTORNEY

Int. Cl.: 30

Prior U.S. Cl.: 46

United States Patent and Trademark Office

Reg. No. 3,399,009

Registered Mar. 18, 2008

**TRADEMARK
PRINCIPAL REGISTER**

WECAM FOUNDATION, INC.

WECAM FOUNDATION, INC. (FLORIDA CORPORATION)
P.O. BOX 1949
ORLANDO, FL 32802

NO CLAIM IS MADE TO THE EXCLUSIVE RIGHT TO USE "FOUNDATION, INC.", APART FROM THE MARK AS SHOWN.

FOR: BEVERAGES MADE OF TEA, IN CLASS 30 (U.S. CL. 46).

SN 77-017,704, FILED 10-10-2006.

FIRST USE 12-1-2007; IN COMMERCE 12-1-2007.

THE MARK CONSISTS OF STANDARD CHARACTERS WITHOUT CLAIM TO ANY PARTICULAR FONT, STYLE, SIZE, OR COLOR.

SAMUEL E. SHARPER JR., EXAMINING ATTORNEY

Int. Cl.: 19

Prior U.S. Cls.: 1, 12, 33, and 50

United States Patent and Trademark Office

Reg. No. 3,399,010

Registered Mar. 18, 2008

**TRADEMARK
PRINCIPAL REGISTER**

GLO-TOP

BLESSING, RON (UNITED STATES INDIVIDUAL)
P.O. BOX 574
DALLAS, OR 97338

THE MARK CONSISTS OF STANDARD CHARACTERS WITHOUT CLAIM TO ANY PARTICULAR FONT, STYLE, SIZE, OR COLOR.

FOR: BUILDING MATERIALS, NAMELY, LUMINOUS COUNTER TOP BOARDS, IN CLASS 19 (U.S. CLS. 1, 12, 33 AND 50).

SN 77-018,234, FILED 10-10-2006.

FIRST USE 8-2-2007; IN COMMERCE 8-2-2007.

ANGELA M. MICHELI, EXAMINING ATTORNEY

Int. Cl.: 36

Prior U.S. Cls.: 100, 101, and 102

United States Patent and Trademark Office

Reg. No. 3,399,011

Registered Mar. 18, 2008

SERVICE MARK
PRINCIPAL REGISTER

PAYTOO

ECASH4.NET CORP (DELAWARE CORPORATION)
113 BARKSDALE PROFESSIONEL CENTER
NEWARK, DE 19711

FOR: BILL PAYMENT SERVICES; COLLECTING LICENSE FEES ON BEHALF OF INDEPENDENT WRITERS AND PUBLISHERS AND MAKING PAYMENTS TO THE COPYRIGHT OWNERS OF THE MUSIC; ELECTRONIC COMMERCE PAYMENT SERVICES, NAMELY, ESTABLISHING FUNDED ACCOUNTS USED TO PURCHASE GOODS AND SERVICES ON THE INTERNET; ELECTRONIC PAYMENT, NAMELY, ELECTRONIC PROCESSING AND TRANSMISSION OF BILL PAYMENT DATA; ELECTRONIC PROCESSING OF INSURANCE CLAIMS AND PAYMENT DATA; EQUIPMENT MAINTENANCE CLAIMS PAYMENT SERVICE FOR BUSINESS; FIDUCIARY TAX PAYMENT PROCESSING SERVICES; MAKING PAYMENTS ON PRE-PAID LONG DISTANCE CALLING CARDS FOR RECHARGING MINUTES; MONEY ORDER PAYMENT GUARANTEE SERVICES; PRE-PAID PURCHASE CARD SERVICES, NAMELY, PROCESSING ELECTRONIC PAYMENTS MADE THROUGH PREPAID CARDS; PRE-PAID PURCHASE CARD SERVICES, NAMELY, PROCESSING ELECTRONIC

PAYMENTS THROUGH PRE-PAID CARDS; PRE-PAID CARD SERVICES IN THE NATURE OF MAKING PAYMENT FOR ADDING AIRTIME TO PREPAID OR PAY-AS-YOU-GO WIRELESS SERVICES; PROVIDING ELECTRONIC PROCESSING OF CREDIT CARD TRANSACTIONS AND ELECTRONIC PAYMENTS VIA A GLOBAL COMPUTER NETWORK; PROVIDING MULTIPLE PAYMENT OPTIONS BY MEANS OF CUSTOMER-OPERATED ELECTRONIC TERMINALS AVAILABLE ON-SITE IN RETAIL STORES; TAX PAYMENT PROCESSING SERVICES; WIRELESS TELEPHONE PAYMENT SERVICES, NAMELY, WIRELESS MOBILE TELEPHONE RATE PLANS, IN CLASS 36 (U.S. CLS. 100, 101 AND 102).

FIRST USE 1-1-2007; IN COMMERCE 1-1-2007.

THE MARK CONSISTS OF STANDARD CHARACTERS WITHOUT CLAIM TO ANY PARTICULAR FONT, STYLE, SIZE, OR COLOR.

SN 77-018,325, FILED 10-11-2006.

LESLEY LAMOTHE, EXAMINING ATTORNEY

Int. Cl.: 42

Prior U.S. Cls.: 100 and 101

United States Patent and Trademark Office

Reg. No. 3,399,012

Registered Mar. 18, 2008

**SERVICE MARK
PRINCIPAL REGISTER**

SOCIAL SAUCE

SOCIAL SAUCE (CALIFORNIA CORPORATION)
213 W. 35TH STREET, SUITE 806
NEW YORK, NY 10001

FOR: COMPUTER SERVICES, NAMELY, HOSTING ONLINE WEB FACILITIES FOR OTHERS FOR ORGANIZING AND CONDUCTING ONLINE MEETINGS AND GATHERINGS, CREATING AND SHARING DIGITAL CONTENT AND MEDIA, AND HOSTING AND PARTICIPATING IN INTERACTIVE DISCUSSIONS; AND COMPUTER SERVICES IN THE NATURE OF CUSTOMIZED AND CUSTOMIZABLE WEB PAGES FEATURING USER-SUPPLIED INFORMATION, INCLUDING PERSONAL PRO-

FILES, DIARIES, REVIEWS, PICTURES, GRAPHICS, ANIMATIONS, AND AVATARS, IN CLASS 42 (U.S. CLS. 100 AND 101).

FIRST USE 1-18-2008; IN COMMERCE 1-18-2008.

THE MARK CONSISTS OF STANDARD CHARACTERS WITHOUT CLAIM TO ANY PARTICULAR FONT, STYLE, SIZE, OR COLOR.

SN 77-019,534, FILED 10-12-2006.

ANGELA M. MICHELI, EXAMINING ATTORNEY

Int. Cl.: 42

Prior U.S. Cls.: 100 and 101

United States Patent and Trademark Office

Reg. No. 3,399,013

Registered Mar. 18, 2008

**SERVICE MARK
PRINCIPAL REGISTER**

SOSAUCE

SOCIAL SAUCE (CALIFORNIA CORPORATION)
213 W. 35TH STREET, SUITE 806
NEW YORK, NY 10001

FOR: COMPUTER SERVICES, NAMELY, HOSTING ONLINE WEB FACILITIES FOR OTHERS FOR ORGANIZING AND CONDUCTING ONLINE MEETINGS AND GATHERINGS, CREATING AND SHARING DIGITAL CONTENT AND MEDIA, AND HOSTING AND PARTICIPATING IN INTERACTIVE DISCUSSIONS; AND COMPUTER SERVICES IN THE NATURE OF CUSTOMIZED AND CUSTOMIZABLE WEB PAGES FEATURING USER-SUPPLIED INFORMATION, INCLUDING PERSONAL PRO-

FILES, DIARIES, REVIEWS, PICTURES, GRAPHICS, ANIMATIONS, AND AVATARS, IN CLASS 42 (U.S. CLS. 100 AND 101).

FIRST USE 1-18-2008; IN COMMERCE 1-18-2008.

THE MARK CONSISTS OF STANDARD CHARACTERS WITHOUT CLAIM TO ANY PARTICULAR FONT, STYLE, SIZE, OR COLOR.

SN 77-019,544, FILED 10-12-2006.

ANGELA M. MICHELI, EXAMINING ATTORNEY

Int. Cl.: 42

Prior U.S. Cls.: 100 and 101

United States Patent and Trademark Office

Reg. No. 3,399,014

Registered Mar. 18, 2008

**SERVICE MARK
PRINCIPAL REGISTER**

Identisphere

IDENTISPHERE INC (MINNESOTA CORPORATION)
SUITE E-1101
8151 - 33RD AVE S
BLOOMINGTON, MN 55425

THE MARK CONSISTS OF STANDARD CHARACTERS WITHOUT CLAIM TO ANY PARTICULAR FONT, STYLE, SIZE, OR COLOR.

FOR: COMPUTER SOFTWARE DEVELOPMENT,
IN CLASS 42 (U.S. CLS. 100 AND 101).

SN 77-019,848, FILED 10-12-2006.

FIRST USE 1-16-2007; IN COMMERCE 1-16-2007.

SHAUNIA CARLYLE, EXAMINING ATTORNEY

Int. Cl.: 35

Prior U.S. Cls.: 100, 101, and 102

United States Patent and Trademark Office

Reg. No. 3,399,015

Registered Mar. 18, 2008

**SERVICE MARK
PRINCIPAL REGISTER**



ROBERT E. HOVEY JR. (ILLINOIS LTD LIAB CO)
SUITE 2005
101 NORTH WACHER DRIVE
CHICAGO, IL 60606 AND
JAMES F. DAVIS II (ILLINOIS LTD LIAB CO)
SUITE 2005
101 NORTH WACKER DRIVE
CHICAGO, IL 60606

FOR: ADVERTISING AGENCIES, NAMELY,
PROMOTING THE SERVICES OF CAR DEALER-
SHIPS THROUGH THE DISTRIBUTION OF PRIN-
TED AND AUDIO PROMOTIONAL MATERIALS
AND BY RENDERING SALES PROMOTION AD-
VICE, IN CLASS 35 (U.S. CLS. 100, 101 AND 102).

FIRST USE 4-30-2006; IN COMMERCE 4-30-2006.

NO CLAIM IS MADE TO THE EXCLUSIVE
RIGHT TO USE "EVENTS", APART FROM THE
MARK AS SHOWN.

THE COLOR(S) BLUE, WHITE, AND SILVER IS/
ARE CLAIMED AS A FEATURE OF THE MARK.

THE MARK CONSISTS OF A CURVED BLUE
ROAD WITH WHITE DASHES ACCENTED BY A
SILVER LINING, TO THE RIGHT OF WHICH
APPEAR THE WORDS "RUSH HOUR" IN BLUE
AND UNDERLINED IN BLUE, BELOW WHICH
APPEARS THE WORD "EVENTS" IN SILVER.

SN 77-020,532, FILED 10-13-2006.

EDWARD FENNESSY, EXAMINING ATTORNEY

Int. Cl.: 28

Prior U.S. Cls.: 22, 23, 38, and 50

United States Patent and Trademark Office

Reg. No. 3,399,016

Registered Mar. 18, 2008

**TRADEMARK
PRINCIPAL REGISTER**

DiRiginal

SOURCENTERPRISES, INC. (CALIFORNIA CORPORATION)
165 E. LIBERTY AVENUE
ANAHEIM, CA 92801

THE MARK CONSISTS OF STANDARD CHARACTERS WITHOUT CLAIM TO ANY PARTICULAR FONT, STYLE, SIZE, OR COLOR.

FOR: BILLIARD PRODUCTS, GAMES, AND ACCESSORIES, NAMELY, BILLIARD BALLS AND BILLIARD GAME PLAYING EQUIPMENT, IN CLASS 28 (U.S. CLS. 22, 23, 38 AND 50).

SN 77-021,153, FILED 10-13-2006.

FIRST USE 6-21-2007; IN COMMERCE 6-21-2007.

JEAN IM, EXAMINING ATTORNEY

Int. Cl.: 35

Prior U.S. Cls.: 100, 101, and 102

United States Patent and Trademark Office

Reg. No. 3,399,017

Registered Mar. 18, 2008

**SERVICE MARK
PRINCIPAL REGISTER**

BRIGHTER PROMOTIONS

CHEMICAL LIGHT, INC. (ILLINOIS CORPORATION)
595 LAKEVIEW PARKWAY
VERNON HILLS, IL 60061

FOR: PROMOTION AND MARKETING SERVICES AND RELATED CONSULTING; PROVIDING PROMOTIONAL AND MERCHANDISING MATERIALS FOR OTHERS, IN CLASS 35 (U.S. CLS. 100, 101 AND 102).

FIRST USE 9-10-2007; IN COMMERCE 9-10-2007.

THE MARK CONSISTS OF STANDARD CHARACTERS WITHOUT CLAIM TO ANY PARTICULAR FONT, STYLE, SIZE, OR COLOR.

NO CLAIM IS MADE TO THE EXCLUSIVE RIGHT TO USE "PROMOTIONS", APART FROM THE MARK AS SHOWN.

SN 77-021,706, FILED 10-16-2006.

BENJAMIN ALLEN, EXAMINING ATTORNEY

Int. Cl.: 10

Prior U.S. Cls.: 26, 39, and 44

United States Patent and Trademark Office

Reg. No. 3,399,018

Registered Mar. 18, 2008

**TRADEMARK
PRINCIPAL REGISTER**

GEMINI

GENERAL MEDVENTURES INTERNATIONAL,
LLC (DELAWARE LTD LIAB CO)
13250 LAKEFRONT DRIVE
EARTH CITY, MO 63045

THE MARK CONSISTS OF STANDARD CHAR-
ACTERS WITHOUT CLAIM TO ANY PARTICULAR
FONT, STYLE, SIZE, OR COLOR.

FOR: MASSAGE MACHINES, IN CLASS 10 (U.S.
CLS. 26, 39 AND 44).

SN 77-022,070, FILED 10-16-2006.

FIRST USE 12-20-2007; IN COMMERCE 12-20-2007.

JENNIFER DIXON, EXAMINING ATTORNEY

Int. Cl.: 35

Prior U.S. Cls.: 100, 101, and 102

United States Patent and Trademark Office

Reg. No. 3,399,019

Registered Mar. 18, 2008

**SERVICE MARK
PRINCIPAL REGISTER**

NECODO

NECODO, LLC (WASHINGTON LTD LIAB CO)
215 2ND AVENUE, S., SUITE M1
SEATTLE, WA 98104

THE MARK CONSISTS OF STANDARD CHAR-
ACTERS WITHOUT CLAIM TO ANY PARTICULAR
FONT, STYLE, SIZE, OR COLOR.

FOR: ON-LINE RETAIL STORE SERVICES FEA-
TURING DOWNLOADABLE PRE-RECORDED MU-
SIC AND VIDEO, IN CLASS 35 (U.S. CLS. 100, 101
AND 102).

SN 77-022,109, FILED 10-16-2006.

FIRST USE 3-20-2007; IN COMMERCE 3-20-2007.

MELVIN AXILBUND, EXAMINING ATTORNEY

Int. Cl.: 36

Prior U.S. Cls.: 100, 101, and 102

United States Patent and Trademark Office

Reg. No. 3,399,020

Registered Mar. 18, 2008

**SERVICE MARK
PRINCIPAL REGISTER**

**ENDURA FINANCIAL FEDERAL
CREDIT UNION**

HONEYWELL FEDERAL CREDIT UNION (UNI-
TED STATES FEDERAL CREDIT UNION)
SUITE 600
6465 WAYZATA BOULEVARD
MINNEAPOLIS, MN 55426

FOR: CREDIT UNION SERVICES, IN CLASS 36
(U.S. CLS. 100, 101 AND 102).

FIRST USE 10-17-2007; IN COMMERCE 10-17-2007.

THE MARK CONSISTS OF STANDARD CHAR-
ACTERS WITHOUT CLAIM TO ANY PARTICULAR
FONT, STYLE, SIZE, OR COLOR.

NO CLAIM IS MADE TO THE EXCLUSIVE
RIGHT TO USE "FINANCIAL FEDERAL CREDIT
UNION", APART FROM THE MARK AS SHOWN.

SN 77-022,127, FILED 10-16-2006.

JAMES MACFARLANE, EXAMINING ATTORNEY

Int. Cl.: 9

Prior U.S. Cls.: 21, 23, 26, 36, and 38

United States Patent and Trademark Office

Reg. No. 3,399,021

Registered Mar. 18, 2008

**TRADEMARK
PRINCIPAL REGISTER**

HOSPIRA MEDNET INTEGRATOR

HOSPIRA, INC. (DELAWARE CORPORATION)
NLEG, HI
275 NORTH FIELD DRIVE
LAKE FOREST, IL 600452579

FOR: COMPONENT OF COMPUTER SOFTWARE FOR PROVIDING COMMUNICATION OF DATA AMONG MEDICAL DEVICES, NAMELY, MEDICATION ADMINISTRATION DEVICES AND PATIENT MONITORING DEVICES, AND BETWEEN SUCH MEDICAL DEVICES AND COMPUTERS, MONITORS OR COMMUNICATIONS DEVICES IN A HOSPITAL OR IN A LOCATION REMOTE FROM THE HOSPITAL TO MONITOR, MANAGE, SUPPORT VERIFICATION AND DOCUMENTATION OF MEDICATION DELIVERY TO PATIENTS, AND IDENTIFY ANY PROBLEMS THEREWITH, IN CLASS 9 (U.S. CLS. 21, 23, 26, 36 AND 38).

FIRST USE 11-16-2007; IN COMMERCE 11-16-2007.

THE MARK CONSISTS OF STANDARD CHARACTERS WITHOUT CLAIM TO ANY PARTICULAR FONT, STYLE, SIZE, OR COLOR.

OWNER OF U.S. REG. NO. 3,005,020.

NO CLAIM IS MADE TO THE EXCLUSIVE RIGHT TO USE "INTEGRATOR", APART FROM THE MARK AS SHOWN.

SN 77-022,524, FILED 10-17-2006.

MARILYN IZZI, EXAMINING ATTORNEY

Int. Cls.: 35 and 40

Prior U.S. Cls.: 100, 101, 102, 103, and 106

United States Patent and Trademark Office

Reg. No. 3,399,022

Registered Mar. 18, 2008

**SERVICE MARK
PRINCIPAL REGISTER**

COLOURS BEYOND COMPARE

COLWELL INDUSTRIES, INC. (MINNESOTA CORPORATION)
123 NORTH THIRD STREET
MINNEAPOLIS, MN 55401

FOR: BUSINESS CONSULTING AND RESEARCH SERVICES IN THE FIELD OF MERCHANDISING AIDS FOR COLOR OR SURFACE MATERIAL SELECTION AND MATCHING, AND CONTROL OF COLOR IN THE MANUFACTURING PROCESS, IN CLASS 35 (U.S. CLS. 100, 101 AND 102).

FIRST USE 4-18-2007; IN COMMERCE 4-18-2007.

FOR: MANUFACTURING SERVICES FOR OTHERS OF PAINT, COLOR AND SURFACE MATERIAL SAMPLES FOR A WIDE VARIETY OF

INDUSTRIES, IN CLASS 40 (U.S. CLS. 100, 103 AND 106).

FIRST USE 4-18-2007; IN COMMERCE 4-18-2007.

THE MARK CONSISTS OF STANDARD CHARACTERS WITHOUT CLAIM TO ANY PARTICULAR FONT, STYLE, SIZE, OR COLOR.

NO CLAIM IS MADE TO THE EXCLUSIVE RIGHT TO USE "COLORS", APART FROM THE MARK AS SHOWN.

SN 77-022,567, FILED 10-17-2006.

EDWARD FENNESSY, EXAMINING ATTORNEY

Int. Cls.: 8, 16, and 21

**Prior U.S. Cls.: 2, 5, 13, 22, 23, 28, 29, 30, 33, 37, 38,
40, 44, and 50**

Reg. No. 3,399,023

United States Patent and Trademark Office

Registered Mar. 18, 2008

**TRADEMARK
PRINCIPAL REGISTER**

RAYTATTZ

W. R. RAYSON CO., INC. (NORTH CAROLINA
CORPORATION)
720 S. DICKERSON ST.
BURGAW, NC 28425

FOR: TATTOO INK CUPS; DISPOSABLE LATEX
GLOVES FOR GENERAL USE; DISPOSABLE PLAS-
TIC GLOVES FOR GENERAL USE, IN CLASS 21
(U.S. CLS. 2, 13, 23, 29, 30, 33, 40 AND 50).

FOR: DISPOSABLE RAZORS, IN CLASS 8 (U.S.
CLS. 23, 28 AND 44).

FIRST USE 1-11-2007; IN COMMERCE 1-11-2007.

FIRST USE 1-11-2007; IN COMMERCE 1-11-2007.

FOR: DISPOSABLE PAPER TOWELS; DISPOS-
ABLE WIPES NOT IMPREGNATED WITH CHEMI-
CALS OR COMPOUNDS; DISPOSABLE PAPER
INSTRUMENT TRAY COVERS, IN CLASS 16 (U.S.
CLS. 2, 5, 22, 23, 29, 37, 38 AND 50).

THE MARK CONSISTS OF STANDARD CHAR-
ACTERS WITHOUT CLAIM TO ANY PARTICULAR
FONT, STYLE, SIZE, OR COLOR.

SN 77-022,576, FILED 10-17-2006.

FIRST USE 1-11-2007; IN COMMERCE 1-11-2007.

DAWN HAN, EXAMINING ATTORNEY

Int. Cl.: 28

Prior U.S. Cls.: 22, 23, 38, and 50

United States Patent and Trademark Office

Reg. No. 3,399,024

Registered Mar. 18, 2008

**TRADEMARK
PRINCIPAL REGISTER**

MASTERPIECE ARTS

KABUSHIKI KAISHA SQUARE ENIX (JAPAN
CORPORATION), AKA SQUARE ENIX CO.,
LTD.,
SHIBUYA-KU
3-22-7 YOYOGI
TOKYO, JAPAN

THE MARK CONSISTS OF STANDARD CHAR-
ACTERS WITHOUT CLAIM TO ANY PARTICULAR
FONT, STYLE, SIZE, OR COLOR.

FOR: DOLLS AND TOY FIGURES, IN CLASS 28
(U.S. CLS. 22, 23, 38 AND 50).

SN 77-022,637, FILED 10-17-2006.

FIRST USE 11-0-2007; IN COMMERCE 12-0-2007.

CHRISTINE COOPER, EXAMINING ATTORNEY

Int. Cl.: 9

Prior U.S. Cls.: 21, 23, 26, 36, and 38

United States Patent and Trademark Office

Reg. No. 3,399,025

Registered Mar. 18, 2008

**TRADEMARK
PRINCIPAL REGISTER**

JACKPOT IN THE BOX

ADRENALIN GAMING, LLC. (NEVADA LTD
LIAB CO)
36 LEWISTON COURT
LADERA RANCH, CA 92694

FOR: GAMING MACHINES, NAMELY, SLOT
MACHINES WITH OR WITHOUT VIDEO OUTPUT
USED IN A CASINO; ELECTRIC OR ELECTRO-
MECHANICAL GAMING TABLES WITH VIDEO
OUTPUT USED IN A CASINO , IN CLASS 9 (U.S.
CLS. 21, 23, 26, 36 AND 38).

FIRST USE 2-1-2005; IN COMMERCE 2-1-2005.

THE MARK CONSISTS OF STANDARD CHAR-
ACTERS WITHOUT CLAIM TO ANY PARTICULAR
FONT, STYLE, SIZE, OR COLOR.

SN 77-024,752, FILED 10-19-2006.

SUSAN LESLIE DUBOIS, EXAMINING ATTORNEY

Int. Cl.: 3

Prior U.S. Cls.: 1, 4, 6, 50, 51, and 52

United States Patent and Trademark Office

Reg. No. 3,399,026

Registered Mar. 18, 2008

TRADEMARK
PRINCIPAL REGISTER



JAFER LIMITED (BERMUDA CORPORATION)
CLARENDON HOUSE, 2 CHURCH STREET
HAMILTON, HM, BERMUDA

FOR: FRAGRANCES FOR PERSONAL USE, TOI-
LET WATER, AND COLOGNE, IN CLASS 3 (U.S.
CLS. 1, 4, 6, 50, 51 AND 52).

FIRST USE 5-4-2006; IN COMMERCE 11-5-2007.

OWNER OF U.S. REG. NO. 2,968,525.

THE COLOR(S) PURPLE, WHITE, YELLOW,
GREEN, AND BLACK IS/ARE CLAIMED AS A
FEATURE OF THE MARK.

THE MARK CONSISTS OF PURPLE FLOWERS
WITH WHITE AND YELLOW CENTERS AND
GREEN AND YELLOW STEMS AND THE WORD
"L'ESSENCE" WRITTEN VERTICALLY, ORIENTED
BOTTOM TO TOP, IN BLACK LETTERING; AND
THE COLOR WHITE APPEARS AS THE BACK-
GROUND COLOR IN THE MARK.

THE FOREIGN WORDING IN THE MARK
TRANSLATES INTO ENGLISH AS THE ESSENCE.

SN 77-025,366, FILED 10-19-2006.

BILL DAWE, EXAMINING ATTORNEY

Int. Cls.: 41 and 44

Prior U.S. Cls.: 100, 101, and 107

United States Patent and Trademark Office

Reg. No. 3,399,027

Registered Mar. 18, 2008

**SERVICE MARK
PRINCIPAL REGISTER**

The logo for Mindforegolf.com features a thick black curved line above the text. The text "mindforegolf" is in a bold, lowercase, sans-serif font, and ".com" is in a smaller, lowercase, sans-serif font to the right. A small black dot is positioned above the "o" in ".com".

STERLING STARS, INC. (NEW YORK CORPORATION)
8 CHATEAUX CIRCLE, SUITE 8H
SCARSDALE, NY 10583

FOR: PERSONAL COACHING SERVICES IN THE FIELD OF GOLF; BUSINESS TRAINING; TRAINING SERVICES IN THE FIELD OF EXECUTIVE COACHING, PERSONAL COACHING, MARKETING, ORGANIZATIONAL EFFECTIVENESS, TEAM BUILDING, PSYCHOLOGICAL TESTING, AND PSYCHOLOGICAL TESTING SERVICES; PROVIDING PERSONAL COACHING SERVICES IN THE FIELD OF GOLF VIA THE INTERNET; PROVIDING BUSINESS TRAINING VIA THE INTERNET; PROVIDING TRAINING SERVICES IN THE FIELD OF EXECUTIVE COACHING, PERSONAL COACHING, MARKETING, ORGANIZATIONAL EFFECTIVENESS, TEAM BUILDING, PSYCHOLOGICAL TESTING, AND PSYCHOLOGICAL TESTING SERVICES, IN CLASS 41 (U.S. CLS. 100, 101 AND 107).

FIRST USE 7-4-2007; IN COMMERCE 9-17-2007.

FOR: PSYCHOLOGICAL COUNSELING, PSYCHOLOGICAL COUNSELING IN THE FIELD OF SPORTS; PSYCHOLOGICAL COUNSELING IN THE NATURE OF PERSONALITY PROFILING, PREFERENCE PROFILING, AND WHOLE BRAIN THINKING; PSYCHOLOGICAL COUNSELING, PSYCHOLOGICAL COUNSELING IN THE FIELD OF SPORTS; PSYCHOLOGICAL COUNSELING IN THE NATURE OF PERSONALITY PROFILING, PREFERENCE PROFILING, AND WHOLE BRAIN THINKING VIA THE INTERNET, IN CLASS 44 (U.S. CLS. 100 AND 101).

FIRST USE 1-25-2007; IN COMMERCE 1-25-2007.

SN 77-026,297, FILED 10-20-2006.

TARAH HARDY, EXAMINING ATTORNEY

Int. Cl.: 38

Prior U.S. Cls.: 100, 101, and 104

United States Patent and Trademark Office

Reg. No. 3,399,028

Registered Mar. 18, 2008

**SERVICE MARK
PRINCIPAL REGISTER**

The logo for MyInternet features the word "MyInternet" in a bold, sans-serif font. The letter "I" is replaced by a stylized human figure with arms raised in a V-shape, representing a person standing on the letter.

DOTSTER, INC. (DELAWARE CORPORATION)
SUITE 300
8100 NE PARKWAY DRIVE
VANCOUVER, WA 98662

FIRST USE 1-1-2006; IN COMMERCE 1-1-2006.

OWNER OF U.S. REG. NO. 2,611,501.

FOR: PROVIDING MULTIPLE-USER ACCESS TO A GLOBAL COMPUTER INFORMATION NETWORK; ELECTRONIC MAIL SERVICES FOR OTHERS OVER A GLOBAL COMPUTER NETWORK; ELECTRONIC MAIL FORWARDING SERVICES FOR OTHERS OVER A GLOBAL COMPUTER NETWORK; WEB SITE FORWARDING SERVICES FOR OTHERS OVER A GLOBAL COMPUTER NETWORK, IN CLASS 38 (U.S. CLS. 100, 101 AND 104).

THE MARK CONSISTS OF THE WORDS "MYINTERNET" WITH THE FIGURE OF A PERSON AS THE LETTER "I".

SN 77-027,909, FILED 10-24-2006.

JIM RINGLE, EXAMINING ATTORNEY

Int. Cl.: 45

Prior U.S. Cls.: 100 and 101

United States Patent and Trademark Office

Reg. No. 3,399,029

Registered Mar. 18, 2008

**SERVICE MARK
PRINCIPAL REGISTER**

KEEPCOMINGBACK.COM

KEEPCOMINGBACK.COM LLC (CALIFORNIA
LTD LIAB CO)
8910 UNIVERSITY CENTER LANE
SUITE 220
SAN DIEGO, CA 92122

FOR: SOCIAL SERVICES, NAMELY, PROVIDING
ONLINE SOCIAL NETWORKING FOR PEOPLE IN
ADDICTION RECOVERY, IN CLASS 45 (U.S. CLS.
100 AND 101).

FIRST USE 7-9-2007; IN COMMERCE 7-9-2007.

THE MARK CONSISTS OF STANDARD CHAR-
ACTERS WITHOUT CLAIM TO ANY PARTICULAR
FONT, STYLE, SIZE, OR COLOR.

SN 77-028,127, FILED 10-24-2006.

IRA J. GOODSID, EXAMINING ATTORNEY

Int. Cl.: 16

Prior U.S. Cls.: 2, 5, 22, 23, 29, 37, 38, and 50

Reg. No. 3,399,030

United States Patent and Trademark Office

Registered Mar. 18, 2008

**TRADEMARK
PRINCIPAL REGISTER**

FUNKY DARLIN'

FUNKY DARLIN', LLC (ALABAMA LTD LIAB
CO)
25558 HIDDEN FOREST LANE
ANDALUSIA, AL 36421

FIRST USE 7-14-2007; IN COMMERCE 7-14-2007.

FOR: ARTWORK, PAINTINGS AND CARDS,
NAMELY, ORIGINAL WATERCOLOR PAINTINGS,
PRINTS CONTAINING SCANNED IMAGES OF
ORIGINAL WATERCOLOR PAINTINGS, GICLEE
PRINTS OF ORIGINAL WATERCOLOR PAINT-
INGS, AND CARDS IMPRINTED WITH SCANNED
IMAGES OF ORIGINAL WATERCOLOR PAINT-
INGS, IN CLASS 16 (U.S. CLS. 2, 5, 22, 23, 29, 37, 38
AND 50).

THE MARK CONSISTS OF STANDARD CHAR-
ACTERS WITHOUT CLAIM TO ANY PARTICULAR
FONT, STYLE, SIZE, OR COLOR.

SN 77-028,519, FILED 10-24-2006.

JACQUELINE A. LAVINE, EXAMINING ATTOR-
NEY

Int. Cl.: 3

Prior U.S. Cls.: 1, 4, 6, 50, 51, and 52

United States Patent and Trademark Office

Reg. No. 3,399,031

Registered Mar. 18, 2008

**TRADEMARK
PRINCIPAL REGISTER**

DAILY NOURISH

TED GIBSON & COMPANY, INC. (NEW YORK CORPORATION)
C/O KANTOR, DAVIDOFF ET AL.
51 EAST 42ND STREET
NEW YORK, NY 10017

THE MARK CONSISTS OF STANDARD CHARACTERS WITHOUT CLAIM TO ANY PARTICULAR FONT, STYLE, SIZE, OR COLOR.

FOR: HAIR CARE PRODUCTS, NAMELY, HAIR CONDITIONERS, IN CLASS 3 (U.S. CLS. 1, 4, 6, 50, 51 AND 52).

SN 77-028,532, FILED 10-24-2006.

FIRST USE 1-23-2007; IN COMMERCE 1-23-2007.

WENDY GOODMAN, EXAMINING ATTORNEY

Int. Cl.: 14

Prior U.S. Cls.: 2, 27, 28, and 50

United States Patent and Trademark Office

Reg. No. 3,399,032

Registered Mar. 18, 2008

**TRADEMARK
PRINCIPAL REGISTER**

RED RIBBON EMBRACELET

THE RED RIBBON FOUNDATION, INC (CON-
NECTICUT CORPORATION)
207 GREENWICH AVENUE
GREENWICH, CT 06830

THE MARK CONSISTS OF STANDARD CHAR-
ACTERS WITHOUT CLAIM TO ANY PARTICULAR
FONT, STYLE, SIZE, OR COLOR.

FOR: CHARITY BRACELETS, IN CLASS 14 (U.S.
CLS. 2, 27, 28 AND 50).

SN 77-029,192, FILED 10-25-2006.

FIRST USE 10-24-2006; IN COMMERCE 10-24-2006.

KAELIE KUNG, EXAMINING ATTORNEY

Int. Cl.: 21

Prior U.S. Cls.: 2, 13, 23, 29, 30, 33, 40, and 50

United States Patent and Trademark Office

Reg. No. 3,399,033

Registered Mar. 18, 2008

**TRADEMARK
PRINCIPAL REGISTER**

CONSERVATION MASTERPIECE

TRU VUE, INC. (ILLINOIS CORPORATION)
9400 WEST 55TH STREET
MCCOOK, IL 60525

FOR: GLASS SHEETS FOR PICTURE FRAMES
AND DISPLAY CASES, IN CLASS 21 (U.S. CLS. 2, 13,
23, 29, 30, 33, 40 AND 50).

FIRST USE 12-18-2006; IN COMMERCE 12-18-2006.

THE MARK CONSISTS OF STANDARD CHAR-
ACTERS WITHOUT CLAIM TO ANY PARTICULAR
FONT, STYLE, SIZE, OR COLOR.

OWNER OF U.S. REG. NOS. 1,590,940, 1,590,942,
AND OTHERS.

SN 77-029,291, FILED 10-25-2006.

CARYN GLASSER, EXAMINING ATTORNEY

Int. Cl.: 5

Prior U.S. Cls.: 6, 18, 44, 46, 51, and 52

United States Patent and Trademark Office

Reg. No. 3,399,034

Registered Mar. 18, 2008

**TRADEMARK
PRINCIPAL REGISTER**



WYETH HOLDINGS CORPORATION (MAINE CORPORATION)
FIVE GIRALDA FARMS
MADISON, NJ 07940

FOR: DIETARY AND NUTRITIONAL SUPPLEMENTS, IN CLASS 5 (U.S. CLS. 6, 18, 44, 46, 51 AND 52).

FIRST USE 6-1-2007; IN COMMERCE 6-1-2007.

OWNER OF U.S. REG. NOS. 1,160,579 AND 1,675,671.

THE COLOR(S) LIGHT AND DARK REDS, LIGHT AND DARK ORANGES, LIGHT AND DARK YELLOWS, LIGHT AND DARK GREENS, AND LIGHT AND DARK BLUES IS/ARE CLAIMED AS A FEATURE OF THE MARK.

THE COLOR(S) LIGHT AND DARK REDS, LIGHT AND DARK ORANGES, LIGHT AND DARK YELLOWS, LIGHT AND DARK GREENS, AND LIGHT AND DARK BLUES APPEAR FROM LEFT TO RIGHT IN AN ARCHING BAND.

THE MARK CONSISTS OF AN ARCHING BAND OF COLORS RANGING, FROM LEFT TO RIGHT, FROM RED TO ORANGE, TO YELLOW, TO GREEN, TO BLUE.

SN 77-029,694, FILED 10-26-2006.

ALYSSA PALADINO, EXAMINING ATTORNEY

Int. Cl.: 3

Prior U.S. Cls.: 1, 4, 6, 50, 51, and 52

United States Patent and Trademark Office

Reg. No. 3,399,035

Registered Mar. 18, 2008

**TRADEMARK
PRINCIPAL REGISTER**

TZ

COSMETIC SPECIALTY LABS, INC. (OKLAHOMA CORPORATION)
210 SW TEXAS AVENUE
LAWTON, OK 735018128

FOR: BODY SCRUBS, BATH GELS, BODY CREAMS, BODY LOTIONS, BATH CRYSTALS, MASSAGE OILS, BODY MISTS, SHAVING CREAMS, SKIN CLEANSERS, BODY LOTIONS, NAMELY, WARMING AND SILICONE LOTIONS, IN CLASS 3 (U.S. CLS. 1, 4, 6, 50, 51 AND 52).

FIRST USE 2-0-2007; IN COMMERCE 3-0-2007.

THE MARK CONSISTS OF STANDARD CHARACTERS WITHOUT CLAIM TO ANY PARTICULAR FONT, STYLE, SIZE, OR COLOR.

SN 77-029,936, FILED 10-26-2006.

KATHERINE CONNOLLY, EXAMINING ATTORNEY

Int. Cl.: 35

Prior U.S. Cls.: 100, 101, and 102

United States Patent and Trademark Office

Reg. No. 3,399,036

Registered Mar. 18, 2008

**SERVICE MARK
PRINCIPAL REGISTER**

MODULAR DEPOT

LEHMANN MANAGEMENT CORP. (OHIO CORPORATION)
6855 ALBERLY LANE
CINCINNATI, OH 45243

FOR: RETAIL AUTOMOBILE PARTS AND ACCESSORIES STORES, IN CLASS 35 (U.S. CLS. 100, 101 AND 102).

FIRST USE 4-25-2003; IN COMMERCE 4-25-2003.

THE MARK CONSISTS OF STANDARD CHARACTERS WITHOUT CLAIM TO ANY PARTICULAR FONT, STYLE, SIZE, OR COLOR.

NO CLAIM IS MADE TO THE EXCLUSIVE RIGHT TO USE "DEPOT", APART FROM THE MARK AS SHOWN.

SN 77-030,667, FILED 10-27-2006.

LEE-ANNE BERNS, EXAMINING ATTORNEY

Int. Cl.: 25

Prior U.S. Cls.: 22 and 39

United States Patent and Trademark Office

Reg. No. 3,399,037

Registered Mar. 18, 2008

**TRADEMARK
PRINCIPAL REGISTER**

JACK HAMMER

100MC, LLC (CALIFORNIA LTD LIAB CO)
SUITE B
12 E. SIR FRANCIS DRAKE BLVD.
LARKSPUR, CA 94939

FOR: CLOTHING, NAMELY, MEN'S, WOMEN'S
AND CHILDREN'S CASUAL AND WORK CLOTH-
ING, NAMELY, CASUAL SHIRTS, WORK SHIRTS,
PANTS, SHORTS, WORK GLOVES, JACKETS, UN-
DERWEAR, TOPS, FOOTWEAR AND HEADWEAR,
IN CLASS 25 (U.S. CLS. 22 AND 39).

FIRST USE 10-1-2007; IN COMMERCE 10-1-2007.

THE MARK CONSISTS OF STANDARD CHAR-
ACTERS WITHOUT CLAIM TO ANY PARTICULAR
FONT, STYLE, SIZE, OR COLOR.

THE NAME JACK HAMMER DOES NOT IDEN-
TIFY A LIVING INDIVIDUAL.

SN 77-030,931, FILED 10-27-2006.

JOHN DALIER, EXAMINING ATTORNEY

Int. Cl.: 43

Prior U.S. Cls.: 100 and 101

United States Patent and Trademark Office

Reg. No. 3,399,038

Registered Mar. 18, 2008

**SERVICE MARK
PRINCIPAL REGISTER**



SODEXHO, INC. (DELAWARE CORPORATION)
9801 WASHINGTONIAN BOULEVARD
GAITHERSBURG, MD 20878

FOR: PREPARING AND SERVING FOODS AND
BEVERAGES; CONTRACT FOOD SERVICES, IN
CLASS 43 (U.S. CLS. 100 AND 101).

FIRST USE 7-18-2006; IN COMMERCE 7-18-2006.

OWNER OF U.S. REG. NO. 2,187,654.

THE MARK CONSISTS OF THE WORDS FRESH
INSPIRATIONS, SHOWN WITH THE DESIGN OF A
STYLIZED FRUIT OR VEGETABLE, A CURVED
LINE AND THE WORDS EXPERIENCE IT!.

SN 77-031,876, FILED 10-30-2006.

RUDY R. SINGLETON, EXAMINING ATTORNEY

Int. Cl.: 43

Prior U.S. Cls.: 100 and 101

United States Patent and Trademark Office

Reg. No. 3,399,039

Registered Mar. 18, 2008

**SERVICE MARK
PRINCIPAL REGISTER**

EXPERIENCE IT!

SODEXHO, INC. (DELAWARE CORPORATION)
9801 WASHINGTONIAN BOULEVARD
GAITHERSBURG, MD 20878

THE MARK CONSISTS OF STANDARD CHAR-
ACTERS WITHOUT CLAIM TO ANY PARTICULAR
FONT, STYLE, SIZE, OR COLOR.

FOR: PREPARING AND SERVING FOODS AND
BEVERAGES; CONTRACT FOOD SERVICES, IN
CLASS 43 (U.S. CLS. 100 AND 101).

SN 77-031,879, FILED 10-30-2006.

FIRST USE 7-18-2006; IN COMMERCE 7-18-2006.

RUDY R. SINGLETON, EXAMINING ATTORNEY

Int. Cl.: 37

Prior U.S. Cls.: 100, 103, and 106

United States Patent and Trademark Office

Reg. No. 3,399,040

Registered Mar. 18, 2008

**SERVICE MARK
PRINCIPAL REGISTER**

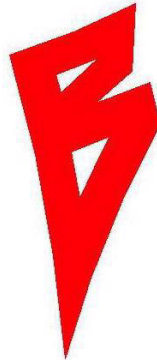

BICYCLE GARAGE

THE BICYCLE GARAGE, LLC (CONNECTICUT
LTD LIAB CO)
300 WEST RD
COLCHESTER, CT 06415

FOR: REPAIR OF BICYCLES, IN CLASS 37 (U.S.
CLS. 100, 103 AND 106).

FIRST USE 10-15-2006; IN COMMERCE 11-1-2006.

NO CLAIM IS MADE TO THE EXCLUSIVE
RIGHT TO USE "BICYCLE GARAGE", APART
FROM THE MARK AS SHOWN.

THE COLOR(S) RED IS/ARE CLAIMED AS A
FEATURE OF THE MARK.

THE MARK CONSISTS OF THE WORDING "BI-
CYCLE GARAGE" IN BLACK AND A STYLIZED
LETTER "B" IN RED.

SN 77-033,077, FILED 10-31-2006.

ALICIA COLLINS, EXAMINING ATTORNEY

Int. Cl.: 25

Prior U.S. Cls.: 22 and 39

United States Patent and Trademark Office

Reg. No. 3,399,041

Registered Mar. 18, 2008

**TRADEMARK
PRINCIPAL REGISTER**

CHRISTlike

CHRISTLIKE ENTERPRISES, LLC (KENTUCKY
LTD LIAB CO)
2112 CORNERSTONE DRIVE
LEXINGTON, KY 40509

FOR: ANKLE SOCKS; ANKLETS; ATHLETIC
SHOES; CANVAS SHOES; CAPRI PANTS; DENIMS;
DRESS SHIRTS; GOLF SHIRTS; HEADBANDS;
JACKETS; JOGGING PANTS; LEATHER SHOES;
LONG SLEEVED VESTS; MEN'S SOCKS; POLO
SHIRTS; SHIRTS FOR SUITS; SHORT-SLEEVED
OR LONG-SLEEVED T-SHIRTS; SHORT-SLEEVED
SHIRTS; SLEEP SHIRTS; SLEEVED OR SLEEVELESS
JACKETS; SOCKS; SPORT SHIRTS; SWEAT PANTS;
T-SHIRTS; THERMAL SOCKS; TOBOGGAN HATS,
PANTS AND CAPS; TRACK PANTS; UNDER-

SHIRTS; WOMEN'S SHOES; WRISTBANDS, ALL
OF THE AFORESAID GOODS HAVING A RELI-
GIOUS PURPOSE, THEME, OR CONNOTATION, IN
CLASS 25 (U.S. CLS. 22 AND 39).

FIRST USE 10-14-2007; IN COMMERCE 3-17-2007.

THE MARK CONSISTS OF STANDARD CHAR-
ACTERS WITHOUT CLAIM TO ANY PARTICULAR
FONT, STYLE, SIZE, OR COLOR.

SN 77-033,368, FILED 10-31-2006.

CIMMERIAN COLEMAN, EXAMINING ATTOR-
NEY

Int. Cl.: 9

Prior U.S. Cls.: 21, 23, 26, 36, and 38

United States Patent and Trademark Office

Reg. No. 3,399,042

Registered Mar. 18, 2008

**TRADEMARK
PRINCIPAL REGISTER**

GEE U

ETERLINK INTERNATIONAL CORPORATION
(DELAWARE CORPORATION)
601 UNIVERSITY AVE STE 278
SACRAMENTO, CA 95825

FOR: CASES FOR ELECTRONIC DIARIES; CASES
FOR MOBILE PHONES; CASES FOR TELEPHONES;
PROTECTIVE CARRYING CASES FOR PORTABLE
MUSIC PLAYERS, NAMELY, MP3 PLAYERS, IN
CLASS 9 (U.S. CLS. 21, 23, 26, 36 AND 38).

FIRST USE 12-2-2007; IN COMMERCE 12-2-2007.

THE MARK CONSISTS OF STANDARD CHAR-
ACTERS WITHOUT CLAIM TO ANY PARTICULAR
FONT, STYLE, SIZE, OR COLOR.

SN 77-033,680, FILED 10-31-2006.

CYNTHIA SLOAN, EXAMINING ATTORNEY

Int. Cl.: 9

Prior U.S. Cls.: 21, 23, 26, 36, and 38

Reg. No. 3,399,043

United States Patent and Trademark Office

Registered Mar. 18, 2008

**TRADEMARK
PRINCIPAL REGISTER**

UGP

NOVA GAMING, LLC (SOUTH CAROLINA LTD
LIAB CO)
220 NORTH MAIN STREET, SUITE 600
GREENVILLE, SC 29211

THE MARK CONSISTS OF STANDARD CHAR-
ACTERS WITHOUT CLAIM TO ANY PARTICULAR
FONT, STYLE, SIZE, OR COLOR.

FOR: COMPUTER PROGRAMS FOR USE WITH
GAMING MACHINES, IN CLASS 9 (U.S. CLS. 21, 23,
26, 36 AND 38).

SN 77-033,884, FILED 11-1-2006.

FIRST USE 11-14-2006; IN COMMERCE 11-14-2006.

CHERYL CLAYTON, EXAMINING ATTORNEY

Int. Cl.: 18

Prior U.S. Cls.: 1, 2, 3, 22, and 41

United States Patent and Trademark Office

Reg. No. 3,399,044

Registered Mar. 18, 2008

**TRADEMARK
PRINCIPAL REGISTER**

Baby Queen

ASA HANDBAGS, INC (CALIFORNIA CORPORATION)

109 E 11TH ST

LOS ANGELES, CA 90015

FOR: HANDBAGS; LUGGAGE; WALLETS, IN CLASS 18 (U.S. CLS. 1, 2, 3, 22 AND 41).

FIRST USE 10-25-2007; IN COMMERCE 11-20-2007.

THE MARK CONSISTS OF STANDARD CHARACTERS WITHOUT CLAIM TO ANY PARTICULAR FONT, STYLE, SIZE, OR COLOR.

NO CLAIM IS MADE TO THE EXCLUSIVE RIGHT TO USE "BABY", APART FROM THE MARK AS SHOWN.

SN 77-034,593, FILED 11-1-2006.

LYDIA BELZER, EXAMINING ATTORNEY

Int. Cl.: 31

Prior U.S. Cls.: 1 and 46

United States Patent and Trademark Office

Reg. No. 3,399,045

Registered Mar. 18, 2008

**TRADEMARK
PRINCIPAL REGISTER**

GROWING YEARS

DEL MONTE CORPORATION (DELAWARE
CORPORATION)
ONE MARKET STREET
SAN FRANCISCO, CA 94105

THE MARK CONSISTS OF STANDARD CHAR-
ACTERS WITHOUT CLAIM TO ANY PARTICULAR
FONT, STYLE, SIZE, OR COLOR.

FOR: PET FOOD, IN CLASS 31 (U.S. CLS. 1 AND
46).

SN 77-035,293, FILED 11-2-2006.

FIRST USE 6-6-2007; IN COMMERCE 6-6-2007.

ANNE FARRELL, EXAMINING ATTORNEY

Int. Cl.: 30

Prior U.S. Cl.: 46

United States Patent and Trademark Office

Reg. No. 3,399,046

Registered Mar. 18, 2008

**TRADEMARK
PRINCIPAL REGISTER**

SNOPRINCE

H.C. BRILL COMPANY, INC. (DELAWARE COR-
PORATION)
1912 MONTREAL ROAD
TUCKER, GA 30084

THE MARK CONSISTS OF STANDARD CHAR-
ACTERS WITHOUT CLAIM TO ANY PARTICULAR
FONT, STYLE, SIZE, OR COLOR.

FOR: FLOUR, IN CLASS 30 (U.S. CL. 46).

SN 77-035,538, FILED 11-2-2006.

FIRST USE 1-0-2001; IN COMMERCE 1-0-2001.

CAROL SPILS, EXAMINING ATTORNEY

Int. Cls.: 21 and 35

**Prior U.S. Cls.: 2, 13, 23, 29, 30, 33, 40, 50, 100, 101,
and 102**

Reg. No. 3,399,047

United States Patent and Trademark Office

Registered Mar. 18, 2008

**TRADEMARK
SERVICE MARK
PRINCIPAL REGISTER**

BIPS

CRYSTALIER, LIMITED (COLORADO COR-
PORATION)
6591 HIGHWAY 73
EVERGREEN, CO 80439

FOR: FIGURINES OF CRYSTAL AND GLASS, IN
CLASS 21 (U.S. CLS. 2, 13, 23, 29, 30, 33, 40 AND 50).

FIRST USE 12-25-2007; IN COMMERCE 12-25-2007.

FOR: RETAIL STORE SERVICES, WHOLESALE
STORE SERVICES, MAIL ORDER SERVICES, AND
ONLINE STORE SERVICES FEATURING FIGUR-

INES OF CRYSTAL AND GLASS, IN CLASS 35 (U.S.
CLS. 100, 101 AND 102).

FIRST USE 12-25-2007; IN COMMERCE 12-25-2007.

THE MARK CONSISTS OF STANDARD CHAR-
ACTERS WITHOUT CLAIM TO ANY PARTICULAR
FONT, STYLE, SIZE, OR COLOR.

SN 77-035,822, FILED 11-2-2006.

THEODORE MCBRIDE, EXAMINING ATTORNEY

Int. Cl.: 9

Prior U.S. Cls.: 21, 23, 26, 36, and 38

United States Patent and Trademark Office

Reg. No. 3,399,048

Registered Mar. 18, 2008

**TRADEMARK
PRINCIPAL REGISTER**

JAZZ NIGHTS

CADILLAC JACK, INC. (GEORGIA CORPORATION)
2420 MEADOWBROOK PARKWAY
DULUTH, GA 30096

THE MARK CONSISTS OF STANDARD CHARACTERS WITHOUT CLAIM TO ANY PARTICULAR FONT, STYLE, SIZE, OR COLOR.

FOR: GAMING DEVICES, NAMELY, GAMING MACHINES, IN CLASS 9 (U.S. CLS. 21, 23, 26, 36 AND 38).

SN 77-036,192, FILED 11-3-2006.

FIRST USE 1-2-2008; IN COMMERCE 1-2-2008.

MELVIN AXILBUND, EXAMINING ATTORNEY

Int. Cl.: 28

Prior U.S. Cls.: 22, 23, 38, and 50

Reg. No. 3,399,049

United States Patent and Trademark Office

Registered Mar. 18, 2008

**TRADEMARK
PRINCIPAL REGISTER**

DUO PRO

NOCONA LEATHER GOODS COMPANY, LTD.
(TEXAS LIMITED PARTNERSHIP)
208 WEST WALNUT STREET
NOCONA, TX 76255

THE MARK CONSISTS OF STANDARD CHAR-
ACTERS WITHOUT CLAIM TO ANY PARTICULAR
FONT, STYLE, SIZE, OR COLOR.

FOR: SPORTING GOODS, NAMELY, BASEBALL
BATS, SOFTBALL BATS, WOOD COMPOSITE BASE-
BALL BATS AND WOOD COMPOSITE SOFTBALL
BATS, IN CLASS 28 (U.S. CLS. 22, 23, 38 AND 50).

SN 77-036,464, FILED 11-3-2006.

FIRST USE 9-1-2007; IN COMMERCE 9-1-2007.

CAROLINE WOOD, EXAMINING ATTORNEY

Int. Cls.: 16 and 44

Prior U.S. Cls.: 2, 5, 22, 23, 29, 37, 38, 50, 100, and 101

United States Patent and Trademark Office

Reg. No. 3,399,050

Registered Mar. 18, 2008

**TRADEMARK
SERVICE MARK
PRINCIPAL REGISTER**

TIME TO TREASURE

EISAI INC. (DELAWARE CORPORATION)

100 TICE BOULEVARD

WOODCLIFF LAKE, NJ 07677

FOR: PUBLICATIONS AND EDUCATIONAL MATERIALS IN THE FIELDS OF AGING, DEMENTIA AND ALZHEIMER'S DISEASE, NAMELY, BROCHURES, BOOKLETS, LEAFLETS, FOLDERS, CIRCULARS, AND INSERTS, IN CLASS 16 (U.S. CLS. 2, 5, 22, 23, 29, 37, 38 AND 50).

FIRST USE 2-0-2007; IN COMMERCE 2-0-2007.

FOR: PROVIDING A DISEASE MANAGEMENT PROGRAM FOR THE DIAGNOSIS, TREATMENT AND MANAGEMENT OF ALZHEIMER'S DISEASE, IN CLASS 44 (U.S. CLS. 100 AND 101).

FIRST USE 2-0-2007; IN COMMERCE 2-0-2007.

THE MARK CONSISTS OF STANDARD CHARACTERS WITHOUT CLAIM TO ANY PARTICULAR FONT, STYLE, SIZE, OR COLOR.

SN 77-036,724, FILED 11-3-2006.

MARILYN IZZI, EXAMINING ATTORNEY

Int. Cl.: 35

Prior U.S. Cls.: 100, 101, and 102

United States Patent and Trademark Office

Reg. No. 3,399,051

Registered Mar. 18, 2008

**SERVICE MARK
PRINCIPAL REGISTER**

SheSpeaks

FREUD, ALIZA (UNITED STATES INDIVIDUAL)
42 HICKORY DR.
MAPLEWOOD, NJ 07040

FOR: ADVERTISING AND MARKETING; ADVERTISING SERVICES, NAMELY, PROMOTING AND MARKETING THE GOODS AND SERVICES OF OTHERS THROUGH ALL PUBLIC COMMUNICATION MEANS; ADVERTISING, MARKETING AND PROMOTION SERVICES; ADVICE IN THE FIELD OF BUSINESS MANAGEMENT AND MARKETING; ARRANGING AND CONDUCTING MARKETING PROMOTIONAL EVENTS FOR OTHERS; BUSINESS ADVICE AND ANALYSIS OF MARKETS; BUSINESS CONSULTATION AND MANAGEMENT REGARDING MARKETING ACTIVITIES AND LAUNCHING OF NEW PRODUCTS; BUSINESS MANAGEMENT CONSULTING WITH RELATION TO STRATEGY, MARKETING, PRODUCTION, PERSONNEL AND RETAIL SALE MATTERS; BUSINESS MARKETING CONSULTING SERVICES; BUSINESS MARKETING SERVICES; BUSINESS RESEARCH; BUSINESS RESEARCH AND SURVEYS; BUSINESS RESEARCH CONSULTATION; BUSINESS RESEARCH USING FOCUS GROUPS; COMMERCIAL INFORMATION AGENCIES; CONDUCTING BUSINESS AND MARKET RESEARCH SURVEYS; CONDUCTING BUSINESS RESEARCH AND SURVEYS; CONDUCTING MARKETING STUDIES; CONDUCTING ON-LINE BUSINESS MANAGEMENT RESEARCH SURVEYS; CONSULTATION SERVICES IN THE FIELD OF COMPANY, BUSINESS SECTOR AND INDUSTRY DATA AND RESEARCH; CONSUMER RESEARCH; COOPERATIVE ADVERTISING AND MARKETING; COOPERATIVE ADVERTISING AND MARKETING SERVICES BY WAY OF SOLICITATION, CUSTOMER SERVICE AND PROVIDING MARKETING INFORMATION VIA WEBSITES ON A GLOBAL COMPUTER NETWORK; CREATION OF MARKETING TOOLS DESIGNED TO INCREASE A CLIENT COMPANY'S KNOWLEDGE OF CUSTOMER

NEEDS, AND ITS COMPETITORS' PRODUCTS AND SERVICES, PRICING, ADVERTISING STRATEGY AND SALES STRATEGY; DEVELOPMENT OF MARKETING STRATEGIES AND CONCEPTS; DIRECT MARKETING ADVERTISING FOR OTHERS; DIRECT MARKETING SERVICES; GENERAL BUSINESS MERCHANDISING SERVICES, NAMELY, MARKETING; IMPLEMENTATION AND FOLLOW-UP OF ADVICE IN THE FIELDS OF MARKETING; INFORMATION OR ENQUIRIES ON BUSINESS AND MARKETING; MARKET ANALYSIS; MARKET MANIPULATION, RESEARCH AND ANALYSIS, WHETHER OR NOT VIA THE INTERNET; MARKET OPINION POLLING STUDIES; MARKET REPORTS AND STUDIES; MARKET RESEARCH; MARKET RESEARCH CONSULTATION; MARKET RESEARCH SERVICES; MARKET RESEARCH STUDIES; MARKET SEGMENTATION CONSULTATION; MARKET STUDY AND ANALYSIS OF MARKET STUDIES; MARKETING CONSULTING; MARKETING PLAN DEVELOPMENT; MARKETING SERVICES, NAMELY PROVIDING INFORMATIONAL WEB PAGES DESIGNED TO GENERATE SALES TRAFFIC VIA HYPERLINKS TO OTHER WEB SITES; MEDIA PLANNING, NAMELY, ADVISING THE CLIENT ON THE CORRECT TIMES AND STATIONS TO ADVERTISE BASED ON MEDIA ANALYSIS OF THE MARKET FOR THAT MEDIA; MULTI-LEVEL MARKETING BUSINESS SERVICES; ON-LINE ADVERTISING AND MARKETING SERVICES; PROMOTING, ADVERTISING AND MARKETING OF THE ON-LINE WEBSITES OF OTHERS; PROMOTION AND MARKETING SERVICES AND RELATED CONSULTING; PROMOTION, ADVERTISING AND MARKETING OF ON-LINE WEBSITES; PROVIDING ADVERTISING, MARKETING AND PROMOTIONAL SERVICES, NAMELY, DEVELOPMENT OF ADVERTISING CAMPAIGNS FOR NEW PRODUCT DEVELOPMENT; PROVIDING BUSINESS MARKETING INFORMATION; PROVIDING MARKETING AND PROMOTION OF SPECIAL EVENTS; PROVIDING

PROMOTIONAL MARKETING SERVICES TO BUSI-
NESSES IN THE BROADBAND AND MEDIA IN-
DUSTRIES; SHOPPING BY RESEARCHERS WHO
POSE AS CUSTOMERS TO EVALUATE THE QUAL-
ITY OF SERVICE DELIVERED; STATISTICAL EVA-
LUATIONS OF MARKETING DATA , IN CLASS 35
(U.S. CLS. 100, 101 AND 102).

FIRST USE 1-15-2007; IN COMMERCE 2-7-2007.

THE MARK CONSISTS OF STANDARD CHAR-
ACTERS WITHOUT CLAIM TO ANY PARTICULAR
FONT, STYLE, SIZE, OR COLOR.

SN 77-036,870, FILED 11-3-2006.

MICHAEL KEATING, EXAMINING ATTORNEY

Int. Cl.: 30

Prior U.S. Cl.: 46

United States Patent and Trademark Office

Reg. No. 3,399,052

Registered Mar. 18, 2008

**TRADEMARK
PRINCIPAL REGISTER**

Throat Cooler

INTEGRATED BEVERAGE GROUP, LTD (NEW
YORK CORPORATION)
4 DUBON COURT
FARMINGDALE, NY 11735

THE MARK CONSISTS OF STANDARD CHAR-
ACTERS WITHOUT CLAIM TO ANY PARTICULAR
FONT, STYLE, SIZE, OR COLOR.

FOR: ICE, IN CLASS 30 (U.S. CL. 46).

SN 77-037,336, FILED 11-6-2006.

FIRST USE 3-0-2007; IN COMMERCE 5-0-2007.

PAULA MAYS, EXAMINING ATTORNEY

Int. Cl.: 43

Prior U.S. Cls.: 100 and 101

United States Patent and Trademark Office

Reg. No. 3,399,053

Registered Mar. 18, 2008

**SERVICE MARK
PRINCIPAL REGISTER**

THE SLICERY

RITCHIE, SUSANNE (UNITED STATES INDIVIDUAL)
POST OFFICE BOX 306
HIGLEY, AZ 85236

FOR: RESTAURANTS, IN CLASS 43 (U.S. CLS. 100 AND 101).

FIRST USE 2-1-2007; IN COMMERCE 7-1-2007.

THE MARK CONSISTS OF STANDARD CHARACTERS WITHOUT CLAIM TO ANY PARTICULAR FONT, STYLE, SIZE, OR COLOR.

SN 77-038,083, FILED 11-7-2006.

KATHERINE E. HALMEN, EXAMINING ATTORNEY

Int. Cls.: 16 and 41

Prior U.S. Cls.: 2, 5, 22, 23, 29, 37, 38, 50, 100, 101, and 107

Reg. No. 3,399,054

United States Patent and Trademark Office

Registered Mar. 18, 2008

**TRADEMARK
SERVICE MARK
PRINCIPAL REGISTER**

MOMENTUM MATH

KAPLAN, INC. (DELAWARE CORPORATION)
888 SEVENTH AVENUE
NEW YORK, NY 10106

FOR: PRINTED EDUCATIONAL MATERIALS IN THE FIELD OF MATHEMATICAL KNOWLEDGE AND SKILLS, IN CLASS 16 (U.S. CLS. 2, 5, 22, 23, 29, 37, 38 AND 50).

FIRST USE 4-2-2007; IN COMMERCE 4-2-2007.

FOR: EDUCATIONAL SERVICES, NAMELY PROGRAMS TO IMPROVE STUDENTS' MATHEMATICAL KNOWLEDGE AND SKILLS, IN CLASS 41 (U.S. CLS. 100, 101 AND 107).

FIRST USE 4-2-2007; IN COMMERCE 4-2-2007.

THE MARK CONSISTS OF STANDARD CHARACTERS WITHOUT CLAIM TO ANY PARTICULAR FONT, STYLE, SIZE, OR COLOR.

NO CLAIM IS MADE TO THE EXCLUSIVE RIGHT TO USE "MATH", APART FROM THE MARK AS SHOWN.

SN 77-038,411, FILED 11-7-2006.

CHRISIE B. KING, EXAMINING ATTORNEY

Int. Cls.: 25 and 36

Prior U.S. Cls.: 22, 39, 100, 101, and 102

United States Patent and Trademark Office

Reg. No. 3,399,055

Registered Mar. 18, 2008

**TRADEMARK
SERVICE MARK
PRINCIPAL REGISTER**

SCHOOLAPALOOZA

AMERICAN LEBANESE SYRIAN ASSOCIATED
CHARITIES, INC. (ILLINOIS CORPORATION)
501 ST. JUDE PLACE
MEMPHIS, TN 381051942

FOR: SHIRTS; SHORT-SLEEVED OR LONG-
SLEEVED T-SHIRTS, IN CLASS 25 (U.S. CLS. 22
AND 39).

FIRST USE 1-25-2007; IN COMMERCE 1-25-2007.

FOR: CHARITABLE FUND RAISING, IN CLASS
36 (U.S. CLS. 100, 101 AND 102).

FIRST USE 1-25-2007; IN COMMERCE 1-25-2007.

THE MARK CONSISTS OF STANDARD CHAR-
ACTERS WITHOUT CLAIM TO ANY PARTICULAR
FONT, STYLE, SIZE, OR COLOR.

SN 77-038,534, FILED 11-7-2006.

MARK SPARACINO, EXAMINING ATTORNEY

Int. Cl.: 6

Prior U.S. Cls.: 2, 12, 13, 14, 23, 25, and 50

United States Patent and Trademark Office

Reg. No. 3,399,056

Registered Mar. 18, 2008

TRADEMARK
PRINCIPAL REGISTER

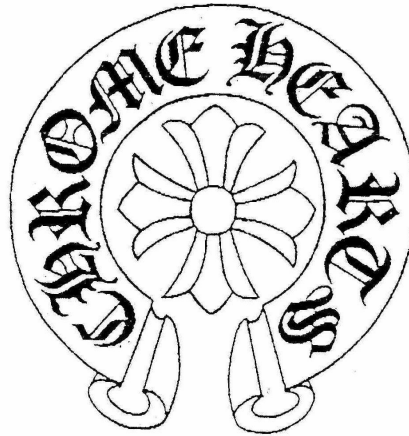

CHROME HEARTS LLC (DELAWARE LTD LIAB
CO)
915 N. MANSFIELD
HOLLYWOOD, CA 90038

FOR: HARDWARE MADE OF METAL, NAMELY,
CABINET PULLS, DOOR KNOBS, DOOR HANDLES
AND DOOR HINGES, IN CLASS 6 (U.S. CLS. 2, 12, 13,
14, 23, 25 AND 50).

FIRST USE 11-22-2006; IN COMMERCE 11-22-2006.

OWNER OF U.S. REG. NOS. 2,192,539, 3,061,598,
AND OTHERS.

NO CLAIM IS MADE TO THE EXCLUSIVE
RIGHT TO USE "CHROME", APART FROM THE
MARK AS SHOWN.

SN 77-039,028, FILED 11-7-2006.

LINDA ORNDORFF, EXAMINING ATTORNEY

Int. Cl.: 9

Prior U.S. Cls.: 21, 23, 26, 36, and 38

United States Patent and Trademark Office

Reg. No. 3,399,057

Registered Mar. 18, 2008

**TRADEMARK
PRINCIPAL REGISTER**

BLUESTRING

AOL LLC (VIRGINIA LTD LIAB CO)
22000 AOL WAY
DULLES, VA 20166

FIRST USE 9-17-2007; IN COMMERCE 9-17-2007.

FOR: DOWNLOADABLE COMPUTER SOFTWARE FOR STORING, ORGANIZING, AND SHARING DATA, INFORMATION, TEXT, IMAGES, GRAPHICS, VIDEOS, MUSIC, ELECTRONIC MAILS, IN CLASS 9 (U.S. CLS. 21, 23, 26, 36 AND 38).

THE MARK CONSISTS OF STANDARD CHARACTERS WITHOUT CLAIM TO ANY PARTICULAR FONT, STYLE, SIZE, OR COLOR.

SN 77-039,426, FILED 11-8-2006.

TOBY BULLOFF, EXAMINING ATTORNEY

Int. Cls.: 35, 41, and 42

Prior U.S. Cls.: 100, 101, 102, and 107

United States Patent and Trademark Office

Reg. No. 3,399,058

Registered Mar. 18, 2008

**SERVICE MARK
PRINCIPAL REGISTER**



THE RED FLAG GROUP LIMITED (HONG KONG CORPORATION)
FLAT 1E, 7A SHIU FAI TERRACE
HONG KONG, HONG KONG

FOR: BUSINESS MANAGEMENT CONSULTANCY AND ADVISORY SERVICES; MANAGEMENT AND BUSINESS CONSULTING SERVICES IN THE FIELD OF COMPLIANCE PROGRAMS , IN CLASS 35 (U.S. CLS. 100, 101 AND 102).

FIRST USE 12-1-2006; IN COMMERCE 12-1-2006.

FOR: BUSINESS TRAINING; PROVIDING ON-LINE TRAINING COURSES AND SEMINARS IN THE FIELD OF COMPLIANCE AND LEGAL ISSUES, IN CLASS 41 (U.S. CLS. 100, 101 AND 107).

FIRST USE 12-1-2006; IN COMMERCE 12-1-2006.

FOR: LEGAL SERVICES; REVIEWING STANDARDS AND PRACTICES TO ASSURE COMPLIANCE WITH ANTI-BRIBERY, ANTI-TRUST,

EXPORT CONTROL AND CORPORATE GOVERNANCE LAWS AND REGULATIONS , IN CLASS 42 (U.S. CLS. 100 AND 101).

FIRST USE 12-1-2006; IN COMMERCE 12-1-2006.

NO CLAIM IS MADE TO THE EXCLUSIVE RIGHT TO USE "GROUP", APART FROM THE MARK AS SHOWN.

THE COLOR(S) RED AND WHITE IS/ARE CLAIMED AS A FEATURE OF THE MARK.

THE WORDS "RED FLAG GROUP" AND THE DIVIDED VERTICAL LINE ARE WHITE ON A RED RECTANGULAR BACKGROUND.

SN 77-040,113, FILED 11-9-2006.

JOHN WILKE, EXAMINING ATTORNEY

Int. Cl.: 25

Prior U.S. Cls.: 22 and 39

United States Patent and Trademark Office

Reg. No. 3,399,059

Registered Mar. 18, 2008

**TRADEMARK
PRINCIPAL REGISTER**

OPERATION RAPID STRIKE

DISGUISE, INC. (DELAWARE CORPORATION)
11906 TECH CENTER COURT
POWAY, CA 92064

THE MARK CONSISTS OF STANDARD CHAR-
ACTERS WITHOUT CLAIM TO ANY PARTICULAR
FONT, STYLE, SIZE, OR COLOR.

FOR: HALLOWEEN AND MASQUERADE COS-
TUMES AND MASKS SOLD IN CONNECTION
THEREWITH; HEADWEAR, FOOTWEAR AND
GLOVES, IN CLASS 25 (U.S. CLS. 22 AND 39).

SN 77-040,262, FILED 11-9-2006.

FIRST USE 8-16-2007; IN COMMERCE 8-16-2007.

BERYL GARDNER, EXAMINING ATTORNEY

Int. Cl.: 9

Prior U.S. Cls.: 21, 23, 26, 36, and 38

United States Patent and Trademark Office

Reg. No. 3,399,060

Registered Mar. 18, 2008

**TRADEMARK
PRINCIPAL REGISTER**

GRIDWAVE RECORDS

GRIDWAVE RECORDS, INC. (ILLINOIS CORPORATION)
1444 ANTHONY LANE
SANDWICH, IL 60548

FOR: PRERECORDED PHONOGRAPH RECORDS, AUDIO CASSETTE TAPES, COMPACT DISCS, DIGITAL VIDEO DISCS, MP3S, PRERECORDED AUDIO VISUAL RECORDS IN ANALOG DISC AND DIGITAL DISC CONFIGURATIONS, AND ANALOG MAGNETIC TAPE AND DIGITAL MAGNETIC TAPE CONFIGURATIONS, ALL FEATURING MUSIC, IN CLASS 9 (U.S. CLS. 21, 23, 26, 36 AND 38).

FIRST USE 7-10-2007; IN COMMERCE 7-13-2007.

THE MARK CONSISTS OF STANDARD CHARACTERS WITHOUT CLAIM TO ANY PARTICULAR FONT, STYLE, SIZE, OR COLOR.

NO CLAIM IS MADE TO THE EXCLUSIVE RIGHT TO USE "RECORDS", APART FROM THE MARK AS SHOWN.

SN 77-040,521, FILED 11-9-2006.

ANTHONY RINKER, EXAMINING ATTORNEY

Int. Cl.: 16

Prior U.S. Cls.: 2, 5, 22, 23, 29, 37, 38, and 50

Reg. No. 3,399,061

United States Patent and Trademark Office

Registered Mar. 18, 2008

**TRADEMARK
PRINCIPAL REGISTER**

T's Diner

TESKY, STEPHEN V. (UNITED STATES INDIVIDUAL)
973 LOMA PINON LOOP NE
RIO RANCHO, NM 87144

THE MARK CONSISTS OF STANDARD CHARACTERS WITHOUT CLAIM TO ANY PARTICULAR FONT, STYLE, SIZE, OR COLOR.

FOR: COMIC STRIPS, IN CLASS 16 (U.S. CLS. 2, 5, 22, 23, 29, 37, 38 AND 50).

SN 77-040,569, FILED 11-9-2006.

FIRST USE 10-19-2007; IN COMMERCE 10-19-2007.

WANDA KAY PRICE, EXAMINING ATTORNEY

Int. Cl.: 41

Prior U.S. Cls.: 100, 101, and 107

United States Patent and Trademark Office

Reg. No. 3,399,062

Registered Mar. 18, 2008

**SERVICE MARK
PRINCIPAL REGISTER**

**THE POWER OF CHILDREN:
MAKING A DIFFERENCE**

THE CHILDREN'S MUSEUM OF INDIANAPOLIS, INC. (INDIANA CORPORATION)
3000 NORTH MERIDIAN STREET
INDIANAPOLIS, IN 46208

THE MARK CONSISTS OF STANDARD CHARACTERS WITHOUT CLAIM TO ANY PARTICULAR FONT, STYLE, SIZE, OR COLOR.

FOR: MUSEUM SERVICES, IN CLASS 41 (U.S. CLS. 100, 101 AND 107).

SN 77-040,743, FILED 11-9-2006.

FIRST USE 11-10-2007; IN COMMERCE 11-10-2007.

JORDAN BAKER, EXAMINING ATTORNEY

Int. Cl.: 41

Prior U.S. Cls.: 100, 101, and 107

United States Patent and Trademark Office

Reg. No. 3,399,063

Registered Mar. 18, 2008

**SERVICE MARK
PRINCIPAL REGISTER**

THE POWER OF CHILDREN

THE CHILDREN'S MUSEUM OF INDIANAPOLIS, INC. (INDIANA CORPORATION)
3000 NORTH MERIDIAN STREET
INDIANAPOLIS, IN 46208

THE MARK CONSISTS OF STANDARD CHARACTERS WITHOUT CLAIM TO ANY PARTICULAR FONT, STYLE, SIZE, OR COLOR.

FOR: MUSEUM SERVICES, IN CLASS 41 (U.S. CLS. 100, 101 AND 107).

SN 77-040,757, FILED 11-9-2006.

FIRST USE 11-10-2007; IN COMMERCE 11-10-2007.

JORDAN BAKER, EXAMINING ATTORNEY

Int. Cl.: 25

Prior U.S. Cls.: 22 and 39

United States Patent and Trademark Office

Reg. No. 3,399,064

Registered Mar. 18, 2008

**TRADEMARK
PRINCIPAL REGISTER**

CLUB LUX

DISGUISE, INC. (DELAWARE CORPORATION)
11906 TECH CENTER COURT
POWAY, CA 92064

THE MARK CONSISTS OF STANDARD CHAR-
ACTERS WITHOUT CLAIM TO ANY PARTICULAR
FONT, STYLE, SIZE, OR COLOR.

FOR: HALLOWEEN AND MASQUERADE COS-
TUMES AND MASKS SOLD IN CONNECTION
THEREWITH; HEADWEAR, FOOTWEAR, GLOVES
AND HOSIERY, IN CLASS 25 (U.S. CLS. 22 AND 39).

SN 77-041,706, FILED 11-10-2006.

FIRST USE 8-6-2007; IN COMMERCE 8-6-2007.

BERYL GARDNER, EXAMINING ATTORNEY

Int. Cl.: 9

Prior U.S. Cls.: 21, 23, 26, 36, and 38

United States Patent and Trademark Office

Reg. No. 3,399,065

Registered Mar. 18, 2008

**TRADEMARK
PRINCIPAL REGISTER**



GATEWAY, INC. (DELAWARE CORPORATION)
7565 IRVINE CENTER DRIVE
IRVINE, CA 926182930

THE MARK CONSISTS OF THE LETTERS F AND
X. THE MARK HAS NO SPECIFIC MEANING OR
COLOR.

FOR: COMPUTERS AND COMPUTER PERIPH-
ERALS, IN CLASS 9 (U.S. CLS. 21, 23, 26, 36 AND 38).

SN 77-041,848, FILED 11-10-2006.

FIRST USE 10-30-2006; IN COMMERCE 10-30-2006.

JOHN WILKE, EXAMINING ATTORNEY

Int. Cl.: 37

Prior U.S. Cls.: 100, 103, and 106

United States Patent and Trademark Office

Reg. No. 3,399,066

Registered Mar. 18, 2008

**SERVICE MARK
PRINCIPAL REGISTER**

SUNPORT HOMES

SUNPORT HOMES, LLC (FLORIDA LTD LIAB
CO)
657 W. LUMSDEN ROAD
BRANDON, FL 33511

FOR: CONSTRUCTION SERVICES, NAMELY,
NEW HOME BUILDING, IN CLASS 37 (U.S. CLS.
100, 103 AND 106).

FIRST USE 8-1-2007; IN COMMERCE 8-1-2007.

THE MARK CONSISTS OF STANDARD CHAR-
ACTERS WITHOUT CLAIM TO ANY PARTICULAR
FONT, STYLE, SIZE, OR COLOR.

NO CLAIM IS MADE TO THE EXCLUSIVE
RIGHT TO USE "HOMES", APART FROM THE
MARK AS SHOWN.

SN 77-042,284, FILED 11-13-2006.

JASON BLAIR, EXAMINING ATTORNEY

Int. Cl.: 11

Prior U.S. Cls.: 13, 21, 23, 31, and 34

United States Patent and Trademark Office

Reg. No. 3,399,067

Registered Mar. 18, 2008

**TRADEMARK
PRINCIPAL REGISTER**

LATITUDE

KOHLER CO. (WISCONSIN CORPORATION)
444 HIGHLAND DRIVE
KOHLER, WI 53044

THE MARK CONSISTS OF STANDARD CHAR-
ACTERS WITHOUT CLAIM TO ANY PARTICULAR
FONT, STYLE, SIZE, OR COLOR.

FOR: SINKS, IN CLASS 11 (U.S. CLS. 13, 21, 23, 31
AND 34).

SN 77-043,813, FILED 11-14-2006.

FIRST USE 1-1-2002; IN COMMERCE 1-1-2002.

ESTHER A. BORSUK, EXAMINING ATTORNEY

Int. Cl.: 43

Prior U.S. Cls.: 100 and 101

United States Patent and Trademark Office

Reg. No. 3,399,068

Registered Mar. 18, 2008

**SERVICE MARK
PRINCIPAL REGISTER**

**ESPECIALLY YOURS CATERING
AND EVENTS**

GOLDEN GATE ANCILLARY LLC (DELAWARE
LTD LIAB CO)

1000 BEVERLY WAY

FORT SMITH, AR 72919

FOR: CATERING SERVICES, IN CLASS 43 (U.S.
CLS. 100 AND 101).

FIRST USE 9-1-2006; IN COMMERCE 9-1-2006.

THE MARK CONSISTS OF STANDARD CHAR-
ACTERS WITHOUT CLAIM TO ANY PARTICULAR
FONT, STYLE, SIZE, OR COLOR.

NO CLAIM IS MADE TO THE EXCLUSIVE
RIGHT TO USE "CATERING AND EVENTS",
APART FROM THE MARK AS SHOWN.

SN 77-044,637, FILED 11-15-2006.

CHRIS WELLS, EXAMINING ATTORNEY

Int. Cl.: 9

Prior U.S. Cls.: 21, 23, 26, 36, and 38

United States Patent and Trademark Office

Reg. No. 3,399,069

Registered Mar. 18, 2008

**TRADEMARK
PRINCIPAL REGISTER**

THE 3 SQUARES

JUST A MOM MARKETING (JAMM), LLC (MISSOURI LTD LIAB CO)
465 DORAL DR.
WARSON WOODS, MO 63122

THE MARK CONSISTS OF STANDARD CHARACTERS WITHOUT CLAIM TO ANY PARTICULAR FONT, STYLE, SIZE, OR COLOR.

FOR: PRE-RECORDED DVDS, CDS AND VIDEO TAPES IN THE FIELD OF CHILDREN'S HEALTH, NUTRITION, AND FITNESS, IN CLASS 9 (U.S. CLS. 21, 23, 26, 36 AND 38).

SN 77-045,438, FILED 11-16-2006.

FIRST USE 12-0-2006; IN COMMERCE 12-0-2006.

TERESA M. RUPP, EXAMINING ATTORNEY

Int. Cl.: 25

Prior U.S. Cls.: 22 and 39

United States Patent and Trademark Office

Reg. No. 3,399,070

Registered Mar. 18, 2008

**TRADEMARK
PRINCIPAL REGISTER**

BSU Clothing Co.

JBF HOLDING LLC (FLORIDA LTD LIAB CO)
SUITE 227
99 NW 183RD STREET
MIAMI GARDENS, FL 33169

THE MARK CONSISTS OF STANDARD CHARACTERS WITHOUT CLAIM TO ANY PARTICULAR FONT, STYLE, SIZE, OR COLOR.

FOR: BELTS; CAPS; CHILDREN'S AND INFANTS' CLOTH BIBS; HOODS; INFANT AND TODDLER ONE PIECE CLOTHING; INFANT CLOTH DIAPERS; JERSEYS; LEATHER BELTS; MANTLES; SHORT SETS; SHOULDER WRAPS; TIES; TOPS; UNDER-ARM CLOTHING SHIELDS; WRAPS, IN CLASS 25 (U.S. CLS. 22 AND 39).

NO CLAIM IS MADE TO THE EXCLUSIVE RIGHT TO USE "CLOTHING CO.", APART FROM THE MARK AS SHOWN.

SN 77-047,091, FILED 11-17-2006.

FIRST USE 12-20-2007; IN COMMERCE 12-20-2007.

ALEX KEAM, EXAMINING ATTORNEY

Int. Cl.: 11

Prior U.S. Cls.: 13, 21, 23, 31, and 34

United States Patent and Trademark Office

Reg. No. 3,399,071

Registered Mar. 18, 2008

**TRADEMARK
PRINCIPAL REGISTER**

YARDS & BEYOND

LI, LI (CANADA INDIVIDUAL)
21 WOODRIVER STREET
RICHMOND HILL, ONTARIO, CANADA L4S1B8
AND
DING, BEI (CANADA INDIVIDUAL)
21 WOODRIVER STREET
RICHMOND HILL, ONTARIO, CANADA L4S1B8

FOR: LIGHTING FIXTURES AND STRUCTURAL
PARTS THEREFOR , IN CLASS 11 (U.S. CLS. 13, 21,
23, 31 AND 34).

FIRST USE 5-15-2007; IN COMMERCE 5-15-2007.

THE MARK CONSISTS OF STANDARD CHAR-
ACTERS WITHOUT CLAIM TO ANY PARTICULAR
FONT, STYLE, SIZE, OR COLOR.

SN 77-047,626, FILED 11-20-2006.

TOBY BULLOFF, EXAMINING ATTORNEY

Int. Cl.: 43

Prior U.S. Cls.: 100 and 101

United States Patent and Trademark Office

Reg. No. 3,399,072

Registered Mar. 18, 2008

**SERVICE MARK
PRINCIPAL REGISTER**

GEMMA

THE BOWERY HOTEL, LLC (NEW YORK LTD
LIAB CO)
335 BOWERY
NEW YORK, NY 10003

THE MARK CONSISTS OF STANDARD CHAR-
ACTERS WITHOUT CLAIM TO ANY PARTICULAR
FONT, STYLE, SIZE, OR COLOR.

FOR: RESTAURANT, BAR, AND CATERING
SERVICES; PROVIDING BANQUET AND SOCIAL
FUNCTION FACILITIES, IN CLASS 43 (U.S. CLS. 100
AND 101).

SN 77-047,727, FILED 11-20-2006.

FIRST USE 7-9-2007; IN COMMERCE 7-9-2007.

ROSELLE HERRERA, EXAMINING ATTORNEY

Int. Cl.: 25

Prior U.S. Cls.: 22 and 39

United States Patent and Trademark Office

Reg. No. 3,399,073

Registered Mar. 18, 2008

**TRADEMARK
PRINCIPAL REGISTER**

SKECH TECHS

SKECHERS U.S.A., INC. II (DELAWARE CORPORATION)
228 MANHATTAN BEACH BOULEVARD
MANHATTAN BEACH, CA 90266

FOR: FOOTWEAR, IN CLASS 25 (U.S. CLS. 22 AND 39).

FIRST USE 6-30-2007; IN COMMERCE 6-30-2007.

THE MARK CONSISTS OF STANDARD CHARACTERS WITHOUT CLAIM TO ANY PARTICULAR FONT, STYLE, SIZE, OR COLOR.

OWNER OF U.S. REG. NOS. 1,851,977, 2,145,468, AND OTHERS.

SN 77-048,313, FILED 11-20-2006.

DAWN FELDMAN, EXAMINING ATTORNEY

Int. Cl.: 44

Prior U.S. Cls.: 100 and 101

United States Patent and Trademark Office

Reg. No. 3,399,074

Registered Mar. 18, 2008

**SERVICE MARK
PRINCIPAL REGISTER**



Delaware Sleep Disorder Centers
"Partners For Sleep Health"

DELAWARE SLEEP DISORDER CENTERS, LLC
(DELAWARE LTD LIAB CO)
200 HYGEIA DRIVE, SUITE 2300
NEWARK, DE 19713

FOR: HEALTH CARE, IN CLASS 44 (U.S. CLS. 100
AND 101).

FIRST USE 3-1-2007; IN COMMERCE 1-11-2008.

NO CLAIM IS MADE TO THE EXCLUSIVE
RIGHT TO USE "DELAWARE SLEEP DISORDER
CENTERS", APART FROM THE MARK AS SHOWN.

THE COLOR(S) WHITE, LAVENDER AND NAVY
BLUE IS/ARE CLAIMED AS A FEATURE OF THE
MARK.

THE COLOR NAVY BLUE APPEARS IN THE
WORDING "DELAWARE SLEEP DISORDER CEN-
TERS" AND IN THE DESIGNS OF THE CRESCENT
MOON AND THE STICK FIGURE IN THE MIDDLE;
LAVENDER APPEARS IN THE WORDING "PART-
NERS FOR SLEEP HEALTH" AND IN THE FIRST
AND THIRD STICK FIGURES; WHITE APPEARS IN
THE OUTLINING OF THE STICK FIGURES
AGAINST THE CRESCENT AND IN THE CIRCLE
WITHIN THE CRESCENT.

SN 77-048,432, FILED 11-21-2006.

REBECCA POVARCHUK, EXAMINING ATTOR-
NEY

Int. Cl.: 44

Prior U.S. Cls.: 100 and 101

United States Patent and Trademark Office

Reg. No. 3,399,075

Registered Mar. 18, 2008

**SERVICE MARK
PRINCIPAL REGISTER**

BE AN AFTER, STAY AN AFTER

WEIGHT WATCHERS INTERNATIONAL, INC.
(VIRGINIA CORPORATION)
11 MADISON AVENUE
NEW YORK, NY 10010

FOR: PROVIDING WEIGHT REDUCTION PLAN-
NING, TREATMENT AND SUPERVISION
THROUGH WEIGHT REDUCTION PROGRAMS
FEATURING COUNSELING AND DIET PLANS;
PROVIDING ADVICE, CONSULTATION AND IN-
FORMATION IN THE FIELD OF WEIGHT CON-
TROL AND NUTRITION, IN CLASS 44 (U.S. CLS. 100
AND 101).

FIRST USE 12-24-2006; IN COMMERCE 12-24-2006.

THE MARK CONSISTS OF STANDARD CHAR-
ACTERS WITHOUT CLAIM TO ANY PARTICULAR
FONT, STYLE, SIZE, OR COLOR.

SN 77-048,488, FILED 11-21-2006.

TIMOTHY FINNEGAN, EXAMINING ATTORNEY

Int. Cl.: 25

Prior U.S. Cls.: 22 and 39

United States Patent and Trademark Office

Reg. No. 3,399,076

Registered Mar. 18, 2008

**TRADEMARK
PRINCIPAL REGISTER**



WENZHOU LIXINLONG IMPORT AND EXPORT
COMPANY LTD (CHINA CORPORATION)
2 JINDA ROAD, QIANHUA INDUSTRY AREA
XINQIAO, WENZHOU, CHINA

FOR: ATHLETIC SHOES; ATHLETIC FOOTWEAR; ATHLETIC UNIFORMS; BASEBALL SHOES; BELTS; BOWLING SHOES; BOXING SHOES; CANVAS SHOES; CYCLING SHOES; DECK-SHOES; FOOTBALL SHOES; GOLF SHOES; GYMNAS TIC SHOES; HANDBALL SHOES; HOCKEY SHOES; HOODS; INFANT AND TODDLER ONE PIECE CLOTHING; INFANTS' SHOES AND BOOTS; JERSEYS; LEATHER BELTS; LEATHER SHOES; LIGHT REFLECTING JACKETS; MEN AND WOMEN JACKETS, COATS, TROUSERS, VESTS; PANTS; PERSPIRATION ABSORBENT UNDERWEAR CLOTHING; RAIN JACKETS; RUBBER SHOES; RUGBY SHOES; RUNNING SHOES; SHIFTS;

SHOES; SHORT SETS; SHOULDER PADS FOR CLOTHING; SHOULDER WRAPS; SKI AND SNOWBOARD SHOES AND PARTS THEREOF; SKI JACKETS; SKIING SHOES; SNOW PANTS; SNOWBOARD PANTS; SOCCER SHOES; SPORTS JACKETS; SUEDE JACKETS; SWEAT PANTS; TAP SHOES; TENNIS SHOES; TIES; TOPS; TRACK AND FIELD SHOES; TRAINING SHOES; VOLLEYBALL SHOES; WATERPROOF JACKETS AND PANTS; WIND RESISTANT JACKETS; WIND-JACKETS; WOMEN'S SHOES; WORK SHOES AND BOOTS; WRAPS, IN CLASS 25 (U.S. CLS. 22 AND 39).

FIRST USE 1-1-2007; IN COMMERCE 12-1-2007.

SN 77-048,823, FILED 11-21-2006.

JACLYN KIDWELL, EXAMINING ATTORNEY

Int. Cl.: 25

Prior U.S. Cls.: 22 and 39

United States Patent and Trademark Office

Reg. No. 3,399,077

Registered Mar. 18, 2008

TRADEMARK
PRINCIPAL REGISTER

JSP

SPORT

WENZHOU LIXINLONG IMPORT AND EXPORT
COMPANY LTD (CHINA CORPORATION)
2 JINDA ROAD
QIANHUA INDUSTRY AREA, XINQIAO
WENZHOU, ZHEJIANG, CHINA

FOR: ATHLETIC FOOTWEAR; ATHLETIC SHOES; ATHLETIC UNIFORMS; BASEBALL SHOES; BELTS; BOWLING SHOES; BOXING SHOES; CANVAS SHOES; CAPRI PANTS; CAPS; CARGO PANTS; CYCLING SHOES; DECK-SHOES; DENIM JACKETS; DENIMS; DOWN JACKETS; FOOTBALL SHOES; FOOTWEAR FOR TRACK AND FIELD ATHLETICS; GOLF SHOES; GYMNAS TIC SHOES; HANDBALL SHOES; HEAVY JACKETS; HOCKEY SHOES; HOODS; INFANT AND TODDLER ONE PIECE CLOTHING; INFANTS' SHOES AND BOOTS; JACKETS; JERSEYS; JOGGING PANTS; LEATHER BELTS; LEATHER JACKETS; LEATHER SHOES; LIGHT-REFLECTING JACKETS; MEN AND WOMEN JACKETS, COATS, TROUSERS, VESTS; PANTS; PERSPIRATION ABSORBENT UNDERWEAR CLOTHING; RAIN JACKETS; RAINPROOF JACKETS; RUBBER SHOES; RUGBY SHOES; RUN-

NING SHOES; SHOES; SHORT SETS; SHOULDER WRAPS; SKI AND SNOWBOARD SHOES AND PARTS THEREOF; SKI JACKETS; SKI PANTS; SLEEVED OR SLEEVELESS JACKETS; SNOW PANTS; SNOWBOARD PANTS; SOCCER SHOES; SPORTS JACKETS; STUFF JACKETS; SUEDE JACKETS; SWEAT PANTS; TENNIS SHOES; TIES; TOPS; TRACK AND FIELD SHOES; TRACK PANTS; TRAINING SHOES; VOLLEYBALL SHOES; WATER-PROOF JACKETS AND PANTS; WIND RESISTANT JACKETS; WIND-JACKETS; WOMEN'S SHOES; WORK SHOES AND BOOTS; WRAPS, IN CLASS 25 (U.S. CLS. 22 AND 39).

FIRST USE 1-1-2007; IN COMMERCE 12-1-2007.

NO CLAIM IS MADE TO THE EXCLUSIVE RIGHT TO USE "SPORT", APART FROM THE MARK AS SHOWN.

SN 77-048,907, FILED 11-21-2006.

JACLYN KIDWELL, EXAMINING ATTORNEY

Int. Cl.: 35

Prior U.S. Cls.: 100, 101, and 102

United States Patent and Trademark Office

Reg. No. 3,399,078

Registered Mar. 18, 2008

**SERVICE MARK
PRINCIPAL REGISTER**

KNOCK KNOCK

BEST WESTERN INTERNATIONAL, INC. (ARI-
ZONA CORPORATION)
6201 NORTH 24TH PARKWAY
PHOENIX, AZ 85016

FOR: PROVIDING CUSTOMER INFORMATION
ABOUT HOTEL, MOTEL AND RESORT HOTEL
RATES AND DISCOUNTS VIA A GLOBAL COMPU-
TER NETWORK, IN CLASS 35 (U.S. CLS. 100, 101
AND 102).

FIRST USE 4-9-2007; IN COMMERCE 4-9-2007.

THE MARK CONSISTS OF STANDARD CHAR-
ACTERS WITHOUT CLAIM TO ANY PARTICULAR
FONT, STYLE, SIZE, OR COLOR.

SN 77-049,242, FILED 11-21-2006.

DAVID COLLIER, EXAMINING ATTORNEY

Int. Cl.: 36

Prior U.S. Cls.: 100, 101, and 102

United States Patent and Trademark Office

Reg. No. 3,399,079

Registered Mar. 18, 2008

**SERVICE MARK
PRINCIPAL REGISTER**

**BE CERTAIN. BE CONFIDENT.
BE SURE ABOUT YOUR HEALTH.**

OXONIA INSURANCE GROUP, INC. (FLORIDA
CORPORATION)
SUITE 200
861 SW 78TH AVENUE
PLANTATION, FL 33324

FOR: INSURANCE AGENCY AND BROKERAGE
SERVICES, IN CLASS 36 (U.S. CLS. 100, 101 AND 102).

FIRST USE 12-5-2006; IN COMMERCE 12-5-2006.

THE MARK CONSISTS OF STANDARD CHAR-
ACTERS WITHOUT CLAIM TO ANY PARTICULAR
FONT, STYLE, SIZE, OR COLOR.

SN 77-049,520, FILED 11-22-2006.

CIMMERIAN COLEMAN, EXAMINING ATTOR-
NEY

Int. Cl.: 42

Prior U.S. Cls.: 100 and 101

United States Patent and Trademark Office

Reg. No. 3,399,080

Registered Mar. 18, 2008

SERVICE MARK
PRINCIPAL REGISTER



NORTHWEST NOTARY NETWORK, LLC (ORE-
GON LTD LIAB CO)
PMB 186
3439 NE SANDY BLVD.
PORTLAND, OR 97232

FOR: NOTARY PUBLIC SERVICES, IN CLASS 42
(U.S. CLS. 100 AND 101).

FIRST USE 10-20-2006; IN COMMERCE 10-20-2006.

NO CLAIM IS MADE TO THE EXCLUSIVE
RIGHT TO USE "NATIONWIDE NOTARY NET-
WORK", APART FROM THE MARK AS SHOWN.

THE COLOR(S) RED, ROYAL BLUE, WHITE AND
NAVY BLUE IS/ARE CLAIMED AS A FEATURE OF
THE MARK.

THE MARK CONSISTS OF THE FOLLOWING:
THE COLOR RED APPEARS IN THE INTERIOR OF
THE INNER MOST CIRCLE AND STAR DESIGNS,
THE COLOR NAVY BLUE APPEARS AS A THIN
BAND COMPRISING THE SECOND CIRCLE FROM
THE CENTER, A THIN BAND COMPRISING THE
FOURTH CIRCLE FROM THE CENTER, A THICK-
ER BAND COMPRISING THE SIXTH OUTERMOST
CIRCLE AND IN THE WORDING "NATIONWIDE
NOTARY NETWORK", THE COLOR WHITE AP-
PEARS IN THE LETTER/NUMBER COMBINATION
"N3" AND THE BACKGROUND OF THE THIRD
CIRCLE FROM THE CENTER AND THE COLOR
ROYAL BLUE APPEARS IN THE FIFTH CIRCLE
FROM THE CENTER.

SN 77-050,417, FILED 11-24-2006.

GENE MACIOL, EXAMINING ATTORNEY

Int. Cl.: 16

Prior U.S. Cls.: 2, 5, 22, 23, 29, 37, 38, and 50

United States Patent and Trademark Office

Reg. No. 3,399,081

Registered Mar. 18, 2008

**TRADEMARK
PRINCIPAL REGISTER**

SPLAT*R KATCH*R

SPLAT*R KATCH*R, INC. (FLORIDA CORPORATION)
5364 EHRlich ROAD #73
TAMPA, FL 33624

FOR: PAPER DROP CLOTHS, IN CLASS 16 (U.S. CLS. 2, 5, 22, 23, 29, 37, 38 AND 50).

FIRST USE 10-27-2006; IN COMMERCE 1-9-2008.

THE MARK CONSISTS OF STANDARD CHARACTERS WITHOUT CLAIM TO ANY PARTICULAR FONT, STYLE, SIZE, OR COLOR.

SN 77-050,870, FILED 11-27-2006.

JOHN SCHUYLER YARD, EXAMINING ATTORNEY

Int. Cl.: 16

Prior U.S. Cls.: 2, 5, 22, 23, 29, 37, 38, and 50

United States Patent and Trademark Office

Reg. No. 3,399,082

Registered Mar. 18, 2008

TRADEMARK
PRINCIPAL REGISTER



SPLAT*R KATCH*R, INC. (FLORIDA CORPORATION)
5364 EHRlich ROAD #73
TAMPA, FL 33624

FOR: PAPER DROP CLOTHS, IN CLASS 16 (U.S. CLS. 2, 5, 22, 23, 29, 37, 38 AND 50).

FIRST USE 10-27-2006; IN COMMERCE 1-9-2008.

THE MARK CONSISTS OF THE WORDS "SPLAT*R KATCH*R" SURROUNDED BY AMORPHOUS SHAPES.

SN 77-050,879, FILED 11-27-2006.

JOHN SCHUYLER YARD, EXAMINING ATTORNEY

Int. Cl.: 44

Prior U.S. Cls.: 100 and 101

United States Patent and Trademark Office

Reg. No. 3,399,083

Registered Mar. 18, 2008

**SERVICE MARK
PRINCIPAL REGISTER**

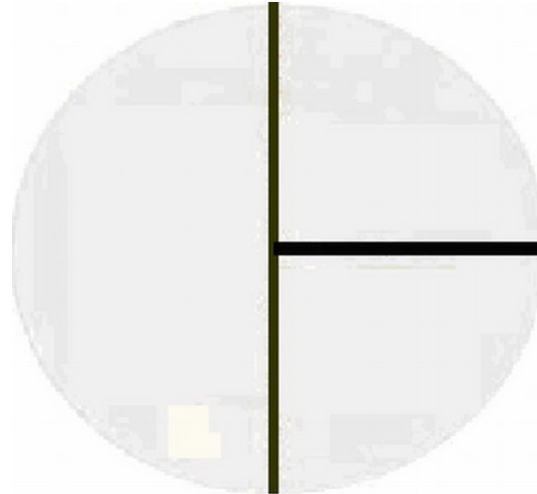

FRIEFELD & ASSOCIATES, LLC (MASSACHU-
SETTS LTD LIAB CO)
8 CEDAR STREET
WOBURN, MA 01801

FOR: FOOD NUTRITION CONSULTATION RE-
GARDING FOOD SERVICE AND WELLNESS PRO-
GRAMS FOR INSTITUTIONS AND INDIVIDUALS,
IN CLASS 44 (U.S. CLS. 100 AND 101).

FIRST USE 6-30-2004; IN COMMERCE 6-30-2004.

THE MARK CONSISTS OF A DINNER PLATE
DIVIDED INTO THREE SECTIONS.

SN 77-051,386, FILED 11-27-2006.

DAVID YONTEF, EXAMINING ATTORNEY

Int. Cl.: 35

Prior U.S. Cls.: 100, 101, and 102

United States Patent and Trademark Office

Reg. No. 3,399,084

Registered Mar. 18, 2008

**SERVICE MARK
PRINCIPAL REGISTER**

CLIMATE COUNTS

STONYFIELD FARM, INC. (DELAWARE CORPORATION)
10 BURTON DRIVE
LONDONDERRY, NH 03053

FOR: PROMOTING PUBLIC AWARENESS OF CLIMATE CHANGE AND THE NEED TO REVERSE ITS DANGERS, IN CLASS 35 (U.S. CLS. 100, 101 AND 102).

FIRST USE 12-4-2006; IN COMMERCE 12-4-2006.

THE MARK CONSISTS OF STANDARD CHARACTERS WITHOUT CLAIM TO ANY PARTICULAR FONT, STYLE, SIZE, OR COLOR.

NO CLAIM IS MADE TO THE EXCLUSIVE RIGHT TO USE "CLIMATE", APART FROM THE MARK AS SHOWN.

SN 77-052,203, FILED 11-28-2006.

STEVEN PEREZ, EXAMINING ATTORNEY

Int. Cls.: 29 and 30

Prior U.S. Cl.: 46

United States Patent and Trademark Office

Reg. No. 3,399,085

Registered Mar. 18, 2008

**TRADEMARK
PRINCIPAL REGISTER**

KEEP IT REAL

AMPC, INC. (IOWA CORPORATION)
2325 NORTH LOOP DRIVE
AMES, IA 50010

FOR: PROTEIN FOR USE AS A FOOD ADDITIVE,
IN CLASS 29 (U.S. CL. 46).

FIRST USE 2-21-2005; IN COMMERCE 2-21-2005.

FOR: FOOD ADDITIVES FOR NON-NUTRITION-
AL PURPOSES FOR USE AS A FLAVORING, IN-
GREDIENT OR FILLER, IN CLASS 30 (U.S. CL. 46).

FIRST USE 2-21-2005; IN COMMERCE 2-21-2005.

THE MARK CONSISTS OF STANDARD CHAR-
ACTERS WITHOUT CLAIM TO ANY PARTICULAR
FONT, STYLE, SIZE, OR COLOR.

SN 77-052,650, FILED 11-29-2006.

MICHAEL LITZAU, EXAMINING ATTORNEY

Int. Cl.: 9

Prior U.S. Cls.: 21, 23, 26, 36, and 38

Reg. No. 3,399,086

United States Patent and Trademark Office

Registered Mar. 18, 2008

**TRADEMARK
PRINCIPAL REGISTER**

BAREFLOW

MATSKIV, VICTOR M. (UKRAINE INDIVIDUAL)
1236 WALKER AVE. #212
WALNUT CREEK, CA 94596

THE MARK CONSISTS OF STANDARD CHAR-
ACTERS WITHOUT CLAIM TO ANY PARTICULAR
FONT, STYLE, SIZE, OR COLOR.

FOR: COMPUTER SOFTWARE FOR COMPUTER
SYSTEM AND APPLICATION DEVELOPMENT, DE-
PLOYMENT AND MANAGEMENT, IN CLASS 9
(U.S. CLS. 21, 23, 26, 36 AND 38).

SN 77-053,626, FILED 11-30-2006.

FIRST USE 11-24-2007; IN COMMERCE 11-24-2007.

COLLEEN DOMBROW, EXAMINING ATTORNEY

Int. Cl.: 40

Prior U.S. Cls.: 100, 103, and 106

United States Patent and Trademark Office

Reg. No. 3,399,087

Registered Mar. 18, 2008

**SERVICE MARK
PRINCIPAL REGISTER**



PIATT, BRETT T. (UNITED STATES INDIVIDUAL)
1133 PASEO LAS NUBES
OXNARD, CA 93030

FOR: IMPRINTING MESSAGES ON T-SHIRTS, IN CLASS 40 (U.S. CLS. 100, 103 AND 106).

FIRST USE 7-1-2007; IN COMMERCE 10-1-2007.

NO CLAIM IS MADE TO THE EXCLUSIVE RIGHT TO USE "COTTON", APART FROM THE MARK AS SHOWN.

THE MARK CONSISTS OF STICK FIGURE SITTING INDIAN STYLE IN FRONT OF A COTTON BALL. UNDER THE LOGO IS THE WORDS "COTTON 4 PEOPLE".

SN 77-053,810, FILED 11-30-2006.

KATHERINE CONNOLLY, EXAMINING ATTORNEY

Int. Cl.: 16

Prior U.S. Cls.: 2, 5, 22, 23, 29, 37, 38, and 50

Reg. No. 3,399,088

United States Patent and Trademark Office

Registered Mar. 18, 2008

**TRADEMARK
PRINCIPAL REGISTER**

Global Warming Warriors

STEINMEYER, NANCY L. (UNITED STATES
INDIVIDUAL)
10215 COUNTRY CLUB ROAD
BULL VALLEY, IL 60098

FOR: PAPER BADGES; PRINTED INSTRUCTION-
AL, EDUCATIONAL, AND TEACHING MATERI-
ALS IN THE FIELD OF GLOBAL WARMING, IN
CLASS 16 (U.S. CLS. 2, 5, 22, 23, 29, 37, 38 AND 50).

FIRST USE 2-6-2007; IN COMMERCE 10-23-2007.

THE MARK CONSISTS OF STANDARD CHAR-
ACTERS WITHOUT CLAIM TO ANY PARTICULAR
FONT, STYLE, SIZE, OR COLOR.

NO CLAIM IS MADE TO THE EXCLUSIVE
RIGHT TO USE "GLOBAL WARMING", APART
FROM THE MARK AS SHOWN.

SN 77-054,927, FILED 12-1-2006.

JORDAN BAKER, EXAMINING ATTORNEY

Int. Cl.: 36

Prior U.S. Cls.: 100, 101, and 102

United States Patent and Trademark Office

Reg. No. 3,399,089

Registered Mar. 18, 2008

**SERVICE MARK
PRINCIPAL REGISTER**

SEACROSS GLOBAL ADVISORS

SEACROSS GLOBAL ADVISORS LLC (DELA-
WARE LTD LIAB CO)
27TH FLOOR
ONE INTERNATIONAL PLACE
BOSTON, MA 02110

FOR: FINANCIAL SERVICES, NAMELY, HEDGE
FUND INVESTMENT SERVICES AND INVEST-
MENT ADVISORY SERVICES, IN CLASS 36 (U.S.
CLS. 100, 101 AND 102).

FIRST USE 4-1-2007; IN COMMERCE 4-1-2007.

THE MARK CONSISTS OF STANDARD CHAR-
ACTERS WITHOUT CLAIM TO ANY PARTICULAR
FONT, STYLE, SIZE, OR COLOR.

NO CLAIM IS MADE TO THE EXCLUSIVE
RIGHT TO USE "GLOBAL ADVISORS", APART
FROM THE MARK AS SHOWN.

SN 77-056,458, FILED 12-4-2006.

JANICE L. MCMORROW, EXAMINING ATTOR-
NEY

Int. Cl.: 3

Prior U.S. Cls.: 1, 4, 6, 50, 51, and 52

Reg. No. 3,399,090

United States Patent and Trademark Office

Registered Mar. 18, 2008

**TRADEMARK
PRINCIPAL REGISTER**

POWERPLASTIC

MOTHERS POLISHES WAXES CLEANERS (CALIFORNIA CORPORATION)
5456 INDUSTRIAL DRIVE
HUNTINGTON BEACH, CA 92649

FOR: PREPARATIONS FOR CLEANING, POLISHING AND PROTECTING PLASTIC, IN CLASS 3 (U.S. CLS. 1, 4, 6, 50, 51 AND 52).

FIRST USE 12-1-2006; IN COMMERCE 12-1-2006.

THE MARK CONSISTS OF STANDARD CHARACTERS WITHOUT CLAIM TO ANY PARTICULAR FONT, STYLE, SIZE, OR COLOR.

OWNER OF U.S. REG. NOS. 3,028,180, 3,053,890, AND 3,062,702.

SN 77-057,680, FILED 12-5-2006.

REBECCA GILBERT, EXAMINING ATTORNEY

Int. Cl.: 35

Prior U.S. Cls.: 100, 101, and 102

United States Patent and Trademark Office

Reg. No. 3,399,091

Registered Mar. 18, 2008

**SERVICE MARK
PRINCIPAL REGISTER**

DUKE AND DUSTY

RAYMOND A. NUZZO (UNITED STATES INDIVIDUAL)
579 THOMPSON AVENUE
EAST HAVEN, CT 06512

FOR: ON-LINE ORDERING SERVICES FEATURING FICTION AND NON-FICTION BOOKS ABOUT ANIMALS; ON-LINE RETAIL STORE SERVICES FEATURING FICTION AND NON-FICTION BOOKS ABOUT ANIMALS , IN CLASS 35 (U.S. CLS. 100, 101 AND 102).

FIRST USE 6-30-2007; IN COMMERCE 6-30-2007.

THE MARK CONSISTS OF STANDARD CHARACTERS WITHOUT CLAIM TO ANY PARTICULAR FONT, STYLE, SIZE, OR COLOR.

THE NAME(S), PORTRAIT(S), AND/OR SIGNATURE(S) SHOWN IN THE MARK DOES NOT IDENTIFY A PARTICULAR LIVING INDIVIDUAL.

SN 77-057,935, FILED 12-6-2006.

GISELLE AGOSTO, EXAMINING ATTORNEY

Int. Cl.: 1

Prior U.S. Cls.: 1, 5, 6, 10, 26, and 46

United States Patent and Trademark Office

Reg. No. 3,399,092

Registered Mar. 18, 2008

**TRADEMARK
PRINCIPAL REGISTER**

BLOX

VISION CO., LLC (COLORADO LTD LIAB CO)
PO BOX 4438
GREENWOOD VILLAGE, CO 80155

FOR: STAIN AND MOISTURE REPELLANT AND FABRIC PROTECTANT FOR USE ON FABRICS, TEXTILES, CARPETS, LEATHER, VINYL, SUEDE, FURNITURE, AND UPHOLSTERY; STAIN AND MOISTURE REPELLANT USED IN THE MANUFACTURE OF FABRICS, TEXTILES, CARPETS, LEATHER, VINYL, SUEDE, FURNITURE, AND

UPHOLSTERY, IN CLASS 1 (U.S. CLS. 1, 5, 6, 10, 26 AND 46).

FIRST USE 10-1-2007; IN COMMERCE 10-1-2007.

THE MARK CONSISTS OF STANDARD CHARACTERS WITHOUT CLAIM TO ANY PARTICULAR FONT, STYLE, SIZE, OR COLOR.

SN 77-059,968, FILED 12-8-2006.

MELVIN AXILBUND, EXAMINING ATTORNEY

Int. Cl.: 28

Prior U.S. Cls.: 22, 23, 38, and 50

United States Patent and Trademark Office

Reg. No. 3,399,093

Registered Mar. 18, 2008

**TRADEMARK
PRINCIPAL REGISTER**

TAG BALL

SOURCENTERPRISES, INC. (CALIFORNIA CORPORATION)
165 E. LIBERTY STREET
ANAHEIM, CA 92801

FOR: BILLIARD PRODUCTS, GAMES AND ACCESSORIES, NAMELY, BILLIARD BALLS AND BILLIARD PLAYING EQUIPMENT, IN CLASS 28 (U.S. CLS. 22, 23, 38 AND 50).

FIRST USE 6-21-2007; IN COMMERCE 6-21-2007.

THE MARK CONSISTS OF STANDARD CHARACTERS WITHOUT CLAIM TO ANY PARTICULAR FONT, STYLE, SIZE, OR COLOR.

NO CLAIM IS MADE TO THE EXCLUSIVE RIGHT TO USE "BALL", APART FROM THE MARK AS SHOWN.

SN 77-060,219, FILED 12-8-2006.

JEAN IM, EXAMINING ATTORNEY

Int. Cl.: 9

Prior U.S. Cls.: 21, 23, 26, 36, and 38

United States Patent and Trademark Office

Reg. No. 3,399,094

Registered Mar. 18, 2008

**TRADEMARK
PRINCIPAL REGISTER**

TORCH ROCK

DESERT DREAMS PRODUCTIONS, LLC (ARI-
ZONA LTD LIAB CO)
10645 N TATUM BLVD
SUITE 200 - 463
PHOENIX, AZ 85028

FOR: MUSICAL ENTERTAINMENT RECORDED
ON CARTRIDGES, DISCS, CD-ROMS, CASSETTES,
TAPES AND MINI DISCS; VIDEO AND COMPUTER
GAME SOFTWARE, IN CLASS 9 (U.S. CLS. 21, 23, 26,
36 AND 38).

FIRST USE 9-14-2006; IN COMMERCE 9-14-2006.

THE MARK CONSISTS OF STANDARD CHAR-
ACTERS WITHOUT CLAIM TO ANY PARTICULAR
FONT, STYLE, SIZE, OR COLOR.

NO CLAIM IS MADE TO THE EXCLUSIVE
RIGHT TO USE "ROCK", APART FROM THE
MARK AS SHOWN.

SN 77-061,337, FILED 12-11-2006.

LINDA M. KING, EXAMINING ATTORNEY

Int. Cl.: 20

Prior U.S. Cls.: 2, 13, 22, 25, 32, and 50

United States Patent and Trademark Office

Reg. No. 3,399,095

Registered Mar. 18, 2008

**TRADEMARK
PRINCIPAL REGISTER**

CLINQS

CLINQS, LLC (DELAWARE LTD LIAB CO)

4B

163 CARLTON AVENUE
BROOKLYN, NY 11205

FOR: DECORATIVE PLASTIC APPLIQUÉS FOR
USE ON SURFACES OF GLASS, METAL, TILE,
ACRYLIC GLASS AND OTHER SOLID SURFACES,
IN CLASS 20 (U.S. CLS. 2, 13, 22, 25, 32 AND 50).

FIRST USE 6-26-2007; IN COMMERCE 6-26-2007.

THE MARK CONSISTS OF STANDARD CHAR-
ACTERS WITHOUT CLAIM TO ANY PARTICULAR
FONT, STYLE, SIZE, OR COLOR.

SN 77-061,573, FILED 12-11-2006.

LINDA LAVACHE, EXAMINING ATTORNEY

Int. Cl.: 36

Prior U.S. Cls.: 100, 101, and 102

United States Patent and Trademark Office

Reg. No. 3,399,096

Registered Mar. 18, 2008

**SERVICE MARK
PRINCIPAL REGISTER**



VAN KAMPEN INVESTMENTS INC. (DELA-
WARE CORPORATION)
1221 AVENUE OF THE AMERICAS
NEW YORK, NY 10036

FOR: FINANCIAL SERVICES, NAMELY, MU-
TUAL FUND BROKERAGE SERVICES, ADMINIS-
TERING MUTUAL FUND INVESTMENTS, AND
FINANCIAL ADVISORY SERVICES , IN CLASS 36
(U.S. CLS. 100, 101 AND 102).

FIRST USE 2-0-2007; IN COMMERCE 2-0-2007.

NO CLAIM IS MADE TO THE EXCLUSIVE
RIGHT TO USE THE GREEK SYMBOL "ALPHA",
APART FROM THE MARK AS SHOWN.

THE MARK CONSISTS OF THE WORDS "VK
ALPHA" IN STYLIZED LETTERS BELOW A GREEK
LOWER CASE LETTER REPRESENTING "ALPHA".

SN 77-061,629, FILED 12-11-2006.

HANNO RITTNER, EXAMINING ATTORNEY

Int. Cls.: 16 and 41

Prior U.S. Cls.: 2, 5, 22, 23, 29, 37, 38, 50, 100, 101, and 107

Reg. No. 3,399,097

United States Patent and Trademark Office

Registered Mar. 18, 2008

**TRADEMARK
SERVICE MARK
PRINCIPAL REGISTER**

MÉTHODE L'AUDACE

MÉTHODE L'AUDACE, LLC (OKLAHOMA LTD
LIAB CO)
12229 SOUTH MAPLEWOOD AVENUE
TULSA, OK 74137

FOR: PRINTED INSTRUCTIONAL, EDUCATIONAL, AND TEACHING MATERIALS IN THE FIELD OF MUSIC LESSONS AND PHILOSOPHY OF TEACHING MUSIC; PRINTED TEACHING ACTIVITY GUIDES IN THE FIELD OF MUSIC LESSONS AND PHILOSOPHY OF TEACHING MUSIC; PUBLICATIONS, NAMELY, BROCHURES, BOOKLETS, AND TEACHING MATERIALS IN THE FIELD OF MUSIC LESSONS AND PHILOSOPHY OF TEACHING MUSIC; PRINTED MUSIC BOOKS; PRINTED LESSONS ON MUSIC; PAPER TEACHING MATERIALS IN THE FIELD OF MUSIC LESSONS AND PHILOSOPHY OF TEACHING MUSIC, IN CLASS 16 (U.S. CLS. 2, 5, 22, 23, 29, 37, 38 AND 50).

FIRST USE 3-0-2006; IN COMMERCE 3-0-2006.

FOR: EDUCATION SERVICES, NAMELY, PROVIDING CLASSES, SEMINARS AND WORKSHOPS IN THE FIELD OF MUSIC; TEACHING IN THE FIELD OF MUSIC; INSTRUCTION IN THE FIELD OF MUSIC; PROVIDING FACILITIES FOR MUSIC TRAINING, IN CLASS 41 (U.S. CLS. 100, 101 AND 107).

FIRST USE 3-0-2006; IN COMMERCE 3-0-2006.

THE MARK CONSISTS OF STANDARD CHARACTERS WITHOUT CLAIM TO ANY PARTICULAR FONT, STYLE, SIZE, OR COLOR.

THE FOREIGN WORDING IN THE MARK TRANSLATES INTO ENGLISH AS METHOD AND AUDACITY.

SN 77-061,686, FILED 12-11-2006.

JANICE KIM, EXAMINING ATTORNEY

Int. Cl.: 9

Prior U.S. Cls.: 21, 23, 26, 36, and 38

United States Patent and Trademark Office

Reg. No. 3,399,098

Registered Mar. 18, 2008

TRADEMARK
PRINCIPAL REGISTER



ABOUNDI, INC. (NEW HAMPSHIRE CORPORATION)
4 BUD WAY, UNIT 10
NASHUA, NH 03063

FOR: LAN (LOCAL AREA NETWORK) ACCESS POINTS FOR CONNECTING NETWORK COMPUTER USERS; LAN (LOCAL OPERATING NETWORK) HARDWARE, IN CLASS 9 (U.S. CLS. 21, 23, 26, 36 AND 38).

FIRST USE 9-1-2007; IN COMMERCE 9-1-2007.

NO CLAIM IS MADE TO THE EXCLUSIVE RIGHT TO USE "COMMERCIAL QUALITY", APART FROM THE MARK AS SHOWN.

THE MARK CONSISTS OF A CIRCULAR MEDALLION HAVING THE WORDS "COMMERCIAL QUALITY" AROUND THE PERIMETER WITH AN EAGLE AND THE ABOUNDI LOGO IN THE INTERIOR.

SN 77-062,144, FILED 12-12-2006.

HOWARD SMIGA, EXAMINING ATTORNEY

Int. Cl.: 8

Prior U.S. Cls.: 23, 28, and 44

United States Patent and Trademark Office

Reg. No. 3,399,099

Registered Mar. 18, 2008

**TRADEMARK
PRINCIPAL REGISTER**

BUTT OUT

HUNTER'S SPECIALTIES, INC. (IOWA CORPORATION)
6000 HUNTINGTON COURT NE
CEDAR RAPIDS, IA 52402

THE MARK CONSISTS OF STANDARD CHARACTERS WITHOUT CLAIM TO ANY PARTICULAR FONT, STYLE, SIZE, OR COLOR.

FOR: HAND TOOL FOR FIELD DRESSING
LARGE GAME ANIMALS, IN CLASS 8 (U.S. CLS.
23, 28 AND 44).

SN 77-062,153, FILED 12-12-2006.

FIRST USE 12-27-2006; IN COMMERCE 12-27-2006.

LINDA LAVACHE, EXAMINING ATTORNEY

Int. Cl.: 19

Prior U.S. Cls.: 1, 12, 33, and 50

United States Patent and Trademark Office

Reg. No. 3,399,100

Registered Mar. 18, 2008

**TRADEMARK
PRINCIPAL REGISTER**

PREMIER
Advantage

PACIFIC COAST BUILDING PRODUCTS, INC.
(CALIFORNIA CORPORATION)
10600 WHITE ROCK ROAD, SUITE 100
RANCHO CORDOVA, CA 95670

OWNER OF U.S. REG. NO. 2,478,033.

FOR: ASPHALT ROOFING SHINGLES, IN CLASS
19 (U.S. CLS. 1, 12, 33 AND 50).

THE MARK CONSISTS OF THE WORDS "PREMIER ADVANTAGE" IN STYLIZED LETTERING.

SN 77-062,423, FILED 12-12-2006.

FIRST USE 9-13-2007; IN COMMERCE 11-12-2007.

APRIL ROACH, EXAMINING ATTORNEY

Int. Cl.: 9

Prior U.S. Cls.: 21, 23, 26, 36, and 38

United States Patent and Trademark Office

Reg. No. 3,399,101

Registered Mar. 18, 2008

**TRADEMARK
PRINCIPAL REGISTER**

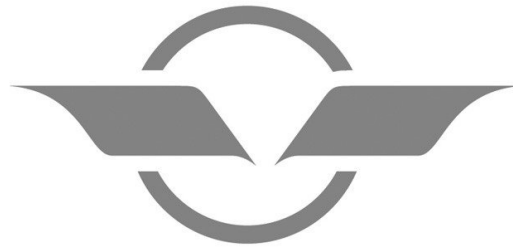

Ever Sport

LIN, GUNAG (UNITED STATES INDIVIDUAL)
3 CRAFTSMAN CT
GREER, SC 29650

FOR: SUNGLASSES, IN CLASS 9 (U.S. CLS. 21, 23,
26, 36 AND 38).

FIRST USE 1-1-2007; IN COMMERCE 1-1-2007.

NO CLAIM IS MADE TO THE EXCLUSIVE
RIGHT TO USE "SPORT" , APART FROM THE
MARK AS SHOWN.

THE MARK CONSISTS OF A CIRCLE SPLIT
HORIZONTALLY WITH TWO WING TYPE FEAT-
URES IN THE MIDDLE, WITH THE WORDS
"EVER SPORT" WRITTEN UNDER THE LOGO.

SN 77-062,515, FILED 12-12-2006.

TINA KUAN, EXAMINING ATTORNEY

Int. Cl.: 9

Prior U.S. Cls.: 21, 23, 26, 36, and 38

United States Patent and Trademark Office

Reg. No. 3,399,102

Registered Mar. 18, 2008

**TRADEMARK
PRINCIPAL REGISTER**

PROSHOW MEDIASOURCE

PHOTODEX CORPORATION (TEXAS CORPORATION)
925 WESTBANK DRIVE
AUSTIN, TX 78745

FOR: COMPUTER SOFTWARE FOR CREATING AND PLAYING MULTI-MEDIA PRESENTATIONS AND INSTRUCTIONAL MANUALS INCLUDED THEREWITH, IN CLASS 9 (U.S. CLS. 21, 23, 26, 36 AND 38).

FIRST USE 1-14-2007; IN COMMERCE 1-14-2007.

THE MARK CONSISTS OF STANDARD CHARACTERS WITHOUT CLAIM TO ANY PARTICULAR FONT, STYLE, SIZE, OR COLOR.

OWNER OF U.S. REG. NO. 2,906,600.

SN 77-063,009, FILED 12-13-2006.

KATHY DE JONGE, EXAMINING ATTORNEY

Int. Cl.: 42

Prior U.S. Cls.: 100 and 101

United States Patent and Trademark Office

Reg. No. 3,399,103

Registered Mar. 18, 2008

SERVICE MARK
PRINCIPAL REGISTER



the
TECHNOLOGY GUIDE
Navigating Technology for Better Solutions

THE TECHNOLOGY GUIDE, LLC (COLORADO
LTD LIAB CO)
5054 E. WEAVER PLACE
CENTENNIAL, CO 80121

FOR: INFORMATION TECHNOLOGY CONSULTATION; CONSULTING SERVICES FOR OTHERS IN THE FIELD OF INFORMATION TECHNOLOGY SYSTEMS ANALYSIS, DESIGN AND IMPLEMENTATION; CONSULTING SERVICES IN THE FIELDS OF SELECTION, DESIGN, IMPLEMENTATION, USE, MONITORING, MAINTENANCE AND REPAIR OF COMPUTER SOFTWARE SYSTEMS FOR OTHERS; INFORMATION TECHNOLOGY SUPPORT SERVICES, NAMELY, DATA, VOICE AND WIRELESS NETWORK IMPLEMENTATION AND MONITORING; TECHNICAL SUPPORT SERVICES, NAMELY, TROUBLESHOOTING OF COMPUTER HARDWARE AND SOFTWARE PROBLEMS; TECHNICAL SUPPORT, NAMELY, MONITORING OF NETWORK SYSTEMS; DESIGN AND DEVELOPMENT OF NETWORKS, DATABASES AND ONLINE COMPUTER SYSTEMS; E-MAIL SYSTEM DESIGN, IMPLEMENTATION, MAINTENANCE AND REPAIR FOR OTHERS; IMPLEMENTATION AND MAINTENANCE FOR OTHERS OF COMPUTER SOFTWARE FOR PBX AND VOIP PHONE SYSTEMS; COMPUTER AND APPLICATION SYSTEMS

TESTING FOR OTHERS; COMPUTER PROGRAMMING, MAINTENANCE AND REPAIR OF COMPUTER SOFTWARE; COMPUTER DIAGNOSTIC SERVICES; COMPUTER SERVICES, NAMELY, VIRUS, SPAM AND SPYWARE PROTECTION; DESIGN, CREATION, HOSTING, MAINTENANCE AND MANAGING OF WEBSITES FOR OTHERS; GRAPHIC DESIGN SERVICES, IN CLASS 42 (U.S. CLS. 100 AND 101).

FIRST USE 1-1-2005; IN COMMERCE 12-1-2005.

NO CLAIM IS MADE TO THE EXCLUSIVE RIGHT TO USE "TECHNOLOGY", APART FROM THE MARK AS SHOWN.

THE MARK CONSISTS, IN PART, OF A STYLIZED COMPASS WITH TWO SEMICIRCULAR ARCS REPRESENTING MOTION EMANATING FROM EACH END OF THE COMPASS NEEDLE WITH DIRECTIONAL DIAMONDS ON THE TOP AND BOTTOM.

SN 77-063,048, FILED 12-13-2006.

STEPHEN AQUILA, EXAMINING ATTORNEY

Int. Cls.: 9 and 18

Prior U.S. Cls.: 1, 2, 3, 21, 22, 23, 26, 36, 38, and 41

United States Patent and Trademark Office

Reg. No. 3,399,104

Registered Mar. 18, 2008

**TRADEMARK
PRINCIPAL REGISTER**



ELIF LEATHER GOODS, LLC (NEW JERSEY
LTD LIAB CO)
11 ELM STREET
RUTHERFORD, NJ 07070

FOR: CASES FOR MOBILE PHONES; CASES FOR
SPECTACLES AND SUNGLASSES; COMPUTER
CARRYING CASES; LAPTOP CARRYING CASES,
IN CLASS 9 (U.S. CLS. 21, 23, 26, 36 AND 38).

FIRST USE 1-1-2007; IN COMMERCE 5-26-2007.

FOR: BACKPACKS; BRIEFCASES; BUSINESS
CARD CASES; BUSINESS CASES; COIN PURSES;
COSMETIC BAGS SOLD EMPTY; GARMENT BAGS
FOR TRAVEL; HANDBAGS; KEY CASES; LEATHER
BAGS, SUITCASES AND WALLETS; LEATHER
BRIEFCASES; LEATHER HANDBAGS; PURSES;

TRAVEL BAGS; WALLETS, IN CLASS 18 (U.S. CLS.
1, 2, 3, 22 AND 41).

FIRST USE 1-1-2007; IN COMMERCE 5-26-2007.

THE COLOR(S) BLACK, WHITE, RED (PANTONE
704) IS/ARE CLAIMED AS A FEATURE OF THE
MARK.

THE MARK CONSISTS OF A BUTTERFLY WITH
A STYLIZED LETTER E IN THE CENTER ALL IN
RED (PANTONE 704), AND NAME ELIF IN DIDOT
FONT IN BLACK.

SN 77-063,320, FILED 12-13-2006.

JILL C. ALT, EXAMINING ATTORNEY

Int. Cl.: 41

Prior U.S. Cls.: 100, 101, and 107

United States Patent and Trademark Office

Reg. No. 3,399,105

Registered Mar. 18, 2008

**SERVICE MARK
PRINCIPAL REGISTER**

XTREMELAB

AIRS HUMAN CAPITAL SOLUTIONS, INC.
(NEW HAMPSHIRE CORPORATION)
58 FOGG FARM ROAD
WHITE RIVER JUNCTION, VT 05001

FOR: EDUCATIONAL SERVICES, NAMELY,
PROVIDING COURSES OF INSTRUCTION TO
TEACH SOURCERS AND RECRUITERS TECHNI-
QUES FOR FINDING CANDIDATES ON THE IN-
TERNET, IN CLASS 41 (U.S. CLS. 100, 101 AND 107).

FIRST USE 12-6-2006; IN COMMERCE 12-6-2006.

THE MARK CONSISTS OF STANDARD CHAR-
ACTERS WITHOUT CLAIM TO ANY PARTICULAR
FONT, STYLE, SIZE, OR COLOR.

SN 77-063,330, FILED 12-13-2006.

MICHAEL LEWIS, EXAMINING ATTORNEY

Int. Cls.: 8 and 16

Prior U.S. Cls.: 2, 5, 22, 23, 28, 29, 37, 38, 44, and 50

United States Patent and Trademark Office

Reg. No. 3,399,106

Registered Mar. 18, 2008

**TRADEMARK
PRINCIPAL REGISTER**



ELMER'S PRODUCTS, INC. (DELAWARE CORPORATION)
ONE EASTON OVAL
COLUMBUS, OH 43219

FOR: HAND TOOLS FOR HOBBIES, ARTS, AND CRAFTS, NAMELY, KNIVES, KNIFE BLADES, MAT CUTTERS, COMPASS CUTTERS, BLADE SAFETY CAPS, C-CLAMPS, PLIERS, CORNER CLAMPS, METAL VISE GRIPS, TWEEZERS, SAWS AND HAND SAW BLADES, METAL VISES, MITRE BOX AND DRILL BITS FOR HAND DRILLS, IN CLASS 8 (U.S. CLS. 23, 28 AND 44).

FIRST USE 2-1-2007; IN COMMERCE 2-1-2007.

FOR: BATTERY POWERED AND MANUALLY OPERATED PENCIL SHARPENERS; OFFICE PRODUCTS, NAMELY, ELECTRIC PENCIL SHARPENER, PAPER TRIMMERS, ELECTRONIC STAPLERS; MANUAL STAPLERS; BATTERY OPERATED LETTER OPENER; PAPER PUNCHES; BULLDOG CLIPS, IN CLASS 16 (U.S. CLS. 2, 5, 22, 23, 29, 37, 38 AND 50).

FIRST USE 2-1-2007; IN COMMERCE 2-1-2007.

OWNER OF U.S. REG. NOS. 2,951,462, 3,199,830, AND OTHERS.

THE COLOR(S) SILVER, BLUE, AND BLACK IS/ARE CLAIMED AS A FEATURE OF THE MARK.

THE MARK CONSISTS OF THE TRADE DRESS CHARACTERIZING THE FRONT FACE OF THE PACKAGING FOR APPLICANT'S GOODS, NAMELY, (1) TWO SILVER VERTICAL BANDS CROSSING TO FORM AN "X" SPANNING THE PACKAGE FACE; (2) TWO BLACK TRIANGLES EXTENDING FROM THE CENTER OF THE "X" UPWARDS AND DOWNWARDS; (3) TWO BLUE TRIANGLES EXTENDING FROM THE CENTER OF THE "X" LEFT AND RIGHT, (4) BEGINNING ON THE SILVER VERTICAL BANDS FORMING THE "X" AND EXTENDING TO THE RIGHT THROUGH THE BLUE TRIANGLE IS THE WORD "X-ACTO" IN SILVER LETTERING, AND (5) BLACK SHADING APPEARING BEHIND THE WORD "X-ACTO".

SN 77-063,980, FILED 12-14-2006.

WILLIAM P. SHANAHAN, EXAMINING ATTORNEY

Int. Cl.: 38

Prior U.S. Cls.: 100, 101, and 104

United States Patent and Trademark Office

Reg. No. 3,399,107

Registered Mar. 18, 2008

**SERVICE MARK
PRINCIPAL REGISTER**



QWEST COMMUNICATIONS INTERNATIONAL
INC. (DELAWARE CORPORATION)
1801 CALIFORNIA STREET
DENVER, CO 80202

FOR: PROVIDING ACCESS TO TELECOMMUNI-
CATION NETWORKS, IN CLASS 38 (U.S. CLS. 100,
101 AND 104).

FIRST USE 6-12-2001; IN COMMERCE 6-12-2004.

THE MARK CONSISTS OF STANDARD CHAR-
ACTERS WITHOUT CLAIM TO ANY PARTICULAR
FONT, STYLE, SIZE, OR COLOR.

OWNER OF U.S. REG. NOS. 2,205,095 AND
2,849,226.

SN 77-065,012, FILED 12-15-2006.

GISELLE AGOSTO, EXAMINING ATTORNEY

Int. Cl.: 31

Prior U.S. Cls.: 1 and 46

United States Patent and Trademark Office

Reg. No. 3,399,108

Registered Mar. 18, 2008

**TRADEMARK
PRINCIPAL REGISTER**

YOU BET WE'RE FRESH!

DEL FRESCO PRODUCE LTD. (CANADA LIMITED COMPANY)
1414 SEACLIFFE DRIVE
KINGSVILLE, ONTARIO, CANADA N9Y2M2

THE MARK CONSISTS OF STANDARD CHARACTERS WITHOUT CLAIM TO ANY PARTICULAR FONT, STYLE, SIZE, OR COLOR.

FOR: FRESH HYDROPONIC VEGETABLES, IN CLASS 31 (U.S. CLS. 1 AND 46).

SN 77-066,576, FILED 12-18-2006.

FIRST USE 2-0-2007; IN COMMERCE 2-0-2007.

DAVID H. STINE, EXAMINING ATTORNEY

Int. Cl.: 41

Prior U.S. Cls.: 100, 101, and 107

United States Patent and Trademark Office

Reg. No. 3,399,109

Registered Mar. 18, 2008

**SERVICE MARK
PRINCIPAL REGISTER**

GREAT STORIES WELL TOLD

HDNET LLC (DELAWARE LTD LIAB CO)
2909 TAYLOR STREET
DALLAS, TX 75226

THE MARK CONSISTS OF STANDARD CHAR-
ACTERS WITHOUT CLAIM TO ANY PARTICULAR
FONT, STYLE, SIZE, OR COLOR.

FOR: ENTERTAINMENT IN THE NATURE OF
ON-GOING TELEVISION PROGRAMS IN THE
FIELD OF MOVIES, IN CLASS 41 (U.S. CLS. 100, 101
AND 107).

SN 77-066,747, FILED 12-18-2006.

FIRST USE 1-5-2007; IN COMMERCE 1-5-2007.

DAVID H. STINE, EXAMINING ATTORNEY

Int. Cl.: 1

Prior U.S. Cls.: 1, 5, 6, 10, 26, and 46

United States Patent and Trademark Office

Reg. No. 3,399,110

Registered Mar. 18, 2008

**TRADEMARK
PRINCIPAL REGISTER**

HONEYWELL LABREADY

HONEYWELL INTERNATIONAL INC. (DELA-
WARE CORPORATION)
101 COLUMBIA ROAD
MORRISTOWN, NJ 07962

FOR: SOLVENTS FOR LABORATORY APPLICA-
TIONS, IN CLASS 1 (U.S. CLS. 1, 5, 6, 10, 26 AND 46).

FIRST USE 4-30-2007; IN COMMERCE 4-30-2007.

THE MARK CONSISTS OF STANDARD CHAR-
ACTERS WITHOUT CLAIM TO ANY PARTICULAR
FONT, STYLE, SIZE, OR COLOR.

OWNER OF U.S. REG. NO. 2,579,957.

SN 77-067,206, FILED 12-19-2006.

LINDA ORNDORFF, EXAMINING ATTORNEY

Int. Cl.: 5

Prior U.S. Cls.: 6, 18, 44, 46, 51, and 52

United States Patent and Trademark Office

Reg. No. 3,399,111

Registered Mar. 18, 2008

**TRADEMARK
PRINCIPAL REGISTER**

BIOSTAT BIOLOGX

SPINAL RESTORATION, INC. (DELAWARE CORPORATION)
4030 WEST BRAKER LANE, SUITE 360
AUSTIN, TX 78759

FOR: PHARMACEUTICAL PREPARATIONS, NAMELY, FIBRIN SEALANT, POLYMERS, BONE CEMENTS AND HYDROGELS FOR FILLING TEARS AND DEFECTS AND PROMOTING HEALING OF THE ANULUS OF THE DEGENERATED SPINAL DISC, IN CLASS 5 (U.S. CLS. 6, 18, 44, 46, 51 AND 52).

FIRST USE 12-18-2007; IN COMMERCE 12-18-2007.

THE MARK CONSISTS OF STANDARD CHARACTERS WITHOUT CLAIM TO ANY PARTICULAR FONT, STYLE, SIZE, OR COLOR.

NO CLAIM IS MADE TO THE EXCLUSIVE RIGHT TO USE "BIOLOGICS", APART FROM THE MARK AS SHOWN.

SN 77-067,448, FILED 12-19-2006.

PETER B. BROMAGHIM, EXAMINING ATTORNEY

Int. Cl.: 35

Prior U.S. Cls.: 100, 101, and 102

United States Patent and Trademark Office

Reg. No. 3,399,112

Registered Mar. 18, 2008

**SERVICE MARK
PRINCIPAL REGISTER**

THINK AGILE WORKFORCE.

TECHNICAL AID CORPORATION (MASSACHU-
SETTS CORPORATION)
888 WASHINGTON STREET
DEDHAM, MA 02026

FOR: EMPLOYMENT AGENCY AND PROVISION
OF CONTRACT WORKER SERVICES, IN CLASS 35
(U.S. CLS. 100, 101 AND 102).

FIRST USE 9-1-2006; IN COMMERCE 9-1-2006.

THE MARK CONSISTS OF STANDARD CHAR-
ACTERS WITHOUT CLAIM TO ANY PARTICULAR
FONT, STYLE, SIZE, OR COLOR.

NO CLAIM IS MADE TO THE EXCLUSIVE
RIGHT TO USE "WORKFORCE", APART FROM
THE MARK AS SHOWN.

SN 77-068,175, FILED 12-20-2006.

LAURIE MAYES, EXAMINING ATTORNEY

Int. Cl.: 35

Prior U.S. Cls.: 100, 101, and 102

United States Patent and Trademark Office

Reg. No. 3,399,113

Registered Mar. 18, 2008

**SERVICE MARK
PRINCIPAL REGISTER**

**THE OFFICE CONSUMABLES
DIVISION FOR BUSY COMPANIES**

X, INC. (CALIFORNIA CORPORATION), DBA
ONE STOP SHOP,
#220
6800 OWENSMOUTH AVENUE
CANOGA PARK, CA 91303

FOR: DISTRIBUTORSHIP IN THE FIELD OF
OFFICE SUPPLIES, NAMELY, TONER AND TONER
CARTRIDGES FOR PRINTERS, FACSIMILE, PHO-
TOCOPYING, AND OTHER IMAGE PRODUCING
MACHINES, INK CARTRIDGES FOR PRINTERS,
FACSIMILE, PHOTOCOPYING, AND OTHER IM-
AGE PRODUCING MACHINES, OFFICE FURNI-
TURE, JANITORIAL AND SANITATION
PRODUCTS AND DATA STORAGE MEDIA, NAME-

LY, FLASH MEMORY, OPTICAL TAPES, AND
MAGNETIC TAPES, IN CLASS 35 (U.S. CLS. 100,
101 AND 102).

FIRST USE 1-1-2007; IN COMMERCE 1-1-2007.

THE MARK CONSISTS OF STANDARD CHAR-
ACTERS WITHOUT CLAIM TO ANY PARTICULAR
FONT, STYLE, SIZE, OR COLOR.

SN 77-068,272, FILED 12-20-2006.

HOWARD B. LEVINE, EXAMINING ATTORNEY

Int. Cl.: 44

Prior U.S. Cls.: 100 and 101

United States Patent and Trademark Office

Reg. No. 3,399,114

Registered Mar. 18, 2008

**SERVICE MARK
PRINCIPAL REGISTER**

TAME YOUR HUNGER

ALLERGAN, INC. (DELAWARE CORPORATION)
2525 DUPONT DRIVE
IRVINE, CA 92612

THE MARK CONSISTS OF STANDARD CHAR-
ACTERS WITHOUT CLAIM TO ANY PARTICULAR
FONT, STYLE, SIZE, OR COLOR.

FOR: PROVIDING INFORMATION DIRECTED
TO CONSUMERS CONCERNING OBESITY TREAT-
MENTS, IN CLASS 44 (U.S. CLS. 100 AND 101).

SN 77-068,776, FILED 12-20-2006.

FIRST USE 8-30-2006; IN COMMERCE 7-27-2007.

MIDGE BUTLER, EXAMINING ATTORNEY

Int. Cl.: 3

Prior U.S. Cls.: 1, 4, 6, 50, 51, and 52

United States Patent and Trademark Office

Reg. No. 3,399,115

Registered Mar. 18, 2008

**TRADEMARK
PRINCIPAL REGISTER**

Seraph

SERAPH COSMETICS, INC. (CALIFORNIA CORPORATION)
1939 ARGYLE AVE #23
HOLLYWOOD, CA 90068

FOR: BODY AND BEAUTY CARE COSMETICS; CLEANSING CREAMS; CONCEALERS; COSMETIC CREAMS FOR SKIN CARE; COSMETIC PENCILS; COSMETIC PREPARATIONS FOR EYE LASHES; COSMETIC PREPARATIONS FOR SKIN RENEWAL; COSMETIC ROUGES; COSMETIC SUN-PROTECTING PREPARATIONS; COSMETICS; COSMETICS NAMELY COMPACTS; MAKE-UP KITS COMPRISED OF EYE SHADOWS, BLUSH, LIP GLOSSES;

PENCILS FOR COSMETIC PURPOSES, IN CLASS 3 (U.S. CLS. 1, 4, 6, 50, 51 AND 52).

FIRST USE 9-26-2007; IN COMMERCE 9-26-2007.

THE MARK CONSISTS OF STANDARD CHARACTERS WITHOUT CLAIM TO ANY PARTICULAR FONT, STYLE, SIZE, OR COLOR.

SN 77-068,854, FILED 12-20-2006.

BRENDAN MCCAULEY, EXAMINING ATTORNEY

Int. Cl.: 18

Prior U.S. Cls.: 1, 2, 3, 22, and 41

United States Patent and Trademark Office

Reg. No. 3,399,116

Registered Mar. 18, 2008

**TRADEMARK
PRINCIPAL REGISTER**



AR NEW YORK LIMITED CORP. (NEW YORK CORPORATION)
50B MILLTOWN ROAD
UNION, NJ 07083

FOR: EVENING HANDBAGS; HANDBAGS, IN CLASS 18 (U.S. CLS. 1, 2, 3, 22 AND 41).

FIRST USE 1-10-2008; IN COMMERCE 1-10-2008.

THE COLOR(S) YELLOW, DARK GREY AND WHITE IS/ARE CLAIMED AS A FEATURE OF THE MARK.

THE MARK CONSISTS OF THE LOGO OF A STANDING DUCK IN YELLOW WITH WHITE GAPS. THE CHARACTERS "ARNY" ARE IN DARK GREY.

SN 77-068,879, FILED 12-20-2006.

MYRIAH HABEEB, EXAMINING ATTORNEY

Int. Cl.: 9

Prior U.S. Cls.: 21, 23, 26, 36, and 38

United States Patent and Trademark Office

Reg. No. 3,399,117

Registered Mar. 18, 2008

**TRADEMARK
PRINCIPAL REGISTER**

VOSTRO

DELL INC. (DELAWARE CORPORATION)
ONE DELL WAY MS#8033
ROUND ROCK, TX 78682

FOR: COMPUTER HARDWARE, NAMELY, LAP-
TOP COMPUTERS, NOTEBOOK COMPUTERS,
DESK TOP COMPUTERS, PERSONAL COMPU-
TERS, COMPUTERS, IN CLASS 9 (U.S. CLS. 21, 23,
26, 36 AND 38).

FIRST USE 7-31-2007; IN COMMERCE 7-31-2007.

THE MARK CONSISTS OF STANDARD CHAR-
ACTERS WITHOUT CLAIM TO ANY PARTICULAR
FONT, STYLE, SIZE, OR COLOR.

THE ENGLISH TRANSLATION OF THE WORD
"VOSTRO" IN THE MARK IS "YOURS".

SN 77-068,993, FILED 12-20-2006.

LOURDES AYALA, EXAMINING ATTORNEY

Int. Cl.: 35

Prior U.S. Cls.: 100, 101, and 102

United States Patent and Trademark Office

Reg. No. 3,399,118

Registered Mar. 18, 2008

**SERVICE MARK
PRINCIPAL REGISTER**

BEAUTIFUL BRANDS

BEAUTIFUL BRANDS INTERNATIONAL, INC.
(OKLAHOMA CORPORATION)
SUITE 400
8801 S. YALE AVE.
TULSA, OK 74137

FOR: CONCEPT AND BRAND DEVELOPMENT
IN THE CAFE, RESTAURANT, FAST FOOD, AND
PHYSICAL FITNESS INDUSTRIES, IN CLASS 35
(U.S. CLS. 100, 101 AND 102).

FIRST USE 9-1-2006; IN COMMERCE 9-1-2006.

THE MARK CONSISTS OF STANDARD CHAR-
ACTERS WITHOUT CLAIM TO ANY PARTICULAR
FONT, STYLE, SIZE, OR COLOR.

NO CLAIM IS MADE TO THE EXCLUSIVE
RIGHT TO USE "BRANDS", APART FROM THE
MARK AS SHOWN.

SN 77-069,004, FILED 12-21-2006.

LAURIE MAYES, EXAMINING ATTORNEY

Int. Cl.: 5

Prior U.S. Cls.: 6, 18, 44, 46, 51, and 52

United States Patent and Trademark Office

Reg. No. 3,399,119

Registered Mar. 18, 2008

**TRADEMARK
PRINCIPAL REGISTER**

prolipid

SCHOLTEN, INGO (FED REP GERMANY INDIVIDUAL)
FLURWEG 3
KONSTANZ, FED REP GERMANY 78464

FOR: DIETARY AND NUTRITIONAL SUPPLEMENTS; NUTRACEUTICALS FOR USE AS A DIETARY SUPPLEMENT, IN CLASS 5 (U.S. CLS. 6, 18, 44, 46, 51 AND 52).

FIRST USE 8-31-2006; IN COMMERCE 10-1-2007.

THE MARK CONSISTS OF STANDARD CHARACTERS WITHOUT CLAIM TO ANY PARTICULAR FONT, STYLE, SIZE, OR COLOR.

PRIORITY CLAIMED UNDER SEC. 44(D) ON FED REP GERMANY APPLICATION NO. 30654011.8, FILED 8-31-2006.

SN 77-069,018, FILED 12-21-2006.

CHERYL CLAYTON, EXAMINING ATTORNEY

Int. Cl.: 25

Prior U.S. Cls.: 22 and 39

United States Patent and Trademark Office

Reg. No. 3,399,120

Registered Mar. 18, 2008

**TRADEMARK
PRINCIPAL REGISTER**

HEYDAY

HAGER DESIGN, INC. (MASSACHUSETTS CORPORATION)
31 BLACKBERRY LANE
FRAMINGHAM, MA 01701

THE MARK CONSISTS OF STANDARD CHARACTERS WITHOUT CLAIM TO ANY PARTICULAR FONT, STYLE, SIZE, OR COLOR.

FOR: FOOTWEAR; CLOTHING, NAMELY, T-SHIRTS, IN CLASS 25 (U.S. CLS. 22 AND 39).

SN 77-069,271, FILED 12-21-2006.

FIRST USE 1-3-2007; IN COMMERCE 8-20-2007.

DORITT L. CARROLL, EXAMINING ATTORNEY

Int. Cl.: 35

Prior U.S. Cls.: 100, 101, and 102

United States Patent and Trademark Office

Reg. No. 3,399,121

Registered Mar. 18, 2008

**SERVICE MARK
PRINCIPAL REGISTER**

VCEO

VCFO HOLDINGS, INC. (DELAWARE CORPORATION)
BUILDING II, SUITE 100
4601 SPICEWOOD SPRINGS RD.
AUSTIN, TX 78759

FOR: OUTSOURCED BUSINESS MANAGEMENT AND CONSULTATION; BUSINESS APPRAISAL; BUSINESS NETWORKING; OPERATION OF A BUSINESS FOR OTHERS, NAMELY, TECHNOLOGY COMPANIES; BUSINESS CONSULTATION, NAMELY, PROVIDING ADVICE AND INFORMATION REGARDING CREATING AND BUILDING A BUSINESS; BUSINESS CONSULTATION, NAMELY, PREPARATION AND ADVICE REGARDING BUSINESS PLANS; ADMINISTRATION AND/OR SUPERVISION OF A COMPANY'S BUSINESS AND/OR

OFFICE OPERATIONS; BUSINESS SERVICES, NAMELY, NEGOTIATING FINANCING TERMS FOR OTHERS AND ASSISTING ENTREPRENEURS AND COMPANIES IN OBTAINING FINANCING AND IN OBTAINING BUSINESS PARTNERS, IN CLASS 35 (U.S. CLS. 100, 101 AND 102).

FIRST USE 11-16-2007; IN COMMERCE 11-16-2007.

THE MARK CONSISTS OF STANDARD CHARACTERS WITHOUT CLAIM TO ANY PARTICULAR FONT, STYLE, SIZE, OR COLOR.

SN 77-069,327, FILED 12-21-2006.

NICHOLAS ALTREE, EXAMINING ATTORNEY

Int. Cl.: 36

Prior U.S. Cls.: 100, 101, and 102

United States Patent and Trademark Office

Reg. No. 3,399,122

Registered Mar. 18, 2008

**SERVICE MARK
PRINCIPAL REGISTER**

Invest West

COMMUNITY WEST FOUNDATION (OHIO
NON-PROFIT CORPORATION)
SUITE 448
20545 CENTER RIDGE ROAD
CLEVELAND, OH 44116

FOR: CHARITABLE FUNDRAISING AND
CHARITABLE SERVICES, NAMELY, PROVIDING
MONETARY CONTRIBUTIONS TO NOT-FOR-
PROFIT OR EDUCATION BASED SERVICES IN
WESTERN GREATER CLEVELAND; FINANCIAL
CONSULTING SERVICES IN THE AREA OF PHI-
LANTHROPY TO INDIVIDUALS AND CHARITA-
BLE ORGANIZATIONS AND PROFESSIONAL
FINANCIAL ADVISORS, IN CLASS 36 (U.S. CLS.
100, 101 AND 102).

FIRST USE 1-1-2007; IN COMMERCE 1-1-2007.

THE MARK CONSISTS OF STANDARD CHAR-
ACTERS WITHOUT CLAIM TO ANY PARTICULAR
FONT, STYLE, SIZE, OR COLOR.

NO CLAIM IS MADE TO THE EXCLUSIVE
RIGHT TO USE "INVEST", APART FROM THE
MARK AS SHOWN.

SN 77-069,355, FILED 12-21-2006.

RAUL CORDOVA, EXAMINING ATTORNEY

Int. Cl.: 30

Prior U.S. Cl.: 46

United States Patent and Trademark Office

Reg. No. 3,399,123

Registered Mar. 18, 2008

**TRADEMARK
PRINCIPAL REGISTER**

FlavorMax

CHR. HANSEN INC. (WISCONSIN CORPORATION)
9015 W. MAPLE STREET
MILWAUKEE, WI 53214

FOR: FLAVOR ENHANCERS USED IN FOOD
AND BEVERAGE PRODUCTS, IN CLASS 30 (U.S.
CL. 46).

FIRST USE 10-29-2006; IN COMMERCE 10-29-2006.

THE MARK CONSISTS OF STANDARD CHARACTERS WITHOUT CLAIM TO ANY PARTICULAR FONT, STYLE, SIZE, OR COLOR.

SN 77-069,728, FILED 12-21-2006.

MATTHEW MCDOWELL, EXAMINING ATTORNEY

Int. Cl.: 10

Prior U.S. Cls.: 26, 39, and 44

United States Patent and Trademark Office

Reg. No. 3,399,124

Registered Mar. 18, 2008

**TRADEMARK
PRINCIPAL REGISTER**

SERENGETI

K2M, INC. (DELAWARE CORPORATION)
SUITE F-1
751 MILLER DRIVE, SE
LEESBURG, VA 20175

THE MARK CONSISTS OF STANDARD CHAR-
ACTERS WITHOUT CLAIM TO ANY PARTICULAR
FONT, STYLE, SIZE, OR COLOR.

FOR: SURGICAL INSTRUMENTS USED IN SPIN-
AL SURGERY, IN CLASS 10 (U.S. CLS. 26, 39 AND
44).

SN 77-070,146, FILED 12-22-2006.

FIRST USE 12-18-2006; IN COMMERCE 12-18-2006.

ANTHONY RINKER, EXAMINING ATTORNEY

Int. Cl.: 30

Prior U.S. Cl.: 46

United States Patent and Trademark Office

Reg. No. 3,399,125

Registered Mar. 18, 2008

**TRADEMARK
PRINCIPAL REGISTER**

DELIMEX TO GO!

TRADEMARK MANAGEMENT COMPANY (DE-
LAWARE CORPORATION)
2541 NORTH STOKESBERRY PLACE, SUITE 100
MERIDIAN, ID 83646

FOR: FROZEN, PACKAGED OR PREPARED
MEXICAN FOODS, NAMELY, TAQUITOS, QUESA-
DILLAS, TAMALES, FAJITAS AND BURRITOS, IN
CLASS 30 (U.S. CL. 46).

FIRST USE 7-5-2006; IN COMMERCE 7-5-2006.

THE MARK CONSISTS OF STANDARD CHAR-
ACTERS WITHOUT CLAIM TO ANY PARTICULAR
FONT, STYLE, SIZE, OR COLOR.

OWNER OF U.S. REG. NOS. 1,658,372 AND
2,329,583.

SN 77-070,309, FILED 12-22-2006.

KEVIN DINALLO, EXAMINING ATTORNEY

Int. Cl.: 43

Prior U.S. Cls.: 100 and 101

United States Patent and Trademark Office

Reg. No. 3,399,126

Registered Mar. 18, 2008

**SERVICE MARK
PRINCIPAL REGISTER**

NEWBRIDGE ON THE CHARLES

HRCA OF DEDHAM, INC. (MASSACHUSETTS
NON-PROFIT CORPORATION)
1200 CENTRE STREET
BOSTON, MA 02131

FOR: PROVIDING A RETIREMENT HOME COMMUNITY FOR SENIOR CITIZENS, IN CLASS 43 (U.S. CLS. 100 AND 101).

FIRST USE 6-30-2006; IN COMMERCE 6-30-2006.

THE MARK CONSISTS OF STANDARD CHARACTERS WITHOUT CLAIM TO ANY PARTICULAR FONT, STYLE, SIZE, OR COLOR.

NO CLAIM IS MADE TO THE EXCLUSIVE RIGHT TO USE "ON THE CHARLES", APART FROM THE MARK AS SHOWN.

SN 77-070,589, FILED 12-22-2006.

MICHAEL GAAFAR, EXAMINING ATTORNEY

Int. Cl.: 9

Prior U.S. Cls.: 21, 23, 26, 36, and 38

United States Patent and Trademark Office

Reg. No. 3,399,127

Registered Mar. 18, 2008

**TRADEMARK
PRINCIPAL REGISTER**

REPLAY

APPASSURE SOFTWARE, INC. (DELAWARE
CORPORATION)
10780 PARKRIDGE BLVD., SUITE 140
RESTON, VA 20191

THE MARK CONSISTS OF STANDARD CHAR-
ACTERS WITHOUT CLAIM TO ANY PARTICULAR
FONT, STYLE, SIZE, OR COLOR.

FOR: COMPUTER SOFTWARE FOR ENABLING
RECOVERY OF COMPUTER APPLICATION DATA
AFTER LOSS OF THE DATA, IN CLASS 9 (U.S. CLS.
21, 23, 26, 36 AND 38).

SN 77-072,348, FILED 12-28-2006.

FIRST USE 6-1-2007; IN COMMERCE 6-1-2007.

JACLYN KIDWELL, EXAMINING ATTORNEY

Int. Cl.: 33

Prior U.S. Cls.: 47 and 49

United States Patent and Trademark Office

Reg. No. 3,399,128

Registered Mar. 18, 2008

**TRADEMARK
PRINCIPAL REGISTER**

MIDNIGHT MOON

PIEDMONT DISTILLERS, INC. (NORTH CAROLINA CORPORATION)

P. O. BOX 472

MADISON, NC 27025

FOR: DISTILLED SPIRITS, IN CLASS 33 (U.S. CLS. 47 AND 49).

FIRST USE 5-7-2007; IN COMMERCE 5-7-2007.

THE MARK CONSISTS OF STANDARD CHARACTERS WITHOUT CLAIM TO ANY PARTICULAR FONT, STYLE, SIZE, OR COLOR.

NO CLAIM IS MADE TO THE EXCLUSIVE RIGHT TO USE "MOON", APART FROM THE MARK AS SHOWN.

SN 77-072,453, FILED 12-28-2006.

ROSELLE HERRERA, EXAMINING ATTORNEY

Int. Cl.: 12

Prior U.S. Cls.: 19, 21, 23, 31, 35, and 44

Reg. No. 3,399,129

United States Patent and Trademark Office

Registered Mar. 18, 2008

**TRADEMARK
PRINCIPAL REGISTER**

RETROBELT USA

RETROBELT USA, LLC (CALIFORNIA LTD LIAB
CO)
13831 ROSWELL AVENUE, SUITE J
CHINO, CA 91710

FOR: THREE POINT AND TWO POINT SEAT
BELTS FOR USE IN CLASSIC AND VINTAGE
VEHICLES, IN CLASS 12 (U.S. CLS. 19, 21, 23, 31, 35
AND 44).

FIRST USE 3-19-2007; IN COMMERCE 3-19-2007.

THE MARK CONSISTS OF STANDARD CHAR-
ACTERS WITHOUT CLAIM TO ANY PARTICULAR
FONT, STYLE, SIZE, OR COLOR.

NO CLAIM IS MADE TO THE EXCLUSIVE
RIGHT TO USE "USA", APART FROM THE MARK
AS SHOWN.

SN 77-072,957, FILED 12-28-2006.

HENRY S. ZAK, EXAMINING ATTORNEY

Int. Cl.: 9

Prior U.S. Cls.: 21, 23, 26, 36, and 38

United States Patent and Trademark Office

Reg. No. 3,399,130

Registered Mar. 18, 2008

**TRADEMARK
PRINCIPAL REGISTER**

Ever Sport

LIN, GUANG (UNITED STATES INDIVIDUAL)
3 CRAFTSMAN CT.
GREER, SC 29650

LENSES; SUNGLASSES, IN CLASS 9 (U.S. CLS. 21,
23, 26, 36 AND 38).

FIRST USE 1-1-2007; IN COMMERCE 1-1-2007.

FOR: CASES FOR SPECTACLES AND SUNGLAS-
SES; FRAMES FOR SPECTACLES AND SUNGLAS-
SES; LENSES FOR SUNGLASSES; SUNGLASS

SN 77-073,312, FILED 12-29-2006.

TINA KUAN, EXAMINING ATTORNEY

Int. Cl.: 9

Prior U.S. Cls.: 21, 23, 26, 36, and 38

United States Patent and Trademark Office

Reg. No. 3,399,131

Registered Mar. 18, 2008

**TRADEMARK
PRINCIPAL REGISTER**

SUPER EASY MONEY

WMS GAMING INC. (DELAWARE CORPORATION)
800 SOUTH NORTHPOINT BOULEVARD
WAUKEGAN, IL 60085

FOR: GAMING MACHINES THAT GENERATE OR DISPLAY WAGER OUTCOMES; GAMING SOFTWARE THAT GENERATES OR DISPLAYS WAGER OUTCOMES OF GAMING MACHINES, IN CLASS 9 (U.S. CLS. 21, 23, 26, 36 AND 38).

FIRST USE 8-8-2007; IN COMMERCE 8-8-2007.

THE MARK CONSISTS OF STANDARD CHARACTERS WITHOUT CLAIM TO ANY PARTICULAR FONT, STYLE, SIZE, OR COLOR.

OWNER OF U.S. REG. NO. 3,004,885.

SN 77-074,527, FILED 1-2-2007.

KIMBERLY FRYE, EXAMINING ATTORNEY

Int. Cl.: 41

Prior U.S. Cls.: 100, 101, and 107

United States Patent and Trademark Office

Reg. No. 3,399,132

Registered Mar. 18, 2008

**SERVICE MARK
PRINCIPAL REGISTER**

MORE TIME

MEREDITH CORPORATION (IOWA CORPORATION)
1716 LOCUST STREET
DES MOINES, IA 503093023

FOR: EDUCATION AND ENTERTAINMENT,
NAMELY, PROVIDING A RADIO PROGRAM FEATURING
A VARIETY OF SUBJECTS OF INTEREST TO WOMEN
OVER THE AGE OF 40, IN CLASS 41 (U.S. CLS. 100,
101 AND 107).

FIRST USE 1-16-2007; IN COMMERCE 1-16-2007.

THE MARK CONSISTS OF STANDARD CHARACTERS
WITHOUT CLAIM TO ANY PARTICULAR FONT, STYLE,
SIZE, OR COLOR.

OWNER OF U.S. REG. NOS. 2,154,334, 3,066,964,
AND 3,076,663.

SN 77-074,592, FILED 1-2-2007.

LAURIE KAUFMAN, EXAMINING ATTORNEY

Int. Cl.: 9

Prior U.S. Cls.: 21, 23, 26, 36, and 38

Reg. No. 3,399,133

United States Patent and Trademark Office

Registered Mar. 18, 2008

**TRADEMARK
PRINCIPAL REGISTER**

MITYX

MTS PRODUCTS (CALIFORNIA CORPORATION)
10671 LANARK STREET
SUN VALLEY, CA 91352

THE MARK CONSISTS OF STANDARD CHARACTERS WITHOUT CLAIM TO ANY PARTICULAR FONT, STYLE, SIZE, OR COLOR.

FOR: COMPUTER OPERATING SYSTEMS; OPERATING SYSTEM PROGRAMS, IN CLASS 9 (U.S. CLS. 21, 23, 26, 36 AND 38).

SN 77-074,627, FILED 1-2-2007.

FIRST USE 10-0-2006; IN COMMERCE 10-0-2006.

WENDY GOODMAN, EXAMINING ATTORNEY

Int. Cl.: 9

Prior U.S. Cls.: 21, 23, 26, 36, and 38

United States Patent and Trademark Office

Reg. No. 3,399,134

Registered Mar. 18, 2008

**TRADEMARK
PRINCIPAL REGISTER**

BAUDTEC

BAUDTEC CORPORATION (TAIWAN CORPORATION)
12F., NO. 181, SEC. 1, DATONG RD.
SIJHIH CITY
TAIPEI COUNTY, TAIWAN

FOR: COMPUTER INTERFACE CARDS, NETWORK COMMUNICATION EQUIPMENT, NAME-
LY, OPTICAL CABLES, INTERNET PHONES,
MODEMS, COMPUTER NETWORK HUBS AND
ROUTERS, GATEWAY ROUTERS IN THE NATURE
OF COMPUTER CONTROL HARDWARE, NAME-
LY, FOR TRANSMITTING AND RECEIVING DATA
OVER COMPUTER NETWORKS, NAMELY, VOICE
OVER INTERNET PROTOCOL, LOCAL AREA NET-
WORK, WIDE LOCAL AREA NETWORK, VIRTUAL
PRIVATE NETWORK, DIGITAL SUBSCRIBER

LINE, AND WIRELESS TELECOMMUNICATIONS
NETWORKS, POWERLINE ETHERNET ADAPTER,
MOBILE MULTIMEDIA VIEWERS IN THE NAT-
URE OF MP3 PLAYER AND MP4 PLAYER, POWER
OVER ETHERNET SWITCHES, IN CLASS 9 (U.S.
CLS. 21, 23, 26, 36 AND 38).

FIRST USE 7-1-2004; IN COMMERCE 12-0-2004.

THE MARK CONSISTS OF STANDARD CHAR-
ACTERS WITHOUT CLAIM TO ANY PARTICULAR
FONT, STYLE, SIZE, OR COLOR.

SN 77-075,750, FILED 1-4-2007.

CARRIE GENOVESE, EXAMINING ATTORNEY

Int. Cl.: 41

Prior U.S. Cls.: 100, 101, and 107

United States Patent and Trademark Office

Reg. No. 3,399,135

Registered Mar. 18, 2008

**SERVICE MARK
PRINCIPAL REGISTER**

BOOKFLIX

SCHOLASTIC INC. (NEW YORK CORPORATION)
557 BROADWAY
NEW YORK, NY 10012

FOR: EDUCATIONAL SERVICES, NAMELY, PROVIDING AN ONLINE READING PROGRAM FOR CHILDREN WHICH INCORPORATES THE USE OF INTERACTIVE FICTIONAL VIDEO STORYBOOKS WITH RELATED NONFICTION PRINT CONTENT AND DISTRIBUTION OF THE NONFICTION PRINT CONTENT IN CONNECTION THEREWITH, IN CLASS 41 (U.S. CLS. 100, 101 AND 107).

FIRST USE 6-12-2007; IN COMMERCE 6-12-2007.

THE MARK CONSISTS OF STANDARD CHARACTERS WITHOUT CLAIM TO ANY PARTICULAR FONT, STYLE, SIZE, OR COLOR.

SN 77-075,994, FILED 1-4-2007.

LEE-ANNE BERNS, EXAMINING ATTORNEY

Int. Cl.: 32

Prior U.S. Cls.: 45, 46, and 48

United States Patent and Trademark Office

Reg. No. 3,399,136

Registered Mar. 18, 2008

**TRADEMARK
PRINCIPAL REGISTER**

IZZE ESQUE

IZZE BEVERAGE CO. (DELAWARE CORPORATION)
2990 CENTER GREEN COURT SOUTH
BOULDER, CO 80308

FOR: LIGHT BEVERAGES, NAMELY, SOFT DRINKS, FRUIT JUICE DRINKS, IN CLASS 32 (U.S. CLS. 45, 46 AND 48).

FIRST USE 5-1-2007; IN COMMERCE 5-1-2007.

THE MARK CONSISTS OF STANDARD CHARACTERS WITHOUT CLAIM TO ANY PARTICULAR FONT, STYLE, SIZE, OR COLOR.

OWNER OF U.S. REG. NO. 2,697,979.

SN 77-076,032, FILED 1-4-2007.

GISELLE AGOSTO, EXAMINING ATTORNEY

Int. Cl.: 36

Prior U.S. Cls.: 100, 101, and 102

United States Patent and Trademark Office

Reg. No. 3,399,137

Registered Mar. 18, 2008

**SERVICE MARK
PRINCIPAL REGISTER**

SAFETYCENTRAL

BROTHERHOOD MUTUAL INSURANCE COM-
PANY (INDIANA CORPORATION)
6400 BROTHERHOOD WAY, P.O. BOX 2227
FORT WAYNE, IN 468012227

FOR: RISK MANAGEMENT SERVICES; RISK
MANAGEMENT CONSULTATION, IN CLASS 36
(U.S. CLS. 100, 101 AND 102).

FIRST USE 1-0-2007; IN COMMERCE 8-31-2007.

THE MARK CONSISTS OF STANDARD CHAR-
ACTERS WITHOUT CLAIM TO ANY PARTICULAR
FONT, STYLE, SIZE, OR COLOR.

NO CLAIM IS MADE TO THE EXCLUSIVE
RIGHT TO USE "SAFETY", APART FROM THE
MARK AS SHOWN.

SN 77-076,083, FILED 1-4-2007.

KATHY DE JONGE, EXAMINING ATTORNEY

Int. Cl.: 5

Prior U.S. Cls.: 6, 18, 44, 46, 51, and 52

United States Patent and Trademark Office

Reg. No. 3,399,138

Registered Mar. 18, 2008

**TRADEMARK
PRINCIPAL REGISTER**

POLY5

E. EXCEL INTERNATIONAL, INC. (UTAH CORPORATION)
9957 SOUTH JORDAN GATEWAY
SANDY, UT 84070

FOR: NUTRITIONAL SUPPLEMENTS, IN POWDER AND CAPSULE FORM, DERIVED PRIMARILY FROM FRUITS, VEGETABLES, HERBS AND OTHER PLANTS, IN CLASS 5 (U.S. CLS. 6, 18, 44, 46, 51 AND 52).

FIRST USE 2-5-2007; IN COMMERCE 2-5-2007.

THE MARK CONSISTS OF STANDARD CHARACTERS WITHOUT CLAIM TO ANY PARTICULAR FONT, STYLE, SIZE, OR COLOR.

SN 77-077,107, FILED 1-5-2007.

NELSON SNYDER, EXAMINING ATTORNEY

Int. Cl.: 30

Prior U.S. Cl.: 46

United States Patent and Trademark Office

Reg. No. 3,399,139

Registered Mar. 18, 2008

**TRADEMARK
PRINCIPAL REGISTER**

REESE'S WHIPPS

HERSHEY CHOCOLATE & CONFECTIONERY
CORPORATION (DELAWARE CORPORATION)

4860 ROBB STREET, SUITE 204
WHEAT RIDGE, CO 80033

FOR: CANDY, IN CLASS 30 (U.S. CL. 46).

FIRST USE 8-20-2007; IN COMMERCE 8-20-2007.

THE MARK CONSISTS OF STANDARD CHARACTERS WITHOUT CLAIM TO ANY PARTICULAR FONT, STYLE, SIZE, OR COLOR.

OWNER OF U.S. REG. NOS. 1,074,163, 1,834,806,
AND OTHERS.

SN 77-077,795, FILED 1-10-2007.

DAVID COLLIER, EXAMINING ATTORNEY

Int. Cl.: 9

Prior U.S. Cls.: 21, 23, 26, 36, and 38

United States Patent and Trademark Office

Reg. No. 3,399,140

Registered Mar. 18, 2008

**TRADEMARK
PRINCIPAL REGISTER**

Mesur

MARK-10 CORPORATION (NEW YORK CORPORATION)
11 DIXON AVENUE
COPIAGUE, NY 11726

FOR: COMPUTER SOFTWARE FOR THE COLLECTION, EDITING, ORGANIZING, MODIFYING, BOOK MARKING, TRANSMISSION, STORAGE AND SHARING OF DATA AND INFORMATION, IN CLASS 9 (U.S. CLS. 21, 23, 26, 36 AND 38).

FIRST USE 10-18-2007; IN COMMERCE 10-18-2007.

THE MARK CONSISTS OF STANDARD CHARACTERS WITHOUT CLAIM TO ANY PARTICULAR FONT, STYLE, SIZE, OR COLOR.

SN 77-077,827, FILED 1-8-2007.

VERNA BETH RIRIE, EXAMINING ATTORNEY

Int. Cl.: 9

Prior U.S. Cls.: 21, 23, 26, 36, and 38

United States Patent and Trademark Office

Reg. No. 3,399,141

Registered Mar. 18, 2008

TRADEMARK
PRINCIPAL REGISTER

buy  ***neers***
A Limited Liability Company

BUYONEERS, LLC (ARIZONA LTD LIAB CO)
3631 W. BUTLER ST.
CHANDLER, AZ 85226

FOR: DIGITAL MATERIALS, NAMELY, CDS, DVDS, DOWNLOADABLE AUDIO AND VIDEO MEDIA FEATURING CLASSICAL MUSIC: PERFORMANCE OR INSTRUCTION, IN CLASS 9 (U.S. CLS. 21, 23, 26, 36 AND 38).

FIRST USE 1-1-2007; IN COMMERCE 3-1-2007.

NO CLAIM IS MADE TO THE EXCLUSIVE RIGHT TO USE "A LIMITED LIABILITY COMPANY", APART FROM THE MARK AS SHOWN.

THE MARK CONSISTS OF THE NAME "BUYONEERS" IN ITALIC FONT. A CIRCLE SURROUNDING A SIDE-VIEW OF THE BUST OF A MAN IN ANTIQUATED ATTIRE, DESIGNED SUCH AS TO GIVE THE IMPRESSION OF A THREE-DIMENSIONAL COIN IS USED IN PLACE OF THE LETTER "O" IN THE AFOREMENTIONED NAME "BUYONEERS". THE PHRASE "A LIMITED LIABILITY COMPANY" APPEARS IN SMALLER LETTERS, RIGHT-ALIGNED UNDER THE AFOREMENTIONED NAME "BUYONEERS".

SN 77-078,523, FILED 1-9-2007.

KIMBERLY FRYE, EXAMINING ATTORNEY

Int. Cl.: 2

Prior U.S. Cls.: 6, 11, and 16

United States Patent and Trademark Office

Reg. No. 3,399,142

Registered Mar. 18, 2008

**TRADEMARK
PRINCIPAL REGISTER**

SEWERTUFF

SEWERTUFF, LLC (ILLINOIS LTD LIAB CO)
2550 EDGINGTON STREET
FRANKLIN PARK, IL 601313403

THE MARK CONSISTS OF STANDARD CHAR-
ACTERS WITHOUT CLAIM TO ANY PARTICULAR
FONT, STYLE, SIZE, OR COLOR.

FOR: ADHESIVE COATINGS FOR THE PROTEC-
TION OF CONCRETE, MASONRY AND STEEL, IN
CLASS 2 (U.S. CLS. 6, 11 AND 16).

SN 77-079,831, FILED 1-10-2007.

FIRST USE 2-1-2007; IN COMMERCE 2-1-2007.

LAURIE MAYES, EXAMINING ATTORNEY

Int. Cl.: 5

Prior U.S. Cls.: 6, 18, 44, 46, 51, and 52

United States Patent and Trademark Office

Reg. No. 3,399,143

Registered Mar. 18, 2008

**TRADEMARK
PRINCIPAL REGISTER**

FORAGE-LYX

RIDLEY BLOCK OPERATIONS, INC. (MINNESOTA CORPORATION)
424 N. RIVERFRONT DRIVE
MANKATO, MN 56002

FOR: ANIMAL FEED SUPPLEMENTS, IN CLASS 5 (U.S. CLS. 6, 18, 44, 46, 51 AND 52).

FIRST USE 2-27-2007; IN COMMERCE 3-5-2007.

THE MARK CONSISTS OF STANDARD CHARACTERS WITHOUT CLAIM TO ANY PARTICULAR FONT, STYLE, SIZE, OR COLOR.

OWNER OF U.S. REG. NOS. 1,407,344, 1,894,794, AND OTHERS.

SN 77-080,205, FILED 1-10-2007.

CARRIE GENOVESE, EXAMINING ATTORNEY

Int. Cl.: 12

Prior U.S. Cls.: 19, 21, 23, 31, 35, and 44

Reg. No. 3,399,144

United States Patent and Trademark Office

Registered Mar. 18, 2008

**TRADEMARK
PRINCIPAL REGISTER**



ON SITE CONCRETE INC. (CALIFORNIA CORPORATION)
5081 PASADENA AVE
SACRAMENTO, CA 958414149

NO CLAIM IS MADE TO THE EXCLUSIVE RIGHT TO USE "CONCRETE", APART FROM THE MARK AS SHOWN.

FOR: CONCRETE MIXING TRUCKS AND TRAILERS FOR USE AT OR ON THE JOB SITE, IN CLASS 12 (U.S. CLS. 19, 21, 23, 31, 35 AND 44).

SN 77-080,320, FILED 1-10-2007.

FIRST USE 4-1-2006; IN COMMERCE 4-1-2006.

WENDY GOODMAN, EXAMINING ATTORNEY

Int. Cl.: 9

Prior U.S. Cls.: 21, 23, 26, 36, and 38

United States Patent and Trademark Office

Reg. No. 3,399,145

Registered Mar. 18, 2008

**TRADEMARK
PRINCIPAL REGISTER**

HEART STUFF

BUILD-A-BEAR RETAIL MANAGEMENT, INC.
(DELAWARE CORPORATION)
1954 INNERBELT BUSINESS CENTER DRIVE
ST. LOUIS, MO 631145760

FOR: ELECTRONIC SOUND DEVICE CONTAINING A RECORDED HEART BEAT SOUND FOR PLACEMENT INSIDE A STUFFED OR PLUSH TOY ANIMAL OR DOLL, IN CLASS 9 (U.S. CLS. 21, 23, 26, 36 AND 38).

FIRST USE 2-1-2007; IN COMMERCE 2-1-2007.

THE MARK CONSISTS OF STANDARD CHARACTERS WITHOUT CLAIM TO ANY PARTICULAR FONT, STYLE, SIZE, OR COLOR.

OWNER OF U.S. REG. NO. 2,399,648.

NO CLAIM IS MADE TO THE EXCLUSIVE RIGHT TO USE "HEART", APART FROM THE MARK AS SHOWN.

SN 77-081,099, FILED 1-11-2007.

KATHY DE JONGE, EXAMINING ATTORNEY

Int. Cl.: 35

Prior U.S. Cls.: 100, 101, and 102

United States Patent and Trademark Office

Reg. No. 3,399,146

Registered Mar. 18, 2008

SERVICE MARK
PRINCIPAL REGISTER



GOURMET MARKET

Fresh Salads • Gourmet Sandwiches • Premium Snacks

HMSHOST CORPORATION (DELAWARE CORPORATION)
6905 ROCKLEDGE DRIVE, MS 7-1
BETHESDA, MD 20817

FOR: FOOD KIOSK SERVICES; RETAIL STORE SERVICES FEATURING CONVENIENCE STORE ITEMS, IN CLASS 35 (U.S. CLS. 100, 101 AND 102).

FIRST USE 4-13-2007; IN COMMERCE 4-13-2007.

NO CLAIM IS MADE TO THE EXCLUSIVE RIGHT TO USE "GOURMET MARKET", "FRESH

SALADS", "GOURMET SANDWICHES" AND "PREMIUM SNACKS", APART FROM THE MARK AS SHOWN.

THE WORD "CIAO" IS TRANSLATED AS "HELLO" AND "GOOD-BYE".

SN 77-081,716, FILED 1-12-2007.

DAVID C. REIHNER, EXAMINING ATTORNEY

Int. Cl.: 35

Prior U.S. Cls.: 100, 101, and 102

United States Patent and Trademark Office

Reg. No. 3,399,147

Registered Mar. 18, 2008

**SERVICE MARK
PRINCIPAL REGISTER**

MAXIMUM REWARDS

FIRST NATIONAL BANK OF OMAHA (UNITED STATES NATIONAL BANKING ASSOCIATION)
STOP 3290
1620 DODGE STREET
OMAHA, NE 68197

FOR: PROMOTING THE SALE OF CREDIT CARD ACCOUNTS THROUGH THE ADMINISTRATION OF INCENTIVE AWARD PROGRAMS, IN CLASS 35 (U.S. CLS. 100, 101 AND 102).

FIRST USE 4-15-2007; IN COMMERCE 4-15-2007.

THE MARK CONSISTS OF STANDARD CHARACTERS WITHOUT CLAIM TO ANY PARTICULAR FONT, STYLE, SIZE, OR COLOR.

NO CLAIM IS MADE TO THE EXCLUSIVE RIGHT TO USE "REWARDS", APART FROM THE MARK AS SHOWN.

SN 77-081,753, FILED 1-12-2007.

BILL DAWE, EXAMINING ATTORNEY

Int. Cl.: 35

Prior U.S. Cls.: 100, 101, and 102

United States Patent and Trademark Office

Reg. No. 3,399,148

Registered Mar. 18, 2008

**SERVICE MARK
PRINCIPAL REGISTER**

AdPerk

REDUCE MY FEE, LLC (CALIFORNIA LTD
LIAB CO)
59 VALLEY VIEW ROAD
GREAT NECK, NY 11021

THE MARK CONSISTS OF STANDARD CHAR-
ACTERS WITHOUT CLAIM TO ANY PARTICULAR
FONT, STYLE, SIZE, OR COLOR.

FOR: PROMOTING THE GOODS AND SERVICES
OF OTHERS BY DISTRIBUTING ADVERTISING
MATERIALS THROUGH A VARIETY OF METH-
ODS, IN CLASS 35 (U.S. CLS. 100, 101 AND 102).

SN 77-081,823, FILED 1-12-2007.

FIRST USE 9-23-2006; IN COMMERCE 5-1-2007.

ALEX KEAM, EXAMINING ATTORNEY

Int. Cl.: 31

Prior U.S. Cls.: 1 and 46

United States Patent and Trademark Office

Reg. No. 3,399,149

Registered Mar. 18, 2008

**TRADEMARK
PRINCIPAL REGISTER**

NATURE'S MENU

SUNSHINE MILLS, INC. (ALABAMA CORPORATION)
PO BOX 676
RED BAY, AL 35582

THE MARK CONSISTS OF STANDARD CHARACTERS WITHOUT CLAIM TO ANY PARTICULAR FONT, STYLE, SIZE, OR COLOR.

FOR: PET FOOD, IN CLASS 31 (U.S. CLS. 1 AND 46).

SN 77-083,446, FILED 1-16-2007.

FIRST USE 5-9-2007; IN COMMERCE 5-9-2007.

CAROL SPILS, EXAMINING ATTORNEY

Int. Cl.: 41

Prior U.S. Cls.: 100, 101, and 107

United States Patent and Trademark Office

Reg. No. 3,399,150

Registered Mar. 18, 2008

**SERVICE MARK
PRINCIPAL REGISTER**

STRIKINGLY DIFFERENT

AMF BOWLING WORLDWIDE, INC. (DELA-
WARE CORPORATION)
8100 AMF DRIVE
MECHANICSVILLE, VA 23111

FOR: BOWLING ALLEY SERVICES; PROVIDING
FACILITIES FOR RECREATIONAL ACTIVITIES,
NAMELY, BILLIARDS; AMUSEMENT CENTERS
FEATURING COIN-OPERATED VIDEO GAMES
AND STAND ALONE VIDEO GAME MACHINES,
IN CLASS 41 (U.S. CLS. 100, 101 AND 107).

FIRST USE 10-31-2005; IN COMMERCE 2-28-2006.

THE MARK CONSISTS OF STANDARD CHAR-
ACTERS WITHOUT CLAIM TO ANY PARTICULAR
FONT, STYLE, SIZE, OR COLOR.

SN 77-084,782, FILED 1-17-2007.

JENNIFER MARTIN, EXAMINING ATTORNEY

Int. Cl.: 9

Prior U.S. Cls.: 21, 23, 26, 36, and 38

United States Patent and Trademark Office

Reg. No. 3,399,151

Registered Mar. 18, 2008

**TRADEMARK
PRINCIPAL REGISTER**

THE WAFER

SAMSUNG ELECTRONICS CO., LTD. (REPUBLIC OF KOREA CORPORATION)
416, MAETAN-DONG, YEONGTONG-GU
SUWON-SI, GYEONGGI-DO, REPUBLIC OF KOREA

FOR: MOBILE TELEPHONES, IN CLASS 9 (U.S. CLS. 21, 23, 26, 36 AND 38).

FIRST USE 5-3-2007; IN COMMERCE 5-3-2007.

THE MARK CONSISTS OF STANDARD CHARACTERS WITHOUT CLAIM TO ANY PARTICULAR FONT, STYLE, SIZE, OR COLOR.

SN 77-085,013, FILED 1-17-2007.

REBECCA EISINGER, EXAMINING ATTORNEY

Int. Cl.: 10

Prior U.S. Cls.: 26, 39, and 44

Reg. No. 3,399,152

United States Patent and Trademark Office

Registered Mar. 18, 2008

**TRADEMARK
PRINCIPAL REGISTER**

ÖLUFFA

SPORTSPOWER, LTD. (HONG KONG CORPORATION)
HOK YUEN STREET
FLAT M, 3 FLOOR, KAISER ESTATE PHASE 3
HUNGHOM KOWLOON, HONG KONG

FOR: ABDOMINAL PADS; ACUPUNCTURE INSTRUMENTS; APPARATUS FOR MAGNET THERAPY; BED VIBRATORS; BLOOD PRESSURE MEASURING APPARATUS; BLOOD PRESSURE MONITORS; CARBON ARC LAMP UNITS FOR THERAPEUTIC PURPOSES; CASES FITTED FOR MEDICAL INSTRUMENTS AND/OR FOR USE BY DOCTORS; CHEMICALLY ACTIVATED HOT AND COLD GEL PACKS FOR MEDICAL PURPOSES; CLINICAL THERMOMETERS; DENTAL INSTRUMENTS, NAMELY, ORAL IRRIGATORS; ELECTRIC FOOT SPA MASSAGERS; ELECTRIC MASSAGE APPARATUS FOR HOUSEHOLD USE; ELECTRIC MASSAGE APPLIANCES, NAMELY, ELECTRIC VIBRATING MASSAGER; ELECTROMEDICAL REHABILITATIVE AND PAIN MANAGEMENT PRODUCTS FOR CLINICAL AND HOME USE, NAMELY, ELECTRICAL NERVE AND MUSCLE STIMULATORS, ULTRASONIC STIMULATORS, MAGNET THERAPY STIMULATORS AND LASER THERAPY STIMULATORS; EXERCISE MACHINES FOR THERAPEUTIC PURPOSES; FEVER THERMOMETERS; GLOVES FOR MASSAGE; GUM MASSAGING INSTRUMENTS; HEATING CUSHIONS FOR MEDICAL PURPOSES; HEATING PADS FOR MEDICAL PURPOSES; INFRARED RADIATOR UNITS FOR THERAPEUTIC PURPOSES; INHALERS FOR THERAPEUTIC USE; INJECTION INSTRUMENTS WITH NEEDLES; LACTATION MASSAGE BARS;

LITHOTOMICAL INSTRUMENTS; MAGNETIC RESONANCE CT APPARATUS; MAGNETS FOR MEDICAL PURPOSES; MASSAGE APPARATUS; MASSAGE APPARATUS; MASSAGE CHAIRS; MASSAGE TABLES; MASSAGERS IN THE NATURE OF ELECTROMECHANICAL MASSAGE MECHANISM FOR CHAIRS; MASSAGING APPARATUS FOR PERSONAL USE; MEDICAL DIAGNOSTIC APPARATUS, ANALYTICAL APPARATUS FOR MEDICAL PURPOSES AND BLOOD PRESSURE MEASURING APPARATUS; MEDICAL HEARING INSTRUMENTS AND PARTS OF SUCH DEVICES; MEDICAL ICE PACKS; MEDICAL PRODUCTS, NAMELY, THERAPEUTIC MATTRESS SUPPORT; ORTHOTICS FOR FEET; THERAPEUTIC EYE HYDRATION GOGGLES FOR THE TREATMENT OF DRY EYES; THERAPEUTIC SAUNAS; THERMAL PACKS FOR FIRST AID PURPOSES; THERMOMETERS FOR MEDICAL PURPOSES; ULTRAVIOLET RADIATOR UNITS FOR THERAPEUTIC PURPOSES; WHIRLPOOLS FOR USE IN HOSPITALS OR FOR THERAPEUTIC USE, IN CLASS 10 (U.S. CLS. 26, 39 AND 44).

FIRST USE 12-31-2007; IN COMMERCE 12-31-2007.

THE MARK CONSISTS OF STANDARD CHARACTERS WITHOUT CLAIM TO ANY PARTICULAR FONT, STYLE, SIZE, OR COLOR.

SN 77-085,029, FILED 1-17-2007.

KATHERINE CONNOLLY, EXA MINING ATTORNEY

Int. Cl.: 5

Prior U.S. Cls.: 6, 18, 44, 46, 51, and 52

United States Patent and Trademark Office

Reg. No. 3,399,153

Registered Mar. 18, 2008

**TRADEMARK
PRINCIPAL REGISTER**

COVERT

LOVELAND PRODUCTS, INC. (COLORADO
CORPORATION)
7251 W. 4TH STREET
GREELEY, CO 80634

THE MARK CONSISTS OF STANDARD CHAR-
ACTERS WITHOUT CLAIM TO ANY PARTICULAR
FONT, STYLE, SIZE, OR COLOR.

FOR: INSECTICIDE, IN CLASS 5 (U.S. CLS. 6, 18,
44, 46, 51 AND 52).

SN 77-085,232, FILED 1-17-2007.

FIRST USE 2-1-2007; IN COMMERCE 2-1-2007.

SANI KHOURI, EXAMINING ATTORNEY

Int. Cl.: 3

Prior U.S. Cls.: 1, 4, 6, 50, 51, and 52

United States Patent and Trademark Office

Reg. No. 3,399,154

Registered Mar. 18, 2008

TRADEMARK
PRINCIPAL REGISTER



JAFER LIMITED (BERMUDA CORPORATION)
CLARENDON HOUSE, 2 CHURCH STREET
HAMILTON, HM, BERMUDA

THE ENGLISH TRANSLATION OF THE WORD
"DEO DE SEDA" IN THE MARK IS GOD OF SILK.

FOR: DEODORANT FOR PERSONAL USE, ANTI-
PERSPIRANTS, IN CLASS 3 (U.S. CLS. 1, 4, 6, 50, 51
AND 52).

SN 77-085,639, FILED 1-18-2007.

FIRST USE 12-31-2005; IN COMMERCE 11-30-2007.

TIMOTHY FINNEGAN, EXAMINING ATTORNEY

Int. Cl.: 19

Prior U.S. Cls.: 1, 12, 33, and 50

United States Patent and Trademark Office

Reg. No. 3,399,155

Registered Mar. 18, 2008

**TRADEMARK
PRINCIPAL REGISTER**

FINELINE

SHAE CORPORATION (CALIFORNIA CORPORATION), DBA PREMIER FLOORING SOLUTIONS,
4920 EAST LANDON DRIVE
ANAHEIM, CA 92807

THE MARK CONSISTS OF STANDARD CHARACTERS WITHOUT CLAIM TO ANY PARTICULAR FONT, STYLE, SIZE, OR COLOR.

FOR: HARDWOOD FLOORING, IN CLASS 19 (U.S. CLS. 1, 12, 33 AND 50).

SN 77-085,683, FILED 1-18-2007.

FIRST USE 12-31-2005; IN COMMERCE 12-31-2005.

REBECCA GILBERT, EXAMINING ATTORNEY

Int. Cl.: 30

Prior U.S. Cl.: 46

United States Patent and Trademark Office

Reg. No. 3,399,156

Registered Mar. 18, 2008

**TRADEMARK
PRINCIPAL REGISTER**

**Southern Elegance Bar-B-Q
Sauce**

CASHWELL III, JOHNNY J (UNITED STATES
INDIVIDUAL)

115 MANNON COURT

MURFREESBORO, TN 37127

FOR: BARBECUE SAUCE, IN CLASS 30 (U.S. CL.
46).

FIRST USE 6-15-2007; IN COMMERCE 9-1-2007.

THE MARK CONSISTS OF STANDARD CHAR-
ACTERS WITHOUT CLAIM TO ANY PARTICULAR
FONT, STYLE, SIZE, OR COLOR.

NO CLAIM IS MADE TO THE EXCLUSIVE
RIGHT TO USE "BAR-B-Q SAUCE", APART FROM
THE MARK AS SHOWN.

SN 77-087,281, FILED 1-20-2007.

HENRY S. ZAK, EXAMINING ATTORNEY

Int. Cl.: 16

Prior U.S. Cls.: 2, 5, 22, 23, 29, 37, 38, and 50

United States Patent and Trademark Office

Reg. No. 3,399,157

Registered Mar. 18, 2008

**TRADEMARK
PRINCIPAL REGISTER**

FUTURE VALUES

FIRSTMERIT CORPORATION (OHIO CORPORATION)
III CASCADE PLAZA
AKRON, OH 44308

FOR: MAGAZINES FEATURING BANKING SERVICES, IN CLASS 16 (U.S. CLS. 2, 5, 22, 23, 29, 37, 38 AND 50).

FIRST USE 1-1-2007; IN COMMERCE 1-1-2007.

THE MARK CONSISTS OF STANDARD CHARACTERS WITHOUT CLAIM TO ANY PARTICULAR FONT, STYLE, SIZE, OR COLOR.

SN 77-087,681, FILED 1-22-2007.

MICHAEL TANNER, EXAMINING ATTORNEY

Int. Cl.: 35

Prior U.S. Cls.: 100, 101, and 102

United States Patent and Trademark Office

Reg. No. 3,399,158

Registered Mar. 18, 2008

**SERVICE MARK
PRINCIPAL REGISTER**

INNOVATIVE SOLUTIONS

GRAY MANUFACTURING COMPANY, INC.
(MISSOURI CORPORATION)
3501 S. LEONARD RD.
P.O. BOX 728
ST. JOSEPH, MO 64502

FOR: DEMONSTRATION OF PRODUCTS,
NAMELY, PRODUCTS IN THE FIELD OF VEHICLE
SERVICE EQUIPMENT AND VEHICLE REPAIR
EQUIPMENT, IN CLASS 35 (U.S. CLS. 100, 101 AND
102).

FIRST USE 1-18-2008; IN COMMERCE 1-18-2008.

THE MARK CONSISTS OF STANDARD CHAR-
ACTERS WITHOUT CLAIM TO ANY PARTICULAR
FONT, STYLE, SIZE, OR COLOR.

NO CLAIM IS MADE TO THE EXCLUSIVE
RIGHT TO USE "SOLUTIONS", APART FROM
THE MARK AS SHOWN.

SN 77-088,032, FILED 1-22-2007.

MIDGE BUTLER, EXAMINING ATTORNEY

Int. Cl.: 5

Prior U.S. Cls.: 6, 18, 44, 46, 51, and 52

Reg. No. 3,399,159

United States Patent and Trademark Office

Registered Mar. 18, 2008

**TRADEMARK
PRINCIPAL REGISTER**

ANAEBAN

KEMIN INDUSTRIES, INC. (IOWA CORPORATION)
2100 MAURY STREET
DES MOINES, IA 50317

FOR: DIETARY SUPPLEMENTS, NAMELY, PROBIOTIC SUBSTANCES FOR USE IN THE TREATMENT OF GASTROINTESTINAL CONDITIONS, DIARRHEA, HEARTBURN, ACID INDIGESTION, LACTOSE INTOLERANCE, IRRITABLE BOWEL SYNDROME, GAS AND FOR THE IMPROVEMENT OF DIGESTIVE HEALTH AND ENHANCEMENT OF THE BODY'S NATURAL IMMUNE SYSTEM; NUTRITIVE SUBSTANCES OF MICROORGANISM CULTURES, NAMELY, MICROORGANISMS AND COMPONENTS THEREOF FOR USE IN THE TREATMENT OF GASTROINTESTINAL CONDITIONS, DIARRHEA, HEARTBURN, ACID INDIGESTION, LACTOSE INTOLERANCE, IRRITABLE BOWEL SYNDROME, GAS AND FOR THE IMPROVEMENT OF DIGESTIVE HEALTH AND ENHANCEMENT OF THE BODY'S NATURAL IMMUNE SYSTEM FOR MEDICAL OR VETERINARY USE; PHARMACEUTICAL AND VETERINARY PREPARATIONS FOR USE IN THE TREATMENT OF GASTROINTESTINAL CONDITIONS, DIARRHEA, HEARTBURN, ACID INDIGESTION, LACTOSE INTOLERANCE, IRRITABLE BOWEL SYNDROME, GAS AND FOR THE IM-

PROVEMENT OF DIGESTIVE HEALTH AND ENHANCEMENT OF THE BODY'S NATURAL IMMUNE SYSTEM; DIETETIC SUBSTANCES, NAMELY, DIETARY SUPPLEMENTS ADAPTED FOR MEDICAL OR VETERINARY USE; BIOLOGICAL AND CHEMICAL PREPARATIONS, NAMELY, DIETARY SUPPLEMENTS FOR USE IN THE TREATMENT OF GASTROINTESTINAL CONDITIONS, DIARRHEA, HEARTBURN, ACID INDIGESTION, LACTOSE INTOLERANCE, IRRITABLE BOWEL SYNDROME, GAS AND FOR THE IMPROVEMENT OF DIGESTIVE HEALTH AND ENHANCEMENT OF THE BODY'S NATURAL IMMUNE SYSTEM; AND DIAGNOSTIC REAGENTS FOR CLINICAL OR MEDICAL OR VETERINARY LABORATORY USE; FERMENTS FOR MEDICAL OR VETERINARY LABORATORY USE, IN CLASS 5 (U.S. CLS. 6, 18, 44, 46, 51 AND 52).

FIRST USE 12-29-2004; IN COMMERCE 5-1-2006.

THE MARK CONSISTS OF STANDARD CHARACTERS WITHOUT CLAIM TO ANY PARTICULAR FONT, STYLE, SIZE, OR COLOR.

SN 77-088,709, FILED 1-23-2007.

ROSELLE HERRERA, EXAMINING ATTORNEY

Int. Cl.: 25

Prior U.S. Cls.: 22 and 39

United States Patent and Trademark Office

Reg. No. 3,399,160

Registered Mar. 18, 2008

**TRADEMARK
PRINCIPAL REGISTER**

HG10mm

ASICS CORPORATION (JAPAN CORPORATION)
1-1 MINATOJIMA-NAKAMACHI 7-CHOME
CHUO-KU, KOBE, JAPAN 650-8555

THE MARK CONSISTS OF STANDARD CHAR-
ACTERS WITHOUT CLAIM TO ANY PARTICULAR
FONT, STYLE, SIZE, OR COLOR.

FOR: FOOTWEAR, IN CLASS 25 (U.S. CLS. 22 AND
39).

SN 77-089,218, FILED 1-23-2007.

FIRST USE 5-20-2007; IN COMMERCE 5-20-2007.

PAUL MORENO, EXAMINING ATTORNEY

Int. Cls.: 9, 38, and 41

Prior U.S. Cls.: 21, 23, 26, 36, 38, 100, 101, 104, and 107

Reg. No. 3,399,161

United States Patent and Trademark Office

Registered Mar. 18, 2008

**TRADEMARK
SERVICE MARK
PRINCIPAL REGISTER**

WOODSMITH SHOP

AUGUST HOME PUBLISHING COMPANY
(IOWA CORPORATION)
2200 GRAND AVENUE
DES MOINES, IA 50312

FOR: DIGITAL MATERIALS, NAMELY, CD'S, DVD'S, DOWNLOADABLE AUDIO AND VIDEO FILES, FEATURING WOODWORKING , IN CLASS 9 (U.S. CLS. 21, 23, 26, 36 AND 38).

FIRST USE 11-10-2007; IN COMMERCE 11-10-2007.

FOR: STREAMING OF VIDEO MATERIAL ON THE INTERNET IN THE FIELD OF WOODWORKING, IN CLASS 38 (U.S. CLS. 100, 101 AND 104).

FIRST USE 10-5-2007; IN COMMERCE 10-5-2007.

FOR: TELEVISION PROGRAMS IN THE FIELD OF WOODWORKING; ENTERTAINMENT IN THE NATURE OF ON-GOING TELEVISION PROGRAMS

IN THE FIELD OF WOODWORKING; ENTERTAINMENT SERVICES, NAMELY, PROVIDING A TELEVISION PROGRAM IN THE FIELD OF WOODWORKING VIA A GLOBAL COMPUTER NETWORK, IN CLASS 41 (U.S. CLS. 100, 101 AND 107).

FIRST USE 11-10-2007; IN COMMERCE 11-10-2007.

THE MARK CONSISTS OF STANDARD CHARACTERS WITHOUT CLAIM TO ANY PARTICULAR FONT, STYLE, SIZE, OR COLOR.

OWNER OF U.S. REG. NOS. 1,179,071 AND 2,171,810.

SN 77-090,281, FILED 1-24-2007.

ELIZABETH KAJUBI, EXAMINING ATTORNEY

Int. Cl.: 25

Prior U.S. Cls.: 22 and 39

United States Patent and Trademark Office

Reg. No. 3,399,162

Registered Mar. 18, 2008

TRADEMARK
PRINCIPAL REGISTER



KEALOPIKO LLC (HAWAII LTD LIAB CO)
PO BO 61642
HONOLULU, HI 96839

FOR: SHIRTS, DRESSES, SKIRTS, AND PANTS,
IN CLASS 25 (U.S. CLS. 22 AND 39).

FIRST USE 9-1-2006; IN COMMERCE 12-1-2006.

NO CLAIM IS MADE TO THE EXCLUSIVE
RIGHT TO USE "STYLED IN HAWAII NEI" ,
APART FROM THE MARK AS SHOWN.

THE ENGLISH TRANSLATION OF KEALOPIKO
IS "THE BELLY OF THE FISH" AND THE ENGLISH
TRANSLATION OF HAWAII NEI IS "ALL OF
HAWAII".

SN 77-090,510, FILED 1-24-2007.

ZHALEH DELANEY, EXAMINING ATTORNEY

Int. Cl.: 30

Prior U.S. Cl.: 46

United States Patent and Trademark Office

Reg. No. 3,399,163

Registered Mar. 18, 2008

TRADEMARK
PRINCIPAL REGISTER



HERSHEY CHOCOLATE & CONFECTIONERY
CORPORATION (DELAWARE CORPORATION)
SUITE 204
4860 ROBB STREET
WHEAT RIDGE, CO 80033

FOR: CANDY; CHOCOLATE; COCOA, IN CLASS
30 (U.S. CL. 46).

FIRST USE 3-31-2007; IN COMMERCE 3-31-2007.

OWNER OF U.S. REG. NO. 3,169,976.

NO CLAIM IS MADE TO THE EXCLUSIVE
RIGHT TO USE "COCOA IS A NATURAL SOURCE

OF FLAVANOL ANTIOXIDANTS", APART FROM
THE MARK AS SHOWN.

THE MARK CONSISTS OF A COCOA BEAN AND
LEAF DESIGN INSIDE TWO CONCENTRIC CIRCLES,
WITH A RECTANGLE ATTACHED TO THE
BOTTOM OF THE OUTER CIRCLE, AND WITH
THE WORDS "COCOA IS A NATURAL SOURCE OF
FLAVANOL ANTIOXIDANTS" ENCIRCLING THE
COCOA BEAN AND LEAF.

SN 77-090,726, FILED 1-25-2007.

DAVID COLLIER, EXAMINING ATTORNEY

Int. Cl.: 25

Prior U.S. Cls.: 22 and 39

United States Patent and Trademark Office

Reg. No. 3,399,164

Registered Mar. 18, 2008

TRADEMARK
PRINCIPAL REGISTER

Bobblair

FUYI INTERNATIONAL TRADING LIMITED
(HONG KONG CORPORATION)
LOT NO 65 TSING YI ISLAND, NT
E 9 9/F PH II, TSING YI IND CTR
HONG KONG, CHINA

FOR: COATS; OVERCOATS; JACKETS; OUTER-
WEAR, NAMELY, BALMACAANS, DUFFLE
COATS, DUST COATS, RAGLAN COATS, TRENCH
COATS, AND RAIN COATS; T-SHIRTS; VESTS;

SWEATERS; DRESSES; SHIRTS; AND PANTS, IN
CLASS 25 (U.S. CLS. 22 AND 39).

FIRST USE 11-16-2007; IN COMMERCE 11-16-2007.

SN 77-090,738, FILED 1-25-2007.

MICHAEL GAAFAR, EXAMINING ATTORNEY

Int. Cl.: 32

Prior U.S. Cls.: 45, 46, and 48

United States Patent and Trademark Office

Reg. No. 3,399,165

Registered Mar. 18, 2008

**TRADEMARK
PRINCIPAL REGISTER**

KÜL FUEL

ULTIMA FITNESS SUPPLEMENTS, LLC (TEXAS
LTD LIAB CO)
#322
4140 LEGACY DRIVE
PLANO, TX 75024

FOR: SPORTS DRINKS, IN CLASS 32 (U.S. CLS. 45,
46 AND 48).

FIRST USE 10-15-2007; IN COMMERCE 11-1-2007.

THE MARK CONSISTS OF STANDARD CHAR-
ACTERS WITHOUT CLAIM TO ANY PARTICULAR
FONT, STYLE, SIZE, OR COLOR.

THE FOREIGN WORDING IN THE MARK
TRANSLATES INTO ENGLISH AS COOL.

SN 77-090,790, FILED 1-25-2007.

TARAH HARDY, EXAMINING ATTORNEY

Int. Cl.: 31

Prior U.S. Cls.: 1 and 46

United States Patent and Trademark Office

Reg. No. 3,399,166

Registered Mar. 18, 2008

TRADEMARK
PRINCIPAL REGISTER



PERFORMANCE PET PRODUCTS, LLC (MINNE-
SOTA LTD LIAB CO)
1120 LAKE AVE
FAIRMONT, MN 56031

FOR: PET TREATS, IN CLASS 31 (U.S. CLS. 1 AND
46).

FIRST USE 2-19-2007; IN COMMERCE 2-19-2007.

OWNER OF U.S. REG. NO. 2,102,185.

NO CLAIM IS MADE TO THE EXCLUSIVE
RIGHT TO USE "CANINE", APART FROM THE
MARK AS SHOWN.

THE MARK CONSISTS OF A DESIGN OF CON-
CENTRIC OVALS, ONE SHADED, PLUS HORNS OF
AN ANIMAL.

SN 77-091,796, FILED 1-26-2007.

DAWN FELDMAN, EXAMINING ATTORNEY

Int. Cls.: 25 and 35

Prior U.S. Cls.: 22, 39, 100, 101, and 102

United States Patent and Trademark Office

Reg. No. 3,399,167

Registered Mar. 18, 2008

**TRADEMARK
SERVICE MARK
PRINCIPAL REGISTER**

RIGHT FIT BY CATHERINES

CATHERINES OF CALIFORNIA, INC. (CALIFORNIA CORPORATION)
10250 CONSTELLATION BLVD., SUITE 2800
LOS ANGELES, CA 900676228

FOR: WOMEN'S WEARING APPAREL, NAMELY, JEANS, PANTS, IN CLASS 25 (U.S. CLS. 22 AND 39).

FIRST USE 8-1-2007; IN COMMERCE 8-1-2007.

FOR: RETAIL STORE SERVICES FEATURING WOMEN'S WEARING APPAREL AND ACCESSORIES; COMPUTERIZED ON-LINE RETAIL STORE SERVICES FEATURING WOMEN'S WEARING APPAREL AND ACCESSORIES; MAIL ORDER CATALOG SERVICES FEATURING WOMEN'S WEARING

APPAREL AND ACCESSORIES, IN CLASS 35 (U.S. CLS. 100, 101 AND 102).

FIRST USE 8-1-2007; IN COMMERCE 8-1-2007.

THE MARK CONSISTS OF STANDARD CHARACTERS WITHOUT CLAIM TO ANY PARTICULAR FONT, STYLE, SIZE, OR COLOR.

OWNER OF U.S. REG. NOS. 1,343,457, 3,006,871, AND OTHERS.

SN 77-091,866, FILED 1-26-2007.

MICHAEL ENGEL, EXAMINING ATTORNEY

Int. Cl.: 35

Prior U.S. Cls.: 100, 101, and 102

United States Patent and Trademark Office

Reg. No. 3,399,168

Registered Mar. 18, 2008

**SERVICE MARK
PRINCIPAL REGISTER**

AUCTIONBLIP

AMERICAN COIN VAULT, INC (NEW YORK
CORPORATION)
PO BOX 878
VALLEY STREAM, NY 11582

THE MARK CONSISTS OF STANDARD CHAR-
ACTERS WITHOUT CLAIM TO ANY PARTICULAR
FONT, STYLE, SIZE, OR COLOR.

FOR: PROVIDING CUSTOMIZED INFORMA-
TION CONCERNING AUCTIONS TO COLLECTORS
AND OTHER BUYERS, IN CLASS 35 (U.S. CLS. 100,
101 AND 102).

SN 77-092,424, FILED 1-26-2007.

FIRST USE 10-1-2007; IN COMMERCE 10-1-2007.

TARAH HARDY, EXAMINING ATTORNEY

Int. Cl.: 35

Prior U.S. Cls.: 100, 101, and 102

United States Patent and Trademark Office

Reg. No. 3,399,169

Registered Mar. 18, 2008

**SERVICE MARK
PRINCIPAL REGISTER**

The logo for "Auctionblip" features the word "Auction" in a black, lowercase, sans-serif font. The word "blip" is in a lowercase, sans-serif font where each letter is a different color: "b" is red, "l" is yellow, "i" is green, and "p" is blue. The letters are slightly shadowed to give a 3D effect.

AMERICAN COIN VAULT, INC (NEW YORK CORPORATION)
PO BOX 878
VALLEY STREAM, NY 11582

FOR: PROVIDING CUSTOMIZED INFORMATION CONCERNING AUCTIONS TO COLLECTORS AND OTHER BUYERS, IN CLASS 35 (U.S. CLS. 100, 101 AND 102).

FIRST USE 10-1-2007; IN COMMERCE 10-1-2007.

THE COLOR(S) BLACK, RED, YELLOW, GREEN AND BLUE IS/ARE CLAIMED AS A FEATURE OF THE MARK.

THE MARK CONSISTS OF THE TERM AUCTION-BLIP, WITH THE LETTER "B" IN RED, THE LETTER "L" IN YELLOW, THE SECOND LETTER "I" IN GREEN, THE LETTER "P" IN BLUE AND THE WORD "AUCTION" IN BLACK.

SN 77-092,469, FILED 1-26-2007.

TARAH HARDY, EXAMINING ATTORNEY

Int. Cl.: 25

Prior U.S. Cls.: 22 and 39

United States Patent and Trademark Office

Reg. No. 3,399,170

Registered Mar. 18, 2008

**TRADEMARK
PRINCIPAL REGISTER**

GOOD LAWYER / BAD LAWYER

ACT OF COMMUNICATION (CALIFORNIA
PARTNERSHIP)
5354 ETHELDO AVE.
CULVER CITY, CA 90230

THE MARK CONSISTS OF STANDARD CHAR-
ACTERS WITHOUT CLAIM TO ANY PARTICULAR
FONT, STYLE, SIZE, OR COLOR.

FOR: BANDANAS; DRESSES; HATS; JACKETS;
PANTS; SHIRTS; SHORTS; SKIRTS; SWEAT SHIRTS;
T-SHIRTS, IN CLASS 25 (U.S. CLS. 22 AND 39).

SN 77-095,151, FILED 1-30-2007.

FIRST USE 2-24-2006; IN COMMERCE 2-15-2007.

SETH A. RAPPAPORT, EXAMINING ATTORNEY

Int. Cl.: 16

Prior U.S. Cls.: 2, 5, 22, 23, 29, 37, 38, and 50

United States Patent and Trademark Office

Reg. No. 3,399,171

Registered Mar. 18, 2008

**TRADEMARK
PRINCIPAL REGISTER**

WORD FORWARD

SCHOLASTIC INC. (NEW YORK CORPORATION)
557 BROADWAY
NEW YORK, NY 10012

FOR: PRINTED EDUCATIONAL AND TEACHING MATERIALS IN THE FIELD OF VOCABULARY INSTRUCTION FOR ELEMENTARY SCHOOLS, IN CLASS 16 (U.S. CLS. 2, 5, 22, 23, 29, 37, 38 AND 50).

FIRST USE 6-1-2007; IN COMMERCE 6-1-2007.

THE MARK CONSISTS OF STANDARD CHARACTERS WITHOUT CLAIM TO ANY PARTICULAR FONT, STYLE, SIZE, OR COLOR.

NO CLAIM IS MADE TO THE EXCLUSIVE RIGHT TO USE "WORD", APART FROM THE MARK AS SHOWN.

SN 77-096,679, FILED 2-1-2007.

LEE-ANNE BERNS, EXAMINING ATTORNEY

Int. Cl.: 10

Prior U.S. Cls.: 26, 39, and 44

United States Patent and Trademark Office

Reg. No. 3,399,172

Registered Mar. 18, 2008

**TRADEMARK
PRINCIPAL REGISTER**

CONFIDISC

HILLIOS, SONIA R. (UNITED STATES INDIVIDUAL)
81 GUNN ROAD
SOUTHAMPTON, MA 01073 AND
HILLIOS, CHRISTOPHER H. (UNITED STATES INDIVIDUAL)
81 GUNN ROAD
SOUTHAMPTON, MA 01073

FOR: HYPODERMIC SYRINGES, IN CLASS 10
(U.S. CLS. 26, 39 AND 44).

FIRST USE 3-16-2007; IN COMMERCE 6-21-2007.

THE MARK CONSISTS OF STANDARD CHARACTERS WITHOUT CLAIM TO ANY PARTICULAR FONT, STYLE, SIZE, OR COLOR.

SN 77-096,838, FILED 2-1-2007.

PAUL CROWLEY, EXAMINING ATTORNEY

Int. Cl.: 41

Prior U.S. Cls.: 100, 101, and 107

United States Patent and Trademark Office

Reg. No. 3,399,173

Registered Mar. 18, 2008

**SERVICE MARK
PRINCIPAL REGISTER**



ARIZONA CHAPTER AMERICAN PARKINSON
DISEASE ASSOCIATION (NEW YORK COR-
PORATION)
2033 E. SPEEDWAY BLVD., #203
TUCSON, AZ 85719

FOR: DEVELOPMENT AND DISSEMINATION
OF EDUCATIONAL MATERIALS OF OTHERS IN
THE FIELD OF PARKINSON'S DISEASE, IN CLASS
41 (U.S. CLS. 100, 101 AND 107).

FIRST USE 1-0-2007; IN COMMERCE 1-0-2007.

NO CLAIM IS MADE TO THE EXCLUSIVE
RIGHT TO USE "ARIZONA CHAPTER" AND
"AMERICAN PARKINSON DISEASE ASSOCIA-
TION", APART FROM THE MARK AS SHOWN.

SN 77-096,880, FILED 2-1-2007.

CHRISTOPHER BUONGIORNO, EXAMINING AT-
TORNEY

Int. Cl.: 28

Prior U.S. Cls.: 22, 23, 38, and 50

United States Patent and Trademark Office

Reg. No. 3,399,174

Registered Mar. 18, 2008

**TRADEMARK
PRINCIPAL REGISTER**

LANCER

TAYLOR MADE GOLF COMPANY, INC. (DELA-
WARE CORPORATION)
5545 FERMI COURT
CARLSBAD, CA 92008

THE MARK CONSISTS OF STANDARD CHAR-
ACTERS WITHOUT CLAIM TO ANY PARTICULAR
FONT, STYLE, SIZE, OR COLOR.

FOR: GOLF ACCESSORY POUCHES; GOLF
BAGS; GOLF GLOVES, IN CLASS 28 (U.S. CLS. 22,
23, 38 AND 50).

SN 77-097,263, FILED 2-1-2007.

FIRST USE 10-0-2006; IN COMMERCE 10-0-2006.

MARGERY A. TIERNEY, EXAMINING ATTORNEY

Int. Cl.: 28

Prior U.S. Cls.: 22, 23, 38, and 50

United States Patent and Trademark Office

Reg. No. 3,399,175

Registered Mar. 18, 2008

**TRADEMARK
PRINCIPAL REGISTER**

ESSEX

TAYLOR MADE GOLF COMPANY, INC. (DELA-
WARE CORPORATION)
5545 FERMI COURT
CARLSBAD, CA 92008

THE MARK CONSISTS OF STANDARD CHAR-
ACTERS WITHOUT CLAIM TO ANY PARTICULAR
FONT, STYLE, SIZE, OR COLOR.

FOR: GOLF ACCESSORY POUCHES; GOLF
BAGS; GOLF GLOVES, IN CLASS 28 (U.S. CLS. 22,
23, 38 AND 50).

SN 77-097,305, FILED 2-1-2007.

FIRST USE 10-0-2006; IN COMMERCE 10-0-2006.

MARGERY A. TIERNEY, EXAMINING ATTORNEY

Int. Cl.: 3

Prior U.S. Cls.: 1, 4, 6, 50, 51, and 52

United States Patent and Trademark Office

Reg. No. 3,399,176

Registered Mar. 18, 2008

**TRADEMARK
PRINCIPAL REGISTER**

**THE SCIENCE OF YOUNGER
LOOKING SKIN**

ALCHEMY WORLDWIDE, LLC (CALIFORNIA
LTD LIAB CO)
15250 VENTURA BLVD, SUITE 300
SHERMAN OAKS, CA 91403

THE MARK CONSISTS OF STANDARD CHAR-
ACTERS WITHOUT CLAIM TO ANY PARTICULAR
FONT, STYLE, SIZE, OR COLOR.

FOR: COSMETICS AND SKIN CARE PRODUCTS,
NAMELY, NON-MEDICATED SKIN CARE PRE-
PARATIONS, IN CLASS 3 (U.S. CLS. 1, 4, 6, 50, 51
AND 52).

SN 77-097,383, FILED 2-1-2007.

FIRST USE 9-14-2006; IN COMMERCE 9-14-2006.

MARY CRAWFORD, EXAMINING ATTORNEY

Int. Cl.: 3

Prior U.S. Cls.: 1, 4, 6, 50, 51, and 52

United States Patent and Trademark Office

Reg. No. 3,399,177

Registered Mar. 18, 2008

**TRADEMARK
PRINCIPAL REGISTER**

ELEMENTAGE

ELEMENTAGE, LLC (DELAWARE LTD LIAB
CO)
754 FIFTH AVENUE
NEW YORK, NY 10019

THE MARK CONSISTS OF STANDARD CHAR-
ACTERS WITHOUT CLAIM TO ANY PARTICULAR
FONT, STYLE, SIZE, OR COLOR.

FOR: HAIR CARE PREPARATIONS, IN CLASS 3
(U.S. CLS. 1, 4, 6, 50, 51 AND 52).

SN 77-097,515, FILED 2-2-2007.

FIRST USE 6-20-2007; IN COMMERCE 6-20-2007.

AISHA SALEM, EXAMINING ATTORNEY

Int. Cl.: 36

Prior U.S. Cls.: 100, 101, and 102

United States Patent and Trademark Office

Reg. No. 3,399,178

Registered Mar. 18, 2008

**SERVICE MARK
PRINCIPAL REGISTER**

**Feed Your Family Feed The
World**

HIGHER CALL INC (PENNSYLVANIA COR-
PORATION)
P.O. BOX 11386
LANCASTER, PA 17605

THE MARK CONSISTS OF STANDARD CHAR-
ACTERS WITHOUT CLAIM TO ANY PARTICULAR
FONT, STYLE, SIZE, OR COLOR.

FOR: PROVIDING A WEBSITE FEATURING
CHARITABLE SERVICES, NAMELY, RAISING
FUNDS THROUGH SELLING PRODUCTS, IN
CLASS 36 (U.S. CLS. 100, 101 AND 102).

SN 77-097,560, FILED 2-2-2007.

FIRST USE 12-7-2007; IN COMMERCE 12-7-2007.

FRED CARL, EXAMINING ATTORNEY

Int. Cl.: 25

Prior U.S. Cls.: 22 and 39

United States Patent and Trademark Office

Reg. No. 3,399,179

Registered Mar. 18, 2008

**TRADEMARK
PRINCIPAL REGISTER**

LANDING FIELD

RALPH GLENN (UNITED STATES INDIVIDUAL)
2104 ADAMS AVENUE
SAN LEANDRO, CA 94577

THE MARK CONSISTS OF STANDARD CHAR-
ACTERS WITHOUT CLAIM TO ANY PARTICULAR
FONT, STYLE, SIZE, OR COLOR.

FOR: DENIMS; HATS; JEANS; KNIT SHIRTS;
SHIRTS; SHORT-SLEEVED OR LONG-SLEEVED T-
SHIRTS; SMALL HATS; T-SHIRTS, IN CLASS 25 (U.S.
CLS. 22 AND 39).

SN 77-097,849, FILED 2-2-2007.

FIRST USE 7-11-2007; IN COMMERCE 7-11-2007.

SIMON TENG, EXAMINING ATTORNEY

Int. Cl.: 42

Prior U.S. Cls.: 100 and 101

United States Patent and Trademark Office

Reg. No. 3,399,180

Registered Mar. 18, 2008

**SERVICE MARK
PRINCIPAL REGISTER**

BRANDRANK

CHARLESBERND AG (FED REP GERMANY
AKTIENGESELLSCHAFT)
MAXIMILIANSTRASSE 26
MÜNCHEN, FED REP GERMANY 80539

THE MARK CONSISTS OF STANDARD CHAR-
ACTERS WITHOUT CLAIM TO ANY PARTICULAR
FONT, STYLE, SIZE, OR COLOR.

FOR: COMPUTER SERVICES, NAMELY, PRO-
VIDING SEARCH ENGINES FOR OBTAINING
DATA ON A GLOBAL COMPUTER NETWORK, IN
CLASS 42 (U.S. CLS. 100 AND 101).

SN 77-098,669, FILED 2-3-2007.

FIRST USE 1-7-2008; IN COMMERCE 1-7-2008.

BRENDAN REGAN, EXAMINING ATTORNEY

Int. Cl.: 38

Prior U.S. Cls.: 100, 101, and 104

United States Patent and Trademark Office

Reg. No. 3,399,181

Registered Mar. 18, 2008

**SERVICE MARK
PRINCIPAL REGISTER**

JABNET

ABOVENET, INC. (DELAWARE CORPORATION)
360 HAMILTON AVENUE
WHITE PLAINS, NY 10601

FOR: A TELECOMMUNICATIONS OPTICAL NETWORK SERVICE PROVIDING PRIVATE, SWITCHABLE CONNECTIVITY BETWEEN CONTENT CREATORS IN THE MOTION PICTURE AND TELEVISION INDUSTRY, IN CLASS 38 (U.S. CLS. 100, 101 AND 104).

FIRST USE 2-28-2007; IN COMMERCE 4-18-2007.

THE MARK CONSISTS OF STANDARD CHARACTERS WITHOUT CLAIM TO ANY PARTICULAR FONT, STYLE, SIZE, OR COLOR.

SN 77-099,554, FILED 2-5-2007.

TRACY CROSS, EXAMINING ATTORNEY

Int. Cl.: 16

Prior U.S. Cls.: 2, 5, 22, 23, 29, 37, 38, and 50

United States Patent and Trademark Office

Reg. No. 3,399,182

Registered Mar. 18, 2008

**TRADEMARK
PRINCIPAL REGISTER**



RICHARDS, CONRAD R (UNITED STATES INDIVIDUAL)
P.O. BOX 660061
FRESH MEADOWS, NY 11366

FOR: EDUCATIONAL PUBLICATIONS, NAME-
LY, TRAINING MANUALS IN THE FIELD OF REAL
ESTATE EDUCATION, IN CLASS 16 (U.S. CLS. 2, 5,
22, 23, 29, 37, 38 AND 50).

FIRST USE 1-0-2007; IN COMMERCE 1-0-2007.

THE COLOR(S) BLUE AND BLACK IS/ARE
CLAIMED AS A FEATURE OF THE MARK.

THE MARK CONSISTS OF "R" STYLISH LETTER
IS BLUE AND "A" STYLISH LETTER IS BLACK.

SN 77-099,818, FILED 2-5-2007.

LAURIE MAYES, EXAMINING ATTORNEY

Int. Cl.: 35

Prior U.S. Cls.: 100, 101, and 102

United States Patent and Trademark Office

Reg. No. 3,399,183

Registered Mar. 18, 2008

**SERVICE MARK
PRINCIPAL REGISTER**

GREENLINK

ALP NETWORKS LLC (CALIFORNIA LTD LIAB
CO)
620 ALLENDALE RD, SUITE 100A
KING OF PRUSSIA, PA 19406

THE MARK CONSISTS OF STANDARD CHAR-
ACTERS WITHOUT CLAIM TO ANY PARTICULAR
FONT, STYLE, SIZE, OR COLOR.

FOR: CUSTOMER LOYALTY SERVICES AND
CUSTOMER CLUB SERVICES, FOR COMMERCIAL,
PROMOTIONAL AND/OR ADVERTISING PURPO-
SES, IN CLASS 35 (U.S. CLS. 100, 101 AND 102).

SN 77-100,091, FILED 2-6-2007.

FIRST USE 5-1-2007; IN COMMERCE 5-1-2007.

ELIZABETH KAJUBI, EXAMINING ATTORNEY

Int. Cl.: 5

Prior U.S. Cls.: 6, 18, 44, 46, 51, and 52

United States Patent and Trademark Office

Reg. No. 3,399,184

Registered Mar. 18, 2008

**TRADEMARK
PRINCIPAL REGISTER**

TWIST 25

WOODWARD, JOHN R. (UNITED STATES INDIVIDUAL)
5405 PARK LANE
DALLAS, TX 75220

THE MARK CONSISTS OF STANDARD CHARACTERS WITHOUT CLAIM TO ANY PARTICULAR FONT, STYLE, SIZE, OR COLOR.

FOR: PHARMACEUTICAL PREPARATIONS FOR THE TREATMENT OF SEXUAL DYSFUNCTION IN FEMALES, IN CLASS 5 (U.S. CLS. 6, 18, 44, 46, 51 AND 52).

SN 77-100,092, FILED 2-6-2007.

FIRST USE 9-14-2007; IN COMMERCE 9-14-2007.

ELIZABETH KAJUBI, EXAMINING ATTORNEY

Int. Cl.: 30

Prior U.S. Cl.: 46

United States Patent and Trademark Office

Reg. No. 3,399,185

Registered Mar. 18, 2008

**TRADEMARK
PRINCIPAL REGISTER**

ENCHANTMINTS

SCORE ACQUISITIONS CORP. (NEW YORK CORPORATION), DBA CODY-KRAMER IMPORTS,
200 CORPORATE DRIVE, SUITE 6
BLAUVELT, NY 10913

FOR: CONFECTIONERY, NAMELY, CANDY, IN CLASS 30 (U.S. CL. 46).

FIRST USE 4-1-2007; IN COMMERCE 4-1-2007.

THE MARK CONSISTS OF STANDARD CHARACTERS WITHOUT CLAIM TO ANY PARTICULAR FONT, STYLE, SIZE, OR COLOR.

SN 77-100,094, FILED 2-6-2007.

MARIA-VICTORIA SUAREZ, EXAMINING ATTORNEY

Int. Cl.: 5

Prior U.S. Cls.: 6, 18, 44, 46, 51, and 52

United States Patent and Trademark Office

Reg. No. 3,399,186

Registered Mar. 18, 2008

**TRADEMARK
PRINCIPAL REGISTER**

BREED-UP

RIDLEY BLOCK OPERATIONS, INC. (MINNESOTA CORPORATION)
424 NORTH RIVERFRONT DRIVE
MANKATO, MN 56002

THE MARK CONSISTS OF STANDARD CHARACTERS WITHOUT CLAIM TO ANY PARTICULAR FONT, STYLE, SIZE, OR COLOR.

FOR: ANIMAL FEED SUPPLEMENTS, IN CLASS 5 (U.S. CLS. 6, 18, 44, 46, 51 AND 52).

SN 77-100,223, FILED 2-6-2007.

FIRST USE 2-28-2007; IN COMMERCE 2-28-2007.

CARRIE GENOVESE, EXAMINING ATTORNEY

Int. Cl.: 5

Prior U.S. Cls.: 6, 18, 44, 46, 51, and 52

United States Patent and Trademark Office

Reg. No. 3,399,187

Registered Mar. 18, 2008

**TRADEMARK
PRINCIPAL REGISTER**

Pro-Stiminol

ZYCAL BIOCEUTICALS, INC. (DELAWARE
CORPORATION)
200 TURNPIKE ROAD
SOUTHBOROUGH, MA 01772

THE MARK CONSISTS OF STANDARD CHAR-
ACTERS WITHOUT CLAIM TO ANY PARTICULAR
FONT, STYLE, SIZE, OR COLOR.

FOR: NUTRITIONAL SUPPLEMENT FOR IM-
PROVING BONE HEALTH, IN CLASS 5 (U.S. CLS.
6, 18, 44, 46, 51 AND 52).

SN 77-100,396, FILED 2-6-2007.

FIRST USE 8-1-2007; IN COMMERCE 8-1-2007.

MICHELE SWAIN, EXAMINING ATTORNEY

Int. Cl.: 33

Prior U.S. Cls.: 47 and 49

United States Patent and Trademark Office

Reg. No. 3,399,188

Registered Mar. 18, 2008

**TRADEMARK
PRINCIPAL REGISTER**

FIND YOUR SPIRIT

VEEV SPIRITS, LLC (CALIFORNIA LTD LIAB
CO)
2631 HUTTON DR.
BEVERLY HILLS, CA 90210

THE MARK CONSISTS OF STANDARD CHAR-
ACTERS WITHOUT CLAIM TO ANY PARTICULAR
FONT, STYLE, SIZE, OR COLOR.

FOR: DISTILLED SPIRITS, IN CLASS 33 (U.S. CLS.
47 AND 49).

SN 77-100,814, FILED 2-6-2007.

FIRST USE 4-22-2007; IN COMMERCE 4-22-2007.

CHARLES L. JENKINS, EXAMINING ATTORNEY

Int. Cl.: 25

Prior U.S. Cls.: 22 and 39

United States Patent and Trademark Office

Reg. No. 3,399,189

Registered Mar. 18, 2008

**TRADEMARK
PRINCIPAL REGISTER**

SWAGGERVILLE

TIMOTHY D. HUDDLESTON, LLC. (FLORIDA
LTD LIAB CO)
24235 NW 160TH AVE
HIGH SPRINGS, FL 32643

FOR: BERMUDA SHORTS; BOARD SHORTS;
BOXER SHORTS; BUTTON-FRONT ALOHA
SHIRTS; CAMP SHIRTS; CAPRI PANTS; CARGO
PANTS; DRESS SHIRTS; FLEECE SHORTS; GOLF
SHIRTS; GYM SHORTS; JOGGING PANTS; KNIT
SHIRTS; NIGHT SHIRTS; NURSE PANTS; OPEN-
NECKED SHIRTS; PANTIES, SHORTS AND BRIEFS;
PANTS; POLO SHIRTS; RUGBY SHORTS; SHIRT
FRONTS; SHIRT YOKES; SHIRTS; SHIRTS FOR
SUITS; SHORT SETS; SHORT TROUSERS; SHORT-
SLEEVED OR LONG-SLEEVED T-SHIRTS; SHORT-
SLEEVED SHIRTS; SHORTS; SKI PANTS; SLEEP
SHIRTS; SLIDING SHORTS; SNOW PANTS; SNOW-

BOARD PANTS; SPORT SHIRTS; SPORTS SHIRTS;
SPORTS SHIRTS WITH SHORT SLEEVES; SWEAT
PANTS; SWEAT SHIRTS; SWEAT SHORTS; T-
SHIRTS; TAP PANTS; TRACK PANTS; WALKING
SHORTS; WATERPROOF JACKETS AND PANTS;
WIND SHIRTS, IN CLASS 25 (U.S. CLS. 22 AND 39).

FIRST USE 8-2-2007; IN COMMERCE 9-24-2007.

THE MARK CONSISTS OF STANDARD CHAR-
ACTERS WITHOUT CLAIM TO ANY PARTICULAR
FONT, STYLE, SIZE, OR COLOR.

SN 77-102,699, FILED 2-8-2007.

TRACY CROSS, EXAMINING ATTORNEY

Int. Cl.: 9

Prior U.S. Cls.: 21, 23, 26, 36, and 38

Reg. No. 3,399,190

United States Patent and Trademark Office

Registered Mar. 18, 2008

**TRADEMARK
PRINCIPAL REGISTER**

ICE-Q

IMAGINE COMMUNICATIONS, INC. (DELA-
WARE CORPORATION)
2053 SAN ELIJO AVENUE
CARDIFF-BY-THE-SEA, CA 92007

THE MARK CONSISTS OF STANDARD CHAR-
ACTERS WITHOUT CLAIM TO ANY PARTICULAR
FONT, STYLE, SIZE, OR COLOR.

FOR: A FEATURE AND CAPABILITY OF DIGI-
TAL VIDEO SOFTWARE AND HARDWARE FOR
MEASURING DIGITAL VIDEO QUALITY, IN
CLASS 9 (U.S. CLS. 21, 23, 26, 36 AND 38).

SN 77-103,057, FILED 2-8-2007.

FIRST USE 11-29-2007; IN COMMERCE 11-29-2007.

CHERYL CLAYTON, EXAMINING ATTORNEY

Int. Cl.: 9

Prior U.S. Cls.: 21, 23, 26, 36, and 38

United States Patent and Trademark Office

Reg. No. 3,399,191

Registered Mar. 18, 2008

**TRADEMARK
PRINCIPAL REGISTER**

Heavenly Harmony

CLOUD 9 GAMES, INC (TEXAS CORPORATION)
16108 BRAESGATE DRIVE
AUSTIN, TX 78717

FOR: COMPUTER GAME SOFTWARE, IN CLASS
9 (U.S. CLS. 21, 23, 26, 36 AND 38).

FIRST USE 6-1-2007; IN COMMERCE 6-1-2007.

THE MARK CONSISTS OF STANDARD CHAR-
ACTERS WITHOUT CLAIM TO ANY PARTICULAR
FONT, STYLE, SIZE, OR COLOR.

SN 77-103,281, FILED 2-9-2007.

MICHAEL LITZAU, EXAMINING ATTORNEY

Int. Cl.: 39

Prior U.S. Cls.: 100 and 105

United States Patent and Trademark Office

Reg. No. 3,399,192

Registered Mar. 18, 2008

**SERVICE MARK
PRINCIPAL REGISTER**

HEALTHY CRUISE

YUND, JENNIFER L. (UNITED STATES INDIVIDUAL)
302 NW 1ST
DELRAY BEACH, FL 33444

NO CLAIM IS MADE TO THE EXCLUSIVE RIGHT TO USE "CRUISE", APART FROM THE MARK AS SHOWN.

FOR: BOAT CRUISES, IN CLASS 39 (U.S. CLS. 100 AND 105).

SN 77-103,738, FILED 2-9-2007.

FIRST USE 9-30-2007; IN COMMERCE 9-30-2007.

THE MARK CONSISTS OF STANDARD CHARACTERS WITHOUT CLAIM TO ANY PARTICULAR FONT, STYLE, SIZE, OR COLOR.

NORA BUCHANAN WILL, EXAMINING ATTORNEY

Int. Cl.: 35

Prior U.S. Cls.: 100, 101, and 102

United States Patent and Trademark Office

Reg. No. 3,399,193

Registered Mar. 18, 2008

**SERVICE MARK
PRINCIPAL REGISTER**



ARTHUR L. GRUEN , MD, INC. (CALIFORNIA CORPORATION)
PO BOX 9350
16236 SAN DEGUITO RD. SUITE 4-22
RANCHO SANTA FE, CA 92607

FOR: BUSINESS MANAGEMENT, BILLING, AND BUSINESS MANAGEMENT CONSULTING SERVICES IN CONNECTION WITH THE FACILITATION OF ON-CALL SPECIALTY PHYSICIAN AND EMERGENCY PHYSICIAN SERVICES PROVIDED TO HOSPITALS AND OTHER HEALTHCARE FACILITIES, IN CLASS 35 (U.S. CLS. 100, 101 AND 102).

FIRST USE 2-28-2007; IN COMMERCE 3-26-2007.

NO CLAIM IS MADE TO THE EXCLUSIVE RIGHT TO USE "HEALTH", APART FROM THE MARK AS SHOWN.

THE MARK CONSISTS OF A PUZZLE PIECE FOLLOWED BY AN UPPERCASE STYLIZED "E", AN UPPERCASE STYLIZED "A" AND THE WORD "HEALTH" IN ALL UPPERCASE LETTERS.

SN 77-104,130, FILED 2-9-2007.

MORGAN WYNNE, EXAMINING ATTORNEY

Int. Cls.: 18, 20, 21, and 25

Prior U.S. Cls.: 1, 2, 3, 13, 22, 23, 25, 29, 30, 32, 33, 39, 40, 41, and 50

Reg. No. 3,399,194

United States Patent and Trademark Office

Registered Mar. 18, 2008

**TRADEMARK
PRINCIPAL REGISTER**



ROCK HARDWEAR (COLORADO LTD LIAB CO)
6126 S PONDS WAY
LITTLETON, CO 80123

FOR: ALL PURPOSE SPORT BAGS; ALL-PURPOSE ATHLETIC BAGS; ALL-PURPOSE CARRYING BAGS; ATHLETIC BAGS; BABY BACKPACKS; BACKPACKS; BAGS AND HOLDALLS FOR SPORTS CLOTHING; BAGS FOR CARRYING BABIES' ACCESSORIES; BAGS FOR SPORTS; CARRY-ALL BAGS; CARRY-ON BAGS; CHALK BAGS; DIAPER BAGS; DUFFEL BAGS; DUFFEL BAGS FOR TRAVEL; DUFFLE BAGS; FANNY PACKS; GARMENT BAGS FOR TRAVEL; GENERAL PURPOSE BAGS FOR CARRYING YOGA EQUIPMENT; GYM BAGS; HIKING BAGS; HIKING POLES; HIKING RUCKSACKS; HIKING STICKS; MESH SHOPPING BAGS; ROLL BAGS; SCHOOL BAGS; SCHOOL BOOK BAGS; SCHOOLCHILDREN'S BACKPACKS; SHAVING BAGS SOLD EMPTY; SHOE BAGS FOR TRAVEL; SHOULDER BAGS; SMALL BACKPACKS; SMALL BAGS FOR MEN; SPORTS BAGS; SPORTS PACKS; SPORTSMAN'S HUNTING BAGS; TOTE BAGS; TRAVEL BAGS; TRAVELING BAGS; WAIST BAGS, IN CLASS 18 (U.S. CLS. 1, 2, 3, 22 AND 41).

FIRST USE 0-0-2000; IN COMMERCE 0-0-2000.

FOR: SLEEPING BAG LINERS; SLEEPING BAGS; SLEEPING MATS; SLUMBER BAGS, IN CLASS 20 (U.S. CLS. 2, 13, 22, 25, 32 AND 50).

FIRST USE 3-31-2007; IN COMMERCE 6-15-2007.

FOR: COFFEE CUPS; CUPS; SPORTS BOTTLES SOLD EMPTY, IN CLASS 21 (U.S. CLS. 2, 13, 23, 29, 30, 33, 40 AND 50).

FIRST USE 3-31-2007; IN COMMERCE 6-15-2007.

FOR: ANKLE BOOTS; ANKLE SOCKS; ANKLETS; ANTI-PERSPIRANT SOCKS; ATHLETIC FOOTWEAR; BEACH FOOTWEAR; BICYCLE GLOVES; BICYCLING GLOVES; BOOTS; BOXER SHORTS; BRIEFS; CAMP SHIRTS; CAPS; CHILDREN'S AND INFANTS' CLOTH BIBS; CHILDREN'S CLOTH EATING BIBS; CHILDREN'S HEADWEAR; CLEATS FOR ATTACHMENT TO SPORTS SHOES; CLIMBING BOOTS; CLOTH BIBS; CLOTHING FOR WEAR IN JUDO PRACTICES; CLOTHING FOR WEAR IN WRESTLING GAMES; CLOTHING, NAMELY, ARM WARMERS; CLOTHING, NAMELY, KNEE WARMERS; CLOTHING, NAMELY, NECK TUBES; CLOTHING, NAMELY, WRAP-AROUNDS; DENIM JACKETS; DENIMS; DOWN JACKETS; FISHERMEN'S JACKETS; FLEECE SHORTS; FLIP FLOPS; FOOTWEAR; FOOTWEAR FOR MEN; FOOTWEAR FOR MEN AND WOMEN; FOOTWEAR FOR TRACK AND FIELD ATHLETICS; FOOTWEAR FOR WOMEN; FOOTWEAR NOT FOR SPORTS; GLOVES; GLOVES INCLUDING THOSE MADE OF SKIN, HIDE OR FUR; GOLF SHIRTS; GYM SHORTS; HATS; HEADWEAR; HIKING BOOTS;

HOODS; INFANT AND TODDLER ONE PIECE CLOTHING; INFANTS' SHOES AND BOOTS; IN-SOLES; JERSEYS; JOGGING PANTS; KNIT SHIRTS; KNITTED UNDERWEAR; LACE BOOTS; LADIES' BOOTS; LADIES' UNDERWEAR; LEATHER BELTS; MEN'S SOCKS; MOTORCYCLE GLOVES; MOUNTAINEERING BOOTS; PANTIES, SHORTS AND BRIEFS; PANTS; POLO SHIRTS; RAIN BOOTS; RAIN JACKETS; RAINPROOF JACKETS; RIDING GLOVES; RUGBY SHORTS; SHORT-SLEEVED OR LONG-SLEEVED T-SHIRTS; SHORT-SLEEVED SHIRTS; SHORTS; SKI BOOT BAGS; SKI BOOTS; SKI GLOVES; SKI JACKETS; SKI PANTS; SKULLIES; SNOW PANTS; SNOWBOARD BOOTS; SNOWBOARD GLOVES; SNOWBOARD PANTS; SOCKS; SPORT SHIRTS; SPORTS BRA; SPORTS JACKETS; SPORTS JERSEYS; SPORTS JERSEYS AND BREECHES FOR SPORTS; SPORTS OVERUNIFORMS; SPORTS SHIRTS; SPORTS SHIRTS WITH SHORT SLEEVES; SWEAT PANTS; SWEAT SHIRTS; SWEAT SHORTS; T-SHIRTS; THONGS; TOPS; TRACK PANTS; UNDERWEAR; WALKING SHORTS; WA-

TERPROOF JACKETS AND PANTS; WIND RESISTANT JACKETS; WIND SHIRTS; WIND-JACKETS; WINTER BOOTS; WOMEN'S UNDERWEAR; WOVEN OR KNITTED UNDERWEAR, IN CLASS 25 (U.S. CLS. 22 AND 39).

FIRST USE 0-0-2000; IN COMMERCE 0-0-2000.

THE COLOR(S) BLACK AND GREY IS/ARE CLAIMED AS A FEATURE OF THE MARK.

THE MARK CONSISTS OF A TRIANGULAR MOUNTAIN SPLIT IN TWO SECTIONS, THE BOTTOM SECTION AND THE UPPER SECTION, THE WORD "ROCK" POSITIONED TO THE LEFT OF THE TRIANGLE, AND THE WORD "HARDWEAR" POSITIONED BELOW THE TRIANGLE.

SN 77-104,701, FILED 2-12-2007.

MICHAEL LITZAU, EXAMINING ATTORNEY

Int. Cl.: 20

Prior U.S. Cls.: 2, 13, 22, 25, 32, and 50

Reg. No. 3,399,195

United States Patent and Trademark Office

Registered Mar. 18, 2008

**TRADEMARK
PRINCIPAL REGISTER**

ATHENS

KRUEGER INTERNATIONAL, INC. (WISCONSIN CORPORATION)
1330 BELLEVUE STREET
GREEN BAY, WI 54302

THE MARK CONSISTS OF STANDARD CHARACTERS WITHOUT CLAIM TO ANY PARTICULAR FONT, STYLE, SIZE, OR COLOR.

FOR: FURNITURE, IN CLASS 20 (U.S. CLS. 2, 13, 22, 25, 32 AND 50).

SN 77-107,351, FILED 2-14-2007.

FIRST USE 8-27-2007; IN COMMERCE 8-27-2007.

JEAN IM, EXAMINING ATTORNEY

Int. Cl.: 26

Prior U.S. Cls.: 37, 39, 40, 42, and 50

United States Patent and Trademark Office

Reg. No. 3,399,196

Registered Mar. 18, 2008

**TRADEMARK
PRINCIPAL REGISTER**

CALI BITS

SKECHERS U.S.A., INC. II (DELAWARE CORPORATION)
228 MANHATTAN BEACH BOULEVARD
MANHATTAN BEACH, CA 90266

FOR: ORNAMENTS FOR FOOTWEAR AND APPAREL, NAMELY, SHOE ORNAMENTS AND APPAREL ORNAMENTS NOT OF PRECIOUS METAL, IN CLASS 26 (U.S. CLS. 37, 39, 40, 42 AND 50).

FIRST USE 3-19-2007; IN COMMERCE 3-19-2007.

THE MARK CONSISTS OF STANDARD CHARACTERS WITHOUT CLAIM TO ANY PARTICULAR FONT, STYLE, SIZE, OR COLOR.

SN 77-107,652, FILED 2-14-2007.

BRENDAN MCCAULEY, EXAMINING ATTORNEY

Int. Cl.: 28

Prior U.S. Cls.: 22, 23, 38, and 50

United States Patent and Trademark Office

Reg. No. 3,399,197

Registered Mar. 18, 2008

**TRADEMARK
PRINCIPAL REGISTER**

STRUT!

ALSIP & COMPANY (WASHINGTON CORPORATION)
1411 4TH AVE.
SUITE 1404
SEATTLE, WA 981012223

THE MARK CONSISTS OF STANDARD CHARACTERS WITHOUT CLAIM TO ANY PARTICULAR FONT, STYLE, SIZE, OR COLOR.

FOR: CARD GAMES AND TRADING CARD GAMES, IN CLASS 28 (U.S. CLS. 22, 23, 38 AND 50).

SN 77-107,766, FILED 2-14-2007.

FIRST USE 11-1-2007; IN COMMERCE 12-7-2007.

CHRISTINA SOBRAL, EXAMINING ATTORNEY

Int. Cl.: 42

Prior U.S. Cls.: 100 and 101

United States Patent and Trademark Office

Reg. No. 3,399,198

Registered Mar. 18, 2008

**SERVICE MARK
PRINCIPAL REGISTER**

BUNCHBALL

BUNCHBALL INC. (DELAWARE CORPORATION)
240-D TWIN DOLPHIN DRIVE
REDWOOD CITY, CA 94065

FOR: APPLICATION SERVICE PROVIDER FEATURING AN APPLICATION PROGRAMMING INTERFACE FOR CREATING COMPUTER GAMES, VIDEO GAMES, SOCIAL NETWORKS AND MULTI-MEDIA NETWORKS; APPLICATION SERVICE PROVIDER, NAMELY, PROVIDING, HOSTING, MANAGING, DESIGNING, DEVELOPING, AND MAINTAINING APPLICATIONS, SOFTWARE, DIGITAL CONTENT, WEBSITES, AND DATABASES IN THE FIELDS OF COMPUTER GAMES, VIDEO GAMES, SOCIAL NETWORKS AND MULTI-MEDIA NETWORKS; DESIGN, DEVELOPMENT AND INSTALLATION OF ONLINE COMPUTER SOFTWARE SYSTEMS; COMPUTER SOFTWARE DESIGN FOR OTHERS; CONSULTING SERVICES IN THE FIELD OF DESIGN, SELECTION, IMPLEMENTATION AND USE OF COMPUTER SOFTWARE FOR OTHERS; CONSULTING SERVICES IN THE FIELD OF DESIGN, SELECTION, IMPLEMENTATION AND USE OF COMPUTER GAMES AND ONLINE COMPUTER GAMES FOR OTHERS; COMPUTER SERVICES, NAMELY, CREATING AN ONLINE COMMUNITY FOR USERS TO PARTICIPATE IN COMPETITIONS, SHOWCASE THEIR SKILLS,

GET FEEDBACK FROM THEIR PEERS, FORM VIRTUAL COMMUNITIES, ENGAGE IN SOCIAL NETWORKING AND IMPROVE THEIR TALENT; AND TECHNICAL SUPPORT SERVICES, NAMELY, TROUBLESHOOTING COMPUTER SOFTWARE PROBLEMS; APPLICATION SERVICE PROVIDER FEATURING AN APPLICATION PROGRAMMING INTERFACE FOR CREATING AVATARS, PROFILES, ONLINE LEADER BOARDS, AND VIRTUAL WORLDS; APPLICATION SERVICE PROVIDER FEATURING COMPUTER SOFTWARE FOR TRACKING USER STATISTICS; AND APPLICATION SERVICE PROVIDER FEATURING COMPUTER SOFTWARE FOR CREATING AND MANAGING CUSTOMER INCENTIVE, REWARD AND REDEMPTION PROGRAMS, IN CLASS 42 (U.S. CLS. 100 AND 101).

FIRST USE 10-31-2005; IN COMMERCE 10-31-2005.

THE MARK CONSISTS OF STANDARD CHARACTERS WITHOUT CLAIM TO ANY PARTICULAR FONT, STYLE, SIZE, OR COLOR.

SN 77-107,866, FILED 2-14-2007.

JOHN DALIER, EXAMINING ATTORNEY

Int. Cl.: 5

Prior U.S. Cls.: 6, 18, 44, 46, 51, and 52

United States Patent and Trademark Office

Reg. No. 3,399,199

Registered Mar. 18, 2008

**TRADEMARK
PRINCIPAL REGISTER**



imVia

SELLION, INC. (RHODE ISLAND CORPORATION)
290 PROSPECT AVENUE
NORTH KINGSTOWN, RI 02852

FOR: DIETARY AND NUTRITIONAL SUPPLEMENTS; HOMEOPATHIC SUPPLEMENTS; VITAMIN SUPPLEMENTS, IN CLASS 5 (U.S. CLS. 6, 18, 44, 46, 51 AND 52).

FIRST USE 1-16-2008; IN COMMERCE 1-16-2008.

THE MARK CONSISTS OF THE WORD "IMVIA" WITH A LEAF ABOVE THE LETTER "V".

SN 77-108,664, FILED 2-15-2007.

ALYSSA PALADINO, EXAMINING ATTORNEY

Int. Cls.: 6 and 12

**Prior U.S. Cls.: 2, 12, 13, 14, 19, 21, 23, 25, 31, 35, 44,
and 50**

Reg. No. 3,399,200

United States Patent and Trademark Office

Registered Mar. 18, 2008

**TRADEMARK
PRINCIPAL REGISTER**



NAUTEC INDUSTRIA METALURGICA LTDA
(BRAZIL CORPORATION)
RUA NESTOR CARLOS FEDRIZZI, 150
CAXIAS DO SUL, BRAZIL 95052-000

FOR: ANCHORS; BUCKLES OF COMMON METAL; CABLE THIMBLES OF METAL; EYE BOLTS; FERRULES OF METAL FOR CANES AND WALKING-STICKS; MARINE ANCHORS; METAL BOLLARDS; METAL CABLE WIRE; METAL CHAINS; METAL CLOSURES FOR CONTAINERS; METAL EXPANSION JOINTS FOR PIPING AND DUCTING; METAL EYE BOLTS; METAL HARDWARE NAMELY, PULLEYS; METAL HARDWARE, NAMELY, WASHERS; METAL HINGES; METAL HOOKS; METAL KEY RINGS; METAL LADDERS; METAL LATCHES; METAL MARINE HARDWARE, NAMELY, THIMBLES; METAL NUTS; METAL PIPE COUPLINGS AND JOINTS; METAL PLUGS; METAL POLES; METAL POSTS; METAL PULLEYS, SPRINGS AND VALVES; METAL RIVETS; METAL SCREWS; METAL WEATHER VANES; METAL WIN-

DOW FRAMES; MOORING BOLLARDS OF METAL; NAILS; WIRE; WIRE ROPES, IN CLASS 6 (U.S. CLS. 2, 12, 13, 14, 23, 25 AND 50).

FIRST USE 7-2-1997; IN COMMERCE 1-1-2006.

FOR: BOATS AND STRUCTURAL PARTS THEREFOR; MAST PLATFORMS FOR YACHTS; MASTS FOR BOATS; SCREW PROPELLERS; YACHTS, IN CLASS 12 (U.S. CLS. 19, 21, 23, 31, 35 AND 44).

FIRST USE 7-2-1997; IN COMMERCE 1-1-2006.

THE MARK CONSISTS OF STYLIZED LETTER "N" FOLLOWED BY STYLIZED WORD "NAUTOS".

SN 77-109,117, FILED 2-16-2007.

REBECCA GILBERT, EXAMINING ATTORNEY

Int. Cl.: 35

Prior U.S. Cls.: 100, 101, and 102

United States Patent and Trademark Office

Reg. No. 3,399,201

Registered Mar. 18, 2008

**SERVICE MARK
PRINCIPAL REGISTER**

SHAMELESS BRIBE

THOMPSON & CO. OF TAMPA, INC. (FLORIDA
CORPORATION)
5401 HANGAR COURT
TAMPA, FL 33634

THE MARK CONSISTS OF STANDARD CHAR-
ACTERS WITHOUT CLAIM TO ANY PARTICULAR
FONT, STYLE, SIZE, OR COLOR.

FOR: MAIL ORDER SERVICES FEATURING
CIGARS, IN CLASS 35 (U.S. CLS. 100, 101 AND 102).

SN 77-109,479, FILED 2-16-2007.

FIRST USE 7-1-2007; IN COMMERCE 7-1-2007.

PAM WILLIS, EXAMINING ATTORNEY

Int. Cl.: 9

Prior U.S. Cls.: 21, 23, 26, 36, and 38

Reg. No. 3,399,202

United States Patent and Trademark Office

Registered Mar. 18, 2008

TRADEMARK
PRINCIPAL REGISTER



ROZIN OPTICAL INTERNATIONAL LLC (FLOR-
IDA LTD LIAB CO)
6090 NW 84TH AVE
MIAMI, FL 33166

FOR: OPTICAL FRAMES, IN CLASS 9 (U.S. CLS.
21, 23, 26, 36 AND 38).

FIRST USE 9-1-1995; IN COMMERCE 9-1-1995.

NO CLAIM IS MADE TO THE EXCLUSIVE
RIGHT TO USE "OCCHIALI", APART FROM THE
MARK AS SHOWN.

THE ENGLISH TRANSLATION OF "ALPI OC-
CHIALI" IS ALPS GLASSES.

SN 77-110,550, FILED 2-19-2007.

PAUL MORENO, EXAMINING ATTORNEY

Int. Cl.: 20

Prior U.S. Cls.: 2, 13, 22, 25, 32, and 50

Reg. No. 3,399,203

United States Patent and Trademark Office

Registered Mar. 18, 2008

**TRADEMARK
PRINCIPAL REGISTER**



WENGER CORPORATION (MINNESOTA CORPORATION)
555 PARK DRIVE
OWATONNA, MN 55060

FOR: FURNITURE, NAMELY, DISPLAY RACKS, CABINETS AND SHELVES, IN CLASS 20 (U.S. CLS. 2, 13, 22, 25, 32 AND 50).

FIRST USE 11-8-2007; IN COMMERCE 11-8-2007.

THE MARK CONSISTS OF THE WORD "ACOUSTIC CABINETS" WITH A BOLD LINE ABOVE AND BELOW THE TEXT. THREE VERTICALLY ORIENTED CURVED LINES EXTEND FROM BOTH OF THE BOLD LINES IN A DIRECTION AWAY FROM THE TEXT.

SN 77-110,705, FILED 2-19-2007.

LINDA ESTRADA, EXAMINING ATTORNEY

Int. Cl.: 3

Prior U.S. Cls.: 1, 4, 6, 50, 51, and 52

United States Patent and Trademark Office

Reg. No. 3,399,204

Registered Mar. 18, 2008

**TRADEMARK
PRINCIPAL REGISTER**

PERIOGEN

ANDERSON, DOUGLAS (UNITED STATES INDIVIDUAL)
2217 WHITMAN STREET
SAN DIEGO, CA 92103

THE MARK CONSISTS OF STANDARD CHARACTERS WITHOUT CLAIM TO ANY PARTICULAR FONT, STYLE, SIZE, OR COLOR.

FOR: NON-MEDICATED MOUTHWASH AND GARGLE, IN CLASS 3 (U.S. CLS. 1, 4, 6, 50, 51 AND 52).

SN 77-111,261, FILED 2-20-2007.

FIRST USE 2-14-2007; IN COMMERCE 3-11-2007.

MICHAEL WEBSTER, EXAMINING ATTORNEY

Int. Cl.: 19

Prior U.S. Cls.: 1, 12, 33, and 50

United States Patent and Trademark Office

Reg. No. 3,399,205

Registered Mar. 18, 2008

**TRADEMARK
PRINCIPAL REGISTER**

CREO-POST

PEACH STATE MFG., INC. (GEORGIA CORPORATION)
4250 STACKS ROAD
COLLEGE PARK, GA 30349

THE MARK CONSISTS OF STANDARD CHARACTERS WITHOUT CLAIM TO ANY PARTICULAR FONT, STYLE, SIZE, OR COLOR.

FOR: NON-METAL FENCE POSTS, IN CLASS 19 (U.S. CLS. 1, 12, 33 AND 50).

SN 77-111,320, FILED 2-20-2007.

FIRST USE 10-17-2007; IN COMMERCE 10-17-2007.

CAROLYN CATALDO, EXAMINING ATTORNEY

Int. Cl.: 19

Prior U.S. Cls.: 1, 12, 33, and 50

United States Patent and Trademark Office

Reg. No. 3,399,206

Registered Mar. 18, 2008

**TRADEMARK
PRINCIPAL REGISTER**

DURA DECKING

PEACH STATE MFG., INC. (GEORGIA CORPORATION)

4250 STACKS ROAD

COLLEGE PARK, GA 30349

FOR: LUMBER, IN CLASS 19 (U.S. CLS. 1, 12, 33 AND 50).

FIRST USE 7-14-1998; IN COMMERCE 7-14-1998.

THE MARK CONSISTS OF STANDARD CHARACTERS WITHOUT CLAIM TO ANY PARTICULAR FONT, STYLE, SIZE, OR COLOR.

NO CLAIM IS MADE TO THE EXCLUSIVE RIGHT TO USE "DECKING", APART FROM THE MARK AS SHOWN.

SN 77-111,323, FILED 2-20-2007.

CAROLYN CATALDO, EXAMINING ATTORNEY

Int. Cl.: 43

Prior U.S. Cls.: 100 and 101

United States Patent and Trademark Office

Reg. No. 3,399,207

Registered Mar. 18, 2008

SERVICE MARK
PRINCIPAL REGISTER



OCEAN CHICKS, INC. (GEORGIA CORPORATION)
SUITE 100
1040 FOUNDER'S BOULEVARD
ATHENS, GA 30606

FOR: RESTAURANT SERVICES, IN CLASS 43
(U.S. CLS. 100 AND 101).

FIRST USE 5-23-2007; IN COMMERCE 5-23-2007.

NO CLAIM IS MADE TO THE EXCLUSIVE
RIGHT TO USE "HOUSE" , APART FROM THE
MARK AS SHOWN.

THE COLOR(S) BLACK, WHITE, TWO SHADES
OF BLUE AND TWO SHADES OF RED IS/ARE
CLAIMED AS A FEATURE OF THE MARK.

THE MARK CONSISTS OF AN OVAL IN TWO
SHADES OF BLUE OUTLINED IN BLACK; WITHIN
THE TOP HALF OF THE OVAL IS THE WORD
"THE" IN BLACK LETTERS AND IN THE LOWER
HALF OF THE OVAL IS THE WORD "HOUSE" IN
BLACK LETTERS, AND A BLACK BANNER STRETCHES
HORIZONTALLY ACROSS THE CENTER OF
THE OVAL WITH THE WORD "TARTAR" IN
WHITE LETTERS ON THE BANNER; AND A SMILING
SHRIMP IN TWO SHADES OF RED ALONG
THE RIGHT SIDE OF THE OVAL. THE SHRIMP IS
OUTLINED IN BLACK AND HAS A WHITE
MOUTH. A SMALL PORTION OF THE BANNER IS
WHITE.

SN 77-111,408, FILED 2-20-2007.

Laurie Mayes, Examining Attorney

Int. Cl.: 9

Prior U.S. Cls.: 21, 23, 26, 36, and 38

United States Patent and Trademark Office

Reg. No. 3,399,208

Registered Mar. 18, 2008

**TRADEMARK
PRINCIPAL REGISTER**

OCEAN

HELIO LLC (DELAWARE LTD LIAB CO)
SUITE 600
10960 WILSHIRE BOULEVARD
LOS ANGELES, CA 90024

CORDER, IN CLASS 9 (U.S. CLS. 21, 23, 26, 36 AND 38).

FIRST USE 5-11-2007; IN COMMERCE 5-11-2007.

FOR: WIRELESS COMMUNICATION DEVICES, NAMELY, MOBILE HANDSETS IN THE NATURE OF A COMBINATION PERSONAL DIGITAL ASSISTANT, TELEPHONE, CAMERA, GLOBAL POSITIONING AND MAPPING DEVICE, TELEVISION, RADIO, VIDEO AND AUDIO PLAYER AND RE-

THE MARK CONSISTS OF STANDARD CHARACTERS WITHOUT CLAIM TO ANY PARTICULAR FONT, STYLE, SIZE, OR COLOR.

SN 77-111,826, FILED 2-20-2007.

DANNEAN HETZEL, EXAMINING ATTORNEY

Int. Cl.: 25

Prior U.S. Cls.: 22 and 39

United States Patent and Trademark Office

Reg. No. 3,399,209

Registered Mar. 18, 2008

**TRADEMARK
PRINCIPAL REGISTER**



QINGBANG, LLC (COLORADO LTD LIAB CO)
P.O. BOX 270392
LOUISVILLE, CO 80027

FIRST USE 8-10-2007; IN COMMERCE 8-10-2007.

FOR: INFANT AND TODDLER ONE PIECE CLOTHING; INFANTS' TROUSERS; PAJAMAS; PANTS; SHIRTS; SHORTS; SOCKS AND STOCKINGS; SWEAT PANTS; SWEAT SHIRTS; SWEAT SHORTS; T-SHIRTS; WALKING SHORTS, IN CLASS 25 (U.S. CLS. 22 AND 39).

THE MARK CONSISTS OF A STYLIZED BABY BEAR WEARING A DIAPER AND WITH A STYLIZED HEART ABOVE ITS HEAD.

SN 77-111,868, FILED 2-20-2007.

JOHN HWANG, EXAMINING ATTORNEY

Int. Cl.: 35

Prior U.S. Cls.: 100, 101, and 102

United States Patent and Trademark Office

Reg. No. 3,399,210

Registered Mar. 18, 2008

**SERVICE MARK
PRINCIPAL REGISTER**

Cute Shoes

MAYBARD COMPANY, LLC (GEORGIA LTD
LIAB CO)
251 HIGHPOINT CROSSING
POWDER SPRINGS, GA 30127

FOR: RETAIL STORE SERVICES IN THE FIELD
OF FOOTWEAR FOR WOMEN AND CHILDREN,
AND FASHION ACCESSORIES SUCH AS PURSES,
HANDBAGS, PANTYHOSE, SOCKS, HATS, SUN-
GLASSES, JEWELRY AS IN EAR RINGS, FINGER
RINGS, NECKLACES, BRACELETS, IN CLASS 35
(U.S. CLS. 100, 101 AND 102).

FIRST USE 4-7-2007; IN COMMERCE 4-7-2007.

THE MARK CONSISTS OF STANDARD CHAR-
ACTERS WITHOUT CLAIM TO ANY PARTICULAR
FONT, STYLE, SIZE, OR COLOR.

NO CLAIM IS MADE TO THE EXCLUSIVE
RIGHT TO USE "SHOES", APART FROM THE
MARK AS SHOWN.

SN 77-112,019, FILED 2-20-2007.

ELI HELLMAN, EXAMINING ATTORNEY

Int. Cl.: 28

Prior U.S. Cls.: 22, 23, 38, and 50

United States Patent and Trademark Office

Reg. No. 3,399,211

Registered Mar. 18, 2008

**TRADEMARK
PRINCIPAL REGISTER**

CAN-DO ROO

PATCH PRODUCTS, INC. (WISCONSIN CORPORATION)
1400 E. INMAN PKWY.
BELOIT, WI 53511

THE MARK CONSISTS OF STANDARD CHARACTERS WITHOUT CLAIM TO ANY PARTICULAR FONT, STYLE, SIZE, OR COLOR.

FOR: PARLOR GAMES, IN CLASS 28 (U.S. CLS. 22, 23, 38 AND 50).

SN 77-113,164, FILED 2-22-2007.

FIRST USE 6-22-2007; IN COMMERCE 6-22-2007.

MORGAN WYNNE, EXAMINING ATTORNEY

Int. Cl.: 3

Prior U.S. Cls.: 1, 4, 6, 50, 51, and 52

United States Patent and Trademark Office

Reg. No. 3,399,212

Registered Mar. 18, 2008

**TRADEMARK
PRINCIPAL REGISTER**



JUNELAB, LLC (MARYLAND LTD LIAB CO)
6308 WISCONSIN AVE.
CHEVY CHASE, MD 20815

FOR: COSMETIC CREAMS, IN CLASS 3 (U.S. CLS.
1, 4, 6, 50, 51 AND 52).

FIRST USE 10-15-2006; IN COMMERCE 1-1-2007.

THE COLOR(S) RED, PINK, YELLOW, WHITE
AND BLUE IS/ARE CLAIMED AS A FEATURE OF
THE MARK.

THE MARK CONSISTS OF THE WORDING"
JUNELAB" IN BLUE LETTERING AND THE DE-
SIGN OF A ROSE WITH RED, PINK, YELLOW AND
WHITE PETALS.

SN 77-113,216, FILED 2-22-2007.

WENDY GOODMAN, EXAMINING ATTORNEY

Int. Cl.: 19

Prior U.S. Cls.: 1, 12, 33, and 50

United States Patent and Trademark Office

Reg. No. 3,399,213

Registered Mar. 18, 2008

**TRADEMARK
PRINCIPAL REGISTER**

CEDA-BOARD

PEACH STATE MFG., INC. (GEORGIA CORPORATION)
4250 STACKS ROAD
COLLEGE PARK, GA 30349

THE MARK CONSISTS OF STANDARD CHARACTERS WITHOUT CLAIM TO ANY PARTICULAR FONT, STYLE, SIZE, OR COLOR.

FOR: NON-METAL FENCE BOARDS, IN CLASS 19 (U.S. CLS. 1, 12, 33 AND 50).

SN 77-113,334, FILED 2-22-2007.

FIRST USE 10-17-2007; IN COMMERCE 10-17-2007.

CAROLYN CATALDO, EXAMINING ATTORNEY

Int. Cl.: 6

Prior U.S. Cls.: 2, 12, 13, 14, 23, 25, and 50

Reg. No. 3,399,214

United States Patent and Trademark Office

Registered Mar. 18, 2008

**TRADEMARK
PRINCIPAL REGISTER**

SECURITY BOSS

SECURITY BOSS MANUFACTURING, LLC (WIS-
CONSIN LTD LIAB CO)
W6320 BURKSHIRE LANE
PLYMOUTH, WI 53073

THE MARK CONSISTS OF STANDARD CHAR-
ACTERS WITHOUT CLAIM TO ANY PARTICULAR
FONT, STYLE, SIZE, OR COLOR.

FOR: PET DOORS, PRIMARILY OF METAL, IN
CLASS 6 (U.S. CLS. 2, 12, 13, 14, 23, 25 AND 50).

SN 77-115,093, FILED 2-23-2007.

FIRST USE 5-17-2007; IN COMMERCE 5-26-2007.

KEVIN CORWIN, EXAMINING ATTORNEY

Int. Cl.: 45

Prior U.S. Cls.: 100 and 101

United States Patent and Trademark Office

Reg. No. 3,399,215

Registered Mar. 18, 2008

**SERVICE MARK
PRINCIPAL REGISTER**

PaperWitness

CHALLENGER-NIBBS, KENDRA (UNITED STATES INDIVIDUAL)
471 GRANT AVENUE, 1R
BROOKLYN, NY 11208

THE MARK CONSISTS OF STANDARD CHARACTERS WITHOUT CLAIM TO ANY PARTICULAR FONT, STYLE, SIZE, OR COLOR.

FOR: LEGAL DOCUMENT PREPARATION SERVICES FOR INDIVIDUALS AND ATTORNEYS, IN CLASS 45 (U.S. CLS. 100 AND 101).

SN 77-115,440, FILED 2-24-2007.

FIRST USE 12-28-2007; IN COMMERCE 12-28-2007.

MARY CRAWFORD, EXAMINING ATTORNEY

Int. Cl.: 35

Prior U.S. Cls.: 100, 101, and 102

United States Patent and Trademark Office

Reg. No. 3,399,216

Registered Mar. 18, 2008

**SERVICE MARK
PRINCIPAL REGISTER**

Compensatory Invoicing

AMBROSE, STEPHEN D (UNITED STATES IN-
DIVIDUAL)
9111 CARTERHAM RD.
RICHMOND, VA 23229

FOR: DATA MANAGEMENT SERVICES FOR
USE IN DEBT COLLECTION, NAMELY, ELECTRO-
NIC DATA COLLECTION AND ONLINE CLAIMS
MANAGEMENT; INVOICING SERVICES, IN CLASS
35 (U.S. CLS. 100, 101 AND 102).

FIRST USE 11-5-2006; IN COMMERCE 1-15-2007.

THE MARK CONSISTS OF STANDARD CHAR-
ACTERS WITHOUT CLAIM TO ANY PARTICULAR
FONT, STYLE, SIZE, OR COLOR.

NO CLAIM IS MADE TO THE EXCLUSIVE
RIGHT TO USE "INVOICING", APART FROM THE
MARK AS SHOWN.

SN 77-115,607, FILED 2-25-2007.

RAUL CORDOVA, EXAMINING ATTORNEY

Int. Cl.: 21

Prior U.S. Cls.: 2, 13, 23, 29, 30, 33, 40, and 50

United States Patent and Trademark Office

Reg. No. 3,399,217

Registered Mar. 18, 2008

**TRADEMARK
PRINCIPAL REGISTER**

ONE TOUCH INSTANT MARINATOR

CRICKET PRODUCTIONS INC (MASSACHU-
SETTS CORPORATION)
225 CEDAR HILL ST. 3RD FLOOR
MARLBORO, MA 01752

FOR: PLASTIC MEAT MARINATING CONTAIN-
ERS, IN CLASS 21 (U.S. CLS. 2, 13, 23, 29, 30, 33, 40
AND 50).

FIRST USE 10-1-2007; IN COMMERCE 10-1-2007.

THE MARK CONSISTS OF STANDARD CHAR-
ACTERS WITHOUT CLAIM TO ANY PARTICULAR
FONT, STYLE, SIZE, OR COLOR.

NO CLAIM IS MADE TO THE EXCLUSIVE
RIGHT TO USE "INSTANT MARINATOR", APART
FROM THE MARK AS SHOWN.

SN 77-116,278, FILED 2-26-2007.

IRA J. GOODSaid, EXAMINING ATTORNEY

Int. Cl.: 8

Prior U.S. Cls.: 23, 28, and 44

United States Patent and Trademark Office

Reg. No. 3,399,218

Registered Mar. 18, 2008

**TRADEMARK
PRINCIPAL REGISTER**

STEELGRIP

EASCO HAND TOOLS, INC. (DELAWARE CORPORATION)

125 POWDER FOREST DRIVE

SIMSBURY, CT 06070

FOR: HAND TOOLS, NAMELY, SCREWDRIVERS, SOCKETS AND RATCHETING WRENCHES, IN CLASS 8 (U.S. CLS. 23, 28 AND 44).

FIRST USE 4-0-2007; IN COMMERCE 4-0-2007.

THE MARK CONSISTS OF STANDARD CHARACTERS WITHOUT CLAIM TO ANY PARTICULAR FONT, STYLE, SIZE, OR COLOR.

OWNER OF U.S. REG. NO. 1,526,506.

SEC. 2(F).

SN 77-116,342, FILED 2-26-2007.

KIMBERLY FRYE, EXAMINING ATTORNEY

Int. Cl.: 5

Prior U.S. Cls.: 6, 18, 44, 46, 51, and 52

Reg. No. 3,399,219

United States Patent and Trademark Office

Registered Mar. 18, 2008

**TRADEMARK
PRINCIPAL REGISTER**

RESVANTAGE

DIVERSIFIED ADVANTAGE GROUP, INC. (CALIFORNIA CORPORATION)
1580 MONROVIA AVENUE
NEWPORT BEACH, CA 92663

THE MARK CONSISTS OF STANDARD CHARACTERS WITHOUT CLAIM TO ANY PARTICULAR FONT, STYLE, SIZE, OR COLOR.

FOR: DIETARY AND NUTRITIONAL SUPPLEMENTS, IN CLASS 5 (U.S. CLS. 6, 18, 44, 46, 51 AND 52).

SN 77-116,713, FILED 2-26-2007.

FIRST USE 8-0-2007; IN COMMERCE 8-0-2007.

CHERYL CLAYTON, EXAMINING ATTORNEY

Int. Cl.: 36

Prior U.S. Cls.: 100, 101, and 102

United States Patent and Trademark Office

Reg. No. 3,399,220

Registered Mar. 18, 2008

**SERVICE MARK
PRINCIPAL REGISTER**

**SIGNATURE ADVANTAGE
BROKERAGE FOR BUSINESS**

SUNTRUST BANKS, INC. (GEORGIA CORPORATION)

200 SOUTH ORANGE AVENUE

ORLANDO, FL 32801

FOR: FINANCIAL SERVICES, NAMELY, TRADITIONAL BANKING COMBINED WITH WEALTH MANAGEMENT, IN CLASS 36 (U.S. CLS. 100, 101 AND 102).

FIRST USE 5-0-2007; IN COMMERCE 5-0-2007.

THE MARK CONSISTS OF STANDARD CHARACTERS WITHOUT CLAIM TO ANY PARTICULAR FONT, STYLE, SIZE, OR COLOR.

OWNER OF U.S. REG. NO. 2,848,314.

NO CLAIM IS MADE TO THE EXCLUSIVE RIGHT TO USE "BROKERAGE FOR BUSINESS", APART FROM THE MARK AS SHOWN.

SN 77-116,903, FILED 2-27-2007.

CAROLYN CATALDO, EXAMINING ATTORNEY

Int. Cl.: 25

Prior U.S. Cls.: 22 and 39

United States Patent and Trademark Office

Reg. No. 3,399,221

Registered Mar. 18, 2008

TRADEMARK
PRINCIPAL REGISTER

Lovelina

BUI, CATHERINE T. (CALIFORNIA SOLE PROPRIETORSHIP)
307 ANDERSON RD.
ALAMEDA, CA 94502

FOR: WOMEN'S CLOTHING, NAMELY, TOPS, SHIRTS, BLOUSES, BOTTOMS, PANTS, CAPRIS, SHORTS, SKIRTS, DRESSES, SOCKS, JACKETS AND COATS, IN CLASS 25 (U.S. CLS. 22 AND 39).

FIRST USE 8-31-2007; IN COMMERCE 11-30-2007.

THE COLOR(S) BLACK AND PINK IS/ARE CLAIMED AS A FEATURE OF THE MARK.

THE COLOR BLACK APPEARS IN THE WORDING "LOVELINA" AND THE COLOR PINK APPEARS IN THE FLOWER DESIGN ABOVE THE "I".

SN 77-117,615, FILED 2-27-2007.

MICHELE SWAIN, EXAMINING ATTORNEY

Prior U.S. Cl.: 200

United States Patent and Trademark Office

Reg. No. 3,399,222

Registered Mar. 18, 2008

**COLLECTIVE MEMBERSHIP
PRINCIPAL REGISTER**

BERKLEE CITY MUSIC NETWORK

BERKLEE COLLEGE OF MUSIC, INC. (MASSACHUSETTS CORPORATION)
1140 BOYLSTON STREET
BOSTON, MA 02215

FOR: INDICATING MEMBERSHIP IN A(N) GROUP OF ENTITIES TEACHING MUSIC IN A PARTICULAR WAY TO UNDERSERVED COMMUNITIES AND UNDERPRIVILEGED CHILDREN, IN CLASS 200 (U.S. CL. 200).

FIRST USE 7-14-2007; IN COMMERCE 7-14-2007.

THE MARK CONSISTS OF STANDARD CHARACTERS WITHOUT CLAIM TO ANY PARTICULAR FONT, STYLE, SIZE, OR COLOR.

NO CLAIM IS MADE TO THE EXCLUSIVE RIGHT TO USE "MUSIC NETWORK", APART FROM THE MARK AS SHOWN.

SN 77-117,768, FILED 2-27-2007.

BRIAN NEVILLE, EXAMINING ATTORNEY

Int. Cl.: 36

Prior U.S. Cls.: 100, 101, and 102

United States Patent and Trademark Office

Reg. No. 3,399,223

Registered Mar. 18, 2008

**SERVICE MARK
PRINCIPAL REGISTER**

IN THE ARENA

IN THE ARENA, INC. (MASSACHUSETTS CORPORATION)
975 MEMORIAL DRIVE, #1105
CAMBRIDGE, MA 02138

FOR: CHARITABLE FUNDRAISING SERVICES RELATED TO ATHLETICS, YOUTH ENRICHMENT, AND CIVIC ENGAGEMENT, IN CLASS 36 (U.S. CLS. 100, 101 AND 102).

FIRST USE 9-9-2006; IN COMMERCE 9-9-2006.

THE MARK CONSISTS OF STANDARD CHARACTERS WITHOUT CLAIM TO ANY PARTICULAR FONT, STYLE, SIZE, OR COLOR.

SN 77-119,311, FILED 3-1-2007.

JENNIFER MARTIN, EXAMINING ATTORNEY

Int. Cl.: 36

Prior U.S. Cls.: 100, 101, and 102

United States Patent and Trademark Office

Reg. No. 3,399,224

Registered Mar. 18, 2008

**SERVICE MARK
PRINCIPAL REGISTER**



IN THE ARENA, INC. (MASSACHUSETTS CORPORATION)
975 MEMORIAL DRIVE, #1105
CAMBRIDGE, MA 02138

FOR: CHARITABLE FUNDRAISING SERVICES RELATED TO ATHLETICS, YOUTH ENRICHMENT, AND CIVIC ENGAGEMENT, IN CLASS 36 (U.S. CLS. 100, 101 AND 102).

THE MARK CONSISTS OF THE HEAD AND ARMS OF A STYLIZED STICK FIGURE. THE ARMS ARE RAISED OVERHEAD, HOLDING UP A CIRCULAR OBJECT. BENEATH THE FIGURE ARE THE WORDS "IN THE ARENA".

SN 77-119,340, FILED 3-1-2007.

FIRST USE 3-13-2007; IN COMMERCE 3-13-2007.

JENNIFER MARTIN, EXAMINING ATTORNEY

Int. Cl.: 10

Prior U.S. Cls.: 26, 39, and 44

United States Patent and Trademark Office

Reg. No. 3,399,225

Registered Mar. 18, 2008

**TRADEMARK
PRINCIPAL REGISTER**

Prima Electra Bur

PRIMA DENTAL GROUP (UNITED KINGDOM
CORPORATION)
9 MADLEAZE ESTATE, BRISTOL ROAD
GLOUCESTER, UNITED KINGDOM GL15SG

FOR: DENTAL BURS, IN CLASS 10 (U.S. CLS. 26,
39 AND 44).

FIRST USE 3-1-2007; IN COMMERCE 3-1-2007.

THE MARK CONSISTS OF STANDARD CHAR-
ACTERS WITHOUT CLAIM TO ANY PARTICULAR
FONT, STYLE, SIZE, OR COLOR.

OWNER OF U.S. REG. NO. 2,856,337.

NO CLAIM IS MADE TO THE EXCLUSIVE
RIGHT TO USE "BUR", APART FROM THE MARK
AS SHOWN.

SN 77-119,627, FILED 3-1-2007.

SANDRA MANIOS, EXAMINING ATTORNEY

Int. Cl.: 10

Prior U.S. Cls.: 26, 39, and 44

United States Patent and Trademark Office

Reg. No. 3,399,226

Registered Mar. 18, 2008

**TRADEMARK
PRINCIPAL REGISTER**

Predator AccuPrep

PRIMA DENTAL GROUP (UNITED KINGDOM
CORPORATION)
9 MADLEAZE ESTATE, BRISTOL ROAD
GLOUCESTER, UNITED KINGDOM GL15SG

FOR: DENTAL BURS, IN CLASS 10 (U.S. CLS. 26,
39 AND 44).

FIRST USE 3-1-2007; IN COMMERCE 3-1-2007.

THE MARK CONSISTS OF STANDARD CHAR-
ACTERS WITHOUT CLAIM TO ANY PARTICULAR
FONT, STYLE, SIZE, OR COLOR.

OWNER OF U.S. REG. NO. 2,757,221.

SN 77-119,663, FILED 3-1-2007.

SANDRA MANIOS, EXAMINING ATTORNEY

Int. Cl.: 30

Prior U.S. Cl.: 46

United States Patent and Trademark Office

Reg. No. 3,399,227

Registered Mar. 18, 2008

**TRADEMARK
PRINCIPAL REGISTER**

MOMMA'S CABIN

MAXIMUM QUALITY FOODS INC. (NEW JERSEY CORPORATION)
3351 TREMLEY POINT ROAD, SUITE #2
LINDEN, NJ 07036

THE MARK CONSISTS OF STANDARD CHARACTERS WITHOUT CLAIM TO ANY PARTICULAR FONT, STYLE, SIZE, OR COLOR.

FOR: TABLE SYRUP, IN CLASS 30 (U.S. CL. 46).

SN 77-119,727, FILED 3-1-2007.

FIRST USE 9-11-2007; IN COMMERCE 9-11-2007.

DOMINIC FATHY, EXAMINING ATTORNEY

Int. Cl.: 1

Prior U.S. Cls.: 1, 5, 6, 10, 26, and 46

Reg. No. 3,399,228

United States Patent and Trademark Office

Registered Mar. 18, 2008

**TRADEMARK
PRINCIPAL REGISTER**

POTENZA

LOVELAND PRODUCTS, INC. (COLORADO
CORPORATION)
7251 W. 4TH STREET
GREELEY, CO 80634

FOR: PLANT GROWTH REGULATORS FOR
AGRICULTURAL USE, IN CLASS 1 (U.S. CLS. 1, 5,
6, 10, 26 AND 46).

FIRST USE 4-17-2007; IN COMMERCE 4-17-2007.

THE MARK CONSISTS OF STANDARD CHAR-
ACTERS WITHOUT CLAIM TO ANY PARTICULAR
FONT, STYLE, SIZE, OR COLOR.

THE FOREIGN WORDING IN THE MARK
TRANSLATES INTO ENGLISH AS POWER, POTEN-
CY, OR MIGHT.

SN 77-119,864, FILED 3-1-2007.

SANI KHOURI, EXAMINING ATTORNEY

Int. Cl.: 35

Prior U.S. Cls.: 100, 101, and 102

United States Patent and Trademark Office

Reg. No. 3,399,229

Registered Mar. 18, 2008

**SERVICE MARK
PRINCIPAL REGISTER**

HUSET

HALLBERG, HOLLY (UNITED STATES INDIVIDUAL)
3821 MALIBU VISTA DRIVE
MALIBU, CA 90265

FOR: RETAIL STORE SERVICES FEATURING SCANDINAVIAN HOUSEWARES AND ART, IN CLASS 35 (U.S. CLS. 100, 101 AND 102).

FIRST USE 4-17-2007; IN COMMERCE 11-6-2007.

THE MARK CONSISTS OF STANDARD CHARACTERS WITHOUT CLAIM TO ANY PARTICULAR FONT, STYLE, SIZE, OR COLOR.

THE ENGLISH TRANSLATION OF THE SWEDISH WORDING "HUSET" IS "HOUSE."

SN 77-120,628, FILED 3-2-2007.

DAVID I, EXAMINING ATTORNEY

Int. Cl.: 42

Prior U.S. Cls.: 100 and 101

United States Patent and Trademark Office

Reg. No. 3,399,230

Registered Mar. 18, 2008

**SERVICE MARK
PRINCIPAL REGISTER**

J. Craig Venter

I N S T I T U T E

J. CRAIG VENTER INSTITUTE, INC. (MARY-
LAND CORPORATION)
9704 MEDICAL CENTER DRIVE
ROCKVILLE, MD 20874

FOR: LABORATORY RESEARCH IN THE FIELD
OF GENOMICS, METAGENOMICS; MEDICAL RE-
SEARCH; PRODUCT RESEARCH AND DEVELOP-
MENT; PROVIDING INFORMATION IN THE
FIELD OF PLANT GENETICS RESEARCH RE-
SOURCES; SCIENTIFIC RESEARCH AND DEVEL-
OPMENT; SCIENTIFIC RESEARCH IN THE FIELD
OF GENETICS AND GENETIC ENGINEERING, IN
CLASS 42 (U.S. CLS. 100 AND 101).

FIRST USE 3-1-2007; IN COMMERCE 3-1-2007.

NO CLAIM IS MADE TO THE EXCLUSIVE
RIGHT TO USE "INSTITUTE", APART FROM THE
MARK AS SHOWN.

THE NAME(S), PORTRAIT(S), AND/OR SIGNA-
TURE(S) SHOWN IN THE MARK IDENTIFIES "J.
CRAIG VENTER", WHOSE CONSENT(S) TO REGIS-
TER IS SUBMITTED.

THE COLOR(S) ORANGE (PANTONE 716),
GREEN (PANTONE 369), BLUE (PANTONE 2995),
RED (PANTONE 1797) AND BLACK IS/ARE
CLAIMED AS A FEATURE OF THE MARK.

THE MARK CONSISTS OF THE LETTERS "J
CRAIG VENTER" (IN MIXED CASE) IN BLACK
MYRIAD PRO SEMIBOLD CONDENSED CEN-
TERED DIRECTLY (JUSTIFIED TO THE FULL
WIDTH OF THE COLOR BAND) ABOVE 4 SOLID
DASHED LINES IN ORANGE (PANTONE 716),
GREEN (PANTONE 369), BLUE (PANTONE 2995),
RED (PANTONE 1797) AND THE LETTERS "INSTI-
TUTE" (ALL CAPITALS) IN BLACK MYRIAD PRO
SEMIBOLD CENTERED (JUSTIFIED TO THE FULL
WIDTH OF THE COLOR BAND) DIRECTLY BELOW
THE 4 SOLID DASHED LINES. A PERIOD (PUN-
CTUATION MARK) IS PLACED AFTER THE "J" AND
BEFORE "CRAIG".

SN 77-121,209, FILED 3-2-2007.

GRETTA YAO, EXAMINING ATTORNEY

Int. Cl.: 16

Prior U.S. Cls.: 2, 5, 22, 23, 29, 37, 38, and 50

Reg. No. 3,399,231

United States Patent and Trademark Office

Registered Mar. 18, 2008

**TRADEMARK
PRINCIPAL REGISTER**

I'M GOING TO WRITE

STERLING PUBLISHING CO., INC. (DELAWARE
CORPORATION)
387 PARK AVENUE SOUTH
NEW YORK, NY 10016

OWNER OF U.S. REG. NO. 3,177,948.

FOR: CHILDREN'S BOOKS, CHILDREN'S IN-
STRUCTIONAL BOOKS AND WORKBOOKS, IN
CLASS 16 (U.S. CLS. 2, 5, 22, 23, 29, 37, 38 AND 50).

NO CLAIM IS MADE TO THE EXCLUSIVE
RIGHT TO USE "WRITE", APART FROM THE
MARK AS SHOWN.

FIRST USE 10-31-2007; IN COMMERCE 10-31-2007.

SN 77-122,371, FILED 3-5-2007.

THE MARK CONSISTS OF STANDARD CHAR-
ACTERS WITHOUT CLAIM TO ANY PARTICULAR
FONT, STYLE, SIZE, OR COLOR.

APRIL ROACH, EXAMINING ATTORNEY

Int. Cl.: 41

Prior U.S. Cls.: 100, 101, and 107

United States Patent and Trademark Office

Reg. No. 3,399,232

Registered Mar. 18, 2008

**SERVICE MARK
PRINCIPAL REGISTER**

NAVIGATING YOUR FUTURE

EMPLOYEE & FAMILY RESOURCES (IOWA CORPORATION)
505 5TH AVENUE
DES MOINES, IA 50309

FOR: LIFE COACHING, NAMELY, PERSONAL COACHING SERVICES IN THE FIELD OF PERSONAL, EMOTIONAL, BUSINESS, PSYCHOLOGICAL, AND SOCIAL DEVELOPMENT; PERSONAL COACHING SERVICES IN THE FIELD OF PERSONAL, EMOTIONAL, BUSINESS, PSYCHOLOGICAL, AND SOCIAL DEVELOPMENT, IN CLASS 41 (U.S. CLS. 100, 101 AND 107).

FIRST USE 6-1-2007; IN COMMERCE 6-1-2007.

THE MARK CONSISTS OF STANDARD CHARACTERS WITHOUT CLAIM TO ANY PARTICULAR FONT, STYLE, SIZE, OR COLOR.

SN 77-122,508, FILED 3-5-2007.

MARY ROSSMAN, EXAMINING ATTORNEY

Int. Cl.: 35

Prior U.S. Cls.: 100, 101, and 102

United States Patent and Trademark Office

Reg. No. 3,399,233

Registered Mar. 18, 2008

**SERVICE MARK
PRINCIPAL REGISTER**

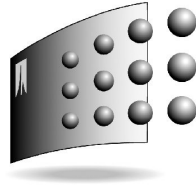

MANAGED *ab intra* **AUDIT**

COCHRAN, R. KEITH (UNITED STATES INDIVIDUAL)
P.O. BOX 141176
IRVING, TX 750141176

THE MARK CONSISTS, IN PART, OF A LOGO HAVING A DIMENSIONAL APPEARANCE WITH ROWS OF ESSENTIALLY SPHERICAL DESIGNS.

FOR: BUSINESS CONSULTATION SERVICES; BUSINESS INFORMATION AND ACCOUNTING ADVISORY SERVICES, IN CLASS 35 (U.S. CLS. 100, 101 AND 102).

SN 77-122,541, FILED 3-5-2007.

FIRST USE 10-16-2007; IN COMMERCE 10-16-2007.

DANNEAN HETZEL, EXAMINING ATTORNEY

Int. Cl.: 11

Prior U.S. Cls.: 13, 21, 23, 31, and 34

United States Patent and Trademark Office

Reg. No. 3,399,234

Registered Mar. 18, 2008

TRADEMARK
PRINCIPAL REGISTER



ROCHESTER, ALTON D. (UNITED STATES INDIVIDUAL)
6214 QUAIL RIDGE DR.
LAKELAND, FL 33813

FOR: WATER CONDITIONING UNITS; WATER SOFTENING UNITS; WATER TREATMENT EQUIPMENT, NAMELY, REVERSE OSMOSIS FILTRATION UNITS, IN CLASS 11 (U.S. CLS. 13, 21, 23, 31 AND 34).

FIRST USE 12-15-2007; IN COMMERCE 12-15-2007.

OWNER OF U.S. REG. NO. 2,453,044.

NO CLAIM IS MADE TO THE EXCLUSIVE RIGHT TO USE "AQUA SOFT", APART FROM THE MARK AS SHOWN.

THE COLOR(S) GREEN, NAVY BLUE AND TURQUOISE IS/ARE CLAIMED AS A FEATURE OF THE MARK.

THE COLOR GREEN APPEARS IN THE WORD "AQUA", THE COLOR NAVY BLUE APPEARS IN THE WORD "SOFT", THE COLOR TURQUOISE APPEARS IN ALL THREE RAIN DROPS.

SN 77-122,761, FILED 3-5-2007.

BILL DAWE, EXAMINING ATTORNEY

Int. Cl.: 6

Prior U.S. Cls.: 2, 12, 13, 14, 23, 25, and 50

United States Patent and Trademark Office

Reg. No. 3,399,235

Registered Mar. 18, 2008

**TRADEMARK
PRINCIPAL REGISTER**

CYBERAL

MAXAL INTERNATIONAL, INC. (MICHIGAN
CORPORATION)
1631 INTERNATIONAL DRIVE
TRAVERSE CITY, MI 49686

THE MARK CONSISTS OF STANDARD CHAR-
ACTERS WITHOUT CLAIM TO ANY PARTICULAR
FONT, STYLE, SIZE, OR COLOR.

FOR: ALUMINUM WELDING WIRE, IN CLASS 6
(U.S. CLS. 2, 12, 13, 14, 23, 25 AND 50).

SN 77-123,432, FILED 3-6-2007.

FIRST USE 12-3-2007; IN COMMERCE 12-3-2007.

CHERYL CLAYTON, EXAMINING ATTORNEY

Int. Cl.: 15

Prior U.S. Cls.: 2, 21, and 36

United States Patent and Trademark Office

Reg. No. 3,399,236

Registered Mar. 18, 2008

**TRADEMARK
PRINCIPAL REGISTER**

Crosscut Custom Guitars

CAGAN, LEIGH DAVID (UNITED STATES IN-
DIVIDUAL)

470 NAVARO WAY UNIT#117

SAN JOSE, CA 95134

FOR: GUITARS, IN CLASS 15 (U.S. CLS. 2, 21 AND
36).

FIRST USE 4-12-2007; IN COMMERCE 7-6-2007.

THE MARK CONSISTS OF STANDARD CHAR-
ACTERS WITHOUT CLAIM TO ANY PARTICULAR
FONT, STYLE, SIZE, OR COLOR.

NO CLAIM IS MADE TO THE EXCLUSIVE
RIGHT TO USE "CUSTOM GUITARS", APART
FROM THE MARK AS SHOWN.

SN 77-123,639, FILED 3-6-2007.

TASNEEM HUSSAIN, EXAMINING ATTORNEY

Int. Cl.: 12

Prior U.S. Cls.: 19, 21, 23, 31, 35, and 44

United States Patent and Trademark Office

Reg. No. 3,399,237

Registered Mar. 18, 2008

**TRADEMARK
PRINCIPAL REGISTER**

BRAUNABILITY

THE BRAUN CORPORATION (INDIANA CORPORATION)
631 W. 11TH ST.
WINAMAC, IN 46996

FOR: MOBILITY PRODUCTS AND RELATED ACCESSORIES FOR THE HANDICAPPED, NAMELY, WHEELCHAIR LIFTS FOR VEHICLES, INCLUDING TRUCKS, VANS, MINIVANS, MOTOR HOMES, BUSES, AND PUBLIC TRANSPORTATION AND STRUCTURAL PARTS THEREFOR; SEAT BASES, POWER SEATS, COMPANION SEATS; DOOR OPERATORS, ELECTRONIC CONTROLLERS FOR WHEELCHAIR LIFTS AND RAMPS, MAGNETIC SWITCHING APPARATUS FOR LOWERED FLOOR MINIVANS; VEHICLE TOP-MOUNTED WHEELCHAIR CARRIERS; HAND CONTROLS FOR THE OPERATION OF WHEELCHAIR LIFTS AND RAMPS; POWER TRANSFER SEATS FOR VEHICLES TO PROVIDE EASIER INGRESS TO AND EGRESS FROM A VEHICLE FOR DISABLED OR MOBILITY IMPAIRED PEOPLE;

LAND VEHICLES, NAMELY, AUTOMOBILES, MOTOR HOMES, VANS, MINIVANS AND BUSES FEATURING LOWERED FLOORS AND LEVEL-CHANGE DEVICES TO FACILITATE INGRESS AND EGRESS FOR PASSENGERS IN WHEELCHAIRS, AND STRUCTURAL PARTS AND FITTINGS FOR THE AFORESAID; LIFTING INSTALLATIONS, NAMELY, LIFTING APPARATUS FOR VEHICLES FOR STORING WHEELCHAIRS IN ROOF-TOP CARRIERS, IN CLASS 12 (U.S. CLS. 19, 21, 23, 31, 35 AND 44).

FIRST USE 10-1-2007; IN COMMERCE 10-1-2007.

THE MARK CONSISTS OF STANDARD CHARACTERS WITHOUT CLAIM TO ANY PARTICULAR FONT, STYLE, SIZE, OR COLOR.

SN 77-123,796, FILED 3-6-2007.

PAUL MORENO, EXAMINING ATTORNEY

Int. Cl.: 36

Prior U.S. Cls.: 100, 101, and 102

United States Patent and Trademark Office

Reg. No. 3,399,238

Registered Mar. 18, 2008

**SERVICE MARK
PRINCIPAL REGISTER**

GOLFSTYLE

SRQ PROPERTY GROUP, LLC (FLORIDA LTD
LIAB CO)
3302 FOUNDERS CLUB DRIVE
SARASOTA, FL 34240

FOR: REAL ESTATE LISTING SERVICES FOR
RESIDENTIAL PROPERTIES, IN CLASS 36 (U.S.
CLS. 100, 101 AND 102).

FIRST USE 8-1-2007; IN COMMERCE 8-1-2007.

THE MARK CONSISTS OF STANDARD CHAR-
ACTERS WITHOUT CLAIM TO ANY PARTICULAR
FONT, STYLE, SIZE, OR COLOR.

SN 77-125,841, FILED 3-8-2007.

NORA BUCHANAN WILL, EXAMINING ATTOR-
NEY

Int. Cl.: 25

Prior U.S. Cls.: 22 and 39

United States Patent and Trademark Office

Reg. No. 3,399,239

Registered Mar. 18, 2008

**TRADEMARK
PRINCIPAL REGISTER**

FRATELLI ORSINI

ADELARD AND EDWARDS, INC (CALIFORNIA CORPORATION)
7TH FL.
219 NORTH MILWAUKEE ST.
MILWAUKEE, WI 53202

FOR: GLOVES INCLUDING THOSE MADE OF SKIN, HIDE OR FUR, IN CLASS 25 (U.S. CLS. 22 AND 39).

FIRST USE 9-1-2007; IN COMMERCE 9-1-2007.

THE MARK CONSISTS OF STANDARD CHARACTERS WITHOUT CLAIM TO ANY PARTICULAR FONT, STYLE, SIZE, OR COLOR.

THE ENGLISH TRANSLATION OF THE ITALIAN WORDING "FRATELLI" IS BROTHERS.

SN 77-126,866, FILED 3-9-2007.

JUDITH HELFMAN, EXAMINING ATTORNEY

Int. Cl.: 37

Prior U.S. Cls.: 100, 103, and 106

United States Patent and Trademark Office

Reg. No. 3,399,240

Registered Mar. 18, 2008

**SERVICE MARK
PRINCIPAL REGISTER**

RodentGuard

ANIMALS B' GONE, INC. (GEORGIA CORPORATION)
73 MC ELHANNON RD. SW
BETHLEHEM, GA 30620

FOR: INSTALLATION OF PHYSICAL STRUCTURAL BARRIERS TO KEEP RODENTS OUT OF HOMES, IN CLASS 37 (U.S. CLS. 100, 103 AND 106).

FIRST USE 11-11-2007; IN COMMERCE 11-11-2007.

THE MARK CONSISTS OF STANDARD CHARACTERS WITHOUT CLAIM TO ANY PARTICULAR FONT, STYLE, SIZE, OR COLOR.

SN 77-128,297, FILED 3-12-2007.

REBECCA POVARCHUK, EXAMINING ATTORNEY

Int. Cl.: 9

Prior U.S. Cls.: 21, 23, 26, 36, and 38

United States Patent and Trademark Office

Reg. No. 3,399,241

Registered Mar. 18, 2008

**TRADEMARK
PRINCIPAL REGISTER**

CHERRY BOMB

PEAVEY ELECTRONICS CORPORATION (DELA-
WARE CORPORATION)
ATTN: LEGAL DEPT.
5022 HARTLEY PEAVEY DRIVE
MERIDIAN, MS 39305

THE MARK CONSISTS OF STANDARD CHAR-
ACTERS WITHOUT CLAIM TO ANY PARTICULAR
FONT, STYLE, SIZE, OR COLOR.

FOR: MICROPHONES, IN CLASS 9 (U.S. CLS. 21,
23, 26, 36 AND 38).

SN 77-128,693, FILED 3-12-2007.

FIRST USE 1-18-2007; IN COMMERCE 1-18-2007.

AMEETA JORDAN, EXAMINING ATTORNEY

Int. Cl.: 5

Prior U.S. Cls.: 6, 18, 44, 46, 51, and 52

Reg. No. 3,399,242

United States Patent and Trademark Office

Registered Mar. 18, 2008

**TRADEMARK
PRINCIPAL REGISTER**

ARTRIKROL

DISTRIBUIDORA DE ALIMENTOS NATURALES
Y NUTRICIONALES, S.A. DE C.V. (MEXICO
SOCIEDAD ANONIMA)
MANUEL AVILA CAMACHO # 44-A
MEXICO, MEXICO 09570

THE MARK CONSISTS OF STANDARD CHAR-
ACTERS WITHOUT CLAIM TO ANY PARTICULAR
FONT, STYLE, SIZE, OR COLOR.

FOR: OINTMENTS FOR MUSCULAR ILLNESS
FOR HUMAN, IN CLASS 5 (U.S. CLS. 6, 18, 44, 46, 51
AND 52).

SN 77-128,934, FILED 3-12-2007.

FIRST USE 1-2-2008; IN COMMERCE 1-2-2008.

CHRISTINA SOBRAL, EXAMINING ATTORNEY

Int. Cl.: 5

Prior U.S. Cls.: 6, 18, 44, 46, 51, and 52

United States Patent and Trademark Office

Reg. No. 3,399,243

Registered Mar. 18, 2008

**TRADEMARK
PRINCIPAL REGISTER**

SALIDOL-NF

DISTRIBUIDORA DE ALIMENTOS NATURALES
Y NUTRICIONALES, S.A. DE C.V. (MEXICO
SOCIEDAD ANONIMA)

44-A

MANUEL AVILA CAMACHO
MEXICO, MEXICO 09570

FOR: OINTMENTS FOR MUSCULAR ILLNESS
FOR HUMAN, IN CLASS 5 (U.S. CLS. 6, 18, 44, 46, 51
AND 52).

FIRST USE 1-2-2008; IN COMMERCE 1-2-2008.

THE MARK CONSISTS OF STANDARD CHAR-
ACTERS WITHOUT CLAIM TO ANY PARTICULAR
FONT, STYLE, SIZE, OR COLOR.

SN 77-128,948, FILED 3-12-2007.

CHRISTINA SOBRAL, EXAMINING ATTORNEY

Int. Cl.: 25

Prior U.S. Cls.: 22 and 39

United States Patent and Trademark Office

Reg. No. 3,399,244

Registered Mar. 18, 2008

TRADEMARK
PRINCIPAL REGISTER

The image shows the word "Graey" written in a highly stylized, cursive script. The letters are interconnected with loops and flourishes, particularly around the 'G' and 'y'. The font is elegant and handwritten in appearance.

KIM, JANET L. (UNITED STATES INDIVIDUAL)
16 ARDEN DRIVE
HARTSDALE, NY 10530

FOR: T-SHIRTS; TOPS; BOTTOMS; PANTS;
SHORTS; SKIRTS; SKIRTS AND DRESSES; DRESSES;
SHIRTS; COATS; JACKETS; LEG WARMERS;
LEG-WARMERS; LEGGINGS; HATS; SWEATERS;
SWEAT SHIRTS; MITTENS; GLOVES; SCARVES;
SWIMSUITS; UNDERWEAR; SOCKS AND STOCK-

INGS; CORSETS; JEANS, IN CLASS 25 (U.S. CLS. 22
AND 39).

FIRST USE 6-26-2007; IN COMMERCE 6-26-2007.

THE MARK CONSISTS OF THE NAME "GRAEY"
IN A STYLIZED FONT.

SN 77-129,087, FILED 3-13-2007.

RONALD MCMORROW, EXAMINING ATTORNEY

Int. Cl.: 3

Prior U.S. Cls.: 1, 4, 6, 50, 51, and 52

United States Patent and Trademark Office

Reg. No. 3,399,245

Registered Mar. 18, 2008

**TRADEMARK
PRINCIPAL REGISTER**



ADVANCE MERCHANDISING COMPANY, INC.
(VIRGINIA CORPORATION)
5673 AIRPORT ROAD
ROANOKE, VA 24012

FOR: DISPOSABLE WIPES IMPREGNATED WITH CHEMICALS OR COMPOUNDS FOR CLEANING AND CONDITIONING LEATHER; DISPOSABLE WIPES IMPREGNATED WITH CHEMICALS OR COMPOUNDS FOR CLEANING GLASS SURFACES, IN CLASS 3 (U.S. CLS. 1, 4, 6, 50, 51 AND 52).

FIRST USE 2-28-2004; IN COMMERCE 7-30-2007.

OWNER OF U.S. REG. NOS. 1,484,796, 1,847,137, AND OTHERS.

NO CLAIM IS MADE TO THE EXCLUSIVE RIGHT TO USE "AUTO PARTS", APART FROM THE MARK AS SHOWN.

THE MARK CONSISTS OF STYLIZED WORDS "ADVANCE AUTO PARTS" IN STACKED FORMAT, FOLLOWED BY A FLAGPOLE AND A CHECKERED FLAG.

SN 77-129,768, FILED 3-13-2007.

BRIAN CALLAGHAN, EXAMINING ATTORNEY

Int. Cl.: 9

Prior U.S. Cls.: 21, 23, 26, 36, and 38

Reg. No. 3,399,246

United States Patent and Trademark Office

Registered Mar. 18, 2008

**TRADEMARK
PRINCIPAL REGISTER**

NIFOMETER

MERCURY ENTERPRISES, INC. (FLORIDA
CORPORATION)
11300 49TH STREET NORTH
CLEARWATER, FL 33762

THE MARK CONSISTS OF STANDARD CHAR-
ACTERS WITHOUT CLAIM TO ANY PARTICULAR
FONT, STYLE, SIZE, OR COLOR.

FOR: NEGATIVE INSPIRATORY FORCE DISPO-
SABLE MANOMETER, IN CLASS 9 (U.S. CLS. 21, 23,
26, 36 AND 38).

SN 77-130,406, FILED 3-14-2007.

FIRST USE 11-16-2007; IN COMMERCE 11-16-2007.

TIMOTHY FINNEGAN, EXAMINING ATTORNEY

Int. Cl.: 25

Prior U.S. Cls.: 22 and 39

United States Patent and Trademark Office

Reg. No. 3,399,247

Registered Mar. 18, 2008

**TRADEMARK
PRINCIPAL REGISTER**



WRANGLER APPAREL CORP. (DELAWARE CORPORATION)
3411 SILVERSIDE ROAD
WILMINGTON, DE 19810

THE MARK CONSISTS OF THREE ANGLES THAT SUGGEST MOUNTAINS OR PEAKS FOLLOWED BY THE WORDS "TERRAIN BY WRANGLER".

FOR: TOPS AND BOTTOMS, IN CLASS 25 (U.S. CLS. 22 AND 39).

SN 77-130,873, FILED 3-14-2007.

FIRST USE 10-16-2007; IN COMMERCE 10-16-2007.

SCOTT SISUN, EXAMINING ATTORNEY

Int. Cl.: 41

Prior U.S. Cls.: 100, 101, and 107

United States Patent and Trademark Office

Reg. No. 3,399,248

Registered Mar. 18, 2008

**SERVICE MARK
PRINCIPAL REGISTER**

We Tigers

KIRSCH, MICHAEL I. (UNITED STATES INDIVIDUAL)
49 KATHLEEN DR.
SYOSSET, NY 11791

THE MARK CONSISTS OF STANDARD CHARACTERS WITHOUT CLAIM TO ANY PARTICULAR FONT, STYLE, SIZE, OR COLOR.

FOR: ENTERTAINMENT SERVICES, NAMELY, LIVE MUSICAL BAND PERFORMANCES, IN CLASS 41 (U.S. CLS. 100, 101 AND 107).

SN 77-131,185, FILED 3-14-2007.

FIRST USE 12-19-2007; IN COMMERCE 12-19-2007.

JAY BESCH, EXAMINING ATTORNEY

Int. Cl.: 35

Prior U.S. Cls.: 100, 101, and 102

United States Patent and Trademark Office

Reg. No. 3,399,249

Registered Mar. 18, 2008

**SERVICE MARK
PRINCIPAL REGISTER**

**Universal Creativity
Unlimited, Inc.**

UNIVERSAL CREATIVITY UNLIMITED, INC.
(CALIFORNIA CORPORATION)
12309 CANTURA STREET
STUDIO CITY, CA 91604

FOR: ADVERTISING AND BUSINESS MANAGEMENT CONSULTANCY; ADVERTISING AND BUSINESS SERVICES, NAMELY, SECURING AIRTIME ON ALL FORMS OF MEDIA COMMUNICATIONS STATIONS, SYSTEMS, NETWORKS, AND SERVICES FOR THE PURPOSE OF PROMOTING THE GOODS AND SERVICES OF OTHERS; ADVERTISING AND PROMOTION SERVICES AND RELATED CONSULTING; ADVERTISING CONSULTATION; ADVICE IN THE FIELD OF BUSINESS MANAGEMENT AND MARKETING; ADVICE RELATING TO THE ORGANISATION AND MANAGEMENT OF BUSINESS; ADVISORY SERVICE FOR ORGANIZATIONAL ISSUES AND BUSINESS ADMINISTRATION, WITH AND WITHOUT THE HELP OF ELECTRONIC DATA BASES; ASSISTANCE IN MANAGEMENT OF BUSINESS ACTIVITIES; ASSISTANCE WITH BUSINESS MANAGEMENT AND PLANNING; BUSINESS ACQUISITIONS CONSULTATION; BUSINESS ADMINISTRATION AND MANAGEMENT; BUSINESS ADMINISTRATION AND OFFICE WORK; BUSINESS ADMINISTRATION

CONSULTANCY; BUSINESS ADVICE AND INFORMATION; BUSINESS ADVICE, INQUIRIES OR INFORMATION; BUSINESS ADVISORY SERVICES, CONSULTANCY AND INFORMATION; BUSINESS MANAGEMENT AND ADVICE; BUSINESS MANAGEMENT AND CONSULTATION; BUSINESS MANAGEMENT CONSULTANCY SERVICES; BUSINESS ORGANIZATION AND OPERATION CONSULTANCY; BUSINESS ORGANIZATIONAL CONSULTATION; BUSINESS PLANNING, IN CLASS 35 (U.S. CLS. 100, 101 AND 102).

FIRST USE 12-28-2006; IN COMMERCE 1-25-2007.

THE MARK CONSISTS OF STANDARD CHARACTERS WITHOUT CLAIM TO ANY PARTICULAR FONT, STYLE, SIZE, OR COLOR.

NO CLAIM IS MADE TO THE EXCLUSIVE RIGHT TO USE "INC.", APART FROM THE MARK AS SHOWN.

SN 77-131,380, FILED 3-14-2007.

BRIAN NEVILLE, EXAMINING ATTORNEY

Int. Cl.: 20

Prior U.S. Cls.: 2, 13, 22, 25, 32, and 50

Reg. No. 3,399,250

United States Patent and Trademark Office

Registered Mar. 18, 2008

**TRADEMARK
PRINCIPAL REGISTER**

SYNERGREEN

MICHIGAN TUBE SWAGERS & FABRICATORS,
INC. (MICHIGAN CORPORATION)
7100 INDUSTRIAL DRIVE
TEMPERANCE, MI 48182

THE MARK CONSISTS OF STANDARD CHAR-
ACTERS WITHOUT CLAIM TO ANY PARTICULAR
FONT, STYLE, SIZE, OR COLOR.

FOR: FURNITURE, IN CLASS 20 (U.S. CLS. 2, 13,
22, 25, 32 AND 50).

SN 77-131,894, FILED 3-15-2007.

FIRST USE 10-22-2007; IN COMMERCE 10-22-2007.

THEODORE MCBRIDE, EXAMINING ATTORNEY

Int. Cl.: 30

Prior U.S. Cl.: 46

United States Patent and Trademark Office

Reg. No. 3,399,251

Registered Mar. 18, 2008

**TRADEMARK
PRINCIPAL REGISTER**

BIKINI PANINI

GRILL VENTURES, INC. (GEORGIA CORPORATION)
132 MONTAG CIRCLE NE
ATLANTA, GA 30307

FOR: SPECIALTY SANDWICHES, IN CLASS 30
(U.S. CL. 46).

FIRST USE 7-9-2007; IN COMMERCE 7-9-2007.

THE MARK CONSISTS OF STANDARD CHARACTERS WITHOUT CLAIM TO ANY PARTICULAR FONT, STYLE, SIZE, OR COLOR.

SN 77-132,644, FILED 3-16-2007.

LEIGH CAROLINE CASE, EXAMINING ATTORNEY

Int. Cl.: 30

Prior U.S. Cl.: 46

United States Patent and Trademark Office

Reg. No. 3,399,252

Registered Mar. 18, 2008

**TRADEMARK
PRINCIPAL REGISTER**

TEENI PANINI

GRILL VENTURES, INC. (GEORGIA CORPORATION)
132 MONTAG CIRCLE NE
ATLANTA, GA 30307

FOR: SPECIALTY SANDWICHES, IN CLASS 30
(U.S. CL. 46).

FIRST USE 7-9-2007; IN COMMERCE 7-9-2007.

THE MARK CONSISTS OF STANDARD CHARACTERS WITHOUT CLAIM TO ANY PARTICULAR FONT, STYLE, SIZE, OR COLOR.

SN 77-132,645, FILED 3-16-2007.

LEIGH CAROLINE CASE, EXAMINING ATTORNEY

Int. Cl.: 35

Prior U.S. Cls.: 100, 101, and 102

United States Patent and Trademark Office

Reg. No. 3,399,253

Registered Mar. 18, 2008

**SERVICE MARK
PRINCIPAL REGISTER**

StudyGlobal

STUDYGLOBAL M&A SL (SPAIN LTD LIAB CO)
PL. FRANCESC MACIA 7, 7-C
BARCELONA, SPAIN

THE MARK CONSISTS OF STANDARD CHAR-
ACTERS WITHOUT CLAIM TO ANY PARTICULAR
FONT, STYLE, SIZE, OR COLOR.

FOR: ADMINISTERING STUDY ABROAD PRO-
GRAMS FOR COLLEGE STUDENTS, IN CLASS 35
(U.S. CLS. 100, 101 AND 102).

SN 77-133,702, FILED 3-17-2007.

FIRST USE 10-30-2000; IN COMMERCE 3-15-2002.

MICHAEL LITZAU, EXAMINING ATTORNEY

Int. Cl.: 5

Prior U.S. Cls.: 6, 18, 44, 46, 51, and 52

United States Patent and Trademark Office

Reg. No. 3,399,254

Registered Mar. 18, 2008

**TRADEMARK
PRINCIPAL REGISTER**

Relaxity

JACK ORETSKY HOLDINGS, LLC (FLORIDA
LTD LIAB CO)
603 VILLAGE BLVD.
SUITE 103
WEST PALM BEACH, FL 33409

FOR: DIETARY SUPPLEMENTS FOR HUMAN
CONSUMPTION; FOOD SUPPLEMENTS; HERBAL
SUPPLEMENTS; HOMEOPATHIC SUPPLEMENTS;
NUTRACEUTICALS FOR USE AS A DIETARY
SUPPLEMENT; VITAMIN AND MINERAL SUPPLE-
MENTS; VITAMIN SUPPLEMENT IN TABLET
FORM FOR USE IN MAKING AN EFFERVESCENT

BEVERAGE WHEN ADDED TO WATER, IN CLASS
5 (U.S. CLS. 6, 18, 44, 46, 51 AND 52).

FIRST USE 10-1-2007; IN COMMERCE 10-1-2007.

THE MARK CONSISTS OF STANDARD CHAR-
ACTERS WITHOUT CLAIM TO ANY PARTICULAR
FONT, STYLE, SIZE, OR COLOR.

SN 77-133,901, FILED 3-18-2007.

LINDSEY RUBIN, EXAMINING ATTORNEY

Int. Cl.: 41

Prior U.S. Cls.: 100, 101, and 107

United States Patent and Trademark Office

Reg. No. 3,399,255

Registered Mar. 18, 2008

**SERVICE MARK
PRINCIPAL REGISTER**

IDRIVEINMOVIE

LAMPESE, RICHARD (UNITED STATES INDIVIDUAL)
186 LOWER SHEEP PASTURE ROAD
SETAUKET, NY 11733 AND
CARPENTER, FRED (UNITED STATES INDIVIDUAL)
186 LOWER SHEEP PASTURE ROAD
SETAUKET, NY 11733

FOR: ENTERTAINMENT SERVICES NAMELY,
PROVIDING A WEBSITE FEATURING, PHOTOGRAPHIC,
AUDIO, VIDEO AND PROSE PRESENTATIONS
FEATURING FULL LENGTH AND SHORT FEATURE
FILMS, MOVIES, AND MOVIE

TRAILERS, IN CLASS 41 (U.S. CLS. 100, 101 AND 107).

FIRST USE 3-23-2007; IN COMMERCE 3-23-2007.

THE MARK CONSISTS OF STANDARD CHARACTERS
WITHOUT CLAIM TO ANY PARTICULAR FONT,
STYLE, SIZE, OR COLOR.

SN 77-134,846, FILED 3-19-2007.

ROBERT STRUCK, EXAMINING ATTORNEY

Int. Cl.: 43

Prior U.S. Cls.: 100 and 101

United States Patent and Trademark Office

Reg. No. 3,399,256

Registered Mar. 18, 2008

**SERVICE MARK
PRINCIPAL REGISTER**



CAL SOL CONCEPTS LLC (CALIFORNIA LTD
LIAB CO)
3751 GEARY BLVD.
SAN FRANCISCO, CA 94118

NO CLAIM IS MADE TO THE EXCLUSIVE
RIGHT TO USE "ROADSIDE BBQ" , APART FROM
THE MARK AS SHOWN.

FOR: RESTAURANT SERVICES, IN CLASS 43
(U.S. CLS. 100 AND 101).

SN 77-135,332, FILED 3-20-2007.

FIRST USE 10-1-2006; IN COMMERCE 10-1-2006.

ELLEN B. AWRICH, EXAMINING ATTORNEY

Int. Cls.: 35 and 42

Prior U.S. Cls.: 100, 101, and 102

United States Patent and Trademark Office

Reg. No. 3,399,257

Registered Mar. 18, 2008

**SERVICE MARK
PRINCIPAL REGISTER**

OurShore

MAYER, CRAIG R. (UNITED STATES INDIVIDUAL)
632 TWELVE OAKS LANE
AUSTIN, TX 78704

FOR: ADVISORY AND CONSULTANCY SERVICES RELATING TO EXPORT, EXPORT SERVICES, EXPORT PROMOTION INFORMATION AND SERVICES; ASSISTANCE, ADVISORY SERVICES AND CONSULTANCY WITH REGARD TO BUSINESS PLANNING, BUSINESS ANALYSIS, BUSINESS MANAGEMENT, AND BUSINESS ORGANIZATION; BUSINESS ADVISORY SERVICES, CONSULTANCY AND INFORMATION; BUSINESS CONSULTATION; BUSINESS CONSULTATION AND MANAGEMENT REGARDING MARKETING ACTIVITIES AND LAUNCHING OF NEW PRODUCTS; BUSINESS CONSULTATION SERVICES; BUSINESS CONSULTING AND BUSINESS INFORMATION FOR ENTERPRISES; BUSINESS CONSULTING AND INFORMATION SERVICES; BUSINESS CONSULTING SERVICES RELATING TO PRODUCT DISTRIBUTION, OPERATIONS MANAGEMENT SERVICES, LOGISTICS, REVERSE LOGISTICS, SUPPLY CHAIN, AND PRODUCTION SYSTEMS AND DISTRIBUTION SOLUTIONS; BUSINESS CONSULTING, MANAGEMENT, PLANNING AND SUPERVISION; BUSINESS MANAGEMENT AND CONSULTATION; BUSINESS MANAGEMENT CONSULTANCY AND ADVISORY SERVICES; BUSINESS MANAGEMENT CONSULTANCY AS WELL AS DEVELOPMENT OF PROCESSES FOR THE ANALYSIS AND THE IMPLEMENTATION OF STRATEGY PLANS AND MANAGEMENT PROJECTS; BUSINESS MANAGEMENT CONSULTANCY SERVICES; BUSINESS MANAGEMENT CONSULTATION; BUSINESS MANAGEMENT CONSULTING AND ADVISORY SERVICES; BUSINESS MANAGEMENT CONSULTING WITH RELATION TO STRATEGY, MARKETING, PRODUCTION, PERSONNEL AND RETAIL SALE MATTERS; BUSINESS ORGANISATION AND MAN-

AGEMENT CONSULTING SERVICES; BUSINESS ORGANIZATION AND OPERATION CONSULTANCY; CONSULTING SERVICES IN BUSINESS ORGANIZATION AND MANAGEMENT; CONSULTING SERVICES IN THE AREA OF SUSTAINABLE BUSINESS SOLUTIONS; ECONOMIC CONSULTING AND INFORMATION FOR THE INDUSTRIAL AND COMMERCIAL SECTORS FOR PLANNING, ORGANIZING, MONITORING AND CARRYING OUT UNIQUE AND COMPLEX PROJECTS IN DIFFERENT SECTORS OF ONE OR SEVERAL COMPANIES; INFORMATION, ADVISORY AND CONSULTANCY SERVICES RELATING TO BUSINESS AND MANAGEMENT OR BUSINESS ADMINISTRATION, INCLUDING SUCH SERVICES PROVIDED ON LINE OR VIA THE INTERNET; MANAGEMENT AND BUSINESS CONSULTING SERVICES IN THE FIELD OF SOFTWARE DEVELOPMENT; PROFESSIONAL BUSINESS CONSULTATION; PROVIDING BUSINESS MANAGEMENT INFORMATION IN CONNECTION WITH CONSULTING AND ADVISORY SERVICES IN THE FIELD OF STRATEGIC PLANNING, IN CLASS 35 (U.S. CLS. 100, 101 AND 102).

FIRST USE 5-12-2007; IN COMMERCE 5-12-2007.

FOR: COMPUTER SOFTWARE CONSULTANCY; COMPUTER SOFTWARE CONSULTATION; CONSULTANCY IN THE FIELD OF SOFTWARE DESIGN; CONSULTING SERVICES IN THE FIELD OF OFFICE AND WORKPLACE AUTOMATION; INFORMATION TECHNOLOGY CONSULTATION; MANAGEMENT AND CONSULTATION IN THE FIELD OF HUMAN FACTORS ENGINEERING, IN CLASS 42 (U.S. CLS. 100 AND 101).

FIRST USE 5-12-2007; IN COMMERCE 5-12-2007.

THE MARK CONSISTS OF STANDARD CHARACTERS WITHOUT CLAIM TO ANY PARTICULAR FONT, STYLE, SIZE, OR COLOR.

SN 77-136,097, FILED 3-20-2007.

ELIZABETH KAJUBI, EXAMINING ATTORNEY

Int. Cl.: 41

Prior U.S. Cls.: 100, 101, and 107

United States Patent and Trademark Office

Reg. No. 3,399,258

Registered Mar. 18, 2008

**SERVICE MARK
PRINCIPAL REGISTER**

SLART

MINSKY, RICHARD P. (UNITED STATES INDIVIDUAL)
413 COUNTY ROUTE 22
HUDSON, NY 12534

FOR: MULTIMEDIA PUBLISHING OF BOOKS, MAGAZINES, JOURNALS, SOFTWARE, GAMES, MUSIC, AND ELECTRONIC PUBLICATIONS; ON-LINE PUBLICATION OF ART; PUBLICATION OF ELECTRONIC MAGAZINES; PUBLICATION OF ELECTRONIC NEWSPAPERS ACCESSIBLE VIA A GLOBAL COMPUTER NETWORK; PUBLICATION OF THE EDITORIAL CONTENT OF SITES ACCESSIBLE VIA A GLOBAL COMPUTER NETWORK; PUBLISHING OF ELECTRONIC PUBLICATIONS; ART EXHIBITIONS; CONDUCTING WORKSHOPS AND SEMINARS IN ART; INSTRUCTION IN THE FIELD OF ART; WORKSHOPS AND SEMINARS IN THE FIELD OF ART; PUBLICATION AND EDITING OF PRINTED MATTER; PUBLICATION OF BOOKS; PUBLICATION OF BOOKS, MAGAZINES, ALMANACS AND JOURNALS; PUBLICATION OF BOOKS, OF MAGAZINES, OF JOURNALS, OF NEWSPAPERS, OF PERIODICALS, OF CATALOGS, OF BROCHURES; PUBLICATION OF BOOKS, REVIEWS; PUBLICATION OF BROCHURES; PUBLICATION OF DOCUMENTS IN THE FIELD OF TRAINING, SCIENCE, PUBLIC LAW AND SOCIAL AFFAIRS; PUBLICATION OF JOURNALS; PUBLICATION OF

LEAFLETS; PUBLICATION OF MAGAZINES; PUBLICATION OF MANUALS; PUBLICATION OF MUSICAL TEXTS; PUBLICATION OF PRINTED MATTER; PUBLICATION OF TEXT BOOKS; PUBLICATION OF TEXTS, BOOKS, JOURNALS; PUBLICATION OF TEXTS, BOOKS, MAGAZINES AND OTHER PRINTED MATTER; EDUCATION IN THE FIELD OF ART RENDERED THROUGH CORRESPONDENCE COURSES; EDUCATION IN THE FIELD OF ART RENDERED THROUGH VIDEO CONFERENCE; EDUCATIONAL SERVICES IN THE NATURE OF ART SCHOOLS; ORGANIZING COMMUNITY FESTIVALS FEATURING A VARIETY OF ACTIVITIES, NAMELY, SPORTING EVENTS, ART EXHIBITIONS, FLEA MARKETS, ETHNIC DANCES AND THE LIKE, IN CLASS 41 (U.S. CLS. 100, 101 AND 107).

FIRST USE 12-9-2006; IN COMMERCE 12-14-2006.

THE MARK CONSISTS OF STANDARD CHARACTERS WITHOUT CLAIM TO ANY PARTICULAR FONT, STYLE, SIZE, OR COLOR.

SN 77-137,283, FILED 3-22-2007.

KATHLEEN LORENZO, EXAMINING ATTORNEY

Int. Cl.: 41

Prior U.S. Cls.: 100, 101, and 107

United States Patent and Trademark Office

Reg. No. 3,399,259

Registered Mar. 18, 2008

**SERVICE MARK
PRINCIPAL REGISTER**

BALANCETRACK

BALANCE (CALIFORNIA CORPORATION)
16TH FLOOR
595 MARKET STREET
SAN FRANCISCO, CA 94105

FOR: EDUCATIONAL SERVICES, NAMELY,
CONDUCTING SEMINARS AND WORKSHOPS IN
THE FIELD OF FINANCIAL LITERACY AND PER-
SONAL FINANCIAL MANAGEMENT AND DISTRI-
BUTION OF COURSE MATERIAL IN
CONNECTION THEREWITH, IN CLASS 41 (U.S.
CLS. 100, 101 AND 107).

FIRST USE 11-8-2007; IN COMMERCE 11-8-2007.

THE MARK CONSISTS OF STANDARD CHAR-
ACTERS WITHOUT CLAIM TO ANY PARTICULAR
FONT, STYLE, SIZE, OR COLOR.

SN 77-137,851, FILED 3-22-2007.

SANDRA MANIOS, EXAMINING ATTORNEY

Int. Cl.: 15

Prior U.S. Cls.: 2, 21, and 36

United States Patent and Trademark Office

Reg. No. 3,399,260

Registered Mar. 18, 2008

**TRADEMARK
PRINCIPAL REGISTER**

The logo consists of the letters 'M', 'P', and 'G' written in a thick, black, cursive script. The 'M' and 'P' are connected at the top, and the 'G' is positioned to the right of the 'P'. The overall style is fluid and handwritten.

MPG BASS GUITARS (COLORADO SOLE PROPRIETORSHIP)
5258 WINDGATE CT
COLORADO SPRINGS, CO 80917

FOR: BASS GUITARS; ELECTRIC BASSES; ELECTRIC GUITARS; GUITARS; MUSICAL INSTRUMENTS, NAMELY, BASS GUITARS, IN CLASS 15 (U.S. CLS. 2, 21 AND 36).

FIRST USE 5-1-2006; IN COMMERCE 8-1-2006.

THE MARK CONSISTS OF THE STYLIZED LETTERING "MPG".

SN 77-139,610, FILED 3-24-2007.

MICHAEL LITZAU, EXAMINING ATTORNEY

Int. Cl.: 5

Prior U.S. Cls.: 6, 18, 44, 46, 51, and 52

United States Patent and Trademark Office

Reg. No. 3,399,261

Registered Mar. 18, 2008

**TRADEMARK
PRINCIPAL REGISTER**

APATRIM

PATENTHEALTH, LLC (OHIO LTD LIAB CO)
3939 EVERHARD ROAD, NW
CANTON, OH 44709

THE MARK CONSISTS OF STANDARD CHAR-
ACTERS WITHOUT CLAIM TO ANY PARTICULAR
FONT, STYLE, SIZE, OR COLOR.

FOR: DIETARY SUPPLEMENTS FOR WEIGHT
LOSS, IN CLASS 5 (U.S. CLS. 6, 18, 44, 46, 51 AND 52).

SN 77-140,595, FILED 3-26-2007.

FIRST USE 8-1-2007; IN COMMERCE 8-1-2007.

ANDREA HACK, EXAMINING ATTORNEY

Int. Cl.: 39

Prior U.S. Cls.: 100 and 105

United States Patent and Trademark Office

Reg. No. 3,399,262

Registered Mar. 18, 2008

**SERVICE MARK
PRINCIPAL REGISTER**

EXPERTFLYER

EXPERT TRAVEL SERVICES, LLC (NEW YORK
LTD LIAB CO)
#311
414 WEST SUNRISE HWY
PATCHOGUE, NY 11772

FOR: TRAVEL INFORMATION SERVICES,
NAMELY, PROVIDING INFORMATION CON-
CERNING TRAVEL AND TRAVEL-RELATED TO-
PICS INCLUDING FARES, FARE RULES,
PENALTIES AND ROUTING INFORMATION,
FLIGHT AVAILABILITY, SEATING WITH SEAT
MAPS, UPGRADES, FREQUENT FLYER MILES,
AWARDS AND UPGRADES, FLIGHT STATUS
AND DELAYS, FLIGHT DETAILS, INCLUDING,
MEALS, EQUIPMENT, FLIGHT TIMES, STOP-
OVERS, AIRPORT SECURITY LINE DELAY INFOR-

MATION, AIRPORT DELAY INFORMATION;
PROVIDING FLIGHT ALERT INFORMATION TO
SUBSCRIBERS VIA E-MAIL, CELL PHONE, PDA,
OR OTHER WIRELESS PORTABLE DEVICE, IN
CLASS 39 (U.S. CLS. 100 AND 105).

FIRST USE 1-27-2004; IN COMMERCE 1-7-2005.

THE MARK CONSISTS OF STANDARD CHAR-
ACTERS WITHOUT CLAIM TO ANY PARTICULAR
FONT, STYLE, SIZE, OR COLOR.

SN 77-140,686, FILED 3-26-2007.

NATALIE POLZER, EXAMINING ATTORNEY

Int. Cl.: 35

Prior U.S. Cls.: 100, 101, and 102

United States Patent and Trademark Office

Reg. No. 3,399,263

Registered Mar. 18, 2008

SERVICE MARK
PRINCIPAL REGISTER



AYLMER, HONEE C (MISSOURI SOLE PROPRIETORSHIP)
9610 N. DITZLER COURT
KANSAS CITY, MO 64157

FOR: RETAIL CLOTHING BOUTIQUES, IN CLASS 35 (U.S. CLS. 100, 101 AND 102).

FIRST USE 8-1-2007; IN COMMERCE 8-1-2007.

THE COLOR(S) BLACK, LIGHT GREEN, PINK, WHITE, PURPLE, DARK GREEN, BLUE, AND YELLOW IS/ARE CLAIMED AS A FEATURE OF THE MARK.

THE MARK CONSISTS OF A PINK FLAMINGO WEARING A PURPLE HAT WITH A LIGHT GREEN

FLOWER ON TOP. AROUND THE FLAMINGO'S NECK IS A WHITE NECKLACE. THE TAIL OF THE FLAMINGO IS COLORED IN BLUE, PURPLE AND YELLOW. SEPARATING THE BLACK CURSIVE WORDS "THE" AND "CALICO" IS THE FLAMINGO'S HEAD. THE BODY OF THE FLAMINGO IS LOCATED IN BETWEEN THE WORDS "FLAM" AND "INGO". THESE LETTERS ARE IN DARK GREEN, RUNNING ACROSS FROM TOP TO BOTTOM INSIDE OF EACH LETTER ARE A NUMBER OF PINK SQUARES.

SN 77-141,674, FILED 3-27-2007.

SIMON TENG, EXAMINING ATTORNEY

Int. Cl.: 18

Prior U.S. Cls.: 1, 2, 3, 22, and 41

United States Patent and Trademark Office

Reg. No. 3,399,264

Registered Mar. 18, 2008

**TRADEMARK
PRINCIPAL REGISTER**

CARD CUBBY

KREPAK, WENDY (UNITED STATES INDIVIDUAL)

1564 EAGLE NEST CIRCLE

WINTER SPRINGS, FL 32708

FOR: LEATHER CARRYING CASES, IN CLASS 18
(U.S. CLS. 1, 2, 3, 22 AND 41).

FIRST USE 11-7-2007; IN COMMERCE 11-7-2007.

THE MARK CONSISTS OF STANDARD CHARACTERS WITHOUT CLAIM TO ANY PARTICULAR FONT, STYLE, SIZE, OR COLOR.

NO CLAIM IS MADE TO THE EXCLUSIVE RIGHT TO USE "CARD", APART FROM THE MARK AS SHOWN.

SN 77-142,401, FILED 3-28-2007.

LINDA E. BLOHM, EXAMINING ATTORNEY

Int. Cl.: 9

Prior U.S. Cls.: 21, 23, 26, 36, and 38

Reg. No. 3,399,265

United States Patent and Trademark Office

Registered Mar. 18, 2008

**TRADEMARK
PRINCIPAL REGISTER**

VOLTLOC

COMRENT INTERNATIONAL, LLC (MARY-
LAND LTD LIAB CO)
7640 INVESTMENT COURT, UNIT A
OWINGS, MD 20736

THE MARK CONSISTS OF STANDARD CHAR-
ACTERS WITHOUT CLAIM TO ANY PARTICULAR
FONT, STYLE, SIZE, OR COLOR.

FOR: PORTABLE MEDIUM VOLTAGE POWER
CABLE DEVICES, IN CLASS 9 (U.S. CLS. 21, 23, 26, 36
AND 38).

SN 77-143,546, FILED 3-29-2007.

FIRST USE 8-1-2007; IN COMMERCE 8-1-2007.

TARAH HARDY, EXAMINING ATTORNEY

Int. Cl.: 28

Prior U.S. Cls.: 22, 23, 38, and 50

United States Patent and Trademark Office

Reg. No. 3,399,266

Registered Mar. 18, 2008

**TRADEMARK
PRINCIPAL REGISTER**

RAG ARM

HADASH, EDWARD (UNITED STATES INDIVIDUAL)
13400 PENN AVE S.
BURNSVILLE, MN 55337

FOR: ATHLETIC GEAR IN THE NATURE OF PERFORMANCE APPAREL, NAMELY, A SLEEVE TO BE WORN ON THE SHOULDER AND ARM FOR MAINTAINING STRENGTH AND ENDURANCE OF A PITCHER'S ARM DURING ATHLETIC ACTIVITY, IN CLASS 28 (U.S. CLS. 22, 23, 38 AND 50).

FIRST USE 5-31-2007; IN COMMERCE 5-31-2007.

THE MARK CONSISTS OF STANDARD CHARACTERS WITHOUT CLAIM TO ANY PARTICULAR FONT, STYLE, SIZE, OR COLOR.

SN 77-143,806, FILED 3-29-2007.

ESTHER BELENKER, EXAMINING ATTORNEY

Int. Cl.: 35

Prior U.S. Cls.: 100, 101, and 102

United States Patent and Trademark Office

Reg. No. 3,399,267

Registered Mar. 18, 2008

**SERVICE MARK
PRINCIPAL REGISTER**

**HOW MARKETERS GET TO
WORK.**

WORKPLACE MEDIA, INC. (OHIO CORPORATION)
9325 PROGRESS PARKWAY
MENTOR, OH 44060

FOR: DIRECT MARKETING SERVICES, NAME-
LY, THE DEVELOPMENT FOR A CLIENT OF A
DIRECT MARKETING PROGRAM THAT TAR-
GETS AND DELIVERS PROMOTIONAL OFFERS
TO POTENTIAL CUSTOMERS IN THE WORK-
PLACE AND ANALYSIS OF THE RESULTS OF
THAT DIRECT MARKETING PROGRAM, IN
CLASS 35 (U.S. CLS. 100, 101 AND 102).

FIRST USE 5-7-2007; IN COMMERCE 5-7-2007.

THE MARK CONSISTS OF STANDARD CHAR-
ACTERS WITHOUT CLAIM TO ANY PARTICULAR
FONT, STYLE, SIZE, OR COLOR.

SN 77-146,195, FILED 4-2-2007.

CARYN GLASSER, EXAMINING ATTORNEY

Int. Cl.: 6

Prior U.S. Cls.: 2, 12, 13, 14, 23, 25, and 50

Reg. No. 3,399,268

United States Patent and Trademark Office

Registered Mar. 18, 2008

**TRADEMARK
PRINCIPAL REGISTER**

EZnSTAL

MASTERCRAFT INDUSTRIES, INC. (WISCONSIN CORPORATION)
120 W. ALLEN ST.
RICE LAKE, WI 54864

FOR: DRAWER GUIDE MOUNTING SYSTEM COMPRISED PRIMARILY OF A SELF-CENTERING METAL MOUNTING BRACKET FOR DRAWERS USED IN THE MANUFACTURE AND ASSEMBLY OF CABINETRY AND FURNITURE, IN CLASS 6 (U.S. CLS. 2, 12, 13, 14, 23, 25 AND 50).

FIRST USE 7-15-2007; IN COMMERCE 7-15-2007.

THE MARK CONSISTS OF STANDARD CHARACTERS WITHOUT CLAIM TO ANY PARTICULAR FONT, STYLE, SIZE, OR COLOR.

SN 77-146,252, FILED 4-2-2007.

CARRIE GENOVESE, EXAMINING ATTORNEY

Int. Cl.: 33

Prior U.S. Cls.: 47 and 49

United States Patent and Trademark Office

Reg. No. 3,399,269

Registered Mar. 18, 2008

**TRADEMARK
PRINCIPAL REGISTER**

L'ESPRIT DE PARIS

LONDON GROUP, LLC (NEW YORK LTD LIAB
CO)

8 PINETREE LANE

OLD WESTBURY, NY 11568

FOR: LIQUEURS, IN CLASS 33 (U.S. CLS. 47 AND
49).

FIRST USE 5-2-2007; IN COMMERCE 5-23-2007.

THE MARK CONSISTS OF STANDARD CHAR-
ACTERS WITHOUT CLAIM TO ANY PARTICULAR
FONT, STYLE, SIZE, OR COLOR.

THE FOREIGN WORDING IN THE MARK
TRANSLATES INTO ENGLISH AS THE SPIRIT OF
PARIS.

SN 77-146,319, FILED 4-2-2007.

AISHA SALEM, EXAMINING ATTORNEY

Int. Cl.: 17

Prior U.S. Cls.: 1, 5, 12, 13, 35, and 50

United States Patent and Trademark Office

Reg. No. 3,399,270

Registered Mar. 18, 2008

**TRADEMARK
PRINCIPAL REGISTER**

ENVIROMET

CELPLAST METALLIZED PRODUCTS LTD. (CANADA CORPORATION)
67 COMMANDER BLVD., UNIT 4
TORONTO, CANADA M1S3M7

FOR: TRANSPARENT, METALLIZED PLASTIC BARRIER FILMS USED AS PACKAGING FOR FOOD AND USED AS INDUSTRIAL OR COMMERCIAL NON-FOOD PACKING , IN CLASS 17 (U.S. CLS. 1, 5, 12, 13, 35 AND 50).

FIRST USE 6-1-2007; IN COMMERCE 8-1-2007.

THE MARK CONSISTS OF STANDARD CHARACTERS WITHOUT CLAIM TO ANY PARTICULAR FONT, STYLE, SIZE, OR COLOR.

SN 77-146,842, FILED 4-2-2007.

REBECCA EISINGER, EXAMINING ATTORNEY

Int. Cl.: 43

Prior U.S. Cls.: 100 and 101

United States Patent and Trademark Office

Reg. No. 3,399,271

Registered Mar. 18, 2008

**SERVICE MARK
PRINCIPAL REGISTER**

pizz.us

SHARIPOVA, ELENA (UNITED STATES INDIVIDUAL)
PO BOX 860868
WAHIAWA, HI 96786

FOR: CAFE-RESTAURANTS; CARRY-OUT RESTAURANTS; DELICATESSENS; FAST-FOOD RESTAURANTS; HOTEL, BAR AND RESTAURANT SERVICES; PROVIDING ON-LINE REVIEWS OF RESTAURANTS AND HOTELS; RESERVATION OF RESTAURANTS; RESTAURANT AND BAR SERVICES; RESTAURANTS; RESTAURANTS FEATURING HOME DELIVERY; SELF SERVICE RESTAURANTS; TAKE-OUT RESTAURANT SERVICES; TRAVEL AGENCY SERVICES, NAMELY, MAKING

RESERVATIONS AND BOOKINGS FOR RESTAURANTS AND MEALS, IN CLASS 43 (U.S. CLS. 100 AND 101).

FIRST USE 8-8-2007; IN COMMERCE 8-8-2007.

THE MARK CONSISTS OF STANDARD CHARACTERS WITHOUT CLAIM TO ANY PARTICULAR FONT, STYLE, SIZE, OR COLOR.

SN 77-146,913, FILED 4-2-2007.

ANDREA SAUNDERS, EXAMINING ATTORNEY

Int. Cl.: 35

Prior U.S. Cls.: 100, 101, and 102

United States Patent and Trademark Office

Reg. No. 3,399,272

Registered Mar. 18, 2008

**SERVICE MARK
PRINCIPAL REGISTER**



ARBOR AND VINE (FLORIDA CORPORATION)
3752 LONG GROVE LANE
PORT ORANGE, FL 32129

FOR: RETAIL STORE SERVICES FEATURING HOME AND GARDEN GOODS AND ON-LINE RETAIL STORE SERVICES FEATURING HOME AND GARDEN GOODS, IN CLASS 35 (U.S. CLS. 100, 101 AND 102).

FIRST USE 10-1-2007; IN COMMERCE 10-1-2007.

NO CLAIM IS MADE TO THE EXCLUSIVE RIGHT TO USE "GARDEN ACCESSORIES", APART FROM THE MARK AS SHOWN.

THE MARK CONSISTS OF STYLIZED LETTERING WITH A BIRD BATH WITH BIRD IN IT TO THE LEFT OF THE "A" IN "ARBOR".

SN 77-147,505, FILED 4-3-2007.

WILLIAM ROSSMAN, EXAMINING ATTORNEY

Int. Cl.: 9

Prior U.S. Cls.: 21, 23, 26, 36, and 38

United States Patent and Trademark Office

Reg. No. 3,399,273

Registered Mar. 18, 2008

**TRADEMARK
PRINCIPAL REGISTER**

Dream Chronicles

PLAYFIRST, INC. (DELAWARE CORPORATION)
120 MONTGOMERY ST., STE. 1370
SAN FRANCISCO, CA 94104

THE MARK CONSISTS OF STANDARD CHARACTERS WITHOUT CLAIM TO ANY PARTICULAR FONT, STYLE, SIZE, OR COLOR.

FOR: COMPUTER GAME SOFTWARE; ELECTRONIC GAME SOFTWARE; GAME SOFTWARE; VIDEO GAME SOFTWARE, IN CLASS 9 (U.S. CLS. 21, 23, 26, 36 AND 38).

SN 77-147,895, FILED 4-3-2007.

FIRST USE 4-26-2007; IN COMMERCE 4-26-2007.

ESTHER BELENKER, EXAMINING ATTORNEY

Int. Cl.: 41

Prior U.S. Cls.: 100, 101, and 107

United States Patent and Trademark Office

Reg. No. 3,399,274

Registered Mar. 18, 2008

**SERVICE MARK
PRINCIPAL REGISTER**

SUNDAY SCHOOL CINEMA

VICTORIA QUADE (UNITED STATES INDIVIDUAL)
710 W. JUNIOR TERRACE
CHICAGO, IL 60613

THE MARK CONSISTS OF STANDARD CHARACTERS WITHOUT CLAIM TO ANY PARTICULAR FONT, STYLE, SIZE, OR COLOR.

FOR: ENTERTAINMENT IN THE NATURE OF LIVE THEATER PRODUCTIONS, IN CLASS 41 (U.S. CLS. 100, 101 AND 107).

SN 77-148,408, FILED 4-4-2007.

FIRST USE 6-3-2007; IN COMMERCE 6-3-2007.

LINDA POWELL, EXAMINING ATTORNEY

Int. Cl.: 36

Prior U.S. Cls.: 100, 101, and 102

United States Patent and Trademark Office

Reg. No. 3,399,275

Registered Mar. 18, 2008

**SERVICE MARK
PRINCIPAL REGISTER**

AIG RETIREMENT

AMERICAN INTERNATIONAL GROUP, INC.
(DELAWARE CORPORATION)

70 PINE STREET

NEW YORK, NY 10270

FOR: INVESTMENT ADVISORY SERVICES; FINANCIAL INVESTMENT IN THE FIELD OF MUTUAL FUNDS, ANNUITIES, RETIREMENT PLANS, AND ESTATE PLANNING, IN CLASS 36 (U.S. CLS. 100, 101 AND 102).

FIRST USE 1-1-2008; IN COMMERCE 1-1-2008.

THE MARK CONSISTS OF STANDARD CHARACTERS WITHOUT CLAIM TO ANY PARTICULAR FONT, STYLE, SIZE, OR COLOR.

OWNER OF U.S. REG. NOS. 1,172,557, 2,965,066, AND OTHERS.

NO CLAIM IS MADE TO THE EXCLUSIVE RIGHT TO USE "RETIREMENT", APART FROM THE MARK AS SHOWN.

SN 77-148,605, FILED 4-4-2007.

KELLY MCCOY, EXAMINING ATTORNEY

Int. Cl.: 30

Prior U.S. Cl.: 46

United States Patent and Trademark Office

Reg. No. 3,399,276

Registered Mar. 18, 2008

**TRADEMARK
PRINCIPAL REGISTER**

SCHWAN'S SAUCE IN SECONDS

SCHWAN'S IP, LLC (MINNESOTA LTD LIAB CO)
115 W. COLLEGE DRIVE
MARSHALL, MN 56258

THE MARK CONSISTS OF STANDARD CHAR-
ACTERS WITHOUT CLAIM TO ANY PARTICULAR
FONT, STYLE, SIZE, OR COLOR.

FOR: SAUCES IN FROZEN CUBE FORM, NAME-
LY, ALFREDO, MARINARA AND CHEDDAR
CHEESE SAUCES, IN CLASS 30 (U.S. CL. 46).

SN 77-149,208, FILED 4-5-2007.

FIRST USE 12-31-2007; IN COMMERCE 12-31-2007.

THEODORE MCBRIDE, EXAMINING ATTORNEY

Int. Cl.: 29

Prior U.S. Cl.: 46

United States Patent and Trademark Office

Reg. No. 3,399,277

Registered Mar. 18, 2008

**TRADEMARK
PRINCIPAL REGISTER**

SUPERB & SIMPLE

J&B WHOLESALE DISTRIBUTING, INC. (MINNESOTA CORPORATION)

P.O. BOX 212
13200 43RD STREET NE
ST. MICHAEL, MN 55376

FOR: FROZEN ENTREES CONSISTING OF SEASONED, MARINATED, BREADED, WRAPPED OR STUFFED MEAT, POULTRY, FISH OR SEAFOOD, IN CLASS 29 (U.S. CL. 46).

FIRST USE 10-0-2007; IN COMMERCE 10-0-2007.

THE MARK CONSISTS OF STANDARD CHARACTERS WITHOUT CLAIM TO ANY PARTICULAR FONT, STYLE, SIZE, OR COLOR.

SN 77-149,396, FILED 4-5-2007.

MICHAEL LITZAU, EXAMINING ATTORNEY

Int. Cl.: 25

Prior U.S. Cls.: 22 and 39

United States Patent and Trademark Office

Reg. No. 3,399,278

Registered Mar. 18, 2008

**TRADEMARK
PRINCIPAL REGISTER**

a b sea

A B SEA, LLC (NEW YORK LTD LIAB CO)
#4
51 CHARLES STREET
NEW YORK, NY 10014

THE MARK CONSISTS OF STANDARD CHAR-
ACTERS WITHOUT CLAIM TO ANY PARTICULAR
FONT, STYLE, SIZE, OR COLOR.

FOR: ONE PIECE GARMENT FOR INFANTS
AND TODDLERS; PANTS; ROBES; SHIRTS, IN
CLASS 25 (U.S. CLS. 22 AND 39).

SN 77-150,208, FILED 4-5-2007.

FIRST USE 10-1-2007; IN COMMERCE 10-1-2007.

MELISSA VALLILLO, EXAMINING ATTORNEY

Int. Cl.: 31

Prior U.S. Cls.: 1 and 46

United States Patent and Trademark Office

Reg. No. 3,399,279

Registered Mar. 18, 2008

**TRADEMARK
PRINCIPAL REGISTER**



RUDY GREEN VENTURES, LLC (KENTUCKY
LTD LIAB CO)
624 EAST MARKET STREET
LOUISVILLE, KY 40202

FOR: PET FOOD; PET TREATS, IN CLASS 31 (U.S.
CLS. 1 AND 46).

FIRST USE 1-1-2007; IN COMMERCE 1-1-2007.

NO CLAIM IS MADE TO THE EXCLUSIVE
RIGHT TO USE "VENTURES LLC." , APART FROM
THE MARK AS SHOWN.

THE MARK CONSISTS OF A STYLIZED RENDITION OF A DOG'S HEAD AND SHOULDERS WITH RADIAL LINES BEGINNING BEHIND THE DOG'S HEAD AND EXTENDING OUTWARD IN THE BACKGROUND; THE DOG'S HEAD APPEARS OVER THE LETTERS "RGV;" AND THE PHRASE "RUDY GREEN VENTURES LLC." IS WRITTEN VERTICALLY ON THE RIGHT BORDER OF THE MARK.

SN 77-150,589, FILED 4-6-2007.

KIMBERLY FRYE, EXAMINING ATTORNEY

Int. Cl.: 10

Prior U.S. Cls.: 26, 39, and 44

United States Patent and Trademark Office

Reg. No. 3,399,280

Registered Mar. 18, 2008

**TRADEMARK
PRINCIPAL REGISTER**

C!

TRANSPHOTON CORP. (FLORIDA CORPORATION)
14350 SW 142ND AVE
MIAMI, FL 33186

THE MARK CONSISTS OF STANDARD CHARACTERS WITHOUT CLAIM TO ANY PARTICULAR FONT, STYLE, SIZE, OR COLOR.

FOR: MEDICAL APPARATUS AND INSTRUMENTS FOR DIAGNOSTIC RADIO PHARMACEUTICAL USE, IN CLASS 10 (U.S. CLS. 26, 39 AND 44).

SN 77-150,910, FILED 4-6-2007.

FIRST USE 6-1-2007; IN COMMERCE 6-1-2007.

MARGERY A. TIERNEY, EXAMINING ATTORNEY

Int. Cl.: 9

Prior U.S. Cls.: 21, 23, 26, 36, and 38

United States Patent and Trademark Office

Reg. No. 3,399,281

Registered Mar. 18, 2008

**TRADEMARK
PRINCIPAL REGISTER**

ULTIMATE NINJA HEROES

NAMCO BANDAI GAMES AMERICA INC. (DE-
LAWARE CORPORATION)
4555 GREAT AMERICA PARKWAY, SUITE 201
SANTA CLARA, CA 95054

FOR: COMPUTER GAME PROGRAMS; COMPU-
TER GAME SOFTWARE; INTERACTIVE MULTI-
MEDIA COMPUTER GAME PROGRAM;
INTERACTIVE VIDEO GAME PROGRAMS; VIDEO
GAME CARTRIDGES; VIDEO GAME SOFTWARE,
IN CLASS 9 (U.S. CLS. 21, 23, 26, 36 AND 38).

FIRST USE 8-28-2007; IN COMMERCE 8-28-2007.

THE MARK CONSISTS OF STANDARD CHAR-
ACTERS WITHOUT CLAIM TO ANY PARTICULAR
FONT, STYLE, SIZE, OR COLOR.

SN 77-150,944, FILED 4-6-2007.

DEIRDRE ROBERTSON, EXAMINING ATTORNEY

Int. Cl.: 41

Prior U.S. Cls.: 100, 101, and 107

United States Patent and Trademark Office

Reg. No. 3,399,282

Registered Mar. 18, 2008

**SERVICE MARK
PRINCIPAL REGISTER**

LIVING THE COUNTRY LIFE

MEREDITH CORPORATION (IOWA CORPORATION)
1716 LOCUST STREET
DES MOINES, IA 503093023

FOR: ENTERTAINMENT, NAMELY, PROVIDING A RADIO PROGRAM FEATURING TOPICS OF INTEREST TO INDIVIDUALS WITH A RURAL LIFESTYLE, IN CLASS 41 (U.S. CLS. 100, 101 AND 107).

FIRST USE 9-4-2007; IN COMMERCE 9-4-2007.

THE MARK CONSISTS OF STANDARD CHARACTERS WITHOUT CLAIM TO ANY PARTICULAR FONT, STYLE, SIZE, OR COLOR.

OWNER OF U.S. REG. NO. 2,716,071.

SN 77-151,011, FILED 4-6-2007.

ZACHARY BELLO, EXAMINING ATTORNEY

Int. Cl.: 31

Prior U.S. Cls.: 1 and 46

United States Patent and Trademark Office

Reg. No. 3,399,283

Registered Mar. 18, 2008

**TRADEMARK
PRINCIPAL REGISTER**

RUDY GREEN'S DOGGY CUISINE

RUDY GREEN VENTURES, LLC (KENTUCKY
LTD LIAB CO)

624 EAST MARKET STREET

LOUISVILLE, KY 40202

FOR: PET FOOD; PET TREATS, IN CLASS 31 (U.S.
CLS. 1 AND 46).

FIRST USE 5-1-2007; IN COMMERCE 5-1-2007.

THE MARK CONSISTS OF STANDARD CHAR-
ACTERS WITHOUT CLAIM TO ANY PARTICULAR
FONT, STYLE, SIZE, OR COLOR.

NO CLAIM IS MADE TO THE EXCLUSIVE
RIGHT TO USE "DOGGY CUISINE", APART FROM
THE MARK AS SHOWN.

SN 77-151,571, FILED 4-9-2007.

KIMBERLY FRYE, EXAMINING ATTORNEY

Int. Cl.: 41

Prior U.S. Cls.: 100, 101, and 107

United States Patent and Trademark Office

Reg. No. 3,399,284

Registered Mar. 18, 2008

**SERVICE MARK
PRINCIPAL REGISTER**

PLAY IT SAFE

CHICKASAW NATION (UNITED STATES FED-
ERALLY-RECOGNIZED INDIAN TRIBE)
520 E. ARLINGTON BLVD.
ADA, OK 74820

THE MARK CONSISTS OF STANDARD CHAR-
ACTERS WITHOUT CLAIM TO ANY PARTICULAR
FONT, STYLE, SIZE, OR COLOR.

FOR: ENTERTAINMENT SERVICES, NAMELY,
PRODUCTION AND DISTRIBUTION OF A GAME
SHOW; PROVIDING FACILITIES FOR GAME
SHOWS, IN CLASS 41 (U.S. CLS. 100, 101 AND 107).

SN 77-152,798, FILED 4-10-2007.

FIRST USE 4-1-2007; IN COMMERCE 4-1-2007.

ELLEN BURNS, EXAMINING ATTORNEY

Int. Cl.: 14

Prior U.S. Cls.: 2, 27, 28, and 50

United States Patent and Trademark Office

Reg. No. 3,399,285

Registered Mar. 18, 2008

**TRADEMARK
PRINCIPAL REGISTER**

UCG

UNITED COLOR GEMS, INC. (NEW YORK COR-
PORATION)
1404 2 WEST 46TH STREET
NEW YORK, NY 10036

THE MARK CONSISTS OF STANDARD CHAR-
ACTERS WITHOUT CLAIM TO ANY PARTICULAR
FONT, STYLE, SIZE, OR COLOR.

FOR: JEWELRY, IN CLASS 14 (U.S. CLS. 2, 27, 28
AND 50).

SN 77-153,256, FILED 4-10-2007.

FIRST USE 3-5-2007; IN COMMERCE 3-5-2007.

TARAH HARDY, EXAMINING ATTORNEY

Int. Cl.: 5

Prior U.S. Cls.: 6, 18, 44, 46, 51, and 52

United States Patent and Trademark Office

Reg. No. 3,399,286

Registered Mar. 18, 2008

**TRADEMARK
PRINCIPAL REGISTER**

FEBREZE TO GO

THE PROCTER & GAMBLE COMPANY (OHIO
CORPORATION)
1 P&G PLAZA
CINCINNATI, OH 45202

THE MARK CONSISTS OF STANDARD CHAR-
ACTERS WITHOUT CLAIM TO ANY PARTICULAR
FONT, STYLE, SIZE, OR COLOR.

FOR: DEODORANTS FOR CLOTHING OR TEX-
TILES, IN CLASS 5 (U.S. CLS. 6, 18, 44, 46, 51 AND 52).

SN 77-153,342, FILED 4-10-2007.

FIRST USE 7-30-2007; IN COMMERCE 7-30-2007.

GEOFFREY FOSDICK, EXAMINING ATTORNEY

Int. Cl.: 7

Prior U.S. Cls.: 13, 19, 21, 23, 31, 34, and 35

Reg. No. 3,399,287

United States Patent and Trademark Office

Registered Mar. 18, 2008

**TRADEMARK
PRINCIPAL REGISTER**

ROTA-RACK

CURRAN MANUFACTURING CORPORATION
(NEW YORK CORPORATION)
200 OSER AVENUE
HAUPPAUGE, NY 11788

THE MARK CONSISTS OF STANDARD CHARACTERS WITHOUT CLAIM TO ANY PARTICULAR FONT, STYLE, SIZE, OR COLOR.

FOR: MACHINERY, NAMELY, PARTS ACCUMULATOR, IN CLASS 7 (U.S. CLS. 13, 19, 21, 23, 31, 34 AND 35).

SN 77-153,609, FILED 4-11-2007.

FIRST USE 6-12-2007; IN COMMERCE 6-12-2007.

MELVIN AXILBUND, EXAMINING ATTORNEY

Int. Cl.: 3

Prior U.S. Cls.: 1, 4, 6, 50, 51, and 52

United States Patent and Trademark Office

Reg. No. 3,399,288

Registered Mar. 18, 2008

**TRADEMARK
PRINCIPAL REGISTER**



MIRACLE WORLD CORPORATION (CALIFORNIA CORPORATION)

2900 GORDON AVE. SUITE 100
SANTA CLARA, CA 95051

FOR: HAIR SHAMPOO AND CONDITIONER, IN CLASS 3 (U.S. CLS. 1, 4, 6, 50, 51 AND 52).

FIRST USE 5-1-2007; IN COMMERCE 5-1-2007.

OWNER OF U.S. REG. NO. 3,134,339.

THE COLOR(S) BLACK, PINK, ORANGE, YELLOW, GREEN, BLUE AND PURPLE IS/ARE CLAIMED AS A FEATURE OF THE MARK.

THE MARK CONSISTS OF A BLACK SINGLE HAIR, SURROUNDED BY THE CIRCULAR STYLIZED WORDING "MIRACLE" IN PINK, ORANGE, YELLOW, GREEN, BLUE AND PURPLE.

SN 77-155,762, FILED 4-13-2007.

DAVID TOOLEY, EXAMINING ATTORNEY

Int. Cl.: 41

Prior U.S. Cls.: 100, 101, and 107

United States Patent and Trademark Office

Reg. No. 3,399,289

Registered Mar. 18, 2008

**SERVICE MARK
PRINCIPAL REGISTER**

Chefs 2 Be

ALL 4 KIDS, LLC (TEXAS LTD LIAB CO)
808 RUSSELL PALMER RD, SUITE 157
KINGWOOD, TX 773391690

FOR: EDUCATIONAL SERVICES, NAMELY, CONDUCTING CLASSES IN THE FIELD OF COOKING AND DISTRIBUTION OF COURSE MATERIAL IN CONNECTION THEREWITH; EDUCATIONAL SERVICES, NAMELY, DEVELOPING, ARRANGING, AND CONDUCTING EDUCATIONAL CONFERENCES AND PROGRAMS AND PROVIDING COURSES OF INSTRUCTION IN THE FIELD OF COOKING; EDUCATIONAL SERVICES, NAMELY, CONDUCTING CLASSES IN THE FIELD OF COOK-

ING; INSTRUCTION IN THE FIELD OF COOKING; PROVIDING A WEBSITE THAT FEATURES INFORMAL INSTRUCTION ON COOKING, IN CLASS 41 (U.S. CLS. 100, 101 AND 107).

FIRST USE 6-6-2006; IN COMMERCE 8-8-2007.

THE MARK CONSISTS OF STANDARD CHARACTERS WITHOUT CLAIM TO ANY PARTICULAR FONT, STYLE, SIZE, OR COLOR.

SN 77-157,124, FILED 4-15-2007.

TARAH HARDY, EXAMINING ATTORNEY

Int. Cl.: 21

Prior U.S. Cls.: 2, 13, 23, 29, 30, 33, 40, and 50

United States Patent and Trademark Office

Reg. No. 3,399,290

Registered Mar. 18, 2008

**TRADEMARK
PRINCIPAL REGISTER**

SEAL SAVER

INVENTAL LABORATORY, INC. (CALIFORNIA
CORPORATION)
P.O. BOX 1990
MORRO BAY, CA 93443

THE MARK CONSISTS OF STANDARD CHAR-
ACTERS WITHOUT CLAIM TO ANY PARTICULAR
FONT, STYLE, SIZE, OR COLOR.

FOR: HOUSEHOLD CONTAINERS FOR FOODS,
IN CLASS 21 (U.S. CLS. 2, 13, 23, 29, 30, 33, 40 AND 50).

SN 77-157,862, FILED 4-16-2007.

FIRST USE 10-20-2007; IN COMMERCE 11-10-2007.

KIMBERLY FRYE, EXAMINING ATTORNEY

Int. Cl.: 42

Prior U.S. Cls.: 100 and 101

United States Patent and Trademark Office

Reg. No. 3,399,291

Registered Mar. 18, 2008

**SERVICE MARK
PRINCIPAL REGISTER**



TPG IT CONSULTING - THE PILOT GROUP, LLC
(TEXAS LTD LIAB CO)
22203 AVALON CANYON CT.
KATY, TX 77450

FOR: INFORMATION TECHNOLOGY CONSULTATION, IN CLASS 42 (U.S. CLS. 100 AND 101).

FIRST USE 4-1-2007; IN COMMERCE 4-28-2007.

NO CLAIM IS MADE TO THE EXCLUSIVE RIGHT TO USE "GROUP" AND "BUSINESS TECHNOLOGY", APART FROM THE MARK AS SHOWN.

THE COLOR(S) NAVY AND BLUE IS/ARE CLAIMED AS A FEATURE OF THE MARK.

THE MARK CONSISTS OF THE WORDS "THE PILOT GROUP" ARE WRITTEN IN TREBUCHET FONT AND ARE NAVY BLUE. THE LETTER O IN THE WORD PILOT IS STYLIZED AS A SHIPS PILOT WHEEL. THE WORDS "NAVIGATING BUSINESS TECHNOLOGY" USE A TREBUCHET FONT BUT ARE REDUCED IN SIZE.

SN 77-158,842, FILED 4-17-2007.

CHRISTINA SOBRAL, EXAMINING ATTORNEY

Int. Cl.: 33

Prior U.S. Cls.: 47 and 49

United States Patent and Trademark Office

Reg. No. 3,399,292

Registered Mar. 18, 2008

**TRADEMARK
PRINCIPAL REGISTER**

FILL·MORE·WINE

KAUTZ VINEYARDS, INC (CALIFORNIA CORPORATION), DBA IRONSTONE VINEYARDS,
1894 SIX MILE ROAD
MURPHYS, CA 95247

THE MARK CONSISTS OF STANDARD CHARACTERS WITHOUT CLAIM TO ANY PARTICULAR FONT, STYLE, SIZE, OR COLOR.

FOR: WINE, IN CLASS 33 (U.S. CLS. 47 AND 49).

SN 77-159,285, FILED 4-18-2007.

FIRST USE 9-30-2007; IN COMMERCE 9-30-2007.

MARGARET POWER, EXAMINING ATTORNEY

Int. Cl.: 1

Prior U.S. Cls.: 1, 5, 6, 10, 26, and 46

United States Patent and Trademark Office

Reg. No. 3,399,293

Registered Mar. 18, 2008

**TRADEMARK
PRINCIPAL REGISTER**

DIVERSACLEAN SRS

CRODA, INC. (DELAWARE CORPORATION)
300 COLUMBUS CIRCLE
EDISON, NJ 08837

FOR: CHEMICALS FOR FURTHER MANUFACTURE OF CLEANING FORMULATIONS FOR USE IN HOUSEHOLD, INSTITUTIONAL AND INDUSTRIAL APPLICATIONS, IN CLASS 1 (U.S. CLS. 1, 5, 6, 10, 26 AND 46).

FIRST USE 2-1-2007; IN COMMERCE 2-1-2007.

THE MARK CONSISTS OF STANDARD CHARACTERS WITHOUT CLAIM TO ANY PARTICULAR FONT, STYLE, SIZE, OR COLOR.

SN 77-159,575, FILED 4-18-2007.

JULIE GUTTADAURO, EXAMINING ATTORNEY

Int. Cl.: 9

Prior U.S. Cls.: 21, 23, 26, 36, and 38

Reg. No. 3,399,294

United States Patent and Trademark Office

Registered Mar. 18, 2008

**TRADEMARK
PRINCIPAL REGISTER**

MAX LIVE

INTEC INC. (FLORIDA CORPORATION)
SUITE 400
7600CORPORATE CENTER DRIVE
MIAMI, FL 33126

FOR: WIRELESS HEADSET INCORPORATING A
MICROPHONE FOR USE WITH A COMPUTER
GAMING DEVICE, AND EARPHONES, IN CLASS 9
(U.S. CLS. 21, 23, 26, 36 AND 38).

FIRST USE 8-17-2004; IN COMMERCE 8-17-2004.

THE MARK CONSISTS OF STANDARD CHAR-
ACTERS WITHOUT CLAIM TO ANY PARTICULAR
FONT, STYLE, SIZE, OR COLOR.

SN 77-165,653, FILED 4-25-2007.

MIDGE BUTLER, EXAMINING ATTORNEY

Int. Cl.: 43

Prior U.S. Cls.: 100 and 101

United States Patent and Trademark Office

Reg. No. 3,399,295

Registered Mar. 18, 2008

**SERVICE MARK
PRINCIPAL REGISTER**

ASTOR COURT

THE SHERATON LLC (DELAWARE LTD LIAB
CO)
1111 WESTCHESTER AVENUE
WHITE PLAINS, NY 10604

FOR: HOTEL SERVICES, NAMELY, PROVIDING
FOOD AND BEVERAGE; RESTAURANT, BAR AND
COCKTAIL LOUNGE SERVICES, IN CLASS 43 (U.S.
CLS. 100 AND 101).

FIRST USE 9-0-1991; IN COMMERCE 9-0-1991.

THE MARK CONSISTS OF STANDARD CHAR-
ACTERS WITHOUT CLAIM TO ANY PARTICULAR
FONT, STYLE, SIZE, OR COLOR.

SN 77-167,065, FILED 4-26-2007.

HANNO RITTNER, EXAMINING ATTORNEY

Int. Cl.: 38

Prior U.S. Cls.: 100, 101, and 104

United States Patent and Trademark Office

Reg. No. 3,399,296

Registered Mar. 18, 2008

**SERVICE MARK
PRINCIPAL REGISTER**

Peerless Network

PEERLESS NETWORK, LLC (ILLINOIS LTD
LIAB CO)
225 W. WASHINGTON ST
SUITE 1285
CHICAGO, IL 60647

FOR: TELECOMMUNICATION SERVICES, NAMELY, LOCAL AND LONG DISTANCE TRANSMISSION OF VOICE, DATA, GRAPHICS BY MEANS OF TELEPHONE, TELEGRAPHIC, CABLE, AND SATELLITE TRANSMISSIONS; TELECOMMUNICATION ACCESS SERVICES; TELECOMMUNICATIONS GATEWAY SERVICES; TELECOMMUNICATIONS RESELLER SERVICES, NAMELY, PROVIDING LONG DISTANCE TELECOMMUNICATION SERVICES; TELECOMMUNICATIONS SERVICES, NAMELY PROVIDING FIBER OPTIC NETWORK SERVICES; TRANSFER OF DATA BY TELECOMMUNICATIONS; TRANSMISSION OF INFORMATION ON OPTICAL TELECOMMUNICATION NETWORKS; COMMUNICATIONS VIA MULTINATIONAL TELECOMMUNICATION NETWORKS; DATA TRANSMISSION AND RECEPTION SERVICES VIA

TELECOMMUNICATION MEANS; HIGH BIT-RATE DATA TRANSMISSION SERVICES FOR TELECOMMUNICATION NETWORK OPERATORS; PROVIDING ACCESS TO TELECOMMUNICATION NETWORKS; PROVIDING ELECTRONIC TELECOMMUNICATION CONNECTIONS; PROVIDING THIRD PARTY USERS WITH ACCESS TO TELECOMMUNICATION INFRASTRUCTURE, IN CLASS 38 (U.S. CLS. 100, 101 AND 104).

FIRST USE 5-21-2007; IN COMMERCE 10-1-2007.

THE MARK CONSISTS OF STANDARD CHARACTERS WITHOUT CLAIM TO ANY PARTICULAR FONT, STYLE, SIZE, OR COLOR.

NO CLAIM IS MADE TO THE EXCLUSIVE RIGHT TO USE "NETWORK", APART FROM THE MARK AS SHOWN.

SN 77-169,096, FILED 4-30-2007.

FRED MANDIR, EXAMINING ATTORNEY

Int. Cl.: 30

Prior U.S. Cl.: 46

United States Patent and Trademark Office

Reg. No. 3,399,297

Registered Mar. 18, 2008

**TRADEMARK
PRINCIPAL REGISTER**

ARBOR TEAS

LOPATIN, JEREMY (UNITED STATES INDIVIDUAL)
1306 W. MADISON ST.
ANN ARBOR, MI 48103 AND
LOPATIN, AUBREY (UNITED STATES INDIVIDUAL)
1306 W. MADISON ST.
ANN ARBOR, MI 48103

THE MARK CONSISTS OF STANDARD CHARACTERS WITHOUT CLAIM TO ANY PARTICULAR FONT, STYLE, SIZE, OR COLOR.

NO CLAIM IS MADE TO THE EXCLUSIVE RIGHT TO USE "TEAS", APART FROM THE MARK AS SHOWN.

FOR: HERB TEA; HERBAL INFUSIONS; TEA; TEA FOR INFUSIONS; TISANES, IN CLASS 30 (U.S. CL. 46).

SN 77-183,911, FILED 5-17-2007.

FIRST USE 10-17-2007; IN COMMERCE 10-17-2007.

BARBARA A. GOLD, EXAMINING ATTORNEY

Int. Cl.: 9

Prior U.S. Cls.: 21, 23, 26, 36, and 38

United States Patent and Trademark Office

Reg. No. 3,399,298

Registered Mar. 18, 2008

**TRADEMARK
PRINCIPAL REGISTER**

PRIVATAG

KLEIN, ELLIOT (UNITED STATES INDIVIDUAL)
UNIT 6K
210 EAST 15TH STREET
NEW YORK, NY 10003

FOR: RADIO FREQUENCY IDENTIFICATION
(RFID) TAGS DESIGNED TO PROTECT AND OP-
TIONALLY SHIELD FROM RFID ENERGY FOR
AIRLINE BAGGAGE IDENTIFICATION WITH
PRIVACY PROTECTION SERVICE FEATURES, IN
CLASS 9 (U.S. CLS. 21, 23, 26, 36 AND 38).

FIRST USE 4-21-2007; IN COMMERCE 9-18-2007.

THE MARK CONSISTS OF STANDARD CHAR-
ACTERS WITHOUT CLAIM TO ANY PARTICULAR
FONT, STYLE, SIZE, OR COLOR.

SN 77-184,382, FILED 5-18-2007.

CARRIE GENOVESE, EXAMINING ATTORNEY

Int. Cl.: 25

Prior U.S. Cls.: 22 and 39

United States Patent and Trademark Office

Reg. No. 3,399,299

Registered Mar. 18, 2008

**TRADEMARK
PRINCIPAL REGISTER**

WEATHERBREAKER

THE ORVIS COMPANY, INC. (VERMONT CORPORATION)
HISTORIC ROUTE 7A
MANCHESTER, VT 05254

THE MARK CONSISTS OF STANDARD CHARACTERS WITHOUT CLAIM TO ANY PARTICULAR FONT, STYLE, SIZE, OR COLOR.

FOR: JACKETS, IN CLASS 25 (U.S. CLS. 22 AND 39).

SN 77-184,639, FILED 5-18-2007.

FIRST USE 1-0-2005; IN COMMERCE 1-0-2005.

LAURIE MAYES, EXAMINING ATTORNEY

Int. Cl.: 6

Prior U.S. Cls.: 2, 12, 13, 14, 23, 25, and 50

United States Patent and Trademark Office

Reg. No. 3,399,300

Registered Mar. 18, 2008

**TRADEMARK
PRINCIPAL REGISTER**



METALS USA BUILDING PRODUCTS, L.P.
(TEXAS LIMITED PARTNERSHIP)
ONE RIVERWAY, SUITE 100
HOUSTON, TX 77056

OWNER OF U.S. REG. NOS. 2,425,483, 2,451,306,
AND OTHERS.

FOR: METAL AND STONE COATED METAL
ROOFING TILES; STONE COATED METAL ROOF-
ING PANELS; METAL ROOF AND PATIO SYSTEM
COMPONENTS COMPRISING OF BEAMS, POSTS,
RAFTERS, TUBES, AND SINGLE SKIN AND
STRUCTURAL INSULATED ROOF PANELS, ALL
MADE OF ALUMINUM OR METAL ALLOY, IN
CLASS 6 (U.S. CLS. 2, 12, 13, 14, 23, 25 AND 50).

NO CLAIM IS MADE TO THE EXCLUSIVE
RIGHT TO USE "ROOFING PRODUCTS", APART
FROM THE MARK AS SHOWN.

THE MARK CONSISTS OF A STYLIZED A.

SN 77-189,290, FILED 5-24-2007.

FIRST USE 7-1-2007; IN COMMERCE 7-1-2007.

SHAUNIA CARLYLE, EXAMINING ATTORNEY

Int. Cl.: 35

Prior U.S. Cls.: 100, 101, and 102

United States Patent and Trademark Office

Reg. No. 3,399,301

Registered Mar. 18, 2008

**SERVICE MARK
PRINCIPAL REGISTER**

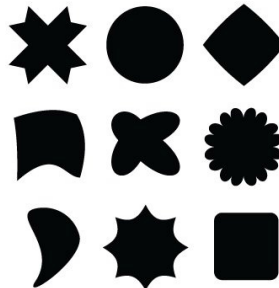

BEST AMERICAN ARTISTS AND ARTISANS,
INC. (OHIO CORPORATION)
193 S. ARDMORE ROAD
COLUMBUS, OH 43209

FOR: ON-LINE RETAIL STORE SERVICES, FEATURING CLOTHING, PERSONAL ACCESSORIES, JEWELRY, GIFTS, BAGS AND HOME DÉCOR AND ACCESSORIES, IN CLASS 35 (U.S. CLS. 100, 101 AND 102).

FIRST USE 7-4-2007; IN COMMERCE 7-4-2007.

THE MARK CONSISTS OF NINE SHAPES SYMMETRICALLY PLACED WITH THREE IN THE TOP ROW, THREE IN THE MIDDLE ROW AND THREE IN THE BOTTOM ROW.

SN 77-975,171, FILED 2-12-2007.

PAUL F. GAST, EXAMINING ATTORNEY

Int. Cl.: 21

Prior U.S. Cls.: 2, 13, 23, 29, 30, 33, 40, and 50

United States Patent and Trademark Office

Reg. No. 3,399,302

Registered Mar. 18, 2008

**TRADEMARK
PRINCIPAL REGISTER**



SOKOL, BRENT D. (UNITED STATES INDIVIDUAL)

418 NORTH LA JOLLA AVENUE

LOS ANGELES, CA 90048 AND

CHIANG, CHIA C. (UNITED STATES INDIVIDUAL)

418 NORTH LA JOLLA AVENUE

LOS ANGELES, CA 90048

FIRST USE 9-14-2007; IN COMMERCE 9-14-2007.

THE MARK CONSISTS OF A RECTANGULAR SHAPE WITH TEXT.

FOR: FRUIT RIPENING BOWLS; SERVINGWARE FOR SERVING FOOD; STORE AND SERVE CONTAINERS FOR FOOD, IN CLASS 21 (U.S. CLS. 2, 13, 23, 29, 30, 33, 40 AND 50).

SN 77-975,172, FILED 11-19-2006.

ROBIN CHOSID, EXAMINING ATTORNEY

Int. Cl.: 28

Prior U.S. Cls.: 22, 23, 38, and 50

United States Patent and Trademark Office

Reg. No. 3,399,303

Registered Mar. 18, 2008

**TRADEMARK
PRINCIPAL REGISTER**

SINDY

PEDIGREE DOLLS & TOYS LIMITED (UNITED
KINGDOM CORPORATION)
THE OLD RECTORY
MATFORD LANE, ST. LEONARDS
EXETER, DEVON, UNITED KINGDOM EX2 4PS

FIRST USE 2-16-2005; IN COMMERCE 2-16-2005.

OWNER OF U.S. REG. NOS. 1,009,666 AND
1,958,544.

FOR: DOLLS AND ACCESSORIES FOR DOLLS;
DOLL BEDS, CLOTHES, FEEDING BOTTLES AND
HOUSES; TOY FIGURINES; TOY MODEL HOBBY
CRAFT KITS, IN CLASS 28 (U.S. CLS. 22, 23, 38 AND
50).

SN 78-159,284, FILED 8-29-2002.

KRISTIN DAHLING, EXAMINING ATTORNEY

Int. Cl.: 25

Prior U.S. Cls.: 22 and 39

United States Patent and Trademark Office

Reg. No. 3,399,304

Registered Mar. 18, 2008

**TRADEMARK
PRINCIPAL REGISTER**



PROCAPS L.P. (CANADA LIMITED PARTNER-
SHIP)
6000 KIERAN STREET
VILLE ST. LAURENT, QUEBEC, CANADA H4S 2B5

FOR: CLOTHING, NAMELY, SHIRTS, JERSEYS,
SHORTS, T-SHIRTS, SWEATSHIRTS; HEADGEAR,
NAMELY, HATS AND CAPS; PAINTBALL JERSEYS,
IN CLASS 25 (U.S. CLS. 22 AND 39).

FIRST USE 7-0-2002; IN COMMERCE 7-0-2002.

NO CLAIM IS MADE TO THE EXCLUSIVE
RIGHT TO USE "PAINTBALL", APART FROM
THE MARK AS SHOWN.

SN 78-161,276, FILED 9-6-2002.

MICHELE SWAIN, EXAMINING ATTORNEY

Int. Cl.: 10

Prior U.S. Cls.: 26, 39, and 44

United States Patent and Trademark Office

Reg. No. 3,399,305

Registered Mar. 18, 2008

**TRADEMARK
PRINCIPAL REGISTER**

SWEEP

BIOCURY MEDICAL INSTRUMENTS, INC. (UNI-
TED STATES INDIVIDUAL)
245 DRYDEN AVENUE, SW
CANTON, OH 44706

FIRST USE 4-12-2006; IN COMMERCE 4-12-2006.

SN 78-179,089, FILED 10-28-2002.

FOR: DENTAL OR ORAL HYGIENE INSTRU-
MENTS; NAMELY, DEVICE USED TO REMOVE
SUBSTANCE BUILD-UP FROM THE TONGUE, IN
CLASS 10 (U.S. CLS. 26, 39 AND 44).

ALICE BENMAMAN, EXAMINING ATTORNEY

Int. Cl.: 9

Prior U.S. Cls.: 21, 23, 26, 36, and 38

United States Patent and Trademark Office

Reg. No. 3,399,306

Registered Mar. 18, 2008

**TRADEMARK
PRINCIPAL REGISTER**

SESA

SYMANTEC CORPORATION (DELAWARE CORPORATION)
20330 STEVENS CREEK BOULEVARD
CUPERTINO, CA 95014

FOR: COMPUTER ANTIVIRUS SOFTWARE; INTERNET SECURITY SOFTWARE; ENTERPRISE SECURITY SOFTWARE; INTRUSION DETECTION SOFTWARE; FIREWALL SOFTWARE; PRIVACY CONTROL SOFTWARE; CONTENT FILTERING SOFTWARE; CLONING SOFTWARE FOR CLONING COMPUTER OPERATING SYSTEMS; COMPUTER SOFTWARE FOR THE CREATION OF A VIRTUAL PRIVATE NETWORK; COMPUTER SOFTWARE AND DOWNLOADABLE COMPUTER SOFTWARE, NAMELY, UTILITY SOFTWARE; COMPUTER UTILITY SOFTWARE FOR REMOVAL OF COMPUTER APPLICATIONS AND SOFTWARE; UTILITY SOFTWARE FOR FACILITATING COMPUTER USE AT REMOTE LOCATIONS AND FOR FACILITATING COMMUNICATIONS AMONG MOBILE USERS OVER NETWORKS; COMPUTER SOFTWARE, NAMELY, MIDDLEWARE FOR INTERFACING CLIENT APPLICATIONS AND NETWORKED OR HOST BASED DATABASES; COMPUTER SOFTWARE AND DOWNLOADABLE COMPUTER SOFTWARE FOR USE IN UPDATING OTHER COMPUTER SOFTWARE; COMPUTER SOFTWARE FOR USE IN NETWORKING APPLICATIONS, NAMELY, COMMUNICATIONS SOFTWARE FOR CONNECTING COMPUTER NETWORK USERS; COMPUTER SOFTWARE FOR SENDING AND RECEIVING FACSIMILE TRANS-

MISSIONS FROM COMPUTERS AND NOTEBOOK COMPUTERS; COMPUTER SOFTWARE FOR CONNECTING AND MANAGING REMOTE COMPUTERS, FOR SYNCHRONIZATION OF FILES THROUGH E-MAIL, FOR PROVIDING SECURITY TO REMOTE COMPUTER USERS, FOR IMPLEMENTING COMPUTER, SOFTWARE AND NETWORK SECURITY MEASURES FOR REMOTE COMPUTER USERS; COMPUTER SOFTWARE FOR FILE MANAGEMENT AND TRANSFER, FOR TELECOMMUTING, FOR FACSIMILE TRANSMISSION, FOR MOBILE COMPUTING AND FOR USE WITH A HOME OR REMOTE OFFICE, NAMELY, FOR REMOTELY ACCESSING OTHER COMPUTER NETWORKS; COMPUTER SOFTWARE AND ELECTRONIC DATABASES RECORDED ON COMPUTER MEDIA FOR USE IN DIAGNOSIS, REPAIR AND CONFIGURATION OF COMPUTERS, COMPUTER SOFTWARE AND COMPUTER PERIPHERALS; USER MANUALS SUPPLIED WITH ALL OF THE FOREGOING; COMPUTER HARDWARE; COMPUTER HARDWARE APPLIANCES THAT PROVIDE FIREWALL, CONTENT FILTERING, INTRUSION ALERT, VIRUS PROTECTION, VIRTUAL PRIVATE NETWORKING AND OTHER SECURITY FUNCTIONS, IN CLASS 9 (U.S. CLS. 21, 23, 26, 36 AND 38).

FIRST USE 11-0-2002; IN COMMERCE 11-0-2002.

SN 78-183,388, FILED 11-8-2002.

GINA HAYES, EXAMINING ATTORNEY

Int. Cl.: 35

Prior U.S. Cls.: 100, 101, and 102

United States Patent and Trademark Office

Reg. No. 3,399,307

Registered Mar. 18, 2008

**SERVICE MARK
PRINCIPAL REGISTER**

BUD LIGHT LOUNGE

ANHEUSER-BUSCH, INCORPORATED (MIS-
SOURI CORPORATION)
ONE BUSCH PLACE, 202-6
ST. LOUIS, MO 63118

NO CLAIM IS MADE TO THE EXCLUSIVE
RIGHT TO USE "LOUNGE", APART FROM THE
MARK AS SHOWN.

FOR: PROMOTING THE CONCERTS OF OTH-
ERS, IN CLASS 35 (U.S. CLS. 100, 101 AND 102).

SN 78-219,203, FILED 2-26-2003.

FIRST USE 4-1-2003; IN COMMERCE 4-1-2003.

OWNER OF U.S. REG. NOS. 666,367, 1,261,873,
AND 2,119,771.

MARIA-VICTORIA SUAREZ, EXAMINING ATTOR-
NEY

Int. Cl.: 9

Prior U.S. Cls.: 21, 23, 26, 36, and 38

United States Patent and Trademark Office

Reg. No. 3,399,308

Registered Mar. 18, 2008

**TRADEMARK
PRINCIPAL REGISTER**

GET US BEFORE THEY GET YOU

CATAPHORA, INC. (DELAWARE CORPORATION)
1200 BRIDGE PARKWAY
REDWOOD CITY, CA 940651159

FOR: COMPUTER SOFTWARE, NAMELY, SOFTWARE FOR ACCESSING, COLLECTING, STORING, ORGANIZING, AGGREGATING, MANAGING, AND ANALYZING ELECTRONIC DOCUMENTS AND DATA FOR USE IN THE LEGAL FIELD; COMPUTER SOFTWARE, NAMELY, LITIGATION-SUPPORT SOFTWARE FOR USE IN THE LEGAL FIELD; COMPUTER SOFTWARE, NAMELY, SOFTWARE FOR REGULATORY COMPLIANCE MANAGEMENT IN THE LEGAL FIELD; COMPUTER SOFTWARE, NAMELY, SOFTWARE TO CREATE CHARTS, GRAPHS, STATISTICAL SUMMARIES

AND DIAGRAMS TO VISUALIZE SEQUENCES OF EVENTS FOR USE IN THE LEGAL FIELD; COMPUTER SOFTWARE, NAMELY, SOFTWARE TO RECONSTRUCT COMPLEX EVIDENCE AND SEQUENCES OF EVENTS FOR USE IN THE LEGAL FIELD; DATABASE MANAGEMENT SOFTWARE; DATABASE MANAGEMENT SOFTWARE FOR USE IN DOCUMENT MANAGEMENT AND KNOWLEDGE MANAGEMENT, IN CLASS 9 (U.S. CLS. 21, 23, 26, 36 AND 38).

FIRST USE 10-11-2007; IN COMMERCE 10-11-2007.

SN 78-225,416, FILED 3-13-2003.

JOHN DALIER, EXAMINING ATTORNEY

Int. Cls.: 36 and 37

Prior U.S. Cls.: 100, 101, 102, 103, and 106

United States Patent and Trademark Office

Reg. No. 3,399,309

Registered Mar. 18, 2008

**SERVICE MARK
PRINCIPAL REGISTER**

TRINITY PLACE

TRINITY MANAGEMENT SERVICES (CALIFORNIA CORPORATION)
333 BAY STEET
SAN FRANCISCO, CA 94133

FOR: RENTING, LEASING, MANAGEMENT OF COMMERCIAL, RETAIL AND RESIDENTIAL REAL ESTATE, IN CLASS 36 (U.S. CLS. 100, 101 AND 102).

FIRST USE 3-21-2007; IN COMMERCE 3-21-2007.

FOR: DEVELOPING COMMERCIAL, RETAIL AND RESIDENTIAL REAL ESTATE; AND PROVIDING MAINTENANCE SERVICES FOR COMMERCIAL, RETAIL AND RESIDENTIAL REAL ESTATE, IN CLASS 37 (U.S. CLS. 100, 103 AND 106).

FIRST USE 3-21-2007; IN COMMERCE 3-21-2007.

OWNER OF U.S. REG. NOS. 1,785,824, 2,604,643, AND OTHERS.

NO CLAIM IS MADE TO THE EXCLUSIVE RIGHT TO USE "PLACE", APART FROM THE MARK AS SHOWN.

SN 78-227,501, FILED 3-19-2003.

CHRISTOPHER BUONGIORNO, EXAMINING ATTORNEY

Int. Cl.: 33

Prior U.S. Cls.: 47 and 49

United States Patent and Trademark Office

Reg. No. 3,399,310

Registered Mar. 18, 2008

**TRADEMARK
PRINCIPAL REGISTER**

VIÑA DE LOS PADRILLOS

CATENA, ERNESTO (ARGENTINA INDIVIDUAL)
RIVADAVIA 413 PISO 7
BUENOS AIRES, ARGENTINA C1002AAC

FOR: WINES, IN CLASS 33 (U.S. CLS. 47 AND 49).

FIRST USE 6-0-2007; IN COMMERCE 10-0-2007.

OWNER OF ARGENTINA REG. NO. 1878983,
DATED 7-19-2002, EXPIRES 7-19-2012.

THE MARK CONSISTS OF THE MARK AS PRESENTED WITHOUT ANY CLAIM AS TO SPECIAL FORM.

THE FOREIGN WORDING IN THE MARK TRANSLATES INTO ENGLISH AS "VINEYARD OF STALLIONS".

SN 78-232,071, FILED 3-31-2003.

JOHN DALIER, EXAMINING ATTORNEY

Int. Cl.: 9

Prior U.S. Cls.: 21, 23, 26, 36, and 38

United States Patent and Trademark Office

Reg. No. 3,399,311

Registered Mar. 18, 2008

TRADEMARK
PRINCIPAL REGISTER

VISUAL *Changes*
SKIN CARE INTERNATIONAL

VISUAL CHANGES SKIN CARE INTERNATIONAL,
INC. (CALIFORNIA CORPORATION)
2491 WEST SHAW AVENUE, SUITE 110
FRESNO, CA 93711

NO CLAIM IS MADE TO THE EXCLUSIVE
RIGHT TO USE "SKIN CARE INTERNATIONAL",
APART FROM THE MARK AS SHOWN.

FOR: PRE-RECORDED ELECTRONIC MEDIA,
NAMELY, COMPACT DISCS ON BEAUTY AND
MOTIVATIONAL TOPICS, IN CLASS 9 (U.S. CLS. 21,
23, 26, 36 AND 38).

SN 78-235,359, FILED 4-8-2003.

FIRST USE 5-31-2004; IN COMMERCE 5-31-2004.

DAVID ELTON, EXAMINING ATTORNEY

Int. Cl.: 9

Prior U.S. Cls.: 21, 23, 26, 36, and 38

United States Patent and Trademark Office

Reg. No. 3,399,312

Registered Mar. 18, 2008

**TRADEMARK
PRINCIPAL REGISTER**

VERSERA ICE

IP UNITY GLENAYRE, INC. (DELAWARE CORPORATION)
11360 LAKEFIELD DRIVE
DULUTH, GA 30097

FOR: COMPUTER HARDWARE; COMPUTER PERIPHERALS; TELECOMMUNICATIONS HARDWARE, NAMELY, DIGITAL TELEPHONE LINE CARDS, FAX CARDS, NETWORK INTERFACE CARDS, SYSTEM DISCS, DISC CONTROLLERS, BACK-UP STREAMING TAPES, POWER SUPPLIES, MODEMS, ALL FOR USE IN TELEPHONY SYSTEMS, MULTIMEDIA MESSAGING SYSTEMS, VOICE NAVIGATION SYSTEMS, VOICE PORTAL SYSTEMS; COMPUTER PROGRAMS FOR TELEPHONY AND MULTIMEDIA MESSAGING SYSTEMS, NAMELY, FOR PROVIDING CALL ANSWERING, UNIVERSAL MAILBOX, MESSAGE STORE AND FORWARDING AND RETRIEVAL, VIRTUAL TELEPHONY, FAX MESSAGING, TEXT

MESSAGING, E-MAIL MESSAGING, VIDEO MESSAGING, SHORT MESSAGE SERVICE, CALL MANAGEMENT, AND INTEGRATED VOICE, FAX, TEXT, E-MAIL AND VIDEO MESSAGING FUNCTIONS; COMPUTER PROGRAMS FOR THE MANAGEMENT AND ANALYSIS OF WIRELESS NETWORKS; COMPUTER PROGRAMS FOR PROVIDING DATA NETWORK ACCESS TO MULTIMEDIA MESSAGING SYSTEMS, IN CLASS 9 (U.S. CLS. 21, 23, 26, 36 AND 38).

FIRST USE 2-0-2005; IN COMMERCE 2-0-2005.

OWNER OF U.S. REG. NO. 2,754,066.

SN 78-239,679, FILED 4-18-2003.

JERI J. FICKES, EXAMINING ATTORNEY

Prior U.S. Cl.: B

United States Patent and Trademark Office

Reg. No. 3,399,313

Registered Mar. 18, 2008

CERTIFICATION MARK
SERVICES
PRINCIPAL REGISTER



WATER QUALITY ASSOCIATION (ILLINOIS CORPORATION)
4151 NAPERVILLE ROAD
LISLE, IL 605321088

FOR: RETAIL SERVICES BY DIRECT SOLICITATION BY SALES AGENTS IN THE FIELD OF WATER QUALITY IMPROVEMENT EQUIPMENT, AND MAIL ORDER SERVICES FEATURING WATER QUALITY IMPROVEMENT EQUIPMENT, IN CLASS B (U.S. CL. B).

FIRST USE 7-23-2003; IN COMMERCE 7-23-2003.

OWNER OF U.S. REG. NOS. 1,111,990, 1,574,057, AND OTHERS.

NO CLAIM IS MADE TO THE EXCLUSIVE RIGHT TO USE "WATER QUALITY ASSOCIATION"

AND "CERTIFIED SALES REPRESENTATIVE", APART FROM THE MARK AS SHOWN.

THE CERTIFICATION MARK, AS USED BY PERSONS AUTHORIZED BY THE CERTIFIER, CERTIFIES THAT THE SERVICES ARE PERFORMED BY PERSONS WHO HAVE SATISFIED THE CERTIFIER'S REQUIREMENTS RELATING TO EXPERIENCE, KNOWLEDGE, EDUCATION AND PROFESSIONAL COMPETENCE AS EVIDENCED BY SUCCESSFUL COMPLETION OF AN EXAMINATION ADMINISTERED BY THE CERTIFIER.

SN 78-239,917, FILED 4-21-2003.

NICHOLAS ALTREE, EXAMINING ATTORNEY

Int. Cl.: 35

Prior U.S. Cls.: 100, 101, and 102

United States Patent and Trademark Office

Reg. No. 3,399,314

Registered Mar. 18, 2008

**SERVICE MARK
PRINCIPAL REGISTER**

HSH NORDBANK

HSH NORDBANK AG (FED REP GERMANY
CORPORATION)
RECHTSABTEILUNG
HAMBURG, FED REP GERMANY 20079

FOR: BUSINESS SERVICES, NAMELY, BUSINESS
MANAGEMENT SERVICES; BUSINESS RESEARCH
SERVICES; BUSINESS ANALYSIS AND FORECAST-
ING SERVICES; BUSINESS MANAGEMENT AND
BUSINESS CONSULTANCY SERVICES; BUSINESS
COST AND BUSINESS STATISTICAL INFORMA-
TION AND ANALYSIS OF SERVICES; TAX PRE-
PARATION AND CONSULTATION SERVICES;
BUSINESS APPRAISAL SERVICES; BUSINESS PRO-

JECT ADVISORY AND INFORMATION SERVICES;
ADVISORY AND CONSULTANCY SERVICES RE-
LATING TO ALL THE AFORESAID, IN CLASS 35
(U.S. CLS. 100, 101 AND 102).

FIRST USE 2-4-2003; IN COMMERCE 2-4-2003.

THE FOREIGN WORDING IN THE MARK
TRANSLATES INTO ENGLISH AS NORTH BANK.

SN 78-241,203, FILED 4-23-2003.

TAMARA FRAZIER, EXAMINING ATTORNEY

Int. Cl.: 16

Prior U.S. Cls.: 2, 5, 22, 23, 29, 37, 38, and 50

United States Patent and Trademark Office

Reg. No. 3,399,315

Registered Mar. 18, 2008

**TRADEMARK
PRINCIPAL REGISTER**

BLACK BULL ENTERTAINMENT

GAREB SHAMUS ENTERPRISES, INC. (NEW
YORK CORPORATION)
151 WELLS AVENUE
CONGERS, NY 109202036

NO CLAIM IS MADE TO THE EXCLUSIVE
RIGHT TO USE "ENTERTAINMENT", APART
FROM THE MARK AS SHOWN.

FOR: STATIONERY, PRINTED PUBLICATIONS,
NAMELY, COMIC BOOKS, STICKERS, DECALS,
PENS, PAINTBRUSHES AND WRITING PADS, IN
CLASS 16 (U.S. CLS. 2, 5, 22, 23, 29, 37, 38 AND 50).

SN 78-246,137, FILED 5-6-2003.

FIRST USE 8-0-2000; IN COMMERCE 8-0-2000.

HENRY S. ZAK, EXAMINING ATTORNEY

Int. Cls.: 25 and 28

Prior U.S. Cls.: 22, 23, 38, 39, and 50

United States Patent and Trademark Office

Reg. No. 3,399,316

Registered Mar. 18, 2008

**TRADEMARK
PRINCIPAL REGISTER**

WAR ADMIRAL

CENTEX/TAYLOR, LLC (DELAWARE LTD LIAB
CO)
14121 PARKE LONG COURT, SUITE 201
CHANTILLY, VA 20151

FOR: GOLF-RELATED CLOTHING, NAMELY,
SHIRTS, SWEATERS, HATS, ALL SOLD IN GOLF-
PRO SHOPS, IN CLASS 25 (U.S. CLS. 22 AND 39).

FIRST USE 7-31-2007; IN COMMERCE 7-31-2007.

FOR: GOLF AND GOLF COURSE RELATED
ACCESSORIES, NAMELY, GOLF BALLS, IN CLASS
28 (U.S. CLS. 22, 23, 38 AND 50).

FIRST USE 7-31-2007; IN COMMERCE 7-31-2007.

SN 78-247,090, FILED 5-8-2003.

CHARLES L. JENKINS, EXAMINING ATTORNEY

Int. Cl.: 25

Prior U.S. Cls.: 22 and 39

United States Patent and Trademark Office

Reg. No. 3,399,317

Registered Mar. 18, 2008

**TRADEMARK
PRINCIPAL REGISTER**



SUNS LEGACY PARTNERS, LLC (DELAWARE
LIMITED LIABILITY COMPANY)
201 EAST JEFFERSON STREET
PHOENIX, AZ 85004

FOR: CLOTHING, NAMELY, HOSIERY, FOOT-
WEAR, BASKETBALL SHOES, BASKETBALL SNEA-
KERS, T-SHIRTS, SHIRTS, SWEATSHIRTS,
SWEATPANTS, PANTS, TANK TOPS, JERSEYS,
SHORTS, PAJAMAS, SPORT SHIRTS, RUGBY
SHIRTS, SWEATERS, BELTS, TIES, NIGHTSHIRTS,
HATS, CAPS, WARM-UP SUITS, WARM-UP PANTS,
WARM-UP TOPS, JACKETS, WIND RESISTANT
JACKETS, PARKAS, COATS, CLOTH BABY BIBS,

HEAD BANDS, WRIST BANDS, APRONS, BOXER
SHORTS, SLACKS, CAPS, EAR MUFFS, GLOVES,
MITTENS, SCARVES, WOVEN AND KNIT SHIRTS,
DRESSES, CHEERLEADING DRESSES AND UNI-
FORMS, IN CLASS 25 (U.S. CLS. 22 AND 39).

FIRST USE 1-1-2003; IN COMMERCE 1-1-2003.

OWNER OF U.S. REG. NO. 1,861,768.

SN 78-247,503, FILED 5-8-2003.

BARBARA GAYNOR, EXAMINING ATTORNEY

Int. Cl.: 3

Prior U.S. Cls.: 1, 4, 6, 50, 51, and 52

United States Patent and Trademark Office

Reg. No. 3,399,318

Registered Mar. 18, 2008

**TRADEMARK
PRINCIPAL REGISTER**

**MAKE
UP
FACTORY**

COSMETIC CREATIV SERVICE GMBH (FED REP
GERMANY CORPORATION)
GAUßSTRABE 13
KARLSFELD, FED REP GERMANY D-85757

FOR: PREPARATIONS FOR BODY AND BEAUTY
CARE, NAMELY SOAPS, NAMELY HAND SOAP,
FACE SOAP, BODY SOAP; PERFUMES; ETHEREAL
OILS FOR PERSONAL USE; WOMEN'S COSMETICS;
EYEBROW COSMETICS; EYEBROW PENCILS; COS-
METIC PREPARATIONS FOR BATHS, NAMELY
BATH OILS AND BATH SALTS; COSMETIC
CREAMS; ARTIFICIAL EYELASHES; ARTIFICIAL
FINGER NAILS; NAIL VARNISH; LIPSTICKS;
BEAUTY MASKS; COSMETIC PREPARATIONS
FOR SLIMMING PURPOSES, NAMELY SLIMMING
CREAMS AND SLIMMING GELS; MAKE-UP POW-
DER; MEN'S COSMETICS, NAMELY AFTER-

SHAVE LOTIONS, SHAVE CREAMS, SKIN
CREAMS, HAIR LOTIONS, SHAMPOOS AND HAIR
DYES, IN CLASS 3 (U.S. CLS. 1, 4, 6, 50, 51 AND 52).

FIRST USE 11-15-2007; IN COMMERCE 11-15-2007.

OWNER OF FED REP GERMANY REG. NO.
30255121, DATED 1-9-2003, EXPIRES 11-30-2012.

NO CLAIM IS MADE TO THE EXCLUSIVE
RIGHT TO USE MAKE UP, APART FROM THE
MARK AS SHOWN.

SN 78-248,434, FILED 5-12-2003.

JOHN DALIER, EXAMINING ATTORNEY

Int. Cl.: 30

Prior U.S. Cl.: 46

United States Patent and Trademark Office

Reg. No. 3,399,319

Registered Mar. 18, 2008

**TRADEMARK
PRINCIPAL REGISTER**

CD-LICIOUS

CHOCOLATE PRINTING COMPANY, INC. (DE-
LAWARE CORPORATION)
600 BAYVIEW AVENUE
INWOOD, NY 11096

FOR: CANDY AND CHOCOLATE, IN CLASS 30
(U.S. CL. 46).

FIRST USE 5-1-2001; IN COMMERCE 5-1-2001.

THE MARK CONSISTS OF STANDARD CHAR-
ACTERS WITHOUT CLAIM TO ANY PARTICULAR
FONT, STYLE, SIZE, OR COLOR.

SN 78-250,949, FILED 5-16-2003.

LEIGH CAROLINE CASE, EXAMINING ATTOR-
NEY

Int. Cls.: 35 and 41

Prior U.S. Cls.: 100, 101, 102, and 107

United States Patent and Trademark Office

Reg. No. 3,399,320

Registered Mar. 18, 2008

**SERVICE MARK
PRINCIPAL REGISTER**

SUMMIT CLUB

JOHNS MANVILLE (DELAWARE CORPORATION)
717 SEVENTEENTH STREET
DENVER, CO 80202

FOR: INCENTIVE AWARD PROGRAMS FOR ROOFING CONTRACTORS TO PROMOTE THE SALE OF ROOFING PRODUCTS AND ON-THE-JOB SAFETY; AND SALES LEADS IN THE NATURE OF REFERRALS TO ROOFING CONTRACTORS IN THE FIELD OF ROOFING SERVICES, IN CLASS 35 (U.S. CLS. 100, 101 AND 102).

FIRST USE 2-11-2005; IN COMMERCE 2-11-2005.

FOR: EDUCATIONAL SERVICES, NAMELY, PROVIDING TRAINING PROGRAMS AND SEMINARS ON THE SUBJECT OF ROOF BUILDING,

PRODUCT INSTALLATION, AND SAFETY; AND EDUCATIONAL SERVICES, NAMELY, PROVIDING INCENTIVES TO ROOFING CONTRACTORS TO DEMONSTRATE EXCELLENCE IN THE FIELD OF ROOFING, IN CLASS 41 (U.S. CLS. 100, 101 AND 107).

FIRST USE 2-11-2005; IN COMMERCE 2-11-2005.

NO CLAIM IS MADE TO THE EXCLUSIVE RIGHT TO USE "CLUB", APART FROM THE MARK AS SHOWN.

SN 78-251,658, FILED 5-19-2003.

REBECCA POVARCHUK, EXAMINING ATTORNEY

Int. Cl.: 9

Prior U.S. Cls.: 21, 23, 26, 36, and 38

Reg. No. 3,399,321

United States Patent and Trademark Office

Registered Mar. 18, 2008

**TRADEMARK
PRINCIPAL REGISTER**

SYNCHROPLEX IMAGING SYSTEMS

SYNCHROPLEX IMAGING SYSTEMS, INC.
(KANSAS CORPORATION)
10809 WEST 115TH PLACE
OVERLAND PARK, KS 66210

NO CLAIM IS MADE TO THE EXCLUSIVE
RIGHT TO USE "IMAGING SYSTEMS", APART
FROM THE MARK AS SHOWN.

FOR: COMPUTER SOFTWARE CONTAINED ON
CD ROM FOR USE IN CONNECTION WITH TEM-
PLATES FOR DIGITAL PHOTOGRAPHY, IN CLASS
9 (U.S. CLS. 21, 23, 26, 36 AND 38).

SN 78-251,890, FILED 5-20-2003.

FIRST USE 9-14-2004; IN COMMERCE 9-14-2004.

SUE LAWRENCE, EXAMINING ATTORNEY

Int. Cls.: 1, 2, 3, 29, and 30

Prior U.S. Cls.: 1, 4, 5, 6, 10, 11, 16, 26, 46, 50, 51, and 52

Reg. No. 3,399,322

United States Patent and Trademark Office

Registered Mar. 18, 2008

**TRADEMARK
PRINCIPAL REGISTER**

Aivaly

S.S. TARIS ZEYTIN VE ZEYTINYAGI TARIM
SATIS KOOPERATIFLERI BIRLIGI (TURKEY
CORPORATION)

YADIGAR SOK.1492 SOK., NO:14
ALSANCAK-IZMIR, TURKEY

FOR: NATURAL MATERIALS FOR USE IN THE
PRODUCTION OF COSMETICS, NAMELY, BOTA-
NICAL EXTRACTS, IN CLASS 1 (U.S. CLS. 1, 5, 6, 10,
26 AND 46).

FIRST USE 8-9-2004; IN COMMERCE 8-9-2004.

FOR: NATURAL MATERIALS FOR USE IN THE
PRODUCTION OF COSMETICS, NAMELY, COLOR-
ANTS, IN CLASS 2 (U.S. CLS. 6, 11 AND 16).

FIRST USE 8-9-2004; IN COMMERCE 8-9-2004.

FOR: BLEACHING PREPARATIONS AND
OTHER SUBSTANCES, NAMELY, BLUEING FOR
LAUNDRY USE; PERFUMERY, COSMETICS, PRE-
MOISTENED COSMETIC AND CLEANING TISSUE
PAPERS, PADS AND COTTONS, NAMELY, COS-
METIC PADS, COTTON FOR COSMETIC PURPO-
SES, SOAPS; PREPARATIONS FOR DENTAL CARE,
NAMELY, TOOTH PASTE, NON-MEDICATED
DENTAL RINSE; SCOURING ABRASIVE PRE-
PARATIONS, NAMELY, SCOURING POWDERS,
POLISHERS, NAMELY, SHOE POLISH, NAIL POL-
ISH; NATURAL MATERIALS FOR PRODUCTION
OF COSMETICS, PERFUMERY AND SOAPS,

NAMELY, ESSENTIAL OILS, IN CLASS 3 (U.S. CLS.
1, 4, 6, 50, 51 AND 52).

FIRST USE 8-9-2004; IN COMMERCE 8-9-2004.

FOR: OLIVES, NAMELY, PROCESSED OLIVES,
PICKLES, EDIBLE OILS AND FATS, MARGARINE,
BUTTER, FRUITS, NAMELY, PROCESSED FRUITS,
TINNED FROZEN FRUITS, COOKED FRUITS,
JAMS, MARMALADE, FRUIT PEEL, STEWED
FRUIT, DRIED FRUIT, PRESERVED FRUIT, FRUIT
PULP, PEANUT AND NUT BUTTER; SALAD OIL, IN
CLASS 29 (U.S. CL. 46).

FIRST USE 8-9-2004; IN COMMERCE 8-9-2004.

FOR: GRAPE MOLASSES, KETCHUP, MAYON-
NAISE, MUSTARD, SAUCES FOR USE AS CONDI-
MENTS, NAMELY, SALAD DRESSING, SAUCES
FOR SALADS, TOMATO SAUCE, NON-NUTRI-
TIONAL AROMATIC PREPARATIONS FOR FOOD,
NOT BEING ESSENTIAL OILS, YEAST, BAKING
POWDERS, VANILLA, SPICES, HERB TEA FOR
FOOD PURPOSES, ICED TEAS, LIME TEA, SAHLEP,
A THICK FERMENTED NON-ALCOHOLIC GRAIN-
BASED BEVERAGE, IN CLASS 30 (U.S. CL. 46).

FIRST USE 8-9-2004; IN COMMERCE 8-9-2004.

SN 78-253,662, FILED 5-23-2003.

KATHY DE JONGE, EXAMINING ATTORNEY

Int. Cl.: 28

Prior U.S. Cls.: 22, 23, 38, and 50

United States Patent and Trademark Office

Reg. No. 3,399,323

Registered Mar. 18, 2008

**TRADEMARK
PRINCIPAL REGISTER**

POLLY WANNA PINATA

CANEPA, VICKIE P. (UNITED STATES INDIVIDUAL)
2853 E. SIERRA DRIVE
WESTLAKE VILLAGE, CA 91362

NO CLAIM IS MADE TO THE EXCLUSIVE RIGHT TO USE "PINATA", APART FROM THE MARK AS SHOWN.

FOR: BIRD TOY, IN CLASS 28 (U.S. CLS. 22, 23, 38 AND 50).

SN 78-255,326, FILED 5-28-2003.

FIRST USE 9-1-2000; IN COMMERCE 7-6-2002.

CHARLES L. JENKINS, EXAMINING ATTORNEY

Int. Cl.: 9

Prior U.S. Cls.: 21, 23, 26, 36, and 38

Reg. No. 3,399,324

United States Patent and Trademark Office

Registered Mar. 18, 2008

**TRADEMARK
PRINCIPAL REGISTER**

NEURFON

MOTOROLA, INC. (DELAWARE CORPORATION)
1303 EAST ALGONQUIN ROAD
LIBERTYVILLE, IL 60196

FOR: SENSORS FOR WIRELESS COMMUNICATION, INTEGRATED CIRCUITS, WIRELESS VOICE, DATA AND VIDEO COMMUNICATIONS AND COMPUTER NETWORKING EQUIPMENT, NAMELY, RADIO TRANSMITTERS, RADIO RECEIVERS, RADIO BASE STATIONS, SWITCHES, ROUTERS, CELL SITES, ANTENNAS, RELAYS, COMPUTER SOFTWARE FOR IMPLEMENTING, OPERATING

AND CUSTOMIZING VOICE, DISPATCH, DATA AND PAGING COMMUNICATION SYSTEMS, COMPUTER SOFTWARE FOR PROVIDING WIRELESS INTERNET ACCESS FROM COMMUNICATIONS EQUIPMENT AND INFRASTRUCTURE, IN CLASS 9 (U.S. CLS. 21, 23, 26, 36 AND 38).

FIRST USE 2-28-2005; IN COMMERCE 2-28-2005.

SN 78-255,958, FILED 5-29-2003.

PATRICIA EVANKO, EXAMINING ATTORNEY

Int. Cl.: 35

Prior U.S. Cls.: 100, 101, and 102

United States Patent and Trademark Office

Reg. No. 3,399,325

Registered Mar. 18, 2008

**SERVICE MARK
PRINCIPAL REGISTER**

EXTREME SPORTS MANAGEMENT

EXTREME MEDIA AND ENTERTAINMENT LLC
(ARIZONA LTD LIAB CO)
7002 EAST FIRST AVENUE
SCOTTSDALE, AZ 85251

FOR: ADVERTISING SERVICES, NAMELY, DISTRIBUTING INFORMATION TO THE PUBLIC REGARDING EVENTS IN THE NATURE OF ENTERTAINMENT; BUSINESS SERVICES, NAMELY, BUSINESS MANAGEMENT, BUSINESS RESEARCH, AND BUSINESS CONSULTATION; MARKETING SERVICES, NAMELY, MARKETING RESEARCH AND MARKETING STUDIES; AND PROMOTIONAL AND PUBLICITY SERVICES, NAMELY, PROMOTING AND PUBLICIZING THE

GOODS AND SERVICES OF OTHERS THROUGH THE DISTRIBUTION OF PRINTED AND AUDIO-VISUAL MATERIALS, IN CLASS 35 (U.S. CLS. 100, 101 AND 102).

FIRST USE 11-0-2007; IN COMMERCE 11-0-2007.

NO CLAIM IS MADE TO THE EXCLUSIVE RIGHT TO USE "MANAGEMENT", APART FROM THE MARK AS SHOWN.

SN 78-255,971, FILED 5-29-2003.

NAAKWAMA ANKRAH, EXAMINING ATTORNEY

Int. Cl.: 36

Prior U.S. Cls.: 100, 101, and 102

United States Patent and Trademark Office

Reg. No. 3,399,326

Registered Mar. 18, 2008

**SERVICE MARK
PRINCIPAL REGISTER**

GRAND CENTRAL CREATIVE CAMPUS

DISNEY ENTERPRISES, INC. (DELAWARE CORPORATION)
500 SOUTH BUENA VISTA STREET
BURBANK, CA 91521

FIRST USE 11-2-2006; IN COMMERCE 11-2-2006.

SN 78-262,171, FILED 6-13-2003.

FOR: REAL ESTATE SERVICES, NAMELY, REAL ESTATE LEASING AND MANAGEMENT SERVICES, IN CLASS 36 (U.S. CLS. 100, 101 AND 102).

NAAKWAMA ANKRAH, EXAMINING ATTORNEY

Int. Cl.: 30

Prior U.S. Cl.: 46

United States Patent and Trademark Office

Reg. No. 3,399,327

Registered Mar. 18, 2008

**TRADEMARK
PRINCIPAL REGISTER**

CREAM GEL

CARGILL, INCORPORATED (DELAWARE COR-
PORATION)
15407 MCGINTY ROAD WEST
WAYZATA, MN 55391

FIRST USE 11-10-2004; IN COMMERCE 11-10-2004.

SN 78-271,029, FILED 7-7-2003.

FOR: FOOD STARCHES, IN CLASS 30 (U.S. CL.
46).

JOHN DALIER, EXAMINING ATTORNEY

Int. Cls.: 25, 35, and 41

Prior U.S. Cls.: 22, 39, 100, 101, 102, and 107

United States Patent and Trademark Office

Reg. No. 3,399,328

Registered Mar. 18, 2008

**TRADEMARK
SERVICE MARK
PRINCIPAL REGISTER**

PATANJALI

COMPTON, PATRICIA, J (UNITED STATES IN-
DIVIDUAL)
347 KEANIANI STREET
KAILUA, HI 96734

FOR: CLOTHING, NAMELY T-SHIRTS, IN CLASS
25 (U.S. CLS. 22 AND 39).

FIRST USE 11-23-2007; IN COMMERCE 11-23-2007.

FOR: ONLINE RETAIL SERVICES FEATURING
YOGA PRODUCTS, IN CLASS 35 (U.S. CLS. 100, 101
AND 102).

FIRST USE 11-21-2007; IN COMMERCE 11-28-2007.

FOR: YOGA TRAINING COURSES, IN CLASS 41
(U.S. CLS. 100, 101 AND 107).

FIRST USE 11-21-2007; IN COMMERCE 11-21-2007.

SN 78-271,844, FILED 7-8-2003.

JOHN DALIER, EXAMINING ATTORNEY

Int. Cl.: 7

Prior U.S. Cls.: 13, 19, 21, 23, 31, 34, and 35

Reg. No. 3,399,329

United States Patent and Trademark Office

Registered Mar. 18, 2008

**TRADEMARK
PRINCIPAL REGISTER**

MICRO SPARK COATING

MITSUBISHI ELECTRIC CORPORATION (JAPAN CORPORATION)
2-3, MARUNOUCHI 2-CHOME, CHIYODA-KU
TOKYO, JAPAN

PRIORITY CLAIMED UNDER SEC. 44(D) ON
JAPAN APPLICATION NO. 2003-054989, FILED 7-2-
2003.

FOR: ELECTRIC DISCHARGE MACHINES FOR
USE IN MAKING A METALLIC OR CERAMIC
LAYER ON THE SURFACE OF METALLIC PRO-
DUCTS OR METALLIC PARTS OF PRODUCTS IN
THE FIELD OF VEHICLES AND INDUSTRIAL
MACHINES AND TOOLS, IN CLASS 7 (U.S. CLS.
13, 19, 21, 23, 31, 34 AND 35).

NO CLAIM IS MADE TO THE EXCLUSIVE
RIGHT TO USE "COATING", APART FROM THE
MARK AS SHOWN.

SN 78-281,098, FILED 7-30-2003.

FIRST USE 6-12-2003; IN COMMERCE 8-31-2004.

GENE MACIOL, EXAMINING ATTORNEY

Int. Cls.: 16, 36, and 41

**Prior U.S. Cls.: 2, 5, 22, 23, 29, 37, 38, 50, 100, 101,
102, and 107**

Reg. No. 3,399,330

United States Patent and Trademark Office

Registered Mar. 18, 2008

**TRADEMARK
SERVICE MARK
PRINCIPAL REGISTER**

FREEDOM TO DISCOVER

BRISTOL-MYERS SQUIBB COMPANY (DELA-
WARE CORPORATION)
345 PARK AVENUE
NEW YORK, NY 10154

FOR: PRINTED MATTTTER, NAMELY, BRO-
CHURES AND PROGRAM LITERATURE, FEAT-
URING INFORMATION IN THE FIELD OF
MEDICAL RESEARCH, IN CLASS 16 (U.S. CLS. 2, 5,
22, 23, 29, 37, 38 AND 50).

FIRST USE 12-31-1977; IN COMMERCE 12-31-1977.

FOR: PROVISION OF GRANTS TO SCIENTISTS
TO CONDUCT MEDICAL RESEARCH, IN CLASS 36
(U.S. CLS. 100, 101 AND 102).

FIRST USE 12-31-1977; IN COMMERCE 12-31-1977.

FOR: ONLINE NEWSLETTERS AND INFORMA-
TION IN THE FIELD OF MEDICAL RESEARCH
AND RESEARCH AWARDS, IN CLASS 41 (U.S. CLS.
100, 101 AND 107).

FIRST USE 12-31-1977; IN COMMERCE 12-31-1977.

SN 78-285,521, FILED 8-11-2003.

RONALD AIKENS, EXAMINING ATTORNEY

Int. Cl.: 9

Prior U.S. Cls.: 21, 23, 26, 36, and 38

United States Patent and Trademark Office

Reg. No. 3,399,331

Registered Mar. 18, 2008

**TRADEMARK
PRINCIPAL REGISTER**



ELECTRO SOURCE, LLC (CALIFORNIA LTD
LIAB CO)
14144 VENTURA BLVD., SUITE 200
SHERMAN OAKS, CA 91423

FOR: COMPUTER CONTROLLER FOR VIDEO GAMES; COMPUTER SOFTWARE FOR USE WITH VIDEO GAMES; STEERING WHEELS FOR VIDEO GAMES; VIDEO GAME CONTROLLER; RACING WHEEL FOR VIDEO GAMES; VIDEO GAME CARTRIDGES; VIDEO GAME DISKS; VIDEO GAME EQUIPMENT CONTAINING MEMORY DEVICES; VIDEO GAME HARDWARE; VIDEO CABLES; VIDEO GAME INTERACTIVE CONTROL FLOOR PADS OR MATS; VIDEO GAME INTERACTIVE REMOTE CONTROL UNITS; VIDEO GAME ACCESSORIES, NAMELY CLEANING KITS, VIDEO GAME

HOLDERS AND STANDS, MULTIPLE PLAYER ADAPTERS, RF SWITCH ADAPTERS FOR CONNECTING VIDEO GAME DEVICES TO EXTERNAL MONITORS, VIDEO GAME CD CLEANERS, VIDEO GAME VIBRATION GENERATORS, COMBINATION DVD AND VIDEO GAME CONTROLLERS, SYSTEM SELECTORS FOR SELECTING BETWEEN MULTIPLE SIGNALS, AND VIDEO GAME SOFTWARE, CD'S AND DISKS, IN CLASS 9 (U.S. CLS. 21, 23, 26, 36 AND 38).

FIRST USE 11-1-2003; IN COMMERCE 11-1-2003.

SN 78-291,947, FILED 8-25-2003.

NAAKWAMA ANKRAH, EXAMINING ATTORNEY

Int. Cls.: 9 and 41

Prior U.S. Cls.: 21, 23, 26, 36, 38, 100, 101, and 107

United States Patent and Trademark Office

Reg. No. 3,399,332

Registered Mar. 18, 2008

**TRADEMARK
SERVICE MARK
PRINCIPAL REGISTER**

FLAGSHIP STUDIOS

FLAGSHIP STUDIOS, INC. (DELAWARE CORPORATION)
139 TOWNSEND STREET, SUITE 200
SAN FRANCISCO, CA 941071922

FOR: COMPUTER GAME SOFTWARE, IN CLASS 9 (U.S. CLS. 21, 23, 26, 36 AND 38).

FIRST USE 10-31-2007; IN COMMERCE 10-31-2007.

FOR: COMPUTER AND VIDEO GAME PRODUCTION; PROVIDING ONLINE INTERACTIVE COM-

PUTER GAMES, IN CLASS 41 (U.S. CLS. 100, 101 AND 107).

FIRST USE 10-31-2007; IN COMMERCE 10-31-2007.

NO CLAIM IS MADE TO THE EXCLUSIVE RIGHT TO USE STUDIOS, APART FROM THE MARK AS SHOWN.

SN 78-296,895, FILED 9-5-2003.

RONALD R. SUSSMAN, EXAMINING ATTORNEY

Int. Cls.: 3 and 21

**Prior U.S. Cls.: 1, 2, 4, 6, 13, 23, 29, 30, 33, 40, 50, 51,
and 52**

Reg. No. 3,399,333

United States Patent and Trademark Office

Registered Mar. 18, 2008

**TRADEMARK
PRINCIPAL REGISTER**

THE POWER OF MAKEUP

TRISH MCEVOY LTD. (NEW YORK CORPORATION)
800A FIFTH AVENUE
NEW YORK, NY 10021

FOR: COSMETICS, NAMELY, FOUNDATION, BLUSH, PRESSED POWDER, UNDER EYE COVER, EYE SHADOW, EYE LINER, LIP GLOSS, AND LIP-STICK, IN CLASS 3 (U.S. CLS. 1, 4, 6, 50, 51 AND 52).

FIRST USE 6-1-2004; IN COMMERCE 6-1-2004.

FOR: COSMETIC CONTAINERS SOLD EMPTY, NAMELY, COMPACTS FOR FOUNDATION, BLUSH, PRESSED POWDER, UNDER EYE COVER,

EYE SHADOW, EYE LINER, LIP GLOSS, AND LIP-STICK, IN CLASS 21 (U.S. CLS. 2, 13, 23, 29, 30, 33, 40 AND 50).

FIRST USE 6-1-2004; IN COMMERCE 6-1-2004.

NO CLAIM IS MADE TO THE EXCLUSIVE RIGHT TO USE "MAKEUP", APART FROM THE MARK AS SHOWN.

SN 78-300,265, FILED 9-15-2003.

WILLIAM BRECKENFELD, EXAMINING ATTORNEY

Int. Cl.: 19

Prior U.S. Cls.: 1, 12, 33, and 50

United States Patent and Trademark Office

Reg. No. 3,399,334

Registered Mar. 18, 2008

**TRADEMARK
PRINCIPAL REGISTER**

OLDE BOSTON

IDEAL CONCRETE BLOCK COMPANY, INC.
(MASSACHUSETTS CORPORATION)
45 POWER ROAD
WESTFORD, MA 01886

NO CLAIM IS MADE TO THE EXCLUSIVE
RIGHT TO USE "BOSTON", APART FROM THE
MARK AS SHOWN.

FOR: CONSTRUCTION MATERIALS, NAMELY,
LANDSCAPE BLOCKS, IN CLASS 19 (U.S. CLS. 1, 12,
33 AND 50).

SN 78-303,989, FILED 9-23-2003.

FIRST USE 7-6-2007; IN COMMERCE 7-6-2007.

CAROLYN GRAY, EXAMINING ATTORNEY

Int. Cl.: 10

Prior U.S. Cls.: 26, 39, and 44

United States Patent and Trademark Office

Reg. No. 3,399,335

Registered Mar. 18, 2008

**TRADEMARK
PRINCIPAL REGISTER**

PATHWAY ACCESS SHEATH CATHETER

ONSET MEDICAL CORPORATION (CALIFORNIA CORPORATION)
SUITE 158
13700 ALTON PARKWAY
IRVINE, CA 92618

FOR: MEDICAL DEVICES, NAMELY, EXPANDABLE ACCESS SHEATHS FOR UROLOGICAL USE SOLD TO UROLOGISTS OR PURCHASING AGENTS FOR UROLOGISTS , IN CLASS 10 (U.S. CLS. 26, 39 AND 44).

FIRST USE 2-19-2004; IN COMMERCE 2-19-2004.

NO CLAIM IS MADE TO THE EXCLUSIVE RIGHT TO USE "ACCESS SHEATH CATHETER", APART FROM THE MARK AS SHOWN.

SN 78-304,647, FILED 9-24-2003.

TRACY WHITTAKER-BROWN, EXAMINING ATTORNEY

Int. Cl.: 18

Prior U.S. Cls.: 1, 2, 3, 22, and 41

United States Patent and Trademark Office

Reg. No. 3,399,336

Registered Mar. 18, 2008

**TRADEMARK
PRINCIPAL REGISTER**

THE PERFECT DRIVE

AIGNER-CLARK LLC (COLORADO LTD LIAB
CO)
9220 KIMMER DRIVE, SUITE 215
LONE TREE, CO 80124

OWNER OF U.S. REG. NOS. 3,263,276, 3,349,270,
AND OTHERS.

FOR: LUGGAGE, IN CLASS 18 (U.S. CLS. 1, 2, 3, 22
AND 41).

SN 78-309,353, FILED 10-3-2003.

FIRST USE 2-16-2007; IN COMMERCE 2-16-2007.

JOHN GARTNER, EXAMINING ATTORNEY

Int. Cl.: 30

Prior U.S. Cl.: 46

United States Patent and Trademark Office

Reg. No. 3,399,337

Registered Mar. 18, 2008

**TRADEMARK
PRINCIPAL REGISTER**

CABO LOCO

WRIGHT BROTHERS SALES & MARKETING,
INC. (WASHINGTON CORPORATION)
22031 - 68TH AVENUE SO.
KENT, WA 98032

THE ENGLISH TRANSLATION OF THE WORD
"CABO LOCO" IN THE MARK IS "CRAZY CAPE".

FOR: CORN-BASED SNACK FOODS, NAMELY,
TORTILLA CHIPS; SALSA, IN CLASS 30 (U.S. CL. 46).

SN 78-321,226, FILED 10-30-2003.

FIRST USE 4-1-2005; IN COMMERCE 4-1-2005.

MONIQUE MILLER, EXAMINING ATTORNEY

Int. Cls.: 9 and 41

Prior U.S. Cls.: 21, 23, 26, 36, 38, 100, 101, and 107

United States Patent and Trademark Office

Reg. No. 3,399,338

Registered Mar. 18, 2008

**TRADEMARK
SERVICE MARK
PRINCIPAL REGISTER**

MASHUP

MUGGERUD, LAWRENCE (UNITED STATES
INDIVIDUAL)
C/O SEDLMAYR & ASSOCIATES, P.C.
200 PARK AVENUE SOUTH, SUITE 1408
NEW YORK, NY 10003

FOR: ELECTRICAL APPARATUS, NAMELY,
PRE-RECORDED PHONOGRAPH RECORDS, COM-
PACT DISCS AND AUDIO CASSETTES FEATUR-
ING MUSIC, IN CLASS 9 (U.S. CLS. 21, 23, 26, 36 AND
38).

FIRST USE 0-0-2003; IN COMMERCE 0-0-2003.

FOR: ENTERTAINMENT SERVICES, NAMELY,
LIVE DJ SERVICES, IN CLASS 41 (U.S. CLS. 100, 101
AND 107).

FIRST USE 0-0-2002; IN COMMERCE 0-0-2002.

THE MARK CONSISTS OF STANDARD CHAR-
ACTERS WITHOUT CLAIM TO ANY PARTICULAR
FONT, STYLE, SIZE, OR COLOR.

SN 78-322,807, FILED 11-4-2003.

CAROLYN GRAY, EXAMINING ATTORNEY

Int. Cl.: 35

Prior U.S. Cls.: 100, 101, and 102

United States Patent and Trademark Office

Reg. No. 3,399,339

Registered Mar. 18, 2008

**SERVICE MARK
PRINCIPAL REGISTER**

PROFILER SERIES

PHARMETRICS, INC. (DELAWARE CORPORATION)
150 COOLIDGE AVENUE
WATERTOWN, MA 02472

FOR: CONSULTING SERVICES, NAMELY, ANALYZING THE MARKET POTENTIAL AND SUCCESS OF PHARMACEUTICAL PRODUCTS AND TRENDS AND USES OF PHARMACEUTICAL PRODUCTS, IN CLASS 35 (U.S. CLS. 100, 101 AND 102).

FIRST USE 1-2-2003; IN COMMERCE 5-13-2003.

THE MARK CONSISTS OF STANDARD CHARACTERS WITHOUT CLAIM TO ANY PARTICULAR FONT, STYLE, SIZE, OR COLOR.

SN 78-324,206, FILED 11-6-2003.

JEFF DEFORD, EXAMINING ATTORNEY

Int. Cls.: 38 and 41

Prior U.S. Cls.: 100, 101, 104, and 107

United States Patent and Trademark Office

Reg. No. 3,399,340

Registered Mar. 18, 2008

**SERVICE MARK
PRINCIPAL REGISTER**

ESPNU

ESPN, INC. (DELAWARE CORPORATION)
ESPN PLAZA
BRISTOL, CT 06010

FOR: ENTERTAINMENT SERVICES, NAMELY, BROADCASTING OF CABLE TELEVISION SPORTS, ENTERTAINMENT, NEWS, SPORTS PROGRAMS, COLLEGE SPORTS EVENTS AND OTHER RELATED AND ANCILLARY PROGRAMMING RENDERED THROUGH THE MEDIA OF TELEVISION AND RADIO, IN CLASS 38 (U.S. CLS. 100, 101 AND 104).

FIRST USE 3-4-2005; IN COMMERCE 3-4-2005.

FOR: ENTERTAINMENT SERVICES, NAMELY, PRODUCTION OF CABLE TELEVISION SPORTS, ENTERTAINMENT, NEWS, SPORTS PROGRAMS, COLLEGE SPORTS EVENTS AND OTHER RELATED AND ANCILLARY PROGRAMMING RENDERED THROUGH THE MEDIA OF TELEVISION AND RADIO; ENTERTAINMENT SERVICES,

NAMELY, PROVIDING TELEVISION PROGRAMMING AND INFORMATION IN THE FIELD OF SPORTS, ENTERTAINMENT, NEWS, SPORTS PROGRAMS, COLLEGE SPORTS EVENTS AND OTHER RELATED AND ANCILLARY PROGRAMMING RENDERED VIA COMPUTER BY MEANS OF A GLOBAL COMPUTER NETWORK, IN CLASS 41 (U.S. CLS. 100, 101 AND 107).

FIRST USE 3-4-2005; IN COMMERCE 3-4-2005.

THE MARK CONSISTS OF STANDARD CHARACTERS WITHOUT CLAIM TO ANY PARTICULAR FONT, STYLE, SIZE, OR COLOR.

OWNER OF U.S. REG. NOS. 1,345,096, 2,147,722, AND OTHERS.

SN 78-326,712, FILED 11-12-2003.

DOMINICK J. SALEMI, EXAMINING ATTORNEY

Int. Cl.: 35

Prior U.S. Cls.: 100, 101, and 102

United States Patent and Trademark Office

Reg. No. 3,399,341

Registered Mar. 18, 2008

**SERVICE MARK
PRINCIPAL REGISTER**

Cartridge Etc.

CARTRIDGE WORLD NORTH AMERICA (CALIFORNIA CORPORATION)
6460 HOLLIS ST
EMERYVILLE, CA 94608

FOR: RETAIL AND WHOLESALE STORE SERVICES, INTERNET RETAIL STORES AND WHOLESALE DISTRIBUTORSHIP SERVICES, MAIL ORDER CATALOG SERVICES ALL FEATURING PRINTER AND PHOTOCOPIER CONSUMABLES IN THE NATURE OF CASH REGISTER RIBBONS, COMPUTER PRINTER INK RIBBONS, DUPLICATING INKS, INKS, INK ROLLERS FOR OFFICE MACHINES, FAX ROLLS, OFFICE MACHINE RIBBONS, PAPER, PRINTER INK FOR INKJET AND LASER PRINTERS, PRINTER CARTRIDGES AND TONER, PHOTOCOPIER CARTRIDGES AND TONER, INCLUDING REPLACING PARTS AND CON-

SUMABLES SUCH AS REFILLING TONER AND INK CARTRIDGES, IN CLASS 35 (U.S. CLS. 100, 101 AND 102).

FIRST USE 11-28-2007; IN COMMERCE 11-28-2007.

THE MARK CONSISTS OF STANDARD CHARACTERS WITHOUT CLAIM TO ANY PARTICULAR FONT, STYLE, SIZE, OR COLOR.

NO CLAIM IS MADE TO THE EXCLUSIVE RIGHT TO USE "CARTRIDGE", APART FROM THE MARK AS SHOWN.

SN 78-328,131, FILED 11-14-2003.

LINDA ESTRADA, EXAMINING ATTORNEY

Int. Cl.: 35

Prior U.S. Cls.: 100, 101, and 102

United States Patent and Trademark Office

Reg. No. 3,399,342

Registered Mar. 18, 2008

**SERVICE MARK
PRINCIPAL REGISTER**

**FREQUENT LAS VEGAS
POINTS**

VEGAS.COM LLC (NEVADA LTD LIAB CO)
SUITE 210
901 N. GREEN VALLEY PARKWAY
HENDERSON, NV 89074

FOR: CREDIT CARD REGISTRATION; THEATRICAL TICKETING AGENCIES; PROMOTING THE SALE OF CREDIT CARD ACCOUNTS THROUGH THE ADMINISTRATION OF INCENTIVE AWARD PROGRAMS , IN CLASS 35 (U.S. CLS. 100, 101 AND 102).

FIRST USE 10-10-2007; IN COMMERCE 10-10-2007.

THE MARK CONSISTS OF STANDARD CHARACTERS WITHOUT CLAIM TO ANY PARTICULAR FONT, STYLE, SIZE, OR COLOR.

NO CLAIM IS MADE TO THE EXCLUSIVE RIGHT TO USE "POINTS", APART FROM THE MARK AS SHOWN.

SN 78-331,083, FILED 11-20-2003.

DAVID MURRAY, EXAMINING ATTORNEY

Int. Cl.: 43

Prior U.S. Cls.: 100 and 101

United States Patent and Trademark Office

Reg. No. 3,399,343

Registered Mar. 18, 2008

**SERVICE MARK
PRINCIPAL REGISTER**

**FREQUENT LAS VEGAS
POINTS**

VEGAS.COM LLC (NEVADA LTD LIAB CO)
SUITE 210
901 NORTH GREEN VALLEY PARKWAY
LAS VEGAS, NV 89074

FOR: TRAVEL SERVICES OFFERED TO CREDIT
CARD HOLDERS, NAMELY, MAKING RESERVA-
TIONS OR BOOKINGS FOR LODGING, IN CLASS 43
(U.S. CLS. 100 AND 101).

FIRST USE 10-10-2007; IN COMMERCE 10-10-2007.

THE MARK CONSISTS OF STANDARD CHAR-
ACTERS WITHOUT CLAIM TO ANY PARTICULAR
FONT, STYLE, SIZE, OR COLOR.

SN 78-331,089, FILED 11-20-2003.

KIMBERLY FRYE, EXAMINING ATTORNEY

Int. Cl.: 30

Prior U.S. Cl.: 46

United States Patent and Trademark Office

Reg. No. 3,399,344

Registered Mar. 18, 2008

**TRADEMARK
PRINCIPAL REGISTER**

PROLIA

CARGILL, INCORPORATED (DELAWARE COR-
PORATION)
15407 MCGINTY ROAD WEST
WAYZATA, MN 55391

THE MARK CONSISTS OF STANDARD CHAR-
ACTERS WITHOUT CLAIM TO ANY PARTICULAR
FONT, STYLE, SIZE, OR COLOR.

FOR: SOY FLOUR, IN CLASS 30 (U.S. CL. 46).

SN 78-333,153, FILED 11-25-2003.

FIRST USE 6-25-2007; IN COMMERCE 6-25-2007.

JOHN DALIER, EXAMINING ATTORNEY

Int. Cl.: 9

Prior U.S. Cls.: 21, 23, 26, 36, and 38

Reg. No. 3,399,345

United States Patent and Trademark Office

Registered Mar. 18, 2008

**TRADEMARK
PRINCIPAL REGISTER**

GRANTPORT

SPONSORDIRECT, LLC (DELAWARE CORPORATION)
SUITE 660
580 WHITE PLAINS ROAD
TARRYTOWN, NY 10591

FOR: COMPUTER SOFTWARE FOR USE IN RECEIVING, SCREENING, RESPONDING TO, MANAGING AND TRACKING UNSOLICITED PHILANTHROPY GRANT PROPOSALS , IN CLASS 9 (U.S. CLS. 21, 23, 26, 36 AND 38).

FIRST USE 11-16-2007; IN COMMERCE 11-16-2007.

THE MARK CONSISTS OF STANDARD CHARACTERS WITHOUT CLAIM TO ANY PARTICULAR FONT, STYLE, SIZE, OR COLOR.

SN 78-333,245, FILED 11-25-2003.

DORITT L. CARROLL, EXAMINING ATTORNEY

Int. Cl.: 18

Prior U.S. Cls.: 1, 2, 3, 22, and 41

United States Patent and Trademark Office

Reg. No. 3,399,346

Registered Mar. 18, 2008

**TRADEMARK
PRINCIPAL REGISTER**

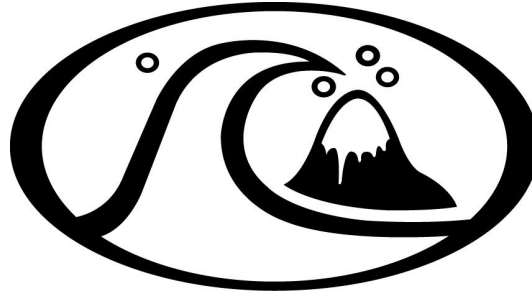

QUIKSILVER, INC. (DELAWARE CORPORATION)
15202 GRAHAM STREET
HUNTINGTON BEACH, CA 92649

FIRST USE 12-5-2007; IN COMMERCE 12-5-2007.

SN 78-335,232, FILED 12-2-2003.

FOR: BACKPACKS, WALLETS, TRAVEL BAGS,
DUFFEL BAGS AND ATHLETIC BAGS, IN CLASS 18
(U.S. CLS. 1, 2, 3, 22 AND 41).

MIDGE BUTLER, EXAMINING ATTORNEY

Int. Cl.: 28

Prior U.S. Cls.: 22, 23, 38, and 50

United States Patent and Trademark Office

Reg. No. 3,399,347

Registered Mar. 18, 2008

**TRADEMARK
PRINCIPAL REGISTER**

ABPONY

SYLMARK HOLDINGS LIMITED (IRELAND
LTD LIAB CO)
17 EARLSFORT TERRACE
DUBLIN 2, IRELAND

THE MARK CONSISTS OF STANDARD CHAR-
ACTERS WITHOUT CLAIM TO ANY PARTICULAR
FONT, STYLE, SIZE, OR COLOR.

FOR: EXERCISE MACHINES, IN CLASS 28 (U.S.
CLS. 22, 23, 38 AND 50).

SN 78-336,027, FILED 12-3-2003.

FIRST USE 10-23-2007; IN COMMERCE 10-23-2007.

ALICE BENMAMAN, EXAMINING ATTORNEY

Int. Cls.: 9, 18, and 25

Prior U.S. Cls.: 1, 2, 3, 21, 22, 23, 26, 36, 38, 39, and 41

United States Patent and Trademark Office

Reg. No. 3,399,348

Registered Mar. 18, 2008

**TRADEMARK
PRINCIPAL REGISTER**

CARIBBEAN JOE

CJ APPAREL GROUP, LLC (DELAWARE LTD
LIAB CO)
SUITE 206
ONE NORTHBROOK PLACE, 5 REVERE DRIVE
NORTHBROOK, IL 60062

FOR: SUNGLASSES; SUNGLASS CASES, IN
CLASS 9 (U.S. CLS. 21, 23, 26, 36 AND 38).

FIRST USE 8-1-2003; IN COMMERCE 8-1-2007.

FOR: HANDBAGS MADE OF CLOTH AND LEA-
THER, SHOULDER BAGS, PURSES, IN CLASS 18
(U.S. CLS. 1, 2, 3, 22 AND 41).

FIRST USE 12-1-2002; IN COMMERCE 7-18-2007.

FOR: LADIES AND MEN'S APPAREL, FOOT-
WEAR AND HEADWEAR, NAMELY, DRESSES,
SUITS, SHIRTS, BLOUSES, SKIRTS, BELTS,
GLOVES, PANTS, JEANS, PEDDLE PUSHERS,
CROPPED PANTS, T-SHIRTS, SHORTS, SWEATERS,

SWEATSHIRTS, JACKETS, VESTS, COATS, PAR-
KAS, RAINWEAR, HATS, CAPS, VISORS, SHAWLS,
SCARVES, TIES, ASCOTS, NECKERCHIEFS, SHOES,
BOOTS, SNEAKERS, SANDALS, SOCKS, SLIPPERS,
SWIMWEAR, SLEEPWEAR, LINGERIE, NIGHT-
GOWNS, NIGHTSHIRTS, PAJAMAS, UNDER-
WEAR, ROBES, NIGHTSHIRTS, IN CLASS 25 (U.S.
CLS. 22 AND 39).

FIRST USE 6-1-2001; IN COMMERCE 6-19-2007.

THE MARK CONSISTS OF STANDARD CHAR-
ACTERS WITHOUT CLAIM TO ANY PARTICULAR
FONT, STYLE, SIZE, OR COLOR.

OWNER OF U.S. REG. NO. 2,845,458.

SN 78-336,621, FILED 12-4-2003.

ANDREA BUTLER, EXAMINING ATTORNEY

Int. Cls.: 9 and 41

Prior U.S. Cls.: 21, 23, 26, 36, 38, 100, 101, and 107

United States Patent and Trademark Office

Reg. No. 3,399,349

Registered Mar. 18, 2008

**TRADEMARK
SERVICE MARK
PRINCIPAL REGISTER**



RECORDS

WARNER BROS. ENTERTAINMENT INC. (DE-
LAWARE CORPORATION)
4000 WARNER BOULEVARD, BLDG. 156, ROOM
3051
BURBANK, CA 91522

FOR: PRE-RECORDED RECORDS, COMPACT
DISCS, AUDIOTAPES, VIDEOTAPES, DVDS AND
AUDIO/VISUAL DISCS, ALL FEATURING MUSIC,
IN CLASS 9 (U.S. CLS. 21, 23, 26, 36 AND 38).

FIRST USE 3-19-1958; IN COMMERCE 3-19-1958.

FOR: ENTERTAINMENT SERVICES IN THE
NATURE OF RECORD PRODUCTION SERVICES,
IN CLASS 41 (U.S. CLS. 100, 101 AND 107).

FIRST USE 3-19-1958; IN COMMERCE 3-19-1958.

OWNER OF U.S. REG. NOS. 1,521,037, 2,726,867,
AND OTHERS.

NO CLAIM IS MADE TO THE EXCLUSIVE
RIGHT TO USE "RECORDS", APART FROM THE
MARK AS SHOWN.

THE MARK CONSISTS OF "WB" IN SHIELD AND
RECORDS.

SN 78-339,960, FILED 12-12-2003.

NICHOLAS ALTREE, EXAMINING ATTORNEY

Int. Cl.: 25

Prior U.S. Cls.: 22 and 39

United States Patent and Trademark Office

Reg. No. 3,399,350

Registered Mar. 18, 2008

**TRADEMARK
PRINCIPAL REGISTER**

SHOOTING STAR

CRYSTAL SPRINGS RANCH, INC. (WYOMING
CORPORATION)
3490 CLUBHOUSE DRIVE
WILSON, WY 83014

FOR: CLOTHING, NAMELY SHIRTS, WESTERN
SHIRTS, BASEBALL CAPS, HATS, WIND-RESIS-
TANT JACKETS, JACKETS, IN CLASS 25 (U.S. CLS.
22 AND 39).

FIRST USE 11-0-2007; IN COMMERCE 11-0-2007.

THE MARK CONSISTS OF STANDARD CHAR-
ACTERS WITHOUT CLAIM TO ANY PARTICULAR
FONT, STYLE, SIZE, OR COLOR.

SN 78-340,705, FILED 12-15-2003.

NAAKWAMA ANKRAH, EXAMINING ATTORNEY

Int. Cl.: 41

Prior U.S. Cls.: 100, 101, and 107

United States Patent and Trademark Office

Reg. No. 3,399,351

Registered Mar. 18, 2008

**SERVICE MARK
PRINCIPAL REGISTER**

SCENE IT?

SCREENLIFE, LLC (WASHINGTON LTD LIAB
CO)
111 SOUTH JACKSON STREET
SEATTLE, WA 98104

FOR: PROVIDING AN ONLINE COMPUTER
GAME, IN CLASS 41 (U.S. CLS. 100, 101 AND 107).

FIRST USE 12-0-2004; IN COMMERCE 12-0-2004.

THE MARK CONSISTS OF STANDARD CHAR-
ACTERS WITHOUT CLAIM TO ANY PARTICULAR
FONT, STYLE, SIZE, OR COLOR.

OWNER OF U.S. REG. NO. 2,751,317.

SN 78-342,828, FILED 12-18-2003.

ELISSA GARBER KON, EXAMINING ATTORNEY

Int. Cl.: 5

Prior U.S. Cls.: 6, 18, 44, 46, 51, and 52

Reg. No. 3,399,352

United States Patent and Trademark Office

Registered Mar. 18, 2008

**TRADEMARK
PRINCIPAL REGISTER**

CITRU-SPERSE

HELENA HOLDING COMPANY (DELAWARE
CORPORATION)
300 DELAWARE AVENUE, 9TH FLOOR - DE 5403
WILMINGTON, DE 19801

THE MARK CONSISTS OF STANDARD CHAR-
ACTERS WITHOUT CLAIM TO ANY PARTICULAR
FONT, STYLE, SIZE, OR COLOR.

FOR: INSECTICIDES AND FUNGICIDES FOR
THE AGRICULTURAL MARKET, IN CLASS 5 (U.S.
CLS. 6, 18, 44, 46, 51 AND 52).

SN 78-342,998, FILED 12-18-2003.

FIRST USE 6-15-2006; IN COMMERCE 6-15-2006.

ELLEN PERKINS, EXAMINING ATTORNEY

Int. Cls.: 7, 11, 37, and 42

**Prior U.S. Cls.: 13, 19, 21, 23, 31, 34, 35, 100, 101, 103,
and 106**

Reg. No. 3,399,353

United States Patent and Trademark Office

Registered Mar. 18, 2008

**TRADEMARK
SERVICE MARK
PRINCIPAL REGISTER**

GE

GENERAL ELECTRIC COMPANY (NEW YORK CORPORATION)

1 RIVER ROAD
SCHENECTADY, NY 12345

FOR: AXIAL AND CENTRIFUGAL COMPRESSORS; RECIPROCATING COMPRESSORS; SCREW AND VANE COMPRESSORS; ROTARY, VACUUM, ELECTRIC, SUBMERSIBLE AND CENTRIFUGAL PUMPS; TURBO EXPANDERS, NAMELY, COMPRESSORS; CNG REFUELING MACHINES FOR LAND VEHICLES AND INDUSTRIAL EQUIPMENT AND ACCESSORIES AND PARTS FOR ALL THE FOREGOING, NAMELY, PUMPS, VALVES, FUEL FILTERS, FILTER CASINGS, DISTRIBUTOR ROTORS, BLADES, BEARINGS AND MECHANICAL SEALS; GAS TURBINES; STEAM TURBINES; STEAM CONDENSERS, IN CLASS 7 (U.S. CLS. 13, 19, 21, 23, 31, 34 AND 35).

FIRST USE 12-31-1996; IN COMMERCE 12-31-1996.

FOR: HEAT EXCHANGERS; CHEMICAL HEAVY WALL REACTORS AND NUCLEAR REACTORS AND ACCESSORIES AND COMPONENT PARTS THEREOF, NAMELY, HEAT PUMPS, STEAM VALVES AND VALES FOR REGULATING THE FLOW OF GASES AND LIQUIDS, IN CLASS 11 (U.S. CLS. 13, 21, 23, 31 AND 34).

FIRST USE 12-31-1996; IN COMMERCE 12-31-1996.

FOR: INSTALLATION, MAINTENANCE AND REPAIR SERVICES FOR COMPRESSORS AND PUMPS, NAMELY, MACHINES, TURBO EXPANDERS, FUEL PUMPS AND FUEL DISTRIBUTION EQUIPMENT, CNG REFUELING EQUIPMENT, GAS TURBINES, STEAM TURBINES, AIR COOLED HEAT EXCHANGERS, STEAM CONDENSERS, HEAVY WALL REACTORS AND TUBULAR REACTORS; OIL AND GAS PIPELINE MAINTENANCE AND REPAIR SERVICES; OIL WELL CASING, TUBING AND DRILL PIPE INSTALLATION; RENTAL OF OIL AND GAS WELL DRILLING TOOLS, IN CLASS 37 (U.S. CLS. 100, 103 AND 106).

FIRST USE 12-31-1996; IN COMMERCE 12-31-1996.

FOR: ENGINEERING SERVICES; TECHNICAL CONSULTATION AND RESEARCH SERVICES IN THE OIL AND GAS INDUSTRIES; OIL AND GAS EXPLORATION SERVICES; GEOPHYSICAL EXPLORATION FOR THE OIL AND GAS INDUSTRIES; ANALYSIS OF OIL AND GAS FIELDS; OIL AND GAS PROSPECTING, NAMELY, WELL LOGGING AND TESTING; OIL AND GAS WELL TESTING; OIL AND GAS PIPELINE INSPECTION; REMOTE MONITORING AND DIAGNOSTIC SERVICES FOR COMPRESSORS AND PUMPS, NAMELY, MACHINES, TURBO EXPANDERS, FUEL

PUMPS AND FUEL DISTRIBUTION EQUIPMENT,
CNG REFUELING EQUIPMENT, GAS TURBINES,
STEAM TURBINES, AIR COOLED HEAT EXCHAN-
GERS, STEAM CONDENSERS, HEAVY WALL RE-
ACTORS AND TUBULAR REACTORS, IN CLASS 42
(U.S. CLS. 100 AND 101).

THE MARK CONSISTS OF STANDARD CHAR-
ACTERS WITHOUT CLAIM TO ANY PARTICULAR
FONT, STYLE, SIZE, OR COLOR.

OWNER OF U.S. REG. NOS. 871,259, 1,020,378,
AND 1,197,111.

SN 78-343,029, FILED 12-18-2003.

FIRST USE 12-31-1996; IN COMMERCE 12-31-1996.

JULIE WATSON, EXAMINING ATTORNEY

Int. Cl.: 3

Prior U.S. Cls.: 1, 4, 6, 50, 51, and 52

United States Patent and Trademark Office

Reg. No. 3,399,354

Registered Mar. 18, 2008

**TRADEMARK
PRINCIPAL REGISTER**

SWANKY MODES

LUCIO SANTORO AND MEERA SANTORO
PARTNERSHIP, THE (UNITED KINGDOM
PARTNERSHIP)
ROTUNDA POINT
11 HARTFIELD CRESCENT WIMBLEDON
LONDON, UNITED KINGDOM SW19 3RL

FOR: PERFUME; COSMETICS, NAMELY, NAIL
VARNISH AND PREPARATIONS FOR REINFOR-
CING AND STRENGTHENING NAILS, NON-MEDI-
CATED LIP-BALMS, LIPSTICK, LIP GLOSS, BODY
GLITTER, BODY SHIMMER, BODY SOUFFLE,
MASCARA, FACE-POWDER, EYE-SHADOWS,
EYE-LINERS; TOILETRIES, NAMELY, BUBBLE-
BATHS, BODY SPRAYS, BODY SPRITZERS, SKIN
MOISTURIZERS, BODY SCRUBS; HAIR LOTIONS,
NAMELY, HAIR GEL, HAIR MOUSSE AND HAIR

SPRAYS, SKIN SOAP, BATH SALTS, BATH BEADS,
SHOWER GELS, ESSENTIAL OILS FOR PERSONAL
USE, DENTIFRICE, HAIR GLITTER, HAIR MAS-
CARA, IN CLASS 3 (U.S. CLS. 1, 4, 6, 50, 51 AND 52).

FIRST USE 6-0-2001; IN COMMERCE 8-15-2007.

THE MARK CONSISTS OF STANDARD CHAR-
ACTERS WITHOUT CLAIM TO ANY PARTICULAR
FONT, STYLE, SIZE, OR COLOR.

OWNER OF U.S. REG. NO. 2,727,234.

SN 78-343,223, FILED 12-19-2003.

MICHELE SWAIN, EXAMINING ATTORNEY

Int. Cl.: 5

Prior U.S. Cls.: 6, 18, 44, 46, 51, and 52

Reg. No. 3,399,355

United States Patent and Trademark Office

Registered Mar. 18, 2008

**TRADEMARK
PRINCIPAL REGISTER**

Transitia

MEDINICHE, INC. (MISSOURI CORPORATION)
167 LAMP & LANTERN VILLAGE, #300
CHESTERFIELD, MO 63017

THE MARK CONSISTS OF STANDARD CHAR-
ACTERS WITHOUT CLAIM TO ANY PARTICULAR
FONT, STYLE, SIZE, OR COLOR.

FOR: DIETARY SUPPLEMENTS, IN CLASS 5 (U.S.
CLS. 6, 18, 44, 46, 51 AND 52).

SN 78-349,709, FILED 1-9-2004.

FIRST USE 10-17-2007; IN COMMERCE 10-17-2007.

ARETHA SOMERVILLE, EXAMINING ATTORNEY

Int. Cls.: 6, 18, 21, and 25

**Prior U.S. Cls.: 1, 2, 3, 12, 13, 14, 22, 23, 25, 29, 30, 33,
39, 40, 41, and 50**

Reg. No. 3,399,356

United States Patent and Trademark Office

Registered Mar. 18, 2008

**TRADEMARK
PRINCIPAL REGISTER**

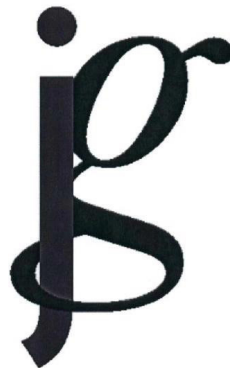

WARNER BROS. RECORDS INC. (DELAWARE CORPORATION)
3300 WARNER BOULEVARD
BURBANK, CA 91505

FOR: METAL KEY CHAINS, IN CLASS 6 (U.S. CLS. 2, 12, 13, 14, 23, 25 AND 50).

FIRST USE 10-10-2007; IN COMMERCE 10-10-2007.

FOR: GYM BAGS, IN CLASS 18 (U.S. CLS. 1, 2, 3, 22 AND 41).

FIRST USE 1-4-2007; IN COMMERCE 1-4-2007.

FOR: MUGS, IN CLASS 21 (U.S. CLS. 2, 13, 23, 29, 30, 33, 40 AND 50).

FIRST USE 10-10-2007; IN COMMERCE 10-10-2007.

FOR: CLOTHING, NAMELY, BASEBALL CAPS, HATS, T-SHIRTS, SWEATSHIRTS AND JACKETS, IN CLASS 25 (U.S. CLS. 22 AND 39).

FIRST USE 12-7-2006; IN COMMERCE 12-7-2006.

SN 78-351,110, FILED 1-13-2004.

JENNIFER MARTIN, EXAMINING ATTORNEY

Int. Cl.: 5

Prior U.S. Cls.: 6, 18, 44, 46, 51, and 52

United States Patent and Trademark Office

Reg. No. 3,399,357

Registered Mar. 18, 2008

**TRADEMARK
PRINCIPAL REGISTER**

MEJORALITO

SMITHKLINE BEECHAM PLC (UNITED KING-
DOM CORPORATION)
980 GREAT WEST ROAD
BRENTFORD, MIDDLESEX, UNITED KINGDOM
TW8 9GS

FOR: ANALGESIC PREPARATIONS, IN CLASS 5
(U.S. CLS. 6, 18, 44, 46, 51 AND 52).

FIRST USE 2-28-2007; IN COMMERCE 2-28-2007.

THE MARK CONSISTS OF STANDARD CHAR-
ACTERS WITHOUT CLAIM TO ANY PARTICULAR
FONT, STYLE, SIZE, OR COLOR.

OWNER OF U.S. REG. NO. 1,311,969.

SN 78-351,805, FILED 1-14-2004.

SHAUNIA CARLYLE, EXAMINING ATTORNEY

Int. Cls.: 16 and 19

Prior U.S. Cls.: 1, 2, 5, 12, 22, 23, 29, 33, 37, 38, and 50

United States Patent and Trademark Office

Reg. No. 3,399,358

Registered Mar. 18, 2008

**TRADEMARK
PRINCIPAL REGISTER**



EAGLE MATERIALS IP LLC (DELAWARE LTD
LIAB CO)
3811 TURTLE CREEK BLVD., SUITE 1100
DALLAS, TX 752194487

FOR: PAPERBOARD, EXCLUDING MAILING
GOODS, IN CLASS 16 (U.S. CLS. 2, 5, 22, 23, 29, 37,
38 AND 50).

FIRST USE 1-23-2007; IN COMMERCE 1-23-2007.

FOR: CONSTRUCTION PRODUCTS, NAMELY,
CEMENT, READYMIX CONCRETE, AGGREGATES
CONSISTING PRIMARILY OF STONE, SAND, AND
GRAVEL FOR USE IN MANUFACTURING CON-
CRETE, ASPHALT AND ROAD BASE; AND GYP-

SUM WALLBOARD, IN CLASS 19 (U.S. CLS. 1, 12, 33
AND 50).

FIRST USE 8-7-2007; IN COMMERCE 8-7-2007.

NO CLAIM IS MADE TO THE EXCLUSIVE
RIGHT TO USE "MATERIALS", APART FROM
THE MARK AS SHOWN.

THE MARK CONSISTS OF THE WORDS "EAGLE
MATERIALS", THE LETTERS "EM" AND AN EA-
GLE'S HEAD.

SN 78-355,884, FILED 1-22-2004.

MICHELE SWAIN, EXAMINING ATTORNEY

Int. Cl.: 3

Prior U.S. Cls.: 1, 4, 6, 50, 51, and 52

United States Patent and Trademark Office

Reg. No. 3,399,359

Registered Mar. 18, 2008

**TRADEMARK
PRINCIPAL REGISTER**

BODY ON TAP

CGE ENTERPRISES, LLC (DELAWARE LTD
LIAB CO)
5650 MAIN STREET
MANCHESTER CENTER, VT 05255

THE MARK CONSISTS OF STANDARD CHAR-
ACTERS WITHOUT CLAIM TO ANY PARTICULAR
FONT, STYLE, SIZE, OR COLOR.

FOR: HAIR SHAMPOOS, AND CONDITIONERS,
IN CLASS 3 (U.S. CLS. 1, 4, 6, 50, 51 AND 52).

SN 78-356,798, FILED 1-23-2004.

FIRST USE 10-1-2007; IN COMMERCE 10-1-2007.

RONALD R. SUSSMAN, EXAMINING ATTORNEY

Int. Cls.: 9 and 42

Prior U.S. Cls.: 21, 23, 26, 36, 38, 100, and 101

United States Patent and Trademark Office

Reg. No. 3,399,360

Registered Mar. 18, 2008

**TRADEMARK
SERVICE MARK
PRINCIPAL REGISTER**

SECURESCOUT

NEXANTIS CORPORATION (JAPAN CORPORATION)
IZUMI NISHIAZABU BLDG. 4F, 4-3-11
NISHIAZABU, MINATO-KU
TOKYO, JAPAN 106

FOR: COMPUTER SOFTWARE FOR WORD PROCESSING AND FOR USE AS A SPREADSHEET; COMPUTER SOFTWARE FOR USE IN FINANCIAL ACCOUNTING, SALES FORCE AUTOMATION, SUPPLY CHAIN MANAGEMENT, CUSTOMER RELATIONSHIP MANAGEMENT AND ENTERPRISE RESOURCE PLANNING; DATABASE MANAGEMENT SOFTWARE FOR USE IN THE FIELD OF HUMAN RESOURCES; COMPUTER SOFTWARE FOR USE IN CAPTURING, ORGANIZING AND SHARING ONLINE CONTENT AND FOR USE IN DATABASE MANAGEMENT; COMPUTER SOFTWARE FOR USE IN PREVENTING PENETRATION OF THE SECURITY OF THE COMPUTER NETWORKS; COMPUTERS AND ELECTRONIC TECHNOLOGY, NAMELY, PERSONAL COMPUTER, PERSONAL DIGITAL ASSISTANCE, PORTABLE MP3 PLAYER, DIGITAL CAMERA, IMAGE SCANNER, DIGITAL PRINTER, CIRCUIT BOARD, HARD

DISK DRIVE, OPTICAL DISC DRIVE, MEMORY CARD, LOCAL AREA NETWORK COMPUTER CARDS FOR CONNECTING PORTABLE COMPUTER DEVICES TO COMPUTER NETWORKS AND MODEM; COMPUTER HARDWARE, IN CLASS 9 (U.S. CLS. 21, 23, 26, 36 AND 38).

FIRST USE 1-1-2004; IN COMMERCE 1-1-2004.

FOR: CREATION AND DESIGN OF COMPUTER SOFTWARE FOR OTHERS; MAINTENANCE OF COMPUTER SOFTWARE; DESIGN OF COMPUTERS FOR OTHERS; LEASING OF COMPUTERS, IN CLASS 42 (U.S. CLS. 100 AND 101).

FIRST USE 1-1-2004; IN COMMERCE 1-1-2004.

THE MARK CONSISTS OF STANDARD CHARACTERS WITHOUT CLAIM TO ANY PARTICULAR FONT, STYLE, SIZE, OR COLOR.

SN 78-361,740, FILED 2-3-2004.

LANA PHAM, EXAMINING ATTORNEY

Int. Cl.: 12

Prior U.S. Cls.: 19, 21, 23, 31, 35, and 44

United States Patent and Trademark Office

Reg. No. 3,399,361

Registered Mar. 18, 2008

**TRADEMARK
PRINCIPAL REGISTER**

MERCURY MILAN

FORD MOTOR COMPANY (DELAWARE CORPORATION)
ONE AMERICAN ROAD
DEARBORN, MI 48126

THE MARK CONSISTS OF STANDARD CHARACTERS WITHOUT CLAIM TO ANY PARTICULAR FONT, STYLE, SIZE, OR COLOR.

FOR: MOTOR VEHICLES, NAMELY, AUTOMOBILES, IN CLASS 12 (U.S. CLS. 19, 21, 23, 31, 35 AND 44).

SN 78-362,223, FILED 2-4-2004.

FIRST USE 2-9-2005; IN COMMERCE 2-9-2005.

BRIAN PINO, EXAMINING ATTORNEY

Int. Cl.: 25

Prior U.S. Cls.: 22 and 39

United States Patent and Trademark Office

Reg. No. 3,399,362

Registered Mar. 18, 2008

**TRADEMARK
PRINCIPAL REGISTER**



VICKY FORM, S.A. DE C.V. (MEXICO CORPORATION)

RECURSOS HIDRAULICOS NO. 2

FRACCIONAMIENTO INDUSTRIAL LA LOMA
TLALNEPNTLA, MEXICO 54060

FOR: CLOTHING, NAMELY, BRAS, T-SHIRTS,
UNDERSHIRTS, PANTIES, BIKINIS, GIRDLES,
CORSETS, BODICES, TOPS AND UNDERSKIRTS,
IN CLASS 25 (U.S. CLS. 22 AND 39).

FIRST USE 9-25-2003; IN COMMERCE 2-12-2004.

PRIORITY CLAIMED UNDER SEC. 44(D) ON
MEXICO APPLICATION NO. 620926, FILED 9-25-
2003.

OWNER OF U.S. REG. NOS. 1,816,944 AND
2,676,614.

THE MARK CONSISTS OF THE WORDS VICKY
FORM TOGETHER WITH A DESIGN OF A BUT-
TERFLY.

SN 78-366,415, FILED 2-11-2004.

YONG KIM, EXAMINING ATTORNEY

Int. Cl.: 30

Prior U.S. Cl.: 46

United States Patent and Trademark Office

Reg. No. 3,399,363

Registered Mar. 18, 2008

TRADEMARK
PRINCIPAL REGISTER



Z INTERNATIONAL, C.A. (VENEZUELA CORPORATION)
CENTRO COMERCIAL CIUDAD TAMANACO
"A" TOWER, 4TH FLOOR, OFFICE #408
CARACAS, VENEZUELA

FOR: COFFEE AND POWDERED CHOCOLATE,
IN CLASS 30 (U.S. CL. 46).

FIRST USE 10-22-2005; IN COMMERCE 10-22-2005.

THE STIPPLING IS A FEATURE OF THE MARK.

THE NAME "DON VEITIA" SHOWN IN THE
MARK DOES NOT IDENTIFY A PARTICULAR
LIVING INDIVIDUAL.

SN 78-367,768, FILED 2-13-2004.

RONALD AIKENS, EXAMINING ATTORNEY

Int. Cl.: 10

Prior U.S. Cls.: 26, 39, and 44

United States Patent and Trademark Office

Reg. No. 3,399,364

Registered Mar. 18, 2008

**TRADEMARK
PRINCIPAL REGISTER**

MAS

NUVASIVE, INC. (DELAWARE CORPORATION)
4545 TOWNE CENTRE COURT
SAN DIEGO, CA 92121

FOR: PRODUCTS FOR USE IN SPINE SURGERY, NAMELY SURGICAL ACCESS SYSTEMS CONSISTING PRIMARILY OF RETRACTORS, NEEDLES, CANNULAE, AND TROCARS; INTERVERTEBRAL IMPLANTS CONSISTING PRIMARILY OF BONE GRAFT AND PROSTHETIC AND FILLING MATERIALS, NAMELY, ARTIFICIAL MATERIALS FOR USE IN SPINAL FUSION SURGERY; AND INTRA-OPERATIVE NERVE MONITORING SYSTEMS, CONSISTING PRIMARILY OF STIMULATION

ELECTRODES, RETURN ELECTRODES, AND CONTROL UNITS AS A COMPONENT THEREOF FOR MEDICAL USE, IN CLASS 10 (U.S. CLS. 26, 39 AND 44).

FIRST USE 10-26-2004; IN COMMERCE 10-26-2004.

THE MARK CONSISTS OF STANDARD CHARACTERS WITHOUT CLAIM TO ANY PARTICULAR FONT, STYLE, SIZE, OR COLOR.

SN 78-373,526, FILED 2-24-2004.

RICHARD A. STRASER, EXAMINING ATTORNEY

Int. Cl.: 16

Prior U.S. Cls.: 2, 5, 22, 23, 29, 37, 38, and 50

Reg. No. 3,399,365

United States Patent and Trademark Office

Registered Mar. 18, 2008

**TRADEMARK
PRINCIPAL REGISTER**

LIFE WITH PRINT

S.D. WARREN COMPANY (PENNSYLVANIA
CORPORATION), DBA SAPPI FINE PAPER
NORTH AMERICA,
225 FRANKLIN STREET
BOSTON, MA 02110

THE MARK CONSISTS OF STANDARD CHAR-
ACTERS WITHOUT CLAIM TO ANY PARTICULAR
FONT, STYLE, SIZE, OR COLOR.

FOR: PRINTING PAPER, IN CLASS 16 (U.S. CLS. 2,
5, 22, 23, 29, 37, 38 AND 50).

SN 78-376,241, FILED 3-1-2004.

FIRST USE 11-20-2007; IN COMMERCE 11-20-2007.

LINDA ESTRADA, EXAMINING ATTORNEY

Int. Cl.: 20

Prior U.S. Cls.: 2, 13, 22, 25, 32, and 50

United States Patent and Trademark Office

Reg. No. 3,399,366

Registered Mar. 18, 2008

**TRADEMARK
PRINCIPAL REGISTER**

ARCHITELLA

HUNTER DOUGLAS INC. (DELAWARE CORPORATION)
2 PARK WAY & ROUTE 17 SOUTH
P.O. BOX 740
UPPER SADDLE RIVER, NJ 07458

THE MARK CONSISTS OF STANDARD CHARACTERS WITHOUT CLAIM TO ANY PARTICULAR FONT, STYLE, SIZE, OR COLOR.

FOR: WINDOW BLINDS AND WINDOW SHADES; DOOR BLINDS AND DOOR SHADES, IN CLASS 20 (U.S. CLS. 2, 13, 22, 25, 32 AND 50).

SN 78-379,477, FILED 3-5-2004.

FIRST USE 10-0-2006; IN COMMERCE 10-0-2006.

LESLIE RICHARDS, EXAMINING ATTORNEY

Int. Cl.: 16

Prior U.S. Cls.: 2, 5, 22, 23, 29, 37, 38, and 50

Reg. No. 3,399,367

United States Patent and Trademark Office

Registered Mar. 18, 2008

**TRADEMARK
PRINCIPAL REGISTER**

TOOL BOX

SELLARS ABSORBENT MATERIALS, INC. (WIS-
CONSIN CORPORATION)
6540 NORTH INDUSTRIAL ROAD
MILWAUKEE, WI 532235812

THE MARK CONSISTS OF STANDARD CHAR-
ACTERS WITHOUT CLAIM TO ANY PARTICULAR
FONT, STYLE, SIZE, OR COLOR.

FOR: PAPER TOWELS COMPRISED OF WOOD
PULP AND BINDING AGENTS, IN CLASS 16 (U.S.
CLS. 2, 5, 22, 23, 29, 37, 38 AND 50).

SN 78-381,365, FILED 3-10-2004.

FIRST USE 4-6-2007; IN COMMERCE 4-6-2007.

LANA PHAM, EXAMINING ATTORNEY

Int. Cl.: 34

Prior U.S. Cls.: 2, 8, 9, and 17

United States Patent and Trademark Office

Reg. No. 3,399,368

Registered Mar. 18, 2008

**TRADEMARK
PRINCIPAL REGISTER**

CRUZ REAL

FAMOUS SMOKE SHOP-PA, INC. (PENNSYLVANIA CORPORATION)
1100 CONROY PLACE
EASTON, PA 18040

FOR: CIGARS, IN CLASS 34 (U.S. CLS. 2, 8, 9 AND 17).

FIRST USE 11-16-2007; IN COMMERCE 11-16-2007.

THE MARK CONSISTS OF STANDARD CHARACTERS WITHOUT CLAIM TO ANY PARTICULAR FONT, STYLE, SIZE, OR COLOR.

THE FOREIGN WORDING IN THE MARK TRANSLATES INTO ENGLISH AS "REAL CROSS".

SN 78-388,975, FILED 3-23-2004.

KRISTIN DAHLING, EXAMINING ATTORNEY

Int. Cl.: 5

Prior U.S. Cls.: 6, 18, 44, 46, 51, and 52

United States Patent and Trademark Office

Reg. No. 3,399,369

Registered Mar. 18, 2008

**TRADEMARK
PRINCIPAL REGISTER**

IXEMPRA

BRISTOL-MYERS SQUIBB COMPANY (DELA-
WARE CORPORATION)
345 PARK AVENUE
NEW YORK, NY 10154

FOR: PHARMACEUTICAL PREPARATIONS FOR
THE TREATMENT AND PREVENTION OF CAN-
CER, IN CLASS 5 (U.S. CLS. 6, 18, 44, 46, 51 AND 52).

FIRST USE 10-22-2007; IN COMMERCE 10-22-2007.

THE MARK CONSISTS OF STANDARD CHAR-
ACTERS WITHOUT CLAIM TO ANY PARTICULAR
FONT, STYLE, SIZE, OR COLOR.

THE MARK DOES NOT HAVE ANY MEANING
IN A FOREIGN LANGUAGE.

SN 78-392,518, FILED 3-29-2004.

THEODORE MCBRIDE, EXAMINING ATTORNEY

Int. Cl.: 10

Prior U.S. Cls.: 26, 39, and 44

United States Patent and Trademark Office

Reg. No. 3,399,370

Registered Mar. 18, 2008

**TRADEMARK
PRINCIPAL REGISTER**

ARCHANGELS

ASHTON INDUSTRIES, INC. (MASSACHUSETTS
CORPORATION)
154 TOPSFIELD ROAD
BOXFORD, MA 01921

THE MARK CONSISTS OF STANDARD CHAR-
ACTERS WITHOUT CLAIM TO ANY PARTICULAR
FONT, STYLE, SIZE, OR COLOR.

FOR: ORTHOTIC INSERTS FOR FOOTWEAR, IN
CLASS 10 (U.S. CLS. 26, 39 AND 44).

SN 78-397,107, FILED 4-6-2004.

FIRST USE 11-2-2007; IN COMMERCE 11-2-2007.

MARILYN IZZI, EXAMINING ATTORNEY

Int. Cl.: 28

Prior U.S. Cls.: 22, 23, 38, and 50

United States Patent and Trademark Office

Reg. No. 3,399,371

Registered Mar. 18, 2008

**TRADEMARK
PRINCIPAL REGISTER**

URBAN NATION

J. LLOYD INTERNATIONAL, INC. (IOWA CORPORATION)
2155 JACOLYN DR. SW
SUITE 6
CEDAR RAPIDS, IA 52404

THE MARK CONSISTS OF STANDARD CHARACTERS WITHOUT CLAIM TO ANY PARTICULAR FONT, STYLE, SIZE, OR COLOR.

FOR: RADIO CONTROLLED AND REMOTE CONTROLLED TOY VEHICLES, IN CLASS 28 (U.S. CLS. 22, 23, 38 AND 50).

SN 78-401,721, FILED 4-14-2004.

FIRST USE 12-13-2007; IN COMMERCE 12-13-2007.

MATTHEW EINSTEIN, EXAMINING ATTORNEY

Int. Cl.: 25

Prior U.S. Cls.: 22 and 39

United States Patent and Trademark Office

Reg. No. 3,399,372

Registered Mar. 18, 2008

**TRADEMARK
PRINCIPAL REGISTER**

ART WORKS

FRUIT OF THE LOOM, INC. (NEW YORK CORPORATION)
LEGAL DEPARTMENT
ONE FRUIT OF THE LOOM DRIVE
BOWLING GREEN, KY 42103

FOR: TEE SHIRTS, IN CLASS 25 (U.S. CLS. 22 AND 39).

FIRST USE 8-20-2007; IN COMMERCE 8-20-2007.

THE MARK CONSISTS OF STANDARD CHARACTERS WITHOUT CLAIM TO ANY PARTICULAR FONT, STYLE, SIZE, OR COLOR.

OWNER OF U.S. REG. NO. 1,260,071.

SN 78-404,608, FILED 4-20-2004.

DEZMONA MIZELLE, EXAMINING ATTORNEY

Int. Cl.: 43

Prior U.S. Cls.: 100 and 101

United States Patent and Trademark Office

Reg. No. 3,399,373

Registered Mar. 18, 2008

**SERVICE MARK
PRINCIPAL REGISTER**

La Bellasera

PACIFIC WEST PROPERTY SERVICES, INC.
(ARIZONA CORPORATION)

7275 E. EASY ST. SUITE B-102

CAREFREE, AZ 85377

FOR: HOTEL SERVICES, IN CLASS 43 (U.S. CLS.
100 AND 101).

FIRST USE 7-27-2007; IN COMMERCE 7-27-2007.

THE MARK CONSISTS OF STANDARD CHARACTERS WITHOUT CLAIM TO ANY PARTICULAR FONT, STYLE, SIZE, OR COLOR.

THE FOREIGN WORDING IN THE MARK TRANSLATES INTO ENGLISH AS "BEAUTIFUL EVENING".

SN 78-410,372, FILED 4-29-2004.

DAWN HAN, EXAMINING ATTORNEY

Int. Cl.: 3

Prior U.S. Cls.: 1, 4, 6, 50, 51, and 52

United States Patent and Trademark Office

Reg. No. 3,399,374

Registered Mar. 18, 2008

**TRADEMARK
PRINCIPAL REGISTER**

GOLDEN SPLENDOR

DESIGNER SKIN, L.L.C. (ARIZONA LTD LIAB
CO)
3312 EAST BROADWAY ROAD
PHOENIX, AZ 85040

THE MARK CONSISTS OF STANDARD CHAR-
ACTERS WITHOUT CLAIM TO ANY PARTICULAR
FONT, STYLE, SIZE, OR COLOR.

FOR: INDOOR TANNING PREPARATIONS, IN
CLASS 3 (U.S. CLS. 1, 4, 6, 50, 51 AND 52).

SN 78-413,119, FILED 5-4-2004.

FIRST USE 12-1-2007; IN COMMERCE 12-1-2007.

ROBIN CHOSID, EXAMINING ATTORNEY

Int. Cls.: 35 and 36

Prior U.S. Cls.: 100, 101, and 102

United States Patent and Trademark Office

Reg. No. 3,399,375

Registered Mar. 18, 2008

**SERVICE MARK
PRINCIPAL REGISTER**

FinanceArk

DALEY, DAHLIA C (UNITED STATES INDIVIDUAL)
8906 HARNESS WAY
BOWIE, MD 20715

FOR: ACCOUNTING SERVICES, TAX CONSULTATION, TAX PREPARATION, IN CLASS 35 (U.S. CLS. 100, 101 AND 102).

FIRST USE 1-1-2003; IN COMMERCE 10-1-2003.

FOR: FINANCIAL PLANNING, FINANCIAL INFORMATION PROVIDED BY ELECTRONIC MEANS, FINANCIAL SERVICES IN THE NATURE

OF AN INVESTMENT SECURITY, INSURANCE BROKERAGE, MORTGAGE BROKERAGE, IN CLASS 36 (U.S. CLS. 100, 101 AND 102).

FIRST USE 1-1-2003; IN COMMERCE 10-1-2003.

THE MARK CONSISTS OF STANDARD CHARACTERS WITHOUT CLAIM TO ANY PARTICULAR FONT, STYLE, SIZE, OR COLOR.

SN 78-415,506, FILED 5-8-2004.

RAUL CORDOVA, EXAMINING ATTORNEY

Int. Cl.: 9

Prior U.S. Cls.: 21, 23, 26, 36, and 38

United States Patent and Trademark Office

Reg. No. 3,399,376

Registered Mar. 18, 2008

**TRADEMARK
PRINCIPAL REGISTER**

ROWDY FILMS

AUSTIN, DALLAS (UNITED STATES INDIVIDUAL)
576-A TRABERT AVENUE, N.W.
ATLANTA, GA 30309

FOR: MUSICAL SOUND RECORDINGS AND AUDIOVISUAL RECORDINGS, IN CLASS 9 (U.S. CLS. 21, 23, 26, 36 AND 38).

FIRST USE 9-0-2007; IN COMMERCE 9-0-2007.

THE MARK CONSISTS OF STANDARD CHARACTERS WITHOUT CLAIM TO ANY PARTICULAR FONT, STYLE, SIZE, OR COLOR.

OWNER OF U.S. REG. NO. 2,315,414.

NO CLAIM IS MADE TO THE EXCLUSIVE RIGHT TO USE "FILMS", APART FROM THE MARK AS SHOWN.

SN 78-416,241, FILED 5-10-2004.

ALICE SUE CARRUTHERS, EXAMINING ATTORNEY

Int. Cl.: 45

Prior U.S. Cls.: 100 and 101

United States Patent and Trademark Office

Reg. No. 3,399,377

Registered Mar. 18, 2008

**SERVICE MARK
PRINCIPAL REGISTER**

Reflection of Life

REFLECTIONS LLC (NEW MEXICO LTD LIAB
CO)
2400 WASHINGTON ST. NE
ALBUQUERQUE, NM 87110

FOR: FUNERAL HOME; FUNERAL SERVICE
UNDERTAKING, IN CLASS 45 (U.S. CLS. 100 AND
101).

FIRST USE 6-1-2004; IN COMMERCE 6-1-2004.

THE MARK CONSISTS OF STANDARD CHAR-
ACTERS WITHOUT CLAIM TO ANY PARTICULAR
FONT, STYLE, SIZE, OR COLOR.

SN 78-423,510, FILED 5-23-2004.

BERYL GARDNER, EXAMINING ATTORNEY

Int. Cls.: 25 and 35

Prior U.S. Cls.: 22, 39, 100, 101, and 102

United States Patent and Trademark Office

Reg. No. 3,399,378

Registered Mar. 18, 2008

**TRADEMARK
SERVICE MARK
PRINCIPAL REGISTER**



ARMCHAIR SAILOR, INC. (WASHINGTON CORPORATION)
2110 WESTLAKE AVE. N.
SEATTLE, WA 98109

FOR: CLOTHING FOR MEN, WOMEN AND CHILDREN, NAMELY, SHIRTS; CLOTHING FOR MEN, WOMEN AND CHILDREN, NAMELY, HATS, IN CLASS 25 (U.S. CLS. 22 AND 39).

FIRST USE 1-1-1987; IN COMMERCE 1-1-1987.

FOR: RETAIL AND ON-LINE RETAIL STORE SERVICES FEATURING WEATHER INSTRUMENTS, COMPASSES, ELECTRONIC AND PAPER NAVIGATION CHARTS, SOFTWARE, BINOCULARS, CLOCKS AND WATCHES, SEXTANTS, WINDVANES, MARINE ART, BOOKS, VIDEOS, GIFTS, MUSIC, GALLEY EQUIPMENT, MODELS

AND MODEL KITS, HATS, SHIRTS, AND LIGHTHOUSES, IN CLASS 35 (U.S. CLS. 100, 101 AND 102).

FIRST USE 1-1-1987; IN COMMERCE 1-1-1987.

NO CLAIM IS MADE TO THE EXCLUSIVE RIGHT TO USE "BOOKS" AND "CHARTS", APART FROM THE MARK AS SHOWN.

THE MARK CONSISTS OF A SAILOR SITTING IN AN ARMCHAIR, READING A BOOK AND SMOKING A PIPE. THE WORDS "ARMCHAIR SAILOR" AND "BOOKS & CHARTS" AND STYLIZED FISH DESIGNS SURROUND THE SAILOR IN A OVAL BORDER PATTERN.

SN 78-424,263, FILED 5-25-2004.

MORGAN WYNNE, EXAMINING ATTORNEY

Int. Cl.: 35

Prior U.S. Cls.: 100, 101, and 102

United States Patent and Trademark Office

Reg. No. 3,399,379

Registered Mar. 18, 2008

**SERVICE MARK
PRINCIPAL REGISTER**

SHOP MINOYA

YAMASAN (TEXAS LIMITED PARTNERSHIP)
3115 PARKER RD., SUITE 285
PLANO, TX 75023

FOR: RETAIL STORE SERVICES FEATURING
LOW-COST GENERAL CONSUMER MERCHAN-
DISE, IN CLASS 35 (U.S. CLS. 100, 101 AND 102).

FIRST USE 7-31-2004; IN COMMERCE 7-31-2004.

THE MARK CONSISTS OF STANDARD CHAR-
ACTERS WITHOUT CLAIM TO ANY PARTICULAR
FONT, STYLE, SIZE, OR COLOR.

NO CLAIM IS MADE TO THE EXCLUSIVE
RIGHT TO USE "SHOP", APART FROM THE MARK
AS SHOWN.

SHOP MINOYA IS A NON-WHIMSICAL COMBI-
NATION OF WORDS THAT VERY ROUGHLY
TRANSLATE, IN A COMBINATION OF ENGLISH
AND JAPANESE, TO SHOP AT MINO'S LITTLE
STORE.

SN 78-435,636, FILED 6-15-2004.

JOHN DALIER, EXAMINING ATTORNEY

Int. Cl.: 10

Prior U.S. Cls.: 26, 39, and 44

United States Patent and Trademark Office

Reg. No. 3,399,380

Registered Mar. 18, 2008

**TRADEMARK
PRINCIPAL REGISTER**

SAM SUGAR TONG

THE SEABERG COMPANY, INC. (OREGON
CORPORATION)
4909 S. COAST HIGHWAY SUITE 245
NEWPORT, OR 97365

OWNER OF U.S. REG. NOS. 1,384,137 AND
2,918,142.

FOR: ORTHOPEDIC SPLINTS, FOREARM OR-
THOSES, ANKLE ORTHOSES, ANKLE BRACES,
AND FOREARM BRACES, IN CLASS 10 (U.S. CLS.
26, 39 AND 44).

NO CLAIM IS MADE TO THE EXCLUSIVE
RIGHT TO USE "SUGAR TONG", APART FROM
THE MARK AS SHOWN.

FIRST USE 8-31-2007; IN COMMERCE 8-31-2007.

SN 78-438,495, FILED 6-21-2004.

THE MARK CONSISTS OF STANDARD CHAR-
ACTERS WITHOUT CLAIM TO ANY PARTICULAR
FONT, STYLE, SIZE, OR COLOR.

LINDA ESTRADA, EXAMINING ATTORNEY

Int. Cl.: 32

Prior U.S. Cls.: 45, 46, and 48

United States Patent and Trademark Office

Reg. No. 3,399,381

Registered Mar. 18, 2008

**TRADEMARK
PRINCIPAL REGISTER**

SIMPLY GRAPEFRUIT

THE COCA-COLA COMPANY (DELAWARE
CORPORATION)
ONE COCA-COLA PLAZA
ATLANTA, GA 30313

FOR: GRAPEFRUIT JUICE BEVERAGES CON-
SISTING OF WATER AND NON-CALORIC SWEET-
NERS, NOT FROM CONCENTRATE, IN CLASS 32
(U.S. CLS. 45, 46 AND 48).

FIRST USE 9-1-2007; IN COMMERCE 9-1-2007.

THE MARK CONSISTS OF STANDARD CHAR-
ACTERS WITHOUT CLAIM TO ANY PARTICULAR
FONT, STYLE, SIZE, OR COLOR.

NO CLAIM IS MADE TO THE EXCLUSIVE
RIGHT TO USE "GRAPEFRUIT", APART FROM
THE MARK AS SHOWN.

SN 78-443,660, FILED 6-30-2004.

JOHN DALIER, EXAMINING ATTORNEY

Int. Cl.: 3

Prior U.S. Cls.: 1, 4, 6, 50, 51, and 52

United States Patent and Trademark Office

Reg. No. 3,399,382

Registered Mar. 18, 2008

**TRADEMARK
PRINCIPAL REGISTER**

BIO-ZYME 3

ACTION LLC (VIRGINIA LIMITED LIABILITY CORPORATION)
547 SUSAN CONSTANT DRIVE
VIRGINIA BEACH, VA 23451

THE MARK CONSISTS OF STANDARD CHARACTERS WITHOUT CLAIM TO ANY PARTICULAR FONT, STYLE, SIZE, OR COLOR.

FOR: CLEANING SOLUTIONS FOR SURGICAL INSTRUMENTS, IN CLASS 3 (U.S. CLS. 1, 4, 6, 50, 51 AND 52).

SN 78-445,676, FILED 7-2-2004.

FIRST USE 7-2-2004; IN COMMERCE 7-2-2004.

MICHAEL ENGEL, EXAMINING ATTORNEY

Int. Cl.: 43

Prior U.S. Cls.: 100 and 101

United States Patent and Trademark Office

Reg. No. 3,399,383

Registered Mar. 18, 2008

**SERVICE MARK
PRINCIPAL REGISTER**

**WHERE EATING
BETTER TASTES
BETTER**

ROSENBERG, BRADLEY, SETH (UNITED STATES INDIVIDUAL)
256 FLIRTATION COURT
HENDERSON, NV 89074

THE MARK CONSISTS OF STANDARD CHARACTERS WITHOUT CLAIM TO ANY PARTICULAR FONT, STYLE, SIZE, OR COLOR.

FOR: RESTAURANT SERVICES, IN CLASS 43 (U.S. CLS. 100 AND 101).

SN 78-445,856, FILED 7-4-2004.

FIRST USE 9-13-2005; IN COMMERCE 9-13-2005.

LESLEY LAMOTHE, EXAMINING ATTORNEY

Int. Cls.: 9, 16, 25, and 28

**Prior U.S. Cls.: 2, 5, 21, 22, 23, 26, 29, 36, 37, 38, 39,
and 50**

Reg. No. 3,399,384

United States Patent and Trademark Office

Registered Mar. 18, 2008

**TRADEMARK
PRINCIPAL REGISTER**

SAMURAI CHAMPLOO

GENEON ENTERTAINMENT (USA) INC. (CALI-
FORNIA CORPORATION)
2265 EAST 220TH STREET
LONG BEACH, CA 90810 AND

VICTOR ENTERTAINMENT, INC. (JAPAN COR-
PORATION)

3-6-7 KITA AOYAMA
MINATO-KU, TOKYO, JAPAN AND
TOKUMA SHOTEN PUBLISHING CO., LTD. (JAPAN
CORPORATION)

2-2-1 SHIBADAIMON
MINATO-KU, TOKYO, JAPAN

FOR: CARTOON VIDEO RECORDINGS; VIDEO
GAME SOFTWARE; MUSICAL SOUND RECORD-
INGS, IN CLASS 9 (U.S. CLS. 21, 23, 26, 36 AND 38).

FIRST USE 1-11-2005; IN COMMERCE 1-11-2005.

FOR: ROLE PLAYING GAME BOOKS; ANIME
FAN GUIDE BOOKS; TRADING CARDS; GRAPHIC
NOVELS; POSTERS; STATIONERY; STICKERS, IN
CLASS 16 (U.S. CLS. 2, 5, 22, 23, 29, 37, 38 AND 50).

FIRST USE 8-0-2005; IN COMMERCE 8-0-2005.

FOR: FOOTWEAR; HEADWEAR; SHIRTS; T-
SHIRTS; JACKETS; SWEATSUITS; MASQUERADE
COSTUMES, IN CLASS 25 (U.S. CLS. 22 AND 39).

FIRST USE 5-0-2005; IN COMMERCE 5-0-2005.

FOR: ACTION FIGURES AND ACCESSORIES
THEREFOR; COLLECTABLE TOY FIGURES; TOY
FIGURES; PLUSH TOYS; TOY WEAPONS; HAND
HELD UNIT FOR PLAYING ELECTRONIC GAMES;
STAND ALONE VIDEO GAME MACHINES; ROLE
PLAYING GAMES, IN CLASS 28 (U.S. CLS. 22, 23, 38
AND 50).

FIRST USE 12-0-2005; IN COMMERCE 12-0-2005.

THE MARK CONSISTS OF STANDARD CHAR-
ACTERS WITHOUT CLAIM TO ANY PARTICULAR
FONT, STYLE, SIZE, OR COLOR.

SN 78-450,004, FILED 7-13-2004.

YONG KIM, EXAMINING ATTORNEY

Int. Cl.: 9

Prior U.S. Cls.: 21, 23, 26, 36, and 38

United States Patent and Trademark Office

Reg. No. 3,399,385

Registered Mar. 18, 2008

**TRADEMARK
PRINCIPAL REGISTER**

DISNEY FLIX

DISNEY ENTERPRISES, INC. (DELAWARE CORPORATION)
500 SOUTH BUENA VISTA STREET
BURBANK, CA 91521

FOR: CAMCORDERS AND COMPUTER SOFTWARE ENABLING USERS TO CREATE MOVIES, IN CLASS 9 (U.S. CLS. 21, 23, 26, 36 AND 38).

FIRST USE 11-29-2007; IN COMMERCE 11-29-2007.

THE MARK CONSISTS OF STANDARD CHARACTERS WITHOUT CLAIM TO ANY PARTICULAR FONT, STYLE, SIZE, OR COLOR.

NO CLAIM IS MADE TO THE EXCLUSIVE RIGHT TO USE "FLICKS", APART FROM THE MARK AS SHOWN.

SN 78-458,041, FILED 7-28-2004.

MATTHEW PAPPAS, EXAMINING ATTORNEY

Int. Cls.: 9, 21, and 25

**Prior U.S. Cls.: 2, 13, 21, 22, 23, 26, 29, 30, 33, 36, 38,
39, 40, and 50**

Reg. No. 3,399,386

United States Patent and Trademark Office

Registered Mar. 18, 2008

**TRADEMARK
PRINCIPAL REGISTER**

20X

WRANGLER APPAREL CORP. (DELAWARE
CORPORATION)
3411 SILVERSIDE ROAD
WILMINGTON, DE 19810

FOR: PROTECTIVE CLOTHING, NAMELY,
GLOVES, IN CLASS 9 (U.S. CLS. 21, 23, 26, 36 AND 38).

FIRST USE 1-31-2007; IN COMMERCE 1-31-2007.

FOR: WORK GLOVES IN THE NATURE OF
HOUSEHOLD GLOVES FOR GENERAL USE; GAR-
DENING GLOVES, IN CLASS 21 (U.S. CLS. 2, 13, 23,
29, 30, 33, 40 AND 50).

FIRST USE 1-31-2007; IN COMMERCE 1-31-2007.

FOR: GLOVES, IN CLASS 25 (U.S. CLS. 22 AND 39).

FIRST USE 1-31-2007; IN COMMERCE 1-31-2007.

THE MARK CONSISTS OF STANDARD CHAR-
ACTERS WITHOUT CLAIM TO ANY PARTICULAR
FONT, STYLE, SIZE, OR COLOR.

OWNER OF U.S. REG. NO. 2,374,103.

SN 78-458,687, FILED 7-29-2004.

JOHN DALIER, EXAMINING ATTORNEY

Int. Cl.: 35

Prior U.S. Cls.: 100, 101, and 102

United States Patent and Trademark Office

Reg. No. 3,399,387

Registered Mar. 18, 2008

**SERVICE MARK
PRINCIPAL REGISTER**

MARINE FOR LIFE

UNITED STATES MARINE CORPS, A COMPONENT OF THE DEPARTMENT OF THE NAVY (UNITED STATES AGENCY OF THE UNITED STATES GOVERNMENT)

CODE BDCC

875 NORTH RANDOLPH STREET
ARLINGTON, VA 222031995

FOR: PROVIDING REFERRALS IN THE FIELDS OF EMPLOYMENT COUNSELING, OUTPLACEMENT AND CAREER NETWORKING SERVICES; PROVIDING REFERRALS IN THE FIELDS OF PRIMARY, SECONDARY AND POSTSECONDARY EDUCATION INCLUDING VOCATIONAL/TECHNICAL EDUCATION; PROVIDING REFERRALS IN THE FIELD OF CHILDCARE; PROVIDING REFERRALS IN THE FIELD OF MILITARY VETERAN'S BENEFITS; PROVIDING ON-LINE DIRECTORY SERVICES FEATURING THE SERVICES OF OTHERS IN THE FIELDS OF EMPLOYMENT COUNSELING, OUTPLACEMENT AND

CAREER NETWORKING, PRIMARY, SECONDARY AND POSTSECONDARY EDUCATION INCLUDING VOCATIONAL/TECHNICAL EDUCATION, CHILDCARE, AND MILITARY VETERAN'S BENEFITS, IN CLASS 35 (U.S. CLS. 100, 101 AND 102).

FIRST USE 12-2-2006; IN COMMERCE 12-2-2006.

THE MARK CONSISTS OF STANDARD CHARACTERS WITHOUT CLAIM TO ANY PARTICULAR FONT, STYLE, SIZE, OR COLOR.

NO CLAIM IS MADE TO THE EXCLUSIVE RIGHT TO USE "MARINE", APART FROM THE MARK AS SHOWN.

SN 78-461,127, FILED 8-3-2004.

BARBARA BROWN, EXAMINING ATTORNEY

Int. Cls.: 16 and 41

Prior U.S. Cls.: 2, 5, 22, 23, 29, 37, 38, 50, 100, 101, and 107

Reg. No. 3,399,388

United States Patent and Trademark Office

Registered Mar. 18, 2008

**TRADEMARK
SERVICE MARK
PRINCIPAL REGISTER**

**Improve your credit
scores improve
your lifestyle**

SNYDER, STEPHEN B. (UNITED STATES INDIVIDUAL)
9102 FALLVIEW DR.
FISHERS, IN 46038

FOR: PRINTED INSTRUCTIONAL, EDUCATIONAL, AND TEACHING MATERIALS IN THE AREAS OF PERSONAL FINANCE, CREDIT SCORES AND CREDIT MANAGEMENT, IN CLASS 16 (U.S. CLS. 2, 5, 22, 23, 29, 37, 38 AND 50).

FIRST USE 3-2-2006; IN COMMERCE 3-2-2006.

FOR: EDUCATIONAL SERVICES, NAMELY, CONDUCTING SEMINARS IN THE FIELD OF PERSONAL FINANCE, CREDIT SCORES AND CREDIT MANAGEMENT; ENTERTAINMENT SERVICES, NAMELY, PRODUCTION OF RADIO AND TELEVISION PROGRAMS IN THE FIELD OF PER-

SONAL FINANCE, CREDIT SCORES AND CREDIT MANAGEMENT; ENTERTAINMENT SERVICES, NAMELY, PERSONAL APPEARANCES ON RADIO AND TELEVISION BY PERSONAL FINANCE EXPERT, IN THE FIELD OF PERSONAL FINANCE, CREDIT SCORES AND CREDIT MANAGEMENT, IN CLASS 41 (U.S. CLS. 100, 101 AND 107).

FIRST USE 3-2-2006; IN COMMERCE 3-2-2006.

THE MARK CONSISTS OF STANDARD CHARACTERS WITHOUT CLAIM TO ANY PARTICULAR FONT, STYLE, SIZE, OR COLOR.

SN 78-462,324, FILED 8-5-2004.

KENNETH E. SHARPERSON, EXAMINING ATTORNEY

Int. Cl.: 7

Prior U.S. Cls.: 13, 19, 21, 23, 31, 34, and 35

United States Patent and Trademark Office

Reg. No. 3,399,389

Registered Mar. 18, 2008

**TRADEMARK
PRINCIPAL REGISTER**

AXCELLER

STEWART STEEL INC. (CANADA CORPORATION)

P.O. BOX 1087

WEYBURN, SASKATCHEWAN, CANADA S4H 2L3

FOR: ROTOR CONVERSION KITS FOR AGRICULTURAL MACHINERY, NAMELY, COMBINES, IN CLASS 7 (U.S. CLS. 13, 19, 21, 23, 31, 34 AND 35).

FIRST USE 3-20-2007; IN COMMERCE 3-20-2007.

THE MARK CONSISTS OF STANDARD CHARACTERS WITHOUT CLAIM TO ANY PARTICULAR FONT, STYLE, SIZE, OR COLOR.

PRIORITY CLAIMED UNDER SEC. 44(D) ON CANADA APPLICATION NO. 1201552, FILED 2-6-2004, REG. NO. TMA655019, DATED 12-14-2005, EXPIRES 12-14-2020.

SN 78-463,455, FILED 8-6-2004.

ELLEN B. AWRICH, EXAMINING ATTORNEY

Int. Cl.: 44

Prior U.S. Cls.: 100 and 101

United States Patent and Trademark Office

Reg. No. 3,399,390

Registered Mar. 18, 2008

**SERVICE MARK
PRINCIPAL REGISTER**

STEALTHNAVIGATOR

MEDTRONIC NAVIGATION, INC. (DELAWARE
CORPORATION)
826 COAL CREEK CIRCLE
LOUISVILLE, CO 80027

FOR: LEASING OF MEDICAL EQUIPMENT ON A
FEE PER USE BASIS, IN CLASS 44 (U.S. CLS. 100
AND 101).

FIRST USE 8-16-2005; IN COMMERCE 8-16-2005.

THE MARK CONSISTS OF STANDARD CHAR-
ACTERS WITHOUT CLAIM TO ANY PARTICULAR
FONT, STYLE, SIZE, OR COLOR.

OWNER OF U.S. REG. NOS. 2,191,709 AND
2,717,661.

SN 78-466,974, FILED 8-13-2004.

AMY HELLA, EXAMINING ATTORNEY

Int. Cls.: 1, 3, 5, 16, and 32

Prior U.S. Cls.: 1, 2, 4, 5, 6, 10, 18, 22, 23, 26, 29, 37, 38, 44, 45, 46, 48, 50, 51, and 52

Reg. No. 3,399,391

United States Patent and Trademark Office

Registered Mar. 18, 2008

**TRADEMARK
PRINCIPAL REGISTER**

H-E-B BABY

HEB GROCERY COMPANY, L.P. (TEXAS LIMITED PARTNERSHIP)
CORPORATE LAW DEPARTMENT
646 SOUTH MAIN
SAN ANTONIO, TX 78204

FOR: DISTILLED WATER, IN CLASS 1 (U.S. CLS. 1, 5, 6, 10, 26 AND 46).

FIRST USE 3-0-2007; IN COMMERCE 3-0-2007.

FOR: BABY HEALTH AND BEAUTY AIDS, NAMELY, HAIR SHAMPOO, SKIN SOAPS, AND BODY WASH; SKIN AND BODY LOTIONS AND MOISTURIZERS, BABY OIL, BABY POWDER, NON-MEDICATED DIAPER RASH OINTMENT AND LOTION; PRE-MOISTENED, DISPOSABLE BABY WIPES, IN CLASS 3 (U.S. CLS. 1, 4, 6, 50, 51 AND 52).

FIRST USE 6-0-2005; IN COMMERCE 6-0-2005.

FOR: INFANT FORMULA; INFANT AND CHILDREN PHARMACEUTICAL PREPARATIONS, NAMELY, PEDIATRIC ELECTROLYTE, IN CLASS 5 (U.S. CLS. 6, 18, 44, 46, 51 AND 52).

FIRST USE 3-0-2003; IN COMMERCE 3-0-2003.

FOR: DISPOSABLE DIAPERS, IN CLASS 16 (U.S. CLS. 2, 5, 22, 23, 29, 37, 38 AND 50).

FIRST USE 3-0-2005; IN COMMERCE 3-0-2005.

FOR: FRUIT JUICE, IN CLASS 32 (U.S. CLS. 45, 46 AND 48).

FIRST USE 2-0-2003; IN COMMERCE 2-0-2003.

THE MARK CONSISTS OF STANDARD CHARACTERS WITHOUT CLAIM TO ANY PARTICULAR FONT, STYLE, SIZE, OR COLOR.

OWNER OF U.S. REG. NOS. 1,867,930, 2,556,749, AND 2,798,052.

NO CLAIM IS MADE TO THE EXCLUSIVE RIGHT TO USE "BABY", APART FROM THE MARK AS SHOWN.

SN 78-469,271, FILED 8-18-2004.

CHRISTOPHER BUONGIORNO, EXAMINING ATTORNEY

Int. Cl.: 10

Prior U.S. Cls.: 26, 39, and 44

United States Patent and Trademark Office

Reg. No. 3,399,392

Registered Mar. 18, 2008

**TRADEMARK
PRINCIPAL REGISTER**

**FUTURE MATRIX
INTERVENTIONAL**

FUTUREMATRIX INTERVENTIONAL, INC.
(TEXAS CORPORATION)
1605 ENTERPRISE AVENUE
ATHENS, TX 75751

FOR: SURGICAL INSTRUMENTS AND APPARATUS FOR USE IN CARDIOVASCULAR SURGERY, INTERVENTIONAL SURGERY AND BIOPSIES; MEDICAL DEVICES, NAMELY, VASCULAR AND CARDIOVASCULAR CATHETERS, BALLOONS, BALLOON INFLATION APPARATUS AND PARTS THEREFOR; MEDICAL DEVICES, NAMELY, BIOPSY INSTRUMENTS, IN CLASS 10 (U.S. CLS. 26, 39 AND 44).

FIRST USE 7-0-2006; IN COMMERCE 7-0-2006.

THE MARK CONSISTS OF STANDARD CHARACTERS WITHOUT CLAIM TO ANY PARTICULAR FONT, STYLE, SIZE, OR COLOR.

NO CLAIM IS MADE TO THE EXCLUSIVE RIGHT TO USE "INTERVENTIONAL", APART FROM THE MARK AS SHOWN.

SN 78-470,039, FILED 8-19-2004.

JOHN DALIER, EXAMINING ATTORNEY

Int. Cl.: 25

Prior U.S. Cls.: 22 and 39

United States Patent and Trademark Office

Reg. No. 3,399,393

Registered Mar. 18, 2008

**TRADEMARK
PRINCIPAL REGISTER**

PILLOW TOP

COLUMBIA INSURANCE COMPANY (NEBRASKA CORPORATION)
3024 HARNEY STREET
OMAHA, NE 68131

THE MARK CONSISTS OF STANDARD CHARACTERS WITHOUT CLAIM TO ANY PARTICULAR FONT, STYLE, SIZE, OR COLOR.

FOR: FOOTWEAR, IN CLASS 25 (U.S. CLS. 22 AND 39).

SN 78-470,294, FILED 8-19-2004.

FIRST USE 6-0-2004; IN COMMERCE 6-0-2004.

LOURDES AYALA, EXAMINING ATTORNEY

Int. Cl.: 42

Prior U.S. Cls.: 100 and 101

United States Patent and Trademark Office

Reg. No. 3,399,394

Registered Mar. 18, 2008

**SERVICE MARK
PRINCIPAL REGISTER**

IONATRON

IONATRON INC. (DELAWARE CORPORATION)
3590 EAST COLUMBIA STREET
TUSCON, AZ 857143440

FOR: RESEARCH AND DEVELOPMENT IN THE AREAS OF BASIC SCIENCE, LASER DEVELOPMENT, ELECTRICAL POWER SUPPLY DEVELOPMENT, SUPPORT EQUIPMENT PRODUCT DEVELOPMENT; ON SITE TESTING OF DELIVERED PRODUCTS, NAMELY, MOBILE, TRANSPORTABLE AND FIXED INTEGRATED DIRECTED ENERGY SYSTEMS UTILIZING LASER INDUCED PLASMA CHANNELING TECHNOLOGY COMPRISED OF LASERS AND ELECTRICAL POWER SUPPLIES FOR USE IN DISABLING VEHICLES AND ELECTRONIC SYSTEMS, NAMELY, COMPU-

TERS AND COMMUNICATIONS EQUIPMENT, FOR USE IN LETHAL AND NON-LETHAL COUNTER PERSONNEL APPLICATIONS AND SPECIAL USES FOR MILITARY AND NON-MILITARY PURPOSES, IN CLASS 42 (U.S. CLS. 100 AND 101).

FIRST USE 4-23-2007; IN COMMERCE 4-23-2007.

THE MARK CONSISTS OF STANDARD CHARACTERS WITHOUT CLAIM TO ANY PARTICULAR FONT, STYLE, SIZE, OR COLOR.

SN 78-471,787, FILED 8-23-2004.

GINA FINK, EXAMINING ATTORNEY

Int. Cl.: 41

Prior U.S. Cls.: 100, 101, and 107

United States Patent and Trademark Office

Reg. No. 3,399,395

Registered Mar. 18, 2008

**SERVICE MARK
PRINCIPAL REGISTER**

Homework on Wheels

DAVID M GRASMICK (CALIFORNIA LIMITED
PARTNERSHIP)
841 N 2ND AVE
UPLAND, CA 91786

FOR: TUTORING AND HELP WITH HOME-
WORK, IN CLASS 41 (U.S. CLS. 100, 101 AND 107).

FIRST USE 9-1-2002; IN COMMERCE 10-1-2002.

THE MARK CONSISTS OF STANDARD CHAR-
ACTERS WITHOUT CLAIM TO ANY PARTICULAR
FONT, STYLE, SIZE, OR COLOR.

SEC. 2(F).

SN 78-474,377, FILED 8-26-2004.

JOHN DALIER, EXAMINING ATTORNEY

Int. Cl.: 16

Prior U.S. Cls.: 2, 5, 22, 23, 29, 37, 38, and 50

Reg. No. 3,399,396

United States Patent and Trademark Office

Registered Mar. 18, 2008

TRADEMARK
PRINCIPAL REGISTER

The logo for "Jada Sunshine" is written in a cursive, handwritten-style font. The word "Jada" is on the left and "Sunshine" is on the right. A small, stylized sunburst icon is positioned above the letter "i" in "Sunshine".

DICKERSON, KIMBERLY (UNITED STATES IN-
DIVIDUAL)
226 E. 70TH STREET APARTMENT 6G
NEW YORK, NY 10021

CHILDREN'S ISSUES; AND INFORMATIONAL
BUSINESS LETTERS PERTAINING TO CHIL-
DREN'S ISSUES, IN CLASS 16 (U.S. CLS. 2, 5, 22, 23,
29, 37, 38 AND 50).

FOR: SERIES OF FICTION CHILDREN'S BOOKS;
NON-FICTION CHILDREN'S BOOKS; MAGAZINES
PERTAINING TO CHILDREN'S ISSUES; PAMPH-
LETS PERTAINING TO CHILDREN'S ISSUES;
NEWSPAPERS; NEWSLETTERS PERTAINING TO
CHILDREN'S ISSUES; JOURNALS PERTAINING TO

FIRST USE 5-5-2006; IN COMMERCE 5-5-2006.

SN 78-482,168, FILED 9-12-2004.

CYNTHIA SLOAN, EXAMINING ATTORNEY

Int. Cls.: 35 and 42

Prior U.S. Cls.: 100, 101, and 102

United States Patent and Trademark Office

Reg. No. 3,399,397

Registered Mar. 18, 2008

**SERVICE MARK
PRINCIPAL REGISTER**

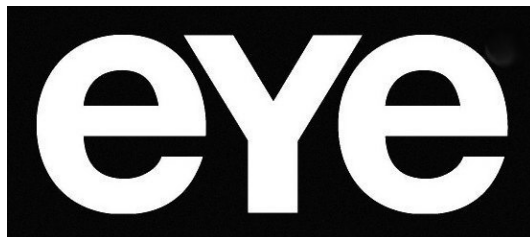

EYE CORP PTY LIMITED (AUSTRALIA CORPORATION)
LEVEL 5
35 SAUNDERS STREET
PYRMONT, NSW, AUSTRALIA 2009

FOR: ADVERTISING SERVICES, NAMELY, PROMOTING THE GOODS AND SERVICES OF OTHERS THROUGH THE USE OF BILLBOARD, DIGITAL SIGNAGE ADVERTISING NETWORKS AND ON-LINE ADVERTISING ON INTERACTIVE COMPUTER COMMUNICATION NETWORKS, OUT-OF-HOME/OUTDOOR ADVERTISING; ADVERTISING VIA LIGHT BOXES, ON STREET FURNITURE AND AT POINT OF SALE; UPDATING AND DISSEMINATION OF ADVERTISING MATERIAL; RENTAL OF ADVERTISING SPACE; MARKETING RESEARCH; DEVELOPMENT OF MARKETING STRATEGIES, CONCEPTS AND MATERIAL IN THE ADVERTIS-

ING FIELD, IN CLASS 35 (U.S. CLS. 100, 101 AND 102).

FIRST USE 3-0-2004; IN COMMERCE 1-3-2006.

FOR: COMPUTER SOFTWARE DESIGN AND MAINTENANCE; GRAPHIC DESIGN OF MULTIMEDIA PRESENTATIONS AND ADVERTISING CAMPAIGNS; GRAPHIC DESIGN OF ADVERTISING MATERIAL, IN CLASS 42 (U.S. CLS. 100 AND 101).

FIRST USE 3-0-2004; IN COMMERCE 1-3-2006.

SN 78-484,389, FILED 9-15-2004.

TRICIA SONNEBORN, EXAMINING ATTORNEY

Int. Cl.: 35

Prior U.S. Cls.: 100, 101, and 102

United States Patent and Trademark Office

Reg. No. 3,399,398

Registered Mar. 18, 2008

**SERVICE MARK
PRINCIPAL REGISTER**

**EARLY WARNING
SYSTEM**

MARKMONITOR INC. (DELAWARE CORPORATION)
391 N. ARCESTER PLACE
BOISE, ID 83704

THE MARK CONSISTS OF STANDARD CHARACTERS WITHOUT CLAIM TO ANY PARTICULAR FONT, STYLE, SIZE, OR COLOR.

FOR: BUSINESS CONSULTATION SERVICES IN THE FIELD OF PREVENTION OF INTERNET FRAUD OR OTHER ILLEGAL ACTIVITIES IN DOMAIN REGISTRATIONS, IN CLASS 35 (U.S. CLS. 100, 101 AND 102).

SN 78-484,671, FILED 9-16-2004.

FIRST USE 9-11-2003; IN COMMERCE 9-11-2003.

MARIA-VICTORIA SUAREZ, EXAMINING ATTORNEY

Int. Cls.: 9 and 42

Prior U.S. Cls.: 21, 23, 26, 36, 38, 100, and 101

United States Patent and Trademark Office

Reg. No. 3,399,399

Registered Mar. 18, 2008

**TRADEMARK
SERVICE MARK
PRINCIPAL REGISTER**

MICROSAIC

MICROSAIC SYSTEMS LIMITED (UNITED KINGDOM CORPORATION)
GMS HOUSE, BOUNDARY ROAD
WOKING, SURREY, UNITED KINGDOM GU21 5BX

FOR: MICRO ELECTRO MECHANICAL SYSTEMS (MEMS) STRUCTURES, NAMELY, INDUCTORS, RELAYS, SWITCHES, CONNECTORS, ELECTRODES, LASERS AND SCANNERS; INTEGRATED CIRCUITS; SOLID STATE INTEGRATED CIRCUITS; SOLID STATE ELECTRICAL INTEGRATED CIRCUITS, MASS SPECTROMETERS AND COMPONENTS THEREFOR, NAMELY, CHIPS, MINIATURE MASS SPECTROMETERS AND COMPONENTS THEREFOR, NAMELY, CHIPS; MEASUREMENT APPARATUS AND DEVICES, NAMELY, MEMS DEVICES FOR THE MEASUREMENT OF CONSTITUENTS OF CHEMICAL COMPOUNDS; SENSOR DEVICES, NAMELY, SENSORS FOR THE ANALYSIS OF CHEMICAL CONSTITUENTS, IN CLASS 9 (U.S. CLS. 21, 23, 26, 36 AND 38).

FIRST USE 11-0-2005; IN COMMERCE 11-0-2005.

FOR: ADVISORY SERVICES RELATED TO THE DESIGN AND FABRICATION OF MICRO ELECTRO MECHANICAL SYSTEMS (MEMS) SYSTEMS; ENGINEERING SERVICES; CIRCUIT DESIGN SERVICES FOR OTHERS; MEMS DESIGN SERVICES FOR OTHERS, IN CLASS 42 (U.S. CLS. 100 AND 101).

FIRST USE 11-0-2005; IN COMMERCE 11-0-2005.

THE MARK CONSISTS OF STANDARD CHARACTERS WITHOUT CLAIM TO ANY PARTICULAR FONT, STYLE, SIZE, OR COLOR.

SN 78-484,955, FILED 9-16-2004.

PRISCILLA MILTON, EXAMINING ATTORNEY

Int. Cls.: 24 and 25

Prior U.S. Cls.: 22, 39, 42, and 50

United States Patent and Trademark Office

Reg. No. 3,399,400

Registered Mar. 18, 2008

**TRADEMARK
PRINCIPAL REGISTER**

CHENONE

CHENONE STORES LIMITED (PAKISTAN CORPORATION)
92-93/E-1, GULBERG III
LAHORE, PAKISTAN

FOR: TEXTILE MATERIAL, NAMELY, HEMP CLOTH, COTTON FABRICS, CORD FABRICS AND ADHESIVE-BONDED CLOTH ALL USED IN THE FURTHER MANUFACTURE OF CLOTHING, CURTAINS AND BEDDING; TEXTILE GOODS, NAMELY, HANDKERCHIEFS OF TEXTILE, NAPKINS OF TEXTILE, BATH TOWELS, TOWEL USED TO COVER PILLOWS, TEXTILE BED AND BATH SHEETS; BED AND TABLE COVERS, NAMELY, BED BLANKETS, BEDSPREADS, BED LINEN, QUILTS, PILLOWCASES, BED SHEETS, BAG-SHAPED QUILT COVERS, CUSHION COVERS, WOOLEN BLANKETS AND TICKING FABRICS, UPHOLSTERY FABRIC USED IN THE MANUFACTURE OF TABLE CLOTHS, TABLE CLOTHS NOT OF PAPER, PLACE-MATS NOT OF PAPER, AND TABLE RUNNERS NOT OF PAPER, IN CLASS 24 (U.S. CLS. 42 AND 50).

FIRST USE 7-28-2007; IN COMMERCE 7-28-2007.

FOR: CLOTHING, NAMELY, PANTS, SHIRTS, DENIM JEANS, OVERALLS, SHORTS, T-SHIRTS, SHIRTS, WORKSHIRTS, BLOUSES, PULLOVERS, TANK TOPS, HALTER TOPS, JERSEYS, JACKETS, WIND RESISTANT JACKETS, RAINCOATS, COATS, VESTS, BLAZERS, SWEATERS, SWEATSHIRTS, SWEATPANTS, WOMEN'S SUITS, MEN'S SUITS, DRESSES, SKIRTS, SWIMMING TRUNKS, BATHING SUITS, BEACH WEAR, BIKINIS, ACTIVE WEAR, NAMELY, SWEATSUITS, CAMISOLES, LINGERIE, NIGHTGOWNS, HOSIERY, BANDANAS, SCARVES, BELTS, GLOVES, AND UNDERWEAR; HEADWEAR; FOOTWEAR, IN CLASS 25 (U.S. CLS. 22 AND 39).

FIRST USE 7-28-2007; IN COMMERCE 7-28-2007.

THE MARK CONSISTS OF STANDARD CHARACTERS WITHOUT CLAIM TO ANY PARTICULAR FONT, STYLE, SIZE, OR COLOR.

SN 78-488,843, FILED 9-23-2004.

PETER B. BROMAGHIM, EXAMINING ATTORNEY

Int. Cl.: 33

Prior U.S. Cls.: 47 and 49

United States Patent and Trademark Office

Reg. No. 3,399,401

Registered Mar. 18, 2008

**TRADEMARK
PRINCIPAL REGISTER**

GOLD LABEL

VINTWOOD INTERNATIONAL, LTD. (NEW
YORK CORPORATION)
40 PROSPECT STREET
HUNTINGTON, NY 11743

FOR: WINE, IN CLASS 33 (U.S. CLS. 47 AND 49).

FIRST USE 9-26-2007; IN COMMERCE 9-26-2007.

THE MARK CONSISTS OF STANDARD CHAR-
ACTERS WITHOUT CLAIM TO ANY PARTICULAR
FONT, STYLE, SIZE, OR COLOR.

SN 78-489,690, FILED 9-26-2004.

MICHELLE DUBOIS, EXAMINING ATTORNEY

Int. Cls.: 18 and 25

Prior U.S. Cls.: 1, 2, 3, 22, 39, and 41

United States Patent and Trademark Office

Reg. No. 3,399,402

Registered Mar. 18, 2008

**TRADEMARK
PRINCIPAL REGISTER**

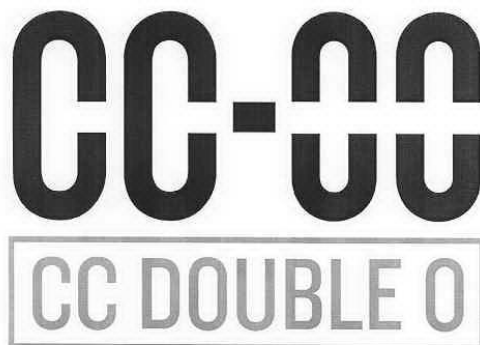

JASPAL COMPANY LIMITED (THAILAND CORPORATION)

1054 SOI. 66/1 SUKHUMVIT ROAD
BANGCHAK PRAKANONG
BANGKOK 10260, THAILAND

FOR: BAGS FOR TRAVEL, TEXTILE SHOPPING BAGS, BACKPACKS, BAGS FOR CAMPERS, NAME-
LY, RUCKSACKS, BAGS FOR CLIMBERS, NAME-
LY, HIKING BAGS, BEACH BAGS, BRIEFCASES,
GARMENT BAGS FOR TRAVEL, HANDBAGS,
MESH NET BAGS FOR SHOPPING, POCKET WAL-
LETS, PURSES, SCHOOL BAGS, SCHOOL SATCH-
ELS, SUITCASES, TRAVELING TRUNKS AND
LUGGAGE, IN CLASS 18 (U.S. CLS. 1, 2, 3, 22 AND
41).

FIRST USE 2-21-2005; IN COMMERCE 11-27-2006.

FOR: SUITS, SHIRTS, T-SHIRTS, BLOUSES WITH
SPAGHETTI STRAPS, VESTS, WAISTCOATS, SLEE-
VELESS SHIRTS, OVERCOATS, JACKETS, PULL-
OVERS, ANORAKS, BATHROBES, KNIT SHIRTS,
TRACKSUITS, EVENING GOWNS, SHORTS, TROU-
SERS, SKIRTS, UNDERWEAR, SCARVES, SHAWLS,
HATS, STOCKINGS, SOCKS, GLOVES, TIES, BELTS,
CASUAL SHOES, SLIPPERS, SPORT SHOES, HIGH
HEELED SHOES, BOOTS AND SANDALS, IN CLASS
25 (U.S. CLS. 22 AND 39).

FIRST USE 2-21-2005; IN COMMERCE 11-27-2006.

SN 78-490,510, FILED 9-28-2004.

JULIE WATSON, EXAMINING ATTORNEY

Int. Cl.: 35

Prior U.S. Cls.: 100, 101, and 102

United States Patent and Trademark Office

Reg. No. 3,399,403

Registered Mar. 18, 2008

**SERVICE MARK
PRINCIPAL REGISTER**

EDIVERSITY NETWORK

STAPLES THE OFFICE SUPERSTORE, LLC (DE-
LAWARE LTD LIAB CO)
500 STAPLES DRIVE
FRAMINGHAM, MA 01702

FOR: MAIL ORDER CATALOG SERVICES AND
COMPUTERIZED ONLINE RETAIL STORE SERVI-
CES FEATURING OFFICE SUPPLIES, OFFICE
EQUIPMENT, INCLUDING COMPUTER HARD-
WARE, COPIERS AND TELEPHONES, AND OFFICE
FURNITURE, IN CLASS 35 (U.S. CLS. 100, 101 AND
102).

FIRST USE 10-0-2005; IN COMMERCE 10-0-2005.

THE MARK CONSISTS OF STANDARD CHAR-
ACTERS WITHOUT CLAIM TO ANY PARTICULAR
FONT, STYLE, SIZE, OR COLOR.

NO CLAIM IS MADE TO THE EXCLUSIVE
RIGHT TO USE "NETWORK", APART FROM THE
MARK AS SHOWN.

SN 78-491,302, FILED 9-29-2004.

MAUREEN DALL, EXAMINING ATTORNEY

Int. Cl.: 44

Prior U.S. Cls.: 100 and 101

United States Patent and Trademark Office

Reg. No. 3,399,404

Registered Mar. 18, 2008

**SERVICE MARK
PRINCIPAL REGISTER**

iMATCH

ESTEE LAUDER INC. (UNITED STATES COR-
PORATION)
767 FIFTH AVENUE
NEW YORK, NY 10153

THE MARK CONSISTS OF STANDARD CHAR-
ACTERS WITHOUT CLAIM TO ANY PARTICULAR
FONT, STYLE, SIZE, OR COLOR.

FOR: BEAUTY CONSULTATION SERVICES, IN
CLASS 44 (U.S. CLS. 100 AND 101).

SN 78-491,499, FILED 9-29-2004.

FIRST USE 9-30-2005; IN COMMERCE 9-30-2005.

KEVIN DINALLO, EXAMINING ATTORNEY

Int. Cl.: 43

Prior U.S. Cls.: 100 and 101

United States Patent and Trademark Office

Reg. No. 3,399,405

Registered Mar. 18, 2008

**SERVICE MARK
PRINCIPAL REGISTER**



APPLE CORE HOTELS, INC. (NEW YORK CORPORATION)
15 WEST 39TH ST., 15TH FL.
NEW YORK, NY 10018

FOR: HOTEL SERVICES, IN CLASS 43 (U.S. CLS. 100 AND 101).

FIRST USE 10-1-2004; IN COMMERCE 10-1-2004.

OWNER OF U.S. REG. NOS. 2,115,441, 2,119,174, AND 2,233,681.

THE COLORS BLACK, WHITE, GREY, RED, YELLOW, GREEN ARE CLAIMED AS A FEATURE OF THE MARK.

THE COLOR BLACK APPEARS IN THE LETTERING OF THE MARK. THE COLORS RED, WHITE, GREY, YELLOW, GREEN AND BLACK APPEAR IN THE APPLE WHICH REPRESENTS THE "O" IN "CORE". THE BACKGROUND COLOR IS WHITE.

THE MARK CONSISTS IN PART OF THE WORD "CORE" IN STYLIZED FORM INCORPORATING THE IMAGE OF AN APPLE AS THE LETTER "O".

SN 78-493,337, FILED 10-1-2004.

DAVID H. STINE, EXAMINING ATTORNEY

Int. Cl.: 44

Prior U.S. Cls.: 100 and 101

United States Patent and Trademark Office

Reg. No. 3,399,406

Registered Mar. 18, 2008

**SERVICE MARK
PRINCIPAL REGISTER**

CHWHEALTH

CATHOLIC HEALTHCARE WEST (CALIFORNIA CORPORATION)
185 BERRY STREET
SAN FRANCISCO, CA 94107

FOR: HEALTHCARE, IN CLASS 44 (U.S. CLS. 100 AND 101).

FIRST USE 11-10-2007; IN COMMERCE 12-6-2007.

THE MARK CONSISTS OF STANDARD CHARACTERS WITHOUT CLAIM TO ANY PARTICULAR FONT, STYLE, SIZE, OR COLOR.

OWNER OF U.S. REG. NOS. 1,560,221, 2,169,650, AND OTHERS.

SN 78-497,264, FILED 10-8-2004.

LEIGH CAROLINE CASE, EXAMINING ATTORNEY

Int. Cls.: 9, 41, and 42

Prior U.S. Cls.: 21, 23, 26, 36, 38, 100, 101, and 107

United States Patent and Trademark Office

Reg. No. 3,399,407

Registered Mar. 18, 2008

**TRADEMARK
SERVICE MARK
PRINCIPAL REGISTER**

GET THERE FASTER.

WEBMETHODS, INC. (UNITED STATES CORPORATION)
3930 PENDER DRIVE
FAIRFAX, VA 22030

FOR: COMPUTER SOFTWARE FOR ALLOWING APPLICATION INTEGRATION BETWEEN DIFFERENT BUSINESSES USING THE GLOBAL COMPUTER NETWORK PROTOCOLS , IN CLASS 9 (U.S. CLS. 21, 23, 26, 36 AND 38).

FIRST USE 4-1-2002; IN COMMERCE 4-1-2002.

FOR: COMPUTER EDUCATION TRAINING SERVICES, NAMELY, TRAINING IN THE USE OF COMPUTER SOFTWARE FOR ALLOWING APPLICATION INTEGRATION BETWEEN DIFFERENT BUSINESSES USING THE GLOBAL COMPUTER NETWORK PROTOCOLS, IN CLASS 41 (U.S. CLS. 100, 101 AND 107).

FIRST USE 4-1-2002; IN COMMERCE 4-1-2002.

FOR: COMPUTER SOFTWARE DESIGN FOR OTHERS; INSTALLATION AND IMPLEMENTATION OF COMPUTER SOFTWARE FOR OTHERS; CONSULTING SERVICES IN THE FIELD OF COMPUTER SOFTWARE FOR ALLOWING APPLICATION INTEGRATION BETWEEN DIFFERENT BUSINESSES USING THE GLOBAL COMPUTER NETWORK PROTOCOLS, IN CLASS 42 (U.S. CLS. 100 AND 101).

FIRST USE 4-1-2002; IN COMMERCE 4-1-2002.

THE MARK CONSISTS OF STANDARD CHARACTERS WITHOUT CLAIM TO ANY PARTICULAR FONT, STYLE, SIZE, OR COLOR.

SN 78-500,765, FILED 10-15-2004.

CHRISTOPHER BUONGIORNO, EXAMINING ATTORNEY

Int. Cl.: 41

Prior U.S. Cls.: 100, 101, and 107

United States Patent and Trademark Office

Reg. No. 3,399,408

Registered Mar. 18, 2008

**SERVICE MARK
PRINCIPAL REGISTER**

Bright Start

AMERICAN ELECTRIC POWER COMPANY,
INC. (NEW YORK CORPORATION)
29TH FLOOR
1 RIVERSIDE PLAZA
COLUMBUS, OH 43215

FOR: EDUCATION IN THE FIELD OF EARLY CHILDHOOD SCIENCE EDUCATION; EDUCATION SERVICES IN THE NATURE OF COURSES AT THE UNIVERSITY LEVEL REGARDING EARLY CHILDHOOD SCIENCE EDUCATION; INSTRUCTION IN THE FIELD OF EARLY CHILDHOOD SCIENCE EDUCATION; TEACHING IN THE FIELD OF EARLY CHILDHOOD SCIENCE EDUCATION; DEVELOPING EDUCATIONAL MANUALS FOR OTHERS IN THE FIELD OF EARLY CHILDHOOD SCIENCE EDUCATION; DEVELOPMENT AND DIS-

SEMINATION OF EDUCATIONAL MATERIALS OF OTHERS IN THE FIELD OF EARLY CHILDHOOD SCIENCE EDUCATION, IN CLASS 41 (U.S. CLS. 100, 101 AND 107).

FIRST USE 7-13-2007; IN COMMERCE 7-13-2007.

THE MARK CONSISTS OF STANDARD CHARACTERS WITHOUT CLAIM TO ANY PARTICULAR FONT, STYLE, SIZE, OR COLOR.

SN 78-501,848, FILED 10-19-2004.

MARIA-VICTORIA SUAREZ, EXAMINING ATTORNEY

Int. Cls.: 35 and 44

Prior U.S. Cls.: 100, 101, and 102

United States Patent and Trademark Office

Reg. No. 3,399,409

Registered Mar. 18, 2008

**SERVICE MARK
PRINCIPAL REGISTER**

**HERBALIFE
NUTRITION CLUB**

HERBALIFE INTERNATIONAL, INC. (NEVADA CORPORATION)
1800 CENTURY PARK EAST
LOS ANGELES, CA 900671501

FOR: PROVIDING INFORMATION IN THE FIELDS OF MULTI-LEVEL MARKETING AND DEVELOPMENT OF SMALL BUSINESSES, IN CLASS 35 (U.S. CLS. 100, 101 AND 102).

FIRST USE 12-0-2004; IN COMMERCE 12-0-2004.

FOR: PROVIDING INFORMATION IN THE FIELDS OF HEALTH AND NUTRITION, IN CLASS 44 (U.S. CLS. 100 AND 101).

FIRST USE 12-0-2004; IN COMMERCE 12-0-2004.

THE MARK CONSISTS OF STANDARD CHARACTERS WITHOUT CLAIM TO ANY PARTICULAR FONT, STYLE, SIZE, OR COLOR.

OWNER OF U.S. REG. NOS. 1,254,211, 2,512,368, AND OTHERS.

NO CLAIM IS MADE TO THE EXCLUSIVE RIGHT TO USE "NUTRITION CLUB", APART FROM THE MARK AS SHOWN.

SN 78-502,406, FILED 10-19-2004.

MARIA-VICTORIA SUAREZ, EXAMINING ATTORNEY

Int. Cl.: 24

Prior U.S. Cls.: 42 and 50

United States Patent and Trademark Office

Reg. No. 3,399,410

Registered Mar. 18, 2008

**TRADEMARK
PRINCIPAL REGISTER**

3W

TIONG LIONG INDUSTRIAL CO., LTD. (TAI-
WAN CORPORATION)
NO. 8, LANE 128, CHUNG-CHING ROAD SEC. 1
TAICHUNG HSIEN, TAIWAN

FOR: FABRIC FOR BOOTS AND SHOES, LINEN
LINING FABRIC FOR SHOES, FABRIC FOR OUT-
DOOR WEAR, COTTON CLOTH, POLYESTER FAB-
RIC, NYLON FABRIC, RAYON FABRIC, SAIL

CLOTH AND FIBERGLASS FABRICS FOR TEXTILE
USE, IN CLASS 24 (U.S. CLS. 42 AND 50).

FIRST USE 10-5-2004; IN COMMERCE 9-19-2007.

SN 78-503,129, FILED 10-20-2004.

WENDY GOODMAN, EXAMINING ATTORNEY

Int. Cl.: 16

Prior U.S. Cls.: 2, 5, 22, 23, 29, 37, 38, and 50

United States Patent and Trademark Office

Reg. No. 3,399,411

Registered Mar. 18, 2008

**TRADEMARK
PRINCIPAL REGISTER**

Jewish Living

ZS PUBLISHING, INC. (CANADA CORPORATION)
9 CEDAR SPRINGS GROVE
TORONTO, ONTARIO, CANADA M3H 5L3

FOR: PERIODICALS AND MAGAZINES IN THE
FIELD OF JEWISH RELIGION AND CULTURE, IN
CLASS 16 (U.S. CLS. 2, 5, 22, 23, 29, 37, 38 AND 50).

FIRST USE 11-15-2007; IN COMMERCE 11-15-2007.

THE MARK CONSISTS OF STANDARD CHARACTERS WITHOUT CLAIM TO ANY PARTICULAR FONT, STYLE, SIZE, OR COLOR.

NO CLAIM IS MADE TO THE EXCLUSIVE RIGHT TO USE "JEWISH", APART FROM THE MARK AS SHOWN.

SN 78-503,505, FILED 10-21-2004.

BRENDAN MCCAULEY, EXAMINING ATTORNEY

Int. Cl.: 34

Prior U.S. Cls.: 2, 8, 9, and 17

United States Patent and Trademark Office

Reg. No. 3,399,412

Registered Mar. 18, 2008

**TRADEMARK
PRINCIPAL REGISTER**

**SHANGHAI TRADING
CO.**

K. HANSOTIA & CO., INC. (FLORIDA CORPORATION)
3705 N.W. 115 AVENUE, BAY #5
MIAMI, FL 33178

FOR: TOBACCO, CIGARETTES, CIGARS, ARTICLES FOR SMOKERS NOT OF PRECIOUS METAL, NAMELY, CIGARETTE LIGHTERS, CIGARETTE CASES, CIGAR CASES, CIGARETTE HOLDERS, AND CIGAR HOLDERS, IN CLASS 34 (U.S. CLS. 2, 8, 9 AND 17).

FIRST USE 8-2-2004; IN COMMERCE 9-1-2004.

THE MARK CONSISTS OF STANDARD CHARACTERS WITHOUT CLAIM TO ANY PARTICULAR FONT, STYLE, SIZE, OR COLOR.

NO CLAIM IS MADE TO THE EXCLUSIVE RIGHT TO USE "TRADING CO.", APART FROM THE MARK AS SHOWN.

SN 78-503,555, FILED 10-21-2004.

RONALD AIKENS, EXAMINING ATTORNEY

Int. Cl.: 36

Prior U.S. Cls.: 100, 101, and 102

United States Patent and Trademark Office

Reg. No. 3,399,413

Registered Mar. 18, 2008

**SERVICE MARK
PRINCIPAL REGISTER**

**THE ROAD TO
HAPPINESS, NOW
OPEN**

FLEETWOOD ENTERPRISES, INC. (DELAWARE
CORPORATION)
3125 MYERS STREET, POST OFFICE BOX 7638
RIVERSIDE, CA 925137638

FOR: FINANCIAL MANAGEMENT SERVICES,
NAMELY, FORMATION, BROKERAGE AND MAN-
AGEMENT OF TIME-SHARE INTERESTS IN RE-
CREATIONAL VEHICLES , IN CLASS 36 (U.S. CLS.
100, 101 AND 102).

FIRST USE 1-0-2005; IN COMMERCE 1-0-2005.

THE MARK CONSISTS OF STANDARD CHAR-
ACTERS WITHOUT CLAIM TO ANY PARTICULAR
FONT, STYLE, SIZE, OR COLOR.

SN 78-503,948, FILED 10-21-2004.

STEVEN PEREZ, EXAMINING ATTORNEY

Int. Cl.: 16

Prior U.S. Cls.: 2, 5, 22, 23, 29, 37, 38, and 50

Reg. No. 3,399,414

United States Patent and Trademark Office

Registered Mar. 18, 2008

**TRADEMARK
PRINCIPAL REGISTER**

KNOWLEDGE  ESSENTIALS

KNOWLEDGE ESSENTIALS, LLC (DELAWARE CORPORATION)
SUITE 320
825 N. BROADWAY AVENUE
OKLAHOMA CITY, OK 73102

FIRST USE 10-27-2007; IN COMMERCE 10-27-2007.

THE STIPPLING IS FOR SHADING PURPOSES ONLY.

FOR: PRINTED INSTRUCTIONAL, EDUCATIONAL AND TEACHING MATERIALS IN THE FIELD OF CHILDREN'S EDUCATION IN MATHEMATICS, SCIENCE, HISTORY, ENGLISH, AND FOREIGN LANGUAGE SKILLS; SERIES OF BOOKS IN THE FIELD OF CHILDREN'S EDUCATION IN MATHEMATICS, SCIENCE, HISTORY, ENGLISH, AND FOREIGN LANGUAGE SKILLS, IN CLASS 16 (U.S. CLS. 2, 5, 22, 23, 29, 37, 38 AND 50).

THE MARK CONSISTS OF THE WORDS "KNOWLEDGE" AND "ESSENTIALS" WITH A BOOK PLACED BETWEEN THE TWO WORDS.

SN 78-504,679, FILED 10-22-2004.

CAROLYN GRAY, EXAMINING ATTORNEY

Int. Cl.: 9

Prior U.S. Cls.: 21, 23, 26, 36, and 38

United States Patent and Trademark Office

Reg. No. 3,399,415

Registered Mar. 18, 2008

**TRADEMARK
PRINCIPAL REGISTER**

THEATREPOINT

VANTAGE CONTROLS, INC. (UTAH CORPORATION)
1061 SOUTH 800 EAST
OREM, UT 84097

FOR: ELECTRICAL AND ELECTRONIC DEVICES, NAMELY, BUILDING AUTOMATION CONTROLLERS, KEYPADS, REMOTE CONTROLS, RS-232 STATIONS, POWER ENCLOSURE HUBS, THERMOSTAT STATIONS, RELAY STATIONS, INPUT STATIONS, OUTPUT STATIONS, INFRA-RED EMITTER STATIONS, DIMMER STATIONS, LCD CONTROL STATIONS, RELAY MODULES, DIMMING MODULES, REMOTE INFRA-RED RECEIVERS, DMX COMMUNICATION STATIONS, WIRELESS TRANSCEIVERS, INTERACTIVE TOUCHSCREEN CONTROLLERS, VIDEO DISPLAY SCREENS FOR HOME AUDIO AND VIDEO DEVICE CONTROL AND MONITORING, AND MODEMS FOR OPERATING BUILDING AUTOMATION SYS-

TEMS, ENVIRONMENTAL CONDITION SYSTEMS, WATER SYSTEMS, AUDIO SYSTEMS, VIDEO SYSTEMS, TELEPHONE SYSTEMS, INTERCOM SYSTEMS, VIDEO AND BUILDING AMENITIES INCLUDING VIDEO CAMERAS, TELEVISIONS, AUDIO AMPLIFIERS, AND RADIOS; AUDIO SPEAKERS; COMPUTER PROGRAMS FOR BUILDING AUTOMATION SYSTEMS, IN CLASS 9 (U.S. CLS. 21, 23, 26, 36 AND 38).

FIRST USE 9-17-2002; IN COMMERCE 9-17-2002.

THE MARK CONSISTS OF STANDARD CHARACTERS WITHOUT CLAIM TO ANY PARTICULAR FONT, STYLE, SIZE, OR COLOR.

SN 78-506,944, FILED 10-27-2004.

MARY ROSSMAN, EXAMINING ATTORNEY

Int. Cls.: 16, 35, 36, 39, 41, 42, 43, 44, and 45

Prior U.S. Cls.: 2, 5, 22, 23, 29, 37, 38, 50, 100, 101, 102, 105, and 107

Reg. No. 3,399,416

United States Patent and Trademark Office

Registered Mar. 18, 2008

**TRADEMARK
SERVICE MARK
PRINCIPAL REGISTER**

SIMPLE LIVING

HEALTHY DIRECTIONS, LLC (DELAWARE LTD
LIAB CO)
7811 MONTROSE ROAD
POTOMAC, MD 20854

FOR: CATALOGS PROVIDING PRODUCTS AND SERVICES IN THE FIELDS OF TIME MANAGEMENT, PERSONAL FINANCES, ORGANIZING, STORAGE SYSTEMS, TRAVEL, ENTERTAINING, PERSONAL GROWTH, CAREER, RELATIONSHIPS, CLEANING, NUTRITION, FOOD, COOKING, HOME DECOR, GARDENING, HEALTH, CLOTHING, PERSONAL CARE AND GROOMING, COSMETICS, FITNESS AND MATTERS OF GENERAL INTEREST RELATED TO LIVING A SIMPLER, MORE FULFILLING LIFESTYLE; NEWSLETTERS FEATURING INFORMATION AND ADVICE AND COMMENTARY IN THE FIELD OF TIME MANAGEMENT, PERSONAL FINANCES, ORGANIZING, STORAGE SYSTEMS, TRAVEL, ENTERTAINING, PERSONAL GROWTH, CAREER, RELATIONSHIPS, CLEANING, NUTRITION, FOOD, COOKING, HOME DECOR, GARDENING, HEALTH, CLOTHING, PERSONAL CARE AND GROOMING, COSMETICS, FITNESS AND MATTERS OF GENERAL INTEREST RELATED TO LIVING A SIMPLER, MORE FULFILLING LIFESTYLE, IN CLASS 16 (U.S. CLS. 2, 5, 22, 23, 29, 37, 38 AND 50).

FIRST USE 1-15-1993; IN COMMERCE 1-15-1993.

FOR: ONLINE CATALOG SERVICES PROVIDING PRODUCTS AND SERVICES IN THE FIELD OF TIME MANAGEMENT, PERSONAL FINANCES, ORGANIZING, STORAGE SYSTEMS, TRAVEL, EN-

TERTAINING, PERSONAL GROWTH, CAREER, RELATIONSHIPS, CLEANING, NUTRITION, FOOD, COOKING, HOME DECOR, GARDENING, HEALTH, CLOTHING, PERSONAL CARE AND GROOMING, COSMETICS, FITNESS AND MATTERS OF GENERAL INTEREST RELATED TO LIVING A SIMPLER, MORE FULFILLING LIFESTYLE, IN CLASS 35 (U.S. CLS. 100, 101 AND 102).

FIRST USE 1-0-1993; IN COMMERCE 12-0-2004.

FOR: ONLINE SERVICES, NAMELY, PROVIDING A WEBSITE FEATURING INFORMATION, ADVICE AND COMMENTARY IN THE FIELD OF PERSONAL FINANCES, IN CLASS 36 (U.S. CLS. 100, 101 AND 102).

FIRST USE 1-0-1993; IN COMMERCE 12-0-2004.

FOR: ONLINE SERVICES, NAMELY, PROVIDING A WEBSITE FEATURING INFORMATION, ADVICE, AND COMMENTARY IN THE FIELD OF TRAVEL, IN CLASS 39 (U.S. CLS. 100 AND 105).

FIRST USE 1-0-1993; IN COMMERCE 12-0-2004.

FOR: ONLINE SERVICES, NAMELY, PROVIDING A WEBSITE FEATURING INFORMATION, ADVICE, AND COMMENTARY IN THE FIELD OF CAREER COUNSELING, FITNESS, AND ENTERTAINING, IN CLASS 41 (U.S. CLS. 100, 101 AND 107).

FIRST USE 9-4-1996; IN COMMERCE 9-4-1996.

FOR: ONLINE SERVICES, NAMELY, PROVIDING A WEBSITE FEATURING INFORMATION, ADVICE, AND COMMENTARY IN THE FIELD OF HOME DECOR, IN CLASS 42 (U.S. CLS. 100 AND 101).

FIRST USE 1-0-1993; IN COMMERCE 12-0-2004.

FOR: ONLINE SERVICES, NAMELY, PROVIDING A WEBSITE FEATURING INFORMATION, ADVICE, AND COMMENTARY IN THE FIELDS OF FOOD, COOKING, AND FOOD PREPARATION, IN CLASS 43 (U.S. CLS. 100 AND 101).

FIRST USE 1-0-1993; IN COMMERCE 12-0-2004.

FOR: ONLINE SERVICES, NAMELY, PROVIDING A WEBSITE FEATURING INFORMATION, ADVICE, AND COMMENTARY IN THE FIELDS OF NUTRITION AND GARDENING; PROVIDING A WEBSITE FEATURING INFORMATION, ADVICE, AND COMMENTARY IN THE FIELDS OF PERSONAL HEALTH AND PERSONAL CARE AND GROOMING, IN CLASS 44 (U.S. CLS. 100 AND 101).

FIRST USE 1-0-1993; IN COMMERCE 12-0-2004.

FOR: ONLINE SERVICES, NAMELY, PROVIDING A WEBSITE FEATURING INFORMATION, ADVICE AND COMMENTARY IN THE FIELDS OF TIME MANAGEMENT, HOME ORGANIZING AND STORAGE SYSTEMS, PERSONAL GROWTH, PERSONAL RELATIONSHIPS, AND MATTERS OF GENERAL INTEREST RELATED TO LIVING A SIMPLER, MORE FULFILLING LIFESTYLE; ONLINE SERVICES NAMELY, PROVIDING A WEBSITE FEATURING FASHION INFORMATION, ADVICE, AND COMMENTARY IN THE FIELDS OF CLOTHING AND COSMETICS, IN CLASS 45 (U.S. CLS. 100 AND 101).

FIRST USE 1-0-1993; IN COMMERCE 12-0-2004.

THE MARK CONSISTS OF STANDARD CHARACTERS WITHOUT CLAIM TO ANY PARTICULAR FONT, STYLE, SIZE, OR COLOR.

SN 78-507,440, FILED 10-28-2004.

CYNTHIA SLOAN, EXAMINING ATTORNEY

Int. Cl.: 25

Prior U.S. Cls.: 22 and 39

United States Patent and Trademark Office

Reg. No. 3,399,417

Registered Mar. 18, 2008

**TRADEMARK
PRINCIPAL REGISTER**

DEATH SQUAD

REID, RALPH (UNITED STATES INDIVIDUAL)
696 VORTEX AVE.
HENDERSON, NV 89002 AND
FALLON, ZACH (UNITED STATES INDIVIDUAL)
696 VORTEX AVE.
HENDERSON, NV 89002

FOR: CLOTHING, NAMELY, SHIRTS, T-SHIRTS,
SHORTS, JACKETS, SWEATERS, AND HATS, IN
CLASS 25 (U.S. CLS. 22 AND 39).

FIRST USE 11-20-2007; IN COMMERCE 11-20-2007.

THE MARK CONSISTS OF STANDARD CHAR-
ACTERS WITHOUT CLAIM TO ANY PARTICULAR
FONT, STYLE, SIZE, OR COLOR.

SN 78-508,666, FILED 10-29-2004.

DAYNA BROWNE, EXAMINING ATTORNEY

Int. Cl.: 41

Prior U.S. Cls.: 100, 101, and 107

United States Patent and Trademark Office

Reg. No. 3,399,418

Registered Mar. 18, 2008

**SERVICE MARK
PRINCIPAL REGISTER**

**THE ART INSTITUTE
OF JACKSONVILLE**

EDUCATION MANAGEMENT LLC (DELAWARE
LTD LIAB CO)
210 SIXTH AVENUE
PITTSBURGH, PA 15222

FOR: EDUCATIONAL SERVICES, NAMELY,
PROVIDING COURSES OF INSTRUCTION AT
THE POSTSECONDARY LEVEL, IN CLASS 41 (U.S.
CLS. 100, 101 AND 107).

FIRST USE 1-8-2007; IN COMMERCE 1-8-2007.

THE MARK CONSISTS OF STANDARD CHAR-
ACTERS WITHOUT CLAIM TO ANY PARTICULAR
FONT, STYLE, SIZE, OR COLOR.

OWNER OF U.S. REG. NOS. 1,608,534, 2,409,652,
AND OTHERS.

NO CLAIM IS MADE TO THE EXCLUSIVE
RIGHT TO USE "ART INSTITUTE", APART FROM
THE MARK AS SHOWN.

SEC. 2(F).

SN 78-508,936, FILED 11-1-2004.

ZHALEH DELANEY, EXAMINING ATTORNEY

Int. Cls.: 9 and 42

Prior U.S. Cls.: 21, 23, 26, 36, 38, 100, and 101

United States Patent and Trademark Office

Reg. No. 3,399,419

Registered Mar. 18, 2008

**TRADEMARK
SERVICE MARK
PRINCIPAL REGISTER**

MX.3

MUREX S.A.S. (FRANCE CORPORATION)
8 RUE BELLINI
PARIS, FRANCE 75116

FOR: COMPUTER SOFTWARE USED FOR VALUATION, MANAGEMENT, AND PROCESSING OF FINANCIAL TRANSACTIONS IN THE FIELDS OF CAPITAL MARKETS, BUSINESS AND FINANCE , IN CLASS 9 (U.S. CLS. 21, 23, 26, 36 AND 38).

FIRST USE 10-0-2004; IN COMMERCE 10-0-2004.

FOR: COMPUTER PROGRAMMING FOR OTHERS, COMPUTER SOFTWARE DESIGN AND UP-

DATING COMPUTER SOFTWARE FOR OTHERS, CONSULTATION SERVICES RELATING TO COMPUTER PROGRAMS, IN CLASS 42 (U.S. CLS. 100 AND 101).

FIRST USE 10-0-2004; IN COMMERCE 10-0-2004.

THE MARK CONSISTS OF STANDARD CHARACTERS WITHOUT CLAIM TO ANY PARTICULAR FONT, STYLE, SIZE, OR COLOR.

SN 78-509,325, FILED 11-1-2004.

KAREN BRACEY, EXAMINING ATTORNEY

Int. Cl.: 5

Prior U.S. Cls.: 6, 18, 44, 46, 51, and 52

United States Patent and Trademark Office

Reg. No. 3,399,420

Registered Mar. 18, 2008

**TRADEMARK
PRINCIPAL REGISTER**

VANILLA MINT CRÉME

S. C. JOHNSON & SON, INC. (WISCONSIN CORPORATION)

1525 HOWE STREET

RACINE, WI 534032236

FOR: AIR FRESHENERS, IN CLASS 5 (U.S. CLS. 6, 18, 44, 46, 51 AND 52).

FIRST USE 11-4-2007; IN COMMERCE 11-4-2007.

THE MARK CONSISTS OF STANDARD CHARACTERS WITHOUT CLAIM TO ANY PARTICULAR FONT, STYLE, SIZE, OR COLOR.

NO CLAIM IS MADE TO THE EXCLUSIVE RIGHT TO USE "VANILLA MINT", APART FROM THE MARK AS SHOWN.

SN 78-510,106, FILED 11-2-2004.

ELISSA GARBER KON, EXAMINING ATTORNEY

Int. Cl.: 28

Prior U.S. Cls.: 22, 23, 38, and 50

United States Patent and Trademark Office

Reg. No. 3,399,421

Registered Mar. 18, 2008

**TRADEMARK
PRINCIPAL REGISTER**



DETROIT PISTONS BASKETBALL COMPANY
(MICHIGAN LIMITED PARTNERSHIP)
2 CHAMPIONSHIP DRIVE
AUBURN HILLS, MI 48326

FOR: TOYS, GAMES AND SPORTING GOODS, NAMELY, BASKETBALLS, GOLF BALLS, PLAYGROUND BALLS, SPORTS BALLS, RUBBER ACTION BALLS AND FOAM ACTION BALLS, PLUSH BALLS, PLASTIC BALLS, BASKETBALL NETS, BASKETBALL BACKBOARDS, MINIATURE BASKETBALL BACKBOARDS, PUMPS FOR INFLATING BASKETBALLS, NEEDLES FOR INFLATING BASKETBALLS, GOLF CLUBS, GOLF BAGS, GOLF PUTTERS, GOLF ACCESSORIES, NAMELY, DIVOT REPAIR TOOLS, TEES, BALL MARKERS, GOLF BAG COVERS, CLUB HEAD COVERS, GOLF GLOVES, GOLF BALL SLEEVES, ELECTRONIC BASKETBALL TABLE TOP GAMES, BASKETBALL TABLE TOP GAMES, BASKETBALL BOARD GAMES, ACTION SKILL GAMES, ADULT'S AND CHILDREN'S PARTY GAMES, TRIVIA INFORMATION GAMES AND ELECTRONIC VIDEO ARCADE GAME MACHINES, BASKETBALL KIT COMPRISED OF A NET AND WHISTLE, DOLLS, DECORATIVE DOLLS, COLLECTIBLE DOLLS, TOY ACTION FIGURES, BOBBLEHEAD ACTION FIGURES, STUFFED TOYS, NOVELTY PLUSH TOYS WITH WIGS, JIGSAW PUZZLES AND CHRISTMAS TREE ORNAMENTS, CHRISTMAS STOCKINGS;

TOY VEHICLES IN THE NATURE OF CARS, TRUCKS AND VANS, ALL CONTAINING BASKETBALL THEMES, NOVELTY FOAM TOYS IN THE SHAPES OF FINGERS AND TROPHIES, TOY TROPHIES, PLAYING CARDS, CARD GAMES, NOISEMAKERS, PET TOYS; BEACH TOYS, NAMELY, BEACH BALLS, INFLATABLE BALLS, TOY PAILS, TOY SHOVELS, SAND TOYS, SAND BOX TOYS, WATER-SQUIRTING TOYS; BEACH AND POOL ACCESSORIES, NAMELY, SWIM FLOATS, POOL FLOATS, FOAM FLOATS, SWIM RINGS, POOL RINGS, FOAM RINGS, BODY BOARDS, SURF BOARDS, SWIM FINS, SURF FINS, ARM FLOATS AND WATER WING SWIM AIDS FOR RECREATIONAL USE; , INFLATABLE TOYS; VOLLEYBALL GAME KITS COMPRISED OF BALL, NET, SIDELINES AND WHISTLE, AND WATER POLO GAME KITS COMPRISED OF BALL, NET AND WHISTLE, IN CLASS 28 (U.S. CLS. 22, 23, 38 AND 50).

FIRST USE 5-21-1996; IN COMMERCE 5-21-1996.

OWNER OF U.S. REG. NOS. 1,085,717, 1,085,719, AND OTHERS.

SN 78-510,590, FILED 11-3-2004.

MARY BOAGNI, EXAMINING ATTORNEY

Int. Cl.: 9

Prior U.S. Cls.: 21, 23, 26, 36, and 38

United States Patent and Trademark Office

Reg. No. 3,399,422

Registered Mar. 18, 2008

**TRADEMARK
PRINCIPAL REGISTER**

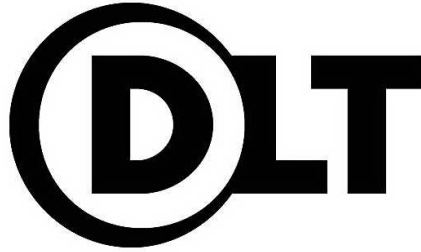

QUANTUM CORPORATION (DELAWARE CORPORATION)
1650 TECHNOLOGY DRIVE SUITE 800
SAN JOSE, CA 95110

FOR: COMPUTER TAPE DRIVES, COMPUTER TAPE CARTRIDGES, COMPUTER TAPE CARTRIDGE AUTOLOADERS, COMPUTER TAPE LIBRARIES WITH MULTIPLE COMPUTER DATA DRIVES, MULTIPLE COMPUTER TAPE CARTRIDGES AND AUTOMATIC COMPUTER TAPE CARTRIDGE LOAD/UNLOAD SYSTEMS AND THE SOFTWARE REQUIRED TO OPERATE THE COMPUTER TAPE DRIVES, AUTOLOADERS AND LI-

BRARIES, IN CLASS 9 (U.S. CLS. 21, 23, 26, 36 AND 38).

FIRST USE 6-1-2005; IN COMMERCE 6-1-2005.

OWNER OF U.S. REG. NOS. 2,373,379, 2,864,338, AND 2,864,339.

SEC. 2(F) AS TO "DLT".

SN 78-510,625, FILED 11-3-2004.

DAVID MURRAY, EXAMINING ATTORNEY

Int. Cl.: 41

Prior U.S. Cls.: 100, 101, and 107

United States Patent and Trademark Office

Reg. No. 3,399,423

Registered Mar. 18, 2008

**SERVICE MARK
PRINCIPAL REGISTER**

CODED ARMS

KONAMI DIGITAL ENTERTAINMENT CO. LTD.
(JAPAN CORPORATION)
9-7-2, AKASAKA, MINATO-KU
TOKYO 107-8324, JAPAN

THE MARK CONSISTS OF STANDARD CHARACTERS WITHOUT CLAIM TO ANY PARTICULAR FONT, STYLE, SIZE, OR COLOR.

FOR: ENTERTAINMENT SERVICES, NAMELY, PROVIDING ON-LINE COMPUTER GAMES; PROVIDING INFORMATION ABOUT COMPUTER GAMES THROUGH THE WEB SITES, IN CLASS 41 (U.S. CLS. 100, 101 AND 107).

OWNER OF U.S. REG. NO. 3,160,967.

SN 78-512,197, FILED 11-5-2004.

FIRST USE 9-18-2007; IN COMMERCE 9-18-2007.

ZHALEH DELANEY, EXAMINING ATTORNEY

Int. Cl.: 9

Prior U.S. Cls.: 21, 23, 26, 36, and 38

United States Patent and Trademark Office

Reg. No. 3,399,424

Registered Mar. 18, 2008

**TRADEMARK
PRINCIPAL REGISTER**

CYBERSET

CYBERSET, LLC (CALIFORNIA LTD LIAB CO)
3739 BALBOA STREET, SUITE 117
SAN FRANCISCO, CA 94121

FOR: MUSICAL SOUND RECORDINGS; MUSICAL VIDEO RECORDINGS; PRERECORDED AUDIO CASSETTES FEATURING MUSIC; PRERECORDED COMPACT DISCS FEATURING MUSIC; PRERECORDED VIDEO CASSETTES FEATURING MUSIC AND MUSICAL PERFORMANCES; PRERECORDED DVDS FEATURING MUSIC AND MUSICAL PERFORMANCES; COMPUTER FILES CONTAINING ENCODED MUSIC THAT IS DOWNLOADED FROM A REMOTE COMPUTER SITE; DOWNLOADABLE MUSICAL SOUND RECORDINGS; DOWNLOADABLE RING TONES AND MU-

SIC VIA A GLOBAL COMPUTER NETWORK AND WIRELESS DEVICES; SOUND RECORDINGS FEATURING MUSIC; DOWNLOADABLE VIDEO RECORDINGS FEATURING MUSIC AND MUSIC PERFORMANCES, IN CLASS 9 (U.S. CLS. 21, 23, 26, 36 AND 38).

FIRST USE 1-31-2005; IN COMMERCE 1-31-2005.

THE MARK CONSISTS OF STANDARD CHARACTERS WITHOUT CLAIM TO ANY PARTICULAR FONT, STYLE, SIZE, OR COLOR.

SN 78-512,217, FILED 11-5-2004.

MARK T. MULLEN, EXAMINING ATTORNEY

Int. Cl.: 37

Prior U.S. Cls.: 100, 103, and 106

United States Patent and Trademark Office

Reg. No. 3,399,425

Registered Mar. 18, 2008

**SERVICE MARK
PRINCIPAL REGISTER**

NSB NOT SO BAD

NSB ASSOCIATES, INC. (CALIFORNIA CORPORATION)
433 NORTH CAMDEN DRIVE, SUITE 820
BEVERLY HILLS, CA 902104412

THE MARK CONSISTS OF STANDARD CHARACTERS WITHOUT CLAIM TO ANY PARTICULAR FONT, STYLE, SIZE, OR COLOR.

FOR: REAL ESTATE DEVELOPMENT SERVICES,
IN CLASS 37 (U.S. CLS. 100, 103 AND 106).

SN 78-513,387, FILED 11-8-2004.

FIRST USE 10-27-2004; IN COMMERCE 10-27-2004.

DAVID TAYLOR, EXAMINING ATTORNEY

Int. Cls.: 11, 15, and 28

Prior U.S. Cls.: 2, 13, 21, 22, 23, 31, 34, 36, 38, and 50

United States Patent and Trademark Office

Reg. No. 3,399,426

Registered Mar. 18, 2008

**TRADEMARK
PRINCIPAL REGISTER**

CHRISTMAS EVE

CAVANAGH GROUP INTERNATIONAL, INC.
(GEORGIA CORPORATION)
SUITE 400
11455 LAKEFIELD DRIVE
DULUTH, GA 30097

FOR: ELECTRIC LIGHTS FOR CHRISTMAS AND
HOLIDAY TREES, IN CLASS 11 (U.S. CLS. 13, 21, 23,
31 AND 34).

FIRST USE 11-0-2006; IN COMMERCE 7-0-2007.

FOR: MUSICAL CHRISTMAS AND HOLIDAY
ORNAMENTS, IN CLASS 15 (U.S. CLS. 2, 21 AND 36).

FIRST USE 11-0-2006; IN COMMERCE 7-0-2007.

FOR: CHRISTMAS AND HOLIDAY TRIM-A-
TREE MERCHANDISE, NAMELY, CHRISTMAS

TREE ORNAMENTS, ARTIFICIAL TREES AND
ARTIFICIAL GARLAND, CHRISTMAS STOCK-
INGS, CHRISTMAS TREE SKIRTS, CHRISTMAS
TREE DECORATIONS, CHRISTMAS SNOW
GLOBES, CHRISTMAS MOBILES, IN CLASS 28
(U.S. CLS. 22, 23, 38 AND 50).

FIRST USE 11-0-2006; IN COMMERCE 7-0-2007.

THE MARK CONSISTS OF STANDARD CHAR-
ACTERS WITHOUT CLAIM TO ANY PARTICULAR
FONT, STYLE, SIZE, OR COLOR.

SN 78-513,555, FILED 11-9-2004.

JUDITH HELFMAN, EXAMINING ATTORNEY

Int. Cl.: 35

Prior U.S. Cls.: 100, 101, and 102

United States Patent and Trademark Office

Reg. No. 3,399,427

Registered Mar. 18, 2008

**SERVICE MARK
PRINCIPAL REGISTER**

BUZZ TRAK

ADP, INC. (DELAWARE CORPORATION)
1950 HASSELL ROAD
HOFFMAN ESTATES, IL 60195

THE MARK CONSISTS OF STANDARD CHAR-
ACTERS WITHOUT CLAIM TO ANY PARTICULAR
FONT, STYLE, SIZE, OR COLOR.

FOR: BUSINESS MARKETING SERVICES, IN
CLASS 35 (U.S. CLS. 100, 101 AND 102).

SN 78-514,744, FILED 11-10-2004.

FIRST USE 12-18-2000; IN COMMERCE 12-18-2000.

MIDGE BUTLER, EXAMINING ATTORNEY

Int. Cl.: 35

Prior U.S. Cls.: 100, 101, and 102

United States Patent and Trademark Office

Reg. No. 3,399,428

Registered Mar. 18, 2008

**SERVICE MARK
PRINCIPAL REGISTER**

PURE JILL

THE J. JILL GROUP, INC. (DELAWARE CORPORATION)
ONE TALBOTS DRIVE
HINGHAM, MA 02043

THE MARK CONSISTS OF STANDARD CHARACTERS WITHOUT CLAIM TO ANY PARTICULAR FONT, STYLE, SIZE, OR COLOR.

FOR: RETAIL OUTLETS, MAIL-ORDER CATALOGUE AND ON-LINE CATALOGUE SERVICES FEATURING CLOTHING AND ACCESSORIES, IN CLASS 35 (U.S. CLS. 100, 101 AND 102).

SN 78-515,393, FILED 11-11-2004.

FIRST USE 2-14-2000; IN COMMERCE 2-14-2000.

MATTHEW PAPPAS, EXAMINING ATTORNEY

Int. Cls.: 9, 35, 36, and 42

Prior U.S. Cls.: 21, 23, 26, 36, 38, 100, 101, and 102

United States Patent and Trademark Office

Reg. No. 3,399,429

Registered Mar. 18, 2008

**TRADEMARK
SERVICE MARK
PRINCIPAL REGISTER**

WORK-LIFE EXPRESS

ACCOR (FRANCE SOCIETE ANONYME)
2 RUE DE LA MARE NEUVE
EVRY, FRANCE 91000

FOR: DOWNLOADABLE ELECTRONIC PUBLICATIONS IN THE NATURE OF NEWSLETTERS, ARTICLES AND INFORMATION SHEETS IN THE FIELD OF HEALTH, EDUCATION, FINANCE, FAMILY ISSUES, DEPENDENT CARE AND LEGAL ISSUES, IN CLASS 9 (U.S. CLS. 21, 23, 26, 36 AND 38).

FIRST USE 5-11-1998; IN COMMERCE 5-11-1998.

FOR: PROVIDING REFERRALS IN THE FIELD OF DEPENDENT CARE, PHYSICAL AND MENTAL HEALTH, MEDICAL CARE, FINANCE, LEGAL MATTERS, TAXES, FAMILY, RETIREMENT, ESTATE PLANNING, REAL ESTATE, HOME MAINTENANCE, CLEANING AND SAFETY, CAREER SERVICES, RELOCATION, TRANSPORTATION, AUTO REPAIR, TRAVEL, EDUCATION, NUTRITION, FITNESS, SHOPPING, ENTERTAINMENT, DINING, RECREATION AND LODGING; PROVIDING INFORMATION AND CONSULTING IN THE FIELD OF RELOCATION AND TAX MATTERS, IN CLASS 35 (U.S. CLS. 100, 101 AND 102).

FIRST USE 5-11-1998; IN COMMERCE 5-11-1998.

FOR: PROVIDING INFORMATION AND CONSULTING IN THE FIELD OF FINANCE, REAL ESTATE AND INSURANCE VIA A CUSTOMIZABLE INTERACTIVE WEBSITE, IN CLASS 36 (U.S. CLS. 100, 101 AND 102).

FIRST USE 10-15-1998; IN COMMERCE 10-15-1998.

FOR: PROVIDING INFORMATION AND CONSULTING SERVICES IN THE FIELD OF LEGAL MATTERS VIA A CUSTOMIZABLE INTERACTIVE WEBSITE, IN CLASS 42 (U.S. CLS. 100 AND 101).

FIRST USE 5-11-1998; IN COMMERCE 5-11-1998.

THE MARK CONSISTS OF STANDARD CHARACTERS WITHOUT CLAIM TO ANY PARTICULAR FONT, STYLE, SIZE, OR COLOR.

SN 78-516,427, FILED 11-12-2004.

GIANCARLO CASTRO, EXAMINING ATTORNEY

Int. Cl.: 35

Prior U.S. Cls.: 100, 101, and 102

United States Patent and Trademark Office

Reg. No. 3,399,430

Registered Mar. 18, 2008

**SERVICE MARK
PRINCIPAL REGISTER**



HOLLYWOOD ENTERTAINMENT CORPORATION (OREGON CORPORATION)
9275 SW PEYTON LANE
WILSONVILLE, OR 97070

FOR: RETAIL STORE SERVICES FEATURING PRE-RECORDED ENTERTAINMENT MEDIA AND ASSOCIATED EQUIPMENT AND ACCESSORIES, VIDEO AND COMPUTER GAMES AND ASSOCIATED EQUIPMENT AND ACCESSORIES, MUSIC AND RELATED HOME ENTERTAINMENT EQUIPMENT AND ACCESSORIES, GAMES, PRINTED

PUBLICATIONS, FOODSTUFFS, TOYS, AND COMPUTER SOFTWARE AND HARDWARE, ALL PROVIDED VIA PHYSICAL ESTABLISHMENTS AND VIA A GLOBAL COMMUNICATION NETWORK, IN CLASS 35 (U.S. CLS. 100, 101 AND 102).

FIRST USE 8-28-2004; IN COMMERCE 8-28-2004.

SN 78-517,619, FILED 11-16-2004.

JAMES MACFARLANE, EXAMINING ATTORNEY

Int. Cl.: 5

Prior U.S. Cls.: 6, 18, 44, 46, 51, and 52

Reg. No. 3,399,431

United States Patent and Trademark Office

Registered Mar. 18, 2008

**TRADEMARK
PRINCIPAL REGISTER**

**CREMA DE VAINILLA
Y MENTA**

S. C. JOHNSON & SON, INC. (WISCONSIN CORPORATION)
1525 HOWE STREET
RACINE, WI 534032236

FOR: AIR FRESHENERS, IN CLASS 5 (U.S. CLS. 6, 18, 44, 46, 51 AND 52).

FIRST USE 11-4-2007; IN COMMERCE 11-4-2007.

THE MARK CONSISTS OF STANDARD CHARACTERS WITHOUT CLAIM TO ANY PARTICULAR FONT, STYLE, SIZE, OR COLOR.

NO CLAIM IS MADE TO THE EXCLUSIVE RIGHT TO USE "VAINILLA Y MENTA", APART FROM THE MARK AS SHOWN.

THE FOREIGN WORDING IN THE MARK TRANSLATES INTO ENGLISH AS VANILLA MINT CREME.

SN 78-518,125, FILED 11-16-2004.

ELISSA GARBER KON, EXAMINING ATTORNEY

Int. Cl.: 9

Prior U.S. Cls.: 21, 23, 26, 36, and 38

Reg. No. 3,399,432

United States Patent and Trademark Office

Registered Mar. 18, 2008

**TRADEMARK
PRINCIPAL REGISTER**

STEER CRAZY

WMS GAMING INC. (DELAWARE CORPORATION)
800 SOUTH NORTHPOINT BOULEVARD
WAUKEGAN, IL 60085

THE MARK CONSISTS OF STANDARD CHARACTERS WITHOUT CLAIM TO ANY PARTICULAR FONT, STYLE, SIZE, OR COLOR.

FOR: GAMING MACHINES, IN CLASS 9 (U.S. CLS. 21, 23, 26, 36 AND 38).

SN 78-518,622, FILED 11-17-2004.

FIRST USE 9-12-2005; IN COMMERCE 9-12-2005.

EVELYN BRADLEY, EXAMINING ATTORNEY

Int. Cl.: 5

Prior U.S. Cls.: 6, 18, 44, 46, 51, and 52

United States Patent and Trademark Office

Reg. No. 3,399,433

Registered Mar. 18, 2008

**TRADEMARK
PRINCIPAL REGISTER**

CERENIA

PFIZER INC. (DELAWARE CORPORATION)
235 EAST 42ND STREET
NEW YORK, NY 10017

FOR: VETERINARY PREPARATIONS AND SUB-
STANCES, NAMELY, AN ANTIEMETIC FOR CA-
NINES, IN CLASS 5 (U.S. CLS. 6, 18, 44, 46, 51 AND 52).

FIRST USE 7-30-2007; IN COMMERCE 7-30-2007.

THE MARK CONSISTS OF STANDARD CHAR-
ACTERS WITHOUT CLAIM TO ANY PARTICULAR
FONT, STYLE, SIZE, OR COLOR.

SN 78-519,568, FILED 11-18-2004.

CHRISIE B. KING, EXAMINING ATTORNEY

Int. Cl.: 9

Prior U.S. Cls.: 21, 23, 26, 36, and 38

Reg. No. 3,399,434

United States Patent and Trademark Office

Registered Mar. 18, 2008

**TRADEMARK
PRINCIPAL REGISTER**

VB

I.E.P.C. CORP (CALIFORNIA CORPORATION)
15179 SPRINGDALE STREET
HUNTINGTON BEACH, CA 92649

THE MARK CONSISTS OF STANDARD CHARACTERS WITHOUT CLAIM TO ANY PARTICULAR FONT, STYLE, SIZE, OR COLOR.

FOR: ELECTRICAL CONTROLLERS USED ALONE OR AS COMPONENTS OF LIGHTING CONTROL NETWORKS, IN CLASS 9 (U.S. CLS. 21, 23, 26, 36 AND 38).

SN 78-519,754, FILED 11-18-2004.

FIRST USE 10-4-2007; IN COMMERCE 10-4-2007.

ARETHA SOMERVILLE, EXAMINING ATTORNEY

Int. Cl.: 28

Prior U.S. Cls.: 22, 23, 38, and 50

United States Patent and Trademark Office

Reg. No. 3,399,435

Registered Mar. 18, 2008

**TRADEMARK
PRINCIPAL REGISTER**



WASHINGTON NATIONALS BASEBALL CLUB,
LLC (D.C. LTD LIAB CO)
RFK STADIUM
2400 E. CAPITAL STREET, S.E.
WASHINGTON, DC 20003

FOR: TOYS AND SPORTING GOODS, NAMELY,
STUFFED TOYS, PLUSH TOYS, BOARD GAMES,
CARD GAMES, TOY TRUCKS, TOY VEHICLES, IN
CLASS 28 (U.S. CLS. 22, 23, 38 AND 50).

FIRST USE 12-31-2004; IN COMMERCE 12-31-2004.

NO CLAIM IS MADE TO THE EXCLUSIVE
RIGHT TO USE "WASHINGTON", APART FROM
THE MARK AS SHOWN.

THE MARK CONSISTS OF THE STYLIZED, IN-
TERLOCKING LETTERS "DC" WITHIN A DESIGN
CONSISTING OF TWO CONCENTRIC CIRCLES
BEARING THE WORDS "WASHINGTON NATION-
ALS" AND TWO STAR DESIGNS.

SN 78-520,966, FILED 11-22-2004.

MICHELLE DUBOIS, EXAMINING ATTORNEY

Int. Cl.: 25

Prior U.S. Cls.: 22 and 39

United States Patent and Trademark Office

Reg. No. 3,399,436

Registered Mar. 18, 2008

**TRADEMARK
PRINCIPAL REGISTER**



WASHINGTON NATIONALS BASEBALL CLUB,
LLC (D.C. LIMITED LIABILITY COMPANY)
RFK STADIUM
2400 E. CAPITOL STREET, S.E.
WASHINGTON, DISTRICT OF COLUMBIA, DC
20003

FOR: CLOTHING, NAMELY, CAPS, HATS,
SHIRTS, T-SHIRTS, PULLOVERS, BASEBALL UNI-
FORMS, JERSEYS, JACKETS, TIES , IN CLASS 25
(U.S. CLS. 22 AND 39).

FIRST USE 11-22-2004; IN COMMERCE 11-22-2004.

NO CLAIM IS MADE TO THE EXCLUSIVE
RIGHT TO USE "WASHINGTON", APART FROM
THE MARK AS SHOWN.

SN 78-520,967, FILED 11-22-2004.

MARIA-VICTORIA SUAREZ, EXAMINING ATTOR-
NEY

Int. Cl.: 35

Prior U.S. Cls.: 100, 101, and 102

United States Patent and Trademark Office

Reg. No. 3,399,437

Registered Mar. 18, 2008

**SERVICE MARK
PRINCIPAL REGISTER**

CALIBER POINT

BUSINESS SOLUTIONS LTD.

CALIBER POINT BUSINESS SOLUTIONS LIMITED (INDIA CORPORATION)
1ST FLOOR, BUILDING NO. 3 SECTOR 2
MILLENIUM BUSINESS PARK
MAHAPE, NAVI MUMBAI, INDIA 400 710

FOR: OUTSOURCING IN THE FIELD OF OFFICE AND BUSINESS ADMINISTRATION SERVICES; DATA PROCESSING SERVICES; COLLECTION, PREPARATION, COMPOSITION, STORAGE, PROCESSING, ACQUISITION AND PROVISION OF BUSINESS INFORMATION, DATA, STATISTICS AND INDICES; PROVIDING STATISTICAL INFORMATION FOR BUSINESS OR COMMERCIAL PURPOSES; SERVICES COMPRISING THE RECORDING, TRANSCRIPTION, COMPOSITION, COMPILATION AND SYSTEMATIZATION OF

WRITTEN COMMUNICATIONS AND RECORDINGS, AS WELL AS THE COMPILATION OF MATHEMATICAL OR STATISTICAL DATA; BUSINESS ADMINISTRATION AND MANAGEMENT, IN CLASS 35 (U.S. CLS. 100, 101 AND 102).

FIRST USE 1-0-2005; IN COMMERCE 1-0-2005.

NO CLAIM IS MADE TO THE EXCLUSIVE RIGHT TO USE "BUSINESS SOLUTIONS LTD.", APART FROM THE MARK AS SHOWN.

SN 78-521,042, FILED 11-22-2004.

LOURDES AYALA, EXAMINING ATTORNEY

Int. Cls.: 16, 35, 41, and 42

Prior U.S. Cls.: 2, 5, 22, 23, 29, 37, 38, 50, 100, 101, 102, and 107

Reg. No. 3,399,438

United States Patent and Trademark Office

Registered Mar. 18, 2008

**TRADEMARK
SERVICE MARK
PRINCIPAL REGISTER**

**GLOBAL INNOVATION
OUTLOOK**

INTERNATIONAL BUSINESS MACHINES CORPORATION (NEW YORK CORPORATION)
NEW ORCHARD ROAD
ARMONK, NY 10504

FOR: PRINTED MATTER, NAMELY, INFORMATIONAL SHEETS, BOOKS, BROCHURES, WRITTEN PRESENTATIONS AND TEACHING MATERIALS, ALL RELATING TO DESIGNING AND DEVELOPING A COMPUTER HARDWARE ARCHITECTURE AND COMPUTER SOFTWARE APPLICATIONS AND PROGRAMS; EDUCATIONAL BOOKS AND PUBLICATIONS, NAMELY, TRAINING MANUALS IN THE FIELD OF INFORMATION TECHNOLOGY AND COMPUTER PRODUCTS AND SERVICES, IN CLASS 16 (U.S. CLS. 2, 5, 22, 23, 29, 37, 38 AND 50).

FIRST USE 6-1-2004; IN COMMERCE 6-1-2004.

FOR: BUSINESS MANAGEMENT CONSULTING SERVICES AND BUSINESS CONSULTING SERVICES; ARRANGING AND CONDUCTING TRADE SHOW EXHIBITIONS IN THE FIELD OF INFORMATION TECHNOLOGY AND COMPUTER PRODUCTS AND SERVICES, IN CLASS 35 (U.S. CLS. 100, 101 AND 102).

FIRST USE 6-1-2004; IN COMMERCE 6-1-2004.

FOR: EDUCATIONAL SERVICES, NAMELY, CONFERENCES, EXHIBITIONS, SYMPOSIUMS,

PRESENTATIONS, TECHNICAL DEMONSTRATIONS AND TRAINING SEMINARS, ALL IN THE FIELD OF INFORMATION TECHNOLOGY AND COMPUTER PRODUCTS AND SERVICES, IN CLASS 41 (U.S. CLS. 100, 101 AND 107).

FIRST USE 6-1-2004; IN COMMERCE 6-1-2004.

FOR: CONSULTING SERVICES CONCERNING DESIGN AND DEVELOPMENT OF COMPUTER SOFTWARE PROGRAMS AND ARCHITECTURE AND COMPUTER HARDWARE ARCHITECTURE; CONSULTING SERVICES IN THE FIELD OF DESIGNING, DEVELOPING AND USING COMPUTER HARDWARE AND COMPUTER SOFTWARE, IN CLASS 42 (U.S. CLS. 100 AND 101).

FIRST USE 6-1-2004; IN COMMERCE 6-1-2004.

THE MARK CONSISTS OF STANDARD CHARACTERS WITHOUT CLAIM TO ANY PARTICULAR FONT, STYLE, SIZE, OR COLOR.

NO CLAIM IS MADE TO THE EXCLUSIVE RIGHT TO USE "GLOBAL" , APART FROM THE MARK AS SHOWN.

SN 78-521,460, FILED 11-22-2004.

ERNEST SHOSHO, EXAMINING ATTORNEY

Int. Cl.: 35

Prior U.S. Cls.: 100, 101, and 102

United States Patent and Trademark Office

Reg. No. 3,399,439

Registered Mar. 18, 2008

SERVICE MARK
PRINCIPAL REGISTER



GEARHART, HENRY (UNITED STATES INDIVIDUAL)
182 BLUE MOUNTAIN LAKE
EAST STROUDSBURG, PA 18301

FOR: RETAIL STORE SERVICES FEATURING CHRISTMAS MERCHANDISE, EXCLUDING CHRISTMAS TREES, IN CLASS 35 (U.S. CLS. 100, 101 AND 102).

FIRST USE 6-0-2007; IN COMMERCE 6-0-2007.

NO CLAIM IS MADE TO THE EXCLUSIVE RIGHT TO USE "CHRISTMAS", APART FROM THE MARK AS SHOWN.

SN 78-522,400, FILED 11-24-2004.

DAVID H. STINE, EXAMINING ATTORNEY

Int. Cl.: 3

Prior U.S. Cls.: 1, 4, 6, 50, 51, and 52

United States Patent and Trademark Office

Reg. No. 3,399,440

Registered Mar. 18, 2008

TRADEMARK
PRINCIPAL REGISTER

Universal
Solutions

O Boticário

BOTICA COMERCIAL FARMACEUTICA LTDA
(BRAZIL CORPORATION)

3450 - AFONSO PENA

AV RUI BARBOSA

SÃO JOSE DOS PINAIS - PARANÁ, BRAZIL 83065-
260

FOR: COSMETICS, PERFUMERY AND PERSONAL HYGIENE PRODUCTS, NAMELY, TOILET WATER, COLOGNE WATER, LAVENDER WATER, TOILET SOAPS, DEODORANT SOAPS, OILS FOR TOILETRY PURPOSES, NON-MEDICATED TOILETRIES, BATH OILS FOR COSMETIC PURPOSES, COSMETIC OILS, NON-MEDICATED BATH SALTS, PRE-SHAVE AND AFTER-SHAVE GELS, LOTIONS AND CREAMS, BODY AND BEAUTY CARE COSMETICS, BEAUTY MASKS, COSMETIC PENCILS,

PRE-MOISTENED COSMETIC WIPES IMPREGNATED WITH COSMETIC LOTIONS, PERFUMERY, HAIR SHAMPOOS AND CONDITIONERS, IN CLASS 3 (U.S. CLS. 1, 4, 6, 50, 51 AND 52).

FIRST USE 11-1-2004; IN COMMERCE 11-1-2004.

OWNER OF U.S. REG. NOS. 2,233,304, 2,946,446, AND OTHERS.

THE ENGLISH TRANSLATION OF THE WORDING "O BOTICÁRIO" IS THE PHARMACIST.

SN 78-522,464, FILED 11-24-2004.

MARY ROSSMAN, EXAMINING ATTORNEY

Int. Cl.: 5

Prior U.S. Cls.: 6, 18, 44, 46, 51, and 52

United States Patent and Trademark Office

Reg. No. 3,399,441

Registered Mar. 18, 2008

**TRADEMARK
PRINCIPAL REGISTER**



BIOCROWN, INC. (CALIFORNIA CORPORATION)
151 N KRAEMER BLVD STE 208
PLACENTIA, CA 928705019

FOR: DIETARY SUPPLEMENTS, IN CLASS 5 (U.S. CLS. 6, 18, 44, 46, 51 AND 52).

FIRST USE 4-11-2005; IN COMMERCE 4-11-2005.

NO CLAIM IS MADE TO THE EXCLUSIVE RIGHT TO USE "SUPPLEMENTS", APART FROM THE MARK AS SHOWN.

THE COLOR(S) BLUE, WHITE, GRAY AND YELLOW IS/ARE CLAIMED AS A FEATURE OF THE MARK.

THE COLORS BLUE, WHITE, YELLOW AND GRAY APPEAR IN THE MARK AS FOLLOWS: "BIOCROWN" IS IN WHITE, "SUPPLEMENTS" IS IN GRAY ON A YELLOW OVAL ALL OVERLAID ON A BLUE BACKGROUND.

SN 78-523,355, FILED 11-28-2004.

CAROLYN GRAY, EXAMINING ATTORNEY

Int. Cl.: 9

Prior U.S. Cls.: 21, 23, 26, 36, and 38

United States Patent and Trademark Office

Reg. No. 3,399,442

Registered Mar. 18, 2008

TRADEMARK
PRINCIPAL REGISTER



DATACOLOR HOLDING AG. (SWITZERLAND
JOINT STOCK COMPANY)
OBERGRUNDSTRASSE 110
CH-6002
LUZERN, SWITZERLAND

FOR: COLOR MEASURING APPARATUSES,
NAMELY, COLORIMETERS AND COLOR MEASURING SOFTWARE FOR COLOR EDITING, COLOR MEASUREMENT AND CALIBRATION OF COMPUTER AND VIDEO DISPLAYS SUCH AS CATHODE RAY TUBE (CRT), LIQUID CRYSTAL DISPLAY (LCD) AND LAPTOP COMPUTER DISPLAYS, IN CLASS 9 (U.S. CLS. 21, 23, 26, 36 AND 38).

FIRST USE 9-24-2004; IN COMMERCE 9-24-2004.

THE COLOR(S) BLACK, GRAY AND RED IS/ARE CLAIMED AS A FEATURE OF THE MARK.

THE COLOR BLACK APPEARS IN THE "SPYDER" PORTION OF THE MARK. THE COLOR GRAY APPEARS IN THE WORDS "COLORVISION" AND "STUDIO." THE COLOR RED APPEARS IN THE "2PRO" PORTION OF THE MARK.

SN 78-523,502, FILED 11-29-2004.

MARIA-VICTORIA SUAREZ, EXAMINING ATTORNEY

Int. Cl.: 9

Prior U.S. Cls.: 21, 23, 26, 36, and 38

United States Patent and Trademark Office

Reg. No. 3,399,443

Registered Mar. 18, 2008

**TRADEMARK
PRINCIPAL REGISTER**

PLOW HARD

LUDINGTON TECHNOLOGIES, INC. (MICHIGAN CORPORATION)
P.O. BOX 693
ESCANABA, MI 49829

FOR: ELECTRICAL PRODUCTS FOR SNOW REMOVAL AND ROAD TRACTION EQUIPMENT, NAMELY, ELECTRICAL CONNECTORS, ELECTRIC SWITCHES, CIRCUITRY, ELECTRONIC CONTROLS FOR MOTORS AND HYDRAULIC SYSTEMS, CONTROL WIRING FOR ELECTRICAL PUMPS, HYDRAULIC SYSTEMS AND LIGHTING SYSTEMS, LIGHT WIRING HARNESES, LIGHTING ADAPTERS, IN CLASS 9 (U.S. CLS. 21, 23, 26, 36 AND 38).

FIRST USE 11-29-2007; IN COMMERCE 11-29-2007.

THE MARK CONSISTS OF STANDARD CHARACTERS WITHOUT CLAIM TO ANY PARTICULAR FONT, STYLE, SIZE, OR COLOR.

NO CLAIM IS MADE TO THE EXCLUSIVE RIGHT TO USE "PLOW", APART FROM THE MARK AS SHOWN.

SN 78-524,735, FILED 11-30-2004.

KIMBERLY PERRY, EXAMINING ATTORNEY

Int. Cl.: 7

Prior U.S. Cls.: 13, 19, 21, 23, 31, 34, and 35

Reg. No. 3,399,444

United States Patent and Trademark Office

Registered Mar. 18, 2008

**TRADEMARK
PRINCIPAL REGISTER**



PENTAIR PUMP GROUP, INC. (DELAWARE CORPORATION)
SUITE 800
5500 WAYZATA BLVD
GOLDEN VALLEY, MN 554161259

OWNER OF U.S. REG. NOS. 1,881,877 AND 1,888,217.

THE MARK CONSISTS OF EDWARDS AND A CIRCULAR DESIGN WITH A GEAR IN THE CENTER.

FOR: ROTARY PUMPS, IN CLASS 7 (U.S. CLS. 13, 19, 21, 23, 31, 34 AND 35).

SN 78-524,933, FILED 12-1-2004.

FIRST USE 3-10-2005; IN COMMERCE 3-10-2005.

ESTHER BELENKER, EXAMINING ATTORNEY

Int. Cl.: 10

Prior U.S. Cls.: 26, 39, and 44

United States Patent and Trademark Office

Reg. No. 3,399,445

Registered Mar. 18, 2008

**TRADEMARK
PRINCIPAL REGISTER**

SURECLICK

AMGEN INC. (DELAWARE CORPORATION)
ONE AMGEN CENTER DRIVE
THOUSAND OAKS, CA 913201799

FOR: INJECTORS FOR MEDICAL PURPOSES;
EXCLUDING INJECTORS FOR GROWTH HOR-
MONE PRODUCTS, IN CLASS 10 (U.S. CLS. 26, 39
AND 44).

FIRST USE 7-31-2006; IN COMMERCE 7-31-2006.

THE MARK CONSISTS OF STANDARD CHAR-
ACTERS WITHOUT CLAIM TO ANY PARTICULAR
FONT, STYLE, SIZE, OR COLOR.

SN 78-525,858, FILED 12-2-2004.

NAKIA HENRY, EXAMINING ATTORNEY

Int. Cl.: 25

Prior U.S. Cls.: 22 and 39

United States Patent and Trademark Office

Reg. No. 3,399,446

Registered Mar. 18, 2008

**TRADEMARK
PRINCIPAL REGISTER**

mōDİD.

GUERRA, JOSEFINA R. (UNITED STATES INDIVIDUAL)
P.O BOX 922612
SYLMAR, CA 91392 AND
GUERRA, RAUL (UNITED STATES INDIVIDUAL)
P.O BOX 922612
SYLMAR, CA 91392

SLEEPWEAR, HATS, SCARVES, BELTS, EXCLUDING FOOTWEAR, IN CLASS 25 (U.S. CLS. 22 AND 39).

FIRST USE 2-0-2006; IN COMMERCE 2-0-2006.

SN 78-527,061, FILED 12-3-2004.

FOR: CLOTHING, NAMELY, T-SHIRTS, BLOUSES, COATS, SWEATSHIRTS, BATHING SUITS,

MARTHA FROMM, EXAMINING ATTORNEY

Int. Cl.: 9

Prior U.S. Cls.: 21, 23, 26, 36, and 38

United States Patent and Trademark Office

Reg. No. 3,399,447

Registered Mar. 18, 2008

**TRADEMARK
PRINCIPAL REGISTER**

**It's All About
Your Dog.**

DOGWATCH INC. (MASSACHUSETTS CORPORATION)
10 MICHIGAN DRIVE
NATICK, MA 01760

FOR: ELECTRONIC PET CONTAINMENT SYSTEMS COMPRISING A TRANSMITTER AND RECEIVER, IN CLASS 9 (U.S. CLS. 21, 23, 26, 36 AND 38).

FIRST USE 7-12-2004; IN COMMERCE 7-12-2004.

THE MARK CONSISTS OF STANDARD CHARACTERS WITHOUT CLAIM TO ANY PARTICULAR FONT, STYLE, SIZE, OR COLOR.

NO CLAIM IS MADE TO THE EXCLUSIVE RIGHT TO USE "DOG", APART FROM THE MARK AS SHOWN.

SN 78-528,190, FILED 12-7-2004.

MICHELE SWAIN, EXAMINING ATTORNEY

Int. Cls.: 9 and 41

Prior U.S. Cls.: 21, 23, 26, 36, 38, 100, 101, and 107

United States Patent and Trademark Office

Reg. No. 3,399,448

Registered Mar. 18, 2008

**TRADEMARK
SERVICE MARK
PRINCIPAL REGISTER**

MAGICAL DROP

KABUSHIKI KAISHA G-MODE (JAPAN CORPORATION), DBA G-MODE CO., LTD.,
9F, SHINJUKU BUNKA QUINT BUILDING
3-22-7, YOYOGI, SHIBUYA-KU
TOKYO, JAPAN

FOR: COMPUTER VIDEO GAME PROGRAMS;
DOWNLOADABLE COMPUTER VIDEO GAME
PROGRAMS; PRERECORDED COMPUTER VIDEO
GAME PROGRAMS ON CARTRIDGES, CAS-
SETTES, MAGNETIC CARDS, AND COMPACT
DISCS, IN CLASS 9 (U.S. CLS. 21, 23, 26, 36 AND 38).

FIRST USE 10-3-2005; IN COMMERCE 10-3-2005.

FOR: ENTERTAINMENT SERVICES, NAMELY,
PROVIDING AN ON-LINE COMPUTER GAME, IN
CLASS 41 (U.S. CLS. 100, 101 AND 107).

FIRST USE 10-3-2005; IN COMMERCE 10-3-2005.

THE MARK CONSISTS OF STANDARD CHAR-
ACTERS WITHOUT CLAIM TO ANY PARTICULAR
FONT, STYLE, SIZE, OR COLOR.

SN 78-530,670, FILED 12-10-2004.

YONG KIM, EXAMINING ATTORNEY

Int. Cl.: 5

Prior U.S. Cls.: 6, 18, 44, 46, 51, and 52

Reg. No. 3,399,449

United States Patent and Trademark Office

Registered Mar. 18, 2008

**TRADEMARK
PRINCIPAL REGISTER**

CITRANATAL

MISSION PHARMACAL COMPANY (TEXAS
CORPORATION)
10999 IH 10 WEST SUITE 1000
SAN ANTONIO, TX 78230

THE MARK CONSISTS OF STANDARD CHAR-
ACTERS WITHOUT CLAIM TO ANY PARTICULAR
FONT, STYLE, SIZE, OR COLOR.

FOR: PRENATAL MULTI-VITAMINS AND MUL-
TI-MINERALS, IN CLASS 5 (U.S. CLS. 6, 18, 44, 46, 51
AND 52).

SN 78-530,760, FILED 12-10-2004.

FIRST USE 11-20-2007; IN COMMERCE 11-20-2007.

LESLEY LAMOTHE, EXAMINING ATTORNEY

Int. Cl.: 8

Prior U.S. Cls.: 23, 28, and 44

United States Patent and Trademark Office

Reg. No. 3,399,450

Registered Mar. 18, 2008

**TRADEMARK
PRINCIPAL REGISTER**



LOGGERHEAD TOOLS LLC (ILLINOIS LTD
LIAB CO)
8310 WEST 127TH STREET
PALOS PARK, IL 60464

FIRST USE 6-0-2006; IN COMMERCE 6-0-2006.

SN 78-532,361, FILED 12-14-2004.

FOR: HAND TOOLS, NAMELY, NUT DRIVERS,
PLIERS, WIRE STRIPPERS, WIRE CUTTERS, IN
CLASS 8 (U.S. CLS. 23, 28 AND 44).

KEVIN DINALLO, EXAMINING ATTORNEY

Int. Cl.: 5

Prior U.S. Cls.: 6, 18, 44, 46, 51, and 52

United States Patent and Trademark Office

Reg. No. 3,399,451

Registered Mar. 18, 2008

**TRADEMARK
PRINCIPAL REGISTER**

PUNCH

E. I. DU PONT DE NEMOURS AND COMPANY
(DELAWARE CORPORATION)
1007 MARKET STREET
WILMINGTON, DE 19898

FOR: FUNGICIDES FOR USE IN AGRICULTURE, IN CLASS 5 (U.S. CLS. 6, 18, 44, 46, 51 AND 52).

FIRST USE 7-3-2007; IN COMMERCE 7-3-2007.

THE MARK CONSISTS OF STANDARD CHARACTERS WITHOUT CLAIM TO ANY PARTICULAR FONT, STYLE, SIZE, OR COLOR.

SN 78-533,707, FILED 12-16-2004.

DOMINIC J. FERRAIUOLO, EXAMINING ATTORNEY

Int. Cl.: 36

Prior U.S. Cls.: 100, 101, and 102

United States Patent and Trademark Office

Reg. No. 3,399,452

Registered Mar. 18, 2008

**SERVICE MARK
PRINCIPAL REGISTER**



MARSHALL BANKFIRST CORP. (MINNESOTA CORPORATION)
225 SOUTH SIXTH STREET
SUITE 2900
MINNEAPOLIS, MN 55402

FOR: BANKING SERVICES, IN CLASS 36 (U.S. CLS. 100, 101 AND 102).

FIRST USE 8-0-2005; IN COMMERCE 8-0-2005.

THE MARK CONSISTS OF A DISTINCTIVE LOGO COMPRISING A FANCIFUL DESIGN OF A MOUNTAIN WITH THE LETTER "M" INSIDE THE MOUNTAIN AND THE WORDS "MARSHALL BANKFIRST" BENEATH THE MOUNTAIN.

SN 78-533,708, FILED 12-16-2004.

DOMINIC J. FERRAIUOLO, EXAMINING ATTORNEY

Int. Cls.: 9, 35, 41, and 42

Prior U.S. Cls.: 21, 23, 26, 36, 38, 100, 101, 102, and 107

Reg. No. 3,399,453

United States Patent and Trademark Office

Registered Mar. 18, 2008

**TRADEMARK
SERVICE MARK
PRINCIPAL REGISTER**

TIMEWATCH

TIMEWATCH PLC (UNITED KINGDOM PUBLIC LIMITED COMPANY (PLC))
65 CLERKENWELL ROAD
LONDON, UNITED KINGDOM EC1R 5BL

FOR: BUSINESS AND PROJECT MANAGEMENT SOFTWARE FOR TIME, BILLING AND EXPENSE RECORDKEEPING, IN CLASS 9 (U.S. CLS. 21, 23, 26, 36 AND 38).

FIRST USE 12-31-1998; IN COMMERCE 12-31-1998.

FOR: CONSULTING SERVICES IN THE FIELD OF RESOURCE AND PROJECT SCHEDULING AND TIME RECORDING, IN CLASS 35 (U.S. CLS. 100, 101 AND 102).

FIRST USE 12-31-1998; IN COMMERCE 12-31-1998.

FOR: TRAINING SERVICES IN THE FIELD OF BUSINESS AND PROJECT MANAGEMENT SOFTWARE; TRAINING SERVICES IN THE FIELD OF RESOURCE AND PROJECT SCHEDULING AND

TIME RECORDING, IN CLASS 41 (U.S. CLS. 100, 101 AND 107).

FIRST USE 12-31-1998; IN COMMERCE 12-31-1998.

FOR: DESIGN AND DEVELOPMENT OF SOFTWARE FOR BUSINESS AND PROJECT MANAGEMENT FOR OTHERS; CONSULTING AND INSTALLATION SERVICES IN THE FIELD OF BUSINESS AND PROJECT MANAGEMENT SOFTWARE, IN CLASS 42 (U.S. CLS. 100 AND 101).

FIRST USE 12-31-1998; IN COMMERCE 12-31-1998.

THE MARK CONSISTS OF STANDARD CHARACTERS WITHOUT CLAIM TO ANY PARTICULAR FONT, STYLE, SIZE, OR COLOR.

SN 78-533,762, FILED 12-16-2004.

CAROL SPILS, EXAMINING ATTORNEY

Int. Cl.: 5

Prior U.S. Cls.: 6, 18, 44, 46, 51, and 52

United States Patent and Trademark Office

Reg. No. 3,399,454

Registered Mar. 18, 2008

**TRADEMARK
PRINCIPAL REGISTER**

**IT'S BETTER TO DO
IT NATURALLY**

HERBORIUM, INC. (DELAWARE CORPORATION)
3 OAK STREET
TEANECK, NJ 07666

THE MARK CONSISTS OF STANDARD CHARACTERS WITHOUT CLAIM TO ANY PARTICULAR FONT, STYLE, SIZE, OR COLOR.

FOR: HERBAL DIETARY SUPPLEMENTS, IN CLASS 5 (U.S. CLS. 6, 18, 44, 46, 51 AND 52).

SN 78-533,861, FILED 12-16-2004.

FIRST USE 2-1-2006; IN COMMERCE 2-1-2006.

JIM RINGLE, EXAMINING ATTORNEY

Int. Cls.: 2, 6, 7, 8, 9, 19, 35, 36, 37, and 42

Prior U.S. Cls.: 1, 2, 6, 11, 12, 13, 14, 16, 19, 21, 23, 25, 26, 28, 31, 33, 34, 35, 36, 38, 44, 50, 100, 101, 102, 103, and 106

Reg. No. 3,399,455

United States Patent and Trademark Office

Registered Mar. 18, 2008

**TRADEMARK
SERVICE MARK
PRINCIPAL REGISTER**

DYWI

DYWIDAG-SYSTEMS INTERNATIONAL GMBH
(FED REP GERMANY LTD LIAB CO)
DYWIDAGSTRASSE 1
D-85609 ASCHHEIM, FED REP GERMANY

FIRST USE 4-0-2004; IN COMMERCE 6-22-2007.

FOR: SET TABLE AND/OR ANTICORROSIVE COATING MATERIALS FOR INJECTION INTO CONSTRUCTION ELEMENTS; ANTICORROSIVE COATING MATERIALS, NAMELY WAX AND GREASE FOR INJECTION INTO CONSTRUCTION ELEMENTS; COATINGS OF HARDENING LIQUID SYNTHETIC MATERIALS FOR USE IN CIVIL ENGINEERING, FOR IMPREGNATING, COATING, CONGLUTINATION, INJECTION AND ANCHORING OF CONSTRUCTION ELEMENTS, IN CLASS 2 (U.S. CLS. 6, 11 AND 16).

FIRST USE 4-0-2004; IN COMMERCE 6-22-2007.

FOR: METAL BUILDING MATERIALS, NAMELY SOFFITS AND FASCIA; PORTABLE BUILDINGS OF METAL; GOODS OF METAL, NOT INCLUDED IN OTHER CLASSES, NAMELY REINFORCING ELEMENTS OF STEEL FOR REINFORCED CONCRETE, STEEL TENDONS FOR PRE-STRESSED CONCRETE IN THE FORM OF RODS, WIRES OR STRANDS; STEEL TENSION ELEMENTS FOR GROUND AND ROCK ANCHORS; ANCHORING ELEMENTS THEREFOR, NAMELY ANCHORING BOLTS, SCREWS, SLEEVES, SHIMS; METAL DUCTS AND SHEATHING, IN CLASS 6 (U.S. CLS. 2, 12, 13, 14, 23, 25 AND 50).

FOR: MACHINES AND POWERED MACHINE TOOLS FOR STRUCTURAL AND CIVIL ENGINEERING, NAMELY MECHANICAL AND HYDRAULIC PRESSES; MACHINES FOR STRAIGHTENING AND BENDING STEEL RODS; MACHINES FOR CUTTING OR ROLLING OF THREADS ON REINFORCING ELEMENTS; MACHINES FOR PROCESSING, INSTALLING, CUTTING, BENDING, BINDING AND ANCHORING OF ROD-SHAPED SUPPORTING ELEMENTS MACHINES FOR INSERTION OF RODS AND STRANDS; MACHINES FOR SCREWING AND AFFIXING METAL RODS; MACHINES FOR TENSIONING OF PRE-STRESSING ELEMENTS; HYDRAULIC JACKS; MACHINES FOR TREATING AND INJECTING SET TABLE AND/OR ANTI-CORROSIVE MATERIALS; EXCAVATING MACHINES FOR UNDERGROUND PIPE LAYING OPERATIONS INVOLVING GROUND DISPLACEMENT OR REMOVAL; CONTROLLABLE HORIZONTAL DRILLING EQUIPMENT AND HORIZONTAL SHIELD DRIVING EQUIPMENT FOR WALK-IN AND NON-WALK-IN PIPELINES; MOVABLE METAL SCAFFOLDING FOR BRIDGE CONSTRUCTION IN CANTILEVER CONSTRUCTION AND INCREMENTAL LAUNCHING; MACHINES FOR THE MANUFACTURING OF PRECAST CONCRETE PARTS, IN CLASS 7 (U.S. CLS. 13, 19, 21, 23, 31, 34 AND 35).

FIRST USE 4-0-2004; IN COMMERCE 6-22-2007.

FOR: HAND-OPERATED TOOLS FOR USE IN STRUCTURAL AND CIVIL ENGINEERING; NAME- LY FOR PROCESSING, INSTALLING, ANCHOR- ING AND BINDING ROD-SHAPED SUPPORTING ELEMENTS, NAMELY CUTTING AND BENDING TOOLS; APPARATUS FOR INSERTION OF RODS, SCREWING APPLIANCES; HAND-OPERATED TOOLS FOR TENSIONING OF PRE-STRESSING ELEMENTS; HAND-OPERATED TOOLS FOR TREATING AND INJECTING SET TABLE AND/OR ANTI-CORROSIVE MATERIALS, IN CLASS 8 (U.S. CLS. 23, 28 AND 44).

FIRST USE 4-0-2004; IN COMMERCE 6-22-2007.

FOR: OPTICAL, ELECTRIC AND ELECTRONIC APPARATUSES FOR USE IN STRUCTURAL AND CIVIL ENGINEERING, NAMELY, FOR MEASUR- ING AND REGISTERING DISTANCES, ANGLES, HEIGHTS AND POSITIONS, NAMELY LASERS, INSTRUMENTS FOR MEASURING LENGTH, AND LEVEL MEASURING MACHINES; SENSOR DEVICES FOR MEASURING AND/OR MONITOR- ING THE REGISTERED TENSION FORCE BY OP- TICAL, ELECTRIC OR ELECTRONIC MEANS, IN CLASS 9 (U.S. CLS. 21, 23, 26, 36 AND 38).

FIRST USE 4-0-2004; IN COMMERCE 6-22-2007.

FOR: NON-METAL BUILDING MATERIALS, NAMELY SOFFITS AND FASCIA; SLIDING MOLD- ING AND CLIMBING FORMS AND ARMAMENTS OF PRIMARILY WOOD; REINFORCING ELE- MENTS OF FIBER COMPOSITES FOR CONCRETE; TENSION ELEMENTS OF FIBER COMPOSITES FOR EARTH AND ROCK ANCHORS; ANCHORING ELE- MENTS THEREFORE, NAMELY ANCHORING BOLTS, SCREWS, SLEEVES, SHIMS OF PLASTIC; PLASTIC DUCTS AND SHEATHING; SET TABLE AND/OR ANTICORROSIVE MATERIALS FOR IN- JECTION INTO CONSTRUCTION ELEMENTS; HARDENING LIQUID SYNTHETIC MATERIALS FOR USE IN CIVIL ENGINEERING, FOR INJE- CTION AND ANCHORING OF CONSTRUCTION ELEMENTS, IN CLASS 19 (U.S. CLS. 1, 12, 33 AND 50).

FIRST USE 4-0-2004; IN COMMERCE 6-22-2007.

FOR: ARRANGING OF CONTRACTUAL CON- STRUCTION TRADE SERVICES WITH THIRD PAR- TIES; BUSINESS MANAGEMENT AND CONSULTING SERVICES FOR STRUCTURAL AND CIVIL ENGINEERING FIRMS; AND DATA PROCESSING IN THE FIELD OF CONSTRUCTION PROJECT MANAGEMENT, IN CLASS 35 (U.S. CLS. 100, 101 AND 102).

FIRST USE 4-0-2004; IN COMMERCE 6-22-2007.

FOR: FINANCIAL CONSULTING SERVICES RE- LATING TO CONSTRUCTION PROJECTS, IN CLASS 36 (U.S. CLS. 100, 101 AND 102).

FIRST USE 4-0-2004; IN COMMERCE 6-22-2007.

FOR: CONSTRUCTION SERVICES, NAMELY IN- STALLING SUPPORTING ELEMENTS IN CON- STRUCTION WORKS, LAYING REINFORCING RODS AND PRESTRESSING ELEMENTS, TEN- SIONING PRE-STRESSING ELEMENTS, ERECTING SCAFFOLDING AND SLIDING MOLDINGS AND CLIMBING FORMS, ERECTING BUILDINGS OF REINFORCED CONCRETE USING SLIDING MOLDINGS AND CLIMBING FORMS, INSTAL- LING SUBTERRANEAN CURTAINS AND POSTS, FIXING GROUND ANCHORS AND ROCK AN- CHORS; MOUNTING TENSION AND COMPRES- SION PILES, GROUND AND ROCK ANCHORS AS WELL AS ROCK AND GROUND SPIKES MADE OF METAL OR FIBER COMPOSITES; INSTALLATION AND ASSEMBLY OF BARS, NAMELY ON SUSPEN- SION BRIDGES AND CABLE-STAYED BRIDGES; REPAIR AND MAINTENANCE WORK ON BUILD- INGS, DEMOLITION OF BUILDINGS, EXCAVA- TION SERVICES, BRIDGE CONSTRUCTION; CONSTRUCTING PERMANENT TRACKS FOR RAILWAYS, CONSTRUCTING EARTHWORKS; CONSTRUCTION OF INDUSTRIAL PLANTS; PAINTING OF CONSTRUCTION ELEMENTS WITH ANTI-CORROSIVE MATERIALS; EARTH EXCAVA- TION THROUGH BLASTING; ROAD AND PATH BUILDING AND BUILDING ROADS FOR VEHI- CLES, NAMELY RAIL-BORNE VEHICLES; TUN- NEL AND MINING GALLERY CONSTRUCTION, CONSTRUCTION OF PIPELINES BY SUBTERRA- NEAN PIPE DRIVE, CONSTRUCTION OF PIPE- LINES AND SUPPORT STRUCTURES IN WATER; RENTAL OF BUILDING CONSTRUCTION MA- CHINES, TOOLS, AND CONSTRUCTION VEHI- CLES, IN CLASS 37 (U.S. CLS. 100, 103 AND 106).

FIRST USE 4-0-2004; IN COMMERCE 6-22-2007.

FOR: ARCHITECTURAL AND CONSTRUCTION DRAFTING, TECHNICAL CONSULTANCY IN THE FIELD OF ARCHITECTURE AND ENGINEERING, ARCHITECTURAL DESIGN AND ENGINEERING SERVICES, COMPUTER PROGRAMMING FOR OTHERS; SCIENTIFIC AND TECHNOLOGICAL RE- SEARCH IN THE FIELD OF STRUCTURAL ENGI- NEERING AND CONSTRUCTION; LABORATORY TESTING SERVICES FOR CONSTRUCTION AND ENGINEERING PRODUCTS AND MATERIALS, IN CLASS 42 (U.S. CLS. 100 AND 101).

FIRST USE 4-0-2004; IN COMMERCE 6-22-2007.

THE MARK CONSISTS OF STANDARD CHAR- ACTERS WITHOUT CLAIM TO ANY PARTICULAR FONT, STYLE, SIZE, OR COLOR.

SN 78-539,384, FILED 12-29-2004.

JOHN E. MICHOS, EXAMINING ATTORNEY

Int. Cls.: 10 and 28

Prior U.S. Cls.: 22, 23, 26, 38, 39, 44, and 50

United States Patent and Trademark Office

Reg. No. 3,399,456

Registered Mar. 18, 2008

**TRADEMARK
PRINCIPAL REGISTER**

MARV

THERAPYZONE, INC. (COLORADO CORPORATION)
1001 WEST ARIZONA AVE.
DENVER, CO 80223

FOR: FITNESS EQUIPMENT AND EXERCISERS, NAMELY, HAND GRIPS; RESISTANCE BANDS, TUBES AND CABLES; ROPES; RUBBER BANDS AND TUBES FOR RESISTANCE EXERCISES; MANUAL CHEST, SHOULDER, ARM, WRIST AND ELBOW EXERCISERS; OVERDOOR PULLEY EXERCISERS; JOINT EXERCISER USED TO IMPROVE RANGE OF MOTION; LEG AND BACK EXTENSION EXERCISERS; MANUAL ROTATOR CUFF, BICEP AND TRICEPS EXERCISERS; ALL USED FOR PHYSICAL THERAPY AND REHABILITATION, IN CLASS 10 (U.S. CLS. 26, 39 AND 44).

FIRST USE 6-9-2005; IN COMMERCE 6-9-2005.

FOR: FITNESS EQUIPMENT AND EXERCISERS, NAMELY, HAND GRIPS; RESISTANCE BANDS, TUBES AND CABLES; ROPES; RUBBER BANDS AND TUBES FOR RESISTANCE EXERCISES; MANUAL CHEST, SHOULDER, ARM, WRIST AND EL-

BOW EXERCISERS; OVERDOOR PULLEY EXERCISERS; JOINT EXERCISER USED TO IMPROVE RANGE OF MOTION; LEG AND BACK EXTENSION EXERCISERS; MANUAL ROTATOR CUFF, BICEP AND TRICEPS EXERCISERS; ALL USED FOR ATHLETIC TRAINING, ATHLETIC CONDITIONING, FLEXIBILITY TRAINING, RANGE OF MOTION TRAINING AND STRENGTH TRAINING, IN CLASS 28 (U.S. CLS. 22, 23, 38 AND 50).

FIRST USE 6-9-2005; IN COMMERCE 6-9-2005.

THE MARK CONSISTS OF STANDARD CHARACTERS WITHOUT CLAIM TO ANY PARTICULAR FONT, STYLE, SIZE, OR COLOR.

THE NAME SHOWN IN THE MARK DOES NOT IDENTIFY A PARTICULAR LIVING INDIVIDUAL.

SN 78-543,494, FILED 1-6-2005.

ANTHONY RINKER, EXAMINING ATTORNEY

Int. Cl.: 16

Prior U.S. Cls.: 2, 5, 22, 23, 29, 37, 38, and 50

United States Patent and Trademark Office

Reg. No. 3,399,457

Registered Mar. 18, 2008

**TRADEMARK
PRINCIPAL REGISTER**

My peace of PEACE

NEWCOME KARTARIK, MARY JO (UNITED STATES INDIVIDUAL)
1013 OAK RIDGE AVENUE
SHOREVIEW, MN 55126

THE MARK CONSISTS OF STANDARD CHARACTERS WITHOUT CLAIM TO ANY PARTICULAR FONT, STYLE, SIZE, OR COLOR.

FOR: CARDS, NAMELY, GREETING, IN CLASS 16 (U.S. CLS. 2, 5, 22, 23, 29, 37, 38 AND 50).

SN 78-546,305, FILED 1-12-2005.

FIRST USE 0-0-2002; IN COMMERCE 0-0-2002.

GEOFFREY FOSDICK, EXAMINING ATTORNEY

Int. Cl.: 35

Prior U.S. Cls.: 100, 101, and 102

United States Patent and Trademark Office

Reg. No. 3,399,458

Registered Mar. 18, 2008

**SERVICE MARK
PRINCIPAL REGISTER**

THE BLUE GENIE

TOWBIN DODGE (NEVADA CORPORATION)
275 AUTO MALL DRIVE
HENDERSON, NV 89014

FIRST USE 1-13-2005; IN COMMERCE 1-13-2005.

FOR: AUTOMOBILE DEALERSHIPS; PROVIDING INFORMATION ABOUT AUTOMOBILES FOR SALE BY MEANS OF THE INTERNET; RETAIL SERVICES BY DIRECT SOLICITATION BY SALES AGENTS IN CONNECTION WITH NEW AND USED AUTOMOBILES, IN CLASS 35 (U.S. CLS. 100, 101 AND 102).

THE MARK CONSISTS OF STANDARD CHARACTERS WITHOUT CLAIM TO ANY PARTICULAR FONT, STYLE, SIZE, OR COLOR.

SN 78-547,207, FILED 1-13-2005.

WILLIAM VERHOSEK, EXAMINING ATTORNEY

Int. Cl.: 42

Prior U.S. Cls.: 100 and 101

United States Patent and Trademark Office

Reg. No. 3,399,459

Registered Mar. 18, 2008

**SERVICE MARK
PRINCIPAL REGISTER**

LeapDesk

RAGAN, RAYMOND K (UNITED STATES INDIVIDUAL)
7402 S 29TH LN
PHOENIX, AZ 85041

FOR: COMPUTER SERVICE, NAMELY, ACTING AS AN APPLICATION SERVICE PROVIDER IN THE FIELD OF KNOWLEDGE MANAGEMENT TO HOST COMPUTER APPLICATION SOFTWARE FOR THE COLLECTION, EDITING, ORGANIZING, MODIFYING, BOOK MARKING, TRANSMISSION, STORAGE AND SHARING OF DATA AND INFORMATION, IN CLASS 42 (U.S. CLS. 100 AND 101).

FIRST USE 7-14-2004; IN COMMERCE 7-14-2004.

THE MARK CONSISTS OF STANDARD CHARACTERS WITHOUT CLAIM TO ANY PARTICULAR FONT, STYLE, SIZE, OR COLOR.

SN 78-549,305, FILED 1-18-2005.

LINDA ESTRADA, EXAMINING ATTORNEY

Int. Cl.: 21

Prior U.S. Cls.: 2, 13, 23, 29, 30, 33, 40, and 50

United States Patent and Trademark Office

Reg. No. 3,399,460

Registered Mar. 18, 2008

**TRADEMARK
PRINCIPAL REGISTER**

COUNTRY BEAR

FINGERHUT DIRECT MARKETING, INC. (DE-
LAWARE CORPORATION)
7777 GOLDEN TRIANGLE DRIVE
EDEN PRAIRIE, MN 55344

FOR: DINNERWARE, NAMELY, DINNER
PLATES, SALAD PLATES, SOUP/CEREAL BOWLS,
MUGS, IN CLASS 21 (U.S. CLS. 2, 13, 23, 29, 30, 33, 40
AND 50).

FIRST USE 4-20-1992; IN COMMERCE 4-20-1992.

THE MARK CONSISTS OF STANDARD CHAR-
ACTERS WITHOUT CLAIM TO ANY PARTICULAR
FONT, STYLE, SIZE, OR COLOR.

OWNER OF U.S. REG. NO. 2,782,394.

SN 78-550,727, FILED 1-20-2005.

CIMMERIAN COLEMAN, EXAMINING ATTOR-
NEY

Int. Cl.: 25

Prior U.S. Cls.: 22 and 39

United States Patent and Trademark Office

Reg. No. 3,399,461

Registered Mar. 18, 2008

**TRADEMARK
PRINCIPAL REGISTER**

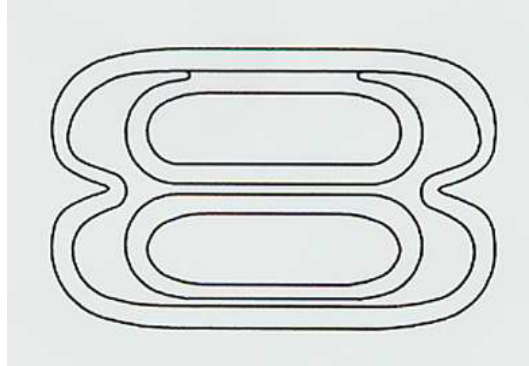

INNOVATIVE FASHION GROUP CORP. (NEW
YORK CORPORATION)
500 SEVENTH AVENUE 16TH FLOOR
NEW YORK, NY 10018

FIRST USE 4-1-2005; IN COMMERCE 4-1-2005.

FOR: CLOTHING, NAMELY, SHIRTS, T-SHIRTS,
PANTS, TOPS, SHORTS, JACKETS, SWEAT SHIRTS,
SPORTS BRAS AND MUSCLE TOPS, IN CLASS 25
(U.S. CLS. 22 AND 39).

SN 78-551,722, FILED 1-21-2005.

MARY ROSSMAN, EXAMINING ATTORNEY

Int. Cl.: 1

Prior U.S. Cls.: 1, 5, 6, 10, 26, and 46

United States Patent and Trademark Office

Reg. No. 3,399,462

Registered Mar. 18, 2008

**TRADEMARK
PRINCIPAL REGISTER**

BAYHYTHERM

BAYER AKTIENGESELLSCHAFT (FED REP
GERMANY JOINT STOCK COMPANY)

D-51368

LEVERKUSEN-BAYERWERK, FED REP GERMA-
NY

FOR: CHEMICAL PRODUCTS FOR INDUSTRIAL
PURPOSES, NAMELY, WATER-RAREFIABLE
BINDING AGENTS FOR THERMALLY HARDEN-
ING LACQUERS, IN CLASS 1 (U.S. CLS. 1, 5, 6, 10, 26
AND 46).

FIRST USE 5-31-2005; IN COMMERCE 1-30-2007.

THE MARK CONSISTS OF STANDARD CHAR-
ACTERS WITHOUT CLAIM TO ANY PARTICULAR
FONT, STYLE, SIZE, OR COLOR.

SN 78-551,761, FILED 1-21-2005.

JIM RINGLE, EXAMINING ATTORNEY

Int. Cl.: 28

Prior U.S. Cls.: 22, 23, 38, and 50

United States Patent and Trademark Office

Reg. No. 3,399,463

Registered Mar. 18, 2008

**TRADEMARK
PRINCIPAL REGISTER**

BOOM BOOM

BRIDGESTONE SPORTS CO., LTD. (JAPAN CORPORATION)
6-22-7, MINAMI-OI, SHINAGAWA-KU
TOKYO, JAPAN 140

FOR: GOLF EQUIPMENT, NAMELY, GOLF BALLS, GOLF CLUBS, GOLF CLUB HEAD COVERS, IN CLASS 28 (U.S. CLS. 22, 23, 38 AND 50).

FIRST USE 1-0-2005; IN COMMERCE 1-0-2005.

THE MARK CONSISTS OF STANDARD CHARACTERS WITHOUT CLAIM TO ANY PARTICULAR FONT, STYLE, SIZE, OR COLOR.

SN 78-553,138, FILED 1-25-2005.

LANA PHAM, EXAMINING ATTORNEY

Int. Cl.: 7

Prior U.S. Cls.: 13, 19, 21, 23, 31, 34, and 35

United States Patent and Trademark Office

Reg. No. 3,399,464

Registered Mar. 18, 2008

**TRADEMARK
PRINCIPAL REGISTER**



International Catalyst Technology

INTERNATIONAL CATALYST TECHNOLOGY,
INC. (DELAWARE CORPORATION)

2347 COMMERCIAL DRIVE

AUBURN HILLS, MI 48326

FOR: EMISSION REDUCTION UNITS FOR MO-
TORS AND ENGINES, NAMELY, CATALYTIC
CONVERTERS, IN CLASS 7 (U.S. CLS. 13, 19, 21, 23,
31, 34 AND 35).

FIRST USE 10-1-2002; IN COMMERCE 10-1-2002.

NO CLAIM IS MADE TO THE EXCLUSIVE
RIGHT TO USE "CATALYST TECHNOLOGY",
APART FROM THE MARK AS SHOWN.

THE MARK CONSISTS OF THE CAPITALIZED
LETTERS "ICT" SET IN A SLANTED OVAL WITH A
HONEYCOMBED BACKGROUND. UNDERNEATH
THE OVAL IS THE WORDING "INTERNATIONAL
CATALYST TECHNOLOGY".

SN 78-554,199, FILED 1-26-2005.

JEFFERY COWARD, EXAMINING ATTORNEY

Int. Cl.: 25

Prior U.S. Cls.: 22 and 39

United States Patent and Trademark Office

Reg. No. 3,399,465

Registered Mar. 18, 2008

**TRADEMARK
PRINCIPAL REGISTER**

INDIGO SIX

CHUNG, JOO HYUN (UNITED STATES INDIVIDUAL)
540 E. JEFFERSON BLVD.
LOS ANGELES, CA 90011

FOR: CLOTHING, NAMELY, PANTS, SHIRTS, SHORTS, SUITS, SKIRTS, JACKETS, T-SHIRTS, JERSEYS, TOPS, BLOUSES, TANK TOPS, COATS, COVERALLS, DRESSES, VESTS, JEANS, SWEATERS, MINISKIRTS, AND PAJAMAS, IN CLASS 25 (U.S. CLS. 22 AND 39).

FIRST USE 2-15-2006; IN COMMERCE 2-15-2006.

THE MARK CONSISTS OF STANDARD CHARACTERS WITHOUT CLAIM TO ANY PARTICULAR FONT, STYLE, SIZE, OR COLOR.

NO CLAIM IS MADE TO THE EXCLUSIVE RIGHT TO USE "INDIGO", APART FROM THE MARK AS SHOWN.

SN 78-555,435, FILED 1-27-2005.

RICHARD A. STRASER, EXAMINING ATTORNEY

Int. Cl.: 6

Prior U.S. Cls.: 2, 12, 13, 14, 23, 25, and 50

Reg. No. 3,399,466

United States Patent and Trademark Office

Registered Mar. 18, 2008

**TRADEMARK
PRINCIPAL REGISTER**

WEEP TRACK

SUTTON, ADAM (UNITED STATES INDIVIDUAL)
44-369 KANEOHE BAY DR.
KANEOHE, HI 96744

FOR: METAL WALL TRACKS FOR USE IN BUILDING CONSTRUCTION, IN CLASS 6 (U.S. CLS. 2, 12, 13, 14, 23, 25 AND 50).

FIRST USE 11-18-2004; IN COMMERCE 5-11-2005.

THE MARK CONSISTS OF STANDARD CHARACTERS WITHOUT CLAIM TO ANY PARTICULAR FONT, STYLE, SIZE, OR COLOR.

NO CLAIM IS MADE TO THE EXCLUSIVE RIGHT TO USE "TRACK", APART FROM THE MARK AS SHOWN.

SN 78-558,431, FILED 2-1-2005.

JOHN DALIER, EXAMINING ATTORNEY

Int. Cl.: 10

Prior U.S. Cls.: 26, 39, and 44

United States Patent and Trademark Office

Reg. No. 3,399,467

Registered Mar. 18, 2008

TRADEMARK
PRINCIPAL REGISTER

AugmentRx

SMYTH, STUART KJ (UNITED STATES INDIVIDUAL)
PO BOX 1059
SHELBURNE, VT 05482

FOR: MEDICAL DEVICES, NAMELY, BIOCERAMIC INJECTABLE COMPOSITES, BIOCERAMIC INJECTABLE DELIVERY KIT FOR SURGERY COMPRISED OF DISPOSABLE FLEXIBLE NEEDLES, RIGID NEEDLES, CYSTOSCOPIC PLACEMENT GUIDE FOR URETHRA, DISPOSABLE ENDOSCOPE SHEATH, ENDOSCOPIC BIOCERAMIC APPLICATION INSTRUMENT, PRESSURE TRANSDUCER, CATHETER, AND SCAFFOLDING FOR TISSUE ENGINEERING, IN CLASS 10 (U.S. CLS. 26, 39 AND 44).

FIRST USE 4-23-2004, THE MARK WAS FIRST USED ANYWHERE IN A DIFFERENT FORM OTHER THAN THAT SOUGHT TO BE REGISTERED ON 04/22/2004.; IN COMMERCE 12-7-2005, THE MARK WAS FIRST USED IN COMMERCE IN A DIFFERENT FORM OTHER THAN THAT SOUGHT TO BE REGISTERED ON 04/22/2004..

THE MARK CONSISTS OF STANDARD CHARACTERS WITHOUT CLAIM TO ANY PARTICULAR FONT, STYLE, SIZE, OR COLOR.

SN 78-558,663, FILED 2-2-2005.

MATTHEW KLINE, EXAMINING ATTORNEY

Int. Cl.: 35

Prior U.S. Cls.: 100, 101, and 102

United States Patent and Trademark Office

Reg. No. 3,399,468

Registered Mar. 18, 2008

**SERVICE MARK
PRINCIPAL REGISTER**

**BE A HERO HIRE A
HERO**

HIRE DISABILITY SOLUTIONS, LLC (NEW
YORK LTD LIAB CO)
74 20TH STREET
BROOKLYN, NY 11232

THE MARK CONSISTS OF STANDARD CHAR-
ACTERS WITHOUT CLAIM TO ANY PARTICULAR
FONT, STYLE, SIZE, OR COLOR.

FOR: ORGANIZING AND CONDUCTING JOB
FAIRS, IN CLASS 35 (U.S. CLS. 100, 101 AND 102).

SN 78-560,568, FILED 2-4-2005.

FIRST USE 8-0-2006; IN COMMERCE 8-0-2006.

MORGAN WYNNE, EXAMINING ATTORNEY

Int. Cl.: 35

Prior U.S. Cls.: 100, 101, and 102

United States Patent and Trademark Office

Reg. No. 3,399,469

Registered Mar. 18, 2008

**SERVICE MARK
PRINCIPAL REGISTER**

REAL REPUBLICAN

HRONCICH, BRIAN M. (UNITED STATES INDIVIDUAL)

600 PARTRIDGE DRIVE

CRANBERRY TOWNSHIP, PA 16066

FOR: ADVERTISING AND BUSINESS ADVICE
RELATING TO POLITICAL CAMPAIGNS, IN CLASS
35 (U.S. CLS. 100, 101 AND 102).

FIRST USE 4-5-2005; IN COMMERCE 4-5-2005.

THE MARK CONSISTS OF STANDARD CHARACTERS WITHOUT CLAIM TO ANY PARTICULAR FONT, STYLE, SIZE, OR COLOR.

NO CLAIM IS MADE TO THE EXCLUSIVE RIGHT TO USE "REPUBLICAN", APART FROM THE MARK AS SHOWN.

SN 78-561,467, FILED 2-6-2005.

AMOS T. MATTHEWS, JR., EXAMINING ATTORNEY

Int. Cls.: 18 and 25

Prior U.S. Cls.: 1, 2, 3, 22, 39, and 41

United States Patent and Trademark Office

Reg. No. 3,399,470

Registered Mar. 18, 2008

**TRADEMARK
PRINCIPAL REGISTER**

Lake People

SCHAUB, ELISA R. (UNITED STATES INDIVIDUAL)
188 ASPEN LANE
SUNRISE BEACH, MO 65079

FOR: BEACH BAGS, IN CLASS 18 (U.S. CLS. 1, 2, 3, 22 AND 41).

FIRST USE 6-8-2001; IN COMMERCE 7-1-2005.

FOR: CLOTHING, NAMELY, SHIRTS, PANTS, SHORTS, HATS, CAPS, VISORS, SANDALS, SWIM

WEAR, NIGHTSHIRTS, AND BEACHWEAR, IN CLASS 25 (U.S. CLS. 22 AND 39).

FIRST USE 6-8-2001; IN COMMERCE 7-1-2005.

THE MARK CONSISTS OF STANDARD CHARACTERS WITHOUT CLAIM TO ANY PARTICULAR FONT, STYLE, SIZE, OR COLOR.

SN 78-561,926, FILED 2-7-2005.

KEVON CHISOLM, EXAMINING ATTORNEY

Int. Cl.: 36

Prior U.S. Cls.: 100, 101, and 102

United States Patent and Trademark Office

Reg. No. 3,399,471

Registered Mar. 18, 2008

**SERVICE MARK
PRINCIPAL REGISTER**

ECX CFI

CHICAGO CLIMATE EXCHANGE, INC. (DELA-
WARE CORPORATION)
190 S. LASALLE STREET, SUITE 1100
CHICAGO, IL 60603

FOR: COMMODITY EXCHANGE SERVICES,
NAMELY, DIOXIDE AND OTHER GREENHOUSE
GAS EMISSIONS EXCHANGE SERVICES THAT
FACILITATE THE TRADING OR SALE OF CAR-
BON DIOXIDE AND OTHER GREENHOUSE GAS
EMISSIONS ALLOWANCES AND OFFSETS BE-
TWEEN BUSINESS AND OTHER MARKET PARTI-
CIPANTS, IN CLASS 36 (U.S. CLS. 100, 101 AND 102).

FIRST USE 4-22-2005; IN COMMERCE 4-22-2005.

THE MARK CONSISTS OF STANDARD CHAR-
ACTERS WITHOUT CLAIM TO ANY PARTICULAR
FONT, STYLE, SIZE, OR COLOR.

SN 78-561,993, FILED 2-7-2005.

DAVID ELTON, EXAMINING ATTORNEY

Int. Cl.: 42

Prior U.S. Cls.: 100 and 101

United States Patent and Trademark Office

Reg. No. 3,399,472

Registered Mar. 18, 2008

**SERVICE MARK
PRINCIPAL REGISTER**



HYBRID AIRCRAFT CONSULTANTS INC. (NE-
VADA CORPORATION)
P.O.B. 880
EDGEWOOD, NM 870150880

FOR: AIRCRAFT DESIGN, NAMELY, DESIGN
AND DEVELOPMENT OF HEAVY-LIFT AND UL-
TRA HEAVY LIFT AIR VEHICLES, IN CLASS 42
(U.S. CLS. 100 AND 101).

FIRST USE 7-3-2003; IN COMMERCE 7-3-2003.

THE COLORS YELLOW, ORANGE, AND BLUE
ARE CLAIMED AS FEATURES OF THE MARK.

THE MARK CONSISTS OF A BACKGROUND OF
A CIRCULAR SUNBURST WITH AN ORANGE
CENTER FADING TO A YELLOW OUTER EDGE
WITH A BLUE HYBRID AIRCRAFT ON THE TOP
WITH BLUE HORIZONTAL LINES RADIATING
FROM THE LEFT SIDE OF THE HYBRID AIR-
CRAFT. THE COLOR BLUE ALSO APPEARS IN THE
WORDING AND IN THE TRIANGLE DESIGN ELE-
MENT.

SN 78-562,746, FILED 2-8-2005.

LAURA HAMMEL, EXAMINING ATTORNEY

Int. Cls.: 5, 9, 16, 35, 41, and 44

Prior U.S. Cls.: 2, 5, 6, 18, 21, 22, 23, 26, 29, 36, 37, 38, 44, 46, 50, 51, 52, 100, 101, 102, and 107

Reg. No. 3,399,473

United States Patent and Trademark Office

Registered Mar. 18, 2008

**TRADEMARK
SERVICE MARK
PRINCIPAL REGISTER**

TRUE MEASURES
O F G E R D

ALTANA PHARMA AG (FED REP GERMANY CORPORATION)
BYK-GULDEN-STR. 2
KONSTANZ, FED REP GERMANY 78467

FOR: (BASED ON 44(E)) PHARMACEUTICAL PREPARATIONS FOR THE TREATMENT OF GASTRO-INTESTINAL DISEASES AND CONDITIONS, IN CLASS 5 (U.S. CLS. 6, 18, 44, 46, 51 AND 52).

FOR: ELECTRONIC INSTRUCTIONAL MATERIALS IN THE FORM OF PRE-RECORDED DVDS FOR THE FIELDS OF MEDICINE AND SCIENCE, IN CLASS 9 (U.S. CLS. 21, 23, 26, 36 AND 38).

FIRST USE 5-25-2006; IN COMMERCE 5-25-2006.

FOR: (BASED ON 44(E)) PRINTED MATTER, NAMELY, BOOKS, JOURNALS, PERIODICALS, PAMPHLETS AND PHOTOGRAPHS, INSTRUCTIONAL AND TEACHING MATERIAL, EXCEPT APPARATUS, NAMELY, PRINTED INSTRUCTIONAL MATERIALS IN THE FORM OF BOOKS, GUIDES, BOOKLETS, BROCHURES AND CHARTS FOR THE FIELDS OF MEDICINE AND SCIENCE, IN CLASS 16 (U.S. CLS. 2, 5, 22, 23, 29, 37, 38 AND 50).

FOR: (BASED ON 44(E)) ARRANGING AND CONDUCTING TRADE SHOW EXHIBITIONS IN THE FIELD OF MEDICAL EDUCATION, IN CLASS 35 (U.S. CLS. 100, 101 AND 102).

FOR: (BASED ON 44(E)) EDUCATIONAL SERVICES, NAMELY, CONDUCTING CLASSES, SEMINARS, CONFERENCES, SYMPOSIA AND

WORKSHOPS FOR CONSUMERS AND HEALTHCARE PROFESSIONALS IN THE FIELD OF HEALTHCARE, MEDICAL RESEARCH AND MEDICAL SCIENCE, IN CLASS 41 (U.S. CLS. 100, 101 AND 107).

FOR: (BASED ON 44(E)) MEDICAL AND PHARMACEUTICAL SERVICES, NAMELY, COUNSELING FOR CONSUMERS AND HEALTHCARE PROFESSIONALS IN THE FIELDS OF HEALTHCARE, MEDICAL RESEARCH AND MEDICAL SCIENCE TO PHYSICIANS AND OTHER MEDICAL SPECIALISTS, IN CLASS 44 (U.S. CLS. 100 AND 101).

PRIORITY CLAIMED UNDER SEC. 44(D) ON FED REP GERMANY APPLICATION NO. 30447126.7/4, FILED 8-14-2004, REG. NO. 30447126, DATED 9-17-2004, EXPIRES 8-31-2014.

OWNER OF U.S. REG. NOS. 2,925,388, 2,935,027, AND 2,938,096.

NO CLAIM IS MADE TO THE EXCLUSIVE RIGHT TO USE "GERD", APART FROM THE MARK AS SHOWN.

THE MARK CONSISTS OF THE WORDS "TRUE MEASURES" ABOVE A RULERED LINE, ABOVE THE WORDS "OF GERD".

SN 78-564,498, FILED 2-10-2005.

MICHAEL KAZAZIAN, EXAMINING ATTORNEY

Int. Cl.: 16

Prior U.S. Cls.: 2, 5, 22, 23, 29, 37, 38, and 50

United States Patent and Trademark Office

Reg. No. 3,399,474

Registered Mar. 18, 2008

**TRADEMARK
PRINCIPAL REGISTER**

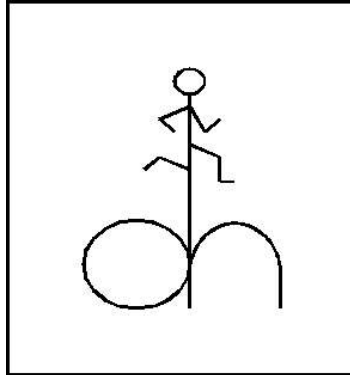

HOLLANDER, TAMEIRA L. (UNITED STATES
INDIVIDUAL)
9681 S. DOVER WAY
LITTLETON, CO 80127

FOR: HANDBOOK DESCRIBING A SIMPLIFIED
METHOD TO EFFECT WEIGHT LOSS THROUGH
BEHAVIOR MODIFICATION USING A COLLEC-
TION OF CHARTS TO IDENTIFY AND RECORD
PROGRESS TOWARD THE USER'S GOALS FOR
FITNESS AND DAILY LIFESTYLE IMPROVE-
MENT, IN CLASS 16 (U.S. CLS. 2, 5, 22, 23, 29, 37, 38
AND 50).

FIRST USE 5-19-2007; IN COMMERCE 5-19-2007.

THE MARK CONSISTS OF LOWERCASE "D"
AND "H" WITH A SHARED STEM CONTAINING
A STICK FIGURE RUNNING, TO SYMBOLIZE
"DYNAMIC HEALTH".

SN 78-565,135, FILED 2-10-2005.

MARY BOAGNI, EXAMINING ATTORNEY

Int. Cl.: 44

Prior U.S. Cls.: 100 and 101

United States Patent and Trademark Office

Reg. No. 3,399,475

Registered Mar. 18, 2008

**SERVICE MARK
PRINCIPAL REGISTER**

**MILLION DOLLAR
BODY**

PRODUCT PARTNERS, LLC (CALIFORNIA CORPORATION)
8383 WILSHIRE BOULEVARD
SUITE 1050
BEVERLY HILLS, CA 90211

FOR: WEIGHT REDUCTION AND DIET PLANNING, IN CLASS 44 (U.S. CLS. 100 AND 101).

FIRST USE 4-0-2007; IN COMMERCE 4-0-2007.

THE MARK CONSISTS OF STANDARD CHARACTERS WITHOUT CLAIM TO ANY PARTICULAR FONT, STYLE, SIZE, OR COLOR.

NO CLAIM IS MADE TO THE EXCLUSIVE RIGHT TO USE "BODY", APART FROM THE MARK AS SHOWN.

SN 78-566,502, FILED 2-14-2005.

DORITT L. CARROLL, EXAMINING ATTORNEY

Int. Cls.: 25 and 41

Prior U.S. Cls.: 22, 39, 100, 101, and 107

United States Patent and Trademark Office

Reg. No. 3,399,476

Registered Mar. 18, 2008

**TRADEMARK
SERVICE MARK
PRINCIPAL REGISTER**

GET LEISURIZED

LEISURE BOY, LLC (WISCONSIN LTD LIAB CO)
W356N5318 LAKESHORE DRIVE
OCONOMOWOC, WI 53058

FOR: CLOTHING, NAMELY, T-SHIRTS, SHIRT,
SHORTS AND HATS, IN CLASS 25 (U.S. CLS. 22 AND
39).

FIRST USE 11-12-2004; IN COMMERCE 1-17-2005.

FOR: ENTERTAINMENT SERVICES IN THE
NATURE OF A CONTINUING REALITY BASED

TELEVISION PROGRAM, IN CLASS 41 (U.S. CLS.
100, 101 AND 107).

FIRST USE 11-12-2004; IN COMMERCE 1-30-2007.

THE MARK CONSISTS OF STANDARD CHAR-
ACTERS WITHOUT CLAIM TO ANY PARTICULAR
FONT, STYLE, SIZE, OR COLOR.

SN 78-567,993, FILED 2-15-2005.

AMY GEARIN, EXAMINING ATTORNEY

Int. Cl.: 3

Prior U.S. Cls.: 1, 4, 6, 50, 51, and 52

United States Patent and Trademark Office

Reg. No. 3,399,477

Registered Mar. 18, 2008

**TRADEMARK
PRINCIPAL REGISTER**



HYUNDAI CORPORATION (REPUBLIC OF KOREA CORPORATION)
226, SHINMUNRO-L KA JONGNO-GU
SEOUL, REPUBLIC OF KOREA

FOR: BATH SOAPS, COSMETIC SOAPS, DEODORANT SOAP, HAIR SHAMPOOS, SOAP FOR BRIGHTENING TEXTILE, SKIN POLISHERS MADE IN PART OF RICE BRAN, CLEANSERS FOR DETERGENT PURPOSES, NAMELY, LAUNDRY DETERGENT, ALMOND SOAP, HAIR RINSES, COSMETIC SOAPS AND DENTIFRICE, IN CLASS 3 (U.S. CLS. 1, 4, 6, 50, 51 AND 52).

FIRST USE 1-2-2007; IN COMMERCE 1-2-2007.

OWNER OF U.S. REG. NOS. 2,967,626, 3,080,116, AND OTHERS.

THE ENGLISH TRANSLATION OF "HYUNDAI" IS MODERN.

SN 78-568,431, FILED 2-16-2005.

JORDAN BAKER, EXAMINING ATTORNEY

Int. Cl.: 5

Prior U.S. Cls.: 6, 18, 44, 46, 51, and 52

Reg. No. 3,399,478

United States Patent and Trademark Office

Registered Mar. 18, 2008

**TRADEMARK
PRINCIPAL REGISTER**

COMBIGAN

ALLERGAN, INC. (DELAWARE CORPORATION)
2525 DUPONT DRIVE
IRVINE, CA 92612

THE MARK CONSISTS OF STANDARD CHAR-
ACTERS WITHOUT CLAIM TO ANY PARTICULAR
FONT, STYLE, SIZE, OR COLOR.

FOR: PHARMACEUTICAL PREPARATIONS FOR
THE TREATMENT OF GLAUCOMA, IN CLASS 5
(U.S. CLS. 6, 18, 44, 46, 51 AND 52).

SN 78-568,827, FILED 2-16-2005.

FIRST USE 8-16-2001; IN COMMERCE 11-12-2007.

PAM WILLIS, EXAMINING ATTORNEY

Int. Cls.: 25 and 28

Prior U.S. Cls.: 22, 23, 38, 39, and 50

United States Patent and Trademark Office

Reg. No. 3,399,479

Registered Mar. 18, 2008

TRADEMARK
PRINCIPAL REGISTER



IDEA AMERICA LLC (MONTANA LTD LIAB CO)
308 GRAHAM STREET
HELENA, MT 59601

FOR: CLOTHING CONSISTING OF OUTERWEAR T-SHIRTS, SWEAT SHIRTS, HATS, CAPS, JACKETS, SHORTS, SWEAT PANTS, POLO SHIRTS AND DRESS SHIRTS, IN CLASS 25 (U.S. CLS. 22 AND 39).

FIRST USE 7-16-2006; IN COMMERCE 7-16-2006.

FOR: SPORTING GOODS SPECIFICALLY FISHING LURES AND CHRISTMAS TREE ORNAMENTS, IN CLASS 28 (U.S. CLS. 22, 23, 38 AND 50).

FIRST USE 7-16-2006; IN COMMERCE 7-16-2006.

THE COLORS RED (PANTONE 032) AND BLACK ARE CLAIMED AS FEATURES OF THE MARK.

THE MARK CONSISTS OF THE WORDS "LUSCIOUS LURES" IN RED DEPICTED AS STYLIZED SCRIPT CHARACTERS HAVING THE COMMON LETTER "L" USED IN EACH WORD, WITH THE FIRST AND LAST LETTERS HAVING STYLIZED FISH HOOK BARB ENDS AND LOOP, AND A WOMANS FACE AND SHOULDERS IN BLACK AND HAIR AND LIPS IN THE COLOR RED.

SN 78-569,390, FILED 2-17-2005.

DAVID C. REIHNER, EXAMINING ATTORNEY

Int. Cl.: 25

Prior U.S. Cls.: 22 and 39

United States Patent and Trademark Office

Reg. No. 3,399,480

Registered Mar. 18, 2008

**TRADEMARK
PRINCIPAL REGISTER**

Ecstasy

AROFF, PATRICK (UNITED STATES INDIVIDUAL)
1930 11TH STREET
SANTA MONICA, CA 90404

FOR: PROMOTIONAL PRODUCTS, NAMELY, ATHLETIC WEAR AND CLOTHING IN THE NATURE OF TOPS, BOTTOMS, SWIMWEAR, JACKETS, DRESSES, PANTS, T-SHIRTS, SHIRTS, SHORTS, SKIRTS, SWEATPANTS, SWEATSHIRTS AND FOOTWEAR DISTRIBUTED IN CONJUNCTION WITH THE PROMOTION OF ALCOHOLIC BEV-

ERAGES OF THE SAME NAME, IN CLASS 25 (U.S. CLS. 22 AND 39).

FIRST USE 8-15-2006; IN COMMERCE 8-15-2006.

THE MARK CONSISTS OF STANDARD CHARACTERS WITHOUT CLAIM TO ANY PARTICULAR FONT, STYLE, SIZE, OR COLOR.

SN 78-573,746, FILED 2-23-2005.

ELISSA GARBER KON, EXAMINING ATTORNEY

Int. Cls.: 16 and 25

Prior U.S. Cls.: 2, 5, 22, 23, 29, 37, 38, 39, and 50

United States Patent and Trademark Office

Reg. No. 3,399,481

Registered Mar. 18, 2008

**TRADEMARK
PRINCIPAL REGISTER**

NEKOMI

MICHAEL DAVID WARD PRODUCTIONS, INC.
(CALIFORNIA CORPORATION)
P.O. BOX 14396
SANTA ROSA, CA 95402

FOR: NOTE CARDS, GREETING CARDS, STATIONERY, BOOKS AND MAGAZINES FEATURING HUMOR AND CHILDREN'S STORIES, GRAPHIC AND PRINTED ART REPRODUCTIONS, PAINTINGS, DRAWINGS, LITHOGRAPHS, IN CLASS 16 (U.S. CLS. 2, 5, 22, 23, 29, 37, 38 AND 50).

FIRST USE 9-15-2006; IN COMMERCE 9-15-2006.

FOR: CLOTHING, NAMELY, T-SHIRTS, IN CLASS 25 (U.S. CLS. 22 AND 39).

FIRST USE 9-15-2006; IN COMMERCE 9-15-2006.

THE MARK CONSISTS OF STANDARD CHARACTERS WITHOUT CLAIM TO ANY PARTICULAR FONT, STYLE, SIZE, OR COLOR.

SN 78-574,499, FILED 2-24-2005.

SUSAN RICHARDS, EXAMINING ATTORNEY

Int. Cl.: 14

Prior U.S. Cls.: 2, 27, 28, and 50

United States Patent and Trademark Office

Reg. No. 3,399,482

Registered Mar. 18, 2008

TRADEMARK
PRINCIPAL REGISTER

Ma Choisie

WIN SUN JEWELLERY COMPANY LIMITED
(HONG KONG CORPORATION)
ROOM 806, CONCORDIA PLAZA
NO. 1 SCIENCE MUSEUM ROAD
TSIMSHATSUI EAST, KOWLOON, HONG KONG

FOR: JEWELLERY, BODY JEWELLERY, PEARLS,
JEWELLERY MOUNTED WITH PEARLS AND
OTHER PRECIOUS STONES, PEARL NECKLACES,
PRECIOUS STONES, CUFF-LINKS, TIE CLIPS,
RINGS, BRACELETS, EARRINGS, NECKLACES,
BROOCHES; CLOCKS, WATCHES, HOROLOGICAL

AND CHRONOMETRIC INSTRUMENTS, IN CLASS
14 (U.S. CLS. 2, 27, 28 AND 50).

FIRST USE 10-17-2006; IN COMMERCE 10-17-2006.

THE FOREIGN WORDING IN THE MARK
TRANSLATES INTO ENGLISH AS "MY CHOICE".

SN 78-580,003, FILED 3-4-2005.

ANNE MADDEN, EXAMINING ATTORNEY

Int. Cls.: 9 and 37

Prior U.S. Cls.: 21, 23, 26, 36, 38, 100, 103, and 106

United States Patent and Trademark Office

Reg. No. 3,399,483

Registered Mar. 18, 2008

**TRADEMARK
SERVICE MARK
PRINCIPAL REGISTER**

CALE

CALE ACCESS AB (SWEDEN CORPORATION)
BOX 1307
171 25 SOLNA, SWEDEN

FOR: PARKING METERS; TICKET MACHINES; PAYING MACHINES IN THE NATURE OF AUTOMATED MACHINES FOR SELF SERVICE PAYMENT OF FEES; MAGNETIC AND OPTICAL DATA MEDIA AND RECORDED COMPUTER SOFTWARE ALL RELATING TO THE OPERATION OF RATE SYSTEMS FOR PARKING METERS AND OTHER ADMINISTRATIVE CONTROLS LINKED TO PARKING METERS REGARDING PAYMENTS AND RESERVATIONS; AUTOMATIC TIME SWITCHES; TIME REGISTERING APPARATUS, NAMELY, TIME REGISTERING DEVICES; MACHINES FOR VENDING APPLICATIONS, NAMELY, VENDING MACHINES; COMPUTER NETWORKING HARDWARE; SOFTWARE MODULES; COMPUTER PROGRAM MONITORS; ACCESS CONTROL AND ALARM MONITORING SYSTEMS, IN CLASS 9 (U.S. CLS. 21, 23, 26, 36 AND 38).

FIRST USE 0-0-1955; IN COMMERCE 0-0-1976.

FOR: PROGRAMS AND SYSTEMS INSTALLATIONS IN THE FIELD OF VEHICLE PARKING; REPAIR SERVICE AND MAINTENANCE OF COMPUTER HARDWARE; INSTALLATION, MAINTENANCE, SERVICE AND REPAIRING ELECTRONIC EQUIPMENT RELATING TO THE OPERATING OF RATE SYSTEMS FOR PARKING METERS AND OTHER ADMINISTRATIVE CONTROLS LINKED TO PARKING METERS REGARDING PAYMENT AND RESERVATIONS; REPAIR, INSTALLATION AND SERVICE OF PARKING METERS, IN CLASS 37 (U.S. CLS. 100, 103 AND 106).

FIRST USE 0-0-1955; IN COMMERCE 0-0-1976.

THE MARK CONSISTS OF STANDARD CHARACTERS WITHOUT CLAIM TO ANY PARTICULAR FONT, STYLE, SIZE, OR COLOR.

SN 78-580,040, FILED 3-4-2005.

ARETHA SOMERVILLE, EXAMINING ATTORNEY

Int. Cl.: 15

Prior U.S. Cls.: 2, 21, and 36

United States Patent and Trademark Office

Reg. No. 3,399,484

Registered Mar. 18, 2008

TRADEMARK
PRINCIPAL REGISTER



YOUNG CHANG AKKI CO, LTD. (REPUBLIC OF
KOREA CORPORATION)
178-55, GAZWA-DONG, SEO-KU
INCHEON, REPUBLIC OF KOREA

FOR: MUSICAL INSTRUMENTS, NAMELY, PIA-
NOS, ORGANS, HARMONICAS AND GUITARS;
AND ELECTRIC MUSICAL INSTRUMENTS,
NAMELY, DIGITAL PIANOS, SYNTHESIZERS,
AND KEYBOARDS, IN CLASS 15 (U.S. CLS. 2, 21
AND 36).

FIRST USE 5-12-2005; IN COMMERCE 5-12-2005.

OWNER OF U.S. REG. NO. 2,194,811.

NO CLAIM IS MADE TO THE EXCLUSIVE
RIGHT TO USE "SINCE 1852", APART FROM THE
MARK AS SHOWN.

"THE NAME(S), PORTRAIT(S), AND/OR SIGNA-
TURE(S) SHOWN IN THE MARK DOES NOT IDEN-
TIFY A PARTICULAR LIVING INDIVIDUAL."

THE MARK CONSISTS OF THE WORDING AL-
BERT WEBER ON ONE LINE AND SINCE 1852
UNDERNEATH A CIRCULAR DESIGN FEATURE.
THE CIRCULAR DESIGN FEATURE IS A MEDAL-
LION ON WHICH ARE EMBOSSED TWO STALKS
OF GRAIN FORMING A CIRCLE INSIDE OF
WHICH IS A BIRD-LIKE IMAGE.

SN 78-581,809, FILED 3-7-2005.

YONG KIM, EXAMINING ATTORNEY

Int. Cls.: 35 and 39

Prior U.S. Cls.: 100, 101, 102, and 105

United States Patent and Trademark Office

Reg. No. 3,399,485

Registered Mar. 18, 2008

**SERVICE MARK
PRINCIPAL REGISTER**

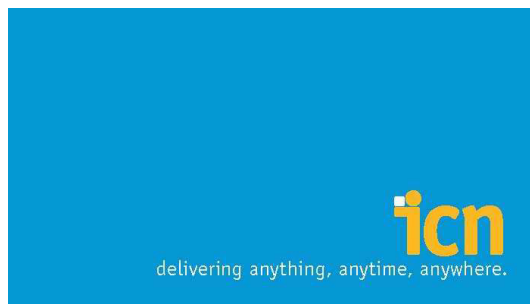

INTERNATIONAL COURIER NETWORK, INC.
(NEW YORK CORPORATION)
SUITE 612
873 BROADWAY
NEW YORK, NY 100031236

FOR: POSTAL SERVICES, NAMELY, MAIL SORTING, HANDLING AND RECEIVING, ORDER FULFILLMENT SERVICES, IN CLASS 35 (U.S. CLS. 100, 101 AND 102).

FIRST USE 3-31-2005; IN COMMERCE 3-31-2005.

FOR: TRANSPORTATION SERVICES, NAMELY, TRANSPORTATION OF DOCUMENTS, GOODS AND PARCELS BY LAND, SEA AND AIR; PACKAGING OF GOODS FOR TRANSPORTATION AND STORAGE; POSTAL SERVICES, NAMELY, PARCEL DELIVERY AND PACKAGING ARTICLES FOR TRANSPORTATION; STORAGE AND DELIVERY OF GOODS; COURIER SERVICES; SHIPPING, NAMELY, FREIGHT TRANSPORTATION BY SHIP, AIRCRAFT, RAIL CARRIER AND MOTOR VEHICLE, AND FREIGHT FORWARDING; FREIGHT BROKERAGE AND FORWARDING OF CARGO; WAREHOUSING SERVICES, NAMELY, STORAGE, DISTRIBUTION, PICK-UP AND PACKAGING FOR

SHIPMENT OF DOCUMENTS, PACKAGES, RAW MATERIALS AND OTHER FREIGHT FOR OTHERS, IN CLASS 39 (U.S. CLS. 100 AND 105).

FIRST USE 3-31-2005; IN COMMERCE 3-31-2005.

NO CLAIM IS MADE TO THE EXCLUSIVE RIGHT TO USE "DELIVERING ANYTHING, ANYTIME, ANYWHERE", APART FROM THE MARK AS SHOWN.

THE COLOR(S) WHITE, BLUE AND GOLD IS/ARE CLAIMED AS A FEATURE OF THE MARK.

THE MARK CONSISTS OF A BLUE RECTANGLE, THE WORDS "DELIVERING ANYTHING, ANYTIME, ANYWHERE." IN WHITE, AND THE LETTERS "ICN" IN GOLD WITH THE LETTER "I" IN THE FORM OF A MAN HOLDING A PACKAGE THAT IS COMPOSED OF A WHITE SQUARE.

SN 78-583,766, FILED 3-9-2005.

DAVID C. REIHNER, EXAMINING ATTORNEY

Int. Cl.: 42

Prior U.S. Cls.: 100 and 101

United States Patent and Trademark Office

Reg. No. 3,399,486

Registered Mar. 18, 2008

**SERVICE MARK
PRINCIPAL REGISTER**

"AutoTracking"

UNITED DEVELOPMENT SYSTEMS, INC. (FLORIDA CORPORATION)
19321C US HWY 19 NORTH SUITE 502
CLEARWATER, FL 33764

FOR: ONLINE NON-DOWNLOADABLE COMPUTER SOFTWARE FOR TEMPORARY USE BY FRANCHISED AUTOMOBILE DEALERSHIPS FOR MANAGING A DATABASE AND CREATING AND ACCESSING DAILY, MONTHLY, QUARTERLY AND ANNUAL REPORTS OF THE EFFECTIVENESS OF THEIR FINANCE AND INSURANCE DEPARTMENTS THROUGH A COMPUTER NETWORK, SUCH SOFTWARE ASSISTING MANAGEMENT IN TRACKING SALES FIGURES, PENETRATION LEVELS FOR PRODUCTS SOLD

BY THEIR FINANCE AND INSURANCE DEPARTMENTS AND REVENUE AMOUNTS FROM EACH SPECIFIC TRANSACTION, IN CLASS 42 (U.S. CLS. 100 AND 101).

FIRST USE 1-18-2007; IN COMMERCE 1-18-2007.

THE MARK CONSISTS OF STANDARD CHARACTERS WITHOUT CLAIM TO ANY PARTICULAR FONT, STYLE, SIZE, OR COLOR.

SN 78-588,369, FILED 3-16-2005.

CAROLYN CATALDO, EXAMINING ATTORNEY

Int. Cl.: 16

Prior U.S. Cls.: 2, 5, 22, 23, 29, 37, 38, and 50

Reg. No. 3,399,487

United States Patent and Trademark Office

Registered Mar. 18, 2008

**TRADEMARK
PRINCIPAL REGISTER**

**FOCUS FOLLOW ONE
COURSE UNTIL
SUCCESSFUL**

GOALSGUY LEARNING SYSTEMS, INC. (FLOR-
IDA CORPORATION)
31681 EAST LAKE ROAD SUITE 139
PALM HARBOR, FL 34685

THE MARK CONSISTS OF STANDARD CHAR-
ACTERS WITHOUT CLAIM TO ANY PARTICULAR
FONT, STYLE, SIZE, OR COLOR.

FOR: SERIES OF BOOKS CONCERNING THE
ACHIEVEMENT OF PERSONAL AND PROFES-
SIONAL GOALS, IN CLASS 16 (U.S. CLS. 2, 5, 22, 23,
29, 37, 38 AND 50).

SN 78-589,452, FILED 3-17-2005.

FIRST USE 9-30-2005; IN COMMERCE 9-30-2005.

TARAH HARDY, EXAMINING ATTORNEY

Int. Cl.: 20

Prior U.S. Cls.: 2, 13, 22, 25, 32, and 50

United States Patent and Trademark Office

Reg. No. 3,399,488

Registered Mar. 18, 2008

**TRADEMARK
PRINCIPAL REGISTER**

**LITTLE DREAM
WEAVERS**

THE ASHTON-DRAKE GALLERIES, LTD. (DE-
LAWARE CORPORATION)
9200 N. MARYLAND AVE.
NILES, IL 60714

FOR: ORNAMENTS OF RESIN, BONE, IVORY,
PLASTER, PLASTIC, WAX, WICKER AND WOOD,
EXCLUDING CHRISTMAS TREE ORNAMENTS, IN
CLASS 20 (U.S. CLS. 2, 13, 22, 25, 32 AND 50).

FIRST USE 3-5-2007; IN COMMERCE 3-5-2007.

THE MARK CONSISTS OF STANDARD CHAR-
ACTERS WITHOUT CLAIM TO ANY PARTICULAR
FONT, STYLE, SIZE, OR COLOR.

OWNER OF U.S. REG. NO. 2,229,577.

SN 78-593,066, FILED 3-23-2005.

MICHAEL WEBSTER, EXAMINING ATTORNEY

Int. Cl.: 40

Prior U.S. Cls.: 100, 103, and 106

United States Patent and Trademark Office

Reg. No. 3,399,489

Registered Mar. 18, 2008

**SERVICE MARK
PRINCIPAL REGISTER**

**RECOGNITION
EXPRESS**

JEFFREY R. TINO (NEVADA CORPORATION)
SUITE 7
6290 HARRISON DRIVE
LAS VEGAS, NV 89120

FOR: MANUFACTURE NAME BADGES, PLAQUES AND SIGNBOARDS OF PLASTIC OR WOODEN PARTS TO ORDER AND/OR SPECIFICATION OF OTHERS, IN CLASS 40 (U.S. CLS. 100, 103 AND 106).

FIRST USE 11-1-1982; IN COMMERCE 11-1-1982.

THE MARK CONSISTS OF STANDARD CHARACTERS WITHOUT CLAIM TO ANY PARTICULAR FONT, STYLE, SIZE, OR COLOR.

NO CLAIM IS MADE TO THE EXCLUSIVE RIGHT TO USE "EXPRESS", APART FROM THE MARK AS SHOWN.

SN 78-594,281, FILED 3-24-2005.

ROBERT C. CLARK JR., EXAMINING ATTORNEY

Int. Cl.: 9

Prior U.S. Cls.: 21, 23, 26, 36, and 38

United States Patent and Trademark Office

Reg. No. 3,399,490

Registered Mar. 18, 2008

**TRADEMARK
PRINCIPAL REGISTER**

CARDSAFE

FRAUDHALT LTD (IRELAND CORPORATION)
EAST WALL ROAD
DOCKLANDS INNOVATION PARK
DUBLIN 3, IRELAND

FOR: ELECTRONIC SYSTEMS FOR VERIFYING HOLOGRAMS, NAMELY, VERIFYING HOLOGRAMS ON CREDIT, DEBIT OR CHARGE CARDS, IDENTIFICATION CARDS, SECURITY CARDS, KEYCARDS OR THE LIKE, AS WELL AS A HOLOGRAM ON A DOCUMENT, SUCH AS A DEED, SECURITY DOCUMENT, LABEL, ADMISSION TICKET, CURRENCY NOTE, LABEL FOR MEDICINE OR A PACKET FOR MEDICINE, OR OTHER SUCH DOCUMENT, LABEL, PACKAGE OR CARD,

WITH THE SYSTEM COMPRISED PRIMARILY OF OPTICAL SCANNERS AND OPERATING SOFTWARE THEREFOR, IN CLASS 9 (U.S. CLS. 21, 23, 26, 36 AND 38).

FIRST USE 3-1-2004; IN COMMERCE 3-1-2004.

THE MARK CONSISTS OF STANDARD CHARACTERS WITHOUT CLAIM TO ANY PARTICULAR FONT, STYLE, SIZE, OR COLOR.

SN 78-594,975, FILED 3-25-2005.

JASON LOTT, EXAMINING ATTORNEY

Int. Cl.: 30

Prior U.S. Cl.: 46

United States Patent and Trademark Office

Reg. No. 3,399,491

Registered Mar. 18, 2008

**TRADEMARK
PRINCIPAL REGISTER**

HAPPY TEA

GARRITANO, FRANCO (UNITED STATES INDIVIDUAL)
4489 CAMROSE AVENUE
SAN DIEGO, CA 92122 AND
ALAVI, MATT (UNITED STATES INDIVIDUAL)
4489 CAMROSE AVENUE
SAN DIEGO, CA 92122 AND
ELLIOTT, KIRK (UNITED STATES INDIVIDUAL)
4489 CAMROSE AVENUE
SAN DIEGO, CA 92122

THE MARK CONSISTS OF STANDARD CHARACTERS WITHOUT CLAIM TO ANY PARTICULAR FONT, STYLE, SIZE, OR COLOR.

NO CLAIM IS MADE TO THE EXCLUSIVE RIGHT TO USE "TEA", APART FROM THE MARK AS SHOWN.

FOR: TEA, IN CLASS 30 (U.S. CL. 46).

SN 78-595,428, FILED 3-25-2005.

FIRST USE 11-1-2004; IN COMMERCE 9-4-2007.

ANTHONY RINKER, EXAMINING ATTORNEY

Int. Cls.: 9 and 42

Prior U.S. Cls.: 21, 23, 26, 36, 38, 100, and 101

United States Patent and Trademark Office

Reg. No. 3,399,492

Registered Mar. 18, 2008

**TRADEMARK
SERVICE MARK
PRINCIPAL REGISTER**



STRATEGY COMPANION TAIWAN CORPORATION (TAIWAN TAIWANESE CORPORATION)

8F-1 FUXING N. RD.

NO. 167

TAIPEI, TAIWAN 104

FOR: BUSINESS INTELLIGENCE SOFTWARE, IN CLASS 9 (U.S. CLS. 21, 23, 26, 36 AND 38).

FIRST USE 12-1-2004; IN COMMERCE 12-1-2004.

FOR: COMPUTER CONSULTATION SERVICES IN THE FIELD OF DESIGN, SELECTION, IMPLEMENTATION AND USE OF COMPUTER HARDWARE AND COMPUTER SYSTEMS RELATING TO BUSINESS INTELLIGENCE HARDWARE AND SOFTWARE, IN CLASS 42 (U.S. CLS. 100 AND 101).

FIRST USE 12-1-2004; IN COMMERCE 12-1-2004.

NO CLAIM IS MADE TO THE EXCLUSIVE RIGHT TO USE "2004 AND ANALYZER", APART FROM THE MARK AS SHOWN.

THE COLOR(S) ORANGE, WHITE, BLUE, YELLOW, GREEN AND BLACK IS/ARE CLAIMED AS A FEATURE OF THE MARK.

THE MARK CONSISTS OF THE WORDS "2004 STRATEGY COMPANION" AND "ANALYZER" AND FIVE 3-DIMENSIONAL BLOCKS, ONE ORANGE IN COLOR, ONE WHITE IN COLOR, ONE BLUE IN COLOR, ONE YELLOW IN COLOR AND ONE GREEN IN COLOR; AND THE COLOR BLACK APPEARS IN ALL WORDING IN THE MARK.

SN 78-596,162, FILED 3-28-2005.

BILL DAWE, EXAMINING ATTORNEY

Int. Cl.: 10

Prior U.S. Cls.: 26, 39, and 44

United States Patent and Trademark Office

Reg. No. 3,399,493

Registered Mar. 18, 2008

**TRADEMARK
PRINCIPAL REGISTER**

HEARTSTRIDE

CARDIAC SCIENCE CORPORATION (DELA-
WARE CORPORATION)
3303 MONTE VILLA PARKWAY
BOTHELL, WA 98021

FOR: MEDICAL EQUIPMENT, NAMELY, COM-
PUTER-BASED STRESS TEST SYSTEMS COM-
PRISED OF COMPUTER HARDWARE AND
SOFTWARE, FOR COLLECTING, ANALYZING,
STORING, AND PRESENTING CARDIOPULMON-
ARY DATA, IN CLASS 10 (U.S. CLS. 26, 39 AND 44).

FIRST USE 4-18-2006; IN COMMERCE 4-18-2006.

THE MARK CONSISTS OF STANDARD CHAR-
ACTERS WITHOUT CLAIM TO ANY PARTICULAR
FONT, STYLE, SIZE, OR COLOR.

SN 78-596,237, FILED 3-28-2005.

DOMINICK J. SALEMI, EXAMINING ATTORNEY

Int. Cl.: 28

Prior U.S. Cls.: 22, 23, 38, and 50

United States Patent and Trademark Office

Reg. No. 3,399,494

Registered Mar. 18, 2008

**TRADEMARK
PRINCIPAL REGISTER**

HEARTSTRIDE

CARDIAC SCIENCE CORPORATION (DELA-
WARE CORPORATION)
3303 MONTE VILLA PARKWAY
BOTHELL, WA 98021

FOR: EXERCISE EQUIPMENT, NAMELY, CON-
TROL APPARATUS FOR MODULATING A USER
WORKOUT ON TREADMILLS, IN CLASS 28 (U.S.
CLS. 22, 23, 38 AND 50).

FIRST USE 4-18-2006; IN COMMERCE 4-18-2006.

THE MARK CONSISTS OF STANDARD CHAR-
ACTERS WITHOUT CLAIM TO ANY PARTICULAR
FONT, STYLE, SIZE, OR COLOR.

SN 78-596,239, FILED 3-28-2005.

DOMINICK J. SALEMI, EXAMINING ATTORNEY

Int. Cl.: 25

Prior U.S. Cls.: 22 and 39

United States Patent and Trademark Office

Reg. No. 3,399,495

Registered Mar. 18, 2008

**TRADEMARK
PRINCIPAL REGISTER**

HERBIN'

CLARDY, GLINDA (UNITED STATES INDIVIDUAL)
1014 HARRISON AVE
HUNTSVILLE, AL 35801

FOR: T-SHIRTS AND HATS, IN CLASS 25 (U.S. CLS. 22 AND 39).

FIRST USE 3-31-2005; IN COMMERCE 3-31-2005.

THE MARK CONSISTS OF STANDARD CHARACTERS WITHOUT CLAIM TO ANY PARTICULAR FONT, STYLE, SIZE, OR COLOR.

SN 78-596,731, FILED 3-29-2005.

MARIA-VICTORIA SUAREZ, EXAMINING ATTORNEY

Int. Cl.: 9

Prior U.S. Cls.: 21, 23, 26, 36, and 38

United States Patent and Trademark Office

Reg. No. 3,399,496

Registered Mar. 18, 2008

**TRADEMARK
PRINCIPAL REGISTER**

PROCEED

CATERPILLAR INC. (DELAWARE CORPORATION)
100 N.E. ADAMS STREET
PEORIA, IL 616299240

FOR: COMPUTER PROGRAMS AND SOFTWARE WHICH APPLY STATISTICAL ANALYSIS, DATA ANALYSIS AND PREDICTIVE ANALYSIS TO SIMULATE, MODEL, PREDICT, AND OPTIMIZE THE OUTCOME OF COMPLEX MANUFACTURING PROCESSES, IN CLASS 9 (U.S. CLS. 21, 23, 26, 36 AND 38).

FIRST USE 8-30-2005; IN COMMERCE 8-30-2005.

THE MARK CONSISTS OF STANDARD CHARACTERS WITHOUT CLAIM TO ANY PARTICULAR FONT, STYLE, SIZE, OR COLOR.

SN 78-597,328, FILED 3-29-2005.

VERNA BETH RIRIE, EXAMINING ATTORNEY

Int. Cl.: 36

Prior U.S. Cls.: 100, 101, and 102

United States Patent and Trademark Office

Reg. No. 3,399,497

Registered Mar. 18, 2008

**SERVICE MARK
PRINCIPAL REGISTER**

ENVIN

ENVIN, LLC (DELAWARE CORPORATION)
SUITE 100
410 EAGLEVIEW BOULEVARD
EXTON, PA 19341

FOR: INSURANCE BROKERAGE SERVICES; INSURANCE BROKERAGE SERVICES IN THE FIELD OF ENVIRONMENTAL INSURANCE; INSURANCE CONSULTATION SERVICES, IN CLASS 36 (U.S. CLS. 100, 101 AND 102).

FIRST USE 1-10-2003; IN COMMERCE 1-10-2003.

THE MARK CONSISTS OF STANDARD CHARACTERS WITHOUT CLAIM TO ANY PARTICULAR FONT, STYLE, SIZE, OR COLOR.

SN 78-598,310, FILED 3-30-2005.

GINA HAYES, EXAMINING ATTORNEY

Int. Cls.: 35 and 42

Prior U.S. Cls.: 100, 101, and 102

United States Patent and Trademark Office

Reg. No. 3,399,498

Registered Mar. 18, 2008

**SERVICE MARK
PRINCIPAL REGISTER**

TSAI, LEE & CHEN PATENT ATTORNEYS COMPANY (TAIWAN CORPORATION)
12TH FL. 148 SONGJIANG RD.
TAIPEI 104, TAIWAN

FOR: CONSULTING SERVICES IN THE FIELD OF BRAND MANAGEMENT AND PROVIDING BRAND STRATEGIES, IN CLASS 35 (U.S. CLS. 100, 101 AND 102).

FIRST USE 2-1-2005; IN COMMERCE 6-1-2005.

FOR: DOMESTIC AND OVERSEAS PATENT AGENT SERVICES IN DEALING WITH AND APPLYING FOR INTELLECTUAL PROPERTY RIGHTS AND THE RELATED MATTERS, NAMELY, PATENT SEARCH AND ANALYSIS, DRAFTING PATENT SPECIFICATION, PATENT PROSECUTION, TRADEMARK SEARCH, TRADE-

MARK MONITORING AND DUE DILIGENCE SERVICES; PREVENTATIVE CONSULTATION SERVICES FOR NEGOTIATING LEASING, LICENSING, RECORDING AND TRANSFERRING OF INTELLECTUAL PROPERTY RIGHTS; LEGAL CONSULTATION AND LITIGATION SUPPORT SERVICES, IN CLASS 42 (U.S. CLS. 100 AND 101).

FIRST USE 2-1-2005; IN COMMERCE 6-1-2005.

THE MARK CONSISTS OF STANDARD CHARACTERS WITHOUT CLAIM TO ANY PARTICULAR FONT, STYLE, SIZE, OR COLOR.

SN 78-598,839, FILED 3-31-2005.

INGRID C. EULIN, EXAMINING ATTORNEY

Int. Cl.: 9

Prior U.S. Cls.: 21, 23, 26, 36, and 38

United States Patent and Trademark Office

Reg. No. 3,399,499

Registered Mar. 18, 2008

**TRADEMARK
PRINCIPAL REGISTER**

**ACCELERATING TIME
TO RESULTS**

PANASAS, INC. (DELAWARE CORPORATION)
6520 KAISER DRIVE
FREMONT, CA 94555

FIRST USE 0-0-2003; IN COMMERCE 0-0-2003.

FOR: DATA STORAGE DEVICES FOR USE IN A COMPUTER NETWORK, NAMELY, DEVICES CONTAINING DISK DRIVES, PROCESSORS, CACHE MEMORY, CONTROLLERS AND LINKS TO CONNECT THE DEVICES WITH COMPUTER NETWORKS AND SOFTWARE FOR DATA STORAGE DEVICES, IN CLASS 9 (U.S. CLS. 21, 23, 26, 36 AND 38).

THE MARK CONSISTS OF STANDARD CHARACTERS WITHOUT CLAIM TO ANY PARTICULAR FONT, STYLE, SIZE, OR COLOR.

SN 78-598,974, FILED 3-31-2005.

BRIAN PINO, EXAMINING ATTORNEY

Int. Cls.: 35, 36, 41, and 44

Prior U.S. Cls.: 100, 101, 102, and 107

United States Patent and Trademark Office

Reg. No. 3,399,500

Registered Mar. 18, 2008

**SERVICE MARK
PRINCIPAL REGISTER**



HEART TO HEART INTERNATIONAL, INC.
(KANSAS NON-PROFIT ORGANIZATION)
401 SOUTH CLAIRBORNE, SUITE 301
OLATHE, KS 66062

FOR: CHARITABLE SERVICES, NAMELY, RECRUITING VOLUNTEERS ON A GLOBAL SCALE AND ORGANIZING AND CONDUCTING VOLUNTEER PROGRAMS AND COMMUNITY DEVELOPMENT SERVICE PROJECTS, IN CLASS 35 (U.S. CLS. 100, 101 AND 102).

FIRST USE 3-5-2007; IN COMMERCE 3-5-2007.

FOR: CHARITABLE SERVICES, NAMELY, ACCEPTING AND ADMINISTERING HUMANITARIAN AID IN THE FORM OF MONETARY CHARITABLE CONTRIBUTIONS, IN CLASS 36 (U.S. CLS. 100, 101 AND 102).

FIRST USE 3-5-2007; IN COMMERCE 3-5-2007.

FOR: CHARITABLE SERVICES, NAMELY, PROVIDING HUMANITARIAN AID IN THE FORM OF TOYS AND SCHOOL SUPPLIES TO CHILDREN IN NEED, IN CLASS 41 (U.S. CLS. 100, 101 AND 107).

FIRST USE 3-5-2007; IN COMMERCE 3-5-2007.

FOR: CHARITABLE SERVICES, NAMELY, PROVIDING HUMANITARIAN AID IN THE FORM OF

MEDICAL SERVICES TO UNDERDEVELOPED COUNTRIES, IN CLASS 44 (U.S. CLS. 100 AND 101).

FIRST USE 3-5-2007; IN COMMERCE 3-5-2007.

NO CLAIM IS MADE TO THE EXCLUSIVE RIGHT TO USE "INTERNATIONAL", APART FROM THE MARK AS SHOWN.

THE COLOR(S) BLACK AND RED IS/ARE CLAIMED AS A FEATURE OF THE MARK.

THE COLOR(S) BLACK APPEARS IN THE WORDS "HEART TO HEART" AND "...CONNECTING YOU TO A WORLD IN NEED". THE COLOR RED APPEARS IN THE WORD "INTERNATIONAL", AS WELL AS WITHIN A FIRST PORTION OF THE SHADED CIRCLE THAT FORMS AN ILLUSTRATIVE HEART PARTIALLY SURROUNDED BY AN UNSHADED OUTLINING HEART AND A SECOND PORTION FORMING THE REMAINDER OF THE SHADED CIRCLE EXCEPT FOR AN UNSHADED PARTIAL CIRCLE FORMED THEREIN.

SN 78-599,934, FILED 4-1-2005.

MARIAM MAHMOUDI, EXAMINING ATTORNEY

Int. Cl.: 41

Prior U.S. Cls.: 100, 101, and 107

United States Patent and Trademark Office

Reg. No. 3,399,501

Registered Mar. 18, 2008

**SERVICE MARK
PRINCIPAL REGISTER**

**INVENTING THE REST
OF OUR LIVES**

LEVINE, SUZANNE BRAUN (UNITED STATES
INDIVIDUAL)
C/O LEVINE, PLOTKIN & MENIN, L.L.P.
1740 BROADWAY
NEW YORK, NY 10019

FIRST USE 6-0-2005; IN COMMERCE 6-0-2005.

THE MARK CONSISTS OF STANDARD CHAR-
ACTERS WITHOUT CLAIM TO ANY PARTICULAR
FONT, STYLE, SIZE, OR COLOR.

FOR: EDUCATIONAL SERVICES, NAMELY,
PROVIDING CONFERENCES, SPEECHES, WORK-
SHOPS, SEMINARS AND TRAINING PROGRAMS
RELATING TO WOMEN'S ISSUES , IN CLASS 41
(U.S. CLS. 100, 101 AND 107).

SN 78-600,874, FILED 4-4-2005.

DAVID MURRAY, EXAMINING ATTORNEY

Int. Cl.: 4

Prior U.S. Cls.: 1, 6, and 15

United States Patent and Trademark Office

Reg. No. 3,399,502

Registered Mar. 18, 2008

**TRADEMARK
PRINCIPAL REGISTER**



SPANJAARD GROUP LIMITED (SOUTH AFRICA CORPORATION)
748-750 FIFTH STREET
WYNBERG, SANDTON 2196, GAUTENG, SOUTH AFRICA

FOR: GEAR OILS; LUBRICATING OILS; PENETRATING OIL; ALL PURPOSE LUBRICANTS; GRAPHITE LUBRICANTS; INDUSTRIAL LUBRICANTS; LUBRICANTS FOR INDUSTRIAL MACHINERY; LUBRICANTS FOR MARINE MACHINERY; AUTOMOTIVE GREASES; GENERAL PURPOSE GREASES; GREASE FOR MACHINES; INDUSTRIAL GREASES; LUBRICATION GREASE FOR VEHICLES; NON-CHEMICAL ADDITIVES FOR MOTOR OILS AND FUELS, IN CLASS 4 (U.S. CLS. 1, 6 AND 15).

FIRST USE 0-0-1998; IN COMMERCE 0-0-1998.

OWNER OF U.S. REG. NO. 1,122,643.

THE COLOR(S) RED, BLACK, AND WHITE IS/ARE CLAIMED AS A FEATURE OF THE MARK.

THE MARK CONSISTS OF A SMALL RED BOX WITH A BLACK AND WHITE SWIRL DIAGONALLY ACROSS IT, UNDERNEATH WHICH IS THE WORD "SPANJAARD" IN BLACK, STYLIZED LETTERING. TO THE RIGHT OF THIS BOX IS THE WORD "SPANJAARD" IN BLACK LETTERING BETWEEN TWO HORIZONTAL RED STRIPES.

SN 78-600,947, FILED 4-4-2005.

G. MAYERSCHOFF, EXAMINING ATTORNEY

Int. Cl.: 7

Prior U.S. Cls.: 13, 19, 21, 23, 31, 34, and 35

Reg. No. 3,399,503

United States Patent and Trademark Office

Registered Mar. 18, 2008

**TRADEMARK
PRINCIPAL REGISTER**

**STRONGER. FASTER.
LONGER LIFE.**

EMERSON ELECTRIC CO. (MISSOURI CORPORATION)
8000 W. FLORISSANT AVE.
ST. LOUIS, MO 63136

THE MARK CONSISTS OF STANDARD CHARACTERS WITHOUT CLAIM TO ANY PARTICULAR FONT, STYLE, SIZE, OR COLOR.

FOR: POWER TOOLS AND POWER TOOL ACCESSORIES, NAMELY, POWER SAW BLADES AND DRILL BITS, IN CLASS 7 (U.S. CLS. 13, 19, 21, 23, 31, 34 AND 35).

SN 78-601,489, FILED 4-4-2005.

FIRST USE 6-20-2005; IN COMMERCE 6-20-2005.

KHANH LE, EXAMINING ATTORNEY

Int. Cl.: 36

Prior U.S. Cls.: 100, 101, and 102

United States Patent and Trademark Office

Reg. No. 3,399,504

Registered Mar. 18, 2008

**SERVICE MARK
PRINCIPAL REGISTER**

**CUBIS FINANCIAL
CORPORATION**

CUBIS FINANCIAL, LTD. (NEVADA LTD LIAB
CO)
325 E WARM SPRINGS RD
LAS VEGAS, NV 89119

FOR: FINANCIAL SERVICES IN THE NATURE
OF PROVIDING PAYROLL CARD, DEBIT CARD,
AND STORED VALUE CARD ACCOUNTS, IN
CLASS 36 (U.S. CLS. 100, 101 AND 102).

FIRST USE 6-15-2005; IN COMMERCE 6-15-2005.

THE MARK CONSISTS OF STANDARD CHAR-
ACTERS WITHOUT CLAIM TO ANY PARTICULAR
FONT, STYLE, SIZE, OR COLOR.

NO CLAIM IS MADE TO THE EXCLUSIVE
RIGHT TO USE "FINANCIAL CORPORATION",
APART FROM THE MARK AS SHOWN.

SN 78-601,737, FILED 4-5-2005.

TEJBIR SINGH, EXAMINING ATTORNEY

Int. Cl.: 10

Prior U.S. Cls.: 26, 39, and 44

United States Patent and Trademark Office

Reg. No. 3,399,505

Registered Mar. 18, 2008

**TRADEMARK
PRINCIPAL REGISTER**

Oxygen is Beautiful

O2 INNOVATIONS LLC (DELAWARE LTD LIAB
CO)
600 LUZERNE AVENUE
WEST PITSTON, PA 18643

FOR: OXYGEN PRODUCTS, EQUIPMENT, AND
DELIVERY SYSTEMS FOR DISPENSING NON-
MEDICAL OXYGEN, NAMELY, PORTABLE OXY-
GEN BAR, OXYGEN CONCENTRATORS, OXYGEN
SUPPLY CYLINDERS, OXYGEN CANISTERS, OXY-
GEN PURIFIERS, OXYGEN MASKS, NASAL CAN-
NULAE, HEADSET WITH OXYGEN DISPENSING
MOUTHPIECE, OXYGEN HOSES, MOUTHPIECES
AND AIR INTAKE FILTERS, AND MOUTHPIECE
COVERS; APPARATUS FOR DISPENSING NON-
MEDICAL OXYGEN AND AROMATHERAPY FOR

RELAXATION THERAPY, IN CLASS 10 (U.S. CLS.
26, 39 AND 44).

FIRST USE 9-0-2005; IN COMMERCE 9-0-2005.

THE MARK CONSISTS OF STANDARD CHAR-
ACTERS WITHOUT CLAIM TO ANY PARTICULAR
FONT, STYLE, SIZE, OR COLOR.

NO CLAIM IS MADE TO THE EXCLUSIVE
RIGHT TO USE "OXYGEN", APART FROM THE
MARK AS SHOWN.

SN 78-603,477, FILED 4-6-2005.

LESLEY LAMOTHE, EXAMINING ATTORNEY

Int. Cls.: 16 and 41

Prior U.S. Cls.: 2, 5, 22, 23, 29, 37, 38, 50, 100, 101, and 107

Reg. No. 3,399,506

United States Patent and Trademark Office

Registered Mar. 18, 2008

**TRADEMARK
SERVICE MARK
PRINCIPAL REGISTER**

Middle Class Millionaire

BEATTIE, ROGER L. (UNITED STATES INDIVIDUAL)
3039 SOUTH 600 WEST
BOUNTIFUL, UT 84011

FOR: PRINTED INSTRUCTIONAL MATERIALS, NAMELY, SERIES OF BOOKS, WORKBOOKS IN THE FIELD OF REAL ESTATE INVESTMENT, INCLUDING AUDIO CDS SOLD AS A UNIT THEREWITH, IN CLASS 16 (U.S. CLS. 2, 5, 22, 23, 29, 37, 38 AND 50).

FIRST USE 1-28-2005; IN COMMERCE 1-28-2005.

FOR: EDUCATIONAL SERVICES, NAMELY, CONDUCTING CLASSES, SEMINARS, AND WORK-

SHOPS IN THE FIELD OF REAL ESTATE INVESTMENT; TRAINING SERVICES IN THE FIELD OF REAL ESTATE INVESTMENT, IN CLASS 41 (U.S. CLS. 100, 101 AND 107).

FIRST USE 3-31-2006; IN COMMERCE 10-25-2006.

THE MARK CONSISTS OF STANDARD CHARACTERS WITHOUT CLAIM TO ANY PARTICULAR FONT, STYLE, SIZE, OR COLOR.

SN 78-604,532, FILED 4-8-2005.

MONIQUE MILLER, EXAMINING ATTORNEY

Int. Cl.: 36

Prior U.S. Cls.: 100, 101, and 102

United States Patent and Trademark Office

Reg. No. 3,399,507

Registered Mar. 18, 2008

**SERVICE MARK
PRINCIPAL REGISTER**

PBS FOUNDATION

PUBLIC BROADCASTING SERVICE (D.C. CORPORATION)
2100 CRYSTAL DRIVE
ARLINGTON, VA 22202

FOR: CHARITABLE FUNDRAISING SERVICES,
IN CLASS 36 (U.S. CLS. 100, 101 AND 102).

FIRST USE 6-0-2007; IN COMMERCE 6-0-2007.

THE MARK CONSISTS OF STANDARD CHARACTERS WITHOUT CLAIM TO ANY PARTICULAR FONT, STYLE, SIZE, OR COLOR.

OWNER OF U.S. REG. NOS. 1,247,905, 2,707,600,
AND OTHERS.

NO CLAIM IS MADE TO THE EXCLUSIVE
RIGHT TO USE "FOUNDATION", APART FROM
THE MARK AS SHOWN.

SN 78-606,657, FILED 4-12-2005.

JOHN DALIER, EXAMINING ATTORNEY

Int. Cl.: 30

Prior U.S. Cl.: 46

United States Patent and Trademark Office

Reg. No. 3,399,508

Registered Mar. 18, 2008

TRADEMARK
PRINCIPAL REGISTER

GrainWise

CARGILL, INCORPORATED (DELAWARE CORPORATION)
15407 MCGINTY ROAD WEST
WAYZATA, MN 55391

THE MARK CONSISTS OF THE BLACK-AND-WHITE LETTERS "GRAINWISE" IN STYLIZED FORM WITH A STALK OF WHEAT USED IN PLACE OF THE DOT ABOVE THE LETTER "I".

FOR: PROCESSED WHEAT, IN CLASS 30 (U.S. CL. 46).

SN 78-607,237, FILED 4-12-2005.

FIRST USE 12-31-2005; IN COMMERCE 12-31-2005.

KIMBERLY PERRY, EXAMINING ATTORNEY

Int. Cls.: 7 and 9

Prior U.S. Cls.: 13, 19, 21, 23, 26, 31, 34, 35, 36, and 38

United States Patent and Trademark Office

Reg. No. 3,399,509

Registered Mar. 18, 2008

**TRADEMARK
PRINCIPAL REGISTER**

M3 PLASMA

ESAB GROUP, INC. (DELAWARE CORPORATION)
411 SOUTH EBENEZER ROAD
FLORENCE, SC 295010545

FOR: PLASMA ARC CUTTING MACHINES, AND PARTS AND SPARES THEREFORE, IN CLASS 7 (U.S. CLS. 13, 19, 21, 23, 31, 34 AND 35).

FIRST USE 6-0-2006; IN COMMERCE 6-0-2006.

FOR: COMPUTER HARDWARE FOR USE WITH PLASMA ARC CUTTING MACHINES; INDUSTRIAL PROCESS CONTROL SOFTWARE FOR USE WITH PLASMA ARC CUTTING MACHINES, IN CLASS 9 (U.S. CLS. 21, 23, 26, 36 AND 38).

FIRST USE 6-0-2006; IN COMMERCE 6-0-2006.

THE MARK CONSISTS OF STANDARD CHARACTERS WITHOUT CLAIM TO ANY PARTICULAR FONT, STYLE, SIZE, OR COLOR.

NO CLAIM IS MADE TO THE EXCLUSIVE RIGHT TO USE "PLASMA", APART FROM THE MARK AS SHOWN.

SN 78-609,223, FILED 4-14-2005.

JOHN DALIER, EXAMINING ATTORNEY

Int. Cl.: 10

Prior U.S. Cls.: 26, 39, and 44

United States Patent and Trademark Office

Reg. No. 3,399,510

Registered Mar. 18, 2008

**TRADEMARK
PRINCIPAL REGISTER**

G50

SIEMENS MEDICAL SOLUTIONS USA, INC.
(DELAWARE CORPORATION)
51 VALLEY STREAM PARKWAY
MALVERN, PA 19355

FOR: ULTRASOUND DIAGNOSTIC SYSTEM,
COMPRISING, ULTRASOUND DIAGNOSTIC AP-
PARATUS, ULTRASOUND PLATFORM AND RE-
LATED SOFTWARE FOR OPERATING
ULTRASOUND MACHINES, AND FOR RECORD-
ING, PROCESSING AND DISPLAYING INFORMA-
TION OBTAINED DURING ULTRASOUND
DIAGNOSTIC PROCEDURES SOLD AS A UNIT

WITH ULTRASOUND SYSTEMS, IN CLASS 10
(U.S. CLS. 26, 39 AND 44).

FIRST USE 11-0-2002; IN COMMERCE 11-0-2002.

THE MARK CONSISTS OF STANDARD CHAR-
ACTERS WITHOUT CLAIM TO ANY PARTICULAR
FONT, STYLE, SIZE, OR COLOR.

SN 78-610,254, FILED 4-15-2005.

MYRIAH HABEEB, EXAMINING ATTORNEY

Int. Cl.: 33

Prior U.S. Cls.: 47 and 49

United States Patent and Trademark Office

Reg. No. 3,399,511

Registered Mar. 18, 2008

**TRADEMARK
PRINCIPAL REGISTER**

TAXI CAB

ALLIED MANAGEMENT, INC. (NEW JERSEY
CORPORATION)
19 SOUTH LIVINGSTON AVENUE
LIVINGSTON, NJ 07039

THE MARK CONSISTS OF STANDARD CHAR-
ACTERS WITHOUT CLAIM TO ANY PARTICULAR
FONT, STYLE, SIZE, OR COLOR.

FOR: WINE, IN CLASS 33 (U.S. CLS. 47 AND 49).

SN 78-611,298, FILED 4-18-2005.

FIRST USE 11-10-2006; IN COMMERCE 11-10-2006.

LANA PHAM, EXAMINING ATTORNEY

Int. Cl.: 5

Prior U.S. Cls.: 6, 18, 44, 46, 51, and 52

United States Patent and Trademark Office

Reg. No. 3,399,512

Registered Mar. 18, 2008

**TRADEMARK
PRINCIPAL REGISTER**

STRINTEX

ESAKI MEDICAL INSTRUMENT CO., LTD. (JAPAN CORPORATION)
44-2 SHIMOHACHINOTSUBO KOTARI
NAGAOKAKYO-SHI, JAPAN

FIRST USE 9-1-2006; IN COMMERCE 9-1-2006.

SN 78-612,994, FILED 4-20-2005.

FOR: MEDICAL ADHESIVE TAPE, IN CLASS 5
(U.S. CLS. 6, 18, 44, 46, 51 AND 52).

REBECCA EISINGER, EXAMINING ATTORNEY

Int. Cl.: 35

Prior U.S. Cls.: 100, 101, and 102

United States Patent and Trademark Office

Reg. No. 3,399,513

Registered Mar. 18, 2008

**SERVICE MARK
PRINCIPAL REGISTER**

SMARTSELL ONLINE

WEST CORPORATION (NEBRASKA CORPORATION)
11808 MIRACLE HILLS DR.
OMAHA, NE 68154

FOR: PROMOTING THE GOODS AND SERVICES OF OTHERS BY MEANS OF PROVIDING AND OPERATING LINKS TO WEB SITES OF OTHERS, PROMOTING THE GOODS AND SERVICES OF OTHERS THROUGH ONLINE ORDERING AND CATALOGUING OF THOSE GOODS AND SERVICES; CUSTOMER SERVICES IN THE FIELD OF ONLINE ORDERING AND GENERAL MERCHANDISING; AND BUSINESS CONSULTATION, IN CLASS 35 (U.S. CLS. 100, 101 AND 102).

FIRST USE 3-1-2004; IN COMMERCE 3-1-2004.

THE MARK CONSISTS OF STANDARD CHARACTERS WITHOUT CLAIM TO ANY PARTICULAR FONT, STYLE, SIZE, OR COLOR.

NO CLAIM IS MADE TO THE EXCLUSIVE RIGHT TO USE "ONLINE", APART FROM THE MARK AS SHOWN.

SN 78-616,051, FILED 4-25-2005.

JERI J. FICKES, EXAMINING ATTORNEY

Int. Cl.: 4

Prior U.S. Cls.: 1, 6, and 15

United States Patent and Trademark Office

Reg. No. 3,399,514

Registered Mar. 18, 2008

**TRADEMARK
PRINCIPAL REGISTER**



VERASUN AURORA CORPORATION (SOUTH
DAKOTA CORPORATION)
100 22ND AVENUE
BROOKINGS, SD 57006

FOR: ETHANOL FUEL AND ETHANOL FUEL
MIXTURES, IN CLASS 4 (U.S. CLS. 1, 6 AND 15).

FIRST USE 5-0-2005; IN COMMERCE 5-0-2005.

THE MARK CONSISTS OF A STYLIZED LETTER
"V" COMBINED WITH A SUN DESIGN, A STY-
LIZED LETTER "E", AND THE STYLIZED NUM-
BERS "8" AND "5", ALL WITHIN A RECTANGLE
WITH ROUNDED CORNERS.

SN 78-617,201, FILED 4-26-2005.

JOHN DALIER, EXAMINING ATTORNEY

Int. Cl.: 4

Prior U.S. Cls.: 1, 6, and 15

United States Patent and Trademark Office

Reg. No. 3,399,515

Registered Mar. 18, 2008

**TRADEMARK
PRINCIPAL REGISTER**

VE85

VERASUN AURORA CORPORATION (SOUTH
DAKOTA CORPORATION)
100 22ND AVENUE
BROOKINGS, SD 57006

THE MARK CONSISTS OF STANDARD CHAR-
ACTERS WITHOUT CLAIM TO ANY PARTICULAR
FONT, STYLE, SIZE, OR COLOR.

FOR: ETHANOL FUEL AND ETHANOL FUEL
MIXTURES, IN CLASS 4 (U.S. CLS. 1, 6 AND 15).

SN 78-617,204, FILED 4-26-2005.

FIRST USE 5-0-2005; IN COMMERCE 5-0-2005.

JOHN DALIER, EXAMINING ATTORNEY

Int. Cl.: 35

Prior U.S. Cls.: 100, 101, and 102

United States Patent and Trademark Office

Reg. No. 3,399,516

Registered Mar. 18, 2008

SERVICE MARK
PRINCIPAL REGISTER

IGONET

International
Global
Opportunity
Network Inc.

INTERNATIONAL GLOBAL OPPORTUNITY
NETWORK LLC (DELAWARE LTD LIAB CO)
2315 AARON STREET
PORT CHARLOTTE, FL 33952

FOR: NETWORK MARKETING BUSINESS SERVICES, NAMELY, MULTI-LEVEL AND DIRECT RETAIL MARKETING FEATURING VOICE OVER INTERNET PROTOCOL AND WIRELESS HIGH SPEED INTERNET SERVICES FOR OTHERS, IN CLASS 35 (U.S. CLS. 100, 101 AND 102).

FIRST USE 11-30-2005; IN COMMERCE 11-30-2005.

NO CLAIM IS MADE TO THE EXCLUSIVE RIGHT TO USE "INTERNATIONAL GLOBAL" AND "NETWORK INC.", APART FROM THE MARK AS SHOWN.

THE COLOR(S) BLUE IS/ARE CLAIMED AS A FEATURE OF THE MARK.

THE COLOR BLUE APPEARS THROUGHOUT THE MARK.

THE MARK CONSISTS OF "INTERNATIONAL GLOBAL OPPORTUNITY NETWORK", THE COMPANY NAME IS SHOWN IN BLUE AND IN GEORGIA FONT. THE COMPANY INTENDS TO DO BUSINESS USING THE ACRONYM "IGONET" WHICH IS SHOWN ALSO IN BLUE AND IN TWO ZEROS FONT STYLE.

SN 78-617,218, FILED 4-26-2005.

WARREN L. OLANDRIA, EXAMINING ATTORNEY

Int. Cl.: 25

Prior U.S. Cls.: 22 and 39

United States Patent and Trademark Office

Reg. No. 3,399,517

Registered Mar. 18, 2008

**TRADEMARK
PRINCIPAL REGISTER**

ONLY MINE

WARD, JOHN, MR. (UNITED STATES INDIVIDUAL)
80 GLENVILLE RD.
GREENWICH, CT 06831

FOR: CLOTHING, NAMELY, SHIRTS AND SWEATERS, IN CLASS 25 (U.S. CLS. 22 AND 39).

FIRST USE 10-30-2005; IN COMMERCE 10-30-2005.

THE MARK CONSISTS OF STANDARD CHARACTERS WITHOUT CLAIM TO ANY PARTICULAR FONT, STYLE, SIZE, OR COLOR.

SN 78-619,892, FILED 4-29-2005.

JANICE L. MCMORROW, EXAMINING ATTORNEY

Int. Cl.: 9

Prior U.S. Cls.: 21, 23, 26, 36, and 38

United States Patent and Trademark Office

Reg. No. 3,399,518

Registered Mar. 18, 2008

**TRADEMARK
PRINCIPAL REGISTER**

10G^C

SUPERIOR ESSEX COMMUNICATIONS LP (DE-
LAWARE LIMITED PARTNERSHIP)
150 INTERSTATE NORTH PARKWAY
ATLANTA, GA 30339

FOR: LOCAL AREA NETWORK DATA AND
TELECOMMUNICATIONS WIRING SYSTEM COM-
PRISED OF HIGH-SPEED COPPER ELECTRICAL
DATA COMMUNICATIONS CABLES AND ELEC-

TRICAL CONNECTORS, IN CLASS 9 (U.S. CLS. 21,
23, 26, 36 AND 38).

FIRST USE 5-0-2005; IN COMMERCE 5-0-2005.

SN 78-620,091, FILED 4-29-2005.

MICHELE SWAIN, EXAMINING ATTORNEY

Int. Cl.: 10

Prior U.S. Cls.: 26, 39, and 44

United States Patent and Trademark Office

Reg. No. 3,399,519

Registered Mar. 18, 2008

**TRADEMARK
PRINCIPAL REGISTER**

VOIKEX

VOIKEX, INC. (CALIFORNIA CORPORATION)
P.O. BOX 1568
MANHATTAN BEACH, CA 902671568

FIRST USE 7-0-2007; IN COMMERCE 7-0-2007.

FOR: MEDICAL DIAGNOSTIC EQUIPMENT,
NAMELY, DEVICES FOR MONITORING AND RE-
CORDING THE INTERVALS BETWEEN KICKS OF
A BABY IN THE BELLY OF AN EXPECTANT
MOTHER, IN CLASS 10 (U.S. CLS. 26, 39 AND 44).

THE MARK CONSISTS OF STANDARD CHAR-
ACTERS WITHOUT CLAIM TO ANY PARTICULAR
FONT, STYLE, SIZE, OR COLOR.

SN 78-620,687, FILED 5-2-2005.

EDWARD NELSON, EXAMINING ATTORNEY

Int. Cl.: 25

Prior U.S. Cls.: 22 and 39

United States Patent and Trademark Office

Reg. No. 3,399,520

Registered Mar. 18, 2008

**TRADEMARK
PRINCIPAL REGISTER**

DESTINATION BOXER SHORTS

SMITH NEWS COMPANY, INC. (CALIFORNIA
CORPORATION)
460 NINTH STREET
SAN FRANCISCO, CA 94103

FOR: BOXER SHORTS SOLD AS SOUVENIR
ITEMS IN RETAIL ESTABLISHMENTS WHERE
SOUVENIRS ARE TYPICALLY SOLD, IN CLASS 25
(U.S. CLS. 22 AND 39).

FIRST USE 4-26-2006; IN COMMERCE 4-26-2006.

THE MARK CONSISTS OF STANDARD CHAR-
ACTERS WITHOUT CLAIM TO ANY PARTICULAR
FONT, STYLE, SIZE, OR COLOR.

NO CLAIM IS MADE TO THE EXCLUSIVE
RIGHT TO USE "BOXER SHORTS", APART FROM
THE MARK AS SHOWN.

SN 78-622,461, FILED 5-4-2005.

JENNIFER VASQUEZ, EXAMINING ATTORNEY

Int. Cls.: 16 and 28

Prior U.S. Cls.: 2, 5, 22, 23, 29, 37, 38, and 50

United States Patent and Trademark Office

Reg. No. 3,399,521

Registered Mar. 18, 2008

**TRADEMARK
PRINCIPAL REGISTER**

POSITIVE PENELOPE

DUMONT, STEFANIE (UNITED STATES INDIVIDUAL)
SUITE 302
2604B EL CAMINO REAL
CARLSBAD, CA 92010

FOR: SERIES OF FICTION BOOKS, IN CLASS 16
(U.S. CLS. 2, 5, 22, 23, 29, 37, 38 AND 50).

FIRST USE 2-15-2006; IN COMMERCE 2-15-2006.

FOR: DOLLS AND ACCESSORIES THEREFOR,
IN CLASS 28 (U.S. CLS. 22, 23, 38 AND 50).

FIRST USE 2-15-2006; IN COMMERCE 2-15-2006.

THE MARK CONSISTS OF STANDARD CHARACTERS WITHOUT CLAIM TO ANY PARTICULAR FONT, STYLE, SIZE, OR COLOR.

SN 78-623,545, FILED 5-5-2005.

JOHN DWYER, EXAMINING ATTORNEY

Int. Cl.: 3

Prior U.S. Cls.: 1, 4, 6, 50, 51, and 52

United States Patent and Trademark Office

Reg. No. 3,399,522

Registered Mar. 18, 2008

**TRADEMARK
PRINCIPAL REGISTER**



PARFUMS CARLO CORINTO PARIS S.A.R.L.
(FRANCE SOCIETE A RESPONSABILITE LIM-
ITEE)

1, RUE DE STOCKHOLM
PARIS, FRANCE 75008

FOR: PERFUMERY, IN CLASS 3 (U.S. CLS. 1, 4, 6,
50, 51 AND 52).

FIRST USE 6-13-2005; IN COMMERCE 6-13-2005.

OWNER OF U.S. REG. NOS. 1,386,458 AND
1,833,590.

NO CLAIM IS MADE TO THE EXCLUSIVE
RIGHT TO USE "PARIS", APART FROM THE
MARK AS SHOWN.

THE NAME(S), PORTRAIT(S), AND/OR SIGNA-
TURE(S) SHOWN IN THE MARK DOES NOT IDEN-
TIFY A PARTICULAR LIVING INDIVIDUAL.

"THE COLOR(S) BLUE AND RED IS/ARE
CLAIMED AS A FEATURE OF THE MARK."

THE MARK CONSISTS OF THE TERM "BLU"
THAT APPEARS IN THE COLOR BLUE, AND THE
TERM "STREMO" THAT APPEARS IN THE COLOR
RED, BOTH EMPHASIZED BY A RED LINE UN-
DERLINE. THE WORDING "CARLO CORINTO
PARIS" ALL APPEARS IN THE COLOR BLUE.

SN 78-624,726, FILED 5-6-2005.

ZHALEH DELANEY, EXAMINING ATTORNEY

Int. Cl.: 41

Prior U.S. Cls.: 100, 101, and 107

United States Patent and Trademark Office

Reg. No. 3,399,523

Registered Mar. 18, 2008

**SERVICE MARK
PRINCIPAL REGISTER**

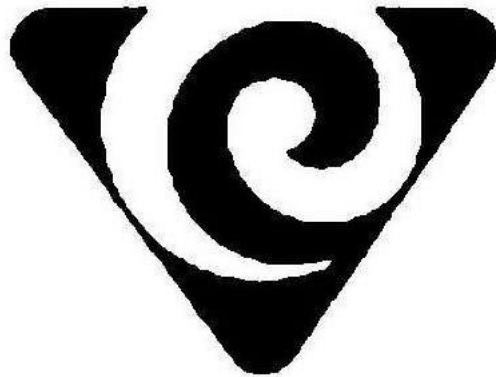

ESCUELA DE DECORACION VERACRUZ AC.
(MEXICO CORPORATION)
AVENIDA DE LAS ROSAS 171 COL. CHAPALITA
ZAPOPAN, MEXICO 44680

THE MARK CONSISTS OF A SPIRAL INSIDE OF
A TRIANGLE WITH ROUNDED EDGES.

FOR: PROVIDING COURSES OF INSTRUCTION
AT THE HIGH SCHOOL AND UNIVERSITY LEVEL,
IN CLASS 41 (U.S. CLS. 100, 101 AND 107).

SN 78-625,962, FILED 5-9-2005.

FIRST USE 10-18-2005; IN COMMERCE 10-18-2005.

WOODROW HARTZOG, EXAMINING ATTORNEY

Int. Cl.: 38

Prior U.S. Cls.: 100, 101, and 104

United States Patent and Trademark Office

Reg. No. 3,399,524

Registered Mar. 18, 2008

**SERVICE MARK
PRINCIPAL REGISTER**

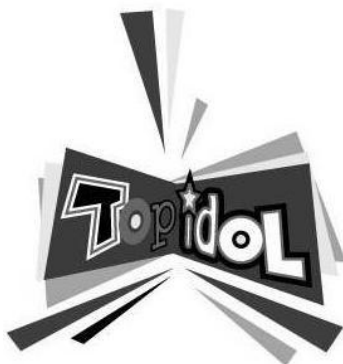

EASTERN BROADCASTING CO., LTD. (TAIWAN CORPORATION)
12 FL., NO. 4, SEC. 1
CHUNG HSIAO W. ROAD
TAIPEI, TAIWAN 100

FOR: CABLE TELEVISION BROADCASTING; BROADCASTING PROGRAMS VIA A GLOBAL COMPUTER NETWORK; TELEVISION BROADCASTING; RADIO BROADCASTING; TELECOMMUNICATION SERVICES, NAMELY, LOCAL AND LONG DISTANCE TRANSMISSION OF VOICE, DATA, GRAPHICS BY MEANS OF TELEPHONE, TELEGRAPHIC, CABLE, SATELLITE TRANSMISSIONS, AND GLOBAL COMPUTER NETWORK; TELECOMMUNICATION SERVICES, NAMELY, PERSONAL COMMUNICATION SERVICES VIA TELEPHONE, TELEGRAMS, FACSIMILE AND COMPUTERS; PROVIDING TELECOMMUNICATIONS CONNECTIONS TO A GLOBAL COMPUTER NETWORK; PROVIDING ELECTRONIC TELECOMMUNICATION CONNECTIONS; COMPUTER AIDED TRANSMISSION OF INFORMATION AND IMAGES; ELECTRONIC DATA TRANSMISSION, NAMELY, TRANSMISSION OF DATABASE INFORMATION FOR IMAGES VIA GLOBAL COMPUTER NETWORK; PROVIDING ON-LINE CHAT ROOMS AND ELECTRONIC BULLETIN BOARDS FOR

TRANSMISSION OF MESSAGES AMONG USERS IN THE FIELD OF GENERAL INTEREST; ON-LINE DOCUMENT AND DATA DELIVERY VIA A GLOBAL COMPUTER NETWORK; COMMUNICATION VIA OPTICAL FIBER NETWORKS; TRANSMISSION OF INFORMATION ON OPTICAL TELECOMMUNICATION NETWORKS; SATELLITE, CABLE, NETWORK TRANSMISSION OF SOUNDS, IMAGES, SIGNALS AND DATA; SATELLITE AIDED TRANSMISSION OF MESSAGES AND IMAGES, IN CLASS 38 (U.S. CLS. 100, 101 AND 104).

FIRST USE 4-14-2005; IN COMMERCE 5-9-2005.

THE GRAY TONES IN THE MARK ARE INTENDED TO INDICATE SHADING OR CONTRAST ONLY.

THE MARK CONSISTS OF THE STYLIZED WORDING "TOPIDOL" WITH THE LETTER "I" HAVING A STAR ABOVE IT, AND A SHADED BOW-TIE SHAPED CARRIER WITH TRIANGLES SURROUNDING THE CARRIER.

SN 78-626,016, FILED 5-9-2005.

JAY BESCH, EXAMINING ATTORNEY

Int. Cls.: 25 and 39

Prior U.S. Cls.: 22, 39, 100, and 105

United States Patent and Trademark Office

Reg. No. 3,399,525

Registered Mar. 18, 2008

**TRADEMARK
SERVICE MARK
PRINCIPAL REGISTER**

A SLICE OF BROOKLYN

MUIA, TONY (UNITED STATES INDIVIDUAL)
226 BAY 10TH STREET
BROOKLYN, NY 11228

FOR: CLOTHING PRODUCTS, NAMELY, T-SHIRTS, SWEATSHIRTS, POLO SHIRTS, DENIM SHIRTS, COTTON LONG-SLEEVE SHIRTS, JACKETS, TURTLENECKS, BLAZERS, SWEATERS, APRONS, BOXER SHORTS, BASEBALL CAPS AND NECKTIES, IN CLASS 25 (U.S. CLS. 22 AND 39).

FIRST USE 5-0-2005; IN COMMERCE 5-0-2005.

FOR: ARRANGING AND CONDUCTING GUIDED TRAVEL TOURS, IN CLASS 39 (U.S. CLS. 100 AND 105).

FIRST USE 5-0-2005; IN COMMERCE 5-0-2005.

THE MARK CONSISTS OF STANDARD CHARACTERS WITHOUT CLAIM TO ANY PARTICULAR FONT, STYLE, SIZE, OR COLOR.

NO CLAIM IS MADE TO THE EXCLUSIVE RIGHT TO USE "BROOKLYN", APART FROM THE MARK AS SHOWN.

SN 78-626,287, FILED 5-10-2005.

MICHAEL WEBSTER, EXAMINING ATTORNEY

Int. Cls.: 25 and 39

Prior U.S. Cls.: 22, 39, 100, and 105

United States Patent and Trademark Office

Reg. No. 3,399,526

Registered Mar. 18, 2008

TRADEMARK
SERVICE MARK
PRINCIPAL REGISTER



MUIA, TONY (UNITED STATES INDIVIDUAL)
226 BAY 10TH STREET
BROOKLYN, NY 11228

FOR: CLOTHING PRODUCTS, NAMELY, T-SHIRTS, SWEATSHIRTS, POLO SHIRTS, DENIM SHIRTS, COTTON LONG-SLEEVE SHIRTS, JACKETS, TURTLENECKS, BLAZERS, SWEATERS, APRONS, BOXER SHORTS, BASEBALL CAPS AND NECKTIES, IN CLASS 25 (U.S. CLS. 22 AND 39).

FIRST USE 5-0-2005; IN COMMERCE 5-0-2005.

FOR: ARRANGING AND CONDUCTING GUIDED TRAVEL TOURS, IN CLASS 39 (U.S. CLS. 100 AND 105).

FIRST USE 5-0-2005; IN COMMERCE 5-0-2005.

NO CLAIM IS MADE TO THE EXCLUSIVE RIGHT TO USE "BROOKLYN" OR "PIZZA TOUR", APART FROM THE MARK AS SHOWN.

SN 78-626,345, FILED 5-10-2005.

MICHAEL WEBSTER, EXAMINING ATTORNEY

Int. Cl.: 42

Prior U.S. Cls.: 100 and 101

United States Patent and Trademark Office

Reg. No. 3,399,527

Registered Mar. 18, 2008

**SERVICE MARK
PRINCIPAL REGISTER**

AFI-TRUE-TEAM

AFI INTERNATIONAL GROUP INC. (CANADA CORPORATION)
8160 PARKHILL DRIVE
MILTON, ONTARIO, CANADA L9T 5V7

FOR: CONTINGENCY PLANNING AND MITIGATION SERVICES FOR BUSINESSES, NAMELY, LABOR AND MANAGEMENT NEGOTIATIONS AND CONSULTING SERVICES IN CONNECTION WITH STRIKES, LOCKOUTS AND LABOR RELATIONS MATTERS, IN CLASS 42 (U.S. CLS. 100 AND 101).

FIRST USE 1-10-2006; IN COMMERCE 1-10-2006.

THE MARK CONSISTS OF STANDARD CHARACTERS WITHOUT CLAIM TO ANY PARTICULAR FONT, STYLE, SIZE, OR COLOR.

PRIORITY CLAIMED UNDER SEC. 44(D) ON CANADA APPLICATION NO. 1248770, FILED 2-25-2005, REG. NO. TMA659380, DATED 2-20-2006, EXPIRES 2-20-2021.

SN 78-627,030, FILED 5-10-2005.

SEAN CROWLEY, EXAMINING ATTORNEY

Int. Cl.: 25

Prior U.S. Cls.: 22 and 39

United States Patent and Trademark Office

Reg. No. 3,399,528

Registered Mar. 18, 2008

**TRADEMARK
PRINCIPAL REGISTER**

A Trailer Hauls Yours

Real Bikers Ride...

DURAY, JANET M (UNITED STATES INDIVIDUAL)
3477 11TH ST S
FARGO, ND 58104

FIRST USE 2-26-2007; IN COMMERCE 2-26-2007.

SN 78-627,230, FILED 5-10-2005.

FOR: T-SHIRTS, JACKETS, SWEATSHIRTS, SHIRTS, BLOUSES, TANK TOPS, IN CLASS 25 (U.S. CLS. 22 AND 39).

ANNE E. GUSTASON, EXAMINING ATTORNEY

Int. Cls.: 29 and 30

Prior U.S. Cl.: 46

United States Patent and Trademark Office

Reg. No. 3,399,529

Registered Mar. 18, 2008

TRADEMARK
PRINCIPAL REGISTER



ANTHONY, ALICE (UNITED STATES INDIVIDUAL), DBA ANTHONY'S HOME OF ALEECE'S PITA CHIPS,
308 ILLINI DRIVE
EAST PEORIA, IL 61611

FOR: CHEESE FOOD; CHEESE SPREADS; FOOD PACKAGE COMBINATIONS CONSISTING PRIMARILY OF CHEESE, MEAT AND/OR PROCESSED FRUIT; FRUIT-BASED SPREADS; HUMMUS; SNACK DIPS EXCLUDING SALSA AND OTHER SAUCES USED AS DIPS; TAPENADES, IN CLASS 29 (U.S. CL. 46).

FIRST USE 6-0-2004; IN COMMERCE 6-0-2004.

FOR: FLOUR-BASED CHIPS; PITA-BREAD CHIPS, IN CLASS 30 (U.S. CL. 46).

FIRST USE 6-0-2004; IN COMMERCE 6-0-2004.

THE COLOR(S) RED AND GOLD IS/ARE CLAIMED AS A FEATURE OF THE MARK.

THE MARK CONSISTS OF THE WORD "ALEECE'S" AND A GRAIN HUSK, WHERE THE COLOR RED APPEARS IN THE WORDING "ALEECE'S", THE COLOR GOLD APPEARS IN THE GRAIN HUSK BELOW THE WORDING "ALEECE'S" AND THE COLOR GOLD OUTLINES THE WORDING "ALEECE'S".

SN 78-627,490, FILED 5-11-2005.

MELISSA VALLILLO, EXAMINING ATTORNEY

Int. Cl.: 20

Prior U.S. Cls.: 2, 13, 22, 25, 32, and 50

United States Patent and Trademark Office

Reg. No. 3,399,530

Registered Mar. 18, 2008

**TRADEMARK
PRINCIPAL REGISTER**

BRILLIANT VIEW MIRROR

CONAIR CORPORATION (DELAWARE CORPORATION)

ONE CUMMINGS POINT ROAD

STAMFORD, CT 06902

FOR: NON-ELECTRIC MIRRORS, IN CLASS 20
(U.S. CLS. 2, 13, 22, 25, 32 AND 50).

FIRST USE 8-0-2005; IN COMMERCE 8-0-2005.

THE MARK CONSISTS OF STANDARD CHARACTERS WITHOUT CLAIM TO ANY PARTICULAR FONT, STYLE, SIZE, OR COLOR.

NO CLAIM IS MADE TO THE EXCLUSIVE RIGHT TO USE "MIRROR", APART FROM THE MARK AS SHOWN.

SN 78-628,428, FILED 5-12-2005.

ALICE BENMAMAN, EXAMINING ATTORNEY

Int. Cl.: 35

Prior U.S. Cls.: 100, 101, and 102

United States Patent and Trademark Office

Reg. No. 3,399,531

Registered Mar. 18, 2008

**SERVICE MARK
PRINCIPAL REGISTER**

IKAN

IKAN TECHNOLOGIES INC. (DELAWARE CORPORATION)
18 CLUB ROAD
RIVERSIDE, CT 06878

FOR: COMPUTERIZED ONLINE ORDERING FEATURING GENERAL MERCHANDISE AND GENERAL CONSUMER GOODS; PROVIDING AN ON-LINE COMPUTER DATABASE FEATURING TRADE INFORMATION IN THE FIELD OF CONSUMPTION AND RECYCLING HABITS OF CONSUMERS; ADVICE ON THE ANALYSIS OF CONSUMER BUYING HABITS AND NEEDS PROVIDED WITH THE HELP OF SENSORY, QUALITY AND QUANTITY-RELATED DATA; DISTRIBUTION OF SAMPLES FOR PUBLICITY PURPOSES; COMMERCIAL INFORMATION AGENCY SERVI-

CES PROVIDING BUSINESS INFORMATION IN THE FIELD OF MARKETING OR DEMOGRAPHIC DATA RELATING TO CONSUMPTION AND RECYCLING HABITS OF CONSUMERS, IN CLASS 35 (U.S. CLS. 100, 101 AND 102).

FIRST USE 9-9-2006; IN COMMERCE 1-31-2007.

THE MARK CONSISTS OF STANDARD CHARACTERS WITHOUT CLAIM TO ANY PARTICULAR FONT, STYLE, SIZE, OR COLOR.

SN 78-632,790, FILED 5-18-2005.

DAVID COLLIER, EXAMINING ATTORNEY

Int. Cl.: 25

Prior U.S. Cls.: 22 and 39

United States Patent and Trademark Office

Reg. No. 3,399,532

Registered Mar. 18, 2008

**TRADEMARK
PRINCIPAL REGISTER**

TRICOTEZ

CHINA UNION (CASHMERE) INTERNATIONAL
GROUP LIMITED (HONG KONG CORPORATION)
FLAT B, 4TH FLOOR, CHEUNG WING IND. BLDG
109-115 WO YI HOP ROAD
KWAI CHUNG, N.T., HONG KONG

FOR: CLOTHING, NAMELY, SHIRTS, SWEATERS,
AND TOPS, IN CLASS 25 (U.S. CLS. 22 AND 39).

FIRST USE 8-31-2007; IN COMMERCE 8-31-2007.

THE MARK CONSISTS OF STANDARD CHARACTERS
WITHOUT CLAIM TO ANY PARTICULAR FONT,
STYLE, SIZE, OR COLOR.

SN 78-633,591, FILED 5-19-2005.

MICHAEL SOUDERS, EXAMINING ATTORNEY

Int. Cl.: 10

Prior U.S. Cls.: 26, 39, and 44

United States Patent and Trademark Office

Reg. No. 3,399,533

Registered Mar. 18, 2008

**TRADEMARK
PRINCIPAL REGISTER**

AXP

THERMOGENESIS CORPORATION (DELA-
WARE CORPORATION)
3146 GOLD CAMP DRIVE
RANCHO CORDOVA, CA 95670

THE MARK CONSISTS OF STANDARD CHAR-
ACTERS WITHOUT CLAIM TO ANY PARTICULAR
FONT, STYLE, SIZE, OR COLOR.

FOR: MEDICAL DEVICES AND EQUIPMENT,
NAMELY, A DEVICE TO HARVEST CELLS FROM
BLOOD OR BONE MARROW, IN CLASS 10 (U.S.
CLS. 26, 39 AND 44).

SN 78-634,312, FILED 5-20-2005.

FIRST USE 9-1-2005; IN COMMERCE 9-1-2005.

LYDIA BELZER, EXAMINING ATTORNEY

Int. Cls.: 25, 35, and 41

Prior U.S. Cls.: 22, 39, 100, 101, 102, and 107

United States Patent and Trademark Office

Reg. No. 3,399,534

Registered Mar. 18, 2008

TRADEMARK
SERVICE MARK
PRINCIPAL REGISTER



RUNNYC.COM LLC (NEW YORK LTD LIAB CO)
78 WINDSOR PLACE
BROOKLYN, NY 11215

FOR: CLOTHING, NAMELY, SHIRTS, T-SHIRTS, SHORT SLEEVED T-SHIRTS, LONG SLEEVED T-SHIRTS, POLO SHIRTS, GOLF SHIRTS, OPEN-NECKED SHIRTS, JOGGING OUTFITS, JOGGING PANTS, JOGGING SUITS, SHORTS, SWEAT SHORTS, SWEAT BANDS, AND SWIM TRUNKS, IN CLASS 25 (U.S. CLS. 22 AND 39).

FIRST USE 4-1-2006; IN COMMERCE 4-1-2006.

FOR: PROMOTING SPORTS COMPETITION AND/OR EVENTS OF OTHERS TO RUNNERS, SWIMMERS, BICYCLISTS, TRIATHLETES AND ATHLETES; PROMOTING THE GOODS AND SERVICES OF OTHERS BY ARRANGING FOR SPONSORS TO AFFILIATE THEIR GOODS AND SERVICES WITH RUNNING; PROMOTING THE GOODS AND SERVICES OF OTHERS BY PROVIDING HYPERTEXT LINKS TO THE WEB SITES OF OTHERS; PROMOTING THE GOODS AND SERVICES OF OTHERS BY PROVIDING A WEB SITE AT WHICH USERS CAN LINK TO INFORMATION, ARTICLES, AND PRODUCTS PERTAINING TO HEALTH AND FITNESS FOR RUNNERS, SWIMMERS, BICYCLISTS, TRIATHLETES AND ATHLETES IN THE ATHLETIC COMMUNITY; PROMOTING, ADVERTISING AND MARKETING OF THE ON-LINE WEBSITES OF OTHERS PERTAINING TO RUNNERS, SWIMMERS, BICYCLISTS, TRIATHLETES AND ATHLETES IN THE

ATHLETIC COMMUNITY, IN CLASS 35 (U.S. CLS. 100, 101 AND 102).

FIRST USE 4-1-2006; IN COMMERCE 4-1-2006.

FOR: PHYSICAL FITNESS CONSULTATION AND INSTRUCTION TO RUNNERS, SWIMMERS, BICYCLISTS, TRIATHLETES AND ATHLETES IN THE ATHLETIC COMMUNITY; AND EDUCATIONAL SERVICES BY PROVIDING CONSULTATION SERVICES IN THE FIELD OF RUNNING, SWIMMING, BICYCLING AND TRIATHLON FOR RUNNERS, SWIMMERS, BICYCLISTS, TRIATHLETES AND ATHLETES IN THE ATHLETIC COMMUNITY, IN CLASS 41 (U.S. CLS. 100, 101 AND 107).

FIRST USE 4-1-2006; IN COMMERCE 4-1-2006.

NO CLAIM IS MADE TO THE EXCLUSIVE RIGHT TO USE "RUN NYC .COM", APART FROM THE MARK AS SHOWN.

THE COLOR(S) ORANGE, BLUE AND WHITE IS/ ARE CLAIMED AS A FEATURE OF THE MARK.

THE MARK CONSISTS OF A LARGE SQUARE DIVIDED INTO FOUR (4) SECTIONS AT FORTY-FIVE (45) DEGREE ANGLES AT EACH CORNER OF THE SQUARE CONVERGING ON A SMALL CENTER WHITE SQUARE. THE COLOR BLUE APPEARS IN THE SECTIONS TO THE LEFT AND RIGHT OF THE CENTER WHITE SQUARE AND IN THE UPPER CASE WORDS "RUN" AND "NYC" AND IN THE LOWER CASE WORDS "STAY FO-

CUSED". THE COLOR ORANGE APPEARS IN THE SECTIONS ABOVE AND BELOW THE CENTER WHITE SQUARE AND IN THE LOWERCASE WORDS ".COM". THE COLOR WHITE ALSO APPEARS IN RANDOMLY DISPERSED QUADRAN-

GLE SHAPES IN EACH OF THE FOUR SECTIONS WITHIN THE LARGE SQUARE.

SN 78-636,451, FILED 5-24-2005.

MICHAEL SOUDERS, EXAMINING ATTORNEY

Int. Cl.: 16

Prior U.S. Cls.: 2, 5, 22, 23, 29, 37, 38, and 50

Reg. No. 3,399,535

United States Patent and Trademark Office

Registered Mar. 18, 2008

**TRADEMARK
PRINCIPAL REGISTER**

FAMILY GUY

TWENTIETH CENTURY FOX FILM CORPORATION
(DELAWARE CORPORATION)
10201 WEST PICO BOULEVARD
LOS ANGELES, CA 90035

THE MARK CONSISTS OF STANDARD CHARACTERS WITHOUT CLAIM TO ANY PARTICULAR FONT, STYLE, SIZE, OR COLOR.

FOR: POSTERS; WALL CALENDARS; GREETING CARDS; NOTE PADS; NOTEBOOKS; TRADING CARDS; MEMO PADS; ADDRESS BOOKS; DATE BOOKS; BOOK COVERS; PENS; PENCILS; FICTIONAL NOVELS; HUMOR BOOKS; COMIC BOOKS, IN CLASS 16 (U.S. CLS. 2, 5, 22, 23, 29, 37, 38 AND 50).

OWNER OF U.S. REG. NOS. 2,314,755, 2,625,497, AND OTHERS.

SN 78-637,052, FILED 5-25-2005.

FIRST USE 4-30-2005; IN COMMERCE 4-30-2005.

JASON ROTH, EXAMINING ATTORNEY

Int. Cls.: 12 and 27

Prior U.S. Cls.: 19, 20, 21, 23, 31, 35, 37, 42, 44, and 50

United States Patent and Trademark Office

Reg. No. 3,399,536

Registered Mar. 18, 2008

**TRADEMARK
PRINCIPAL REGISTER**



FORMOSA SAINT JOSE CORP. (TAIWAN CORPORATION)
NO. 319, JIASHING STREET
TAIPEI, TAIWAN 106

FOR: STEERING WHEEL COVERS, FITTED COVERS FOR AUTOMOBILES AND MOTORCYCLES, IN CLASS 12 (U.S. CLS. 19, 21, 23, 31, 35 AND 44).

FIRST USE 8-11-2000; IN COMMERCE 9-21-2006.

FOR: FLOOR MATS FOR VEHICLES, IN CLASS 27 (U.S. CLS. 19, 20, 37, 42 AND 50).

FIRST USE 8-11-2000; IN COMMERCE 3-13-2006.

OWNER OF TAIWAN REG. NO. 1120831, DATED 9-16-2004, EXPIRES 9-15-2014.

SN 78-637,077, FILED 5-25-2005.

KARANENDRA S. CHHINA, EXAMINING ATTORNEY

Int. Cl.: 36

Prior U.S. Cls.: 100, 101, and 102

United States Patent and Trademark Office

Reg. No. 3,399,537

Registered Mar. 18, 2008

**SERVICE MARK
PRINCIPAL REGISTER**

**EMERALD HILL CAPITAL
PARTNERS**

EMERALD HILL CAPITAL PARTNERS, LLC
(DELAWARE LTD LIAB CO)
3500 SOUTH DUPONT HIGHWAY
DOVER, DE 19901

FOR: FUNDS INVESTMENT AND INVESTMENT
OF FUNDS FOR OTHERS, IN CLASS 36 (U.S. CLS.
100, 101 AND 102).

FIRST USE 10-25-2007; IN COMMERCE 10-25-2007.

THE MARK CONSISTS OF STANDARD CHAR-
ACTERS WITHOUT CLAIM TO ANY PARTICULAR
FONT, STYLE, SIZE, OR COLOR.

NO CLAIM IS MADE TO THE EXCLUSIVE
RIGHT TO USE "CAPITAL PARTNERS", APART
FROM THE MARK AS SHOWN.

SN 78-638,105, FILED 5-26-2005.

MONIQUE MILLER, EXAMINING ATTORNEY

Int. Cl.: 10

Prior U.S. Cls.: 26, 39, and 44

United States Patent and Trademark Office

Reg. No. 3,399,538

Registered Mar. 18, 2008

**TRADEMARK
PRINCIPAL REGISTER**

FATHOM

BOSTON SCIENTIFIC SCIMED, INC. (MINNESOTA CORPORATION)
ONE SCIMED PLACE
MAPLE GROVE, MN 55311

THE MARK CONSISTS OF STANDARD CHARACTERS WITHOUT CLAIM TO ANY PARTICULAR FONT, STYLE, SIZE, OR COLOR.

FOR: MEDICAL GUIDEWIRES FOR USE IN PERIPHERAL VASCULATURE, IN CLASS 10 (U.S. CLS. 26, 39 AND 44).

SN 78-638,222, FILED 5-26-2005.

FIRST USE 7-1-2005; IN COMMERCE 7-1-2005.

LANA PHAM, EXAMINING ATTORNEY

Int. Cl.: 42

Prior U.S. Cls.: 100 and 101

United States Patent and Trademark Office

Reg. No. 3,399,539

Registered Mar. 18, 2008

**SERVICE MARK
PRINCIPAL REGISTER**

The Natural Tag

DATAFLOW/ALASKA, INC. (ALASKA CORPORATION)
STE. 3-450
800 E. DIMOND BLVD.
ANCHORAGE, AK 99515

FOR: PROVIDES AUTOMATED ANALYSIS SERVICES VIA NON-DOWNLOADABLE COMPUTER SOFTWARE FOR USE IN THE RECOGNITION OF INDIVIDUAL ANIMALS TO DETERMINE POPULATION LEVELS OF FREE RANGING ANIMALS, IN CLASS 42 (U.S. CLS. 100 AND 101).

FIRST USE 5-3-2005; IN COMMERCE 5-3-2005.

THE MARK CONSISTS OF STANDARD CHARACTERS WITHOUT CLAIM TO ANY PARTICULAR FONT, STYLE, SIZE, OR COLOR.

SN 78-638,249, FILED 5-26-2005.

HOWARD B. LEVINE, EXAMINING ATTORNEY

Int. Cl.: 3

Prior U.S. Cls.: 1, 4, 6, 50, 51, and 52

United States Patent and Trademark Office

Reg. No. 3,399,540

Registered Mar. 18, 2008

**TRADEMARK
PRINCIPAL REGISTER**

CLEAN RUSH

L'OREAL USA CREATIVE, INC. (DELAWARE
CORPORATION)
575 FIFTH AVENUE
NEW YORK, NY 10017

FOR: HAIR CARE PREPARATION, IN CLASS 3
(U.S. CLS. 1, 4, 6, 50, 51 AND 52).

FIRST USE 4-0-2006; IN COMMERCE 4-0-2006.

THE MARK CONSISTS OF STANDARD CHAR-
ACTERS WITHOUT CLAIM TO ANY PARTICULAR
FONT, STYLE, SIZE, OR COLOR.

OWNER OF U.S. REG. NOS. 2,595,884 AND
2,900,869.

SN 78-641,030, FILED 6-1-2005.

JASON ROTH, EXAMINING ATTORNEY

Int. Cl.: 18

Prior U.S. Cls.: 1, 2, 3, 22, and 41

United States Patent and Trademark Office

Reg. No. 3,399,541

Registered Mar. 18, 2008

**TRADEMARK
PRINCIPAL REGISTER**

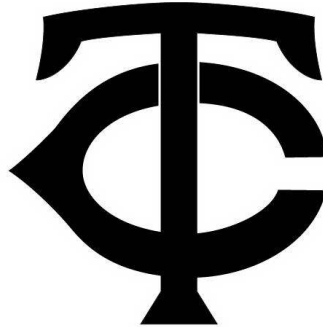

MINNESOTA TWINS, LLC (DELAWARE LTD
LIAB CO)
34 KIRBY PUCKETT PLACE
THE METRODOME
MINNEAPOLIS, MN 55415

FIRST USE 4-0-2005; IN COMMERCE 4-0-2005.

OWNER OF U.S. REG. NOS. 1,210,584 AND
1,535,265.

FOR: ATHLETIC BAGS, OVERNIGHT BAGS,
DUFFEL BAGS, TOTE BAGS, LUNCH TOTES, AT-
TACHÉ CASES, BRIEFCASES, PURSES, WALLETS,
BILLFOLDS, FANNY PACKS, WAIST PACKS, BUSI-
NESS CARD CASES, LUGGAGE TAGS, CARD
CASES, DOG COLLARS, AND DOG LEASHES, IN
CLASS 18 (U.S. CLS. 1, 2, 3, 22 AND 41).

THE MARK CONSISTS OF THE LETTERS "TC" IN
STYLIZED FORM .

SN 78-642,362, FILED 6-2-2005.

DORITT L. CARROLL, EXAMINING ATTORNEY

Int. Cl.: 16

Prior U.S. Cls.: 2, 5, 22, 23, 29, 37, 38, and 50

Reg. No. 3,399,542

United States Patent and Trademark Office

Registered Mar. 18, 2008

**TRADEMARK
PRINCIPAL REGISTER**

Jesse James

VANILLA GORILLA, L.P. (CALIFORNIA LIMITED PARTNERSHIP)
718 ANAHEIM ST.
LONG BEACH, CA 90813

FOR: PAPER OR CARDBOARD ARTICLES AND PRINTED MATTER, NAMELY, POSTERS, COLORING BOOKS, CHILDREN'S STORYBOOKS, LOOSE LEAF BINDERS, SCRAPBOOK ALBUMS, CELLS AND TWO-DIMENSIONAL PRINTS, CARDBOARD, STATIONERY, MOUNTED AND/OR UNMOUNTED PHOTOGRAPHS, COMIC BOOKS, NOTEBOOKS, PENCILS, STICKERS, ERASERS, PENCIL SHARP-

ENERS, PENCIL CASES, STAPLERS, WRITING PAPER, ENVELOPES, PAPER WEIGHTS, PAPER COASTERS, PAPER MATS, DRAWING RULERS, TRADING CARDS, IN CLASS 16 (U.S. CLS. 2, 5, 22, 23, 29, 37, 38 AND 50).

FIRST USE 5-31-2004; IN COMMERCE 5-31-2004.

SN 78-645,802, FILED 6-7-2005.

ALLISON HOLTZ, EXAMINING ATTORNEY

Int. Cls.: 9 and 35

Prior U.S. Cls.: 21, 23, 26, 36, 38, 100, 101, and 102

United States Patent and Trademark Office

Reg. No. 3,399,543

Registered Mar. 18, 2008

**TRADEMARK
SERVICE MARK
PRINCIPAL REGISTER**

ORGANIZATIONSCAN

MONITOR COMPANY GROUP LIMITED PART-
NERSHIP (DELAWARE PARTNERSHIP)
TWO CANAL PARK
CAMBRIDGE, MA 02141

FOR: COMPUTER SOFTWARE FOR DATA ANA-
LYSIS IN THE FIELD OF BUSINESS MANAGE-
MENT AND CONSULTING , IN CLASS 9 (U.S. CLS.
21, 23, 26, 36 AND 38).

FIRST USE 0-0-1995; IN COMMERCE 0-0-1995.

FOR: BUSINESS MANAGEMENT CONSULTING
SERVICES, IN CLASS 35 (U.S. CLS. 100, 101 AND 102).

FIRST USE 6-7-2005; IN COMMERCE 6-7-2005.

THE MARK CONSISTS OF STANDARD CHAR-
ACTERS WITHOUT CLAIM TO ANY PARTICULAR
FONT, STYLE, SIZE, OR COLOR.

SN 78-646,009, FILED 6-8-2005.

ELISSA GARBER KON, EXAMINING ATTORNEY

Int. Cl.: 16

Prior U.S. Cls.: 2, 5, 22, 23, 29, 37, 38, and 50

United States Patent and Trademark Office

Reg. No. 3,399,544

Registered Mar. 18, 2008

**TRADEMARK
PRINCIPAL REGISTER**

GREEN STONE OF HEALING

TALMADGE, CANDACE L. (UNITED STATES
INDIVIDUAL)
907 SYCAMORE LANE
LANCASTER, TX 751461451

THE MARK CONSISTS OF STANDARD CHAR-
ACTERS WITHOUT CLAIM TO ANY PARTICULAR
FONT, STYLE, SIZE, OR COLOR.

FOR: SERIES OF FICTION BOOKS, IN CLASS 16
(U.S. CLS. 2, 5, 22, 23, 29, 37, 38 AND 50).

SN 78-649,598, FILED 6-13-2005.

FIRST USE 3-25-2005; IN COMMERCE 3-25-2005.

JILL C. ALT, EXAMINING ATTORNEY

Int. Cls.: 25 and 26

Prior U.S. Cls.: 22, 37, 39, 40, 42, and 50

United States Patent and Trademark Office

Reg. No. 3,399,545

Registered Mar. 18, 2008

**TRADEMARK
PRINCIPAL REGISTER**

NIGHT TERRORZ

NIGHT TERRORZ INC. (NEW YORK CORPORATION)
88-25 GETTYSBURG STREET
BELLEROSE, NY 11426

FOR: CLOTHING, NAMELY, CAPS, JACKETS, JEANS, JERSEYS, PAJAMAS, PANTS, T-SHIRTS AND UNDERWEAR, IN CLASS 25 (U.S. CLS. 22 AND 39).

FIRST USE 12-20-2006; IN COMMERCE 12-20-2006.

FOR: CLOTH PATCHES FOR CLOTHING, IN CLASS 26 (U.S. CLS. 37, 39, 40, 42 AND 50).

FIRST USE 12-20-2006; IN COMMERCE 12-20-2006.

THE MARK CONSISTS OF STANDARD CHARACTERS WITHOUT CLAIM TO ANY PARTICULAR FONT, STYLE, SIZE, OR COLOR.

SN 78-651,907, FILED 6-16-2005.

MATTHEW PAPPAS, EXAMINING ATTORNEY

Int. Cl.: 30

Prior U.S. Cl.: 46

United States Patent and Trademark Office

Reg. No. 3,399,546

Registered Mar. 18, 2008

**TRADEMARK
PRINCIPAL REGISTER**

JUMBUCKS

AUSSIE FRANCHISING LLC (DELAWARE LTD
LIAB CO)
THE NAAMAN'S BUILDING, SUITE 206
3501 SILVERSIDE ROAD
WILMINGTON, DE 19810

THE MARK CONSISTS OF STANDARD CHAR-
ACTERS WITHOUT CLAIM TO ANY PARTICULAR
FONT, STYLE, SIZE, OR COLOR.

FOR: PIES WITH VARIOUS FILLINGS, IN CLASS
30 (U.S. CL. 46).

SN 78-652,290, FILED 6-16-2005.

FIRST USE 8-1-2003; IN COMMERCE 6-1-2006.

THEODORE MCBRIDE, EXAMINING ATTORNEY

Int. Cl.: 25

Prior U.S. Cls.: 22 and 39

United States Patent and Trademark Office

Reg. No. 3,399,547

Registered Mar. 18, 2008

**TRADEMARK
PRINCIPAL REGISTER**

SALUS

YU, BRYAN (UNITED STATES INDIVIDUAL)
2301 E. 55TH ST.
VERNON, CA 90058

FOR: CLOTHING, NAMELY, SHIRTS, PANTS,
SHORTS, TANK TOPS, BLOUSES, COATS, JACK-
ETS, SWEATSHIRTS, SWEATPANTS, SMOCKS,
OVERALLS, DRESSES, AND T-SHIRTS, IN CLASS
25 (U.S. CLS. 22 AND 39).

FIRST USE 1-1-2006; IN COMMERCE 1-1-2006.

THE MARK CONSISTS OF STANDARD CHAR-
ACTERS WITHOUT CLAIM TO ANY PARTICULAR
FONT, STYLE, SIZE, OR COLOR.

THE FOREIGN WORDING IN THE MARK
TRANSLATES INTO ENGLISH AS SAFETY, HELP
OR ASSISTANCE, HEALTH, WELLNESS.

SN 78-654,144, FILED 6-20-2005.

KELLEY WELLS, EXAMINING ATTORNEY

Int. Cl.: 35

Prior U.S. Cls.: 100, 101, and 102

United States Patent and Trademark Office

Reg. No. 3,399,548

Registered Mar. 18, 2008

**SERVICE MARK
PRINCIPAL REGISTER**

AUTHORCONNECT

AUTHORCONNECT (CALIFORNIA PARTNER-
SHIP)
833 BANCROFT WAY
BERKELEY, CA 94710

FOR: ONLINE ADVERTISING AND PROMO-
TIONAL SERVICES FOR AUTHORS, PUBLISHERS,
AND OTHERS WHO PROVIDE WRITING-RELA-
TED SERVICES; ONLINE RETAIL SERVICES FEAT-
URING BOOKS; AND ONLINE DATABASE
MANAGEMENT SERVICES, IN CLASS 35 (U.S.
CLS. 100, 101 AND 102).

FIRST USE 11-0-2006; IN COMMERCE 11-0-2006.

THE MARK CONSISTS OF STANDARD CHAR-
ACTERS WITHOUT CLAIM TO ANY PARTICULAR
FONT, STYLE, SIZE, OR COLOR.

SN 78-656,148, FILED 6-22-2005.

ELLEN B. AWRICH, EXAMINING ATTORNEY

Int. Cl.: 4

Prior U.S. Cls.: 1, 6, and 15

United States Patent and Trademark Office

Reg. No. 3,399,549

Registered Mar. 18, 2008

**TRADEMARK
PRINCIPAL REGISTER**

CREOSOTE SWEEPING LOG

CHIMNEY SWEEPING LOG, LLC (NEVADA
LIMITED LIABILITY CORPORATION)
SUITE 170-A
3763 HOWARD HUGHES PARKWAY
LAS VEGAS, NV 89109

FOR: CHEMICALLY TREATED FIREPLACE LOG
USED IN FIREPLACES AND WOODSTOVES, IN
CLASS 4 (U.S. CLS. 1, 6 AND 15).

FIRST USE 6-1-2005; IN COMMERCE 9-1-2005.

THE MARK CONSISTS OF STANDARD CHAR-
ACTERS WITHOUT CLAIM TO ANY PARTICULAR
FONT, STYLE, SIZE, OR COLOR.

OWNER OF U.S. REG. NO. 2,798,087.

NO CLAIM IS MADE TO THE EXCLUSIVE
RIGHT TO USE "CREOSOTE" AND "LOG", APART
FROM THE MARK AS SHOWN.

SN 78-656,466, FILED 6-22-2005.

WOODROW HARTZOG, EXAMINING ATTORNEY

Int. Cl.: 35

Prior U.S. Cls.: 100, 101, and 102

United States Patent and Trademark Office

Reg. No. 3,399,550

Registered Mar. 18, 2008

**SERVICE MARK
PRINCIPAL REGISTER**

Sleep Remedies

MATTRESS FIRM, INC. (DELAWARE CORPORATION), DBA MATTRESS FIRM,
5815 GULF FREEWAY
HOUSTON, TX 77023

NO CLAIM IS MADE TO THE EXCLUSIVE
RIGHT TO USE "SLEEP", APART FROM THE
MARK AS SHOWN.

FOR: RETAIL STORE SERVICES FEATURING
SLEEP PRODUCTS, IN CLASS 35 (U.S. CLS. 100, 101
AND 102).

SN 78-656,811, FILED 6-23-2005.

FIRST USE 12-8-2007; IN COMMERCE 12-8-2007.

DAWN HAN, EXAMINING ATTORNEY

Int. Cl.: 9

Prior U.S. Cls.: 21, 23, 26, 36, and 38

Reg. No. 3,399,551

United States Patent and Trademark Office

Registered Mar. 18, 2008

**TRADEMARK
PRINCIPAL REGISTER**

THE ULTIMATE EVERYWEAR LENS

INSIGHT EQUITY A.P.X., LP (TEXAS LIMITED
PARTNERSHIP), DBA VISION-EASE LENS,
SUITE 250
1400 CIVIC PLACE
SOUTHLAKE, TX 76092

FOR: OPHTHALMIC LENSES FOR EYEGLASSES,
IN CLASS 9 (U.S. CLS. 21, 23, 26, 36 AND 38).

FIRST USE 12-0-2005; IN COMMERCE 12-0-2005.

THE MARK CONSISTS OF STANDARD CHAR-
ACTERS WITHOUT CLAIM TO ANY PARTICULAR
FONT, STYLE, SIZE, OR COLOR.

NO CLAIM IS MADE TO THE EXCLUSIVE
RIGHT TO USE "ULTIMATE" AND "LENS", APART
FROM THE MARK AS SHOWN.

SN 78-657,288, FILED 6-23-2005.

JEFFERY COWARD, EXAMINING ATTORNEY

Int. Cl.: 24

Prior U.S. Cls.: 42 and 50

United States Patent and Trademark Office

Reg. No. 3,399,552

Registered Mar. 18, 2008

TRADEMARK
PRINCIPAL REGISTER

DESIGN BY THE
P i e c e

FABRIC EDITIONS LLC (SOUTH CAROLINA LTD LIAB CO), AKA FE ACQUISITION LLC, 7025 AUGUSTA ROAD GREENVILLE, SC 29605

FOR: PRE-CUT FABRICS; FABRIC PATCHWORK PIECES AND QUILT AND CRAFT KITS COMPRISED OF FABRIC PATCHWORK PIECES, IN CLASS 24 (U.S. CLS. 42 AND 50).

FIRST USE 8-31-2005; IN COMMERCE 8-31-2005.

THE COLOR GRAY IS INTENDED TO INDICATE SHADING ONLY.

THE MARK CONSISTS OF THE PHRASE "DESIGN BY THE" PLACED OVER THE WORD "PIECE". THE LETTERS IN THE PHRASE "DESIGN BY THE" ARE STYLIZED IN A SLIGHTLY CURLY FONT. THE LETTERS "P", "I", "E", "C" AND "E", IN THE WORD "PIECE", ARE SEPARATED FROM ONE ANOTHER, WITH EACH LETTER PLACED INSIDE A POLYGON. THE DASHED BORDER SURROUNDING THE LETTERS "P", "I", "E", "C", AND "E", ARE A FEATURE OF THE MARK.

SN 78-657,583, FILED 6-24-2005.

DOMINIC FATHY, EXAMINING ATTORNEY

Int. Cl.: 28

Prior U.S. Cls.: 22, 23, 38, and 50

United States Patent and Trademark Office

Reg. No. 3,399,553

Registered Mar. 18, 2008

**TRADEMARK
PRINCIPAL REGISTER**

DYNASTY PLUS

HILLERICH & BRADSBY CO. (KENTUCKY CORPORATION)
800 WEST MAIN STREET
LOUISVILLE, KY 40202

FOR: GOLF CLUBS, IN CLASS 28 (U.S. CLS. 22, 23, 38 AND 50).

FIRST USE 11-27-2007; IN COMMERCE 11-27-2007.

THE MARK CONSISTS OF STANDARD CHARACTERS WITHOUT CLAIM TO ANY PARTICULAR FONT, STYLE, SIZE, OR COLOR.

OWNER OF U.S. REG. NOS. 1,110,611 AND 2,725,773.

SN 78-657,703, FILED 6-24-2005.

EVELYN BRADLEY, EXAMINING ATTORNEY

Int. Cl.: 21

Prior U.S. Cls.: 2, 13, 23, 29, 30, 33, 40, and 50

United States Patent and Trademark Office

Reg. No. 3,399,554

Registered Mar. 18, 2008

**TRADEMARK
PRINCIPAL REGISTER**

WELL EQUIPPED KITCHEN

THE TJX COMPANIES, INC. (DELAWARE CORPORATION)
770 COCHITUATE ROAD
FRAMINGHAM, MA 01701

FOR: STEMWARE, NAMELY, GOBLETS, WINE GLASSES, CHAMPAGNE FLUTES, CORDIAL GLASSES, COCKTAIL GLASSES, MARTINI GLASSES, AND MARGARITA GLASSES; DINNERWARE, NAMELY, DINNER PLATES, SALAD PLATES, SOUP BOWLS, AND CEREAL BOWLS; SERVEWARE, NAMELY, DIVIDED PLATES, SERVING PLATTERS, CHIP AND DIP PLATTERS, SERVING BOWLS, AND PITCHERS; CANDLE STICKS MADE OF CRYSTAL OR GLASS; AND VASES MADE OF CRYSTAL OR GLASS, IN CLASS 21 (U.S. CLS. 2, 13, 23, 29, 30, 33, 40 AND 50).

FIRST USE 11-8-2007; IN COMMERCE 11-8-2007.

THE MARK CONSISTS OF STANDARD CHARACTERS WITHOUT CLAIM TO ANY PARTICULAR FONT, STYLE, SIZE, OR COLOR.

OWNER OF U.S. REG. NOS. 2,608,231 AND 2,667,058.

NO CLAIM IS MADE TO THE EXCLUSIVE RIGHT TO USE "KITCHEN", APART FROM THE MARK AS SHOWN.

SN 78-657,867, FILED 6-24-2005.

DAVID H. STINE, EXAMINING ATTORNEY

Int. Cl.: 25

Prior U.S. Cls.: 22 and 39

United States Patent and Trademark Office

Reg. No. 3,399,555

Registered Mar. 18, 2008

**TRADEMARK
PRINCIPAL REGISTER**

Kokeshi Ink

LEE, SACHIHO (JAPAN INDIVIDUAL)
24421 MADISON ST.
TORRANCE, CA 90505

FOR: T-SHIRTS, DRESSES, SKIRTS, BLOUSES,
PANTS, SHOES, HATS, HEADGEAR, NAMELY,
CAPS, JACKETS, SWEATERS, KNIT SHIRTS, WO-
VEN SWEATERS, COATS, HOSIERY, UNDER-
WEAR, TANK TOPS, HALTER TOPS, SLEEPWEAR,
HOODED SWEATSHIRTS, SWEATSHIRTS, IN
CLASS 25 (U.S. CLS. 22 AND 39).

FIRST USE 3-1-2007; IN COMMERCE 3-1-2007.

THE MARK CONSISTS OF STANDARD CHAR-
ACTERS WITHOUT CLAIM TO ANY PARTICULAR
FONT, STYLE, SIZE, OR COLOR.

NO CLAIM IS MADE TO THE EXCLUSIVE
RIGHT TO USE "KOKESHI", APART FROM THE
MARK AS SHOWN.

THE WORD "KOKESHI" IN THE MARK TRANS-
LATES INTO ENGLISH AS JAPANESE WOODEN
DOLL.

SN 78-658,248, FILED 6-24-2005.

CHARLOTTE CORWIN, EXAMINING ATTORNEY

Int. Cl.: 25

Prior U.S. Cls.: 22 and 39

United States Patent and Trademark Office

Reg. No. 3,399,556

Registered Mar. 18, 2008

**TRADEMARK
PRINCIPAL REGISTER**

NANOPORA

KOLON GLOTECH, INC. (REPUBLIC OF KOREA CORPORATION)
KOLON TOWER, 1-23, BYULYANG-DONG
KWACHEON-CITY, KYUNGGI-DO, REPUBLIC OF KOREA 427-040

FOR: STOCKINGS, SHOES, SHIRTS, OVER-COATS, JACKETS, UNDERCLOTHING, WATER-PROOF CLOTHING, NAMELY, JACKETS, COATS, HATS, CAPS, SLICKERS, PANTS, SHORTS, SHIRTS, T-SHIRTS, AND SWEATSHIRTS, BATHING SUITS, DRESSING GOWNS, READY-MADE CLOTHING, NAMELY, JACKETS, COATS, HATS, CAPS, SLICKERS, PANTS, SHORTS, SHIRTS, T-SHIRTS, AND SWEATSHIRTS, OUTER CLOTHING, NAMELY,

JACKETS, COATS, HATS, CAPS, SLICKERS, PANTS, SHORTS, SHIRTS, T-SHIRTS, AND SWEATSHIRTS, IN CLASS 25 (U.S. CLS. 22 AND 39).

FIRST USE 9-1-2006; IN COMMERCE 8-1-2007.

THE MARK CONSISTS OF STANDARD CHARACTERS WITHOUT CLAIM TO ANY PARTICULAR FONT, STYLE, SIZE, OR COLOR.

SN 78-659,534, FILED 6-28-2005.

CAROLYN CATALDO, EXAMINING ATTORNEY

Int. Cl.: 24

Prior U.S. Cls.: 42 and 50

United States Patent and Trademark Office

Reg. No. 3,399,557

Registered Mar. 18, 2008

**TRADEMARK
PRINCIPAL REGISTER**

NANOPORA

KOLON GLOTECH, INC. (REPUBLIC OF KOREA CORPORATION)
KOLON TOWER, 1-23, BYULYANG-DONG
KWACHEON-CITY, KYUNGGI-DO, REPUBLIC OF KOREA 427-040

FOR: COTTON FABRICS, NON-WOVEN TEXTILE FABRICS FOR USE IN THE MANUFACTURE OF CLOTHING; COATED FABRICS WITH RESINS SUCH AS POLYURETHANE, NYLON, POLYESTER, ACRYL FOR USE IN THE MANUFACTURE OF CLOTHING; AND ACETATE FABRICS OR COMBINATIONS THEREOF FOR USE IN THE MANUFACTURE OF CLOTHING; LAMINATED FABRICS WITH RESIN SUCH AS POLYURETHANE, WATER

PROOFING FABRIC, KNITTED FABRICS, FOR USE IN THE MANUFACTURE OF CLOTHING, IN CLASS 24 (U.S. CLS. 42 AND 50).

FIRST USE 9-1-2006; IN COMMERCE 8-1-2007.

THE MARK CONSISTS OF STANDARD CHARACTERS WITHOUT CLAIM TO ANY PARTICULAR FONT, STYLE, SIZE, OR COLOR.

SN 78-659,536, FILED 6-28-2005.

CAROLYN CATALDO, EXAMINING ATTORNEY

Int. Cl.: 7

Prior U.S. Cls.: 13, 19, 21, 23, 31, 34, and 35

Reg. No. 3,399,558

United States Patent and Trademark Office

Registered Mar. 18, 2008

**TRADEMARK
PRINCIPAL REGISTER**

STARGATE

STOWE WOODWARD COMPANY LLC (DELA-
WARE LTD LIAB CO)
14101 CAPITAL BLVD.
YOUNGSVILLE, NC 27596

FOR: MACHINE PARTS, NAMELY, POLYMERIC
COVERS FOR SUPERCALNDAR ROLLS AND
OTHER INDUSTRIAL ROLLS FOR USE, FOR EX-
AMPLE, IN THE PAPERMAKING AND PRINT
INDUSTRIES , IN CLASS 7 (U.S. CLS. 13, 19, 21, 23,
31, 34 AND 35).

FIRST USE 2-3-2006; IN COMMERCE 2-3-2006.

THE MARK CONSISTS OF STANDARD CHAR-
ACTERS WITHOUT CLAIM TO ANY PARTICULAR
FONT, STYLE, SIZE, OR COLOR.

SN 78-660,695, FILED 6-29-2005.

ELLEN B. AWRICH, EXAMINING ATTORNEY

Int. Cl.: 1

Prior U.S. Cls.: 1, 5, 6, 10, 26, and 46

United States Patent and Trademark Office

Reg. No. 3,399,559

Registered Mar. 18, 2008

**TRADEMARK
PRINCIPAL REGISTER**

Chicks' Mix

D & S FARMS (NEW JERSEY LIMITED LIABILITY PARTNERSHIP)
230 BUCK ROAD
PITTSBORO, NJ 08318

THE MARK CONSISTS OF STANDARD CHARACTERS WITHOUT CLAIM TO ANY PARTICULAR FONT, STYLE, SIZE, OR COLOR.

FOR: ORGANIC PLANT FOOD, NAMELY, POULTRY MANURE PELLETS, IN CLASS 1 (U.S. CLS. 1, 5, 6, 10, 26 AND 46).

SN 78-660,955, FILED 6-29-2005.

FIRST USE 1-27-2007; IN COMMERCE 1-27-2007.

CAROL SPILS, EXAMINING ATTORNEY

Int. Cl.: 41

Prior U.S. Cls.: 100, 101, and 107

United States Patent and Trademark Office

Reg. No. 3,399,560

Registered Mar. 18, 2008

SERVICE MARK
PRINCIPAL REGISTER



SKYWALKER
SOUND

LUCASFILM LTD. (CALIFORNIA CORPORATION)
PO BOX 29901
SAN FRANCISCO, CA 94129

FOR: AUDIO SERVICES, NAMELY, SOUND DESIGN, SOUND EDITING, SOUND RECORDING, SOUND MIXING, PRODUCTION OF SOUND EFFECTS FOR MOTION PICTURES, TELEVISION, VIDEO, TRAILERS, COMPUTER GAMES, VIDEO GAMES, COMMERCIALS, WEBSITES AND THEME RIDES; RENTAL OF STAGES, STUDIOS AND EQUIPMENT FOR SOUND DESIGN, EDITING, RECORDING, MIXING AND SOUND EFFECT PRODUCTION; TECHNICAL CONSULTING RELATING TO AUDIO SERVICES, NAMELY, SOUND DESIGN, EDITING, RECORDING, MIXING AND PRODUCTION OF SOUND EFFECTS IN MOTION PICTURES, TV, VIDEO, TRAILERS, COMPUTER GAMES, VIDEO GAMES, COMMERCIALS, WEBSITES AND

THEME RIDES, IN CLASS 41 (U.S. CLS. 100, 101 AND 107).

FIRST USE 6-12-2005; IN COMMERCE 6-12-2005.

OWNER OF U.S. REG. NOS. 2,621,715 AND 2,729,615.

NO CLAIM IS MADE TO THE EXCLUSIVE RIGHT TO USE "SOUND", APART FROM THE MARK AS SHOWN.

THE MARK CONSISTS OF THE WORDS "SKYWALKER SOUND" WITH THE DESIGN OF A BIRD IN A CIRCLE.

SN 78-662,707, FILED 7-1-2005.

CYNTHIA SLOAN, EXAMINING ATTORNEY

Int. Cl.: 32

Prior U.S. Cls.: 45, 46, and 48

United States Patent and Trademark Office

Reg. No. 3,399,561

Registered Mar. 18, 2008

**TRADEMARK
PRINCIPAL REGISTER**

WILD OLIVE

COASTAL PROMOTIONS, INC. (FLORIDA CORPORATION)
8828 MARLAMOR LANE
WEST PALM BEACH, FL 33412

THE MARK CONSISTS OF STANDARD CHARACTERS WITHOUT CLAIM TO ANY PARTICULAR FONT, STYLE, SIZE, OR COLOR.

FOR: NON-ALCOHOLIC FRUIT FLAVORED COCKTAIL MIXES EXCLUDING MIXES FOR DIRTY MARTINIS, IN CLASS 32 (U.S. CLS. 45, 46 AND 48).

SN 78-663,914, FILED 7-5-2005.

FIRST USE 11-11-2005; IN COMMERCE 11-11-2005.

PAUL F. GAST, EXAMINING ATTORNEY

Int. Cl.: 28

Prior U.S. Cls.: 22, 23, 38, and 50

United States Patent and Trademark Office

Reg. No. 3,399,562

Registered Mar. 18, 2008

**TRADEMARK
PRINCIPAL REGISTER**

PJ PARTY

MATTEL, INC. (DELAWARE CORPORATION)
M1-1518
333 CONTINENTAL BLVD.
EL SEGUNDO, CA 902455012

THE MARK CONSISTS OF STANDARD CHARACTERS WITHOUT CLAIM TO ANY PARTICULAR FONT, STYLE, SIZE, OR COLOR.

FOR: TOYS, GAMES AND PLAYTHINGS, NAME-
LY, DOLLS, DOLL CLOTHING AND DOLL ACCES-
SORIES, IN CLASS 28 (U.S. CLS. 22, 23, 38 AND 50).

SN 78-664,311, FILED 7-6-2005.

FIRST USE 12-4-2007; IN COMMERCE 12-4-2007.

GEOFFREY FOSDICK, EXAMINING ATTORNEY

Int. Cl.: 8

Prior U.S. Cls.: 23, 28, and 44

United States Patent and Trademark Office

Reg. No. 3,399,563

Registered Mar. 18, 2008

**TRADEMARK
PRINCIPAL REGISTER**

**KEEPING OUR COUNTRY CLEAN
ONE PILE AT A TIME**

KOLLER ENTERPRISES, INC. (MISSOURI CORPORATION)
1400 SOUTH OLD HIGHWAY 141
P.O. BOX 718
FENTON, MO 63026

THE MARK CONSISTS OF STANDARD CHARACTERS WITHOUT CLAIM TO ANY PARTICULAR FONT, STYLE, SIZE, OR COLOR.

FOR: RAKES AND GRABBERS, NAMELY, CLAW TONGS FOR COLLECTING AND DISPOSING OF PET WASTE, IN CLASS 8 (U.S. CLS. 23, 28 AND 44).

SN 78-664,455, FILED 7-6-2005.

FIRST USE 3-0-2006; IN COMMERCE 3-0-2006.

RENEE SERVANCE, EXAMINING ATTORNEY

Int. Cl.: 30

Prior U.S. Cl.: 46

United States Patent and Trademark Office

Reg. No. 3,399,564

Registered Mar. 18, 2008

**TRADEMARK
PRINCIPAL REGISTER**



DEHART, GREGORY M. (UNITED STATES IN-
DIVIDUAL)
15229 ISLA VISTA RD.
JAMUL, CA 91935

FIRST USE 7-6-2005; IN COMMERCE 7-6-2005.

SN 78-664,607, FILED 7-6-2005.

FOR: COFFEE, IN CLASS 30 (U.S. CL. 46).

DAVID MURRAY, EXAMINING ATTORNEY

Int. Cl.: 35

Prior U.S. Cls.: 100, 101, and 102

United States Patent and Trademark Office

Reg. No. 3,399,565

Registered Mar. 18, 2008

**SERVICE MARK
PRINCIPAL REGISTER**

GOAUTO.COM

ELECTRONIC CREATIONS CORP. (COLORADO
CORPORATION)
P.O. BOX 1379
SANTA ROSA, CA 95402

FOR: COMPUTER SERVICES, NAMELY OPER-
ATING A MARKETPLACE ON A GLOBAL COMPU-
TER NETWORK FOR BUYERS AND SELLERS OF
AUTOMOBILES AND OTHER MEANS OF PERSONAL
TRANSPORTATION, IN CLASS 35 (U.S. CLS.
100, 101 AND 102).

FIRST USE 8-15-2006; IN COMMERCE 12-6-2007.

THE MARK CONSISTS OF STANDARD CHAR-
ACTERS WITHOUT CLAIM TO ANY PARTICULAR
FONT, STYLE, SIZE, OR COLOR.

SN 78-665,059, FILED 7-6-2005.

WILLIAM VERHOSEK, EXAMINING ATTORNEY

Int. Cls.: 41 and 42

Prior U.S. Cls.: 100, 101, and 107

United States Patent and Trademark Office

Reg. No. 3,399,566

Registered Mar. 18, 2008

**SERVICE MARK
PRINCIPAL REGISTER**

DGDawg Reels

DGDAWG REELS (CALIFORNIA PARTNER-
SHIP)
5004 TARPAN COURT
ELK GROVE, CA 95757

FOR: PHOTO EDITING, IN CLASS 41 (U.S. CLS.
100, 101 AND 107).

FIRST USE 11-1-2007; IN COMMERCE 11-1-2007.

FOR: DESIGN AND DEVELOPMENT OF MULTI-
MEDIA PRODUCTS , IN CLASS 42 (U.S. CLS. 100
AND 101).

FIRST USE 11-1-2007; IN COMMERCE 11-1-2007.

THE MARK CONSISTS OF STANDARD CHAR-
ACTERS WITHOUT CLAIM TO ANY PARTICULAR
FONT, STYLE, SIZE, OR COLOR.

SN 78-667,374, FILED 7-11-2005.

LESLEY LAMOTHE, EXAMINING ATTORNEY

Int. Cl.: 9

Prior U.S. Cls.: 21, 23, 26, 36, and 38

United States Patent and Trademark Office

Reg. No. 3,399,567

Registered Mar. 18, 2008

**TRADEMARK
PRINCIPAL REGISTER**

SINGULAR

CABOT SAFETY INTERMEDIATE CORPORATION (DELAWARE CORPORATION)
650 DAWSON DRIVE
NEWARK, DE 19713

FOR: RESPIRATORS, NAMELY, SAFETY MASK-STYLE RESPIRATORS, RESPIRATOR FILTERS, RESPIRATOR MASK FILTERS AND CARTRIDGES, AND PARTS THEREOF, FOR FILTERING PARTICULATE MATTER ONLY AND NOT FOR ARTIFICIAL RESPIRATION OR FOR USE WITH THERAPEUTIC RESPIRATION EQUIPMENT OR FOR THE TREATMENT OF RESPIRATORY DIS-

EASES OR DISORDERS, IN CLASS 9 (U.S. CLS. 21, 23, 26, 36 AND 38).

FIRST USE 10-0-2005; IN COMMERCE 10-0-2005.

THE MARK CONSISTS OF STANDARD CHARACTERS WITHOUT CLAIM TO ANY PARTICULAR FONT, STYLE, SIZE, OR COLOR.

SN 78-667,462, FILED 7-11-2005.

KATHRYN COWARD, EXAMINING ATTORNEY

Int. Cl.: 17

Prior U.S. Cls.: 1, 5, 12, 13, 35, and 50

United States Patent and Trademark Office

Reg. No. 3,399,568

Registered Mar. 18, 2008

**TRADEMARK
PRINCIPAL REGISTER**

SUNNY HOSE

TKJ CORPORATION (JAPAN CORPORATION)
4-30 ROPPONGI 1-CHOME, MINATO-KU
TOKYO, JAPAN 106-8510

FOR: NON-METALLIC HOSE PIPES, IN CLASS 17
(U.S. CLS. 1, 5, 12, 13, 35 AND 50).

FIRST USE 0-0-1962; IN COMMERCE 0-0-1998.

THE MARK CONSISTS OF STANDARD CHAR-
ACTERS WITHOUT CLAIM TO ANY PARTICULAR
FONT, STYLE, SIZE, OR COLOR.

NO CLAIM IS MADE TO THE EXCLUSIVE
RIGHT TO USE "HOSE", APART FROM THE MARK
AS SHOWN.

SN 78-668,238, FILED 7-12-2005.

LINDA E. BLOHM, EXAMINING ATTORNEY

Int. Cls.: 16, 18, 21, 25, and 32

**Prior U.S. Cls.: 1, 2, 3, 5, 13, 22, 23, 29, 30, 33, 37, 38,
39, 40, 41, 45, 46, 48, and 50**

Reg. No. 3,399,569

United States Patent and Trademark Office

Registered Mar. 18, 2008

**TRADEMARK
PRINCIPAL REGISTER**

KRAKOOSH

ALTICOR INC. (MICHIGAN CORPORATION)
78-2G
7575 FULTON STREET EAST
ADA, MI 49355

FOR: HEALTH AND FITNESS MAGAZINES AND
CATALOGS AND STICKERS, IN CLASS 16 (U.S. CLS.
2, 5, 22, 23, 29, 37, 38 AND 50).

FIRST USE 10-16-2005; IN COMMERCE 10-15-2005.

FOR: BACKPACKS AND ALL-PURPOSE SPORT
BAGS, IN CLASS 18 (U.S. CLS. 1, 2, 3, 22 AND 41).

FIRST USE 10-16-2005; IN COMMERCE 10-16-2005.

FOR: PLASTIC WATER BOTTLES SOLD EMPTY,
IN CLASS 21 (U.S. CLS. 2, 13, 23, 29, 30, 33, 40 AND 50).

FIRST USE 10-15-2005; IN COMMERCE 10-15-2005.

FOR: CLOTHING, NAMELY, T-SHIRTS, SHIRTS,
SWEAT SUITS; HEADWEAR, IN CLASS 25 (U.S. CLS.
22 AND 39).

FIRST USE 10-16-2005; IN COMMERCE 10-16-2005.

FOR: ENERGY DRINKS, IN CLASS 32 (U.S. CLS.
45, 46 AND 48).

FIRST USE 10-16-2005; IN COMMERCE 10-16-2005.

THE MARK CONSISTS OF STANDARD CHAR-
ACTERS WITHOUT CLAIM TO ANY PARTICULAR
FONT, STYLE, SIZE, OR COLOR.

SN 78-668,336, FILED 7-12-2005.

MICHAEL WIENER, EXAMINING ATTORNEY

Int. Cl.: 16

Prior U.S. Cls.: 2, 5, 22, 23, 29, 37, 38, and 50

Reg. No. 3,399,570

United States Patent and Trademark Office

Registered Mar. 18, 2008

**TRADEMARK
PRINCIPAL REGISTER**



DENVER NUGGETS LIMITED PARTNERSHIP,
THE (DELAWARE LIMITED PARTNERSHIP)
PEPSI CENTER
1000 CHOPPER PLACE
DENVER, CO 80204

FOR: PUBLICATIONS AND PRINTED MATTER, NAMELY BASKETBALL TRADING CARDS, TRADING CARDS, STICKERS, DECALS, COMMEMORATIVE BASKETBALL STAMPS, COLLECTIBLE CARDBOARD TRADING DISCS, MEMO BOARDS, CLIPBOARDS, PAPER COASTERS, POST CARDS, PLACE MATS OF PAPER, FACIAL TISSUES, NOTE CARDS, MEMO PADS, NOTE PADS, BALL POINT PENS, RUBBER BANDS, PENCILS, PEN AND PAPER HOLDERS, DESKTOP DOCUMENT STANDS, SCRAP BOOKS, RUBBER STAMPS, PAPER BANNERS AND FLAGS, BOOKMARKS, 3-RING BINDERS, STATIONERY FOLDERS, WIREBOUND NOTEBOOKS, PORTFOLIO NOTEBOOKS, UNMOUNTED AND MOUNTED PHOTOGRAPHS, POSTERS, CALENDARS, BUMPER STICKERS, BOOK COVERS, WRAPPING PAPER, CHILDREN'S ACTIVITY BOOKS, CHILDREN'S COLORING BOOKS, STATISTICAL BOOKS, GUIDE BOOKS, AND REFERENCE BOOKS IN THE FIELD OF

BASKETBALL, MAGAZINES IN THE FIELD OF BASKETBALL, CATALOGS FEATURING BASKETBALL, COMMEMORATIVE GAME AND SOUVENIR PROGRAMS, PAPER PENNANTS, STATIONERY, STATIONERY-TYPE PORTFOLIOS, INVITATION CARDS, PRINTED CERTIFICATES, GREETING CARDS, CHRISTMAS CARDS, HOLIDAY CARDS, STATISTICAL SHEETS FOR BASKETBALL TOPICS, NEWSLETTERS, BROCHURES, PAMPHLETS, AND GAME SCHEDULES IN THE FIELD OF BASKETBALL, BANK CHECKS, CHECK BOOK COVERS, CHECK BOOK HOLDERS, CREDIT CARDS AND TELEPHONE CALLING CARDS NOT MAGNETICALLY ENCODED, IN CLASS 16 (U.S. CLS. 2, 5, 22, 23, 29, 37, 38 AND 50).

FIRST USE 11-1-2006; IN COMMERCE 11-1-2006.

THE MARK CONSISTS OF TWO CROSSING PICKAXES OVER A BASKETBALL WITH A MOUNTAIN DESIGN ALL INSIDE A CIRCLE.

SN 78-668,801, FILED 7-12-2005.

MICHELE SWAIN, EXAMINING ATTORNEY

Int. Cl.: 28

Prior U.S. Cls.: 22, 23, 38, and 50

United States Patent and Trademark Office

Reg. No. 3,399,571

Registered Mar. 18, 2008

**TRADEMARK
PRINCIPAL REGISTER**

ALL-AMERICAN MUTT COMPANY

VIVIO, LAVERN W. (UNITED STATES INDIVIDUAL)
529 LAWRENCE LANE
SPRINGFIELD, TN 37122

FOR: COMBINATION GAME SETS, NAMELY, COMBINATION GAME SETS MADE OF WOOD FOR CHECKERS, CHESS, BACKGAMMON AND/OR CHINESE CHECKERS; SHUT THE BOX BOARD GAME SETS MADE OF WOOD; AND TOY WOODEN BUILDING BLOCK SETS, IN CLASS 28 (U.S. CLS. 22, 23, 38 AND 50).

FIRST USE 12-1-2007; IN COMMERCE 12-1-2007.

THE MARK CONSISTS OF STANDARD CHARACTERS WITHOUT CLAIM TO ANY PARTICULAR FONT, STYLE, SIZE, OR COLOR.

NO CLAIM IS MADE TO THE EXCLUSIVE RIGHT TO USE "COMPANY", APART FROM THE MARK AS SHOWN.

SN 78-669,146, FILED 7-13-2005.

MARK T. MULLEN, EXAMINING ATTORNEY

Int. Cl.: 3

Prior U.S. Cls.: 1, 4, 6, 50, 51, and 52

United States Patent and Trademark Office

Reg. No. 3,399,572

Registered Mar. 18, 2008

**TRADEMARK
PRINCIPAL REGISTER**

NATURE'S MOISTURE FOR YOUR
HAIR

LABORATOIRE COSMEPRO INC. (CANADA
CORPORATION)

486 TRANS-CANADA

LONGUEUIL, CANADA J4G 1N8

FOR: HAIR SHAMPOO AND HAIR CONDITION-
ER, IN CLASS 3 (U.S. CLS. 1, 4, 6, 50, 51 AND 52).

FIRST USE 4-2-2007; IN COMMERCE 4-2-2007.

THE MARK CONSISTS OF STANDARD CHAR-
ACTERS WITHOUT CLAIM TO ANY PARTICULAR
FONT, STYLE, SIZE, OR COLOR.

NO CLAIM IS MADE TO THE EXCLUSIVE
RIGHT TO USE "HAIR", APART FROM THE MARK
AS SHOWN.

SN 78-671,171, FILED 7-15-2005.

CAROLYN GRAY, EXAMINING ATTORNEY

Int. Cl.: 9

Prior U.S. Cls.: 21, 23, 26, 36, and 38

United States Patent and Trademark Office

Reg. No. 3,399,573

Registered Mar. 18, 2008

**TRADEMARK
PRINCIPAL REGISTER**

SUNRX

INSIGHT EQUITY A.P.X., LP (TEXAS LIMITED
PARTNERSHIP), DBA VISION-EASE LENS,
SUITE 250
1400 CIVIC PLACE
SOUTHLAKE, TX 76092

FOR: OPHTHALMIC LENSES FOR EYEGLASSES,
IN CLASS 9 (U.S. CLS. 21, 23, 26, 36 AND 38).

FIRST USE 8-0-1991; IN COMMERCE 8-0-1991.

THE MARK CONSISTS OF STANDARD CHAR-
ACTERS WITHOUT CLAIM TO ANY PARTICULAR
FONT, STYLE, SIZE, OR COLOR.

OWNER OF U.S. REG. NOS. 1,742,188, 2,569,678,
AND OTHERS.

SN 78-672,507, FILED 7-18-2005.

VERNA BETH RIRIE, EXAMINING ATTORNEY

Int. Cl.: 35

Prior U.S. Cls.: 100, 101, and 102

United States Patent and Trademark Office

Reg. No. 3,399,574

Registered Mar. 18, 2008

**SERVICE MARK
PRINCIPAL REGISTER**

YOUR SLEEP PRESCRIPTION

MATTRESS FIRM, INC. (DELAWARE CORPORATION), DBA MATTRESS FIRM,
5815 GULF FREEWAY
HOUSTON, TX 77023

THE MARK CONSISTS OF STANDARD CHARACTERS WITHOUT CLAIM TO ANY PARTICULAR FONT, STYLE, SIZE, OR COLOR.

FOR: RETAIL STORES FEATURING SLEEP PRODUCTS, IN CLASS 35 (U.S. CLS. 100, 101 AND 102).

SN 78-672,818, FILED 7-18-2005.

FIRST USE 12-2-2007; IN COMMERCE 12-2-2007.

PETER B. BROMAGHIM, EXAMINING ATTORNEY

Int. Cl.: 12

Prior U.S. Cls.: 19, 21, 23, 31, 35, and 44

Reg. No. 3,399,575

United States Patent and Trademark Office

Registered Mar. 18, 2008

**TRADEMARK
PRINCIPAL REGISTER**

FlexRim

BENEFICIAL DESIGNS, INC. (NEVADA CORPORATION)
C/O SULLIVAN LAW OFFICES
NO. 201, 1650 N. LUCERNE
MINDEN, NV 89423

THE MARK CONSISTS OF STANDARD CHARACTERS WITHOUT CLAIM TO ANY PARTICULAR FONT, STYLE, SIZE, OR COLOR.

FOR: WHEELS FOR WHEELCHAIRS, IN CLASS 12 (U.S. CLS. 19, 21, 23, 31, 35 AND 44).

SN 78-673,912, FILED 7-19-2005.

FIRST USE 9-18-2007; IN COMMERCE 9-18-2007.

STEVEN JACKSON, EXAMINING ATTORNEY

Int. Cl.: 11

Prior U.S. Cls.: 13, 21, 23, 31, and 34

United States Patent and Trademark Office

Reg. No. 3,399,576

Registered Mar. 18, 2008

**TRADEMARK
PRINCIPAL REGISTER**

XCELIS

BE AEROSPACE, INC. (DELAWARE CORPORATION)
1400 CORPORATE WAY
WELLINGTON, FL 33414

THE MARK CONSISTS OF STANDARD CHARACTERS WITHOUT CLAIM TO ANY PARTICULAR FONT, STYLE, SIZE, OR COLOR.

FOR: AIRPLANE GALLEY REFRIGERATION EQUIPMENT, NAMELY, FOOD AND BEVERAGE CHILLING UNITS, IN CLASS 11 (U.S. CLS. 13, 21, 23, 31 AND 34).

SN 78-674,695, FILED 7-20-2005.

FIRST USE 11-0-2005; IN COMMERCE 11-0-2005.

RENEE SERVANCE, EXAMINING ATTORNEY

Int. Cl.: 36

Prior U.S. Cls.: 100, 101, and 102

United States Patent and Trademark Office

Reg. No. 3,399,577

Registered Mar. 18, 2008

**SERVICE MARK
PRINCIPAL REGISTER**



FIRST CHOICE MORTGAGE, INC. (WISCONSIN CORPORATION)
SUITE 103
W229 N1433 WESTWOOD DRIVE
WAUKESHA, WI 53186

FOR: MORTGAGE LENDING SERVICES, IN CLASS 36 (U.S. CLS. 100, 101 AND 102).

FIRST USE 1-1-2007; IN COMMERCE 1-1-2007.

NO CLAIM IS MADE TO THE EXCLUSIVE RIGHT TO USE "MORTGAGE", APART FROM THE MARK AS SHOWN.

SN 78-675,097, FILED 7-21-2005.

BARBARA RUTLAND, EXAMINING ATTORNEY

Int. Cls.: 1, 17, and 19

Prior U.S. Cls.: 1, 5, 6, 10, 12, 13, 26, 33, 35, 46, and 50

United States Patent and Trademark Office

Reg. No. 3,399,578

Registered Mar. 18, 2008

**TRADEMARK
PRINCIPAL REGISTER**

KERDI

SCHLUTER-SYSTEMS KG (FED REP GERMANY
LIMITED PARTNERSHIP)
SCHMOLESTRASSE 7
ISERLOHN, FED REP GERMANY D-58640

FOR: ADHESIVES FOR SETTING MORTARS, IN
CLASS 1 (U.S. CLS. 1, 5, 6, 10, 26 AND 46).

FIRST USE 12-31-2005; IN COMMERCE 12-31-2005.

FOR: SETTING MATERIALS COMPRISED OF
CAULKINGS, IN CLASS 17 (U.S. CLS. 1, 5, 12, 13, 35
AND 50).

FIRST USE 12-31-2005; IN COMMERCE 12-31-2005.

FOR: SETTING MATERIALS COMPRISED OF
MORTARS, IN CLASS 19 (U.S. CLS. 1, 12, 33 AND 50).

FIRST USE 12-31-2005; IN COMMERCE 12-31-2005.

THE MARK CONSISTS OF STANDARD CHAR-
ACTERS WITHOUT CLAIM TO ANY PARTICULAR
FONT, STYLE, SIZE, OR COLOR.

OWNER OF U.S. REG. NO. 1,645,259.

SN 78-675,231, FILED 7-21-2005.

JULIE WATSON, EXAMINING ATTORNEY

Int. Cl.: 28

Prior U.S. Cls.: 22, 23, 38, and 50

United States Patent and Trademark Office

Reg. No. 3,399,579

Registered Mar. 18, 2008

**TRADEMARK
PRINCIPAL REGISTER**

TS1

TRUE FITNESS TECHNOLOGY, INC. (MISSOURI CORPORATION)
865 HOFF ROAD
O'FALLON, MO 63366

FOR: EXERCISE EQUIPMENT, NAMELY, TREADMILLS, ELLIPTICAL TRAINERS, STATIONARY CYCLES, WEIGHT LIFTING AND STRENGTH MACHINES, AND MULTIPURPOSE STRETCHING APPARATUS TO ENHANCE FLEXIBILITY AND TO EXERCISE, REHABILITATE AND IMPROVE PERFORMANCE OF SPECIFIC BODY MOVEMENTS

AND ACTIVITIES, IN CLASS 28 (U.S. CLS. 22, 23, 38 AND 50).

FIRST USE 5-0-2006; IN COMMERCE 5-0-2006.

THE MARK CONSISTS OF STANDARD CHARACTERS WITHOUT CLAIM TO ANY PARTICULAR FONT, STYLE, SIZE, OR COLOR.

SN 78-675,335, FILED 7-21-2005.

REBECCA EISINGER, EXAMINING ATTORNEY

Int. Cl.: 33

Prior U.S. Cls.: 47 and 49

United States Patent and Trademark Office

Reg. No. 3,399,580

Registered Mar. 18, 2008

**TRADEMARK
PRINCIPAL REGISTER**

PETIT BISTRO

PALM BAY IMPORTS, INC. (FLORIDA CORPORATION)

48 HARBOR PARK DRIVE

PORT WASHINGTON, NY 11050

FOR: ALCOHOLIC BEVERAGES, NAMELY, WINE, IN CLASS 33 (U.S. CLS. 47 AND 49).

FIRST USE 5-17-2006; IN COMMERCE 5-17-2006.

THE MARK CONSISTS OF STANDARD CHARACTERS WITHOUT CLAIM TO ANY PARTICULAR FONT, STYLE, SIZE, OR COLOR.

THE ENGLISH TRANSLATION OF THE WORDING "PETIT BISTRO" IN THE MARK IS SMALL CAFÉ.

SN 78-676,552, FILED 7-22-2005.

MICHELE SWAIN, EXAMINING ATTORNEY

Int. Cl.: 16

Prior U.S. Cls.: 2, 5, 22, 23, 29, 37, 38, and 50

United States Patent and Trademark Office

Reg. No. 3,399,581

Registered Mar. 18, 2008

**TRADEMARK
PRINCIPAL REGISTER**

THE KOREA HERALD

HERALD MEDIA INC. (REPUBLIC OF KOREA
CORPORATION)

JUNG-GU

1-12, 3-GA, HOEHYEON-DONG

SEOUL, REPUBLIC OF KOREA -

FOR: NEWSPAPERS, IN CLASS 16 (U.S. CLS. 2, 5,
22, 23, 29, 37, 38 AND 50).

FIRST USE 8-15-1965; IN COMMERCE 9-14-2007.

THE MARK CONSISTS OF STANDARD CHAR-
ACTERS WITHOUT CLAIM TO ANY PARTICULAR
FONT, STYLE, SIZE, OR COLOR.

NO CLAIM IS MADE TO THE EXCLUSIVE
RIGHT TO USE "KOREA", APART FROM THE
MARK AS SHOWN.

SN 78-678,735, FILED 7-26-2005.

BRENDAN MCCAULEY, EXAMINING ATTORNEY

Int. Cls.: 9 and 16

Prior U.S. Cls.: 2, 5, 21, 22, 23, 26, 29, 36, 37, 38, and 50

United States Patent and Trademark Office

Reg. No. 3,399,582

Registered Mar. 18, 2008

**TRADEMARK
PRINCIPAL REGISTER**

STIX FONTS

THE INSTITUTE OF ELECTRICAL AND ELECTRONICS ENGINEERS, INC. (NEW YORK CORPORATION)
445 HOES LANE
PISCATAWAY, NJ 08855

FOR: PRINTING FONTS THAT CAN BE DOWNLOADED PROVIDED BY MEANS OF ELECTRONIC TRANSMISSION, IN CLASS 9 (U.S. CLS. 21, 23, 26, 36 AND 38).

FIRST USE 10-31-2007; IN COMMERCE 10-31-2007.

FOR: PRINTING FONTS, IN CLASS 16 (U.S. CLS. 2, 5, 22, 23, 29, 37, 38 AND 50).

FIRST USE 10-31-2007; IN COMMERCE 10-31-2007.

THE MARK CONSISTS OF STANDARD CHARACTERS WITHOUT CLAIM TO ANY PARTICULAR FONT, STYLE, SIZE, OR COLOR.

NO CLAIM IS MADE TO THE EXCLUSIVE RIGHT TO USE "FONTS", APART FROM THE MARK AS SHOWN.

SN 78-678,931, FILED 7-26-2005.

LEE-ANNE BERNS, EXAMINING ATTORNEY

Int. Cl.: 11

Prior U.S. Cls.: 13, 21, 23, 31, and 34

United States Patent and Trademark Office

Reg. No. 3,399,583

Registered Mar. 18, 2008

**TRADEMARK
PRINCIPAL REGISTER**

CIRRUS COOLING

METAL FORM MANUFACTURING COMPANY
(ARIZONA CORPORATION)
5960 WEST WASHINGTON
PHOENIX, AZ 85043

FOR: HEATING, VENTILATION AND AIR CONDITIONING EQUIPMENT, NAMELY, EVAPORATIVE COOLERS, VENTILATING FANS, AIR DUCTS AND PLENUMS, AIR FLOW SILENCERS, EVAPORATIVE COOLING PADS, AND AIR CONDITIONERS FOR COMMERCIAL AND HOUSEHOLD USE, IN CLASS 11 (U.S. CLS. 13, 21, 23, 31 AND 34).

FIRST USE 12-31-2005; IN COMMERCE 12-31-2005.

THE MARK CONSISTS OF STANDARD CHARACTERS WITHOUT CLAIM TO ANY PARTICULAR FONT, STYLE, SIZE, OR COLOR.

NO CLAIM IS MADE TO THE EXCLUSIVE RIGHT TO USE "COOLING", APART FROM THE MARK AS SHOWN.

SN 78-679,932, FILED 7-27-2005.

TAMARA FRAZIER, EXAMINING ATTORNEY

Int. Cl.: 35

Prior U.S. Cls.: 100, 101, and 102

United States Patent and Trademark Office

Reg. No. 3,399,584

Registered Mar. 18, 2008

**SERVICE MARK
PRINCIPAL REGISTER**

**REMEDIES FOR A GREAT
NIGHT'S SLEEP**

MATTRESS FIRM, INC. (DELAWARE CORPORATION), DBA MATTRESS FIRM,
5815 GULF FREEWAY
HOUSTON, TX 77023

THE MARK CONSISTS OF STANDARD CHARACTERS WITHOUT CLAIM TO ANY PARTICULAR FONT, STYLE, SIZE, OR COLOR.

FOR: RETAIL STORES FEATURING SLEEP PRODUCTS, IN CLASS 35 (U.S. CLS. 100, 101 AND 102).

SN 78-680,446, FILED 7-28-2005.

FIRST USE 11-24-2007; IN COMMERCE 11-24-2007.

PETER B. BROMAGHIM, EXAMINING ATTORNEY

Int. Cl.: 1

Prior U.S. Cls.: 1, 5, 6, 10, 26, and 46

Reg. No. 3,399,585

United States Patent and Trademark Office

Registered Mar. 18, 2008

**TRADEMARK
PRINCIPAL REGISTER**

STARFLEX

EQUISTAR CHEMICALS, LP (DELAWARE LIMITED PARTNERSHIP)
1221 MCKINNEY, SUITE 700
HOUSTON, TX 77010

THE MARK CONSISTS OF STANDARD CHARACTERS WITHOUT CLAIM TO ANY PARTICULAR FONT, STYLE, SIZE, OR COLOR.

FOR: POLYMERS SOLD IN BULK FOR USE IN MANUFACTURING IN A VARIETY OF INDUSTRIES, IN CLASS 1 (U.S. CLS. 1, 5, 6, 10, 26 AND 46).

SN 78-680,788, FILED 7-28-2005.

FIRST USE 11-2-2007; IN COMMERCE 11-2-2007.

MATTHEW PAPPAS, EXAMINING ATTORNEY

Int. Cl.: 25

Prior U.S. Cls.: 22 and 39

United States Patent and Trademark Office

Reg. No. 3,399,586

Registered Mar. 18, 2008

**TRADEMARK
PRINCIPAL REGISTER**

US PROUD

GARZA, RAYNALDO (UNITED STATES INDIVIDUAL)
SUITE 475
14 MONARCH BAY PLAZA
MONARCH BEACH, CA 92629

FIRST USE 7-3-2005; IN COMMERCE 2-13-2007.

THE MARK CONSISTS OF STANDARD CHARACTERS WITHOUT CLAIM TO ANY PARTICULAR FONT, STYLE, SIZE, OR COLOR.

FOR: APPAREL, NAMELY, T-SHIRTS, SHIRTS, TANK TOPS, JOGGING SUITS, POLO SHIRTS, JACKETS, SWEAT SUITS, PANTS; HEADGEAR, NAMELY, CAPS, HATS, HEADBANDS AND BEANIES; AND FOOTWEAR, NAMELY, ATHLETIC SHOES, SNEAKERS, IN CLASS 25 (U.S. CLS. 22 AND 39).

SN 78-682,230, FILED 7-31-2005.

KIMBERLY FRYE, EXAMINING ATTORNEY

Int. Cl.: 9

Prior U.S. Cls.: 21, 23, 26, 36, and 38

Reg. No. 3,399,587

United States Patent and Trademark Office

Registered Mar. 18, 2008

**TRADEMARK
PRINCIPAL REGISTER**

EVERY DAY'S A WIN

DENISE N. BOOTHMAN AND GEORGE J.
BOOTHMAN, IV PARTNERSHIP, THE (PENN-
SYLVANIA PARTNERSHIP), DBA EVERY
DAY'S A WIN,

9603 DITMAN STREET
PHILADELPHIA, PA 19114

FOR: EAR PLUGS FOR SWIMMING, IN CLASS 9
(U.S. CLS. 21, 23, 26, 36 AND 38).

FIRST USE 8-1-2007; IN COMMERCE 8-1-2007.

THE MARK CONSISTS OF STANDARD CHAR-
ACTERS WITHOUT CLAIM TO ANY PARTICULAR
FONT, STYLE, SIZE, OR COLOR.

SN 78-682,907, FILED 8-1-2005.

LANA PHAM, EXAMINING ATTORNEY

Int. Cl.: 11

Prior U.S. Cls.: 13, 21, 23, 31, and 34

United States Patent and Trademark Office

Reg. No. 3,399,588

Registered Mar. 18, 2008

**TRADEMARK
PRINCIPAL REGISTER**

CHAUVET Q-SCAN

CHAUVET & SONS, INC. (FLORIDA CORPORATION)
3000 NORTH 29TH COURT
HOLLYWOOD, FL 33020

FOR: COMMERCIAL ENTERTAINMENT LIGHTING SYSTEM CONSISTING OF LIGHTS COMPRISED OF LASERS AND ELECTRONIC EFFECTS LIGHTING FOR PARTY-THEMED DECORATIVE PURPOSES, IN CLASS 11 (U.S. CLS. 13, 21, 23, 31 AND 34).

FIRST USE 7-0-2007; IN COMMERCE 7-0-2007.

THE MARK CONSISTS OF STANDARD CHARACTERS WITHOUT CLAIM TO ANY PARTICULAR FONT, STYLE, SIZE, OR COLOR.

OWNER OF U.S. REG. NO. 2,890,766.

SN 78-683,567, FILED 8-2-2005.

ELLEN B. AWRICH, EXAMINING ATTORNEY

Int. Cl.: 9

Prior U.S. Cls.: 21, 23, 26, 36, and 38

United States Patent and Trademark Office

Reg. No. 3,399,589

Registered Mar. 18, 2008

**TRADEMARK
PRINCIPAL REGISTER**

LANROAMER

TEST-UM, INC. (CALIFORNIA CORPORATION)
808 CALLE PLANO
CAMARILLO, CA 93012

FOR: APPARATUS FOR VERIFICATION OF WIR-
ING FAULTS AND CONFIGURATIONS OF DATA
CABLES, IN CLASS 9 (U.S. CLS. 21, 23, 26, 36 AND 38).

FIRST USE 2-0-2006; IN COMMERCE 2-0-2006.

THE MARK CONSISTS OF STANDARD CHAR-
ACTERS WITHOUT CLAIM TO ANY PARTICULAR
FONT, STYLE, SIZE, OR COLOR.

SN 78-683,705, FILED 8-2-2005.

WILLIAM BRECKENFELD, EXAMINING ATTOR-
NEY

Int. Cls.: 35 and 42

Prior U.S. Cls.: 100, 101, and 102

United States Patent and Trademark Office

Reg. No. 3,399,590

Registered Mar. 18, 2008

**SERVICE MARK
PRINCIPAL REGISTER**

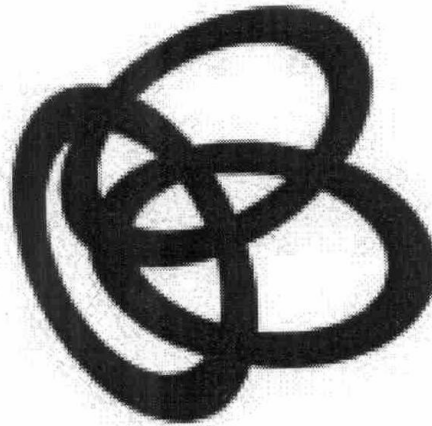

VERICAL, INCORPORATED (DELAWARE CORPORATION)
1800 DIAGONAL ROAD, SUITE 600
ALEXANDRIA, VA 22314

FOR: ONLINE RETAIL AND WHOLESALE STORE SERVICES IN THE FIELD OF ELECTRONIC EQUIPMENT AND COMPONENTS; PROVIDING RETAIL AND WHOLESALE INFORMATION ABOUT THE AVAILABILITY OF AND DEMAND FOR ELECTRONIC EQUIPMENT AND COMPONENTS, IN CLASS 35 (U.S. CLS. 100, 101 AND 102).

FIRST USE 4-0-2007; IN COMMERCE 4-0-2007.

FOR: PROVIDING AUTHENTICATION AND QUALITY ASSURANCE SERVICES IN THE FIELD OF ELECTRONIC EQUIPMENT AND COMPONENTS, IN CLASS 42 (U.S. CLS. 100 AND 101).

FIRST USE 4-0-2007; IN COMMERCE 4-0-2007.

THE MARK CONSISTS OF THREE INTER-TWINED RINGS.

SN 78-685,673, FILED 8-4-2005.

TAMARA FRAZIER, EXAMINING ATTORNEY

Int. Cls.: 16, 35, and 44

Prior U.S. Cls.: 2, 5, 22, 23, 29, 37, 38, 50, 100, 101, and 102

Reg. No. 3,399,591

United States Patent and Trademark Office

Registered Mar. 18, 2008

**TRADEMARK
SERVICE MARK
PRINCIPAL REGISTER**



PHILIP MORRIS USA INC. (VIRGINIA CORPORATION)
6601 WEST BROAD STREET
RICHMOND, VA 23230

FOR: BROCHURES, PAMPHLETS, INFORMATIONAL TIP SHEETS ABOUT YOUTH SMOKING PREVENTION, POSITIVE YOUTH DEVELOPMENT, AND SMOKING CESSATION PROGRAMS; PRINTED SIGNS MADE OF PAPER AND CARDBOARD; STATIONERY; PRINTED INSTRUCTIONAL, EDUCATIONAL AND TEACHING MATERIALS IN THE FIELD OF YOUTH SMOKING PREVENTION, POSITIVE YOUTH DEVELOPMENT, AND SMOKING CESSATION PROGRAMS, IN CLASS 16 (U.S. CLS. 2, 5, 22, 23, 29, 37, 38 AND 50).

FIRST USE 10-31-2005; IN COMMERCE 10-31-2005.

FOR: PROMOTING PUBLIC AWARENESS OF THE NEED FOR YOUTH SMOKING PREVENTION, POSITIVE YOUTH DEVELOPMENT, AND SMOKING CESSATION PROGRAMS, IN CLASS 35 (U.S. CLS. 100, 101 AND 102).

FIRST USE 10-31-2005; IN COMMERCE 10-31-2005.

FOR: PROVIDING A WEBSITE FEATURING YOUTH SMOKING PREVENTION, POSITIVE YOUTH DEVELOPMENT, AND SMOKING CESSATION PROGRAM INFORMATION, IN CLASS 44 (U.S. CLS. 100 AND 101).

FIRST USE 10-31-2005; IN COMMERCE 10-31-2005.

NO CLAIM IS MADE TO THE EXCLUSIVE RIGHT TO USE "PREVENCION DEL CONSUMO DE TABACO EN LOS JOVENES", APART FROM THE MARK AS SHOWN.

THE COLOR(S) BLUE AND GREEN IS/ARE CLAIMED AS A FEATURE OF THE MARK.

THE MARK CONSISTS OF THE WORDS "PREVENCION DEL CONSUMO DE TABACO EN LOS JOVENES" IN BLUE AND AN INTERLOCKING SQUARE DESIGN IN GREEN AND BLUE TO THE LEFT OF THE WORDING.

THE FOREIGN WORDING IN THE MARK TRANSLATES INTO ENGLISH AS PREVENTION OF THE CONSUMPTION OF TOBACCO IN YOUTH OR YOUTH SMOKING PREVENTION.

SN 78-688,593, FILED 8-9-2005.

LOURDES AYALA, EXAMINING ATTORNEY

Int. Cl.: 41

Prior U.S. Cls.: 100, 101, and 107

United States Patent and Trademark Office

Reg. No. 3,399,592

Registered Mar. 18, 2008

**SERVICE MARK
PRINCIPAL REGISTER**

**NILD Group Educational
Therapy**

NATIONAL INSTITUTE FOR LEARNING DIS-
ABILITIES, INC. (VIRGINIA CORPORATION)
107 SEEKEL STREET
NORFOLK, VA 235054415

FOR: EDUCATIONAL SERVICES IN THE NAT-
URE OF SPECIAL EDUCATION PROGRAMS WITH-
IN SCHOOLS WHICH FOCUS ON STIMULATING
DEFICIT AREAS OF PERCEPTION AND COGNI-
TION IN ORDER TO ENABLE SPECIAL NEEDS
STUDENTS TO BECOME ACTIVE, INDEPENDENT
LEARNERS IN THE REGULAR CLASSROOM, IN
CLASS 41 (U.S. CLS. 100, 101 AND 107).

FIRST USE 6-11-2007; IN COMMERCE 6-11-2007.

THE MARK CONSISTS OF STANDARD CHAR-
ACTERS WITHOUT CLAIM TO ANY PARTICULAR
FONT, STYLE, SIZE, OR COLOR.

OWNER OF U.S. REG. NOS. 2,386,890 AND
2,496,597.

NO CLAIM IS MADE TO THE EXCLUSIVE
RIGHT TO USE "GROUP EDUCATIONAL THER-
APY", APART FROM THE MARK AS SHOWN.

SN 78-689,257, FILED 8-10-2005.

ESTHER BELENKER, EXAMINING ATTORNEY

Int. Cl.: 9

Prior U.S. Cls.: 21, 23, 26, 36, and 38

Reg. No. 3,399,593

United States Patent and Trademark Office

Registered Mar. 18, 2008

**TRADEMARK
PRINCIPAL REGISTER**

AUTHENTIFAX

AUTHENTIDATE HOLDING CORP. (DELA-
WARE CORPORATION)
CONNELL CORPORATE CENTER
300 CONNELL DRIVE, 5TH FLOOR
BERKELEY HEIGHTS, NJ 07922

FOR: DOCUMENT AND DATA MANAGEMENT
AND PROCESSING SOFTWARE FOR USE IN AU-
THENTICATION, TIME STAMPING AND VERIFI-
CATION OF DOCUMENTS AND DATA FILES,
STORAGE, TRANSMISSION AND RETRIEVAL OF
DOCUMENTS AND DATA FILES, CONVERSION
OF DOCUMENTS INTO ELECTRONIC, MAGNET-
IC, OPTICAL OR OTHER FORMATS, AND CODING

OF DOCUMENTS AND DATA FILES IN THE FIELD
OF ELECTRONIC DOCUMENT MANAGEMENT,
IN CLASS 9 (U.S. CLS. 21, 23, 26, 36 AND 38).

FIRST USE 2-0-2005; IN COMMERCE 2-0-2005.

THE MARK CONSISTS OF STANDARD CHAR-
ACTERS WITHOUT CLAIM TO ANY PARTICULAR
FONT, STYLE, SIZE, OR COLOR.

SN 78-691,668, FILED 8-12-2005.

JOHN DALIER, EXAMINING ATTORNEY

Int. Cl.: 41

Prior U.S. Cls.: 100, 101, and 107

United States Patent and Trademark Office

Reg. No. 3,399,594

Registered Mar. 18, 2008

**SERVICE MARK
PRINCIPAL REGISTER**



UNIVERSITY OF NORTH CAROLINA AT
GREENSBORO, THE (NORTH CAROLINA
EDUCATIONAL INSTITUTION)

303 MOSSMAN BUILDING
1000 SPRING GARDEN STREET
GREENSBORO, NC 27412

FOR: EDUCATION SERVICES IN THE NATURE
OF COURSES AT THE UNIVERSITY LEVEL FOR
HIGH SCHOOL STUDENTS, IN CLASS 41 (U.S. CLS.
100, 101 AND 107).

FIRST USE 8-25-2005; IN COMMERCE 5-30-2007.

OWNER OF U.S. REG. NO. 1,776,610.

NO CLAIM IS MADE TO THE EXCLUSIVE
RIGHT TO USE "SCHOOL" AND "REAL COLLEGE

CREDIT IN HIGH SCHOOL", APART FROM THE
MARK AS SHOWN.

THE COLORS GRAY, BLUE, AND WHITE ARE
CLAIMED AS A FEATURE OF THE MARK.

THE "I" IS WHITE OUTLINED IN GRAY, THE
BACKGROUND OVAL IS BLUE OUTLINED IN
GRAY, THE WORD "SCHOOL" IS BLUE OUTLINED
IN GRAY, AND THE WORDING "UNCG" AND
"REAL COLLEGE CREDIT IN HIGH SCHOOL" IS
GRAY.

SN 78-692,890, FILED 8-15-2005.

MICHAEL GAAFAR, EXAMINING ATTORNEY

Int. Cl.: 16

Prior U.S. Cls.: 2, 5, 22, 23, 29, 37, 38, and 50

Reg. No. 3,399,595

United States Patent and Trademark Office

Registered Mar. 18, 2008

**TRADEMARK
PRINCIPAL REGISTER**

FLIRTY FLORALS

MEADWESTVACO CORPORATION (DELAWARE
CORPORATION)
MEADWESTVACO CORPORATE CENTER
11013 WEST BROAD STREET
GLEN ALLEN, VA 23060

FOR: NOTEBOOKS; BINDERS; STATIONERY-
TYPE PORTFOLIOS; FILE FOLDERS; MEMO
BOOKS, IN CLASS 16 (U.S. CLS. 2, 5, 22, 23, 29, 37, 38
AND 50).

FIRST USE 9-16-2007; IN COMMERCE 9-16-2007.

THE MARK CONSISTS OF STANDARD CHAR-
ACTERS WITHOUT CLAIM TO ANY PARTICULAR
FONT, STYLE, SIZE, OR COLOR.

NO CLAIM IS MADE TO THE EXCLUSIVE
RIGHT TO USE FLORALS, APART FROM THE
MARK AS SHOWN.

SN 78-693,281, FILED 8-16-2005.

AMY HELLA, EXAMINING ATTORNEY

Int. Cl.: 42

Prior U.S. Cls.: 100 and 101

United States Patent and Trademark Office

Reg. No. 3,399,596

Registered Mar. 18, 2008

**SERVICE MARK
PRINCIPAL REGISTER**

COURTEXPRESS

WEST PUBLISHING CORPORATION (MINNESOTA CORPORATION)
610 OPPERMAN DRIVE
EAGAN, MN 55123

FOR: PROVIDING LITIGATION INFORMATION FROM UNITED STATES COURTS VIA THE GLOBAL COMPUTER NETWORK, IN CLASS 42 (U.S. CLS. 100 AND 101).

FIRST USE 3-1-1999; IN COMMERCE 3-1-1999.

THE MARK CONSISTS OF STANDARD CHARACTERS WITHOUT CLAIM TO ANY PARTICULAR FONT, STYLE, SIZE, OR COLOR.

OWNER OF U.S. REG. NO. 2,364,478.

SN 78-694,648, FILED 8-17-2005.

JANET LEE, EXAMINING ATTORNEY

Int. Cls.: 8, 9, 14, and 25

Prior U.S. Cls.: 2, 21, 22, 23, 26, 27, 28, 36, 38, 39, 44,
and 50

Reg. No. 3,399,597

United States Patent and Trademark Office

Registered Mar. 18, 2008

TRADEMARK
PRINCIPAL REGISTER



OPTIMUS INTERNATIONAL, INC. (TEXAS CORPORATION)
321 GREENFIELD DRIVE
MURPHY, TX 75094

FOR: REPLICAS HISTORICAL WEAPONS, NAMELY, ROMAN, MEDIEVAL, RENAISSANCE, CIVIL WAR, AND PIRATE WEAPONS, NAMELY, AXES; BLADES FOR KNIVES USED AS WEAPONS AND SWORDS; DAGGERS; FLAILS; JAPANESE SWORDS; MACES; PIKES; SABRES; SIDE ARMS, NOT INCLUDING FIREARMS, NAMELY, SWORDS, SPEARS, AND WAR HAMMERS; SWORD BELTS, IN CLASS 8 (U.S. CLS. 23, 28 AND 44).

FIRST USE 7-25-2005; IN COMMERCE 7-25-2005.

FOR: REPLICAS HISTORICAL BODY ARMOR, NAMELY, ROMAN, MEDIEVAL, RENAISSANCE, CIVIL WAR, AND PIRATE BODY ARMOR AND PROTECTIVE BODY ARMOR, CHAIN MAIL AND GAUNTLETS; PROTECTIVE CLOTHING; PROTECTIVE HELMETS; HAND-HELD PROTECTIVE SHIELDS USED AS BODY ARMOR; AND SLASH AND STAB RESISTANT BODY ARMOR, IN CLASS 9 (U.S. CLS. 21, 23, 26, 36 AND 38).

FIRST USE 7-25-2005; IN COMMERCE 7-25-2005.

FOR: WITNESSING AND EVANGELISM TOOLS, NAMELY, NON-MONETARY COINS, IN CLASS 14 (U.S. CLS. 2, 27, 28 AND 50).

FIRST USE 3-31-2006; IN COMMERCE 3-31-2006.

FOR: THEMED REPLICAS HISTORICAL CLOTHING, NAMELY, ROMAN, MEDIEVAL, RENAISSANCE, CIVIL WAR, AND PIRATE ATTIRE, NAMELY, BELTS, BELTS MADE OF LEATHER, BLOUSES, CAPES, FOLK COSTUMES, COSTUMES FOR USE IN ROLE PLAYING GAMES, DRESSES, FOOTWEAR, GLOVES, GOWNS, HALLOWEEN COSTUMES, HATS, JERKINS, JERSEYS, LEATHER SHOES, MASQUERADE COSTUMES AND MASKS SOLD IN CONNECTION THEREWITH, MEN'S AND WOMEN'S JACKETS, COATS, NECKTIES, DRESS SHIRTS, CASUAL SHIRTS, TROUSERS, VESTS, PETTICOATS, RELIGIOUS COSTUMES IN THE NATURE OF ROBES, TUNICS, HEAD WEAR, SANDALS AND FOOTWEAR, SHIRTS, SHIRTS, TOGAS, NON-CLERICAL TUNICS, WOMEN'S CEREMONIAL DRESSES, AND WRIST BANDS, IN CLASS 25 (U.S. CLS. 22 AND 39).

FIRST USE 7-25-2005; IN COMMERCE 7-25-2005.

NO CLAIM IS MADE TO THE EXCLUSIVE RIGHT TO USE "REAL ARMOR" AND REPRESENTATION OF THE SWORD, APART FROM THE MARK AS SHOWN.

THE MARK CONSISTS OF THE WORDS REAL ARMOR OF GOD IN STYLIZED LETTERING. A SWORD EXTENDS THROUGH THE "O" IN ARMOR AND A DIAMOND SHAPE IS CENTERED WITHIN THE "O" IN GOD.

SN 78-694,751, FILED 8-17-2005.

WILLIAM VERHOSEK, EXAMINING ATTORNEY

Int. Cl.: 2

Prior U.S. Cls.: 6, 11, and 16

United States Patent and Trademark Office

Reg. No. 3,399,598

Registered Mar. 18, 2008

**TRADEMARK
PRINCIPAL REGISTER**

SIMPLY PLAYFUL

TRUE VALUE COMPANY (DELAWARE COR-
PORATION)
8600 WEST BRYN MAWR AVENUE
CHICAGO, IL 606313505

THE MARK CONSISTS OF STANDARD CHAR-
ACTERS WITHOUT CLAIM TO ANY PARTICULAR
FONT, STYLE, SIZE, OR COLOR.

FOR: PAINT, IN CLASS 2 (U.S. CLS. 6, 11 AND 16).

SN 78-695,898, FILED 8-18-2005.

FIRST USE 2-0-2006; IN COMMERCE 2-0-2006.

LINDA M. KING, EXAMINING ATTORNEY

Int. Cls.: 9 and 16

Prior U.S. Cls.: 2, 5, 21, 22, 23, 26, 29, 36, 37, 38, and 50

United States Patent and Trademark Office

Reg. No. 3,399,599

Registered Mar. 18, 2008

**TRADEMARK
PRINCIPAL REGISTER**

Fred The Mouse

HALLER, REESE R. (UNITED STATES INDIVIDUAL)
5225 THREE MILE ROAD
BAY CITY, MI 48706

FOR: AUDIO RECORDINGS FEATURING A SERIES OF FICTIONAL STORIES, IN CLASS 9 (U.S. CLS. 21, 23, 26, 36 AND 38).

FIRST USE 12-1-2007; IN COMMERCE 12-1-2007.

FOR: SERIES OF FICTION BOOKS, IN CLASS 16 (U.S. CLS. 2, 5, 22, 23, 29, 37, 38 AND 50).

FIRST USE 9-7-2005; IN COMMERCE 9-7-2005.

THE MARK CONSISTS OF STANDARD CHARACTERS WITHOUT CLAIM TO ANY PARTICULAR FONT, STYLE, SIZE, OR COLOR.

SN 78-695,940, FILED 8-18-2005.

RONALD MCMORROW, EXAMINING ATTORNEY

Int. Cl.: 25

Prior U.S. Cls.: 22 and 39

United States Patent and Trademark Office

Reg. No. 3,399,600

Registered Mar. 18, 2008

**TRADEMARK
PRINCIPAL REGISTER**

LATIN ATHLETIC

GACITUA, MAXIMILIANO (AUSTRALIA INDIVIDUAL)
PO BOX 2238
NEW YORK, NY 10108

FOR: T-SHIRTS, JACKETS, JUMPER, JEANS, SOCKS, UNDERWEAR, TRACK SUITS, PULLOVER, SHIRTS, PANTS, SKIRTS, SUITS, COATS, HATS, CAPS, SHOES, SNEAKERS, IN CLASS 25 (U.S. CLS. 22 AND 39).

FIRST USE 5-5-2005; IN COMMERCE 1-10-2006.

THE MARK CONSISTS OF STANDARD CHARACTERS WITHOUT CLAIM TO ANY PARTICULAR FONT, STYLE, SIZE, OR COLOR.

NO CLAIM IS MADE TO THE EXCLUSIVE RIGHT TO USE "ATHLETIC", APART FROM THE MARK AS SHOWN.

SN 78-697,013, FILED 8-21-2005.

DOMINIC FATHY, EXAMINING ATTORNEY

Int. Cl.: 3

Prior U.S. Cls.: 1, 4, 6, 50, 51, and 52

United States Patent and Trademark Office

Reg. No. 3,399,601

Registered Mar. 18, 2008

**TRADEMARK
PRINCIPAL REGISTER**

PROLIGHTEN

W LAB ACQUISITION CORP. (DELAWARE CORPORATION)
ONE EXETER PLAZA
699 BOYLSTON STREET - 3RD FLOOR
BOSTON, MA 02116

THE MARK CONSISTS OF STANDARD CHARACTERS WITHOUT CLAIM TO ANY PARTICULAR FONT, STYLE, SIZE, OR COLOR.

FOR: NON-MEDICATED SKIN CARE PREPARATIONS, IN CLASS 3 (U.S. CLS. 1, 4, 6, 50, 51 AND 52).

SN 78-697,401, FILED 8-22-2005.

FIRST USE 8-10-2005; IN COMMERCE 8-10-2005.

NAAKWAMA ANKRAH, EXAMINING ATTORNEY

Int. Cl.: 25

Prior U.S. Cls.: 22 and 39

United States Patent and Trademark Office

Reg. No. 3,399,602

Registered Mar. 18, 2008

**TRADEMARK
PRINCIPAL REGISTER**

LOLA

MAX RAVE, LLC (DELAWARE LTD LIAB CO)
2761 FRUITLAND AVENUE
VERNON, CA 90058

FOR: CLOTHING FOR GIRLS AND WOMEN, NAMELY, JACKETS, COATS, LEATHER COATS, RAIN COATS, DRESSES, EVENING GOWNS, DRESS SHIRTS, KNIT SHIRTS, SUITS, BLOUSES, T-SHIRTS, SKIRTS, SWEATERS, TURTLENECKS, VESTS, CARDIGANS, SUITS, PANTS, SLACKS, TROUSERS, JEANS, NIGHTGOWNS, SLEEP WEAR, STOCKINGS, PAJAMAS, NECKTIES, GLOVES, SCARVES, TANK TOPS, SHORTS, BELTS, UNDERWEAR, PANTIES, BODY SUITS, SLIPS, BRAS, LINGERIE, BATHING SUITS, FOOTWEAR, SHOES, BEACH SHOES, SANDALS, BOOTS, SLIPPERS, HEADBANDS, HATS

AND HEADWEAR, IN CLASS 25 (U.S. CLS. 22 AND 39).

FIRST USE 12-0-2005; IN COMMERCE 12-0-2005.

THE MARK CONSISTS OF STANDARD CHARACTERS WITHOUT CLAIM TO ANY PARTICULAR FONT, STYLE, SIZE, OR COLOR.

OWNER OF U.S. REG. NOS. 1,301,774 AND 2,463,053.

SN 78-698,589, FILED 8-23-2005.

ELISSA GARBER KON, EXAMINING ATTORNEY

Int. Cl.: 35

Prior U.S. Cls.: 100, 101, and 102

United States Patent and Trademark Office

Reg. No. 3,399,603

Registered Mar. 18, 2008

**SERVICE MARK
PRINCIPAL REGISTER**

LIVEINMARIN.COM

VANCE FROST (CALIFORNIA SOLE PROPRIETORSHIP)
58 OAKLAND AVENUE
SAN ANSELMO, CA 94960

THE MARK CONSISTS OF STANDARD CHARACTERS WITHOUT CLAIM TO ANY PARTICULAR FONT, STYLE, SIZE, OR COLOR.

FOR: REAL ESTATE ADVERTISING SERVICES,
IN CLASS 35 (U.S. CLS. 100, 101 AND 102).

SN 78-699,160, FILED 8-24-2005.

FIRST USE 9-17-2004; IN COMMERCE 12-27-2004.

ALICE BENMAMAN, EXAMINING ATTORNEY

Int. Cls.: 1 and 3

Prior U.S. Cls.: 1, 4, 5, 6, 10, 26, 46, 50, 51, and 52

United States Patent and Trademark Office

Reg. No. 3,399,604

Registered Mar. 18, 2008

**TRADEMARK
PRINCIPAL REGISTER**

TINOSORB

CIBA SPECIALTY CHEMICALS CORPORATION
(DELAWARE CORPORATION)
540 WHITE PLAINS ROAD
TARRYTOWN, NY 105919005

FOR: ACTIVE CHEMICAL SUNSCREEN AGENTS
USED IN THE MANUFACTURE OF COSMETICS,
IN CLASS 1 (U.S. CLS. 1, 5, 6, 10, 26 AND 46).

FIRST USE 9-25-2007; IN COMMERCE 9-25-2007.

FOR: PERSONAL SUNSCREEN LOTION AND
CREAMS; PERSONAL SUN BLOCK LOTIONS AND
CREAMS, IN CLASS 3 (U.S. CLS. 1, 4, 6, 50, 51 AND
52).

FIRST USE 9-25-2007; IN COMMERCE 9-25-2007.

THE MARK CONSISTS OF STANDARD CHAR-
ACTERS WITHOUT CLAIM TO ANY PARTICULAR
FONT, STYLE, SIZE, OR COLOR.

OWNER OF U.S. REG. NO. 2,432,284.

SN 78-699,627, FILED 8-24-2005.

EMILY CHUO, EXAMINING ATTORNEY

Int. Cl.: 9

Prior U.S. Cls.: 21, 23, 26, 36, and 38

United States Patent and Trademark Office

Reg. No. 3,399,605

Registered Mar. 18, 2008

**TRADEMARK
PRINCIPAL REGISTER**

GREAT WALL

WMS GAMING INC. (DELAWARE CORPORATION)
800 SOUTH NORTHPOINT BOULEVARD
WAUKEGAN, IL 60085

THE MARK CONSISTS OF STANDARD CHARACTERS WITHOUT CLAIM TO ANY PARTICULAR FONT, STYLE, SIZE, OR COLOR.

FOR: GAMING MACHINES, IN CLASS 9 (U.S. CLS. 21, 23, 26, 36 AND 38).

SN 78-700,183, FILED 8-25-2005.

FIRST USE 9-12-2005; IN COMMERCE 9-12-2005.

ANNE MADDEN, EXAMINING ATTORNEY

Int. Cl.: 41

Prior U.S. Cls.: 100, 101, and 107

United States Patent and Trademark Office

Reg. No. 3,399,606

Registered Mar. 18, 2008

**SERVICE MARK
PRINCIPAL REGISTER**

RAD GIRLS

INSEL, RACHEL LAUREN (UNITED STATES
INDIVIDUAL)
P.O. BOX 26597
LOS ANGELES, CA 90026

THE MARK CONSISTS OF STANDARD CHAR-
ACTERS WITHOUT CLAIM TO ANY PARTICULAR
FONT, STYLE, SIZE, OR COLOR.

FOR: ENTERTAINMENT IN THE NATURE OF
AN ON-GOING REALITY BASED TELEVISION
PROGRAM, IN CLASS 41 (U.S. CLS. 100, 101 AND
107).

SN 78-700,838, FILED 8-25-2005.

FIRST USE 6-15-2005; IN COMMERCE 3-1-2007.

KAREN BRACEY, EXAMINING ATTORNEY

Int. Cl.: 36

Prior U.S. Cls.: 100, 101, and 102

United States Patent and Trademark Office

Reg. No. 3,399,607

Registered Mar. 18, 2008

**SERVICE MARK
PRINCIPAL REGISTER**

STRATEGIC WEALTH PORTFOLIOS

UBS FINANCIAL SERVICES INC. (DELAWARE
CORPORATION)
1200 HARBOR BLVD.
WEEHAWKEN, NJ 070866791

FOR: STOCK BROKERAGE, MONEY MANAGE-
MENT, AND INVESTMENT ADVISORY SERVICES,
IN CLASS 36 (U.S. CLS. 100, 101 AND 102).

FIRST USE 10-0-2006; IN COMMERCE 10-0-2006.

THE MARK CONSISTS OF STANDARD CHAR-
ACTERS WITHOUT CLAIM TO ANY PARTICULAR
FONT, STYLE, SIZE, OR COLOR.

NO CLAIM IS MADE TO THE EXCLUSIVE
RIGHT TO USE "PORTFOLIOS", APART FROM
THE MARK AS SHOWN.

SN 78-701,004, FILED 8-26-2005.

MARCIE MILONE, EXAMINING ATTORNEY

Int. Cl.: 43

Prior U.S. Cls.: 100 and 101

United States Patent and Trademark Office

Reg. No. 3,399,608

Registered Mar. 18, 2008

**SERVICE MARK
PRINCIPAL REGISTER**

La Bonita Inn and Suites

MA DURGA PARTNERSHIP INC. (TEXAS CORPORATION)
813 PLUMWOOD DRIVE
SCHAUMBURG, IL 60173

FOR: HOTELS, IN CLASS 43 (U.S. CLS. 100 AND 101).

FIRST USE 8-1-2005; IN COMMERCE 8-1-2005.

THE MARK CONSISTS OF STANDARD CHARACTERS WITHOUT CLAIM TO ANY PARTICULAR FONT, STYLE, SIZE, OR COLOR.

NO CLAIM IS MADE TO THE EXCLUSIVE RIGHT TO USE "INN AND SUITES", APART FROM THE MARK AS SHOWN.

THE ENGLISH TRANSLATION OF THE WORDING "LA BONITA" IN THE MARK IS THE BEAUTIFUL.

SN 78-702,014, FILED 8-28-2005.

TRACY CROSS, EXAMINING ATTORNEY

Int. Cl.: 36

Prior U.S. Cls.: 100, 101, and 102

United States Patent and Trademark Office

Reg. No. 3,399,609

Registered Mar. 18, 2008

**SERVICE MARK
PRINCIPAL REGISTER**

DISCS

CITIGROUP GLOBAL MARKETS INC. (NEW
YORK CORPORATION)
388 GREENWICH STREET
NEW YORK, NY 10013

THE MARK CONSISTS OF STANDARD CHAR-
ACTERS WITHOUT CLAIM TO ANY PARTICULAR
FONT, STYLE, SIZE, OR COLOR.

FOR: FINANCIAL AND INVESTMENT SERVI-
CES, NAMELY IN THE NATURE OF AN INVEST-
MENT SECURITY, IN CLASS 36 (U.S. CLS. 100, 101
AND 102).

SN 78-705,103, FILED 9-1-2005.

FIRST USE 8-0-2005; IN COMMERCE 9-0-2005.

TARAH HARDY, EXAMINING ATTORNEY

Int. Cl.: 41

Prior U.S. Cls.: 100, 101, and 107

United States Patent and Trademark Office

Reg. No. 3,399,610

Registered Mar. 18, 2008

**SERVICE MARK
PRINCIPAL REGISTER**

Kona Buzz

BENNET, CARESSA D. (UNITED STATES INDIVIDUAL)

7705 OLDCHESTER RD.

BETHESDA, MD 20817 AND

POKONOSKY, JEFF (UNITED STATES INDIVIDUAL)

113-223

7770 REGENTS RD.

SAN DIEGO, CA 92122

FOR: EDUCATION SERVICES, NAMELY, PROVIDING INFORMATION ON ATHLETES AND THE TRIATHLONS IN WHICH THEY PARTICIPATE; ENTERTAINMENT IN THE NATURE OF TRIATHLONS, IN CLASS 41 (U.S. CLS. 100, 101 AND 107).

FIRST USE 1-1-2007; IN COMMERCE 1-1-2007.

THE MARK CONSISTS OF STANDARD CHARACTERS WITHOUT CLAIM TO ANY PARTICULAR FONT, STYLE, SIZE, OR COLOR.

NO CLAIM IS MADE TO THE EXCLUSIVE RIGHT TO USE "KONA", APART FROM THE MARK AS SHOWN.

SN 78-707,430, FILED 9-6-2005.

DOMINIC J. FERRAIUOLO, EXAMINING ATTORNEY

Int. Cl.: 35

Prior U.S. Cls.: 100, 101, and 102

United States Patent and Trademark Office

Reg. No. 3,399,611

Registered Mar. 18, 2008

**SERVICE MARK
PRINCIPAL REGISTER**

NOR1

NOR1, INC. (DELAWARE CORPORATION)
18986 TILSON AVENUE
CUPERTINO, CA 95014

FIRST USE 5-25-2005; IN COMMERCE 5-25-2005.

FOR: ONLINE ORDERING SERVICES, NAMELY,
PROVIDING FOR THE PURCHASE OF TICKETS TO
SPORTING EVENTS, SHOWS, CONCERTS, LOD-
GING, TRAVEL PACKAGES, AND TRANSPORTA-
TION, BY MEANS OF A GLOBAL COMPUTER
NETWORK, IN CLASS 35 (U.S. CLS. 100, 101 AND
102).

THE MARK CONSISTS OF STANDARD CHAR-
ACTERS WITHOUT CLAIM TO ANY PARTICULAR
FONT, STYLE, SIZE, OR COLOR.

SN 78-707,766, FILED 9-7-2005.

PETER B. BROMAGHIM, EXAMINING ATTORNEY

Int. Cl.: 44

Prior U.S. Cls.: 100 and 101

United States Patent and Trademark Office

Reg. No. 3,399,612

Registered Mar. 18, 2008

**SERVICE MARK
PRINCIPAL REGISTER**

E-NATE

E-NATE INC. (CANADA CORPORATION)
8 PLACE DU COMMERCE
MONTREAL, QUEBEC, CANADA H3E 1N3

THE MARK CONSISTS OF STANDARD CHARACTERS WITHOUT CLAIM TO ANY PARTICULAR FONT, STYLE, SIZE, OR COLOR.

FOR: WEBSITE SERVICES, NAMELY, PROVIDING A WEBSITE FOR USE BY CHIROPRACTORS AND OTHER PROFESSIONALS IN THE FIELD OF HEALTH CARE FOR ALL ASPECTS OF THEIR PRACTICE, NAMELY, MAINTAINING FILES AND RECORDS CONCERNING THE MEDICAL CONDITION OF PATIENTS, MAINTAINING PATIENT'S PERSONAL MEDICAL RECORDS AND FILES, IN CLASS 44 (U.S. CLS. 100 AND 101).

PRIORITY CLAIMED UNDER SEC. 44(D) ON CANADA APPLICATION NO. 1249803, FILED 3-8-2005, REG. NO. TMA668289, DATED 7-19-2006, EXPIRES 7-19-2021.

SN 78-707,932, FILED 9-7-2005.

FIRST USE 1-0-2005; IN COMMERCE 4-10-2006.

MICHAEL GAAFAR, EXAMINING ATTORNEY

Int. Cls.: 9, 12, 18, 20, 35, 41, 43, and 44

Prior U.S. Cls.: 1, 2, 3, 13, 19, 21, 22, 23, 25, 26, 31, 32, 35, 36, 38, 41, 44, 50, 100, 101, 102, and 107

Reg. No. 3,399,613

United States Patent and Trademark Office

Registered Mar. 18, 2008

**TRADEMARK
SERVICE MARK
PRINCIPAL REGISTER**

DOG GONE SMART

ONTHANK, CHRISTOPHER (UNITED STATES INDIVIDUAL)
15 OLD BOSTON ROAD
WILTON, CT 06897

FOR: PRE-RECORDED DVDS AND VIDEO CASSETTES FEATURING DOG TRAINING INSTRUCTION, IN CLASS 9 (U.S. CLS. 21, 23, 26, 36 AND 38).

FIRST USE 8-1-2005; IN COMMERCE 8-1-2005.

FOR: SEAT COVERS FOR VEHICLES, IN CLASS 12 (U.S. CLS. 19, 21, 23, 31, 35 AND 44).

FIRST USE 12-20-2007; IN COMMERCE 12-20-2007.

FOR: PET LEASHES, PET COLLARS, DOG JACKETS, AND FABRIC CRATE PADS FOR USE IN PET TRAINING, IN CLASS 18 (U.S. CLS. 1, 2, 3, 22 AND 41).

FIRST USE 10-30-2007; IN COMMERCE 10-30-2007.

FOR: DOG BEDS; CRATE PADS FOR CUSHIONING AS PET BEDDING, IN CLASS 20 (U.S. CLS. 2, 13, 22, 25, 32 AND 50).

FIRST USE 12-15-2006; IN COMMERCE 12-15-2006.

FOR: RETAIL STORE SERVICES FEATURING PET SUPPLIES, IN CLASS 35 (U.S. CLS. 100, 101 AND 102).

FIRST USE 8-28-1998; IN COMMERCE 8-28-1998.

FOR: DOG TRAINING SERVICES; DOG SWIMMING INSTRUCTION; ORGANIZING AND CONDUCTING DOG SHOWS AND EXHIBITIONS, IN CLASS 41 (U.S. CLS. 100, 101 AND 107).

FIRST USE 2-28-1995; IN COMMERCE 2-28-1995.

FOR: PROVIDING CANINE CENTER SERVICES, NAMELY, DAYCARE AND BOARDING SERVICES, IN CLASS 43 (U.S. CLS. 100 AND 101).

FIRST USE 8-28-1998; IN COMMERCE 8-28-1998.

FOR: PROVIDING CANINE CENTER SERVICES, NAMELY, CANINE REHABILITATION, DOG WASHING AND DOG WALKING SERVICES, IN CLASS 44 (U.S. CLS. 100 AND 101).

FIRST USE 8-20-2002; IN COMMERCE 8-20-2002.

THE MARK CONSISTS OF STANDARD CHARACTERS WITHOUT CLAIM TO ANY PARTICULAR FONT, STYLE, SIZE, OR COLOR.

SN 78-708,085, FILED 9-7-2005.

JUDITH HELFMAN, EXAMINING ATTORNEY

Int. Cl.: 22

Prior U.S. Cls.: 1, 2, 7, 19, 22, 42, and 50

United States Patent and Trademark Office

Reg. No. 3,399,614

Registered Mar. 18, 2008

**TRADEMARK
PRINCIPAL REGISTER**

Cyberlon

ASAHI KASEI FIBERS CORPORATION (JAPAN CORPORATION)
2-6, DOJIMAHAMA 1-CHOME, KITA-KU
OSAKA, JAPAN

FOR: ROPES, SYNTHETIC CORDS, SYNTHETIC FIBERS FOR CABLES; SYNTHETIC FIBERS FOR REINFORCING CONCRETE AND ASPHALTS; SYNTHETIC FIBERS FOR REINFORCING PLASTICS; SYNTHETIC FIBERS FOR INSULATION FOR PRINTED CIRCUIT BOARDS, BATTERY SEPARATORS, ELECTROLYTIC CAPACITOR, PARTLY-PROCESSED FRICTION MATERIALS OF BRAKE LININGS AND CLUTCH FACINGS AND REINFORCING SYNTHETIC FIBER GASKETS; AND SYNTHETIC

FIBERS FOR MANUFACTURING CUT RESISTANT GLOVES, IN CLASS 22 (U.S. CLS. 1, 2, 7, 19, 22, 42 AND 50).

FIRST USE 8-4-2006; IN COMMERCE 11-1-2006.

THE MARK CONSISTS OF STANDARD CHARACTERS WITHOUT CLAIM TO ANY PARTICULAR FONT, STYLE, SIZE, OR COLOR.

SN 78-708,943, FILED 9-8-2005.

BILL DAWE, EXAMINING ATTORNEY

Int. Cls.: 25 and 41

Prior U.S. Cls.: 22, 39, 100, 101, and 107

Reg. No. 3,399,615

United States Patent and Trademark Office

Registered Mar. 18, 2008

**TRADEMARK
SERVICE MARK
PRINCIPAL REGISTER**

UNITED PRO CYCLING TEAM

UNITED CYCLING, LLC (NEVADA LTD LIAB
CO)
620 NEWPORT CENTER DRIVE
SUITE 1100
NEWPORT BEACH, CA 92660

FOR: CLOTHING, NAMELY, APRONS, ASCOTS, ATHLETIC FOOTWEAR, ATHLETIC SHOES, ATHLETIC UNIFORMS, BANDANAS, CAPS, BATH SLIPPERS, BATHING CAPS, BATHING SUITS, BATHING TRUNKS, BATHROBES, BEACH COVER-UPS, BEACH SHOES, BEACHWEAR, BEANIES, BELTS, BERETS, BERMUDA SHORTS, BIKINIS, BLAZERS, BLOUSES, BODY SHAPERS, BODY SUITS, BOXER SHORTS, BRAS, BRASSIERES, BRIEFS, CAMP SHIRTS, CAPS, CARDIGANS, CHEF'S HATS, WRAP-AROUNDS, COATS, COLLARS, CROP TOPS, CUFFS, DENIM JACKETS, EAR MUFFS, GOLF SHIRTS, GYM SHORTS, HALTER TOPS, HATS, HEAD BANDS, HEADWEAR, INFANTWEAR, JACKETS, JEANS, JOGGING SUITS, LEATHER JACKETS, LEG WARMERS, LEGGINGS, LIGHT-REFLECTING JACKETS, LINGERIE, LOUNGEWEAR, MOCK TURTLE-NECK SWEATERS, MONEY BELTS, MUFFLERS, NECK BANDS, NECKWEAR, NIGHT SHIRTS, PAJAMAS, PANTIES, PANTS, POLO SHIRTS, PONCHOS, PULLOVERS, RAIN JACKETS, SANDALS, SASHES, SCARVES, SHAWLS, SHIRTS, SHOES, SHORTS, SLEEP SHIRTS, SLEEPWEAR, SLIPPERS, SNEAKERS, SOCKS, SPORT COATS, SPORT SHIRTS, SUN VISORS, SWEAT BANDS, SWEAT PANTS, SWEAT SHIRTS, SWEAT SHORTS, SWEAT SUITS, SWEATERS, SWEAT SOCKS, SWIM CAPS, SWIM TRUNKS,

SWIM WEAR, SWIMMING CAPS, SWIMSUITS, TANK TOPS, T-SHIRTS, VISORS, V-NECK SWEATERS, WIND RESISTANT JACKETS, WRIST BANDS, AND WRISTBANDS CONTAINING A COOLING SUBSTANCE TO COOL THE WEARER, IN CLASS 25 (U.S. CLS. 22 AND 39).

FIRST USE 2-19-2006; IN COMMERCE 2-19-2006.

FOR: ENTERTAINMENT SERVICES IN THE NATURE OF BICYCLE RACES BY A PROFESSIONAL RACING TEAM; ENTERTAINMENT SERVICES, NAMELY, PARTICIPATION BY A BICYCLE RACING TEAM IN ORGANIZED BICYCLE RACES, AND PERSONAL APPEARANCES BY MEMBERS OF THE BICYCLE RACING TEAM AT RELATED EVENTS, NAMELY, BICYCLE SHOWS AND EXHIBITIONS, IN CLASS 41 (U.S. CLS. 100, 101 AND 107).

FIRST USE 2-19-2006; IN COMMERCE 2-19-2006.

THE MARK CONSISTS OF STANDARD CHARACTERS WITHOUT CLAIM TO ANY PARTICULAR FONT, STYLE, SIZE, OR COLOR.

NO CLAIM IS MADE TO THE EXCLUSIVE RIGHT TO USE PRO CYCLING TEAM, APART FROM THE MARK AS SHOWN.

SN 78-709,043, FILED 9-8-2005.

NICHOLAS ALTREE, EXAMINING ATTORNEY

Int. Cl.: 19

Prior U.S. Cls.: 1, 12, 33, and 50

United States Patent and Trademark Office

Reg. No. 3,399,616

Registered Mar. 18, 2008

**TRADEMARK
PRINCIPAL REGISTER**

ARIZON

AIRSTRUCTURES WORLDWIDE, LTD. (MISSOURI CORPORATION)
11880 DORSETT ROAD
ST. LOUIS, MO 63043

FOR: BUILDING STRUCTURES, NAMELY, NON-METAL AIR SUPPORTED BUILDINGS AND NON-METAL TENSION SUPPORTED BUILDINGS, NON-METAL FRAME SUPPORTED BUILDINGS, AND NON-METAL FRAME SUPPORTED FABRIC BUILDINGS, IN CLASS 19 (U.S. CLS. 1, 12, 33 AND 50).

FIRST USE 2-20-2006; IN COMMERCE 10-3-2006.

THE MARK CONSISTS OF STANDARD CHARACTERS WITHOUT CLAIM TO ANY PARTICULAR FONT, STYLE, SIZE, OR COLOR.

SN 78-710,888, FILED 9-12-2005.

CAROL SPILS, EXAMINING ATTORNEY

Int. Cl.: 35

Prior U.S. Cls.: 100, 101, and 102

United States Patent and Trademark Office

Reg. No. 3,399,617

Registered Mar. 18, 2008

**SERVICE MARK
PRINCIPAL REGISTER**

PRACTICE LIFECYCLE

PRACTICE LIFECYCLE, LLC (DELAWARE CORPORATION)
20 CABOT BOULEVARD, SUITE 300
BOSTON, MA 02045

FOR: ADVISE IN THE FIELD OF BUSINESS MANAGEMENT AND MARKETING, NAMELY, ADVERTISING, PROMOTION, MARKETING AND BUSINESS STRATEGY FOR FINANCIAL ADVISORS, INVESTMENT ADVISORS, ACCOUNTANTS AND ATTORNEY; PROFESSIONAL BUSINESS CONSULTATION; BUSINESS ORGANIZATION ADVICE, NAMELY, PROVIDING CRITICAL INFORMATION TO BUSINESS PROFESSIONAL WHO

NEED TO MAKE DECISIONS FOR NEAR TERM AND LONG TERM STRATEGIC PLANNING, IN CLASS 35 (U.S. CLS. 100, 101 AND 102).

FIRST USE 9-14-2005; IN COMMERCE 11-1-2007.

THE MARK CONSISTS OF STANDARD CHARACTERS WITHOUT CLAIM TO ANY PARTICULAR FONT, STYLE, SIZE, OR COLOR.

SN 78-712,636, FILED 9-14-2005.

LESLEY LAMOTHE, EXAMINING ATTORNEY

Int. Cl.: 9

Prior U.S. Cls.: 21, 23, 26, 36, and 38

United States Patent and Trademark Office

Reg. No. 3,399,618

Registered Mar. 18, 2008

**TRADEMARK
PRINCIPAL REGISTER**

IDVAULT

GUARDID SYSTEMS, INC. (DELAWARE CORPORATION)
1900 SOUTH NORFOLK STREET
SAN MATEO, CA 94403

FOR: COMPUTER HARDWARE, NAMELY, HAND-HELD DEVICES FOR MAINTAINING ON-LINE PASSWORDS AND CONFIDENTIAL INFORMATION, IN CLASS 9 (U.S. CLS. 21, 23, 26, 36 AND 38).

FIRST USE 6-6-2006; IN COMMERCE 6-6-2006.

THE MARK CONSISTS OF STANDARD CHARACTERS WITHOUT CLAIM TO ANY PARTICULAR FONT, STYLE, SIZE, OR COLOR.

SN 78-713,043, FILED 9-14-2005.

DAVID C. REIHNER, EXAMINING ATTORNEY

Int. Cl.: 28

Prior U.S. Cls.: 22, 23, 38, and 50

United States Patent and Trademark Office

Reg. No. 3,399,619

Registered Mar. 18, 2008

**TRADEMARK
PRINCIPAL REGISTER**

YELLOW FEVER

YELLOW FEVER #1, LLC, MANAGING MEMBER, JAMISON ERNEST REVOCABLE TRUST (NEW YORK LTD LIAB CO)
1251 AVENUE OF THE AMERICAS
C/O DLA PIPER US LLP, ATTN: DAVID HRYCK
NEW YORK, NY 10020

FOR: ATHLETIC SPORTING GOODS, NAMELY, ATHLETIC WRIST AND JOINT SUPPORTS; BABY MULTIPLE ACTIVITY TOYS; BAGS FOR SKATEBOARDS; BAGS SPECIALLY ADAPTED FOR SPORTS EQUIPMENT; BALL BEARINGS FOR SKATEBOARDS; BATH TOYS; BATTERY OPERATED ACTION TOYS; BENDABLE TOYS; CAT TOYS; COLLECTABLE TOY FIGURES; DOG TOYS; ELECTRIC ACTION TOYS; INFLATABLE TOYS; MUSICAL TOYS; PLUSH TOYS; PUNCHING TOYS; SAFETY PADDING FOR SKATEBOARDING; SKATEBOARD WHEELS; SKATEBOARDS; SPORT

BALLS; SPORTS EQUIPMENT FOR BOXING, MARTIAL ARTS, AND THE LIKE, NAMELY PROTECTIVE BRAS; TOY MASKS; WATER SQUIRTING TOYS, IN CLASS 28 (U.S. CLS. 22, 23, 38 AND 50).

FIRST USE 3-7-2006; IN COMMERCE 3-7-2006.

THE MARK CONSISTS OF STANDARD CHARACTERS WITHOUT CLAIM TO ANY PARTICULAR FONT, STYLE, SIZE, OR COLOR.

OWNER OF U.S. REG. NOS. 2,856,048 AND 2,961,075.

SN 78-713,997, FILED 9-15-2005.

MICHAEL WIENER, EXAMINING ATTORNEY

Int. Cl.: 41

Prior U.S. Cls.: 100, 101, and 107

United States Patent and Trademark Office

Reg. No. 3,399,620

Registered Mar. 18, 2008

**SERVICE MARK
PRINCIPAL REGISTER**

TMZ

WARNER BROS. ENTERTAINMENT INC. (DE-
LAWARE CORPORATION)
4000 WARNER BOULEVARD
BURBANK, CA 91522

FOR: ENTERTAINMENT SERVICES IN THE
NATURE OF LIVE-ACTION, COMEDY, AND DRA-
MA TELEVISION SERIES; PRODUCTION OF LIVE-
ACTION, COMEDY, AND DRAMA TELEVISION
SERIES , IN CLASS 41 (U.S. CLS. 100, 101 AND 107).

FIRST USE 9-10-2007; IN COMMERCE 9-10-2007.

THE MARK CONSISTS OF STANDARD CHAR-
ACTERS WITHOUT CLAIM TO ANY PARTICULAR
FONT, STYLE, SIZE, OR COLOR.

SN 78-714,214, FILED 9-15-2005.

CAROLYN CATALDO, EXAMINING ATTORNEY

Int. Cl.: 41

Prior U.S. Cls.: 100, 101, and 107

United States Patent and Trademark Office

Reg. No. 3,399,621

Registered Mar. 18, 2008

**SERVICE MARK
PRINCIPAL REGISTER**



WNBA ENTERPRISES, LLC (DELAWARE LTD
LIAB CO)
450 HARMON MEADOW BOULEVARD
SECAUCUS, NJ 07094

FOR: ENTERTAINMENT AND EDUCATIONAL SERVICES IN THE NATURE OF ONGOING TELEVISION AND RADIO PROGRAMS IN THE FIELD OF BASKETBALL AND RENDERING LIVE BASKETBALL GAMES AND BASKETBALL EXHIBITIONS; THE PRODUCTION AND DISTRIBUTION OF RADIO AND TELEVISION BROADCASTS OF BASKETBALL GAMES, BASKETBALL EVENTS AND PROGRAMS IN THE FIELD OF BASKETBALL; CONDUCTING AND ARRANGING BASKETBALL CLINICS AND CAMPS, COACHES CLINICS AND CAMPS, DANCE TEAM CLINICS AND CAMPS AND BASKETBALL EVENTS; ENTERTAINMENT SERVICES IN THE NATURE OF PERSONAL APPEARANCES BY A COSTUMED MASCOT AND/OR DANCE TEAM AT BASKETBALL GAMES AND EXHIBITIONS, CLINICS, CAMPS, PROMOTIONS, AND OTHER BASKETBALL-RELATED EVENTS, SPECIAL EVENTS AND PARTIES; FAN CLUB SERVICES; ENTERTAINMENT SERVICES, NAMELY, PROVIDING A WEBSITE FEATURING THE FOLLOWING CONTENT TELEVISION HIGHLIGHTS, INTERACTIVE TELEVISION HIGHLIGHTS, VIDEO RECORDINGS, VIDEO STREAM RECORDINGS,

INTERACTIVE VIDEO HIGHLIGHT SELECTIONS, RADIO PROGRAMS, RADIO HIGHLIGHTS AND AUDIO RECORDINGS IN THE FIELD OF BASKETBALL, BASKETBALL NEWS IN THE NATURE OF INFORMATION, STATISTICS AND TRIVIA ABOUT BASKETBALL, ON-LINE COMPUTER GAMES, VIDEO GAMES, INTERACTIVE VIDEO GAMES, ACTION SKILL GAMES, ARCADE GAMES, ADULTS' AND CHILDREN'S PARTY GAMES, BOARD GAMES, PUZZLES AND TRIVIA GAMES, PROVIDING ON-LINE MAGAZINES, GUIDES, NEWSLETTERS, COLORING BOOKS AND GAME SCHEDULES IN THE FIELD OF BASKETBALL OVER THE INTERNET, PROVIDING AN ONLINE COMPUTER DATABASE IN THE FIELD OF BASKETBALL, IN CLASS 41 (U.S. CLS. 100, 101 AND 107).

FIRST USE 9-20-2005; IN COMMERCE 9-20-2005.

THE MARK CONSISTS OF A BASKETBALL SITTING ON A CLOUD TO THE RIGHT OF A CITY SKYLINE WITH THREE SKYSCRAPERS. A STYLIZED LETTER "S" WRAPS AROUND THE SKYSCRAPERS.

SN 78-715,537, FILED 9-19-2005.

JASON BLAIR, EXAMINING ATTORNEY

Int. Cl.: 35

Prior U.S. Cls.: 100, 101, and 102

United States Patent and Trademark Office

Reg. No. 3,399,622

Registered Mar. 18, 2008

**SERVICE MARK
PRINCIPAL REGISTER**

POWERED BY NOR1

NOR1, INC. (DELAWARE CORPORATION)
18986 TILSON AVENUE
CUPERTINO, CA 95014

FIRST USE 5-0-2005; IN COMMERCE 5-0-2005.

FOR: ONLINE ORDERING SERVICES, NAMELY,
PROVIDING FOR THE PURCHASE OF TICKETS TO
SPORTING EVENTS, SHOWS, CONCERTS, LOD-
GING, TRAVEL PACKAGES, AND TRANSPORTA-
TION, BY MEANS OF A GLOBAL COMPUTER
NETWORK, IN CLASS 35 (U.S. CLS. 100, 101 AND
102).

THE MARK CONSISTS OF STANDARD CHAR-
ACTERS WITHOUT CLAIM TO ANY PARTICULAR
FONT, STYLE, SIZE, OR COLOR.

SN 78-718,243, FILED 9-22-2005.

PETER B. BROMAGHIM, EXAMINING ATTORNEY

Int. Cl.: 35

Prior U.S. Cls.: 100, 101, and 102

United States Patent and Trademark Office

Reg. No. 3,399,623

Registered Mar. 18, 2008

**SERVICE MARK
PRINCIPAL REGISTER**

NOR1 UPGRADE

NOR1 UPGRADE (DELAWARE CORPORATION)
18986 TILSON AVENUE
CUPERTINO, CA 95014

FOR: ONLINE ORDERING SERVICES, NAMELY,
PROVIDING FOR THE PURCHASE OF TICKETS TO
SPORTING EVENTS, SHOWS, CONCERTS, LOD-
GING, TRAVEL PACKAGES, AND TRANSPORTA-
TION, BY MEANS OF A GLOBAL COMPUTER
NETWORK, IN CLASS 35 (U.S. CLS. 100, 101 AND
102).

FIRST USE 5-0-2005; IN COMMERCE 5-0-2005.

THE MARK CONSISTS OF STANDARD CHAR-
ACTERS WITHOUT CLAIM TO ANY PARTICULAR
FONT, STYLE, SIZE, OR COLOR.

SN 78-718,249, FILED 9-22-2005.

PETER B. BROMAGHIM, EXAMINING ATTORNEY

Int. Cl.: 35

Prior U.S. Cls.: 100, 101, and 102

United States Patent and Trademark Office

Reg. No. 3,399,624

Registered Mar. 18, 2008

**SERVICE MARK
PRINCIPAL REGISTER**

NOR1, INC. (DELAWARE CORPORATION)
18986 TILSON AVENUE
CUPERTINO, CA 95014

NETWORK, IN CLASS 35 (U.S. CLS. 100, 101 AND
102).

FOR: ONLINE ORDERING SERVICES, NAMELY,
PROVIDING FOR THE PURCHASE OF TICKETS TO
SPORTING EVENTS, SHOWS, CONCERTS, LOD-
GING, TRAVEL PACKAGES, AND TRANSPORTA-
TION, BY MEANS OF A GLOBAL COMPUTER

FIRST USE 5-0-2005; IN COMMERCE 5-0-2005.

SN 78-718,623, FILED 9-22-2005.

PETER B. BROMAGHIM, EXAMINING ATTORNEY

Int. Cl.: 35

Prior U.S. Cls.: 100, 101, and 102

United States Patent and Trademark Office

Reg. No. 3,399,625

Registered Mar. 18, 2008

**SERVICE MARK
PRINCIPAL REGISTER**

Funky Giraffe

KRALIK, JONATHAN, C (UNITED STATES IN-
DIVIDUAL)
1040 VISTA VIEW DRIVE
SALT LAKE CITY, UT 84108

THE MARK CONSISTS OF STANDARD CHAR-
ACTERS WITHOUT CLAIM TO ANY PARTICULAR
FONT, STYLE, SIZE, OR COLOR.

FOR: RETAIL STORES FEATURING CLOTHING,
AND TOYS, IN CLASS 35 (U.S. CLS. 100, 101 AND
102).

SN 78-719,282, FILED 9-23-2005.

FIRST USE 8-1-1998; IN COMMERCE 7-13-2004.

RENEE MCCRAY, EXAMINING ATTORNEY

Int. Cl.: 5

Prior U.S. Cls.: 6, 18, 44, 46, 51, and 52

United States Patent and Trademark Office

Reg. No. 3,399,626

Registered Mar. 18, 2008

**TRADEMARK
PRINCIPAL REGISTER**

DURABOND TECHNOLOGY

W.F. YOUNG, INCORPORATED (MASSACHU-
SETTS CORPORATION)

302 BENTON DRIVE

EAST LONGMEADOW, MA 01028

FOR: INSECT REPELLENTS, IN CLASS 5 (U.S.
CLS. 6, 18, 44, 46, 51 AND 52).

FIRST USE 12-9-2005; IN COMMERCE 12-9-2005.

THE MARK CONSISTS OF STANDARD CHAR-
ACTERS WITHOUT CLAIM TO ANY PARTICULAR
FONT, STYLE, SIZE, OR COLOR.

NO CLAIM IS MADE TO THE EXCLUSIVE
RIGHT TO USE "TECHNOLOGY", APART FROM
THE MARK AS SHOWN.

SN 78-719,508, FILED 9-23-2005.

JEAN IM, EXAMINING ATTORNEY

Int. Cl.: 33

Prior U.S. Cls.: 47 and 49

United States Patent and Trademark Office

Reg. No. 3,399,627

Registered Mar. 18, 2008

**TRADEMARK
PRINCIPAL REGISTER**

"THE WINE DRINKER'S VODKA"

DIVINE VODKA, LLC (NEVADA LTD LIAB CO)
10983 HILLS ROAD
BARODA, MI 49101

NO CLAIM IS MADE TO THE EXCLUSIVE
RIGHT TO USE "VODKA", APART FROM THE
MARK AS SHOWN.

FOR: VODKA, IN CLASS 33 (U.S. CLS. 47 AND 49).

FIRST USE 10-3-2006; IN COMMERCE 10-3-2006.

SN 78-720,473, FILED 9-26-2005.

THE MARK CONSISTS OF STANDARD CHAR-
ACTERS WITHOUT CLAIM TO ANY PARTICULAR
FONT, STYLE, SIZE, OR COLOR.

ALYSSA PALADINO, EXAMINING ATTORNEY

Int. Cl.: 19

Prior U.S. Cls.: 1, 12, 33, and 50

United States Patent and Trademark Office

Reg. No. 3,399,628

Registered Mar. 18, 2008

**TRADEMARK
PRINCIPAL REGISTER**

LODGEWOOD

CLOPAY BUILDING PRODUCTS R&D COMPAN-
NY, INC. (DELAWARE CORPORATION), DBA
CLOPAY BUILDING PRODUCTS COMPANY,
INC.,

8585 DUKE BOULEVARD
MASON, OH 45040

FOR: NON-METAL GARAGE DOORS, IN CLASS
19 (U.S. CLS. 1, 12, 33 AND 50).

FIRST USE 9-30-2005; IN COMMERCE 9-30-2005.

THE MARK CONSISTS OF STANDARD CHAR-
ACTERS WITHOUT CLAIM TO ANY PARTICULAR
FONT, STYLE, SIZE, OR COLOR.

SN 78-721,529, FILED 9-27-2005.

DARRYL SPRUILL, EXAMINING ATTORNEY

Int. Cl.: 9

Prior U.S. Cls.: 21, 23, 26, 36, and 38

United States Patent and Trademark Office

Reg. No. 3,399,629

Registered Mar. 18, 2008

**TRADEMARK
PRINCIPAL REGISTER**

POLIWALL A CRACKER

TECHGUARD SECURITY L.L.C. (MISSOURI
LTD LIAB CO)
SUITE 206
743 SPIRIT 40 PARK DRIVE
CHESTERFIELD, MO 63005

FOR: COMPUTER SECURITY PRODUCTS,
NAMELY, COMPUTER SOFTWARE AND HARD-
WARE TO PROVIDE SECURE ACCESS AND TO
PREVENT UNAUTHORIZED ACCESS TO COMPU-
TER NETWORKS AND SYSTEMS, AND USER
MANUALS AND TECHNICAL/INSTRUCTIONAL

MANUALS SOLD THEREWITH, IN CLASS 9 (U.S.
CLS. 21, 23, 26, 36 AND 38).

FIRST USE 8-0-2006; IN COMMERCE 8-0-2006.

THE MARK CONSISTS OF STANDARD CHAR-
ACTERS WITHOUT CLAIM TO ANY PARTICULAR
FONT, STYLE, SIZE, OR COLOR.

SN 78-721,671, FILED 9-27-2005.

PAM WILLIS, EXAMINING ATTORNEY

Int. Cls.: 35, 39, and 43

Prior U.S. Cls.: 100, 101, 102, and 105

United States Patent and Trademark Office

Reg. No. 3,399,630

Registered Mar. 18, 2008

**SERVICE MARK
PRINCIPAL REGISTER**

CENRES

CENTRAL RESERVATION ASSOCIATION OF
DESTINATION RESORTS, INC. (COLORADO
CORPORATION)

4841 S. XENIA STREET
DENVER, CO 80237

FOR: PROMOTING THE RESERVATION AND
BOOKING SERVICES OF OTHERS BY DISTRIBUT-
ING ADVERTISING MATERIALS THROUGH A
VARIETY OF METHODS, IN CLASS 35 (U.S. CLS.
100, 101 AND 102).

FIRST USE 12-0-2007; IN COMMERCE 12-0-2007.

FOR: PROVIDING INFORMATION AND MAK-
ING RESERVATIONS AND BOOKINGS FOR
TRANSPORTATION; ORGANIZATION, BOOKING
AND ARRANGEMENT OF EXCURSIONS, DAY
TRIPS AND SIGHTSEEING TOURS; TRAVEL AND
TOUR INFORMATION AND RESERVATION SER-
VICES; TRAVEL INFORMATION SERVICES,
NAMESLY, TRAVEL AND TOUR INFORMATION
SERVICE VIA THE INTERNET AND TELEPHONE;
COORDINATING TRAVEL ARRANGEMENTS FOR

INDIVIDUALS AND FOR GROUPS , IN CLASS 39
(U.S. CLS. 100 AND 105).

FIRST USE 12-0-2007; IN COMMERCE 12-0-2007.

FOR: PROVIDING INFORMATION AND MAK-
ING RESERVATIONS AND BOOKINGS FOR TEM-
PORARY LODGING; PROVIDING INFORMATION
AND MAKING RESERVATIONS AND BOOKINGS
FOR RESTAURANTS AND MEALS; TRAVEL
AGENCY SERVICES, NAMESLY, RESERVATIONS
AND BOOKING FOR TEMPORARY LODGING
VIA THE INTERNET AND TELEPHONE, IN CLASS
43 (U.S. CLS. 100 AND 101).

FIRST USE 12-0-2007; IN COMMERCE 12-0-2007.

THE MARK CONSISTS OF STANDARD CHAR-
ACTERS WITHOUT CLAIM TO ANY PARTICULAR
FONT, STYLE, SIZE, OR COLOR.

SN 78-722,820, FILED 9-28-2005.

MICHAEL SOUDERS, EXAMINING ATTORNEY

Int. Cl.: 38

Prior U.S. Cls.: 100, 101, and 104

United States Patent and Trademark Office

Reg. No. 3,399,631

Registered Mar. 18, 2008

**SERVICE MARK
PRINCIPAL REGISTER**

ES LA COMPANIA

CELLCO PARTNERSHIP (DELAWARE PART-
NERSHIP), DBA VERIZON WIRELESS,
ONE VERIZON WAY
VC52N058
BASKING RIDGE, NJ 079201097

FOR: TELECOMMUNICATIONS SERVICES,
NAMELY, WIRELESS PHONE SERVICES, IN CLASS
38 (U.S. CLS. 100, 101 AND 104).

FIRST USE 9-8-2006; IN COMMERCE 9-8-2006.

THE MARK CONSISTS OF STANDARD CHAR-
ACTERS WITHOUT CLAIM TO ANY PARTICULAR
FONT, STYLE, SIZE, OR COLOR.

THE FOREIGN WORDING IN THE MARK
TRANSLATES INTO ENGLISH AS IT'S THE COM-
PANY.

SN 78-722,932, FILED 9-29-2005.

KIMBERLY PERRY, EXAMINING ATTORNEY

Int. Cl.: 25

Prior U.S. Cls.: 22 and 39

United States Patent and Trademark Office

Reg. No. 3,399,632

Registered Mar. 18, 2008

TRADEMARK
PRINCIPAL REGISTER



YOU NEVER KNOW, INC. (GEORGIA CORPORATION)
8 OAK HILL DRIVE
NEWNAN, GA 30263

FOR: HATS AND SHIRTS, IN CLASS 25 (U.S. CLS. 22 AND 39).

FIRST USE 8-1-2006; IN COMMERCE 6-1-2007.

THE COLORS BLACK, WHITE, YELLOW, ORANGE AND GRAY ARE CLAIMED AS A FEATURE OF THE MARK.

THE MARK CONSISTS OF A BLACK TRIANGLE DESIGN WITH A YELLOW AND ORANGE SUN IN THE CENTER. A GRAY LIGHTENING BOLT CUTS

THROUGH THE CENTER OF THE SUN. THE WORDS "UNLEASH YOUR POTENTIAL" APPEAR IN WHITE UNDERNEATH THE SUN AND LIGHTENING BOLT.

THE MARK CONSISTS OF A TRIANGLE WITH A STYLIZED SUN IN THE CENTER AND A LIGHTENING BOLT SLANTING DOWNWARD FROM RIGHT TO LEFT ACROSS THE SUN. THE WORDING "UNLEASH YOUR POTENTIAL" APPEARS IN CAPITAL LETTERS ACROSS THE BOTTOM OF THE TRIANGLE.

SN 78-723,204, FILED 9-29-2005.

TINA BROWN, EXAMINING ATTORNEY

Int. Cl.: 9

Prior U.S. Cls.: 21, 23, 26, 36, and 38

United States Patent and Trademark Office

Reg. No. 3,399,633

Registered Mar. 18, 2008

**TRADEMARK
PRINCIPAL REGISTER**

GLOWGRIP

RADIO SYSTEMS CORPORATION (DELAWARE
CORPORATION)
10427 ELECTRIC AVENUE
KNOXVILLE, TN 37932

THE MARK CONSISTS OF STANDARD CHAR-
ACTERS WITHOUT CLAIM TO ANY PARTICULAR
FONT, STYLE, SIZE, OR COLOR.

FOR: HAND-HELD TRANSMITTERS FOR ELEC-
TRONIC ANIMAL CONFINEMENT SYSTEMS AND
ELECTRONIC ANIMAL TRAINING SYSTEMS, IN
CLASS 9 (U.S. CLS. 21, 23, 26, 36 AND 38).

SN 78-723,340, FILED 9-29-2005.

FIRST USE 2-28-2007; IN COMMERCE 2-28-2007.

KAREN K. BUSH, EXAMINING ATTORNEY

Int. Cl.: 39

Prior U.S. Cls.: 100 and 105

United States Patent and Trademark Office

Reg. No. 3,399,634

Registered Mar. 18, 2008

**SERVICE MARK
PRINCIPAL REGISTER**



PHAETON AVIATION, INC. (NORTH CAROLINA CORPORATION)
32512 ARCHDALE
CHAPEL HILL, NC 27517

FOR: AIR TRANSPORTATION SERVICES; AIRCRAFT CHARTERING SERVICES, IN CLASS 39 (U.S. CLS. 100 AND 105).

FIRST USE 5-29-2007; IN COMMERCE 5-29-2007.

NO CLAIM IS MADE TO THE EXCLUSIVE RIGHT TO USE "AVIATION" AND THE HAWKER 800 DESIGN, APART FROM THE MARK AS SHOWN.

THE COLOR(S) DARK GREEN, LIGHT BLUE, WHITE, SILVER AND GOLD IS/ARE CLAIMED AS A FEATURE OF THE MARK.

THE MARK CONSISTS OF THE DESIGN OF A HAWKER 800 AIRCRAFT WITH CONTRAILS EMANATING FROM BEHIND THE AIRCRAFT WITH THE AIRCRAFT FLYING BETWEEN THE WORDS PHAETON AND AVIATION. THE NOSE CONE OF THE AIRCRAFT IS WHITE WITH GOLD STRIPES AND DARK GREEN. THE WINGS OF THE AIRCRAFT ARE SILVER, THE WORDS PHAETON AND AVIATION ARE DARK GREEN AND THE CONTRAIL IS LIGHT BLUE.

SN 78-723,892, FILED 9-30-2005.

SALLY SHIH, EXAMINING ATTORNEY

Int. Cl.: 20

Prior U.S. Cls.: 2, 13, 22, 25, 32, and 50

Reg. No. 3,399,635

United States Patent and Trademark Office

Registered Mar. 18, 2008

**TRADEMARK
PRINCIPAL REGISTER**

JEWEL

OFS SALES CORP. (INDIANA CORPORATION)
PO BOX 100 4611 SOUTH 400 WEST
HUNTINGBURG, IN 47542

THE MARK CONSISTS OF STANDARD CHAR-
ACTERS WITHOUT CLAIM TO ANY PARTICULAR
FONT, STYLE, SIZE, OR COLOR.

FOR: OFFICE FURNITURE, IN CLASS 20 (U.S.
CLS. 2, 13, 22, 25, 32 AND 50).

SN 78-725,850, FILED 10-4-2005.

FIRST USE 3-2-2007; IN COMMERCE 3-2-2007.

MICHAEL WEBSTER, EXAMINING ATTORNEY

Int. Cls.: 35 and 42

Prior U.S. Cls.: 100, 101, and 102

United States Patent and Trademark Office

Reg. No. 3,399,636

Registered Mar. 18, 2008

**SERVICE MARK
PRINCIPAL REGISTER**

order in ▪ dine out ▪ online

CLICKEATS, INC. (WASHINGTON CORPORATION)
2018 130TH AVE., S.E.
BELLEVUE, WA 98005

FOR: MARKETING SERVICES, NAMELY, PROVIDING A WEB SITE WITH AN ON LINE DIRECTORY AND INFORMATIONAL SERVICES, DESIGNED TO GENERATE SALES TRAFFIC VIA HYPERLINKS TO WEB SITES OF PARTICIPATING RESTAURANTS, IN CLASS 35 (U.S. CLS. 100, 101 AND 102).

FIRST USE 6-15-2005; IN COMMERCE 5-4-2007.

FOR: PROVIDING ONLINE NON-DOWNLOADABLE APPLICATION SOFTWARE TO RESTAURANTS IN ORDER TO FACILITATE THE RESTAURANTS' CREATION OF INTERACTIVE WEB SITES FOR ONLINE FOOD ORDERING AND

MENU MANAGEMENT, IN CLASS 42 (U.S. CLS. 100 AND 101).

FIRST USE 6-15-2005; IN COMMERCE 5-4-2007.

NO CLAIM IS MADE TO THE EXCLUSIVE RIGHT TO USE "ONLINE", APART FROM THE MARK AS SHOWN.

THE MARK CONSISTS OF THE WORDS "ORDER IN DINE OUT ONLINE" WRITTEN IN A STYLIZED FONT WITH A SQUARE BULLET BETWEEN THE WORDS "IN" AND "DINE" AND BETWEEN THE WORDS "OUT" AND "ONLINE".

SN 78-726,204, FILED 10-4-2005.

MICHAEL WIENER, EXAMINING ATTORNEY

Int. Cl.: 41

Prior U.S. Cls.: 100, 101, and 107

United States Patent and Trademark Office

Reg. No. 3,399,637

Registered Mar. 18, 2008

**SERVICE MARK
PRINCIPAL REGISTER**

GAME HEAD

NETWORK ENTERPRISES, INC. (TENNESSEE
CORPORATION)
1515 BROADWAY
NEW YORK, NY 10036

FOR: ENTERTAINMENT SERVICES IN THE
NATURE OF AN ON-GOING TELEVISION SERIES,
FEATURING LIVE ACTION, COMEDY AND DRA-
MA; PROVIDING ONLINE INFORMATION IN THE
FIELD OF ENTERTAINMENT CONCERNING TEL-
EVISION PROGRAMS, IN CLASS 41 (U.S. CLS. 100,
101 AND 107).

FIRST USE 5-9-2007; IN COMMERCE 5-9-2007.

THE MARK CONSISTS OF STANDARD CHAR-
ACTERS WITHOUT CLAIM TO ANY PARTICULAR
FONT, STYLE, SIZE, OR COLOR.

NO CLAIM IS MADE TO THE EXCLUSIVE
RIGHT TO USE "GAME", APART FROM THE
MARK AS SHOWN.

SN 78-726,828, FILED 10-5-2005.

CHARLES L. JENKINS, EXAMINING ATTORNEY

Int. Cl.: 20

Prior U.S. Cls.: 2, 13, 22, 25, 32, and 50

United States Patent and Trademark Office

Reg. No. 3,399,638

Registered Mar. 18, 2008

**TRADEMARK
PRINCIPAL REGISTER**

bébéPOD

PRINCE LIONHEART, INC. (CALIFORNIA CORPORATION)
2421 S. WESTGATE ROAD
SANTA MARIA, CA 93455

OWNER OF U.S. REG. NO. 3,041,974.

FOR: INFANT TRAINING DEVICE IN THE NATURE OF SEATS, FOR HELPING INFANTS SIT UPRIGHT AND HELPING INFANTS TO LEARN TO SIT UPRIGHT, IN CLASS 20 (U.S. CLS. 2, 13, 22, 25, 32 AND 50).

THE ENGLISH TRANSLATION OF THE WORD "BÉBÉ" MEANS "BABY".

SN 78-727,449, FILED 10-5-2005.

FIRST USE 5-0-2005; IN COMMERCE 1-1-2006.

JORDAN BAKER, EXAMINING ATTORNEY

Int. Cl.: 44

Prior U.S. Cls.: 100 and 101

United States Patent and Trademark Office

Reg. No. 3,399,639

Registered Mar. 18, 2008

**SERVICE MARK
PRINCIPAL REGISTER**



PFIZER INC. (DELAWARE CORPORATION)
235 EAST 42ND STREET
NEW YORK, NY 10017

FOR: MEDICAL INFORMATION SERVICES, NAMELY, PROVIDING INFORMATION RELATING TO DIABETIC NERVE PAIN AND THE TREATMENT THEREOF; ONLINE INFORMATION SERVICES, NAMELY, PROVIDING INFORMATION RELATING TO DIABETIC NERVE PAIN AND THE TREATMENT THEREOF VIA A GLOBAL COMPUTER NETWORK, IN CLASS 44 (U.S. CLS. 100 AND 101).

FIRST USE 11-5-2005; IN COMMERCE 11-5-2005.

NO CLAIM IS MADE TO THE EXCLUSIVE RIGHT TO USE "DIABETIC NERVE PAIN", APART FROM THE MARK AS SHOWN.

THE MARK CONSISTS OF TWO FOOT PRINTS IN THE MIDDLE OF THE PHRASE "STEP FORWARD FROM DIABETIC NERVE PAIN" IN A BOX.

SN 78-727,901, FILED 10-6-2005.

SUSAN LESLIE DUBOIS, EXAMINING ATTORNEY

Int. Cl.: 16

Prior U.S. Cls.: 2, 5, 22, 23, 29, 37, 38, and 50

United States Patent and Trademark Office

Reg. No. 3,399,640

Registered Mar. 18, 2008

**TRADEMARK
PRINCIPAL REGISTER**

Valet

UNITED INFOXCHANGE, LLC (NEW HAMP-
SHIRE LTD LIAB CO)
12 KENT WAY
BYFIELD, MA 01922

FOR: PERIODICAL MAGAZINES FEATURING
NEWS AND INFORMATION RELATING TO THE
HEALTH CARE INDUSTRY, SPECIFICALLY NEWS
AND ARTICLES ON HEALTH CARE STUDIES AND
BREAKTHROUGHS IN DIETARY AND NUTRI-
TIONAL SUPPLEMENTS, PERSONALIZED IN-
HOME HEALTH ASSESSMENT SERVICES, AND
NEWS ON CURRENT HEALTH EVENTS, BUSINESS
LEADERS AND AWARDS GIVEN FOR ACHIEVE-

MENTS IN THE HEALTH CARE INDUSTRY, IN
CLASS 16 (U.S. CLS. 2, 5, 22, 23, 29, 37, 38 AND 50).

FIRST USE 9-1-2007; IN COMMERCE 9-1-2007.

THE MARK CONSISTS OF STANDARD CHAR-
ACTERS WITHOUT CLAIM TO ANY PARTICULAR
FONT, STYLE, SIZE, OR COLOR.

SN 78-728,232, FILED 10-6-2005.

WILLIAM ROSSMAN, EXAMINING ATTORNEY

Int. Cl.: 9

Prior U.S. Cls.: 21, 23, 26, 36, and 38

United States Patent and Trademark Office

Reg. No. 3,399,641

Registered Mar. 18, 2008

**TRADEMARK
PRINCIPAL REGISTER**



MEADWESTVACO CORPORATION (DELAWARE CORPORATION)
MEADWESTVACO CORPORATE CENTER
11013 WEST BROAD STREET
GLEN ALLEN, VA 23060

FIRST USE 9-16-2007; IN COMMERCE 9-16-2007.

OWNER OF U.S. REG. NOS. 1,072,214, 2,194,133,
AND OTHERS.

FOR: PROTECTIVE CARRYING CASES FOR PORTABLE MUSIC PLAYERS NAMELY MP3 PLAYERS; PROTECTIVE CARRYING CASES FOR PERSONAL DIGITAL ASSISTANTS (PDA); CASES FOR MOBILE PHONES; COMPUTER CARRYING CASES, IN CLASS 9 (U.S. CLS. 21, 23, 26, 36 AND 38).

SN 78-732,261, FILED 10-13-2005.

CAROLYN CATALDO, EXAMINING ATTORNEY

Int. Cl.: 16

Prior U.S. Cls.: 2, 5, 22, 23, 29, 37, 38, and 50

United States Patent and Trademark Office

Reg. No. 3,399,642

Registered Mar. 18, 2008

**TRADEMARK
PRINCIPAL REGISTER**



MEADWESTVACO CORPORATION (DELAWARE
CORPORATION)
MEADWESTVACO CORPORATE CENTER
11013 WEST BROAD STREET
GLEN ALLEN, VA 23060

OWNER OF U.S. REG. NOS. 1,072,214, 2,194,133,
AND OTHERS.

FOR: LUNCH BAGS, IN CLASS 16 (U.S. CLS. 2, 5,
22, 23, 29, 37, 38 AND 50).

SN 78-732,262, FILED 10-13-2005.

FIRST USE 4-30-2007; IN COMMERCE 4-30-2007.

KAELIE KUNG, EXAMINING ATTORNEY

Int. Cl.: 43

Prior U.S. Cls.: 100 and 101

United States Patent and Trademark Office

Reg. No. 3,399,643

Registered Mar. 18, 2008

**SERVICE MARK
PRINCIPAL REGISTER**

PURE MAGIC

MARRIOTT INTERNATIONAL, INC. (DELA-
WARE CORPORATION)
10400 FERNWOOD ROAD
BETHESDA, MD 20817

FOR: HOTEL SERVICES; RESTAURANT, BAR
AND COCKTAIL LOUNGE SERVICES; RESORT
LODGING SERVICES; AND RESERVATION SERVI-
CES FOR HOTEL ACCOMMODATIONS FOR OTH-
ERS, IN CLASS 43 (U.S. CLS. 100 AND 101).

FIRST USE 10-0-2005; IN COMMERCE 10-0-2005.

THE MARK CONSISTS OF STANDARD CHAR-
ACTERS WITHOUT CLAIM TO ANY PARTICULAR
FONT, STYLE, SIZE, OR COLOR.

SN 78-732,691, FILED 10-13-2005.

SANDRA MANIOS, EXAMINING ATTORNEY

Int. Cl.: 5

Prior U.S. Cls.: 6, 18, 44, 46, 51, and 52

Reg. No. 3,399,644

United States Patent and Trademark Office

Registered Mar. 18, 2008

**TRADEMARK
PRINCIPAL REGISTER**

TOTECT

TOPOTARGET A/S (DENMARK CORPORATION)
SYMBION, 3 FRUEBJERGVEJ
COPENHAGEN, DENMARK DK-2100

THE MARK CONSISTS OF STANDARD CHAR-
ACTERS WITHOUT CLAIM TO ANY PARTICULAR
FONT, STYLE, SIZE, OR COLOR.

FOR: PHARMACEUTICAL PREPARATIONS FOR
THE PROPHYLAXIS AND TREATMENT OF TISSUE
DAMAGE CAUSED BY CYTOTOXIC AGENTS, IN
CLASS 5 (U.S. CLS. 6, 18, 44, 46, 51 AND 52).

SN 78-732,996, FILED 10-13-2005.

FIRST USE 10-15-2007; IN COMMERCE 10-15-2007.

JOHN DWYER, EXAMINING ATTORNEY

Int. Cl.: 1

Prior U.S. Cls.: 1, 5, 6, 10, 26, and 46

Reg. No. 3,399,645

United States Patent and Trademark Office

Registered Mar. 18, 2008

**TRADEMARK
PRINCIPAL REGISTER**

AEROCLAY

SCHIRALDI, DAVID ANTHONY (UNITED STATES INDIVIDUAL)
22432 WESTCHESTER RD
SHAKER HEIGHTS, OH 44122

INCLUDE CHINA CLAY THAT HAS BEEN DRIED AND AIR SEPARATED TO REMOVE COARSE PARTICLES, IN CLASS 1 (U.S. CLS. 1, 5, 6, 10, 26 AND 46).

FOR: CERAMIC COMPOSITIONS IN THE SOLID STATE FOR MANUFACTURE OF FIBROUS MONOLITHIC CERAMIC COMPARTMENTS FOR USE IN HIGH TEMPERATURE APPLICATIONS; POLYMER COMPOSITIONS USED IN THE MANUFACTURE OF COMMERCIAL AND INDUSTRIAL GOODS, NAMELY, CELL-CONTAINING CONSTRUCTS, LOW DENSITY COMPOSITES, LOW DENSITY MOLDED FOAMS, FREEZE DRIED FOAMS, SOLID FOAMS, FOAM PARTICLES, AND RANDOM MATRIX FORMS, WHEREIN THE GOODS DO NOT

FIRST USE 1-31-2007; IN COMMERCE 1-31-2007.

THE MARK CONSISTS OF STANDARD CHARACTERS WITHOUT CLAIM TO ANY PARTICULAR FONT, STYLE, SIZE, OR COLOR.

SN 78-735,839, FILED 10-18-2005.

BARBARA GAYNOR, EXAMINING ATTORNEY

Int. Cl.: 10

Prior U.S. Cls.: 26, 39, and 44

United States Patent and Trademark Office

Reg. No. 3,399,646

Registered Mar. 18, 2008

**TRADEMARK
PRINCIPAL REGISTER**

N-560

NELLCOR PURITAN BENNETT INCORPORATED (DELAWARE CORPORATION)
6165 GUNBARREL AVENUE
BOULDER, CO 80301

THE MARK CONSISTS OF STANDARD CHARACTERS WITHOUT CLAIM TO ANY PARTICULAR FONT, STYLE, SIZE, OR COLOR.

FOR: MEDICAL DEVICES, NAMELY, PULSE OXIMETERS, IN CLASS 10 (U.S. CLS. 26, 39 AND 44).

SN 78-736,278, FILED 10-19-2005.

FIRST USE 7-3-2006; IN COMMERCE 7-3-2006.

KAREN K. BUSH, EXAMINING ATTORNEY

Int. Cls.: 3 and 41

Prior U.S. Cls.: 1, 4, 6, 50, 51, 52, 100, 101, and 107

United States Patent and Trademark Office

Reg. No. 3,399,647

Registered Mar. 18, 2008

**TRADEMARK
SERVICE MARK
PRINCIPAL REGISTER**

SHINE AT JUSTICE

TWEEN BRANDS INVESTMENT, LLC (OHIO
LTD LIAB CO)
8323 WALTON PKWY.
NEW ALBANY, OH 43054

FOR: COSMETICS, ARTIFICIAL FINGERNAILS,
BEAUTY CREAMS AND GELS, DECORATIVE
TRANSFERS AND SKIN JEWELS FOR COSMETIC
PURPOSES, DUSTING POWDERS, PERFUMES
AND PERSONAL FRAGRANCES, HAIR CARE PRE-
PARATIONS AND DYES, MAKE-UP KITS COM-
PRISED OF COSMETICS AND BEAUTY CARE
PRODUCTS, AND FINGER AND TOE NAIL CARE
PRODUCTS, POLISH AND REMOVER, IN CLASS 3
(U.S. CLS. 1, 4, 6, 50, 51 AND 52).

FIRST USE 10-20-2005; IN COMMERCE 8-21-2006.

FOR: ENTERTAINMENT SERVICES, NAMELY,
CONDUCTING PARTIES, IN CLASS 41 (U.S. CLS.
100, 101 AND 107).

FIRST USE 10-20-2005; IN COMMERCE 8-21-2006.

THE MARK CONSISTS OF STANDARD CHAR-
ACTERS WITHOUT CLAIM TO ANY PARTICULAR
FONT, STYLE, SIZE, OR COLOR.

OWNER OF U.S. REG. NOS. 2,990,417 AND
3,006,487.

SN 78-737,488, FILED 10-20-2005.

MATTHEW EINSTEIN, EXAMINING ATTORNEY

Int. Cls.: 28 and 41

Prior U.S. Cls.: 22, 23, 38, 50, 100, 101, and 107

United States Patent and Trademark Office

Reg. No. 3,399,648

Registered Mar. 18, 2008

**TRADEMARK
SERVICE MARK
PRINCIPAL REGISTER**

FIT TO SPEED

COBRA GOLF INCORPORATED (DELAWARE CORPORATION)
1812 ASTON AVENUE
CARLSBAD, CA 92008

FOR: GOLF EQUIPMENT, NAMELY, GOLF CLUBS, IN CLASS 28 (U.S. CLS. 22, 23, 38 AND 50).

FIRST USE 10-0-2006; IN COMMERCE 10-0-2006.

FOR: FITTING OF GOLF CLUBS TO INDIVIDUAL USERS, IN CLASS 41 (U.S. CLS. 100, 101 AND 107).

FIRST USE 10-0-2006; IN COMMERCE 10-0-2006.

THE MARK CONSISTS OF STANDARD CHARACTERS WITHOUT CLAIM TO ANY PARTICULAR FONT, STYLE, SIZE, OR COLOR.

SN 78-737,693, FILED 10-21-2005.

JEFFERY COWARD, EXAMINING ATTORNEY

Int. Cl.: 30

Prior U.S. Cl.: 46

United States Patent and Trademark Office

Reg. No. 3,399,649

Registered Mar. 18, 2008

**TRADEMARK
PRINCIPAL REGISTER**



BUEHLER FOOD MARKETS, INCORPORATED
(OHIO CORPORATION)
1401 OLD MANSFIELD ROAD
WOOSTER, OH 44691

OWNER OF U.S. REG. NO. 3,216,569.

FOR: COFFEE; TEA; COCOA; PREPARED COFFEE AND COFFEE-BASED BEVERAGES; PREPARED EXPRESSO AND EXPRESSO-BASED BEVERAGES; BEVERAGES MADE OF TEA; CHAI; BULK COFFEE BEANS; ICED TEA; READY-TO-DRINK TEA; CHOCOLATE FOOD BEVERAGES NOT BEING DAIRY BASED OR VEGETABLE BASED; CHOCOLATE FOOD BEVERAGES NOT BEING DAIRY-BASED OR VEGETABLE BASED WITH COFFEE FLAVORS; HOT CHOCOLATE; COCOA BEVERAGES WITH MILK, IN CLASS 30 (U.S. CL. 46).

NO CLAIM IS MADE TO THE EXCLUSIVE RIGHT TO USE "COFFEE CO", APART FROM THE MARK AS SHOWN.

THE MARK CONSISTS OF TWO MEN PADDLING A CANOE ABOVE THE OUTLINE OF THE STATE OF OHIO, WITH THE WORDS "SCENIC RIVER COFFEE CO" SUPERIMPOSED OVER THE STATE OUTLINE.

SN 78-737,967, FILED 10-21-2005.

FIRST USE 2-4-2006; IN COMMERCE 2-4-2006.

DAVID YONTEF, EXAMINING ATTORNEY

Int. Cl.: 42

Prior U.S. Cls.: 100 and 101

United States Patent and Trademark Office

Reg. No. 3,399,650

Registered Mar. 18, 2008

**SERVICE MARK
PRINCIPAL REGISTER**

EZBlue

HERITAGE PRESERVATION CORPORATION
(SOUTH CAROLINA CORPORATION)
145 N. CHURCH STREET, #32
SPARTANBURG, SC 29306

FIRST USE 11-7-2005; IN COMMERCE 11-7-2005.

FOR: PROVIDING TEMPORARY USE OF NON-DOWNLOADABLE SOFTWARE VIA A GLOBAL COMPUTER NETWORK FOR ELECTRONIC DOCUMENT EDITING FOR THE FINANCIAL MARKETS COMMUNITY SERVING INVESTMENT BANKS, SECURITY LAW FIRMS, CORPORATIONS AND INVESTMENT FUNDS, IN CLASS 42 (U.S. CLS. 100 AND 101).

THE MARK CONSISTS OF STANDARD CHARACTERS WITHOUT CLAIM TO ANY PARTICULAR FONT, STYLE, SIZE, OR COLOR.

SN 78-737,995, FILED 10-21-2005.

GENE MACIOL, EXAMINING ATTORNEY

Int. Cl.: 9

Prior U.S. Cls.: 21, 23, 26, 36, and 38

United States Patent and Trademark Office

Reg. No. 3,399,651

Registered Mar. 18, 2008

**TRADEMARK
PRINCIPAL REGISTER**

MYSPACE RECORDS

MYSPACE, INC. (DELAWARE CORPORATION)
407 N. MAPLE DRIVE
BEVERLY HILLS, CA 90210

FOR: PRERECORDED MUSIC ON DVD AND
OTHER MEDIA, IN CLASS 9 (U.S. CLS. 21, 23, 26, 36
AND 38).

FIRST USE 11-30-2005; IN COMMERCE 11-30-2005.

THE MARK CONSISTS OF STANDARD CHAR-
ACTERS WITHOUT CLAIM TO ANY PARTICULAR
FONT, STYLE, SIZE, OR COLOR.

NO CLAIM IS MADE TO THE EXCLUSIVE
RIGHT TO USE "RECORDS", APART FROM THE
MARK AS SHOWN.

SN 78-738,140, FILED 10-21-2005.

ANGELA M. MICHELI, EXAMINING ATTORNEY

Int. Cls.: 10, 35, and 44

Prior U.S. Cls.: 26, 39, 44, 100, 101, and 102

Reg. No. 3,399,652

United States Patent and Trademark Office

Registered Mar. 18, 2008

**TRADEMARK
SERVICE MARK
PRINCIPAL REGISTER**



VILEX, INC. (DELAWARE CORPORATION)
345 OLD CURRY HOLLOW ROAD
PITTSBURGH, PA 15236

FOR: SURGICAL INSTRUMENTS, NAMELY, METAL SURGICAL TOOLS TO FACILITATE THE IMPLANTATION OF ORTHOPEDIC AND PODIATRY SURGICAL IMPLANTS; POWER SYSTEMS AND ACCESSORIES FOR SURGICAL USE, NAMELY, ELECTRIC POWERED CONSOLE WITH CONTROL/DISPLAY PANEL, POWER CORD, FOOT SWITCH, MOTOR CORD, MOTOR, AND METAL SURGICAL TOOLS TO FACILITATE THE IMPLANTATION OF ORTHOPEDIC AND PODIATRY SURGICAL IMPLANTS; AND ORTHOPEDIC AND PODIATRIC SURGICAL IMPLANTS COMPRISING ARTIFICIAL MATERIAL, IN CLASS 10 (U.S. CLS. 26, 39 AND 44).

FIRST USE 7-15-1996; IN COMMERCE 7-15-1996.

FOR: DISTRIBUTORSHIP SERVICES IN THE FIELD OF PODIATRIC IMPLANTS AND SURGICAL INSTRUMENTS; RETAIL CONSIGNMENT BY

REPRESENTATIVES IN THE FIELD OF PODIATRIC IMPLANTS AND SURGICAL INSTRUMENTS; RETAIL SERVICES BY DIRECT TELEPHONE SOLICITATION BY SALES AGENTS IN THE FIELD OF PODIATRIC IMPLANTS AND SURGICAL INSTRUMENTS; INDEPENDENT SALES REPRESENTATIVES IN THE FIELD OF PODIATRIC IMPLANTS AND SURGICAL INSTRUMENTS, IN CLASS 35 (U.S. CLS. 100, 101 AND 102).

FIRST USE 12-31-1996; IN COMMERCE 12-31-1996.

FOR: RENTAL OF MEDICAL EQUIPMENT IN THE FIELD OF PODIATRIC IMPLANTS AND SURGICAL INSTRUMENTS, IN CLASS 44 (U.S. CLS. 100 AND 101).

FIRST USE 12-31-1996; IN COMMERCE 12-31-1996.

OWNER OF U.S. REG. NO. 3,043,406.

SN 78-739,251, FILED 10-24-2005.

RAUL CORDOVA, EXAMINING ATTORNEY

Int. Cl.: 45

Prior U.S. Cls.: 100 and 101

United States Patent and Trademark Office

Reg. No. 3,399,653

Registered Mar. 18, 2008

**SERVICE MARK
PRINCIPAL REGISTER**

TEENS FOR JEANS

DO SOMETHING!, INC. (NEW YORK NON-
PROFIT CORPORATION)
423 WEST 55TH STREET 8TH FLOOR
NEW YORK, NY 10019

FOR: CHARITABLE SERVICES, NAMELY, OR-
GANIZING YOUTH GROUPS TO UNDERTAKE
PROJECTS TO BENEFIT THE NEEDY AND THE
COMMUNITY TO ENCOURAGE LEADERSHIP,
CHARACTER, COMPASSION, AND GOOD CITI-
ZENSHIP; CHARITABLE SERVICES, NAMELY,
PROVIDING CLOTHING TO NEEDY PERSONS, IN
CLASS 45 (U.S. CLS. 100 AND 101).

FIRST USE 1-7-2008; IN COMMERCE 1-7-2008.

THE MARK CONSISTS OF STANDARD CHAR-
ACTERS WITHOUT CLAIM TO ANY PARTICULAR
FONT, STYLE, SIZE, OR COLOR.

SN 78-740,352, FILED 10-25-2005.

SOPHIA S. KIM, EXAMINING ATTORNEY

Int. Cls.: 35 and 36

Prior U.S. Cls.: 100, 101, and 102

United States Patent and Trademark Office

Reg. No. 3,399,654

Registered Mar. 18, 2008

SERVICE MARK
PRINCIPAL REGISTER



GROVE FARM COMPANY, INCORPORATED
(HAWAII CORPORATION)
P.O. BOX 662069
LIHUE, HI 96766

FOR: REAL ESTATE SALES MANAGEMENT;
REAL ESTATE AUCTIONS; REAL ESTATE MAR-
KETING SERVICES, NAMELY, ON-LINE SERVICES
FEATURING TOURS OF RESIDENTIAL AND COM-
MERCIAL REAL ESTATE, IN CLASS 35 (U.S. CLS.
100, 101 AND 102).

FIRST USE 10-23-2005; IN COMMERCE 10-23-2005.

FOR: ASSESSMENT AND MANAGEMENT OF
REAL ESTATE; FINANCIAL INVESTMENT IN THE
FIELD OF REAL ESTATE; FINANCIAL VALUA-
TION OF PERSONAL PROPERTY AND REAL ES-
TATE; LAND ACQUISITION, NAMELY, REAL
ESTATE BROKERAGE; LEASING OF REAL ES-
TATE; OPERATING MARKETPLACES FOR SELL-

ERS OF REAL ESTATE; PROVIDING
INFORMATION IN THE FIELD OF REAL ESTATE
BY MEANS OF LINKING THE WEB SITE TO
OTHER WEB SITES FEATURING REAL ESTATE
INFORMATION; REAL ESTATE ACQUISITION
SERVICES; REAL ESTATE AGENCIES; REAL ES-
TATE APPRAISAL; REAL ESTATE BROKERAGE;
REAL ESTATE CONSULTATION, IN CLASS 36 (U.S.
CLS. 100, 101 AND 102).

FIRST USE 10-23-2005; IN COMMERCE 10-23-2005.

NO CLAIM IS MADE TO THE EXCLUSIVE
RIGHT TO USE "SINCE 1864", APART FROM THE
MARK AS SHOWN.

SN 78-741,299, FILED 10-26-2005.

JANICE L. MCMORROW, EXAMINING ATTOR-
NEY

Int. Cls.: 35 and 36

Prior U.S. Cls.: 100, 101, and 102

United States Patent and Trademark Office

Reg. No. 3,399,655

Registered Mar. 18, 2008

**SERVICE MARK
PRINCIPAL REGISTER**

Wealthco

KURTZ, MITCHELL A. (UNITED STATES INDIVIDUAL)
30 ROCKEFELLER CENTER
NEW YORK, NY 10112

FOR: TAX PLANNING AND BUSINESS CORPORATE AND ORGANIZATIONAL SUCCESSION PLANNING, IN CLASS 35 (U.S. CLS. 100, 101 AND 102).

FIRST USE 9-7-2006; IN COMMERCE 9-7-2006.

FOR: FINANCIAL SERVICES, NAMELY, COMPREHENSIVE FINANCIAL PLANNING INCLUDING ASSISTING OTHERS WITH INVESTMENT

PLANNING, RETIREMENT PLANNING, ESTATE PLANNING, BUSINESS PLANNING, AND INSURANCE PLANNING, IN CLASS 36 (U.S. CLS. 100, 101 AND 102).

FIRST USE 9-7-2006; IN COMMERCE 9-7-2006.

THE MARK CONSISTS OF STANDARD CHARACTERS WITHOUT CLAIM TO ANY PARTICULAR FONT, STYLE, SIZE, OR COLOR.

SN 78-742,618, FILED 10-28-2005.

RENEE MCCRAY, EXAMINING ATTORNEY

Int. Cl.: 42

Prior U.S. Cls.: 100 and 101

United States Patent and Trademark Office

Reg. No. 3,399,656

Registered Mar. 18, 2008

**SERVICE MARK
PRINCIPAL REGISTER**

INNOVATION INTELLIGENCE

ALTAIR ENGINEERING, INC. (MICHIGAN CORPORATION)
1820 E. BIG BEAVER ROAD
TROY, MI 480832031

FOR: ENGINEERING CONSULTATION SERVICES IN THE FIELD OF ENGINEERING AND INFORMATION TECHNOLOGY; ENGINEERING RESEARCH AND DESIGN FOR OTHERS IN THE FIELDS OF ENGINEERING AND INFORMATION TECHNOLOGY, IN CLASS 42 (U.S. CLS. 100 AND 101).

FIRST USE 11-10-2006; IN COMMERCE 11-10-2006.

THE MARK CONSISTS OF STANDARD CHARACTERS WITHOUT CLAIM TO ANY PARTICULAR FONT, STYLE, SIZE, OR COLOR.

SN 78-743,785, FILED 10-31-2005.

ANTHONY RINKER, EXAMINING ATTORNEY

Int. Cls.: 2, 3, 9, 37, 40, 41, and 42

Prior U.S. Cls.: 1, 4, 6, 11, 16, 21, 23, 26, 36, 38, 50, 51, 52, 100, 101, 103, 106, and 107

Reg. No. 3,399,657

United States Patent and Trademark Office

Registered Mar. 18, 2008

**TRADEMARK
SERVICE MARK
PRINCIPAL REGISTER**



ELECTRONICS FOR IMAGING, INC. (DELAWARE CORPORATION)
303 VELOCITY WAY
FOSTER CITY, CA 94404

FOR: PRINTING INKS; NEWS INKS; FLEXOGRAPHIC INKS; PRINTING VARNISH; COLOR PRINTING PIGMENTS; COLORANTS FOR USE IN THE MANUFACTURE OF PRINTING INKS AND LACQUERS FOR PRINTING PURPOSES; PRINTERS' INK AND INK JET PRINTERS INK; INK FOR USE WITH DIGITAL PRINTERS AND TONER CARTRIDGES FOR USE WITH DIGITAL PRINTERS; PRINTING INKS FOR USE BY COMMERCIAL AND INDUSTRIAL PRINTERS IN THE GRAPHIC ARTS INDUSTRY, IN CLASS 2 (U.S. CLS. 6, 11 AND 16).

FIRST USE 2-0-2003; IN COMMERCE 4-0-2003.

FOR: PRINTING PRESS WASH SOLUTION, IN CLASS 3 (U.S. CLS. 1, 4, 6, 50, 51 AND 52).

FIRST USE 2-0-2003; IN COMMERCE 4-0-2003.

FOR: LASER PRINTERS; DIGITAL PRINTERS; INK JET PRINTERS; DOT MATRIX PRINTERS; COMPUTER PRINTERS; COMPUTER SOFTWARE PROGRAM THAT CALCULATES COST PARAMETERS FOR PRINTING JOBS; COMPUTER HARDWARE AND SOFTWARE FOR PRE-FLIGHTING, COLOR MANAGEMENT, IMAGE PROCESSING, RASTER IMAGE PROCESSING, AND COLOR AND IMAGE CALIBRATION; COMPONENT PARTS FOR PRINTERS, NAMELY, PRINTHEADS, PRINthead CONTROL ELECTRONICS, MACHINE CONTROL ELECTRONICS, INK DELIVERY UNITS, PAPER HANDLING UNITS, CURING STATIONS FOR ATTACHMENT TO PRINTERS, CURING LAMPS FOR

ATTACHMENT TO PRINTERS, DRYING STATIONS FOR ATTACHMENT TO PRINTERS, PRINTHEAD MOUNTINGS FOR ATTACHMENT TO PRINTERS, PRINthead MAINTENANCE UNITS, RASTER IMAGE PROCESSING UNITS, IN CLASS 9 (U.S. CLS. 21, 23, 26, 36 AND 38).

FIRST USE 2-0-2003; IN COMMERCE 4-0-2003.

FOR: INSTALLATION, REPAIR AND MAINTENANCE OF PRINTING EQUIPMENT, IN CLASS 37 (U.S. CLS. 100, 103 AND 106).

FIRST USE 2-0-2003; IN COMMERCE 4-0-2003.

FOR: PRINTING; OFFSET PRINTING; CUSTOM MANUFACTURE OF INK AND INK RELATED PRODUCTS; CONSULTATION SERVICES, NAMELY, ADVICE RELATING TO THE MANUFACTURE OF INK AND INK RELATED PRODUCTS; CONSULTATION SERVICES RELATING TO DIGITAL PRINTING; PROVIDING INFORMATION IN THE FIELD OF PRINTING VIA THE INTERNET, IN CLASS 40 (U.S. CLS. 100, 103 AND 106).

FIRST USE 2-0-2003; IN COMMERCE 4-0-2003.

FOR: TRAINING SERVICES IN THE FIELD OF PRINTING, IN CLASS 41 (U.S. CLS. 100, 101 AND 107).

FIRST USE 2-0-2003; IN COMMERCE 4-0-2003.

FOR: TECHNICAL CONSULTATION AND RESEARCH IN THE FIELD OF PRINTING; CONSULTING SERVICES IN THE FIELD OF DESIGN, SELECTION, IMPLEMENTATION, INTEGRATION AND USE OF DIGITAL PRINTING SYSTEMS FOR OTHERS; PRINTING PROCESS CONSULTATION,

NAMELY, PROVIDING QUALITY ASSURANCE AND EVALUATION SERVICES IN THE FIELD OF PRINTING PROCESSES, PRINTING PROJECTS, INK TO PAPER APPLICATION PROCESSES AND PRINTED DOCUMENTATION BINDING PROCESSES, FOR PURPOSES OF IMPROVING QUALITY, EFFICIENCY, REDUCING WASTE AND INCREASING PRODUCTIVITY; GRAPHIC ART DESIGNS; PROVIDING SPECIFIC INFORMATION AS REQUESTED BY CUSTOMERS VIA THE INTERNET, IN CLASS 42 (U.S. CLS. 100 AND 101).

FIRST USE 2-0-2003; IN COMMERCE 4-0-2003.

THE COLOR(S) RED AND BLACK IS/ARE CLAIMED AS A FEATURE OF THE MARK.

THE MARK CONSISTS OF A STYLIZED UPPER CASE "J" WITH THE UPPER PORTION IN RED AND THE LOWER PORTION IN BLACK, THE LETTERS ETRION IN BLACK, AND THE "DOT" OVER THE LETTER "I" IN RED.

SN 78-744,632, FILED 11-1-2005.

KARANENDRA S. CHHINA, EXAMINING ATTORNEY

Int. Cl.: 33

Prior U.S. Cls.: 47 and 49

United States Patent and Trademark Office

Reg. No. 3,399,658

Registered Mar. 18, 2008

**TRADEMARK
PRINCIPAL REGISTER**

Parrot Mountain

SHOPPERS VILLAGE LIQUORS, LLC (KEN-
TUCKY LTD LIAB CO)
SUITE 100
343 WALLER AVENUE
LEXINGTON, KY 40504

THE MARK CONSISTS OF STANDARD CHAR-
ACTERS WITHOUT CLAIM TO ANY PARTICULAR
FONT, STYLE, SIZE, OR COLOR.

FOR: WINE, IN CLASS 33 (U.S. CLS. 47 AND 49).

SN 78-745,129, FILED 11-2-2005.

FIRST USE 11-1-2007; IN COMMERCE 11-1-2007.

ROBERT C. CLARK JR., EXAMINING ATTORNEY

Int. Cl.: 9

Prior U.S. Cls.: 21, 23, 26, 36, and 38

United States Patent and Trademark Office

Reg. No. 3,399,659

Registered Mar. 18, 2008

**TRADEMARK
PRINCIPAL REGISTER**

GUNPEY

KABUSHIKI KAISHA BANDAI (JAPAN CORPORATION), AKA BANDAI CO., LTD.,
1-4-8 KOMAGATA
TAITO-KU, JAPAN

FOR: PRE-RECORDED PROGRAMS FOR GAMES WITH LIQUID CRYSTAL DISPLAYS; COMPUTER PROGRAMS FEATURING STILL IMAGES WITH SOUND, DYNAMIC IMAGES WITH SOUND AND VIDEOS OF DOWNLOADABLE CHARACTERS; HOME COMPUTER GAMES RECORDED ON DISCS, IN CLASS 9 (U.S. CLS. 21, 23, 26, 36 AND 38).

FIRST USE 11-14-2006; IN COMMERCE 11-14-2006.

THE MARK CONSISTS OF STANDARD CHARACTERS WITHOUT CLAIM TO ANY PARTICULAR FONT, STYLE, SIZE, OR COLOR.

OWNER OF JAPAN REG. NO. 4408568, DATED 8-11-2000, EXPIRES 8-11-2010.

SN 78-745,264, FILED 11-2-2005.

BARBARA BROWN, EXAMINING ATTORNEY

Int. Cl.: 14

Prior U.S. Cls.: 2, 27, 28, and 50

United States Patent and Trademark Office

Reg. No. 3,399,660

Registered Mar. 18, 2008

**TRADEMARK
PRINCIPAL REGISTER**

WWBD

RUBIN, STEPHAN R. (UNITED STATES INDIVIDUAL)
C/O STEPHEN AND COMPANY
10 EAST 38TH STREET
NEW YORK, NY 10016

THE MARK CONSISTS OF STANDARD CHARACTERS WITHOUT CLAIM TO ANY PARTICULAR FONT, STYLE, SIZE, OR COLOR.

FOR: JEWELRY, IN CLASS 14 (U.S. CLS. 2, 27, 28 AND 50).

SN 78-745,574, FILED 11-2-2005.

FIRST USE 10-29-2007; IN COMMERCE 10-29-2007.

PATRICIA EVANKO, EXAMINING ATTORNEY

Int. Cl.: 13

Prior U.S. Cls.: 2 and 9

United States Patent and Trademark Office

Reg. No. 3,399,661

Registered Mar. 18, 2008

**TRADEMARK
PRINCIPAL REGISTER**

E*STAR

AUSTIN POWDER COMPANY (OHIO CORPORATION)
25800 SCIENCE PARK DRIVE
CLEVELAND, OH 44122

FOR: DETONATORS, IN CLASS 13 (U.S. CLS. 2 AND 9).

FIRST USE 5-0-2007; IN COMMERCE 5-0-2007.

THE MARK CONSISTS OF STANDARD CHARACTERS WITHOUT CLAIM TO ANY PARTICULAR FONT, STYLE, SIZE, OR COLOR.

OWNER OF U.S. REG. NOS. 1,497,635, 1,555,697, AND OTHERS.

SN 78-745,576, FILED 11-2-2005.

PATRICIA EVANKO, EXAMINING ATTORNEY

Int. Cl.: 14

Prior U.S. Cls.: 2, 27, 28, and 50

United States Patent and Trademark Office

Reg. No. 3,399,662

Registered Mar. 18, 2008

**TRADEMARK
PRINCIPAL REGISTER**

WHAT WOULD BUDDHA DO?

RUBIN, STEPHAN R. (UNITED STATES INDIVIDUAL)
C/O STEPHEN AND COMPANY
10 EAST 38TH STREET
NEW YORK, NY 10016

THE MARK CONSISTS OF STANDARD CHARACTERS WITHOUT CLAIM TO ANY PARTICULAR FONT, STYLE, SIZE, OR COLOR.

FOR: JEWELRY, IN CLASS 14 (U.S. CLS. 2, 27, 28 AND 50).

SN 78-745,580, FILED 11-2-2005.

FIRST USE 10-29-2007; IN COMMERCE 10-29-2007.

PATRICIA EVANKO, EXAMINING ATTORNEY

Prior U.S. Cl.: A

United States Patent and Trademark Office

Reg. No. 3,399,663

Registered Mar. 18, 2008

**CERTIFICATION MARK
GOODS
PRINCIPAL REGISTER**

RANGE READY

BOEHRINGER INGELHEIM VETMEDICA, INC.
(DELAWARE CORPORATION)
2621 NORTH BELT HIGHWAY
ST. JOSEPH, MO 645062002

FOR: LIVESTOCK, NAMELY CATTLE, IN CLASS
A (U.S. CL. A).

FIRST USE 1-31-2006; IN COMMERCE 1-31-2006.

THE MARK CONSISTS OF STANDARD CHAR-
ACTERS WITHOUT CLAIM TO ANY PARTICULAR
FONT, STYLE, SIZE, OR COLOR.

THE CERTIFICATION MARK AS USED BY PER-
SONS AUTHORIZED BY THE CERTIFIER CERTI-
FIES THAT SUCH PERSONS ARE RAISING BULLS
AND HEIFERS (CATTLE/LIVESTOCK) USING CER-
TIFIER'S VACCINES AND FOLLOWING CERTI-
FIER'S PROTOCOLS.

SN 78-746,662, FILED 11-3-2005.

PAUL F. GAST, EXAMINING ATTORNEY

Int. Cls.: 16 and 25

Prior U.S. Cls.: 2, 5, 22, 23, 29, 37, 38, 39, and 50

United States Patent and Trademark Office

Reg. No. 3,399,664

Registered Mar. 18, 2008

**TRADEMARK
PRINCIPAL REGISTER**

LOWEEN

MICHAEL DAVID WARD PRODUCTIONS, INC.
(CALIFORNIA CORPORATION)
P.O. BOX 14396
SANTA ROSA, CA 95402

FOR: NOTE CARDS, GREETING CARDS, STATIONERY, BOOKS AND MAGAZINES FEATURING HUMOR AND CHILDREN'S STORIES, AND PAINTINGS, IN CLASS 16 (U.S. CLS. 2, 5, 22, 23, 29, 37, 38 AND 50).

FIRST USE 5-19-2006; IN COMMERCE 5-19-2006.

FOR: T-SHIRTS, IN CLASS 25 (U.S. CLS. 22 AND 39).

FIRST USE 5-19-2006; IN COMMERCE 5-19-2006.

THE MARK CONSISTS OF STANDARD CHARACTERS WITHOUT CLAIM TO ANY PARTICULAR FONT, STYLE, SIZE, OR COLOR.

SN 78-746,938, FILED 11-4-2005.

SUSAN RICHARDS, EXAMINING ATTORNEY

Int. Cls.: 36 and 44

Prior U.S. Cls.: 100, 101, and 102

United States Patent and Trademark Office

Reg. No. 3,399,665

Registered Mar. 18, 2008

**SERVICE MARK
PRINCIPAL REGISTER**

PAVILION SUITES

WINGATE HEALTHCARE, INC. (DELAWARE
CORPORATION)
63 KENDRICK STREET
NEEDHAM, MA 02494

FOR: LEASING, RENTAL AND MANAGEMENT
OF REAL ESTATE IN THE NATURE OF SENIOR
RESIDENTIAL RETIREMENT, INDEPENDENT
LIVING, ASSISTED LIVING, SKILLED NURSING,
NURSING HOME AND LONG TERM CARE FACIL-
ITIES, IN CLASS 36 (U.S. CLS. 100, 101 AND 102).

FIRST USE 10-0-2006; IN COMMERCE 10-0-2006.

FOR: PROVIDING SKILLED NURSING, NUR-
SING HOME AND LONG TERM CARE NURSING
FACILITIES, IN CLASS 44 (U.S. CLS. 100 AND 101).

FIRST USE 10-0-2006; IN COMMERCE 10-0-2006.

THE MARK CONSISTS OF STANDARD CHAR-
ACTERS WITHOUT CLAIM TO ANY PARTICULAR
FONT, STYLE, SIZE, OR COLOR.

NO CLAIM IS MADE TO THE EXCLUSIVE
RIGHT TO USE "SUITES", APART FROM THE
MARK AS SHOWN.

SN 78-747,142, FILED 11-4-2005.

DOMINIC FATHY, EXAMINING ATTORNEY

Int. Cl.: 9

Prior U.S. Cls.: 21, 23, 26, 36, and 38

Reg. No. 3,399,666

United States Patent and Trademark Office

Registered Mar. 18, 2008

**TRADEMARK
PRINCIPAL REGISTER**

HOLOSTATION

3DH COMMUNICATIONS, INC. (GEORGIA CORPORATION)
5555 OAKBROOK PARKWAY, STE. 400
NORCROSS, GA 30093

FOR: COMPUTERS, COMPUTER HARDWARE, COMPUTER SOFTWARE PROGRAMS FOR USE IN SCANNING, GENERATING AND DISPLAYING THREE-DIMENSIONAL IMAGERY IN THE FIELDS OF EDUCATION, MARKETING, ADVERTISING, MEDICINE, NATURAL RESOURCES, GAMING, MEDIA PRODUCTION, FAITH BASED INDUSTRIES, TELECOMMUNICATIONS AND BROADCASTING, COMPUTER PERIPHERALS AND

USERS MANUALS SOLD AS A UNIT THEREWITH, IN CLASS 9 (U.S. CLS. 21, 23, 26, 36 AND 38).

FIRST USE 9-1-2006; IN COMMERCE 9-1-2006.

THE MARK CONSISTS OF STANDARD CHARACTERS WITHOUT CLAIM TO ANY PARTICULAR FONT, STYLE, SIZE, OR COLOR.

SN 78-748,186, FILED 11-7-2005.

BRIAN NEVILLE, EXAMINING ATTORNEY

Int. Cl.: 9

Prior U.S. Cls.: 21, 23, 26, 36, and 38

United States Patent and Trademark Office

Reg. No. 3,399,667

Registered Mar. 18, 2008

**TRADEMARK
PRINCIPAL REGISTER**

HOLOPLAYER

3DH COMMUNICATIONS, INC. (GEORGIA CORPORATION)
5555 OAKBROOK PARKWAY, STE. 400
NORCROSS, GA 30093

FOR: COMPUTER SOFTWARE FOR GRAPHICAL APPLICATIONS, NAMELY, FOR THE CREATION, DELIVERY, EDITING AND VIEWING OF THREE-DIMENSIONAL MULTIMEDIA , IN CLASS 9 (U.S. CLS. 21, 23, 26, 36 AND 38).

FIRST USE 9-1-2006; IN COMMERCE 9-1-2006.

THE MARK CONSISTS OF STANDARD CHARACTERS WITHOUT CLAIM TO ANY PARTICULAR FONT, STYLE, SIZE, OR COLOR.

SN 78-748,192, FILED 11-7-2005.

BRIAN NEVILLE, EXAMINING ATTORNEY

Int. Cls.: 40 and 41

Prior U.S. Cls.: 100, 101, 103, 106, and 107

United States Patent and Trademark Office

Reg. No. 3,399,668

Registered Mar. 18, 2008

**SERVICE MARK
PRINCIPAL REGISTER**

**LEADING THE DIMENSIONAL
REVOLUTION**

3DH COMMUNICATIONS, INC. (GEORGIA CORPORATION)
5555 OAKBROOK PARKWAY, STE. 400
NORCROSS, GA 30093

FOR: SCANNING OF THREE-DIMENSIONAL MULTIMEDIA CONTENT FOR OTHERS, IN CLASS 40 (U.S. CLS. 100, 103 AND 106).

FIRST USE 2-1-2006; IN COMMERCE 2-1-2006.

FOR: PRODUCTION OF THREE-DIMENSIONAL MULTIMEDIA CONTENT FOR OTHERS, NAMELY, PLANNING, STORYBOARDING, MODELING, ANI-

MATION AND VIDEO CAPTURE, IN CLASS 41 (U.S. CLS. 100, 101 AND 107).

FIRST USE 2-1-2006; IN COMMERCE 2-1-2006.

THE MARK CONSISTS OF STANDARD CHARACTERS WITHOUT CLAIM TO ANY PARTICULAR FONT, STYLE, SIZE, OR COLOR.

SN 78-748,221, FILED 11-7-2005.

BRIAN NEVILLE, EXAMINING ATTORNEY

Int. Cl.: 10

Prior U.S. Cls.: 26, 39, and 44

United States Patent and Trademark Office

Reg. No. 3,399,669

Registered Mar. 18, 2008

**TRADEMARK
PRINCIPAL REGISTER**

E4D

D4D TECHNOLOGIES, LLC (DELAWARE LTD
LIAB CO)
630 INTERNATIONAL PARKWAY, SUITE 150
RICHARDSON, TX 75081

FOR: DENTAL INSTRUMENTS, NAMELY, DEN-
TAL TOOLS, IMAGING SYSTEMS, SOFTWARE
AND MILLING MACHINES FOR MANUFACTUR-
ING DENTAL PROSTHETICS , IN CLASS 10 (U.S.
CLS. 26, 39 AND 44).

FIRST USE 2-2-2007; IN COMMERCE 2-2-2007.

THE MARK CONSISTS OF STANDARD CHAR-
ACTERS WITHOUT CLAIM TO ANY PARTICULAR
FONT, STYLE, SIZE, OR COLOR.

SN 78-748,735, FILED 11-7-2005.

MICHAEL ENGEL, EXAMINING ATTORNEY

Int. Cl.: 9

Prior U.S. Cls.: 21, 23, 26, 36, and 38

Reg. No. 3,399,670

United States Patent and Trademark Office

Registered Mar. 18, 2008

**TRADEMARK
PRINCIPAL REGISTER**

SANSAY

SANSAY, INC. (CALIFORNIA CORPORATION)
6450 LUSK BOULEVARD, SUITE 204
SAN DIEGO, CA 92121

THE MARK CONSISTS OF STANDARD CHAR-
ACTERS WITHOUT CLAIM TO ANY PARTICULAR
FONT, STYLE, SIZE, OR COLOR.

FOR: COMPUTER HARDWARE FOR TELECOM-
MUNICATIONS AND DATA NETWORKING, IN
CLASS 9 (U.S. CLS. 21, 23, 26, 36 AND 38).

SN 78-748,811, FILED 11-7-2005.

FIRST USE 12-31-2003; IN COMMERCE 12-31-2003.

IRA J. GOODSaid, EXAMINING ATTORNEY

Int. Cls.: 9 and 42

Prior U.S. Cls.: 21, 23, 26, 36, 38, 100, and 101

United States Patent and Trademark Office

Reg. No. 3,399,671

Registered Mar. 18, 2008

**TRADEMARK
SERVICE MARK
PRINCIPAL REGISTER**



COMPUTER ASSOCIATES THINK, INC. (DELAWARE CORPORATION)
ONE COMPUTER ASSOCIATES PLAZA
ISLANDIA, NY 11749

FOR: HOUSE MARK OF COMPUTER SOFTWARE PRODUCTS, NAMELY, ENTERPRISE MANAGEMENT SOFTWARE FOR DISTRIBUTING SOFTWARE AMONG COMPUTERS, MAINTAINING HARDWARE AND SOFTWARE INVENTORIES, CONFIGURING COMPUTERS, AND PROTECTING LOCAL DATA AND MANAGING REMOTE COMPUTER SYSTEMS, COMPUTER SOFTWARE FOR CREATING AND ACCESSING SEARCHABLE DATABASES OF THE USERS' BUSINESS INFORMATION BY AUTHORIZED USERS; COMPUTER SOFTWARE FOR COMPUTER APPLICATION DEVELOPMENT, COMPUTER SOFTWARE FOR DATA STORAGE MANAGEMENT, DATABASE MANAGEMENT SOFTWARE, COMPUTER SOFTWARE FOR COMPUTER USER IDENTIFICATION AND AUTHENTICATION, PASSWORD AUTHENTICATION, SIGN-ON CONTROL AND ENCRYPTION; COMPUTER SOFTWARE FOR ADMINISTRATION OF COMPUTER LOCAL AREA NETWORKS, VIRTUAL PRIVATE NETWORKS AND WIDE AREA NETWORKS; COMPUTER SOFTWARE FOR COLLECTING, VIEWING AND ANALYZING COMPUTER HARDWARE INVENTORY DATA; COMPUTER BUSINESS APPLICATION SOFTWARE FOR STORAGE OF DATA, DATA SECURITY PROTECTION, DATA BACKUP, DATA RESTORING AND DATA SHARING DIRECTLY FOR THE USER OR FOR ANOTHER APPLICATION PROGRAM FOR USE IN BUSINESS; COMPUTER

SOFTWARE FOR MONITORING AND CONTROLLING ACCESS TO GLOBAL COMPUTER NETWORKS, COMPUTER SOFTWARE FOR MONITORING, TRACKING, TROUBLESHOOTING AND INVESTIGATING WEB INFRASTRUCTURE; AND COMPUTER SOFTWARE FOR DATA RETENTION AND DATA INDEXING TO DEMONSTRATE BEST PRACTICES WITH REGULATIONS APPLICABLE TO THE INDUSTRY FOR USE IN THE FIELDS OF DATA COMMUNICATIONS AND TELECOMMUNICATIONS, IN CLASS 9 (U.S. CLS. 21, 23, 26, 36 AND 38).

FIRST USE 1-5-2006; IN COMMERCE 1-5-2006.

FOR: COMPUTER CONSULTING SERVICES; COMPUTER SECURITY SERVICES, NAMELY, RESTRICTING ACCESS TO AND BY COMPUTER NETWORKS TO AND OF UNDESIREDS WEBSITES, MEDIA AND INDIVIDUALS AND FACILITIES; DATA ENCRYPTION SERVICES, NAMELY, ADMINISTRATION OF DIGITAL KEYS AND DIGITAL CERTIFICATES TO ENSURE SECURITY OF ELECTRONICALLY TRANSMITTED DATA AND INFORMATION; TECHNICAL SUPPORT, NAMELY, REMOTE AND ON-SITE MONITORING OF NETWORK SYSTEMS; ON-LINE TECHNICAL SUPPORT SERVICES, NAMELY, TROUBLESHOOTING OF COMPUTER HARDWARE AND SOFTWARE PROBLEMS VIA A GLOBAL COMPUTER NETWORK; ON-LINE COMPUTER SERVICES, NAMELY, PROVIDING UPGRADES OF COMPUTER SOFTWARE AND MAINTENANCE OF INTERNAL COMPUTER NETWORK SOFTWARE; COMPUTER NETWORK

DESIGN SERVICES FOR OTHERS, IN CLASS 42
(U.S. CLS. 100 AND 101).

OWNER OF U.S. REG. NOS. 2,396,840, 2,784,648,
AND 2,858,307.

SN 78-749,491, FILED 11-8-2005.

FIRST USE 1-5-2006; IN COMMERCE 1-5-2006.

DAWN HAN, EXAMINING ATTORNEY

Int. Cls.: 3 and 5

Prior U.S. Cls.: 1, 4, 6, 18, 44, 46, 50, 51, and 52

United States Patent and Trademark Office

Reg. No. 3,399,672

Registered Mar. 18, 2008

**TRADEMARK
PRINCIPAL REGISTER**

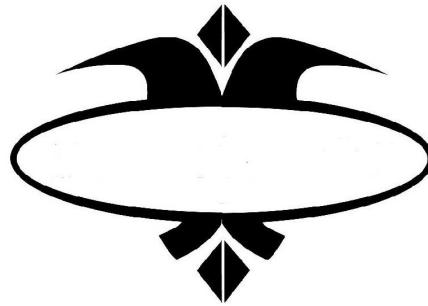

SUMMIT LABORATORIES, INC. (ILLINOIS CORPORATION)
17010 S. HALSTED ST.
HARVEY, IL 60426

FOR: DEPIATORIES; DEPIATORY CREAMS; EXFOLIANTS FOR SKIN; HAIR CARE PREPARATIONS; HAIR CONDITIONERS; SKIN CREAMS; SKIN MOISTURIZER; SKIN TONERS; SKIN WHITENING CREAMS, IN CLASS 3 (U.S. CLS. 1, 4, 6, 50, 51 AND 52).

FIRST USE 10-31-2003; IN COMMERCE 10-31-2003.

FOR: HAIR GROWTH STIMULANTS, IN CLASS 5 (U.S. CLS. 6, 18, 44, 46, 51 AND 52).

FIRST USE 10-31-2003; IN COMMERCE 10-31-2003.

OWNER OF U.S. REG. NO. 828,884.

THE MARK CONSISTS OF A STYLIZED DEPICTION OF A JESTER'S HAT.

SN 78-749,527, FILED 11-8-2005.

DAVID HOFFMAN, EXAMINING ATTORNEY

Int. Cl.: 9

Prior U.S. Cls.: 21, 23, 26, 36, and 38

United States Patent and Trademark Office

Reg. No. 3,399,673

Registered Mar. 18, 2008

**TRADEMARK
PRINCIPAL REGISTER**

EPLANE

ROBOTOOLZ LIMITED (HONG KONG CORPORATION)
UNIT 6-10, 28/F, MODERN WAREHOUSE
6 SHING YIP STREET
KWUN TONG, KOWLOON, HONG KONG

FOR: SURVEYING APPARATUS, NAMELY, AN ALIGNMENT TOOL USING A LASER FOR DETERMINING ELEVATION LEVELS, IN CLASS 9 (U.S. CLS. 21, 23, 26, 36 AND 38).

FIRST USE 3-0-2006; IN COMMERCE 3-0-2006.

THE MARK CONSISTS OF STANDARD CHARACTERS WITHOUT CLAIM TO ANY PARTICULAR FONT, STYLE, SIZE, OR COLOR.

SN 78-749,680, FILED 11-8-2005.

ELLEN B. AWRICH, EXAMINING ATTORNEY

Int. Cl.: 30

Prior U.S. Cl.: 46

United States Patent and Trademark Office

Reg. No. 3,399,674

Registered Mar. 18, 2008

**TRADEMARK
PRINCIPAL REGISTER**

MIDNIGHT REVERIE

CHOCOLAFABRIKEN LINDT & SPRÜNGLI
AG (SWITZERLAND CORPORATION)
SEESTRAßE 204 CH-8802
KILCHBERG, SWITZERLAND

THE MARK CONSISTS OF STANDARD CHAR-
ACTERS WITHOUT CLAIM TO ANY PARTICULAR
FONT, STYLE, SIZE, OR COLOR.

FOR: CHOCOLATE BARS, IN CLASS 30 (U.S. CL.
46).

SN 78-749,711, FILED 11-8-2005.

FIRST USE 11-9-2007; IN COMMERCE 11-9-2007.

JASON ROTH, EXAMINING ATTORNEY

Int. Cl.: 8

Prior U.S. Cls.: 23, 28, and 44

United States Patent and Trademark Office

Reg. No. 3,399,675

Registered Mar. 18, 2008

TRADEMARK
PRINCIPAL REGISTER



THE PREMIUM CONNECTION, INC. (NEVADA CORPORATION)
6165 SOUTH PECOS
LAS VEGAS, NV 89120

FOR: LAWN AND GARDEN TOOLS, NAMELY, HAND OPERATED PRUNERS, CULTIVATORS, TROWELS, SPADES, WEEDING BLADES, GARDENING SHEARS AND CLIPPERS, SHOVELS, HAND OPERATED LAWN EDGERS, NON-ELECTRIC WEED TRIMMERS, HOES, HAND OPERATED LOPPERS; GARDENING TOOL KITS CONSISTING OF COMBINATIONS OF THE ABOVE GARDENING TOOLS, PROTECTIVE GARDENING GLOVES,

GARDENING APRON AND UTILITY BELT SOLD AS A UNIT, IN CLASS 8 (U.S. CLS. 23, 28 AND 44).

FIRST USE 1-14-2005; IN COMMERCE 4-30-2005.

NO CLAIM IS MADE TO THE EXCLUSIVE RIGHT TO USE "GARDEN", APART FROM THE MARK AS SHOWN.

SN 78-753,311, FILED 11-14-2005.

KRISTINA MORRIS, EXAMINING ATTORNEY

Int. Cl.: 20

Prior U.S. Cls.: 2, 13, 22, 25, 32, and 50

Reg. No. 3,399,676

United States Patent and Trademark Office

Registered Mar. 18, 2008

**TRADEMARK
PRINCIPAL REGISTER**

SPEED CONNECT

AMERICAN STANDARD INTERNATIONAL INC.
(DELAWARE CORPORATION)
33RD FLOOR
1370 AVENUE OF THE AMERICAS
NEW YORK, NY 10019

FOR: NON-METAL FASTENING AND CONNECTION DEVICES FOR SANITARY INSTALLATIONS, NAMELY, NON-METAL FASTENERS FOR TOILETS, FAUCETS AND DRAINS, IN CLASS 20 (U.S. CLS. 2, 13, 22, 25, 32 AND 50).

FIRST USE 11-1-2005; IN COMMERCE 1-1-2006.

THE MARK CONSISTS OF STANDARD CHARACTERS WITHOUT CLAIM TO ANY PARTICULAR FONT, STYLE, SIZE, OR COLOR.

NO CLAIM IS MADE TO THE EXCLUSIVE RIGHT TO USE "CONNECT", APART FROM THE MARK AS SHOWN.

SN 78-753,426, FILED 11-14-2005.

ELIZABETH HUGHITT, EXAMINING ATTORNEY

Int. Cls.: 16 and 25

Prior U.S. Cls.: 2, 5, 22, 23, 29, 37, 38, 39, and 50

United States Patent and Trademark Office

Reg. No. 3,399,677

Registered Mar. 18, 2008

**TRADEMARK
PRINCIPAL REGISTER**



HALLMARK, DAVID A. (UNITED STATES IN-
DIVIDUAL)
P.O. BOX 975
IMAGINATION COUNTS, LLC
PORTSMOUTH, NH 03802

FOR: BALL POINT PENS; ENVELOPES FOR
STATIONERY USE; MAPS; MOUNTED POSTERS;
POSTERS; IRON-ON TRANSFERS, IN CLASS 16
(U.S. CLS. 2, 5, 22, 23, 29, 37, 38 AND 50).

FIRST USE 7-1-2006; IN COMMERCE 1-4-2007.

FOR: BASEBALL CAPS; T-SHIRTS, IN CLASS 25
(U.S. CLS. 22 AND 39).

FIRST USE 7-1-2006; IN COMMERCE 1-4-2007.

THE MARK CONSISTS OF STYLIZED WORDS
"VIN" AND "FIZ" WITH A BUNCH OF GRAPES
BETWEEN THE WORDS.

SN 78-753,458, FILED 11-14-2005.

ALYSSA PALADINO, EXAMINING ATTORNEY

Int. Cl.: 6

Prior U.S. Cls.: 2, 12, 13, 14, 23, 25, and 50

United States Patent and Trademark Office

Reg. No. 3,399,678

Registered Mar. 18, 2008

**TRADEMARK
PRINCIPAL REGISTER**

GUARDIAN PET FENCE SYSTEMS

GUARDIAN POOL FENCE SYSTEMS, INC. (CALIFORNIA CORPORATION)
14715 AETNA STREET
VAN NUYS, CA 91411

OWNER OF U.S. REG. NOS. 2,273,407 AND 2,963,700.

FOR: FENCE SYSTEM COMPRISED OF WIRE MESH SECTIONS AND METAL SUPPORT POLES FOR CONTAINING PETS, IN CLASS 6 (U.S. CLS. 2, 12, 13, 14, 23, 25 AND 50).

NO CLAIM IS MADE TO THE EXCLUSIVE RIGHT TO USE "PET FENCE SYSTEMS", APART FROM THE MARK AS SHOWN.

FIRST USE 10-31-2007; IN COMMERCE 10-31-2007.

SN 78-753,621, FILED 11-14-2005.

THE MARK CONSISTS OF STANDARD CHARACTERS WITHOUT CLAIM TO ANY PARTICULAR FONT, STYLE, SIZE, OR COLOR.

CHARLES L. JENKINS, EXAMINING ATTORNEY

Int. Cl.: 19

Prior U.S. Cls.: 1, 12, 33, and 50

United States Patent and Trademark Office

Reg. No. 3,399,679

Registered Mar. 18, 2008

**TRADEMARK
PRINCIPAL REGISTER**

**FLEXIBLE ARMOR AGAINST THE
ELEMENTS**

CONKLIN COMPANY, INC. (MINNESOTA COR-
PORATION)
P.O. BOX 155
SHAKOPE, MN 55379

THE MARK CONSISTS OF STANDARD CHAR-
ACTERS WITHOUT CLAIM TO ANY PARTICULAR
FONT, STYLE, SIZE, OR COLOR.

FOR: PETROLEUM-BASED ASPHALT COAT-
INGS, ASPHALT PRIMERS, ASPHALT FILLER,
AND ASPHALT PATCH, IN CLASS 19 (U.S. CLS. 1,
12, 33 AND 50).

SN 78-755,295, FILED 11-16-2005.

FIRST USE 9-0-2007; IN COMMERCE 9-0-2007.

MARY ROSSMAN, EXAMINING ATTORNEY

Int. Cl.: 44

Prior U.S. Cls.: 100 and 101

United States Patent and Trademark Office

Reg. No. 3,399,680

Registered Mar. 18, 2008

**SERVICE MARK
PRINCIPAL REGISTER**

**BASCOM PALMER SURGERY
CENTER**

UNIVERSITY OF MIAMI (FLORIDA NON-PROF-
IT CORPORATION)
PLUMER BUILDING SUITE 10
P.O. BOX 248052
CORAL GABLES, FL 33146

FOR: HEALTH CARE SERVICES, NAMELY, PRO-
VIDING EYE TREATMENT FOR DISEASES OF THE
EYE TO OUTPATIENTS, IN CLASS 44 (U.S. CLS. 100
AND 101).

FIRST USE 8-1-2006; IN COMMERCE 8-1-2006.

THE MARK CONSISTS OF STANDARD CHAR-
ACTERS WITHOUT CLAIM TO ANY PARTICULAR
FONT, STYLE, SIZE, OR COLOR.

OWNER OF U.S. REG. NO. 3,052,875.

NO CLAIM IS MADE TO THE EXCLUSIVE
RIGHT TO USE "SURGERY CENTER", APART
FROM THE MARK AS SHOWN.

SN 78-755,821, FILED 11-17-2005.

DANIEL BRODY, EXAMINING ATTORNEY

Int. Cls.: 9, 37, and 42

Prior U.S. Cls.: 21, 23, 26, 36, 38, 100, 101, 103, and 106

Reg. No. 3,399,681

United States Patent and Trademark Office

Registered Mar. 18, 2008

**TRADEMARK
SERVICE MARK
PRINCIPAL REGISTER**

MEDIAMORFX

ILLUMINATING CONCEPTS, LTD. (MICHIGAN CORPORATION)
30733 W. TEN MILE ROAD
FARMINGTON HILLS, MI 48336

FOR: COMPUTER HARDWARE AND SOFTWARE FOR MONITORING, CONTROLLING AND INTEGRATING MULTIMEDIA DEVICES, NAMELY, AUDIO, VIDEO, DIGITAL MEDIA AND GRAPHICS CONTENT DELIVERY DEVICES AND LIGHTING SYSTEMS, NAMELY, SENSORS, TWO WAY COMMUNICATION DEVICES, LIGHTING CONTROLS AND ELECTRIC LIGHTING FIXTURES AND PARTS AND ACCESSORIES THEREFOR TO CREATE AUDIOVISUAL EFFECTS IN COMBINATION WITH DIGITAL CONTENT AND MULTIMEDIA OUTPUT FOR PERSONAL USE AND USE BY BUSINESSES AND GOVERNMENTAL AGENCIES, IN CLASS 9 (U.S. CLS. 21, 23, 26, 36 AND 38).

FIRST USE 12-8-2002; IN COMMERCE 2-2-2004.

FOR: INSTALLATION, REPAIR, AND MAINTENANCE OF COMPUTER HARDWARE AND SOFTWARE, MULTIMEDIA PRODUCTS AND

LIGHTING SYSTEMS FOR PERSONAL USE AND USE BY BUSINESSES AND GOVERNMENTAL AGENCIES, IN CLASS 37 (U.S. CLS. 100, 103 AND 106).

FIRST USE 12-8-2002; IN COMMERCE 2-2-2004.

FOR: ANALYSIS, DESIGN AND DEVELOPMENT OF COMPUTER HARDWARE AND SOFTWARE, MULTIMEDIA PRODUCTS AND LIGHTING SYSTEMS FOR PERSONAL USE AND USE BY BUSINESSES AND GOVERNMENTAL AGENCIES, INSTALLATION, REPAIR AND MAINTENANCE OF COMPUTER SOFTWARE, IN CLASS 42 (U.S. CLS. 100 AND 101).

FIRST USE 12-8-2002; IN COMMERCE 2-2-2004.

THE MARK CONSISTS OF STANDARD CHARACTERS WITHOUT CLAIM TO ANY PARTICULAR FONT, STYLE, SIZE, OR COLOR.

SN 78-755,866, FILED 11-17-2005.

LOURDES AYALA, EXAMINING ATTORNEY

Int. Cl.: 35

Prior U.S. Cls.: 100, 101, and 102

United States Patent and Trademark Office

Reg. No. 3,399,682

Registered Mar. 18, 2008

**SERVICE MARK
PRINCIPAL REGISTER**

DININGFEVER

DININGFEVER LLC (DELAWARE LTD LIAB
CO)
APT C
76 MORRIS STREET
JERSEY CITY, NJ 07302

COMMUNICATIONS NETWORKS, IN CLASS 35
(U.S. CLS. 100, 101 AND 102).

FIRST USE 2-28-2006; IN COMMERCE 2-28-2006.

FOR: ADVERTISING AND PUBLICITY SERVI-
CES, NAMELY, PROMOTING THE GOODS, SERVI-
CES, BRAND IDENTITY AND COMMERCIAL
INFORMATION AND NEWS OF THIRD PARTIES
THROUGH PRINT, AUDIO, VIDEO, DIGITAL AND
ON-LINE MEDIUM; ADVERTISING BY TRANSMIS-
SION OF ONLINE PUBLICITY FOR THIRD PAR-
TIES THROUGH ELECTRONIC

THE MARK CONSISTS OF STANDARD CHAR-
ACTERS WITHOUT CLAIM TO ANY PARTICULAR
FONT, STYLE, SIZE, OR COLOR.

SN 78-756,111, FILED 11-17-2005.

VERNA BETH RIRIE, EXAMINING ATTORNEY

Int. Cl.: 33

Prior U.S. Cls.: 47 and 49

United States Patent and Trademark Office

Reg. No. 3,399,683

Registered Mar. 18, 2008

TRADEMARK
PRINCIPAL REGISTER



LA RIOJANA COOPERATIVA VITIVINIFRUTICOLA DE LA RIOJA LIMITADA (ARGENTINA CORPORATION)
LA PLATA 646
CHILECITO, LA RIOJA, ARGENTINA

FOR: WINES, IN CLASS 33 (U.S. CLS. 47 AND 49).

FIRST USE 10-31-2005; IN COMMERCE 5-31-2006.

NO CLAIM IS MADE TO THE EXCLUSIVE RIGHT TO USE "ARGENTINA", APART FROM THE MARK AS SHOWN.

THE MARK CONSISTS OF A POLO PLAYER MOUNTED ON HORSE SURROUNDED BY A CIRCLE WITH THE WORDING "RAZA ARGENTINA" CONTAINED INSIDE THE CIRCLE BORDER.

THE FOREIGN WORDING IN THE MARK TRANSLATES INTO ENGLISH AS "RACE ARGENTINE".

SN 78-756,184, FILED 11-17-2005.

ANDREA K. NADELMAN, EXAMINING ATTORNEY

Int. Cls.: 18, 20, 24, and 25

Prior U.S. Cls.: 1, 2, 3, 13, 22, 25, 32, 39, 41, 42, and 50

United States Patent and Trademark Office

Reg. No. 3,399,684

Registered Mar. 18, 2008

**TRADEMARK
PRINCIPAL REGISTER**

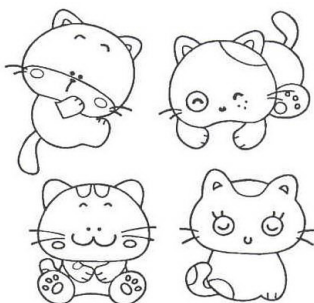

THANG LONG GARMENTS COMPANY LIM-
ITED (VIETNAM LTD LIAB CO)
62/4 TRAN BINH TRONG STREET, WARD 8
VUNG TAU CITY, BA RIA - VUNG TAU PROVINCE,
VIETNAM 10000

FOR: HANDBAGS, TRAVEL BAGS, SHOULDER
BAGS, PURSES, DRAWSTRING POUCHES, FELT
POUCHES, POUCHES OF LEATHER, LEATHER
BAGS FOR MERCHANDISE PACKAGING IN THE
NATURE OF ENVELOPES OR POUCHES, TOOL
POUCHES SOLD EMPTY, WALLETS, IN CLASS 18
(U.S. CLS. 1, 2, 3, 22 AND 41).

FIRST USE 1-30-2007; IN COMMERCE 1-30-2007.

FOR: MATTRESSES, CUSHIONS, PILLOWS, PET
CUSHIONS, PICTURE FRAMES NOT OF PRECIOUS
METAL, NAME-PLATE OF TEXTILE, IN CLASS 20
(U.S. CLS. 2, 13, 22, 25, 32 AND 50).

FIRST USE 1-30-2007; IN COMMERCE 1-30-2007.

FOR: BED BLANKETS, TEXTILE PLACE MATS,
PILLOWCASES, COVERS FOR CUSHIONS, CUR-
TAINS, TABLE CLOTHS NOT OF PAPER, MAT-
TRESS COVERS, TEXTILE WALL HANGINGS, IN
CLASS 24 (U.S. CLS. 42 AND 50).

FIRST USE 1-30-2007; IN COMMERCE 1-30-2007.

FOR: APRONS, JACKETS, PYJAMAS, TROUSERS,
JUMPER SKIRT, T-SHIRT, SLIPPERS, HATS, BLOU-
SES, GLOVES OF TEXTILE, IN CLASS 25 (U.S. CLS.
22 AND 39).

FIRST USE 1-30-2007; IN COMMERCE 1-30-2007.

SN 78-756,645, FILED 11-17-2005.

TARAH HARDY, EXAMINING ATTORNEY

Int. Cls.: 16 and 41

Prior U.S. Cls.: 2, 5, 22, 23, 29, 37, 38, 50, 100, 101, and 107

Reg. No. 3,399,685

United States Patent and Trademark Office

Registered Mar. 18, 2008

**TRADEMARK
SERVICE MARK
PRINCIPAL REGISTER**

VIKTOR'S PROMISE

MATTHEY-JOHNSON, PHYLLIS A. (UNITED STATES INDIVIDUAL)
19 ASHLEY DRIVE
DILLSBURG, PA 17019

FOR: PAPER AND PRINTED MATTER, NAME-
LY, PRE-WRITTEN ARTICLES FOR REPUBLICA-
TION BY OTHERS IN BOOKLETS, BROCHURES,
MAGAZINES, MANUALS, NEWSLETTERS, NEWS-
PAPERS, PAMPHLETS AND PERIODICALS FEAT-
URING INFORMATION AND STORIES
RELATING PRIMARILY TO ORPHAN AND DESTI-
TUTE CHILDREN WORLDWIDE; ALBUMS, NAME-
LY, PHOTOGRAPH AND SCRAPBOOK; BOOK
COVERS; BOOKMARKS, CALENDARS, COLORING
AND ACTIVITY BOOKS; PRINTED GREETING
CARDS; PENS AND PENCILS; PHOTOGRAPHS
AND PRINTS MOUNTED AND UNMOUNTED;
PORTRAITS; POSTERS, POSTCARDS; STATION-
ERY, NAMELY, BINDERS, FOLDERS, NOTE-

BOOKS, PADS; STICKERS AND DECALS, IN
CLASS 16 (U.S. CLS. 2, 5, 22, 23, 29, 37, 38 AND 50).

FIRST USE 11-18-2005; IN COMMERCE 11-18-2005.

FOR: CHARITABLE SERVICES, NAMELY, PRO-
VIDING PLAY EQUIPMENT, IN CLASS 41 (U.S. CLS.
100, 101 AND 107).

FIRST USE 11-18-2005; IN COMMERCE 11-18-2005.

THE MARK CONSISTS OF STANDARD CHAR-
ACTERS WITHOUT CLAIM TO ANY PARTICULAR
FONT, STYLE, SIZE, OR COLOR.

SN 78-756,664, FILED 11-17-2005.

RICHARD A. STRASER, EXAMINING ATTORNEY

Int. Cl.: 16

Prior U.S. Cls.: 2, 5, 22, 23, 29, 37, 38, and 50

Reg. No. 3,399,686

United States Patent and Trademark Office

Registered Mar. 18, 2008

**TRADEMARK
PRINCIPAL REGISTER**

Ms. W's Workshop

WIENER, ALLISON LEIGH (UNITED STATES
INDIVIDUAL)
6 BROOKDALE LANE
CHAPPAQUA, NY 10514

THE MARK CONSISTS OF STANDARD CHAR-
ACTERS WITHOUT CLAIM TO ANY PARTICULAR
FONT, STYLE, SIZE, OR COLOR.

FOR: EDUCATIONAL SKILL KITS CONSISTING
OF PLASTIC SHAPES AND PLASTIC STRINGS FOR
TEACHING MATHEMATICAL CONCEPTS, IN
CLASS 16 (U.S. CLS. 2, 5, 22, 23, 29, 37, 38 AND 50).

SN 78-757,177, FILED 11-18-2005.

FIRST USE 5-18-2006; IN COMMERCE 5-18-2006.

MARY BOAGNI, EXAMINING ATTORNEY

Int. Cl.: 38

Prior U.S. Cls.: 100, 101, and 104

United States Patent and Trademark Office

Reg. No. 3,399,687

Registered Mar. 18, 2008

**SERVICE MARK
PRINCIPAL REGISTER**

MOG

MOG, INC. (DELAWARE CORPORATION)
285 LOS ALTOS DRIVE
KENSINGTON, CA 94708

SHARING INFORMATION VIA COMMUNICATIONS NETWORKS, IN CLASS 38 (U.S. CLS. 100, 101 AND 104).

FOR: PROVIDING ON-LINE CHAT ROOMS, ELECTRONIC BULLETIN BOARDS, AND ON-LINE FORUMS FOR TRANSMISSION OF MESSAGES AMONG COMPUTER USERS CONCERNING MUSIC, MOVIES, AND TELEVISION; PROVIDING EMAIL AND INSTANT MESSAGING SERVICES; TRANSMISSION OF AUDIO AND VIDEO FILES VIA COMMUNICATIONS NETWORKS; TRANSMISSION OF PEER TO PEER NETWORKING AND FILE

FIRST USE 6-20-2006; IN COMMERCE 6-20-2006.

THE MARK CONSISTS OF STANDARD CHARACTERS WITHOUT CLAIM TO ANY PARTICULAR FONT, STYLE, SIZE, OR COLOR.

SN 78-757,434, FILED 11-18-2005.

LAURIE KAUFMAN, EXAMINING ATTORNEY

Int. Cl.: 42

Prior U.S. Cls.: 100 and 101

United States Patent and Trademark Office

Reg. No. 3,399,688

Registered Mar. 18, 2008

**SERVICE MARK
PRINCIPAL REGISTER**

MOG

MOG, INC. (DELAWARE CORPORATION)
285 LOS ALTOS DRIVE
KENSINGTON, CA 94708

PROFILES AND INFORMATION, IN CLASS 42 (U.S. CLS. 100 AND 101).

FIRST USE 6-20-2006; IN COMMERCE 6-20-2006.

FOR: COMPUTER SERVICES, NAMELY, HOSTING WEB SITES OF OTHERS WHO USE THEIR WEB SITE FOR THE PURPOSE OF CONDUCTING ON-LINE MEETINGS AND INTERACTIVE DISCUSSIONS; AND COMPUTER SERVICES IN THE NATURE OF CUSTOMIZED WEB PAGES FEATURING USER-DEFINED INFORMATION, PERSONAL

THE MARK CONSISTS OF STANDARD CHARACTERS WITHOUT CLAIM TO ANY PARTICULAR FONT, STYLE, SIZE, OR COLOR.

SN 78-757,438, FILED 11-18-2005.

LAURIE KAUFMAN, EXAMINING ATTORNEY

Int. Cl.: 36

Prior U.S. Cls.: 100, 101, and 102

United States Patent and Trademark Office

Reg. No. 3,399,689

Registered Mar. 18, 2008

**SERVICE MARK
PRINCIPAL REGISTER**

DEDICATION TO VALUE

SYSCO CORPORATION (DELAWARE CORPORATION)
1390 ENCLAVE PARKWAY
HOUSTON, TX 770771390

THE MARK CONSISTS OF STANDARD CHARACTERS WITHOUT CLAIM TO ANY PARTICULAR FONT, STYLE, SIZE, OR COLOR.

FOR: FINANCIAL MANAGEMENT SERVICES IN THE HEALTHCARE INDUSTRY, IN CLASS 36 (U.S. CLS. 100, 101 AND 102).

SN 78-757,767, FILED 11-20-2005.

FIRST USE 2-1-2006; IN COMMERCE 2-1-2006.

ANDREW RHIM, EXAMINING ATTORNEY

Int. Cl.: 35

Prior U.S. Cls.: 100, 101, and 102

United States Patent and Trademark Office

Reg. No. 3,399,690

Registered Mar. 18, 2008

**SERVICE MARK
PRINCIPAL REGISTER**

DEDICATION TO VALUE

SYSCO CORPORATION (DELAWARE CORPORATION)
1390 ENCLAVE PARKWAY
HOUSTON, TX 770771390

FOR: DISTRIBUTORSHIP SERVICES IN THE FIELD OF FOOD AND RELATED NON-FOOD ITEMS TO THE HEALTHCARE INDUSTRY, IN CLASS 35 (U.S. CLS. 100, 101 AND 102).

FIRST USE 2-1-2006; IN COMMERCE 2-1-2006.

THE MARK CONSISTS OF STANDARD CHARACTERS WITHOUT CLAIM TO ANY PARTICULAR FONT, STYLE, SIZE, OR COLOR.

SN 78-757,768, FILED 11-20-2005.

ANDREW RHIM, EXAMINING ATTORNEY

Int. Cl.: 41

Prior U.S. Cls.: 100, 101, and 107

United States Patent and Trademark Office

Reg. No. 3,399,691

Registered Mar. 18, 2008

**SERVICE MARK
PRINCIPAL REGISTER**

DEDICATION TO VALUE

SYSCO CORPORATION (DELAWARE CORPORATION)
1390 ENCLAVE PARKWAY
HOUSTON, TX 770771390

FOR: EDUCATION AND TRAINING SERVICES FOR HEALTHCARE PROFESSIONALS, NAMELY, PROVIDING TRAINING COURSES AND TRAINING PRESENTATIONS IN THE FIELDS OF FOOD SAFETY, DIET PLANNING AND SUPERVISION, AND MENU PLANNING, IN CLASS 41 (U.S. CLS. 100, 101 AND 107).

FIRST USE 2-1-2006; IN COMMERCE 2-1-2006.

THE MARK CONSISTS OF STANDARD CHARACTERS WITHOUT CLAIM TO ANY PARTICULAR FONT, STYLE, SIZE, OR COLOR.

SN 78-757,769, FILED 11-20-2005.

ANDREW RHIM, EXAMINING ATTORNEY

Int. Cls.: 40 and 41

Prior U.S. Cls.: 100, 101, 103, 106, and 107

United States Patent and Trademark Office

Reg. No. 3,399,692

Registered Mar. 18, 2008

**SERVICE MARK
PRINCIPAL REGISTER**

CO3

ASCENT MEDIA GROUP, LLC (DELAWARE
LTD LIAB CO)
520 BROADWAY, 5TH FLOOR
SANTA MONICA, CA 90401

FOR: FILM AND VIDEO PROCESSING SERVICES, NAMELY, COLOR CORRECTION, IMAGE STANDARDS CONVERSION, ELECTRONICALLY PRODUCING VIDEOTAPE FROM MOTION PICTURE FILM; MOTION PICTURE FILM AND VIDEOTAPE DATA COMPRESSION SERVICES; VIDEOTAPE, AUDIO TAPE AND MOTION PICTURE FILM DUPLICATION; DUPLICATION OF STANDARD AND HIGH-DEFINITION AUDIOVISUAL DAILIES/RUSHES, PREVIEWS AND DIGITAL INTERMEDIATES FOR OTHERS; FINISHING AND COMPOSITING OF FILM AND VIDEO AND CONFORMING OF SAME, IN CLASS 40 (U.S. CLS. 100, 103 AND 106).

FIRST USE 12-31-1997; IN COMMERCE 12-31-1997.

FOR: MOTION PICTURE FILM, VIDEOTAPE AND DIGITAL VIDEO LABORATORY AND POST-PRODUCTION SERVICES, NAMELY, FEATURE FILM MASTERING SERVICES; POST-PRODUCTION SERVICES FOR THE TELEVISION AND MOTION PICTURE INDUSTRY IN THE NATURE OF PROVIDING COMPUTER GENERATED SPECIAL EFFECTS; PRODUCTION OF STANDARD AND HIGH-DEFINITION AUDIOVISUAL DAILIES/RUSHES, PREVIEWS AND DIGITAL INTERMEDIATES FOR OTHERS; TITLING FOR FILM AND TELEVISION, IN CLASS 41 (U.S. CLS. 100, 101 AND 107).

FIRST USE 12-31-1997; IN COMMERCE 12-31-1997.

THE MARK CONSISTS OF STANDARD CHARACTERS WITHOUT CLAIM TO ANY PARTICULAR FONT, STYLE, SIZE, OR COLOR.

SN 78-758,728, FILED 11-21-2005.

BARNEY CHARLON, EXAMINING ATTORNEY

Int. Cl.: 21

Prior U.S. Cls.: 2, 13, 23, 29, 30, 33, 40, and 50

Reg. No. 3,399,693

United States Patent and Trademark Office

Registered Mar. 18, 2008

**TRADEMARK
PRINCIPAL REGISTER**

LURE

J & D BRUSH CO., INC. (NEW YORK CORPORATION)
5 ADAMS AVENUE
HAUPPAUGE, NY 11788

FOR: HAIR COMBS AND HAIR BRUSHES, IN
CLASS 21 (U.S. CLS. 2, 13, 23, 29, 30, 33, 40 AND 50).

FIRST USE 11-26-2007; IN COMMERCE 11-26-2007.

THE MARK CONSISTS OF STANDARD CHARACTERS WITHOUT CLAIM TO ANY PARTICULAR FONT, STYLE, SIZE, OR COLOR.

SN 78-759,059, FILED 11-22-2005.

NORA BUCHANAN WILL, EXAMINING ATTORNEY

Int. Cls.: 18, 20, 24, and 25

Prior U.S. Cls.: 1, 2, 3, 13, 22, 25, 32, 39, 41, 42, and 50

United States Patent and Trademark Office

Reg. No. 3,399,694

Registered Mar. 18, 2008

**TRADEMARK
PRINCIPAL REGISTER**

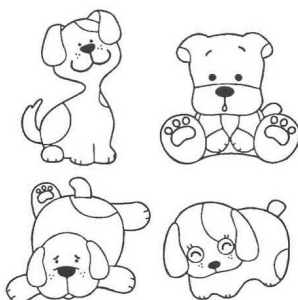

THANG LONG GARMENTS COMPANY LIM-
ITED (VIETNAM LTD LIAB CO)
62/4 TRAN BINH TRONG STREET, WARD 8
VUNG TAU CITY, BA RIA-VUNG TAU PROVINCE,
VIETNAM 10000

FOR: HANDBAGS, TRAVEL BAGS, SHOULDER
BAGS, PURSES, DRAWSTRING POUCHES, FELT
POUCHES, POUCHES OF LEATHER, LEATHER
BAGS FOR MERCHANDISE PACKAGING IN THE
NATURE OF ENVELOPES OR POUCHES, TOOL
POUCHES SOLD EMPTY, WALLETS, IN CLASS 18
(U.S. CLS. 1, 2, 3, 22 AND 41).

FIRST USE 1-30-2007; IN COMMERCE 1-30-2007.

FOR: MATTRESSES, CUSHIONS, PILLOWS, PET
CUSHIONS, PICTURE FRAMES NOT OF PRECIOUS
METAL, NAME-PLATE OF TEXTILE, IN CLASS 20
(U.S. CLS. 2, 13, 22, 25, 32 AND 50).

FIRST USE 1-30-2007; IN COMMERCE 1-30-2007.

FOR: BED BLANKETS, TEXTILE PLACE MATS,
PILLOWCASES, COVERS FOR CUSHIONS, CUR-
TAINS, TABLE CLOTHS NOT OF PAPER, MAT-
TRESS COVERS, TEXTILE WALL HANGINGS, IN
CLASS 24 (U.S. CLS. 42 AND 50).

FIRST USE 1-30-2007; IN COMMERCE 1-30-2007.

FOR: APRONS, JACKETS, PYJAMAS, TROUSERS,
JUMPER SKIRT, T-SHIRT, SLIPPERS, HATS, BLOU-
SES, GLOVES OF TEXTILE, IN CLASS 25 (U.S. CLS.
22 AND 39).

FIRST USE 1-30-2007; IN COMMERCE 1-30-2007.

SN 78-759,910, FILED 11-23-2005.

TARAH HARDY, EXAMINING ATTORNEY

Int. Cl.: 25

Prior U.S. Cls.: 22 and 39

United States Patent and Trademark Office

Reg. No. 3,399,695

Registered Mar. 18, 2008

**TRADEMARK
PRINCIPAL REGISTER**



MAJOR LEAGUE BASEBALL PROPERTIES, INC.
(NEW YORK CORPORATION)
245 PARK AVENUE
NEW YORK, NY 10167

FOR: CLOTHING, NAMELY, CAPS, HATS, VISORS, SHIRTS, T-SHIRTS, T, VESTS, PANTS, BASEBALL UNIFORMS, JERSEYS, IN CLASS 25 (U.S. CLS. 22 AND 39).

FIRST USE 6-0-2004; IN COMMERCE 6-0-2004.

OWNER OF U.S. REG. NOS. 2,573,096, 2,971,015, AND OTHERS.

SN 78-760,130, FILED 11-23-2005.

KELLY BOULTON, EXAMINING ATTORNEY

Int. Cls.: 9, 37, and 42

Prior U.S. Cls.: 21, 23, 26, 36, 38, 100, 101, 103, and 106

Reg. No. 3,399,696

United States Patent and Trademark Office

Registered Mar. 18, 2008

**TRADEMARK
SERVICE MARK
PRINCIPAL REGISTER**

BOSSDEV

BOSSDEV INC. (NEVADA CORPORATION)
300 MAPLE PARK BLVD. #304
ST. CLAIR SHORES, MI 48081

FOR: DOWNLOADABLE COMPUTER SOFTWARE FOR USE IN KNOWLEDGE AND LOGISTICS MANAGEMENT THAT MAY BE ACCESSIBLE VIA A GLOBAL COMPUTER NETWORK; DOWNLOADABLE COMPUTER SOFTWARE FOR USE IN KNOWLEDGE, INVENTORY AND FINANCE MANAGEMENT THAT MAY BE ACCESSIBLE VIA A GLOBAL COMPUTER NETWORK; COMPUTER SOFTWARE FOR THE COLLECTION, EDITING, ORGANIZING, MODIFYING, TRANSMISSION, OUTPUT AND SHARING OF DATA AND INFORMATION; DOWNLOADABLE COMPUTER SOFTWARE FEATURING EDUCATION AND TRAINING IN KNOWLEDGE, INVENTORY AND FINANCE MANAGEMENT THAT MAY BE ACCESSIBLE VIA A GLOBAL COMPUTER NETWORK, IN CLASS 9 (U.S. CLS. 21, 23, 26, 36 AND 38).

FIRST USE 4-0-2005; IN COMMERCE 4-0-2005.

FOR: MAINTENANCE AND REPAIR OF COMPUTER HARDWARE AND COMPUTER NETWORKS, IN CLASS 37 (U.S. CLS. 100, 103 AND 106).

FIRST USE 4-0-2005; IN COMMERCE 4-0-2005.

FOR: PROVIDING TEMPORARY USE OF ON-LINE NON-DOWNLOADABLE SOFTWARE FOR USE IN KNOWLEDGE AND LOGISTICS MANAGEMENT THAT MAY BE ACCESSIBLE VIA A GLOBAL COMPUTER NETWORK; PROVIDING TEMPORARY USE OF ON-LINE NON-DOWNLOADABLE

SOFTWARE FOR USE IN KNOWLEDGE, INVENTORY AND FINANCE MANAGEMENT THAT MAY BE ACCESSIBLE VIA A GLOBAL COMPUTER NETWORK; PROVIDING TEMPORARY USE OF ON-LINE NON-DOWNLOADABLE SOFTWARE FEATURING EDUCATION AND TRAINING IN KNOWLEDGE, INVENTORY AND FINANCE MANAGEMENT THAT MAY BE ACCESSIBLE VIA A GLOBAL COMPUTER NETWORK; DESIGN, DEVELOPMENT, IMPLEMENTATION AND MAINTENANCE OF COMPUTER SOFTWARE SYSTEMS THAT MAY BE ACCESSIBLE VIA A GLOBAL COMPUTER NETWORK; DESIGN, DEVELOPMENT, IMPLEMENTATION AND MAINTENANCE OF COMPUTER SOFTWARE SYSTEMS FOR USE WITH EDUCATION AND TRAINING THAT MAY BE ACCESSIBLE VIA A GLOBAL COMPUTER NETWORK; CREATING AND MAINTAINING WEB SITES AND WEB CONTENT FOR OTHERS; CONSULTING SERVICES IN THE FIELD OF COMPUTER HARDWARE AND SOFTWARE; PROVIDING QUALITY ASSURANCE AND ADVISORY SERVICES IN THE FIELD OF COMPUTER SOFTWARE AND HARDWARE; MAINTENANCE AND REPAIR OF COMPUTER SOFTWARE, IN CLASS 42 (U.S. CLS. 100 AND 101).

FIRST USE 6-0-2004; IN COMMERCE 6-0-2004.

THE MARK CONSISTS OF STANDARD CHARACTERS WITHOUT CLAIM TO ANY PARTICULAR FONT, STYLE, SIZE, OR COLOR.

SN 78-760,555, FILED 11-23-2005.

DAVID YONTEF, EXAMINING ATTORNEY

Int. Cl.: 9

Prior U.S. Cls.: 21, 23, 26, 36, and 38

United States Patent and Trademark Office

Reg. No. 3,399,697

Registered Mar. 18, 2008

**TRADEMARK
PRINCIPAL REGISTER**

PYRA

CHEER APPAREL, LLC (NORTH CAROLINA
LTD LIAB CO)
520 ELLIOT STREET, SUITE 200
CHARLOTTE, NC 28202

THE MARK CONSISTS OF STANDARD CHAR-
ACTERS WITHOUT CLAIM TO ANY PARTICULAR
FONT, STYLE, SIZE, OR COLOR.

FOR: PROTECTIVE APPAREL FOR CHEER-
LEADING, IN CLASS 9 (U.S. CLS. 21, 23, 26, 36 AND
38).

SN 78-761,068, FILED 11-26-2005.

FIRST USE 11-28-2007; IN COMMERCE 11-28-2007.

BRIAN PINO, EXAMINING ATTORNEY

Int. Cl.: 41

Prior U.S. Cls.: 100, 101, and 107

United States Patent and Trademark Office

Reg. No. 3,399,698

Registered Mar. 18, 2008

**SERVICE MARK
PRINCIPAL REGISTER**

Science and Math Matter

YOUTHNET OF GREATER KANSAS CITY (MISSOURI NON-PROFIT CORPORATION)
SUITE 104
101 WEST 9TH STREET
KANSAS CITY, MO 641051718

FOR: CHARITABLE EDUCATION SERVICES, NAMELY, PROVIDING INFORMATION, RESEARCH AND ASSISTANCE WITH HOMEWORK ASSIGNMENTS TO STUDENTS ATTENDING GRADES KINDERGARTEN THROUGH TWELFTH GRADES VIA TELEPHONE CALL CENTER AND ONLINE RESPONSE SERVICES ON ALL SUBJECTS COVERED IN GRADES KINDERGARTEN THROUGH TWELFTH GRADE, INCLUDING SCIENCE AND MATH, IN CLASS 41 (U.S. CLS. 100, 101 AND 107).

FIRST USE 12-1-2006; IN COMMERCE 12-1-2006.

THE MARK CONSISTS OF STANDARD CHARACTERS WITHOUT CLAIM TO ANY PARTICULAR FONT, STYLE, SIZE, OR COLOR.

NO CLAIM IS MADE TO THE EXCLUSIVE RIGHT TO USE "SCIENCE AND MATH", APART FROM THE MARK AS SHOWN.

SN 78-761,589, FILED 11-28-2005.

SANDRA MANIOS, EXAMINING ATTORNEY

Int. Cl.: 16

Prior U.S. Cls.: 2, 5, 22, 23, 29, 37, 38, and 50

United States Patent and Trademark Office

Reg. No. 3,399,699

Registered Mar. 18, 2008

**TRADEMARK
PRINCIPAL REGISTER**



INTEGRITY PARTNERS, INC. (CALIFORNIA CORPORATION)
SUITE A
7120 ARIZONA AVENUE
LOS ANGELES, CA 90045

FIRST USE 5-2-2006; IN COMMERCE 5-2-2006.

FOR: EXERCISE WORKBOOKS; EXERCISE JOURNALS; EXERCISE DIARIES; MEAL PLAN WORKBOOKS; MEAL PLAN JOURNALS; MEAL PLAN DIARIES, IN CLASS 16 (U.S. CLS. 2, 5, 22, 23, 29, 37, 38 AND 50).

NO CLAIM IS MADE TO THE EXCLUSIVE RIGHT TO USE "AB", APART FROM THE MARK AS SHOWN.

SN 78-761,718, FILED 11-28-2005.

REBECCA EISINGER, EXAMINING ATTORNEY

Int. Cl.: 40

Prior U.S. Cls.: 100, 103, and 106

United States Patent and Trademark Office

Reg. No. 3,399,700

Registered Mar. 18, 2008

SERVICE MARK
PRINCIPAL REGISTER



BROWN, JEFF (UNITED STATES INDIVIDUAL)
4531 LA BREA STREET
OXNARD, CA 93035

FOR: MICRO-BREWERY SERVICES, IN CLASS 40
(U.S. CLS. 100, 103 AND 106).

FIRST USE 1-17-2007; IN COMMERCE 2-7-2007.

NO CLAIM IS MADE TO THE EXCLUSIVE
RIGHT TO USE "BREWING COMPANY", APART
FROM THE MARK AS SHOWN.

THE MARK CONSISTS, IN PART, OF A TRIDENT
WITH THE LETTERS "HBL" FORMING THE TINES
OF THE TRIDENT, CROSSED SURFBOARDS AND
OCEAN RIPPLES THAT APPEAR AT THE BOTTOM
OF THE TRIDENT.

SN 78-762,835, FILED 11-29-2005.

TRICIA SONNEBORN, EXAMINING ATTORNEY

Int. Cl.: 29

Prior U.S. Cl.: 46

United States Patent and Trademark Office

Reg. No. 3,399,701

Registered Mar. 18, 2008

TRADEMARK
PRINCIPAL REGISTER



TJ SEVEN INCORPORATION (CALIFORNIA CORPORATION)
613 CARLOTTA CIRCLE
PINOLE, CA 94564

THE NON-LATIN CHARACTER(S) IN THE MARK TRANSLITERATES INTO SANG WUT SUEI, AND THIS MEANS INTERNAL WATER IN ENGLISH.

FOR: EDIBLE BIRD'S NESTS, IN CLASS 29 (U.S. CL. 46).

FIRST USE 2-15-2006; IN COMMERCE 2-15-2006.

SN 78-763,377, FILED 11-30-2005.

NO CLAIM IS MADE TO THE EXCLUSIVE RIGHT TO USE THE CHINESE CHARACTERS REPRESENTING "SUPREME NEST", APART FROM THE MARK AS SHOWN.

JANICE L. MCMORROW, EXAMINING ATTORNEY

Int. Cl.: 16

Prior U.S. Cls.: 2, 5, 22, 23, 29, 37, 38, and 50

United States Patent and Trademark Office

Reg. No. 3,399,702

Registered Mar. 18, 2008

**TRADEMARK
PRINCIPAL REGISTER**

THE SOLUTION DECK

BURGOS, MARGARET ANN (UNITED STATES
INDIVIDUAL)

SUITE 1B

155 EAST 73RD STREET

NEW YORK, NY 10021

FOR: TAROT CARDS, IN CLASS 16 (U.S. CLS. 2, 5,
22, 23, 29, 37, 38 AND 50).

FIRST USE 11-16-2007; IN COMMERCE 11-21-2007.

THE MARK CONSISTS OF STANDARD CHAR-
ACTERS WITHOUT CLAIM TO ANY PARTICULAR
FONT, STYLE, SIZE, OR COLOR.

NO CLAIM IS MADE TO THE EXCLUSIVE
RIGHT TO USE "DECK", APART FROM THE
MARK AS SHOWN.

SN 78-763,383, FILED 11-30-2005.

WARREN L. OLANDRIA, EXAMINING ATTOR-
NEY

Int. Cl.: 25

Prior U.S. Cls.: 22 and 39

United States Patent and Trademark Office

Reg. No. 3,399,703

Registered Mar. 18, 2008

**TRADEMARK
PRINCIPAL REGISTER**



PAIVA, INC. (INDIANA CORPORATION)
3308 NORTH MITTHOEFFER ROAD
INDIANAPOLIS, IN 46235

HEAD WEAR AND FOOTWEAR, IN CLASS 25 (U.S.
CLS. 22 AND 39).

FIRST USE 4-0-2006; IN COMMERCE 4-0-2006.

FOR: WOMEN'S CLOTHING, NAMELY WO-
MEN'S SPORTS APPAREL IN THE NATURE OF
BRA TOPS, PANTS, SHIRTS AND SHORTS; AND

SN 78-763,654, FILED 11-30-2005.

ODESSA BIBBINS, EXAMINING ATTORNEY

Int. Cls.: 9 and 35

Prior U.S. Cls.: 21, 23, 26, 36, 38, 100, 101, and 102

United States Patent and Trademark Office

Reg. No. 3,399,704

Registered Mar. 18, 2008

**TRADEMARK
SERVICE MARK
PRINCIPAL REGISTER**

SOFTWARE SAVERS

VIDEO PROFESSOR, INC. (COLORADO CORPORATION)
12055 WEST 2ND PLACE
LAKEWOOD, CO 80228

FOR: SOFTWARE USED IN THE FIELD OF TRAINING, NAMELY, SOFTWARE USED FOR TRAINING AND INSTRUCTION IN THE USE OF COMPUTERS AND COMPUTER SOFTWARE, IN CLASS 9 (U.S. CLS. 21, 23, 26, 36 AND 38).

FIRST USE 8-30-2002; IN COMMERCE 8-30-2002.

FOR: COMPUTERIZED ONLINE RETAIL STORE SERVICES AND MAIL ORDER SERVICES FEATURING COMPUTER SOFTWARE AND COMPUTER SOFTWARE UPDATES, IN CLASS 35 (U.S. CLS. 100, 101 AND 102).

FIRST USE 8-30-2002; IN COMMERCE 8-30-2002.

THE MARK CONSISTS OF STANDARD CHARACTERS WITHOUT CLAIM TO ANY PARTICULAR FONT, STYLE, SIZE, OR COLOR.

OWNER OF U.S. REG. NO. 2,962,585.

NO CLAIM IS MADE TO THE EXCLUSIVE RIGHT TO USE "SOFTWARE", APART FROM THE MARK AS SHOWN.

SN 78-764,342, FILED 12-1-2005.

NAAKWAMA ANKRAH, EXAMINING ATTORNEY

Int. Cl.: 9

Prior U.S. Cls.: 21, 23, 26, 36, and 38

Reg. No. 3,399,705

United States Patent and Trademark Office

Registered Mar. 18, 2008

**TRADEMARK
PRINCIPAL REGISTER**



ZELKOVA (GEORGIA GENERAL PARTNER-
SHIP)
5014 RIVER OVERLOOK WAY
LITHONIA, GA 30038

DOWNLOADABLE AUDIO AND VIDEO RECORD-
INGS CONTAINING HEALTH AND FITNESS EX-
ERCISE PROGRAMS, IN CLASS 9 (U.S. CLS. 21, 23,
26, 36 AND 38).

FOR: PRE-RECORDED AUDIO PROGRAMS ON
PHONOGRAPH ALBUMS, COMPACT DISCS, PHO-
NOGRAPH RECORDS, AUDIO CASSETTES, MP3,
INTEGRATED CIRCUITS, MAGNETIC DATA CAR-
RIERS, AND DIGITAL AUDIO TAPES CONTAIN-
ING HEALTH AND FITNESS EXERCISE
PROGRAMS; PRE-RECORDED AUDIOVISUAL
PROGRAMS ON VIDEO CASSETTES, LASER DISCS,
DVDS, AND CD-ROMS CONTAINING HEALTH
AND FITNESS EXERCISE PROGRAMS; AND

FIRST USE 5-0-2006; IN COMMERCE 5-0-2006.

NO CLAIM IS MADE TO THE EXCLUSIVE
RIGHT TO USE "TRAINER", APART FROM THE
MARK AS SHOWN.

SN 78-765,296, FILED 12-2-2005.

COLLEEN KEARNEY, EXAMINING ATTORNEY

Int. Cl.: 25

Prior U.S. Cls.: 22 and 39

United States Patent and Trademark Office

Reg. No. 3,399,706

Registered Mar. 18, 2008

**TRADEMARK
PRINCIPAL REGISTER**

ZEATRO

EQUITEXX, INC. (CALIFORNIA CORPORATION)
4526 CALIFORNIA STREET
SAN FRANCISCO, CA 94118

THE MARK CONSISTS OF STANDARD CHARACTERS WITHOUT CLAIM TO ANY PARTICULAR FONT, STYLE, SIZE, OR COLOR.

FOR: EQUESTRIAN APPAREL, NAMELY RIDING BOOTS, PANTS, COATS AND GLOVES, IN CLASS 25 (U.S. CLS. 22 AND 39).

SN 78-765,297, FILED 12-2-2005.

FIRST USE 8-5-2004; IN COMMERCE 8-5-2004.

KIM SAITO, EXAMINING ATTORNEY

Int. Cl.: 12

Prior U.S. Cls.: 19, 21, 23, 31, 35, and 44

Reg. No. 3,399,707

United States Patent and Trademark Office

Registered Mar. 18, 2008

**TRADEMARK
PRINCIPAL REGISTER**

KHAM SIN

CAMPAGNOLO S.R.L. (ITALY LTD LIAB CO)
VIA DELLA CHIMICA, 4
VICENZA, ITALY

FOR: BICYCLES; BICYCLE PARTS, COMPONENTS AND ACCESSORIES, NAMELY, BICYCLE FRAMES, TUBES AND CONNECTORS FOR BICYCLE FRAMES, BICYCLE WHEELS, RIMS AND SPOKES FOR BICYCLE WHEELS, PEDALS, HUBS, FAST-LOCKING APPARATUS, NAMELY, WHEEL HUBS FEATURING QUICK RELEASE SKEWERS CONTROLLED BY CAM LEVERS FOR FAST LOCKING OF SAME, CHANGE-SPEED GEARS AND FRONT CHANGERS, CRANKS, SIMPLE AND MULTIPLE GEAR WHEELS, CRANKS WITH GEAR WHEELS, DERAILLEURS, CRANKS, SIMPLE AND MULTIPLE GEAR WHEELS, CRANKS WITH GEAR WHEELS, GEARS, FREE WHEELS, DRIVE CHAINS, BRAKES, DRIVE AND CONTROL APPARATUS FOR CHANGE-SPEED GEARS, DERAILLEURS AND BRAKES, CABLE GUIDES, KNOBS, CONTROLS AND LEVERS, PILLARS AND SADDLES,

PUMPS AND PUMP BEARINGS, PINS AND BEARINGS FOR CRANKS AND PEDALS, STEERING KNUCKLES AND BEARINGS AND BUSHES THEREFOR, FRONT AND BACK FORKS, CABLES AND SHEATHES, FASTENING CLIPS, CENTRAL MOVEMENT CASES, HANDLE-BAR CONNECTIONS AND HANDLE-BARS, FORKS AND CUSHIONED FORKS, KICKSTANDS, BICYCLE STANDS, TIRES AND TUBULAR TIRES, INNER TUBES, TIRES FOR BICYCLES, ALL FOR BICYCLES, IN CLASS 12 (U.S. CLS. 19, 21, 23, 31, 35 AND 44).

FIRST USE 4-27-2006; IN COMMERCE 5-17-2006.

THE MARK CONSISTS OF STANDARD CHARACTERS WITHOUT CLAIM TO ANY PARTICULAR FONT, STYLE, SIZE, OR COLOR.

SN 78-765,342, FILED 12-2-2005.

COLLEEN KEARNEY, EXAMINING ATTORNEY

Int. Cl.: 28

Prior U.S. Cls.: 22, 23, 38, and 50

United States Patent and Trademark Office

Reg. No. 3,399,708

Registered Mar. 18, 2008

**TRADEMARK
PRINCIPAL REGISTER**



BATTAT INCORPORATED (DELAWARE CORPORATION)
44 MARTINA CIRCLE
PLATTSBURGH, NY 12901

OWNER OF U.S. REG. NOS. 3,054,702 AND
3,073,159.

FOR: SAND TOYS FOR BEACH PLAY INCLUDING TOY SAND MOLDS, TOY VEHICLES, TOY BUCKETS, AND TOY GARDENING TOOLS IN THE NATURE OF HOES, RAKES, WATERING CANS, AND WHEELBARROWS, AND PLASTIC TUB CONTAINERS FOR THE TOYS SOLD AS A UNIT, IN CLASS 28 (U.S. CLS. 22, 23, 38 AND 50).

THE MARK CONSISTS OF THE WORD SAND-FUN PARTIALLY SURROUNDED BY A STYLIZED SUN RAY DESIGN.

SN 78-765,371, FILED 12-2-2005.

FIRST USE 3-31-2006; IN COMMERCE 3-31-2006.

GEORGE LORENZO, EXAMINING ATTORNEY

Int. Cl.: 44

Prior U.S. Cls.: 100 and 101

United States Patent and Trademark Office

Reg. No. 3,399,709

Registered Mar. 18, 2008

**SERVICE MARK
PRINCIPAL REGISTER**

SACH

SAN ANTONIO COMMUNITY HOSPITAL (CALI-
FORNIA CORPORATION)
999 SAN BERNARDINO ROAD
UPLAND, CA 91786

THE MARK CONSISTS OF STANDARD CHAR-
ACTERS WITHOUT CLAIM TO ANY PARTICULAR
FONT, STYLE, SIZE, OR COLOR.

FOR: HOSPITALS, IN CLASS 44 (U.S. CLS. 100
AND 101).

SN 78-766,134, FILED 12-3-2005.

FIRST USE 7-30-2007; IN COMMERCE 7-30-2007.

SETH A. RAPPAPORT, EXAMINING ATTORNEY

Int. Cl.: 25

Prior U.S. Cls.: 22 and 39

United States Patent and Trademark Office

Reg. No. 3,399,710

Registered Mar. 18, 2008

**TRADEMARK
PRINCIPAL REGISTER**

Oxford Golf Collection

OXFORD INDUSTRIES, INC. (GEORGIA CORPORATION)
222 PIEDMONT AVE., NE
ATLANTA, GA 30308

FOR: PANTS; SHIRTS; SWEATERS, IN CLASS 25
(U.S. CLS. 22 AND 39).

FIRST USE 1-1-2007; IN COMMERCE 1-1-2007.

THE MARK CONSISTS OF STANDARD CHARACTERS WITHOUT CLAIM TO ANY PARTICULAR FONT, STYLE, SIZE, OR COLOR.

OWNER OF U.S. REG. NOS. 3,003,702 AND 3,014,444.

NO CLAIM IS MADE TO THE EXCLUSIVE RIGHT TO USE "GOLF COLLECTION", APART FROM THE MARK AS SHOWN.

SEC. 2(F).

SN 78-766,553, FILED 12-5-2005.

GEORGE LORENZO, EXAMINING ATTORNEY

Int. Cl.: 33

Prior U.S. Cls.: 47 and 49

United States Patent and Trademark Office

Reg. No. 3,399,711

Registered Mar. 18, 2008

**TRADEMARK
PRINCIPAL REGISTER**

WinePod

PROVINA, INCORPORATED (CALIFORNIA CORPORATION)

6059 WHITEHAVEN CT.

SAN JOSE, CA 95138

FOR: KITS FOR MAKING WINE, IN CLASS 33 (U.S. CLS. 47 AND 49).

FIRST USE 1-15-2006; IN COMMERCE 2-18-2006.

THE MARK CONSISTS OF STANDARD CHARACTERS WITHOUT CLAIM TO ANY PARTICULAR FONT, STYLE, SIZE, OR COLOR.

NO CLAIM IS MADE TO THE EXCLUSIVE RIGHT TO USE "WINE", APART FROM THE MARK AS SHOWN.

SN 78-766,780, FILED 12-5-2005.

CAROLYN GRAY, EXAMINING ATTORNEY

Int. Cl.: 7

Prior U.S. Cls.: 13, 19, 21, 23, 31, 34, and 35

United States Patent and Trademark Office

Reg. No. 3,399,712

Registered Mar. 18, 2008

**TRADEMARK
PRINCIPAL REGISTER**

ProFormHT

HY-TECH WORLDWIDE, INC. (NEVADA CORPORATION)
1800 E. SAHARA AVENUE #107
LAS VEGAS, NV 89104

THE MARK CONSISTS OF STANDARD CHARACTERS WITHOUT CLAIM TO ANY PARTICULAR FONT, STYLE, SIZE, OR COLOR.

FOR: MACHINES FOR HYDROFORMING PLASTIC SHEETS, IN CLASS 7 (U.S. CLS. 13, 19, 21, 23, 31, 34 AND 35).

SN 78-766,977, FILED 12-5-2005.

FIRST USE 2-28-2007; IN COMMERCE 2-28-2007.

LAURA KOVALSKY, EXAMINING ATTORNEY

Int. Cl.: 9

Prior U.S. Cls.: 21, 23, 26, 36, and 38

United States Patent and Trademark Office

Reg. No. 3,399,713

Registered Mar. 18, 2008

**TRADEMARK
PRINCIPAL REGISTER**

ENTRADA

GLOBAL NAVIGATION INC. (CALIFORNIA CORPORATION)
1935 PUDDINGSTONE DRIVE
LA VERNE, CA 91750

FOR: GLOBAL POSITIONING SYSTEM (GPS) CONSISTING OF COMPUTERS, COMPUTER SOFTWARE, TRANSMITTERS, RECEIVERS, AND NETWORK INTERFACE DEVICES; NAVIGATION APPARATUS FOR VEHICLES IN THE NATURE OF ON-BOARD COMPUTERS, IN CLASS 9 (U.S. CLS. 21, 23, 26, 36 AND 38).

FIRST USE 6-12-2007; IN COMMERCE 6-12-2007.

THE MARK CONSISTS OF STANDARD CHARACTERS WITHOUT CLAIM TO ANY PARTICULAR FONT, STYLE, SIZE, OR COLOR.

THE ENGLISH TRANSLATION OF "ENTRADA" IS ENTRANCE.

SN 78-767,564, FILED 12-6-2005.

LAURIE KAUFMAN, EXAMINING ATTORNEY

Int. Cl.: 3

Prior U.S. Cls.: 1, 4, 6, 50, 51, and 52

Reg. No. 3,399,714

United States Patent and Trademark Office

Registered Mar. 18, 2008

**TRADEMARK
PRINCIPAL REGISTER**

Wrinkle Recovery

INTERNATIONAL SPECIALTY TREATMENTS,
LLC (CONNECTICUT LTD LIAB CO)
20 MAIN STREET
OAKVILLE, CT 06779

FOR: NON-MEDICATED ANTI-AGING SKIN
CARE PRODUCTS, NAMELY, SERUMS, CLEANS-
ERS, TONERS, CREAMS, LOTIONS, EYE GEL, EYE
CREAM, MASKS, SCRUBS, FOUNDATION, LIP
COLOR, LIP TREATMENTS, BLUSH, EYE SHA-
DOW, POWDER AND SOAP, IN CLASS 3 (U.S. CLS.
1, 4, 6, 50, 51 AND 52).

FIRST USE 3-4-2006; IN COMMERCE 3-4-2006.

THE MARK CONSISTS OF STANDARD CHAR-
ACTERS WITHOUT CLAIM TO ANY PARTICULAR
FONT, STYLE, SIZE, OR COLOR.

NO CLAIM IS MADE TO THE EXCLUSIVE
RIGHT TO USE "WRINKLE", APART FROM THE
MARK AS SHOWN.

SN 78-767,740, FILED 12-6-2005.

KAREN K. BUSH, EXAMINING ATTORNEY

Int. Cl.: 9

Prior U.S. Cls.: 21, 23, 26, 36, and 38

United States Patent and Trademark Office

Reg. No. 3,399,715

Registered Mar. 18, 2008

**TRADEMARK
PRINCIPAL REGISTER**

LOVEMYPETSGPS

LOVEMYPETS, LLC (SOUTH CAROLINA LTD
LIAB CO)
2801 WADE HAMPTON BLVD, #101
TAYLORS, SC 29687

FOR: TRANSMITTER AND RECEIVER USED TO
LOCATE LOST PETS; ELECTRONIC ANIMAL
TRACKING UNIT COMPRISING TRANSMITTER
AND RECEIVER COLLARS, IN CLASS 9 (U.S. CLS.
21, 23, 26, 36 AND 38).

FIRST USE 9-18-2007; IN COMMERCE 9-18-2007.

THE MARK CONSISTS OF STANDARD CHAR-
ACTERS WITHOUT CLAIM TO ANY PARTICULAR
FONT, STYLE, SIZE, OR COLOR.

SN 78-769,161, FILED 12-8-2005.

HENRY S. ZAK, EXAMINING ATTORNEY

Int. Cl.: 9

Prior U.S. Cls.: 21, 23, 26, 36, and 38

United States Patent and Trademark Office

Reg. No. 3,399,716

Registered Mar. 18, 2008

**TRADEMARK
PRINCIPAL REGISTER**

STRATEGIC CONVERSATIONS

NEW YORK CENTER FOR COACHING, INC.,
THE (NEW YORK CORPORATION)
SUITE 408
14 EAST 4TH STREET
NEW YORK, NY 10012

FOR: ELECTRONIC PUBLICATIONS, NAMELY,
BOOKS FEATURING INTERPERSONAL COMMUN-
ICATION RECORDED ON COMPUTER MEDIA;
PRE-RECORDED CDS AND AUDIO RECORDINGS
IN THE FIELD OF INTERPERSONAL COMMUNI-
CATION, IN CLASS 9 (U.S. CLS. 21, 23, 26, 36 AND 38).

FIRST USE 6-7-2006; IN COMMERCE 6-28-2006.

THE MARK CONSISTS OF STANDARD CHAR-
ACTERS WITHOUT CLAIM TO ANY PARTICULAR
FONT, STYLE, SIZE, OR COLOR.

NO CLAIM IS MADE TO THE EXCLUSIVE
RIGHT TO USE "CONVERSATIONS", APART
FROM THE MARK AS SHOWN.

SN 78-769,341, FILED 12-8-2005.

ATTIYA MALIK, EXAMINING ATTORNEY

Int. Cl.: 41

Prior U.S. Cls.: 100, 101, and 107

United States Patent and Trademark Office

Reg. No. 3,399,717

Registered Mar. 18, 2008

**SERVICE MARK
PRINCIPAL REGISTER**

ANACONDAS

GAREB SHAMUS ENTERPRISES, INC. (NEW
YORK CORPORATION)
151 WELLS AVENUE
CONGERS, NY 10920

THE MARK CONSISTS OF STANDARD CHAR-
ACTERS WITHOUT CLAIM TO ANY PARTICULAR
FONT, STYLE, SIZE, OR COLOR.

FOR: ENTERTAINMENT SERVICES, NAMELY
MARTIAL ARTS SPORTING EVENTS, IN CLASS 41
(U.S. CLS. 100, 101 AND 107).

SN 78-770,112, FILED 12-9-2005.

FIRST USE 4-29-2006; IN COMMERCE 4-29-2006.

DAVID COLLIER, EXAMINING ATTORNEY

Int. Cl.: 35

Prior U.S. Cls.: 100, 101, and 102

United States Patent and Trademark Office

Reg. No. 3,399,718

Registered Mar. 18, 2008

**SERVICE MARK
PRINCIPAL REGISTER**

IT'SUGAR

IT'SUGAR LLC (DELAWARE LIMITED LIABILITY COMPANY)
6 GLENVILLE STREET
GREENWICH, CT 06831

FOR: RETAIL STORE SERVICES FEATURING BULK CANDY, NOVELTY CANDY, CONFECTIONARY-BASED GOODS, CHOCOLATE, NUTS, DAIRY PRODUCTS, BAKED GOODS, CANDY-RELATED MERCHANDISE AND GIFT ITEMS, IN CLASS 35 (U.S. CLS. 100, 101 AND 102).

FIRST USE 1-18-2006; IN COMMERCE 6-28-2006.

THE MARK CONSISTS OF STANDARD CHARACTERS WITHOUT CLAIM TO ANY PARTICULAR FONT, STYLE, SIZE, OR COLOR.

SN 78-770,237, FILED 12-9-2005.

SARA THOMAS, EXAMINING ATTORNEY

Int. Cl.: 24

Prior U.S. Cls.: 42 and 50

United States Patent and Trademark Office

Reg. No. 3,399,719

Registered Mar. 18, 2008

**TRADEMARK
PRINCIPAL REGISTER**

NBT

C.M.I. ENTERPRISES, INC. (FLORIDA CORPORATION)
5590 N.W. 163 STREET
MIAMI, FL 33014

FOR: PROTECTIVE COATINGS SOLD AS AN INTEGRAL COMPONENT OF VINYL TEXTILES AND VINYL-COATED SYNTHETIC FABRICS FOR THE MANUFACTURE OF RESIDENTIAL, COMMERCIAL, INDUSTRIAL, MARINE, AIRCRAFT AND AUTOMOTIVE UPHOLSTERY AND TRIM, IN CLASS 24 (U.S. CLS. 42 AND 50).

FIRST USE 9-19-2006; IN COMMERCE 9-19-2006.

THE MARK CONSISTS OF STANDARD CHARACTERS WITHOUT CLAIM TO ANY PARTICULAR FONT, STYLE, SIZE, OR COLOR.

SN 78-770,238, FILED 12-9-2005.

PAUL CROWLEY, EXAMINING ATTORNEY

Int. Cl.: 38

Prior U.S. Cls.: 100, 101, and 104

United States Patent and Trademark Office

Reg. No. 3,399,720

Registered Mar. 18, 2008

**SERVICE MARK
PRINCIPAL REGISTER**

ALL ROAD COMMUNICATIONS

LIBERATION MANAGEMENT LLC (RHODE ISLAND LTD LIAB CO)

3370 BRANT ST.

SAN DIEGO, CA 92103

FOR: SATELLITE COMMUNICATION SERVICES,
IN CLASS 38 (U.S. CLS. 100, 101 AND 104).

FIRST USE 6-1-2006; IN COMMERCE 6-1-2006.

THE MARK CONSISTS OF STANDARD CHARACTERS WITHOUT CLAIM TO ANY PARTICULAR FONT, STYLE, SIZE, OR COLOR.

NO CLAIM IS MADE TO THE EXCLUSIVE RIGHT TO USE "COMMUNICATIONS", APART FROM THE MARK AS SHOWN.

SN 78-770,522, FILED 12-9-2005.

DAYNA BROWNE, EXAMINING ATTORNEY

Int. Cl.: 38

Prior U.S. Cls.: 100, 101, and 104

United States Patent and Trademark Office

Reg. No. 3,399,721

Registered Mar. 18, 2008

**SERVICE MARK
PRINCIPAL REGISTER**

The logo for Xuite features the word "Xuite" in a stylized, rounded font. The letter 'X' is significantly larger than the other letters. The 'i' and 'e' at the end of the word have small, circular icons resembling game controller buttons (a directional pad and a button) positioned above them.

CHUNGHWA TELECOM CO., LTD. (TAIWAN CORPORATION)
NO. 21-3, SECTION 1, HSIN-YI ROAD
TAIPEI, TAIWAN

FOR: TELECOMMUNICATIONS ROUTING AND JUNCTION SERVICES; PROVIDING FRAME RELAY CONNECTIVITY SERVICES FOR DATA TRANSFER; VOICE MAIL SERVICES; PROVIDING MULTIPLE USER DIAL-UP AND DEDICATED ACCESS TO THE INTERNET; DELIVERY OF PERSONALIZED GREETING CARDS TO OTHERS VIA ELECTRONIC MAIL; RENTAL OF SET-TOP BOXES FOR USE WITH TELEVISIONS; VOICE OVER IP SERVICES; PROVIDING TELECOMMUNICATIONS CONNECTIONS TO A GLOBAL COMPUTER NETWORK; SATELLITE TRANSMISSION SERVICES; TELEPHONE VOICE MESSAGING SERVICES; VOICE OVER INTERNET PROTOCOL (VOIP) SERVICES; ELECTRONIC DATA INTERCHANGE (EDI) SERVICES; PROVIDING ON-LINE CHAT ROOMS FOR TRANSMISSION OF MESSAGES AMONG COMPUTER USERS IN THE FIELD OF GENERAL INTEREST; PROVIDING ON-LINE ELECTRONIC BULLETIN BOARDS FOR TRANSMISSION OF MESSAGES AMONG COMPUTER USERS IN THE FIELD OF GENERAL INTEREST; COMMUNICATION BY TELEGRAM; DELIVERY OF MESSAGES BY ELECTRONIC TRANSMISSION; ELECTRONIC MAIL SERVICES; ELECTRONIC STORE-AND-FORWARD MESSAGING; ELECTRONIC TRANSMISSION OF DATA AND DOCUMENTS VIA COMPUTER TERMINALS; ELECTRONIC TRANSMISSION OF MESSAGES AND DATA; TELEPHONE COMMUNICATION SERVICES; VIDEO TEXT SERVICES; ELECTRONIC DELIVERY OF IMAGES AND PHOTOGRAPHS VIA A GLOBAL COMPUTER NETWORK; E-MAIL FORWARDING SERVICES; PROVIDING ON-LINE FORUMS FOR TRANSMISSION

OF MESSAGES AMONG COMPUTER USERS CONCERNING GENERAL INTERESTS; STREAMING OF AUDIO MATERIAL ON THE INTERNET; STREAMING OF VIDEO MATERIAL ON THE INTERNET; WEB MESSAGING; WEB SITE FORWARDING SERVICES; WIRELESS BROADBAND COMMUNICATION SERVICES; INSTANT MESSAGING SERVICES; COMMUNICATIONS SERVICES, NAMELY, TRANSMITTING STREAMED SOUND AND AUDIO-VISUAL RECORDINGS VIA THE INTERNET; PROVIDING ON-LINE LIST SERVERS FOR TRANSMISSION OF MESSAGES AMONG COMPUTER USERS CONCERNING GENERAL INTEREST; TELECOMMUNICATIONS SERVICES, NAMELY PROVIDING FIBER OPTIC NETWORK SERVICES; WORLDWIDE SWITCHED TEXT AND MESSAGE TRANSMISSION SERVICES; PROVIDING ON-LINE CHAT ROOMS AND ELECTRONIC BULLETIN BOARDS FOR TRANSMISSION OF MESSAGES AMONG USERS IN THE FIELD OF GENERAL INTEREST; PAY-PER-VIEW TELEVISION TRANSMISSION SERVICES; COMMUNICATION SERVICES, NAMELY, ELECTRONIC TRANSMISSION OF DATA AND DOCUMENTS AMONG USERS OF COMPUTERS; TELEPHONE TELECOMMUNICATIONS SERVICES PROVIDED VIA PREPAID TELEPHONE CALLING CARDS; PROVIDING ON-LINE COMMUNICATIONS LINKS WHICH TRANSFER THE WEBSITE USER TO OTHER LOCAL AND GLOBAL WEB PAGES; PROVIDING PRIVATE AND SECURE REAL TIME ELECTRONIC COMMUNICATION OVER A COMPUTER NETWORK; VOICE CHAT SERVICES; WEB CASTING SERVICES; VIDEO-ON-DEMAND TRANSMISSION SERVICES; WIRELESS FACSIMILE MAIL SERVICES; CELLULAR TELEPHONE COMMUNICATION; COMMUNICATION BY ELECTRONIC COMPUTER TERMINALS; COMMUNICATION VIA COMPUTER TERMINALS, BY DIGITAL

TRANSMISSION OR BY SATELLITE; COMMUNICATIONS BY COMPUTER TERMINALS; COMMUNICATIONS VIA FIBER-OPTIC NETWORKS; DATA COMMUNICATION BY ELECTRONIC MAIL; INFORMATION TRANSMISSION SERVICES VIA DIGITAL NETWORKS; INFORMATION TRANSMISSION VIA ELECTRONIC COMMUNICATION NETWORKS; PROVIDING E-MAIL SERVICES; SECURE E-MAIL SERVICES; VIRTUAL CHAT ROOMS ESTABLISHED VIA TEXT MESSAGING; ELECTRONIC, ELECTRIC, AND DIGITAL TRANSMISSION OF VOICE, DATA, IMAGES, SIGNALS, AND MESSAGES, IN CLASS 38 (U.S. CLS. 100, 101 AND 104).

FIRST USE 4-1-2005; IN COMMERCE 4-1-2005.

THE MARK CONSISTS OF THE STYLIZED LETTERS "XUITE" WITH THE DOT ABOVE THE "I" HAVING A FLOWER PETAL LIKE CONTOUR CONTAINED THEREIN WITH THE "E" HAVING THE PETAL LIKE CONTOUR CONTAINED IN AN UPPER PORTION THEREOF.

SN 78-771,667, FILED 12-12-2005.

LINDA E. BLOHM, EXAMINING ATTORNEY

Int. Cl.: 39

Prior U.S. Cls.: 100 and 105

United States Patent and Trademark Office

Reg. No. 3,399,722

Registered Mar. 18, 2008

**SERVICE MARK
PRINCIPAL REGISTER**

TripFilter

PRICELINE.COM INCORPORATED (DELA-
WARE CORPORATION)
800 CONNECTICUT AVENUE
NORWALK, CT 06854

FOR: PROVIDING TRAVEL INFORMATION VIA
AN ONLINE WEB SITE THAT CUSTOMIZES TRA-
VEL AND TRANSPORTATION SEARCH RESULTS
COMPILED BY THE USER, IN CLASS 39 (U.S. CLS.
100 AND 105).

FIRST USE 12-0-2005; IN COMMERCE 12-0-2005.

THE MARK CONSISTS OF THE COINED, SINGLE
WORD "TRIPFILTER", WITH THE "T" AND THE
"F" IN A LARGER FONT THAN THE REST OF THE
LETTERS.

SN 78-772,270, FILED 12-13-2005.

MARGERY A. TIERNEY, EXAMINING ATTORNEY

Int. Cl.: 7

Prior U.S. Cls.: 13, 19, 21, 23, 31, 34, and 35

Reg. No. 3,399,723

United States Patent and Trademark Office

Registered Mar. 18, 2008

**TRADEMARK
PRINCIPAL REGISTER**

MOTOR MATTRESS

DMS ELECTRIC APPARATUS SERVICE, INC.
(MICHIGAN CORPORATION)
630 GIBSON STREET
KALAMAZOO, MI 49007

FOR: INDUSTRIAL MACHINE MOTOR MOUNTS
IN THE NATURE OF TRANSITION BASES THAT
ACCOMMODATE DIFFERENT TYPES AND SIZES
OF INDUSTRIAL MOTORS , IN CLASS 7 (U.S. CLS.
13, 19, 21, 23, 31, 34 AND 35).

FIRST USE 10-9-2006; IN COMMERCE 10-9-2006.

THE MARK CONSISTS OF STANDARD CHAR-
ACTERS WITHOUT CLAIM TO ANY PARTICULAR
FONT, STYLE, SIZE, OR COLOR.

NO CLAIM IS MADE TO THE EXCLUSIVE
RIGHT TO USE "MOTOR", APART FROM THE
MARK AS SHOWN.

SN 78-772,608, FILED 12-13-2005.

KATHERINE CHANG, EXAMINING ATTORNEY

Int. Cl.: 41

Prior U.S. Cls.: 100, 101, and 107

United States Patent and Trademark Office

Reg. No. 3,399,724

Registered Mar. 18, 2008

**SERVICE MARK
PRINCIPAL REGISTER**

DISNEY'S GAME CAFE

DISNEY ENTERPRISES, INC. (DELAWARE CORPORATION)
500 SOUTH BUENA VISTA STREET
BURBANK, CA 91521

FOR: ENTERTAINMENT SERVICES, NAMELY, PROVIDING ON-LINE COMPUTER GAMES; PROVIDING A WEB SITE FOR DOWNLOADING VIDEO GAMES, COMPUTER GAMES AND INTERACTIVE GAMES, IN CLASS 41 (U.S. CLS. 100, 101 AND 107).

FIRST USE 12-30-2005; IN COMMERCE 12-30-2005.

THE MARK CONSISTS OF STANDARD CHARACTERS WITHOUT CLAIM TO ANY PARTICULAR FONT, STYLE, SIZE, OR COLOR.

NO CLAIM IS MADE TO THE EXCLUSIVE RIGHT TO USE GAME, APART FROM THE MARK AS SHOWN.

SN 78-773,082, FILED 12-14-2005.

SHAUNIA CARLYLE, EXAMINING ATTORNEY

Int. Cl.: 44

Prior U.S. Cls.: 100 and 101

United States Patent and Trademark Office

Reg. No. 3,399,725

Registered Mar. 18, 2008

**SERVICE MARK
PRINCIPAL REGISTER**

THE WOMEN'S CENTER AT THE
GEORGE WASHINGTON
UNIVERSITY HOSPITAL

UHS OF DELAWARE, INC. (DELAWARE COR-
PORATION)
367 SOUTH GULPH ROAD
KING OF PRUSSIA, PA 194060958

FOR: MEDICAL, HEALTHCARE AND HOSPITAL
SERVICES, IN CLASS 44 (U.S. CLS. 100 AND 101).

FIRST USE 5-4-2005; IN COMMERCE 5-4-2005.

THE MARK CONSISTS OF STANDARD CHAR-
ACTERS WITHOUT CLAIM TO ANY PARTICULAR
FONT, STYLE, SIZE, OR COLOR.

OWNER OF U.S. REG. NOS. 2,909,837 AND
2,909,838.

NO CLAIM IS MADE TO THE EXCLUSIVE
RIGHT TO USE "WOMEN'S CENTER" AND "UNI-
VERSITY HOSPITAL", APART FROM THE MARK
AS SHOWN.

SN 78-773,420, FILED 12-14-2005.

MARK T. MULLEN, EXAMINING ATTORNEY

Int. Cl.: 30

Prior U.S. Cl.: 46

United States Patent and Trademark Office

Reg. No. 3,399,726

Registered Mar. 18, 2008

**TRADEMARK
PRINCIPAL REGISTER**

AMAZING ALOHA

JOLLIBEE FOODS CORPORATION (PHILIPPINES CORPORATION)
#10 EMERALD AVENUE, ORTIGAS CENTER
7TH FLOOR, JOLLIBEE PLAZA BUILDING
PASIG CITY 1600, PHILIPPINES

FOR: SANDWICHES, IN CLASS 30 (U.S. CL. 46).

FIRST USE 2-9-2004; IN COMMERCE 2-9-2004.

THE MARK CONSISTS OF STANDARD CHARACTERS WITHOUT CLAIM TO ANY PARTICULAR FONT, STYLE, SIZE, OR COLOR.

SN 78-773,483, FILED 12-14-2005.

AMOS T. MATTHEWS, JR., EXAMINING ATTORNEY

Int. Cl.: 15

Prior U.S. Cls.: 2, 21, and 36

United States Patent and Trademark Office

Reg. No. 3,399,727

Registered Mar. 18, 2008

**TRADEMARK
PRINCIPAL REGISTER**

JACK DANIEL'S

JACK DANIEL'S PROPERTIES, INC. (DELA-
WARE CORPORATION)
SUITE 528
4040 CIVIC CENTER DRIVE
SAN RAFAEL, CA 94903

FOR: GUITARS, GUITAR PICKS, IN CLASS 15
(U.S. CLS. 2, 21 AND 36).

FIRST USE 4-15-2004; IN COMMERCE 4-15-2004.

THE MARK CONSISTS OF STANDARD CHAR-
ACTERS WITHOUT CLAIM TO ANY PARTICULAR
FONT, STYLE, SIZE, OR COLOR.

OWNER OF U.S. REG. NOS. 1,290,702, 2,898,085,
AND OTHERS.

THE NAME(S), PORTRAIT(S), AND/OR SIGNA-
TURE(S) SHOWN IN THE MARK DOES NOT IDEN-
TIFY A PARTICULAR LIVING INDIVIDUAL.

SN 78-773,588, FILED 12-14-2005.

BARBARA RUTLAND, EXAMINING ATTORNEY

Int. Cl.: 3

Prior U.S. Cls.: 1, 4, 6, 50, 51, and 52

United States Patent and Trademark Office

Reg. No. 3,399,728

Registered Mar. 18, 2008

**TRADEMARK
PRINCIPAL REGISTER**

BIOFOS BIOTECHNOLOGY

ROJAS, CESAR MAURICIO ROJAS (COLOMBIA
INDIVIDUAL)
AV. DORADO NO 69C-03
EDIFICIO CAPITAL II TORRE C-OFI 901-902
BOGOTA, COLOMBIA

FOR: COSMETICS, IN CLASS 3 (U.S. CLS. 1, 4, 6, 50,
51 AND 52).

FIRST USE 5-3-2007; IN COMMERCE 5-3-2007.

THE MARK CONSISTS OF STANDARD CHAR-
ACTERS WITHOUT CLAIM TO ANY PARTICULAR
FONT, STYLE, SIZE, OR COLOR.

NO CLAIM IS MADE TO THE EXCLUSIVE
RIGHT TO USE "BIOTECHNOLOGY", APART
FROM THE MARK AS SHOWN.

THE WORDING "BIOFOS" HAS NO MEANING
IN A FOREIGN LANGUAGE.

SN 78-773,824, FILED 12-15-2005.

KELLY BOULTON, EXAMINING ATTORNEY

Int. Cl.: 44

Prior U.S. Cls.: 100 and 101

United States Patent and Trademark Office

Reg. No. 3,399,729

Registered Mar. 18, 2008

**SERVICE MARK
PRINCIPAL REGISTER**

LUMIÈRE

PHOTO THERAPEUTICS LIMITED (ENGLAND
CORPORATION)
STATION BUSINESS CENTRE
3RD FLOOR STATION HOUSE, STAMFORD NEW
ROADAD
ALTRINCHAM, CHESHIRE, UNITED KINGDOM
WA14 1EP

FOR: PROVIDING COSMETIC AND MEDICAL
INFORMATION, IN CLASS 44 (U.S. CLS. 100 AND
101).

FIRST USE 8-2-2004; IN COMMERCE 8-2-2004.

THE MARK CONSISTS OF STANDARD CHAR-
ACTERS WITHOUT CLAIM TO ANY PARTICULAR
FONT, STYLE, SIZE, OR COLOR.

THE ENGLISH TRANSLATION OF "LUMIÈRE"
IS "LIGHT", "DAYLIGHT" OR "DAY".

SN 78-773,938, FILED 12-15-2005.

PAUL F. GAST, EXAMINING ATTORNEY

Int. Cl.: 18

Prior U.S. Cls.: 1, 2, 3, 22, and 41

United States Patent and Trademark Office

Reg. No. 3,399,730

Registered Mar. 18, 2008

**TRADEMARK
PRINCIPAL REGISTER**

Dream Walker

ZUTIS, CERENA WEST (UNITED STATES INDIVIDUAL)
1773 LAKE STREET
SAN MATEO, CA 94403

THE MARK CONSISTS OF STANDARD CHARACTERS WITHOUT CLAIM TO ANY PARTICULAR FONT, STYLE, SIZE, OR COLOR.

FOR: DOG HARNESS, IN CLASS 18 (U.S. CLS. 1, 2, 3, 22 AND 41).

SN 78-774,195, FILED 12-15-2005.

FIRST USE 1-12-2006; IN COMMERCE 7-21-2006.

ANNE MADDEN, EXAMINING ATTORNEY

Int. Cl.: 3

Prior U.S. Cls.: 1, 4, 6, 50, 51, and 52

United States Patent and Trademark Office

Reg. No. 3,399,731

Registered Mar. 18, 2008

**TRADEMARK
PRINCIPAL REGISTER**

LIPPIN' LARGE

DEL LABORATORIES, INC. (DELAWARE COR-
PORATION)
726 REXCORP. PLAZA
P.O. BOX 9357
UNIONDALE, NY 115539357

THE MARK CONSISTS OF STANDARD CHAR-
ACTERS WITHOUT CLAIM TO ANY PARTICULAR
FONT, STYLE, SIZE, OR COLOR.

FOR: COSMETICS; LIPSTICK; NON-MEDICATED
LIP CARE PREPARATIONS, IN CLASS 3 (U.S. CLS. 1,
4, 6, 50, 51 AND 52).

SN 78-774,764, FILED 12-16-2005.

FIRST USE 12-1-2007; IN COMMERCE 12-1-2007.

ANDREW RHIM, EXAMINING ATTORNEY

Int. Cl.: 9

Prior U.S. Cls.: 21, 23, 26, 36, and 38

United States Patent and Trademark Office

Reg. No. 3,399,732

Registered Mar. 18, 2008

**TRADEMARK
PRINCIPAL REGISTER**

E/ONE SENTRY

ENVIRONMENT ONE CORPORATION (NEW
YORK CORPORATION)
2773 BALLTOWN ROAD
NISKAYUNA, NY 12309

FOR: INDICATOR AND COMMUNICATION PA-
NEL FOR UTILITY SYSTEM, NAMELY, AN
ALARM INDICATOR AND PREDICTIVE STATUS
NOTIFIER FOR A GRINDER PUMP STATION OF A
LOW PRESSURE SEWER SYSTEM, IN CLASS 9 (U.S.
CLS. 21, 23, 26, 36 AND 38).

FIRST USE 11-8-2007; IN COMMERCE 11-8-2007.

THE MARK CONSISTS OF STANDARD CHAR-
ACTERS WITHOUT CLAIM TO ANY PARTICULAR
FONT, STYLE, SIZE, OR COLOR.

OWNER OF U.S. REG. NO. 2,333,343.

SN 78-774,767, FILED 12-16-2005.

ARETHA SOMERVILLE, EXAMINING ATTORNEY

Int. Cl.: 1

Prior U.S. Cls.: 1, 5, 6, 10, 26, and 46

United States Patent and Trademark Office

Reg. No. 3,399,733

Registered Mar. 18, 2008

**TRADEMARK
PRINCIPAL REGISTER**

COSMO-FLUX

COSMOAGRO, S.A. (COLOMBIA SOCIEDAD AN-
ONIMA)
ZONA FRANCA DEL PACIFICO, KM 6, VIA
YUMBO- AEROPUERTO
PALMIRA VALLE, COLOMBIA

FOR: NON IONIC ADJUVANT COMPOUND TO
BE USED WITH AGROCHEMICAL COMPOUNDS,
IN CLASS 1 (U.S. CLS. 1, 5, 6, 10, 26 AND 46).

FIRST USE 12-31-1999; IN COMMERCE 8-1-2007.

THE MARK CONSISTS OF STANDARD CHAR-
ACTERS WITHOUT CLAIM TO ANY PARTICULAR
FONT, STYLE, SIZE, OR COLOR.

OWNER OF COLOMBIA REG. NO. 171341, DA-
TED 12-30-1994, EXPIRES 12-30-2014.

SN 78-774,806, FILED 12-16-2005.

RAMONA ORTIGA, EXAMINING ATTORNEY

Int. Cls.: 18, 25, 32, and 33

Prior U.S. Cls.: 1, 2, 3, 22, 39, 41, 45, 46, 47, 48, and 49

United States Patent and Trademark Office

Reg. No. 3,399,734

Registered Mar. 18, 2008

**TRADEMARK
PRINCIPAL REGISTER**

MIKE'S LIGHT

MARK ANTHONY INTERNATIONAL SRL (BARBADOS CORPORATION)
STEVMAR HOUSE, SUITE 302
ROCKLEY, CHRIST CHURCH, BARBADOS BB15137

FOR: BAGS, NAMELY, BACKPACKS, IN CLASS 18 (U.S. CLS. 1, 2, 3, 22 AND 41).

FIRST USE 10-20-2004; IN COMMERCE 10-20-2004.

FOR: CLOTHING, NAMELY, SHIRTS, T-SHIRTS, IN CLASS 25 (U.S. CLS. 22 AND 39).

FIRST USE 1-5-2004; IN COMMERCE 1-5-2004.

FOR: FLAVORED BREWED MALT-BASED ALCOHOLIC BEVERAGES IN THE NATURE OF A BEER, IN CLASS 32 (U.S. CLS. 45, 46 AND 48).

FIRST USE 1-5-2004; IN COMMERCE 1-5-2004.

FOR: FLAVORED ALCOHOLIC MALT COOLERS, IN CLASS 33 (U.S. CLS. 47 AND 49).

FIRST USE 1-5-2004; IN COMMERCE 1-5-2004.

THE MARK CONSISTS OF STANDARD CHARACTERS WITHOUT CLAIM TO ANY PARTICULAR FONT, STYLE, SIZE, OR COLOR.

OWNER OF U.S. REG. NOS. 2,501,401, 2,577,759, AND OTHERS.

NO CLAIM IS MADE TO THE EXCLUSIVE RIGHT TO USE "LIGHT" AS TO THE GOODS IN INTERNATIONAL CLASSES 32 AND 33, APART FROM THE MARK AS SHOWN.

SN 78-775,379, FILED 12-16-2005.

WOODROW HARTZOG, EXAMINING ATTORNEY

Int. Cl.: 19

Prior U.S. Cls.: 1, 12, 33, and 50

United States Patent and Trademark Office

Reg. No. 3,399,735

Registered Mar. 18, 2008

**TRADEMARK
PRINCIPAL REGISTER**

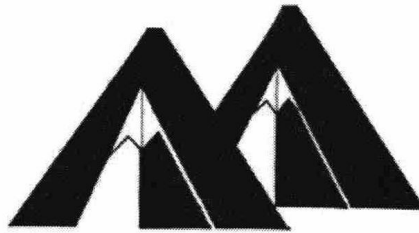

SUMMIT STONE, INC. (OHIO CORPORATION)
P. O. BOX 227
NORTH LAWRENCE, OH 446660227

THE MARK CONSISTS OF TWO STYLIZED
MOUNTAINS WITH ONE OVERLAPPING THE
OTHER.

FOR: STONE FOR BUILDING AND CONSTRUCTION, IN CLASS 19 (U.S. CLS. 1, 12, 33 AND 50).

SN 78-775,907, FILED 12-19-2005.

FIRST USE 6-6-2005; IN COMMERCE 6-6-2005.

SETH A. RAPPAPORT, EXAMINING ATTORNEY

Int. Cl.: 25

Prior U.S. Cls.: 22 and 39

United States Patent and Trademark Office

Reg. No. 3,399,736

Registered Mar. 18, 2008

**TRADEMARK
PRINCIPAL REGISTER**

LORD OF BALLS

100MC, LLC (CALIFORNIA LTD LIAB CO)
SUITE B
12 E. SIR FRANCIS DRAKE BLVD.
LARKSPUR, CA 94939

FIRST USE 1-1-2001; IN COMMERCE 1-1-2001.

FOR: CLOTHING, NAMELY, MEN'S, WOMEN'S
AND CHILDREN'S CASUAL AND DRESS CLOTH-
ING, NAMELY, DRESS AND CASUAL SHIRTS,
BLOUSES, PANTS, SHORTS, JACKETS, UNDER-
WEAR, TOPS, FOOTWEAR AND HEADWEAR, IN
CLASS 25 (U.S. CLS. 22 AND 39).

THE MARK CONSISTS OF STANDARD CHAR-
ACTERS WITHOUT CLAIM TO ANY PARTICULAR
FONT, STYLE, SIZE, OR COLOR.

SN 78-776,393, FILED 12-19-2005.

RONALD AIKENS, EXAMINING ATTORNEY

Int. Cls.: 35 and 39

Prior U.S. Cls.: 100, 101, 102, and 105

United States Patent and Trademark Office

Reg. No. 3,399,737

Registered Mar. 18, 2008

**SERVICE MARK
PRINCIPAL REGISTER**

**GREATWIDE DEDICATED
TRANSPORT**

GREATWIDE LOGISTICS SERVICES, INC. (DE-
LAWARE CORPORATION)
SUITE 300-S
12404 PARK CENTRAL DRIVE
DALLAS, TX 75251

FOR: WAREHOUSE MANAGEMENT AND OP-
ERATION; AND FREIGHT MANAGEMENT,
NAMELY, PROVIDING ELECTRONIC TRACKING
OF FREIGHT INFORMATION TO OTHERS, AND
INFORMATION MANAGEMENT SERVICES,
NAMELY, SHIPMENT PROCESSING, PREPARING
SHIPMENT DOCUMENTS AND INVOICES,
TRACKING DOCUMENTS, PACKAGES AND
FREIGHT OVER COMPUTER NETWORKS, INTRA-
NETS AND INTERNETS, IN CLASS 35 (U.S. CLS. 100,
101 AND 102).

FIRST USE 1-6-2006; IN COMMERCE 1-6-2006.

FOR: FREIGHT TRANSPORTATION BY TRUCK;
AND TRANSPORT BROKERAGE, IN CLASS 39 (U.S.
CLS. 100 AND 105).

FIRST USE 1-6-2006; IN COMMERCE 1-6-2006.

THE MARK CONSISTS OF STANDARD CHAR-
ACTERS WITHOUT CLAIM TO ANY PARTICULAR
FONT, STYLE, SIZE, OR COLOR.

NO CLAIM IS MADE TO THE EXCLUSIVE
RIGHT TO USE "DEDICATED TRANSPORT",
APART FROM THE MARK AS SHOWN.

SN 78-776,497, FILED 12-19-2005.

PATRICIA EVANKO, EXAMINING ATTORNEY

Int. Cl.: 14

Prior U.S. Cls.: 2, 27, 28, and 50

United States Patent and Trademark Office

Reg. No. 3,399,738

Registered Mar. 18, 2008

**TRADEMARK
PRINCIPAL REGISTER**

CRIMSON GOLD

THE HERFF JONES COMPANY OF INDIANA,
INC. (INDIANA CORPORATION)

4625 WEST 62ND STREET

INDIANAPOLIS, IN 46268

FOR: JEWELRY; JEWELRY FINDINGS;
WATCHES, IN CLASS 14 (U.S. CLS. 2, 27, 28 AND 50).

FIRST USE 1-11-2006; IN COMMERCE 1-11-2006.

THE MARK CONSISTS OF STANDARD CHAR-
ACTERS WITHOUT CLAIM TO ANY PARTICULAR
FONT, STYLE, SIZE, OR COLOR.

NO CLAIM IS MADE TO THE EXCLUSIVE
RIGHT TO USE "GOLD", APART FROM THE
MARK AS SHOWN.

SN 78-777,356, FILED 12-20-2005.

ATTIYA MALIK, EXAMINING ATTORNEY

Int. Cls.: 9, 37, 40, and 42

Prior U.S. Cls.: 21, 23, 26, 36, 38, 100, 101, 103, and 106

Reg. No. 3,399,739

United States Patent and Trademark Office

Registered Mar. 18, 2008

**TRADEMARK
SERVICE MARK
PRINCIPAL REGISTER**



KIOSK INFORMATION SYSTEMS, INC. (COLORADO CORPORATION)
346 SOUTH ARTHUR AVENUE
LOUISVILLE, CO 80027

FOR: KIOSKS, NAMELY, COMPUTER-OPERATED KIOSKS COMPRISED OF COMPUTER HARDWARE AND SOFTWARE FOR USE IN A WIDE VARIETY OF APPLICATIONS, NAMELY, ALLOWING THE PUBLIC TO ACCESS INFORMATION, OBTAIN GOODS AND SERVICES, AND CARRY ON TRANSACTIONS VIA A GLOBAL COMPUTER NETWORK, NAMELY, THE PURCHASE OF GOODS AND SERVICES, AND ELECTRONIC CASH, CREDIT AND DEBIT TRANSACTIONS, IN CLASS 9 (U.S. CLS. 21, 23, 26, 36 AND 38).

FIRST USE 1-9-2006; IN COMMERCE 1-9-2006.

FOR: INSTALLATION AND MAINTENANCE OF COMPUTER-OPERATED KIOSKS USED FOR PROVIDING ACCESS TO A GLOBAL COMPUTER NETWORK, IN CLASS 37 (U.S. CLS. 100, 103 AND 106).

FIRST USE 1-9-2006; IN COMMERCE 1-9-2006.

FOR: CUSTOM MANUFACTURE OF COMPUTER-OPERATED KIOSKS USED FOR PROVIDING ACCESS TO A GLOBAL COMPUTER NETWORK, IN CLASS 40 (U.S. CLS. 100, 103 AND 106).

FIRST USE 1-9-2006; IN COMMERCE 1-9-2006.

FOR: CUSTOM DESIGN OF COMPUTER-OPERATED KIOSKS USED FOR PROVIDING ACCESS TO A GLOBAL COMPUTER NETWORK; INSTALLATION AND MAINTENANCE OF COMPUTER SOFTWARE IN COMPUTER-OPERATED KIOSKS USED FOR PROVIDING ACCESS TO A GLOBAL COMPUTER NETWORK, IN CLASS 42 (U.S. CLS. 100 AND 101).

FIRST USE 1-9-2006; IN COMMERCE 1-9-2006.

NO CLAIM IS MADE TO THE EXCLUSIVE RIGHT TO USE "KIOSK", APART FROM THE MARK AS SHOWN.

SN 78-777,543, FILED 12-20-2005.

ELLEN BURNS, EXAMINING ATTORNEY

Int. Cl.: 41

Prior U.S. Cls.: 100, 101, and 107

United States Patent and Trademark Office

Reg. No. 3,399,740

Registered Mar. 18, 2008

**SERVICE MARK
PRINCIPAL REGISTER**

THE PAUSE METHOD

ILANI, DORIT SUSAN (UNITED STATES INDIVIDUAL)
P.O. BOX 264
DESERT HOT SPRINGS, CA 92240

THE MARK CONSISTS OF STANDARD CHARACTERS WITHOUT CLAIM TO ANY PARTICULAR FONT, STYLE, SIZE, OR COLOR.

FOR: PSYCHO-EDUCATIONAL SERVICES AND MEDITATION TRAINING FEATURING TECHNIQUES FOR EFFECTIVE RESPONSE TO DAILY LIFE IN THE FORM OF GROUP INSTRUCTION OFFERED AT BUSINESS ORGANIZATIONS AND CORPORATIONS, IN CLASS 41 (U.S. CLS. 100, 101 AND 107).

NO CLAIM IS MADE TO THE EXCLUSIVE RIGHT TO USE "METHOD", APART FROM THE MARK AS SHOWN.

SN 78-778,434, FILED 12-21-2005.

FIRST USE 7-11-2006; IN COMMERCE 7-11-2006.

ALYSSA PALADINO, EXAMINING ATTORNEY

Int. Cl.: 11

Prior U.S. Cls.: 13, 21, 23, 31, and 34

United States Patent and Trademark Office

Reg. No. 3,399,741

Registered Mar. 18, 2008

**TRADEMARK
PRINCIPAL REGISTER**

ALPINE AIR

ARAMCO IMPORTS INC. (CALIFORNIA CORPORATION)
6431 BANDINE BLVD.
COMMERCE , CALIFORNIA 90040 USA, CA 90040

FOR: ELECTRIC FANS; ELECTRIC HEATING FANS FOR COMMERCIAL AND INDUSTRIAL USE, IN CLASS 11 (U.S. CLS. 13, 21, 23, 31 AND 34).

FIRST USE 12-28-2005; IN COMMERCE 8-0-2006.

THE MARK CONSISTS OF STANDARD CHARACTERS WITHOUT CLAIM TO ANY PARTICULAR FONT, STYLE, SIZE, OR COLOR.

NO CLAIM IS MADE TO THE EXCLUSIVE RIGHT TO USE "AIR", APART FROM THE MARK AS SHOWN.

SN 78-778,746, FILED 12-21-2005.

DAVID YONTEF, EXAMINING ATTORNEY

Int. Cl.: 31

Prior U.S. Cls.: 1 and 46

United States Patent and Trademark Office

Reg. No. 3,399,742

Registered Mar. 18, 2008

**TRADEMARK
PRINCIPAL REGISTER**

Brush 'Ems

DAD'S PRODUCTS CO., INC. (PENNSYLVANIA
CORPORATION), DBA DAD'S PET CARE,
ATTN: JACE WALLACE
18746 MILL STREET
MEADVILLE, PA 16335

THE MARK CONSISTS OF STANDARD CHAR-
ACTERS WITHOUT CLAIM TO ANY PARTICULAR
FONT, STYLE, SIZE, OR COLOR.

FOR: CAT TREATS; DOG TREATS; PET FOOD, IN
CLASS 31 (U.S. CLS. 1 AND 46).

SN 78-779,903, FILED 12-22-2005.

FIRST USE 6-15-2007; IN COMMERCE 6-15-2007.

WOODROW HARTZOG, EXAMINING ATTORNEY

Int. Cls.: 16, 35, and 41

Prior U.S. Cls.: 2, 5, 22, 23, 29, 37, 38, 50, 100, 101, 102, and 107

Reg. No. 3,399,743

United States Patent and Trademark Office

Registered Mar. 18, 2008

**TRADEMARK
SERVICE MARK
PRINCIPAL REGISTER**

WHAT DO YOU DO?

MANPOWER INC. (WISCONSIN CORPORATION)
5301 NORTH IRONWOOD ROAD
MILWAUKEE, WI 53217

FOR: PRINTED TESTING MATERIALS FOR USE IN ASSESSING JOB SKILLS; PRINTED INSTRUCTIONAL MATERIALS FOR USE IN JOB SKILL TRAINING; PRINTED INSTRUCTIONAL MATERIALS IN THE FIELD OF HUMAN RESOURCES; STRUCTURED INTERVIEW FORMS USED TO INTERVIEW JOB APPLICANTS OVER THE TELEPHONE TO DETERMINE VERBAL COMMUNICATION SKILLS, INCLUDING PACE, VOLUME, SOUND QUALITY, ENUNCIATION, AND COMMAND OF THE LANGUAGE; INTERVIEW FORMS, INSTRUCTION SHEETS, AND AUDIO CASSETTE TAPES SOLD AND USED AS A UNIT FOR TRAINING THE INTERVIEWERS; STRUCTURED JOB SKILLS FORM USED TO IDENTIFY AND RECORD EMPLOYMENT SKILLS AND SKILL LEVELS AND TO CREATE EMPLOYMENT CAREER DEVELOPMENT PLANS FOR JOB APPLICANTS, AND INSTRUCTIONAL MANUALS FOR USE THEREWITH, DISTRIBUTED AS A UNIT; PRINTED TESTING MATERIALS USED TO EVALUATE EMPLOYEE SKILLS AT TASKS NEEDED FOR LIGHT INDUSTRIAL WORK AND INSTRUCTIONAL MANUALS SOLD TOGETHER AS A UNIT; WRITTEN TEST AND SCORING MATERIALS, AND SAMPLE AUDIOCASSETTE DICTATION TAPES FURNISHED THEREWITH AS A UNIT, FOR EVALUATING THE PROFICIENCY OF COMPUTERIZED OFFICE EQUIPMENT OPERATORS; PRINTED EMPLOYEE INTAKE FORMS; BUSINESS FORMS; PRINTED AND PARTIALLY PRINTED FORMS; PRINTED TRAINING MANUALS FOR JOB SKILL TRAINING; PRINTED MONOGRAPHS, NEWSLETTERS AND BULLETINS, ALL IN THE FIELD OF HUMAN RESOURCES; MAGAZINES AND NEWS-

LETTERS, REPORTS AND PRINTED INSTRUCTIONAL MATERIALS FEATURING ARTICLES ABOUT CAREER MANAGEMENT, CAREER PLACEMENT, CAREER RECRUITING, EMPLOYMENT COUNSELING, EMPLOYMENT OUTPLACEMENT, HUMAN RESOURCE CONSULTATION, PERSONNEL MANAGEMENT CONSULTATION, PERSONNEL RETENTION CONSULTATION, CAREER MANAGEMENT CONSULTATION, RETIREMENT COUNSELING AND PLANNING, IN CLASS 16 (U.S. CLS. 2, 5, 22, 23, 29, 37, 38 AND 50).

FIRST USE 2-21-2006; IN COMMERCE 2-21-2006.

FOR: EMPLOYMENT AGENCY SERVICES; TEMPORARY AND PERMANENT EMPLOYMENT AGENCY SERVICES; EMPLOYEE LEASING; EMPLOYMENT RELATED SERVICES, NAMELY PROVIDING JOB PLACEMENT, CAREER DEVELOPMENT, EMPLOYMENT RECRUITMENT, AND GENERAL EMPLOYMENT INFORMATION TO OTHERS; PERSONNEL MANAGEMENT, HUMAN RESOURCES MANAGEMENT; SUPPLYING TO OTHERS ON A TEMPORARY AND PERMANENT BASIS ENGINEERS, COMPUTER PROGRAMMERS, DRAFTSMEN, AND SKILLED TECHNICAL PERSONNEL; PROVIDING AND MANAGING CONTRACT PERSONNEL PROGRAMS; ANALYZING AND CONSULTING ON PERSONNEL NEEDS; PROVIDING CONTRACT, TEMPORARY, AND PERMANENT PERSONNEL STAFFING SERVICES; ARRANGING FOR AND MANAGING THE PROVISION OF TEMPORARY CONTRACT PERSONNEL; PERSONNEL MANAGEMENT AND CONSULTANCY SERVICES; PROVIDING INFORMATION AND CONSULTANCY SERVICES ON THE PROCUREMENT OF TEMPORARY, CONTRACT, AND PERMANENT PERSONNEL; COMPUTER ON-LINE ORDERING VIA A

GLOBAL INFORMATION NETWORK, AND PROVIDING COMPUTER ON-LINE REPORTS VIA A GLOBAL INFORMATION NETWORK, ALL IN THE FIELD OF PERSONNEL PROCUREMENT; HUMAN RESOURCES CONSULTING ON RECRUITING AND TESTING OF EMPLOYEES; CONTRACT AND PERMANENT STAFFING AGENCY SERVICES FEATURING STAFF PROFESSIONALS IN FINANCE, INFORMATION TECHNOLOGY, ENGINEERING, SCIENTIFIC AND TECHNICAL PERSONNEL, AS WELL AS OFFICE ADMINISTRATIVE STAFF, FACTORY STAFF, INDUSTRIAL STAFF AND CALL CENTER STAFF; SERVING AS A HUMAN RESOURCE DEPARTMENT FOR OTHERS; TESTING TO DETERMINE EMPLOYMENT SKILLS; EMPLOYMENT COUNSELING; WORK-FORCE DEVELOPMENT SERVICES, NAMELY, PERSONNEL MANAGEMENT SERVICES; PROVIDING CAREER INFORMATION VIA A WEBSITE ON A GLOBAL INFORMATION NETWORK; PROVIDING INFORMATION ON JOBS VIA A WEBSITE ON A GLOBAL INFORMATION NETWORK; PROVIDING AN ON-LINE COMPUTER DATABASE IN THE FIELDS OF CONTRACT AND PERMANENT PERSONNEL STAFFING; PROVIDING EMPLOYEE SCREENING AND ASSESSMENT TOOLS VIA A WEBSITE ON A GLOBAL INFORMATION NETWORK; RESUME LISTING SERVICES; RESUME MATCHING SERVICES; BUSINESS PROCESS OUTSOURCING SERVICES; PROVISION OF TESTING SERVICES DESIGNED TO DETERMINE THE INDUSTRIAL SKILLS, DEXTERITY AND HAND-EYE COORDINATION OF EMPLOYEE AND TEMPORARY HELP PERSONNEL; PERSONALITY TESTING AND PROFILING SERVICES FOR USE IN THE FIELD OF HUMAN RESOURCES; TEMPORARY PERSONNEL SERVICES; PLACEMENT OF TEMPORARY PERSONNEL; PLACEMENT OF PERMANENT PERSONNEL; PERSONNEL RECRUITMENT; EMPLOYMENT AGENCY SERVICES; PSYCHOLOGICAL TESTING FOR THE SELECTION OF PERSONNEL TO DETERMINE THEIR SUITABILITY FOR EMPLOYMENT; TESTING OF INDIVIDUALS TO DETERMINE EMPLOYMENT SKILLS; PROVISION OF JOB CANDIDATE EVALUATION AND SELECTION SERVICES; DEMONSTRATION AND SALES PROMOTION SERVICES; OFFICE FUNCTIONS; BUSINESS INFORMATION AND CONSULTANCY SERVICES RELATING TO THE PROCUREMENT OF TEMPORARY AND CONTRACT PERSONNEL; PERSONNEL MANAGEMENT AND CONSULTING SERVICES IN THE FIELD OF HUMAN RESOURCES; BUSINESS CONSULTATION SERVICES, NAMELY CAREER MANAGEMENT SERVICES, CAREER PLACEMENT SERVICES, CAREER RECRUITING SERVICES, EMPLOYMENT COUNSELING SERVICES, EMPLOYMENT OUTPLACEMENT SERVICES, CAREER RECRUITING SERVICES, EMPLOYMENT COUNSELING SERVICES, EMPLOYMENT OUTPLACEMENT

SERVICES, HUMAN RESOURCE CONSULTATION SERVICES, PERSONNEL MANAGEMENT CONSULTATION SERVICES, PERSONNEL RETENTION CONSULTATION SERVICES AND CAREER MANAGEMENT CONSULTATION SERVICES; RESUME LISTING SERVICES; RESUME MATCHING SERVICES; BUSINESS PROCESS OUTSOURCING SERVICES; TEMPORARY PROFESSIONAL PERSONNEL SERVICES; PLACEMENT OF TEMPORARY PROFESSIONAL PERSONNEL; RECRUITMENT OF PROFESSIONAL PERSONNEL; EMPLOYMENT AGENCIES FOR THE PLACEMENT OF PROFESSIONAL PERSONNEL; TESTING OF INDIVIDUALS TO DETERMINE EMPLOYMENT SKILLS; TESTING DESIGNED TO DETERMINE THE INDUSTRIAL SKILLS, DEXTERITY AND HAND-EYE COORDINATION OF EMPLOYEE AND TEMPORARY HELP PERSONNEL; PERSONNEL TESTING OF ALL KINDS, NAMELY TESTING OF JOB AND BUSINESS SKILLS, INFORMATION TECHNOLOGY AND SOFTWARE USE SKILLS, PERSONALITY TESTING AND PROFILING FOR USE IN THE FIELD OF HUMAN RESOURCES, IN CLASS 35 (U.S. CLS. 100, 101 AND 102).

FIRST USE 2-21-2006; IN COMMERCE 2-21-2006.

FOR: PROVIDING TRAINING IN BUSINESS AND JOB SKILLS AND OFFICE TECHNOLOGY; PROVIDING ON-LINE COURSES OF STUDY IN THE FOLLOWING - INFORMATION TECHNOLOGY, SOFTWARE USE, JOB AND BUSINESS SKILLS VIA A WEBSITE ON A GLOBAL INFORMATION NETWORK; CAREER COUNSELING SERVICES; EDUCATION AND TRAINING SERVICES, NAMELY, PROVIDING TRAINING IN RELATION TO JOB SEARCH, CAREER DEVELOPMENT, SELF-MARKETING, INTERVIEW SKILLS, RESEARCH WORKSHOPS AND TRAINING OF HUMAN RESOURCE PERSONNEL IN EMPLOYMENT SEPARATION ISSUES; INSTRUCTION SERVICES RELATING TO BUSINESS AND DATA PROCESSING; TRAINING SERVICES FOR PERSONNEL, NAMELY, TRAINING IN ACCOUNTING SKILLS, INFORMATION TECHNOLOGY SKILLS, OFFICE SKILLS, CLERICAL SKILLS CALL CENTER SKILLS, CUSTOMER SERVICE SKILLS, WORD PROCESSING SKILLS; PROVISION OF SKILL ASSESSMENT COURSES, IN CLASS 41 (U.S. CLS. 100, 101 AND 107).

FIRST USE 2-21-2006; IN COMMERCE 2-21-2006.

THE MARK CONSISTS OF STANDARD CHARACTERS WITHOUT CLAIM TO ANY PARTICULAR FONT, STYLE, SIZE, OR COLOR.

SN 78-780,208, FILED 12-23-2005.

LINDA E. BLOHM, EXAMINING ATTORNEY

Int. Cls.: 35, 41, and 42

Prior U.S. Cls.: 100, 101, 102, and 107

United States Patent and Trademark Office

Reg. No. 3,399,744

Registered Mar. 18, 2008

**SERVICE MARK
PRINCIPAL REGISTER**

ICON

ACCORDENCE, INC. (CALIFORNIA CORPORATION)
533 AIRPORT BOULEVARD
BURLINGAME, CA 94010

FOR: BUSINESS CONSULTING SERVICES IN THE FIELDS OF BUSINESS NEGOTIATION, BUSINESS PERSUASION AND CONFLICT RESOLUTION IN BUSINESS , IN CLASS 35 (U.S. CLS. 100, 101 AND 102).

FIRST USE 1-0-2005; IN COMMERCE 1-0-2005.

FOR: TRAINING SERVICES IN THE FIELDS OF NEGOTIATION, PERSUASION AND CONFLICT RESOLUTION, IN CLASS 41 (U.S. CLS. 100, 101 AND 107).

FIRST USE 1-0-2005; IN COMMERCE 1-0-2005.

FOR: MEDIATION SERVICES; CONSULTING IN THE FIELD OF LABOR NEGOTIATION AND CONFLICT RESOLUTION IN MEDIATION, IN CLASS 42 (U.S. CLS. 100 AND 101).

FIRST USE 1-0-2005; IN COMMERCE 1-0-2005.

THE MARK CONSISTS OF STANDARD CHARACTERS WITHOUT CLAIM TO ANY PARTICULAR FONT, STYLE, SIZE, OR COLOR.

SN 78-780,302, FILED 12-23-2005.

DANIEL CAPSHAW, EXAMINING ATTORNEY

Int. Cl.: 42

Prior U.S. Cls.: 100 and 101

United States Patent and Trademark Office

Reg. No. 3,399,745

Registered Mar. 18, 2008

**SERVICE MARK
PRINCIPAL REGISTER**

ISLANDA

GIGATOR LLC (HAWAII LTD LIAB CO)
45-116 MOAKAKA PLACE
KANEOHE, HI 96744

FIRST USE 2-19-2007; IN COMMERCE 2-19-2007.

FOR: COMPUTER SOFTWARE DEVELOPMENT;
DESIGN AND DEVELOPMENT OF ONLINE COM-
PUTER SOFTWARE SYSTEMS; INFORMATION
TECHNOLOGY CONSULTATION; INTEGRATION
OF COMPUTER SYSTEMS AND NETWORKS , IN
CLASS 42 (U.S. CLS. 100 AND 101).

THE MARK CONSISTS OF STANDARD CHAR-
ACTERS WITHOUT CLAIM TO ANY PARTICULAR
FONT, STYLE, SIZE, OR COLOR.

SN 78-780,463, FILED 12-23-2005.

ALYSSA PALADINO, EXAMINING ATTORNEY

Int. Cl.: 9

Prior U.S. Cls.: 21, 23, 26, 36, and 38

United States Patent and Trademark Office

Reg. No. 3,399,746

Registered Mar. 18, 2008

**TRADEMARK
PRINCIPAL REGISTER**

RIGHTFAX

CAPTARIS, INC. (WASHINGTON CORPORATION)
SUITE 400
10885 N.E. 4TH STREET
BELLEVUE, WA 98004

FOR: COMPUTER SOFTWARE FOR ASSEMBLING, PROCESSING, MANAGING, TRANSMITTING AND ARCHIVING OF FACSIMILES; COMPUTER SOFTWARE FOR FACILITATING INTEGRATION OF FAX FUNCTIONALITY WITH EMAIL SYSTEMS, CUSTOMER RELATION MANAGEMENT SYSTEMS, ENTERPRISE RESOURCE PLANNING SYSTEMS, DOCUMENT MANAGEMENT SYSTEMS, CONTENT MANAGEMENT SYSTEMS, DATABASE SYSTEMS, SCANNING, COPY, AND PRINTING SYSTEMS, AND COMPUTER LEGACY SYSTEMS; COMPUTER SOFTWARE FOR

FACSIMILE TRANSMISSION VIA FAX DEVICE, EMAIL AND INTERNET DELIVERY; COMPUTER SOFTWARE FOR SECURE DELIVERY OF ELECTRONIC DOCUMENTS, IN CLASS 9 (U.S. CLS. 21, 23, 26, 36 AND 38).

FIRST USE 5-12-1997; IN COMMERCE 5-12-1997.

THE MARK CONSISTS OF STANDARD CHARACTERS WITHOUT CLAIM TO ANY PARTICULAR FONT, STYLE, SIZE, OR COLOR.

OWNER OF U.S. REG. NO. 2,578,897.

SN 78-780,504, FILED 12-23-2005.

LAURIE KAUFMAN, EXAMINING ATTORNEY

Int. Cls.: 35, 38, and 42

Prior U.S. Cls.: 100, 101, 102, and 104

United States Patent and Trademark Office

Reg. No. 3,399,747

Registered Mar. 18, 2008

**SERVICE MARK
PRINCIPAL REGISTER**

IT'S ABOUT TIME

PROXYMED, INC. (FLORIDA CORPORATION)
SUITE 200
1854 SHACKLEFORD COURT
NORCROSS, GA 30093

FOR: MEDICAL CLAIMS MANAGEMENT SERVICES, NAMELY, RECEIVING, IMAGING, DATA ENTERING, AND RE-PRICING OF TRANSACTIONS THAT ARE ORIGINATED BY PHYSICIANS, HOSPITALS, AND ANCILLARY MEDICAL CARE PROVIDERS, AND REVIEWING HOSPITAL-ORIGINATED INVOICES; COMPUTERIZED DATABASE MANAGEMENT SERVICES IN THE FIELD OF HEALTH CARE AND MEDICAL CLAIMS, IN CLASS 35 (U.S. CLS. 100, 101 AND 102).

FIRST USE 12-9-2005; IN COMMERCE 12-9-2005.

FOR: PROVIDING ACCESS VIA A COMPUTER NETWORK SUCH AS A GLOBAL COMPUTER NETWORK, TO FACILITIES FOR ENABLING PHYSICIANS, PHARMACIES, LABORATORIES, PAYERS AND OTHERS IN THE FIELD OF HEALTHCARE TO ENTER AND PROCESS TRANSACTIONS IN THE FIELD OF HEALTHCARE THROUGH THE SECURE EXCHANGE OF ELECTRONIC MESSAGES, IN CLASS 38 (U.S. CLS. 100, 101 AND 104).

FIRST USE 12-9-2005; IN COMMERCE 12-9-2005.

FOR: PROVIDING TEMPORARY USE OF ON-LINE, NON-DOWNLOADABLE SOFTWARE FOR ENABLING PHYSICIANS, PHARMACIES, LABORATORIES, PAYORS AND OTHERS TO ENTER AND PROCESS TRANSACTIONS IN THE HEALTHCARE FIELD; PROVIDING TEMPORARY USE OF ON-LINE, NON-DOWNLOADABLE COMPUTER SOFTWARE FOR ORDERING CLINICAL TESTS AND FOR REPORTING AND RETRIEVING RESULTS OF SUCH TESTS; PROVIDING TEMPORARY USE OF NON-DOWNLOADABLE COMPUTER SOFTWARE FOR MONITORING AND COMMUNICATING INFORMATION TO USERS AS TO THE STATUS OF PRINTERS USED BY PHARMACIES, CLINICS, PHYSICIAN OFFICES, MEDICAL LABORATORIES OR OTHERS IN THE HEALTHCARE FIELD, IN CLASS 42 (U.S. CLS. 100 AND 101).

FIRST USE 12-9-2005; IN COMMERCE 12-9-2005.

THE MARK CONSISTS OF STANDARD CHARACTERS WITHOUT CLAIM TO ANY PARTICULAR FONT, STYLE, SIZE, OR COLOR.

SN 78-780,846, FILED 12-27-2005.

JULIE GUTTADAURO, EXAMINING ATTORNEY

Int. Cl.: 9

Prior U.S. Cls.: 21, 23, 26, 36, and 38

Reg. No. 3,399,748

United States Patent and Trademark Office

Registered Mar. 18, 2008

**TRADEMARK
PRINCIPAL REGISTER**



MERIT INDUSTRIES, INC. (DELAWARE CORPORATION)
2525 STATE ROAD
BENSALEM, PA 19020

FOR: DIGITAL JUKE BOXES, VIDEO TOUCH SCREENS AND VIDEO DISPLAY MONITORS, IN CLASS 9 (U.S. CLS. 21, 23, 26, 36 AND 38).

FIRST USE 1-19-2006; IN COMMERCE 1-19-2006.

NO CLAIM IS MADE TO THE EXCLUSIVE RIGHT TO USE "INTERNET JUKEBOX", APART FROM THE MARK AS SHOWN.

THE MARK CONSISTS OF AN OVAL BETWEEN THE WORDING "MOD BOX" ABOVE THE WORDING "INTERNET JUKEBOX" AND A CIRCLE BETWEEN THE WORDING "INTERNET" AND "JUKEBOX".

SN 78-781,475, FILED 12-28-2005.

KRISTINA MORRIS, EXAMINING ATTORNEY

Int. Cl.: 18

Prior U.S. Cls.: 1, 2, 3, 22, and 41

United States Patent and Trademark Office

Reg. No. 3,399,749

Registered Mar. 18, 2008

**TRADEMARK
PRINCIPAL REGISTER**

OMT

DAN RIVER INC. (GEORGIA CORPORATION)
2291 MEMORIAL DRIVE
DANVILLE, VA 24541

THE MARK CONSISTS OF STANDARD CHAR-
ACTERS WITHOUT CLAIM TO ANY PARTICULAR
FONT, STYLE, SIZE, OR COLOR.

FOR: SCENT CONTROL CHEMICAL INGREDI-
ENT SOLD AS AN INTEGRAL COMPONENT OF
DUFFLE BAGS, IN CLASS 18 (U.S. CLS. 1, 2, 3, 22
AND 41).

SN 78-781,646, FILED 12-28-2005.

FIRST USE 6-26-2006; IN COMMERCE 6-26-2006.

BRIAN PINO, EXAMINING ATTORNEY

Int. Cl.: 25

Prior U.S. Cls.: 22 and 39

United States Patent and Trademark Office

Reg. No. 3,399,750

Registered Mar. 18, 2008

**TRADEMARK
PRINCIPAL REGISTER**

OMT

DAN RIVER INC. (GEORGIA CORPORATION)
2291 MEMORIAL DRIVE
DANVILLE, VA 24541

SOCKS, UNDERCLOTHES, GLOVES, RAINWEAR,
IN CLASS 25 (U.S. CLS. 22 AND 39).

FIRST USE 3-14-2006; IN COMMERCE 3-14-2006.

FOR: SCENT CONTROL CHEMICAL INGREDI-
ENT SOLD AS AN INTEGRAL COMPONENT OF
CLOTHING, NAMELY, SHIRTS, HEAVYWEIGHT
SHIRTS, LIGHTWEIGHT SHIRTS, T-SHIRTS, UN-
DER SHIRTS, JACKETS, BOMBER JACKETS,
PANTS, HUNTING PANTS, FLEECE VESTS, UN-
DER SHIRTS, CARGO PANTS, OVERALLS, COVER-
ALLS, SHORTS, TOPS, PULLOVERS, COATS,
CLOTH SKI BIBS, HEADWEAR, CAPS, HATS,

THE MARK CONSISTS OF STANDARD CHAR-
ACTERS WITHOUT CLAIM TO ANY PARTICULAR
FONT, STYLE, SIZE, OR COLOR.

SN 78-781,650, FILED 12-28-2005.

BRIAN PINO, EXAMINING ATTORNEY

Int. Cl.: 30

Prior U.S. Cl.: 46

United States Patent and Trademark Office

Reg. No. 3,399,751

Registered Mar. 18, 2008

**TRADEMARK
PRINCIPAL REGISTER**

EXCEL ICE CREAM

OLD MEETING HOUSE HOMEMADE ICE
CREAM LLC (FLORIDA CORPORATION)
4004 SOUTH MACDILL AVENUE
TAMPA, FL 33611

FOR: ICE CREAM, ICE-CREAM PIES, ICE-
CREAM CAKES, NOVELTY ICE CREAMS, ICE
CREAM SANDWICHES, ICE CREAM MIXES, ICE
CREAM SUBSTITUTES, SOY-BASED ICE CREAM
SUBSTITUTES, IN CLASS 30 (U.S. CL. 46).

FIRST USE 1-1-2005; IN COMMERCE 1-1-2005.

THE MARK CONSISTS OF STANDARD CHAR-
ACTERS WITHOUT CLAIM TO ANY PARTICULAR
FONT, STYLE, SIZE, OR COLOR.

NO CLAIM IS MADE TO THE EXCLUSIVE
RIGHT TO USE "ICE CREAM", APART FROM
THE MARK AS SHOWN.

SN 78-781,683, FILED 12-28-2005.

SAMUEL E. SHARPER JR., EXAMINING ATTOR-
NEY

Int. Cl.: 29

Prior U.S. Cl.: 46

United States Patent and Trademark Office

Reg. No. 3,399,752

Registered Mar. 18, 2008

**TRADEMARK
PRINCIPAL REGISTER**

OAXAQUEÑA

MARQUEZ BROTHERS INTERNATIONAL, INC.
(CALIFORNIA CORPORATION)

5801 RUE FERRARI

SAN JOSE, CA 95138

FOR: CHEESE, CREAM, CREAM CHEESE,
CHEESE SPREADS, IN CLASS 29 (U.S. CL. 46).

FIRST USE 1-31-2006; IN COMMERCE 1-31-2006.

THE MARK CONSISTS OF STANDARD CHAR-
ACTERS WITHOUT CLAIM TO ANY PARTICULAR
FONT, STYLE, SIZE, OR COLOR.

THE FOREIGN WORDING IN THE MARK
TRANSLATES INTO ENGLISH AS A WOMEN
FROM OAXACA.

SN 78-781,698, FILED 12-28-2005.

KATHRYN COWARD, EXAMINING ATTORNEY

Int. Cl.: 10

Prior U.S. Cls.: 26, 39, and 44

United States Patent and Trademark Office

Reg. No. 3,399,753

Registered Mar. 18, 2008

**TRADEMARK
PRINCIPAL REGISTER**

The logo for VertiFlex features the word "VertiFlex" in a bold, sans-serif font. The letter "i" in "Verti" has a dot. The letter "x" in "Flex" is stylized, composed of a series of small, dark, circular dots arranged in a diagonal line that forms the shape of the letter.

VERTIFLEX, INC. (DELAWARE CORPORATION)
1351 CALLE AVANZADO
SAN CLEMENTE, CA 92673

FOR: SURGICAL IMPLANTS COMPRISING ARTIFICIAL MATERIAL, IN CLASS 10 (U.S. CLS. 26, 39 AND 44).

FIRST USE 8-25-2005; IN COMMERCE 9-19-2006.

THE MARK CONSISTS OF THE TERM "VERTIFLEX" WITH UPPERCASE "V" AND "F", A STYLIZED "X" AND THE REMAINDER OF THE LETTERS IN LOWERCASE.

SN 78-781,858, FILED 12-28-2005.

BRIAN NEVILLE, EXAMINING ATTORNEY

Int. Cls.: 9, 35, 38, and 41

**Prior U.S. Cls.: 21, 23, 26, 36, 38, 100, 101, 102, 104,
and 107**

Reg. No. 3,399,754

United States Patent and Trademark Office

Registered Mar. 18, 2008

**TRADEMARK
SERVICE MARK
PRINCIPAL REGISTER**

DIGDOO

ACK VENTURES HOLDINGS, LLC (DELAWARE
LTD LIAB CO)
C/O CHAPIN, BALLERANO & CHESLACK
1201 GEORGE BUSH BOULEVARD
DELRAY BEACH, FL 33483

FOR: COMPUTER APPLICATION SOFTWARE FOR MOBILE PHONES; COMPUTER GAME PROGRAMS; COMPUTER GAME SOFTWARE; COMPUTER SOFTWARE FOR WIRELESS CONTENT DELIVERY; COMPUTER SOFTWARE TO ENABLE THE TRANSMISSION OF PHOTOGRAPHS TO MOBILE TELEPHONES; DOWNLOADABLE RING TONES, GRAPHICS AND MUSIC VIA A GLOBAL COMPUTER NETWORK AND WIRELESS DEVICES; ELECTRONIC GAME PROGRAMS; ELECTRONIC GAME SOFTWARE FOR CELLULAR TELEPHONES; ELECTRONIC GAME SOFTWARE FOR HANDHELD ELECTRONIC DEVICES; ELECTRONIC GAME SOFTWARE FOR WIRELESS DEVICES; MOBILE COMPUTING AND OPERATING PLATFORMS CONSISTING OF DATA TRANSCEIVERS, WIRELESS NETWORKS AND GATEWAYS FOR COLLECTION AND MANAGEMENT OF DATA, IN CLASS 9 (U.S. CLS. 21, 23, 26, 36 AND 38).

FIRST USE 3-21-2006; IN COMMERCE 3-21-2006.

FOR: DISTRIBUTORSHIPS IN THE FIELD OF WIRELESS GAME SOFTWARE AND WIRELESS ENTERTAINMENT SOFTWARE, IN CLASS 35 (U.S. CLS. 100, 101 AND 102).

FIRST USE 3-21-2006; IN COMMERCE 3-21-2006.

FOR: WIRELESS COMMUNICATIONS SERVICES, NAMELY, TRANSMISSION OF GRAPHICS TO MOBILE TELEPHONES; WIRELESS ELECTRONIC TRANSMISSION OF VOICE SIGNALS, DATA, FACSIMILES, IMAGES AND INFORMATIONS, IN CLASS 38 (U.S. CLS. 100, 101 AND 104).

FIRST USE 3-21-2006; IN COMMERCE 3-21-2006.

FOR: ORGANIZATION OF GAMES; PROVIDING A COMPUTER GAME THAT MAY BE ACCESSED NETWORK-WIDE BY NETWORK USERS; PROVIDING INFORMATION ON-LINE RELATING TO COMPUTER GAMES AND COMPUTER ENHANCEMENTS FOR GAMES, IN CLASS 41 (U.S. CLS. 100, 101 AND 107).

FIRST USE 3-21-2006; IN COMMERCE 3-21-2006.

THE MARK CONSISTS OF STANDARD CHARACTERS WITHOUT CLAIM TO ANY PARTICULAR FONT, STYLE, SIZE, OR COLOR.

SN 78-782,033, FILED 12-28-2005.

KAREN K. BUSH, EXAMINING ATTORNEY

Int. Cl.: 9

Prior U.S. Cls.: 21, 23, 26, 36, and 38

United States Patent and Trademark Office

Reg. No. 3,399,755

Registered Mar. 18, 2008

**TRADEMARK
PRINCIPAL REGISTER**

BOYO
VISION

VISION TECH AMERICA, INC. (CALIFORNIA CORPORATION)
625 ELLIS STREET, SUITE 202
MOUNTAIN VIEW, CA 94043

FOR: MOBILE ELECTRONICS SYSTEMS, NAME-
LY, MOBILE COMPUTERS, MOBILE RADIOS, MO-
BILE TELEPHONES; ELECTRONIC
NAVIGATIONAL DEVICES, NAMELY, WIRELESS
TELEPHONY APPARATUS AND GLOBAL POSI-
TIONING SYSTEM (GPS) CONSISTING OF COMPU-
TER SOFTWARE FOR NAVIGATION AND
NAVIGATIONAL RECEIVERS; AUTOMOBILE
BACKUP VIEW SYSTEMS CONSISTING OF VIDEO
CAMERAS, VIDEO MONITORS, AND ELECTRICAL
CONTROLLERS, IN CLASS 9 (U.S. CLS. 21, 23, 26, 36
AND 38).

FIRST USE 12-1-2005; IN COMMERCE 12-1-2005.

NO CLAIM IS MADE TO THE EXCLUSIVE
RIGHT TO USE "VISION", APART FROM THE
MARK AS SHOWN.

THE MARK CONSISTS OF THE TERM "BOYO"
WHICH IS IN LARGE CAPITAL LETTERS. THE
"O'S" OF "BOYO" EACH HAVE A DOT INSIDE
THEM. THE "O'S" AND THE "Y" ARE INTENDED
TO FORM EYES WITH A NOSE. UNDER THE "Y" IS
THE TERM "VISION".

SN 78-782,626, FILED 12-29-2005.

JAY BESCH, EXAMINING ATTORNEY

Int. Cl.: 25

Prior U.S. Cls.: 22 and 39

United States Patent and Trademark Office

Reg. No. 3,399,756

Registered Mar. 18, 2008

**TRADEMARK
PRINCIPAL REGISTER**

David Mushegain

MUSHEGAIN, DAVID EDWARD (UNITED STATES INDIVIDUAL)
404 PLUMOSA AVE
PASADENA, CA 91107

FOR: MEN'S, WOMEN'S AND CHILDREN'S CLOTHING AND FASHION ACCESSORIES, NAMELY, DRESSES, COATS, SHORTS, SHIRTS, DRESS SHIRTS, PANTS, DRESS PANTS, JEANS, SWEATERS, JACKETS, SUITS, TUXEDOS, DINNER JACKETS, T-SHIRTS, BLOUSES, KNIT TOPS, HALTER TOPS, SMOCK TOPS, VESTS, WIND RESISTANT JACKETS, JOGGING SUITS, SWEATSHIRTS, SWEATPANTS, SKI JACKETS, SKI PANTS, MUFFLERS, HEAD BANDS, HEAD WARMERS, BELTS, GLOVES, MITTENS, SHAWLS, SASHES, SCARVES, PONCHOS, SHOULDER WRAPS, NECKERCHIEFS, STOCKINGS, LEG WARMERS, ARM WARMERS, HOSIERY, SOCKS, TIGHTS, LEGGINGS, LEOTARDS, PAJAMAS, ROBES, NIGHTGOWNS, PANTIES, BRAS, GARTER BELTS, UNDERWEAR,

UNDERSHIRTS, RAINWEAR, RAINCOATS, SWIMWEAR, BATHING SUITS, COVER-UPS, AND WOMEN'S LINGERIE, FOOTWEAR, HEADWEAR, NECK TIES, CAPS, AND HATS, IN CLASS 25 (U.S. CLS. 22 AND 39).

FIRST USE 1-1-2002; IN COMMERCE 1-1-2005.

THE MARK CONSISTS OF STANDARD CHARACTERS WITHOUT CLAIM TO ANY PARTICULAR FONT, STYLE, SIZE, OR COLOR.

THE NAME "DAVID MUSHEGAIN" IDENTIFIES A LIVING INDIVIDUAL WHOSE CONSENT IS OF RECORD.

SN 78-782,654, FILED 12-29-2005.

MATTHEW PAPPAS, EXAMINING ATTORNEY

Int. Cl.: 35

Prior U.S. Cls.: 100, 101, and 102

United States Patent and Trademark Office

Reg. No. 3,399,757

Registered Mar. 18, 2008

**SERVICE MARK
PRINCIPAL REGISTER**

HOLODRIVES

CONNOR, ROBERT, A. (UNITED STATES INDIVIDUAL)
100 3RD AVENUE SOUTH, #304
MINNEAPOLIS, MN 55401

THE MARK CONSISTS OF STANDARD CHARACTERS WITHOUT CLAIM TO ANY PARTICULAR FONT, STYLE, SIZE, OR COLOR.

FOR: ADVERTISING VIA ELECTRONIC MEDIA AND SPECIFICALLY THE INTERNET, IN CLASS 35 (U.S. CLS. 100, 101 AND 102).

SN 78-783,099, FILED 12-30-2005.

FIRST USE 11-26-2007; IN COMMERCE 11-26-2007.

LANA PHAM, EXAMINING ATTORNEY

Int. Cl.: 39

Prior U.S. Cls.: 100 and 105

United States Patent and Trademark Office

Reg. No. 3,399,758

Registered Mar. 18, 2008

**SERVICE MARK
PRINCIPAL REGISTER**

**Aeropoint Delivery
Solutions**

AIR COURIER DISPATCH, INC. (NEW YORK CORPORATION)
1395 SOUTH MARIETTA PARKWAY
MARIETTA, GA 30067

FOR: TRANSPORTATION AND DELIVERY OF PERSONAL PROPERTY BY AIR, RAIL, BOAT, AND MOTOR VEHICLE, IN CLASS 39 (U.S. CLS. 100 AND 105).

FIRST USE 6-1-2006; IN COMMERCE 6-1-2006.

THE MARK CONSISTS OF STANDARD CHARACTERS WITHOUT CLAIM TO ANY PARTICULAR FONT, STYLE, SIZE, OR COLOR.

NO CLAIM IS MADE TO THE EXCLUSIVE RIGHT TO USE "DELIVERY SOLUTIONS", APART FROM THE MARK AS SHOWN.

SN 78-783,203, FILED 12-30-2005.

RUDY R. SINGLETON, EXAMINING ATTORNEY

Int. Cl.: 21

Prior U.S. Cls.: 2, 13, 23, 29, 30, 33, 40, and 50

Reg. No. 3,399,759

United States Patent and Trademark Office

Registered Mar. 18, 2008

**TRADEMARK
PRINCIPAL REGISTER**



MID-WEST METAL PRODUCTS, INC. (INDIANA
CORPORATION)
P.O. BOX 1031
MUNCIE, IN 47308

NO CLAIM IS MADE TO THE EXCLUSIVE
RIGHT TO USE "FERRET", APART FROM THE
MARK AS SHOWN.

FOR: CAGES FOR PETS, IN CLASS 21 (U.S. CLS. 2,
13, 23, 29, 30, 33, 40 AND 50).

SN 78-783,733, FILED 1-2-2006.

FIRST USE 6-30-2007; IN COMMERCE 6-30-2007.

MARY ROSSMAN, EXAMINING ATTORNEY

Int. Cl.: 16

Prior U.S. Cls.: 2, 5, 22, 23, 29, 37, 38, and 50

United States Patent and Trademark Office

Reg. No. 3,399,760

Registered Mar. 18, 2008

**TRADEMARK
PRINCIPAL REGISTER**

LAYMAN THOMAS'

KOVARCIK, THOMAS J. (UNITED STATES IN-
DIVIDUAL)
APT 2-J
136 EAST 55TH ST
NEW YORK, NY 10022

THE MARK CONSISTS OF STANDARD CHAR-
ACTERS WITHOUT CLAIM TO ANY PARTICULAR
FONT, STYLE, SIZE, OR COLOR.

FOR: HEALTH BOOKS, COOKBOOKS, AND
CHILDREN'S BOOKS, IN CLASS 16 (U.S. CLS. 2, 5,
22, 23, 29, 37, 38 AND 50).

SN 78-785,378, FILED 1-5-2006.

FIRST USE 8-1-2007; IN COMMERCE 8-1-2007.

NAAKWAMA ANKRAH, EXAMINING ATTORNEY

Int. Cl.: 28

Prior U.S. Cls.: 22, 23, 38, and 50

United States Patent and Trademark Office

Reg. No. 3,399,761

Registered Mar. 18, 2008

TRADEMARK
PRINCIPAL REGISTER



TRUE TEMPER SPORTS, INC. (DELAWARE
CORPORATION)
SUITE 200
8275 TOURNAMENT DRIVE
MEMPHIS, TN 38125

FIRST USE 3-0-2007; IN COMMERCE 3-0-2007.

SN 78-785,912, FILED 1-5-2006.

FOR: GOLF CLUB SHAFTS, IN CLASS 28 (U.S.
CLS. 22, 23, 38 AND 50).

BRIAN NEVILLE, EXAMINING ATTORNEY

Int. Cl.: 35

Prior U.S. Cls.: 100, 101, and 102

United States Patent and Trademark Office

Reg. No. 3,399,762

Registered Mar. 18, 2008

**SERVICE MARK
PRINCIPAL REGISTER**

Digital Landing

ACCELLER, INC. (FLORIDA CORPORATION),
DBA BUYTELCO,
815 NW 57TH AVENUE
SUITE 400
MIAMI, FL 33126

FOR: COMPARATIVE MARKETING AND ADVERTISING SERVICES FOR PROVIDERS OF RESIDENTIAL AND BUSINESS TELECOMMUNICATIONS SERVICES, NAMELY, FOR PROVIDERS OF BROADBAND CABLE, DSL, FIBER-OPTIC AND SATELLITE INTERNET ACCESS SERVICES, CABLE AND SATELLITE TELEVISION, VOICE OVER IP, AND LONG-DISTANCE TELEPHONE SERVICES TO HOME USERS; OPERATION OF TELEPHONE CALL CENTERS FOR OTHERS FOR PURPOSES OF MARKETING OF TELECOMMUNICATIONS AND OTHER DIGITAL

SERVICES TO HOME USERS AND MARKETING CONSULTING RELATED THERETO, IN CLASS 35 (U.S. CLS. 100, 101 AND 102).

FIRST USE 3-1-2007; IN COMMERCE 7-1-2007.

THE MARK CONSISTS OF STANDARD CHARACTERS WITHOUT CLAIM TO ANY PARTICULAR FONT, STYLE, SIZE, OR COLOR.

NO CLAIM IS MADE TO THE EXCLUSIVE RIGHT TO USE "DIGITAL", APART FROM THE MARK AS SHOWN.

SN 78-786,532, FILED 1-6-2006.

RONALD MCMORROW, EXAMINING ATTORNEY

Int. Cl.: 10

Prior U.S. Cls.: 26, 39, and 44

United States Patent and Trademark Office

Reg. No. 3,399,763

Registered Mar. 18, 2008

**TRADEMARK
PRINCIPAL REGISTER**

GIF-H180

OLYMPUS CORPORATION (JAPAN JOINT
STOCK COMPANY)

43-2, HATAGAYA 2-CHOME, SHIBUYA-KU

TOKYO, JAPAN

FOR: MEDICAL AND SURGICAL VIDEO ENDO-
SCOPES, IN CLASS 10 (U.S. CLS. 26, 39 AND 44).

FIRST USE 1-2-2006; IN COMMERCE 1-2-2006.

THE MARK CONSISTS OF STANDARD CHAR-
ACTERS WITHOUT CLAIM TO ANY PARTICULAR
FONT, STYLE, SIZE, OR COLOR.

OWNER OF U.S. REG. NOS. 1,816,763, 2,840,901,
AND 2,978,653.

SN 78-786,607, FILED 1-6-2006.

ALEXANDER L. POWERS, EXAMINING ATTOR-
NEY

Int. Cls.: 18, 25, and 28

Prior U.S. Cls.: 1, 2, 3, 22, 23, 38, 39, 41, and 50

United States Patent and Trademark Office

Reg. No. 3,399,764

Registered Mar. 18, 2008

**TRADEMARK
PRINCIPAL REGISTER**

MISSION SOCCER

CINTEX INTERNATIONAL (CANADA) LIMITED
(CANADA CORPORATION)
976 MEYERSIDE DRIVE
MISSISSAUGA, ONTARIO, CANADA L5T 1R9

FOR: ALL PURPOSE SPORT BAGS, TRAVELING BAGS, HANDBAGS, KNAPSACKS, WAIST PACKS, SHOEBAGS FOR TRAVEL, BRIEFCASES, SUITCASES AND UMBRELLAS, IN CLASS 18 (U.S. CLS. 1, 2, 3, 22 AND 41).

FIRST USE 10-9-2003; IN COMMERCE 11-5-2007.

FOR: CLOTHING FOR SPORTS AND LEISURE, NAMELY, SPORTS SUITS, JACKETS, RAIN PROOF JACKETS, T-SHIRTS, TROUSERS, SHORTS, HATS, CAPS, PARKAS, SWEATERS, SOCKS, GLOVES AND SPORT GLOVES, BLUE JEANS, KNITTED JOGGING SUITS, KNITTED SHORTS, KNITTED PULL-OVERS, KNITTED TROUSERS, KNITTED CARDIGANS, BATHING CAPS, BATHING SUITS, SHIRTS, SKI SUITS, LINGERIE, FOOTWEAR AND SPORTS FOOTWEAR, SWEAT BANDS, IN CLASS 25 (U.S. CLS. 22 AND 39).

FIRST USE 10-9-2003; IN COMMERCE 11-5-2007.

FOR: GYMNASTIC AND SPORTING GOODS AND EQUIPMENT, NAMELY, SOCCER BALLS, FOOTBALLS, BASKETBALLS, TENNIS BALLS, SPORTS BALLS, SMALL SPORTS BALLS; ATHLETIC SPORTING GOODS, NAMELY, ATHLETIC WRIST AND JOINT SUPPORTS, SHIN GUARDS WITH OR WITHOUT ANKLE GUARDS, KNEE BRACES, THIGH BRACES, IN CLASS 28 (U.S. CLS. 22, 23, 38 AND 50).

FIRST USE 10-9-2003; IN COMMERCE 11-5-2007.

THE MARK CONSISTS OF STANDARD CHARACTERS WITHOUT CLAIM TO ANY PARTICULAR FONT, STYLE, SIZE, OR COLOR.

OWNER OF CANADA REG. NO. TMA591,945, DATED 10-9-2003, EXPIRES 10-9-2018.

NO CLAIM IS MADE TO THE EXCLUSIVE RIGHT TO USE "SOCCER", APART FROM THE MARK AS SHOWN.

SN 78-787,310, FILED 1-9-2006.

JOHN E. MICHOS, EXAMINING ATTORNEY

Int. Cl.: 3

Prior U.S. Cls.: 1, 4, 6, 50, 51, and 52

United States Patent and Trademark Office

Reg. No. 3,399,765

Registered Mar. 18, 2008

**TRADEMARK
PRINCIPAL REGISTER**

PURRFECT EYES

BIO-LOGIC AQUA TECHNOLOGIES, INC. (DE-
LAWARE CORPORATION)
5001 LOWER RIVER ROAD
GRANTS PASS, OR 97526

FOR: NON-MEDICATED GROOMING PRE-
PARATIONS FOR CATS, NAMELY, EYE LIQUID,
NAMELY, PURIFIED WATER IN A SPRAY CON-
TAINER FOR REFRESHING TEAR FILM , IN
CLASS 3 (U.S. CLS. 1, 4, 6, 50, 51 AND 52).

FIRST USE 2-22-2007; IN COMMERCE 2-22-2007.

THE MARK CONSISTS OF STANDARD CHAR-
ACTERS WITHOUT CLAIM TO ANY PARTICULAR
FONT, STYLE, SIZE, OR COLOR.

NO CLAIM IS MADE TO THE EXCLUSIVE
RIGHT TO USE "EYES", APART FROM THE MARK
AS SHOWN.

SN 78-788,603, FILED 1-10-2006.

ANTHONY RINKER, EXAMINING ATTORNEY

Int. Cl.: 5

Prior U.S. Cls.: 6, 18, 44, 46, 51, and 52

United States Patent and Trademark Office

Reg. No. 3,399,766

Registered Mar. 18, 2008

**TRADEMARK
PRINCIPAL REGISTER**

ESSENTIAL EYE WASH

BIO-LOGIC AQUA TECHNOLOGIES, INC. (DE-
LAWARE CORPORATION)
5001 LOWER RIVER ROAD
GRANTS PASS, OR 97526

FOR: EYE WASH, NAMELY, PURIFIED WATER
IN A SPRAY CONTAINER FOR REFRESHING
TEAR FILM, IN CLASS 5 (U.S. CLS. 6, 18, 44, 46, 51
AND 52).

FIRST USE 3-5-2007; IN COMMERCE 5-5-2007.

THE MARK CONSISTS OF STANDARD CHAR-
ACTERS WITHOUT CLAIM TO ANY PARTICULAR
FONT, STYLE, SIZE, OR COLOR.

NO CLAIM IS MADE TO THE EXCLUSIVE
RIGHT TO USE "EYE WASH", APART FROM THE
MARK AS SHOWN.

SN 78-788,627, FILED 1-10-2006.

ANTHONY RINKER, EXAMINING ATTORNEY

Int. Cl.: 30

Prior U.S. Cl.: 46

United States Patent and Trademark Office

Reg. No. 3,399,767

Registered Mar. 18, 2008

**TRADEMARK
PRINCIPAL REGISTER**

FRU-TEA

INTERNATIONAL COFFEE & TEA, LLC (DELA-
WARE LTD LIAB CO), DBA THE COFFEE
BEAN AND TEA LEAF,
1945 SOUTH LA CIENEGA BOULEVARD
LOS ANGELES, CA 90034

THE MARK CONSISTS OF STANDARD CHAR-
ACTERS WITHOUT CLAIM TO ANY PARTICULAR
FONT, STYLE, SIZE, OR COLOR.

FOR: LOOSE TEA, TEA BAGS, HOT TEA, ICED
TEA, AND TEA-BASED BEVERAGES, IN CLASS 30
(U.S. CL. 46).

SN 78-788,809, FILED 1-10-2006.

FIRST USE 3-1-2006; IN COMMERCE 3-1-2006.

BARBARA RUTLAND, EXAMINING ATTORNEY

Int. Cl.: 3

Prior U.S. Cls.: 1, 4, 6, 50, 51, and 52

United States Patent and Trademark Office

Reg. No. 3,399,768

Registered Mar. 18, 2008

**TRADEMARK
PRINCIPAL REGISTER**

Melancholy Baby

PERFECT PERCEPTIONS, LLC (PENNSYLVANIA
LTD LIAB CO)
11 ROSE LANE
FLOURTOWN, PA 19031

THE MARK CONSISTS OF STANDARD CHAR-
ACTERS WITHOUT CLAIM TO ANY PARTICULAR
FONT, STYLE, SIZE, OR COLOR.

FOR: COSMETICS, IN CLASS 3 (U.S. CLS. 1, 4, 6, 50,
51 AND 52).

SN 78-789,838, FILED 1-11-2006.

FIRST USE 4-1-2007; IN COMMERCE 6-1-2007.

PAUL E. FAHRENKOPF, EXAMINING ATTORNEY

Int. Cl.: 12

Prior U.S. Cls.: 19, 21, 23, 31, 35, and 44

United States Patent and Trademark Office

Reg. No. 3,399,769

Registered Mar. 18, 2008

**TRADEMARK
PRINCIPAL REGISTER**

SpareGuard

PHY-CON INC. (ILLINOIS CORPORATION)
9817 SOUTH TRIPP AVE
OAK LAWN, IL 60453

THE MARK CONSISTS OF STANDARD CHAR-
ACTERS WITHOUT CLAIM TO ANY PARTICULAR
FONT, STYLE, SIZE, OR COLOR.

FOR: ANTI-THEFT DEVICE FOR USE WITH
AUTOMOBILE SPARE TIRES, IN CLASS 12 (U.S.
CLS. 19, 21, 23, 31, 35 AND 44).

SN 78-790,024, FILED 1-12-2006.

FIRST USE 12-0-2006; IN COMMERCE 7-18-2007.

WANDA KAY PRICE, EXAMINING ATTORNEY

Int. Cl.: 20

Prior U.S. Cls.: 2, 13, 22, 25, 32, and 50

Reg. No. 3,399,770

United States Patent and Trademark Office

Registered Mar. 18, 2008

**TRADEMARK
PRINCIPAL REGISTER**

4040 Locust

URBAN OUTFITTERS (DELAWARE), INC. (DE-
LAWARE CORPORATION)
5000 BROAD STREET
PHILADELPHIA, PA 191121492

THE MARK CONSISTS OF STANDARD CHAR-
ACTERS WITHOUT CLAIM TO ANY PARTICULAR
FONT, STYLE, SIZE, OR COLOR.

FOR: INDOOR HOME FURNITURE, IN CLASS 20
(U.S. CLS. 2, 13, 22, 25, 32 AND 50).

SN 78-790,349, FILED 1-12-2006.

FIRST USE 5-12-2006; IN COMMERCE 5-12-2006.

PAUL E. FAHRENKOPF, EXAMINING ATTORNEY

Int. Cl.: 9

Prior U.S. Cls.: 21, 23, 26, 36, and 38

Reg. No. 3,399,771

United States Patent and Trademark Office

Registered Mar. 18, 2008

**TRADEMARK
PRINCIPAL REGISTER**

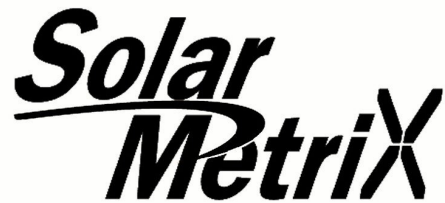
The logo for Solar MetriX features the word "Solar" in a bold, italicized sans-serif font. A horizontal line is drawn beneath "Solar", which then curves upwards and underlines the word "MetriX". "MetriX" is also in a bold, italicized sans-serif font, with the "X" having a distinctive shape.

WEISS INSTRUMENTS, INC. (NEW YORK CORPORATION)
905 WAVERLY AVENUE
HOLTSVILLE, NY 11742

FOR: THERMOMETERS AND PRESSURE GAUGES, IN CLASS 9 (U.S. CLS. 21, 23, 26, 36 AND 38).

FIRST USE 2-0-2007; IN COMMERCE 2-0-2007.

NO CLAIM IS MADE TO THE EXCLUSIVE RIGHT TO USE "SOLAR", APART FROM THE MARK AS SHOWN.

SN 78-791,457, FILED 1-13-2006.

CIMMERIAN COLEMAN, EXAMINING ATTORNEY

Int. Cl.: 16

Prior U.S. Cls.: 2, 5, 22, 23, 29, 37, 38, and 50

United States Patent and Trademark Office

Reg. No. 3,399,772

Registered Mar. 18, 2008

**TRADEMARK
PRINCIPAL REGISTER**



SWANSON, JOHN WESTWOOD (UNITED STATES INDIVIDUAL)
1521 NE HANCOCK
PORTLAND, OR 97212

THE MARK CONSISTS OF THE DESIGN OF AN ANVIL INCORPORATED INTO A STYLIZED LETTER "M".

FOR: FLASH CARDS FOR THE EDUCATION OF CHILDREN ABOUT SUNDRY OBJECTS, IN CLASS 16 (U.S. CLS. 2, 5, 22, 23, 29, 37, 38 AND 50).

SN 78-792,579, FILED 1-16-2006.

FIRST USE 4-5-2007; IN COMMERCE 8-13-2007.

ANDREA K. NADELMAN, EXAMINING ATTORNEY

Int. Cl.: 5

Prior U.S. Cls.: 6, 18, 44, 46, 51, and 52

United States Patent and Trademark Office

Reg. No. 3,399,773

Registered Mar. 18, 2008

**TRADEMARK
PRINCIPAL REGISTER**

CUTBACK

NUFARM AMERICAS INC. (ILLINOIS CORPORATION)
150 HARVESTER DRIVE, SUITE 200
BURR RIDGE, IL 60527

FOR: HERBICIDES FOR AGRICULTURAL USE; HERBICIDES FOR DOMESTIC USE; INSECTICIDES; PESTICIDES FOR AGRICULTURAL, COMMERCIAL, DOMESTIC AND INDUSTRIAL USE, IN CLASS 5 (U.S. CLS. 6, 18, 44, 46, 51 AND 52).

FIRST USE 1-31-2007; IN COMMERCE 1-31-2007.

THE MARK CONSISTS OF STANDARD CHARACTERS WITHOUT CLAIM TO ANY PARTICULAR FONT, STYLE, SIZE, OR COLOR.

SN 78-792,672, FILED 1-17-2006.

JENNIFER VASQUEZ, EXAMINING ATTORNEY

Int. Cl.: 33

Prior U.S. Cls.: 47 and 49

United States Patent and Trademark Office

Reg. No. 3,399,774

Registered Mar. 18, 2008

TRADEMARK
PRINCIPAL REGISTER



Z & U SPIRITUOSEN MARKETING GMBH (AUSTRIA GMBH)
HEILIGENSTÄDTER STRASSE 43
A-1190 VIENNA, AUSTRIA

FOR: ALCOHOLIC BEVERAGES, NAMELY, DISTILLED SPIRITS, AND LIQUEURS, IN CLASS 33 (U.S. CLS. 47 AND 49).

FIRST USE 3-31-2006; IN COMMERCE 3-31-2006.

OWNER OF U.S. REG. NOS. 1,493,429 AND 3,142,303.

NO CLAIM IS MADE TO THE EXCLUSIVE RIGHT TO USE "IMPORTED", "SINCE 1790", "HUNGARIAN HERB LIQUEUR ESTABLISHED IN 1790", AND "750 ML LIQUEUR 35% ALC. BY VOL.", APART FROM THE MARK AS SHOWN.

THE COLOR(S) BLACK, RED, GREEN, GOLD AND WHITE IS/ARE CLAIMED AS A FEATURE OF THE MARK.

THE COLOR BLACK APPEARS IN THE DEPICTION OF THE THREE-DIMENSIONAL BOTTLE DESIGN, THE SHADING INSIDE THE CREST, THE NUMBERS "1790", THE CENTER OF THE LETTER "A" IN THE WHITE WORDING "ZWACK", AND THE WORDING "HUNGARIAN HERB LIQUEUR ESTABLISHED IN 1790". THE COLOR WHITE APPEARS ON THE OUTSIDE BORDER OF THE RED CIRCLE, THE OUTSIDE BORDER OF THE CROSS IN THE CIRCLE, AND IN THE WORDING "IMPORTED IMPORTED" "ZWACK", "SINCE

1790", AND "750 ML LIQUEUR 35% ALC. BY VOL.". THE COLOR GOLD APPEARS ON THE DEPICTION OF THE CROSS AT THE CENTER OF THE RED CIRCLE, THE HERALDIC LIONS, CROWN, CREST OUTLINE, LETTER "Z", AND THE WORDING "ZWACK" IN THE DESIGN OF THE LIONS AND THE CREST LOCATED ON THE BOTTLE NECK. THE COLOR RED APPEARS AT THE CLOSURE OF THE BOTTLE, ON THE DEPICTION OF THE CIRCLE SURROUNDING THE CROSS, AND IN THE THREE-DIMENSIONAL SHADING OF THE CROSS IN THE CENTER OF THE CIRCLE. THE COLOR GREEN APPEARS ON THE DEPICTION OF THE BOTTLENECK BELOW THE RED CLOSURE. THE THREE DIMENSIONAL MARK CONSISTS OF A BOTTLE IN BLACK WITH RED CLOSURE AND THE GOLD CROSS WITH WHITE BORDERS IN THE CENTER OF THE RED CIRCLE WITH WHITE BORDERS.

THE MARK CONSISTS OF A THREE-DIMENSIONAL BOTTLE DESIGN CONTAINING A DESIGN OF THE LETTER "Z" WITHIN A CREST THAT HAS AN OPEN TOP CROWN OVER IT, A BANNER UNDER IT, AND ONE HERALDIC LION ON THE RIGHT AND LEFT OF THE CREST. THE MARK CONSISTS OF THE WORDING "1790 ZWACK IMPORTED IMPORTED", "ZWACK", "SINCE 1790", "HUNGARIAN HERB LIQUEUR ESTABLISHED IN 1790", AND "750 ML LIQUEUR 35% ALC. BY VOL."

SN 78-793,274, FILED 1-17-2006.

AMY MCMENAMIN, EXAMINING ATTORNEY

Int. Cl.: 25

Prior U.S. Cls.: 22 and 39

United States Patent and Trademark Office

Reg. No. 3,399,775

Registered Mar. 18, 2008

**TRADEMARK
PRINCIPAL REGISTER**



MAGNETO LLC (CALIFORNIA LTD LIAB CO)
27 MORRELL STREET
SAN FRANCISCO, CA 94109

FIRST USE 8-20-2006; IN COMMERCE 8-20-2006.

FOR: SHIRTS, T-SHIRTS, SWEATSHIRTS, PULL-
OVERS, HATS, VISORS, WRISTBANDS, BELTS,
GLOVES, CAPS, HEAD BANDS, BANDANAS AND
JERSEYS, IN CLASS 25 (U.S. CLS. 22 AND 39).

SN 78-793,353, FILED 1-17-2006.

PAUL F. GAST, EXAMINING ATTORNEY

Int. Cl.: 12

Prior U.S. Cls.: 19, 21, 23, 31, 35, and 44

United States Patent and Trademark Office

Reg. No. 3,399,776

Registered Mar. 18, 2008

TRADEMARK
PRINCIPAL REGISTER



CHINA NATIONAL AERO-TECHNOLOGY IMP.
& EXP. GUANGZHOU CORPORATION (CHI-
NA CORPORATION)

39-1 ZHUSIGANG 2 ST.
DONGSHAN, GUANGZHOU, CHINA 510080

FOR: VEHICLES, NAMELY, ELECTRIC CARS,
MOTORIZED GOLF CARTS, ALL TERRAIN VEHI-
CLES (ATV'S), RECREATIONAL VEHICLES, NAME-
LY, CAMPERS, RAILWAY CARS, AUTOMOBILES,
CAMPER SHELLS, TRAILER HITCHES, MOTOR-
CYCLES, BABY CARRIAGES, HANDCARTS WITH
WHEELS AND WHEELCHAIRS, IN CLASS 12 (U.S.
CLS. 19, 21, 23, 31, 35 AND 44).

FIRST USE 2-1-2004; IN COMMERCE 8-1-2006.

THE COLOR(S) RED, ORANGE, YELLOW, AND
BLACK IS/ARE CLAIMED AS A FEATURE OF THE
MARK.

THE COLOR RED APPEARS IN THE LOWER
PORTION OF THE HORIZONTAL BARS AND IN
THE STYLIZED LETTER "T", THE COLOR OR-
ANGE APPEARS IN THE UPPER HORIZONTAL
BAR, THE ORANGE CHANGING TO YELLOW AT
THE NARROW END OF THE BAR, AND THE
COLOR BLACK APPEARS IN THE LETTERS
"ONARO" AND IN THE OUTLINE OF THE LOWER
PORTION OF THE STYLIZED LETTER "T".

SN 78-793,491, FILED 1-18-2006.

ALEX KEAM, EXAMINING ATTORNEY

Int. Cl.: 10

Prior U.S. Cls.: 26, 39, and 44

United States Patent and Trademark Office

Reg. No. 3,399,777

Registered Mar. 18, 2008

**TRADEMARK
PRINCIPAL REGISTER**

OMNIPAD

ACCELERATED CARE PLUS CORP. (DELA-
WARE CORPORATION)
4850 JOULE STREET, SUITE A-1
RENO, NV 89502

THE MARK CONSISTS OF STANDARD CHAR-
ACTERS WITHOUT CLAIM TO ANY PARTICULAR
FONT, STYLE, SIZE, OR COLOR.

FOR: SENSORY LIGHT THERAPY UNIT, IN
CLASS 10 (U.S. CLS. 26, 39 AND 44).

SN 78-793,723, FILED 1-18-2006.

FIRST USE 9-0-2006; IN COMMERCE 9-0-2006.

MICHELLE DUBOIS, EXAMINING ATTORNEY

Int. Cl.: 25

Prior U.S. Cls.: 22 and 39

United States Patent and Trademark Office

Reg. No. 3,399,778

Registered Mar. 18, 2008

**TRADEMARK
PRINCIPAL REGISTER**

cultured soles

ROBINSON & MARSHALL TRADING CO, LLC
(GEORGIA LTD LIAB CO)
2890-A GA HWY 212
SUITE 105
CONYERS, GA 30094

THE MARK CONSISTS OF STANDARD CHAR-
ACTERS WITHOUT CLAIM TO ANY PARTICULAR
FONT, STYLE, SIZE, OR COLOR.

FOR: SHOES, HATS, SOCKS, SHIRTS, JEANS,
WRISTBANDS AND HEADBANDS, IN CLASS 25
(U.S. CLS. 22 AND 39).

SN 78-794,256, FILED 1-18-2006.

FIRST USE 2-2-2005; IN COMMERCE 9-2-2006.

MICHAEL WIENER, EXAMINING ATTORNEY

Int. Cl.: 1

Prior U.S. Cls.: 1, 5, 6, 10, 26, and 46

United States Patent and Trademark Office

Reg. No. 3,399,779

Registered Mar. 18, 2008

**TRADEMARK
PRINCIPAL REGISTER**

AGRITECH

BUNGE OILS, INC. (DELAWARE CORPORATION)
11720 BORMAN DRIVE
ST. LOUIS, MO 63146

THE MARK CONSISTS OF STANDARD CHARACTERS WITHOUT CLAIM TO ANY PARTICULAR FONT, STYLE, SIZE, OR COLOR.

FOR: HYDRAULIC FLUIDS FOR GENERAL USE,
IN CLASS 1 (U.S. CLS. 1, 5, 6, 10, 26 AND 46).

SN 78-794,595, FILED 1-19-2006.

FIRST USE 12-0-2006; IN COMMERCE 12-0-2006.

MICHELE SWAIN, EXAMINING ATTORNEY

Int. Cl.: 11

Prior U.S. Cls.: 13, 21, 23, 31, and 34

United States Patent and Trademark Office

Reg. No. 3,399,780

Registered Mar. 18, 2008

**TRADEMARK
PRINCIPAL REGISTER**

CHOICEFLO FILTRATION

MOEN INCORPORATED (DELAWARE CORPORATION)
25300 AL MOEN DRIVE
NORTH OLMSTED, OH 440708022

FOR: FAUCETS, NAMELY KITCHEN FAUCETS, FAUCET HANDLES, AND FAUCET VALVES; WATER FILTRATION UNITS FOR DOMESTIC USE; PLUMBING FITTINGS, NAMELY, FAUCET FILTERS; WATER FILTERS; AND WATER FILTER CARTRIDGES, IN CLASS 11 (U.S. CLS. 13, 21, 23, 31 AND 34).

FIRST USE 10-15-2007; IN COMMERCE 10-15-2007.

THE MARK CONSISTS OF STANDARD CHARACTERS WITHOUT CLAIM TO ANY PARTICULAR FONT, STYLE, SIZE, OR COLOR.

NO CLAIM IS MADE TO THE EXCLUSIVE RIGHT TO USE "FILTRATION", APART FROM THE MARK AS SHOWN.

SN 78-794,726, FILED 1-19-2006.

LYDIA BELZER, EXAMINING ATTORNEY

Int. Cl.: 9

Prior U.S. Cls.: 21, 23, 26, 36, and 38

United States Patent and Trademark Office

Reg. No. 3,399,781

Registered Mar. 18, 2008

**TRADEMARK
PRINCIPAL REGISTER**

QUADSYSTEMS

QUADSYSTEMS (WISCONSIN CORPORATION)
N63 W23075 HWY. 74
SUSSEX, WI 53089

FOR: COMPUTER SOFTWARE IN THE FIELD OF
PRINT PRODUCTION, GRAPHIC DESIGN, PRE-
PRESS LAYOUT AND COMMERCIAL PRINTING,
IN CLASS 9 (U.S. CLS. 21, 23, 26, 36 AND 38).

FIRST USE 9-0-2005; IN COMMERCE 10-0-2007.

THE MARK CONSISTS OF STANDARD CHAR-
ACTERS WITHOUT CLAIM TO ANY PARTICULAR
FONT, STYLE, SIZE, OR COLOR.

OWNER OF U.S. REG. NOS. 1,434,317, 2,569,525,
AND OTHERS.

SN 78-794,952, FILED 1-19-2006.

ELLEN BURNS, EXAMINING ATTORNEY

Int. Cls.: 9, 16, 41, and 45

**Prior U.S. Cls.: 2, 5, 21, 22, 23, 26, 29, 36, 37, 38, 50,
100, 101, and 107**

Reg. No. 3,399,782

United States Patent and Trademark Office

Registered Mar. 18, 2008

**TRADEMARK
SERVICE MARK
PRINCIPAL REGISTER**

Soul Wings

KOBACKER, SOPHIA T. (AUSTRALIA INDIVIDUAL)
668 N COAST HWY #234
LAGUNA BEACH, CA 92651

FOR: AUDIO VISUAL RECORDINGS RELATING TO LIFE VISION, LIFE ENHANCEMENT, ANGEL COMMUNICATION, SPIRITUALITY, HEALING AND FENG SHUI, FEATURING MUSIC, SPOKEN WORD AND RECORDED SOUNDS RECORDED ON CD'S, DVD'S AND OTHER ELECTRONIC FORMATS, IN CLASS 9 (U.S. CLS. 21, 23, 26, 36 AND 38).

FIRST USE 9-24-2004; IN COMMERCE 7-1-2005.

FOR: ORACLE CARDS, PRINTED EDUCATIONAL MATERIALS, BOOKS AND MAGAZINES RELATING TO LIFE VISION, LIFE ENHANCEMENT, ANGEL COMMUNICATION, SPIRITUALITY, HEALING AND FENG SHUI, IN CLASS 16 (U.S. CLS. 2, 5, 22, 23, 29, 37, 38 AND 50).

FIRST USE 9-24-2004; IN COMMERCE 7-1-2005.

FOR: EDUCATION SERVICES, NAMELY, PROVIDING CLASSES, SEMINARS, WORKSHOPS, INFORMAL PROGRAMS, TUTORING AND MENTORING IN THE FIELD OF LIFE VISION, LIFE ENHANCEMENT, ANGEL COMMUNICATION, SPIRITUALITY, HEALING AND FENG SHUI, THROUGH ON-LINE AND OFF-LINE MEANS AND PRINTABLE MATERIALS DISTRIBUTED THEREWITH; ENTERTAINMENT SERVICES, NAMELY, PROVIDING A WEBSITE FEATURING, PHOTO-

GRAPHIC, AUDIO, VIDEO AND PROSE PRESENTATIONS FEATURING LIFE VISION AND ENHANCEMENT AND SPIRITUALITY, AND PRESENTATION OF LIVE SHOW PERFORMANCES ABOUT LIFE VISION, LIFE ENHANCEMENT, ANGEL COMMUNICATION, SPIRITUALITY, HEALING AND FENG SHUI, IN CLASS 41 (U.S. CLS. 100, 101 AND 107).

FIRST USE 9-24-2004; IN COMMERCE 7-1-2005.

FOR: PROVIDING ON-LINE INFORMATION AND CONSULTATION IN THE FIELD OF SPIRITUALITY, SELF-HELP, AND PERSONAL EMPOWERMENT SUBJECT MATTERS SUCH AS LIFE VISION, LIFE ENHANCEMENT, ANGEL COMMUNICATION, SPIRITUALITY, AND SPIRITUAL HEALING, IN CLASS 45 (U.S. CLS. 100 AND 101).

FIRST USE 9-24-2004; IN COMMERCE 7-1-2005.

THE MARK CONSISTS OF STANDARD CHARACTERS WITHOUT CLAIM TO ANY PARTICULAR FONT, STYLE, SIZE, OR COLOR.

NO CLAIM IS MADE TO THE EXCLUSIVE RIGHT TO USE "SOUL", APART FROM THE MARK AS SHOWN.

SN 78-795,118, FILED 1-19-2006.

GINA FINK, EXAMINING ATTORNEY

Int. Cl.: 41

Prior U.S. Cls.: 100, 101, and 107

United States Patent and Trademark Office

Reg. No. 3,399,783

Registered Mar. 18, 2008

**SERVICE MARK
PRINCIPAL REGISTER**

The Beams

SPACE RADIO PRODUCTIONS LLC (MASSACHUSETTS LTD LIAB CO)
27 TAFT HILL TERRACE NO. 6
ROSLINDALE, MA 02131

FOR: AUDIO RECORDING AND PRODUCTION; ENTERTAINMENT IN THE NATURE OF VISUAL AND AUDIO PERFORMANCES, NAMELY, MUSICAL, VARIETY, NEWS AND COMEDY SHOWS; ENTERTAINMENT NAMELY, PRODUCTION OF CHILDREN'S AUDIO PROGRAMMING; ENTERTAINMENT SERVICES, NAMELY, PROVIDING A RADIO PROGRAM IN THE FIELD OF CHILDREN'S PROGRAMMING VIA A GLOBAL COMPUTER NETWORK; ENTERTAINMENT, NAMELY A CON-

TINUING CHILDREN'S AUDIO SHOW BROADCAST OVER TELEVISION, SATELLITE, AUDIO, AND VIDEO MEDIA, IN CLASS 41 (U.S. CLS. 100, 101 AND 107).

FIRST USE 6-1-2006; IN COMMERCE 6-1-2006.

THE MARK CONSISTS OF STANDARD CHARACTERS WITHOUT CLAIM TO ANY PARTICULAR FONT, STYLE, SIZE, OR COLOR.

SN 78-795,185, FILED 1-19-2006.

NAAKWAMA ANKRAH, EXAMINING ATTORNEY

Int. Cl.: 42

Prior U.S. Cls.: 100 and 101

United States Patent and Trademark Office

Reg. No. 3,399,784

Registered Mar. 18, 2008

**SERVICE MARK
PRINCIPAL REGISTER**

VICUS THERAPEUTICS

VICUS THERAPEUTICS, LLC (DELAWARE LIMITED LIABILITY COMPANY)
SUITE 400
55 MADISON AVENUE
MORRISTOWN, NJ 07960

FOR: DISCOVERY, DEVELOPMENT, RESEARCH AND TESTING OF PHARMACEUTICAL PREPARATIONS FOR OTHERS, IN CLASS 42 (U.S. CLS. 100 AND 101).

FIRST USE 3-13-2006; IN COMMERCE 3-13-2006.

THE MARK CONSISTS OF STANDARD CHARACTERS WITHOUT CLAIM TO ANY PARTICULAR FONT, STYLE, SIZE, OR COLOR.

NO CLAIM IS MADE TO THE EXCLUSIVE RIGHT TO USE "THERAPEUTICS", APART FROM THE MARK AS SHOWN.

SN 78-795,327, FILED 1-19-2006.

MELVIN AXILBUND, EXAMINING ATTORNEY

Int. Cl.: 12

Prior U.S. Cls.: 19, 21, 23, 31, 35, and 44

United States Patent and Trademark Office

Reg. No. 3,399,785

Registered Mar. 18, 2008

**TRADEMARK
PRINCIPAL REGISTER**

S371

CONTINENTAL AUTOMOTIVE LICENSING
CORP. (MICHIGAN CORPORATION)
ONE CONTINENTAL DRIVE
AUBURN HILLS, MI 48326

THE MARK CONSISTS OF STANDARD CHAR-
ACTERS WITHOUT CLAIM TO ANY PARTICULAR
FONT, STYLE, SIZE, OR COLOR.

FOR: TIRES, IN CLASS 12 (U.S. CLS. 19, 21, 23, 31,
35 AND 44).

SN 78-795,604, FILED 1-20-2006.

FIRST USE 9-26-2006; IN COMMERCE 9-26-2006.

SUSAN RICHARDS, EXAMINING ATTORNEY

Int. Cls.: 17 and 24

Prior U.S. Cls.: 1, 5, 12, 13, 35, 42, and 50

United States Patent and Trademark Office

Reg. No. 3,399,786

Registered Mar. 18, 2008

**TRADEMARK
PRINCIPAL REGISTER**

Comfor-Prene

CATALYST INTERNATIONAL, INC. (PENNSYLVANIA CORPORATION)
1050 ASHLAND AVENUE
FOLCROFT, PA 19032

FOR: HIGH DENSITY OPEN CELL URETHANE FOAM FOR DESIGNING CUSHIONING PRODUCTS FOR DIRECT CONTACT WITH THE SKIN, IN CLASS 17 (U.S. CLS. 1, 5, 12, 13, 35 AND 50).

FIRST USE 6-30-2006; IN COMMERCE 6-30-2006.

FOR: FABRIC MATERIAL, NAMELY, HIGH PERFORMANCE POLYURETHANE FOAM USED IN THE MANUFACTURE OF MEDICAL, SURGICAL

AND ORTHOPEDIC SOFT GOODS, SPORTSWEAR, OUTERWEAR, FOOTWEAR, GLOVES AND MILITARY CLOTHING, IN CLASS 24 (U.S. CLS. 42 AND 50).

FIRST USE 6-30-2006; IN COMMERCE 6-30-2006.

THE MARK CONSISTS OF STANDARD CHARACTERS WITHOUT CLAIM TO ANY PARTICULAR FONT, STYLE, SIZE, OR COLOR.

SN 78-795,865, FILED 1-20-2006.

STEVEN JACKSON, EXAMINING ATTORNEY

Int. Cl.: 36

Prior U.S. Cls.: 100, 101, and 102

United States Patent and Trademark Office

Reg. No. 3,399,787

Registered Mar. 18, 2008

**SERVICE MARK
PRINCIPAL REGISTER**

**ENHANCED DECISION
MANAGEMENT**

VESTA CREDIT SOLUTIONS, LLC (OREGON
LTD LIAB CO)
11950 SW GARDEN PLACE
PORTLAND, WA 97223

FOR: COMPUTERIZED FINANCIAL SERVICES
IN THE FIELD OF CUSTOMER QUALIFICATION,
RISK ASSESSMENT AND TELECOMMUNICA-
TIONS CUSTOMER ACCOUNT ACTIVATION, IN
CLASS 36 (U.S. CLS. 100, 101 AND 102).

FIRST USE 2-1-2005; IN COMMERCE 2-1-2005.

THE MARK CONSISTS OF STANDARD CHAR-
ACTERS WITHOUT CLAIM TO ANY PARTICULAR
FONT, STYLE, SIZE, OR COLOR.

NO CLAIM IS MADE TO THE EXCLUSIVE
RIGHT TO USE "MANAGEMENT", APART FROM
THE MARK AS SHOWN.

SN 78-796,082, FILED 1-20-2006.

RAUL CORDOVA, EXAMINING ATTORNEY

Int. Cl.: 36

Prior U.S. Cls.: 100, 101, and 102

United States Patent and Trademark Office

Reg. No. 3,399,788

Registered Mar. 18, 2008

**SERVICE MARK
PRINCIPAL REGISTER**

EDM

VESTA CREDIT SOLUTIONS, LLC (OREGON
LTD LIAB CO)
11950 SW GARDEN PLACE
PORTLAND, WA 97223

FOR: COMPUTERIZED FINANCIAL SERVICES
IN THE FIELD OF CUSTOMER QUALIFICATION,
RISK ASSESSMENT AND TELECOMMUNICA-
TIONS CUSTOMER ACCOUNT ACTIVATION, IN
CLASS 36 (U.S. CLS. 100, 101 AND 102).

FIRST USE 2-1-2005; IN COMMERCE 2-1-2005.

THE MARK CONSISTS OF STANDARD CHAR-
ACTERS WITHOUT CLAIM TO ANY PARTICULAR
FONT, STYLE, SIZE, OR COLOR.

SN 78-796,087, FILED 1-20-2006.

RAUL CORDOVA, EXAMINING ATTORNEY

Int. Cl.: 42

Prior U.S. Cls.: 100 and 101

United States Patent and Trademark Office

Reg. No. 3,399,789

Registered Mar. 18, 2008

**SERVICE MARK
PRINCIPAL REGISTER**

PHARMAPOINT

ENCLARITY, INC. (DELAWARE CORPORATION)
65 ENTERPRISE, SUITE 345
ALISO VIEJO, CA 92656

FOR: APPLICATION SERVICE PROVIDER (ASP) FEATURING DATA INTEGRATION AND MARKET RESEARCH SOFTWARE IN THE HEALTHCARE, PHARMACEUTICAL AND INSURANCE RELATED FIELDS, IN CLASS 42 (U.S. CLS. 100 AND 101).

FIRST USE 1-31-2006; IN COMMERCE 1-31-2006.

THE MARK CONSISTS OF STANDARD CHARACTERS WITHOUT CLAIM TO ANY PARTICULAR FONT, STYLE, SIZE, OR COLOR.

SN 78-796,286, FILED 1-20-2006.

BENJAMIN OKEKE, EXAMINING ATTORNEY

Int. Cl.: 42

Prior U.S. Cls.: 100 and 101

United States Patent and Trademark Office

Reg. No. 3,399,790

Registered Mar. 18, 2008

**SERVICE MARK
PRINCIPAL REGISTER**

DEVICEPOINT

ENCLARITY, INC. (DELAWARE CORPORATION)
65 ENTERPRISE, SUITE 345
ALISO VIEJO, CA 92656

THE MARK CONSISTS OF STANDARD CHARACTERS WITHOUT CLAIM TO ANY PARTICULAR FONT, STYLE, SIZE, OR COLOR.

FOR: APPLICATION SERVICE PROVIDER (ASP) FEATURING DATA INTEGRATION SOFTWARE IN THE HEALTHCARE FIELD, IN CLASS 42 (U.S. CLS. 100 AND 101).

SN 78-796,295, FILED 1-20-2006.

FIRST USE 1-31-2006; IN COMMERCE 1-31-2006.

BENJAMIN OKEKE, EXAMINING ATTORNEY

Int. Cl.: 3

Prior U.S. Cls.: 1, 4, 6, 50, 51, and 52

United States Patent and Trademark Office

Reg. No. 3,399,791

Registered Mar. 18, 2008

**TRADEMARK
PRINCIPAL REGISTER**

RESTORATE

HD NUTRITION, INC. (CALIFORNIA CORPORATION)
320 KALMUS DRIVE
COSTA MESA, CA 92626

THE MARK CONSISTS OF STANDARD CHARACTERS WITHOUT CLAIM TO ANY PARTICULAR FONT, STYLE, SIZE, OR COLOR.

FOR: AMINO ACIDS SOLD AS AN INGREDIENT OF AND FOR ENHANCING THE ABSORPTION OF NON-MEDICATED TOPICAL SKIN CARE PRODUCTS, IN CLASS 3 (U.S. CLS. 1, 4, 6, 50, 51 AND 52).

SN 78-796,820, FILED 1-23-2006.

FIRST USE 3-0-2006; IN COMMERCE 3-0-2006.

MICHAEL WEBSTER, EXAMINING ATTORNEY

Int. Cls.: 9 and 42

Prior U.S. Cls.: 21, 23, 26, 36, 38, 100, and 101

United States Patent and Trademark Office

Reg. No. 3,399,792

Registered Mar. 18, 2008

**TRADEMARK
SERVICE MARK
PRINCIPAL REGISTER**

ACCOMPLICE

EXELOGY INCORPORATED (DELAWARE CORPORATION)
1085 TASMAN DR. #885
SUNNYVALE, CA 94089

FOR: COMPUTER SOFTWARE FOR MANAGING, VIEWING AND EDITING PERSONAL INFORMATION, FILES, DOCUMENTS AND MESSAGES; COMPUTER SOFTWARE FOR TASK AND CALENDAR MANAGEMENT; COMPUTER SOFTWARE FOR E-MAIL MANAGEMENT; COMPUTER SOFTWARE FOR PROJECT COLLABORATION; MOBILE COMPUTERS; COMMUNICATIONS DEVICES, NAMELY, PERSONAL DIGITAL ASSISTANTS AND CELL PHONES, IN CLASS 9 (U.S. CLS. 21, 23, 26, 36 AND 38).

FIRST USE 2-6-2006; IN COMMERCE 10-13-2006.

FOR: COMPUTER CONSULTING SERVICES, IN CLASS 42 (U.S. CLS. 100 AND 101).

FIRST USE 10-13-2006; IN COMMERCE 10-13-2006.

THE MARK CONSISTS OF STANDARD CHARACTERS WITHOUT CLAIM TO ANY PARTICULAR FONT, STYLE, SIZE, OR COLOR.

SN 78-796,879, FILED 1-23-2006.

MATTHEW EINSTEIN, EXAMINING ATTORNEY

Int. Cl.: 41

Prior U.S. Cls.: 100, 101, and 107

United States Patent and Trademark Office

Reg. No. 3,399,793

Registered Mar. 18, 2008

**SERVICE MARK
PRINCIPAL REGISTER**

BIG AL

REV. KEMPF, JOSEPH G. (UNITED STATES
INDIVIDUAL)
403 NORTH MAIN STREET
O'FALLON, MO 63366

FOR: EDUCATIONAL ENTERTAINMENT,
NAMELY, A CONTINUING SHOW FEATURING
MORALS AND RELIGION DISTRIBUTED OVER
TELEVISION, SATELLITE, AUDIO AND VIDEO
MEDIA, WIRELESS COMMUNICATION, VIDEO
ON DEMAND AND THE INTERNET, IN CLASS 41
(U.S. CLS. 100, 101 AND 107).

FIRST USE 9-4-2007; IN COMMERCE 9-4-2007.

THE MARK CONSISTS OF STANDARD CHAR-
ACTERS WITHOUT CLAIM TO ANY PARTICULAR
FONT, STYLE, SIZE, OR COLOR.

SN 78-797,973, FILED 1-24-2006.

KATHERINE M. DUBRAY, EXAMINING ATTOR-
NEY

Int. Cl.: 9

Prior U.S. Cls.: 21, 23, 26, 36, and 38

United States Patent and Trademark Office

Reg. No. 3,399,794

Registered Mar. 18, 2008

**TRADEMARK
PRINCIPAL REGISTER**

ROCKFORD ACOUSTIC DESIGN

ROCKFORD CORPORATION (ARIZONA CORPORATION)
600 SOUTH ROCKFORD DRIVE
TEMPE, AZ 85281

FOR: AUDIO EQUIPMENT, NAMELY STEREOS, CD PLAYERS, MP3 PLAYERS, RADIOS, AUDIO SPEAKERS, WOOFERS, SUBWOOFERS, SPEAKER ENCLOSURES, SPEAKER HOUSINGS, AMPLIFIERS, POWER AMPLIFIERS, PREAMPLIFIERS, EQUALIZERS, CROSSOVERS, SIGNAL PROCESSORS, ACCESSORIES FOR AUDIO EQUIPMENT, IN CLASS 9 (U.S. CLS. 21, 23, 26, 36 AND 38).

FIRST USE 8-1-2006; IN COMMERCE 8-1-2006.

THE MARK CONSISTS OF STANDARD CHARACTERS WITHOUT CLAIM TO ANY PARTICULAR FONT, STYLE, SIZE, OR COLOR.

OWNER OF U.S. REG. NOS. 1,216,478, 2,679,953, AND 2,840,359.

NO CLAIM IS MADE TO THE EXCLUSIVE RIGHT TO USE "ACOUSTIC DESIGN", APART FROM THE MARK AS SHOWN.

SN 78-798,472, FILED 1-24-2006.

JAMES A. RAUEN, EXAMINING ATTORNEY

Int. Cl.: 9

Prior U.S. Cls.: 21, 23, 26, 36, and 38

United States Patent and Trademark Office

Reg. No. 3,399,795

Registered Mar. 18, 2008

**TRADEMARK
PRINCIPAL REGISTER**



ROCKFORD CORPORATION (ARIZONA CORPORATION)
600 SOUTH ROCKFORD DRIVE
TEMPE, AZ 85281

FIRST USE 8-1-2006; IN COMMERCE 8-1-2006.

OWNER OF U.S. REG. NOS. 1,216,478, 2,679,953,
AND 2,840,359.

FOR: AUDIO EQUIPMENT, NAMELY STEREOS, CD PLAYERS, MP3 PLAYERS, RADIOS, AUDIO SPEAKERS, WOOFERS, SUBWOOFERS, SPEAKER ENCLOSURES, SPEAKER HOUSINGS, AMPLIFIERS, POWER AMPLIFIERS, PREAMPLIFIERS, EQUALIZERS, CROSSOVERS, SIGNAL PROCESSORS, ACCESSORIES FOR AUDIO EQUIPMENT, IN CLASS 9 (U.S. CLS. 21, 23, 26, 36 AND 38).

NO CLAIM IS MADE TO THE EXCLUSIVE RIGHT TO USE "ACOUSTIC DESIGN", APART FROM THE MARK AS SHOWN.

SN 78-798,474, FILED 1-24-2006.

JAMES A. RAUEN, EXAMINING ATTORNEY

Int. Cls.: 2 and 9

Prior U.S. Cls.: 6, 11, 16, 21, 23, 26, 36, and 38

United States Patent and Trademark Office

Reg. No. 3,399,796

Registered Mar. 18, 2008

**TRADEMARK
PRINCIPAL REGISTER**

MK IMAGING

MITSUBISHI KAGAKU IMAGING CORP. (DE-
LAWARE CORPORATION)
401 VOLVO PARKWAY
CHESAPEAKE, VA 23320

FOR: PRINTER, COPIER AND FACSIMILE MA-
CHINE SUPPLIES, NAMELY, TONER, IN CLASS 2
(U.S. CLS. 6, 11 AND 16).

FIRST USE 3-0-2006; IN COMMERCE 3-0-2006.

FOR: PARTS AND ACCESSORIES AND REPLA-
CEMENT PARTS FOR PRINTERS, COPIERS AND
FACSIMILE MACHINES, NAMELY, DRUMS AND
DRUM UNITS, IN CLASS 9 (U.S. CLS. 21, 23, 26, 36
AND 38).

FIRST USE 3-0-2006; IN COMMERCE 3-0-2006.

THE MARK CONSISTS OF STANDARD CHAR-
ACTERS WITHOUT CLAIM TO ANY PARTICULAR
FONT, STYLE, SIZE, OR COLOR.

NO CLAIM IS MADE TO THE EXCLUSIVE
RIGHT TO USE "IMAGING", APART FROM THE
MARK AS SHOWN.

SN 78-798,544, FILED 1-24-2006.

CHRIS WELLS, EXAMINING ATTORNEY

Int. Cl.: 3

Prior U.S. Cls.: 1, 4, 6, 50, 51, and 52

United States Patent and Trademark Office

Reg. No. 3,399,797

Registered Mar. 18, 2008

TRADEMARK
PRINCIPAL REGISTER

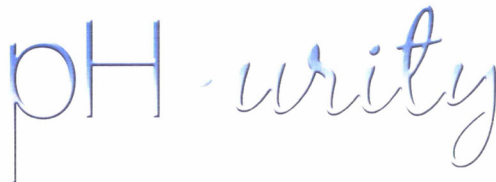
The image shows the trademark 'pH-writy' written in blue ink. The 'pH' is in a simple, blocky font, while 'writy' is in a cursive, handwritten style. A horizontal line is drawn through the middle of the 'pH' and the 'w'.

KOVACH, BARBARA, J (UNITED STATES INDIVIDUAL)
30870 FRANKLIN ROAD
FRANKLIN, MI 480251461 AND
DARWISH, TIMOTHY, A (UNITED STATES INDIVIDUAL)
30870 FRANKLIN ROAD
FRANKLIN, MI 480251461

FOR: ALL-PURPOSE CLEANERS; AUTOMOBILE CLEANERS; CARPET CLEANERS; CLEANER FOR USE ON HARD SURFACES; CLEANING PREPARATIONS FOR HOUSEHOLD PURPOSES; CLEANING PREPARATIONS FOR HARD SURFACES; DEGREASING PREPARATIONS FOR HOUSEHOLD PURPOSES; DEGREASING PREPARATIONS NOT USED IN MANUFACTURING PROCESSES FOR CLEANING METAL, PLASTIC AND SYNTHETIC SURFACES; DETERGENTS FOR AUTOMOBILES; FLOOR STRIPPING/CLEANING PREPARATION; GLASS CLEANERS; HOUSEHOLD CLEANING PRE-

PARATIONS; OVEN CLEANERS; PET STAIN REMOVERS; PREPARATIONS FOR CLEANING, PROTECTING AND PRESERVING VEHICLE SURFACES; SPOT REMOVER; STAIN REMOVERS; UPHOLSTERY CLEANERS; WHITEWALL CLEANERS, IN CLASS 3 (U.S. CLS. 1, 4, 6, 50, 51 AND 52).

FIRST USE 11-30-2005; IN COMMERCE 12-1-2006.

THE COLOR(S) BLUE, WHITE AND BLACK IS/ARE CLAIMED AS A FEATURE OF THE MARK.

THE COLOR(S) BLUE, WHITE AND BLACK APPEAR IN THE LETTERS.

SN 78-798,604, FILED 1-24-2006.

ROBERT C. CLARK JR., EXAMINING ATTORNEY

Int. Cl.: 43

Prior U.S. Cls.: 100 and 101

United States Patent and Trademark Office

Reg. No. 3,399,798

Registered Mar. 18, 2008

**SERVICE MARK
PRINCIPAL REGISTER**

AMERICA RUNS ON DUNKIN'

DD IP HOLDER LLC (DELAWARE LTD LIAB
CO)
P.O. BOX 9141
CANTON, MA 02021

FOR: RESTAURANT SERVICES AND CARRY-
OUT FOOD SERVICES, IN CLASS 43 (U.S. CLS. 100
AND 101).

FIRST USE 4-10-2006; IN COMMERCE 4-20-2006.

THE MARK CONSISTS OF STANDARD CHAR-
ACTERS WITHOUT CLAIM TO ANY PARTICULAR
FONT, STYLE, SIZE, OR COLOR.

OWNER OF U.S. REG. NOS. 748,901, 2,751,008,
AND OTHERS.

SN 78-798,803, FILED 1-25-2006.

ELIZABETH HUGHITT, EXAMINING ATTORNEY

Int. Cl.: 42

Prior U.S. Cls.: 100 and 101

United States Patent and Trademark Office

Reg. No. 3,399,799

Registered Mar. 18, 2008

**SERVICE MARK
PRINCIPAL REGISTER**

NERM

PCI INSURANCE, INC. (PENNSYLVANIA NON-
PROFIT CORPORATION)
417 WALNUT STREET
HARRISBURG, PA 17101

FOR: PROVIDING TEMPORARY USE OF NON-
DOWNLOADABLE COMPUTER SOFTWARE FOR
EMPLOYEE BENEFIT MANAGEMENT, NAMELY,
PREPARING CONSOLIDATED INVOICES, IN
CLASS 42 (U.S. CLS. 100 AND 101).

FIRST USE 6-1-2004; IN COMMERCE 6-1-2004.

THE MARK CONSISTS OF STANDARD CHAR-
ACTERS WITHOUT CLAIM TO ANY PARTICULAR
FONT, STYLE, SIZE, OR COLOR.

SN 78-799,124, FILED 1-25-2006.

MICHAEL KAZAZIAN, EXAMINING ATTORNEY

Int. Cls.: 9, 16, 35, 36, 37, 38, and 42

**Prior U.S. Cls.: 2, 5, 21, 22, 23, 26, 29, 36, 37, 38, 50,
100, 101, 102, 103, 104, and 106**

Reg. No. 3,399,800

United States Patent and Trademark Office

Registered Mar. 18, 2008

**TRADEMARK
SERVICE MARK
PRINCIPAL REGISTER**

EMBARQ

EMBARQ HOLDINGS COMPANY LLC (DELA-
WARE LTD LIAB CO)
5454 W. 110TH
OVERLAND PARK, KS 66211

FOR: PRE-PAID MAGNETICALLY-ENCODED
CALLING CARDS; TELEPHONES; DOWNLOA-
DABLE SOFTWARE FOR USE AS A DATABASE VIA
A GLOBAL COMPUTER NETWORK THAT EN-
ABLES THE USER TO DOWNLOAD GAMES, RING
TONES, GRAPHICS AND MUSIC TO COMPUTERS
AND WIRELESS DEVICES, IN CLASS 9 (U.S. CLS. 21,
23, 26, 36 AND 38).

FIRST USE 5-17-2006; IN COMMERCE 5-17-2006.

FOR: PRE-PAID NON-MAGNETICALLY ENCO-
DED CALLING CARDS, IN CLASS 16 (U.S. CLS. 2, 5,
22, 23, 29, 37, 38 AND 50).

FIRST USE 5-17-2006; IN COMMERCE 5-17-2006.

FOR: RETAIL STORE SERVICES FEATURING
TELECOMMUNICATIONS PRODUCTS AND SER-
VICES, NAMELY, TELECOMMUNICATIONS SER-
VICE PLANS AND TELECOMMUNICATIONS
SERVICE ACTIVATION, TELEPHONES AND TELE-
PHONE ACCESSORIES; OPERATION OF TELE-
COMMUNICATION NETWORK FACILITIES FOR
OTHERS, IN CLASS 35 (U.S. CLS. 100, 101 AND 102).

FIRST USE 5-17-2006; IN COMMERCE 5-17-2006.

FOR: PRE-PAID TELECOMMUNICATIONS PAY-
MENT AND TELEPHONE CALLING CARD SERVI-
CES, IN CLASS 36 (U.S. CLS. 100, 101 AND 102).

FIRST USE 5-17-2006; IN COMMERCE 5-17-2006.

FOR: INSTALLATION OF TELECOMMUNICA-
TIONS EQUIPMENT, IN CLASS 37 (U.S. CLS. 100, 103
AND 106).

FIRST USE 5-17-2006; IN COMMERCE 5-17-2006.

FOR: AUDIO AND VIDEO TELECONFEREN-
CING SERVICES, IN CLASS 38 (U.S. CLS. 100, 101
AND 104).

FIRST USE 5-17-2006; IN COMMERCE 5-17-2006.

FOR: COMPUTER SERVICES, NAMELY, RE-
STRICTING ACCESS TO AND BY COMPUTER
NETWORKS TO AND OF UNDESIRE WEB SITES,
MEDIA, INDIVIDUALS AND FACILITIES TO PRE-
VENT DISTRIBUTED DENIAL (DDOS) ATTACKS
ON NETWORKS AND SERVERS, IN CLASS 42 (U.S.
CLS. 100 AND 101).

FIRST USE 5-17-2006; IN COMMERCE 5-17-2006.

THE MARK CONSISTS OF STANDARD CHAR-
ACTERS WITHOUT CLAIM TO ANY PARTICULAR
FONT, STYLE, SIZE, OR COLOR.

SN 78-799,208, FILED 1-25-2006.

ALYSSA PALADINO, EXAMINING ATTORNEY

Int. Cl.: 9

Prior U.S. Cls.: 21, 23, 26, 36, and 38

United States Patent and Trademark Office

Reg. No. 3,399,801

Registered Mar. 18, 2008

**TRADEMARK
PRINCIPAL REGISTER**

SPINWAVE

SPINWAVE SYSTEMS, INC. (DELAWARE CORPORATION)
235 LITTLETON ROAD
WESTFORD, MA 01886

FOR: ELECTRONIC COMMUNICATIONS INSTRUMENTS AND COMPONENTS, NAMELY, A WIRELESS SENSOR NETWORKING SYSTEM OF SENSORS AND LOW-POWER, SHORT-DISTANCE WIRELESS COMMUNICATIONS HARDWARE AND SOFTWARE USED TO PROPAGATE SENSOR DATA AND CONTROL ACTUATORS, IN CLASS 9 (U.S. CLS. 21, 23, 26, 36 AND 38).

FIRST USE 1-28-2007; IN COMMERCE 2-23-2007.

THE MARK CONSISTS OF STANDARD CHARACTERS WITHOUT CLAIM TO ANY PARTICULAR FONT, STYLE, SIZE, OR COLOR.

SN 78-799,710, FILED 1-26-2006.

JULIE WATSON, EXAMINING ATTORNEY

Int. Cl.: 36

Prior U.S. Cls.: 100, 101, and 102

United States Patent and Trademark Office

Reg. No. 3,399,802

Registered Mar. 18, 2008

**SERVICE MARK
PRINCIPAL REGISTER**

**INFINITY SAFEGUARD
INSURANCE COMPANY**

INFINITY INSURANCE COMPANY (INDIANA
CORPORATION)
3700 COLONNADE PARKWAY
BIRMINGHAM, AL 35243

OWNER OF U.S. REG. NOS. 1,818,191, 2,472,418,
AND OTHERS.

FOR: PROPERTY AND CASUALTY INSURANCE
UNDERWRITING SERVICES, IN CLASS 36 (U.S.
CLS. 100, 101 AND 102).

NO CLAIM IS MADE TO THE EXCLUSIVE
RIGHT TO USE "INSURANCE COMPANY", APART
FROM THE MARK AS SHOWN.

FIRST USE 4-9-2007; IN COMMERCE 4-9-2007.

SN 78-800,125, FILED 1-26-2006.

THE MARK CONSISTS OF STANDARD CHAR-
ACTERS WITHOUT CLAIM TO ANY PARTICULAR
FONT, STYLE, SIZE, OR COLOR.

DAVID COLLIER, EXAMINING ATTORNEY

Int. Cl.: 28

Prior U.S. Cls.: 22, 23, 38, and 50

United States Patent and Trademark Office

Reg. No. 3,399,803

Registered Mar. 18, 2008

TRADEMARK
PRINCIPAL REGISTER

CYBER SUNDAY

WORLD WRESTLING ENTERTAINMENT, INC.
(DELAWARE CORPORATION)
1241 EAST MAIN STREET
STAMFORD, CT 06902

FOR: TOY ACTION FIGURES AND ACCESSORIES THEREFOR; CASES FOR ACTION FIGURES; TOY VEHICLES; BOARD GAMES; PLAYING CARDS; TOY SPINNING TOPS; STAND ALONE VIDEO OUTPUT GAME MACHINES FEATURING WRESTLING; ARCADE GAMES RELATED TO WRESTLING; PINBALL GAMES RELATED TO WRESTLING; HAND-HELD UNITS FOR PLAYING ELECTRONIC GAME; TABLETOP ACTION SKILL GAMES RELATED TO WRESTLING; JIGSAW PUZZLES; KITES; TOY WRESTLING RINGS; DOLLS; BOBBLE-HEAD DOLLS; PUPPETS; STUFFED TOY ANIMALS; CARD GAMES; TOY GUITARS; WATER GUNS; VINYL PRODUCTS FOR PLAYING IN A POOL, NAMELY, FLOATING PILLOW BACK LOUNGE CHAIR, INFLATABLE TOY RAFTS FOR AQUATIC RECREATIONAL USE; CHRISTMAS TREE DECORATIONS; COSTUME MASKS; TOY BELTS, DOLL FURNITURE; PARTY FAVORS IN THE NATURE OF CRACKERS AND NOISEMAK-

ERS; SKATEBOARDS; BOWLING BALLS AND ACCESSORIES, NAMELY, BOWLING GLOVES, WRIST SUPPORTS, BOWLING BALL BAGS; WINDUP TOYS; TOY SCOOTERS; BOWLING PINS; KNEE AND ELBOW PADS FOR ATHLETIC USE; YO-YO'S; PLASTIC MODEL KITS FOR MAKING TOY VEHICLES; POOL CUES; NOVELTY TOYS, NAMELY, TOY BANKS MADE OF TIN; TOY GUM MACHINES; TOY CANDY BOWL MECHANICAL DISPENSERS; TOY STICK GUM DISPENSERS; TOY GUM FIGURE MAKERS; TOY FOAM HANDS; CONFETTI, IN CLASS 28 (U.S. CLS. 22, 23, 38 AND 50).

FIRST USE 12-31-2006; IN COMMERCE 12-31-2006.

THE MARK CONSISTS OF STANDARD CHARACTERS WITHOUT CLAIM TO ANY PARTICULAR FONT, STYLE, SIZE, OR COLOR.

SN 78-800,294, FILED 1-26-2006.

JIM RINGLE, EXAMINING ATTORNEY

Int. Cl.: 12

Prior U.S. Cls.: 19, 21, 23, 31, 35, and 44

Reg. No. 3,399,804

United States Patent and Trademark Office

Registered Mar. 18, 2008

**TRADEMARK
PRINCIPAL REGISTER**

FAR HARBOUR 39

CONTAINER YACHTS LLC (DELAWARE LTD
LIAB CO)

534 DELAWARE AVENUE, SUITE 302

BUFFALO, NY 14202

FOR: BOAT, IN CLASS 12 (U.S. CLS. 19, 21, 23, 31, 35
AND 44).

FIRST USE 10-18-2007; IN COMMERCE 10-18-2007.

THE MARK CONSISTS OF STANDARD CHAR-
ACTERS WITHOUT CLAIM TO ANY PARTICULAR
FONT, STYLE, SIZE, OR COLOR.

NO CLAIM IS MADE TO THE EXCLUSIVE
RIGHT TO USE "39", APART FROM THE MARK
AS SHOWN.

SN 78-800,363, FILED 1-26-2006.

MELVIN AXILBUND, EXAMINING ATTORNEY

Int. Cl.: 12

Prior U.S. Cls.: 19, 21, 23, 31, 35, and 44

United States Patent and Trademark Office

Reg. No. 3,399,805

Registered Mar. 18, 2008

**TRADEMARK
PRINCIPAL REGISTER**

FH 39

CONTAINER YACHTS LLC (DELAWARE LTD
LIAB CO)

534 DELAWARE AVENUE, SUITE 302

BUFFALO, NY 14202

FOR: BOAT, IN CLASS 12 (U.S. CLS. 19, 21, 23, 31, 35
AND 44).

FIRST USE 10-18-2007; IN COMMERCE 10-18-2007.

THE MARK CONSISTS OF STANDARD CHAR-
ACTERS WITHOUT CLAIM TO ANY PARTICULAR
FONT, STYLE, SIZE, OR COLOR.

NO CLAIM IS MADE TO THE EXCLUSIVE
RIGHT TO USE "39", APART FROM THE MARK
AS SHOWN.

SN 78-800,385, FILED 1-26-2006.

MELVIN AXILBUND, EXAMINING ATTORNEY

Int. Cl.: 25

Prior U.S. Cls.: 22 and 39

United States Patent and Trademark Office

Reg. No. 3,399,806

Registered Mar. 18, 2008

**TRADEMARK
PRINCIPAL REGISTER**

VERRIDE

KURIHARA CORPORATION (JAPAN CORPORATION)
2-7-6, UTSUBO-HONMACHI
NISHI-KU, OSAKA-SHI
OSAKA-FU, JAPAN

FOR: KNITWEAR, NAMELY, KNIT SHIRTS, KNITTED CAPS, KNITTED HATS, KNITTED UNDERWEAR; T-SHIRTS; JERSEYS; SPORT COATS; SPORT SHIRTS; POLO SHIRTS; SWEAT SHIRTS; SWEAT PANTS; SWEAT SUITS; BANDANAS; MUFFLERS; EAR MUFFS; GLOVES, SOCKS; HEADGEAR, NAMELY, HATS AND CAPS; BERETS; VISORS; SUN VISORS; HEADBANDS; SANDALS; EXCLUDING SUNGLASSES, EYEGLASSES, EYEWEAR OR EYEWEAR ACCESSORIES, NAMELY, EYEGLASS CASES, EYEGLASS FRAMES, EYE-

GLASS CHAINS AND EYEGLASS LENSES; AND FURTHER EXCLUDING ALL HEADGEAR FEATURING SHADED TRANSLUCENT BILLS OR OTHERWISE SUGGESTIVE OR IMITATIVE OF SUNGLASSES, EYEGLASSES OR EYEWEAR, IN CLASS 25 (U.S. CLS. 22 AND 39).

FIRST USE 3-1-2007; IN COMMERCE 3-1-2007.

THE MARK CONSISTS OF STANDARD CHARACTERS WITHOUT CLAIM TO ANY PARTICULAR FONT, STYLE, SIZE, OR COLOR.

SN 78-802,528, FILED 1-30-2006.

SUSAN RICHARDS, EXAMINING ATTORNEY

Int. Cl.: 9

Prior U.S. Cls.: 21, 23, 26, 36, and 38

Reg. No. 3,399,807

United States Patent and Trademark Office

Registered Mar. 18, 2008

**TRADEMARK
PRINCIPAL REGISTER**

LIGHT-N-LOK

TYCO ELECTRONICS CORPORATION (PENNSYLVANIA CORPORATION)
2901 FULLING MILL ROAD
MIDDLETOWN, PA 17057

THE MARK CONSISTS OF STANDARD CHARACTERS WITHOUT CLAIM TO ANY PARTICULAR FONT, STYLE, SIZE, OR COLOR.

FOR: ELECTRICAL CONNECTORS FOR BALLASTS IN FLUORESCENT LIGHTING FIXTURES, IN CLASS 9 (U.S. CLS. 21, 23, 26, 36 AND 38).

SN 78-802,651, FILED 1-30-2006.

FIRST USE 10-31-2007; IN COMMERCE 10-31-2007.

VERNA BETH RIRIE, EXAMINING ATTORNEY

Int. Cl.: 20

Prior U.S. Cls.: 2, 13, 22, 25, 32, and 50

Reg. No. 3,399,808

United States Patent and Trademark Office

Registered Mar. 18, 2008

**TRADEMARK
PRINCIPAL REGISTER**

TOUGH FOR ALL YOUR STUFF

RSI HOME PRODUCTS MANAGEMENT, INC.
(DELAWARE CORPORATION)
12TH FLOOR
620 NEWPORT CENTER DRIVE
NEWPORT BEACH, CA 92660

FOR: CABINETS, NAMELY, KITCHEN CABINETS, BATHROOM CABINETS, MEDICINE CABINETS, MIRRORED CABINETS, STORAGE CABINETS AND GARAGE CABINETS; MIRRORS; COUNTERTOPS; STORAGE ACCESSORIES, NAMELY, BARS FOR HANGING CLOTHES, SLIDING CLOTHES RAILS, CLOTHES HANGERS, STORAGE RACKS, SHOE RACKS, BELT RACKS, TIE RACKS; PLASTIC STORAGE BINS, GARAGE STORAGE

CABINETS AND METAL AND NON-METAL GARAGE SHELVING; WORK BENCH; WALL-MOUNTED TOOL RACK, IN CLASS 20 (U.S. CLS. 2, 13, 22, 25, 32 AND 50).

FIRST USE 5-31-2007; IN COMMERCE 5-31-2007.

THE MARK CONSISTS OF STANDARD CHARACTERS WITHOUT CLAIM TO ANY PARTICULAR FONT, STYLE, SIZE, OR COLOR.

SN 78-802,730, FILED 1-30-2006.

NAAKWAMA ANKRAH, EXAMINING ATTORNEY

Int. Cl.: 25

Prior U.S. Cls.: 22 and 39

United States Patent and Trademark Office

Reg. No. 3,399,809

Registered Mar. 18, 2008

**TRADEMARK
PRINCIPAL REGISTER**

TALISHA ARZIKI

SHOE MAGNATE, INC. (CALIFORNIA CORPORATION)

18560 E. SAN JOSE AVENUE

CITY OF INDUSTRY, CA 91748

FOR: SHOES, IN CLASS 25 (U.S. CLS. 22 AND 39).

FIRST USE 1-26-2006; IN COMMERCE 3-1-2006.

THE MARK CONSISTS OF STANDARD CHARACTERS WITHOUT CLAIM TO ANY PARTICULAR FONT, STYLE, SIZE, OR COLOR.

THE NAME SHOWN IN THE MARK DOES NOT IDENTIFY A PARTICULAR LIVING INDIVIDUAL.

SN 78-803,385, FILED 1-31-2006.

RICHARD WHITE, EXAMINING ATTORNEY

Int. Cl.: 25

Prior U.S. Cls.: 22 and 39

United States Patent and Trademark Office

Reg. No. 3,399,810

Registered Mar. 18, 2008

**TRADEMARK
PRINCIPAL REGISTER**

KREWE OF COUSINS

STEWART, ANNE C (UNITED STATES INDIVIDUAL)
896 RIVER PARK DR.
MEMPHIS, TN 38103

THE MARK CONSISTS OF STANDARD CHARACTERS WITHOUT CLAIM TO ANY PARTICULAR FONT, STYLE, SIZE, OR COLOR.

FOR: CLOTHING AND OTHER APPAREL, NAMELY, PANTS, SHIRTS, WRISTBANDS, AND CAPS, IN CLASS 25 (U.S. CLS. 22 AND 39).

SN 78-803,395, FILED 1-31-2006.

FIRST USE 5-1-2006; IN COMMERCE 5-1-2006.

SHAUNIA CARLYLE, EXAMINING ATTORNEY

Int. Cls.: 3, 5, 19, and 20

**Prior U.S. Cls.: 1, 2, 4, 6, 12, 13, 18, 22, 25, 32, 33, 44,
46, 50, 51, and 52**

Reg. No. 3,399,811

United States Patent and Trademark Office

Registered Mar. 18, 2008

**TRADEMARK
PRINCIPAL REGISTER**

MOUNTAIN HOME CEDAR

ARKANSAS FACE VENEER COMPANY, INC.
(ARKANSAS CORPORATION)
706 CENTER STREET
BENTON, AR 72014

FOR: CEDAR AROMA ROOM SPRAYS, CEDAR
SACHETS, IN CLASS 3 (U.S. CLS. 1, 4, 6, 50, 51 AND
52).

FIRST USE 10-1-2005; IN COMMERCE 10-1-2005.

FOR: CEDAR WOOD NOVELTY PRODUCTS FOR
USE AS CLOTHING PROTECTORS AND DEODOR-
IZERS IN THE FORM OF BLOCKS, BALLS, BEARS,
HEARTS, CUBES, HOOK-UPS, AND HANGER
RINGS, IN CLASS 5 (U.S. CLS. 6, 18, 44, 46, 51 AND
52).

FIRST USE 10-1-2005; IN COMMERCE 10-1-2005.

FOR: CEDAR WOOD PRODUCTS, NAMELY,
PANELING AND MOLDING, IN CLASS 19 (U.S.
CLS. 1, 12, 33 AND 50).

FIRST USE 10-1-2005; IN COMMERCE 10-1-2005.

FOR: CEDAR WOOD PRODUCTS, NAMELY,
KITS CONSISTING PRIMARILY OF WOOD PA-
NELS FOR USE IN LINING CLOSETS; SHELVING;
CEDAR WOOD DRAWER LINERS, IN CLASS 20
(U.S. CLS. 2, 13, 22, 25, 32 AND 50).

FIRST USE 10-1-2005; IN COMMERCE 10-1-2005.

THE MARK CONSISTS OF STANDARD CHAR-
ACTERS WITHOUT CLAIM TO ANY PARTICULAR
FONT, STYLE, SIZE, OR COLOR.

NO CLAIM IS MADE TO THE EXCLUSIVE
RIGHT TO USE "CEDAR", APART FROM THE
MARK AS SHOWN.

SN 78-803,529, FILED 1-31-2006.

CYNTHIA SLOAN, EXAMINING ATTORNEY

Int. Cl.: 25

Prior U.S. Cls.: 22 and 39

United States Patent and Trademark Office

Reg. No. 3,399,812

Registered Mar. 18, 2008

**TRADEMARK
PRINCIPAL REGISTER**

SOUTHPOLE

WICKED FASHIONS, INC. (NEW YORK COR-
PORATION)
222 BRIDGE PLAZA SOUTH
FORT LEE, NJ 07024

THE MARK CONSISTS OF STANDARD CHAR-
ACTERS WITHOUT CLAIM TO ANY PARTICULAR
FONT, STYLE, SIZE, OR COLOR.

FOR: FOOTWEAR, IN CLASS 25 (U.S. CLS. 22 AND
39).

SN 78-803,556, FILED 1-31-2006.

FIRST USE 1-10-2007; IN COMMERCE 1-10-2007.

CYNTHIA SLOAN, EXAMINING ATTORNEY

Int. Cl.: 42

Prior U.S. Cls.: 100 and 101

United States Patent and Trademark Office

Reg. No. 3,399,813

Registered Mar. 18, 2008

**SERVICE MARK
PRINCIPAL REGISTER**

TRUST SOURCE

IDENTRUST, INC. (DELAWARE CORPORATION)
55 HAWTHORNE ST., SUITE 400
SAN FRANCISCO, CA 94105

FOR: DIGITAL CERTIFICATION AND SECURITY SERVICES, NAMELY, ISSUANCE AND VALIDATION OF DIGITAL CERTIFICATES PROVIDING AUTHENTICATION OF THE SOURCE OF A DIGITAL COMMUNICATION, AND AUTHENTICATION OF IDENTITY AND/OR OF A DIGITAL SIGNATURE IN AN ELECTRONIC TRANSACTION OR COMMUNICATION; COMPUTER CONSULTATION IN THE FIELD OF NETWORK SECURITY AND AUTHENTICATION OF DIGITAL SIGNATURES IN AN ELECTRONIC TRANSACTION OR COMMUNICATION; DESIGN OF COMPUTER HARDWARE, SOFTWARE, AND SPECIFICATIONS USED FOR NETWORK SECURITY AND AUTHENTICATION OF DIGITAL SIGNATURES AND IDENTITIES IN

AN ELECTRONIC TRANSACTION OR COMMUNICATION; TECHNICAL SUPPORT SERVICES, NAMELY, TROUBLESHOOTING OF COMPUTER HARDWARE AND SOFTWARE PROBLEMS VIA TELEPHONE, EMAIL AND IN PERSON, IN CLASS 42 (U.S. CLS. 100 AND 101).

FIRST USE 10-1-2007; IN COMMERCE 10-1-2007.

THE MARK CONSISTS OF STANDARD CHARACTERS WITHOUT CLAIM TO ANY PARTICULAR FONT, STYLE, SIZE, OR COLOR.

OWNER OF U.S. REG. NOS. 2,314,670 AND 2,319,404.

SN 78-803,812, FILED 1-31-2006.

TIMOTHY FINNEGAN, EXAMINING ATTORNEY

Int. Cl.: 42

Prior U.S. Cls.: 100 and 101

United States Patent and Trademark Office

Reg. No. 3,399,814

Registered Mar. 18, 2008

**SERVICE MARK
PRINCIPAL REGISTER**

TRUST INFRASTRUCTURE

IDENTRUST, INC. (DELAWARE CORPORATION)
55 HAWTHORNE ST., SUITE 400
SAN FRANCISCO, CA 94105

FOR: DIGITAL CERTIFICATION AND SECURITY SERVICES, NAMELY, ISSUANCE AND VALIDATION OF DIGITAL CERTIFICATES PROVIDING AUTHENTICATION OF THE SOURCE OF A DIGITAL COMMUNICATION, AND AUTHENTICATION OF IDENTITY AND/OR OF A DIGITAL SIGNATURE IN AN ELECTRONIC TRANSACTION OR COMMUNICATION; COMPUTER CONSULTATION IN THE FIELD OF NETWORK SECURITY AND AUTHENTICATION OF DIGITAL SIGNATURES IN AN ELECTRONIC TRANSACTION OR COMMUNICATION; DESIGN OF COMPUTER HARDWARE, SOFTWARE, AND SPECIFICATIONS USED FOR NETWORK SECURITY AND AUTHENTICATION OF DIGITAL SIGNATURES AND IDENTITIES IN AN ELECTRONIC TRANSACTION OR COMMUNICATION; TECHNICAL SUPPORT SERVICES,

NAMELY, TROUBLESHOOTING OF COMPUTER HARDWARE AND SOFTWARE PROBLEMS VIA TELEPHONE, EMAIL AND IN PERSON, IN CLASS 42 (U.S. CLS. 100 AND 101).

FIRST USE 10-1-2007; IN COMMERCE 10-1-2007.

THE MARK CONSISTS OF STANDARD CHARACTERS WITHOUT CLAIM TO ANY PARTICULAR FONT, STYLE, SIZE, OR COLOR.

OWNER OF U.S. REG. NO. 2,359,508.

NO CLAIM IS MADE TO THE EXCLUSIVE RIGHT TO USE "INFRASTRUCTURE", APART FROM THE MARK AS SHOWN.

SN 78-803,821, FILED 1-31-2006.

TIMOTHY FINNEGAN, EXAMINING ATTORNEY

Int. Cl.: 18

Prior U.S. Cls.: 1, 2, 3, 22, and 41

United States Patent and Trademark Office

Reg. No. 3,399,815

Registered Mar. 18, 2008

**TRADEMARK
PRINCIPAL REGISTER**



MORGAN MOTOR COMPANY LIMITED (UNI-
TED KINGDOM COMPANY)
PICKERSLEIGH ROAD MALVERN LINK
WORCESTERSHIRE, UNITED KINGDOM WR14
2LL

FOR: TRUNKS, SUIT CASES, TRAVELING BAGS,
LEATHER KEY HOLDERS, LEATHER KEY RINGS,
UMBRELLAS, ATTACHE CASES, BRIEFCASES,
LEATHER SUIT BAGS, WALLETS, PURSES, BUSI-
NESS CARD HOLDERS AND DOCUMENT CASES
ALL OF SKIN OR LEATHER, TOILETRY CASES

SOLD EMPTY AND VANITY CASES SOLD EMPTY,
RUCKSACKS, WAIST PACKS, AND SADDLERY, IN
CLASS 18 (U.S. CLS. 1, 2, 3, 22 AND 41).

FIRST USE 2-27-2007; IN COMMERCE 2-27-2007.

OWNER OF U.S. REG. NO. 1,715,474.

SN 78-804,937, FILED 2-1-2006.

JILL C. ALT, EXAMINING ATTORNEY

Int. Cl.: 36

Prior U.S. Cls.: 100, 101, and 102

United States Patent and Trademark Office

Reg. No. 3,399,816

Registered Mar. 18, 2008

**SERVICE MARK
PRINCIPAL REGISTER**

ON DECK FOR THE CURE

THE SUSAN G. KOMEN BREAST CANCER
FOUNDATION, INC. (TEXAS NON-PROFIT
CORPORATION)
5005 LBJ FREEWAY, SUITE 250
DALLAS, TX 75244

FOR: CHARITABLE FUNDRAISING SERVICES,
NAMELY, RAISING MONEY FOR BREAST CAN-
CER RESEARCH AND RAISING MONEY FOR
LOCAL COMMUNITY BREAST HEALTH AWARE-
NESS PROGRAMS, IN CLASS 36 (U.S. CLS. 100, 101
AND 102).

FIRST USE 2-0-2006; IN COMMERCE 2-0-2006.

THE MARK CONSISTS OF STANDARD CHAR-
ACTERS WITHOUT CLAIM TO ANY PARTICULAR
FONT, STYLE, SIZE, OR COLOR.

OWNER OF U.S. REG. NOS. 1,593,469, 2,075,352,
AND 2,406,792.

SN 78-805,285, FILED 2-2-2006.

FRED CARL, EXAMINING ATTORNEY

Int. Cl.: 9

Prior U.S. Cls.: 21, 23, 26, 36, and 38

United States Patent and Trademark Office

Reg. No. 3,399,817

Registered Mar. 18, 2008

**TRADEMARK
PRINCIPAL REGISTER**

All Flash

NEC ELECTRONICS CORPORATION (JAPAN
CORPORATION)
1753, SHIMONUMABE
NAKAHARA-KU, KAWASAKI
KANAGAWA, JAPAN

FOR: SEMICONDUCTORS, INTEGRATED CIR-
CUITS, MICROCONTROLLERS, FLASH MICRO-
CONTROLLERS, COMPUTER MEMORIES,
NAMELY, FLASH MEMORIES, READY ONLY
MEMORIES (ROMS), RANDOM ACCESS MEMOR-
IES (RAMS), IN CLASS 9 (U.S. CLS. 21, 23, 26, 36 AND
38).

FIRST USE 2-14-2006; IN COMMERCE 2-14-2006.

THE MARK CONSISTS OF STANDARD CHAR-
ACTERS WITHOUT CLAIM TO ANY PARTICULAR
FONT, STYLE, SIZE, OR COLOR.

NO CLAIM IS MADE TO THE EXCLUSIVE
RIGHT TO USE "FLASH", APART FROM THE
MARK AS SHOWN.

SN 78-806,248, FILED 2-3-2006.

ANNE FARRELL, EXAMINING ATTORNEY

Int. Cl.: 41

Prior U.S. Cls.: 100, 101, and 107

United States Patent and Trademark Office

Reg. No. 3,399,818

Registered Mar. 18, 2008

**SERVICE MARK
PRINCIPAL REGISTER**

NGS

NICE GUY STRATEGIES, LLC (MASSACHU-
SETTS LIMITED LIABILITY COMPANY)
58 MILK STREET
NEWBURYPORT, MA 01950

FOR: EDUCATIONAL SERVICES, NAMELY,
CONDUCTING WORKSHOPS AND SEMINARS IN
THE FIELD OF BUSINESS BEHAVIORS, PRACTI-
CES, AND STRATEGIES, IN CLASS 41 (U.S. CLS. 100,
101 AND 107).

FIRST USE 4-17-2007; IN COMMERCE 4-17-2007.

THE MARK CONSISTS OF STANDARD CHAR-
ACTERS WITHOUT CLAIM TO ANY PARTICULAR
FONT, STYLE, SIZE, OR COLOR.

SN 78-806,332, FILED 2-3-2006.

LEE-ANNE BERNS, EXAMINING ATTORNEY

Int. Cl.: 10

Prior U.S. Cls.: 26, 39, and 44

United States Patent and Trademark Office

Reg. No. 3,399,819

Registered Mar. 18, 2008

**TRADEMARK
PRINCIPAL REGISTER**

ORLUS

ORTHOLUTION CO., LTD. (REPUBLIC OF KOREA CORPORATION)
207-HO, DUNCHON B/D, 416-4 SEONGNAE-DONG
KANGDONG-GU
SEOUL, REPUBLIC OF KOREA

FOR: ORTHODONTIC MACHINES AND INSTRUMENTS FOR DENTAL PURPOSES; PROSTHETIC MACHINES AND INSTRUMENTS FOR DENTAL PURPOSES; DENTAL TREATMENT UNITS, NAMELY, DENTAL FIXATION SCREWS, GUIDED BONE REGENERATION (GBR) SCREWS, IN CLASS 10 (U.S. CLS. 26, 39 AND 44).

FIRST USE 5-9-2006; IN COMMERCE 5-9-2006.

THE MARK CONSISTS OF STANDARD CHARACTERS WITHOUT CLAIM TO ANY PARTICULAR FONT, STYLE, SIZE, OR COLOR.

SN 78-806,596, FILED 2-3-2006.

KATHY DE JONGE, EXAMINING ATTORNEY

Int. Cl.: 25

Prior U.S. Cls.: 22 and 39

United States Patent and Trademark Office

Reg. No. 3,399,820

Registered Mar. 18, 2008

**TRADEMARK
PRINCIPAL REGISTER**

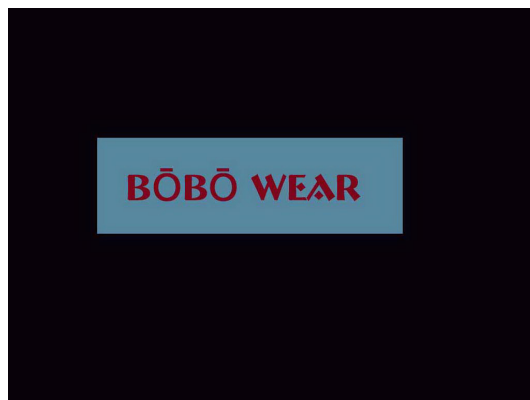

BOBO WEAR, INC. (PENNSYLVANIA CORPORATION)
207 W GIRARD AVE
PHILADELPHIA, PA 19125

FOR: ATHLETIC SHOES; CANVAS SHOES; CAPRI PANTS; DENIMS; POLO SHIRTS; SHIRTS; SHORT-SLEEVED OR LONG-SLEEVED T-SHIRTS; SHORT-SLEEVED SHIRTS; SWEAT PANTS; SWEAT SHIRTS; T-SHIRTS; WOMEN'S SHOES, IN CLASS 25 (U.S. CLS. 22 AND 39).

FIRST USE 1-10-2007; IN COMMERCE 1-10-2007.

NO CLAIM IS MADE TO THE EXCLUSIVE RIGHT TO USE "WEAR", APART FROM THE MARK AS SHOWN.

THE COLOR(S) BLACK, SLATE BLUE AND BRICK RED IS/ARE CLAIMED AS A FEATURE OF THE MARK.

THE COLOR BLACK APPEARS IN AN OUTER RECTANGLE; THE COLOR SLATE BLUE APPEARS IN AN INNER RECTANGLE CONTAINING THE WORDS BOBO WEAR; THE COLOR BRICK RED APPEARS ON THE LETTERS OF THE WORDS BOBO WEAR AND THE MACRON SYMBOL OVER THE LETTER O IN THE WORD BOBO.

THE MARK CONSISTS OF "BOBO WEAR" WITH A MACRON SYMBOL ABOVE THE LETTER O IN THE WORD BOBO AND DESIGN.

SN 78-807,361, FILED 2-4-2006.

SAMUEL E. SHARPER JR., EXAMINING ATTORNEY

Int. Cls.: 35 and 36

Prior U.S. Cls.: 100, 101, and 102

United States Patent and Trademark Office

Reg. No. 3,399,821

Registered Mar. 18, 2008

**SERVICE MARK
PRINCIPAL REGISTER**

SAGE ALLIANCES

SAGE RETAIL, INC. (ILLINOIS CORPORATION)
733 WOODRIDGE
GLENCOE, IL 60022

FOR: MARKETING SERVICES FOR COMMERCIAL PROPERTY OWNERS, NAMELY, THE PROVISION OF SIGNAGE FOR COMMERCIAL PROPERTIES; REAL ESTATE CONSULTING SERVICES TO COMMERCIAL PROPERTY OWNERS IN THE NATURE OF PROPERTY ENHANCEMENT STRATEGIES AND REGARDING THE PROPER BALANCE OF BUILDING AMENITIES SUCH AS RESTAURANTS, COFFEE SHOPS AND SUNDRY SHOPS; REAL ESTATE BROKERAGE SERVICES, NAMELY, MATCHING COMMERCIAL PROPERTY OWNERS WITH RESTAURANT, COFFEE SHOP AND SUNDRY SHOP OPERATORS FOR THE PURPOSE OF ESTABLISHING A LEASE, IN CLASS 35 (U.S. CLS. 100, 101 AND 102).

FIRST USE 12-1-2007; IN COMMERCE 12-1-2007.

FOR: REAL ESTATE BROKERAGE SERVICES FOR COMMERCIAL PROPERTY OWNERS TO ASSIST IN PROCURING RETAIL TENANTS, IN CLASS 36 (U.S. CLS. 100, 101 AND 102).

FIRST USE 12-1-2007; IN COMMERCE 12-1-2007.

THE MARK CONSISTS OF STANDARD CHARACTERS WITHOUT CLAIM TO ANY PARTICULAR FONT, STYLE, SIZE, OR COLOR.

NO CLAIM IS MADE TO THE EXCLUSIVE RIGHT TO USE "ALLIANCES", APART FROM THE MARK AS SHOWN.

SN 78-808,181, FILED 2-6-2006.

REBECCA POVARCHUK, EXAMINING ATTORNEY

Int. Cl.: 35

Prior U.S. Cls.: 100, 101, and 102

United States Patent and Trademark Office

Reg. No. 3,399,822

Registered Mar. 18, 2008

**SERVICE MARK
PRINCIPAL REGISTER**

CUBIXX

ASD SPECIALTY HEALTHCARE, INC. (CALIFORNIA CORPORATION), DBA AMERISOUR-CEBERGEN SPECIALTY GROUP,
3101 GAYLORD PARKWAY, 1N-186
FRISCO, TX 75034

FOR: PHARMACEUTICAL MANAGEMENT SERVICES FOR OTHERS, NAMELY, INVENTORY MANAGEMENT, REPLENISHING AND RESET-TING SERVICES AND AUTOMATED INVENTORY MONITORING SERVICES, IN CLASS 35 (U.S. CLS. 100, 101 AND 102).

FIRST USE 12-6-2005; IN COMMERCE 2-10-2006.

THE MARK CONSISTS OF STANDARD CHARACTERS WITHOUT CLAIM TO ANY PARTICULAR FONT, STYLE, SIZE, OR COLOR.

SN 78-808,194, FILED 2-6-2006.

AMEETA JORDAN, EXAMINING ATTORNEY

Int. Cl.: 44

Prior U.S. Cls.: 100 and 101

United States Patent and Trademark Office

Reg. No. 3,399,823

Registered Mar. 18, 2008

**SERVICE MARK
PRINCIPAL REGISTER**



THE GENERAL HOSPITAL CORPORATION
(MASSACHUSETTS CORPORATION)
55 FRUIT STREET
BOSTON, MA 02114

FOR: COUNSELING IN THE FIELD OF HEALTH AND WELLNESS; HEALTH CARE SERVICES IN THE NATURE OF A PROGRAM IN WHICH PARTICIPANTS ARE ENCOURAGED TO ADOPT HEALTHY PRACTICES AND IMPROVE THEIR OVERALL FITNESS, IN CLASS 44 (U.S. CLS. 100 AND 101).

FIRST USE 1-21-2005; IN COMMERCE 1-21-2005.

OWNER OF U.S. REG. NOS. 1,451,530 AND 2,384,444.

NO CLAIM IS MADE TO THE EXCLUSIVE RIGHT TO USE "FIT" AND "1811", APART FROM THE MARK AS SHOWN.

THE MARK CONSISTS OF THE DESIGN OF A STYLIZED HUMAN FIGURE WITH RAISED ARMS HOLDING A BARBELL, WITH THE LETTERS "B" AND "E" SHOWN ON THE CIRCULAR ENDS OF THE BARBELL, WITH A SHIELD DESIGN ON THE CHEST OF THE HUMAN FIGURE CONTAINING THE INITIALS "MGH", THE NUMBER "1811" AND A STYLIZED REPRESENTATION OF THE DOME AND PEDIMENT OF A BUILDING, AND WITH THE WORD "FIT" SHOWN BENEATH THE HUMAN FIGURE, ALL SHOWN WITHIN A CIRCLE.

SN 78-808,295, FILED 2-6-2006.

JAY BESCH, EXAMINING ATTORNEY

Int. Cls.: 6, 11, and 21

**Prior U.S. Cls.: 2, 12, 13, 14, 21, 23, 25, 29, 30, 31, 33,
34, 40, and 50**

Reg. No. 3,399,824

United States Patent and Trademark Office

Registered Mar. 18, 2008

**TRADEMARK
PRINCIPAL REGISTER**

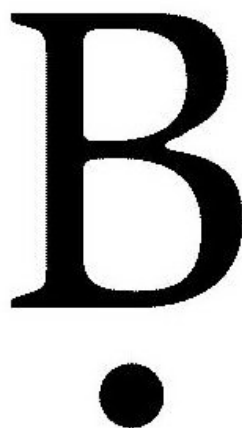
A large, bold, black serif letter 'B' is centered on the page. Below the letter is a solid black circle, serving as a period. The entire graphic is centered horizontally.

TRUE VALUE COMPANY (DELAWARE COR-
PORATION)
8600 WEST BRYN MAWR AVENUE
CHICAGO, IL 606313505

FOR: METAL ROBE HOOKS, IN CLASS 6 (U.S.
CLS. 2, 12, 13, 14, 23, 25 AND 50).

FIRST USE 11-0-2005; IN COMMERCE 11-0-2005.

FOR: FAUCETS; BATH HARDWARE, NAMELY,
FIXED SPOUTS ON WALLS AND DIRECTLY ON
THE BATHS AND BASINS, IN CLASS 11 (U.S. CLS.
13, 21, 23, 31 AND 34).

FIRST USE 11-0-2005; IN COMMERCE 11-0-2005.

FOR: BATH ACCESSORIES, NAMELY, TOWEL
BARS, TOWEL RINGS, TOILET TISSUE HOLDERS,
IN CLASS 21 (U.S. CLS. 2, 13, 23, 29, 30, 33, 40 AND 50).

FIRST USE 11-0-2005; IN COMMERCE 11-0-2005.

SN 78-809,630, FILED 2-8-2006.

JIM RINGLE, EXAMINING ATTORNEY

Int. Cls.: 25 and 28

Prior U.S. Cls.: 22, 23, 38, 39, and 50

United States Patent and Trademark Office

Reg. No. 3,399,825

Registered Mar. 18, 2008

**TRADEMARK
PRINCIPAL REGISTER**

WINGED EXPRESS

MARCELLUS, ALVIN, A. (UNITED STATES IN-
DIVIDUAL)
3204 W. STONYBROOK DRIVE
ANAHEIM, CA 92804

FOR: HATS; JACKETS; SHIRTS, IN CLASS 25 (U.S.
CLS. 22 AND 39).

FIRST USE 1-0-1969; IN COMMERCE 1-0-1969.

FOR: MODEL CARS, IN CLASS 28 (U.S. CLS. 22, 23,
38 AND 50).

FIRST USE 11-15-2005; IN COMMERCE 11-15-2005.

THE MARK CONSISTS OF STANDARD CHAR-
ACTERS WITHOUT CLAIM TO ANY PARTICULAR
FONT, STYLE, SIZE, OR COLOR.

SN 78-810,500, FILED 2-8-2006.

KATHY DE JONGE, EXAMINING ATTORNEY

Int. Cl.: 28

Prior U.S. Cls.: 22, 23, 38, and 50

United States Patent and Trademark Office

Reg. No. 3,399,826

Registered Mar. 18, 2008

**TRADEMARK
PRINCIPAL REGISTER**

TOT POD

LEACHCO, INC. (OKLAHOMA CORPORATION)
130 E. 10TH STREET
ADA, OK 74820

FOR: ACTIVITY CENTERS, NAMELY, PLAY
MATS CONTAINING MULTIPLE ACTIVITY TOYS
FOR INFANTS, TODDLERS, AND CHILDREN, IN
CLASS 28 (U.S. CLS. 22, 23, 38 AND 50).

FIRST USE 12-21-2007; IN COMMERCE 12-21-2007.

THE MARK CONSISTS OF STANDARD CHAR-
ACTERS WITHOUT CLAIM TO ANY PARTICULAR
FONT, STYLE, SIZE, OR COLOR.

NO CLAIM IS MADE TO THE EXCLUSIVE
RIGHT TO USE "TOT", APART FROM THE MARK
AS SHOWN.

SN 78-810,587, FILED 2-8-2006.

BARBARA BROWN, EXAMINING ATTORNEY

Int. Cls.: 9 and 11

Prior U.S. Cls.: 13, 21, 23, 26, 31, 34, 36, and 38

United States Patent and Trademark Office

Reg. No. 3,399,827

Registered Mar. 18, 2008

**TRADEMARK
PRINCIPAL REGISTER**

TRAILTRACKER

VECTOR PRODUCTS, INC. (FLORIDA CORPORATION)
8100 S.W. 10TH STREET, SUITE 3000
PLANTATION, FL 33324

FOR: COMBINATION TV AND LANTERN-STYLE FLASHLIGHT AND LED/AM/FM WEATHER BAND RADIO WITH INCLEMENT WEATHER WARNING SYSTEM, DYNAMO-POWERED AND RECHARGEABLE CAPABILITIES SOLD AS A UNIT; AM/FM WEATHER BAND RADIO WITH INCLEMENT WEATHER WARNING SYSTEM, DYNAMO-POWERED AND RECHARGEABLE CAPABILITIES; WALKIE-TALKIES; PORTABLE TWO-WAY HAND-HELD RADIOS; TWO-WAY RADIOS, IN CLASS 9 (U.S. CLS. 21, 23, 26, 36 AND 38).

FIRST USE 1-12-2006; IN COMMERCE 1-12-2006.

FOR: COMBINATION ELECTRIC LANTERN, FLASHLIGHT AND LED/AM/FM WEATHER BAND RADIO WITH INCLEMENT WEATHER WARNING SYSTEM, DYNAMO-POWERED AND RECHARGEABLE CAPABILITIES, SOLD AS A UNIT , IN CLASS 11 (U.S. CLS. 13, 21, 23, 31 AND 34).

FIRST USE 1-12-2006; IN COMMERCE 1-12-2006.

THE MARK CONSISTS OF STANDARD CHARACTERS WITHOUT CLAIM TO ANY PARTICULAR FONT, STYLE, SIZE, OR COLOR.

SN 78-810,844, FILED 2-9-2006.

MATTHEW EINSTEIN, EXAMINING ATTORNEY

Int. Cl.: 25

Prior U.S. Cls.: 22 and 39

United States Patent and Trademark Office

Reg. No. 3,399,828

Registered Mar. 18, 2008

**TRADEMARK
PRINCIPAL REGISTER**

LIFE'S EDGE

ROBERTSON, ALAN SCOTT (UNITED STATES
INDIVIDUAL)
10319 SETTLE RD.
SANTEE, CA 92071

THE MARK CONSISTS OF STANDARD CHAR-
ACTERS WITHOUT CLAIM TO ANY PARTICULAR
FONT, STYLE, SIZE, OR COLOR.

FOR: SHIRTS AND HATS, IN CLASS 25 (U.S. CLS.
22 AND 39).

SN 78-810,902, FILED 2-9-2006.

FIRST USE 3-1-2007; IN COMMERCE 3-1-2007.

ELLEN BURNS, EXAMINING ATTORNEY

Int. Cl.: 35

Prior U.S. Cls.: 100, 101, and 102

United States Patent and Trademark Office

Reg. No. 3,399,829

Registered Mar. 18, 2008

SERVICE MARK
PRINCIPAL REGISTER



WHIRLED MUSIC PUBLISHING, INC. (ARIZONA CORPORATION)
10017 N 16TH AVE
PHOENIX, AZ 85021

FIRST USE 4-1-2002; IN COMMERCE 4-1-2002.

FOR: ADVERTISING AND PROMOTION, NAME-
LY, LICENSING OF COMPACT DISCS AND INTER-
NET LINKS FEATURING PRE-RECORDED MUSIC
FOR USE IN TELEVISION, RADIO, WIRELESS
COMMUNICATION DEVICES AND INTERNET
BROADCASTING AND DISTRIBUTION, IN CLASS
35 (U.S. CLS. 100, 101 AND 102).

NO CLAIM IS MADE TO THE EXCLUSIVE
RIGHT TO USE "MUSIC", APART FROM THE
MARK AS SHOWN.

SN 78-811,157, FILED 2-9-2006.

MICHAEL SOUDERS, EXAMINING ATTORNEY

Int. Cls.: 5, 16, and 42

**Prior U.S. Cls.: 2, 5, 6, 18, 22, 23, 29, 37, 38, 44, 46, 50,
51, 52, 100, and 101**

Reg. No. 3,399,830

United States Patent and Trademark Office

Registered Mar. 18, 2008

**TRADEMARK
SERVICE MARK
PRINCIPAL REGISTER**

**UNIQUE DELIVERY, PROVEN
RESULTS**

SOMERSET PHARMACEUTICALS, INC. (DELA-
WARE CORPORATION)
2202 NORTH WEST SHORE BOULEVARD #450
TAMPA, FL 33607

FOR: PHARMACEUTICAL PREPARATIONS FOR
THE TREATMENT OF DEPRESSION, AND OTHER
NEUROLOGICAL AND/OR MENTAL CONDITIONS
OR DISEASES, ADMINISTERED THROUGH A
TRANSDERMAL PATCH, IN CLASS 5 (U.S. CLS. 6,
18, 44, 46, 51 AND 52).

FIRST USE 4-1-2006; IN COMMERCE 4-1-2006.

FOR: PRINTED MATTER, NAMELY, PROMO-
TIONAL MATERIALS, INFORMATIONAL MATE-
RIALS, BROCHURES, PAMPHLETS,
NEWSLETTERS AND STATIONERY RELATING
TO PHARMACEUTICALS AND THE TREATMENT

AND PREVENTION OF DISEASES, IN CLASS 16
(U.S. CLS. 2, 5, 22, 23, 29, 37, 38 AND 50).

FIRST USE 4-1-2006; IN COMMERCE 4-1-2006.

FOR: PHARMACEUTICAL RESEARCH AND DE-
VELOPMENT SERVICES, IN CLASS 42 (U.S. CLS. 100
AND 101).

FIRST USE 4-1-2006; IN COMMERCE 4-1-2006.

THE MARK CONSISTS OF STANDARD CHAR-
ACTERS WITHOUT CLAIM TO ANY PARTICULAR
FONT, STYLE, SIZE, OR COLOR.

SN 78-811,907, FILED 2-10-2006.

DAVID COLLIER, EXAMINING ATTORNEY

Int. Cl.: 14

Prior U.S. Cls.: 2, 27, 28, and 50

United States Patent and Trademark Office

Reg. No. 3,399,831

Registered Mar. 18, 2008

**TRADEMARK
PRINCIPAL REGISTER**

dangler studios

DANGLER, PAUL J. (UNITED STATES INDIVIDUAL)

1695 10TH ST. SUITE 200

SARASOTA, FL 34236

FOR: JEWELRY, IN CLASS 14 (U.S. CLS. 2, 27, 28 AND 50).

FIRST USE 1-1-2000; IN COMMERCE 1-1-2000.

THE MARK CONSISTS OF STANDARD CHARACTERS WITHOUT CLAIM TO ANY PARTICULAR FONT, STYLE, SIZE, OR COLOR.

NO CLAIM IS MADE TO THE EXCLUSIVE RIGHT TO USE "STUDIOS", APART FROM THE MARK AS SHOWN.

SN 78-812,255, FILED 2-10-2006.

SETH A. RAPPAPORT, EXAMINING ATTORNEY

Int. Cl.: 25

Prior U.S. Cls.: 22 and 39

United States Patent and Trademark Office

Reg. No. 3,399,832

Registered Mar. 18, 2008

**TRADEMARK
PRINCIPAL REGISTER**

ZERY'S

ENTEBI HAMUI, ALFONSO (MEXICO INDIVIDUAL)

ANDRÓMACO NO. 84, 2º PISO
COL. AMPLIACIÓN GRANADA
MÉXICO, MÉXICO, D.F., MEXICO

FOR: SUITS, JACKETS, TROUSERS, SHIRTS,
TIES, SHOES, SOCKS, T-SHIRTS, SWEATERS,
JEANS AND COATS, FOR KIDS, YOUNG PEOPLE
AND GENTLEMEN, IN CLASS 25 (U.S. CLS. 22 AND
39).

FIRST USE 12-14-1989; IN COMMERCE 2-10-2006.

THE MARK CONSISTS OF STANDARD CHARACTERS WITHOUT CLAIM TO ANY PARTICULAR FONT, STYLE, SIZE, OR COLOR.

SN 78-812,759, FILED 2-11-2006.

WON TEAK OH, EXAMINING ATTORNEY

Int. Cl.: 30

Prior U.S. Cl.: 46

United States Patent and Trademark Office

Reg. No. 3,399,833

Registered Mar. 18, 2008

**TRADEMARK
PRINCIPAL REGISTER**

REVOLUTION ICED

REVOLUTION TEA, LLC (ARIZONA LTD LIAB
CO)
5120 W. BUCKEYE STE. 5
PHOENIX, AZ 85043

OWNER OF U.S. REG. NO. 2,964,518.

FOR: TEA, TEA-BASED BEVERAGES, AROMAT-
IC TEAS, FRUIT TEAS AND FRUIT FLAVORED
TEA, AND HERBAL TEAS, IN CLASS 30 (U.S. CL. 46).

NO CLAIM IS MADE TO THE EXCLUSIVE
RIGHT TO USE "ICED", APART FROM THE MARK
AS SHOWN.

FIRST USE 5-1-2006; IN COMMERCE 5-1-2006.

SN 78-813,504, FILED 2-13-2006.

THE MARK CONSISTS OF STANDARD CHAR-
ACTERS WITHOUT CLAIM TO ANY PARTICULAR
FONT, STYLE, SIZE, OR COLOR.

BRIAN NEVILLE, EXAMINING ATTORNEY

Int. Cl.: 9

Prior U.S. Cls.: 21, 23, 26, 36, and 38

United States Patent and Trademark Office

Reg. No. 3,399,834

Registered Mar. 18, 2008

**TRADEMARK
PRINCIPAL REGISTER**

MEDTIMES

MTS MEDICATION TECHNOLOGIES, INC. (DELAWARE CORPORATION)
2003 GRANDY BLVD.
ST. PETERSBURG, FL 33702

FOR: COMPUTER WORKSTATION FOR MANAGEMENT AND SECURE ACCESS TO MEDICATION, CONSISTING OF COMPUTER HARDWARE, COMPUTER SOFTWARE, AND AN ELECTRONIC STORAGE UNIT; COMPUTER SOFTWARE, NAMELY, SOFTWARE FOR TRACKING, DELIVERY, IDENTIFICATION, STORAGE, ADMINISTERING, AUDITING, REPORTING AND MANAGEMENT OF MEDICATION; COMPUTER SOFTWARE, NAMELY, SOFTWARE FOR MANAGEMENT AND

SECURE STORAGE OF INFORMATION RELATING TO MEDICINE, PATIENTS, DOCTORS, PHARMACIES AND HEALTH CARE FACILITIES, IN CLASS 9 (U.S. CLS. 21, 23, 26, 36 AND 38).

FIRST USE 8-19-2003; IN COMMERCE 8-19-2003.

THE MARK CONSISTS OF STANDARD CHARACTERS WITHOUT CLAIM TO ANY PARTICULAR FONT, STYLE, SIZE, OR COLOR.

SN 78-813,666, FILED 2-13-2006.

ZACHARY BELLO, EXAMINING ATTORNEY

Int. Cl.: 36

Prior U.S. Cls.: 100, 101, and 102

United States Patent and Trademark Office

Reg. No. 3,399,835

Registered Mar. 18, 2008

**SERVICE MARK
PRINCIPAL REGISTER**

LONGHORN

KRISTYNIK, KRIS (UNITED STATES INDIVIDUAL)
SUITE 4450
1445 ROSS AVENUE
DALLAS, TX 75202

FOR: HEDGE FUND MANAGEMENT AND INVESTMENT; EQUITY CAPITAL MANAGEMENT SERVICES; INVESTMENT AND FINANCIAL ADVISORY AND MANAGEMENT SERVICES, IN CLASS 36 (U.S. CLS. 100, 101 AND 102).

FIRST USE 5-0-2006; IN COMMERCE 5-0-2006.

THE MARK CONSISTS OF STANDARD CHARACTERS WITHOUT CLAIM TO ANY PARTICULAR FONT, STYLE, SIZE, OR COLOR.

SN 78-813,834, FILED 2-13-2006.

AMY HELLA, EXAMINING ATTORNEY

Int. Cl.: 3

Prior U.S. Cls.: 1, 4, 6, 50, 51, and 52

United States Patent and Trademark Office

Reg. No. 3,399,836

Registered Mar. 18, 2008

**TRADEMARK
PRINCIPAL REGISTER**

KEEPIN IT REAL

AMIR, INC. (MINNESOTA CORPORATION)
2755 HIGHWAY 55
EAGAN, MN 55121

FOR: HAIR CARE PRODUCTS, NAMELY, SHAM-
POO, HAIR CONDITIONER, HAIR SPRAY, HAIR
CARE GELS AND CREAMS, AND HAIR REPAIR
CREAMS, IN CLASS 3 (U.S. CLS. 1, 4, 6, 50, 51 AND
52).

FIRST USE 8-1-2007; IN COMMERCE 8-1-2007.

THE MARK CONSISTS OF STANDARD CHAR-
ACTERS WITHOUT CLAIM TO ANY PARTICULAR
FONT, STYLE, SIZE, OR COLOR.

SN 78-814,137, FILED 2-14-2006.

DAVID MURRAY, EXAMINING ATTORNEY

Int. Cls.: 40 and 42

Prior U.S. Cls.: 100, 101, 103, and 106

United States Patent and Trademark Office

Reg. No. 3,399,837

Registered Mar. 18, 2008

**SERVICE MARK
PRINCIPAL REGISTER**

NTH/WORKS

PRECISION TOOL, DIE AND MACHINE CO.,
INC. (KENTUCKY CORPORATION)
6901 PRESTON HIGHWAY
LOUISVILLE, KY 40219

FOR: ASSEMBLY OF PRODUCTS FOR OTHERS,
POWDER COATING AND ELECTROSTATIC
PAINTING, REPROGRAPHIC IMAGING SERVI-
CES, NAMELY, PHOTOGRAPHIC REPRODUC-
TION AND PRINTING ON METAL FOR OTHERS,
SCREEN PRINTING, METAL FABRICATION, FIN-
ISHING AND STAMPING, IN CLASS 40 (U.S. CLS.
100, 103 AND 106).

FIRST USE 4-3-2006; IN COMMERCE 4-3-2006.

FOR: INDUSTRIAL DESIGN CONSULTING SER-
VICES, IN CLASS 42 (U.S. CLS. 100 AND 101).

FIRST USE 4-3-2006; IN COMMERCE 4-3-2006.

THE MARK CONSISTS OF STANDARD CHAR-
ACTERS WITHOUT CLAIM TO ANY PARTICULAR
FONT, STYLE, SIZE, OR COLOR.

THE WORDING "NTH" HAS NO MEANING
OTHER THAN TRADEMARK SIGNIFICANCE.

SN 78-814,640, FILED 2-14-2006.

KATHERINE CONNOLLY, EXAMINING ATTOR-
NEY

Int. Cl.: 37

Prior U.S. Cls.: 100, 103, and 106

United States Patent and Trademark Office

Reg. No. 3,399,838

Registered Mar. 18, 2008

**SERVICE MARK
PRINCIPAL REGISTER**

BUILDING A WIRELESS WORLD

TRI-POWER GROUP, INC. (CALIFORNIA CORPORATION)
85 NICHOLSON LANE
SAN JOSE, CA 95134

THE MARK CONSISTS OF STANDARD CHARACTERS WITHOUT CLAIM TO ANY PARTICULAR FONT, STYLE, SIZE, OR COLOR.

FOR: CUSTOM CONSTRUCTION OF WIRELESS TELECOMMUNICATIONS NETWORKS, AND CONSULTING SERVICES IN CONNECTION THEREWITH, IN CLASS 37 (U.S. CLS. 100, 103 AND 106).

SN 78-814,673, FILED 2-14-2006.

FIRST USE 11-30-2005; IN COMMERCE 11-30-2005.

REBECCA GILBERT, EXAMINING ATTORNEY

Int. Cl.: 9

Prior U.S. Cls.: 21, 23, 26, 36, and 38

Reg. No. 3,399,839

United States Patent and Trademark Office

Registered Mar. 18, 2008

**TRADEMARK
PRINCIPAL REGISTER**

BURSTING BALLOONS

ROCKET GAMING SYSTEMS, LLC (DELAWARE
LTD LIAB CO)
8311 W. SUNSET RD., SUITE 110
LAS VEGAS, NV 89113

THE MARK CONSISTS OF STANDARD CHAR-
ACTERS WITHOUT CLAIM TO ANY PARTICULAR
FONT, STYLE, SIZE, OR COLOR.

FOR: GAMING MACHINES, NAMELY, BINGO-
RELATED GAMES AND SLOT MACHINES, IN
CLASS 9 (U.S. CLS. 21, 23, 26, 36 AND 38).

SN 78-814,928, FILED 2-14-2006.

FIRST USE 11-13-2007; IN COMMERCE 11-13-2007.

MONIQUE MILLER, EXAMINING ATTORNEY

Int. Cl.: 6

Prior U.S. Cls.: 2, 12, 13, 14, 23, 25, and 50

Reg. No. 3,399,840

United States Patent and Trademark Office

Registered Mar. 18, 2008

**TRADEMARK
PRINCIPAL REGISTER**

TURBOTORQUE

GRANT PRIDECO, L.P. (DELAWARE LIMITED
PARTNERSHIP)
SUITE 900
400 NORTH SAM HOUSTON PARKWAY EAST
HOUSTON, TX 77060

FOR: THREADED METAL DRILL PIPE CONNEC-
TIONS USED ON METAL DRILL PIPE FOR THE
DRILLING OF OIL AND GAS WELLS AND OTHER
EARTH BOREHOLES , IN CLASS 6 (U.S. CLS. 2, 12,
13, 14, 23, 25 AND 50).

FIRST USE 4-30-2007; IN COMMERCE 4-30-2007.

THE MARK CONSISTS OF STANDARD CHAR-
ACTERS WITHOUT CLAIM TO ANY PARTICULAR
FONT, STYLE, SIZE, OR COLOR.

SN 78-815,423, FILED 2-15-2006.

ALEXANDER L. POWERS, EXAMINING ATTOR-
NEY

Int. Cl.: 9

Prior U.S. Cls.: 21, 23, 26, 36, and 38

Reg. No. 3,399,841

United States Patent and Trademark Office

Registered Mar. 18, 2008

**TRADEMARK
PRINCIPAL REGISTER**

TIKI TALK

ARISTOCRAT TECHNOLOGIES AUSTRALIA
PTY LTD (AUSTRALIA LTD LIAB CO)
71 LONGUEVILLE ROAD
LANE COVE, NEW SOUTH WALES, AUSTRALIA
2066

FOR: GAMING DEVICES, NAMELY, GAMING
MACHINES AND COMPUTER SOFTWARE USED
THEREWITH TO ENABLE THE GAMING MA-
CHINE TO RUN, IN CLASS 9 (U.S. CLS. 21, 23, 26,
36 AND 38).

FIRST USE 9-6-2007; IN COMMERCE 9-6-2007.

THE MARK CONSISTS OF STANDARD CHAR-
ACTERS WITHOUT CLAIM TO ANY PARTICULAR
FONT, STYLE, SIZE, OR COLOR.

SN 78-816,879, FILED 2-16-2006.

JOHN DWYER, EXAMINING ATTORNEY

Int. Cl.: 43

Prior U.S. Cls.: 100 and 101

United States Patent and Trademark Office

Reg. No. 3,399,842

Registered Mar. 18, 2008

**SERVICE MARK
PRINCIPAL REGISTER**

SCOPOLOGY

HAYMAN, DENISE (UNITED STATES INDIVIDUAL)
7610 UNION PARK AVENUE
MIDVALE, UT 84047

THE MARK CONSISTS OF STANDARD CHARACTERS WITHOUT CLAIM TO ANY PARTICULAR FONT, STYLE, SIZE, OR COLOR.

FOR: RESTAURANT SERVICES, IN CLASS 43 (U.S. CLS. 100 AND 101).

SN 78-816,947, FILED 2-16-2006.

FIRST USE 8-10-2006; IN COMMERCE 8-10-2006.

RONALD AIKENS, EXAMINING ATTORNEY

Int. Cl.: 33

Prior U.S. Cls.: 47 and 49

United States Patent and Trademark Office

Reg. No. 3,399,843

Registered Mar. 18, 2008

**TRADEMARK
PRINCIPAL REGISTER**

WHITE GOLD

"WHITE GOLD", LLC (RUSSIAN FED. LTD LIAB
CO)
KORP. 21A, D. 34, KUTUZOVSKY PROSPEKT
MOSCOW, RUSSIAN FED. 121170

FOR: APERITIFS; ORAK; BRANDY; WINE; WHIS-
KEY; GIN; VODKA; PREPARED ALCOHOLIC
COCKTAILS; LIQUEURS; ALCOHOLIC BEVERA-
GES, NAMELY, ALCOHOLIC COFFEE-BASED BEV-
ERAGE; ALCOHOLIC TEA-BASED BEVERAGE;
ALCOHOLIC PUNCH; CALVADOS; CHAMPAGNE;
COGNAC; CURACAO; HERB LIQUEURS; OUZO;
SCHNAPPS; TEQUILA; ALCOHOLIC BEVERAGES
CONTAINING FRUIT; DISTILLED SPIRITS; MEAD;

PEPPERMINT LIQUEURS; ALCOHOLIC BITTERS;
RUM; SAKE; HARD CIDER; RICE ALCOHOL, IN
CLASS 33 (U.S. CLS. 47 AND 49).

FIRST USE 8-0-2005; IN COMMERCE 8-0-2005.

THE MARK CONSISTS OF STANDARD CHAR-
ACTERS WITHOUT CLAIM TO ANY PARTICULAR
FONT, STYLE, SIZE, OR COLOR.

SN 78-817,190, FILED 2-17-2006.

SALLY SHIH, EXAMINING ATTORNEY

Int. Cl.: 33

Prior U.S. Cls.: 47 and 49

United States Patent and Trademark Office

Reg. No. 3,399,844

Registered Mar. 18, 2008

TRADEMARK
PRINCIPAL REGISTER



"WHITE GOLD", LLC (RUSSIAN FED. LTD LIAB
CO)
KORP. 21A, D. 34, KUTUZOVSKY PROSPEKT
MOSCOW, RUSSIAN FED. 121170

FOR: APERITIFS; ORAK; BRANDY; WINE; WHIS-
KEY; GIN; VODKA; PREPARED ALCOHOLIC
COCKTAILS; LIQUEURS; ALCOHOLIC BEVERA-
GES, NAMELY, ALCOHOLIC COFFEE-BASED BEV-
ERAGE; ALCOHOLIC TEA-BASED BEVERAGE;
ALCOHOLIC PUNCH; CALVADOS; CHAMPAGNE;
COGNAC; CURACAO; HERB LIQUEURS; OUZO;
SCHNAPPS; TEQUILA; ALCOHOLIC BEVERAGES
CONTAINING FRUIT; DISTILLED SPIRITS; MEAD;
PEPPERMINT LIQUEURS; ALCOHOLIC BITTERS;
RUM; SAKE; HARD CIDER; RICE ALCOHOL, IN
CLASS 33 (U.S. CLS. 47 AND 49).

FIRST USE 8-0-2005; IN COMMERCE 8-0-2005.

THE COLOR(S) THREE SHADES OF GOLD, BLUE
AND WHITE IS/ARE CLAIMED AS A FEATURE OF
THE MARK.

THE MARK CONSISTS OF A STYLIZED SHAPE
WITH A BACKGROUND OF A FIRST SHADE OF
"GOLD", A BLUE TRIM LINE THEREWITHIN, AN
INNER OUTLINE OF A SECOND SHADE OF
"GOLD", AND AN INNER FIELD OF A THIRD
SHADE OF "GOLD", WITH THE WORDS "WHITE
GOLD" THEREIN IN "WHITE."

SN 78-817,194, FILED 2-17-2006.

SALLY SHIH, EXAMINING ATTORNEY

Int. Cl.: 19

Prior U.S. Cls.: 1, 12, 33, and 50

United States Patent and Trademark Office

Reg. No. 3,399,845

Registered Mar. 18, 2008

**TRADEMARK
PRINCIPAL REGISTER**

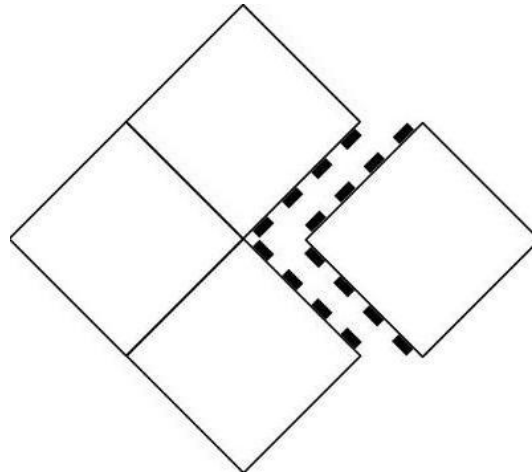

COMC LLC (NEBRASKA LTD LIAB CO)
14001 CHALCO VALLEY PARKWAY
OMAHA, NE 68138

FOR: NON-METAL FLOOR TILES, IN CLASS 19
(U.S. CLS. 1, 12, 33 AND 50).

FIRST USE 6-14-2006; IN COMMERCE 6-14-2006.

THE MARK CONSISTS OF FOUR SQUARES
REPRESENTING INTERLOCKING FLOOR TILES
WITH ONE DISENGAGED TILE.

SN 78-817,224, FILED 2-17-2006.

WILLIAM P. SHANAHAN, EXAMINING ATTOR-
NEY

Int. Cl.: 29

Prior U.S. Cl.: 46

United States Patent and Trademark Office

Reg. No. 3,399,846

Registered Mar. 18, 2008

**TRADEMARK
PRINCIPAL REGISTER**

FLAVOR LOCK CAP

KRAFT FOODS HOLDINGS, INC. (DELAWARE
CORPORATION)
THREE LAKES DRIVE
NORTHFIELD, IL 60093

FOR: CAPS TO SEAL IN FLAVOR SOLD AS AN
INTEGRAL COMPONENT OF PACKAGING FOR
CHEESE, IN CLASS 29 (U.S. CL. 46).

FIRST USE 6-1-2007; IN COMMERCE 6-1-2007.

THE MARK CONSISTS OF STANDARD CHAR-
ACTERS WITHOUT CLAIM TO ANY PARTICULAR
FONT, STYLE, SIZE, OR COLOR.

NO CLAIM IS MADE TO THE EXCLUSIVE
RIGHT TO USE "CAP", APART FROM THE MARK
AS SHOWN.

SN 78-818,017, FILED 2-17-2006.

JAMES MACFARLANE, EXAMINING ATTORNEY

Int. Cl.: 3

Prior U.S. Cls.: 1, 4, 6, 50, 51, and 52

United States Patent and Trademark Office

Reg. No. 3,399,847

Registered Mar. 18, 2008

**TRADEMARK
PRINCIPAL REGISTER**

Save your Rainforest

SAVE YOUR WORLD, LLC (NEW JERSEY LTD
LIAB CO)
P.O. BOX 745
SHORT HILLS, NJ 07078

THE MARK CONSISTS OF STANDARD CHAR-
ACTERS WITHOUT CLAIM TO ANY PARTICULAR
FONT, STYLE, SIZE, OR COLOR.

FOR: SHAMPOO, HAIR CONDITIONER, SOAPS,
FACE CREAM, IN CLASS 3 (U.S. CLS. 1, 4, 6, 50, 51
AND 52).

SN 78-818,761, FILED 2-20-2006.

FIRST USE 5-23-2007; IN COMMERCE 5-23-2007.

BRENDAN REGAN, EXAMINING ATTORNEY

Int. Cl.: 21

Prior U.S. Cls.: 2, 13, 23, 29, 30, 33, 40, and 50

Reg. No. 3,399,848

United States Patent and Trademark Office

Registered Mar. 18, 2008

**TRADEMARK
PRINCIPAL REGISTER**

RAYA

THERMOS L.L.C. (DELAWARE LIMITED LIABILITY COMPANY)
2550 WEST GOLF ROAD
ROLLING MEADOWS, IL 60008

THE MARK CONSISTS OF STANDARD CHARACTERS WITHOUT CLAIM TO ANY PARTICULAR FONT, STYLE, SIZE, OR COLOR.

FOR: LUNCHBOXES, COOLER BAGS AND THERMALLY INSULATED TOTE BAGS FOR CARRYING CLOSED CONTAINERS OF FOOD AND BEVERAGES, IN CLASS 21 (U.S. CLS. 2, 13, 23, 29, 30, 33, 40 AND 50).

OWNER OF U.S. REG. NO. 2,984,199.

SN 78-818,764, FILED 2-20-2006.

FIRST USE 2-15-2007; IN COMMERCE 2-15-2007.

DANNEAN HETZEL, EXAMINING ATTORNEY

Int. Cl.: 10

Prior U.S. Cls.: 26, 39, and 44

United States Patent and Trademark Office

Reg. No. 3,399,849

Registered Mar. 18, 2008

**TRADEMARK
PRINCIPAL REGISTER**

PROSTOP

ARTHREX, INC. (DELAWARE CORPORATION)
1370 CREEKSIDE BLVD.
NAPLES, FL 34108

THE MARK CONSISTS OF STANDARD CHAR-
ACTERS WITHOUT CLAIM TO ANY PARTICULAR
FONT, STYLE, SIZE, OR COLOR.

FOR: MEDICAL IMPLANTS, NAMELY, AN IM-
PLANT COMPRISING ARTIFICIAL MATERIALS
USED FOR ARTHROEREISIS REPAIR, IN CLASS
10 (U.S. CLS. 26, 39 AND 44).

SN 78-819,079, FILED 2-20-2006.

FIRST USE 7-27-2006; IN COMMERCE 7-27-2006.

SALLY SHIH, EXAMINING ATTORNEY

Int. Cl.: 40

Prior U.S. Cls.: 100, 103, and 106

United States Patent and Trademark Office

Reg. No. 3,399,850

Registered Mar. 18, 2008

**SERVICE MARK
PRINCIPAL REGISTER**

RESOPREG

PANOLAM INDUSTRIES INTERNATIONAL,
INC. (DELAWARE CORPORATION)
20 PROGRESS DRIVE
SHELTON, CT 06484

FOR: PAPER TREATMENT, IN CLASS 40 (U.S.
CLS. 100, 103 AND 106).

FIRST USE 12-29-1964; IN COMMERCE 12-29-1964.

THE MARK CONSISTS OF STANDARD CHAR-
ACTERS WITHOUT CLAIM TO ANY PARTICULAR
FONT, STYLE, SIZE, OR COLOR.

OWNER OF U.S. REG. NO. 800,838.

SN 78-819,410, FILED 2-21-2006.

ALICIA COLLINS, EXAMINING ATTORNEY

Int. Cl.: 4

Prior U.S. Cls.: 1, 6, and 15

United States Patent and Trademark Office

Reg. No. 3,399,851

Registered Mar. 18, 2008

**TRADEMARK
PRINCIPAL REGISTER**

POLYPHOS

CUSTOM SYNTHESIS, LLC (NORTH CAROLINA
LTD LIAB CO)
P.O. BOX 5254
ANDERSON, SC 29623

THE MARK CONSISTS OF STANDARD CHAR-
ACTERS WITHOUT CLAIM TO ANY PARTICULAR
FONT, STYLE, SIZE, OR COLOR.

FOR: LUBRICATING OILS, IN CLASS 4 (U.S. CLS.
1, 6 AND 15).

SN 78-819,500, FILED 2-21-2006.

FIRST USE 7-1-2007; IN COMMERCE 1-2-2008.

REBECCA EISINGER, EXAMINING ATTORNEY

Int. Cl.: 12

Prior U.S. Cls.: 19, 21, 23, 31, 35, and 44

United States Patent and Trademark Office

Reg. No. 3,399,852

Registered Mar. 18, 2008

**TRADEMARK
PRINCIPAL REGISTER**

OSHKOSH

OSHKOSH TRUCK CORPORATION (WISCONSIN CORPORATION)

2307 OREGON STREET

OSHKOSH, WI 549032566

FOR: LAND VEHICLES, NAMELY, TACTICAL WHEELED VEHICLES FOR ON AND OFF-ROAD APPLICATIONS, IN CLASS 12 (U.S. CLS. 19, 21, 23, 31, 35 AND 44).

FIRST USE 9-30-1976; IN COMMERCE 9-30-1976.

THE MARK CONSISTS OF STANDARD CHARACTERS WITHOUT CLAIM TO ANY PARTICULAR FONT, STYLE, SIZE, OR COLOR.

OWNER OF U.S. REG. NOS. 840,787 AND 1,194,281.

SEC. 2(F).

SN 78-819,569, FILED 2-21-2006.

ANDREA K. NADELMAN, EXAMINING ATTORNEY

Int. Cl.: 29

Prior U.S. Cl.: 46

United States Patent and Trademark Office

Reg. No. 3,399,853

Registered Mar. 18, 2008

**TRADEMARK
PRINCIPAL REGISTER**

SHOWBOAT

BBI, INC. (DELAWARE CORPORATION)
300 DELAWARE AVENUE, SUITE 900
WILMINGTON, DE 19801

FOR: CANNED PORK AND BEANS IN TOMATO
SAUCE, BEANS AND PEAS IN SAUCE OR BRINE,
IN CLASS 29 (U.S. CL. 46).

FIRST USE 5-0-1954; IN COMMERCE 5-0-1954.

THE MARK CONSISTS OF STANDARD CHAR-
ACTERS WITHOUT CLAIM TO ANY PARTICULAR
FONT, STYLE, SIZE, OR COLOR.

OWNER OF U.S. REG. NOS. 1,035,452 AND
2,151,718.

SN 78-819,633, FILED 2-21-2006.

FRED CARL, EXAMINING ATTORNEY

Int. Cl.: 42

Prior U.S. Cls.: 100 and 101

United States Patent and Trademark Office

Reg. No. 3,399,854

Registered Mar. 18, 2008

**SERVICE MARK
PRINCIPAL REGISTER**

EDITSENSE

CHARLESBERND AG (FED REP GERMANY
AKTIENGESELLSCHAFT)
MAXIMILIANSTRABE 26
MÜNCHEN, FED REP GERMANY 80539

THE MARK CONSISTS OF STANDARD CHAR-
ACTERS WITHOUT CLAIM TO ANY PARTICULAR
FONT, STYLE, SIZE, OR COLOR.

FOR: PROVIDING CUSTOMIZED ON-LINE WEB
PAGES FEATURING USER-DEFINED INFORMA-
TION, WHICH INCLUDES SEARCH ENGINES AND
ON-LINE WEB LINKS TO OTHER WEB SITES , IN
CLASS 42 (U.S. CLS. 100 AND 101).

SN 78-819,731, FILED 2-21-2006.

FIRST USE 2-21-2006; IN COMMERCE 7-15-2007.

KATHERINE E. HALMEN, EXAMINING ATTOR-
NEY

Int. Cl.: 30

Prior U.S. Cl.: 46

United States Patent and Trademark Office

Reg. No. 3,399,855

Registered Mar. 18, 2008

**TRADEMARK
PRINCIPAL REGISTER**

BITS 'N PIECES

STEAK N SHAKE LLC (INDIANA LTD LIAB CO)
500 CENTURY BUILDING
36 SOUTH PENNSYLVANIA STREET
INDIANAPOLIS, IN 46204

THE MARK CONSISTS OF STANDARD CHAR-
ACTERS WITHOUT CLAIM TO ANY PARTICULAR
FONT, STYLE, SIZE, OR COLOR.

FOR: MILK SHAKES, IN CLASS 30 (U.S. CL. 46).

SN 78-820,693, FILED 2-22-2006.

FIRST USE 5-17-2006; IN COMMERCE 5-17-2006.

KHANH LE, EXAMINING ATTORNEY

Int. Cl.: 42

Prior U.S. Cls.: 100 and 101

United States Patent and Trademark Office

Reg. No. 3,399,856

Registered Mar. 18, 2008

**SERVICE MARK
PRINCIPAL REGISTER**

HODGEPODGE

HODGE, BRUCE (UNITED STATES INDIVIDUAL)
PO BOX 428
GREENFIELD, NY 12833

THE MARK CONSISTS OF STANDARD CHARACTERS WITHOUT CLAIM TO ANY PARTICULAR FONT, STYLE, SIZE, OR COLOR.

FOR: COMPUTER SERVICES, NAMELY, PROVIDING SEARCH ENGINES FOR OBTAINING DATA ON A GLOBAL COMPUTER NETWORK, IN CLASS 42 (U.S. CLS. 100 AND 101).

SN 78-821,852, FILED 2-23-2006.

FIRST USE 7-31-2007; IN COMMERCE 7-31-2007.

MICHELE SWAIN, EXAMINING ATTORNEY

Int. Cl.: 35

Prior U.S. Cls.: 100, 101, and 102

United States Patent and Trademark Office

Reg. No. 3,399,857

Registered Mar. 18, 2008

**SERVICE MARK
PRINCIPAL REGISTER**

PRODUCTPIPE

HODGE, BRUCE (UNITED STATES INDIVIDUAL)
PO BOX 428
GREENFIELD, NY 12833

FOR: PROVIDING CONSUMER PRODUCT INFORMATION; PROVIDING COMPARISON SHOPPING INFORMATION, PROVIDING ONLINE DIRECTORY INFORMATION SERVICES ALSO FEATURING HYPERLINKS TO OTHER WEBSITES, DISSEMINATION OF ADVERTISING FOR OTHERS VIA THE INTERNET; ONLINE ADVERTISING SERVICES FOR OTHERS, NAMELY PROVIDING AD-

VERTISING SPACE ON INTERNET WEB SITES, IN CLASS 35 (U.S. CLS. 100, 101 AND 102).

FIRST USE 7-31-2007; IN COMMERCE 7-31-2007.

THE MARK CONSISTS OF STANDARD CHARACTERS WITHOUT CLAIM TO ANY PARTICULAR FONT, STYLE, SIZE, OR COLOR.

SN 78-821,866, FILED 2-23-2006.

MICHELE SWAIN, EXAMINING ATTORNEY

Int. Cl.: 35

Prior U.S. Cls.: 100, 101, and 102

United States Patent and Trademark Office

Reg. No. 3,399,858

Registered Mar. 18, 2008

**SERVICE MARK
PRINCIPAL REGISTER**

KEEPYOU COMPANY

KEEPYOU, COMPANY (NEVADA CORPORATION)
SUITE 105
1200 SOUTH FOURTH STREET
LAS VEGAS, NV 89104

FOR: PROVIDING NON-MEDICAL ASSISTED LIVING SERVICES IN THE NATURE OF SCHEDULING APPOINTMENTS, ANSWERING THE TELEPHONE, CHECKING MESSAGES, MAIL SORTING, HANDLING AND RECEIVING, AND SECRETARIAL AND CLERICAL SERVICES, IN CLASS 35 (U.S. CLS. 100, 101 AND 102).

FIRST USE 2-13-2006; IN COMMERCE 2-13-2006.

THE MARK CONSISTS OF STANDARD CHARACTERS WITHOUT CLAIM TO ANY PARTICULAR FONT, STYLE, SIZE, OR COLOR.

SN 78-822,116, FILED 2-23-2006.

JIM RINGLE, EXAMINING ATTORNEY

Int. Cl.: 43

Prior U.S. Cls.: 100 and 101

United States Patent and Trademark Office

Reg. No. 3,399,859

Registered Mar. 18, 2008

**SERVICE MARK
PRINCIPAL REGISTER**

KEEPYOU COMPANY

KEEPYOU, COMPANY (NEVADA CORPORATION)
1200 SOUTH FOURTH STREET
SUITE 105
LAS VEGAS, NV 89104

FOR: PROVIDING NON-MEDICAL ASSISTED LIVING SERVICES IN THE NATURE OF MEAL PLANNING, DIET PLANNING, MEAL PREPARATION, MONITORING AND ASSISTING IN EATING, DRINKING AND DIET, AND PET DAY CARE, IN CLASS 43 (U.S. CLS. 100 AND 101).

FIRST USE 2-13-2006; IN COMMERCE 2-13-2006.

THE MARK CONSISTS OF STANDARD CHARACTERS WITHOUT CLAIM TO ANY PARTICULAR FONT, STYLE, SIZE, OR COLOR.

SN 78-822,191, FILED 2-23-2006.

JIM RINGLE, EXAMINING ATTORNEY

Int. Cl.: 3

Prior U.S. Cls.: 1, 4, 6, 50, 51, and 52

United States Patent and Trademark Office

Reg. No. 3,399,860

Registered Mar. 18, 2008

TRADEMARK
PRINCIPAL REGISTER



SERAPH COSMETICS, INC. (CALIFORNIA CORPORATION)
1939 ARGYLE AVE. #23
HOLLYWOOD, CA 90068

FOR: BODY AND BEAUTY CARE COSMETICS; CLEANSING CREAMS; CONCEALERS; COSMETIC CREAMS FOR SKIN CARE; COSMETIC PENCILS; COSMETIC PREPARATIONS FOR EYE LASHES; COSMETIC PREPARATIONS FOR SKIN RENEWAL; COSMETIC ROUGES; COSMETIC SUN-PROTECTING PREPARATIONS; COSMETICS; COSMETICS, NAMELY, COMPACTS; MAKE-UP KITS COMPRISED OF EYE SHADOWS, BLUSH, LIP GLOSSES; PENCILS FOR COSMETIC PURPOSES, IN CLASS 3 (U.S. CLS. 1, 4, 6, 50, 51 AND 52).

FIRST USE 9-26-2007; IN COMMERCE 9-26-2007.

THE COLORS BLACK AND WHITE ARE CLAIMED AS A FEATURE OF THE MARK.

THE MARK CONSISTS OF "SERAPH" IN CAPITAL LETTERS OVER A GIRL ANGEL WITH WINGS HOLDING THE WORLD FLOATING BETWEEN HER HANDS.

SN 78-822,267, FILED 2-23-2006.

KATHERINE M. DUBRAY, EXAMINING ATTORNEY

Int. Cl.: 29

Prior U.S. Cl.: 46

United States Patent and Trademark Office

Reg. No. 3,399,861

Registered Mar. 18, 2008

**TRADEMARK
PRINCIPAL REGISTER**

REDDER IS BETTER

COMPART FAMILY FARMS, INC. (MINNESOTA
CORPORATION)
45198 400TH STREET
NICOLLET, MN 56074

THE MARK CONSISTS OF STANDARD CHAR-
ACTERS WITHOUT CLAIM TO ANY PARTICULAR
FONT, STYLE, SIZE, OR COLOR.

FOR: MEAT, IN CLASS 29 (U.S. CL. 46).

SN 78-823,174, FILED 2-24-2006.

FIRST USE 5-7-2006; IN COMMERCE 5-7-2006.

SUNG IN, EXAMINING ATTORNEY

Int. Cl.: 22

Prior U.S. Cls.: 1, 2, 7, 19, 22, 42, and 50

Reg. No. 3,399,862

United States Patent and Trademark Office

Registered Mar. 18, 2008

**TRADEMARK
PRINCIPAL REGISTER**



NEMO EQUIPMENT, INC. (DELAWARE CORPORATION)
UNIT 2A
100 FACTORY ST
NASHUA, NH 03060

FIRST USE 4-7-2005; IN COMMERCE 4-7-2005.

THE MARK CONSISTS OF THE LETTER "N" FORMING A SHIELD.

FOR: CAMPING ACCESSORIES, NAMELY, TENTS, IN CLASS 22 (U.S. CLS. 1, 2, 7, 19, 22, 42 AND 50).

SN 78-823,253, FILED 2-24-2006.

KELLEY WELLS, EXAMINING ATTORNEY

Int. Cl.: 16

Prior U.S. Cls.: 2, 5, 22, 23, 29, 37, 38, and 50

Reg. No. 3,399,863

United States Patent and Trademark Office

Registered Mar. 18, 2008

**TRADEMARK
PRINCIPAL REGISTER**

BOX POUCH

TOTANI CORPORATION (JAPAN CORPORATION)
4-44 NAKAKUZE-CHO, KUZE
MINAMI-KU, KYOTO, JAPAN 601-8213

FOR: GENERAL PURPOSE PLASTIC BAGS;
PLASTIC SHOPPING BAGS, IN CLASS 16 (U.S. CLS.
2, 5, 22, 23, 29, 37, 38 AND 50).

FIRST USE 10-10-2007; IN COMMERCE 10-10-2007.

THE MARK CONSISTS OF STANDARD CHARACTERS WITHOUT CLAIM TO ANY PARTICULAR FONT, STYLE, SIZE, OR COLOR.

NO CLAIM IS MADE TO THE EXCLUSIVE RIGHT TO USE "POUCH", APART FROM THE MARK AS SHOWN.

SN 78-824,871, FILED 2-28-2006.

SCOTT SISUN, EXAMINING ATTORNEY

Int. Cl.: 10

Prior U.S. Cls.: 26, 39, and 44

United States Patent and Trademark Office

Reg. No. 3,399,864

Registered Mar. 18, 2008

**TRADEMARK
PRINCIPAL REGISTER**

PROGRIP

HYPOGUARD AMERICA LIMITED (UNITED
KINGDOM COMPANY)
5198 WEST 76TH STREET
EDINA, MN 55439

FOR: SLIPPAGE CONTROL PADS MADE OF
RUBBER-LIKE MATERIAL SOLD AS AN INTE-
GRAL COMPONENT OF BLOOD GLUCOSE ME-
TERS; BLOOD GLUCOSE METERS, IN CLASS 10
(U.S. CLS. 26, 39 AND 44).

FIRST USE 4-14-2006; IN COMMERCE 4-14-2006.

THE MARK CONSISTS OF STANDARD CHAR-
ACTERS WITHOUT CLAIM TO ANY PARTICULAR
FONT, STYLE, SIZE, OR COLOR.

SN 78-826,038, FILED 3-1-2006.

PAUL F. GAST, EXAMINING ATTORNEY

Int. Cl.: 38

Prior U.S. Cls.: 100, 101, and 104

United States Patent and Trademark Office

Reg. No. 3,399,865

Registered Mar. 18, 2008

**SERVICE MARK
PRINCIPAL REGISTER**



CITY OF NORTH KANSAS CITY (MISSOURI
MUNICIPAL CORPORATION)
2010 HOWELL
NORTH KANSAS CITY, MO 64116

FOR: PROVIDING HIGH SPEED INTERNET AC-
CESS; DIGITAL TELECOMMUNICATIONS AND
INFORMATION SERVICES, NAMELY, THE ELEC-
TRONIC TRANSMISSION OF DATA, VOICE, MU-

SIC, AND IMAGES; E-MAIL SERVICES, IN CLASS 38
(U.S. CLS. 100, 101 AND 104).

FIRST USE 12-7-2005; IN COMMERCE 12-7-2005.

SN 78-826,135, FILED 3-1-2006.

MARK PILARO, EXAMINING ATTORNEY

Int. Cl.: 38

Prior U.S. Cls.: 100, 101, and 104

United States Patent and Trademark Office

Reg. No. 3,399,866

Registered Mar. 18, 2008

**SERVICE MARK
PRINCIPAL REGISTER**

LINKCITY

CITY OF NORTH KANSAS CITY (MISSOURI
MUNICIPAL CORPORATION)
2010 HOWELL
NORTH KANSAS CITY, MO 64116

FOR: PROVIDING HIGH SPEED INTERNET AC-
CESS; DIGITAL TELECOMMUNICATIONS AND
INFORMATION SERVICES, NAMELY, THE ELEC-
TRONIC TRANSMISSION OF DATA, VOICE, MU-
SIC, AND IMAGES; E-MAIL SERVICES, IN CLASS 38
(U.S. CLS. 100, 101 AND 104).

FIRST USE 12-7-2005; IN COMMERCE 12-7-2005.

THE MARK CONSISTS OF STANDARD CHAR-
ACTERS WITHOUT CLAIM TO ANY PARTICULAR
FONT, STYLE, SIZE, OR COLOR.

SN 78-826,144, FILED 3-1-2006.

MARK PILARO, EXAMINING ATTORNEY

Int. Cls.: 35, 38, 41, and 42

Prior U.S. Cls.: 100, 101, 102, 104, and 107

United States Patent and Trademark Office

Reg. No. 3,399,867

Registered Mar. 18, 2008

**SERVICE MARK
PRINCIPAL REGISTER**

IMG WORLDWIDE, INC. (OHIO CORPORATION)
SUITE 100

IMG CENTER, 1360 EAST NINTH STREET
CLEVELAND, OH 441141782

FOR: MANAGEMENT OF CELEBRITIES, PERFORMING ARTISTS, MODELS, PROFESSIONAL ATHLETES, BROADCASTERS, AUTHORS AND DESIGNERS; BUSINESS SERVICES, NAMELY, MANAGEMENT OF THE PERSONAL AFFAIRS OF OTHERS; ASSISTANCE IN MANAGEMENT OF BUSINESS ACTIVITIES AND EVENTS; PROCURING AND NEGOTIATING CONTRACTS, LICENSES, AND ENDORSEMENTS FOR OTHERS; PROMOTING THE GOODS AND SERVICES OF OTHERS VIA ELECTRONIC MEDIA; ADVERTISING SERVICES; PROVIDING COMMERCIAL INFORMATION, VIA PRINT AND ELECTRONIC MEDIA, IN THE FIELDS OF FASHION, SPORTS, CONSUMER PRODUCTS, LICENSING AND ENDORSEMENTS; ADVERTISING AND PUBLICITY SERVICES, NAMELY, PROMOTING THE GOODS, SERVICES, BRAND IDENTITY, AND COMMERCIAL INFORMATION AND NEWS OF THIRD PARTIES THROUGH PRINT, AUDIO, VIDEO, DIGITAL AND ON-LINE MEDIA; ADVERTISING, INCLUDING PROMOTION OF PRODUCTS AND SERVICES OF THIRD PARTIES THROUGH SPONSORING ARRANGEMENTS AND LICENSE AGREEMENTS; ADVERTISING CONSULTATION; COMMERCIAL CONSULTANCY; MARKETING CONSULTING; SPONSORSHIP CONSULTING; SALES PROMOTION AND PUBLIC RELATIONS CONSULTING SERVICES; MODELING AGENCIES; PLANNING AND CONDUCTING OF TRADE SHOWS, EVENTS, EXHIBITIONS AND PRESENTATIONS FOR PROMOTING THE GOODS AND SERVICES OF OTHERS; MARKETING AND PROMOTIONAL SERVICES FOR RECREATIONAL OR LEISURE FACILITIES

OWNED BY OTHERS, IN CLASS 35 (U.S. CLS. 100, 101 AND 102).

FIRST USE 3-31-2006; IN COMMERCE 3-31-2006.

FOR: STREAMING OF VIDEO MATERIAL ON THE INTERNET AND OTHER ELECTRONIC MEDIA, IN CLASS 38 (U.S. CLS. 100, 101 AND 104).

FIRST USE 3-31-2006; IN COMMERCE 3-31-2006.

FOR: ARRANGING AND CONDUCTING ATHLETIC COMPETITIONS AND EVENTS, FASHION SHOWS, EXHIBITIONS, CONFERENCES, CONCERTS, HOME AND GARDEN SHOWS, AWARD CEREMONIES, AND GENERAL ENTERTAINMENT SHOWS; ENTERTAINMENT SERVICES, NAMELY, PROVIDING TELEVISION AND OTHER VIDEO PROGRAMS IN THE FIELDS OF SPORTS, FASHION, REALITY PROGRAMMING AND GENERAL ENTERTAINMENT; PRODUCTION OF VIDEO PROGRAM CONTENT; PUBLISHING OF PRINTED PUBLICATIONS, BOOKS AND MAGAZINES; PUBLISHING OF ELECTRONIC PUBLICATIONS; PROVIDING INFORMATION IN THE FIELD OF SPORTS, ARTS AND ENTERTAINMENT VIA ELECTRONIC MEDIA; INSTRUCTION IN TENNIS, GOLF, SOCCER, BASEBALL, BASKETBALL, IMPROVING PHYSICAL ATHLETIC PERFORMANCE, MENTAL CONDITIONING FOR IMPROVED PERFORMANCE IN SPORTS AND ATHLETIC ACTIVITIES AND LIFE SKILLS, AND OFFICIATING AND CAMPS COMPRISING SUCH INSTRUCTION, IN CLASS 41 (U.S. CLS. 100, 101 AND 107).

FIRST USE 3-31-2006; IN COMMERCE 3-31-2006.

FOR: LICENSING OF INTELLECTUAL PROPERTY, IN CLASS 42 (U.S. CLS. 100 AND 101).

FIRST USE 3-31-2006; IN COMMERCE 3-31-2006.

OWNER OF U.S. REG. NOS. 1,232,130, 2,333,751,
AND OTHERS.

THE COLOR(S) BLUE IS/ARE CLAIMED AS A
FEATURE OF THE MARK.

THE MARK CONSISTS OF THE LETTERS "IMG"
WITH THREE TRIANGLES IN THE MIDDLE OF
THE LETTER "M", ALL IN BLUE.

SN 78-826,401, FILED 3-1-2006.

HENRY S. ZAK, EXAMINING ATTORNEY

Int. Cl.: 9

Prior U.S. Cls.: 21, 23, 26, 36, and 38

United States Patent and Trademark Office

Reg. No. 3,399,868

Registered Mar. 18, 2008

**TRADEMARK
PRINCIPAL REGISTER**

CORE. PERFORMANCE WORKWEAR

ERGODYNE CORPORATION (MINNESOTA
CORPORATION)
1021 BANDANA BOULEVARD EAST
SUITE 220
ST. PAUL, MN 55108

FOR: PROTECTIVE CLOTHING, IN CLASS 9 (U.S.
CLS. 21, 23, 26, 36 AND 38).

FIRST USE 11-17-2007; IN COMMERCE 11-17-2007.

THE MARK CONSISTS OF STANDARD CHAR-
ACTERS WITHOUT CLAIM TO ANY PARTICULAR
FONT, STYLE, SIZE, OR COLOR.

NO CLAIM IS MADE TO THE EXCLUSIVE
RIGHT TO USE "WORKWEAR", APART FROM
THE MARK AS SHOWN.

SN 78-827,021, FILED 3-2-2006.

KAREN BRACEY, EXAMINING ATTORNEY

Int. Cl.: 43

Prior U.S. Cls.: 100 and 101

United States Patent and Trademark Office

Reg. No. 3,399,869

Registered Mar. 18, 2008

**SERVICE MARK
PRINCIPAL REGISTER**

6 COLUMBUS HOTEL

THOMPSON HOTELS LLC (DELAWARE LIMITED LIABILITY COMPANY)

100 VANDAM STREET, 4TH FLOOR

NEW YORK, NY 10013

FOR: HOTEL SERVICES, IN CLASS 43 (U.S. CLS. 100 AND 101).

FIRST USE 10-1-2007; IN COMMERCE 10-1-2007.

THE MARK CONSISTS OF STANDARD CHARACTERS WITHOUT CLAIM TO ANY PARTICULAR FONT, STYLE, SIZE, OR COLOR.

NO CLAIM IS MADE TO THE EXCLUSIVE RIGHT TO USE "HOTEL", APART FROM THE MARK AS SHOWN.

SN 78-827,487, FILED 3-2-2006.

SEAN CROWLEY, EXAMINING ATTORNEY

Int. Cl.: 3

Prior U.S. Cls.: 1, 4, 6, 50, 51, and 52

United States Patent and Trademark Office

Reg. No. 3,399,870

Registered Mar. 18, 2008

**TRADEMARK
PRINCIPAL REGISTER**

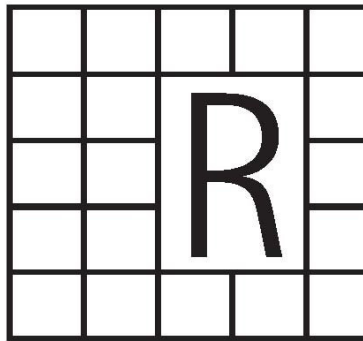

APPLIED GENETICS INCORPORATED DER-
MATICS (DELAWARE CORPORATION)
205 BUFFALO AVENUE
FREEPORT, NY 11520

THE MARK CONSISTS OF THE LETTER "R"
AND A GRID.

FOR: NON-MEDICATED SKIN CARE PREPARA-
TIONS, IN CLASS 3 (U.S. CLS. 1, 4, 6, 50, 51 AND 52).

SN 78-828,213, FILED 3-3-2006.

FIRST USE 3-16-2006; IN COMMERCE 3-16-2006.

ANNE MADDEN, EXAMINING ATTORNEY

Int. Cl.: 35

Prior U.S. Cls.: 100, 101, and 102

United States Patent and Trademark Office

Reg. No. 3,399,871

Registered Mar. 18, 2008

**SERVICE MARK
PRINCIPAL REGISTER**

EBAY EXPRESS

EBAY INC. (DELAWARE CORPORATION)
2145 HAMILTON AVENUE
SAN JOSE, CA 95125

FIRST USE 4-24-2006; IN COMMERCE 4-24-2006.

FOR: PROVIDING A SEARCHABLE ONLINE ADVERTISING GUIDE FEATURING THE GOODS AND SERVICES OF ONLINE VENDORS; PROVIDING A SEARCHABLE ONLINE EVALUATION DATABASE FOR BUYERS AND SELLERS; ADVERTISING AND ADVERTISEMENT SERVICES; CUSTOMER LOYALTY SERVICES AND CUSTOMER CLUB SERVICES FOR COMMERCIAL, PROMOTIONAL AND ADVERTISING PURPOSES; PROMOTING THE GOODS AND SERVICES OF OTHERS, IN CLASS 35 (U.S. CLS. 100, 101 AND 102).

THE MARK CONSISTS OF STANDARD CHARACTERS WITHOUT CLAIM TO ANY PARTICULAR FONT, STYLE, SIZE, OR COLOR.

OWNER OF U.S. REG. NOS. 2,218,732 AND 2,420,512.

SN 78-829,199, FILED 3-3-2006.

RONALD MCMORROW, EXAMINING ATTORNEY

Int. Cl.: 38

Prior U.S. Cls.: 100, 101, and 104

United States Patent and Trademark Office

Reg. No. 3,399,872

Registered Mar. 18, 2008

**SERVICE MARK
PRINCIPAL REGISTER**

EBAY EXPRESS

EBAY INC. (DELAWARE CORPORATION)
2145 HAMILTON AVENUE
SAN JOSE, CA 95125

FIRST USE 4-24-2006; IN COMMERCE 4-24-2006.

FOR: TELECOMMUNICATIONS SERVICES, NAMELY, THE ELECTRONIC TRANSMISSION OF DATA AND INFORMATION; PAGING SERVICES; PROVIDING AN ONLINE, INTERACTIVE BULLETIN BOARD FOR THE TRANSMISSION OF MESSAGES AMONG COMPUTER USERS CONCERNING HOBBIES, COLLECTIBLES, TRADING, AND THE SALE OF GOODS AND SERVICES VIA A GLOBAL COMMUNICATIONS NETWORK, IN CLASS 38 (U.S. CLS. 100, 101 AND 104).

THE MARK CONSISTS OF STANDARD CHARACTERS WITHOUT CLAIM TO ANY PARTICULAR FONT, STYLE, SIZE, OR COLOR.

OWNER OF U.S. REG. NOS. 2,218,732 AND 2,420,512.

SN 78-829,200, FILED 3-3-2006.

RONALD MCMORROW, EXAMINING ATTORNEY

Int. Cl.: 7

Prior U.S. Cls.: 13, 19, 21, 23, 31, 34, and 35

Reg. No. 3,399,873

United States Patent and Trademark Office

Registered Mar. 18, 2008

**TRADEMARK
PRINCIPAL REGISTER**

8 MARK III

MARVEL MANUFACTURING COMPANY, INC.
(WISCONSIN CORPORATION)
3501 MARVEL DRIVE
OSHKOSH, WI 54902

FOR: POWER-OPERATED BAND SAWS AND
METAL CUTTING MACHINES, IN CLASS 7 (U.S.
CLS. 13, 19, 21, 23, 31, 34 AND 35).

FIRST USE 3-27-2006; IN COMMERCE 3-27-2006.

THE MARK CONSISTS OF STANDARD CHAR-
ACTERS WITHOUT CLAIM TO ANY PARTICULAR
FONT, STYLE, SIZE, OR COLOR.

OWNER OF U.S. REG. NO. 1,569,259.

SN 78-829,770, FILED 3-6-2006.

KAREN K. BUSH, EXAMINING ATTORNEY

Int. Cl.: 29

Prior U.S. Cl.: 46

United States Patent and Trademark Office

Reg. No. 3,399,874

Registered Mar. 18, 2008

**TRADEMARK
PRINCIPAL REGISTER**

BELLACCINO

TULLY'S COFFEE CORPORATION (WASHINGTON CORPORATION)
3100 AIRPORT WAY SOUTH
SEATTLE, WA 981342116

FOR: FLAVORED MILK; DAIRY-BASED BEVERAGES; SOY BEVERAGES; FLAVORED SOY BEVERAGES; AND SOY-BASED BEVERAGES, IN CLASS 29 (U.S. CL. 46).

FIRST USE 8-1-2006; IN COMMERCE 8-1-2006.

THE MARK CONSISTS OF STANDARD CHARACTERS WITHOUT CLAIM TO ANY PARTICULAR FONT, STYLE, SIZE, OR COLOR.

SN 78-829,924, FILED 3-6-2006.

RICHARD A. STRASER, EXAMINING ATTORNEY

Int. Cl.: 33

Prior U.S. Cls.: 47 and 49

United States Patent and Trademark Office

Reg. No. 3,399,875

Registered Mar. 18, 2008

**TRADEMARK
PRINCIPAL REGISTER**

LAYER CAKE

ONE TRUE VINE, LLC (CALIFORNIA LTD LIAB
CO)
1104 ADAMS STREET
SUITE 3
ST. HELENA, CA 94574

THE MARK CONSISTS OF STANDARD CHAR-
ACTERS WITHOUT CLAIM TO ANY PARTICULAR
FONT, STYLE, SIZE, OR COLOR.

FOR: WHITE WINE, RED WINE, IN CLASS 33
(U.S. CLS. 47 AND 49).

SN 78-830,337, FILED 3-6-2006.

FIRST USE 7-0-2006; IN COMMERCE 7-0-2006.

VERNA BETH RIRIE, EXAMINING ATTORNEY

Int. Cl.: 35

Prior U.S. Cls.: 100, 101, and 102

United States Patent and Trademark Office

Reg. No. 3,399,876

Registered Mar. 18, 2008

**SERVICE MARK
PRINCIPAL REGISTER**

**converting knowledge into
action**

PRAXILIENT, INC. (WISCONSIN CORPORATION)
1218 FAWN DRIVE
NEENAH, WI 54956

FOR: BUSINESS CONSULTING AND INFORMATION SERVICES; BUSINESS CONSULTING SERVICES RELATING TO PRODUCT DISTRIBUTION, OPERATIONS MANAGEMENT SERVICES, LOGISTICS, REVERSE LOGISTICS, SUPPLY CHAIN, AND PRODUCTION SYSTEMS AND DISTRIBUTION SOLUTIONS; BUSINESS MANAGEMENT CONSULTANCY AS WELL AS DEVELOPMENT OF PROCESSES FOR THE ANALYSIS AND THE IM-

PLEMENTATION OF STRATEGY PLANS AND MANAGEMENT PROJECTS, IN CLASS 35 (U.S. CLS. 100, 101 AND 102).

FIRST USE 12-28-2005; IN COMMERCE 12-28-2005.

THE MARK CONSISTS OF STANDARD CHARACTERS WITHOUT CLAIM TO ANY PARTICULAR FONT, STYLE, SIZE, OR COLOR.

SN 78-830,742, FILED 3-7-2006.

JENNIFER VASQUEZ, EXAMINING ATTORNEY

Int. Cl.: 25

Prior U.S. Cls.: 22 and 39

United States Patent and Trademark Office

Reg. No. 3,399,877

Registered Mar. 18, 2008

**TRADEMARK
PRINCIPAL REGISTER**

Freetimers

EASY CHOICES, INC. (FLORIDA CORPORATION)
240 MEDALLION BLVD. APT. H
MADEIRA BEACH, FL 33708

THE MARK CONSISTS OF STANDARD CHARACTERS WITHOUT CLAIM TO ANY PARTICULAR FONT, STYLE, SIZE, OR COLOR.

FOR: GOLF SHIRTS; POLO SHIRTS; SHORT-SLEEVED OR LONG-SLEEVED T-SHIRTS; T-SHIRTS, IN CLASS 25 (U.S. CLS. 22 AND 39).

SN 78-832,020, FILED 3-8-2006.

FIRST USE 6-0-2006; IN COMMERCE 11-26-2007.

PAUL CROWLEY, EXAMINING ATTORNEY

Int. Cl.: 3

Prior U.S. Cls.: 1, 4, 6, 50, 51, and 52

United States Patent and Trademark Office

Reg. No. 3,399,878

Registered Mar. 18, 2008

**TRADEMARK
PRINCIPAL REGISTER**

WAIT A MINUTE

BATH & BODY WORKS, INC. (DELAWARE
CORPORATION)
7 LIMITED PARKWAY EAST
REYNOLDSBURG, OH 43068

THE MARK CONSISTS OF STANDARD CHAR-
ACTERS WITHOUT CLAIM TO ANY PARTICULAR
FONT, STYLE, SIZE, OR COLOR.

FOR: PERSONAL CARE PRODUCTS, NAMELY,
NAIL POLISH DRYING DROPS, IN CLASS 3 (U.S.
CLS. 1, 4, 6, 50, 51 AND 52).

SN 78-832,353, FILED 3-8-2006.

FIRST USE 6-6-2007; IN COMMERCE 6-6-2007.

HEATHER SAPP, EXAMINING ATTORNEY

Int. Cl.: 7

Prior U.S. Cls.: 13, 19, 21, 23, 31, 34, and 35

Reg. No. 3,399,879

United States Patent and Trademark Office

Registered Mar. 18, 2008

**TRADEMARK
PRINCIPAL REGISTER**

REELTIGHT

STOWE WOODWARD LLC (DELAWARE LIMITED LIABILITY COMPANY)
1 TECHNOLOGY DRIVE
WESTBOROUGH TECHNOLOGY PARK
WESTBOROUGH, MA 01581

FOR: MACHINE PARTS, NAMELY, INDUSTRIAL ROLL COVERS FOR USE IN PAPERMAKING MACHINES, IN CLASS 7 (U.S. CLS. 13, 19, 21, 23, 31, 34 AND 35).

FIRST USE 2-2-2006; IN COMMERCE 2-2-2006.

THE MARK CONSISTS OF STANDARD CHARACTERS WITHOUT CLAIM TO ANY PARTICULAR FONT, STYLE, SIZE, OR COLOR.

SN 78-832,465, FILED 3-8-2006.

DAYNA BROWNE, EXAMINING ATTORNEY

Int. Cl.: 7

Prior U.S. Cls.: 13, 19, 21, 23, 31, 34, and 35

United States Patent and Trademark Office

Reg. No. 3,399,880

Registered Mar. 18, 2008

**TRADEMARK
PRINCIPAL REGISTER**

WIRESAVER

STOWE WOODWARD LLC (DELAWARE LTD
LIAB CO)
1 TECHNOLOGY DRIVE
WESTBOROUGH TECHNOLOGY PARK
WESTBOROUGH, MA 01581

FOR: MACHINE PARTS, NAMELY, INDUSTRIAL
ROLL COVERS FOR USE IN PAPERMAKING MA-
CHINES, IN CLASS 7 (U.S. CLS. 13, 19, 21, 23, 31, 34
AND 35).

FIRST USE 2-2-2006; IN COMMERCE 2-2-2006.

THE MARK CONSISTS OF STANDARD CHAR-
ACTERS WITHOUT CLAIM TO ANY PARTICULAR
FONT, STYLE, SIZE, OR COLOR.

SN 78-832,475, FILED 3-8-2006.

DAYNA BROWNE, EXAMINING ATTORNEY

Int. Cl.: 7

Prior U.S. Cls.: 13, 19, 21, 23, 31, 34, and 35

Reg. No. 3,399,881

United States Patent and Trademark Office

Registered Mar. 18, 2008

**TRADEMARK
PRINCIPAL REGISTER**

R2

STOWE WOODWARD LLC (DELAWARE LTD
LIAB CO)
1 TECHNOLOGY DRIVE
WESTBOROUGH TECHNOLOGY PARK
WESTBOROUGH, MA 01581

FOR: MACHINE PARTS, NAMELY, INDUSTRIAL
ROLL COVERS FOR USE IN PAPERMAKING MA-
CHINES, IN CLASS 7 (U.S. CLS. 13, 19, 21, 23, 31, 34
AND 35).

FIRST USE 2-2-2006; IN COMMERCE 2-2-2006.

THE MARK CONSISTS OF STANDARD CHAR-
ACTERS WITHOUT CLAIM TO ANY PARTICULAR
FONT, STYLE, SIZE, OR COLOR.

SN 78-832,477, FILED 3-8-2006.

DAYNA BROWNE, EXAMINING ATTORNEY

Int. Cl.: 7

Prior U.S. Cls.: 13, 19, 21, 23, 31, 34, and 35

Reg. No. 3,399,882

United States Patent and Trademark Office

Registered Mar. 18, 2008

**TRADEMARK
PRINCIPAL REGISTER**

EC1000

STOWE WOODWARD LLC (DELAWARE LIMITED LIABILITY COMPANY)
1 TECHNOLOGY DRIVE
WESTBOROUGH TECHNOLOGY PARK
WESTBOROUGH, MA 01581

FOR: MACHINE PARTS, NAMELY, INDUSTRIAL ROLL COVERS FOR USE IN PAPERMAKING MACHINES, IN CLASS 7 (U.S. CLS. 13, 19, 21, 23, 31, 34 AND 35).

FIRST USE 2-2-2006; IN COMMERCE 2-2-2006.

THE MARK CONSISTS OF STANDARD CHARACTERS WITHOUT CLAIM TO ANY PARTICULAR FONT, STYLE, SIZE, OR COLOR.

SN 78-832,484, FILED 3-8-2006.

DAYNA BROWNE, EXAMINING ATTORNEY

Int. Cl.: 36

Prior U.S. Cls.: 100, 101, and 102

United States Patent and Trademark Office

Reg. No. 3,399,883

Registered Mar. 18, 2008

**SERVICE MARK
PRINCIPAL REGISTER**

Q-P3

WELLPOINT, INC. (INDIANA CORPORATION)
120 MONUMENT CIRCLE
INDIANAPOLIS, IN 46204

FOR: HEALTH INSURANCE UNDERWRITING
SERVICES FEATURING A PROGRAM TO RE-
WARD PARTICIPATING PHYSICIANS BASED
UPON PERFORMANCE CRITERIA, IN CLASS 36
(U.S. CLS. 100, 101 AND 102).

FIRST USE 11-19-2007; IN COMMERCE 11-19-2007.

THE MARK CONSISTS OF STANDARD CHAR-
ACTERS WITHOUT CLAIM TO ANY PARTICULAR
FONT, STYLE, SIZE, OR COLOR.

SN 78-832,679, FILED 3-8-2006.

MATTHEW EINSTEIN, EXAMINING ATTORNEY

Int. Cl.: 9

Prior U.S. Cls.: 21, 23, 26, and 38

Reg. No. 3,399,884

United States Patent and Trademark Office

Registered Mar. 18, 2008

**TRADEMARK
PRINCIPAL REGISTER**

**LEVITON ARCHITECTURAL
EDITION**

LEVITON MANUFACTURING CO., INC. (DELA-
WARE CORPORATION)
59-25 LITTLE NECK PARKWAY
LITTLE NECK, NY 11362

FOR: LOUDSPEAKERS; VOLUME CONTROLS;
SUBWOOFERS; AUDIO/VIDEO RECEIVERS; CD
PLAYERS; DVD PLAYERS; DIGITAL MEDIA PLAY-
ERS; HOME THEATER SYSTEMS AND MULTI-
ROOM MUSIC SYSTEMS COMPRISING AUDIO-
VIDEO ELECTRONIC COMPONENTS, NAMELY,
SUBWOOFERS, AUDIO/VIDEO RECEIVERS, CD
PLAYERS, DVD PLAYERS AND DIGITAL MEDIA
PLAYERS; INSTALLATION ACCESSORIES SOLD
AS A UNIT WITH THE AFOREMENTIONED
SOUND EQUIPMENT, NAMELY, BRACKETS, DIS-
TRIBUTION MODULES, WALL PLATES, IN CLASS
9 (U.S. CLS. 21, 23, 26, 36 AND 38).

FIRST USE 7-19-2006; IN COMMERCE 8-1-2006.

THE MARK CONSISTS OF STANDARD CHAR-
ACTERS WITHOUT CLAIM TO ANY PARTICULAR
FONT, STYLE, SIZE, OR COLOR.

OWNER OF U.S. REG. NOS. 1,892,953, 2,795,564,
AND OTHERS.

NO CLAIM IS MADE TO THE EXCLUSIVE
RIGHT TO USE "ARCHITECTURAL EDITION",
APART FROM THE MARK AS SHOWN.

SN 78-832,731, FILED 3-8-2006.

JAY BESCH, EXAMINING ATTORNEY

Int. Cl.: 9

Prior U.S. Cls.: 21, 23, 26, 36, and 38

Reg. No. 3,399,885

United States Patent and Trademark Office

Registered Mar. 18, 2008

**TRADEMARK
PRINCIPAL REGISTER**

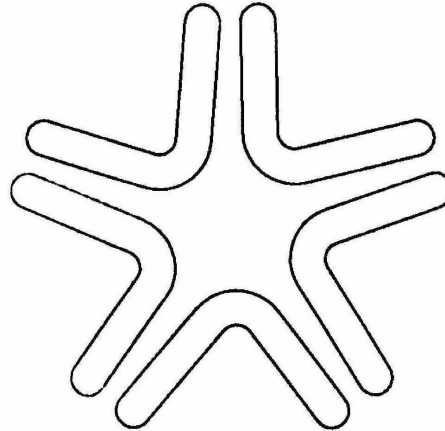

MICROSOFT CORPORATION (WASHINGTON CORPORATION)
ONE MICROSOFT WAY
REDMOND, WA 980526399

FIRST USE 3-0-2006; IN COMMERCE 3-0-2006.

SN 78-832,853, FILED 3-8-2006.

FOR: HOUSE MARK FOR A FULL LINE OF
COMPUTER SOFTWARE, IN CLASS 9 (U.S. CLS. 21,
23, 26, 36 AND 38).

JULIE GUTTADAURO, EXAMINING ATTORNEY

Int. Cl.: 5

Prior U.S. Cls.: 6, 18, 44, 46, 51, and 52

Reg. No. 3,399,886

United States Patent and Trademark Office

Registered Mar. 18, 2008

**TRADEMARK
PRINCIPAL REGISTER**

BRONCORUB

DISTRIBUIDORA DE ALIMENTOS NATURALES
Y NUTRICIONALES, S.A. DE C.V. (MEXICO
CORPORATION)
MANUEL AVILA CAMACHO #44-A SANTA MARIA
MEXICO, DISTRITO FEDERAL, MEXICO 09570

FOR: MEDICINES AND PHARMACEUTICAL
PREPARATIONS, NAMELY, MEDICATED OINT-
MENTS MADE OF NATURAL EXTRACTS FOR
TREATING RESPIRATORY ILLNESS, IN CLASS 5
(U.S. CLS. 6, 18, 44, 46, 51 AND 52).

FIRST USE 8-22-2002; IN COMMERCE 8-22-2002.

THE MARK CONSISTS OF STANDARD CHAR-
ACTERS WITHOUT CLAIM TO ANY PARTICULAR
FONT, STYLE, SIZE, OR COLOR.

OWNER OF U.S. REG. NO. 2,605,751.

SN 78-833,861, FILED 3-9-2006.

SUE LAWRENCE, EXAMINING ATTORNEY

Int. Cl.: 1

Prior U.S. Cls.: 1, 5, 6, 10, 26, and 46

United States Patent and Trademark Office

Reg. No. 3,399,887

Registered Mar. 18, 2008

**TRADEMARK
PRINCIPAL REGISTER**



GANZHOU RARE EARTH METALS CO., LTD.
(CHINA CORPORATION)
QILI TOWN, GANZHOU CITY
JIANGXI PROVINCE, CHINA

FIRST USE 2-21-2004; IN COMMERCE 3-10-2006.

FOR: RARE EARTH METALS; LANTHANUM;
CERIUM; PRASEODYMIUM; NEODYMIUM; SA-
MARIUM; EUROPIUM; CHEMICALS FOR USE IN
INDUSTRY, SCIENCE AND PHOTOGRAPHY,
NAMELY GADOLINIUM, LUTECIUM; YTTRIUM;
DYSPROSIUM; TERBIUM; HOLMIUM; ERBIUM;
THULIUM; YTTERBIUM; ALLOYS OF RARE
EARTH METALS, IN CLASS 1 (U.S. CLS. 1, 5, 6, 10,
26 AND 46).

THE NON-LATIN CHARACTER(S) IN THE
MARK TRANSLITERATES INTO KE; LI, AND THIS
MEANS SCIENCE; TO STRIVE IN ENGLISH.

SN 78-834,915, FILED 3-10-2006.

ALICE BENMAMAN, EXAMINING ATTORNEY

Int. Cl.: 41

Prior U.S. Cls.: 100, 101, and 107

United States Patent and Trademark Office

Reg. No. 3,399,888

Registered Mar. 18, 2008

**SERVICE MARK
PRINCIPAL REGISTER**



MACATAWA BANK CORPORATION (MICHIGAN CORPORATION)
10753 MACATAWA DRIVE
HOLLAND, MI 49424

OWNER OF U.S. REG. NO. 2,874,480.

FOR: EDUCATIONAL SERVICES, NAMELY, CONDUCTING PROGRAMS IN THE FIELD OF TEACHING CHILDREN ABOUT SAVING AND MANAGING MONEY, IN CLASS 41 (U.S. CLS. 100, 101 AND 107).

NO CLAIM IS MADE TO THE EXCLUSIVE RIGHT TO USE "KIDS CLUB BY MACATAWA BANK", APART FROM THE MARK AS SHOWN.

SN 78-835,336, FILED 3-13-2006.

FIRST USE 4-17-2006; IN COMMERCE 4-17-2006.

BILL DAWE, EXAMINING ATTORNEY

Int. Cls.: 35 and 41

Prior U.S. Cls.: 100, 101, 102, and 107

United States Patent and Trademark Office

Reg. No. 3,399,889

Registered Mar. 18, 2008

**SERVICE MARK
PRINCIPAL REGISTER**



COMMON GROUND ALLIANCE (D.C. CORPORATION)
SUITE 300
14500 AVION PARKWAY
CHANTILLY, VA 20151

FOR: PROMOTION AND MARKETING SERVICES RELATING TO THE USE OF THE TELEPHONE FOR CONNECTING EXCAVATORS AND CONSUMERS TO NORTH AMERICAN NOTIFICATION CENTERS WHICH CONTACT UTILITY COMPANIES TO MARK THE LOCATION OF UNDERGROUND FACILITIES PRIOR TO EXCAVATION, IN CLASS 35 (U.S. CLS. 100, 101 AND 102).

FIRST USE 3-0-2007; IN COMMERCE 3-0-2007.

FOR: EDUCATION SERVICES, NAMELY, SEMINARS, CLASSES, WORKSHOPS, AND ON-LINE VERSIONS OF THE SAME RELATING TO THE USE OF THE TELEPHONE FOR CONNECTING EXCAVATORS AND CONSUMERS TO NORTH AMERICAN NOTIFICATION CENTERS WHICH CONTACT UTILITY COMPANIES TO MARK THE LOCATION OF UNDERGROUND FACILITIES

PRIOR TO EXCAVATION AND DISTRIBUTION OF COURSE MATERIALS IN CONNECTION THEREWITH, IN CLASS 41 (U.S. CLS. 100, 101 AND 107).

FIRST USE 3-0-2007; IN COMMERCE 3-0-2007.

THE COLORS BLACK, YELLOW, GREEN, GRAY, AND BROWN ARE CLAIMED AS A FEATURE OF THE MARK.

THE MARK CONSISTS OF THE NUMERALS 811 IN YELLOW WITH A STYLIZED LIGHT AND DARK GRAY SHOVEL HEAD EXTENDING FROM THE MIDDLE 1. THE SHOVEL IS PENETRATING A STYLIZED PIECE OF GROUND COLORED IN GREEN AND BROWN AND THE IMAGES ARE ALL OUTLINED IN BLACK.

SN 78-836,042, FILED 3-13-2006.

WILLIAM P. SHANAHAN, EXAMINING ATTORNEY

Int. Cl.: 41

Prior U.S. Cls.: 100, 101, and 107

United States Patent and Trademark Office

Reg. No. 3,399,890

Registered Mar. 18, 2008

**SERVICE MARK
PRINCIPAL REGISTER**

IMPACT

PACIFIC CLUB IMPACT FOUNDATION (CALI-
FORNIA CORPORATION)
4110 MACARTHUR BLVD.
NEWPORT BEACH, CA 92660

THE MARK CONSISTS OF STANDARD CHAR-
ACTERS WITHOUT CLAIM TO ANY PARTICULAR
FONT, STYLE, SIZE, OR COLOR.

FOR: PROVIDING RECOGNITION BY WAY OF
AWARDS TO DEMONSTRATE EXCELLENCE IN
THE FIELD OF ATHLETICS, IN CLASS 41 (U.S. CLS.
100, 101 AND 107).

SN 78-836,767, FILED 3-14-2006.

FIRST USE 11-15-2007; IN COMMERCE 11-15-2007.

PAUL F. GAST, EXAMINING ATTORNEY

Int. Cl.: 9

Prior U.S. Cls.: 21, 23, 26, 36, and 38

United States Patent and Trademark Office

Reg. No. 3,399,891

Registered Mar. 18, 2008

**TRADEMARK
PRINCIPAL REGISTER**

TREASURE MOUNTAIN KENO

SPIELO MANUFACTURING ULC (CANADA CORPORATION)
328 URQUHART AVENUE
MONCTON, NEW BRUNSWICK, CANADA E1H 2R6

FOR: RECONFIGURABLE CASINO AND LOTTERY GAMING EQUIPMENT, NAMELY, SLOT MACHINES, AND OPERATIONAL COMPUTER GAME SOFTWARE THEREFOR, IN CLASS 9 (U.S. CLS. 21, 23, 26, 36 AND 38).

FIRST USE 9-4-2006; IN COMMERCE 9-4-2006.

THE MARK CONSISTS OF STANDARD CHARACTERS WITHOUT CLAIM TO ANY PARTICULAR FONT, STYLE, SIZE, OR COLOR.

NO CLAIM IS MADE TO THE EXCLUSIVE RIGHT TO USE "KENO", APART FROM THE MARK AS SHOWN.

SN 78-836,838, FILED 3-14-2006.

LAURIE MAYES, EXAMINING ATTORNEY

Int. Cl.: 11

Prior U.S. Cls.: 13, 21, 23, 31, and 34

United States Patent and Trademark Office

Reg. No. 3,399,892

Registered Mar. 18, 2008

**TRADEMARK
PRINCIPAL REGISTER**

DÉCCO BATH & SHOWER WORKS

LEHERT, ANDREW J. (UNITED STATES INDIVIDUAL), DBA DECCO BATH & SHOWER WORKS, CORP.,

3020 MEANDERING WAY R101
FORT MYERS, FL 33905

FOR: BATHTUB AND SHOWER ENCLOSURES,
IN CLASS 11 (U.S. CLS. 13, 21, 23, 31 AND 34).

FIRST USE 11-30-2006; IN COMMERCE 11-30-2006.

THE MARK CONSISTS OF STANDARD CHARACTERS WITHOUT CLAIM TO ANY PARTICULAR FONT, STYLE, SIZE, OR COLOR.

NO CLAIM IS MADE TO THE EXCLUSIVE RIGHT TO USE "BATH & SHOWER", APART FROM THE MARK AS SHOWN.

SN 78-838,688, FILED 3-16-2006.

STEVEN PEREZ, EXAMINING ATTORNEY

Int. Cl.: 19

Prior U.S. Cls.: 1, 12, 33, and 50

United States Patent and Trademark Office

Reg. No. 3,399,893

Registered Mar. 18, 2008

**TRADEMARK
PRINCIPAL REGISTER**

THE PREFERRED NAME IN STONE

OWENS CORNING INTELLECTUAL CAPITAL,
LLC (DELAWARE LTD LIAB CO)
ONE OWENS CORNING PARKWAY
TOLEDO, OH 43659

FOR: MANUFACTURED STONE; MANUFACTURED STONE VENEER, IN CLASS 19 (U.S. CLS. 1, 12, 33 AND 50).

FIRST USE 10-31-2006; IN COMMERCE 10-31-2006.

THE MARK CONSISTS OF STANDARD CHARACTERS WITHOUT CLAIM TO ANY PARTICULAR FONT, STYLE, SIZE, OR COLOR.

NO CLAIM IS MADE TO THE EXCLUSIVE RIGHT TO USE "STONE", APART FROM THE MARK AS SHOWN.

SN 78-840,912, FILED 3-20-2006.

LAURIE KAUFMAN, EXAMINING ATTORNEY

Int. Cl.: 10

Prior U.S. Cls.: 26, 39, and 44

United States Patent and Trademark Office

Reg. No. 3,399,894

Registered Mar. 18, 2008

TRADEMARK
PRINCIPAL REGISTER



FANARO, MARY (UNITED STATES INDIVIDUAL)
3306 COY ST.
SHERMAN OAKS, CA 91423

FOR: CONDOMS, IN CLASS 10 (U.S. CLS. 26, 39 AND 44).

FIRST USE 12-3-2007; IN COMMERCE 12-3-2007.

NO CLAIM IS MADE TO THE EXCLUSIVE RIGHT TO USE "CONDOMS", APART FROM THE MARK AS SHOWN.

THE COLOR(S) BROWN, RED, YELLOW, GREEN, PINK AND BLACK IS/ARE CLAIMED AS A FEATURE OF THE MARK.

THE COLOR BROWN APPEARS IN THE TERMS "PEACE" AND "OF MIND", THE COLOR RED APPEARS IN THE PEACE HAND DESIGN, THE COLOR YELLOW APPEARS IN THE TOP PORTION OF THE MAP OF AFRICA, THE COLOR GREEN APPEARS IN THE BOTTOM HALF OF THE MAP OF AFRICA, THE TERM PINK APPEARS IN THE TERM "CONDOMS" AND THE COLOR BLACK APPEARS IN THE RECTANGLE BEHIND THE ENTIRE DESIGN AND WORDING IN THE MARK.

SN 78-841,258, FILED 3-20-2006.

CAROLINE WOOD, EXAMINING ATTORNEY

Int. Cl.: 39

Prior U.S. Cls.: 100 and 105

United States Patent and Trademark Office

Reg. No. 3,399,895

Registered Mar. 18, 2008

**SERVICE MARK
PRINCIPAL REGISTER**

**We do it ... so you don't
have to.**

REALTY RESCUE, INC. (CALIFORNIA COR-
PORATION)
1139 1/2 CARDIFF AVENUE
LOS ANGELES, CA 90035

THE MARK CONSISTS OF STANDARD CHAR-
ACTERS WITHOUT CLAIM TO ANY PARTICULAR
FONT, STYLE, SIZE, OR COLOR.

FOR: STORAGE AND DELIVERY OF REALTY
SIGNS, IN CLASS 39 (U.S. CLS. 100 AND 105).

SN 78-841,369, FILED 3-20-2006.

FIRST USE 4-1-2006; IN COMMERCE 4-20-2006.

HOWARD SMIGA, EXAMINING ATTORNEY

Int. Cl.: 42

Prior U.S. Cls.: 100 and 101

United States Patent and Trademark Office

Reg. No. 3,399,896

Registered Mar. 18, 2008

**SERVICE MARK
PRINCIPAL REGISTER**

JETDESK

BALDWIN AVIATION, INC. (SOUTH CAROLINA
CORPORATION)
9 SAILWING LANE
SUITE 600
HILTON HEAD ISLAND, SC 29926

THE MARK CONSISTS OF STANDARD CHAR-
ACTERS WITHOUT CLAIM TO ANY PARTICULAR
FONT, STYLE, SIZE, OR COLOR.

FOR: HELP DESK SERVICES TO SUPPORT AVIA-
TION CONSULTING SERVICES AND RELATED
PRODUCTS, IN CLASS 42 (U.S. CLS. 100 AND 101).

SN 78-841,894, FILED 3-21-2006.

FIRST USE 2-1-2006; IN COMMERCE 3-7-2006.

LYDIA BELZER, EXAMINING ATTORNEY

Int. Cl.: 25

Prior U.S. Cls.: 22 and 39

United States Patent and Trademark Office

Reg. No. 3,399,897

Registered Mar. 18, 2008

**TRADEMARK
PRINCIPAL REGISTER**

FLYTOX

MOUTAHIR, MEHDI (MOROCCO INDIVIDUAL)
25 RINGGOLD STREET
PROVIDENCE, RI 02903

FOR: BELTS; CAPS; COATS; GLOVES; HATS;
PANTS; SANDALS; SHIRTS; SHOES; SKIRTS;
SLEEPWEAR; SNEAKERS; SOCKS; T-SHIRTS; TIES;
UNDERWEAR; VESTS, IN CLASS 25 (U.S. CLS. 22
AND 39).

FIRST USE 4-2-2007; IN COMMERCE 4-2-2007.

THE MARK CONSISTS OF STANDARD CHAR-
ACTERS WITHOUT CLAIM TO ANY PARTICULAR
FONT, STYLE, SIZE, OR COLOR.

SN 78-842,115, FILED 3-21-2006.

ANDREA K. NADELMAN, EXAMINING ATTOR-
NEY

Int. Cl.: 3

Prior U.S. Cls.: 1, 4, 6, 50, 51, and 52

United States Patent and Trademark Office

Reg. No. 3,399,898

Registered Mar. 18, 2008

**TRADEMARK
PRINCIPAL REGISTER**

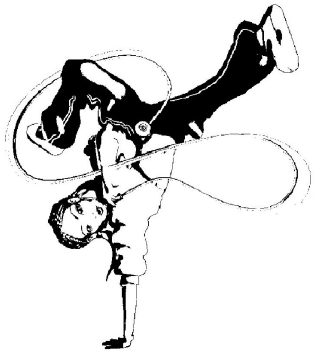

PEPPERMINTS SALON, INC. (NEW YORK CORPORATION)
157-22 POWELLS COVE BOULEVARD
BEECHHURST, NY 11357

FIRST USE 10-15-2007; IN COMMERCE 10-15-2007.

SN 78-842,262, FILED 3-21-2006.

FOR: COSMETICS, NAMELY, LIP GLOSS, IN CLASS 3 (U.S. CLS. 1, 4, 6, 50, 51 AND 52).

CHRISTINE COOPER, EXAMINING ATTORNEY

Int. Cl.: 3

Prior U.S. Cls.: 1, 4, 6, 50, 51, and 52

United States Patent and Trademark Office

Reg. No. 3,399,899

Registered Mar. 18, 2008

**TRADEMARK
PRINCIPAL REGISTER**



PEPPERMINTS SALON, INC. (NEW YORK COR-
PORATION)
157-22 POWELLS COVE BOULEVARD
BEECHHURST, NY 11357

FIRST USE 10-15-2007; IN COMMERCE 10-15-2007.

SN 78-842,282, FILED 3-21-2006.

FOR: COSMETICS, NAMELY, LIP GLOSS, IN
CLASS 3 (U.S. CLS. 1, 4, 6, 50, 51 AND 52).

CHRISTINE COOPER, EXAMINING ATTORNEY

Int. Cl.: 9

Prior U.S. Cls.: 21, 23, 26, 36, and 38

United States Patent and Trademark Office

Reg. No. 3,399,900

Registered Mar. 18, 2008

**TRADEMARK
PRINCIPAL REGISTER**



GARMIN LTD. (CAYMAN ISLANDS CORPORATION)
PO BOX 30464 SMB, 5TH FLOOR, HARBOUR PL
103 S. CHURCH STREET
GEORGE TOWN, CAYMAN ISLANDS

FOR: THEFT DETERRENT SOFTWARE SOLD AS
A COMPONENT OF GLOBAL POSITIONING SYSTEM (GPS) UNITS, IN CLASS 9 (U.S. CLS. 21, 23, 26, 36 AND 38).

FIRST USE 5-0-2006; IN COMMERCE 5-0-2006.

OWNER OF U.S. REG. NOS. 2,949,731 AND 3,107,462.

NO CLAIM IS MADE TO THE EXCLUSIVE RIGHT TO USE "GPS LOCK", APART FROM THE MARK AS SHOWN.

SN 78-842,295, FILED 3-21-2006.

ANNE FARRELL, EXAMINING ATTORNEY

Int. Cl.: 3

Prior U.S. Cls.: 1, 4, 6, 50, 51, and 52

United States Patent and Trademark Office

Reg. No. 3,399,901

Registered Mar. 18, 2008

**TRADEMARK
PRINCIPAL REGISTER**



PEPPERMINTS SALON, INC. (NEW YORK COR-
PORATION)
157-22 POWELLS COVE BOULEVARD
BEECHHURST, NY 11357

FIRST USE 10-15-2007; IN COMMERCE 10-15-2007.

SN 78-842,298, FILED 3-21-2006.

FOR: COSMETICS, NAMELY, LIP GLOSS, IN
CLASS 3 (U.S. CLS. 1, 4, 6, 50, 51 AND 52).

CHRISTINE COOPER, EXAMINING ATTORNEY

Int. Cl.: 3

Prior U.S. Cls.: 1, 4, 6, 50, 51, and 52

United States Patent and Trademark Office

Reg. No. 3,399,902

Registered Mar. 18, 2008

**TRADEMARK
PRINCIPAL REGISTER**



PEPPERMINTS SALON, INC. (NEW YORK COR-
PORATION)
157-22 POWELLS COVE BOULEVARD
BEECHHURST, NY 11357

FIRST USE 10-15-2007; IN COMMERCE 10-15-2007.

SN 78-842,311, FILED 3-21-2006.

FOR: COSMETICS, NAMELY, LIP GLOSS, IN
CLASS 3 (U.S. CLS. 1, 4, 6, 50, 51 AND 52).

CHRISTINE COOPER, EXAMINING ATTORNEY

Int. Cl.: 5

Prior U.S. Cls.: 6, 18, 44, 46, 51, and 52

Reg. No. 3,399,903

United States Patent and Trademark Office

Registered Mar. 18, 2008

**TRADEMARK
PRINCIPAL REGISTER**

PUNICAGEN

GENCOR PACIFIC, INC. (TEXAS CORPORATION)
10025 CIRCLEVIEW DRIVE
AUSTIN, TX 78733

THE MARK CONSISTS OF STANDARD CHARACTERS WITHOUT CLAIM TO ANY PARTICULAR FONT, STYLE, SIZE, OR COLOR.

FOR: DIETARY SUPPLEMENTS, IN CLASS 5 (U.S. CLS. 6, 18, 44, 46, 51 AND 52).

SN 78-842,427, FILED 3-21-2006.

FIRST USE 8-6-2007; IN COMMERCE 8-6-2007.

MICHELE SWAIN, EXAMINING ATTORNEY

Int. Cl.: 39

Prior U.S. Cls.: 100 and 105

United States Patent and Trademark Office

Reg. No. 3,399,904

Registered Mar. 18, 2008

SERVICE MARK
PRINCIPAL REGISTER



REALTY RESCUE, INC. (CALIFORNIA CORPORATION)
1139 1/2 CARDIFF AVENUE
LOS ANGELES, CA 90035

FOR: STORAGE AND DELIVERY OF REALTY/OPEN HOUSE SIGNS, IN CLASS 39 (U.S. CLS. 100 AND 105).

FIRST USE 4-1-2006; IN COMMERCE 4-20-2006.

NO CLAIM IS MADE TO THE EXCLUSIVE RIGHT TO USE "REALTY", APART FROM THE MARK AS SHOWN.

THE COLOR(S) WHITE, RED, BLACK AND BLUE IS/ARE CLAIMED AS A FEATURE OF THE MARK.

THE MARK CONSISTS OF A BLACK REAL ESTATE SIGN ENCIRCLED BY A RED AND WHITE LIFE PRESERVER, ON A BLUE BACKGROUND WITH LETTERS FORMING THE WORDS REALTY RESCUE. THE WORDS, REALTY RESCUE, IS WHITE.

SN 78-843,375, FILED 3-22-2006.

HOWARD SMIGA, EXAMINING ATTORNEY

Int. Cl.: 35

Prior U.S. Cls.: 100, 101, and 102

United States Patent and Trademark Office

Reg. No. 3,399,905

Registered Mar. 18, 2008

SERVICE MARK
PRINCIPAL REGISTER



KUDEVIZ, LARRY (UNITED STATES INDIVIDUAL)
507 WATTS AVENUE
GREENVILLE, SC 29601

FOR: DIRECT MAIL ADVERTISING, IN CLASS 35
(U.S. CLS. 100, 101 AND 102).

FIRST USE 7-0-2006; IN COMMERCE 7-0-2006.

NO CLAIM IS MADE TO THE EXCLUSIVE RIGHT TO USE "TARGETMARKET", APART FROM THE MARK AS SHOWN.

THE COLOR(S) BLACK, RED, BLUE, AND YELLOW IS/ARE CLAIMED AS A FEATURE OF THE MARK.

THE MARK CONSISTS OF THE COLORS BLACK, RED, YELLOW AND BLUE APPEAR IN THE

WORDING "GENESIS", IN THAT THE WORDING "GENESIS" APPEARS IN LOWERCASE LETTERS IN BLACK AND A CHECKERBOARD OF RED, BLUE, YELLOW AND BLACK SQUARES APPEARS IN THE SMALL LETTER "G". THE WORDING "TARGET-MARKET" APPEARS IN BLACK IN ALL CAPITAL LETTERS BELOW THE TERM "GENESIS". THE WORDING "ONE-TO-ONE" IS SITUATED BELOW THE WORDING "TARGETMARKET", WITH THE TERM "ONE" APPEARING IN BLACK, THE TERM "-TO-" APPEARING IN BLUE AND THE TERM "ONE" APPEARING IN RED. FINALLY, A TARGET DESIGN APPEARS IN BLACK, BLUE, RED AND YELLOW TO THE RIGHT OF WORDING "GENESIS". THREE YELLOW ARROWS WITH RED ENDS ARE STICKING OUT OF THE TARGET.

SN 78-843,608, FILED 3-22-2006.

LINDA ORNDORFF, EXAMINING ATTORNEY

Int. Cl.: 44

Prior U.S. Cls.: 100 and 101

United States Patent and Trademark Office

Reg. No. 3,399,906

Registered Mar. 18, 2008

**SERVICE MARK
PRINCIPAL REGISTER**

ZIP PASS

PHYSICIANS IMMEDIATE CARE, LTD. (ILLINOIS CORPORATION)

11475 N. 2ND STREET

MACHESNEY PARK, IL 61115

FOR: MEDICAL SERVICES, IN CLASS 44 (U.S. CLS. 100 AND 101).

FIRST USE 3-24-2006; IN COMMERCE 3-24-2006.

THE MARK CONSISTS OF STANDARD CHARACTERS WITHOUT CLAIM TO ANY PARTICULAR FONT, STYLE, SIZE, OR COLOR.

NO CLAIM IS MADE TO THE EXCLUSIVE RIGHT TO USE "PASS", APART FROM THE MARK AS SHOWN.

SN 78-843,964, FILED 3-23-2006.

MICHAEL GAAFAR, EXAMINING ATTORNEY

Int. Cl.: 28

Prior U.S. Cls.: 22, 23, 38, and 50

United States Patent and Trademark Office

Reg. No. 3,399,907

Registered Mar. 18, 2008

**TRADEMARK
PRINCIPAL REGISTER**

The logo for RE-MENT features a stylized red letter 'R' with a red dot above it. To the right of the 'R' is the word 'e-MENT' in a bold, black, sans-serif font. The 'e' is lowercase, while 'MENT' is uppercase.

RE-MENT INTERNATIONAL, INC. (VIRGINIA CORPORATION)
SUITE A-239
1452 CULVER DR.
IRVINE, CA 92604

FIRST USE 8-21-2006; IN COMMERCE 8-21-2006.

THE COLOR(S) RED AND BLACK IS/ARE CLAIMED AS A FEATURE OF THE MARK.

FOR: MINIATURE TOY FIGURES OF FOOD, BEVERAGES, COOKWARE, BAKE WARE, KITCHENWARE, APPLIANCES, FURNITURE, HOUSEHOLD GOODS AND ACCESSORIES, CLOTHING, SHOES AND CLOTHING ACCESSORIES, ANIMALS, COSMETICS, JEWELRIES, HISTORICAL MONUMENTS, CITY SKYLINES, PATRIOTIC ITEMS, AND SEASONAL AND HOLIDAY ITEMS, IN CLASS 28 (U.S. CLS. 22, 23, 38 AND 50).

THE MARK CONSISTS OF THE COLOR RED APPEARING ON THE LETTER "R", WHILE THE COLOR BLACK APPEARS ON THE LETTERS "E-MENT".

SN 78-843,990, FILED 3-23-2006.

KELLY MCCOY, EXAMINING ATTORNEY

Int. Cl.: 28

Prior U.S. Cls.: 22, 23, 38, and 50

United States Patent and Trademark Office

Reg. No. 3,399,908

Registered Mar. 18, 2008

**TRADEMARK
PRINCIPAL REGISTER**



RE-MENT INTERNATIONAL, INC. (VIRGINIA CORPORATION)
SUITE A-239
14252 CULVER DR.
IRVINE, CA 92604

FOR: MINIATURE TOY FIGURES OF FOOD, BEVERAGES, COOKWARE, BAKE WARE, KITCHENWARE, APPLIANCES, FURNITURE, HOUSEHOLD GOODS AND ACCESSORIES, CLOTHING, SHOES AND CLOTHING ACCESSORIES, ANIMALS, COSMETICS, JEWELRIES, HISTORICAL MONUMENTS, CITY SKYLINES, PATRIOTIC ITEMS, AND SEASONAL AND HOLIDAY ITEMS, IN CLASS 28 (U.S. CLS. 22, 23, 38 AND 50).

FIRST USE 8-21-2006; IN COMMERCE 8-21-2006.

THE MARK CONSISTS OF A STYLIZED VERSION OF THE JAPANESE HIRAGANA CHARACTER.

THE NON-LATIN CHARACTER(S) IN THE MARK TRANSLITERATES INTO THE PHONETIC SOUNDS "POO" AND "CHEE", AND THIS MEANS NOTHING IN ENGLISH.

SN 78-843,993, FILED 3-23-2006.

KELLY MCCOY, EXAMINING ATTORNEY

Int. Cl.: 33

Prior U.S. Cls.: 47 and 49

United States Patent and Trademark Office

Reg. No. 3,399,909

Registered Mar. 18, 2008

**TRADEMARK
PRINCIPAL REGISTER**

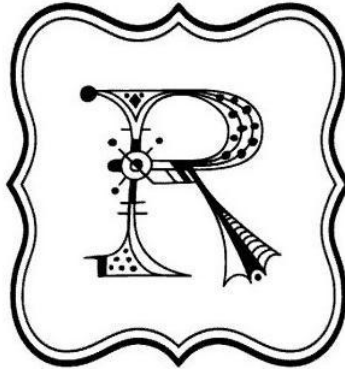

PHILIPS, DANIEL (UNITED STATES INDIVIDUAL)
P.O. BOX 5107
OXNARD, CA 930315107

THE MARK CONSISTS OF A STYLIZED LETTER "R".

FOR: WINE, IN CLASS 33 (U.S. CLS. 47 AND 49).

SN 78-844,913, FILED 3-23-2006.

FIRST USE 12-12-2007; IN COMMERCE 12-12-2007.

ROBERT C. CLARK JR., EXAMINING ATTORNEY

Int. Cl.: 25

Prior U.S. Cls.: 22 and 39

United States Patent and Trademark Office

Reg. No. 3,399,910

Registered Mar. 18, 2008

**TRADEMARK
PRINCIPAL REGISTER**

SQUALO PUERTO ESCONDIDO

JASSO, BERNARDO CUEVA (MEXICO INDIVIDUAL)
MELCHOR OCAMPO 584 BODEGA 10, EL VIGIA
GUADALAJARA, MEXICO 45100

FOR: CLOTHING, NAMELY, BEACHWEAR, SHORTS, SKIRTS, PANTS, SHIRTS, BLOUSES, TOPS, TAN TOPS, T SHIRTS, SWEATSHIRTS AND SWIMWEAR; HEADWEAR, NAMELY, HATS AND CAPS; FOOTWEAR, NAMELY, SANDALS AND SHOES, IN CLASS 25 (U.S. CLS. 22 AND 39).

FIRST USE 11-15-2007; IN COMMERCE 11-15-2007.

THE MARK CONSISTS OF STANDARD CHARACTERS WITHOUT CLAIM TO ANY PARTICULAR FONT, STYLE, SIZE, OR COLOR.

NO CLAIM IS MADE TO THE EXCLUSIVE RIGHT TO USE "PUERTO ESCONDIDO", APART FROM THE MARK AS SHOWN.

THE FOREIGN WORDING IN THE MARK TRANSLATES INTO ENGLISH AS "SHARK" FOR "SQUALO" AND "HIDDEN PORT" FOR "PUERTO ESCONDIDO".

SN 78-845,317, FILED 3-24-2006.

PETER B. BROMAGHIM, EXAMINING ATTORNEY

Int. Cl.: 9

Prior U.S. Cls.: 21, 23, 26, 36, and 38

United States Patent and Trademark Office

Reg. No. 3,399,911

Registered Mar. 18, 2008

**TRADEMARK
PRINCIPAL REGISTER**

KEG STRIP

HADALA, ANTHONY J. (ALGERIA INDIVIDUAL)
POST OFFICE BOX 41040
BRECKSVILLE, OH 441410040

OWNER OF U.S. REG. NO. 2,772,602.

FOR: LIQUID LEVEL SENSORS, IN CLASS 9 (U.S. CLS. 21, 23, 26, 36 AND 38).

NO CLAIM IS MADE TO THE EXCLUSIVE RIGHT TO USE "KEG", APART FROM THE MARK AS SHOWN.

FIRST USE 1-7-2008; IN COMMERCE 1-7-2008.

SN 78-847,998, FILED 3-28-2006.

THE MARK CONSISTS OF STANDARD CHARACTERS WITHOUT CLAIM TO ANY PARTICULAR FONT, STYLE, SIZE, OR COLOR.

RONALD AIKENS, EXAMINING ATTORNEY

Int. Cl.: 30

Prior U.S. Cl.: 46

United States Patent and Trademark Office

Reg. No. 3,399,912

Registered Mar. 18, 2008

**TRADEMARK
PRINCIPAL REGISTER**

SANTA CATARINA

SUSTAINABLE AGRICO, L.L.C. (DELAWARE
CORPORATION)
3209 RICHARDS LANE
SANTE FE, NM 87505

THE MARK CONSISTS OF STANDARD CHAR-
ACTERS WITHOUT CLAIM TO ANY PARTICULAR
FONT, STYLE, SIZE, OR COLOR.

FOR: ORGANIC CHOCOLATE, IN CLASS 30 (U.S.
CL. 46).

SN 78-848,690, FILED 3-29-2006.

FIRST USE 8-0-2006; IN COMMERCE 8-0-2006.

SUSAN STIGLITZ, EXAMINING ATTORNEY

Int. Cl.: 9

Prior U.S. Cls.: 21, 23, 26, 36, and 38

United States Patent and Trademark Office

Reg. No. 3,399,913

Registered Mar. 18, 2008

**TRADEMARK
PRINCIPAL REGISTER**

WAVEPOD

GE HEALTHCARE BIOSCIENCE BIOPROCESS
CORP. (DELAWARE CORPORATION)
800 CENTENNIAL AVENUE
PISCATAWAY, NJ 08854

FOR: LABORATORY EQUIPMENT, NAMELY, LABORATORY INSTRUMENTS FOR MEASURING AND CONTROLLING CELL AND FERMENTATION BIOREACTORS; LABORATORY INSTRUMENTS FOR MEASURING AND CONTROLLING CELL AND FERMENTATION BIOREACTORS FOR USE IN THE PHARMACEUTICAL AND CHEMICAL INDUSTRIES; APPARATUS FOR CELL CULTURE FOR LABORATORY AND INDUSTRIAL USE, NAMELY, INSTRUMENTS FOR MEASURING AND CONTROLLING CELL AND FERMENTATION BIOREACTORS; ELECTRONIC TEST AND MEASUREMENT DEVICES FOR USE IN THE PHARMACEUTICAL AND CHEMICAL INDUSTRIES, NAMELY, INSTRUMENTATION USED TO

MEASURE AND CONTROL CELL AND FERMENTATION BIOREACTORS; TOOL MEASURING INSTRUMENTS; COMPUTER-CONTROLLED ELECTRONIC APPARATUS FOR ELECTROPHYSIOLOGICAL MEASUREMENT AND TESTING OF CELLS; ELECTRONIC APPARATUS FOR ELECTROPHYSIOLOGICAL MEASUREMENT AND TESTING OF CELLS, IN CLASS 9 (U.S. CLS. 21, 23, 26, 36 AND 38).

FIRST USE 4-16-2007; IN COMMERCE 4-16-2007.

THE MARK CONSISTS OF STANDARD CHARACTERS WITHOUT CLAIM TO ANY PARTICULAR FONT, STYLE, SIZE, OR COLOR.

SN 78-850,025, FILED 3-30-2006.

MELVIN AXILBUND, EXAMINING ATTORNEY

Int. Cls.: 16 and 41

Prior U.S. Cls.: 2, 5, 22, 23, 29, 37, 38, 50, 100, 101, and 107

United States Patent and Trademark Office

Reg. No. 3,399,914

Registered Mar. 18, 2008

**TRADEMARK
SERVICE MARK
PRINCIPAL REGISTER**

THE GERLACH MODEL

GERLACH, PAUL H. (UNITED STATES INDIVIDUAL)
6472 CAMDEN AVE., SUITE 107
SAN JOSE, CA 95120

FOR: PRINTED INSTRUCTIONAL, EDUCATIONAL, AND TEACHING MATERIALS IN THE FIELDS OF BUSINESS, PSYCHOLOGY, PERSONAL DEVELOPMENT AND ACHIEVEMENT, PERSONAL AWARENESS, AND SELF-HELP, IN CLASS 16 (U.S. CLS. 2, 5, 22, 23, 29, 37, 38 AND 50).

FIRST USE 8-15-2007; IN COMMERCE 8-15-2007.

FOR: PERSONAL LIFE COACHING SESSIONS, NAMELY, CONDUCTING INDIVIDUAL SESSIONS, GROUP SESSIONS, CLASSES, SEMINARS, WORKSHOPS, PRESENTATIONS, TRAINING PRO-

GRAMS, MENTORING, AND PROVIDING COURSES OF INSTRUCTION IN THE FIELDS OF BUSINESS, PSYCHOLOGY, PERSONAL DEVELOPMENT AND ACHIEVEMENT, PERSONAL AWARENESS, AND SELF-HELP, IN CLASS 41 (U.S. CLS. 100, 101 AND 107).

FIRST USE 8-15-2007; IN COMMERCE 8-15-2007.

THE MARK CONSISTS OF STANDARD CHARACTERS WITHOUT CLAIM TO ANY PARTICULAR FONT, STYLE, SIZE, OR COLOR.

SN 78-851,071, FILED 3-31-2006.

JASON ROTH, EXAMINING ATTORNEY

Int. Cl.: 25

Prior U.S. Cls.: 22 and 39

United States Patent and Trademark Office

Reg. No. 3,399,915

Registered Mar. 18, 2008

TRADEMARK
PRINCIPAL REGISTER



ALSTON, BRUCE (UNITED STATES INDIVIDUAL)
SUITE 100
1111 COMSTOCK DRIVE
CHARLOTTE, NC 28214

SWEAT PANTS, SWEAT BANDS, RAIN COATS, RAIN HATS, WIND RESISTANT JACKETS, WIND PANTS, SKI PANTS, SKI JACKETS, COATS, HATS, CAPS, MITTENS AND GLOVES, IN CLASS 25 (U.S. CLS. 22 AND 39).

FOR: FULL LINE OF ACTIVE WEAR, NAMELY, SHIRTS, T-SHIRTS, TANK TOPS, ATHLETIC SHIRTS, SPORTS BRAS, SWIM SUITS, WET SUITS, SHORTS, PANTS, LONG UNDERWEAR BOTTOMS, LONG UNDERWEAR TOPS, BATHROBES, ATHLETIC PANTS, LEGGINGS, WARMUP SUITS, PULL-OVERS, SWEAT SUITS, SWEAT SHIRTS,

FIRST USE 4-7-2006; IN COMMERCE 4-7-2006.

SN 78-851,116, FILED 3-31-2006.

DOMINICK J. SALEMI, EXAMINING ATTORNEY

Int. Cls.: 5 and 30

Prior U.S. Cls.: 6, 18, 44, 46, 51, and 52

United States Patent and Trademark Office

Reg. No. 3,399,916

Registered Mar. 18, 2008

**TRADEMARK
PRINCIPAL REGISTER**

DAFENG

HERBA ENTERPRISE, INC. (CALIFORNIA CORPORATION)
1150 THOMAS AVENUE
SAN FRANCISCO, CA 94124

FOR: DIETARY SUPPLEMENTS, DIETARY FOOD SUPPLEMENTS AND NUTRITIONAL SUPPLEMENTS, IN CLASS 5 (U.S. CLS. 6, 18, 44, 46, 51 AND 52).

FIRST USE 9-0-2007; IN COMMERCE 9-0-2007.

FOR: TEA, HERBAL TEA FOR FOOD PURPOSES AND HERBAL FOOD BEVERAGES, IN CLASS 30 (U.S. CL. 46).

FIRST USE 9-0-2007; IN COMMERCE 9-0-2007.

THE MARK CONSISTS OF STANDARD CHARACTERS WITHOUT CLAIM TO ANY PARTICULAR FONT, STYLE, SIZE, OR COLOR.

THE FOREIGN WORDING IN THE MARK TRANSLATES INTO ENGLISH AS "BIG HARVEST".

SN 78-851,875, FILED 3-31-2006.

LEIGH CAROLINE CASE, EXAMINING ATTORNEY

Int. Cl.: 37

Prior U.S. Cls.: 100, 103, and 106

United States Patent and Trademark Office

Reg. No. 3,399,917

Registered Mar. 18, 2008

**SERVICE MARK
PRINCIPAL REGISTER**

**"Here goes the
Neighborhood"**

HOMEFRONTS L.L.C. (MICHIGAN LTD LIAB
CO)
2905 FINGERS DR
GRAND RAPIDS, MI 49525

THE MARK CONSISTS OF STANDARD CHAR-
ACTERS WITHOUT CLAIM TO ANY PARTICULAR
FONT, STYLE, SIZE, OR COLOR.

FOR: REMODELING OF BUILDING EXTER-
IORS, IN CLASS 37 (U.S. CLS. 100, 103 AND 106).

SN 78-852,466, FILED 4-3-2006.

FIRST USE 4-1-2006; IN COMMERCE 7-15-2006.

JEFF DEFORD, EXAMINING ATTORNEY

Int. Cl.: 6

Prior U.S. Cls.: 2, 12, 13, 14, 23, 25, and 50

United States Patent and Trademark Office

Reg. No. 3,399,918

Registered Mar. 18, 2008

**TRADEMARK
PRINCIPAL REGISTER**

Pressin

RIFAST SYSTEMS LLC (ILLINOIS LTD LIAB CO)
3550 WEST PRATT AVENUE
LINCOLNWOOD, IL 60712

THE MARK CONSISTS OF STANDARD CHAR-
ACTERS WITHOUT CLAIM TO ANY PARTICULAR
FONT, STYLE, SIZE, OR COLOR.

FOR: METAL FASTENERS, NAMELY, SCREWS,
NUTS, BOLTS AND CLINCH AND STAKE FASTEN-
ERS, IN CLASS 6 (U.S. CLS. 2, 12, 13, 14, 23, 25 AND
50).

SN 78-852,964, FILED 4-3-2006.

FIRST USE 12-10-2006; IN COMMERCE 12-10-2006.

NICHOLAS ALTREE, EXAMINING ATTORNEY

Int. Cl.: 10

Prior U.S. Cls.: 26, 39, and 44

United States Patent and Trademark Office

Reg. No. 3,399,919

Registered Mar. 18, 2008

**TRADEMARK
PRINCIPAL REGISTER**



GENDEX CORPORATION (DELAWARE COR-
PORATION)
901 W. OAKTON STREET
DES PLAINES, IL 60018

OWNER OF U.S. REG. NO. 1,310,934.

FOR: DENTAL X-RAY APPARATUS, IN CLASS 10
(U.S. CLS. 26, 39 AND 44).

SN 78-853,112, FILED 4-4-2006.

FIRST USE 8-27-2007; IN COMMERCE 8-27-2007.

MICHELE SWAIN, EXAMINING ATTORNEY

Int. Cl.: 10

Prior U.S. Cls.: 26, 39, and 44

United States Patent and Trademark Office

Reg. No. 3,399,920

Registered Mar. 18, 2008

**TRADEMARK
PRINCIPAL REGISTER**

expert DC

**GENDEX CORPORATION (DELAWARE COR-
PORATION)
901 W. OAKTON STREET
DES PLAINES, IL 60018**

FIRST USE 8-27-2007; IN COMMERCE 8-27-2007.

SN 78-853,115, FILED 4-4-2006.

**FOR: DENTAL X-RAY APPARATUS, IN CLASS 10
(U.S. CLS. 26, 39 AND 44).**

MICHELE SWAIN, EXAMINING ATTORNEY

Int. Cl.: 30

Prior U.S. Cl.: 46

United States Patent and Trademark Office

Reg. No. 3,399,921

Registered Mar. 18, 2008

**TRADEMARK
PRINCIPAL REGISTER**

VENETO

SUSTAINABLE AGRICO, L.L.C. (DELAWARE
CORPORATION)
3209 RICHARDS LANE
SANTE FE, NM 87505

THE MARK CONSISTS OF STANDARD CHAR-
ACTERS WITHOUT CLAIM TO ANY PARTICULAR
FONT, STYLE, SIZE, OR COLOR.

FOR: ORGANIC CHOCOLATE, IN CLASS 30 (U.S.
CL. 46).

SN 78-853,512, FILED 4-4-2006.

FIRST USE 8-0-2006; IN COMMERCE 8-0-2006.

SUSAN STIGLITZ, EXAMINING ATTORNEY

Int. Cl.: 44

Prior U.S. Cls.: 100 and 101

United States Patent and Trademark Office

Reg. No. 3,399,922

Registered Mar. 18, 2008

**SERVICE MARK
PRINCIPAL REGISTER**

Group-Stat

LIFECLINIC INTERNATIONAL, INC. (MARY-
LAND CORPORATION)
4032 BLACKBURN LANE
BURTONSVILLE, MD 20866

FOR: REMOTE MONITORING OF DATA INDI-
CATIVE OF THE HEALTH OR CONDITION OF AN
INDIVIDUAL OR GROUP OF INDIVIDUALS, IN
CLASS 44 (U.S. CLS. 100 AND 101).

FIRST USE 11-30-2006; IN COMMERCE 11-30-2006.

THE MARK CONSISTS OF STANDARD CHAR-
ACTERS WITHOUT CLAIM TO ANY PARTICULAR
FONT, STYLE, SIZE, OR COLOR.

SN 78-853,588, FILED 4-4-2006.

MARIA-VICTORIA SUAREZ, EXAMINING ATTOR-
NEY

Int. Cl.: 9

Prior U.S. Cls.: 21, 23, 26, 36, and 38

United States Patent and Trademark Office

Reg. No. 3,399,923

Registered Mar. 18, 2008

**TRADEMARK
PRINCIPAL REGISTER**

PIRATE REVENGE

SCHOLASTIC INC. (NEW YORK CORPORATION)
557 BROADWAY
NEW YORK, NY 10012

THE MARK CONSISTS OF STANDARD CHARACTERS WITHOUT CLAIM TO ANY PARTICULAR FONT, STYLE, SIZE, OR COLOR.

FOR: PRERECORDED CD-ROMS, VIDEOS AND INTERACTIVE MULTIMEDIA COMPUTER GAME SOFTWARE FOR CHILDREN, IN CLASS 9 (U.S. CLS. 21, 23, 26, 36 AND 38).

SN 78-854,624, FILED 4-5-2006.

FIRST USE 11-1-2006; IN COMMERCE 11-1-2006.

MARY ROSSMAN, EXAMINING ATTORNEY

Int. Cl.: 9

Prior U.S. Cls.: 21, 23, 26, 36, and 38

United States Patent and Trademark Office

Reg. No. 3,399,924

Registered Mar. 18, 2008

**TRADEMARK
PRINCIPAL REGISTER**

OUT OF TIME

SCHOLASTIC INC. (NEW YORK CORPORATION)
557 BROADWAY
NEW YORK, NY 10012

FOR: PRERECORDED CD-ROMS, VIDEOS AND INTERACTIVE MULTIMEDIA COMPUTER GAME SOFTWARE FOR CHILDREN, IN CLASS 9 (U.S. CLS. 21, 23, 26, 36 AND 38).

FIRST USE 11-1-2006; IN COMMERCE 11-1-2006.

THE MARK CONSISTS OF STANDARD CHARACTERS WITHOUT CLAIM TO ANY PARTICULAR FONT, STYLE, SIZE, OR COLOR.

SN 78-855,374, FILED 4-6-2006.

MARY ROSSMAN, EXAMINING ATTORNEY

Int. Cl.: 41

Prior U.S. Cls.: 100, 101, and 107

United States Patent and Trademark Office

Reg. No. 3,399,925

Registered Mar. 18, 2008

**SERVICE MARK
PRINCIPAL REGISTER**

BUENA FORTUNA

PROMOFILM US LLC (FLORIDA LIMITED LIABILITY CORPORATION)

7395 W. 19TH COURT

HIALEAH, FL 33014

FOR: ENTERTAINMENT IN THE FORM OF A TELEVISION GAME SHOW, IN CLASS 41 (U.S. CLS. 100, 101 AND 107).

FIRST USE 1-0-2007; IN COMMERCE 1-0-2007.

THE MARK CONSISTS OF STANDARD CHARACTERS WITHOUT CLAIM TO ANY PARTICULAR FONT, STYLE, SIZE, OR COLOR.

THE FOREIGN WORDING IN THE MARK TRANSLATES INTO ENGLISH AS GOOD FORTUNE.

SN 78-855,816, FILED 4-6-2006.

NORA BUCHANAN WILL, EXAMINING ATTORNEY

Int. Cls.: 29 and 30

Prior U.S. Cl.: 46

United States Patent and Trademark Office

Reg. No. 3,399,926

Registered Mar. 18, 2008

**TRADEMARK
PRINCIPAL REGISTER**

SONORA VALLEY

SARGENTO FOODS, INC. (WISCONSIN CORPORATION)
ONE PERSNICKETY PLACE
PLYMOUTH, WI 53073

FOR: CHEESE, CHEESE DIP, IN CLASS 29 (U.S. CL. 46).

FIRST USE 10-1-2006; IN COMMERCE 10-1-2006.

FOR: SNACK MIX CONSISTING PRIMARILY OF CHEESE, CHEESE SAUCES, PRETZELS, CRACKERS OR CHIPS; SNACK FOOD, NAMELY, CHEESE,

CHEESE SAUCES, PRETZELS, CRACKERS OR CHIPS; CHEESE SAUCE, IN CLASS 30 (U.S. CL. 46).

FIRST USE 10-1-2006; IN COMMERCE 10-1-2006.

THE MARK CONSISTS OF STANDARD CHARACTERS WITHOUT CLAIM TO ANY PARTICULAR FONT, STYLE, SIZE, OR COLOR.

SN 78-855,901, FILED 4-6-2006.

SUSAN STIGLITZ, EXAMINING ATTORNEY

Int. Cl.: 41

Prior U.S. Cls.: 100, 101, and 107

United States Patent and Trademark Office

Reg. No. 3,399,927

Registered Mar. 18, 2008

**SERVICE MARK
PRINCIPAL REGISTER**

THE ORIGINAL VANDELLAS

HELTON, ANNETTE (UNITED STATES INDIVIDUAL)
18932 DRESDEN
DETROIT, MI 48205 AND
HOLMES, ROSALIND (UNITED STATES INDIVIDUAL)
17361 KENTUCKY
DETROIT, MI 48221

FIRST USE 2-28-2006; IN COMMERCE 2-28-2006.

THE MARK CONSISTS OF STANDARD CHARACTERS WITHOUT CLAIM TO ANY PARTICULAR FONT, STYLE, SIZE, OR COLOR.

SN 78-856,972, FILED 4-7-2006.

FOR: ENTERTAINMENT IN THE NATURE OF LIVE MUSICAL PERFORMANCES, IN CLASS 41 (U.S. CLS. 100, 101 AND 107).

JENNIFER MARTIN, EXAMINING ATTORNEY

Int. Cl.: 9

Prior U.S. Cls.: 21, 23, 26, 36, and 38

Reg. No. 3,399,928

United States Patent and Trademark Office

Registered Mar. 18, 2008

**TRADEMARK
PRINCIPAL REGISTER**



IMARKET SERVICES, LLC (ARIZONA LIMITED
LIABILITY COMPANY)
1158 26TH STREET, SUITE 463
SANTA MONICA, CA 90403

FOR: DOWNLOADABLE AUDIO AND VIDEO
MATERIALS ON THE INTERNET, NAMELY, LIVE
AND PRE-RECORDED DOWNLOADABLE SOUND
RECORDINGS AND VIDEO CLIPS FEATURING
COMEDY MATERIAL FOR ENTERTAINMENT

PURPOSES, IN CLASS 9 (U.S. CLS. 21, 23, 26, 36
AND 38).

FIRST USE 2-24-2006; IN COMMERCE 2-24-2006.

SN 78-857,045, FILED 4-7-2006.

REBECCA POVARCHUK, EXAMINING ATTOR-
NEY

Int. Cls.: 25 and 41

Prior U.S. Cls.: 22, 39, 100, 101, and 107

United States Patent and Trademark Office

Reg. No. 3,399,929

Registered Mar. 18, 2008

**TRADEMARK
SERVICE MARK
PRINCIPAL REGISTER**

BETWEEN MIRAGES

BM DIRECT (MINNESOTA SOLE PROPRIETOR-
SHIP)
1146 33RD ST. NW
ROCHESTER, MN 55901

FOR: CLOTHING, NAMELY, SHIRTS, T-SHIRTS
AND HATS, IN CLASS 25 (U.S. CLS. 22 AND 39).

FIRST USE 5-11-2007; IN COMMERCE 5-11-2007.

FOR: ENTERTAINMENT SERVICES, NAMELY,
LIVE PERFORMANCES BY A MUSICAL GROUP, IN
CLASS 41 (U.S. CLS. 100, 101 AND 107).

FIRST USE 5-11-2007; IN COMMERCE 5-11-2007.

THE MARK CONSISTS OF STANDARD CHAR-
ACTERS WITHOUT CLAIM TO ANY PARTICULAR
FONT, STYLE, SIZE, OR COLOR.

SN 78-857,332, FILED 4-9-2006.

KAPIL BHANOT, EXAMINING ATTORNEY

Int. Cl.: 41

Prior U.S. Cls.: 100, 101, and 107

United States Patent and Trademark Office

Reg. No. 3,399,930

Registered Mar. 18, 2008

**SERVICE MARK
PRINCIPAL REGISTER**

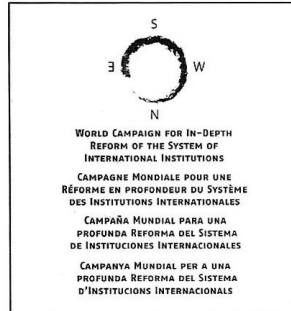

FUNDACIÓ UBUNTU (SPAIN FOUNDATION)
EDIFICIO NEXUS II
C/ JORDI GIRONA, 29
BARCELONA, SPAIN 08034

FOR: EDUCATIONAL AND CULTURAL TRAINING SERVICES IN THE FIELD OF HUMAN RIGHTS WITH THE AIM OF DEVELOPING A WORLD CAMPAIGN FOR REFORMING THE SYSTEM OF INTERNATIONAL POLITICAL AND CULTURAL INSTITUTIONS, IN CLASS 41 (U.S. CLS. 100, 101 AND 107).

FIRST USE 6-13-2005; IN COMMERCE 4-13-2007.

NO CLAIM IS MADE TO THE EXCLUSIVE RIGHT TO USE "WORLD CAMPAIGN", "CAMPAGNE MONDIALE", "CAMPAÑA MUNDIAL" AND "CAMPANYA MUNDIAL", APART FROM THE MARK AS SHOWN.

THE FOREIGN WORDING IN THE MARK TRANSLATES INTO ENGLISH AS WORLD CAMPAIGN FOR IN-DEPTH REFORM OF THE SYSTEM OF INTERNATIONAL INSTITUTIONS.

SN 78-858,198, FILED 4-10-2006.

KATHY DE JONGE, EXAMINING ATTORNEY

Int. Cls.: 1 and 30

Prior U.S. Cls.: 1, 5, 6, 10, 26, and 46

United States Patent and Trademark Office

Reg. No. 3,399,931

Registered Mar. 18, 2008

**TRADEMARK
PRINCIPAL REGISTER**

**LOOKING FOR FLAVOR? LOOK
FOR THE "D"**

ACH FOOD COMPANIES, INC. (TENNESSEE
CORPORATION)
7171 GOODLETT FARMS PARKWAY
CORDOVA, TN 381064909

FOR: EMULSIFIERS FOR USE IN THE MANU-
FACTURE OF FOOD AND PASTRIES, IN CLASS 1
(U.S. CLS. 1, 5, 6, 10, 26 AND 46).

FIRST USE 3-22-2004; IN COMMERCE 3-22-2004.

FOR: SPICES; PEPPER; SALT; SEASONINGS; FLA-
VORED SALT; GARLIC SALT; SAUCES FOR MEAT,
SEAFOOD AND VEGETABLES; GRAVIES; GARLIC
POWDER; BAKERY GOODS—NAMELY, DOUGHS
AND PASTRIES; EDIBLE CAKE AND DESSERT

DECORATIONS; GRAVY MIXES; MEAT TENDER-
IZERS; MARINADE BAG WITH MIXTURES OF
SPICES AND SEASONING SOLD AS A UNIT, IN
CLASS 30 (U.S. CL. 46).

FIRST USE 3-22-2004; IN COMMERCE 3-22-2004.

THE MARK CONSISTS OF STANDARD CHAR-
ACTERS WITHOUT CLAIM TO ANY PARTICULAR
FONT, STYLE, SIZE, OR COLOR.

SN 78-858,247, FILED 4-10-2006.

CAROLINE WOOD, EXAMINING ATTORNEY

Int. Cl.: 29

Prior U.S. Cl.: 46

United States Patent and Trademark Office

Reg. No. 3,399,932

Registered Mar. 18, 2008

**TRADEMARK
PRINCIPAL REGISTER**

ACTIVE LIFESTYLE

THE KROGER CO. OF MICHIGAN (MICHIGAN
CORPORATION)
18334 LAUREL PARK DRIVE NORTH
LIVONIA, MI 481522686

THE MARK CONSISTS OF STANDARD CHAR-
ACTERS WITHOUT CLAIM TO ANY PARTICULAR
FONT, STYLE, SIZE, OR COLOR.

FOR: YOGURT, IN CLASS 29 (U.S. CL. 46).

SN 78-858,262, FILED 4-10-2006.

FIRST USE 1-1-2007; IN COMMERCE 1-1-2007.

ALICE BENMAMAN, EXAMINING ATTORNEY

Int. Cl.: 20

Prior U.S. Cls.: 2, 13, 22, 25, 32, and 50

Reg. No. 3,399,933

United States Patent and Trademark Office

Registered Mar. 18, 2008

**TRADEMARK
PRINCIPAL REGISTER**

DELIGHTFILL

KLEAR-VU CORPORATION (MASSACHUSETTS
CORPORATION)
135 ALDEN STREET
FALL RIVER, MA 02723

THE MARK CONSISTS OF STANDARD CHAR-
ACTERS WITHOUT CLAIM TO ANY PARTICULAR
FONT, STYLE, SIZE, OR COLOR.

FOR: CUSHIONS FOR CHAIRS AND STOOLS, IN
CLASS 20 (U.S. CLS. 2, 13, 22, 25, 32 AND 50).

SN 78-858,856, FILED 4-11-2006.

FIRST USE 12-1-2006; IN COMMERCE 12-1-2006.

ANNE FARRELL, EXAMINING ATTORNEY

Int. Cls.: 41 and 44

Prior U.S. Cls.: 100, 101, and 107

United States Patent and Trademark Office

Reg. No. 3,399,934

Registered Mar. 18, 2008

**SERVICE MARK
PRINCIPAL REGISTER**

POSITION THERAPY

BR CONSULTING, INC. (NEW JERSEY CORPORATION)
340 JORDAN ROAD
SEDONA, AZ 86336

FOR: INSTRUCTION SERVICES, NAMELY, CLASSES IN NATURAL HEALING METHODS, POSTURE, BREATHING, MEDITATION TO INCREASE ENERGY, AND IMPROVE PHYSICAL, ENERGETIC AND PSYCHO-EMOTIONAL HEALTH, IN CLASS 41 (U.S. CLS. 100, 101 AND 107).

FIRST USE 1-20-2006; IN COMMERCE 1-20-2006.

FOR: HEALTHCARE SERVICES USING EXERCISES; MEDICAL SERVICES USING THERAPEUTIC EXERCISES, IN CLASS 44 (U.S. CLS. 100 AND 101).

FIRST USE 1-20-2006; IN COMMERCE 1-20-2006.

THE MARK CONSISTS OF STANDARD CHARACTERS WITHOUT CLAIM TO ANY PARTICULAR FONT, STYLE, SIZE, OR COLOR.

NO CLAIM IS MADE TO THE EXCLUSIVE RIGHT TO USE "THERAPY", APART FROM THE MARK AS SHOWN.

SN 78-858,862, FILED 4-11-2006.

DAVID I, EXAMINING ATTORNEY

Int. Cl.: 41

Prior U.S. Cls.: 100, 101, and 107

United States Patent and Trademark Office

Reg. No. 3,399,935

Registered Mar. 18, 2008

**SERVICE MARK
PRINCIPAL REGISTER**

CAVE KIDS

HANNA-BARBERA PRODUCTIONS, INC. (DELAWARE CORPORATION)
4000 WARNER BOULEVARD
BURBANK, CA 91522

FOR: ENTERTAINMENT SERVICES IN THE NATURE OF LIVE-ACTION, COMEDY, DRAMA AND ANIMATED TELEVISION SERIES; PRODUCTION OF LIVE-ACTION, COMEDY, DRAMA AND ANIMATED TELEVISION SERIES; DISTRIBUTION AND DISPLAY OF LIVE-ACTION, COMEDY, DRAMA AND ANIMATED MOTION PICTURE THEATRICAL FILMS; PRODUCTION OF LIVE-ACTION, COMEDY, DRAMA AND ANIMATED MOTION PICTURE THEATRICAL FILMS; THEATRICAL PERFORMANCES BOTH ANIMATED AND LIVE ACTION; INTERNET SERVICES PROVIDING INFORMATION VIA AN ELECTRONIC GLOBAL COMPUTER NETWORK IN THE FIELD OF ENTERTAINMENT RELATING SPECIFICALLY TO MOVIES AND TELEVISION; PROVIDING NEWS ABOUT CURRENT EVENTS AND ENTERTAINMENT, AND INFORMATION RELATED TO EDUCATION AND CULTURAL EVENTS, VIA A GLOBAL COMPUTER NETWORK; AND PROVID-

ING ENTERTAINMENT INFORMATION VIA AN ELECTRONIC GLOBAL COMMUNICATIONS NETWORK FEATURING LIVE-ACTION, COMEDY, DRAMA AND ANIMATED PROGRAMS AND PRODUCTION OF LIVE-ACTION COMEDY, DRAMA AND ANIMATED MOTION PICTURE FILMS FOR DISTRIBUTION VIA A GLOBAL COMPUTER NETWORK, IN CLASS 41 (U.S. CLS. 100, 101 AND 107).

FIRST USE 8-18-2007; IN COMMERCE 8-18-2007.

THE MARK CONSISTS OF STANDARD CHARACTERS WITHOUT CLAIM TO ANY PARTICULAR FONT, STYLE, SIZE, OR COLOR.

OWNER OF U.S. REG. NO. 2,454,377.

NO CLAIM IS MADE TO THE EXCLUSIVE RIGHT TO USE "KIDS", APART FROM THE MARK AS SHOWN.

SN 78-859,249, FILED 4-11-2006.

TOBY BULLOFF, EXAMINING ATTORNEY

Int. Cl.: 9

Prior U.S. Cls.: 21, 23, 26, 36, and 38

United States Patent and Trademark Office

Reg. No. 3,399,936

Registered Mar. 18, 2008

**TRADEMARK
PRINCIPAL REGISTER**

MUSIC FOR TUNES

ID INTERACTIVE LLC (FLORIDA LTD LIAB CO)
1801 SOUTH FEDERAL HIGHWAY, SUITE 300
DELRAY BEACH, OH 33483

FOR: GAMING MACHINES, NAMELY, DEVICES
WHICH ACCEPT A WAGER, AND COMPUTER
SOFTWARE ASSOCIATED THEREWITH, IN CLASS
9 (U.S. CLS. 21, 23, 26, 36 AND 38).

FIRST USE 3-21-2006; IN COMMERCE 11-8-2006.

THE MARK CONSISTS OF STANDARD CHAR-
ACTERS WITHOUT CLAIM TO ANY PARTICULAR
FONT, STYLE, SIZE, OR COLOR.

SN 78-859,503, FILED 4-12-2006.

KARANENDRA S. CHHINA, EXAMINING ATTOR-
NEY

Int. Cl.: 38

Prior U.S. Cls.: 100, 101, and 104

United States Patent and Trademark Office

Reg. No. 3,399,937

Registered Mar. 18, 2008

**SERVICE MARK
PRINCIPAL REGISTER**

CONNECT UP

CONSTANT CONTACT, INC. (DELAWARE CORPORATION)
1601 TRAPELO ROAD, SUITE 329
WALTHAM, MA 02451

FOR: PROVIDING ONLINE CHAT ROOMS AND ELECTRONIC BULLETIN BOARDS IN THE FIELD OF ONLINE MARKETING, IN CLASS 38 (U.S. CLS. 100, 101 AND 104).

FIRST USE 6-1-2007; IN COMMERCE 6-1-2007.

THE MARK CONSISTS OF STANDARD CHARACTERS WITHOUT CLAIM TO ANY PARTICULAR FONT, STYLE, SIZE, OR COLOR.

SN 78-859,684, FILED 4-12-2006.

ELLEN BURNS, EXAMINING ATTORNEY

Int. Cl.: 36

Prior U.S. Cls.: 100, 101, and 102

United States Patent and Trademark Office

Reg. No. 3,399,938

Registered Mar. 18, 2008

**SERVICE MARK
PRINCIPAL REGISTER**

GUARANTEES MATTER

NEW YORK LIFE INSURANCE COMPANY
(NEW YORK CORPORATION)
51 MADISON AVENUE
NEW YORK, NY 10010

FOR: PROVIDING A WEBSITE FEATURING INFORMATION ON FINANCIAL SERVICES, RETIREMENT, INSURANCE, INVESTMENTS AND LIFE PLANNING, IN CLASS 36 (U.S. CLS. 100, 101 AND 102).

FIRST USE 5-5-2006; IN COMMERCE 5-5-2006.

THE MARK CONSISTS OF STANDARD CHARACTERS WITHOUT CLAIM TO ANY PARTICULAR FONT, STYLE, SIZE, OR COLOR.

SN 78-860,276, FILED 4-12-2006.

JEFF DEFORD, EXAMINING ATTORNEY

Int. Cl.: 14

Prior U.S. Cls.: 2, 27, 28, and 50

United States Patent and Trademark Office

Reg. No. 3,399,939

Registered Mar. 18, 2008

**TRADEMARK
PRINCIPAL REGISTER**

CRYSTAL-BIBLE

GRAPHILUX INTERNATIONAL S.A. (LUXEM-
BOURG CORPORATION)
25A BOULEVARD ROYAL
LUXEMBOURG, LUXEMBOURG 2449

THE MARK CONSISTS OF STANDARD CHAR-
ACTERS WITHOUT CLAIM TO ANY PARTICULAR
FONT, STYLE, SIZE, OR COLOR.

FOR: WATCHES; JEWELRY, NAMELY, RINGS,
CHAINS, PENDANTS, BROOCHES, CUFF LINKS,
TIE PINS, IN CLASS 14 (U.S. CLS. 2, 27, 28 AND 50).

SN 78-860,432, FILED 4-12-2006.

FIRST USE 5-30-2006; IN COMMERCE 5-30-2006.

GEOFFREY FOSDICK, EXAMINING ATTORNEY

Int. Cl.: 24

Prior U.S. Cls.: 42 and 50

United States Patent and Trademark Office

Reg. No. 3,399,940

Registered Mar. 18, 2008

**TRADEMARK
PRINCIPAL REGISTER**

NANOCIDE

C.M.I. ENTERPRISES, INC. (FLORIDA CORPORATION)
5590 N.W. 163 STREET
MIAMI, FL 33014

FOR: PROTECTIVE COATINGS SOLD AS AN INTEGRAL COMPONENT OF VINYL TEXTILES AND VINYL COATED SYNTHETIC AND NON-SYNTHETIC FABRICS FOR THE MANUFACTURE OF RESIDENTIAL, COMMERCIAL, INDUSTRIAL, MARINE, AIRCRAFT AND AUTOMOTIVE UPHOLSTERY AND TRIM, IN CLASS 24 (U.S. CLS. 42 AND 50).

FIRST USE 9-27-2006; IN COMMERCE 9-27-2006.

THE MARK CONSISTS OF STANDARD CHARACTERS WITHOUT CLAIM TO ANY PARTICULAR FONT, STYLE, SIZE, OR COLOR.

SN 78-861,688, FILED 4-14-2006.

PAUL CROWLEY, EXAMINING ATTORNEY

Int. Cls.: 2 and 19

Prior U.S. Cls.: 1, 6, 11, 12, 16, 33, and 50

United States Patent and Trademark Office

Reg. No. 3,399,941

Registered Mar. 18, 2008

**TRADEMARK
PRINCIPAL REGISTER**



CONKIN COMPANY, INC. (MINNESOTA CORPORATION)
P.O. BOX 155
SHAKOPEE, MN 55379

FOR: EXTERIOR AND INTERIOR PAINTS; COATINGS IN THE NATURE OF WOOD SEALERS AND PROTECTORS, IN CLASS 2 (U.S. CLS. 6, 11 AND 16).

FIRST USE 9-0-2007; IN COMMERCE 9-0-2007.

FOR: PETROLEUM-BASED ASPHALT COATINGS, ASPHALT PRIMERS; ASPHALT FILLER, AND ASPHALT PATCH, IN CLASS 19 (U.S. CLS. 1, 12, 33 AND 50).

FIRST USE 9-0-2007; IN COMMERCE 9-0-2007.

THE COLOR(S) SEPIA IS/ARE CLAIMED AS A FEATURE OF THE MARK.

THE MARK CONSISTS OF A SEPIA COLORED ARMADILLO.

SN 78-861,692, FILED 4-14-2006.

MARY ROSSMAN, EXAMINING ATTORNEY

Int. Cls.: 9 and 11

Prior U.S. Cls.: 13, 21, 23, 26, 31, 34, 36, and 38

United States Patent and Trademark Office

Reg. No. 3,399,942

Registered Mar. 18, 2008

**TRADEMARK
PRINCIPAL REGISTER**



VECTOR PRODUCTS, INC. (FLORIDA CORPORATION)
4140 S.W. 28TH WAY
FT. LAUDERDALE, FL 33312

FOR: COMBINATION TV AND LANTERN-STYLE FLASHLIGHT AND LED/AM/FM WEATHER BAND RADIO WITH INCLEMENT WEATHER WARNING SYSTEM, DYNAMO-POWERED AND RECHARGEABLE CAPABILITIES SOLD AS A UNIT; AM/FM WEATHER BAND RADIO WITH INCLEMENT WEATHER WARNING SYSTEM, DYNAMO-POWERED AND RECHARGEABLE CAPABILITIES, IN CLASS 9 (U.S. CLS. 21, 23, 26, 36 AND 38).

FIRST USE 3-31-2006; IN COMMERCE 3-31-2006.

FOR: COMBINATION ELECTRIC LANTERN, FLASHLIGHT AND LED/AM/FM WEATHER BAND RADIO WITH INCLEMENT WEATHER WARNING SYSTEM, DYNAMO-POWERED AND RECHARGEABLE CAPABILITIES, SOLD AS A UNIT, IN CLASS 11 (U.S. CLS. 13, 21, 23, 31 AND 34).

FIRST USE 3-31-2006; IN COMMERCE 3-31-2006.

SN 78-861,921, FILED 4-14-2006.

MATTHEW EINSTEIN, EXAMINING ATTORNEY

Int. Cl.: 25

Prior U.S. Cls.: 22 and 39

United States Patent and Trademark Office

Reg. No. 3,399,943

Registered Mar. 18, 2008

**TRADEMARK
PRINCIPAL REGISTER**

SMILY GREEN

T-TOWN, L.L.C. (ARIZONA CORPORATION)
2440 E. GLENN STREET #2202
TUCSON, AZ 85728

FOR: CLOTHING, NAMELY, SHIRTS, HATS,
BEANIES, AND UNDERGARMENTS, IN CLASS 25
(U.S. CLS. 22 AND 39).

FIRST USE 4-20-2006; IN COMMERCE 4-20-2006.

THE MARK CONSISTS OF STANDARD CHAR-
ACTERS WITHOUT CLAIM TO ANY PARTICULAR
FONT, STYLE, SIZE, OR COLOR.

NO CLAIM IS MADE TO THE EXCLUSIVE
RIGHT TO USE "GREEN", APART FROM THE
MARK AS SHOWN.

THE NAME SHOWN IN THE MARK DOES NOT
IDENTIFY A LIVING INDIVIDUAL.

SN 78-862,558, FILED 4-17-2006.

RICHARD A. STRASER, EXAMINING ATTORNEY

Int. Cl.: 25

Prior U.S. Cls.: 22 and 39

United States Patent and Trademark Office

Reg. No. 3,399,944

Registered Mar. 18, 2008

**TRADEMARK
PRINCIPAL REGISTER**

SOCK OF THE MONTH CLUB

OZONE DESIGN INC. (NEW YORK CORPORATION)
224 WEST 29TH STREET, 10TH FLOOR
NEW YORK, NY 10001

FOR: APPAREL, NAMELY, SOCKS, HOSIERY, UNDERWEAR, BODY STOCKINGS, T-SHIRTS, LEGGINGS, LEG WARMERS, LEOTARDS, UNITARDS, KNEE-HIGH STOCKINGS, TIGHTS FOR WOMEN, MEN AND CHILDREN OF NYLON, COTTON OR OTHER TEXTILE FIBERS, BODY SUITS, IN CLASS 25 (U.S. CLS. 22 AND 39).

FIRST USE 12-1-2007; IN COMMERCE 12-1-2007.

THE MARK CONSISTS OF STANDARD CHARACTERS WITHOUT CLAIM TO ANY PARTICULAR FONT, STYLE, SIZE, OR COLOR.

SN 78-862,672, FILED 4-17-2006.

LINDA MICKLEBURGH, EXAMINING ATTORNEY

Int. Cl.: 25

Prior U.S. Cls.: 22 and 39

United States Patent and Trademark Office

Reg. No. 3,399,945

Registered Mar. 18, 2008

**TRADEMARK
PRINCIPAL REGISTER**

ANYBODY

QVC, INC. (DELAWARE CORPORATION)
STUDIO PARK
WEST CHESTER, PA 19380

THE MARK CONSISTS OF STANDARD CHAR-
ACTERS WITHOUT CLAIM TO ANY PARTICULAR
FONT, STYLE, SIZE, OR COLOR.

FOR: LINGERIE; LOUNGEWEAR; SLEEPWEAR,
IN CLASS 25 (U.S. CLS. 22 AND 39).

SN 78-862,714, FILED 4-17-2006.

FIRST USE 2-28-2007; IN COMMERCE 2-28-2007.

WON TEAK OH, EXAMINING ATTORNEY

Int. Cl.: 41

Prior U.S. Cls.: 100, 101, and 107

United States Patent and Trademark Office

Reg. No. 3,399,946

Registered Mar. 18, 2008

**SERVICE MARK
PRINCIPAL REGISTER**

ROCK APOCALYPSE

KAROTTKI, SALVADOR K. (UNITED STATES
INDIVIDUAL), DBA S.B. RECORDING COM-
PANY,
512 N. MCCLURG CT.
CHICAGO, IL 60611

FOR: ENTERTAINMENT SERVICES, NAMELY,
ARRANGING AND CONDUCTING LIVE MUSIC
CONCERTS, IN CLASS 41 (U.S. CLS. 100, 101 AND
107).

FIRST USE 3-0-2006; IN COMMERCE 7-8-2006.

THE MARK CONSISTS OF STANDARD CHAR-
ACTERS WITHOUT CLAIM TO ANY PARTICULAR
FONT, STYLE, SIZE, OR COLOR.

NO CLAIM IS MADE TO THE EXCLUSIVE
RIGHT TO USE "ROCK", APART FROM THE
MARK AS SHOWN.

SN 78-863,474, FILED 4-18-2006.

INGRID C. EULIN, EXAMINING ATTORNEY

Int. Cl.: 25

Prior U.S. Cls.: 22 and 39

United States Patent and Trademark Office

Reg. No. 3,399,947

Registered Mar. 18, 2008

**TRADEMARK
PRINCIPAL REGISTER**



VANDERKAM, JACOB (UNITED STATES INDIVIDUAL)
P.O. BOX 291122
PHELAN, CA 92329

FOR: CLOTHING, NAMELY, SHIRTS, SWEATSHIRTS, HATS, PANTS, SHORTS, SWIMWEAR, SHOES, JACKETS, SOCKS, UNDERWEAR, GLOVES BELTS AND ARMBANDS, IN CLASS 25 (U.S. CLS. 22 AND 39).

FIRST USE 7-1-2007; IN COMMERCE 10-24-2007.

THE MARK CONSISTS OF A HIGHLY STYLIZED LION'S HEAD.

SN 78-863,532, FILED 4-18-2006.

DANNEAN HETZEL, EXAMINING ATTORNEY

Int. Cl.: 24

Prior U.S. Cls.: 42 and 50

United States Patent and Trademark Office

Reg. No. 3,399,948

Registered Mar. 18, 2008

**TRADEMARK
PRINCIPAL REGISTER**



NEWTON, STEVEN J. (MISSOURI NON-PROFIT ORGANIZATION)
525 CAVE HOLLOW RD
CLEVER, MO 656316313

FOR: CLOTH AND FABRIC FLAGS FEATURING A SILVER COLORED STAR CREATED TO HONOR WOUNDED ARMED FORCES PERSONNEL, IN CLASS 24 (U.S. CLS. 42 AND 50).

FIRST USE 7-1-2005; IN COMMERCE 5-1-2006.

THE COLOR(S) RED, WHITE, BLUE AND SILVER IS/ARE CLAIMED AS A FEATURE OF THE MARK.

THE MARK CONSISTS OF RED OUTSIDE BORDER SIZE OF 4 INCHES THEN WHITE BORDER SIZE OF 4 INCHES THEN SOLID BLUE INSIDE SIZE OF 21 INCHES THEN SILVER STAR CENTERED IN BLUE FIELD SIZE OF 17 INCHES.

SN 78-864,615, FILED 4-19-2006.

HOWARD SMIGA, EXAMINING ATTORNEY

Int. Cl.: 17

Prior U.S. Cls.: 1, 5, 12, 13, 35, and 50

Reg. No. 3,399,949

United States Patent and Trademark Office

Registered Mar. 18, 2008

**TRADEMARK
PRINCIPAL REGISTER**

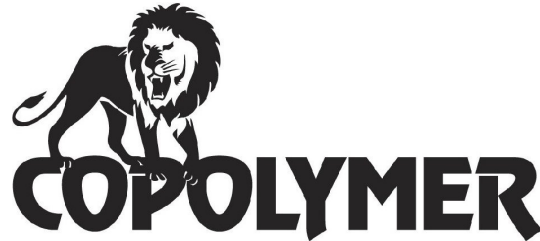

LION COPOLYMER, LLC (DELAWARE LTD
LIAB CO)
5955 SCENIC HIGHWAY
BATON ROUGE, LA 70805

NO CLAIM IS MADE TO THE EXCLUSIVE
RIGHT TO USE "COPOLYMER", APART FROM
THE MARK AS SHOWN.

FOR: ELASTOMERIC POLYMERS, NAMELY,
RUBBER, IN CLASS 17 (U.S. CLS. 1, 5, 12, 13, 35
AND 50).

SN 78-865,668, FILED 4-20-2006.

FIRST USE 2-0-2006; IN COMMERCE 2-0-2006.

MICHAEL ENGEL, EXAMINING ATTORNEY

Int. Cl.: 42

Prior U.S. Cls.: 100 and 101

United States Patent and Trademark Office

Reg. No. 3,399,950

Registered Mar. 18, 2008

**SERVICE MARK
PRINCIPAL REGISTER**

Knowledge is Power

3TIER ENVIRONMENTAL FORECAST GROUP,
INC (WASHINGTON CORPORATION)
2001 SIXTH AVENUE, SUITE 2100
SEATTLE, WA 98121

THE MARK CONSISTS OF STANDARD CHAR-
ACTERS WITHOUT CLAIM TO ANY PARTICULAR
FONT, STYLE, SIZE, OR COLOR.

FOR: WEATHER FORECASTING AND CON-
SULTING IN THE FIELD OF ASSESSMENT OF
SOURCES OF RENEWABLE ENERGY, IN CLASS
42 (U.S. CLS. 100 AND 101).

SN 78-865,800, FILED 4-20-2006.

FIRST USE 7-31-2006; IN COMMERCE 7-31-2006.

ANNE FARRELL, EXAMINING ATTORNEY

Int. Cl.: 20

Prior U.S. Cls.: 2, 13, 22, 25, 32, and 50

United States Patent and Trademark Office

Reg. No. 3,399,951

Registered Mar. 18, 2008

**TRADEMARK
PRINCIPAL REGISTER**



EXPERIENCE HENDRIX, L.L.C. (WASHINGTON
LIMITED LIABILITY COMPANY)
14501 INTERURBAN AVENUE SOUTH
SEATTLE, WA 98168

FOR: NON-METAL AND NON-LEATHER KEY
CHAINS; PLAQUES, IN CLASS 20 (U.S. CLS. 2, 13, 22,
25, 32 AND 50).

FIRST USE 10-24-2003; IN COMMERCE 12-16-2003.

OWNER OF U.S. REG. NOS. 2,245,408, 3,072,909,
AND OTHERS.

NO CLAIM IS MADE TO THE EXCLUSIVE
RIGHT TO USE "AUTHENTIC", APART FROM
THE MARK AS SHOWN.

THE NAME(S), PORTRAIT(S), AND/OR SIGNA-
TURE(S) SHOWN IN THE MARK DOES NOT IDEN-
TIFY A PARTICULAR LIVING INDIVIDUAL.

THE MARK CONSISTS OF THE WORD "AU-
THENTIC" ABOVE AND THE WORD "HENDRIX"
BELOW A DESIGN OF A MAN'S HEAD AND
SHOULDERS.

SN 78-866,262, FILED 4-20-2006.

MARK PILARO, EXAMINING ATTORNEY

Int. Cl.: 9

Prior U.S. Cls.: 21, 23, 26, 36, and 38

United States Patent and Trademark Office

Reg. No. 3,399,952

Registered Mar. 18, 2008

**TRADEMARK
PRINCIPAL REGISTER**

Royal Crown Jewels

MULTIMEDIA GAMES, INC. (TEXAS CORPORATION)
206 WILD BASIN RD. S. BLDG B - 4TH FLR
AUSTIN, TX 78746

FOR: GAMING MACHINES, NAMELY, ELECTRONIC SLOT AND BINGO MACHINES; VIDEO LOTTERY TERMINALS, IN CLASS 9 (U.S. CLS. 21, 23, 26, 36 AND 38).

FIRST USE 9-1-2006; IN COMMERCE 9-1-2006.

THE MARK CONSISTS OF STANDARD CHARACTERS WITHOUT CLAIM TO ANY PARTICULAR FONT, STYLE, SIZE, OR COLOR.

OWNER OF U.S. REG. NOS. 2,521,216 AND 2,769,429.

SN 78-867,112, FILED 4-21-2006.

MICHAEL LEWIS, EXAMINING ATTORNEY

Int. Cls.: 9, 38, and 41

Prior U.S. Cls.: 21, 23, 26, 36, 38, 100, 101, 104, and 107

Reg. No. 3,399,953

United States Patent and Trademark Office

Registered Mar. 18, 2008

**TRADEMARK
SERVICE MARK
PRINCIPAL REGISTER**



TAPUZ PEOPLE LTD. (ISRAEL CORPORATION)
30 BEN GURION ST
RAMAT GAN, ISRAEL 52573

FOR: COMMUNICATIONS SOFTWARE FOR CONNECTING PEOPLE OVER THE INTERNET, FIX AND MOBILE, USING CHATS, MESSAGE BOARDS, INSTANT MESSENGER AND TALK BACKS; COMPUTER SOFTWARE FOR ENABLING LIVE AND RECORDED VIDEO BROADCASTING USING WEB CAMS OR MOBILE PHONES, WATCHING LIVE OR RECORDED VIDEO SHOWS OR FILES, UPLOADING, POSTING, DISPLAYING, TAGGING AND SHARING LIVE AND RECORDED VIDEO FILES, PROVIDING ELECTRONIC MEDIA OR INFORMATION OVER THE INTERNET, FIX AND MOBILE, TELEVISION OR OTHER COMMUNICATIONS NETWORK, IN CLASS 9 (U.S. CLS. 21, 23, 26, 36 AND 38).

FIRST USE 3-21-2004; IN COMMERCE 5-15-2007.

FOR: BROADCASTING PROGRAMS VIA A GLOBAL COMPUTER NETWORK; MOBILE MEDIA AND ENTERTAINMENT SERVICES IN THE NATURE OF ELECTRONIC TRANSMISSION OF ENTERTAINMENT MEDIA CONTENT, IN CLASS 38 (U.S. CLS. 100, 101 AND 104).

FIRST USE 3-21-2004; IN COMMERCE 5-15-2007.

FOR: ENTERTAINMENT IN THE NATURE OF LIVE PERFORMANCES BY PEOPLE USING WEB

CAMS OR MOBILE PHONES; ENTERTAINMENT, NAMELY, A CONTINUING LIVE AND RECORDED VIDEO REALITY SHOW BROADCAST OVER TELEVISION, SATELLITE, AUDIO, AND VIDEO MEDIA; ONLINE JOURNALS, NAMELY, BLOGS FEATURING LIVE AND RECORDED VIDEO SHOWS USING WEB CAMS OR MOBILE PHONES, IN CLASS 41 (U.S. CLS. 100, 101 AND 107).

FIRST USE 3-21-2004; IN COMMERCE 5-15-2007.

NO CLAIM IS MADE TO THE EXCLUSIVE RIGHT TO USE "BLOGTV", APART FROM THE MARK AS SHOWN.

THE COLOR(S) ORANGE, OLIVE GREEN AND BLACK IS/ARE CLAIMED AS A FEATURE OF THE MARK.

THE MARK CONSISTS OF THE EXPRESSION "BLOGTV". THE WORD "BLOG" IS OLIVE GREEN AND "TV" IS ORANGE WITH BLACK OUTLINE AND AN ORANGE KEYHOLE WITH A BLACK EYEBALL INSIDE WITH BLACK OUTLINE IN BLACK BRACKETS ABOVE THE EXPRESSION "BLOGTV".

SN 78-867,654, FILED 4-24-2006.

CAROLYN CATALDO, EXAMINING ATTORNEY

Int. Cl.: 28

Prior U.S. Cls.: 22, 23, 38, and 50

United States Patent and Trademark Office

Reg. No. 3,399,954

Registered Mar. 18, 2008

**TRADEMARK
PRINCIPAL REGISTER**

ZIPLINE ATTACK

MATTEL, INC. (DELAWARE CORPORATION)
M1-1518
333 CONTINENTAL BLVD.
EL SEGUNDO, CA 902455012

FOR: TOYS, GAMES AND PLAYTHINGS, NAME-
LY, TOY ACTION FIGURES, TOY FIGURES, TOY
FIGURE PLAYSETS, AND ACCESSORIES FOR ALL
OF THE FOREGOING, IN CLASS 28 (U.S. CLS. 22, 23,
38 AND 50).

FIRST USE 2-27-2007; IN COMMERCE 2-27-2007.

THE MARK CONSISTS OF STANDARD CHAR-
ACTERS WITHOUT CLAIM TO ANY PARTICULAR
FONT, STYLE, SIZE, OR COLOR.

SN 78-867,973, FILED 4-24-2006.

MELVIN AXILBUND, EXAMINING ATTORNEY

Int. Cls.: 16 and 44

Prior U.S. Cls.: 2, 5, 22, 23, 29, 37, 38, 50, 100, and 101

United States Patent and Trademark Office

Reg. No. 3,399,955

Registered Mar. 18, 2008

**TRADEMARK
SERVICE MARK
PRINCIPAL REGISTER**

RELEASE THE RELIEF

PFIZER INC. (DELAWARE CORPORATION)
235 EAST 42ND STREET
NEW YORK, NY 10017

FOR: PRINTED MATERIALS, NAMELY, BOOK-
LETS, BROCHURES, NEWSLETTERS, MANUALS,
LEAFLETS, CHARTS, CATALOGS AND POSTERS
RELATED TO URINARY DISEASES AND URIN-
ARY PROBLEMS, IN CLASS 16 (U.S. CLS. 2, 5, 22, 23,
29, 37, 38 AND 50).

FIRST USE 5-31-2006; IN COMMERCE 5-31-2006.

FOR: MEDICAL INFORMATION SERVICES,
NAMELY, PROVIDING INFORMATION RELATED

TO URINARY DISEASES AND URINARY PRO-
BLEMS; ON-LINE INFORMATION SERVICES,
NAMELY, PROVIDING INFORMATION RELATED
TO URINARY DISEASES AND URINARY PRO-
BLEMS, IN CLASS 44 (U.S. CLS. 100 AND 101).

FIRST USE 5-31-2006; IN COMMERCE 5-31-2006.

THE MARK CONSISTS OF STANDARD CHAR-
ACTERS WITHOUT CLAIM TO ANY PARTICULAR
FONT, STYLE, SIZE, OR COLOR.

SN 78-868,256, FILED 4-24-2006.

ELLEN PERKINS, EXAMINING ATTORNEY

Int. Cl.: 30

Prior U.S. Cl.: 46

United States Patent and Trademark Office

Reg. No. 3,399,956

Registered Mar. 18, 2008

**TRADEMARK
PRINCIPAL REGISTER**

Harvest Hill

QUALITY FOOD BRANDS, INC. (NEVADA CORPORATION)
223 UNDERHILL BLVD.
SYOSSET, NY 11791

THE MARK CONSISTS OF STANDARD CHARACTERS WITHOUT CLAIM TO ANY PARTICULAR FONT, STYLE, SIZE, OR COLOR.

FOR: CAKE MIXES, COOKIE MIXES, MUFFIN MIXES, PANCAKE MIXES, MIXES FOR BAKERY GOODS, IN CLASS 30 (U.S. CL. 46).

SN 78-870,719, FILED 4-27-2006.

FIRST USE 8-1-2006; IN COMMERCE 9-1-2006.

JUDITH HELFMAN, EXAMINING ATTORNEY

Int. Cl.: 9

Prior U.S. Cls.: 21, 23, 26, and 38

United States Patent and Trademark Office

Reg. No. 3,399,957

Registered Mar. 18, 2008

**TRADEMARK
PRINCIPAL REGISTER**



INNOVATI, INC. (TAIWAN CORPORATION)
2F, NO.290, SEC.2 JINGGUO RD.
HSINCHU, TAIWAN

FOR: MICROCOMPUTERS; MICRO-PROCESSORS; CENTRAL PROCESSING UNITS (CPU); MICROPROCESSORS, COMPUTER HARDWARE; PERSONAL COMPUTER; ELECTRIC DATA PROCESSOR; COMPUTERS; DISC MEMORIES; COMPUTER PROGRAMS FOR WORD PROCESSING AND THE SOFTWARE IS FILED-SPECIFIC FOR USE IN INTEGRATED DEVELOPMENT ENVIRONMENT OF MICROCONTROLLER-BASED SYSTEMS; COMPUTER SOFTWARE FOR WORD PROCESSING AND THE SOFTWARE IS FILED-SPECIFIC FOR USE IN INTEGRATED DEVELOPMENT ENVIRONMENT OF MICROCONTROLLER-BASED SYSTEMS; COMPUTER SOFTWARE FOR WORD PROCESSING AND THE SOFTWARE IS FILED-SPECIFIC FOR USE IN INTEGRATED DEVELOPMENT ENVIRONMENT OF MICROCONTROLLER-BASED SYSTEMS AND MAY BE DOWNLOADED FROM A GLOBAL COMPUTER NETWORK; COMPUTER SOFTWARE PLATFORMS FOR ROBOTICS CONTROL FOR MICROCONTROLLER-BASED SYSTEMS; COMPUTER FIRMWARE FOR ROBOTICS USE IN CONTROL AND COMMUNICATION OF

MICROCONTROLLER-BASED SYSTEMS; PROGRAM WRITER, NAMELY, PROGRAM WRITER IS AN APPARATUS TO WRITE MACHINE CODE INTO THE MICROCONTROLLER UNIT FOR CONTROLLING ROBOTICS; PROGRAMMING MACHINE, NAMELY, PROGRAM MACHINE IS AN APPARATUS TO WRITE MACHINE CODE INTO THE MICROCONTROLLER UNIT FOR CONTROLLING ROBOTICS; MICRO-PROCESSOR EMULATOR, NAMELY, MICRO-PROCESSOR EMULATOR IS A HARDWARE UNIT TO SIMULATE THE ROBOTICS' BEHAVIORS ACCORDING TO USER'S PROGRAM; MICRO-COMPUTER SIMULATOR, NAMELY, MICROCOMPUTER SIMULATOR IS JUST A SOFTWARE UTILITY TO VIRTUALLY SIMULATE THE ROBOTICS' BEHAVIORS ACCORDING TO USER'S PROGRAM; READ-ONLY DISC MEMORIES; READ-ONLY COMPUTER MEMORIES; FLOATING-POINT COMPUTER CHIP; INTEGRATED CIRCUIT BOARD, IN CLASS 9 (U.S. CLS. 21, 23, 26, 36 AND 38).

FIRST USE 10-30-2007; IN COMMERCE 10-30-2007.

SN 78-870,757, FILED 4-27-2006.

GINA FINK, EXAMINING ATTORNEY

Int. Cl.: 20

Prior U.S. Cls.: 2, 13, 22, 25, 32, and 50

Reg. No. 3,399,958

United States Patent and Trademark Office

Registered Mar. 18, 2008

**TRADEMARK
PRINCIPAL REGISTER**

CARDSICLE

THRIVENT FINANCIAL LIFELONG RESOUR-
CES INC. (MINNESOTA CORPORATION)
4321 NORTH BALLARD ROAD
APPLETON, WI 54919

THE MARK CONSISTS OF STANDARD CHAR-
ACTERS WITHOUT CLAIM TO ANY PARTICULAR
FONT, STYLE, SIZE, OR COLOR.

FOR: NONEDIBLE, PLASTIC CREDIT CARD
HOLDERS IN WHICH CREDIT CARDS CAN BE
FROZEN FOR SAFE KEEPING, IN CLASS 20 (U.S.
CLS. 2, 13, 22, 25, 32 AND 50).

SN 78-871,958, FILED 4-28-2006.

FIRST USE 5-14-2007; IN COMMERCE 5-14-2007.

JILL C. ALT, EXAMINING ATTORNEY

Int. Cl.: 20

Prior U.S. Cls.: 2, 13, 22, 25, 32, and 50

United States Patent and Trademark Office

Reg. No. 3,399,959

Registered Mar. 18, 2008

**TRADEMARK
PRINCIPAL REGISTER**

Card\$icle
Credit card spending. | Stop it COLD.

THRIVENT FINANCIAL LIFELONG RESOUR-
CES INC. (MINNESOTA CORPORATION)
4321 NORTH BALLARD ROAD
APPLETON, WI 54919

FIRST USE 5-14-2007; IN COMMERCE 5-14-2007.

FOR: NONEDIBLE, PLASTIC CREDIT CARD
HOLDERS IN WHICH CREDIT CARDS CAN BE
FROZEN FOR SAFE KEEPING, IN CLASS 20 (U.S.
CLS. 2, 13, 22, 25, 32 AND 50).

SN 78-871,974, FILED 4-28-2006.

JILL C. ALT, EXAMINING ATTORNEY

Int. Cl.: 41

Prior U.S. Cls.: 100, 101, and 107

United States Patent and Trademark Office

Reg. No. 3,399,960

Registered Mar. 18, 2008

**SERVICE MARK
PRINCIPAL REGISTER**

ANGELO DIABLO

REIS, NICHOLAS (UNITED STATES INDIVIDUAL)

C2

21-45 28TH ST.

LONG ISLAND CITY, NY 11105

FOR: ENTERTAINMENT SERVICES IN THE NATURE OF LIVE PERFORMANCES BY A MUSICAL BAND, IN CLASS 41 (U.S. CLS. 100, 101 AND 107).

FIRST USE 2-2-2007; IN COMMERCE 2-2-2007.

THE MARK CONSISTS OF STANDARD CHARACTERS WITHOUT CLAIM TO ANY PARTICULAR FONT, STYLE, SIZE, OR COLOR.

THE NAME ANGELO DIABLO DOES NOT IDENTIFY A LIVING INDIVIDUAL.

SN 78-874,525, FILED 5-2-2006.

FRED CARL, EXAMINING ATTORNEY

Int. Cl.: 25

Prior U.S. Cls.: 22 and 39

United States Patent and Trademark Office

Reg. No. 3,399,961

Registered Mar. 18, 2008

**TRADEMARK
PRINCIPAL REGISTER**

PRENDIDO

CHAVEZ, EDUARDO (UNITED STATES INDIVIDUAL)
1813 LEXINGTON AVENUE SOUTH
MENDOTA HEIGHTS, MN 55118

THE MARK CONSISTS OF STANDARD CHARACTERS WITHOUT CLAIM TO ANY PARTICULAR FONT, STYLE, SIZE, OR COLOR.

FOR: HEADWEAR, NAMELY CAPS; CLOTHING, NAMELY, SHIRTS, T-SHIRTS, SWEATPANTS, SHORTS AND JACKETS, IN CLASS 25 (U.S. CLS. 22 AND 39).

SN 78-874,603, FILED 5-2-2006.

FIRST USE 8-22-2007; IN COMMERCE 8-22-2007.

KIMBERLY PERRY, EXAMINING ATTORNEY

Int. Cl.: 41

Prior U.S. Cls.: 100, 101, and 107

United States Patent and Trademark Office

Reg. No. 3,399,962

Registered Mar. 18, 2008

**SERVICE MARK
PRINCIPAL REGISTER**



INDUSTRIOUS KID, INC. (CALIFORNIA CORPORATION)
311 OAK STREET, #104
OAKLAND, CA 94607

LOAD AND DOWNLOAD ART AND CREATIVE PROJECTS, IN CLASS 41 (U.S. CLS. 100, 101 AND 107).

FIRST USE 6-16-2006; IN COMMERCE 6-16-2006.

FOR: EDUCATIONAL AND ENTERTAINMENT SERVICES, NAMELY, AN INTERACTIVE ONLINE COMMUNITY IN WHICH CHILDREN CAN UP-

SN 78-874,818, FILED 5-2-2006.

LAURIE KAUFMAN, EXAMINING ATTORNEY

Int. Cl.: 33

Prior U.S. Cls.: 47 and 49

United States Patent and Trademark Office

Reg. No. 3,399,963

Registered Mar. 18, 2008

**TRADEMARK
PRINCIPAL REGISTER**

WILLIAM WESLEY

GOLDRIDGEPINOT.COM LLC (CALIFORNIA
LIMITED LIABILITY COMPANY)

P.O. BOX 749

SEBASTOPOL, CA 95473

FOR: WINE, IN CLASS 33 (U.S. CLS. 47 AND 49).

FIRST USE 5-0-2007; IN COMMERCE 5-0-2007.

THE MARK CONSISTS OF STANDARD CHAR-
ACTERS WITHOUT CLAIM TO ANY PARTICULAR
FONT, STYLE, SIZE, OR COLOR.

"WILLIAM WESLEY" DOES NOT IDENTIFY A
LIVING INDIVIDUAL.

SN 78-874,840, FILED 5-2-2006.

GEORGE LORENZO, EXAMINING ATTORNEY

Int. Cl.: 41

Prior U.S. Cls.: 100, 101, and 107

United States Patent and Trademark Office

Reg. No. 3,399,964

Registered Mar. 18, 2008

**SERVICE MARK
PRINCIPAL REGISTER**



COSBY, BRIAN K (UNITED STATES INDIVIDUAL)
2906 WOODFIELD DR.
REX, GA 30273

NO CLAIM IS MADE TO THE EXCLUSIVE RIGHT TO USE "MUSIC" AND "PUBLISHING/PRODUCTIONS", APART FROM THE MARK AS SHOWN.

FOR: MUSIC COMPOSITION FOR OTHERS; MUSIC PRODUCTION SERVICES; MUSIC PUBLISHING, IN CLASS 41 (U.S. CLS. 100, 101 AND 107).

SN 78-874,957, FILED 5-3-2006.

FIRST USE 11-1-2007; IN COMMERCE 11-1-2007.

DAVID COLLIER, EXAMINING ATTORNEY

Int. Cl.: 42

Prior U.S. Cls.: 100 and 101

United States Patent and Trademark Office

Reg. No. 3,399,965

Registered Mar. 18, 2008

**SERVICE MARK
PRINCIPAL REGISTER**

ISEEK

QAMHIYAH, ABIR (UNITED STATES INDIVIDUAL), DBA ISEEK,
SUITE 2105
2625 NORTH LOOP DRIVE
AMES, IA 50010

FOR: PROVIDING TEMPORARY USE OF NON-DOWNLOADABLE COMPUTER SEARCH ENGINE SHAPE BASED SOFTWARE FOR OBTAINING DATA IN THE FORM OF PICTURES, MODELS, IMAGES AND DIAGRAMS VIA A GLOBAL COMPUTER NETWORK AND COMPUTER SERVICES, NAMELY, PROVIDING TEMPORARY USE OF ONLINE NON-DOWNLOADABLE COMPUTER SEARCH ENGINE SHAPE BASED SOFTWARE

FOR OBTAINING DATA IN THE FORM OF PICTURES, MODELS, IMAGES AND DIAGRAMS VIA A GLOBAL COMPUTER NETWORK, IN CLASS 42 (U.S. CLS. 100 AND 101).

FIRST USE 6-26-2006; IN COMMERCE 6-26-2006.

THE MARK CONSISTS OF STANDARD CHARACTERS WITHOUT CLAIM TO ANY PARTICULAR FONT, STYLE, SIZE, OR COLOR.

SN 78-875,052, FILED 5-3-2006.

AMY MCMENAMIN, EXAMINING ATTORNEY

Int. Cl.: 16

Prior U.S. Cls.: 2, 5, 22, 23, 29, 37, 38, and 50

United States Patent and Trademark Office

Reg. No. 3,399,966

Registered Mar. 18, 2008

TRADEMARK
PRINCIPAL REGISTER



ANIMALATIONS LLC (NEVADA LTD LIAB CO)
4186 MELODIA SONGO COURT
LAS VEGAS, NV 89135

FOR: PRINTED MATTER FEATURING INSPIRA-
TIONAL MESSAGES, NAMELY, BOOK MARKS
AND STICKERS, IN CLASS 16 (U.S. CLS. 2, 5, 22, 23,
29, 37, 38 AND 50).

FIRST USE 2-1-2007; IN COMMERCE 2-1-2007.

THE COLOR(S) TAN, BROWN, BLACK, PURPLE,
ORANGE, RED AND YELLOW IS/ARE CLAIMED
AS A FEATURE OF THE MARK.

THE MARK CONSISTS OF AN OWL WITH A TAN
FACE, A LIGHT BROWN BODY, DARK BROWN
WINGS, A RED TONGUE, YELLOW CLAWS EYES
AND FACE, AND BLACK FEET AND PERCH, WITH
THE WORDS, ORIN THE OWL APPEARING IN
PURPLE WITH AN ORANGE OUTLINE.

SN 78-875,990, FILED 5-3-2006.

KELLY MCCOY, EXAMINING ATTORNEY

Int. Cl.: 42

Prior U.S. Cls.: 100 and 101

United States Patent and Trademark Office

Reg. No. 3,399,967

Registered Mar. 18, 2008

**SERVICE MARK
PRINCIPAL REGISTER**

FOUNDATION NETWORK SERVICES

DIGITAL TELEMEDIA INC. (NEW YORK CORPORATION), DBA LOGICWORKS,
11 BEACH STREET
3RD FLOOR
NEW YORK, NY 10013

FOR: MANAGED HOSTING SERVICES, NAME-
LY, HOSTING COMPUTER SOFTWARE APPLICA-
TIONS OF OTHERS, HOSTING AND MANAGING
THE WEB SITES OF OTHERS ON A COMPUTER
SERVER, HOSTING OF DIGITAL CONTENT ON
THE INTERNET, ADMINISTRATION AND MAIN-
TENANCE OF DIGITAL CONTENT AND MEDIA
FOR USE IN CONNECTION WITH DATA TRANS-
MISSION NETWORKS, IN CLASS 42 (U.S. CLS. 100
AND 101).

FIRST USE 11-0-2006; IN COMMERCE 11-0-2006.

THE MARK CONSISTS OF STANDARD CHAR-
ACTERS WITHOUT CLAIM TO ANY PARTICULAR
FONT, STYLE, SIZE, OR COLOR.

NO CLAIM IS MADE TO THE EXCLUSIVE
RIGHT TO USE "NETWORK SERVICES", APART
FROM THE MARK AS SHOWN.

SN 78-876,257, FILED 5-4-2006.

MATTHEW EINSTEIN, EXAMINING ATTORNEY

Int. Cl.: 44

Prior U.S. Cls.: 100 and 101

United States Patent and Trademark Office

Reg. No. 3,399,968

Registered Mar. 18, 2008

**SERVICE MARK
PRINCIPAL REGISTER**

**Putting the Hospitality
Back Into Hospital**

CYPRESS FAIRBANKS MEDICAL CENTER, INC.
(TEXAS CORPORATION)
13737 NOEL ROAD, SUITE 100
DALLAS, TX 75240

THE MARK CONSISTS OF STANDARD CHAR-
ACTERS WITHOUT CLAIM TO ANY PARTICULAR
FONT, STYLE, SIZE, OR COLOR.

FOR: HEALTH CARE, IN CLASS 44 (U.S. CLS. 100
AND 101).

SN 78-876,262, FILED 5-4-2006.

FIRST USE 7-6-2007; IN COMMERCE 7-6-2007.

MICHAEL SOUDERS, EXAMINING ATTORNEY

Int. Cl.: 41

Prior U.S. Cls.: 100, 101, and 107

United States Patent and Trademark Office

Reg. No. 3,399,969

Registered Mar. 18, 2008

**SERVICE MARK
PRINCIPAL REGISTER**

VARSITY COLLECTION

AMERICAN READING COMPANY (PENNSYLVANIA CORPORATION)
201 S. GULPH ROAD
KING OF PRUSSIA, PA 19406

FOR: EDUCATIONAL SERVICES, NAMELY, A READING PROGRAM FOR MIDDLE, HIGH SCHOOL AND OLDER STUDENTS AND A PROGRAM FOR ASSESSING THE LEVEL OF DIFFICULTY OF BOOKS AS PART OF A READING PROGRAM, IN CLASS 41 (U.S. CLS. 100, 101 AND 107).

FIRST USE 6-24-1998; IN COMMERCE 6-24-1998.

THE MARK CONSISTS OF STANDARD CHARACTERS WITHOUT CLAIM TO ANY PARTICULAR FONT, STYLE, SIZE, OR COLOR.

NO CLAIM IS MADE TO THE EXCLUSIVE RIGHT TO USE "COLLECTION", APART FROM THE MARK AS SHOWN.

SN 78-877,406, FILED 5-5-2006.

JANICE KIM, EXAMINING ATTORNEY

Int. Cl.: 35

Prior U.S. Cls.: 100, 101, and 102

United States Patent and Trademark Office

Reg. No. 3,399,970

Registered Mar. 18, 2008

**SERVICE MARK
PRINCIPAL REGISTER**

LOFT FOR LIFE

ANNCO, INC. (DELAWARE CORPORATION)
476 WHEELERS FARMS ROAD
MILFORD, CT 06461

FIRST USE 10-0-2006; IN COMMERCE 10-0-2006.

FOR: ON-LINE AND IN STORE RETAIL STORE
SERVICES IN THE FIELDS OF CLOTHING, FOOT-
WEAR, HANDBAGS, SMALL LEATHER ACCES-
SORIES, JEWELRY, TOILETRIES, BATH
PRODUCTS, AND COSMETIC PRODUCTS , IN
CLASS 35 (U.S. CLS. 100, 101 AND 102).

THE MARK CONSISTS OF STANDARD CHAR-
ACTERS WITHOUT CLAIM TO ANY PARTICULAR
FONT, STYLE, SIZE, OR COLOR.

SN 78-877,897, FILED 5-5-2006.

DEIRDRE ROBERTSON, EXAMINING ATTORNEY

Int. Cl.: 9

Prior U.S. Cls.: 21, 23, 26, 36, and 38

United States Patent and Trademark Office

Reg. No. 3,399,971

Registered Mar. 18, 2008

**TRADEMARK
PRINCIPAL REGISTER**

Combat Controller

SIERRA NEVADA CORPORATION (NEVADA CORPORATION)
444 SALOMON CIRCLE
SPARKS, NV 89434

FOR: HANDHELD REMOTE CONTROL INTERFACE FOR REMOTE NAVIGATION OF HANDHELD COMPUTER TO BE USED IN CONJUNCTION WITH HELMET-MOUNTED HEADS-UP LCD DISPLAY, IN CLASS 9 (U.S. CLS. 21, 23, 26, 36 AND 38).

FIRST USE 9-7-2004; IN COMMERCE 9-7-2004.

THE MARK CONSISTS OF STANDARD CHARACTERS WITHOUT CLAIM TO ANY PARTICULAR FONT, STYLE, SIZE, OR COLOR.

SN 78-878,465, FILED 5-8-2006.

DAVID C. REIHNER, EXAMINING ATTORNEY

Int. Cl.: 9

Prior U.S. Cls.: 21, 23, 26, 36, and 38

United States Patent and Trademark Office

Reg. No. 3,399,972

Registered Mar. 18, 2008

**TRADEMARK
PRINCIPAL REGISTER**

TACTISIGHT

SIERRA NEVADA CORPORATION (NEVADA CORPORATION)
444 SALOMON CIRCLE
SPARKS, NV 89434

FOR: TACTICAL INFORMATION SYSTEM CONSISTING OF A HELMET-MOUNTED HIGH RANGE COLOR CAMERA FOR CAPTURING VIDEO AND STILL IMAGERY, HAND-HELD COMPUTER, AND A LCD DISPLAY CAPABLE OF DISPLAYING COMPUTER DISPLAYS OR VIDEOS FROM THE CAMERA, WHICH ARE ATTACHABLE TO A HELMET OR THE BODY, IN CLASS 9 (U.S. CLS. 21, 23, 26, 36 AND 38).

FIRST USE 3-1-2004; IN COMMERCE 3-1-2004.

THE MARK CONSISTS OF STANDARD CHARACTERS WITHOUT CLAIM TO ANY PARTICULAR FONT, STYLE, SIZE, OR COLOR.

THE WORDING "TACTISIGHT" HAS NO MEANING IN A FOREIGN LANGUAGE.

SN 78-878,541, FILED 5-8-2006.

DAVID C. REIHNER, EXAMINING ATTORNEY

Int. Cl.: 28

Prior U.S. Cls.: 22, 23, 38, and 50

United States Patent and Trademark Office

Reg. No. 3,399,973

Registered Mar. 18, 2008

**TRADEMARK
PRINCIPAL REGISTER**

KATHLEEN MCKENZIE

MISSION CITY PRESS, INC. (TEXAS CORPORATION)

8122 DATAPOINT DRIVE, SUITE 1000

SAN ANTONIO, TX 78229

FOR: DOLL ACCESSORIES; DOLLS, IN CLASS 28 (U.S. CLS. 22, 23, 38 AND 50).

FIRST USE 8-30-2006; IN COMMERCE 8-30-2006.

THE MARK CONSISTS OF STANDARD CHARACTERS WITHOUT CLAIM TO ANY PARTICULAR FONT, STYLE, SIZE, OR COLOR.

THE NAME(S), PORTRAIT(S), AND/OR SIGNATURE(S) SHOWN IN THE MARK DOES NOT IDENTIFY A PARTICULAR LIVING INDIVIDUAL.

SN 78-881,775, FILED 5-11-2006.

SUE LAWRENCE, EXAMINING ATTORNEY

Int. Cl.: 36

Prior U.S. Cls.: 100, 101, and 102

United States Patent and Trademark Office

Reg. No. 3,399,974

Registered Mar. 18, 2008

**SERVICE MARK
PRINCIPAL REGISTER**



MRU HOLDINGS, INC. (DELAWARE CORPORATION)
13TH FLOOR
590 MADISON AVENUE
NEW YORK, NY 10036

FOR: FINANCIAL SERVICES, NAMELY, CONSUMER LENDING SERVICES; PROVIDING LOAN FINANCING TO STUDENTS; GUARANTEEING LOAN FINANCING TO STUDENTS; AND PROVIDING FINANCIAL AID TO STUDENTS IN EX-

CHANGE FOR A FIXED PERCENTAGE OF THE STUDENTS INCOME FOR A SPECIFIED PERIOD, IN CLASS 36 (U.S. CLS. 100, 101 AND 102).

FIRST USE 7-7-2007; IN COMMERCE 7-7-2007.

SN 78-882,142, FILED 5-12-2006.

CIMMERIAN COLEMAN, EXAMINING ATTORNEY

Int. Cls.: 25 and 30

Prior U.S. Cls.: 22, 39, and 46

United States Patent and Trademark Office

Reg. No. 3,399,975

Registered Mar. 18, 2008

**TRADEMARK
PRINCIPAL REGISTER**

QRO

MOLEON, GARY (UNITED STATES INDIVIDUAL)
162 KEMAH ROAD
RIDGEWOOD, NJ 07450

FOR: BASEBALL CAPS; CHEF'S HATS; HATS; HEADGEAR, NAMELY, HATS AND CAPS; SMALL HATS, IN CLASS 25 (U.S. CLS. 22 AND 39).

FIRST USE 5-12-2006; IN COMMERCE 5-12-2006.

FOR: ARTICHOKE SAUCE; BARBECUE SAUCE; CHEESE SAUCE; CHILI SAUCE; CONDIMENT, NAMELY, PEPPER SAUCE; FISH SAUCE; HOT SAUCE; MIX FOR MAKING COMBINED NOODLE AND SAUCE DISH; PICANTE SAUCE; PIZZA

SAUCE; READY-MADE SAUCES; SALAD SAUCES; SAUCES; SAUCES FOR BARBECUED MEAT; SLOPPY JOE SAUCE; SOY SAUCE; SOY SAUCE; SPAGHETTI SAUCE; TARTAR SAUCE; TERIYAKI SAUCE; TOMATO SAUCE, IN CLASS 30 (U.S. CL. 46).

FIRST USE 5-12-2006; IN COMMERCE 5-12-2006.

THE MARK CONSISTS OF STANDARD CHARACTERS WITHOUT CLAIM TO ANY PARTICULAR FONT, STYLE, SIZE, OR COLOR.

SN 78-882,686, FILED 5-12-2006.

WON TEAK OH, EXAMINING ATTORNEY

Int. Cls.: 25 and 30

Prior U.S. Cls.: 22, 39, and 46

United States Patent and Trademark Office

Reg. No. 3,399,976

Registered Mar. 18, 2008

**TRADEMARK
PRINCIPAL REGISTER**

**THE HOT HEARD 'ROUND THE
WORLD**

MOLEON, GARY (UNITED STATES INDIVIDUAL)
162 KEMAH ROAD
RIDGEWOOD, NJ 07450

FOR: BASEBALL CAPS; CHEF'S HATS; HATS; HEADGEAR, NAMELY, HATS AND CAPS; SMALL HATS, IN CLASS 25 (U.S. CLS. 22 AND 39).

FIRST USE 5-12-2006; IN COMMERCE 5-12-2006.

FOR: ARTICHOKE SAUCE; BARBECUE SAUCE; CHEESE SAUCE; CHILI SAUCE; CONDIMENT, NAMELY, PEPPER SAUCE; FISH SAUCE; HOT SAUCE; MIX FOR MAKING COMBINED NOODLE AND SAUCE DISH; PICANTE SAUCE; PIZZA

SAUCE; READY-MADE SAUCES; SALAD SAUCES; SAUCES; SAUCES FOR BARBECUED MEAT; SLOPPY JOE SAUCE; SOY SAUCE; SOY SAUCE; SPAGHETTI SAUCE; TARTAR SAUCE; TERIYAKI SAUCE; TOMATO SAUCE, IN CLASS 30 (U.S. CL. 46).

FIRST USE 5-12-2006; IN COMMERCE 5-12-2006.

THE MARK CONSISTS OF STANDARD CHARACTERS WITHOUT CLAIM TO ANY PARTICULAR FONT, STYLE, SIZE, OR COLOR.

SN 78-882,698, FILED 5-12-2006.

WON TEAK OH, EXAMINING ATTORNEY

Int. Cls.: 35 and 36

Prior U.S. Cls.: 100, 101, and 102

United States Patent and Trademark Office

Reg. No. 3,399,977

Registered Mar. 18, 2008

**SERVICE MARK
PRINCIPAL REGISTER**



STARBRIDGE

STARBRIDGE LLC (CALIFORNIA LTD LIAB CO)
1875 LYNDON ROAD
SAN DIEGO, CA 92103

FOR: ACQUISITION AND MERGER CONSULTATION; BUSINESS ACQUISITION AND MERGER CONSULTATION; BUSINESS ACQUISITIONS CONSULTATION; BUSINESS CONSULTATION SERVICES; BUSINESS CONSULTING AND BUSINESS INFORMATION FOR ENTERPRISES; BUSINESS MANAGEMENT CONSULTATION; BUSINESS MERGER CONSULTATION; BUSINESS ORGANIZATION AND OPERATION CONSULTANCY; BUSINESS RELOCATION CONSULTING; BUSINESS RESEARCH CONSULTATION; BUSINESS SERVICES, NAMELY, MATCHING POTENTIAL PRIVATE INVESTORS WITH ENTREPRENEURS NEEDING FUNDING; COMMERCIAL CONSULTANCY; CONSULTANCY SERVICES REGARDING BUSINESS STRATEGIES; CONSULTATION IN THE FIELD OF BUSINESS ACQUISITIONS; CONSULTATION SERVICES IN THE FIELD OF COMPANY, BUSINESS SECTOR AND INDUSTRY DATA AND RESEARCH, IN CLASS 35 (U.S. CLS. 100, 101 AND 102).

FIRST USE 3-13-2006; IN COMMERCE 5-13-2006.

FOR: CAPITAL INVESTMENT CONSULTATION; EQUITY CAPITAL INVESTMENT; MANAGEMENT OF A CAPITAL INVESTMENT FUND; REAL ESTATE EQUITY SHARING, NAMELY, MANAGING AND ARRANGING FOR CO-OWNERSHIP OF REAL ESTATE; VENTURE CAPITAL FUNDING SERVICES TO EMERGING AND START-UP COMPANIES; VENTURE CAPITAL SERVICES, NAMELY, PROVIDING FINANCING TO EMERGING AND START-UP COMPANIES, IN CLASS 36 (U.S. CLS. 100, 101 AND 102).

FIRST USE 3-13-2006; IN COMMERCE 5-13-2006.

THE COLOR(S) DARK BLUE AND GOLD IS/ARE CLAIMED AS A FEATURE OF THE MARK.

THE MARK CONSISTS OF TWO CONJOINED RINGS WITH AN EIGHT-SIDED STAR AT THE AREA OF CONJUNCTION OF THE TWO RINGS. THE RINGS AND COMPANY NAME ARE BLUE AND THE STAR IS GOLD.

SN 78-883,088, FILED 5-13-2006.

KIMBERLY PERRY, EXAMINING ATTORNEY

Int. Cl.: 14

Prior U.S. Cls.: 2, 27, 28, and 50

United States Patent and Trademark Office

Reg. No. 3,399,978

Registered Mar. 18, 2008

**TRADEMARK
PRINCIPAL REGISTER**

CROCODILEHALL

CORD, BARRY STEVEN (UNITED STATES IN-
DIVIDUAL)
119 WEST 40TH STREET
NEW YORK, NY 10018

FOR: ARTICLES MADE WHOLLY OR IN PART
OF PRECIOUS METALS, NAMELY, RINGS, EARR-
INGS, NECKLACES, BRACELETS, PENDANTS,
WATCHES, CUFF LINKS, CIGARETTE LIGHTERS
AND BELT BUCKLES , IN CLASS 14 (U.S. CLS. 2, 27,
28 AND 50).

FIRST USE 6-15-2006; IN COMMERCE 6-15-2006.

THE MARK CONSISTS OF STANDARD CHAR-
ACTERS WITHOUT CLAIM TO ANY PARTICULAR
FONT, STYLE, SIZE, OR COLOR.

SN 78-883,247, FILED 5-15-2006.

ELI HELLMAN, EXAMINING ATTORNEY

Int. Cl.: 7

Prior U.S. Cls.: 13, 19, 21, 23, 31, 34, and 35

Reg. No. 3,399,979

United States Patent and Trademark Office

Registered Mar. 18, 2008

**TRADEMARK
PRINCIPAL REGISTER**

NAPA POWER SPORT

NATIONAL AUTOMOTIVE PARTS ASSOCIATION (MICHIGAN CORPORATION)
2999 CIRCLE 75 PARKWAY
ATLANTA, GA 30339

OWNER OF U.S. REG. NOS. 840,448 AND 1,656,107.

FOR: OIL FILTERS, AIR FILTERS FOR VEHICLE MOTORS AND ENGINES, AND FUEL FILTERS, IN CLASS 7 (U.S. CLS. 13, 19, 21, 23, 31, 34 AND 35).

NO CLAIM IS MADE TO THE EXCLUSIVE RIGHT TO USE "POWER SPORT", APART FROM THE MARK AS SHOWN.

FIRST USE 7-0-2007; IN COMMERCE 7-0-2007.

SN 78-883,782, FILED 5-15-2006.

THE MARK CONSISTS OF STANDARD CHARACTERS WITHOUT CLAIM TO ANY PARTICULAR FONT, STYLE, SIZE, OR COLOR.

TIMOTHY FINNEGAN, EXAMINING ATTORNEY

Int. Cl.: 28

Prior U.S. Cls.: 22, 23, 38, and 50

United States Patent and Trademark Office

Reg. No. 3,399,980

Registered Mar. 18, 2008

**TRADEMARK
PRINCIPAL REGISTER**

MOT Sensor

PIXART IMAGING INC. (TAIWAN CORPORATION)
5F., NO. 5, INNOVATION ROAD I
SCIENCE-BASED INDUSTRIAL PARK
HSIN-CHU, TAIWAN

FOR: HAND HELD UNIT FOR PLAYING VIDEO
GAMES, IN CLASS 28 (U.S. CLS. 22, 23, 38 AND 50).

FIRST USE 10-1-2007; IN COMMERCE 10-12-2007.

THE MARK CONSISTS OF STANDARD CHARACTERS WITHOUT CLAIM TO ANY PARTICULAR FONT, STYLE, SIZE, OR COLOR.

NO CLAIM IS MADE TO THE EXCLUSIVE RIGHT TO USE "SENSOR", APART FROM THE MARK AS SHOWN.

SN 78-887,554, FILED 5-19-2006.

LINDA E. BLOHM, EXAMINING ATTORNEY

Int. Cl.: 9

Prior U.S. Cls.: 21, 23, 26, 36, and 38

Reg. No. 3,399,981

United States Patent and Trademark Office

Registered Mar. 18, 2008

**TRADEMARK
PRINCIPAL REGISTER**



ETRIAL COMMUNICATIONS, INC. (COLORADO CORPORATION)
9060 E. 29TH AVE.
DENVER, CO 80238

FIRST USE 7-1-2006; IN COMMERCE 7-1-2006.

FOR: COMPUTER SOFTWARE FOR ASSISTANCE IN LITIGATION AND PREPARATION OF TRIAL AND APPELLATE BRIEFS; COMPUTER SOFTWARE FOR ASSISTANCE IN LITIGATION AND PREPARATION OF TRIAL AND APPELLATE BRIEFS THAT MAY BE DOWNLOADED FROM A GLOBAL COMPUTER NETWORK, IN CLASS 9 (U.S. CLS. 21, 23, 26, 36 AND 38).

THE MARK CONSISTS OF A LYNX EMERGING FROM A CD-ROM, WHICH IS EMERGING FROM A SERIES OF JEWEL CASES.

SN 78-888,077, FILED 5-19-2006.

SEAN CROWLEY, EXAMINING ATTORNEY

Int. Cl.: 9

Prior U.S. Cls.: 21, 23, 26, 36, and 38

United States Patent and Trademark Office

Reg. No. 3,399,982

Registered Mar. 18, 2008

**TRADEMARK
PRINCIPAL REGISTER**

BARMATE

BARMATE LIMITED (UNITED KINGDOM CORPORATION)
BARMATE LTD, NORTHWAY HOUSE
1379 HIGH ROAD
WHETSTONE, LONDON, UNITED KINGDOM
N209LP

FOR: REAL-TIME LOCATION SYSTEM COMPRISING COMPUTER HARDWARE AND COMPUTER SOFTWARE FOR USE IN DETERMINING THE PHYSICAL LOCATION OF CUSTOMERS REQUIRING FOOD AND BEVERAGE SERVICE IN THE FOOD AND BEVERAGE AND HOSPITALITY IN-

DUSTRY, IN CLASS 9 (U.S. CLS. 21, 23, 26, 36 AND 38).

FIRST USE 10-12-2007; IN COMMERCE 10-12-2007.

THE MARK CONSISTS OF STANDARD CHARACTERS WITHOUT CLAIM TO ANY PARTICULAR FONT, STYLE, SIZE, OR COLOR.

SN 78-889,717, FILED 5-23-2006.

ALEX KEAM, EXAMINING ATTORNEY

Int. Cl.: 9

Prior U.S. Cls.: 21, 23, 26, 36, and 38

Reg. No. 3,399,983

United States Patent and Trademark Office

Registered Mar. 18, 2008

**TRADEMARK
PRINCIPAL REGISTER**

HYUNDAI

HYNIX SEMICONDUCTOR INC. (REPUBLIC OF KOREA CORPORATION)
SAN 136-1, AMI-RI, BUBAL-EUB, ICHON
KYOUNGKI-DO, REPUBLIC OF KOREA

FOR: AUDIO MIXERS, AUDIO AMPLIFIERS, AUDIO PROCESSING EQUIPMENT, NAMELY LIMITERS AND COMPRESSORS; AUDIO SPEAKERS, SPEAKERS FOR COMPUTERS, CDMA (CODE DIVISION MULTIPLE ACCESS) PHONES, GSM (GLOBAL SYSTEM FOR MOBILE COMMUNICATIONS) PHONES, DMB (DIGITAL MULTIMEDIA BROADCASTING) PHONES; CD PLAYERS; VCD (VIDEO COMPACT DISK) PLAYERS; DVD PLAYERS; SATELLITE RECEIVERS; CRT (CATHODE-RAY TUBE) TV'S, LCD (LIQUID CRYSTAL DISPLAY) TV'S, PDP (PLASMA DISPLAY PANEL) TV, TELEVISION APPARATUS FOR PROJECTION PURPOSES; BATTERIES; FAX MACHINES; MP3 PLAYERS; GLOBAL POSITIONING SYSTEM (GPS) CONSISTING OF COMPUTERS, COMPUTER SOFTWARE, TRANSMITTERS, RECEIVERS, AND NETWORK INTERFACE DEVICES; CAMERAS, DIGITAL CAMERAS; CAR NAVIGATION COMPUTERS, NAVIGATION APPARATUS FOR VEHICLES IN THE NATURE OF ON-BOARD COMPUTERS, TV RECEIVERS; TV PROMPTER; VIDEO GAME MACHINES FOR USE WITH TELEVISION; TV SATELLITE BROADCASTING RECEIVERS; DMB (DIGITAL MULTIMEDIA

BROADCASTING) RECEIVERS; PHOTO-TELEGRAPHY APPARATUS; MOVIE PROJECTORS, MULTIMEDIA PROJECTORS, VIDEO PROJECTORS, LIQUID CRYSTAL DISPLAY (LCD) PROJECTORS; VIDEO GAME INTERACTIVE HAND HELD REMOTE CONTROLS FOR PLAYING ELECTRONIC GAMES; PMP (PORTABLE MULTIMEDIA PLAYER); DIGITAL DOOR LOCKS, ELECTRIC OR ELECTRONIC DOOR OPENERS AND ELECTRONIC DOOR CLOSING SYSTEMS; HOME AUTOMATION SYSTEM COMPRISING COMPUTERS, OPERATING SOFTWARE, VIDEO CAMERAS, LIGHTING CONTROL PANELS, LIGHTING CONTROL SOFTWARE FOR HOME BANKING, HOME SECURITY AND HOME LIGHTING AND COOLING, VIDEO MONITOR TO DOOR CAMERA, AUDIO OR VIDEO INTERCOM, ACCESS CONTROL AND ALARM MONITORING SYSTEMS, TELEVISIONS AND PHONES FOR KITCHEN , IN CLASS 9 (U.S. CLS. 21, 23, 26, 36 AND 38).

FIRST USE 12-21-2006; IN COMMERCE 12-21-2006.

OWNER OF U.S. REG. NO. 1,432,737.

SN 78-890,437, FILED 5-23-2006.

BARBARA BROWN, EXAMINING ATTORNEY

Int. Cl.: 36

Prior U.S. Cls.: 100, 101, and 102

United States Patent and Trademark Office

Reg. No. 3,399,984

Registered Mar. 18, 2008

**SERVICE MARK
PRINCIPAL REGISTER**

PURITY

FIRST NATIONAL BANK OF OMAHA (UNITED STATES FEDERALLY CHARTERED BANKING ASSOCIATION)
1620 DODGE STREET
OMAHA, NE 68197

THE MARK CONSISTS OF STANDARD CHARACTERS WITHOUT CLAIM TO ANY PARTICULAR FONT, STYLE, SIZE, OR COLOR.

FOR: CREDIT CARD SERVICES, IN CLASS 36 (U.S. CLS. 100, 101 AND 102).

SN 78-890,788, FILED 5-15-2006.

FIRST USE 7-28-2006; IN COMMERCE 7-28-2006.

NELSON SNYDER, EXAMINING ATTORNEY

Int. Cl.: 9

Prior U.S. Cls.: 21, 23, 26, 36, and 38

United States Patent and Trademark Office

Reg. No. 3,399,985

Registered Mar. 18, 2008

**TRADEMARK
PRINCIPAL REGISTER**

GAMBLERS EDGE POKER

GAMETECH INTERNATIONAL, INC. (DELA-
WARE CORPORATION)
900 SANDHILL ROAD
RENO, NV 89521

FOR: GAMING EQUIPMENT, NAMELY, VIDEO
POKER GAME MACHINES, IN CLASS 9 (U.S. CLS.
21, 23, 26, 36 AND 38).

FIRST USE 6-8-2007; IN COMMERCE 6-8-2007.

THE MARK CONSISTS OF STANDARD CHAR-
ACTERS WITHOUT CLAIM TO ANY PARTICULAR
FONT, STYLE, SIZE, OR COLOR.

NO CLAIM IS MADE TO THE EXCLUSIVE
RIGHT TO USE "GAMBLERS" AND "POKER",
APART FROM THE MARK AS SHOWN.

SN 78-891,268, FILED 5-24-2006.

REBECCA EISINGER, EXAMINING ATTORNEY

Int. Cl.: 41

Prior U.S. Cls.: 100, 101, and 107

United States Patent and Trademark Office

Reg. No. 3,399,986

Registered Mar. 18, 2008

**SERVICE MARK
PRINCIPAL REGISTER**

Nigels 11

KIRKPATRICK, CHRISTOPHER (UNITED STATES INDIVIDUAL)
ATTN: MICHAEL MARKARIAN
130 N. BRAND AVE., SUITE 400
GLENDALE, CA 91203

FOR: ENTERTAINMENT SERVICES, NAMELY, LIVE PERFORMANCES BY A MUSICAL BAND, IN CLASS 41 (U.S. CLS. 100, 101 AND 107).

FIRST USE 12-1-2005; IN COMMERCE 1-1-2007.

THE MARK CONSISTS OF STANDARD CHARACTERS WITHOUT CLAIM TO ANY PARTICULAR FONT, STYLE, SIZE, OR COLOR.

THE NAME "NIGELS 11" DOES NOT IDENTIFY A LIVING INDIVIDUAL.

SN 78-892,588, FILED 5-25-2006.

MYRIAH HABEEB, EXAMINING ATTORNEY

Int. Cl.: 9

Prior U.S. Cls.: 21, 23, 26, 36, and 38

Reg. No. 3,399,987

United States Patent and Trademark Office

Registered Mar. 18, 2008

**TRADEMARK
PRINCIPAL REGISTER**

FIREFISH

HARRIS CORPORATION (DELAWARE CORPORATION)
1025 WEST NASA BOULEVARD
MELBOURNE, FL 32919

THE MARK CONSISTS OF STANDARD CHARACTERS WITHOUT CLAIM TO ANY PARTICULAR FONT, STYLE, SIZE, OR COLOR.

FOR: COMPUTER SOFTWARE, NAMELY, APPLICATION SOFTWARE FOR EXTRACTING INFORMATION FROM CELLULAR TELEPHONES AND CELLULAR TELEPHONE SIM CARDS, IN CLASS 9 (U.S. CLS. 21, 23, 26, 36 AND 38).

SN 78-892,695, FILED 5-25-2006.

FIRST USE 6-19-2007; IN COMMERCE 6-19-2007.

KARANENDRA S. CHHINA, EXAMINING ATTORNEY

Int. Cl.: 36

Prior U.S. Cls.: 100, 101, and 102

United States Patent and Trademark Office

Reg. No. 3,399,988

Registered Mar. 18, 2008

**SERVICE MARK
PRINCIPAL REGISTER**

SCOTIALINE GOLD

THE BANK OF NOVA SCOTIA (CANADA CHAR-
TERED BANK)
44 KING STREET WEST
TORONTO, ONTARIO, CANADA M5H 1H1

FOR: BANKING AND CREDIT CARD SERVICES,
IN CLASS 36 (U.S. CLS. 100, 101 AND 102).

FIRST USE 4-0-2005; IN COMMERCE 11-0-2007.

THE MARK CONSISTS OF STANDARD CHAR-
ACTERS WITHOUT CLAIM TO ANY PARTICULAR
FONT, STYLE, SIZE, OR COLOR.

OWNER OF U.S. REG. NOS. 1,003,026, 1,427,782,
AND OTHERS.

SN 78-892,737, FILED 5-25-2006.

MYRIAH HABEEB, EXAMINING ATTORNEY

Int. Cl.: 21

Prior U.S. Cls.: 2, 13, 23, 29, 30, 33, 40, and 50

United States Patent and Trademark Office

Reg. No. 3,399,989

Registered Mar. 18, 2008

**TRADEMARK
PRINCIPAL REGISTER**

EZSTREET

STELLAR MANUFACTURING, INC. (OREGON
CORPORATION)
21095 QUAIL LN.
BEND, OR 97701

FOR: GARBAGE CANS, IN CLASS 21 (U.S. CLS. 2,
13, 23, 29, 30, 33, 40 AND 50).

FIRST USE 3-31-2007; IN COMMERCE 3-31-2007.

THE MARK CONSISTS OF STANDARD CHAR-
ACTERS WITHOUT CLAIM TO ANY PARTICULAR
FONT, STYLE, SIZE, OR COLOR.

SN 78-892,931, FILED 5-25-2006.

CHRISTOPHER BUONGIORNO, EXAMINING AT-
TORNEY

Int. Cl.: 9

Prior U.S. Cls.: 21, 23, 26, 36, and 38

United States Patent and Trademark Office

Reg. No. 3,399,990

Registered Mar. 18, 2008

**TRADEMARK
PRINCIPAL REGISTER**

VONAGE TALK

VONAGE MARKETING INC. (DELAWARE CORPORATION)
23 MAIN STREET
HOLMDEL, NJ 07733

FOR: COMPUTER TELEPHONY SOFTWARE, NAMELY, SOFTWARE APPLICATION FOR ESTABLISHING AND PERFORMING PHONE CALLS OVER A VARIETY OF NETWORKS IN THE NATURE OF THE INTERNET, IN CLASS 9 (U.S. CLS. 21, 23, 26, 36 AND 38).

FIRST USE 7-10-2007; IN COMMERCE 7-10-2007.

THE MARK CONSISTS OF STANDARD CHARACTERS WITHOUT CLAIM TO ANY PARTICULAR FONT, STYLE, SIZE, OR COLOR.

OWNER OF U.S. REG. NOS. 2,614,773, 2,804,958, AND 2,848,258.

NO CLAIM IS MADE TO THE EXCLUSIVE RIGHT TO USE "TALK", APART FROM THE MARK AS SHOWN.

SN 78-893,098, FILED 5-25-2006.

CAROLYN GRAY, EXAMINING ATTORNEY

Int. Cl.: 35

Prior U.S. Cls.: 100, 101, and 102

United States Patent and Trademark Office

Reg. No. 3,399,991

Registered Mar. 18, 2008

SERVICE MARK
PRINCIPAL REGISTER



PREVALENCE HEALTH, LLC (ILLINOIS LTD
LIAB CO)
1400 MEADOWBROOK ROAD
SUITE 101
JACKSON, MS 39211

FOR: RETAIL PHARMACY SERVICES, IN CLASS
35 (U.S. CLS. 100, 101 AND 102).

FIRST USE 9-1-2006; IN COMMERCE 9-1-2006.

NO CLAIM IS MADE TO THE EXCLUSIVE
RIGHT TO USE "TRADE MARK", APART FROM
THE MARK AS SHOWN.

THE MARK CONSISTS OF OVAL DESIGN WITH
PESTLE AND MORTAR ABOVE "TED'S MEDS" .

SN 78-894,550, FILED 5-26-2006.

ELLEN B. AWRICH, EXAMINING ATTORNEY

Int. Cl.: 10

Prior U.S. Cls.: 26, 39, and 44

United States Patent and Trademark Office

Reg. No. 3,399,992

Registered Mar. 18, 2008

**TRADEMARK
PRINCIPAL REGISTER**

CompriFoam

BSN MEDICAL GMBH (FED REP GERMANY
CORPORATION)

QUICKBORNSTRASSE 24

HAMBURG, FED REP GERMANY 20253

FOR: PADDING MATERIAL FOR MEDICAL
PURPOSES, NAMELY, PADDING APPLIED AS A
LAYER UNDER A BANDAGE OR COMPRESSION
STOCKING TO EVENLY DISTRIBUTE PRESSURE,
IN CLASS 10 (U.S. CLS. 26, 39 AND 44).

FIRST USE 7-0-2006; IN COMMERCE 7-0-2006.

THE MARK CONSISTS OF STANDARD CHAR-
ACTERS WITHOUT CLAIM TO ANY PARTICULAR
FONT, STYLE, SIZE, OR COLOR.

PRIORITY CLAIMED UNDER SEC. 44(D) ON FED
REP GERMANY APPLICATION NO. 30626727.6,
FILED 4-26-2006.

OWNER OF U.S. REG. NOS. 1,747,623 AND
3,063,947.

SN 78-895,871, FILED 5-30-2006.

FRED CARL, EXAMINING ATTORNEY

Int. Cl.: 25

Prior U.S. Cls.: 22 and 39

United States Patent and Trademark Office

Reg. No. 3,399,993

Registered Mar. 18, 2008

TRADEMARK
PRINCIPAL REGISTER



FRUITFEET, INC. (DELAWARE CORPORATION)
APT 5B
304 W 105 STREET
NEW YORK, NY 10025

FOR: SHIRTS, HATS, AND SHOES, IN CLASS 25
(U.S. CLS. 22 AND 39).

FIRST USE 10-15-2006; IN COMMERCE 12-1-2006.

THE COLOR(S) BLUE AND WHITE IS/ARE
CLAIMED AS A FEATURE OF THE MARK.

THE COLOR LIGHT BLUE APPEARS IN SIDE
THE DEPICTION OF A PEACH, THE COLOR DARK
BLUE APPEARS IN THE WORDS "PÊCHE»BLU
MADE FOR TRANSIT" AND IN THE OUTER SHAPE
OF THE PEACH, AND THE COLOR WHITE AP-
PEARS AS THE BONES OF A FISH AND IN THE
NUMBERS AND THE LETTER "A", NAMELY
"0001A".

THE FOREIGN WORDING IN THE MARK
TRANSLATES INTO ENGLISH AS BLUE PEACH.

SN 78-897,364, FILED 5-31-2006.

MICHAEL WEBSTER, EXAMINING ATTORNEY

Int. Cl.: 9

Prior U.S. Cls.: 21, 23, 26, 36, and 38

United States Patent and Trademark Office

Reg. No. 3,399,994

Registered Mar. 18, 2008

**TRADEMARK
PRINCIPAL REGISTER**

LAND OF THE WILD

SPIELO MANUFACTURING ULC (CANADA
CORPORATION)
328 URQUHART AVENUE
MONCTON, NEW BRUNSWICK, CANADA E1H 2R6

FOR: RECONFIGURABLE CASINO AND LOT-
TERY GAMING EQUIPMENT, NAMELY, SLOT
MACHINES, AND OPERATIONAL COMPUTER
GAME SOFTWARE THEREFOR , IN CLASS 9 (U.S.
CLS. 21, 23, 26, 36 AND 38).

FIRST USE 9-12-2007; IN COMMERCE 9-12-2007.

THE MARK CONSISTS OF STANDARD CHAR-
ACTERS WITHOUT CLAIM TO ANY PARTICULAR
FONT, STYLE, SIZE, OR COLOR.

SN 78-898,218, FILED 6-1-2006.

LAURIE MAYES, EXAMINING ATTORNEY

Int. Cl.: 41

Prior U.S. Cls.: 100, 101, and 107

United States Patent and Trademark Office

Reg. No. 3,399,995

Registered Mar. 18, 2008

**SERVICE MARK
PRINCIPAL REGISTER**

Photography By Faith

MERRITT, LORI FAITH (UNITED STATES IN-
DIVIDUAL)

PO BOX 89296

TUCSON, AZ 85752

FOR: PHOTOGRAPHY SERVICES, IN CLASS 41
(U.S. CLS. 100, 101 AND 107).

FIRST USE 1-28-2005; IN COMMERCE 2-14-2005.

THE MARK CONSISTS OF STANDARD CHAR-
ACTERS WITHOUT CLAIM TO ANY PARTICULAR
FONT, STYLE, SIZE, OR COLOR.

NO CLAIM IS MADE TO THE EXCLUSIVE
RIGHT TO USE "PHOTOGRAPHY", APART FROM
THE MARK AS SHOWN.

SN 78-898,554, FILED 6-1-2006.

DAWN HAN, EXAMINING ATTORNEY

Int. Cl.: 33

Prior U.S. Cls.: 47 and 49

United States Patent and Trademark Office

Reg. No. 3,399,996

Registered Mar. 18, 2008

**TRADEMARK
PRINCIPAL REGISTER**

TOMERO

CAP VISTALBA SOCIEDAD ANONIMA (ARGENTINA CORPORATION)
GUTIERREZ 323
MENDOZA, ARGENTINA 5500

THE MARK CONSISTS OF STANDARD CHARACTERS WITHOUT CLAIM TO ANY PARTICULAR FONT, STYLE, SIZE, OR COLOR.

FOR: ALCOHOLIC BEVERAGES, NAMELY, WINES, IN CLASS 33 (U.S. CLS. 47 AND 49).

SN 78-899,113, FILED 6-2-2006.

FIRST USE 4-30-2006; IN COMMERCE 6-30-2006.

NELSON SNYDER, EXAMINING ATTORNEY

Int. Cl.: 9

Prior U.S. Cls.: 21, 23, 26, 36, and 38

United States Patent and Trademark Office

Reg. No. 3,399,997

Registered Mar. 18, 2008

**TRADEMARK
PRINCIPAL REGISTER**

DJ REKHA

SANGAMENT, INC. (NEW YORK CORPORATION)
414 WILLOW STREET
WESTBURY, NY 11590

FOR: AUDIO RECORDINGS FEATURING MUSIC; DOWNLOADABLE MUSICAL SOUND RECORDINGS; DOWNLOADABLE RING TONES, GRAPHICS AND MUSIC VIA A GLOBAL COMPUTER NETWORK AND WIRELESS DEVICES; DOWNLOADABLE VIDEO RECORDINGS FEATURING MUSIC; MUSICAL SOUND RECORDINGS; MUSICAL VIDEO RECORDINGS; PHONOGRAPH RECORD SLEEVES; PHONOGRAPH RECORDS FEATURING MUSIC; PLASTIC AND CARDBOARD CASES FOR STORING RECORD ALBUMS; PRE-RECORDED CD'S, VIDEO TAPES, LASER DISKS AND DVD'S FEATURING MUSIC; VIDEO RECORDINGS FEATURING MUSIC; VISUAL RECORDINGS AND AUDIO VISUAL RECORDINGS FEATURING MUSIC AND ANIMATION, IN CLASS 9 (U.S. CLS. 21, 23, 26, 36 AND 38).

FIRST USE 1-10-1996; IN COMMERCE 9-25-2007.

THE MARK CONSISTS OF STANDARD CHARACTERS WITHOUT CLAIM TO ANY PARTICULAR FONT, STYLE, SIZE, OR COLOR.

NO CLAIM IS MADE TO THE EXCLUSIVE RIGHT TO USE "DJ", APART FROM THE MARK AS SHOWN.

THE NAME(S), PORTRAIT(S), AND/OR SIGNATURE(S) SHOWN IN THE MARK IDENTIFIES "REKHA" MALHOTRA A/K/A "DJ REKHA", WHOSE CONSENT(S) TO REGISTER IS SUBMITTED.

SN 78-899,191, FILED 6-2-2006.

CAROLYN CATALDO, EXAMINING ATTORNEY

Int. Cls.: 9, 16, 25, 28, and 41

**Prior U.S. Cls.: 2, 5, 21, 22, 23, 26, 29, 36, 37, 38, 39,
50, 100, 101, and 107**

Reg. No. 3,399,998

United States Patent and Trademark Office

Registered Mar. 18, 2008

**TRADEMARK
SERVICE MARK
PRINCIPAL REGISTER**

PIRATES MUTINY

PIRATES MUTINY, LLC (FLORIDA LTD LIAB
CO)
CALLE JOAQUIN SOROLLA 17 BAJOS
MAGALUF, MALLORCA, SPAIN 07181

FOR: PRE-RECORDED CD'S, LASER DISKS AND
DVD'S FEATURING A THEATRICAL PRODUCTION,
IN CLASS 9 (U.S. CLS. 21, 23, 26, 36 AND 38).

FIRST USE 9-1-2006; IN COMMERCE 9-1-2006.

FOR: BALL POINT PENS; COLOURED PENS;
EVENT PROGRAMS; GENERAL PURPOSE PLASTIC
BAGS; GIFT CARDS; INK PENS; MAPS; MER-
CHANDISE BAGS; PENS; POSTERS; POSTERS
MADE OF PAPER; SOUVENIR PROGRAMS CON-
CERNING THEATRICAL PRODUCTION; TEMPOR-
ARY TATTOOS; TRADING CARDS, IN CLASS 16
(U.S. CLS. 2, 5, 22, 23, 29, 37, 38 AND 50).

FIRST USE 9-1-2006; IN COMMERCE 9-1-2006.

FOR: BANDANAS; BASEBALL CAPS; CAPS; CAPS
WITH VISORS; DRESS SHIRTS; HALLOWEEN COS-
TUMES; KNIT SHIRTS; MASQUERADE COS-
TUMES; POLO SHIRTS; SHORT-SLEEVED OR
LONG-SLEEVED T-SHIRTS; SKULL CAPS; SWEAT

SHIRTS; T-SHIRTS, IN CLASS 25 (U.S. CLS. 22 AND
39).

FIRST USE 9-1-2006; IN COMMERCE 9-1-2006.

FOR: PLUSH TOYS; STUFFED TOY ANIMALS;
TOY SWORDS, IN CLASS 28 (U.S. CLS. 22, 23, 38 AND
50).

FIRST USE 9-1-2006; IN COMMERCE 9-1-2006.

FOR: ENTERTAINMENT IN THE NATURE OF
THEATER PRODUCTIONS; ENTERTAINMENT
NAMELY, PRODUCTION OF THEATRICAL
SHOWS, IN CLASS 41 (U.S. CLS. 100, 101 AND 107).

FIRST USE 9-1-2006; IN COMMERCE 9-1-2006.

THE MARK CONSISTS OF STANDARD CHAR-
ACTERS WITHOUT CLAIM TO ANY PARTICULAR
FONT, STYLE, SIZE, OR COLOR.

SN 78-902,032, FILED 6-6-2006.

TARAH HARDY, EXAMINING ATTORNEY

Int. Cl.: 9

Prior U.S. Cls.: 21, 23, 26, 36, and 38

Reg. No. 3,399,999

United States Patent and Trademark Office

Registered Mar. 18, 2008

**TRADEMARK
PRINCIPAL REGISTER**

BIG LEAP

LEAPFROG ENTERPRISES, INC. (DELAWARE CORPORATION)
SUITE 100
6401 HOLLIS STREET
EMERYVILLE, CA 94608

FOR: EDUCATIONAL KITS COMPRISED PRIMARILY OF PRERECORDED AUDIO AND VIDEO COMPACT DISCS AND CASSETTES, BOOKS, CARDS, PUZZLES MADE OF PAPER AND CARDBOARD, INSTRUCTIONAL MANUALS, POSTERS, ELECTRONIC AND INTERACTIVE MULTIPLE ACTIVITY TOYS, ELECTRONIC AND INTERACTIVE PLUSH TOYS, ELECTRONIC COLORING AND READING TOYS, HAND HELD UNIT FOR PLAYING ELECTRONIC GAMES, MAGNETIC LETTERS AND NUMBERS, MAGNETIC READING GAMES, MAGNETIC SPELLING GAMES AND MAGNETIC MATH GAMES, ELECTRONIC EDUCATIONAL GAME MACHINES FOR CHILDREN, BATTERY-OPERATED LEARNING UNITS AND BATTERY POWERED GAME UNITS IN THE NATURE OF

EDUCATIONAL GAME MACHINES AND PRINTED MATTER, NAMELY, PRINTED GUIDES FOR TEACHERS AND CLASSROOM USE, BOOKS AND FLASH CARDS ALL IN THE FIELDS OF AN FOR TEACHING CHILDREN READING, MATH, PHONICS, SPELLING AND LANGUAGE ARTS ALL SOLD AS A UNIT, IN CLASS 9 (U.S. CLS. 21, 23, 26, 36 AND 38).

FIRST USE 4-30-2006; IN COMMERCE 4-30-2006.

THE MARK CONSISTS OF STANDARD CHARACTERS WITHOUT CLAIM TO ANY PARTICULAR FONT, STYLE, SIZE, OR COLOR.

OWNER OF U.S. REG. NOS. 2,705,238, 2,798,129, AND OTHERS.

SN 78-902,163, FILED 6-6-2006.

LOURDES AYALA, EXAMINING ATTORNEY

Int. Cl.: 42

Prior U.S. Cls.: 100 and 101

United States Patent and Trademark Office

Reg. No. 3,400,000

Registered Mar. 18, 2008

**SERVICE MARK
PRINCIPAL REGISTER**



NEOTOOL, LLC (TEXAS LTD LIAB CO)
6509 WINDCREST DRIVE
SUITE160B
PLANO, TX 750243074

FOR: COMPUTER SOFTWARE DEVELOPMENT,
IN CLASS 42 (U.S. CLS. 100 AND 101).

FIRST USE 5-0-2006; IN COMMERCE 5-0-2006.

OWNER OF U.S. REG. NOS. 2,797,181, 2,800,022,
AND 2,819,165.

THE COLOR(S) GREEN, YELLOW, RED, BLUE
AND BLACK IS/ARE CLAIMED AS A FEATURE OF
THE MARK.

THE MARK CONSISTS OF FOUR ARROWS
POINTING TO A MIDDLE POINT FORMING A
SQUARE-LIKE FIGURE, THE ARROWS BEING
THE COLORS, CLOCKWISE FROM THE UPPER
LEFT, GREEN, YELLOW, BLUE AND RED; THE
BLACK WORD NEOTOOL APPEARS TO THE
RIGHT OF THE FIGURE.

SN 78-902,334, FILED 6-6-2006.

RON FAIRBANKS, EXAMINING ATTORNEY

Int. Cl.: 9

Prior U.S. Cls.: 21, 23, 26, 36, and 38

United States Patent and Trademark Office

Reg. No. 3,400,001

Registered Mar. 18, 2008

**TRADEMARK
PRINCIPAL REGISTER**

SWORDCRAFT STORY

KABUSHIKI KAISHA BANPRESTO (BANPRESTO
CO., LTD.) (JAPAN CORPORATION)
12-2, HIGASHI-SHINAGAWA, 4-CHOME
SHINAGAWA-KU, TOKYO, JAPAN

FOR: COMPUTER GAME SOFTWARE, NAMELY
VIDEO GAME CARTRIDGE, IN CLASS 9 (U.S. CLS.
21, 23, 26, 36 AND 38).

FIRST USE 4-25-2003; IN COMMERCE 7-25-2006.

THE MARK CONSISTS OF STANDARD CHAR-
ACTERS WITHOUT CLAIM TO ANY PARTICULAR
FONT, STYLE, SIZE, OR COLOR.

NO CLAIM IS MADE TO THE EXCLUSIVE
RIGHT TO USE "STORY", APART FROM THE
MARK AS SHOWN.

SN 78-902,438, FILED 6-7-2006.

MATTHEW EINSTEIN, EXAMINING ATTORNEY

Int. Cl.: 38

Prior U.S. Cls.: 100, 101, and 104

United States Patent and Trademark Office

Reg. No. 3,400,002

Registered Mar. 18, 2008

**SERVICE MARK
PRINCIPAL REGISTER**

FullFiggas

GLASS, PATRICK, D (UNITED STATES INDIVIDUAL)
8351 KATHERINE CLAIRE LN
SAN DIEGO, CA 92127

FOR: PROVIDING ON-LINE ELECTRONIC BULLETIN BOARDS FOR TRANSMISSION OF MESSAGES AMONG COMPUTER USERS CONCERNING FULL FIGURED PEOPLE, IN CLASS 38 (U.S. CLS. 100, 101 AND 104).

FIRST USE 4-4-2005; IN COMMERCE 4-4-2005.

THE MARK CONSISTS OF STANDARD CHARACTERS WITHOUT CLAIM TO ANY PARTICULAR FONT, STYLE, SIZE, OR COLOR.

SN 78-902,768, FILED 6-7-2006.

MARGERY A. TIERNEY, EXAMINING ATTORNEY

Int. Cl.: 32

Prior U.S. Cls.: 45, 46, and 48

United States Patent and Trademark Office

Reg. No. 3,400,003

Registered Mar. 18, 2008

**TRADEMARK
PRINCIPAL REGISTER**

GRATITUDE WATER

FOX, SANDY (UNITED STATES INDIVIDUAL)
4225 ALCOVE AVENUE
STUDIO CITY, CA 91604 AND
LANG, LEX (UNITED STATES INDIVIDUAL)
4225 ALCOVE AVENUE
STUDIO CITY, CA 91604

FOR: BOTTLED SPRING WATER AND FRUIT
JUICES, IN CLASS 32 (U.S. CLS. 45, 46 AND 48).

FIRST USE 8-1-2007; IN COMMERCE 8-1-2007.

THE MARK CONSISTS OF STANDARD CHAR-
ACTERS WITHOUT CLAIM TO ANY PARTICULAR
FONT, STYLE, SIZE, OR COLOR.

NO CLAIM IS MADE TO THE EXCLUSIVE
RIGHT TO USE "WATER", APART FROM THE
MARK AS SHOWN.

SN 78-902,819, FILED 6-7-2006.

STEVEN R. FINE, EXAMINING ATTORNEY

Int. Cl.: 42

Prior U.S. Cls.: 100 and 101

United States Patent and Trademark Office

Reg. No. 3,400,004

Registered Mar. 18, 2008

**SERVICE MARK
PRINCIPAL REGISTER**

SMART School Tool

NATIONAL INFRASTRUCTURE INSTITUTE
(VIRGINIA CORPORATION)
1900 NORTH BEAUREGARD STREET, SUITE 300
ALEXANDRIA, VA 22311

FOR: APPLICATION SERVICE PROVIDER (ASP)
FEATURING SOFTWARE FOR ASSESSING SECURITY
IN SCHOOLS, IN CLASS 42 (U.S. CLS. 100 AND
101).

FIRST USE 3-15-2005; IN COMMERCE 3-15-2005.

THE MARK CONSISTS OF STANDARD CHAR-
ACTERS WITHOUT CLAIM TO ANY PARTICULAR
FONT, STYLE, SIZE, OR COLOR.

NO CLAIM IS MADE TO THE EXCLUSIVE
RIGHT TO USE "SCHOOL TOOL", APART FROM
THE MARK AS SHOWN.

SN 78-903,872, FILED 6-8-2006.

GENE MACIOL, EXAMINING ATTORNEY

Int. Cl.: 37

Prior U.S. Cls.: 100, 103, and 106

United States Patent and Trademark Office

Reg. No. 3,400,005

Registered Mar. 18, 2008

**SERVICE MARK
PRINCIPAL REGISTER**



MEGATRAN, INC. (FLORIDA CORPORATION)
1680 NW 96 AVENUE
DORAL, FL 331722843

FOR: CONSTRUCTION MANAGEMENT; CONSTRUCTION OF ELECTRIC UTILITY INFRASTRUCTURE AND UNDERGROUND UTILITIES, IN CLASS 37 (U.S. CLS. 100, 103 AND 106).

FIRST USE 7-27-2007; IN COMMERCE 7-27-2007.

THE MARK CONSISTS OF A STYLIZED LETTER "M" WITH A LINE EXTENDING HORIZONTALLY

FROM THE RIGHT EDGE OF THIS LETTER; THE WORD "MEGATRAN" SITTING ATOP THE HORIZONTALLY EXTENDING LINE AND CONSISTING OF STYLIZED ALL-CAPITAL LETTERS WITH THE "M" BEING LARGER THAN THE REMAINING LETTERS; AND THE WORDS "THE POWER OF EXPERIENCE" IMMEDIATELY BELOW THE HORIZONTALLY EXTENDING LINE.

SN 78-904,011, FILED 6-8-2006.

BRETT J. GOLDEN, EXAMINING ATTORNEY

Int. Cl.: 29

Prior U.S. Cl.: 46

United States Patent and Trademark Office

Reg. No. 3,400,006

Registered Mar. 18, 2008

**TRADEMARK
PRINCIPAL REGISTER**

CAPSTONE

MAIN STREET INGREDIENTS LLC (WISCONSIN
LTD LIAB CO)
2340 ENTERPRISE AVENUE
LA CROSSE, WI 546021628

FOR: NONDAIRY CREAMERS; CHEESE POW-
DERS; MILK POWDERS; CULTURED BUTTER-
MILK POWDERS; YOGURT POWDERS; SWEET
AND SOUR CREAM POWDERS; DAIRY AND NON-
DAIRY WHIPPED TOPPING BASES; DAIRY-BASED
BEVERAGE BLENDS; SOUPS, FLOW AGENTS FOR
SHREDDED CHEESE, NAMELY, MILK POWDER
PROTEIN BASED ADDITIVE TO PREVENT MOLD

AND PREVENT CLUMPING, IN CLASS 29 (U.S. CL.
46).

FIRST USE 1-8-2007; IN COMMERCE 1-8-2007.

THE MARK CONSISTS OF STANDARD CHAR-
ACTERS WITHOUT CLAIM TO ANY PARTICULAR
FONT, STYLE, SIZE, OR COLOR.

SN 78-904,515, FILED 6-9-2006.

MICHELE SWAIN, EXAMINING ATTORNEY

Int. Cls.: 16 and 35

Prior U.S. Cls.: 2, 5, 22, 23, 29, 37, 38, 50, 100, 101, and 102

Reg. No. 3,400,007

United States Patent and Trademark Office

Registered Mar. 18, 2008

**TRADEMARK
SERVICE MARK
PRINCIPAL REGISTER**

SCBIZ

SETCOM MEDIA, INC. (SOUTH CAROLINA CORPORATION)
389 JOHNNIE DODDS BLVD., SUITE 200
MT. PLEASANT, SC 29464

FOR: PRINTED PUBLICATIONS FEATURING BUSINESS NEWS, BUSINESS AND ECONOMIC DATA AND REGIONAL DEVELOPMENT INFORMATION, IN CLASS 16 (U.S. CLS. 2, 5, 22, 23, 29, 37, 38 AND 50).

FIRST USE 2-9-2007; IN COMMERCE 2-9-2007.

FOR: PROVIDING BUSINESS AND ECONOMIC DATA AND REGIONAL DEVELOPMENT INFOR-

MATION VIA THE INTERNET; PROVIDING BUSINESS NEWS VIA THE INTERNET, IN CLASS 35 (U.S. CLS. 100, 101 AND 102).

FIRST USE 2-26-2007; IN COMMERCE 2-26-2007.

THE MARK CONSISTS OF STANDARD CHARACTERS WITHOUT CLAIM TO ANY PARTICULAR FONT, STYLE, SIZE, OR COLOR.

SN 78-905,023, FILED 6-9-2006.

RONALD AIKENS, EXAMINING ATTORNEY

Int. Cl.: 35

Prior U.S. Cls.: 100, 101, and 102

United States Patent and Trademark Office

Reg. No. 3,400,008

Registered Mar. 18, 2008

**SERVICE MARK
PRINCIPAL REGISTER**

ABC SHOP

KABUNGA INC (TEXAS CORPORATION)
1415 ELDRIDGE PKWY # 628
HOUSTON, TX 77077

FIRST USE 1-10-2006; IN COMMERCE 7-18-2006.

FOR: COMPUTERIZED ONLINE ORDERING
FEATURING GENERAL MERCHANDISE AND
GENERAL CONSUMER GOODS; PROVIDING A
SEARCHABLE ONLINE ADVERTISING GUIDE
FEATURING THE GOODS AND SERVICES OF
OTHER ONLINE VENDORS ON THE INTERNET;
PROVIDING AN ONLINE COMMERCIAL INFOR-
MATION DIRECTORY ON THE INTERNET, IN
CLASS 35 (U.S. CLS. 100, 101 AND 102).

THE MARK CONSISTS OF STANDARD CHAR-
ACTERS WITHOUT CLAIM TO ANY PARTICULAR
FONT, STYLE, SIZE, OR COLOR.

NO CLAIM IS MADE TO THE EXCLUSIVE
RIGHT TO USE "SHOP", APART FROM THE MARK
AS SHOWN.

SN 78-905,535, FILED 6-11-2006.

MICHELE SWAIN, EXAMINING ATTORNEY

Int. Cl.: 25

Prior U.S. Cls.: 22 and 39

United States Patent and Trademark Office

Reg. No. 3,400,009

Registered Mar. 18, 2008

TRADEMARK
PRINCIPAL REGISTER

Life begins on the water

BOAT MARKETING CORPORATION (DELA-
WARE CORPORATION)
21 BRIDGE STREET
WESTPORT, CT 06880

FOR: BELTS; BERMUDA SHORTS; FLEECE
PULLOVERS; FLEECE SHORTS; FOUL WEATHER
GEAR; JERSEYS; OPEN-NECKED SHIRTS; PANTS;
PIQUET SHIRTS; POLO SHIRTS; SHIRTS; SHORT-
SLEEVED SHIRTS; SHORTS; SOCKS; SPORT
SHIRTS; SPORTS SHIRTS WITH SHORT SLEEVES;
SWEAT PANTS; SWEAT SHIRTS; SWIM WEAR; T-
SHIRTS; TIES; TOPS; WATERPROOF JACKETS

AND PANTS; WIND SHIRTS; WRAPS, IN CLASS 25
(U.S. CLS. 22 AND 39).

FIRST USE 7-1-2003; IN COMMERCE 1-30-2007.

THE MARK CONSISTS OF WORDS: "LIFE BE-
GINS ON THE WATER". NO CLAIM FOR COLOR IS
MADE AS COLORS WILL VARY ACROSS DIFFER-
ENT COLORED GARMENTS.

SN 78-905,553, FILED 6-11-2006.

SUSAN STIGLITZ, EXAMINING ATTORNEY

Int. Cl.: 42

Prior U.S. Cls.: 100 and 101

United States Patent and Trademark Office

Reg. No. 3,400,010

Registered Mar. 18, 2008

**SERVICE MARK
PRINCIPAL REGISTER**

FORECASTING A BETTER FUTURE

BARON SERVICES, INC. (DELAWARE CORPORATION)
4930 RESEARCH DRIVE
HUNTSVILLE, AL 35805

FOR: PROVIDING REAL-TIME AND HISTORICAL WEATHER INFORMATION TO STATIONARY AND MOBILE USERS, VIA SATELLITE, RADIO, AND CELLULAR PHONE TRANSMITTERS AND VIA LOCAL AND GLOBAL COMPUTERS; PROVIDING WEATHER-RELATED DATA AND INFORMATION AND WEATHER-RELATED IMAGES THROUGH A DISTRIBUTION NETWORK; PROVIDING REAL-TIME AND HISTORICAL WEATHER INFORMATION, NAMELY, PROVIDING WEATHER INFORMATION THAT FEATURES THE GRAPHICAL DISPLAY OF RADAR, LIGHTNING, THUNDERSTORMS, WIND VELOCITY,

WIND SHEAR, WIND ROTATION, PRECIPITATION, STORM LOCATION, STORM TRACKING, AND OTHER WEATHER PHENOMENON AND WEATHER DATA; PROVIDING WEATHER INFORMATION SERVICES, IN CLASS 42 (U.S. CLS. 100 AND 101).

FIRST USE 1-31-2004; IN COMMERCE 1-31-2004.

THE MARK CONSISTS OF STANDARD CHARACTERS WITHOUT CLAIM TO ANY PARTICULAR FONT, STYLE, SIZE, OR COLOR.

SN 78-906,241, FILED 6-12-2006.

CAROL SPILS, EXAMINING ATTORNEY

Int. Cls.: 9 and 41

Prior U.S. Cls.: 21, 23, 26, 36, 38, 100, 101, and 107

United States Patent and Trademark Office

Reg. No. 3,400,011

Registered Mar. 18, 2008

**TRADEMARK
SERVICE MARK
PRINCIPAL REGISTER**

WORLD IN CONFLICT

MASSIVE ENTERTAINMENT AB (SWEDEN
CORPORATION)
BOX 4297
MALMO, SWEDEN 203 14

FOR: COMPUTER GAME SOFTWARE AND IN-
STRUCTION MANUALS SOLD AS A UNIT THERE-
WITH; COMPUTER SCREEN SAVER SOFTWARE;
ENTERTAINMENT SOFTWARE IN THE NATURE
OF A GAME CAPABLE OF BEING PLAYED ON A
PERSONAL COMPUTER, TELEVISION GAMING
SYSTEM, OR GLOBAL COMPUTER NETWORK,
DOWNLOADABLE ELECTRONIC PUBLICATIONS
IN THE NATURE OF NEWSLETTERS, MAGAZINES
AND CATALOGS IN THE FIELD OF COMPUTER
GAMES; MOUSE PADS, IN CLASS 9 (U.S. CLS. 21, 23,
26, 36 AND 38).

FIRST USE 9-18-2007; IN COMMERCE 9-18-2007.

FOR: PROVIDING ON-LINE COMPUTER
GAMES, TIPS AND STRATEGIES FOR COMPUTER
GAMES; ARRANGING AND CONDUCTING COM-
PUTER GAME COMPETITIONS , IN CLASS 41 (U.S.
CLS. 100, 101 AND 107).

FIRST USE 9-18-2007; IN COMMERCE 9-18-2007.

THE MARK CONSISTS OF STANDARD CHAR-
ACTERS WITHOUT CLAIM TO ANY PARTICULAR
FONT, STYLE, SIZE, OR COLOR.

SN 78-907,411, FILED 6-13-2006.

JORDAN BAKER, EXAMINING ATTORNEY

Int. Cl.: 3

Prior U.S. Cls.: 1, 4, 6, 50, 51, and 52

Reg. No. 3,400,012

United States Patent and Trademark Office

Registered Mar. 18, 2008

**TRADEMARK
PRINCIPAL REGISTER**

**Youthology 90 Second
Wrinkle Removing Eye Serum**

ALCHEMY WORLDWIDE, LLC (CALIFORNIA
LTD LIAB CO)
15250 VENTURA BLVD, SUITE 300
SHERMAN OAKS, CA 91403

FOR: COSMETICS AND SKIN CARE PRODUCTS,
NAMELY, NON-MEDICATED EYE SERUM, NON-
MEDICATED FACIAL MASK; AND NON-MEDICA-
TED ANTI-WRINKLE SERUM , IN CLASS 3 (U.S.
CLS. 1, 4, 6, 50, 51 AND 52).

FIRST USE 9-14-2006; IN COMMERCE 9-14-2006.

THE MARK CONSISTS OF STANDARD CHAR-
ACTERS WITHOUT CLAIM TO ANY PARTICULAR
FONT, STYLE, SIZE, OR COLOR.

NO CLAIM IS MADE TO THE EXCLUSIVE
RIGHT TO USE "90 SECOND WRINKLE REMOV-
ING EYE SERUM", APART FROM THE MARK AS
SHOWN.

SN 78-908,530, FILED 6-14-2006.

HANNO RITTNER, EXAMINING ATTORNEY

Int. Cl.: 20

Prior U.S. Cls.: 2, 13, 22, 25, 32, and 50

United States Patent and Trademark Office

Reg. No. 3,400,013

Registered Mar. 18, 2008

**TRADEMARK
PRINCIPAL REGISTER**

BONE - THRONE

RAFFA, ANTHONY (UNITED STATES INDIVIDUAL)
8768 TOREY PINES TER
ORLANDO, FL 32819

THE MARK CONSISTS OF STANDARD CHARACTERS WITHOUT CLAIM TO ANY PARTICULAR FONT, STYLE, SIZE, OR COLOR.

FOR: PET BEDS AND PILLOWS, IN CLASS 20 (U.S. CLS. 2, 13, 22, 25, 32 AND 50).

SN 78-910,247, FILED 6-16-2006.

FIRST USE 7-1-2006; IN COMMERCE 11-15-2006.

BENJAMIN ALLEN, EXAMINING ATTORNEY

Int. Cls.: 3 and 5

Prior U.S. Cls.: 1, 4, 6, 18, 44, 46, 50, 51, and 52

United States Patent and Trademark Office

Reg. No. 3,400,014

Registered Mar. 18, 2008

**TRADEMARK
PRINCIPAL REGISTER**

KOLORZ

FOREMOST DENTAL LLC (DELAWARE LTD
LIAB CO)
242 SOUTH DEAN STREET
ENGLEWOOD, NJ 07631

FOR: DENTAL PRODUCTS, NAMELY, PROPHY
PASTE, IN CLASS 3 (U.S. CLS. 1, 4, 6, 50, 51 AND 52).

FIRST USE 12-28-2006; IN COMMERCE 12-28-2006.

FOR: DENTAL PRODUCTS, NAMELY, FLUOR-
IDE GEL AND FLUORIDE FOAM FOR USE IN

PREVENTIVE DENTISTRY; TOPICAL ANESTHET-
ICS, IN CLASS 5 (U.S. CLS. 6, 18, 44, 46, 51 AND 52).

FIRST USE 12-27-2006; IN COMMERCE 12-27-2006.

THE MARK CONSISTS OF STANDARD CHAR-
ACTERS WITHOUT CLAIM TO ANY PARTICULAR
FONT, STYLE, SIZE, OR COLOR.

SN 78-910,855, FILED 6-19-2006.

RUSS HERMAN, EXAMINING ATTORNEY

Int. Cls.: 16 and 17

Prior U.S. Cls.: 1, 2, 5, 12, 13, 22, 23, 29, 35, 37, 38, and 50

United States Patent and Trademark Office

Reg. No. 3,400,015

Registered Mar. 18, 2008

**TRADEMARK
PRINCIPAL REGISTER**

POLYNASH

BERRY PLASTICS HOLDING CORPORATION
(DELAWARE CORPORATION)
101 OAKLEY STREET
EVANSVILLE, IN 47710

FIRST USE 12-1-2006; IN COMMERCE 12-1-2006.

FOR: ADHESIVE TAPE FOR STATIONERY AND
HOUSEHOLD USE, IN CLASS 16 (U.S. CLS. 2, 5, 22,
23, 29, 37, 38 AND 50).

THE MARK CONSISTS OF STANDARD CHAR-
ACTERS WITHOUT CLAIM TO ANY PARTICULAR
FONT, STYLE, SIZE, OR COLOR.

FIRST USE 12-1-2006; IN COMMERCE 12-1-2006.

SN 78-911,235, FILED 6-19-2006.

FOR: ADHESIVE TAPE FOR INDUSTRIAL AND
COMMERCIAL USE, IN CLASS 17 (U.S. CLS. 1, 5, 12,
13, 35 AND 50).

WILLIAM VERHOSEK, EXAMINING ATTORNEY

Int. Cl.: 1

Prior U.S. Cls.: 1, 5, 6, 10, 26, and 46

United States Patent and Trademark Office

Reg. No. 3,400,016

Registered Mar. 18, 2008

**TRADEMARK
PRINCIPAL REGISTER**

SALT CELL GUARD

SMARTPOOL INCORPORATED (DELAWARE
CORPORATION)
687 PROSPECT ST.
LAKEWOOD, NJ 08701

FOR: WATER TREATMENT CHEMICALS FOR
USE IN SWIMMING POOLS, SPAS AND HOT TUBS,
IN CLASS 1 (U.S. CLS. 1, 5, 6, 10, 26 AND 46).

FIRST USE 9-30-2006; IN COMMERCE 9-30-2006.

THE MARK CONSISTS OF STANDARD CHAR-
ACTERS WITHOUT CLAIM TO ANY PARTICULAR
FONT, STYLE, SIZE, OR COLOR.

NO CLAIM IS MADE TO THE EXCLUSIVE
RIGHT TO USE "SALT CELL", APART FROM THE
MARK AS SHOWN.

SN 78-911,589, FILED 6-19-2006.

JIM RINGLE, EXAMINING ATTORNEY

Int. Cl.: 35

Prior U.S. Cls.: 100, 101, and 102

United States Patent and Trademark Office

Reg. No. 3,400,017

Registered Mar. 18, 2008

**SERVICE MARK
PRINCIPAL REGISTER**

ProStyle

NEOPSY SYSTEMS LLC (COLORADO LTD LIAB
CO)
THE CAIRN BUILDING
727 E 16TH AVENUE
DENVER, CO 802032003

FOR: TESTING JOB APPLICANTS FOR OTHERS TO DETERMINE BEHAVIORAL CHARACTERISTICS OF INDIVIDUALS FOR PURPOSES OF JOB PLACEMENT AND ADVANCEMENT VIA A GLOBAL COMPUTER NETWORK; TESTING TO DETERMINE PROFESSIONAL COMPETENCY, NAMELY, PROVIDING ASSESSMENTS OF JOB APPLICANTS CONCERNING THE PSYCHOLOGICAL ATTRIBUTES AND COMPETENCIES WITH SUCCESSFUL PROFILES ASSOCIATED WITH CERTAIN PROFESSIONS AND SPECIALTIES, THE LIKELIHOOD OF SUCCESS AND PREDICTED PER-

FORMANCE IN CERTAIN PROFESSIONS AND SPECIALTIES, STRENGTHS AND WEAKNESSES OF JOB APPLICANTS AGAINST SPECIFIC SUCCESS PROFILES, AND SUGGESTED AREAS FOR PROFESSIONAL DEVELOPMENTAL FOCUS WITHIN CERTAIN PROFESSIONS AND SPECIALTIES, IN CLASS 35 (U.S. CLS. 100, 101 AND 102).

FIRST USE 3-12-2007; IN COMMERCE 3-12-2007.

THE MARK CONSISTS OF STANDARD CHARACTERS WITHOUT CLAIM TO ANY PARTICULAR FONT, STYLE, SIZE, OR COLOR.

SN 78-911,783, FILED 6-19-2006.

MICHELE SWAIN, EXAMINING ATTORNEY

Int. Cl.: 36

Prior U.S. Cls.: 100, 101, and 102

United States Patent and Trademark Office

Reg. No. 3,400,018

Registered Mar. 18, 2008

**SERVICE MARK
PRINCIPAL REGISTER**

ITALCAMBIO

CORPORACION ITALCAMBIO, C.A. (VENEZUE-
LA CORPORATION)
AV.URDANETA EDIF.CAMORUCO ANIMAS A.
PLAT
CARACAS, VENEZUELA

THE MARK CONSISTS OF STANDARD CHAR-
ACTERS WITHOUT CLAIM TO ANY PARTICULAR
FONT, STYLE, SIZE, OR COLOR.

FOR: CURRENCY AND FOREIGN EXCHANGE
TRANSACTIONS SERVICES, IN CLASS 36 (U.S. CLS.
100, 101 AND 102).

SN 78-911,941, FILED 6-20-2006.

FIRST USE 9-9-1950; IN COMMERCE 9-9-1950.

DANNEAN HETZEL, EXAMINING ATTORNEY

Int. Cl.: 35

Prior U.S. Cls.: 100, 101, and 102

United States Patent and Trademark Office

Reg. No. 3,400,019

Registered Mar. 18, 2008

**SERVICE MARK
PRINCIPAL REGISTER**



DIAMOND AND JEWELRY GALLERY, INC.
(CALIFORNIA CORPORATION)
21400 VENTURA BLVD.
WOODLAND HILLS, CA 91364

FOR: WHOLESALE AND RETAIL STORE SERVICES FEATURING JEWELRY, IN CLASS 35 (U.S. CLS. 100, 101 AND 102).

FIRST USE 7-0-2006; IN COMMERCE 7-0-2006.

NO CLAIM IS MADE TO THE EXCLUSIVE RIGHT TO USE "DIAMOND AND JEWELRY GALLERY", APART FROM THE MARK AS SHOWN.

THE MARK CONSISTS OF A HAND HOLDING A DIAMOND, AN AMPERSAND INSIDE OF A SQUARE AFTER THE WORD "DIAMOND" AND FOLLOWED BY THE WORDS "JEWELRY GALLERY", THE WORDS BEING UNDERLINED.

SN 78-913,698, FILED 6-21-2006.

CHRISTINE COOPER, EXAMINING ATTORNEY

Int. Cl.: 9

Prior U.S. Cls.: 21, 23, 26, 36, and 38

United States Patent and Trademark Office

Reg. No. 3,400,020

Registered Mar. 18, 2008

**TRADEMARK
PRINCIPAL REGISTER**

OPTIFLEX

VOLK OPTICAL INC. (OHIO CORPORATION)
7893 ENTERPRISE DRIVE
MENTOR, OH 44060

FOR: ELECTROMECHANICAL DEVICE, NAME-
LY, A TENSION-CONTROLLED MECHANICAL
ARM FOR HOLDING, MOVING AND POSITION-
ING OPHTHALMIC LENSES, IN CLASS 9 (U.S. CLS.
21, 23, 26, 36 AND 38).

FIRST USE 3-30-2007; IN COMMERCE 3-30-2007.

THE MARK CONSISTS OF STANDARD CHAR-
ACTERS WITHOUT CLAIM TO ANY PARTICULAR
FONT, STYLE, SIZE, OR COLOR.

SN 78-914,327, FILED 6-22-2006.

KEVON CHISOLM, EXAMINING ATTORNEY

Int. Cl.: 9

Prior U.S. Cls.: 21, 23, 26, 36, and 38

United States Patent and Trademark Office

Reg. No. 3,400,021

Registered Mar. 18, 2008

**TRADEMARK
PRINCIPAL REGISTER**

DC IN A BOX

COMMONWEALTH EDISON COMPANY (ILLINOIS CORPORATION)

10 SOUTH DEARBORN ST

CHICAGO, IL 60603

FOR: ELECTRICAL SUBSTATIONS, IN CLASS 9
(U.S. CLS. 21, 23, 26, 36 AND 38).

FIRST USE 12-1-2003; IN COMMERCE 4-1-2005.

THE MARK CONSISTS OF STANDARD CHARACTERS WITHOUT CLAIM TO ANY PARTICULAR FONT, STYLE, SIZE, OR COLOR.

NO CLAIM IS MADE TO THE EXCLUSIVE RIGHT TO USE "DC", APART FROM THE MARK AS SHOWN.

SN 78-914,667, FILED 6-22-2006.

TARAH HARDY, EXAMINING ATTORNEY

Int. Cl.: 17

Prior U.S. Cls.: 1, 5, 12, 13, 35, and 50

United States Patent and Trademark Office

Reg. No. 3,400,022

Registered Mar. 18, 2008

**TRADEMARK
PRINCIPAL REGISTER**

FRM

US GREENFIBER, LLC (DELAWARE LIMITED
LIABILITY COMPANY)
2500 DISTRIBUTION ST.
CHARLOTTE, NC 28203

FIRST USE 4-21-2005; IN COMMERCE 4-21-2005.

FOR: FIRE BARRIER SYSTEM COMPRISED OF
CHEMICALLY TREATED LOOSE FILL FIBER;
ACOUSTICAL INSULATION FOR BUILDINGS; AR-
CHITECTURAL ACOUSTICAL PRODUCTS, NAME-
LY, SOUND ABSORBERS AND DIFFUSERS
CONSISTING OF CHEMICALLY TREATED LOOSE
FILL FIBER; BUILDING INSULATION, IN CLASS 17
(U.S. CLS. 1, 5, 12, 13, 35 AND 50).

THE MARK CONSISTS OF STANDARD CHAR-
ACTERS WITHOUT CLAIM TO ANY PARTICULAR
FONT, STYLE, SIZE, OR COLOR.

SN 78-915,244, FILED 6-23-2006.

JIM RINGLE, EXAMINING ATTORNEY

Int. Cl.: 9

Prior U.S. Cls.: 21, 23, 26, 36, and 38

United States Patent and Trademark Office

Reg. No. 3,400,023

Registered Mar. 18, 2008

**TRADEMARK
PRINCIPAL REGISTER**

TRUSPEED

LASER TECHNOLOGY, INC. (COLORADO CORPORATION)

7070 S. TUCSON WAY

ENGLEWOOD, CO 80112 AND

KAMA-TECH, HK LTD. (HONG KONG CORPORATION)

9TH FLOOR, SUITE 4

33 CANTON ROAD, TOWER 3

TSIM SHA TSUI, HONG KONG

FIRST USE 10-13-2007; IN COMMERCE 10-13-2007.

THE MARK CONSISTS OF STANDARD CHARACTERS WITHOUT CLAIM TO ANY PARTICULAR FONT, STYLE, SIZE, OR COLOR.

SN 78-915,265, FILED 6-23-2006.

FOR: LASER SPEED GUNS USED TO MEASURE SPEED AND DISTANCE, IN CLASS 9 (U.S. CLS. 21, 23, 26, 36 AND 38).

ODESSA BIBBINS, EXAMINING ATTORNEY

Int. Cl.: 33

Prior U.S. Cls.: 47 and 49

United States Patent and Trademark Office

Reg. No. 3,400,024

Registered Mar. 18, 2008

**TRADEMARK
PRINCIPAL REGISTER**

PAMPAS DEL SUR

TRIVENTO BODEGAS Y VINEDOS S.A. (ARGENTINA CORPORATION)

CANAL PESCARA 9347, RUSSELL, MAIPU

MENDOZA, ARGENTINA

FOR: WINE, IN CLASS 33 (U.S. CLS. 47 AND 49).

FIRST USE 12-31-2002; IN COMMERCE 10-30-2007.

THE MARK CONSISTS OF STANDARD CHARACTERS WITHOUT CLAIM TO ANY PARTICULAR FONT, STYLE, SIZE, OR COLOR.

"THE FOREIGN WORDING IN THE MARK TRANSLATES INTO ENGLISH AS OF THE SOUTH."

SN 78-916,303, FILED 6-25-2006.

FRED CARL, EXAMINING ATTORNEY

Int. Cl.: 11

Prior U.S. Cls.: 13, 21, 23, 31, and 34

United States Patent and Trademark Office

Reg. No. 3,400,025

Registered Mar. 18, 2008

**TRADEMARK
PRINCIPAL REGISTER**

AIR FUSION

HEATER CRAFT MARINE PRODUCTS (IDAHO
CORPORATION)
6672 BOEKEL ROAD
RATHDRUM, ID 83858

THE MARK CONSISTS OF STANDARD CHAR-
ACTERS WITHOUT CLAIM TO ANY PARTICULAR
FONT, STYLE, SIZE, OR COLOR.

FOR: HEATERS AND AIR CONDITIONERS FOR
BOATS, CARS, TRUCKS AND RECREATIONAL
VEHICLES, IN CLASS 11 (U.S. CLS. 13, 21, 23, 31
AND 34).

SN 78-917,240, FILED 6-26-2006.

FIRST USE 10-6-2006; IN COMMERCE 10-6-2006.

LINDA E. BLOHM, EXAMINING ATTORNEY

Int. Cl.: 10

Prior U.S. Cls.: 26, 39, and 44

United States Patent and Trademark Office

Reg. No. 3,400,026

Registered Mar. 18, 2008

TRADEMARK
PRINCIPAL REGISTER



COHERA MEDICAL, INC. (PENNSYLVANIA
CORPORATION)
209 SANDUSKY STREET
PITTSBURGH, PA 15212

FOR: SYNTHETIC BIODEGRADABLE PREPARA-
TIONS, NAMELY SURGICAL GLUE, FOR THE
PURPOSES OF DEEP WOUND TREATMENT AND
SOFT TISSUE REPAIR NOT FOR USE BY DENTAL
SURGEONS, IN CLASS 10 (U.S. CLS. 26, 39 AND 44).

FIRST USE 11-29-2007; IN COMMERCE 11-29-2007.

NO CLAIM IS MADE TO THE EXCLUSIVE
RIGHT TO USE "TISSUE GLUE", APART FROM
THE MARK AS SHOWN.

THE MARK CONSISTS OF THE STYLIZED
WORD "TISSUGLU" PARTIALLY ENCIRCLED BY
A SPHERE FORMING FROM THE SECOND LET-
TER "U".

SN 78-917,254, FILED 6-26-2006.

MICHAEL TANNER, EXAMINING ATTORNEY

Int. Cl.: 12

Prior U.S. Cls.: 19, 21, 23, 31, 35, and 44

Reg. No. 3,400,027

United States Patent and Trademark Office

Registered Mar. 18, 2008

**TRADEMARK
PRINCIPAL REGISTER**



MONAHAN PRODUCTS, LLC (MASSACHUSETTS LIMITED LIABILITY CORPORATION)
371 LIBERTY STREET
ROCKLAND, MA 02370

FOR: BABY STROLLERS, IN CLASS 12 (U.S. CLS. 19, 21, 23, 31, 35 AND 44).

FIRST USE 9-10-2006; IN COMMERCE 9-10-2006.

NO CLAIM IS MADE TO THE EXCLUSIVE RIGHT TO USE "BABY", APART FROM THE MARK AS SHOWN.

THE COLOR(S) WHITE AND ORANGE IS/ARE CLAIMED AS A FEATURE OF THE MARK.

THE MARK CONSISTS OF WHITE LETTERING WITH AN ORANGE BACKGROUND AND ORANGE FLOWER ABOVE THE FIRST "B".

SN 78-917,520, FILED 6-27-2006.

DANIEL CAPSHAW, EXAMINING ATTORNEY

Int. Cl.: 9

Prior U.S. Cls.: 21, 23, 26, 36, and 38

Reg. No. 3,400,028

United States Patent and Trademark Office

Registered Mar. 18, 2008

**TRADEMARK
PRINCIPAL REGISTER**

STATICOFF

STATICOFF, LLC (MAINE LTD LIAB CO)
30 FERN LANE
SOUTH PORTLAND, ME 04106

THE MARK CONSISTS OF STANDARD CHAR-
ACTERS WITHOUT CLAIM TO ANY PARTICULAR
FONT, STYLE, SIZE, OR COLOR.

FOR: ELECTROSTATIC DISCHARGE DEVICE
FOR PREVENTING ELECTRICAL SHOCK, IN
CLASS 9 (U.S. CLS. 21, 23, 26, 36 AND 38).

SN 78-918,725, FILED 6-28-2006.

FIRST USE 5-19-2006; IN COMMERCE 12-11-2007.

RONALD AIKENS, EXAMINING ATTORNEY

Int. Cl.: 44

Prior U.S. Cls.: 100 and 101

United States Patent and Trademark Office

Reg. No. 3,400,029

Registered Mar. 18, 2008

**SERVICE MARK
PRINCIPAL REGISTER**

The logo for SoundGene features the word "SoundGene" in a serif font. "Sound" is in dark blue, "Gene" is in green, and there are three light blue sound waves to the right of "Gene".

PEDIATRIX MEDICAL GROUP, INC. (FLORIDA CORPORATION)
1301 CONCORD TERRACE
SUNRISE, FL 333232825

FOR: PROVIDING ANALYTICAL TESTING SERVICES FOR PRE-LINGUAL HEARING LOSS USING ANALYSIS OF DNA MUTATIONS ASSOCIATED WITH HEARING LOSS, IN CLASS 44 (U.S. CLS. 100 AND 101).

FIRST USE 1-0-2007; IN COMMERCE 1-0-2007.

THE COLOR(S) DARK BLUE, GREEN AND LIGHT BLUE IS/ARE CLAIMED AS A FEATURE OF THE MARK.

THE TERM "SOUND" IS DARK BLUE. THE TERM "GENE" IS GREEN. THE SOUND WAVES ARE LIGHT BLUE.

SN 78-918,904, FILED 6-28-2006.

MICHAEL KEATING, EXAMINING ATTORNEY

Int. Cl.: 19

Prior U.S. Cls.: 1, 12, 33, and 50

United States Patent and Trademark Office

Reg. No. 3,400,030

Registered Mar. 18, 2008

**TRADEMARK
PRINCIPAL REGISTER**

ILTIS

SOFT-LITE L.L.C. (DELAWARE LTD LIAB CO)
10250 PHILIPP PARKWAY
STREETSBORO, OH 44241

THE MARK CONSISTS OF STANDARD CHAR-
ACTERS WITHOUT CLAIM TO ANY PARTICULAR
FONT, STYLE, SIZE, OR COLOR.

FOR: VINYL WINDOWS, IN CLASS 19 (U.S. CLS. 1,
12, 33 AND 50).

SN 78-919,859, FILED 6-29-2006.

FIRST USE 11-20-2006; IN COMMERCE 11-20-2006.

ATTIYA MALIK, EXAMINING ATTORNEY

Int. Cl.: 28

Prior U.S. Cls.: 22, 23, 38, and 50

United States Patent and Trademark Office

Reg. No. 3,400,031

Registered Mar. 18, 2008

**TRADEMARK
PRINCIPAL REGISTER**

TURBO TORNADO

MATTEL, INC. (DELAWARE CORPORATION)
MAIL STOP M1-1518
333 CONTINENTAL BOULEVARD
EL SEGUNDO, CA 90245

FOR: TOYS, GAMES AND PLAYTHINGS, NAME-
LY, TOY ACTION FIGURES, TOY FIGURES, AND
ACCESSORIES FOR ALL OF THE FOREGOING, IN
CLASS 28 (U.S. CLS. 22, 23, 38 AND 50).

FIRST USE 3-2-2007; IN COMMERCE 3-2-2007.

THE MARK CONSISTS OF STANDARD CHAR-
ACTERS WITHOUT CLAIM TO ANY PARTICULAR
FONT, STYLE, SIZE, OR COLOR.

SN 78-920,875, FILED 6-30-2006.

ANGELA M. MICHELI, EXAMINING ATTORNEY

Int. Cl.: 41

Prior U.S. Cls.: 100, 101, and 107

United States Patent and Trademark Office

Reg. No. 3,400,032

Registered Mar. 18, 2008

**SERVICE MARK
PRINCIPAL REGISTER**

PRO FOOTBALL NOW

COMCAST SPORTS MANAGEMENT SERVICES
LLC (DELAWARE LTD LIAB CO)
3601 SOUTH BROAD STREET
PHILADELPHIA, PA 19148

FOR: ENTERTAINMENT SERVICES, NAMELY, A
SERIES OF TELEVISION PROGRAMS FEATURING
SPORTS COMMENTARY, DISCUSSIONS AND IN-
TERVIEWS ON THE TOPIC OF PROFESSIONAL
FOOTBALL, IN CLASS 41 (U.S. CLS. 100, 101 AND
107).

FIRST USE 9-7-2006; IN COMMERCE 9-7-2006.

THE MARK CONSISTS OF STANDARD CHAR-
ACTERS WITHOUT CLAIM TO ANY PARTICULAR
FONT, STYLE, SIZE, OR COLOR.

NO CLAIM IS MADE TO THE EXCLUSIVE
RIGHT TO USE "PRO FOOTBALL", APART FROM
THE MARK AS SHOWN.

SN 78-921,171, FILED 6-30-2006.

FRED CARL, EXAMINING ATTORNEY

Int. Cl.: 3

Prior U.S. Cls.: 1, 4, 6, 50, 51, and 52

United States Patent and Trademark Office

Reg. No. 3,400,033

Registered Mar. 18, 2008

**TRADEMARK
PRINCIPAL REGISTER**

RESTORING SHINE

THE PROCTER & GAMBLE COMPANY (OHIO
CORPORATION)
ONE PROCTER & GAMBLE PLAZA
CINCINNATI, OH 45202

THE MARK CONSISTS OF STANDARD CHAR-
ACTERS WITHOUT CLAIM TO ANY PARTICULAR
FONT, STYLE, SIZE, OR COLOR.

FOR: HAIR CARE PREPARATIONS, IN CLASS 3
(U.S. CLS. 1, 4, 6, 50, 51 AND 52).

SN 78-921,327, FILED 6-30-2006.

FIRST USE 1-31-2007; IN COMMERCE 1-31-2007.

FRANK LATTUCA, EXAMINING ATTORNEY

Int. Cl.: 44

Prior U.S. Cls.: 100 and 101

United States Patent and Trademark Office

Reg. No. 3,400,034

Registered Mar. 18, 2008

SERVICE MARK
PRINCIPAL REGISTER



REESE, PAUL DAVID (MASSACHUSETTS CORPORATION)
125 FOX ROAD, UNIT 501
WALTHAM, MA 02451

NO CLAIM IS MADE TO THE EXCLUSIVE RIGHT TO USE "THE CHILDREN'S STRABISMUS CENTER", APART FROM THE MARK AS SHOWN.

FOR: MEDICAL SERVICES, NAMELY, OPHTHALMOLOGY, IN CLASS 44 (U.S. CLS. 100 AND 101).

SN 78-921,701, FILED 7-2-2006.

FIRST USE 10-1-1993; IN COMMERCE 10-1-1993.

SALLY SHIH, EXAMINING ATTORNEY

Int. Cl.: 25

Prior U.S. Cls.: 22 and 39

United States Patent and Trademark Office

Reg. No. 3,400,035

Registered Mar. 18, 2008

**TRADEMARK
PRINCIPAL REGISTER**

JUST DO YOUR BEST

SCOTT, SYLVIA (UNITED STATES INDIVIDUAL)
1637 WESTWAY DRIVE
CHARLESTON, SC 29412

FOR: HATS; HEADBANDS; HEADBANDS AGAINST SWEATING; JACKETS; PANTS; SHORT-SLEEVED OR LONG-SLEEVED T-SHIRTS; SKIRTS AND DRESSES; SWEATERS, IN CLASS 25 (U.S. CLS. 22 AND 39).

FIRST USE 4-1-2007; IN COMMERCE 4-1-2007.

THE MARK CONSISTS OF STANDARD CHARACTERS WITHOUT CLAIM TO ANY PARTICULAR FONT, STYLE, SIZE, OR COLOR.

SN 78-922,235, FILED 7-4-2006.

DAWN FELDMAN, EXAMINING ATTORNEY

Int. Cl.: 30

Prior U.S. Cl.: 46

United States Patent and Trademark Office

Reg. No. 3,400,036

Registered Mar. 18, 2008

**TRADEMARK
PRINCIPAL REGISTER**

CARR'S MELTS

UNITED BISCUITS (UK) LIMITED (UNITED
KINGDOM CORPORATION)
HAYES PARK HAYES END ROAD
HAYES, MIDDLESEX, UNITED KINGDOM UB48EE

FOR: SAVOURY BISCUITS, CRACKERS, IN
CLASS 30 (U.S. CL. 46).

FIRST USE 6-0-1999; IN COMMERCE 7-0-2007.

THE MARK CONSISTS OF STANDARD CHAR-
ACTERS WITHOUT CLAIM TO ANY PARTICULAR
FONT, STYLE, SIZE, OR COLOR.

OWNER OF U.S. REG. NOS. 310,969 AND 2,396,154.

NO CLAIM IS MADE TO THE EXCLUSIVE
RIGHT TO USE "MELTS", APART FROM THE
MARK AS SHOWN.

SN 78-922,392, FILED 7-5-2006.

WANDA KAY PRICE, EXAMINING ATTORNEY

Int. Cls.: 9 and 42

Prior U.S. Cls.: 21, 23, 26, 36, 38, 100, and 101

United States Patent and Trademark Office

Reg. No. 3,400,037

Registered Mar. 18, 2008

**TRADEMARK
SERVICE MARK
PRINCIPAL REGISTER**

ratchet

RATCHET, INC. (MINNESOTA CORPORATION)
SUITE 300
411 WASHINGTON AVENUE N
MINNEAPOLIS, MN 55401

FOR: COMPUTER SOFTWARE USED FOR BUILDING, OPERATING, MAINTAINING, AND UPGRADING WEBSITES, DATABASES, AND INTERACTIVE COMPUTER NETWORKS IN THE FIELD OF ONLINE COMMERCE, ADVERTISING, AND PUBLIC RELATIONS, FOR WEB AND DESK-TOP APPLICATIONS, IN CLASS 9 (U.S. CLS. 21, 23, 26, 36 AND 38).

FIRST USE 6-23-2006; IN COMMERCE 6-30-2006.

FOR: COMPUTER SOFTWARE CONSULTATION, COMPUTER SOFTWARE DESIGN, COMPUTER

PROGRAMMING, MAINTENANCE OF COMPUTER SOFTWARE, AND COMPUTER SOFTWARE DEVELOPMENT FOR BUILDING, OPERATING, MAINTAINING, AND UPGRADING WEBSITES, DATABASES, AND INTERACTIVE COMPUTER NETWORKS IN THE FIELD OF ONLINE COMMERCE, ADVERTISING, AND PUBLIC RELATIONS, IN CLASS 42 (U.S. CLS. 100 AND 101).

FIRST USE 6-23-2006; IN COMMERCE 6-30-2006.

THE MARK CONSISTS OF STANDARD CHARACTERS WITHOUT CLAIM TO ANY PARTICULAR FONT, STYLE, SIZE, OR COLOR.

SN 78-922,479, FILED 7-5-2006.

RICHARD A. STRASER, EXAMINING ATTORNEY

Int. Cls.: 9 and 42

Prior U.S. Cls.: 21, 23, 26, 36, 38, 100, and 101

United States Patent and Trademark Office

Reg. No. 3,400,038

Registered Mar. 18, 2008

**TRADEMARK
SERVICE MARK
PRINCIPAL REGISTER**

RATCHET

RATCHET, INC. (MINNESOTA CORPORATION)
411 WASHINGTON AVENUE N
MINNEAPOLIS, MN 55401

FOR: COMPUTER SOFTWARE USED FOR BUILDING, OPERATING, MAINTAINING, AND UPGRADING WEBSITES, DATABASES, AND INTERACTIVE COMPUTER NETWORKS IN THE FIELD OF ONLINE COMMERCE, ADVERTISING, AND PUBLIC RELATIONS, FOR WEB AND DESKTOP APPLICATIONS, IN CLASS 9 (U.S. CLS. 21, 23, 26, 36 AND 38).

FIRST USE 6-23-2006; IN COMMERCE 6-30-2006.

FOR: COMPUTER SOFTWARE CONSULTATION, COMPUTER SOFTWARE DESIGN, COMPUTER

PROGRAMMING, MAINTENANCE OF COMPUTER SOFTWARE, AND COMPUTER SOFTWARE DEVELOPMENT FOR BUILDING, OPERATING, MAINTAINING, AND UPGRADING WEBSITES, DATABASES, AND INTERACTIVE COMPUTER NETWORKS IN THE FIELD OF ONLINE COMMERCE, ADVERTISING, AND PUBLIC RELATIONS, IN CLASS 42 (U.S. CLS. 100 AND 101).

FIRST USE 6-23-2006; IN COMMERCE 6-30-2006.

THE MARK CONSISTS OF STYLIZED PRESENTATION OF THE WORD "RATCHET".

SN 78-922,532, FILED 7-5-2006.

RICHARD A. STRASER, EXAMINING ATTORNEY

Int. Cls.: 9 and 42

Prior U.S. Cls.: 21, 23, 26, 36, 38, 100, and 101

United States Patent and Trademark Office

Reg. No. 3,400,039

Registered Mar. 18, 2008

**TRADEMARK
SERVICE MARK
PRINCIPAL REGISTER**



RATCHET, INC. (MINNESOTA CORPORATION)
SUITE 300
411 WASHINGTON AVENUE N
MINNEAPOLIS, MN 55401

FOR: COMPUTER SOFTWARE USED FOR BUILDING, OPERATING, MAINTAINING, AND UPGRADING WEBSITES, DATABASES, AND INTERACTIVE COMPUTER NETWORKS IN THE FIELD OF ONLINE COMMERCE, ADVERTISING, AND PUBLIC RELATIONS, FOR WEB AND DESKTOP APPLICATIONS, IN CLASS 9 (U.S. CLS. 21, 23, 26, 36 AND 38).

FIRST USE 6-23-2006; IN COMMERCE 6-30-2006.

FOR: COMPUTER SOFTWARE CONSULTATION, COMPUTER SOFTWARE DESIGN, COMPUTER

PROGRAMMING, MAINTENANCE OF COMPUTER SOFTWARE, AND COMPUTER SOFTWARE DEVELOPMENT FOR BUILDING, OPERATING, MAINTAINING, AND UPGRADING WEBSITES, DATABASES, AND INTERACTIVE COMPUTER NETWORKS IN THE FIELD OF ONLINE COMMERCE, ADVERTISING, AND PUBLIC RELATIONS, IN CLASS 42 (U.S. CLS. 100 AND 101).

FIRST USE 6-23-2006; IN COMMERCE 6-30-2006.

THE MARK CONSISTS OF ABSTRACTION OF RATCHET.

SN 78-922,544, FILED 7-5-2006.

RICHARD A. STRASER, EXAMINING ATTORNEY

Int. Cl.: 7

Prior U.S. Cls.: 13, 19, 21, 23, 31, 34, and 35

Reg. No. 3,400,040

United States Patent and Trademark Office

Registered Mar. 18, 2008

**TRADEMARK
PRINCIPAL REGISTER**

KID+

HY-KO PRODUCTS COMPANY (OHIO CORPORATION)
60 MEADOW LANE
NORTHFIELD, OH 44067

THE MARK CONSISTS OF STANDARD CHARACTERS WITHOUT CLAIM TO ANY PARTICULAR FONT, STYLE, SIZE, OR COLOR.

FOR: MACHINES FOR MATCHING CUT KEYS TO KEY BLANKS, CUTTING KEY BLANKS, AND MONITORING KEY INVENTORIES, IN CLASS 7 (U.S. CLS. 13, 19, 21, 23, 31, 34 AND 35).

SN 78-922,597, FILED 7-5-2006.

FIRST USE 5-31-2005; IN COMMERCE 3-31-2007.

MARK RADEMACHER, EXAMINING ATTORNEY

Int. Cl.: 12

Prior U.S. Cls.: 19, 21, 23, 31, 35, and 44

United States Patent and Trademark Office

Reg. No. 3,400,041

Registered Mar. 18, 2008

**TRADEMARK
PRINCIPAL REGISTER**

BMF WHEELS

BROCK WELD (UNITED STATES INDIVIDUAL)
16433 VALLEY VIEW AVENUE
CERRITOS, CA 90703

FOR: LAND VEHICLES PARTS, NAMELY,
WHEELS, IN CLASS 12 (U.S. CLS. 19, 21, 23, 31, 35
AND 44).

FIRST USE 5-1-2007; IN COMMERCE 10-1-2007.

THE MARK CONSISTS OF STANDARD CHAR-
ACTERS WITHOUT CLAIM TO ANY PARTICULAR
FONT, STYLE, SIZE, OR COLOR.

NO CLAIM IS MADE TO THE EXCLUSIVE
RIGHT TO USE "WHEELS", APART FROM THE
MARK AS SHOWN.

SN 78-922,899, FILED 7-5-2006.

DAVID MURRAY, EXAMINING ATTORNEY

Int. Cl.: 9

Prior U.S. Cls.: 21, 23, 26, 36, and 38

United States Patent and Trademark Office

Reg. No. 3,400,042

Registered Mar. 18, 2008

**TRADEMARK
PRINCIPAL REGISTER**

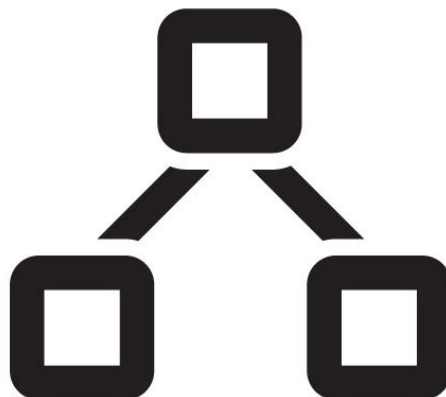

AUSTHINK SOFTWARE PTY LTD (AUSTRALIA
PROPRIETARY LIMITED COMPANY)
UNIT 15, 233 CARDIGAN STREET
CARLTON, VICTORIA, AUSTRALIA 3053

FOR: COMPUTER SOFTWARE AND PROGRAMS
FOR USE IN THE VISUAL REPRESENTATION,
MANIPULATION AND EVALUATION OF IDEA
CONCEPTUAL RELATIONSHIPS, ARGUMENT
AND ARGUMENT STRUCTURES FOR USE IN
EDUCATION, BUSINESS, GOVERNMENT AND
FOR PERSONAL USE; COMPUTER SOFTWARE
FOR THE CREATION AND MANIPULATION OF
GROUPING, IDEA, CONCEPT, MIND AND ARGU-
MENT MAPS FOR USE IN EDUCATION, BUSINESS,
GOVERNMENT AND FOR PERSONAL USE, IN
CLASS 9 (U.S. CLS. 21, 23, 26, 36 AND 38).

FIRST USE 7-19-2006; IN COMMERCE 8-31-2006.

THE MARK CONSISTS OF THREE SQUARES
WITH ROUNDED CORNERS IN AN TRIANGLE
ARRANGEMENT. THERE ARE STRAIGHT LINES
BETWEEN THE BOTTOM OF THE SQUARE AT THE
APEX OF THE TRIANGLE AND THE TOP OF THE
SQUARES AT THE FOOT OF THE TRIANGLE.
THESE LINES DO NOT TOUCH THE SQUARE AT
THE APEX OR THE SQUARES BELOW.

SN 78-923,171, FILED 7-6-2006.

MYRIAH HABEEB, EXAMINING ATTORNEY

Int. Cl.: 9

Prior U.S. Cls.: 21, 23, 26, 36, and 38

Reg. No. 3,400,043

United States Patent and Trademark Office

Registered Mar. 18, 2008

**TRADEMARK
PRINCIPAL REGISTER**

ZAZOOX

KIOSK INFORMATION SYSTEMS, INC. (COLOR-
ADO CORPORATION)
346 SOUTH ARTHUR AVENUE
LOUISVILLE, CO 80027

FOR: INTERACTIVE COMPUTER SYSTEMS
COMPRISED OF SELF-SERVICE TERMINALS
AND GAMING STATIONS, FEATURING INPUT
DEVICES NAMELY, CREDIT CARD READERS,
CLUB CARD READERS, BILL ACCEPTORS, COIN
ACCEPTORS, BILL AND COIN RECYCLERS, KEY-
BOARD INPUT, BAR CODE SCANNER, PAYMENT
ENGINE AND RELATED SOFTWARE FOR A VARI-
ETY OF PAYMENT METHODS INCLUDING CASH,
CREDIT, DEBIT, VOUCHER OR PREPAID AC-
COUNTS FOR VARIOUS APPLICATIONS, NAMELY
VIDEO DOWNLOAD AND PRE-VIEWING, MUSIC
DOWNLOAD AND PREVIEWING, ONLINE AMU-
SEMENT GAMING, INTERNET ACCESS, EMAIL,
VIDEO EMAIL, DIGITAL PHOTO PROCESSING,

CELL PHONE RING TONE AND OTHER CONTENT
DELIVERY, NAMELY, GAMES, AUDIO BOOKS,
MOVIES, VIDEOS, AND TELEVISION SHOWS,
VOICE OVER INTERNET PROTOCOL USAGE
(VOIP), BILL PAYMENT, ON-LINE SHOPPING, MO-
VIE RENTAL AND VIEWING, TV RENTAL AND
VIEWING AND OTHER ONLINE OR INTERNET
APPLICATIONS, NAMELY PC GAMES, IN CLASS 9
(U.S. CLS. 21, 23, 26, 36 AND 38).

FIRST USE 12-18-2006; IN COMMERCE 12-18-2006.

THE MARK CONSISTS OF STANDARD CHAR-
ACTERS WITHOUT CLAIM TO ANY PARTICULAR
FONT, STYLE, SIZE, OR COLOR.

SN 78-923,824, FILED 7-6-2006.

TASNEEM HUSSAIN, EXAMINING ATTORNEY

Int. Cl.: 9

Prior U.S. Cls.: 21, 23, 26, 36, and 38

United States Patent and Trademark Office

Reg. No. 3,400,044

Registered Mar. 18, 2008

**TRADEMARK
PRINCIPAL REGISTER**

High Dream

PAXIOM, INC. (CANADA CORPORATION)
2525 LOUIS AMOS
MONTREAL, CANADA H8T 1C3

THE MARK CONSISTS OF STANDARD CHAR-
ACTERS WITHOUT CLAIM TO ANY PARTICULAR
FONT, STYLE, SIZE, OR COLOR.

FOR: WEIGHING EQUIPMENT, NAMELY,
SCALES AND BALANCES, IN CLASS 9 (U.S. CLS.
21, 23, 26, 36 AND 38).

SN 78-925,030, FILED 7-7-2006.

FIRST USE 1-1-2005; IN COMMERCE 1-1-2005.

JASON BLAIR, EXAMINING ATTORNEY

Int. Cl.: 11

Prior U.S. Cls.: 13, 21, 23, 31, and 34

United States Patent and Trademark Office

Reg. No. 3,400,045

Registered Mar. 18, 2008

**TRADEMARK
PRINCIPAL REGISTER**

EZ CRANK

EXCALIBUR ELECTRONICS, INC. (FLORIDA
CORPORATION)

13755 SW 119TH AVENUE

MIAMI, FL 33186

FOR: FLASHLIGHTS, IN CLASS 11 (U.S. CLS. 13,
21, 23, 31 AND 34).

FIRST USE 8-31-2006; IN COMMERCE 8-31-2006.

THE MARK CONSISTS OF STANDARD CHAR-
ACTERS WITHOUT CLAIM TO ANY PARTICULAR
FONT, STYLE, SIZE, OR COLOR.

NO CLAIM IS MADE TO THE EXCLUSIVE
RIGHT TO USE "CRANK", APART FROM THE
MARK AS SHOWN.

SN 78-925,508, FILED 7-10-2006.

MYRIAH HABEEB, EXAMINING ATTORNEY

Int. Cls.: 7, 9, and 12

Prior U.S. Cls.: 13, 19, 21, 23, 26, 31, 34, 35, 36, 38, and 44

Reg. No. 3,400,046

United States Patent and Trademark Office

Registered Mar. 18, 2008

**TRADEMARK
PRINCIPAL REGISTER**

YEC

YAMAGUCHI ELECTRIC INDUSTRY CO., LTD.
(JAPAN CORPORATION)
3-11-0 IKEJIRI, SETAGAYA-KU
TOKYO, 154, JAPAN

FOR: AUTOMOTIVE IGNITION COMPONENTS,
NAMELY, DISTRIBUTOR CAPS, ROTORS, COILS,
PLUGS, PLUG WIRES, CONDENSERS , IN CLASS 7
(U.S. CLS. 13, 19, 21, 23, 31, 34 AND 35).

FIRST USE 7-1-1963; IN COMMERCE 7-1-1963.

FOR: ELECTRICAL SWITCHES AND IGNITION
CONTROL MODULES, IN CLASS 9 (U.S. CLS. 21, 23,
26, 36 AND 38).

FIRST USE 7-1-1963; IN COMMERCE 7-1-1963.

FOR: MOTOR VEHICLE BACKUP BEEPERS, IN
CLASS 12 (U.S. CLS. 19, 21, 23, 31, 35 AND 44).

FIRST USE 7-1-1963; IN COMMERCE 7-1-1963.

THE MARK CONSISTS OF STANDARD CHAR-
ACTERS WITHOUT CLAIM TO ANY PARTICULAR
FONT, STYLE, SIZE, OR COLOR.

SN 78-926,767, FILED 7-11-2006.

FRANK LATTUCA, EXAMINING ATTORNEY

Int. Cl.: 41

Prior U.S. Cls.: 100, 101, and 107

United States Patent and Trademark Office

Reg. No. 3,400,047

Registered Mar. 18, 2008

**SERVICE MARK
PRINCIPAL REGISTER**

THE HONORS CLUB

MWR HOLDINGS, LLC (DELAWARE LTD LIAB
CO)
SUITE 110
10 SYLVAN WAY
PARSIPPANY, NJ 07054

FOR: EDUCATIONAL SERVICES, NAMELY, A
TUTORING PROGRAM FOR ENABLING PARENTS
TO PROVIDE TUTORING TO THEIR CHILDREN IN
ALL ACADEMIC FIELDS, INCLUDING ASSISTING
THE CHILDREN WITH THEIR EVERYDAY HOME-
WORK FROM SCHOOL, IN CLASS 41 (U.S. CLS. 100,
101 AND 107).

FIRST USE 12-15-2007; IN COMMERCE 12-15-2007.

THE MARK CONSISTS OF STANDARD CHAR-
ACTERS WITHOUT CLAIM TO ANY PARTICULAR
FONT, STYLE, SIZE, OR COLOR.

SN 78-927,949, FILED 7-12-2006.

CHRISTINA SOBRAL, EXAMINING ATTORNEY

Int. Cl.: 11

Prior U.S. Cls.: 13, 21, 23, 31, and 34

United States Patent and Trademark Office

Reg. No. 3,400,048

Registered Mar. 18, 2008

**TRADEMARK
PRINCIPAL REGISTER**

HEAT GRABBER

VOGELZANG INTERNATIONAL CORPORA-
TION (MICHIGAN CORPORATION)
400 WEST 17TH STREET
HOLLAND, MI 49423

FOR: AN APPARATUS FOR RECYCLING AND
RETAINING HEAT FROM A HEAT SOURCE IN
THE NATURE OF FIREPLACE INSERTS USED AS
HEAT EXCHANGERS, IN CLASS 11 (U.S. CLS. 13, 21,
23, 31 AND 34).

FIRST USE 11-1-2007; IN COMMERCE 11-1-2007.

THE MARK CONSISTS OF STANDARD CHAR-
ACTERS WITHOUT CLAIM TO ANY PARTICULAR
FONT, STYLE, SIZE, OR COLOR.

NO CLAIM IS MADE TO THE EXCLUSIVE
RIGHT TO USE "HEAT", APART FROM THE MARK
AS SHOWN.

SN 78-928,885, FILED 7-13-2006.

CHRIS WELLS, EXAMINING ATTORNEY

Int. Cl.: 16

Prior U.S. Cls.: 2, 5, 22, 23, 29, 37, 38, and 50

Reg. No. 3,400,049

United States Patent and Trademark Office

Registered Mar. 18, 2008

**TRADEMARK
PRINCIPAL REGISTER**

3rd HAND

BORG UNLIMITED INC. (CALIFORNIA CORPORATION)
909 DIVINA VISTA STREET
MONTEREY PARK, CA 91754

THE MARK CONSISTS OF STANDARD CHARACTERS WITHOUT CLAIM TO ANY PARTICULAR FONT, STYLE, SIZE, OR COLOR.

FOR: PLASTIC PAGES FOR HOLDING PLAYS, GAME PLANS, SCHEDULES AND ROUTINES FOR ATHLETIC USE, IN CLASS 16 (U.S. CLS. 2, 5, 22, 23, 29, 37, 38 AND 50).

SN 78-929,141, FILED 7-13-2006.

FIRST USE 8-1-2006; IN COMMERCE 8-1-2006.

DAVID ELTON, EXAMINING ATTORNEY

Int. Cls.: 35 and 36

Prior U.S. Cls.: 100, 101, and 102

United States Patent and Trademark Office

Reg. No. 3,400,050

Registered Mar. 18, 2008

**SERVICE MARK
PRINCIPAL REGISTER**

DISCLOSURE INSIGHT

SEC INSIGHT, INC. (MINNESOTA CORPORATION)
P.O. BOX 47331
PLYMOUTH, MN 55447

FOR: ANALYZING AND COMPILING INFORMATION ON SEC FILINGS AND RELATED INVESTMENT DATA FOR MEASURING THE PERFORMANCE OF FINANCIAL MARKETS, IN CLASS 35 (U.S. CLS. 100, 101 AND 102).

FIRST USE 7-0-2007; IN COMMERCE 7-0-2007.

FOR: PROVIDING FINANCIAL INFORMATION AND INVESTMENT INFORMATION SERVICES REGARDING SEC SECURITIES FILINGS AND RELA-

TED FINANCIAL INVESTMENTS, IN CLASS 36 (U.S. CLS. 100, 101 AND 102).

FIRST USE 7-0-2007; IN COMMERCE 7-0-2007.

THE MARK CONSISTS OF STANDARD CHARACTERS WITHOUT CLAIM TO ANY PARTICULAR FONT, STYLE, SIZE, OR COLOR.

NO CLAIM IS MADE TO THE EXCLUSIVE RIGHT TO USE "DISCLOSURE", APART FROM THE MARK AS SHOWN.

SN 78-929,808, FILED 7-14-2006.

WILLIAM VERHOSEK, EXAMINING ATTORNEY

Int. Cl.: 2

Prior U.S. Cls.: 6, 11, and 16

United States Patent and Trademark Office

Reg. No. 3,400,051

Registered Mar. 18, 2008

**TRADEMARK
PRINCIPAL REGISTER**

THE BEAUTY GOES ON

THE VALSPAR CORPORATION (DELAWARE
CORPORATION)
1101 SOUTH THIRD STREET
MINNEAPOLIS, MN 55415

FOR: FULL LINE OF INTERIOR AND EXTERIOR
COATINGS, NAMELY, PAINTS, STAINS, VARN-
ISHES AND PRIMERS FOR WOOD, PLASTIC, ME-
TAL, FIBERGLASS, PLASTER, CONCRETE, GLASS,
AND PAPER SURFACES, RESIDENTIAL AND
COMMERCIAL BUILDINGS, SIDING, FURNI-
TURE, MOTOR VEHICLES, TRAILERS, INDUS-
TRIAL EQUIPMENT, FARM EQUIPMENT,

CONTAINERS, METAL GOODS, AND APPLIAN-
CES, IN CLASS 2 (U.S. CLS. 6, 11 AND 16).

FIRST USE 1-0-2007; IN COMMERCE 1-0-2007.

THE MARK CONSISTS OF STANDARD CHAR-
ACTERS WITHOUT CLAIM TO ANY PARTICULAR
FONT, STYLE, SIZE, OR COLOR.

SN 78-931,147, FILED 7-17-2006.

MORGAN WYNNE, EXAMINING ATTORNEY

Int. Cl.: 14

Prior U.S. Cls.: 2, 27, 28, and 50

United States Patent and Trademark Office

Reg. No. 3,400,052

Registered Mar. 18, 2008

**TRADEMARK
PRINCIPAL REGISTER**

SOLIRI

MOVADO LLC (DELAWARE LTD LIAB CO)
SILVERSIDE CARR EXECUTIVE CENTER
501 SILVERSIDE ROAD
WILMINGTON, DE 19809

THE MARK CONSISTS OF STANDARD CHAR-
ACTERS WITHOUT CLAIM TO ANY PARTICULAR
FONT, STYLE, SIZE, OR COLOR.

FOR: JEWELRY, IN CLASS 14 (U.S. CLS. 2, 27, 28
AND 50).

SN 78-931,644, FILED 7-18-2006.

FIRST USE 6-20-2007; IN COMMERCE 6-20-2007.

RONALD AIKENS, EXAMINING ATTORNEY

Int. Cl.: 29

Prior U.S. Cl.: 46

United States Patent and Trademark Office

Reg. No. 3,400,053

Registered Mar. 18, 2008

**TRADEMARK
PRINCIPAL REGISTER**



ATTACK, INDÚSTRIA COMÉRCIO E REPRESENTAÇÕES LTDA. (BRAZIL CORPORATION)
RUA DR. NEREU RAMOS, NO. 750
GASPAR, SANTA CATARINA, BRAZIL

FOR: JAM, NAMELY, CUPUASSÚ JAM, PASSION FRUIT JAM, ASSAI JAM, BANANA JAM, GUAVA JAM, ORANGE JAM, STRAWBERRY JAM, GRAPE JAM, ORANGE JAM; PRESERVED VEGETABLES IN BRINE, NAMELY, WHOLE MINI-CORN IN BRINE, MINI-CARROTS IN BRINE, HEARTS OF REAL PALM OR PALMETTO IN BRINE; PICKLES; PRESERVED VEGETABLES, NAMELY, CUCUM-

BERS; PRESERVED HEARTS OF PALM; DRIED VEGETABLES; CRYSTALLIZED FRUIT; PROCESSED FRUIT, IN CLASS 29 (U.S. CL. 46).

FIRST USE 10-20-2006; IN COMMERCE 10-20-2006.

THE FOREIGN WORDING IN THE MARK TRANSLATES INTO ENGLISH AS HOME & FARM.

SN 78-932,240, FILED 7-18-2006.

MICHAEL TANNER, EXAMINING ATTORNEY

Int. Cl.: 36

Prior U.S. Cls.: 100, 101, and 102

United States Patent and Trademark Office

Reg. No. 3,400,054

Registered Mar. 18, 2008

**SERVICE MARK
PRINCIPAL REGISTER**

DISCOVER CUSTOM

DISCOVER RE MANAGERS, INC. (DELAWARE
CORPORATION)
5 BATTERSON PARK ROAD
FARMINGTON, CT 06032

FOR: PROPERTY AND CASUALTY INSURANCE
UNDERWRITING SERVICES, NAMELY, IN THE
FIELD OF COMMERCIAL INSURANCE, IN CLASS
36 (U.S. CLS. 100, 101 AND 102).

FIRST USE 5-31-2006; IN COMMERCE 8-31-2006.

THE MARK CONSISTS OF STANDARD CHAR-
ACTERS WITHOUT CLAIM TO ANY PARTICULAR
FONT, STYLE, SIZE, OR COLOR.

OWNER OF U.S. REG. NOS. 2,424,266, 2,424,267,
AND 2,424,268.

SN 78-932,244, FILED 7-18-2006.

JULIE WATSON, EXAMINING ATTORNEY

Int. Cls.: 9, 38, 41, and 42

Prior U.S. Cls.: 21, 23, 26, 36, 38, 100, 101, 104, and 107

United States Patent and Trademark Office

Reg. No. 3,400,055

Registered Mar. 18, 2008

**TRADEMARK
SERVICE MARK
PRINCIPAL REGISTER**

UBROADCAST

UBROADCAST, INC. (NEVADA CORPORATION)
311 4TH AVENUE, SUITE 307
SAN DIEGO, CA 92101

FOR: DOWNLOADABLE SOFTWARE THAT EN-
ABLES MULTIPLE USERS WITH THE ABILITY TO
BROADCAST AND LISTEN TO PROGRAMS VIA
THE INTERNET, IN CLASS 9 (U.S. CLS. 21, 23, 26, 36
AND 38).

FIRST USE 1-30-2006; IN COMMERCE 1-30-2007.

FOR: TRANSMISSION OF INFORMATION AND
BROADCASTING OF RADIO SHOWS VIA THE
INTERNET, PROVIDING MULTIPLE USERS WITH
THE ABILITY AND ACCESS TO BROADCAST AND
LISTEN TO LIVE RADIO SHOWS VIA THE INTER-
NET, WHEREIN SUCH RADIO SHOWS INCLUDE
BOTH LIVE AND PRE-RECORDED CONTENT, IN
CLASS 38 (U.S. CLS. 100, 101 AND 104).

FIRST USE 1-30-2006; IN COMMERCE 1-30-2007.

FOR: ENTERTAINMENT SERVICES IN THE
NATURE OF CONTENT PREPARATION FOR IN-
TERNET RADIO SHOWS, IN CLASS 41 (U.S. CLS.
100, 101 AND 107).

FIRST USE 1-30-2006; IN COMMERCE 1-30-2007.

FOR: PROVIDING ONLINE NONDOWNLOAD-
ABLE SOFTWARE THAT ENABLES MULTIPLER
USERS WITH THE ABILITY TO BROADCAST AND
LISTEN TO RADIO PROGRAMS VIA THE INTER-
NET; HOSTING OF DIGITAL CONTENT ON THE
INTERNET, IN CLASS 42 (U.S. CLS. 100 AND 101).

FIRST USE 1-30-2006; IN COMMERCE 1-30-2007.

THE MARK CONSISTS OF STANDARD CHAR-
ACTERS WITHOUT CLAIM TO ANY PARTICULAR
FONT, STYLE, SIZE, OR COLOR.

SN 78-932,327, FILED 7-18-2006.

CHERYL CLAYTON, EXAMINING ATTORNEY

Int. Cls.: 9, 38, 41, and 42

Prior U.S. Cls.: 21, 23, 26, 36, 38, 100, 101, 104, and 107

Reg. No. 3,400,056

United States Patent and Trademark Office

Registered Mar. 18, 2008

**TRADEMARK
SERVICE MARK
PRINCIPAL REGISTER**



UBROADCAST, INC. (NEVADA CORPORATION)
311 4TH STREET, SUITE 307
SAN DIEGO, CA 92101

FOR: DOWNLOADABLE SOFTWARE THAT EN-
ABLES MULTIPLE USERS WITH THE ABILITY TO
BROADCAST AND LISTEN TO PROGRAMS VIA
THE INTERNET, IN CLASS 9 (U.S. CLS. 21, 23, 26, 36
AND 38).

FIRST USE 1-30-2006; IN COMMERCE 1-30-2007.

FOR: TRANSMISSION OF INFORMATION AND
BROADCASTING OF RADIO SHOWS VIA THE
INTERET, PROVIDING MULTIPLE USERS WITH
THE ABILITY AND ACCESS TO BROADCAST AND
LISTEN TO LIVE RADIO SHOWS VIA THE INTER-
NET, WHEREIN SUCH RADIO SHOWS INCLUDE
BOTH LIVE AND PRE-CORDED CONTENT, IN
CLASS 38 (U.S. CLS. 100, 101 AND 104).

FIRST USE 1-30-2006; IN COMMERCE 1-30-2007.

FOR: ENTERTAINMENT SERVICES IN THE
NATURE OF CONTENT PREPARATION FOR IN-
TERNET RADIO SHOWS, IN CLASS 41 (U.S. CLS.
100, 101 AND 107).

FIRST USE 1-30-2006; IN COMMERCE 1-30-2007.

FOR: PROVIDING ONLINE NONDOWNLOAD-
ABLE SOFTWARE THAT ENABLES MULTIPLER
USERS WITH THE ABILITY TO BROADCAST AND
LISTEN TO PROGRAMS VIA THE INTERNET;
HOSTING OF DIGITAL CONTENT ON THE INTER-
NET, IN CLASS 42 (U.S. CLS. 100 AND 101).

FIRST USE 1-30-2006; IN COMMERCE 1-30-2007.

THE MARK CONSISTS OF THE WORD
"UBROADCAST" WITH 3 SEMI-CIRCLES REPRE-
SENTING PULSES TO THE LEFT OF AND OVER
THE "U".

SN 78-932,336, FILED 7-18-2006.

CHERYL CLAYTON, EXAMINING ATTORNEY

Int. Cl.: 28

Prior U.S. Cls.: 22, 23, 38, and 50

United States Patent and Trademark Office

Reg. No. 3,400,057

Registered Mar. 18, 2008

**TRADEMARK
PRINCIPAL REGISTER**

SWING SCIENCE

SWING SCIENCE, LLC (INDIANA LTD LIAB CO)
6828 HILLSDALE COURT, SUITE A
INDIANAPOLIS, IN 46250

FOR: GOLF CLUBS AND COMPONENTS, NAME-
LY, SHAFTS, HEADS AND GRIPS; GOLF CLUB
BAGS, IN CLASS 28 (U.S. CLS. 22, 23, 38 AND 50).

FIRST USE 11-17-2005; IN COMMERCE 11-17-2005.

THE MARK CONSISTS OF STANDARD CHAR-
ACTERS WITHOUT CLAIM TO ANY PARTICULAR
FONT, STYLE, SIZE, OR COLOR.

OWNER OF U.S. REG. NO. 2,261,104.

SN 78-932,780, FILED 7-19-2006.

JAY BESCH, EXAMINING ATTORNEY

Int. Cls.: 35 and 36

Prior U.S. Cls.: 100, 101, and 102

United States Patent and Trademark Office

Reg. No. 3,400,058

Registered Mar. 18, 2008

**SERVICE MARK
PRINCIPAL REGISTER**



HR CAPITAL MANAGEMENT (MARYLAND CORPORATION)
7361 CALHOUN PL, STE 510
ROCKVILLE, MD 20855

FOR: SERVING AS A HUMAN RESOURCES DEPARTMENT FOR OTHERS; PERSONNEL PLACEMENT AND RECRUITMENT; TRANSCRIPTION OF WRITTEN LEGAL DOCUMENTS AND NOTES , IN CLASS 35 (U.S. CLS. 100, 101 AND 102).

FIRST USE 11-1-2005; IN COMMERCE 1-1-2006.

FOR: ADMINISTRATION OF EMPLOYEE BENEFITS PLANS, IN CLASS 36 (U.S. CLS. 100, 101 AND 102).

FIRST USE 11-1-2005; IN COMMERCE 1-1-2006.

THE COLOR(S) BLUE, LIGHT BLUE, AND BLACK IS/ARE CLAIMED AS A FEATURE OF THE MARK.

THE FIRST STYLIZED FIGURE HAS BLACK HEAD WITH A BLUE CHEST AND ARMS, THE SECOND STYLIZED FIGURE HAS A BLACK HEAD AND LIGHT BLUE CHEST ARMS; THE THIRD STYLIZED FIGURE HAS A BLACK HEAD WITH A BLUE CHEST AND ARMS, THE WORD "PAY" APPEARS IN BLACK AND THE WORD "STAFF" APPEARS IN BLUE.

SN 78-934,448, FILED 7-21-2006.

SHARON MEIER, EXAMINING ATTORNEY

Int. Cl.: 35

Prior U.S. Cls.: 100, 101, and 102

United States Patent and Trademark Office

Reg. No. 3,400,059

Registered Mar. 18, 2008

**SERVICE MARK
PRINCIPAL REGISTER**



HR CAPITAL MANAGEMENT, INC. (MARY-
LAND CORPORATION)
7361 CALHOUN PL, STE 510
ROCKVILLE, MD 20855

FOR: EMPLOYMENT AGENCY SERVICES,
NAMELY, TEMPORARY AND PERMANENT
STAFFING, PERSONNEL RECRUITMENT, AND
HUMAN RESOURCES MANAGEMENT, IN CLASS
35 (U.S. CLS. 100, 101 AND 102).

FIRST USE 6-1-2006; IN COMMERCE 6-1-2006.

THE COLOR(S) BLACK, BLUE, AND YELLOW IS/
ARE CLAIMED AS A FEATURE OF THE MARK.

THE FIRST STYLIZED FIGURE CONSISTS OF A
BLACK HEAD AND A BLUE CHEST AND ARMS.

THE SECOND STYLIZED FIGURE CONSISTS OF A
BLACK HEAD AND A YELLOW CHEST AND
ARMS. THE THIRD STYLIZED FIGURE CONSISTS
OF A BLACK HEAD AND BLUE CHEST AND
ARMS. THE COLOR BLUE APPEARS IN THE
WORDING "TALENT" AND IN THE UNDERLINE
DESIGN. THE COLOR YELLOW APPEARS IN THE
WORDING "PRO". THE COLOR BLACK APPEARS
IN THE WORDING "PEOPLE RESOURCE SOLU-
TIONS".

SN 78-934,499, FILED 7-21-2006.

CIMMERIAN COLEMAN, EXAMINING ATTOR-
NEY

Int. Cl.: 44

Prior U.S. Cls.: 100 and 101

United States Patent and Trademark Office

Reg. No. 3,400,060

Registered Mar. 18, 2008

**SERVICE MARK
PRINCIPAL REGISTER**

PEOPLE WHO ASK, KNOW.

THE VANDERBILT UNIVERSITY (TENNESSEE
NON-PROFIT CORPORATION)
305 KIRKLAND HALL
NASHVILLE, TN 37240

FOR: HEALTH CARE SERVICES; HOSPITAL
SERVICES; MEDICAL CLINICS; MEDICAL COUN-
SELING; MEDICAL EVALUATION SERVICES,
NAMELY, FUNCTIONAL ASSESSMENT PRO-
GRAM FOR PATIENTS RECEIVING MEDICAL
SERVICES FOR PURPOSES OF GUIDING TREAT-
MENT AND ASSESSING PROGRAM EFFECTIVE-
NESS; MEDICAL SERVICES; NUTRITION
COUNSELING; PHYSICAL REHABILITATION SER-
VICES; PROVIDING INFORMATION IN THE
FIELDS OF DISEASES, DISEASE PREVENTION,
HEALTH CARE, MEDICINE AND MEDICAL SER-

VICES; AND PROVIDING INFORMATION VIA A
GLOBAL COMMUNICATIONS NETWORK IN THE
FIELDS OF DISEASES, DISEASE PREVENTION,
HEALTH CARE, MEDICINE AND MEDICAL SER-
VICES, IN CLASS 44 (U.S. CLS. 100 AND 101).

FIRST USE 9-18-2006; IN COMMERCE 9-18-2006.

THE MARK CONSISTS OF STANDARD CHAR-
ACTERS WITHOUT CLAIM TO ANY PARTICULAR
FONT, STYLE, SIZE, OR COLOR.

SN 78-935,356, FILED 7-22-2006.

JASON ROTH, EXAMINING ATTORNEY

Int. Cl.: 3

Prior U.S. Cls.: 1, 4, 6, 50, 51, and 52

United States Patent and Trademark Office

Reg. No. 3,400,061

Registered Mar. 18, 2008

**TRADEMARK
PRINCIPAL REGISTER**

JewelTherapy

RHOADES, DEAN L. (UNITED STATES INDIVIDUAL)
9107 WILSHIRE BLVD., SUITE 600
BEVERLY HILLS, CA 90210

FOR: COSMETICS, NAMELY, SKIN TONERS, SKIN CREME, SKIN MOISTURIZERS, HYDRATING MOISTURIZERS, FACIAL AND BODY SCRUBS, FACIAL LOTION, BODY LOTION AND FACIAL AND SKIN CLEANSERS, IN CLASS 3 (U.S. CLS. 1, 4, 6, 50, 51 AND 52).

FIRST USE 11-1-2007; IN COMMERCE 11-1-2007.

THE MARK CONSISTS OF STANDARD CHARACTERS WITHOUT CLAIM TO ANY PARTICULAR FONT, STYLE, SIZE, OR COLOR.

OWNER OF U.S. REG. NO. 2,896,222.

SN 78-936,352, FILED 7-24-2006.

PATRICIA EVANKO, EXAMINING ATTORNEY

Int. Cl.: 15

Prior U.S. Cls.: 2, 21, and 36

United States Patent and Trademark Office

Reg. No. 3,400,062

Registered Mar. 18, 2008

**TRADEMARK
PRINCIPAL REGISTER**



JACK DANIEL'S PROPERTIES, INC. (DELA-
WARE CORPORATION)
SUITE 528
4040 CIVIC CENTER DRIVE
SAN RAFAEL, CA 94903

FOR: GUITAR STRAPS, IN CLASS 15 (U.S. CLS. 2,
21 AND 36).

FIRST USE 10-7-2004; IN COMMERCE 10-7-2004.

OWNER OF U.S. REG. NOS. 1,290,702, 2,898,085,
AND OTHERS.

NO CLAIM IS MADE TO THE EXCLUSIVE
RIGHT TO USE "BRAND", APART FROM THE
MARK AS SHOWN.

THE NAME(S), PORTRAIT(S), AND/OR SIGNA-
TURE(S) SHOWN IN THE MARK DOES NOT IDEN-
TIFY A PARTICULAR LIVING INDIVIDUAL.

THE MARK CONSISTS OF THE WORDS "JACK
DANIEL'S" ARCHED OVER THE WORDS AND
NUMERAL "OLD NO 7 BRAND" INSIDE A CIRCLE;
THE "O" IN THE WORD "NO" IS UNDERLINED.

SN 78-936,416, FILED 7-24-2006.

MICHAEL GAFFAR, EXAMINING ATTORNEY

Int. Cl.: 25

Prior U.S. Cls.: 22 and 39

United States Patent and Trademark Office

Reg. No. 3,400,063

Registered Mar. 18, 2008

**TRADEMARK
PRINCIPAL REGISTER**

GLYDER

YELL STEEL ENTERPRISE CO. INC. (CALIFORNIA CORPORATION)
1231 E. DYER ROAD SUITE# 280
SANTA ANA, CA 92705

FOR: BASEBALL CAPS; BOXER SHORTS; CAP VISORS; FLEECE SHORTS; GOLF SHIRTS; GYM SHORTS; JOGGING PANTS; KNIT SHIRTS; KNITTED CAPS; KNITTED UNDERWEAR; OPEN-NECKED SHIRTS; SHORTS AND BRIEFS; PANTS; PIQUET SHIRTS; POLO SHIRTS; RUGBY SHORTS; SHORT-SLEEVED OR LONG-SLEEVED T-SHIRTS; SHORT-SLEEVED SHIRTS; SHORTS; SLEEP SHIRTS; SLIDING SHORTS; SPORT SHIRTS; SWEAT BANDS; SWEAT SHIRTS; SWEAT SHORTS; SWEAT SUITS; T-SHIRTS; TRACK PANTS; TROUSERS FOR

SWEATING; WALKING SHORTS; WATERPROOF JACKETS AND PANTS; WIND SHIRTS; WOVEN OR KNITTED UNDERWEAR, IN CLASS 25 (U.S. CLS. 22 AND 39).

FIRST USE 12-4-2007; IN COMMERCE 12-4-2007.

THE MARK CONSISTS OF STANDARD CHARACTERS WITHOUT CLAIM TO ANY PARTICULAR FONT, STYLE, SIZE, OR COLOR.

SN 78-936,953, FILED 7-25-2006.

STEPHANIE ALI, EXAMINING ATTORNEY

Int. Cl.: 9

Prior U.S. Cls.: 21, 23, 26, 36, and 38

United States Patent and Trademark Office

Reg. No. 3,400,064

Registered Mar. 18, 2008

**TRADEMARK
PRINCIPAL REGISTER**

RAM JACK

GREGORY ENTERPRISES, INC. (OKLAHOMA
CORPORATION)
3065 FOREST LANE
GARLAND, TX 75042

FOR: COMPUTER SOFTWARE FOR USE IN
FOUNDATION DESIGN AND DETERMINING PIER
AND PILE CAPACITY, IN CLASS 9 (U.S. CLS. 21, 23,
26, 36 AND 38).

FIRST USE 8-28-2007; IN COMMERCE 8-28-2007.

THE MARK CONSISTS OF STANDARD CHAR-
ACTERS WITHOUT CLAIM TO ANY PARTICULAR
FONT, STYLE, SIZE, OR COLOR.

OWNER OF U.S. REG. NOS. 1,539,595 AND
1,592,360.

SN 78-937,020, FILED 7-25-2006.

THOMAS MANOR, EXAMINING ATTORNEY

Int. Cl.: 33

Prior U.S. Cls.: 47 and 49

United States Patent and Trademark Office

Reg. No. 3,400,065

Registered Mar. 18, 2008

**TRADEMARK
PRINCIPAL REGISTER**

BENVOLIO

JACKSON WINE ESTATES INTERNATIONAL
LIMITED (IRELAND CORPORATION)
CHERRYWOOD BUSINESS PARK, BUILDING D
LOUGHLINSTOWN
COUNTY DUBLIN, IRELAND

THE MARK CONSISTS OF STANDARD CHAR-
ACTERS WITHOUT CLAIM TO ANY PARTICULAR
FONT, STYLE, SIZE, OR COLOR.

FOR: WINE, IN CLASS 33 (U.S. CLS. 47 AND 49).

SN 78-937,223, FILED 7-25-2006.

FIRST USE 2-7-2007; IN COMMERCE 2-12-2007.

BRIAN NEVILLE, EXAMINING ATTORNEY

Int. Cl.: 12

Prior U.S. Cls.: 19, 21, 23, 31, 35, and 44

United States Patent and Trademark Office

Reg. No. 3,400,066

Registered Mar. 18, 2008

**TRADEMARK
PRINCIPAL REGISTER**

MA-Z4S

CHENG SHIN RUBBER USA, INC. (GEORGIA
CORPORATION)
545 OLD PEACHTREE ROAD
SUWANEE, GA 30024

THE MARK CONSISTS OF STANDARD CHAR-
ACTERS WITHOUT CLAIM TO ANY PARTICULAR
FONT, STYLE, SIZE, OR COLOR.

FOR: TIRES, IN CLASS 12 (U.S. CLS. 19, 21, 23, 31,
35 AND 44).

SN 78-937,846, FILED 7-26-2006.

FIRST USE 7-0-2007; IN COMMERCE 7-0-2007.

MARY ROSSMAN, EXAMINING ATTORNEY

Int. Cl.: 28

Prior U.S. Cls.: 22, 23, 38, and 50

United States Patent and Trademark Office

Reg. No. 3,400,067

Registered Mar. 18, 2008

**TRADEMARK
PRINCIPAL REGISTER**

B.A.S.H.

FICKETT, GLENN A. (UNITED STATES INDIVIDUAL)
1135 SUNBURST LANE
TEMPE, AZ 85284

FOR: ARCHERY EQUIPMENT, NAMELY, QUIVERS; ARCHERY QUIVERS; CASES IN THE FORM OF QUIVERS FOR SPORTS IMPLEMENTS, IN CLASS 28 (U.S. CLS. 22, 23, 38 AND 50).

FIRST USE 2-0-2007; IN COMMERCE 2-0-2007.

THE MARK CONSISTS OF STANDARD CHARACTERS WITHOUT CLAIM TO ANY PARTICULAR FONT, STYLE, SIZE, OR COLOR.

SN 78-937,907, FILED 7-26-2006.

KELLY BOULTON, EXAMINING ATTORNEY

Int. Cl.: 35

Prior U.S. Cls.: 100, 101, and 102

United States Patent and Trademark Office

Reg. No. 3,400,068

Registered Mar. 18, 2008

**SERVICE MARK
PRINCIPAL REGISTER**

**EBENEZER'S FURNITURE FOR
THE LITTLE BIT OF SCROOGE IN
ALL OF US**

MILLER BROTHERS FURNITURE (PENNSYLVANIA CORPORATION)
PO BOX 338
FALLSCREEK, PA 15840

NO CLAIM IS MADE TO THE EXCLUSIVE RIGHT TO USE "FURNITURE", APART FROM THE MARK AS SHOWN.

FOR: RETAIL FURNITURE STORES, IN CLASS 35 (U.S. CLS. 100, 101 AND 102).

THE NAME "EBENEZER" DOES NOT IDENTIFY A LIVING INDIVIDUAL.

FIRST USE 8-1-2006; IN COMMERCE 11-29-2007.

SN 78-938,246, FILED 7-26-2006.

THE MARK CONSISTS OF STANDARD CHARACTERS WITHOUT CLAIM TO ANY PARTICULAR FONT, STYLE, SIZE, OR COLOR.

MICHAEL LITZAU, EXAMINING ATTORNEY

Int. Cl.: 38

Prior U.S. Cls.: 100, 101, and 104

United States Patent and Trademark Office

Reg. No. 3,400,069

Registered Mar. 18, 2008

**SERVICE MARK
PRINCIPAL REGISTER**

LatinosConnected

ALVAREZ, VERONICA M. (CANADA INDIVIDUAL)
110 S. FAIRFAX AVE. # A11-94
LOS ANGELES, CA 90036

FOR: PROVIDING AN ONLINE COMMUNITY FOR LATINOS AND HISPANICS FEATURING ONLINE CHAT ROOMS, FORUMS, DISCUSSION GROUPS AND INTERACTIVE BULLETIN BOARDS FOR POSTING AND SHARING INFORMATION AND FOR TRANSMISSION OF MESSAGES AMONG COMPUTER USERS CONCERNING ACTIVITIES, IMMIGRATION, POLITICS, HEALTH, FAMILY, BUSINESS, EVENTS, CULTURE, MUSIC, ARTS, SPORTS, RECIPES AND INFORMATION ON A WIDE VARIETY OF TOPICS OF GENERAL

INTEREST TO COMMUNITY MEMBERS; AND TRANSMISSION AND SHARING OF MESSAGES, DATA, VIDEO AND IMAGES, IN CLASS 38 (U.S. CLS. 100, 101 AND 104).

FIRST USE 12-1-2006; IN COMMERCE 12-1-2006.

THE MARK CONSISTS OF STANDARD CHARACTERS WITHOUT CLAIM TO ANY PARTICULAR FONT, STYLE, SIZE, OR COLOR.

SN 78-938,303, FILED 7-26-2006.

VERNA BETH RIRIE, EXAMINING ATTORNEY

Int. Cl.: 33

Prior U.S. Cls.: 47 and 49

United States Patent and Trademark Office

Reg. No. 3,400,070

Registered Mar. 18, 2008

**TRADEMARK
PRINCIPAL REGISTER**



LENBRIDGE FORGE PTY. LTD. (AUSTRALIA
CORPORATION)
10 ST. HUBERTS ROAD
COLDSTREAM, AUSTRALIA 3770

FIRST USE 12-31-2006; IN COMMERCE 12-31-2006.

SN 78-939,085, FILED 7-27-2006.

FOR: WINES, BOTTLED TABLE WINES, IN
CLASS 33 (U.S. CLS. 47 AND 49).

JOHN DALIER, EXAMINING ATTORNEY

Int. Cl.: 3

Prior U.S. Cls.: 1, 4, 6, 50, 51, and 52

United States Patent and Trademark Office

Reg. No. 3,400,071

Registered Mar. 18, 2008

**TRADEMARK
PRINCIPAL REGISTER**

SUPREME SOLUTION

J. P. DURGA, L.L.C. (WASHINGTON LTD LIAB
CO)
P.O. BOX 65346
PORT LUDLOW, WA 983650346

NO CLAIM IS MADE TO THE EXCLUSIVE
RIGHT TO USE "SOLUTION", APART FROM THE
MARK AS SHOWN.

FOR: SKIN MOISTURIZER, IN CLASS 3 (U.S. CLS.
1, 4, 6, 50, 51 AND 52).

SN 78-939,292, FILED 7-27-2006.

FIRST USE 10-31-2006; IN COMMERCE 10-31-2006.

THE MARK CONSISTS OF STANDARD CHAR-
ACTERS WITHOUT CLAIM TO ANY PARTICULAR
FONT, STYLE, SIZE, OR COLOR.

JANICE L. MCMORROW, EXAMINING ATTOR-
NEY

Int. Cls.: 9 and 41

Prior U.S. Cls.: 21, 23, 26, 36, 38, 100, 101, and 107

United States Patent and Trademark Office

Reg. No. 3,400,072

Registered Mar. 18, 2008

**TRADEMARK
SERVICE MARK
PRINCIPAL REGISTER**

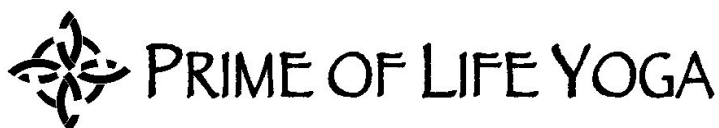

PAYNE, LARRY J. (UNITED STATES INDIVIDUAL)
4150 TIVOLI AVE
LOS ANGELES, CA 90066

FOR: AUDIO RECORDINGS FEATURING A STYLE AND PRESENTATION OF YOGA AND RELATED INFORMATION INCORPORATING INSTRUCTION AND TECHNIQUES DESIGNED FOR THE PARTICULAR NEEDS AND GOALS OF PEOPLE OVER 40 FOR OPTIMUM WELL-BEING; DOWNLOADABLE ELECTRONIC PUBLICATIONS IN THE NATURE OF BOOKS AND MAGAZINES IN THE FIELD OF A STYLE AND PRESENTATION OF YOGA AND RELATED INFORMATION INCORPORATING INSTRUCTION AND TECHNIQUES DESIGNED FOR THE PARTICULAR NEEDS AND GOALS OF PEOPLE OVER 40 FOR OPTIMUM WELL-BEING; PRE-RECORDED CD'S, VIDEO TAPES, LASER DISKS AND DVD'S FEATURING A STYLE AND PRESENTATION OF YOGA AND RELATED INFORMATION INCORPORATING INSTRUCTION AND TECHNIQUES DESIGNED FOR THE PARTICULAR NEEDS AND GOALS OF PEOPLE OVER 40 FOR OPTIMUM WELL-BEING; VIDEO RECORDINGS FEATURING A STYLE AND PRESENTATION OF YOGA AND RELATED INFORMATION INCORPORATING INSTRUCTION AND TECHNIQUES DESIGNED FOR THE PARTICULAR NEEDS AND GOALS OF PEOPLE OVER 40 FOR OPTIMUM WELL-BEING, IN CLASS 9 (U.S. CLS. 21, 23, 26, 36 AND 38).

FIRST USE 8-28-2006; IN COMMERCE 8-28-2006.

FOR: EDUCATION SERVICES, NAMELY, PROVIDING SEMINARS, WORKSHOPS, CLASSES, RE-

TREATS, LECTURES, AND CULTURAL ACTIVITIES IN THE FIELDS OF A STYLE AND PRESENTATION OF YOGA AND RELATED INFORMATION INCORPORATING INSTRUCTION AND TECHNIQUES DESIGNED FOR THE PARTICULAR NEEDS AND GOALS OF PEOPLE OVER 40 FOR OPTIMUM WELL-BEING; ENTERTAINMENT SERVICES, NAMELY, PROVIDING A RADIO PROGRAM IN THE FIELD OF A STYLE AND PRESENTATION OF YOGA AND RELATED INFORMATION INCORPORATING INSTRUCTION AND TECHNIQUES DESIGNED FOR THE PARTICULAR NEEDS AND GOALS OF PEOPLE OVER 40 FOR OPTIMUM WELL-BEING VIA A GLOBAL COMPUTER NETWORK; ENTERTAINMENT, NAMELY, A CONTINUING EDUCATIONAL SHOW BROADCAST OVER TELEVISION, SATELLITE, AUDIO, AND VIDEO MEDIA FEATURING A STYLE AND PRESENTATION OF YOGA AND RELATED INFORMATION INCORPORATING INSTRUCTION AND TECHNIQUES DESIGNED FOR THE PARTICULAR NEEDS AND GOALS OF PEOPLE OVER 40 FOR OPTIMUM WELL-BEING, IN CLASS 41 (U.S. CLS. 100, 101 AND 107).

FIRST USE 12-18-2007; IN COMMERCE 12-18-2007.

NO CLAIM IS MADE TO THE EXCLUSIVE RIGHT TO USE "YOGA" , APART FROM THE MARK AS SHOWN.

SN 78-939,488, FILED 7-27-2006.

CHRISTINE COOPER, EXAMINING ATTORNEY

Int. Cl.: 9

Prior U.S. Cls.: 21, 23, 26, 36, and 38

Reg. No. 3,400,073

United States Patent and Trademark Office

Registered Mar. 18, 2008

**TRADEMARK
PRINCIPAL REGISTER**

VisiPlus

CHECKPOINT SYSTEMS, INC. (PENNSYLVANIA
CORPORATION)
101 WOLF DRIVE, P. O. BOX 188
THOROFARE, NJ 08086

THE MARK CONSISTS OF STANDARD CHAR-
ACTERS WITHOUT CLAIM TO ANY PARTICULAR
FONT, STYLE, SIZE, OR COLOR.

FOR: OPTICAL SENSOR TO MEASURE TRAFFIC
COUNTS IN RETAIL ENVIRONMENTS, IN CLASS 9
(U.S. CLS. 21, 23, 26, 36 AND 38).

SN 78-939,827, FILED 7-28-2006.

FIRST USE 5-30-2006; IN COMMERCE 6-5-2006.

DAVID I, EXAMINING ATTORNEY

Int. Cl.: 25

Prior U.S. Cls.: 22 and 39

United States Patent and Trademark Office

Reg. No. 3,400,074

Registered Mar. 18, 2008

**TRADEMARK
PRINCIPAL REGISTER**



DAEDAL VENTURES, LLC (WASHINGTON LTD
LIAB CO)
P.O. BOX 347
REDMOND, WA 980730347

NO CLAIM IS MADE TO THE EXCLUSIVE
RIGHT TO USE "GARMENT" , APART FROM THE
MARK AS SHOWN.

FOR: CLOTHING, NAMELY, WOMEN'S UNDER-
WEAR, IN CLASS 25 (U.S. CLS. 22 AND 39).

SN 78-940,030, FILED 7-28-2006.

FIRST USE 10-1-2007; IN COMMERCE 12-27-2007.

CHRISTINE COOPER, EXAMINING ATTORNEY

Int. Cl.: 31

Prior U.S. Cls.: 1 and 46

United States Patent and Trademark Office

Reg. No. 3,400,075

Registered Mar. 18, 2008

**TRADEMARK
PRINCIPAL REGISTER**

PEIDI

SHANGHAI PEIDI BRAND INT'L TRADE CO.,
LTD (CHINA LIMITED COMPANY)
UNIT 2502 LONG YU PLAZA
1036 PU DONG SOUTH ROAD
SHANGHAI, CHINA 200120

FOR: FOOD AND EDIBLE TREATS FOR PETS,
INCLUDING DOGS, CATS, BIRDS, FISH, REPTILES,
HORSES, HAMSTERS, GERBILS, FERRETS, RAB-
BITS, SUGAR GLIDERS, AND GUINEA PIGS, IN
CLASS 31 (U.S. CLS. 1 AND 46).

FIRST USE 12-0-2006; IN COMMERCE 12-0-2006.

THE MARK CONSISTS OF STANDARD CHAR-
ACTERS WITHOUT CLAIM TO ANY PARTICULAR
FONT, STYLE, SIZE, OR COLOR.

THE WORDING "PEIDI" HAS NO MEANING IN
A FOREIGN LANGUAGE.

SN 78-941,139, FILED 7-31-2006.

JACQUELINE A. LAVINE, EXAMINING ATTOR-
NEY

Int. Cl.: 31

Prior U.S. Cls.: 1 and 46

United States Patent and Trademark Office

Reg. No. 3,400,076

Registered Mar. 18, 2008

**TRADEMARK
PRINCIPAL REGISTER**



SHANGHAI PEIDI BRAND INT'L TRADE CO.,
LTD. (CHINA LTD LIAB CO)
UNIT 2502 LONG YU PLAZA
1036 PU DONG SOUTH ROAD
SHANGHAI, CHINA 200120

FIRST USE 12-0-2006; IN COMMERCE 12-0-2006.

THE MARK CONSISTS OF A STYLIZED DESIGN
OF A DOG.

FOR: PET TOYS IN THE NATURE OF EDIBLE
PET CHEWS; FOOD AND TREATS FOR PETS,
INCLUDING DOGS, CATS, BIRDS, FISH, REPTILES,
HORSES, HAMSTERS, GERBILS, FERRETS, RAB-
BITS, SUGAR GLIDERS AND GUINEA PIGS, IN
CLASS 31 (U.S. CLS. 1 AND 46).

SN 78-941,179, FILED 7-31-2006.

ATTIYA MALIK, EXAMINING ATTORNEY

Int. Cl.: 9

Prior U.S. Cls.: 21, 23, 26, 36, and 38

United States Patent and Trademark Office

Reg. No. 3,400,077

Registered Mar. 18, 2008

**TRADEMARK
PRINCIPAL REGISTER**

QUICK FLIP

PRIME WIRE & CABLE, INC. (CALIFORNIA
CORPORATION)
7457 NEENAH STREET
LOS ANGELES, CA 90040

THE MARK CONSISTS OF STANDARD CHAR-
ACTERS WITHOUT CLAIM TO ANY PARTICULAR
FONT, STYLE, SIZE, OR COLOR.

FOR: ELECTRICAL EXTENSION CORDS, IN
CLASS 9 (U.S. CLS. 21, 23, 26, 36 AND 38).

SN 78-941,691, FILED 7-31-2006.

FIRST USE 9-30-2006; IN COMMERCE 9-30-2006.

JOHN DALIER, EXAMINING ATTORNEY

Int. Cl.: 3

Prior U.S. Cls.: 1, 4, 6, 50, 51, and 52

United States Patent and Trademark Office

Reg. No. 3,400,078

Registered Mar. 18, 2008

**TRADEMARK
PRINCIPAL REGISTER**

LASHZILLA

ELLA BLUE INC. (CALIFORNIA CORPORATION)
3324 BENDIX WAY
ELK GROVE, CA 95758

THE MARK CONSISTS OF STANDARD CHARACTERS WITHOUT CLAIM TO ANY PARTICULAR FONT, STYLE, SIZE, OR COLOR.

FOR: COSMETICS, IN CLASS 3 (U.S. CLS. 1, 4, 6, 50, 51 AND 52).

SN 78-941,836, FILED 8-1-2006.

FIRST USE 11-15-2007; IN COMMERCE 11-15-2007.

JULIE GUTTADAURO, EXAMINING ATTORNEY

Int. Cl.: 35

Prior U.S. Cls.: 100, 101, and 102

United States Patent and Trademark Office

Reg. No. 3,400,079

Registered Mar. 18, 2008

**SERVICE MARK
PRINCIPAL REGISTER**

Clean, Green, Fun!

ORANGE COUNTY PARKS AND RECREATION
DIVISION (FLORIDA NON PROFIT COUNTY
GOVERNMENT)

4801 W. COLONIAL DRIVE
ORLANDO, FL 32808

FOR: ADVERTISING THROUGH ALL PUBLIC
COMMUNICATION MEANS, IN CLASS 35 (U.S. CLS.
100, 101 AND 102).

FIRST USE 4-6-2007; IN COMMERCE 4-6-2007.

THE COLOR(S) GREEN, ORANGE AND BLUE IS/
ARE CLAIMED AS A FEATURE OF THE MARK.

THE COLORS GREEN, ORANGE AND BLUE
APPEAR IN THE WORDS CLEAN, GREEN AND
FUN RESPECTIVELY.

SN 78-943,214, FILED 8-2-2006.

PAM WILLIS, EXAMINING ATTORNEY

Int. Cl.: 11

Prior U.S. Cls.: 13, 21, 23, 31, and 34

United States Patent and Trademark Office

Reg. No. 3,400,080

Registered Mar. 18, 2008

**TRADEMARK
PRINCIPAL REGISTER**

ACCUREX

GREENHECK FAN CORPORATION (WISCONSIN CORPORATION)
P.O. BOX 410
SCHOFIELD, WI 544760410

FOR: VENTILATION EXHAUST FANS; HEATING AND COOLING VENTILATION EQUIPMENT, NAMELY, HOT AND COOL AIR BLOWERS, GAS AND ELECTRIC HEATERS FOR COMMERCIAL AND INDUSTRIAL USE, DIRECT EXPANSION AND CHILLED WATER COOLERS FOR COOLING AIR; EXHAUST HOODS FOR KITCHENS; AND

VENTILATION CONTROL DAMPERS, IN CLASS 11 (U.S. CLS. 13, 21, 23, 31 AND 34).

FIRST USE 8-31-2007; IN COMMERCE 8-31-2007.

THE MARK CONSISTS OF STANDARD CHARACTERS WITHOUT CLAIM TO ANY PARTICULAR FONT, STYLE, SIZE, OR COLOR.

SN 78-943,483, FILED 8-2-2006.

PAUL CROWLEY, EXAMINING ATTORNEY

Int. Cl.: 35

Prior U.S. Cls.: 100, 101, and 102

United States Patent and Trademark Office

Reg. No. 3,400,081

Registered Mar. 18, 2008

**SERVICE MARK
PRINCIPAL REGISTER**

HireSelect

CRITERIA CORPORATION (CALIFORNIA CORPORATION)
SUITE 302
10474 S. SANTA MONICA BLVD
LOS ANGELES, CA 90025

FOR: CONSULTING SERVICES IN THE FIELD OF HUMAN RESOURCES DEVELOPMENT, NAMELY, FOR THE PROMOTION OF EMPLOYEE RETENTION, CAREER GROWTH, AND INCREASED PRODUCTIVITY FOR EMPLOYEES AND EMPLOYERS; EMPLOYMENT COUNSELING AND RECRUITING; EMPLOYMENT HIRING, RECRUITING, PLACEMENT, STAFFING AND CAREER NETWORKING SERVICES; PSYCHOLOGICAL TESTING FOR THE SELECTION OF PERSONNEL; TESTING TO DETERMINE EMPLOYMENT SKILLS; TESTING TO DETERMINE JOB

COMPETENCY; TESTING TO DETERMINE PROFESSIONAL COMPETENCY; WORK ANALYSIS TO DETERMINE WORKER SKILL SETS AND OTHER WORKER REQUIREMENTS, IN CLASS 35 (U.S. CLS. 100, 101 AND 102).

FIRST USE 4-11-2007; IN COMMERCE 4-11-2007.

THE MARK CONSISTS OF STANDARD CHARACTERS WITHOUT CLAIM TO ANY PARTICULAR FONT, STYLE, SIZE, OR COLOR.

SN 78-943,654, FILED 8-2-2006.

AMOS T. MATTHEWS, JR., EXAMINING ATTORNEY

Int. Cl.: 33

Prior U.S. Cls.: 47 and 49

United States Patent and Trademark Office

Reg. No. 3,400,082

Registered Mar. 18, 2008

**TRADEMARK
PRINCIPAL REGISTER**



DIVAS UNCORKED, INC. (MASSACHUSETTS
CORPORATION)
1070 RANDOLPH AVE
MILTON, MA 02186

FIRST USE 8-30-2006; IN COMMERCE 9-0-2006.

SN 78-944,268, FILED 8-3-2006.

FOR: WINE, IN CLASS 33 (U.S. CLS. 47 AND 49).

CAROLYN CATALDO, EXAMINING ATTORNEY

Int. Cl.: 38

Prior U.S. Cls.: 100, 101, and 104

United States Patent and Trademark Office

Reg. No. 3,400,083

Registered Mar. 18, 2008

**SERVICE MARK
PRINCIPAL REGISTER**



RCN TELECOM SERVICES, INC. (PENNSYLVANIA CORPORATION)
105 CARNEGIE CENTER
PRINCETON, NJ 08540

NO CLAIM IS MADE TO THE EXCLUSIVE RIGHT TO USE "MUSIC", APART FROM THE MARK AS SHOWN.

FOR: TELECOMMUNICATION SERVICES, NAMELY, THE ONLINE TRANSMISSION OF STREAMED AND DOWNLOADABLE MUSIC FILES, IN CLASS 38 (U.S. CLS. 100, 101 AND 104).

THE MARK CONSISTS, IN PART, OF A SOLID STAR.

FIRST USE 8-16-2006; IN COMMERCE 9-1-2006.

SN 78-944,392, FILED 8-3-2006.

OWNER OF U.S. REG. NOS. 2,230,674, 2,403,440, AND OTHERS.

SANDRA MANIOS, EXAMINING ATTORNEY

Int. Cl.: 9

Prior U.S. Cls.: 21, 23, 26, 36, and 38

United States Patent and Trademark Office

Reg. No. 3,400,084

Registered Mar. 18, 2008

**TRADEMARK
PRINCIPAL REGISTER**

VISIBALLISTICS

SURVIVAL ARMOR, INC. (DELAWARE COR-
PORATION)
INTERNATIONAL CENTER I, UNIT 8
13881 PLANTATION ROAD
FORT MYERS, FL 33912

THE MARK CONSISTS OF STANDARD CHAR-
ACTERS WITHOUT CLAIM TO ANY PARTICULAR
FONT, STYLE, SIZE, OR COLOR.

FOR: BULLET-PROOF VESTS, IN CLASS 9 (U.S.
CLS. 21, 23, 26, 36 AND 38).

SN 78-944,831, FILED 8-4-2006.

FIRST USE 4-26-2007; IN COMMERCE 4-26-2007.

KAPIL BHANOT, EXAMINING ATTORNEY

Int. Cl.: 9

Prior U.S. Cls.: 21, 23, 26, 36, and 38

Reg. No. 3,400,085

United States Patent and Trademark Office

Registered Mar. 18, 2008

**TRADEMARK
PRINCIPAL REGISTER**

VERTEX

SURVIVAL ARMOR, INC. (DELAWARE COR-
PORATION)
INTERNATIONAL CENTER I, UNIT 8
13881 PLANTATION ROAD
FORT MYERS, FL 33912

THE MARK CONSISTS OF STANDARD CHAR-
ACTERS WITHOUT CLAIM TO ANY PARTICULAR
FONT, STYLE, SIZE, OR COLOR.

FOR: BULLET-PROOF VESTS, IN CLASS 9 (U.S.
CLS. 21, 23, 26, 36 AND 38).

SN 78-944,845, FILED 8-4-2006.

FIRST USE 4-26-2007; IN COMMERCE 4-26-2007.

KAPIL BHANOT, EXAMINING ATTORNEY

Int. Cl.: 42

Prior U.S. Cls.: 100 and 101

United States Patent and Trademark Office

Reg. No. 3,400,086

Registered Mar. 18, 2008

**SERVICE MARK
PRINCIPAL REGISTER**

SCHWAB EQUIVIEW

CHARLES SCHWAB & CO., INC. (CALIFORNIA
CORPORATION)
101 MONTGOMERY STREET
SAN FRANCISCO, CA 94104

FOR: PROVIDING ONLINE NON-DOWNLOAD-
ABLE SOFTWARE FOR USE IN ADMINISTRATION
OF EQUITY COMPENSATION PLANS, IN CLASS 42
(U.S. CLS. 100 AND 101).

FIRST USE 10-30-2006; IN COMMERCE 10-30-2006.

THE MARK CONSISTS OF STANDARD CHAR-
ACTERS WITHOUT CLAIM TO ANY PARTICULAR
FONT, STYLE, SIZE, OR COLOR.

SN 78-945,105, FILED 8-4-2006.

ANTHONY RINKER, EXAMINING ATTORNEY

Int. Cl.: 25

Prior U.S. Cls.: 22 and 39

United States Patent and Trademark Office

Reg. No. 3,400,087

Registered Mar. 18, 2008

**TRADEMARK
PRINCIPAL REGISTER**

14 MILMIL 14

LANIFICIO ERMENEGILDO ZEGNA & FIGLI
S.P.A. (ITALY CORPORATION)
VIA ROMA 99/100
TRIVERO, BIELLA, ITALY 13059

THE MARK CONSISTS OF STANDARD CHAR-
ACTERS WITHOUT CLAIM TO ANY PARTICULAR
FONT, STYLE, SIZE, OR COLOR.

FOR: TROUSERS, SUITS, AND JACKETS, IN
CLASS 25 (U.S. CLS. 22 AND 39).

SN 78-945,471, FILED 8-4-2006.

FIRST USE 11-23-2006; IN COMMERCE 11-23-2006.

TAMARA FRAZIER, EXAMINING ATTORNEY

Int. Cl.: 29

Prior U.S. Cl.: 46

United States Patent and Trademark Office

Reg. No. 3,400,088

Registered Mar. 18, 2008

**TRADEMARK
PRINCIPAL REGISTER**

TROPICAL TWIST

JOHN B. SANFILIPPO & SON, INC. (DELAWARE
CORPORATION)
1703 N. RANDALL ROAD
ELGIN, IL 601237820

THE MARK CONSISTS OF STANDARD CHAR-
ACTERS WITHOUT CLAIM TO ANY PARTICULAR
FONT, STYLE, SIZE, OR COLOR.

FOR: SNACK MIXES CONSISTING PRIMARILY
OF PROCESSED NUTS AND PROCESSED FRUITS,
IN CLASS 29 (U.S. CL. 46).

SN 78-945,689, FILED 8-4-2006.

FIRST USE 4-12-2006; IN COMMERCE 6-6-2006.

GINA HAYES, EXAMINING ATTORNEY

Int. Cls.: 38 and 41

Prior U.S. Cls.: 100, 101, 104, and 107

United States Patent and Trademark Office

Reg. No. 3,400,089

Registered Mar. 18, 2008

**SERVICE MARK
PRINCIPAL REGISTER**

PATIENT POWER

PATIENT POWER (WASHINGTON LTD LIAB
CO)
9220 SE 68TH STREET
MERCER ISLAND, WA 980405135

FOR: TELECOMMUNICATION SERVICES,
NAMELY, BROADCAST AND TRANSMISSION OF
CONTENT IN THE FORM OF LIVE AND ON-
DEMAND TALK SHOW STYLE BROADCASTS RE-
GARDING HEALTH AND MEDICAL TOPICS ON-
LINE AND OVER THE INTERNET, RADIO, CEL-
LULAR TELEPHONES, AND OTHER ELECTRONIC
MEDIA WHEREBY HEALTHCARE CONSUMERS,
PROSPECTIVE PATIENTS, PATIENTS, CARE-
GIVERS AND THE GENERAL PUBLIC CAN HEAR
DIRECTLY FROM RENOWNED MEDICAL EX-
PERTS ON TOPICS OF THEIR CHOICE AND, AT
THEIR OPTION, TO ASK QUESTIONS, IN CLASS 38
(U.S. CLS. 100, 101 AND 104).

FIRST USE 2-13-2005; IN COMMERCE 2-13-2005.

FOR: PRODUCTION AND DISTRIBUTION OF
AUDIO CONTENT FROM RADIO AND ONLINE
BROADCASTS REGARDING THE FIELDS OF
HEALTH AND MEDICINE, IN CLASS 41 (U.S. CLS.
100, 101 AND 107).

FIRST USE 2-13-2005; IN COMMERCE 2-13-2005.

THE MARK CONSISTS OF STANDARD CHAR-
ACTERS WITHOUT CLAIM TO ANY PARTICULAR
FONT, STYLE, SIZE, OR COLOR.

NO CLAIM IS MADE TO THE EXCLUSIVE
RIGHT TO USE "PATIENT", APART FROM THE
MARK AS SHOWN.

SN 78-945,889, FILED 8-6-2006.

CAROLYN CATALDO, EXAMINING ATTORNEY

Int. Cls.: 39 and 43

Prior U.S. Cls.: 100, 101, and 105

United States Patent and Trademark Office

Reg. No. 3,400,090

Registered Mar. 18, 2008

**SERVICE MARK
PRINCIPAL REGISTER**



TRAVEL GROUP ADVENTURES, INC. (CALIFORNIA CORPORATION)
420 S. EUCLID STREET, SUITE 101
ANAHEIM, CA 92802

FOR: ARRANGING TRAVEL TOURS; COORDINATING TRAVEL ARRANGEMENTS FOR INDIVIDUALS AND FOR GROUPS; ORGANISATION OF SIGHTSEEING TOURS; ORGANISATION OF TRAVEL; ORGANIZATION OF EXCURSIONS, SIGHTSEEING TOURS, HOLIDAYS, TOURS AND TRAVEL; ORGANIZATION, BOOKING AND ARRANGEMENT OF EXCURSIONS, DAY TRIPS AND SIGHTSEEING TOURS, IN CLASS 39 (U.S. CLS. 100 AND 105).

FIRST USE 5-17-2007; IN COMMERCE 5-17-2007.

FOR: MAKING HOTEL RESERVATIONS FOR OTHERS; PROVIDING TRAVEL LODGING INFORMATION SERVICES AND TRAVEL LODGING BOOKING AGENCY SERVICES FOR TRAVELERS; RESERVATION OF HOTEL ROOMS FOR TRAVELERS; TRAVEL AGENCY SERVICES, NAMELY, MAKING RESERVATIONS AND BOOKING FOR TEMPORARY LODGING, IN CLASS 43 (U.S. CLS. 100 AND 101).

FIRST USE 5-17-2007; IN COMMERCE 5-17-2007.

NO CLAIM IS MADE TO THE EXCLUSIVE RIGHT TO USE "INTERNATIONAL TRAVEL", APART FROM THE MARK AS SHOWN.

THE COLOR(S) ORANGE, RED, GRAY, BLACK, AND WHITE IS/ARE CLAIMED AS A FEATURE OF THE MARK.

THE COLORS RED, BLACK, ORANGE AND WHITE APPEAR IN THE SPECIAL FORM SQUARE DESIGN AND THE COLOR BLACK APPEARS IN THE WORDING OF THE MARK.

THE MARK CONSISTS OF GEOMETRICAL SHAPES FORMING ONE SQUARE.

SN 78-946,458, FILED 8-7-2006.

PAM WILLIS, EXAMINING ATTORNEY

Int. Cls.: 16 and 35

Prior U.S. Cls.: 2, 5, 22, 23, 29, 37, 38, 50, 100, 101, and 102

Reg. No. 3,400,091

United States Patent and Trademark Office

Registered Mar. 18, 2008

**TRADEMARK
SERVICE MARK
PRINCIPAL REGISTER**



SETCOM MEDIA, INC. (SOUTH CAROLINA CORPORATION)
389 JOHNNIE DODDS BLVD., SUITE 200
MT. PLEASANT, SC 29464

FOR: PRINTED PUBLICATIONS FEATURING BUSINESS NEWS, BUSINESS AND ECONOMIC DATA AND REGIONAL DEVELOPMENT INFORMATION, IN CLASS 16 (U.S. CLS. 2, 5, 22, 23, 29, 37, 38 AND 50).

FIRST USE 2-9-2007; IN COMMERCE 2-9-2007.

FOR: PROVIDING BUSINESS AND ECONOMIC DATA AND REGIONAL DEVELOPMENT INFORMATION VIA THE INTERNET; PROVIDING BUSINESS NEWS VIA THE INTERNET, IN CLASS 35 (U.S. CLS. 100, 101 AND 102).

FIRST USE 2-26-2007; IN COMMERCE 2-26-2007.

SN 78-946,586, FILED 8-7-2006.

RONALD AIKENS, EXAMINING ATTORNEY

Int. Cls.: 16 and 35

Prior U.S. Cls.: 2, 5, 22, 23, 29, 37, 38, 50, 100, 101, and 102

Reg. No. 3,400,092

United States Patent and Trademark Office

Registered Mar. 18, 2008

**TRADEMARK
SERVICE MARK
PRINCIPAL REGISTER**

**SOUTH CAROLINA'S MEDIA
ENGINE FOR ECONOMIC GROWTH**

SETCOM MEDIA, INC. (SOUTH CAROLINA CORPORATION)
389 JOHNNIE DODDS BLVD., SUITE 200
MT. PLEASANT, SC 29464

FOR: PRINTED PUBLICATIONS FEATURING BUSINESS NEWS, BUSINESS AND ECONOMIC DATA AND REGIONAL DEVELOPMENT INFORMATION, IN CLASS 16 (U.S. CLS. 2, 5, 22, 23, 29, 37, 38 AND 50).

FIRST USE 2-26-2007; IN COMMERCE 2-26-2007.

FOR: PROVIDING BUSINESS AND ECONOMIC DATA AND REGIONAL DEVELOPMENT INFOR-

MATION VIA THE INTERNET; PROVIDING BUSINESS NEWS VIA THE INTERNET, IN CLASS 35 (U.S. CLS. 100, 101 AND 102).

FIRST USE 2-9-2007; IN COMMERCE 2-9-2007.

THE MARK CONSISTS OF STANDARD CHARACTERS WITHOUT CLAIM TO ANY PARTICULAR FONT, STYLE, SIZE, OR COLOR.

SN 78-946,595, FILED 8-7-2006.

RONALD AIKENS, EXAMINING ATTORNEY

Int. Cl.: 20

Prior U.S. Cls.: 2, 13, 22, 25, 32, and 50

Reg. No. 3,400,093

United States Patent and Trademark Office

Registered Mar. 18, 2008

**TRADEMARK
PRINCIPAL REGISTER**

TWOFOLD

IGNITE USA, LLC (ILLINOIS LTD LIAB CO)
MC37
954 W. WASHINGTON BLVD.
CHICAGO, IL 60607

THE MARK CONSISTS OF STANDARD CHAR-
ACTERS WITHOUT CLAIM TO ANY PARTICULAR
FONT, STYLE, SIZE, OR COLOR.

FOR: WORKBENCH, IN CLASS 20 (U.S. CLS. 2, 13,
22, 25, 32 AND 50).

SN 78-947,478, FILED 8-8-2006.

FIRST USE 7-30-2007; IN COMMERCE 7-30-2007.

DAVID COLLIER, EXAMINING ATTORNEY

Int. Cl.: 41

Prior U.S. Cls.: 100, 101, and 107

United States Patent and Trademark Office

Reg. No. 3,400,094

Registered Mar. 18, 2008

**SERVICE MARK
PRINCIPAL REGISTER**

Paris Keeling

PARIS, MARTY E. (UNITED STATES INDIVIDUAL)
3360 MAIDEN HWY
LINCOLNTON, NC 28092

FOR: ENTERTAINMENT IN THE NATURE OF VISUAL AND AUDIO PERFORMANCES, NAMELY, MUSICAL BAND, ROCK GROUP, GYMNASTIC, DANCE, AND BALLET PERFORMANCES, IN CLASS 41 (U.S. CLS. 100, 101 AND 107).

FIRST USE 10-31-2006; IN COMMERCE 10-31-2006.

THE MARK CONSISTS OF STANDARD CHARACTERS WITHOUT CLAIM TO ANY PARTICULAR FONT, STYLE, SIZE, OR COLOR.

"PARIS KEELING" DOES NOT IDENTIFY A LIVING INDIVIDUAL.

SN 78-947,850, FILED 8-8-2006.

JASON BLAIR, EXAMINING ATTORNEY

Int. Cl.: 40

Prior U.S. Cls.: 100, 103, and 106

United States Patent and Trademark Office

Reg. No. 3,400,095

Registered Mar. 18, 2008

SERVICE MARK
PRINCIPAL REGISTER



GRAPHIC SERVICES IMAGING, INC. (MICHIGAN CORPORATION)

7464 19 MILE RD.

STERLING HEIGHTS, MI 48314

FOR: ELECTRONIC IMAGING, SCANNING, DIGITIZING, ALTERATION AND/OR RETOUCHING OF PHOTOGRAPHIC IMAGES; PHOTOGRAPHIC RETOUCHING, IN CLASS 40 (U.S. CLS. 100, 103 AND 106).

FIRST USE 10-1-2006; IN COMMERCE 1-1-2007.

NO CLAIM IS MADE TO THE EXCLUSIVE RIGHT TO USE "STUDIO", APART FROM THE MARK AS SHOWN.

THE COLOR(S) BLUE, YELLOW, MAGENTA, RED, BLACK, GRAY AND GOLDENROD IS/ARE CLAIMED AS A FEATURE OF THE MARK.

THE MARK CONSISTS OF THREE CONCENTRIC CIRCLES BISECTED HORIZONTALLY AND VERTICALLY BY TWO PERPENDICULAR LINES WHICH EXTEND BEYOND THE OUTERMOST CIRCLE. THE FOUR AREA SEGMENTS FORMED BY THE INTERSECTION OF THE HORIZONTAL AND VERTICAL LINES AND THE MIDDLE AND INNERMOST CONCENTRIC CIRCLES ARE COLORED BLUE, MAGENTA, YELLOW AND BLACK. THE FOUR QUADRANTS OF THE INNERMOST CIRCLE ARE GRAY. THE STYLIZED BLOCK LETTERS "GSI" IN THE COLOR GOLDENROD ARE ON A BLACK HORIZONTALLY-ELONGATED ELLIPSE. FOLLOWING THE LETTERS "GSI" IS THE WORD STUDIO IN YELLOW LETTERS. A HORIZONTAL RED LINE EXTENDS FROM THE END OF THE WORD STUDIO BEYOND THE HORIZONTALLY-ELONGATED BLACK ELLIPSE.

SN 78-948,251, FILED 8-9-2006.

GISELLE AGOSTO, EXAMINING ATTORNEY

Int. Cl.: 19

Prior U.S. Cls.: 1, 12, 33, and 50

United States Patent and Trademark Office

Reg. No. 3,400,096

Registered Mar. 18, 2008

**TRADEMARK
PRINCIPAL REGISTER**

VERAZZO STONE

KEYSTONE RETAINING WALL SYSTEMS, INC.
(MINNESOTA CORPORATION)
4444 WEST 78TH STREET
MINNEAPOLIS, MN 55435

FOR: MODULAR CONCRETE BLOCKS USED TO
CONSTRUCT EARTH RETAINING WALLS; MOD-
ULAR CONCRETE BLOCKS USED IN LANDSCAP-
ING APPLICATIONS , IN CLASS 19 (U.S. CLS. 1, 12,
33 AND 50).

FIRST USE 7-31-2006; IN COMMERCE 2-8-2007.

THE MARK CONSISTS OF STANDARD CHAR-
ACTERS WITHOUT CLAIM TO ANY PARTICULAR
FONT, STYLE, SIZE, OR COLOR.

NO CLAIM IS MADE TO THE EXCLUSIVE
RIGHT TO USE "STONE", APART FROM THE
MARK AS SHOWN.

SN 78-949,352, FILED 8-10-2006.

DANNEAN HETZEL, EXAMINING ATTORNEY

Int. Cl.: 44

Prior U.S. Cls.: 100 and 101

United States Patent and Trademark Office

Reg. No. 3,400,097

Registered Mar. 18, 2008

**SERVICE MARK
PRINCIPAL REGISTER**

INFUSCIENCE

INFUSCIENCE, INC. (DELAWARE CORPORATION)
1790 NATIONS DR. SUITE 510
GURNEE, IL 60031

FOR: HOME INFUSION CARE THERAPY SERVICES; CATHETER CARE; PARENTERAL NUTRITION THERAPY, ENTERAL NUTRITION THERAPY, ANTIBIOTIC THERAPY, BONE MARROW AND SOLID ORGAN TRANSPLANT SUPPORT SERVICES; IMMUNE DEFICIENCY AND NEUROLOGICAL DISORDER TREATMENTS; INTRAVENOUS IMMUNE GLOBIN THERAPY; TREATMENT OF BLEEDING DISORDERS; AND

PAIN MANAGEMENT SERVICES, IN CLASS 44 (U.S. CLS. 100 AND 101).

FIRST USE 2-0-2007; IN COMMERCE 2-0-2007.

THE MARK CONSISTS OF STANDARD CHARACTERS WITHOUT CLAIM TO ANY PARTICULAR FONT, STYLE, SIZE, OR COLOR.

SN 78-949,468, FILED 8-10-2006.

JAMES STEIN, EXAMINING ATTORNEY

Int. Cls.: 35 and 41

Prior U.S. Cls.: 100, 101, 102, and 107

United States Patent and Trademark Office

Reg. No. 3,400,098

Registered Mar. 18, 2008

**SERVICE MARK
PRINCIPAL REGISTER**

**MPWR: More Possibilities
Within Reach**

MCFERSON, CASSANDRA (UNITED STATES
INDIVIDUAL)

315 FRANKLIN ST. NE #310
WASHINGTON, DC 20002

FOR: ADVERTISING AND PUBLICITY SERVICES; PROVIDING CONSUMER INFORMATION SERVICES AND MAKING REFERRALS IN THE FIELD OF ENTERTAINMENT SERVICES FOR PRODUCTS, SERVICES, EVENTS, ACTIVITIES, FACILITIES AND LOCATIONS; PROVIDING INFORMATION ABOUT THE GOODS AND SERVICES OF OTHERS VIA THE GLOBAL COMPUTER NETWORK; PROVIDING ON-LINE DIRECTORY INFORMATION SERVICES ALSO FEATURING HYPERLINKS TO OTHER WEB SITES, IN CLASS 35 (U.S. CLS. 100, 101 AND 102).

FIRST USE 10-1-2006; IN COMMERCE 3-25-2007.

FOR: ONLINE JOURNALS, NAMELY, BLOGS FEATURING NEWS, INFORMATION, DIARIES, COMMENTARY, PHOTOS, MINI-ESSAYS, PROJECT UPDATES, PROFESSIONAL, AUTOBIOGRAPHICAL, AND BIOGRAPHICAL OR PERSONAL INFORMATION TO CONNECT INDIVIDUALS IN THE FIELD OF PERSONAL INTERESTS, PROFESSIONAL INTERESTS, LEISURE INTERESTS, AND OTHER GENERAL INTERESTS, IN CLASS 41 (U.S. CLS. 100, 101 AND 107).

FIRST USE 9-23-2004; IN COMMERCE 3-25-2007.

THE MARK CONSISTS OF STANDARD CHARACTERS WITHOUT CLAIM TO ANY PARTICULAR FONT, STYLE, SIZE, OR COLOR.

SN 78-949,557, FILED 8-10-2006.

DOMINIC FATHY, EXAMINING ATTORNEY

Int. Cl.: 30

Prior U.S. Cl.: 46

United States Patent and Trademark Office

Reg. No. 3,400,099

Registered Mar. 18, 2008

TRADEMARK
PRINCIPAL REGISTER



YANG, XIAOYONG (CHINA INDIVIDUAL)
NO. 15, UNIT 5, NO. 82 FANGCAO EAST ST.
GAOXIN DISTRICT, CHENGDU CITY
SICHUAN PROVINCE, CHINA

FOR: COFFEE; COCOA; TEA; SUGAR; CHOCOLATE; CANDY; HONEY; BISCUITS; COOKIES; CONFECTIONERY, NAMELY, PASTILLES; PANCAKES; PASTRIES; RICE CAKES; PROCESSED OATS; PIES; PROCESSED CEREALS; CORN FLAKES; FLOUR-BASED CHIPS; DRIED SUGARED CAKES OF RICE FLOUR, NAMELY, RAKUGAN; CHINESE RICE NOODLES, NAMELY, BIFUN, UNCOOKED; POPCORN; SOYA FLOUR; FARINACEOUS FOOD PASTES FOR HUMAN CONSUMPTION; EDIBLE FRUIT ICES; ICE CUBES; COOKING SALT; VINEGAR; RELISH; YEAST; FOOD FLAVORINGS, NON-ESSENTIAL OILS; STARCH-BASED THICKENERS FOR WHIPPED

CREAM; RICE-BASED SNACK FOODS; APPLE FRITTERS; BANANA FRITTERS; PINEAPPLE FRITTERS; CORN FRITTERS; RICE CRACKERS, NAMELY, SENBEI; EGG ROLLS; CONFECTIONERY, NAMELY, MOON CAKE; FRIED DOUGH COOKIES, NAMELY, KARINTOH, IN CLASS 30 (U.S. CL. 46).

FIRST USE 5-30-2005; IN COMMERCE 8-10-2005.

THE NON-LATIN CHARACTERS IN THE MARK TRANSLITERATE TO "MI"; "LAO"; "TOU" AND THESE MEAN BEIGE; OLD; FIRST IN ENGLISH.

SN 78-949,932, FILED 8-11-2006.

TARAH HARDY, EXAMINING ATTORNEY

Int. Cl.: 9

Prior U.S. Cls.: 21, 23, 26, 36, and 38

United States Patent and Trademark Office

Reg. No. 3,400,100

Registered Mar. 18, 2008

**TRADEMARK
PRINCIPAL REGISTER**

kidthing

KIDTHING, INC. (CALIFORNIA CORPORATION)
PO BOX 2883
DEL MAR, CA 920145883

FOR: CHILDREN'S DOWNLOADABLE EDUCATIONAL SOFTWARE, IN CLASS 9 (U.S. CLS. 21, 23, 26, 36 AND 38).

FIRST USE 5-1-2007; IN COMMERCE 5-1-2007.

THE MARK CONSISTS OF STANDARD CHARACTERS WITHOUT CLAIM TO ANY PARTICULAR FONT, STYLE, SIZE, OR COLOR.

NO CLAIM IS MADE TO THE EXCLUSIVE RIGHT TO USE "KID", APART FROM THE MARK AS SHOWN.

SN 78-950,741, FILED 8-11-2006.

RON FAIRBANKS, EXAMINING ATTORNEY

Int. Cl.: 28

Prior U.S. Cls.: 22, 23, 38, and 50

United States Patent and Trademark Office

Reg. No. 3,400,101

Registered Mar. 18, 2008

**TRADEMARK
PRINCIPAL REGISTER**

SMOKEY

MATTEL, INC. (DELAWARE CORPORATION)
MAIL STOP M1-1518
333 CONTINENTAL BOULEVARD
EL SEGUNDO, CA 90245

THE MARK CONSISTS OF STANDARD CHAR-
ACTERS WITHOUT CLAIM TO ANY PARTICULAR
FONT, STYLE, SIZE, OR COLOR.

FOR: TOYS, GAMES AND PLAYTHINGS, NAME-
LY, TOY VEHICLES AND ACCESSORIES THERE-
FOR, IN CLASS 28 (U.S. CLS. 22, 23, 38 AND 50).

SN 78-950,755, FILED 8-11-2006.

FIRST USE 9-4-2007; IN COMMERCE 9-4-2007.

JENNIFER VASQUEZ, EXAMINING ATTORNEY

Int. Cl.: 9

Prior U.S. Cls.: 21, 23, 26, 36, and 38

Reg. No. 3,400,102

United States Patent and Trademark Office

Registered Mar. 18, 2008

**TRADEMARK
PRINCIPAL REGISTER**

EdgeryDoo

MANLEY, MARLEEN R. (UNITED STATES INDIVIDUAL)
5892 BRIDGEMONT PLACE
ACWORTH, GA 30101 AND
MANLEY, BYRON J. (UNITED STATES INDIVIDUAL)
5892 BRIDGEMONT PLACE
ACWORTH, GA 30101

FIRST USE 11-3-2006; IN COMMERCE 11-3-2006.

THE MARK CONSISTS OF STANDARD CHARACTERS WITHOUT CLAIM TO ANY PARTICULAR FONT, STYLE, SIZE, OR COLOR.

SN 78-950,898, FILED 8-12-2006.

FOR: GRADUATED RULERS, IN CLASS 9 (U.S. CLS. 21, 23, 26, 36 AND 38).

KATHERINE CONNOLLY, EXAMINING ATTORNEY

Int. Cl.: 12

Prior U.S. Cls.: 19, 21, 23, 31, 35, and 44

Reg. No. 3,400,103

United States Patent and Trademark Office

Registered Mar. 18, 2008

**TRADEMARK
PRINCIPAL REGISTER**

WORLD

SCHWINN ACQUISITION, LLC (DELAWARE
LTD LIAB CO)
4902 HAMMERSLEY ROAD
MADISON, WI 53711

THE MARK CONSISTS OF STANDARD CHAR-
ACTERS WITHOUT CLAIM TO ANY PARTICULAR
FONT, STYLE, SIZE, OR COLOR.

FOR: BICYCLES AND ELECTRIC BICYCLES, IN
CLASS 12 (U.S. CLS. 19, 21, 23, 31, 35 AND 44).

SN 78-951,023, FILED 8-13-2006.

FIRST USE 11-0-2007; IN COMMERCE 11-0-2007.

AMY MCMENAMIN, EXAMINING ATTORNEY

Int. Cl.: 26

Prior U.S. Cls.: 37, 39, 40, 42, and 50

United States Patent and Trademark Office

Reg. No. 3,400,104

Registered Mar. 18, 2008

**TRADEMARK
PRINCIPAL REGISTER**

RIBBON TRENDS

HOBBY LOBBY STORES, INC. (OKLAHOMA CORPORATION)

7707 S.W. 44TH STREET

OKLAHOMA CITY, OK 73179

FOR: ORNAMENTAL RIBBONS MADE OF TEXTILES; RIBBONS, IN CLASS 26 (U.S. CLS. 37, 39, 40, 42 AND 50).

FIRST USE 9-11-2006; IN COMMERCE 9-11-2006.

THE MARK CONSISTS OF STANDARD CHARACTERS WITHOUT CLAIM TO ANY PARTICULAR FONT, STYLE, SIZE, OR COLOR.

NO CLAIM IS MADE TO THE EXCLUSIVE RIGHT TO USE "RIBBON", APART FROM THE MARK AS SHOWN.

SN 78-951,372, FILED 8-14-2006.

WILLIAM BRECKENFELD, EXAMINING ATTORNEY

Int. Cl.: 11

Prior U.S. Cls.: 13, 21, 23, 31, and 34

United States Patent and Trademark Office

Reg. No. 3,400,105

Registered Mar. 18, 2008

**TRADEMARK
PRINCIPAL REGISTER**

MIRAGE

THE VOLLRATH COMPANY, L.L.C. (WISCONSIN LTD LIAB CO)
1236 N. 18TH STREET P.O. BOX 611
SHEBOYGAN, WI 530820611

THE MARK CONSISTS OF STANDARD CHARACTERS WITHOUT CLAIM TO ANY PARTICULAR FONT, STYLE, SIZE, OR COLOR.

FOR: COOKING RANGES, IN CLASS 11 (U.S. CLS. 13, 21, 23, 31 AND 34).

SN 78-951,636, FILED 8-14-2006.

FIRST USE 5-31-2007; IN COMMERCE 7-31-2007.

ALICE BENMAMAN, EXAMINING ATTORNEY

Int. Cl.: 5

Prior U.S. Cls.: 6, 18, 44, 46, 51, and 52

Reg. No. 3,400,106

United States Patent and Trademark Office

Registered Mar. 18, 2008

**TRADEMARK
PRINCIPAL REGISTER**

ECH-CELLENT

A. M. TODD COMPANY (MICHIGAN CORPORATION)
1717 DOUGLAS AVENUE
PO BOX 50711
KALAMAZOO, MI 49005

THE MARK CONSISTS OF STANDARD CHARACTERS WITHOUT CLAIM TO ANY PARTICULAR FONT, STYLE, SIZE, OR COLOR.

FOR: MEDICINAL HERB EXTRACTS, IN CLASS 5 (U.S. CLS. 6, 18, 44, 46, 51 AND 52).

SN 78-952,205, FILED 8-15-2006.

FIRST USE 3-0-2007; IN COMMERCE 3-0-2007.

WON TEAK OH, EXAMINING ATTORNEY

Int. Cls.: 1 and 16

**Prior U.S. Cls.: 1, 2, 5, 6, 10, 22, 23, 26, 29, 37, 38, 46,
and 50**

Reg. No. 3,400,107

United States Patent and Trademark Office

Registered Mar. 18, 2008

**TRADEMARK
PRINCIPAL REGISTER**

PEGA DE LOCURA

KOLALOKA INDUSTRIES, LP (TEXAS LIMITED
PARTNERSHIP)
SUITE 111
3100 CARLISLE STREET
DALLAS, TX 75204

THE MARK CONSISTS OF STANDARD CHAR-
ACTERS WITHOUT CLAIM TO ANY PARTICULAR
FONT, STYLE, SIZE, OR COLOR.

FOR: ADHESIVES FOR GENERAL INDUSTRIAL
USE, IN CLASS 1 (U.S. CLS. 1, 5, 6, 10, 26 AND 46).

THE FOREIGN WORDING IN THE MARK
TRANSLATES INTO ENGLISH AS "IT BEATS OF
MADNESS".

FIRST USE 12-10-2007; IN COMMERCE 12-10-2007.

FOR: ADHESIVES FOR STATIONERY AND
HOUSEHOLD USE, IN CLASS 16 (U.S. CLS. 2, 5, 22,
23, 29, 37, 38 AND 50).

SN 78-953,205, FILED 8-16-2006.

FIRST USE 12-10-2007; IN COMMERCE 12-10-2007.

CHRISTOPHER BUONGIORNO, EXAMINING AT-
TORNEY

Int. Cls.: 1 and 16

**Prior U.S. Cls.: 1, 2, 5, 6, 10, 22, 23, 26, 29, 37, 38, 46,
and 50**

Reg. No. 3,400,108

United States Patent and Trademark Office

Registered Mar. 18, 2008

**TRADEMARK
PRINCIPAL REGISTER**

HAPPY GLUE

KOLALOKA INDUSTRIES, LP (TEXAS LTD LIAB
CO)
SUITE 111
3100 CARLISLE STREET
DALLAS, TX 75204

THE MARK CONSISTS OF STANDARD CHAR-
ACTERS WITHOUT CLAIM TO ANY PARTICULAR
FONT, STYLE, SIZE, OR COLOR.

FOR: ADHESIVES FOR GENERAL INDUSTRIAL
USE, IN CLASS 1 (U.S. CLS. 1, 5, 6, 10, 26 AND 46).

NO CLAIM IS MADE TO THE EXCLUSIVE
RIGHT TO USE "GLUE", APART FROM THE MARK
AS SHOWN.

FIRST USE 12-10-2007; IN COMMERCE 12-10-2007.

FOR: ADHESIVES FOR STATIONERY AND
HOUSEHOLD USE, IN CLASS 16 (U.S. CLS. 2, 5, 22,
23, 29, 37, 38 AND 50).

SN 78-953,208, FILED 8-16-2006.

FIRST USE 12-10-2007; IN COMMERCE 12-10-2007.

CHRISTOPHER BUONGIORNO, EXAMINING AT-
TORNEY

Int. Cl.: 36

Prior U.S. Cls.: 100, 101, and 102

United States Patent and Trademark Office

Reg. No. 3,400,109

Registered Mar. 18, 2008

**SERVICE MARK
PRINCIPAL REGISTER**

SUNDEX ADVANTAGE

SUN LIFE ASSURANCE COMPANY OF CANADA (CANADA CORPORATION)
150 KING STREET WEST, SUITE 1400
TORONTO, ONTARIO, CANADA M5H 1J9

FOR: INSURANCE SERVICES, NAMELY, ANNUITY UNDERWRITING SERVICES, CONSULTATION AND BROKERAGE SERVICES, IN CLASS 36 (U.S. CLS. 100, 101 AND 102).

FIRST USE 9-5-2006; IN COMMERCE 9-5-2006.

THE MARK CONSISTS OF STANDARD CHARACTERS WITHOUT CLAIM TO ANY PARTICULAR FONT, STYLE, SIZE, OR COLOR.

OWNER OF U.S. REG. NOS. 2,974,073 AND 3,106,670.

SN 78-953,584, FILED 8-16-2006.

ROBIN MITTLER, EXAMINING ATTORNEY

Int. Cl.: 30

Prior U.S. Cl.: 46

United States Patent and Trademark Office

Reg. No. 3,400,110

Registered Mar. 18, 2008

**TRADEMARK
PRINCIPAL REGISTER**

SMART & DELICIOUS WRAPS

LA TORTILLA FACTORY INC. (CALIFORNIA
CORPORATION)

3300 WESTWIND BLVD.

SANTA ROSA, CA 95403

FOR: TORTILLAS AND SANDWICH WRAPS, IN
CLASS 30 (U.S. CL. 46).

FIRST USE 10-31-2006; IN COMMERCE 10-31-2006.

THE MARK CONSISTS OF STANDARD CHAR-
ACTERS WITHOUT CLAIM TO ANY PARTICULAR
FONT, STYLE, SIZE, OR COLOR.

NO CLAIM IS MADE TO THE EXCLUSIVE
RIGHT TO USE "DELICIOUS WRAPS", APART
FROM THE MARK AS SHOWN.

SN 78-953,743, FILED 8-16-2006.

AISHA SALEM, EXAMINING ATTORNEY

Int. Cl.: 30

Prior U.S. Cl.: 46

United States Patent and Trademark Office

Reg. No. 3,400,111

Registered Mar. 18, 2008

**TRADEMARK
PRINCIPAL REGISTER**

SMART & DELICIOUS TORTILLAS

LA TORTILLA FACTORY INC. (CALIFORNIA
CORPORATION)

3300 WESTWIND BLVD.

SANTA ROSA, CA 95403

FOR: TORTILLAS AND SANDWICH WRAPS, IN
CLASS 30 (U.S. CL. 46).

FIRST USE 2-28-2007; IN COMMERCE 2-28-2007.

THE MARK CONSISTS OF STANDARD CHAR-
ACTERS WITHOUT CLAIM TO ANY PARTICULAR
FONT, STYLE, SIZE, OR COLOR.

NO CLAIM IS MADE TO THE EXCLUSIVE
RIGHT TO USE "DELICIOUS TORTILLAS", APART
FROM THE MARK AS SHOWN.

SN 78-953,750, FILED 8-16-2006.

AISHA SALEM, EXAMINING ATTORNEY

Int. Cls.: 25, 41, and 43

Prior U.S. Cls.: 22, 39, 100, 101, and 107

United States Patent and Trademark Office

Reg. No. 3,400,112

Registered Mar. 18, 2008

**TRADEMARK
SERVICE MARK
PRINCIPAL REGISTER**



PLANET HOLLYWOOD (REGION IV), INC.
(MINNESOTA CORPORATION)
7598 W. SAND LAKE ROAD
ORLANDO, FL 32819

FOR: CLOTHING, NAMELY, T-SHIRTS, SHIRTS,
SWEATSHIRTS, POLO SHIRTS, SPORT SHIRTS,
SHORTS, JACKETS AND CAPS , IN CLASS 25 (U.S.
CLS. 22 AND 39).

FIRST USE 11-16-2007; IN COMMERCE 11-16-2007.

FOR: CASINO ENTERTAINMENT SERVICES, IN
CLASS 41 (U.S. CLS. 100, 101 AND 107).

FIRST USE 11-16-2007; IN COMMERCE 11-16-2007.

FOR: HOTEL, RESTAURANT AND BAR SERVI-
CES, IN CLASS 43 (U.S. CLS. 100 AND 101).

FIRST USE 11-16-2007; IN COMMERCE 11-16-2007.

THE COLOR(S) RED AND BLUE IS/ARE
CLAIMED AS A FEATURE OF THE MARK.

THE MARK CONSISTS OF TWO RED LOWER
CASE LETTERS, "PH", THAT ARE PLACED WITHIN
TWO BLUE CONCENTRIC SEMI-CIRCLES OF DIF-
FERENT DIAMETERS.

SN 78-954,154, FILED 8-17-2006.

SUSAN LESLIE DUBOIS, EXAMINING ATTORNEY

Int. Cl.: 6

Prior U.S. Cls.: 2, 12, 13, 14, 23, 25, and 50

United States Patent and Trademark Office

Reg. No. 3,400,113

Registered Mar. 18, 2008

**TRADEMARK
PRINCIPAL REGISTER**

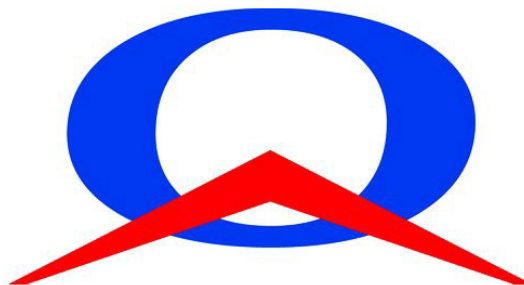

VARCO PRUDEN BUILDINGS, INC. (DELA-
WARE CORPORATION)
3200 PLAYERS CLUB CIRCLE
MEMPHIS, TN 38125

FOR: METAL BUILDINGS AND CONSTRUCTION PRODUCTS, NAMELY, PREFABRICATED METAL BUILDINGS, PRIMARY STEEL STRUCTURAL FRAMING, SECONDARY STEEL STRUCTURAL COMPONENTS, NAMELY, METAL JOISTS, METAL PIPES, METAL TUBES FOR INDUSTRIAL USE, AND METAL WALL AND ROOFING PANELS, IN CLASS 6 (U.S. CLS. 2, 12, 13, 14, 23, 25 AND 50).

FIRST USE 0-0-2006; IN COMMERCE 0-0-2006.

OWNER OF U.S. REG. NO. 926,653.

THE COLOR(S) RED AND BLUE IS/ARE CLAIMED AS A FEATURE OF THE MARK.

THE MARK CONSISTS OF A CHEVRON DESIGN IN THE COLOR RED IN FRONT OF AN "O" DESIGN IN THE COLOR BLUE.

SN 78-954,566, FILED 8-17-2006.

LINDA ESTRADA, EXAMINING ATTORNEY

Int. Cl.: 9

Prior U.S. Cls.: 21, 23, 26, 36, and 38

United States Patent and Trademark Office

Reg. No. 3,400,114

Registered Mar. 18, 2008

**TRADEMARK
PRINCIPAL REGISTER**

WHITESMOKE.COM

WHITESMOKE, INC. (DELAWARE CORPORATION)
THE BRANDYWINE BUILDING, 17TH FLOOR
1000 WEST STREET
WILMINGTON, DE 19801

FOR: COMPUTER SOFTWARE FOR USE IN WORD PROCESSING, ELECTRONIC MAIL WRITING AND ELECTRONIC INSTANT MESSAGING, TO SPELL-CHECK, GRAMMAR-CHECK, SUGGEST WORD SELECTION, SUGGEST ALTERNATE TERMINOLOGY TO ENRICH TEXT, AND PROVIDE WORD-PROCESSING TEMPLATES FOR LETTERS, EMAILS, LEGAL DOCUMENTS, AND OTHER BUSINESS AND PROFESSIONAL DOCUMENTS, FOR PERSONALIZATION; COMPUTER SOFTWARE TO PROVIDE DICTIONARY DEFINITIONS, FOR USE AS A DICTIONARY, FOR USE AS A THESAURUS,

AND TO PROVIDE ACCESS TO AN ONLINE MEDICAL DICTIONARY AND THESAURUS; COMPUTER SOFTWARE TO PROVIDE ASSISTANCE IN THE PREPARATION OF ON-LINE WRITTEN DATING PROFILES , IN CLASS 9 (U.S. CLS. 21, 23, 26, 36 AND 38).

FIRST USE 12-31-2003; IN COMMERCE 12-31-2003.

THE MARK CONSISTS OF STANDARD CHARACTERS WITHOUT CLAIM TO ANY PARTICULAR FONT, STYLE, SIZE, OR COLOR.

SN 78-954,922, FILED 8-17-2006.

JAMES A. RAUEN, EXAMINING ATTORNEY

Int. Cl.: 28

Prior U.S. Cls.: 22, 23, 38, and 50

United States Patent and Trademark Office

Reg. No. 3,400,115

Registered Mar. 18, 2008

**TRADEMARK
PRINCIPAL REGISTER**

DEAR GRANDPA

TY INC. (DELAWARE CORPORATION)
280 CHESTNUT
WESTMONT, IL 60559

FOR: PLUSH TOYS; SOFT SCULPTURE PLUSH
TOYS; SOFT SCULPTURE TOYS; STUFFED TOY
ANIMALS; STUFFED TOY BEARS; STUFFED TOYS,
IN CLASS 28 (U.S. CLS. 22, 23, 38 AND 50).

FIRST USE 3-30-2007; IN COMMERCE 3-30-2007.

THE MARK CONSISTS OF STANDARD CHAR-
ACTERS WITHOUT CLAIM TO ANY PARTICULAR
FONT, STYLE, SIZE, OR COLOR.

SN 78-955,116, FILED 8-18-2006.

MATTHEW MCDOWELL, EXAMINING ATTOR-
NEY

Int. Cl.: 35

Prior U.S. Cls.: 100, 101, and 102

United States Patent and Trademark Office

Reg. No. 3,400,116

Registered Mar. 18, 2008

**SERVICE MARK
PRINCIPAL REGISTER**

**PKF - PEOPLE THE KEY TO
OUR FUTURE**

PANNELL KERR FORSTER OF TEXAS, P.C.
(TEXAS PROFESSIONAL CORPORATION)
5847 SAN FELIPE STREET, SUITE 2400
HOUSTON, TX 770573163

FOR: BUSINESS ADVISORY SERVICES AND
ACCOUNTING SERVICES FOR OTHERS; BUSINESS
CONSULTING SERVICES; ACCOUNTING SERVI-
CES; BUSINESS AUDITING SERVICES; ACCOUNT
AUDITING; TAX CONSULTATION AND ADVI-
SORY SERVICES; PROVIDING BUSINESS MAN-
AGEMENT INFORMATION IN CONNECTION
WITH CONSULTING AND ADVISORY SERVICES

IN THE FIELD OF STRATEGIC PLANNING, IN
CLASS 35 (U.S. CLS. 100, 101 AND 102).

FIRST USE 10-13-2006; IN COMMERCE 10-13-2006.

THE MARK CONSISTS OF STANDARD CHAR-
ACTERS WITHOUT CLAIM TO ANY PARTICULAR
FONT, STYLE, SIZE, OR COLOR.

SN 78-955,728, FILED 8-18-2006.

WILLIAM ROSSMAN, EXAMINING ATTORNEY

Int. Cl.: 4

Prior U.S. Cls.: 1, 6, and 15

United States Patent and Trademark Office

Reg. No. 3,400,117

Registered Mar. 18, 2008

**TRADEMARK
PRINCIPAL REGISTER**



AMERICA YA MEI LI CHEMICAL ENGINEERING LIMITED (HONG KONG CORPORATION)
LONGGUAN CHEMICAL ENGINEERING FACTORY
LUOGANG INDUSTRIAL ZONE, ZENGCHENG CITY
GUANGZHOU, CHINA

FOR: INDUSTRIAL LUBRICANTS; DUST BINDING COMPOSITIONS; ALL PURPOSE LUBRICANTS; GRANULAR ABSORBENT OIL-BASED COMPOSITION FOR ABSORBING SPILLS FROM

FLOORS; BELT DRESSINGS; MOTOR OIL; INDUSTRIAL OILS; CUTTING FLUIDS; MINERAL OIL FOR USE IN THE MANUFACTURE OF PAINT; SOYBEAN OIL FOR USE IN THE MANUFACTURE OF PAINTS AND OTHER COATINGS; INDUSTRIAL GREASES, IN CLASS 4 (U.S. CLS. 1, 6 AND 15).

FIRST USE 4-18-2000; IN COMMERCE 2-26-2007.

SN 78-956,165, FILED 8-21-2006.

ELIZABETH KAJUBI, EXAMINING ATTORNEY

Int. Cl.: 35

Prior U.S. Cls.: 100, 101, and 102

United States Patent and Trademark Office

Reg. No. 3,400,118

Registered Mar. 18, 2008

SERVICE MARK
PRINCIPAL REGISTER

aedon 
staffing

GOLDEN GATE ANCILLARY LLC (DELAWARE
LTD LIAB CO)
1000 BEVERLY WAY
FORT SMITH, AR 72919

FOR: TEMPORARY STAFFING, NAMELY, TEM-
PORARY EMPLOYMENT AGENCIES, IN CLASS 35
(U.S. CLS. 100, 101 AND 102).

FIRST USE 4-22-2004; IN COMMERCE 4-22-2004.

OWNER OF U.S. REG. NOS. 2,952,410 AND
3,151,939.

NO CLAIM IS MADE TO THE EXCLUSIVE
RIGHT TO USE "STAFFING", APART FROM THE
MARK AS SHOWN.

THE MARK CONSISTS OF THE LITERAL ELE-
MENT "AEDON" AND FOUR GEOMETRIC SHAPES

REPRESENTING A MAN AND A RIBBON. THE
GEOMETRIC SHAPES CONSIST OF A CIRCLE
REPRESENTING THE HEAD OF THE MAN, AN
UPTURNED CRESCENT REPRESENTING THE UP-
PER BODY OF THE MAN, A DOWN-TURNED
CRESCENT REPRESENTING THE LOWER HALF
OF THE MAN, AND A CRESCENT WITH THE
POINTS FACING THE LEFT REPRESENTING THE
RIBBON. THE RIGHT TIPS OF THE CRESCENT
REPRESENTING THE MAN'S UPPER AND LOWER
HALF ARE TOUCHING THE TOP AND BOTTOM
OF THE CRESCENT REPRESENTING THE RIBBON
AND THE LITERAL ELEMENT "STAFFING."

SN 78-956,190, FILED 8-21-2006.

CHRIS WELLS, EXAMINING ATTORNEY

Int. Cl.: 9

Prior U.S. Cls.: 21, 23, 26, 36, and 38

United States Patent and Trademark Office

Reg. No. 3,400,119

Registered Mar. 18, 2008

**TRADEMARK
PRINCIPAL REGISTER**

IT PAID FROM OUTER SPACE

WMS GAMING INC. (DELAWARE CORPORATION)
800 SOUTH NORTHPOINT BOULEVARD
WAUKEGAN, IL 60085

FOR: GAMING MACHINES THAT GENERATE OR DISPLAY WAGER OUTCOMES; GAMING SOFTWARE THAT GENERATES OR DISPLAYS WAGER OUTCOMES OF GAMING MACHINES, IN CLASS 9 (U.S. CLS. 21, 23, 26, 36 AND 38).

FIRST USE 11-14-2006; IN COMMERCE 11-14-2006.

THE MARK CONSISTS OF STANDARD CHARACTERS WITHOUT CLAIM TO ANY PARTICULAR FONT, STYLE, SIZE, OR COLOR.

SN 78-956,249, FILED 8-21-2006.

ANNE FARRELL, EXAMINING ATTORNEY

Int. Cl.: 9

Prior U.S. Cls.: 21, 23, 26, 36, and 38

Reg. No. 3,400,120

United States Patent and Trademark Office

Registered Mar. 18, 2008

**TRADEMARK
PRINCIPAL REGISTER**

CRYSTAL FOREST

WMS GAMING INC. (DELAWARE CORPORATION)
800 SOUTH NORTHPOINT BOULEVARD
WAUKEGAN, IL 60085

FOR: GAMING MACHINES THAT GENERATE OR DISPLAY WAGER OUTCOMES; GAMING SOFTWARE THAT GENERATES OR DISPLAYS WAGER OUTCOMES OF GAMING MACHINES, IN CLASS 9 (U.S. CLS. 21, 23, 26, 36 AND 38).

FIRST USE 11-14-2006; IN COMMERCE 11-14-2006.

THE MARK CONSISTS OF STANDARD CHARACTERS WITHOUT CLAIM TO ANY PARTICULAR FONT, STYLE, SIZE, OR COLOR.

SN 78-956,341, FILED 8-21-2006.

ANNE FARRELL, EXAMINING ATTORNEY

Int. Cl.: 16

Prior U.S. Cls.: 2, 5, 22, 23, 29, 37, 38, and 50

Reg. No. 3,400,121

United States Patent and Trademark Office

Registered Mar. 18, 2008

TRADEMARK
PRINCIPAL REGISTER

DrySleeve

PUERINI, RUSSELL ANTHONY (UNITED STATES INDIVIDUAL)
55 BEACH VIEW TER.
MIDDLETOWN, RI 02842

FOR: PAPER SLEEVES AND CARDBOARD SLEEVES, NAMELY, PAPER AND CARDBOARD CUP SLEEVES DESIGNED TO FIT IN BEVERAGE CARRIERS; PAPER AND CARDBOARD CUP SLEEVES FOR HOLDING A BEVERAGE; PAPER AND CARDBOARD SLEEVES FOR HOLDING A BEVERAGE CONTAINER; PAPER AND CARDBOARD DISPOSABLE MUG HANDLES; REUSABLE HANDLES OF PAPER AND CARDBOARD FOR DISPOSABLE CUPS; PAPER AND CARDBOARD CUP SLEEVES WITH HANDLES; PAPER AND CARDBOARD SLEEVES THAT CAN BE PRINTED

UPON, ALLOWING CUPS TO FUNCTION AS MUGS; SLEEVES OF RECYCLED PAPER AND CARDBOARD FOR HOLDING DISPOSABLE BEVERAGE CONTAINERS, IN CLASS 16 (U.S. CLS. 2, 5, 22, 23, 29, 37, 38 AND 50).

FIRST USE 8-7-2006; IN COMMERCE 8-7-2006.

THE MARK CONSISTS OF STANDARD CHARACTERS WITHOUT CLAIM TO ANY PARTICULAR FONT, STYLE, SIZE, OR COLOR.

SN 78-956,347, FILED 8-21-2006.

KATHERINE CHANG, EXAMINING ATTORNEY

Int. Cl.: 43

Prior U.S. Cls.: 100 and 101

United States Patent and Trademark Office

Reg. No. 3,400,122

Registered Mar. 18, 2008

**SERVICE MARK
PRINCIPAL REGISTER**



BURRITO BEACH, LLC (ILLINOIS LTD LIAB
CO)
414 N. ORLEANS
CHICAGO, IL 60610

FOR: RESTAURANT SERVICES FEATURING
MEXICAN FOOD, SMOOTHIES, AND OTHER BEV-
ERAGES, IN CLASS 43 (U.S. CLS. 100 AND 101).

FIRST USE 8-18-2006; IN COMMERCE 8-18-2006.

NO CLAIM IS MADE TO THE EXCLUSIVE
RIGHT TO USE "SMOOTHIES", APART FROM
THE MARK AS SHOWN.

THE MARK CONSISTS OF A FANCIFUL DEPIC-
TION OF THE WORDS "SMOOTHY'S SHACK"
OVERLAYING A SURF BOARD ILLUSTRATION.

SN 78-956,591, FILED 8-21-2006.

FRANK LATTUCA, EXAMINING ATTORNEY

Int. Cl.: 43

Prior U.S. Cls.: 100 and 101

United States Patent and Trademark Office

Reg. No. 3,400,123

Registered Mar. 18, 2008

SERVICE MARK
PRINCIPAL REGISTER



BASILE, RACHEL P. (NORTH CAROLINA LTD
LIAB CO)
8025 ARDREY KELL RD SUITE 102
CHARLOTTE, NC 28277

FOR: CATERING FOR THE PROVISION OF
FOOD AND BEVERAGES; CATERING OF FOOD
AND DRINKS; FOOD PREPARATION; PREPARA-
TION OF FOOD AND BEVERAGES, IN CLASS 43
(U.S. CLS. 100 AND 101).

FIRST USE 9-14-2006; IN COMMERCE 9-14-2006.

THE COLOR(S) BROWN, ORANGE, YELLOW,
GREY AND WHITE IS/ARE CLAIMED AS A FEAT-
URE OF THE MARK.

THE MARK CONSISTS OF THE COLOR BROWN
APPEARS IN THE WORDING "SWITCHIN KITCH-

ENS" AND AS BACKGROUND TO THE WORDING
"PREPARE DINNER IN OURS. ENJOY IT IN
YOURS". THE COLOR ORANGE APPEARS AS AN
OVAL BACKGROUND TO THE OVERALL MARK.
THE COLOR YELLOW APPEARS AS AN OVAL
BAND NEXT TO THE ORANGE OVAL BACK-
GROUND. THE COLOR GREY APPEARS AS LIN-
ING TO THE OVERALL DESIGN AND THE
UTENSIL DESIGN. THE COLOR WHITE APPEARS
IN THE LETTERING "PREPARE DINNER IN OURS.
ENJOY IT IN YOURS" AND AS LINING TO THE
OVERALL DESIGN AND TO THE WORDING
"SWITCHIN KITCHENS".

SN 78-956,713, FILED 8-21-2006.

TIMOTHY FINNEGAN, EXAMINING ATTORNEY

Int. Cl.: 44

Prior U.S. Cls.: 100 and 101

United States Patent and Trademark Office

Reg. No. 3,400,124

Registered Mar. 18, 2008

**SERVICE MARK
PRINCIPAL REGISTER**

GOLDEN CLINICAL SERVICES

GOLDEN GATE ANCILLARY LLC (DELAWARE
LTD LIAB CO)

1000 BEVERLY WAY

FORT SMITH, AR 72919

FOR: HEALTH CARE SERVICES, IN CLASS 44
(U.S. CLS. 100 AND 101).

FIRST USE 9-1-2006; IN COMMERCE 9-1-2006.

THE MARK CONSISTS OF STANDARD CHAR-
ACTERS WITHOUT CLAIM TO ANY PARTICULAR
FONT, STYLE, SIZE, OR COLOR.

NO CLAIM IS MADE TO THE EXCLUSIVE
RIGHT TO USE "CLINICAL SERVICES", APART
FROM THE MARK AS SHOWN.

SN 78-956,842, FILED 8-21-2006.

CHRIS WELLS, EXAMINING ATTORNEY

Int. Cls.: 41 and 43

Prior U.S. Cls.: 100, 101, and 107

United States Patent and Trademark Office

Reg. No. 3,400,125

Registered Mar. 18, 2008

SERVICE MARK
PRINCIPAL REGISTER



BERKSON, HOWARD C. (UNITED STATES IN-
DIVIDUAL)
SUITE 200
1495 PACIFIC HIGHWAY
SAN DIEGO, CA 92101

FOR: ENTERTAINMENT IN THE NATURE OF
VISUAL AND AUDIO PERFORMANCES, AND MU-
SICAL, VARIETY, NEWS AND COMEDY SHOWS;
ENTERTAINMENT IN THE NATURE OF VISUAL
AND AUDIO PERFORMANCES, NAMELY, MUSI-
CAL BAND, ROCK GROUP, GYMNASTIC, DANCE,
AND BALLET PERFORMANCES; ENTERTAIN-
MENT NAMELY, LIVE PERFORMANCES BY A
MUSICAL BAND; ENTERTAINMENT, NAMELY,
LIVE MUSIC CONCERTS; ENTERTAINMENT,
NAMELY, LIVE PERFORMANCES BY MUSICAL
BANDS; PRESENTATION OF LIVE SHOW PERFOR-

MANCES; PRESENTATION OF MUSICAL PERFOR-
MANCE, IN CLASS 41 (U.S. CLS. 100, 101 AND 107).

FIRST USE 5-14-2007; IN COMMERCE 5-14-2007.

FOR: RESTAURANT AND BAR SERVICES, IN
CLASS 43 (U.S. CLS. 100 AND 101).

FIRST USE 5-14-2007; IN COMMERCE 5-14-2007.

THE MARK CONSISTS OF STYLIZED WORD
"ANTHOLOGY" PRINTED ON A MUSICAL STAFF
COMPRISED OF FIVE HORIZONTAL LINES.

SN 78-957,383, FILED 8-22-2006.

ALYSSA PALADINO, EXAMINING ATTORNEY

Int. Cl.: 37

Prior U.S. Cls.: 100, 103, and 106

United States Patent and Trademark Office

Reg. No. 3,400,126

Registered Mar. 18, 2008

**SERVICE MARK
PRINCIPAL REGISTER**

WEST 57TH

RHODES DESIGN AND DEVELOPMENT COR-
PORATION (NEVADA CORPORATION)
4730 SOUTH APACHE ROAD
LAS VEGAS, NV 89147

FOR: HOMEBUILDING SERVICES IN THE NAT-
URE OF HOUSE BUILDING AND REPAIR, AND
BUILDING RENOVATION IN THE FIELD OF RE-
SIDENTIAL HOUSES; DEVELOPMENT OF REAL
PROPERTY, NAMELY, REPAIR, IMPROVEMENT,
AND NEW CONSTRUCTION OF SINGLE-FAMILY
AND MULTI-FAMILY RESIDENTIAL AND MAS-
TER-PLANNED RESIDENTIAL AND COMMER-

CIAL COMMUNITIES, IN CLASS 37 (U.S. CLS. 100,
103 AND 106).

FIRST USE 10-1-2006; IN COMMERCE 10-1-2006.

THE MARK CONSISTS OF STANDARD CHAR-
ACTERS WITHOUT CLAIM TO ANY PARTICULAR
FONT, STYLE, SIZE, OR COLOR.

SN 78-957,644, FILED 8-22-2006.

ADA HAN, EXAMINING ATTORNEY

Int. Cl.: 37

Prior U.S. Cls.: 100, 103, and 106

United States Patent and Trademark Office

Reg. No. 3,400,127

Registered Mar. 18, 2008

**SERVICE MARK
PRINCIPAL REGISTER**

RHODES RANCH

RHODES DESIGN AND DEVELOPMENT COR-
PORATION (NEVADA CORPORATION)
4730 SOUTH FORT APACHE ROAD
LAS VEGAS, NV 89147

FOR: HOMEBUILDING SERVICES IN THE NAT-
URE OF HOUSE BUILDING AND REPAIR, AND
BUILDING RENOVATION IN THE FIELD OF RE-
SIDENTIAL HOUSES; DEVELOPMENT OF REAL
PROPERTY, NAMELY, REPAIR, IMPROVEMENT,
AND NEW CONSTRUCTION OF SINGLE-FAMILY
AND MULTI-FAMILY RESIDENTIAL AND MAS-
TER-PLANNED RESIDENTIAL AND COMMER-

CIAL COMMUNITIES, IN CLASS 37 (U.S. CLS. 100,
103 AND 106).

FIRST USE 4-1-2006; IN COMMERCE 4-1-2006.

THE MARK CONSISTS OF STANDARD CHAR-
ACTERS WITHOUT CLAIM TO ANY PARTICULAR
FONT, STYLE, SIZE, OR COLOR.

SN 78-957,661, FILED 8-22-2006.

ADA HAN, EXAMINING ATTORNEY

Int. Cl.: 44

Prior U.S. Cls.: 100 and 101

United States Patent and Trademark Office

Reg. No. 3,400,128

Registered Mar. 18, 2008

**SERVICE MARK
PRINCIPAL REGISTER**

AEGIS THERAPIES

GOLDEN GATE ANCILLARY LLC (DELAWARE
LTD LIAB CO)
1000 BEVERLY WAY
FORT SMITH, AR 72919

OWNER OF U.S. REG. NOS. 2,916,563 AND
3,049,860.

FOR: OCCUPATIONAL, PHYSICAL, AND
SPEECH THERAPY SERVICES, IN CLASS 44 (U.S.
CLS. 100 AND 101).

NO CLAIM IS MADE TO THE EXCLUSIVE
RIGHT TO USE "THERAPIES", APART FROM THE
MARK AS SHOWN.

FIRST USE 4-22-2004; IN COMMERCE 4-22-2004.

SN 78-957,720, FILED 8-22-2006.

THE MARK CONSISTS OF STANDARD CHAR-
ACTERS WITHOUT CLAIM TO ANY PARTICULAR
FONT, STYLE, SIZE, OR COLOR.

CHRIS WELLS, EXAMINING ATTORNEY

Int. Cl.: 44

Prior U.S. Cls.: 100 and 101

United States Patent and Trademark Office

Reg. No. 3,400,129

Registered Mar. 18, 2008

SERVICE MARK
PRINCIPAL REGISTER



GOLDEN GATE ANCILLARY LLC (DELAWARE
LTD LIAB CO)
1000 BEVERLY WAY
FORT SMITH, AR 72919

FOR: OCCUPATIONAL, PHYSICAL, AND
SPEECH THERAPY SERVICES, IN CLASS 44 (U.S.
CLS. 100 AND 101).

FIRST USE 4-22-2004; IN COMMERCE 4-22-2004.

OWNER OF U.S. REG. NOS. 2,916,563 AND
3,049,860.

NO CLAIM IS MADE TO THE EXCLUSIVE
RIGHT TO USE "THERAPIES", APART FROM THE
MARK AS SHOWN.

THE MARK CONSISTS OF LITERAL ELEMENT
"AEGIS" WITH AN ABSTRACT MAN DANCING
WITH A RIBBON THEN THE LITERAL ELEMENT
BELOW THE MAN IS "THERAPIES".

SN 78-957,744, FILED 8-22-2006.

CHRIS WELLS, EXAMINING ATTORNEY

Int. Cl.: 44

Prior U.S. Cls.: 100 and 101

United States Patent and Trademark Office

Reg. No. 3,400,130

Registered Mar. 18, 2008

**SERVICE MARK
PRINCIPAL REGISTER**

AEGIS ACUTE REHAB

GOLDEN GATE ANCILLARY LLC (DELAWARE
LTD LIAB CO)
1000 BEVERLY WAY
FORST SMITH, AR 72919

OWNER OF U.S. REG. NOS. 2,916,563 AND
3,049,860.

FOR: OCCUPATIONAL, PHYSICAL, AND
SPEECH THERAPY SERVICES, IN CLASS 44 (U.S.
CLS. 100 AND 101).

NO CLAIM IS MADE TO THE EXCLUSIVE
RIGHT TO USE "ACUTE REHAB", APART FROM
THE MARK AS SHOWN.

FIRST USE 2-17-2005; IN COMMERCE 2-17-2005.

SN 78-957,755, FILED 8-22-2006.

THE MARK CONSISTS OF STANDARD CHAR-
ACTERS WITHOUT CLAIM TO ANY PARTICULAR
FONT, STYLE, SIZE, OR COLOR.

CHRIS WELLS, EXAMINING ATTORNEY

Int. Cl.: 44

Prior U.S. Cls.: 100 and 101

United States Patent and Trademark Office

Reg. No. 3,400,131

Registered Mar. 18, 2008

**SERVICE MARK
PRINCIPAL REGISTER**



GOLDEN GATE ANCILLARY LLC (DELAWARE
LTD LIAB CO)
1000 BEVERLY WAY
FORT SMITH, AR 72919

FOR: OCCUPATIONAL, PHYSICAL, AND
SPEECH THERAPY SERVICES, IN CLASS 44 (U.S.
CLS. 100 AND 101).

FIRST USE 2-17-2005; IN COMMERCE 2-17-2005.

OWNER OF U.S. REG. NOS. 2,916,563 AND
3,049,860.

NO CLAIM IS MADE TO THE EXCLUSIVE
RIGHT TO USE "ACUTE REHAB", APART FROM
THE MARK AS SHOWN.

THE MARK CONSISTS OF LITERAL ELEMENT
"AEGIS" WITH AN ABSTRACT MAN DANCING
WITH A RIBBON THEN THE LITERAL ELEMENTS
BELOW THE MAN ARE "ACUTE REHAB."

SN 78-957,758, FILED 8-22-2006.

CHRIS WELLS, EXAMINING ATTORNEY

Int. Cl.: 32

Prior U.S. Cls.: 45, 46, and 48

United States Patent and Trademark Office

Reg. No. 3,400,132

Registered Mar. 18, 2008

**TRADEMARK
PRINCIPAL REGISTER**

PAP

ORTEGA, ROLANDO (CHILE INDIVIDUAL)
81 C MADISON AVENUE
HEMSTEAD, NY 11550

THE MARK CONSISTS OF STANDARD CHAR-
ACTERS WITHOUT CLAIM TO ANY PARTICULAR
FONT, STYLE, SIZE, OR COLOR.

FOR: SOFT DRINKS, NAMELY, CARBONATED
SOFT DRINKS, IN CLASS 32 (U.S. CLS. 45, 46 AND
48).

SN 78-957,883, FILED 8-22-2006.

FIRST USE 10-31-2006; IN COMMERCE 10-31-2006.

ELIZABETH BEYER, EXAMINING ATTORNEY

Int. Cl.: 11

Prior U.S. Cls.: 13, 21, 23, 31, and 34

United States Patent and Trademark Office

Reg. No. 3,400,133

Registered Mar. 18, 2008

**TRADEMARK
PRINCIPAL REGISTER**

SOUTHHAVEN

KOHLER CO. (WISCONSIN CORPORATION)
444 HIGHLAND DRIVE
KOHLER, WI 53044

FOR: SINKS, IN CLASS 11 (U.S. CLS. 13, 21, 23, 31
AND 34).

FIRST USE 7-1-2003; IN COMMERCE 7-1-2003.

THE MARK CONSISTS OF STANDARD CHAR-
ACTERS WITHOUT CLAIM TO ANY PARTICULAR
FONT, STYLE, SIZE, OR COLOR.

OWNER OF U.S. REG. NOS. 2,182,297, 2,909,243,
AND 3,158,740.

SN 78-958,084, FILED 8-22-2006.

ESTHER A. BORSUK, EXAMINING ATTORNEY

Int. Cl.: 28

Prior U.S. Cls.: 22, 23, 38, and 50

United States Patent and Trademark Office

Reg. No. 3,400,134

Registered Mar. 18, 2008

**TRADEMARK
PRINCIPAL REGISTER**

TOTALLY CHARMED

MATTEL, INC. (DELAWARE CORPORATION)
MAIL STOP M1-1518
333 CONTINENTAL BOULEVARD
EL SEGUNDO, CA 90245

FOR: TOYS, GAMES AND PLAYTHINGS, NAME-
LY, DOLLS, DOLL CLOTHING AND DOLL ACCES-
SORIES, TOY FIGURES AND ACCESSORIES
THEREFOR, IN CLASS 28 (U.S. CLS. 22, 23, 38 AND
50).

FIRST USE 4-4-2007; IN COMMERCE 4-4-2007.

THE MARK CONSISTS OF STANDARD CHAR-
ACTERS WITHOUT CLAIM TO ANY PARTICULAR
FONT, STYLE, SIZE, OR COLOR.

SN 78-958,109, FILED 8-22-2006.

ELIZABETH BEYER, EXAMINING ATTORNEY

Int. Cl.: 9

Prior U.S. Cls.: 21, 23, 26, 36, and 38

United States Patent and Trademark Office

Reg. No. 3,400,135

Registered Mar. 18, 2008

**TRADEMARK
PRINCIPAL REGISTER**

ARTONELICO

KABUSHIKI KAISHA BANPRESTO (BANPRESTO
CO., LTD.) (JAPAN CORPORATION)
12-2, HIGASHI-SHINAGAWA 4-CHOME
SHINAGAWA-KU, TOKYO, JAPAN

THE MARK CONSISTS OF STANDARD CHAR-
ACTERS WITHOUT CLAIM TO ANY PARTICULAR
FONT, STYLE, SIZE, OR COLOR.

FOR: COMPUTER GAME SOFTWARE, NAMELY,
VIDEO GAME CARTRIDGE, IN CLASS 9 (U.S. CLS.
21, 23, 26, 36 AND 38).

SN 78-958,192, FILED 8-23-2006.

FIRST USE 1-26-2006; IN COMMERCE 2-6-2007.

JANICE L. MCMORROW, EXAMINING ATTOR-
NEY

Int. Cl.: 9

Prior U.S. Cls.: 21, 23, 26, 36, and 38

Reg. No. 3,400,136

United States Patent and Trademark Office

Registered Mar. 18, 2008

**TRADEMARK
PRINCIPAL REGISTER**

SensorMetric

SENSORY ANALYTICS, LLC (NORTH CAROLINA LTD LIAB CO)
4413-C WEST MARKET STREET
GREENSBORO, NC 27407

FOR: SOFTWARE FOR MEASUREMENT STANDARD DEVICES FOR NANOMETROLOGY, NAMELY, MEASURING TOOLS HAVING A PATTERN IN THE MICROMETER OR NANOMETER RANGES , IN CLASS 9 (U.S. CLS. 21, 23, 26, 36 AND 38).

FIRST USE 6-30-2006; IN COMMERCE 6-30-2006.

THE MARK CONSISTS OF STANDARD CHARACTERS WITHOUT CLAIM TO ANY PARTICULAR FONT, STYLE, SIZE, OR COLOR.

SN 78-958,200, FILED 8-23-2006.

MICHAEL GAAFAR, EXAMINING ATTORNEY

Int. Cls.: 5 and 44

Prior U.S. Cls.: 6, 18, 44, 46, 51, 52, 100, and 101

United States Patent and Trademark Office

Reg. No. 3,400,137

Registered Mar. 18, 2008

**TRADEMARK
SERVICE MARK
PRINCIPAL REGISTER**



CARDIAC WELLNESS SUPPLEMENTS LLC
(NORTH CAROLINA LTD LIAB CO)
310 SOUTH MCCASKEY RD.
WRIGHTSVILLE BEACH, NC 27892

FOR: NUTRITIONAL AND DIETARY SUPPLEMENTS, IN CLASS 5 (U.S. CLS. 6, 18, 44, 46, 51 AND 52).

FIRST USE 7-1-2007; IN COMMERCE 7-1-2007.

FOR: HEART DISEASE PREVENTION, WELLNESS AND REHABILITATION SERVICES, NAMELY, THE PROVISION OF MEDICAL ADVISORY AND PHYSICAL THERAPY SERVICES FOR PRE-

VENTION OF HEART DISEASE, EARLY ASSESSMENT OF CARDIOVASCULAR RISK FACTORS, MAINTENANCE OF CARDIAC WELLNESS, CARDIOVASCULAR RISK REDUCTION AND CARDIAC REHABILITATION; AND INDIVIDUAL AND GROUP CARDIOVASCULAR HEALTH COUNSELING; MEDICAL IMAGING SERVICES, IN CLASS 44 (U.S. CLS. 100 AND 101).

FIRST USE 7-1-2007; IN COMMERCE 7-1-2007.

SN 78-958,515, FILED 8-23-2006.

LINDA ORNDORFF, EXAMINING ATTORNEY

Int. Cl.: 30

Prior U.S. Cl.: 46

United States Patent and Trademark Office

Reg. No. 3,400,138

Registered Mar. 18, 2008

TRADEMARK
PRINCIPAL REGISTER



JUDY'S CANDY COMPANY (CALIFORNIA CORPORATION)
1225 8TH STREET
BERKELEY, CA 94710

FOR: CANDY, IN CLASS 30 (U.S. CL. 46).

FIRST USE 11-8-2006; IN COMMERCE 11-8-2006.

OWNER OF U.S. REG. NO. 2,533,954.

NO CLAIM IS MADE TO THE EXCLUSIVE
RIGHT TO USE "CANDY COMPANY"; "HAND-

MADE" AND "THE OLD-FASHIONED WAY",
APART FROM THE MARK AS SHOWN.

THE MARK CONSISTS OF THE WORDS "JUDY'S
CANDY COMPANY HANDMADE THE OLD-FASH-
IONED WAY" WITHIN AN OVAL CIRCLE.

SN 78-958,613, FILED 8-23-2006.

KATHLEEN LORENZO, EXAMINING ATTORNEY

Int. Cl.: 20

Prior U.S. Cls.: 2, 13, 22, 25, 32, and 50

United States Patent and Trademark Office

Reg. No. 3,400,139

Registered Mar. 18, 2008

**TRADEMARK
PRINCIPAL REGISTER**

NOT JUST ANOTHER... LINE OF BULL

TURNBULL ENTERPRISES, INC. (CALIFORNIA
CORPORATION)
P.O. BOX 7169
SAN CARLOS, CA 94070

THE MARK CONSISTS OF STANDARD CHAR-
ACTERS WITHOUT CLAIM TO ANY PARTICULAR
FONT, STYLE, SIZE, OR COLOR.

FOR: PLASTIC FIGURINES, IN CLASS 20 (U.S.
CLS. 2, 13, 22, 25, 32 AND 50).

SN 78-959,056, FILED 8-23-2006.

FIRST USE 5-1-2007; IN COMMERCE 5-1-2007.

MICHELE SWAIN, EXAMINING ATTORNEY

Int. Cl.: 41

Prior U.S. Cls.: 100, 101, and 107

United States Patent and Trademark Office

Reg. No. 3,400,140

Registered Mar. 18, 2008

**SERVICE MARK
PRINCIPAL REGISTER**

EASY AS EMAIL

BERMAN INVESTMENT GROUP (NEVADA LTD
LIAB CO)
1301 DOVE STREET, SUITE 870
NEWPORT BEACH, CA 92660

FOR: EDUCATIONAL SERVICES, NAMELY,
CONDUCTING CLASSES, SEMINARS, CONFEREN-
CES, MENTORING, AND WORKSHOPS IN THE
FIELD OF PERSONAL IMPROVEMENT , IN CLASS
41 (U.S. CLS. 100, 101 AND 107).

FIRST USE 1-7-2008; IN COMMERCE 1-7-2008.

THE MARK CONSISTS OF STANDARD CHAR-
ACTERS WITHOUT CLAIM TO ANY PARTICULAR
FONT, STYLE, SIZE, OR COLOR.

SN 78-959,993, FILED 8-24-2006.

SUSAN RICHARDS, EXAMINING ATTORNEY

Int. Cl.: 17

Prior U.S. Cls.: 1, 5, 12, 13, 35, and 50

Reg. No. 3,400,141

United States Patent and Trademark Office

Registered Mar. 18, 2008

**TRADEMARK
PRINCIPAL REGISTER**

STRONGSEAM

STRAIGHT LINE INSULATION I, LP (TEXAS
LIMITED PARTNERSHIP)
1101 MICHIGAN STREET
SOUTH HOUSTON, TX 77587

FOR: BUILDING INSULATION SYSTEM CON-
SISTING OF INTERLOCKING COMPOSITE PA-
NELS CREATED FROM A METALLIC OUTER
SKIN LAMINATED TO THERMAL INSULATION ,
IN CLASS 17 (U.S. CLS. 1, 5, 12, 13, 35 AND 50).

FIRST USE 1-14-2008; IN COMMERCE 1-14-2008.

THE MARK CONSISTS OF STANDARD CHAR-
ACTERS WITHOUT CLAIM TO ANY PARTICULAR
FONT, STYLE, SIZE, OR COLOR.

SN 78-960,017, FILED 8-24-2006.

ELISSA GARBER KON, EXAMINING ATTORNEY

Int. Cl.: 6

Prior U.S. Cls.: 2, 12, 13, 14, 23, 25, and 50

United States Patent and Trademark Office

Reg. No. 3,400,142

Registered Mar. 18, 2008

**TRADEMARK
PRINCIPAL REGISTER**

CUSTOM HEMISPHERIC

CUSTOM METALCRAFT, INC. (MISSOURI CORPORATION)
2332 E. DIVISION
SPRINGFIELD, MO 65802

FOR: ROUND BOTTOM INDUSTRIAL MIXING VESSEL MADE PRIMARILY OF METAL, IN CLASS 6 (U.S. CLS. 2, 12, 13, 14, 23, 25 AND 50).

FIRST USE 7-1-2006; IN COMMERCE 7-1-2006.

THE MARK CONSISTS OF STANDARD CHARACTERS WITHOUT CLAIM TO ANY PARTICULAR FONT, STYLE, SIZE, OR COLOR.

NO CLAIM IS MADE TO THE EXCLUSIVE RIGHT TO USE "CUSTOM", APART FROM THE MARK AS SHOWN.

SN 78-960,331, FILED 8-25-2006.

ZACHARY BELLO, EXAMINING ATTORNEY

Prior U.S. Cl.: B

United States Patent and Trademark Office

Reg. No. 3,400,143

Registered Mar. 18, 2008

**CERTIFICATION MARK
SERVICES
PRINCIPAL REGISTER**

CREd

HEARTLAND INSTITUTE OF FINANCIAL EDUCATION (COLORADO NON-PROFIT CORPORATION)
SUITE 1100
2851 S. PARKER ROAD
AURORA, CO 80014

FOR: EDUCATION SERVICES IN THE FIELD OF RETIREMENT, IN CLASS B (U.S. CL. B).

FIRST USE 11-14-2007; IN COMMERCE 11-14-2007.

THE MARK CONSISTS OF STANDARD CHARACTERS WITHOUT CLAIM TO ANY PARTICULAR FONT, STYLE, SIZE, OR COLOR.

CERTIFICATION THAT INDIVIDUALS HAVE COMPLETED A SERIES OF PROFESSIONAL EDUCATIONAL ENDEAVORS AND HAVE MET A SET OF COMPETENCY AND QUALIFICATION STANDARDS, ESTABLISHED BY THE CERTIFIER, PERTAINING TO PROVIDING RETIREMENT EDUCATION.

SN 78-960,695, FILED 8-25-2006.

SHAUNIA CARLYLE, EXAMINING ATTORNEY

Int. Cl.: 25

Prior U.S. Cls.: 22 and 39

United States Patent and Trademark Office

Reg. No. 3,400,144

Registered Mar. 18, 2008

**TRADEMARK
PRINCIPAL REGISTER**



STEWART, GREGORY J. (UNITED STATES IN-
DIVIDUAL)
336 RIVERSIDE DRIVE APT. 2B
NEW YORK, NY 10025

FOR: T-SHIRTS, IN CLASS 25 (U.S. CLS. 22 AND
39).

FIRST USE 8-1-2004; IN COMMERCE 10-22-2006.

THE COLOR(S) RED, WHITE, BLACK AND SIL-
VER IS/ARE CLAIMED AS A FEATURE OF THE
MARK.

THE MARK CONSISTS OF PEACE SIGN SYMBOL
WITH "JOIN THE OPPOSITION" DESIGN IN RED
AND BLACK WITH RED STARS DOTTING THE
"I"'S SYMBOLIZING A STRONG FORCE UNITED
FOR PEACE.

SN 78-961,317, FILED 8-27-2006.

CHRIS WELLS, EXAMINING ATTORNEY

Int. Cl.: 7

Prior U.S. Cls.: 13, 19, 21, 23, 31, 34, and 35

Reg. No. 3,400,145

United States Patent and Trademark Office

Registered Mar. 18, 2008

**TRADEMARK
PRINCIPAL REGISTER**

QuickKut

TOOLINGHOUSE.COM (MICHIGAN CORPORATION)
1080 N TRUHN ROAD
FOWLERVILLE, MI 48836

THE MARK CONSISTS OF STANDARD CHARACTERS WITHOUT CLAIM TO ANY PARTICULAR FONT, STYLE, SIZE, OR COLOR.

FOR: MILLING CUTTERS; POWER TOOLS, NAMELY, END MILLS, IN CLASS 7 (U.S. CLS. 13, 19, 21, 23, 31, 34 AND 35).

SN 78-961,479, FILED 8-28-2006.

FIRST USE 1-1-2008; IN COMMERCE 1-1-2008.

DANIEL BRODY, EXAMINING ATTORNEY

Int. Cl.: 3

Prior U.S. Cls.: 1, 4, 6, 50, 51, and 52

United States Patent and Trademark Office

Reg. No. 3,400,146

Registered Mar. 18, 2008

**TRADEMARK
PRINCIPAL REGISTER**

**LANEIGE DESIGNING PEARL
PACT**

AMOREPACIFIC CORPORATION (REPUBLIC OF
KOREA CORPORATION)
181, 2-KA, HANGANG-RO, YONGSAN-KU
SEOUL, REPUBLIC OF KOREA 140-777

FOR: SOLID MAKE-UP POWDER FOR COM-
PACTS; LIQUID FOUNDATION; CREAMY FOUN-
DATION; MAKE-UP FOUNDATIONS; FACE
POWDER, IN CLASS 3 (U.S. CLS. 1, 4, 6, 50, 51 AND
52).

FIRST USE 5-0-2006; IN COMMERCE 7-0-2006.

THE MARK CONSISTS OF STANDARD CHAR-
ACTERS WITHOUT CLAIM TO ANY PARTICULAR
FONT, STYLE, SIZE, OR COLOR.

OWNER OF U.S. REG. NOS. 2,110,811, 2,408,553,
AND 3,087,975.

SN 78-961,727, FILED 8-28-2006.

THOMAS MANOR, EXAMINING ATTORNEY

Int. Cl.: 41

Prior U.S. Cls.: 100, 101, and 107

United States Patent and Trademark Office

Reg. No. 3,400,147

Registered Mar. 18, 2008

**SERVICE MARK
PRINCIPAL REGISTER**



LAMANS, KRIS (UNITED STATES INDIVIDUAL)
SUITE 315
10945 BLUFFSIDE DR.
STUDIO CITY, CA 91604

FOR: ENTERTAINMENT SERVICES, NAMELY,
PROVIDING A SERIES OF TELEVISION PRO-
GRAMS RELATING TO AFRO-AMERICAN MUSI-
CIANS WHO HAVE INFLUENCED OTHER
MUSICAL STYLES IN AMERICA AND THE
WORLD, IN CLASS 41 (U.S. CLS. 100, 101 AND 107).

FIRST USE 9-1-2007; IN COMMERCE 9-1-2007.

NO CLAIM IS MADE TO THE EXCLUSIVE
RIGHT TO USE "USA", APART FROM THE MARK
AS SHOWN.

THE COLOR(S) BRASS AND DARK GREY IS/ARE
CLAIMED AS A FEATURE OF THE MARK.

THE MARK CONSISTS OF AN OLD STYLE
MICROPHONE WITH LETTERING ON THE FACE
PLATE. THE COLOR BRASS APPEARS IN THE
LETTERING, THE TOP AND BOTTOM RIBBED
PORTIONS OF THE MICROPHONE, THE SIDE
PIVOT DISC, AND THE MICROPHONE SUPPORT
RING. THE COLOR DARK GREY APPEARS IN THE
MICROPHONE FACE PLATE, THE MICROPHONE
PIVOT POINTS, AND THE MICROPHONE STAND.

SN 78-961,803, FILED 8-28-2006.

DAVID I, EXAMINING ATTORNEY

Int. Cl.: 6

Prior U.S. Cls.: 2, 12, 13, 14, 23, 25, and 50

United States Patent and Trademark Office

Reg. No. 3,400,148

Registered Mar. 18, 2008

**TRADEMARK
PRINCIPAL REGISTER**

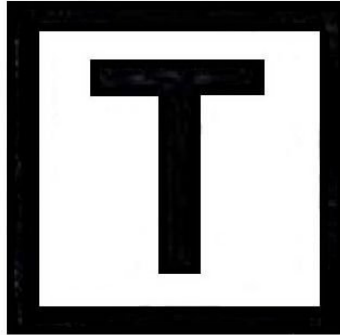

TUBOS DE ACERO DE MEXICO S.A. (MEXICO
CORPORATION)
VIA XAPALA
KM433.7 CARRETERA MEXICO VERACRUZ
VERACRUZ, MEXICO 91697

FIRST USE 7-10-2006; IN COMMERCE 10-0-2006.

SN 78-962,061, FILED 8-28-2006.

FOR: METAL TUBE CONNECTORS, IN CLASS 6
(U.S. CLS. 2, 12, 13, 14, 23, 25 AND 50).

CHRISTINE COOPER, EXAMINING ATTORNEY

Int. Cl.: 41

Prior U.S. Cls.: 100, 101, and 107

United States Patent and Trademark Office

Reg. No. 3,400,149

Registered Mar. 18, 2008

**SERVICE MARK
PRINCIPAL REGISTER**



IGT (NEVADA CORPORATION)
9295 PROTOTYPE DRIVE
RENO, NV 895218986

FOR: PROVIDING A COMPUTER GAME OVER
GLOBAL COMPUTER NETWORKS; PROVIDING
AN ONLINE LIBRARY OF DOWNLOADABLE
GAMES, IN CLASS 41 (U.S. CLS. 100, 101 AND 107).

FIRST USE 12-22-2005; IN COMMERCE 12-22-2005.

OWNER OF U.S. REG. NOS. 1,194,245, 1,208,011,
AND 2,909,296.

SN 78-962,223, FILED 8-28-2006.

MIDGE BUTLER, EXAMINING ATTORNEY

Int. Cl.: 7

Prior U.S. Cls.: 13, 19, 21, 23, 31, 34, and 35

United States Patent and Trademark Office

Reg. No. 3,400,150

Registered Mar. 18, 2008

**TRADEMARK
PRINCIPAL REGISTER**

REVOLITHIUM

MATSUSHITA ELECTRIC WORKS, LTD. (JAPAN CORPORATION)
1048, OAZA KADOMA, KADOMA-SHI
OSAKA, JAPAN 571-8686

FOR: METALWORKING MACHINE TOOLS; CUTTING MACHINES FOR METALWORKING; DRILLING MACHINES FOR METALWORKING; GRINDING MACHINES FOR METALWORKING; SAW TOOTH SETTING MACHINES FOR LUMBERING OR WOODWORKING SAWS; WOODWORKING SAW TOOTH SETTING MACHINES; PLYWOOD FINISHING MACHINES; ELECTRIC DRIVERS; POWER OPERATED WRENCHES; POWER OPERATED ELECTRIC DRILLS; POWER TOOLS, NAMELY, IMPACT DRIVERS; ROTARY HAMMER DRILLS; POWER OPERATED CIRCU-

LAR SAWS; RECIPROCATING SAWS; POWER OPERATED CAULKING GUNS; GRINDING MACHINES FOR METALWORKING; POWER OPERATED RIVET GUNS; JIG SAWS, IN CLASS 7 (U.S. CLS. 13, 19, 21, 23, 31, 34 AND 35).

FIRST USE 11-1-2006; IN COMMERCE 11-1-2006.

THE MARK CONSISTS OF STANDARD CHARACTERS WITHOUT CLAIM TO ANY PARTICULAR FONT, STYLE, SIZE, OR COLOR.

SN 78-962,840, FILED 8-29-2006.

LINDA LAVACHE, EXAMINING ATTORNEY

Int. Cl.: 42

Prior U.S. Cls.: 100 and 101

United States Patent and Trademark Office

Reg. No. 3,400,151

Registered Mar. 18, 2008

**SERVICE MARK
PRINCIPAL REGISTER**

EXTERIOR PORTFOLIO

CRANE PLASTICS SIDING LLC (OHIO LTD
LIAB CO)
P.O. BOX 1058
1441 UNIVERSAL ROAD
COLUMBUS, OH 43216

FOR: PROVIDING TEMPORARY USE OF ON-
LINE NON-DOWNLOADABLE SOFTWARE FOR
HOME DESIGN, IN CLASS 42 (U.S. CLS. 100 AND
101).

FIRST USE 1-1-2007; IN COMMERCE 1-1-2007.

THE MARK CONSISTS OF STANDARD CHAR-
ACTERS WITHOUT CLAIM TO ANY PARTICULAR
FONT, STYLE, SIZE, OR COLOR.

SN 78-963,061, FILED 8-29-2006.

MICHAEL KEATING, EXAMINING ATTORNEY

Int. Cl.: 19

Prior U.S. Cls.: 1, 12, 33, and 50

United States Patent and Trademark Office

Reg. No. 3,400,152

Registered Mar. 18, 2008

**TRADEMARK
PRINCIPAL REGISTER**

THINK OUTSIDE.

CRANE PLASTICS SIDING LLC (OHIO LTD
LIAB CO)
P.O. BOX 1058
1441 UNIVERSAL ROAD
COLUMBUS, OH 43216

THE MARK CONSISTS OF STANDARD CHAR-
ACTERS WITHOUT CLAIM TO ANY PARTICULAR
FONT, STYLE, SIZE, OR COLOR.

FOR: VINYL SIDING, IN CLASS 19 (U.S. CLS. 1, 12,
33 AND 50).

SN 78-963,073, FILED 8-29-2006.

FIRST USE 1-1-2007; IN COMMERCE 1-1-2007.

MICHAEL KEATING, EXAMINING ATTORNEY

Int. Cl.: 35

Prior U.S. Cls.: 100, 101, and 102

United States Patent and Trademark Office

Reg. No. 3,400,153

Registered Mar. 18, 2008

**SERVICE MARK
PRINCIPAL REGISTER**



MAINTENANCE SUPPLY HEADQUARTERS, LP
(DELAWARE LIMITED PARTNERSHIP)
12315 PARC CREST DRIVE
SUITE 100
STAFFORD, TX 77477

FOR: WHOLESALE DISTRIBUTORSHIP AND RE-
TAIL STORE SERVICES FEATURING BUILDING
MAINTENANCE SUPPLIES, PARTS, TOOLS AND
ACCESSORIES, IN CLASS 35 (U.S. CLS. 100, 101 AND
102).

FIRST USE 0-0-2006; IN COMMERCE 0-0-2006.

NO CLAIM IS MADE TO THE EXCLUSIVE
RIGHT TO USE "MAINTENANCE SUPPLY", APART
FROM THE MARK AS SHOWN.

SN 78-963,228, FILED 8-29-2006.

ALICE BENMAMAN, EXAMINING ATTORNEY

Int. Cl.: 44

Prior U.S. Cls.: 100 and 101

United States Patent and Trademark Office

Reg. No. 3,400,154

Registered Mar. 18, 2008

**SERVICE MARK
PRINCIPAL REGISTER**



LASER | COSMETICS | MEDSPA

CALVIN N. TSAO (TEXAS INCORPORATED
PROFESSIONAL ASSOCIATION)
12131 WESTHEIMER
SUITE F
HOUSTON, TX 77036

FOR: MEDICAL CLINICS, IN CLASS 44 (U.S. CLS.
100 AND 101).

FIRST USE 11-3-2006; IN COMMERCE 11-3-2006.

NO CLAIM IS MADE TO THE EXCLUSIVE
RIGHT TO USE "LASER" AND "COSMETICS"
AND "MEDSPA", APART FROM THE MARK AS
SHOWN.

THE COLOR(S) LIGHT GREEN, WHITE, GREEN
AND BLACK IS/ARE CLAIMED AS A FEATURE OF
THE MARK.

THE COLOR LIGHT GREEN APPEARS IN THE
CIRCLE. THE COLOR WHITE APPEARS IN THE
LETTER "I" WITHIN THE CIRCLE. THE COLOR
GREEN APPEARS IN THE WORDING "IMPRES-
SIONS" SUPERIMPOSED OVER THE CIRCLE AND
LETTER "I". THE COLOR BLACK APPEARS IN THE
WORDING "LASER", "COSMETICS", AND "MED-
SPA" AND THE TWO VERTICAL LINES IN BE-
TWEEN THE WORDING "LASER" AND
"COSMETICS" AND "COSMETICS" AND "MED-
SPA".

SN 78-963,398, FILED 8-29-2006.

LEE-ANNE BERNS, EXAMINING ATTORNEY

Int. Cl.: 7

Prior U.S. Cls.: 13, 19, 21, 23, 31, 34, and 35

United States Patent and Trademark Office

Reg. No. 3,400,155

Registered Mar. 18, 2008

**TRADEMARK
PRINCIPAL REGISTER**

Xeno-Quadro



SEJINIGB CO., LTD. (REPUBLIC OF KOREA CORPORATION)
BLOCK 301-101, PUCHON TECHNO PARK, #365
SAMJEONG-DONG, OJEONG-GU, PUCHON-CITY
KYUNGGI-DO, REPUBLIC OF KOREA

FOR: GEAR BOXES FOR MACHINES; TRANSMISSION GEARS FOR MACHINES; INDUSTRIAL ROBOTS, IN CLASS 7 (U.S. CLS. 13, 19, 21, 23, 31, 34 AND 35).

FIRST USE 10-18-2007; IN COMMERCE 10-18-2007.

THE MARK CONSISTS IN PART OF A STYLIZED GEAR AND CIRCLE DESIGN.

SN 78-963,571, FILED 8-30-2006.

FRED MANDIR, EXAMINING ATTORNEY

Int. Cl.: 35

Prior U.S. Cls.: 100, 101, and 102

United States Patent and Trademark Office

Reg. No. 3,400,156

Registered Mar. 18, 2008

**SERVICE MARK
PRINCIPAL REGISTER**

ARXANALYSIS

ARXCEL, INC. (NEW YORK CORPORATION)
6400 SHERIDAN DRIVE, SUITE 206
WILLIAMSVILLE, NY 14221

FIRST USE 8-31-2006; IN COMMERCE 8-31-2006.

FOR: BUSINESS SERVICES; NAMELY, ADVISING OTHERS WITH RESPECT TO THE DESIGN, DEVELOPMENT, ACQUISITION AND ANALYSIS OF MANAGED HEALTH CARE AND PRESCRIPTION DRUG BENEFIT PLANS, IN CLASS 35 (U.S. CLS. 100, 101 AND 102).

THE MARK CONSISTS OF STANDARD CHARACTERS WITHOUT CLAIM TO ANY PARTICULAR FONT, STYLE, SIZE, OR COLOR.

SN 78-963,838, FILED 8-30-2006.

GENE MACIOL, EXAMINING ATTORNEY

Int. Cl.: 35

Prior U.S. Cls.: 100, 101, and 102

United States Patent and Trademark Office

Reg. No. 3,400,157

Registered Mar. 18, 2008

**SERVICE MARK
PRINCIPAL REGISTER**

GUIDEPOINT GLOBAL

GUIDEPOINT GLOBAL, LLC (NEW YORK LTD
LIAB CO)
444 MADISON AVENUE
26TH FLOOR
NEW YORK, NY 10022

FOR: INFORMATION IN BUSINESS MATTERS
AND BUSINESS CONSULTING AND INFORMA-
TION SERVICES, IN CLASS 35 (U.S. CLS. 100, 101
AND 102).

FIRST USE 11-27-2007; IN COMMERCE 11-27-2007.

THE MARK CONSISTS OF STANDARD CHAR-
ACTERS WITHOUT CLAIM TO ANY PARTICULAR
FONT, STYLE, SIZE, OR COLOR.

NO CLAIM IS MADE TO THE EXCLUSIVE
RIGHT TO USE "GLOBAL", APART FROM THE
MARK AS SHOWN.

SN 78-963,859, FILED 8-30-2006.

WILLIAM VERHOSEK, EXAMINING ATTORNEY

Int. Cl.: 6

Prior U.S. Cls.: 2, 12, 13, 14, 23, 25, and 50

Reg. No. 3,400,158

United States Patent and Trademark Office

Registered Mar. 18, 2008

**TRADEMARK
PRINCIPAL REGISTER**

The logo for "Isotube" features the word "Isotube" in a bold, sans-serif font. Above the letters "I", "s", and "o" is a thick, black horizontal bar that spans the width of these three letters. The bar has a slightly textured or metallic appearance, with small vertical lines at its ends. The "I" and "s" are connected to the bar, while the "o" is positioned below it. The "T" and "u" are also connected to the bar, and the "b" and "e" are positioned below it.

ISOTECH LABORATORIES, INC. (ILLINOIS
CORPORATION)
1308 PARKLAND COURT
CHAMPAIGN, IL 61820

FIRST USE 6-30-2000; IN COMMERCE 6-30-2000.

OWNER OF U.S. REG. NO. 2,838,483.

FOR: METAL CONTAINERS FOR THE HAR-
VESTING AND TRANSPORTATION OF GASEOUS
OR LIQUID SAMPLES FOR TESTING, IN CLASS 6
(U.S. CLS. 2, 12, 13, 14, 23, 25 AND 50).

SN 78-963,863, FILED 8-30-2006.

WILLIAM VERHOSEK, EXAMINING ATTORNEY

Int. Cls.: 39 and 43

Prior U.S. Cls.: 100, 101, and 105

United States Patent and Trademark Office

Reg. No. 3,400,159

Registered Mar. 18, 2008

**SERVICE MARK
PRINCIPAL REGISTER**



TOPPER'S PIZZA, INC. (ILLINOIS CORPORATION)
261 SOUTH 4TH STREET
WHITEWATER, WI 53190

FOR: PIZZA DELIVERY SERVICES, IN CLASS 39
(U.S. CLS. 100 AND 105).

FIRST USE 8-31-2006, THE MARK WAS FIRST
USED ANYWHERE IN A DIFFERENT FORM
OTHER THAN THAT SOUGHT TO BE
REGISTERED ON 04/00/1993.; IN COMMERCE
8-31-2006, 04/00/1993..

FOR: RESTAURANT SERVICES, IN CLASS 43
(U.S. CLS. 100 AND 101).

FIRST USE 8-31-2006, THE MARK WAS FIRST
USED ANYWHERE IN A DIFFERENT FORM

OTHER THAN THAT SOUGHT TO BE
REGISTERED ON 04/00/1993.; IN COMMERCE
8-31-2006, 04/00/1993..

OWNER OF U.S. REG. NOS. 2,716,892, 3,055,127,
AND OTHERS.

NO CLAIM IS MADE TO THE EXCLUSIVE
RIGHT TO USE "PIZZA", APART FROM THE
MARK AS SHOWN.

THE MARK CONSISTS OF THE WORDS "TOP-
PERS PIZZA" ON A GEOMETRIC DESIGN WITH A
CROWN ABOVE, ALL WITH A DROP SHADOW.

SN 78-963,992, FILED 8-30-2006.

ALEX KEAM, EXAMINING ATTORNEY

Int. Cls.: 1 and 17

Prior U.S. Cls.: 1, 5, 6, 10, 12, 13, 26, 35, 46, and 50

United States Patent and Trademark Office

Reg. No. 3,400,160

Registered Mar. 18, 2008

**TRADEMARK
PRINCIPAL REGISTER**

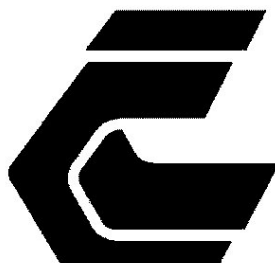

CALP CORPORATION (JAPAN CORPORATION)
1-277, KANDA-IZUMICHO, CHIYODA-KU
TOKYO, JAPAN

FOR: UNPROCESSED PLASTICS IN ALL FORMS,
IN CLASS 1 (U.S. CLS. 1, 5, 6, 10, 26 AND 46).

FIRST USE 5-26-1979; IN COMMERCE 4-13-2005.

FOR: PLASTICS IN THE FORM OF PELLETS AND
SHEETS FOR USE IN MANUFACTURING; SEMI-
PROCESSED PLASTICS IN THE FORM OF PELLETS

OR SHEETS, IN CLASS 17 (U.S. CLS. 1, 5, 12, 13, 35
AND 50).

FIRST USE 5-26-1979; IN COMMERCE 4-13-2005.

OWNER OF JAPAN REG. NO. 1731320, DATED 11-
27-1984, EXPIRES 11-27-2014.

SN 78-964,109, FILED 8-30-2006.

BARNEY CHARLON, EXAMINING ATTORNEY

Int. Cl.: 9

Prior U.S. Cls.: 21, 23, 26, 36, and 38

Reg. No. 3,400,161

United States Patent and Trademark Office

Registered Mar. 18, 2008

**TRADEMARK
PRINCIPAL REGISTER**



KIOSK INFORMATION SYSTEMS, INC. (COLOR-
ADO CORPORATION)
346 SOUTH ARTHUR AVENUE
LOUISVILLE, CO 80027

FOR: INTERACTIVE COMPUTER SYSTEMS
COMPRISED OF SELF-SERVICE TERMINALS
AND GAMING STATIONS, FEATURING INPUT
DEVICES, NAMELY, CREDIT CARD READERS,
CLUB CARD READERS, BILL ACCEPTORS, COIN
ACCEPTORS, BILL AND COIN RECYCLERS, KEY-
BOARD INPUT, BAR CODE SCANNER, PAYMENT
ENGINE AND RELATED SOFTWARE FOR A VARI-
ETY OF PAYMENT METHODS INCLUDING CASH,
CREDIT, DEBIT, VOUCHER OR PREPAID AC-
COUNTS FOR VARIOUS APPLICATIONS, NAME-
LY, VIDEO DOWNLOAD AND PRE-VIEWING,
MUSIC DOWNLOAD AND PREVIEWING, ONLINE

AMUSEMENT GAMING, INTERNET ACCESS,
EMAIL, VIDEO EMAIL, DIGITAL PHOTO PROCES-
SING, CELL PHONE RING TONE AND OTHER
CONTENT DELIVERY, NAMELY, GAMES, AUDIO
BOOKS, MOVIES, VIDEOS, AND TELEVISION
SHOWS, VOICE OVER INTERNET PROTOCOL
USAGE (VOIP), BILL PAYMENT, ON-LINE SHOP-
PING, MOVIE RENTAL AND VIEWING, TV REN-
TAL AND VIEWING AND OTHER ONLINE OR
INTERNET APPLICATIONS, NAMELY PC GAMES,
IN CLASS 9 (U.S. CLS. 21, 23, 26, 36 AND 38).

FIRST USE 12-18-2006; IN COMMERCE 12-18-2006.

SN 78-964,183, FILED 8-30-2006.

TASNEEM HUSSAIN, EXAMINING ATTORNEY

Int. Cl.: 41

Prior U.S. Cls.: 100, 101, and 107

United States Patent and Trademark Office

Reg. No. 3,400,162

Registered Mar. 18, 2008

**SERVICE MARK
PRINCIPAL REGISTER**

TAKE A MEETING

FINAL DRAFT, INC. (CALIFORNIA CORPORATION)
26707 W. AGOURA ROAD
CALABASAS, CA 91302

FOR: ORGANIZING AND CONDUCTING SEMINARS, CONFERENCES AND EXPOSITIONS IN THE FIELD OF ENTERTAINMENT, NAMELY, SCRIPT-WRITING, SCRIPT DEVELOPMENT, AND SCRIPT-WRITING CAREER ADVICE , IN CLASS 41 (U.S. CLS. 100, 101 AND 107).

FIRST USE 1-1-2006; IN COMMERCE 1-1-2006.

THE MARK CONSISTS OF STANDARD CHARACTERS WITHOUT CLAIM TO ANY PARTICULAR FONT, STYLE, SIZE, OR COLOR.

SN 78-964,346, FILED 8-30-2006.

MATTHEW PAPPAS, EXAMINING ATTORNEY

Int. Cl.: 29

Prior U.S. Cl.: 46

United States Patent and Trademark Office

Reg. No. 3,400,163

Registered Mar. 18, 2008

**TRADEMARK
PRINCIPAL REGISTER**

LOTSA' NOODLES

THF EQUITIES, LP (DELAWARE LIMITED
PARTNERSHIP)

SUITE 1070

TWO WESTBROOK CORPORATE CENTER

WESTCHESTER, IL 60154

FOR: SOUP, IN CLASS 29 (U.S. CL. 46).

FIRST USE 3-31-2007; IN COMMERCE 3-31-2007.

THE MARK CONSISTS OF STANDARD CHAR-
ACTERS WITHOUT CLAIM TO ANY PARTICULAR
FONT, STYLE, SIZE, OR COLOR.

NO CLAIM IS MADE TO THE EXCLUSIVE
RIGHT TO USE "NOODLES", APART FROM THE
MARK AS SHOWN.

SN 78-964,629, FILED 8-31-2006.

ARETHA SOMERVILLE, EXAMINING ATTORNEY

Int. Cl.: 30

Prior U.S. Cl.: 46

United States Patent and Trademark Office

Reg. No. 3,400,164

Registered Mar. 18, 2008

**TRADEMARK
PRINCIPAL REGISTER**

MARBLE MIX'INS

SIGNATURE BRANDS LLC (DELAWARE LTD
LIAB CO)
808 SW 12TH STREET
OCALA, FL 344780279

FOR: CANDY, CANDY PIECES, DOUGH, BATTERS, CHOCOLATE CHIPS AND CONFECTIONARY, ALL AS ADD-INS FOR FROZEN DESERTS, IN CLASS 30 (U.S. CL. 46).

FIRST USE 4-0-2006; IN COMMERCE 4-0-2006.

THE MARK CONSISTS OF STANDARD CHARACTERS WITHOUT CLAIM TO ANY PARTICULAR FONT, STYLE, SIZE, OR COLOR.

NO CLAIM IS MADE TO THE EXCLUSIVE RIGHT TO USE "MIX'INS", APART FROM THE MARK AS SHOWN.

SN 78-964,764, FILED 8-31-2006.

RON FAIRBANKS, EXAMINING ATTORNEY

Int. Cl.: 32

Prior U.S. Cls.: 45, 46, and 48

United States Patent and Trademark Office

Reg. No. 3,400,165

Registered Mar. 18, 2008

**TRADEMARK
PRINCIPAL REGISTER**

MEIJER FRUIT COOLERS

MEIJER, INC. (MICHIGAN CORPORATION)
2929 WALKER AVE., N.W.
GRAND RAPIDS, MI 49544

OWNER OF U.S. REG. NOS. 1,192,121, 1,333,646,
AND 2,261,210.

FOR: FRUIT JUICES; FRUIT-FLAVORED
DRINKS, IN CLASS 32 (U.S. CLS. 45, 46 AND 48).

NO CLAIM IS MADE TO THE EXCLUSIVE
RIGHT TO USE "FRUIT COOLERS", APART FROM
THE MARK AS SHOWN.

FIRST USE 5-12-2007; IN COMMERCE 5-12-2007.

SN 78-965,118, FILED 8-31-2006.

THE MARK CONSISTS OF STANDARD CHAR-
ACTERS WITHOUT CLAIM TO ANY PARTICULAR
FONT, STYLE, SIZE, OR COLOR.

COLLEEN DOMBROW, EXAMINING ATTORNEY

Int. Cl.: 9

Prior U.S. Cls.: 21, 23, 26, 36, and 38

United States Patent and Trademark Office

Reg. No. 3,400,166

Registered Mar. 18, 2008

**TRADEMARK
PRINCIPAL REGISTER**

DoorPass

ADVANCED BIOMETRIC SOLUTIONS, INC.
(NEW YORK CORPORATION)
110 WALL STREET SUITE 7-5
NEW YORK, NY 10005

THE MARK CONSISTS OF STANDARD CHARACTERS WITHOUT CLAIM TO ANY PARTICULAR FONT, STYLE, SIZE, OR COLOR.

FOR: SOFTWARE FOR HUMAN RESOURCES MANAGEMENT WITH AN INTEGRATED BIOMETRIC IDENTITY VERIFICATION SECURITY SYSTEM, IN CLASS 9 (U.S. CLS. 21, 23, 26, 36 AND 38).

SN 78-965,222, FILED 8-31-2006.

FIRST USE 10-1-2007; IN COMMERCE 10-1-2007.

THOMAS MANOR, EXAMINING ATTORNEY

Int. Cl.: 31

Prior U.S. Cls.: 1 and 46

United States Patent and Trademark Office

Reg. No. 3,400,167

Registered Mar. 18, 2008

**TRADEMARK
PRINCIPAL REGISTER**



LA HIGUERA S.A. (CHILE CORPORATION)
SANTA MARIA
JAHUEL S/N
SAN FELIPE, CHILE

FOR: FRESH FRUIT, EXCLUDING FIGS, IN
CLASS 31 (U.S. CLS. 1 AND 46).

FIRST USE 6-0-2007; IN COMMERCE 6-0-2007.

PRIORITY CLAIMED UNDER SEC. 44(D) ON
CHILE APPLICATION NO. 738.677, FILED 8-2-2006.

THE FOREIGN WORDING IN THE MARK
TRANSLATES INTO ENGLISH AS THE FIG TREE.

SN 78-965,283, FILED 8-31-2006.

KEVIN DINALLO, EXAMINING ATTORNEY

Int. Cl.: 16

Prior U.S. Cls.: 2, 5, 22, 23, 29, 37, 38, and 50

United States Patent and Trademark Office

Reg. No. 3,400,168

Registered Mar. 18, 2008

**TRADEMARK
PRINCIPAL REGISTER**

Marriage University

CRAIG ANTHONY POLSTON (VIRGINIA SOLE PROPRIETORSHIP)
6910 CEDAR CREST DRIVE
FREDERICKSBURG, VA 22407

FOR: BOOKLETS IN THE FIELD OF MARRIAGE AND FAMILY ENRICHMENT; BOOKS IN THE FIELD OF MARRIAGE AND FAMILY ENRICHMENT; EDUCATIONAL BOOKS FEATURING LESSONS ON MARRIAGE AND FAMILY ENRICHMENT; GUIDE BOOKS FEATURING LESSONS ON MARRIAGE AND FAMILY ENRICHMENT; PRINTED GUIDES FOR LESSONS ON MARRIAGE AND FAMILY ENRICHMENT; PRINTED PRODUCTS, NAMELY, PRODUCT GUIDES FEATURING LESSONS ON MARRIAGE AND FAMILY ENRICHMENT; PRINTED TEACHING ACTIVITY GUIDES IN THE FIELD OF LESSONS ON MARRIAGE AND FAMILY ENRICHMENT; PUBLICATIONS, NAMELY, BROCHURES, BOOKLETS,

AND TEACHING MATERIALS IN THE FIELD OF LESSONS ON MARRIAGE AND FAMILY ENRICHMENT; RELIGIOUS BOOKS; STUDY GUIDES, IN CLASS 16 (U.S. CLS. 2, 5, 22, 23, 29, 37, 38 AND 50).

FIRST USE 10-12-2007; IN COMMERCE 10-15-2007.

THE MARK CONSISTS OF STANDARD CHARACTERS WITHOUT CLAIM TO ANY PARTICULAR FONT, STYLE, SIZE, OR COLOR.

NO CLAIM IS MADE TO THE EXCLUSIVE RIGHT TO USE "MARRIAGE", APART FROM THE MARK AS SHOWN.

SN 78-965,528, FILED 8-31-2006.

ROBERT STRUCK, EXAMINING ATTORNEY

Int. Cl.: 33

Prior U.S. Cls.: 47 and 49

United States Patent and Trademark Office

Reg. No. 3,400,169

Registered Mar. 18, 2008

**TRADEMARK
PRINCIPAL REGISTER**

BEDARRA VINEYARDS

HARRIS, JEFFREY P. (UNITED STATES INDIVIDUAL)
440 W. NORTH STREET
HEALDSBURG, CA 95448

NO CLAIM IS MADE TO THE EXCLUSIVE RIGHT TO USE "VINEYARDS", APART FROM THE MARK AS SHOWN.

FOR: WINES, IN CLASS 33 (U.S. CLS. 47 AND 49).

FIRST USE 10-13-2007; IN COMMERCE 10-24-2007.

SN 78-965,570, FILED 8-31-2006.

THE MARK CONSISTS OF STANDARD CHARACTERS WITHOUT CLAIM TO ANY PARTICULAR FONT, STYLE, SIZE, OR COLOR.

IRA J. GOODSID, EXAMINING ATTORNEY

Int. Cls.: 25 and 26

Prior U.S. Cls.: 22, 37, 39, 40, 42, and 50

United States Patent and Trademark Office

Reg. No. 3,400,170

Registered Mar. 18, 2008

**TRADEMARK
PRINCIPAL REGISTER**

GONGSHOW

1514890 ONTARIO INC. (CANADA CORPORATION), DBA GONGSHOW GEAR,
1979 BLAKENEY ROAD
PAKENHAM, ONTARIO, CANADA K0A 2X0

FOR: CLOTHING, NAMELY, HATS, SHIRTS,
PANTS, SHOES AND JACKETS, IN CLASS 25 (U.S.
CLS. 22 AND 39).

FIRST USE 10-1-2005; IN COMMERCE 10-1-2006.

FOR: BELT BUCKLES, IN CLASS 26 (U.S. CLS. 37,
39, 40, 42 AND 50).

FIRST USE 10-1-2005; IN COMMERCE 10-1-2006.

THE MARK CONSISTS OF STANDARD CHARACTERS WITHOUT CLAIM TO ANY PARTICULAR FONT, STYLE, SIZE, OR COLOR.

OWNER OF U.S. REG. NO. 3,101,236.

SN 78-965,747, FILED 9-1-2006.

JOHN WILKE, EXAMINING ATTORNEY

Int. Cl.: 9

Prior U.S. Cls.: 21, 23, 26, 36, and 38

United States Patent and Trademark Office

Reg. No. 3,400,171

Registered Mar. 18, 2008

**TRADEMARK
PRINCIPAL REGISTER**

VIVA VISION TV

VIVA VISION, INC. (CALIFORNIA CORPORATION)
SUITE 307
10171 PACIFIC MESA BLVD.
SAN DIEGO, CA 92121

FOR: COMPUTER SOFTWARE AND HARDWARE FOR USE IN DELIVERING LIVE STREAMING VIDEO OVER A COMPUTER NETWORK SERVER FOR A GLOBAL INFORMATION NETWORK, OR THROUGH OTHER VIDEO TRANSMISSION VEHICLES, NAMELY, WIRELESS DEVICES, IN CLASS 9 (U.S. CLS. 21, 23, 26, 36 AND 38).

FIRST USE 11-14-2006; IN COMMERCE 11-14-2006.

THE MARK CONSISTS OF STANDARD CHARACTERS WITHOUT CLAIM TO ANY PARTICULAR FONT, STYLE, SIZE, OR COLOR.

NO CLAIM IS MADE TO THE EXCLUSIVE RIGHT TO USE "TV", APART FROM THE MARK AS SHOWN.

SN 78-965,969, FILED 9-1-2006.

DAVID H. STINE, EXAMINING ATTORNEY

Int. Cl.: 21

Prior U.S. Cls.: 2, 13, 23, 29, 30, 33, 40, and 50

United States Patent and Trademark Office

Reg. No. 3,400,172

Registered Mar. 18, 2008

**TRADEMARK
PRINCIPAL REGISTER**

REVOSPAA

CNI USA CORP, INC. (NEVADA CORPORATION)
7469 W. LAKE MEAD BLVD
LAS VEGAS, NV 89128

FOR: BATH BRUSHES; BATH PRODUCTS,
NAMELY, LOOFAH SPONGES; COSMETIC BRU-
SHES; EXFOLIATING PADS; POWER-OPERATED
BRUSH USED TO CLEAN AND EXFOLIATE THE
SKIN; SCRUBBING BRUSHES; SPONGE MASSA-
GERS, IN CLASS 21 (U.S. CLS. 2, 13, 23, 29, 30, 33, 40
AND 50).

FIRST USE 10-15-2007; IN COMMERCE 12-17-2007.

THE COLOR(S) BLUE IS/ARE CLAIMED AS A
FEATURE OF THE MARK.

THE ENTIRE MARK APPEARS IN THE COLOR
BLUE.

THE MARK CONSISTS OF STYLIZED LETTERS
WITH THE LETTER "O" SIMULATING A REVOL-
VING ACTION.

SN 78-966,867, FILED 9-5-2006.

MIDGE BUTLER, EXAMINING ATTORNEY

Int. Cl.: 9

Prior U.S. Cls.: 21, 23, 26, 36, and 38

United States Patent and Trademark Office

Reg. No. 3,400,173

Registered Mar. 18, 2008

**TRADEMARK
PRINCIPAL REGISTER**

SIMTEMPLATE

MSC.SOFTWARE CORPORATION (DELAWARE
CORPORATION)
2 MACARTHUR PLACE
SANTA ANA, CA 92707

FOR: FEATURE OF COMPUTER SOFTWARE,
NAMELY, ENTERPRISE SIMULATION PROCESS
AUTOMATION TEMPLATES FOR ENGINEERING
ANALYSIS, IN CLASS 9 (U.S. CLS. 21, 23, 26, 36 AND
38).

FIRST USE 9-28-2006; IN COMMERCE 9-28-2006.

THE MARK CONSISTS OF STANDARD CHAR-
ACTERS WITHOUT CLAIM TO ANY PARTICULAR
FONT, STYLE, SIZE, OR COLOR.

OWNER OF U.S. REG. NO. 3,030,400.

SN 78-966,904, FILED 9-5-2006.

JENNIFER VASQUEZ, EXAMINING ATTORNEY

Int. Cl.: 20

Prior U.S. Cls.: 2, 13, 22, 25, 32, and 50

Reg. No. 3,400,174

United States Patent and Trademark Office

Registered Mar. 18, 2008

**TRADEMARK
PRINCIPAL REGISTER**

MIGHTYMATE

BOSSMATE, LLC (TENNESSEE LTD LIAB CO)
118 PARMENAS LANE
CHATTANOOGA, TN 37405

THE MARK CONSISTS OF STANDARD CHAR-
ACTERS WITHOUT CLAIM TO ANY PARTICULAR
FONT, STYLE, SIZE, OR COLOR.

FOR: WORK SURFACES, IN CLASS 20 (U.S. CLS.
2, 13, 22, 25, 32 AND 50).

SN 78-967,180, FILED 9-5-2006.

FIRST USE 9-25-2006; IN COMMERCE 9-25-2006.

CYNTHIA SLOAN, EXAMINING ATTORNEY

Int. Cl.: 35

Prior U.S. Cls.: 100, 101, and 102

United States Patent and Trademark Office

Reg. No. 3,400,175

Registered Mar. 18, 2008

**SERVICE MARK
PRINCIPAL REGISTER**

VENDORCONNECTION

SERVINGSCHOOLS.COM (MAINE CORPORATION)
245 COMMERCIAL STREET PO BOX 9781
PORTLAND, ME 041045081

FOR: PROVIDING ONLINE DIRECTORIES OF PRODUCTS AND SERVICES BY BUSINESSES THAT FOCUS ON SCHOOLS AND PROVIDING LINKS TO THESE WEBSITES , IN CLASS 35 (U.S. CLS. 100, 101 AND 102).

FIRST USE 9-1-2006; IN COMMERCE 9-1-2006.

THE MARK CONSISTS OF STANDARD CHARACTERS WITHOUT CLAIM TO ANY PARTICULAR FONT, STYLE, SIZE, OR COLOR.

SN 78-967,269, FILED 9-5-2006.

MARGERY A. TIERNEY, EXAMINING ATTORNEY

Int. Cl.: 1

Prior U.S. Cls.: 1, 5, 6, 10, 26, and 46

United States Patent and Trademark Office

Reg. No. 3,400,176

Registered Mar. 18, 2008

**TRADEMARK
PRINCIPAL REGISTER**

AMERIFILL

AMERITYRE (NEVADA CORPORATION)
1501 INDUSTRIAL ROAD
BOULDER CITY, NV 89005

THE MARK CONSISTS OF STANDARD CHAR-
ACTERS WITHOUT CLAIM TO ANY PARTICULAR
FONT, STYLE, SIZE, OR COLOR.

FOR: CHEMICAL COMPOUNDS FOR USE AS A
TIRE FILL TO FILL THE VOID IN A PNEUMATIC
TIRE, IN CLASS 1 (U.S. CLS. 1, 5, 6, 10, 26 AND 46).

SN 78-967,270, FILED 9-5-2006.

FIRST USE 1-3-2008; IN COMMERCE 1-3-2008.

MARGERY A. TIERNEY, EXAMINING ATTORNEY

Int. Cl.: 6

Prior U.S. Cls.: 2, 12, 13, 14, 23, 25, and 50

United States Patent and Trademark Office

Reg. No. 3,400,177

Registered Mar. 18, 2008

**TRADEMARK
PRINCIPAL REGISTER**

BETTA TREASURES COLLECTION

CREATIVE DESIGN GROUP (FLORIDA CORPORATION)
3201 SOUTHWEST, 15TH STREET
DEERFIELD, FL 33442

FOR: SCULPTURES MADE OF NON-PRECIOUS METALS, IN CLASS 6 (U.S. CLS. 2, 12, 13, 14, 23, 25 AND 50).

FIRST USE 2-0-2007; IN COMMERCE 2-0-2007.

THE MARK CONSISTS OF STANDARD CHARACTERS WITHOUT CLAIM TO ANY PARTICULAR FONT, STYLE, SIZE, OR COLOR.

NO CLAIM IS MADE TO THE EXCLUSIVE RIGHT TO USE "BETTA" AND "COLLECTION", APART FROM THE MARK AS SHOWN.

SN 78-968,259, FILED 9-6-2006.

JULIE WATSON, EXAMINING ATTORNEY

Int. Cl.: 9

Prior U.S. Cls.: 21, 23, 26, 36, and 38

Reg. No. 3,400,178

United States Patent and Trademark Office

Registered Mar. 18, 2008

**TRADEMARK
PRINCIPAL REGISTER**

NOPEC

NOPEC, INC. (CALIFORNIA CORPORATION)
655 S RAYMOND AVENUE
PASADENA, CA 91105

FIRST USE 9-14-2006; IN COMMERCE 10-16-2006.

FOR: APPARATUS FOR CONVERTING ELECTRONIC RADIATION TO ELECTRICAL ENERGY, NAMELY, PHOTOVOLTAIC ROOFING MEMBERS; APPARATUS FOR CONVERTING ELECTRONIC RADIATION TO ELECTRICAL ENERGY, NAMELY, PHOTOVOLTAIC SOLAR MODULES, IN CLASS 9 (U.S. CLS. 21, 23, 26, 36 AND 38).

THE MARK CONSISTS OF STANDARD CHARACTERS WITHOUT CLAIM TO ANY PARTICULAR FONT, STYLE, SIZE, OR COLOR.

SN 78-968,332, FILED 9-6-2006.

SUSAN LESLIE DUBOIS, EXAMINING ATTORNEY

Int. Cl.: 35

Prior U.S. Cls.: 100, 101, and 102

United States Patent and Trademark Office

Reg. No. 3,400,179

Registered Mar. 18, 2008

**SERVICE MARK
PRINCIPAL REGISTER**

EXPERIENCE THE FOOD

THE FRESH MARKET, INC. (NORTH CAROLINA CORPORATION)
628 GREEN VALLEY ROAD, SUITE 500
GREENSBORO, NC 27408

THE MARK CONSISTS OF STANDARD CHARACTERS WITHOUT CLAIM TO ANY PARTICULAR FONT, STYLE, SIZE, OR COLOR.

FOR: RETAIL GROCERY STORE SERVICES, IN CLASS 35 (U.S. CLS. 100, 101 AND 102).

SN 78-968,399, FILED 9-6-2006.

FIRST USE 12-26-2007; IN COMMERCE 12-26-2007.

BRENDAN REGAN, EXAMINING ATTORNEY

Int. Cl.: 30

Prior U.S. Cl.: 46

United States Patent and Trademark Office

Reg. No. 3,400,180

Registered Mar. 18, 2008

**TRADEMARK
PRINCIPAL REGISTER**

Chocolives

REAS' OLIVE RANCH INC. (ARIZONA CORPORATION)
2055 S COTTONWOOD DR
TEMPE, AZ 85282

THE MARK CONSISTS OF STANDARD CHARACTERS WITHOUT CLAIM TO ANY PARTICULAR FONT, STYLE, SIZE, OR COLOR.

FOR: CONFECTIONERY, NAMELY, CHOCOLATE MOLDED INTO THE SHAPE OF OLIVES AND STUFFED WITH NUTS AND/OR CREAMS, IN CLASS 30 (U.S. CL. 46).

SN 78-968,513, FILED 9-6-2006.

FIRST USE 1-14-2008; IN COMMERCE 1-14-2008.

GINA FINK, EXAMINING ATTORNEY

Int. Cl.: 38

Prior U.S. Cls.: 100, 101, and 104

United States Patent and Trademark Office

Reg. No. 3,400,181

Registered Mar. 18, 2008

**SERVICE MARK
PRINCIPAL REGISTER**

MYPATH TV

NETCHOICETV INC. (DELAWARE CORPORATION)
11870 MILL STREET
PETALUMA, CA 94952

FOR: STREAMING OF VIDEO MATERIAL ON
THE INTERNET, IN CLASS 38 (U.S. CLS. 100, 101
AND 104).

FIRST USE 9-0-2006; IN COMMERCE 9-0-2006.

THE MARK CONSISTS OF STANDARD CHARACTERS WITHOUT CLAIM TO ANY PARTICULAR FONT, STYLE, SIZE, OR COLOR.

NO CLAIM IS MADE TO THE EXCLUSIVE RIGHT TO USE "TV", APART FROM THE MARK AS SHOWN.

SN 78-968,525, FILED 9-6-2006.

WENDY GOODMAN, EXAMINING ATTORNEY

Int. Cl.: 43

Prior U.S. Cls.: 100 and 101

United States Patent and Trademark Office

Reg. No. 3,400,182

Registered Mar. 18, 2008

**SERVICE MARK
PRINCIPAL REGISTER**

VIP WORLD

LIFESTYLE HOLIDAYS VACATION CLUB, INC.
(BR. VIRGIN ISLANDS CORPORATION)
EPS#P-5151; P.O. BOX 02-5261
MIAMI, FL 331025261

THE MARK CONSISTS OF STANDARD CHAR-
ACTERS WITHOUT CLAIM TO ANY PARTICULAR
FONT, STYLE, SIZE, OR COLOR.

FOR: COCKTAIL LOUNGES; RESTAURANT
AND BAR SERVICES; RESTAURANTS, IN CLASS
43 (U.S. CLS. 100 AND 101).

SN 78-968,676, FILED 9-7-2006.

FIRST USE 8-31-2006; IN COMMERCE 8-31-2006.

JIM RINGLE, EXAMINING ATTORNEY

Int. Cl.: 43

Prior U.S. Cls.: 100 and 101

United States Patent and Trademark Office

Reg. No. 3,400,183

Registered Mar. 18, 2008

**SERVICE MARK
PRINCIPAL REGISTER**

**TELL IT ONLY TO YOUR BEST
FRIENDS**

LIFESTYLE HOLIDAYS VACATION CLUB, INC.
(BR.VIRGIN ISLANDS CORPORATION)
EPS#P-5151; P. O. BOX 02-5261
MIAMI, FL 331025261

THE MARK CONSISTS OF STANDARD CHAR-
ACTERS WITHOUT CLAIM TO ANY PARTICULAR
FONT, STYLE, SIZE, OR COLOR.

FOR: COCKTAIL LOUNGES; RESTAURANT
AND BAR SERVICES; RESTAURANTS, IN CLASS
43 (U.S. CLS. 100 AND 101).

SN 78-968,685, FILED 9-7-2006.

FIRST USE 8-31-2006; IN COMMERCE 8-31-2006.

JIM RINGLE, EXAMINING ATTORNEY

Int. Cl.: 25

Prior U.S. Cls.: 22 and 39

United States Patent and Trademark Office

Reg. No. 3,400,184

Registered Mar. 18, 2008

**TRADEMARK
PRINCIPAL REGISTER**

ZERO 2 HERO

DISGUISE, INC. (DELAWARE CORPORATION)
11906 TECH CENTER COURT
POWAY, CA 92064

THE MARK CONSISTS OF STANDARD CHAR-
ACTERS WITHOUT CLAIM TO ANY PARTICULAR
FONT, STYLE, SIZE, OR COLOR.

FOR: HALLOWEEN AND MASQUERADE COS-
TUMES AND MASKS SOLD IN CONNECTION
THEREWITH; HEADWEAR, FOOTWEAR, GLOVES
AND HOSIERY, IN CLASS 25 (U.S. CLS. 22 AND 39).

SN 78-968,965, FILED 9-7-2006.

FIRST USE 9-6-2007; IN COMMERCE 9-6-2007.

BERYL GARDNER, EXAMINING ATTORNEY

Int. Cl.: 41

Prior U.S. Cls.: 100, 101, and 107

United States Patent and Trademark Office

Reg. No. 3,400,185

Registered Mar. 18, 2008

**SERVICE MARK
PRINCIPAL REGISTER**

QUEST MEDED

MEDED RESOURCES, LLC (DELAWARE LTD
LIAB CO)
6031 UNIVERSITY BOULEVARD
ELLCOTT CITY, MD 21043

FOR: PROVIDING CONTINUING MEDICAL
EDUCATION COURSES FOR HEALTHCARE PRO-
FESSIONALS; EDUCATION SERVICES, NAMELY,
CONDUCTING PROGRAMS IN THE FIELD OF
QUALITY IMPROVEMENT IN HEALTHCARE, IN
CLASS 41 (U.S. CLS. 100, 101 AND 107).

FIRST USE 12-7-2006; IN COMMERCE 12-7-2006.

THE MARK CONSISTS OF STANDARD CHAR-
ACTERS WITHOUT CLAIM TO ANY PARTICULAR
FONT, STYLE, SIZE, OR COLOR.

NO CLAIM IS MADE TO THE EXCLUSIVE
RIGHT TO USE "MED ED", APART FROM THE
MARK AS SHOWN.

SN 78-969,909, FILED 9-8-2006.

ADA HAN, EXAMINING ATTORNEY

Int. Cl.: 28

Prior U.S. Cls.: 22, 23, 38, and 50

United States Patent and Trademark Office

Reg. No. 3,400,186

Registered Mar. 18, 2008

**TRADEMARK
PRINCIPAL REGISTER**

CLASSIC

WHAM-O, INC. (DELAWARE CORPORATION)
5903 CHRISTIE AVENUE
EMERYVILLE, CA 94608

THE MARK CONSISTS OF STANDARD CHAR-
ACTERS WITHOUT CLAIM TO ANY PARTICULAR
FONT, STYLE, SIZE, OR COLOR.

FOR: GAMES AND PLAYTHINGS, NAMELY,
TOY FLYING DISCS AND SAUCERS USED IN
SPORT AND RECREATIONAL ACTIVITIES AND
GAMES, IN CLASS 28 (U.S. CLS. 22, 23, 38 AND 50).

SN 78-970,012, FILED 9-8-2006.

FIRST USE 0-0-1998; IN COMMERCE 0-0-1998.

JAMES MACFARLANE, EXAMINING ATTORNEY

Int. Cl.: 5

Prior U.S. Cls.: 6, 18, 44, 46, 51, and 52

United States Patent and Trademark Office

Reg. No. 3,400,187

Registered Mar. 18, 2008

**TRADEMARK
PRINCIPAL REGISTER**

HOODIA FUSION

CROSBY SERVICES, INC. (UTAH CORPORATION)
383 WEST 4020 NORTH
PROVO, UT 84604

FOR: DIETARY AND NUTRITIONAL SUPPLEMENTS; DIETARY AND NUTRITIONAL SUPPLEMENTS FOR SUPPRESSING APPETITE, BURNING FAT, AND BOOSTING ENERGY, IN CLASS 5 (U.S. CLS. 6, 18, 44, 46, 51 AND 52).

FIRST USE 2-28-2007; IN COMMERCE 2-28-2007.

THE MARK CONSISTS OF STANDARD CHARACTERS WITHOUT CLAIM TO ANY PARTICULAR FONT, STYLE, SIZE, OR COLOR.

NO CLAIM IS MADE TO THE EXCLUSIVE RIGHT TO USE "HOODIA", APART FROM THE MARK AS SHOWN.

SN 78-970,386, FILED 9-8-2006.

LINDA POWELL, EXAMINING ATTORNEY

Int. Cl.: 28

Prior U.S. Cls.: 22, 23, 38, and 50

United States Patent and Trademark Office

Reg. No. 3,400,188

Registered Mar. 18, 2008

**TRADEMARK
PRINCIPAL REGISTER**

CORE

SHIMANO INC. (JAPAN CORPORATION)
3-77 OIMATSU-CHO, SAKAI-KU
SAKAI CITY, JAPAN 590-8577

FOR: FISHING REELS; FISHING TACKLE, IN
CLASS 28 (U.S. CLS. 22, 23, 38 AND 50).

FIRST USE 7-11-2007; IN COMMERCE 7-11-2007.

THE MARK CONSISTS OF STANDARD CHAR-
ACTERS WITHOUT CLAIM TO ANY PARTICULAR
FONT, STYLE, SIZE, OR COLOR.

OWNER OF JAPAN REG. NO. 4683753, DATED 6-
20-2003, EXPIRES 6-20-2013.

SN 78-970,591, FILED 9-8-2006.

BILL DAWE, EXAMINING ATTORNEY

Int. Cl.: 20

Prior U.S. Cls.: 2, 13, 22, 25, 32, and 50

United States Patent and Trademark Office

Reg. No. 3,400,189

Registered Mar. 18, 2008

**TRADEMARK
PRINCIPAL REGISTER**

ENCHANTED FAIRY DOORS

DON MECHANICS ENTERPRISES, LTD. (TEXAS
LIMITED PARTNERSHIP)
SUITE 100
4112 BILLY MITCHELL DRIVE
ADDISON, TX 75001

FOR: DECORATIVE MINIATURE ENTRYWAYS
OF POLYRESIN FEATURING VARIOUS STYLES
OF CASINGS, DOORS, TRANSOMS, SIDELIGHTS,
SIDE PANELS AND ENTRANCE STEPS, IN CLASS
20 (U.S. CLS. 2, 13, 22, 25, 32 AND 50).

FIRST USE 3-20-2007; IN COMMERCE 3-20-2007.

THE MARK CONSISTS OF STANDARD CHAR-
ACTERS WITHOUT CLAIM TO ANY PARTICULAR
FONT, STYLE, SIZE, OR COLOR.

NO CLAIM IS MADE TO THE EXCLUSIVE
RIGHT TO USE "DOORS", APART FROM THE
MARK AS SHOWN.

SN 78-970,595, FILED 9-8-2006.

MICHELE SWAIN, EXAMINING ATTORNEY

Int. Cl.: 33

Prior U.S. Cls.: 47 and 49

United States Patent and Trademark Office

Reg. No. 3,400,190

Registered Mar. 18, 2008

**TRADEMARK
PRINCIPAL REGISTER**

CHARTER COUNTRY

SAZERAC COMPANY, INC. (LOUISIANA COR-
PORATION)
803 JEFFERSON HIGHWAY
P.O. BOX 52821
NEW ORLEANS, LA 701522821

FOR: ALCOHOLIC BEVERAGES, NAMELY,
WHISKEY, IN CLASS 33 (U.S. CLS. 47 AND 49).

FIRST USE 9-0-2004; IN COMMERCE 9-0-2004.

THE MARK CONSISTS OF STANDARD CHAR-
ACTERS WITHOUT CLAIM TO ANY PARTICULAR
FONT, STYLE, SIZE, OR COLOR.

OWNER OF U.S. REG. NOS. 1,309,275 AND
1,825,377.

SN 78-970,747, FILED 9-9-2006.

CHARLOTTE CORWIN, EXAMINING ATTORNEY

Int. Cl.: 12

Prior U.S. Cls.: 19, 21, 23, 31, 35, and 44

Reg. No. 3,400,191

United States Patent and Trademark Office

Registered Mar. 18, 2008

**TRADEMARK
PRINCIPAL REGISTER**

INR

REINOSO RODRIGUEZ, CESAR TULIO (CO-
LOMBIA INDIVIDUAL)
CARRERA 27 NO. 65-39
BOGOTÁ, COLOMBIA

THE MARK CONSISTS OF STANDARD CHAR-
ACTERS WITHOUT CLAIM TO ANY PARTICULAR
FONT, STYLE, SIZE, OR COLOR.

FOR: LAND VEHICLES; LAND VEHICLE PARTS,
NAMELY, SUSPENSION BUSHINGS; WHEEL RIMS;
PNEUMATIC TYRES, IN CLASS 12 (U.S. CLS. 19, 21,
23, 31, 35 AND 44).

SN 78-970,837, FILED 9-10-2006.

FIRST USE 12-31-1996; IN COMMERCE 12-31-2004.

KATHERINE CHANG, EXAMINING ATTORNEY

Int. Cl.: 35

Prior U.S. Cls.: 100, 101, and 102

United States Patent and Trademark Office

Reg. No. 3,400,192

Registered Mar. 18, 2008

**SERVICE MARK
PRINCIPAL REGISTER**

STENOMED

JOHN C. JEPPESEN, DMD, INC. (CALIFORNIA
CORPORATION)
SUITE C
178 S. VICTORIA AVE.
VENTURA, CA 93003

THE MARK CONSISTS OF STANDARD CHAR-
ACTERS WITHOUT CLAIM TO ANY PARTICULAR
FONT, STYLE, SIZE, OR COLOR.

FOR: BILLING SERVICES; MEDICAL TRAN-
SCRIPTION SERVICES, IN CLASS 35 (U.S. CLS. 100,
101 AND 102).

SN 78-970,871, FILED 9-10-2006.

FIRST USE 1-16-2008; IN COMMERCE 1-16-2008.

DAWN HAN, EXAMINING ATTORNEY

Int. Cl.: 41

Prior U.S. Cls.: 100, 101, and 107

United States Patent and Trademark Office

Reg. No. 3,400,193

Registered Mar. 18, 2008

**SERVICE MARK
PRINCIPAL REGISTER**

CLINICAL LINE LEARNING

C/HCA, INC. (DELAWARE CORPORATION)
ONE PARK PLAZA
NASHVILLE, TN 37203

FOR: ONLINE EDUCATIONAL INSTRUCTION
IN THE FIELD OF HEALTHCARE; ONLINE
HEALTHCARE TRAINING IN THE FIELD OF
HEALTHCARE, IN CLASS 41 (U.S. CLS. 100, 101
AND 107).

FIRST USE 10-13-2006; IN COMMERCE 10-13-2006.

THE MARK CONSISTS OF STANDARD CHAR-
ACTERS WITHOUT CLAIM TO ANY PARTICULAR
FONT, STYLE, SIZE, OR COLOR.

NO CLAIM IS MADE TO THE EXCLUSIVE
RIGHT TO USE "CLINICAL" AND "LEARNING",
APART FROM THE MARK AS SHOWN.

SN 78-971,036, FILED 9-11-2006.

KELLY BOULTON, EXAMINING ATTORNEY

Int. Cl.: 1

Prior U.S. Cls.: 1, 5, 6, 10, 26, and 46

United States Patent and Trademark Office

Reg. No. 3,400,194

Registered Mar. 18, 2008

**TRADEMARK
PRINCIPAL REGISTER**

ARCTIC SHIELD

LYONDELL CHEMICAL COMPANY (DELA-
WARE CORPORATION)
1221 MCKINNEY, SUITE 700
HOUSTON, TX 77010

FOR: DEICER FLUIDS USED ON AIRCRAFT, IN
CLASS 1 (U.S. CLS. 1, 5, 6, 10, 26 AND 46).

FIRST USE 12-21-2007; IN COMMERCE 12-21-2007.

THE MARK CONSISTS OF STANDARD CHAR-
ACTERS WITHOUT CLAIM TO ANY PARTICULAR
FONT, STYLE, SIZE, OR COLOR.

OWNER OF U.S. REG. NO. 2,973,703.

SN 78-971,090, FILED 9-11-2006.

MICHAEL LITZAU, EXAMINING ATTORNEY

Int. Cl.: 35

Prior U.S. Cls.: 100, 101, and 102

United States Patent and Trademark Office

Reg. No. 3,400,195

Registered Mar. 18, 2008

**SERVICE MARK
PRINCIPAL REGISTER**

VCONTROLLER

VCFO HOLDINGS, INC (DELAWARE CORPORATION)
BUILDING II, SUITE 100
4601 SPICEWOOD SPRINGS RD.
AUSTIN, TX 78759

FOR: BUSINESS MANAGEMENT AND CONSULTATION SERVICES IN THE NATURE OF BUDGETING, FORECASTING AND ACCOUNTING SERVICES, IN CLASS 35 (U.S. CLS. 100, 101 AND 102).

FIRST USE 7-19-2007; IN COMMERCE 7-19-2007.

THE MARK CONSISTS OF STANDARD CHARACTERS WITHOUT CLAIM TO ANY PARTICULAR FONT, STYLE, SIZE, OR COLOR.

SN 78-971,608, FILED 9-11-2006.

NICHOLAS ALTREE, EXAMINING ATTORNEY

Int. Cl.: 3

Prior U.S. Cls.: 1, 4, 6, 50, 51, and 52

United States Patent and Trademark Office

Reg. No. 3,400,196

Registered Mar. 18, 2008

**TRADEMARK
PRINCIPAL REGISTER**

DEPSEA

SMOOTHING

FOUNDATION

L'OREAL (FRANCE SOCIETE ANONYME)
14, RUE ROYALE
PARIS, FRANCE 75008

NO CLAIM IS MADE TO THE EXCLUSIVE
RIGHT TO USE "SMOOTHING" , APART FROM
THE MARK AS SHOWN.

FOR: HAIR STYLING PREPARATIONS, IN
CLASS 3 (U.S. CLS. 1, 4, 6, 50, 51 AND 52).

SN 78-971,665, FILED 9-11-2006.

FIRST USE 8-1-2007; IN COMMERCE 8-1-2007.

SHAUNIA CARLYLE, EXAMINING ATTORNEY

Int. Cl.: 25

Prior U.S. Cls.: 22 and 39

United States Patent and Trademark Office

Reg. No. 3,400,197

Registered Mar. 18, 2008

**TRADEMARK
PRINCIPAL REGISTER**

HIDDEN JEANS

PARK, KENNY J. (UNITED STATES INDIVIDUAL)
1015 CROCKER ST., #Q-20
LOS ANGELES, CA 90021

FOR: BOTTOMS; JACKETS; JEANS; PANTS; SHIRTS; SHORTS; TANK-TOPS; TOPS, IN CLASS 25 (U.S. CLS. 22 AND 39).

FIRST USE 1-15-2008; IN COMMERCE 1-15-2008.

THE MARK CONSISTS OF STANDARD CHARACTERS WITHOUT CLAIM TO ANY PARTICULAR FONT, STYLE, SIZE, OR COLOR.

NO CLAIM IS MADE TO THE EXCLUSIVE RIGHT TO USE "JEANS", APART FROM THE MARK AS SHOWN.

SN 78-972,230, FILED 9-12-2006.

JOHN DWYER, EXAMINING ATTORNEY

Int. Cl.: 3

Prior U.S. Cls.: 1, 4, 6, 50, 51, and 52

United States Patent and Trademark Office

Reg. No. 3,400,198

Registered Mar. 18, 2008

**TRADEMARK
PRINCIPAL REGISTER**

LIZ CLAIBORNE RED SUNSET

L. C. LICENSING, INC. (DELAWARE CORPORATION)
1441 BROADWAY
NEW YORK, NY 10018

OWNER OF U.S. REG. NOS. 2,916,333, 3,089,407,
AND OTHERS.

FOR: PERFUMES, IN CLASS 3 (U.S. CLS. 1, 4, 6, 50,
51 AND 52).

THE NAME "LIZ CLAIBORNE" IDENTIFIES A
LIVING INDIVIDUAL WHOSE CONSENT IS OF
RECORD.

FIRST USE 9-18-2006; IN COMMERCE 9-18-2006.

SN 78-972,509, FILED 9-12-2006.

THE MARK CONSISTS OF STANDARD CHAR-
ACTERS WITHOUT CLAIM TO ANY PARTICULAR
FONT, STYLE, SIZE, OR COLOR.

SETH A. RAPPAPORT, EXAMINING ATTORNEY

Int. Cls.: 10 and 21

Prior U.S. Cls.: 2, 13, 23, 26, 29, 30, 33, 39, 40, 44, and 50

Reg. No. 3,400,199

United States Patent and Trademark Office

Registered Mar. 18, 2008

**TRADEMARK
PRINCIPAL REGISTER**

REJUVAWAND

LIGHT DIMENSIONS, INC. (DELAWARE CORPORATION)
650 HIGH STREET
SUITE 100
PALO ALTO, CA 94301

FOR: LIGHT-ENHANCED PRODUCTS FOR COSMETIC AND THERAPEUTIC USE, NAMELY, LASER AND OTHER LIGHT-ENHANCED DEVICES, NAMELY, LIGHT-EMITTING SKIN-TREATMENT WANDS AND LIGHT-EMITTING HAIRBRUSHES, COMBS AND TOOTHBRUSHES, FOR PERSONAL CARE AND TREATMENT OF SKIN, HAIR, AND TEETH, IN CLASS 10 (U.S. CLS. 26, 39 AND 44).

FIRST USE 2-28-2007; IN COMMERCE 2-28-2007.

FOR: HAND-HELD PRODUCTS FOR SKIN CARE TREATMENT, HAIR CARE AND ORAL CARE,

NAMELY, WRINKLE-REDUCING WANDS, ACNE-TREATMENT WANDS, HAIRBRUSHES, COMBS AND TOOTHBRUSHES; PERSONAL CARE PRODUCTS FOR COSMETIC USE AT HOME, NAMELY, HAIRBRUSHES, COMBS AND TOOTHBRUSHES, IN CLASS 21 (U.S. CLS. 2, 13, 23, 29, 30, 33, 40 AND 50).

FIRST USE 2-28-2007; IN COMMERCE 2-28-2007.

THE MARK CONSISTS OF STANDARD CHARACTERS WITHOUT CLAIM TO ANY PARTICULAR FONT, STYLE, SIZE, OR COLOR.

SN 78-972,932, FILED 9-12-2006.

CIMMERIAN COLEMAN, EXAMINING ATTORNEY

Int. Cl.: 9

Prior U.S. Cls.: 21, 23, 26, 36, and 38

United States Patent and Trademark Office

Reg. No. 3,400,200

Registered Mar. 18, 2008

**TRADEMARK
PRINCIPAL REGISTER**

SPRAYWARE

SPRAYING SYSTEMS CO. (ILLINOIS CORPORATION)
P.O. BOX 7900
WHEATON, IL 60189

FOR: COMPUTER SOFTWARE FOR DETERMINING OPTIMAL SPRAY NOZZLES AND ACCESSORY REQUIREMENTS FOR SPRAY APPLICATIONS AND ALLOWING SUBSEQUENT ORDERING OF THE SELECTED SPRAY NOZZLES AND ACCESSORIES OVER A GLOBAL COMPUTER NETWORK, IN CLASS 9 (U.S. CLS. 21, 23, 26, 36 AND 38).

FIRST USE 1-1-2007; IN COMMERCE 7-26-2007.

THE MARK CONSISTS OF STANDARD CHARACTERS WITHOUT CLAIM TO ANY PARTICULAR FONT, STYLE, SIZE, OR COLOR.

SN 78-973,309, FILED 9-13-2006.

MICHAEL ENGEL, EXAMINING ATTORNEY

Int. Cl.: 41

Prior U.S. Cls.: 100, 101, and 107

United States Patent and Trademark Office

Reg. No. 3,400,201

Registered Mar. 18, 2008

**SERVICE MARK
PRINCIPAL REGISTER**

PAYROLL UNIVERSITY

WELLS FARGO & COMPANY (DELAWARE
CORPORATION)
1700 WELLS FARGO CENTER, MAC N9305-176
SIXTH AND MARQUETTE
MINNEAPOLIS, MN 55479

FOR: EDUCATIONAL SERVICES, NAMELY PRO-
VIDING TRAINING AND CLASSES, SEMINARS,
WORKSHOPS, CONFERENCES, AND ONLINE
TRAINING AND CLASSES, SEMINARS, WORK-
SHOPS, CONFERENCES IN THE FIELDS OF BUSI-
NESS PAYROLL SERVICES, IN CLASS 41 (U.S. CLS.
100, 101 AND 107).

FIRST USE 11-10-2006; IN COMMERCE 11-10-2006.

THE MARK CONSISTS OF STANDARD CHAR-
ACTERS WITHOUT CLAIM TO ANY PARTICULAR
FONT, STYLE, SIZE, OR COLOR.

NO CLAIM IS MADE TO THE EXCLUSIVE
RIGHT TO USE "PAYROLL", APART FROM THE
MARK AS SHOWN.

SN 78-973,631, FILED 9-13-2006.

SETH A. RAPPAPORT, EXAMINING ATTORNEY

Int. Cl.: 9

Prior U.S. Cls.: 21, 23, 26, 36, and 38

United States Patent and Trademark Office

Reg. No. 3,400,202

Registered Mar. 18, 2008

**TRADEMARK
PRINCIPAL REGISTER**

Baikal Films

IVB, INC. (CALIFORNIA CORPORATION)
15235 HART STREET
VAN NUYS, CA 914065225

FOR: PRE-RECORDED CD'S, VIDEO TAPES, LASER DISKS AND DVD'S FEATURING DOCUMENTARIES WITH THE SUBJECT MATTER OF YOUTH, NATURIST, HISTORICAL, SOCIAL, CULTURAL, MILITARY, EDUCATIONAL AND SPORT ACTIVITIES MOSTLY IN EASTERN EUROPE, IN CLASS 9 (U.S. CLS. 21, 23, 26, 36 AND 38).

FIRST USE 1-1-2000; IN COMMERCE 1-1-2000.

THE MARK CONSISTS OF STANDARD CHARACTERS WITHOUT CLAIM TO ANY PARTICULAR FONT, STYLE, SIZE, OR COLOR.

NO CLAIM IS MADE TO THE EXCLUSIVE RIGHT TO USE "FILMS", APART FROM THE MARK AS SHOWN.

SEC. 2(F).

SN 78-973,779, FILED 9-13-2006.

SUNG IN, EXAMINING ATTORNEY

Int. Cl.: 41

Prior U.S. Cls.: 100, 101, and 107

United States Patent and Trademark Office

Reg. No. 3,400,203

Registered Mar. 18, 2008

**SERVICE MARK
PRINCIPAL REGISTER**

TRASH OR TREASURE

GALLERY OF THE MASTERS, INC. (MISSOURI
CORPORATION)
9650 CLAYTON RD.
ST. LOUIS, MO 63124

FOR: ENTERTAINMENT SERVICES, NAMELY,
CONDUCTING EXHIBITIONS IN THE FIELD OF
EVALUATING AND APPRAISING ART, AN-
TIQUES, AND OTHER ITEMS OF PERSONAL PROP-
ERTY, IN CLASS 41 (U.S. CLS. 100, 101 AND 107).

FIRST USE 10-14-2006; IN COMMERCE 10-14-2006.

THE MARK CONSISTS OF STANDARD CHAR-
ACTERS WITHOUT CLAIM TO ANY PARTICULAR
FONT, STYLE, SIZE, OR COLOR.

SN 78-974,209, FILED 9-14-2006.

HOWARD SMIGA, EXAMINING ATTORNEY

Int. Cl.: 9

Prior U.S. Cls.: 21, 23, 26, 36, and 38

Reg. No. 3,400,204

United States Patent and Trademark Office

Registered Mar. 18, 2008

**TRADEMARK
PRINCIPAL REGISTER**

LUKE

DIGITAL PAYMENT TECHNOLOGIES CORP.
(CANADA CORPORATION)
4105 GRANDVIEW HIGHWAY
BURNABY, BRITISH COLUMBIA, CANADA V5C
6B4

THE MARK CONSISTS OF STANDARD CHAR-
ACTERS WITHOUT CLAIM TO ANY PARTICULAR
FONT, STYLE, SIZE, OR COLOR.

FOR: ELECTRONIC, AUTOMATED PAYMENT
STATIONS, IN CLASS 9 (U.S. CLS. 21, 23, 26, 36 AND
38).

SN 78-974,252, FILED 9-14-2006.

FIRST USE 12-30-2006; IN COMMERCE 12-30-2006.

KHANH LE, EXAMINING ATTORNEY

Int. Cl.: 16

Prior U.S. Cls.: 2, 5, 22, 23, 29, 37, 38, and 50

Reg. No. 3,400,205

United States Patent and Trademark Office

Registered Mar. 18, 2008

**TRADEMARK
PRINCIPAL REGISTER**

HORIZON

HORIZON CHRISTIAN FELLOWSHIP (CALI-
FORNIA CORPORATION)
5331 MT. ALIFAN DRIVE
SAN DIEGO, CA 92111

FIRST USE 12-31-1978; IN COMMERCE 12-31-1978.

FOR: PUBLICATIONS, NAMELY, BIBLES DIS-
TRIBUTED IN PRINT FORM; PUBLICATIONS,
NAMELY, MAGAZINES, BOOKS AND BOOKLETS
IN THE FIELD OF RELIGION, DISTRIBUTED IN
PRINT FORM; RELIGIOUS BOOKS; AND RELI-
GIOUS CIRCULAR LETTERS, IN CLASS 16 (U.S.
CLS. 2, 5, 22, 23, 29, 37, 38 AND 50).

THE MARK CONSISTS OF STANDARD CHAR-
ACTERS WITHOUT CLAIM TO ANY PARTICULAR
FONT, STYLE, SIZE, OR COLOR.

SN 78-974,856, FILED 9-14-2006.

JOHN DALIER, EXAMINING ATTORNEY

Int. Cl.: 25

Prior U.S. Cls.: 22 and 39

United States Patent and Trademark Office

Reg. No. 3,400,206

Registered Mar. 18, 2008

**TRADEMARK
PRINCIPAL REGISTER**

RED MONKEY

PENDERGRASS, TORRY (UNITED STATES IN-
DIVIDUAL)
7209 SANTA MONICA BLVD
WEST HOLLYWOOD, CA 90046

FOR: CLOTHING, NAMELY, PANTS, VESTS, T-
SHIRTS, SWEATSHIRTS, JEANS, JACKETS; FOOT-
WEAR, NAMELY, THONGS AND FLIP-FLOPS, IN
CLASS 25 (U.S. CLS. 22 AND 39).

FIRST USE 1-31-2002; IN COMMERCE 8-31-2002.

THE MARK CONSISTS OF STANDARD CHAR-
ACTERS WITHOUT CLAIM TO ANY PARTICULAR
FONT, STYLE, SIZE, OR COLOR.

OWNER OF U.S. REG. NOS. 2,634,447, 2,634,448,
AND 2,648,538.

SN 78-977,339, FILED 1-30-2006.

LANA PHAM, EXAMINING ATTORNEY

Int. Cl.: 14

Prior U.S. Cls.: 2, 27, 28, and 50

United States Patent and Trademark Office

Reg. No. 3,400,207

Registered Mar. 18, 2008

**TRADEMARK
PRINCIPAL REGISTER**

CRITTER CRUSADE

GAMBILL, SHANNON (UNITED STATES INDIVIDUAL)
2536 RIDGEWOOD AVENUE
LOUISVILLE, KY 40217

FOR: CHILDREN'S TRINKETS, NAMELY, NECKLACES, BRACELETS AND ANKLE BRACELETS, FOR WEAR AROUND THE NECK, ANKLES AND WRISTS; BELT BUCKLES OF PRECIOUS METAL, IN CLASS 14 (U.S. CLS. 2, 27, 28 AND 50).

FIRST USE 6-24-2005; IN COMMERCE 6-24-2005.

THE MARK CONSISTS OF STANDARD CHARACTERS WITHOUT CLAIM TO ANY PARTICULAR FONT, STYLE, SIZE, OR COLOR.

SN 78-978,712, FILED 11-1-2005.

EDWARD FENNESSY, EXAMINING ATTORNEY

Int. Cls.: 9, 38, and 41

Prior U.S. Cls.: 21, 23, 26, 36, 38, 100, 101, 104, and 107

Reg. No. 3,400,208

United States Patent and Trademark Office

Registered Mar. 18, 2008

**TRADEMARK
SERVICE MARK
PRINCIPAL REGISTER**

here!

PS HERE LLC (TEXAS LTD LIAB CO)
SUITE 650
8411 PRESTON ROAD
DALLAS, TX 752255523

FOR: PRE-RECORDED DVDS IN THE FIELD OF COMEDY, DRAMA, MUSICALS, ROMANCE, EROTICA, MYSTERY, SUSPENSE, HORROR, ACTION, DOCUMENTARY, NEWS, VARIETY TALK SHOWS AND FAMILY, IN CLASS 9 (U.S. CLS. 21, 23, 26, 36 AND 38).

FIRST USE 5-22-2006; IN COMMERCE 5-22-2006.

FOR: CABLE AND SATELLITE TELEVISION BROADCASTING, IN CLASS 38 (U.S. CLS. 100, 101 AND 104).

FIRST USE 8-19-2003; IN COMMERCE 8-19-2003.

FOR: PRODUCTION AND DISTRIBUTION OF MOTION PICTURES, MADE FOR TELEVISION MOVIES, AND TELEVISION SERIES, IN THE FIELD OF COMEDY, DRAMA, MUSICALS, ROMANCE, EROTICA, MYSTERY, SUSPENSE, HORROR, ACTION, DOCUMENTARY, NEWS, VARIETY TALK

SHOWS AND FAMILY; TELEVISION PROGRAMMING; PROVIDING MOTION PICTURES OVER A GLOBAL COMPUTER NETWORK; ENTERTAINMENT IN THE NATURE OF THE DISPLAY OF MOTION PICTURES AND MADE FOR TELEVISION MOVIES, IN THE FIELD OF COMEDY, DRAMA, MUSICALS, ROMANCE, EROTICA, MYSTERY, SUSPENSE, HORROR, ACTION, DOCUMENTARY, NEWS, VARIETY TALK SHOWS AND FAMILY; ENTERTAINMENT IN THE NATURE OF ONGOING TELEVISION PROGRAMS IN THE FIELD OF COMEDY, DRAMA, MUSICALS, ROMANCE, EROTICA, MYSTERY, SUSPENSE, HORROR, ACTION, DOCUMENTARY, NEWS, VARIETY TALK SHOWS AND FAMILY; AND CONDUCTING A FILM FESTIVAL, IN CLASS 41 (U.S. CLS. 100, 101 AND 107).

FIRST USE 2-22-2002; IN COMMERCE 2-22-2002.

THE STIPPLING IS FOR SHADING PURPOSES ONLY.

SN 78-978,922, FILED 12-1-2004.

JIM RINGLE, EXAMINING ATTORNEY

Int. Cl.: 39

Prior U.S. Cls.: 100 and 105

United States Patent and Trademark Office

Reg. No. 3,400,209

Registered Mar. 18, 2008

**SERVICE MARK
PRINCIPAL REGISTER**

ENGINES OF CHANGE

UNION PACIFIC RAILROAD COMPANY (DELA-
WARE CORPORATION)
1400 DOUGLAS STREET
OMAHA, NE 68179

THE MARK CONSISTS OF STANDARD CHAR-
ACTERS WITHOUT CLAIM TO ANY PARTICULAR
FONT, STYLE, SIZE, OR COLOR.

FOR: FREIGHT TRANSPORTATION BY TRAIN,
IN CLASS 39 (U.S. CLS. 100 AND 105).

SN 78-978,974, FILED 9-9-2005.

FIRST USE 1-0-2006; IN COMMERCE 1-0-2006.

PRISCILLA MILTON, EXAMINING ATTORNEY

Int. Cls.: 2 and 19

Prior U.S. Cls.: 1, 6, 11, 12, 16, 33, and 50

United States Patent and Trademark Office

Reg. No. 3,400,210

Registered Mar. 18, 2008

**TRADEMARK
PRINCIPAL REGISTER**

CBP

CUSTOM BUILDING PRODUCTS, INC. (DELAWARE CORPORATION)
13001 SEAL BEACH BOULEVARD
SEAL BEACH, CA 90740

FOR: SEALER COATINGS FOR USE ON CERAMIC TILE, NATURAL STONE FLOORS, CONCRETE, AND MASONRY; FLOOR PROTECTION VARNISHES FOR USE ON CERAMIC TILE, NATURAL STONE FLOORS, CONCRETE, AND MASONRY, IN CLASS 2 (U.S. CLS. 6, 11 AND 16).

FIRST USE 3-15-2006; IN COMMERCE 3-15-2006.

FOR: FLOOR PATCHING MATERIALS, NAMELY, SEALERS FOR CERAMIC TILE, NATURAL

STONE FLOORS, CONCRETE, AND MASONRY, IN CLASS 19 (U.S. CLS. 1, 12, 33 AND 50).

FIRST USE 3-15-2006; IN COMMERCE 3-15-2006.

THE MARK CONSISTS OF STANDARD CHARACTERS WITHOUT CLAIM TO ANY PARTICULAR FONT, STYLE, SIZE, OR COLOR.

SN 78-979,386, FILED 10-27-2005.

ALEXANDER L. POWERS, EXAMINING ATTORNEY

Int. Cls.: 9 and 41

Prior U.S. Cls.: 21, 23, 26, 36, 38, 100, 101, and 107

United States Patent and Trademark Office

Reg. No. 3,400,211

Registered Mar. 18, 2008

**TRADEMARK
SERVICE MARK
PRINCIPAL REGISTER**

HERE!

PS HERE LLC (TEXAS LTD LIAB CO)
SUITE 650
8411 PRESTON ROAD
DALLAS, TX 752255523

FOR: PRE-RECORDED DVDS IN THE FIELD OF COMEDY, DRAMA, MUSICALS, ROMANCE, EROTICA, MYSTERY, SUSPENSE, HORROR, ACTION, DOCUMENTARY, NEWS, VARIETY TALK SHOWS AND FAMILY, IN CLASS 9 (U.S. CLS. 21, 23, 26, 36 AND 38).

FIRST USE 5-22-2006; IN COMMERCE 5-22-2006.

FOR: PRODUCTION AND DISTRIBUTION OF MOTION PICTURES, MADE FOR TELEVISION MOVIES, AND TELEVISION SERIES, IN THE FIELD OF COMEDY, DRAMA, MUSICALS, ROMANCE, EROTICA, MYSTERY, SUSPENSE, HORROR, ACTION, DOCUMENTARY, NEWS, VARIETY TALK SHOWS AND FAMILY; TELEVISION PROGRAMMING; PROVIDING MOTION PICTURES OVER A GLOBAL COMPUTER NETWORK; ENTERTAINMENT IN THE NATURE OF THE DISPLAY OF

MOTION PICTURES AND MADE FOR TELEVISION MOVIES, IN THE FIELD OF COMEDY, DRAMA, MUSICALS, ROMANCE, EROTICA, MYSTERY, SUSPENSE, HORROR, ACTION, DOCUMENTARY, NEWS, VARIETY TALK SHOWS AND FAMILY; ENTERTAINMENT IN THE NATURE OF ONGOING TELEVISION PROGRAMS IN THE FIELD OF COMEDY, DRAMA, MUSICALS, ROMANCE, EROTICA, MYSTERY, SUSPENSE, HORROR, ACTION, DOCUMENTARY, NEWS, VARIETY TALK SHOWS AND FAMILY; AND CONDUCTING A FILM FESTIVAL, IN CLASS 41 (U.S. CLS. 100, 101 AND 107).

FIRST USE 2-22-2002; IN COMMERCE 2-22-2002.

THE MARK CONSISTS OF STANDARD CHARACTERS WITHOUT CLAIM TO ANY PARTICULAR FONT, STYLE, SIZE, OR COLOR.

SN 78-979,387, FILED 9-8-2004.

JIM RINGLE, EXAMINING ATTORNEY

Int. Cl.: 9

Prior U.S. Cls.: 21, 23, 26, 36, and 38

Reg. No. 3,400,212

United States Patent and Trademark Office

Registered Mar. 18, 2008

**TRADEMARK
PRINCIPAL REGISTER**

XFY

JUSTSYSTEMS CORPORATION (JAPAN CORPORATION)

108-4 HIRAISHI-WAKAMATSU, KAWAUCHI-CHO,
TOKUSHIMA-SHI
TOKUSHIMA, JAPAN 771-0189

FOR: BLANK MAGNETIC COMPUTER DISCS AND BLANK OPTICAL DISCS ON WHICH COMPUTER PROGRAMS ARE RECORDED; DOWNLOADABLE ELECTRONIC PUBLICATIONS, NAMELY, MAGAZINE AND MANUAL FEATURING INFORMATION ABOUT COMPUTER SOFTWARE; COMPUTER PROGRAMS, NAMELY, PROGRAMS TO DESIGN, CREATE, EDIT AND PUBLISH XML AND WORD PROCESSING DOCUMENTS; COMPUTER PROGRAMS THAT ASSIST USERS IN DESIGNING, CREATING, EDITING, PUBLISHING AND COMPLETING XML AND WORD PROCESSING DOCUMENTS; COMPUTER PROGRAMS FOR ENHANCING THE CAPABILITIES OF WEB BROWSER SOFTWARE; COMPUTER PROGRAMS FOR DEVELOPING OTHER COMPUTER PROGRAMS; COMPILER PROGRAMS, EDITOR PROGRAMS, DEBUGGER PROGRAMS AND UTILITY PROGRAMS FOR CREATING AND TESTING OTHER COMPUTER PROGRAMS, CREATING INTERNAL NETWORK AND INTERNET APPLICATIONS; COMPUTER PROGRAMS FOR ASSISTING DEVELOPERS IN CREATING PROGRAM CODE FOR USE IN MULTIPLE APPLICATION PROGRAMS; INTERNAL COMPUTER NETWORKS AND THE INTERNET; COMPUTER PROGRAMS FOR RUNNING DEVELOPMENT PROGRAMS AND APPLICATION PROGRAMS; COMPUTER PROGRAMS FOR PROVIDING ACCESS TO XML DOCUMENTS AND PROVIDING MANIPULATION

CAPABILITIES OF XML DOCUMENTS; COMPUTER PROGRAMS FOR CREATION, MANAGEMENT AND DEVELOPMENT OF XML SCHEMA; COMPUTER PROGRAMS FOR CONNECTING TO REMOTE COMPUTERS AND COMPUTER NETWORKS VIA GLOBAL COMMUNICATIONS NETWORKS TO ALLOW THE EXCHANGE OF INFORMATION AND DATA AND THE BROWSING OF WEBSITES; COMPUTER PROGRAMS FOR SEARCHING THE CONTENTS OF REMOTE COMPUTERS AND COMPUTER NETWORKS; COMPUTER PROGRAMS FOR ACCESSING, CREATING, EDITING AND MANAGING GENERAL USE DATABASES AND TRANSFERRING DATA TO AND FROM DATABASES; ELECTRONIC SPREADSHEET SOFTWARE; COMPUTER PROGRAMS FOR USE IN THE WORD PROCESSING, CALENDAR AND SCHEDULING, DESKTOP PUBLISHING, IMAGE EDITING, GRAPHICS CREATION AND EDITING, DRAWING, CREATION OF MULTIMEDIA PRESENTATIONS, CUSTOMER MANAGEMENT, BUSINESS PLANNING, AND BUSINESS FINANCIAL MANAGEMENT; COMPUTER PROGRAMS FOR DESIGNING, CREATING, MAINTAINING AND ACCESSING CUSTOMIZED INTERNAL NETWORK SITES AND INTERNET SITES; COMPUTER PROGRAMS FOR MANAGING, VIEWING, AND EDITING FILES, DOCUMENTS, ADDRESS BOOK PROGRAMS, PROGRAMS FOR CORRECTING TYPOGRAPHICAL AND CAPITALIZATION ERRORS, COMPUTER PROGRAMS, NAMELY, GRAPHICS, IMAGING AND PRESENTATION PROGRAMS FOR PRINTED AND ELECTRONIC DOCUMENTS AND PRESENTATIONS, AND USER MANUALS SOLD TOGETHER WITH THE PROGRAMS AS A UNIT, IN CLASS 9 (U.S. CLS. 21, 23, 26, 36 AND 38).

FIRST USE 11-16-2004; IN COMMERCE 11-16-2004.

SN 78-979,427, FILED 11-16-2004.

THE MARK CONSISTS OF STANDARD CHARACTERS WITHOUT CLAIM TO ANY PARTICULAR FONT, STYLE, SIZE, OR COLOR.

WENDY GOODMAN, EXAMINING ATTORNEY

Int. Cl.: 28

Prior U.S. Cls.: 22, 23, 38, and 50

United States Patent and Trademark Office

Reg. No. 3,400,213

Registered Mar. 18, 2008

TRADEMARK
PRINCIPAL REGISTER



PROCAPS L.P. (CANADA LIMITED PARTNER-
SHIP)
6000 KIERAN STREET
VILLE ST. LAURENT, QUEBEC, CANADA H4S 2B5

NO CLAIM IS MADE TO THE EXCLUSIVE
RIGHT TO USE "PAINTBALL", APART FROM
THE MARK AS SHOWN.

FOR: PAINTBALLS, IN CLASS 28 (U.S. CLS. 22, 23,
38 AND 50).

SN 78-979,576, FILED 9-6-2002.

FIRST USE 10-26-2004; IN COMMERCE 10-26-2004.

MICHELE SWAIN, EXAMINING ATTORNEY

Int. Cls.: 16 and 41

Prior U.S. Cls.: 2, 5, 22, 23, 29, 37, 38, 50, 100, 101, and 107

Reg. No. 3,400,214

United States Patent and Trademark Office

Registered Mar. 18, 2008

**TRADEMARK
SERVICE MARK
PRINCIPAL REGISTER**

SUCCESS IN SIGHT

MID-CONTINENT RESEARCH FOR EDUCATION AND LEARNING (MISSOURI CORPORATION)
4601 DTC BOULEVARD, SUITE 500
DENVER, CO 80237

FOR: PRINTED EDUCATIONAL AND TEACHING MATERIALS, NAMELY, BOOKS, WORKBOOKS, TRAINING MANUALS AND INSTRUCTIONAL MANUALS IN THE FIELD OF K THROUGH 12 EDUCATION SCHOOL IMPROVEMENTS, K THROUGH 12 EDUCATION STANDARDS BASED PROGRAM DEVELOPMENT, K THROUGH 12 EDUCATION STUDENT ASSESSMENT EVALUATION AND K THROUGH 12 EDUCATION POLICY STUDIES, K THROUGH 12 EDUCATION STRATEGIC PLANNING AND K THROUGH 12 EDUCATION LEADERSHIP DEVELOPMENT, IN CLASS 16 (U.S. CLS. 2, 5, 22, 23, 29, 37, 38 AND 50).

FIRST USE 0-0-2006; IN COMMERCE 0-0-2006.

FOR: PROVIDING EDUCATIONAL TRAINING AND COURSES OF INSTRUCTION, NAMELY, SEMINARS, WORKSHOPS, AND PROFESSIONAL DEVELOPMENT CLASSES, IN THE FIELD OF K THROUGH 12 EDUCATION SCHOOL IMPROVEMENTS, K THROUGH 12 EDUCATION STANDARDS BASED PROGRAM DEVELOPMENT, K THROUGH 12 EDUCATION STUDENT ASSESS-

MENT EVALUATION AND K THROUGH 12 EDUCATION POLICY STUDIES, K THROUGH 12 EDUCATION STRATEGIC PLANNING AND K THROUGH 12 EDUCATION LEADERSHIP DEVELOPMENT; CONDUCTING EDUCATIONAL RESEARCH FOR OTHERS IN THE FIELD OF K THROUGH 12 EDUCATION SCHOOL IMPROVEMENT; DEVELOPMENT OF EDUCATIONAL PROGRAMS FOR OTHERS IN THE FIELD OF K THROUGH 12 SCHOOL IMPROVEMENT; EDUCATIONAL CONSULTING SERVICES FOR OTHERS IN THE FIELD OF K THROUGH 12 EDUCATION SCHOOL IMPROVEMENTS, K THROUGH 12 EDUCATION STANDARDS BASED PROGRAM DEVELOPMENT, K THROUGH 12 EDUCATION STUDENT ASSESSMENT EVALUATION AND K THROUGH 12 EDUCATION POLICY STUDIES, K THROUGH 12 EDUCATION STRATEGIC PLANNING AND K THROUGH 12 EDUCATION LEADERSHIP DEVELOPMENT, IN CLASS 41 (U.S. CLS. 100, 101 AND 107).

FIRST USE 0-0-2006; IN COMMERCE 0-0-2006.

THE MARK CONSISTS OF STANDARD CHARACTERS WITHOUT CLAIM TO ANY PARTICULAR FONT, STYLE, SIZE, OR COLOR.

SN 78-979,606, FILED 7-29-2005.

DAVID COLLIER, EXAMINING ATTORNEY

Prior U.S. Cl.: A

United States Patent and Trademark Office

Reg. No. 3,400,215

Registered Mar. 18, 2008

**CERTIFICATION MARK
GOODS
PRINCIPAL REGISTER**

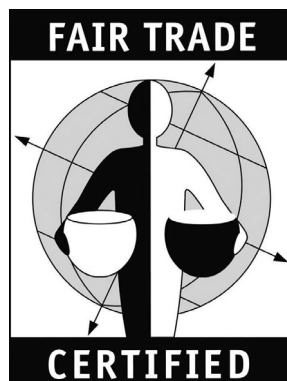

TRANSFAIR USA (MINNESOTA CORPORATION)
1500 BROADWAY
SUITE 400
OAKLAND, CA 94612

FOR: ORANGES, FLOWERS AND VANILLA, IN CLASS A (U.S. CL. A).

FIRST USE 9-30-2006; IN COMMERCE 9-30-2006.

OWNER OF U.S. REG. NOS. 2,868,219 AND 2,989,872.

NO CLAIM IS MADE TO THE EXCLUSIVE RIGHT TO USE "FAIR TRADE CERTIFIED", APART FROM THE MARK AS SHOWN.

THE CERTIFIER AUTHORIZES THIRD PARTIES WHO MEET THE CERTIFIER'S CERTIFICATION STANDARDS TO USE THE MARK IN COMMERCE TO DEMONSTRATE THE CERTIFIER'S CERTIFICATION OF GOODS LISTED IN THE APPLICATION. THE CERTIFIER IS EXERCISING LEGITIMATE CONTROL OVER THE USE OF THE MARK IN COMMERCE IN CONNECTION WITH CERTIFIER'S AUTHORIZATION OF THIRD PARTIES TO DISPLAY THE MARK AS A CERTIFICATION OF SUCH THIRD PARTIES' GOODS.

SN 78-979,621, FILED 9-6-2005.

RONALD AIKENS, EXAMINING ATTORNEY

Int. Cl.: 24

Prior U.S. Cls.: 42 and 50

United States Patent and Trademark Office

Reg. No. 3,400,216

Registered Mar. 18, 2008

**TRADEMARK
PRINCIPAL REGISTER**

SILVERFRESH

LACE LASTICS COMPANY, INC. (NORTH CAROLINA CORPORATION)
610 PINE TREE ROAD P.O. BOX 508
OXFORD, NC 27565

FOR: BED LINEN; BED SHEETS; AND PILLOW CASES, IN CLASS 24 (U.S. CLS. 42 AND 50).

FIRST USE 5-24-2007; IN COMMERCE 5-24-2007.

THE MARK CONSISTS OF STANDARD CHARACTERS WITHOUT CLAIM TO ANY PARTICULAR FONT, STYLE, SIZE, OR COLOR.

SN 78-979,628, FILED 1-6-2006.

CIMMERIAN COLEMAN, EXAMINING ATTORNEY

Int. Cl.: 41

Prior U.S. Cls.: 100, 101, and 107

United States Patent and Trademark Office

Reg. No. 3,400,217

Registered Mar. 18, 2008

**SERVICE MARK
PRINCIPAL REGISTER**

**CHEF PAUL PRUDHOMME'S
ALWAYS COOKING**

MAGIC SEASONING BLENDS, INC. (LOUISIANA
CORPORATION)
720 DISTRIBUTORS ROW
HARAHAN, LA 70123

FOR: ENTERTAINMENT SERVICES, NAMELY, A
TELEVISION SERIES IN THE FIELD OF COOKING,
IN CLASS 41 (U.S. CLS. 100, 101 AND 107).

FIRST USE 5-5-2007; IN COMMERCE 5-5-2007.

THE MARK CONSISTS OF STANDARD CHAR-
ACTERS WITHOUT CLAIM TO ANY PARTICULAR
FONT, STYLE, SIZE, OR COLOR.

OWNER OF U.S. REG. NOS. 1,637,034, 2,685,885,
AND OTHERS.

THE NAME(S), PORTRAIT(S), AND/OR SIGNA-
TURE(S) SHOWN IN THE MARK IDENTIFIES
CHEF PAUL PRUDHOMME, WHOSE CONSENT(S)
TO REGISTER IS SUBMITTED.

SN 78-979,629, FILED 8-18-2006.

KAREN BRACEY, EXAMINING ATTORNEY

Int. Cl.: 35

Prior U.S. Cls.: 100, 101, and 102

United States Patent and Trademark Office

Reg. No. 3,400,218

Registered Mar. 18, 2008

**SERVICE MARK
PRINCIPAL REGISTER**

September is Sapphire Month

ANDIN INTERNATIONAL INC. (NEW YORK CORPORATION)
609 GREENWICH STREET
NEW YORK, NY 10014

FOR: ADVERTISING SERVICES, FOR THIRD PARTIES, IN CONNECTION WITH THE COMMERCIALIZATION AND SALE OF JEWELRY, CREATION OF MARKETING TOOLS DESIGNED TO INCREASE A CLIENT COMPANY'S KNOWLEDGE OF CUSTOMER NEEDS AND ITS COMPETITORS PRODUCTS, PRICING, ADVERTISING STRATEGY AND SALES STRATEGY, COOPERATIVE ADVERTISING AND MARKETING AND DISSEMINATION OF ADVERTISING MATERIALS, IN CLASS 35 (U.S. CLS. 100, 101 AND 102).

FIRST USE 9-1-2007; IN COMMERCE 9-1-2007.

THE MARK CONSISTS OF STANDARD CHARACTERS WITHOUT CLAIM TO ANY PARTICULAR FONT, STYLE, SIZE, OR COLOR.

NO CLAIM IS MADE TO THE EXCLUSIVE RIGHT TO USE "SAPPHIRE", APART FROM THE MARK AS SHOWN.

SN 78-979,639, FILED 1-31-2006.

TINA BROWN, EXAMINING ATTORNEY

Int. Cl.: 25

Prior U.S. Cls.: 22 and 39

United States Patent and Trademark Office

Reg. No. 3,400,219

Registered Mar. 18, 2008

**TRADEMARK
PRINCIPAL REGISTER**

INDIGO ROYALTY

SWAT.FAME, INC. (CALIFORNIA CORPORATION)
16425 EAST GALE AVENUE
CITY OF INDUSTRY, CA 91745

FOR: CLOTHING, NAMELY, PANTS, CAPRIS, CROPS, BOTTOMS, SHORTS, BERMUDA SHORTS, SKIRTS, IN CLASS 25 (U.S. CLS. 22 AND 39).

FIRST USE 8-0-2006; IN COMMERCE 8-0-2006.

THE MARK CONSISTS OF STANDARD CHARACTERS WITHOUT CLAIM TO ANY PARTICULAR FONT, STYLE, SIZE, OR COLOR.

NO CLAIM IS MADE TO THE EXCLUSIVE RIGHT TO USE "INDIGO", APART FROM THE MARK AS SHOWN.

SN 78-979,640, FILED 11-30-2005.

KATHERINE STOIDES, EXAMINING ATTORNEY

Int. Cl.: 25

Prior U.S. Cls.: 22 and 39

United States Patent and Trademark Office

Reg. No. 3,400,220

Registered Mar. 18, 2008

**TRADEMARK
PRINCIPAL REGISTER**

SEXY BEAST

RYAN BASICS LLC (NEW YORK LTD LIAB CO)
SUITE 5C
145 AVENUE OF THE AMERICAS
NEW YORK, NY 10013

THE MARK CONSISTS OF STANDARD CHAR-
ACTERS WITHOUT CLAIM TO ANY PARTICULAR
FONT, STYLE, SIZE, OR COLOR.

FOR: TANK TOPS; T-SHIRTS, IN CLASS 25 (U.S.
CLS. 22 AND 39).

SN 78-979,642, FILED 5-24-2006.

FIRST USE 5-1-2007; IN COMMERCE 5-1-2007.

KIMBERLY FRYE, EXAMINING ATTORNEY

Int. Cl.: 8

Prior U.S. Cls.: 23, 28, and 44

United States Patent and Trademark Office

Reg. No. 3,400,221

Registered Mar. 18, 2008

**TRADEMARK
PRINCIPAL REGISTER**

MAXCRAFT

MICHIGAN INDUSTRIAL TOOLS (MICHIGAN CORPORATION)
3707 ROGER B. CHAFFEE MEMORIAL DR. S.E.
GRAND RAPIDS, MI 49548

FOR: HAND TOOLS, NAMELY, SOCKET WRENCHES, SCREWDRIVERS, SCREWDRIVER BITS, PLIERS, PRY BARS, BOLT CUTTERS, CLAMPS, FILES, CHISELS, UTILITY KNIVES, HAND SAWS, METAL CUTTERS, SCRAPERS, KNIVES, ADJUSTABLE WRENCHES, RATCHET WRENCHES, SOCKET WRENCH EXTENSIONS AND EXTENSION BARS; WRENCHES, SCREWDRIVERS, PLIERS, AND HAMMERS; HEX KEY WRENCHES, HAMMERS,

TIN SNIPS, WIRE STRIPPERS AND CUTTERS, IN CLASS 8 (U.S. CLS. 23, 28 AND 44).

FIRST USE 12-1-2005; IN COMMERCE 12-1-2005.

THE MARK CONSISTS OF STANDARD CHARACTERS WITHOUT CLAIM TO ANY PARTICULAR FONT, STYLE, SIZE, OR COLOR.

SN 78-979,651, FILED 11-17-2005.

MAUREEN DALL, EXAMINING ATTORNEY

Int. Cl.: 25

Prior U.S. Cls.: 22 and 39

United States Patent and Trademark Office

Reg. No. 3,400,222

Registered Mar. 18, 2008

**TRADEMARK
PRINCIPAL REGISTER**

BAHA MAR

BAHA MAR RESORTS LTD (BAHAMAS CORPORATION)
LYFORD CAY MANOR, WEST BLDG.,LYFORD CAY
NEW PROVIDENCE, BAHAMAS

FOR: CLOTHES, NAMELY, RESORT-WEAR SHIRTS, JACKETS, SWEATERS, CAPS, HATS, SHORTS, PANTS, FOOTWEAR, SWIMMING AND

TENNIS CLOTHING , IN CLASS 25 (U.S. CLS. 22 AND 39).

FIRST USE 11-12-2007; IN COMMERCE 11-12-2007.

SN 78-979,659, FILED 8-1-2003.

JOHN E. MICHOS, EXAMINING ATTORNEY

Int. Cl.: 25

Prior U.S. Cls.: 22 and 39

United States Patent and Trademark Office

Reg. No. 3,400,223

Registered Mar. 18, 2008

**TRADEMARK
PRINCIPAL REGISTER**

HARBOR VIEW FARM

AFFIRMED ENTERPRISES, LLC (FLORIDA LTD
LIAB CO)
THE KENILWORTH
10205 COLLINS AVENUE #509
BAL HARBOUR, FL 33154

THE MARK CONSISTS OF STANDARD CHAR-
ACTERS WITHOUT CLAIM TO ANY PARTICULAR
FONT, STYLE, SIZE, OR COLOR.

FOR: HATS, IN CLASS 25 (U.S. CLS. 22 AND 39).

SN 78-979,666, FILED 9-20-2004.

FIRST USE 12-31-2005; IN COMMERCE 12-31-2005.

GEOFFREY FOSDICK, EXAMINING ATTORNEY

Int. Cl.: 45

Prior U.S. Cls.: 100 and 101

United States Patent and Trademark Office

Reg. No. 3,400,224

Registered Mar. 18, 2008

**SERVICE MARK
PRINCIPAL REGISTER**

FOOD FOR THE SOUL

FULLERTON, DONNA M. (UNITED STATES
INDIVIDUAL)
220 EAST 22ND STREET
NEW YORK, NY 10010

FOR: INFORMATION, ADVISORY AND CON-
SULTANCY SERVICES IN THE FIELD OF MOTIVA-
TION AND PERSONAL DEVELOPMENT
PROVIDED VIA A GLOBAL COMPUTER NET-
WORK, IN CLASS 45 (U.S. CLS. 100 AND 101).

FIRST USE 11-27-2005; IN COMMERCE 11-27-2005.

THE MARK CONSISTS OF STANDARD CHAR-
ACTERS WITHOUT CLAIM TO ANY PARTICULAR
FONT, STYLE, SIZE, OR COLOR.

SN 78-979,668, FILED 12-28-2005.

MELVIN AXILBUND, EXAMINING ATTORNEY

Int. Cl.: 45

Prior U.S. Cls.: 100 and 101

United States Patent and Trademark Office

Reg. No. 3,400,225

Registered Mar. 18, 2008

**SERVICE MARK
PRINCIPAL REGISTER**

GUIDESAFE

PREPARED RESPONSE, INC. (WASHINGTON
CORPORATION)
600 UNIVERSITY STREET
SUITE 1525
SEATTLE, WA 98101

THE MARK CONSISTS OF STANDARD CHAR-
ACTERS WITHOUT CLAIM TO ANY PARTICULAR
FONT, STYLE, SIZE, OR COLOR.

FOR: PROVIDING ON-LINE INFORMATION IN
THE FIELD OF EMERGENCY PROCEDURE, IN
CLASS 45 (U.S. CLS. 100 AND 101).

SN 78-979,672, FILED 6-7-2006.

FIRST USE 3-12-2007; IN COMMERCE 3-12-2007.

TOBY BULLOFF, EXAMINING ATTORNEY

Int. Cls.: 35 and 36

Prior U.S. Cls.: 100, 101, and 102

United States Patent and Trademark Office

Reg. No. 3,400,226

Registered Mar. 18, 2008

**SERVICE MARK
PRINCIPAL REGISTER**

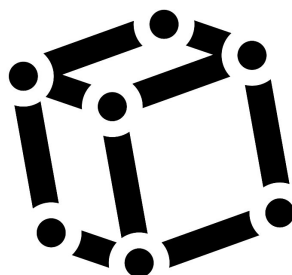

LYTIX LLC (DELAWARE LTD LIAB CO)
590 MADISON AVENUE
21ST FLOOR
NEW YORK, NY 100222524

FOR: BUSINESS CONSULTING AND INFORMATION SERVICES; CONSULTING SERVICES, NAMELY, RESEARCH AND ANALYSIS IN THE FIELDS OF BUSINESS INTELLIGENCE, CORPORATE OWNERSHIP AND CONTROL, CORPORATE MANAGEMENT, ACCOUNTING; PROVIDING INFORMATION IN THE FIELDS OF BUSINESS INTELLIGENCE, CORPORATE OWNERSHIP AND CONTROL, CORPORATE MANAGEMENT, ACCOUNTING; ANALYZING AND COMPILING DATA FOR USE IN THE FIELDS OF BUSINESS INTELLIGENCE, CORPORATE OWNERSHIP AND CONTROL, CORPORATE MANAGEMENT, ACCOUNTING, IN CLASS 35 (U.S. CLS. 100, 101 AND 102).

FIRST USE 5-0-2006; IN COMMERCE 5-0-2006.

FOR: CONSULTING SERVICES, NAMELY, RESEARCH AND ANALYSIS IN THE FIELD OF FINANCIAL INTELLIGENCE FOR MAPPING CORPORATE RELATIONSHIPS AND TRANSACTIONS INVOLVING CORPORATIONS, INDIVIDUALS, AND GOVERNMENT ENTITIES; PROVIDING INFORMATION IN THE FIELD OF FINANCIAL INTELLIGENCE FOR MAPPING CORPORATE RELATIONSHIPS AND TRANSACTIONS INVOLVING CORPORATIONS, INDIVIDUALS, AND GOVERNMENT ENTITIES; ANALYZING AND COMPILING DATA FOR USE IN THE FIELD OF FINANCIAL INTELLIGENCE FOR MAPPING CORPORATE RELATIONSHIPS AND TRANSACTIONS INVOLVING CORPORATIONS, INDIVIDUALS, AND GOVERNMENT ENTITIES , IN CLASS 36 (U.S. CLS. 100, 101 AND 102).

FIRST USE 5-0-2006; IN COMMERCE 5-0-2006.

SN 78-979,676, FILED 12-1-2005.

KAREN K. BUSH, EXAMINING ATTORNEY

Int. Cl.: 37

Prior U.S. Cls.: 100, 103, and 106

United States Patent and Trademark Office

Reg. No. 3,400,227

Registered Mar. 18, 2008

**SERVICE MARK
PRINCIPAL REGISTER**

ENCANTA HILLS

FOX RIDGE INVESTMENTS, LLC (UTAH LTD
LIAB CO)
3940 N. TRAVERSE MOUNTAIN ROAD
LEHI, UT 84043

FOR: REAL ESTATE DEVELOPMENT SERVICES,
CONSTRUCTION SERVICES, NAMELY, PLAN-
NING AND DEVELOPING OF RESIDENTIAL COM-
MUNITIES, IN CLASS 37 (U.S. CLS. 100, 103 AND
106).

FIRST USE 9-5-2007; IN COMMERCE 9-5-2007.

THE MARK CONSISTS OF STANDARD CHAR-
ACTERS WITHOUT CLAIM TO ANY PARTICULAR
FONT, STYLE, SIZE, OR COLOR.

SN 78-979,703, FILED 5-3-2006.

DAVID MURRAY, EXAMINING ATTORNEY

Int. Cl.: 11

Prior U.S. Cls.: 13, 21, 23, 31, and 34

United States Patent and Trademark Office

Reg. No. 3,400,228

Registered Mar. 18, 2008

**TRADEMARK
PRINCIPAL REGISTER**

DEAU PASSE

INTERNATIONAL GROWER'S SUPPLY INCORPORATED (CALIFORNIA CORPORATION)
2643 SOUTH FAIRFAX AVE.
CULVER CITY, CA 90232

FOR: AIR PURIFYING EQUIPMENT NAMELY, CHARCOAL CARBON FILTERS FOR USE IN GREENHOUSES, HOUSES, DOG RUNS, AIR DUCTS, POWER VENTILATED AIR DUCTS, AND AIR FILTRATION DUCTS; AIR FILTER MACHINES FOR USE IN PLANT GROWING PROCESSES, IN CLASS 11 (U.S. CLS. 13, 21, 23, 31 AND 34).

FIRST USE 10-1-2007; IN COMMERCE 10-15-2007.

THE MARK CONSISTS OF STANDARD CHARACTERS WITHOUT CLAIM TO ANY PARTICULAR FONT, STYLE, SIZE, OR COLOR.

THE FOREIGN WORDING IN THE MARK TRANSLATES INTO ENGLISH AS "OF WATER PASSING".

SN 78-979,713, FILED 11-17-2004.

TIMOTHY FINNEGAN, EXAMINING ATTORNEY

Int. Cl.: 41

Prior U.S. Cls.: 100, 101, and 107

United States Patent and Trademark Office

Reg. No. 3,400,229

Registered Mar. 18, 2008

**SERVICE MARK
SUPPLEMENTAL REGISTER**

GICLEE STUDIO

HADDAD'S FINE ART INC. (CALIFORNIA CORPORATION)
3855 E. MIRALOMA AVE.
ANAHEIM, CA 92806

FOR: FINE ART PUBLICATION SERVICES, NAMELY, SCANNING THE WORKS OF OTHERS WITH OPTIONAL COLOR CORRECTION AND IMAGE MANIPULATION; PREPARING DIGITAL FILES OF THE WORKS OF OTHERS FOR MAKING BOTH DIGITAL AND LITHOGRAPHIC REPRODUCTIONS; AND ARTISTIC SERVICES, NAMELY, HAND EMBELLISHING THE FINE ART WORKS OF OTHERS, IN CLASS 41 (U.S. CLS. 100, 101 AND 107).

FIRST USE 9-16-2004; IN COMMERCE 9-16-2004.

THE MARK CONSISTS OF STANDARD CHARACTERS WITHOUT CLAIM TO ANY PARTICULAR FONT, STYLE, SIZE, OR COLOR.

NO CLAIM IS MADE TO THE EXCLUSIVE RIGHT TO USE "GICLEE", APART FROM THE MARK AS SHOWN.

SER. NO. 76-609,967, FILED P.R. 8-30-2004; AM. S.R. 12-22-2007.

JASON TURNER, EXAMINING ATTORNEY

Int. Cl.: 43

Prior U.S. Cls.: 100 and 101

United States Patent and Trademark Office

Reg. No. 3,400,230

Registered Mar. 18, 2008

**SERVICE MARK
SUPPLEMENTAL REGISTER**

Fresh Sauté & Grill

NOODLES & COMPANY (DELAWARE CORPORATION)

520 ZANG STREET, SUITE D

BROOMFILED, CO 80021

FOR: RESTAURANT SERVICES, IN CLASS 43
(U.S. CLS. 100 AND 101).

FIRST USE 3-1-2005; IN COMMERCE 3-1-2005.

THE MARK CONSISTS OF STANDARD CHARACTERS WITHOUT CLAIM TO ANY PARTICULAR FONT, STYLE, SIZE, OR COLOR.

NO CLAIM IS MADE TO THE EXCLUSIVE RIGHT TO USE "GRILL", APART FROM THE MARK AS SHOWN.

SER. NO. 76-631,356, FILED P.R. 2-15-2005; AM. S.R. 11-1-2007.

B. PARADEWELAI, EXAMINING ATTORNEY

Int. Cl.: 14

Prior U.S. Cls.: 2, 27, 28, and 50

United States Patent and Trademark Office

Reg. No. 3,400,231

Registered Mar. 18, 2008

TRADEMARK
SUPPLEMENTAL REGISTER



RAMOS, LEONARDO (UNITED STATES INDIVIDUAL)
4382 MAHOGANY RIDGE DR.
WESTON, FL 33331

FOR: JEWELRY, IN CLASS 14 (U.S. CLS. 2, 27, 28 AND 50).

FIRST USE 12-5-2007; IN COMMERCE 12-5-2007.

THE FOREIGN WORDING IN THE MARK TRANSLATES INTO ENGLISH AS "JESUS CHRIST OUR KING AND SAVIOR."

SER. NO. 76-653,117, FILED P.R. 1-9-2006; AM. S.R. 1-10-2008.

ELLEN B. AWRICH, EXAMINING ATTORNEY

Int. Cl.: 42

Prior U.S. Cls.: 100 and 101

United States Patent and Trademark Office

Reg. No. 3,400,232

Registered Mar. 18, 2008

**SERVICE MARK
SUPPLEMENTAL REGISTER**

THE DELIBERATION CENTER

BERNETT RESEARCH SERVICES, INC. (MASSACHUSETTS CORPORATION), DBA BERNETT RESEARCH,
WORLD TRADE CENTER EAST
2 SEAPORT LANE, 9TH FLOOR
BOSTON, MA 02210

FOR: LEGAL SERVICES, NAMELY, MOCK JURY SURVEYING FOR MODELING TRIAL OUTCOMES BY MEANS OF DATA COLLECTED FROM POLLING, IN-PERSON AND ONLINE FOCUS GROUPS, SURVEYS AND QUESTIONNAIRES, AND TABULATION AND ANALYSIS OF SUCH DATA TO PROVIDE JURY PROFILING INFORMATION TO AID JURY SELECTION AND DEVELOPING TRAIL STRATAGEMS FOR LAW FIRMS AND THIRD PARTY AGENTS, IN CLASS 42 (U.S. CLS. 100 AND 101).

FIRST USE 4-2-2007; IN COMMERCE 4-2-2007.

THE MARK CONSISTS OF STANDARD CHARACTERS WITHOUT CLAIM TO ANY PARTICULAR FONT, STYLE, SIZE, OR COLOR.

NO CLAIM IS MADE TO THE EXCLUSIVE RIGHT TO USE "CENTER" , APART FROM THE MARK AS SHOWN.

SER. NO. 76-659,222, FILED P.R. 4-27-2006; AM. S.R. 4-5-2007.

ZHALEH DELANEY, EXAMINING ATTORNEY

Int. Cl.: 10

Prior U.S. Cls.: 26, 39, and 44

United States Patent and Trademark Office

Reg. No. 3,400,233

Registered Mar. 18, 2008

TRADEMARK
SUPPLEMENTAL REGISTER

Tube Tie

VARTEC SOLUTIONS, INC. (OHIO CORPORATION)
7570 FOXDALE CIRCLE
HUDSON, OH 44236

FOR: SURGICAL, MEDICAL, DENTAL AND VETERINARY APPARATUS AND INSTRUMENTS, NAMELY, SECURING DEVICES FOR ENDOTRACHEAL TUBES, IN CLASS 10 (U.S. CLS. 26, 39 AND 44).

FIRST USE 5-18-2006; IN COMMERCE 5-18-2006.

SER. NO. 76-664,135, FILED P.R. 8-4-2006; AM. S.R. 12-20-2007.

CIMMERIAN COLEMAN, EXAMINING ATTORNEY

Int. Cl.: 41

Prior U.S. Cls.: 100, 101, and 107

United States Patent and Trademark Office

Reg. No. 3,400,234

Registered Mar. 18, 2008

**SERVICE MARK
SUPPLEMENTAL REGISTER**

COLORADO SLEEP SCHOOL OF THE ROCKIES

COLORADO SLEEP CENTER OF THE ROCKIES,
LLC (COLORADO LTD LIAB CO)
2500 ROCKY MOUNTAIN AVENUE, SUITE 310
LOVELAND, CO 80538

FOR: EDUCATION SERVICES, NAMELY, PRO-
VIDING CLASSES, SEMINARS, WORKSHOPS, TU-
TORING, AND MENTORING IN THE FIELD OF
SLEEP MEDICINE , IN CLASS 41 (U.S. CLS. 100, 101
AND 107).

FIRST USE 12-15-2007; IN COMMERCE 12-15-2007.

THE MARK CONSISTS OF STANDARD CHAR-
ACTERS WITHOUT CLAIM TO ANY PARTICULAR
FONT, STYLE, SIZE, OR COLOR.

NO CLAIM IS MADE TO THE EXCLUSIVE
RIGHT TO USE "SLEEP SCHOOL", APART FROM
THE MARK AS SHOWN.

SER. NO. 76-673,139, FILED P.R. 2-26-2007; AM. S.R.
12-17-2007.

SANI KHOURI, EXAMINING ATTORNEY

Int. Cl.: 14

Prior U.S. Cls.: 2, 27, 28, and 50

United States Patent and Trademark Office

Reg. No. 3,400,235

Registered Mar. 18, 2008

**TRADEMARK
SUPPLEMENTAL REGISTER**

GOLDS

GOLDART INTERNATIONAL INC. (NEW JERSEY CORPORATION)
1305 FRANKLIN AVENUE, SUITE 245
GARDEN CITY, NY 11530

FOR: JEWELRY MADE IN WHOLE OR IN SUBSTANTIAL PART OF PART OF PRECIOUS METALS AND THEIR ALLOYS, NAMELY, GOLD; GOODS MADE AND COATED IN WHOLE OR SUBSTANTIAL PART OF GOLD, NAMELY, GOLD BARS, BADGES, BEADS FOR USE IN THE MANUFACTURE OF JEWELRY, BRACELETS, BROOCHES, BELT BUCKLES, WATCH WINDING BUTTONS, JEWELRY CHAINS, CHARMS, FAMILY CRESTS, CROSSES, CRUCIFIXES, CUFFLINKS, EARRINGS, LOCKETS, MONEY CLIPS, NECKLACES, PENDANTS, ORNAMENTAL PINS, RINGS, ST. CHRISTOPHER MEDALLIONS, STAR OF DAVID MEDALLIONS, TIE CLIPS, SLIDES FOR BOLO TIES,

TIE PINS; PRECIOUS STONES AFFIXED IN PART TO GOLD; HOROLOGICAL AND CHRONOMETRIC INSTRUMENTS MADE IN WHOLE OR IN SUBSTANTIAL PART OF GOLD; CLOCKS, WATCHES AND WATCHBANDS MADE IN WHOLE OR IN SUBSTANTIAL PART OF GOLD, IN CLASS 14 (U.S. CLS. 2, 27, 28 AND 50).

FIRST USE 2-12-2003; IN COMMERCE 2-12-2003.

THE MARK CONSISTS OF STANDARD CHARACTERS WITHOUT CLAIM TO ANY PARTICULAR FONT, STYLE, SIZE, OR COLOR.

SER. NO. 76-673,434, FILED P.R. 3-1-2007; AM. S.R. 1-17-2008.

WILLIAM ROSSMAN, EXAMINING ATTORNEY

Int. Cl.: 28

Prior U.S. Cls.: 22, 23, 38, and 50

United States Patent and Trademark Office

Reg. No. 3,400,236

Registered Mar. 18, 2008

**TRADEMARK
SUPPLEMENTAL REGISTER**

SATO

SATO, GARRY (UNITED STATES INDIVIDUAL)
1625 17TH STREET
SUITE 5
SANTA MONICA, CA 90404

FOR: FISHING EQUIPMENT, NAMELY, FISHING TACKLE AND ACCESSORIES, FISHING LINE WINDERS AND FISHING KITS COMPRISING TOOLS AND SUPPLIES FOR MAKING FISHING LINE CONNECTIONS, IN CLASS 28 (U.S. CLS. 22, 23, 38 AND 50).

FIRST USE 1-0-2002; IN COMMERCE 1-0-2003.

THE MARK CONSISTS OF STANDARD CHARACTERS WITHOUT CLAIM TO ANY PARTICULAR FONT, STYLE, SIZE, OR COLOR.

SER. NO. 76-673,448, FILED P.R. 3-2-2007; AM. S.R. 12-26-2007.

BENJAMIN ALLEN, EXAMINING ATTORNEY

Int. Cl.: 42

Prior U.S. Cls.: 100 and 101

United States Patent and Trademark Office

Reg. No. 3,400,237

Registered Mar. 18, 2008

**SERVICE MARK
SUPPLEMENTAL REGISTER**

SORENSEN FORENSICS

SORENSEN GENOMICS, L.L.C. (UTAH LTD
LIAB CO)
2511 SOUTH WEST TEMPLE
SALT LAKE CITY, UT 84115

FOR: LABORATORY SERVICES, NAMELY, DNA-
BASED HUMAN IDENTIFICATION TESTING FOR
FORENSIC PURPOSES, IN CLASS 42 (U.S. CLS. 100
AND 101).

FIRST USE 10-3-2006; IN COMMERCE 10-3-2006.

THE MARK CONSISTS OF STANDARD CHAR-
ACTERS WITHOUT CLAIM TO ANY PARTICULAR
FONT, STYLE, SIZE, OR COLOR.

NO CLAIM IS MADE TO THE EXCLUSIVE
RIGHT TO USE FORENSICS, APART FROM THE
MARK AS SHOWN.

SER. NO. 76-673,885, FILED P.R. 3-12-2007; AM. S.R.
12-27-2007.

ELLEN PERKINS, EXAMINING ATTORNEY

Int. Cl.: 44

Prior U.S. Cls.: 100 and 101

United States Patent and Trademark Office

Reg. No. 3,400,238

Registered Mar. 18, 2008

**SERVICE MARK
SUPPLEMENTAL REGISTER**

NEUROSCIENCE CENTER OF THE ROCKIES

COLORADO SLEEP CENTER OF THE ROCKIES,
LLC (COLORADO LTD LIAB CO)
2500 ROCKY MOUNTAIN AVENUE, SUITE 310
LOVELAND, CO 80538

FOR: MEDICAL SERVICES, NAMELY, CONSULTATION, DIAGNOSIS, AND TREATMENT OF SLEEP DISORDERS, IN CLASS 44 (U.S. CLS. 100 AND 101).

FIRST USE 12-14-2007; IN COMMERCE 12-14-2007.

THE MARK CONSISTS OF STANDARD CHARACTERS WITHOUT CLAIM TO ANY PARTICULAR FONT, STYLE, SIZE, OR COLOR.

NO CLAIM IS MADE TO THE EXCLUSIVE RIGHT TO USE "NEUROSCIENCE CENTER", APART FROM THE MARK AS SHOWN.

SER. NO. 76-674,010, FILED P.R. 3-13-2007; AM. S.R. 12-17-2007.

SANI KHOURI, EXAMINING ATTORNEY

Int. Cl.: 20

Prior U.S. Cls.: 2, 13, 22, 25, 32, and 50

Reg. No. 3,400,239

United States Patent and Trademark Office

Registered Mar. 18, 2008

**TRADEMARK
SUPPLEMENTAL REGISTER**

INKJET PILLOWS

SUPERIOR FIBER MILLS, INC. (NEW YORK CORPORATION)
181 LOMBARDY STREET
BROOKLYN, NY 11222

NO CLAIM IS MADE TO THE EXCLUSIVE RIGHT TO USE "PILLOWS", APART FROM THE MARK AS SHOWN.

FOR: DECORATED THROW PILLOWS, IN CLASS 20 (U.S. CLS. 2, 13, 22, 25, 32 AND 50).

SER. NO. 76-675,366, FILED P.R. 4-11-2007; AM. S.R. 1-17-2008.

FIRST USE 3-20-2007; IN COMMERCE 3-20-2007.

THE MARK CONSISTS OF STANDARD CHARACTERS WITHOUT CLAIM TO ANY PARTICULAR FONT, STYLE, SIZE, OR COLOR.

REBECCA POVARCHUK, EXAMINING ATTORNEY

Int. Cls.: 9, 35, and 41

Prior U.S. Cls.: 21, 23, 26, 36, 38, 100, 101, 102, and 107

Reg. No. 3,400,240

United States Patent and Trademark Office

Registered Mar. 18, 2008

**TRADEMARK
SERVICE MARK
SUPPLEMENTAL REGISTER**

COALITION FOR PSYCHOLOGY IN SCHOOLS AND EDUCATION

AMERICAN PSYCHOLOGICAL ASSOCIATION
(D.C. NOT-FOR-PROFIT CORPORATION)
750 FIRST STREET N.E.
WASHINGTON, DC 200024242

FOR: DOWNLOADABLE ELECTRONIC PUBLICATIONS IN THE FIELD OF PSYCHOLOGY AND THE APPLICATION OF PSYCHOLOGY TO EDUCATION, IN CLASS 9 (U.S. CLS. 21, 23, 26, 36 AND 38).

FIRST USE 3-0-2003; IN COMMERCE 3-0-2003.

FOR: PROMOTING THE PUBLIC AWARENESS FOR THE IMPORTANCE OF HIGH QUALITY APPLICATION OF PSYCHOLOGY TO PROGRAMS AND POLICIES FOR SCHOOLS AND EDUCATION, IN CLASS 35 (U.S. CLS. 100, 101 AND 102).

FIRST USE 12-0-2002; IN COMMERCE 12-0-2002.

FOR: EDUCATIONAL TRAINING AND WORKSHOPS IN THE FIELD OF PSYCHOLOGY AND THE APPLICATION OF PSYCHOLOGY TO EDUCATION; EDUCATIONAL RESEARCH IN THE FIELD OF PSYCHOLOGY, AND DEVELOPMENT AND DISSEMINATION OF EDUCATIONAL MATERIALS OF OTHERS IN THE FIELD OF PSYCHOLOGY, IN CLASS 41 (U.S. CLS. 100, 101 AND 107).

FIRST USE 12-0-2002; IN COMMERCE 12-0-2002.

THE MARK CONSISTS OF STANDARD CHARACTERS WITHOUT CLAIM TO ANY PARTICULAR FONT, STYLE, SIZE, OR COLOR.

SER. NO. 76-675,981, FILED P.R. 4-25-2007; AM. S.R. 1-3-2008.

JOHN DWYER, EXAMINING ATTORNEY

Int. Cl.: 39

Prior U.S. Cls.: 100 and 105

United States Patent and Trademark Office

Reg. No. 3,400,241

Registered Mar. 18, 2008

**SERVICE MARK
SUPPLEMENTAL REGISTER**



trips²italy

TRIPS2ITALY, LLC (TEXAS LTD LIAB CO)
2650 FOUNTAINVIEW DRIVE, SUITE 113
HOUSTON, TX 77057

BOOKING AGENCIES, IN CLASS 39 (U.S. CLS. 100
AND 105).

FIRST USE 1-1-2003; IN COMMERCE 1-1-2003.

FOR: ARRANGING GUIDED, PACKAGED, AND
PERSONALIZED TRAVEL TOURS; TRAVEL AGEN-
CY, NAMELY, MAKING RESERVATIONS AND
BOOKINGS FOR TRANSPORTATION; TRAVEL

SER. NO. 76-679,494, FILED P.R. 7-13-2007; AM. S.R.
1-4-2008.

CHARLES L. JENKINS, EXAMINING ATTORNEY

Int. Cl.: 35

Prior U.S. Cls.: 100, 101, and 102

United States Patent and Trademark Office

Reg. No. 3,400,242

Registered Mar. 18, 2008

**SERVICE MARK
SUPPLEMENTAL REGISTER**

LAS VEGAS PROPERTIES

WHITE, TERRI (UNITED STATES INDIVIDUAL)
7812 RAMBLEWOOD AVE.
LAS VEGAS, NV 89128

FOR: BUSINESS RELOCATION, PERSONNEL RELOCATION, EMPLOYEE RELOCATION AND INFORMATION, REAL ESTATE MARKETING SERVICES, NAMELY, ON-LINE SERVICES FEATURING TOURS OF RESIDENTIAL HOMES, IN CLASS 35 (U.S. CLS. 100, 101 AND 102).

FIRST USE 7-1-1996; IN COMMERCE 7-1-1996.

THE MARK CONSISTS OF STANDARD CHARACTERS WITHOUT CLAIM TO ANY PARTICULAR FONT, STYLE, SIZE, OR COLOR.

NO CLAIM IS MADE TO THE EXCLUSIVE RIGHT TO USE "PROPERTIES", APART FROM THE MARK AS SHOWN.

SER. NO. 76-681,777, FILED P.R. 9-12-2007; AM. S.R. 1-8-2008.

DEZMONA MIZELLE, EXAMINING ATTORNEY

Int. Cls.: 35 and 36

Prior U.S. Cls.: 100, 101, and 102

United States Patent and Trademark Office

Reg. No. 3,400,243

Registered Mar. 18, 2008

**SERVICE MARK
SUPPLEMENTAL REGISTER**

PREMIER PRIVATE WEALTH

LWBJ WEALTH RESOURCES, LLC (IOWA LTD
LIAB CO)
4200 UNIVERSITY, SUITE 410
WEST DES MOINES, IA 50266

FOR: TAX PLANNING SERVICES; BUSINESS
DEVELOPMENT SERVICES, NAMELY, PROVID-
ING START-UP SUPPORT FOR BUSINESSES OF
OTHERS, IN CLASS 35 (U.S. CLS. 100, 101 AND 102).

FIRST USE 9-1-2006; IN COMMERCE 9-1-2006.

FOR: FINANCIAL CONSULTATION PROVIDED
TO HIGH NET WORTH INDIVIDUALS, NAMELY,
FINANCIAL ADMINISTRATION AND ESTATE
PLANNING, IN CLASS 36 (U.S. CLS. 100, 101 AND
102).

FIRST USE 9-1-2006; IN COMMERCE 9-1-2006.

THE MARK CONSISTS OF STANDARD CHAR-
ACTERS WITHOUT CLAIM TO ANY PARTICULAR
FONT, STYLE, SIZE, OR COLOR.

NO CLAIM IS MADE TO THE EXCLUSIVE
RIGHT TO USE "PRIVATE WEALTH", APART
FROM THE MARK AS SHOWN.

SER. NO. 77-006,318, FILED P.R. 9-25-2006; AM. S.R.
8-16-2007.

ELISSA GARBER KON, EXAMINING ATTORNEY

Int. Cls.: 36 and 39

Prior U.S. Cls.: 100, 101, 102, and 105

United States Patent and Trademark Office

Reg. No. 3,400,244

Registered Mar. 18, 2008

**SERVICE MARK
SUPPLEMENTAL REGISTER**

**COUNTRYWIDE ASSET & AUTO
RECOVERY**

COUNTRYWIDE ASSET & AUTO RECOVERY,
L.P. (TEXAS LIMITED PARTNERSHIP)
38 WORTHINGTON ACCESS
MARYLAND HEIGHTS, MO 63043

FOR: DEBT RECOVERY SERVICES AND REPOSSSESSION OF ASSETS, NAMELY, AUTOMOBILES AND OTHER COLLATERAL, IN CLASS 36 (U.S. CLS. 100, 101 AND 102).

FIRST USE 5-2-2006; IN COMMERCE 5-2-2006.

FOR: TRANSPORT AND STORAGE OF ASSETS, NAMELY, AUTOMOBILES AND OTHER COLLATERAL, RECOVERED THROUGH REPOSSESSION, IN CLASS 39 (U.S. CLS. 100 AND 105).

FIRST USE 5-2-2006; IN COMMERCE 5-2-2006.

THE MARK CONSISTS OF STANDARD CHARACTERS WITHOUT CLAIM TO ANY PARTICULAR FONT, STYLE, SIZE, OR COLOR.

NO CLAIM IS MADE TO THE EXCLUSIVE RIGHT TO USE "ASSET & AUTO RECOVERY", APART FROM THE MARK AS SHOWN.

SER. NO. 77-010,971, FILED P.R. 9-29-2006; AM. S.R. 1-14-2008.

MARK PILARO, EXAMINING ATTORNEY

Int. Cl.: 9

Prior U.S. Cls.: 21, 23, 26, 36, and 38

United States Patent and Trademark Office

Reg. No. 3,400,245

Registered Mar. 18, 2008

**TRADEMARK
SUPPLEMENTAL REGISTER**

IMMERSIVE MEDIA

IMMERSIVE MEDIA COMPANY (OREGON CORPORATION)
2407 SE 10TH AVENUE
PORTLAND, OR 97214

FOR: SOFTWARE AND ELECTRONICS, NAME-
LY, PANORAMIC DIGITAL CAMERAS, AND IM-
AGE SOFTWARE FOR DISPLAYING AND
PROCESSING STILL AND PANORAMIC MOTION
PICTURES, IN CLASS 9 (U.S. CLS. 21, 23, 26, 36 AND
38).

FIRST USE 6-10-2004; IN COMMERCE 6-10-2004.

THE MARK CONSISTS OF STANDARD CHAR-
ACTERS WITHOUT CLAIM TO ANY PARTICULAR
FONT, STYLE, SIZE, OR COLOR.

OWNER OF U.S. REG. NO. 2,493,953.

NO CLAIM IS MADE TO THE EXCLUSIVE
RIGHT TO USE "MEDIA", APART FROM THE
MARK AS SHOWN.

SER. NO. 77-015,638, FILED P.R. 10-6-2006; AM. S.R.
2-6-2008.

SANI KHOURI, EXAMINING ATTORNEY

Int. Cls.: 44 and 45

Prior U.S. Cls.: 100 and 101

United States Patent and Trademark Office

Reg. No. 3,400,246

Registered Mar. 18, 2008

**SERVICE MARK
SUPPLEMENTAL REGISTER**

**The New York Center for
Children**

THE NEW YORK CENTER FOR CHILDREN
(NEW YORK NOT-FOR-PROFIT CORPORATION)
333 EAST 70TH STREET
NEW YORK, NY 10021

FOR: MEDICAL SERVICES, NAMELY, EVALUATION AND TREATMENT SERVICES FOR ABUSED CHILDREN, IN CLASS 44 (U.S. CLS. 100 AND 101).

FIRST USE 1-0-2007; IN COMMERCE 1-0-2007.

FOR: SOCIAL SERVICES, NAMELY, EVALUATION AND TREATMENT SERVICES FOR ABUSED CHILDREN, IN CLASS 45 (U.S. CLS. 100 AND 101).

FIRST USE 1-0-2007; IN COMMERCE 1-0-2007.

THE MARK CONSISTS OF STANDARD CHARACTERS WITHOUT CLAIM TO ANY PARTICULAR FONT, STYLE, SIZE, OR COLOR.

NO CLAIM IS MADE TO THE EXCLUSIVE RIGHT TO USE "CENTER FOR CHILDREN", APART FROM THE MARK AS SHOWN.

SER. NO. 77-023,040, FILED P.R. 10-17-2006; AM. S.R. 12-13-2007.

PAUL MORENO, EXAMINING ATTORNEY

Int. Cl.: 34

Prior U.S. Cls.: 2, 8, 9, and 17

United States Patent and Trademark Office

Reg. No. 3,400,247

Registered Mar. 18, 2008

**TRADEMARK
SUPPLEMENTAL REGISTER**

ORNELAS

HERNANDEZ DOMINGUEZ, BAUDELIO (MEX-
ICO INDIVIDUAL)

CERRO DE LA ESTRELLA NO. 375

CO. CAMPESTRE CHUBURUSCO, DEL. COYOA-
CÁN

MEXICO, MEXICO 04200

FOR: MATCHES; TOBACCO, IN CLASS 34 (U.S.
CLS. 2, 8, 9 AND 17).

THE MARK CONSISTS OF STANDARD CHAR-
ACTERS WITHOUT CLAIM TO ANY PARTICULAR
FONT, STYLE, SIZE, OR COLOR.

OWNER OF MEXICO REG. NO. 937733, DATED 5-
31-2006, EXPIRES 5-17-2016.

SER. NO. 77-025,501, FILED P.R. 10-20-2006; AM.
S.R. 11-26-2007.

KATHRYN COWARD, EXAMINING ATTORNEY

Int. Cl.: 44

Prior U.S. Cls.: 100 and 101

United States Patent and Trademark Office

Reg. No. 3,400,248

Registered Mar. 18, 2008

**SERVICE MARK
SUPPLEMENTAL REGISTER**

THE PHYSICIAN'S RX

THE PHYSICIAN'S RX, INC. (FLORIDA CORPORATION)
6920 ANNAPOLIS COURT
PARKLAND, FL 33067

THE MARK CONSISTS OF STANDARD CHARACTERS WITHOUT CLAIM TO ANY PARTICULAR FONT, STYLE, SIZE, OR COLOR.

FOR: SERVICES IN THE NATURE OF DISPENSING OF PHARMACEUTICALS, IN CLASS 44 (U.S. CLS. 100 AND 101).

SER. NO. 77-027,859, FILED P.R. 10-24-2006; AM. S.R. 12-14-2007.

FIRST USE 3-15-2006; IN COMMERCE 3-15-2006.

VERNA BETH RIRIE, EXAMINING ATTORNEY

Int. Cl.: 19

Prior U.S. Cls.: 1, 12, 33, and 50

United States Patent and Trademark Office

Reg. No. 3,400,249

Registered Mar. 18, 2008

**TRADEMARK
SUPPLEMENTAL REGISTER**

Coral Cast

CORAL CAST, LLC (NEW YORK LTD LIAB CO)
31 COMMERCIAL COURT
PLAINVIEW, NY 11803

FOR: BIRD BATHS MADE OF CONCRETE;
BLOCKS OF CONCRETE; CONCRETE; CONCRETE
BEAMS; CONCRETE BIRD BATHS; CONCRETE
BLOCKS; CONCRETE BUILDING MATERIALS,
NAMELY, CONCRETE; CONCRETE FLOORS; CON-
CRETE PANELS; CONCRETE RETAINING WALLS;
CONCRETE SCULPTURES; CONCRETE WALLS;
CONCRETE WALLS FOR BUILDING; DESKTOP
STATUARY MADE OF CONCRETE; FIGURES OF
CONCRETE; INDUSTRIAL CONCRETE FOR USE
IN CIVIL ENGINEERING WORKS; MONUMENTS

OF CONCRETE; NON-METAL CASTING FORMS
FOR CONCRETE; SLABS OF CONCRETE; STATUES
OF CONCRETE; STATUETTES OF CONCRETE, IN
CLASS 19 (U.S. CLS. 1, 12, 33 AND 50).

FIRST USE 8-1-2006; IN COMMERCE 8-15-2006.

THE MARK CONSISTS OF STANDARD CHAR-
ACTERS WITHOUT CLAIM TO ANY PARTICULAR
FONT, STYLE, SIZE, OR COLOR.

SER. NO. 77-052,029, FILED P.R. 11-28-2006; AM.
S.R. 9-27-2007.

MARK PILARO, EXAMINING ATTORNEY

Int. Cl.: 15

Prior U.S. Cls.: 2, 21, and 36

United States Patent and Trademark Office

Reg. No. 3,400,250

Registered Mar. 18, 2008

**TRADEMARK
SUPPLEMENTAL REGISTER**

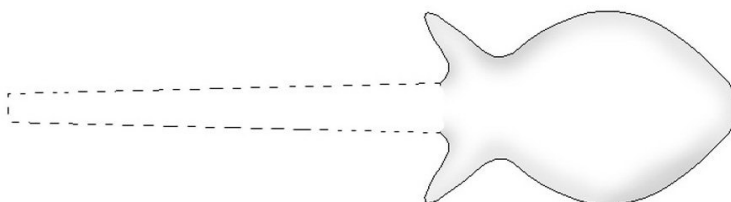

GOLDFISH GUITARS LLC (TEXAS LTD LIAB
CO)
1300 OCEANSIDE LANE
LEAGUE CITY, TX 77573

FOR: CARRYING CASES FOR MUSICAL INSTRUMENTS; DRUMS; MUSIC PITCH PIPES; MUSICAL INSTRUMENT STANDS; MUSICAL INSTRUMENTS; MUSICAL INSTRUMENTS, NAMELY, BASS GUITARS; MUSICAL INSTRUMENTS, NAMELY, ELECTRIC GUITARS AND ACOUSTIC GUITARS; PICKS FOR STRINGED INSTRUMENTS; STANDS FOR MUSICAL INSTRUMENTS; STRING INSTRUMENTS, NAMELY, ACOUSTIC, ACOUSTIC/ELECTRIC AND ELECTRIC GUITARS AND ACOUSTIC, ACOUSTIC/ELECTRIC AND ELECTRIC BASSES AND REPLACEMENT

PARTS, AND STRINGED INSTRUMENT ACCESSORIES, NAMELY, INSTRUMENT CASES, STANDS, PICKS, STRAPS AND STRINGS; TUNERS FOR MUSICAL INSTRUMENTS, IN CLASS 15 (U.S. CLS. 2, 21 AND 36).

FIRST USE 12-10-2000; IN COMMERCE 12-7-2002.

THE MARK CONSISTS OF THE CONFIGURATION OF THE BODY OF A GUITAR, IN THE SHAPE OF A FISH.

SER. NO. 77-060,799, FILED P.R. 12-9-2006; AM. S.R. 2-13-2008.

SARA THOMAS, EXAMINING ATTORNEY

Int. Cl.: 32

Prior U.S. Cls.: 45, 46, and 48

United States Patent and Trademark Office

Reg. No. 3,400,251

Registered Mar. 18, 2008

**TRADEMARK
SUPPLEMENTAL REGISTER**

Pagosa Brewing Company

TONY'S TAPS LLC D/B/A PAGOSA BREWING
COMPANY (COLORADO LTD LIAB CO)
P.O. BOX 3069
100 N. PAGOSA BLVD.
PAGOSA SPRINGS, CO 81147

FOR: BEVERAGES, NAMELY, BEER, BREWED
MALT-BASED ALCOHOLIC BEVERAGE IN THE
NATURE OF A BEER, PALE BEER, ALE, PORTER,
STOUT, GINGER BEER, ROOT BEER, SOFT
DRINKS, IN CLASS 32 (U.S. CLS. 45, 46 AND 48).

FIRST USE 11-29-2005; IN COMMERCE 6-19-2006.

THE MARK CONSISTS OF STANDARD CHAR-
ACTERS WITHOUT CLAIM TO ANY PARTICULAR
FONT, STYLE, SIZE, OR COLOR.

SER. NO. 77-065,609, FILED P.R. 12-15-2006; AM.
S.R. 12-15-2006.

ROBIN CHOSID, EXAMINING ATTORNEY

Int. Cl.: 11

Prior U.S. Cls.: 13, 21, 23, 31, and 34

United States Patent and Trademark Office

Reg. No. 3,400,252

Registered Mar. 18, 2008

**TRADEMARK
SUPPLEMENTAL REGISTER**

CUSTOM FAUCETRY

CALIFORNIA FAUCETS (CALIFORNIA CORPORATION)
5231 ARGOSY DRIVE
HUNTINGTON BEACH, CA 92649

FOR: FAUCETS; AND PLUMBING FITTINGS, NAMELY, DRAINS, SPOUTS, FAUCET FILTERS, FAUCET VALVES, DRAIN COVERS, CONNECTOR HOSES, TUB SPOUTS, SHOWER HEADS, AND HAND SHOWERS, IN CLASS 11 (U.S. CLS. 13, 21, 23, 31 AND 34).

FIRST USE 6-30-2007; IN COMMERCE 6-30-2007.

THE MARK CONSISTS OF STANDARD CHARACTERS WITHOUT CLAIM TO ANY PARTICULAR FONT, STYLE, SIZE, OR COLOR.

SER. NO. 77-065,617, FILED P.R. 12-15-2006; AM. S.R. 1-2-2008.

GEOFFREY FOSDICK, EXAMINING ATTORNEY

Int. Cl.: 45

Prior U.S. Cls.: 100 and 101

United States Patent and Trademark Office

Reg. No. 3,400,253

Registered Mar. 18, 2008

**SERVICE MARK
SUPPLEMENTAL REGISTER**

CIVIL JUSTICE PROSECUTORS

LABOVICK, LABOVICK & WALD, P.A. (FLOR-
IDA CORPORATION)
SUITE 102
935 MILITARY TRAIL
JUPITER, FL 33458

FOR: LEGAL SERVICES, IN CLASS 45 (U.S. CLS.
100 AND 101).

FIRST USE 1-15-2007; IN COMMERCE 1-15-2007.

THE MARK CONSISTS OF STANDARD CHAR-
ACTERS WITHOUT CLAIM TO ANY PARTICULAR
FONT, STYLE, SIZE, OR COLOR.

SER. NO. 77-068,184, FILED P.R. 12-20-2006; AM.
S.R. 1-2-2008.

RONALD MCMORROW, EXAMINING ATTORNEY

Int. Cl.: 30

Prior U.S. Cl.: 46

United States Patent and Trademark Office

Reg. No. 3,400,254

Registered Mar. 18, 2008

**TRADEMARK
SUPPLEMENTAL REGISTER**

MEDITERRANEAN CLASSICS

KENOVER MARKETING CORP. (NEW YORK
CORPORATION)
9 TWENTY-NINTH STREET
BROOKLYN, NY 11232

FOR: COUSCOUS, IN CLASS 30 (U.S. CL. 46).

FIRST USE 11-7-2007; IN COMMERCE 11-7-2007.

THE MARK CONSISTS OF STANDARD CHAR-
ACTERS WITHOUT CLAIM TO ANY PARTICULAR
FONT, STYLE, SIZE, OR COLOR.

SER. NO. 77-071,820, FILED P.R. 12-27-2006; AM.
S.R. 11-14-2007.

RENEE SERVANCE, EXAMINING ATTORNEY

Int. Cl.: 10

Prior U.S. Cls.: 26, 39, and 44

Reg. No. 3,400,255

United States Patent and Trademark Office

Registered Mar. 18, 2008

**TRADEMARK
SUPPLEMENTAL REGISTER**

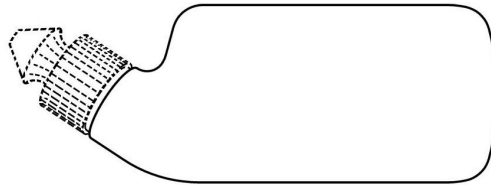

BEWELL HEALTH PRODUCTS, INC. (MISSOURI CORPORATION)
1204 SUTTON DRIVE
COLUMBIA, MO 65203

FOR: BOTTLE FOR ORGANIC NASAL RINSING SOLUTION FOR NASAL WASHING FOR THE PURPOSE OF REFRESHING NASAL MEMBRANE LINE, MOISTURIZE AND WASH AWAY NASAL PARTICLES, IN CLASS 10 (U.S. CLS. 26, 39 AND 44).

FIRST USE 10-1-2004; IN COMMERCE 10-1-2004.

THE MARK CONSISTS OF A BOTTLE FOR AN ORGANIC NASAL WASH SOLUTION, THE BOTTLE HAVING CURVED EDGES AND AN ANGLED NECK SO THAT THE DIRECTION OF SPRAY IS OFFSET FROM THE LONGITUDINAL AXIS OF THE BOTTLE.

SER. NO. 77-086,236, FILED P.R. 1-19-2007; AM. S.R. 1-16-2008.

SHAUNIA CARLYLE, EXAMINING ATTORNEY

Int. Cls.: 35 and 36

Prior U.S. Cls.: 100, 101, and 102

United States Patent and Trademark Office

Reg. No. 3,400,256

Registered Mar. 18, 2008

**SERVICE MARK
SUPPLEMENTAL REGISTER**

**EVIDENCE-INFORMED CASE
RATES**

PROMETHEUS PAYMENT, INC. (MASSACHU-
SETTS CORPORATION)
C/O ERICA HEPP, ESQ., ROPES & GRAY LLP
ONE INTERNATIONAL PLACE
BOSTON, MA 02110

FOR: PROMOTING PUBLIC AWARENESS OF
THE NEED FOR IMPROVED HEALTH CARE BILL-
ING, REIMBURSEMENT, AND PAYMENT MOD-
ELS AND FOR IMPROVED HEALTH CARE
QUALITY AND EFFICIENCY; PROVIDING ON-
LINE INFORMATION IN THE FIELD OF HEALTH
CARE BILLING; QUALITY IMPROVEMENT SER-
VICES IN THE FIELD OF HEALTH CARE PAY-
MENT, NAMELY, BUSINESS CONSULTATION IN
THE FIELD OF BILLING AND PROVIDER REIM-
BURSEMENT; CONSULTING SERVICES IN THE
COST AND PAYMENT MANAGEMENT OF
HEALTH CARE; CONDUCTING INCENTIVE
AWARD PROGRAMS TO PROMOTE THE QUAL-
ITY AND EFFICIENCY OF HEALTH CARE PROVI-
DERS; PROVIDING CONSUMER INFORMATION

IN THE FIELD OF RATING OF THE QUALITY AND
EFFICIENCY OF HEALTH CARE PROVIDERS, IN
CLASS 35 (U.S. CLS. 100, 101 AND 102).

FIRST USE 11-30-2006; IN COMMERCE 11-30-2006.

FOR: PROVIDING ONLINE INFORMATION IN
THE FIELD OF INSURANCE CLAIMS PAYMENT
TO HEALTH CARE PROVIDERS, IN CLASS 36 (U.S.
CLS. 100, 101 AND 102).

FIRST USE 11-30-2006; IN COMMERCE 11-30-2006.

THE MARK CONSISTS OF STANDARD CHAR-
ACTERS WITHOUT CLAIM TO ANY PARTICULAR
FONT, STYLE, SIZE, OR COLOR.

SER. NO. 77-092,331, FILED P.R. 1-26-2007; AM. S.R.
11-19-2007.

REBECCA GILBERT, EXAMINING ATTORNEY

Int. Cl.: 25

Prior U.S. Cls.: 22 and 39

United States Patent and Trademark Office

Reg. No. 3,400,257

Registered Mar. 18, 2008

**TRADEMARK
SUPPLEMENTAL REGISTER**

Lake Wear

KMITO, MICHAEL (UNITED STATES INDIVIDUAL)

66 JAYS LANE

HANOVER, MA 02339

FOR: BATHROBES; BEACH COVERUPS; GOLF SHIRTS; HATS; JACKETS; LOUNGEWEAR; T-SHIRTS; VISORS, IN CLASS 25 (U.S. CLS. 22 AND 39).

FIRST USE 11-15-2007; IN COMMERCE 11-20-2007.

THE MARK CONSISTS OF STANDARD CHARACTERS WITHOUT CLAIM TO ANY PARTICULAR FONT, STYLE, SIZE, OR COLOR.

NO CLAIM IS MADE TO THE EXCLUSIVE RIGHT TO USE "WEAR", APART FROM THE MARK AS SHOWN.

SER. NO. 77-101,909, FILED P.R. 2-7-2007; AM. S.R. 12-4-2007.

JENNY PARK, EXAMINING ATTORNEY

Int. Cl.: 5

Prior U.S. Cls.: 6, 18, 44, 46, 51, and 52

United States Patent and Trademark Office

Reg. No. 3,400,258

Registered Mar. 18, 2008

**TRADEMARK
SUPPLEMENTAL REGISTER**

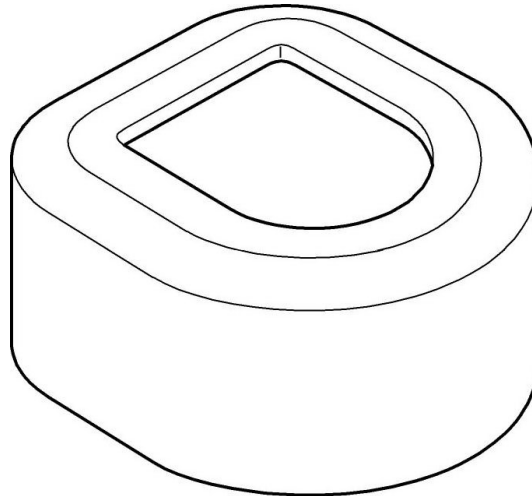

WARNER CHILCOTT COMPANY, INC. (PUERTO RICO CORPORATION)
UNION STREET KM 1.1.
FAJARDO, PUERTO RICO 00738

FOR: PHARMACEUTICAL PREPARATIONS, NAMELY HORMONE PREPARATIONS FOR MEDICAL USE, IN CLASS 5 (U.S. CLS. 6, 18, 44, 46, 51 AND 52).

FIRST USE 2-0-2000; IN COMMERCE 2-0-2000.

THE MARK CONSISTS OF D-SHAPED TABLET.

SER. NO. 77-102,740, FILED P.R. 2-8-2007; AM. S.R. 2-9-2008.

DAVID MURRAY, EXAMINING ATTORNEY

Int. Cl.: 41

Prior U.S. Cls.: 100, 101, and 107

United States Patent and Trademark Office

Reg. No. 3,400,259

Registered Mar. 18, 2008

**SERVICE MARK
SUPPLEMENTAL REGISTER**

ONLINESEATS.COM

ONLINESEATS.COM INC. (ILLINOIS CORPORATION)
2614 NORTH CALIFORNIA
CHICAGO, IL 60647

THE MARK CONSISTS OF STANDARD CHARACTERS WITHOUT CLAIM TO ANY PARTICULAR FONT, STYLE, SIZE, OR COLOR.

FOR: ARRANGING FOR TICKET RESERVATIONS FOR SHOWS AND OTHER EVENTS, IN CLASS 41 (U.S. CLS. 100, 101 AND 107).

SER. NO. 77-103,288, FILED P.R. 2-9-2007; AM. S.R. 11-29-2007.

FIRST USE 8-15-2003; IN COMMERCE 8-15-2003.

MARY CRAWFORD, EXAMINING ATTORNEY

Int. Cls.: 41 and 42

Prior U.S. Cls.: 100, 101, and 107

United States Patent and Trademark Office

Reg. No. 3,400,260

Registered Mar. 18, 2008

**SERVICE MARK
SUPPLEMENTAL REGISTER**

LEGALNEWSLINE.COM

THE CHAMBER OF COMMERCE OF THE UNITED STATES OF AMERICA (D.C. CORPORATION)
1615 H STREET, N.W.
WASHINGTON, DC 20062

FOR: NEWS AGENCIES, NAMELY, GATHERING AND DISSEMINATION OF NEWS; NEWS ANALYSIS AND FEATURES DISTRIBUTION; NEWS REPORTING SERVICES; NEWS SYNDICATION FOR THE BROADCASTING INDUSTRY; NEWS SYNDICATION REPORTING; PROVIDING NEWS IN THE NATURE OF CURRENT EVENT REPORTING; NEWS AGENCY SERVICES, NAMELY, THE GATHERING AND DISSEMINATION OF NEWS CONCERNING LEGAL REFORM ISSUES, IN CLASS 41 (U.S. CLS. 100, 101 AND 107).

FIRST USE 11-15-2006; IN COMMERCE 11-15-2006.

FOR: PROVIDING ONLINE INFORMATION IN THE FIELD OF LEGAL REFORM ISSUES, IN CLASS 42 (U.S. CLS. 100 AND 101).

FIRST USE 11-15-2006; IN COMMERCE 11-15-2006.

THE MARK CONSISTS OF STANDARD CHARACTERS WITHOUT CLAIM TO ANY PARTICULAR FONT, STYLE, SIZE, OR COLOR.

SER. NO. 77-104,975, FILED P.R. 2-12-2007; AM. S.R. 12-3-2007.

CHRISTOPHER BUONGIORNO, EXAMINING ATTORNEY

Int. Cl.: 9

Prior U.S. Cls.: 21, 23, 26, 36, and 38

United States Patent and Trademark Office

Reg. No. 3,400,261

Registered Mar. 18, 2008

**TRADEMARK
SUPPLEMENTAL REGISTER**



DAWG PRODUCTIONS LLC (MICHIGAN LTD
LIAB CO)
7652 BEE BALM COURT
DEXTER, MI 48130

NO CLAIM IS MADE TO THE EXCLUSIVE
RIGHT TO USE "DETROIT", APART FROM THE
MARK AS SHOWN.

FOR: MUSICAL SOUND RECORDINGS, IN
CLASS 9 (U.S. CLS. 21, 23, 26, 36 AND 38).

SER. NO. 77-106,278, FILED P.R. 2-13-2007; AM. S.R.
2-5-2008.

FIRST USE 10-1-2006; IN COMMERCE 10-1-2006.

NATALIE POLZER, EXAMINING ATTORNEY

Int. Cl.: 9

Prior U.S. Cls.: 21, 23, 26, 36, and 38

United States Patent and Trademark Office

Reg. No. 3,400,262

Registered Mar. 18, 2008

**TRADEMARK
SUPPLEMENTAL REGISTER**

CAB CASH

WILLOUGHBY, JASON (UNITED STATES INDIVIDUAL)
1605 TREEMONT AVENUE
JUPITER, FL 33469

FOR: MAGNETICALLY ENCODED PRE-PAID PAYMENT CARDS USED IN PROVIDING PAYMENT FOR CAB OR TAXI SERVICES, IN CLASS 9 (U.S. CLS. 21, 23, 26, 36 AND 38).

FIRST USE 1-0-2007; IN COMMERCE 1-0-2007.

THE MARK CONSISTS OF STANDARD CHARACTERS WITHOUT CLAIM TO ANY PARTICULAR FONT, STYLE, SIZE, OR COLOR.

SER. NO. 77-106,411, FILED P.R. 2-13-2007; AM. S.R. 1-3-2008.

LEIGH CAROLINE CASE, EXAMINING ATTORNEY

Int. Cl.: 9

Prior U.S. Cls.: 21, 23, 26, 36, and 38

United States Patent and Trademark Office

Reg. No. 3,400,263

Registered Mar. 18, 2008

**TRADEMARK
SUPPLEMENTAL REGISTER**

UNIVERSITY CAB CASH

WILLOUGHBY, JASON (UNITED STATES INDIVIDUAL)
1605 TREEMONT AVENUE
JUPITER, FL 33469

FOR: MAGNETICALLY-ENCODED PRE-PAID PAYMENT CARDS USED IN PROVIDING PAYMENT FOR CAB OR TAXI SERVICES, IN CLASS 9 (U.S. CLS. 21, 23, 26, 36 AND 38).

FIRST USE 1-0-2007; IN COMMERCE 1-0-2007.

THE MARK CONSISTS OF STANDARD CHARACTERS WITHOUT CLAIM TO ANY PARTICULAR FONT, STYLE, SIZE, OR COLOR.

SER. NO. 77-106,417, FILED P.R. 2-13-2007; AM. S.R. 1-3-2008.

LEIGH CAROLINE CASE, EXAMINING ATTORNEY

Int. Cl.: 42

Prior U.S. Cls.: 100 and 101

United States Patent and Trademark Office

Reg. No. 3,400,264

Registered Mar. 18, 2008

**SERVICE MARK
SUPPLEMENTAL REGISTER**

Event Console

THE ACTIVE NETWORK, INC. (DELAWARE
CORPORATION)
10182 TELESIS COURT, SUITE 300
SAN DIEGO, CA 92121

FOR: PROVIDING WEB-BASED NON-DOWN-
LOADABLE CORPORATE EVENT MANAGEMENT
AND PLANNING SOFTWARE, IN CLASS 42 (U.S.
CLS. 100 AND 101).

FIRST USE 4-25-2006; IN COMMERCE 4-25-2006.

THE MARK CONSISTS OF STANDARD CHAR-
ACTERS WITHOUT CLAIM TO ANY PARTICULAR
FONT, STYLE, SIZE, OR COLOR.

SER. NO. 77-106,621, FILED P.R. 2-13-2007; AM. S.R.
1-7-2008.

HEATHER THOMPSON, EXAMINING ATTORNEY

Int. Cls.: 31 and 42

Prior U.S. Cls.: 1, 46, 100, and 101

United States Patent and Trademark Office

Reg. No. 3,400,265

Registered Mar. 18, 2008

**TRADEMARK
SERVICE MARK
SUPPLEMENTAL REGISTER**

THE ENERGY CROP COMPANY

CERES, INC. (DELAWARE CORPORATION)
1535 RANCHO CONEJO BOULEVARD
THOUSAND OAKS, CA 913201440

FOR: AGRICULTURAL SEEDS, IN CLASS 31 (U.S. CLS. 1 AND 46).

FIRST USE 10-29-2007; IN COMMERCE 10-29-2007.

FOR: PROVIDING INFORMATION IN THE FIELD OF BIOFUEL RESEARCH; SCIENTIFIC RESEARCH SERVICES IN THE FIELD OF BIOFUELS, IN CLASS 42 (U.S. CLS. 100 AND 101).

FIRST USE 3-21-2007; IN COMMERCE 3-21-2007.

THE MARK CONSISTS OF STANDARD CHARACTERS WITHOUT CLAIM TO ANY PARTICULAR FONT, STYLE, SIZE, OR COLOR.

NO CLAIM IS MADE TO THE EXCLUSIVE RIGHT TO USE "COMPANY", APART FROM THE MARK AS SHOWN.

SER. NO. 77-108,216, FILED P.R. 2-15-2007; AM. S.R. 11-13-2007.

SCOTT BIBB, EXAMINING ATTORNEY

Int. Cl.: 16

Prior U.S. Cls.: 2, 5, 22, 23, 29, 37, 38, and 50

United States Patent and Trademark Office

Reg. No. 3,400,266

Registered Mar. 18, 2008

**TRADEMARK
SUPPLEMENTAL REGISTER**

**SUBURBAN REAL ESTATE
NEWS.COM**

SUBURBAN PUBLISHING CORPORATION
(MASSACHUSETTS CORPORATION)
10 FIRST AVENUE
PEABODY, MA 01961

FOR: PRINTED PUBLICATIONS CONTAINING
ADVERTISING FOR OTHERS IN THE NATURE OF
REAL ESTATE PROPERTIES AND INFORMATION
RELATED TO THE REAL ESTATE INDUSTRY, IN
CLASS 16 (U.S. CLS. 2, 5, 22, 23, 29, 37, 38 AND 50).

FIRST USE 2-0-2006; IN COMMERCE 2-0-2006.

THE MARK CONSISTS OF STANDARD CHAR-
ACTERS WITHOUT CLAIM TO ANY PARTICULAR
FONT, STYLE, SIZE, OR COLOR.

NO CLAIM IS MADE TO THE EXCLUSIVE
RIGHT TO USE "REAL ESTATE NEWS.COM",
APART FROM THE MARK AS SHOWN.

SER. NO. 77-110,772, FILED P.R. 2-19-2007; AM. S.R.
12-10-2007.

JORDAN BAKER, EXAMINING ATTORNEY

Int. Cl.: 41

Prior U.S. Cls.: 100, 101, and 107

United States Patent and Trademark Office

Reg. No. 3,400,267

Registered Mar. 18, 2008

**SERVICE MARK
SUPPLEMENTAL REGISTER**

SPIRITUAL CAPITALISM

RESSLER, MONIKA (UNITED STATES INDIVIDUAL)
SUITE 1117
1123 BROADWAY ST.
NEW YORK, NY 10010

FOR: EDUCATION SERVICES, NAMELY, PROVIDING SEMINARS, LECTURES AND WORKSHOPS IN THE FIELD OF SELF HELP, AND EMPOWERMENT, IN CLASS 41 (U.S. CLS. 100, 101 AND 107).

FIRST USE 1-1-2003; IN COMMERCE 9-1-2004.

THE MARK CONSISTS OF STANDARD CHARACTERS WITHOUT CLAIM TO ANY PARTICULAR FONT, STYLE, SIZE, OR COLOR.

SER. NO. 77-112,329, FILED P.R. 2-21-2007; AM. S.R. 1-8-2008.

RONALD MCMORROW, EXAMINING ATTORNEY

Int. Cl.: 42

Prior U.S. Cls.: 100 and 101

United States Patent and Trademark Office

Reg. No. 3,400,268

Registered Mar. 18, 2008

**SERVICE MARK
SUPPLEMENTAL REGISTER**

L.A. Design Studio

TONY C. BADALATO (UNITED STATES INDIVIDUAL)

965 N. RANCHO ROAD

THOUSAND OAKS, CA 91362

FOR: COMPUTER AIDED DESIGN FOR OTHERS; COMPUTER NETWORK DESIGN FOR OTHERS; COMPUTER SERVICES IN THE NATURE OF CUSTOMIZED WEB PAGES FEATURING USER-DEFINED INFORMATION, PERSONAL PROFILES AND INFORMATION; COMPUTER SERVICES, NAMELY, DESIGNING AND IMPLEMENTING NETWORK WEB PAGES FOR OTHERS; COMPUTER SERVICES, NAMELY, MANAGING WEB SITES FOR OTHERS; GRAPHIC DESIGN SERVICES; HOSTING THE WEB SITES OF OTHERS ON A

COMPUTER SERVER FOR A GLOBAL COMPUTER NETWORK, IN CLASS 42 (U.S. CLS. 100 AND 101).

FIRST USE 11-16-2000; IN COMMERCE 11-16-2000.

THE MARK CONSISTS OF STANDARD CHARACTERS WITHOUT CLAIM TO ANY PARTICULAR FONT, STYLE, SIZE, OR COLOR.

NO CLAIM IS MADE TO THE EXCLUSIVE RIGHT TO USE "DESIGN", APART FROM THE MARK AS SHOWN.

SER. NO. 77-114,074, FILED P.R. 2-22-2007; AM. S.R. 12-11-2007.

CAROLYN GRAY, EXAMINING ATTORNEY

Int. Cl.: 35

Prior U.S. Cls.: 100, 101, and 102

United States Patent and Trademark Office

Reg. No. 3,400,269

Registered Mar. 18, 2008

**SERVICE MARK
SUPPLEMENTAL REGISTER**

INTEGRATED SYSTEMS RUSSIA

INTEGRATED SYSTEMS EVENTS LLC (DELA-
WARE LTD LIAB CO)
11242 WAPLES MILL ROAD, SUITE 200
FAIRFAX, VA 22030

FOR: ORGANIZING, PROMOTING AND CON-
DUCTING CONFERENCES AND TRADE SHOWS
CONCERNING THE PRODUCTS AND SERVICES
OF AND TOPICS OF INTEREST TO THOSE IN THE
AUDIO/VIDEO, PROJECTION, PRESENTATION
AND AUDIOVISUAL COMMUNICATIONS INDUS-
TRIES, IN CLASS 35 (U.S. CLS. 100, 101 AND 102).

FIRST USE 11-8-2007; IN COMMERCE 11-8-2007.

THE MARK CONSISTS OF STANDARD CHAR-
ACTERS WITHOUT CLAIM TO ANY PARTICULAR
FONT, STYLE, SIZE, OR COLOR.

OWNER OF U.S. REG. NOS. 2,956,011, 2,962,666,
AND 3,003,039.

NO CLAIM IS MADE TO THE EXCLUSIVE
RIGHT TO USE "RUSSIA", APART FROM THE
MARK AS SHOWN.

SER. NO. 77-114,434, FILED P.R. 2-23-2007; AM. S.R.
1-4-2008.

ADA HAN, EXAMINING ATTORNEY

Int. Cls.: 38 and 41

Prior U.S. Cls.: 100, 101, 104, and 107

United States Patent and Trademark Office

Reg. No. 3,400,270

Registered Mar. 18, 2008

**SERVICE MARK
SUPPLEMENTAL REGISTER**

ADIRONDACK RADIO

RYAN, DENNIS (UNITED STATES INDIVIDUAL)
717 PLANK ROAD
CLIFTON PARK, NY 12065

FOR: RADIO BROADCAST SERVICES, NAMELY,
THE TRANSMISSION OF LIVE AND PRERECOR-
DED AUDIO PROGRAMS OVER THE INTERNET,
IN CLASS 38 (U.S. CLS. 100, 101 AND 104).

FIRST USE 11-28-2007; IN COMMERCE 11-28-2007.

FOR: SPECIAL EVENT PLANNING; SPECIAL
EVENT PLANNING CONSULTATION; EDUCA-
TIONAL SERVICES, NAMELY, PRESENTATIONS

AND SEMINARS IN THE FIELD OF ADVERTISING
AND PUBLIC RELATIONS, IN CLASS 41 (U.S. CLS.
100, 101 AND 107).

FIRST USE 8-10-2007; IN COMMERCE 8-10-2007.

THE MARK CONSISTS OF STANDARD CHAR-
ACTERS WITHOUT CLAIM TO ANY PARTICULAR
FONT, STYLE, SIZE, OR COLOR.

SER. NO. 77-114,846, FILED P.R. 2-23-2007; AM. S.R.
1-2-2008.

TINA KUAN, EXAMINING ATTORNEY

Int. Cls.: 41, 44, and 45

Prior U.S. Cls.: 100, 101, and 107

United States Patent and Trademark Office

Reg. No. 3,400,271

Registered Mar. 18, 2008

**SERVICE MARK
SUPPLEMENTAL REGISTER**

**PROFESSIONAL DIAGNOSTICS &
SAFETY**

PROFESSIONAL DIAGNOSTICS & SAFETY, INC.
(INDIANA CORPORATION)
1961 EAST MARKET STREET
NAPPANEE, IN 46550

FOR: PROMOTING A SAFE, SECURE, AND
DRUG FREE WORK PLACE, NAMELY, PROVID-
ING TRAINING ON SAFETY IN THE WORKPLACE,
IN CLASS 41 (U.S. CLS. 100, 101 AND 107).

FIRST USE 8-1-2006; IN COMMERCE 8-14-2006.

FOR: MEDICAL SERVICES THAT PROMOTE A
SAFE, SECURE AND DRUG FREE WORK PLACE,
NAMELY, PRE AND POST EMPLOYMENT DRUG
SCREENING, IN CLASS 44 (U.S. CLS. 100 AND 101).

FIRST USE 8-1-2006; IN COMMERCE 8-14-2006.

FOR: PROMOTING A SAFE, SECURE AND
DRUG FREE WORK PLACE, NAMELY, PRE-EM-
PLOYMENT BACKGROUND SCREENING, IN
CLASS 45 (U.S. CLS. 100 AND 101).

FIRST USE 8-1-2006; IN COMMERCE 8-14-2006.

THE MARK CONSISTS OF STANDARD CHAR-
ACTERS WITHOUT CLAIM TO ANY PARTICULAR
FONT, STYLE, SIZE, OR COLOR.

SER. NO. 77-115,815, FILED P.R. 2-26-2007; AM. S.R.
12-19-2007.

BRIAN PINO, EXAMINING ATTORNEY

Int. Cl.: 42

Prior U.S. Cls.: 100 and 101

United States Patent and Trademark Office

Reg. No. 3,400,272

Registered Mar. 18, 2008

**SERVICE MARK
SUPPLEMENTAL REGISTER**

Computing Utility

ENKI LLC (CALIFORNIA LTD LIAB CO)
1049-C EL MONTE AVE #32
MOUNTAIN VIEW, CA 94040

FOR: APPLICATION SERVICE PROVIDER (ASP), NAMELY, HOSTING COMPUTER SOFTWARE APPLICATIONS OF OTHERS; COMPUTER COLOCATION SERVICES, NAMELY, PROVIDING FACILITIES FOR THE LOCATION OF COMPUTER SERVERS WITH THE EQUIPMENT OF OTHERS; COMPUTER CONSULTATION IN THE FIELD OF COMPUTER SECURITY; COMPUTER DIAGNOSTIC SERVICES; COMPUTER MONITORING SERVICE WHICH TRACKS HARDWARE PERFORMANCE AND PROCESSES AND SENDS OUT HISTORICAL REPORTS AND ALERTS; COMPUTER SECURITY SERVICE, NAMELY, RESTRICTING ACCESS TO AND BY COMPUTER NETWORKS TO AND OF UNDESIREED WEB SITES, MEDIA AND INDIVIDUALS AND FACILITIES; COMPUTER SERVICES, NAMELY, MONITORING AND REPORTING ON THE PERFORMANCE, AVAILABILITY, AND ERRORS OF WEBSITES OF OTHERS; COMPUTER SERVICES, NAMELY, MONITORING, TESTING, ANALYZING, AND REPORTING ON THE INTERNET TRAFFIC CONTROL AND CONTENT CONTROL OF THE WEBSITES OF OTHERS; COMPUTER SERVICES, NAMELY, DATA RECOVERY SERVICES; COMPUTER SERVICES, NAMELY, MONITORING THE WEBSITES OF OTHERS TO IMPROVE SCALABILITY AND PERFORMANCE OF

WEBSITES OF OTHERS; COMPUTER TIME-SHARING SERVICES; HOSTING OF DIGITAL CONTENT ON THE INTERNET; HOSTING THE WEB SITES OF OTHERS ON A COMPUTER SERVER FOR A GLOBAL COMPUTER NETWORK; INSTALLATION OF COMPUTER SOFTWARE; LEASING COMPUTER FACILITIES; MONITORING THE COMPUTER SYSTEMS OF OTHERS FOR TECHNICAL PURPOSES AND PROVIDING BACK-UP COMPUTER PROGRAMS AND FACILITIES; PERIODIC UPGRADING OF COMPUTER SOFTWARE FOR OTHERS; RECOVERY OF COMPUTER DATA; REMOTE MONITORING SERVICES OF HEATING, VENTILATING AND AIR CONDITIONING APPARATUS; RENTAL OF A DATABASE SERVER (TO THIRD PARTIES); RENTAL OF WEB SERVERS; TECHNICAL SUPPORT, NAMELY, MONITORING OF NETWORK SYSTEMS; UPDATING OF COMPUTER SOFTWARE FOR OTHERS; WEB SITE HOSTING SERVICES, IN CLASS 42 (U.S. CLS. 100 AND 101).

FIRST USE 2-25-2007; IN COMMERCE 2-25-2007.

THE MARK CONSISTS OF STANDARD CHARACTERS WITHOUT CLAIM TO ANY PARTICULAR FONT, STYLE, SIZE, OR COLOR.

SER. NO. 77-116,152, FILED P.R. 2-26-2007; AM. S.R. 1-16-2008.

APRIL ROACH, EXAMINING ATTORNEY

Int. Cl.: 9

Prior U.S. Cls.: 21, 23, 26, 36, and 38

United States Patent and Trademark Office

Reg. No. 3,400,273

Registered Mar. 18, 2008

**TRADEMARK
SUPPLEMENTAL REGISTER**

REPLAYSERVICE

CODESTREET, LLC (NEW YORK LTD LIAB CO)
9TH FLOOR
11 WEST 42ND STREET
NEW YORK, NY 10036

FOR: COMPUTER SOFTWARE PROGRAM FOR
CAPTURING, RECORDING, AND REPLAYING
MARKET DATA AND FOR PROVIDING MESSA-
GING MIDDLEWARE PROTOCOLS , IN CLASS 9
(U.S. CLS. 21, 23, 26, 36 AND 38).

FIRST USE 8-1-2003; IN COMMERCE 8-1-2003.

THE MARK CONSISTS OF STANDARD CHAR-
ACTERS WITHOUT CLAIM TO ANY PARTICULAR
FONT, STYLE, SIZE, OR COLOR.

SER. NO. 77-118,045, FILED P.R. 2-28-2007; AM. S.R.
1-10-2008.

NICHOLAS ALTREE, EXAMINING ATTORNEY

Int. Cls.: 35 and 36

Prior U.S. Cls.: 100, 101, and 102

United States Patent and Trademark Office

Reg. No. 3,400,274

Registered Mar. 18, 2008

**SERVICE MARK
SUPPLEMENTAL REGISTER**

Probate Liquidators

PROBATE UNCOVERED, INC. (FLORIDA CORPORATION)
SUITE B
6263 PARK BLVD.
PINELLAS PARK, FL 33781

FOR: MATCHING CONSUMERS WITH REAL ESTATE PROFESSIONALS IN THE FIELD OF REAL ESTATE SERVICES VIA COMPUTER NETWORK; PROMOTING THE GOODS OF OTHERS BY MEANS OF ON-LINE REAL TIME PRESENTATION FOR INSPECTION, VIEWING OR SHOWING OF PROBATED PROPERTY; PROVIDING INTERACTIVE SALES ASSESSMENT SERVICES VIA THE TELEPHONE FOR MEASURING THE SKILLS AND KNOWLEDGE OF FIELD SALES FORCES IN REAL WORLD SELLING SITUATIONS; REAL ESTATE ADVERTISING SERVICES; REAL ESTATE AUCTIONS; REAL ESTATE MARKETING SERVICES IN THE FIELD OF PROBATE; REAL ESTATE MARKETING SERVICES, NAMELY, ON-LINE SERVICES FEATURING TOURS OF RESIDENTIAL AND COMMERCIAL REAL ESTATE; REAL ESTATE SALES MANAGEMENT, IN CLASS 35 (U.S. CLS. 100, 101 AND 102).

FIRST USE 12-31-2001; IN COMMERCE 12-31-2001.

FOR: ASSESSMENT AND MANAGEMENT OF REAL ESTATE; ESTATE PLANNING; ESTATE TRUST MANAGEMENT; EVALUATION OF REAL PROPERTY; FINANCIAL INVESTMENT IN THE FIELD OF PROBATE LIQUIDATION SERVICES; FINANCIAL SERVICES, NAMELY, ESTATE SETTLEMENT SERVICES; FINANCIAL VALUATION OF PERSONAL PROPERTY AND REAL ESTATE; HOUSING SERVICES, NAMELY, REAL PROPERTY ACQUISITION AND CONSUMER FINANCING TO FACILITATE HOME OWNERSHIP; LAND ACQUISITION, NAMELY, REAL ESTATE BROKERAGE;

LEASING OF REAL ESTATE; LEASING OF REAL PROPERTY; PROVIDING INFORMATION IN THE FIELD OF REAL ESTATE BY MEANS OF LINKING THE WEB SITE TO OTHER WEB SITES FEATURING REAL ESTATE INFORMATION; PROVIDING INFORMATION IN THE FIELD OF REAL ESTATE VIA THE INTERNET; PROVIDING ONLINE INFORMATION IN THE FIELD CHARITABLE MONETARY GIVING THROUGH FINANCIAL AND ESTATE PLANNING; PROVIDING REAL ESTATE LISTINGS AND REAL ESTATE INFORMATION VIA THE INTERNET; REAL ESTATE ACQUISITION SERVICES; REAL ESTATE CONSULTANCY; REAL ESTATE CONSULTATION; REAL ESTATE EQUITY SHARING, NAMELY, MANAGING AND ARRANGING FOR CO-OWNERSHIP OF REAL ESTATE; REAL ESTATE INVESTMENT; REAL ESTATE LISTING; REAL ESTATE MANAGEMENT; REAL ESTATE MANAGEMENT CONSULTATION; REAL ESTATE PROCUREMENT FOR OTHERS; REAL ESTATE SERVICES, NAMELY, RENTAL OF VACATION HOMES, CONDOMINIUMS, CABINS, AND VILLAS USING PAY PER CLICK ADVERTISING ON A GLOBAL COMPUTER NETWORK; REAL ESTATE SYNDICATION; REAL ESTATE TRUSTEE SERVICES; REAL ESTATE VALUATION SERVICES; REAL ESTATE VALUATIONS, IN CLASS 36 (U.S. CLS. 100, 101 AND 102).

FIRST USE 12-31-2001; IN COMMERCE 12-31-2001.

THE MARK CONSISTS OF STANDARD CHARACTERS WITHOUT CLAIM TO ANY PARTICULAR FONT, STYLE, SIZE, OR COLOR.

SER. NO. 77-121,796, FILED P.R. 3-4-2007; AM. S.R. 12-17-2007.

ALICE BENMAMAN, EXAMINING ATTORNEY

Int. Cl.: 9

Prior U.S. Cls.: 21, 23, 26, 36, and 38

United States Patent and Trademark Office

Reg. No. 3,400,275

Registered Mar. 18, 2008

**TRADEMARK
SUPPLEMENTAL REGISTER**

GEAR GUARD

POOLE, RUSSELL J. (UNITED STATES INDIVIDUAL)
2507 LIVINGSTON STREET
GREENSBORO, NC 27406

FOR: PROTECTIVE CLOTHING, IN CLASS 9 (U.S. CLS. 21, 23, 26, 36 AND 38).

FIRST USE 9-1-2005; IN COMMERCE 9-1-2005.

THE MARK CONSISTS OF STANDARD CHARACTERS WITHOUT CLAIM TO ANY PARTICULAR FONT, STYLE, SIZE, OR COLOR.

SER. NO. 77-121,984, FILED P.R. 3-5-2007; AM. S.R. 12-6-2007.

YAT SYE, LEE, EXAMINING ATTORNEY

Int. Cl.: 45

Prior U.S. Cls.: 100 and 101

United States Patent and Trademark Office

Reg. No. 3,400,276

Registered Mar. 18, 2008

**SERVICE MARK
SUPPLEMENTAL REGISTER**

**The Nation's Public
Interest Law Firm**

PUBLIC JUSTICE, P.C. (D.C. CORPORATION)
SUITE 200
1825 K STREET, NW
WASHINGTON, DC 20006

FOR: LEGAL SERVICES, IN CLASS 45 (U.S. CLS.
100 AND 101).

FIRST USE 12-1-2007; IN COMMERCE 12-1-2007.

THE MARK CONSISTS OF STANDARD CHAR-
ACTERS WITHOUT CLAIM TO ANY PARTICULAR
FONT, STYLE, SIZE, OR COLOR.

NO CLAIM IS MADE TO THE EXCLUSIVE
RIGHT TO USE "PUBLIC INTEREST LAW FIRM",
APART FROM THE MARK AS SHOWN.

SER. NO. 77-122,516, FILED P.R. 3-5-2007; AM. S.R.
12-12-2007.

ALICE SUE CARRUTHERS, EXAMINING ATTOR-
NEY

Int. Cl.: 41

Prior U.S. Cls.: 100, 101, and 107

United States Patent and Trademark Office

Reg. No. 3,400,277

Registered Mar. 18, 2008

**SERVICE MARK
SUPPLEMENTAL REGISTER**

QUICK FIX MEALS

TELEVISION FOOD NETWORK, G.P. (DELA-
WARE PARTNERSHIP)
1180 AVENUE OF THE AMERICAS
NEW YORK, NY 10036

FOR: ENTERTAINMENT SERVICES IN THE
NATURE OF AN ON-GOING FOOD PROGRAM
BROADCAST OVER TELEVISION, VIA SATELLITE,
AND THROUGH OTHER AUDIOVISUAL MEDIA ,
IN CLASS 41 (U.S. CLS. 100, 101 AND 107).

FIRST USE 4-30-2006; IN COMMERCE 4-30-2006.

THE MARK CONSISTS OF STANDARD CHAR-
ACTERS WITHOUT CLAIM TO ANY PARTICULAR
FONT, STYLE, SIZE, OR COLOR.

SER. NO. 77-123,063, FILED P.R. 3-6-2007; AM. S.R.
1-9-2008.

ALICE BENMAMAN, EXAMINING ATTORNEY

Int. Cl.: 36

Prior U.S. Cls.: 100, 101, and 102

United States Patent and Trademark Office

Reg. No. 3,400,278

Registered Mar. 18, 2008

**SERVICE MARK
SUPPLEMENTAL REGISTER**

**INVESTMENT COUNSELORS OF
REDLANDS**

INVESTMENT COUNSELORS OF REDLANDS
LLC (DELAWARE LTD LIAB CO)
101 E. REDLANDS BOULEVARDS #138
REDLANDS, CA 92373

FOR: INVESTMENT ADVISORY SERVICES, IN
CLASS 36 (U.S. CLS. 100, 101 AND 102).

FIRST USE 7-1-2005; IN COMMERCE 1-10-2006.

THE MARK CONSISTS OF STANDARD CHAR-
ACTERS WITHOUT CLAIM TO ANY PARTICULAR
FONT, STYLE, SIZE, OR COLOR.

NO CLAIM IS MADE TO THE EXCLUSIVE
RIGHT TO USE "INVESTMENT COUNSELORS",
APART FROM THE MARK AS SHOWN.

SER. NO. 77-123,752, FILED P.R. 3-6-2007; AM. S.R.
12-19-2007.

KATHERINE M. DUBRAY, EXAMINING ATTOR-
NEY

Int. Cls.: 20, 24, 25, and 27

Prior U.S. Cls.: 2, 13, 19, 20, 22, 25, 32, 37, 39, 42, and 50

United States Patent and Trademark Office

Reg. No. 3,400,279

Registered Mar. 18, 2008

**TRADEMARK
SUPPLEMENTAL REGISTER**

PURE ORGANIC

LONDON LUXURY LLC (NEW YORK LTD LIAB
CO)
SUITE 613
271 NORTH AVENUE
NEW ROCHELLE, NY 10801

FOR: FILLED PILLOWS, IN CLASS 20 (U.S. CLS. 2,
13, 22, 25, 32 AND 50).

FIRST USE 2-0-2006; IN COMMERCE 2-0-2006.

FOR: BEDDING, NAMELY, PILLOW PROTEC-
TORS IN THE NATURE OF PILLOW COVERS,
MATTRESS PROTECTORS IN THE NATURE OF
MATTRESS COVERS, COMFORTERS, COMFOR-
TER COVERS, BED SHEETS, SHEET COVERS, DU-
VET COVERS AND MATTRESS PADS; TOWELS
AND SHOWER CURTAINS, IN CLASS 24 (U.S. CLS.
42 AND 50).

FIRST USE 2-0-2006; IN COMMERCE 2-0-2006.

FOR: BATH ROBES, IN CLASS 25 (U.S. CLS. 22
AND 39).

FIRST USE 2-0-2006; IN COMMERCE 2-0-2006.

FOR: BATH MATS AND BATH RUGS, IN CLASS
27 (U.S. CLS. 19, 20, 37, 42 AND 50).

FIRST USE 2-0-2006; IN COMMERCE 2-0-2006.

THE MARK CONSISTS OF STANDARD CHAR-
ACTERS WITHOUT CLAIM TO ANY PARTICULAR
FONT, STYLE, SIZE, OR COLOR.

SER. NO. 77-124,470, FILED P.R. 3-7-2007; AM. S.R.
12-18-2007.

SANI KHOURI, EXAMINING ATTORNEY

Int. Cl.: 41

Prior U.S. Cls.: 100, 101, and 107

United States Patent and Trademark Office

Reg. No. 3,400,280

Registered Mar. 18, 2008

**SERVICE MARK
SUPPLEMENTAL REGISTER**

PAIN FREE YOGA

SUNSTONE YOGA, L.L.C. (TEXAS LTD LIAB CO)
2907 ROUTH STREET
DALLAS, TX 75201

FOR: YOGA INSTRUCTION; EDUCATION SERVICES, NAMELY, PROVIDING CLASSES, SEMINARS, CONFERENCES AND WORKSHOPS IN THE FIELDS OF YOGA, FITNESS, HEALTH, AND MASSAGE THERAPY, AND DISTRIBUTING COURSE MATERIALS IN CONNECTION THEREWITH; YOGA INSTRUCTION, NAMELY, EDUCATIONAL TRAINING COURSES TO CERTIFY YOGA INSTRUCTORS, IN CLASS 41 (U.S. CLS. 100, 101 AND 107).

FIRST USE 8-1-2006; IN COMMERCE 8-1-2006.

THE MARK CONSISTS OF STANDARD CHARACTERS WITHOUT CLAIM TO ANY PARTICULAR FONT, STYLE, SIZE, OR COLOR.

NO CLAIM IS MADE TO THE EXCLUSIVE RIGHT TO USE "YOGA", APART FROM THE MARK AS SHOWN.

SER. NO. 77-124,509, FILED P.R. 3-7-2007; AM. S.R. 12-10-2007.

CAROL SPILS, EXAMINING ATTORNEY

Int. Cl.: 41

Prior U.S. Cls.: 100, 101, and 107

United States Patent and Trademark Office

Reg. No. 3,400,281

Registered Mar. 18, 2008

**SERVICE MARK
SUPPLEMENTAL REGISTER**

GET PAID TO DO YOGA

SUNSTONE YOGA, L.L.C. (TEXAS LTD LIAB CO)
2907 ROUTH STREET
DALLAS, TX 75201

FOR: YOGA INSTRUCTION, NAMELY, PROMOTING ATTENDANCE IN YOGA CLASSES BY MEANS OF A PREFERRED CUSTOMER PROGRAM FEATURING DISCOUNTS AND RELATED BENEFITS TO REWARD CUSTOMERS , IN CLASS 41 (U.S. CLS. 100, 101 AND 107).

FIRST USE 11-1-2005; IN COMMERCE 1-1-2006.

THE MARK CONSISTS OF STANDARD CHARACTERS WITHOUT CLAIM TO ANY PARTICULAR FONT, STYLE, SIZE, OR COLOR.

SER. NO. 77-124,534, FILED P.R. 3-7-2007; AM. S.R. 12-10-2007.

CAROL SPILS, EXAMINING ATTORNEY

Int. Cl.: 36

Prior U.S. Cls.: 100, 101, and 102

United States Patent and Trademark Office

Reg. No. 3,400,282

Registered Mar. 18, 2008

**SERVICE MARK
SUPPLEMENTAL REGISTER**

**MISSOURI PROFESSIONALS
MUTUAL**

MISSOURI PROFESSIONALS MUTUAL (MISSOURI CORPORATION)

287 NORTH LINDBERGH BLVD

ST. LOUIS, MO 63141

FOR: INSURANCE UNDERWRITING SERVICES
IN THE FIELD OF MEDICAL MALPRACTICE, IN
CLASS 36 (U.S. CLS. 100, 101 AND 102).

FIRST USE 1-31-2007; IN COMMERCE 1-31-2007.

THE MARK CONSISTS OF STANDARD CHARACTERS WITHOUT CLAIM TO ANY PARTICULAR FONT, STYLE, SIZE, OR COLOR.

NO CLAIM IS MADE TO THE EXCLUSIVE RIGHT TO USE "MUTUAL", APART FROM THE MARK AS SHOWN.

SER. NO. 77-127,154, FILED P.R. 3-9-2007; AM. S.R. 12-20-2007.

REBECCA GILBERT, EXAMINING ATTORNEY

Int. Cl.: 14

Prior U.S. Cls.: 2, 27, 28, and 50

United States Patent and Trademark Office

Reg. No. 3,400,283

Registered Mar. 18, 2008

**TRADEMARK
SUPPLEMENTAL REGISTER**

THE PERFECT PRINCESS CUT

I.DO. DIAMONDS, INC. (NEVADA CORPORATION)
SUITE 860
3800 HOWARD HUGHES PKWY.
LAS VEGAS, NV 89169

FOR: CUT DIAMONDS, IN CLASS 14 (U.S. CLS. 2, 27, 28 AND 50).

FIRST USE 5-23-2007; IN COMMERCE 5-23-2007.

THE MARK CONSISTS OF STANDARD CHARACTERS WITHOUT CLAIM TO ANY PARTICULAR FONT, STYLE, SIZE, OR COLOR.

NO CLAIM IS MADE TO THE EXCLUSIVE RIGHT TO USE "PRINCESS CUT", APART FROM THE MARK AS SHOWN.

SER. NO. 77-127,361, FILED P.R. 3-9-2007; AM. S.R. 1-28-2008.

MICHELLE DUBOIS, EXAMINING ATTORNEY

Int. Cl.: 35

Prior U.S. Cls.: 100, 101, and 102

United States Patent and Trademark Office

Reg. No. 3,400,284

Registered Mar. 18, 2008

**SERVICE MARK
SUPPLEMENTAL REGISTER**

Best of the Caribbean

LAYNE, CARRIE M (UNITED STATES INDIVIDUAL)
2301 STONE CREEK
PLANO, TX 75075

FOR: ADVERTISING AGENCIES; ADVERTISING AGENCIES, NAMELY, PROMOTING THE GOODS AND SERVICES OF OTHERS; ADVERTISING AND ADVERTISEMENT SERVICES; ADVERTISING AND BUSINESS MANAGEMENT CONSULTANCY; ADVERTISING AND BUSINESS SERVICES, NAMELY, SECURING AIRTIME ON ALL FORMS OF MEDIA COMMUNICATIONS STATIONS, SYSTEMS, NETWORKS, AND SERVICES FOR THE PURPOSE OF PROMOTING THE GOODS AND SERVICES OF OTHERS; ADVERTISING AND COMMERCIAL INFORMATION SERVICES, VIA THE INTERNET; ADVERTISING AND MARKETING; ADVERTISING AND PROMOTION SERVICES AND RELATED CONSULTING; ADVERTISING AND PUBLICITY SERVICES; ADVERTISING AND PUBLICITY SERVICES, NAMELY, PROMOTING THE GOODS, SERVICES, BRAND IDENTITY AND COMMERCIAL INFORMATION AND NEWS OF THIRD PARTIES THROUGH PRINT, AUDIO, VIDEO, DIGITAL AND ON-LINE MEDIUM; ADVERTISING CONSULTATION; ADVERTISING FLYER DISTRIBUTION; ADVERTISING PARTICULARLY SERVICES FOR THE PROMOTION OF GOODS; ADVERTISING SERVICES; ADVERTISING SERVICES OF A RADIO AND TELEVISION ADVERTISING AGENCY; ADVERTISING SERVICES, NAMELY, PROVIDING ADVERTISING SPACE IN A PERIODICAL; ADVERTISING SERVICES, NAMELY, CREATING CORPORATE AND BRAND IDENTITY FOR OTHERS; ADVERTISING SERVICES, NAMELY, CREATING CORPORATE LOGOS FOR OTHERS; ADVERTISING SERVICES, NAMELY, PROMOTING AND MARKETING THE GOODS AND SERVICES OF OTHERS THROUGH ALL PUBLIC COMMUNICATION MEANS; ADVERTISING SERVICES, NAMELY, PROMOTING THE FOOD AND WINE OF OTHERS;

ADVERTISING SERVICES, NAMELY, PROMOTING THE GIFT CARDS OF OTHERS; ADVERTISING THROUGH ALL PUBLIC COMMUNICATION MEANS; ADVERTISING VIA ELECTRONIC MEDIA AND SPECIFICALLY THE INTERNET; ADVERTISING, INCLUDING PROMOTION RELATING TO THE SALE OF ARTICLES AND SERVICES FOR THIRD PARTIES BY THE TRANSMISSION OF ADVERTISING MATERIAL AND THE DISSEMINATION OF ADVERTISING MESSAGES ON COMPUTER NETWORKS; ADVERTISING, MARKETING AND PROMOTION SERVICES; COOPERATIVE ADVERTISING AND MARKETING SERVICES BY WAY OF SOLICITATION, CUSTOMER SERVICE AND PROVIDING MARKETING INFORMATION VIA WEBSITES ON A GLOBAL COMPUTER NETWORK; CREATING AND UPDATING ADVERTISING MATERIAL; CREATION OF MARKETING TOOLS DESIGNED TO INCREASE A CLIENT COMPANY'S KNOWLEDGE OF CUSTOMER NEEDS, AND ITS COMPETITORS' PRODUCTS AND SERVICES, PRICING, ADVERTISING STRATEGY AND SALES STRATEGY; DESIGN OF ADVERTISING MATERIALS FOR OTHERS; DIRECT MAIL ADVERTISING; DIRECT MARKETING ADVERTISING FOR OTHERS; DISPLAYING ADVERTISEMENTS FOR OTHERS; DISSEMINATION OF ADVERTISEMENTS AND OF ADVERTISING MATERIAL; DISSEMINATION OF ADVERTISING FOR OTHERS VIA AN ON-LINE COMMUNICATIONS NETWORK ON THE INTERNET; DISSEMINATION OF ADVERTISING FOR OTHERS VIA THE INTERNET; DISSEMINATION OF ADVERTISING MATERIAL; DISSEMINATION OF ADVERTISING MATTER; DISTRIBUTION AND DISSEMINATION OF ADVERTISING MATERIALS; DISTRIBUTION OF ADVERTISING MAIL AND OF ADVERTISING SUPPLEMENTS ATTACHED TO REGULAR EDITIONS; DISTRIBUTION OF PRODUCTS FOR ADVERTISING PURPOSES; ELECTRONIC BILLBOARD ADVERTISING; ELECTRONIC COMMERCE SERVICES, NAMELY, PROVIDING INFOR-

MATION ABOUT PRODUCTS VIA TELECOMMUNICATION NETWORKS FOR ADVERTISING AND SALES PURPOSES; LAYOUT SERVICES FOR ADVERTISING PURPOSES; MEDIA BUYING ADVICE, NAMELY, ADVISING THE CLIENT HOW MUCH MEDIA TIME, AND AT WHAT TIMES THE CLIENT SHOULD BE PURCHASING ADVERTISING; MEDIA PLANNING, NAMELY, ADVISING THE CLIENT ON THE CORRECT TIMES AND STATIONS TO ADVERTISE BASED ON MEDIA ANALYSIS OF THE MARKET FOR THAT MEDIA; ON-LINE ADVERTISING AND MARKETING SERVICES; ON-LINE ADVERTISING ON COMPUTER COMMUNICATION NETWORKS; PLACING ADVERTISEMENTS FOR OTHERS; PLANNING AND CONDUCTING OF TRADE FAIRS, EXHIBITIONS AND PRESENTATIONS FOR ECONOMIC OR ADVERTISING PURPOSES; PREPARATION AND REALIZATION OF MEDIA AND ADVERTISING PLANS AND CONCEPTS; PREPARATION OF CUSTOM ADVERTISEMENTS FOR OTHERS; PREPARATION OF CUSTOM OR NON-CUSTOM ADVERTISING FOR BUSINESSES FOR DISSEMINATION VIA THE WEB, CD OR DVD FOR OPTIONAL UPLOAD OR DOWNLOAD TO A COMPUTER; PREPARING ADVERTISEMENTS FOR OTHERS; PREPARING AND PLACING ADVERTISEMENTS FOR OTHERS; PREPARING AND PLACING OF ADVERTISEMENTS; PREPARING AND PLACING OUTDOOR ADVERTISEMENTS FOR OTHERS; PROMOTING THE GOODS AND SERVICES OF OTHERS BY DISTRIBUTING ADVERTISING MATERIALS THROUGH A VARIETY OF METHODS; PROMOTING THE

GOODS AND SERVICES OF OTHERS BY PREPARING AND PLACING ADVERTISEMENTS IN AN ELECTRONIC MAGAZINE ACCESSED THROUGH A GLOBAL COMPUTER NETWORK; PROMOTING, ADVERTISING AND MARKETING OF THE ON-LINE WEBSITES OF OTHERS; PROMOTION, ADVERTISING AND MARKETING OF ON-LINE WEBSITES; PROVIDING A SEARCHABLE ONLINE ADVERTISING GUIDE FEATURING THE GOODS AND SERVICES OF OTHER ON-LINE VENDORS ON THE INTERNET; PROVIDING A WEB SITE THAT ENABLES USERS TO POST ITEMS FOR SALE THROUGH ON-LINE CLASSIFIED ADVERTISEMENTS; PROVIDING A WEB SITE WHICH FEATURES ADVERTISEMENTS FOR THE GOODS AND SERVICES OF OTHERS ON A GLOBAL COMPUTER NETWORK; PROVIDING SPACE AT A WEB SITE FOR THE ADVERTISEMENT OF THE GOODS AND SERVICES OF OTHERS; REAL ESTATE ADVERTISING SERVICES, IN CLASS 35 (U.S. CLS. 100, 101 AND 102).

FIRST USE 6-8-2007; IN COMMERCE 6-8-2007.

THE MARK CONSISTS OF STANDARD CHARACTERS WITHOUT CLAIM TO ANY PARTICULAR FONT, STYLE, SIZE, OR COLOR.

SER. NO. 77-130,695, FILED P.R. 3-14-2007; AM. S.R. 1-2-2008.

AMY HELLA, EXAMINING ATTORNEY

Int. Cl.: 16

Prior U.S. Cls.: 2, 5, 22, 23, 29, 37, 38, and 50

United States Patent and Trademark Office

Reg. No. 3,400,285

Registered Mar. 18, 2008

**TRADEMARK
SUPPLEMENTAL REGISTER**

WATCH COLLECTOR

CURTCO ROBB MEDIA, LLC (DELAWARE LTD
LIAB CO)
29160 HEATHERCLIFF ROAD, SUITE 200
MALIBU, CA 90265

FOR: MAGAZINES FEATURING ARTICLES RE-
LATED TO WATCHES, TIME PIECES, WATCH
TECHNOLOGY, WATCHMAKING SKILLS,
CRAFTSMEN, REGIONS, CENTERS AND CUL-
TURES , IN CLASS 16 (U.S. CLS. 2, 5, 22, 23, 29, 37,
38 AND 50).

FIRST USE 9-12-2007; IN COMMERCE 9-12-2007.

THE MARK CONSISTS OF STANDARD CHAR-
ACTERS WITHOUT CLAIM TO ANY PARTICULAR
FONT, STYLE, SIZE, OR COLOR.

SER. NO. 77-130,861, FILED P.R. 3-14-2007; AM. S.R.
12-21-2007.

VIVIAN MICZNIK FIRST, EXAMINING ATTOR-
NEY

Int. Cl.: 3

Prior U.S. Cls.: 1, 4, 6, 50, 51, and 52

United States Patent and Trademark Office

Reg. No. 3,400,286

Registered Mar. 18, 2008

**TRADEMARK
SUPPLEMENTAL REGISTER**

WHITE TRAYS

SMITHKLINE BEECHAM CORPORATION
(PENNSYLVANIA CORPORATION)
200 NORTH 16TH STREET
PHILADELPHIA, PA 19102

THE MARK CONSISTS OF STANDARD CHAR-
ACTERS WITHOUT CLAIM TO ANY PARTICULAR
FONT, STYLE, SIZE, OR COLOR.

FOR: TOOTH WHITENING PREPARATIONS
AND ACCELERATORS, IN CLASS 3 (U.S. CLS. 1, 4,
6, 50, 51 AND 52).

SER. NO. 77-130,866, FILED P.R. 3-14-2007; AM. S.R.
12-19-2007.

FIRST USE 1-19-2007; IN COMMERCE 1-19-2007.

JAMES LOVELACE, EXAMINING ATTORNEY

Int. Cl.: 33

Prior U.S. Cls.: 47 and 49

United States Patent and Trademark Office

Reg. No. 3,400,287

Registered Mar. 18, 2008

**TRADEMARK
SUPPLEMENTAL REGISTER**

FUERST POTESKIN

MELLO TRADING AG (SWITZERLAND AK-
TIENGESELLSCHAFT)
TORGASSE 4
ZURICH, SWITZERLAND 8024

FOR: ALCOHOLIC BEVERAGES, NAMELY, VOD-
KA, RUM AND GIN, IN CLASS 33 (U.S. CLS. 47 AND
49).

THE MARK CONSISTS OF STANDARD CHAR-
ACTERS WITHOUT CLAIM TO ANY PARTICULAR
FONT, STYLE, SIZE, OR COLOR.

OWNER OF ERPN CMNTY TM OFC REG. NO.
1000835, DATED 3-17-2000, EXPIRES 11-26-2008.

THE ENGLISH TRANSLATION OF THE WORD
"FUERST" IN THE MARK IS "PRINCE".

SER. NO. 77-134,260, FILED P.R. 3-19-2007; AM. S.R.
12-5-2007.

SUSAN RICHARDS, EXAMINING ATTORNEY

Int. Cl.: 41

Prior U.S. Cls.: 100, 101, and 107

United States Patent and Trademark Office

Reg. No. 3,400,288

Registered Mar. 18, 2008

**SERVICE MARK
SUPPLEMENTAL REGISTER**

Miss Teenage Philippines

PADAMA, ARTURO (UNITED STATES INDIVIDUAL)
8550 COURTNEY DRIVE
WALDORF, MD 206034955 AND
PADAMA, TRINIDAD PANGALIMAN (UNITED STATES INDIVIDUAL)
8550 COURTNEY DRIVE
WALDORF, MD 206034955

FOR: ENTERTAINMENT IN THE NATURE OF BEAUTY PAGEANTS , IN CLASS 41 (U.S. CLS. 100, 101 AND 107).

FIRST USE 5-27-2007; IN COMMERCE 5-27-2007.

THE MARK CONSISTS OF STANDARD CHARACTERS WITHOUT CLAIM TO ANY PARTICULAR FONT, STYLE, SIZE, OR COLOR.

SER. NO. 77-134,557, FILED P.R. 3-19-2007; AM. S.R. 11-25-2007.

PAULA MAYS, EXAMINING ATTORNEY

Int. Cl.: 45

Prior U.S. Cls.: 100 and 101

United States Patent and Trademark Office

Reg. No. 3,400,289

Registered Mar. 18, 2008

**SERVICE MARK
SUPPLEMENTAL REGISTER**

Legalizate

ZIMMERMAN, MICHAEL (UNITED STATES IN-
DIVIDUAL)
P.O. BOX 172
WACO, TX 76703

FOR: LEGAL SERVICES, IN CLASS 45 (U.S. CLS.
100 AND 101).

FIRST USE 3-19-2007; IN COMMERCE 3-19-2007.

THE MARK CONSISTS OF STANDARD CHAR-
ACTERS WITHOUT CLAIM TO ANY PARTICULAR
FONT, STYLE, SIZE, OR COLOR.

THE FOREIGN WORDING IN THE MARK
TRANSLATES INTO ENGLISH AS "LEGALIZE
YOU".

SER. NO. 77-134,625, FILED P.R. 3-19-2007; AM. S.R.
10-25-2007.

DOMINIC J. FERRAIUOLO, EXAMINING ATTOR-
NEY

Int. Cl.: 44

Prior U.S. Cls.: 100 and 101

United States Patent and Trademark Office

Reg. No. 3,400,290

Registered Mar. 18, 2008

**SERVICE MARK
SUPPLEMENTAL REGISTER**

TherapyCare

MENCHE, DAVID S. (UNITED STATES INDIVIDUAL)
263 7TH AVENUE, SUITE 2A
BROOKLYN, NY 11215

FOR: PHYSICAL THERAPY, IN CLASS 44 (U.S. CLS. 100 AND 101).

FIRST USE 5-1-2007; IN COMMERCE 5-1-2007.

THE MARK CONSISTS OF STANDARD CHARACTERS WITHOUT CLAIM TO ANY PARTICULAR FONT, STYLE, SIZE, OR COLOR.

SER. NO. 77-134,668, FILED P.R. 3-19-2007; AM. S.R. 1-9-2008.

NICHOLAS ALTREE, EXAMINING ATTORNEY

Int. Cl.: 42

Prior U.S. Cls.: 100 and 101

United States Patent and Trademark Office

Reg. No. 3,400,291

Registered Mar. 18, 2008

**SERVICE MARK
SUPPLEMENTAL REGISTER**

Speaker Resource Center

THE ACTIVE NETWORK, INC. (DELAWARE
CORPORATION)
10182 TELESIS COURT, SUITE 300
SAN DIEGO, CA 92121

FOR: PROVIDING WEB-BASED NON-DOWN-
LOADABLE CORPORATE EVENT MANAGEMENT
AND PLANNING SOFTWARE USED BY SESSION
SPEAKERS AND CONTENT MANAGERS , IN
CLASS 42 (U.S. CLS. 100 AND 101).

FIRST USE 6-1-2003; IN COMMERCE 6-1-2003.

THE MARK CONSISTS OF STANDARD CHAR-
ACTERS WITHOUT CLAIM TO ANY PARTICULAR
FONT, STYLE, SIZE, OR COLOR.

SER. NO. 77-135,432, FILED P.R. 3-20-2007; AM. S.R.
1-7-2008.

HEATHER THOMPSON, EXAMINING ATTORNEY

Int. Cl.: 16

Prior U.S. Cls.: 2, 5, 22, 23, 29, 37, 38, and 50

United States Patent and Trademark Office

Reg. No. 3,400,292

Registered Mar. 18, 2008

**TRADEMARK
SUPPLEMENTAL REGISTER**

Cash Pads

WESTERN NATIONAL BANK (ARIZONA NA-
TIONAL BANKING ASSOCIATION)
SUITE 100
2525 E. CAMELBACK ROAD
PHOENIX, CO 85016

FOR: CARD STOCK SURROUNDING A STACK
OF PAPER CURRENCY, BUNDLED TO PROVIDE
ENHANCED ACCESSIBILITY, IN CLASS 16 (U.S.
CLS. 2, 5, 22, 23, 29, 37, 38 AND 50).

FIRST USE 6-13-2005; IN COMMERCE 6-13-2005.

THE MARK CONSISTS OF STANDARD CHAR-
ACTERS WITHOUT CLAIM TO ANY PARTICULAR
FONT, STYLE, SIZE, OR COLOR.

SER. NO. 77-136,369, FILED P.R. 3-21-2007; AM. S.R.
1-7-2008.

MICHAEL LITZAU, EXAMINING ATTORNEY

Int. Cl.: 16

Prior U.S. Cls.: 2, 5, 22, 23, 29, 37, 38, and 50

United States Patent and Trademark Office

Reg. No. 3,400,293

Registered Mar. 18, 2008

**TRADEMARK
SUPPLEMENTAL REGISTER**

REDEEMABLE FOR

HUNT-GOLLIDAY, PASHA S. (UNITED STATES
INDIVIDUAL)
5628 S. INDIANA AVENUE
CHICAGO, IL 60637

FOR: ADHESIVE TAPES FOR STATIONERY OR
HOUSEHOLD PURPOSES, NOTE PADS, NOTE PA-
PER, ANNOUNCEMENT CARDS, GREETING
CARDS, AND STATIONERY , IN CLASS 16 (U.S.
CLS. 2, 5, 22, 23, 29, 37, 38 AND 50).

FIRST USE 3-1-1994; IN COMMERCE 6-22-1994.

THE MARK CONSISTS OF STANDARD CHAR-
ACTERS WITHOUT CLAIM TO ANY PARTICULAR
FONT, STYLE, SIZE, OR COLOR.

SER. NO. 77-137,278, FILED 3-22-2007.

JOHN DALIER, EXAMINING ATTORNEY

Int. Cl.: 29

Prior U.S. Cl.: 46

United States Patent and Trademark Office

Reg. No. 3,400,294

Registered Mar. 18, 2008

**TRADEMARK
SUPPLEMENTAL REGISTER**

Peel & Heat

KINGS COMMAND FOODS, INC. (WASHING-
TON CORPORATION)
7622 S 188TH
KENT, WA 98032

FOR: PROCESSED MEAT, IN CLASS 29 (U.S. CL.
46).

FIRST USE 1-2-2008; IN COMMERCE 1-2-2008.

THE MARK CONSISTS OF STANDARD CHAR-
ACTERS WITHOUT CLAIM TO ANY PARTICULAR
FONT, STYLE, SIZE, OR COLOR.

SER. NO. 77-138,913, FILED P.R. 3-23-2007; AM. S.R.
1-7-2008.

TINA KUAN, EXAMINING ATTORNEY

Int. Cl.: 10

Prior U.S. Cls.: 26, 39, and 44

United States Patent and Trademark Office

Reg. No. 3,400,295

Registered Mar. 18, 2008

**TRADEMARK
SUPPLEMENTAL REGISTER**

HEARTSTITCH

SUTURA, INC. (DELAWARE CORPORATION)
17080 NEWHOPE STREET
FOUNTAIN VALLEY, CA 92708

FOR: MEDICAL DEVICES, NAMELY, SUTURING
DEVICES, IN CLASS 10 (U.S. CLS. 26, 39 AND 44).

FIRST USE 8-27-2007; IN COMMERCE 8-27-2007.

THE MARK CONSISTS OF STANDARD CHAR-
ACTERS WITHOUT CLAIM TO ANY PARTICULAR
FONT, STYLE, SIZE, OR COLOR.

SER. NO. 77-139,342, FILED P.R. 3-23-2007; AM. S.R.
1-4-2008.

AMY ALFIERI, EXAMINING ATTORNEY

Int. Cl.: 41

Prior U.S. Cls.: 100, 101, and 107

United States Patent and Trademark Office

Reg. No. 3,400,296

Registered Mar. 18, 2008

**SERVICE MARK
SUPPLEMENTAL REGISTER**

**CERTIFICATE PROGRAM FOR
STRINGS**

AMERICAN STRING TEACHERS ASSOCIATION
(IOWA INC. ASSOCIATION)
4153 CHAIN BRIDGE ROAD
FAIRFAX, VA 22030

FOR: EDUCATIONAL SERVICES, NAMELY,
CONDUCTING PROGRAMS AND EDUCATIONAL
ASSESSMENT OF STUDENTS' TECHNICAL AND
MUSICAL PROGRESS IN THE FIELD OF STRING
INSTRUMENTS, AND DISTRIBUTION, OF CURRI-
CULUM GUIDE MATERIAL FOR SELECTION OF
STUDY, THEREWITH, IN CLASS 41 (U.S. CLS. 100,
101 AND 107).

FIRST USE 12-31-1997; IN COMMERCE 12-31-1997.

THE MARK CONSISTS OF STANDARD CHAR-
ACTERS WITHOUT CLAIM TO ANY PARTICULAR
FONT, STYLE, SIZE, OR COLOR.

NO CLAIM IS MADE TO THE EXCLUSIVE
RIGHT TO USE "PROGRAM", APART FROM THE
MARK AS SHOWN.

SER. NO. 77-139,665, FILED P.R. 3-25-2007; AM. S.R.
1-4-2008.

LINDA E. BLOHM, EXAMINING ATTORNEY

Int. Cl.: 41

Prior U.S. Cls.: 100, 101, and 107

United States Patent and Trademark Office

Reg. No. 3,400,297

Registered Mar. 18, 2008

**SERVICE MARK
SUPPLEMENTAL REGISTER**

PRESERVATION DENTAL

DEMRAY, WILLIAM S. (UNITED STATES INDIVIDUAL)
371 E. MAIN STREET
NORTHVILLE, MI 48167 AND
LEBLOCH, DENISE S. (UNITED STATES INDIVIDUAL)
38W558 BURR
ST. CHARLES, IL 60175

FOR: EDUCATIONAL SERVICES, NAMELY, CONDUCTING SEMINARS IN THE FIELD OF DENTISTRY, IN CLASS 41 (U.S. CLS. 100, 101 AND 107).

FIRST USE 7-0-2004; IN COMMERCE 7-0-2004.

THE MARK CONSISTS OF STANDARD CHARACTERS WITHOUT CLAIM TO ANY PARTICULAR FONT, STYLE, SIZE, OR COLOR.

SER. NO. 77-139,850, FILED P.R. 3-26-2007; AM. S.R. 12-23-2007.

MARTHA FROMM, EXAMINING ATTORNEY

Int. Cl.: 44

Prior U.S. Cls.: 100 and 101

United States Patent and Trademark Office

Reg. No. 3,400,298

Registered Mar. 18, 2008

**SERVICE MARK
SUPPLEMENTAL REGISTER**

PRESERVATION DENTAL

DEMRAY, WILLIAM S. (UNITED STATES INDIVIDUAL)
371 E. MAIN STREET
NORTHVILLE, MI 48167 AND
LEBLOCH, DENISE S. (UNITED STATES INDIVIDUAL)
38558 BURR
ST. CHARLES, IL 60175

THE MARK CONSISTS OF STANDARD CHARACTERS WITHOUT CLAIM TO ANY PARTICULAR FONT, STYLE, SIZE, OR COLOR.

NO CLAIM IS MADE TO THE EXCLUSIVE RIGHT TO USE "DENTAL", APART FROM THE MARK AS SHOWN.

FOR: DENTIST SERVICES, IN CLASS 44 (U.S. CLS. 100 AND 101).

SER. NO. 77-139,851, FILED P.R. 3-26-2007; AM. S.R. 12-19-2007.

FIRST USE 10-18-2001; IN COMMERCE 1-7-2007.

MARTHA FROMM, EXAMINING ATTORNEY

Int. Cls.: 36 and 37

Prior U.S. Cls.: 100, 101, 102, 103, and 106

United States Patent and Trademark Office

Reg. No. 3,400,299

Registered Mar. 18, 2008

**SERVICE MARK
SUPPLEMENTAL REGISTER**

BOLCH

BOLCH, LLC (GEORGIA LTD LIAB CO)
#6
675 WEST PACES FERRY ROAD
ATLANTA, GA 30327

FOR: REAL ESTATE BROKERAGE, IN CLASS 36
(U.S. CLS. 100, 101 AND 102).

FIRST USE 11-1-2006; IN COMMERCE 11-1-2006.

FOR: REAL ESTATE DEVELOPMENT , IN CLASS
37 (U.S. CLS. 100, 103 AND 106).

FIRST USE 11-1-2006; IN COMMERCE 11-1-2006.

THE MARK CONSISTS OF STANDARD CHAR-
ACTERS WITHOUT CLAIM TO ANY PARTICULAR
FONT, STYLE, SIZE, OR COLOR.

SER. NO. 77-140,058, FILED P.R. 3-26-2007; AM. S.R.
1-9-2008.

BRIAN PINO, EXAMINING ATTORNEY

Int. Cl.: 15

Prior U.S. Cls.: 2, 21, and 36

United States Patent and Trademark Office

Reg. No. 3,400,300

Registered Mar. 18, 2008

**TRADEMARK
SUPPLEMENTAL REGISTER**

STEINBACH

WRIGHT, MARCUS J. (UNITED STATES INDIVIDUAL)
2-3-10 KOTOBUKI
HIGASHI-OSAKA, JAPAN 577-0837

FOR: MUSICAL INSTRUMENTS, IN CLASS 15
(U.S. CLS. 2, 21 AND 36).

FIRST USE 9-30-2004; IN COMMERCE 9-30-2004.

THE MARK CONSISTS OF STANDARD CHARACTERS WITHOUT CLAIM TO ANY PARTICULAR FONT, STYLE, SIZE, OR COLOR.

OWNER OF U.S. REG. NO. 3,003,106.

SER. NO. 77-140,715, FILED P.R. 3-26-2007; AM. S.R. 1-7-2008.

HENRY S. ZAK, EXAMINING ATTORNEY

Int. Cl.: 9

Prior U.S. Cls.: 21, 23, 26, 36, and 38

United States Patent and Trademark Office

Reg. No. 3,400,301

Registered Mar. 18, 2008

**TRADEMARK
SUPPLEMENTAL REGISTER**

PRECISION FIT

MIZUNO CORPORATION (JAPAN CORPORATION)
CHUO-KU, OSAKA-SHI
1-23, KITAHAMA 4-CHOME
OSAKA, JAPAN 541-8538

FOR: INSTRUMENT FOR MEASURING FOOT PATTERNS AND SHAPES, IN CLASS 9 (U.S. CLS. 21, 23, 26, 36 AND 38).

FIRST USE 2-15-2007; IN COMMERCE 3-20-2007.

THE MARK CONSISTS OF STANDARD CHARACTERS WITHOUT CLAIM TO ANY PARTICULAR FONT, STYLE, SIZE, OR COLOR.

SER. NO. 77-141,526, FILED P.R. 3-27-2007; AM. S.R. 1-1-2008.

TARAH HARDY, EXAMINING ATTORNEY

Int. Cl.: 41

Prior U.S. Cls.: 100, 101, and 107

United States Patent and Trademark Office

Reg. No. 3,400,302

Registered Mar. 18, 2008

**SERVICE MARK
SUPPLEMENTAL REGISTER**

TOY COLLECTOR MAGAZINE

QUATRIN MEDIA, LLC (DELAWARE LTD
LIAB CO)

100 CROSSWAYS PARK WEST, SUITE 214

WOODBURY, NY 11797

FOR: ONLINE MAGAZINE IN THE FIELD OF
TOYS, IN CLASS 41 (U.S. CLS. 100, 101 AND 107).

FIRST USE 6-1-2007; IN COMMERCE 6-1-2007.

THE MARK CONSISTS OF STANDARD CHAR-
ACTERS WITHOUT CLAIM TO ANY PARTICULAR
FONT, STYLE, SIZE, OR COLOR.

NO CLAIM IS MADE TO THE EXCLUSIVE
RIGHT TO USE "MAGAZINE", APART FROM THE
MARK AS SHOWN.

SER. NO. 77-142,239, FILED P.R. 3-28-2007; AM. S.R.
1-7-2008.

ALEX KEAM, EXAMINING ATTORNEY

Int. Cl.: 9

Prior U.S. Cls.: 21, 23, 26, 36, and 38

United States Patent and Trademark Office

Reg. No. 3,400,303

Registered Mar. 18, 2008

**TRADEMARK
SUPPLEMENTAL REGISTER**

AssetExplorer

ADVENTNET, INC (CALIFORNIA CORPORATION)
SUITE 115
5200 FRANKLIN DRIVE
PLEASANTON, CA 94588

FOR: ASSET MANAGEMENT SOFTWARE FOR TRACKING AND MANAGING IT AND NON-IT ASSETS OF ENTERPRISES, IN CLASS 9 (U.S. CLS. 21, 23, 26, 36 AND 38).

FIRST USE 1-24-2007; IN COMMERCE 1-31-2007.

THE MARK CONSISTS OF STANDARD CHARACTERS WITHOUT CLAIM TO ANY PARTICULAR FONT, STYLE, SIZE, OR COLOR.

SER. NO. 77-143,381, FILED 3-29-2007.

STEVEN JACKSON, EXAMINING ATTORNEY

Int. Cl.: 42

Prior U.S. Cls.: 100 and 101

United States Patent and Trademark Office

Reg. No. 3,400,304

Registered Mar. 18, 2008

**SERVICE MARK
SUPPLEMENTAL REGISTER**

Exhibitor Resource Center

THE ACTIVE NETWORK, INC. (DELAWARE
CORPORATION)
10182 TELESIS COURT, SUITE 300
SAN DIEGO, CA 92121

FOR: PROVIDING WEB-BASED NON-DOWN-
LOADABLE CORPORATE EVENT MANAGEMENT
AND PLANNING SOFTWARE USED BY EVENT
EXHIBITORS AND SUPPORT STAFF , IN CLASS 42
(U.S. CLS. 100 AND 101).

FIRST USE 9-1-2003; IN COMMERCE 9-1-2003.

THE MARK CONSISTS OF STANDARD CHAR-
ACTERS WITHOUT CLAIM TO ANY PARTICULAR
FONT, STYLE, SIZE, OR COLOR.

SER. NO. 77-144,038, FILED P.R. 3-29-2007; AM. S.R.
1-7-2008.

HEATHER THOMPSON, EXAMINING ATTORNEY

Int. Cl.: 35

Prior U.S. Cls.: 100, 101, and 102

United States Patent and Trademark Office

Reg. No. 3,400,305

Registered Mar. 18, 2008

**SERVICE MARK
SUPPLEMENTAL REGISTER**

OUTSOURCE TELECOM

OUTSOURCE TELECOM, LLC (CALIFORNIA
LTD LIAB CO)
SUITE 120
1970 E. GRAND AVE.
EL SEGUNDO, CA 90245

FOR: HUMAN CAPITAL MANAGEMENT OUT-
SOURCING SERVICES; EMPLOYMENT HIRING,
RECRUITING, PLACEMENT, STAFFING AND CA-
REER NETWORKING SERVICES; OUTSOURCING
SERVICES; PERSONNEL PLACEMENT AND RE-
CRUITMENT, IN CLASS 35 (U.S. CLS. 100, 101 AND
102).

FIRST USE 1-6-2004; IN COMMERCE 1-6-2004.

THE MARK CONSISTS OF STANDARD CHAR-
ACTERS WITHOUT CLAIM TO ANY PARTICULAR
FONT, STYLE, SIZE, OR COLOR.

NO CLAIM IS MADE TO THE EXCLUSIVE
RIGHT TO USE "OUTSOURCE", APART FROM
THE MARK AS SHOWN.

SER. NO. 77-144,214, FILED P.R. 3-29-2007; AM. S.R.
1-8-2008.

ELLEN BURNS, EXAMINING ATTORNEY

Int. Cl.: 35

Prior U.S. Cls.: 100, 101, and 102

United States Patent and Trademark Office

Reg. No. 3,400,306

Registered Mar. 18, 2008

**SERVICE MARK
SUPPLEMENTAL REGISTER**

2-FOR-1 FLIGHTS

JPMORGAN CHASE & CO. (DELAWARE CORPORATION)
270 PARK AVENUE
NEW YORK, NY 10017

FOR: BANKING AND FINANCIAL SERVICES, NAMELY, PROMOTING THE SALE OF GOODS AND SERVICES OF OTHERS BY AWARDED PURCHASE POINTS FOR CREDIT CARD USE, IN CLASS 35 (U.S. CLS. 100, 101 AND 102).

FIRST USE 4-1-2007; IN COMMERCE 4-1-2007.

THE MARK CONSISTS OF STANDARD CHARACTERS WITHOUT CLAIM TO ANY PARTICULAR FONT, STYLE, SIZE, OR COLOR.

SER. NO. 77-146,014, FILED P.R. 4-2-2007; AM. S.R. 1-9-2008.

MARK T. MULLEN, EXAMINING ATTORNEY

Int. Cl.: 5

Prior U.S. Cls.: 6, 18, 44, 46, 51, and 52

United States Patent and Trademark Office

Reg. No. 3,400,307

Registered Mar. 18, 2008

**TRADEMARK
SUPPLEMENTAL REGISTER**

PURE PROTEIN

DR. ORGANICS, INC (MINNESOTA CORPORATION)

8774 EGAN DR

SAVAGE, MN 55378

FOR: NUTRITIONAL SUPPLEMENT, IN CLASS 5
(U.S. CLS. 6, 18, 44, 46, 51 AND 52).

FIRST USE 3-1-2007; IN COMMERCE 3-1-2007.

THE MARK CONSISTS OF STANDARD CHARACTERS WITHOUT CLAIM TO ANY PARTICULAR FONT, STYLE, SIZE, OR COLOR.

NO CLAIM IS MADE TO THE EXCLUSIVE RIGHT TO USE "PROTEIN", APART FROM THE MARK AS SHOWN.

SER. NO. 77-146,167, FILED 4-2-2007.

DANIEL CAPSHAW, EXAMINING ATTORNEY

Int. Cl.: 29

Prior U.S. Cl.: 46

United States Patent and Trademark Office

Reg. No. 3,400,308

Registered Mar. 18, 2008

**TRADEMARK
SUPPLEMENTAL REGISTER**

**POULET ROUGE FERMIER DU
PIEDMONT**

JOYCE FOODS, INC. (NORTH CAROLINA CORPORATION)
4787 KINNAMON ROAD
WINSTON SALEM, NC 27103

FOR: UNCOOKED POULTRY PARTS, IN CLASS 29 (U.S. CL. 46).

FIRST USE 8-0-2005; IN COMMERCE 8-0-2005.

THE MARK CONSISTS OF STANDARD CHARACTERS WITHOUT CLAIM TO ANY PARTICULAR FONT, STYLE, SIZE, OR COLOR.

NO CLAIM IS MADE TO THE EXCLUSIVE RIGHT TO USE "POULET", APART FROM THE MARK AS SHOWN.

THE ENGLISH TRANSLATION OF "POULET ROUGE FERMIER DU PIEDMONT" IS "RED FARM CHICKENS FROM THE PIEDMONT".

SER. NO. 77-146,997, FILED P.R. 4-3-2007; AM. S.R. 1-7-2008.

RICHARD WHITE, EXAMINING ATTORNEY

Int. Cl.: 42

Prior U.S. Cls.: 100 and 101

United States Patent and Trademark Office

Reg. No. 3,400,309

Registered Mar. 18, 2008

**SERVICE MARK
SUPPLEMENTAL REGISTER**

**ACTIVE STORAGE COST
MANAGEMENT**

IMT PARTNERS INC. (DELAWARE CORPORATION)
7 TECHNOLOGY DRIVE
NORTH CHELMSFORD, MA 01863

FOR: TECHNOLOGICAL CONSULTATION IN
THE TECHNOLOGY FIELD OF DATA MANAGEMENT
AND STORAGE, IN CLASS 42 (U.S. CLS. 100
AND 101).

FIRST USE 6-30-2006; IN COMMERCE 6-30-2006.

THE MARK CONSISTS OF STANDARD CHARACTERS
WITHOUT CLAIM TO ANY PARTICULAR
FONT, STYLE, SIZE, OR COLOR.

SER. NO. 77-147,101, FILED P.R. 4-3-2007; AM. S.R.
1-7-2008.

HEATHER SAPP, EXAMINING ATTORNEY

Int. Cl.: 41

Prior U.S. Cls.: 100, 101, and 107

United States Patent and Trademark Office

Reg. No. 3,400,310

Registered Mar. 18, 2008

**SERVICE MARK
SUPPLEMENTAL REGISTER**

FAST CARS & SUPERSTARS

THE GILLETTE COMPANY (DELAWARE CORPORATION)
PRUDENTIAL TOWER BUILDING
BOSTON, MA 02199

FOR: ENTERTAINMENT SERVICES IN THE NATURE OF AN ON-GOING REALITY BASED TELEVISION PROGRAM; PROVIDING INFORMATION IN THE FIELD OF ENTERTAINMENT FEATURING INFORMATION ON A REALITY BASED TELEVISION PROGRAM BY MEANS OF A GLOBAL COMPUTER NETWORK, IN CLASS 41 (U.S. CLS. 100, 101 AND 107).

FIRST USE 6-7-2007; IN COMMERCE 6-7-2007.

THE MARK CONSISTS OF STANDARD CHARACTERS WITHOUT CLAIM TO ANY PARTICULAR FONT, STYLE, SIZE, OR COLOR.

SER. NO. 77-147,492, FILED P.R. 4-3-2007; AM. S.R. 12-27-2007.

WOODROW HARTZOG, EXAMINING ATTORNEY

Int. Cl.: 30

Prior U.S. Cl.: 46

United States Patent and Trademark Office

Reg. No. 3,400,311

Registered Mar. 18, 2008

**TRADEMARK
SUPPLEMENTAL REGISTER**

CAKALACKY COFFEE ROASTERS

CAKALACKY COFFEE ROASTERS INC.
(NORTH CAROLINA CORPORATION)

1705 MAPLE CREEK DRIVE

ROCKY MOUNT, NC 27803

FOR: COFFEE AND TEA, IN CLASS 30 (U.S. CL.
46).

FIRST USE 11-1-2006; IN COMMERCE 11-1-2006.

THE MARK CONSISTS OF STANDARD CHAR-
ACTERS WITHOUT CLAIM TO ANY PARTICULAR
FONT, STYLE, SIZE, OR COLOR.

NO CLAIM IS MADE TO THE EXCLUSIVE
RIGHT TO USE "COFFEE", APART FROM THE
MARK AS SHOWN.

SER. NO. 77-149,207, FILED P.R. 4-5-2007; AM. S.R.
12-17-2007.

NAKIA HENRY, EXAMINING ATTORNEY

Int. Cl.: 3

Prior U.S. Cls.: 1, 4, 6, 50, 51, and 52

United States Patent and Trademark Office

Reg. No. 3,400,312

Registered Mar. 18, 2008

**TRADEMARK
SUPPLEMENTAL REGISTER**

ULTIMATE ORGANICS

HOUSE OF CHEATHAM, INC. (GEORGIA CORPORATION)
1550 ROADHAVEN DRIVE
STONE MOUNTAIN, GA 30083

FOR: BODY LOTION; BODY OIL; BODY CREAM,
IN CLASS 3 (U.S. CLS. 1, 4, 6, 50, 51 AND 52).

FIRST USE 8-1-2004; IN COMMERCE 8-1-2004.

THE MARK CONSISTS OF STANDARD CHARACTERS WITHOUT CLAIM TO ANY PARTICULAR FONT, STYLE, SIZE, OR COLOR.

OWNER OF U.S. REG. NOS. 2,606,209 AND 2,708,162.

NO CLAIM IS MADE TO THE EXCLUSIVE RIGHT TO USE "ORGANICS", APART FROM THE MARK AS SHOWN.

SER. NO. 77-150,664, FILED P.R. 4-6-2007; AM. S.R. 1-11-2008.

CARYN GLASSER, EXAMINING ATTORNEY

Int. Cl.: 3

Prior U.S. Cls.: 1, 4, 6, 50, 51, and 52

United States Patent and Trademark Office

Reg. No. 3,400,313

Registered Mar. 18, 2008

**TRADEMARK
SUPPLEMENTAL REGISTER**

MEN'S ORGANICS

HOUSE OF CHEATHAM, INC. (GEORGIA CORPORATION)
1550 ROADHAVEN DRIVE
STONE MOUNTAIN, GA 30083

FOR: HAIR CARE PREPARATIONS, IN CLASS 3
(U.S. CLS. 1, 4, 6, 50, 51 AND 52).

FIRST USE 8-1-2006; IN COMMERCE 8-1-2006.

THE MARK CONSISTS OF STANDARD CHARACTERS WITHOUT CLAIM TO ANY PARTICULAR FONT, STYLE, SIZE, OR COLOR.

OWNER OF U.S. REG. NOS. 2,606,209 AND 2,708,162.

NO CLAIM IS MADE TO THE EXCLUSIVE RIGHT TO USE "ORGANICS", APART FROM THE MARK AS SHOWN.

SER. NO. 77-150,672, FILED P.R. 4-6-2007; AM. S.R. 1-11-2008.

CARYN GLASSER, EXAMINING ATTORNEY

Int. Cl.: 36

Prior U.S. Cls.: 100, 101, and 102

United States Patent and Trademark Office

Reg. No. 3,400,314

Registered Mar. 18, 2008

**SERVICE MARK
SUPPLEMENTAL REGISTER**

IMAGE CHECKING

AMERICAN BANK & TRUST COMPANY (UNITED STATES NATIONAL BANKING ASSOCIATION), DBA AMBANK HOLDINGS, INC.,

4301 EAST 53RD STREET

DAVENPORT, IA 52807

FOR: BANKING SERVICES, IN CLASS 36 (U.S. CLS. 100, 101 AND 102).

FIRST USE 5-0-2007; IN COMMERCE 5-0-2007.

THE MARK CONSISTS OF STANDARD CHARACTERS WITHOUT CLAIM TO ANY PARTICULAR FONT, STYLE, SIZE, OR COLOR.

NO CLAIM IS MADE TO THE EXCLUSIVE RIGHT TO USE "CHECKING", APART FROM THE MARK AS SHOWN.

SER. NO. 77-150,856, FILED P.R. 4-6-2007; AM. S.R. 1-4-2008.

REBECCA EISINGER, EXAMINING ATTORNEY

Int. Cl.: 16

Prior U.S. Cls.: 2, 5, 22, 23, 29, 37, 38, and 50

United States Patent and Trademark Office

Reg. No. 3,400,315

Registered Mar. 18, 2008

**TRADEMARK
SUPPLEMENTAL REGISTER**

MOTORCYCLE LIFESTYLE

BLORE, NORMAN (UNITED STATES INDIVIDUAL)
123 BENNETT ST.
GREENVILLE, SC 29601

FOR: MAGAZINES FEATURING MOTORCYCLES AND MOTORCYCLE RELATED EVENTS, ACCESSORIES, NEWS AND RELATED INFORMATION, IN CLASS 16 (U.S. CLS. 2, 5, 22, 23, 29, 37, 38 AND 50).

FIRST USE 7-1-2007; IN COMMERCE 7-1-2007.

THE MARK CONSISTS OF STANDARD CHARACTERS WITHOUT CLAIM TO ANY PARTICULAR FONT, STYLE, SIZE, OR COLOR.

SER. NO. 77-156,368, FILED P.R. 4-13-2007; AM. S.R. 1-10-2008.

MARIAM MAHMOUDI, EXAMINING ATTORNEY

Int. Cl.: 35

Prior U.S. Cls.: 100, 101, and 102

United States Patent and Trademark Office

Reg. No. 3,400,316

Registered Mar. 18, 2008

**SERVICE MARK
SUPPLEMENTAL REGISTER**

Salon Showroom

SALON SHOWROOMS, INC. (NEW YORK CORPORATION)
6500 JOY ROAD
EAST SYRACUSE, NY 13057

FOR: CATALOG ORDERING SERVICE FEATURING BARBER CHAIRS, HAIRDRESSER CHAIRS, AND MIRRORED CABINETS, IN CLASS 35 (U.S. CLS. 100, 101 AND 102).

FIRST USE 3-1-2007; IN COMMERCE 4-1-2007.

THE MARK CONSISTS OF STANDARD CHARACTERS WITHOUT CLAIM TO ANY PARTICULAR FONT, STYLE, SIZE, OR COLOR.

SER. NO. 77-157,264, FILED 4-16-2007.

MICHAEL GAAFAR, EXAMINING ATTORNEY

Int. Cl.: 17

Prior U.S. Cls.: 1, 5, 12, 13, 35, and 50

United States Patent and Trademark Office

Reg. No. 3,400,317

Registered Mar. 18, 2008

**TRADEMARK
SUPPLEMENTAL REGISTER**

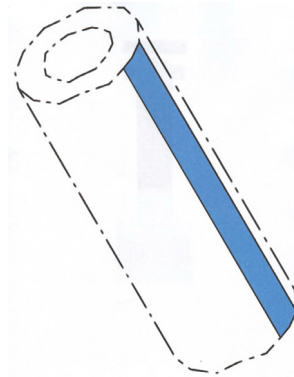

PLASTIC SPECIALTIES AND TECHNOLOGIES,
INC. (DELAWARE CORPORATION)
201 INDUSTRIAL PARKWAY
SOMERVILLE, NJ 08876

FOR: PLASTIC TUBES FOR USE IN AERATION
TUBING, IN CLASS 17 (U.S. CLS. 1, 5, 12, 13, 35 AND
50).

FIRST USE 7-31-2006; IN COMMERCE 7-31-2006.

THE COLOR(S) BLUE IS/ARE CLAIMED AS A
FEATURE OF THE MARK.

THE MARK CONSISTS OF THE COLOR BLUE
APPLIED TO TUBING AS A SINGLE STRIPE
ALONG ITS LENGTH. THE DOTTED OUTLINE OF
THE GOODS IS INTENDED TO SHOW THE POR-
TION OF THE MARK ON THE GOODS AND IS NOT
PART OF THE MARK.

SER. NO. 77-165,484, FILED P.R. 4-25-2007; AM. S.R.
12-18-2007.

HANNO RITTNER, EXAMINING ATTORNEY

Int. Cl.: 25

Prior U.S. Cls.: 22 and 39

United States Patent and Trademark Office

Reg. No. 3,400,318

Registered Mar. 18, 2008

**TRADEMARK
SUPPLEMENTAL REGISTER**

Will dance for MARGARITAS

DC STANFA ENTERPRISES, LLC (OHIO LTD
LIAB CO)
1763 WOODPINE
CINCINNATI, OH 45255

FOR: CLOTHING, NAMELY, BEACH WEAR,
BEACH COVER-UPS, SHIRTS, TANK-TOPS,
SKIRTS, SWEATSHIRTS, T-SHIRTS, JACKETS,
PANTS, SHORTS; HEADGEAR, NAMELY, HEAD-
WEAR AND SCARVES, HATS, CAPS, BASEBALL
CAPS, AND VISORS, IN CLASS 25 (U.S. CLS. 22 AND
39).

FIRST USE 3-1-2006; IN COMMERCE 3-1-2006.

THE MARK CONSISTS OF STANDARD CHAR-
ACTERS WITHOUT CLAIM TO ANY PARTICULAR
FONT, STYLE, SIZE, OR COLOR.

SER. NO. 77-165,992, FILED P.R. 4-26-2007; AM. S.R.
1-7-2008.

TOBY BULLOFF, EXAMINING ATTORNEY

Int. Cl.: 35

Prior U.S. Cls.: 100, 101, and 102

United States Patent and Trademark Office

Reg. No. 3,400,319

Registered Mar. 18, 2008

**SERVICE MARK
SUPPLEMENTAL REGISTER**

**DIRECT SELLING MEN'S
ALLIANCE**

DIRECT SELLING WOMEN'S ALLIANCE, INC.
(NEVADA CORPORATION)
111 HEKILI STREET, A-139
KAILUA, HI 96734

FOR: ASSOCIATION SERVICES, NAMELY, PROMOTING THE INTERESTS OF INDEPENDENT DIRECT SELLERS THROUGH THE OFFERINGS OF INFORMATION, SUPPORT, AND BUSINESS BUILDING TOOLS, IN CLASS 35 (U.S. CLS. 100, 101 AND 102).

FIRST USE 8-1-2007; IN COMMERCE 8-1-2007.

THE MARK CONSISTS OF STANDARD CHARACTERS WITHOUT CLAIM TO ANY PARTICULAR FONT, STYLE, SIZE, OR COLOR.

NO CLAIM IS MADE TO THE EXCLUSIVE RIGHT TO USE "MEN'S ALLIANCE", APART FROM THE MARK AS SHOWN.

SER. NO. 77-166,231, FILED P.R. 4-26-2007; AM. S.R. 8-30-2007.

JEAN IM, EXAMINING ATTORNEY

Int. Cl.: 16

Prior U.S. Cls.: 2, 5, 22, 23, 29, 37, 38, and 50

United States Patent and Trademark Office

Reg. No. 3,400,320

Registered Mar. 18, 2008

**TRADEMARK
SUPPLEMENTAL REGISTER**

Baby Calendar

CREATIONS BY YOU (COLORADO CORPORATION)

1500 W. HAMPDEN AVE. #4E
ENGLEWOOD, CO 80110

FOR: ARTS AND CRAFTS KITS COMPRISED OF DRAWING PAPER, STICKERS, ENVELOPES AND ADHESIVE TAPE DISPENSERS FOR HOUSEHOLD OR STATIONERY USE , IN CLASS 16 (U.S. CLS. 2, 5, 22, 23, 29, 37, 38 AND 50).

FIRST USE 6-13-2003; IN COMMERCE 6-13-2003.

THE MARK CONSISTS OF STANDARD CHARACTERS WITHOUT CLAIM TO ANY PARTICULAR FONT, STYLE, SIZE, OR COLOR.

NO CLAIM IS MADE TO THE EXCLUSIVE RIGHT TO USE "CALENDAR", APART FROM THE MARK AS SHOWN.

SER. NO. 77-168,922, FILED P.R. 4-30-2007; AM. S.R. 1-3-2008.

KATHERINE CONNOLLY, EXAMINING ATTORNEY

Int. Cl.: 16

Prior U.S. Cls.: 2, 5, 22, 23, 29, 37, 38, and 50

United States Patent and Trademark Office

Reg. No. 3,400,321

Registered Mar. 18, 2008

**TRADEMARK
SUPPLEMENTAL REGISTER**

Kid Clock

CREATIONS BY YOU (COLORADO CORPORATION)

1500 W. HAMPDEN AVE. #4E
ENGLEWOOD, CO 80110

FOR: ARTS AND CRAFTS KITS COMPRISED OF DRAWING PAPER, MARKERS, ADHESIVE TAPE DISPENSERS FOR HOUSEHOLD OR STATIONERY USE AND ENVELOPES , IN CLASS 16 (U.S. CLS. 2, 5, 22, 23, 29, 37, 38 AND 50).

FIRST USE 2-29-2000; IN COMMERCE 2-29-2000.

THE MARK CONSISTS OF STANDARD CHARACTERS WITHOUT CLAIM TO ANY PARTICULAR FONT, STYLE, SIZE, OR COLOR.

NO CLAIM IS MADE TO THE EXCLUSIVE RIGHT TO USE "CLOCK", APART FROM THE MARK AS SHOWN.

SER. NO. 77-169,243, FILED P.R. 4-30-2007; AM. S.R. 1-3-2008.

KATHERINE CONNOLLY, EXAMINING ATTORNEY

Int. Cl.: 35

Prior U.S. Cls.: 100, 101, and 102

United States Patent and Trademark Office

Reg. No. 3,400,322

Registered Mar. 18, 2008

**SERVICE MARK
SUPPLEMENTAL REGISTER**

**THE NATIONAL SHOW FOR PET
RETAILERS**

WORLD WIDE PET INDUSTRY ASSOCIATION
(CALIFORNIA CORPORATION)
135 W. LEMON AVENUE
MONROVIA, CA 91016

FOR: ORGANIZING AND SPONSORING TRADE
SHOW EXHIBITIONS IN THE FIELD OF DOMES-
TICATED ANIMALS AND RELATED PRODUCTS
AND SERVICES, AND THE DISTRIBUTION OF
PROGRAMS AND PRINTED ADVERTISING MA-
TERIALS IN CONNECTION THEREWITH, IN
CLASS 35 (U.S. CLS. 100, 101 AND 102).

FIRST USE 2-0-2007; IN COMMERCE 2-0-2007.

THE MARK CONSISTS OF STANDARD CHAR-
ACTERS WITHOUT CLAIM TO ANY PARTICULAR
FONT, STYLE, SIZE, OR COLOR.

NO CLAIM IS MADE TO THE EXCLUSIVE
RIGHT TO USE "SHOW", APART FROM THE
MARK AS SHOWN.

SER. NO. 77-174,493, FILED P.R. 5-7-2007; AM. S.R.
1-29-2008.

DAVID C. REIHNER, EXAMINING ATTORNEY

Int. Cl.: 30

Prior U.S. Cl.: 46

United States Patent and Trademark Office

Reg. No. 3,400,323

Registered Mar. 18, 2008

**TRADEMARK
SUPPLEMENTAL REGISTER**

OATMEAL BOWLS

BOB EVANS RESTAURANTS OF MICHIGAN,
INC. (DELAWARE CORPORATION)
PMB 415
2232 S. MAIN STREET
ANN ARBOR, MD 48103

OWNER OF U.S. REG. NO. 2,733,559.

NO CLAIM IS MADE TO THE EXCLUSIVE
RIGHT TO USE "OATMEAL", APART FROM THE
MARK AS SHOWN.

FOR: OATMEAL, IN CLASS 30 (U.S. CL. 46).

FIRST USE 7-5-2007; IN COMMERCE 7-5-2007.

SER. NO. 77-174,536, FILED P.R. 5-7-2007; AM. S.R.
12-19-2007.

THE MARK CONSISTS OF STANDARD CHAR-
ACTERS WITHOUT CLAIM TO ANY PARTICULAR
FONT, STYLE, SIZE, OR COLOR.

ANGELA GAW, EXAMINING ATTORNEY

Int. Cl.: 44

Prior U.S. Cls.: 100 and 101

United States Patent and Trademark Office

Reg. No. 3,400,324

Registered Mar. 18, 2008

**SERVICE MARK
SUPPLEMENTAL REGISTER**

**Dental Center of the
Rockies**

KRAMER, STEVEN (UNITED STATES INDIVIDUAL)

#4

1424 E. HORSETOOTH RD.
FORT COLLINS, CO 80525 AND
KRAMER, MARK (UNITED STATES INDIVIDUAL)

#4

1424 E. HORSETOOTH RD.
FORT COLLINS, CO 80525 AND
KRAMER, JEFF (UNITED STATES INDIVIDUAL)

#4

1424 E. HORSETOOTH RD.
FORT COLLINS, CO 80525

FOR: DENTISTRY, IN CLASS 44 (U.S. CLS. 100 AND 101).

FIRST USE 1-15-2008; IN COMMERCE 1-15-2008.

THE MARK CONSISTS OF STANDARD CHARACTERS WITHOUT CLAIM TO ANY PARTICULAR FONT, STYLE, SIZE, OR COLOR.

NO CLAIM IS MADE TO THE EXCLUSIVE RIGHT TO USE "DENTAL CENTER", APART FROM THE MARK AS SHOWN.

SER. NO. 77-181,185, FILED P.R. 5-15-2007; AM. S.R. 2-12-2008.

JAY BESCH, EXAMINING ATTORNEY

Int. Cl.: 31

Prior U.S. Cls.: 1 and 46

United States Patent and Trademark Office

Reg. No. 3,400,325

Registered Mar. 18, 2008

**TRADEMARK
SUPPLEMENTAL REGISTER**

GOURMET WRAPS

LOVING PETS CORPORATION (NEW JERSEY
CORPORATION)

SUITE 4

2553 ROUTE 130

CRANBERRY, NJ 08512

FOR: PET TREATS, IN CLASS 31 (U.S. CLS. 1 AND
46).

FIRST USE 3-15-2007; IN COMMERCE 5-15-2007.

THE MARK CONSISTS OF STANDARD CHAR-
ACTERS WITHOUT CLAIM TO ANY PARTICULAR
FONT, STYLE, SIZE, OR COLOR.

NO CLAIM IS MADE TO THE EXCLUSIVE
RIGHT TO USE "WRAPS", APART FROM THE
MARK AS SHOWN.

SER. NO. 77-184,090, FILED P.R. 5-17-2007; AM. S.R.
1-7-2008.

BRIAN CALLAGHAN, EXAMINING ATTORNEY

Int. Cls.: 16 and 41

Prior U.S. Cls.: 2, 5, 22, 23, 29, 37, 38, 50, 100, 101, and 107

United States Patent and Trademark Office

Reg. No. 3,400,326

Registered Mar. 18, 2008

**TRADEMARK
SERVICE MARK
SUPPLEMENTAL REGISTER**

ULTIMATE HOTEL GUIDE

NORTHSTAR TRAVEL MEDIA, LLC (DELA-
WARE LTD LIAB CO)
100 LIGHTING WAY, 2ND FLOOR
SECAUCUS, NJ 07094

FOR: MAGAZINES FEATURING TRAVEL AND
INFORMATION CONCERNING HOTELS, CRUISES,
TOUR OPERATORS, AIRLINES AND PRIVATE
JETS, IN CLASS 16 (U.S. CLS. 2, 5, 22, 23, 29, 37, 38
AND 50).

FIRST USE 12-10-2007; IN COMMERCE 12-10-2007.

FOR: ON-LINE PUBLICATION OF MAGAZINES
FEATURING TRAVEL AND INFORMATION CON-

CERNING HOTELS, CRUISES, TOUR OPERATORS,
AIRLINES AND PRIVATE JETS, IN CLASS 41 (U.S.
CLS. 100, 101 AND 107).

FIRST USE 12-10-2007; IN COMMERCE 12-10-2007.

THE MARK CONSISTS OF STANDARD CHAR-
ACTERS WITHOUT CLAIM TO ANY PARTICULAR
FONT, STYLE, SIZE, OR COLOR.

SER. NO. 77-188,709, FILED P.R. 5-23-2007; AM. S.R.
12-27-2007.

KELLEY WELLS, EXAMINING ATTORNEY

Int. Cl.: 42

Prior U.S. Cls.: 100 and 101

United States Patent and Trademark Office

Reg. No. 3,400,327

Registered Mar. 18, 2008

**SERVICE MARK
SUPPLEMENTAL REGISTER**

CONFIGURE-PRICE-QUOTE

FIREPOND, INC. (DELAWARE CORPORATION)
181 WELLS AVENUE
NEWTON, MA 02459

FOR: PROVIDING ONLINE NON-DOWNLOADABLE SOFTWARE, NAMELY, PROVIDING AN ONLINE NON-DOWNLOADABLE SUITE OF COMPUTER SOFTWARE THAT ENABLES A COMPANY'S SALES FORCE AND SUPPORTING ORGANIZATIONS TO CONFIGURE COMPLEX PRODUCTS AND SERVICES, ACCURATELY PRICE PRODUCTS AND SERVICES, DEVELOP PRICE QUOTES, GENERATE HIGH QUALITY PROPOSALS, AUTOMATE AND SIMPLIFY PRODUCT PRICING AND CONFIGURATION, IMPROVE ORDER ACCURACY AND REDUCE THE COST OF SALES,

OPTIMIZE SALES PROCESSES, CREATE PRODUCT CATALOGS, AND PROVIDE AN INTERACTIVE SELLING SYSTEM, IN CLASS 42 (U.S. CLS. 100 AND 101).

FIRST USE 8-0-2005; IN COMMERCE 8-0-2005.

THE MARK CONSISTS OF STANDARD CHARACTERS WITHOUT CLAIM TO ANY PARTICULAR FONT, STYLE, SIZE, OR COLOR.

SER. NO. 77-190,937, FILED P.R. 5-25-2007; AM. S.R. 1-9-2008.

PAUL F. GAST, EXAMINING ATTORNEY

Int. Cl.: 9

Prior U.S. Cls.: 21, 23, 26, 36, and 38

United States Patent and Trademark Office

Reg. No. 3,400,328

Registered Mar. 18, 2008

**TRADEMARK
SUPPLEMENTAL REGISTER**

PC-OVER-IP

TERADICI CORPORATION (CANADA CORPORATION)
4400 DOMINION STREET, SUITE 500
BURNABY, CANADA

FOR: INTEGRATED CIRCUITS AND SOFTWARE FOR COMMUNICATION WITH AND REMOTE USE OF PERSONAL COMPUTER INTERFACES FOR COMMUNICATION OF GRAPHICS, VIDEO DISPLAYS, AUDIO, KEYBOARDS, PRINTERS, REMOVABLE MEDIA AND OTHER COMPUTER PERIPHERALS, IN CLASS 9 (U.S. CLS. 21, 23, 26, 36 AND 38).

FIRST USE 0-0-2006; IN COMMERCE 0-0-2006.

THE MARK CONSISTS OF STANDARD CHARACTERS WITHOUT CLAIM TO ANY PARTICULAR FONT, STYLE, SIZE, OR COLOR.

SER. NO. 77-198,180, FILED P.R. 6-5-2007; AM. S.R. 12-19-2007.

KYLE PEETE, EXAMINING ATTORNEY

Int. Cl.: 14

Prior U.S. Cls.: 2, 27, 28, and 50

United States Patent and Trademark Office

Reg. No. 3,400,329

Registered Mar. 18, 2008

**TRADEMARK
SUPPLEMENTAL REGISTER**

THE PRAYER BELL COLLECTION

INTERNATIONAL BULLION AND METAL BRO-
KERS (USA) INC. (FLORIDA CORPORATION)
14051 NW 14TH STREET
SUNRISE, FL 33323

FOR: JEWELRY, IN CLASS 14 (U.S. CLS. 2, 27, 28
AND 50).

FIRST USE 11-1-2006; IN COMMERCE 11-1-2006.

THE MARK CONSISTS OF STANDARD CHAR-
ACTERS WITHOUT CLAIM TO ANY PARTICULAR
FONT, STYLE, SIZE, OR COLOR.

SER. NO. 77-203,007, FILED P.R. 6-11-2007; AM. S.R.
10-11-2007.

KHANH LE, EXAMINING ATTORNEY

Int. Cl.: 16

Prior U.S. Cls.: 2, 5, 22, 23, 29, 37, 38, and 50

United States Patent and Trademark Office

Reg. No. 3,400,330

Registered Mar. 18, 2008

**TRADEMARK
SUPPLEMENTAL REGISTER**

WESTCHESTER HEALTH & LIFE

WAINSCOT MEDIA LLC (DELAWARE LTD LIAB
CO)
110 SUMMIT AVENUE
MONTVALE, NJ 07645

FOR: MAGAZINES FEATURING ARTICLES ON
GOOD HEALTH PRACTICES, MEDICAL THERA-
PIES AND PEOPLE OF INTEREST, IN CLASS 16 (U.S.
CLS. 2, 5, 22, 23, 29, 37, 38 AND 50).

FIRST USE 9-25-2006; IN COMMERCE 9-25-2006.

THE MARK CONSISTS OF STANDARD CHAR-
ACTERS WITHOUT CLAIM TO ANY PARTICULAR
FONT, STYLE, SIZE, OR COLOR.

OWNER OF U.S. REG. NOS. 2,855,371, 3,208,858,
AND 3,278,194.

SER. NO. 77-203,551, FILED P.R. 6-12-2007; AM. S.R.
1-2-2008.

JORDAN BAKER, EXAMINING ATTORNEY

Int. Cl.: 44

Prior U.S. Cls.: 100 and 101

United States Patent and Trademark Office

Reg. No. 3,400,331

Registered Mar. 18, 2008

**SERVICE MARK
SUPPLEMENTAL REGISTER**

National Kidney Registry

KIDNEYLIFE LLC (NEW YORK LTD LIAB CO)
80 OAKNECK LANE
WEST ISLIP, NY 11795

FOR: CONSULTING SERVICES CONCERNING
KIDNEY EXCHANGES IN THE MEDICAL FIELD,
NAMELY, TO HEALTH CARE PROVIDERS, HOSPI-
TALS, CLINICS, KIDNEY DONORS AND KIDNEY
RECIPIENTS, IN CLASS 44 (U.S. CLS. 100 AND 101).

FIRST USE 8-1-2007; IN COMMERCE 8-1-2007.

THE MARK CONSISTS OF STANDARD CHAR-
ACTERS WITHOUT CLAIM TO ANY PARTICULAR
FONT, STYLE, SIZE, OR COLOR.

SER. NO. 77-204,388, FILED P.R. 6-12-2007; AM. S.R.
1-9-2008.

ESTHER A. BORSUK, EXAMINING ATTORNEY

Int. Cl.: 36

Prior U.S. Cls.: 100, 101, and 102

United States Patent and Trademark Office

Reg. No. 3,400,332

Registered Mar. 18, 2008

**SERVICE MARK
SUPPLEMENTAL REGISTER**

Enhanced Care Rider

LEGACY MARKETING GROUP (CALIFORNIA CORPORATION)
2090 MARINA AVENUE
PETALUMA, CA 94954

FOR: ANNUITY UNDERWRITING FEATURING AN OPTIONAL RIDER THAT GENERATES ADDITIONAL ANNUITY VALUE WHEN THE DESIGNATED ANNUITANT RECEIVES SPECIFIED CARE SERVICES, IN CLASS 36 (U.S. CLS. 100, 101 AND 102).

FIRST USE 4-22-2007; IN COMMERCE 4-22-2007.

THE MARK CONSISTS OF STANDARD CHARACTERS WITHOUT CLAIM TO ANY PARTICULAR FONT, STYLE, SIZE, OR COLOR.

NO CLAIM IS MADE TO THE EXCLUSIVE RIGHT TO USE "RIDER", APART FROM THE MARK AS SHOWN.

SER. NO. 77-209,379, FILED P.R. 6-19-2007; AM. S.R. 12-10-2007.

KYLE PEETE, EXAMINING ATTORNEY

Int. Cl.: 20

Prior U.S. Cls.: 2, 13, 22, 25, 32, and 50

United States Patent and Trademark Office

Reg. No. 3,400,333

Registered Mar. 18, 2008

**TRADEMARK
SUPPLEMENTAL REGISTER**

Cartoon Furniture

RANDALL S. PORTER (UNITED STATES INDIVIDUAL)
13486 2ND STREET
YUCAIPA, CA 92399 AND
SHARON R. RICHARDSON (UNITED STATES INDIVIDUAL)
13486 2ND STREET
YUCAIPA, CA 92399

FOR: BEDROOM FURNITURE; CABINETS; COMPUTER FURNITURE; DOORS FOR FURNITURE; ENTERTAINMENT CENTERS; FURNITURE; FURNITURE CHESTS; FURNITURE FOR DISPLAYING GOODS; FURNITURE FOR HOUSE, OFFICE AND GARDEN; FURNITURE FRAMES; LIVING ROOM FURNITURE; MIRRORS; OFFICE FURNITURE; OUTDOOR FURNITURE; SEATING FURNITURE;

SEATS; TABLES; TOY BOXES, IN CLASS 20 (U.S. CLS. 2, 13, 22, 25, 32 AND 50).

FIRST USE 1-1-2006; IN COMMERCE 1-1-2006.

THE MARK CONSISTS OF STANDARD CHARACTERS WITHOUT CLAIM TO ANY PARTICULAR FONT, STYLE, SIZE, OR COLOR.

NO CLAIM IS MADE TO THE EXCLUSIVE RIGHT TO USE "FURNITURE", APART FROM THE MARK AS SHOWN.

SER. NO. 77-213,687, FILED P.R. 6-22-2007; AM. S.R. 12-19-2007.

JAMES GRIFFIN, EXAMINING ATTORNEY

Int. Cl.: 9

Prior U.S. Cls.: 21, 23, 26, 36, and 38

United States Patent and Trademark Office

Reg. No. 3,400,334

Registered Mar. 18, 2008

**TRADEMARK
SUPPLEMENTAL REGISTER**

JpegSizer

MARTIN, PETER G (GREAT BRITAIN INDIVIDUAL)
5412 126TH PLACE SE
BELLEVUE, WA 98006

FOR: COMPUTER GRAPHICS SOFTWARE, IN CLASS 9 (U.S. CLS. 21, 23, 26, 36 AND 38).

FIRST USE 12-11-2002; IN COMMERCE 9-1-2004.

THE MARK CONSISTS OF STANDARD CHARACTERS WITHOUT CLAIM TO ANY PARTICULAR FONT, STYLE, SIZE, OR COLOR.

SER. NO. 77-218,591, FILED P.R. 6-29-2007; AM. S.R. 11-28-2007.

MARLENE BELL, EXAMINING ATTORNEY

Int. Cl.: 3

Prior U.S. Cls.: 1, 4, 6, 50, 51, and 52

United States Patent and Trademark Office

Reg. No. 3,400,335

Registered Mar. 18, 2008

**TRADEMARK
SUPPLEMENTAL REGISTER**

CARRINGTON

GARCEAU, ARTHUR H. (UNITED STATES IN-
DIVIDUAL)
1411 N. 16TH COURT
HOLLYWOOD, FL 33020

FOR: EAU DE PERFUME; LIQUID PERFUMES;
PERFUME; PERFUME OILS; COLOGNE; EAU DE
COLOGNE; EAU DE TOILETTE, IN CLASS 3 (U.S.
CLS. 1, 4, 6, 50, 51 AND 52).

FIRST USE 2-13-2007; IN COMMERCE 2-13-2007.

THE MARK CONSISTS OF STANDARD CHAR-
ACTERS WITHOUT CLAIM TO ANY PARTICULAR
FONT, STYLE, SIZE, OR COLOR.

SER. NO. 77-225,347, FILED P.R. 7-9-2007; AM. S.R.
12-24-2007.

LOURDES AYALA, EXAMINING ATTORNEY

Int. Cl.: 42

Prior U.S. Cls.: 100 and 101

United States Patent and Trademark Office

Reg. No. 3,400,336

Registered Mar. 18, 2008

**SERVICE MARK
SUPPLEMENTAL REGISTER**

WEBSITEWIZARD

IMPLIX SP. Z O.O. (POLAND LTD LIAB CO)
BALLADYNY 26
GDYNIA, POLAND 81-524

FOR: COMPUTER HARDWARE AND SOFTWARE CONSULTING SERVICES; SUPPORT AND CONSULTATION SERVICES FOR MANAGING COMPUTER SYSTEMS, NAMELY, PROVIDING DATA MANAGEMENT, APPLICATION MANAGEMENT, AND PERFORMANCE OPTIMIZATION AND RECOVERY OF MAINFRAME AND DISTRIBUTED SYSTEMS COMPUTERS AND THE DATABASES AND BUSINESS APPLICATIONS, PROGRAMS, AND SYSTEMS THAT OPERATE THEREIN; INFORMATION RELATING TO COMPUTER HARDWARE OR SOFTWARE PROVIDED ON-LINE FROM A GLOBAL COMPUTER NETWORK OR THE INTERNET, NAMELY, INFORMATION RELATING TO WEB-SITES BUILDER SOFTWARE; GRAPHIC DESIGN FOR THE COMPILATION OF WEB PAGES ON THE INTERNET; PROVISION OF WEB PAGES TO AND FOR THIRD PARTIES; CREATING AND MAINTAINING WEBSITES FOR OTHERS; HOSTING THE WEBSITES OF OTHERS; COMPUTER SERVICES, NAMELY, DESIGN, CONSTRUCTION, MAINTENANCE AND HOSTING OF WEB SITES FOR OTHERS; HOSTING THE ONLINE AND MULTIMEDIA CONTENT OF OTHERS VIA A WEB SITE ON A GLOBAL COMPU-

TER NETWORK AND OTHER COMMUNICATION NETWORKS; TECHNICAL SUPPORT SERVICES, NAMELY, PROVIDING HELP DESK SERVICES AND ADVICE REGARDING WEB SITE DESIGN, CONSTRUCTION, MAINTENANCE, OPTIMIZATION, AND REGARDING THE CREATION OF ONLINE COMMUNITIES AND PERSONAL PORTALS; HOSTING OF DIGITAL CONTENT ON THE INTERNET, NAMELY, DIGITAL IMAGE HOSTING SERVICES; PROVIDING A WEBSITE FOR USE BY OTHERS TO DESIGN AND BUILD WEBSITES CONTAINING INSTANT MESSAGING, MESSAGE BOARDS, EMAIL, VIDEO EMAIL, WEBCAM, ECOMMERCE CAPABILITIES AND OTHER TECHNOLOGIES, NAMELY, E-PRODUCTS DISTRIBUTION AND PAYMENT SYSTEM, IN CLASS 42 (U.S. CLS. 100 AND 101).

FIRST USE 10-1-2002; IN COMMERCE 1-1-2003.

THE MARK CONSISTS OF STANDARD CHARACTERS WITHOUT CLAIM TO ANY PARTICULAR FONT, STYLE, SIZE, OR COLOR.

SER. NO. 77-230,257, FILED P.R. 7-16-2007; AM. S.R. 11-5-2007.

KENNETH E. SHARPERSON, EXAMINING ATTORNEY

Int. Cl.: 35

Prior U.S. Cls.: 100, 101, and 102

United States Patent and Trademark Office

Reg. No. 3,400,337

Registered Mar. 18, 2008

**SERVICE MARK
SUPPLEMENTAL REGISTER**

MOTORCYCLE SUPERSTORE

MOTORCYCLE SUPERSTORE, INC. (OREGON CORPORATION)

1904 SKY PARK DR.

MEDFORD, OR 97504

FOR: ON-LINE RETAIL STORE SERVICES FEATURING ITEMS RELATED TO THE MOTORCYCLING LIFESTYLE, IN CLASS 35 (U.S. CLS. 100, 101 AND 102).

FIRST USE 11-1-1998; IN COMMERCE 11-1-1998.

THE MARK CONSISTS OF STANDARD CHARACTERS WITHOUT CLAIM TO ANY PARTICULAR FONT, STYLE, SIZE, OR COLOR.

OWNER OF U.S. REG. NO. 2,794,846.

NO CLAIM IS MADE TO THE EXCLUSIVE RIGHT TO USE "SUPERSTORE", APART FROM THE MARK AS SHOWN.

SER. NO. 77-231,969, FILED P.R. 7-17-2007; AM. S.R. 1-9-2008.

KIMBERLY PERRY, EXAMINING ATTORNEY

Int. Cls.: 38 and 41

Prior U.S. Cls.: 100, 101, 104, and 107

United States Patent and Trademark Office

Reg. No. 3,400,338

Registered Mar. 18, 2008

**SERVICE MARK
SUPPLEMENTAL REGISTER**

MOTORCYCLE USA

MOTORCYCLE USA, LLC (OREGON LTD LIAB
CO)
1904 SKY PARK DR.
MEDFORD, OR 97504

FOR: PROVIDING ON-LINE FORUMS FOR
TRANSMISSION OF MESSAGES AMONG COMPU-
TER USERS CONCERNING THE SUBJECT OF
MOTORCYCLES, IN CLASS 38 (U.S. CLS. 100, 101
AND 104).

FIRST USE 9-1-1997; IN COMMERCE 9-1-1997.

FOR: ENTERTAINMENT SERVICES, NAMELY,
PROVIDING ON-LINE INFORMATION AND
NEWS, GUIDES FOR DAY RIDES, TRAIL AND
RACE TRACKS AND ELECTRONIC GAME SERVI-

CES, ALL CONCERNING THE SUBJECT OF MO-
TORCYCLES IN THE NATURE OF
MOTORCYCLING LIFESTYLES AND EVENTS, IN
CLASS 41 (U.S. CLS. 100, 101 AND 107).

FIRST USE 9-1-1997; IN COMMERCE 9-1-1997.

THE MARK CONSISTS OF STANDARD CHAR-
ACTERS WITHOUT CLAIM TO ANY PARTICULAR
FONT, STYLE, SIZE, OR COLOR.

OWNER OF U.S. REG. NO. 2,794,846.

SER. NO. 77-231,973, FILED P.R. 7-17-2007; AM. S.R.
1-9-2008.

KIMBERLY PERRY, EXAMINING ATTORNEY

Int. Cl.: 36

Prior U.S. Cls.: 100, 101, and 102

United States Patent and Trademark Office

Reg. No. 3,400,339

Registered Mar. 18, 2008

**SERVICE MARK
SUPPLEMENTAL REGISTER**

**SUSTAINABLE RESOURCE
VENTURES**

SUSTAINABLE RESOURCE VENTURES, LLC
(MASSACHUSETTS LTD LIAB CO)
60 THOREAU STREET, SUITE 108
CONCORD, MA 01742

THE MARK CONSISTS OF STANDARD CHAR-
ACTERS WITHOUT CLAIM TO ANY PARTICULAR
FONT, STYLE, SIZE, OR COLOR.

FOR: FINANCIAL AND INVESTMENT SERVI-
CES, NAMELY, THE MANAGEMENT OF PRIVATE
EQUITY AND VENTURE CAPITAL INVESTMENT
FUNDS, IN CLASS 36 (U.S. CLS. 100, 101 AND 102).

SER. NO. 77-232,342, FILED P.R. 7-18-2007; AM. S.R.
1-3-2008.

FIRST USE 5-22-2007; IN COMMERCE 5-22-2007.

KRISTINA MORRIS, EXAMINING ATTORNEY

Int. Cl.: 29

Prior U.S. Cl.: 46

United States Patent and Trademark Office

Reg. No. 3,400,340

Registered Mar. 18, 2008

**TRADEMARK
SUPPLEMENTAL REGISTER**

**Rocky Mountain Gourmet
Steaks**

HAINLINE, JEFFREY D. (UNITED STATES IN-
DIVIDUAL)
3495 W BROADWAY
MISSOULA, MT 59808

NO CLAIM IS MADE TO THE EXCLUSIVE
RIGHT TO USE "STEAKS", APART FROM THE
MARK AS SHOWN.

FOR: MEAT, IN CLASS 29 (U.S. CL. 46).

FIRST USE 3-25-2004; IN COMMERCE 3-25-2004.

THE MARK CONSISTS OF STANDARD CHAR-
ACTERS WITHOUT CLAIM TO ANY PARTICULAR
FONT, STYLE, SIZE, OR COLOR.

SER. NO. 77-237,515, FILED P.R. 7-24-2007; AM. S.R.
1-8-2008.

REBECCA EISINGER, EXAMINING ATTORNEY

Int. Cl.: 44

Prior U.S. Cls.: 100 and 101

United States Patent and Trademark Office

Reg. No. 3,400,341

Registered Mar. 18, 2008

**SERVICE MARK
SUPPLEMENTAL REGISTER**

Doctors Notes on Demand

PASSPORTMD, INC (FLORIDA CORPORATION)
255 NE 2ND AVE. #326
DELRAY BEACH, FL 33444

FOR: MAINTAINING PERSONAL MEDICAL HISTORY RECORDS AND FILES, IN CLASS 44 (U.S. CLS. 100 AND 101).

FIRST USE 7-15-2007; IN COMMERCE 7-15-2007.

THE MARK CONSISTS OF STANDARD CHARACTERS WITHOUT CLAIM TO ANY PARTICULAR FONT, STYLE, SIZE, OR COLOR.

SER. NO. 77-238,998, FILED P.R. 7-26-2007; AM. S.R. 1-8-2008.

MARK PILARO, EXAMINING ATTORNEY

Int. Cl.: 44

Prior U.S. Cls.: 100 and 101

United States Patent and Trademark Office

Reg. No. 3,400,342

Registered Mar. 18, 2008

**SERVICE MARK
SUPPLEMENTAL REGISTER**

Preferred Care At Home

HELP AT HOME INC (TENNESSEE CORPORATION)
10808 AVENIDA SANTA ANA
BOCA RATON, FL 33498

FOR: PROVIDING CARE AT HOME SERVICES, NAMELY, HOME HEALTH CARE SERVICES; NURSING HOME CARE SERVICES TO HOMEBOUND SENIORS, THE MENTALLY OR PHYSICALLY CHALLENGED, AND DISABLED; AT HOME COMPANION CARE TO THE ELDERLY, NEW MOTHERS, THOSE RECUPERATING FROM ILLNESS OR ACCIDENT, THE MENTALLY OR PHYSICALLY CHALLENGED, NAMELY, HOME HEALTH CARE SERVICES; MEDICAL CLINIC DAY CARE SERVI-

CES FOR SICK CHILDREN FEATURING DROP-IN AND SICK CHILD CARE; NURSING CARE, IN CLASS 44 (U.S. CLS. 100 AND 101).

FIRST USE 7-15-2007; IN COMMERCE 7-15-2007.

THE MARK CONSISTS OF STANDARD CHARACTERS WITHOUT CLAIM TO ANY PARTICULAR FONT, STYLE, SIZE, OR COLOR.

SER. NO. 77-244,181, FILED P.R. 8-1-2007; AM. S.R. 1-8-2007.

MICHAEL KAZAZIAN, EXAMINING ATTORNEY

Int. Cl.: 35

Prior U.S. Cls.: 100, 101, and 102

United States Patent and Trademark Office

Reg. No. 3,400,343

Registered Mar. 18, 2008

**SERVICE MARK
SUPPLEMENTAL REGISTER**

ifashionmall

EMODA.COM CORPORATION (PENNSYLVANIA
CORPORATION)
SUITE 253
525 S. 4TH STREET
PHILADELPHIA, PA 19147

FOR: ON-LINE RETAIL STORE SERVICES IN
THE FIELD OF CLOTHING, CLOTHING ACCES-
SORIES, SHOES AND SLIPPERS, LEATHER GOODS
AND BAGS, IN CLASS 35 (U.S. CLS. 100, 101 AND
102).

FIRST USE 12-15-2001; IN COMMERCE 12-15-2001.

THE MARK CONSISTS OF STANDARD CHAR-
ACTERS WITHOUT CLAIM TO ANY PARTICULAR
FONT, STYLE, SIZE, OR COLOR.

SER. NO. 77-245,574, FILED P.R. 8-2-2007; AM. S.R.
1-8-2008.

JENNIFER VASQUEZ, EXAMINING ATTORNEY

Int. Cl.: 16

Prior U.S. Cls.: 2, 5, 22, 23, 29, 37, 38, and 50

United States Patent and Trademark Office

Reg. No. 3,400,344

Registered Mar. 18, 2008

**TRADEMARK
SUPPLEMENTAL REGISTER**

MIDDLESEX HEALTH & LIFE

WAINSCOT MEDIA LLC (DELAWARE LTD LIAB
CO)
110 SUMMIT AVENUE
MONTVALE, NJ 07645

FOR: MAGAZINES FEATURING ARTICLES ON
GOOD HEALTH PRACTICES, MEDICAL THERA-
PIES AND PEOPLE OF INTEREST, IN CLASS 16 (U.S.
CLS. 2, 5, 22, 23, 29, 37, 38 AND 50).

FIRST USE 7-10-2007; IN COMMERCE 7-10-2007.

THE MARK CONSISTS OF STANDARD CHAR-
ACTERS WITHOUT CLAIM TO ANY PARTICULAR
FONT, STYLE, SIZE, OR COLOR.

OWNER OF U.S. REG. NOS. 2,855,371, 3,208,858,
AND 3,278,194.

SER. NO. 77-248,637, FILED P.R. 8-7-2007; AM. S.R.
1-2-2008.

JORDAN BAKER, EXAMINING ATTORNEY

Int. Cl.: 41

Prior U.S. Cls.: 100, 101, and 107

United States Patent and Trademark Office

Reg. No. 3,400,345

Registered Mar. 18, 2008

**SERVICE MARK
SUPPLEMENTAL REGISTER**

NATIONAL TWENTY GOAL

UNITED STATES POLO ASSOCIATION (ILLINOIS CORPORATION)
STE. 430
771 CORPORATE DRIVE
LEXINGTON, KY 40503

FOR: ENTERTAINMENT SERVICES, NAMELY, ORGANIZING AND CONDUCTING POLO EVENTS AND TOURNAMENTS, IN CLASS 41 (U.S. CLS. 100, 101 AND 107).

FIRST USE 0-0-2006; IN COMMERCE 0-0-2006.

THE MARK CONSISTS OF STANDARD CHARACTERS WITHOUT CLAIM TO ANY PARTICULAR FONT, STYLE, SIZE, OR COLOR.

NO CLAIM IS MADE TO THE EXCLUSIVE RIGHT TO USE "TWENTY GOAL", APART FROM THE MARK AS SHOWN.

SER. NO. 77-251,136, FILED P.R. 8-9-2007; AM. S.R. 12-14-2007.

ALICE BENMAMAN, EXAMINING ATTORNEY

Int. Cl.: 36

Prior U.S. Cls.: 100, 101, and 102

United States Patent and Trademark Office

Reg. No. 3,400,346

Registered Mar. 18, 2008

**SERVICE MARK
SUPPLEMENTAL REGISTER**

EL BANCO DE LAS VEGAS

GARZA, RAYNALDO (UNITED STATES INDIVIDUAL)

14 MONARCH BAY PLAZA, SUITE 475

MONARCH BEACH, CA 92629

FOR: BANKING SERVICES AND RELATED FINANCIAL SERVICES, NAMELY, PERSONAL AND BUSINESS SAVINGS, HOME LOANS, BUSINESS LOANS, INVESTMENT ADVISORY SERVICES AND PORTFOLIO ANALYSIS SERVICES, IN CLASS 36 (U.S. CLS. 100, 101 AND 102).

FIRST USE 9-17-2006; IN COMMERCE 5-5-2007.

THE MARK CONSISTS OF STANDARD CHARACTERS WITHOUT CLAIM TO ANY PARTICULAR FONT, STYLE, SIZE, OR COLOR.

NO CLAIM IS MADE TO THE EXCLUSIVE RIGHT TO USE "EL BANCO", APART FROM THE MARK AS SHOWN.

THE ENGLISH TRANSLATION OF THE WORD "EL BANCO DE" IN THE MARK IS THE BANK OF.

SER. NO. 77-252,911, FILED P.R. 8-10-2007; AM. S.R. 12-31-2007.

RUSS HERMAN, EXAMINING ATTORNEY

Int. Cl.: 41

Prior U.S. Cls.: 100, 101, and 107

United States Patent and Trademark Office

Reg. No. 3,400,347

Registered Mar. 18, 2008

**SERVICE MARK
SUPPLEMENTAL REGISTER**

MEXICAN MOVIE CRITIC

GARZA, RAYNALDO (UNITED STATES INDIVIDUAL)
14 MONARCH BAY PLAZA, SUITE 475
RAYNALDO GARZA
MONARCH CITY, CA 92629

FOR: ENTERTAINMENT SERVICES, NAMELY, LIVE STAGE PERFORMANCES BY A FICTIONAL CHARACTER; ENTERTAINMENT IN THE NATURE OF AN ONGOING TELEVISION PROGRAM FEATURING PERFORMANCES BY A FICTIONAL CHARACTER; ENTERTAINMENT SERVICES IN THE NATURE OF LIVE STAGE PERFORMANCES TRANSMITTED VIA SATELLITE OR GLOBAL COMPUTER NETWORKS AND PRESENTED BY WAY OF ON-GOING TELEVISION, RADIO AND INTERNET PROGRAMS FEATURING COMEDY AND MUSICAL PERFORMANCES AND DEMONSTRATIONS AND/OR DISCUSSIONS RELATING TO COOKING, POLITICS, CURRENT NEWS, FINANCE, SPORTS, MOTION PICTURES, BEAUTY PAGEANTS AND AWARD SHOWS; PRODUCTION

AND DISTRIBUTION OF TELEVISION AND RADIO PROGRAMS; PRODUCTION AND DISTRIBUTION OF TELEVISION AND RADIO PROGRAMS VIA THE INTERNET FOR OTHERS; PRODUCTION OF AUDIO AND VIDEO RECORDINGS FOR OTHERS, IN CLASS 41 (U.S. CLS. 100, 101 AND 107).

FIRST USE 6-21-2007; IN COMMERCE 7-26-2007.

THE MARK CONSISTS OF STANDARD CHARACTERS WITHOUT CLAIM TO ANY PARTICULAR FONT, STYLE, SIZE, OR COLOR.

NO CLAIM IS MADE TO THE EXCLUSIVE RIGHT TO USE "MOVIE CRITIC", APART FROM THE MARK AS SHOWN.

SER. NO. 77-253,135, FILED P.R. 8-12-2007; AM. S.R. 1-8-2008.

RUSS HERMAN, EXAMINING ATTORNEY

Int. Cl.: 41

Prior U.S. Cls.: 100, 101, and 107

United States Patent and Trademark Office

Reg. No. 3,400,348

Registered Mar. 18, 2008

**SERVICE MARK
SUPPLEMENTAL REGISTER**

**THE WASHINGTON AREA'S
FAVORITE PARTY BAND!**

COLE, RICHARD M. (UNITED STATES INDIVIDUAL)

13116 MERCURY LANE
FAIRFAX, VA 220333711 AND

REAGLE, WILLIAM P. (UNITED STATES INDIVIDUAL)

13116 MERCURY LANE
FAIRFAX, VA 220333711 AND

REAGLE, JESSICA M. (UNITED STATES INDIVIDUAL)

13116 MERCURY LANE
FAIRFAX, VA 220333711 AND

TROCCOLI, FRANK (UNITED STATES INDIVIDUAL)

13116 MERCURY LANE
FAIRFAX, VA 220333711 AND

KOVALCIK, JEROME (UNITED STATES INDIVIDUAL)

13116 MERCURY LANE
FAIRFAX, VA 220333711 AND

FARTHING, JESSE L. (UNITED STATES INDIVIDUAL)

13116 MERCURY LANE
FAIRFAX, VA 220333711

FOR: ENTERTAINMENT, NAMELY, LIVE PERFORMANCES BY A MUSICAL BAND, IN CLASS 41 (U.S. CLS. 100, 101 AND 107).

FIRST USE 2-1-2007; IN COMMERCE 2-1-2007.

THE MARK CONSISTS OF STANDARD CHARACTERS WITHOUT CLAIM TO ANY PARTICULAR FONT, STYLE, SIZE, OR COLOR.

SER. NO. 77-256,393, FILED P.R. 8-15-2007; AM. S.R. 12-14-2007.

HEATHER BIDDULPH, EXAMINING ATTORNEY

Int. Cl.: 41

Prior U.S. Cls.: 100, 101, and 107

United States Patent and Trademark Office

Reg. No. 3,400,349

Registered Mar. 18, 2008

**SERVICE MARK
SUPPLEMENTAL REGISTER**

CHINESE NEW YEAR LAS VEGAS

/RAYNALDO GARZA/ (UNITED STATES INDIVIDUAL)
14 MONARCH BAY PLAZA, SUITE 475
MONARCH BEACH, CA 92629

FOR: ENTERTAINMENT SERVICES, NAMELY, CONDUCTING AN ANNUAL FESTIVAL FEATURING PARADES, MUSICAL CONCERTS, SHOWS, PAGEANTS, ARTS AND CRAFTS, DANCING, GAMES AND FOOD, RAFFLES, A STREET CARNIVAL, CULTURAL EVENTS, GOLF, MARATHON AND BICYCLE TOURNAMENTS, CASINO GAMING, MASQUERADE PARTIES, COSTUME, SINGING, DANCING AND COOKING CONTESTS; PROVIDING A HALL OF FAME MUSEUM FEATURING ITEMS FROM EVERY ASPECT OF THE ASIAN CULTURE; EDUCATIONAL SERVICES IN THE NATURE OF TOURNAMENTS AND CONTESTS, NAMELY, READING, WRITING, AND ARITHMETIC, SPELLING, SCIENCE, HISTORY, HEALTH AND FITNESS AND ARTS AND CRAFTS; ENTERTAINMENT SERVICES, IN THE NATURE OF TOURNAMENTS AND CONTESTS, NAMELY, RODEOS, BOXING, GAMING, SOCCER, FOOTBALL, RUGBY, GAMING, BASEBALL, GOLF, RUN-

NING, VOLLEYBALL, BASKETBALL, CAR RACING, SWIMMING, MARATHONS, TRIATHLONS, KARATE, CYCLING, BILLIARDS, STREET BASKETBALL, JOKES, MAGIC, SINGING, DANCING, ART, COOKING AND FASHION; ENTERTAINMENT SERVICES, NAMELY, LIVE STAGE PERFORMANCES FEATURING ASIAN MUSIC AND DANCE, AND ONGOING TELEVISION, SATELLITE, RADIO AND INTERNET PROGRAMS IN THE FIELDS OF COMEDY, MUSIC, AND ASIAN CULTURE; AND PRODUCTION AND DISTRIBUTION OF TELEVISION, RADIO AND INTERNET PROGRAMS FOR OTHERS, IN CLASS 41 (U.S. CLS. 100, 101 AND 107).

FIRST USE 5-6-2007; IN COMMERCE 6-20-2007.

THE MARK CONSISTS OF STANDARD CHARACTERS WITHOUT CLAIM TO ANY PARTICULAR FONT, STYLE, SIZE, OR COLOR.

SER. NO. 77-258,249, FILED P.R. 8-17-2007; AM. S.R. 1-2-2008.

PATRICIA EVANKO, EXAMINING ATTORNEY

Int. Cl.: 8

Prior U.S. Cls.: 23, 28, and 44

Reg. No. 3,400,350

United States Patent and Trademark Office

Registered Mar. 18, 2008

**TRADEMARK
SUPPLEMENTAL REGISTER**

KLIPPER KAP

LIBERATORE-GRANA, SHARI (UNITED STATES
INDIVIDUAL)
8611 BRIGHT AVENUE
WHITTIER, CA 90602

THE MARK CONSISTS OF STANDARD CHAR-
ACTERS WITHOUT CLAIM TO ANY PARTICULAR
FONT, STYLE, SIZE, OR COLOR.

FOR: FITTED PLASTIC COVERS AND FITTED
VINYL COVERS USED TO COVER HAIR TRIM-
MERS AND CLIPPERS, IN CLASS 8 (U.S. CLS. 23, 28
AND 44).

SER. NO. 77-263,833, FILED P.R. 8-24-2007; AM. S.R.
12-27-2007.

FIRST USE 11-1-2006; IN COMMERCE 11-1-2006.

KAREN K. BUSH, EXAMINING ATTORNEY

Int. Cl.: 44

Prior U.S. Cls.: 100 and 101

United States Patent and Trademark Office

Reg. No. 3,400,351

Registered Mar. 18, 2008

**SERVICE MARK
SUPPLEMENTAL REGISTER**

MAMMO-GRAM

TENET HEALTHSYSTEM MEDICAL, INC. (DE-
LAWARE CORPORATION)
13737 NOEL RD., STE. 100
DALLAS, TX 75240

FOR: PROVIDING HEALTH INFORMATION, IN
CLASS 44 (U.S. CLS. 100 AND 101).

FIRST USE 9-30-2007; IN COMMERCE 9-30-2007.

THE MARK CONSISTS OF STANDARD CHAR-
ACTERS WITHOUT CLAIM TO ANY PARTICULAR
FONT, STYLE, SIZE, OR COLOR.

SER. NO. 77-271,221, FILED P.R. 9-4-2007; AM. S.R.
1-7-2008.

RICHARD A. STRASER, EXAMINING ATTORNEY

Int. Cl.: 41

Prior U.S. Cls.: 100, 101, and 107

United States Patent and Trademark Office

Reg. No. 3,400,352

Registered Mar. 18, 2008

**SERVICE MARK
SUPPLEMENTAL REGISTER**

**INSTITUTE OF MEDICINE AND
PUBLIC HEALTH**

THE INSTITUTE OF MEDICINE AND PUBLIC
HEALTH OF NEW JERSEY, INC. (NEW JER-
SEY CORPORATION)
TWO PRINCESS ROAD
LAWRENCEVILLE, NJ 08648

FOR: MEDICAL TRAINING AND TEACHING;
ORGANISATION OF CONFERENCES AND SYM-
POSIA IN THE FIELD OF MEDICAL SCIENCE;
PROVIDING CONTINUING MEDICAL EDUCA-
TION COURSES, IN CLASS 41 (U.S. CLS. 100, 101
AND 107).

FIRST USE 12-1-2003; IN COMMERCE 12-1-2003.

THE MARK CONSISTS OF STANDARD CHAR-
ACTERS WITHOUT CLAIM TO ANY PARTICULAR
FONT, STYLE, SIZE, OR COLOR.

NO CLAIM IS MADE TO THE EXCLUSIVE
RIGHT TO USE "INSTITUTE", APART FROM THE
MARK AS SHOWN.

SER. NO. 77-272,051, FILED P.R. 9-5-2007; AM. S.R.
1-9-2008.

COLLEEN DOMBROW, EXAMINING ATTORNEY

Int. Cl.: 21

Prior U.S. Cls.: 2, 13, 23, 29, 30, 33, 40, and 50

United States Patent and Trademark Office

Reg. No. 3,400,353

Registered Mar. 18, 2008

**TRADEMARK
SUPPLEMENTAL REGISTER**



LAPOLLA, ANTHONY J. (UNITED STATES IN-
DIVIDUAL)
9809 RIVER ROAD
MARCY, NY 13403

FOR: SCRUBBING BRUSHES, IN CLASS 21 (U.S.
CLS. 2, 13, 23, 29, 30, 33, 40 AND 50).

FIRST USE 2-14-2007; IN COMMERCE 3-31-2007.

NO CLAIM IS MADE TO THE EXCLUSIVE
RIGHT TO USE "BRUSH" AND "SCRUBBER",
APART FROM THE MARK AS SHOWN.

THE MARK CONSISTS OF THE WORDS "DRILL"
AND "BRUSH" SEPARATED BY A GRAPHIC OF A
CORDLESS DRILL WITH THE PRODUCT BRUSH
ATTACHED.

SER. NO. 77-272,480, FILED P.R. 9-5-2007; AM. S.R.
12-20-2007.

H. M. FISHER, EXAMINING ATTORNEY

Int. Cls.: 35 and 43

Prior U.S. Cls.: 100, 101, and 102

United States Patent and Trademark Office

Reg. No. 3,400,354

Registered Mar. 18, 2008

**SERVICE MARK
SUPPLEMENTAL REGISTER**

ONE BUCK BUFFET

RESORTS INTERNATIONAL HOLDINGS, LLC
(DELAWARE LTD LIAB CO)
SUITE 1435
660 MADISON AVENUE
NEW YORK, NY 10021

FOR: CUSTOMER LOYALTY PROGRAM, NAME-
LY A PROGRAM TO AWARD DINING DISCOUNTS
TO PATRONS AND CUSTOMERS, IN CLASS 35 (U.S.
CLS. 100, 101 AND 102).

FIRST USE 8-17-2007; IN COMMERCE 8-17-2007.

FOR: RESTAURANT AND HOTEL SERVICES, IN
CLASS 43 (U.S. CLS. 100 AND 101).

FIRST USE 8-17-2007; IN COMMERCE 8-17-2007.

THE MARK CONSISTS OF STANDARD CHAR-
ACTERS WITHOUT CLAIM TO ANY PARTICULAR
FONT, STYLE, SIZE, OR COLOR.

NO CLAIM IS MADE TO THE EXCLUSIVE
RIGHT TO USE "BUFFET", APART FROM THE
MARK AS SHOWN.

SER. NO. 77-273,017, FILED P.R. 9-6-2007; AM. S.R.
1-11-2008.

SUSAN LESLIE DUBOIS, EXAMINING ATTORNEY

Int. Cl.: 35

Prior U.S. Cls.: 100, 101, and 102

United States Patent and Trademark Office

Reg. No. 3,400,355

Registered Mar. 18, 2008

**SERVICE MARK
SUPPLEMENTAL REGISTER**

Global Cardio Care

SOULATI, SARA (UNITED STATES INDIVIDUAL)
633 AERICK STREET
INGLEWOOD, CA 90301

FOR: MANAGEMENT OF HEALTH CARE CLINICS FOR OTHERS, IN CLASS 35 (U.S. CLS. 100, 101 AND 102).

FIRST USE 3-1-2002; IN COMMERCE 4-1-2002.

THE MARK CONSISTS OF STANDARD CHARACTERS WITHOUT CLAIM TO ANY PARTICULAR FONT, STYLE, SIZE, OR COLOR.

NO CLAIM IS MADE TO THE EXCLUSIVE RIGHT TO USE "CARDIO CARE", APART FROM THE MARK AS SHOWN.

SER. NO. 77-275,615, FILED 9-10-2007.

RONALD MCMORROW, EXAMINING ATTORNEY

Int. Cl.: 13

Prior U.S. Cls.: 2 and 9

United States Patent and Trademark Office

Reg. No. 3,400,356

Registered Mar. 18, 2008

**TRADEMARK
SUPPLEMENTAL REGISTER**

Safety Bullet

WORLEY, F. MICHAEL (UNITED STATES INDIVIDUAL)
SUITE 10
949 JENKS AVE.
PANAMA CITY BEACH, FL 32401

FOR: FIREARM DISABLING DEVICES, NAMELY, GUN LOCKS IN THE NATURE OF ROUNDS OF AMMUNITION WHICH WHEN FIRED LOCKS THE FIREARM MAKING IT INOPERABLE, IN CLASS 13 (U.S. CLS. 2 AND 9).

FIRST USE 11-30-2007; IN COMMERCE 11-30-2007.

THE MARK CONSISTS OF STANDARD CHARACTERS WITHOUT CLAIM TO ANY PARTICULAR FONT, STYLE, SIZE, OR COLOR.

NO CLAIM IS MADE TO THE EXCLUSIVE RIGHT TO USE "BULLET", APART FROM THE MARK AS SHOWN.

SER. NO. 77-275,807, FILED P.R. 9-10-2007; AM. S.R. 1-8-2007.

HEATHER SAPP, EXAMINING ATTORNEY

Int. Cl.: 40

Prior U.S. Cls.: 100, 103, and 106

United States Patent and Trademark Office

Reg. No. 3,400,357

Registered Mar. 18, 2008

**SERVICE MARK
SUPPLEMENTAL REGISTER**

Gerber Fabrication

GERBER, RYAN D (UNITED STATES INDIVIDUAL)
2225 WEST 110TH STREET
CLEVELAND, OH 44102

FOR: CUSTOM FABRICATION OF COUNTER TOPS; CABINET MAKING; CUSTOM CONSTRUCTION OF DISPLAY UNITS; PROVIDING WORKSHOP FACILITIES FOR BUILDING, WOODWORKING OR FRAMING PURPOSES; MILLWORKING, IN CLASS 40 (U.S. CLS. 100, 103 AND 106).

FIRST USE 1-1-2007; IN COMMERCE 1-1-2007.

THE MARK CONSISTS OF STANDARD CHARACTERS WITHOUT CLAIM TO ANY PARTICULAR FONT, STYLE, SIZE, OR COLOR.

NO CLAIM IS MADE TO THE EXCLUSIVE RIGHT TO USE "FABRICATION", APART FROM THE MARK AS SHOWN.

SER. NO. 77-276,626, FILED P.R. 9-11-2007; AM. S.R. 12-17-2007.

ROBERT LAVACHE, EXAMINING ATTORNEY

Int. Cl.: 3

Prior U.S. Cls.: 1, 4, 6, 50, 51, and 52

United States Patent and Trademark Office

Reg. No. 3,400,358

Registered Mar. 18, 2008

**TRADEMARK
SUPPLEMENTAL REGISTER**

Shinkafa

BOLIN, NGOZI E. (UNITED STATES INDIVIDUAL)
13908 PICKADILLY PLACE
SYLMAR, CA 91342

FOR: BODY AND BEAUTY CARE COSMETICS; HAIR RELAXERS; HAIR CONDITIONERS; HAIR CREAMS; HAIR SHAMPOO; HAIR STRAIGHTENING PREPARATIONS; HAIR NOURISHERS; BODY CREAMS; BODY WASHES; FACE AND BODY CREAMS; FACIAL MASKS, IN CLASS 3 (U.S. CLS. 1, 4, 6, 50, 51 AND 52).

FIRST USE 1-11-2007; IN COMMERCE 1-19-2007.

THE MARK CONSISTS OF STANDARD CHARACTERS WITHOUT CLAIM TO ANY PARTICULAR FONT, STYLE, SIZE, OR COLOR.

THE ENGLISH TRANSLATION OF THE WORD "SHINKAFA" IN THE MARK IS "RICE".

SER. NO. 77-279,255, FILED P.R. 9-13-2007; AM. S.R. 1-7-2008.

MICHAEL GAAFAR, EXAMINING ATTORNEY

Int. Cl.: 35

Prior U.S. Cls.: 100, 101, and 102

United States Patent and Trademark Office

Reg. No. 3,400,359

Registered Mar. 18, 2008

**SERVICE MARK
SUPPLEMENTAL REGISTER**

**Center for Performance
Measurement**

INTERNATIONAL CITY/COUNTY MANAGE-
MENT ASSOCIATION (ICMA) (D.C. NON-
PROFIT ASSOCIATION)
777 NORTH CAPITOL STREET, NE SUITE 500
WASHINGTON, DC 20002

FOR: ASSOCIATION SERVICES, NAMELY, PRO-
MOTING THE INTERESTS OF LOCAL AND INTER-
NATIONAL GOVERNMENTS , IN CLASS 35 (U.S.
CLS. 100, 101 AND 102).

FIRST USE 12-16-1997; IN COMMERCE 12-16-1997.

THE MARK CONSISTS OF STANDARD CHAR-
ACTERS WITHOUT CLAIM TO ANY PARTICULAR
FONT, STYLE, SIZE, OR COLOR.

SER. NO. 77-284,381, FILED P.R. 9-20-2007; AM. S.R.
1-11-2008.

LAURA KOVALSKY, EXAMINING ATTORNEY

Int. Cl.: 30

Prior U.S. Cl.: 46

United States Patent and Trademark Office

Reg. No. 3,400,360

Registered Mar. 18, 2008

**TRADEMARK
SUPPLEMENTAL REGISTER**

PREMIUM SELECT

DESIGN PAC, INC. (ILLINOIS CORPORATION)
2457 W NORTH AVENUE
MELROSE PARK, IL 60160

FOR: COOKIES, IN CLASS 30 (U.S. CL. 46).

FIRST USE 9-1-2000; IN COMMERCE 10-1-2001.

THE MARK CONSISTS OF STANDARD CHARACTERS WITHOUT CLAIM TO ANY PARTICULAR FONT, STYLE, SIZE, OR COLOR.

SER. NO. 77-287,099, FILED P.R. 9-24-2007; AM. S.R. 1-11-2008.

DAVID ELTON, EXAMINING ATTORNEY

Int. Cl.: 35

Prior U.S. Cls.: 100, 101, and 102

United States Patent and Trademark Office

Reg. No. 3,400,361

Registered Mar. 18, 2008

**SERVICE MARK
SUPPLEMENTAL REGISTER**

Supply Chain Coach

FRENCH, THOMAS (UNITED STATES INDIVIDUAL)
7172 REGIONAL ST.
DUBLIN, CA 94568

FOR: BUSINESS CONSULTING SERVICES RELATING TO PRODUCT DISTRIBUTION, OPERATIONS MANAGEMENT SERVICES, LOGISTICS, REVERSE LOGISTICS, SUPPLY CHAIN, AND PRODUCTION SYSTEMS AND DISTRIBUTION SOLUTIONS, IN CLASS 35 (U.S. CLS. 100, 101 AND 102).

FIRST USE 1-15-2005; IN COMMERCE 1-15-2005.

THE MARK CONSISTS OF STANDARD CHARACTERS WITHOUT CLAIM TO ANY PARTICULAR FONT, STYLE, SIZE, OR COLOR.

SER. NO. 77-288,978, FILED 9-26-2007.

DEIRDRE ROBERTSON, EXAMINING ATTORNEY

Int. Cl.: 44

Prior U.S. Cls.: 100 and 101

United States Patent and Trademark Office

Reg. No. 3,400,362

Registered Mar. 18, 2008

**SERVICE MARK
SUPPLEMENTAL REGISTER**

KATZ CARDIOSLEEP CENTERS

DR. JOSE KATZ (UNITED STATES INDIVIDUAL)
11 HIGHVIEW COURT
CLOSTER, NJ 07624

FOR: MEDICAL CLINICS, IN CLASS 44 (U.S. CLS. 100 AND 101).

FIRST USE 6-1-2006; IN COMMERCE 6-1-2006.

THE MARK CONSISTS OF STANDARD CHARACTERS WITHOUT CLAIM TO ANY PARTICULAR FONT, STYLE, SIZE, OR COLOR.

NO CLAIM IS MADE TO THE EXCLUSIVE RIGHT TO USE "CARDIOSLEEP CENTERS", APART FROM THE MARK AS SHOWN.

SER. NO. 77-288,996, FILED 9-26-2007.

JACQUELINE A. LAVINE, EXAMINING ATTORNEY

Int. Cl.: 29

Prior U.S. Cl.: 46

United States Patent and Trademark Office

Reg. No. 3,400,363

Registered Mar. 18, 2008

**TRADEMARK
SUPPLEMENTAL REGISTER**

Zesty Fried Queso Bites

WEISS, ALLAN C (UNITED STATES INDIVIDUAL)

831 4TH AVENUE

DALLAS, TX 75226

FOR: ZESTY FRIED QUESO BITES, IN CLASS 29 (U.S. CL. 46).

FIRST USE 8-1-2007; IN COMMERCE 8-1-2007.

THE MARK CONSISTS OF STANDARD CHARACTERS WITHOUT CLAIM TO ANY PARTICULAR FONT, STYLE, SIZE, OR COLOR.

NO CLAIM IS MADE TO THE EXCLUSIVE RIGHT TO USE "ZESTY " OR "FRIED", APART FROM THE MARK AS SHOWN.

SER. NO. 77-289,043, FILED 9-26-2007.

REGINA DRUMMOND, EXAMINING ATTORNEY

Int. Cl.: 42

Prior U.S. Cls.: 100 and 101

United States Patent and Trademark Office

Reg. No. 3,400,364

Registered Mar. 18, 2008

**SERVICE MARK
SUPPLEMENTAL REGISTER**

VIRTUAL DRILLING

ENSAGA ENERGY GROUP LLC (DELAWARE
LTD LIAB CO)
SUITE 807
320 SOUTH BOSTON AVENUE
TULSA, OK 74103

FOR: ANALYSIS AND TESTING FOR OIL WORK-
INGS; ANALYSIS FOR OIL RESEARCH; ANALYSIS
OF OIL FIELDS; ANALYSIS SERVICES FOR OIL
FIELD EXPLORATION; EXPLORATION AND
SEARCHING OF OIL AND GAS; GAS EXPLORA-
TION; GEOPHYSICAL EXPLORATION FOR THE
OIL, GAS AND MINING INDUSTRIES; OIL EX-
PLORATION; OIL FIELD EXPLORATION; OIL
FIELD SURVEYING; OIL PROSPECTING; OIL PRO-
SPECTING, NAMELY, WELL LOGGING AND TEST-
ING; PETROLEUM EXPLORATION; PROVIDING
TECHNOLOGY INFORMATION IN THE OIL AND

GAS INDUSTRY; SURVEYING OF OIL BEDS AND
FIELDS, IN CLASS 42 (U.S. CLS. 100 AND 101).

FIRST USE 6-1-2005; IN COMMERCE 6-1-2005.

THE MARK CONSISTS OF STANDARD CHAR-
ACTERS WITHOUT CLAIM TO ANY PARTICULAR
FONT, STYLE, SIZE, OR COLOR.

NO CLAIM IS MADE TO THE EXCLUSIVE
RIGHT TO USE "VIRTUAL", APART FROM THE
MARK AS SHOWN.

SER. NO. 77-289,529, FILED 9-26-2007.

NELSON SNYDER, EXAMINING ATTORNEY

Int. Cl.: 41

Prior U.S. Cls.: 100, 101, and 107

United States Patent and Trademark Office

Reg. No. 3,400,365

Registered Mar. 18, 2008

**SERVICE MARK
SUPPLEMENTAL REGISTER**

EXPERT ADMISSIONS

EXPERT ADMISSIONS, LLC (FLORIDA LTD
LIAB CO)
1550 MADRUGA AVENUE, SUITE 410
CORAL GABLES, FL 33146

FOR: EDUCATIONAL COUNSELING SERVICES,
NAMELY, ASSISTING STUDENTS IN PLANNING
AND PREPARING FOR FURTHER EDUCATION,
IN SELECTING AND APPLYING TO COLLEGES
AND UNIVERSITIES AND IN APPLYING FOR
SCHOLARSHIPS AND FINANCIAL AID, IN CLASS
41 (U.S. CLS. 100, 101 AND 107).

FIRST USE 9-14-2007; IN COMMERCE 9-14-2007.

THE MARK CONSISTS OF STANDARD CHAR-
ACTERS WITHOUT CLAIM TO ANY PARTICULAR
FONT, STYLE, SIZE, OR COLOR.

SER. NO. 77-291,152, FILED 9-28-2007.

DOMINICK J. SALEMI, EXAMINING ATTORNEY

Int. Cl.: 6

Prior U.S. Cls.: 2, 12, 13, 14, 23, 25, and 50

United States Patent and Trademark Office

Reg. No. 3,400,366

Registered Mar. 18, 2008

**TRADEMARK
SUPPLEMENTAL REGISTER**

CHICAGO CLAMP SYSTEMS

CHICAGO CLAMP COMPANY, LLC (ILLINOIS
LTD LIAB CO)

2350 SOUTH 27TH AVENUE

BROADVIEW, IL 60155

FOR: METAL CLAMP, IN CLASS 6 (U.S. CLS. 2, 12,
13, 14, 23, 25 AND 50).

FIRST USE 6-1-2007; IN COMMERCE 6-1-2007.

THE MARK CONSISTS OF STANDARD CHAR-
ACTERS WITHOUT CLAIM TO ANY PARTICULAR
FONT, STYLE, SIZE, OR COLOR.

NO CLAIM IS MADE TO THE EXCLUSIVE
RIGHT TO USE "CLAMP SYSTEMS", APART FROM
THE MARK AS SHOWN.

SER. NO. 77-293,028, FILED 10-1-2007.

ATTIYA MALIK, EXAMINING ATTORNEY

Int. Cl.: 11

Prior U.S. Cls.: 13, 21, 23, 31, and 34

United States Patent and Trademark Office

Reg. No. 3,400,367

Registered Mar. 18, 2008

**TRADEMARK
SUPPLEMENTAL REGISTER**

3 in 1 De-icer

ALLIED PRECISION INDUSTRIES, INC. (ILLINOIS CORPORATION)
705 E. NORTH STREET
ELBURN, IL 60119

FOR: ELECTRIC DEICER, IN CLASS 11 (U.S. CLS. 13, 21, 23, 31 AND 34).

FIRST USE 4-3-2007; IN COMMERCE 4-3-2007.

THE MARK CONSISTS OF STANDARD CHARACTERS WITHOUT CLAIM TO ANY PARTICULAR FONT, STYLE, SIZE, OR COLOR.

NO CLAIM IS MADE TO THE EXCLUSIVE RIGHT TO USE "DE-ICER", APART FROM THE MARK AS SHOWN.

SER. NO. 77-293,244, FILED P.R. 10-1-2007; AM. S.R. 1-10-2008.

MATTHEW MCDOWELL, EXAMINING ATTORNEY

Int. Cl.: 42

Prior U.S. Cls.: 100 and 101

United States Patent and Trademark Office

Reg. No. 3,400,368

Registered Mar. 18, 2008

**SERVICE MARK
SUPPLEMENTAL REGISTER**

PEOPLEDATA

ZABA, INC. (DELAWARE CORPORATION)
#323
22647 VENTURA BLVD.
WOODLAND HILLS, CA 91364

FOR: PROVIDING INFORMATION AT THE SPECIFIC REQUEST OF END-USERS BY MEANS OF TELEPHONE OR GLOBAL COMPUTER NETWORKS, IN CLASS 42 (U.S. CLS. 100 AND 101).

FIRST USE 2-22-2002; IN COMMERCE 5-7-2002.

THE MARK CONSISTS OF STANDARD CHARACTERS WITHOUT CLAIM TO ANY PARTICULAR FONT, STYLE, SIZE, OR COLOR.

SER. NO. 77-297,812, FILED 10-5-2007.

FLORENTINA BLANDU, EXAMINING ATTORNEY

Int. Cl.: 25

Prior U.S. Cls.: 22 and 39

United States Patent and Trademark Office

Reg. No. 3,400,369

Registered Mar. 18, 2008

**TRADEMARK
SUPPLEMENTAL REGISTER**

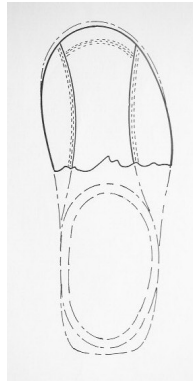

SALOMON S.A. (FRANCE SOCIÉTÉ ANONYME
(SA))
LIEUDIT "LA RAVOIRE"
METZ-TESSY, FRANCE 74370

FOR: FOOTWEAR, IN CLASS 25 (U.S. CLS. 22 AND
39).

FIRST USE 12-22-1998; IN COMMERCE 12-22-1998.

THE MARK CONSISTS OF THE FRONT PART OF
A VAMP WITH A CENTRAL LONGITUDINAL
STRIPE OVERLAID LATERALLY FROM BOTH
SIDES BY ARCUATE LONGITUDINAL STRIPES
WHICH SUGGEST STITCHING OF A SPORTS BALL.

SER. NO. 77-315,608, FILED 10-29-2007.

REBECCA SMITH, EXAMINING ATTORNEY

Int. Cls.: 1 and 10

Prior U.S. Cls.: 1, 5, 6, 10, 26, 39, 44, and 46

United States Patent and Trademark Office

Reg. No. 3,400,370

Registered Mar. 18, 2008

**TRADEMARK
SUPPLEMENTAL REGISTER**

INDIANA NANOTECH

INDIANA NANOTECH, LLC (INDIANA LTD
LIAB CO)
SUITE 334
351 WEST 10TH STREET
INDIANAPOLIS, IN 46202

FOR: CHEMICAL ADDITIVES FOR USE IN THE MANUFACTURE OF A WIDE VARIETY OF GOODS; CHEMICAL ADDITIVES FOR USE IN THE MANUFACTURE OF PHARMACEUTICALS, COSMETICS, FOOD, VITAMINS; CHEMICAL ADDITIVES FOR USE AS CLEANSING, DEODORIZING AND REFRESHING INGREDIENTS IN THE MANUFACTURE OF MOUTH SPRAYS, DENTAL CEMENTS AND MEDICINES FOR DENTAL PURPOSES; OXIDES; SYNTHETIC AND NATURAL OXIDES IN THE FORM OF POWDERS, LIQUIDS, PASTES AND GRANULES; SPECIALTY CHEMICALS, NAMELY, CHEMICAL ADDITIVES FOR GENERAL INDUSTRIAL USE IN THE MANUFACTURE OF A WIDE VARIETY OF GOODS, IN CLASS 1 (U.S. CLS. 1, 5, 6, 10, 26 AND 46).

FIRST USE 11-30-2007; IN COMMERCE 11-30-2007.

FOR: COATINGS SOLD AS AN INTEGRAL COMPONENT OF MEDICAL STENTS AND OTHER IMPLANTABLE MEDICAL DEVICES, IN CLASS 10 (U.S. CLS. 26, 39 AND 44).

FIRST USE 11-30-2007; IN COMMERCE 11-30-2007.

THE MARK CONSISTS OF STANDARD CHARACTERS WITHOUT CLAIM TO ANY PARTICULAR FONT, STYLE, SIZE, OR COLOR.

NO CLAIM IS MADE TO THE EXCLUSIVE RIGHT TO USE "NANOTECH", APART FROM THE MARK AS SHOWN.

SER. NO. 77-975,097, FILED P.R. 3-8-2007; AM. S.R. 1-2-2008.

JOHN DWYER, EXAMINING ATTORNEY

Int. Cl.: 25

Prior U.S. Cls.: 22 and 39

United States Patent and Trademark Office

Reg. No. 3,400,371

Registered Mar. 18, 2008

**TRADEMARK
SUPPLEMENTAL REGISTER**



JACQUELINE PODLASKI (UNITED STATES IN-
DIVIDUAL)
PO BOX 266
HOLTSVILLE, NY 11742

THE MARK CONSISTS OF A WOMAN WITH A
BLOOMING BELLY AS THE "B" IN "BELLYLI-
CIOUS".

FOR: MATERNITY APPAREL, NAMELY, BRAS,
SHIRTS, PANTS, SHORTS, AND DRESSES, IN
CLASS 25 (U.S. CLS. 22 AND 39).

SER. NO. 78-313,664, FILED P.R. 10-15-2003; AM.
S.R. 2-4-2008.

FIRST USE 6-12-2003; IN COMMERCE 7-24-2003.

KATHERINE CHANG, EXAMINING ATTORNEY

Int. Cl.: 35

Prior U.S. Cls.: 100, 101, and 102

United States Patent and Trademark Office

Reg. No. 3,400,372

Registered Mar. 18, 2008

**SERVICE MARK
SUPPLEMENTAL REGISTER**

**GREEK FINANCIAL
MANAGEMENT**

GREEK FINANCIAL MANAGEMENT, INC. (IL-
LINOIS CORPORATION)

P.O. BOX 5987

BLOOMINGTON, IL 617025987

FOR: BOOKKEEPING AND ACCOUNTING SER-
VICES, CONSULTING SERVICES IN BUSINESS OR-
GANIZATION AND MANAGEMENT, IN CLASS 35
(U.S. CLS. 100, 101 AND 102).

FIRST USE 3-0-2005; IN COMMERCE 3-0-2005.

THE MARK CONSISTS OF STANDARD CHAR-
ACTERS WITHOUT CLAIM TO ANY PARTICULAR
FONT, STYLE, SIZE, OR COLOR.

NO CLAIM IS MADE TO THE EXCLUSIVE
RIGHT TO USE "FINANCIAL MANAGEMENT",
APART FROM THE MARK AS SHOWN.

SER. NO. 78-555,699, FILED P.R. 1-28-2005; AM. S.R.
12-18-2006.

ANDREA K. NADELMAN, EXAMINING ATTOR-
NEY

Int. Cl.: 16

Prior U.S. Cls.: 2, 5, 22, 23, 29, 37, 38, and 50

United States Patent and Trademark Office

Reg. No. 3,400,373

Registered Mar. 18, 2008

**TRADEMARK
SUPPLEMENTAL REGISTER**

REAL FOOD

GREENSPRING MEDIA GROUP, INC (MINNE-
SOTA CORPORATION)
600 US TRUST BUILDING
720 SECOND AVENUE SOUTH
MINNEAPOLIS, MN 55402

FOR: MAGAZINES FEATURING LIFESTYLES
AND ORGANIC FOODS, IN CLASS 16 (U.S. CLS. 2,
5, 22, 23, 29, 37, 38 AND 50).

FIRST USE 11-1-2005; IN COMMERCE 11-1-2005.

THE MARK CONSISTS OF STANDARD CHAR-
ACTERS WITHOUT CLAIM TO ANY PARTICULAR
FONT, STYLE, SIZE, OR COLOR.

SER. NO. 78-556,856, FILED P.R. 1-31-2005; AM. S.R.
11-1-2007.

ALLISON SCHRODY, EXAMINING ATTORNEY

Int. Cl.: 33

Prior U.S. Cls.: 47 and 49

United States Patent and Trademark Office

Reg. No. 3,400,374

Registered Mar. 18, 2008

**TRADEMARK
SUPPLEMENTAL REGISTER**

adegaborba.pt

ADEGA COOPERATIVA DE BORBA, CRL (POR-
TUGAL CORPORATION)

ROSSIO DE CIMA, APARTADO 20

BORBA 7150-999, PORTUGAL

FOR: WINES, IN CLASS 33 (U.S. CLS. 47 AND 49).

FIRST USE 1-0-2005; IN COMMERCE 1-0-2005.

THE MARK CONSISTS OF STANDARD CHAR-
ACTERS WITHOUT CLAIM TO ANY PARTICULAR
FONT, STYLE, SIZE, OR COLOR.

THE ENGLISH TRANSLATION OF MARK IS
WINE PRODUCER OF BORBA.

SER. NO. 78-569,686, FILED P.R. 2-17-2005; AM. S.R.
2-6-2008.

KATHY DE JONGE, EXAMINING ATTORNEY

Int. Cl.: 45

Prior U.S. Cls.: 100 and 101

United States Patent and Trademark Office

Reg. No. 3,400,375

Registered Mar. 18, 2008

**SERVICE MARK
SUPPLEMENTAL REGISTER**

rateyourdate

BERGER JACQUELINE M (AUSTRALIA INDIVIDUAL)
9 HOVEA PLACE
REDHEAD, AUSTRALIA 2290

FOR: WEB SITE SERVICES FEATURING ONLINE DATING CLUB, IN CLASS 45 (U.S. CLS. 100 AND 101).

FIRST USE 11-24-2004; IN COMMERCE 11-24-2004.

THE MARK CONSISTS OF STANDARD CHARACTERS WITHOUT CLAIM TO ANY PARTICULAR FONT, STYLE, SIZE, OR COLOR.

SER. NO. 78-585,819, FILED P.R. 3-11-2005; AM. S.R. 7-27-2007.

GINA HAYES, EXAMINING ATTORNEY

Int. Cl.: 30

Prior U.S. Cl.: 46

United States Patent and Trademark Office

Reg. No. 3,400,376

Registered Mar. 18, 2008

**TRADEMARK
SUPPLEMENTAL REGISTER**

GRAN NATALE

PANDURATA ALIMENTOS LTDA. (BRAZIL
CORPORATION)
RUA CAVADAS, 930
GUARULHOS, SAO PAULO, BRAZIL 07044-000

FOR: PANETTONES, IN CLASS 30 (U.S. CL. 46).

FIRST USE 0-0-1999; IN COMMERCE 10-19-2006.

THE MARK CONSISTS OF STANDARD CHAR-
ACTERS WITHOUT CLAIM TO ANY PARTICULAR
FONT, STYLE, SIZE, OR COLOR.

THE FOREIGN WORDING IN THE MARK
TRANSLATES INTO ENGLISH AS GREAT CHRIST-
MAS.

SER. NO. 78-603,862, FILED P.R. 4-7-2005; AM. S.R.
1-30-2008.

KRISTIN DAHLING, EXAMINING ATTORNEY

Int. Cl.: 43

Prior U.S. Cls.: 100 and 101

United States Patent and Trademark Office

Reg. No. 3,400,377

Registered Mar. 18, 2008

**SERVICE MARK
SUPPLEMENTAL REGISTER**

GIANT SICILIAN

AGAKHANYAN, ARARAT (ARMENIA INDIVIDUAL)
350 N. GLENOAKS BLVD., STE. 203
BURBANK, CA 91502

FOR: RESTAURANT SERVICES, NAMELY, DINE IN, TAKE OUT AND HOME DELIVERY OF LARGE 36 INCH AND ABOVE PARTY PIZZAS, IN CLASS 43 (U.S. CLS. 100 AND 101).

FIRST USE 6-1-2001; IN COMMERCE 12-1-2005.

THE MARK CONSISTS OF STANDARD CHARACTERS WITHOUT CLAIM TO ANY PARTICULAR FONT, STYLE, SIZE, OR COLOR.

SER. NO. 78-686,876, FILED P.R. 8-5-2005; AM. S.R. 1-9-2008.

BRENDAN MCCAULEY, EXAMINING ATTORNEY

Int. Cl.: 25

Prior U.S. Cls.: 22 and 39

United States Patent and Trademark Office

Reg. No. 3,400,378

Registered Mar. 18, 2008

**TRADEMARK
SUPPLEMENTAL REGISTER**



GET LIT ENTERPRISES INC. (FLORIDA CORPORATION)
500 MARQUESA DR
CORAL GABLES, FL 33156

FOR: CLOTHING, NAMELY, SHIRTS, T-SHIRTS, POLO SHIRTS, TANK TOPS, SWEATSHIRTS, PANTS, SHORTS, RAINGEAR, JACKETS, WIND RESISTANT JACKETS, HATS AND VISORS, IN CLASS 25 (U.S. CLS. 22 AND 39).

FIRST USE 3-5-2007; IN COMMERCE 3-5-2007.

SER. NO. 78-687,579, FILED P.R. 8-8-2005; AM. S.R. 12-21-2007.

KATHLEEN M. VANSTON, EXAMINING ATTORNEY

Int. Cl.: 1

Prior U.S. Cls.: 1, 5, 6, 10, 26, and 46

United States Patent and Trademark Office

Reg. No. 3,400,379

Registered Mar. 18, 2008

**TRADEMARK
SUPPLEMENTAL REGISTER**

BIOBASED TECHNOLOGIES

BIOBASED CHEMICALS, LLC (ARKANSAS CORPORATION)
3715 N. BUSINESS DRIVE, SUITE 107
FAYETTEVILLE, AR 72703

FOR: AGRICULTURALLY BASED POLYOLS FOR USE IN THE PRODUCTION OF POLYURETHANE, IN CLASS 1 (U.S. CLS. 1, 5, 6, 10, 26 AND 46).

FIRST USE 10-15-2005; IN COMMERCE 10-15-2005.

THE MARK CONSISTS OF STANDARD CHARACTERS WITHOUT CLAIM TO ANY PARTICULAR FONT, STYLE, SIZE, OR COLOR.

OWNER OF U.S. REG. NO. 3,220,894.

NO CLAIM IS MADE TO THE EXCLUSIVE RIGHT TO USE "TECHNOLOGIES", APART FROM THE MARK AS SHOWN.

SER. NO. 78-751,855, FILED P.R. 11-11-2005; AM. S.R. 6-27-2007.

AMOS T. MATTHEWS, JR., EXAMINING ATTORNEY

Int. Cl.: 16

Prior U.S. Cls.: 2, 5, 22, 23, 29, 37, 38, and 50

United States Patent and Trademark Office

Reg. No. 3,400,380

Registered Mar. 18, 2008

**TRADEMARK
SUPPLEMENTAL REGISTER**

PUZZLE READERS

WEEKLY READER CORPORATION (DELA-
WARE CORPORATION)
200 STAMFORD PLACE
STAMFORD, CT 06912

FOR: BOOKS FOR TEACHING AND DEVELOP-
ING LITERACY, VISUAL DISCRIMINATION AND
FINE MOTOR SKILLS IN CHILDREN, IN CLASS 16
(U.S. CLS. 2, 5, 22, 23, 29, 37, 38 AND 50).

FIRST USE 1-1-2006; IN COMMERCE 1-1-2006.

THE MARK CONSISTS OF STANDARD CHAR-
ACTERS WITHOUT CLAIM TO ANY PARTICULAR
FONT, STYLE, SIZE, OR COLOR.

NO CLAIM IS MADE TO THE EXCLUSIVE
RIGHT TO USE "READERS", APART FROM THE
MARK AS SHOWN.

SER. NO. 78-752,304, FILED P.R. 11-11-2005; AM.
S.R. 7-23-2007.

KELLY MCCOY, EXAMINING ATTORNEY

Int. Cl.: 19

Prior U.S. Cls.: 1, 12, 33, and 50

United States Patent and Trademark Office

Reg. No. 3,400,381

Registered Mar. 18, 2008

**TRADEMARK
SUPPLEMENTAL REGISTER**

NORTH AMERICAN PIPE

NORTH AMERICAN PIPE CORPORATION (DE-
LAWARE CORPORATION)

2801 POST OAK BOULEVARD, SUITE 600

HOUSTON, TX 77056

FOR: RIGID NON-METALLIC PIPE FOR CON-
VEYING LIQUID AND SEMI-LIQUID MATERIALS,
IN CLASS 19 (U.S. CLS. 1, 12, 33 AND 50).

FIRST USE 6-14-2007; IN COMMERCE 6-14-2007.

THE MARK CONSISTS OF STANDARD CHAR-
ACTERS WITHOUT CLAIM TO ANY PARTICULAR
FONT, STYLE, SIZE, OR COLOR.

NO CLAIM IS MADE TO THE EXCLUSIVE
RIGHT TO USE "PIPE", APART FROM THE MARK
AS SHOWN.

SER. NO. 78-755,077, FILED P.R. 11-16-2005; AM.
S.R. 1-14-2008.

REBECCA GILBERT, EXAMINING ATTORNEY

Int. Cls.: 37, 39, and 43

Prior U.S. Cls.: 100, 101, 103, 105, and 106

United States Patent and Trademark Office

Reg. No. 3,400,382

Registered Mar. 18, 2008

**SERVICE MARK
SUPPLEMENTAL REGISTER**

The logo for Milano Manhattan features the word "milano" in a lowercase, sans-serif font with a light blue color. Below it, the word "Manhattan" is written in a larger, bold, lowercase, sans-serif font with a dark blue color. The "M" in "Manhattan" is significantly larger and more prominent than the other letters.

CLUB MILANOMANHATTAN (ITALY CORPORATION)

VIA GALLERIA DEL CORSO 2
MILAN, ITALY 20122

FOR: VEHICLE REPAIR, NAMELY, VEHICLES MAINTENANCE AND REPAIR; AIRPLANES MAINTENANCE AND REPAIR; AIRPLANES CLEANING AND WASHING; CLEANING OF INTERIOR SURFACES OF BUILDINGS; LAUNDERING; PROVIDING INFORMATION WITH RELATION TO AIRCRAFT CONSTRUCTION, REPAIR AND MAINTENANCE; BUILDING CONSTRUCTION SUPERVISION; CLEANING OF EXTERIOR SURFACES OF BUILDINGS; WAREHOUSE CONSTRUCTION AND REPAIR; MAINTENANCE, REPAIR AND CLEANING OF LINEN; INSTALLATION, MAINTENANCE AND REPAIR OF COMPUTER HARDWARE; CONSTRUCTION OF AIRPORTS; CLEANING OF CLOTHING; MAINTENANCE, REPAIR AND CLEANING OF EARTHENWARE, IN CLASS 37 (U.S. CLS. 100, 103 AND 106).

FOR: TRANSPORT OF GOODS; PACKAGING AND STORAGE OF GOODS; TRANSPORTATION OF ANIMALS BY AIR; ARRANGING OF TRAVEL TOURS; TOUR ESCORTING OF TRAVELLERS; AIR TRANSPORT; AERONAUTICAL TRANSPORT; FREIGHT TRANSPORTATION BY AIRPLANE, BOAT, TRUCK AND TRAIN; TOURIST OFFICES, NAMELY, TOURIST AGENCY SERVICES, EXCLUDING HOTEL AND BOARDING HOUSES RESERVATIONS; VEHICLE TOWING; BUS TRANSPORT; CAR TRANSPORT; CAR RENTAL CHAUFFEUR SERVICES; PARCEL DELIVERY; PACKING OF GOODS FOR TRANSPORTATION; RENTAL OF STORAGE CONTAINERS; MESSAGE DELIVERY; FREIGHT-BROKERAGE; TRANSPORT-BROKERAGE; STORAGE OF FOOD STUFFS; DELIVERY OF NEWSPAPERS; DELIVERY OF

GOODS AND WARES BY AIR; WRAPPING OF GOODS, NAMELY, WRAPPING SERVICES FOR BAGGAGE PROTECTION DURING TRAVEL; WAREHOUSING INFORMATION; RENTAL OF WAREHOUSE SPACE; ORGANIZATION OF EXCURSIONS; FREIGHT FORWARDING; FREIGHT, NAMELY, FREIGHT AIR TRANSPORT; GARAGE SPACE RENTAL; TRANSPORTATION INFORMATION, NAMELY, TRAVEL AND TOUR INFORMATION SERVICE; PROVIDING INFORMATION ABOUT TRANSPORTATION OF GOODS AND ANIMALS; RENTAL OF WHEELCHAIRS; PARKING SPACE RENTAL; RENTAL OF VEHICLES; COURIER SERVICES; CAR PARKING; PASSENGER TRANSPORT; PILOTING, NAMELY, AIRPLANE PILOTING; BOOKING OF SEATS FOR TRAVEL; SALVAGING, NAMELY, AIRCRAFT SALVAGE; RESCUE OPERATIONS, NAMELY, AMBULANCE TRANSPORT BY AIR; TAXI TRANSPORT; SIGHT-SEEING, NAMELY, CONDUCTING SIGHTSEEING TOURS FOR OTHERS; FREIGHT FORWARDING; TRANSPORT RESERVATION, NAMELY, TRANSPORTATION RESERVATION SERVICES; TRANSPORTATION RESERVATION SERVICES FOR GOODS AND ANIMALS; ARMORED-CAR TRANSPORT; AIRPORT BAGGAGE CHECK-IN SERVICES; AIRPORT GOODS CHECK-IN SERVICES; AIRPORT PASSENGER CHECK-IN SERVICES; LOADING AND UNLOADING OF GOODS INTO AND FROM AIRPLANES; LOANING AND RENTAL OF AIRPLANES; PLACING OF AIRPLANES AT DISPOSAL, NAMELY, TOWING AND PARKING OF AIRPLANES, IN CLASS 39 (U.S. CLS. 100 AND 105).

FOR: RESTAURANTS; BAR SERVICES; BAR-RESTAURANTS SERVICES; CAFES; PROVIDING TEMPORARY ACCOMMODATION; CANTEN SERVICES; RENTAL OF TRANSPORTABLE BUILDINGS; CHILDREN'S CRECHES; HOTELS; RESERVATION OF HOTEL ROOMS FOR TRAVELLERS;

SELF-SERVICE RESTAURANTS; RENTAL OF FOOD SERVICE AND BAR EQUIPMENT IN THE NATURE OF CHAIRS, TABLES, TABLE LINEN, GLASSWARE; RENTAL OF TEMPORARY ACCOMMODATION; RENTAL OF MEETING ROOMS; RENTAL OF TENTS; ACCOMMODATIONS, NAMELY, HOTELS AND BOARDING HOUSES; RESERVATION OF TEMPORARY ACCOMMODATION FOR TRAVELLERS; TOURIST HOMES; FAST-FOOD RESTAURANTS AND SNACK-BARS; MEALS, NAMELY, MAKING RESERVATIONS AND BOOKINGS FOR MEALS; PROVIDING IN-FLIGHT MEAL SERVICES IN AN AIRPLANE AND IN AIRPORTS; PROVIDING OF TEMPORARY ACCOMMODA-

TION IN AIRPLANES AND IN AIRPORTS; PROVIDING FACILITIES FOR EXHIBITIONS; CATERING OF FOOD AND DRINK, IN CLASS 43 (U.S. CLS. 100 AND 101).

PRIORITY CLAIMED UNDER SEC. 44(D) ON ERPN CMNTY TM OFC APPLICATION NO. 4713509, FILED 10-27-2005, REG. NO. 004713509, DATED 11-14-2006, EXPIRES 10-27-2015.

SER. NO. 78-756,442, FILED P.R. 11-17-2005; AM. S.R. 2-11-2008.

ANDREW RHIM, EXAMINING ATTORNEY

Int. Cl.: 9

Prior U.S. Cls.: 21, 23, 26, 36, and 38

United States Patent and Trademark Office

Reg. No. 3,400,383

Registered Mar. 18, 2008

**TRADEMARK
SUPPLEMENTAL REGISTER**

PODCASTREADY

INFOSTRUCTURE SOLUTIONS, L.L.C. (TEXAS
LTD LIAB CO)
P.O. BOX 30090
HOUSTON, TX 77249

THE MARK CONSISTS OF STANDARD CHAR-
ACTERS WITHOUT CLAIM TO ANY PARTICULAR
FONT, STYLE, SIZE, OR COLOR.

FOR: PORTABLE LISTENING DEVICES, NAME-
LY, MP3 PLAYERS, IN CLASS 9 (U.S. CLS. 21, 23, 26,
36 AND 38).

SER. NO. 78-761,085, FILED P.R. 11-26-2005; AM.
S.R. 11-12-2006.

FIRST USE 4-1-2005; IN COMMERCE 4-1-2005.

WANDA KAY PRICE, EXAMINING ATTORNEY

Int. Cl.: 41

Prior U.S. Cls.: 100, 101, and 107

United States Patent and Trademark Office

Reg. No. 3,400,384

Registered Mar. 18, 2008

**SERVICE MARK
SUPPLEMENTAL REGISTER**

BOOKS INTO FILM

PYRAMID PRODUCTIONS INC. (CANADA CORPORATION)
2875 - 107TH AVENUE SE
CALGARY, CANADA

FOR: ENTERTAINMENT IN THE NATURE OF ON-GOING TELEVISION PROGRAMS IN THE FIELD OF POPULAR CULTURE; ENTERTAINMENT, NAMELY, PRODUCTION OF TELEVISION SHOWS IN THE FIELD OF POPULAR CULTURE; ENTERTAINMENT SERVICES, NAMELY, PROVIDING A TELEVISION PROGRAM IN THE FIELD OF POPULAR CULTURE VIA A GLOBAL COMPUTER NETWORK; PRODUCTION OF CABLE TELEVISION PROGRAMS; PRODUCTION OF TELEVISION PROGRAMS; TELEVISION PRODUCTION; TELEVI-

SION SHOW PRODUCTION, IN CLASS 41 (U.S. CLS. 100, 101 AND 107).

THE MARK CONSISTS OF STANDARD CHARACTERS WITHOUT CLAIM TO ANY PARTICULAR FONT, STYLE, SIZE, OR COLOR.

PRIORITY CLAIMED UNDER SEC. 44(D) ON CANADA APPLICATION NO. 1281416, FILED 9-30-2005, REG. NO. TMA702005, DATED 11-29-2007, EXPIRES 11-29-2022.

SER. NO. 78-764,428, FILED P.R. 12-1-2005; AM. S.R. 2-5-2008.

MICHAEL KEATING, EXAMINING ATTORNEY

Int. Cl.: 3

Prior U.S. Cls.: 1, 4, 6, 50, 51, and 52

United States Patent and Trademark Office

Reg. No. 3,400,385

Registered Mar. 18, 2008

**TRADEMARK
SUPPLEMENTAL REGISTER**

NIGHT BLOOMING LILY

STUART-CURTIS FAMILY TRUST (NEW YORK
TRUST)
550 SEVENTH AVENUE
NEW YORK, NY 90018

THE MARK CONSISTS OF STANDARD CHAR-
ACTERS WITHOUT CLAIM TO ANY PARTICULAR
FONT, STYLE, SIZE, OR COLOR.

FOR: PERFUME, IN CLASS 3 (U.S. CLS. 1, 4, 6, 50,
51 AND 52).

SER. NO. 78-769,640, FILED P.R. 12-8-2005; AM. S.R.
7-23-2007.

FIRST USE 12-31-2006; IN COMMERCE 12-31-2006.

PAULA MAHONEY, EXAMINING ATTORNEY

Int. Cl.: 32

Prior U.S. Cls.: 45, 46, and 48

United States Patent and Trademark Office

Reg. No. 3,400,386

Registered Mar. 18, 2008

**TRADEMARK
SUPPLEMENTAL REGISTER**

EXCELLENCE IN BREWING

SHIPYARD BREWING COMPANY (MAINE LTD
LIAB CO)
86 NEWBURY STREET
PORTLAND, ME 04101

FOR: BEER, IN CLASS 32 (U.S. CLS. 45, 46 AND 48).

FIRST USE 7-31-2007; IN COMMERCE 7-31-2007.

THE MARK CONSISTS OF STANDARD CHAR-
ACTERS WITHOUT CLAIM TO ANY PARTICULAR
FONT, STYLE, SIZE, OR COLOR.

SER. NO. 78-780,869, FILED P.R. 12-27-2005; AM.
S.R. 8-1-2007.

REBECCA EISINGER, EXAMINING ATTORNEY

Int. Cl.: 7

Prior U.S. Cls.: 13, 19, 21, 23, 31, 34, and 35

Reg. No. 3,400,387

United States Patent and Trademark Office

Registered Mar. 18, 2008

**TRADEMARK
SUPPLEMENTAL REGISTER**

JAM-SENSOR

EMERSON ELECTRIC CO. (MISSOURI CORPORATION)
8000 WEST FLORISSANT AVE.
ST. LOUIS, MO 63136

THE MARK CONSISTS OF STANDARD CHARACTERS WITHOUT CLAIM TO ANY PARTICULAR FONT, STYLE, SIZE, OR COLOR.

FOR: ELECTRONIC INTEGRATED CIRCUIT SOLD AS A COMPONENT PART OF FOOD WASTE DISPOSERS AND GARBAGE DISPOSALS, IN CLASS 7 (U.S. CLS. 13, 19, 21, 23, 31, 34 AND 35).

SER. NO. 78-782,545, FILED P.R. 12-29-2005; AM. S.R. 1-30-2008.

FIRST USE 5-15-2006; IN COMMERCE 5-15-2006.

MICHAEL GAAFAR, EXAMINING ATTORNEY

Int. Cls.: 35, 38, and 42

Prior U.S. Cls.: 100, 101, 102, and 104

United States Patent and Trademark Office

Reg. No. 3,400,388

Registered Mar. 18, 2008

**SERVICE MARK
SUPPLEMENTAL REGISTER**

CARRIER DIRECT

VOIP, INC. (TEXAS CORPORATION)
SUITE 712
12330 SW 53RD STREET
FORT LAUDERDALE, FL 33330

FOR: ADMINISTRATION, BILLING AND RE-
CONCILIATION OF ACCOUNTS ON BEHALF OF
OTHERS, IN CLASS 35 (U.S. CLS. 100, 101 AND 102).

FIRST USE 8-31-2005; IN COMMERCE 8-31-2005.

FOR: COMMUNICATIONS VIA FIBER-OPTIC
NETWORKS, WIRELESS BROADBAND COMMU-
NICATION SERVICES, TELECOMMUNICATIONS
GATEWAY SERVICES, ELECTRONIC VOICE MES-
SAGING, NAMELY, THE RECORDING AND SUB-
SEQUENT TRANSMISSION OF VOICE MESSAGES
BY TELEPHONE, PROVIDING THIRD PARTY
USERS WITH ACCESS TO TELECOMMUNICATION
INFRASTRUCTURE IN THE NATURE OF PROVID-
ING ACCESS TO TOOLS THAT AUTOMATICALLY
PROVISION NEW ACCOUNTS, DIRECT INWARD
DIALING, AND 800 SERVICES, PROVIDING THE
AFORESAID TELECOMMUNICATIONS SERVICES
FOR IP ENABLING FACILITIES-BASED CARRI-
ERS, IN CLASS 38 (U.S. CLS. 100, 101 AND 104).

FIRST USE 8-31-2005; IN COMMERCE 8-31-2005.

FOR: TELECOMMUNICATIONS TECHNICAL
SUPPORT SERVICES, NAMELY, DIAGNOSTICS IN

THE NATURE OF TROUBLESHOOTING OF COM-
PUTER HARDWARE AND SOFTWARE PROBLEMS
IN THE FIELD OF TELECOMMUNICATIONS,
COMPUTER MONITORING SERVICE WHICH
TRACKS TELECOMMUNICATIONS HARDWARE
PERFORMANCE AND PROCESSES AND SENDS
OUT HISTORICAL REPORTS AND ALERTS, COM-
PUTER DISASTER RECOVERY PLANNING, TECH-
NICAL SUPPORT, NAMELY, REAL-TIME
MONITORING OF NETWORK SYSTEMS, COMPU-
TER PROGRAMMING FOR OTHERS, NAMELY,
PROVIDING EXTENSIBLE MARKUP LANGUAGE
BASED PROVISIONING AND MANAGEMENT IN
THE TELECOMMUNICATIONS FIELD, IN CLASS
42 (U.S. CLS. 100 AND 101).

FIRST USE 8-31-2005; IN COMMERCE 8-31-2005.

THE MARK CONSISTS OF STANDARD CHAR-
ACTERS WITHOUT CLAIM TO ANY PARTICULAR
FONT, STYLE, SIZE, OR COLOR.

NO CLAIM IS MADE TO THE EXCLUSIVE
RIGHT TO USE "CARRIER" , APART FROM THE
MARK AS SHOWN.

SER. NO. 78-801,958, FILED P.R. 1-30-2006; AM. S.R.
7-11-2007.

KATHERINE CHANG, EXAMINING ATTORNEY

Int. Cl.: 25

Prior U.S. Cls.: 22 and 39

United States Patent and Trademark Office

Reg. No. 3,400,389

Registered Mar. 18, 2008

**TRADEMARK
SUPPLEMENTAL REGISTER**

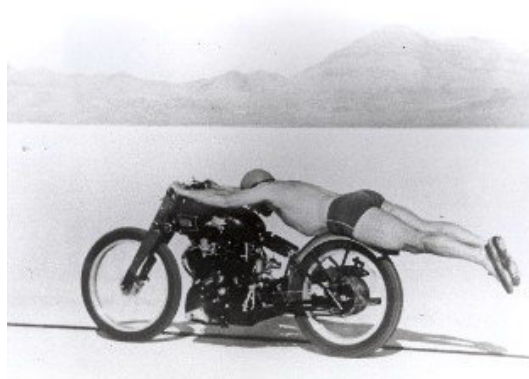

HARRIS, HERB (UNITED STATES INDIVIDUAL)
66 ST. STEPHENS SCHOOL ROAD
AUSTIN, TX 78746

FOR: SHIRTS, IN CLASS 25 (U.S. CLS. 22 AND 39).

FIRST USE 9-12-1997; IN COMMERCE 12-27-1999.

THE LIKENESS (OR, "PORTRAIT") IN THE MARK DOES NOT IDENTIFY A LIVING INDIVIDUAL.

THE COLOR(S) BLACK, WHITE AND GRAY IS/ARE CLAIMED AS A FEATURE OF THE MARK.

THE COLOR BLACK APPEARS WITHIN THE MOTORCYCLE, ITS WHEELS, THE MAN'S

TRUNKS AND SHOES, AND THE SHADOW ON THE GROUND. THE COLOR GRAY APPEARS WITHIN THE MOTORCYCLE RIMS, THE MOUNTAIN RANGE, AND AS THE COLOR OF THE MAN'S SKIN. THE COLOR WITH APPEARS IN THE SAND IN THE DESERT

THE MARK CONSISTS OF A MAN LAYING DOWN ON A MOTORCYCLE WEARING SWIMMING TRUNKS AND TENNIS SHOES RACING TO SET SPEED RECORD. THE MAN IS IN THE DESERT WITH MOUNTAINS IN THE BACKGROUND.

SER. NO. 78-803,567, FILED P.R. 1-31-2006; AM. S.R. 7-25-2006.

DAVID COLLIER, EXAMINING ATTORNEY

Int. Cls.: 36 and 41

Prior U.S. Cls.: 100, 101, 102, and 107

United States Patent and Trademark Office

Reg. No. 3,400,390

Registered Mar. 18, 2008

**SERVICE MARK
SUPPLEMENTAL REGISTER**

**NATIONAL BLACK MBA
FOUNDATION**

NATIONAL BLACK MBA ASSOCIATION, INC.
(NEW YORK CORPORATION)
SUITE 1400
180 N. MICHIGAN AVENUE
CHICAGO, IL 60601

FOR: CHARITABLE FUND RAISING DEDICATED TO PROMOTING EDUCATION IN THE AFRICAN-AMERICAN COMMUNITY, IN CLASS 36 (U.S. CLS. 100, 101 AND 102).

FIRST USE 8-17-2005; IN COMMERCE 8-17-2005.

FOR: EDUCATIONAL SERVICES, NAMELY, DEVELOPING, ARRANGING, AND CONDUCTING EDUCATIONAL CONFERENCES AND PROGRAMS AND PROVIDING COURSES OF INSTRUCTION IN THE FIELD OF PROMOTING ECONOMIC WEALTH IN THE AFRICAN-AMERICAN COMMUNITY; EDUCATIONAL SERVICES, NAMELY, CONDUCTING PROGRAMS, WORKSHOPS, SEMINARS FOCUSED ON INCREASING THE NUMBER OF AFRICAN AMERICANS IN BUSINESS EDUCATIONAL PROGRAMS THROUGHOUT THE WORLD; AND EDUCATIONAL SERVICES, NAME-

LY, CONDUCTING EDUCATIONAL PROGRAMS FOCUSED ON ENCOURAGING AND SUPPORTING YOUNG AFRICAN-AMERICANS INTERESTED IN PURSUING CAREERS IN MANAGEMENT, IN CLASS 41 (U.S. CLS. 100, 101 AND 107).

FIRST USE 8-17-2005; IN COMMERCE 8-17-2005.

THE MARK CONSISTS OF STANDARD CHARACTERS WITHOUT CLAIM TO ANY PARTICULAR FONT, STYLE, SIZE, OR COLOR.

OWNER OF U.S. REG. NOS. 2,701,696 AND 2,828,815.

NO CLAIM IS MADE TO THE EXCLUSIVE RIGHT TO USE "FOUNDATION", APART FROM THE MARK AS SHOWN.

SER. NO. 78-829,443, FILED P.R. 3-5-2006; AM. S.R. 1-2-2007.

LESLEY LAMOTHE, EXAMINING ATTORNEY

Int. Cl.: 42

Prior U.S. Cls.: 100 and 101

United States Patent and Trademark Office

Reg. No. 3,400,391

Registered Mar. 18, 2008

**SERVICE MARK
SUPPLEMENTAL REGISTER**

Engineers Who Write

ENGINEERSHOWRITE (CALIFORNIA CORPORATION)
2148 HARRISON ST.
SANTA CLARA, CA 95050

FOR: TECHNICAL WRITING FOR OTHERS, IN CLASS 42 (U.S. CLS. 100 AND 101).

FIRST USE 7-4-2005; IN COMMERCE 7-18-2005.

THE MARK CONSISTS OF STANDARD CHARACTERS WITHOUT CLAIM TO ANY PARTICULAR FONT, STYLE, SIZE, OR COLOR.

SER. NO. 78-843,928, FILED P.R. 3-23-2006; AM. S.R. 3-5-2007.

BARBARA GAYNOR, EXAMINING ATTORNEY

Int. Cl.: 35

Prior U.S. Cls.: 100, 101, and 102

United States Patent and Trademark Office

Reg. No. 3,400,392

Registered Mar. 18, 2008

**SERVICE MARK
SUPPLEMENTAL REGISTER**

INTERNATIONAL COMMERCE
AGENCY

CREATIVE COMMERCE, LLC (DELAWARE LTD
LIAB CO)
109 BANK STREET
NEW YORK, NY 10014

FOR: ADVERTISING, MARKETING, AND PROMOTIONAL SERVICES; BUSINESS MARKETING CONSULTING SERVICES; PUBLIC RELATIONS; BUSINESS ADMINISTRATION; BUSINESS MANAGEMENT SERVICES; PROCURING OF CONTRACTS FOR THE PURCHASE AND SALE OF GOODS; ONLINE RETAIL STORES SERVICES FEATURING A WIDE VARIETY OF CONSUMER GOODS AND SERVICES OF OTHERS; PROVIDING HOME SHOPPING SERVICES FEATURING A WIDE VARIETY OF CONSUMER GOODS OF OTHERS BY MEANS OF TELEVISION AND THE INTERNET; IMPORT AND EXPORT AGENCY SERVICES; DIRECT RESPONSE RETAIL SERVICES BY MEANS

OF INFOMERCIALS IN THE FIELD OF CONSUMER GOODS, IN CLASS 35 (U.S. CLS. 100, 101 AND 102).

FIRST USE 3-31-2006; IN COMMERCE 3-31-2006.

THE MARK CONSISTS OF STANDARD CHARACTERS WITHOUT CLAIM TO ANY PARTICULAR FONT, STYLE, SIZE, OR COLOR.

NO CLAIM IS MADE TO THE EXCLUSIVE RIGHT TO USE "AGENCY", APART FROM THE MARK AS SHOWN.

SER. NO. 78-853,517, FILED P.R. 4-4-2006; AM. S.R. 12-3-2007.

ANGELA M. MICHELI, EXAMINING ATTORNEY

Int. Cl.: 13

Prior U.S. Cls.: 2 and 9

United States Patent and Trademark Office

Reg. No. 3,400,393

Registered Mar. 18, 2008

**TRADEMARK
SUPPLEMENTAL REGISTER**

BIG SMILEY

THE TRUSTEES OF THE SALISH TRUST, A
WASHINGTON TRUST, THE TRUSTEES
COMPRISING MARVIN WILBUR, SR., JOAN
WILBUR, LENORA WILBUR-COOK, C. MAR-
VIN WILBUR, JR. AND MICHAEL WILBUR,
ALL U.S. CITIZENS (WASHINGTON TRUST)
10041 SOUTH MARCH POINT ROAD
ANACORTES, WA 98221

FOR: FIREWORKS, IN CLASS 13 (U.S. CLS. 2 AND
9).

FIRST USE 6-13-2006; IN COMMERCE 6-13-2006.

THE MARK CONSISTS OF STANDARD CHAR-
ACTERS WITHOUT CLAIM TO ANY PARTICULAR
FONT, STYLE, SIZE, OR COLOR.

SER. NO. 78-860,166, FILED P.R. 4-12-2006; AM. S.R.
3-26-2007.

DAVID MURRAY, EXAMINING ATTORNEY

Int. Cl.: 35

Prior U.S. Cls.: 100, 101, and 102

United States Patent and Trademark Office

Reg. No. 3,400,394

Registered Mar. 18, 2008

**SERVICE MARK
SUPPLEMENTAL REGISTER**

1800DIAPERS

1800DIAPERS, INC. (DELAWARE CORPORATION)
1404 GULLY ROAD
NEPTUNE, NJ 07753

THE MARK CONSISTS OF STANDARD CHARACTERS WITHOUT CLAIM TO ANY PARTICULAR FONT, STYLE, SIZE, OR COLOR.

FOR: ON-LINE RETAIL STORE SERVICES FEATURING BABY-CARE PRODUCTS AND ACCESSORIES, IN CLASS 35 (U.S. CLS. 100, 101 AND 102).

SER. NO. 78-860,837, FILED 4-13-2006.

FIRST USE 1-11-2005; IN COMMERCE 1-11-2005.

CURTIS FRENCH, EXAMINING ATTORNEY

Int. Cl.: 13

Prior U.S. Cls.: 2 and 9

United States Patent and Trademark Office

Reg. No. 3,400,395

Registered Mar. 18, 2008

**TRADEMARK
SUPPLEMENTAL REGISTER**

BOWTIE WITH RING

THE TRUSTEES OF THE SALISH TRUST, A
WASHINGTON TRUST, THE TRUSTEES
COMPRISING OF C. MARVIN WILBUR, SR.,
JOAN WILBUR, LENORA WILBUR-COOK, C.
MARVIN WILBUR, JR., MICHAEL WILBUR,
ALL U.S. CITIZENS (WASHINGTON TRUST)
10041 SOUTH MARCH POINT ROAD
ANACORTES, WA 98221

FOR: FIREWORKS, IN CLASS 13 (U.S. CLS. 2 AND
9).

FIRST USE 6-2-2006; IN COMMERCE 6-2-2006.

THE MARK CONSISTS OF STANDARD CHAR-
ACTERS WITHOUT CLAIM TO ANY PARTICULAR
FONT, STYLE, SIZE, OR COLOR.

SER. NO. 78-860,893, FILED P.R. 4-13-2006; AM. S.R.
3-26-2007.

AMY MCMENAMIN, EXAMINING ATTORNEY

Int. Cl.: 42

Prior U.S. Cls.: 100 and 101

United States Patent and Trademark Office

Reg. No. 3,400,396

Registered Mar. 18, 2008

**SERVICE MARK
SUPPLEMENTAL REGISTER**

UNIVERSAL PDF

CODEMANTRA, LLC (PENNSYLVANIA LTD
LIAB CO)
SUITE 400
600 WEST GERMANTOWN PIKE
PLYMOUTH MEETING, PA 19462

FOR: COMPUTER SERVICES, NAMELY, CON-
VERSION OF ELECTRONIC DOCUMENTS FROM
DIFFERENT FILE FORMATS INTO PORTABLE
DOCUMENT FORMAT (PDF) , IN CLASS 42 (U.S.
CLS. 100 AND 101).

FIRST USE 11-1-2004; IN COMMERCE 11-1-2004.

THE MARK CONSISTS OF STANDARD CHAR-
ACTERS WITHOUT CLAIM TO ANY PARTICULAR
FONT, STYLE, SIZE, OR COLOR.

NO CLAIM IS MADE TO THE EXCLUSIVE
RIGHT TO USE "PDF", APART FROM THE MARK
AS SHOWN.

SER. NO. 78-863,324, FILED P.R. 4-18-2006; AM. S.R.
11-19-2007.

KELLY BOULTON, EXAMINING ATTORNEY

Int. Cl.: 30

Prior U.S. Cl.: 46

United States Patent and Trademark Office

Reg. No. 3,400,397

Registered Mar. 18, 2008

**TRADEMARK
SUPPLEMENTAL REGISTER**

POPCORN CHIPS

MCGREGOR AND MACALLAN (NEVADA CORPORATION)

925 WILD OAK DRIVE

SANTA ROSA, CA 95409

FOR: CHIPS MADE FROM POPPED CORN, IN CLASS 30 (U.S. CL. 46).

FIRST USE 3-22-2007; IN COMMERCE 3-22-2007.

THE MARK CONSISTS OF STANDARD CHARACTERS WITHOUT CLAIM TO ANY PARTICULAR FONT, STYLE, SIZE, OR COLOR.

NO CLAIM IS MADE TO THE EXCLUSIVE RIGHT TO USE "CHIPS", APART FROM THE MARK AS SHOWN.

SER. NO. 78-875,268, FILED P.R. 5-3-2006; AM. S.R. 1-4-2008.

JAMES MACFARLANE, EXAMINING ATTORNEY

Int. Cl.: 9

Prior U.S. Cls.: 21, 23, 26, 36, and 38

United States Patent and Trademark Office

Reg. No. 3,400,398

Registered Mar. 18, 2008

**TRADEMARK
SUPPLEMENTAL REGISTER**

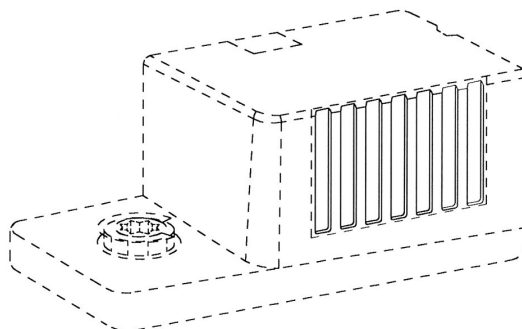

ELODRIVE GMBH (FED REP GERMANY CORPORATION)

WERFSTRASSE 34

MINDEN, FED REP GERMANY 32423

FOR: ELECTRONIC ACTUATORS FOR AIR-HANDLING SYSTEMS, IN CLASS 9 (U.S. CLS. 21, 23, 26, 36 AND 38).

FIRST USE 1-31-2001; IN COMMERCE 1-31-2001.

THE MARK CONSISTS OF A SERIES OF REPEATING PARALLEL GROOVES COVERING SUBSTANTIALLY ALL OF THE ENTIRE SURFACE OF THE TWO OPPOSITE SIDES OF THE GOODS. THE BROKEN LINES IN THE DRAWING SHOW PLACEMENT OF THE MARK AND DO NOT COMPRISE A PORTION OF THE MARK.

SER. NO. 78-893,829, FILED P.R. 5-26-2006; AM. S.R. 5-1-2007.

RON FAIRBANKS, EXAMINING ATTORNEY

Int. Cl.: 20

Prior U.S. Cls.: 2, 13, 22, 25, 32, and 50

Reg. No. 3,400,399

United States Patent and Trademark Office

Registered Mar. 18, 2008

**TRADEMARK
SUPPLEMENTAL REGISTER**

**THE INVISIBLE MEDIA FRAME
SYSTEM**

TRUCK ADS, LLC (VIRGINIA LTD LIAB CO)
2028 VIRGINIA AVENUE
MCLEAN, VA 22101

THE MARK CONSISTS OF STANDARD CHAR-
ACTERS WITHOUT CLAIM TO ANY PARTICULAR
FONT, STYLE, SIZE, OR COLOR.

FOR: PLASTIC FASTENERS FOR MOUNTING
BANNERS, IN CLASS 20 (U.S. CLS. 2, 13, 22, 25, 32
AND 50).

SER. NO. 78-897,290, FILED P.R. 5-31-2006; AM. S.R.
1-2-2008.

FIRST USE 12-20-2005; IN COMMERCE 12-20-2005.

ELLEN B. AWRICH, EXAMINING ATTORNEY

Int. Cls.: 9 and 42

Prior U.S. Cls.: 21, 23, 26, 36, 38, 100, and 101

United States Patent and Trademark Office

Reg. No. 3,400,400

Registered Mar. 18, 2008

**TRADEMARK
SERVICE MARK
SUPPLEMENTAL REGISTER**

SPOKEN COMMUNICATIONS

INTELLISIST, INC. (WASHINGTON CORPORATION)

11061 NE 2ND STREET, STE 200

BELLEVUE, WA 98004

FOR: COMPUTER HARDWARE AND SOFTWARE, NAMELY, AUTOMATED AND HUMAN-GUIDED VOICE, TEXT MESSAGING, AND COMMUNICATIONS HARDWARE AND SOFTWARE FOR USE IN OPERATING AUTOMATED TELEPHONE CALL CENTERS, IN CLASS 9 (U.S. CLS. 21, 23, 26, 36 AND 38).

FIRST USE 3-5-2006; IN COMMERCE 3-5-2006.

FOR: INFORMATION TECHNOLOGY ENGINEERING, CONSULTING, AND DEVELOPMENT FOR OTHERS OF AUTOMATED TELEPHONE CALL CENTERS, IN CLASS 42 (U.S. CLS. 100 AND 101).

FIRST USE 3-5-2006; IN COMMERCE 3-5-2006.

THE MARK CONSISTS OF STANDARD CHARACTERS WITHOUT CLAIM TO ANY PARTICULAR FONT, STYLE, SIZE, OR COLOR.

SER. NO. 78-906,317, FILED P.R. 6-12-2006; AM. S.R. 12-24-2007.

JEFF DEFORD, EXAMINING ATTORNEY

Int. Cl.: 36

Prior U.S. Cls.: 100, 101, and 102

United States Patent and Trademark Office

Reg. No. 3,400,401

Registered Mar. 18, 2008

**SERVICE MARK
SUPPLEMENTAL REGISTER**

PROTECTED PORTFOLIO

JPMORGAN CHASE & CO. (DELAWARE CORPORATION)
270 PARK AVENUE
NEW YORK, NY 10017

THE MARK CONSISTS OF STANDARD CHARACTERS WITHOUT CLAIM TO ANY PARTICULAR FONT, STYLE, SIZE, OR COLOR.

FOR: BANKING SERVICES; INVESTMENT BANKING SERVICES, IN CLASS 36 (U.S. CLS. 100, 101 AND 102).

SER. NO. 78-924,835, FILED P.R. 7-7-2006; AM. S.R. 1-15-2008.

FIRST USE 4-0-2006; IN COMMERCE 4-0-2006.

COLLEEN DOMBROW, EXAMINING ATTORNEY

Int. Cl.: 21

Prior U.S. Cls.: 2, 13, 23, 29, 30, 33, 40, and 50

United States Patent and Trademark Office

Reg. No. 3,400,402

Registered Mar. 18, 2008

**TRADEMARK
SUPPLEMENTAL REGISTER**

**Sustainable Food & Garden
Solutions**

ECO-HARVEST INC. (FLORIDA CORPORATION)
2620 GRIFFIN ROAD
LEESBURG, FL 34748

FIRST USE 12-20-2007; IN COMMERCE 12-20-2007.

FOR: HYDROPONIC GARDEN KIT FOR HOME
USE COMPRISING GROWING CONTAINERS AND
ALSO INCLUDING HYDROPONIC FERTILIZERS,
SEEDS, SUBSTRATE, DRAIN COMPONENTS, AND
ELECTRONIC CONTROL PANEL FOR WATERING,
IN CLASS 21 (U.S. CLS. 2, 13, 23, 29, 30, 33, 40 AND 50).

THE MARK CONSISTS OF STANDARD CHAR-
ACTERS WITHOUT CLAIM TO ANY PARTICULAR
FONT, STYLE, SIZE, OR COLOR.

SER. NO. 78-934,540, FILED P.R. 7-21-2006; AM. S.R.
12-20-2007.

ROSELLE HERRERA, EXAMINING ATTORNEY

Int. Cl.: 41

Prior U.S. Cls.: 100, 101, and 107

United States Patent and Trademark Office

Reg. No. 3,400,403

Registered Mar. 18, 2008

**SERVICE MARK
SUPPLEMENTAL REGISTER**

**INVESTMENT ADVISER
COMPLIANCE CERTIFICATE
PROGRAM**

SOURCE MEDIA INC. (DELAWARE CORPORATION)
27TH FLOOR
ONE STATE STREET PLAZA
NEW YORK, NY 10004

FOR: PROFESSIONAL EDUCATIONAL SERVICES, NAMELY, CLASSES, TRAINING SESSIONS, SEMINARS AND ONLINE SEMINARS IN THE FIELD OF FINANCIAL REGULATIONS FOR FINANCIAL AND COMPLIANCE PROFESSIONALS, IN CLASS 41 (U.S. CLS. 100, 101 AND 107).

FIRST USE 10-11-2004; IN COMMERCE 10-11-2004.

THE MARK CONSISTS OF STANDARD CHARACTERS WITHOUT CLAIM TO ANY PARTICULAR FONT, STYLE, SIZE, OR COLOR.

NO CLAIM IS MADE TO THE EXCLUSIVE RIGHT TO USE "CERTIFICATE PROGRAM", APART FROM THE MARK AS SHOWN.

SER. NO. 78-943,397, FILED P.R. 8-2-2006; AM. S.R. 6-11-2007.

KRISTINA MORRIS, EXAMINING ATTORNEY

Int. Cl.: 35

Prior U.S. Cls.: 100, 101, and 102

United States Patent and Trademark Office

Reg. No. 3,400,404

Registered Mar. 18, 2008

**SERVICE MARK
SUPPLEMENTAL REGISTER**

marketamerica

MARKET AMERICA, INC. (NORTH CAROLINA CORPORATION)
1302 PLEASANT RIDGE ROAD
GREENSBORO, NC 27409

FOR: WHOLESALE DISTRIBUTORSHIPS, ON-LINE WHOLESALE DISTRIBUTORSHIPS, RETAIL STORE AND ONLINE RETAIL STORE SERVICES FEATURING DIETARY SUPPLEMENTS, NUTRITIONALLY FORTIFIED BEVERAGES, COSMETICS, FACE AND BODY CRÈMES AND LOTIONS, SHAMPOOS, TOOTHPASTE, HOME AND AUTOMOTIVE CARE PRODUCTS, WATER FILTERS, WEIGHT MANAGEMENT FOOD AND BEVERAGE PRODUCTS, SPORTS DRINKS, COFFEE, CAPPUCCINO, HERBICIDES, INSECTICIDES, PESTICIDES AND FUNGICIDES FOR HOME, GARDEN AND LAWN USE AND FOR PROFESSIONAL USE; PROMOTING THE GOODS AND SERVICES OF OTHERS, NAMELY WEIGHT MANAGEMENT FOODS AND BEVERAGE PRODUCTS INCLUDING ON THE

INTERNET; ADVERTISING AND MARKETING FOR OTHERS OF ON-LINE WEBSITES, IN CLASS 35 (U.S. CLS. 100, 101 AND 102).

FIRST USE 8-5-2006; IN COMMERCE 8-5-2006.

OWNER OF U.S. REG. NOS. 1,847,850 AND 2,042,709.

THE COLOR(S) BLACK AND BLUE IS/ARE CLAIMED AS A FEATURE OF THE MARK.

THE COLOR BLACK APPEARS IN THE WORD "MARKET". THE COLOR BLUE APPEARS IN THE WORD "AMERICA".

SER. NO. 78-944,919, FILED P.R. 8-4-2006; AM. S.R. 1-28-2008.

BRENDAN MCCAULEY, EXAMINING ATTORNEY

Int. Cl.: 9

Prior U.S. Cls.: 21, 23, 26, 36, and 38

United States Patent and Trademark Office

Reg. No. 3,400,405

Registered Mar. 18, 2008

**TRADEMARK
SUPPLEMENTAL REGISTER**

DOGGIE CLASSICAL

MIRABITO, JUDY (UNITED STATES INDIVIDUAL)

9A CANTERBERRY COURT

HUDSON, NH 03051

FOR: COMPACT DISCS FEATURING MUSIC, IN CLASS 9 (U.S. CLS. 21, 23, 26, 36 AND 38).

FIRST USE 4-2-2006; IN COMMERCE 4-2-2006.

THE MARK CONSISTS OF STANDARD CHARACTERS WITHOUT CLAIM TO ANY PARTICULAR FONT, STYLE, SIZE, OR COLOR.

NO CLAIM IS MADE TO THE EXCLUSIVE RIGHT TO USE "CLASSICAL", APART FROM THE MARK AS SHOWN.

SER. NO. 78-957,245, FILED P.R. 8-22-2006; AM. S.R. 1-10-2008.

BERNICE MIDDLETON, EXAMINING ATTORNEY

Int. Cl.: 42

Prior U.S. Cls.: 100 and 101

United States Patent and Trademark Office

Reg. No. 3,400,406

Registered Mar. 18, 2008

**SERVICE MARK
SUPPLEMENTAL REGISTER**

ISOTHERMING

PROCESS DYNAMICS, INC. (ARKANSAS CORPORATION)
2434 DEANE SOLOMON
FAYETTEVILLE, AR 72704

FOR: ENGINEERING, DESIGN AND TECHNOLOGICAL CONSULTATION AND ADVICE IN THE TECHNOLOGICAL FIELDS OF REFINING AND TREATMENT OF PETROLEUM AND HYDROCARBON PRODUCTS AND PETROLEUM AND HYDROCARBON PLANT AND REACTOR DESIGN, IN CLASS 42 (U.S. CLS. 100 AND 101).

FIRST USE 2-0-2005; IN COMMERCE 2-0-2005.

THE MARK CONSISTS OF STANDARD CHARACTERS WITHOUT CLAIM TO ANY PARTICULAR FONT, STYLE, SIZE, OR COLOR.

SER. NO. 78-957,315, FILED P.R. 8-22-2006; AM. S.R. 2-9-2008.

REBECCA GILBERT, EXAMINING ATTORNEY

Int. Cl.: 35

Prior U.S. Cls.: 100, 101, and 102

United States Patent and Trademark Office

Reg. No. 3,400,407

Registered Mar. 18, 2008

**SERVICE MARK
SUPPLEMENTAL REGISTER**

DECKEXPO

HANLEY-WOOD, LLC (DELAWARE LTD LIAB
CO)
SUITE 600
ONE THOMAS CIRCLE, N.W.
WASHINGTON, DC 20005

FOR: ORGANIZING AND CONDUCTING
TRADE SHOWS FEATURING PRODUCTS, MATE-
RIALS, EQUIPMENT AND SERVICES RELATING
TO THE DECK, DOCK AND RAILING INDUSTRY ,
IN CLASS 35 (U.S. CLS. 100, 101 AND 102).

FIRST USE 3-13-2003; IN COMMERCE 3-13-2003.

THE MARK CONSISTS OF STANDARD CHAR-
ACTERS WITHOUT CLAIM TO ANY PARTICULAR
FONT, STYLE, SIZE, OR COLOR.

SER. NO. 78-959,722, FILED P.R. 8-24-2006; AM. S.R.
1-11-2008.

PAULA MAHONEY, EXAMINING ATTORNEY

Int. Cl.: 35

Prior U.S. Cls.: 100, 101, and 102

United States Patent and Trademark Office

Reg. No. 3,400,408

Registered Mar. 18, 2008

**SERVICE MARK
SUPPLEMENTAL REGISTER**

ARTWEENS

INTERWORLD TELEVISION, INC (FLORIDA
CORPORATION)
3308 PRESTON RD SUITE 350-227
PLANO, TX 75093

FOR: PROMOTION USING AUDIOVISUAL MED-
IA, IN CLASS 35 (U.S. CLS. 100, 101 AND 102).

FIRST USE 1-19-2006; IN COMMERCE 3-10-2006.

THE MARK CONSISTS OF STANDARD CHAR-
ACTERS WITHOUT CLAIM TO ANY PARTICULAR
FONT, STYLE, SIZE, OR COLOR.

SER. NO. 78-966,741, FILED P.R. 9-4-2006; AM. S.R.
9-4-2006.

MARK PILARO, EXAMINING ATTORNEY

Int. Cls.: 35, 41, and 42

Prior U.S. Cls.: 100, 101, 102, and 107

United States Patent and Trademark Office

Reg. No. 3,400,409

Registered Mar. 18, 2008

**SERVICE MARK
SUPPLEMENTAL REGISTER**

MEDIA IMAGERY

TKL MEDIA, LLC (NEW JERSEY LTD LIAB CO),
DBA MEDIA IMAGERY,
7905 BROWNING ROAD
SUITE 218
PENNSAUKEN, NJ 08109

FOR: CREATING AND UPDATING ADVERTISING MATERIAL; PREPARING AND PLACING OF ADVERTISEMENTS, INCLUDING OUTDOOR ADVERTISEMENTS SUCH AS BILLBOARDS, FOR OTHERS; ADVERTISING AND PUBLICITY SERVICES; DIRECT MAIL ADVERTISING; AND ADVERTISING SERVICES, NAMELY, DEVELOPMENT OF ADVERTISING CAMPAIGNS FOR PRINT MEDIA, IN CLASS 35 (U.S. CLS. 100, 101 AND 102).

FIRST USE 10-17-2002; IN COMMERCE 11-6-2002.

FOR: FILM EDITING; EDITING AND RECORDING OF SOUNDS AND VIDEO IMAGES; MOTION PICTURE FILM PRODUCTION; TELEVISION PRODUCTION; RADIO ENTERTAINMENT PRODUCTION; PRODUCTION OF CABLE TELEVISION PROGRAMS; PRODUCTION OF VIDEO AND CREATION OF VISUAL EFFECTS FOR OTHERS FOR USE IN DIGITAL VIDEO DISCS, TELEVISION

PROGRAMS AND ON WEBSITES; PRODUCTION OF VIDEO DISCS FOR OTHERS; AND PHOTOGRAPHY SERVICES, IN CLASS 41 (U.S. CLS. 100, 101 AND 107).

FIRST USE 10-17-2002; IN COMMERCE 11-6-2002.

FOR: DESIGNING WEBSITES FOR ADVERTISING PURPOSES, IN CLASS 42 (U.S. CLS. 100 AND 101).

FIRST USE 10-17-2002; IN COMMERCE 11-6-2002.

THE MARK CONSISTS OF STANDARD CHARACTERS WITHOUT CLAIM TO ANY PARTICULAR FONT, STYLE, SIZE, OR COLOR.

NO CLAIM IS MADE TO THE EXCLUSIVE RIGHT TO USE "MEDIA", APART FROM THE MARK AS SHOWN.

SER. NO. 78-968,618, FILED P.R. 9-6-2006; AM. S.R. 12-17-2007.

ZHALEH DELANEY, EXAMINING ATTORNEY

Int. Cl.: 16

Prior U.S. Cls.: 2, 5, 22, 23, 29, 37, 38, and 50

Reg. No. 3,400,410

United States Patent and Trademark Office

Registered Mar. 18, 2008

**TRADEMARK
SUPPLEMENTAL REGISTER**

CHIP CUSTOMIZER

A-Z SOFTWARE SOLUTIONS AND SERVICES
(CALIFORNIA CORPORATION)
2619 SUNSHINE VALLEY CT.
SIMI VALLEY, CA 93063

FOR: STICKER KIT COMPRISED OF STICKERS
AND COMPUTER SOFTWARE FOR THE PURPOSE
OF CUSTOMIZING AND PERSONALIZING POKER
CHIPS, IN CLASS 16 (U.S. CLS. 2, 5, 22, 23, 29, 37, 38
AND 50).

FIRST USE 3-1-2006; IN COMMERCE 3-1-2006.

THE MARK CONSISTS OF STANDARD CHAR-
ACTERS WITHOUT CLAIM TO ANY PARTICULAR
FONT, STYLE, SIZE, OR COLOR.

SER. NO. 78-972,902, FILED P.R. 9-12-2006; AM. S.R.
2-5-2008.

BERNICE MIDDLETON, EXAMINING ATTORNEY

Int. Cl.: 9

Prior U.S. Cls.: 21, 23, 26, 36, and 38

United States Patent and Trademark Office

Reg. No. 3,400,411

Registered Mar. 18, 2008

**TRADEMARK
SUPPLEMENTAL REGISTER**

EETIMES

CMP MEDIA LLC (DELAWARE LIMITED LIABILITY COMPANY)
600 COMMUNITY DRIVE
MANHASSET, NY 11030

FOR: DOWNLOADABLE ELECTRONIC MAGAZINES IN THE FIELDS OF ELECTRONICS, ENGINEERING, COMPUTERS, HIGH TECHNOLOGY AND OFFICE SYSTEMS MANAGEMENT, IN CLASS 9 (U.S. CLS. 21, 23, 26, 36 AND 38).

FIRST USE 3-1-2003; IN COMMERCE 3-1-2003.

THE MARK CONSISTS OF STANDARD CHARACTERS WITHOUT CLAIM TO ANY PARTICULAR FONT, STYLE, SIZE, OR COLOR.

SER. NO. 78-978,191, FILED P.R. 2-2-2006; AM. S.R. 1-29-2007.

LOURDES AYALA, EXAMINING ATTORNEY