



Advisory Circular

Subject:	FUEL VENTING AND EXHAUST EMISSION REQUIREMENTS FOR TURBINE ENGINE POWERED AIRPLANES	Date:	06/27/03	AC No:	34-1B
		Initiated by:	AEE-300	Change:	

1. **PURPOSE** The intent of this advisory Circular (AC) is to promote uniformity of implementation of the emissions certification requirements of Part 34 of the Federal Aviation Regulations. FAR 34 is unusually complex in that it must reflect the requirements of the Clean Air Act, Sections 232 and 233, the EPA, 40 CFR Part 87 and ICAO Annex 16, Volume II, Second Edition, July 1993, as well as the FAA's mandated charter. This advisory circular brings these seemingly disparate requirements together to provide a single source of information and advice to individuals and agencies interested in FAR 34.

- a. Contents

This revised Advisory Circular (AC) contains updated information, including anticipated adoption of ICAO CAPE 4 post December 31, 2003 rules, describing the standards and requirements for aircraft fuel venting and engine emission certification and presents explanatory and supplementary information, as necessary, to identify acceptable means of compliance. The information contained in this document sets forth acceptable means, but not the sole means, by which compliance may be shown with the requirements of Federal Aviation Regulations (FAR) Part 34 of the United States Code of Federal Regulations (CFR) Title 14. The regulation that this AC references is 14 CFR Part 34 and its Amendments (hereinafter referred to as "Part 34").

Pursuant to the Clean Air Act (CAA), Sections 231 and 232, Part 34 necessarily must conform to Environmental Protection Agency (EPA) Title 40, Part 87, "Control of Air Pollution From Aircraft and Aircraft Engines; Emission Standards and Test Procedures". Therefore any change in procedures, of a substantive nature, must be discussed with, and approved by, the Administrator of the EPA. This is mentioned explicitly in Part 34 and in this AC for those areas of particular concern. In addition, users of this AC, as well as Part 34, must be aware of any changes to 40 CFR Part 87 which have not yet been included in either Part 34 or this AC. In such instances the requirements described in these documents must defer to 40 CFR Part 87, unless and until approval is obtained from the Administrator of the EPA.

- b. Advisory Nature

Like other Federal Aviation Administration (FAA) advisory circulars, the language within this document is intended to be permissive and advisory in nature, except for explanations of regulatory language that are mandatory. In addition, the compliance methods chosen by the applicant are voluntary within the framework of the regulation as written. Mandatory terms used in this AC, such as "must" and "shall", are used only in the sense of ensuring the applicability of these particular methods of compliance when the acceptable means of compliance described herein are used. This AC does not change regulatory requirements and does not authorize changes in, or deviations from, regulatory requirements.

- c. Document Format

This AC contains a section-by-section review and explanation of 14 CFR Part 34. In order to assist the user, each explanation is provided as a separate, sequentially numbered, paragraph. In general, each paragraph is presented as follows in Figure 1:

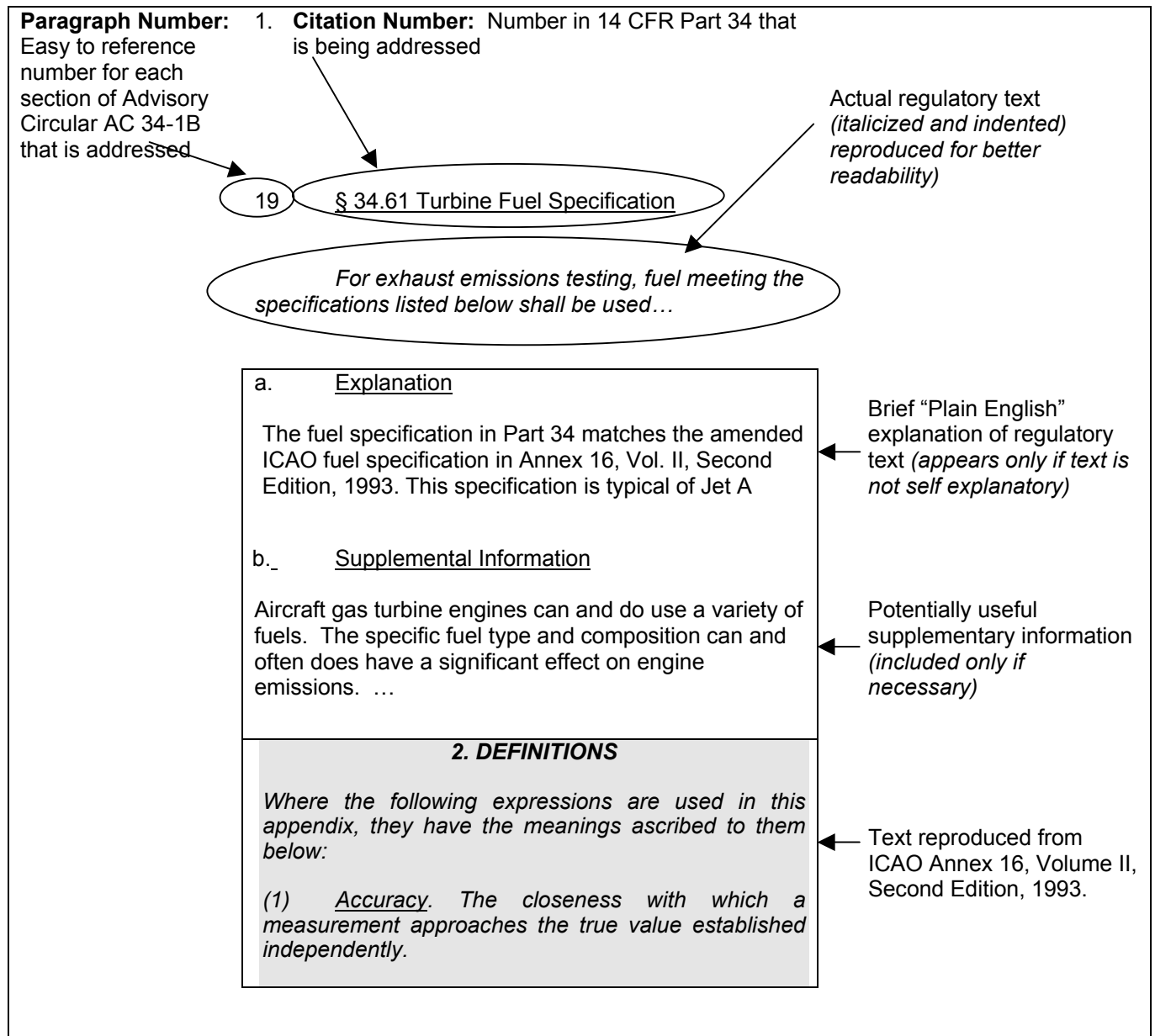

FIGURE 1: Document Format

In addition to the section-by-section explanations, this AC includes 3 additional chapters that explain specific appendices from ICAO, Annex 16, Volume II. Second Edition, July 1993. These have been included to make this AC relatively self contained, since these appendices are explicitly referenced within Part 34. Specifically:

- FAR 34 Subpart G refers to ICAO Appendices 3, 5 and 6.
- FAR 34 Subpart H refers to ICAO Appendices 2 and 6.

These ICAO appendices, 3,5 and 6, deal with detailed technical issues regarding instrumentation and measurement techniques and statistically derived compliance procedures. As such they are relatively complex and have been kept distinct from the rest of the AC as separate chapters. Typically, only those readers who are interested in specific equations and/or details regarding measurement techniques and compliance procedures will need to read these sections.

d. Audience

The intended audience for this AC includes engine specialists from the FAA (aircraft certification and flight standards), aircraft and aircraft engine industry, aircraft certification applicants, foreign governments, airline customers, airport operators, the scientific community, and other interested persons.

e. AC Intent

The intent of this AC is to establish a clear understanding between the regulatory authorities, aircraft engine users, local governments, and the aircraft engine industry of the engine emissions certification processes and to present historical policies, guidance material and interpretations that have been used in the aircraft engine certification process.

f. Document Use

Sequential paragraphs are indicated in this AC to improve usage. The regulatory section numbers, together with the regulatory language are indented and italicized. In addition, text from ICAO Annex 16 is included (shaded and italicized) where appropriate.

g. Technical Advancement:

Since the introduction of engine emission standards in 1973 (38 FR 19088, July 17, 1973), acceptable means and procedures for measurement, testing, data reduction, evaluation and compliance reporting have advanced considerably. For the purpose of certification and compliance, applicants have, over time, developed, evaluated and had approved engine specific alternate but equivalent testing, measurement and data reduction procedures. Approval, in these instances, is obtained through the FAA, Office of Environment and Energy (AEE) located in the FAA Headquarters in Washington DC.

h. FAA Certification Process:

The FAA administrative certification process is shown in Figure 2. Each step in the appropriate process must be completed before proceeding to the next step. Specific details of this process can be found in a memorandum "Inter-Office Management Plan for Aircraft Engine Fuel Venting and Exhaust Emissions", appended to this Advisory Circular as Exhibit 1. As a part of its compliance responsibilities, FAA can either conduct the emission tests or delegate that responsibility to the engine manufacturer, which is then monitored by the FAA. Since the FAA does not have the resources or the funding to test engines themselves, FAA selects engineers at each plant to serve as representatives (called Designated Engineering Representatives or DERs) for the FAA while the manufacturer performs the test procedures. DER's responsibilities include evaluating the test plan, the test engine, the test equipment, and the final testing report sent to the FAA.

i. Exclusions

There are no sections excluded from this AC.

2. CANCELLATION

Advisory Circular 34-1A, Fuel Venting and Exhaust Emission Requirements for Turbine Engine Powered Airplanes, dated June 30, 2001, is canceled.

FAA Certification Process (Administrative)

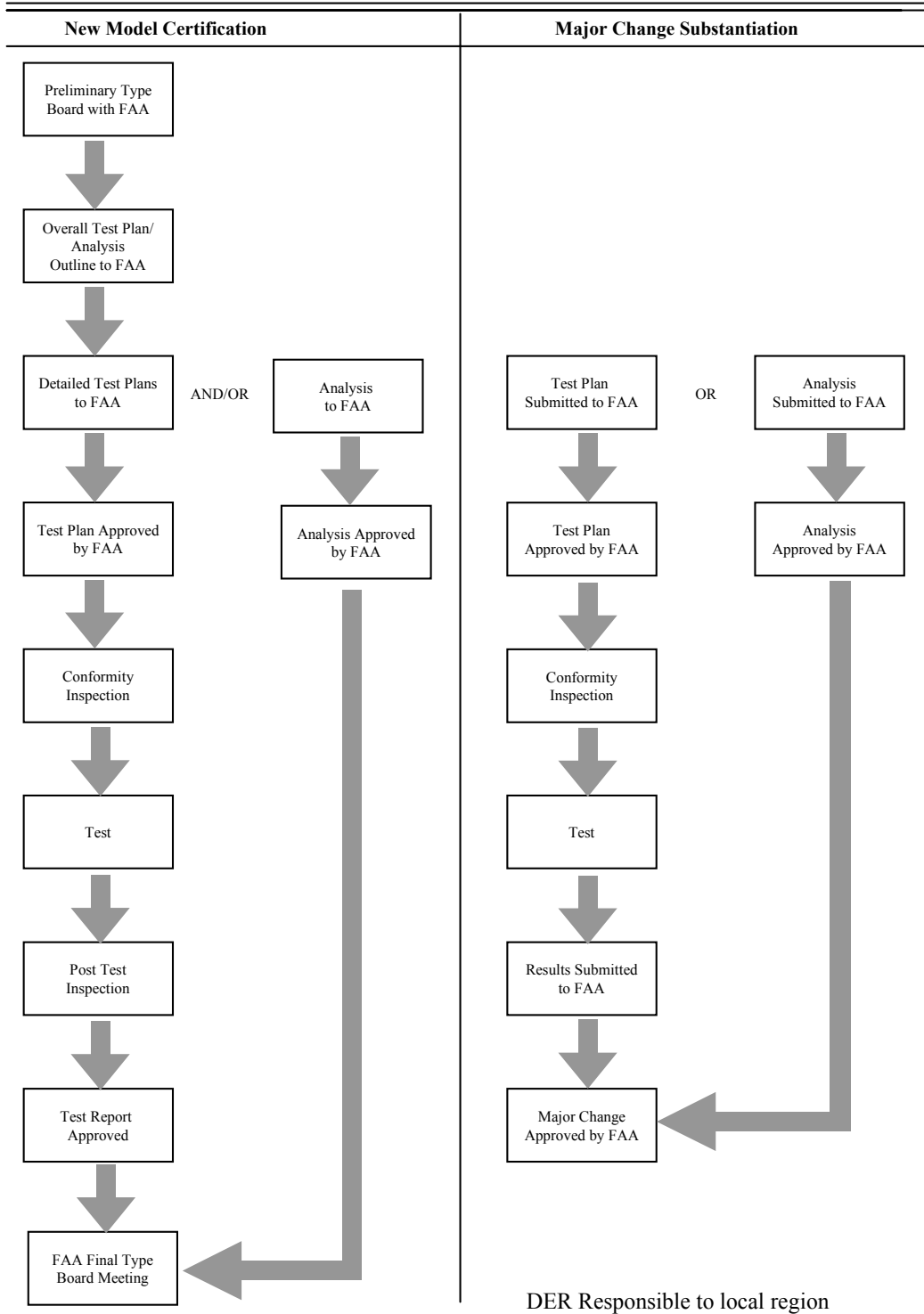

FIGURE 2. FAA Certification Process

3.	TABLE OF CONTENTS	
1.	PURPOSE.....	1
a.	Contents.....	1
b.	Advisory Nature.....	1
c.	Document Format	1
d.	Audience	3
e.	AC Intent	3
f.	Document Use	3
g.	Technical Advancement:.....	3
h.	FAA Certification Process:.....	3
	FAA Certification Process - Figure 2.....	4
i.	Exclusions	3
2.	CANCELLATION.....	3
3.	TABLE OF CONTENTS	5
4.	REFERENCES.....	7
I.	14 CFR PART 34 Subpart A—General Provisions	7
5.	§34.1 DEFINITIONS.	7
6.	§34.2 <i>Abbreviations</i>	10
7.	§ 34.3 GENERAL REQUIREMENTS.	12
8.	§34.4 [RESERVED].....	17
9.	§34.5 SPECIAL TEST PROCEDURES..	17
10.	§34.6 AIRCRAFT SAFETY.	18
11.	§34.7 EXEMPTIONS.....	18
II.	Subpart B — Engine Fuel Venting Emissions - (New and In-Use Aircraft Gas Turbine Engines)	21
12.	§34.10 APPLICABILITY.....	21
13.	§34.11 STANDARD FOR FUEL VENTING EMISSIONS.	21
III.	Subpart C — Exhaust Emissions (New Aircraft Gas Turbine Engines)	23

14.	§ 34.20 APPLICABILITY.....	23
15.	§ 34.21 STANDARDS FOR EXHAUST EMISSIONS.....	23
IV.	Subpart D — Exhaust Emissions (In-Use Aircraft Gas Turbine Engines)Error! Bookmark not defined.	
16.	§ 34.30 APPLICABILITY.....	27
17.	§ 34.31 STANDARDS FOR EXHAUST EMISSIONS.....	27
V.	Subpart E — [Reserved].....	28
VI.	Subpart F — [Reserved].....	29
VII.	Subpart G — Test Procedures for Engine Exhaust Gaseous Emissions (Aircraft and Aircraft Gas Turbine Engines).....	30
18.	§34.60 INTRODUCTION.....	30
19.	§34.61 TURBINE FUEL SPECIFICATION.....	30
20.	§34.62 TEST PROCEDURE (PROPULSION ENGINES).....	32
21.	§34.63 [RESERVED].....	33
22.	§34.64 SAMPLING AND ANALYTICAL PROCEDURES FOR MEASURING GASEOUS EXHAUST EMISSIONS. ...	33
23.	§34.65—§34.70 [RESERVED].....	33
24.	§ 34.71 COMPLIANCE WITH GASEOUS EMISSION STANDARDS.....	33
VIII.	Subpart H — Test Procedures for Engine Smoke Emissions (Aircraft and Aircraft Gas Turbine Engines).....	33
25.	§34.80 INTRODUCTION.....	34
26.	§34.81 FUEL SPECIFICATIONS.....	35
27.	§34.82 SAMPLING AND ANALYTICAL PROCEDURES FOR MEASURING - SMOKE EXHAUST EMISSIONS.	36
28.	§34.83 – §34.88 [RESERVED].....	36
29.	§34.89 COMPLIANCE WITH SMOKE EMISSION STANDARDS.	36
IX.	ICAO ANNEX 16, VOLUME II, Second Edition, July, 1993, APPENDIX 6.....	38
X.	ICAO ANNEX 16, VOLUME II, Second Edition, July, 1993, APPENDIX 3.....	42
XI.	ICAO ANNEX 16, VOLUME II, Second Edition, July, 1993, APPENDIX 5.....	80
XII.	ICAO ANNEX 16, VOLUME II, Second Edition, July, 1993, APPENDIX 2.....	121
30	EXHIBIT 1 Inter-Office Management Plan	131

4. REFERENCES

- (1) Clean Air Act as amended, 42 U.S.C. 7571 and 7601.
- (2) *14 CFR ch. 1 (1-1-97 edition), Federal Aviation Administration, Department of Transportation, Subchapter A, Definitions.*
- (3) 40 CFR Part 87, Environmental Protection Agency, *Control of Air Pollution from Aircraft and Aircraft Engines; Emission Standards and Test Procedures; Final and Proposed Rule, Federal Register, Vol. 62, No. 89, Thursday, May 8, 1997.*
- (4) Federal Aviation Regulations, Part 34, *Fuel Venting and Exhaust Emission Requirements for Turbine Engine Powered Airplanes, February 3, 1999.*
- (5) International Civil Aviation Organization, International Standards and Recommended Practices, Environmental Protection, Annex 16, Volume II, Aircraft Engine Emissions, Second Edition — July 1993.
- (6) SAE International, SAE AEROSPACE RECOMMENDED PRACTICE ARP 1256, *Procedure for the Continuous Sampling and Measurement of Gaseous Emissions from Aircraft Turbine Engines.*
- (7) SAE International, SAE AEROSPACE RECOMMENDED PRACTICE ARP 1179, *Aircraft Gas Turbine Engine Exhaust Smoke Measurement.*
- (8) SAE International, SAE AEROSPACE RECOMMENDED PRACTICE ARP 1533, *Procedure for the Calculation of Gaseous Emissions from Aircraft Turbine Engines.*

I. 14 CFR 34 Subpart A General Provisions

5. 34.1 Definitions

As used in this AC, all terms not defined herein shall have the meaning given them in the Clean Air Act, as amended (42 U.S.C. 7401 et. seq.):

Supplemental Information:

Section 232 of the Clean Air Act, as amended, directs the Secretary of Transportation to issue regulations to ensure compliance with 40 CFR part 87. 40 CFR part 87 calls out, by reference, specific sections of ICAO Annex 16, Volume II, Second edition, 1993. ICAO Annex 16 includes definitions which should be added to the definitions in Part 34 to provide understanding and completeness. Following is a combined list of definitions required when fulfilling the requirements of Part 34. The ICAO definitions are italicized and shaded. Some discussion is provided where further clarification is needed.

Act means the Clean Air Act, as amended (42 U.S.C. 7401 et. seq.).

Administrator means the Administrator of the Federal Aviation Administration or any person to whom he has delegated his authority in the matter concerned.

Administrator of the EPA means the Administrator of the Environmental Protection Agency and any other officer or employee of the Environmental Protection Agency to whom the authority involved may be delegated.

Aircraft as used in this part means any airplane as defined in 14 CFR part 1 for which a U.S. standard airworthiness certificate or equivalent foreign airworthiness certificate is issued.

Aircraft engine means a propulsion engine which is installed in, or which is manufactured for installation in, an aircraft.

Supplemental Information: This definition applies to those engines for which a U.S. standard airworthiness certificate or equivalent foreign airworthiness certificate is issued.

Aircraft gas turbine engine means a turboprop, turbofan, or turbojet aircraft engine.

Explanation:

As with the overall intent of this regulation piston engines are excluded.

Afterburning. A mode of engine operation wherein a combustion system fed (in whole or part) by vitiated air is used.

Approach Phase. The operating phase defined by the time during which the engine is operated in the approach operating mode.

Class TP means all aircraft turboprop engines.

Class TF means all turbofan or turbojet aircraft engines or aircraft engines designed for applications that otherwise would have been fulfilled by turbojet and turbofan engines except engines of class T3, T8, and TSS.

Explanation:

Applications, which could fulfill these requirements, are propfans, unducted fans, and advanced unducted fans.

Class T3 means all aircraft gas turbine engines of the JT3D model family.

Class T8 means all aircraft gas turbine engines of the JT8D model family.

Class TSS means all aircraft gas turbine engines employed for propulsion of aircraft designed to operate at supersonic flight speeds.

Climb phase: The operating phase defined by the time during which the engine is operated in the climb operating mode.

Commercial aircraft engine means any aircraft engine used or intended for use by an "air carrier" (including those engaged in "intrastate air transportation") or a "commercial operator" (including those engaged in "intrastate air transportation") as these terms are defined in the Federal Aviation Act and the Federal Aviation Regulations.

Commercial aircraft gas turbine engine means a turboprop, turbofan, or turbojet commercial aircraft engine.

Date of manufacture of an engine is the date the inspection acceptance records reflect that the engine is complete and meets the FAA approved type design.

Emission measurement system means all of the equipment necessary to transport the emission sample and measure the level of emissions. This includes the sample system and the instrumentation system.

Explanation:

The intention is to delineate all of the equipment and devices to extract, transport, condition, differentiate and measure the concentrations of "exhaust emissions" – see 4.a. (17). If inlet species are measured, for monitoring or corrections, as part of the certification process the equipment and devices used should be included as part of the "Emissions measurement system".

Engine model means all commercial aircraft turbine engines, which are of the same general series, displacement, and design characteristics and are approved under the same type certificate.

Supplemental Information:

For the purposes of a working definition, with respect to emissions certification, when considering the similarity or equivalence of engines, similar or equivalent engine models should be taken as those engines approved under the same type certificate. For example, from 14 CFR ch. 1 (1-1-97 edition), Federal Aviation Administration Department of Transportation, Subchapter A, Definitions: "Type": (3) As used with respect to the certification of aircraft engines means those engines which are similar in design. For example, JT8D and JT8D-7 are engines of the same type, and JT9D-3A and JT9D-7 are engines of the same type.

Exhaust emissions means substances emitted into the atmosphere from the exhaust discharge nozzle of an aircraft or aircraft engine.

Fuel venting emissions means raw fuel, exclusive of hydrocarbons in the exhaust emissions, discharged from aircraft gas turbine engines during all normal ground and flight operations.

In-use aircraft gas turbine engine means an aircraft gas turbine engine, which is in service.

New aircraft turbine engine means an aircraft gas turbine engine, which has never been in service.

Explanation:

This definition should be viewed with respect to “In-use aircraft gas turbine engine” and relative to the intent of 40 CFR Part 87, Subpart B, Engine Fuel Venting emissions (New and In-Use Aircraft Gas Turbine Engines), Subpart C, Exhaust Emissions (New Aircraft Gas Turbine Engines), and Subpart D, Exhaust Emissions (In-Use Aircraft Gas Turbine Engines).

Any engine intended for revenue service but which has never been in service is by definition new and must meet the provisions of Subpart B and C for fuel venting, gaseous and smoke emissions. This sets the baseline for regulation and control of emissions from aircraft gas turbine engines. Alternatively the definition for in-use aircraft gas turbine engines is intended, for those engines in service, to prevent deterioration of fuel venting and/or smoke emissions beyond the maximum allowable for new engines. In other words, the first time a particular engine sees revenue service it is “new” and ever after it is “in-use”. The fact that a given engine model is in revenue service does not relieve a newly manufactured engine of this model of being considered as “new”. Although this interpretation could impose severe penalties on the engine manufacturer in the demonstration of compliance, the allowance, and universal use, of ICAO Annex 16, Volume II, Appendix 6, Compliance Procedure for Gaseous Emissions and Smoke solves the problem by specifying a limited engine preproduction compliance procedure which relieves the manufacturer from having to test every engine and, in effect, follows the engine in time, i.e., there is no requirement for the testing of engines in-use.

Oxides of Nitrogen. The sum of the amounts of the nitric oxide and nitrogen dioxide contained in a gas sample calculated as if the nitric oxide were in the form of nitrogen dioxide.

Power Setting: means the power or thrust output of an engine in terms of kilonewtons thrust for turbojet and turbofan engines or shaft power in terms of kilowatts for turboprop engines.

Rated Output (rO): means the maximum power/thrust available for takeoff at standard day conditions as approved for the engine by the Federal Aviation Administration, including reheat contribution where applicable, but excluding any contribution due to water injection and excluding any emergency power/thrust rating.

Explanation:

For the purpose of this regulation “maximum power/thrust available for takeoff” is taken to mean under normal operating conditions. The definition as stated has caused some confusion because of a maximum thrust emergency rating even though the definition, as it appears in 14 CFR Part 34, excludes any emergency power/thrust rating. Some of the confusion may be due to the parent definition in 40 CFR 87, which does not explicitly exclude the emergency power/thrust rating. The intent is clear however from 40 CFR Part 87, Subpart G, 87.60 (c): “... determine mass emissions through calculations during a simulated aircraft landing-takeoff cycle (LTO). The LTO cycle is based on time in mode data during high activity periods at major airports.” The use of emergency power/thrust during takeoff would be an extraordinary and abnormal situation. Further, 40 CFR Part 87 (87.64) requires the use of ICAO Annex 16, Volume II, 1993, Appendix 3. Appendix 3 defines Rated Output, rO, as “ F_{00} ,” which is further defined as: “The maximum thrust available for take-off under normal operating conditions at ISA sea level static conditions, without the use of water injection, as approved by the applicable certificating authority”.

Rated pressure ratio (rPR): means the ratio between the combustor inlet pressure and the engine inlet pressure achieved by an engine operation at rated output.

REFERENCE DAY CONDITIONS: MEANS THE REFERENCE AMBIENT CONDITIONS TO WHICH THE GASEOUS EMISSIONS (HC AND SMOKE) ARE TO BE CORRECTED. THE REFERENCE DAY CONDITIONS ARE AS FOLLOWS: TEMPERATURE = 15 °C, SPECIFIC HUMIDITY = 0.00629 KG H₂O/KG OF DRY AIR, AND PRESSURE = 101325 PA.

Reference pressure ratio. The ratio of the mean total pressure at the last compressor discharge plane of the compressor to the mean total pressure at the compressor entry plane when the engine is developing take-off thrust rating in ISA sea level static conditions.

Sample System: means the system, which provides for the transportation of the gaseous emissions sample from the sample probe to the inlet of the instrumentation system.

Supplemental information:

A 'Sample System' is required for smoke emissions as well as for gaseous emission. Detailed specifications, for each, are described in ICAO Appendices 2 and 3. There are differences in requirements between the two systems but it is not unusual to satisfy the separate requirements with an appropriately designed single sample system.

Shaft Power: means only the measured shaft power out put of a turboprop engine.

Smoke: means the matter in exhaust emissions, which obscures the transmission of light.

Smoke Number (SN): means the dimensionless term quantifying smoke emissions.

Standard day conditions: means standard ambient conditions as described in the United States Standard Atmosphere 1976, (i.e., temperature = 15 °C, specific humidity = 0.00 kg H₂O/kg dry air, and pressure = 101325 Pa.)

Take-off phase. The operating phase defined by the time during which the engine is operated at the rated output.

Taxi/idle (in): means those aircraft operations involving taxi and idle between the time of landing roll-out and final shutdown of all propulsion engines.

Taxi/idle (out): means those aircraft operations involving taxi and idle between the time of initial starting of the propulsion engine(s) used for the taxi and the turn onto the duty runway.

Unburned hydrocarbons. The total of hydrocarbon compounds of all classes and molecular weights contained in a gas sample, calculated as if the were in the form of methane.

6. §34.2 Abbreviations

The abbreviations used in this part have the following meanings in both upper and lower case

CO	Carbon Monoxide
EPA	United States Environmental Protection Agency
FAA	Federal Aviation Administration, United States Department of Transportation
HC	Hydrocarbons
HP	Horsepower
hr	Hour(s)
H₂O	water
kg	Kilogram(s)
kJ	Kilojoule(s)
LTO	Landing and takeoff
min	Minute(s)

NO(X)	Oxides of Nitrogen
Pa	Pascal(s)
rO	Rated Output
rPR	Rated pressure ratio
sec	Second(s)
SP	Shaft power
SN	Smoke number
T	Temperature, degrees Kelvin
TIM	Time in mode
W	Watt(s)
Deg.	C Degrees Celsius
%	Percent

Supplemental information:

In addition to the abbreviations listed in §34.2 there are a large number of abbreviations from other sources that are used in AC 34. Those abbreviations listed in ICAO Annex 16 as Symbols are italicized and shaded. Only those Symbols from ICAO that are not duplicated in Part 34 are listed.

AC	FAA Advisory Circular
ACO	Local FAA Aircraft Certification Office
AEE	FAA Office of Environment and Energy
AFM	Airplane Flight Manual
APP	Approach
APU	Auxiliary Power Unit
ARP	Aerospace Recommended Practice
CAA	Clean Air Act
CFR	Code of Federal Regulations
CI	Confidence Interval (90%)
CO₂	Carbon Dioxide
<i>D_p</i>	<i>The mass of any gaseous pollutant emitted during the reference emissions landing and take-off cycle</i>
DER	Designated Engineering Representative
EPA	United States Environmental Protection Agency.
EI	Emission Index
EPR	Engine Pressure Ratio (Power Setting Parameter)
<i>F_n</i>	<i>Thrust in International Standard Atmosphere (ISA), sea level conditions, for the given operating mode</i>
<i>F_{q0}</i>	<i>Rated output</i>
<i>F₀₀</i>	<i>Rated output with afterburning applied</i>
FAR	Federal Aviation Regulation (CFR Title 14)
FCAA	Foreign Civil Aviation Authority
FID	Flame Ionization Detector
FPR	Fan Pressure Ratio
ICAO	International Civil Aviation Organization
JAA	Joint Airworthiness Authorities (of Europe)
JAR	Joint Airworthiness Requirements (of Europe)
Log	logarithmic value to base 10
M	meter
MJ	Mega Joules
MSL	Mean Sea Level altitude, feet
N/A	Not Applicable
NIST	National Institute of Standards and Technology
<i>NO</i>	<i>Nitric oxide</i>
<i>NO₂</i>	<i>Nitrogen dioxide</i>
ppmC	Parts per million carbon
ref.	Reference
RH	Relative Humidity, %

rms	root-mean-square
rpm	Revolutions Per Minute
SAE	SAE International (formerly Society of Automotive Engineers)
Sec	Second(s)
TC	Type Certificate
TIM	Time in mode
TO	Takeoff
VNTSC	Volpe National Transportation System Center (D.O.T.)
W	Watt(s)
°C	Degrees Celsius.
%	Percent
π_{00}	Reference pressure ratio

7. 34.3 General requirements:

§ 34.3(a)

- (a) *This part provides for the approval or acceptance by the Administrator or the Administrator of the EPA of testing and sampling methods, analytical techniques, and related equipment not identical to those specified in this part. Before either approves or accepts any such alternate, equivalent, or otherwise nonidentical procedures or equipment, the Administrator or the Administrator of the EPA shall consult with the other in determining whether or not the action requires rulemaking under sections 231 and 232 of the Clean Air Act, as amended, consistent with the responsibilities of the Administrator of the EPA and the Secretary of Transportation under sections 231 and 232 of the Clean Air Act.*

Explanation

This part provides for the flexibility needed to accommodate changing engine designs and possible changes and/or improvements in testing, sampling methods, analytical techniques and related equipment. This part does not provide guidelines or any systematic means of demonstrating equivalence of non-identical procedures or equipment. 40 CFR part 87, calls out, by reference, those sampling and analytical procedures specified by ICAO. ICAO does not specify particular equipment but does detail accuracy, operational and performance requirements wherever possible. For example, ICAO states the method of detection for each of the pollutants along with details of calibration and operation but does not list specific pieces of equipment. Presumably each emissions certification test would require demonstration that each analytical technique and piece of equipment met the ICAO requirements. Similarly, it is the intent of 34.3(a) that any alternate method proposed demonstrate that it met the ICAO operational and performance requirements or their equivalent. Each such instance would, necessarily, need to be considered on its own merit.

§ 34.3 (b) through (f):

- (b) *Under section 232 of the Act, the Secretary of Transportation issues regulations to ensure compliance with 40 CFR part 87. This authority has been delegated to the Administrator of the FAA (49 CFR 1.47).*
- (c) *U.S. airplanes. This Federal Aviation Regulation (FAR) applies to civil airplanes that are powered by aircraft gas turbine engines of the classes specified herein and that have U.S. standard airworthiness certificates.*
- (d) *Foreign airplanes. Pursuant to the definition of "aircraft" in 40 CFR 87.1(c), this FAR applies to civil airplanes that are powered by aircraft gas turbine engines of the classes specified herein and that have foreign airworthiness certificates that are equivalent to U.S. standard airworthiness certificates. This FAR applies only to those foreign civil airplanes that, if registered in the United States, would be required by applicable Federal Aviation Regulations to have a U.S. standard airworthiness certificate in order to conduct the operations intended for the airplane. Pursuant to 40 CFR 87.3(c), this FAR does not apply where it would be inconsistent with an obligation assumed by the United States to a foreign country in a treaty, convention, or agreement.*

- (e) *Reference in this regulation to 40 CFR part 87 refers to title 40 of the Code of Federal Regulations, chapter I--Environmental Protection Agency, part 87, Control of Air Pollution from Aircraft and Aircraft Engines (40 CFR part 87).*
- (f) *This part contains regulations to ensure compliance with certain standards contained in 40 CFR part 87. If EPA takes any action, including the issuance of an exemption or issuance of a revised or alternate procedure, test method, or other regulation, the effect of which is to relax or delay the effective date of any provision of 40 CFR part 87 that is made applicable to an aircraft under this FAR, the Administrator of FAA will grant a general administrative waiver of its more stringent requirements until this FAR is amended to reflect the more relaxed requirements prescribed by EPA.*

Explanation

Authority under Section 232, Clean Air Act, as amended, is to "insure compliance with all standards prescribed under section 231 by the Administrator" of the EPA. If the Administrator of the EPA takes any of the actions described in 34.3 (f) the Administrator of FAA must respond accordingly. In such instances some or all of Part 34 may not be applicable until such time as Part 34 is reissued. In the past any such action taken by the EPA has been reflected in the issuance of a revised or amended version of 40 CFR part 87. This would then serve as the primary reference for all substantive information.

If the EPA changes 40 CFR Part 87 to relax any of the standards, and the relaxed standards apply to aircraft pursuant to Part 34, then the FAA Administrator will grant a general waiver to use the relaxed EPA standard until such time as Part 34 is reissued. It should be noted that a general waiver is not a waiver that can be applied for by an individual, but is a waiver that is issued by the Administrator to all persons subject to Part 34 that is affected by the relaxed or changed 40 CFR Part 87 standards.

§ 34.3(g)

- (g) *Unless otherwise stated, all terminology and abbreviations in this FAR that are defined in 40 CFR part 87 have the meaning specified in that part, and all terms in 40 CFR part 87 that are not defined in that part but that are used in this FAR have the meaning given them in the Clean Air Act, as amended by Public Law 91-604.*

Explanation

40 CFR part 87 specifies, by reference, selected sections of ICAO Annex 16, Volume II, Aircraft Engine Emissions, Second edition, 1993. Namely, Appendices 2, 3, 5, and 6 of Annex 16 provides definitions that are specifically applicable to these referenced appendices and are necessary to an understanding of the requirements described therein. These definitions can be considered to be part of 40 CFR Part 87.

§ 34.3 (h), (i)

- (h) *All interpretations of 40 CFR part 87 that are rendered by the EPA also apply to this FAR.*
- (i) *If the EPA, under 40 CFR 87.3(a), approves or accepts any testing and sampling procedures or methods, analytical techniques, or related equipment not identical to those specified in that part, this FAR requires an applicant to show that such alternate, equivalent, or otherwise nonidentical procedures have been complied with, and that such alternate equipment was used to show compliance, unless the applicant elects to comply with those procedures, methods, techniques, and equipment specified in 40 CFR part 87.*

Explanation

Similar to 34.3 (a) any, individual or agency requesting acceptance and approval for testing, sampling procedures or methods, analytical techniques, or related equipment not identical to those specified, having demonstrated equivalency, must prove to the satisfaction of the FAA that the alternate, equivalent, or otherwise nonidentical procedures have been complied with, and the approved procedures, methods, analytical techniques and related equipment was used to show compliance. Once approval has been obtained from the EPA the requirement to prove that the alternate equivalent, or otherwise nonidentical procedures have been complied with are similar to the requirements for the standard procedures. If the individual or agency reconsiders this, they are free to use the standard testing procedures. The Request Process for §34.3, is shown graphically in FIGURE 3, "EXCEPTIONS TO FAR 34".

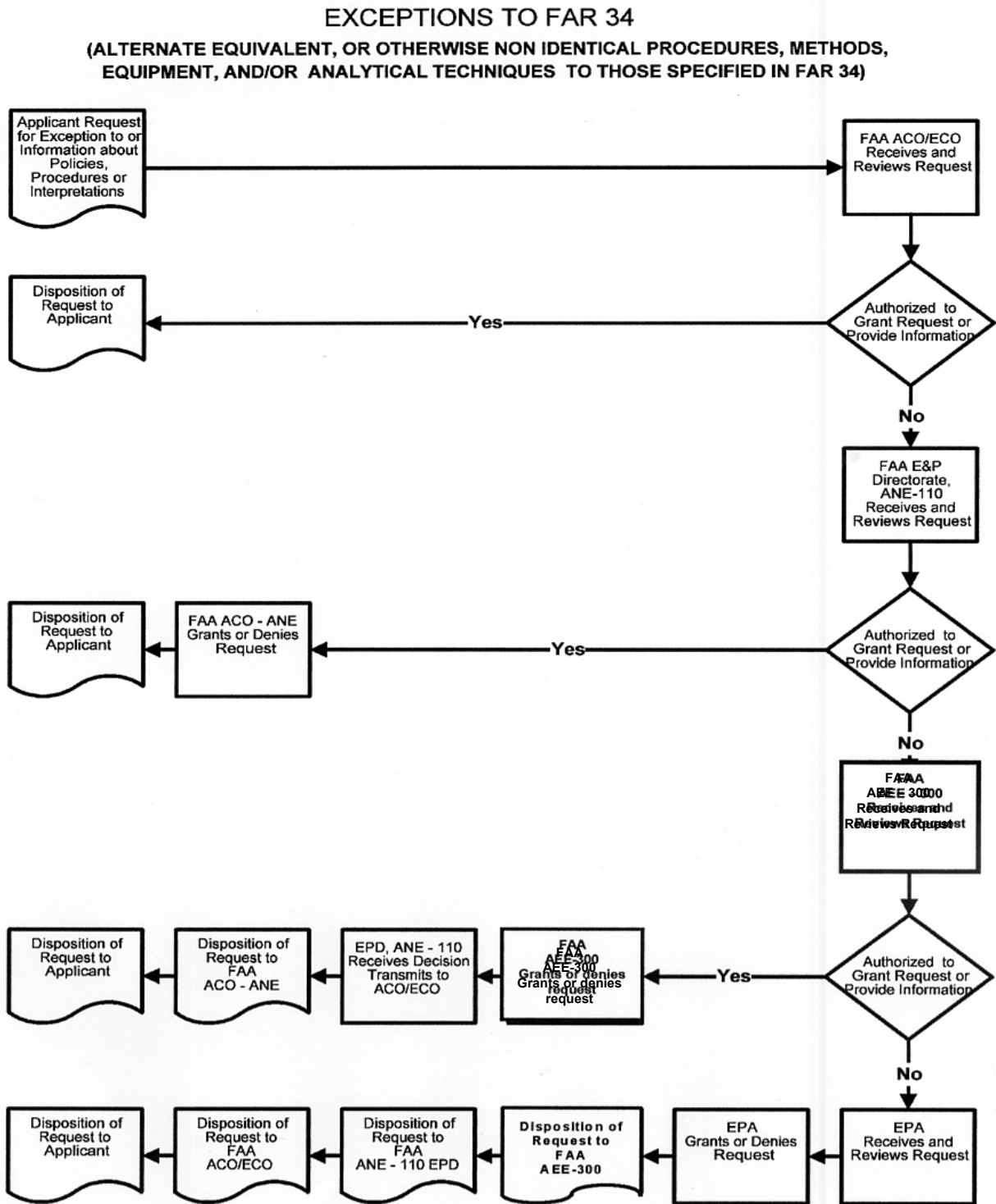

FIGURE 3 Request Process for Alternate, Equivalent or Otherwise Nonidentical Procedures

§ 34.3 (j)

- (j) *If the EPA, under 40 CFR 87.5, prescribes special test procedures for any aircraft or aircraft engine that is not susceptible to satisfactory testing by the procedures in 40 CFR part 87, the applicant must show the Administrator that those special test procedures have been complied with.*

Explanation

The FAA has this responsibility under Section 232, CAA as amended. As with 34.3 (a) and (i) the applicant must provide evidence to the FAA that the special test procedures have been complied with as approved.

§ 34.3 (k)

- (k) *Wherever 40 CFR part 87 requires agreement, acceptance, or approval by the Administrator of the EPA, this FAR requires a showing that such agreement or approval has been obtained.*

Explanation

The FAA has this responsibility under Section 232, CAA as amended. The Request Process for Alternate, Equivalent or Otherwise Nonidentical Procedures is shown in Figure 3.

§ 34.3 (l)

- (l) *Pursuant to 42 U.S.C. 7573, no state or political subdivision thereof may adopt or attempt to enforce any standard respecting emissions of any air pollutant from any aircraft or engine thereof unless that standard is identical to a standard made applicable to the aircraft by the terms of this FAR.*

Explanation

42 U.S.C. 7573 refers to Section 233 of the Clean Air Act as amended. Section 233 of the Clean Air Act as amended preempts the adoption or enforcement of any emissions standard not identical to the standards promulgated in 40 CFR part 87, and enforced through 14 CFR Part 34.

§ 34.3 (m)

- (m) *If EPA, by regulation or exemption, relaxes a provision of 40 CFR part 87 that is implemented in this FAR, no state or political subdivision thereof may adopt or attempt to enforce the terms of this FAR that are superseded by the relaxed requirement.*

Explanation

Similar to 34.3 (l) above with authority from Section 233 of the Clean Air Act as amended.

§ 34.3 (n)

- (n) *If any provision of this FAR is rendered inapplicable to a foreign aircraft as provided in 40 CFR 87.3(c) (international agreements), and §34.3(d) of this FAR, that provision may not be adopted or enforced against that foreign aircraft by a state or political subdivision thereof.*

Explanation

Similar to 34.3 (l) (m) above with authority from Section 233 of the Clean Air Act as amended. Standardization and control of emissions from commercial aircraft is the responsibility of the Federal government.

§ 34.3 (o)

- (o) *For exhaust emissions requirements of this FAR that apply beginning February 1, 1974, January 1, 1976, January 1, 1978, January 1, 1984, and August 9, 1985, continued compliance with those requirements is shown for engines for which the type design has been shown to meet those requirements, if the engine is maintained in accordance with applicable maintenance requirements for 14 CFR chapter I. All methods of demonstrating compliance and all model designations previously found acceptable to the Administrator shall be deemed to continue to be an acceptable demonstration of compliance with the specific standards for which they were approved.*

Explanation

With respect to emissions engines are not expected to deteriorate significantly in time so if they met emissions requirements in the past and are maintained in accordance with FAA requirements they will be considered to be in compliance.

§ 34.3 (p)

- (p) *Each applicant must allow the Administrator to make, or witness, any test necessary to determine compliance with the applicable provisions of this FAR.*

Explanation

Emissions compliance testing is typically performed at the engine manufacturers' facility. Because of the expense and complexity of emissions sampling and analytical equipment, engine manufacturers use the same procedures and equipment, to the extent possible, for all emissions certification testing. Once an emissions certification test has been witnessed and approved, future, similar tests, can be evaluated at little risk, by means of the engine certification test plan and the engine test and emissions measurement equipment operational documentation. Changes in test equipment and/or procedures should be evaluated for each situation. For example, changing an analytical instrument from one manufacturer to another without on site inspection would pose little risk, whereas changing from a single point, traversing, sampling probe to an integrating traversing sampling rake might warrant review and discussion and perhaps inspection of the equipment involved.

8. §34.4 [Reserved]
9. §34.5 Special Test Procedures:

The Administrator or the Administrator of the EPA may, upon written application by a manufacturer or operator of aircraft or aircraft engines, approve test procedures for any aircraft or aircraft engine that is not susceptible to satisfactory testing by the procedures set forth herein. Prior to taking action on any such application, the Administrator or the Administrator of the EPA shall consult with the other.

Explanation

The particular configuration of a given engine may lend itself to testing by some means other than that implied in Part 34. For example it may be beneficial to sample, for emissions, a mixed fan flow engine from the core

rather than from the standard co-annular core/fan flow discharge nozzle. Because of the restrictions placed on the location of the emissions sampling probe this would be difficult if not impossible. By adopting a scheme of separating the two flows, fan and core without adversely affecting engine performance, a viable core only sample could be taken. Such a scheme would have to be reviewed and approved by the FAA. The request process for approval is shown in Figure 3.

10. §34.6 Aircraft safety

- (a) *The provisions of this part will be revised if at any time the Administrator determines that an emission standard cannot be met within the specified time without creating a safety hazard.*

Explanation

The Administrator must assure appropriate consideration of aircraft safety when considering meeting emissions standards within any time frame.

- (b) *Consistent with 40 CFR 87.6, if the FAA Administrator determines that any emission control regulation in this part cannot be safely applied to an aircraft, that provision may not be adopted or enforced against that aircraft by any state or political subdivision thereof.*

Explanation

Authority for Part 34.6 (b) comes from Section 233, Clean Air Act as amended. In addition, aircraft, in 34.6(b) should be interpreted to mean “aircraft and aircraft engine”.

11. §34.7 Exemptions

Notwithstanding part 11 of the Federal Aviation Regulations (14 CFR part 11), all petitions for rulemaking involving either the substance of an emission standard or test procedure prescribed by the EPA that is incorporated in this FAR, or the compliance date for such standard or procedure, must be submitted to the EPA. Information copies of such petitions are invited by the FAA. Petitions for rulemaking or exemption involving provisions of this FAR that do not affect the substance or the compliance date of an emission standard or test procedure that is prescribed by the EPA, and petitions for exemptions under the provisions for which the EPA has specifically granted exemption authority to the Secretary of Transportation are subject to part 11 of the Federal Aviation Regulations (14 CFR part 11). Petitions for rulemaking or exemptions involving these FARs must be submitted to the FAA.

(a):

Exemptions based on flights for short durations at infrequent intervals. The emission standards of this part do not apply to engines which power aircraft operated in the United States for short durations at infrequent intervals. Such operations are limited to:

- (1) *Flights of an aircraft for the purpose of export to a foreign country, including any flights essential to demonstrate the integrity of an aircraft prior to a flight to a point outside the United States.*
- (2) *Flights to a base where repairs, alterations or maintenance are to be performed, or to a point of storage, or for the purpose of returning an aircraft to service.*
- (3) *Official visits by representatives of foreign governments.*
- (4) *Other flights the Administrator determines, after consultation with the Administrator of the EPA, to be for short durations at infrequent intervals. A request for such a determination shall be made before the flight takes place.*

- (b) *Exemptions for very low production engine models. The emissions standards of this part do not apply to engines of very low production after the date of applicability. For the purpose of this part, "very low production" is limited to a maximum total production for United States civil aviation applications of no more than 200 units covered by the same type certificate after January 1, 1984. Engines manufactured under this provision must be reported to the FAA by serial number on or before the date of manufacture and exemptions granted under this provision are not transferable to any other engine.*
- (c) *Exemptions for new engines in other categories. The emissions standards of this part do not apply to engines for which the Administrator determines, with the concurrence of the Administrator of the EPA, that application of any standard under Sec. 34.21 is not justified, based upon consideration of—*
 - (1) *Adverse economic impact on the manufacturer;*
 - (2) *Adverse economic impact on the aircraft and airline industries at large;*
 - (3) *Equity in administering the standards among all economically competing parties;*
 - (4) *Public health and welfare effects; and*
 - (5) *Other factors which the Administrator, after consultation with the Administrator of the EPA, may deem relevant to the case in question.*
- (d) *Time-limited exemptions for in-use engines. The emissions standards of this part do not apply to aircraft or aircraft engines for time periods which the Administrator determines, with the concurrence of the Administrator of the EPA, that any applicable standard under Sec. 34.11(a), or Sec. 34.31(a), should not be applied based upon consideration of--*
 - (1) *Documentation demonstrating that all good faith efforts to achieve compliance with such standard have been made;*
 - (2) *Documentation demonstrating that the inability to comply with such standard is due to circumstances beyond the control of the owner or operator of the aircraft; and*
 - (3) *A plan in which the owner or operator of the aircraft shows that he will achieve compliance in the shortest time which is feasible.*

Explanation

The EPA is mandated to address all sources of air pollution which may endanger the public health or welfare. From Federal Register, Vol. 62, No. 89, Thursday, May 8, 1997, "Currently, aircraft are about 2 percent of the total U.S. mobile source NO_x and CO ground level emissions inventory. Commercial aircraft emissions are about 70 and 30 percent respectively of these NO_x and CO aircraft emissions inventories." While of concern, and determined by the Administrator of the EPA to be in need of regulatory control, commercial aircraft emissions constitute a relatively small fraction of the total mobile sources emissions burden. The likely contribution from the allowable exemptions listed in categories 34.7 (a) - (d) are a small fraction of an already small fraction. EPA has granted a blanket exemption from the standards for all models of engines which satisfy a criterion for low production engines. The FAA has been granted, by the EPA, responsibility for acting on petitions for exemptions of any sort.

From ICAO Annex 16, Volume II, Second edition, 1993, Chapter 2, "TURBO-JET AND TURBOFAN ENGINES INTENDED FOR PROPULSION ONLY AT SUBSONIC SPEEDS":

Note: In considering exemptions, certificating authorities should take into account the probable numbers of engines that will be produced and their impact on the environment. When such an exemption is granted, the certificating authority should consider imposing a time limit on the future production of such engines for installation on new aircraft, although production of such engines as spares should be permitted indefinitely.

(e)

Applications for exemption from this part shall be submitted in duplicate to the Administrator in accordance with the procedures established by the Administrator in part 11.

Explanation

34.7 (e), and the prefacing remarks to this subsection, do not appear in 40 CFR Part 87, subsection 84.7. They are an addition and reflect the differing roles and responsibilities between the EPA which establishes the regulatory standards, and the FAA, which enforces these standards. Applications for exemptions which do not significantly impact or compromise the substance or compliance date of an emission standard or test procedure or for which the EPA has granted authority to the Secretary of Transportation should be submitted to the FAA subject to 14 CFR part 11. Petitions of a substantive nature relating to emission standards and test procedures must be submitted to the EPA with copies requested by the FAA.

(g):

No state or political subdivision thereof may attempt to enforce a standard respecting emissions from an aircraft or engine if such aircraft or engine has been exempted from such standard under this part.

Explanation

This is an interpretation of Section 233, Clean Air Act as amended, maintaining authority over aircraft and aircraft engine emissions while allowing exemptions for the reasons specified in 34.7 (a) - (d).

II Subpart B—Engine Fuel Venting Emissions
(New and In-use Aircraft Gas Turbine Engines)

12. §34.10 Applicability
- (a) *The provisions of this subpart are applicable to all new aircraft gas turbine engines of classes T3, T8, TSS and TF equal to or greater than 36 kilonewton (8090 pounds) rated output, manufactured on or after January 1, 1974, and to all in-use aircraft gas turbine engines of classes T3, T8, TSS and TF equal to or greater than 36 kilonewtons (8090 pounds) rated output manufactured after February 1, 1974.*
 - (b) *The provisions of this subpart are also applicable to all new aircraft gas turbine engines of class TF less than 36 kilonewtons (8090 pounds) rated output and class TP manufactured on or after January 1, 1975, and to all in-use aircraft gas turbine engines of class TF less than 36 kilonewtons (8090 pounds) rated output and class TP manufactured after January 1, 1975.*
13. §34.11 Standard for fuel venting emissions:
- (a) *No fuel venting emissions shall be discharged into the atmosphere from any new or in-use aircraft gas turbine engine subject to the subpart. This paragraph is directed at the elimination of intentional discharge to the atmosphere of fuel drained from fuel nozzle manifolds after engines are shut down and does not apply to normal fuel seepage from shaft seals, joints, and fittings.*
 - (b) *Conformity with the standard set forth in paragraph (a) of this section shall be determined by inspection of the method designed to eliminate these emissions.*
 - (c) *As applied to an airframe or an engine, any manufacturer or operator may show compliance with the fuel venting and emissions requirements of this section that were effective beginning February 1, 1974 or January 1, 1975, by any means that prevents the intentional discharge of fuel from fuel nozzle manifolds after the engines are shut down. Acceptable means of compliance include one of the following:*
 - (1) *Incorporation of an FAA approved system that recirculates the fuel back into the fuel system.*
 - (2) *Capping or securing the pressurization and drain valves.*
 - (3) *Manually draining the fuel from a holding tank into a container.*

Explanation

Table 1 summarizes the Engine Fuel Venting Emissions Standards as described in Part 34.

It is normal for aircraft gas turbine engine fuel systems to operate in a pressurized condition. This pressure is relieved after the engines are shut down. Raw fuel allowed to drain uncontained or onto hot internal engine parts will result in the discharge of hydrocarbons from the aircraft into the environment. These hydrocarbons pass into the atmosphere, adding to the local air pollution burden. The objective of this regulation is to eliminate the intentional discharge, into the atmosphere, of fuel drained from the engine fuel manifolds after the engine is shut down following normal flight or ground operations. This regulation is not intended to apply to normal fuel seepage from shaft seals, joints and fittings.

Table 1: ENGINE FUEL VENTING EMISSIONS
(New and In-Use Aircraft Gas Turbine Engines)

ENGINE CLASS	EFFECTIVE DATE	STANDARD
T3, T8, TSS, TF ≥ 36 kilonewtons (8090 lbs.)	All new aircraft gas turbine engines manufactured on or after January 1, 1974	Prohibition of fuel venting emissions discharged into the atmosphere
T3, T8, TSS, TF ≥ 36 kilonewtons	All in-use aircraft gas turbine engines manufactured after February 1, 1974	Prohibition of fuel venting emissions discharged into the atmosphere
TF < 36 kilonewtons TP	All new and in-use aircraft gas turbine engines manufactured on or after January 1, 1975	Prohibition of fuel venting emissions discharged into the atmosphere

Compliance is by inspection of the method designed or chosen to prevent these emissions. Acceptable means of compliance include recirculating fuel back into the fuel system, by means of an FAA approved system, capping or securing the pressurization and drain valve or manually draining the fuel from a holding tank into a container. In the latter case this fuel must be disposed of in an environmentally sound manner. It should be noted that unlike meeting emissions levels which are clearly the responsibility of the engine manufacturer meeting fuel venting standards can be assigned to the operator depending upon which strategy is chosen to prevent the intentional discharge from the fuel manifold after the engine is shut down. Most, if not all, modern aircraft are designed and constructed to meet this regulation.

As a point of observation, it should be noted that turboshaft engines are not included in these requirements.

**III. Subpart C — Exhaust Emissions
(New Aircraft Gas Turbine Engines)**

14. § 34.20 Applicability

The provisions of this subpart are applicable to all aircraft gas turbine engines of the classes specified beginning on the dates specified in § 34.21.

15. § 34.21 Standards for exhaust emissions

- (a) *Exhaust emissions of smoke from each new aircraft gas turbine engine of class T8 manufactured on or after February 1, 1974, shall not exceed a smoke number (SN) of 30.*
- (b) *Exhaust emissions of smoke from each new aircraft gas turbine engine of class TF and of rated output of 129 kilonewtons (29,000 pounds) thrust or greater, manufactured on or after January 1, 1976, shall not exceed:*

$$SN = 83.6(rO)^{-0.274} \text{ (rO is in kilonewtons)}$$

- (c) *Exhaust emissions of smoke from each new aircraft gas turbine engine of class T3 manufactured on or after January 1, 1978, shall not exceed a smoke number (SN) of 25.*
- (d) *Gaseous exhaust emissions from each new commercial aircraft gas turbine engine shall not exceed:*

(1) Classes, TF, T3, T8 engines greater than 26.7 kilonewtons (kN) rated output:

(i) Engines manufactured on or after January 1, 1984:

Hydrocarbons: 19.6 grams/kilonewton rO.

(ii) Engines manufactured on or after July 7, 1997.

Carbon Monoxide: 118 grams/kilonewton rO.

(iii) Engines of a type or model of which the date of manufacture of the first individual production model was on or before December 31, 1995 and for which the date of manufacture of the individual engine was on or before December 31, 1999.

Oxides of Nitrogen: $(40 + 2(rPR))$ grams/kilonewton rO.

(iv) Engines of a type or model of which the date of manufacture of the first individual production model was after December 31, 1995 or for which the date of manufacture of the individual engine was after December 31, 1999:

Oxides of Nitrogen: $(32 + 1.6(rPR))$ grams/kilonewton rO.

(v) The emission standards prescribed in paragraphs (d)(1)(iii) and (iv) of this section apply as prescribed beginning July 7, 1997.

(vi) Engines of type or model for which the date of manufacture of the first individual production model was after December 31, 2003:

(A) For engines with a pressure ratio of 30 or less:

(1) For Engines with a maximum rated thrust of more than 89.0 kN:

Oxides of Nitrogen: (19 + 1.6 rPR) grams/kilonewton rO.

- (2) *For engines with a maximum rated thrust of more than 26.7 kN but not more than 89.0 kN:*

Oxides of Nitrogen: (37.572 + 1.6 rPR – 0.2087 rO) grams/Kilonewton rO.

- (B) *For engines with a pressure ratio of more than 30 but less than 62.5:*

- (1) *For engines with a maximum rated thrust of more than 89.0 kN:*

Oxides of Nitrogen: (7 + 2.0 rPR) grams/kilonewton rO.

- (2) *For engines with a maximum rated thrust of more than 26.7 kN but more than 89.0 kN:*

Oxides of Nitrogen: (42.71 + 1.4286 rPR – 0.4013 rO + 0.00642 rPR(rO)) grams/kilonewton rO.

- (C) *For engines with a pressure ratio of 62.5 or more:*

Oxides of Nitrogen: (32 + 1.6 rPR) grams/kilonewton rO.

Explanation: The emission standards described in paragraphs (d)(1)(vi)(A), (B), and (C) of this section are contingent upon promulgation by EPA and FAA in their respective regulations and standards. They list the current ICAO CAPE 4 requirements and represent a continuation of the harmonization program with ICAO.

Supplemental Information:

The date of the first individual production model is generally interpreted to mean the date of type certification.

- (2) *Class TSS: Engines manufactured on or after January 1, 1984:*

Hydrocarbons = 140(0.92)^{rPR} grams/kilonewton rO.

- (e) *Smoke exhaust emissions from each gas turbine engine of the classes specified below shall not exceed:*

- (1) *Class TF of rated output less than 26.7 kilonewtons (6000 pounds) manufactured on or after August 9, 1985.*

SN = 83.6(rO)^{-0.274} (rO is in kilonewtons) not to exceed a maximum of SN = 50.

- (2) *Classes T3, T8, TSS, and TF of rated output equal to or greater than 26.7 kilonewtons (6000 pounds) manufactured on or after January 1, 1984.*

SN = 83.6(rO)^{-0.274} (rO is in kilonewtons) not to exceed a maximum of SN = 50.

- (3) *Class TP or rated output equal to or greater than 1,000 kilowatts (1340 Hp) manufactured on or after January 1, 1984.*

SN = 187(rO)^{-0.168} (rO is in kilowatts).

- (f) *The standards set forth in paragraphs (a), (b), (c), (d) and (e) of this section refer to a composite gaseous emission sample representing the operating cycles set forth in the applicable sections of subpart G of this part, and exhaust smoke emissions emitted during operations of the engine as specified in the applicable sections of subpart H of this part, measured and calculated in accordance with the procedures set forth in those subparts.*

Explanation

For TF, T3 and T8 engines the following chart (Figure 4) provides a graphical representation of the smoke emissions requirements. This chart reflects the requirements of Subpart D as well. In general, the threshold of plume visibility can be expected to lie between SN 25 and SN 30. However, visibility is a complex function of the tailpipe diameter, viewing angle, background and meteorological conditions. Differences in any one, or any combination, of these factors, from the average, can be expected to influence this relationship. For example, a plume which is not visible when viewed in a direction normal to its axis could appear to be visible when viewed at an angle more nearly parallel to its axis. In addition apparent plume visibility seems to vary with local ambient humidity. That is, when plumes can be seen they seem to become darker as humidity increases. The regulatory intent is to assure a non-visible plume when viewed in a direction normal to the plume axis.

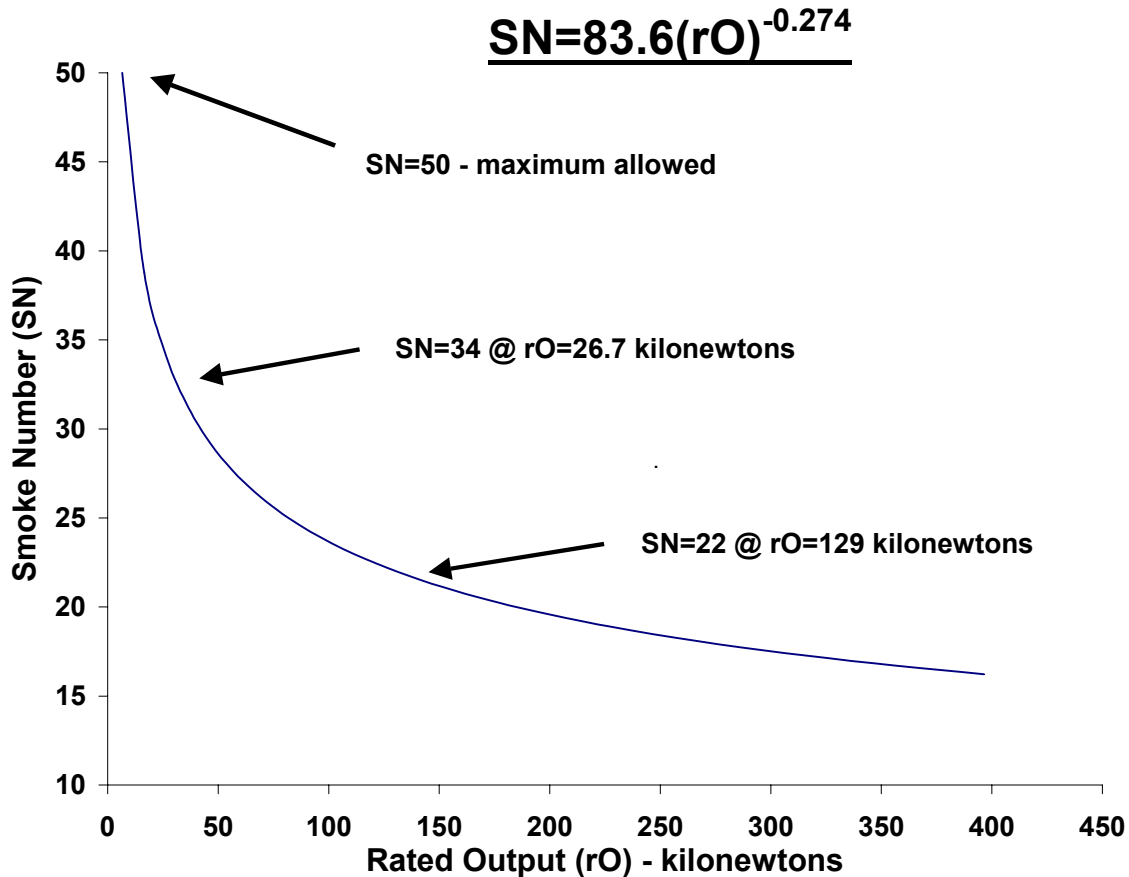

FIGURE 4: Smoke Emission Requirements For New or In Use TF, T3, and T8 Engines

(3) – 49. Reserved

Table 2: Exhaust Emissions - Summary of Requirements

CLASS	DATE	STANDARD
T8	Each aircraft gas turbine engine in use, or manufactured, on or after February 1, 1974	$SN \leq 30$
TF ≥ 129 kN (29,000 pounds)	Each aircraft gas turbine engine in use, or manufactured, on or after January 1, 1976	$SN \leq 83.6 \times (rO)^{-0.274}$ (rO in kN)
T3	Each new aircraft gas turbine engine manufactured on or after January 1, 1978	$SN \leq 25$
TF, T3, T8 >26.7 kN (6,000 pounds)	Each new aircraft gas turbine engine manufactured on or after January 1, 1984 Each new aircraft gas turbine engine manufactured on or after July 7, 1997	$HC \leq 19.6$ g/kN rO $CO \leq 118$ g/kN rO
TF, T3, T8 >26.7 kN	Engines where the first production model was manufactured on or before December 31, 1995 and where the date of manufacture of the engine was on or before December 31, 1999 - effective July 7, 1997	$NO_x \leq (40 + 2(rPR))$ g/kN rO
TF, T3, T8 >26.7 kN	Engines where the first production model was manufactured after December 31, 1995 and where date of manufacture of the engine was after December 31, 1999 - effective July 7, 1997	$NO_x \leq (32 + 1.6(rPR))$ g/kN rO
<u>For rPR ≤ 30 and:</u> 26.7 kN < TF, T3, T8 ≤ 89.0 kN TF, T3, T8 >89.0 kN	Engines of a type or model for which the date of manufacture of the first individual production model was after December 31, 2003	$NO_x \leq (37.572 + 1.6 rPR - 0.2087 rO)$ g/kN rO $NO_x \leq (19 + 1.6 rPR)$ g/kN rO
<u>For $30 < rPR < 62.5$ and:</u> 26.7 kN < TF, T3, T8 ≤ 89.0 kN TF, T3, T8 >89.0 kN	Engines of a type or model for which the date of manufacture of the first individual production model was after December 31, 2003	$NO_x \leq (42.71 + 1.4286 rPR - 0.4013 rO + 0.0642 rPR(rO))$ g/kN rO $NO_x \leq (7 + 2.0 rPR)$ g/kN rO
<u>For rPR ≥ 62.5:</u> All engines	Engines of a type or model for which the date of manufacture of the first individual production model was after December 31, 2003	$NO_x \leq (32 + 1.6 rPR)$ g/kN rO
TF < 26.7 kN	Each gas turbine engine manufactured on or after August 9, 1985	$SN \leq 83.6 \times (rO)^{-0.274} \leq 50$ (rO in kN)
T3, T8, TSS, TF ≥ 26.7 kN	Each gas turbine engine manufactured on or after January 1, 1984	$SN \leq 83.6 \times (rO)^{-0.274} \leq 50$ (rO in kN)
TSS	Each gas turbine engine manufactured on or after January 1, 1984	$HC \leq 140 (0.92)^{rPR}$ g/kN rO
TP $\geq 1,000$ kW (1340 HP)	Each gas turbine engine manufactured on or after January 1, 1984	$SN \leq 187 \times (rO)^{-0.168}$ (rO in kW)

Explanation:

Table 2, above, is a summary listing (by class of aircraft engine) of the smoke and gaseous emission regulatory levels for both new and in-use engines. Included as well are the ICAO CAPE 4 NO_x standards effective after 12/31/2003, listed in terms of rated pressure ratio.

**IV. Subpart D — Exhaust Emissions
(In-Use Aircraft Gas Turbine Engines)**

50. § 34.30 Applicability

The provisions of this subpart are applicable to all aircraft gas turbine engines of the classes specified beginning on the dates specified in § 34.31.

(4) § 34.31 Standards for exhaust emissions

- (a) *Exhaust emissions of smoke from each in-use aircraft gas turbine engine of Class T8, beginning February 1, 1974 shall not exceed a smoke number (SN) of 30.*
- (b) *Exhaust emissions of smoke from each in-use aircraft gas turbine engine of Class TF and of rated output of 129 kilonewtons (29,000 pounds) thrust or greater, beginning January 1, 1976, shall not exceed:*

$$SN = 83.6(rO)^{-0.274} \text{ (rO is in kilonewtons)}$$

- (c) *The standards set forth in paragraphs (a) and (b) of this section refer to exhaust smoke emissions emitted during operations of the engine as specified in the applicable section of subpart H of this part, and measured and calculated in accordance with the procedure set forth in this subpart.*

Explanation

Table 2, above lists by Class and by applicable date the smoke and gaseous emission regulatory levels.

(Note: this table is attached to Subpart C of this AC as a composite C-D compilation of requirements)

V Subpart E — [Reserved]

**VI. Subpart F —
[Reserved]**

VII. Subpart G — Test Procedures for Engine Exhaust Gaseous Emissions (Aircraft and Aircraft Gas Turbine Engines)

18. §34.60 Introduction

- (a) *Except as provided under §34.5, the procedures described in this subpart shall constitute the test program used to determine the conformity of new aircraft gas turbine engines with the applicable standards set forth in this part.*
- (b) *The test consists of operating the engine at prescribed power settings on an engine dynamometer (for engines producing primarily shaft power) or thrust measuring test stand (for engines producing primarily thrust). The exhaust gases generated during engine operation must be sampled continuously for specific component analysis through the analytical train.*
- (c) *The exhaust emissions test is designed to measure hydrocarbons, carbon monoxide, carbon dioxide and oxides of nitrogen concentrations, and to determine mass emissions through calculations during a simulated aircraft landing-takeoff cycle (LTO). The LTO cycle is based on time in mode data during high activity periods at major airports. The test for propulsion engines consists of at least the following four modes of engine operation: taxi/idle, takeoff, climbout, and approach. The mass emissions for these modes are combined to yield the reported values.*
- (d) *When an engine is tested for exhaust emissions on an engine dynamometer or test stand, the complete engine shall be used with all accessories which might reasonably be expected to influence emissions to the atmosphere installed and functioning, if not otherwise prohibited by §34.62(a)(2).*
- (e) *Other gaseous emissions measurement systems may be used if shown to yield equivalent results and if approved in advance by the Administrator or the Administrator of the EPA.*

Supplemental Information

Engines have generally been tested without off-take bleeds and accessory loads other than those necessary for the engine's basic operation, consistent with ICAO Annex 16, paragraph 2.1.5.2. Paragraph 34.60(d) is intended to be consistent with the procedures specified in Annex 16, with consideration for special cases where accessory loads might be large enough to influence emissions.

19. §34.61 Turbine Fuel Specification

For exhaust emissions testing, fuel meeting the specifications listed below shall be used. Additives used for the purpose of smoke suppression (such as organometallic compounds) shall not be present.

Explanation:

The fuel specification in Part 34 matches the, amended, ICAO fuel specification in Annex 16, Vol. II, Second Edition, 1993. This specification is typical of Jet A aviation fuel. Although EPA chose to adopt, by reference, the measurement and compliance procedures of ICAO Annex 16, Vol. II, Second Edition, Appendix, 2, 3, 5 and 6, they chose not to adopt by reference the ICAO fuel specification. Instead they listed the fuel properties and allowable ranges of values.

**Specification for Fuel to be Used in Aircraft
Turbine Engine Emissions Testing**

Property	Allowable range of values
Density kg/m ³ at 15°C	780 – 820
Distillation temperature °C	
10 % boiling point	155 – 201
Final boiling point	235 – 285
Net heat of combustion MJ/kg	42.86 – 43.50
Aromatics, volume %	15 – 23
Naphthalenes, volume %	1.0 – 3.5
Smoke point, mm	20 – 28
Hydrogen, mass %	13.4 – 14.1
Sulphur, mass %	less than 0.3%
Kinematic viscosity at -20°C, mm ² /s	2.5 – 6.5

Supplemental information:

Aircraft gas turbine engines can and do use a variety of fuels. The specific fuel type and composition can and often does have a significant effect on engine emissions. Knowing the fuel types in general use is important in establishing a baseline of emissions from the existing and future fleet of commercial aircraft which affects regulatory requirements. It is important when comparing emission levels from one engine with those from another. It is particularly important in evaluating engine emission levels relative to a regulation that was based, in part, on an assumed fuel specification. Because fuel type and composition varies it was necessary to establish a fuel specification which fairly represented typical aircraft gas turbine engine fuels which are in use. The ICAO amended fuel specification is a reasonable international consensus specification, which was the result of over fifteen years of study and negotiation.

In 1972 the EPA Proposed Rule Making specified ASTM D1655 as the requirement that test fuels must meet. They allowed the use of nonmetallic additives as specified in ASTM D1655 but prohibited the use of additives used for the purpose of smoke suppression.

In 1981 ICAO published "International Standards and Recommended Practices Environmental Protection, Annex 16, Volume II, Aircraft Emissions, first edition, 1981" which included a specific detailed turbine engine test fuel specification. In 1982 the EPA adopted the 1981 ICAO fuel specification bringing the U.S. into alignment with ICAO. However, in 1984 the EPA changed its fuel specification, broadening the ranges of allowable test fuel naphthalenes, aromatics and hydrogen content, viscosity and final boiling point values in response to manufacturers difficulty in obtaining fuels meeting the ICAO test fuel specification. The EPA expected ICAO to amend its fuel specification to match the EPA specification.

In 1988 ICAO did amend its fuel specification but rather than addressing the disparity between EPA and ICAO it further widened the range of acceptable fuels by broadening, again, the ranges of allowable test fuel naphthalenes, aromatics and hydrogen content, viscosity and final boiling point values.

In 1993 ICAO, once again, amended its fuel specification substituting density for specific gravity and changing the units of net heat of combustion from kilojoule/kilogram (kJ/kg) to megajoule/kilogram(MJ/kg). EPA analyzed and evaluated the resulting ICAO fuel specification with respect to its effect on aircraft gas turbine engine emissions and on general fuel availability in the

U.S. One particular concern was a decision by EPA to adopt the ICAO NOx standards. Fuel type and composition affect emissions and these standards were based on the latest ICAO fuel specification. If the EPA decided not to adopt the ICAO fuel specifications the U.S. and ICAO NOx standards would not be entirely consistent.

EPA found that changing from specific gravity to density and kilojoules to megajoules would, obviously, not affect either emissions or fuel availability. In comparing actual U.S. jet fuel characteristics to differences between EPA and ICAO test fuel specifications EPA concluded that, for distillation temperatures and hydrogen content, where there were differences, the effect would be negligible, i.e., "not discernable". For the broader range of aromatics and naphthalenes, testing on the high end of the range would be more severe for emissions and would not effect in-use emissions. That is, based on current U.S. jet fuel characteristics, fuels used by in-use aircraft gas turbine engines would be likely to have lower values of aromatics and naphthalenes than used in testing and therefore lower emissions. As a result EPA adopted the 1993 ICAO test fuel specification for the purpose of certification emission testing.

Part 34 reflects, as it must, the EPA standard. Although not spelled out in Part 34 the EPA states that manufacturers should, unless otherwise specified, comply with the latest version of the aviation test fuel specifications from the American Society for Testing and Materials, ASTM, "Standard Specifications for Aviation Turbine Fuels," D1655. There is no mention of the use of non metallic additives. Additives used for smoke suppression, such as organometallic compounds, shall not be present.

20. §34.62 Test procedure (propulsion engines).

(a)(1) *The engine shall be tested in each of the following engine operating modes which simulate aircraft operation to determine its mass emission rates. The actual power setting, when corrected to standard day conditions, should correspond to the following percentages of rated output. Analytical correction for variations from reference day conditions and minor variations in actual power setting should be specified and/or approved by the Administrator:*

Mode	Class		
	TP	TF, T3, T8	TSS
Taxi/idle	(*)	(*)	(*)
Takeoff	100	100	100
Climbout	90	85	65
Descent	NA	NA	15
Approach	30	30	34

* See paragraph (2) of this section

(2) *The taxi/idle operating modes shall be carried out at a power setting of 7 percent rated thrust unless the Administrator determines that the unique characteristics of an engine model undergoing certification testing at 7 percent would result in substantially different HC and CO emissions than if the engine model were tested at the manufacturers' recommended idle power setting. In such cases the Administrator shall specify an alternative test condition.*

(3) *The times in mode (TIM) shall be as specified below:*

Mode	Class		
	TP	TF, T3, T8	TSS
Taxi/idle	26.0 Min.	26.0	26.0
Takeoff	0.5	0.7	1.2
Climbout	2.5	2.2	2.0
Descent	N/A	N/A	1.2
Approach	4.5	4.0	2.3

(b) *Emissions testing shall be conducted on warmed-up engines which have achieved a steady operating temperature.*

21. §34.63 [Reserved]

22. §34.64 *Sampling and analytical procedures for measuring gaseous exhaust emissions.*

The system and procedures for sampling and measurement of gaseous emissions shall be done in accordance with Appendices 3 and 5 to International Civil Aviation Organization (ICAO) Annex 16, Environmental Protection, Volume II, Aircraft Engine Emissions, Second Edition, July 1993, which are incorporated herein by reference. This incorporation by reference was approved by the Director of the Federal Register in accordance with 5 U.S.C. 552(a) and 1 CFR part 51. This document can be obtained from the International Civil Aviation Organization (ICAO), Document Sales Unit, P.O. Box 400, Succursale: Place de L'Aviation Internationale, 1000 Sherbrooke Street West, Suite 400, Montreal, Quebec, Canada H3A 2R2. Copies may be reviewed at the FAA Office of the Chief Counsel, Rules Docket, Room 916, Federal Aviation Administration Headquarters Building, 800 Independence Avenue, SW., Washington, DC, or at the FAA New England Regional Office, 12 New England Executive Park, Burlington, Massachusetts, or at the Office of the Federal Register, 800 North Capitol Street, NW., Suite 700, Washington, DC.

23. § 34.65—34.70 [Reserved]

24. § 34.71 Compliance with gaseous emission standards

Compliance with each gaseous emission standard by an aircraft engine shall be determined by comparing the pollutant level in grams/kilowatt/thrust/cycle or grams/kilowatt/cycle as calculated pursuant to §34.64 with the applicable emission standard under this part. An acceptable alternative to testing every engine is described in Appendix 6 to ICAO Annex 16, Environmental Protection, Volume II—Aircraft Engine Emissions. Second Edition, July 1993, effective March 20, 1997. This incorporation by reference was approved by the Director of the Federal Register in accordance with 5 U.S.C. 552(a) and 1 CFR part 51. This document can be obtained from, and copies may be reviewed at the respective addresses listed in §34.64. Other methods of demonstrating compliance may be approved by the FAA Administrator with the concurrence of the Administrator of the EPA.

[(Amdt. 34-2, Eff. 9/98)]

VIII. Subpart H — Test Procedures for Engine Smoke Emissions (Aircraft and Aircraft Gas Turbine Engines)

25. §34.80 Introduction

Except as provided under §34.5, the procedures described in this subpart shall constitute the test program to be used to determine the conformity of new and in-use gas turbine engines with the applicable standards set forth in this part. The test is essentially the same as that described in §§34.60-34.62, except that the test is designed to determine the smoke emission level at various operating points representative of engine usage in aircraft. Other smoke measurement systems may be used if shown to yield equivalent results and if approved in advance by the Administrator or the Administrator of the EPA.

Supplemental information

The regulatory smoke standards established by EPA and ICAO were set to ensure the invisibility of the engine exhaust when viewed across the plume. Smoke level is determined indirectly, by means of the loss of reflectance of a filter used to trap smoke particles from a prescribed mass of exhaust per unit area of filter. The result is a dimensionless number "SN." Using generalized relationships between engine thrust and exhaust duct diameters, an empirically derived relationship between smoke number (SN) and engine thrust was developed. The information available to develop this relationship came from early gas turbine engines with straight jet or low bypass ratios. There was little or no dilution of the engine core exhaust gas which is not the case with modern, high bypass, engines. ICAO, which defines – by reference – the measurement standard, requires smoke to be measured at or near the engine exhaust nozzle exit plane, which is consistent with the requirements for using SN as an indicator of visibility for the early engines. Some current engine designs, however, extend the bypass cowling beyond the core nozzle and for these, by definition, the measurement plane includes the bypass airflow. This results in a lower SN, and some question about the relationship of SN to plume visibility for these designs. Introduction of ultra high bypass ratio engines, such as the ducted or unducted prop fan engines will serve to further complicate this situation. The measurement method itself has proven to be physically robust, repeatable and reliable, but time consuming and expensive – particularly for traverse testing.

As a direct result of the narrowly defined smoke number, demanded by the prescribed method of measurement and its implied correlation with engine exhaust plume visibility, finding an alternate, equivalent smoke method has proven to be challenging. Such a method must necessarily correlate with smoke number, not with plume visibility, i.e., any measured value arrived at using an alternate method must be associated unambiguously with an equivalent smoke number. Some engine manufacturers use an optical device that provides continuous, almost real time smoke measurement. This device is patterned after the Hartridge optical smoke meter. Their experience has been that the optical measurements correlate well with in-house ICAO Appendix 2 stained filter measurements with considerable savings in engine test time. If an engine manufacturer wanted to use such a device for certification it would be allowed upon demonstration, by means of actual test data, that the device was equivalent to Appendix 2. It should be mentioned that the correction found at a single manufacturer's facility has not been demonstrated between engine manufacturers facilities so some caution is advised when assessing equivalency. Because smoke measurement is time consuming, particularly during traversing, and places great demands on the engine, finding an alternate and less costly method is and will continue to be attractive.

The smoke measurement standard was developed for engines that generated smoke at considerably higher levels than are seen today. This affects the relative accuracy of the method. The measurement is considered (by the SAE E-31 committee which developed the method) to be no more accurate than ± 3 SN. At smoke levels of SN 50-60 this represents an accuracy of 6-5%. At regulatory standards of 30 and below, relative accuracy becomes 10-20% or more.

Also significant is the requirement to "...provide evidence to the certification authority, by means of detailed traverses, that the proposed probe design and position does provide a representative sample for each prescribed power setting." ICAO Appendix 2 does not provide a definition of "representative" nor does it specify any procedures by which conformance to this requirement can be demonstrated. Because traversing is time consuming, costly, and highly problematic with some new engine designs, this lack of definition and test of 'representativeness' is a serious problem and must be addressed, almost uniquely, for each emissions certification test for which there is a traversing requirement. As with gaseous emissions to a first approximation how well the exhaust was sampled can be estimated from a carbon balance which relates the total carbon measured (mostly CO₂) to a measured value of fuel-air ratio. For engine modes above idle a necessary condition could be agreement between fuel-air ratios arrived at from emissions and performance measurements within $\pm 10\%$. This would not, however, be a sufficient condition. The variability of smoke is typically greater than the variability of CO₂, the dominant species, and so additional work needs to be done. Because smoke, as with the gaseous emissions, seems to be normally (gaussian) distributed, in the core at least, standard statistical techniques can be used to estimate the mean value for the exhaust and the number of sampling points necessary to arrive at the required confidence level. The information to do this can come from prior data or from trial traverses on the current or previous, similar, engines. Note that evidence of a satisfactory probe design can be as simple as having proven the design on a previous, similar, engine. Similarity would, then, need to be proven to the certifying authority.

The smoke sampling and measurement procedures standardized in ICAO Annex 16, Volume II, second edition, 1993, Appendix 2, are derived from an SAE standard, SAE Aerospace Recommended Practice (ARP) 1179, Aircraft Gas Turbine Exhaust Smoke Measurement. ARP 1179, first issued in 1971, is the result of a collaborative government/industry effort to develop a consensus standard for measuring smoke from these sources. It is a dynamic standard which is actively managed by the SAE E-31 committee but has changed little over the years. ICAO maintains an observer on the E-31 committee. Agreeable changes in ARP 1179 can be reflected in future versions of ICAO Appendix 2. With the ICAO procedures being called out by reference (40 CFR part 87), any changes in Appendix 2 will necessarily be reflected in the requirements of Part 34.

The relationship of CO₂ to fuel is straight forward given the fuel formulation. For example, a typical kerosenic fuel in the middle of the specification for fuel hydrogen mass ration would have a formulation C₁₂H₂₃. Knowing the atomic weights of carbon (12) and Hydrogen (1.008) you calculate the relative mass of carbon in this fuel molecule to be 0.86, or 1 kg of fuel would contain 0.86 kg of carbon. Taking the atomic weight of oxygen to be 16, a similar calculation shows that 1 kg of fuel, upon complete combustion, would yield 3.16 kg of CO₂ (these numbers are rounded for illustrative purposes). For an engine running at high power, say a fuel to air of 0.02 kg fuel/kg air the resulting CO₂ mass ratio would be $.02 \times 3.16$ or approximately .063 kg CO₂ per kg of air. Taking the molecular weight of CO₂ to be 44.01, air to be 28.96 and the specific weight of air to be 1.225 kg/m³ the volumetric ratio is seen to be 0.0416 or 4.16%. Since CO₂ instruments read in volumetric percent, this is the value the instrument should read when the engine is operating at 0.02 f/a. Obviously the reverse calculation, fuel to air ratio from measured volumetric CO₂, proceeds in a similar fashion. This relationship is convenient as a nominal indicator of sampling status assuming you know the fuel to air ratio, i.e., by multiplying the fuel to air ratio by 200 you should arrive at an approximate value of CO₂ in volumetric percent.

26. §34.81 Fuel Specifications

Fuel having specifications as provided in §34.61 shall be used in smoke emission testing.

Supplemental information

The requirement for emissions certification testing with a fuel which meets a particular specification provides a fixed point of reference for the engine. It provides for some degree of control over the effect of fuel composition on smoke formation and emission. It also helps in the assessment of the

effects of changing technology. It will not ensure continued conformance to the smoke emissions standards if a fuel outside of the ICAO fuel specification is used in practice.

27. §34.82 Sampling and analytical procedures for measuring - smoke exhaust emissions

The system and procedures for sampling and measurement of smoke emissions shall be done in accordance with Appendix 2 to International Civil Aviation Organization (ICAO) Annex 16, Volume II—Aircraft Engine Emissions, Second Edition, July 1993. This incorporation by reference was approved by the Director of the Federal Register in accordance with 5 U.S.C. 552(a) and 1 CFR part 51. These materials are incorporated as they exist on the date of the approval and a notice of any change in these materials will be published in the Federal Register. Frequent changes are not anticipated. This document can be obtained from the International Civil Aviation, P.O. Box 400, Succursale: Place de L' Aviation Internationale, 1000 Sherbrooke Street West, Montreal, Quebec, Canada H3H 2R2. Copies may be inspected at the FAA Office of the Chief Counsel, Rules Docket, room 916, Federal Aviation Administration Headquarters Building, 800 Independence Avenue, SW., Washington, DC, or at the FAA New England Regional Office, 12 New England Executive Park, Burlington, Massachusetts, or at the Office of the Federal Register, 800 North Capitol Street, NW., suite 700, Washington, DC.

Supplemental information

ICAO Appendix 2 was derived, almost exclusively, from SAE Aerospace Recommended Practice ARP1179 "Aircraft Gas Turbine Engine Exhaust Smoke Measurement." This Aerospace Recommended Practices and, by implication, ICAO Appendix 2 truly represents a significant cross section of the affected aircraft community. The U.S. government was represented by the EPA and precedents, the FAA, Bureau of Mines, NASA, Air Force and the Navy. The commercial sector included airlines, airframe manufacturers, engine manufacturers, fuel suppliers, calibration gas suppliers and instrument manufacturers. Over the years, as the methods evolved, many tests were conducted both by individual groups and as collaborative efforts. Data and information that resulted was freely shared, discussed and factored into this ARP as appropriate. The method that resulted, while not perfect, is well understood, repeatable and is robust. However there are some problems which have arisen due to changing engine designs and the intent of ensuring low visibility exhaust plumes.

28. §34.83 – 34.88 [Reserved]

29. §34.89 Compliance with smoke emission standards

Compliance with each smoke emission standard shall be determined by comparing the plot of the smoke number as a function of power setting with the applicable emission standard under this part. The smoke number at every power setting must be such that there is a high degree of confidence that the standard will not be exceeded by any engine of the model being tested. An acceptable alternative to testing every engine is described in Appendix 6 to ICAO, Annex 16, Environmental Protection, Volume II, Aircraft Engine Emissions, Second Edition, July 1993. This incorporation by reference was approved by the Director of the Federal Register in accordance with 5 U.S.C. 552(a) and 1 CFR part 51. This document can be obtained from the address listed in 34.64. Other methods of demonstrating compliance may be approved by the Administrator with the concurrence of the Administrator of the EPA.

Supplemental information

In agreeing to use the ICAO Compliance procedures, EPA has concluded, by implication, that the combination of the test and the compliance procedures will result in assurance that, with 90% confidence 100% of the engines produced, model and type, will meet the smoke standard if the engine or engines tested for smoke, meet the standard.

[THIS PAGE INTENTIONALLY LEFT BLANK]

IX. ICAO MANUAL APPENDIX 6

ICAO MANUAL APPENDIX 6. COMPLIANCE PROCEDURE FOR GASEOUS EMISSIONS AND SMOKE

1. GENERAL

The following general principles shall be followed for compliance with the regulatory levels set forth in Volume II, Part III, 2.2, 2.3, 3.2 and 3.3 of this Annex:

- a) the manufacturer shall be allowed to select for certification testing any number of engines, including a single engine if so desired;*
- b) all the results obtained during the certification tests shall be taken into account by the certification authority;*
- c) a total of at least 3 engine tests shall be conducted, so that if a single engine is presented for certification it must be tested at least 3 times;*
- d) if a given engine is tested several times, the arithmetic mean value of the tests shall be considered to be the mean value for that engine. The certification result (x) is then the mean of the values (X) obtained for each engine tested;*
- e) the manufacturer shall provide to the certifying authority, the information specified in Volume II, Part III, 2.4 or 3.4 of this Annex as appropriate;*
- f) the engines submitted for testing shall have emissions features representative of the engine type for which certification is sought. However, at least one of the engines shall be substantially configured to the production standard of the engine type and have fully representative operating and performance characteristics. One of these engines shall be declared to be the reference standard engine. The methods for correcting to this reference standard engine from any other engines tested shall have the approval of the national certifying authority. The methods for correcting test results for ambient effects shall be those outlined in 7 of Appendix 3 or 7 of Appendix 5, as applicable.*

2. COMPLIANCE PROCEDURES

The certifying authority shall award a certificate of compliance if the mean of the values measured and corrected (to the reference standard engine and reference ambient conditions) for all the engines tested, when converted to a characteristic level using the appropriate factor which is determined by the number of engines tested (i) as shown in the table below, does not exceed the regulatory level.

Note.- The characteristic level of the Smoke Number or gaseous pollutant emissions is the mean of the values of all the engines tested, measured and corrected to the reference standard engine and reference ambient conditions divided by the coefficient corresponding to the number of engines tested. as shown in the table below

Number of engines tested (i)	CO	HC	NO _x	SN
1	0.814 7	0.649 3	0.862 7	0.776 9
2	0.877 7	0.768 5	0.909 4	0.852 7
3	0.924 6	0.857 2	0.944 1	0.909 1
4	0.934 7	0.876 4	0.951 6	0.921 3
5	0.941 6	0.889 4	0.956 7	0.929 6
6	0.946 7	0.899 0	0.960 5	0.935 8
7	0.950 6	0.906 5	0.963 4	0.940 5
8	0.953 8	0.912 6	0.965 8	0.944 4
9	0.956 5	0.917 6	0.967 7	0.947 6
10	0.958 7	0.921 8	0.969 4	0.950 2
more than 10	$1 - \frac{0.130 59}{\sqrt{i}}$	$1 - \frac{0.247 24}{\sqrt{i}}$	$1 - \frac{0.096 78}{\sqrt{i}}$	$1 - \frac{0.157 36}{\sqrt{i}}$

3. PROCEDURE IN THE CASE OF FAILURE

Note.- when a certification test fails, it does not necessarily mean that the engine type does not comply with the requirements, but it may mean that the confidence given to the certifying authority in compliance is not sufficiently high, i.e. less than 90 per cent. Consequently, the manufacturer should be allowed to present additional evidence of engine type compliance.

- 3.1 *If an engine type fails a certification test, the certifying authority shall permit the manufacturer, if he so wishes, to conduct additional tests on the certification engines. If the total results available still show that the engine type fails the certification requirements, the manufacturer shall be allowed to test as many additional engines as desired. The resulting test results shall then be considered with all previous data.*
- 3.2 *If the result is still failure, the manufacturer shall be allowed to select one or more engines for modification. The results of the tests already made on the selected engine(s) while unmodified shall be inspected, and further testing shall be done so that at least three tests are available. The mean of these tests shall be determined for each engine and described as the "unmodified mean"*
- 3.3 *The engine(s) may then be modified, and at least three tests shall be conducted on the modified engine(s), the mean of which shall be described as the "modified mean" in each case. This "modified mean" shall be compared to the "unmodified mean" to give a proportional improvement which shall then be applied to the previous certification test result to determine if compliance has been achieved. It shall be determined before testing of any modified engine is begun that the modification(s) comply with the appropriate airworthiness requirements.*
- 3.4 *This procedure shall be repeated until compliance has been demonstrated or the engine type application is withdrawn.*

4. REPORTING OF DATA TO THE CERTIFICATING AUTHORITY

The measured data shall be reported to the certifying authority. In addition the following data shall be reported for each test:

- a) sample temperature;*
- b) sample pressure;*
- c) actual sample volume at sampling conditions;*
- d) actual sample flow rate as sampling conditions; and*
- e) leak and cleanliness checks substantiation (see 2.5.2)*

[THIS PAGE INTENTIONALLY LEFT BLANK]

**X. ICAO MANUAL APPENDIX 3
INSTRUMENTATION AND MEASUREMENT TECHNIQUES
FOR GASEOUS EMISSIONS**

1. INTRODUCTION

Note. — The procedures specified in this appendix are concerned with the acquisition of representative exhaust samples and their transmission to, and analysis by, the emissions measuring system. The procedures do not apply to engines employing afterburning. The methods proposed are representative of the best readily available and most established practice.

Variations in the procedure contained in this appendix shall only be allowed after prior application to and approval by the certificating authority.

Supplemental Information

The methods recommended in ICAO Annex 16 Volume II, Second Edition, 1993 were adopted from SAE Aerospace Recommended Practice ARP 1256, "Procedure for the Continuous Sampling and Measurement of Gaseous Emissions from Aircraft Turbine Engines". ARP 1256 was first issued 10-1-71, by SAE committee E-31, Aircraft Exhaust Emission Measurement. This ARP was developed by user groups in the aircraft industry who were interested in measuring and understanding emissions from aircraft gas turbine engines. Subsequent to the issuance of ARP 1256, in 1971, the methods proposed were, with the exception of NO_x, adopted by the EPA in 40 CFR part 87, Part II, December 12, 1972.

The exception in NO_x measurement involved the adoption of chemiluminescence by the EPA in 40 CFR 87 and NDIR/NDUV by SAE E-31 in ARP 1256. Chemiluminescence, although a new technique at the time, was clearly the superior method and quickly adopted by the user community, incorporated into ARP 1256, replacing NDIR/NDUV, and recommended by ICAO in Annex 16, Volume II, first edition, 1981. The methods of measurement recommended in ICAO Annex 16, Volume II, first edition, 1981 were incorporated, by reference, into EPA 40 CFR 87, in 1982, Federal Register, Vol. 47, No. 251. These recommended methods represent the best readily available and most established practice.

2. DEFINITIONS

Where the following expressions are used in this appendix, they have the meanings ascribed to them below:

- (1) *Accuracy. The closeness with which a measurement approaches the true value established independently.*
- (2) *Air/fuel ratio. The mass rate of airflow through the hot section of the engine divided by the mass rate of fuel flow to the engine.*
- (3) *Calibration gas. A high accuracy reference gas to be used for alignment, adjustment and periodic checks of instruments.*
- (4) *Concentration. The volume fraction of the component of interest in the gas mixture - expressed as volume percentage or as parts per million.*
- (5) *Exhaust nozzle. In the exhaust emissions sampling of gas turbine engines where the jet effluxes are not mixed (as in some turbofan engines for example) the nozzle considered is that for the gas generator (core) flow only. Where, however, the jet efflux is mixed the nozzle considered is the total exit nozzle.*
- (6) *Flame ionization detector. A hydrogen-air diffusion flame detector that produces a signal nominally proportional to the mass-flow rate of hydrocarbons entering the flame per unit of time -*

generally assumed responsive to the number of carbon atoms entering the flame.

- (7) Interference. Instrument response due to presence of components other than the gas (or vapour) that is to be measured.
- (8) Noise. Random variation in instrument output not associated with characteristics of the sample to which the instrument is responding, and distinguishable from its drift characteristics.
- (9) Non-dispersive infra-red analyser. An instrument that by absorption of infra-red energy selectively measures specific components.
- (10) Parts per million (ppm). The unit volume concentration of a gas per million unit volume of the gas mixture of which it is a part.
- (11) Parts per million carbon (ppmC). The mole fraction of hydrocarbon multiplied by 10^6 measured on a methane-equivalence basis. Thus, 1 ppm of methane is indicated as 1 ppmC. To convert ppm concentration of any hydrocarbon to an equivalent ppmC value, multiply ppm concentration by the number of carbon atoms per molecule of the gas. For example, 1 ppm propane translates as 3 ppmC hydrocarbon, 1 ppm hexane as 6 ppmC hydrocarbon.
- (12) Reference gas. A mixture of gases of specified and known composition used as the basis for interpreting instrument response in terms of the concentration of the gas to which the instrument is responding.
- (13) Repeatability. The closeness with which a measurement upon a given, invariant sample can be reproduced in short-term repetitions of the measurement with no intervening instrument adjustment.
- (14) Resolution. The smallest change in a measurement which can be detected.
- (15) Response. The change in instrument output signal that occurs with change in sample concentration. Also the output signal corresponding to a given sample concentration.
- (16) Stability. The closeness with which repeated measurements upon a given invariant sample can be maintained over a given period of time.
- (17) Zero drift. Time-related deviation of instrument output from zero set point when it is operating on gas free of the component to be measured.
- (19) Zero gas. A gas to be used in establishing the zero, or no-response, adjustment of an instrument.

3. DATA REQUIRED

3.1 Gaseous emissions

Concentrations of the following emissions shall be determined:

- (a) Hydrocarbons (HC): a combined estimate of all hydrocarbon compounds present in the exhaust gas.

Supplemental information

Gas turbine engine exhaust gases typically contain a variety of hydrocarbon compounds. The specific compounds present and their relative concentrations are usually unknown. Flame Ionization Detectors (FID), used to measure hydrocarbons, do not respond equally to all hydrocarbon compounds - differential hydrocarbon response. Although the differential hydrocarbon response is to be held within specific bounds, the resulting measurement is an estimate of the hydrocarbon compounds present in the exhaust gas.

(b) Carbon monoxide (CO).

(c) Carbon dioxide (CO₂).

Note.— CO₂ is not considered a pollutant but its concentration is required for calculation and check purposes.

(d) Oxides of nitrogen (NO_x) an estimate of the sum of the two oxides, nitric oxide (NO) and nitrogen dioxide (NO₂).

(e) Nitric oxide (NO).

Supplemental information

The measurement of oxides of nitrogen, using an NO specific device, requires the conversion of NO₂ in the exhaust gas to NO. The conversion efficiency of the device used must be known and must be greater than 90%. Measurements of NO_x are adjusted for conversion efficiency. The resulting values are considered to be estimates of the NO_x concentration in the exhaust gas.

3.2 Other information

In order to normalize the emissions measurement data and to quantify the engine test characteristics, the following additional information shall be provided:

- *inlet temperature;*
- *inlet humidity;*
- *atmospheric pressure;*
- *hydrogen/carbon ratio of fuel;*
- *other required engine parameters (for example, thrust, rotor speeds, turbine temperatures and gas-generator air flow).*

This data shall be obtained either by direct measurement or by calculation as presented in Attachment F to this appendix.

4. GENERAL ARRANGEMENT OF THE SYSTEM

No desiccants, dryers, water traps or related equipment shall be used to treat the exhaust sample flowing to the oxides of nitrogen and the hydrocarbon analysis instrumentation. Requirements for the various component sub-systems are given in 5, but the following list gives some qualifications and variations:

- a) *it is assumed that each of the various individual sub-systems includes the necessary flow control, conditioning and measurement facilities;*
- b) *the necessity for a dump and/or a hot-sample pump will depend on ability to meet the sample transfer time and analysis sub-system sample flow rate requirements. This in turn depends on the exhaust sample driving pressure and line losses. It is considered that these pumps usually will be necessary at certain engine running conditions; and*
- c) *the position of the hot pump, relative to the gas analysis sub-systems, may be varied as required. (For example, some HC analysers contain hot pumps and so may be judged capable of being used upstream of the system hot pump.)*

Note.- Figure A3-1 is a schematic drawing of the exhaust gas sampling and analytical system and typifies the basic requirements for emissions testing.

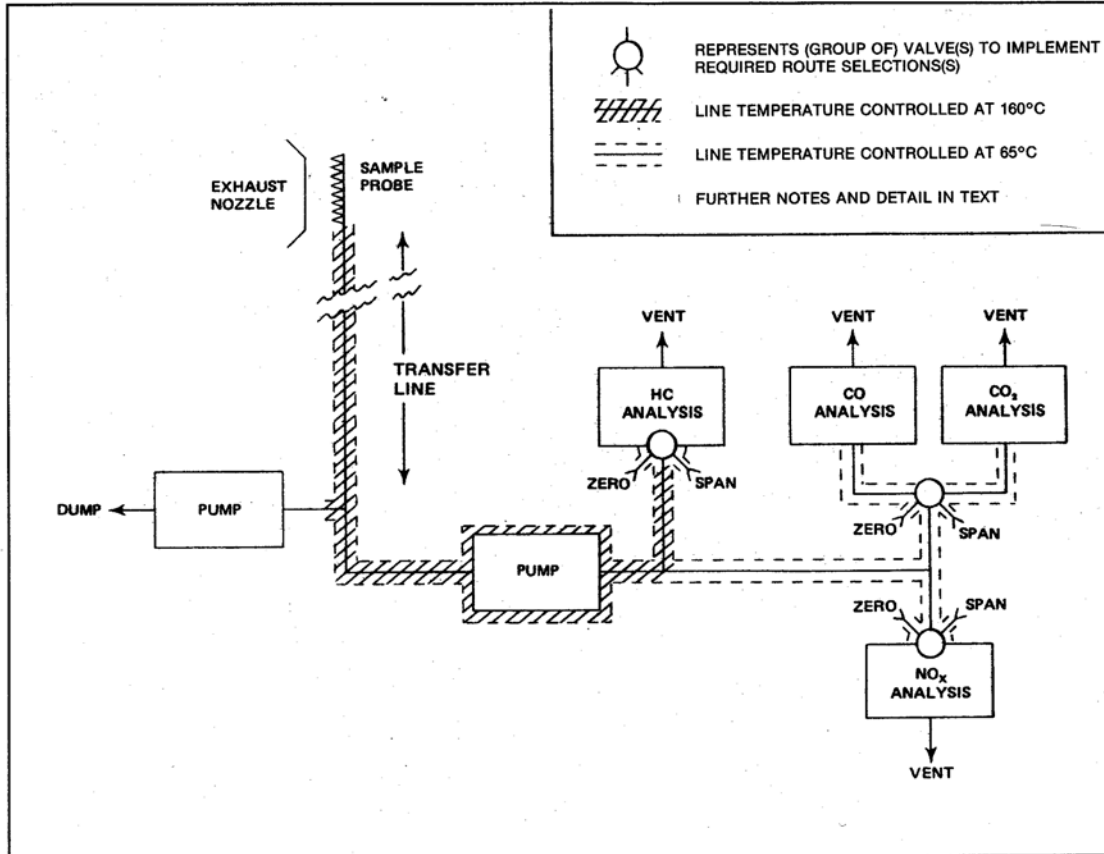

Figure A3-1 Sampling and Analysis System

Supplemental information

Water is a major product of combustion. Its removal upstream of the measuring instruments is desirable. Removal would minimize possible interference effects, where the instrument responds to the water present as well as to the gas or vapor being measured. It would also prevent or minimize water condensing in the instruments, which could cause erratic flow and/or contamination. In the worst case the instrument would be rendered inoperable until thoroughly cleaned. Some devices which remove water are known to remove hydrocarbons and oxides of nitrogen as well.

For most aircraft gas turbine engines and most engine running modes, supplemental pumps will be needed to match the engine exhaust flow with the probe system pressure drop mandated requirement (80% at the probe entrance orifices), the sample line residence time and pressure drop, and the need to remove excess flow from the sampling system. In general the size and location of the pumps and the associated flow control devices are determined from the particular sampling system configuration.

Pumps used for the purpose of sample transfer must be heated. Their location is determined by the particular test configuration. Usually, because of the sample gas physical properties and the need to maintain temperature and flow control within the FID used for hydrocarbon analysis, some instruments utilize internal heated, inert sample transfer pumps. If loss of hydrocarbons in the sampling system is a concern, the FID can be located upstream of the system hot pump as close as physical constraints will allow (temperature, noise, vibration).

5. DESCRIPTION OF COMPONENT PARTS

Note.— A general description and specification of the principal elements in the engine exhaust emissions measurement system follows. Greater detail, where necessary, will be found in Attachments A, B and C to this appendix.

5.1 Sampling system

5.1.1 Sampling probe

- a) *The probe shall be made of stainless steel. If a mixing probe is used, all sampling orifices shall be of equal diameter;*
- b) *the probe design shall be such that at least 80 per cent of the pressure drop through the probe assembly is taken at the orifices;*

Supplemental information

While there is no need to approximate isokinetic conditions when sampling for non-particulates, good practice requires minimum disturbance to the sampled stream as practical. This is especially true when there is concern over spatial variability in gas species concentration, which is the case for the gas turbine engine exhaust plume.

- c) *the number of sampling orifices shall not be less than 12;*

Supplemental information

12 sampling orifices, for an averaging probe, or 12 sampling points for a single point traversing probe, should be considered acceptable only in extreme circumstances or when this number of sampling points has clearly been demonstrated to yield a representative sample.

- d) *the sampling plane shall be as close to the engine exhaust nozzle exit plane as permitted by considerations of engine performance but in any case shall be within 0.5 nozzle diameter of the exit plane;*

Supplemental information

For non-coplanar fan/core exhaust nozzles, care must be taken in locating the sampling plane within 0.5 nozzle diameters of the exit plane inasmuch as there can be two exit planes. The exit plane, from which this distance is measured, is the plane of the final exhaust nozzle – usually the core. The distance allowed would be determined from the larger, fan exhaust nozzle. Further, for these engines, locating the sampling probe as close to the engine exhaust nozzle exit plane as permitted could compromise the requirement to make measurements of the 'total exit nozzle' as defined. Given this ambiguity and the requirement to determine the concentration of species generated by the engine – restricted to the core flow until mixed out – every effort should be made to sample core flow only. This may require a special extension to the core nozzle which will require FAA approval.

and

- e) *the applicant shall provide evidence to the certificating authority, by means of detailed traverses, that the proposed probe design and position does provide a representative sample for each prescribed power setting.*

Supplemental information:

There are no standard definitions of representative sample for emissions from aircraft gas turbine engines nor is there a specification for detailed traverse. The most commonly used definition, arrived at from decades of testing and collaborative analytical exercises by user groups, seems to be the following: for engine modes above idle, (i.e., approach, climb-out and take-off) the integrated average of the measured species should agree with the true average within 10 %. For idle this agreement is $\pm 15\%$.

This is similar to the values quoted in section 6.4 of this Appendix, for the carbon balance check. However there is a significant difference. For the carbon balance check, a comparison is made between sets of independently related measured values. With knowledge about the combustion process and the hydrogen to carbon ratio of the fuel used, an estimate can be made from the measured carbon containing species – most of which is CO_2 , – of the engine average fuel-to-air ratio. The engine fuel-to-air ratio can be independently arrived at from measured fuel and airflow. These two values can be compared and an estimate made of how well the exhaust stream was sampled for carbon containing compounds. However, as mentioned, CO_2 far outweighs the influence of any other carbon bearing species in the calculation of fuel-to-air ratios. The spatial variability of CO_2 will determine how many sampling points are required and how these sampling points should be distributed. CO_2 has been found to consistently exhibit the least variability of all the species of interest – CO , HC , NO_x , and smoke. This suggests that it would be possible to meet the criteria – for carbon balance without having obtained a representative sample – using the same 10 and 15% criteria, of the other species. In other words, obtaining a carbon balance, while a necessary condition for a representative sample, can not be considered to be a sufficient condition.

Historically, each engine manufacturer or testing agency appears to have addressed this problem in unique and sometimes novel ways. The simplest method is as follows:

- Recognizing that gas turbine engines are, for most emissions sampling purposes, axi-symmetric, sample the exhaust plume, point by point, with a sufficient number of points to be able to estimate, by statistical means, the true engine average species concentration for each of the species of interest. Engine exhaust species are close enough to normally (Gaussian) distributed to make simple statistical tools acceptable.
- Using these sampling points and the measured concentration values, for each of the species of interest, analytically generate contour plots of constant concentration (isopleths) at each power setting tested. There are a number of computer programs available for workstations or desktop computers to do this.
- For any given probe or rake design analytically overlay the design on the contour plots, estimate the average probe/rake values and compare to the estimated true average arrived at from the detailed traverse.

If the comparisons match the carbon balance criteria, within 10% for engine powers above idle and $\pm 15\%$ at idle, the probe/rake can be considered to be representative. This process may have to be repeated until an acceptable design is found.

When applying this analytical technique (for core flow only), multiport rake designs which have proven most robust have four sampling arms spaced 90 degrees apart with sampling orifices located on centers of equal area. The sampling ports are equally distributed across the sampling arms. The analysis will determine the minimum number of sampling ports necessary to yield a representative sample.

All data used in arriving at a probe/rake design should be made available to the certifying agency.

5.2 HC analyser

The measurement of total hydrocarbon sample content shall be made by an analyser using the heated flame ionization detector (FID), between the electrodes of which passes an ionization current proportional to the mass rate of hydrocarbon entering a hydrogen flame. The analyser shall be deemed to include components arranged to control temperature and flow rates of sample, sample bypass, fuel and diluent gases, and to enable effective span and zero calibration checks.

Note. — An over-all specification is given in Attachment A to this appendix

5.3 CO and CO₂ analysers

Non-dispersive infra-red analysers shall be used for the measurements of these components, and shall be of the design which utilizes differential energy absorption in parallel reference and sample gas cells, the cell or group of cells for each of these gas constituents being sensitized appropriately. This analysis sub-system shall include all necessary functions for the control and handling of sample, zero and span gas flows. Temperature control shall be that appropriate to whichever basis of measurement, wet or dry, is chosen.

Note.— An over-all specification is given in Attachment B to this appendix

5.4 NO_x analyser

The measurement of NO concentration shall be by the chemiluminescent method in which the measure of the radiation intensity emitted during the reaction of the NO in the sample with added O₃ is the measure of the NO concentration. The NO₂ component shall be converted to NO in a converter of the requisite efficiency prior to measurement. The resultant NO_x measurement system shall include all necessary flow, temperature and other controls and provide for routine zero and span calibration as well as for converter efficiency checks.

Note. — An over-all specification is given in Attachment C to this appendix

6. GENERAL TEST PROCEDURES

6.1 Engine operation

6.1.1 The engine shall be operated on a static test facility which is suitable and properly equipped for high accuracy performance testing.

6.1.2 The emissions tests shall be made at the power settings prescribed by the certificating authority. The engine shall be stabilized at each setting.

6.2 Major Instrument calibration

Note. — The general objective of this calibration is to confirm stability and linearity.

6.2.1 The applicant shall satisfy the certificating authority that the calibration of the analytical system is valid at the time of the test.

6.2.2 For the hydrocarbon analyser this calibration shall include checks that the detector oxygen and differential hydrocarbon responses are within the limits specified, as laid down in Attachment A to this appendix. The efficiency of the NO₂/NO converter shall also be checked and verified to meet the requirements in Attachment C to this appendix.

6.2.3 *The procedure for checking the performance of each analyser shall be as follows (using the calibration and test gases as specified in Attachment D to this appendix):*

- a) *introduce zero gas and adjust instrument zero, recording setting as appropriate;*
- b) *for each range to be used operationally, introduce calibration gas of (nominally) 90 per cent range full-scale deflection (FSD) concentration; adjust instrument gain accordingly and record its setting;*
- c) *introduce approximately 30 per cent, 60 per cent, and 90 per cent range FSD concentration and record analyser readings;*
- d) *fit a least squares straight line to the zero, 30 per cent, 60 per cent and 90 per cent concentration points. For the CO and/or CO₂ analyser used in their basic form without linearization of output, a least squares curve of appropriate mathematical formulation shall be fitted using additional calibration points if judged necessary. If any point deviates by more than 2 per cent of the full scale value (or ± 1 ppm*, whichever is greater) then a calibration curve shall be prepared for operational use.*

** Except for the CO₂ analyser, for which the value shall be ± 100 ppm.*

*** A more comprehensive and precise alternative methodology which is acceptable is presented in Attachment E to this appendix.*

Supplemental Information:

For most, if not all modern analyzers, the adjustment and recording of settings is performed by an internal computer. When the computer stores the calibration coefficients and generates a least square curve for each operational range, this should be considered equivalent to those system controls performed manually in older systems as described in 6.2.3.

6.3 Operation

6.3.1 *No measurements shall be made until all instruments and sample transfer lines are warmed up and stable and the following checks have been carried out:*

- a) *leakage check: prior to a series of tests the system shall be checked for leakage by isolating the probe and the analysers, connecting and operating a vacuum pump of equivalent performance to that used in the smoke measurement system to verify that the system leakage flow rate is less than 0.4 L/min referred to normal temperature and pressure;*
- b) *cleanliness check: isolate the gas sampling system from the probe and connect the end of the sampling line to a source of zero gas. Warm the system up to the operational temperature needed to perform hydrocarbon measurements. Operate the sample flow pump and set the flow rate to that used during engine emission testing. Record the hydrocarbon analyser reading. The reading shall not exceed 1 per cent of the engine idle emission level or 1 ppm (both expressed as methane), whichever is the greater.*

Note 1.— It is good practice to back-purge the sampling lines during engine running, while the probe is in the engine exhaust but emissions are not being measured. to ensure that no significant contamination occurs.

Note. 2.— It is also good practice to monitor the inlet air quality at the start and end of testing and at least once per hour during a test. If levels are considered significant, then they should be taken into account.

6.3.2 *The following procedure shall be adopted for operational measurements:*

- a) apply appropriate zero gas and make any necessary instrument adjustments;
- b) apply appropriate calibration gas at a nominal 90 per cent FSD concentration for the ranges to be used, adjust and record gain settings accordingly;
- c) when the engine has been stabilized at the requisite operating mode, continue to run it and observe pollutant concentrations until a stabilized reading is obtained, which shall be recorded;
- d) recheck zero and calibration points at the end of the test and also at intervals not greater than 1 hour during tests. If either has changed by more than ± 2 per cent of range FSD, the test shall be repeated after restoration of the instrument to within its specification.

6.4 Carbon balance check

Each test shall include a check that the air/fuel ratio as estimated from the integrated sample total carbon concentration exclusive of smoke, agrees with the estimate based on engine air/fuel ratio within ± 15 per cent for the taxi/ground idle mode, and within 10 per cent for all other modes (see 7.1.2).

7. CALCULATIONS

7.1 Gaseous emissions

7.1.1 General

The analytical measurements made shall be the concentrations of the various classes of pollutant, as detected at their respective analysers for the several engine operation modes, and these values shall be reported. In addition, other parameters shall be computed and reported, as follows**.

** A more comprehensive and precise alternative methodology which is acceptable is presented in Attachment E to this appendix.

7.1.2 Basic parameters

$$EI(\text{CO}) = \left(\frac{[\text{CO}]}{[\text{CO}_2] + [\text{CO}] + [\text{HC}]} \right) \left(\frac{10^3 M_{\text{CO}}}{M_{\text{C}} + (n/m) M_{\text{H}}} \right) (1 + T (P_0/m))$$

$$EI(\text{HC}) = \left(\frac{[\text{HC}]}{[\text{CO}_2] + [\text{CO}] + [\text{HC}]} \right) \left(\frac{10^3 M_{\text{HC}}}{M_{\text{C}} + (n/m) M_{\text{H}}} \right) (1 + T (P_0/m))$$

$$EI(\text{NO}_x) = \left(\frac{[\text{NO}_x]}{[\text{CO}_2] + [\text{CO}] + [\text{HC}]} \right) \left(\frac{10^3 M_{\text{NO}_x}}{M_{\text{C}} + (n/m) M_{\text{H}}} \right) (1 + T (P_0/m))$$

Supplemental information:

The basic descriptive parameter for gaseous emissions is the emission index (EI), defined as the mass of a product of combustion, in grams, divided by the mass of fuel used in kilograms, i.e., grams per kilogram.

$$\text{Air / fuel ratio} = (P_0/m) \left[\frac{M_{\text{AIR}}}{M_{\text{C}} + (n/m)M_{\text{H}}} \right]$$

where:

and:

$$Z = \frac{2 - [\text{CO}] - \left(\left[\frac{2}{x} \right] - \left[\frac{y}{2x} \right] \right) [\text{HC}] + [\text{NO}_2]}{[\text{CO}_2] + [\text{CO}] + [\text{HC}]}$$

M_{AIR} Molecular mass of dry air = 28.966 g or, where appropriate, = (32 R + 28.156 4 S + 44.011 7) g

M_{HC} molecular mass of exhaust hydrocarbon, taken as CH_4 = 16.043 g

M_{CO} molecular mass of CO = 28.011 g

M_{NO_2} molecular mass of NO_2 = 46.008 g

M_{C} molecular mass of carbon = 12.011 g

M_{H} molecular mass of hydrogen = 1.008 g

R concentration of O_2 in dry air, by volume = 0.209 5 normally

S concentration of N_2 + rare gases in dry air, by volume = 0.709 2 normally

T concentration of CO_2 in dry air, by volume = 0.000 3 normally

[HC] mean concentration of exhaust hydrocarbons vol/vol, expressed as carbon

[CO] mean concentration of CO vol/vol, wet

[CO_2] mean concentration of CO_2 vol/vol, wet

[NO_x] mean concentration of NO_x vol/vol, wet = [NO + NO_2]

[NO] mean concentration of NO in exhaust sample, vol/vol, wet

[NO_2] mean concentration of NO_2 in exhaust sample, vol/vol, wet

$$= \frac{([\text{NO}_x]_c) - [\text{NO}]}{\eta}$$

[NO_x]_c mean concentration of NO in exhaust sample after passing through the NO_2/NO converter, vol/vol, wet

η efficiency of NO_2/NO converter

h humidity of ambient air, vol water/vol dry air

m number of C atoms in characteristic fuel molecule

n number of H atoms in characteristic fuel molecule

x number of C atoms in characteristic exhaust hydrocarbon molecule

y number of H atoms in characteristic exhaust hydrocarbon molecule

The value of n/m , the ratio of the atomic hydrogen to atomic carbon of the fuel used, is evaluated by fuel type analysis. The ambient air humidity, h , shall be measured at each set condition. In the absence of contrary evidence as to the characterization (x, y) of the exhaust hydrocarbons, the values $x=1, y=4$ are to be used. If dry or semi-dry CO and CO₂ measurements are to be used then these shall first be converted to the equivalent wet concentration as shown in Attachment E to this appendix, which also contains interference correction formulas for use as required.

7.1.3 Correction of emission indices to reference conditions

Corrections shall be made to the measured engine emission indices for all pollutants in all relevant engine operating modes to account for deviations from the reference conditions (ISA at sea level) of the actual test inlet air conditions of temperature and pressure. The reference value for humidity shall be 0.00629 kg water/kg dry air.

Thus, $EI_{corrected} = K \times EI_{measured}$, where the generalized expression for K is:

$$K = \left(P_{Bref} / P_B \right)^a \times \left(FAR_{ref} / FAR_B \right)^b \times \exp \left(d \left| T_{Bref} - T_B \right| / c \right) \times \exp \left(d \left| h - 0.00629 \right| \right)$$

P_B	Combustor inlet pressure, measured
T_B	Combustor inlet temperature, measured
FAR_B	Fuel/air ratio in the combustor
h	Ambient air humidity
P_{ref}	ISA sea level pressure
T_{ref}	ISA sea level temperature
P_{Bref}	Pressure at the combustor inlet of the engine tested (or the reference engine if the data is corrected to a reference engine) associated with T_B under ISA sea level conditions
T_{Bref}	Temperature at the combustor inlet under ISA sea level conditions for the engine tested (or the reference engine if the data is corrected to a reference engine). This temperature is the temperature associated with each thrust level specified for each mode.
FAR_{ref}	Fuel/air ratio in the combustor under ISA sea level conditions for the engine tested (or the reference engine if the data is to be corrected to a reference engine).
a, b, c, d	Specific constants which may vary for each pollutant and each engine type

The combustor inlet parameters shall preferably be measured but may be calculated from ambient conditions by appropriate formulas.

7.1.4 Using the recommended curve fitting technique to relate emission indices to combustor inlet temperature effectively eliminates the $\exp((T_{Bref} - T_B)/c)$ term from the generalized equation and for most cases the (FAR_{ref}/FAR_B) term may be considered unity. For the emissions indices of CO and HC many testing facilities have determined that the humidity term is sufficiently close to unity to be eliminated from the expression and that the exponent of the (P_{Bref}/P_B) term is close to unity.

Thus,

$EI(CO)_{corrected} = EI_{derived\ from}$
 $(P_B/P_{Bref}) EI(CO) \text{ v. } T_B, \text{ curve}$

$EI(HC)_{corrected} = EI_{derived\ from}$
 $(P_B/P_{Bref}) EI(HC) \text{ v. } T_B, \text{ curve}$

$EI(NO_x)$ corrected = EI derived from

$EI(NO_x) (P_{Bref}/P_B)^{0.5} \exp (19 |h - 0.006 29|)$ v. T_B curve

If this recommended method for the CO and HC emissions index correction does not provide a satisfactory correlation, an alternative method using parameters derived from component tests may be used.

Supplemental Information

In the generalized correction, for K the term (P_B/P_{Bref}) , (in the EI(CO) and EI(HC) expressions) should be (P_{Bref}/P_B)

Any other methods used for making corrections to CO, HC and NO, emission indices shall have the approval of the certificating authority.

7.2 Control parameter functions

(D_p, F_{oo}, π)

7.2.1 Definitions

D_p	The mass of any gaseous pollutant emitted during the reference emissions landing and take-off cycle.
F_{oo}	The maximum thrust available for take-off under normal operating conditions at ISA sea level static conditions, without the use of water injection, as approved by the applicable certificating authority.
π	The ratio of the mean total pressure at the last compressor discharge plane of the compressor to the mean total pressure at the compressor entry plane when the engine is developing take-off thrust rating at ISA sea level static conditions.

7.2.2 The emission indices (EI) for each pollutant, corrected for pressure and humidity (as appropriate) to the reference ambient atmospheric conditions as indicated in 7.1.4 and if necessary to the reference engine, shall be obtained for the required LTO engine operating mode settings (n) of idle, approach, climb-out and take-off, at each of the equivalent corrected thrust conditions. A minimum of three test points shall be required to define the idle mode. The following relationships shall be determined for each pollutant:

- between EI and T_B ; and
- between W_f (engine fuel mass flow rate) and T_B ; and
- between $F_{n,}$ (corrected to ISA sea level conditions) and T_B , (corrected to ISA sea level conditions);

Note. — These are illustrated, for example, by Figure 3-2 a), b) and c).

When the engine being tested is not a "reference" engine, the data may be corrected to "reference" engine conditions using the relationships b) and c) obtained from a reference engine. A reference engine is defined as an engine substantially configured to the description of the engine to be certificated and accepted by the certificating authority to be representative of the engine type for which certification is sought.

The manufacturer shall also supply to the certifying authority all of the necessary engine performance data to substantiate these relationships and for ISA sea level ambient conditions:

- d) maximum rated thrust (F_{oo}); and
- e) engine pressure ratio (π) at maximum rated thrust.

Note.— These are illustrated by Figure A3-2 d).

7.2.3 The estimation of EI for each pollutant at each of the required engine mode settings, corrected to the reference ambient conditions, shall comply with the following general procedure:

- a) at each mode ISA thrust condition F_n determine the equivalent combustor inlet temperature (T_B) (Figure 3-2 c));
- b) from the EI/T_B characteristic (Figure 3-2 a)), determine the EI_n value corresponding to T_B ;
- c) from the W_f/T_B characteristic (Figure 3-2 b)), determine the W_{fn} value corresponding to T_B ;

Note the ISA maximum rated thrust and pressure ratio values. These are F_{oo} and π respectively (Figure 3-2 d));

calculate, for each pollutant $D_p = \sum (EI_n)(W_{fn})(t)$

t time in LTO mode (minutes)

W_{fn} fuel mass flow rate (kg/min)

\sum is the summation for the set of modes comprising the reference LTO cycle.

7.2.4 While the methodology described above is the recommended method, the certifying authority may accept equivalent mathematical procedures which utilize mathematical expressions representing the curves illustrated if the expression have been derived using an accepted curve fitting technique

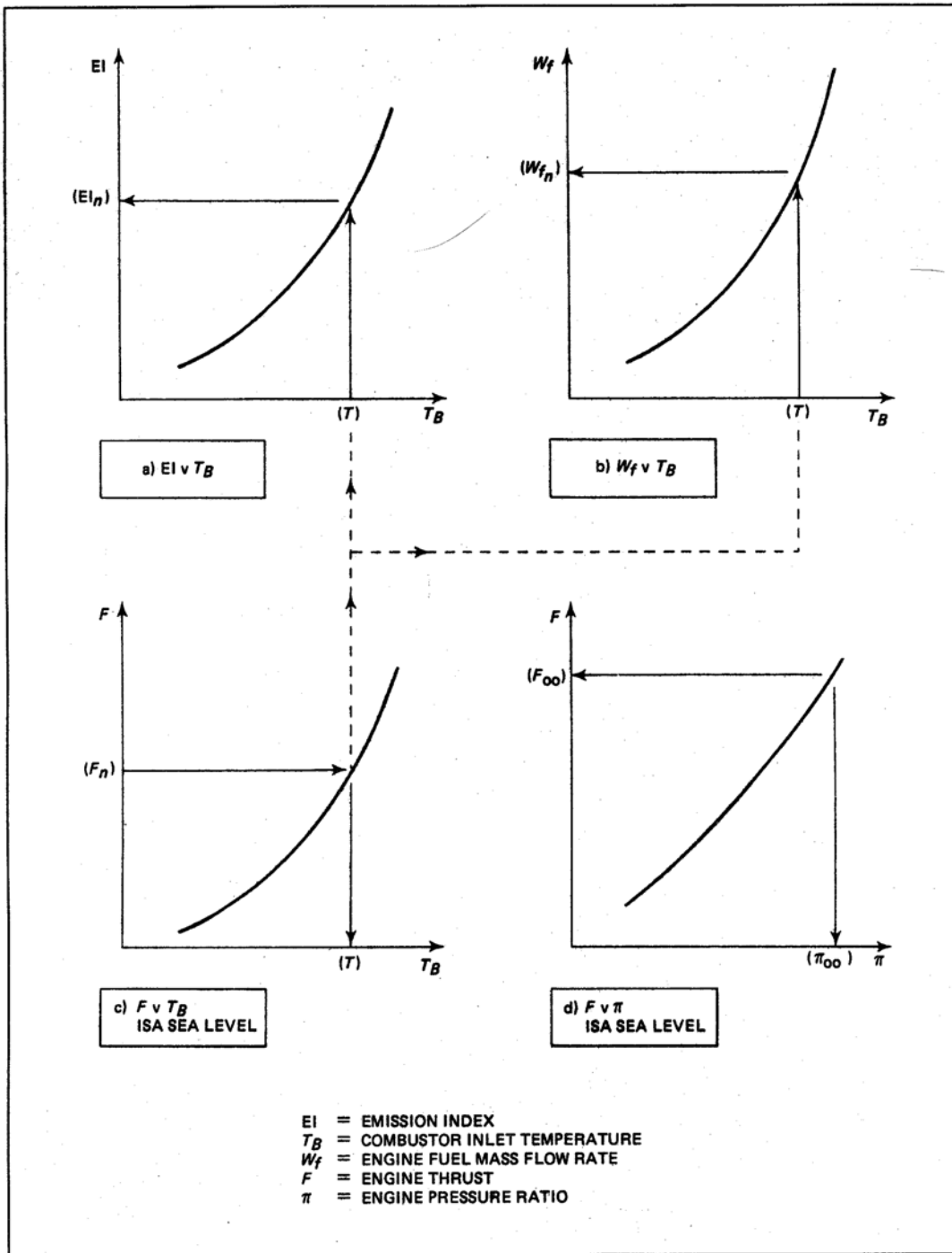

Figure A3-2 ICAO Calculation Procedure

7.3 Exceptions to the proposed procedures

In those cases where the configuration of the engine or other extenuating conditions exist which would prohibit the use of this procedure, the certifying authority, after receiving satisfactory technical evidence of equivalent results obtained by an alternative procedure, may approve an alternative procedure.

**ATTACHMENT A TO ICAO MANUAL APPENDIX 3.
SPECIFICATION FOR HC ANALYSER**

Note 1.- As outlined in 5.2 of Appendix 3, the measuring element in this analyser is the flame ionization detector (FID) in which the whole or a representative portion of the sample flow is admitted into a hydrogen-fueled flame. With suitably positioned electrodes an ionisation current can be established which is a function of the mass rate of hydrocarbon entering the flame. It is this current which, referred to an appropriate zero, is amplified and ranged to provide the output response as a measure of the hydrocarbon concentration expressed as ppmC equivalent.

Note 2. — See Attachment D for information on calibration and test gases.

1. GENERAL

Precautions: The performance specifications indicated are generally for analyser full scale. Errors at part scale may be a significantly greater percentage of reading. The relevance and importance of such increases shall be considered when preparing to make measurements. If better performance is necessary, then appropriate precautions shall be taken.

Supplemental information

The performance specifications for these analyzers, given in terms of full scale response, can have a significant and adverse impact on part scale measurements. In extreme instances, concentrations of HC at high power, such as take-off, can differ from concentrations at idle, by orders of magnitude e.g., 3,500 ppmC at idle and 10 ppmC at take-off. The FID specification suggests the high level can be 5,000 ppmC. For most modern engines the idle concentrations are considerably lower but still of concern when setting up the FID to maintain suitable accuracy of measurement. In general, where concentrations of species to be measured are known to vary this way, it is always good practice to use a multi-range instrument and to adjust ranges such as to keep the measurement in the upper 30% of the instrument response range. A measurement made at 20% of full scale could result in an error 5 times the error specified as a percent of full scale. Calibrations should be performed on each range used as required.

The instrument to be used shall be such as to maintain the temperature of the detector and sample-handling components at a set point temperature within the range 155°C to 165°C to a stability of ±2°C. The leading specification points shall be as follows, the detector response having been optimized and the instrument generally having stabilized:

Supplemental information

Stability is usually defined in terms of a time interval which, because this is a temperature control set point, can be taken as the duration of the test.

a) Total range: 0 to 5 000 ppmC in appropriate ranges.

Supplemental information

A total range of 0 to 5,000 ppmC, while appropriate for the engines in use when Annex 16 was published in 1981, is broader than needed for today's engines. Given practical limitations on instrument design the result could restrict the number of appropriate instrument ranges available in any single instrument. Restricting the number of ranges available makes it difficult to follow good measurement practices by restricting measurements to the upper 30% of range.

b) Resolution: better than 0.5 per cent of full scale of range used or 0.5 ppmC, whichever is greater.

- c) *Repeatability: better than ± 1 per cent of full scale of range used. or ± 0.5 ppmC. whichever is greater.*
- d) *Stability: better than ± 2 per cent of full scale of range used or ± 1.0 ppmC, whichever is greater, in a period of 1 hour.*
- e) *Zero drift: less than ± 1 per cent of full scale of range used or ± 0.5 ppmC, whichever is greater, in a period of 1 hour.*
- f) *Noise: 0.5 Hz and greater, less than ± 1 per cent of full scale of range used or ± 0.5 ppmC, whichever is greater.*

Supplemental information

The FID requires fuel and oxidant gases for operation. The fuel gas is typically either a mixture of hydrogen and nitrogen or hydrogen and helium. If the noise specification cannot be met and a hydrogen/nitrogen mixture is being used as the fuel gas, it sometimes helps to change to a hydrogen/helium mixture.

- g) *Response time: shall not exceed 10 seconds from inlet of the sample to the analysis system, to the achievement of 90 per cent of the final reading.*
- h) *Linearity: response with propane in air shall be linear for each range within ± 2 per cent of full scale, otherwise calibration corrections shall be used.*

Supplemental information

The performance specifications for the HC analyzer are typical of those analyzers offered by major instrument manufacturers.

2. SYNERGISTIC EFFECTS

Note.- In application there are two aspects of performance which can affect the accuracy of measurement:

- a) *the oxygen effect (whereby differing proportions of oxygen present in the sample give differing indicated hydrocarbon concentration for constant actual HC concentrations); and*
- b) *the relative hydrocarbon response (whereby there is a different response to the same sample hydrocarbon concentrations expressed as equivalent ppmC, dependent on the class or admixture of classes of hydrocarbon compounds).*

The magnitude of the effects noted above shall be determined as follows and limited accordingly.

Oxygen response: measure the response with two blends of propane, at approximately 500 ppmC concentration known to a relative accuracy of ± 1 per cent, as follows:

- 1) *propane in 10 ± 1 per cent O₂, balance N₂*
- 2) *propane in 21 ± 1 per cent O₂, balance N₂*

If R_1 and R_2 are the respective normalized responses then $(R_1 - R_2)$ shall be less than 3 per cent of R_1 .

Supplemental information

The typical range of O₂ concentrations in the core exhaust gas from idle to take-off, is approximately 18% at idle, to 15% (or somewhat less) at take-off. The specification for a response of <3% between samples of 10% and 21% is conservative, effectively limiting the differential response to <1% over the range of interest. If needed the O₂ response can be minimized by adjusting the FID burner fuel/air ratio.

Differential hydrocarbon response: measure the response with four blends of different hydrocarbons in air, at concentrations of approximately 500 ppmC, known to a relative accuracy of ±1 per cent, as follows:

- a) propane in zero air*
- b) propylene in zero air*
- c) toluene in zero air*
- d) n-hexane in zero air.*

If R_a , R_b , R_c and R_d are, respectively, the normalized responses (with respect to propane), then $(R_a - R_b)$, $(R_a - R_c)$ and $(R_a - R_d)$ shall each be less than 5 per cent of R_a .

Supplemental information

Although assumed to respond as a carbon number counter, for the purposes of testing engine exhaust, the FID response is known to vary somewhat with the particular hydrocarbon or class of hydrocarbons being measured. For example three molecules of methane, CH₄, will not necessarily result in the same instrument response as one molecule of propane, C₃H₈. Because of this differential response it is sometimes helpful to think of the FID as responding to an “effective” carbon number. It is important to ensure the instrument responds acceptably to all of the hydrocarbons in the engine exhaust. This group of hydrocarbons – propylene, toluene, and n-hexane – with propane as a reference was chosen to represent, in terms of differential response, the range of hydrocarbons expected in the exhaust.

3. OPTIMIZATION OF DETECTOR RESPONSE AND ALIGNMENT

3.1 *The manufacturer's instructions for initial setting up procedures and ancillary services and supplies required shall be implemented, and the instrument allowed to stabilize. All setting adjustments shall involve iterative zero checking, and correction as necessary. Using as sample a mixture of approximately 500 ppmC of propane in air, the response characteristics for variations first in fuel flow and then, near an optimum fuel flow, for variations in dilution air flow to select its optimum shall be determined. The oxygen and differential hydrocarbon responses shall then be determined as indicated above.*

Supplemental information

The FID detector response and alignment can be optimized by adjusting the FID burner fuel and air flow while sampling a mixture containing approximately 500 ppmC propane. Care should be taken when changing fuel flow that the instrument zero does not shift. If it does the instrument zero should be reset. Response curves, illustrating this process, shown below in Figures A3-3 and A3-4, were taken from 40 CFR Part 87, Control of Air Pollution from Aircraft and Aircraft Engines, Federal Register, Vol. 43, No. 58 — Friday, March 24, 1978. They were taken, in turn, from SAE ARP1256, "Procedure for the Continuous Sampling and Measurement of Gaseous Emissions from Aircraft Turbine Engines".

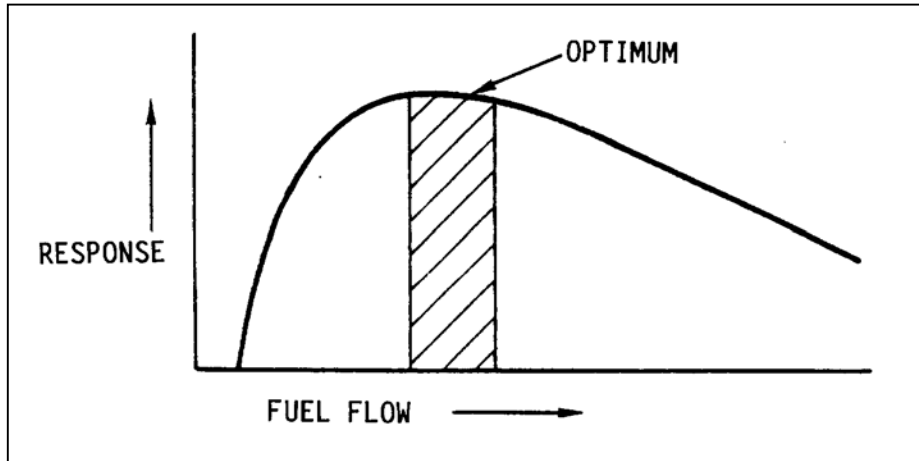

Figure A3-3 Typical Fuel Flow Response Curve

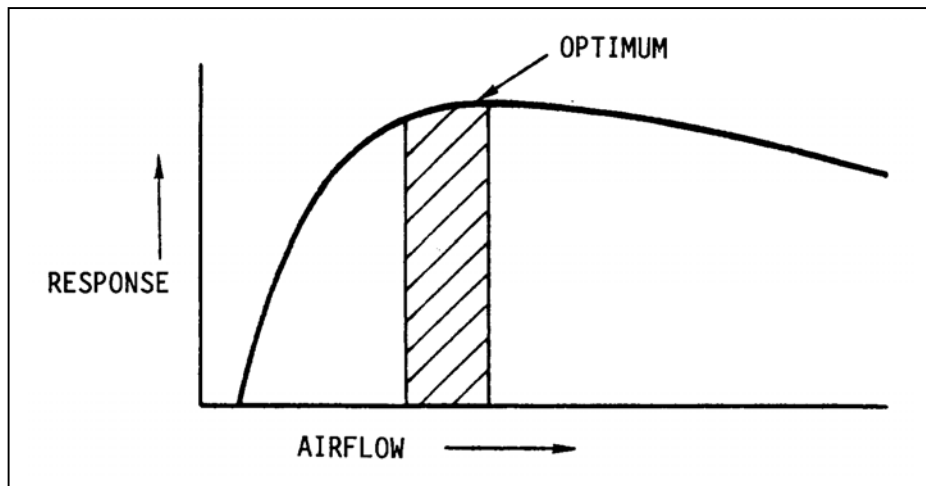

Figure A3-4 Typical Airflow Response Curve

The objective of this procedure is to select operating flow rates which will give near maximum response with least variation for minor fuel flow variations. It may be necessary to repeat this operation in an iterative fashion:

- Adjust the fuel flow to maximize output;
- Adjust zero if necessary;
- Adjust the air flow to maximize output
- Readjust the fuel flow, if necessary, and
- Repeat until the burner output is optimized.

3.2 The linearity of each analyser range shall be checked by applying propane in air samples at concentrations of approximately 30, 60 and 90 per cent of full scale. The maximum response deviation of any of these points from a least squares straight line (fitted to the points and zero) shall not exceed ± 2 per cent of full scale value. If it does, a calibration curve shall be prepared for operational use.

Explanation

Table A3-1 summarizes the performance specifications of an HC analyzer.

Table A3-1 HC ANALYZER PERFORMANCE SPECIFICATIONS

Parameter	Value
Total Range	0 to 5,000 ppmC
Resolution	better than 0.5 percent full scale range used or 0.5 ppmC whichever is greater
Repeatability	better than ± 1 percent full scale range used or ± 0.5 ppmC whichever is greater
Stability	better than ± 2 percent full scale range used or ± 1 ppmC whichever is greater in a period of 1 hour
Zero drift	$< \pm 1$ percent full scale range used or ± 0.5 ppmC, whichever is greater in a period of 1 hour
Noise	0.5 Hz and greater, $<$ than ± 1 percent full scale range used or ± 0.5 ppmC, whichever is greater
Response time	≤ 10 seconds from inlet of sample to achieve 90 percent of final reading
Linearity	± 2 percent full scale to propane in air, for each range used, or calibration correction required

**ATTACHMENT B TO ICAO MANUAL APPENDIX 3.
SPECIFICATION FOR CO AND CO₂ ANALYSERS**

Note 1.- Paragraph 5.3 of Appendix 3 summarizes the characteristics of the analysis sub-system to be employed for the individual measurements of CO and CO₂ concentrations in the exhaust gas sample. The instruments are based on the principle of non-dispersive absorption of infra-red radiation in parallel reference and sample gas cells. The required ranges of sensitivity are obtained by use of stacked sample cells or changes in electronic circuitry or both. Interferences from gases with overlapping absorption bands may be minimised by gas absorption filters and/or optical filters. preferably the latter.

Note 2. — See Attachment D for information on calibration and test gases.

Precautions: *The performance specifications indicated are generally for analyser full scale. Errors at part scale may be a significantly greater percentage of reading. The relevance and importance of such increases shall be considered when preparing to make measurements. If better performance is necessary, then appropriate precautions shall be taken.*

Supplemental information

The performance specifications for these analyzers, given in terms of full scale response, can have a significant and adverse impact on part scale measurements. This needs to be considered when planning and executing the test and in evaluating the accuracy of the measurements after the test. Concentrations of CO, when going from the idle mode to take-off, can differ by orders of magnitude. In general, where concentrations of species to be measured are known to vary this way, it is always good practice to use a multi-range instrument and to choose ranges such as to keep the measurement in the upper 30% of scale on the range in use, where possible. A measurement made at 20% of full scale could result in an error 5 times the error specified as a percent of full scale. This is a general precaution. Some modern instruments with internal electronic ranging and calibration capability can be used over their entire range without penalty. Calibrations should be performed on each range used as required. Relative to the precautions mentioned above, ranges are chosen such that the instrument responds in the upper 30% of scale for the range in use. While this may not always be possible it should be a goal.

The principal performance specification shall be as follows:

CO Analyser

- a) Total range: 0 to 2 500 ppm in appropriate ranges.*
- b) Resolution: better than 0.5 per cent of full scale of range used or 1 ppm, whichever is greater.*
- c) Repeatability: better than ± 1 per cent of full scale of range used, or ± 2 ppm, whichever is greater.*
- d) Stability: better than ± 2 per cent of full scale of range used or ± 2 ppm, whichever is greater, in a period of 1 hour.*
- e) Zero drift: less than ± 1 per cent of full scale of range used or ± 2 ppm, whichever is greater, in a period of 1 hour.*
- f) Noise: 0.5 Hz and greater, less than ± 1 per cent of full scale of range used or ± 1 ppm, whichever is greater.*
- g) Interferences: to be limited with respect to indicated CO concentration as follows:*
 - 1) less than 500 ppm/per cent ethylene concentration*

Supplemental information

It is unlikely that high concentrations of ethylene will be found in gas turbine engine exhaust. The highest concentration of hydrocarbons is found at idle, corresponding to the highest concentrations of CO. If all of the hydrocarbons were ethylene, C₂H₄, and the concentration were 100% of the maximum range, 5,000 ppmC, – corresponding to 2,500 ppm ethylene, the allowable interference would be less than 125 ppm, or less than 5% of the highest CO range, 2,500 ppm. Since the interference limit is in absolute terms, the relative error will increase for measurements made at less than full scale. If ethylene is present in significant concentrations then corrections to the data are required.

2) *less than 2 ppm/per cent CO₂ concentration*

3) *less than 2 ppm/per cent water vapour.**

Supplemental information

These two interferents, CO₂ and water vapor, are additive. Being the major products of combustion they increase and decrease together and are at their highest levels at the highest power. Unfortunately concentrations of CO tend to be at their lowest concentrations at the highest power. This can cause significant problems in the accuracy of the measurement even if the interference limits are met. It is not unusual for tests to be conducted with the sample dried before measurement and the interference due to the remaining interferent, CO₂, compensated for through use of gas or optical filters. It does bear mentioning that the contribution of high power CO concentrations to the total gross CO emission measured over the LTO cycle is relatively small.

If the interference limitation(s) for CO₂ and/or water vapour cannot be met, appropriate correction factors shall be determined, reported and applied.

Note.- It is recommended as consistent with good practice that such correction procedures be adopted in all cases.

**Need not apply where measurements are on a "dry" basis.*

CO₂ Analyser

a) *Total range: 0 to 10 per cent in appropriate ranges.*

Supplemental information

Although the total range specified for CO₂ is 0 to 10% concentrations most often will vary between 1% and 5%. This range is considerably narrower than that for CO. Never-the-less good practice dictates using ranges that keep the instrument response in the upper 30% of the meter scale as appropriate.

b) *Resolution: better than 0.5 per cent of full scale of range used or 100 ppm, whichever is greater.*

c) *Repeatability: better than ±1 per cent of full scale of range used or ±100 ppm, whichever is greater.*

d) *Stability: better than ±2 per cent of full scale of range used or ±100 ppm, whichever is greater, in a period of 1 hour.*

e) *Zero drift: less than ±1 per cent of full scale of range used or ±100 ppm, whichever is greater, in a period of 1 hour.*

f) *Noise: 0.5 Hz and greater, less than ±1 per cent of full scale of range used or ±100 ppm, whichever is greater.*

g) *The effect of oxygen (O₂) on the CO₂ analyser response shall be checked. For a change from 0 per*

cent O₂ to 21 per cent O₂, the response of a given CO₂ concentration shall not change by more than 2 per cent of reading. If this limit cannot be met an appropriate correction factor shall be applied.

Supplemental information

Gas turbine engines use a considerable amount of internal cooling air that mixes with the combustion products before exiting the engine. Oxygen rich exhaust samples warrant close attention.

Note.— It is recommended as consistent with good practice that such correction procedures be adopted in all cases.

CO and CO₂ Analysers

- a) *Response time: shall not exceed 10 seconds from inlet of the sample to the analysis system, to the achievement of 90 per cent of the final reading.*
- b) *Sample temperature: the normal mode of operation is for analysis of the sample in its (untreated) "wet" condition. This requires that the sample cell and all other components in contact with the sample in this sub-system be maintained at a temperature of not less than 50 C, with a stability of ±2 C. The option to measure CO and CO₂ on a dry basis (with suitable water traps) is allowed, in which case unheated analysers are permissible and the interference limits for H₂O vapour removed, and subsequent correction for inlet water vapour and water of combustion is required.*

Supplemental information

Stability is defined in terms of a time interval which, because this is a temperature control set point, can be taken as the duration of the test, or one hour to be consistent with the stability limits placed on the detection system.

The temperature quoted for the CO and CO₂ subsystems, 50°C, is on the low end of the sample line specification, 65°C ±15°C. Good practice would suggest that the subsystem temperature be approximately the same as the sample gas temperature. If the samples are dried and the analyzers unheated, it would be reasonable to lower the sample temperature to that of the analyzer. If water is removed prior to analysis, corrections must be applied to compensate for the loss of water of combustion and inlet water vapor. Correction procedures are detailed in Attachment F of this Appendix.

c) Calibration curves:

- i) *Analyzers with a linear signal output characteristic shall be checked on all working ranges using calibration gases at known concentrations of approximately 0, 30, 60 and 90 per cent of full scale. The maximum response deviation of any of these points from a least squares straight line, fitted to the points and the zero reading, shall not exceed ±2 per cent of the full scale value. If it does then a calibration curve shall be prepared for operational use.*

Supplemental information

Straight line fits to sets of linear data can be arrived at graphically or analytically. If graphically, the results are subject to interpretation, i.e., best estimate by 'eye' by individual. If analytically, there is assurance that each case and all data are handled the same way each time. The most appropriate technique is to perform a linear regression, or 'least-squares fit' for a line. The calibration gas values are the independent "variables and are assumed to be correct (to have negligible error) for the purpose of this analysis. The instrument response values are the "dependent" variables and are assumed to have errors and that these errors are normally (Gaussian) distributed about the true line. The equation describing the straight line is:

$$y_i = A + B \cdot x_i$$

true value for response $y_i = A$ (a constant) + B (another constant) * (calibration gas value x_i)

For instruments which have been adjusted such that zero input results in zero output, and where the variance is known to be proportional to the reading the slope B can be shown to be equal to the ratio of the averages and can be expressed as:

$$\frac{\bar{y}}{\bar{x}}$$

Often A and B are not such simple values for intercept and slope but must be calculated as if the variance were not known to be proportional to the instrument response. Again if we set the instrument to read zero for zero gas input then A = 0 which makes the calculation relatively simple. The generalized expression for B can be found in any elementary statistics or error analysis text and is:

$$B = \frac{N \sum_{i=1}^N x_i y_i - \sum_{i=1}^N x_i \sum_{i=1}^N y_i}{N \sum_{i=1}^N x_i^2 - \left(\sum_{i=1}^N x_i \right)^2}$$

Where x_i is the calibration gas value and y_i is the instrument response and N refers to the number of points used in the analysis.

With $N = 4$, corresponding to 0, 30, 60 and 90% of full scale, this equation can be rewritten as:

$$B = \frac{4 \sum_{i=1}^4 x_i y_i - \sum_{i=1}^4 x_i \sum_{i=1}^4 y_i}{4 \sum_{i=1}^4 x_i^2 - \left(\sum_{i=1}^4 x_i \right)^2}$$

A simple table, for the four sets of values, can be used for organizing the information thereby simplifying the calculation:

Measurement number i	x_i cal. gas value i	y_i response i	x_i^2	$x_i y_i$
1				
2				
3				
4				
N = 4	Σx_i	Σy_i	Σx_i^2	$\Sigma x_i y_i$

If the instrument is not set to zero-zero (zero response for zero input) then A must be determined. The equation for A is (for $N = 4$) is:

The table shown earlier can be used to organize the elements of this equation as well.

Usually the next step would be to calculate the uncertainty in y_i about this line. However, instead of controlling uncertainty about the line, ICAO chose to set an absolute limit of $\pm 2\%$ deviation of the full scale value for each point. This should make clear the advantage in using the upper region (top 30%) of the range for all measurements.

ii) Analyzers with a non-linear signal output characteristic, and those that do not meet the requirements of linearity given above, shall have calibration curves prepared for all working ranges using calibration gases at known concentrations of approximately 0, 30, 60 and 90 per cent of full scale. Additional mixes shall be used, if necessary, to define the curve shape properly.

Supplemental information

For analyzers with a non-linear signal output characteristic calibration curves shall be prepared, again using approximately 0, 30, 60 and 90% of full scale calibration gases. If a curve is substantially non-linear in shape, it is recommended that additional calibration gases be used with values between the ones specified. These calibration curves can be determined analytically using a least squares fit, but in this case the fit would be to a polynomial or exponential. The equations for doing this can be found in any basic text on statistics or error analysis. It should be noted that for exponential fits it is often convenient to work with the logarithm of the expression, which reduces the problem to a least-squares-fit about a line as is described above. (This technique is used in analyzing smoke filters as required in 3.0 of Appendix 2). Although not stated explicitly, the presumption is that the same $\pm 2\%$ of full scale response deviation is true for non-linear as well as linear instruments. The use of a gas divider is an acceptable alternative to acquiring and maintaining additional gas resources.

Table A3-2 summarizes the specifications for CO and CO₂ analyzers. These are typical of those analyzers offered by major analyzer manufacturers.

Table A3-2 NDIR ANALYZER PERFORMANCE SPECIFICATIONS

Parameter	Value	
	CO ₂	CO
Total Range	0 to 10% in appropriate ranges	0 to 2 500 ppm in appropriate ranges
Resolution	better than 0.5% fs range used or 100 ppm whichever greater	better than 0.5% fs range used or 1 ppm whichever greater
Repeatability	better than ±1% fs range used or ±100 ppm whichever greater	better than ±1% fs range used or ±2 ppm whichever greater
Stability	better than ±2% fs range used or ±100 ppm whichever greater period of 1 hr	better than ±2% fs range used or ±2 ppm whichever greater period of 1 hr
Zero Drift	< ±1% fs range used or ±100 ppm whichever greater period of 1 hr	< ±1% fs range used or ±2 ppm whichever greater period of 1 hr
Noise	≥0.5 Hz, <±1% fs range used or ±100 ppm, whichever greater	≥0.5 Hz, <±1% fs range used or ±1 ppm, whichever greater
Interference	≤ 2% of reading for O ₂ between 0 and 21%	<500 ppm/% ethylene <2 ppm/% CO ₂ <2 ppm/% water vapor
Response Time	≤10 seconds from instrument inlet to 90% fs	≤10 seconds from instrument inlet to 90% fs
Sample Temperature	wet samples ≥50°C stability ± 2°C	wet samples ≥50°C stability ± 2°C

**ATTACHMENT C TO ICAO MANUAL APPENDIX 3.
SPECIFICATION FOR NO_x ANALYSER**

Note. — See Attachment D for information on calibration and test gases.

1. *As indicated in 5.4 of Appendix 3, the measurement of the oxides of nitrogen concentration shall be by the chemiluminescent technique in which radiation emitted by the reaction of NO and O₃ is measured. This method is not sensitive to NO₂ and therefore the sample shall be passed through a converter in which NO₂ is converted to NO before the measurement of total NO_x is made. Both the original NO and the total NO_x concentrations shall be recorded. Thus by difference, a measure of the NO₂ concentration shall be obtained.*
2. *The instrument to be used shall be complete with all necessary flow control components, such as regulators, valves, flowmeters, etc. Materials in contact with the sample gas shall be restricted to those, which are resistant to attack by oxides of nitrogen, such as stainless steel, glass, etc. The temperature of the sample shall everywhere be maintained at values, consistent with the local pressures, which avoid condensation of water.*

Precautions: *The performance specifications indicated are generally for analyzer full scale. Errors at part scale may be a significantly greater percentage of reading. The relevance and importance of such increases shall be considered when preparing to make measurements. If better performance is necessary, then appropriate precautions shall be taken.*

Supplemental information

The performance specifications for these analyzers given in terms of full scale response can have a significant and adverse impact on part scale measurements. This needs to be considered when planning and executing the test and in evaluating the accuracy of the measurements after the test. Concentrations of NO_x, when going from the idle mode to take-off, can differ by orders of magnitude. In general, where concentrations of species to be measured are known to vary this way, it is always good practice to use a multi-range instrument, and to choose ranges such as to keep the measurement in the upper 30% of scale on the range in use. A measurement made at 20% of full scale could result in an error 5 times the error specified as a percent of full scale. This is a general precaution. Some modern instruments with internal electronic ranging and calibration capability can be used over their entire range without penalty. Calibrations should be performed on each range used as required.

3. *The principal performance specification, determined for the instrument operated in an ambient temperature stable to within 2 C, shall be as follows:*
 - a) *Total range: 0 to 2 500 ppm in appropriate ranges.*
 - b) *Resolution: better than 0.5 per cent of full scale of range used or 1 ppm, whichever is greater.*
 - c) *Repeatability: better than ±1 per cent of full scale of range used, or ±1 ppm, whichever is greater.*
 - d) *Stability: better than ±2 per cent of full scale of range used or ±1 ppm, whichever is greater, in a period of 1 hour.*
 - e) *Zero drift: less than ±1 per cent of full scale of range used or ±1 ppm, whichever is greater, in a period of 1 hour.*
 - f) *Noise: 0.5 Hz and greater, less than ±1.0 per cent of full scale of range used or ±1 ppm, whichever is greater, in a period of 2 hours.*

- g) *Interference: suppression for samples containing CO₂ and water vapour shall be limited as follows:*
- *less than 0.05 per cent reading/per cent CO₂ concentration;*
 - *less than 0.1 per cent reading/per cent water vapour concentration.*

If the interference limitation(s) for CO₂ and/or water vapour cannot be met, appropriate correction factors shall be determined, reported, and applied.

Note.- It is recommended as consistent with good practice that such correction procedures be adopted in all cases.

- h) *Response time: shall not exceed 10 seconds from inlet of the sample to the analysis system to the achievement of 90 per cent of the final reading.*
- i) *Linearity: better than ±2 per cent of full scale of range used or ±2 ppm, whichever is greater.*
- j) *Converter: this shall be designed and operated in such a manner as to reduce NO₂ present in the sample to NO. The converter shall not affect the NO originally in the sample.*

Supplemental information

Correction: ...”in such a manner” ... “should read” ... “in such a manner”

The converter efficiency shall not be less than 90 per cent.

This efficiency value shall be used to correct the measured sample NO₂ value (i.e. [NO_x]_c - [NO]) to that which would have been obtained if the efficiency had not been 100 per cent.

Supplemental information

The last sentence should read as follows:

“This efficiency value shall be used to correct the measured sample NO₂ value (i.e. [NO_x]_c - [NO]) to that which would have been obtained if the efficiency had been 100 per cent.”

A procedure for determining the NO₂ to NO conversion efficiency, in the absence of any specific manufacturer’s instructions, may be found in 40 CFR Part 87, Control of Air Pollution from Aircraft and Aircraft Engines, Federal Register, Vol. 43, No. 58 — Friday, March 24, 1978. It was taken, in turn, from SAE ARP1256, "Procedure for the Continuous Sampling and Measurement of Gaseous Emissions from Aircraft Turbine Engines".

Figure A3-5: NO_x Converter Efficiency Detector Schematic

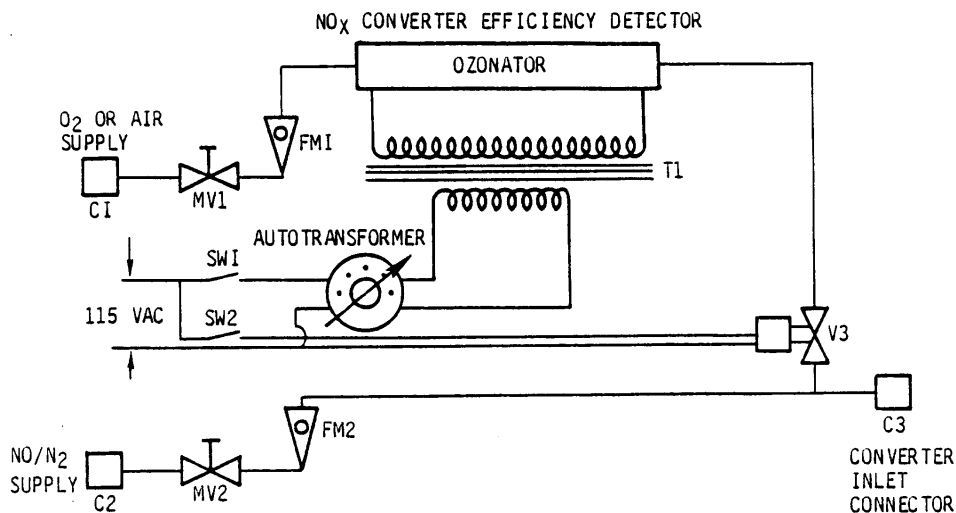

Figure A3-5 schematically depicts such a device. This device is intended for use with the NO_x analyzer specified in Attachment C. It depends on the reaction: $\text{NO} + \text{O}_3 = \text{NO}_2 + \text{O}_2$

Starting with a known concentration of NO in N₂, measurements are made through – and bypassing – the chemiluminescence analyzer converter, the inlet to which is shown as “C3” in the diagram. With the NO_x converter ozonator alternately on, reducing the NO concentration by approximately 80%, and off, allowing 100% of the NO to reach the analyzer the analyzer’s converter efficiency can be determined. This efficiency should be used to correct test data as required.

The specific instructions for using this device, from 40 CFR part 87, are as follows:

- (i) Attach the NO/N₂ supply (150-250 ppm.) at “C2”, the O₂ supply at “C1”, and the analyzer inlet connection to the efficiency detector at C3. If lower concentrations of NO are used, air may be used in place of O₂ to facilitate better control of the NO₂ generated during step (iv).
- (ii) With the efficiency detector Variac (*Note: SAE uses the term autotransformer*) off, place the NO_x converter in bypass mode and close valve “V3”. Open valve “MV2” until sufficient flow and stable readings are obtained at the analyzer. Zero and span the analyzer output to indicate the value of the NO concentration being used. Record this concentration.
- (iii) Open valve V3 (on/off flow control solenoid valve for O₂) and adjust valve “MV1” (O₂ supply metering valve) to blend enough O₂ to lower the NO concentration (ii) to about 10 percent. Record this concentration.
- (iv) Turn on the ozonator and increase its supply voltage until the NO concentration of (iii) is reduced to about 20 percent of (ii). NO is now being formed from the NO + O₂ reaction. There must always be at least 10 percent unreacted NO at this point. Record this concentration.
- (v) When a stable reading has been obtained from (iv), place the NO_x converter in the convert mode. The analyzer will now indicate the total NO_x concentration. Record this concentration.
- (vi) Turn off the ozonator and allow the analyzer reading to stabilize. The mixture NO + O₃ is still passing through the converter. This reading is the total NO_x concentration of the dilute NO span gas used in step (iii). Record this concentration.

- (vii) Close valve V3. The NO concentration should be equal to or greater than the reading of (ii) indicating whether the NO contains any NO₂.

Calculate the efficiency of the NO_x converter by substituting the concentrations obtained during the test into the following equation:

$$\% \text{Eff.} = \frac{(v) - (iv)}{(vi) - (iv)} \times 100\%$$

To improve the effectiveness of thermal converters, particularly those with efficiencies of less than 90%, it is sometimes helpful to raise the temperature of the converter.

Table A3-3 NO_x ANALYZER PERFORMANCE SPECIFICATION

Parameter	Value
Total Range	0 to 2 500 ppm in appropriate ranges
Resolution	better than 0.5 percent full scale range used or 1 ppm whichever is greater
Repeatability	better than ±1 percent full scale range used or 1 ppm whichever is greater
Stability	better than ±2 percent full scale range used or ±1 ppm whichever is greater in a period of 2 hours
Zero Drift	< ±1 percent full scale range used or ±1 ppm, whichever is greater in a period of 2 hours
Noise	≥0.5 Hz, <±1 percent fs range used or ±1 ppm, whichever greater period of 2 hours
Interference	< 0.05 percent reading/ percent CO ₂ < 0.1 percent reading/ percent water vapor
Response Time	≤ 10 seconds from inlet of sample to achieve 90 percent of final reading
Linearity	better than ±2 percent full scale for each range used or ± 2ppm, whichever greater
Converter Efficiency	≥ 90 percent

Table A3-3 summarizes the specifications for NO_x analyzers. These are typical of those analyzers offered by major analyzer manufacturers.

**ATTACHMENT D TO ICAO MANUAL APPENDIX 3.
CALIBRATION AND TEST GASES**

Table of calibration gases

<i>Analyzer</i>	<i>Gas</i>	<i>Accuracy*</i>
HC	<i>propane in zero air</i>	<i>±2 per cent or ±0.05 ppm**</i>
CO ₂	<i>CO₂ in zero air</i>	<i>±2 per cent or ±100 ppm**</i>
CO	<i>CO in zero air</i>	<i>±2 per cent or ±2 ppm**</i>
NO _x	<i>NO_x in zero nitrogen</i>	<i>±2 per cent or ±1 ppm**</i>

* Taken over the 95 per cent confidence interval.

** Whichever is greater

The above gases are required to carry out the routine calibration of analyzers during normal operational use.

<i>Analyzer</i>	<i>Gas</i>	<i>Accuracy*</i>
HC	<i>propane in 10 ±1 per cent O₂ balance zero nitrogen</i>	<i>±1 per cent</i>
HC	<i>propane in 21 ±1 per cent O₂ balance zero nitrogen</i>	<i>±1 per cent</i>
HC	<i>propylene in zero air</i>	<i>±1 per cent</i>
HC	<i>toluene in zero air</i>	<i>±1 per cent</i>
HC	<i>n-hexane in zero air</i>	<i>±1 per cent</i>
HC	<i>propane in zero air</i>	<i>±1 per cent</i>
CO ₂	<i>CO₂ in zero air</i>	<i>±1 per cent</i>
CO ₂	<i>CO₂ in zero nitrogen</i>	<i>±1 per cent</i>
CO	<i>CO in zero air</i>	<i>±1 per cent</i>
NO _x	<i>NO in zero nitrogen</i>	<i>±1 per cent</i>

* Taken over the 95 per cent confidence interval

The above gases are required to carry out the tests of Attachments A, B, and C.

Carbon monoxide and carbon dioxide calibration gases may be blended singly or as dual component mixtures. Three component mixtures of carbon monoxide, carbon dioxide, and propane in zero air may be used, provided the

stability of the mixture is assured.

Zero gas as specified for the CO, CO₂, and HC analyzers shall be zero air (which includes "artificial" air with 20 to 22 per cent O₂ blended with N₂). For the NO_x analyzer zero nitrogen shall be used as the zero gas. Impurities in both kinds of zero gas shall be restricted to be less than the following concentrations:

*1 ppm C
1 ppm CO
100 ppm CO₂
1 ppm NO_x*

The applicant shall ensure that commercial gases supplied to him do in fact meet this specification, or are so specified by the vendor.

Supplemental information

Calibration and test gases are readily available, with traceability to the National Institute of Standards and Technology (NIST), from commercial suppliers. Gases with an accuracy of $\pm 1\%$ are considered "primary" standards and intended for use where the highest accuracy and reliability are needed. Very tight controls over cylinder material, age, and history are considered good practice, if not essential. Periodic checks of the accuracy of assay for each cylinder is advisable. Gases such as CO, CO₂, and propane with a certified accuracy of $\pm 2\%$ can be obtained as multi-component mixtures. This will reduce the number of gas cylinders needed for testing. The importance of this becomes obvious when considering the calibration requirements for each instrument and each range. Managing just the minimum number of calibration and test gases can be challenging. For example, an average certification test, when backup gases are counted, can require 100 two component cylinders, or more. The stability of the components in each mixture should be checked periodically. If the assay no longer agrees with the certified analysis, the cylinder should be returned to the supplier or discarded as appropriate.

Because of the accuracy required and the sophistication of the techniques necessary to produce and analyze gases to these standards, most testing laboratories rely on the commercial suppliers analysis and certification for primary accuracy and use in-house checks via instrument response for consistency of assay. It is good practice to recheck all calibration and working standard gases immediately prior to a certification test.

All calibration gas monitoring data should be kept and made available to the certifying agency if required.

Although not a calibration gas or, strictly speaking, a test gas, the FID analyzer fuel and oxidant gases should also meet a hydrocarbon specification. For hydrogen/nitrogen or hydrogen/helium fuel mixtures, total hydrocarbons present should be < 1 ppmC. The oxidant should be hydrocarbon free grade air, containing < 1 ppmC hydrocarbon. The SAE in ARP 1256 restricts the FID fuel gas to a 40% hydrogen, 60% helium mixture which is required to meet this hydrocarbon level specification.

**ATTACHMENT E TO ICAO MANUAL APPENDIX 3. THE CALCULATION OF THE EMISSIONS
PARAMETERS - BASIS, MEASUREMENT CORRECTIONS AND
ALTERNATIVE NUMERICAL METHOD**

1. SYMBOLS			
		P_7	number of moles of NO_2 in the exhaust sample per mole of fuel
AFR	air/fuel ratio, the ratio of the mass flow rate of dry air to that of the fuel	P_8	number of moles of NO in the exhaust sample per mole of fuel
EI	emission index; $10^3 \times$ mass flow rate of gaseous emission product in exhaust per unit mass flow rate of fuel	P_T	$P_1 + P_2 + P_3 + P_4 + P_5 + P_6 + P_7 + P_8$
K	ratio of concentration measured wet to that measured dry (after cold trap)	R	concentration of O_2 in dry air, by volume = 0.2095 normally
L, L'	analyzer interference coefficient for interference by CO_2	S	concentration of N_2 + rare gases in dry air, by volume = 0.7902 normally
M, M'	analyzer interference coefficient for interference by H_2O	T	concentration of CO_2 in dry air, by volume = 0.0003 normally
M_{AIR}	molecular mass of dry air = 28.966 g or, where appropriate, = $(32 R + 28.156 4 S + 44.011 T)$ g	P_0	number of moles of air per mole of fuel in initial air/fuel mixture
M_{CO}	molecular mass of CO = 28.011 g	Z	symbol used and defined in 3.4
M_{HC}	molecular mass of exhaust hydrocarbon, taken as CH_4 = 16.043 g	$[\text{CO}_2]$	mean concentration of CO_2 in exhaust sample, vol/vol
M_{NO_2}	molecular mass of NO_2 = 46.008 g	$[\text{CO}]$	mean concentration of CO in exhaust sample, vol/vol
M_{C}	atomic mass of carbon = 12.011 g	$[\text{HC}]$	mean concentration of HC in exhaust sample, vol C/vol
M_{H}	atomic mass of hydrogen = 1.008 g	$[\text{NO}]$	mean concentration of NO in exhaust sample, vol/vol
P_1	number of moles of CO_2 in the exhaust sample per mole of fuel	$[\text{NO}_2]$	mean concentration of NO_2 in exhaust sample, vol/vol
P_2	number of moles of N_2 in the exhaust sample per mole of fuel	$[\text{NO}_x]$	mean concentration of NO and NO_2 in exhaust sample, vol/vol
P_3	number of moles of O_2 in the exhaust sample per mole of fuel	$[\text{NO}_x]_c$	mean concentration of NO in exhaust sample, after passing through the NO_2/NO converter, vol/vol
P_4	number of moles of H_2O in the exhaust sample per mole of fuel	$[\text{NO}_2]$	mean = $\frac{([\text{NO}_x]_c - [\text{NO}])}{\eta}$
P_5	number of moles of CO in the exhaust sample per mole of fuel	$[]_d$	mean concentration in exhaust sample after cold trap, vol/vol
P_6	number of moles of C_xH_y in the exhaust sample per mole of fuel	$[]_m$	mean concentration measurement indicated before instrument correction applied, vol/vol

h	humidity of ambient air, vol water/vol dry air
h_d	humidity of exhaust sample leaving "drier" or "cold trap", vol water/vol dry sample
m	number of C atoms in characteristic fuel molecule
n	number of H atoms in characteristic fuel molecule
x	number of C atoms in characteristic exhaust hydrocarbon molecule
y	number of H atoms in characteristic exhaust hydrocarbon molecule
η	efficiency of NO ₂ /NO converter

2. BASIS OF CALCULATION OF EI AND AFR PARAMETERS

2.1 It is assumed that the balance between the original fuel and air mixture and the resultant state of the exhaust emissions as sampled can be represented by the following equation:

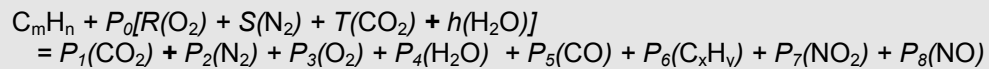

from which the required parameters can, by definition, be expressed as

$$EI(CO) = P_5 \left(\frac{10^3 M_{CO}}{mM_C + nM_H} \right)$$

$$EI(HC) = xP_6 \left(\frac{10^3 M_{HC}}{mM_C + nM_H} \right)$$

expressed as methane equivalent

$$EI(NO_X) = (P_7 + P_8) \left[\frac{10^3 M_{NO_2}}{mM_C + nM_H} \right]$$

expressed as NO₂ equivalent

$$AFR = P_0 \left(\frac{M_{AIR}}{mM_C + nM_H} \right)$$

Supplemental information

This is a slightly different formulation for AFR than that stated in 7.1.2, "Basic parameters". In this formulation m , the "number of C atoms in characteristic fuel molecule" is placed within the bracket. There is no particular advantage to using one formulation over the other.

- 2.2 Values for fuel hydrocarbon composition (m, n) are assigned by fuel specification or analysis. If only the ratio n/m is so determined, the value $m = 12$ may be assigned. The mole fractions of the dry air constituents (R, S, T) are normally taken to be the recommended standard values but alternative values may be assigned, subject to the restriction $R + S + T = 1$ and the approval of the certifying authority.
- 2.3 The ambient air humidity, h , is as measured at each test condition. It is recommended that, in the absence of contrary evidence as to the characterization (x, y) of the exhaust hydrocarbon, values of $x = 1$ and $y = 4$ are assigned.
- 2.4 Determination of the remaining unknowns requires the solution of the following set of linear simultaneous equations, where (1) to (4) derive from the fundamental atomic conservation relationships and (5) to (9) represent the gaseous product concentration relationships.

$$\begin{aligned}(1) \quad & M = TP_0 = P_1 + P_5 + xP_6 \\(2) \quad & n + 2hP_0 = 2P_4 + yP_6 \\(3) \quad & (2R + 2T + h)P_0 = 2P_1 + 2P_3 + P_4 + P_5 + 2P_7 + P_8 \\(4) \quad & 2SP_0 = 2P_2 + P_7 + P_8 \\(5) \quad & [\text{CO}_2] P_T = P_1 \\(6) \quad & [\text{CO}] P_T = P_5 \\(7) \quad & [\text{HC}] P_T = xP_6 \\(8) \quad & [\text{NO}_x]_c P_T = P_7 + P_8 \\(9) \quad & [\text{NO}] P_T = P_8 \\(10) \quad & P_T = P_1 + P_2 + P_3 + P_4 + P_5 + P_6 + P_7 + P_8\end{aligned}$$

The above set of conditional equations is for the case where all measured concentrations are true ones, that is, not subject to interference effects or to the need to correct for sample drying. In practice, interference effects are usually present to a significant degree in the CO, NO_x and NO measurements, and the option to measure CO₂ and CO on a dry or partially dry basis is often used. The necessary modifications to the relevant equations are described in 2.5 and 2.6.

- 2.5 The interference effects are mainly caused by the presence of CO₂ and H₂O in the sample which can affect the CO and the NO_x analysers in basically different ways. The CO analyzer is prone to a zero-shifting effect and the NO_x analyzer to a sensitivity change, represented thus:

$$[\text{CO}] = [\text{CO}]_m + L[\text{CO}_2] + M[\text{H}_2\text{O}]$$

$$\text{and } [\text{NO}_x]_c = [\text{NO}_x]_{cm}(1 + L[\text{CO}_2] + M[\text{H}_2\text{O}])$$

which transform into the following alternative equations to (6), (8) and (9), when interference effects require to be corrected,

$$\begin{aligned} (6A) \quad & [\text{CO}]_m P_T + LP_1 + MP_4 = P_5 \\ (8A) \quad & [\text{NO}_x]_{cm} (P_T + L'P_1 + M'P_4) = P_7 + P_8 \\ (9A) \quad & [\text{NO}]_m (P_T + L'P_1 + M'P_4) = P_8 \end{aligned}$$

The option to measure CO₂ and CO concentrations on a dry or partially dry sample basis, that is, with a sample humidity reduced to h_d, requires the use of modified conditional equations as follows:

$$\begin{aligned} (5A) \quad & [\text{CO}_2]_d (P_T - P_4)(1 + h_d) = P_1 \\ & \text{and} \\ & [\text{CO}]_d (P_T - P_4)(1 + h_d) + P_5 \end{aligned}$$

However, the CO analyzer may also be subject to interference effects as described in 2.5 above and so the complete alternative CO measurement concentration equation becomes

$$(6B) \quad [\text{CO}]_{md} (P_T - P_4)(1 + h_d) + LP_1 + Mh_d (P_T - P_4) = P_5$$

3. ANALYTICAL FORMULATIONS

3.1 General

Equations (1) to (10) can be reduced to yield the analytical formulations for the EI and AFR parameters, as given in 7.1 to this appendix. This reduction is a process of progressive elimination of the roots P₀, P₁ through P₈, P_T making the assumptions that all concentration measurements are of the "wet" sample and do not require interference corrections or the like. In practice the option is often chosen to make the CO₂ and CO concentration measurements on a "dry" or "semi-dry" basis; also it is often found necessary to make interference corrections. Formulations for use in these various circumstances are given in 3.2, 3.3 and 3.4 below.

3.2 Equation for conversion of dry concentration measurements to wet basis

Concentration wet = K x concentration dry; that is.

$$[] = K []_d$$

The following expression for K applies when CO and CO₂ are determined on a "dry" basis:

$$K = \frac{\left\{ 4 + (n/m)T + (|n/m|T - 2h) \left([\text{NO}_2] - (2[\text{HC}]/x) \right) + (2+h) \left(|y/x| - |n/m| [\text{HC}] \right) \right\} (1+h_d)}{(2+h) \left\{ 2 + (n/m)(1+h_d) \left([\text{CO}_2]_d \right) \right\} - (|n/m|T - 2h) \left(1 - |1+h_d| [\text{CO}]_d \right)}$$

3.3 Interference corrections

The measurement of CO and/or NO may require corrections for interference by the sample CO₂ and water concentrations before use in the above analytical equations. Such corrections can normally be expressed in the following general ways:

$$[\text{CO}] = [\text{CO}]_m + L[\text{CO}_2] + M[\text{H}_2\text{O}]$$

$$[\text{CO}]_d = [\text{CO}]_{md} + L[\text{CO}_2]_d + M\left(\frac{h_d}{1+h_d}\right)$$

$$[\text{NO}] = [\text{NO}]_m (1 + L'[\text{CO}_2] + M'[\text{H}_2\text{O}])$$

$$\eta[\text{NO}_2] = ([\text{NO}_x]_{cm} - [\text{NO}]_m)(1 + L'[\text{CO}_2] + M'[\text{H}_2\text{O}])$$

3.4 Equation for estimation of sample water content

Water concentration in sample

$$[\text{H}_2\text{O}] = \frac{(|n/2m + h| P_0/m |)([\text{CO}_2] + [\text{CO}] + [\text{HC}])}{1 + T(P_0/m)} - (y/2x)[\text{HC}]$$

Where

$$P_0/m = \frac{2Z - (n/m)}{4(1 + h - |TZ/2|)}$$

and

$$Z = \frac{2 - [\text{CO}] - (|2/x| - |y/2x|)[\text{HC}] + [\text{NO}_2]}{[\text{CO}_2] + [\text{CO}] + [\text{HC}]}$$

It should be noted that this estimate is a function of the various analyses concentration readings, which may themselves require water interference correction. For better accuracy an iterative procedure is required in these cases with successive recalculation of the water concentration until the requisite stability is obtained. The use of the alternative numerical solution methodology (4) avoids this difficulty.

4. ALTERNATIVE METHODOLOGY -NUMERICAL SOLUTION

- 4.1 *As an alternative to the analytical procedures summarized in 3 above, it is possible to obtain readily the emissions indices, fuel/air ratio, corrected wet concentrations, etc., by a numerical solution of equations (1) to (10) for each set of measurements, using a digital computer.*
- 4.2 *In the equation set (1) to (10) the actual concentration measurements are substituted using whichever of the alternative equations (5A), (6A), etc. applies for the particular measuring system, to take account of interference corrections and/or dried sample measurements.*
- 4.3 *Suitable simple two-dimensional array equation-solving computer programmes are widely available and their use for this purpose is convenient and flexible, allowing ready incorporation and identification of any sample drying options and interference or other corrections.*

Supplemental information

Details explaining various calculation procedures can be found in AeroSpace Recommended Practice (ARP) 1533, Procedure for the Calculation of Gaseous Emissions from Aircraft Turbine Engines. ARP 1533 includes, among other things, the combustion chemical equations, the basic matrix solution with computer programs, derivation of equations and a sample calculation.

[THIS PAGE INTENTIONALLY LEFT BLANK]

XI. ICAO MANUAL APPENDIX 5

INSTRUMENTATION AND MEASUREMENT TECHNIQUES FOR GASEOUS EMISSIONS FROM AFTERBURNING GAS TURBINE ENGINES

1. INTRODUCTION

Note.- The procedures specified in this appendix are concerned with the acquisition of representative exhaust samples and their transmission to, and analysis by, the emissions measuring system. These procedures only apply when afterburning is employed. The methods proposed are representative of the best readily available and most established modern practice. The need to correct for ambient conditions is recognized and a method will be specified when one becomes available. Meanwhile any correction methods used when afterburning is employed should be approved by the certificating authority.

Variations in the procedure contained in this appendix shall only be allowed after prior application to and approval by the certificating authority.

Supplemental information

This sampling and analytical procedure only applies to afterburning engines, while operating in the afterburning mode. Smoke and gaseous emissions levels in the exhaust plume of these engines, while in the non-afterburning mode, are determined using the standard procedures described in ICAO Annex 16, Volume II, Appendices 2 and 3. Smoke is not measured during afterburning operation.

Experience in sampling and analyzing emissions in the plume of afterburning engines is sparse, and the resultant methodology not as well proven as for non-afterburning engines. In fact no effort, similar to that which resulted in SAE AeroSpace Recommended Practice ARP 1256, for non-afterburning engines, has emerged for the afterburning case.

Sampling in the same region as required for non-afterburning engines would involve highly cooled and robust sampling probes, an understanding of the reaction chemistry in the exhaust plume and a detailed history of the gaseous species as they proceeded downstream to a point where the reaction could be considered complete or frozen. An alternative approach, and that adopted in ICAO Appendix 5, is to sample sufficiently far downstream to be in the well mixed, turbulent and relatively cool region of the plume where all reactions, for all practical purposes, have ceased. Having taken this approach, ICAO does make allowance for alternatives, providing their viability can be demonstrated to the certificating authority.

The analytical instrumentation used for non-afterburning engines has been found suitable for measuring gaseous emissions from afterburning engines with due care to be taken for measuring low concentration levels resulting from mixing the engine exhaust plume with ambient air. This mixing, with its resulting low concentrations suggests that close attention be paid to the ambient levels of CO, CO₂, HC, and NO_x. Proven methods for incorporating ambient corrections into these calculations have not been fully developed and are left to the testing agency to develop, use and validate.

The sampling and analytical methods recommended in Appendix 5 were likely influenced by the work of T. F. Lyon, et al, on military engines, (under U.S. Air Force contract – AFAPL-TR-75-52, “Development of Emissions Measurement Techniques for Afterburning Turbine Engines”, T. F. Lyons, et al, General Electric Company, 1 Apr 73 – 31 Mar 75). Considerable insight can be gained from this report particularly in regard to sampling and validating the data. Validating data obtained in the far plume requires the assumption that the individual species CO, HC, and NO_x, relative to CO₂, form

linearly related, bivariate Gaussian normal data sets to a high degree and for which correlation coefficient calculations are meaningful. The Lyon, et al, data seems to bear out this assumption.

2. DEFINITIONS

Where the following expressions are used without further explanation in this appendix, they have the meanings ascribed to them below:

Accuracy. *The closeness with which a measurement approaches the true value established independently.*

Calibration gas. *A high accuracy reference gas to be used for alignment, adjustment and periodic checks of instruments.*

Concentration. *The volume fraction of the component of interest in the gas mixture - expressed as volume percentage or as parts per million.*

Flame ionization detector. *A hydrogen-air diffusion flame detector that produces a signal nominally proportional to the mass-flow rate of hydrocarbons entering the flame per unit of time - generally assumed responsive to the number of carbon atoms entering the flame.*

Interference. *Instrument response due to presence of components other than the gas (or vapour) that is to be measured.*

Noise. *Random variation in instrument output not associated with characteristics of the sample to which the instrument is responding, and distinguishable from its drift characteristics*

Non-dispersive infra-red analyzer. *An instrument that by absorption of infra-red energy selectively measures specific components.*

Parts per million (ppm). *The unit volume concentration of a gas per million unit volume of the gas mixture of which it is a part.*

Parts per million carbon (ppmC). *The mole fraction of hydrocarbon multiplied by 10^6 measured on a methane-equivalence basis. Thus, 1 ppm of methane is indicated as 1 ppmC. To convert ppm concentration of any hydrocarbon to an equivalent ppmC value, multiply ppm concentration by the number of carbon atoms per molecule of the gas. For example, 1 ppm propane translates as 3 ppmC hydrocarbon; 1 ppm hexane as 6 ppmC hydrocarbon*

Plume. *Total external engine exhaust flow, including any ambient air with which the exhaust mixes.*

Reference gas. *A mixture of gases of specified and known composition used as the basis for interpreting instrument response in terms of the concentration of the gas to which the instrument is responding.*

Repeatability. *The closeness with which a measurement upon a given, invariant sample can be reproduced in short-term repetitions of the measurement with no intervening instrument adjustment.*

Resolution. *The smallest change in a measurement which can be detected.*

Response. *The change in instrument output signal that occurs with change in sample concentration. Also the output signal corresponding to a given sample concentration.*

Stability. The closeness with which repeated measurements upon a given invariant sample can be maintained over a given period of time.

Zero drift Time-related deviation of instrument output from zero set point when it is operating on gas free of the component to be measured.

Zero gas. A gas to be used in establishing the zero, or no-response, adjustment of an instrument.

3.1 Gaseous emissions

Concentrations of the following emissions shall be determined:

- a) Hydrocarbons (HC): a combined estimate of all hydrocarbon compounds present in the exhaust gas.
- b) Carbon monoxide (CO).
- c) Carbon dioxide (CO₂)

Note.- CO₂ is not considered a pollutant but its concentration is required for calculation and check purposes.

- d) Oxides of nitrogen (NO_x): an estimate of the sum of the two oxides, nitric oxide (NO) and nitrogen dioxide (NO₂).
- e) Nitric oxide (NO).

3.2 Other information

In order to normalize the emissions measurement data and to quantify the engine test characteristics, other information in addition to the requirements of Chapter 3, 3.4 shall be provided as follows:

- inlet temperature;
- inlet humidity;
- atmospheric pressure;
- wind vectors relative to engine exhaust axis;
- hydrogen/carbon ratio of fuel;
- engine installation details;
- other required engine parameters (for example, thrust, rotor speeds, turbine temperatures);
- pollutant concentration data and statistical validation parameters.

This data shall be obtained either by direct measurement or by calculation, as presented in Attachment F to this appendix.

4. GENERAL ARRANGEMENT OF THE SYSTEM

Owing to the reactive nature of the exhaust plume from engines using afterburning, it is necessary to ensure that the measured emissions do in fact correspond to those actually emitted into the surrounding atmosphere. This is achieved by sampling the plume sufficiently far downstream from the engine that the exhaust gases have cooled to a temperature where reactions have ceased. No desiccants, dryers, water traps or related equipment shall be used to treat the exhaust sample flowing to the oxides of nitrogen and the hydrocarbon analysis instrumentation. Requirements for the various component sub-systems are given in 5, but the

following list gives some qualifications and variations:

- a) it is assumed that each of the various individual subsystems includes the necessary flow control, conditioning and measurement facilities;
- b) the necessity for a dump and/or a hot-sample pump will depend on the ability to meet the sample transfer time and analysis sub-system sample flow rate requirements. This in turn depends on the exhaust sample-driving pressure and line losses. It is considered that these pumps usually will be necessary at certain engine running conditions; and
- c) the position of the hot pump, relative to the gas analysis sub-systems, may be varied as required. (For example, some HC analysers contain hot pumps and so may be judged capable of being used upstream of the system hot pump)

Note.- Figures A5-1 and A5-2 are schematic drawings of the exhaust gas sampling and analytical system and typify the basic requirements for emissions testing

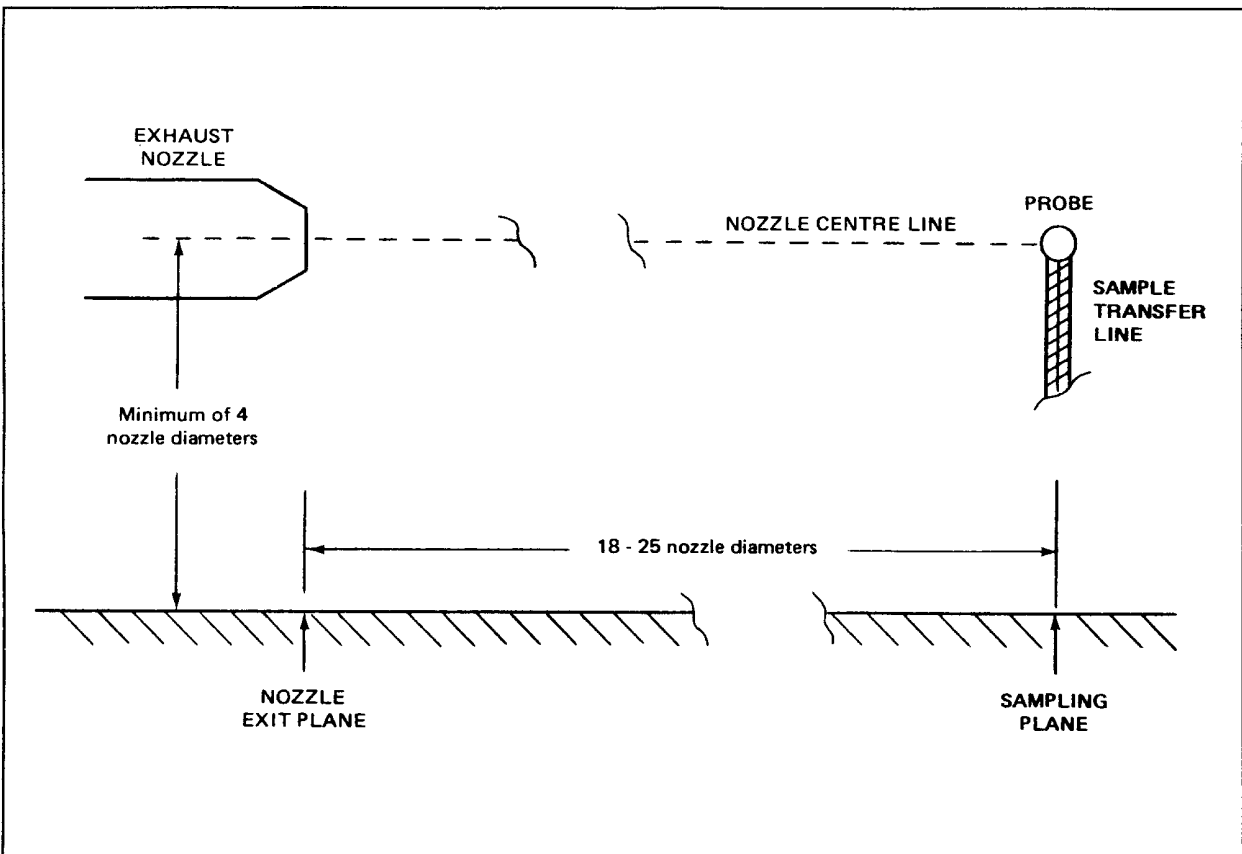

Figure A5-1. Exhaust gas sampling system, schematic

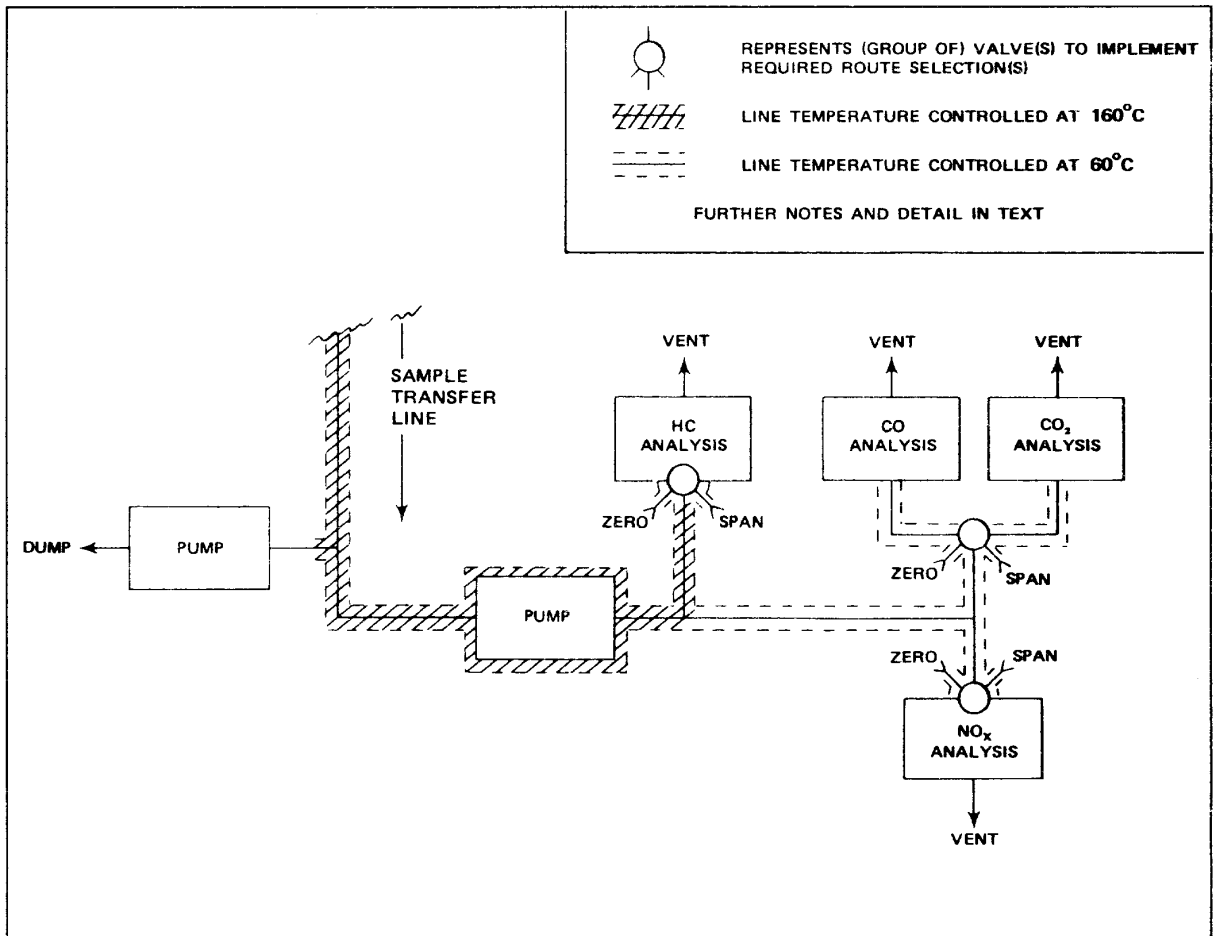

Figure A5-2. Sample transfer and analysis system, schematic

Supplemental information

In contrast to non-afterburning jet engine exhaust, local temperatures in the plume of an afterburning engine can be extremely high (in excess of 2,000° C) and very reactive. Measuring emissions in the hot, reactive part of the exhaust plume places a heavy burden on probe design and provides no assurance that the species measured are those which eventually contribute to atmospheric pollution. It is possible to calculate the final combustion products from species measured in the reacting flow. The methods however are complex, error prone, and the results subject to question.

Additionally, the concentration profiles in the plane of the exhaust plume immediately downstream of the engine exhaust nozzle are highly variable and make obtaining a representative sample difficult, time consuming and costly. Sampling at some distance downstream of the nozzle exit takes advantage of the turbulent mixing in the plume which serves to cool the gases to the point where chemical reactions cease, and to smooth the concentration profiles, making sampling easier. This occurs through mixing of the exhaust gases with ambient air. This dilution must be accounted for when the data are analyzed and calculations are made.

Depending on the amount of dilution, special care may be required in having suitable concentration ranges for the analytical instruments. This will be true of the calibration and standard gases as well. Because the products of combustion are the same for non-afterburning and afterburning engines, the same cautions apply to both.

The following diagram, Figure A5-3, from AFAPL-TR-75-52, illustrates the degree of severity of the problem:

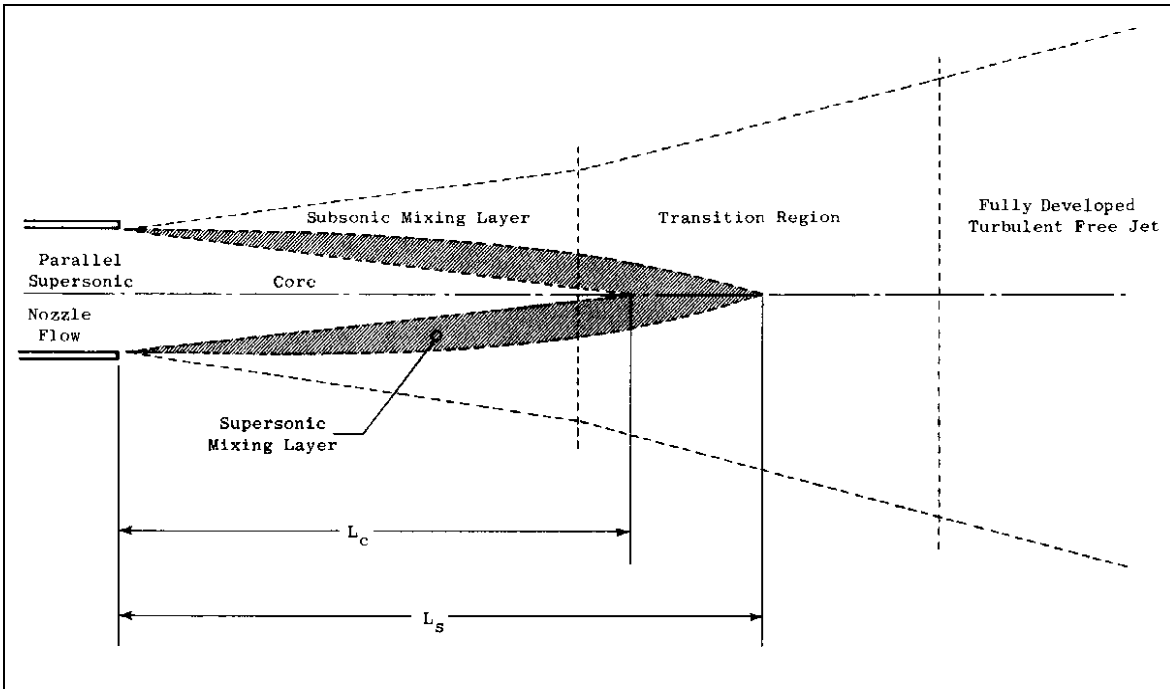

Figure A5-3 Exhaust Concentration Profile

5. DESCRIPTION OF COMPONENT PARTS

Note.— A general description and specification of the principal elements in the engine exhaust emissions measurement system follows. Greater detail, where necessary, will be found in Attachments A, B and C to this appendix.

5.1 Sampling system

5.1.1 Sampling probe

- a) *The probe shall be constructed so that individual samples can be withdrawn at various locations across a diameter of the plume. Mixed samples shall not be permitted.*
- b) *The material with which the sample is in contact shall be stainless steel and its temperature shall be maintained at a value not less than 60°C.*
- c) *The sampling plane shall be perpendicular to the projected engine nozzle centre line, and shall be situated as close as possible to a position 18 nozzle diameters from the nozzle exit plane, consistent with 7.1.2, but in no case greater than 25 nozzle diameters. The nozzle exit diameter shall be for the maximum engine power condition. Between and including exit and sampling planes there shall be an unobstructed region of at least 4 nozzle exit diameters in radial distance about the project engine nozzle centre line.*

d) *The minimum number of sampling points shall be equal to 11. The measurement plane, located at a distance X from the engine shall be divided into three sections demarcated by circles centred around the exhaust stream axis with radii*

$$R1 = 0.05X$$

$$R2 = 0.09X$$

and a minimum of 3 samples shall be taken from each section. The difference between the number of samples in each section must be less than 3. The sample taken at the most remote distance from the axis shall be from a point located at a radius of between 0.11X and 0.16X.

5.1.2 Sampling lines

The sample shall be transferred from the probe to the analysers via a line of 4.0 to 8.5 mm inside diameter, taking the shortest route practicable and using a flow rate such that the transport time is less than 10 seconds. The line shall be maintained at a temperature of 160°C ±15°C (with a stability of ±10°C). When sampling to measure HC, CO, CO₂ and NO_x components, the line shall be constructed in stainless steel or carbon-loaded grounded PTFE.

Supplemental information

To be consistent with appendix 5, Figure 5-2, "Sample transfer and analysis system, schematic", this paragraph should be changed to read:

"The sample shall be transferred from the probe to the analysers via a line of 4.0 to 8.5 mm inside diameter, taking the shortest route practicable and using a flow rate such that the transport time is less than 10 seconds. The line shall be maintained at a temperature of 160°C ±15°C (with a stability of ±10°C) except for the branch which supplies samples to the CO, CO₂, and NO_x analysers. This branch line shall be maintained at a temperature of 60°C ±15°C (with a stability of ±10°C). When sampling to measure HC, CO, CO₂ and NO_x components, the line shall be constructed in stainless steel or carbon-loaded grounded PTFE."

5.2 HC analyzer

The measurement of total hydrocarbon sample content shall be made by an analyzer using the heated flame ionization detector (FID), between the electrodes of which passes an ionization current proportional to the mass rate of hydrocarbon entering a hydrogen flame. The analyzer shall be deemed to include components arranged to control temperature and flow rates of sample, sample bypass, fuel and diluent gases, and to enable effective span and zero calibration checks.

Note.- An over-all specification is given in Attachment A to this appendix.

5.3 CO and CO₂ analysers

Non-dispersive infra-red analysers shall be used for the measurement of these components, and shall be of the design which utilizes differential energy absorption in parallel reference and sample gas cells, the cell or group of cells for each of these gas constituents being sensitized appropriately. This analysis sub-system shall include all necessary functions for the control and handling of sample, zero and span gas flows. Temperature control shall be that appropriate to whichever basis of measurement, wet or dry, is chosen.

Note - An over-all specification is given in Attachment B to this appendix.

5.4 NO_x analyzer

The measurement of NO concentration shall be by the chemiluminescent method in which the measure of the radiation intensity emitted during the reaction of the NO in the sample with added O₃ is the measure of the NO concentration. The NO₂ component shall be converted to NO in a converter of the requisite efficiency prior to measurement. The resultant NO_x measurement system shall include all necessary flow, temperature and other controls and provide for routine zero and span calibration as well as for converter efficiency checks.

Note.- An over-all specification is given in Attachment C to this appendix.

6. GENERAL TEST PROCEDURES

6.1 Engine operation

The engine shall be operated on an open air static test facility which is suitable and properly equipped for high accuracy performance testing, and which conforms to the requirements for sampling probe installation as specified in 5.1. The emissions tests shall be made at the power settings prescribed by the certificating authority. The engine shall be stabilized at each setting.

6.2 Ambient air conditions

6.2.1 A check shall be made on the ambient concentrations of CO, HC, CO₂ and NO, with the engine under test running at the test condition. Unusually high concentrations indicate abnormal conditions such as exhaust gas recirculation, fuel spillage or some other source of unwanted emissions in the test area and such situations shall be rectified or avoided as appropriate.

Note.- For guidance, the normal ambient concentration of CO₂ is 0.03 per cent, and ambient concentration levels for CO and HC of 5 ppm and NO_x of 0.5 ppm are unlikely to be exceeded under normal conditions.

6.2.2 Extreme climatic conditions, such as those involving precipitation or excessive wind speed shall also be avoided.

6.3 Major instrument calibration

Note.- The general objective of this calibration is to confirm stability and linearity.

6.3.1 The applicant shall satisfy the certificating authority that the calibration of the analytical system is valid at the time of the test.

6.3.2 For the hydrocarbon analyzer this calibration shall include checks that the detector oxygen and differential hydrocarbon responses are within the limits specified in Attachment A to this appendix. The efficiency of the NO₂/NO converter shall also be checked and verified to meet the requirements in Attachment C to this appendix.

6.3.3 The procedure for checking the performance of each analyzer shall be as follows (using the calibration and test gases as specified in Attachment D to this appendix):

- a) introduce zero gas and adjust instrument zero, recording setting as appropriate;
- b) for each range to be used operationally, introduce calibration gas of (nominally) 90 per cent range full-scale deflection (FSD) concentration; adjust instrument gain accordingly and record its setting;

- c) *introduce approximately 30 per cent, 60 per cent, and 90 per cent range FSD concentrations and record analyzer readings;*
- d) *fit a least squares straight line to the zero, 30 per cent, 60 per cent and 90 per cent concentration points. For the CO and/or CO₂ analyzer used in its basic form without linearization of output, a least squares curve of appropriate mathematical formulation shall be fitted using additional calibration points if judged necessary. If any point deviates by more than 2 per cent of the full scale value (or ± 1 ppm*, whichever is greater) then a calibration curve shall be prepared for operational use*

** Except for the CO₂ analyzer. for which the value shall be ± 100 ppm*

6.4 Operation

6.4.1 *No measurements shall be made until all instruments and sample transfer lines are warmed up and stable and the following checks have been carried out:*

- a) *leakage check: prior to a series of tests the system shall be checked for leakage by isolating the probe and the analysers, connecting and operating a vacuum pump of equivalent performance to that used in the smoke measurement system to verify that the system leakage flow rate is less than 0.4 L/min referred to normal temperature and pressure;*
- b) *cleanliness check: isolate the gas sampling system from the probe and connect the end of the sampling line to a source of zero gas. Warm the system up to the operational temperature needed to perform hydrocarbon measurements. Operate the sample flow pump and set the flow rate to that used during engine emission testing. Record the hydrocarbon analyzer reading. The reading shall not exceed 1 per cent of the engine idle emission level or 1 ppm (both expressed as methane), whichever is the greater.*

Note 1.-It is good practice to back-purge the sampling lines during engine running, while the probe is in the engine exhaust but emissions are not being measured, to ensure that no significant contamination occurs.

Note. 2-It is also good practice to monitor the inlet air quality at the start and end of testing and at least once per hour during a test. If levels are considered significant, then they should be taken into account.

6.4.2 *The following procedure shall be adopted for operational measurements:*

- a) *apply appropriate zero gas and make any necessary instrument adjustments;*
- b) *apply appropriate calibration gas at a nominal 90 per cent FSD concentration for the ranges to be used, adjust and record gain settings accordingly;*
- c) *when the engine has been stabilized at the requisite operating conditions and sampling location, continue to run it and observe pollutant concentrations until a stabilized reading is obtained, which shall be recorded At the same engine operating condition repeat the measurement procedure for each of the remaining sampling locations;*
- d) *recheck zero and calibration points at the end of the test and also at intervals not greater than 1 hour during tests. If either has changed by more than ± 2 per cent*

of full scale of range, the test shall be repeated after restoration of the instrument to within its specification.

Supplemental information

Note 2: For significant levels in the inlet air, say 1% of full scale of appropriate range in use acceptable practice would allow subtracting out the inlet concentration from that measured in the exhaust.

One objective of this sampling protocol is to take advantage of the relatively low spatial variability of the exhaust species by sampling in the fully turbulent free jet zone. Doing this requires a method of data analysis which accounts for dilution air which is well mixed with the core jet by calculating emission indices using a total carbon balance and ensuring – through a cross correlation calculation – that the CO₂ correlates well with each of the other species, acceptable accuracy is achieved.

7. CALCULATIONS

7.1 Gaseous emissions

7.1.1 General

The analytical measurements made shall be the concentrations of the various classes of pollutant, at the relevant afterburning mode(s) of the engine, at the various locations in the sampling plane. In addition to the recording of these basic parameters, other parameters shall be computed and reported, as follows.

7.1.2 Analysis and validation of measurements

a) *At each engine setting, the concentrations measured at different probe sampling positions must be averaged as follows:*

$$C_{i\text{ moy}} = \sum_{j=1}^n C_{ij}$$

where:

$\sum_{j=1}^n$ *Summation of the total number n of sampling positions used.*

C_{ij} *Concentration of species i measured at the j th sampling position.*

$C_{i\text{ moy}}$ *average or mean concentration of species i.*

All dry concentration measurements shall be converted into real wet concentrations. (See Attachment E to this appendix).

b) The quality of the measurements for each pollutant will be determined through a comparison with measurements of CO₂, using the correlation coefficient:

$$r_i = \frac{n \sum_{j=1}^n C_{ij} CO_{2j} - \sum_{j=1}^n C_{ij} \sum_{j=1}^n CO_{2j}}{\sqrt{\left(\sum_{j=1}^n C_{ij}^2 - \frac{(\sum_{j=1}^n C_{ij})^2}{n} \right) \left(\sum_{j=1}^n CO_{2j}^2 - \frac{(\sum_{j=1}^n CO_{2j})^2}{n} \right)}}$$

Values of r_i which are near to 1 indicate that measurements taken over the entire sampling period are sufficiently stable and that the curves are Gaussian. In the event that r_i is less than 0.95, measurements must be repeated in a sampling plane located at a more remote distance from the aircraft engine. The measurement process, per se, is then followed by the same calculations and the same demonstration as previously.

7.1.3 Basic parameters

$$E I(CO) = \left(\frac{[CO]}{[CO_2] + [CO] + [HC]} \right) \left(\frac{10^3 M_{CO}}{M_C + (n/m) M_H} \right) (1 + T (P_0/m))$$

$$E I(HC) = \left(\frac{[HC]}{[CO_2] + [CO] + [HC]} \right) \left(\frac{10^3 M_{HC}}{M_C + (n/m) M_H} \right) (1 + T (P_0/m))$$

$$E I(NO_x) = \left(\frac{[NO_x]}{[CO_2] + [CO] + [HC]} \right) \left(\frac{10^3 M_{NO_x}}{M_C + (n/m) M_H} \right) (1 + T (P_0/m))$$

Supplemental information

The basic descriptive parameter for gaseous emissions is the emission index (EI), defined as the mass of a product of combustion, in grams, divided by the mass of fuel used in kilograms, i.e., grams per kilogram.

$$\text{Air / fuel ratio} = \frac{P_0/m}{M_C + (n/m) M_H} \frac{M_{AIR}}{M_H}$$

where:

$$P_0/m = \frac{2Z - (n/m)}{4(1 + h - [TZ/2])}$$

and

$$Z = \frac{2 - [\text{CO}] - ([2/x] - [y/2x])[\text{HC}] + [\text{NO}_2]}{[\text{CO}_2] + [\text{CO}] + [\text{HC}]}$$

M_{AIR}	molecular mass of dry air = 28.966 g or, where appropriate, = (32 R + 28.156 4 S + 44.011 T) g
M_{HC}	molecular mass of exhaust hydrocarbon, taken as CH ₄ = 16.043 g
M_{CO}	molecular mass of CO = 28.011 g
M_{NO_2}	molecular mass of NO ₂ = 46.008 g
M_{C}	molecular mass of carbon = 12.011 g
M_{H}	molecular mass of hydrogen = 1.008 g
R	concentration of O ₂ in dry air, by volume = 0.209 5 normally
S	concentration of N ₂ + rare gases in dry air, by volume = 0.709 2 normally
T	concentration of CO ₂ in dry air, by volume = 0.000 3 normally
[HC]	mean concentration of exhaust hydrocarbons vol/vol, expressed as carbon
[CO]	mean concentration of CO vol/vol, wet
[CO ₂]	mean concentration of CO ₂ vol/vol, wet
[NO _x]	mean concentration of NO _x vol/vol, wet = [NO + NO ₂]
[NO]	mean concentration of NO in exhaust sample, vol/vol, wet $= \frac{([\text{NO}_x]_c) - [\text{NO}]}{\eta}$
[NO ₂]	mean concentration of NO ₂ in exhaust sample, vol/vol, wet
[NO _x] _c	mean concentration of NO in exhaust sample after passing through the NO ₂ /NO converter, vol/vol, wet
η	efficiency of NO ₂ /NO converter
h	humidity of ambient air, vol water/vol dry air
m	number of C atoms in characteristic fuel molecule
n	number of H atoms in characteristic fuel molecule
x	number of C atoms in characteristic exhaust hydrocarbon molecule
y	number of H atoms in characteristic exhaust hydrocarbon molecule

The value of n/m, the ratio of the atomic hydrogen to atomic carbon of the fuel used, is evaluated by fuel type analysis. The ambient air humidity, h, shall be measured at each set condition. In the absence of contrary evidence as to the characterization (x, y) of the exhaust hydrocarbons, the values x= 1, y=4 are to be used. If dry or semi-dry CO and CO₂ measurements are to be used then these shall first be converted to the equivalent wet concentration as shown in Attachment E to this appendix, which also contains interference correction formulas for use as required.

7.1.4 Correction of emission indices to reference conditions

Corrections shall be made to the measured engine emission indices for all pollutants in all relevant engine operating modes to account for deviations from the reference conditions (ISA at sea level) of the actual test inlet air conditions of temperature and pressure. The reference value for humidity shall be 0.00629 kg water/kg dry air.

Thus, EI corrected = K x EI measured, where the generalized expression for K is:

$$K = \left(P_{Bref} / P_B \right)^a \times \left(FAR_{ref} / FAR_B \right)^b \times \exp \left(| T_{Bref} - T_B | / c \right) \times \exp \left(d | h - 0.00629 | \right)$$

P_B	Combustor inlet pressure, measured
T_B	Combustor inlet temperature, measured
FAR_B	Fuel/air ratio in the combustor
h	Ambient air humidity
P_{ref}	ISA sea level pressure
T_{ref}	ISA sea level temperature
P_{Bref}	Pressure at the combustor inlet of the engine tested (or the reference engine if the data is corrected to a reference engine) associated with T_B under ISA sea level conditions
T_{Bref}	Temperature at the combustor inlet under ISA sea level conditions for the engine tested (or the reference engine if the data is corrected to a reference engine). This temperature is the temperature associated with each thrust level specified for each mode.
FAR_{ref}	Fuel/air ratio in the combustor under ISA sea level conditions for the engine tested (or the reference engine if the data is to be corrected to a reference engine).
a, b, c, d	Specific constants which may vary for each pollutant and each engine type

The combustor inlet parameters shall preferably be measured but may be calculated from ambient conditions by appropriate formulas.

7.1.5 *Using the recommended curve fitting technique to relate emission indices to combustor inlet temperature effectively eliminates the $\exp((T_{Bref} - T_B)/c)$ term from the generalized equation and for most cases the (FAR_{ref}/FAR_B) term may be considered unity. For the emissions indices of CO and HC many testing facilities have determined that the humidity term is sufficiently close to unity to be eliminated from the expression and that the exponent of the (P_{Bref}/P_B) term is close to unity.*

Thus,

EI(CO) corrected = EI derived from
 (P_B/P_{Bref}) EI(CO) v. T_B , curve

EI(HC) corrected = EI derived from
 (P_B/P_{Bref}) EI(HC) v. T_B , curve

EI(NO_x) corrected = EI derived from
 $(P_{Bref}/P_B)^{0.5} \exp(19|h - 0.00629|)$ v. T_B curve

Supplemental information

From the generalized correction for K , the term (P_B/P_{Bref}) – in the EI(CO) and EI(HC) expressions – should be (P_{Bref}/P_B) .

If this recommended method for the CO and HC emissions index correction does not provide a satisfactory correlation, an alternative method using parameters derived from component tests may be used.

Any other methods used for making corrections to CO, HC and NO, emission indices shall have the approval of the certificating authority.

7.2 Control parameter functions

(D_p, F_{oo}, π)

7.2.1 Definitions

D_p	The mass of any gaseous pollutant emitted during the reference emissions landing and take-off cycle.
F_{oo}	The maximum thrust available for take-off under normal operating conditions at ISA sea level static conditions, without the use of water injection, as approved by the applicable certificating authority.
π	The ratio of the mean total pressure at the last compressor discharge plane of the compressor to the mean total pressure at the compressor entry plane when the engine is developing take-off thrust rating at ISA sea level static conditions.

7.2.2 The emission indices (EI) for each pollutant, corrected for pressure and humidity (as appropriate) to the reference ambient atmospheric conditions as indicated in 7.1.4 and if necessary to the reference engine, shall be obtained for the required LTO engine operating mode settings (n) of idle, approach, climb-out and take-off, at each of the equivalent corrected thrust conditions. A minimum of three test points shall be required to define the idle mode. The following relationships shall be determined for each pollutant:

- a) between EI and T_B ; and
- b) between W_f (engine fuel mass flow rate) and T_B ; and
- c) between F_n , (corrected to ISA sea level conditions) and T_B , (corrected to ISA sea level conditions);

Note. — These are illustrated, for example, by Figure 5-3 a), b) and c).

When the engine being tested is not a "reference" engine, the data may be corrected to "reference" engine conditions using the relationships b) and c) obtained from a reference engine. A reference engine is defined as an engine substantially configured to the description of the engine to be certificated and accepted by the certificating authority to be representative of the engine type for which certification is sought.

The manufacturer shall also supply to the certificating authority all of the necessary engine performance data to substantiate these relationships and for ISA sea level ambient conditions:

- d) maximum rated thrust (F_{oo}); and
- e) engine pressure ratio (B) at maximum rated thrust.

Note.— These are illustrated by Figure A5-4 d).

7.2.3 The estimation of EI for each pollutant at each of the required engine mode settings, corrected to the reference ambient conditions, shall comply with the following general procedure:

- a) at each mode ISA thrust condition F_n determine the equivalent combustor inlet temperature (T_B) (Figure 3-2 c));

- b) from the EI/T_B characteristic (Figure 3-2 a)), determine the EI_n value corresponding to T_B ;
- c) from the W_f/T_B characteristic (Figure 3-2 b)), determine the W_{fn} value corresponding to T_B ;

note the ISA maximum rated thrust and pressure ratio values. These are F_{oo} and π respectively (Figure 3-2 d));

calculate, for each pollutant $D_p = \sum (EI_n)(W_{fn})(t)$

t time in LTO mode (minutes)

W_{fn} fuel mass flow rate (kg/min)

\sum is the summation for the set of modes comprising the reference LTO cycle.

7.2.4 While the methodology described above is the recommended method, the certificating authority may accept equivalent mathematical procedures which utilize mathematical expressions representing the curves illustrated if the expression have been derived using an accepted curve fitting technique.

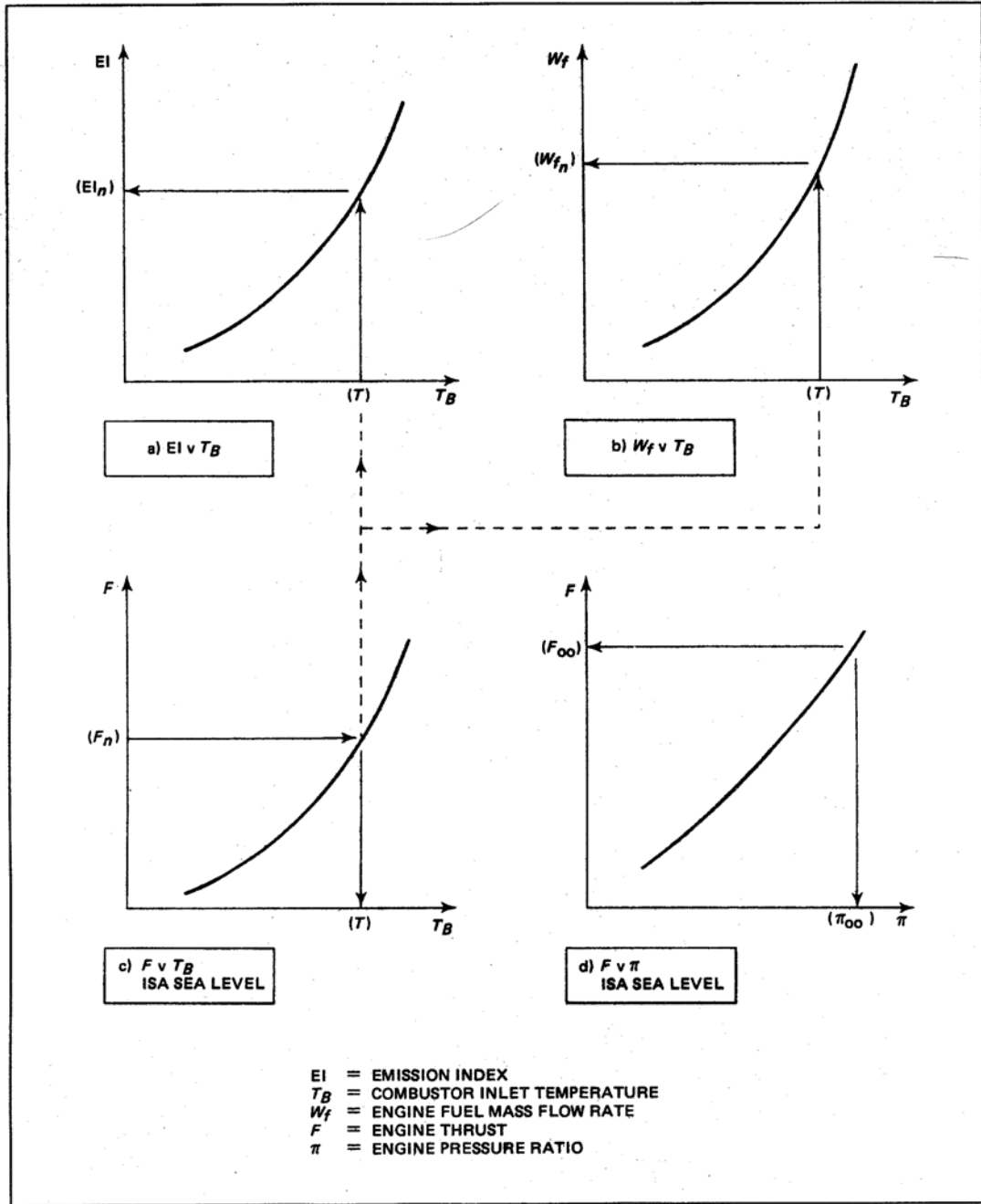

Figure A5-4 Calculation Procedure

7.3 Exceptions to the proposed procedures

In those cases where the configuration of the engine or other extenuating conditions exist which would prohibit the use of this procedure, the certifying authority, after receiving satisfactory technical evidence of equivalent results obtained by an alternative procedure, may approve an alternative procedure.

ATTACHMENT A TO ICAO MANUAL APPENDIX 5. SPECIFICATION FOR HC ANALYSER

Note 1.- As outlined in 5.2 of Appendix 5, the measuring element in this analyzer is the flame ionization detector (FID) in which the whole or a representative portion of the sample flow is admitted into a hydrogen-fueled flame. With suitably positioned electrodes an ionisation current can be established which is a function of the mass rate of hydrocarbon entering the flame. It is this current which, referred to an appropriate zero, is amplified and ranged to provide the output response as a measure of the hydrocarbon concentration expressed as ppmC equivalent.

Note 2.— See Attachment D for information on calibration and test gases.

1. GENERAL

Precautions: The performance specifications indicated are generally for analyzer full scale. Errors at part scale may be a significantly greater percentage of reading. The relevance and importance of such increases shall be considered when preparing to make measurements. If better performance is necessary, then appropriate precautions shall be taken.

Supplemental information

The performance specifications for these analyzers, given in terms of full scale response, can have a significant and adverse impact on part scale measurements. If this instrument is used for both the afterburning and non afterburning modes, which is likely, then the comments made in Appendix 3, Attachment A apply here as well. In extreme instances, concentrations of HC at high power, such as take-off, can differ from concentrations at idle by orders of magnitude, e.g., 3,500 ppmC at idle and 10 ppmC at take-off. The FID specification suggests the high level can be 5,000 ppmC. For most modern engines the idle concentrations are considerably lower, but still of concern when setting up the FID to maintain suitable accuracy of measurement. In general, where concentrations of species to be measured are known to vary this way it is always good practice to use a multi-range instrument and to adjust ranges such as to keep the measurement in the upper 30% of the instrument response range. A measurement made at 20% of full scale could result in an error 5 times the error specified as a percent of full scale. This is a general precaution. Some modern instruments with internal electronic ranging and calibration capability can be used over their entire range without penalty. Calibrations should be performed on each range used as required.

The instrument to be used shall be such as to maintain the temperature of the detector and sample-handling components at a set point temperature within the range 155°C to 165°C to a stability of ± 2 °C. The leading specification points shall be as follows, the detector response having been optimized and the instrument generally having stabilized:

Supplemental information

Stability is usually defined in terms of a time interval which, because this is a temperature control set point, can be taken as the duration of the test.

- a) *Total range: 0 to 500 ppmC in appropriate ranges.*

Supplemental information

The total range of 0 – 500 ppmC reflects its singular use for testing afterburning engines. Since the operational range specified in Appendix 3, Attachment A, covers the non-afterburning range too, an instrument with a total range of 0 – 5,000 ppmC which incorporates a range of 0 – 500 ppmC is likely to be the instrument of choice. As far as possible, measurements should be restricted to the upper 30% of full scale on the range or ranges used except as noted above.

- b) *Resolution: better than 0.5 per cent of full scale of range used or 0.5 ppmC, whichever is greater.*
- c) *Repeatability: better than ± 1 per cent of full scale of range used. or ± 0.5 ppmC, whichever is greater.*
- d) *Stability: better than ± 2 per cent of full scale of range used or ± 1.0 ppmC, whichever is greater, in a period of 1 hour.*
- e) *Zero drift: less than ± 1 per cent of full scale of range used or ± 0.5 ppmC, whichever is greater, in a period of 1 hour.*
- f) *Noise: 0.5 Hz and greater, less than ± 1 per cent of full scale of range used or ± 0.5 ppmC, whichever is greater.*

Supplemental information

The FID requires fuel and oxidant gases for operation. The fuel gas is typically either a mixture of hydrogen and nitrogen or hydrogen and helium. If the noise specification cannot be met and a hydrogen/nitrogen mixture is being used as the fuel gas, it sometimes helps to change to a hydrogen/helium mixture.

- g) *Response time: shall not exceed 10 seconds from inlet of the sample to the analysis system, to the achievement of 90 per cent of the final reading.*
- h) *Linearity: response with propane in air shall be linear for each range within ± 2 per cent of full scale, otherwise calibration corrections shall be used.*

2. SYNERGISTIC EFFECTS

Note.- In application there are two aspects of performance which can affect the accuracy of measurement:

- a) *the oxygen effect (whereby differing proportions of oxygen present in the sample give differing indicated hydrocarbon concentration for constant actual HC concentrations); and*
- b) *the relative hydrocarbon response (whereby there is a different response to the same sample hydrocarbon concentrations expressed as equivalent ppmC, dependent on the class or admixture of classes of hydrocarbon compounds).*

The magnitude of the effects noted above shall be determined as follows and limited accordingly.

Oxygen response: measure the response with two blends of propane, at approximately 500 ppmC concentration known to a relative accuracy of ± 1 per cent, as follows:

- 1) *propane in 10 ± 1 per cent O₂, balance N₂*

2) propane in 21 ± 1 per cent O_2 , balance N_2

If R_1 and R_2 are the respective normalized responses then $(R_1 - R_2)$ shall be less than 3 per cent of R_1 .

Supplemental information

Unlike the non-afterburning case, the range of oxygen values can vary over a fairly wide range. This will be influenced by the location of the sampling plane and the degree of mixing of ambient air with the reacted plume. If needed, the O_2 response can be minimized by adjusting the FID burner fuel/air ratio.

Differential hydrocarbon response: measure the response with four blends of different hydrocarbons in air, at concentrations of approximately 500 ppmC, known to a relative accuracy of ± 1 per cent, as follows:

- a) propane in zero air
- b) propylene in zero air
- c) toluene in zero air
- d) n-hexane in zero air.

If R_a , R_b , R_c and R_d are, respectively, the normalized responses (with respect to propane), then $(R_a - R_b)$, $(R_a - R_c)$ and $(R_a - R_d)$ shall each be less than 5 per cent of R_a .

Supplemental information

Although assumed to respond as a carbon number counter, for the purposes of testing engine exhaust, the FID response is known to vary somewhat with the particular hydrocarbon or class of hydrocarbons being measured. For example, three molecules of methane, (CH_4), will not necessarily result in the same instrument response as one molecule of propane, (C_3H_8). Because of this differential response it is sometimes helpful to think of the FID as responding to an “effective” carbon number. It is important to ensure the instrument responds acceptably to all of the hydrocarbons in the engine exhaust. This group of hydrocarbons – propylene, toluene, and n-hexane, with propane as a reference – was chosen to represent, in terms of instrument response, the range of hydrocarbons expected in the exhaust.

3. OPTIMIZATION OF DETECTOR RESPONSE AND ALIGNMENT

3.1 *The manufacturer's instructions for initial setting up procedures and ancillary services and supplies required shall be implemented, and the instrument allowed to stabilize. All setting adjustments shall involve iterative zero checking, and correction as necessary. Using as sample a mixture of approximately 500 ppmC of propane in air, the response characteristics for variations first in fuel flow and then, near an optimum fuel flow, for variations in dilution air flow to select its optimum shall be determined. The oxygen and differential hydrocarbon responses shall then be determined as indicated above.*

Supplemental procedure

The FID detector response and alignment can be optimized by adjusting the FID burner fuel and air flow while sampling a mixture containing approximately 500 ppmC propane. Care should be taken when changing fuel flow that the instrument zero response point does not shift. If it does, the instrument zero should be reset. Response curves illustrating this process, shown below in Figures A5-5 and A5-6, were taken from 40 CFR Part 87, Control of Air Pollution from Aircraft and Aircraft Engines, Federal Register, Vol. 43, No. 58 — Friday, March 24, 1978. They were taken, in turn, from

SAE ARP1256, "Procedure for the Continuous Sampling and Measurement of Gaseous Emissions from Aircraft Turbine Engines".

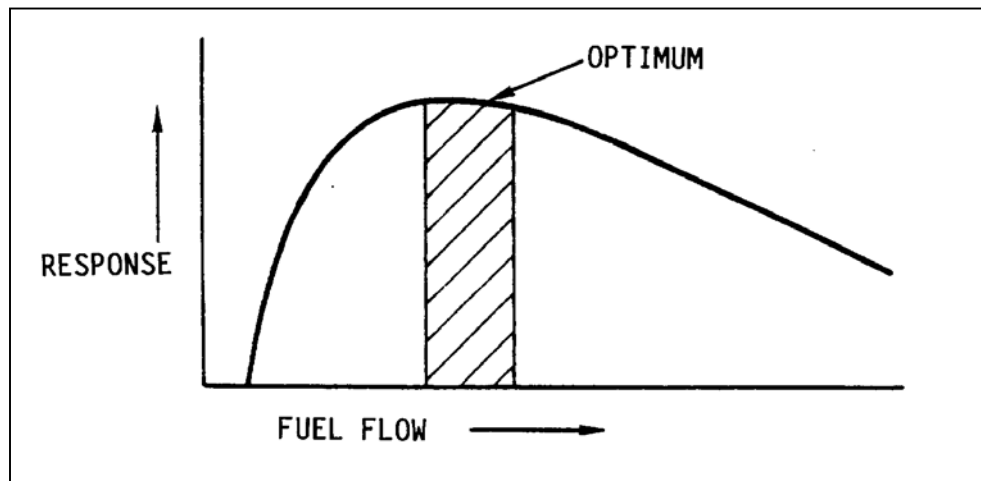

Figure A5-5 Typical Fuel Flow Response Curve

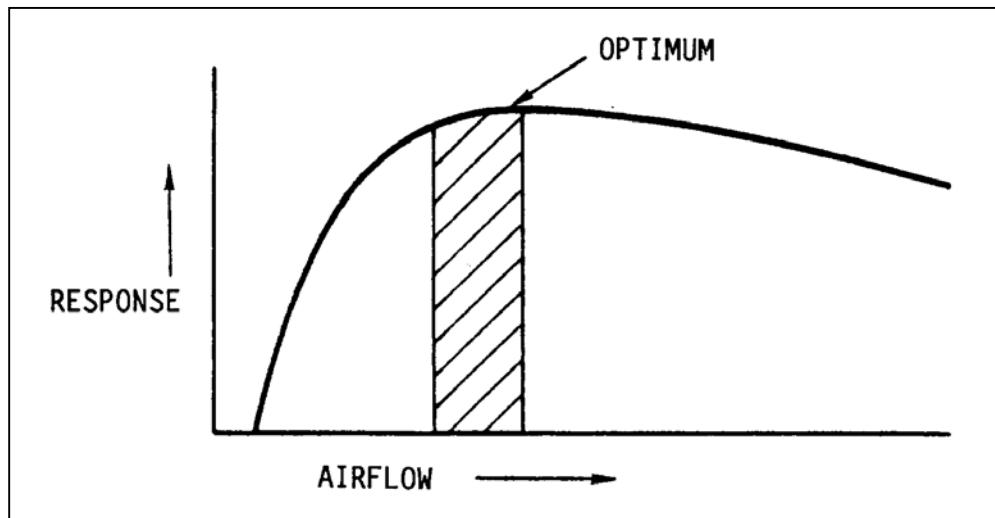

Figure A5-6 Typical Airflow Response Curve

The objective of this procedure is to select operating flow rates that will give near maximum response with least variation for minor changes in fuel flow. It may be necessary to repeat this operation in an iterative fashion:

- Adjust the fuel flow to maximize output;
- Adjust zero if necessary;
- Adjust the air flow to maximize output;
- Readjust the fuel flow, if necessary; and
- Repeat until the burner output is optimized.

3.2 *The linearity of each analyzer range shall be checked by applying propane in air samples at concentrations of approximately 30, 60 and 90 per cent of full scale. The maximum response deviation of any of these points from a least squares straight line (fitted to the points and zero) shall not exceed ±2 per cent of full scale value. If it does, a calibration curve shall be prepared for operational use.*

Table A5-1 HC ANALYZER PERFORMANCE SPECIFICATIONS

Parameter	Value
Total Range	0 to 500 ppmC (5 000ppmC for non AB)
Resolution	better than 0.5% full scale range used or 0.5 ppmC whichever is greater
Repeatability	better than ±1% full scale range used or ±0.5 ppmC whichever is greater
Stability	better than ±2% full scale range used or ±1 ppmC whichever is greater in a period of 1 hour
Zero drift	< ±1% full scale range used or ±0.5 ppmC, whichever is greater in a period of 1 hour
Noise	0.5 Hz and greater, < than ±1% full scale range used or ±0.5 ppmC, whichever is greater
Response time	≤ 10 seconds from inlet of sample to achieve 90% of final reading
Linearity	±2% full scale to propane in air, for each range used, or calibration correction required

The performance specifications shown in Table A5-1 are typical of those analyzers offered by major analyzer manufacturers.

**ATTACHMENT B TO ICAO MANUAL APPENDIX 5.
SPECIFICATION FOR CO AND CO₂ ANALYSERS**

Note 1.- Paragraph 5.3 of Appendix 5 summarizes the characteristics of the analysis sub-system to be employed for the individual measurements of CO and CO₂ concentrations in the exhaust gas sample. The instruments are based on the principle of non-dispersive absorption of infra-red radiation in parallel reference and sample gas cells. The required ranges of sensitivity are obtained by use of stacked sample cells or changes in electronic circuitry or both. Interferences from gases with overlapping absorption bands may be minimised by gas absorption filters and/or optical filters. preferably the latter.

Note 2.— See attachment D for information on calibration and test gases.

Precautions: *The performance specifications indicated are generally for analyzer full scale. Errors at part scale may be a significantly greater percentage of reading. The relevance and importance of such increases shall be considered when preparing to make measurements. If better performance is necessary, then appropriate precautions shall be taken.*

Supplemental information

The performance specifications for these analyzers given in terms of full scale response can have a significant and adverse impact on part scale measurements. This needs to be considered when planning and executing the test and in evaluating the accuracy of the measurements after the test. Concentrations of CO, when going from the idle mode to take-off, can differ by orders of magnitude. In general, where concentrations of species to be measured are known to vary this way, it is always good practice to use a multi-range instrument and to choose ranges such as to keep the measurement in the upper 30% of scale on the range in use. A measurement made at 20% of full scale could result in an error 5 times the error specified as a percent of full scale. This is a general precaution. Some modern instruments with internal electronic ranging and calibration capability can be used over their entire range without penalty. Calibrations should be performed on each range used as required.

The principal performance specification shall be as follows:

CO Analyzer

b) Total range: 0 to 2 500 ppm in appropriate ranges.

Relative to the precautions mentioned above ranges are chosen that the instrument responds in the upper 30% of scale for the range in use. While this may not always be possible it should be a goal.

b) Resolution: better than 0.5 per cent of full scale of range used or 1 ppm, whichever is greater.

c) Repeatability: better than ± 1 per cent of full scale of range used, or ± 2 ppm, whichever is greater.

e) Stability: better than ± 2 per cent of full scale of range used or ± 2 ppm, whichever is greater, in a period of 1 hour.

e) Zero drift: less than ± 1 per cent of full scale of range used or ± 2 ppm, whichever is greater, in a period of 1 hour.

f) Noise: 0.5 Hz and greater, less than ± 1 per cent of full scale of range used or ± 1 ppm, whichever is greater.

g) Interferences: to be limited with respect to indicated CO concentration as follows:

1) less than 500 ppm/per cent ethylene concentration

Supplemental information

It is unlikely that high concentrations of ethylene will be found in gas turbine engine exhaust. The highest concentration of hydrocarbons is found at idle, corresponding to the highest concentrations of CO. If all of the hydrocarbons were ethylene (C₂H₄), and the concentration were 100% of the maximum range, 5,000 ppmC, –corresponding to 2,500 ppm ethylene – the allowable interference would be less than 125 ppm, or less than 5% of the highest CO range, 2,500 ppm. Since the interference limit is in absolute terms, the relative error will increase for measurements made at less than full scale. If ethylene is suspected of being present in significant concentrations, then corrections to the data are required.

2) less than 2 ppm/per cent CO₂ concentration

*4) less than 2 ppm/per cent water vapour.**

Supplemental information

These two interferents, CO₂ and water vapor, are additive. Being the major products of combustion they increase and decrease together, and are at their highest levels at the highest power. Unfortunately concentrations of CO tend to be at their lowest concentrations at the highest power. This can cause significant problems in the accuracy of the measurement even if the interference limits are met. It is not unusual for tests to be conducted with the sample dried before measurement and the interference due to the remaining interferent, CO₂, compensated for through use of gas or optical filters. It does bear mentioning that the contribution of high power CO concentrations to the total gross CO emission measured over the LTO cycle is relatively small.

If the interference limitation(s) for CO₂ and/or water vapour cannot be met, appropriate correction factors shall be determined, reported and applied.

Note.- It is recommended as consistent with good practice that such correction procedures be adopted in all cases.

** Need not apply where measurements are on a "dry" basis.*

CO₂ Analyzer

d) Total range: 0 to 10 per cent in appropriate ranges.

Supplemental information

Although the total range specified for CO₂ is 0 to 10%, concentrations most often will vary between 1% and 5%. This range is considerably narrower than that for CO. Never the less, good practice dictates using ranges that keep the instrument response in the upper 30% of the meter scale except as noted above.

b) Resolution: better than 0.5 per cent of full scale of range used or 100 ppm, whichever is greater.

c) Repeatability: better than ±1 per cent of full scale of range used or ±100 ppm, whichever is greater.

d) Stability: better than ±2 per cent of full scale of range used or ±100 ppm, whichever is

greater, in a period of 1 hour.

- e) Zero drift: less than ± 1 per cent of full scale of range used or ± 100 ppm, whichever is greater, in a period of 1 hour.
- f) Noise: 0.5 Hz and greater, less than ± 1 per cent of full scale of range used or ± 100 ppm, whichever is greater.
- h) The effect of oxygen (O_2) on the CO_2 analyzer response shall be checked. For a change from 0 per cent O_2 to 21 per cent O_2 , the response of a given CO_2 concentration shall not change by more than 2 per cent of reading. If this limit cannot be met an appropriate correction factor shall be applied.

Supplemental information

Gas turbine engines use a considerable amount of internal cooling air that mixes with the combustion products before exiting the engine. This results in an oxygen rich exhaust sample that warrants close attention.

Note.— It is recommended as consistent with good practice that such correction procedures be adopted in all cases.

CO and CO_2 Analysers

- a) *Response time: shall not exceed 10 seconds from inlet of the sample to the analysis system, to the achievement of 90 per cent of the final reading.*
- b) *Sample temperature: the normal mode of operation is for analysis of the sample in its (untreated) "wet" condition. This requires that the sample cell and all other components in contact with the sample in this sub-system be maintained at a temperature of not less than 50 C, with a stability of ± 2 C. The option to measure CO and CO_2 on a dry basis (with suitable water traps) is allowed, in which case unheated analysers are permissible and the interference limits for H_2O vapour removed, and subsequent correction for inlet water vapour and water of combustion is required.*

Supplemental information

Stability is defined in terms of a time interval which, because this is a temperature control set point, can be taken as the duration of the test, or one hour to be consistent with the stability limits placed on the detection system.

The temperature quoted for the CO and CO_2 subsystems, 50°C, is on the low end of the sample line specification, 65°C ± 15 °C. Good practice would suggest that the subsystem temperature be approximately the same as the sample gas temperature. If the samples are dried and the analyzers unheated it would be reasonable to lower the sample temperature to that of the analyzer. If water is removed prior to analysis corrections must be applied to compensate for the loss of water of combustion and inlet water vapor. Correction procedures are detailed in Attachment F of this Appendix.

- c) *Calibration curves:*
- j) *Analysers with a linear signal output characteristic shall be checked on all working ranges using calibration gases at known concentrations of approximately 0, 30, 60 and 90 per cent of full scale. The maximum response deviation of any of these points from a least squares straight line, fitted to the points and the zero reading, shall not exceed ± 2 per cent of the full scale value. If it does then a calibration curve shall be prepared for operational use.*

Supplemental information

Straight line fits to sets of linear data can be arrived at graphically or analytically. If graphically, the results are subject to interpretation, i.e., best estimate by 'eye' by individual. If analytically, there is assurance that each case and all data are handled the same way each time. The technique is to perform a linear regression, or 'least-squares fit' for a line. The calibration gas values are the "independent" variables and are assumed to be correct, to have negligible error, for the purpose of this analysis. The instrument response values are the dependent variables and are assumed to have errors and that these errors are normally (Gaussian) distributed about the true line. The equation describing the straight line is:

$$y_i = A + B \cdot x_i$$

true value for response $y_i = A$ (a constant) + B (another constant) * (calibration gas value x_i)

For instruments which have been adjusted such that zero input results in zero output, and where the variance is known to be proportional to the reading the slope B can be shown to be equal to the ratio of the averages and can be expressed as:

$$\frac{\bar{y}}{\bar{x}}$$

Often A and B are not such simple values for intercept and slope but must be calculated as if the variance were not known to be proportional to the instrument response. Again if we set the instrument to read zero for zero gas input then $A = 0$ which makes the calculation relatively simple. The generalized expression for B can be found in any elementary statistics or error analysis text and is:

$$B = \frac{N \sum_{i=1}^N x_i y_i - \sum_{i=1}^N x_i \sum_{i=1}^N y_i}{N \sum_{i=1}^N x_i^2 - \left(\sum_{i=1}^N x_i \right) \left(\sum_{i=1}^N y_i \right)}$$

Where x_i is the calibration gas value and y_i is the instrument response and N refers to the number of points used in the analysis.

With $N = 4$, corresponding to 0, 30, 60 and 90% of full scale, this equation can be rewritten as:

$$B = \frac{4 \sum_{i=1}^4 x_i y_i - \sum_{i=1}^4 x_i \sum_{i=1}^4 y_i}{4 \sum_{i=1}^4 x_i^2 - \left(\sum_{i=1}^4 x_i \right) \left(\sum_{i=1}^4 y_i \right)}$$

A simple table, for the four sets of values, can be used for organizing the information, thereby simplifying the calculation:

Measurement number i	x cal. gas value i	y response i	x_i^2	$x_i y_i$
1				
2				
3				
4				
$N = 4$	Σx_i	Σy_i	Σx_i^2	$\Sigma x_i y_i$

If the instrument is not set to zero-zero (zero response for zero input), then A must be determined. The equation for A (for $N = 4$) is:

$$A = \frac{\sum_{i=1}^4 x_i \sum_{i=1}^4 y_i}{4 \sum_{i=1}^4 x_i^2 - \left(\sum_{i=1}^4 x_i\right)^2}$$

The table shown earlier can be used to organize the elements of this equation as well.

Usually the next step would be to calculate the uncertainty in y_i about this line. However, instead of controlling uncertainty about the line, ICAO chose to set an absolute limit of $\pm 2\%$ deviation of the full scale value for each point. This should make clear the advantage in using the upper region (top 30%) of the range for all measurements.

ii) *Analysers with a non-linear signal output characteristic, and those that do not meet the requirements of linearity given above, shall have calibration curves prepared for all working ranges using calibration gases at known concentrations of approximately 0, 30, 60 and 90 per cent of full scale. Additional mixes shall be used, if necessary, to define the curve shape properly.*

Supplemental information

For analyzers with a non-linear signal output characteristic, calibration curves shall be prepared, again using approximately 0, 30, 60 and 90% of full scale calibration gases. If a curve is substantially non-linear in shape, it is recommended that additional calibration gases be used with values between the ones specified. These calibration curves can be determined analytically using a least squares fit, but in this case the fit would be to a polynomial or exponential. The equations for doing this can be found in any basic text on statistics or error analysis. It should be noted that for exponential fits it is often convenient to work with the logarithm of the expression, which reduces the problem to a least-squares-fit about a line as is described above. This technique is used in analyzing smoke filters as required in 3. of Appendix 2. Although not stated explicitly, the presumption is that the same $\pm 2\%$ of full scale response deviation is true for non-linear as well as linear instruments.

Table A5-2 summarizes the specifications for CO and CO₂ analyzers. These are typical of those analyzers offered by major analyzer manufacturers.

Table A5-2 NDIR ANALYZER PERFORMANCE SPECIFICATIONS

Parameter	Value	
	CO ₂	CO
Total Range	0 to 10% in appropriate ranges	0 to 2 500 ppm in appropriate ranges
Resolution	better than 0.5% fs range used or 100 ppm whichever greater	better than 0.5% fs range used or 1 ppm whichever greater
Repeatability	better than ±1% fs range used or ±100 ppm whichever greater	better than ±1% fs range used or ±2 ppm whichever greater
Stability	better than ±2% fs range used or ±100 ppm whichever greater period of 1 hr	better than ±2% fs range used or ±2 ppm whichever greater period of 1 hr
Zero Drift	< ±1% fs range used or ±100 ppm whichever greater period of 1 hr	< ±1% fs range used or ±2 ppm whichever greater period of 1 hr
Noise	≥0.5 Hz, <±1% FS RANGE USED OR ±100 PPM, WHICHEVER GREATER	≥0.5 Hz, <±1% fs range used or ±1 ppm, whichever greater
Interference	≤ 2% of reading for O ₂ between 0 and 21%	<500 ppm/% ethylene <2 ppm/% CO ₂ <2 ppm/% water vapor
Response Time	≤10 seconds from instrument inlet to 90% fs	≤10 seconds from instrument inlet to 90% fs
Sample Temperature	wet samples ≥50°C stability ± 2°C	wet samples ≥50°C stability ± 2°C

**ATTACHMENT C TO ICAO MANUAL APPENDIX 5.
SPECIFICATION FOR NO_x ANALYSER**

Note.— See attachment D for information on calibration and test gases.

1. *As indicated in 5.4 of Appendix 5, the measurement of the oxides of nitrogen concentration shall be by the chemiluminescent technique in which radiation emitted by the reaction of NO and O₃ is measured. This method is not sensitive to NO₂ and therefore the sample shall be passed through a converter in which NO₂ is converted to NO before the measurement of total NO_x is made. Both the original NO and the total NO_x concentrations shall be recorded. Thus by difference, a measure of the NO₂ concentration shall be obtained.*
2. *The instrument to be used shall be complete with all necessary flow control components, such as regulators, valves, flowmeters, etc. Materials in contact with the sample gas shall be restricted to those which are resistant to attack by oxides of nitrogen, such as stainless steel, glass, etc. The temperature of the sample shall everywhere be maintained at values, consistent with the local pressures, which avoid condensation of water.*

Precautions: *The performance specifications indicated are generally for analyzer full scale. Errors at part scale may be a significantly greater percentage of reading. The relevance and importance of such increases shall be considered when preparing to make measurements. If better performance is necessary, then appropriate precautions shall be taken.*

Supplemental information

The performance specifications for these analyzers given in terms of full scale response can have a significant and adverse impact on part scale measurements. This needs to be considered when planning and executing the test, and in evaluating the accuracy of the measurements after the test. Concentrations of NO_x, when going from the idle mode to take-off, can differ by orders of magnitude. In general, where concentrations of species to be measured are known to vary this way, it is always good practice to use a multi-range instrument, and to choose ranges such as to keep the measurement in the upper 30% of scale on the range in use. A measurement made at 20% of full scale could result in an error 5 times the error specified as a percent of full scale. This is a general precaution. Some modern instruments with internal electronic ranging and calibration capability can be used over their entire range without penalty. Calibrations should be performed on each range used as required.

3. *The principal performance specification, determined for the instrument operated in an ambient temperature stable to within 2 C, shall be as follows:*
 - a) *Total range: 0 to 2 500 ppm in appropriate ranges.*
 - b) *Resolution: better than 0.5 per cent of full scale of range used or 1 ppm, whichever is greater.*
 - c) *Repeatability: better than ±1 per cent of full scale of range used, or ±1 ppm, whichever is greater.*
 - d) *Stability: better than ±2 per cent of full scale of range used or ±1 ppm, whichever is greater, in a period of 1 hour.*

- e) *Zero drift: less than ±1 per cent of full scale of range used or ±1 ppm, whichever is greater, in a period of 1 hour.*
- f) *Noise: 0.5 Hz and greater, less than ±1.0 per cent of full scale of range used or ±1 ppm, whichever is greater, in a period of 2 hours.*
- g) *Interference: suppression for samples containing CO₂ and water vapour, shall be limited as follows:*
- *less than 0.05 per cent reading/per cent CO₂ concentration;*
 - *less than 0.1 per cent reading/per cent water vapour concentration.*
- If the interference limitation(s) for CO₂ and/or water vapour cannot be met, appropriate correction factors shall be determined, reported and applied.*
- Note.- It is recommended as consistent with good practice that such correction procedures be adopted in all cases.*
- h) *Response time: shall not exceed 10 seconds from inlet of the sample to the analysis system to the achievement of 90 per cent of the final reading.*
- i) *Linearity: better than ±2 per cent of full scale of range used or ±2 ppm, whichever is greater.*
- j) *Converter: this shall be designed and operated in such a manner as to reduce NO₂ present in the sample to NO. The converter shall not affect the NO originally in the sample.*

Supplemental information

...”in such a matter” ... should read ... “in such a manner”

The converter efficiency shall not be less than 90 per cent.

This efficiency value shall be used to correct the measured sample NO₂ value (i.e. [NO_x]_c - [NO]) to that which would have been obtained if the efficiency had not been 100 per cent.

Supplemental information

The last sentence should read as follows:

“This efficiency value shall be used to correct the measured sample NO₂ value (ie. [NO_x]_c -[NO]) to that which would have been obtained if the efficiency had been 100 per cent.”

A procedure for determining the NO₂ to NO conversion efficiency, in the absence of any specific manufacturer’s instructions, may be found in 40 CFR Part 87, Control of Air Pollution from Aircraft and Aircraft Engines, Federal Register, Vol. 43, No. 58 — Friday, March 24, 1978. It was taken, in turn, from SAE ARP1256, "Procedure for the Continuous Sampling and Measurement of Gaseous Emissions from Aircraft Turbine Engines".

Figure A5-7: NO_x Converter Efficiency Detector Schematic

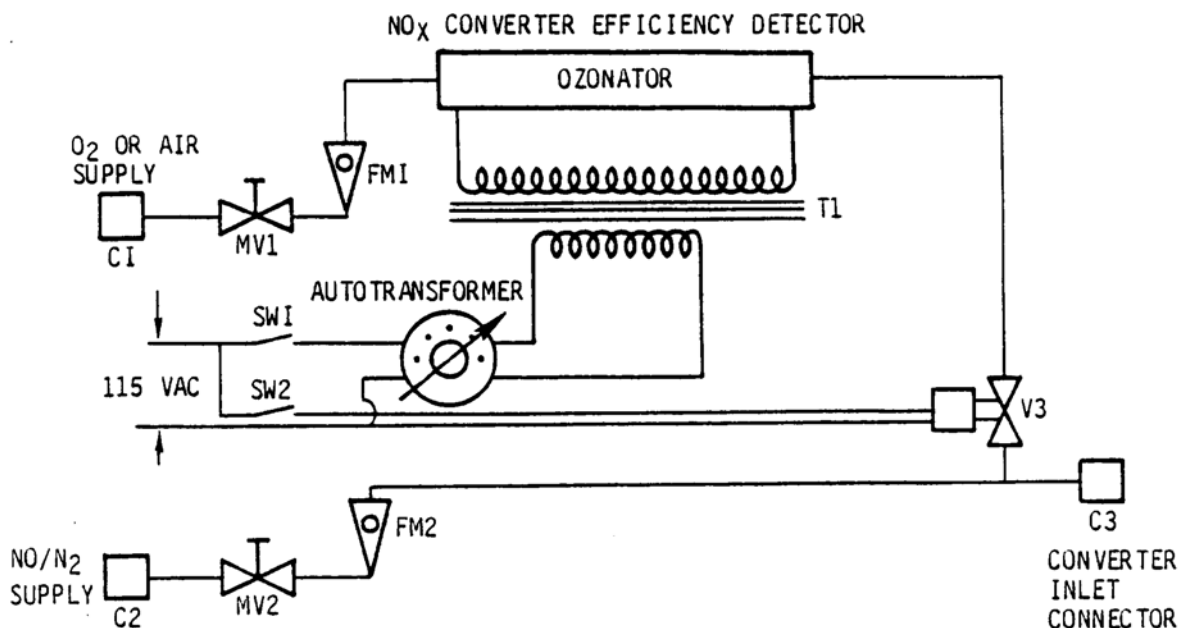
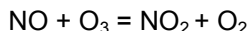

Figure A5-7 schematically depicts such a device. This device is intended for use with the NO_x analyzer specified in Attachment C. It depends on the reaction:



Starting with a known concentration of NO in N₂, measurements are made through – and bypassing – the chemiluminescence analyzer converter, the inlet to which is shown as “C3” in the diagram. With the NO_x converter ozonator alternately on, reducing the NO concentration by approximately 80%, and off, allowing 100% of the NO to reach the analyzer the analyzer’s converter efficiency can be determined. This efficiency should be used to correct test data as required.

Note: it has been suggested that NO be mixed with Argon to avoid possible formation of NO in the ozonator.

The specific instructions for using this device, from 40 CFR part 87, are as follows:

- (i) Attach the NO/N₂ supply (150-250 ppm.) at “C2”, the O₂ supply at “C1” and the analyzer inlet connection to the efficiency detector at C3. If lower concentrations of NO are used, air may be used in place of O₂ to facilitate better control of the NO₂ generated during step (iv).
- (ii) With the efficiency detector Variac (*Note: SAE uses the term autotransformer*) off, place the NO_x converter in bypass mode and close valve “V3”. Open valve “MV2” until sufficient flow and stable readings are obtained at the analyzer. Zero and span the analyzer output to indicate the value of the NO concentration being used. Record this concentration.
- (iii) Open valve V3 (on/off flow control solenoid valve for O₂) and adjust valve “MV1” (O₂ supply metering valve) to blend enough O₂ to lower the NO concentration (ii) to about 10 percent. Record this concentration.
- (iv) Turn on the ozonator and increase its supply voltage until the NO concentration of (iii) is reduced to about 20 percent of (ii). NO is now being formed from the NO + O₂ reaction. There must always be at least 10 percent unreacted NO at this point. Record this concentration.

- (v) When a stable reading has been obtained from (iv), place the NO_x converter in the convert mode. The analyzer will now indicate the total NO_x concentration. Record this concentration.
- (vi) Turn off the ozonator and allow the analyzer reading to stabilize. The mixture NO + O₃ is still passing through the converter. This reading is the total NO_x concentration of the dilute NO span gas used in step (iii). Record this concentration.
- (vii) Close valve V3. The NO concentration should be equal to or greater than the reading of (ii) indicating whether the NO contains any NO₂.

Calculate the efficiency of the NO_x converter by substituting the concentrations obtained during the test into the following equation:

$$\%Eff. = \frac{v - iv}{vi - iv} \times 100\%$$

To improve the effectiveness of thermal converters, particularly those with efficiencies of less than 90%, it is sometimes helpful to raise the temperature of the converter.

Table A5-3 NO_x ANALYZER PERFORMANCE SPECIFICATION

Parameter	Value
Total Range	0 to 2 500 ppm in appropriate ranges
Resolution	BETTER THAN 0.5 PERCENT FULL SCALE RANGE USED OR 1 PPM WHICHEVER IS GREATER
Repeatability	better than ±1 percent full scale range used or 1 ppm whichever is greater
Stability	better than ±2 percent% full scale range used or ±1 ppm whichever is greater in a period of 2 hours
Zero Drift	< ±1 percent% full scale range used or ±1 ppm, whichever is greater in a period of 2 hours
Noise	≥0.5 Hz, <±1 percent fs range used or ±1 ppm, whichever greater period of 2 hours
Interference	< 0.05 percent reading/percent CO ₂ < 0.1 percent reading/percent water vapor
Response Time	≤ 10 seconds from inlet of sample to achieve 90 percent of final reading
Linearity	better than ±2 percent full scale for each range used or ± 2ppm, whichever greater
Converter Efficiency	≥ 90 percent

Table A5-3 summarizes the specifications shown are typical of those analyzers offered by major analyzer manufacturers.

**ATTACHMENT D TO ICAO MANUAL APPENDIX 5.
CALIBRATION AND TEST GASES**

Table of calibration gases

<i>Analyser</i>	<i>Gas</i>	<i>Accuracy*</i>
HC	propane in zero air	±2 per cent or ±0.05 ppm**
CO ₂	CO ₂ in zero air	±2 per cent or ±100 ppm**
CO	CO in zero air	±2 per cent or ±2 ppm**
NO _x	NO _x in zero nitrogen	±2 per cent or ±1 ppm**

* Taken over the 95 per cent confidence interval.
** Whichever is greater

The above gases are required to carry out the routine calibration of analysers during normal operational use.

<i>Analyser</i>	<i>Gas</i>	<i>Accuracy*</i>
HC	propane in 10 ±1 per cent O ₂ balance zero nitrogen	±1 per cent
HC	propane in 21 ±1 per cent O ₂ balance zero nitrogen	±1 per cent
HC	propylene in zero air	±1 per cent
HC	toluene in zero air	±1 per cent
HC	n-hexane in zero air	±1 per cent
HC	propane in zero air	±1 per cent
CO ₂	CO ₂ in zero air	±1 per cent
CO ₂	CO ₂ in zero nitrogen	±1 per cent
CO	CO in zero air	±1 per cent
NO _x	NO in zero nitrogen	±1 per cent

* Taken over the 95 per cent confidence interval

The above gases are required to carry out the tests of Attachments A, B and C.

Carbon monoxide and carbon dioxide calibration gases may be blended singly or as dual component mixtures. Three component mixtures of carbon monoxide, carbon dioxide and propane in zero air may be used, provided the stability of the mixture is assured.

Zero gas as specified for the CO, CO₂ and HC analysers shall be zero air (which includes "artificial" air with 20 to 22 per cent O₂ blended with N₂). For the NO_x analyser zero nitrogen shall be used as the zero gas. Impurities in both kinds of zero gas shall be restricted to be less than the following concentrations:

*1 ppm C
1 ppm CO
100 ppm CO₂
1 ppm NO_x*

The applicant shall ensure that commercial gases supplied to him do in fact meet this specification, or are so specified by the vendor.

Supplemental information

Calibration and test gases are readily available, with traceability to the National Institute of Standards and Technology (NIST), from commercial suppliers. Gases with an accuracy of $\pm 1\%$ are considered "primary" standards and intended for use where the highest accuracy and reliability are needed. Very tight controls over cylinder material, age, and history are considered good practice, if not essential. Periodic checks of the accuracy of assay for each cylinder is advisable. Gases such as CO, CO₂, and propane with a certified accuracy of $\pm 2\%$ can be obtained as multi-component mixtures. This will reduce the number of gas cylinders needed for testing. The importance of this becomes obvious when considering the calibration requirements for each instrument and each range. Managing just the minimum number of calibration and test gases can be challenging. For example, an average certification test, when backup gases are counted, can require 100 two component cylinders, or more. The stability of the components in each mixture should be checked periodically. If the assay no longer agrees with the certified analysis, the cylinder should be returned to the supplier or discarded as appropriate.

Because of the accuracy required and the sophistication of the techniques necessary to produce and analyze gases to these standards, most testing laboratories rely on the commercial suppliers analysis and certification for primary accuracy and use in-house checks via instrument response for consistency of assay. It is good practice to recheck all calibration and working standard gases immediately prior to a certification test.

All calibration gas monitoring data should be kept and made available to the certifying agency if required.

Although not a calibration gas or, strictly speaking, a test gas, the FID analyzer fuel and oxidant gases should also meet a hydrocarbon specification. For hydrogen/nitrogen or hydrogen/helium fuel mixtures, total hydrocarbons present should be < 1 ppmC. The oxidant should be hydrocarbon free grade air, containing < 1 ppmC hydrocarbon. The SAE in ARP 1256 restricts the FID fuel gas to a 40% hydrogen, 60% helium mixture which is required to meet this hydrocarbon level specification.

**ATTACHMENT E TO ICAO MANUAL APPENDIX 5.
THE CALCULATION OF THE EMISSIONS
PARAMETERS - BASIS, MEASUREMENT CORRECTIONS AND
ALTERNATIVE NUMERICAL METHOD**

1. SYMBOLS			
		P_7	number of moles of NO ₂ in the exhaust sample per mole of fuel
AFR	air/fuel ratio, the ratio of the mass flow rate of dry air to that of the fuel	P_8	number of moles of NO in the exhaust sample per mole of fuel
EI	emission index; $10^3 \times$ mass flow rate of gaseous emission product in exhaust per unit mass flow rate of fuel	P_T	$P_1 + P_2 + P_3 + P_4 + P_5 + P_6 + P_7 + P_8$
K	ratio of concentration measured wet to that measured dry (after cold trap)	R	concentration of O ₂ in dry air, by volume = 0.2095 normally
L, L'	analyser interference coefficient for interference by CO ₂	S	concentration of N ₂ + rare gases in dry air, by volume = 0.7902 normally
M, M'	analyser interference coefficient for interference by H ₂ O	T	concentration of CO ₂ in dry air, by volume = 0.0003 normally
M_{AIR}	molecular mass of dry air = 28.966 g or, where appropriate, = (32 R + 28.156 4 S + 44.011 T) g	P_0	number of moles of air per mole of fuel in initial air/fuel mixture
M_{CO}	molecular mass of CO = 28.011 g	Z	symbol used and defined in 3.4
M_{HC}	molecular mass of exhaust hydrocarbon, taken as CH ₄ = 16.043 g	[CO ₂]	mean concentration of CO ₂ in exhaust sample, vol/vol
M_{NO_2}	molecular mass of NO ₂ = 46.008 g	[CO]	mean concentration of CO in exhaust sample, vol/vol
M_C	atomic mass of carbon = 12.011 g	[HC]	mean concentration of HC in exhaust sample, vol C/vol
M_H	atomic mass of hydrogen = 1.008 g	[NO]	mean concentration of NO in exhaust sample, vol/vol
P_1	number of moles of CO ₂ in the exhaust sample per mole of fuel	[NO ₂]	mean concentration of NO ₂ in exhaust sample, vol/vol
P_2	number of moles of N ₂ in the exhaust sample per mole of fuel	[NO _x]	mean concentration of NO and NO ₂ in exhaust sample, vol/vol
P_3	number of moles of O ₂ in the exhaust sample per mole of fuel	[NO _x] _c	mean concentration of NO in exhaust sample. after passing through the NO ₂ /NO converter, vol/vol
P_4	number of moles of H ₂ O in the exhaust sample per mole of fuel	[NO ₂]	mean = $\frac{([NO_x]_c - [NO])}{\eta}$
P_5	number of moles of CO in the exhaust sample per mole of fuel	[] _d	mean concentration in exhaust sample after cold trap, vol/vol
P_6	number of moles of C _x H _y in the exhaust	[] _m	mean concentration measurement

sample per mole of fuel

indicated before instrument correction
applied, vol/vol

h	humidity of ambient air, vol water/vol dry air
h_d	humidity of exhaust sample leaving "drier" or "cold trap", vol water/vol dry sample
m	number of C atoms in characteristic fuel molecule
n	number of H atoms in characteristic fuel molecule
x	number of C atoms in characteristic exhaust hydrocarbon molecule
y	number of H atoms in characteristic exhaust hydrocarbon molecule
η	efficiency of NO ₂ /NO converter

2. BASIS OF CALCULATION OF EI AND AFR PARAMETERS

2.2 It is assumed that the balance between the original fuel and air mixture and the resultant state of the exhaust emissions as sampled can be represented by the following equation:

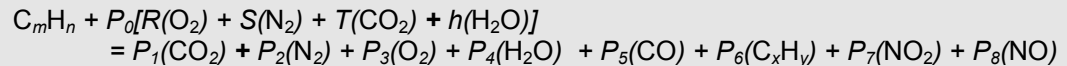

from which the required parameters can, by definition, be expressed as

$$EI(CO) = P_3 \left[\frac{10^3 M_{CO}}{mM_C + nM_H} \right]$$

$$EI(HC) = xP_6 \left[\frac{10^3 M_{HC}}{mM_C + nM_H} \right]$$

expressed as methane equivalent

$$EI(NO_x) = (P_7 + P_8) \left[\frac{10^3 M_{NO_2}}{mM_C + nM_H} \right]$$

$$AFR = P_0 \left[\frac{M_{AIR}}{mM_C + nM_H} \right]$$

expressed as NO₂ equivalent

Supplemental information

This is a slightly different formulation for AFR than that stated in 7.1.3, "Basic parameters". In this formulation "m", the number of C atoms in characteristic fuel molecule is placed within the bracket. There is no particular advantage to using one formulation over the other.

- 2.2 Values for fuel hydrocarbon composition (rn, n) are assigned by fuel specification or analysis. If only the ratio n/m is so determined, the value $m = 12$ may be assigned. The mole fractions of the dry air constituents (R, S, T) are normally taken to be the recommended standard values but alternative values may be assigned, subject to the restriction $R + S + T = 1$ and the approval of the certifying authority.
- 2.3 The ambient air humidity, h , is as measured at each test condition. It is recommended that, in the absence of contrary evidence as to the characterization (x, y) of the exhaust hydrocarbon, values of $x = 1$ and $y = 4$ are assigned.
- 2.4 Determination of the remaining unknowns requires the solution of the following set of linear simultaneous equations, where (1) to (4) derive from the fundamental atomic conservation relationships and (5) to (9) represent the gaseous product concentration relationships.

$$(1) \quad M = TP_0 = P_1 + P_5 + xP_6$$

$$(2) \quad n + 2hP_0 = 2P_4 + yP_6$$

$$(3) \quad (2R + 2T + h)P_0 = 2P_1 + 2P_3 + P_4 + P_5 + 2P_7 + P_8$$

$$(4) \quad 2SP_0 = 2P_2 + P_7 + P_8$$

$$(5) \quad [\text{CO}_2]P_T = P_1$$

$$(6) \quad [\text{CO}]P_T = P_5$$

$$(7) \quad [\text{HC}]P_T = xP_6$$

$$(8) \quad [\text{NO}_x]_c P_T = \eta P_7 + P_8$$

$$(9) \quad [\text{NO}]P_T = P_8$$

$$(10) \quad P_T = P_1 + P_2 + P_3 + P_4 + P_5 + P_6 + P_7 + P_8$$

The above set of conditional equations is for the case where all measured concentrations are true ones, that is, not subject to interference effects or to the need to correct for sample drying. In practice, interference effects are usually present to a significant degree in the CO, NO_x and NO measurements, and the option to measure CO₂ and CO on a dry or partially dry basis is often used. The necessary modifications to the relevant equations are described in 2.5 and 2.6.

- 2.5 The interference effects are mainly caused by the presence of CO₂ and H₂O in the sample which can affect the CO and the NO_x analysers in basically different ways. The CO analyser is prone to a zero-shifting effect and the NO_x analyser to a sensitivity change, represented thus:

$$[\text{CO}] = [\text{CO}]_m + L[\text{CO}_2] + M[\text{H}_2\text{O}]$$

$$\text{and } [\text{NO}_x]_c = [\text{NO}_x]_{cm}(1 + L[\text{CO}_2] + M[\text{H}_2\text{O}])$$

which transform into the following alternative equations to (6), (8) and (9), when interference effects require to be corrected,

$$(6A) \quad [\text{CO}]_m P_T + LP_1 + MP_4 = P_5$$

$$(8A) \quad [\text{NO}_x]_{cm} (PT + L'P_1 + M'P_4) = \eta P_7 + P_8$$

$$(9A) \quad [\text{NO}]_m (P_T + L'P_1 + M'P_4) = P_8$$

The option to measure CO₂ and CO concentrations on a dry or partially dry sample basis, that is, with a sample humidity reduced to h_d, requires the use of modified conditional equations as follows:

$$(5A) \quad [\text{CO}_2]_d (P_T - P_4)(1 + h_d) = P_1$$

and

$$[\text{CO}]_d (P_T - P_4)(1 + h_d) = P_5$$

However, the CO analyser may also be subject to interference effects as described in 2.5 above and so the complete alternative CO measurement concentration equation becomes

$$(6B) \quad [\text{CO}]_{md} (P_T - P_4)(1 + h_d) + LP_1 + Mh_d (P_T - P_4) = P_5$$

3. ANALYTICAL FORMULATIONS

3.1 General

Equations (1) to (10) can be reduced to yield the analytical formulations for the EI and AFR ameters, as given in 7.1 to this appendix. This reduction is a process of progressive elimination of the roots P₀, P₁ through P₈, P_T making the assumptions that all concentration measurements are of the "wet" sample and do not require interference corrections or the like. In practice the option is often chosen to make the CO₂ and CO concentration measurements on a "dry" or "semi-dry" basis; also it is often found necessary to make interference corrections. Formulations for use in these various circumstances are given in 3.2, 3.3 and 3.4 below.

3.2 Equation for conversion of dry concentration measurements to wet basis

Concentration wet = K x concentration dry; that is.

$$[] = K []_d$$

The following expression for K applies when CO and CO₂ are determined on a "dry" basis:

$$K = \frac{\left\{ 4 + (n/m)T + (|n/m|T - 2h) \left([\text{NO}_2] - (2[\text{HC}]/x) \right) + (2+h) \left(|y/x| - [n/m] \right) [\text{HC}] \right\} (1+h_d)}{(2+h) \left\{ 2 + (n/m)(1+h_d) \left([\text{CO}_2]_d \right) \right\} - (|n/m|T - 2h) \left(1 - |1+h_d| [\text{CO}]_d \right)}$$

3.3 Interference corrections

The measurement of CO and/or NO may require corrections for interference by the sample CO₂ and water concentrations before use in the above analytical equations. Such corrections can normally be expressed in the following general ways:

$$[\text{CO}] = [\text{CO}]_m + L[\text{CO}_2] + M[\text{H}_2\text{O}]$$

$$[\text{CO}]_d = [\text{CO}]_{md} + L[\text{CO}_2] + M \left(\frac{h_d}{1+h_d} \right)$$

$$[\text{NO}] = [\text{NO}]_m (1 + L[\text{CO}_2] + M[\text{H}_2\text{O}])$$

$$\eta[\text{NO}_2] = ([\text{NO}_x]_{cm} - [\text{NO}]_m)(1 + L[\text{CO}_2] + M[\text{H}_2\text{O}])$$

3.4 Equation for estimation of sample water content

Water concentration in sample

$$[\text{H}_2\text{O}] = \frac{(|n/2m| + h|P_0/m|)([\text{CO}_2] + [\text{CO}] + [\text{HC}])}{1 + T(P_0/m)} - (y/2x)[\text{HC}]$$

Where

$$P_0/m = \frac{2Z - (n/m)}{4(1 + h - [TZ/2])}$$

and

$$Z = \frac{2 - [\text{CO}] - (|2/x| - |y/2x|)[\text{HC}] + [\text{NO}_2]}{[\text{CO}_2] + [\text{CO}] + [\text{HC}]}$$

It should be noted that this estimate is a function of the various analyses concentration readings, which may themselves require water interference correction. For better accuracy an iterative procedure is required in these cases with successive recalculation of the water concentration until the requisite stability is obtained. The use of the alternative numerical solution methodology (4) avoids this difficulty.

4. ALTERNATIVE METHODOLOGY -NUMERICAL SOLUTION

- 4.1 *As an alternative to the analytical procedures summarized in 3 above, it is possible to obtain readily the emissions indices, fuel/air ratio, corrected wet concentrations, etc., by a numerical solution of equations (1) to (10) for each set of measurements, using a digital computer.*
- 4.2 *In the equation set (1) to (10) the actual concentration measurements are substituted using whichever of the alternative equations (5A), (6A), etc. applies for the particular measuring system, to take account of interference corrections and/or dried sample measurements.*
- 4.3 *Suitable simple two-dimensional array equation-solving computer programmes are widely available and their use for this purpose is convenient and flexible, allowing ready incorporation and identification of any sample drying options and interference or other corrections.*

Supplemental information

Details explaining various calculation procedures, can be found in ARP 1533, "Procedure for the Calculation of Gaseous Emissions from Aircraft Turbine Engines." ARP 1533 includes, among other things, the combustion chemical equation, the basic matrix solution with computer programs, derivation of equations and a sample calculation.

**ATTACHMENT F TO ICAO MANUAL APPENDIX 5.
SPECIFICATIONS FOR ADDITIONAL DATA**

As required in 3.2 of Appendix 5, in addition to the measured sample constituent concentrations, the following data shall also be provided:

- a) *inlet temperature: measured as the total temperature at a point within one diameter of the engine intake plane to an accuracy of ± 0.5 C;*
- b) *inlet humidity (kg water/kg dry air): measured at a point within 15 m of the intake plane ahead of the engine to an accuracy of ± 5 per cent of reading;*
- c) *atmospheric pressure: measured within 1 km of the engine test location and corrected as necessary to the test stand altitude to an accuracy of ± 100 Pa;*
- d) *fuel mass flow: by direct measurement to an accuracy of ± 2 per cent;*
- e) *fuel H/C ratio: defined as n/m , where C_mH_n is the equivalent hydrocarbon representation of the fuel used in the test and evaluated by reference to the engine fuel type analysis;*
- f) *engine parameters:*
 - 1) *thrust: by direct measurement to an accuracy of ± 1 per cent at take-off power and ± 5 per cent at the minimum thrust used in the certification test, with linear variation between these points;*
 - 2) *rotation speed(s): by direct measurement to an accuracy of at least ± 0.5 per cent;*
 - 3) *gas generator airflow: determined to an accuracy of ± 2 per cent by reference to engine performance calibration.*

The parameters a), b), d) and f) shall be determined at each engine emissions test setting, while c) shall be determined at intervals of not less than 1 hour over a period encompassing that of the emissions tests.

[THIS PAGE INTENTIONALLY LEFT BLANK]

XII. ICAO MANUAL APPENDIX 2 APPENDIX 2. SMOKE EMISSION EVALUATION

Supplemental information

The smoke measurement standard described in ICAO Annex 16, Volume II, Second Edition, 1993, Appendix 2, is an indirect measure of smoke plume visibility which is obtained by using a filter to trap smoke particles contained in a predetermined mass of exhaust gas, and measuring the loss of reflectance, i.e., degree of staining, of this filter relative to the absolute reflectance of the filter when clean or free of stain. It is a reasonably repeatable, simple procedure, but does not provide a direct measure of either plume visibility or any properties of the smoke particles, size, size distribution or mass. The SAE estimates the practically achievable precision of the smoke number by this method to be within ± 3 SN (smoke numbers). The equivalent SAE procedure is found in Aerospace Recommended Practice ARP1179, "Aircraft Gas Turbine Engine Exhaust Smoke Measurement".

1. INTRODUCTION AND DEFINITIONS

Note.- The procedures specified here are concerned with the acquisition of representative exhaust samples and their transmission to, and analysis by, the emissions measuring system.

1.1 *Variations in the procedure contained in this Appendix shall only be allowed after prior application to and approval by the certificating authority.*

1.2 *Where the following expressions and symbols are used in this Appendix, they have the meanings ascribed to them below:*

Sampling reference size. *The sample mass, 16.2 kg/m² of stained filter area, which if passed through the filter material results in a change of reflectance which gives a value of the SN parameter.*

Sampling size. *A chosen exhaust sample, the magnitude of whose mass (expressed in kilograms per square metre of stained filter surface area) lies in the range prescribed in 2.5.3 h) of this Appendix which, when passed through the filter material, causes a change in reflectance yielding a value for the SN' parameter.*

Sampling volume. *The chosen sample volume (expressed in cubic metres) whose equivalent mass, calculated as indicated in 3 of this Appendix, conforms to the above definition of sampling size.*

SN. Smoke Number; *Dimensionless term quantifying smoke emission level based upon the staining of a filter by the reference mass of exhaust gas sample, and rated on a scale of 0 to 100 (see 3 of this Appendix).*

SN'. *Smoke Number obtained from an individual smoke sample, not necessarily of the reference size, as defined in 3 of this Appendix.*

W.. *Mass of individual exhaust gas smoke sample, in kilograms, calculated from the measurements of sample volume, pressure and temperature (see 3 of this Appendix).*

2. MEASUREMENT OF SMOKE EMISSIONS

2.1 Sampling probe for smoke emissions

- a) *The probe shall be made of stainless steel. if a mixing probe is used, all sampling orifices shall be of equal diameter.*
- b) *The probe design shall be such that at least 80 per cent of the pressure drop through the probe assembly is taken at the orifices.*
- c) *The number of sampling orifices shall not be less than 12.*
- d) *The sampling plane shall be as close to the engine exhaust nozzle exit plane as permitted by considerations of engine performance but in any case shall be within 0.5 nozzle diameters of the exit plane.*
- e) *The applicant shall provide evidence to the certificating authority, by means of detailed traverses, that the proposed probe design and position does provide a representative sample for each prescribed power setting.*

Supplemental information

The following diagram, Figure A2-1, is an artists rendition of an averaging probe in a cruciform configuration, with the minimum number of 12 orificies located on centers of equal area. While typical of averaging probes the actual design is not limited to a cruciform configuration. As with any design, this configuration would have to be proven by means of a detailed traverse.

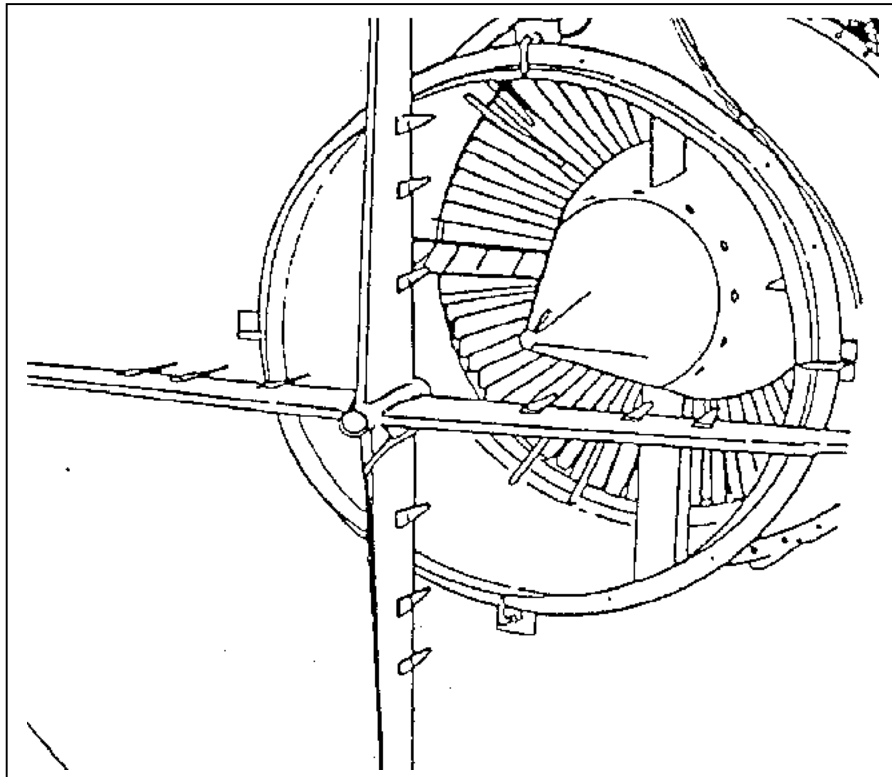

Supplemental Figure A2-1: 12 Point Cruciform Core Averaging Rake

Sampling emissions from aircraft gas turbine engines is difficult and has been under continual study and development. Lacking a definition of representative or constraints on a traversing pattern or protocol, some technical guidance can be obtained from looking at the methods described in early versions of SAE ARP 1179 and the Federal Regulations, developed primarily from experience within the industry in testing turbojet engines.

ARP 1179 stated that the tip of the sampling probe must be located between the engine exit plane and 6 inches downstream of the plane. The probe was to be oriented normal to this plane.

An initial traverse was required to arrive at an appropriate probe location for subsequent testing and a minimum traverse pattern was defined. This was a requirement for any given engine model or installation and at each engine power setting. The traverse was to be made radially at two locations 90 degrees apart, with 5 equal area sampling locations on each of the two radii. For each power setting, the point nearest the arithmetic average SN of the 10 points, was to be identified and entered as a permanent record of the particular engine or installation. All subsequent samples for that particular power setting were to be taken at this location. The sampling traverse needs to be repeated after any engine modification involving possible aerodynamic changes.

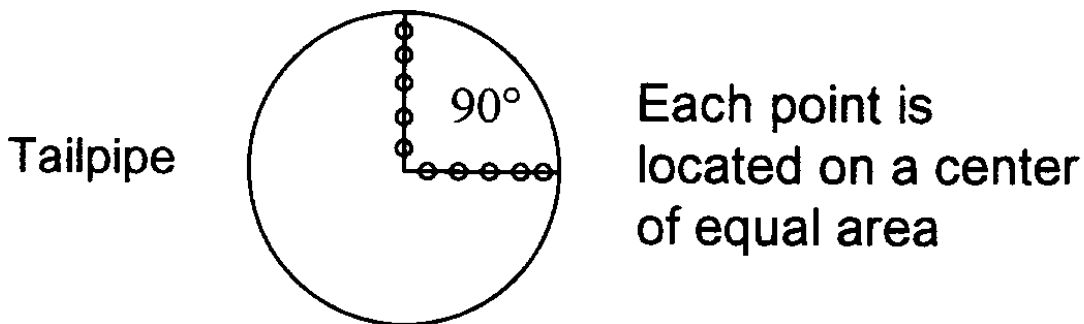

Supplemental Figure A2-2: ARP1179 Early Traverse Pattern

In the first version of 40 CFR Part 87, Federal Register, Vol. 38, No. 136, July 17, 1973, the sampling protocol required a minimum of 12 sampling points. Either mixing or individual probes were acceptable. At least three different radial positions were to be used in each of four sampling quadrants. If the minimum of 12 sampling points were used, the points in circumferentially adjacent sampling areas were to be separated in any direction by a distance not less than 0.1 tailpipe radius or 0.1 annular height, as applicable; if the number of sampling points (n) was greater than 12, they were to be equal in number in each quadrant or sector, and the minimum separations were to be reduced by a factor of 12/n.

The axial sampling plane had to be as close to the plane of the exit nozzle as engine performance parameters would permit, but in any case had to be within one exit nozzle diameter of the exit plane.

In all cases, the probe had to be designed to obtain a representative sample over the area of the entire exhaust nozzle, on mixed fan engines, nonmixed fan engines, turbojets, turboprops, and auxiliary power engines. Finally, the multipoint probe had to be designed to minimize the errors due to pollutant stratification, whether the stratification was due to combustor design, mixing, lack of mixing, or engine design such as mixing of fan and core air.

In Federal Register Vol. 43, No. 58, March 24, 1978, this sampling protocol was modified to include a specific angular reference, i.e., if the minimum of 12 sampling points were used, the points in circumferentially adjacent sampling areas were to be separated by at least 80° angular displacement. The most recent version of ARP 1179 has the axial location of the sampling plane as close to the exit nozzle as engine performance parameters permit, but in any case within 0.5 exit nozzle diameter of the exit plane.

The sampling points are to be arranged over the exhaust nozzle exit area for straight turbojet, turboprop, turboshaft, and mixed flow (or confluent flow) fan engines, and over the core nozzle exit area for nonmixed fan engines. In order to promote uniformity of smoke measurements, a specific probe design must be standardized for use with a given type or series of engines, and the suitability of this probe must be demonstrated, by means of detailed traverse measurements in the sampling plane.

Sampling for smoke has been and continues to be a difficult problem to address and manage. If at all possible, samples should be taken from the core and analytically extended to the total exhaust plume. As with gaseous emissions, consensus seems to be that averaging probes sampling points should be located on centers of equal area rather than equal spacing. The number of sampling orifices should probably be more than the 12 minimum required.

2.2 Sampling line for smoke emissions

2.2.1 *The sample shall be transferred from the probe to the sample collection system via a line of 4.0 to 8.5 mm inside diameter taking the shortest route practicable which shall in no case be greater than 25 m. The line temperature shall be maintained at a temperature between 60°C and 175°C with a stability of $\pm 15^\circ\text{C}$, except for the distance required to cool the gas from the engine exhaust temperature down to the line control temperature.*

2.2.2 *Sampling lines shall be as "straight through" as possible. Any necessary bends shall have radii which are greater than 10 times the inside diameter of the lines. The material of the lines shall be such as to discourage build-up of particulate matter or static electricity.*

Note. — Stainless steel, copper or carbon-loaded grounded polytetrafluoroethylene (PTFE) meet these requirements.

Supplemental information

The line from the probe to the sampling system should be heated to prevent water from condensing. It should be short and relatively straight to discourage loss of particulate matter to the walls and at bends. It should be of reasonably small diameter to keep the flow rate high, minimizing particle dropout and wall loss. It should be constructed of a material that discourages static buildup which can lead to particle loss. If carbon-loaded polytetrafluoroethylene (PTFE - Teflon) is used as a line material it is important that the sample gas have a chance to cool before entering the sample line to protect the Teflon from burning.

2.3 Smoke analysis system

Note. — The method prescribed herein is based upon the measurement of the reduction in reflectance of a filter when stained by a given mass flow of exhaust sample.

The arrangement of the various components of the system for acquiring the necessary stained filter samples shall be as shown schematically in Figure 2-1. An optional bypass around the volume meter may be installed to facilitate meter reading. The major elements of the system shall meet the following requirements:

- a) *sample size measurement: a wet or dry positive displacement volume meter shall be used to measure sample volume to an accuracy of ± 2 per cent. The pressure and temperature at entry to this meter shall also be measured to accuracies of 0.2 per cent and $\pm 2^\circ\text{C}$ respectively;*
- b) *sample flow rate measurement: the sample flow rate shall be maintained at a value of 14 ± 0.5 L/min and the flowmeter for this purpose shall be able to make this measurement*

with an accuracy of ± 5 per cent;

c) *filter and holder: the filter holder shall be constructed in corrosion-resistant material and shall have the flow channel configuration shown in Figure 2-1. The filter material shall be Whatman type No. 4, or any equivalent approved by the certifying authority;*

d) *valves: four valve elements shall be provided as indicated in Figure 2-1:*

1) *valve A shall be a quick-acting, full-flow, flow diverter enabling the incoming sample to be directed through the measuring filter or around the bypass circuits of shut off;*

2) *Note. — Valve A may, if necessary, consist of two valves interlocked to give the requisite function.*

2) *valves B and C shall be throttling valves used to establish the system flow rate;*

3) *valve D shall be a shut-off valve to enable the filter holder to be isolated;*

all valves shall be made of corrosion-resistant material;

e) *vacuum pump: this pump shall have a no-flow vacuum capability of -75 kPa with respect to atmospheric pressure; its full-flow rate shall not be less than 28 L/min at normal temperature and pressure;*

f) *temperature control: the incoming sample line through to the filter holder shall be maintained at a temperature between 60 °C and 175 °C with a stability of ± 15 °C;*

Note. — The objective is to prevent water condensation prior to reaching the filter holder and within it.

g) *If it is desired to draw a higher sample flow rate through the probe than through the filter holder, an optional flow splitter may be located between the probe and valve A (Figure 2-1), to dump excess flow. The dump line shall be as close as possible to probe off-take and shall not affect the ability of the sampling system to maintain the required 80 per cent pressure drop across the probe assembly. The dump flow may also be sent to the CO₂ analyser of complete emissions analysis system.*

h) *If a flow splitter is used, a test shall be conducted to demonstrate that the flow splitter does not change the smoke level passing to the filter holder. This may be accomplished by reversing the outlet lines from the flow splitter and showing that, within the accuracy of the method, the smoke level does not change.*

i) *leak performance: the sub-system shall meet the requirements of the following test:*

1) *clamp clean filter material into holder,*

2) *shut off valve A, fully open valves B, C and D.*

3) *run vacuum pump for one minute to reach equilibrium conditions;*

4) *continue to pump and measure the volume flow through the meter over a period of five minutes. This volume shall not exceed 5 L (referred to normal temperature and pressure) and the system shall not be used until this standard has been achieved.*

j) *reflectometer: the measurements of the reflectance of the filter material shall be by an instrument conforming to the American National Standards Institute (ANSI) Standard No.*

PH2.17/1977 for diffuse reflection density. The diameter of the reflectometer light beam on the filter paper shall not exceed $D/2$ nor be less than $D/10$ where D is the diameter of filter stained spot as defined in Figure 2-1.

Supplemental information

Maintaining the diameter of the reflectometer light beam on the filter paper between these limits insures averaging over a reasonable area of the filter. This is most important for stained spots which are not uniform in consistency of stain due to edge effects at the boundary of the stain and graininess within the spot particularly for lightly loaded filters, i.e., low SN.

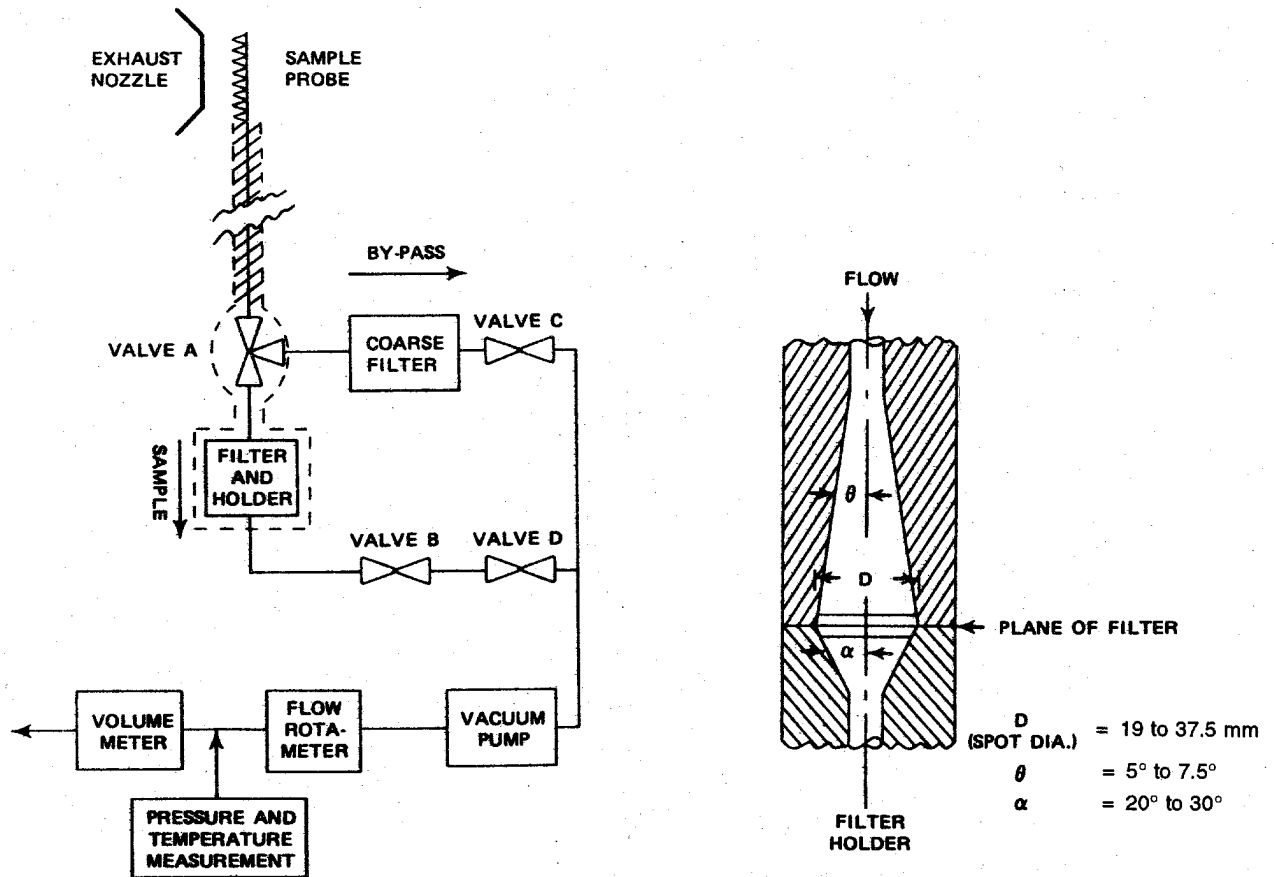

Figure A2-3. Smoke analysis system

2.4 Fuel specifications

The fuel shall meet the specifications of Appendix 4. Additives used for the purpose of smoke suppression (such as organo-metallic compounds) shall not be present.

Supplemental information

This fuel specification requirement is preempted by FAR 34 Subpart H, §34.81, Fuel specifications, which state "fuel having specifications as provided in §34.61 shall be used in smoke emission testing."

2.5 Smoke measurement procedures

2.51 Engine operation

2.5.1.1 *The engine shall be operated on a static test facility which is suitable and properly equipped for high accuracy performance testing.*

2.5.1.2 *The tests shall be made at the power settings approved by the certificating authority. The engine shall be stabilized at each setting.*

2.5.2 Leakage and cleanliness checks

No measurements shall be made until all sample transfer lines and valves are warmed up and stable. Prior to a series of tests the system shall be checked for leakage and cleanliness as follows:

a) *leakage check: isolate probe and close off end of sample line, perform leakage test as specified in 2.3g) with the exceptions that valve A is opened and set to "bypass", valve D is closed and that the leakage limit is 2 L. Restore probe and line interconnections;*

b) *cleanliness check:*

- 1) *open valves B, C and D;*
- 2) *run vacuum pump and alternately set valve A to "bypass" and "sample" to purge the entire system with clean air for five minutes;*
- 3) *set valve A to "bypass";*
- 4) *close valve D and clamp clean filter material into holder. Open valve D;*
- 5) *set valve A to "sample" and reset back to "bypass" after 50 kg of air per square metre of filter has passed through the filter material;*
- 6) *measure resultant filter spot SN' as described in paragraph 3 of this Appendix.;*
- 7) *If this SN' exceeds 3, the system shall be cleaned (or otherwise rectified) until a value lower than 3 is obtained.*

The system shall not be used until the requirements of these leakage and cleanliness checks have been met.

Supplemental information

Leakage checks are to ensure clean air does not leak into the system, thereby diluting the sample and lowering the SN. Cleanliness checks ensure that the sample will not be contaminated, resulting in higher than warranted SN values. To minimize contamination problems, if the probe cannot be moved out of the sampling stream during engine start up, the probe and lines can be back pressured with a suitable clean gas.

2.5.3 Smoke measurement

Smoke measurement shall be made independently of other measurements unless the smoke values so measured are significantly below the limiting values, or unless it can be demonstrated that the smoke values from simultaneous smoke and gaseous emission measurements are valid, in which case smoke measurements made be made simultaneously with gaseous emissions measurements. In all cases the bend radius requirements for sampling lines detailed in 2.2.2 shall be strictly observed. The smoke analysis sub-system shall be set up and conform to the

specifications of 2.3. Referring to Figure 2-1, the following shall be the major operations in acquiring the stained filter specimens:

- a) during engine operations with the probe in position, valve A shall not be placed in the no-flow condition, otherwise particulate buildup in the lines might be encouraged;
- b) set valve A to "bypass" close valve D and clamp clean filter into holder. Continue to draw exhaust sample in the bypass setting for at least five minutes while the engine is at or near to the requisite operating mode, valve C being set to give a flow rate of 14 ± 0.5 L/min;
- c) open valve D and set valve A to "sample", use valve B to set flow rate again to value set in b);
- d) set valve A to "bypass" and close valve D, clamp clean filter material into the holder;

Supplemental procedure

As a result of the manufacturing process, Whatman type No. 4 filters will be found to be slightly different, one side to the other, when measured using a reflectometer. This difference can approach 2 SN in value. During the filter cutting process, (filter disks are cut from larger sheets), the filters take on a slight set so there are distinct concave and convex sides. Filters seem to be cut, packaged and shipped in batches which preserves the top/bottom-concave/convex relationship. To eliminate unnecessary errors in measurement, it is advisable to load the filters in the filter holder in a consistent manner, i.e., always concave or convex side up. This should be kept in mind as well when determining the absolute reflectance of the clean filter, e.g., if the filter is placed in the filter holder concave side up, that is facing the sampling stream, then the absolute reflectance of the concave side is the reference measurement to be made.

- e) when the engine is stabilized on condition, allow one minute of sample flow with settings as at d);
- f) open valve D, set valve A to "sample", reset flow rate if necessary, and allow chosen sample volume (see h) to pass, before setting valve A back to "bypass" and close valve D;
- g) set aside stained filter for analysis, clamp clean filter into holder;
- h) the chosen sample sizes shall be such as to be within the range of 12 kg to 21 kg of exhaust gas per square metre of filter, and shall include samples which are either at the value of 16.2 kg of exhaust gas per square metre of filter or lie above and below that value. The number of samples at each engine operating condition shall not be less than 3 and e) to g) shall be repeated as necessary.

3. CALCULATION OF SMOKE NUMBER FROM MEASURED DATA

The stained filter specimens obtained as outlined in 2.5.3 shall be analysed using a reflectometer as specified in 2.3. The backing material used shall be black with an absolute reflectance of less than 3 per cent. The absolute reflectance reading R_s of each stained filter shall be used to calculate the reduction in reflectance by

$$SN' = 100(1-R_s/R_w)$$

Where R_w is the absolute reflectance of clean filter material.

Supplemental information

Reflectometers sometimes come equipped with a pseudo 'black body' cup like device which is used to set the meter zero response. It is not a good idea to use a device like this as backing material, although it does have an absolute reflectance of less than 3%. A solid surface, which applies light and equal pressure over the filter area to be measured, and which meets the less than 3% absolute reflectance requirement, is preferred.

The masses of the various samples shall be calculated by

$$W = 0.348 PV/T \times 10^{-2} \text{ (kg)}$$

Where P and T are, respectively, the sample pressure in pascals and the temperature in kelvin, measured immediately upstream of the volume meter. V is the measured sample volume in cubic metres.

For each engine condition in the case that the sample sizes range above and below the reference value, the various values of SN' and W shall be plotted as SN' versus log W/A, where A is the filter stain area (m²). Using a least squares straight line fit, the value of SN' for W/A=16.2 kg/m² shall be estimated and reported as the Smoke Number (SN) for that engine mode. Where sampling at the reference size value only is employed, the reported SN shall be the arithmetic average of the various individual values of SN'.

Supplemental information

Experience has shown that plotting the set of measured SN's against the logarithm of the equivalent W/A's results in a straight line. ICAO requires a least squares straight line fit to the SN' vs. log W/A data, sometimes referred to as the regression of SN' on log W/A.

The calculation is straightforward, and for the limited data sets involved with jet engine testing, can be performed on a hand held calculator or by means of a desktop computer spreadsheet. The values to be calculated are the straight line intercept, **a**, and slope, **b**. The equations to be solved for the least squares estimates of the intercept and slope, $SN' \equiv y_i$ and $\log(W/A) \equiv X_i$, are:

$$y = a + bx$$

$$b = \frac{\sum_{i=1}^n (x_i - \bar{x})(y_i - \bar{y})}{\sum_{i=1}^n (x_i - \bar{x})^2}$$

\bar{X} and \bar{Y} are the means of X_i and Y_i respectively and i refers to the sample number. For the testing required a simple table with columns for sample number i , SN', W/A, log (W/A) and $[\log(W/A)]^2$ in collecting and organizing the data and intermediate calculations.

For example, in the case where the minimum number of 3 smoke samples is taken a table might look like:

Table A2-1 TABLE FOR CALCULATING SN

Sample number <i>i</i>	(SN' _{<i>i</i>})	Log(W _{<i>i</i>} /A)	log(W _{<i>i</i>} /A)*(SN' _{<i>i</i>})	[log(W _{<i>i</i>} /A)] ²
1				
2				
3				
Average				
Sum				

Using this table and the previously calculated values of SN prime and W/A, it is a simple matter to calculate the estimated slope and intercept, and from them the least squares straight line. The reporting value of SN can be estimated from a plot of this straight line or calculated from the equation.

**Engine and Propeller Directorate
And
Office of Environment and Energy**

**Inter-Office Management Plan for Aircraft Engine
Fuel Venting and Exhaust Emissions**

The Engine and Propeller Directorate (EPD) and the Office of Environment and Energy (AEE) agree that an inter-office management plan is needed to strengthen FAA's Participation in, and oversight of aircraft engine fuel venting and exhaust emission certification. The Participating entities believe that the actions and procedures identified in this document provide the foundation for a Fuel Venting and Exhaust Emissions Procedures management plan.

The objective of this management plan is to define the roles and responsibilities of both entities, optimize the use of FAA resources, and provide adequate technical and procedural guidance for demonstrating compliance to 14 Code of Federal Regulations (CFR) Part 34. These actions are needed to:

1. Strengthen the FAA's surveillance of aircraft engine fuel venting and exhaust emissions certification;
2. Improve the application of technical guidance and procedural practices, and
3. Promote improved inter-office communication and cooperation.

Roles and Responsibilities: EPD and AEE agree that to achieve a step improvement in business practices between their respective organizations, the roles and responsibilities of Participating organizations need to be clearly defined. The following describes those roles and responsibilities:

XIII. Organization	Role	Responsibility
Office of Environment and Energy	Regulatory and Standardization	<ul style="list-style-type: none"> • Liaison with ICAO and CAEP • Coordinates with EPA (40 CFR Part 87) • Codifies fuel venting and exhaust emissions regulations (14 CFR 34) • Processes applications for Exemptions (14 CFR Part 11) • Audits and evaluates delegated functions • Approves new or equivalent test procedures (14 CFR 34) • Provides Policy and Guidance (AC-34)

Organization	Role	Responsibility
Engine and Propeller Directorate (EPD)	Implementation and Compliance	<ul style="list-style-type: none"> • Provides resources
ANE-110	Directorate Contact Point	<ul style="list-style-type: none"> • Acts as EPD Focal Point for AEE on engine technology issues and any other general issues • Assures compliance to 14 CFR Part 33.1(b). • Indirectly monitors all non-standard certification requests (Exemptions & Equivalent Safety Findings) as well as all AEE guidance and policy publications.
ACE/ECO	Compliance	<ul style="list-style-type: none"> • Issues type certificates • Reviews and approves engine fuel venting and exhaust emissions test plans and test data • Determines compliance with 14 CFR Part 34 • Appoints Designated Engineering Representatives (DERs) and assesses their qualifications for witnessing tests and reviewing test plans and test data, in accordance with the DER appointment and renewal process as defined within 14 CFR Part 183. • Supervises DERs on the fuel venting and exhaust emissions compliance requirements

Delegation: Delegation of Authority to support the roles and responsibilities in fuel venting and exhaust emission certification programs is extended to the Participating entities and is defined by AEE as follows:

1. AEE delegates the determination of compliance and acceptability of test plans, test data and test reports to the cognizant ACO/ECO organization.
2. AEE accepts the use of DERs as an extension of its delegation to the cognizant ACE/ECO organization.

Performance:

AEE will periodically evaluate the performance of its delegation to the ACOs/ECO by

1. Observing the conduct of standard test practices and witnessing the conduct of new or alternate methods of compliance, as deemed necessary.
2. Conducting a random audit of smoke and emissions test plans for appropriate content.
3. Notifying ACOs/ECO/ANE-110 in a timely manner of both the need for and the extent of Participation in the certification process.
4. Reviewing DER oversight, such as qualifications and appointment.

The ACOs will provide:

1. Timely notification to AEE staff of upcoming smoke and emission test dates and locations.
2. Timely responses to requests for test plans and test reports for audit purposes.

Performance Metrics: AEE and EPD will implement the following performance metrics that will monitor fuel venting and exhaust emissions delegated functions:

1. The elapsed time for AEE to respond to ACOs/ECO/ANE-110 requests for policy/guidance.
2. The elapsed time for AEE to respond to requests for Exemptions.
3. AEE attendance or Participation in DER Recurrent Seminars
4. The percentage of recent emission compliance findings that comply with policy and guidance.

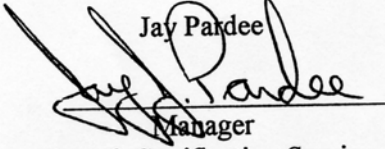
Jay Pandee
Manager
Aircraft Certification Service
Engine and Propeller Directorate

JAN 31 2000

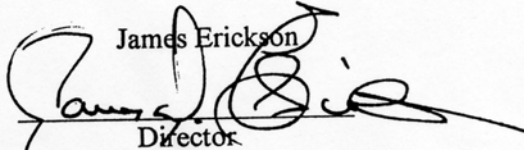
James Erickson
Director
Office of Environment and Energy

JAN 31 2000