

**Int. Cl.: 30**

**Prior U.S. Cl.: 46**

**United States Patent and Trademark Office**

**Reg. No. 3,464,843**

**Registered July 15, 2008**

**TRADEMARK  
PRINCIPAL REGISTER**

**MAYFAIR**

COLUMBIA INSURANCE COMPANY (NEBRASKA CORPORATION)  
4016 FARNAM STREET  
OMAHA, NE 68131

FIRST USE 9-22-1941; IN COMMERCE 5-0-1965.

SER. NO. 75-558,229, FILED 9-25-1998.

FOR: PREMIUM CANDIES, IN CLASS 30 (U.S. CL. 46).

MARK PILARO, EXAMINING ATTORNEY



**Int. Cl.: 1**

**Prior U.S. Cls.: 1, 5, 6, 10, 26 and 46**

**United States Patent and Trademark Office**

**Reg. No. 3,464,844**

**Registered July 15, 2008**

**TRADEMARK  
PRINCIPAL REGISTER**

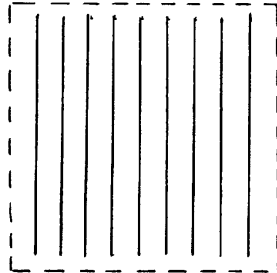

RED LINE SYNTHETIC OIL CORPORATION  
(CALIFORNIA CORPORATION)  
6100 EGRET COURT  
BENECIA, CA 94510

FOR: COMBINATION WETTING AGENT, HEAT  
TRANSFER IMPROVER AND CORROSION INHI-  
BITOR USED FOR AUTOMOTIVE AND INDUS-  
TRIAL COOLING SYSTEMS , IN CLASS 1 (U.S. CLS.  
1, 5, 6, 10, 26 AND 46).

FIRST USE 11-7-1989; IN COMMERCE 11-7-1989.

THE MARK CONSISTS OF THE COLOR PINK AS  
APPLIED TO THE GOODS. THE DOTTED OUTLINE  
OF GOODS IS INTENDED TO SHOW THE POSI-  
TION OF THE MARK AND IS NOT A PART OF THE  
MARK. THE DRAWING IS LINED FOR THE COL-  
OR PINK.

SEC. 2(F).

SER. NO. 75-595,342, FILED 11-23-1998.

IRA J. GOODSaid, EXAMINING ATTORNEY

**Int. Cl.: 12**

**Prior U.S. Cls.: 19, 21, 23, 31, 35 and 44**

**Reg. No. 3,464,845**

**United States Patent and Trademark Office**

**Registered July 15, 2008**

---

**TRADEMARK  
PRINCIPAL REGISTER**

*Daytona*

AMERICAN MARINE HOLDINGS, INC. (DELA-  
WARE CORPORATION)  
7110 21ST STREET EAST  
SARASOTA, FL 34243

FIRST USE 7-0-1998; IN COMMERCE 7-0-1998.

SER. NO. 75-734,320, FILED 6-22-1999.

FOR: BOATS, IN CLASS 12 (U.S. CLS. 19, 21, 23, 31,  
35 AND 44).

JOHN HWANG, EXAMINING ATTORNEY

**Int. Cl.: 25**

**Prior U.S. Cls.: 22 and 39**

**United States Patent and Trademark Office**

**Reg. No. 3,464,846**

**Registered July 15, 2008**

**TRADEMARK  
PRINCIPAL REGISTER**

**babY2k**

ELLIOT SOLOMON (CALIFORNIA CORPORATION)  
1818-8 RORY LANE  
SIMI VALLEY, CA 93063

FOR: CLOTHING FOR BABIES, TODDLERS, CHILDREN, TEENS AND ADULTS, NAMELY, CLOTH BIBS, INFANT'S AND CHILDREN'S UNDERWEAR, JACKETS, WIND RESISTANT JACKETS, SWEATERS, BASEBALL CAPS, HATS, T-SHIRTS, POLO STYLE SHIRTS, DRESS SHIRTS, LONG-SLEEVE SHIRTS, TANK TOPS, JERSEYS,

SWEATSHIRTS, PANTS, SHORTS, SWEATPANTS, UNDERGARMENTS, DRESSES, JUMPSUITS, SKIRTS, BOOTIES, SOCKS, SLIPPERS AND OVERCOATS, IN CLASS 25 (U.S. CLS. 22 AND 39).

FIRST USE 6-6-1999; IN COMMERCE 6-6-1999.

SER. NO. 75-738,044, FILED 6-28-1999.

INGA ERVIN, EXAMINING ATTORNEY

**Int. Cls.: 9 and 42**

**Prior U.S. Cls.: 21, 23, 26, 36, 38, 100 and 101**

**United States Patent and Trademark Office**

**Reg. No. 3,464,847**

**Registered July 15, 2008**

**TRADEMARK  
SERVICE MARK  
PRINCIPAL REGISTER**

**CITIZEN**

CITIZEN HOLDINGS KABUSHIKI KAISHA (JAPAN CORPORATION), TA CITIZEN HOLDINGS CO., LTD.  
1-12, 6.-CHOME TANASHI-CHO  
NISHI-TOKYO-SHI, TOKYO, JAPAN 1888511

FOR: COMPUTER SOFTWARE FOR USE IN THE MAINTENANCE, DIAGNOSIS, AND REPAIR OF MACHINE TOOLS AND NUMERICALLY CONTROLLED MACHINE TOOLS, IN CLASS 9 (U.S. CLS. 21, 23, 26, 36 AND 38).

FOR: UPDATING OF COMPUTER SOFTWARE, COMPUTER SOFTWARE DESIGN FOR OTHERS, REMOTE MONITORING OF COMPUTER SYSTEMS, REMOTE DIAGNOSIS OF COMPUTER SYSTEMS, ALL RELATING TO MACHINING OPERATIONS OF NUMERICALLY CONTROLLED MACHINE TOOLS; RENTAL OF COMPUTER SOFTWARE CONCERNING MACHINING OPERATIONS; COMPUTER SERVICES, NAMELY, PROVIDING TEMPORARY USE OF ON-LINE NON-DOWN-

LOADABLE SOFTWARE FOR USE IN THE MAINTENANCE, DIAGNOSIS AND REPAIR OF MACHINE TOOLS AND NUMERICALLY CONTROLLED MACHINES; COMPUTER SERVICES, NAMELY, PROVIDING INFORMATION VIA GLOBAL COMPUTER NETWORKS REGARDING COMPUTER SOFTWARE FOR USE IN THE MAINTENANCE, DIAGNOSIS AND REPAIR OF MACHINE TOOLS AND NUMERICALLY CONTROLLED MACHINES, IN CLASS 42 (U.S. CLS. 100 AND 101).

OWNER OF JAPAN REG. NO. 5056407, DATED 6-22-2007, EXPIRES 6-21-2017.

OWNER OF U.S. REG. NOS. 803,079 AND 1,309,811.

SER. NO. 75-787,071, FILED 8-27-1999.

DAWN HAN, EXAMINING ATTORNEY

**Int. Cl.: 44**

**Prior U.S. Cls.: 100 and 101**

**United States Patent and Trademark Office**

**Reg. No. 3,464,848**

**Registered July 15, 2008**

---

**SERVICE MARK  
PRINCIPAL REGISTER**

**HEALTHQUOTIENT**

WM, INC. (OREGON CORPORATION)  
111 EIGHTH AVENUE  
SEVENTH FLOOR  
NEW YORK, NY 10011

USE IN THE FIELD OF PREVENTATIVE HEALTH  
CARE, IN CLASS 44 (U.S. CLS. 100 AND 101).

FIRST USE 6-0-1998; IN COMMERCE 6-0-1998.

FOR: PROVIDING ONLINE HEALTH RISK AS-  
SESSMENT AND PROFILING TOOLS, NAMELY,  
HEALTH QUESTIONNAIRES, HEALTH INFORMA-  
TION AND HEALTH-RELATED ARTICLES FOR

SER. NO. 75-903,245, FILED 1-25-2000.

MICHELE SWAIN, EXAMINING ATTORNEY

**Int. Cls.: 6, 9, 14, 16, 18, 20, 21, 26 and 28**

**Prior U.S. Cls.: 1, 2, 3, 5, 12, 13, 14, 21, 22, 23, 25, 26, 27, 28, 29, 30, 32, 33, 36, 37, 38, 39, 40, 41, 42 and 50**

**Reg. No. 3,464,849**

**United States Patent and Trademark Office**

**Registered July 15, 2008**

**TRADEMARK  
PRINCIPAL REGISTER**



ROUSH FENWAY RACING, LLC (DELAWARE LTD LIAB CO)  
4600 ROUSH PLACE  
CONCORD, NC 28027

FOR: METAL GOODS, NAMELY, LICENSE PLATES, METAL NAME PLATES, AND METAL SIGN BOARDS, ALL RELATED TO THE FIELD OF PROFESSIONAL AUTOMOBILE RACING, IN CLASS 6 (U.S. CLS. 2, 12, 13, 14, 23, 25 AND 50).

FIRST USE 6-1-1999; IN COMMERCE 6-1-1999.

FOR: ELECTRICAL AND SCIENTIFIC APPARATUS, NAMELY, MAGNETS, AND PROTECTIVE HELMETS, ALL RELATED TO THE FIELD OF PROFESSIONAL AUTOMOBILE RACING, IN CLASS 9 (U.S. CLS. 21, 23, 26, 36 AND 38).

FIRST USE 6-1-1999; IN COMMERCE 6-1-1999.

FOR: PRECIOUS METALS AND THEIR ALLOYS, NAMELY, BELT BUCKLES MADE OF PRECIOUS METAL, ALL RELATED TO THE FIELD OF PROFESSIONAL AUTOMOBILE RACING, IN CLASS 14 (U.S. CLS. 2, 27, 28 AND 50).

FIRST USE 6-1-1999; IN COMMERCE 6-1-1999.

FOR: PRINTED MATTER, NAMELY, BUMPER STICKERS, DECALS, POSTERS, PHOTOGRAPHIC PRINTS, BINDERS, NOTE PADS, AND PAPER SIGN BOARDS, ALL RELATED TO THE FIELD OF PROFESSIONAL AUTOMOBILE RACING, IN CLASS 16 (U.S. CLS. 2, 5, 22, 23, 29, 37, 38 AND 50).

FIRST USE 6-1-1999; IN COMMERCE 6-1-1999.

FOR: LEATHER GOODS, NAMELY, BACK PACKS, FANNY PACKS, DUFFEL BAGS, AND LEATHER SHOPPING BAGS, ALL RELATED TO THE FIELD OF PROFESSIONAL AUTOMOBILE RACING, IN CLASS 18 (U.S. CLS. 1, 2, 3, 22 AND 41).

FIRST USE 6-1-1999; IN COMMERCE 6-1-1999.

FOR: PLASTIC NOVELTY LICENSE PLATES, PLASTIC FLAGS, NON-METAL KEY CHAINS, AND SEAT CUSHIONS, ALL RELATED TO THE FIELD OF PROFESSIONAL AUTOMOBILE RACING, IN CLASS 20 (U.S. CLS. 2, 13, 22, 25, 32 AND 50).

FIRST USE 6-1-1999; IN COMMERCE 6-1-1999.

FOR: HOUSE WARES AND GLASS, NAMELY, PORTABLE COOLERS, BEVERAGE GLASSWARE, MUGS, THERMAL INSULATED CONTAINERS FOR FOOD OR BEVERAGES, NON-METAL PIGGY BANKS, AND LUNCH BOXES, ALL RELATED TO THE FIELD OF PROFESSIONAL AUTOMOBILE RACING, IN CLASS 21 (U.S. CLS. 2, 13, 23, 29, 30, 33, 40 AND 50).

FIRST USE 6-1-1999; IN COMMERCE 6-1-1999.

FOR: FANCY GOODS, NAMELY, BELT BUCKLES NOT OF PRECIOUS METAL FOR CLOTHING AND ORNAMENTAL NOVELTY PINS, ALL RELATED TO THE FIELD OF PROFESSIONAL AUTOMOBILE RACING, IN CLASS 26 (U.S. CLS. 37, 39, 40, 42 AND 50).

FIRST USE 6-1-1999; IN COMMERCE 6-1-1999.

FOR: TOYS, NAMELY, MINIATURE CARS AND TRUCKS, DIE-CAST CARS, RADIO-CONTROLLED CARS, AND MODEL CARS, ALL RELATED TO THE FIELD OF PROFESSIONAL AUTOMOBILE RACING, IN CLASS 28 (U.S. CLS. 22, 23, 38 AND 50).

FIRST USE 6-1-1999; IN COMMERCE 6-1-1999.

SER. NO. 75-983,627, FILED 3-1-2000.

DAVID H. STINE, EXAMINING ATTORNEY

**Int. Cls.: 9 and 10**

**Prior U.S. Cls.: 21, 23, 26, 36, 38, 39 and 44**

**United States Patent and Trademark Office**

**Reg. No. 3,464,850**

**Registered July 15, 2008**

**TRADEMARK  
PRINCIPAL REGISTER**

**THE CREATION MATRIX**

CYNOVAD INC. (CANADA CORPORATION)  
9710 TRANSCANADA HIGHWAY  
VILLE SAINT-LAURENT, CANADA H4S 1V9

FOR: DIGITAL SCANNING DEVICES, COMPUTER SOFTWARE FOR USE WITH DIGITAL SCANNERS FOR THE PURPOSE OF CAPTURING IMAGES FOR THE DESIGN AND MANUFACTURE OF DENTAL PROSTHESES; PRODUCTION MANAGEMENT SOFTWARE FOR THE MANUFACTURING OF DENTAL PROSTHESES AND THE MANAGEMENT OF A DENTAL PROSTHESES MANUFACTURING FACILITY, IN CLASS 9 (U.S. CLS. 21, 23, 26, 36 AND 38).

FOR: DENTAL PROSTHESES; NAMELY, COPINGS, CROWNS, BRIDGES, INLAYS, ONLAYS, IMPLANTS AND ATTACHMENTS, IN CLASS 10 (U.S. CLS. 26, 39 AND 44).

PRIORITY CLAIMED UNDER SEC. 44(D) ON CANADA APPLICATION NO. 1075303, FILED 9-18-2000, REG. NO. TMA585,462, DATED 7-17-2003, EXPIRES 7-17-2018.

SER. NO. 76-149,439, FILED 10-19-2000.

NICHOLAS ALTREE, EXAMINING ATTORNEY



**Int. Cl.: 37**

**Prior U.S. Cls.: 100, 103 and 106**

**United States Patent and Trademark Office**

**Reg. No. 3,464,851**

**Registered July 15, 2008**

**SERVICE MARK  
PRINCIPAL REGISTER**



STEALTH, LTD. (WEST VIRGINIA CORPORATION)  
4969-B WASHINGTON STREET, WEST  
CROSS LANES, WV 25313

FOR: GENERAL CONTRACTING SERVICES, NAMELY, CONSTRUCTION MANAGEMENT; POURING CONCRETE; INSTALLATION OF DRAINAGE NETWORK CONSISTING OF SEALING THE STRUCTURE SIDEWALLS BELOW THE GROUND LEVEL; EXCAVATION SERVICES; AND STEEL ERECTORS; AND ELECTRICAL CONTRACTOR SERVICES, NAMELY, ELECTRICAL REPAIRS AND INSTALLATION OF LIGHTING IN AREAS USED FOR TRANSPORTATION OF MOTOR VEHI-

CLES AND EQUIPMENT; AND INSTALLATION OF ELECTRICAL SIGNALING AND FUND COLLECTION SYSTEMS USED FOR TRAFFIC CONTROL, IN CLASS 37 (U.S. CLS. 100, 103 AND 106).

FIRST USE 9-7-1993; IN COMMERCE 9-7-1993.

NO CLAIM IS MADE TO THE EXCLUSIVE RIGHT TO USE "LTD.", APART FROM THE MARK AS SHOWN.

SER. NO. 76-150,192, FILED 10-20-2000.

PAUL F. GAST, EXAMINING ATTORNEY

Int. Cls.: 9, 16, 35, 38 and 42

Prior U.S. Cls.: 2, 5, 21, 22, 23, 26, 29, 36, 37, 38, 50,  
100, 101, 102 and 104

Reg. No. 3,464,852

United States Patent and Trademark Office

Registered July 15, 2008

TRADEMARK  
SERVICE MARK  
PRINCIPAL REGISTER

移动梦网

CHINA MOBILE LIMITED (HONG KONG CORPORATION)

60TH FLOOR, THE CENTRE

99 QUEEN'S ROAD CENTRAL, HONG KONG

FOR: TELECOMMUNICATIONS AND DATA COMMUNICATIONS INSTALLATIONS, APPARATUS, AND INSTRUMENTS, NAMELY, CORDLESS, MOBILE, CELLULAR, WIRELESS, SATELLITE AND DIGITAL TELEPHONES, SPEAKPHONES, PAGERS, PERSONAL DIGITAL ASSISTANTS; INTEGRATED AND PRINTED CIRCUITS; TELEPHONE SYSTEMS, COMPRISED OF A HANDSET AND CONSOLE UNIT; TELEPHONE DIALERS; TELEPHONE STATION MESSAGE DETAIL RECORDERS; MOBILE TELECOMMUNICATION EQUIPMENT COMPRISING A CONTROL TELEPHONE UNIT, TRANSCIVER AND ANTENNA; MOBILE TELEPHONES AND COMPONENT PARTS THEREOF; BATTERY POWER PLANTS FOR USE IN PROVIDING AND MANAGING ENERGY SUPPLY REQUIREMENTS IN THE TELECOMMUNICATIONS INDUSTRY; RADIOS INCORPORATING TELEPHONES AND CLOCKS, AND TELEPHONES INCORPORATING RADIOS AND CLOCKS; COMPUTERS; LIGHTWAVE DATA LINKS, NAMELY, TRANSMITTERS AND RECEIVERS; MODEMS; TELEPHONE INSTALLATION APPARATUS, NAMELY, PHONEMOUNTS, DUAL OUTLET ADAPTORS, TELEPHONE OUTLETS, MODULAR JACKS, WIRE JUNCTIONS AND PLUG-IN CONVERTERS; INTERACTIVE TELEVISION UNITS FOR ACQUISITION OF INFORMATION FROM DATA BASES; TELECOMMUNICATIONS SWITCHING APPARATUS; COMPUTER PERIPHERALS; FACSIMILE MACHINES; DOCUMENT SCANNER, NAMELY,

FOCUSING LENSES, IMAGE DETECTORS, MEMORY UNITS, CIRCUIT BOARDS AND INTERFACE UNITS; VOICE AND DATA TRANSMITTING, CARRYING AND RECEIVING EQUIPMENT, NAMELY, TELECOMMUNICATION CARRIERS, CENTRAL OFFICE AND REMOTE TERMINALS, CHANNEL BANKS, ELECTRONIC PLUG-INS AND PAIR-GAIN APPARATUS; NETWORK MULTIPLEXER; DATA COMMUNICATION MULTIPLEXERS AND CONCENTRATOR; VIDEOTEX TERMINALS AND ELECTRIC EMERGENCY CALL UNITS; TELEPHONE ANSWERING MACHINES; VIDEOPHONES; VIDEO TELECONFERENCING PRODUCTS, NAMELY, SWITCHES, MODEMS, SPEAKERS AND VIDEO DISPLAY TUBES; COMPUTER HARDWARE, AND FIRMWARE USED FOR ACCESSING THE INTERNET AND FOR A CELLULAR TELEPHONE NETWORK; COMPUTER HARDWARE, NAMELY, BASE TRANSCIVERS AND CONTROLLERS FOR A CELLULAR TELEPHONE NETWORK, SWITCHES, ROUTERS, MODEMS, ANTENNAS, WAVE GUIDES, MULTIPLEXERS, ACCESS CONCENTRATORS; COMPUTER SOFTWARE FOR DATA PROCESSING; COMPUTER SOFTWARE FOR SWITCHING TELEPHONE CALLS OVER TELECOMMUNICATIONS NETWORKS, FOR REMOTE CONTROL OF MOBILE NETWORKS, AND FOR ACCESSING THE INTERNET; MICROPROCESSORS; MICROPROCESSOR BASED COMMUNICATORS, NAMELY, WRITING STYLI AND TABLETS; ELECTRONIC APPARATUS, NAMELY, MODEMS, SMART CARDS AND DATA CARDS FOR SCRAMBLING, DESCRAMBLING, ENCODING AND DECODING OF VOICE, DATA, IMAGE AND VIDEO TRANSMISSION; COMPUTER KEYBOARDS; COMPUTER HARDWARE AND SOFTWARE USED FOR PROCESSING ELECTRO-

NIC MONEY TRANSACTIONS; FLOOR DUCTS FOR HOUSING ELECTRIC CABLES; ELECTRICAL CABLES, COAXIAL CABLES, FIBER OPTIC CABLES, COMPUTER CABLES, TELEPHONE CABLES, COPPER CABLES FOR RECORDING, STORING, TRANSMISSION, RECEIVING AND REPRODUCING OF DATA, SOUND, IMAGES AND VIDEO; TRANSCEIVERS AND CONTROLLERS FOR TELECOMMUNICATIONS EQUIPMENT; AUDIO VISUAL APPARATUS AND INSTRUMENTS FOR RECORDING, TRANSMISSION PROCESSING AND REPRODUCTION OF SOUND OR IMAGES, NAMELY, RADIO, TELEVISION AND WIRELESS RECEIVING APPARATUS AND INSTRUMENTS; SOUND RECORDING AND SOUND REPRODUCING APPARATUS AND INSTRUMENTS AND TAPES AND CASSETTES THEREFORE; VIDEO-TAPE RECORDERS AND TAPES THEREFORE; SOUND AMPLIFIERS; STEREOPHONIC UNITS; PUBLIC ADDRESS SYSTEMS; LOUDSPEAKERS; HEADPHONES; GRAMOPHONE RECORDS AND PRE-RECORDED MAGNETIC TAPES AND CASSETTES THEREFORE ALL FEATURING MUSIC FOR TAPE RECORDERS; ENCODED CARDS, NAMELY, MAGNETICALLY ENCODED DEBIT CARDS, MAGNETICALLY ENCODED CREDIT CARDS AND MAGNETICALLY ENCODED TELEPHONE CARDS; SMART CARDS FOR STORING VALUE OR DATA; ELECTRONIC DOWNLOADABLE PUBLICATIONS FROM THE INTERNET, NAMELY, ADVERTISING MATERIALS, MAPS, NEWSPAPERS, MAGAZINES AND INSTRUCTIONAL MATERIALS RELATING TO BUSINESS, COMMERCIAL, FINANCIAL, TELECOMMUNICATIONS, TRANSPORTATION AND TRAVELING, EDUCATION, ENTERTAINMENT, SPORTING AND CULTURAL ACTIVITIES, SCIENCE AND TECHNOLOGY, LEGAL SERVICES, MEDICAL AND HEALTHCARE SERVICES, FOOD AND BEVERAGE SERVICES, PERSONAL AND SOCIAL SERVICES AND SECURITY SERVICES; TESTING APPARATUS, NAMELY, PROBES FOR TESTING INTEGRATED CIRCUITS; SIGNALING APPARATUS, NAMELY, SIGNAL TRANSMITTERS; WIRELESS APPLICATION PROTOCOL (WAP) COMPUTER GAME SOFTWARE THAT MAY BE DOWNLOADED FROM A GLOBAL COMPUTER NETWORK, IN CLASS 9 (U.S. CLS. 21, 23, 26, 36 AND 38).

FOR: PRINTED MATERIAL, NAMELY, INSTRUCTIONAL AND TEACHING MANUALS, INSTRUCTION CARDS, BOOKS, PAMPHLETS AND USER GUIDES ALL FEATURING INFORMATION IN THE FIELDS OF TELECOMMUNICATIONS, COMPUTERS, AND COMPUTER APPLICATIONS, IN CLASS 16 (U.S. CLS. 2, 5, 22, 23, 29, 37, 38 AND 50).

FOR: BUSINESS ADVISORY, CONSULTANCY, RESEARCH AND INFORMATION SERVICES RELATING TO DATABASES AND THE INTERNET PROVIDED ONLINE; COMPILATION OF BUSINESS AND COMMERCIAL INFORMATION; RESEARCH, EDITING AND PUBLICATION OF BUSINESS AND COMMERCIAL INFORMATION; PROMOTING THE GOODS AND SERVICES OF OTHERS BY PREPARING AND PLACING ADVERTISEMENTS

IN AN ELECTRONIC FORM ACCESSED THROUGH THE INTERNET; BILLBOARD ADVERTISING, OUTDOOR ADVERTISING, RADIO ADVERTISING, TELEVISION ADVERTISING AND E-MAIL ADVERTISING; DATA PROCESSING; PRODUCTION, PREPARATION AND PRESENTATION OF ADVERTISING MATTER; COMPILATION OF BUSINESS DIRECTORIES; MARKET ANALYSIS AND RESEARCH; COMPILATION OF BUSINESS DATA; TRANSCRIPTION OF DATA; PREPARATION OF BUSINESS REPORTS; PROVIDING SALES PROMOTION ADVICE AND CONSULTANCY; COMPUTERIZED DATABASE MANAGEMENT SERVICES; COMPILATION OF ADVERTISEMENTS FOR USE ON WEB PAGES; BUSINESS INFORMATION, ADVERTISING AND PROMOTIONAL SERVICES PROVIDED ON-LINE FROM A COMPUTER DATABASE OR BY MEANS OF WEB PAGES ON THE INTERNET; INTEGRATED TRACKING AND MANAGEMENT OF COMMERCIAL TRANSACTIONS ON THE INTERNET; COMPUTERIZED DATABASE MANAGEMENT RELATING TO COMPILATION AND SYSTEMIZATION OF INFORMATION INTO COMPUTER DATABASE; TELEPHONE ANSWERING SERVICES AND MESSAGE HANDLING SERVICES; BUSINESS MANAGEMENT OF PROMOTIONAL AND INCENTIVE SCHEMES, IN CLASS 35 (U.S. CLS. 100, 101 AND 102).

FOR: TELECOMMUNICATIONS SERVICES, NAMELY, THE ELECTRONIC TRANSMISSION OF VOICE, DATA, INFORMATION, VIDEO AND FACSIMILE; LOCAL, LONG DISTANCE, AND INTERNATIONAL VOICE, TEXT, FACSIMILE, VIDEO AND DATA TELECOMMUNICATIONS SERVICES; FRAME RELAY TELECOMMUNICATIONS SERVICES; VIRTUAL NETWORK TELECOMMUNICATIONS SERVICES; ELECTRONIC DATA TRANSMISSION PACKET SERVICES; COMPUTER AIDED TRANSMISSION OF MESSAGES AND IMAGES; AUDIO AND VIDEO TELECONFERENCING SERVICES; PRIVATE LINE VOICE, TEXT, FACSIMILE, VIDEO AND DATA TELECOMMUNICATIONS SERVICES; INTEGRATED SERVICES DIGITAL NETWORK (ISDN) TELECOMMUNICATIONS SERVICES; TELECOMMUNICATIONS SERVICES, NAMELY, THE ELECTRONIC TRANSMISSION OF VOICE, DATA, INFORMATION, VIDEO AND FACSIMILE; LOCAL, LONG DISTANCE, AND INTERNATIONAL VOICE, TEXT, FACSIMILE, VIDEO AND DATA TELECOMMUNICATIONS SERVICES; E-MAIL SERVICES; MOBILE PHONE ASSISTED DATA INFORMATION AND IMAGE TRANSMISSION; CHATROOM, PROVIDING CO-LOCATION SERVICES FOR VOICE, VIDEO AND DATA COMMUNICATIONS APPLICATIONS, NETWORKS AND SYSTEMS; PROVIDING USER ACCESS TO THE INTERNET; PROVIDING TELECOMMUNICATIONS ACCESS AND CONNECTIONS TO THE INTERNET OR DATABASES; AUDIO AND VIDEO BROADCASTING SERVICES; WIRELESS TRANSMISSION OF VOICE, DATA AND FACSIMILE, TRANSMISSION OF DATA AND OF INFORMATION BY ELECTRONIC MEANS, COMPUTER, CABLE, RADIO, RADIOPAGING, TELEPRINTER, TELELETTER, ELECTRONIC MAIL, FAX MACHINE, TELEVISION, MICROWAVE, LA-

SER BEAM AND SATELLITE; INFORMATION AND ADVISORY SERVICES RELATING TO TELECOMMUNICATIONS AND BROADCASTING PROVIDED ONLINE OR BY WAP, CMNET, GSM, GPRS, 3G AND PLMN MEANS; ELECTRONIC DATA INTERCHANGE SERVICES; LEASING AND RENTAL OF TELECOMMUNICATIONS APPARATUS, INSTALLATIONS, INSTRUMENTS, AND SIGNALING APPARATUS, NAMELY, MOBILE, CELLULAR, WIRELESS, SATELLITE, AND DIGITAL TELEPHONES, PAGERS, PERSONAL DIGITAL ASSISTANTS, ELECTRONIC MAIL BOXES; TELECOMMUNICATIONS RESELLER SERVICES, NAMELY, PROVIDING LONG DISTANCE TELECOMMUNICATIONS SERVICES AND TELECOMMUNICATIONS AIR TIME BROKERAGE SERVICES; PROVIDING MULTIPLE USER ACCESS TO GLOBAL COMPUTER INFORMATION NETWORKS FOR THE TRANSFER AND DISSEMINATION OF A WIDE RANGE OF INFORMATION, IN CLASS 38 (U.S. CLS. 100, 101 AND 104).

FOR: EXPERT, PROFESSIONAL AND SCIENTIFIC CONSULTANCY SERVICES, TESTING SERVICES, RESEARCH AND DEVELOPMENT SERVICES, DESIGN AND INSPECTION SERVICES, ALL RELATING TO THE INTERNET, BY MEANS OF DESIGN, DEVELOPMENT, CUSTOMIZATION, INTEGRATION AND UPGRADING OF COMPUTER SOFTWARE, COMPUTER HARDWARE CONSULTANCY, RECOVERY OF COMPUTER DATA, COMPUTER SOFTWARE MAINTENANCE, COMPUTER SOFTWARE SECURITY, COMPUTER SYSTEM ANALYSIS; RENTAL AND LEASING OF COMPUTERS AND COMPUTER DATA PROCESSING APPARATUS; COMPUTER PROGRAMMING; COMPUTER NETWORK DESIGN AND INSTALLATION SERVICES FOR OTHERS; INSTALLATION AND MAINTENANCE OF COMPUTER SOFTWARE; SYSTEMS INTEGRATION SERVICES; DESIGNING WEB SITES FOR OTHERS, NAMELY, DESIGN DRAWING AND COMMISSIONED WRITING, ALL FOR THE COMPILATION OF WEB PAGES ON THE INTERNET; COMPUTER SERVICES, NAMELY, COMPUTER PROGRAMMING, COMPUTER SOFTWARE DESIGN, DEVELOPMENT, CUSTOMIZATION, INTEGRATION AND UPGRADING; EDITING AND SYSTEMIZATION OF DATA IN COMPUTER DATABASES; COMPU-

TER NETWORK DESIGN FOR OTHERS; WEB-SITE DESIGN, HOSTING AND MAINTENANCE SERVICES; APPLICATION SERVICE PROVIDER, NAMELY, PROVIDING, HOSTING, MANAGING, DEVELOPING, AND MAINTAINING APPLICATIONS, SOFTWARE, WEBSITES, AND DATABASES IN THE FIELDS OF PERSONAL PRODUCTIVITY, WIRELESS COMMUNICATION, MOBILE INFORMATION ACCESS, AND REMOTE DATA MANAGEMENT FOR WIRELESS DELIVERY OF CONTENT TO HANDHELD COMPUTERS, LAPTOPS AND MOBILE ELECTRONIC DEVICES, IN CLASS 42 (U.S. CLS. 100 AND 101).

PRIORITY CLAIMED UNDER SEC. 44(D) ON HONG KONG APPLICATION NO. 2001/04732, FILED 3-22-2001, REG. NO. B05130/2004, DATED 3-22-2001, EXPIRES 3-22-2011.

PRIORITY CLAIMED UNDER SEC. 44(D) ON HONG KONG APPLICATION NO. 2001/04731, FILED 3-22-2001, REG. NO. B16030/2003, DATED 3-22-2001, EXPIRES 3-22-2011.

PRIORITY CLAIMED UNDER SEC. 44(D) ON HONG KONG APPLICATION NO. 2001/04730, FILED 3-22-2001, REG. NO. B05129/2004, DATED 3-22-2001, EXPIRES 3-22-2011.

PRIORITY CLAIMED UNDER SEC. 44(D) ON HONG KONG APPLICATION NO. 2001/04729, FILED 3-22-2001, REG. NO. B16029/2003, DATED 3-22-2001, EXPIRES 3-22-2011.

PRIORITY CLAIMED UNDER SEC. 44(D) ON HONG KONG APPLICATION NO. 2001/04728, FILED 3-22-2001, REG. NO. B16018/2003, DATED 3-22-2001, EXPIRES 3-22-2011.

THE TRANSLITERATION AND TRANSLATION OF THE CHINESE CHARACTERS APPEARING IN THE MARK ARE YE DONG MENG WANG AND THE ENGLISH TRANSLATION IS "MOVING DREAM NET."

SER. NO. 76-286,950, FILED 7-18-2001.

MONIQUE MILLER, EXAMINING ATTORNEY

**Int. Cl.: 36**

**Prior U.S. Cls.: 100, 101 and 102**

**United States Patent and Trademark Office**

**Reg. No. 3,464,853**

**Registered July 15, 2008**

**SERVICE MARK  
PRINCIPAL REGISTER**

**LINCOLN BENEFIT LIFE**

LINCOLN BENEFIT LIFE COMPANY (NEBRASKA CORPORATION)  
LINCOLN BENEFIT LIFE DRIVE  
2940 SOUTH 84TH STREET  
LINCOLN, NE 68506

FOR: LIFE INSURANCE UNDERWRITING AND ADMINISTRATION SERVICES; ANNUITY UNDERWRITING, NAMELY, GROUP AND INDIVIDUAL ANNUITY UNDERWRITING; AND LONG-TERM CARE INSURANCE, IN CLASS 36 (U.S. CLS. 100, 101 AND 102).

FIRST USE 0-0-1938; IN COMMERCE 0-0-1938.

NO CLAIM IS MADE TO THE EXCLUSIVE RIGHT TO USE "LIFE", APART FROM THE MARK AS SHOWN.

SER. NO. 76-322,876, FILED 10-9-2001.

RICHARD A. STRASER, EXAMINING ATTORNEY

**Int. Cl.: 39**

**Prior U.S. Cls.: 100 and 105**

**United States Patent and Trademark Office**

**Reg. No. 3,464,854**

**Registered July 15, 2008**

**SERVICE MARK  
PRINCIPAL REGISTER**

**MARCO POLO CLUB**

ABERCROMBIE & KENT GROUP OF COMPANIES, S.A. (LUXEMBOURG CORPORATION)  
5 BOULEVARD ROYAL  
ROYAL ROME II, 1ST FLOOR, L-2449, LUXEMBOURG

FOR: OPERATING A TRAVELLERS CLUB; ARRANGING AND PROVIDING RESERVATIONS AND BOOKINGS FOR TRANSPORTATION AND SIGHTSEEING TOURS FOR MEMBERS OF A TRAVEL CLUB, IN CLASS 39 (U.S. CLS. 100 AND 105).

FIRST USE 3-0-1983; IN COMMERCE 3-0-1983.

NO CLAIM IS MADE TO THE EXCLUSIVE RIGHT TO USE "CLUB", APART FROM THE MARK AS SHOWN.

SER. NO. 76-426,911, FILED 7-1-2002.

JAMES GRIFFIN, EXAMINING ATTORNEY

**Int. Cls.: 9, 40 and 42**

**Prior U.S. Cls.: 21, 23, 26, 36, 38, 100, 101, 103 and 106**

**United States Patent and Trademark Office**

**Reg. No. 3,464,855**

**Registered July 15, 2008**

**TRADEMARK  
SERVICE MARK  
PRINCIPAL REGISTER**

**VALIFAST**

FASINTERNATIONAL S.R.L. (ITALY CORPORATION)

VIA KORISTKA, 10  
MILANO, ITALY

FOR: SENSOR CALIBRATION UNITS; THERMAL VALIDATION UNITS; ELECTRIC, ELECTRONICAL AND THERMIC TESTING MACHINES, COMPUTER MONITORS, BLANK MAGNETIC DATA CARRIERS AND RECORDING DISCS; APPARATUS FOR THE RECORDING, TRANSMISSION OR REPRODUCTION OF SOUND OR IMAGES, NAMELY, DATA-LOGGER, DATA-ACQUISITION UNITS AND SOFTWARE; AND THERMAL VALIDATION REPORTING SOFTWARE, IN CLASS 9 (U.S. CLS. 21, 23, 26, 36 AND 38).

FOR: CUSTOM MANUFACTURE OF SENSOR CALIBRATION, THERMAL VALIDATION, MONITORS, ELECTRIC AND ELECTRONICAL AND

THERMIC TESTING MACHINES, IN CLASS 40 (U.S. CLS. 100, 103 AND 106).

FOR: INDUSTRIAL ANALYSIS AND RESEARCH SERVICES IN THE FIELD OF THERMAL VALIDATION PROCESSES; DESIGN AND DEVELOPMENT OF COMPUTER HARDWARE AND SOFTWARE FOR OTHERS; PLAN DESIGN SERVICES, NAMELY, DESIGN AND DEVELOPMENT OF SYSTEMS FOR DATA COLLECTION AND PROCESSING FOR OTHERS, IN CLASS 42 (U.S. CLS. 100 AND 101).

PRIORITY CLAIMED UNDER SEC. 44(D) ON ITALY APPLICATION NO. MI2002C00485, FILED 5-14-2002, REG. NO. 0001003884, DATED 4-14-2006, EXPIRES 4-14-2022.

SER. NO. 76-460,032, FILED 10-17-2002.

KEVON CHISOLM, EXAMINING ATTORNEY

**Int. Cl.: 3**

**Prior U.S. Cls.: 1, 4, 6, 50, 51 and 52**

**United States Patent and Trademark Office**

**Reg. No. 3,464,856**

**Registered July 15, 2008**

**TRADEMARK  
PRINCIPAL REGISTER**

**PURE PASSION**

BIOLAB INTERNATIONAL INCORPORATED  
(CANADA CORPORATION)  
130 DENISON STREET  
MARKHAM, ONTARIO, CANADA L3R 1B6

FOR: HAIR CARE PRODUCTS, NAMELY, SHAM-  
POO, CONDITIONER, RINSE PREPARATIONS,  
STYLING GEL, HAIR SPRAY; SKIN CARE PRO-  
DUCTS, NAMELY, CLEANSING PREPARATIONS,  
LIQUID FOAM BATH, SHOWER GEL, MOISTURIZ-  
ING CREAMS AND LOTIONS, SUNTAN CREAMS,  
OILS AND LOTIONS, MASSAGE LOTIONS, SHAV-  
ING CREAMS, HAND CREAMS AND LOTIONS,  
BAR AND LIQUID SOAPS, AND GIFT SETS COM-

PRISED OF HAIR CARE PREPARATIONS AND  
SKIN CARE PREPARATIONS, IN CLASS 3 (U.S.  
CLS. 1, 4, 6, 50, 51 AND 52).

PRIORITY CLAIMED UNDER SEC. 44(D) ON  
CANADA APPLICATION NO. 1,163,810, FILED 1-7-  
2003, REG. NO. TMA699,390, DATED 10-24-2007,  
EXPIRES 10-24-2022.

SER. NO. 76-481,857, FILED 1-13-2003.

SOPHIA S. KIM, EXAMINING ATTORNEY



Int. Cls.: 35 and 36

Prior U.S. Cls.: 100, 101 and 102

United States Patent and Trademark Office

Reg. No. 3,464,857

Registered July 15, 2008

**SERVICE MARK  
PRINCIPAL REGISTER**



STEPHENS, EDWIN K. (UNITED STATES INDIVIDUAL)

999 WISCONSIN STREET, UNIT 4  
SAN FRANCISCO, CA 94107

FOR: BUSINESS ACQUISITION AND MERGER CONSULTATION, IN CLASS 35 (U.S. CLS. 100, 101 AND 102).

FIRST USE 6-17-2003; IN COMMERCE 6-17-2003.

FOR: REAL ESTATE ACQUISITION SERVICES, IN CLASS 36 (U.S. CLS. 100, 101 AND 102).

FIRST USE 6-17-2003; IN COMMERCE 6-17-2003.

THE COLOR GREY IS A FEATURE OF THE MARK AND THE COLOR GREY APPEARS IN A PORTION OF THE CLOUDS AS WELL AS A PORTION OF THE SKY AREA AND DESCENDING AIRCRAFT DEPICTION. ACCORDINGLY, THE COLOR GRAY IS NOT INTENDED TO INDICATE SHADING ONLY.

THE MARK CONSISTS OF THE WORDING "STEALTH ACQUISITIONS REAL ESTATE & BUSINESS" ACCOMPANIED BY THE DESIGN OF AN AIRPLANE FLYING AMONG THE CLOUDS.

SER. NO. 76-531,694, FILED 7-18-2003.

DORITT L. CARROLL, EXAMINING ATTORNEY

**Int. Cl.: 9**

**Prior U.S. Cls.: 21, 23, 26, 36 and 38**

**United States Patent and Trademark Office**

**Reg. No. 3,464,858**

**Registered July 15, 2008**

**TRADEMARK  
PRINCIPAL REGISTER**



SPRINGER-VERLAG GMBH (FED REP GERMA-  
NY LTD LIAB CO)  
TIERGARTENSTRASSE 17  
D-69121 HEIDELBERG, FED REP GERMANY

FOR: ELECTRONIC PUBLICATIONS, NAMELY,  
JOURNALS IN THE FIELD OF SCIENCE, RECOR-  
DED ON OPTICAL COMPUTER STORAGE MEDIA  
OR DOWNLOADABLE FROM THE INTERNET , IN  
CLASS 9 (U.S. CLS. 21, 23, 26, 36 AND 38).

PRIORITY CLAIMED UNDER SEC. 44(D) ON  
ERPNTM OFC APPLICATION NO.  
033320348, FILED 8-19-2003, REG. NO. 033320348,  
DATED 8-24-2007, EXPIRES 8-19-2013.

THE COLOR(S) GREEN, WHITE AND YELLOW  
IS/ARE CLAIMED AS A FEATURE OF THE MARK.

THE MARK CONSISTS OF THE WORD "TAG" IN  
OLIVE GREEN OVER A BACKGROUND OF WHITE  
AND VARIOUS MUTED TONES OF YELLOW  
ALONG THE TOP, BOTTOM AND LEFT SIDE OF  
THE MARK.

SER. NO. 76-549,875, FILED 10-8-2003.

JACQUELINE A. LAVINE, EXAMINING ATTOR-  
NEY

**Int. Cl.: 36**

**Prior U.S. Cls.: 100, 101 and 102**

**United States Patent and Trademark Office**

**Reg. No. 3,464,859**

**Registered July 15, 2008**

**SERVICE MARK  
PRINCIPAL REGISTER**



**Farmers & Merchants  
Trust Company**

FARMERS AND MERCHANTS TRUST COMP-  
ANY OF LONG BEACH (CALIFORNIA COR-  
PORATION)  
302 PINE AVENUE  
LONG BEACH, CA 90802

FOR: FINANCIAL TRUST RELATED SERVICES,  
NAMELY, ESTATE TRUST MANAGEMENT AND  
INVESTMENT ADVICE, IN CLASS 36 (U.S. CLS. 100,  
101 AND 102).

FIRST USE 1-1-1998; IN COMMERCE 1-1-1998.

NO CLAIM IS MADE TO THE EXCLUSIVE  
RIGHT TO USE "TRUST COMPANY", APART  
FROM THE MARK AS SHOWN.

SER. NO. 76-561,873, FILED 11-24-2003.

BENJAMIN ALLEN, EXAMINING ATTORNEY

**Int. Cl.: 36**

**Prior U.S. Cls.: 100, 101 and 102**

**United States Patent and Trademark Office**

**Reg. No. 3,464,860**

**Registered July 15, 2008**

**SERVICE MARK  
PRINCIPAL REGISTER**



**Farmers & Merchants  
Bank**

FARMERS AND MERCHANTS BANK OF LONG  
BEACH (CALIFORNIA CORPORATION)  
302 PINE AVENUE  
LONG BEACH, CA 90802

FOR: FINANCIAL BANKING SERVICES, NAME-  
LY, CHECKING ACCOUNTS, SAVINGS AC-  
COUNTS, LOAN FINANCING AND INVESTMENT  
ADVICE, IN CLASS 36 (U.S. CLS. 100, 101 AND 102).

FIRST USE 1-1-1998; IN COMMERCE 1-1-1998.

NO CLAIM IS MADE TO THE EXCLUSIVE  
RIGHT TO USE "BANK", APART FROM THE  
MARK AS SHOWN.

SER. NO. 76-562,353, FILED 12-1-2003.

BENJAMIN ALLEN, EXAMINING ATTORNEY

**Int. Cl.: 10**

**Prior U.S. Cls.: 26, 39 and 44**

**United States Patent and Trademark Office**

**Reg. No. 3,464,861**

**Registered July 15, 2008**

**TRADEMARK  
PRINCIPAL REGISTER**

**QUEST**

QUEST MEDICAL, INC. (TEXAS CORPORATION)  
ONE ALLENTOWN PARKWAY  
ALLEN, TX 750024211

FOR: MEDICAL EQUIPMENT AND PRODUCTS, NAMELY, INTRAVENOUS FLUID DELIVERY SETS COMPRISED OF TUBING WITH INJECTION PORTS AND SITES, AND INTRAVENOUS FLUID DELIVERY 1 CONTROLLERS; SURGICAL VASCULAR RETRACTING DEVICES; AORTIC PUNCHES; BLOOD CLOTTING TIME TESTING SYSTEMS COMPRISED OF TESTING UNIT AND TUBES; INTRAUTERINE PRESSURE MONITORING DEVICES; CARDIOPLEGIA DELIVERY AND CONTROL SYSTEMS, NAMELY, CANNULAES, PERFUSION SETS, AS WELL AS CARDIOPLEGIA PUMPS AND

MONITORS; AND INFLATION DEVICES FOR BALLOON CATHETERS, IN CLASS 10 (U.S. CLS. 26, 39 AND 44).

FIRST USE 3-0-1980; IN COMMERCE 3-0-1980.

THE MARK CONSISTS OF STANDARD CHARACTERS WITHOUT CLAIM TO ANY PARTICULAR FONT, STYLE, SIZE, OR COLOR.

OWNER OF U.S. REG. NO. 1,266,236.

SER. NO. 76-571,195, FILED 1-21-2004.

INGRID C. EULIN, EXAMINING ATTORNEY

**Int. Cls.: 9, 11, 41 and 42**

**Prior U.S. Cls.: 13, 21, 23, 26, 31, 34, 36, 38, 100, 101  
and 107**

**Reg. No. 3,464,862**

**United States Patent and Trademark Office**

**Registered July 15, 2008**

**TRADEMARK  
SERVICE MARK  
PRINCIPAL REGISTER**

**富士通**

FUJITSU LIMITED (JAPAN CORPORATION)  
1-1, KAMIKODANAKA, 4-CHOME, NAKAHARA-  
KU  
KAWASAKI-SHI, KANAGAWA-KEN, JAPAN

FOR: COMMUNICATION EQUIPMENT, NAME-  
LY TELEPHONE SETS, TELEPHONE SWITCHING  
APPARATUS, FACSIMILE APPARATUS, DIGITAL  
DATA TRANSMISSION APPARATUS, RADIO AND  
TELEVISION TRANSMITTING AND RECEIVING  
APPARATUS AND RADAR APPARATUS; ROUT-  
TERS, MODEMS; ELECTRICAL WIRES; COMMU-  
NICATION CABLES AND OPTICAL FIBERS;  
REMOTE CONTROL AND TELEMETERING APPA-  
RATUS; COMPUTER PROGRAMS FOR SYSTEM  
MANAGEMENT, NETWORK MANAGEMENT, DA-  
TABASE MANAGEMENT, ENTERPRISE RE-  
SOURCE PLANNING (ERP), SUPPLY CHAIN  
MANAGEMENT, E-COMMERCE, TRANSACTION  
DEAL MANAGEMENT, ORDER AND SERVICE  
MANAGEMENT, ENGLISH-JAPANESE/JAPANESE-  
ENGLISH TRANSLATION, SOFTWARE DEVELOP-  
MENT, PROVIDING E-BUSINESS PLATFORMS  
AND MANUFACTURING PROCESS MANAGE-  
MENT; COMPUTER HARDWARE; DISPLAY MONI-  
TORS, KEYBOARDS, PRINTERS, BLANK  
RECORDING MAGNETIC DISKS, COMPUTER  
PERIPHERALS AND TERMINALS FOR USE IN  
DATA PROCESSING SYSTEMS; CASH REGISTERS  
AND DISPENSERS; SEMICONDUCTOR DEVICES,  
NAMELY, INTEGRATED CIRCUITS, SEMICON-  
DUCTOR MEMORIES, AND COMPUTER HARD-  
WARE MICROPROCESSORS; ELECTRIC AND  
ELECTRONIC PARTS AND COMPONENTS NAME-  
LY RELAYS, CONNECTORS, SWITCHES AND BAT-  
TERIES; OPTICAL-DISCS, OPTICAL-DISC DRIVES,  
MAGNETO-OPTICAL DISCS, MAGNETO-OPTICAL  
DISC DRIVES, MAGNETIC DISCS, MAGNETIC

DISC DRIVES, MAGNETIC TAPES, MAGNETIC  
TAPE DRIVES; COMPUTER APPARATUS FOR  
GAMES ADAPTED OR USED WITH TELEVISION  
RECEIVERS; AUDIO FREQUENCY MACHINES  
AND APPARATUS PROJECTION APPARATUS,  
NAMELY, LIQUID CRYSTAL DISPLAY PROJEC-  
TORS; CAMERAS, NAMELY DIGITAL CAMCOR-  
DERS, CHARGE COUPLED DEVICE CAMERAS  
AND SURVEILLANCE CAMERAS, IN CLASS 9  
(U.S. CLS. 21, 23, 26, 36 AND 38).

FOR: ELECTRIC LAMPS; FLUORESCENT  
LAMPS, HOME AIR-CONDITIONING APPARATUS;  
AND HOUSEHOLD ELECTROTHERMIC APPLI-  
ANCE FOR HEATING HOMES, IN CLASS 11 (U.S.  
CLS. 13, 21, 23, 31 AND 34).

FOR: TRANSLATION OF LANGUAGES VIA A  
GLOBAL COMPUTER NETWORK, IN CLASS 41  
(U.S. CLS. 100, 101 AND 107).

FOR: COMPUTER PROGRAMMING; COMPU-  
TER SOFTWARE DESIGN; INSTALLATION AND  
SETUP OF COMPUTER SOFTWARE; MAINTEN-  
ANCE AND UPDATING OF COMPUTER SOFT-  
WARE; REMOTE CONTROLLING AND  
SUPERVISING OF COMPUTER SYSTEMS AND  
NETWORKS, COMPUTER SYSTEM ANALYSIS;  
CONSULTANCY IN THE FIELD OF COMPUTER  
HARDWARE AND SOFTWARE; PROVIDING IN-  
FORMATION REGARDING DESIGN, DEVELOP-  
MENT AND MAINTENANCE OF COMPUTER  
SOFTWARE; RENTAL AND LEASING OF COMPU-  
TERS, SERVERS AND COMPUTER SOFTWARE;  
DATA PROCESSING SERVICES USING COMPU-  
TERS; AND RESEARCH AND DEVELOPMENT FOR  
OTHERS IN THE FIELD OF COMPUTER HARD-  
WARE AND SOFTWARE, COMMUNICATION SYS-

TEMS, AND SEMICONDUCTOR DEVICES, IN CLASS 42 (U.S. CLS. 100 AND 101).

OWNER OF JAPAN REG. NO. 3285415, DATED 4-18-1997, EXPIRES 4-18-2017.

OWNER OF JAPAN REG. NO. 4320495, DATED 10-1-1999, EXPIRES 10-1-2009.

OWNER OF JAPAN REG. NO. 4320493, DATED 10-1-1999, EXPIRES 10-1-2009.

OWNER OF JAPAN REG. NO. 588393, DATED 6-6-1962, EXPIRES 6-6-2012.

THE MARK CONSISTS OF THREE JAPANESE CHARACTERS WHICH TRANSLATE INTO THE ENGLISH WORD FUJITSU.

THE JAPANESE CHARACTERS IN THE MARK TRANSLITERATE TO FU-JI-TSU-U WHICH MEANS MT. FUJI AND COMMUNICATIONS IN ENGLISH.

THE MARK CONSISTS OF THREE JAPANESE CHARACTERS WHICH TRANSLATE INTO THE ENGLISH WORD FUJITSU.

SER. NO. 76-578,687, FILED 3-2-2004.

JOHN E. MICHOS, EXAMINING ATTORNEY

**Int. Cl.: 3**

**Prior U.S. Cls.: 1, 4, 6, 50, 51 and 52**

**Reg. No. 3,464,863**

**United States Patent and Trademark Office**

**Registered July 15, 2008**

---

**TRADEMARK  
PRINCIPAL REGISTER**

**COLOR REFLECT**

TRANS-INDIA PRODUCTS, INC. (CALIFORNIA CORPORATION)

3354 A COFFEY LANE

SANTA ROSA, CA 95403

FOR: HAIR CARE PRODUCTS, NAMELY, SHAMPOOS AND CONDITIONERS, IN CLASS 3 (U.S. CLS. 1, 4, 6, 50, 51 AND 52).

FIRST USE 2-27-2004; IN COMMERCE 2-27-2004.

THE MARK CONSISTS OF STANDARD CHARACTERS WITHOUT CLAIM TO ANY PARTICULAR FONT, STYLE, SIZE, OR COLOR.

NO CLAIM IS MADE TO THE EXCLUSIVE RIGHT TO USE "COLOR", APART FROM THE MARK AS SHOWN.

SER. NO. 76-579,591, FILED 3-8-2004.

ANNE E. GUSTASON, EXAMINING ATTORNEY



**Int. Cls.: 9 and 42**

**Prior U.S. Cls.: 21, 23, 26, 36, 38, 100 and 101**

**Reg. No. 3,464,864**

**United States Patent and Trademark Office**

**Registered July 15, 2008**

**TRADEMARK  
SERVICE MARK  
PRINCIPAL REGISTER**

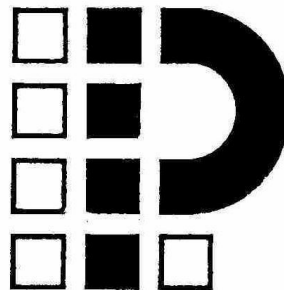

PIXELA CORPORATION (JAPAN CORPORATION)  
2-10-70, NANBA-NAKA  
NANIWA-KU, OSAKA-SHI  
OSAKA, JAPAN

FOR: ELECTRONIC TUNER DEVICES FOR PORTABLE TELEVISIONS, RADIO RECEIVERS AND MOBILE PHONES; ANALOG TUNERS FOR PERSONAL COMPUTERS; TERRESTRIAL DIGITAL BROADCASTING TUNERS; RADIO TUNERS; COMMUNICATION CIRCUITS FOR LAN CONNECTION; ANTENNA; OPTICAL SIGNAL TRANSMITTERS, DIGITAL SIGNAL TRANSMITTERS, AND CABLE TELEVISION SIGNAL TRANSMITTERS; NAVIGATION APPARATUS FOR VEHICLES IN THE NATURE OF ON-BOARD COMPUTERS, SATELLITE NAVIGATION APPARATUS, NAMELY, A GLOBAL POSITIONING SYSTEM; RADARS; TELEPHONES; MOBILE PHONES; FACSIMILE MACHINES; TELEVISIONS; LOUDSPEAKERS; SEMICONDUCTOR CHIPS; SEMICONDUCTOR INTEGRATED CIRCUITS; SEMICONDUCTORS FOR USE IN PERSONAL COMPUTERS, DIGITAL CAMERAS, DIGITAL VIDEO CAMERAS AND CELLULAR PHONES; SEMICONDUCTORS FOR USE IN SURVEILLANCE CAMERAS; DIODES; SILICON WAFERS; TRANSISTORS; MICROPROCESSORS; PRINTED CIRCUITS AND PRINTED CIRCUIT BOARDS; WIRELESS LAN HARDWARE; LOCAL AREA NETWORK HARDWARE; DIGITAL PICTURE RECORDERS; EXPANSION CARDS FOR PROCESSING IMAGES WITHIN A PERSONAL COMPUTER; DVD-R AND DVD-RAM DRIVES; VIDEO CAPTURE CIRCUIT BOARDS; VIDEO CAPTURE BOARDS FOR A PERSONAL

COMPUTER; VIDEO CAPTURE BOARDS CONNECTABLE TO A PERSONAL COMPUTER; PERSONAL COMPUTER PERIPHERAL DEVICES; COMPUTER SOFTWARE FOR PLAYING, RECORDING AND EDITING SOUND, IMAGE AND DATA SIGNALS AND COMPUTER SOFTWARE FOR MANAGING COLLECTIONS OF SOUND, IMAGE AND DATA SIGNALS ON COMPUTER DISC DRIVES; SOFTWARE DOWNLOADED IN A PERSONAL COMPUTER FOR PROCESSING A VIDEO IMAGE; OPERATING SOFTWARE FOR DIGITAL CAMERAS, DIGITAL VIDEO CAMERAS AND SURVEILLANCE CAMERAS; IMAGE AND VIDEO PROCESSING SOFTWARE FOR CELLULAR PHONES, CAR NAVIGATION COMPUTERS AND PDAS; SOFTWARE FOR CONTROL OF SEMICONDUCTORS IN PERSONAL COMPUTERS, DIGITAL CAMERAS, DIGITAL VIDEO CAMERAS, SURVEILLANCE CAMERAS, CELLULAR PHONES, CAR NAVIGATION COMPUTERS, AND PDA AND OTHER MOBILE TERMINALS; PRE-RECORDED CD-ROMS, DVD-ROMS, DVD-RAMS, ELECTRONIC CIRCUITS, MAGNETIC TAPES, MAGNETIC DISKS, OPTICAL DISKS, MAGNETIC CARDS AND OTHER STORAGE MEDIA, FEATURING COMPUTER PROGRAMS THAT ACCESS, CORRECT AND EDIT DIGITAL IMAGES; COMPUTERS; ELECTRONIC CIRCUITS FOR HAND-HELD GAMES WITH LIQUID CRYSTAL DISPLAYS; COMPUTER SOFTWARE RECORDED ON CD-ROMS FOR HAND-HELD GAMES WITH LIQUID CRYSTAL DISPLAYS; ELECTRONIC CIRCUITS FOR ELECTRONIC MUSICAL INSTRUMENTS; COMPUTER SOFTWARE RECORDED ON CD-ROMS FOR OPERATING ELECTRONIC MUSICAL INSTRUMENT; ELEC-

TRONIC PUBLICATIONS, NAMELY, USER MANUALS FOR COMPUTER HARDWARE AND SOFTWARE THAT IS DOWNLOADABLE AND IS RECORDED ON COMPUTER MEDIA; PRE-RECORDED CD-ROMS, DVD-ROMS, DVD-RAMS, ELECTRONIC CIRCUITS, MAGNETIC TAPES, MAGNETIC DISKS, OPTICAL DISKS, MAGNETIC CARDS AND OTHER STORAGE MEDIA, FEATURING IMAGES AND TEXT FROM MAGAZINES, BOOKS, NEWSPAPERS, MAPS, PHOTOGRAPHS AND GRAPHIC ART; PRE-RECORDED VIDEO DISKS AND VIDEO TAPES FEATURING MUSIC, PLAYS, RECITALS AND MOVIES; VEHICLE DRIVING TRAINING SIMULATORS; SPORTS TRAINING SIMULATORS; DIGITAL CAMERAS; DIGITAL VIDEO CAMERAS; SURVEILLANCE CAMERAS; FILM SCANNERS; FILM SCANNERS THAT CONVERT ANALOG DATA TO DIGITAL DATA; AUTOMATIC LIQUID-LEVEL CONTROL MACHINES AND INSTRUMENTS, AUTOMATIC ELECTRICAL DISTRIBUTION APPARATUS; MAGNETIC MEASURING MACHINES AND INSTRUMENTS FOR MEASURING WAVEFORM, WAVELENGTHS, FREQUENCY, RADIO FREQUENCY INTENSITY, AND TEMPORAL CHANGES THEREOF; AND ELECTRIC WIRES AND CABLES FOR LAN INTERCONNECTING SYSTEM AND OTHER ELECTRIC WIRES AND WIRES AND CABLES, IN CLASS 9 (U.S. CLS. 21, 23, 26, 36 AND 38).

FOR: DESIGN OF SEMICONDUCTOR CHIPS FOR OTHERS; DESIGN OF ELECTRONIC TUNER DEVICES FOR OTHERS; RESEARCH AND DEVELOPMENT ON SEMICONDUCTOR CHIPS; RESEARCH AND DEVELOPMENT ON ELECTRONIC TUNER DEVICES; ADVISE ON THE FIELD OF DESIGNING AND PROGRAMMING IMAGE PROCESSING HARDWARE AND IMAGE PROCESSING SOFTWARE; DESIGNING AND PROGRAMMING OR MAINTENANCE OF COMPUTER PROGRAMS;

DESIGNING OF MACHINES, APPARATUS, INSTRUMENTS INCLUDING THEIR PARTS, NAMELY, DIGITAL THERMOMETERS, HYGROMETERS, PHOTOMETERS AND ANEMOMETERS OR SYSTEMS COMPOSED OF SUCH MACHINES, APPARATUS AND INSTRUMENTS; PROVIDING OF ON-LINE NON-DOWNLOADABLE SOFTWARE FOR PLAYING, RECORDING AND EDITING SOUND, IMAGE AND DATA SIGNALS AND PROVIDING OF ON-LINE NON-DOWNLOADABLE SOFTWARE FOR MANAGING COLLECTIONS OF SOUND, IMAGE AND DATA SIGNALS ON COMPUTER DISC DRIVES; LICENSING OF INTELLECTUAL PROPERTY FOR OTHERS; CONSULTANCY SERVICES RELATING TO THE LICENSING OF INTELLECTUAL PROPERTY; DESIGNING OF COMPUTER HARDWARE AND SOFTWARE, TELEVISIONS, RADIO RECEIVERS, AND THEIR PARTS AND ACCESSORIES; RESEARCH AND DEVELOPMENT FOR OTHERS WITH RESPECT TO MECHANICAL ENGINEERING, COMPUTERS AND AUTOMOBILES; TESTING, INSPECTION AND RESEARCH OF PHARMACEUTICALS, COSMETICS AND FOODSTUFF; TESTING AND RESEARCH ON ELECTRICITY; TESTING AND RESEARCH ON MACHINES, APPARATUS AND INSTRUMENTS; COPYRIGHT LICENSING SERVICES; RENTAL AND LEASING OF COMPUTERS; AND RENTAL OF LABORATORY APPARATUS AND INSTRUMENTS, IN CLASS 42 (U.S. CLS. 100 AND 101).

PRIORITY CLAIMED UNDER SEC. 44(D) ON JAPAN APPLICATION NO. 2004-105842, FILED 11-18-2004, REG. NO. 4918203, DATED 12-22-2005, EXPIRES 12-22-2015.

SER. NO. 76-627,660, FILED 1-12-2005.

REBECCA EISINGER, EXAMINING ATTORNEY

**Int. Cls.: 6 and 40**

**Prior U.S. Cls.: 2, 12, 13, 14, 23, 25, 50, 100, 103 and 106**

**United States Patent and Trademark Office**

**Reg. No. 3,464,865**

Registered July 15, 2008

**TRADEMARK  
SERVICE MARK  
PRINCIPAL REGISTER**

**MURIWALL**

MURIDAL INC. (CANADA CORPORATION)  
316 MARION STREET  
LE GARDEUR, QUEBEC, J5Z 4W8, CANADA

FOR: BUILDING WALL FRAMING AND CURTAIN WALLS PRIMARILY MADE OF METAL BUT ALSO INCLUDING GLASS COMPONENTS, IN CLASS 6 (U.S. CLS. 2, 12, 13, 14, 23, 25 AND 50).

FOR: CUSTOM MANUFACTURE OF BUILDING WALL FRAMING AND CURTAIN WALLS TO THE SPECIFICATIONS OF OTHERS, IN CLASS 40 (U.S. CLS. 100, 103 AND 106).

THE MARK CONSISTS OF STANDARD CHARACTERS WITHOUT CLAIM TO ANY PARTICULAR FONT, STYLE, SIZE, OR COLOR.

PRIORITY CLAIMED UNDER SEC. 44(D) ON CANADA APPLICATION NO. 1246170, FILED 2-4-2005, REG. NO. TMA706652, DATED 2-6-2008, EXPIRES 2-6-2023.

SER. NO. 76-643,058, FILED 7-18-2005.

GRETTA YAO, EXAMINING ATTORNEY

**Int. Cl.: 20**

**Prior U.S. Cls.: 2, 13, 22, 25, 32 and 50**

**United States Patent and Trademark Office**

**Reg. No. 3,464,866**

**Registered July 15, 2008**

**TRADEMARK  
PRINCIPAL REGISTER**



CASCADES CANADA INC. (CANADA CORPORATION)  
772 SHERBROOKE STREET WEST, SUITE 100  
MONTREAL, QUEBEC, CANADA H3A 1G1

FOR: URBAN FURNITURE, NAMELY, BENCHES, CHAIRS, PICNIC TABLES, RECYCLING UNITS COMPRISING PLASTIC STORAGE CONTAINERS FOR DOMESTIC USE, BIKE STORAGE RACKS, AND NON-METAL COMPOST BINS, IN CLASS 20 (U.S. CLS. 2, 13, 22, 25, 32 AND 50).

PRIORITY CLAIMED UNDER SEC. 44(D) ON CANADA APPLICATION NO. 1278255, FILED 11-3-2005, REG. NO. TMA689186, DATED 6-7-2007, EXPIRES 6-7-2022.

SER. NO. 76-650,022, FILED 11-4-2005.

JASON TURNER, EXAMINING ATTORNEY

**Int. Cl.: 41**

**Prior U.S. Cls.: 100, 101 and 107**

**United States Patent and Trademark Office**

**Reg. No. 3,464,867**

**Registered July 15, 2008**

**SERVICE MARK  
PRINCIPAL REGISTER**



LYNDI LTD. (IOWA CORPORATION)  
2419 5TH AVENUE SOUTH  
FORT DODGE, IA 50501

FOR: EDUCATIONAL SERVICES, NAMELY, PROVIDING COURSES OF INSTRUCTION IN HAIR CUTTING, HAIR STYLING, HAIRDRESSING SERVICES, AND DISTRIBUTING COURSE MATERIAL IN CONNECTION THEREWITH, IN CLASS 41 (U.S. CLS. 100, 101 AND 107).

NO CLAIM IS MADE TO THE EXCLUSIVE RIGHT TO USE "INTERNATIONAL COLLEGE", APART FROM THE MARK AS SHOWN.

THE DESIGN CONSISTS OF STYLIZED CURSIVE LETTERS "L" AND "J" BOARDED BY A STYLIZED THREE QUARTERS CIRCLE CONTAINING THE WORD "COLLEGE" IN THE LOWER RIGHT HAND SECTION AND THE WORD "INTERNATIONAL" IN THE UPPER RIGHT HAND SECTION OF THE OPEN PART OF THE THREE QUARTERS CIRCLE.

SER. NO. 76-651,170, FILED 11-30-2005.

FIRST USE 10-20-2003; IN COMMERCE 10-20-2003.

ERNEST SHOSHO, EXAMINING ATTORNEY

**Int. Cl.: 9**

**Prior U.S. Cls.: 21, 23, 26, 36 and 38**

**Reg. No. 3,464,868**

**United States Patent and Trademark Office**

**Registered July 15, 2008**

---

**TRADEMARK  
PRINCIPAL REGISTER**

**WelcomHome**

DELTEK, INC. (DELAWARE CORPORATION)  
13880 DULLES CORNER LANE  
HERNDON, VA 20171

FIRST USE 6-5-2000; IN COMMERCE 6-5-2000.

FOR: ELECTRICAL AND SCIENTIFIC APPARATUS, NAMELY, A DOWNLOADABLE SOFTWARE INTERFACE PROGRAM THAT ALLOWS USERS TO ACCESS PROJECT INFORMATION, IN CLASS 9 (U.S. CLS. 21, 23, 26, 36 AND 38).

THE MARK CONSISTS OF STANDARD CHARACTERS WITHOUT CLAIM TO ANY PARTICULAR FONT, STYLE, SIZE, OR COLOR.

SER. NO. 76-652,958, FILED 1-5-2006.

SHANNON TWOHIG, EXAMINING ATTORNEY

**Int. Cls.: 9, 16 and 42**

**Prior U.S. Cls.: 2, 5, 21, 22, 23, 26, 29, 36, 37, 38, 50,  
100 and 101**

**Reg. No. 3,464,869**

**United States Patent and Trademark Office**

**Registered July 15, 2008**

**TRADEMARK  
SERVICE MARK  
PRINCIPAL REGISTER**

# **POWERTRACE**

COREL CORPORATION (CANADA CORPORATION)  
1600 CARLING AVENUE  
OTTAWA, ONTARIO KLZ 8R7, CANADA

FOR: COMPUTER SOFTWARE, NAMELY SOFTWARE FOR USE IN CONVERTING BITMAP IMAGE FILES TO EDITABLE AND SCALABLE VECTOR GRAPHICS, FOR USE IN VIEWING AND EDITING VECTOR GRAPHICS, SMOOTHING CURVED LINES AND ADJUSTING DETAILS IN THE GRAPHICS, PROVIDING USERS WITH INFORMATION ABOUT THE NUMBER OF NODES, COLOURS, AND OBJECTS IN THE GRAPHICS, AND GENERATING A MODIFIABLE COLOUR PALETTE FOR THE GRAPHICS, IN CLASS 9 (U.S. CLS. 21, 23, 26, 36 AND 38).

FOR: COMPUTER SOFTWARE MANUALS FOR USE WITH GRAPHICS SOFTWARE, IN CLASS 16 (U.S. CLS. 2, 5, 22, 23, 29, 37, 38 AND 50).

FOR: COMPUTER SOFTWARE PROGRAMMING AND CONSULTING, IN CLASS 42 (U.S. CLS. 100 AND 101).

THE MARK CONSISTS OF STANDARD CHARACTERS WITHOUT CLAIM TO ANY PARTICULAR FONT, STYLE, SIZE, OR COLOR.

PRIORITY CLAIMED UNDER SEC. 44(D) ON CANADA APPLICATION NO. 1276407, FILED 10-20-2005, REG. NO. TMA687,408, DATED 5-9-2007, EXPIRES 5-29-2022.

SER. NO. 76-653,187, FILED 1-6-2006.

AMEETA JORDAN, EXAMINING ATTORNEY

**Int. Cl.: 38**

**Prior U.S. Cls.: 100, 101 and 104**

**United States Patent and Trademark Office**

**Reg. No. 3,464,870**

**Registered July 15, 2008**

**SERVICE MARK  
PRINCIPAL REGISTER**

**XFONE**

XFONE, INC. (NEVADA CORPORATION)  
2506 LAKELAND DRIVE, SUITE 100  
JACKSON, MS 39232

FIRST USE 9-1-2000; IN COMMERCE 9-1-2000.

FOR: TELEPHONE COMMUNICATIONS SERVICES AND PROVIDING MULTIPLE USER DIAL-UP AND DEDICATED ACCESS TO THE INTERNET, IN CLASS 38 (U.S. CLS. 100, 101 AND 104).

SER. NO. 76-655,063, FILED 2-14-2006.

NICHOLAS ALTREE, EXAMINING ATTORNEY



**Int. Cl.: 9**

**Prior U.S. Cls.: 21, 23, 26, 36 and 38**

**Reg. No. 3,464,871**

**United States Patent and Trademark Office**

**Registered July 15, 2008**

**TRADEMARK  
PRINCIPAL REGISTER**

**APDM (ACCESSORY POWER DISTRIBUTION MODULE)**

MARKETING WORLDWIDE CORP (DELAWARE CORPORATION)  
2212 GRAND COMMERCE DRIVE  
HOWELL, MI 48855

THE MARK CONSISTS OF STANDARD CHARACTERS WITHOUT CLAIM TO ANY PARTICULAR FONT, STYLE, SIZE, OR COLOR.

FOR: ELECTRICAL POWER DISTRIBUTION SWITCHABLE FUSE BLOCK TO BE INSTALLED IN VARIOUS VEHICLES TO EASILY AND SAFELY CONNECT MULTIPLE AUTOMOTIVE OR OTHER ELECTRIC ACCESSORIES TO THE MAIN POWER, IN CLASS 9 (U.S. CLS. 21, 23, 26, 36 AND 38).

NO CLAIM IS MADE TO THE EXCLUSIVE RIGHT TO USE "ACCESSORY POWER DISTRIBUTION MODULE", APART FROM THE MARK AS SHOWN.

SER. NO. 76-656,116, FILED 3-6-2006.

FIRST USE 11-1-2005; IN COMMERCE 11-1-2005.

ANNE MADDEN, EXAMINING ATTORNEY

**Int. Cl.: 10**

**Prior U.S. Cls.: 26, 39 and 44**

**Reg. No. 3,464,872**

**United States Patent and Trademark Office**

**Registered July 15, 2008**

**TRADEMARK  
PRINCIPAL REGISTER**



ELITE SCRUBS & MEDICAL UNIFORMS, INC.  
(NEW YORK CORPORATION), DBA BEVERLY HILLS UNIFORM CLOTHING  
2 CYPRESS AVENUE  
KINGS POINT, NY 11024

THE COLOR(S) RED AND NAVY BLUE IS/ARE CLAIMED AS A FEATURE OF THE MARK.

FOR: SURGICAL SCRUB SUITS, SCRUB TOPS, SCRUB PANTS AND SURGICAL GOWNS, IN CLASS 10 (U.S. CLS. 26, 39 AND 44).

THE MARK CONSISTS OF THE COLOR NAVY BLUE THAT APPEARS IN THE LETTER B AND THE BACKGROUND OF THE MARK. THE COLOR RED APPEARS IN THE LETTER H AND THE WORDING "BEVERLY HILLS UNIFORMS", AS WELL AS IN THE OUTLINE OF THE MARK.

FIRST USE 9-0-2003; IN COMMERCE 9-0-2003.

OWNER OF U.S. REG. NO. 3,322,111.

SER. NO. 76-657,181, FILED 3-23-2006.

NO CLAIM IS MADE TO THE EXCLUSIVE RIGHT TO USE "UNIFORMS", APART FROM THE MARK AS SHOWN.

SIMON TENG, EXAMINING ATTORNEY

**Int. Cls.: 35, 37 and 42**

**Prior U.S. Cls.: 100, 101, 102, 103 and 106**

**Reg. No. 3,464,873**

**United States Patent and Trademark Office**

**Registered July 15, 2008**

**SERVICE MARK  
PRINCIPAL REGISTER**



HOME PERFORMANCE ENTERPRISES, LLC  
(DELAWARE LTD LIAB CO)  
1201 LOUISIANA STREET, SUITE 2700  
HOUSTON, TX 77002

FOR: INFORMATION IN THE FIELD OF HOME ENERGY EFFICIENCY AND CONSULTATION RELATED THERETO, IN CLASS 35 (U.S. CLS. 100, 101 AND 102).

FIRST USE 9-1-2005; IN COMMERCE 9-1-2005.

FOR: HEATING, VENTILATING AND AIR CONDITIONING REPAIR AND MAINTENANCE SERVICES; CONSULTATION IN THE FIELDS OF ENERGY-RELATED MODIFICATIONS FOR THE HOME, AND REPAIRING AND MAINTAINING HOME APPLIANCES; CONSTRUCTION, MAINTENANCE AND RENOVATION OF ENERGY-RELATED MODIFICATIONS FOR THE HOME; INSTALLATION OF REPLACEMENT WINDOWS AND INSULATION; MAINTENANCE OF HOME

APPLIANCES, HEATING, VENTILATING, AND AIR CONDITIONING SYSTEMS, IN CLASS 37 (U.S. CLS. 100, 103 AND 106).

FIRST USE 9-1-2005; IN COMMERCE 9-1-2005.

FOR: TESTING, ANALYSIS AND EVALUATION OF HOME ENERGY EFFICIENCY; INSPECTION AND SAFETY ASSESSMENT OF THE PERFORMANCE OF HOME APPLIANCES, HEATING, VENTILATING, AND AIR CONDITIONING SYSTEMS, IN CLASS 42 (U.S. CLS. 100 AND 101).

FIRST USE 9-1-2005; IN COMMERCE 9-1-2005.

SEC. 2(F) AS TO "GREENHOMES AMERICA".

SER. NO. 76-662,785, FILED 7-10-2006.

TRACY CROSS, EXAMINING ATTORNEY

**Int. Cl.: 41**

**Prior U.S. Cls.: 100, 101 and 107**

**United States Patent and Trademark Office**

**Reg. No. 3,464,874**

**Registered July 15, 2008**

**SERVICE MARK  
PRINCIPAL REGISTER**

**VIEWFINDER PRODUCTIONS**

VIEWFINDER PRODUCTIONS, LLC (MASSA-  
CHUSETTS LTD LIAB CO)  
423 BROADWAY  
SUITE 403 A  
BOSTON, MA 02127

FOR: SPECIAL EVENT PLANNING AND EVENT  
PLANNING CONSULTATION, IN CLASS 41 (U.S.  
CLS. 100, 101 AND 107).

FIRST USE 2-1-2004; IN COMMERCE 2-1-2004.

THE MARK CONSISTS OF STANDARD CHAR-  
ACTERS WITHOUT CLAIM TO ANY PARTICULAR  
FONT, STYLE, SIZE, OR COLOR.

NO CLAIM IS MADE TO THE EXCLUSIVE  
RIGHT TO USE "PRODUCTIONS", APART FROM  
THE MARK AS SHOWN.

SER. NO. 76-662,832, FILED 7-11-2006.

WANDA KAY PRICE, EXAMINING ATTORNEY

**Int. Cl.: 33**

**Prior U.S. Cls.: 47 and 49**

**United States Patent and Trademark Office**

**Reg. No. 3,464,875**

**Registered July 15, 2008**

**TRADEMARK  
PRINCIPAL REGISTER**

**CHATEAU CANON**

CHÂTEAU CANON (FRANCE CORPORATION)  
33330 SAINT-EMILION, FRANCE

FOR: WINE, IN CLASS 33 (U.S. CLS. 47 AND 49).

FIRST USE 1-1-1800; IN COMMERCE 0-0-1960.

THE MARK CONSISTS OF STANDARD CHAR-  
ACTERS WITHOUT CLAIM TO ANY PARTICULAR  
FONT, STYLE, SIZE, OR COLOR.

NO CLAIM IS MADE TO THE EXCLUSIVE  
RIGHT TO USE "CHATEAU", APART FROM THE  
MARK AS SHOWN.

SER. NO. 76-663,642, FILED 7-25-2006.

JANICE KIM, EXAMINING ATTORNEY

**Int. Cl.: 41**

**Prior U.S. Cls.: 100, 101 and 107**

**United States Patent and Trademark Office**

**Reg. No. 3,464,876**

**Registered July 15, 2008**

**SERVICE MARK  
PRINCIPAL REGISTER**

**OCS**

OAKS CHRISTIAN SCHOOL (CALIFORNIA RELIGIOUS CORPORATION ORGANIZED UNDER THE NONPROFIT RELIGIOUS CORPORATION LAW), DBA OAKS CHRISTIAN HIGH SCHOOL, OAKS CHRISTIAN MIDDLE SCHOOL  
31749 LA TIENDA DRIVE  
WESTLAKE VILLAGE, CA 91362

FOR: EDUCATIONAL SERVICES, NAMELY, ACADEMIC SERVICES IN THE NATURE OF PROVIDING COURSES OF INSTRUCTION FOR THE MIDDLE AND HIGH SCHOOL LEVELS; PROVIDING COURSES OF INSTRUCTION ON RELIGION,

SPORTS, AND CULTURE AT THE MIDDLE AND HIGH SCHOOL LEVELS, IN CLASS 41 (U.S. CLS. 100, 101 AND 107).

FIRST USE 7-1-2003; IN COMMERCE 7-1-2003.

THE MARK CONSISTS OF STANDARD CHARACTERS WITHOUT CLAIM TO ANY PARTICULAR FONT, STYLE, SIZE, OR COLOR.

SER. NO. 76-664,340, FILED 8-9-2006.

COLLEEN KEARNEY, EXAMINING ATTORNEY

**Int. Cl.: 9**

**Prior U.S. Cls.: 21, 23, 26, 36 and 38**

**Reg. No. 3,464,877**

**United States Patent and Trademark Office**

**Registered July 15, 2008**

---

**TRADEMARK  
PRINCIPAL REGISTER**

**WAFERXAM**

ADE CORPORATION (MASSACHUSETTS CORPORATION)  
80 WILSON WAY  
WESTWOOD, MA 020901806

FIRST USE 7-11-2005; IN COMMERCE 7-11-2005.

FOR: EVALUATION MACHINES, NAMELY, INSPECTION AND MEASUREMENT MACHINES FOR DEFECT AND PARTICLE DETECTION FOR SEMI-CONDUCTOR-BASED PRODUCTS, AND ASSOCIATED OPERATING SOFTWARE, IN CLASS 9 (U.S. CLS. 21, 23, 26, 36 AND 38).

THE MARK CONSISTS OF STANDARD CHARACTERS WITHOUT CLAIM TO ANY PARTICULAR FONT, STYLE, SIZE, OR COLOR.

SER. NO. 76-664,449, FILED 8-10-2006.

JASON ROTH, EXAMINING ATTORNEY

**Int. Cl.: 41**

**Prior U.S. Cls.: 100, 101 and 107**

**United States Patent and Trademark Office**

**Reg. No. 3,464,878**

**Registered July 15, 2008**

**SERVICE MARK  
PRINCIPAL REGISTER**

***NEED A CHANCE, INC.***

NEED A CHANCE, INC. (ALABAMA CORPORATION)

P.O. BOX 396  
NEW CASTLE, AL 35119

FOR: COMMUNITY ASSISTANCE PROGRAMS TO EDUCATE AND TRAIN MODERATE, LOW, AND VERY LOW INCOME FAMILIES AND INDIVIDUALS, NAMELY, AFTER-SCHOOL TUTORING OF STUDENTS, LIVE PERFORMANCES BY CHILD PERFORMANCE TROOPS TO EDUCATE AGAINST DRUG, ALCOHOL AND TOBACCO USE, TRAINING IN TENANT RIGHTS IN PUBLIC HOUSING, AND TRAINING IN FINANCIAL LITERACY FOR WOMEN, IN CLASS 41 (U.S. CLS. 100, 101 AND 107).

FIRST USE 5-1-2005; IN COMMERCE 5-1-2005.

THE MARK CONSISTS OF STANDARD CHARACTERS WITHOUT CLAIM TO ANY PARTICULAR FONT, STYLE, SIZE, OR COLOR.

NO CLAIM IS MADE TO THE EXCLUSIVE RIGHT TO USE "INC.", APART FROM THE MARK AS SHOWN.

SER. NO. 76-665,298, FILED 8-29-2006.

ASMAT KHAN, EXAMINING ATTORNEY



Int. Cl.: 32

Prior U.S. Cls.: 45, 46 and 48

United States Patent and Trademark Office

Reg. No. 3,464,879

Registered July 15, 2008

TRADEMARK  
PRINCIPAL REGISTER

The logo for 'Tea'd UP' features the word 'Tea'd' in a black, cursive script font. Below it, the word 'UP' is written in a bold, black, hand-drawn style font with thick, irregular strokes.

TEALIFE, L.P. (TEXAS LIMITED PARTNERSHIP)  
7819 PURDUE AVENUE  
DALLAS, TX 75225

FIRST USE 9-1-2006; IN COMMERCE 9-1-2006.

SER. NO. 76-666,169, FILED 9-18-2006.

FOR: ENERGY DRINK, IN CLASS 32 (U.S. CLS. 45,  
46 AND 48).

TEJBIR SINGH, EXAMINING ATTORNEY

Int. Cl.: 25

Prior U.S. Cls.: 22 and 39

United States Patent and Trademark Office

Reg. No. 3,464,880

Registered July 15, 2008

TRADEMARK  
PRINCIPAL REGISTER

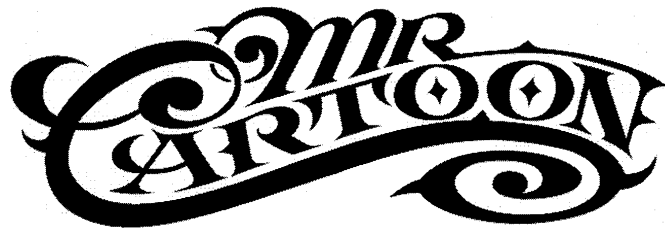

MISTER CARTOON HOLDINGS LLC (CALIFOR-  
NIA LTD LIAB CO)  
1375 EAST 6TH STREET  
#2  
LOS ANGELES, CA 90021

DRESSES, VISORS, JACKETS, COATS, SOCKS, IN  
CLASS 25 (U.S. CLS. 22 AND 39).

FIRST USE 4-5-1993; IN COMMERCE 4-5-1993.

FOR: WEARING APPAREL, NAMELY, SHIRTS,  
T-SHIRTS, HATS, PANTS, SHORTS, SWEAT SHIRTS,  
SWEAT PANTS, SWEATERS, SLACKS, SKIRTS,

SER. NO. 76-666,277, FILED 9-19-2006.

SUZANNE BLANE, EXAMINING ATTORNEY

**Int. Cls.: 9, 16 and 41**

**Prior U.S. Cls.: 2, 5, 21, 22, 23, 26, 29, 36, 37, 38, 50,  
100, 101 and 107**

**Reg. No. 3,464,881**

**United States Patent and Trademark Office**

**Registered July 15, 2008**

**TRADEMARK  
SERVICE MARK  
PRINCIPAL REGISTER**

**MCCLASKEY**

MCCLASKEY, DAVID J. (UNITED STATES IN-  
DIVIDUAL)

680 BUTTERMILK ROAD  
BLOUNTVILLE, TN 37615

FOR: MAGNETIC DATA CARRIERS, NAMELY,  
VIDEO TAPES CONCERNING QUALITY MANAGE-  
MENT, IN CLASS 9 (U.S. CLS. 21, 23, 26, 36 AND 38).

FIRST USE 6-26-1998; IN COMMERCE 6-26-1998.

FOR: PAPER GOODS AND PRINTED MATTER,  
NAMELY, MANUALS, BOOKS AND INSTRUC-  
TIONAL MATERIALS CONCERNING QUALITY  
MANAGEMENT, IN CLASS 16 (U.S. CLS. 2, 5, 22,  
23, 29, 37, 38 AND 50).

FIRST USE 6-26-1998; IN COMMERCE 6-26-1998.

FOR: EDUCATIONAL SERVICES, NAMELY,  
PROVIDING COURSES IN THE FIELD OF QUAL-  
ITY MANAGEMENT AND PERFORMANCE EX-  
CELLENCE, IN CLASS 41 (U.S. CLS. 100, 101 AND  
107).

FIRST USE 6-26-1998; IN COMMERCE 6-26-1998.

THE MARK CONSISTS OF STANDARD CHAR-  
ACTERS WITHOUT CLAIM TO ANY PARTICULAR  
FONT, STYLE, SIZE, OR COLOR.

OWNER OF U.S. REG. NO. 2,303,023.

SEC. 2(F).

SER. NO. 76-666,342, FILED 9-18-2006.

LINDA ORNDORFF, EXAMINING ATTORNEY

**Int. Cl.: 40**

**Prior U.S. Cls.: 100, 103 and 106**

**United States Patent and Trademark Office**

**Reg. No. 3,464,882**

**Registered July 15, 2008**

**SERVICE MARK  
PRINCIPAL REGISTER**

**SCHIESS BRIGHTON**

BRIGHTON EQUIPMENT CORPORATION (NEW  
JERSEY CORPORATION)  
3RD FLOOR, NORTHERN TOWER  
MACK-CALI CENTRE III140 EAST RIDGEWOOD  
AVENUE  
PARAMUS, NJ 07652

FOR: CUSTOM MANUFACTURE OF INDUS-  
TRIAL EQUIPMENT, NAMELY, MACHINE TOOLS,  
IN CLASS 40 (U.S. CLS. 100, 103 AND 106).

FIRST USE 6-1-2005; IN COMMERCE 6-1-2005.

THE MARK CONSISTS OF STANDARD CHAR-  
ACTERS WITHOUT CLAIM TO ANY PARTICULAR  
FONT, STYLE, SIZE, OR COLOR.

SER. NO. 76-666,829, FILED 9-29-2006.

SUNG IN, EXAMINING ATTORNEY

**Int. Cl.: 9**

**Prior U.S. Cls.: 21, 23, 26, 36 and 38**

**Reg. No. 3,464,883**

**United States Patent and Trademark Office**

**Registered July 15, 2008**

**TRADEMARK  
PRINCIPAL REGISTER**

**CBAK**

SHENZHEN BAK BATTERY CO., LTD. (CHINA CORPORATION)  
BUILDING 10, ZHENDA INDUSTRIAL ZONE  
KUICHONG TOWN, LONGGANG DIST.  
SHENZHEN, CHINA

FOR: BATTERIES; ELECTRIC ACCUMULATORS FOR VEHICLES; BATTERIES FOR VEHICLES; BATTERY CHARGERS; ELECTRIC ACCUMULATORS; SOLAR CELLS; BATTERIES FOR LIGHTING; ELECTRICAL CELLS AND BATTERIES; CAPACITORS; PHOTOVOLTAIC CELLS; COMPONENT PARTS OF BATTERIES NAMELY, VENT CAPS; MOBILE TELEPHONE BATTERIES; PERSONAL STEREOS; VENDING MACHINES; ELECTRIC NAVIGATIONAL INSTRUMENTS FOR VEHICLES; WALKIETALKIES; CAMCORDERS; NOTEBOOK COMPUTERS;

MECHANICAL SIGNS; ALARM CENTRAL UNITS; BATTERY PACKS; BATTERY CASES; RECHARGEABLE ELECTRIC BATTERIES; RENEWABLE BATTERY SYSTEM TO PROVIDE BACKUP POWER; BATTERY CABLES; BATTERY CHARGE DEVICES; BATTERY TERMINAL CONNECTOR CLAMPS, IN CLASS 9 (U.S. CLS. 21, 23, 26, 36 AND 38).

FIRST USE 11-20-2006; IN COMMERCE 11-20-2006.

OWNER OF U.S. REG. NO. 2,949,968.

SER. NO. 76-669,835, FILED 12-1-2006.

REBECCA SMITH, EXAMINING ATTORNEY

**Int. Cl.: 2**

**Prior U.S. Cls.: 6, 11 and 16**

**United States Patent and Trademark Office**

**Reg. No. 3,464,884**

**Registered July 15, 2008**

**TRADEMARK  
PRINCIPAL REGISTER**

**STRONGFLOOR**

STRONGWALL INDUSTRIES, INC. (NEW JERSEY CORPORATION)  
107 CHESTNUT ST.  
RIDGEWOOD, NJ 07450

FOR: HIGH PERFORMANCE CHEMICALLY RESISTANT AND WATERPROOF AND ABRASION RESISTANT FLOORING SYSTEMS COMPRISED OF PRIMERS AND COATINGS TO BE APPLIED OVER CONCRETE AND METAL SURFACES , IN CLASS 2 (U.S. CLS. 6, 11 AND 16).

FIRST USE 1-2-1990; IN COMMERCE 1-2-1990.

THE MARK CONSISTS OF STANDARD CHARACTERS WITHOUT CLAIM TO ANY PARTICULAR FONT, STYLE, SIZE, OR COLOR.

OWNER OF U.S. REG. NO. 2,002,640.

SEC. 2(F).

SER. NO. 76-670,185, FILED 12-11-2006.

ASMAT KHAN, EXAMINING ATTORNEY

Int. Cl.: 30

Prior U.S. Cl.: 46

United States Patent and Trademark Office

Reg. No. 3,464,885

Registered July 15, 2008

TRADEMARK  
PRINCIPAL REGISTER



MARUKYO SEIKA KABUSHIKI KAISHA (JAPAN CORPORATION)  
2002-2, HATAGASAKI, YONAGO-SHI  
TOTTORI 683-0845, JAPAN

FOR: BAKED RED BEAN CAKE CALLED DORAYAKI, IN CLASS 30 (U.S. CL. 46).

FIRST USE 5-31-2006; IN COMMERCE 5-31-2006.

NO CLAIM IS MADE TO THE EXCLUSIVE RIGHT TO USE "DORAYAKI" AND "KURI TAPPURI IRI JIKASEI TU BUAN", APART FROM THE MARK AS SHOWN.

THE NON-LATIN CHARACTERS IN THE MARK TRANSLITERATE TO "DORAYAKI" AND "KURI TAPPURI IRI JIKASEI TU BUAN" AND THIS MEANS "BAKED RED BEAN CAKE" AND "THE HOMEMADE HALF SMASHED BEAN JAM WITH FULLY CHESTNUT" IN ENGLISH.

SER. NO. 76-670,927, FILED 12-29-2006.

ANTHONY RINKER, EXAMINING ATTORNEY

**Int. Cl.: 9**

**Prior U.S. Cls.: 21, 23, 26, 36 and 38**

**Reg. No. 3,464,886**

**United States Patent and Trademark Office**

**Registered July 15, 2008**

---

**TRADEMARK  
PRINCIPAL REGISTER**



UPE, INC. (OHIO CORPORATION)  
3401 BRECKSVILLE RD. #110  
RICHFIELD, OH 44286

TED CIRCUIT BOARDS, IN CLASS 9 (U.S. CLS. 21,  
23, 26, 36 AND 38).

FIRST USE 8-11-1993; IN COMMERCE 8-11-1993.

FOR: ELECTRICAL COMPONENTS, NAMELY,  
CAPACITORS, SEMI-CONDUCTORS, RESISTORS,  
FUSES, BUSS BARS AND HEAT SINKS AND PRIN-

SER. NO. 76-673,199, FILED 2-26-2007.

ASMAT KHAN, EXAMINING ATTORNEY



**Int. Cl.: 42**

**Prior U.S. Cls.: 100 and 101**

**United States Patent and Trademark Office**

**Reg. No. 3,464,887**

**Registered July 15, 2008**

**SERVICE MARK  
PRINCIPAL REGISTER**

**IQMM**

INFORMATION IMPACT INTERNATIONAL,  
INC. (TENNESSEE CORPORATION)  
871 NIALTA LANE, SUITE 100  
BRENTWOOD, TN 37027

FOR: CONSULTING SERVICES IN THE FIELD  
OF INFORMATION MANAGEMENT AND INFOR-  
MATION QUALITY MANAGEMENT; COMPUTER  
CONSULTATION, NAMELY, CONSULTATION AS  
TO THE PRINCIPLES, PROCEDURES, STAND-  
ARDS, METRICS, TEMPLATES, AND GUIDE  
LINES FOR IMPROVING AND MAINTAINING  
DATA AND INFORMATION QUALITY IN INFOR-

MATION SYSTEMS AND COMPUTER SYSTEMS, IN  
CLASS 42 (U.S. CLS. 100 AND 101).

FIRST USE 10-31-2000; IN COMMERCE 10-31-2000.

THE MARK CONSISTS OF STANDARD CHAR-  
ACTERS WITHOUT CLAIM TO ANY PARTICULAR  
FONT, STYLE, SIZE, OR COLOR.

SER. NO. 76-673,749, FILED 3-8-2007.

SCOTT BIBB, EXAMINING ATTORNEY

**Int. Cl.: 2**

**Prior U.S. Cls.: 6, 11 and 16**

**United States Patent and Trademark Office**

**Reg. No. 3,464,888**

**Registered July 15, 2008**

**TRADEMARK  
PRINCIPAL REGISTER**

**PROFLOOR EPOXY**

PRO GUARD COATINGS, INC. (PENNSYLVANIA CORPORATION)  
1 INDUSTRIAL WAY  
P. O. BOX 289  
DENVER, PA 175190289

FOR: EPOXY COATING FOR USE ON CONCRETE INDUSTRIAL FLOORS, IN CLASS 2 (U.S. CLS. 6, 11 AND 16).

FIRST USE 1-2-2007; IN COMMERCE 1-2-2007.

THE MARK CONSISTS OF STANDARD CHARACTERS WITHOUT CLAIM TO ANY PARTICULAR FONT, STYLE, SIZE, OR COLOR.

NO CLAIM IS MADE TO THE EXCLUSIVE RIGHT TO USE "EPOXY", APART FROM THE MARK AS SHOWN.

SER. NO. 76-674,111, FILED 3-15-2007.

MICHAEL GAAFAR, EXAMINING ATTORNEY

**Int. Cl.: 9**

**Prior U.S. Cls.: 21, 23, 26, 36 and 38**

**Reg. No. 3,464,889**

**United States Patent and Trademark Office**

**Registered July 15, 2008**

**TRADEMARK  
PRINCIPAL REGISTER**

**UNILINE**

UNILINE SAFETY SYSTEMS LIMITED (UNITED KINGDOM CORPORATION)  
ASTON FIELDS INDUSTRIAL ESTATE  
3 SHERWOOD ROAD  
BROMSGROVE, WORCESTERSHIRE B60 3DU, UNITED KINGDOM

FOR: INDUSTRIAL SAFETY APPARATUS FOR PROTECTING WORKERS FROM FALLING WHILE WORKING AT HEIGHTS, NAMELY, BARS, ANCHORS, HARNESES, LINES, LANYARDS, CARABINERS, ANCHORAGE CONNECTORS AND PARTS THEREFOR, IN CLASS 9 (U.S. CLS. 21, 23, 26, 36 AND 38).

FIRST USE 5-0-2000; IN COMMERCE 11-22-2001.

THE MARK CONSISTS OF STANDARD CHARACTERS WITHOUT CLAIM TO ANY PARTICULAR FONT, STYLE, SIZE, OR COLOR.

PRIORITY CLAIMED UNDER SEC. 44(D) ON ERPN CMNTY TM OFC APPLICATION NO. 005628433, FILED 1-19-2007, REG. NO. 005628433, DATED 2-5-2008, EXPIRES 1-19-2017.

OWNER OF U.S. REG. NO. 3,115,722.

SER. NO. 76-674,276, FILED 3-19-2007.

PAM WILLIS, EXAMINING ATTORNEY

**Int. Cl.: 41**

**Prior U.S. Cls.: 100, 101 and 107**

**United States Patent and Trademark Office**

**Reg. No. 3,464,890**

**Registered July 15, 2008**

**SERVICE MARK  
PRINCIPAL REGISTER**

**PROFESSIONAL RINGMEN'S  
INSTITUTE**

BRIAN RIGBY AUCTIONEERS, LLC (MISSOURI  
LTD LIAB CO)  
123 JOHNSTOWN DRIVE  
ROGERSVILLE, MO 65742

FOR: PRACTICAL, EFFECTIVE, HANDS-ON  
TRAINING IN THE DEVELOPMENT OF SKILLS  
USED BY PROFESSIONAL RINGMEN SERVING  
THE AUCTION INDUSTRY, IN CLASS 41 (U.S. CLS.  
100, 101 AND 107).

FIRST USE 3-10-1996; IN COMMERCE 3-10-1996.

THE MARK CONSISTS OF STANDARD CHAR-  
ACTERS WITHOUT CLAIM TO ANY PARTICULAR  
FONT, STYLE, SIZE, OR COLOR.

NO CLAIM IS MADE TO THE EXCLUSIVE  
RIGHT TO USE "INSTITUTE", APART FROM THE  
MARK AS SHOWN.

SEC. 2(F).

SER. NO. 76-674,305, FILED 3-19-2007.

KRISTINA MORRIS, EXAMINING ATTORNEY

**Int. Cl.: 9**

**Prior U.S. Cls.: 21, 23, 26, 36 and 38**

**Reg. No. 3,464,891**

**United States Patent and Trademark Office**

**Registered July 15, 2008**

**TRADEMARK  
PRINCIPAL REGISTER**

**SUREFRAC**

SEISMIC MICRO-TECHNOLOGY, INC. (TEXAS CORPORATION)  
8584 KATY FREEWAY, SUITE 400  
HOUSTON, TX 77024

FOR: COMPUTER SOFTWARE AND ACCOMPANYING PRINTED MANUALS FOR USE WITH EXPLORATION AND PRODUCTION TECHNOLOGY IN THE OIL AND GAS AND ENVIRONMENTAL INDUSTRIES AND RESERVOIR ENGINEERING, NAMELY, COMPUTING AND PROCESSING UNSTRUCTURED AND TIME DEPENDENT GRID SYSTEMS TO ALLOW FOR MODEL FORMULATION FOR MODIFICATION, SPATIALLY AND IN

TIME, IN THE ANALYSIS OF SUBSURFACE OIL, MINERAL AND GAS DEPOSITS, IN CLASS 9 (U.S. CLS. 21, 23, 26, 36 AND 38).

FIRST USE 9-15-2003; IN COMMERCE 9-15-2003.

THE MARK CONSISTS OF STANDARD CHARACTERS WITHOUT CLAIM TO ANY PARTICULAR FONT, STYLE, SIZE, OR COLOR.

SER. NO. 76-674,569, FILED 3-26-2007.

DAWN FELDMAN, EXAMINING ATTORNEY

**Int. Cl.: 45**

**Prior U.S. Cls.: 100 and 101**

**United States Patent and Trademark Office**

**Reg. No. 3,464,892**

**Registered July 15, 2008**

**SERVICE MARK  
PRINCIPAL REGISTER**

**ATTORNEYDONEYDEAL**

LAWYERDONEYDEAL CORP. (CANADA CORPORATION)  
60A WELLESLEY STREET WEST  
TORONTO, ONTARIO, CANADA M5S 3L2

FOR: LEGAL DOCUMENT PREPARATION SERVICES, NAMELY, PREPARING DOCUMENTS FOR SIGNING FOR REAL ESTATE ACQUISITION AND DISPOSITION TRANSACTIONS AND MORTGAGE TRANSACTIONS, FOR OTHERS, OVER THE GLOBAL COMPUTER NETWORK, IN CLASS 45 (U.S. CLS. 100 AND 101).

FIRST USE 2-1-2006; IN COMMERCE 2-1-2006.

THE MARK CONSISTS OF STANDARD CHARACTERS WITHOUT CLAIM TO ANY PARTICULAR FONT, STYLE, SIZE, OR COLOR.

SER. NO. 76-674,827, FILED 3-29-2007.

CARYN GLASSER, EXAMINING ATTORNEY

**Int. Cl.: 12**

**Prior U.S. Cls.: 19, 21, 23, 31, 35 and 44**

**Reg. No. 3,464,893**

**United States Patent and Trademark Office**

**Registered July 15, 2008**

**TRADEMARK  
PRINCIPAL REGISTER**



ADVANCED METALFORMING TECHNOLOGIES, INC. (CALIFORNIA CORPORATION)  
950 RICHMOND AVENUE  
OXNARD, CA 93030

NO CLAIM IS MADE TO THE EXCLUSIVE RIGHT TO USE "MOTORCYCLE", APART FROM THE MARK AS SHOWN.

FOR: MOTORCYCLE WHEELS AND ACCESSORIES, IN CLASS 12 (U.S. CLS. 19, 21, 23, 31, 35 AND 44).

SER. NO. 76-674,865, FILED 3-30-2007.

FIRST USE 3-1-2006; IN COMMERCE 3-1-2006.

OWNER OF U.S. REG. NO. 2,997,710.

AMEETA JORDAN, EXAMINING ATTORNEY

Int. Cl.: 41

Prior U.S. Cls.: 100, 101 and 107

United States Patent and Trademark Office

Reg. No. 3,464,894

Registered July 15, 2008

SERVICE MARK  
PRINCIPAL REGISTER



UNIVISION COMMUNICATIONS INC. (DELA-  
WARE CORPORATION)

5999 CENTER DRIVE  
LOS ANGELES, CA 90045

FOR: CONCERT PROMOTION SERVICES, IN  
CLASS 41 (U.S. CLS. 100, 101 AND 107).

FIRST USE 9-9-2001; IN COMMERCE 9-9-2001.

NO CLAIM IS MADE TO THE EXCLUSIVE  
RIGHT TO USE "MUSICA", APART FROM THE  
MARK AS SHOWN.

THE ENGLISH TRANSLATION OF "AMOR A LA  
MÚSICA" IS "LOVE FOR MUSIC."

SER. NO. 76-674,951, FILED 4-3-2007.

KAPIL BHANOT, EXAMINING ATTORNEY



**Int. Cl.: 12**

**Prior U.S. Cls.: 19, 21, 23, 31, 35 and 44**

**Reg. No. 3,464,895**

**United States Patent and Trademark Office**

**Registered July 15, 2008**

---

**TRADEMARK  
PRINCIPAL REGISTER**



ADVANCED METALFORMING TECHNOLOGIES, INC. (CALIFORNIA CORPORATION)  
950 RICHMOND AVENUE  
OXNARD, CA 93030

OWNER OF U.S. REG. NO. 2,997,710.

FOR: AUTOMOBILE WHEELS AND ACCESSORIES, IN CLASS 12 (U.S. CLS. 19, 21, 23, 31, 35 AND 44).

SER. NO. 76-674,972, FILED 4-3-2007.

FIRST USE 12-1-2005; IN COMMERCE 12-1-2005.

AMEETA JORDAN, EXAMINING ATTORNEY

**Int. Cl.: 41**

**Prior U.S. Cls.: 100, 101 and 107**

**United States Patent and Trademark Office**

**Reg. No. 3,464,896**

**Registered July 15, 2008**

**SERVICE MARK  
PRINCIPAL REGISTER**

ALL CITY PROJECT, INC. (NEW YORK CORPORATION)  
P.O. BOX 169  
NEW YORK, NY 10002

FOR: EDUCATIONAL SERVICES, NAMELY, SERIES OF PUBLIC SEMINARS, SERIES OF PUBLIC WORKSHOPS, SERIES OF PUBLIC EXHIBITIONS, AND EDUCATIONAL INITIATIVES, NAMELY, CLASSES, SEMINARS AND WORKSHOPS IN THE FIELD OF THE HISTORY, CULTURE, PSYCHOL-

OGY AND CONTROVERSIES RELATING TO GRAFFITI, IN CLASS 41 (U.S. CLS. 100, 101 AND 107).

FIRST USE 11-0-2005; IN COMMERCE 11-0-2005.

SER. NO. 76-675,031, FILED 4-4-2007.

KATHERINE E. HALMEN, EXAMINING ATTORNEY

**Int. Cls.: 2, 3 and 37**

**Prior U.S. Cls.: 1, 4, 6, 11, 16, 50, 51, 52, 100, 103 and 106**

**Reg. No. 3,464,897**

**United States Patent and Trademark Office**

**Registered July 15, 2008**

**TRADEMARK  
SERVICE MARK  
PRINCIPAL REGISTER**

**SMT<sup>2</sup>**

SMT PERFORMANCE PRODUCTS, INC. (DELAWARE CORPORATION)  
640 CRAWFORD STREET  
FITCHBURG, MA 01420

FOR: AUTOMOTIVE PRODUCTS AND ACCESSORIES FOR THE AUTOMOTIVE AFTER MARKET INDUSTRY, NAMELY, AUTOMOTIVE ANTI-CORROSIVE PREPARATIONS, NAMELY, ANTI-CORROSIVE PAINTS; AUTOMOTIVE ANTIRUST PREPARATIONS, NAMELY, ANTI-RUST GREASES; AUTOMOTIVE FRICTION REDUCING COATINGS; TOUCH-UP PAINTS FOR AUTOMOBILES; LEATHER STAINS; PIGMENTS; COLORANTS FOR USE IN THE MANUFACTURE OF FOOD; COLORANTS FOR USE IN THE MANUFACTURE OF PRINTING INK; UNDERCOATING FOR VEHICLE CHASSIS; NATURAL RESINS FOR USE IN THE MANUFACTURE OF ADHESIVES, IN CLASS 2 (U.S. CLS. 6, 11 AND 16).

FIRST USE 8-8-2001; IN COMMERCE 8-8-2001.

FOR: AUTOMOTIVE PRODUCTS AND ACCESSORIES FOR THE AUTOMOTIVE AFTER MARKET INDUSTRY, NAMELY, WINDSCREEN CLEANING LIQUIDS, POLISHING PREPARATIONS, POLISHING WAX, LEATHER POLISHES, WAXES FOR LEATHER, AUTOMOTIVE WAXES, AUTOMOTIVE WASH, CLEANING SOLVENT USED TO DEGREASE ENGINES, CARBURETOR JET CLEANER, RUST-REMOVING PREPARATIONS; WASHING-UP LIQUIDS; CLEANING AND POLISHING PAPER; ABRASIVE CLOTH, IN CLASS 3 (U.S. CLS. 1, 4, 6, 50, 51 AND 52).

FIRST USE 8-8-2001; IN COMMERCE 8-8-2001.

FOR: VEHICLE REPAIR AND MAINTENANCE; VEHICLE SERVICE STATIONS; ANTI-RUST TREATMENT FOR VEHICLES; VEHICLE POLISHING; VEHICLE LUBRICATION; CAR WASHING; MOTOR VEHICLE MAINTENANCE AND REPAIR; CUSTOM SHIPBUILDING; MOTOR VEHICLE WASHING; TIRE RETREADING; RUST-PROOFING, NAMELY, ANTI-RUST TREATMENT OF VEHICLES; BUILDING CONSTRUCTION SUPERVISION; WAREHOUSE CONSTRUCTION AND REPAIR; MINING EXTRACTION; MACHINERY INSTALLATION, MAINTENANCE AND REPAIR; PHOTOGRAPHIC APPARATUS REPAIR; CLEANING OF EXTERNAL SURFACES OF BUILDINGS; HEATING EQUIPMENT INSTALLATION AND REPAIR; UPHOLSTERY REPAIR; FURNITURE MAINTENANCE; AIRPLANE MAINTENANCE AND REPAIR; CLOCK AND WATCH REPAIR; SAFE MAINTENANCE AND REPAIR; PHOTOGRAPHIC APPARATUS REPAIR; DRY CLEANING; DISINFECTING; PUMP REPAIR, IN CLASS 37 (U.S. CLS. 100, 103 AND 106).

FIRST USE 8-8-2001; IN COMMERCE 8-8-2001.

OWNER OF U.S. REG. NOS. 2,888,171, 3,190,433 AND OTHERS.

SER. NO. 76-675,106, FILED 4-5-2007.

WILLIAM ROSSMAN, EXAMINING ATTORNEY

**Int. Cls.: 2, 3 and 37**

**Prior U.S. Cls.: 1, 4, 6, 11, 16, 50, 51, 52, 100, 103 and 106**

**Reg. No. 3,464,898**

**United States Patent and Trademark Office**

**Registered July 15, 2008**

**TRADEMARK  
SERVICE MARK  
PRINCIPAL REGISTER**



SMT PERFORMANCE PRODUCTS, INC. (DELAWARE CORPORATION)  
640 CRAWFORD STREET  
FITCHBURG, MA 01420

FOR: AUTOMOTIVE PRODUCTS AND ACCESSORIES FOR THE AUTOMOTIVE AFTER MARKET INDUSTRY, NAMELY, AUTOMOTIVE ANTI-CORROSIVE PREPARATIONS, NAMELY, ANTI-CORROSIVE PAINTS; AUTOMOTIVE ANTIRUST PREPARATIONS, NAMELY, ANTI-RUST GREASES; AUTOMOTIVE FRICTION REDUCING COATINGS; TOUCH-UP PAINTS FOR AUTOMOBILES; LEATHER STAINS; PIGMENTS; COLORANTS FOR USE IN THE MANUFACTURE OF FOOD; COLORANTS FOR USE IN THE MANUFACTURE OF PRINTING INK; UNDERCOATING FOR VEHICLE CHASSIS; NATURAL RESINS FOR USE IN THE MANUFACTURE OF ADHESIVES, IN CLASS 2 (U.S. CLS. 6, 11 AND 16).

FIRST USE 8-8-2001; IN COMMERCE 8-8-2001.

FOR: AUTOMOTIVE PRODUCTS AND ACCESSORIES FOR THE AUTOMOTIVE AFTER MARKET INDUSTRY, NAMELY, WINDSCREEN CLEANING LIQUIDS, POLISHING PREPARATIONS, POLISHING WAX, LEATHER POLISHES, WAXES FOR LEATHER, AUTOMOTIVE WAXES, AUTOMOTIVE WASH, CLEANING SOLVENT USED TO DE-

GREASE ENGINES, CARBURETOR JET CLEANER, RUST-REMOVING PREPARATIONS; WASHING-UP LIQUIDS; CLEANING AND POLISHING PAPER; ABRASIVE CLOTH, IN CLASS 3 (U.S. CLS. 1, 4, 6, 50, 51 AND 52).

FIRST USE 8-8-2001; IN COMMERCE 8-8-2001.

FOR: VEHICLE REPAIR AND MAINTENANCE; VEHICLE SERVICE STATIONS; ANTI-RUST TREATMENT FOR VEHICLES; VEHICLE POLISHING; VEHICLE LUBRICATION; CAR WASHING; MOTOR VEHICLE MAINTENANCE AND REPAIR; CUSTOM SHIPBUILDING; MOTOR VEHICLE WASHING; TIRE RETREADING; RUST-PROOFING, NAMELY, ANTI-RUST TREATMENT OF VEHICLES; BUILDING CONSTRUCTION SUPERVISION; WAREHOUSE CONSTRUCTION AND REPAIR; MINING EXTRACTION; MACHINERY INSTALLATION, MAINTENANCE AND REPAIR; PHOTOGRAPHIC APPARATUS REPAIR; CLEANING OF EXTERNAL SURFACES OF BUILDINGS; HEATING EQUIPMENT INSTALLATION AND REPAIR; UPHOLSTERY REPAIR; FURNITURE MAINTENANCE; AIRPLANE MAINTENANCE AND REPAIR; CLOCK AND WATCH REPAIR; SAFE MAINTENANCE AND REPAIR; PHOTOGRAPHIC APPARATUS REPAIR; DRY CLEANING; DISINFECTING; PUMP REPAIR, IN CLASS 37 (U.S. CLS. 100, 103 AND 106).

FIRST USE 8-8-2001; IN COMMERCE 8-8-2001.

SER. NO. 76-675,107, FILED 4-5-2007.

OWNER OF U.S. REG. NO. 2,993,755 AND OTHERS.

WILLIAM ROSSMAN, EXAMINING ATTORNEY

**Int. Cl.: 44**

**Prior U.S. Cls.: 100 and 101**

**United States Patent and Trademark Office**

**Reg. No. 3,464,899**

**Registered July 15, 2008**

**SERVICE MARK  
PRINCIPAL REGISTER**

**PERSONAL PROFILE**

AIS MARKETING SERVICES, INC. (NEW YORK CORPORATION)  
7222 EAST GAINES RANCH ROAD, # 144  
SCOTTSDALE, AZ 85258

FOR: PERSONAL COSMETIC ANALYSIS, COLOR ANALYSIS FOR COSMETIC PURPOSES AND COUNSELING IN THE FIELDS OF COSMETICS AND HEALTH AND HYGIENE , IN CLASS 44 (U.S. CLS. 100 AND 101).

FIRST USE 10-1-1990; IN COMMERCE 10-1-1990.

THE MARK CONSISTS OF STANDARD CHARACTERS WITHOUT CLAIM TO ANY PARTICULAR FONT, STYLE, SIZE, OR COLOR.

SEC. 2(F).

SER. NO. 76-675,193, FILED 4-9-2007.

ROBIN MITTLER, EXAMINING ATTORNEY

**Int. Cl.: 45**

**Prior U.S. Cls.: 100 and 101**

**United States Patent and Trademark Office**

**Reg. No. 3,464,900**

**Registered July 15, 2008**

**SERVICE MARK  
PRINCIPAL REGISTER**

**PERSONAL PROFILE**

AIS MARKETING SERVICES, INC. (NEW YORK CORPORATION)  
7222 EAST GAINNEY RANCH ROAD, # 144  
SCOTTSDALE, AZ 85258

FOR: PERSONAL FASHION CONSULTING SERVICES, FASHION INFORMATION SERVICES, AND COUNSELING IN THE FIELDS OF FASHION AND WARDROBE STYLE , IN CLASS 45 (U.S. CLS. 100 AND 101).

FIRST USE 10-1-1990; IN COMMERCE 10-1-1990.

THE MARK CONSISTS OF STANDARD CHARACTERS WITHOUT CLAIM TO ANY PARTICULAR FONT, STYLE, SIZE, OR COLOR.

SEC. 2(F).

SER. NO. 76-675,194, FILED 4-9-2007.

ROBIN MITTLER, EXAMINING ATTORNEY

Int. Cl.: 33

Prior U.S. Cls.: 47 and 49

United States Patent and Trademark Office

Reg. No. 3,464,901

Registered July 15, 2008

TRADEMARK  
PRINCIPAL REGISTER



QUINTESSENTIAL, L.L.C. (CALIFORNIA LTD  
LIAB CO)  
64 CULBERTSON CT.  
NAPA, CA 94574

FOR: WINES, IN CLASS 33 (U.S. CLS. 47 AND 49).

FIRST USE 1-15-2004; IN COMMERCE 1-15-2004.

THE COLOR(S) BROWN AND WHITE IS/ARE  
CLAIMED AS A FEATURE OF THE MARK.

THE COLOR BROWN APPEARS IN THE WORD-  
ING "TWO ANGELS" AND IN THE DESIGN OF THE  
TWO ANGELS, GRAPES AND BASKET; THE COL-  
OR WHITE APPEARS IN THE BACKGROUND AND  
IN THE DESIGN OF THE TWO ANGELS, GRAPES  
AND BASKET.

SER. NO. 76-675,291, FILED 4-10-2007.

LINDA POWELL, EXAMINING ATTORNEY



**Int. Cls.: 14, 18 and 25**

**Prior U.S. Cls.: 1, 2, 3, 22, 27, 28, 39, 41 and 50**

**United States Patent and Trademark Office**

**Reg. No. 3,464,902**

**Registered July 15, 2008**

**TRADEMARK  
PRINCIPAL REGISTER**

*La Chica Chic*

LA CHICA CHIC, INC. (CALIFORNIA CORPORATION)  
2535 KETTNER BLVD., STE 3A5  
SAN DIEGO, CA 92107

FOR: JEWELRY, IN CLASS 14 (U.S. CLS. 2, 27, 28 AND 50).

FIRST USE 1-1-2006; IN COMMERCE 1-1-2006.

FOR: HANDBAGS, IN CLASS 18 (U.S. CLS. 1, 2, 3, 22 AND 41).

FIRST USE 1-1-2006; IN COMMERCE 1-1-2006.

FOR: WOMEN'S ACCESSORIES, NAMELY, BELTS, IN CLASS 25 (U.S. CLS. 22 AND 39).

FIRST USE 1-1-2006; IN COMMERCE 1-1-2006.

THE ENGLISH TRANSLATION OF THE WORD "LA CHICA" IN THE MARK IS "THE GIRL".

SER. NO. 76-675,924, FILED 4-24-2007.

JESSICA A. POWERS, EXAMINING ATTORNEY

**Int. Cls.: 35, 39, 41 and 43**

**Prior U.S. Cls.: 100, 101, 102, 105 and 107**

**United States Patent and Trademark Office**

**Reg. No. 3,464,903**

**Registered July 15, 2008**

**SERVICE MARK  
PRINCIPAL REGISTER**

**DAMON EXECUTIVE  
EVENT PLANNERS**

DAMON EXECUTIVE EVENT PLANNERS, LLC  
(DELAWARE LTD LIAB CO)  
PO BOX 789  
HOCKESSIN, DE 19707

FOR: BUSINESS PLANNING SERVICES, ARRANGING AND CONDUCTING BUSINESS CONFERENCES, BUSINESS MEETING PLANNING, IN CLASS 35 (U.S. CLS. 100, 101 AND 102).

FIRST USE 1-0-2007; IN COMMERCE 2-0-2007.

FOR: TRAVEL AGENCY SERVICES, NAMELY, MAKING RESERVATIONS AND BOOKINGS FOR TRANSPORTATION, RESEARCHING TRAVEL OPTIONS, RESEARCHING DESTINATION INFORMATION, CREATING PERSONALIZED ITINERARIES, IN CLASS 39 (U.S. CLS. 100 AND 105).

FIRST USE 1-0-2007; IN COMMERCE 2-0-2007.

FOR: SPECIAL EVENT PLANNING, NAMELY, PLANNING DINNERS AND ENTERTAINMENT

EVENTS, ARRANGING OF SEMINARS AND CONFERENCES, IN CLASS 41 (U.S. CLS. 100, 101 AND 107).

FIRST USE 1-0-2007; IN COMMERCE 2-0-2007.

FOR: MAKING HOTEL RESERVATIONS FOR OTHERS, IN CLASS 43 (U.S. CLS. 100 AND 101).

FIRST USE 1-0-2007; IN COMMERCE 2-0-2007.

THE MARK CONSISTS OF STANDARD CHARACTERS WITHOUT CLAIM TO ANY PARTICULAR FONT, STYLE, SIZE, OR COLOR.

NO CLAIM IS MADE TO THE EXCLUSIVE RIGHT TO USE "EXECUTIVE EVENT PLANNERS", APART FROM THE MARK AS SHOWN.

SER. NO. 76-676,078, FILED 4-27-2007.

ANNE E. GUSTASON, EXAMINING ATTORNEY

**Int. Cl.: 41**

**Prior U.S. Cls.: 100, 101 and 107**

**Reg. No. 3,464,904**

**United States Patent and Trademark Office**

**Registered July 15, 2008**

**SERVICE MARK  
PRINCIPAL REGISTER**



HATTERAS MARLIN CLUB, INC. (NORTH CAROLINA CORPORATION)  
P.O. BOX 218  
SAXON CUT DRIVE  
HATTERAS, NC 27943

FIRST USE 0-0-1962; IN COMMERCE 0-0-1962.

THE MARK CONSISTS OF A FLAG BEARING THE LETTERS "HMC" PARTIALLY ENCLOSED IN A FISH HOOK.

FOR: YACHT CLUB SERVICES; RECREATIONAL SERVICES, NAMELY, PROVIDING BOATING AND FISHING FACILITIES; ORGANIZATION OF SPORT FISHING COMPETITIONS, AND FISHING GUIDE SERVICES, IN CLASS 41 (U.S. CLS. 100, 101 AND 107).

SER. NO. 76-676,169, FILED 4-30-2007.

EVELYN BRADLEY, EXAMINING ATTORNEY

**Int. Cl.: 41**

**Prior U.S. Cls.: 100, 101 and 107**

**United States Patent and Trademark Office**

**Reg. No. 3,464,905**

**Registered July 15, 2008**

**SERVICE MARK  
PRINCIPAL REGISTER**

**NEW YORK  
KOREAN ALPINE CLUB**

NEW YORK ALPINE CLUB, INC. (NEW YORK CORPORATION)  
11 WEST 30TH STREET, SUITE 2R  
NEW YORK, NY 10001

FOR: RECREATIONAL SERVICES, NAMELY, PROVIDING AND ENCOURAGING OPPORTUNITIES FOR OUTDOOR RECREATION, NAMELY, HIKING, MOUNTAINEERING AND CLIMBING MOUNTAINS , IN CLASS 41 (U.S. CLS. 100, 101 AND 107).

FIRST USE 4-25-1974; IN COMMERCE 4-25-1974.

THE MARK CONSISTS OF STANDARD CHARACTERS WITHOUT CLAIM TO ANY PARTICULAR FONT, STYLE, SIZE, OR COLOR.

NO CLAIM IS MADE TO THE EXCLUSIVE RIGHT TO USE "CLUB", APART FROM THE MARK AS SHOWN.

SEC. 2(F).

SER. NO. 76-676,238, FILED 4-30-2007.

PAUL F. GAST, EXAMINING ATTORNEY

Int. Cl.: 41

Prior U.S. Cls.: 100, 101 and 107

United States Patent and Trademark Office

Reg. No. 3,464,906

Registered July 15, 2008

SERVICE MARK  
PRINCIPAL REGISTER

뉴욕한인산악회

NEW YORK ALPINE CLUB, INC. (NEW YORK CORPORATION)  
11 WEST 30TH STREET 2ND FLOOR  
NEW YORK, NY 10001

FOR: RECREATIONAL SERVICES, NAMELY, PROVIDING AND ENCOURAGING OPPORTUNITIES FOR OUTDOOR RECREATION, NAMELY, HIKING, MOUNTAINEERING AND CLIMBING MOUNTAINS, IN CLASS 41 (U.S. CLS. 100, 101 AND 107).

FIRST USE 4-25-1974; IN COMMERCE 4-25-1974.

NO CLAIM IS MADE TO THE EXCLUSIVE RIGHT TO USE "CLUB" AND THE NON-LATIN

CHARACTERS THAT TRANSLATE TO "CLUB", APART FROM THE MARK AS SHOWN.

THE NON-LATIN CHARACTERS IN THE MARK TRANSLITERATE TO "NEW YORK HANIN SANAKHUI" AND THIS MEANS "NEW YORK KOREAN ALPINE CLUB" IN ENGLISH.

SEC. 2(F).

SER. NO. 76-676,239, FILED 4-30-2007.

PAUL F. GAST, EXAMINING ATTORNEY

**Int. Cl.: 44**

**Prior U.S. Cls.: 100 and 101**

**United States Patent and Trademark Office**

**Reg. No. 3,464,907**

**Registered July 15, 2008**

**SERVICE MARK  
PRINCIPAL REGISTER**

**SINUS DYNAMICS**

GENERAL HOME PHARMACY INC (CALIFORNIA CORPORATION)  
755 LAKEFIELD RD STE D  
WESTLAKE VILLAGE, CA 91361

FOR: LEASING OF MEDICAL EQUIPMENT, NAMELY, NEBULIZERS AND PROVISION OF CUSTOMIZED MEDICATIONS AND MATERIAL TREATMENT INFORMATION FOR USE THEREWITH FOR TREATMENT OF PATIENTS WITH SINUSITIS, IN CLASS 44 (U.S. CLS. 100 AND 101).

FIRST USE 0-0-2006; IN COMMERCE 0-0-2006.

THE MARK CONSISTS OF STANDARD CHARACTERS WITHOUT CLAIM TO ANY PARTICULAR FONT, STYLE, SIZE, OR COLOR.

NO CLAIM IS MADE TO THE EXCLUSIVE RIGHT TO USE "SINUS", APART FROM THE MARK AS SHOWN.

SER. NO. 76-676,421, FILED 5-4-2007.

CHRIS DONINGER, EXAMINING ATTORNEY

**Int. Cl.: 44**

**Prior U.S. Cls.: 100 and 101**

**United States Patent and Trademark Office**

**Reg. No. 3,464,908**

**Registered July 15, 2008**

**SERVICE MARK  
PRINCIPAL REGISTER**

**GIVE YOUR SMILE SEX APPEAL**

HERMAN, MICHAEL (UNITED STATES INDIVIDUAL)  
212 ALBON ROAD  
HEWLETT, NY 11557

THE MARK CONSISTS OF STANDARD CHARACTERS WITHOUT CLAIM TO ANY PARTICULAR FONT, STYLE, SIZE, OR COLOR.

FOR: TEETH WHITENING SERVICES, IN CLASS 44 (U.S. CLS. 100 AND 101).

SER. NO. 76-676,436, FILED 5-3-2007.

FIRST USE 9-0-1999; IN COMMERCE 9-0-1999.

STEVEN PEREZ, EXAMINING ATTORNEY

**Int. Cls.: 35 and 42**

**Prior U.S. Cls.: 100, 101 and 102**

**United States Patent and Trademark Office**

**Reg. No. 3,464,909**

**Registered July 15, 2008**

**SERVICE MARK  
PRINCIPAL REGISTER**

**EVEREST**

EVEREST GLOBAL, INC. (TEXAS CORPORATION)  
13455 NOEL RD., SUITE 2100  
DALLAS, TX 75240

FOR: PROVIDING BUSINESS RESEARCH AND ANALYSIS SERVICES IN THE FIELDS OF SOURCING AND OUTSOURCING; THE MANAGEMENT OF BUSINESS PROCESS, BUSINESS MANAGEMENT, AND DEVELOPMENT OF BUSINESS SOLUTIONS, PROVIDING SOURCING AND OUTSOURCING CONSULTATION SERVICES IN THE FIELD OF BUSINESS PROCESSES; PROVIDING SOURCING AND OUTSOURCING CONSULTATION SERVICES IN THE FIELDS OF INFORMATION TECHNOLOGY, IN CLASS 35 (U.S. CLS. 100, 101 AND 102).

FIRST USE 11-11-1994; IN COMMERCE 11-11-1994.

FOR: PROVIDING RESEARCH AND ANALYSIS SERVICES IN THE FIELD OF INFORMATION TECHNOLOGY, IN CLASS 42 (U.S. CLS. 100 AND 101).

FIRST USE 5-1-1991; IN COMMERCE 5-1-1991.

THE MARK CONSISTS OF STANDARD CHARACTERS WITHOUT CLAIM TO ANY PARTICULAR FONT, STYLE, SIZE, OR COLOR.

SER. NO. 76-676,462, FILED 5-7-2007.

YAT SYE, LEE, EXAMINING ATTORNEY



**Int. Cls.: 35 and 42**

**Prior U.S. Cls.: 100, 101 and 102**

**United States Patent and Trademark Office**

**Reg. No. 3,464,910**

**Registered July 15, 2008**

**SERVICE MARK  
PRINCIPAL REGISTER**



EVEREST GLOBAL, INC. (TEXAS CORPORATION)  
13455 NOEL RD., SUITE 2100  
DALLAS, TX 75240

FOR: PROVIDING BUSINESS RESEARCH AND ANALYSIS SERVICES IN THE FIELDS OF SOURCING AND OUTSOURCING; THE MANAGEMENT OF BUSINESS PROCESS, BUSINESS MANAGEMENT, AND DEVELOPMENT OF BUSINESS SOLUTIONS, PROVIDING SOURCING AND OUTSOURCING CONSULTATION SERVICES IN THE FIELD OF BUSINESS PROCESSES; PROVIDING SOURCING AND OUTSOURCING CONSULTATION SERVICES IN THE FIELDS OF INFORMATION TECHNOLOGY, IN CLASS 35 (U.S. CLS. 100, 101 AND 102).

FIRST USE 2-23-2005; IN COMMERCE 2-23-2005.

FOR: PROVIDING RESEARCH AND ANALYSIS SERVICES IN THE FIELD OF INFORMATION TECHNOLOGY, IN CLASS 42 (U.S. CLS. 100 AND 101).

FIRST USE 2-23-2005; IN COMMERCE 2-23-2005.

NO CLAIM IS MADE TO THE EXCLUSIVE RIGHT TO USE "RESEARCH INSTITUTE", APART FROM THE MARK AS SHOWN.

SER. NO. 76-676,464, FILED 5-7-2007.

YAT SYE, LEE, EXAMINING ATTORNEY

**Int. Cl.: 28**

**Prior U.S. Cls.: 22, 23, 38 and 50**

**United States Patent and Trademark Office**

**Reg. No. 3,464,911**

**Registered July 15, 2008**

**TRADEMARK  
PRINCIPAL REGISTER**

# **BEST IN SHOW**

MIRACLES FOR FUN LIMITED (HONG KONG CORPORATION)

14/F

YALE IND. CENTRE 61-63 AU PUI WAN ST. FOTAN SHATIN, HONG KONG

FOR: PLUSH TOYS, TOY ANIMALS AND ACCESSORIES THEREFORE, TOY ACTION FIGURES, TOY FIGURES, TOY SNOW GLOBES, TOY DOLL DRESS-UP CLOTHING, DOLL CASES, DOLL CLOTHING, DOLL COSTUMES, DOLL FURNI-

TURE, DOLLS AND PLAY SETS AND ACCESSORIES THEREFORE, IN CLASS 28 (U.S. CLS. 22, 23, 38 AND 50).

FIRST USE 1-18-2003; IN COMMERCE 1-18-2003.

SER. NO. 76-676,505, FILED 5-7-2007.

TRACY WHITTAKER-BROWN, EXAMINING ATTORNEY

**Int. Cl.: 7**

**Prior U.S. Cls.: 13, 19, 21, 23, 31, 34 and 35**

**United States Patent and Trademark Office**

**Reg. No. 3,464,912**

**Registered July 15, 2008**

**TRADEMARK  
PRINCIPAL REGISTER**

HERRMANN ULTRASONICS, INC. (ILLINOIS CORPORATION)  
620 ESTES AVE.  
SCHAUMBURG, IL 60193

THE MARK CONSISTS OF STANDARD CHARACTERS WITHOUT CLAIM TO ANY PARTICULAR FONT, STYLE, SIZE, OR COLOR.

FOR: ULTRASONIC WELDING AND CUTTING MACHINES AND STRUCTURAL PARTS THEREOF, IN CLASS 7 (U.S. CLS. 13, 19, 21, 23, 31, 34 AND 35).

SER. NO. 76-676,506, FILED 5-7-2007.

FIRST USE 12-0-1989; IN COMMERCE 1-0-1990.

JAMES LOVELACE, EXAMINING ATTORNEY

**Int. Cls.: 16 and 41**

**Prior U.S. Cls.: 2, 5, 22, 23, 29, 37, 38, 50, 100, 101 and 107**

**Reg. No. 3,464,913**

**United States Patent and Trademark Office**

**Registered July 15, 2008**

**TRADEMARK  
SERVICE MARK  
PRINCIPAL REGISTER**

**RACHEL'S CHALLENGE**

RACHEL'S CHALLENGE (COLORADO NON-PROFIT CORPORATION)  
P.O. BOX 261698  
LITTLETON, CO 80163

FOR: PRINTED EDUCATIONAL AND TRAINING MATERIALS IN THE FIELD OF TEACHING POSITIVE INFLUENCE, GOAL-SETTING, JOURNALING, KINDNESS, ACCEPTANCE, AND NON-VIOLENCE IN SCHOOLS, IN CLASS 16 (U.S. CLS. 2, 5, 22, 23, 29, 37, 38 AND 50).

FIRST USE 7-19-2002; IN COMMERCE 7-19-2002.

FOR: EDUCATION SERVICES, NAMELY, CONDUCTING PROGRAMS IN THE FIELD OF TEACH-

ING POSITIVE INFLUENCE, GOAL-SETTING, JOURNALING, KINDNESS, ACCEPTANCE, AND NON-VIOLENCE IN SCHOOLS, IN CLASS 41 (U.S. CLS. 100, 101 AND 107).

FIRST USE 7-19-2002; IN COMMERCE 7-19-2002.

THE MARK CONSISTS OF STANDARD CHARACTERS WITHOUT CLAIM TO ANY PARTICULAR FONT, STYLE, SIZE, OR COLOR.

SER. NO. 76-676,546, FILED 5-8-2007.

KAPIL BHANOT, EXAMINING ATTORNEY

**Int. Cl.: 4**

**Prior U.S. Cls.: 1, 6 and 15**

**United States Patent and Trademark Office**

**Reg. No. 3,464,914**

**Registered July 15, 2008**

---

**TRADEMARK  
PRINCIPAL REGISTER**

**CANDLE WARMERS ETC**

CANDLE WARMERS ETC., INC. (NEVADA CORPORATION)  
P.O. BOX 1024  
LAYTON, UT 84040

FIRST USE 3-0-2002; IN COMMERCE 11-0-2002.

SEC. 2(F).

FOR: PERFUMED ARTICLES MADE OF PARAFFIN WAX, NAMELY, CANDLES WITH WICKS AND CANDLES WITHOUT WICKS, IN CLASS 4 (U.S. CLS. 1, 6 AND 15).

SER. NO. 76-676,550, FILED 5-8-2007.

KRISTIN DAHLING, EXAMINING ATTORNEY

**Int. Cl.: 43**

**Prior U.S. Cls.: 100 and 101**

**United States Patent and Trademark Office**

**Reg. No. 3,464,915**

**Registered July 15, 2008**

**SERVICE MARK  
PRINCIPAL REGISTER**

**PARADISE AWAITS**

MAUI LAND & PINEAPPLE COMPANY, INC.  
(HAWAII CORPORATION)  
700 VILLAGE ROAD  
LAHAINA, HI 96761

FOR: RESORT SERVICES, NAMELY, PROVIDING TEMPORARY LODGING SERVICES IN THE NATURE OF A CONDOMINIUM HOTEL AND HOTELS; RESTAURANTS, IN CLASS 43 (U.S. CLS. 100 AND 101).

FIRST USE 4-1-2006; IN COMMERCE 4-1-2006.

THE MARK CONSISTS OF STANDARD CHARACTERS WITHOUT CLAIM TO ANY PARTICULAR FONT, STYLE, SIZE, OR COLOR.

SER. NO. 76-676,564, FILED 5-8-2007.

JENNY PARK, EXAMINING ATTORNEY

**Int. Cl.: 43**

**Prior U.S. Cls.: 100 and 101**

**United States Patent and Trademark Office**

**Reg. No. 3,464,916**

**Registered July 15, 2008**

**SERVICE MARK  
PRINCIPAL REGISTER**

**THE BEAUTIFUL SIDE OF MAUI**

MAUI LAND & PINEAPPLE COMPANY, INC.  
(HAWAII CORPORATION)  
700 VILLAGE ROAD  
LAHAINA, HI 96761

FOR: RESORT SERVICES, NAMELY, PROVIDING TEMPORARY LODGING SERVICES IN THE NATURE OF A CONDOMINIUM HOTEL AND HOTELS; RESTAURANTS, IN CLASS 43 (U.S. CLS. 100 AND 101).

FIRST USE 1-1-2004; IN COMMERCE 1-1-2004.

THE MARK CONSISTS OF STANDARD CHARACTERS WITHOUT CLAIM TO ANY PARTICULAR FONT, STYLE, SIZE, OR COLOR.

NO CLAIM IS MADE TO THE EXCLUSIVE RIGHT TO USE "MAUI", APART FROM THE MARK AS SHOWN.

SER. NO. 76-676,565, FILED 5-8-2007.

JENNY PARK, EXAMINING ATTORNEY

**Int. Cls.: 38 and 41**

**Prior U.S. Cls.: 100, 101, 104 and 107**

**United States Patent and Trademark Office**

**Reg. No. 3,464,917**

**Registered July 15, 2008**

**SERVICE MARK  
PRINCIPAL REGISTER**

# DIGITAL ARTIFAX

ZADIKOW, DARA SHRENSEL (UNITED STATES  
INDIVIDUAL)  
857 ATLANTIC AVENUE, APT. 5  
BROOKLYN, NY 11238

FOR: VIDEO SERVICES, NAMELY, STREAMING  
OF VIDEO MATERIAL ON THE INTERNET, VIDEO  
BROADCASTING, IN CLASS 38 (U.S. CLS. 100, 101  
AND 104).

FIRST USE 8-13-2006; IN COMMERCE 8-13-2006.

FOR: VIDEO SERVICES, NAMELY, PRODUC-  
TION OF VIDEO DISCS AND VIDEO CASSETTES  
AND MUSIC VIDEO RECORDINGS FOR OTHERS;  
VIDEO TAPE EDITING; VIDEO RECORDING OF

LIVE EVENTS; DIGITAL VIDEO EDITING, IN  
CLASS 41 (U.S. CLS. 100, 101 AND 107).

FIRST USE 8-13-2006; IN COMMERCE 8-13-2006.

THE MARK CONSISTS OF STANDARD CHAR-  
ACTERS WITHOUT CLAIM TO ANY PARTICULAR  
FONT, STYLE, SIZE, OR COLOR.

NO CLAIM IS MADE TO THE EXCLUSIVE  
RIGHT TO USE "DIGITAL" , APART FROM THE  
MARK AS SHOWN.

SER. NO. 76-676,572, FILED 5-8-2007.

ADA HAN, EXAMINING ATTORNEY



**Int. Cls.: 9 and 28**

**Prior U.S. Cls.: 21, 22, 23, 26, 36, 38 and 50**

**United States Patent and Trademark Office**

**Reg. No. 3,464,918**

**Registered July 15, 2008**

**TRADEMARK  
PRINCIPAL REGISTER**

**JAY AT PLAY**

JAY FRANCO &SON, INC. (NEW YORK CORPORATION)  
295 FIFTH AVENUE, SUITE 312  
NEW YORK, NY 10017

FOR: AUDIO SPEAKERS AND AMPLIFIERS ATTACHED TO PILLOWS OR TOYS, IN CLASS 9 (U.S. CLS. 21, 23, 26, 36 AND 38).

FIRST USE 1-0-2005; IN COMMERCE 1-0-2005.

FOR: PLUSH TOY ANIMALS, STUFFED TOY FIGURES, AND TOY PILLOWS, IN CLASS 28 (U.S. CLS. 22, 23, 38 AND 50).

FIRST USE 1-0-2005; IN COMMERCE 1-0-2005.

THE MARK CONSISTS OF STANDARD CHARACTERS WITHOUT CLAIM TO ANY PARTICULAR FONT, STYLE, SIZE, OR COLOR.

SER. NO. 76-676,682, FILED 5-11-2007.

RON FAIRBANKS, EXAMINING ATTORNEY

Int. Cl.: 35

Prior U.S. Cls.: 100, 101 and 102

Reg. No. 3,464,919

United States Patent and Trademark Office

Registered July 15, 2008

SERVICE MARK  
PRINCIPAL REGISTER



ROEHL TRANSPORT, INC. (WISCONSIN CORPORATION)  
1916 E. 29TH STREET  
MARSHFIELD, WI 54449

NO CLAIM IS MADE TO THE EXCLUSIVE RIGHT TO USE "PROGRAM", APART FROM THE MARK AS SHOWN.

FOR: EMPLOYEE RECRUITING SERVICES IN THE FIELD OF TRUCK DRIVING, IN CLASS 35 (U.S. CLS. 100, 101 AND 102).

SER. NO. 76-676,926, FILED 5-16-2007.

FIRST USE 1-19-2007; IN COMMERCE 1-19-2007.

BARBARA BROWN, EXAMINING ATTORNEY

**Int. Cl.: 36**

**Prior U.S. Cls.: 100, 101 and 102**

**United States Patent and Trademark Office**

**Reg. No. 3,464,920**

**Registered July 15, 2008**

**SERVICE MARK  
PRINCIPAL REGISTER**

**PUT OUR KNOWLEDGE ON YOUR SIDE**

THE LANDOVER CORPORATION (WASHING-  
TON CORPORATION)  
7525 SE 24TH ST, SUITE 630  
MERCER ISLAND, WA 98040

THE MARK CONSISTS OF STANDARD CHAR-  
ACTERS WITHOUT CLAIM TO ANY PARTICULAR  
FONT, STYLE, SIZE, OR COLOR.

FOR: REAL ESTATE AGENCY AND BROKER-  
AGE SERVICES; REAL ESTATE VALUATION AND  
APPRAISAL SERVICES, IN CLASS 36 (U.S. CLS. 100,  
101 AND 102).

SER. NO. 76-676,968, FILED 5-16-2007.

FIRST USE 1-15-2007; IN COMMERCE 1-15-2007.

CHARLES L. JENKINS, EXAMINING ATTORNEY

Int. Cl.: 41

Prior U.S. Cls.: 100, 101 and 107

United States Patent and Trademark Office

Reg. No. 3,464,921

Registered July 15, 2008

SERVICE MARK  
PRINCIPAL REGISTER



YASH RAJ FILMS PVT. LTD. (INDIA CORPORATION)  
5 SHAH INDUSTRIAL ESTATE  
VEERA DESAI RD  
ANDHERI (WEST), INDIA 400053

FOR: ENTERTAINMENT SERVICES, NAMELY, IN THE NATURE OF MOTION PICTURE FILM PRODUCTION AND FILM DISTRIBUTION; MUSIC PRODUCTION AND PROVIDING FOR THE STREAMING AND DOWNLOAD OF MUSIC; ENTERTAINMENT, NAMELY, LIVE MUSIC CONCERTS AND PERFORMANCES; PRODUCTION OF VIDEO GAMES SOFTWARE COMPATIBLE TO VARIOUS PLATFORMS; GENERAL ENTERTAINMENT, NAMELY, LIVE PERFORMANCES BY ACTORS AND MUSICIANS; INSTRUCTION IN THE FIELD OF ACTING AND MUSIC; PROVIDING INTERACTIVE COMPUTER GAMES AND ACTIVITIES, NAMELY, AN ONLINE ACTIVITY WHERE YOU CREATE YOUR OWN PRODUCT USING MUSIC, FILM AND IMAGES OF ACTORS; PROVIDING SPORTS INFORMATION, NEWS AND GENERAL INFORMATION ON INDIAN FILM AND MUSIC, WHICH ARE DISTRIBUTED OVER TELEVISION, SATELLITE, CABLE, AUDIO AND VIDEO MEDIA AND THROUGH ONLINE SERVICES AND COMPUTER SERVICES AVAILABLE VIA A MULTI-USER GLOBAL COMPUTER INFORMATION NETWORK; TELEVISION PROGRAMMING AND PRODUCTION SERVICES; PRODUCTION, AND

PROVIDING FOR INTERNET AND RETAIL CIRCULATION, DISTRIBUTION AND RENTAL OF MOTION PICTURES; ENTERTAINMENT SERVICES, NAMELY, LIVE STAGE PRESENTATIONS IN THE NATURE OF LIVE SHOW PERFORMANCES AND LIVE THEATER PRODUCTIONS AND FILM EXHIBITION; ENTERTAINMENT SERVICES, NAMELY, ORGANIZING AND CONDUCTING LIVE MUSICAL STAGE SHOWS, LIVE NIGHT CLUB SHOWS; ARRANGING OF CONTESTS; ENTERTAINMENT SERVICES, NAMELY, ORGANIZING AND CONDUCTING DANCE EVENTS; ENTERTAINMENT IN THE NATURE OF CONDUCTING PARTIES; ENTERTAINMENT SERVICES, NAMELY, ORGANIZATION OF DANCE AND SINGING COMPETITIONS AND GAMES; ARRANGING OF CONTESTS FEATURING QUIZZES; ENTERTAINMENT SERVICES, NAMELY, ORGANIZATION, PRESENTATION AND PRODUCTION OF GAME SHOWS, LIVE PERFORMANCES BY MUSICIANS AND ACTORS THAT INCLUDE AUDIENCE PARTICIPATION, IN CLASS 41 (U.S. CLS. 100, 101 AND 107).

FIRST USE 4-1-2003; IN COMMERCE 4-1-2003.

SER. NO. 76-676,986, FILED 5-17-2007.

WILLIAM ROSSMAN, EXAMINING ATTORNEY

**Int. Cls.: 39 and 43**

**Prior U.S. Cls.: 100, 101 and 105**

**United States Patent and Trademark Office**

**Reg. No. 3,464,922**

**Registered July 15, 2008**

**SERVICE MARK  
PRINCIPAL REGISTER**

**AFFORDABLETOURS.COM**

CASTLES OF THE WORLD, INC. (TEXAS CORPORATION), DBA AFFORDABLETOURS.COM  
11150 CASH ROAD  
STAFFORD, TX 77477

FOR: TRAVEL AGENCY SERVICES, NAMELY, MAKING RESERVATIONS AND BOOKINGS FOR TRANSPORTATION; CRUISE SHIP SERVICES, IN CLASS 39 (U.S. CLS. 100 AND 105).

FIRST USE 3-20-2002; IN COMMERCE 3-20-2002.

FOR: TRAVEL AGENCY SERVICES, NAMELY, MAKING RESERVATIONS AND BOOKINGS FOR TEMPORARY LODGING, RESTAURANTS AND

MEALS; RESORT LODGING SERVICES, IN CLASS 43 (U.S. CLS. 100 AND 101).

FIRST USE 3-20-2002; IN COMMERCE 3-20-2002.

THE MARK CONSISTS OF STANDARD CHARACTERS WITHOUT CLAIM TO ANY PARTICULAR FONT, STYLE, SIZE, OR COLOR.

SEC. 2(F).

SER. NO. 76-677,043, FILED 5-18-2007.

MICHAEL SOUDERS, EXAMINING ATTORNEY

**Int. Cl.: 5**

**Prior U.S. Cls.: 6, 18, 44, 46, 51 and 52**

**Reg. No. 3,464,923**

**United States Patent and Trademark Office**

**Registered July 15, 2008**

**TRADEMARK  
PRINCIPAL REGISTER**

**NANOBEE**

LEE, SEAN SANGSOO (UNITED STATES INDIVIDUAL)  
3200 WILSHIRE BOULEVARD, #1450  
LOS ANGELES, CA 90010

FOR: HEALTH SUPPLEMENTS, NAMELY, DIETARY, NUTRITIONAL, HERBAL, VITAMIN, MINERAL, AND FOOD SUPPLEMENTS, MEAL REPLACEMENT AND DIETARY AND NUTRITIONAL SUPPLEMENT DRINK MIXES, MEAL REPLACEMENT BARS, DRINKS, POWDERS, AND SHAKES; NUTRACEUTICAL DIETARY SUPPLE-

MENTS, IN CLASS 5 (U.S. CLS. 6, 18, 44, 46, 51 AND 52).

FIRST USE 1-1-2007; IN COMMERCE 1-1-2007.

THE MARK CONSISTS OF STANDARD CHARACTERS WITHOUT CLAIM TO ANY PARTICULAR FONT, STYLE, SIZE, OR COLOR.

SER. NO. 76-677,089, FILED 5-18-2007.

LOURDES AYALA, EXAMINING ATTORNEY

**Int. Cl.: 5**

**Prior U.S. Cls.: 6, 18, 44, 46, 51 and 52**

**United States Patent and Trademark Office**

**Reg. No. 3,464,924**

**Registered July 15, 2008**

**TRADEMARK  
PRINCIPAL REGISTER**

**NANOPOUCH**

LEE, SEAN SANGSOO (UNITED STATES INDIVIDUAL)  
3200 WILSHIRE BOULEVARD, #1450  
LOS ANGELES, CA 90010

FOR: HEALTH SUPPLEMENTS, NAMELY, DIETARY, NUTRITIONAL, HERBAL, VITAMIN, MINERAL, AND FOOD SUPPLEMENTS, MEAL REPLACEMENT AND DIETARY AND NUTRITIONAL SUPPLEMENT DRINK MIXES, MEAL REPLACEMENT BARS, DRINKS, POWDERS, AND SHAKES; NUTRACEUTICAL DIETARY SUPPLE-

MENTS, IN CLASS 5 (U.S. CLS. 6, 18, 44, 46, 51 AND 52).

FIRST USE 1-1-2007; IN COMMERCE 1-1-2007.

THE MARK CONSISTS OF STANDARD CHARACTERS WITHOUT CLAIM TO ANY PARTICULAR FONT, STYLE, SIZE, OR COLOR.

SER. NO. 76-677,090, FILED 5-18-2007.

LOURDES AYALA, EXAMINING ATTORNEY

**Int. Cl.: 36**

**Prior U.S. Cls.: 100, 101 and 102**

**United States Patent and Trademark Office**

**Reg. No. 3,464,925**

**Registered July 15, 2008**

**SERVICE MARK  
PRINCIPAL REGISTER**

**TOMPKINS INVESTMENT SERVICES**

TOMPKINS TRUST COMPANY (NEW YORK  
BANKING COMPANY)  
110 N. TIOGA STREET  
ITHACA, NY 14850

FOR: BANKING AND INVESTMENT ADVISORY  
SERVICES, FINANCIAL PLANNING SERVICES, ES-  
TATE PLANNING SERVICES, RETIREMENT PLAN-  
NING SERVICES, WEALTH MANAGEMENT  
SERVICES, AND MONEY MANAGEMENT SERVI-  
CES, IN CLASS 36 (U.S. CLS. 100, 101 AND 102).

FIRST USE 12-31-2001; IN COMMERCE 12-31-2001.

THE MARK CONSISTS OF STANDARD CHAR-  
ACTERS WITHOUT CLAIM TO ANY PARTICULAR  
FONT, STYLE, SIZE, OR COLOR.

NO CLAIM IS MADE TO THE EXCLUSIVE  
RIGHT TO USE "INVESTMENT SERVICES", APART  
FROM THE MARK AS SHOWN.

SEC. 2(F).

SER. NO. 76-677,127, FILED 5-18-2007.

REGINA DRUMMOND, EXAMINING ATTORNEY



**Int. Cl.: 36**

**Prior U.S. Cls.: 100, 101 and 102**

**United States Patent and Trademark Office**

**Reg. No. 3,464,926**

**Registered July 15, 2008**

**SERVICE MARK  
PRINCIPAL REGISTER**

**AM&M FINANCIAL SERVICES**

TOMPKINS TRUST COMPANY (NEW YORK  
BANKING COMPANY)  
110 N. TIOGA STREET  
ITHACA, NY 14850

FOR: INSURANCE SERVICES, NAMELY, INSUR-  
ANCE AGENCY SERVICES, IN CLASS 36 (U.S. CLS.  
100, 101 AND 102).

FIRST USE 12-31-2000; IN COMMERCE 12-31-2000.

THE MARK CONSISTS OF STANDARD CHAR-  
ACTERS WITHOUT CLAIM TO ANY PARTICULAR  
FONT, STYLE, SIZE, OR COLOR.

NO CLAIM IS MADE TO THE EXCLUSIVE  
RIGHT TO USE "FINANCIAL SERVICES", APART  
FROM THE MARK AS SHOWN.

SER. NO. 76-677,128, FILED 5-18-2007.

REGINA DRUMMOND, EXAMINING ATTORNEY

**Int. Cl.: 36**

**Prior U.S. Cls.: 100, 101 and 102**

**United States Patent and Trademark Office**

**Reg. No. 3,464,927**

**Registered July 15, 2008**

**SERVICE MARK  
PRINCIPAL REGISTER**



TOMPKINS TRUST COMPANY (NEW YORK  
BANKING COMPANY)  
110 N. TIOGA STREET  
ITHACA, NY 14850

FOR: BANKING SERVICES, INVESTMENT AD-  
VISORY SERVICES, FUNDS INVESTMENT SERVI-  
CES, INSURANCE AGENCY SERVICES, RISK  
MANAGEMENT SERVICES, AND MONEY MAN-  
AGEMENT SERVICES, IN CLASS 36 (U.S. CLS. 100,  
101 AND 102).

FIRST USE 12-31-1978; IN COMMERCE 12-31-1978.

THE MARK CONSISTS OF AN ACORN ABOVE  
TWO OAK LEAVES.

SER. NO. 76-677,130, FILED 5-18-2007.

REGINA DRUMMOND, EXAMINING ATTORNEY

**Int. Cl.: 41**

**Prior U.S. Cls.: 100, 101 and 107**

**United States Patent and Trademark Office**

**Reg. No. 3,464,928**

**Registered July 15, 2008**

---

**SERVICE MARK  
PRINCIPAL REGISTER**

**MOMS ON THE MOVE**

SWAIN ENTERTAINMENT, INC. (PENNSYLVANIA CORPORATION)  
6 WEST LANCASTER AVENUE  
ARDMORE, PA 19003

FOR: PROVIDING ON-LINE NON-DOWNLOADABLE ELECTRONIC PUBLICATIONS, NAMELY, NEWSLETTERS FEATURING INFORMATION IN THE FIELDS OF PARENTING AND FAMILY ISSUES, HEALTH, RELATIONSHIPS, STYLE, WOMEN AND BUSINESS, HOME AND FOOD, TRAVEL AND NETWORKING; PROVIDING ELECTRONIC PUBLICATIONS, NAMELY, NEWSLETTERS FEATUR-

ING INFORMATION IN THE FIELDS OF PARENTING AND FAMILY ISSUES, HEALTH, RELATIONSHIPS, STYLE, WOMEN AND BUSINESS, HOME AND FOOD, TRAVEL, AND NETWORKING SENT VIA E-MAIL, IN CLASS 41 (U.S. CLS. 100, 101 AND 107).

FIRST USE 12-16-2005; IN COMMERCE 12-16-2005.

SER. NO. 76-677,166, FILED 5-21-2007.

RON FAIRBANKS, EXAMINING ATTORNEY

**Int. Cl.: 5**

**Prior U.S. Cls.: 6, 18, 44, 46, 51 and 52**

**United States Patent and Trademark Office**

**Reg. No. 3,464,929**

**Registered July 15, 2008**

**TRADEMARK  
PRINCIPAL REGISTER**

**RE STORE ALL**

J. C. FISHER ENTERPRISES, INC (FLORIDA CORPORATION)

3201 N. FEDERAL HWY., SUITE 201  
FORT LAUDERDALE, FL 33306

FOR: ORAL ANALGESIC DIETARY SUPPLEMENT, NAMELY, A DIETARY SUPPLEMENT THAT REDUCES ARTHRITIC JOINT PAIN AND INFLAMATION, IN CLASS 5 (U.S. CLS. 6, 18, 44, 46, 51 AND 52).

FIRST USE 1-10-2003; IN COMMERCE 1-10-2003.

THE MARK CONSISTS OF STANDARD CHARACTERS WITHOUT CLAIM TO ANY PARTICULAR FONT, STYLE, SIZE, OR COLOR.

SER. NO. 76-677,212, FILED 5-21-2007.

JAMES MACFARLANE, EXAMINING ATTORNEY

**Int. Cl.: 36**

**Prior U.S. Cls.: 100, 101 and 102**

**United States Patent and Trademark Office**

**Reg. No. 3,464,930**

**Registered July 15, 2008**

**SERVICE MARK  
PRINCIPAL REGISTER**

**TOMPKINS CHARITABLE GIFT FUND**

TOMPKINS TRUST COMPANY (NEW YORK  
BANKING COMPANY)  
110 N. TIOGA STREET  
ITHACA, NY 14850

FOR: BANKING SERVICES, INVESTMENT OF  
FUNDS FOR CHARITABLE PURPOSES; CHARITA-  
BLE FUND RAISING SERVICES; AND FINANCIAL  
MANAGEMENT SERVICES, IN CLASS 36 (U.S. CLS.  
100, 101 AND 102).

FIRST USE 12-31-2001; IN COMMERCE 12-31-2001.

THE MARK CONSISTS OF STANDARD CHAR-  
ACTERS WITHOUT CLAIM TO ANY PARTICULAR  
FONT, STYLE, SIZE, OR COLOR.

NO CLAIM IS MADE TO THE EXCLUSIVE  
RIGHT TO USE "CHARITABLE GIFT FUND",  
APART FROM THE MARK AS SHOWN.

SEC. 2(F).

SER. NO. 76-677,288, FILED 5-23-2007.

REGINA DRUMMOND, EXAMINING ATTORNEY

**Int. Cl.: 36**

**Prior U.S. Cls.: 100, 101 and 102**

**United States Patent and Trademark Office**

**Reg. No. 3,464,931**

**Registered July 15, 2008**

**SERVICE MARK  
PRINCIPAL REGISTER**

**TOMPKINS TRUST COMPANY**

TOMPKINS TRUST COMPANY (NEW YORK  
BANKING COMPANY)  
110 N. TIOGA STREET  
ITHACA, NY 14850

NO CLAIM IS MADE TO THE EXCLUSIVE  
RIGHT TO USE "TRUST COMPANY", APART  
FROM THE MARK AS SHOWN.

FOR: BANKING, INVESTMENT ADVISORY SER-  
VICES AND FUNDS INVESTMENT, IN CLASS 36  
(U.S. CLS. 100, 101 AND 102).

SEC. 2(F).

FIRST USE 12-31-2001; IN COMMERCE 12-31-2001.

SER. NO. 76-677,289, FILED 5-23-2007.

THE MARK CONSISTS OF STANDARD CHAR-  
ACTERS WITHOUT CLAIM TO ANY PARTICULAR  
FONT, STYLE, SIZE, OR COLOR.

REGINA DRUMMOND, EXAMINING ATTORNEY

**Int. Cl.: 36**

**Prior U.S. Cls.: 100, 101 and 102**

**United States Patent and Trademark Office**

**Reg. No. 3,464,932**

**Registered July 15, 2008**

**SERVICE MARK  
PRINCIPAL REGISTER**

**TOMPKINS INSURANCE AGENCIES**

TOMPKINS TRUST COMPANY (NEW YORK  
BANKING COMPANY)  
110 N. TIOGA STREET  
ITHACA, NY 14850

NO CLAIM IS MADE TO THE EXCLUSIVE  
RIGHT TO USE "INSURANCE AGENCIES", APART  
FROM THE MARK AS SHOWN.

FOR: INSURANCE AGENCY SERVICES, IN  
CLASS 36 (U.S. CLS. 100, 101 AND 102).

SEC. 2(F).

FIRST USE 12-31-2002; IN COMMERCE 12-31-2002.

SER. NO. 76-677,290, FILED 5-23-2007.

THE MARK CONSISTS OF STANDARD CHAR-  
ACTERS WITHOUT CLAIM TO ANY PARTICULAR  
FONT, STYLE, SIZE, OR COLOR.

REGINA DRUMMOND, EXAMINING ATTORNEY

**Int. Cl.: 37**

**Prior U.S. Cls.: 100, 103 and 106**

**United States Patent and Trademark Office**

**Reg. No. 3,464,933**

**Registered July 15, 2008**

**SERVICE MARK  
PRINCIPAL REGISTER**

**1-800-STEEMER**

STANLEY STEEMER INTERNATIONAL, INC.  
(OHIO CORPORATION)  
5500 STANLEY STEEMER PARKWAY  
DUBLIN, OH 43016

FOR: CARPET AND UPHOLSTERY CLEANING;  
INSTALLATION, REPAIR, MAINTENANCE AND  
CLEANING OF HEATING, VENTILATING AND  
AIR CONDITIONING SYSTEMS; HARDWOOD  
FLOOR REFINISHING; TILE AND GROUT CLEAN-  
ING; WATER DAMAGE RESTORATION IN THE  
NATURE OF CLEANING SERVICES, IN CLASS 37  
(U.S. CLS. 100, 103 AND 106).

FIRST USE 3-31-2002; IN COMMERCE 3-31-2002.

THE MARK CONSISTS OF STANDARD CHAR-  
ACTERS WITHOUT CLAIM TO ANY PARTICULAR  
FONT, STYLE, SIZE, OR COLOR.

OWNER OF U.S. REG. NOS. 1,006,675, 2,871,734  
AND OTHERS.

SEC. 2(F).

SER. NO. 76-677,299, FILED 5-23-2007.

ANDREA SAUNDERS, EXAMINING ATTORNEY



Int. Cl.: 25

Prior U.S. Cls.: 22 and 39

**United States Patent and Trademark Office**

**Reg. No. 3,464,934**

Registered July 15, 2008

**TRADEMARK  
PRINCIPAL REGISTER**



SOURCE ADVANTAGE LTD. (OHIO LIMITED  
LIABILITY CORPORATION), DBA RED CAR-  
PET STUDIOS  
4325 INDECO COURT  
CINCINNATI, OH 45241

NO CLAIM IS MADE TO THE EXCLUSIVE  
RIGHT TO USE "FUZZY FOOTIES", APART FROM  
THE MARK AS SHOWN.

FOR: SLIPPERS, IN CLASS 25 (U.S. CLS. 22 AND  
39).

SER. NO. 76-677,349, FILED 5-24-2007.

FIRST USE 7-1-2006; IN COMMERCE 7-1-2006.

ANGELA M. MICHELI, EXAMINING ATTORNEY

Int. Cl.: 35

Prior U.S. Cls.: 100, 101 and 102

United States Patent and Trademark Office

Reg. No. 3,464,935

Registered July 15, 2008

SERVICE MARK  
PRINCIPAL REGISTER



DELICIOUS ORGANICS INC. (FLORIDA CORPORATION)  
20815 N.E. 16TH AVENUE  
SUITE B38  
NORTH MIAMI BEACH, FL 33179

FOR: RETAIL ORGANIC GROCERY STORE SERVICES PROVIDED ON-LINE AND VIA BRICK AND MORTAR FACILITIES, IN CLASS 35 (U.S. CLS. 100, 101 AND 102).

FIRST USE 9-1-2003; IN COMMERCE 9-1-2003.

NO CLAIM IS MADE TO THE EXCLUSIVE RIGHT TO USE "DELICIOUS" AND "ORGANICS", APART FROM THE MARK AS SHOWN.

SER. NO. 76-677,361, FILED 5-24-2007.

ANGELA M. MICHELI, EXAMINING ATTORNEY

**Int. Cl.: 21**

**Prior U.S. Cls.: 2, 13, 23, 29, 30, 33, 40 and 50**

**United States Patent and Trademark Office**

**Reg. No. 3,464,936**

**Registered July 15, 2008**

**TRADEMARK  
PRINCIPAL REGISTER**

**THE ESSENCE OF NEW ORLEANS . . . IN A CUP**

AMERICAN COFFEE COMPANY, INC. (LOUISIANA CORPORATION)  
800 MAGAZINE STREET  
NEW ORLEANS, LA 70130

THE MARK CONSISTS OF STANDARD CHARACTERS WITHOUT CLAIM TO ANY PARTICULAR FONT, STYLE, SIZE, OR COLOR.

FOR: COFFEE MUGS, IN CLASS 21 (U.S. CLS. 2, 13, 23, 29, 30, 33, 40 AND 50).

SER. NO. 76-677,421, FILED 5-25-2007.

FIRST USE 4-30-2000; IN COMMERCE 4-30-2000.

CAROLYN CATALDO, EXAMINING ATTORNEY

**Int. Cls.: 36 and 37**

**Prior U.S. Cls.: 100, 101, 102, 103 and 106**

**United States Patent and Trademark Office**

**Reg. No. 3,464,937**

**Registered July 15, 2008**

**SERVICE MARK  
PRINCIPAL REGISTER**

**THAT'S THE LOGIC OF LENNAR**

LENNAR PACIFIC PROPERTIES MANAGE-  
MENT, INC. (DELAWARE CORPORATION)

700 N.W. 107TH AVENUE  
MIAMI, FL 33172

FOR: CONSULTATION IN THE FIELDS OF REAL ESTATE MANAGEMENT AND REAL ESTATE BROKERING; REAL ESTATE MANAGEMENT AND REAL ESTATE BROKERAGE SERVICES OF RESIDENTIAL COMMUNITIES, UNDEVELOPED PROPERTIES AND INDIVIDUAL RESIDENCES; FINANCIAL SERVICES, NAMELY, MORTGAGE SERVICES, TITLE INSURANCE SERVICES, AND INSURANCE AGENCY SERVICES, IN CLASS 36 (U.S. CLS. 100, 101 AND 102).

FIRST USE 2-1-2007; IN COMMERCE 2-1-2007.

FOR: REAL ESTATE DEVELOPMENT AND PLANNING SERVICES, NAMELY, DEVELOPING, LAYING OUT AND CONSTRUCTING RESIDENTIAL COMMUNITIES AND INDIVIDUAL RESIDENCES, IN CLASS 37 (U.S. CLS. 100, 103 AND 106).

FIRST USE 2-1-2007; IN COMMERCE 2-1-2007.

THE MARK CONSISTS OF STANDARD CHARACTERS WITHOUT CLAIM TO ANY PARTICULAR FONT, STYLE, SIZE, OR COLOR.

OWNER OF U.S. REG. NOS. 2,606,292, 2,850,270 AND OTHERS.

SER. NO. 76-677,519, FILED 5-29-2007.

BRIAN CALLAGHAN, EXAMINING ATTORNEY

**Int. Cl.: 35**

**Prior U.S. Cls.: 100, 101 and 102**

**United States Patent and Trademark Office**

**Reg. No. 3,464,938**

**Registered July 15, 2008**

---

**SERVICE MARK  
PRINCIPAL REGISTER**

**10 GRAND LAND !**

WYNNE FORD, INC. (VIRGINIA CORPORATION)  
1020 WEST MERCURY BLVD.  
HAMPTON, VA 23666

FIRST USE 10-13-2006; IN COMMERCE 10-13-2006.

SER. NO. 76-677,574, FILED 5-29-2007.

FOR: AUTOMOBILE DEALERSHIP, IN CLASS 35  
(U.S. CLS. 100, 101 AND 102).

ELIZABETH KAJUBI, EXAMINING ATTORNEY

**Int. Cl.: 9**

**Prior U.S. Cls.: 21, 23, 26, 36 and 38**

**Reg. No. 3,464,939**

**United States Patent and Trademark Office**

**Registered July 15, 2008**

**TRADEMARK  
PRINCIPAL REGISTER**



HERITAGE DESIGNS, LLC (ARIZONA LTD LIAB  
CO)  
P.O. BOX 10779  
PHOENIX, AZ 85064

FOR: COMPUTER SOFTWARE FOR USE IN  
DONOR MANAGEMENT AND FUNDRAISING  
MANAGEMENT, IN CLASS 9 (U.S. CLS. 21, 23, 26,  
36 AND 38).

FIRST USE 11-19-2004; IN COMMERCE 1-14-2005.

OWNER OF U.S. REG. NO. 2,547,774.

THE COLOR(S) GREEN, BROWN, PURPLE,  
WHITE AND BLACK IS/ARE CLAIMED AS A  
FEATURE OF THE MARK.

THE MARK CONSISTS OF FOUR SMALLER  
TRIANGLES PLACED TOGETHER AS ONE LARGE  
TRIANGLE WITH THE COLOR GREEN APPEAR-  
ING IN THE TOP LEFT TRIANGLE, THE COLOR  
BROWN APPEARING IN THE TOP RIGHT TRIAN-  
GLE, THE COLOR PURPLE APPEARING IN THE  
BOTTOM TRIANGLE AND THE COLOR WHITE IN  
THE CENTER TRIANGLE APPEAR WITH THE  
WORDING "MATCHMAKER" IN BLACK TO THE  
LOWER RIGHT HAND SIDE OF THE MARK.

SER. NO. 76-677,576, FILED 5-29-2007.

WILLIAM ROSSMAN, EXAMINING ATTORNEY

**Int. Cl.: 5**

**Prior U.S. Cls.: 6, 18, 44, 46, 51 and 52**

**Reg. No. 3,464,940**

**United States Patent and Trademark Office**

**Registered July 15, 2008**

**TRADEMARK  
PRINCIPAL REGISTER**



CER-BURG ENTERPRISES, INC. (FLORIDA CORPORATION)  
2040 S. RIDGEWOOD AVE.  
S. DAYTONA, FL 321198437

THE MARK CONSISTS OF THE WORDS "CER-BURG ENTERPRISES, INC." WITH THE LETTER "C" IN THE FORM OF A CIRCULAR ARROW DESIGN WHICH ENCLOSES A HEART DESIGN.

FOR: HIGH FIBER FOOD SUPPLEMENTS, IN CLASS 5 (U.S. CLS. 6, 18, 44, 46, 51 AND 52).

SER. NO. 76-677,701, FILED 5-31-2007.

FIRST USE 3-1-2007; IN COMMERCE 3-1-2007.

NO CLAIM IS MADE TO THE EXCLUSIVE RIGHT TO USE "ENTERPRISES, INC.", APART FROM THE MARK AS SHOWN.

KATHERINE E. HALMEN, EXAMINING ATTORNEY

**Int. Cl.: 9**

**Prior U.S. Cls.: 21, 23, 26, 36 and 38**

**United States Patent and Trademark Office**

**Reg. No. 3,464,941**

**Registered July 15, 2008**

**TRADEMARK  
PRINCIPAL REGISTER**



CONSTRAINTS MANAGEMENT GROUP (WA-  
SHINGTON LTD LIAB CO)  
2355 GRIFFIN AVENUE, SUITE I  
ENUMCLAW, WA 98022

THE MARK CONSISTS OF THE STYLIZED LET-  
TER "R" NEXT TO A PLUS SIGN

FOR: COMPUTER SOFTWARE FOR INVEN-  
TORY MANAGEMENT, IN CLASS 9 (U.S. CLS. 21,  
23, 26, 36 AND 38).

SER. NO. 76-677,704, FILED 6-1-2007.

FIRST USE 3-0-2005; IN COMMERCE 3-0-2005.

YAT SYE, LEE, EXAMINING ATTORNEY



**Int. Cl.: 36**

**Prior U.S. Cls.: 100, 101 and 102**

**United States Patent and Trademark Office**

**Reg. No. 3,464,942**

**Registered July 15, 2008**

**SERVICE MARK  
PRINCIPAL REGISTER**

**PLUMB FUNDS**

WISCONSIN CAPITAL FUNDS, INC. (MARY-  
LAND CORPORATION)  
1200 JOHN Q. HAMMONS DRIVE  
SECOND FLOOR  
MADISON, WI 53717

FOR: MUTUAL FUND INVESTMENT SERVICES;  
MUTUAL FUND BROKERAGE SERVICES, IN  
CLASS 36 (U.S. CLS. 100, 101 AND 102).

FIRST USE 5-24-2007; IN COMMERCE 5-24-2007.

THE MARK CONSISTS OF STANDARD CHAR-  
ACTERS WITHOUT CLAIM TO ANY PARTICULAR  
FONT, STYLE, SIZE, OR COLOR.

NO CLAIM IS MADE TO THE EXCLUSIVE  
RIGHT TO USE "FUNDS", APART FROM THE  
MARK AS SHOWN.

SER. NO. 76-677,824, FILED 6-5-2007.

REBECCA EISINGER, EXAMINING ATTORNEY

**Int. Cl.: 37**

**Prior U.S. Cls.: 100, 103 and 106**

**United States Patent and Trademark Office**

**Reg. No. 3,464,943**

**Registered July 15, 2008**

**SERVICE MARK  
PRINCIPAL REGISTER**

**POOLSIDE CONCIERGE**

MCELANEY, DAVE (UNITED STATES INDIVIDUAL)  
640 RHODES DRIVE  
PALO ALTO, CA 94303

FOR: SERVICES FOR HOMEOWNERS, NAMELY, POOL AND SPA CLEANING AND MAINTENANCE, POOL CHEMICAL BALANCING AND POOL EQUIPMENT REPAIR AND SERVICE; DECK MAINTENANCE AND POWER WASHING, PET WASTE DISPOSAL FOR OTHERS, AT HOME CAR WASHING; LAUNDRY SERVICE FOR TOWELS, DRY CLEANING SERVICES; MAINTENANCE AND REPAIR OF PATIO FURNITURE, CLEANING OF FURNITURE AND HOUSEHOLD GOODS, CLEANING OF RESIDENTIAL HOUSES, SUPPLYING PROPANE TANKS BY MEANS OF AN EXCHANGE PROGRAM, MAINTENANCE OF OUTDOOR ILLUMINATING TORCHES, MAINTENANCE, SERVICING AND CONSTRUCTION OF PATIOS,

EXTERIOR WALL CONSTRUCTION, EXTERIOR FIREPLACE AND HEATING INSTALLATION AND SERVICE, IN CLASS 37 (U.S. CLS. 100, 103 AND 106).

FIRST USE 2-1-2007; IN COMMERCE 3-1-2007.

THE MARK CONSISTS OF STANDARD CHARACTERS WITHOUT CLAIM TO ANY PARTICULAR FONT, STYLE, SIZE, OR COLOR.

NO CLAIM IS MADE TO THE EXCLUSIVE RIGHT TO USE "POOLSIDE", APART FROM THE MARK AS SHOWN.

SER. NO. 76-677,830, FILED 6-4-2007.

SUZANNE BLANE, EXAMINING ATTORNEY

**Int. Cl.: 41**

**Prior U.S. Cls.: 100, 101 and 107**

**United States Patent and Trademark Office**

**Reg. No. 3,464,944**

**Registered July 15, 2008**

**SERVICE MARK  
PRINCIPAL REGISTER**



PINKVEIL LLC (CALIFORNIA LTD LIAB CO)  
11812 GORHAM AVENUE, #203  
LOS ANGELES, CA 90049

THE MARK COMPRISES THE LETTERS "PINK-  
VEIL" AND A VEIL FLOWING FROM THE LETTER  
"P".

FOR: PLANNING AND ORGANIZING BACHE-  
LORETTE PARTIES FOR OTHERS, IN CLASS 41  
(U.S. CLS. 100, 101 AND 107).

SER. NO. 76-677,841, FILED 6-5-2007.

FIRST USE 3-20-2007; IN COMMERCE 3-20-2007.

KELLEY WELLS, EXAMINING ATTORNEY

**Int. Cl.: 41**

**Prior U.S. Cls.: 100, 101 and 107**

**United States Patent and Trademark Office**

**Reg. No. 3,464,945**

**Registered July 15, 2008**

**SERVICE MARK  
PRINCIPAL REGISTER**

**WHERE FABULOUS MEETS FUN**

PINKVEIL LLC (CALIFORNIA LTD LIAB CO)  
11812 GORHAM AVENUE, #203  
LOS ANGELES, CA 90049

THE MARK CONSISTS OF STANDARD CHAR-  
ACTERS WITHOUT CLAIM TO ANY PARTICULAR  
FONT, STYLE, SIZE, OR COLOR.

FOR: PLANNING AND ORGANIZING BACHE-  
LORETTE PARTIES FOR OTHERS, IN CLASS 41  
(U.S. CLS. 100, 101 AND 107).

SER. NO. 76-677,842, FILED 6-5-2007.

FIRST USE 3-20-2007; IN COMMERCE 3-20-2007.

KELLEY WELLS, EXAMINING ATTORNEY

**Int. Cls.: 1 and 5**

**Prior U.S. Cls.: 1, 5, 6, 10, 18, 26, 44, 46, 51 and 52**

**United States Patent and Trademark Office**

**Reg. No. 3,464,946**

**Registered July 15, 2008**

**TRADEMARK  
PRINCIPAL REGISTER**

**3DNA**

DATASCOPE TRADEMARK CORP. (DELAWARE CORPORATION)  
1011 CENTRE ROAD, SUITE 300  
WILMINGTON, DE 19805

FOR: CHEMICAL REAGENTS FOR SCIENTIFIC OR RESEARCH USE, IN CLASS 1 (U.S. CLS. 1, 5, 6, 10, 26 AND 46).

FIRST USE 6-30-1998; IN COMMERCE 6-30-1998.

FOR: MEDICAL DIAGNOSTIC REAGENTS, IN CLASS 5 (U.S. CLS. 6, 18, 44, 46, 51 AND 52).

FIRST USE 6-30-1998; IN COMMERCE 6-30-1998.

THE MARK CONSISTS OF STANDARD CHARACTERS WITHOUT CLAIM TO ANY PARTICULAR FONT, STYLE, SIZE, OR COLOR.

SER. NO. 76-677,851, FILED 6-6-2007.

JULIE WATSON, EXAMINING ATTORNEY

**Int. Cl.: 41**

**Prior U.S. Cls.: 100, 101 and 107**

**United States Patent and Trademark Office**

**Reg. No. 3,464,947**

**Registered July 15, 2008**

**SERVICE MARK  
PRINCIPAL REGISTER**

# **TORSION PROCESS**

KNIGHT, J Z (UNITED STATES INDIVIDUAL)  
14507 YELM HIGHWAY S.E.  
YELM, WA 98597

FOR: EDUCATIONAL SERVICES, NAMELY,  
CONDUCTING CLASSES, SEMINARS, CONFEREN-  
CES, WORKSHOPS AND FIELD EXERCISES IN A  
SPIRITUAL DISCIPLINE, TO WIT – THE USING OF  
ONE’S MIND TO CREATE A TORSION FIELD  
WHEREBY ONE CAN BUILD A WORMHOLE IN  
TIME/SPACE, ALTER REALITY AND CREATE DI-  
MENSIONAL PHENOMENA SUCH AS INVISIBIL-  
ITY, LEVITATION, BILOCATION,

TELEPORTATION AND OTHERS, IN CLASS 41  
(U.S. CLS. 100, 101 AND 107).

FIRST USE 11-5-2002; IN COMMERCE 11-5-2002.

THE MARK CONSISTS OF STANDARD CHAR-  
ACTERS WITHOUT CLAIM TO ANY PARTICULAR  
FONT, STYLE, SIZE, OR COLOR.

SER. NO. 76-677,891, FILED 6-6-2007.

KELLEY WELLS, EXAMINING ATTORNEY

**Int. Cl.: 41**

**Prior U.S. Cls.: 100, 101 and 107**

**United States Patent and Trademark Office**

**Reg. No. 3,464,948**

**Registered July 15, 2008**

**SERVICE MARK  
PRINCIPAL REGISTER**

**CREATE YOUR DAY**

KNIGHT, J Z (UNITED STATES INDIVIDUAL)  
14507 YELM HIGHWAY S.E.  
YELM, WA 98597

FOR: EDUCATIONAL SERVICES, NAMELY,  
PROVIDING CLASSES, SEMINARS, WORKSHOPS,  
TUTORING AND MENTORING IN THE FIELD OF  
SPIRITUAL DISCIPLINES, WHEREIN THE STU-  
DENTS ARE TAUGHT TO INTENTIONALLY CRE-  
ATE, EARLY IN THE MORNING AND BEFORE  
COMMENCING THEIR DAILY ACTIVITIES, A  
CONSTRUCTIVE PLAN OF EXPERIENCES AND

EVENTS FOR THE DAY, IN CLASS 41 (U.S. CLS. 100,  
101 AND 107).

FIRST USE 9-1-1992; IN COMMERCE 9-1-1992.

THE MARK CONSISTS OF STANDARD CHAR-  
ACTERS WITHOUT CLAIM TO ANY PARTICULAR  
FONT, STYLE, SIZE, OR COLOR.

SER. NO. 76-677,947, FILED 6-7-2007.

KELLEY WELLS, EXAMINING ATTORNEY

**Int. Cl.: 41**

**Prior U.S. Cls.: 100, 101 and 107**

**United States Patent and Trademark Office**

**Reg. No. 3,464,949**

**Registered July 15, 2008**

**SERVICE MARK  
PRINCIPAL REGISTER**

**NEIGHBORHOOD WALK**

KNIGHT, J Z (UNITED STATES INDIVIDUAL)  
14507 YELM HIGHWAY S.E.  
YELM, WA 98597

FIRST USE 7-6-2003; IN COMMERCE 7-6-2003.

FOR: EDUCATIONAL SERVICES, NAMELY,  
PROVIDING CLASSES, SEMINARS, WORKSHOPS,  
TUTORING AND MENTORING IN THE FIELD OF  
SPIRITUAL DISCIPLINES, WHEREIN STUDENTS  
ARE TAUGHT TO INTENTIONALLY MODIFY,  
WHILE WALKING, THEIR SET PATTERNS OF  
THINKING AND REPLACE THEM WITH NEW  
ONES OF THEIR OWN CHOICE, IN CLASS 41 (U.S.  
CLS. 100, 101 AND 107).

THE MARK CONSISTS OF STANDARD CHAR-  
ACTERS WITHOUT CLAIM TO ANY PARTICULAR  
FONT, STYLE, SIZE, OR COLOR.

NO CLAIM IS MADE TO THE EXCLUSIVE  
RIGHT TO USE "WALK", APART FROM THE  
MARK AS SHOWN.

SER. NO. 76-677,949, FILED 6-7-2007.

KELLEY WELLS, EXAMINING ATTORNEY



**Int. Cl.: 22**

**Prior U.S. Cls.: 1, 2, 7, 19, 22, 42 and 50**

**Reg. No. 3,464,950**

**United States Patent and Trademark Office**

**Registered July 15, 2008**

**TRADEMARK  
PRINCIPAL REGISTER**

**UNI-WEB**

UNIROPE LIMITED (CANADA CORPORATION)

3070 UNIVERSAL DRIVE

MISSISSAUGA, ONTARIO, CANADA L4X 2C8

FOR: LIFTING SLINGS, NAMELY, NYLON WEB-  
BING SLINGS AND SLING ASSEMBLIES AND  
FITTINGS THEREFOR, IN CLASS 22 (U.S. CLS. 1, 2,  
7, 19, 22, 42 AND 50).

THE MARK CONSISTS OF STANDARD CHAR-  
ACTERS WITHOUT CLAIM TO ANY PARTICULAR  
FONT, STYLE, SIZE, OR COLOR.

OWNER OF CANADA REG. NO. TMA244612,  
DATED 5-9-1980, RENEWED AS REG. NO.  
TMA244612, DATED 5-9-1995, EXPIRES 5-9-2010.

SER. NO. 76-678,019, FILED 6-8-2007.

JULIE GUTTADAURO, EXAMINING ATTORNEY

**Int. Cl.: 6**

**Prior U.S. Cls.: 2, 12, 13, 14, 23, 25 and 50**

**Reg. No. 3,464,951**

**United States Patent and Trademark Office**

**Registered July 15, 2008**

**TRADEMARK  
PRINCIPAL REGISTER**

**UNI-LOC**

UNIROPE LIMITED (CANADA CORPORATION)  
3070 UNIVERSAL DRIVE  
MISSISSAUGA, ONTARIO, CANADA L4X 2C8

OWNER OF CANADA REG. NO. TMA225804,  
DATED 2-3-1978, RENEWED AS REG. NO.  
TMA225804, DATED 4-18-2007, EXPIRES 4-18-2022.

FOR: WIRE ROPE SLINGS, WIRE ROPE, AND  
FITTINGS FOR SWAGING ON TO WIRE ROPES, IN  
CLASS 6 (U.S. CLS. 2, 12, 13, 14, 23, 25 AND 50).

SER. NO. 76-678,020, FILED 6-8-2007.

THE MARK CONSISTS OF STANDARD CHAR-  
ACTERS WITHOUT CLAIM TO ANY PARTICULAR  
FONT, STYLE, SIZE, OR COLOR.

JULIE GUTTADAURO, EXAMINING ATTORNEY

**Int. Cl.: 30**

**Prior U.S. Cl.: 46**

**United States Patent and Trademark Office**

**Reg. No. 3,464,952**

**Registered July 15, 2008**

**TRADEMARK  
PRINCIPAL REGISTER**

**ORGANIC CHEF**

VICTORIA PACKING CORPORATION (NEW YORK CORPORATION)  
443 EAST 100TH STREET  
BROOKLYN, NY 11236

FOR: PASTA SAUCES, NAMELY, MARINARA SAUCE, VODKA SAUCE, SPICY VODKA SAUCE, FRADIIVOLO SAUCE, ROASTED GARLIC SAUCE, TOMATO BASIL SAUCE, PUTTANESCA SAUCE, MUSHROOMS SAUCE, EGGPLANT SAUCE, ARTICHOKE SAUCE AND PESTO SAUCE; PASTA SAUCES WITH MEAT, NAMELY, CRUMBLED SAUSAGE PASTA SAUCE, SAUSAGE SLICES SAUCE, BOLOGNESE SAUCE, MINI MEATBALLS SAUCE AND ROASTED WHITE CHICKEN SAUCE; ORGANIC PASTA SAUCE; COOKING SAUCES; PEPPER SAUCES; VINEGARS, NAMELY, BALSAMIC VINEGAR, RED WINE VINEGAR, PURE WHITE WINE VINEGAR AND DISTILLED VINEGAR; SALSAS; CAPERS; SALAD DRESSINGS; SPICES, NAMELY, BLACK PEPPER, CRUSHED RED

PEPPER, BASIL, NUTMEG, BAY LEAVES, GARLIC, CHILI POWDER, CINNAMON, WHOLE CLOVES, CUMIN, CURRY POWDER, FENNEL SEEDS, ITALIAN SEASONING, OREGANO, PAPRIKA, PARSLEY, THYME, CHIVES AND LEMON PEPPER SEASONING, IN CLASS 30 (U.S. CL. 46).

FIRST USE 12-5-2006; IN COMMERCE 1-10-2007.

THE MARK CONSISTS OF STANDARD CHARACTERS WITHOUT CLAIM TO ANY PARTICULAR FONT, STYLE, SIZE, OR COLOR.

NO CLAIM IS MADE TO THE EXCLUSIVE RIGHT TO USE "ORGANIC", APART FROM THE MARK AS SHOWN.

SER. NO. 76-678,104, FILED 6-11-2007.

JAY FLOWERS, EXAMINING ATTORNEY

**Int. Cl.: 43**

**Prior U.S. Cls.: 100 and 101**

**United States Patent and Trademark Office**

**Reg. No. 3,464,953**

**Registered July 15, 2008**

**SERVICE MARK  
PRINCIPAL REGISTER**



PERCASSO'S, LLC (FLORIDA LTD LIAB CO)  
265 EAST MARION AVENUE  
PUNTA GORDA, FL 33950

FOR: GOURMET COFFEE CAFÉ SERVICES, IN  
CLASS 43 (U.S. CLS. 100 AND 101).

FIRST USE 4-1-2007; IN COMMERCE 4-1-2007.

NO CLAIM IS MADE TO THE EXCLUSIVE  
RIGHT TO USE "GOURMET COFFEE", APART  
FROM THE MARK AS SHOWN.

SER. NO. 76-678,175, FILED 6-13-2007.

NORA BUCHANAN WILL, EXAMINING ATTOR-  
NEY

**Int. Cl.: 25**

**Prior U.S. Cls.: 22 and 39**

**United States Patent and Trademark Office**

**Reg. No. 3,464,954**

**Registered July 15, 2008**

**TRADEMARK  
PRINCIPAL REGISTER**

**FEEL THE HEAT**

FULL FRICTION APPAREL, INC. (ILLINOIS  
CORPORATION)  
310 BUSSE HIGHWAY  
UNIT 275  
PARK RIDGE, IL 60068

FOR: CLOTHING, NAMELY, T-SHIRTS, SHORTS,  
PANTS AND HATS, IN CLASS 25 (U.S. CLS. 22 AND  
39).

FIRST USE 5-16-2007; IN COMMERCE 5-16-2007.

THE MARK CONSISTS OF STANDARD CHAR-  
ACTERS WITHOUT CLAIM TO ANY PARTICULAR  
FONT, STYLE, SIZE, OR COLOR.

SER. NO. 76-678,251, FILED 6-8-2007.

JOHN SCHUYLER YARD, EXAMINING ATTOR-  
NEY

Int. Cl.: 25

Prior U.S. Cls.: 22 and 39

**United States Patent and Trademark Office**

**Reg. No. 3,464,955**

Registered July 15, 2008

**TRADEMARK  
PRINCIPAL REGISTER**



Full  
Friction

FULL FRICTION APPAREL, INC. (ILLINOIS  
CORPORATION)  
310 BUSSE HIGHWAY  
UNIT 275  
PARK RIDGE, IL 60068

FIRST USE 5-16-2007; IN COMMERCE 5-16-2007.

SER. NO. 76-678,253, FILED 6-8-2007.

FOR: CLOTHING, NAMELY, T-SHIRTS, SHORTS,  
PANTS AND HATS, IN CLASS 25 (U.S. CLS. 22 AND  
39).

JOHN SCHUYLER YARD, EXAMINING ATTOR-  
NEY

**Int. Cl.: 25**

**Prior U.S. Cls.: 22 and 39**

**United States Patent and Trademark Office**

**Reg. No. 3,464,956**

**Registered July 15, 2008**

**TRADEMARK  
PRINCIPAL REGISTER**

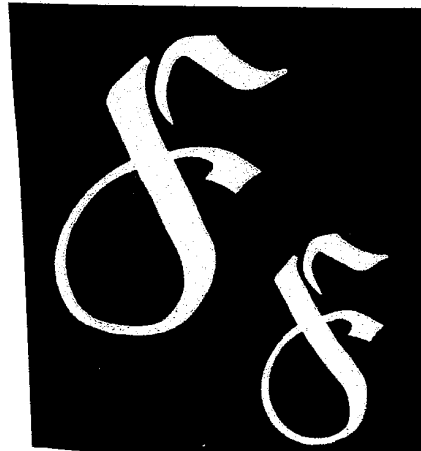

FULL FRICTION APPAREL, INC. (ILLINOIS  
CORPORATION)  
310 BUSSE HIGHWAY  
UNIT 275  
PARK RIDGE, IL 60068

FIRST USE 5-16-2007; IN COMMERCE 5-16-2007.

SER. NO. 76-678,254, FILED 6-8-2007.

FOR: CLOTHING, NAMELY, T-SHIRTS, SHORTS,  
PANTS AND HATS, IN CLASS 25 (U.S. CLS. 22 AND  
39).

JOHN SCHUYLER YARD, EXAMINING ATTOR-  
NEY

Int. Cl.: 9

Prior U.S. Cls.: 21, 23, 26, 36 and 38

United States Patent and Trademark Office

Reg. No. 3,464,957

Registered July 15, 2008

TRADEMARK  
PRINCIPAL REGISTER



MARCELINO, EVERARDO AVILA (MEXICO INDIVIDUAL)  
CJON DEL TANQUE II  
SANTO TOMAS, EDO., MEXICO 51100

FOR: PRE - RECORDED COMPACT DISCS, VIDEOTAPES, LASER DISKS AND DVD'S FEATURING MUSIC, IN CLASS 9 (U.S. CLS. 21, 23, 26, 36 AND 38).

FIRST USE 1-1-2000; IN COMMERCE 1-1-2000.

NO CLAIM IS MADE TO THE EXCLUSIVE RIGHT TO USE "MEXICO", APART FROM THE MARK AS SHOWN.

THE COLOR(S) PURPLE, GOLD, RED, WHITE AND BLUE IS/ARE CLAIMED AS A FEATURE OF THE MARK.

THE COLOR PURPLE IS THE PRIMARY COLOR OF THE MARK INCLUDING THE LETTERS OF THE WORDING "EL TRONO" THE COLOR GOLD OUTLINES THE LETTERS OF THE WORDS "EL TRONO" AND THE COLOR RED APPEARS AS A SHADOW OUTLINE OF THE WORDS "EL TRONO" AND IN THE LETTERS "CO" OF "MEXICO", THE COLOR BLUE APPEARS IN THE LETTERS "ME" OF "MEXICO" AND THE COLOR WHITE APPEARS IN THE LETTERS "XI" OF "MEXICO".

THE ENGLISH TRANSLATION OF THE WORD "EL TRONO DE MEXICO" IN THE MARK IS: "THE THRONE OF MEXICO".

SER. NO. 76-678,270, FILED 6-15-2007.

JILL C. ALT, EXAMINING ATTORNEY



**Int. Cl.: 5**

**Prior U.S. Cls.: 6, 18, 44, 46, 51 and 52**

**United States Patent and Trademark Office**

**Reg. No. 3,464,958**

**Registered July 15, 2008**

**TRADEMARK  
PRINCIPAL REGISTER**

**BIO3X**

BIO3X LLC (UTAH LTD LIAB CO)  
4802 N 400 W, SUITE 107  
PARK CITY, UT 84098

THE MARK CONSISTS OF STANDARD CHAR-  
ACTERS WITHOUT CLAIM TO ANY PARTICULAR  
FONT, STYLE, SIZE, OR COLOR.

FOR: ANTIMICROBIAL DISINFECTANT SPRAY  
FOR SANITARY PURPOSES, IN CLASS 5 (U.S. CLS.  
6, 18, 44, 46, 51 AND 52).

SER. NO. 76-678,296, FILED 6-15-2007.

FIRST USE 1-1-2007; IN COMMERCE 1-1-2007.

MICHAEL KAZAZIAN, EXAMINING ATTORNEY

**Int. Cls.: 9, 14 and 18**

**Prior U.S. Cls.: 1, 2, 3, 21, 22, 23, 26, 27, 28, 36, 38, 41  
and 50**

**Reg. No. 3,464,959**

**United States Patent and Trademark Office**

**Registered July 15, 2008**

**TRADEMARK  
PRINCIPAL REGISTER**

FASHIONATION 

MERKURY INNOVATIONS LLC (NEW YORK  
LTD LIAB CO)  
180 MAIDEN LANE, 28TH FLOOR  
NEW YORK, NY 10038

FOR: COMPUTER PERIPHERALS; KEYBOARDS;  
COMPUTER KEYPADS; COMPUTER MICE; MO-  
BILE COMPUTING ACCESSORIES, NAMELY, BAT-  
TERIES, BATTERY CHARGERS, BATTERY  
RECHARGERS, ADAPTERS, ELECTRIC AND  
PLUG CONNECTORS, ELECTRICAL CABLES;  
COMPUTERS; NOTEBOOK COMPUTERS; COMPU-  
TER HUBS; COMPUTER CARRYING CASES; BAGS,  
CASES AND POUCHES FOR USE WITH COMPU-  
TERS, CAMERAS, PRINTERS, TELEPHONES,  
CELLPHONES AND OTHER PORTABLE ELECTRO-  
NIC EQUIPMENT, NAMELY, MP3 PLAYERS AND  
DIGITAL CAMERAS; DIGITAL PHOTO FRAMES  
FOR DISPLAYING DIGITAL PICTURES, VIDEO  
CLIPS AND MUSIC; CAMERA TRIPODS; CD STO-  
RAGE WALLETS; AUDIO SPEAKERS; HEAD-  
PHONES; HEADSETS FOR USE WITH  
COMPUTERS AND TELEPHONES; RADIOS INCOR-  
PORATING CLOCKS; RADIO AND TELEVISION  
TRANSMITTERS; ELECTRONIC GAME PRO-

GRAMS AND SOFTWARE; CASES FOR PHOTO-  
GRAPHIC APPARATUS AND SOUND RECORDING  
INSTRUMENTS, IN CLASS 9 (U.S. CLS. 21, 23, 26, 36  
AND 38).

FIRST USE 12-20-2006; IN COMMERCE 12-20-2006.

FOR: CLOCKS INCORPORATING RADIOS;  
ALARM CLOCKS; CLOCKS; AND CASES FOR  
CLOCKS, IN CLASS 14 (U.S. CLS. 2, 27, 28 AND 50).

FIRST USE 12-20-2006; IN COMMERCE 12-20-2006.

FOR: ATTACHÉ CASES; BRIEFCASES; TRAVEL-  
ING BAGS AND CASES; SUITCASES; KEY-CASES;  
LEATHER BAGS FOR MERCHANDISE PACKA-  
GING; SHOULDER STRAPS, IN CLASS 18 (U.S.  
CLS. 1, 2, 3, 22 AND 41).

FIRST USE 12-20-2006; IN COMMERCE 12-20-2006.

SER. NO. 76-678,419, FILED 6-19-2007.

CYNTHIA SLOAN, EXAMINING ATTORNEY

**Int. Cl.: 41**

**Prior U.S. Cls.: 100, 101 and 107**

**United States Patent and Trademark Office**

**Reg. No. 3,464,960**

**Registered July 15, 2008**

**SERVICE MARK  
PRINCIPAL REGISTER**

**THE MAD-LADS**

WILLIAMS, RICHARD W. (UNITED STATES IN-  
DIVIDUAL)  
310 BRAKEWOOD DRIVE  
MEMPHIS, TN 38109

FOR: ENTERTAINMENT SERVICES, NAMELY,  
LIVE PERFORMANCES RENDERED BY A VOCAL  
GROUP, IN CLASS 41 (U.S. CLS. 100, 101 AND 107).

FIRST USE 11-4-1982; IN COMMERCE 11-4-1982.

THE MARK CONSISTS OF STANDARD CHAR-  
ACTERS WITHOUT CLAIM TO ANY PARTICULAR  
FONT, STYLE, SIZE, OR COLOR.

OWNER OF U.S. REG. NO. 1,377,644.

SER. NO. 76-678,901, FILED 6-29-2007.

RAMONA ORTIGA, EXAMINING ATTORNEY

**Int. Cls.: 9 and 41**

**Prior U.S. Cls.: 21, 23, 26, 36, 38, 100, 101 and 107**

**United States Patent and Trademark Office**

**Reg. No. 3,464,961**

**Registered July 15, 2008**

**TRADEMARK  
SERVICE MARK  
PRINCIPAL REGISTER**



BARKING LIZARDS TECHNOLOGIES (TEXAS CORPORATION)  
1751 INTERNATIONAL PKWY, STE 115  
RICHARDSON, TX 75081

FOR: COMPUTER SOFTWARE FOR USE IN PLAYING INTERACTIVE COMPUTER, ELECTRONIC, AND VIDEO CONSOLE GAMES; COMPUTER SOFTWARE FOR USE IN PLAYING INTERACTIVE GAMES ON HANDHELD DEVICES SUCH AS PORTABLE GAME CONSOLES, CELLULAR PHONES, AND OTHER WIRELESS DEVICES; COMPUTER SOFTWARE FOR USE IN PLAYING INTERACTIVE COMPUTER, ELECTRONIC, AND VIDEO CONSOLE GAMES STORED ON CDS, DVDS, GAME CARTRIDGES, AND OTHER GAME DISCS; PROVIDING INTERACTIVE DOWNLOADABLE ENTERTAINMENT SOFTWARE FOR COMPUTERS, CONSOLES, VIDEO GAMES, AND PORTABLE DEVICES; COMPUTER SOFTWARE FOR USE IN PLAYING GAMES STORED ON CDS, DVDS, GAME CARTRIDGES, AND OTHER GAME DISCS, IN CLASS 9 (U.S. CLS. 21, 23, 26, 36 AND 38).

FIRST USE 2-7-2005; IN COMMERCE 2-5-2005.

FOR: ENTERTAINMENT SERVICES, NAMELY, PROVIDING INFORMATION ON-LINE RELATING TO COMPUTER GAMES, IN CLASS 41 (U.S. CLS. 100, 101 AND 107).

FIRST USE 2-7-2005; IN COMMERCE 2-7-2005.

THE COLOR(S) BLACK, WHITE, GREEN, YELLOW, AND YELLOW-GREEN IS/ARE CLAIMED AS A FEATURE OF THE MARK.

THE MARK CONSISTS OF A WHITE LIZARD IN THE FORM OF A VIDEO GAME CONTROLLER WITH A BLACK BORDER AND GREEN CONTROLLER BUTTONS ON A TILED GRADIENT BACKGROUND THAT TRANSITIONS FROM GREEN ON THE LEFT TO YELLOW ON THE RIGHT. THE WORDS "BARKING LIZARDS" APPEAR IN ALL CAPITAL LETTERS ABOVE AND BELOW THE DEPICTION OF THE LIZARD ON A BLACK BACKGROUND, WITH "BARKING" ON THE TOP WITH A GRADIENT TRANSITION FROM YELLOW ON THE TOP TO GREEN ON THE BOTTOM, AND "LIZARDS" ON THE BOTTOM TRANSITIONING FROM GREEN ON THE TOP TO YELLOW ON THE BOTTOM. THE WHITE BACKGROUND OUTSIDE OF THE LETTERS AND DEPICTION OF THE LIZARD IS NOT CLAIMED AS A FEATURE OF THE MARK.

SER. NO. 76-679,009, FILED 7-2-2007.

KAREN K. BUSH, EXAMINING ATTORNEY

**Int. Cl.: 13**

**Prior U.S. Cls.: 2 and 9**

**United States Patent and Trademark Office**

**Reg. No. 3,464,962**

**Registered July 15, 2008**

**TRADEMARK  
PRINCIPAL REGISTER**

**SUPERIOR SEALPAC**

SUPERIOR SIGNAL COMPANY, INC. (NEW JERSEY CORPORATION)  
WEST GREYSTONE ROAD  
OLD BRIDGE, NJ 08857

NO CLAIM IS MADE TO THE EXCLUSIVE RIGHT TO USE "SUPERIOR" , APART FROM THE MARK AS SHOWN.

FOR: SMOKE BOMBS, IN CLASS 13 (U.S. CLS. 2 AND 9).

SER. NO. 76-679,321, FILED 7-9-2007.

FIRST USE 9-30-1983; IN COMMERCE 9-30-1983.

MARILYN IZZI, EXAMINING ATTORNEY

**Int. Cl.: 32**

**Prior U.S. Cls.: 45, 46 and 48**

**Reg. No. 3,464,963**

**United States Patent and Trademark Office**

**Registered July 15, 2008**

**TRADEMARK  
PRINCIPAL REGISTER**

**MORNING ORANGE**

4C FOODS CORPORATION (NEW YORK COR-  
PORATION)  
580 FOUNTAIN AVENUE  
BROOKLYN, NY 11208

FOR: POWDERED DRY DRINK MIXES FOR  
FLAVORED ORANGE DRINKS, IN CLASS 32 (U.S.  
CLS. 45, 46 AND 48).

FIRST USE 2-20-2007; IN COMMERCE 2-20-2007.

THE MARK CONSISTS OF STANDARD CHAR-  
ACTERS WITHOUT CLAIM TO ANY PARTICULAR  
FONT, STYLE, SIZE, OR COLOR.

NO CLAIM IS MADE TO THE EXCLUSIVE  
RIGHT TO USE "ORANGE", APART FROM THE  
MARK AS SHOWN.

SER. NO. 76-679,327, FILED 7-10-2007.

TRACY CROSS, EXAMINING ATTORNEY

**Int. Cls.: 9 and 16**

**Prior U.S. Cls.: 2, 5, 21, 22, 23, 26, 29, 36, 37, 38 and 50**

**Reg. No. 3,464,964**

**United States Patent and Trademark Office**

**Registered July 15, 2008**

**TRADEMARK  
PRINCIPAL REGISTER**

**GRUPO NELSON**

THOMAS NELSON, INC. (TENNESSEE CORPORATION)  
P.O. BOX 141000  
NASHVILLE, TN 372141000

FOR: PRERECORDED AUDIO AND VIDEO PRODUCTS, NAMELY, AUDIO AND VIDEO COMPACT DISCS, CASSETTE TAPES, CD-ROMS, AND DVDS FEATURING BIBLE TOPICS, RELIGION, LEADERSHIP, BUSINESS TOPICS, INSPIRATIONAL TOPICS, CHILDREN'S STORIES, AND MUSIC, IN CLASS 9 (U.S. CLS. 21, 23, 26, 36 AND 38).

FIRST USE 10-20-2006; IN COMMERCE 10-20-2006.

FOR: BIBLES, BOOKS FEATURING PARENTING AND FAMILY ISSUES, PERSONAL FINANCE, HEALTH AND FITNESS, SELF-HELP, POPULAR CULTURE, RELIGIOUS TOPICS, LEADERSHIP TOPICS, VIDEO TOPICS, INSPIRATIONAL TOPICS,

AND CHILDREN'S STORIES, IN CLASS 16 (U.S. CLS. 2, 5, 22, 23, 29, 37, 38 AND 50).

FIRST USE 10-20-2006; IN COMMERCE 10-20-2006.

THE MARK CONSISTS OF STANDARD CHARACTERS WITHOUT CLAIM TO ANY PARTICULAR FONT, STYLE, SIZE, OR COLOR.

NO CLAIM IS MADE TO THE EXCLUSIVE RIGHT TO USE "GRUPO", APART FROM THE MARK AS SHOWN.

THE ENGLISH TRANSLATION OF THE WORD "GRUPO" IN THE MARK IS GROUP.

SER. NO. 76-679,789, FILED 7-23-2007.

YAT SYE, LEE, EXAMINING ATTORNEY

**Int. Cl.: 9**

**Prior U.S. Cls.: 21, 23, 26, 36 and 38**

**United States Patent and Trademark Office**

**Reg. No. 3,464,965**

**Registered July 15, 2008**

**TRADEMARK  
PRINCIPAL REGISTER**

**CUBIS**

SARTORIUS AG (FED REP GERMANY CORPORATION)  
WEENDER LANDSTRASSE 94-108  
GOETTINGEN, FED REP GERMANY D-37075

FOR: SCIENTIFIC APPARATUS, NAMELY, COMPACT WEIGHING SCALES FOR INDUSTRIAL AND LABORATORY USE, IN CLASS 9 (U.S. CLS. 21, 23, 26, 36 AND 38).

THE MARK CONSISTS OF STANDARD CHARACTERS WITHOUT CLAIM TO ANY PARTICULAR FONT, STYLE, SIZE, OR COLOR.

PRIORITY CLAIMED UNDER SEC. 44(D) ON ERPN CMNTY TM OFC APPLICATION NO. 005777677, FILED 3-22-2007, REG. NO. 005777677, DATED 1-14-2008, EXPIRES 3-22-2017.

SER. NO. 76-679,942, FILED 7-26-2007.

SUZANNE BLANE, EXAMINING ATTORNEY



**Int. Cls.: 14, 18 and 25**

**Prior U.S. Cls.: 1, 2, 3, 22, 27, 28, 39, 41 and 50**

**United States Patent and Trademark Office**

**Reg. No. 3,464,966**

**Registered July 15, 2008**

**TRADEMARK  
PRINCIPAL REGISTER**



**VIRGINS  
SAINTS & ANGELS**

VSA DESIGNS, INC. (NEVADA CORPORATION)  
20335 VENTURA BLVD., SUITE 430  
WOODLAND HILLS, CA 91364

FOR: JEWELRY, IN CLASS 14 (U.S. CLS. 2, 27, 28  
AND 50).

FIRST USE 6-1-2001; IN COMMERCE 6-1-2001.

FOR: LEATHER GOODS, NAMELY, PURSES,  
WALLETS, DUFFLE BAGS, IN CLASS 18 (U.S. CLS.  
1, 2, 3, 22 AND 41).

FIRST USE 6-1-2001; IN COMMERCE 6-1-2001.

FOR: CLOTHING, NAMELY, PANTS, SHIRTS,  
SKIRTS, BLOUSES, SWEATERS, HATS, SHOES, IN  
CLASS 25 (U.S. CLS. 22 AND 39).

FIRST USE 6-1-2001; IN COMMERCE 6-1-2001.

THE MARK CONSISTS OF A HEART CONTAIN-  
ING THE LETTERS "SVA" WITH A LEAF EXTEND-  
ING FROM THE TOP OF THE HEART. BELOW THE  
GRAPHIC ARE THE WORDS "VIRGINS SAINTS &  
ANGLES".

SER. NO. 76-680,018, FILED 7-30-2007.

ALYSSA PALADINO, EXAMINING ATTORNEY

**Int. Cl.: 18**

**Prior U.S. Cls.: 1, 2, 3, 22 and 41**

**United States Patent and Trademark Office**

**Reg. No. 3,464,967**

**Registered July 15, 2008**

**TRADEMARK  
PRINCIPAL REGISTER**



X-CLUSIVE TRADING (ARIZONA CORPORATION)  
3033 N 35TH AVE STE 3  
PHOENIX, AZ 85017

THE ENGLISH TRANSLATION OF THE WORD  
"VIA NOVA" IN THE MARK IS "NEW WAY".

FOR: WOMEN'S HANDBAGS AND PURSES, IN  
CLASS 18 (U.S. CLS. 1, 2, 3, 22 AND 41).

SER. NO. 76-680,259, FILED 8-3-2007.

FIRST USE 8-1-2006; IN COMMERCE 8-1-2006.

DAYNA BROWNE, EXAMINING ATTORNEY

**Int. Cl.: 34**

**Prior U.S. Cls.: 2, 8, 9 and 17**

**United States Patent and Trademark Office**

**Reg. No. 3,464,968**

**Registered July 15, 2008**

---

**TRADEMARK  
PRINCIPAL REGISTER**

**FLOR DE NICARAGUA**

JOYA DE NICARAGUA S.A. (NICARAGUA CORPORATION)  
DEL PORTON DEL HOSPITAL  
EL RETIRO, 2C AL LAGO  
MANAGUA, NICARAGUA

FOR: CIGARS, IN CLASS 34 (U.S. CLS. 2, 8, 9 AND 17).

FIRST USE 2-25-2002; IN COMMERCE 2-25-2002.

THE MARK CONSISTS OF STANDARD CHARACTERS WITHOUT CLAIM TO ANY PARTICULAR FONT, STYLE, SIZE, OR COLOR.

NO CLAIM IS MADE TO THE EXCLUSIVE RIGHT TO USE "NICARAGUA", APART FROM THE MARK AS SHOWN.

THE ENGLISH TRANSLATION OF THE MARK IS FLOWER OF NICARAGUA.

SER. NO. 76-680,275, FILED 8-3-2007.

LEIGH CAROLINE CASE, EXAMINING ATTORNEY

**Int. Cl.: 41**

**Prior U.S. Cls.: 100, 101 and 107**

**United States Patent and Trademark Office**

**Reg. No. 3,464,969**

**Registered July 15, 2008**

**SERVICE MARK  
PRINCIPAL REGISTER**



CENTER FOR THE ART OF TRANSLATION  
(CALIFORNIA NON-PROFIT CORPORATION)  
35 STILLMAN STREET, SUITE 201  
SAN FRANCISCO, CA 94107

FOR: EDUCATIONAL SERVICES, NAMELY,  
PROVIDING CLASSROOM PROGRAMS FOR ELE-  
MENTARY AND MIDDLE SCHOOLS IN THE SUB-  
JECTS OF WRITING, LITERATURE, POETRY, AND  
TRANSLATION, IN CLASS 41 (U.S. CLS. 100, 101  
AND 107).

FIRST USE 0-0-2005; IN COMMERCE 0-0-2005.

NO CLAIM IS MADE TO THE EXCLUSIVE  
RIGHT TO USE "POETRY", APART FROM THE  
MARK AS SHOWN.

SER. NO. 76-680,453, FILED 8-8-2007.

REBECCA SMITH, EXAMINING ATTORNEY

Int. Cl.: 14

Prior U.S. Cls.: 2, 27, 28 and 50

United States Patent and Trademark Office

Reg. No. 3,464,970

Registered July 15, 2008

TRADEMARK  
PRINCIPAL REGISTER



TRACY ZELLER ENTERPRISES, INC. (INDIANA CORPORATION)  
111 S. RED BANK ROAD  
EVANSVILLE, IN 47712

FOR: JEWELRY, NAMELY, TIE TACKS, CHARMS AND PENDANTS IN THE DESIGN OF MINIATURE HAND REPRODUCTIONS, IN CLASS 14 (U.S. CLS. 2, 27, 28 AND 50).

FIRST USE 8-4-2006; IN COMMERCE 8-4-2006.

NO CLAIM IS MADE TO THE EXCLUSIVE RIGHT TO USE "LITTLE HANDS" OR THE DESIGN

OF THE HANDPRINTS, APART FROM THE MARK AS SHOWN.

THE MARK CONSISTS OF THE WORDS "WEE LITTLE HANDS" IN LOWER CASE LETTERS WITH THE WORD "LITTLE" SITUATED ADJACENT AND DIAGONAL TO THE WORD "WEE" WITH TWO CHILD-LIKE HANDPRINTS SITUATED TO THE RIGHT OF THE LITERAL ELEMENT OF THE MARK.

SER. NO. 76-680,463, FILED 8-8-2007.

BONNIE LUKEN, EXAMINING ATTORNEY

Int. Cl.: 3

Prior U.S. Cls.: 1, 4, 6, 50, 51 and 52

United States Patent and Trademark Office

Reg. No. 3,464,971

Registered July 15, 2008

TRADEMARK  
PRINCIPAL REGISTER

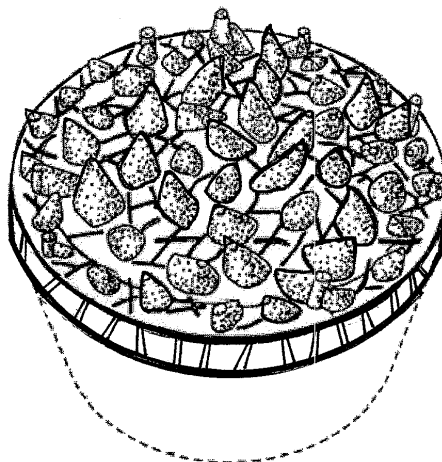

INDUSTRIAS WET LINE S.A. DE C.V. (MEXICO CORPORATION)  
FRANCISCO I MADERO 40  
GUADALAJARA, MEXICO 44680

FOR: STYLING GEL FOR HAIR, IN CLASS 3 (U.S. CLS. 1, 4, 6, 50, 51 AND 52).

FIRST USE 7-0-2005; IN COMMERCE 7-0-2005.

THE STIPPLING IS FOR SHADING PURPOSES.

THE MARK CONSISTS OF THE CONFIGURATION OF A CONTAINER LID FOR THE GOODS.

THE TOP OF THE CONTAINER IS COMPRISED OF THREE-DIMENSIONAL, TRIANGULAR CONE-LIKE DESIGNS THAT RISE UP FROM THE BASE OF THE LID TO RESEMBLE STIFFLY-SPIKED HAIR. THE RIM OF THE CONTAINER IS COMPRISED OF IRREGULAR VERTICAL LINES. THE MATTER SHOWN BY THE BROKEN LINES IS NOT A PART OF THE MARK AND SERVES ONLY TO SHOW THE MARK'S POSITION ON THE CONTAINER FOR THE GOODS.

SER. NO. 76-680,492, FILED 8-9-2007.

AMY GEARIN, EXAMINING ATTORNEY

**Int. Cl.: 1**

**Prior U.S. Cls.: 1, 5, 6, 10, 26 and 46**

**Reg. No. 3,464,972**

**United States Patent and Trademark Office**

**Registered July 15, 2008**

---

**TRADEMARK  
PRINCIPAL REGISTER**

**RHIZO FUEL**

ROOTGROW, INC. (NEW YORK CORPORATION)

135 ALLEN BLVD., SUITE #1  
FARMINGDALE, NY 11735

FOR: FERTILIZER COMPOSED OF BIO-STIMULANT, BENEFICIAL BACTERIA, FUNGI AND MYCORRHIZAL THAT PROMOTES THE GROWTH AND HEALTH OF TREES AND SHRUBS, IN CLASS 1 (U.S. CLS. 1, 5, 6, 10, 26 AND 46).

FIRST USE 2-1-2007; IN COMMERCE 2-1-2007.

THE MARK CONSISTS OF STANDARD CHARACTERS WITHOUT CLAIM TO ANY PARTICULAR FONT, STYLE, SIZE, OR COLOR.

SER. NO. 76-680,553, FILED 8-10-2007.

KAREN K. BUSH, EXAMINING ATTORNEY

**Int. Cl.: 41**

**Prior U.S. Cls.: 100, 101 and 107**

**United States Patent and Trademark Office**

**Reg. No. 3,464,973**

**Registered July 15, 2008**

**SERVICE MARK  
PRINCIPAL REGISTER**

**Hogwash**

NELSON , SCOTT ALLAN (UNITED STATES  
INDIVIDUAL)  
2232 YOSEMITE DR. # 203  
LOS ANGELES, CA 90041

THE COLOR(S) RED IS/ARE CLAIMED AS A  
FEATURE OF THE MARK.

FOR: ENTERTAINMENT IN THE NATURE OF  
LIVE PERFORMANCES BY SCANTILY DRESSED,  
TOPLESS, AND/OR NAKED WOMEN CLEANING  
MOTORCYCLES INSIDE A BAR, SALOON, CASINO,  
HOTEL, NIGHTCLUB, OR OUTDOORS, IN CLASS  
41 (U.S. CLS. 100, 101 AND 107).

THE MARK CONSISTS OF THE TERM, "HOG-  
WASH", IN RED STYLIZED LETTERS.

SER. NO. 76-680,700, FILED 8-15-2007.

FIRST USE 2-3-2007; IN COMMERCE 2-3-2007.

BARBARA A. GOLD, EXAMINING ATTORNEY



**Int. Cl.: 41**

**Prior U.S. Cls.: 100, 101 and 107**

**United States Patent and Trademark Office**

**Reg. No. 3,464,974**

**Registered July 15, 2008**

**SERVICE MARK  
PRINCIPAL REGISTER**



**Bottom-Line Leadership**

PCI GLOBAL, INC. (NEW YORK CORPORATION)  
411 HACKENSACK AVENUE  
HACKENSACK, NJ 07601

FOR: EDUCATION SERVICES, NAMELY, CONDUCTING SEMINARS, WORKSHOPS AND CONFERENCES FOR CORPORATE EXECUTIVES IN THE FIELD OF BUSINESS MANAGEMENT, IN CLASS 41 (U.S. CLS. 100, 101 AND 107).

FIRST USE 7-20-2001; IN COMMERCE 7-20-2001.

OWNER OF U.S. REG. NO. 2,469,187.

NO CLAIM IS MADE TO THE EXCLUSIVE RIGHT TO USE "BOTTOM-LINE LEADERSHIP", APART FROM THE MARK AS SHOWN.

SER. NO. 76-680,723, FILED 8-15-2007.

BARBARA GAYNOR, EXAMINING ATTORNEY

**Int. Cl.: 36**

**Prior U.S. Cls.: 100, 101 and 102**

**United States Patent and Trademark Office**

**Reg. No. 3,464,975**

**Registered July 15, 2008**

**SERVICE MARK  
PRINCIPAL REGISTER**

**PERFORMANCE TRUST MARKET MINUTE**

PERFORMANCE TRUST CAPITAL PARTNERS,  
LLC (ILLINOIS LTD LIAB CO)  
500 WEST MADISON STREET - SUITE 350  
CHICAGO, IL 60661

FOR: PROVIDING INFORMATION IN THE  
FIELD OF FIXED-INCOME FINANCIAL MARKETS  
AND SECURITIES TO FINANCIAL INSTITUTIONS,  
IN CLASS 36 (U.S. CLS. 100, 101 AND 102).

FIRST USE 5-10-2005; IN COMMERCE 5-10-2005.

THE MARK CONSISTS OF STANDARD CHAR-  
ACTERS WITHOUT CLAIM TO ANY PARTICULAR  
FONT, STYLE, SIZE, OR COLOR.

OWNER OF U.S. REG. NO. 3,268,845.

SER. NO. 76-680,726, FILED 8-16-2007.

ALEXANDER L. POWERS, EXAMINING ATTOR-  
NEY

**Int. Cl.: 5**

**Prior U.S. Cls.: 6, 18, 44, 46, 51 and 52**

**United States Patent and Trademark Office**

**Reg. No. 3,464,976**

**Registered July 15, 2008**

**TRADEMARK  
PRINCIPAL REGISTER**

**HYDROFERA BLUE**

HYDROFERA, LLC (CONNECTICUT LTD LIAB  
CO)  
322 MAIN STREET  
WILIMANTIC, CT 06226

OWNER OF U.S. REG. NO. 2,332,072.

FOR: MEDICAL SPONGES, NAMELY, WOUND  
DRESSINGS; CONTRACEPTIVE SPONGES, IN  
CLASS 5 (U.S. CLS. 6, 18, 44, 46, 51 AND 52).

NO CLAIM IS MADE TO THE EXCLUSIVE  
RIGHT TO USE "BLUE", APART FROM THE MARK  
AS SHOWN.

FIRST USE 3-1-2003; IN COMMERCE 3-1-2003.

SER. NO. 76-680,834, FILED 8-17-2007.

THE MARK CONSISTS OF STANDARD CHAR-  
ACTERS WITHOUT CLAIM TO ANY PARTICULAR  
FONT, STYLE, SIZE, OR COLOR.

AISHA SALEM, EXAMINING ATTORNEY

**Int. Cl.: 5**

**Prior U.S. Cls.: 6, 18, 44, 46, 51 and 52**

**United States Patent and Trademark Office**

**Reg. No. 3,464,977**

**Registered July 15, 2008**

**TRADEMARK  
PRINCIPAL REGISTER**

**METABOOSTER**

THE SUNRIDER CORPORATION (UTAH CORPORATION), DBA SUNRIDER INTERNATIONAL  
1625 ABALONE AVENUE  
TORRANCE, CA 90501

FOR: NUTRITIONAL SUPPLEMENTS; DIETARY SUPPLEMENTS; HERBAL SUPPLEMENTS IN THE FORM OF TABLETS, CAPSULES, LIQUID, POWDERS, AND GEL CAPSULES; VITAMINS; AND HERBAL NUTRITIONAL SUPPLEMENTS, IN CLASS 5 (U.S. CLS. 6, 18, 44, 46, 51 AND 52).

FIRST USE 3-0-2006; IN COMMERCE 3-0-2006.

THE MARK CONSISTS OF STANDARD CHARACTERS WITHOUT CLAIM TO ANY PARTICULAR FONT, STYLE, SIZE, OR COLOR.

SER. NO. 76-681,153, FILED 8-27-2007.

KAREN BRACEY, EXAMINING ATTORNEY

**Int. Cls.: 9 and 41**

**Prior U.S. Cls.: 21, 23, 26, 36, 38, 100, 101 and 107**

**United States Patent and Trademark Office**

**Reg. No. 3,464,978**

**Registered July 15, 2008**

**TRADEMARK  
SERVICE MARK  
PRINCIPAL REGISTER**

**INTEGRATIVE RESTORATION**

MILLER, RICHARD C. (UNITED STATES INDIVIDUAL)  
305 RIVIERA CIRCLE  
LARKSPUR, CA 94939

FOR: COMPACT DISCS AND DVDS FEATURING INSTRUCTION IN THE FIELD OF YOGA, IN CLASS 9 (U.S. CLS. 21, 23, 26, 36 AND 38).

FIRST USE 11-1-2005; IN COMMERCE 11-1-2005.

FOR: EDUCATIONAL SERVICES, NAMELY, CONDUCTION OF CLASSES, SEMINARS AND TEACHER TRAINING IN THE FIELD OF YOGA AND

DISTRIBUTING COURSE MATERIALS IN CONNECTION THEREWITH; YOGA INSTRUCTION, IN CLASS 41 (U.S. CLS. 100, 101 AND 107).

FIRST USE 11-1-2005; IN COMMERCE 11-1-2005.

THE MARK CONSISTS OF STANDARD CHARACTERS WITHOUT CLAIM TO ANY PARTICULAR FONT, STYLE, SIZE, OR COLOR.

SER. NO. 76-681,199, FILED 8-27-2007.

COLLEEN KEARNEY, EXAMINING ATTORNEY

**Int. Cls.: 9 and 41**

**Prior U.S. Cls.: 21, 23, 26, 36, 38, 100, 101 and 107**

**Reg. No. 3,464,979**

**United States Patent and Trademark Office**

**Registered July 15, 2008**

**TRADEMARK  
SERVICE MARK  
PRINCIPAL REGISTER**

**INTEGRATIVE RESTORATION IREST**

MILLER, RICHARD C. (UNITED STATES INDIVIDUAL)  
305 RIVIERA CIRCLE  
LARKSPUR, CA 94939

FOR: COMPACT DISCS AND DVDS FEATURING INSTRUCTION IN THE FIELD OF YOGA, IN CLASS 9 (U.S. CLS. 21, 23, 26, 36 AND 38).

FIRST USE 11-1-2005; IN COMMERCE 11-1-2005.

FOR: EDUCATIONAL SERVICES, NAMELY, CONDUCTION OF CLASSES, SEMINARS AND TEACHER TRAINING IN THE FIELD OF YOGA AND

DISTRIBUTING COURSE MATERIALS IN CONNECTION THEREWITH; YOGA INSTRUCTION, IN CLASS 41 (U.S. CLS. 100, 101 AND 107).

FIRST USE 11-1-2005; IN COMMERCE 11-1-2005.

THE MARK CONSISTS OF STANDARD CHARACTERS WITHOUT CLAIM TO ANY PARTICULAR FONT, STYLE, SIZE, OR COLOR.

SER. NO. 76-681,200, FILED 8-27-2007.

COLLEEN KEARNEY, EXAMINING ATTORNEY

**Int. Cl.: 7**

**Prior U.S. Cls.: 13, 19, 21, 23, 31, 34 and 35**

**United States Patent and Trademark Office**

**Reg. No. 3,464,980**

**Registered July 15, 2008**

**TRADEMARK  
PRINCIPAL REGISTER**

**HYD-RO-AC**

MICROMATIC LLC (DELAWARE LTD LIAB CO)  
525 BERNE STREET  
BERNE, IN 46711

THE MARK CONSISTS OF STANDARD CHAR-  
ACTERS WITHOUT CLAIM TO ANY PARTICULAR  
FONT, STYLE, SIZE, OR COLOR.

FOR: HYDRAULIC ROTARY ACTUATORS, IN  
CLASS 7 (U.S. CLS. 13, 19, 21, 23, 31, 34 AND 35).

SER. NO. 76-681,237, FILED 8-28-2007.

FIRST USE 9-8-1986; IN COMMERCE 9-8-1986.

KELLEY WELLS, EXAMINING ATTORNEY

**Int. Cl.: 38**

**Prior U.S. Cls.: 100, 101 and 104**

**United States Patent and Trademark Office**

**Reg. No. 3,464,981**

**Registered July 15, 2008**

**SERVICE MARK  
PRINCIPAL REGISTER**

**APA PSYCNET**

AMERICAN PSYCHOLOGICAL ASSOCIATION  
(D.C. NOT-FOR-PROFIT ASSOCIATION)  
750 FIRST STREET, N.E.  
WASHINGTON, DC 200024242

FOR: PROVIDING ACCESS TO DATABASES FEATURING INFORMATION IN THE FIELDS OF BEHAVIORAL AND SOCIAL SCIENCES; PROVIDING MULTIPLE USER ACCESS TO GLOBAL COMPUTER INFORMATION NETWORKS FOR THE TRANSFER AND DISSEMINATION OF INFORMATION IN THE FIELDS OF BEHAVIORAL AND SOCIAL SCIENCES, IN CLASS 38 (U.S. CLS. 100, 101 AND 104).

FIRST USE 3-13-2007; IN COMMERCE 6-23-2007.

THE MARK CONSISTS OF STANDARD CHARACTERS WITHOUT CLAIM TO ANY PARTICULAR FONT, STYLE, SIZE, OR COLOR.

OWNER OF U.S. REG. NOS. 1,860,897, 1,993,039 AND OTHERS.

SER. NO. 76-681,315, FILED 8-29-2007.

BERYL GARDNER, EXAMINING ATTORNEY



**Int. Cl.: 9**

**Prior U.S. Cls.: 21, 23, 26, 36 and 38**

**United States Patent and Trademark Office**

**Reg. No. 3,464,982**

**Registered July 15, 2008**

**TRADEMARK  
PRINCIPAL REGISTER**

**FINDERS EXPRESS COMPUTERS**

FINDERS EXPRESS COMPUTERS, INC. (OKLAHOMA CORPORATION)  
216 NORTH MAIN ST.  
SAND SPRINGS, OK 74063

FOR: COMPUTERS, NAMELY, DESKTOPS AND LAPTOPS, IN CLASS 9 (U.S. CLS. 21, 23, 26, 36 AND 38).

FIRST USE 4-1-1998; IN COMMERCE 4-1-1998.

THE MARK CONSISTS OF STANDARD CHARACTERS WITHOUT CLAIM TO ANY PARTICULAR FONT, STYLE, SIZE, OR COLOR.

NO CLAIM IS MADE TO THE EXCLUSIVE RIGHT TO USE "EXPRESS COMPUTERS", APART FROM THE MARK AS SHOWN.

SER. NO. 76-681,474, FILED 9-4-2007.

KELLEY WELLS, EXAMINING ATTORNEY

**Int. Cl.: 37**

**Prior U.S. Cls.: 100, 103 and 106**

**United States Patent and Trademark Office**

**Reg. No. 3,464,983**

**Registered July 15, 2008**

**SERVICE MARK  
PRINCIPAL REGISTER**

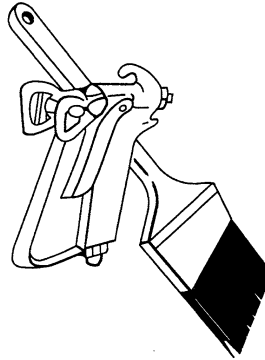

SWEENEY, LARRY L. (UNITED STATES INDIVIDUAL)  
253 EAST 4TH STREET  
BATTLE MOUNTAIN, NV 89820

PAINT SPRAY GUN AND BRUSH DESIGN

FOR: PAINTING SERVICES, IN CLASS 37 (U.S. CLS. 100, 103 AND 106).

SER. NO. 76-681,656, FILED 9-7-2007.

FIRST USE 11-30-2006; IN COMMERCE 11-30-2006.

ELLEN PERKINS, EXAMINING ATTORNEY

**Int. Cl.: 44**

**Prior U.S. Cls.: 100 and 101**

**United States Patent and Trademark Office**

**Reg. No. 3,464,984**

**Registered July 15, 2008**

**SERVICE MARK  
PRINCIPAL REGISTER**

**CREATING NEW YORK'S MOST BEAUTIFUL SMILES**

FISHMAN ROTH CHASE, LLP (NEW YORK LTD  
LIAB CO)  
220 EAST 63RD ST. LOBBY F  
NEW YORK, NY 10065

THE MARK CONSISTS OF STANDARD CHAR-  
ACTERS WITHOUT CLAIM TO ANY PARTICULAR  
FONT, STYLE, SIZE, OR COLOR.

FOR: DENTISTRY SERVICES PROVIDED IN A  
DENTAL OFFICE, IN CLASS 44 (U.S. CLS. 100 AND  
101).

SER. NO. 76-681,683, FILED 9-10-2007.

FIRST USE 1-0-2007; IN COMMERCE 1-0-2007.

TASHIA BUNCH, EXAMINING ATTORNEY

**Int. Cl.: 20**

**Prior U.S. Cls.: 2, 13, 22, 25, 32 and 50**

**United States Patent and Trademark Office**

**Reg. No. 3,464,985**

**Registered July 15, 2008**

**TRADEMARK  
PRINCIPAL REGISTER**

**RB GORMAN**

MANIFESTO, INC. (ILLINOIS CORPORATION),  
DBA RB GORMAN  
755 NORTH WELLS  
CHICAGO, IL 60610

FOR: FURNITURE, IN CLASS 20 (U.S. CLS. 2, 13,  
22, 25, 32 AND 50).

FIRST USE 10-0-1992; IN COMMERCE 10-0-1992.

THE MARK CONSISTS OF STANDARD CHAR-  
ACTERS WITHOUT CLAIM TO ANY PARTICULAR  
FONT, STYLE, SIZE, OR COLOR.

THE MARK "RB GORMAN" DOES NOT REFER  
TO ANY PARTICULAR INDIVIDUAL.

SER. NO. 76-681,767, FILED 9-12-2007.

ANNE MADDEN, EXAMINING ATTORNEY

**Int. Cl.: 9**

**Prior U.S. Cls.: 21, 23, 26, 36 and 38**

**United States Patent and Trademark Office**

**Reg. No. 3,464,986**

**Registered July 15, 2008**

**TRADEMARK  
PRINCIPAL REGISTER**



LIVIN' & LUVIN', LLC (VIRGINIA LTD LIAB CO)  
1915 S. ADMIRE  
CHOCTAW, OK 73020

THE COLOR(S) RED AND BLACK IS/ARE  
CLAIMED AS A FEATURE OF THE MARK.

FOR: EMERGENCY MEDICAL COMPUTER STO-  
RAGE DEVICES, NAMELY, BRACELET THUMB  
DRIVES FEATURING EMERGENCY MEDICAL  
IDENTIFICATION INFORMATION, IN CLASS 9  
(U.S. CLS. 21, 23, 26, 36 AND 38).

THE MARK CONSISTS OF THE COLOR RED  
APPEARS IN THE HEART DESIGN AND THE  
COLOR BLACK APPEARS IN THE WORDING  
"LUVIN' HEART FAMILY MEDICAL ID".

FIRST USE 6-1-2006; IN COMMERCE 6-1-2006.

SER. NO. 76-682,004, FILED 9-17-2007.

NO CLAIM IS MADE TO THE EXCLUSIVE  
RIGHT TO USE "FAMILY MEDICAL ID", APART  
FROM THE MARK AS SHOWN.

WARREN L. OLANDRIA, EXAMINING ATTOR-  
NEY

**Int. Cls.: 35 and 41**

**Prior U.S. Cls.: 100, 101, 102 and 107**

**United States Patent and Trademark Office**

**Reg. No. 3,464,987**

**Registered July 15, 2008**

**SERVICE MARK  
PRINCIPAL REGISTER**

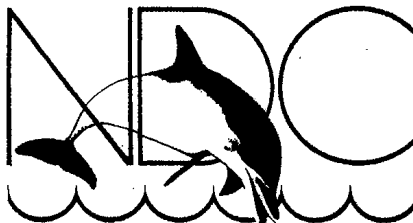

THE DIVERS CHOICE LLC (D.C. LTD LIAB CO)  
4932 WISCONSIN AVENUE, N.W.  
WASHINGTON, DC 20016

FIRST USE 4-1-1980; IN COMMERCE 4-1-1980.

FOR: RETAIL STORE SERVICES FEATURING  
WATERWEAR, DIVING EQUIPMENT, AND UN-  
DERWATER ATHLETIC PRODUCTS, IN CLASS 35  
(U.S. CLS. 100, 101 AND 102).

THE MARK CONSISTS OF A JUMPING DOL-  
PHIN JUMPING THROUGH THE LETTER "D" IN  
THE ACRONYM "NDC" AND WAVY LINES ON  
THE BOTTOM MADE TO LOOK LIKE WATER.

FIRST USE 4-1-1980; IN COMMERCE 4-1-1980.

SER. NO. 76-682,025, FILED 9-17-2007.

FOR: EDUCATIONAL SERVICES, NAMELY,  
CONDUCTING CLASSES IN THE FIELD OF SCUBA  
DIVING, IN CLASS 41 (U.S. CLS. 100, 101 AND 107).

WARREN L. OLANDRIA, EXAMINING ATTOR-  
NEY

**Int. Cl.: 41**

**Prior U.S. Cls.: 100, 101 and 107**

**United States Patent and Trademark Office**

**Reg. No. 3,464,988**

**Registered July 15, 2008**

**SERVICE MARK  
PRINCIPAL REGISTER**

**INYU TRAINING**

JOB CONSULTING, INC (LOUISIANA LIMITED  
LIABILITY CORPORATION)  
316 WEST 15TH AVE  
COVINGTON, LA 70433

FOR: EDUCATIONAL SERVICES, NAMELY,  
CONDUCTING CLASSES, SEMINARS, CONFEREN-  
CES, WORKSHOPS IN THE FIELD OF BUSINESS  
MANAGEMENT AND DISTRIBUTION OF COURSE  
MATERIALS , IN CLASS 41 (U.S. CLS. 100, 101 AND  
107).

FIRST USE 6-1-2007; IN COMMERCE 6-1-2007.

THE MARK CONSISTS OF STANDARD CHAR-  
ACTERS WITHOUT CLAIM TO ANY PARTICULAR  
FONT, STYLE, SIZE, OR COLOR.

NO CLAIM IS MADE TO THE EXCLUSIVE  
RIGHT TO USE "TRAINING", APART FROM THE  
MARK AS SHOWN.

SER. NO. 76-682,027, FILED 9-17-2007.

WARREN L. OLANDRIA, EXAMINING ATTOR-  
NEY

**Int. Cl.: 17**

**Prior U.S. Cls.: 1, 5, 12, 13, 35 and 50**

**Reg. No. 3,464,989**

**United States Patent and Trademark Office**

**Registered July 15, 2008**

**TRADEMARK  
PRINCIPAL REGISTER**

**ULTRACOMP**

TRI-STAR PLASTICS, CORP. (MASSACHUSETTS  
CORPORATION)  
906 BOSTON TURNPIKE  
SHREWSBURY, MA 01545

THE MARK CONSISTS OF STANDARD CHAR-  
ACTERS WITHOUT CLAIM TO ANY PARTICULAR  
FONT, STYLE, SIZE, OR COLOR.

FOR: PLASTIC COMPOSITE MATERIALS IN THE  
FORM OF SHEETS, RODS, AND TUBES USED TO  
MANUFACTURE BEARINGS, IN CLASS 17 (U.S.  
CLS. 1, 5, 12, 13, 35 AND 50).

SER. NO. 76-682,177, FILED 9-21-2007.

FIRST USE 1-1-1995; IN COMMERCE 1-1-1995.

GRETТА YAO, EXAMINING ATTORNEY



**Int. Cl.: 5**

**Prior U.S. Cls.: 6, 18, 44, 46, 51 and 52**

**United States Patent and Trademark Office**

**Reg. No. 3,464,990**

**Registered July 15, 2008**

**TRADEMARK  
PRINCIPAL REGISTER**

**Let Nature Ease Your Pain**

THETA BIOMED. CONSULT. DEVELOP., INC.  
(MASSACHUSETTS CORPORATION)  
14 PARKMAN ST.  
BROOKLINE, MA 02446

THE MARK CONSISTS OF STANDARD CHAR-  
ACTERS WITHOUT CLAIM TO ANY PARTICULAR  
FONT, STYLE, SIZE, OR COLOR.

FOR: DIETARY NUTRICEUTICAL FOR USE IN  
TREATING HUMAN DISEASE, NAMELY, INFLAM-  
MATORY DISEASE, IN CLASS 5 (U.S. CLS. 6, 18, 44,  
46, 51 AND 52).

SER. NO. 76-682,183, FILED 9-21-2007.

FIRST USE 5-14-2001; IN COMMERCE 5-14-2001.

LAURIE MAYES, EXAMINING ATTORNEY

**Int. Cl.: 35**

**Prior U.S. Cls.: 100, 101 and 102**

**United States Patent and Trademark Office**

**Reg. No. 3,464,991**

**Registered July 15, 2008**

**SERVICE MARK  
PRINCIPAL REGISTER**

**SPLENDOR KOI & POND**

ATLANTA KOI & POND, INC. (GEORGIA CORPORATION)  
1552 ROSEWOOD CIRCLE  
MARIETTA, GA 30067

FOR: RETAIL STORE SERVICES FEATURING IMPORTED AND AMERICAN BRED KOI FISH AND FISH AND POND SUPPLIES; ONLINE RETAIL STORE SERVICES FEATURING IMPORTED AND AMERICAN BRED KOI FISH AND FISH AND POND SUPPLIES, IN CLASS 35 (U.S. CLS. 100, 101 AND 102).

FIRST USE 8-27-2007; IN COMMERCE 8-27-2007.

THE MARK CONSISTS OF STANDARD CHARACTERS WITHOUT CLAIM TO ANY PARTICULAR FONT, STYLE, SIZE, OR COLOR.

NO CLAIM IS MADE TO THE EXCLUSIVE RIGHT TO USE "KOI & POND", APART FROM THE MARK AS SHOWN.

THE ENGLISH TRANSLATION OF THE WORD "KOI" IS A JAPANESE WORD MEANING CARP.

SER. NO. 76-682,191, FILED 9-21-2007.

JENNIFER MARTIN, EXAMINING ATTORNEY

**Int. Cl.: 21**

**Prior U.S. Cls.: 2, 13, 23, 29, 30, 33, 40 and 50**

**United States Patent and Trademark Office**

**Reg. No. 3,464,992**

**Registered July 15, 2008**

**TRADEMARK  
PRINCIPAL REGISTER**

*VOGEL* **FINEST KOLINSKY**

RIO PRODUCTS (CALIFORNIA PARTNERSHIP)  
8712 HUMMINGBIRD AVENUE  
FOUNTAIN VALLEY, CA 92708

THE COLOR(S) SILVER IS/ARE CLAIMED AS A  
FEATURE OF THE MARK.

FOR: NAIL BRUSHES, IN CLASS 21 (U.S. CLS. 2,  
13, 23, 29, 30, 33, 40 AND 50).

THE MARK CONSISTS OF THE WORDS "VOGEL  
FINEST KOLINSKY" IN THE COLOR SILVER.

FIRST USE 4-0-2002; IN COMMERCE 4-0-2002.

SER. NO. 76-682,195, FILED 9-21-2007.

NO CLAIM IS MADE TO THE EXCLUSIVE  
RIGHT TO USE "FINEST KOLINSKY", APART  
FROM THE MARK AS SHOWN.

ALYSSA PALADINO, EXAMINING ATTORNEY

**Int. Cl.: 42**

**Prior U.S. Cls.: 100 and 101**

**United States Patent and Trademark Office**

**Reg. No. 3,464,993**

**Registered July 15, 2008**

---

**SERVICE MARK  
PRINCIPAL REGISTER**

**SERVICELOGIQ**

MAHLE POWERTRAIN, INC. (MICHIGAN CORPORATION)  
4100 VINCENTI CT.  
NOVI, MI 48375

FOR: PROVIDING TEMPORARY USE OF ON-LINE NON-DOWNLOADABLE COMPUTER SOFTWARE USED TO DIAGNOSE VEHICLE DEFECTS AND THEIR CAUSES, IN CLASS 42 (U.S. CLS. 100 AND 101).

FIRST USE 5-15-2005; IN COMMERCE 5-15-2005.

THE MARK CONSISTS OF STANDARD CHARACTERS WITHOUT CLAIM TO ANY PARTICULAR FONT, STYLE, SIZE, OR COLOR.

SER. NO. 76-682,238, FILED 9-24-2007.

JENNIFER VASQUEZ, EXAMINING ATTORNEY

**Int. Cl.: 35**

**Prior U.S. Cls.: 100, 101 and 102**

**United States Patent and Trademark Office**

**Reg. No. 3,464,994**

**Registered July 15, 2008**

**SERVICE MARK  
PRINCIPAL REGISTER**

**RINCON MUSICAL**

RINCON MUSICAL INC. (NEW YORK CORPORATION)  
696 10TH AVENUE  
NEW YORK, NY 10019

OWNER OF U.S. REG. NO. 2,575,367.

FOR: RETAIL MUSIC AND INSTRUMENT STORE FEATURING PRE-RECORDED COMPACT DISCS, DVD'S, DVR'S, MUSICAL INSTRUMENTS AND ACCESSORIES, AND DISTRIBUTORSHIPS FOR PRE-RECORDED COMPACT DISCS, DVD'S, DVR'S, MUSICAL INSTRUMENTS AND ACCESSORIES THEREFOR, IN CLASS 35 (U.S. CLS. 100, 101 AND 102).

NO CLAIM IS MADE TO THE EXCLUSIVE RIGHT TO USE "MUSICAL", APART FROM THE MARK AS SHOWN.

THE ENGLISH TRANSLATION OF "RINCON" IS CORNER.

SER. NO. 76-682,301, FILED 9-25-2007.

FIRST USE 11-1-2005; IN COMMERCE 11-1-2005.

PAUL E. FAHRENKOPF, EXAMINING ATTORNEY

**Int. Cl.: 35**

**Prior U.S. Cls.: 100, 101 and 102**

**United States Patent and Trademark Office**

**Reg. No. 3,464,995**

**Registered July 15, 2008**

**SERVICE MARK  
PRINCIPAL REGISTER**

# **PRAISE PROMOS**

THE MICHAEL GROUP, INC. (INDIANA CORPORATION)  
8888 KEYSTONE CROSSING, SUITE 1300  
INDIANAPOLIS, IN 46240

FOR: ENTERTAINMENT MARKETING SERVICES, NAMELY, PROMOTION FOR INDEPENDENT CHRISTIAN RECORDING ARTISTS, IN CLASS 35 (U.S. CLS. 100, 101 AND 102).

FIRST USE 8-6-2007; IN COMMERCE 8-6-2007.

THE MARK CONSISTS OF STANDARD CHARACTERS WITHOUT CLAIM TO ANY PARTICULAR FONT, STYLE, SIZE, OR COLOR.

NO CLAIM IS MADE TO THE EXCLUSIVE RIGHT TO USE "PROMOS", APART FROM THE MARK AS SHOWN.

SER. NO. 76-682,417, FILED 9-28-2007.

MORGAN WYNNE, EXAMINING ATTORNEY

**Int. Cl.: 35**

**Prior U.S. Cls.: 100, 101 and 102**

**United States Patent and Trademark Office**

**Reg. No. 3,464,996**

**Registered July 15, 2008**

**SERVICE MARK  
PRINCIPAL REGISTER**

**CONCERTS FOR KINDNESS**

THE MICHAEL GROUP, INC. (INDIANA CORPORATION)  
8888 KEYSTONE CROSSING, SUITE 1300  
INDIANAPOLIS, IN 46240

FOR: ENTERTAINMENT MARKETING SERVICES, NAMELY, PROMOTION FOR INDEPENDENT CHRISTIAN RECORDING ARTISTS, IN CLASS 35 (U.S. CLS. 100, 101 AND 102).

FIRST USE 8-6-2007; IN COMMERCE 8-6-2007.

THE MARK CONSISTS OF STANDARD CHARACTERS WITHOUT CLAIM TO ANY PARTICULAR FONT, STYLE, SIZE, OR COLOR.

NO CLAIM IS MADE TO THE EXCLUSIVE RIGHT TO USE "CONCERTS", APART FROM THE MARK AS SHOWN.

SER. NO. 76-682,419, FILED 9-28-2007.

MORGAN WYNNE, EXAMINING ATTORNEY

**Int. Cl.: 25**

**Prior U.S. Cls.: 22 and 39**

**United States Patent and Trademark Office**

**Reg. No. 3,464,997**

**Registered July 15, 2008**

**TRADEMARK  
PRINCIPAL REGISTER**

**COMMANDhOSE**

RANDALL S. CORPORATION (WASHINGTON  
CORPORATION)  
1852 1ST STREET  
KIRKLAND, WA 98033

THE MARK CONSISTS OF STANDARD CHAR-  
ACTERS WITHOUT CLAIM TO ANY PARTICULAR  
FONT, STYLE, SIZE, OR COLOR.

FOR: MEN'S, WOMEN'S AND CHILDREN'S NY-  
LON HOSIERY FEATURING IMAGES IN THE  
NATURE OF TATTOO DESIGNS, IN CLASS 25  
(U.S. CLS. 22 AND 39).

SER. NO. 76-682,467, FILED 10-1-2007.

FIRST USE 3-15-2007; IN COMMERCE 3-15-2007.

MELISSA VALLILLO, EXAMINING ATTORNEY



**Int. Cl.: 25**

**Prior U.S. Cls.: 22 and 39**

**United States Patent and Trademark Office**

**Reg. No. 3,464,998**

**Registered July 15, 2008**

**TRADEMARK  
PRINCIPAL REGISTER**

**bARACCI**

FARHAD & GIL MOTAVASSELAN (CALIFORNIA PARTNERSHIP)  
9501 WILSHIRE BOULEVARD  
BEVERLY HILLS, CA 90212

FOR: CLOTHING, NAMELY, TOPS AND BOTTOMS, DESIGNER GOWNS, COCKTAIL DRESSES, SUITS, SHIRTS, FOOTWEAR, HEADWEAR, ALL FOR RETAIL AND WHOLESALE, IN CLASS 25 (U.S. CLS. 22 AND 39).

FIRST USE 5-15-1986; IN COMMERCE 5-15-1986.

SEC. 2(F).

SER. NO. 76-682,663, FILED 10-5-2007.

REBECCA POVARCHUK, EXAMINING ATTORNEY

**Int. Cl.: 25**

**Prior U.S. Cls.: 22 and 39**

**United States Patent and Trademark Office**

**Reg. No. 3,464,999**

**Registered July 15, 2008**

**TRADEMARK  
PRINCIPAL REGISTER**

**BLOODFIST**

ABOLSUTE SOLUTIONS INC (CALIFORNIA  
CORPORATION)  
STE D4 #161  
15555 MAIN ST.  
HESPERIA, CA 923453466

THE MARK CONSISTS OF STANDARD CHAR-  
ACTERS WITHOUT CLAIM TO ANY PARTICULAR  
FONT, STYLE, SIZE, OR COLOR.

FOR: T-SHIRTS, SWEAT SHIRTS, SHORTS, AND  
SWEAT PANTS, IN CLASS 25 (U.S. CLS. 22 AND 39).

SER. NO. 76-682,739, FILED 10-9-2007.

FIRST USE 8-9-2007; IN COMMERCE 8-9-2007.

SIMON TENG, EXAMINING ATTORNEY

Int. Cl.: 25

Prior U.S. Cls.: 22 and 39

**United States Patent and Trademark Office**

**Reg. No. 3,465,000**

Registered July 15, 2008

**TRADEMARK  
PRINCIPAL REGISTER**

plug: in

HONG, ERNESTO FRANCISCO (UNITED STATES INDIVIDUAL)  
411 PINATA PLACE  
FULLTERON, CA 92835

SCARVES AND UNDERWEAR, IN CLASS 25 (U.S. CLS. 22 AND 39).

FIRST USE 8-1-2007; IN COMMERCE 8-1-2007.

FOR: CLOTHING, NAMELY, DRESSES, SKIRTS, SUITS, BLOUSES, SHOES, PANTS, SHORTS, SWEATERS, JACKETS, COATS, HOSIERY, HATS, BELTS,

SER. NO. 76-682,897, FILED 10-12-2007.

MYRIAH HABEEB, EXAMINING ATTORNEY

**Int. Cl.: 41**

**Prior U.S. Cls.: 100, 101 and 107**

**United States Patent and Trademark Office**

**Reg. No. 3,465,001**

**Registered July 15, 2008**

**SERVICE MARK  
PRINCIPAL REGISTER**

**Theon Education Resources**

MARTIN ROSENBERG (UNITED STATES INDIVIDUAL)  
37 KESTREL DRIVE  
VOORHEES, NJ 08043

FOR: EDUCATION SERVICES, NAMELY, PROVIDING TUTORIAL SESSIONS IN THE FIELDS OF MATHEMATICS, BUSINESS, AND ECONOMICS, IN CLASS 41 (U.S. CLS. 100, 101 AND 107).

FIRST USE 9-7-2007; IN COMMERCE 9-7-2007.

THE MARK CONSISTS OF STANDARD CHARACTERS WITHOUT CLAIM TO ANY PARTICULAR FONT, STYLE, SIZE, OR COLOR.

NO CLAIM IS MADE TO THE EXCLUSIVE RIGHT TO USE "EDUCATION RESOURCES", APART FROM THE MARK AS SHOWN.

SER. NO. 76-682,899, FILED 10-12-2007.

MYRIAH HABEEB, EXAMINING ATTORNEY

**Int. Cl.: 33**

**Prior U.S. Cls.: 47 and 49**

**United States Patent and Trademark Office**

**Reg. No. 3,465,002**

**Registered July 15, 2008**

**TRADEMARK  
PRINCIPAL REGISTER**

**NITTANY**

MOUNT NITTANY VINEYARD AND WINERY,  
INC. (PENNSYLVANIA CORPORATION)  
300 HOUSER ROAD  
CENTRE HALL, PA 16828

THE MARK CONSISTS OF STANDARD CHAR-  
ACTERS WITHOUT CLAIM TO ANY PARTICULAR  
FONT, STYLE, SIZE, OR COLOR.

SEC. 2(F).

FOR: WINES, IN CLASS 33 (U.S. CLS. 47 AND 49).

SER. NO. 76-682,974, FILED 10-16-2007.

FIRST USE 9-0-1990; IN COMMERCE 7-0-1990.

CHRISTINE COOPER, EXAMINING ATTORNEY

**Int. Cls.: 35, 36 and 39**

**Prior U.S. Cls.: 100, 101, 102 and 105**

**United States Patent and Trademark Office**

**Reg. No. 3,465,003**

**Registered July 15, 2008**

**SERVICE MARK  
PRINCIPAL REGISTER**



FLIGHT OPTIONS, LLC (DELAWARE LTD LIAB  
CO)  
26180 CURTISS-WRIGHT PARKWAY  
CLEVELAND, OH 44143

FOR: PROVIDING TEMPORARY EMPLOYMENT SERVICES IN THE NATURE OF PROVIDING FLIGHT CREW SERVICES FOR OTHERS; AIRCRAFT MANAGEMENT SERVICES, NAMELY, ARRANGING FOR THE MAINTENANCE AND CREWING OF AIRCRAFT OWNERS; CONSUMER LOYALTY SERVICES FOR PROMOTIONAL AND ADVERTISING PURPOSES, NAMELY, ADMINISTRATION OF FREQUENT FLYER PROGRAM THAT PROVIDES FLYING TIME THROUGH USE OF A MEMBERSHIP JET CARD, IN CLASS 35 (U.S. CLS. 100, 101 AND 102).

FIRST USE 7-23-2007; IN COMMERCE 7-23-2007.

FOR: ARRANGING FOR THE SALE AND FINANCING OF OWNERSHIP INTERESTS IN AIRPLANES; MANAGING FRACTIONAL INTERESTS FOR AIRCRAFT; AIRPLANE BROKERAGE SERVI-

CES, NAMELY, ARRANGING FOR THE ACQUISITION AND SALES, FRACTIONAL SALES, AND OWNERSHIP OF AIRPLANES FOR OTHERS, IN CLASS 36 (U.S. CLS. 100, 101 AND 102).

FIRST USE 7-23-2007; IN COMMERCE 7-23-2007.

FOR: AIRCRAFT CHARTERING SERVICES; LOANING AND RENTAL OF AIRPLANES; LEASING OF AIRCRAFT; AIR TRANSPORTATION SERVICES FEATURING A FREQUENT FLYER BONUS PROGRAM, NAMELY, PROVIDING FLYING TIME THROUGH USE OF A MEMBERSHIP JET CARD, IN CLASS 39 (U.S. CLS. 100 AND 105).

FIRST USE 7-23-2007; IN COMMERCE 7-23-2007.

OWNER OF U.S. REG. NO. 2,653,535.

SER. NO. 76-682,980, FILED 10-16-2007.

EMILY CHUO, EXAMINING ATTORNEY

**Int. Cl.: 29**

**Prior U.S. Cl.: 46**

**United States Patent and Trademark Office**

**Reg. No. 3,465,004**

**Registered July 15, 2008**

**TRADEMARK  
PRINCIPAL REGISTER**



DALIAN YOULIAN SEAFOOD CO., LTD. (CHINA CORPORATION)  
678 YOUYI STREET, JINZHOU DISTRICT  
DALIAN LIAONING, CHINA 116100

FOR: SEAFOOD FOR HUMAN CONSUMPTION, NAMELY, IMITATION CRABMEAT AND CRAB CAKE; SEAFOOD PRODUCTS, NAMELY, FROZEN SEAFOOD AND COOKED SEAFOOD PRODUCTS, NAMELY, COOKED SEAFOOD, IN CLASS 29 (U.S. CL. 46).

FIRST USE 10-28-1995; IN COMMERCE 10-28-1995.

OWNER OF CHINA REG. NO. 787129, DATED 10-28-1995, EXPIRES 10-27-2015.

SER. NO. 76-683,114, FILED 10-19-2007.

LINDA ORNDORFF, EXAMINING ATTORNEY

**Int. Cl.: 35**

**Prior U.S. Cls.: 100, 101 and 102**

**United States Patent and Trademark Office**

**Reg. No. 3,465,005**

**Registered July 15, 2008**

**SERVICE MARK  
PRINCIPAL REGISTER**

**DETAILS IN THE MAIL**

PROACTIVE HEALTHCARE COMMUNICA-  
TIONS, INC. (NEW JERSEY CORPORATION)  
600 EAST CRESCENT AVENUE, SUITE 201  
UPPER SADDLE RIVER, NJ 074581850

FOR: DISSEMINATION OF ADVERTISEMENTS  
AND OF ADVERTISING MATERIAL, AND CON-  
DUCTING MARKET RESEARCH SURVEYS IN THE  
PHARMACEUTICAL FIELD, IN CLASS 35 (U.S. CLS.  
100, 101 AND 102).

FIRST USE 2-22-1996; IN COMMERCE 2-22-1996.

THE MARK CONSISTS OF STANDARD CHAR-  
ACTERS WITHOUT CLAIM TO ANY PARTICULAR  
FONT, STYLE, SIZE, OR COLOR.

SER. NO. 76-683,298, FILED 10-25-2007.

GEOFFREY FOSDICK, EXAMINING ATTORNEY



**Int. Cl.: 21**

**Prior U.S. Cls.: 2, 13, 23, 29, 30, 33, 40 and 50**

**United States Patent and Trademark Office**

**Reg. No. 3,465,006**

**Registered July 15, 2008**

**TRADEMARK  
PRINCIPAL REGISTER**

**MAGNESIUM THERMIC BOOSTER**

TURBO POWER, INC. (NEW YORK CORPORATION)

31-40 DOWNING STREET

FLUSHING, NY 11354

FOR: HAND-HELD HAIR STYLING BRUSHES,  
IN CLASS 21 (U.S. CLS. 2, 13, 23, 29, 30, 33, 40 AND 50).

FIRST USE 9-1-2007; IN COMMERCE 9-1-2007.

THE MARK CONSISTS OF STANDARD CHARACTERS WITHOUT CLAIM TO ANY PARTICULAR FONT, STYLE, SIZE, OR COLOR.

NO CLAIM IS MADE TO THE EXCLUSIVE RIGHT TO USE "MAGNESIUM THERMIC", APART FROM THE MARK AS SHOWN.

SER. NO. 76-683,413, FILED 10-29-2007.

BRENDAN REGAN, EXAMINING ATTORNEY

**Int. Cl.: 33**

**Prior U.S. Cls.: 47 and 49**

**United States Patent and Trademark Office**

**Reg. No. 3,465,007**

**Registered July 15, 2008**

**TRADEMARK  
PRINCIPAL REGISTER**

**THE POLYNESIAN**

WOW CAFE AND WINGERY (LOUISIANA LIMITED LIABILITY CORPORATION)  
109 NEW CAMELLIA BOULEVARD, SUITE 200  
COVINGTON, LA 70433

FIRST USE 6-1-2006; IN COMMERCE 6-1-2006.

SER. NO. 76-683,502, FILED 10-30-2007.

FOR: ALCOHOLIC BEVERAGES EXCEPT BEERS,  
IN CLASS 33 (U.S. CLS. 47 AND 49).

AISHA CLARKE, EXAMINING ATTORNEY

**Int. Cl.: 35**

**Prior U.S. Cls.: 100, 101 and 102**

**United States Patent and Trademark Office**

**Reg. No. 3,465,008**

**Registered July 15, 2008**

---

**SERVICE MARK  
PRINCIPAL REGISTER**

**MODERNCONNOISSEUR**

ADVANCE MAGAZINE PUBLISHERS INC. (NEW  
YORK CORPORATION)  
4 TIMES SQUARE  
NEW YORK, NY 10036

FOR: MEMBERSHIP CLUB SERVICES PROVID-  
ING DISCOUNTS AND PROCESSING REBATES  
FOR THE SERVICES OF OTHERS, IN CLASS 35  
(U.S. CLS. 100, 101 AND 102).

FIRST USE 8-1-2007; IN COMMERCE 8-1-2007.

THE MARK CONSISTS OF STANDARD CHAR-  
ACTERS WITHOUT CLAIM TO ANY PARTICULAR  
FONT, STYLE, SIZE, OR COLOR.

SER. NO. 76-683,529, FILED 10-31-2007.

HEATHER SAPP, EXAMINING ATTORNEY

**Int. Cl.: 37**

**Prior U.S. Cls.: 100, 103 and 106**

**United States Patent and Trademark Office**

**Reg. No. 3,465,009**

**Registered July 15, 2008**

**SERVICE MARK  
PRINCIPAL REGISTER**

**We Banish Butts**

PETIT, RAY (UNITED STATES INDIVIDUAL)  
201 W. VINEYARD CT.  
CAPE MAY, NJ 08204

THE MARK CONSISTS OF STANDARD CHARACTERS WITHOUT CLAIM TO ANY PARTICULAR FONT, STYLE, SIZE, OR COLOR.

FOR: CLEANING OF BUILDINGS AND OUTDOOR AREAS, NAMELY, REMOVAL OF CIGARETTE BUTTS AND FILTERS, IN CLASS 37 (U.S. CLS. 100, 103 AND 106).

SER. NO. 76-683,556, FILED 11-1-2007.

FIRST USE 10-18-2007; IN COMMERCE 10-18-2007.

PAM WILLIS, EXAMINING ATTORNEY

**Int. Cl.: 25**

**Prior U.S. Cls.: 22 and 39**

**United States Patent and Trademark Office**

**Reg. No. 3,465,010**

**Registered July 15, 2008**

**TRADEMARK  
PRINCIPAL REGISTER**

LANDAU FOR HER

LANDAU UNIFORMS, INCORPORATED (TEN-  
NESSEE CORPORATION)

8410 SANDIDGE ROAD

OLIVE BRANCH, MS 386540516

FOR: CLOTHING FOR WOMEN HEALTHCARE  
PROFESSIONALS, NAMELY, NON-SURGICAL  
SCRUB SHIRTS AND PANTS, TOPS, TUNICS,  
SHIRTS, PANTS, WARM-UP JACKETS, AND LAB  
COATS, IN CLASS 25 (U.S. CLS. 22 AND 39).

FIRST USE 8-1-2007; IN COMMERCE 8-1-2007.

THE MARK CONSISTS OF STANDARD CHAR-  
ACTERS WITHOUT CLAIM TO ANY PARTICULAR  
FONT, STYLE, SIZE, OR COLOR.

OWNER OF U.S. REG. NOS. 1,345,902, 3,270,833  
AND OTHERS.

NO CLAIM IS MADE TO THE EXCLUSIVE  
RIGHT TO USE "FOR HER", APART FROM THE  
MARK AS SHOWN.

SER. NO. 76-683,563, FILED 11-1-2007.

KAPIL BHANOT, EXAMINING ATTORNEY

**Int. Cl.: 28**

**Prior U.S. Cls.: 22, 23, 38 and 50**

**United States Patent and Trademark Office**

**Reg. No. 3,465,011**

**Registered July 15, 2008**

**TRADEMARK  
PRINCIPAL REGISTER**

**SNEAKY PETE**

EGGLER, LAEL C. (UNITED STATES INDIVIDUAL), DBA THE GAINES COMPANY  
BOX 35, ROUTE 349  
GAINES, PA 16921

THE MARK CONSISTS OF STANDARD CHARACTERS WITHOUT CLAIM TO ANY PARTICULAR FONT, STYLE, SIZE, OR COLOR.

FOR: FISHING TACKLE AND LURES, IN CLASS 28 (U.S. CLS. 22, 23, 38 AND 50).

SER. NO. 76-683,630, FILED 11-5-2007.

FIRST USE 11-10-1957; IN COMMERCE 11-10-1957.

DAVID YONTEF, EXAMINING ATTORNEY

**Int. Cl.: 2**

**Prior U.S. Cls.: 6, 11 and 16**

**United States Patent and Trademark Office**

**Reg. No. 3,465,012**

**Registered July 15, 2008**

**TRADEMARK  
PRINCIPAL REGISTER**

**DURASEAL**

HARGIS INDUSTRIES LP (TEXAS LIMITED  
PARTNERSHIP)  
6357 REYNOLDS ROAD  
TYLER, TX 75712

THE MARK CONSISTS OF STANDARD CHAR-  
ACTERS WITHOUT CLAIM TO ANY PARTICULAR  
FONT, STYLE, SIZE, OR COLOR.

FOR: PROTECTIVE COATINGS TO PREVENT  
CORROSION FOR METAL FASTENERS FOR USE  
IN THE BUILDING AND CONSTRUCTION INDUS-  
TRIES, IN CLASS 2 (U.S. CLS. 6, 11 AND 16).

SER. NO. 76-683,644, FILED 11-5-2007.

FIRST USE 0-0-1996; IN COMMERCE 0-0-1996.

DAWN FELDMAN, EXAMINING ATTORNEY

**Int. Cl.: 37**

**Prior U.S. Cls.: 100, 103 and 106**

**United States Patent and Trademark Office**

**Reg. No. 3,465,013**

**Registered July 15, 2008**

**SERVICE MARK  
PRINCIPAL REGISTER**

**ADVANCED PEST MANAGEMENT**

APM, INC. (MARYLAND CORPORATION)  
170 WEST MAIN STREET  
ELKTON, MD 21921

OWNER OF U.S. REG. NO. 1,449,899 AND OTHERS.

FOR: TERMITE AND PEST CONTROL SERVICES,  
IN CLASS 37 (U.S. CLS. 100, 103 AND 106).

NO CLAIM IS MADE TO THE EXCLUSIVE  
RIGHT TO USE "PEST MANAGEMENT", APART  
FROM THE MARK AS SHOWN.

FIRST USE 7-14-1987; IN COMMERCE 7-14-1987.

SER. NO. 76-683,676, FILED 11-5-2007.

THE MARK CONSISTS OF STANDARD CHAR-  
ACTERS WITHOUT CLAIM TO ANY PARTICULAR  
FONT, STYLE, SIZE, OR COLOR.

FLORENTINA BLANDU, EXAMINING ATTORNEY



**Int. Cl.: 36**

**Prior U.S. Cls.: 100, 101 and 102**

**United States Patent and Trademark Office**

**Reg. No. 3,465,014**

**Registered July 15, 2008**

**SERVICE MARK  
PRINCIPAL REGISTER**



SAFE CREDIT UNION (CALIFORNIA STATE-  
CHARTERED CREDIT UNION AND NON-  
PROFIT CORPORATION)  
3720 MADISON AVENUE  
NORTH HIGHLANDS, CA 95660

FOR: CREDIT UNION SERVICES, COMMERCIAL  
AND CONSUMER LENDING SERVICES, IN CLASS  
36 (U.S. CLS. 100, 101 AND 102).

FIRST USE 3-13-2006; IN COMMERCE 3-13-2006.

OWNER OF U.S. REG. NOS. 2,093,097, 2,294,483  
AND OTHERS.

SER. NO. 76-683,691, FILED 11-6-2007.

ROSELLE HERRERA, EXAMINING ATTORNEY

**Int. Cl.: 36**

**Prior U.S. Cls.: 100, 101 and 102**

**United States Patent and Trademark Office**

**Reg. No. 3,465,015**

**Registered July 15, 2008**

**SERVICE MARK  
PRINCIPAL REGISTER**

**SAFE**

SAFE CREDIT UNION (CALIFORNIA STATE-  
CHARTERED CREDIT UNION AND NON-  
PROFIT CORPORATION)  
3720 MADISON AVENUE  
NORTH HIGHLANDS, CA 95660

FOR: CREDIT UNION SERVICES, COMMERCIAL  
AND CONSUMER LENDING SERVICES, IN CLASS  
36 (U.S. CLS. 100, 101 AND 102).

FIRST USE 8-26-1953; IN COMMERCE 8-26-1953.

THE MARK CONSISTS OF STANDARD CHAR-  
ACTERS WITHOUT CLAIM TO ANY PARTICULAR  
FONT, STYLE, SIZE, OR COLOR.

OWNER OF U.S. REG. NOS. 2,093,097, 2,294,483  
AND OTHERS.

SER. NO. 76-683,692, FILED 11-6-2007.

ROSELLE HERRERA, EXAMINING ATTORNEY

**Int. Cl.: 6**

**Prior U.S. Cls.: 2, 12, 13, 14, 23, 25 and 50**

**United States Patent and Trademark Office**

**Reg. No. 3,465,016**

**Registered July 15, 2008**

**TRADEMARK  
PRINCIPAL REGISTER**

**CLAMPETTE**

CLAMPETTE, INCORPORATED (TEXAS CORPORATION)  
P.O. DRAWER 380250  
DUNCANVILLE, TX 751380250

THE MARK CONSISTS OF STANDARD CHARACTERS WITHOUT CLAIM TO ANY PARTICULAR FONT, STYLE, SIZE, OR COLOR.

FOR: PIPE REPAIR TOOLS, NAMELY, METAL CLAMPS AND COUPLINGS, IN CLASS 6 (U.S. CLS. 2, 12, 13, 14, 23, 25 AND 50).

SER. NO. 76-683,728, FILED 11-7-2007.

FIRST USE 3-0-1963; IN COMMERCE 3-0-1963.

KEVIN DINALLO, EXAMINING ATTORNEY

**Int. Cl.: 5**

**Prior U.S. Cls.: 6, 18, 44, 46, 51 and 52**

**United States Patent and Trademark Office**

**Reg. No. 3,465,017**

**Registered July 15, 2008**

**TRADEMARK  
PRINCIPAL REGISTER**

**CHICKXIDE**

BIRKO CORPORATION (COLORADO CORPORATION)  
9152 YOSEMITE STREET  
HENDERSON, CO 80640

FOR: ANTIMICROBIAL COMPOSITIONS FOR PROCESSING POULTRY TO REDUCE THE INCIDENCE OF SALMONELLA AND OTHER PATHOGENS ON FOOD PRODUCTS, IN CLASS 5 (U.S. CLS. 6, 18, 44, 46, 51 AND 52).

FIRST USE 9-27-2007; IN COMMERCE 11-2-2007.

THE MARK CONSISTS OF STANDARD CHARACTERS WITHOUT CLAIM TO ANY PARTICULAR FONT, STYLE, SIZE, OR COLOR.

SER. NO. 76-683,752, FILED 11-7-2007.

LAURIE MAYES, EXAMINING ATTORNEY

**Int. Cls.: 37, 40, 42 and 45**

**Prior U.S. Cls.: 100, 101, 103 and 106**

**United States Patent and Trademark Office**

**Reg. No. 3,465,018**

**Registered July 15, 2008**

**SERVICE MARK  
PRINCIPAL REGISTER**

# Peak Environmental

PEAK ENVIRONMENTAL, LLC (NEW YORK CORPORATION)  
23 LAKE STREET, PO BOX 424  
OWEGO, NY 13827

FOR: ENVIRONMENTAL REMEDIATION SERVICES, NAMELY, WASTE DISPOSAL; MARINE CONSTRUCTION, IN CLASS 37 (U.S. CLS. 100, 103 AND 106).

FIRST USE 9-18-2002; IN COMMERCE 1-31-2003.

FOR: ENVIRONMENTAL REMEDIATION SERVICES, NAMELY, SOIL, WASTE AND/OR WATER TREATMENT SERVICES; ENVIRONMENTAL REMEDIATION SERVICES, NAMELY, SOIL TREATMENT SERVICES; MOLD REMEDIATION SERVICES, IN CLASS 40 (U.S. CLS. 100, 103 AND 106).

FIRST USE 9-18-2002; IN COMMERCE 1-31-2003.

FOR: CONSULTING SERVICES IN THE FIELD OF ENVIRONMENTAL ASSESSMENT, COMPLIANCE AND PLANNING; ENGINEERING SERVICES FOR BUILDING AND PROPERTY CONDITION ASSESSMENT, FACILITY MANAGEMENT, REPAIR AND RESTORATION, BUILDING INSTRUMENTATION AND MONITORING, AND ENVIRONMENTAL CONSULTING; ENVIRONMENTAL SERVICES, NAMELY DETECTION OF CONTAMINANTS IN WATER; ENVIRONMENTAL SERVICES, NAMELY, TECHNICAL CONSULTATION IN THE FIELD OF ENVIRONMENTAL SCIENCE, ENGINEERING SERVICES, DESIGN FOR OTHERS IN THE FIELD OF ENVIRONMENTAL ENGINEERING, DESIGNING AND TESTING OF NEW ENVIRONMENTALLY FRIENDLY PRODUCTS FOR OTHERS; ENVIRONMENTAL TEST-

ING AND INSPECTION SERVICES; EVALUATION AND TESTING OF REAL ESTATE FOR THE PRESENCE OF HAZARDOUS MATERIAL; PREPARING ENVIRONMENTAL COMPLIANCE REPORTS; RESEARCH AND DEVELOPMENT AND CONSULTATION RELATED THERETO IN THE FIELD OF ENVIRONMENTAL REMEDIATION, IN CLASS 42 (U.S. CLS. 100 AND 101).

FIRST USE 9-18-2002; IN COMMERCE 1-31-2003.

FOR: CONSULTATION SERVICES IN THE FIELD OF THE SAFETY NEEDS OF COMMERCIAL AND INDUSTRIAL COMPANIES; INSPECTION OF FACTORIES FOR SAFETY PURPOSES; REVIEWING STANDARDS AND PRACTICES TO ASSURE COMPLIANCE WITH STATE AND FEDERAL ENVIRONMENTAL LAWS AND REGULATIONS; SAFETY INSPECTION AUDITS TO IMPROVE SAFETY OF CONSTRUCTION WORKERS ON RESIDENTIAL CONSTRUCTION SITES, IN CLASS 45 (U.S. CLS. 100 AND 101).

FIRST USE 9-18-2002; IN COMMERCE 1-31-2003.

THE MARK CONSISTS OF STANDARD CHARACTERS WITHOUT CLAIM TO ANY PARTICULAR FONT, STYLE, SIZE, OR COLOR.

NO CLAIM IS MADE TO THE EXCLUSIVE RIGHT TO USE "ENVIRONMENTAL", APART FROM THE MARK AS SHOWN.

SER. NO. 76-683,798, FILED 11-7-2007.

JILL C. ALT, EXAMINING ATTORNEY

**Int. Cls.: 37, 40, 42 and 45**

**Prior U.S. Cls.: 100, 101, 103 and 106**

**United States Patent and Trademark Office**

**Reg. No. 3,465,019**

**Registered July 15, 2008**

**SERVICE MARK  
PRINCIPAL REGISTER**



PEAK ENVIRONMENTAL, LLC (NEW YORK CORPORATION)  
23 LAKE STREET, PO BOX 424  
OWEGO, NY 13827

FOR: ENVIRONMENTAL REMEDIATION SERVICES, NAMELY, WASTE DISPOSAL; MARINE CONSTRUCTION, IN CLASS 37 (U.S. CLS. 100, 103 AND 106).

FIRST USE 9-18-2002; IN COMMERCE 1-31-2003.

FOR: ENVIRONMENTAL REMEDIATION SERVICES, NAMELY, SOIL, WASTE AND/OR WATER TREATMENT SERVICES; ENVIRONMENTAL REMEDIATION SERVICES, NAMELY, SOIL TREATMENT SERVICES; MOLD REMEDIATION SERVICES, IN CLASS 40 (U.S. CLS. 100, 103 AND 106).

FIRST USE 9-18-2002; IN COMMERCE 1-31-2003.

FOR: CONSULTING SERVICES IN THE FIELD OF ENVIRONMENTAL ASSESSMENT, COMPLIANCE AND PLANNING; ENGINEERING SERVICES FOR BUILDING AND PROPERTY CONDITION ASSESSMENT, FACILITY MANAGEMENT, REPAIR AND RESTORATION, BUILDING INSTRUMENTATION AND MONITORING, AND ENVIRONMENTAL CONSULTING; ENVIRONMENTAL SERVICES, NAMELY DETECTION OF CONTAMINANTS IN WATER; ENVIRONMENTAL SERVICES, NAMELY, TECHNICAL CONSULTATION IN THE FIELD OF ENVIRONMENTAL SCIENCE, ENGINEERING SERVICES, DESIGN FOR OTHERS IN THE FIELD OF ENVIRONMENTAL ENGINEERING, DESIGNING AND TESTING OF

NEW ENVIRONMENTALLY FRIENDLY PRODUCTS FOR OTHERS; ENVIRONMENTAL TESTING AND INSPECTION SERVICES; EVALUATION AND TESTING OF REAL ESTATE FOR THE PRESENCE OF HAZARDOUS MATERIAL; PREPARING ENVIRONMENTAL COMPLIANCE REPORTS; RESEARCH AND DEVELOPMENT AND CONSULTATION RELATED THERETO IN THE FIELD OF ENVIRONMENTAL REMEDIATION, IN CLASS 42 (U.S. CLS. 100 AND 101).

FIRST USE 9-18-2002; IN COMMERCE 1-31-2003.

FOR: CONSULTATION SERVICES IN THE FIELD OF THE SAFETY NEEDS OF COMMERCIAL AND INDUSTRIAL COMPANIES; INSPECTION OF FACTORIES FOR SAFETY PURPOSES; REVIEWING STANDARDS AND PRACTICES TO ASSURE COMPLIANCE WITH STATE AND FEDERAL ENVIRONMENTAL LAWS AND REGULATIONS; SAFETY INSPECTION AUDITS TO IMPROVE SAFETY OF CONSTRUCTION WORKERS ON RESIDENTIAL CONSTRUCTION SITES, IN CLASS 45 (U.S. CLS. 100 AND 101).

FIRST USE 9-18-2002; IN COMMERCE 1-31-2003.

NO CLAIM IS MADE TO THE EXCLUSIVE RIGHT TO USE "ENVIRONMENTAL LLC", APART FROM THE MARK AS SHOWN.

SER. NO. 76-683,799, FILED 11-7-2007.

JILL C. ALT, EXAMINING ATTORNEY

**Int. Cl.: 36**

**Prior U.S. Cls.: 100, 101 and 102**

**United States Patent and Trademark Office**

**Reg. No. 3,465,020**

**Registered July 15, 2008**

---

**SERVICE MARK  
PRINCIPAL REGISTER**

**NFIB SELECT**

NATIONAL FEDERATION OF INDEPENDENT  
BUSINESS (CALIFORNIA CORPORATION)  
53 CENTURY BOULEVARD  
NASHVILLE, TN 37214

THE MARK CONSISTS OF STANDARD CHAR-  
ACTERS WITHOUT CLAIM TO ANY PARTICULAR  
FONT, STYLE, SIZE, OR COLOR.

FOR: INSURANCE UNDERWRITING IN THE  
FIELD OF HEALTH, IN CLASS 36 (U.S. CLS. 100,  
101 AND 102).

SER. NO. 76-683,814, FILED 11-8-2007.

FIRST USE 10-1-2007; IN COMMERCE 10-1-2007.

CAROLYN GRAY, EXAMINING ATTORNEY

**Int. Cl.: 45**

**Prior U.S. Cls.: 100 and 101**

**United States Patent and Trademark Office**

**Reg. No. 3,465,021**

**Registered July 15, 2008**

**SERVICE MARK  
PRINCIPAL REGISTER**

**W2WLINK.COM**

W2W MEDIA, LLC (TEXAS LTD LIAB CO)  
4424 NASHWOOD  
DALLAS, TX 75244

FOR: PROFESSIONAL AND SOCIAL NETWORKING SERVICES PROVIDED VIA AN ONLINE DATABASE FEATURING PROFESSIONAL AND SOCIAL NETWORKING RESOURCES, ARTICLES, AND INTERVIEWS, IN CLASS 45 (U.S. CLS. 100 AND 101).

FIRST USE 9-10-2007; IN COMMERCE 9-10-2007.

THE MARK CONSISTS OF STANDARD CHARACTERS WITHOUT CLAIM TO ANY PARTICULAR FONT, STYLE, SIZE, OR COLOR.

SER. NO. 76-683,817, FILED 11-8-2007.

CAROLYN GRAY, EXAMINING ATTORNEY



**Int. Cl.: 9**

**Prior U.S. Cls.: 21, 23, 26, 36 and 38**

**Reg. No. 3,465,022**

**United States Patent and Trademark Office**

**Registered July 15, 2008**

**TRADEMARK  
PRINCIPAL REGISTER**

**JERRY SPRINGER UNDRESSED  
UNCENSORED! UNLEASHED**

UNIVERSAL TV DISTRIBUTION HOLDINGS  
LLC (DELAWARE LTD LIAB CO)  
100 UNIVERSAL CITY PLAZA  
UNIVERSAL CITY, CA 91608

FOR: PRERECORDED DVDS FEATURING EPI-  
ISODES FROM A TELEVISION TALK SHOW SERIES,  
IN CLASS 9 (U.S. CLS. 21, 23, 26, 36 AND 38).

FIRST USE 7-0-2007; IN COMMERCE 7-0-2007.

OWNER OF U.S. REG. NO. 1,823,330.

NO CLAIM IS MADE TO THE EXCLUSIVE  
RIGHT TO USE "UNCENSORED", APART FROM  
THE MARK AS SHOWN.

"JERRY SPRINGER" IS THE NAME OF A LIVING  
INDIVIDUAL WHOSE CONSENT TO REGISTRA-  
TION IS OF RECORD.

SER. NO. 76-683,936, FILED 11-13-2007.

ANDREA K. NADELMAN, EXAMINING ATTOR-  
NEY

**Int. Cl.: 10**

**Prior U.S. Cls.: 26, 39 and 44**

**Reg. No. 3,465,023**

**United States Patent and Trademark Office**

**Registered July 15, 2008**

**TRADEMARK  
PRINCIPAL REGISTER**

**CARDIOCAPTURE**

CARDIOLABS, INC. (TENNESSEE CORPORATION)  
SUITE B-L, 109 HOLIDAY COURT  
FRANKLIN, TN 37067

THE MARK CONSISTS OF STANDARD CHARACTERS WITHOUT CLAIM TO ANY PARTICULAR FONT, STYLE, SIZE, OR COLOR.

FOR: MEDICAL INSTRUMENT FOR CARDIOVASCULAR DIAGNOSTICS, IN CLASS 10 (U.S. CLS. 26, 39 AND 44).

SER. NO. 76-684,008, FILED 11-14-2007.

FIRST USE 9-12-2006; IN COMMERCE 10-2-2006.

TRACY WHITTAKER-BROWN, EXAMINING ATTORNEY

**Int. Cl.: 16**

**Prior U.S. Cls.: 2, 5, 22, 23, 29, 37, 38 and 50**

**Reg. No. 3,465,024**

**United States Patent and Trademark Office**

**Registered July 15, 2008**

**TRADEMARK  
PRINCIPAL REGISTER**

**5280**

PARADISE PEN COMPANY (COLORADO CORPORATION)  
2433 CURTIS STREET  
DENVER, CO 80205

THE MARK CONSISTS OF STANDARD CHARACTERS WITHOUT CLAIM TO ANY PARTICULAR FONT, STYLE, SIZE, OR COLOR.

FOR: WRITING INSTRUMENTS, NAMELY, PENS, IN CLASS 16 (U.S. CLS. 2, 5, 22, 23, 29, 37, 38 AND 50).

SER. NO. 76-684,051, FILED 11-15-2007.

FIRST USE 12-31-2002; IN COMMERCE 12-31-2002.

DAYNA BROWNE, EXAMINING ATTORNEY

**Int. Cl.: 21**

**Prior U.S. Cls.: 2, 13, 23, 29, 30, 33, 40 and 50**

**United States Patent and Trademark Office**

**Reg. No. 3,465,025**

**Registered July 15, 2008**

**TRADEMARK  
PRINCIPAL REGISTER**

**TAPPENING**

YAVERBAUM, ERIC (UNITED STATES INDIVIDUAL)  
187 LARCHMONT AVENUE  
LARCHMONT, NY 10538

THE MARK CONSISTS OF STANDARD CHARACTERS WITHOUT CLAIM TO ANY PARTICULAR FONT, STYLE, SIZE, OR COLOR.

FOR: WATER BOTTLES SOLD EMPTY, IN CLASS 21 (U.S. CLS. 2, 13, 23, 29, 30, 33, 40 AND 50).

SER. NO. 76-684,068, FILED 11-15-2007.

FIRST USE 10-1-2007; IN COMMERCE 10-15-2007.

KRISTINA MORRIS, EXAMINING ATTORNEY

**Int. Cl.: 35**

**Prior U.S. Cls.: 100, 101 and 102**

**United States Patent and Trademark Office**

**Reg. No. 3,465,026**

**Registered July 15, 2008**

**SERVICE MARK  
PRINCIPAL REGISTER**

**KN\*BS4LESS.COM**

MYKNOBS.COM, INC. (NEW YORK CORPORATION)  
19-22 45TH STREET  
ASTORIA, NY 11105

FOR: RETAIL STORES AND COMPUTERIZED  
ON-LINE ORDERING SERVICES FEATURING  
DECORATIVE HARDWARE, BATHROOM DECOR,  
HOME ACCENTS AND ACCESSORIES, IN CLASS 35  
(U.S. CLS. 100, 101 AND 102).

FIRST USE 2-25-2005; IN COMMERCE 2-25-2005.

THE MARK CONSISTS OF STANDARD CHARACTERS WITHOUT CLAIM TO ANY PARTICULAR FONT, STYLE, SIZE, OR COLOR.

SER. NO. 76-684,080, FILED 11-16-2007.

SAMUEL E. SHARPER JR., EXAMINING ATTORNEY

**Int. Cl.: 16**

**Prior U.S. Cls.: 2, 5, 22, 23, 29, 37, 38 and 50**

**United States Patent and Trademark Office**

**Reg. No. 3,465,027**

**Registered July 15, 2008**

**TRADEMARK  
PRINCIPAL REGISTER**

**LYZIWRAPS**

CHILDS, JOCELYN (UNITED STATES INDIVIDUAL)  
2012 E. 4TH AVENUE  
DENVER, CO 80206

FOR: REUSABLE GIFT WRAP ENVELOPE, IN CLASS 16 (U.S. CLS. 2, 5, 22, 23, 29, 37, 38 AND 50).

FIRST USE 7-15-2007; IN COMMERCE 8-15-2007.

THE MARK CONSISTS OF STANDARD CHARACTERS WITHOUT CLAIM TO ANY PARTICULAR FONT, STYLE, SIZE, OR COLOR.

SER. NO. 76-684,082, FILED 11-16-2007.

SAMUEL E. SHARPER JR., EXAMINING ATTORNEY

**Int. Cl.: 35**

**Prior U.S. Cls.: 100, 101 and 102**

**United States Patent and Trademark Office**

**Reg. No. 3,465,028**

**Registered July 15, 2008**

**SERVICE MARK  
PRINCIPAL REGISTER**

**NRP**

ROOFLINK (TEXAS NON-PROFIT CORPORATION), DBA NATIONAL ROOFING PARTNERS

10555 NEWKIRK ROAD, SUITE 520  
DALLAS, TX 75220

FOR: TRADE ASSOCIATION SERVICES, NAME-  
LY, PROVIDING BUSINESS PRODUCT AND SER-  
VICE INFORMATION TO, AND PROMOTING THE  
INTERESTS OF BUSINESSES WITHIN THE ROOF-  
ING, SHEET METAL, AND WATER PROOFING  
INDUSTRY, IN CLASS 35 (U.S. CLS. 100, 101 AND  
102).

FIRST USE 2-0-2006; IN COMMERCE 2-0-2006.

THE MARK CONSISTS OF STANDARD CHAR-  
ACTERS WITHOUT CLAIM TO ANY PARTICULAR  
FONT, STYLE, SIZE, OR COLOR.

SER. NO. 76-684,083, FILED 11-16-2007.

SAMUEL E. SHARPER JR., EXAMINING ATTOR-  
NEY

**Int. Cl.: 16**

**Prior U.S. Cls.: 2, 5, 22, 23, 29, 37, 38 and 50**

**United States Patent and Trademark Office**

**Reg. No. 3,465,029**

**Registered July 15, 2008**

**TRADEMARK  
PRINCIPAL REGISTER**

**WRAPITECTURE**

CHILDS, JOCELYN (UNITED STATES INDIVIDUAL)  
2012 E. 4TH AVENUE  
DENVER, CO 80206

FOR: REUSABLE GIFT WRAP ENVELOPE, IN CLASS 16 (U.S. CLS. 2, 5, 22, 23, 29, 37, 38 AND 50).

FIRST USE 9-1-2007; IN COMMERCE 9-1-2007.

THE MARK CONSISTS OF STANDARD CHARACTERS WITHOUT CLAIM TO ANY PARTICULAR FONT, STYLE, SIZE, OR COLOR.

SER. NO. 76-684,087, FILED 11-16-2007.

SAMUEL E. SHARPER JR., EXAMINING ATTORNEY



**Int. Cl.: 6**

**Prior U.S. Cls.: 2, 12, 13, 14, 23, 25 and 50**

**Reg. No. 3,465,030**

**United States Patent and Trademark Office**

**Registered July 15, 2008**

**TRADEMARK  
PRINCIPAL REGISTER**

**TUFFBAND**

POSTLE INDUSTRIES, INC. (OHIO CORPORATION)  
P.O. BOX 42037  
CLEVELAND, OH 44142

FOR: WELDING WIRES FOR HARDFACING AND HARBANDING, THAT IS, THE APPLICATION OF WELD MATERIAL ON THE INNER OR OUTER SURFACE OF DRILLING TOOLS, NAMELY, TOOL JOINTS, DRILL COLLARS, DOWN HOLE TOOLS AND DRILL BITS, USED FOR DRILLING AND BORING OPERATIONS, NAMELY, DRILLING OIL AND GAS WELLS, WATER WELLS, EPA TEST WELLS, SOIL TESTING, CORE SAMPLING, DIRECTIONAL DRILLING, TUNNELING AND HORIZON-

TAL DIRECTIONAL DRILLING, TO REDUCE WEAR OF SAID DRILLING TOOLS, IN CLASS 6 (U.S. CLS. 2, 12, 13, 14, 23, 25 AND 50).

FIRST USE 10-1-2007; IN COMMERCE 10-1-2007.

THE MARK CONSISTS OF STANDARD CHARACTERS WITHOUT CLAIM TO ANY PARTICULAR FONT, STYLE, SIZE, OR COLOR.

SER. NO. 76-684,088, FILED 11-16-2007.

SAMUEL E. SHARPER JR., EXAMINING ATTORNEY

**Int. Cl.: 25**

**Prior U.S. Cls.: 22 and 39**

**United States Patent and Trademark Office**

**Reg. No. 3,465,031**

**Registered July 15, 2008**

---

**TRADEMARK  
PRINCIPAL REGISTER**

**LAYERED  
WITH LOVE**

KIM, TIMOTHY INSUK (UNITED STATES INDIVIDUAL)  
3149 EL CAMINITO STREET  
LA CRESCENTA, CA 91214

FOR: WOMEN'S CLOTHING, NAMELY, DRESSES, SKIRTS, SUITS, BLOUSES, T-SHIRTS, SWEATERS, PANTS, SHORTS, JACKETS, COATS, SOCKS, HOSIERY, HATS, SCARVES AND UNDERWEAR, IN CLASS 25 (U.S. CLS. 22 AND 39).

FIRST USE 7-1-2004; IN COMMERCE 7-1-2004.

THE MARK CONSISTS OF STANDARD CHARACTERS WITHOUT CLAIM TO ANY PARTICULAR FONT, STYLE, SIZE, OR COLOR.

SER. NO. 76-684,112, FILED 11-16-2007.

MARK PILARO, EXAMINING ATTORNEY

**Int. Cl.: 41**

**Prior U.S. Cls.: 100, 101 and 107**

**Reg. No. 3,465,032**

**United States Patent and Trademark Office**

**Registered July 15, 2008**

---

**SERVICE MARK  
PRINCIPAL REGISTER**

**THINK LIKE A THIEF**

SEGUIN, MARK (UNITED STATES INDIVIDUAL)  
12181 FM 724  
TYLER, TX 75704

THE MARK CONSISTS OF STANDARD CHARACTERS WITHOUT CLAIM TO ANY PARTICULAR FONT, STYLE, SIZE, OR COLOR.

FOR: IDENTIFY THEFT TRAINING PROGRAM,  
IN CLASS 41 (U.S. CLS. 100, 101 AND 107).

SER. NO. 76-684,143, FILED 11-19-2007.

FIRST USE 1-1-2007; IN COMMERCE 11-1-2007.

JEAN IM, EXAMINING ATTORNEY

**Int. Cl.: 42**

**Prior U.S. Cls.: 100 and 101**

**United States Patent and Trademark Office**

**Reg. No. 3,465,033**

**Registered July 15, 2008**

**SERVICE MARK  
PRINCIPAL REGISTER**

**SPECSMT**

ASSEMBLED PRODUCTS CORPORATION (AR-  
KANSAS CORPORATION)  
115 E. LINDEN  
ROGERS, AR 72756

FOR: PROVIDING TEMPORARY USE OF ON-  
LINE, NON-DOWNLOADABLE SOFTWARE TO AS-  
SIST IN THE DESIGN OF CENTRALIZED  
PRESSURE WASHER SYSTEMS, IN CLASS 42 (U.S.  
CLS. 100 AND 101).

FIRST USE 10-11-2007; IN COMMERCE 10-11-2007.

THE MARK CONSISTS OF STANDARD CHAR-  
ACTERS WITHOUT CLAIM TO ANY PARTICULAR  
FONT, STYLE, SIZE, OR COLOR.

OWNER OF U.S. REG. NOS. 1,740,907, 3,243,296  
AND OTHERS.

SER. NO. 76-684,153, FILED 11-19-2007.

KHANH LE, EXAMINING ATTORNEY

**Int. Cl.: 9**

**Prior U.S. Cls.: 21, 23, 26, 36 and 38**

**United States Patent and Trademark Office**

**Reg. No. 3,465,034**

**Registered July 15, 2008**

**TRADEMARK  
PRINCIPAL REGISTER**

**CELLECTIVE**

CELLECTIVE CASE, INC. (NEW YORK CORPORATION)  
10 WEST 33RD STREET - SUITE 1221  
NEW YORK, NY 10001

FOR: LEATHER AND IMITATION LEATHER CARRYING CASES FOR CELLULAR TELEPHONES, COMPUTERS AND ELECTRONIC DATA ORGANIZERS, IN CLASS 9 (U.S. CLS. 21, 23, 26, 36 AND 38).

FIRST USE 4-1-2002; IN COMMERCE 4-1-2002.

THE MARK CONSISTS OF STANDARD CHARACTERS WITHOUT CLAIM TO ANY PARTICULAR FONT, STYLE, SIZE, OR COLOR.

SER. NO. 76-684,192, FILED 11-19-2007.

LA TONIA FISHER, EXAMINING ATTORNEY

**Int. Cl.: 16**

**Prior U.S. Cls.: 2, 5, 22, 23, 29, 37, 38 and 50**

**United States Patent and Trademark Office**

**Reg. No. 3,465,035**

**Registered July 15, 2008**

**TRADEMARK  
PRINCIPAL REGISTER**

**THE WELL WORKPLACE**

WELLNESS COUNCILS OF AMERICA (NEBRASKA NON-PROFIT CORPORATION)

9802 NICHOLAS STREET, SUITE 315  
OMAHA, NE 68114

FOR: NEWSLETTERS IN THE FIELD OF HEALTH INFORMATION, IN CLASS 16 (U.S. CLS. 2, 5, 22, 23, 29, 37, 38 AND 50).

FIRST USE 3-0-1999; IN COMMERCE 3-0-1999.

THE MARK CONSISTS OF STANDARD CHARACTERS WITHOUT CLAIM TO ANY PARTICULAR FONT, STYLE, SIZE, OR COLOR.

OWNER OF U.S. REG. NO. 1,726,503.

SEC. 2(F).

SER. NO. 76-684,199, FILED 11-19-2007.

CHRISTINA SOBRAL, EXAMINING ATTORNEY

**Int. Cl.: 25**

**Prior U.S. Cls.: 22 and 39**

**United States Patent and Trademark Office**

**Reg. No. 3,465,036**

**Registered July 15, 2008**

**TRADEMARK  
PRINCIPAL REGISTER**

**OOH! LA, LA! COUTURE**

OOH! LA, LA! COUTURE, LLC (DELAWARE LTD  
LIAB CO)  
117 BLEEKER STREET  
PORT JEFFERSON, NY 11777

THE MARK CONSISTS OF STANDARD CHAR-  
ACTERS WITHOUT CLAIM TO ANY PARTICULAR  
FONT, STYLE, SIZE, OR COLOR.

FOR: CHILDREN'S CLOTHING, NAMELY,  
SHIRTS, ONE PIECE UNDERGARMENTS, DRES-  
SES, T-SHIRTS, DENIM JEANS, DENIM JACKETS,  
SHORTS, CAPRIS, SWEAT PANTS, SWEAT SHIRTS,  
ZIPPERED SWEAT SHIRTS, SKORTS, SKEGGINGS,  
NAMELY, SKIRTS WITH ATTACHED LEGGINGS,  
LEGGINGS, GAUCHOS, BOLEROS, AND PANTS, IN  
CLASS 25 (U.S. CLS. 22 AND 39).

NO CLAIM IS MADE TO THE EXCLUSIVE  
RIGHT TO USE "COUTURE", APART FROM THE  
MARK AS SHOWN.

SER. NO. 76-684,200, FILED 11-20-2007.

FIRST USE 0-0-2005; IN COMMERCE 0-0-2005.

KATHRYN COWARD, EXAMINING ATTORNEY

**Int. Cl.: 9**

**Prior U.S. Cls.: 21, 23, 26, 36 and 38**

**United States Patent and Trademark Office**

**Reg. No. 3,465,037**

**Registered July 15, 2008**

**TRADEMARK  
PRINCIPAL REGISTER**

**SMART BLAST**

BLASTECH, INC. (GEORGIA CORPORATION)  
4965 ATLANTA HIGHWAY  
ALPHARETTA, GA 30004

FOR: COMPUTERIZED ELECTRONIC CONTROLS FOR DIRECTING THE OUTPUT OF MOVABLE SHOT BLAST WHEELS ONTO VARIOUS WORK PIECES, IN CLASS 9 (U.S. CLS. 21, 23, 26, 36 AND 38).

FIRST USE 12-0-1997; IN COMMERCE 12-0-1997.

THE MARK CONSISTS OF STANDARD CHARACTERS WITHOUT CLAIM TO ANY PARTICULAR FONT, STYLE, SIZE, OR COLOR.

NO CLAIM IS MADE TO THE EXCLUSIVE RIGHT TO USE "SMART", APART FROM THE MARK AS SHOWN.

SER. NO. 76-684,204, FILED 11-20-2007.

BRIAN NEVILLE, EXAMINING ATTORNEY



**Int. Cl.: 9**

**Prior U.S. Cls.: 21, 23, 26, 36 and 38**

**Reg. No. 3,465,038**

**United States Patent and Trademark Office**

**Registered July 15, 2008**

---

**TRADEMARK  
PRINCIPAL REGISTER**

**Crane Song Ltd.**

HILL, DAVID (UNITED STATES INDIVIDUAL)  
2117 E 5TH ST  
SUPERIOR, WI 54880

FOR: APPARATUS FOR RECORDING SOUND,  
IN CLASS 9 (U.S. CLS. 21, 23, 26, 36 AND 38).

FIRST USE 1-1-1995; IN COMMERCE 11-1-1995.

THE MARK CONSISTS OF STANDARD CHAR-  
ACTERS WITHOUT CLAIM TO ANY PARTICULAR  
FONT, STYLE, SIZE, OR COLOR.

NO CLAIM IS MADE TO THE EXCLUSIVE  
RIGHT TO USE "LTD.", APART FROM THE MARK  
AS SHOWN.

SER. NO. 76-684,218, FILED 11-21-2007.

IRA J. GOODSaid, EXAMINING ATTORNEY

**Int. Cl.: 4**

**Prior U.S. Cls.: 1, 6 and 15**

**United States Patent and Trademark Office**

**Reg. No. 3,465,039**

**Registered July 15, 2008**

**TRADEMARK  
PRINCIPAL REGISTER**

**MASTERDRAW**

ETNA PRODUCTS, INC. (OHIO CORPORATION)  
16824 PARK CIRCLE DRIVE  
CHAGRIN FALLS, OH 44023

FOR: INDUSTRIAL METALWORKING LUBRICANTS FOR COATINGS AND DEEP DRAWING AND FORMING OF METALS, IN CLASS 4 (U.S. CLS. 1, 6 AND 15).

FIRST USE 0-0-1990; IN COMMERCE 0-0-1990.

THE MARK CONSISTS OF STANDARD CHARACTERS WITHOUT CLAIM TO ANY PARTICULAR FONT, STYLE, SIZE, OR COLOR.

OWNER OF U.S. REG. NO. 747,473 AND OTHERS.

SER. NO. 76-684,229, FILED 11-21-2007.

STEVEN JACKSON, EXAMINING ATTORNEY

**Int. Cl.: 19**

**Prior U.S. Cls.: 1, 12, 33 and 50**

**United States Patent and Trademark Office**

**Reg. No. 3,465,040**

**Registered July 15, 2008**

**TRADEMARK  
PRINCIPAL REGISTER**

**COPPER CHAINMAIL**

GALAXY GLASS CORPORATION, INC. (NEW  
JERSEY CORPORATION)  
277 FAIRFIELD ROAD  
FAIRFIELD, NJ 07004

FOR: CUSTOM MANUFACTURED AND FABRI-  
CATED NON-CERAMIC BUILDING MATERIALS,  
NAMELY, GLASS, MİRRORED GLASS, MARBLE,  
GRANITE, LIMESTONE, ONYX AND SEMI-PRE-  
CIOUS INCORPORATED NATURAL STONE PA-  
NELS AND SLABS USED FOR FLOORING, WALL  
PANELS, CEILINGS, FIREPLACE SURROUNDS,  
COUNTERTOPS AND FURNITURE, NAMELY, TA-  
BLES, CABINETS AND DISPLAY UNITS FOR USE  
IN UPSCALE RESIDENTIAL, CORPORATE AND  
COMMERCIAL BUILDINGS, INCLUDING RETAIL  
STORES, SHOWROOMS, MUSEUMS, RESTAU-

RANTS, HOTELS AND CASINOS, IN CLASS 19  
(U.S. CLS. 1, 12, 33 AND 50).

FIRST USE 1-1-1998; IN COMMERCE 1-1-1998.

THE MARK CONSISTS OF STANDARD CHAR-  
ACTERS WITHOUT CLAIM TO ANY PARTICULAR  
FONT, STYLE, SIZE, OR COLOR.

NO CLAIM IS MADE TO THE EXCLUSIVE  
RIGHT TO USE "COPPER", APART FROM THE  
MARK AS SHOWN.

SER. NO. 76-684,245, FILED 11-21-2007.

KATHRYN COWARD, EXAMINING ATTORNEY

**Int. Cl.: 7**

**Prior U.S. Cls.: 13, 19, 21, 23, 31, 34 and 35**

**Reg. No. 3,465,041**

**United States Patent and Trademark Office**

**Registered July 15, 2008**

**TRADEMARK  
PRINCIPAL REGISTER**

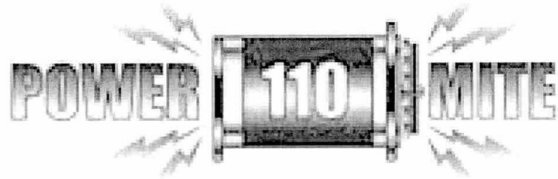

FABCO GENERATORS, INC. (NEW YORK CORPORATION), DBA FABCO POWER  
P.O. BOX 582  
CHESTER, NY 10918

NO CLAIM IS MADE TO THE EXCLUSIVE RIGHT TO USE "110" AND "POWER", APART FROM THE MARK AS SHOWN.

FOR: VEHICLE MOUNTED A.C. ALTERNATORS,  
IN CLASS 7 (U.S. CLS. 13, 19, 21, 23, 31, 34 AND 35).

SER. NO. 76-684,274, FILED 11-21-2007.

FIRST USE 11-0-1970; IN COMMERCE 11-0-1970.

JESSICA A. POWERS, EXAMINING ATTORNEY

Int. Cl.: 16

Prior U.S. Cls.: 2, 5, 22, 23, 29, 37, 38 and 50

United States Patent and Trademark Office

Reg. No. 3,465,042

Registered July 15, 2008

TRADEMARK  
PRINCIPAL REGISTER

**J'ADORE MAGAZINE**

FRANCIS, COURTNEY (UNITED STATES INDIVIDUAL)  
3535 PEACHTREE ROAD, SUITE 520  
ATLANTA, GA 30326

FOR: SERIES OF ADULT ENTERTAINMENT AND LIFESTYLE MAGAZINES, IN CLASS 16 (U.S. CLS. 2, 5, 22, 23, 29, 37, 38 AND 50).

FIRST USE 6-1-2006; IN COMMERCE 6-1-2006.

THE MARK CONSISTS OF STANDARD CHARACTERS WITHOUT CLAIM TO ANY PARTICULAR FONT, STYLE, SIZE, OR COLOR.

NO CLAIM IS MADE TO THE EXCLUSIVE RIGHT TO USE "MAGAZINE", APART FROM THE MARK AS SHOWN.

THE ENGLISH TRANSLATION OF "J'ADORE" IS "I ADORE".

SER. NO. 76-684,287, FILED 11-26-2007.

ALICE SUE CARRUTHERS, EXAMINING ATTORNEY

**Int. Cl.: 30**

**Prior U.S. Cl.: 46**

**United States Patent and Trademark Office**

**Reg. No. 3,465,043**

**Registered July 15, 2008**

**TRADEMARK  
PRINCIPAL REGISTER**

**SMOKIN' BUFFALO AWARD WINNING BBQ SAUCE**

BUFFALO ROCK COMPANY (ALABAMA COR-  
PORATION)  
C/O MELISSA JONES THOMAS  
111 OXMOOR ROAD  
BIRMINGHAM, AL 35209

FOR: CONDIMENTS, NAMELY, BARBECUE  
SAUCE, IN CLASS 30 (U.S. CL. 46).

FIRST USE 8-1-2007; IN COMMERCE 8-1-2007.

THE MARK CONSISTS OF STANDARD CHAR-  
ACTERS WITHOUT CLAIM TO ANY PARTICULAR  
FONT, STYLE, SIZE, OR COLOR.

NO CLAIM IS MADE TO THE EXCLUSIVE  
RIGHT TO USE "AWARD WINNING BBQ SAUCE",  
APART FROM THE MARK AS SHOWN.

SER. NO. 76-684,308, FILED 11-26-2007.

NICHOLAS ALTREE, EXAMINING ATTORNEY

**Int. Cl.: 29**

**Prior U.S. Cl.: 46**

**United States Patent and Trademark Office**

**Reg. No. 3,465,044**

**Registered July 15, 2008**

**TRADEMARK  
PRINCIPAL REGISTER**

**ASIAN PEARL**

RUGGIERO SEAFOOD, INC. (NEW JERSEY  
CORPORATION)  
117 AVENUE L  
NEWARK, NJ 07105

THE MARK CONSISTS OF STANDARD CHAR-  
ACTERS WITHOUT CLAIM TO ANY PARTICULAR  
FONT, STYLE, SIZE, OR COLOR.

FOR: FROZEN SQUID, IN CLASS 29 (U.S. CL. 46).

SER. NO. 76-684,341, FILED 11-26-2007.

FIRST USE 10-1-2007; IN COMMERCE 10-1-2007.

TAMARA FRAZIER, EXAMINING ATTORNEY

**Int. Cl.: 41**

**Prior U.S. Cls.: 100, 101 and 107**

**United States Patent and Trademark Office**

**Reg. No. 3,465,045**

**Registered July 15, 2008**

**SERVICE MARK  
PRINCIPAL REGISTER**



WINDOWS COVERINGS ASSOCIATION OF  
AMERICA (MISSOURI CORPORATION)  
2646 HIGHWAY 109  
SUITE 205  
GROVER, MO 63040

FIRST USE 4-0-2007; IN COMMERCE 4-0-2007.

OWNER OF U.S. REG. NO. 1,462,292.

FOR: EDUCATIONAL SERVICES, NAMELY,  
CONDUCTING TRAINING COURSES IN THE  
FIELD OF WINDOW TREATMENT SELLING AND  
ADVERTISING FOR WINDOW COVERINGS DEAL-  
ERS , IN CLASS 41 (U.S. CLS. 100, 101 AND 107).

SER. NO. 76-684,351, FILED 11-26-2007.

SANDRA MANIOS, EXAMINING ATTORNEY



**Int. Cl.: 30**

**Prior U.S. Cl.: 46**

**United States Patent and Trademark Office**

**Reg. No. 3,465,046**

**Registered July 15, 2008**

**TRADEMARK  
PRINCIPAL REGISTER**

**ALPINE TOUCH**

ALPINE TOUCH INC. (DELAWARE CORPORATION)  
714 MAIN AVENUE NORTH  
CHOTEAU, MT 59422

THE MARK CONSISTS OF STANDARD CHARACTERS WITHOUT CLAIM TO ANY PARTICULAR FONT, STYLE, SIZE, OR COLOR.

FOR: DRY GRANULAR ALL PURPOSE FOOD SEASONING, IN CLASS 30 (U.S. CL. 46).

SER. NO. 76-684,375, FILED 11-28-2007.

FIRST USE 10-20-1966; IN COMMERCE 10-20-1966.

MATTHEW EINSTEIN, EXAMINING ATTORNEY

**Int. Cl.: 41**

**Prior U.S. Cls.: 100, 101 and 107**

**United States Patent and Trademark Office**

**Reg. No. 3,465,047**

**Registered July 15, 2008**

**SERVICE MARK  
PRINCIPAL REGISTER**

**WAY OF LIFE**

THE QUIET HOUR, INC. (CALIFORNIA CORPORATION)  
630 BROOKSIDE, BOX 3000  
REDLANDS, CA 923731500

FOR: EDUCATIONAL SERVICES, NAMELY, A BIBLE STUDY COURSE AND BIBLE STUDY LESSONS PROVIDED VIA THE INTERNET, IN CLASS 41 (U.S. CLS. 100, 101 AND 107).

FIRST USE 12-0-2001; IN COMMERCE 12-0-2001.

THE MARK CONSISTS OF STANDARD CHARACTERS WITHOUT CLAIM TO ANY PARTICULAR FONT, STYLE, SIZE, OR COLOR.

SER. NO. 76-684,377, FILED 11-28-2007.

HOWARD B. LEVINE, EXAMINING ATTORNEY

**Int. Cl.: 21**

**Prior U.S. Cls.: 2, 13, 23, 29, 30, 33, 40 and 50**

**Reg. No. 3,465,048**

**United States Patent and Trademark Office**

**Registered July 15, 2008**

---

**TRADEMARK  
PRINCIPAL REGISTER**

**DIP-N-GO**

PWP INDUSTRIES (CALIFORNIA CORPORATION)  
3751 SEVILLE AVENUE  
VERNON, CA 90058

THE MARK CONSISTS OF STANDARD CHARACTERS WITHOUT CLAIM TO ANY PARTICULAR FONT, STYLE, SIZE, OR COLOR.

FOR: PLASTIC FOOD CONTAINER, IN CLASS 21  
(U.S. CLS. 2, 13, 23, 29, 30, 33, 40 AND 50).

SER. NO. 76-684,408, FILED 11-28-2007.

FIRST USE 6-29-2007; IN COMMERCE 6-29-2007.

SAMUEL E. SHARPER JR., EXAMINING ATTORNEY

**Int. Cl.: 35**

**Prior U.S. Cls.: 100, 101 and 102**

**United States Patent and Trademark Office**

**Reg. No. 3,465,049**

**Registered July 15, 2008**

**SERVICE MARK  
PRINCIPAL REGISTER**

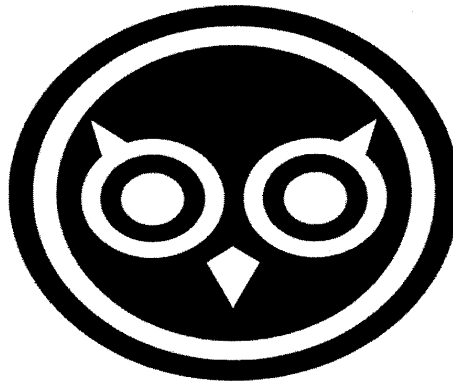

530 MEDIA LAB, INC. (CALIFORNIA CORPORATION)  
115 WEST 4TH STREET, SUITE C-1  
LONG BEACH, CA 90802

FIRST USE 3-5-2007; IN COMMERCE 3-5-2007.

SER. NO. 76-684,416, FILED 11-28-2007.

FOR: ADVERTISING AND MARKETING SERVICES FOR OTHERS, IN CLASS 35 (U.S. CLS. 100, 101 AND 102).

PETER B. BROMAGHIM, EXAMINING ATTORNEY

**Int. Cl.: 35**

**Prior U.S. Cls.: 100, 101 and 102**

**United States Patent and Trademark Office**

**Reg. No. 3,465,050**

**Registered July 15, 2008**

**SERVICE MARK  
PRINCIPAL REGISTER**

**530MEDIALAB**

530 MEDIA LAB, INC. (CALIFORNIA CORPORATION)  
115 WEST 4TH STREET, SUITE C-1  
LONG BEACH, CA 90802

THE MARK CONSISTS OF STANDARD CHARACTERS WITHOUT CLAIM TO ANY PARTICULAR FONT, STYLE, SIZE, OR COLOR.

FOR: ADVERTISING AND MARKETING SERVICES FOR OTHERS, IN CLASS 35 (U.S. CLS. 100, 101 AND 102).

SER. NO. 76-684,417, FILED 11-28-2007.

FIRST USE 3-12-2001; IN COMMERCE 11-12-2002.

PETER B. BROMAGHIM, EXAMINING ATTORNEY

Int. Cl.: 35

Prior U.S. Cls.: 100, 101 and 102

United States Patent and Trademark Office

Reg. No. 3,465,051

Registered July 15, 2008

SERVICE MARK  
PRINCIPAL REGISTER



IMAGE MARKETING OF FLORIDA, LLC (DE-  
LAWARE LTD LIAB CO)  
POST OFFICE BOX 690573  
ORLANDO, FL 32869

FOR: PROMOTING THE GOODS AND SERVICES  
OF OTHERS THROUGH THE DISTRIBUTION OF  
DISCOUNT CARDS, IN CLASS 35 (U.S. CLS. 100, 101  
AND 102).

FIRST USE 3-21-2007; IN COMMERCE 3-21-2007.

NO CLAIM IS MADE TO THE EXCLUSIVE  
RIGHT TO USE "KIDS EAT FREE CARD", APART  
FROM THE MARK AS SHOWN.

THE COLOR(S) RED, YELLOW, GREEN, OR-  
ANGE AND BLUE IS/ARE CLAIMED AS A FEAT-  
URE OF THE MARK.

THE DESIGN CONSISTS OF THE STYLIZED  
WORDS "KIDS EAT FREE CARD". THE WORDS

"KIDS" AND "EAT" APPEAR NEXT TO EACH  
OTHER. THE "K" IN "KIDS" IS CAPITALIZED  
AND RED. THE "I" IN "KIDS" IS LOWER CASE  
AND YELLOW. THE "D" IN "KIDS" IS LOWER  
CASE AND GREEN. THE "S" IN "KIDS" IS LOWER  
CASE AND ORANGE. THE "E" IN "EAT" IS LOWER  
CASE, BLUE AND OUTLINED IN WHITE WITH A  
RED DOT THAT APPEARS IN THE UPPER POR-  
TION OF THE "E". THE "A" IN "EAT" IS LOWER  
CASE AND YELLOW. THE "T" IN "EAT" IS LOWER  
CASE AND RED. THE LETTERS IN THE WORD  
"FREE" ARE CAPITALIZED RED LETTERS, AND  
APPEAR INDENTED AND BELOW THE WORDS  
"KIDS EAT". THE WORD "CARD" IS BLUE, IN-  
DENTED AND APPEARS BELOW THE WORD  
"FREE". THE LETTER "C" IN "CARD" IS CAPITA-  
LIZED.

SER. NO. 76-684,419, FILED 11-29-2007.

MATTHEW MCDOWELL, EXAMINING ATTOR-  
NEY

**Int. Cl.: 20**

**Prior U.S. Cls.: 2, 13, 22, 25, 32 and 50**

**Reg. No. 3,465,052**

**United States Patent and Trademark Office**

**Registered July 15, 2008**

**TRADEMARK  
PRINCIPAL REGISTER**



ERGOCRAFT CONTRACT SOLUTIONS (CALIFORNIA CORPORATION)  
10730 BELL COURT  
RANCHO CUCAMONGA, CA 91730

DESKS; PEDESTAL; NON-METAL BIN; COMPUTER CART; PEDESTAL FOR MACHINE BEING OFFICE FURNITURE; AND WORK BENCHES, IN CLASS 20 (U.S. CLS. 2, 13, 22, 25, 32 AND 50).

FOR: OFFICE FURNITURE, NAMELY, SEATING, NAMELY, CHAIR, TASK CHAIR, EXECUTIVE CHAIR, STACKING CHAIR, GUEST CHAIR, FOLDING CHAIR, CHURCH CHAIR; STOOL; DESK; TABLE; BOOKCASE; CASEGOODS, NAMELY, DISPLAY CASES, DISPLAY UNITS BEING FURNITURE; HUTCH; CREDENZA; STORAGE CABINET; RETURN, NAMELY, RETURN BEING A RECONFIGURABLE UNIT OF DESKS; BRIDGE, NAMELY, BRIDGE BEING A RECONFIGURABLE UNIT OF

FIRST USE 9-17-2007; IN COMMERCE 9-17-2007.

NO CLAIM IS MADE TO THE EXCLUSIVE RIGHT TO USE "CONTRACT" , APART FROM THE MARK AS SHOWN.

SER. NO. 76-684,422, FILED 11-21-2007.

ANDREA K. NADELMAN, EXAMINING ATTORNEY

**Int. Cl.: 35**

**Prior U.S. Cls.: 100, 101 and 102**

**United States Patent and Trademark Office**

**Reg. No. 3,465,053**

**Registered July 15, 2008**

---

**SERVICE MARK  
PRINCIPAL REGISTER**



AMERICAN COLLEGE OF RADIOLOGY (CALI-  
FORNIA NON-PROFIT CORPORATION)  
1891 PRESTON WHITE DRIVE  
RESTON, VA 201914397

FIRST USE 4-0-2006; IN COMMERCE 4-0-2006.

SER. NO. 76-684,423, FILED 11-28-2007.

FOR: SURVEY AND DATA COMPILATION AND  
COMPARISON SERVICES IN THE FIELD OF RA-  
DIATION THERAPY GIVEN TO CANCER PA-  
TIENTS, IN CLASS 35 (U.S. CLS. 100, 101 AND 102).

SAMUEL E. SHARPER JR., EXAMINING ATTOR-  
NEY



**Int. Cl.: 37**

**Prior U.S. Cls.: 100, 103 and 106**

**United States Patent and Trademark Office**

**Reg. No. 3,465,054**

**Registered July 15, 2008**

**SERVICE MARK  
PRINCIPAL REGISTER**

# Inverlad

REAL ESTATE INVERLAD DEVELOPMENT,  
LLC (FLORIDA LTD LIAB CO)  
205 S. EOLA DRIVE, SUITE B  
ORLANDO, FL 32801

THE MARK CONSISTS OF STANDARD CHAR-  
ACTERS WITHOUT CLAIM TO ANY PARTICULAR  
FONT, STYLE, SIZE, OR COLOR.

FOR: REAL ESTATE SERVICES, NAMELY, REAL  
ESTATE DEVELOPMENT AND CONSTRUCTION  
SERVICES, IN CLASS 37 (U.S. CLS. 100, 103 AND 106).

SER. NO. 76-684,448, FILED 11-29-2007.

FIRST USE 4-11-2002; IN COMMERCE 4-11-2002.

ANDREA SAUNDERS, EXAMINING ATTORNEY

**Int. Cl.: 37**

**Prior U.S. Cls.: 100, 103 and 106**

**United States Patent and Trademark Office**

**Reg. No. 3,465,055**

**Registered July 15, 2008**

**SERVICE MARK  
PRINCIPAL REGISTER**

# **Real Estate Inverlad**

REAL ESTATE INVERLAD DEVELOPMENT,  
LLC (FLORIDA LTD LIAB CO)  
205 S. EOLA DRIVE, SUITE B  
ORLANDO, FL 32801

FOR: REAL ESTATE SERVICES, NAMELY, REAL  
ESTATE DEVELOPMENT AND CONSTRUCTION  
SERVICES, IN CLASS 37 (U.S. CLS. 100, 103 AND 106).

FIRST USE 4-11-2002; IN COMMERCE 4-11-2002.

THE MARK CONSISTS OF STANDARD CHAR-  
ACTERS WITHOUT CLAIM TO ANY PARTICULAR  
FONT, STYLE, SIZE, OR COLOR.

NO CLAIM IS MADE TO THE EXCLUSIVE  
RIGHT TO USE "REAL ESTATE", APART FROM  
THE MARK AS SHOWN.

SER. NO. 76-684,460, FILED 11-29-2007.

ANDREA SAUNDERS, EXAMINING ATTORNEY

Int. Cl.: 36

Prior U.S. Cls.: 100, 101 and 102

United States Patent and Trademark Office

Reg. No. 3,465,056

Registered July 15, 2008

**SERVICE MARK  
PRINCIPAL REGISTER**



CU COOPERATIVE SYSTEMS, INC. (CALIFORNIA COOPERATIVE CORPORATION)  
9692 HAVEN AVENUE  
RANCHO CUCAMONGA, CA 91730

FOR: FINANCIAL SERVICES FOR CREDIT UNIONS, NAMELY, ELECTRONIC FUNDS TRANSFER SERVICES, ATM NETWORK SERVICES, ATM DRIVING AND MONITORING SERVICES, TRANSACTION SWITCHING SERVICES, DEBIT CARD SERVICES, NETWORK SECURITY SERVICES, AUTHORIZATION PROCESSING SERVICES, PROGRAM ADMINISTRATION SERVICES, PRE-PAID CARDS, STORED VALUE AND GIFT CARDS SERVICES, IN CLASS 36 (U.S. CLS. 100, 101 AND 102).

FIRST USE 5-0-2006; IN COMMERCE 5-0-2006.

OWNER OF U.S. REG. NO. 2,497,862.

NO CLAIM IS MADE TO THE EXCLUSIVE RIGHT TO USE "CO-OP CARD SERVICES", APART FROM THE MARK AS SHOWN.

SER. NO. 76-684,463, FILED 11-29-2007.

DEZMONA MIZELLE, EXAMINING ATTORNEY

**Int. Cl.: 36**

**Prior U.S. Cls.: 100, 101 and 102**

**United States Patent and Trademark Office**

**Reg. No. 3,465,057**

**Registered July 15, 2008**

**SERVICE MARK  
PRINCIPAL REGISTER**



CU COOPERATIVE SYSTEMS, INC. (CALIFORNIA COOPERATIVE CORPORATION)  
9692 HAVEN AVENUE  
RANCHO CUCAMONGA, CA 91730

FOR: FINANCIAL SERVICES FOR CREDIT UNIONS, NAMELY, ELECTRONIC FUNDS TRANSFER SERVICES, ATM NETWORK SERVICES, ATM DRIVING AND MONITORING SERVICES, TRANSACTION SWITCHING SERVICES, DEBIT CARD SERVICES, NETWORK SECURITY SERVICES, AUTHORIZATION PROCESSING SERVICES, PROGRAM ADMINISTRATION SERVICES, SHARED BRANCHING SERVICES IN THE NATURE OF PROVIDING A COOPERATIVE CREDIT UNION SERVICES NETWORK, PRE-PAID CARDS, STORED

VALUE AND GIFT CARDS SERVICES, IN CLASS 36 (U.S. CLS. 100, 101 AND 102).

FIRST USE 5-0-2006; IN COMMERCE 5-0-2006.

OWNER OF U.S. REG. NO. 2,497,862.

NO CLAIM IS MADE TO THE EXCLUSIVE RIGHT TO USE "CO-OP FINANCIAL SERVICES" , APART FROM THE MARK AS SHOWN.

SER. NO. 76-684,466, FILED 11-29-2007.

DEZMONA MIZELLE, EXAMINING ATTORNEY

Int. Cl.: 36

Prior U.S. Cls.: 100, 101 and 102

United States Patent and Trademark Office

Reg. No. 3,465,058

Registered July 15, 2008

**SERVICE MARK  
PRINCIPAL REGISTER**

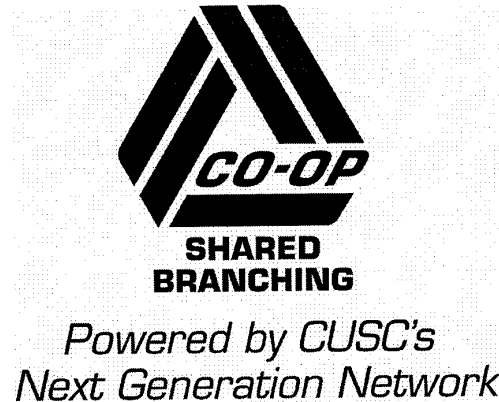

CU COOPERATIVE SYSTEMS, INC. (CALIFORNIA COOPERATIVE CORPORATION)  
9692 HAVEN AVENUE  
RANCHO CUCAMONGA, CA 91730

FOR: SHARED BRANCHING SERVICES, NAME-  
LY, A COOPERATIVE CREDIT UNION SERVICES  
NETWORK, IN CLASS 36 (U.S. CLS. 100, 101 AND  
102).

FIRST USE 8-0-2007; IN COMMERCE 8-0-2007.

OWNER OF U.S. REG. NO. 2,497,862.

NO CLAIM IS MADE TO THE EXCLUSIVE  
RIGHT TO USE "CO-OP SHARED BRANCHING",  
APART FROM THE MARK AS SHOWN.

SER. NO. 76-684,495, FILED 11-30-2007.

DEZMONA MIZELLE, EXAMINING ATTORNEY

**Int. Cl.: 36**

**Prior U.S. Cls.: 100, 101 and 102**

**United States Patent and Trademark Office**

**Reg. No. 3,465,059**

**Registered July 15, 2008**

**SERVICE MARK  
PRINCIPAL REGISTER**

**SMITH BROTHERS. BE SURE.**

SMITH BROTHERS INSURANCE, INC. (CON-  
NECTICUT CORPORATION)  
68 NATIONAL DRIVE  
GLASTONBURY, CT 06033

FOR: INSURANCE AGENCY SERVICES IN THE  
FIELDS OF COMMERCIAL PROPERTY AND CA-  
SUALTY, HOMEOWNERS', RENTERS', AUTOMO-  
BILE, MOTORCYCLE, BOAT, PROPERTY,  
ACCIDENT, MEDICAL, LONG TERM CARE, DIS-  
ABILITY, AND GROUP INSURANCE; CONSULT-  
ING IN THE FIELDS OF INSURANCE, RISK  
MANAGEMENT, HUMAN RESOURCES, BENE-  
FITS, AND FINANCIAL PLANNING, IN CLASS 36  
(U.S. CLS. 100, 101 AND 102).

FIRST USE 5-24-2007; IN COMMERCE 5-24-2007.

THE MARK CONSISTS OF STANDARD CHAR-  
ACTERS WITHOUT CLAIM TO ANY PARTICULAR  
FONT, STYLE, SIZE, OR COLOR.

NO CLAIM IS MADE TO THE EXCLUSIVE  
RIGHT TO USE "BROTHERS", APART FROM THE  
MARK AS SHOWN.

SER. NO. 76-684,502, FILED 11-30-2007.

EDWARD FENNESSY, EXAMINING ATTORNEY

**Int. Cl.: 7**

**Prior U.S. Cls.: 13, 19, 21, 23, 31, 34 and 35**

**Reg. No. 3,465,060**

**United States Patent and Trademark Office**

**Registered July 15, 2008**

**TRADEMARK  
PRINCIPAL REGISTER**

**VERSACOPE**

DAITO SEIKI CO., LTD. (JAPAN CORPORATION)  
2-26, HIGASHIHATSUSHIMA  
AMAGASAKI-SHI, HYOGO PREF, JAPAN

THE MARK CONSISTS OF STANDARD CHARACTERS WITHOUT CLAIM TO ANY PARTICULAR FONT, STYLE, SIZE, OR COLOR.

FOR: CUTTING MACHINES FOR METALWORKING, IN CLASS 7 (U.S. CLS. 13, 19, 21, 23, 31, 34 AND 35).

SER. NO. 76-684,531, FILED 11-30-2007.

FIRST USE 8-2-2007; IN COMMERCE 9-3-2007.

MARY BOAGNI, EXAMINING ATTORNEY

**Int. Cl.: 13**

**Prior U.S. Cls.: 2 and 9**

**United States Patent and Trademark Office**

**Reg. No. 3,465,061**

**Registered July 15, 2008**

---

**TRADEMARK  
PRINCIPAL REGISTER**

**CODY**

A. UBERTI S.R.L. (ITALY COMPANY)  
VIA VITTORIO EMANUELE II  
NO. 1, BRESCIA, ITALY

FIRST USE 11-30-2007; IN COMMERCE 11-30-2007.

SER. NO. 76-684,540, FILED 12-3-2007.

FOR: REPLICAS FIREARMS, IN CLASS 13 (U.S.  
CLS. 2 AND 9).

JENNIFER HETU, EXAMINING ATTORNEY



**Int. Cl.: 30**

**Prior U.S. Cl.: 46**

**United States Patent and Trademark Office**

**Reg. No. 3,465,062**

**Registered July 15, 2008**

**TRADEMARK  
PRINCIPAL REGISTER**

**FOX Z. DOODLE**

WISE FOODS, INC. (DELAWARE CORPORATION)  
228 RASELEY STREET  
BERWICK, PA 18603

FOR: SNACKS, NAMELY, CHEESE-FLAVORED PUFFED CORN SNACKS, TORTILLA CHIPS, POPPED POPCORN, CORN CHIPS, CHEESE SNACK CRACKERS, PEANUT BUTTER SNACK CRACKERS, COOKIES AND BROWNIES, IN CLASS 30 (U.S. CL. 46).

FIRST USE 12-31-1991; IN COMMERCE 12-31-1991.

THE MARK CONSISTS OF STANDARD CHARACTERS WITHOUT CLAIM TO ANY PARTICULAR FONT, STYLE, SIZE, OR COLOR.

OWNER OF U.S. REG. NOS. 644,839, 2,767,184 AND OTHERS.

SER. NO. 76-684,560, FILED 12-3-2007.

H. M. FISHER, EXAMINING ATTORNEY

**Int. Cl.: 42**

**Prior U.S. Cls.: 100 and 101**

**United States Patent and Trademark Office**

**Reg. No. 3,465,063**

**Registered July 15, 2008**

**SERVICE MARK  
PRINCIPAL REGISTER**

**ARKANOVA**

ARKANOVA ENERGY CORPORATION (NEVADA CORPORATION)  
21 WATERWAY AVENUE, SUITE 300  
THE WOODLANDS, TX 77380

FOR: EXPLORATION AND SEARCHING FOR GAS AND OIL, IN CLASS 42 (U.S. CLS. 100 AND 101).

FIRST USE 6-0-2006; IN COMMERCE 10-27-2006.

THE MARK CONSISTS OF STANDARD CHARACTERS WITHOUT CLAIM TO ANY PARTICULAR FONT, STYLE, SIZE, OR COLOR.

SER. NO. 76-684,565, FILED 12-3-2007.

ROBERT LAVACHE, EXAMINING ATTORNEY

**Int. Cl.: 14**

**Prior U.S. Cls.: 2, 27, 28 and 50**

**United States Patent and Trademark Office**

**Reg. No. 3,465,064**

**Registered July 15, 2008**

**TRADEMARK  
PRINCIPAL REGISTER**

**VINTA CHICK**

MCKINNEY, ELIZABETH (UNITED STATES INDIVIDUAL), DBA VINTA CHICK  
23 SOUTH DOWNY WILLOW CREEK  
THE WOODLANDS, TX 77382

THE MARK CONSISTS OF STANDARD CHARACTERS WITHOUT CLAIM TO ANY PARTICULAR FONT, STYLE, SIZE, OR COLOR.

FOR: JEWELRY, IN CLASS 14 (U.S. CLS. 2, 27, 28 AND 50).

SER. NO. 76-684,566, FILED 12-3-2007.

FIRST USE 9-6-2007; IN COMMERCE 9-22-2007.

JIM RINGLE, EXAMINING ATTORNEY

**Int. Cl.: 5**

**Prior U.S. Cls.: 6, 18, 44, 46, 51 and 52**

**United States Patent and Trademark Office**

**Reg. No. 3,465,065**

**Registered July 15, 2008**

**TRADEMARK  
PRINCIPAL REGISTER**

**TETCAINE**

OCUSOFT, INC. (TEXAS CORPORATION)  
P.O. BOX 429  
RICHMOND, TX 774050429

THE MARK CONSISTS OF STANDARD CHAR-  
ACTERS WITHOUT CLAIM TO ANY PARTICULAR  
FONT, STYLE, SIZE, OR COLOR.

FOR: OPHTHALMIC, TOPICAL ANESTHETIC, IN  
CLASS 5 (U.S. CLS. 6, 18, 44, 46, 51 AND 52).

SER. NO. 76-684,574, FILED 12-3-2007.

FIRST USE 6-1-1996; IN COMMERCE 6-1-1996.

JIM RINGLE, EXAMINING ATTORNEY

**Int. Cl.: 32**

**Prior U.S. Cls.: 45, 46 and 48**

**Reg. No. 3,465,066**

**United States Patent and Trademark Office**

**Registered July 15, 2008**

---

**TRADEMARK  
PRINCIPAL REGISTER**

**2XE**

FLAVOR SYSTEMS INTERNATIONAL, INC.  
(OHIO CORPORATION)  
9950 COMMERCE PARK DRIVE  
CINCINNATI, OH 45246

THE MARK CONSISTS OF STANDARD CHARACTERS WITHOUT CLAIM TO ANY PARTICULAR FONT, STYLE, SIZE, OR COLOR.

FOR: ENERGY DRINKS, IN CLASS 32 (U.S. CLS. 45, 46 AND 48).

SER. NO. 76-684,630, FILED 12-4-2007.

FIRST USE 9-26-2007; IN COMMERCE 9-26-2007.

ANTHONY RINKER, EXAMINING ATTORNEY

**Int. Cl.: 9**

**Prior U.S. Cls.: 21, 23, 26, 36 and 38**

**United States Patent and Trademark Office**

**Reg. No. 3,465,067**

**Registered July 15, 2008**

**TRADEMARK  
PRINCIPAL REGISTER**

**MADE FOR PRAISE**

LIFEWAY CHRISTIAN RESOURCES OF THE  
SOUTHERN BAPTIST CONVENTION (TEN-  
NESSEE CORPORATION)  
ONE LIFEWAY PLAZA  
NASHVILLE, TN 37234

FOR: COMPACT DISKS FEATURING MUSIC, IN  
CLASS 9 (U.S. CLS. 21, 23, 26, 36 AND 38).

FIRST USE 8-14-1996; IN COMMERCE 8-14-1996.

THE MARK CONSISTS OF STANDARD CHAR-  
ACTERS WITHOUT CLAIM TO ANY PARTICULAR  
FONT, STYLE, SIZE, OR COLOR.

OWNER OF U.S. REG. NO. 2,079,388.

SER. NO. 76-684,713, FILED 12-7-2007.

ANDREA SAUNDERS, EXAMINING ATTORNEY

Int. Cl.: 7

Prior U.S. Cls.: 13, 19, 21, 23, 31, 34 and 35

United States Patent and Trademark Office

Reg. No. 3,465,068

Registered July 15, 2008

TRADEMARK  
PRINCIPAL REGISTER



BAD BOY, INC. (ARKANSAS CORPORATION)  
102 INDUSTRIAL DRIVE  
BATESVILLE, AR 72501

NO CLAIM IS MADE TO THE EXCLUSIVE  
RIGHT TO USE "MOWERS", APART FROM THE  
MARK AS SHOWN.

FOR: COMMERCIAL RIDING LAWN MOWERS,  
IN CLASS 7 (U.S. CLS. 13, 19, 21, 23, 31, 34 AND 35).

SER. NO. 76-684,780, FILED 12-10-2007.

FIRST USE 10-5-2007; IN COMMERCE 10-10-2007.

INGRID C. EULIN, EXAMINING ATTORNEY

**Int. Cl.: 16**

**Prior U.S. Cls.: 2, 5, 22, 23, 29, 37, 38 and 50**

**Reg. No. 3,465,069**

**United States Patent and Trademark Office**

**Registered July 15, 2008**

---

**TRADEMARK  
PRINCIPAL REGISTER**

**FUNTIVITIES**

LC TRADEMARKS, INC. (MICHIGAN CORPORATION)  
C/O FOX OFFICE CENTRE  
2211 WOODWARD AVENUE  
DETROIT, MI 482013400

FOR: CHILDREN'S ACTIVITY BOOKS, IN CLASS  
16 (U.S. CLS. 2, 5, 22, 23, 29, 37, 38 AND 50).

FIRST USE 2-0-2005; IN COMMERCE 2-0-2005.

THE MARK CONSISTS OF STANDARD CHARACTERS WITHOUT CLAIM TO ANY PARTICULAR FONT, STYLE, SIZE, OR COLOR.

SER. NO. 76-684,804, FILED 12-6-2007.

WARREN L. OLANDRIA, EXAMINING ATTORNEY



**Int. Cl.: 30**

**Prior U.S. Cl.: 46**

**United States Patent and Trademark Office**

**Reg. No. 3,465,070**

**Registered July 15, 2008**

**TRADEMARK  
PRINCIPAL REGISTER**

**DISCOVER YOUR INNER CONNOISSEUR**

CHOCOLADEFABRIKEN LINDT & SPRÜNGLI  
AG (SWITZERLAND CORPORATION)  
SEESTRAÙE 204  
CH-8802 KILCHBERG, SWITZERLAND

FIRST USE 8-0-2007; IN COMMERCE 8-0-2007.

SER. NO. 76-684,871, FILED 12-12-2007.

FOR: CHOCOLATE, IN CLASS 30 (U.S. CL. 46).

DOMINICK J. SALEMI, EXAMINING ATTORNEY

Int. Cl.: 36

Prior U.S. Cls.: 100, 101 and 102

United States Patent and Trademark Office

Reg. No. 3,465,071

Registered July 15, 2008

**SERVICE MARK  
PRINCIPAL REGISTER**



CU COOPERATIVE SYSTEMS, INC. (CALIFORNIA COOPERATIVE CORPORATION)  
9692 HAVEN AVENUE  
RANCHO CUCAMONGA, CA 91730

FOR: FINANCIAL SERVICES FOR CREDIT UNIONS, NAMELY, ELECTRONIC FUNDS TRANSFER SERVICES, ATM NETWORK SERVICES, ATM DRIVING AND MONITORING SERVICES, TRANSACTION SWITCHING SERVICES, DEBIT CARD SERVICES, NETWORK SECURITY SERVICES, AUTHORIZATION PROCESSING SERVICES, PROGRAM ADMINISTRATION SERVICES, PRE-PAID CARDS, STORED VALUE AND GIFT CARDS SERVICES, IN CLASS 36 (U.S. CLS. 100, 101 AND 102).

FIRST USE 5-0-2006; IN COMMERCE 5-0-2006.

OWNER OF U.S. REG. NO. 2,497,862.

NO CLAIM IS MADE TO THE EXCLUSIVE RIGHT TO USE "CO-OP ATM PROCESSING", APART FROM THE MARK AS SHOWN.

SER. NO. 76-684,898, FILED 12-13-2007.

DEZMONA MIZELLE, EXAMINING ATTORNEY

**Int. Cl.: 41**

**Prior U.S. Cls.: 100, 101 and 107**

**United States Patent and Trademark Office**

**Reg. No. 3,465,072**

**Registered July 15, 2008**

**SERVICE MARK  
PRINCIPAL REGISTER**

**THE STEVE WILKOS SHOW**

UNIVERSAL TV DISTRIBUTION HOLDINGS  
LLC (DELAWARE LIMITED LIABILITY COR-  
PORATION)  
100 UNIVERSAL CITY PLAZA  
UNIVERSAL CITY, CA 91608

FOR: ENTERTAINMENT SERVICES IN THE  
NATURE OF AN ON-GOING TELEVISION TALK  
SHOW; ENTERTAINMENT SERVICES, NAMELY, A  
WEBSITE PROVIDING INFORMATION RELATED  
TO A TELEVISION TALK SHOW AND RELATED  
ENTERTAINMENT TOPICS VIA A GLOBAL COM-  
PUTER NETWORK, IN CLASS 41 (U.S. CLS. 100, 101  
AND 107).

FIRST USE 9-10-2007; IN COMMERCE 9-10-2007.

THE MARK CONSISTS OF STANDARD CHAR-  
ACTERS WITHOUT CLAIM TO ANY PARTICULAR  
FONT, STYLE, SIZE, OR COLOR.

NO CLAIM IS MADE TO THE EXCLUSIVE  
RIGHT TO USE "SHOW", APART FROM THE  
MARK AS SHOWN.

"STEVE WILKOS" IS THE NAME OF A LIVING  
INDIVIDUAL WHOSE CONSENT IS OF RECORD.

SER. NO. 76-684,958, FILED 12-14-2007.

ANDREA K. NADELMAN, EXAMINING ATTOR-  
NEY

**Int. Cl.: 16**

**Prior U.S. Cls.: 2, 5, 22, 23, 29, 37, 38 and 50**

**United States Patent and Trademark Office**

**Reg. No. 3,465,073**

**Registered July 15, 2008**

**TRADEMARK  
PRINCIPAL REGISTER**

**EXPLORE THE BIBLE**

LIFEWAY CHRISTIAN RESOURCES OF THE  
SOUTHERN BAPTIST CONVENTION (TEN-  
NESSEE CORPORATION)

ONE LIFEWAY PLAZA  
NASHVILLE, TN 37234

FOR: PERIODICAL MAGAZINES RELATING TO  
BIBLE CURRICULUM, IN CLASS 16 (U.S. CLS. 2, 5,  
22, 23, 29, 37, 38 AND 50).

FIRST USE 9-1-1996; IN COMMERCE 9-1-1996.

THE MARK CONSISTS OF STANDARD CHAR-  
ACTERS WITHOUT CLAIM TO ANY PARTICULAR  
FONT, STYLE, SIZE, OR COLOR.

OWNER OF U.S. REG. NO. 2,121,508.

NO CLAIM IS MADE TO THE EXCLUSIVE  
RIGHT TO USE "BIBLE", APART FROM THE  
MARK AS SHOWN.

SER. NO. 76-685,121, FILED 12-20-2007.

ANDREA SAUNDERS, EXAMINING ATTORNEY

**Int. Cl.: 5**

**Prior U.S. Cls.: 6, 18, 44, 46, 51 and 52**

**Reg. No. 3,465,074**

**United States Patent and Trademark Office**

**Registered July 15, 2008**

**TRADEMARK  
PRINCIPAL REGISTER**

**BEEFXIDE**

BIRKO CORPORATION (COLORADO CORPORATION)  
9152 YOSEMITE STREET  
HENDERSON, CO 80640

FIRST USE 11-9-2007; IN COMMERCE 11-9-2007.

FOR: ANTIMICROBIAL COMPOSITIONS FOR PROCESSING BEEF AND OTHER NON-POULTRY MEAT CARCASSES TO REDUCE THE INCIDENCE OF SALMONELLA AND OTHER PATHOGENS ON FOOD PRODUCTS, IN CLASS 5 (U.S. CLS. 6, 18, 44, 46, 51 AND 52).

THE MARK CONSISTS OF STANDARD CHARACTERS WITHOUT CLAIM TO ANY PARTICULAR FONT, STYLE, SIZE, OR COLOR.

SER. NO. 76-685,402, FILED 12-31-2007.

LAURIE MAYES, EXAMINING ATTORNEY

**Int. Cl.: 35**

**Prior U.S. Cls.: 100, 101 and 102**

**United States Patent and Trademark Office**

**Reg. No. 3,465,075**

**Registered July 15, 2008**

**SERVICE MARK  
PRINCIPAL REGISTER**

**WOW Café and Wingery**

WOW CAFE AND WINGERY (LOUISIANA LIMITED LIABILITY CORPORATION)

109 NEW CAMELLIA BOULEVARD, SUITE 200  
COVINGTON, LA 70433

FOR: FRANCHISE SERVICES, NAMELY, OFFERING BUSINESS MANAGEMENT ASSISTANCE IN THE ESTABLISHMENT AND OPERATION OF RESTAURANTS, IN CLASS 35 (U.S. CLS. 100, 101 AND 102).

FIRST USE 6-1-2004; IN COMMERCE 6-1-2004.

THE MARK CONSISTS OF STANDARD CHARACTERS WITHOUT CLAIM TO ANY PARTICULAR FONT, STYLE, SIZE, OR COLOR.

OWNER OF U.S. REG. NOS. 2,816,457 AND 2,848,926.

NO CLAIM IS MADE TO THE EXCLUSIVE RIGHT TO USE "CAFÉ AND WINGERY", APART FROM THE MARK AS SHOWN.

SER. NO. 76-685,723, FILED 1-11-2008.

AISHA CLARKE, EXAMINING ATTORNEY

**Int. Cl.: 16**

**Prior U.S. Cls.: 2, 5, 22, 23, 29, 37, 38 and 50**

**United States Patent and Trademark Office**

**Reg. No. 3,465,076**

**Registered July 15, 2008**

**TRADEMARK  
PRINCIPAL REGISTER**

**CONSTRUCTION EXECUTIVE**

ASSOCIATED BUILDERS AND CONTRACTORS,  
INC. (MARYLAND CORPORATION)  
4250 NORTH FAIRFAX DRIVE, 9TH FLOOR  
ARLINGTON, VA 22203

FOR: MAGAZINES IN THE FIELD OF CON-  
STRUCTION, IN CLASS 16 (U.S. CLS. 2, 5, 22, 23, 29,  
37, 38 AND 50).

FIRST USE 1-0-2003; IN COMMERCE 1-0-2003.

THE MARK CONSISTS OF STANDARD CHAR-  
ACTERS WITHOUT CLAIM TO ANY PARTICULAR  
FONT, STYLE, SIZE, OR COLOR.

OWNER OF U.S. REG. NO. 2,844,102.

SEC. 2(F).

SER. NO. 76-686,383, FILED 1-31-2008.

DAVID I, EXAMINING ATTORNEY

**Int. Cl.: 35**

**Prior U.S. Cls.: 100, 101 and 102**

**United States Patent and Trademark Office**

**Reg. No. 3,465,077**

**Registered July 15, 2008**

**SERVICE MARK  
PRINCIPAL REGISTER**

**FLOWLINE**

MTU AERO ENGINES GMBH (FED REP GER-  
MANY LTD LIAB CO)  
DACHAUER STRASSE 665  
MUNICH, FED REP GERMANY 80995

PRIORITY CLAIMED UNDER SEC. 44(D) ON  
ERPNTY TM OFC APPLICATION NO.  
003117652, FILED 4-2-2003, REG. NO. 003117652,  
DATED 12-8-2006, EXPIRES 4-2-2013.

FOR: INVENTORY MANAGEMENT IN THE  
FIELD OF STOCKPLANNING AND STOCKKEEP-  
ING NEW PARTS, SPARE PARTS, ASSEMBLIES  
AND MODULES OF JET PROPULSION UNITS  
AND GAS TURBINES, IN CLASS 35 (U.S. CLS. 100,  
101 AND 102).

SER. NO. 76-978,587, FILED 6-3-2003.

PAUL F. GAST, EXAMINING ATTORNEY



**Int. Cl.: 9**

**Prior U.S. Cls.: 21, 23, 26, 36 and 38**

**Reg. No. 3,465,078**

**United States Patent and Trademark Office**

**Registered July 15, 2008**

**TRADEMARK  
PRINCIPAL REGISTER**

**IATROGEN**

MORSE, M. L. (UNITED STATES INDIVIDUAL)  
140 RIVER PARK LANE  
GREAT FALLS, VA 22066

FIRST USE 2-0-2001; IN COMMERCE 2-0-2001.

FOR: PHARMACEUTICAL RISK ANALYSIS SOFTWARE FOR PUBLIC HEALTH SYSTEMS, PRIVATE HEALTH PLANS AND CONSUMERS; DOWNLOADABLE, ELECTRONIC PUBLICATIONS, NAMELY, REPORTS FEATURING INFORMATION ON ADVERSE DRUG REACTIONS IN THE MEDICAL AND HEALTHCARE FIELDS, RECORDED ON COMPUTER MEDIA, IN CLASS 9 (U.S. CLS. 21, 23, 26, 36 AND 38).

THE MARK CONSISTS OF STANDARD CHARACTERS WITHOUT CLAIM TO ANY PARTICULAR FONT, STYLE, SIZE, OR COLOR.

"IATROGEN" HAS NO MEANING IN A FOREIGN LANGUAGE.

SER. NO. 76-978,646, FILED 9-10-2004.

TEJBIR SINGH, EXAMINING ATTORNEY

**Int. Cl.: 41**

**Prior U.S. Cls.: 100, 101 and 107**

**United States Patent and Trademark Office**

**Reg. No. 3,465,079**

**Registered July 15, 2008**

**SERVICE MARK  
PRINCIPAL REGISTER**

# True Vegas

TRUE VEGAS PRODUCTIONS LLC (NEVADA  
LTD LIAB CO)  
9509 CORAL WAY  
LAS VEGAS, NV 89117

FOR: ENTERTAINMENT IN THE NATURE OF ON-GOING TELEVISION PROGRAMS IN THE FIELD OF DOCUMENTARY FILMS; ENTERTAINMENT IN THE NATURE OF TELEVISION NEWS SHOWS; ENTERTAINMENT, NAMELY, PRODUCTION OF TELEVISION SHOWS AND DOCUMENTARY FILMS; ENTERTAINMENT, NAMELY, A CONTINUING DOCUMENTARY SHOW BROADCAST OVER TELEVISION, SATELLITE, AUDIO, AND VIDEO MEDIA; ENTERTAINMENT, NAMELY, TELEVISION NEWS SHOWS, IN CLASS 41 (U.S. CLS. 100, 101 AND 107).

FIRST USE 2-17-2006; IN COMMERCE 5-16-2006.

THE MARK CONSISTS OF STANDARD CHARACTERS WITHOUT CLAIM TO ANY PARTICULAR FONT, STYLE, SIZE, OR COLOR.

NO CLAIM IS MADE TO THE EXCLUSIVE RIGHT TO USE "VEGAS", APART FROM THE MARK AS SHOWN.

SER. NO. 77-000,088, FILED 9-15-2006.

ANDREA BUTLER, EXAMINING ATTORNEY

**Int. Cl.: 25**

**Prior U.S. Cls.: 22 and 39**

**United States Patent and Trademark Office**

**Reg. No. 3,465,080**

**Registered July 15, 2008**

**TRADEMARK  
PRINCIPAL REGISTER**

**The Cross of Forgiveness**

THE 247 GROUP PTY LTD (AUSTRALIA CORPORATION)  
627 MILITARY ROAD  
MOSMAN, AUSTRALIA 2088

FOR: CLOTHING, NAMELY, SHIRTS, PANTS, TOPS, UNDERWEAR, SOCKS, COATS, JUMPERS, AND JACKETS; FOOTWEAR AND HEAD WEAR, IN CLASS 25 (U.S. CLS. 22 AND 39).

THE MARK CONSISTS OF STANDARD CHARACTERS WITHOUT CLAIM TO ANY PARTICULAR FONT, STYLE, SIZE, OR COLOR.

PRIORITY CLAIMED UNDER SEC. 44(D) ON AUSTRALIA APPLICATION NO. 1120528, FILED 6-23-2006, REG. NO. 1120528, DATED 6-23-2006, EXPIRES 6-23-2013.

SER. NO. 77-001,900, FILED 9-18-2006.

KAREN BRACEY, EXAMINING ATTORNEY

**Int. Cls.: 35 and 39**

**Prior U.S. Cls.: 100, 101, 102 and 105**

**United States Patent and Trademark Office**

**Reg. No. 3,465,081**

**Registered July 15, 2008**

**SERVICE MARK  
PRINCIPAL REGISTER**

# SECOND POST

MILKROUND ONLINE LTD (UNITED KINGDOM PRIVATE LIMITED COMPANY)  
DEANS COURT  
1-3 LONDON ROAD  
BICESTER, OXON, UNITED KINGDOM OX266BU

FOR: ADVERTISING SERVICES, NAMELY, RECRUITMENT ADVERTISING SERVICES, PLACING ADVERTISING FOR JOBS, EMPLOYERS AND POTENTIAL EMPLOYEES FOR OTHERS; BUSINESS MANAGEMENT; BUSINESS ADMINISTRATION; PROVIDING OFFICE FUNCTIONS; PUBLICITY SERVICES; PERSONNEL RECRUITMENT SERVICES; RECRUITMENT OF GRADUATE STUDENTS FOR EMPLOYERS; EMPLOYMENT OUTPLACEMENT SERVICES AND PERSONNEL PLACEMENT AGENCY SERVICES; PREPARING AND PLACING ADVERTISEMENTS FOR JOB VACANCIES FOR OTHERS; PROVIDING AN ON-LINE SEARCHABLE DATABASE FEATURING CLASSIFIED AD LISTINGS AND EMPLOYMENT OPPORTUNITIES; BUSINESS AND MANAGEMENT CONSULTANCY SERVICES; HUMAN RESOURCE MANAGEMENT AND CONSULTATION; PROVISION OF ADVERTISING SPACE BY ELECTRONIC MEANS AND GLOBAL INFORMATION NETWORKS; BUSINESS MANAGEMENT SERVICES, NAMELY, POSTING JOBS, TRACKING APPLICANT, WORK FLOW AND CANDIDATE COMMUNICATIONS; PREPARATION OF CURRICULUM VITAE; ADVISORY

AND CONSULTANCY SERVICES IN RELATION TO EMPLOYMENT AND RECRUITMENT; COMPILING INFORMATION IN THE FIELD OF HUMAN RESOURCES, IN CLASS 35 (U.S. CLS. 100, 101 AND 102).

FOR: ELECTRONIC STORAGE OF INFORMATION, NAMELY, FILES AND DOCUMENTS IN THE FIELD OF EMPLOYMENT, RECRUITMENT AND HUMAN RESOURCES, IN CLASS 39 (U.S. CLS. 100 AND 105).

THE MARK CONSISTS OF STANDARD CHARACTERS WITHOUT CLAIM TO ANY PARTICULAR FONT, STYLE, SIZE, OR COLOR.

PRIORITY CLAIMED UNDER SEC. 44(D) ON ERPN CMNTY TM OFC APPLICATION NO. 005353859, FILED 9-19-2006, REG. NO. 005353859, DATED 9-18-2007, EXPIRES 9-19-2016.

NO CLAIM IS MADE TO THE EXCLUSIVE RIGHT TO USE "POST", APART FROM THE MARK AS SHOWN.

SER. NO. 77-002,170, FILED 9-19-2006.

WILLIAM ROSSMAN, EXAMINING ATTORNEY

**Int. Cl.: 3**

**Prior U.S. Cls.: 1, 4, 6, 50, 51 and 52**

**Reg. No. 3,465,082**

**United States Patent and Trademark Office**

**Registered July 15, 2008**

**TRADEMARK  
PRINCIPAL REGISTER**

**VITALITY INSTITUTE**

SOUTH BEACH VITALITY INSTITUTE, L.L.C.  
(FLORIDA LTD LIAB CO)  
2ND FLOOR  
844 ALTON ROAD  
MIAMI BEACH, FL 33139

FOR: SKIN CARE PRODUCTS, NAMELY, MOISTURIZING LOTIONS, SUN PROTECTION LOTIONS AND SKIN REJUVENATING LOTIONS, IN CLASS 3 (U.S. CLS. 1, 4, 6, 50, 51 AND 52).

FIRST USE 8-31-2005; IN COMMERCE 8-31-2005.

THE MARK CONSISTS OF STANDARD CHARACTERS WITHOUT CLAIM TO ANY PARTICULAR FONT, STYLE, SIZE, OR COLOR.

NO CLAIM IS MADE TO THE EXCLUSIVE RIGHT TO USE "INSTITUTE", APART FROM THE MARK AS SHOWN.

SER. NO. 77-002,547, FILED 9-19-2006.

ALICIA COLLINS, EXAMINING ATTORNEY

Int. Cl.: 43

Prior U.S. Cls.: 100 and 101

United States Patent and Trademark Office

Reg. No. 3,465,083

Registered July 15, 2008

SERVICE MARK  
PRINCIPAL REGISTER



BARK KENNEL & BOARDING, LLC (CALIFORNIA LIMITED LIABILITY CORPORATION)  
1759 ENTERPRISE BLVD  
SACRAMENTO, CA 95691

FOR: KENNEL SERVICES, IN CLASS 43 (U.S. CLS. 100 AND 101).

FIRST USE 10-1-2005; IN COMMERCE 10-1-2005.

NO CLAIM IS MADE TO THE EXCLUSIVE RIGHT TO USE "HOTELS", APART FROM THE MARK AS SHOWN.

THE MARK CONSISTS OF THE WORD "WAG" WITH THE LOWER PART OF THE LETTER "G" HAVING AN EXTRA LINE ON EITHER SIDE OF IT, SO AS TO BE SUGGESTIVE OF A TAIL WAGGING, AND THE WORD "HOTELS". THE COLOR GRAY IS NOT BEING CLAIMED AS A FEATURE OF THE MARK.

SER. NO. 77-004,205, FILED 9-21-2006.

JILL C. ALT, EXAMINING ATTORNEY

Int. Cl.: 13

Prior U.S. Cls.: 2 and 9

United States Patent and Trademark Office

Reg. No. 3,465,084

Registered July 15, 2008

TRADEMARK  
PRINCIPAL REGISTER



CHINA SUNSONG (SHENZHEN) IMPORT & EXPORT CO., LTD (CHINA CORPORATION)  
C25C, CHANGAN GARDEN  
BAIHUA 4 ROAD  
SHENZHEN, GUANGDONG, CHINA

FOR: GUNPOWDER, NAMELY, TINDER, PYROPHORIC SUBSTANCES; PRIMINGS, NAMELY, EXPLOSIVE PRIMERS; FIREWORKS, BENGAL LIGHTS, PYROTECHNIC PRODUCTS, NAMELY, PYROTECHNIC MISSILES AND PYROTECHNIC CHARGES, EXPLOSIVES, NAMELY, EXPLOSIVE FOG SIGNALS, FIRECRACKER, SMOKE FLOWER-AGE IN THE NATURE OF SMOKE PROJECTILES; SIGNAL ROCKERS, AMMONIUM NITRATE EXPLOSIVES, DETONATING FUSES FOR EXPLOSIVES, FIRING LANYARDS PLATFORMS FOR

EXPLOSIVES, EXPLOSIVE POWDERS, IN CLASS 13 (U.S. CLS. 2 AND 9).

FIRST USE 5-1-2006; IN COMMERCE 7-1-2006.

NO CLAIM IS MADE TO THE EXCLUSIVE RIGHT TO USE "FIREWORKS", APART FROM THE MARK AS SHOWN.

THE MARK CONSISTS OF TWO ENGLISH WORDS "LEGEND", "FIREWORKS" AND THE DEVICES OF TWO FIREWORKS.

SER. NO. 77-004,925, FILED 9-22-2006.

RAMONA ORTIGA, EXAMINING ATTORNEY

**Int. Cl.: 36**

**Prior U.S. Cls.: 100, 101 and 102**

**United States Patent and Trademark Office**

**Reg. No. 3,465,085**

**Registered July 15, 2008**

**SERVICE MARK  
PRINCIPAL REGISTER**

**LIQUIDNET H2O**

LIQUIDNET HOLDINGS, INC. (DELAWARE  
CORPORATION)  
12TH FLOOR  
498 7TH AVENUE  
NEW YORK, NY 10018

FUND TRANSFER AND TRANSACTION SERVI-  
CES; INVESTMENT BROKERAGE; INVESTMENT  
BY ELECTRONIC MEANS; STOCK BROKERAGE,  
IN CLASS 36 (U.S. CLS. 100, 101 AND 102).

FOR: BROKERAGE HOUSES IN THE FIELD OF  
STOCKS, COMMODITIES, AND FUTURES;  
BROKERAGE IN THE FIELD OF STOCKS;  
BROKERAGE OF SHARES AND OTHER SECURI-  
TIES; BROKERAGE OF SHARES OR STOCKS AND  
OTHER SECURITIES; FINANCIAL SERVICES,  
NAMELY, ASSISTING OTHERS WITH THE COM-  
PLETION OF FINANCIAL TRANSACTIONS FOR  
STOCKS, BONDS, SECURITIES AND EQUITIES;  
FINANCIAL SERVICES, NAMELY, INVESTMENT

FIRST USE 6-9-2005; IN COMMERCE 7-11-2005.

THE MARK CONSISTS OF STANDARD CHAR-  
ACTERS WITHOUT CLAIM TO ANY PARTICULAR  
FONT, STYLE, SIZE, OR COLOR.

SER. NO. 77-005,452, FILED 9-22-2006.

BERNICE MIDDLETON, EXAMINING ATTORNEY



**Int. Cl.: 35**

**Prior U.S. Cls.: 100, 101 and 102**

**United States Patent and Trademark Office**

**Reg. No. 3,465,086**

**Registered July 15, 2008**

**SERVICE MARK  
PRINCIPAL REGISTER**

**BRIGHTER FUTURES**

EPSON AMERICA, INC. (CALIFORNIA CORPORATION)  
3840 KILROY AIRPORT WAY  
LONG BEACH, CA 90806

FOR: ADMINISTRATION OF A PROGRAM FOR ENABLING EDUCATIONAL INSTITUTION PARTICIPANTS TO OBTAIN DISCOUNTS ON GOODS IN THE FIELD OF ELECTRONICS, NAMELY, PRINTERS, SCANNERS, PROJECTORS, AND OTHER PERIPHERAL COMPUTER DEVICES, SOLD THROUGH A NETWORK OF RESELLERS, IN CLASS 35 (U.S. CLS. 100, 101 AND 102).

FIRST USE 5-14-2004; IN COMMERCE 5-14-2004.

THE MARK CONSISTS OF STANDARD CHARACTERS WITHOUT CLAIM TO ANY PARTICULAR FONT, STYLE, SIZE, OR COLOR.

SER. NO. 77-005,613, FILED 9-22-2006.

BERNICE MIDDLETON, EXAMINING ATTORNEY

**Int. Cl.: 41**

**Prior U.S. Cls.: 100, 101 and 107**

**United States Patent and Trademark Office**

**Reg. No. 3,465,087**

**Registered July 15, 2008**

---

**SERVICE MARK  
PRINCIPAL REGISTER**

**STICKY BURR**

LECHNER, JOHN (UNITED STATES INDIVIDUAL)  
152 GREAT PLAIN AVENUE  
NEEDHAM, MA 02492

FOR: ONLINE ENTERTAINMENT AND EDUCATIONAL SERVICES FOR CHILDREN, NAMELY, PROVIDING A WEBSITE FEATURING FICTIONAL STORIES, FICTIONAL MAPS, COMPUTER GAMES, PRE-RECORDED MUSIC, COMICS, ANIMATION SHORTS, AND A FAN CLUB, IN CLASS 41 (U.S. CLS. 100, 101 AND 107).

FIRST USE 8-3-1997; IN COMMERCE 8-3-1997.

THE MARK CONSISTS OF STANDARD CHARACTERS WITHOUT CLAIM TO ANY PARTICULAR FONT, STYLE, SIZE, OR COLOR.

SER. NO. 77-007,357, FILED 9-26-2006.

MICHAEL WEBSTER, EXAMINING ATTORNEY

**Int. Cl.: 22**

**Prior U.S. Cls.: 1, 2, 7, 19, 22, 42 and 50**

**Reg. No. 3,465,088**

**United States Patent and Trademark Office**

**Registered July 15, 2008**

---

**TRADEMARK  
PRINCIPAL REGISTER**

**AIRSTOP**

ABC INDUSTRIES, INC. (INDIANA CORPORATION)  
P.O. BOX 77  
WARSAW, IN 465810077

FOR: BRATTICE CLOTH, IN CLASS 22 (U.S. CLS. 1, 2, 7, 19, 22, 42 AND 50).

FIRST USE 8-8-1991; IN COMMERCE 8-8-1991.

THE MARK CONSISTS OF STANDARD CHARACTERS WITHOUT CLAIM TO ANY PARTICULAR FONT, STYLE, SIZE, OR COLOR.

SEC. 2(F).

SER. NO. 77-007,823, FILED 9-26-2006.

SCOTT BIBB, EXAMINING ATTORNEY

**Int. Cl.: 20**

**Prior U.S. Cls.: 2, 13, 22, 25, 32 and 50**

**United States Patent and Trademark Office**

**Reg. No. 3,465,089**

**Registered July 15, 2008**

**TRADEMARK  
PRINCIPAL REGISTER**

**MEDICASE**

MANREX LIMITED (CANADA CORPORATION)  
300 CREE CRESCENT  
WINNIPEG, MANITOBA, CANADA R3J3W9

FOR: CONTAINER FOR TRANSPORTATION  
AND STORAGE OF MEDICATIONS, IN CLASS 20  
(U.S. CLS. 2, 13, 22, 25, 32 AND 50).

THE MARK CONSISTS OF STANDARD CHAR-  
ACTERS WITHOUT CLAIM TO ANY PARTICULAR  
FONT, STYLE, SIZE, OR COLOR.

PRIORITY CLAIMED UNDER SEC. 44(D) ON  
CANADA APPLICATION NO. 1317902, FILED 9-26-  
2006, REG. NO. TMA705056, DATED 1-21-2008, EX-  
PIRES 1-21-2023.

SER. NO. 77-008,648, FILED 9-27-2006.

MARY BOAGNI, EXAMINING ATTORNEY

**Int. Cl.: 14**

**Prior U.S. Cls.: 2, 27, 28 and 50**

**United States Patent and Trademark Office**

**Reg. No. 3,465,090**

**Registered July 15, 2008**

**TRADEMARK  
PRINCIPAL REGISTER**

**Yellow Rabbit**

YELLOW RABBIT PRODUCTIONS (COLORADO  
SOLE PROPRIETORSHIP)  
3255 VALLEJO ST. #A  
DENVER, CO 80211

THE MARK CONSISTS OF STANDARD CHAR-  
ACTERS WITHOUT CLAIM TO ANY PARTICULAR  
FONT, STYLE, SIZE, OR COLOR.

FOR: JEWELRY, IN CLASS 14 (U.S. CLS. 2, 27, 28  
AND 50).

SER. NO. 77-008,668, FILED 9-27-2006.

FIRST USE 1-1-2005; IN COMMERCE 1-1-2005.

IRA J. GOODSaid, EXAMINING ATTORNEY

**Int. Cl.: 36**

**Prior U.S. Cls.: 100, 101 and 102**

**United States Patent and Trademark Office**

**Reg. No. 3,465,091**

**Registered July 15, 2008**

**SERVICE MARK  
PRINCIPAL REGISTER**

**THE ADVISOR PARTNERSHIP  
PROGRAM (TAPP)**

LEGG MASON INVESTOR SERVICES, LLC (DE-  
LAWARE LTD LIAB CO)

100 LIGHT STREET

BALTIMORE, MD 21202

FOR: FINANCIAL SERVICES, NAMELY, ASSET  
MANAGEMENT SERVICES, IN CLASS 36 (U.S. CLS.  
100, 101 AND 102).

FIRST USE 12-0-2005; IN COMMERCE 12-0-2005.

THE MARK CONSISTS OF STANDARD CHAR-  
ACTERS WITHOUT CLAIM TO ANY PARTICULAR  
FONT, STYLE, SIZE, OR COLOR.

NO CLAIM IS MADE TO THE EXCLUSIVE  
RIGHT TO USE "THE ADVISOR PARTNERSHIP  
PROGRAM", APART FROM THE MARK AS  
SHOWN.

SER. NO. 77-008,839, FILED 9-27-2006.

MARY BOAGNI, EXAMINING ATTORNEY

**Int. Cl.: 9**

**Prior U.S. Cls.: 21, 23, 26, 36 and 38**

**United States Patent and Trademark Office**

**Reg. No. 3,465,092**

**Registered July 15, 2008**

**TRADEMARK  
PRINCIPAL REGISTER**



WIRED FOR CHANGE, INC. (D.C. CORPORATION)  
1700 CONNECTICUT AVENUE, SUITE 403  
WASHINGTON, DC 20009

FOR: COMPUTER SOFTWARE, NAMELY, SOFTWARE DEVELOPMENT TOOLS FOR THE CREATION OF MOBILE INTERNET APPLICATIONS AND CLIENT INTERFACES, IN CLASS 9 (U.S. CLS. 21, 23, 26, 36 AND 38).

FIRST USE 8-21-2006; IN COMMERCE 8-21-2006.

THE COLOR(S) LIGHT BLUE AND LIGHT GREEN IS/ARE CLAIMED AS A FEATURE OF THE MARK.

THE MARK CONSISTS OF A BUTTERFLY AND THE WORDS "WIRED FOR CHANGE". THE COLOR LIGHT BLUE APPEARS IN THE DESIGN OF THE BUTTERFLY AND IN THE WORDING "WIRED FOR" AND THE COLOR LIGHT GREEN APPEARS IN THE DOTS OF THE BUTTERFLY DESIGN AND IN THE WORDING "CHANGE".

SER. NO. 77-009,258, FILED 9-28-2006.

ATTIYA MALIK, EXAMINING ATTORNEY

**Int. Cl.: 41**

**Prior U.S. Cls.: 100, 101 and 107**

**United States Patent and Trademark Office**

**Reg. No. 3,465,093**

**Registered July 15, 2008**

**SERVICE MARK  
PRINCIPAL REGISTER**

# Sityodtong

MARK DELLAGROTTE (UNITED STATES INDIVIDUAL)  
100 BROADWAY STREET  
SOMERVILLE, MA 02145

FOR: MARTIAL ARTS INSTRUCTION; OPERATING OF MARTIAL ARTS' SCHOOLS, IN CLASS 41 (U.S. CLS. 100, 101 AND 107).

FIRST USE 12-31-1997; IN COMMERCE 12-31-1997.

THE MARK CONSISTS OF STANDARD CHARACTERS WITHOUT CLAIM TO ANY PARTICULAR FONT, STYLE, SIZE, OR COLOR.

THE FOREIGN WORDING IN THE MARK TRANSLATES INTO ENGLISH AS "STUDENT OF YODTONG" OR "STUDENT OF THE MASTER."

SER. NO. 77-009,922, FILED 9-28-2006.

DARRYL SPRUILL, EXAMINING ATTORNEY



**Int. Cls.: 16 and 41**

**Prior U.S. Cls.: 2, 5, 22, 23, 29, 37, 38, 50, 100, 101 and 107**

**Reg. No. 3,465,094**

**United States Patent and Trademark Office**

**Registered July 15, 2008**

**TRADEMARK  
SERVICE MARK  
PRINCIPAL REGISTER**

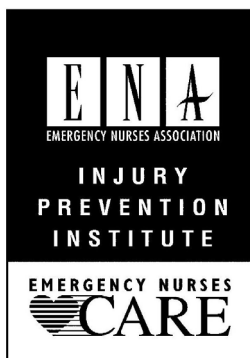

EMERGENCY NURSES ASSOCIATION (ILLINOIS CORPORATION)  
915 LEE STREET  
DES PLAINES, IL 600166569

FIRST USE 1-0-2003; IN COMMERCE 1-0-2003.

FOR: PRINTED MATERIALS, NAMELY, EDUCATIONAL PROGRAMS, BROCHURES, FACT SHEETS AND NEWSLETTERS IN THE FIELDS OF ALCOHOL AWARENESS, AGING, SAFETY AWARENESS, AND VEHICLE PASSENGER SAFETY, IN CLASS 16 (U.S. CLS. 2, 5, 22, 23, 29, 37, 38 AND 50).

OWNER OF U.S. REG. NOS. 2,063,252 AND 2,115,464.

NO CLAIM IS MADE TO THE EXCLUSIVE RIGHT TO USE "EMERGENCY NURSES" AND "INJURY PREVENTION INSTITUTE", APART FROM THE MARK AS SHOWN.

FIRST USE 1-0-2003; IN COMMERCE 1-0-2003.

SEC. 2(F) AS TO "EMERGENCY NURSES ASSOCIATION".

FOR: EDUCATIONAL SERVICES, NAMELY, CONDUCTING EDUCATIONAL PRESENTATIONS IN THE FIELDS OF ALCOHOL AWARENESS, AGING, SAFETY AWARENESS, AND VEHICLE PASSENGER SAFETY, IN CLASS 41 (U.S. CLS. 100, 101 AND 107).

SER. NO. 77-009,996, FILED 9-28-2006.

DEZMONA MIZELLE, EXAMINING ATTORNEY

**Int. Cls.: 35, 41 and 42**

**Prior U.S. Cls.: 100, 101, 102 and 107**

**United States Patent and Trademark Office**

**Reg. No. 3,465,095**

**Registered July 15, 2008**

**SERVICE MARK  
PRINCIPAL REGISTER**

# DESIGN 21

FELISSIMO CORPORATION (JAPAN CORPORATION)  
59 NANIWA-MACHI CHUO-KU  
KOBE, JAPAN 650-0035

FOR: CHARITABLE SERVICES, NAMELY, ORGANIZING VOLUNTEER PROGRAMS; ON-LINE RETAIL STORE SERVICES FEATURING JEWELRY, IN CLASS 35 (U.S. CLS. 100, 101 AND 102).

FIRST USE 8-7-2006; IN COMMERCE 8-7-2006.

FOR: ARRANGING OF DESIGN CONTESTS; ENTERTAINMENT SERVICES, NAMELY, ARRANGING, CONDUCTING, ORGANIZING AND JUDGING DESIGN COMPETITIONS, IN CLASS 41 (U.S. CLS. 100, 101 AND 107).

FIRST USE 7-31-1994; IN COMMERCE 7-31-1994.

FOR: COMPUTER SERVICES, NAMELY, HOSTING ONLINE WEB FACILITIES FOR OTHERS FOR ORGANIZING AND CONDUCTING ONLINE

MEETINGS, GATHERINGS, AND INTERACTIVE DISCUSSIONS REGARDING DESIGN, PHILANTHROPY, AND FUNDRAISING; COMPUTER SERVICES IN THE NATURE OF CUSTOMIZED WEB PAGES FEATURING USER-DEFINED INFORMATION, USER PROFILES AND USER INFORMATION, IN CLASS 42 (U.S. CLS. 100 AND 101).

FIRST USE 8-7-2006; IN COMMERCE 8-7-2006.

THE MARK CONSISTS OF STANDARD CHARACTERS WITHOUT CLAIM TO ANY PARTICULAR FONT, STYLE, SIZE, OR COLOR.

NO CLAIM IS MADE TO THE EXCLUSIVE RIGHT TO USE "DESIGN", APART FROM THE MARK AS SHOWN.

SER. NO. 77-010,069, FILED 9-28-2006.

KEVIN CORWIN, EXAMINING ATTORNEY

**Int. Cl.: 38**

**Prior U.S. Cls.: 100, 101 and 104**

**United States Patent and Trademark Office**

**Reg. No. 3,465,096**

**Registered July 15, 2008**

**SERVICE MARK  
PRINCIPAL REGISTER**



KAHL, EDWARD (UNITED STATES INDIVIDUAL)  
2157 SE SCOTT AVE.  
GRESHAM, OR 97080

FOR: TELECOMMUNICATIONS CONSULTATION, IN CLASS 38 (U.S. CLS. 100, 101 AND 104).

FIRST USE 1-21-2006; IN COMMERCE 7-13-2006.

NO CLAIM IS MADE TO THE EXCLUSIVE RIGHT TO USE "NETWORKS", APART FROM THE MARK AS SHOWN.

THE COLOR(S) BLACK, BLUE IS/ARE CLAIMED AS A FEATURE OF THE MARK.

THE MARK CONSISTS OF "EDEL NETWORKS" WITH 4 WAVES ABOVE THE SECOND "E" IN "EDEL". "EDT" AND "L" IS IN BLACK AND THE SECOND "E" IN "EDEL" WITH THE WAVES ABOVE IT AND NETWORKS IN BLUE. "EDEL NETWORKS" IS LOWER CASE.

SER. NO. 77-011,296, FILED 10-1-2006.

LINDA E. BLOHM, EXAMINING ATTORNEY

**Int. Cl.: 7**

**Prior U.S. Cls.: 13, 19, 21, 23, 31, 34 and 35**

**United States Patent and Trademark Office**

**Reg. No. 3,465,097**

**Registered July 15, 2008**

**TRADEMARK  
PRINCIPAL REGISTER**

**ZAP-LOK**

ZAP-LOK PIPELINE SYSTEMS, INC. (MASSACHUSETTS CORPORATION)  
3RD FLOOR  
22 HILLIARD STREET  
CAMBRIDGE, MA 02138

FOR: PIPE JOINING EQUIPMENT, NAMELY, HYDRAULIC PRESSES, AUXILIARY POWER UNITS FOR SUPPLYING ELECTRICAL POWER TO HEAT AND POWER GENERATORS, ROLLER CONVEYORS, MACHINE PARTS, NAMELY, PRESS ROLLERS FOR USE WITH MECHANICAL

PRESSES, IN CLASS 7 (U.S. CLS. 13, 19, 21, 23, 31, 34 AND 35).

FIRST USE 5-0-1971; IN COMMERCE 5-0-1971.

THE MARK CONSISTS OF STANDARD CHARACTERS WITHOUT CLAIM TO ANY PARTICULAR FONT, STYLE, SIZE, OR COLOR.

SER. NO. 77-011,470, FILED 10-2-2006.

CHARLOTTE CORWIN, EXAMINING ATTORNEY

**Int. Cl.: 41**

**Prior U.S. Cls.: 100, 101 and 107**

**United States Patent and Trademark Office**

**Reg. No. 3,465,098**

**Registered July 15, 2008**

**SERVICE MARK  
PRINCIPAL REGISTER**

**ZAP-LOK**

ZAP-LOK PIPELINE SYSTEMS, INC. (MASSACHUSETTS CORPORATION)  
22 HILLIARD STREET, 3RD FLOOR  
CAMBRIDGE, MA 02138

FOR: EDUCATIONAL SERVICES, NAMELY, SEMINARS, CLASSES, AND WORKSHOPS ON PIPE JOINING EQUIPMENT FOR OTHERS IN THE FIELD OF OIL PIPELINE LAYING AND CONSTRUCTION; TRAINING IN THE USE AND OPERATION OF PIPE JOINING EQUIPMENT IN THE FIELD OF OIL PIPELINE LAYING AND CON-

STRUCTION, IN CLASS 41 (U.S. CLS. 100, 101 AND 107).

FIRST USE 5-0-1971; IN COMMERCE 5-0-1971.

THE MARK CONSISTS OF STANDARD CHARACTERS WITHOUT CLAIM TO ANY PARTICULAR FONT, STYLE, SIZE, OR COLOR.

SER. NO. 77-011,475, FILED 10-2-2006.

CHARLOTTE CORWIN, EXAMINING ATTORNEY

Int. Cl.: 42

Prior U.S. Cls.: 100 and 101

United States Patent and Trademark Office

Reg. No. 3,465,099

Registered July 15, 2008

SERVICE MARK  
PRINCIPAL REGISTER

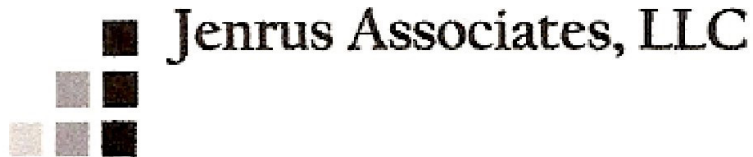

WELCH, STEVEN E. (UNITED STATES INDIVIDUAL)  
15439 EAGLE TAVERN LANE  
CENTREVILLE, VA 20120

FOR: CONSULTATION SERVICES IN THE FIELD OF COMMERCIAL, INDUSTRIAL AND INSTITUTIONAL FACILITIES PLANNING AND DESIGN, IN CLASS 42 (U.S. CLS. 100 AND 101).

FIRST USE 9-7-2006; IN COMMERCE 9-7-2006.

NO CLAIM IS MADE TO THE EXCLUSIVE RIGHT TO USE "ASSOCIATES, LLC", APART FROM THE MARK AS SHOWN.

THE COLOR(S) GRAY AND BLACK IS/ARE CLAIMED AS A FEATURE OF THE MARK.

"THE MARK CONSISTS OF A BLOCK LOGO WITH THE LEFT SQUARE LIGHT GRAY, THE TWO MIDDLE SQUARES MEDIUM GRAY AND THE THREE RIGHT SQUARES BLACK. THE WORDS "JENRUS ASSOCIATES," "LLC" APPEAR IN BLACK."

SER. NO. 77-012,061, FILED 10-2-2006.

KATHRYN COWARD, EXAMINING ATTORNEY

**Int. Cl.: 36**

**Prior U.S. Cls.: 100, 101 and 102**

**United States Patent and Trademark Office**

**Reg. No. 3,465,100**

**Registered July 15, 2008**

**SERVICE MARK  
PRINCIPAL REGISTER**

**SAN TAN INSURANCE**

SAN TAN INSURANCE SERVICES, LLC (ARIZONA LTD LIAB CO)  
SUITE 113  
2335 S. LINDSAY ROAD  
GILBERT, AZ 85296

FOR: HOME, AUTOMOBILE, LIFE, HEALTH AND BUSINESS INSURANCE SERVICES, NAMELY, FIELD UNDERWRITING, BROKERAGE, AND INSURANCE AGENCY SERVICES , IN CLASS 36 (U.S. CLS. 100, 101 AND 102).

FIRST USE 4-1-2006; IN COMMERCE 4-1-2006.

THE MARK CONSISTS OF STANDARD CHARACTERS WITHOUT CLAIM TO ANY PARTICULAR FONT, STYLE, SIZE, OR COLOR.

NO CLAIM IS MADE TO THE EXCLUSIVE RIGHT TO USE "INSURANCE", APART FROM THE MARK AS SHOWN.

SER. NO. 77-012,517, FILED 10-3-2006.

REBECCA EISINGER, EXAMINING ATTORNEY

**Int. Cl.: 43**

**Prior U.S. Cls.: 100 and 101**

**United States Patent and Trademark Office**

**Reg. No. 3,465,101**

**Registered July 15, 2008**

**SERVICE MARK  
PRINCIPAL REGISTER**



JANSEN ENTERPRISES, INC. (OREGON CORPORATION)  
128 SW 3RD AVE.  
ALBANY, OR 97321

FOR: RESTAURANT SERVICES, IN CLASS 43  
(U.S. CLS. 100 AND 101).

FIRST USE 8-0-2006; IN COMMERCE 8-0-2006.

NO CLAIM IS MADE TO THE EXCLUSIVE  
RIGHT TO USE "SMOKEHOUSE CAFE" , APART  
FROM THE MARK AS SHOWN.

THE COLOR(S) RED, YELLOW, ORANGE,  
BLACK AND WHITE IS/ARE CLAIMED AS A  
FEATURE OF THE MARK.

THE MARK CONSISTS OF THE WORD "SMOKEHOUSE" IN BLACK LETTERING WITH A WHITE AND RED OUTLINE. THE WORD "CAFE" APPEARS BELOW "SMOKEHOUSE" IN BLACK LETTERING WITH A WHITE AND RED OUTLINE. THERE IS A FLAME WITH AN ORANGE BOTTOM FADING INTO A YELLOW TOP WITH A BLACK OUTLINE BETWEEN THE WORDS "SMOKE" AND "HOUSE".

SER. NO. 77-012,541, FILED 10-3-2006.

KAPIL BHANOT, EXAMINING ATTORNEY



**Int. Cls.: 35 and 37**

**Prior U.S. Cls.: 100, 101, 102, 103 and 106**

**United States Patent and Trademark Office**

**Reg. No. 3,465,102**

**Registered July 15, 2008**

**SERVICE MARK  
PRINCIPAL REGISTER**

**AAE**

AAE ACQUISITION, LLC (DELAWARE LTD  
LIAB CO)  
13764 AIRLINE HIGHWAY  
BATON ROUGE, LA 70817

FIRST USE 9-0-1998; IN COMMERCE 9-0-1998.

FOR: RETAIL STORE SERVICES FEATURING  
CONSTRUCTION EQUIPMENT, IN CLASS 35 (U.S.  
CLS. 100, 101 AND 102).

THE MARK CONSISTS OF STANDARD CHAR-  
ACTERS WITHOUT CLAIM TO ANY PARTICULAR  
FONT, STYLE, SIZE, OR COLOR.

FIRST USE 9-0-1998; IN COMMERCE 9-0-1998.

SER. NO. 77-012,811, FILED 10-3-2006.

FOR: MAINTENANCE, REPAIR, AND RENTAL  
OF CONSTRUCTION EQUIPMENT, IN CLASS 37  
(U.S. CLS. 100, 103 AND 106).

CAROLINE WOOD, EXAMINING ATTORNEY

**Int. Cl.: 36**

**Prior U.S. Cls.: 100, 101 and 102**

**United States Patent and Trademark Office**

**Reg. No. 3,465,103**

**Registered July 15, 2008**

**SERVICE MARK  
PRINCIPAL REGISTER**

NEIGHBORHOOD EXCELLENCE  
INITIATIVE

BANK OF AMERICA CORPORATION (DELA-  
WARE CORPORATION)  
100 NORTH TRYON STREET  
CHARLOTTE, NC 28255

FOR: PHILANTHROPIC SERVICES, NAMELY,  
PROVIDING LOANS AND GRANTS TO COMMU-  
NITY LEADERS AND NON-PROFIT ORGANIZA-  
TIONS TO HELP IMPROVE NEIGHBORHOODS, IN  
CLASS 36 (U.S. CLS. 100, 101 AND 102).

FIRST USE 5-24-2004; IN COMMERCE 5-24-2004.

THE MARK CONSISTS OF STANDARD CHAR-  
ACTERS WITHOUT CLAIM TO ANY PARTICULAR  
FONT, STYLE, SIZE, OR COLOR.

SER. NO. 77-013,245, FILED 10-4-2006.

ERNEST SHOSHO, EXAMINING ATTORNEY

Int. Cl.: 30

Prior U.S. Cl.: 46

United States Patent and Trademark Office

Reg. No. 3,465,104

Registered July 15, 2008

TRADEMARK  
PRINCIPAL REGISTER

JAVA STATION  
— ESPRESSO —

---



*A Sip of Seattle...*

JAVA STATION, LLC (WASHINGTON LTD LIAB  
CO)

1927 N. MAIN ST.

DAVENPORT, IA 52803

FOR: COFFEE, COFFEE BEANS, COFFEE-BASED  
BEVERAGES CONTAINING MILK, PREPARED  
COFFEE AND COFFEE-BASED BEVERAGES AND  
ROASTED COFFEE BEANS, IN CLASS 30 (U.S. CL.  
46).

FIRST USE 12-1-2004; IN COMMERCE 2-16-2006.

OWNER OF U.S. REG. NO. 3,017,554.

NO CLAIM IS MADE TO THE EXCLUSIVE  
RIGHT TO USE "JAVA", "ESPRESSO" AND "SEAT-  
TLE", APART FROM THE MARK AS SHOWN.

THE COLOR(S) GREEN, TAN, BROWN AND  
BLACK IS/ARE CLAIMED AS A FEATURE OF  
THE MARK.

THE MARK CONSISTS OF TWO PORTIONS. THE  
FIRST PORTION OF THE LITERAL ELEMENT OF  
THE MARK IS "JAVA STATION ESPRESSO". THE  
LETTERS ARE STYLIZED AND BLACK IN COLOR  
AND POSITIONED ABOVE A GREEN LINE. BELOW  
THE LITERAL ELEMENT AND GREEN LINE IS  
THE DESIGN OF A CUP ON A SAUCER. THE  
OUTLINE OF THE CUP IS THE COLOR GREEN  
AND THE OUTLINE OF THE SAUCER PLATE IS  
THE COLOR BROWN. THE BODY OF THE SAUCER  
PLATE IS THE COLOR TAN. THE BODY OF THE  
CUP IS BROWN WITH THREE (3) SHORT HORI-  
ZONTAL LINES REPRESENTING THE CURVE OF  
THE CUP IN THE COLOR GREEN. A VERTICAL  
WAVE LIKE LINE IS ABOVE THE CUP AND MAY  
REPRESENT STEAM RISING FROM THE CUP IN  
BROWN. BELOW THE CUP DESIGN IS THE SEC-  
OND PORTION OF THE LITERAL ELEMENT OF  
THE MARK, "A SIP OF SEATTLE". THE LETTERS  
ARE STYLIZED AND BLACK IN COLOR FOL-  
LOWED BY THREE PERIODS.

SER. NO. 77-014,234, FILED 10-5-2006.

DAVID HOFFMAN, EXAMINING ATTORNEY

**Int. Cl.: 41**

**Prior U.S. Cls.: 100, 101 and 107**

**United States Patent and Trademark Office**

**Reg. No. 3,465,105**

**Registered July 15, 2008**

**SERVICE MARK  
PRINCIPAL REGISTER**

**Physician Heal Thyself  
Retreats**

THIRUVENGADAM, RAMA, T. (UNITED STATES INDIVIDUAL)  
P.O. BOX 1261  
KEALAKEKUA, HI 96750

FOR: EDUCATIONAL SERVICES, NAMELY, PROVIDING RETREATS FOR HEALTH PROFESSIONALS TO TEACH SELF-HEALING AND ENHANCED WELL-BEING, OFFER ASSISTANCE IN CREATING BALANCED LIVES, AND FACILITATE EMPOWERING THROUGH MUTUAL SHARING AND SUPPORT, IN CLASS 41 (U.S. CLS. 100, 101 AND 107).

FIRST USE 11-8-2003; IN COMMERCE 6-1-2006.

THE MARK CONSISTS OF STANDARD CHARACTERS WITHOUT CLAIM TO ANY PARTICULAR FONT, STYLE, SIZE, OR COLOR.

NO CLAIM IS MADE TO THE EXCLUSIVE RIGHT TO USE "RETREATS", APART FROM THE MARK AS SHOWN.

SER. NO. 77-014,601, FILED 10-5-2006.

WILLIAM P. SHANAHAN, EXAMINING ATTORNEY

**Int. Cl.: 6**

**Prior U.S. Cls.: 2, 12, 13, 14, 23, 25 and 50**

**Reg. No. 3,465,106**

**United States Patent and Trademark Office**

**Registered July 15, 2008**

---

**TRADEMARK  
PRINCIPAL REGISTER**

**CANAC**

KOHLER CANADA CO. (CANADA CORPORATION)  
1959 UPPER WEST STREET  
SUITE 900  
HALIFAX, NOVA SCOTIA, CANADA B3JX2

FOR: HARDWARE FOR KITCHEN AND BATH CABINETS, NAMELY, METAL KNOBS AND METAL HANDLES, IN CLASS 6 (U.S. CLS. 2, 12, 13, 14, 23, 25 AND 50).

FIRST USE 4-0-2006; IN COMMERCE 4-0-2006.

THE MARK CONSISTS OF STANDARD CHARACTERS WITHOUT CLAIM TO ANY PARTICULAR FONT, STYLE, SIZE, OR COLOR.

SER. NO. 77-015,137, FILED 10-5-2006.

NAPOLEON SHARMA, EXAMINING ATTORNEY

**Int. Cls.: 9 and 10**

**Prior U.S. Cls.: 21, 23, 26, 36, 38, 39 and 44**

**United States Patent and Trademark Office**

**Reg. No. 3,465,107**

**Registered July 15, 2008**

**TRADEMARK  
PRINCIPAL REGISTER**

**TRUEFIELD**

SEEING MACHINES LTD (AUSTRALIA CORPORATION)  
CORNER GARRAN AND EGGLESTON ROADS  
INNOVATIONS BUILDING, LEVEL 3  
ACTON, AUSTRALIA ACT 2601

FOR: COMPUTER SOFTWARE FOR OPERATING GLAUCOMA AND VISION TESTING APPARATUS; COMPUTER SOFTWARE FOR RECORDING, STORING, AND DISPLAYING THE RESULTS OF VISION AND GLAUCOMA TESTS, IN CLASS 9 (U.S. CLS. 21, 23, 26, 36 AND 38).

FOR: MEDICAL AND SURGICAL APPARATUS AND EQUIPMENT, NAMELY, MEDICAL APPARATUS FOR TESTING AND TREATING GLAUCOMA,

VISION, AND DISEASES OF THE HUMAN VISUAL SYSTEM, IN CLASS 10 (U.S. CLS. 26, 39 AND 44).

THE MARK CONSISTS OF STANDARD CHARACTERS WITHOUT CLAIM TO ANY PARTICULAR FONT, STYLE, SIZE, OR COLOR.

PRIORITY CLAIMED UNDER SEC. 44(D) ON AUSTRALIA APPLICATION NO. 1120966, FILED 6-27-2006, REG. NO. 1120966, DATED 6-27-2006, EXPIRES 6-27-2016.

SER. NO. 77-015,452, FILED 10-6-2006.

JORDAN BAKER, EXAMINING ATTORNEY

**Int. Cl.: 35**

**Prior U.S. Cls.: 100, 101 and 102**

**United States Patent and Trademark Office**

**Reg. No. 3,465,108**

**Registered July 15, 2008**

---

**SERVICE MARK  
PRINCIPAL REGISTER**

# After These Messages

THE GREEN TEAM CORP. (NEW YORK CORPORATION), DBA GREEN TEAM ADVERTISING

9 DESBROSSES STREET SUITE 312  
NEW YORK, NY 10013

FOR: ADVERTISING AND PUBLICITY SERVICES, NAMELY, PROMOTING THE GOODS, SERVICES, BRAND IDENTITY AND COMMERCIAL INFORMATION AND NEWS OF THIRD PARTIES THROUGH PRINT, AUDIO, VIDEO, DIGITAL AND ON-LINE MEDIUM, IN CLASS 35 (U.S. CLS. 100, 101 AND 102).

FIRST USE 1-19-2006; IN COMMERCE 1-19-2006.

THE MARK CONSISTS OF STANDARD CHARACTERS WITHOUT CLAIM TO ANY PARTICULAR FONT, STYLE, SIZE, OR COLOR.

SER. NO. 77-016,605, FILED 10-9-2006.

SIMON TENG, EXAMINING ATTORNEY

**Int. Cl.: 38**

**Prior U.S. Cls.: 100, 101 and 104**

**United States Patent and Trademark Office**

**Reg. No. 3,465,109**

**Registered July 15, 2008**

**SERVICE MARK  
PRINCIPAL REGISTER**



MILLINGTON CATV, INC. (TENNESSEE CORPORATION)

5115 EASLEY STREET  
MILLINGTON, TN 38053

FOR: INTERNET SERVICE PROVIDER (ISP);  
PROVIDING BROADBAND INTERNET ACCESS;  
PROVIDING WI-FI BROADBAND INTERNET ACCESS,  
IN CLASS 38 (U.S. CLS. 100, 101 AND 104).

FIRST USE 2-1-2006; IN COMMERCE 2-1-2006.

THE MARK CONSISTS OF THE WORD "XIPLINE" IN A STYLIZED FONT. THE LETTER "X" HAS ARROW-SHAPED SERIFS ON EACH LEG. EACH OF THE ARROW-SHAPED SERIFS POINTS OUTWARD IN A DIFFERENT DIRECTION. THE OTHER LETTERS HAVE NO SERIFS, BUT THE FONT GROWS WIDER TOWARD THE END OF THE LEGS OF EACH LETTER.

SER. NO. 77-016,847, FILED 10-9-2006.

ESTHER BELENKER, EXAMINING ATTORNEY



**Int. Cl.: 35**

**Prior U.S. Cls.: 100, 101 and 102**

**United States Patent and Trademark Office**

**Reg. No. 3,465,110**

**Registered July 15, 2008**

**SERVICE MARK  
PRINCIPAL REGISTER**



PACIFIC WEST ASSOCIATION OF REALTORS  
(CALIFORNIA CORPORATION)  
1601 E. ORANGEWOOD AVENUE  
ANAHEIM, CA 92805

FOR: PROVIDING AN ONLINE ELECTRONIC  
DATABASE THAT PROVIDES MEMBERSHIP RE-  
LATIONSHIP TRACKING SERVICES TO INDIVI-  
DUALS AND ORGANIZATIONS, IN CLASS 35 (U.S.  
CLS. 100, 101 AND 102).

FIRST USE 3-13-2002; IN COMMERCE 3-13-2002.

NO CLAIM IS MADE TO THE EXCLUSIVE  
RIGHT TO USE "MEMBER RELATIONSHIP  
TRACKING", APART FROM THE MARK AS  
SHOWN.

THE COLOR(S) BLACK, GRAY AND RED IS/ARE  
CLAIMED AS A FEATURE OF THE MARK.

THE MARK CONSISTS OF BLACK AND GRAY  
LETTERS "MRT" IN CAPITAL LETTERS WITH A  
WEDGED SHAPE RED STRIPE SET BEHIND THE  
LETTERS AND THE WORDS "MEMBER RE-  
LATIONSHIP TRACKING" IN BLACK LOCATED AT  
THE BOTTOM.

SER. NO. 77-017,601, FILED 10-10-2006.

INGA ERVIN, EXAMINING ATTORNEY

**Int. Cl.: 41**

**Prior U.S. Cls.: 100, 101 and 107**

**United States Patent and Trademark Office**

**Reg. No. 3,465,111**

**Registered July 15, 2008**

**SERVICE MARK  
PRINCIPAL REGISTER**

**CYBERKNIFE UNIVERSITY**

ACCURAY INCORPORATED (CALIFORNIA  
CORPORATION)  
1310 CHESAPEAKE TERRACE  
SUNNYVALE, CA 94089

FOR: EDUCATIONAL SERVICES, NAMELY, VIRTUAL CLASSES AND TRAINING IN MEDICAL RADIOTHERAPY TO PHYSICIANS, MEDICAL PROFESSIONALS AND THE HEALTHCARE COMMUNITY, NAMELY, MEDICAL TECHNICIANS, THERAPISTS, RESEARCHERS, ADMINISTRATORS AND COUNSELORS, IN CLASS 41 (U.S. CLS. 100, 101 AND 107).

FIRST USE 5-1-2006; IN COMMERCE 5-1-2006.

THE MARK CONSISTS OF STANDARD CHARACTERS WITHOUT CLAIM TO ANY PARTICULAR FONT, STYLE, SIZE, OR COLOR.

OWNER OF U.S. REG. NO. 2,159,142.

NO CLAIM IS MADE TO THE EXCLUSIVE RIGHT TO USE "UNIVERSITY", APART FROM THE MARK AS SHOWN.

SER. NO. 77-018,644, FILED 10-11-2006.

CHRISTOPHER BUONGIORNO, EXAMINING ATTORNEY

**Int. Cls.: 35 and 42**

**Prior U.S. Cls.: 100, 101 and 102**

**United States Patent and Trademark Office**

**Reg. No. 3,465,112**

**Registered July 15, 2008**

**SERVICE MARK  
PRINCIPAL REGISTER**

**METROPOLITAN RESEARCH  
ASSOCIATES**

METROPOLITAN RESEARCH ASSOCIATES,  
INC. (DELAWARE CORPORATION)  
19TH FLOOR  
666 THIRD AVENUE  
NEW YORK, NY 10017

FOR: STAFFING SERVICES IN THE FIELD OF  
CLINICAL RESEARCH, NAMELY, PROVIDING  
PROFESSIONAL AND MEDICAL PERSONNEL ON  
A TEMPORARY BASIS TO PHARMACEUTICAL,  
MEDICAL DEVICE, AND BIOTECHNOLOGY COM-  
PANIES TO ASSIST WITH MEDICAL RESEARCH  
AND CLINICAL TESTING, IN CLASS 35 (U.S. CLS.  
100, 101 AND 102).

FIRST USE 1-0-1995; IN COMMERCE 1-0-1995.

FOR: MEDICAL RESEARCH AND CLINICAL  
TESTING, NAMELY, CONDUCTING AND MANA-  
GING CLINICAL TRIALS AND PRODUCT DEVEL-

OPMENT STUDIES OF PHARMACEUTICAL,  
BIOTECHNOLOGY, AND HEALTHCARE PRO-  
DUCTS AND DEVICES, IN CLASS 42 (U.S. CLS. 100  
AND 101).

FIRST USE 1-0-1995; IN COMMERCE 1-0-1995.

THE MARK CONSISTS OF STANDARD CHAR-  
ACTERS WITHOUT CLAIM TO ANY PARTICULAR  
FONT, STYLE, SIZE, OR COLOR.

NO CLAIM IS MADE TO THE EXCLUSIVE  
RIGHT TO USE "RESEARCH ASSOCIATES", APART  
FROM THE MARK AS SHOWN.

SER. NO. 77-019,111, FILED 10-11-2006.

BILL DAWE, EXAMINING ATTORNEY

**Int. Cls.: 6, 9, 12, 16, 21, 24, 25, 28 and 41**

**Prior U.S. Cls.: 2, 5, 12, 13, 14, 19, 21, 22, 23, 25, 26, 29, 30, 31, 33, 35, 36, 37, 38, 39, 40, 42, 44, 50, 100, 101 and 107**

**Reg. No. 3,465,113**

**United States Patent and Trademark Office**

**Registered July 15, 2008**

**TRADEMARK  
SERVICE MARK  
PRINCIPAL REGISTER**

**KASEY KAHNE**

KASEY KAHNE, INC. (NORTH CAROLINA CORPORATION)

106 MILFORD CIRCLE

MOORESVILLE, NC 28117

FOR: METAL KEY RINGS AND KEY CHAINS, METAL LICENSE PLATES, METAL TOOL BOXES, IN CLASS 6 (U.S. CLS. 2, 12, 13, 14, 23, 25 AND 50).

FIRST USE 1-1-2003; IN COMMERCE 1-1-2003.

FOR: SUNGLASSES; EYEGLASS FRAMES; SUNGLASS AND EYEGLASS CASES; DECORATIVE MAGNETS; THERMOMETERS; MOBILE TELEPHONES; MOBILE TELEPHONE CASES AND CARRIERS, RACING SCANNERS WITH FM RADIO AND HEADPHONES; TAPE MEASURES; MP3 MUSIC PLAYERS; MEMORY CARDS FOR ELECTRONIC DEVICES; MPV VIDEO PLAYERS; POCKET-SIZED TELEVISIONS AND VIDEO PLAYERS; AM/FM RADIOS; COMPUTER PERIPHERALS, NAMELY, COMPUTER MICE, COMPUTER MICE PADS, COMPUTER DISC CASES, COMPUTER CARRYING CASES AND KEYBOARD WRIST PADS FOR COMPUTER USERS; COMPUTER SOFTWARE FOR ENTERING AND COMPILING INFORMATION ABOUT RACING AND RACE CAR DRIVERS; COMPUTER SCREEN SAVER SOFTWARE, COMPUTER VIDEO GAME SOFTWARE AND GAME CARTRIDGES; PRE-RECORDED AUDIO TAPES, VIDEOTAPES, COMPACT DISCS AND DVDS FEATURING SPORTS; WALKIE-TALKIES AND BINOCULARS, IN CLASS 9 (U.S. CLS. 21, 23, 26, 36 AND 38).

FIRST USE 12-1-2004; IN COMMERCE 12-1-2004.

FOR: VISOR COVERS FOR CAR WINDSHIELD VISORS; AUTOMOBILES WINDSHIELD SUNSHADES; AUTOMOBILE SPLASH GUARDS; METAL LICENSE PLATE HOLDERS; AUTOMOBILE HOODS; LICENSE PLATE HOLDERS NOT OF METAL; LICENSE PLATE FRAMES NOT OF METAL; CAR SEAT COVERS, STEERING WHEEL COVERS, AUTOMOBILE CD HOLDERS; WHEELS AND WHEEL COVERS FOR AUTOMOBILES AND MOTORCYCLES; SEMI-FITTED COVERS FOR VEHICLES; METAL AUTOMOBILE GRILL INSERTS CONSISTING OF DECORATIONS INSERTED INTO AUTOMOBILE GRILLS, IN CLASS 12 (U.S. CLS. 19, 21, 23, 31, 35 AND 44).

FIRST USE 1-1-2004; IN COMMERCE 1-1-2004.

FOR: PAPER GOODS AND PRINTED MATERIAL, NAMELY, BROCHURES, MAGAZINES, NEWSLETTERS, PAMPHLETS, SOUVENIR PROGRAMS, STATISTICAL RECORD SHEETS, AND BOOKS FEATURING SPORTS AND MUSIC; TRADING CARDS; COMMEMORATIVE STAMPS SHEETS; POSTCARDS; NOTE CARDS; POSTERS; STICKERS; BUMPER STICKERS; DECALS; STATIC DECALS; STATIC CLING DECALS; CALENDARS; PAPER PLACE MATS; PAPER PENNANTS; PAPER BANNERS; UNMOUNTED AND MOUNTED PHOTOGRAPHS; ART PRINTS; PHOTOGRAPHIC PRINTS; LITHOGRAPHIC PRINTS; MEMO PADS; NOTE PADS; PENS; PENCILS; BINDERS; FOLDERS; BOOK COVERS; STATIONERY AND STATIONERY TYPE PORTFOLIOS; LIFE-SIZE STANDUP PHOTOGRAPHS; PAPER CAKE DECORATIONS, PHOTO ALBUMS, IN CLASS 16 (U.S. CLS. 2, 5, 22, 23, 29, 37, 38 AND 50).

FIRST USE 1-1-2004; IN COMMERCE 1-1-2004.

FOR: HOUSEWARES AND GLASS, NAMELY, BOTTLE OPENERS ATTACHED TO KEY CHAINS; SHOT GLASSES; PLATES, DRINKING GLASSES, CUPS, MUGS AND DRINKING STEINS; BOTTLE OPENERS; RUBBER, PLASTIC OR FOAM INSULATING FOOD CONTAINERS, PORTABLE COOLERS AND INSULATING BEVERAGE HOLDERS; WATER BOTTLES SOLD EMPTY; TRASH CANS; WASTEBASKETS; LUNCH BOXES; NON-METAL DECORATIVE BOXES DESIGNED FOR DISPLAY OF SOUVENIRS AND RACING MEMORABILIA; FIGURINES AND SCULPTURES MADE OF CHINA, PORCELAIN, EARTHENWARE, GLASS, CRYSTAL, TERRA COTTA AND CERAMIC; STATUE AND FIGURINE DISPLAYS MADE OF CHINA, PORCELAIN, EARTHENWARE, GLASS, CRYSTAL, TERRA COTTA AND CERAMIC FEATURING SPORTS AND MUSIC SCENES; PLASTIC COASTERS; TOOTHBRUSHES; ELECTRIC TOOTHBRUSHES; PEWTER-EMBELLISHED BEVERAGE GLASSWARE AND COFFEE MUGS; THERMAL INSULATED WRAP FOR CANS TO KEEP CONTENTS COOL; COFFEE CARAFES; THERMAL FLASKS; SOUP AND COFFEE CONTAINERS WITH CUPS; UTENSILS FOR BARBECUE, NAMELY, FORKS, TONGS, AND TURNERS; SALT AND PEPPER SHAKERS; SUGAR BOWLS; CREAMER PITCHERS; CONDIMENT SHAKERS; FREEZABLE CAN COOLERS; FREEZABLE MUGS; CANDLE HOLDERS; CUTTING BOARDS, CERAMIC PLATES, DISHES, MUGS AND CUPS; PORTABLE COOLER IN THE SHAPE OF A HELMET; PIGGY BANKS; COOKIE JARS; PET BOWLS; WASTE BASKETS; BATHROOM ACCESSORIES, NAMELY, SOAP DISHES, CUPS, TOOTHBRUSH HOLDERS AND SMALL CONTAINERS, IN CLASS 21 (U.S. CLS. 2, 13, 23, 29, 30, 33, 40 AND 50).

FIRST USE 1-1-2004; IN COMMERCE 1-1-2004.

FOR: TABLECLOTHS NOT MADE OF PAPER; SHEETS; PILLOWCASES; PILLOW SHAMS; BEACH TOWELS AND BATH TOWELS; FABRIC FLAGS, PENNANTS, AND BANNERS; THROWS; FABRIC WALLHANGINGS, IN CLASS 24 (U.S. CLS. 42 AND 50).

FIRST USE 1-1-2004; IN COMMERCE 1-1-2004.

FOR: CLOTHING, NAMELY, SWEATSHIRTS, SWEAT PANTS, SWEAT SUITS, WARM-UP SUITS, SHIRTS, SPORT SHIRTS, GOLF SHIRTS, T-SHIRTS, TANK TOPS, SWEATERS, DRESSES, SKIRTS, JERSEYS, LONG PANTS, SPORT SHORTS, SHORTS, BATHING SUITS, PANTS, JACKETS, COATS, HATS, CAPS, BANDANAS, VISORS, BELTS, SUSPENDERS, HEAD BANDS, WRIST BANDS, SOCKS, HOSIERY, FOOTWEAR, GLOVES, SCARVES, NECKTIES, RAINCOATS, PONCHOS, PAJAMAS, NIGHT SHIRTS, NIGHT GOWNS AND ROBES; MASQUER-

ADE COSTUMES, NAMELY, REPLICA DRIVER SUITS, BASEBALL UNIFORMS; INFANT WEAR; AND CLOTH BABY BIBS NOT OF PAPER; MEN'S AND WOMEN'S TWILL REPLICA DRIVER SUIT JACKETS; LEATHER JACKETS, IN CLASS 25 (U.S. CLS. 22 AND 39).

FIRST USE 1-1-2002; IN COMMERCE 1-1-2002.

FOR: TOYS AND SPORTING GOODS, NAMELY, TOY REPLICA DRIVER HELMETS; MINIATURE REPLICA AUTOMOBILES, AUTOMOBILE HOODS, AIRPLANES, TRUCKS, BOATS, MOTORCYCLES AND ALL-TERRAIN VEHICLES; RADIO-CONTROLLED TOY CARS, AIRPLANES, TRUCKS, BOATS, MOTORCYCLES AND ALL-TERRAIN VEHICLES; TOY MODEL AUTOMOBILES, AIRPLANES, TRUCKS, BOATS, MOTORCYCLES AND ALL-TERRAIN VEHICLES; AUTOMOBILE, AIRPLANE, TRUCK, BOAT, MOTORCYCLE, AND ALL-TERRAIN VEHICLE TOY BANKS; TOY SLOT TRACK CARS AND TRUCKS; TOY PEDAL STOCK CARS AND TRUCKS; SPORTS BALLS, NAMELY, BASEBALLS, BASKETBALLS, FOOTBALLS, BEACH BALLS, TENNIS BALLS, VOLLEYBALLS, SOCCER BALLS AND GOLF BALLS; GOLF BAGS; BASEBALL TABLE TOP GAMES; SPORTS BOARD GAMES; DOLLS; STUFFED TOYS; STUFFED TOY ANIMALS; STUFFED TOY CARS AND TRUCKS; TOY ACTION FIGURES; CHRISTMAS TREE ORNAMENTS; BALLOONS; MINIATURE RACING HELMETS; AND YO-YOS; STAND ALONE AND HANDHELD VIDEO GAME MACHINES; PLAYING CARDS; BEAN BAGS; SNOW GLOBES; RIDE-ON MINIATURE TOY VEHICLES; STRATEGY CARD GAMES; LOTTERY TICKETS, IN CLASS 28 (U.S. CLS. 22, 23, 38 AND 50).

FIRST USE 11-1-2000; IN COMMERCE 11-1-2000.

FOR: ENTERTAINMENT SERVICES IN THE NATURE OF PARTICIPATING IN PROFESSIONAL AUTOMOBILE RACES AND AUTO RACING EXHIBITIONS, IN CLASS 41 (U.S. CLS. 100, 101 AND 107).

FIRST USE 1-1-2001; IN COMMERCE 1-1-2001.

THE MARK CONSISTS OF STANDARD CHARACTERS WITHOUT CLAIM TO ANY PARTICULAR FONT, STYLE, SIZE, OR COLOR.

THE NAME(S), PORTRAIT(S), AND/OR SIGNATURE(S) SHOWN IN THE MARK IDENTIFIES "KASEY KAHNE", WHOSE CONSENT(S) TO REGISTER IS SUBMITTED.

SER. NO. 77-019,391, FILED 10-12-2006.

ANGELA M. MICHELI, EXAMINING ATTORNEY

**Int. Cls.: 37 and 42**

**Prior U.S. Cls.: 100, 101, 103 and 106**

**United States Patent and Trademark Office**

**Reg. No. 3,465,114**

**Registered July 15, 2008**

**SERVICE MARK  
PRINCIPAL REGISTER**



FORRESTERTECH, LLC (MISSOURI LTD LIAB  
CO)  
605 N. BOONVILLE AVE.  
SPRINGFIELD, MO 65806

FOR: INSTALLATION SERVICES IN THE FIELD  
OF HOME AND COMMERCIAL AUTOMATION  
SYSTEMS, AUDIO AND VIDEO SYSTEMS, HOME  
THEATER SYSTEMS, ENTERTAINMENT CEN-  
TERS, GAMING CENTERS, SECURITY SYSTEMS,  
COMPUTER AND TECHNOLOGY NETWORKS, IN  
CLASS 37 (U.S. CLS. 100, 103 AND 106).

FIRST USE 7-14-2004; IN COMMERCE 7-14-2004.

FOR: DESIGN OF HOME AND COMMERCIAL  
AUTOMATION SYSTEMS, AUDIO AND VIDEO  
SYSTEMS, HOME THEATER SYSTEMS, ENTER-  
TAINMENT CENTERS, GAMING CENTERS, SE-  
CURITY SYSTEMS, COMPUTER AND  
TECHNOLOGY NETWORKS, IN CLASS 42 (U.S.  
CLS. 100 AND 101).

FIRST USE 7-14-2004; IN COMMERCE 7-14-2004.

SER. NO. 77-021,593, FILED 10-16-2006.

DAVID TAYLOR, EXAMINING ATTORNEY

**Int. Cls.: 11 and 21**

**Prior U.S. Cls.: 2, 13, 21, 23, 29, 30, 31, 33, 34, 40 and 50**

**United States Patent and Trademark Office**

**Reg. No. 3,465,115**

**Registered July 15, 2008**

**TRADEMARK  
PRINCIPAL REGISTER**



BEST DIRECT (INTERNATIONAL) LIMITED  
(UNITED KINGDOM CORPORATION)  
ASPECT GATE, 166 COLLEGE ROAD  
HARROW, MIDDLESEX, UNITED KINGDOM  
HA11BH

FOR: APPARATUS FOR COOKING, NAMELY,  
ELECTRIC MULTI-LAYER COOKERS, IN CLASS 11  
(U.S. CLS. 13, 21, 23, 31 AND 34).

FOR: KITCHEN CONTAINERS, NAMELY, POTS,  
PANS, HEAT-INSULATED CONTAINERS FOR  
FOOD AND BEVERAGES, NON-ELECTRIC PRES-  
SURE COOKERS, NON-ELECTRIC MULTI-LAYER  
COOKERS, AND NON-ELECTRIC STOVE-TOP  
COOKERS, IN CLASS 21 (U.S. CLS. 2, 13, 23, 29, 30,  
33, 40 AND 50).

PRIORITY CLAIMED UNDER SEC. 44(D) ON  
ERPNTY TM OFC APPLICATION NO.  
005391677, FILED 10-4-2006, REG. NO. 005391677,  
DATED 11-5-2007, EXPIRES 10-4-2016.

THE MARK CONSISTS OF THE TERM "THER-  
MACHEF" WITH A DEPICTION OF A CHEF'S HAT  
ON TOP OF THE LETTER "C", SHADING BEHIND  
ALL OF THE LETTERS, AND A SHADED OVAL  
BENEATH THE LETTER "C".

SER. NO. 77-022,460, FILED 10-17-2006.

MARY ROSSMAN, EXAMINING ATTORNEY

**Int. Cl.: 35**

**Prior U.S. Cls.: 100, 101 and 102**

**United States Patent and Trademark Office**

**Reg. No. 3,465,116**

**Registered July 15, 2008**

**SERVICE MARK  
PRINCIPAL REGISTER**

**FIRST CHICAGO ADVISORS**

FIRST CHICAGO ADVISORS, INC. (ILLINOIS  
CORPORATION)  
32 OTIS ROAD  
BARRINGTON, IL 60010

FOR: ACQUISITION AND MERGER CONSULTA-  
TION; ADVISORY SERVICES RELATING TO BUSI-  
NESS MANAGEMENT AND BUSINESS  
OPERATIONS; BUSINESS ADVISORY SERVICES,  
CONSULTANCY AND INFORMATION , IN CLASS  
35 (U.S. CLS. 100, 101 AND 102).

FIRST USE 2-1-2005; IN COMMERCE 2-1-2005.

THE MARK CONSISTS OF STANDARD CHAR-  
ACTERS WITHOUT CLAIM TO ANY PARTICULAR  
FONT, STYLE, SIZE, OR COLOR.

NO CLAIM IS MADE TO THE EXCLUSIVE  
RIGHT TO USE "CHICAGO ADVISORS", APART  
FROM THE MARK AS SHOWN.

SER. NO. 77-022,750, FILED 10-17-2006.

SETH A. RAPPAPORT, EXAMINING ATTORNEY



**Int. Cls.: 6, 7 and 9**

**Prior U.S. Cls.: 2, 12, 13, 14, 19, 21, 23, 25, 26, 31, 34, 35, 36, 38 and 50**

**Reg. No. 3,465,117**

**United States Patent and Trademark Office**

**Registered July 15, 2008**

**TRADEMARK  
PRINCIPAL REGISTER**



KONECRANES, INC. (TEXAS CORPORATION)  
4401 GATEWAY BLVD  
SPRINGFIELD, OH 45502

FOR: SPARE AND REPLACEMENT PARTS FOR USE ON OVERHEAD TRAVELING CRANES, GANTRY CRANES AND OTHER CRANES AND HOISTS, NAMELY, WIRE ROPES AND METAL HOOKS, IN CLASS 6 (U.S. CLS. 2, 12, 13, 14, 23, 25 AND 50).

FIRST USE 12-12-2001; IN COMMERCE 12-12-2001.

FOR: SPARE AND REPLACEMENT PARTS FOR USE ON OVERHEAD TRAVELING CRANES, GANTRY CRANES AND OTHER CRANES AND HOISTS, NAMELY, DRUMS, BODY PIECES, MOTORS, LOAD BLOCKS, ROTORS, BRAKES, COILS, TROLLEYS, CABLE CLAMPS, SHAFTS, WHEELS AND AXLES, GEARING, PINIONS, CONTACT POINTS, AXLES, SHEAVES, TRUCKS, GASKETS, BEARINGS, BUSHINGS, BRUSHES AND HOLDERS, BUMPERS, COUPLINGS, SPRINGS AND PINS, IN CLASS 7 (U.S. CLS. 13, 19, 21, 23, 31, 34 AND 35).

FIRST USE 12-12-2001; IN COMMERCE 12-12-2001.

FOR: SPARE AND REPLACEMENT PARTS FOR USE ON OVERHEAD TRAVELING CRANES, GANTRY CRANES AND OTHER CRANES AND HOISTS, NAMELY, ELECTRIC LIMIT SWITCHES, MAGNETS, ELECTRONIC PUSH BUTTON CONTROLS, ELECTRICAL FUSES, JUNCTION BOXES, ELECTRICAL CIRCUIT TERMINALS AND CURRENT AND ELECTRICITY COLLECTORS, IN CLASS 9 (U.S. CLS. 21, 23, 26, 36 AND 38).

FIRST USE 12-12-2001; IN COMMERCE 12-12-2001.

THE NAME "SHEPARD NILES" SHOWN IN THE MARK DOES NOT IDENTIFY A PARTICULAR LIVING INDIVIDUAL.

THE MARK CONSISTS OF THE WORDS "SHEPARD NILES" TO THE RIGHT OF A STYLIZED ROUND GEAR DESIGN.

SER. NO. 77-022,777, FILED 10-17-2006.

JULIE WATSON, EXAMINING ATTORNEY

**Int. Cls.: 6, 7 and 9**

**Prior U.S. Cls.: 2, 12, 13, 14, 19, 21, 23, 25, 26, 31, 34, 35, 36, 38 and 50**

**Reg. No. 3,465,118**

**United States Patent and Trademark Office**

**Registered July 15, 2008**

**TRADEMARK  
PRINCIPAL REGISTER**

# Shepard Niles

KONECRANES, INC. (TEXAS CORPORATION)  
4401 GATEWAY BLVD  
SPRINGFIELD, OH 45502

FOR: SPARE AND REPLACEMENT PARTS FOR USE ON OVERHEAD TRAVELING CRANES, GANTRY CRANES AND OTHER CRANES AND HOISTS, NAMELY, WIRE ROPES AND METAL HOOKS, IN CLASS 6 (U.S. CLS. 2, 12, 13, 14, 23, 25 AND 50).

FIRST USE 12-12-2001; IN COMMERCE 12-12-2001.

FOR: SPARE AND REPLACEMENT PARTS FOR USE ON OVERHEAD TRAVELING CRANES, GANTRY CRANES AND OTHER CRANES AND HOISTS, NAMELY, DRUMS, BODY PIECES, MOTORS, LOAD BLOCKS, ROTORS, BRAKES, COILS, TROLLEYS, CABLE CLAMPS, SHAFTS, WHEELS AND AXLES, GEARING, PINIONS, CONTACT POINTS, AXLES, SHEAVES, TRUCKS, GASKETS, BEARINGS, BUSHINGS, BRUSHES AND HOLDERS, BUMPERS, COUPLINGS, SPRINGS AND PINS, IN CLASS 7 (U.S. CLS. 13, 19, 21, 23, 31, 34 AND 35).

FIRST USE 12-12-2001; IN COMMERCE 12-12-2001.

FOR: SPARE AND REPLACEMENT PARTS FOR USE ON OVERHEAD TRAVELING CRANES, GANTRY CRANES AND OTHER CRANES AND HOISTS, NAMELY, ELECTRIC LIMIT SWITCHES, MAGNETS, ELECTRONIC PUSH BUTTON CONTROLS, ELECTRICAL FUSES, JUNCTION BOXES, ELECTRICAL CIRCUIT TERMINALS AND CURRENT AND ELECTRICITY COLLECTORS, IN CLASS 9 (U.S. CLS. 21, 23, 26, 36 AND 38).

FIRST USE 12-12-2001; IN COMMERCE 12-12-2001.

THE MARK CONSISTS OF STANDARD CHARACTERS WITHOUT CLAIM TO ANY PARTICULAR FONT, STYLE, SIZE, OR COLOR.

THE NAME(S), PORTRAIT(S), AND/OR SIGNATURE(S) SHOWN IN THE MARK DOES NOT IDENTIFY A PARTICULAR LIVING INDIVIDUAL.

SER. NO. 77-022,783, FILED 10-17-2006.

JULIE WATSON, EXAMINING ATTORNEY

**Int. Cls.: 29 and 30**

**Prior U.S. Cl.: 46**

**United States Patent and Trademark Office**

**Reg. No. 3,465,119**

**Registered July 15, 2008**

**TRADEMARK  
PRINCIPAL REGISTER**

**ZILCH**

EMERALD FOODS LIMITED (NEW ZEALAND  
CORPORATION)  
1 ACCENT DRIVE  
EAST TAMAKI, AUCKLAND, NEW ZEALAND

FOR: MILK AND MILK PRODUCTS, INCLUDING FERMENTED MILK PRODUCTS, EXCLUDING ICE CREAM, ICE MILK AND FROZEN YOGURTS; YOGURT; DAIRY PRODUCTS, EXCLUDING ICE CREAM, ICE MILK AND FROZEN YOGURTS, IN CLASS 29 (U.S. CL. 46).

FOR: FROZEN CONFECTIONERY; ICE CREAM; ICE CREAM PRODUCTS, NAMELY, ICE CREAMS AND ICE CREAM MIXES; FROZEN CONFECTIONS, FROZEN YOGURTS; CHILLED DESSERTS,

NAMELY, PUDDINGS, SORBETS AND MOUSSES, IN CLASS 30 (U.S. CL. 46).

THE MARK CONSISTS OF STANDARD CHARACTERS WITHOUT CLAIM TO ANY PARTICULAR FONT, STYLE, SIZE, OR COLOR.

PRIORITY CLAIMED UNDER SEC. 44(D) ON NEW ZEALAND APPLICATION NO. 749496, FILED 6-13-2006, REG. NO. 749496, DATED 6-13-2006, EXPIRES 6-13-2013.

SER. NO. 77-022,841, FILED 10-17-2006.

DAVID COLLIER, EXAMINING ATTORNEY

**Int. Cls.: 9, 18 and 25**

**Prior U.S. Cls.: 1, 2, 3, 21, 22, 23, 26, 36, 38, 39 and 41**

**Reg. No. 3,465,120**

**United States Patent and Trademark Office**

**Registered July 15, 2008**

**TRADEMARK  
PRINCIPAL REGISTER**

**DREAM CONTROL**

DREAM CONTROL, INC. (NEW YORK CORPORATION)  
265 WEST 37TH STREET  
9TH FLOOR  
NEW YORK, NY 10018

FOR: EYEWEAR ACCESSORIES, NAMELY, STRAPS, NECK CORDS AND HEAD STRAPS WHICH RESTRAIN EYEWEAR FROM MOVEMENT ON A WEARER; PROTECTIVE EYEWEAR; SAFETY EYEWEAR; SPORTS EYEWEAR, IN CLASS 9 (U.S. CLS. 21, 23, 26, 36 AND 38).

FIRST USE 8-8-2006; IN COMMERCE 8-8-2006.

FOR: LEATHER AND IMITATION LEATHER BAGS; LEATHER BAGS, SUITCASES AND WALLETS; LEATHER BRIEFCASES; LEATHER CASES; LEATHER CASES FOR KEYS; LEATHER FOR SHOES; LEATHER HANDBAGS; LEATHER KEY CASES; LEATHER KEY CHAINS; LEATHER PURSES, IN CLASS 18 (U.S. CLS. 1, 2, 3, 22 AND 41).

FIRST USE 8-8-2006; IN COMMERCE 8-8-2006.

FOR: BATHROBES; BELTS; BELTS MADE OF LEATHER; CAPS; CHILDREN'S AND INFANTS' CLOTH BIBS; COATS; DENIMS; DRESSES; FOOTWEAR; GLOVES; HATS; JERSEYS; LEATHER BELTS; LEATHER COATS; LEATHER HEADWEAR; LEATHER JACKETS; LEATHER PANTS; LEATHER SHOES; OVERALLS; PAJAMAS; PANTS; PULL-OVERS; SHIRTS; SKIRTS; SOCKS; STOCKINGS; SWEATERS; SWIMSUITS; T-SHIRTS; TIES; TIGHTS; TROUSERS; UNDERCLOTHES, IN CLASS 25 (U.S. CLS. 22 AND 39).

FIRST USE 8-8-2006; IN COMMERCE 8-8-2006.

THE MARK CONSISTS OF STANDARD CHARACTERS WITHOUT CLAIM TO ANY PARTICULAR FONT, STYLE, SIZE, OR COLOR.

SER. NO. 77-023,219, FILED 10-17-2006.

WENDY JUN, EXAMINING ATTORNEY

**Int. Cl.: 9**

**Prior U.S. Cls.: 21, 23, 26, 36 and 38**

**Reg. No. 3,465,121**

**United States Patent and Trademark Office**

**Registered July 15, 2008**

---

**TRADEMARK  
PRINCIPAL REGISTER**

**CaseNET**

CASENET, INC. (DELAWARE CORPORATION)  
204 SECOND AVENUE  
WALTHAM, MA 02451

THE MARK CONSISTS OF STANDARD CHAR-  
ACTERS WITHOUT CLAIM TO ANY PARTICULAR  
FONT, STYLE, SIZE, OR COLOR.

FOR: COMPUTER SOFTWARE FOR MANAGING  
SERVICES AND RECORDS IN THE FIELDS OF  
INSURANCE AND HEALTH CARE SERVICES, IN  
CLASS 9 (U.S. CLS. 21, 23, 26, 36 AND 38).

SER. NO. 77-023,334, FILED 10-17-2006.

FIRST USE 10-1-2004; IN COMMERCE 10-1-2004.

ROSELLE HERRERA, EXAMINING ATTORNEY

**Int. Cl.: 1**

**Prior U.S. Cls.: 1, 5, 6, 10, 26 and 46**

**Reg. No. 3,465,122**

**United States Patent and Trademark Office**

**Registered July 15, 2008**

---

**TRADEMARK  
PRINCIPAL REGISTER**

**RhizoPhos**

AGRIMAR CORPORATION (DELAWARE COR-  
PORATION)  
5634 ATLANTA HWY. SUITE 200  
FLOWERY BRANCH, GA 30542

THE MARK CONSISTS OF STANDARD CHAR-  
ACTERS WITHOUT CLAIM TO ANY PARTICULAR  
FONT, STYLE, SIZE, OR COLOR.

FOR: FERTILIZERS FOR AGRICULTURAL USE,  
IN CLASS 1 (U.S. CLS. 1, 5, 6, 10, 26 AND 46).

SER. NO. 77-023,469, FILED 10-18-2006.

FIRST USE 6-30-2004; IN COMMERCE 6-30-2004.

MARK PILARO, EXAMINING ATTORNEY

**Int. Cl.: 35**

**Prior U.S. Cls.: 100, 101 and 102**

**United States Patent and Trademark Office**

**Reg. No. 3,465,123**

**Registered July 15, 2008**

**SERVICE MARK  
PRINCIPAL REGISTER**

**VOX THE VOTE**

TRUSTEES OF DARTMOUTH COLLEGE (NEW  
HAMPSHIRE NON-PROFIT CORPORATION)  
DARTMOUTH COLLEGE  
HANOVER, NH 03755

FOR: VOTER INFORMATION SERVICES FOR  
THE ALUMNI OF DARTMOUTH COLLEGE,  
NAMELY, PROVIDING INFORMATION ABOUT  
CANDIDATES AND VOTING PROCEDURES TO  
ENCOURAGE ALUMNI PARTICIPATION IN  
ALUMNI GOVERNANCE; VOTING ORGANIZA-  
TION SERVICES FOR THE ALUMNI OF DART-  
MOUTH COLLEGE, NAMELY, ORGANIZING  
CANDIDATES AND VOTING PROCEDURES TO  
ENCOURAGE ALUMNI PARTICIPATION IN  
ALUMNI GOVERNANCE, IN CLASS 35 (U.S. CLS.  
100, 101 AND 102).

FIRST USE 7-26-2006; IN COMMERCE 7-26-2006.

THE MARK CONSISTS OF STANDARD CHAR-  
ACTERS WITHOUT CLAIM TO ANY PARTICULAR  
FONT, STYLE, SIZE, OR COLOR.

OWNER OF U.S. REG. NOS. 2,951,584, 3,007,350  
AND OTHERS.

THE FOREIGN WORDING IN THE MARK  
TRANSLATES INTO ENGLISH AS "VOICE."

SER. NO. 77-023,905, FILED 10-18-2006.

JASON LOTT, EXAMINING ATTORNEY

**Int. Cls.: 7 and 12**

**Prior U.S. Cls.: 13, 19, 21, 23, 31, 34, 35 and 44**

**United States Patent and Trademark Office**

**Reg. No. 3,465,124**

**Registered July 15, 2008**

**TRADEMARK  
PRINCIPAL REGISTER**

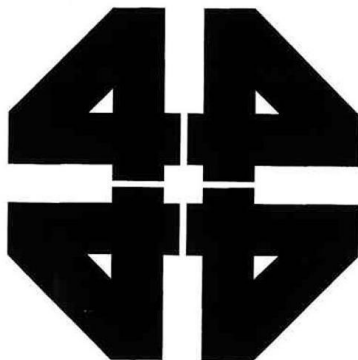

LIFT SYSTEMS, INC. (ILLINOIS CORPORATION)  
P.O. BOX 906  
216 - 40TH STREET  
MOLINE, IL 612660906

FOR: POWER-OPERATED LIFTING, MOVING AND SPANNING EQUIPMENT, NAMELY, LIFTS USED TO MOVE HEAVY OBJECTS; LIFTING SYSTEMS COMPRISED OF GANTRY CRANES, MACHINE PARTS, SPECIFICALLY, LIFT CYLINDERS, FORKLIFTS, SPENT NUCLEAR FUEL CASK PNEUMATIC TRANSPORTERS; POWER-OPERATED MOBILE LIFTING EQUIPMENT, NAMELY, LIFTS USED TO MOVE HEAVY OBJECTS; HYDRAULIC JACKS FOR LIFTING HEAVY OBJECTS, IN CLASS 7 (U.S. CLS. 13, 19, 21, 23, 31, 34 AND 35).

FIRST USE 0-0-1983; IN COMMERCE 0-0-1983.

FOR: INDUSTRIAL TRAILERS; MOTOR CARS FOR TRANSPORT ON LAND, NAMELY, SPENT NUCLEAR FUEL CASK TRANSPORTERS, IN CLASS 12 (U.S. CLS. 19, 21, 23, 31, 35 AND 44).

FIRST USE 0-0-1983; IN COMMERCE 0-0-1983.

THE MARK CONSISTS OF INTERLACING 4'S DESIGN.

SER. NO. 77-025,050, FILED 10-19-2006.

DAVID COLLIER, EXAMINING ATTORNEY



**Int. Cls.: 9, 10, 17, 22, 23, 24, 28 and 40**

**Prior U.S. Cls.: 1, 2, 5, 7, 12, 13, 19, 21, 22, 23, 26, 35, 36, 38, 39, 42, 43, 44, 50, 100, 103 and 106**

**Reg. No. 3,465,125**

**United States Patent and Trademark Office**

**Registered July 15, 2008**

**TRADEMARK  
SERVICE MARK  
PRINCIPAL REGISTER**

**DYNEEMA THE WORLD'S  
STRONGEST FIBER**

DSM IP ASSETS B.V. (NETHERLANDS CORPORATION)  
HET OVERLOON 1  
HEERLEN, NETHERLANDS 6411TE

FOR: GLOVES FOR THE PROTECTION AGAINST ACCIDENTS; CLOTHING, HEADGEAR AND FOOTWEAR FOR THE PROTECTION AGAINST ACCIDENTS, NAMELY BULLET-RESISTANT VESTS, SAFETY HELMETS FOR MILITARY AND LAW ENFORCEMENT USE, BOMB-DISPOSAL SUITS, PROTECTIVE HELMETS; NETS, FABRICS AND TEXTILES FOR THE PROTECTION AGAINST ACCIDENTS, NAMELY SAFETY NETS USED IN THE CONSTRUCTION INDUSTRY, BOMB BLANKETS, BOMB TENTS AND BLAST CURTAINS, COMMERCIAL SAFETY NETS, LIFE NETS, IN CLASS 9 (U.S. CLS. 21, 23, 26, 36 AND 38).

FOR: SURGICAL APPARATUS AND INSTRUMENTS, NAMELY, PINS, PLATES, RODS, BONE SCREWS AND NAILS, STENTS, INSERTS, ALL FOR TISSUE OR BONE REPAIR AND RECONSTRUCTION; ARTIFICIAL LIMBS, EYES AND TEETH; SUTURES; THREADS FOR BIOMEDICAL AND MEDICAL USE; SURGICAL COMPRESSES MADE FROM FIBER, YARN AND THREAD; SURGICAL MESHES FOR USE IN SOFT TISSUE REPAIR; SURGICAL IMPLANTS COMPRISING ARTIFICIAL MATERIAL INCLUDING POLYETHYLENE FIBERS; SURGICAL THREAD COMPRISED OF POLYETHYLENE FIBERS; AND SUTURES COMPRISED OF POLYETHYLENE FIBER., IN CLASS 10 (U.S. CLS. 26, 39 AND 44).

FOR: PLASTIC FIBERS FOR USE IN THE MANUFACTURE OF STRIPS, SHEETS, PLATES, SLABS AND PANELS USED IN CONNECTION WITH GARMENTS FOR BALLISTIC PROTECTION; RUBBER THREADS NOT FOR TEXTILE USE; SYNTHETIC

PLASTIC AS SEMI-FINISHED PRODUCTS IN FORM OF PLATES AND PANELS; PLASTICS AS SEMI-PROCESSED MATERIALS IN THE FORMS OF STRIPS, SHEETS, PLATES, SLABS OR PANELS; POLYETHYLENE FIBER COMPOSITE MATERIAL FOR USE IN THE MANUFACTURE OF CONTAINER PANELS, THE PROTECTIVE BODY OF RACE CARS AND RACE BOATS, IN CLASS 17 (U.S. CLS. 1, 5, 12, 13, 35 AND 50).

FOR: FIBERS FOR TEXTILE USE, E;G; POLYETHYLENE FIBERS; STRING, ROPES AND CORDS, NAMELY, TOWING STRAPS, OFFSHORE POSITIONING ROPES, COMMERCIAL FISHING ROPES, ROUNDSLINGS AND LINES MADE OF POLYETHYLENE FIBER FOR USE IN MOORING, TREE CLIMBING, AND YACHTING, IN CLASS 22 (U.S. CLS. 1, 2, 7, 19, 22, 42 AND 50).

FOR: YARNS FOR TEXTILE USE; THREADS FOR TEXTILE USE, YARNS; THREAD., IN CLASS 23 (U.S. CL. 43).

FOR: FABRICS, NAMELY, TEXTILE FABRICS FOR THE MANUFACTURE OF CLOTHING FOR INDUSTRIAL USE, REINFORCEMENT FABRICS FOR SPORTS EQUIPMENT AND SPORTS CLOTHING, SURF AND SKATE BOARD REINFORCEMENT FABRIC, HOCKEY STICK REINFORCEMENT FABRIC, HELMET REINFORCEMENT FABRIC, SKI REINFORCEMENT FABRIC, DIVING SUITS REINFORCEMENT FABRIC, IN CLASS 24 (U.S. CLS. 42 AND 50).

FOR: FISHING TACKLES, IN CLASS 28 (U.S. CLS. 22, 23, 38 AND 50).

FOR: TREATMENT OF MATERIALS, NAMELY,  
TREATMENT OF POLYETHYLENE FIBERS., IN  
CLASS 40 (U.S. CLS. 100, 103 AND 106).

THE MARK CONSISTS OF STANDARD CHAR-  
ACTERS WITHOUT CLAIM TO ANY PARTICULAR  
FONT, STYLE, SIZE, OR COLOR.

OWNER OF BENELUX REG. NO. 0799402, DATED  
4-5-2006, EXPIRES 2-5-2016.

NO CLAIM IS MADE TO THE EXCLUSIVE  
RIGHT TO USE "THE WORLD'S STRONGEST FI-  
BER", APART FROM THE MARK AS SHOWN.

SER. NO. 77-025,305, FILED 10-19-2006.

SHAUNIA CARLYLE, EXAMINING ATTORNEY

**Int. Cl.: 9**

**Prior U.S. Cls.: 21, 23, 26, 36 and 38**

**Reg. No. 3,465,126**

**United States Patent and Trademark Office**

**Registered July 15, 2008**

---

**TRADEMARK  
PRINCIPAL REGISTER**

**JAS**

JENA-OPTRONIK GMBH (FED REP GERMANY  
LTD LIAB CO)  
PRÜSSINGSTRASSE 41  
JENA, FED REP GERMANY 07745

PRIORITY CLAIMED UNDER SEC. 44(D) ON  
ERPNTY TM OFC APPLICATION NO.  
005104138, FILED 5-11-2006, REG. NO. 005104138,  
DATED 4-3-2007, EXPIRES 5-11-2016.

FOR: AERIAL CAMERAS, IN CLASS 9 (U.S. CLS.  
21, 23, 26, 36 AND 38).

SER. NO. 77-026,148, FILED 10-20-2006.

THE MARK CONSISTS OF STANDARD CHAR-  
ACTERS WITHOUT CLAIM TO ANY PARTICULAR  
FONT, STYLE, SIZE, OR COLOR.

SHAUNIA CARLYLE, EXAMINING ATTORNEY

**Int. Cl.: 9**

**Prior U.S. Cls.: 21, 23, 26, 36 and 38**

**Reg. No. 3,465,127**

**United States Patent and Trademark Office**

**Registered July 15, 2008**

---

**TRADEMARK  
PRINCIPAL REGISTER**

**TT TRADER**

TRADING TECHNOLOGIES INTERNATIONAL,  
INC. (DELAWARE CORPORATION)  
222 S. RIVERSIDE PLAZA  
CHICAGO, IL 60606

FOR: COMPUTER SOFTWARE USED FOR RISK  
MANAGEMENT, TRADING, ROUTING, PRICING,  
REPORTING AND PROCESSING OF SECURITIES,  
COMMODITIES, FUTURES, OPTIONS, EQUITY  
AND DEBT INSTRUMENTS, INSURANCE RELAT-  
ED FINANCIAL PRODUCTS, ENERGY RELATED  
FINANCIAL PRODUCTS, CURRENCIES, AND  
ELECTRONIC AND FOREIGN EXCHANGES, IN  
CLASS 9 (U.S. CLS. 21, 23, 26, 36 AND 38).

FIRST USE 8-1-2006; IN COMMERCE 8-1-2006.

THE MARK CONSISTS OF STANDARD CHAR-  
ACTERS WITHOUT CLAIM TO ANY PARTICULAR  
FONT, STYLE, SIZE, OR COLOR.

OWNER OF U.S. REG. NOS. 2,526,827, 2,994,278  
AND OTHERS.

NO CLAIM IS MADE TO THE EXCLUSIVE  
RIGHT TO USE "TRADER", APART FROM THE  
MARK AS SHOWN.

SER. NO. 77-026,923, FILED 10-23-2006.

CORY BOONE, EXAMINING ATTORNEY

Int. Cl.: 9

Prior U.S. Cls.: 21, 23, 26, 36 and 38

Reg. No. 3,465,128

United States Patent and Trademark Office

Registered July 15, 2008

TRADEMARK  
PRINCIPAL REGISTER



RF MONOLITHICS, INC. (DELAWARE CORPORATION)  
4441 SIGMA ROAD  
DALLAS, TX 75244

FIRST USE 9-27-2006; IN COMMERCE 9-27-2006.

THE WORDING "ALEIER" HAS NO MEANING  
IN A FOREIGN LANGUAGE.

FOR: SOFTWARE AND HARDWARE IN THE  
FIELD OF ENTERPRISE ASSET MANAGEMENT,  
COMPUTERIZED MAINTENANCE MANAGE-  
MENT, AND MACHINE AND PROCESS MONITOR-  
ING AND CONTROL, IN CLASS 9 (U.S. CLS. 21, 23,  
26, 36 AND 38).

SER. NO. 77-027,311, FILED 10-23-2006.

ALICE SUE CARRUTHERS, EXAMINING ATTOR-  
NEY

**Int. Cl.: 37**

**Prior U.S. Cls.: 100, 103 and 106**

**Reg. No. 3,465,129**

**United States Patent and Trademark Office**

**Registered July 15, 2008**

**SERVICE MARK  
PRINCIPAL REGISTER**



PEARCE, JASON (UNITED STATES INDIVIDUAL), DBA PEARCE CONSTRUCTION  
313 VIA CLOUSA  
REDONDO BEACH, CA 90277

THE COLOR(S) RED, BLACK AND WHITE IS/ARE CLAIMED AS A FEATURE OF THE MARK.

FOR: CONSTRUCTION SERVICES, NAMELY, PLANNING, LAYING OUT AND CUSTOM CONSTRUCTION OF RESIDENTIAL AND COMMERCIAL COMMUNITIES, IN CLASS 37 (U.S. CLS. 100, 103 AND 106).

"PEARCE" APPEARS IN RED, THE WORD "CONSTRUCTION" APPEARS IN BLACK AND THE OVAL FORMING THE LETTER "P" IS FROM LEFT TO RIGHT IN BLACK, RED AND WHITE.

FIRST USE 10-1-1999; IN COMMERCE 0-0-2000.

SER. NO. 77-027,524, FILED 10-23-2006.

NO CLAIM IS MADE TO THE EXCLUSIVE RIGHT TO USE CONSTRUCTION, APART FROM THE MARK AS SHOWN.

EDWARD NELSON, EXAMINING ATTORNEY

**Int. Cl.: 38**

**Prior U.S. Cls.: 100, 101 and 104**

**United States Patent and Trademark Office**

**Reg. No. 3,465,130**

**Registered July 15, 2008**

**SERVICE MARK  
PRINCIPAL REGISTER**

**AT&T ANYHOUR ADVANTAGE  
PLAN WITH CITY SAVINGS**

AT&T INTELLECTUAL PROPERTY II, L.P. (NE-  
VADA LIMITED PARTNERSHIP)  
645 EAST PLUMB LANE  
RENO, NV 89502

OWNER OF U.S. REG. NOS. 1,296,936, 3,274,801  
AND OTHERS.

FOR: TELECOMMUNICATIONS SERVICES,  
NAMELY, THE ELECTRONIC TRANSMISSION OF  
VOICE, DATA, FACSIMILE, VIDEO AND INFOR-  
MATION, IN CLASS 38 (U.S. CLS. 100, 101 AND 104).

NO CLAIM IS MADE TO THE EXCLUSIVE  
RIGHT TO USE ANY HOUR ADVANTAGE PLAN  
WITH CITY SAVINGS, APART FROM THE MARK  
AS SHOWN.

FIRST USE 9-30-2003; IN COMMERCE 9-30-2003.

SER. NO. 77-027,879, FILED 10-24-2006.

THE MARK CONSISTS OF STANDARD CHAR-  
ACTERS WITHOUT CLAIM TO ANY PARTICULAR  
FONT, STYLE, SIZE, OR COLOR.

JULIE WATSON, EXAMINING ATTORNEY

**Int. Cl.: 41**

**Prior U.S. Cls.: 100, 101 and 107**

**United States Patent and Trademark Office**

**Reg. No. 3,465,131**

**Registered July 15, 2008**

**SERVICE MARK  
PRINCIPAL REGISTER**



WORLD SERIES OF BACKGAMMON ENTERPRISES LIMITED (UNITED KINGDOM PRIVATE LIMITED COMPANY)  
166 STANLEY ROAD  
TEDDINGTON, UNITED KINGDOM TW118UD

FOR: ENTERTAINMENT SERVICES, NAMELY, SPONSORING, ORGANIZING, CONDUCTING, AND EXHIBITING GLOBAL BACKGAMMON EVENTS AND TOURNAMENTS RENDERED LIVE AND THROUGH THE MEDIA OF TELEVISION AND THE INTERNET; PROVIDING BACKGAMMON NEWS AND INFORMATION VIA A GLOBAL COMPUTER NETWORK; PRODUCTION OF TELEVISION PROGRAMS RELATING TO BACKGAMMON; ELECTRONIC GAMES SERVICES RELATING TO BACKGAMMON, PROVIDED BY MEANS OF THE INTERNET; PROVISION OF ONLINE ELECTRONIC PUBLICATIONS RELATING TO BACKGAMMON, IN CLASS 41 (U.S. CLS. 100, 101 AND 107).

PRIORITY CLAIMED UNDER SEC. 44(D) ON ERPN CMNTY TM OFC APPLICATION NO. 005250337, FILED 8-9-2006, REG. NO. 005250337, DATED 1-23-2008, EXPIRES 8-9-2016.

NO CLAIM IS MADE TO THE EXCLUSIVE RIGHT TO USE "WORLD SERIES OF BACKGAMMON", APART FROM THE MARK AS SHOWN.

THE COLOR(S) BLACK, WHITE, YELLOW, AND RED IS/ARE CLAIMED AS A FEATURE OF THE MARK.

THE COLOR BLACK APPEARS IN THE TRIANGLE ON THE LEFT AND IN THE DOTS ON THE DESIGN OF THE DIE; THE COLOR WHITE APPEARS ON THE BACKGAMMON PLAYING PIECE IN THE TRIANGLE ON THE LEFT AND IN THE DIE IN THE TRIANGLE ON THE RIGHT; THE COLOR YELLOW APPEARS IN THE WORDING "WORLD SERIES OF BACKGAMMON"; THE COLOR RED APPEARS IN THE TRIANGLE ON THE RIGHT.

SER. NO. 77-028,665, FILED 10-25-2006.

MARLENE BELL, EXAMINING ATTORNEY



**Int. Cl.: 21**

**Prior U.S. Cls.: 2, 13, 23, 29, 30, 33, 40 and 50**

**Reg. No. 3,465,132**

**United States Patent and Trademark Office**

**Registered July 15, 2008**

---

**TRADEMARK  
PRINCIPAL REGISTER**

**JESSWARE**

JESSWARE, INC. (DELAWARE CORPORATION)  
2850 WEST COLUMBUS AVENUE  
CHICAGO, IL 60652

THE MARK CONSISTS OF STANDARD CHAR-  
ACTERS WITHOUT CLAIM TO ANY PARTICULAR  
FONT, STYLE, SIZE, OR COLOR.

FOR: CONTAINERS AND TRAYS FOR THE  
STORAGE AND ORGANIZATION OF HOUSEHOLD  
GOODS AND OFFICE PRODUCTS, IN CLASS 21  
(U.S. CLS. 2, 13, 23, 29, 30, 33, 40 AND 50).

SER. NO. 77-029,671, FILED 10-26-2006.

FIRST USE 4-30-2006; IN COMMERCE 4-30-2006.

THEODORE MCBRIDE, EXAMINING ATTORNEY

Int. Cl.: 33

Prior U.S. Cls.: 47 and 49

United States Patent and Trademark Office

Reg. No. 3,465,133

Registered July 15, 2008

TRADEMARK  
PRINCIPAL REGISTER

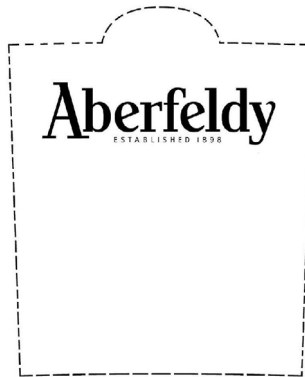

BACARDI & COMPANY LIMITED (LIECHTEN-  
STEIN CORPORATION)  
AEULESTRASSE 5  
VADUZ, LIECHTENSTEIN FL-9490

FOR: WHISKY, IN CLASS 33 (U.S. CLS. 47 AND  
49).

FIRST USE 9-6-2006; IN COMMERCE 9-6-2006.

NO CLAIM IS MADE TO THE EXCLUSIVE  
RIGHT TO USE "ESTABLISHED 1898" , APART  
FROM THE MARK AS SHOWN.

THE MARK CONSISTS OF THE WORD "ABER-  
FELDY" ABOVE THE WORDING "ESTABLISHED  
1898" WITH THE DOTTED PORTION OF THE  
MARK USED TO INDICATE THE PLACEMENT  
OF THE WORDING ON THE LABEL.

SER. NO. 77-030,500, FILED 10-26-2006.

JAMES LOVELACE, EXAMINING ATTORNEY

Int. Cl.: 36

Prior U.S. Cls.: 100, 101 and 102

United States Patent and Trademark Office

Reg. No. 3,465,134

Registered July 15, 2008

**SERVICE MARK  
PRINCIPAL REGISTER**



YOUR CHOICE REAL ESTATE, INC. (FLORIDA CORPORATION)  
151-18 COLLEGE DRIVE  
ORANGE PARK, FL 32065

FOR: APPRAISAL OF REAL ESTATE; APPRAISALS FOR INSURANCE CLAIMS OF REAL ESTATE; ASSESSMENT AND MANAGEMENT OF REAL ESTATE; ESTATE PLANNING; ESTATE TRUST MANAGEMENT; EVALUATION OF REAL PROPERTY; FINANCIAL INVESTMENT IN THE FIELD OF REAL ESTATE; FINANCIAL VALUATION OF PERSONAL PROPERTY AND REAL ESTATE; LAND ACQUISITION, NAMELY, REAL ESTATE BROKERAGE; LEASING OF REAL ESTATE; LEASING OF REAL PROPERTY; OPERATING MARKETPLACES FOR SELLERS OF GOODS AND/OR SERVICES; PROVIDING INFORMATION IN THE FIELD OF REAL ESTATE BY MEANS OF LINKING THE WEB SITE TO OTHER WEB SITES FEATURING REAL ESTATE INFORMATION; PROVIDING ONLINE INFORMATION IN THE FIELD CHARITABLE MONETARY GIVING THROUGH FINANCIAL AND ESTATE PLANNING; REAL ESTATE ACQUISITION SERVICES; REAL ESTATE AGENCIES; REAL ESTATE APPRAISAL; REAL ESTATE BROKERAGE; REAL ESTATE CONSULTANCY; REAL ESTATE CONSULTATION; REAL ESTATE EQUITY SHARING, NAMELY, MANAGING AND ARRANGING FOR CO-OWNERSHIP OF REAL ESTATE; REAL ESTATE ESCROW SERVICES; REAL ESTATE INVESTMENT; REAL ESTATE LISTING; REAL ESTATE MANAGEMENT; REAL ESTATE MANAGEMENT CONSULTATION; REAL ESTATE MULTIPLE LISTING SERVICES; REAL ESTATE PROCUREMENT FOR OTHERS;

REAL ESTATE SERVICES, NAMELY, RENTAL OF VACATION HOMES, CONDOMINIUMS, CABINS, AND VILLAS USING PAY PER CLICK ADVERTISING ON A GLOBAL COMPUTER NETWORK; REAL ESTATE SYNDICATION; REAL ESTATE TIME-SHARING; REAL ESTATE TRUSTEE SERVICES; REAL ESTATE VALUATION SERVICES; REAL ESTATE VALUATIONS; VACATION REAL ESTATE TIME SHARE EXCHANGE SERVICES; VACATION REAL ESTATE TIME-SHARING, IN CLASS 36 (U.S. CLS. 100, 101 AND 102).

FIRST USE 9-27-2006; IN COMMERCE 9-27-2006.

NO CLAIM IS MADE TO THE EXCLUSIVE RIGHT TO USE "REAL ESTATE", APART FROM THE MARK AS SHOWN.

THE COLOR(S) BLUE AND BLACK IS/ARE CLAIMED AS A FEATURE OF THE MARK.

THE MARK CONSISTS OF THE APPEARANCE OF A HOUSE, THE TOP HAS DARK BLUE AND LIGHT BLUE LINES TO SHAPE THE ROOF, THE "YOUR CHOICE" TEXT IS BLACK AND HAS A BLUE 'CHECK' IN THE LETTER "O" IN THE WORD "CHOICE." THERE IS A LIGHT BLUE AND DARK BLUE LINE BELOW THE "YOUR CHOICE" TEXT. AT THE BOTTOM OF THE MARK, THE TEXT "REAL ESTATE" IS IN BLACK.

SER. NO. 77-031,762, FILED 10-29-2006.

DAVID HOFFMAN, EXAMINING ATTORNEY

**Int. Cl.: 42**

**Prior U.S. Cls.: 100 and 101**

**United States Patent and Trademark Office**

**Reg. No. 3,465,135**

**Registered July 15, 2008**

**SERVICE MARK  
PRINCIPAL REGISTER**

**EZANGA**

EZANGA.COM, INC. (DELAWARE CORPORATION)  
219 CARTER DRIVE  
MIDDLETOWN, DE 19709

THE MARK CONSISTS OF STANDARD CHARACTERS WITHOUT CLAIM TO ANY PARTICULAR FONT, STYLE, SIZE, OR COLOR.

FOR: COMPUTER SERVICES, NAMELY, PROVIDING SEARCH ENGINES FOR OBTAINING DATA ON THIRD PARTY WEBSITES, IN CLASS 42 (U.S. CLS. 100 AND 101).

SER. NO. 77-032,011, FILED 10-30-2006.

FIRST USE 11-11-2003; IN COMMERCE 11-11-2003.

NAAKWAMA ANKRAH, EXAMINING ATTORNEY

**Int. Cl.: 8**

**Prior U.S. Cls.: 23, 28 and 44**

**Reg. No. 3,465,136**

**United States Patent and Trademark Office**

**Registered July 15, 2008**

**TRADEMARK  
PRINCIPAL REGISTER**

# PRO-CHEF

WHOLE POWER INDUSTRIAL & TRADING CO.  
LTD. OF YANGJIANG (CHINA CORPORATION)  
DONGCHENG TOWN, YANGDONG  
NO. 6, N. AREA, NAHUO INDUSTRIAL DIST.  
YANGJIANG, GUANDONG, CHINA 529932

FOR: BLADES FOR KITCHEN KNIVES; BUTCHER KNIVES; CARVING KNIVES; CHEF KNIVES; CUTLERY, NAMELY, FORKS, SPOONS, KNIVES; DIVING KNIVES; FISH SLICING KITCHEN KNIVES; FISHING KNIVES; FOLDING KNIVES; GRAPEFRUIT TRIMMER, NAMELY, A KITCHEN KNIFE WITH SERRATED EDGES; HAND TOOLS, NAMELY, KNIFE SHARPENERS; HAND-OPERATED CHOPPERS; HAND-OPERATED SLICERS; HAND-OPERATED VEGETABLE SHREDDERS; HOUSEHOLD KNIVES; HUNTING KNIVES; JACK KNIVES; KNIFE SHARPENERS; KITCHEN KNIVES; KNIVES FOR SLAUGHTERING ANIMALS AND

KITCHEN; MACHETES; MANUALLY OPERATED TREE PRUNERS; OYSTER OPENERS; PEN KNIVES; PIZZA CUTTERS; PRUNING SCISSORS; SCALING KNIVES; SCISSORS; SHARPENING STEELS; SHARPENING WHEELS FOR KNIVES AND BLADES; VEGETABLE SLICERS, IN CLASS 8 (U.S. CLS. 23, 28 AND 44).

THE MARK CONSISTS OF STANDARD CHARACTERS WITHOUT CLAIM TO ANY PARTICULAR FONT, STYLE, SIZE, OR COLOR.

OWNER OF CHINA REG. NO. 3478751, DATED 8-28-2004, EXPIRES 8-28-2014.

SER. NO. 77-032,091, FILED 10-30-2006.

JULIE GUTTADAURO, EXAMINING ATTORNEY

**Int. Cl.: 41**

**Prior U.S. Cls.: 100, 101 and 107**

**United States Patent and Trademark Office**

**Reg. No. 3,465,137**

**Registered July 15, 2008**

**SERVICE MARK  
PRINCIPAL REGISTER**

# Strange Land

GILL, SEAN (UNITED STATES INDIVIDUAL)  
5080 S GREENBROOK TERRACE #1102  
GREENFIELD, WI 53220

FIRST USE 4-17-1999; IN COMMERCE 11-15-1999.

FOR: ENTERTAINMENT, NAMELY, LIVE MUSIC CONCERTS; ENTERTAINMENT, NAMELY, LIVE PERFORMANCES BY MUSICAL BANDS; ENTERTAINMENT, NAMELY, LIVE PERFORMANCES BY ROCK GROUPS, IN CLASS 41 (U.S. CLS. 100, 101 AND 107).

THE MARK CONSISTS OF STANDARD CHARACTERS WITHOUT CLAIM TO ANY PARTICULAR FONT, STYLE, SIZE, OR COLOR.

SER. NO. 77-033,083, FILED 10-31-2006.

KAREN SEVERSON, EXAMINING ATTORNEY

**Int. Cl.: 9**

**Prior U.S. Cls.: 21, 23, 26, 36 and 38**

**United States Patent and Trademark Office**

**Reg. No. 3,465,138**

**Registered July 15, 2008**

**TRADEMARK  
PRINCIPAL REGISTER**

**SOLLEAD**

ANRITSU KABUSHIKI KAISHA (JAPAN CORPORATION), DBA ANRITSU CORPORATION  
5-1-1 ONNA, ATSUGI-SHI  
KANAGAWA, JAPAN

FOR: THREE-DIMENSIONAL PROFILOMETER FOR ELECTRONIC CIRCUIT BOARDS; SURFACE MOUNT INSPECTOR FOR ELECTRONIC CIRCUIT BOARDS; SOLDER PASTE INSPECTOR FOR ELECTRONIC CIRCUIT BOARDS, IN CLASS 9 (U.S. CLS. 21, 23, 26, 36 AND 38).

THE MARK CONSISTS OF STANDARD CHARACTERS WITHOUT CLAIM TO ANY PARTICULAR FONT, STYLE, SIZE, OR COLOR.

PRIORITY CLAIMED UNDER SEC. 44(D) ON JAPAN APPLICATION NO. 2006-090515, FILED 9-28-2006, REG. NO. 5061316, DATED 7-6-2007, EXPIRES 7-6-2017.

SER. NO. 77-033,290, FILED 10-31-2006.

JILL C. ALT, EXAMINING ATTORNEY

**Int. Cl.: 24**

**Prior U.S. Cls.: 42 and 50**

**United States Patent and Trademark Office**

**Reg. No. 3,465,139**

**Registered July 15, 2008**

**TRADEMARK  
PRINCIPAL REGISTER**

**HIS LOVING MAJESTY'S  
COLLECTION**

FLY YOUR FAITH GALLERY, INC. (GEORGIA  
CORPORATION)

100 ROBINSON BEND TRAIL

PEACHTREE CITY, GA 30269

FOR: NYLON AND POLYESTER FLAGS AND  
BANNERS, IN CLASS 24 (U.S. CLS. 42 AND 50).

FIRST USE 4-1-2003; IN COMMERCE 4-1-2003.

THE MARK CONSISTS OF STANDARD CHAR-  
ACTERS WITHOUT CLAIM TO ANY PARTICULAR  
FONT, STYLE, SIZE, OR COLOR.

NO CLAIM IS MADE TO THE EXCLUSIVE  
RIGHT TO USE "COLLECTION", APART FROM  
THE MARK AS SHOWN.

SER. NO. 77-033,442, FILED 10-31-2006.

DANIEL BRODY, EXAMINING ATTORNEY



Int. Cl.: 9

Prior U.S. Cls.: 21, 23, 26, 36 and 38

Reg. No. 3,465,140

United States Patent and Trademark Office

Registered July 15, 2008

TRADEMARK  
PRINCIPAL REGISTER



GOLDEN VOICE COMPUTER TECHNOLOGY  
CO., LTD. (TAIWAN CORPORATION)  
TAOYUAN COUNTY 320  
NO. 79, DONG YUAN RD.  
JHONGLI CITY, TAIWAN 320

FOR: COMPUTER HARDWARE; COMPUTER SOFTWARE, NAMELY, COMPUTER GAME SOFTWARE, COMPUTER SEARCH ENGINE SOFTWARE, COMPUTER SOFTWARE FOR APPLICATION AND DATABASE INTEGRATION, COMPUTER SOFTWARE FOR CREATING SEARCHABLE DATABASES OF INFORMATION AND DATA; VIDEO TAPE RECORDERS; VIDEO DISC RECORDERS; COMPACT DISC RECORDERS; DIGITAL VIDEO DISC (DVD) RECORDERS; DIGITAL AUDIO TAPE RECORDERS; VIDEODISC PLAYERS; AUDIO SPEAKERS; AUDIO EQUIPMENT, NAMELY, AMPLIFIERS; ELECTRONIC AUDIO EFFECTS APPARATUS, NAMELY ELECTRIC AUDIO PLAYBACK UNITS WITH LIGHTS AND SPEAKERS, DIGITAL AUDIO PLAYERS AND AUDIO MIXERS; KARAOKE MACHINE; MOTION PICTURE FILMS FEATURING ADVENTURE, ACTION, COMEDY AND ANIMATION FILMS, PRE-RECORDED VIDEO CASSETTES AND VIDEO

DISCS FEATURING ADVENTURE, ACTION, COMEDY; PRE-RECORDED VIDEO CASSETTES FEATURING MUSIC; VIDEO RECORDING FEATURING MUSIC; COMPACT DISCS AND PRE-RECORDED DIGITAL VIDEO DISKS FEATURING MUSIC, IN CLASS 9 (U.S. CLS. 21, 23, 26, 36 AND 38).

FIRST USE 6-15-2006; IN COMMERCE 6-15-2006.

NO CLAIM IS MADE TO THE EXCLUSIVE RIGHT TO USE "VOICE", APART FROM THE MARK AS SHOWN.

THE COLOR(S) BLACK AND YELLOW IS/ARE CLAIMED AS A FEATURE OF THE MARK.

THE COLOR BLACK APPEARS IN THE WORDS "GOLDEN VOICE" AND IN PART OF THE "V DESIGN"; THE COLOR YELLOW APPEARS IN THE "V DESIGN".

SER. NO. 77-033,470, FILED 10-31-2006.

B. PARADEWELAI, EXAMINING ATTORNEY

**Int. Cl.: 25**

**Prior U.S. Cls.: 22 and 39**

**United States Patent and Trademark Office**

**Reg. No. 3,465,141**

**Registered July 15, 2008**

**TRADEMARK  
PRINCIPAL REGISTER**



SEYCHELLES IMPORTS, LLC (CALIFORNIA  
LTD LIAB CO)  
800 NORTH SEPULVEDA BOULEVARD  
EL SEGUNDO, CA 90245

THE MARK CONSISTS OF A RECTANGULAR  
DESIGN FEATURING TWO STRIPES ON EACH  
SIDE.

FOR: FOOTWEAR, IN CLASS 25 (U.S. CLS. 22 AND  
39).

SER. NO. 77-033,703, FILED 10-31-2006.

FIRST USE 10-1-2000; IN COMMERCE 10-1-2000.

GINA HAYES, EXAMINING ATTORNEY

**Int. Cl.: 16**

**Prior U.S. Cls.: 2, 5, 22, 23, 29, 37, 38 and 50**

**Reg. No. 3,465,142**

**United States Patent and Trademark Office**

**Registered July 15, 2008**

**TRADEMARK  
PRINCIPAL REGISTER**

The logo for The Baltimore Sun, featuring the words "THE" and "SUN" in a serif font, with a small crest or emblem between them.

THE BALTIMORE SUN COMPANY (MARY-  
LAND CORPORATION)  
501 NORTH CALVERT STREET  
BALTIMORE, MD 212780001

FIRST USE 5-17-1837; IN COMMERCE 5-17-1837.

SER. NO. 77-034,973, FILED 11-2-2006.

FOR: NEWSPAPER AND NEWSPAPER SUPPLE-  
MENTS FOR GENERAL CIRCULATION, IN CLASS  
16 (U.S. CLS. 2, 5, 22, 23, 29, 37, 38 AND 50).

LA TONIA FISHER, EXAMINING ATTORNEY

**Int. Cl.: 20**

**Prior U.S. Cls.: 2, 13, 22, 25, 32 and 50**

**United States Patent and Trademark Office**

**Reg. No. 3,465,143**

**Registered July 15, 2008**

**TRADEMARK  
PRINCIPAL REGISTER**

# Haute Living

HAUTE LIVING, LLC (ILLINOIS LTD LIAB CO)  
222 W KINZIE STREET  
CHICAGO, IL 60610

THE MARK CONSISTS OF STANDARD CHAR-  
ACTERS WITHOUT CLAIM TO ANY PARTICULAR  
FONT, STYLE, SIZE, OR COLOR.

FOR: FURNITURE, IN CLASS 20 (U.S. CLS. 2, 13,  
22, 25, 32 AND 50).

SER. NO. 77-036,123, FILED 11-3-2006.

FIRST USE 9-1-2006; IN COMMERCE 9-1-2006.

CAROLINE WOOD, EXAMINING ATTORNEY

**Int. Cl.: 36**

**Prior U.S. Cls.: 100, 101 and 102**

**United States Patent and Trademark Office**

**Reg. No. 3,465,144**

**Registered July 15, 2008**

**SERVICE MARK  
PRINCIPAL REGISTER**

**ARCO CAPITAL MANAGEMENT**

ARCO CAPITAL MANAGEMENT LIMITED  
(CAYMAN ISLANDS LIMITED COMPANY)  
WALKER HOUSE - PO BOX 265GT, MARY STREET  
C/O WALKERS (IAN GOBIN)  
GEORGE TOWN, CAYMAN ISLANDS

FOR: FINANCIAL SERVICES, NAMELY, FINANCIAL AND INVESTMENT ANALYSIS, FINANCIAL ADVISORY AND INVESTMENT ADVICE; INVESTMENT BANKING SERVICES; FINANCIAL INVESTMENT ADVISORY SERVICES; FINANCING ADVICE AND ANALYSIS; ALL OF THE FORGOING RELATED TO EMERGING MARKETS AND EXCLUDING MORTGAGE BROKERAGE AND LENDING SERVICES, IN CLASS 36 (U.S. CLS. 100, 101 AND 102).

FIRST USE 8-1-2006; IN COMMERCE 8-1-2006.

THE MARK CONSISTS OF STANDARD CHARACTERS WITHOUT CLAIM TO ANY PARTICULAR FONT, STYLE, SIZE, OR COLOR.

NO CLAIM IS MADE TO THE EXCLUSIVE RIGHT TO USE "CAPITAL MANAGEMENT", APART FROM THE MARK AS SHOWN.

SER. NO. 77-037,999, FILED 11-6-2006.

BRENDAN MCCAULEY, EXAMINING ATTORNEY

**Int. Cl.: 36**

**Prior U.S. Cls.: 100, 101 and 102**

**United States Patent and Trademark Office**

**Reg. No. 3,465,145**

**Registered July 15, 2008**

**SERVICE MARK  
PRINCIPAL REGISTER**

**ARCO**

ARCO CAPITAL MANAGEMENT LIMITED  
(CAYMAN ISLANDS LIMITED COMPANY)  
WALKER HOUSE - PO BOX 265GT, MARY STREET  
C/O WALKERS (IAN GOBIN)  
GEORGE TOWN, CAYMAN ISLANDS

FOR: FINANCIAL SERVICES, NAMELY, FINANCIAL AND INVESTMENT ANALYSIS, FINANCIAL ADVISORY AND INVESTMENT ADVICE; INVESTMENT BANKING SERVICES; FINANCIAL INVESTMENT ADVISORY SERVICES; FINANCING ADVICE AND ANALYSIS; ALL OF THE FORGOING RELATED TO EMERGING MARKETS AND EXCLUDING MORTGAGE BROKERAGE AND LEND-

ING SERVICES, IN CLASS 36 (U.S. CLS. 100, 101 AND 102).

FIRST USE 8-1-2006; IN COMMERCE 8-1-2006.

THE MARK CONSISTS OF STANDARD CHARACTERS WITHOUT CLAIM TO ANY PARTICULAR FONT, STYLE, SIZE, OR COLOR.

SER. NO. 77-038,013, FILED 11-6-2006.

BRENDAN MCCAULEY, EXAMINING ATTORNEY

**Int. Cl.: 36**

**Prior U.S. Cls.: 100, 101 and 102**

**United States Patent and Trademark Office**

**Reg. No. 3,465,146**

**Registered July 15, 2008**

**SERVICE MARK  
PRINCIPAL REGISTER**

ARCO CAPITAL CORPORATION

ARCO CAPITAL MANAGEMENT LIMITED  
(CAYMAN ISLANDS LIMITED COMPANY)  
WALKER HOUSE - PO BOX 265GT, MARY STREET  
C/O WALKERS (IAN GOBIN)  
GEORGE TOWN, CAYMAN ISLANDS

FOR: FINANCIAL SERVICES, NAMELY, FINANCIAL AND INVESTMENT ANALYSIS, FINANCIAL ADVISORY AND INVESTMENT ADVICE; INVESTMENT BANKING SERVICES; FINANCIAL INVESTMENT ADVISORY SERVICES; FINANCING ADVICE AND ANALYSIS; ALL OF THE FORGOING RELATED TO EMERGING MARKETS AND EXCLUDING MORTGAGE BROKERAGE AND LENDING SERVICES, IN CLASS 36 (U.S. CLS. 100, 101 AND 102).

FIRST USE 8-1-2006; IN COMMERCE 8-1-2006.

THE MARK CONSISTS OF STANDARD CHARACTERS WITHOUT CLAIM TO ANY PARTICULAR FONT, STYLE, SIZE, OR COLOR.

NO CLAIM IS MADE TO THE EXCLUSIVE RIGHT TO USE "CAPITAL CORPORATION", APART FROM THE MARK AS SHOWN.

SER. NO. 77-038,015, FILED 11-6-2006.

BRENDAN MCCAULEY, EXAMINING ATTORNEY

**Int. Cl.: 35**

**Prior U.S. Cls.: 100, 101 and 102**

**United States Patent and Trademark Office**

**Reg. No. 3,465,147**

**Registered July 15, 2008**

**SERVICE MARK  
PRINCIPAL REGISTER**

**JOB-HUNT**

NETABILITY, INC. (MASSACHUSETTS CORPORATION)  
186 MAIN STREET  
MARLBOROUGH, MA 01752

FOR: BUSINESS AND CAREER NETWORKING SERVICES, IN CLASS 35 (U.S. CLS. 100, 101 AND 102).

FIRST USE 12-31-1998; IN COMMERCE 12-31-1998.

THE MARK CONSISTS OF STANDARD CHARACTERS WITHOUT CLAIM TO ANY PARTICULAR FONT, STYLE, SIZE, OR COLOR.

SEC. 2(F).

SER. NO. 77-038,271, FILED 11-7-2006.

MIDGE BUTLER, EXAMINING ATTORNEY



Int. Cl.: 37

Prior U.S. Cls.: 100, 103 and 106

United States Patent and Trademark Office

Reg. No. 3,465,148

Registered July 15, 2008

SERVICE MARK  
PRINCIPAL REGISTER



MAVERICK STIMULATION COMPANY, LLC  
(COLORADO LTD LIAB CO)  
88 INVERNESS CIRCLE EAST, UNIT G-101  
ENGLEWOOD, CO 80112

FOR: OIL AND GAS DRILLING SERVICES,  
NAMELY TUBING SERVICES FOR OTHERS; OIL  
WELL COIL-TUBING SERVICES FOR OTHERS IN  
OIL FIELD APPLICATIONS , IN CLASS 37 (U.S. CLS.  
100, 103 AND 106).

FIRST USE 12-31-2000; IN COMMERCE 12-31-2000.

OWNER OF U.S. REG. NO. 2,264,193.

NO CLAIM IS MADE TO THE EXCLUSIVE  
RIGHT TO USE "COIL TUBING SERVICES, LLC",  
APART FROM THE MARK AS SHOWN.

THE MARK CONSISTS OF THE WORDS "MA-  
VERICK COIL TUBING SERVICES, LLC" WITH A  
REPRESENTATION OF AN OIL DERRICK AND AN  
UNDERLINE.

SER. NO. 77-039,726, FILED 11-8-2006.

WILLIAM ROSSMAN, EXAMINING ATTORNEY

**Int. Cl.: 28**

**Prior U.S. Cls.: 22, 23, 38 and 50**

**United States Patent and Trademark Office**

**Reg. No. 3,465,149**

**Registered July 15, 2008**

**TRADEMARK  
PRINCIPAL REGISTER**



DOLFISH PTY LTD (AUSTRALIA COMPANY)  
P.O. BOX 5258  
SOUTH MURWILLUMBAH  
NEW SOUTH WALES, AUSTRALIA 2484

OWNER OF U.S. REG. NOS. 3,014,605 AND  
3,217,378.

NO CLAIM IS MADE TO THE EXCLUSIVE  
RIGHT TO USE "FISH US", APART FROM THE  
MARK AS SHOWN.

FOR: FISHING RELATED SPORTING GOODS,  
NAMELY, FISHING LURE BOXES, HAND-HELD  
FISHING NETS FOR SPORTSMEN; FISHING  
TACKLE, FISHING RODS, FISHING REELS, FISH-  
ING HOOKS, FISHING LINES, FISHING SINKERS;  
SOFT AND HARD BODY LURES FOR FISHING;  
FISHING TACKLE BOXES; CASES FOR FISHING  
RODS AND REELS; FISHING HOLDALLS, NAME-  
LY, SPORTSMEN'S FISHING BAGS; FISHING  
GAFFS, DOWNRIGGERS, IN CLASS 28 (U.S. CLS.  
22, 23, 38 AND 50).

THE COLOR(S) RED, WHITE, BLUE AND BLACK  
IS/ARE CLAIMED AS A FEATURE OF THE MARK.

THE COLOR RED APPEARS IN THE STRIPES;  
THE COLOR WHITE APPEARS IN THE STARS, THE  
STRIPES AND OUTLINE OF THE WORDING  
"FISHUS"; THE COLOR BLUE APPEARS IN THE  
BACKGROUND OF THE WORDING "FISH"; THE  
COLOR BLACK APPEARS IN THE OUTLINE OF  
THE WORDING "FISHUS" AND THE BACK-  
GROUND OF THE MARK.

PRIORITY CLAIMED UNDER SEC. 44(D) ON  
AUSTRALIA APPLICATION NO. 1135784, FILED 9-  
16-2006, REG. NO. 1135784, DATED 9-16-2006, EX-  
PIRES 9-16-2016.

SER. NO. 77-040,083, FILED 11-8-2006.

LEIGH LOWRY, EXAMINING ATTORNEY

**Int. Cl.: 20**

**Prior U.S. Cls.: 2, 13, 22, 25, 32 and 50**

**Reg. No. 3,465,150**

**United States Patent and Trademark Office**

**Registered July 15, 2008**

---

**TRADEMARK  
PRINCIPAL REGISTER**

**CR-III**

BERRY PLASTICS CORPORATION (DELAWARE  
CORPORATION)  
101 OAKLEY STREET, P.O. BOX 959  
EVANSVILLE, IN 477060959

FOR: CHILD RESISTANT CLOSURES AND CAPS  
NOT OF METAL OR PAPER, FOR USE ON CON-  
TAINERS AND BOTTLES, IN CLASS 20 (U.S. CLS. 2,  
13, 22, 25, 32 AND 50).

FIRST USE 8-9-1994; IN COMMERCE 8-9-1994.

THE MARK CONSISTS OF STANDARD CHAR-  
ACTERS WITHOUT CLAIM TO ANY PARTICULAR  
FONT, STYLE, SIZE, OR COLOR.

OWNER OF U.S. REG. NO. 1,133,139.

SER. NO. 77-040,777, FILED 11-9-2006.

TOBY BULLOFF, EXAMINING ATTORNEY

**Int. Cl.: 9**

**Prior U.S. Cls.: 21, 23, 26, 36 and 38**

**United States Patent and Trademark Office**

**Reg. No. 3,465,151**

**Registered July 15, 2008**

**TRADEMARK  
PRINCIPAL REGISTER**

# Candy Shoppe

OCEAN OPTICAL COMPANY, INC. (FLORIDA CORPORATION)  
6001 MONARCH BLVD.  
LEESBURG, FL 34748

FOR: EYEGLOSS FRAMES; EYEGASSES; FRAMES FOR EYEGASSES AND PINCE-NEZ; FRAMES FOR GLASSES AND PINCE-NEZ; FRAMES FOR SPECTACLES AND PINCE-NEZ; FRAMES FOR SPECTACLES AND SUNGLASSES; READING EYEGASSES; SPECTACLE FRAMES; SPECTACLE FRAMES MADE OF METAL AND OF SYNTHETIC MATERIAL; SPECTACLE FRAMES MADE OF METAL OR A COMBINATION OF METAL AND PLASTICS; SPECTACLE FRAMES MADE

OF METAL OR OF A COMBINATION OF METAL AND PLASTIC; SPECTACLES; UNMOUNTED SPECTACLE FRAMES, IN CLASS 9 (U.S. CLS. 21, 23, 26, 36 AND 38).

FIRST USE 6-1-2006; IN COMMERCE 6-5-2006.

THE MARK CONSISTS OF STANDARD CHARACTERS WITHOUT CLAIM TO ANY PARTICULAR FONT, STYLE, SIZE, OR COLOR.

SER. NO. 77-041,075, FILED 11-9-2006.

EMILY CHUO, EXAMINING ATTORNEY

**Int. Cls.: 6 and 18**

**Prior U.S. Cls.: 1, 2, 3, 12, 13, 14, 22, 23, 25, 41 and 50**

**United States Patent and Trademark Office**

**Reg. No. 3,465,152**

**Registered July 15, 2008**

**TRADEMARK  
PRINCIPAL REGISTER**

**CONTENDER**

MUSTAD NETHERLANDS B.V. (NETHERLANDS  
LTD LIAB CO)  
HET HELMHOUT 12  
NL-1012 KK DRACHTEN, NETHERLANDS

FOR: METAL HORSESHOE NAILS, IN CLASS 6  
(U.S. CLS. 2, 12, 13, 14, 23, 25 AND 50).

FOR: METAL HORSESHOES; NON-METAL  
HORSESHOES AND NON-METAL HORSESHOE  
NAILS, IN CLASS 18 (U.S. CLS. 1, 2, 3, 22 AND 41).

THE MARK CONSISTS OF STANDARD CHAR-  
ACTERS WITHOUT CLAIM TO ANY PARTICULAR  
FONT, STYLE, SIZE, OR COLOR.

PRIORITY CLAIMED UNDER SEC. 44(D) ON  
ERPNTY TM OFC APPLICATION NO.  
5105259, FILED 5-10-2006, REG. NO. 005105259, DA-  
TED 2-8-2007, EXPIRES 2-8-2017.

SER. NO. 77-041,292, FILED 11-10-2006.

TRACY CROSS, EXAMINING ATTORNEY

**Int. Cls.: 3, 21, 35 and 45**

**Prior U.S. Cls.: 1, 2, 4, 6, 13, 23, 29, 30, 33, 40, 50, 51,  
52, 100, 101 and 102**

**Reg. No. 3,465,153**

**United States Patent and Trademark Office**

**Registered July 15, 2008**

**TRADEMARK  
SERVICE MARK  
PRINCIPAL REGISTER**



MOUNTAIN INUKSHUK ENTERPRISES, INC.  
(CANADA CORPORATION)  
820 MAIN STREET  
CANMORE, ALBERTA, CANADA T1W2B7

FOR: AROMATHERAPY AND MASSAGE PRODUCTS, NAMELY, ESSENTIAL OILS, MASSAGE OILS, MASSAGE LOTIONS AND CREAMS, MISTING AROMATHERAPY FACIAL AND BODY SPRAYS, AND SKIN SCRUBS; DRYER POUCHES FILLED WITH POTPOURRI AND HERBS TO REDUCE STATIC IN DRYERS AND TO GIVE CLOTHES FRESH SCENTS; LIP BALMS; BODY CARE PRODUCTS, NAMELY, NON-MEDICATED SKIN CARE PREPARATIONS, LOTIONS, CREAMS, BAR AND LIQUID SOAPS; BATH PRODUCTS, NAMELY, BATH GELS, SALTS, AND MILK LOTIONS; SOCKET-LIKE EYE PILLOWS CONTAINING FRAGRANCES; PERFUMERY USING ESSENTIAL OILS FOR THERAPEUTIC RUBS; NON-MEDICATED LIQUIDS, CREAMS AND LOTIONS FOR THERAPEUTIC TREATMENT OF ECZEMA AND ACNE; PRE-PACKAGED SPECIALTY BASKETS CONSISTING OF AROMATHERAPY AND MASSAGE PRODUCTS, NAMELY, ESSENTIAL OILS, MASSAGE OILS, SKIN CREAMS, PERFUMERY, AND BATH SALTS; BATH ACCESSORIES, NAMELY, PUMICE STONES FOR PERSONAL USE, IN CLASS 3 (U.S. CLS. 1, 4, 6, 50, 51 AND 52).

FOR: BATH PRODUCTS, NAMELY, LOOFAH SPONGES; DISHES, IN CLASS 21 (U.S. CLS. 2, 13, 23, 29, 30, 33, 40 AND 50).

FOR: WHOLESALE DISTRIBUTORSHIPS, RETAIL STORE SERVICES, AND ONLINE RETAIL STORE SERVICES, ALL FEATURING AROMATHERAPY AND MASSAGE PRODUCTS, BODY CARE PRODUCTS, BATH PRODUCTS, PERFUMERY, AND NON-MEDICATED SKIN CARE PRODUCTS FOR THE THERAPEUTIC TREATMENT OF SKIN CONDITIONS; FRANCHISING, NAMELY, OFFERING TECHNICAL ASSISTANCE IN THE ESTABLISHMENT AND/OR OPERATION OF RETAIL STORES FEATURING AROMATHERAPY, MASSAGE, PERFUMERY, AND BODY AND BATH CARE PRODUCTS, IN CLASS 35 (U.S. CLS. 100, 101 AND 102).

FOR: PREPARATION OF CUSTOMIZED GIFT BASKETS, IN CLASS 45 (U.S. CLS. 100 AND 101).

PRIORITY CLAIMED UNDER SEC. 44(D) ON CANADA APPLICATION NO. 1313696, FILED 8-21-2006, REG. NO. TMA703,441, DATED 12-18-2007, EXPIRES 12-18-2022.

NO CLAIM IS MADE TO THE EXCLUSIVE RIGHT TO USE "ROCKY MOUNTAIN SOAP COMPANY", APART FROM THE MARK AS SHOWN.

SER. NO. 77-042,675, FILED 11-13-2006.

BARBARA A. GOLD, EXAMINING ATTORNEY

**Int. Cls.: 11 and 40**

**Prior U.S. Cls.: 13, 21, 23, 31, 34, 100, 103 and 106**

**United States Patent and Trademark Office**

**Reg. No. 3,465,154**

**Registered July 15, 2008**

**TRADEMARK  
SERVICE MARK  
PRINCIPAL REGISTER**

**ENVIRONMENTAL WATER SYSTEMS**

EWS, INC. (NEVADA CORPORATION)  
105-J8  
9101 W. SAHARA AVENUE  
LAS VEGAS, NV 89117

FOR: EQUIPMENT FOR FILTERING, TREATING, CONDITIONING AND SOFTENING WATER, NAMELY, POINT OF USE FILTRATION UNITS, DRINKING WATER FILTRATION UNITS, REVERSE OSMOSIS FILTRATION UNITS; POINT OF ENTRY WATER FILTRATION, TREATMENT, CONDITIONING AND SOFTENING EQUIPMENT, NAMELY, WHOLE HOME WATER FILTRATION AND CONDITIONING UNITS, PRE-SEDIMENT WATER SOFTENING UNITS, AND UNITS THAT REMOVE IRON, MANGANESE AND HYDROGEN SULFIDE FROM WATER, AND PH BALANCING UNITS, IN CLASS 11 (U.S. CLS. 13, 21, 23, 31 AND 34).

FIRST USE 1-1-1993; IN COMMERCE 1-1-1994.

FOR: WATER FILTRATION, TREATMENT, CONDITIONING AND SOFTENING SERVICES, IN CLASS 40 (U.S. CLS. 100, 103 AND 106).

FIRST USE 1-1-1993; IN COMMERCE 1-1-1994.

THE MARK CONSISTS OF STANDARD CHARACTERS WITHOUT CLAIM TO ANY PARTICULAR FONT, STYLE, SIZE, OR COLOR.

NO CLAIM IS MADE TO THE EXCLUSIVE RIGHT TO USE "WATER SYSTEMS", APART FROM THE MARK AS SHOWN.

SEC. 2(F).

SER. NO. 77-044,542, FILED 11-15-2006.

ALEX KEAM, EXAMINING ATTORNEY

**Int. Cl.: 9**

**Prior U.S. Cls.: 21, 23, 26, 36 and 38**

**Reg. No. 3,465,155**

**United States Patent and Trademark Office**

**Registered July 15, 2008**

**TRADEMARK  
PRINCIPAL REGISTER**

# SOLARSTORM

SOLARFLARE COMMUNICATIONS, INC. (DELAWARE CORPORATION)  
9501 JERONIMO ROAD, SUITE 100  
IRVINE, CA 92618

FOR: SCIENTIFIC, OPTICAL, AND SIGNALING APPARATUS AND INSTRUMENTS, NAMELY, NETWORK HARDWARE AND FIRMWARE FOR USE IN RELATION TO NETWORK CONNECTIVITY, NETWORK ADAPTERS AND INTERNET ADAPTERS; DATA PROCESSORS AND COMPUTERS; COMPUTER HARDWARE AND FIRMWARE, FOR USE IN RELATION TO NETWORK CONNECTIVITY; COMPUTER SOFTWARE FOR DRIVERS FOR NETWORK INTERFACE CARDS AND DEVICES, NAMELY, SOFTWARE ENCODED ON A CD-ROM AND ON A HARDWARE MEMORY SUCH AS A FLASH CHIP, AND SOFTWARE DOWNLOADABLE FROM THE INTERNET, FOR USE IN RELATION TO NETWORK CONNECTIVITY; TELECOMMUNICATIONS APPARATUS, NAMELY, TELECOMMUNICATION SWITCHES, ROUTERS, MODEMS, GATEWAYS, HUBS AND TELEPHONES; APPARATUS FOR RECORDING, TRANSMISSION OR REPRODUCTION OF SOUND OR IMAGES,

NAMELY, VIDEO TAPE RECORDERS, AUDIO TAPE RECORDERS; BLANK MAGNETIC DATA CARRIERS; TELECOMMUNICATIONS INSTRUMENTS, NAMELY, TELECOMMUNICATION SWITCHES, ROUTERS, MODEMS, GATEWAYS, HUBS AND TELEPHONES; NETWORK INTERFACE DEVICES; NETWORK INTERFACE CARDS; REPLACEMENT PARTS AND FITTINGS FOR ALL THE AFORESAID GOODS, IN CLASS 9 (U.S. CLS. 21, 23, 26, 36 AND 38).

THE MARK CONSISTS OF STANDARD CHARACTERS WITHOUT CLAIM TO ANY PARTICULAR FONT, STYLE, SIZE, OR COLOR.

PRIORITY CLAIMED UNDER SEC. 44(D) ON UNITED KINGDOM APPLICATION NO. 2430292, FILED 8-18-2006, REG. NO. 2430292, DATED 8-18-2006, EXPIRES 8-18-2016.

SER. NO. 77-045,796, FILED 11-16-2006.

EMILY CHUO, EXAMINING ATTORNEY



**Int. Cls.: 9 and 42**

**Prior U.S. Cls.: 21, 23, 26, 36, 38, 100 and 101**

**Reg. No. 3,465,156**

**United States Patent and Trademark Office**

**Registered July 15, 2008**

**TRADEMARK  
SERVICE MARK  
PRINCIPAL REGISTER**

# ABALTAT MUSE

MEITICHEOL TEORANTA (IRELAND CORPORATION)  
53 GLEANN NA COILLE, BEARNA ROAD  
GALWAY, IRELAND

FOR: MUSIC NOTATION AND SEQUENCING SOFTWARE; SOUND PROCESSING AND MUSICAL ORCHESTRATION SOFTWARE; COMPUTER SOFTWARE FOR CREATING, EDITING, CONTROLLING, VIEWING, PRINTING, REPRODUCING, PRODUCING, RECORDING AND PLAYING MUSIC; COMPUTER VOICE ANNOTATION PROGRAMS; COMPUTER SOFTWARE FOR VIDEO COMPOSITING, SOUND EDITING, AND SOUND MIXING; INTERACTIVE SOFTWARE FOR MUSICAL COMPOSITION; COMPUTER SOFTWARE FOR TRANSPOSING MUSICAL SCORES, TRANSCRIBING MUSICAL NOTATION INTO MUSICAL COMPOSITIONS OR FOR TRANSCRIBING MUSICAL COMPOSITIONS INTO MUSICAL NOTATIONS; PREPACKAGED COMPUTER SOFTWARE AND DOWNLOADABLE COMPUTER SOFTWARE, FILES AND DATA, ALL IN THE FIELD OF MUSIC, MUSIC NOTATION, MUSIC PUBLISHING, MUSIC DISTRIBUTION, MUSIC EDUCATION, MUSIC PRACTICE, MUSIC PERFORMANCE, MUSIC ACCOMPANIMENT, MUSIC RECORDING, MUSIC PERFORMANCE ASSESSMENT AND MUSIC THEORY ASSESSMENT; AUDIOVISUAL PRODUCTS, NAMELY, PRERECORDED AUDIO OR VIDEO TAPES FEATURING MUSIC OR SPEECH; PRERECORDED DVDS, CDS, CASSETTES AND DIGITAL VIDEO DISKS FEATURING DIGITAL FILES CONTAINING PHOTOGRAPHS, VIDEOS, GRAPHICS, AUDIO, ANIMATIONS, SLIDESHOWS, SONG LYRICS, MUSIC NOTATION AND MUSIC DATA; VIDEO DRIVE SOUNDTRACK COMPOSITION SYSTEMS COMPRISED OF SOFTWARE FOR COMPOSING MUSIC TO INTEGRATE WITH EXISTING VIDEO RECORDINGS; SCIENTIFIC, NAUTICAL, SURVEYING, PHOTOGRAPHIC, CINEMATO-

GRAPHIC, OPTICAL, WEIGHING, MEASURING, SIGNALING, CHECKING, SUPERVISION, LIFE-SAVING AND TEACHING APPARATUS AND INSTRUMENTS, NAMELY, SAMPLERS FOR COMPUTERS IN THE NATURE OF SOFTWARE THAT PLAYS AND GENERATES INSTRUMENTAL SOUNDS IN REAL TIME, MUSIC SYNTHESIZERS, COMPUTER SOFTWARE MUSIC INTERFACES FOR COMPUTERS, DIGITAL VIDEO AND AUDIO PLAYERS AND RECORDERS, PRERECORDED SOUND SAMPLES ON CD, DVD, COMPUTER MEMORIES OR OTHER OPTICAL OR MAGNETIC MEDIA IN THE FIELD OF MUSIC, DOWNLOADABLE ELECTRONIC DATA FILES FEATURING MUSIC ACCOMPANIMENTS; DOWNLOADABLE ELECTRONIC PUBLICATIONS IN THE NATURE OF MAGAZINES, NEWSLETTERS, JOURNALS, AND BOOKS IN THE FIELD OF MUSIC; APPARATUS FOR RECORDING, TRANSMISSION OR REPRODUCTION OF SOUND OR IMAGES; MAGNETIC DATA CARRIERS; RECORDING DISCS; CASH REGISTERS, CALCULATING MACHINES, DATA PROCESSING EQUIPMENT AND COMPUTERS, IN CLASS 9 (U.S. CLS. 21, 23, 26, 36 AND 38).

FOR: ADVISORY SERVICES RELATING TO COMPUTER SOFTWARE; DESIGN, INSTALLATION AND MAINTENANCE OF COMPUTER SOFTWARE; COMPUTER SOFTWARE CONSULTANCY AND DEVELOPMENT; CUSTOM DESIGN OF SOFTWARE PACKAGES; SOFTWARE DESIGN AND CREATION; COMPUTER SYSTEMS ANALYSIS; DEVELOPMENT AND CREATION OF AUDIOVISUAL POST PRODUCTION SOLUTIONS FOR THE TELEVISION AND FILM INDUSTRIES; DEVELOPMENT AND CREATION OF AUDIOVISUAL POST-PRODUCTION SOLUTIONS FOR THE TELEVISION AND FILM INDUSTRIES, NAMELY, DEVELOPMENT, INSTALLATION AND MAINTENANCE OF SOFTWARE TO FACILITATE THE CREATING,

EDITING, CONTROLLING, MANIPULATION, VIEWING, PRINTING, REPRODUCING, PRODUCING, RECORDING AND PLAYING OF MUSIC OR VIDEO FOR THE TELEVISION AND FILM INDUSTRIES, IN CLASS 42 (U.S. CLS. 100 AND 101).

THE MARK CONSISTS OF STANDARD CHARACTERS WITHOUT CLAIM TO ANY PARTICULAR FONT, STYLE, SIZE, OR COLOR.

PRIORITY CLAIMED UNDER SEC. 44(D) ON IRELAND APPLICATION NO. 234355, FILED 5-24-2006, REG. NO. 234355, DATED 5-24-2006, EXPIRES 5-24-2016.

SER. NO. 77-046,638, FILED 11-17-2006.

MARGERY A. TIERNEY, EXAMINING ATTORNEY

Int. Cl.: 38

Prior U.S. Cls.: 100, 101 and 104

United States Patent and Trademark Office

Reg. No. 3,465,157

Registered July 15, 2008

SERVICE MARK  
PRINCIPAL REGISTER

Keith and The Girl



KEITH AND THE GIRL (NEW YORK LTD LIAB  
CO)  
PO BOX 660097  
FLUSHING, NY 11366

FOR: PODCASTING SERVICES, IN CLASS 38 (U.S.  
CLS. 100, 101 AND 104).

FIRST USE 1-2-2005; IN COMMERCE 1-2-2005.

THE NAME "KEITH" SHOWN IN THE MARK  
IDENTIFIES KEITH MALLEY, WHOSE CONSENT  
IS OF RECORD.

THE COLOR(S) WHITE, GREEN, BLACK, PUR-  
PLE, FLESH TONE, BROWN/GOLD, BLUE, AND  
GRAY IS/ARE CLAIMED AS A FEATURE OF THE  
MARK.

THE MARK CONSISTS OF GREEN LETTERING,  
GREEN ISLAND ATOP WHICH FIGURES ARE  
STANDING, BLACK FIGURE OUTLINES, WHITE  
FACES OF FIGURES, PURPLE DRESS ON FEMALE  
FIGURE, FLESH TONES ON MALE FIGURE BODY,  
FEET AND HANDS AND FLESH TONES ON FE-  
MALE FIGURE HANDS, NECK AND FEET,  
BROWN/GOLD IN CUP HELD BY MALE FIGURE,  
BLUE ON MICROPHONE HELD BY FEMALE FIG-  
URE, GRAY IN MICROPHONE AND HAIR OF  
FEMALE FIGURE. GREEN LETTERING STATES  
"KEITH AND THE GIRL".

SER. NO. 77-046,838, FILED 11-17-2006.

REBECCA EISINGER, EXAMINING ATTORNEY

**Int. Cls.: 35, 41 and 42**

**Prior U.S. Cls.: 100, 101, 102 and 107**

**United States Patent and Trademark Office**

**Reg. No. 3,465,158**

**Registered July 15, 2008**

**SERVICE MARK  
PRINCIPAL REGISTER**



**American Board  
of Internal Medicine**

AMERICAN BOARD OF INTERNAL MEDICINE  
(IOWA CORPORATION)  
SUITE 1700  
510 WALNUT STREET  
PHILADELPHIA, PA 19106

FOR: MAINTAINING A REGISTRY OF CERTIFIED PRACTITIONERS OF INTERNAL MEDICINE AND ITS SUBSPECIALTIES FOR OTHERS, IN CLASS 35 (U.S. CLS. 100, 101 AND 102).

FIRST USE 11-0-2006; IN COMMERCE 11-0-2006.

FOR: DEVELOPING AND ADMINISTERING STANDARDIZED TESTS TO DETERMINE QUALIFICATION IN THE FIELD OF INTERNAL MEDICINE AND ITS SUBSPECIALTIES; ISSUANCE TO PHYSICIANS OF CERTIFICATES OR OTHER RECOGNITION OF SPECIAL KNOWLEDGE OF INTERNAL MEDICINE AND ITS SUBSPECIALTIES; CONSULTING SERVICES IN THE FIELD OF INTERNAL MEDICINE EDUCATION, NAMELY, PROVIDING CONSULTATIONS TO HOSPITALS AND OTHER INSTITUTIONS THAT OFFER MEDICAL RESIDENCY TRAINING PROGRAMS REGARDING THE DESIGN OF THE RESIDENCY TRAINING PROGRAMS AS IT PERTAINS TO INTERNAL MEDICINE AND ITS SUBSPECIALTIES, IN CLASS 41 (U.S. CLS. 100, 101 AND 107).

FIRST USE 11-0-2006; IN COMMERCE 11-0-2006.

FOR: DEVELOPMENT AND MAINTENANCE OF PRACTICE STANDARDS FOR INTERNAL MEDICINE AND ITS SUBSPECIALTIES, IN CLASS 42 (U.S. CLS. 100 AND 101).

FIRST USE 11-0-2006; IN COMMERCE 11-0-2006.

OWNER OF U.S. REG. NOS. 2,078,669, 2,086,985, AND 2,356,843.

NO CLAIM IS MADE TO THE EXCLUSIVE RIGHT TO USE "BOARD OF INTERNAL MEDICINE", APART FROM THE MARK AS SHOWN.

THE MARK CONSISTS OF THE LETTERS ABIM ENCLOSED IN A SHADED CIRCLE; TO THE RIGHT OF THE CIRCLE THE WORDS AMERICAN BOARD APPEAR ON ONE LINE AND THE WORDS OF INTERNAL MEDICINE APPEAR ON THE NEXT LINE .

SEC. 2(F) THE PHRASE "AMERICAN BOARD OF INTERNAL MEDICINE" HAS BECOME DISTINCTIVE OF THE GOODS AND/OR SERVICES AS EVIDENCED BY OWNERSHIP OF U.S. REGISTRATION 2086985 ON THE PRINCIPAL REGISTER FOR THE SAME MARK FOR RELATED GOODS OR SERVICES..

SER. NO. 77-047,492, FILED 11-20-2006.

ALYSSA PALADINO, EXAMINING ATTORNEY

**Int. Cl.: 9**

**Prior U.S. Cls.: 21, 23, 26, 36 and 38**

**Reg. No. 3,465,159**

**United States Patent and Trademark Office**

**Registered July 15, 2008**

**TRADEMARK  
PRINCIPAL REGISTER**

# DIZZLER

IDV8, INC. (ARIZONA CORPORATION)  
SUITE 103  
15550 N. 84TH STREET  
SCOTTSDALE, AZ 85260

FOR: COMMUNICATIONS COMPUTERS; DOWNLOADABLE COMMUNICATIONS SOFTWARE FOR CONNECTING USERS TO GLOBAL COMPUTER NETWORK; DOWNLOADABLE COMPUTER APPLICATION SOFTWARE FOR MOBILE PHONES; DOWNLOADABLE COMPUTER E-COMMERCE SOFTWARE TO ALLOW USERS TO PERFORM ELECTRONIC BUSINESS TRANSACTIONS VIA A GLOBAL COMPUTER NETWORK; DOWNLOADABLE COMPUTER GAME SOFTWARE; DOWNLOADABLE COMPUTER PROGRAMS FOR PRE-RECORDED GAMES; DOWNLOADABLE COMPUTER PROGRAMS FOR SEARCHING THE CONTENTS OF COMPUTERS AND COMPUTER NETWORKS BY REMOTE CONTROL; DOWNLOADABLE COMPUTER PROGRAMS FOR COMMUNICATIONS, MUSIC, VIDEO AND GAMES, NAMELY, DOWNLOADABLE COMPUTER SOFTWARE FOR PROCESSING DIGITAL MUSIC FILES, GRAPHICS SOFTWARE, GAME SOFTWARE, AND COMPUTER SOFTWARE FOR COMMUNICATING WITH USERS OF HAND-HELD COMPUTERS AND FOR CONNECTING COMPUTER NETWORK USERS TO A GLOBAL COMPUTER NETWORK; DOWNLOADABLE COMPUTER SEARCH ENGINE SOFTWARE; DOWNLOADABLE COMPUTER SHAREWARE FOR COMMUNICATIONS, MUSIC, VIDEO, AND GAMES, NAMELY, DOWNLOADABLE COMPUTER SOFTWARE FOR PROCESSING DIGITAL MUSIC FILES, GRAPHICS SOFTWARE, GAME SOFTWARE, AND COMPUTER SOFTWARE FOR COMMUNICATING WITH USERS OF HAND-

HELD COMPUTERS AND FOR CONNECTING COMPUTER NETWORK USES TO A GLOBAL COMPUTER NETWORK; DOWNLOADABLE COMPUTER SOFTWARE FOR ACCESSING INFORMATION DIRECTORIES THAT MAY BE DOWNLOADED FROM THE GLOBAL COMPUTER NETWORK; DOWNLOADABLE COMPUTER SOFTWARE FOR COMMUNICATING WITH USERS OF HAND-HELD COMPUTERS; DOWNLOADABLE COMPUTER SOFTWARE FOR CREATING SEARCHABLE DATABASES OF INFORMATION AND DATA; DOWNLOADABLE COMPUTER SOFTWARE FOR MANIPULATING DIGITAL AUDIO INFORMATION FOR USE IN AUDIO MEDIA APPLICATIONS; DOWNLOADABLE COMPUTER SOFTWARE FOR ORGANIZING AND VIEWING DIGITAL IMAGES AND PHOTOGRAPHS; DOWNLOADABLE COMPUTER SOFTWARE FOR PROCESSING DIGITAL MUSIC FILES; DOWNLOADABLE COMPUTER SOFTWARE FOR COMMUNICATIONS, MUSIC, VIDEO AND GAMES; DOWNLOADABLE COMPUTER SOFTWARE TO ENHANCE THE AUDIO-VISUAL CAPABILITIES OF MULTIMEDIA APPLICATIONS, NAMELY, FOR THE INTEGRATION OF TEXT, AUDIO, GRAPHICS, STILL IMAGES AND MOVING, IN CLASS 9 (U.S. CLS. 21, 23, 26, 36 AND 38).

FIRST USE 10-1-2006; IN COMMERCE 10-1-2006.

THE MARK CONSISTS OF STANDARD CHARACTERS WITHOUT CLAIM TO ANY PARTICULAR FONT, STYLE, SIZE, OR COLOR.

SER. NO. 77-048,904, FILED 11-21-2006.

JACLYN KIDWELL, EXAMINING ATTORNEY

**Int. Cls.: 9 and 41**

**Prior U.S. Cls.: 21, 23, 26, 36, 38, 100, 101 and 107**

**United States Patent and Trademark Office**

**Reg. No. 3,465,160**

**Registered July 15, 2008**

**TRADEMARK  
SERVICE MARK  
PRINCIPAL REGISTER**

# Chain reaction

ATRONIC INTERNATIONAL GMBH (FED REP  
GERMANY GMBH)  
BORSIGSTR. 26  
LÜBBECKE, FED REP GERMANY 32312

FOR: ELECTRIC AND ELECTRONIC, COIN AND  
TOKEN-OPERATED GAMING MACHINES, NAME-  
LY, SLOT MACHINES WITH OR WITHOUT VIDEO  
OUTPUT AND VIDEO LOTTERY TERMINALS;  
MULTI-USER AND NETWORKED GAMING MA-  
CHINES WITH OR WITHOUT VIDEO OUTPUT OR  
VIDEO LOTTERY TERMINALS; ACCOUNTING AP-  
PARATUS FOR COIN AND TOKEN OPERATED  
MACHINES FOR GAMING AND AMUSEMENT  
PURPOSES, AND PARTS FOR THE AFORESAID  
GOODS; COMPUTER PROGRAMS FOR OPERAT-  
ING ELECTRIC AND ELECTRONIC MACHINES  
FOR GAMING OR AMUSEMENT PURPOSES, OR  
COMBINATION THEREOF; COMPUTER PRO-  
GRAMS FOR CASINO APPLICATIONS, NAMELY,  
FOR CONTROLLING GAMING MACHINES FOR  
WINNING CASINO JACKPOT GAMES , IN CLASS 9  
(U.S. CLS. 21, 23, 26, 36 AND 38).

FOR: ENTERTAINMENT IN THE NATURE OF  
CASINO SERVICES FEATURING A PROGRESSIVE  
GAMING MACHINE JACKPOT INVOLVING ONE  
OR MORE GAMING MACHINES, NAMELY A  
JACKPOT OR PRIZE WITH A FIXED MINIMUM  
VALUE WHICH INCREASES UNTIL THE JACKPOT  
IS WON, IN CLASS 41 (U.S. CLS. 100, 101 AND 107).

THE MARK CONSISTS OF STANDARD CHAR-  
ACTERS WITHOUT CLAIM TO ANY PARTICULAR  
FONT, STYLE, SIZE, OR COLOR.

PRIORITY CLAIMED UNDER SEC. 44(D) ON  
ERPNTY TM OFC APPLICATION NO.  
005455431, FILED 11-10-2006, REG. NO. 005455431,  
DATED 11-15-2007, EXPIRES 11-10-2016.

SER. NO. 77-049,517, FILED 11-22-2006.

LYDIA BELZER, EXAMINING ATTORNEY

**Int. Cls.: 9, 35, 38 and 41**

**Prior U.S. Cls.: 21, 23, 26, 36, 38, 100, 101, 102, 104  
and 107**

**Reg. No. 3,465,161**

**United States Patent and Trademark Office**

**Registered July 15, 2008**

**TRADEMARK  
SERVICE MARK  
PRINCIPAL REGISTER**



SCIENCE DAILY, LLC (MARYLAND LTD LIAB  
CO)  
14904 TALKING ROCK COURT  
NORTH POTOMAC, MD 20878

FOR: DOWNLOADABLE VIDEO RECORDINGS AND AUDIO RECORDINGS IN THE FIELDS OF HEALTH, SCIENCE, HISTORY, BUSINESS, FINANCE, NEWS, WEATHER, SPORTS, CURRENT EVENTS, SCIENCE FAIR INFORMATION, ART, HEALTH CARE, MEDICAL CONDITIONS, MEDICAL DISEASES, MEDICAL TREATMENTS, NUTRITION, PHARMACEUTICALS, PERSONAL CARE, PSYCHOLOGY, SOCIOLOGY, POLITICAL SCIENCE, MEDICINE, BIOLOGY, AGRICULTURE, ECOLOGY, BIOTECHNOLOGY, EVOLUTION, MICROBIOLOGY, BOTANY, ZOOLOGY, EARTH SCIENCE, GLOBAL WARMING, ENVIRONMENTAL ISSUES, ENVIRONMENTAL SCIENCE, NATURAL DISASTERS, CLIMATE, ASTRONOMY, COSMOLOGY, SPACE EXPLORATION, CHEMISTRY, ENERGY TECHNOLOGY, AVIATION, NANOTECHNOLOGY, ELECTRICITY, ENGINEERING, VIRTUAL REALITY, ROBOTICS, PHYSICS, QUANTUM PHYSICS, COMPUTERS, PHOTOGRAPHY, SOFTWARE, COMPUTER SCIENCE, COMPUTER MODELING, ARTIFICIAL INTELLIGENCE, MATHEMATICS, PALEOBIOLOGY, PALEONTOLOGY, RUINS, ANTHROPOLOGY, ARCHEOLOGY, PATENT INFORMATION, ENTERTAINMENT AND SHOPPING, IN CLASS 9 (U.S. CLS. 21, 23, 26, 36 AND 38).

FIRST USE 1-0-2005; IN COMMERCE 1-0-2005.

FOR: ONLINE RETAIL STORE SERVICES AND ONLINE MAIL ORDER SERVICES FEATURING BOOKS, MUSIC, VIDEOTAPES, AUDIOCASSETTES, COMPACT DISCS, DIGITAL VIDEO DISCS, VIDEO

GAMES, SOFTWARE, DOWNLOADABLE PRE-RECORDED MUSIC AND VIDEO, FLOPPY DISCS AND CD-ROMS, PRINTED MATTERS, PHONOGRAPHS, RECORDED MUSIC, TOYS, APPAREL, OFFICE PRODUCTS AND ACCESSORIES, PET SUPPLIES, SPORTING GOODS, MOTOR VEHICLES AND ACCESSORIES, SCOOTERS AND BICYCLES, COMPUTERS AND COMPUTER ACCESSORIES, COMPUTERIZED DEVICES, GOURMET FOOD, HOUSEHOLD ELECTRONIC APPLIANCES, APPLIED ELECTRONIC MACHINES AND APPARATUS, DEVICES, LABORATORY EQUIPMENT AND SUPPLIES, SCIENCE FAIR MATERIALS AND SCIENCE KITS, PHOTOGRAPHY INSTRUMENTS, MUSICAL INSTRUMENTS AND FITTINGS THEREOF, PHOTOGRAPHS, STATIONERY, JEWELRY AND WATCHES, HOROLOGICAL INSTRUMENTS AND PARTS THEREOF, TELESCOPES, MEASURING INSTRUMENTS, PHYSICAL AND CHEMICAL INSTRUMENTS, CHEMICALS, SOAPS, PERFUMERY, COSMETICS, PAINTS, PRESERVATIVES, LEATHER, IMITATION LEATHER, BAGS AND THEIR SUBSTITUTES, UMBRELLAS, FURNITURE, FABRIC, INDOOR ORNAMENTS OF TEXTILE, PLANTS, PHARMACEUTICALS, LIGHTS, IRONS AND STEELS, POTS, TABLEWARE, HEATERS, COSMETIC UTENSILS, YARNS AND THREAD FOR TEXTILE USE, KITCHEN AND HOUSEHOLD UTENSILS, GAMES AND PLAYTHINGS, ELECTRONIC PUBLICATIONS AND GREETING CARDS; PROVIDING ON-LINE INFORMATION IN THE FIELDS OF EMPLOYMENT, RECRUITMENT, CAREERS, PERSONAL ISSUES RELATED TO CAREERS AND WORK LIFE, JOB RESOURCES, JOB LISTINGS, AND RESUMES; PROVIDING ON-LINE EMPLOYMENT PLACEMENT SERVICES, NAMELY, RESUME MATCHING SERVICES VIA A GLOBAL COMPUTER NETWORK; PROVIDING

ONLINE ADVERTISING OF THE GOODS AND SERVICES OF OTHERS BY PLACING ADVERTISEMENTS AND PROMOTIONAL DISPLAYS IN AN ELECTRONIC ONLINE WEB SITE ACCESSED THROUGH A GLOBAL COMPUTER NETWORK; PROMOTING GOODS AND SERVICES OF OTHERS BY PLACING ADVERTISEMENTS AND PROMOTIONAL DISPLAYS IN AN ELECTRONIC ONLINE WEB SITE ACCESSED THROUGH A GLOBAL COMPUTER NETWORK, IN CLASS 35 (U.S. CLS. 100, 101 AND 102).

FIRST USE 0-0-1998; IN COMMERCE 0-0-1998.

FOR: TELECOMMUNICATIONS SERVICES, NAMELY, ELECTRONIC ORGANIZATION AND TRANSMISSION OF TEXT, AUDIO, VIDEO, IMAGES, COMPUTER SOFTWARE AND MULTIMEDIA DATA VIA COMPUTER AND OTHER COMMUNICATIONS NETWORKS; CHAT ROOM SERVICES; BROADCASTING SERVICES AND PROVISION OF TELECOMMUNICATIONS ACCESS TO VIDEO AND AUDIO CONTENT PROVIDED VIA VIDEO-ON-DEMAND SERVICE VIA THE INTERNET; STREAMING OF VIDEO MATERIAL OVER THE INTERNET; AND WEBCASTING SERVICES IN THE FIELDS OF HEALTH, SCIENCE, HISTORY, BUSINESS, FINANCE, NEWS, CURRENT EVENTS, WEATHER, SPORTS, CURRENT EVENTS, SCIENCE FAIR INFORMATION, ART, HEALTH CARE, MEDICAL CONDITIONS, MEDICAL DISEASES, MEDICAL TREATMENTS, NUTRITION, PHARMACEUTICALS, PERSONAL CARE, PSYCHOLOGY, SOCIOLOGY, POLITICAL SCIENCE, MEDICINE, BIOLOGY, AGRICULTURE, ECOLOGY, BIOTECHNOLOGY, EVOLUTION, MICROBIOLOGY, BOTANY, ZOOLOGY, EARTH SCIENCE, GLOBAL WARMING, ENVIRONMENTAL ISSUES, ENVIRONMENTAL SCIENCE, NATURAL DISASTERS, CLIMATE, ASTRONOMY, COSMOLOGY, SPACE EXPLORATION, CHEMISTRY, ENERGY TECHNOLOGY, AVIATION, NANOTECHNOLOGY, ELECTRICITY, ENGINEERING, VIRTUAL REALITY, ROBOTICS, PHYSICS, QUANTUM PHYSICS, COMPUTERS, PHOTOGRAPHY, SOFTWARE, COMPUTER SCIENCE, COMPUTER MODELING, ARTIFICIAL INTELLIGENCE, MATHEMATICS, PALEOBIOLOGY, PALEONTOLOGY, RUINS, ANTHROPOLOGY, ARCHEOLOGY, PATENT INFORMATION, ENTERTAINMENT AND SHOPPING AND TO CONTENT PROVIDERS WHO PROVIDE REFERENCE MATERIALS AND INFORMATION IN A WIDE VARIETY OF FIELDS; PROVIDING ELECTRONIC DATA TRANSMISSION CONTAINING ARTICLES, TEXT, AUDIO, VIDEO, GAMES, AND FILES WITH WEB LINKS IN THE FIELDS OF HEALTH, SCIENCE, HISTORY, BUSINESS, FINANCE, NEWS, CURRENT EVENTS, WEATHER, SPORTS, CURRENT EVENTS, SCIENCE FAIR INFORMATION, ART, HEALTH CARE, MEDICAL CONDITIONS, MEDICAL DISEASES, MEDICAL TREATMENTS, NUTRITION, PHARMACEUTICALS, PERSONAL CARE, PSYCHOLOGY, SOCIOLOGY, POLITICAL SCIENCE, MEDICINE, BIOLOGY, AGRICULTURE, ECOLOGY, BIOTECHNOLOGY, EVOLUTION, MICROBIOLOGY, BOTANY, ZOOLOGY, EARTH

SCIENCE, GLOBAL WARMING, ENVIRONMENTAL ISSUES, ENVIRONMENTAL SCIENCE, NATURAL DISASTERS, CLIMATE, ASTRONOMY, COSMOLOGY, SPACE EXPLORATION, CHEMISTRY, ENERGY TECHNOLOGY, AVIATION, NANOTECHNOLOGY, ELECTRICITY, ENGINEERING, VIRTUAL REALITY, ROBOTICS, PHYSICS, QUANTUM PHYSICS, COMPUTERS, PHOTOGRAPHY, SOFTWARE, COMPUTER SCIENCE, COMPUTER MODELING, ARTIFICIAL INTELLIGENCE, MATHEMATICS, PALEOBIOLOGY, PALEONTOLOGY, RUINS, ANTHROPOLOGY, ARCHEOLOGY, PATENT INFORMATION, ENTERTAINMENT AND SHOPPING; MAKING WEB FEEDS AVAILABLE TO PROVIDE A SUMMARY OF RECENTLY ADDED CONTENT IN THE FIELDS OF HEALTH, SCIENCE, BUSINESS, FINANCE, HISTORY, NEWS, WEATHER, SPORTS, CURRENT EVENTS, ART, ENTERTAINMENT AND SHOPPING, HEALTH CARE, MEDICAL CONDITIONS, MEDICAL DISEASES, MEDICAL TREATMENTS, NUTRITION, PHARMACEUTICALS, PERSONAL CARE, MEDICINE, PSYCHOLOGY, SOCIOLOGY, POLITICAL SCIENCE, MEDICINE, BIOLOGY, AGRICULTURE, ECOLOGY, BIOTECHNOLOGY, EVOLUTION, MICROBIOLOGY, BOTANY, ZOOLOGY, EARTH SCIENCE, GLOBAL WARMING, ENVIRONMENTAL ISSUES, ENVIRONMENTAL SCIENCE, NATURAL DISASTERS, CLIMATE, ASTRONOMY, COSMOLOGY, SPACE EXPLORATION, CHEMISTRY, ENERGY TECHNOLOGY, NANOTECHNOLOGY, ELECTRICITY, AVIATION, ENGINEERING, VIRTUAL REALITY, ROBOTICS, PHYSICS, QUANTUM PHYSICS, COMPUTERS, PHOTOGRAPHY, SOFTWARE, COMPUTER SCIENCE, COMPUTER MODELING, ARTIFICIAL INTELLIGENCE, MATHEMATICS, PALEOBIOLOGY, PALEONTOLOGY, RUINS, ANTHROPOLOGY, ARCHEOLOGY, PATENT INFORMATION, SCIENCE FAIR INFORMATION, ENTERTAINMENT AND SHOPPING, IN CLASS 38 (U.S. CLS. 100, 101 AND 104).

FIRST USE 0-0-1995; IN COMMERCE 0-0-1995.

FOR: PROVIDING NEWSLETTERS VIA EMAIL AND ONLINE PUBLICATIONS IN THE FIELDS OF HEALTH, SCIENCE, HISTORY, BUSINESS, FINANCE, NEWS, WEATHER, SPORTS, CURRENT EVENTS, SCIENCE FAIR INFORMATION, ART, HEALTH CARE, MEDICAL CONDITIONS, MEDICAL DISEASES, MEDICAL TREATMENTS, NUTRITION, PHARMACEUTICALS, PERSONAL CARE, PSYCHOLOGY, SOCIOLOGY, POLITICAL SCIENCE, MEDICINE, BIOLOGY, AGRICULTURE, ECOLOGY, BIOTECHNOLOGY, EVOLUTION, MICROBIOLOGY, BOTANY, ZOOLOGY, EARTH SCIENCE, GLOBAL WARMING, ENVIRONMENTAL ISSUES, ENVIRONMENTAL SCIENCE, NATURAL DISASTERS, CLIMATE, ASTRONOMY, COSMOLOGY, SPACE EXPLORATION, CHEMISTRY, ENERGY TECHNOLOGY, AVIATION, NANOTECHNOLOGY, ELECTRICITY, ENGINEERING, VIRTUAL REALITY, ROBOTICS, PHYSICS, QUANTUM PHYSICS, COMPUTERS, PHOTOGRAPHY, SOFTWARE, COMPUTER SCIENCE, COMPUTER MODELING, ARTIFICIAL INTELLIGENCE, MATHEMATICS, PALEOBIOLOGY, PALEONTOLOGY,



GY, RUINS, ANTHROPOLOGY, ARCHEOLOGY, PATENT INFORMATION, ENTERTAINMENT AND SHOPPING; PUBLICATION OF ELECTRONIC MAGAZINES AND NEWSPAPERS; ARRANGING OF CONTESTS; ENTERTAINMENT SERVICES, NAMELY, PROVIDING ONLINE COMPUTER GAMES, IN CLASS 41 (U.S. CLS. 100, 101 AND 107).

FIRST USE 0-0-1995; IN COMMERCE 0-0-1995.

THE COLOR(S) BLACK, WHITE, GRAY, BLUE AND RED IS/ARE CLAIMED AS A FEATURE OF THE MARK.

THE MARK CONSISTS OF BLACK BACKGROUND WITH THE WORD "SCIENCE" IN BLUE; THE WORD "DAILY" IN RED; A GRAY UNDERLINE; AND THE WORDS "YOUR SOURCE FOR THE LATEST RESEARCH NEWS" IN WHITE.

SEC. 2(F).

SER. NO. 77-050,711, FILED 11-26-2006.

JACQUELINE A. LAVINE, EXAMINING ATTORNEY

**Int. Cls.: 6, 7, 12, 40 and 42**

**Prior U.S. Cls.: 2, 12, 13, 14, 19, 21, 23, 25, 31, 34, 35,  
44, 50, 100, 101, 103 and 106**

**Reg. No. 3,465,162**

**United States Patent and Trademark Office**

**Registered July 15, 2008**

**TRADEMARK  
SERVICE MARK  
PRINCIPAL REGISTER**



FRITZ WINTER EISENGIESSEREI GMBH & CO.  
KG (FED REP GERMANY KOMMANDITGE-  
SELLSCHAFT (KG))  
ALBERT-SCHWEITZER-STRASSE 15  
D-35260 STADTALLENDORF, FED REP GERMANY

FOR: COMMON METALS AND THEIR ALLOYS,  
IN PARTICULAR FOR USE IN THE MANUFAC-  
TURE OF ENGINE BLOCKS, CYLINDER HEADS,  
CAMSHAFTS, CRANKSHAFTS, AND BRAKE  
DISCS; UNWROUGHT AND SEMI-WROUGHT  
CAST IRON; METAL CASTINGS, IN CLASS 6 (U.S.  
CLS. 2, 12, 13, 14, 23, 25 AND 50).

FOR: COMPONENT PARTS OF MOTORS AND  
ENGINES, NAMELY, CRANKSHAFTS, CAM  
SHAFTS, AND CYLINDER HEADS; DISC BRAKES  
FOR MACHINES, IN CLASS 7 (U.S. CLS. 13, 19, 21, 23,  
31, 34 AND 35).

FOR: DISC BRAKES FOR LAND VEHICLES, IN  
CLASS 12 (U.S. CLS. 19, 21, 23, 31, 35 AND 44).

FOR: FOUNDRY SERVICES, NAMELY, CASTING  
OF METAL PARTS FOR OTHERS; TECHNICAL

CONSULTANCY SERVICES IN THE FIELD OF  
MANUFACTURE OF CASTINGS, IN CLASS 40  
(U.S. CLS. 100, 103 AND 106).

FOR: ENGINEERING SERVICES, NAMELY, EN-  
GINEERING SERVICES FOR THE METAL CAST-  
ING INDUSTRY; TECHNICAL CONSULTANCY  
SERVICES IN THE FIELD OF DESIGN; DESIGN  
OF METAL CASTINGS, IN CLASS 42 (U.S. CLS. 100  
AND 101).

PRIORITY CLAIMED UNDER SEC. 44(D) ON FED  
REP GERMANY APPLICATION NO. 30649998,  
FILED 8-14-2006, REG. NO. 30649998, DATED 2-5-  
2007, EXPIRES 8-31-2016.

THE MARK CONSISTS OF THE UPPER-CASE  
LETTERS "F" AND "W" SURROUNDED BY A  
CIRCLE.

SER. NO. 77-050,846, FILED 11-27-2006.

ANDREA BUTLER, EXAMINING ATTORNEY

**Int. Cl.: 43**

**Prior U.S. Cls.: 100 and 101**

**United States Patent and Trademark Office**

**Reg. No. 3,465,163**

**Registered July 15, 2008**

**SERVICE MARK  
PRINCIPAL REGISTER**



D'AMICO HOLDING COMPANY (MINNESOTA CORPORATION)

SUITE 175

211 NORTH FIRST STREET

MINNEAPOLIS, MN 55401

FOR: RESTAURANT AND BAR SERVICES, IN CLASS 43 (U.S. CLS. 100 AND 101).

FIRST USE 12-11-2006; IN COMMERCE 12-11-2006.

OWNER OF U.S. REG. NOS. 2,164,891 AND 2,423,292.

NO CLAIM IS MADE TO THE EXCLUSIVE RIGHT TO USE "LOCANDA" AND "RISTORANTE", APART FROM THE MARK AS SHOWN.

THE MARK CONSISTS OF A DISTINCTIVE DESIGN LOGO INCLUDING THE LOCANDA D'AMICO MARK.

THE ENGLISH TRANSLATION OF RISTORANTE AND LOCANDA IS RESTAURANT AND INN, RESPECTIVELY.

SER. NO. 77-052,554, FILED 11-28-2006.

RON FAIRBANKS, EXAMINING ATTORNEY

**Int. Cl.: 43**

**Prior U.S. Cls.: 100 and 101**

**United States Patent and Trademark Office**

**Reg. No. 3,465,164**

**Registered July 15, 2008**

**SERVICE MARK  
PRINCIPAL REGISTER**

**LOCANDA D'AMICO**

D'AMICO HOLDING COMPANY (MINNESOTA  
CORPORATION)  
SUITE 175  
211 NORTH FIRST STREET  
MINNEAPOLIS, MN 55401

FOR: RESTAURANT AND BAR SERVICES, IN  
CLASS 43 (U.S. CLS. 100 AND 101).

FIRST USE 12-11-2006; IN COMMERCE 12-11-2006.

THE MARK CONSISTS OF STANDARD CHAR-  
ACTERS WITHOUT CLAIM TO ANY PARTICULAR  
FONT, STYLE, SIZE, OR COLOR.

OWNER OF U.S. REG. NOS. 2,164,891 AND  
2,423,292.

NO CLAIM IS MADE TO THE EXCLUSIVE  
RIGHT TO USE "LOCANDA", APART FROM THE  
MARK AS SHOWN.

THE ENGLISH TRANSLATION OF THE WORD  
LOCANDA IN THE MARK IS INN.

SER. NO. 77-052,555, FILED 11-28-2006.

RON FAIRBANKS, EXAMINING ATTORNEY

**Int. Cl.: 35**

**Prior U.S. Cls.: 100, 101 and 102**

**United States Patent and Trademark Office**

**Reg. No. 3,465,165**

**Registered July 15, 2008**

**SERVICE MARK  
PRINCIPAL REGISTER**

**KEEP AMERICA PLAYING**

PROFILE PRODUCTS LLC (DELAWARE LTD  
LIAB CO)  
750 LAKE COOK ROAD, SUITE 440  
BUFFALO GROVE, IL 60089

FOR: PROMOTIONAL SERVICES, NAMELY,  
PROMOTION OF THE SAFETY AND PERFOR-  
MANCE OF ATHLETIC FIELDS; PROMOTING  
THE SPECIAL EVENTS OF OTHERS REGARDING  
SPORTS FIELD EDUCATION; PUBLIC ADVOCACY  
TO PROMOTE AWARENESS OF THE IMPOR-  
TANCE OF ATHLETIC FIELD SAFETY AND PER-

FORMANCE, IN CLASS 35 (U.S. CLS. 100, 101 AND  
102).

FIRST USE 1-31-2007; IN COMMERCE 1-31-2007.

THE MARK CONSISTS OF STANDARD CHAR-  
ACTERS WITHOUT CLAIM TO ANY PARTICULAR  
FONT, STYLE, SIZE, OR COLOR.

SER. NO. 77-053,097, FILED 11-29-2006.

JAMES LOVELACE, EXAMINING ATTORNEY

Int. Cl.: 35

Prior U.S. Cls.: 100, 101 and 102

United States Patent and Trademark Office

Reg. No. 3,465,166

Registered July 15, 2008

SERVICE MARK  
PRINCIPAL REGISTER



TONAL POEM'S MULTIMEDIA INCORPORATED (PENNSYLVANIA CORPORATION)  
5741 MEMORIAL ROAD  
GERMANSVILLE, PA 18053

FOR: BUSINESS ADVICE AND ANALYSIS OF MARKETS, IN CLASS 35 (U.S. CLS. 100, 101 AND 102).

FIRST USE 7-1-2001; IN COMMERCE 7-1-2001.

NO CLAIM IS MADE TO THE EXCLUSIVE RIGHT TO USE "MARKET", APART FROM THE MARK AS SHOWN.

THE COLOR(S) BLACK, WHITE, GREEN, BLUE AND ORANGE IS/ARE CLAIMED AS A FEATURE OF THE MARK.

THE MARK CONSISTS OF THE COLOR BLACK APPEARING IN THE OUTLINE OF THE RECTANGLE, IN THE BACKGROUND WHERE THE WORDING "MARKET" APPEARS, AND IN THE LETTERING "READER". THE COLOR WHITE APPEARS IN THE LETTERING "MARKET" AND "PRO" AND IN THE BACKGROUND WHERE THE WORDING "READER" APPEARS. THE COLOR GREEN APPEARS IN THE BACKGROUND WHERE THE LETTER "P" APPEARS. THE COLOR BLUE APPEARS IN THE BACKGROUND WHERE THE LETTER "R" APPEARS. THE COLOR ORANGE APPEARS IN THE BACKGROUND WHERE THE LETTER "O" APPEARS.

SER. NO. 77-053,680, FILED 11-30-2006.

TINA BROWN, EXAMINING ATTORNEY

**Int. Cl.: 25**

**Prior U.S. Cls.: 22 and 39**

**United States Patent and Trademark Office**

**Reg. No. 3,465,167**

**Registered July 15, 2008**

**TRADEMARK  
PRINCIPAL REGISTER**



K-SWISS INC. (DELAWARE CORPORATION)  
31248 OAK CREST DRIVE  
WESTLAKE VILLAGE, CA 91361

FOR: SHOES, IN CLASS 25 (U.S. CLS. 22 AND 39).

FIRST USE 10-11-2006; IN COMMERCE 10-11-2006.

OWNER OF U.S. REG. NOS. 1,029,423, 2,996,552  
AND OTHERS.

"THE MARK CONSISTS OF FIVE DIAGONAL  
STRIPES ON THE SIDE OF A SHOE, THE MIDDLE

STRIPE BEING SLIGHTLY WIDER THAN THE  
OTHER FOUR STRIPES. THE BROKEN LINES IN  
THE DRAWING THAT DEPICT A SHOE ARE  
INCLUDED MERELY TO SHOW THE POSITION  
OF THE MARK AND ARE NOT PART OF THE  
MARK".

SEC. 2(F).

SER. NO. 77-056,268, FILED 12-4-2006.

BARBARA BROWN, EXAMINING ATTORNEY

**Int. Cl.: 31**

**Prior U.S. Cls.: 1 and 46**

**United States Patent and Trademark Office**

**Reg. No. 3,465,168**

**Registered July 15, 2008**

**TRADEMARK  
PRINCIPAL REGISTER**

**WILDERNESS BLEND**

MERRICK PET CARE, INC. (TEXAS CORPORATION)

101 S.E. 11TH AVE.

AMARILLO, TX 79101

FOR: PET FOOD, IN CLASS 31 (U.S. CLS. 1 AND 46).

FIRST USE 11-4-2004; IN COMMERCE 11-21-2004.

THE MARK CONSISTS OF STANDARD CHARACTERS WITHOUT CLAIM TO ANY PARTICULAR FONT, STYLE, SIZE, OR COLOR.

NO CLAIM IS MADE TO THE EXCLUSIVE RIGHT TO USE "BLEND", APART FROM THE MARK AS SHOWN.

SER. NO. 77-056,405, FILED 12-4-2006.

JOHN KELLY, EXAMINING ATTORNEY



**Int. Cl.: 32**

**Prior U.S. Cls.: 45, 46 and 48**

**United States Patent and Trademark Office**

**Reg. No. 3,465,169**

**Registered July 15, 2008**

**TRADEMARK  
PRINCIPAL REGISTER**

**SANGRIA IMPERIAL**

NID HOLDING, INC. (DELAWARE CORPORATION)  
615 SOUTH DUPONT HIGHWAY  
DOVER, DE 19901

FOR: NON-ALCOHOLIC FRUIT JUICE BEVERAGES, IN CLASS 32 (U.S. CLS. 45, 46 AND 48).

THE MARK CONSISTS OF STANDARD CHARACTERS WITHOUT CLAIM TO ANY PARTICULAR FONT, STYLE, SIZE, OR COLOR.

PRIORITY CLAIMED UNDER SEC. 44(D) ON MEXICO APPLICATION NO. 793132, FILED 7-7-2006, REG. NO. 987644, DATED 6-7-2007, EXPIRES 7-7-2016.

NO CLAIM IS MADE TO THE EXCLUSIVE RIGHT TO USE "SANGRIA", APART FROM THE MARK AS SHOWN.

SER. NO. 77-058,370, FILED 12-6-2006.

HEATHER THOMPSON, EXAMINING ATTORNEY

**Int. Cl.: 41**

**Prior U.S. Cls.: 100, 101 and 107**

**United States Patent and Trademark Office**

**Reg. No. 3,465,170**

**Registered July 15, 2008**

**SERVICE MARK  
PRINCIPAL REGISTER**

**COMEDY PLAYGROUND**

COMEDY PLAYGROUND, LLC (CALIFORNIA  
LTD LIAB CO)  
1418 N. SIERRA BONITA AVENUE  
LOS ANGELES, CA 90046

FOR: EDUCATIONAL SERVICES, NAMELY, CONDUCTING CLASSES, SEMINARS AND WORKSHOPS IN THE FIELD OF COMEDY, STAND UP COMEDY, WRITING, IMPROVISATION AND PERFORMANCE AND DISTRIBUTION OF COURSE MATERIAL IN CONNECTION THEREWITH; EDUCATIONAL SERVICES, NAMELY, CONDUCTING CLASSES, SEMINARS AND WORKSHOPS IN THE FIELD OF COMEDY, STAND UP COMEDY, WRITING, IMPROVISATION AND PERFORMANCE; ENTERTAINMENT IN THE NATURE OF LIVE COMEDY SHOWS, INCLUDING STAND UP COMEDY, IMPROVISATIONAL COMEDY AND SKETCH COMEDY; ENTERTAINMENT SERVICES, NAMELY, PROVIDING A WEBSITE FEATURING, PHOTOGRAPHIC, AUDIO, VIDEO AND PROSE

PRESENTATIONS FEATURING COMEDY WORKSHOPS AND PERFORMANCES; WORKSHOPS AND SEMINARS IN THE FIELD OF COMEDY, STAND UP COMEDY, WRITING, IMPROVISATION AND PERFORMANCE, IN CLASS 41 (U.S. CLS. 100, 101 AND 107).

FIRST USE 9-1-1999; IN COMMERCE 10-18-2002.

THE MARK CONSISTS OF STANDARD CHARACTERS WITHOUT CLAIM TO ANY PARTICULAR FONT, STYLE, SIZE, OR COLOR.

NO CLAIM IS MADE TO THE EXCLUSIVE RIGHT TO USE "COMEDY", APART FROM THE MARK AS SHOWN.

SER. NO. 77-058,635, FILED 12-6-2006.

MELVIN AXILBUND, EXAMINING ATTORNEY

**Int. Cl.: 4**

**Prior U.S. Cls.: 1, 6 and 15**

**United States Patent and Trademark Office**

**Reg. No. 3,465,171**

**Registered July 15, 2008**

**TRADEMARK  
PRINCIPAL REGISTER**

**Z LOOB**

LYNX ENTERPRISES, INC (OHIO CORPORATION)  
2184 SCHLICHTER DRIVE  
HAMILTON, OH 45015

FOR: INDUSTRIAL LUBRICANTS FOR LUBRICATING CONVEYOR CHAINS IN THE BEVERAGE AND BREWERY INDUSTRIES, IN CLASS 4 (U.S. CLS. 1, 6 AND 15).

FIRST USE 11-1-2003; IN COMMERCE 11-1-2003.

THE MARK CONSISTS OF STANDARD CHARACTERS WITHOUT CLAIM TO ANY PARTICULAR FONT, STYLE, SIZE, OR COLOR.

NO CLAIM IS MADE TO THE EXCLUSIVE RIGHT TO USE "LUBE", APART FROM THE MARK AS SHOWN.

SER. NO. 77-058,936, FILED 12-7-2006.

DANNEAN HETZEL, EXAMINING ATTORNEY

**Int. Cls.: 20 and 24**

**Prior U.S. Cls.: 2, 13, 22, 25, 32, 42 and 50**

**United States Patent and Trademark Office**

**Reg. No. 3,465,172**

**Registered July 15, 2008**

**TRADEMARK  
PRINCIPAL REGISTER**

**NATURA SMART TECHNOLOGY**

NATURA WORLD INC. (CANADA CORPORATION)  
ONE NATURA WAY  
CAMBRIDGE, ONTARIO N3C 0A4

FOR: MATTRESS TOPPERS, PILLOWS, MATTRESSES, IN CLASS 20 (U.S. CLS. 2, 13, 22, 25, 32 AND 50).

FOR: MATTRESS PADS, DUVETS AND COMFORTERS, IN CLASS 24 (U.S. CLS. 42 AND 50).

THE MARK CONSISTS OF STANDARD CHARACTERS WITHOUT CLAIM TO ANY PARTICULAR FONT, STYLE, SIZE, OR COLOR.

PRIORITY CLAIMED UNDER SEC. 44(D) ON CANADA APPLICATION NO. 1325445, FILED 11-23-2006, REG. NO. TMA702,341, DATED 12-4-2007, EXPIRES 12-4-2022.

NO CLAIM IS MADE TO THE EXCLUSIVE RIGHT TO USE "TECHNOLOGY", APART FROM THE MARK AS SHOWN.

SER. NO. 77-059,595, FILED 12-7-2006.

ANNE MADDEN, EXAMINING ATTORNEY

**Int. Cl.: 45**

**Prior U.S. Cls.: 100 and 101**

**United States Patent and Trademark Office**

**Reg. No. 3,465,173**

**Registered July 15, 2008**

**SERVICE MARK  
PRINCIPAL REGISTER**



403 LABS, LLC (DELAWARE LTD LIAB CO)  
27 NORTH WACKER DRIVE, SUITE 204  
CHICAGO, IL 60606

FOR: MONITORING OF COMPUTER SYSTEMS  
FOR SECURITY PURPOSES, IN CLASS 45 (U.S. CLS.  
100 AND 101).

FIRST USE 9-12-2005; IN COMMERCE 9-23-2005.

THE COLOR(S) WHITE AND BLUE IS/ARE  
CLAIMED AS A FEATURE OF THE MARK.

THE MARK CONSISTS OF THE COLOR WHITE  
APPEARS IN THE WORDING 403 AND THE COLOR  
BLUE APPEARS IN THE RECTANGULAR SHAPED  
BOX DESIGN.

SER. NO. 77-060,495, FILED 12-8-2006.

B. PARADEWELAI, EXAMINING ATTORNEY

**Int. Cl.: 10**

**Prior U.S. Cls.: 26, 39 and 44**

**United States Patent and Trademark Office**

**Reg. No. 3,465,174**

**Registered July 15, 2008**

**TRADEMARK  
PRINCIPAL REGISTER**



**ALL-TEMP**

ALL-TEMP CORPORATION (CALIFORNIA CORPORATION)  
44625 YUCCA AVENUE  
LANCASTER, CA 93534

FOR: THERMAL PACKS FOR FIRST AID PURPOSES, IN CLASS 10 (U.S. CLS. 26, 39 AND 44).

FIRST USE 5-14-1990; IN COMMERCE 5-14-1990.

THE COLOR(S) RED, BLUE AND WHITE IS/ARE CLAIMED AS A FEATURE OF THE MARK.

THE MARK CONSISTS OF A BLUE WORD "ALL" WITH WHITE "SNOW " PILED ON TOP, A BLUE HYPHEN WITH WHITE "SNOW" PILED ON TOP, AND A RED WORD "TEMP" WITH WHITE FLAMES OUTLINED IN RED RECEDING INTO THE TOP OF THE LETTERS.

SER. NO. 77-060,617, FILED 12-8-2006.

LINDA E. BLOHM, EXAMINING ATTORNEY

**Int. Cl.: 44**

**Prior U.S. Cls.: 100 and 101**

**United States Patent and Trademark Office**

**Reg. No. 3,465,175**

**Registered July 15, 2008**

**SERVICE MARK  
PRINCIPAL REGISTER**

**GATEWAY HEALTH PLAN PCM**

GATEWAY HEALTH PLAN, L.P. (PENNSYLVANIA LIMITED PARTNERSHIP)  
U.S. STEEL TOWER, 40TH FLOOR  
600 GRANT STREET  
PITTSBURGH, PA 15219

FOR: PROVIDING MANAGED HEALTH CARE SERVICES FOR MEMBERS, IN CLASS 44 (U.S. CLS. 100 AND 101).

FIRST USE 10-1-2001; IN COMMERCE 8-1-2002.

THE MARK CONSISTS OF STANDARD CHARACTERS WITHOUT CLAIM TO ANY PARTICULAR FONT, STYLE, SIZE, OR COLOR.

OWNER OF U.S. REG. NO. 2,526,416.

NO CLAIM IS MADE TO THE EXCLUSIVE RIGHT TO USE "HEALTH PLAN PCM", APART FROM THE MARK AS SHOWN.

SER. NO. 77-062,946, FILED 12-13-2006.

STEVEN JACKSON, EXAMINING ATTORNEY

**Int. Cls.: 9 and 16**

**Prior U.S. Cls.: 2, 5, 21, 22, 23, 26, 29, 36, 37, 38 and 50**

**Reg. No. 3,465,176**

**United States Patent and Trademark Office**

**Registered July 15, 2008**

**TRADEMARK  
PRINCIPAL REGISTER**

**QUALIGRAM**

QUALIGRAM SOFTWARE INC, (CANADA CORPORATION)  
BUREAU 2420  
500 PLACE D'ARMES  
MONTREAL, QUEBEC, CANADA H2Y2W2

FOR: SOFTWARE FOR USE IN DESCRIBING BUSINESS PROCESSES AND PROCEDURES IN THE FORM OF GRAPHICS; DOWNLOADABLE PUBLICATIONS IN ELECTRONIC FORMAT IN THE NATURE OF NEWSLETTERS AND PERIODICALS IN THE FIELD OF BUSINESS PROCESSES AND PROCEDURES; AND ELECTRONIC INSTRUCTION MANUALS FEATURING TRAINING FOR USE OF THE ABOVE-NOTED SOFTWARE, IN CLASS 9 (U.S. CLS. 21, 23, 26, 36 AND 38).

FOR: PRINTED INSTRUCTION MANUALS RELATING TO SOFTWARE FOR DESCRIBING PROCESSES AND PROCEDURES IN THE FIELD OF GRAPHICS, IN CLASS 16 (U.S. CLS. 2, 5, 22, 23, 29, 37, 38 AND 50).

THE MARK CONSISTS OF STANDARD CHARACTERS WITHOUT CLAIM TO ANY PARTICULAR FONT, STYLE, SIZE, OR COLOR.

OWNER OF CANADA REG. NO. TMA666424, DATED 6-21-2006, EXPIRES 6-21-2021.

SER. NO. 77-065,114, FILED 12-15-2006.

Laurie Kaufman, Examining Attorney



**Int. Cls.: 35 and 39**

**Prior U.S. Cls.: 100, 101, 102 and 105**

**United States Patent and Trademark Office**

**Reg. No. 3,465,177**

**Registered July 15, 2008**

**SERVICE MARK  
PRINCIPAL REGISTER**



**MOVING SOLUTIONS**

**Don't just move, move well**

THE EXTRA STEP, INC. D/B/A MOVING SOLUTIONS (PENNSYLVANIA CORPORATION)  
115 W. EAGLE ROAD  
HAVERTOWN, PA 19083

FOR: RELOCATIONS SERVICES, NAMELY, PLANNING AND IMPLEMENTING MOVES OF HOMES AND OFFICES INCLUDING DEVELOPING FLOOR PLAN, ASSISTING WITH HOUSEHOLD DOWNSIZING, DECLUTTERING, SORTING AND ORGANIZING, SCHEDULING AND OVERSEEING MOVERS, ARRANGING FOR OTHERS FOR SHIPPING OF HOUSEHOLD ITEMS; RETAIL STORE FEATURING CARDBOARD BOXES, PACKING TAPE, PACKING PAPER, PLASTIC PACKAGING OR CUSHIONING MATERIAL THAT CONTAINS ENCAPSULATED AIR CELLS; PROVIDING WEBSITE CONTAINING INFORMATION IN THE FIELD OF RELOCATION SERVICES, NAMELY, PROVIDING INFORMATION ABOUT RELOCATION AND PROVIDING LINKS IN THE FIELD OF RELOCATION; FRANCHISE SERVICES, NAMELY, OFFERING TECHNICAL ASSISTANCE IN THE ESTABLISHMENT AND/OR OPERATION OF RELOCATION SERVICES BUSINESSES, IN CLASS 35 (U.S. CLS. 100, 101 AND 102).

FIRST USE 4-0-2006; IN COMMERCE 4-0-2006.

FOR: PACKING AND UNPACKING ARTICLES FOR TRANSPORTATION, IN CLASS 39 (U.S. CLS. 100 AND 105).

FIRST USE 4-0-2006; IN COMMERCE 4-0-2006.

OWNER OF U.S. REG. NO. 2,138,525.

NO CLAIM IS MADE TO THE EXCLUSIVE RIGHT TO USE "MOVING", APART FROM THE MARK AS SHOWN.

"THE MARK CONSISTS OF THE WORDING "MOVING SOLUTIONS" WITH A WINDOW IN THE SHAPE OF A SEMI-CIRCLE ABOVE IT AND THE WORDING "DON'T JUST MOVE, MOVE WELL" BELOW IT."

SER. NO. 77-066,600, FILED 12-18-2006.

JANET LEE, EXAMINING ATTORNEY

**Int. Cl.: 41**

**Prior U.S. Cls.: 100, 101 and 107**

**United States Patent and Trademark Office**

**Reg. No. 3,465,178**

**Registered July 15, 2008**

**SERVICE MARK  
PRINCIPAL REGISTER**

**WORLD TRAVEL MARKET**

ELSEVIER PROPERTIES SA (SWITZERLAND SOCIETE ANONYME)  
3, ESPACE DE L'EUROPE  
NEUCHATEL, SWITZERLAND 2000

FOR: ORGANIZATION, ARRANGING AND CONDUCTING OF EXHIBITIONS AND EXPOSITIONS RELATING TO TRAVEL; EDUCATIONAL AND TRAINING SERVICES, NAMELY, CONDUCTING CONFERENCES, CONVENTIONS, SEMINARS AND WORKSHOPS RELATING TO TRAVEL AND TOURISM; ONLINE PROVISION AND DISSEMINATION OF INFORMATION RELATING TO TRAVEL CONFERENCES, EDUCATIONAL/CULTURAL EXHIBITIONS AND EXPOSITIONS, CONVENTIONS, SEMINARS, WORKSHOPS AND EVENTS, IN CLASS 41 (U.S. CLS. 100, 101 AND 107).

FIRST USE 0-0-1998; IN COMMERCE 0-0-1998.

THE MARK CONSISTS OF STANDARD CHARACTERS WITHOUT CLAIM TO ANY PARTICULAR FONT, STYLE, SIZE, OR COLOR.

NO CLAIM IS MADE TO THE EXCLUSIVE RIGHT TO USE "TRAVEL MARKET", APART FROM THE MARK AS SHOWN.

SER. NO. 77-066,966, FILED 12-19-2006.

SHAUNIA CARLYLE, EXAMINING ATTORNEY

**Int. Cls.: 6, 20 and 33**

**Prior U.S. Cls.: 2, 12, 13, 14, 22, 23, 25, 32, 47, 49 and 50**

**United States Patent and Trademark Office**

**Reg. No. 3,465,179**

**Registered July 15, 2008**

**TRADEMARK  
PRINCIPAL REGISTER**

**WINETENDER**

VACU VIN INNOVATIONS LTD. (UNITED KINGDOM CORPORATION)  
20-21 QUEENSWAY QUAY MARINA  
QUEENSWAY, GIBRALTAR, UNITED KINGDOM

FOR: METAL TAPS FOR WINE, IN CLASS 6 (U.S. CLS. 2, 12, 13, 14, 23, 25 AND 50).

FOR: NON-METAL TAPS FOR WINE, IN CLASS 20 (U.S. CLS. 2, 13, 22, 25, 32 AND 50).

FOR: WINES, IN CLASS 33 (U.S. CLS. 47 AND 49).

THE MARK CONSISTS OF STANDARD CHARACTERS WITHOUT CLAIM TO ANY PARTICULAR FONT, STYLE, SIZE, OR COLOR.

OWNER OF ERPN CMNTY TM OFC REG. NO. 0797638, DATED 4-6-2006, EXPIRES 3-30-2016.

SER. NO. 77-067,662, FILED 12-19-2006.

TARAH HARDY, EXAMINING ATTORNEY

**Int. Cl.: 41**

**Prior U.S. Cls.: 100, 101 and 107**

**United States Patent and Trademark Office**

**Reg. No. 3,465,180**

**Registered July 15, 2008**

**SERVICE MARK  
PRINCIPAL REGISTER**

**Results Leadership Group**

RESULTS LEADERSHIP GROUP, LLC (MARY-  
LAND LTD LIAB CO)  
2707 JENNINGS ROAD  
KENSINGTON, MD 20895

FOR: TRAINING SERVICES IN THE FIELDS OF  
ORGANIZATIONAL EFFECTIVENESS AND AC-  
COUNTABILITY MANAGEMENT FOR GOVERN-  
MENTAL ENTITIES AND NONPROFIT  
ORGANIZATIONS, IN CLASS 41 (U.S. CLS. 100, 101  
AND 107).

FIRST USE 12-5-2006; IN COMMERCE 12-5-2006.

THE MARK CONSISTS OF STANDARD CHAR-  
ACTERS WITHOUT CLAIM TO ANY PARTICULAR  
FONT, STYLE, SIZE, OR COLOR.

NO CLAIM IS MADE TO THE EXCLUSIVE  
RIGHT TO USE "GROUP", APART FROM THE  
MARK AS SHOWN.

SER. NO. 77-068,023, FILED 12-20-2006.

ANNE FARRELL, EXAMINING ATTORNEY

Int. Cl.: 44

Prior U.S. Cls.: 100 and 101

United States Patent and Trademark Office

Reg. No. 3,465,181

Registered July 15, 2008

SERVICE MARK  
PRINCIPAL REGISTER



LEGENBRE, STACY (CALIFORNIA SOLE PROPRIETORSHIP)  
337 S. BREA BLVD  
BREA, CA 92821

NO CLAIM IS MADE TO THE EXCLUSIVE RIGHT TO USE "BARBER SHOP" , APART FROM THE MARK AS SHOWN.

FOR: HAIR CUTTING, IN CLASS 44 (U.S. CLS. 100 AND 101).

SER. NO. 77-068,963, FILED 12-20-2006.

FIRST USE 1-8-1992; IN COMMERCE 1-8-1992.

KRISTIN DAHLING, EXAMINING ATTORNEY

**Int. Cl.: 41**

**Prior U.S. Cls.: 100, 101 and 107**

**United States Patent and Trademark Office**

**Reg. No. 3,465,182**

**Registered July 15, 2008**

**SERVICE MARK  
PRINCIPAL REGISTER**



L'ARENA DES CANADIENS INC. (THROUGH  
ITS DIVISION GILLET ENTERTAINMENT  
GROUP) (CANADA CORPORATION)

7TH FLOOR  
1275 RUE SAINT-ANTOINE OUEST  
MONTREAL, QUEBEC, CANADA H3C5L2

FOR: ENTERTAINMENT SERVICES, NAMELY,  
LIVE MUSIC CONCERTS AND MUSIC PRODUCTION  
EVENTS, IN CLASS 41 (U.S. CLS. 100, 101 AND  
107).

OWNER OF CANADA REG. NO. TMA699,027,  
DATED 10-19-2007, EXPIRES 10-19-2022.

NO CLAIM IS MADE TO THE EXCLUSIVE  
RIGHT TO USE "MUSIC AND ARTS FESTIVAL",  
APART FROM THE MARK AS SHOWN.

SER. NO. 77-069,064, FILED 12-21-2006.

KAPIL BHANOT, EXAMINING ATTORNEY

**Int. Cl.: 14**

**Prior U.S. Cls.: 2, 27, 28 and 50**

**United States Patent and Trademark Office**

**Reg. No. 3,465,183**

**Registered July 15, 2008**

**TRADEMARK  
PRINCIPAL REGISTER**

**BEAD BOUTIQUE**

WESTRIM, INC. (DELAWARE CORPORATION)  
7855 HAYVENHURST AVENUE  
VAN NUYS, CA 91406

FOR: JEWELRY, IMITATION JEWELRY, COSTUME JEWELRY AND PARTS THEREOF, NAMELY, WOOD BEADS, CLAY BEADS, METAL BEADS, PLASTIC BEADS, GLASS BEADS, STRINGS OF BEADS, PEARLS, RHINESTONES, DECORATIVE JEWELRY CHAIN, RING CASTINGS OF PRECIOUS METAL, PIN CASTINGS OF PRECIOUS METAL, MINIATURE ANIMAL AND FISH FIGURINES MADE OF PRECIOUS METALS, ORNAMENTAL PINS, JEWELRY BRACELETS, CHARMS, JEWELRY CHAINS, EAR CLIPS, TIE CLIPS, EARRINGS, FIGURES OF PRECIOUS METALS, JEWELRY BOXES, NECKLACES, PENDANTS, RINGS BEING JEWELRY, SCULPTURES OF PRECIOUS METALS,

WATCH FOBS, AND JEWELRY FINDINGS, IN CLASS 14 (U.S. CLS. 2, 27, 28 AND 50).

FIRST USE 7-31-1999; IN COMMERCE 7-31-1999.

THE MARK CONSISTS OF STANDARD CHARACTERS WITHOUT CLAIM TO ANY PARTICULAR FONT, STYLE, SIZE, OR COLOR.

NO CLAIM IS MADE TO THE EXCLUSIVE RIGHT TO USE "BEAD", APART FROM THE MARK AS SHOWN.

SEC. 2(F).

SER. NO. 77-069,432, FILED 12-21-2006.

SONYA STEPHENS, EXAMINING ATTORNEY

**Int. Cl.: 12**

**Prior U.S. Cls.: 19, 21, 23, 31, 35 and 44**

**United States Patent and Trademark Office**

**Reg. No. 3,465,184**

**Registered July 15, 2008**

**TRADEMARK  
PRINCIPAL REGISTER**



FRENSEMEYER, DIETMAR (FED REP GERMA-  
NY INDIVIDUAL)  
FRANKESTRASSE 17  
ACHERN, FED REP GERMANY 77855

FOR: BRAKE SYSTEMS FOR VEHICLES, BRAKE  
LININGS AND SHOES FOR VEHICLES, FRONT  
BRAKE SYSTEMS FOR VEHICLES, REAR BRAKE  
SYSTEMS FOR VEHICLES, BRAKE COMPONENTS  
FOR VEHICLES, NAMELY, BRAKE LINES, BRAKE  
ROTORS, BRAKE CYLINDERS, BRAKE DISKS,  
AND BRAKE PADS, IN CLASS 12 (U.S. CLS. 19, 21,  
23, 31, 35 AND 44).

OWNER OF FED REP GERMANY REG. NO.  
30163343, DATED 1-24-2002, EXPIRES 6-12-2011.

NO CLAIM IS MADE TO THE EXCLUSIVE  
RIGHT TO USE "THE BRAKES", APART FROM  
THE MARK AS SHOWN.

THE COLOR(S) BLACK, RED, AND WHITE IS/  
ARE CLAIMED AS A FEATURE OF THE MARK.

THE MARK CONSISTS OF THE WORDS "MO-  
VIT", IN CAPITAL LETTERS, AND "THE BRAKES",  
IN LOWER CASE LETTERS. THE LETTERS OF ALL  
WORDS ARE IN BLACK ON A WHITE BACK-  
GROUND. THE RIGHT THIRD OF THE LETTER  
"O" IN "MOVIT" IS COVERED WITH A SOLID RED  
SEMI-CIRCLE. A RED DOT, ALIGNED WITH THE  
TOP-MOST PORTION OF THE WORD "MOVIT",  
SEPARATES THE LETTERS "V" AND "I" IN "MO-  
VIT". THE WORDS "THE BRAKES" APPEAR IM-  
MEDIATELY BELOW THE WORD "MOVIT".

SER. NO. 77-071,310, FILED 12-26-2006.

MICHAEL KEATING, EXAMINING ATTORNEY



**Int. Cls.: 25 and 26**

**Prior U.S. Cls.: 22, 37, 39, 40, 42, 50 and 200**

**United States Patent and Trademark Office**

**Reg. No. 3,465,185**

**Registered July 15, 2008**

**TRADEMARK  
COLLECTIVE MEMBERSHIP  
PRINCIPAL REGISTER**

**RED KNIGHTS**

RED KNIGHTS INTERNATIONAL FIREFIGHTERS MOTORCYCLE CLUB, INC. (MASSACHUSETTS CORPORATION)  
326 MINOTT ROAD  
WESTMINSTER, MA 01473

FOR: CLOTHING, NAMELY, T-SHIRTS, SWEATERS, SWEAT SHIRTS, JACKETS, CAPS, AND BANDANAS, IN CLASS 25 (U.S. CLS. 22 AND 39).

FIRST USE 1-1-1983; IN COMMERCE 1-1-1983.

FOR: ORNAMENTAL CLOTH PATCHES AND EMBROIDERED PATCHES FOR CLOTHING, IN CLASS 26 (U.S. CLS. 37, 39, 40, 42 AND 50).

FIRST USE 1-1-1983; IN COMMERCE 1-1-1983.

FOR: INDICATING MEMBERSHIP IN A SOCIAL MOTORCYCLE CLUB, IN CLASS 200 (U.S. CL. 200).

FIRST USE 1-1-1983; IN COMMERCE 1-1-1983.

THE MARK CONSISTS OF STANDARD CHARACTERS WITHOUT CLAIM TO ANY PARTICULAR FONT, STYLE, SIZE, OR COLOR.

OWNER OF U.S. REG. NO. 2,881,438.

SER. NO. 77-071,435, FILED 12-26-2006.

KATHERINE M. DUBRAY, EXAMINING ATTORNEY

**Int. Cl.: 1**

**Prior U.S. Cls.: 1, 5, 6, 10, 26 and 46**

**Reg. No. 3,465,186**

**United States Patent and Trademark Office**

**Registered July 15, 2008**

**TRADEMARK  
PRINCIPAL REGISTER**

**SOFTAZOLINE**

KAWAKEN FINE CHEMICALS CO., LTD. (JAPAN CORPORATION)  
2-3-3, NIHONBASHI HORIDOME-CHO, CHUO-KU  
TOKYO, JAPAN

FOR: SURFACE ACTIVE CHEMICAL AGENTS, NAMELY, SURFACTANTS FOR USE IN THE MANUFACTURE OF DETERGENTS, PERSONAL CARE PRODUCTS, DENTAL CARE PRODUCTS, HARD SURFACE CLEANERS; TEXTILE AUXILIARIES; CHEMICAL ADDITIVES FOR USE IN THE MANUFACTURE OF PHARMACEUTICAL PREPARATIONS FOR WOUNDS, IN CLASS 1 (U.S. CLS. 1, 5, 6, 10, 26 AND 46).

THE MARK CONSISTS OF STANDARD CHARACTERS WITHOUT CLAIM TO ANY PARTICULAR FONT, STYLE, SIZE, OR COLOR.

OWNER OF JAPAN REG. NO. 4283043, DATED 6-11-1999, EXPIRES 6-11-2009.

SER. NO. 77-071,729, FILED 12-27-2006.

KAPIL BHANOT, EXAMINING ATTORNEY

**Int. Cl.: 33**

**Prior U.S. Cls.: 47 and 49**

**United States Patent and Trademark Office**

**Reg. No. 3,465,187**

**Registered July 15, 2008**

**TRADEMARK  
PRINCIPAL REGISTER**

**SAINTS AND SINNERS**

COLD HEAVEN CELLARS LLC (CALIFORNIA  
LTD LIAB CO)  
C/O KOENIG & ASSOCIATES  
226 E. CANON PERDIDO, SUITE M  
SANTA BARBARA, CA 93067

THE MARK CONSISTS OF STANDARD CHAR-  
ACTERS WITHOUT CLAIM TO ANY PARTICULAR  
FONT, STYLE, SIZE, OR COLOR.

FOR: WINE; WINES, IN CLASS 33 (U.S. CLS. 47  
AND 49).

SER. NO. 77-073,622, FILED 12-29-2006.

FIRST USE 12-27-2004; IN COMMERCE 12-27-2004.

THEODORE MCBRIDE, EXAMINING ATTORNEY

**Int. Cl.: 42**

**Prior U.S. Cls.: 100 and 101**

**United States Patent and Trademark Office**

**Reg. No. 3,465,188**

**Registered July 15, 2008**

**SERVICE MARK  
PRINCIPAL REGISTER**

**The Organic Mechanic**

CORSAUT, CHRISTOPHER R (UNITED STATES  
INDIVIDUAL)  
230 SUNDEW LANE  
PASADENA, MD 21122

THE MARK CONSISTS OF STANDARD CHAR-  
ACTERS WITHOUT CLAIM TO ANY PARTICULAR  
FONT, STYLE, SIZE, OR COLOR.

FOR: CONSULTATION SERVICES IN THE FIELD  
OF ALTERNATIVE ENERGY DEVELOPMENT, IN  
CLASS 42 (U.S. CLS. 100 AND 101).

SER. NO. 77-073,832, FILED 12-30-2006.

FIRST USE 10-31-2005; IN COMMERCE 11-25-2007.

ANTHONY RINKER, EXAMINING ATTORNEY

**Int. Cl.: 42**

**Prior U.S. Cls.: 100 and 101**

**United States Patent and Trademark Office**

**Reg. No. 3,465,189**

**Registered July 15, 2008**

**SERVICE MARK  
PRINCIPAL REGISTER**

**RCM 21**

JTH GROUP LLC (ALABAMA LTD LIAB CO)  
P. O. BOX 221  
4338 LONGLEAF DRIVE COUNTRY ROAD 99  
WEDOWEE, AL 362780221

FOR: ENGINEERING SERVICES, NAMELY, ENGINEERING FOR THE PHYSICAL AND NON-PHYSICAL ASSETS; MANAGEMENT AND CONSULTATION IN THE FIELD OF HUMAN FACTORS ENGINEERING; TECHNOLOGY CONSULTATION AND RESEARCH IN THE FIELD OF PHYSICAL ASSETS AND INTEGRATION, IN CLASS 42 (U.S. CLS. 100 AND 101).

FIRST USE 2-1-2006; IN COMMERCE 2-4-2006.

THE MARK CONSISTS OF STANDARD CHARACTERS WITHOUT CLAIM TO ANY PARTICULAR FONT, STYLE, SIZE, OR COLOR.

NO CLAIM IS MADE TO THE EXCLUSIVE RIGHT TO USE "RCM", APART FROM THE MARK AS SHOWN.

SER. NO. 77-073,936, FILED 12-31-2006.

APRIL ROACH, EXAMINING ATTORNEY

Int. Cl.: 25

Prior U.S. Cls.: 22 and 39

**United States Patent and Trademark Office**

**Reg. No. 3,465,190**

Registered July 15, 2008

**TRADEMARK  
PRINCIPAL REGISTER**

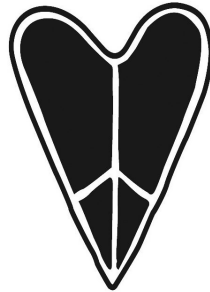

*Peace through Love*

SPEAKS, VIRGINIA G. (UNITED STATES INDIVIDUAL)  
2109 PONTOTOC AVENUE  
NASHVILLE, TN 37206

THE MARK CONSISTS OF A HEART WITH THE PEACE SYMBOL INSIDE AND THE WORDS "PEACE THROUGH LOVE".

FOR: BASEBALL CAPS, IN CLASS 25 (U.S. CLS. 22 AND 39).

SER. NO. 77-074,202, FILED 1-2-2007.

FIRST USE 6-17-2006; IN COMMERCE 6-17-2006.

KATHERINE STOIDES, EXAMINING ATTORNEY

**Int. Cls.: 25 and 26**

**Prior U.S. Cls.: 22, 37, 39, 40, 42, 50 and 200**

**United States Patent and Trademark Office**

**Reg. No. 3,465,191**

**Registered July 15, 2008**

**TRADEMARK  
COLLECTIVE MEMBERSHIP  
PRINCIPAL REGISTER**

**RKMC**

RED KNIGHTS INTERNATIONAL FIREFIGHTERS MOTORCYCLE CLUB, INC. (MASSACHUSETTS CORPORATION)  
326 MINOTT ROAD  
WESTMINSTER, MA 01473

FOR: CLOTHING, NAMELY, T-SHIRTS, SWEATERS, SWEAT SHIRTS, JACKETS, CAPS, AND BANDANAS, IN CLASS 25 (U.S. CLS. 22 AND 39).

FIRST USE 1-1-1983; IN COMMERCE 1-1-1983.

FOR: ORNAMENTAL CLOTH PATCHES AND EMBROIDERED PATCHES FOR CLOTHING, IN CLASS 26 (U.S. CLS. 37, 39, 40, 42 AND 50).

FIRST USE 1-1-1983; IN COMMERCE 1-1-1983.

FOR: INDICATING MEMBERSHIP IN A SOCIAL MOTORCYCLE CLUB, IN CLASS 200 (U.S. CL. 200).

FIRST USE 1-1-1983; IN COMMERCE 1-1-1983.

THE MARK CONSISTS OF STANDARD CHARACTERS WITHOUT CLAIM TO ANY PARTICULAR FONT, STYLE, SIZE, OR COLOR.

OWNER OF U.S. REG. NO. 2,881,438.

SER. NO. 77-074,360, FILED 1-2-2007.

KATHERINE M. DUBRAY, EXAMINING ATTORNEY

Int. Cl.: 41

Prior U.S. Cls.: 100, 101 and 107

United States Patent and Trademark Office

Reg. No. 3,465,192

Registered July 15, 2008

SERVICE MARK  
PRINCIPAL REGISTER



MCKOY, WAYNE (UNITED STATES INDIVIDUAL)  
SUITE 5  
5716 RODMAN STREET  
HOLLYWOOD, FL 33023

FOR: ENTERTAINMENT IN THE NATURE OF PRODUCING MUSICAL AUDIO AND VIDEO RECORDINGS, IN CLASS 41 (U.S. CLS. 100, 101 AND 107).

FIRST USE 1-12-1994; IN COMMERCE 10-11-1999.

NO CLAIM IS MADE TO THE EXCLUSIVE RIGHT TO USE "RECORDS", APART FROM THE MARK AS SHOWN.

THE COLOR(S) RED, GREEN, YELLOW, BLUE AND BLACK IS/ARE CLAIMED AS A FEATURE OF THE MARK.

THE MARK CONSISTS OF THE COLOR RED APPEARS IN THE WORDING "DROP DI BASS". THE COLOR YELLOW APPEARS IN THE WORDING "RECORDS" AND ON THE STRIPES ON THE INNER WHEEL OF THE TANK. THE TANK APPEARS IN GREEN AND BLACK. THE COLOR BLACK APPEARS ON THE OUTLINE OF THE LETTERING. THE MUSICAL NOTES CONSIST OF BLUE, GREEN AND YELLOW.

SER. NO. 77-074,580, FILED 1-2-2007.

ESTHER A. BORSUK, EXAMINING ATTORNEY



**Int. Cl.: 44**

**Prior U.S. Cls.: 100 and 101**

**United States Patent and Trademark Office**

**Reg. No. 3,465,193**

**Registered July 15, 2008**

**SERVICE MARK  
PRINCIPAL REGISTER**

**MOM MATTERS**

GATEWAY HEALTH PLAN, L.P. (PENNSYLVANIA LIMITED PARTNERSHIP)  
U.S. STEEL TOWER, 40TH FLOOR  
600 GRANT STREET  
PITTSBURGH, PA 15219

FOR: MANAGED HEALTH CARE SERVICES PROVIDED BY OTHERS IN THE FIELDS OF MATERNITY CARE, PRENATAL CARE, POST NATAL CARE AND INFANT CARE , IN CLASS 44 (U.S. CLS. 100 AND 101).

FIRST USE 1-1-1996; IN COMMERCE 1-1-1996.

THE MARK CONSISTS OF STANDARD CHARACTERS WITHOUT CLAIM TO ANY PARTICULAR FONT, STYLE, SIZE, OR COLOR.

NO CLAIM IS MADE TO THE EXCLUSIVE RIGHT TO USE "MOM", APART FROM THE MARK AS SHOWN.

SER. NO. 77-074,583, FILED 1-2-2007.

STEVEN JACKSON, EXAMINING ATTORNEY

**Int. Cl.: 33**

**Prior U.S. Cls.: 47 and 49**

**United States Patent and Trademark Office**

**Reg. No. 3,465,194**

**Registered July 15, 2008**

**TRADEMARK  
PRINCIPAL REGISTER**

**Durell Vineyards**

SAND HILL WINES, LLC (CALIFORNIA LTD  
LIAB CO)  
PO BOX 1676, 1951 FELDER RD  
SONOMA, CA 95476

NO CLAIM IS MADE TO THE EXCLUSIVE  
RIGHT TO USE "VINEYARDS", APART FROM  
THE MARK AS SHOWN.

FOR: WINE; WINES, IN CLASS 33 (U.S. CLS. 47  
AND 49).

SEC. 2(F).

FIRST USE 6-1-1985; IN COMMERCE 6-1-1985.

SER. NO. 77-075,044, FILED 1-3-2007.

THE MARK CONSISTS OF STANDARD CHAR-  
ACTERS WITHOUT CLAIM TO ANY PARTICULAR  
FONT, STYLE, SIZE, OR COLOR.

DAWN HAN, EXAMINING ATTORNEY

Int. Cl.: 9

Prior U.S. Cls.: 21, 23, 26, 36 and 38

United States Patent and Trademark Office

Reg. No. 3,465,195

Registered July 15, 2008

TRADEMARK  
PRINCIPAL REGISTER

ace antenna<sup>A</sup>

ACE ANTENNA COMPANY, INC. (CALIFORNIA CORPORATION)  
16181 SCIENTIFIC WAY #3  
IRVINE, CA 92618

FOR: CELLULAR ANTENNAS, CORDLESS TELEPHONE ANTENNAS, CB TRANSCEIVER ANTENNAS, HAND-HELD RADIO ANTENNAS, LAND MOBILE RADIO ANTENNAS, PCN ANTENNAS, PAGER ANTENNAS, AEROSPACE ANTENNAS, MARINE ANTENNAS, BOOSTER ANTENNAS, TELECOMMUNICATIONS EQUIPMENT, NAMELY, BAND PASS FILTERS, RF COMBINERS FOR CONNECTING SIGNALS FROM MULTIPLE SOURCES TO A SINGLE ANTENNA, BAND REJECT FILTERS, SATELLITE-SPIKE ANTENNAS, CELLULAR RF BAND POWER AMPLIFIERS, AUTOMOBILE CEL-

LULAR REPEATERS, WIRELESS CELLULAR AND PAGER REPEATERS, BI-DIRECTIONAL AMPLIFIERS, COAXIAL CIRCULATORS, HYBRID COUPLERS FOR COMBINING RF SIGNALS, BROAD BAND AMPLIFIERS, FERRITE ISOLATORS, BI-DIRECTIONAL AMPLIFIERS, LOW NOISE AMPLIFIERS AND LOW NOISE BLOCK DOWN CONVERTERS, IN CLASS 9 (U.S. CLS. 21, 23, 26, 36 AND 38).

FIRST USE 1-2-2005; IN COMMERCE 1-2-2005.

OWNER OF U.S. REG. NO. 1,931,164.

SER. NO. 77-075,612, FILED 1-4-2007.

JASON ROTH, EXAMINING ATTORNEY

**Int. Cl.: 6**

**Prior U.S. Cls.: 2, 12, 13, 14, 23, 25 and 50**

**Reg. No. 3,465,196**

**United States Patent and Trademark Office**

**Registered July 15, 2008**

**TRADEMARK  
PRINCIPAL REGISTER**

**ALTACHE**

ANDRELL INVESTMENTS PTY LTD (AUSTRALIA LTD LIAB CO)  
150 TOONGARRA ROAD  
IPSWICH QLD 4305, AUSTRALIA

FOR: ALUMINUM AND ALUMINUM ALLOYS IN THE FORM OF SHEETS, PLATES, STRIPS, FOILS, LAMINATES, RODS, TUBES, WIRES, EXTRUDED SHAPED SECTIONS, CASTINGS, EXTRUDED BARS, AND PANELS FOR FURTHER MANUFACTURE; METAL NAILS, METAL SCREWS, METAL RIVETS AND OTHER FASTENERS, NAMELY, METAL BOLTS, AND METAL CLIPS; METAL HANDRAILS; METAL CLADDING FOR CONSTRUCTION AND BUILDING, METAL BRACKETS FOR METAL CLADDING USED TO ATTACH THE CLADDING

TOGETHER OR TO SUPPORTS, IN CLASS 6 (U.S. CLS. 2, 12, 13, 14, 23, 25 AND 50).

THE MARK CONSISTS OF STANDARD CHARACTERS WITHOUT CLAIM TO ANY PARTICULAR FONT, STYLE, SIZE, OR COLOR.

OWNER OF AUSTRALIA REG. NO. 1121960, DATED 7-5-2006, EXPIRES 7-5-2016.

SER. NO. 77-076,040, FILED 1-4-2007.

AMOS T. MATTHEWS, JR., EXAMINING ATTORNEY

Int. Cl.: 43

Prior U.S. Cls.: 100 and 101

United States Patent and Trademark Office

Reg. No. 3,465,197

Registered July 15, 2008

SERVICE MARK  
PRINCIPAL REGISTER

*The Wine Guyz*



*Grapes, Grillin' & Gourmet*

THE WINE GUYZ (WISCONSIN CORPORATION)  
122 KING STREET  
LACROSSE, WI 54601

FOR: RESTAURANTS, IN CLASS 43 (U.S. CLS. 100  
AND 101).

FIRST USE 3-0-2005; IN COMMERCE 8-0-2005.

NO CLAIM IS MADE TO THE EXCLUSIVE  
RIGHT TO USE "GRILLING & GOURMET", APART  
FROM THE MARK AS SHOWN.

THE MARK CONSISTS OF THREE SQUARES,  
ONE WITH A BUNCH OF GRAPES, ONE WITH A  
GRILL AND ONE WITH A CHEF'S HAT. THE  
WORDS "GRAPES", "GRILLIN' & GOURMET"  
ARE UNDERNEATH THE SQUARES. "THE WINE  
GUYZ" IS AT THE TOP OF THE THREE SQUARES  
IN CURSIVE FONT.

SER. NO. 77-077,174, FILED 1-5-2007.

LAURA KOVALSKY, EXAMINING ATTORNEY

**Int. Cls.: 32 and 33**

**Prior U.S. Cls.: 45, 46, 47, 48 and 49**

**United States Patent and Trademark Office**

**Reg. No. 3,465,198**

**Registered July 15, 2008**

**TRADEMARK  
PRINCIPAL REGISTER**

**LILLI BIFFAR**

LILLI BIFFAR-HIRSCHBIL (FED REP GERMA-  
NY CORPORATION)  
AN DER ALTENBACH 29  
WACHENHEIM, FED REP GERMANY 67157

FOR: NON-ALCOHOLIC BEVERAGES, NAME-  
LY, MALT BEVERAGES, CARBONATED BEVERA-  
GES, BEVERAGES CONTAINING FRUIT JUICES,  
AND BEVERAGES WITH TEA FLAVOR; FRUIT  
JUICES; AND FRUIT BEVERAGES, IN CLASS 32  
(U.S. CLS. 45, 46 AND 48).

FOR: ALCOHOLIC BEVERAGES EXCEPT BEERS;  
WINES; DISTILLED SPIRITS; AND LIQUEURS, IN  
CLASS 33 (U.S. CLS. 47 AND 49).

THE MARK CONSISTS OF STANDARD CHAR-  
ACTERS WITHOUT CLAIM TO ANY PARTICULAR  
FONT, STYLE, SIZE, OR COLOR.

PRIORITY CLAIMED UNDER SEC. 44(D) ON FED  
REP GERMANY APPLICATION NO. 30641736.7,  
FILED 7-7-2006, REG. NO. 30641736, DATED 9-29-  
2006, EXPIRES 7-31-2016.

THE NAME "LILLI BAFFAR" IDENTIFIES A  
LIVING INDIVIDUAL WHOSE CONSENT IS OF  
RECORD.

SER. NO. 77-078,362, FILED 1-8-2007.

SUSAN LESLIE DUBOIS, EXAMINING ATTORNEY

**Int. Cl.: 9**

**Prior U.S. Cls.: 21, 23, 26, 36 and 38**

**Reg. No. 3,465,199**

**United States Patent and Trademark Office**

**Registered July 15, 2008**

**TRADEMARK  
PRINCIPAL REGISTER**

**ace technologyA**

ACE ANTENNA COMPANY, INC. (CALIFORNIA CORPORATION)  
16181 SCIENTIFIC WAY #3  
IRVINE, CA 92618

FOR: CELLULAR ANTENNAS, CORDLESS TELEPHONE ANTENNAS, CB TRANSCEIVER ANTENNAS, HAND-HELD RADIO ANTENNAS, LAND MOBILE RADIO ANTENNAS, PCN ANTENNAS, PAGER ANTENNAS, AEROSPACE ANTENNAS, MARINE ANTENNAS, BOOSTER ANTENNAS, TELECOMMUNICATIONS EQUIPMENT, NAMELY, BAND PASS FILTERS, RF COMBINERS FOR CONNECTING SIGNALS FROM MULTIPLE SOURCES TO A SINGLE ANTENNA, BAND REJECT FILTERS, SATELLITE-SPIKE ANTENNAS, CELLULAR RF BAND POWER AMPLIFIERS, AUTOMOBILE CELLULAR REPEATERS, WIRELESS CELLULAR AND

PAGER REPEATERS, BI-DIRECTIONAL AMPLIFIERS, COAXIAL CIRCULATORS, HYBRID COUPLERS FOR COMBINING RF SIGNALS, BROAD BAND AMPLIFIERS, FERRITE ISOLATORS, BI-DIRECTIONAL AMPLIFIERS, LOW NOISE AMPLIFIERS AND LOW NOISE BLOCK DOWN CONVERTERS, IN CLASS 9 (U.S. CLS. 21, 23, 26, 36 AND 38).

FIRST USE 1-2-2005; IN COMMERCE 1-2-2005.

THE MARK CONSISTS OF STANDARD CHARACTERS WITHOUT CLAIM TO ANY PARTICULAR FONT, STYLE, SIZE, OR COLOR.

SER. NO. 77-078,506, FILED 1-9-2007.

CARRIE GENOVESE, EXAMINING ATTORNEY

**Int. Cl.: 12**

**Prior U.S. Cls.: 19, 21, 23, 31, 35 and 44**

**Reg. No. 3,465,200**

**United States Patent and Trademark Office**

**Registered July 15, 2008**

**TRADEMARK  
PRINCIPAL REGISTER**

**ROCKY MOUNTAIN FORM**

GROUPE PROCYCLE INC./PROCYCLE GROUP  
INC. (CANADA CORPORATION), DBA  
ROCKY MOUNTAIN BICYCLES  
SAINT-GEORGES DE BEAUCE  
9095-25TH AVENUE  
QUEBEC, CANADA G6A1A1

FOR: BICYCLES, BICYCLE FRAMES AND BI-  
CYCLE FRAME TUBES, IN CLASS 12 (U.S. CLS. 19,  
21, 23, 31, 35 AND 44).

THE MARK CONSISTS OF STANDARD CHAR-  
ACTERS WITHOUT CLAIM TO ANY PARTICULAR  
FONT, STYLE, SIZE, OR COLOR.

PRIORITY CLAIMED UNDER SEC. 44(D) ON  
CANADA APPLICATION NO. 1327201, FILED 12-7-  
2006, REG. NO. TMA701,876, DATED 11-28-2007,  
EXPIRES 11-28-2022.

OWNER OF U.S. REG. NOS. 2,189,228 AND  
2,473,134.

SER. NO. 77-079,220, FILED 1-9-2007.

CHARLOTTE CORWIN, EXAMINING ATTORNEY



**Int. Cl.: 12**

**Prior U.S. Cls.: 19, 21, 23, 31, 35 and 44**

**United States Patent and Trademark Office**

**Reg. No. 3,465,201**

**Registered July 15, 2008**

**TRADEMARK  
PRINCIPAL REGISTER**



DOWCO, INC. (WISCONSIN CORPORATION)  
4230 CLIPPER DRIVE  
MANITOWOC, WI 54220

FOR: SPECIFICALLY-ADAPTED SIDE BAGS AND COMPARTMENTS IN THE NATURE OF SADDLEBAGS AND PANNIER BAGS FOR STORAGE OF PERSONAL ITEMS AND GEAR WHICH ATTACH TO POWER SPORTS EQUIPMENT, SUCH AS MOTORCYCLES, IN CLASS 12 (U.S. CLS. 19, 21, 23, 31, 35 AND 44).

THE MARK CONSISTS OF THE WORD "FASTRAX" WITH THE TAIL OF THE LETTER F EXTENDED TO CIRCLE THE WORD "FASTRAX" AND COMPLETE THE LETTER X, AND A STAR IN THE INSIDE OF THE UPPER RIGHT PART OF THE CIRCLE.

SER. NO. 77-079,969, FILED 1-10-2007.

FIRST USE 12-15-2006; IN COMMERCE 3-1-2007.

JENNIFER HETU, EXAMINING ATTORNEY

**Int. Cl.: 12**

**Prior U.S. Cls.: 19, 21, 23, 31, 35 and 44**

**Reg. No. 3,465,202**

**United States Patent and Trademark Office**

**Registered July 15, 2008**

**TRADEMARK  
PRINCIPAL REGISTER**

**FASTRAX**

DOWCO, INC. (WISCONSIN CORPORATION)  
4230 CLIPPER DRIVE  
MANITOWOC, WI 54220

FIRST USE 12-15-2006; IN COMMERCE 3-1-2007.

FOR: SPECIFICALLY-ADAPTED SIDE BAGS AND COMPARTMENTS IN THE NATURE OF SADDLEBAGS AND PANNIER BAGS FOR STORAGE OF PERSONAL ITEMS AND GEAR WHICH ATTACH TO POWER SPORTS EQUIPMENT, SUCH AS MOTORCYCLES, IN CLASS 12 (U.S. CLS. 19, 21, 23, 31, 35 AND 44).

THE MARK CONSISTS OF STANDARD CHARACTERS WITHOUT CLAIM TO ANY PARTICULAR FONT, STYLE, SIZE, OR COLOR.

SER. NO. 77-079,983, FILED 1-10-2007.

JENNIFER HETU, EXAMINING ATTORNEY

**Int. Cl.: 9**

**Prior U.S. Cls.: 21, 23, 26, 36 and 38**

**Reg. No. 3,465,203**

**United States Patent and Trademark Office**

**Registered July 15, 2008**

**TRADEMARK  
PRINCIPAL REGISTER**

**HILL BILLIONS**

ARISTOCRAT TECHNOLOGIES AUSTRALIA  
PTY LTD (AUSTRALIA CORPORATION)  
71 LONGUEVILLE ROAD  
LANE COVE, NSW, AUSTRALIA 2066

PRIORITY CLAIMED UNDER SEC. 44(D) ON  
AUSTRALIA APPLICATION NO. 1128716, FILED 8-  
10-2006, REG. NO. 1128716, DATED 8-10-2006, EX-  
PIRES 8-10-2016.

FOR: GAMING MACHINES; COMPUTER HARD-  
WARE; DOWNLOADABLE GAME SOFTWARE;  
ELECTRONIC GAME SOFTWARE, IN CLASS 9  
(U.S. CLS. 21, 23, 26, 36 AND 38).

SER. NO. 77-080,373, FILED 1-10-2007.

THE MARK CONSISTS OF STANDARD CHAR-  
ACTERS WITHOUT CLAIM TO ANY PARTICULAR  
FONT, STYLE, SIZE, OR COLOR.

JESSICA A. POWERS, EXAMINING ATTORNEY

**Int. Cl.: 16**

**Prior U.S. Cls.: 2, 5, 22, 23, 29, 37, 38 and 50**

**Reg. No. 3,465,204**

**United States Patent and Trademark Office**

**Registered July 15, 2008**

---

**TRADEMARK  
PRINCIPAL REGISTER**

**ATMP**

INTERNATIONAL PRESS OF BOSTON, INC.  
(MASSACHUSETTS CORPORATION)  
387 SOMERVILLE AVENUE  
SOMERVILLE, MA 02143

THE MARK CONSISTS OF STANDARD CHAR-  
ACTERS WITHOUT CLAIM TO ANY PARTICULAR  
FONT, STYLE, SIZE, OR COLOR.

FOR: PRINTED PUBLICATIONS, NAMELY,  
JOURNALS IN THE FIELD OF MATHEMATICS,  
APPLIED MATHEMATICS AND PHYSICS, IN  
CLASS 16 (U.S. CLS. 2, 5, 22, 23, 29, 37, 38 AND 50).

SER. NO. 77-080,678, FILED 1-11-2007.

FIRST USE 9-30-1997; IN COMMERCE 9-30-1997.

RENEE SERVANCE, EXAMINING ATTORNEY

**Int. Cl.: 25**

**Prior U.S. Cls.: 22 and 39**

**United States Patent and Trademark Office**

**Reg. No. 3,465,205**

**Registered July 15, 2008**

**TRADEMARK  
PRINCIPAL REGISTER**

**It's Hip To Be Green**

HAWKINS, LISA A (NORTH CAROLINA SOLE  
PROPRIETORSHIP)  
49 EVERGREEN AVE  
ASHEVILLE, NC 28806

THE MARK CONSISTS OF STANDARD CHAR-  
ACTERS WITHOUT CLAIM TO ANY PARTICULAR  
FONT, STYLE, SIZE, OR COLOR.

FOR: SHIRTS AND HATS, IN CLASS 25 (U.S. CLS.  
22 AND 39).

SER. NO. 77-081,175, FILED 1-11-2007.

FIRST USE 9-20-2006; IN COMMERCE 9-20-2006.

HEATHER BIDDULPH, EXAMINING ATTORNEY

**Int. Cl.: 9**

**Prior U.S. Cls.: 21, 23, 26, 36 and 38**

**Reg. No. 3,465,206**

**United States Patent and Trademark Office**

**Registered July 15, 2008**

**TRADEMARK  
PRINCIPAL REGISTER**

***ChloroSense***

PALINTEST LIMITED (UNITED KINGDOM LTD  
LIAB CO)  
PALINTEST HOUSE  
KINGSWAY, TEAM VALLEY  
GATESHEAD, TYNE & WEAR, ENGLAND NE110NS

FOR: WATER TESTING INSTRUMENTATION  
FOR MONITORING AND DETECTING CONTAM-  
INATION; DISPOSABLE, SINGLE-USE, SCREEN-  
PRINTED ELECTROCHEMICAL SENSOR AND AS-  
SOCIATED ELECTRONIC CONTROL UNIT, FOR  
CHEMICAL ANALYSIS OF CHLORINE RESIDUAL

IN DRINKING WATER, IN CLASS 9 (U.S. CLS. 21, 23,  
26, 36 AND 38).

PRIORITY CLAIMED UNDER SEC. 44(D) ON  
UNITED KINGDOM APPLICATION NO. 2428047,  
FILED 7-25-2006, REG. NO. 2428047, DATED 1-26-  
2007, EXPIRES 7-25-2016.

SER. NO. 77-083,544, FILED 1-16-2007.

JAMES STEIN, EXAMINING ATTORNEY

**Int. Cl.: 40**

**Prior U.S. Cls.: 100, 103 and 106**

**United States Patent and Trademark Office**

**Reg. No. 3,465,207**

**Registered July 15, 2008**

**SERVICE MARK  
PRINCIPAL REGISTER**



GREEN BAY CONVERTING, INC. (WISCONSIN CORPORATION)

P.O. BOX 12500

GREEN BAY, WI 543072500

FOR: MANUFACTURE OF ABSORBENT TISSUE PRODUCTS, NAMELY, FACIAL TISSUE, BATHROOM TISSUE, PAPER NAPKINS, PAPER TOWELS, PAPER WIPES FOR INDUSTRIAL AND COMMERCIAL USE, AND PAPER TABLE COVERS TO ORDER AND/OR SPECIFICATION OF OTHERS, IN CLASS 40 (U.S. CLS. 100, 103 AND 106).

FIRST USE 7-1-1999; IN COMMERCE 1-1-2005.

OWNER OF U.S. REG. NO. 2,866,496.

NO CLAIM IS MADE TO THE EXCLUSIVE RIGHT TO USE "GREEN BAY" AND "INC.", APART FROM THE MARK AS SHOWN.

THE MARK CONSISTS OF A DIGITAL COPY OF THE OWNER'S LETTERHEAD AS USED IN COMMERCE DEPICTING THE DESIGN AND WORDS LOCATED IN THE UPPER RIGHT-HAND CORNER OF THE OWNER'S LETTERHEAD.

SER. NO. 77-084,188, FILED 1-16-2007.

INGA ERVIN, EXAMINING ATTORNEY

**Int. Cl.: 29**

**Prior U.S. Cl.: 46**

**United States Patent and Trademark Office**

**Reg. No. 3,465,208**

**Registered July 15, 2008**

**TRADEMARK  
PRINCIPAL REGISTER**

**PANNARELLO**

MONTI TRENTINI USA LLC (ILLINOIS LTD  
LIAB CO)  
SUITE 404  
40 EAST CHICAGO AVENUE  
CHICAGO, IL 60611

THE MARK CONSISTS OF STANDARD CHAR-  
ACTERS WITHOUT CLAIM TO ANY PARTICULAR  
FONT, STYLE, SIZE, OR COLOR.

FOR: CHEESE, IN CLASS 29 (U.S. CL. 46).

SER. NO. 77-085,918, FILED 1-18-2007.

FIRST USE 1-5-2007; IN COMMERCE 1-5-2007.

JIM RINGLE, EXAMINING ATTORNEY



**Int. Cls.: 16 and 41**

**Prior U.S. Cls.: 2, 5, 22, 23, 29, 37, 38, 50, 100, 101 and 107**

**Reg. No. 3,465,209**

**United States Patent and Trademark Office**

**Registered July 15, 2008**

**TRADEMARK  
SERVICE MARK  
PRINCIPAL REGISTER**

# Adventure Quest

RENAISSANCE ADVENTURES LLC (COLORADO LTD LIAB CO)  
302 PEARL STREET  
BOULDER, CO 80302

FOR: LIVE ACTION AND TABLE TOP ROLE PLAYING GAME EQUIPMENT IN THE NATURE OF GAME BOOK MANUALS, IN CLASS 16 (U.S. CLS. 2, 5, 22, 23, 29, 37, 38 AND 50).

FIRST USE 0-0-1998; IN COMMERCE 0-0-1998.

FOR: ORGANIZATION OF LIVE ACTION AND TABLE TOP ROLE PLAYING GAMES; ENTERTAINMENT IN THE FORM OF RECREATIONAL SERVI-

CES, NAMELY, LIVE ACTION AND TABLE TOP ROLE PLAYING GAMES, IN CLASS 41 (U.S. CLS. 100, 101 AND 107).

FIRST USE 0-0-1995; IN COMMERCE 0-0-1995.

THE MARK CONSISTS OF STANDARD CHARACTERS WITHOUT CLAIM TO ANY PARTICULAR FONT, STYLE, SIZE, OR COLOR.

SER. NO. 77-086,127, FILED 1-18-2007.

REBECCA EISINGER, EXAMINING ATTORNEY

**Int. Cl.: 41**

**Prior U.S. Cls.: 100, 101 and 107**

**United States Patent and Trademark Office**

**Reg. No. 3,465,210**

**Registered July 15, 2008**

**SERVICE MARK  
PRINCIPAL REGISTER**

**Alkemé**

ELIZABETH QUINTANILLA (PERU INDIVIDUAL)  
550 E. MCKELLIPS RD., APT. 1123  
MESA, AZ 85203

FOR: ENTERTAINMENT SERVICES, NAMELY, CONCERT BOOKING IN THE NATURE OF LIVE PERFORMANCES BY MUSICAL BANDS, PRODUCTION OF SOUND AND MUSIC VIDEO RECORDINGS AND MUSIC PUBLISHING SERVICES, IN CLASS 41 (U.S. CLS. 100, 101 AND 107).

FIRST USE 12-31-2005; IN COMMERCE 12-31-2005.

THE MARK CONSISTS OF STANDARD CHARACTERS WITHOUT CLAIM TO ANY PARTICULAR FONT, STYLE, SIZE, OR COLOR.

SER. NO. 77-087,039, FILED 1-19-2007.

ANDREA BUTLER, EXAMINING ATTORNEY

**Int. Cl.: 29**

**Prior U.S. Cl.: 46**

**United States Patent and Trademark Office**

**Reg. No. 3,465,211**

**Registered July 15, 2008**

**TRADEMARK  
PRINCIPAL REGISTER**

**HOLLYWOOD**

THE DANNON COMPANY, INC. (DELAWARE  
CORPORATION)  
100 HILLSIDE AVENUE, FLOOR 3  
WHITE PLAINS, NY 106032863

FOR: YOGURT; DAIRY-BASED SNACK FOODS  
EXCLUDING ICE CREAM, ICE MILK AND FRO-  
ZEN YOGURT, IN CLASS 29 (U.S. CL. 46).

FIRST USE 4-30-2006; IN COMMERCE 4-30-2006.

THE MARK CONSISTS OF STANDARD CHAR-  
ACTERS WITHOUT CLAIM TO ANY PARTICULAR  
FONT, STYLE, SIZE, OR COLOR.

SER. NO. 77-087,056, FILED 1-19-2007.

DAVID YONTEF, EXAMINING ATTORNEY

**Int. Cl.: 30**

**Prior U.S. Cl.: 46**

**United States Patent and Trademark Office**

**Reg. No. 3,465,212**

**Registered July 15, 2008**

**TRADEMARK  
PRINCIPAL REGISTER**

**PUD'N CRÈME**

H.C. BRILL COMPANY, INC. (DELAWARE CORPORATION)  
1912 MONTREAL ROAD  
TUCKER, GA 30084

FOR: BULK FOOD MIXES FOR BAKERY GOODS; A WIDE VARIETY OF BAKERY GOODS, IN CLASS 30 (U.S. CL. 46).

FIRST USE 10-0-1994; IN COMMERCE 10-0-1994.

THE MARK CONSISTS OF STANDARD CHARACTERS WITHOUT CLAIM TO ANY PARTICULAR FONT, STYLE, SIZE, OR COLOR.

OWNER OF U.S. REG. NO. 1,845,792.

SEC. 2(F).

SER. NO. 77-087,209, FILED 1-19-2007.

SUSAN LESLIE DUBOIS, EXAMINING ATTORNEY

**Int. Cl.: 5**

**Prior U.S. Cls.: 6, 18, 44, 46, 51 and 52**

**United States Patent and Trademark Office**

**Reg. No. 3,465,213**

**Registered July 15, 2008**

**TRADEMARK  
PRINCIPAL REGISTER**

**DAIWA HEALTH DEVELOPMENT**

DAIWA HEALTH DEVELOPMENT INC. (CALIFORNIA CORPORATION)  
10866 WILSHIRE BLVD., SUITE 370  
LOS ANGELES, CA 90024

FOR: NUTRACEUTICALS FOR USE AS A DIETARY SUPPLEMENT; NUTRITIONAL AND DIETARY SUPPLEMENTS; FUNCTIONAL FOODS AND FUNCTIONAL FOOD ADDITIVES, NAMELY, DIETARY FIBER, PROCESSED RICE BRAN, ENZYMATICALLY MODIFIED RICE BRAN AND DERIVATIVES THEREOF, FERMENTED SOYBEAN EXTRACTS, DRIED PURIFIED FILTRATE OF BACILLUS SUBTILLIS NATTO CULTURE, AND NATURAL DIGESTIVE AID CONSISTING OF LACTOBACILLUS CULTURE, ALL FOR USE AS FOOD SUPPLEMENTS, IN CLASS 5 (U.S. CLS. 6, 18, 44, 46, 51 AND 52).

FIRST USE 9-0-2005; IN COMMERCE 9-0-2005.

THE MARK CONSISTS OF STANDARD CHARACTERS WITHOUT CLAIM TO ANY PARTICULAR FONT, STYLE, SIZE, OR COLOR.

NO CLAIM IS MADE TO THE EXCLUSIVE RIGHT TO USE "HEALTH DEVELOPMENT", APART FROM THE MARK AS SHOWN.

THE ENGLISH TRANSLATION OF THE WORD "DAIWA" IN THE MARK IS GREAT HARMONY.

SER. NO. 77-088,255, FILED 1-22-2007.

LINDSEY RUBIN, EXAMINING ATTORNEY

**Int. Cls.: 35, 36 and 38**

**Prior U.S. Cls.: 100, 101, 102 and 104**

**United States Patent and Trademark Office**

**Reg. No. 3,465,214**

**Registered July 15, 2008**

**SERVICE MARK  
PRINCIPAL REGISTER**

**TOSCAFUND**

TOSCAFUND LIMITED (UNITED KINGDOM  
PRIVATE LIMITED COMPANY)  
7TH FLOOR, 90 LONG ACRE  
LONDON, UNITED KINGDOM WC2E9RA

FOR: ADVERTISING; BUSINESS MANAGEMENT; BUSINESS ADMINISTRATION; BUSINESS MANAGEMENT, ASSISTANCE AND ADVISORY SERVICES; BUSINESS APPRAISAL SERVICES; MARKET SURVEY SERVICES; ECONOMIC FORECASTING, IN CLASS 35 (U.S. CLS. 100, 101 AND 102).

FOR: INFORMATION SERVICES RELATING TO STOCKS, BONDS AND COMMODITY PRICES, INDICES AND TRADED VOLUMES; STOCKS, BONDS AND COMMODITY QUOTATION SERVICES; PROVIDING STOCK MARKET INFORMATION; INVESTMENT SERVICES, NAMELY, SHARE REGISTER ANALYSIS; GLOBAL EQUITY HEDGE FUND INVESTMENT SERVICES; EQUITY SECURITIES; FINANCIAL SERVICES, NAMELY, ASSISTING OTHERS WITH THE COMPLETION OF FINANCIAL TRANSACTIONS FOR STOCKS, BONDS, SECURITIES AND EQUITIES; MUTUAL FUND INVESTMENT; PENSION VALUATION SERVICES; FINANCIAL AND CREDIT INFORMATION IN THE NATURE OF INVESTMENTS AND PRICES OF STOCKS, BONDS, SECURITIES AND EQUITIES; FINANCIAL ANALYSIS; FINANCIAL CONSULTANCY; STOCK EXCHANGE PRICE QUOTATIONS; SECURITIES BROKERAGE SERVICES; PROVIDING INFORMATION RELATING TO THE EQUITY MARKET; INVESTMENT CONSULTANCY; INVESTMENT PORTFOLIO MANAGEMENT SERVI-

CES; FINANCIAL ANALYSIS, MANAGEMENT AND ADVICE; ASSET MANAGEMENT CONSULTATION; INVESTMENT BANKING; CAPITAL INVESTMENT CONSULTATION; ADVISORY INFORMATION AND CONSULTANCY SERVICES RELATING TO ALL THE AFORESAID SERVICES; PROVIDING AN ONLINE INTERACTIVE DATABASE RELATING TO FINANCE AND INVESTMENT, IN CLASS 36 (U.S. CLS. 100, 101 AND 102).

FOR: TELECOMMUNICATION SERVICES, NAMELY, PROVISION OF ELECTRONIC MAIL SERVICES; ELECTRONIC MESSAGE TRANSMISSION; INTERNET TELEPHONY SERVICES; INTERNET SERVICE PROVIDER; PROVIDING REMOTE INTERNET ACCESS; PROVISION OF ACCESS TO DATA OR DOCUMENTS STORED ELECTRONICALLY IN CENTRAL FILES FOR REMOTE CONSULTATION, IN CLASS 38 (U.S. CLS. 100, 101 AND 104).

THE MARK CONSISTS OF STANDARD CHARACTERS WITHOUT CLAIM TO ANY PARTICULAR FONT, STYLE, SIZE, OR COLOR.

PRIORITY CLAIMED UNDER SEC. 44(D) ON ERPN CMNTY TM OFC APPLICATION NO. 005248588, FILED 8-9-2006, REG. NO. 005248588, DATED 10-29-2007, EXPIRES 8-9-2016.

SER. NO. 77-088,984, FILED 1-23-2007.

LESLEY LAMOTHE, EXAMINING ATTORNEY

**Int. Cl.: 11**

**Prior U.S. Cls.: 13, 21, 23, 31 and 34**

**United States Patent and Trademark Office**

**Reg. No. 3,465,215**

**Registered July 15, 2008**

**TRADEMARK  
PRINCIPAL REGISTER**

**Irridrator**

SPRINKLER GUYS, INC. (SOUTH DAKOTA  
CORPORATION)  
P.O. BOX 230  
BLACK HAWK, SD 57718

THE MARK CONSISTS OF STANDARD CHAR-  
ACTERS WITHOUT CLAIM TO ANY PARTICULAR  
FONT, STYLE, SIZE, OR COLOR.

FOR: IRRIGATION SPRINKLERS, IN CLASS 11  
(U.S. CLS. 13, 21, 23, 31 AND 34).

SER. NO. 77-089,255, FILED 1-23-2007.

FIRST USE 12-15-2006; IN COMMERCE 12-15-2006.

KELLY BOULTON, EXAMINING ATTORNEY

Int. Cl.: 35

Prior U.S. Cls.: 100, 101 and 102

United States Patent and Trademark Office

Reg. No. 3,465,216

Registered July 15, 2008

**SERVICE MARK  
PRINCIPAL REGISTER**



UNITED SUPERMARKETS, L.L.C. (TEXAS LTD  
LIAB CO)  
7830 ORLANDO AVENUE  
LUBBOCK, TX 794936170

FOR: RETAIL STORE SERVICES, NAMELY,  
PHARMACY, RETAIL DRUG STORE AND GENERAL  
MERCHANDISE STORE SERVICES, IN CLASS 35  
(U.S. CLS. 100, 101 AND 102).

FIRST USE 0-0-1983; IN COMMERCE 0-0-1983.

NO CLAIM IS MADE TO THE EXCLUSIVE  
RIGHT TO USE "RX" OR "PHARMACY", APART  
FROM THE MARK AS SHOWN.

THE MARK CONSISTS OF A LARGE "RX" CENTERED OVER THE WORD "MARKET" IN ALL CAPS, WHICH IS CENTERED OVER THE WORD "STREET" IN ALL CAPS, WHICH IS CENTERED OVER THE WORD "PHARMACY", IN ALL CAPS IN A SMALLER FONT. THE ENTIRE MARK IS CONTAINED IN A RECTANGLE WITH ROUNDED CORNERS, AND THE BACKGROUND OF THE PART OF THE RECTANGLE CONTAINING THE WORDS "MARKET STREET PHARMACY" IS DARKENED.

SER. NO. 77-089,681, FILED 1-24-2007.

ALYSSA PALADINO, EXAMINING ATTORNEY



**Int. Cl.: 36**

**Prior U.S. Cls.: 100, 101 and 102**

**United States Patent and Trademark Office**

**Reg. No. 3,465,217**

**Registered July 15, 2008**

---

**SERVICE MARK  
PRINCIPAL REGISTER**

**CHAMPIONS FOR KIDS**

FIFTH AVENUE OF LONG ISLAND REALTY  
ASSOCIATES (NEW YORK PARTNERSHIP)  
2110 NORTHERN BOULEVARD  
MANHASSET, NY 11030

FOR: CHARITABLE FUND RAISING SERVICES,  
IN CLASS 36 (U.S. CLS. 100, 101 AND 102).

FIRST USE 2-13-2005; IN COMMERCE 2-13-2005.

THE MARK CONSISTS OF STANDARD CHAR-  
ACTERS WITHOUT CLAIM TO ANY PARTICULAR  
FONT, STYLE, SIZE, OR COLOR.

OWNER OF U.S. REG. NO. 2,450,674.

SER. NO. 77-091,223, FILED 1-25-2007.

KIMBERLY FRYE, EXAMINING ATTORNEY

**Int. Cl.: 42**

**Prior U.S. Cls.: 100 and 101**

**United States Patent and Trademark Office**

**Reg. No. 3,465,218**

**Registered July 15, 2008**

**SERVICE MARK  
PRINCIPAL REGISTER**

# T-Mobile Max

DEUTSCHE TELEKOM AG (FED REP GERMA-  
NY CORPORATION)  
FRIEDRICH-EBERT-ALLEE 140  
BONN, FED REP GERMANY 53113

FOR: COMPUTER PROGRAMMING SERVICES FOR OTHERS; RENTAL OF COMPUTER SOFTWARE AND HARDWARE FOR ONLINE ACCESS; DATA ENCRYPTION SERVICES; APPLICATION SERVICE PROVIDER, NAMELY, HOSTING COMPUTER SOFTWARE APPLICATIONS FOR OTHERS, HOSTING OF DIGITAL CONTENT ON THE INTERNET; HOSTING THE WEBSITES OF OTHERS ON A COMPUTER SERVER FOR A GLOBAL COMPUTER NETWORK; COMPUTER SERVICES, NAMELY, CREATING INDEXES OF INFORMATION AVAILABLE ON COMPUTER NETWORKS; PROVIDING INFORMATION VIA THE TELEPHONE AND THE GLOBAL COMMUNICATION NETWORKS IN THE FIELD OF INFORMATION TECHNOLOGY; CONSULTING SERVICES IN THE FIELD OF DESIGN, SELECTION, IMPLEMENTATION AND USE OF COMPUTER HARDWARE AND SOFTWARE SYSTEMS FOR OTHERS; INSTALLATION, MAINTENANCE AND REPAIR OF COMPUTER SOFTWARE; TECHNICAL PROJECT PLANNING SERVICES RE-

LATED TO TELECOMMUNICATIONS EQUIPMENT; PROVIDING INFORMATION AT THE SPECIFIC REQUEST OF END-USERS BY MEANS OF TELEPHONE OR GLOBAL COMMUNICATIONS NETWORKS; PROVIDING TEMPORARY USE OF ONLINE NON-DOWNLOADABLE TELECOMMUNICATIONS SOFTWARE FOR PROVIDING MULTIPLE USER ACCESS TO THE GLOBAL COMPUTER NETWORK, IN CLASS 42 (U.S. CLS. 100 AND 101).

THE MARK CONSISTS OF STANDARD CHARACTERS WITHOUT CLAIM TO ANY PARTICULAR FONT, STYLE, SIZE, OR COLOR.

PRIORITY CLAIMED UNDER SEC. 44(D) ON FED REP GERMANY APPLICATION NO. 30645648638, FILED 7-26-2006, REG. NO. 30645648, DATED 3-29-2007, EXPIRES 7-31-2016.

OWNER OF U.S. REG. NOS. 2,282,432, 2,914,146 AND OTHERS.

SER. NO. 77-091,250, FILED 1-25-2007.

PAUL E. FAHRENKOPF, EXAMINING ATTORNEY

**Int. Cl.: 38**

**Prior U.S. Cls.: 100, 101 and 104**

**United States Patent and Trademark Office**

**Reg. No. 3,465,219**

**Registered July 15, 2008**

**SERVICE MARK  
PRINCIPAL REGISTER**

# T-Mobile Max

DEUTSCHE TELEKOM AG (FED REP GERMA-  
NY CORPORATION)  
FRIEDRICH-EBERT-ALLEE 140  
BONN, FED REP GERMANY 53113

FOR: TELECOMMUNICATION AND INFORMATION TECHNOLOGY SERVICES, NAMELY, ELECTRIC, DIGITAL, CELLULAR AND WIRELESS TRANSMISSION OF VOICE, DATA, INFORMATION IMAGES, SIGNALS AND MESSAGES AND TRANSMISSION OF VOICE, DATA, IMAGES, AUDIO, VIDEO AND INFORMATION VIA TELEPHONE, TELEVISION AND GLOBAL COMMUNICATION NETWORKS; PROVIDING TELECOMMUNICATIONS CONNECTIONS OVER A GLOBAL COMMUNICATIONS NETWORK, ELECTRONIC STORE-AND-FORWARD MESSAGING; RENTAL OF TELECOMMUNICATIONS EQUIPMENT, NAMELY, EQUIPMENT FOR ELECTRONIC ACCESS TO GLOBAL TELECOMMUNICATIONS NETWORK, EQUIPMENT FOR TRANSMITTING, RECEIVING, RECORDING AND MONITORING VOICE, DATA, INFORMATION IMAGES, SIGNALS, MESSAGES COMPRISED OF DATA AND WORD PROCESSORS, AND TELECOMMUNICATIONS HARDWARE COMPONENTS AND PERIPHERALS THEREOF FOR USE IN THE TELECOMMUNICATIONS INDUSTRY, AND RENTAL OF EQUIPMENT FOR TRANSMITTING, RECEIVING, RECORDING AND MONITORING COMPUTER PROGRAMS FOR USE IN OPERATING AND

ACCESSING TELECOMMUNICATIONS SYSTEMS; AUDIO AND VIDEO BROADCASTING; PROVIDING MULTIPLE-USER DIAL-UP AND DEDICATED ACCESS TO THE INTERNET; PERSONAL COMMUNICATIONS SERVICES; PAGER SERVICES; TRANSMISSION AND BROADCAST OF AUDIO AND VIDEO PROGRAMMING; LEASING OF TELECOMMUNICATIONS EQUIPMENT, COMPONENTS AND SYSTEMS; PROVIDING INFORMATION VIA THE TELEPHONE AND THE GLOBAL COMMUNICATION NETWORKS IN THE FIELD OF TELECOMMUNICATIONS; CONSULTING IN THE FIELD OF TELECOMMUNICATIONS, IN CLASS 38 (U.S. CLS. 100, 101 AND 104).

THE MARK CONSISTS OF STANDARD CHARACTERS WITHOUT CLAIM TO ANY PARTICULAR FONT, STYLE, SIZE, OR COLOR.

PRIORITY CLAIMED UNDER SEC. 44(D) ON FED REP GERMANY APPLICATION NO. 30645648638, FILED 7-26-2006, REG. NO. 30645648, DATED 3-29-2007, EXPIRES 7-31-2016.

OWNER OF U.S. REG. NOS. 2,282,432, 2,914,146 AND OTHERS.

SER. NO. 77-091,252, FILED 1-25-2007.

PAUL E. FAHRENKOPF, EXAMINING ATTORNEY

**Int. Cl.: 38**

**Prior U.S. Cls.: 100, 101 and 104**

**United States Patent and Trademark Office**

**Reg. No. 3,465,220**

**Registered July 15, 2008**

**SERVICE MARK  
PRINCIPAL REGISTER**

# T-Mobile Basix

DEUTSCHE TELEKOM AG (FED REP GERMA-  
NY CORPORATION)  
FRIEDRICH-EBERT-ALLEE 140  
BONN, FED REP GERMANY 53113

FOR: TELECOMMUNICATION AND INFORMATION TECHNOLOGY SERVICES, NAMELY, ELECTRIC, DIGITAL, CELLULAR AND WIRELESS TRANSMISSION OF VOICE, DATA, INFORMATION IMAGES, SIGNALS AND MESSAGES AND TRANSMISSION OF VOICE, DATA, IMAGES, AUDIO, VIDEO AND INFORMATION VIA TELEPHONE, TELEVISION AND GLOBAL COMMUNICATION NETWORKS; PROVIDING TELECOMMUNICATIONS CONNECTIONS OVER A GLOBAL COMMUNICATIONS NETWORK, ELECTRONIC STORE-AND-FORWARD MESSAGING; RENTAL OF TELECOMMUNICATIONS EQUIPMENT, NAMELY, EQUIPMENT FOR ELECTRONIC ACCESS TO GLOBAL TELECOMMUNICATIONS NETWORK, EQUIPMENT FOR TRANSMITTING, RECEIVING, RECORDING AND MONITORING VOICE, DATA, INFORMATION IMAGES, SIGNALS, MESSAGES COMPRISED OF DATA AND WORD PROCESSORS, AND TELECOMMUNICATIONS HARDWARE COMPONENTS AND PERIPHERALS THEREOF FOR USE IN THE TELECOMMUNICATIONS INDUSTRY, AND RENTAL OF EQUIPMENT FOR TRANSMITTING, RECEIVING, RECORDING AND MONITORING COMPUTER PROGRAMS FOR USE IN OPERATING AND

ACCESSING TELECOMMUNICATIONS SYSTEMS; AUDIO AND VIDEO BROADCASTING; PROVIDING MULTIPLE-USER DIAL-UP AND DEDICATED ACCESS TO THE INTERNET; PERSONAL COMMUNICATIONS SERVICES; PAGER SERVICES; TRANSMISSION AND BROADCAST OF AUDIO AND VIDEO PROGRAMMING; LEASING OF TELECOMMUNICATIONS EQUIPMENT, COMPONENTS AND SYSTEMS; PROVIDING INFORMATION VIA THE TELEPHONE AND THE GLOBAL COMMUNICATION NETWORKS IN THE FIELD OF TELECOMMUNICATIONS; CONSULTING IN THE FIELD OF TELECOMMUNICATIONS, IN CLASS 38 (U.S. CLS. 100, 101 AND 104).

THE MARK CONSISTS OF STANDARD CHARACTERS WITHOUT CLAIM TO ANY PARTICULAR FONT, STYLE, SIZE, OR COLOR.

PRIORITY CLAIMED UNDER SEC. 44(D) ON FED REP GERMANY APPLICATION NO. 30645649438, FILED 7-26-2006, REG. NO. 30645649, DATED 3-29-2007, EXPIRES 7-31-2016.

OWNER OF U.S. REG. NOS. 2,282,432, 2,914,146 AND OTHERS.

SER. NO. 77-091,379, FILED 1-25-2007.

PAUL E. FAHRENKOPF, EXAMINING ATTORNEY

**Int. Cl.: 36**

**Prior U.S. Cls.: 100, 101 and 102**

**United States Patent and Trademark Office**

**Reg. No. 3,465,221**

**Registered July 15, 2008**

**SERVICE MARK  
PRINCIPAL REGISTER**

# T-Mobile Basix

DEUTSCHE TELEKOM AG (FED REP GERMA-  
NY CORPORATION)  
FRIEDRICH-EBERT-ALLEE 140  
BONN, FED REP GERMANY 53113

FOR: INSURANCE SERVICES, NAMELY, INSURANCE BROKERAGE, INSURANCE CLAIMS PROCESSING; FINANCIAL SERVICES, NAMELY, CLEARING OF SECURE FINANCIAL TRANSACTIONS THROUGH ONLINE SERVICES; FINANCIAL ANALYSIS AND CONSULTATION; FINANCIAL INFORMATION PROVIDED BY ELECTRONIC MEANS; FINANCIAL INFORMATION PROCESSING; FINANCIAL PORTFOLIO MANAGEMENT; FINANCIAL SERVICES, NAMELY, FINANCIAL CONSULTATION IN THE FIELD OF FINANCIAL SECURITIES; SAFE DEPOSIT BOX SERVICES FOR THE SAFEKEEPING OF SECURITIES; FINANCIAL SPONSORSHIP OF SPORTS, EDUCATIONAL AND ENTERTAINMENT PROGRAMS AND EVENTS; COMMERCIAL LENDING SERVICES; MONETARY EXCHANGE; CREDIT CARD SERVICES; TELEPHONE CALLING CARD SERVICES; ELECTRONIC COMMERCE SERVICES, NAMELY, ELECTRONIC DEBIT AND CREDIT CARD TRANSACTION PROCESSING SERVICES, FUNDS TRANSFER AND BILL PAYMENT-PROCESSING SERVICES; DISCOUNT BROKERAGE SERVICES; SECURITY BROKERAGE; BROKERAGE IN THE FIELD OF INSURANCE, STOCKS, COMMODITIES; CUSTOM BROKERAGE FOR THIRD PARTIES IN THE FIELD OF INSURANCE, STOCKS, COMMODITIES; BROKERAGE OF SHARES AND VENTURE CAPITAL FUNDING

SERVICES TO START-UP COMPANIES; BROKERAGE OF FUND SHARES; BROKERAGE OF PRODUCTIVE INVESTMENT OF FUNDS; REAL ESTATE SERVICES, NAMELY, BROKERAGE, MANAGEMENT, LEASING, AND APPRAISAL OF REAL PROPERTY; CONSULTING SERVICES RELATING TO INSURANCE SERVICES, NAMELY, PROVIDING INFORMATION AND BROKERAGE OF INSURANCES IN THE FIELD OF HOME INSURANCE, ACCIDENT INSURANCE AND HEALTH INSURANCE; CONSULTING SERVICES RELATING TO BANK SERVICES; PROVIDING INFORMATION VIA THE TELEPHONE AND THE GLOBAL COMMUNICATION NETWORKS IN THE FIELD OF FINANCE, IN CLASS 36 (U.S. CLS. 100, 101 AND 102).

THE MARK CONSISTS OF STANDARD CHARACTERS WITHOUT CLAIM TO ANY PARTICULAR FONT, STYLE, SIZE, OR COLOR.

PRIORITY CLAIMED UNDER SEC. 44(D) ON FED REP GERMANY APPLICATION NO. 30645649438, FILED 7-26-2006, REG. NO. 30645649, DATED 3-29-2007, EXPIRES 7-31-2016.

OWNER OF U.S. REG. NOS. 2,282,432, 2,914,146 AND OTHERS.

SER. NO. 77-091,380, FILED 1-25-2007.

PAUL E. FAHRENKOPF, EXAMINING ATTORNEY

**Int. Cl.: 9**

**Prior U.S. Cls.: 21, 23, 26, 36 and 38**

**Reg. No. 3,465,222**

**United States Patent and Trademark Office**

**Registered July 15, 2008**

**TRADEMARK  
PRINCIPAL REGISTER**

# T-Mobile Basix

DEUTSCHE TELEKOM AG (FED REP GERMA-  
NY CORPORATION)  
FRIEDRICH-EBERT-ALLEE 140  
BONN, FED REP GERMANY 53113

FOR: ELECTRIC, ELECTRONIC, OPTICAL, MEASURING, SIGNALING, CONTROLLING AND TEACHING APPARATUS AND INSTRUMENTS, ALL FOR USE WITH TELECOMMUNICATIONS, NAMELY, APPARATUS FOR PRODUCING SOUND, IMAGES OR DATA; BLANK MAGNETIC AND OPTICAL DATA CARRIERS; DATA PROCESSORS; COMPUTERS, NAMELY, MICROCOMPUTERS, MINICOMPUTERS, COMPUTER CENTRAL PROCESSORS, COMPUTER MONITORS, COMPUTER KEYBOARDS, COMPUTER TERMINALS, COMPUTER MEMORIES, COMPUTER LASER PRINTERS, COMPUTER IMPACT PRINTERS, COMPUTER DOT MATRIX PRINTERS, COMPUTERS AND INSTRUCTIONAL MANUALS SOLD AS A UNIT; COMPUTER MEMORY HARDWARE; COMPUTER INTERFACE APPARATUS, NAMELY, COMPUTER INTERFACE BOARDS, COMPUTER MOUSE AND MOUSE PAD, COMPUTER PERIPHERALS AND PARTS THEREOF; COMPUTER SOFTWARE PROGRAMS FOR USE IN OPERATING TELECOMMUNICATIONS AND BUSINESS MANAGEMENT SYSTEMS AND RELATED INSTRUCTION MANUALS SOLD AS A UNIT; COMPUTER SOFTWARE FOR FINANCIAL ACCOUNTING, FOR THE PROVISION OF ONLINE INFORMATION SERVICES IN THE FIELD OF NEWS, SPORTS, ENTERTAINMENT, CULTURE, BUSINESS AND FINANCE, WEATHER AND TRAVEL, NETWORK MANAGEMENT, COMPUTER PROXY, FOR CONTROLLING ACCESS AND ALARM MONITORING OF HOMES, APARTMENTS, BUILDINGS AND OTHER PROPERTIES, BILLING ANALYSIS, NETWORK ACCESS CONTROL AND FOR CREATING AND MAINTAINING FIREWALLS; COMPUTER SOFTWARE PROGRAMS FOR ACCESSING A GLOBAL COMPUTER NETWORK AND INTERACTIVE COMPUTER COM-

MUNICATIONS NETWORKS; OPTICAL FIBERS SOLD AS A COMPONENT OF FIBER OPTICAL CABLES; FIBER OPTIC CABLES; OPTICAL SCANNERS; OPTICAL CHARACTER READERS; OPTICAL BLANK DISCS; OPTICAL GLASS FOR SIGNAL TRANSMISSION; OPTIC TRANSMITTERS FOR RADIO, TELEPHONE; OPTIC RECEIVERS FOR TELEPHONE, AUDIO, VIDEO; OPTICAL SIGNAL PROCESSORS; OPTIC TELECOMMUNICATIONS SWITCHES; OPTICAL ATTENUATORS; OPTICAL AMPLIFIERS; OPTICAL CHARACTER RECOGNITION APPARATUS, FOR USE IN THE TELECOMMUNICATIONS FIELD, AND PARTS THEREOF; TELEPHONE LOCAL AREA NETWORKS; TELECOMMUNICATION AUDIO, VIDEO AND DATA COMMUNICATIONS SYSTEMS, NAMELY, DIGITAL AND ANALOGUE SIGNAL TRANSMITTERS; RECEIVERS AND CONVERTERS FOR USE WITH TELEPHONE, AUDIO, VIDEO; RADIO AND TELEPHONE TRANSMITTERS; COMMUNICATION RECEIVERS AND SERVERS FOR TELEPHONE, AUDIO, VIDEO; TELEPHONE ANSWERING MACHINES; TELEPROMPTERS; TELETYPEWRITERS AND PARTS THEREOF, NAMELY, CALLER IDENTIFICATION BOXES, DIALING ASSEMBLIES, TELEPHONE UNITS, AUDIO OPERATED RELAYS, AUDIO/VIDEO SIGNAL AND OPTICAL FILTERS, PROTECTORS AND AUTOMATIC SIGNALING AND CONTROL EQUIPMENT, TELEMETERS, WIRELESS AND CELLULAR TELEPHONES, AND RADIO PAGERS; INTERCOMS; FACSIMILE MACHINE; ELECTRONIC MAIL APPARATUS FOR ELECTRONIC EXCHANGE OF DATA IMAGES AND MESSAGES; ELECTRICAL WIRE; ELECTRICAL WIRE CONNECTORS; INTEGRATED CIRCUITS; PRINTED CIRCUITS; ELECTRIC CIRCUITS; CIRCUIT BREAKERS; PRINTED CIRCUIT BOARDS; CIRCUIT CONNECTORS; ELECTRICAL CONTROLLERS; ELECTRICAL CONVERTERS; ELECTRICAL CONDUCTORS; ELECTRICAL FUSES; ELECTRIC LUMINESCENT DISPLAY PANELS; ELECTRICAL SWITCH PLATES;

ELECTRIC PLUGS; ELECTRIC COILS; ANTENNAS; ELECTRICAL CABLES; COMPUTER CABLES; COMPUTER CHIPS; SILICON CHIPS; CHRONOGRAPHS FOR USE AS SPECIALIZED TIME RECORDING APPARATUS; COMPUTER BUFFERS; BLANK COMPUTER DISCS; BLANK COMPUTER FLOPPY DISKS; COMPUTER HARD DISCS; ACOUSTIC CONDUITS; ELECTRICAL CONDUITS; FIBER OPTIC CONDUITS AND PARTS THEREOF; COMPACT DISC PLAYERS; AUDIO AND VIDEO TAPE RECORDERS; AUDIO AND VIDEOTAPE PLAYERS; AUDIO AND VIDEOCASSETTE RECORDERS; AUDIO AND VIDEOCASSETTE PLAYERS; BLANK AUDIO AND VIDEOTAPES, CASSETTES, DISCS AND MICROFICHE; AUDIO AND VIDEO TAPES, CASSETTES, DISCS AND MICROFICHE FEATURING INFORMATION CONCERNING TELECOMMUNICATIONS, AND CONCERNING PERSONAL AND BUSINESS MANAGEMENT SYSTEMS; AUDIO AND VIDEO RECORDINGS IN THE FIELD OF TELECOMMUNICATIONS, INFORMATION TECHNOLOGY AND SAFETY; TELEVISION AND TELEVISION PERIPHERAL EQUIPMENT, NAMELY, CAMERAS, SET TOP BOXES, REMOTE CONTROL UNITS FOR INTERACTIVE AND NON-INTERACTIVE USE; VIDEO MONITORS; AUTOMATIC VENDING MACHINES AND TIMING MECHANISMS THEREFOR AND PARTS THEREOF; MACHINE READABLE, MAGNETICALLY ENCODED CARDS, NAMELY, PREPAID TELEPHONE CALLING CARDS AND CREDIT CARDS; BLANK SMART CARDS; MAGNETIC CODED CARD READERS; DATA PROCESSORS AND READERS; WORD PROCESSORS; MICROPROCESSORS; ELECTRONIC ENCRYPTION UNITS; DEMAGNETIZERS FOR MAGNETIC TAPES AND PARTS THEREOF; LASERS NOT FOR MEDICAL USE; LIGHT EMITTING DIODES; LIGHT EMITTING DIODE DISPLAYS; COMPUTER, DATA AND VIDEO NETWORKING AND CONFERENCING EQUIPMENT, NAMELY, TELECONFERENCING EQUIPMENT AND AUDIO-VISUAL TEACHING EQUIPMENT IN THE NATURE OF OVERHEAD FILM, PHOTOGRAPHIC AND

SLIDE PROJECTORS; PROJECTION SCREENS; COMPUTER BASED INFORMATION DISPLAY EQUIPMENT, NAMELY, COMPUTERS WHICH DISPLAY INFORMATION ON AN OVERHEAD SCREEN; PORTABLE DEVICES, NAMELY, LAPTOPS, HANDHELD AND POCKET COMPUTERS, WIRELESS FAX MACHINES; PERSONAL COMMUNICATIONS EQUIPMENT, NAMELY, PERSONAL DIGITAL ASSISTANTS; CALCULATORS AND RELATED PERIPHERALS; SATELLITE PROCESSORS, SATELLITE AND SATELLITE COMMUNICATION EARTH STATIONS BOTH STATIONARY AND MOVEABLE; COMPUTER GAME PROGRAMS FOR CHILDREN AND ADULTS; VIDEO AND COMPUTER GAME CARTRIDGES; AUDIO AND VIDEO RECORDINGS IN THE FIELD OF NEWS, SPORTS, ENTERTAINMENT, CULTURE, BUSINESS AND FINANCE, WEATHER AND TRAVEL; PRE-RECORDED COMPACT DISCS, AUDIOCASSETTE TAPES, VIDEOCASSETTE TAPES, DIGITAL AUDIO-TAPES AND DIGITAL VIDEO DISCS FEATURING MUSICAL, VARIETY, NEWS AND COMEDY SHOWS; CARRYING CASES FOR POCKET CALCULATORS AND CELLPHONES; TELECOMMUNICATIONS SOFTWARE, IN CLASS 9 (U.S. CLS. 21, 23, 26, 36 AND 38).

THE MARK CONSISTS OF STANDARD CHARACTERS WITHOUT CLAIM TO ANY PARTICULAR FONT, STYLE, SIZE, OR COLOR.

PRIORITY CLAIMED UNDER SEC. 44(D) ON FED REP GERMANY APPLICATION NO. 30645649438, FILED 7-26-2006, REG. NO. 30645649, DATED 3-29-2007, EXPIRES 7-31-2016.

OWNER OF U.S. REG. NOS. 2,282,432, 2,914,146 AND OTHERS.

SER. NO. 77-091,384, FILED 1-25-2007.

PAUL E. FAHRENKOPF, EXAMINING ATTORNEY

**Int. Cl.: 35**

**Prior U.S. Cls.: 100, 101 and 102**

**United States Patent and Trademark Office**

**Reg. No. 3,465,223**

**Registered July 15, 2008**

**SERVICE MARK  
PRINCIPAL REGISTER**

**HORSELIFE**

WESTERN-ENGLISH TRADE ASSOCIATION  
(COLORADO CORPORATION)

#4323

451 EAST 48TH AVENUE  
DENVER, CO 80216

FOR: PROMOTING PUBLIC AWARENESS OF  
HORSE RELATED ACTIVITIES AND HUMAN IN-  
VOLVEMENT IN HORSE RELATED ACTIVITIES,  
IN CLASS 35 (U.S. CLS. 100, 101 AND 102).

FIRST USE 11-0-2005; IN COMMERCE 11-0-2005.

THE MARK CONSISTS OF STANDARD CHAR-  
ACTERS WITHOUT CLAIM TO ANY PARTICULAR  
FONT, STYLE, SIZE, OR COLOR.

SER. NO. 77-091,847, FILED 1-26-2007.

JAY BESCH, EXAMINING ATTORNEY



**Int. Cl.: 36**

**Prior U.S. Cls.: 100, 101 and 102**

**United States Patent and Trademark Office**

**Reg. No. 3,465,224**

**Registered July 15, 2008**

**SERVICE MARK  
PRINCIPAL REGISTER**

**INVISTA**

INVISTA REAL ESTATE INVESTMENT MAN-  
AGEMENT LIMITED (UNITED KINGDOM  
LIMITED COMPANY)

EXCHEQUER COURT

33 ST. MARY AXE

LONDON, ENGLAND EC3A 8AA

FOR: REAL ESTATE INVESTMENT FUND MAN-  
AGEMENT SERVICES, IN CLASS 36 (U.S. CLS. 100,  
101 AND 102).

THE MARK CONSISTS OF STANDARD CHAR-  
ACTERS WITHOUT CLAIM TO ANY PARTICULAR  
FONT, STYLE, SIZE, OR COLOR.

PRIORITY CLAIMED UNDER SEC. 44(D) ON  
UNITED KINGDOM APPLICATION NO. 2432293,  
FILED 9-12-2006, REG. NO. 2432293, DATED 9-12-  
2006, EXPIRES 9-12-2016.

SER. NO. 77-092,358, FILED 1-26-2007.

NAPOLEON SHARMA, EXAMINING ATTORNEY

Int. Cl.: 30

Prior U.S. Cl.: 46

United States Patent and Trademark Office

Reg. No. 3,465,225

Registered July 15, 2008

TRADEMARK  
PRINCIPAL REGISTER

SWEET ARAYSSI

ARAYSSI INC. (NEW YORK CORPORATION)  
7216 5TH AVENUE  
BROOKLYN, NY 11209

FOR: MIDDLE EASTERN PASTRIES AND BAKERY GOODS, NAMELY, BAKLAWA (HONEY AND CASHEW OR PISTACHIO NUT BARS LAYERED IN FILO DOUGH), BURMA (SHREDDED FILO DOUGH WRAPPED AROUND CASHEW OR PISTACHIO NUTS, FRIED), KOLWSHKOR (LAYERED FILO DOUGH STUFFED WITH CASHEW OR PISTACHIO NUTS), BIRDS NESTS (LAYERED FILO DOUGH FILLED WITH CASHEW OR PISTACHIO NUTS), BALLORIA (SHREDDED FILO DOUGH BARS FILLED WITH PISTACHIO NUTS AND ROSEWATER), HADAF (HONEY AND WALNUT BARS LAYERED IN FILO DOUGH), MAAMOUL MADD (WALNUT ALMOND CAKE), SEFOUF (SAFFRON SEMOLINA CAKE), NAMMOURA (COCONUT SEMOLINA CAKE), GHORAYBE (COOKIE), MESHABAK MACARON AWAMEH (SEMOLINA DONUTS WITH ANISE SEED), KANAFE CHEESE (SWEET SEMOLINA LAYERED WITH CHEESE AND SYRUP), HALAWET EL JIBN (SEMOLINA WITH SWEETENED CURD CHEESE AND CREAM), OSMALLIA (LAYERED SHREDDED FILO DOUGH WITH

CREAM FILLING), MAFROUKE (SEMOLINA AND NUTS SWEETENED WITH CREAM), AICHEL SE-RAIL (BREAD SOAKED IN ORANGE WATER WITH A CREAM FILLING), KATAYEF (SOFT CREAM-FILLED PANCAKE), CHAABIYAT (FILO DOUGH CAKES WITH ORANGE CREAM AND PISTACHIO FILLING), HALAWET EL JIBN (ROLLED FILO DOUGH CAKE STUFFED WITH CREAM AND CHEESE), KELLAJ (CREAM-FILLED RICE PAPER PANCAKE, FRIED), MINI MAAMOUL (SMALL WALNUT ALMOND CAKE), IN CLASS 30 (U.S. CL. 46).

FIRST USE 1-25-1994; IN COMMERCE 1-25-1994.

THE MARK CONSISTS OF STANDARD CHARACTERS WITHOUT CLAIM TO ANY PARTICULAR FONT, STYLE, SIZE, OR COLOR.

NO CLAIM IS MADE TO THE EXCLUSIVE RIGHT TO USE "SWEET", APART FROM THE MARK AS SHOWN.

SER. NO. 77-093,765, FILED 1-29-2007.

MARK SPARACINO, EXAMINING ATTORNEY

**Int. Cl.: 42**

**Prior U.S. Cls.: 100 and 101**

**United States Patent and Trademark Office**

**Reg. No. 3,465,226**

**Registered July 15, 2008**

**SERVICE MARK  
PRINCIPAL REGISTER**

**TRIALSTAT**

TRIALSTAT CORPORATION (CANADA CORPORATION)  
44 BYWARD MARKET SQUARE, SUITE 270  
OTTAWA, ONTARIO, CANADA K1N7A2

FOR: ON-LINE WEB BASED PLATFORM FEATURING HOSTED SOFTWARE FOR MANAGING WORK FLOW, DOCUMENTS, AND DATA USED IN RELATION TO EVALUATING RESEARCH RESULTS IN ALL DISCIPLINES, NAMELY, SYSTEMATIC REVIEWS OF RESEARCH WORK, IN CLASS 42 (U.S. CLS. 100 AND 101).

THE MARK CONSISTS OF STANDARD CHARACTERS WITHOUT CLAIM TO ANY PARTICULAR FONT, STYLE, SIZE, OR COLOR.

PRIORITY CLAIMED UNDER SEC. 44(D) ON CANADA APPLICATION NO. 1331884, FILED 1-18-2007, REG. NO. TMA704,419, DATED 1-11-2008, EXPIRES 1-11-2023.

SER. NO. 77-095,028, FILED 1-30-2007.

MARGARET POWER, EXAMINING ATTORNEY

**Int. Cl.: 35**

**Prior U.S. Cls.: 100, 101 and 102**

**United States Patent and Trademark Office**

**Reg. No. 3,465,227**

**Registered July 15, 2008**

**SERVICE MARK  
PRINCIPAL REGISTER**



MOVIE CLIPS, INC. (FLORIDA CORPORATION)  
9240 BONITA BEACH ROAD, STE 3300  
BONITA SPRINGS, FL 34135

FOR: DIRECT MAIL ADVERTISING; DIRECT  
MARKETING ADVERTISING FOR OTHERS, IN  
CLASS 35 (U.S. CLS. 100, 101 AND 102).

FIRST USE 7-18-2005; IN COMMERCE 7-18-2005.

NO CLAIM IS MADE TO THE EXCLUSIVE  
RIGHT TO USE "MOVIE CLIPS", APART FROM  
THE MARK AS SHOWN.

THE MARK CONSISTS OF THE WORDS "MOVIE  
CLIPS" ON A STRIP OF FILM.

SER. NO. 77-095,731, FILED 1-31-2007.

JOSETTE BEVERLY, EXAMINING ATTORNEY

**Int. Cl.: 3**

**Prior U.S. Cls.: 1, 4, 6, 50, 51 and 52**

**Reg. No. 3,465,228**

**United States Patent and Trademark Office**

**Registered July 15, 2008**

---

**TRADEMARK  
PRINCIPAL REGISTER**

**THE HOLY MUD COMPANY**

THE HOLY MUD COMPANY (FLORIDA CORPORATION)

12 PARADISE LANE

TREASURE ISLAND, FL 33706

FOR: BODY AND FACIAL MASKS, IN CLASS 3  
(U.S. CLS. 1, 4, 6, 50, 51 AND 52).

FIRST USE 1-1-2004; IN COMMERCE 1-1-2004.

THE MARK CONSISTS OF STANDARD CHARACTERS WITHOUT CLAIM TO ANY PARTICULAR FONT, STYLE, SIZE, OR COLOR.

NO CLAIM IS MADE TO THE EXCLUSIVE RIGHT TO USE "MUD COMPANY", APART FROM THE MARK AS SHOWN.

SER. NO. 77-095,733, FILED 1-31-2007.

JOSETTE BEVERLY, EXAMINING ATTORNEY

Int. Cl.: 36

Prior U.S. Cls.: 100, 101 and 102

United States Patent and Trademark Office

Reg. No. 3,465,229

Registered July 15, 2008

SERVICE MARK  
PRINCIPAL REGISTER



REAL ESTATE INVESTORS NETWORK, LLC  
(COLORADO LTD LIAB CO)  
5650 GREENWOOD PLAZA BLVD. #144  
GREENWOOD VILLAGE, CO 80111

THE COLOR(S) BLUE, WHITE, GREEN, YELLOW, ORANGE AND BLACK IS/ARE CLAIMED AS A FEATURE OF THE MARK.

FOR: ADVICE RELATING TO INVESTMENTS IN THE FIELD OF REAL ESTATE; FINANCIAL INVESTMENT IN THE FIELD OF REAL ESTATE; FINANCIAL SERVICES, NAMELY, MORTGAGE PLANNING; FINANCIAL VALUATION OF PERSONAL PROPERTY AND REAL ESTATE; INVESTMENT ADVICE IN THE FIELD OF REAL ESTATE; INVESTMENT ADVISORY SERVICES IN THE FIELD OF REAL ESTATE; INVESTMENT BY ELECTRONIC MEANS IN THE FIELD OF REAL ESTATE; INVESTMENT CLUBS IN THE FIELD OF REAL ESTATE; INVESTMENT CONSULTATION IN THE FIELD OF REAL ESTATE; MORTGAGE BROKERAGE; MORTGAGE LENDING; MORTGAGE PROCUREMENT FOR OTHERS; MORTGAGE SERVICES, NAMELY, BUYER PRE-QUALIFICATION OF MORTGAGES FOR MORTGAGE BROKERS AND BANKS; OPERATING MARKETPLACES FOR SELLERS OF GOODS AND/OR SERVICES IN THE FIELD OF REAL ESTATE; REAL ESTATE CONSULTANCY; REAL ESTATE CONSULTATION; REAL ESTATE CONSULTATION; REAL ESTATE LISTING; REAL ESTATE MANAGEMENT CONSULTATION; REAL ESTATE PROCUREMENT FOR OTHERS; REAL ESTATE SERVICES, NAMELY, RENTAL OF VACATION HOMES, CONDOMINIUMS, CABINS, AND VILLAS USING PAY PER CLICK ADVERTISING ON A GLOBAL COMPUTER NETWORK; REAL ESTATE VALUATION SERVICES; REAL ESTATE VALUATIONS, IN CLASS 36 (U.S. CLS. 100, 101 AND 102).

THE MARK CONSISTS OF: FOUR ARROWS POINTING OUTWARD IN THE FORM OF A COMPASS EACH AT 90 DEGREE ANGLES FROM THE OTHER AND ALL CONNECTED AT THE BASE. EACH ARROW RESEMBLES A HOUSE. THE ARROW LOGO IS SLIGHTLY LARGER THAN THE WORDING. THE NORTH FACING ARROW (HOUSE) IS BLUE AND HAS A SMALL DOOR-LIKE CUT OUT THAT IS THE COLOR WHITE AND IS ONE-THIRD THE WIDTH OF THE NORTH FACING ARROW (HOUSE). THE EAST FACING ARROW (HOUSE) IS GREEN AND POINTS DIRECTLY AT THE MIDDLE OF THE WORD MARK REINUSA. THE SOUTH FACING ARROW (HOUSE) IS YELLOW, AND THE NORTHWEST CORNER OF THE SOUTH ARROW (HOUSE) BEGINS AT THE SOUTHWEST CORNER OF THE CUT OUT DOOR OF THE NORTH FACING ARROW (HOUSE). THE WEST FACING ARROW (HOUSE) IS ORANGE AND SLIGHTLY LOWER THAN THE EAST FACING ARROW (HOUSE). THE WORD MARK "REINUSA" IS COMPOSED IN BOLD TYPE FACE. THE "R" IS CAPITALIZED AND ALL OTHER LETTERS ARE LOWER CASE. THE LETTERS "R", "E", "I", AND "N" ARE WRITTEN IN STANDARD BLACK FONT. THE LETTERS "U", "S", AND "A" ARE A BLUE COLOR THAT MATCHES THE COLOR OF THE NORTH FACING ARROW.

FIRST USE 4-2-2006; IN COMMERCE 4-2-2006.

SER. NO. 77-095,981, FILED 1-31-2007.

NO CLAIM IS MADE TO THE EXCLUSIVE RIGHT TO USE "USA", APART FROM THE MARK AS SHOWN.

TRACY WHITTAKER-BROWN, EXAMINING ATTORNEY

Int. Cl.: 41

Prior U.S. Cls.: 100, 101 and 107

United States Patent and Trademark Office

Reg. No. 3,465,230

Registered July 15, 2008

SERVICE MARK  
PRINCIPAL REGISTER



COLLEGE DIRECTIONS, LLC (NEW YORK LTD  
LIAB CO)  
SUITE 208  
1010 NORTHERN BLVD.  
GREAT NECK, NY 11021

FOR: EDUCATIONAL CONSULTING SERVICES,  
NAMELY, ASSISTING AND ADVISING STUDENTS  
IN PREPARING FOR, SELECTING AND APPLYING  
TO COLLEGES, SECONDARY SCHOOLS AND  
GRADUATE SCHOOLS, IN CLASS 41 (U.S. CLS.  
100, 101 AND 107).

FIRST USE 5-1-2004; IN COMMERCE 5-1-2004.

NO CLAIM IS MADE TO THE EXCLUSIVE  
RIGHT TO USE "COLLEGE" AND "LLC", APART  
FROM THE MARK AS SHOWN.

THE MARK CONSISTS OF AN OUTLINE OF A  
SOMEWHAT PLAYFUL VERSION OF A COLLEGE-  
CAMPUS TYPE BUILDING. UNDERNEATH THE  
BUILDING THE WORDS "COLLEGE DIRECTIONS,  
LLC" APPEAR IN CAPITAL LETTERS. UNDER-  
NEATH ARE THE WORDS "ADVICE AND SUP-  
PORT FOR YOUR EDUCATIONAL JOURNEY".

SER. NO. 77-096,066, FILED 1-31-2007.

STEVEN PEREZ, EXAMINING ATTORNEY

Int. Cl.: 41

Prior U.S. Cls.: 100, 101 and 107

United States Patent and Trademark Office

Reg. No. 3,465,231

Registered July 15, 2008

SERVICE MARK  
PRINCIPAL REGISTER



SNOW SUMMIT SKI CORPORATION (CALIFORNIA CORPORATION)  
PO BOX 77, 880 SUMMIT BLVD.  
BIG BEAR LAKE, CA 92315

FOR: PROVIDING FACILITIES FOR RECREATION ACTIVITIES, NAMELY, A SPORTING AND ENTERTAINMENT DESTINATION THAT PROVIDES ENTERTAINMENT AND RECREATIONAL SERVICES FOR YEAR-ROUND SPORTING ACTIVITIES, NAMELY, SKIING AND SNOWBOARDING; PROVIDING SLOPES FOR RECREATIONAL SKIING AND SNOWBOARDING; ARRANGING AND CONDUCTING SKI AND SNOWBOARD COMPETITIONS, RACES, EXHIBITIONS AND SHOWS; OFFERING SKI RENTALS, SKI INSTRUCTION, AND SNOWBOARDING CAMP, IN CLASS 41 (U.S. CLS. 100, 101 AND 107).

FIRST USE 10-11-2002; IN COMMERCE 10-11-2002.

OWNER OF U.S. REG. NO. 1,545,722.

NO CLAIM IS MADE TO THE EXCLUSIVE RIGHT TO USE "PARK", APART FROM THE MARK AS SHOWN.

THE MARK CONSISTS OF A STYLIZED "THE PARK BEAR MOUNTAIN" WITH "PARK" BEING CENTERED AND IN LARGER FONT. THESE STYLIZED WORDS ARE PLACED OVER TWO U-SHAPED PATTERNS WHEREIN A CLAW IS CENTERED ON THE TOP PORTION OF THE PATTERN.

SER. NO. 77-096,518, FILED 2-1-2007.

NAPOLEON SHARMA, EXAMINING ATTORNEY



**Int. Cls.: 7 and 37**

**Prior U.S. Cls.: 13, 19, 21, 23, 31, 34, 35, 100, 103 and 106**

**Reg. No. 3,465,232**

**United States Patent and Trademark Office**

**Registered July 15, 2008**

**TRADEMARK  
SERVICE MARK  
PRINCIPAL REGISTER**

•  
synèrgy

THYSSENKRUPP ELEVATOR AG (FED REP GERMANY CORPORATION)  
AUGUST-THYSSEN-STR. 1  
DUSSELDORF, FED REP GERMANY 40211

FOR: HYDRAULICALLY, PNEUMATICALLY, ELECTRICALLY AND MACHINE OPERATED ELEVATORS, ESCALATORS, PASSENGER CONVEYORS, MOVING WALKWAYS, PASSENGER-BOARDING BRIDGES, AND TRACTION ELEVATORS FOR PERSONS, GOODS AND LOADS, IN CLASS 7 (U.S. CLS. 13, 19, 21, 23, 31, 34 AND 35).

FOR: INSTALLATION, REPAIR AND MAINTENANCE OF TECHNICAL BUILDING FACILITIES, NAMELY, HYDRAULICALLY, PNEUMATICALLY,

ELECTRICALLY AND MACHINE OPERATED ELEVATORS, ESCALATORS, PASSENGER CONVEYORS, MOVING WALKWAYS, PASSENGER-BOARDING BRIDGES, AND TRACTION ELEVATORS FOR PERSONS, GOODS AND LOADS, IN CLASS 37 (U.S. CLS. 100, 103 AND 106).

PRIORITY CLAIMED UNDER SEC. 44(D) ON FED REP GERMANY APPLICATION NO. 30648277.0, FILED 8-4-2006, REG. NO. 30648277, DATED 8-4-2006, EXPIRES 8-31-2016.

SER. NO. 77-096,550, FILED 2-1-2007.

DOMINICK J. SALEMI, EXAMINING ATTORNEY

**Int. Cl.: 35**

**Prior U.S. Cls.: 100, 101 and 102**

**United States Patent and Trademark Office**

**Reg. No. 3,465,233**

**Registered July 15, 2008**

**SERVICE MARK  
PRINCIPAL REGISTER**

**NOISEBOT**

SPEKIS, BRIAN D (PENNSYLVANIA SOLE PROPRIETORSHIP)  
P.O. BOX 11531  
PITTSBURGH, PA 15238

THE MARK CONSISTS OF STANDARD CHARACTERS WITHOUT CLAIM TO ANY PARTICULAR FONT, STYLE, SIZE, OR COLOR.

FOR: ON-LINE RETAIL STORE SERVICES FEATURING APPAREL, NAMELY, T-SHIRTS, HOODED SWEATSHIRTS AND TOTE BAGS, IN CLASS 35 (U.S. CLS. 100, 101 AND 102).

SER. NO. 77-097,420, FILED 2-1-2007.

FIRST USE 11-1-2005; IN COMMERCE 11-1-2005.

AISHA CLARKE, EXAMINING ATTORNEY

**Int. Cl.: 9**

**Prior U.S. Cls.: 21, 23, 26, 36 and 38**

**United States Patent and Trademark Office**

**Reg. No. 3,465,234**

**Registered July 15, 2008**

**TRADEMARK  
PRINCIPAL REGISTER**

**DATAVIEW360**

GDS LINK LLC (TEXAS LTD LIAB CO)  
5646 MILTON STREET, SUITE 207  
DALLAS, TX 75206

THE MARK CONSISTS OF STANDARD CHAR-  
ACTERS WITHOUT CLAIM TO ANY PARTICULAR  
FONT, STYLE, SIZE, OR COLOR.

FOR: COMPUTER SOFTWARE FOR CREDIT  
DATA AGGREGATION AND SCORING, IN CLASS  
9 (U.S. CLS. 21, 23, 26, 36 AND 38).

SER. NO. 77-097,571, FILED 2-2-2007.

FIRST USE 2-2-2007; IN COMMERCE 2-2-2007.

JUSTINE D. PARKER, EXAMINING ATTORNEY

**Int. Cl.: 35**

**Prior U.S. Cls.: 100, 101 and 102**

**United States Patent and Trademark Office**

**Reg. No. 3,465,235**

**Registered July 15, 2008**

**SERVICE MARK  
PRINCIPAL REGISTER**



PHILLIP LENTINI (UNITED STATES INDIVIDUAL)  
SUITE 125  
13762 WEST STATE ROAD 84  
DAVIE, FL 33325

FOR: ADVERTISING VIA ELECTRONIC MEDIA AND SPECIFICALLY THE INTERNET; DISSEMINATION OF ADVERTISING FOR OTHERS VIA THE INTERNET; FACILITATING THE EXCHANGE OF NEEDED INFORMATION FOR FINANCIAL COMPENSATION VIA THE INTERNET; PROVIDING A SEARCHABLE ONLINE ADVERTISING GUIDE FEATURING THE GOODS AND SERVICES OF OTHER ON-LINE VENDORS ON THE INTERNET;

PROVIDING AND RENTAL OF ADVERTISING SPACE ON THE INTERNET, IN CLASS 35 (U.S. CLS. 100, 101 AND 102).

FIRST USE 4-29-2006; IN COMMERCE 4-29-2006.

NO CLAIM IS MADE TO THE EXCLUSIVE RIGHT TO USE "GEAR BY OWNER" AND "877-601-GEAR", APART FROM THE MARK AS SHOWN.

SER. NO. 77-097,583, FILED 2-2-2007.

ERNEST SHOSHO, EXAMINING ATTORNEY

**Int. Cls.: 9 and 41**

**Prior U.S. Cls.: 21, 23, 26, 36, 38, 100, 101 and 107**

**Reg. No. 3,465,236**

**United States Patent and Trademark Office**

**Registered July 15, 2008**

**TRADEMARK  
SERVICE MARK  
PRINCIPAL REGISTER**

**Nina**

TOLINS, NINA MARIE (UNITED STATES INDIVIDUAL)  
C/O MAGICSONG PRODUCTIONS, INC.  
138 BAYVIEW AVENUE  
PORT WASHINGTON, NY 11050

FOR: PRE-RECORDED CDS, VIDEO TAPES, LASER DISKS AND DVDS ALL OF THE FOREGOING FEATURING MUSIC BY A RECORDING ARTIST, IN CLASS 9 (U.S. CLS. 21, 23, 26, 36 AND 38).

FIRST USE 1-1-2004; IN COMMERCE 1-1-2004.

FOR: ENTERTAINMENT IN THE NATURE OF LIVE PERFORMANCES BY A MUSICAL ARTIST, IN CLASS 41 (U.S. CLS. 100, 101 AND 107).

FIRST USE 8-22-2004; IN COMMERCE 8-22-2004.

THE MARK CONSISTS OF STANDARD CHARACTERS WITHOUT CLAIM TO ANY PARTICULAR FONT, STYLE, SIZE, OR COLOR.

THE NAME(S), PORTRAIT(S), AND/OR SIGNATURE(S) SHOWN IN THE MARK IDENTIFIES A LIVING FEMALE INDIVIDUAL, WHOSE CONSENT(S) TO REGISTER IS MADE OF RECORD.

SEC. 2(F).

SER. NO. 77-098,734, FILED 2-4-2007.

BERYL GARDNER, EXAMINING ATTORNEY

**Int. Cl.: 7**

**Prior U.S. Cls.: 13, 19, 21, 23, 31, 34 and 35**

**United States Patent and Trademark Office**

**Reg. No. 3,465,237**

**Registered July 15, 2008**

**TRADEMARK  
PRINCIPAL REGISTER**



ITS RENTAL AND SALES, INC. (TEXAS CORPORATION)

5847 SAN FELIPE, SUITE 4375  
HOUSTON, TX 77057

FOR: WELL DRILLING MACHINES; WELL DRILLING EQUIPMENT FOR USE IN THE OIL AND GAS INDUSTRIES, NAMELY, POWER DRILL BITS FOR METAL DRILLING, COUPLINGS FOR MACHINES, MILLING-DRILLING MACHINES, AND WHIPSTOCKS, IN CLASS 7 (U.S. CLS. 13, 19, 21, 23, 31, 34 AND 35).

FIRST USE 0-0-1986; IN COMMERCE 0-0-1986.

THE COLOR(S) ORANGE, WHITE AND BLUE IS/ ARE CLAIMED AS A FEATURE OF THE MARK.

THE MARK CONSISTS OF THE COLOR ORANGE, WHICH APPEARS IN THE LARGE CIRCLE, WHITE APPEARS IN THE LETTERING "ITS" AND THE CIRCLE ABOVE THE LETTER "I", AND THE COLOR BLUE APPEARS IN THE CURVED BAND AROUND THE BOTTOM HALF OF THE CIRCLE.

SER. NO. 77-100,972, FILED 2-6-2007.

REBECCA POVARCHUK, EXAMINING ATTORNEY

Int. Cl.: 25

Prior U.S. Cls.: 22 and 39

United States Patent and Trademark Office

Reg. No. 3,465,238

Registered July 15, 2008

TRADEMARK  
PRINCIPAL REGISTER

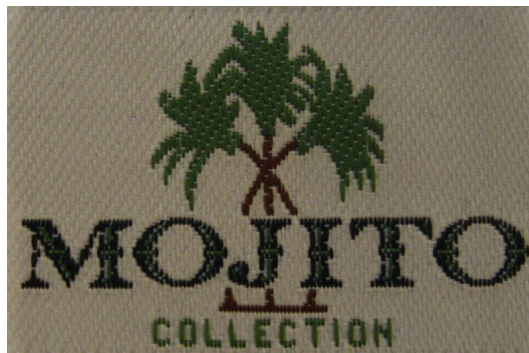

NATURAL COLLECTION, CORP. (CALIFORNIA CORPORATION)  
2277 EAST 16TH STREET  
LOS ANGELES, CA 90021

FOR: BLOUSES; BUTTON-FRONT ALOHA SHIRTS; CAMP SHIRTS; CAPRI PANTS; CARGO PANTS; DENIM JACKETS; DENIMS; DOWN JACKETS; DRESS SHIELDS; DRESS SHIRTS; DRESS SUITS; DRESSES; DRESSES MADE FROM SKINS; DRESSING GOWNS; EVENING DRESSES; FISHERMEN'S JACKETS; FUR COATS AND JACKETS; FUR JACKETS; GOLF SHIRTS; HEAVY JACKETS; JACKET LINERS; JACKETS; JOGGING PANTS; KNIT SHIRTS; LEATHER JACKETS; LEATHER PANTS; LIGHT-REFLECTING JACKETS; LONG JACKETS; MEN AND WOMEN JACKETS, COATS, TROUSERS, VESTS; NIGHT SHIRTS; NON-DISPOSABLE CLOTH TRAINING PANTS; NURSE DRESSES; NURSE PANTS; OPEN-NECKED SHIRTS; PANTS; PETTI-PANTS; PIQUE SHIRTS; PLEATED SKIRTS FOR FORMAL KIMONOS (HAKAMA); POLO SHIRTS; RAIN JACKETS; RAINPROOF JACKETS; SHIRT FRONTS; SHIRT YOKES; SHIRTS; SHIRTS FOR SUITS; SHORT-SLEEVED OR LONG-SLEEVED T-SHIRTS; SHORT-SLEEVED SHIRTS; SKI JACKETS; SKI PANTS; SKIRT SUITS; SKIRTS; SKIRTS AND DRESSES; SLEEP SHIRTS; SLEEVED OR SLEEVELESS JACKETS; SMOKING JACKETS; SNOW PANTS; SNOWBOARD PANTS; SPORT SHIRTS; SPORTS JACKETS; SPORTS SHIRTS; SPORTS

SHIRTS WITH SHORT SLEEVES; STUFF JACKETS; SUEDE JACKETS; SWEAT PANTS; SWEAT SHIRTS; T-SHIRTS; TAP PANTS; TOBOGGAN HATS, PANTS AND CAPS; TRACK PANTS; WATERPROOF JACKETS AND PANTS; WEDDING DRESSES; WIND RESISTANT JACKETS; WIND SHIRTS; WIND-JACKETS; WOMEN'S CEREMONIAL DRESSES, IN CLASS 25 (U.S. CLS. 22 AND 39).

FIRST USE 5-19-2006; IN COMMERCE 5-19-2006.

NO CLAIM IS MADE TO THE EXCLUSIVE RIGHT TO USE "COLLECTION", APART FROM THE MARK AS SHOWN.

THE COLOR(S) GREEN, BROWN AND TAN IS/ ARE CLAIMED AS A FEATURE OF THE MARK.

THE COLOR(S) GREEN AND BROWN APPEAR IN THE DESIGN ELEMENTS OF THE PALM TREES BELOW WHICH IS LOCATED THE WORDING "MOJITO" IN BROWN BELOW WHICH IS LOCATED THE WORDING "COLLECTION" IN GREEN AND ALL THE DESIGN ELEMENT(S) AND WORDING APPEAR AGAINST A TAN RECTANGLE.

SER. NO. 77-101,859, FILED 2-7-2007.

NAPOLEON SHARMA, EXAMINING ATTORNEY

**Int. Cl.: 41**

**Prior U.S. Cls.: 100, 101 and 107**

**United States Patent and Trademark Office**

**Reg. No. 3,465,239**

**Registered July 15, 2008**

**SERVICE MARK  
PRINCIPAL REGISTER**

**Sisters: Take Charge**

HEBNI NUTRITION CONSULTANTS, INC.  
(FLORIDA CORPORATION)  
4630 S. KIRKMAN ROAD, SUITE 201  
ORLANDO, FL 32811

FOR: EDUCATION SERVICES, NAMELY, PROVIDING SEMINARS, WORKSHOPS AND CLASSES IN THE FIELD OF HEALTH EDUCATION, IN CLASS 41 (U.S. CLS. 100, 101 AND 107).

FIRST USE 12-15-2003; IN COMMERCE 3-1-2004.

THE MARK CONSISTS OF STANDARD CHARACTERS WITHOUT CLAIM TO ANY PARTICULAR FONT, STYLE, SIZE, OR COLOR.

THE FOREIGN WORDING IN THE MARK TRANSLATES INTO ENGLISH AS EBONY.

SEC. 2(F).

SER. NO. 77-102,479, FILED 2-8-2007.

LINDA POWELL, EXAMINING ATTORNEY



**Int. Cl.: 12**

**Prior U.S. Cls.: 19, 21, 23, 31, 35 and 44**

**Reg. No. 3,465,240**

**United States Patent and Trademark Office**

**Registered July 15, 2008**

**TRADEMARK  
PRINCIPAL REGISTER**

**BOROUGHSH**

GRUPE PROCYCLE INC./PROCYCLE GROUP  
INC. (CANADA CORPORATION), DBA  
ROCKY MOUNTAIN BICYCLES  
SAINT-GEORGES DE BEAUCE  
9095-25TH AVENUE  
QUEBEC, CANADA G6A1A1

PRIORITY CLAIMED UNDER SEC. 44(D) ON  
CANADA APPLICATION NO. 1332566, FILED 1-24-  
2007, REG. NO. TMA704,975, DATED 1-18-2008, EX-  
PIRES 1-18-2023.

FOR: BICYCLES AND BICYCLE FRAMES, IN  
CLASS 12 (U.S. CLS. 19, 21, 23, 31, 35 AND 44).

SER. NO. 77-102,943, FILED 2-8-2007.

THE MARK CONSISTS OF STANDARD CHAR-  
ACTERS WITHOUT CLAIM TO ANY PARTICULAR  
FONT, STYLE, SIZE, OR COLOR.

JOHN E. MICHOS, EXAMINING ATTORNEY

**Int. Cl.: 7**

**Prior U.S. Cls.: 13, 19, 21, 23, 31, 34 and 35**

**United States Patent and Trademark Office**

**Reg. No. 3,465,241**

**Registered July 15, 2008**

**TRADEMARK  
PRINCIPAL REGISTER**



VALLEY-TODECO, INC. (CALIFORNIA CORPORATION)  
12975 BRADLEY AVENUE  
SYLMAR, CA 91342

OWNER OF U.S. REG. NO. 1,058,213.

FOR: SPHERICAL BEARINGS FOR USE IN AIR-CRAFT ENGINES, IN CLASS 7 (U.S. CLS. 13, 19, 21, 23, 31, 34 AND 35).

THE MARK CONSISTS OF THE LETTER "T" SURROUNDED BY THE LETTER "V".

SER. NO. 77-104,155, FILED 2-9-2007.

FIRST USE 6-7-1975; IN COMMERCE 6-7-1975.

ESTHER BELENKER, EXAMINING ATTORNEY

**Int. Cls.: 6 and 7**

**Prior U.S. Cls.: 2, 12, 13, 14, 19, 21, 23, 25, 31, 34, 35  
and 50**

**Reg. No. 3,465,242**

**United States Patent and Trademark Office**

**Registered July 15, 2008**

**TRADEMARK  
PRINCIPAL REGISTER**



VALLEY-TODECO, INC. (CALIFORNIA CORPORATION)

12975 BRADLEY AVENUE

SYLMAR, CA 91342

FOR: METAL FASTENERS, NAMELY, BOLTS, NAILS, RIVETS, SCREWS, NUTS AND WASHERS, IN CLASS 6 (U.S. CLS. 2, 12, 13, 14, 23, 25 AND 50).

FIRST USE 0-0-1970; IN COMMERCE 0-0-1970.

FOR: SPHERICAL BEARINGS FOR USE IN AIRCRAFT ENGINES, IN CLASS 7 (U.S. CLS. 13, 19, 21, 23, 31, 34 AND 35).

FIRST USE 0-0-1970; IN COMMERCE 0-0-1970.

THE MARK CONSISTS OF THE LETTER "T" WITHIN THE LETTER "V".

SER. NO. 77-104,179, FILED 2-9-2007.

ESTHER BELENKER, EXAMINING ATTORNEY

**Int. Cl.: 19**

**Prior U.S. Cls.: 1, 12, 33 and 50**

**United States Patent and Trademark Office**

**Reg. No. 3,465,243**

**Registered July 15, 2008**

**TRADEMARK  
PRINCIPAL REGISTER**

**SOF-LOC**

TILE GRUPO AMERICA, INC. (TEXAS CORPORATION)  
450 SOUTH RONALD REAGAN BLVD.  
ORLANDO, FL 327505405

THE MARK CONSISTS OF STANDARD CHARACTERS WITHOUT CLAIM TO ANY PARTICULAR FONT, STYLE, SIZE, OR COLOR.

FOR: FLOORING UNDERLAYMENTS, IN CLASS 19 (U.S. CLS. 1, 12, 33 AND 50).

SER. NO. 77-104,745, FILED 2-12-2007.

FIRST USE 10-1-2006; IN COMMERCE 10-1-2006.

JOHN GARTNER, EXAMINING ATTORNEY

**Int. Cl.: 25**

**Prior U.S. Cls.: 22 and 39**

**United States Patent and Trademark Office**

**Reg. No. 3,465,244**

**Registered July 15, 2008**

**TRADEMARK  
PRINCIPAL REGISTER**

**VERRADO**

DMB WHITE TANK, LLC (ARIZONA LTD LIAB  
CO)  
7600 E. DOUBLETREE RANCH ROAD, SUITE 300  
SCOTTSDALE, AZ 85258

FOR: CLOTHING, NAMELY, T-SHIRTS, SPORT  
SHIRTS, JACKETS, HATS, SWEATERS, FOOT-  
WEAR, SHORTS, PANTS, WARM UP SUITS, HEAD-  
BANDS, WRIST BANDS, DRESS SHIRTS, POLO  
SHIRTS AND VISORS, IN CLASS 25 (U.S. CLS. 22  
AND 39).

FIRST USE 2-0-2004; IN COMMERCE 2-0-2004.

THE MARK CONSISTS OF STANDARD CHAR-  
ACTERS WITHOUT CLAIM TO ANY PARTICULAR  
FONT, STYLE, SIZE, OR COLOR.

OWNER OF U.S. REG. NOS. 2,849,391, 3,181,460  
AND OTHERS.

SER. NO. 77-104,907, FILED 2-12-2007.

APRIL ROACH, EXAMINING ATTORNEY

**Int. Cls.: 6 and 7**

**Prior U.S. Cls.: 2, 12, 13, 14, 19, 21, 23, 25, 31, 34, 35  
and 50**

**Reg. No. 3,465,245**

**United States Patent and Trademark Office**

**Registered July 15, 2008**

**TRADEMARK  
PRINCIPAL REGISTER**

**VT**

VALLEY-TODECO, INC. (CALIFORNIA CORPORATION)  
12975 BRADLEY AVENUE  
SYLMAR, CA 91342

FOR: METAL FASTENERS, NAMELY, BOLTS, NAILS, RIVETS, SCREWS, NUTS AND WASHERS, IN CLASS 6 (U.S. CLS. 2, 12, 13, 14, 23, 25 AND 50).

FIRST USE 9-21-1979; IN COMMERCE 9-21-1979.

FOR: SPHERICAL BEARINGS FOR USE IN AIRCRAFT ENGINES, IN CLASS 7 (U.S. CLS. 13, 19, 21, 23, 31, 34 AND 35).

FIRST USE 9-21-1979; IN COMMERCE 9-21-1979.

THE MARK CONSISTS OF STANDARD CHARACTERS WITHOUT CLAIM TO ANY PARTICULAR FONT, STYLE, SIZE, OR COLOR.

OWNER OF U.S. REG. NO. 1,058,213.

SER. NO. 77-105,071, FILED 2-12-2007.

ESTHER BELENKER, EXAMINING ATTORNEY

**Int. Cls.: 11, 17, 22 and 24**

**Prior U.S. Cls.: 1, 2, 5, 7, 12, 13, 19, 21, 22, 23, 31, 34, 35, 42 and 50**

**Reg. No. 3,465,246**

**United States Patent and Trademark Office**

**Registered July 15, 2008**

**TRADEMARK  
PRINCIPAL REGISTER**

**ABC INDUSTRIES**

ABC INDUSTRIES, INC. (INDIANA CORPORATION)  
P.O. BOX 77  
WARSAW, IN 46581

FOR: DUCTS FOR VENTILATING MINES AND TUNNELS, AND FOR HEATING, VENTILATING AND AIR CONDITIONING IN COMMERCIAL AND INDUSTRIAL INSTALLATIONS, IN CLASS 11 (U.S. CLS. 13, 21, 23, 31 AND 34).

FIRST USE 10-10-1998; IN COMMERCE 10-10-1998.

FOR: PLASTIC TUBING FOR VENTILATING MINES AND TUNNELS, AND FOR HEATING, VENTILATING AND AIR CONDITIONING IN COMMERCIAL AND INDUSTRIAL INSTALLATIONS, IN CLASS 17 (U.S. CLS. 1, 5, 12, 13, 35 AND 50).

FIRST USE 10-10-1989; IN COMMERCE 10-10-1989.

FOR: INDUSTRIAL TEXTILE CLOTH, NAMELY, BRATTICE CLOTH, IN CLASS 22 (U.S. CLS. 1, 2, 7, 19, 22, 42 AND 50).

FIRST USE 10-10-1989; IN COMMERCE 10-10-1989.

FOR: INDUSTRIAL TEXTILE CLOTH, NAMELY, MULTIPLE-PLY FABRICS SOLD IN ROLL-GOOD FORM FOR USE IN THE MANUFACTURE OF BAGS, CURTAINS, TENTS, UPHOLSTERY AND OTHER RELATED USES, IN CLASS 24 (U.S. CLS. 42 AND 50).

FIRST USE 10-10-1989; IN COMMERCE 10-10-1989.

THE MARK CONSISTS OF STANDARD CHARACTERS WITHOUT CLAIM TO ANY PARTICULAR FONT, STYLE, SIZE, OR COLOR.

OWNER OF U.S. REG. NO. 1,767,820.

NO CLAIM IS MADE TO THE EXCLUSIVE RIGHT TO USE "INDUSTRIES" , APART FROM THE MARK AS SHOWN.

SER. NO. 77-105,941, FILED 2-13-2007.

CYNTHIA SLOAN, EXAMINING ATTORNEY

**Int. Cls.: 9 and 35**

**Prior U.S. Cls.: 21, 23, 26, 36, 38, 100, 101 and 102**

**United States Patent and Trademark Office**

**Reg. No. 3,465,247**

**Registered July 15, 2008**

**TRADEMARK  
SERVICE MARK  
PRINCIPAL REGISTER**

# TRADEMOTION

INTELLIGENTZ CORPORATION (DELAWARE CORPORATION)  
115 E. 5TH STREET, SUITE 200  
AUSTIN, TX 78701

FOR: COMPUTER E-COMMERCE SOFTWARE TO ALLOW USERS TO PERFORM ELECTRONIC BUSINESS TRANSACTIONS VIA A GLOBAL COMPUTER NETWORK; COMPUTER SOFTWARE FOR MANAGING LOGISTICS VIA A GLOBAL COMMUNICATION NETWORK IN THE FIELD OF INFORMATION TECHNOLOGY, INCLUDING SUPPORT, CALL TRACKING, JOB SCHEDULING, SERVICE MANAGEMENT, PROCUREMENT, INVENTORY CONTROL, ASSET TRACKING, SERVICE LEVEL AGREEMENT NOTIFICATIONS AND WARNINGS, PROJECT MANAGEMENT AND PROJECT MANAGEMENT AND EXECUTION, IN CLASS 9 (U.S. CLS. 21, 23, 26, 36 AND 38).

FIRST USE 6-28-2000; IN COMMERCE 6-28-2000.

FOR: PROCURING OF CONTRACTS FOR THE PURCHASE OF REPAIR SERVICES AND REPLACEMENT PARTS BETWEEN REPAIR SHOPS AND INSURANCE AGENCIES; ORDER FULFILLMENT SERVICES; SALES VOLUME TRACKING FOR OTHERS; COMPUTERIZED ON-LINE ORDERING SERVICES IN THE FIELD OF AUTOMOTIVE PARTS; ELECTRONIC CATALOG SERVICES FEATURING AUTOMOTIVE PARTS; ONLINE AUCTION SERVICES, IN CLASS 35 (U.S. CLS. 100, 101 AND 102).

FIRST USE 6-28-2000; IN COMMERCE 6-28-2000.

THE MARK CONSISTS OF STANDARD CHARACTERS WITHOUT CLAIM TO ANY PARTICULAR FONT, STYLE, SIZE, OR COLOR.

SER. NO. 77-106,398, FILED 2-13-2007.

KATHERINE E. HALMEN, EXAMINING ATTORNEY



**Int. Cls.: 6 and 7**

**Prior U.S. Cls.: 2, 12, 13, 14, 19, 21, 23, 25, 31, 34, 35  
and 50**

**Reg. No. 3,465,248**

**United States Patent and Trademark Office**

**Registered July 15, 2008**

**TRADEMARK  
PRINCIPAL REGISTER**



VALLEY-TODECO, INC. (CALIFORNIA CORPORATION)  
12975 BRADLEY AVENUE  
SYLMAR, CA 91342

FIRST USE 9-21-1979; IN COMMERCE 9-21-1979.

OWNER OF U.S. REG. NO. 1,058,213.

FOR: METAL FASTENERS, NAMELY, BOLTS, NAILS, RIVETS, SCREWS, NUTS AND WASHERS, IN CLASS 6 (U.S. CLS. 2, 12, 13, 14, 23, 25 AND 50).

THE MARK CONSISTS OF THE LETTER "T" POSITIONED ABOVE THE LETTER "V".

FIRST USE 9-21-1979; IN COMMERCE 9-21-1979.

SER. NO. 77-106,508, FILED 2-13-2007.

FOR: SPHERICAL BEARINGS FOR USE IN AIR-CRAFT ENGINES, IN CLASS 7 (U.S. CLS. 13, 19, 21, 23, 31, 34 AND 35).

ESTHER BELENKER, EXAMINING ATTORNEY

**Int. Cls.: 35 and 41**

**Prior U.S. Cls.: 100, 101, 102 and 107**

**United States Patent and Trademark Office**

**Reg. No. 3,465,249**

**Registered July 15, 2008**

**SERVICE MARK  
PRINCIPAL REGISTER**

**WINE MADE EASY**

DROWN CORP. (NEW YORK CORPORATION)  
14 STRAFFORD COURT  
EAST AMHERST, NY 14051

FOR: ON-LINE RETAIL STORE SERVICES FEATURING WINE; RETAIL WINE STORE SERVICES; PROMOTING THE SALE OF WINE OF OTHERS THROUGH THE USE OF IN-STORE DISPLAYS, POINT OF SALE MATERIALS, PRINTED PROMOTIONAL MATERIALS, CATALOGS, AND WEBSITE DISPLAYS; PROVIDING RETAIL WINE AND LIQUOR STORES ADVERTISING, MARKETING AND PROMOTIONAL SERVICES, NAMELY, DEVELOPMENT OF ADVERTISING AND MARKETING CAMPAIGNS FOR PRINT, WEB DESIGN, AND VIDEO; ADVERTISING, MARKETING AND PROMOTION SERVICES OF SPECIAL EVENTS CONCERNING WINE, WINE REGIONS, WINERIES AND VINEYARDS, WINE AND FOOD PAIRINGS, AND ENTERTAINING, IN CLASS 35 (U.S. CLS. 100, 101 AND 102).

FIRST USE 7-7-1998; IN COMMERCE 7-7-1998.

FOR: CONDUCTING ENTERTAINMENT EXHIBITIONS IN THE NATURE OF WINE FESTIVALS AND EVENTS THAT FEATURE WINE TASTINGS AND WINE AND FOOD TASTINGS; EDUCATION-

AL SERVICES, NAMELY, PROVIDING COURSES OF INSTRUCTION AND SEMINARS IN WINE SELECTION, WINE EVALUATION, WINE ETIQUETTE, ENTERTAINING, WINE REGIONS, WINERIES AND VINEYARDS, AND WINE AND FOOD PAIRINGS; ORGANIZING AND CONDUCTING ENTERTAINMENT EXHIBITIONS THAT FEATURE WINE AND CULINARY DEMONSTRATIONS, IN CLASS 41 (U.S. CLS. 100, 101 AND 107).

FIRST USE 7-7-1998; IN COMMERCE 7-7-1998.

THE MARK CONSISTS OF STANDARD CHARACTERS WITHOUT CLAIM TO ANY PARTICULAR FONT, STYLE, SIZE, OR COLOR.

OWNER OF U.S. REG. NO. 2,528,835.

NO CLAIM IS MADE TO THE EXCLUSIVE RIGHT TO USE "WINE", APART FROM THE MARK AS SHOWN.

SER. NO. 77-107,444, FILED 2-14-2007.

REBECCA POVARCHUK, EXAMINING ATTORNEY

**Int. Cl.: 32**

**Prior U.S. Cls.: 45, 46 and 48**

**Reg. No. 3,465,250**

**United States Patent and Trademark Office**

**Registered July 15, 2008**

**TRADEMARK  
PRINCIPAL REGISTER**

# Glacial Milk

GLACIA NOVA, LLC (NEVADA LTD LIAB CO)  
SUITE 2247  
311 W THIRD STREET  
CARSON CITY, NV 89703

FOR: BOTTLED GLACIAL WATER, IN CLASS 32  
(U.S. CLS. 45, 46 AND 48).

FIRST USE 8-24-1997; IN COMMERCE 8-24-1997.

THE MARK CONSISTS OF STANDARD CHARACTERS WITHOUT CLAIM TO ANY PARTICULAR FONT, STYLE, SIZE, OR COLOR.

NO CLAIM IS MADE TO THE EXCLUSIVE RIGHT TO USE "GLACIAL", APART FROM THE MARK AS SHOWN.

SER. NO. 77-107,929, FILED 2-15-2007.

HOWARD B. LEVINE, EXAMINING ATTORNEY

**Int. Cls.: 35, 38 and 41**

**Prior U.S. Cls.: 100, 101, 102, 104 and 107**

**United States Patent and Trademark Office**

**Reg. No. 3,465,251**

**Registered July 15, 2008**

**SERVICE MARK  
PRINCIPAL REGISTER**

# DTM POWER

DTM NETWORK, LLC (NEW YORK LTD LIAB  
CO)  
104 SMITH AVENUE  
KINGSTON, NY 12401

FOR: PROMOTING MOTORSPORTS AND AUTO-  
MOTIVE EVENTS, IN CLASS 35 (U.S. CLS. 100, 101  
AND 102).

FIRST USE 2-14-2007; IN COMMERCE 2-14-2007.

FOR: PROVIDING ONLINE BULLETIN BOARDS  
FOR TRANSMISSION OF MESSAGES AMONG  
COMPUTER USERS CONCERNING AUTOMO-  
BILES, MOTORSPORTS AND AUTOMOTIVE  
EVENTS, AND REGIONAL DISCUSSIONS OF AU-  
TOMOBILES, MOTORSPORTS AND AUTOMOTIVE  
EVENTS, AND GENERAL INTEREST, IN CLASS 38  
(U.S. CLS. 100, 101 AND 104).

FIRST USE 10-30-2001; IN COMMERCE 10-30-2001.

FOR: PROVIDING ONLINE INFORMATION IN  
THE FIELD OF MOTORSPORTS EVENTS, SHOWS,  
RALLIES, DRIVES AND MEETS; ENTERTAIN-  
MENT SERVICES, NAMELY, PROVIDING A WEB-  
SITE FEATURING PHOTOGRAPHIC, AUDIO,  
VIDEO AND PROSE PRESENTATIONS FEATUR-  
ING AUTOMOBILES AND MOTORSPORTS, IN  
CLASS 41 (U.S. CLS. 100, 101 AND 107).

FIRST USE 10-30-2001; IN COMMERCE 10-30-2001.

THE MARK CONSISTS OF STANDARD CHAR-  
ACTERS WITHOUT CLAIM TO ANY PARTICULAR  
FONT, STYLE, SIZE, OR COLOR.

SER. NO. 77-108,058, FILED 2-15-2007.

ANDREA K. NADELMAN, EXAMINING ATTOR-  
NEY

**Int. Cl.: 28**

**Prior U.S. Cls.: 22, 23, 38 and 50**

**United States Patent and Trademark Office**

**Reg. No. 3,465,252**

**Registered July 15, 2008**

**TRADEMARK  
PRINCIPAL REGISTER**



MARUSHINKOGYO KABUSHIKIKAISHA (JAPAN KABUSHIKI KAISHA)  
NO. 9-35, 3-CHOME, LIZUKA, KAWAGUCHI-SHI  
SAITAMA-KEN, JAPAN

FOR: TOY PISTOLS, WAX FOR SKIS, AMUSEMENT GAME MACHINES; TOYS FOR DOMESTIC PETS, DOLLS, GO GAMES, JAPANESE CHESS, DICE, JAPANESE DICE GAMES, DICE CUPS, CHESS GAMES, CHECKERS, CHECKER SETS, DOMINOES, PLAYING CARDS, JAPANESE PLAYING CARDS, MAH-JONG, BILLIARD GAME PLAYING EQUIPMENT, AND FISHING TACKLE, IN CLASS 28 (U.S. CLS. 22, 23, 38 AND 50).

OWNER OF JAPAN REG. NO. 4652155, DATED 3-14-2003, EXPIRES 3-14-2013.

NO CLAIM IS MADE TO THE EXCLUSIVE RIGHT TO USE "8MMBB", APART FROM THE MARK AS SHOWN.

"THE COLOR(S) RED AND BLACK IS/ARE CLAIMED AS A FEATURE OF THE MARK."

"THE MARK CONSISTS OF A HIGHLY STYLIZED DESIGN OF THE TERM "8MMBB" SHOWN IN BLACK AND IN A BUBBLE FORMAT WITH A NON-COLORED SURROUNDING AREA THAT IS IN TURN OUTLINED IN BLACK. THE TERM "8MMBB" IS SUPERIMPOSED OVER A DETAILED BULLS-EYE TYPE DESIGN DISPLAYING AT LEAST THREE BLACK CONCENTRIC CIRCLES THAT ARE FURTHER SURROUNDED BY NON-COLORED CIRCLE SPACING. THE OUTERMOST CONCENTRIC CIRCLE IS SHOWN IN RED, AS ARE THE TRIANGULAR DESIGNS POINT FROM ABOVE AND BELOW THE DESIGN."

SER. NO. 77-108,401, FILED 2-15-2007.

MARLENE BELL, EXAMINING ATTORNEY

Int. Cl.: 30

Prior U.S. Cl.: 46

United States Patent and Trademark Office

Reg. No. 3,465,253

Registered July 15, 2008

TRADEMARK  
PRINCIPAL REGISTER



LINGHAM & SON (MALAYSIA) SDN. BHD.  
(MALAYSIA CORPORATION)  
47400 PETALING JAYA  
25B, JALAN 21/56B, DAMANSARA UTAMA  
SELANGOR DARUL EHSAN, MALAYSIA 011321

THE MARK CONSISTS OF TWO BANNERS EN-  
CLOSING 5 STARS EACH AND BETWEEN THE  
BANNERS, AN INVERTED SHIELD WITH FOUR  
HEARTS SEPARATED BY A HORIZONTAL BAR.

FOR: SAUCES, CHILI SAUCES, IN CLASS 30 (U.S.  
CL. 46).

SER. NO. 77-108,683, FILED 2-15-2007.

FIRST USE 0-0-1908; IN COMMERCE 7-17-1992.

MARK T. MULLEN, EXAMINING ATTORNEY

**Int. Cl.: 36**

**Prior U.S. Cls.: 100, 101 and 102**

**United States Patent and Trademark Office**

**Reg. No. 3,465,254**

**Registered July 15, 2008**

**SERVICE MARK  
PRINCIPAL REGISTER**



SOUTHERN UNITED FIRE INSURANCE COMPANY (ALABAMA CORPORATION)  
ONE SOUTHERN WAY  
MOBILE, AL 36619

FOR: INSURANCE SERVICES, NAMELY, WRITING PROPERTY AND CASUALTY INSURANCE, IN CLASS 36 (U.S. CLS. 100, 101 AND 102).

FIRST USE 8-16-1993; IN COMMERCE 8-16-1993.

THE COLOR(S) NAVY BLUE IS/ARE CLAIMED AS A FEATURE OF THE MARK.

THE MARK CONSIST OF THE WORDS "SOUTHERN UNITED", WITH A HORIZONTAL LINE BE-

TWEEN THESE WORDS, AND WITH A STYLIZED DESIGN AT THE TOP OF THE COLUMN MARK TO THE LEFT OF THE LITERAL ELEMENTS IN THE MARK. THE COLOR NAVY BLUE APPEARS THROUGHOUT THE LETTERS OF THE WORD "SOUTHERN UNITED", IN THE HORIZONTAL LINE BETWEEN THE LITERAL ELEMENTS IN THE MARK, AND THROUGHOUT THE STYLIZED DESIGN IN THE COLUMN TO THE LEFT OF THE LITERAL ELEMENTS IN THE MARK.

SER. NO. 77-108,838, FILED 2-15-2007.

HEATHER BIDDULPH, EXAMINING ATTORNEY

**Int. Cl.: 28**

**Prior U.S. Cls.: 22, 23, 38 and 50**

**United States Patent and Trademark Office**

**Reg. No. 3,465,255**

**Registered July 15, 2008**

**TRADEMARK  
PRINCIPAL REGISTER**

# Ditch Blade

ALTMAN, JEREMY (UNITED STATES INDIVIDUAL)

400 HEADGATE DR.

MARTINEZ, GA 30907

FOR: ARTIFICIAL FISHING LURES, IN CLASS 28 (U.S. CLS. 22, 23, 38 AND 50).

FIRST USE 2-16-2007; IN COMMERCE 2-16-2007.

THE MARK CONSISTS OF STANDARD CHARACTERS WITHOUT CLAIM TO ANY PARTICULAR FONT, STYLE, SIZE, OR COLOR.

NO CLAIM IS MADE TO THE EXCLUSIVE RIGHT TO USE "BLADE", APART FROM THE MARK AS SHOWN.

SER. NO. 77-108,991, FILED 2-16-2007.

REBECCA SMITH, EXAMINING ATTORNEY



**Int. Cl.: 35**

**Prior U.S. Cls.: 100, 101 and 102**

**United States Patent and Trademark Office**

**Reg. No. 3,465,256**

**Registered July 15, 2008**

**SERVICE MARK  
PRINCIPAL REGISTER**

**FINANCIAL INDEPENDENCE  
GROUP**

FINANCIAL INDEPENDENCE GROUP, INC.  
(NORTH CAROLINA CORPORATION)  
19520 W. CATAWBA AVENUE, SUITE 200  
CORNELIUS, NC 28031

FOR: PROMOTION OF FINANCIAL AND INSUR-  
ANCE SERVICES ON BEHALF OF OTHERS, IN  
CLASS 35 (U.S. CLS. 100, 101 AND 102).

FIRST USE 11-17-1982; IN COMMERCE 11-17-1982.

THE MARK CONSISTS OF STANDARD CHAR-  
ACTERS WITHOUT CLAIM TO ANY PARTICULAR  
FONT, STYLE, SIZE, OR COLOR.

SEC. 2(F).

SER. NO. 77-109,422, FILED 2-16-2007.

AMOS T. MATTHEWS, JR., EXAMINING ATTOR-  
NEY

**Int. Cl.: 16**

**Prior U.S. Cls.: 2, 5, 22, 23, 29, 37, 38 and 50**

**United States Patent and Trademark Office**

**Reg. No. 3,465,257**

**Registered July 15, 2008**

**TRADEMARK  
PRINCIPAL REGISTER**

# Pro Creator

RAMBOD, HANY (UNITED STATES INDIVIDUAL)  
228 PRINCE STREET  
LOS GATOS, CA 95032

FOR: MAGAZINE COLUMNS ABOUT HEALTH AND PERSONAL TRAINING, IN CLASS 16 (U.S. CLS. 2, 5, 22, 23, 29, 37, 38 AND 50).

FIRST USE 7-1-2003; IN COMMERCE 9-1-2003.

THE MARK CONSISTS OF STANDARD CHARACTERS WITHOUT CLAIM TO ANY PARTICULAR FONT, STYLE, SIZE, OR COLOR.

SER. NO. 77-110,587, FILED 2-19-2007.

JANICE L. MCMORROW, EXAMINING ATTORNEY

**Int. Cl.: 42**

**Prior U.S. Cls.: 100 and 101**

**United States Patent and Trademark Office**

**Reg. No. 3,465,258**

**Registered July 15, 2008**

**SERVICE MARK  
PRINCIPAL REGISTER**

**EMERGING THREAT  
INTELLIGENCE**

CATBIRD NETWORKS, INC. (DELAWARE CORPORATION)  
95 REVERE DRIVE, SUITE B  
NORTHBROOK, IL 60062

FOR: COMPUTER SERVICES, NAMELY, MEASURING, MONITORING, AND PROTECTING THE PERFORMANCE OF APPLICATIONS, COMPUTER SYSTEMS AND NETWORKS ON CORPORATE, PRIVATE, AND PUBLIC NETWORKS AND THE GLOBAL COMPUTER NETWORK IN ORDER TO IMPROVE THE PERFORMANCE OF SUCH SYSTEMS AND NETWORKS, IN CLASS 42 (U.S. CLS. 100 AND 101).

FIRST USE 8-15-2006; IN COMMERCE 8-15-2006.

THE MARK CONSISTS OF STANDARD CHARACTERS WITHOUT CLAIM TO ANY PARTICULAR FONT, STYLE, SIZE, OR COLOR.

NO CLAIM IS MADE TO THE EXCLUSIVE RIGHT TO USE "EMERGING THREAT", APART FROM THE MARK AS SHOWN.

SER. NO. 77-112,412, FILED 2-21-2007.

MARGARET POWER, EXAMINING ATTORNEY

**Int. Cl.: 28**

**Prior U.S. Cls.: 22, 23, 38 and 50**

**United States Patent and Trademark Office**

**Reg. No. 3,465,259**

**Registered July 15, 2008**

**TRADEMARK  
PRINCIPAL REGISTER**

**WHO'D YOU RATHER?**

WHO'D YOU RATHER? INC. (CANADA CORPORATION)

#2

181 WYCHWOOD AVE.  
TORONTO, CANADA M6C2T4

FOR: GAMES, NAMELY, BOARD GAMES, CARD GAMES, NOT INCLUDING ORDINARY PLAYING CARDS, CHESS GAMES, DICE GAMES, ORDINARY PLAYING CARDS, PINBALL GAMES, ROLE-PLAYING GAMES, AND STAND ALONE VIDEO GAME MACHINES, IN CLASS 28 (U.S. CLS. 22, 23, 38 AND 50).

FIRST USE 1-30-2001; IN COMMERCE 9-1-2004.

THE MARK CONSISTS OF STANDARD CHARACTERS WITHOUT CLAIM TO ANY PARTICULAR FONT, STYLE, SIZE, OR COLOR.

SER. NO. 77-113,454, FILED 2-22-2007.

PAULA MAHONEY, EXAMINING ATTORNEY

**Int. Cl.: 30**

**Prior U.S. Cl.: 46**

**United States Patent and Trademark Office**

**Reg. No. 3,465,260**

**Registered July 15, 2008**

**TRADEMARK  
PRINCIPAL REGISTER**

**THOSE THINGS**

KARAMESINES, MICHAEL (UNITED STATES  
INDIVIDUAL)  
59 WEST INDIANA AVENUE  
VALPARAISO, IN 46383

THE MARK CONSISTS OF STANDARD CHAR-  
ACTERS WITHOUT CLAIM TO ANY PARTICULAR  
FONT, STYLE, SIZE, OR COLOR.

FOR: BREAD AND PIZZA DOUGH, IN CLASS 30  
(U.S. CL. 46).

SER. NO. 77-113,616, FILED 2-22-2007.

FIRST USE 1-1-2004; IN COMMERCE 1-1-2004.

SKYE YOUNG, EXAMINING ATTORNEY

**Int. Cls.: 35, 36 and 42**

**Prior U.S. Cls.: 100, 101 and 102**

**United States Patent and Trademark Office**

**Reg. No. 3,465,261**

**Registered July 15, 2008**

**SERVICE MARK  
PRINCIPAL REGISTER**



PARIS RE (FRANCE SOCIETE ANONYME)  
39 RUE DU COLISÉE  
75008 PARIS, FRANCE

FOR: COMPUTERIZED FILE MANAGEMENT; COMPILATION OF METEOROLOGICAL AND HYDROMETEOROLOGICAL INFORMATION INTO COMPUTER DATABASES; SYSTEMIZATION OF SUCH INFORMATION INTO COMPUTER DATABASES; BUSINESS MANAGEMENT AND PROFESSIONAL BUSINESS CONSULTING IN THE FIELDS OF INSURANCE, REINSURANCE, METEOROLOGY AND HYDROMETEOROLOGY, AND FINANCIAL SERVICES; AND FINANCIAL APPRAISAL, NAMELY, BUSINESS APPRAISAL IN THE FIELDS OF METEOROLOGY AND HYDROMETEOROLOGY, INCLUDING WEATHER DERIVATIVES, IN CLASS 35 (U.S. CLS. 100, 101 AND 102).

FOR: FINANCIAL AFFAIRS, NAMELY, FINANCIAL CONSULTATION AND FINANCIAL MANAGEMENT IN THE FIELDS OF INSURANCE AND REINSURANCE AND WEATHER DERIVATIVES; FINANCIAL ANALYSIS; CAPITAL INVESTMENT, NAMELY, CAPITAL INVESTMENT CONSULTATION SERVICES, EQUITY CAPITAL INVESTMENT; MANAGEMENT OF ASSETS; BROKERAGE, NAMELY, INSURANCE AND REINSURANCE BROKERAGE; FINANCIAL EVALUATIONS, NAMELY, FOR INSURANCE AND REINSURANCE PURPOSES; INSURANCE AND REINSURANCE SERVICES, NAMELY, INSURANCE AND REINSURANCE ADMINISTRATION, INSURANCE AND REINSURANCE CONSULTATION, INSURANCE AND REINSURANCE UNDERWRITING SERVICES FOR ALL TYPES OF INSURANCE AND REINSURANCE AND FOR WEATHER DERIVATIVES, AND INSUR-

ANCE AND REINSURANCE UNDERWRITING CONSULTATION SERVICES, IN CLASS 36 (U.S. CLS. 100, 101 AND 102).

FOR: DESIGN OF COMPUTER SYSTEMS AND SOFTWARE RELATED TO METEOROLOGY AND HYDROMETEOROLOGY, RECOVERY OF DATA RELATED TO CLIMATIC EVENTS, TECHNICAL RESEARCHES IN METEOROLOGY AND HYDROMETEOROLOGY, DESIGN OF COMPUTER PROGRAMS RELATED TO METEOROLOGY AND HYDROMETEOROLOGY, IN CLASS 42 (U.S. CLS. 100 AND 101).

PRIORITY CLAIMED UNDER SEC. 44(D) ON FRANCE APPLICATION NO. 063467414, FILED 12-5-2006, REG. NO. 433195096, DATED 12-5-2006, EXPIRES 12-5-2016.

NO CLAIM IS MADE TO THE EXCLUSIVE RIGHT TO USE "PARIS RE", APART FROM THE MARK AS SHOWN.

THE COLOR(S) GRAY (PANTONE 431); YELLOW (PANTONE 143); AND RED (PANTONE 1805) IS/ARE CLAIMED AS A FEATURE OF THE MARK.

THE COLOR GRAY APPEARS IN THE WORDING "PARIS RE". IN THE DESIGN, THE COLOR YELLOW APPEARS IN THE SHORTER ARC OVER THE "R" IN "RE", AND THE COLOR RED APPEARS IN THE LONGER ARC OVER THE "E" IN "RE".

SER. NO. 77-114,722, FILED 2-23-2007.

INGRID C. EULIN, EXAMINING ATTORNEY

**Int. Cls.: 38 and 42**

**Prior U.S. Cls.: 100, 101 and 104**

**United States Patent and Trademark Office**

**Reg. No. 3,465,262**

**Registered July 15, 2008**

**SERVICE MARK  
PRINCIPAL REGISTER**

# ATTACHMORE

ATTACHMORE SERVICES, LLC (ARIZONA LTD  
LIAB CO)  
3230 EL CAMINO DEL CERRO  
TUCSON, AZ 85745

FOR: COMMUNICATION SERVICES, NAMELY, ELECTRONIC TRANSMISSION OF DATA AND DOCUMENTS AMONG USERS OF COMPUTERS; DATA COMMUNICATION BY ELECTRONIC MAIL; DATA TRANSMISSION AND RECEPTION SERVICES VIA TELECOMMUNICATION MEANS; ELECTRONIC DATA INTERCHANGE (EDI) SERVICES; ELECTRONIC TRANSMISSION OF MESSAGES AND DATA; PROVISION OF ACCESS TO DATA OR DOCUMENTS STORED ELECTRONICALLY IN CENTRAL FILES FOR REMOTE CONSULTATION, IN CLASS 38 (U.S. CLS. 100, 101 AND 104).

FIRST USE 2-23-2007; IN COMMERCE 2-23-2007.

FOR: COMPUTER SERVICE, NAMELY, ACTING AS AN APPLICATION SERVICE PROVIDER IN THE FIELD OF KNOWLEDGE MANAGEMENT TO HOST COMPUTER APPLICATION SOFTWARE FOR SEARCHING AND RETRIEVING INFORMATION FROM DATABASES AND COMPUTER NETWORKS; HOSTING OF DIGITAL CONTENT ON THE INTERNET, IN CLASS 42 (U.S. CLS. 100 AND 101).

FIRST USE 2-23-2007; IN COMMERCE 2-23-2007.

THE MARK CONSISTS OF STANDARD CHARACTERS WITHOUT CLAIM TO ANY PARTICULAR FONT, STYLE, SIZE, OR COLOR.

SER. NO. 77-115,280, FILED 2-23-2007.

MORGAN WYNNE, EXAMINING ATTORNEY

**Int. Cl.: 41**

**Prior U.S. Cls.: 100, 101 and 107**

**United States Patent and Trademark Office**

**Reg. No. 3,465,263**

**Registered July 15, 2008**

**SERVICE MARK  
PRINCIPAL REGISTER**

**TRU-ACE**

ARCHIE L. ROUNDTREE, JR. (UNITED STATES  
INDIVIDUAL)  
P. O. BOX 772  
APPLE VALLEY, CA 92307 AND  
ARCHIE L. ROUNDTREE, SR. (UNITED STATES  
INDIVIDUAL)  
P. O. BOX 772  
APPLE VALLEY, CA 92307

FIRST USE 10-1-2005; IN COMMERCE 10-1-2005.

THE MARK CONSISTS OF STANDARD CHAR-  
ACTERS WITHOUT CLAIM TO ANY PARTICULAR  
FONT, STYLE, SIZE, OR COLOR.

FOR: SONGWRITING AND LIVE MUSICAL PER-  
FORMANCES; LIVE THEATRICAL/ACTING PER-  
FORMANCES, IN CLASS 41 (U.S. CLS. 100, 101 AND  
107).

SER. NO. 77-115,554, FILED 2-24-2007.

DAYNA BROWNE, EXAMINING ATTORNEY



**Int. Cl.: 9**

**Prior U.S. Cls.: 21, 23, 26, 36 and 38**

**Reg. No. 3,465,264**

**United States Patent and Trademark Office**

**Registered July 15, 2008**

**TRADEMARK  
PRINCIPAL REGISTER**

**SPHINX**

LEMKE, MARTHA (UNITED STATES INDIVIDUAL)  
P. O. BOX 802771  
DALLAS, TX 75380

FIRST USE 2-15-1996; IN COMMERCE 2-15-1996.

FOR: HOME AND OFFICE AUTOMATION SYSTEMS COMPRISING WIRELESS AND WIRED CONTROLLERS, CONTROLLED DEVICES, AND SOFTWARE FOR LIGHTING, HVAC, SECURITY, SAFETY AND OTHER HOME AND OFFICE MONITORING AND CONTROL APPLICATIONS, IN CLASS 9 (U.S. CLS. 21, 23, 26, 36 AND 38).

THE MARK CONSISTS OF STANDARD CHARACTERS WITHOUT CLAIM TO ANY PARTICULAR FONT, STYLE, SIZE, OR COLOR.

SER. NO. 77-115,842, FILED 2-26-2007.

KYLE PEETE, EXAMINING ATTORNEY

**Int. Cl.: 36**

**Prior U.S. Cls.: 100, 101 and 102**

**United States Patent and Trademark Office**

**Reg. No. 3,465,265**

**Registered July 15, 2008**

**SERVICE MARK  
PRINCIPAL REGISTER**

**LITTLE GRAD**

LITTLE GRAD, INC. (CALIFORNIA CORPORATION)  
SUITE 126  
875 MAHLER ROAD  
BURLINGAME, CA 94010

FOR: FINANCIAL SERVICES, NAMELY, DIRECT DEPOSITED SAVINGS PROGRAMS FOR COLLEGE TUITION 529 PLANS, IN CLASS 36 (U.S. CLS. 100, 101 AND 102).

FIRST USE 10-18-2005; IN COMMERCE 10-18-2005.

THE MARK CONSISTS OF STANDARD CHARACTERS WITHOUT CLAIM TO ANY PARTICULAR FONT, STYLE, SIZE, OR COLOR.

NO CLAIM IS MADE TO THE EXCLUSIVE RIGHT TO USE "GRAD", APART FROM THE MARK AS SHOWN.

SER. NO. 77-117,524, FILED 2-27-2007.

STEVEN PEREZ, EXAMINING ATTORNEY

**Int. Cl.: 25**

**Prior U.S. Cls.: 22 and 39**

**United States Patent and Trademark Office**

**Reg. No. 3,465,266**

**Registered July 15, 2008**

**TRADEMARK  
PRINCIPAL REGISTER**

**Blue Art**

SAMUEL, FEMI O (UNITED STATES INDIVIDUAL)  
1715 KEMPER STREET  
LOS ANGELES, CA 90065

FOR: MEN'S, WOMEN'S AND CHILDREN'S APPAREL, FOOTWEAR, LEATHERWEAR, KNITWEAR AND OUTERWEAR, NAMELY, SHIRTS, T-SHIRTS, POLO SHIRTS, SWEAT SHIRTS, PANTS, VESTS, SWEATERS, SUITS, TIES, TANK TOPS, CROP TOPS, UNDERWEAR, JEANS, JACKETS, COATS, SHOES, SNEAKERS, BELTS, BOOTS,

SHORTS, TOPS, BLOUSES, SKIRTS, DRESSES, HEADWEAR, IN CLASS 25 (U.S. CLS. 22 AND 39).

FIRST USE 5-0-2000; IN COMMERCE 1-0-2002.

THE MARK CONSISTS OF STANDARD CHARACTERS WITHOUT CLAIM TO ANY PARTICULAR FONT, STYLE, SIZE, OR COLOR.

SER. NO. 77-117,828, FILED 2-27-2007.

RUSS HERMAN, EXAMINING ATTORNEY

Int. Cl.: 35

Prior U.S. Cls.: 100, 101 and 102

United States Patent and Trademark Office

Reg. No. 3,465,267

Registered July 15, 2008

SERVICE MARK  
PRINCIPAL REGISTER

LinkTrust

BURSTABIT MEDIA, INC. (UTAH CORPORATION)  
3130 WEST MAPLE LOOP  
SUITE G-75  
LEHI, UT 84043

FOR: ADVERTISING, MARKETING AND PROMOTION SERVICES; BUSINESS MARKETING SERVICES; MARKET REPORTS AND STUDIES; SALES VOLUME TRACKING FOR OTHERS, IN CLASS 35 (U.S. CLS. 100, 101 AND 102).

FIRST USE 9-4-2004; IN COMMERCE 9-4-2004.

THE COLOR(S) LIGHT GREY, DARK GREY, LIME GREEN, GREEN, DARK GREEN IS/ARE CLAIMED AS A FEATURE OF THE MARK.

THE MARK CONSISTS OF THE WORD "LINKTRUST" WITH A HORIZONTALLY ADJACENT, FOUR SIDED INFINITE LOOPING GRAPHIC. EACH OF THE FOUR CORNERS OF THE GRAPHIC IS A DIFFERENT COLOR OR COLORS. EACH CORNER OF THE INFINITE GRAPHIC IS SEPARATED AND NOT CONNECTED TO ANY OTHER CORNER OF THE INFINITE GRAPHIC. THE COL-

ORS CONTAINED IN THE MARK ARE LIGHT GREY, DARK GREY, LIME GREEN, GREEN, AND DARK GREEN. THESE COLORS APPEAR IN THE MARK AS FOLLOWS: LIME GREEN - UPPER LEFT PORTION OF UPPER LEFT PORTION OF INFINITE GRAPHIC; GREEN - LOWER RIGHT PORTION OF UPPER LEFT PORTION OF INFINITE GRAPHIC, AND UPPER PORTION THE WORD "TRUST"; DARK GREEN - LOWER RIGHT PORTION OF INFINITE GRAPHIC, AND LOWER PORTION OF THE WORD "TRUST"; LIGHT GREY - LOWER LEFT PORTION OF INFINITE GRAPHIC, AND LOWER PORTION OF THE WORD "LINK"; DARK GREY - UPPER PORTION OF THE WORD "LINK" AND UPPER RIGHT PORTION OF INFINITE GRAPHIC. THE INDICATED COLORS THAT APPEAR IN THE WORD "LINKTRUST" RUN HORIZONTALLY THROUGH THE WORD ALONG A WAVY OR CURVED BOUNDARY WITH THE UPPER AND LOWER PORTIONS OF THE INDICATED COLORS VARYING ALONG THE WAVY OR CURVED BOUNDARY.

SER. NO. 77-120,110, FILED 3-1-2007.

JENNIFER VASQUEZ, EXAMINING ATTORNEY

**Int. Cl.: 9**

**Prior U.S. Cls.: 21, 23, 26, 36 and 38**

**Reg. No. 3,465,268**

**United States Patent and Trademark Office**

**Registered July 15, 2008**

**TRADEMARK  
PRINCIPAL REGISTER**

**NEiWorks**

NORAN-LAND ENGINEERING CORP. (CALIFORNIA CORPORATION), DBA NORAN ENGINEERING, INC.  
5555 GARDEN GROVE BLVD. 300  
WESTMINSTER, CA 92683

FOR: COMPUTER SOFTWARE FOR USE BY ENGINEERS AND PRODUCT DESIGNERS THAT FACILITATES THE DESIGN, ANALYSIS, AND SIMULATION OF PRODUCTS BY USING THE TECHNIQUE KNOWN AS FINITE ELEMENT ANALYSIS, IN CLASS 9 (U.S. CLS. 21, 23, 26, 36 AND 38).

FIRST USE 9-2-2004; IN COMMERCE 9-2-2004.

THE MARK CONSISTS OF STANDARD CHARACTERS WITHOUT CLAIM TO ANY PARTICULAR FONT, STYLE, SIZE, OR COLOR.

OWNER OF U.S. REG. NO. 3,001,362.

SER. NO. 77-120,257, FILED 3-1-2007.

GENE MACIOL, EXAMINING ATTORNEY

**Int. Cl.: 9**

**Prior U.S. Cls.: 21, 23, 26, 36 and 38**

**Reg. No. 3,465,269**

**United States Patent and Trademark Office**

**Registered July 15, 2008**

**TRADEMARK  
PRINCIPAL REGISTER**



**in line with your process**

KDF ELECTRONIC & VACUUM SERVICES, INC.  
(NEW YORK CORPORATION)  
10 VOLVO DRIVE  
ROCKLEIGH, NJ 07647

CLEANING SPUTTERERS AND ETCHING SPUTTERERS; AND CATHODE RAY TUBES, IN CLASS 9 (U.S. CLS. 21, 23, 26, 36 AND 38).

FIRST USE 1-1-2000; IN COMMERCE 1-1-2000.

FOR: SYSTEMS AND PARTS THEREFORE USED IN THE PRODUCTION OF SEMICONDUCTORS, NAMELY, PHOTOMASKS; WIRELESS RADIO FREQUENCY GENERATORS; PRINTED CIRCUITS AND POWER SUPPLIES; SEMI-CONDUCTING AND SEMI-INSULATING AND POLYCRYSTALLINE GALLIUM ARSENIDE IN THE FORM OF WAFERS; HIGH DENSITY INTERCONNECTORS; ELECTRIC OR ELECTRONIC SENSORS FOR SENSING LIGHT; OPTO-ELECTRONICS, NAMELY, LASERS AND BLANK OPTICAL DISCS; FLAT ELECTRIC LUMINESCENT DISPLAY PANELS; RADIO FREQUENCY POWER DEVICES, NAMELY, RADIO FREQUENCY GENERATORS AND POWER SUPPLIES; SPUTTERING SYSTEMS, NAMELY, THIN FILM MAKING SPUTTERERS; SURFACE

THE MARK CONSISTS OF "KDF" IN LARGE BOLD CAP LETTERS WITH THREE FILLED IN SQUARES IN A ROW TO THE RIGHT OF "KDF" AND THREE FILLED IN SQUARES IN THREE MORE ROWS SCATTERED UNDER THE FIRST ROW, EACH ROW OF SQUARES IS SLIGHTLY SMALLER THAN THE PREVIOUS ROW OF SQUARES, UNDER THE "D" ARE THE WORDS IN LINE WITH YOUR PROCESS.

SER. NO. 77-121,144, FILED 3-2-2007.

ALLISON HOLTZ, EXAMINING ATTORNEY

**Int. Cl.: 9**

**Prior U.S. Cls.: 21, 23, 26, 36 and 38**

**Reg. No. 3,465,270**

**United States Patent and Trademark Office**

**Registered July 15, 2008**

**TRADEMARK  
PRINCIPAL REGISTER**

**Prayata**

PRAYATA LLC (COLORADO LTD LIAB CO)  
7325 E. 14TH AVE  
DENVER, CO 80220

NO CLAIM IS MADE TO THE EXCLUSIVE  
RIGHT TO USE "PRAYATA", APART FROM THE  
MARK AS SHOWN.

FOR: PRE-RECORDED CDS, VIDEO TAPES, LA-  
SER DISKS AND DVDS FEATURING MUSIC; PRE-  
RECORDED ELECTRONIC MEDIA FEATURING  
MUSIC, IN CLASS 9 (U.S. CLS. 21, 23, 26, 36 AND 38).

THE FOREIGN WORDING IN THE MARK  
TRANSLATES INTO ENGLISH AS "PURITY".

FIRST USE 4-1-2004; IN COMMERCE 4-15-2004.

SER. NO. 77-121,411, FILED 3-2-2007.

THE MARK CONSISTS OF STANDARD CHAR-  
ACTERS WITHOUT CLAIM TO ANY PARTICULAR  
FONT, STYLE, SIZE, OR COLOR.

BERNICE MIDDLETON, EXAMINING ATTORNEY

**Int. Cls.: 18 and 22**

**Prior U.S. Cls.: 1, 2, 3, 7, 19, 22, 41, 42 and 50**

**United States Patent and Trademark Office**

**Reg. No. 3,465,271**

**Registered July 15, 2008**

**TRADEMARK  
PRINCIPAL REGISTER**

# Funtote

TRYSAIL INC. (NEW YORK CORPORATION)  
P.O. BOX 1498  
NEW YORK, NY 10276

FOR: BEACH BAGS; CARRY-ALL BAGS; DIAPER BAGS; GARMENT BAGS FOR TRAVEL; GYM BAGS; MESSENGER BAGS; TEXTILE SHOPPING BAGS; TOTE BAGS; WRISTLET BAGS, IN CLASS 18 (U.S. CLS. 1, 2, 3, 22 AND 41).

FIRST USE 12-11-2005; IN COMMERCE 7-3-2006.

FOR: MULTI-PURPOSE CLOTH BAGS, IN CLASS 22 (U.S. CLS. 1, 2, 7, 19, 22, 42 AND 50).

FIRST USE 12-11-2005; IN COMMERCE 7-3-2006.

THE MARK CONSISTS OF STANDARD CHARACTERS WITHOUT CLAIM TO ANY PARTICULAR FONT, STYLE, SIZE, OR COLOR.

SER. NO. 77-121,626, FILED 3-3-2007.

BENJAMIN ALLEN, EXAMINING ATTORNEY



**Int. Cl.: 43**

**Prior U.S. Cls.: 100 and 101**

**United States Patent and Trademark Office**

**Reg. No. 3,465,272**

**Registered July 15, 2008**

**SERVICE MARK  
PRINCIPAL REGISTER**

**CHAGO AHOGADAS**

JESUS LAGUNA (UNITED STATES INDIVIDUAL)  
6426 WHITTIER BLVD  
LOS ANGELES, CA 90022 AND  
SANTIAGO LAGUNA (UNITED STATES INDIVIDUAL)  
6426 WHITTIER BLVD  
LOS ANGELES, CA 90022

FOR: RESTAURANTS, IN CLASS 43 (U.S. CLS. 100 AND 101).

FIRST USE 6-7-2006; IN COMMERCE 6-7-2006.

THE MARK CONSISTS OF STANDARD CHARACTERS WITHOUT CLAIM TO ANY PARTICULAR FONT, STYLE, SIZE, OR COLOR.

THE FOREIGN WORDING IN THE MARK TRANSLATES INTO ENGLISH AS "CHAGO" DIPPED OR DROWNED.

SER. NO. 77-121,830, FILED 3-4-2007.

LINDA MICKLEBURGH, EXAMINING ATTORNEY

**Int. Cl.: 29**

**Prior U.S. Cl.: 46**

**United States Patent and Trademark Office**

**Reg. No. 3,465,273**

**Registered July 15, 2008**

**TRADEMARK  
PRINCIPAL REGISTER**

**CATALINA**

CATALINA FINER FOOD CORPORATION  
(FLORIDA CORPORATION)  
POST OFFICE BOX 15815  
TAMPA, FL 33684

FOR: CHICKEN, HAM AND CHEESE CRO-  
QUETTES; STUFFED POTATOS; STUFFED YUCA;  
AND BLACK BEAN SOUP, IN CLASS 29 (U.S. CL. 46).

FIRST USE 0-0-1975; IN COMMERCE 3-15-1975.

THE MARK CONSISTS OF STANDARD CHAR-  
ACTERS WITHOUT CLAIM TO ANY PARTICULAR  
FONT, STYLE, SIZE, OR COLOR.

OWNER OF U.S. REG. NO. 1,071,547.

SER. NO. 77-121,937, FILED 3-5-2007.

JANICE KIM, EXAMINING ATTORNEY

**Int. Cl.: 41**

**Prior U.S. Cls.: 100, 101 and 107**

**United States Patent and Trademark Office**

**Reg. No. 3,465,274**

**Registered July 15, 2008**

**SERVICE MARK  
PRINCIPAL REGISTER**



BENCHMARK EDUCATION CO., LLC (NEW YORK LTD LIAB CO)  
629, 5TH AVENUE  
PELHAM, NY 10803

FOR: EDUCATIONAL SERVICES, NAMELY, PROVIDING COURSES OF INSTRUCTION AT THE PRIMARY LEVEL AND DISTRIBUTION OF COURSE MATERIAL IN CONNECTION THEREWITH, IN CLASS 41 (U.S. CLS. 100, 101 AND 107).

FIRST USE 9-21-1999; IN COMMERCE 9-21-1999.

OWNER OF U.S. REG. NO. 2,279,081.

THE COLOR(S) YELLOW AND RED IS/ARE CLAIMED AS A FEATURE OF THE MARK.

THE MARK CONSISTS OF YELLOW SUNBURST DESIGN. LETTERS "E" AND "C" ARE CAPITALIZED AND ALL LETTERING IS IN RED.

SER. NO. 77-122,090, FILED 3-5-2007.

CHARLES L. JENKINS, EXAMINING ATTORNEY

**Int. Cl.: 45**

**Prior U.S. Cls.: 100 and 101**

**United States Patent and Trademark Office**

**Reg. No. 3,465,275**

**Registered July 15, 2008**

**SERVICE MARK  
PRINCIPAL REGISTER**



KINGDOM SECURITY, LLC (VIRGINIA LTD  
LIAB CO)  
529 EAST SKYLINE DRIVE  
PURCELLVILLE, VA 20132

FOR: PERSONAL SECURITY CONSULTATION,  
IN CLASS 45 (U.S. CLS. 100 AND 101).

FIRST USE 2-28-2007; IN COMMERCE 2-28-2007.

NO CLAIM IS MADE TO THE EXCLUSIVE  
RIGHT TO USE "SECURITY", APART FROM THE  
MARK AS SHOWN.

THE MARK CONSISTS OF A LION'S HEAD  
TURN SLIGHTLY RIGHT WITH THE WORD KING-  
DOM ARCHED ABOVE IN ALL CAPS AND THE  
WORD SECURITY CENTERED BELOW GOING  
STRAIGHT ACROSS.

SER. NO. 77-122,741, FILED 3-5-2007.

KATHLEEN M. VANSTON, EXAMINING ATTOR-  
NEY

**Int. Cl.: 36**

**Prior U.S. Cls.: 100, 101 and 102**

**United States Patent and Trademark Office**

**Reg. No. 3,465,276**

**Registered July 15, 2008**

**SERVICE MARK  
PRINCIPAL REGISTER**

# Juggernaut Capital

JUGGERNAUT CAPITAL, LLC (DELAWARE  
LTD LIAB CO)  
21ST FLOOR  
67 WALL STREET  
NEW YORK, NY 10005

FOR: FINANCIAL SERVICES, NAMELY, FINANCIAL FORECASTING, FINANCIAL ANALYSIS, SECURITIES INVESTMENT, FINANCIAL ASSET MANAGEMENT, CREATION OF ALGORITHMIC TRADING STRATEGIES, IN CLASS 36 (U.S. CLS. 100, 101 AND 102).

FIRST USE 3-28-2005; IN COMMERCE 3-28-2005.

THE MARK CONSISTS OF STANDARD CHARACTERS WITHOUT CLAIM TO ANY PARTICULAR FONT, STYLE, SIZE, OR COLOR.

NO CLAIM IS MADE TO THE EXCLUSIVE RIGHT TO USE "CAPITAL", APART FROM THE MARK AS SHOWN.

SER. NO. 77-123,420, FILED 3-6-2007.

INGA ERVIN, EXAMINING ATTORNEY

**Int. Cl.: 6**

**Prior U.S. Cls.: 2, 12, 13, 14, 23, 25 and 50**

**Reg. No. 3,465,277**

**United States Patent and Trademark Office**

**Registered July 15, 2008**

---

**TRADEMARK  
PRINCIPAL REGISTER**

**LIFELINEMOBILE**

LIFELINE MOBILE, INC. (OHIO CORPORATION)  
2050 MCGAW ROAD  
COLUMBUS, OH 432074800

THE MARK CONSISTS OF STANDARD CHAR-  
ACTERS WITHOUT CLAIM TO ANY PARTICULAR  
FONT, STYLE, SIZE, OR COLOR.

FOR: PORTABLE MOBILE METAL OFFICE  
BUILDINGS, IN CLASS 6 (U.S. CLS. 2, 12, 13, 14, 23,  
25 AND 50).

SER. NO. 77-124,355, FILED 3-7-2007.

FIRST USE 2-28-2006; IN COMMERCE 2-28-2006.

MICHELLE DUBOIS, EXAMINING ATTORNEY

**Int. Cls.: 38 and 42**

**Prior U.S. Cls.: 100, 101 and 104**

**United States Patent and Trademark Office**

**Reg. No. 3,465,278**

**Registered July 15, 2008**

**SERVICE MARK  
PRINCIPAL REGISTER**

# VTOUCH

WALCHEM CORPORATION (MASSACHUSETTS  
CORPORATION)  
5 BOYNTON ROAD  
HOLLISTON, MA 01746

FOR: PROVIDING ON-DEMAND ELECTRONIC  
TELECOMMUNICATION CONNECTIONS TO RE-  
MOTE FLUID PROCESS CONTROLLING AND  
MONITORING DEVICES OVER A GLOBAL COM-  
PUTER INFORMATION NETWORK , IN CLASS 38  
(U.S. CLS. 100, 101 AND 104).

FIRST USE 7-31-2007; IN COMMERCE 7-31-2007.

FOR: COMPUTER SERVICES, NAMELY, PRO-  
VIDING INFORMATION IN THE FIELD OF FLUID

PROCESS CONTROL AND MONITORING FROM  
REMOTE FLUID PROCESS CONTROLLING AND  
MONITORING DEVICES OVER A GLOBAL COM-  
PUTER INFORMATION NETWORK, IN CLASS 42  
(U.S. CLS. 100 AND 101).

FIRST USE 7-31-2007; IN COMMERCE 7-31-2007.

THE MARK CONSISTS OF STANDARD CHAR-  
ACTERS WITHOUT CLAIM TO ANY PARTICULAR  
FONT, STYLE, SIZE, OR COLOR.

SER. NO. 77-125,340, FILED 3-8-2007.

LINDA ESTRADA, EXAMINING ATTORNEY

**Int. Cls.: 11 and 42**

**Prior U.S. Cls.: 13, 21, 23, 31, 34, 100 and 101**

**United States Patent and Trademark Office**

**Reg. No. 3,465,279**

**Registered July 15, 2008**

**TRADEMARK  
SERVICE MARK  
PRINCIPAL REGISTER**

# CONSERVAL

CONSERVAL ENGINEERING INC. (CANADA CORPORATION)  
200 WILDCAT ROAD  
TORONTO, CANADA M3J2N5

FOR: SOLAR COLLECTION SYSTEMS FOR PRODUCING ELECTRICITY AND HEATING, AIR VENTILATING, AND AIR HUMIDIFICATION, COMPRISING FANS, INSULATION, METAL SIDING, METAL ROOF PANELS, GLAZING, INTEGRAL AIR CHANNELS, AIR INTAKES, DUCTS, BURNERS, CONTROLLERS, PHOTO VOLTAIC PANELS, DAMPERS, AND HEAT LOSS RECOVERY COMPONENTS, NAMELY, METAL SIDING AND METAL ROOFING ACTING AS HEAT TRANSFER SURFACES, AND CONTROLS FOR ALL OF THE FOREGOING, IN CLASS 11 (U.S. CLS. 13, 21, 23, 31 AND 34).

FIRST USE 0-0-2005; IN COMMERCE 0-0-2005.

FOR: ENGINEERING SERVICES AND TECHNICAL ENGINEERING CONSULTING SERVICES RE-

LATING TO SOLAR COLLECTION SYSTEMS FOR PRODUCING ELECTRICITY AND HEATING, AIR VENTILATING, AND INDUSTRIAL AIR HUMIDIFICATION, AND HEAT LOSS RECOVERY SYSTEMS, IN CLASS 42 (U.S. CLS. 100 AND 101).

FIRST USE 0-0-2005; IN COMMERCE 0-0-2005.

THE MARK CONSISTS OF STANDARD CHARACTERS WITHOUT CLAIM TO ANY PARTICULAR FONT, STYLE, SIZE, OR COLOR.

OWNER OF CANADA REG. NO. TMA585539, DATED 7-17-2003, EXPIRES 7-17-2018.

OWNER OF U.S. REG. NO. 1,456,392.

SER. NO. 77-125,556, FILED 3-8-2007.

RUDY R. SINGLETON, EXAMINING ATTORNEY



**Int. Cls.: 9, 38, 42 and 45**

**Prior U.S. Cls.: 21, 23, 26, 36, 38, 100, 101 and 104**

**Reg. No. 3,465,280**

**United States Patent and Trademark Office**

**Registered July 15, 2008**

**TRADEMARK  
SERVICE MARK  
PRINCIPAL REGISTER**

**FAMOUS FOR 15 MEGABYTES**

AUTONOMY CORPORATION PLC (UNITED KINGDOM CORPORATION)  
CAMBRIDGE BUSINESS PARK, COWLEY ROAD  
CAMBRIDGE, UNITED KINGDOM CB40WZ

FOR: COMPUTER SOFTWARE THAT AUTOMATICALLY INSERTS TAGS AND AUTOMATICALLY HYPERLINKS SIMILAR AND RELATED INFORMATION; COMPUTER SOFTWARE ENABLING BUSINESS TO IMPLEMENT INTELLIGENT, SCALEABLE AND AUTOMATED APPLICATIONS THAT HANDLE MULTI-MEDIA CONTENT; COMPUTER SOFTWARE THAT AUTOMATES KEY OPERATIONS ON UNSTRUCTURED INFORMATION SUCH AS EMAILS, VOICE DATA AND INFORMATION, GRAPHICS, WEB PAGES AND PEOPLE, NAMELY, USER DATA, THUS ABLE TO POWER ANY APPLICATION DEPENDENT ON ANY TYPE OF INFORMATION, NAMELY, E-COMMERCE, CUSTOMER RELATIONSHIP MANAGEMENT, KNOWLEDGE MANAGEMENT, ENTERPRISE INFORMATION, PORTALS AND ON-LINE PUBLISHING APPLICATIONS; COMPUTER SOFTWARE AND PROGRAMS FOR SEARCHING, RETRIEVING AND PROFILING INFORMATION BY COMPUTER SYSTEMS, COMPUTER NETWORKS, THE INTERNET, INTRANETS, DATABASES AND OTHER DIGITAL DOMAINS; COMPUTER SOFTWARE AND PROGRAMS FOR PROVIDING ACCESS TO THE INTERNET AND RUNNING WEB SITE SEARCHES; COMPUTER SOFTWARE AND PROGRAMS WHICH DELIVER TO USERS INFORMATION AND VIDEO VIA DESKTOP COMPUTERS, MOBILE TELEPHONES, PERSONAL DIGITAL APPARATUS AND OTHER HANDHELD DIGITAL DEVICES; COMPUTER SOFTWARE AND PROGRAMS WHICH PROVIDE INFORMATION FROM THE COMPUTER SYSTEMS, COMPUTER NETWORK, THE INTERNET, INTRANETS, DATABASES AND OTHER DIGITAL DOMAINS WHICH ENABLES USERS TO BE AUTOMATICALLY ALERTED TO

THE EXISTENCE OF OTHER PEOPLE WHOSE INTERESTS COINCIDE WITH THEIR OWN AND TO BE GIVEN THEIR E-MAIL AND TELEPHONE DETAILS; COMPUTER SOFTWARE AND PROGRAMS CAPABLE OF ADAPTING THEIR BEHAVIOR ACCORDING TO A USER'S INSTRUCTIONS OR RESPONSES BY PERSONALIZING AND PROFILING END-USERS; COMPUTER SOFTWARE FOR THE RETRIEVAL, PROFILING, MANAGEMENT, AND DELIVERY OF DATA AND VIDEO IN KNOWLEDGE MANAGEMENT, NEWS MEDIA, AND E-COMMERCE SOFTWARE APPLICATIONS; COMPUTER SOFTWARE AND PROGRAMS FOR THE DELIVERY AND EXCHANGE OF BUSINESS INFORMATION TO DESKTOP COMPUTERS, MOBILE TELEPHONES, PERSONAL DIGITAL APPARATUS AND OTHER HANDHELD DIGITAL DEVICES; COMPUTER PROGRAMS AND COMPUTER SOFTWARE HAVING A SEARCH CAPABILITY AND FUNCTIONALITY FOR KNOWLEDGE MANAGEMENT AND ENTERPRISE PORTAL SYSTEMS TO BE IMPLEMENTED IN THE COMPUTER SYSTEMS, COMPUTER NETWORK, THE INTERNET, INTRANETS, DATABASES AND OTHER DIGITAL DOMAINS AND E-COMMERCE SITES; COMPUTER PROGRAMS AND COMPUTER SOFTWARE HAVING AN AUTOMATED APPLICATION WHICH CAN HANDLE MULTIMEDIA, E-COMMERCE, CUSTOMER RELATIONSHIP MANAGEMENT, KNOWLEDGE MANAGEMENT AND ENTERPRISE INFORMATION PORTALS FOR E-COMMERCE BUSINESS ENTITIES; COMPUTER PROGRAMS AND COMPUTER SOFTWARE FOR ALERTING USERS TO THE DEVELOPMENT OF NEW STORIES, FINANCIAL EVENTS AND THE LATEST SPORTS RESULTS AND TO OTHER STORIES AND INFORMATION AND TO PROVIDE USERS WITH LINKS, SOUND BITES OR VIDEO FOOTAGE OF LATEST EVENTS AS SELECTED BY THE USER; COMPUTER PROGRAMS AND COMPUTER SOFTWARE FOR USE BY AND WITH THE BROADCAST AND MED-

IA INDUSTRIES FOR UPLOADING AND DOWNLOADING VIDEOS AND OTHER DIGITAL CONTENT VIA A GLOBAL COMPUTER NETWORK; COMPUTER PROGRAMS AND COMPUTER SOFTWARE FOR THE PROVISION OF DATABASE MANAGEMENT PRODUCTIVITY SOLUTIONS FOR BUSINESS AND CONSUMERS FOR THE HANDLING OF BROADCAST NEWS, DIGITAL TELEVISION, CONVERGENT MEDIA AND REAL TIME CONTENT GENERATED BY BUSINESSES AND USERS; COMPUTER SOFTWARE AND COMPUTER PROGRAMS FOR TAKING AND ASSEMBLING A REPOSITORY OF UNSTRUCTURED DATA, AGENTS AND PROFILES AND AUTOMATICALLY PARTITIONING THE DATA SO THAT SIMILAR INFORMATION, SUCH AS DATA WITH RELATED FEATURES, IS CLUSTERED TOGETHER, EACH CLUSTER REPRESENTING A CONCEPT AREA WITHIN THE KNOWLEDGE BASE AND CONTAINING A SET OF ITEMS WITH COMMON PROPERTIES; COMPUTER SOFTWARE AND PROGRAMS USED TO READ AND EVALUATE CONTENT LOCATED ON GLOBAL COMPUTER NETWORKS, DATABASES AND NETWORKS, IN CLASS 9 (U.S. CLS. 21, 23, 26, 36 AND 38).

FOR: PROVIDING REMOTE ACCESS TO THE INTERNET FOR RUNNING WEB SITE SEARCHES, IN CLASS 38 (U.S. CLS. 100, 101 AND 104).

FOR: CONSULTANCY, DESIGN, DEVELOPMENT AND IMPLEMENTATION SERVICES RELATING TO COMPUTER SOFTWARE AND PROGRAMS; MAINTENANCE AND UPDATING OF COMPUTER SOFTWARE AND COMPUTER PROGRAMS; COMPUTER SERVICES RELATING TO PROVIDING COMPUTER SOFTWARE AND PROGRAMS FOR SEARCHING, RETRIEVING, PROFILING, MANAGING, SORTING, SELECTING AND STORING INFORMATION AVAILABLE VIA THE INTERNET OR OTHER COMMUNICATION NETWORKS, NAMELY, COMPUTER SOFTWARE CONSULTATION AND TECHNICAL SERVICES IN THE NATURE OF TROUBLESHOOTING OF COMPUTER HARDWARE AND SOFTWARE PROBLEMS; COMPUTER SERVICES RELATING TO PROVIDING COMPUTER SOFTWARE AND PROGRAMS TO CREATE, ANALYZE, AND EXTRACT INFORMATION FROM THE INTERNET AND TO AUTOMATICALLY MAINTAIN PERSONALIZED PORTAL SITES BY ONLINE PUBLISHERS AND CORPORATIONS, NAMELY, PROVIDING TEMPORARY USE OF ONLINE NONDOWNLOADABLE COMPUTER SOFTWARE AND PROGRAMS FOR CREATING, ANALYZING AND EXTRACTING INFORMATION FROM THE INTERNET TO AUTOMATICALLY UPDATE PERSONALIZED PORTAL WEBSITES; COMPUTER SERVICES RELATING TO PROVIDING COMPUTER SOFTWARE AND PROGRAMS WHICH ANALYZE AND EXTRACT IDEAS AND PROFILES IN TEXT FROM THE INTERNET ENABLING THE PROFILING OF USERS, NAMELY, DESIGNING AND UPDATING COMPUTER SOFTWARE AND PROGRAMS FOR OTHERS TO ANALYZE AND EXTRACT IDEAS AND PROFILES FROM INTERNET TEXT FOR PROFILING USERS; PROVIDING DESIGN, DEVELOPMENT, CUSTOMI-

ZATION, IMPLEMENTATION AND MAINTENANCE SERVICES FOR KNOWLEDGE MANAGEMENT, NEW MEDIA AND E-COMMERCE SOFTWARE APPLICATIONS AND PROGRAMS THAT PROVIDE INFORMATION AND VIDEO VIA A GLOBAL COMPUTER INFORMATION NETWORK; COMPUTER SERVICES, NAMELY, PROVIDING SEARCH ENGINES FOR OBTAINING, MAINTAINING AND DELIVERING DATA AND VIDEO ON A GLOBAL COMPUTER NETWORK OR TO A MOBILE TELEPHONE OR TO PERSONAL DIGITAL APPARATUS AND OTHER HANDHELD DIGITAL DEVICES AND A DESKTOP COMPUTER, IN THE FIELD OF INFORMATION MANAGEMENT; COMPUTER SERVICES, NAMELY, DESIGN, DEVELOPMENT, CUSTOMIZATION, IMPLEMENTATION AND MAINTENANCE SERVICES FOR NON-DOWNLOADABLE COMPUTER SOFTWARE FOR ON-LINE NAVIGATION OF THE GLOBAL COMPUTER NETWORK AND FOR RUNNING WEB SITE SEARCHES ONLINE; CONSULTANCY, DESIGN, DEVELOPMENT AND IMPLEMENTATION SERVICES RELATING TO COMPUTER PROGRAMS AND COMPUTER SOFTWARE FOR USE BY AND WITH THE BROADCAST AND MEDIA INDUSTRIES; CONSULTANCY, DESIGN, DEVELOPMENT AND IMPLEMENTATION SERVICES RELATING TO COMPUTER PROGRAMS AND COMPUTER SOFTWARE FOR THE PERSONALIZATION OF BROADCAST NEWS, DIGITAL TELEVISION, CONVERGENT MEDIA AND REAL TIME CONTENT BY BUSINESSES AND CONSUMERS; COMPUTER DESIGN AND IMPLEMENTATION SERVICES RELATING TO COMPUTER SOFTWARE AND PROGRAMS WHICH AUTOMATICALLY SEARCH THE GLOBAL COMPUTER NETWORKS TO AUTOMATICALLY LOCATE, READ AND EVALUATE INFORMATION ACCORDING TO PARAMETERS SET BY THE USER FOR THE USER'S REVIEW; TECHNICAL SUPPORT SERVICES AND COMPUTER SOFTWARE CONSULTANCY SERVICES. NAMELY, TROUBLESHOOTING OF COMPUTER SOFTWARE AND PROGRAMS WHICH AUTOMATICALLY SEARCH THE GLOBAL COMPUTER NETWORKS TO AUTOMATICALLY LOCATE, READ AND EVALUATE INFORMATION ACCORDING TO PARAMETERS SET BY THE USER FOR THE USER'S REVIEW; PROVIDING TEMPORARY USE OF NON-DOWNLOADABLE SOFTWARE FOR CONDUCTING SEARCHES ON DATA HELD IN E-COMMERCE WEB SITES; RENTAL AND PROVIDING TEMPORARY USE OF NON-DOWNLOADABLE COMPUTER SOFTWARE AND PROGRAMS FOR SEARCHING, RETRIEVAL AND PROFILING OF INFORMATION VIA COMPUTER SYSTEMS, COMPUTER NETWORKS AND THE INTERNET; RENTAL OF COMPUTER SOFTWARE AND PROGRAMS WHICH AUTOMATICALLY SEARCH THE GLOBAL COMPUTER NETWORKS TO AUTOMATICALLY LOCATE, READ AND EVALUATE INFORMATION ACCORDING TO PARAMETERS SET BY THE USER FOR THE USER'S REVIEW; PROVIDING SEARCH ENGINES FOR OBTAINING DATA FROM A DATABASE FOR DELIVERY TO A GLOBAL COMPUTER NETWORK, A MOBILE TELEPHONE, A PERSONAL DIGITAL APPARATUS

AND OTHER HANDHELD DIGITAL DEVICES AND DESKTOP COMPUTERS, IN CLASS 42 (U.S. CLS. 100 AND 101).

FOR: LICENSING OF COMPUTER SOFTWARE AND COMPUTER PROGRAMS; LICENSING OF COMPUTER SOFTWARE AND COMPUTER PROGRAMS THAT AUTOMATICALLY SEARCH GLOBAL COMPUTER NETWORKS AND THE INTERNET TO LOCATE, READ AND EVALUATE INFORMATION ACCORDING TO PARAMETERS SET BY THE USER, IN CLASS 45 (U.S. CLS. 100 AND 101).

THE MARK CONSISTS OF STANDARD CHARACTERS WITHOUT CLAIM TO ANY PARTICULAR FONT, STYLE, SIZE, OR COLOR.

OWNER OF UNITED KINGDOM REG. NO. 2445151, DATED 1-30-2007, EXPIRES 1-30-2017.

SER. NO. 77-126,688, FILED 3-9-2007.

APRIL ROACH, EXAMINING ATTORNEY

**Int. Cl.: 35**

**Prior U.S. Cls.: 100, 101 and 102**

**United States Patent and Trademark Office**

**Reg. No. 3,465,281**

**Registered July 15, 2008**

**SERVICE MARK  
PRINCIPAL REGISTER**

**Blox**

RYDELL COMPANY, LLC (CALIFORNIA LTD  
LIAB CO)  
27702 CROWN VALLEY PKWY  
SUITE #D-4, #127  
LADERA RANCH, CA 92694

THE MARK CONSISTS OF STANDARD CHAR-  
ACTERS WITHOUT CLAIM TO ANY PARTICULAR  
FONT, STYLE, SIZE, OR COLOR.

FOR: ADVERTISING AND COMMERCIAL IN-  
FORMATION SERVICES, VIA THE INTERNET, IN  
CLASS 35 (U.S. CLS. 100, 101 AND 102).

SER. NO. 77-127,500, FILED 3-9-2007.

FIRST USE 11-1-2005; IN COMMERCE 11-1-2005.

BRIAN CALLAGHAN, EXAMINING ATTORNEY

**Int. Cl.: 43**

**Prior U.S. Cls.: 100 and 101**

**United States Patent and Trademark Office**

**Reg. No. 3,465,282**

**Registered July 15, 2008**

**SERVICE MARK  
PRINCIPAL REGISTER**

**QUATTRO GASTRONOMIA  
ITALIANA**

KNR RESTAURANT GROUP, LLC (FLORIDA  
LTD LIAB CO)  
1691 MICHIGAN AVENUE, SUITE 325  
MIAMI BEACH, FL 331392557

FOR: RESTAURANTS, IN CLASS 43 (U.S. CLS. 100  
AND 101).

FIRST USE 8-2-2006; IN COMMERCE 8-2-2006.

THE MARK CONSISTS OF STANDARD CHAR-  
ACTERS WITHOUT CLAIM TO ANY PARTICULAR  
FONT, STYLE, SIZE, OR COLOR.

NO CLAIM IS MADE TO THE EXCLUSIVE  
RIGHT TO USE "GASTRONOMIA ITALIANA",  
APART FROM THE MARK AS SHOWN.

THE FOREIGN WORDING IN THE MARK  
TRANSLATES INTO ENGLISH AS FOUR ITALIAN  
FOOD SHOP.

SER. NO. 77-127,850, FILED 3-11-2007.

SAIMA MAKHDOOM, EXAMINING ATTORNEY

**Int. Cl.: 30**

**Prior U.S. Cl.: 46**

**United States Patent and Trademark Office**

**Reg. No. 3,465,283**

**Registered July 15, 2008**

**TRADEMARK  
PRINCIPAL REGISTER**

**CHICK'N CRISP**

BURGER KING BRANDS, INC. (DELAWARE  
CORPORATION)  
5505 BLUE LAGOON DRIVE  
MIAMI, FL 33126

FOR: SANDWICHES SOLD IN RESTAURANTS  
FOR CONSUMPTION ON OR OFF THE PREMISES,  
IN CLASS 30 (U.S. CL. 46).

FIRST USE 3-0-1998; IN COMMERCE 3-0-1998.

THE MARK CONSISTS OF STANDARD CHAR-  
ACTERS WITHOUT CLAIM TO ANY PARTICULAR  
FONT, STYLE, SIZE, OR COLOR.

NO CLAIM IS MADE TO THE EXCLUSIVE  
RIGHT TO USE "CHICKEN", APART FROM THE  
MARK AS SHOWN.

SER. NO. 77-128,249, FILED 3-12-2007.

TINA BROWN, EXAMINING ATTORNEY

**Int. Cl.: 16**

**Prior U.S. Cls.: 2, 5, 22, 23, 29, 37, 38 and 50**

**United States Patent and Trademark Office**

**Reg. No. 3,465,284**

**Registered July 15, 2008**

**TRADEMARK  
PRINCIPAL REGISTER**



MOHAWK FINE PAPERS INC. (NEW YORK  
CORPORATION)  
465 SARATOGA STREET  
COHOES, NY 12047

FOR: PAPER, IN CLASS 16 (U.S. CLS. 2, 5, 22, 23, 29,  
37, 38 AND 50).

FIRST USE 5-1-2007; IN COMMERCE 5-1-2007.

NO CLAIM IS MADE TO THE EXCLUSIVE  
RIGHT TO USE "MADE CARBON NEUTRAL",  
APART FROM THE MARK AS SHOWN.

THE MARK CONSISTS OF THE WORDING  
"MADE CARBON NEUTRAL" BELOW THE LET-  
TERS "C" AND "N" WHICH APPEAR IN STYLIZED  
LETTERING.

SER. NO. 77-128,820, FILED 3-12-2007.

JEFFERY COWARD, EXAMINING ATTORNEY

**Int. Cl.: 37**

**Prior U.S. Cls.: 100, 103 and 106**

**United States Patent and Trademark Office**

**Reg. No. 3,465,285**

**Registered July 15, 2008**

**SERVICE MARK  
PRINCIPAL REGISTER**



ROOFING SERVICES INTERNATIONAL (CALIFORNIA CORPORATION)  
8285 BUCKHORN ST  
SAN DIEGO, CA 92111

FOR: ROOFING CONSULTATION; ROOFING INSTALLATION; ROOFING REPAIR; ROOFING SERVICES, IN CLASS 37 (U.S. CLS. 100, 103 AND 106).

FIRST USE 12-31-1993; IN COMMERCE 12-31-1993.

NO CLAIM IS MADE TO THE EXCLUSIVE RIGHT TO USE "ROOFING", APART FROM THE MARK AS SHOWN.

THE MARK CONSISTS OF A SILHOUETTED SKYLINE. TO THE RIGHT OF THE SILHOUETTED SKYLINE IS THE WORDING "RSI". UNDERNEATH THE SILHOUETTED SKYLINE AND THE WORDING "RSI", IS THE WORDING "ROOFING". UNDERNEATH THE WORDING "ROOFING" IS THE WORDING "WHEN YOU THINK ROOFING...THINK RSI!".

SER. NO. 77-129,417, FILED 3-13-2007.

TASHIA BUNCH, EXAMINING ATTORNEY



Int. Cl.: 19

Prior U.S. Cls.: 1, 12, 33 and 50

United States Patent and Trademark Office

Reg. No. 3,465,286

Registered July 15, 2008

TRADEMARK  
PRINCIPAL REGISTER



WORLD TEXTILE AND BAG, INC. (CALIFORNIA CORPORATION)  
2319 THISTLE DOWN DRIVE  
ROSEVILLE, CA 95661

FOR: STORM WATER PREVENTION PLAN PRODUCTS FOR THE CONSTRUCTION INDUSTRY, NAMELY, NONMETALLIC DRAIN INLET FILTERS AND EROSION CONTROL FENCING, AND SAND AND GRAVEL BAGS FOR SEDIMENT CONTROL, IN CLASS 19 (U.S. CLS. 1, 12, 33 AND 50).

FIRST USE 7-7-2006; IN COMMERCE 9-1-2006.

NO CLAIM IS MADE TO THE EXCLUSIVE RIGHT TO USE "HEAVYWEIGHT BAG", APART FROM THE MARK AS SHOWN.

THE MARK CONSISTS OF PAIR OF BOXING GLOVES FACING OPPOSITE DIRECTIONS FOLLOWED BY THE WORDS "THE HEAVYWEIGHT BAG".

SER. NO. 77-129,487, FILED 3-13-2007.

MICHELLE DUBOIS, EXAMINING ATTORNEY

**Int. Cl.: 35**

**Prior U.S. Cls.: 100, 101 and 102**

**United States Patent and Trademark Office**

**Reg. No. 3,465,287**

**Registered July 15, 2008**

**SERVICE MARK  
PRINCIPAL REGISTER**

TRI-CAP FINANCIAL SERVICES  
INC.

TRI-CAP FINANCIAL SERVICES, INC. (GEOR-  
GIA CORPORATION)  
SUITE 240  
2400 LAKE PARK DRIVE  
SMYRNA, GA 30080

FOR: ACCOUNTING SERVICES; BOOKKEEP-  
ING; TAX AND TAXATION PLANNING, ADVICE,  
INFORMATION, AND CONSULTANCY SERVICES;  
TAX FILING SERVICES; TAX PREPARATION , IN  
CLASS 35 (U.S. CLS. 100, 101 AND 102).

FIRST USE 12-7-2004; IN COMMERCE 12-10-2004.

THE MARK CONSISTS OF STANDARD CHAR-  
ACTERS WITHOUT CLAIM TO ANY PARTICULAR  
FONT, STYLE, SIZE, OR COLOR.

NO CLAIM IS MADE TO THE EXCLUSIVE  
RIGHT TO USE "FINANCIAL SERVICES INC.",  
APART FROM THE MARK AS SHOWN.

SER. NO. 77-130,452, FILED 3-14-2007.

ELLEN B. AWRICH, EXAMINING ATTORNEY

Int. Cl.: 44

Prior U.S. Cls.: 100 and 101

United States Patent and Trademark Office

Reg. No. 3,465,288

Registered July 15, 2008

SERVICE MARK  
PRINCIPAL REGISTER



*For the smile of your life*

PACKARD ORTHODONTICS , P. A. (TEXAS  
UNINC. ASSOCIATION)  
SUITE 100  
840 CENTRAL PARKWAY EAST  
PLANO, TX 75074

FOR: ORTHODONTIC SERVICES, IN CLASS 44  
(U.S. CLS. 100 AND 101).

FIRST USE 10-0-1997; IN COMMERCE 10-0-1997.

NO CLAIM IS MADE TO THE EXCLUSIVE  
RIGHT TO USE "ORTHODONTICS", APART FROM  
THE MARK AS SHOWN.

THE COLOR(S) RED AND BLACK IS/ARE  
CLAIMED AS A FEATURE OF THE MARK.

THE MARK CONSISTS OF THE WORD "APPLE  
ORTHODONTIX" IN BLACK WITH A RED UNDER-  
SCORE OVER THE WORD "ORTHODONTIX", AD-  
JACENT TO A RED CIRCLE HAVING A PARTIAL  
WHITE SILHOUETTE OF AN APPLE WITH A LEAF  
AND STEM, BELOW WHICH ARE THE WORDS  
"FOR THE SMILE OF YOUR LIFE" IN RED.

SER. NO. 77-131,342, FILED 3-14-2007.

BENJAMIN ALLEN, EXAMINING ATTORNEY

Int. Cl.: 41

Prior U.S. Cls.: 100, 101 and 107

United States Patent and Trademark Office

Reg. No. 3,465,289

Registered July 15, 2008

SERVICE MARK  
PRINCIPAL REGISTER

G E M  
s t a t i o n

PAITCHELL, JEFFREY MAX (UNITED STATES  
INDIVIDUAL)  
117 BENDER DRIVE  
CLIFTON, NJ 07013

FOR: ENTERTAINMENT IN THE NATURE OF  
VISUAL AND AUDIO PERFORMANCES, NAMELY,  
MUSICAL BAND, ROCK GROUP, GYMNASTIC,  
DANCE, AND BALLET PERFORMANCES, IN  
CLASS 41 (U.S. CLS. 100, 101 AND 107).

FIRST USE 11-2-2006; IN COMMERCE 11-2-2006.

THE MARK CONSISTS OF THE WORD "GEM" IN  
LARGE CAPITAL LETTERS CONSISTING OF AN  
OUTLINE AND HOLLOW INSIDE ABOVE A HOR-  
IZONTAL LINE. BELOW THE HORIZONTAL LINE  
IS THE WORD "STATION" IN SMALLER LOWER  
CASE LETTERS.

SER. NO. 77-131,601, FILED 3-15-2007.

JENNIFER HETU, EXAMINING ATTORNEY

**Int. Cl.: 29**

**Prior U.S. Cl.: 46**

**United States Patent and Trademark Office**

**Reg. No. 3,465,290**

**Registered July 15, 2008**

**TRADEMARK  
PRINCIPAL REGISTER**

**EAST COAST BLEND**

GRANDE CHEESE COMPANY (ILLINOIS CORPORATION)

DAIRY ROAD

P.O. BOX 67

BROWNSVILLE, WI 53006

FOR: CHEESE, IN CLASS 29 (U.S. CL. 46).

FIRST USE 9-4-2007; IN COMMERCE 9-4-2007.

THE MARK CONSISTS OF STANDARD CHARACTERS WITHOUT CLAIM TO ANY PARTICULAR FONT, STYLE, SIZE, OR COLOR.

NO CLAIM IS MADE TO THE EXCLUSIVE RIGHT TO USE "BLEND", APART FROM THE MARK AS SHOWN.

SER. NO. 77-133,486, FILED 3-16-2007.

DEZMONA MIZELLE, EXAMINING ATTORNEY

**Int. Cls.: 9, 16 and 41**

**Prior U.S. Cls.: 2, 5, 21, 22, 23, 26, 29, 36, 37, 38, 50,  
100, 101 and 107**

**Reg. No. 3,465,291**

**United States Patent and Trademark Office**

**Registered July 15, 2008**

**TRADEMARK  
SERVICE MARK  
PRINCIPAL REGISTER**

# ROCKS & WATER

HACKETT, ZANNAH (UNITED STATES INDIVIDUAL)  
PO BOX 231143  
ENCINITAS, CA 92024 AND  
HACKETT, DAVID (UNITED STATES INDIVIDUAL)  
PO BOX 231143  
ENCINITAS, CA 92024

FOR: CINEMATOGRAPHIC FILMS, FILM STRIPS AND MOTION PICTURE FILMS FEATURING SELF-IMPROVEMENT, SELF-HELP, PERSONAL GROWTH, INSPIRATIONAL, AND CHILDREN'S TOPICS; AUDIO-VISUAL TEACHING APPARATUS, NAMELY, EDUCATIONAL SOFTWARE FOR CHILDREN AND ADULTS, FEATURING PERSONAL GROWTH, SELF-IMPROVEMENT, SELF-HELP, INSPIRATIONAL, AND CHILDREN'S TOPICS; ELECTRONIC PUBLICATIONS, NAMELY, BOOKS AND MAGAZINES FEATURING SELF-IMPROVEMENT, SELF-HELP, PERSONAL GROWTH, INSPIRATIONAL, AND CHILDREN'S TOPICS RECORDED ON COMPUTER MEDIA; ELECTRONIC GAME PROGRAMS; INTERACTIVE VIDEO GAME MACHINES FOR USE WITH TELEVISIONS; COMPUTER SOFTWARE FOR USE IN COMPUTER GAMES AND ELECTRONIC GAMES; COMPUTER PROGRAMS, NAMELY, DIGITAL GAME PROGRAMS ADAPTED FOR USE WITH TELEVISION RECEIVERS; ELECTRONIC GAME SOFTWARE FOR MOBILE PHONES; COMPUTER PROGRAMS, NAMELY, DIGITAL GAME PROGRAMS ADAPTED FOR USE WITH TELEVISION RECEIVERS; ELECTRONIC GAME SOFTWARE FOR MOBILE PHONES; DIGITAL RECORDINGS, NAMELY, PRERECORDED COMPACT DISCS FEATURING SELF-IMPROVEMENT, SELF-HELP, PERSONAL GROWTH, INSPIRATIONAL, AND CHILDREN'S TOPICS; PRERECORDED AUDIO TAPES, AUDIO TAPE CASSETTES, VIDEO TAPES, LASER DISCS, COMPACT DISCS, MULTIMEDIA SOFTWARE RECORDED ON INTERACTIVE CD ROMS AND DVDS FEATURING SELF-IMPROVEMENT, SELF-HELP, PERSONAL GROWTH, INSPIRATIONAL, AND CHILDREN'S TOPICS, IN CLASS 9 (U.S. CLS. 21, 23, 26, 36 AND 38).

FIRST USE 3-11-2007; IN COMMERCE 3-11-2007.

FOR: PAPER; CARDBOARD; PAPER ARTICLES, NAMELY, BOOKS, ANNUAL MAGAZINES, MAGAZINES, NEWSLETTERS, PERIODICALS, JOURNALS, MANUALS, CATALOGUES, PAMPHLETS, LEAFLETS, AND PRINTED INSTRUCTIONAL AND TEACHING MATERIALS, COMIC BOOKS, GRAPHIC NOVELS, CALENDARS, GREETING CARDS, STATIONERY, NOTE PADS, NOTE CARDS, PAPER LABELS, POSTERS, BOOK COVERS, AND BOOK MARKS, ALL FEATURING ARTWORK AND ARTICLES, INTERVIEWS, REFERENCES, AND QUOTATIONS ON SELF-HELP, SELF-IMPROVEMENT, PERSONAL GROWTH, INSPIRATIONAL, AND CHILDREN'S TOPICS; SERIES OF NON-FICTION BOOKS IN THE FIELD OF SELF IMPROVEMENT, INTENDED TO MOTIVATE; PRINTED INSTRUCTIONAL, TEACHING AND EDUCATION MATERIALS IN THE FIELD OF SELF IMPROVEMENT, INTENDED TO MOTIVATE; COMIC BOOKS; SONG BOOKS; MAGAZINES FEATURING INFORMATION IN THE FIELD OF MOTIVATIONAL SELF HELP; NEWSLETTERS FEATURING INFORMATION IN THE FIELD OF MOTIVATIONAL SELF HELP; NEWSPAPERS; ALBUMS, NAMELY, PHOTOGRAPH ALBUMS; PRINTED PERIODICALS FEATURING INFORMATION IN THE FIELD OF MOTIVATIONAL SELF HELP; JOURNALS FEATURING INFORMATION IN THE FIELD OF MOTIVATIONAL SELF HELP; CATALOGS FEATURING INFORMATION IN THE FIELD OF MOTIVATIONAL SELF HELP; MANUALS IN THE FIELD OF INFORMATION IN THE FIELD OF MOTIVATIONAL SELF HELP; MAPS; PAMPHLETS AND LEAFLETS FEATURING INFORMATION IN THE FIELD OF MOTIVATIONAL SELF HELP; POSTERS; BOOK COVERS; BOOK MARKS; CALENDARS; GREETING CARDS; STATIONERY; NOTE PADS; PAPER LABELS, IN CLASS 16 (U.S. CLS. 2, 5, 22, 23, 29, 37, 38 AND 50).

FIRST USE 3-11-2007; IN COMMERCE 3-11-2007.

FOR: WORKSHOPS, SEMINARS AND TRAVEL SEMINARS IN THE FIELD OF SELF IMPROVEMENT, INTENDED TO MOTIVATE; EDUCATIONAL SERVICES, NAMELY, CONDUCTING CERTIFICATE PROGRAMS IN THE FIELD OF SELF IMPROVEMENT, INTENDING TO MOTIVATE; EDUCATION AND ENTERTAINMENT SERVICES, NAMELY, LECTURES IN THE FIELD OF SELF IMPROVEMENT, INTENDED TO MOTIVATE, PRODUCTION OF TELEVISION PROGRAMS, RADIO PROGRAMS, CINEMATOGRAPHIC FILMS, AND THEATRE SHOWS FEATURING MUSIC AND DOCUMENTARIES, DRAMAS, COMEDIES, AND CARTOONS IN THE FIELD OF SELF IMPROVEMENT, INTENDED TO MOTIVATE; PRODUCTION OF TELEVISION, RADIO, SATELLITE TELEVISION, CABLE TELEVISION, SUBSCRIPTION TELEVISION, AND PAY-PER-VIEW TELEVISION PROGRAMS, MOBILE TELEPHONE VIDEO PROGRAMS, AND INTERNET VIDEO PROGRAMS; PRODUCTION OF VIDEO TAPES AND VIDEO DISCS FEATURING MUSIC AND DOCUMENTARIES, DRAMAS, COME-

DIES, AND CARTOONS IN THE FIELD OF SELF IMPROVEMENT, INTENDED TO MOTIVATE; INTERACTIVE ENTERTAINMENT SERVICES FOR USE WITH A MOBILE PHONE, NAMELY, PRE-RECORDED VOICEMAIL MESSAGES, TEXT MESSAGES AND EMAILS IN THE FIELD OF SELF IMPROVEMENT, INTENDED TO MOTIVATE; PROVIDING ON-LINE SERVICES, NAMELY, COMPUTER-BASED GAMES IN THE FIELD OF SELF IMPROVEMENT, INTENDED TO MOTIVATE, IN CLASS 41 (U.S. CLS. 100, 101 AND 107).

FIRST USE 3-11-2007; IN COMMERCE 3-11-2007.

THE MARK CONSISTS OF STANDARD CHARACTERS WITHOUT CLAIM TO ANY PARTICULAR FONT, STYLE, SIZE, OR COLOR.

SER. NO. 77-133,865, FILED 3-18-2007.

KEVIN DINALLO, EXAMINING ATTORNEY

**Int. Cls.: 38, 42 and 45**

**Prior U.S. Cls.: 100, 101 and 104**

**United States Patent and Trademark Office**

**Reg. No. 3,465,292**

**Registered July 15, 2008**

**SERVICE MARK  
PRINCIPAL REGISTER**

# Ivy Legal

IVY LEGAL (NEW YORK SOLE PROPRIETORSHIP)  
258 W. 71 ST, STE 1A  
NEW YORK, NY 10023

FOR: ON-LINE DOCUMENT DELIVERY VIA A GLOBAL COMPUTER NETWORK, IN CLASS 38 (U.S. CLS. 100, 101 AND 104).

FIRST USE 2-14-2006; IN COMMERCE 9-18-2006.

FOR: PUBLIC DOCUMENT FILING SERVICES VIA A GLOBAL COMPUTER NETWORK, IN CLASS 42 (U.S. CLS. 100 AND 101).

FIRST USE 2-14-2006; IN COMMERCE 9-18-2006.

FOR: PROVIDING LEGAL DOCUMENT PREPARATION SERVICES; PROVIDING GENERAL LEGAL INFORMATION VIA A WEBSITE ON A GLOBAL COMPUTER NETWORK, IN CLASS 45 (U.S. CLS. 100 AND 101).

FIRST USE 2-14-2006; IN COMMERCE 9-18-2006.

THE MARK CONSISTS OF STANDARD CHARACTERS WITHOUT CLAIM TO ANY PARTICULAR FONT, STYLE, SIZE, OR COLOR.

SER. NO. 77-133,910, FILED 3-18-2007.

ALLISON HOLTZ, EXAMINING ATTORNEY



**Int. Cl.: 9**

**Prior U.S. Cls.: 21, 23, 26, 36 and 38**

**Reg. No. 3,465,293**

**United States Patent and Trademark Office**

**Registered July 15, 2008**

---

**TRADEMARK  
PRINCIPAL REGISTER**

**LATITUDE**

DELL INC. (DELAWARE CORPORATION)  
ONE DELL WAY  
ROUND ROCK, TX 78682

FOR: COMPUTERS, PARTS AND FITTINGS THEREFOR, LCD DISPLAY, KEYBOARD, HARD DISC DRIVES, OPTICAL DISC DRIVES, DIGITAL VIDEO DISC DRIVES, READ/WRITE DRIVES, CABLE AND CONNECTORS, ALL FOR USE WITH COMPUTERS, IN CLASS 9 (U.S. CLS. 21, 23, 26, 36 AND 38).

FIRST USE 4-4-1994; IN COMMERCE 4-4-1994.

THE MARK CONSISTS OF STANDARD CHARACTERS WITHOUT CLAIM TO ANY PARTICULAR FONT, STYLE, SIZE, OR COLOR.

OWNER OF U.S. REG. NO. 1,962,286.

SER. NO. 77-134,124, FILED 3-19-2007.

JESSICA FATHY, EXAMINING ATTORNEY

Int. Cl.: 35

Prior U.S. Cls.: 100, 101 and 102

**United States Patent and Trademark Office**

**Reg. No. 3,465,294**

Registered July 15, 2008

---

**SERVICE MARK  
PRINCIPAL REGISTER**

*Living Well.*  
**Heart and Soul.**

UNITED SUPERMARKETS, L.L.C. (TEXAS LIMITED LIABILITY COMPANY)  
7830 ORLANDO AVENUE  
LUBBOCK, TX 794936170

FIRST USE 1-0-2007; IN COMMERCE 1-0-2007.

SER. NO. 77-134,169, FILED 3-19-2007.

FOR: RETAIL GROCERY STORES, IN CLASS 35  
(U.S. CLS. 100, 101 AND 102).

ALYSSA PALADINO, EXAMINING ATTORNEY

**Int. Cl.: 5**

**Prior U.S. Cls.: 6, 18, 44, 46, 51 and 52**

**United States Patent and Trademark Office**

**Reg. No. 3,465,295**

**Registered July 15, 2008**

**TRADEMARK  
PRINCIPAL REGISTER**

**PREPANDRIX**

GLAXOSMITHKLINE BIOLOGICALS, S.A. (BEL-  
GIUM CORPORATION)  
RUE DE L'INSTITUT 89  
RIXENSART, BELGIUM B-1330

FOR: VACCINES FOR HUMAN USE, IN CLASS 5  
(U.S. CLS. 6, 18, 44, 46, 51 AND 52).

THE MARK CONSISTS OF STANDARD CHAR-  
ACTERS WITHOUT CLAIM TO ANY PARTICULAR  
FONT, STYLE, SIZE, OR COLOR.

PRIORITY CLAIMED UNDER SEC. 44(D) ON  
UNITED KINGDOM APPLICATION NO. 2442781,  
FILED 1-5-2007.

OWNER OF BENELUX REG. NO. 0839003, DATED  
2-26-2008, EXPIRES 2-25-2018.

SER. NO. 77-134,513, FILED 3-19-2007.

MORGAN WYNNE, EXAMINING ATTORNEY

**Int. Cl.: 9**

**Prior U.S. Cls.: 21, 23, 26, 36 and 38**

**United States Patent and Trademark Office**

**Reg. No. 3,465,296**

**Registered July 15, 2008**

**TRADEMARK  
PRINCIPAL REGISTER**



ACLOQUE, J. PATRICK (UNITED STATES INDIVIDUAL)  
293 REICHEL ROAD, APT D  
NEW MILFORD, NJ 07646

FOR: COMPUTER SOFTWARE TO RUN AND MANAGE BUSINESS PROCESSES, NAMELY, TAKING CUSTOMER ORDERS, MANAGING SUPPLIES, AND MANUFACTURING ALL FOR ENTERPRISE REQUIREMENT PLANNING PURPOSES, IN CLASS 9 (U.S. CLS. 21, 23, 26, 36 AND 38).

FIRST USE 1-15-2007; IN COMMERCE 1-15-2007.

NO CLAIM IS MADE TO THE EXCLUSIVE RIGHT TO USE "INFORMATION SYSTEM", APART FROM THE MARK AS SHOWN.

THE COLOR(S) WHITE, BLACK AND BLUE IS/ ARE CLAIMED AS A FEATURE OF THE MARK.

THE COLOR WHITE APPEARS IN THE WORD "HAALUBIZ", THE COLOR BLACK APPEARS IN THE WORDS "INFORMATION SYSTEM" AND THE COLOR BLUE APPEARS IN THE BACKGROUND OF THE MARK.

SER. NO. 77-135,330, FILED S.R. 3-20-2007 AM. P.R. 3-7-2008.

LINDA M. KING, EXAMINING ATTORNEY

**Int. Cl.: 36**

**Prior U.S. Cls.: 100, 101 and 102**

**United States Patent and Trademark Office**

**Reg. No. 3,465,297**

**Registered July 15, 2008**

**SERVICE MARK  
PRINCIPAL REGISTER**

# DesignOne

VICTOR O. SCHINNERER & COMPANY, INC,  
(DELAWARE CORPORATION)  
TWO WISCONSIN CIRCLE  
CHEVY CHASE, MD 208157022

FOR: INSURANCE CONSULTING, UNDER-  
WRITING, MANAGEMENT, WHOLESALE BRO-  
KERING AND AGENCY SERVICES, NAMELY,  
PROVIDING A PACKAGE INSURANCE POLICY  
IN THE FIELDS OF PROFESSIONAL LIABILITY,  
PROPERTY, CASUALTY, UMBRELLA, WORKERS  
COMPENSATION, BUSINESS AUTO AND EMPLOY-  
MENT PRACTICES TO ARCHITECTS, ENGINEERS,  
SURVEYORS, LANDSCAPE ARCHITECTS AND

OTHER DESIGN PROFESSIONALS, IN CLASS 36  
(U.S. CLS. 100, 101 AND 102).

FIRST USE 0-0-1999; IN COMMERCE 0-0-1999.

THE MARK CONSISTS OF STANDARD CHAR-  
ACTERS WITHOUT CLAIM TO ANY PARTICULAR  
FONT, STYLE, SIZE, OR COLOR.

SER. NO. 77-135,602, FILED 3-20-2007.

MICHAEL LEWIS, EXAMINING ATTORNEY

**Int. Cl.: 18**

**Prior U.S. Cls.: 1, 2, 3, 22 and 41**

**Reg. No. 3,465,298**

**United States Patent and Trademark Office**

**Registered July 15, 2008**

---

**TRADEMARK  
PRINCIPAL REGISTER**

**KOZY KASHMIR**

KOZY KASHMIR, INC. (PENNSYLVANIA CORPORATION)  
25825 SCIENCE PARK DRIVE  
BEACHWOOD, OH 44122

FOR: CLOTHING FOR DOMESTIC PETS CONSISTING IN WHOLE OR SUBSTANTIAL PART OF CASHMERE, IN CLASS 18 (U.S. CLS. 1, 2, 3, 22 AND 41).

FIRST USE 6-20-2002; IN COMMERCE 6-20-2002.

THE MARK CONSISTS OF STANDARD CHARACTERS WITHOUT CLAIM TO ANY PARTICULAR FONT, STYLE, SIZE, OR COLOR.

NO CLAIM IS MADE TO THE EXCLUSIVE RIGHT TO USE "CASHMERE", APART FROM THE MARK AS SHOWN.

SER. NO. 77-135,914, FILED 3-20-2007.

ANDREA BUTLER, EXAMINING ATTORNEY

**Int. Cls.: 9 and 42**

**Prior U.S. Cls.: 21, 23, 26, 36, 38, 100 and 101**

**United States Patent and Trademark Office**

**Reg. No. 3,465,299**

**Registered July 15, 2008**

**TRADEMARK  
SERVICE MARK  
PRINCIPAL REGISTER**

**3D MVP**

3D MVP, LLC (MARYLAND LTD LIAB CO)  
3917 DANCE MILL ROAD  
PHOENIX, MD 21131

FOR: COMPUTER SOFTWARE FOR COACHING  
INSTRUCTION WITHIN THE FIELD OF AMERI-  
CAN STYLE FOOTBALL, IN CLASS 9 (U.S. CLS. 21,  
23, 26, 36 AND 38).

FIRST USE 7-10-2006; IN COMMERCE 7-10-2006.

FOR: DESIGN, DEVELOPMENT AND IMPLE-  
MENTATION OF SOFTWARE, IN CLASS 42 (U.S.  
CLS. 100 AND 101).

FIRST USE 7-10-2006; IN COMMERCE 7-10-2006.

THE MARK CONSISTS OF STANDARD CHAR-  
ACTERS WITHOUT CLAIM TO ANY PARTICULAR  
FONT, STYLE, SIZE, OR COLOR.

NO CLAIM IS MADE TO THE EXCLUSIVE  
RIGHT TO USE "3D", APART FROM THE MARK  
AS SHOWN.

SER. NO. 77-136,328, FILED 3-21-2007.

KAREN BRACEY, EXAMINING ATTORNEY

**Int. Cl.: 7**

**Prior U.S. Cls.: 13, 19, 21, 23, 31, 34 and 35**

**United States Patent and Trademark Office**

**Reg. No. 3,465,300**

**Registered July 15, 2008**

**TRADEMARK  
PRINCIPAL REGISTER**

# Hercules

IDFI INC. (IOWA CORPORATION)  
WWW.IDFI.COM  
931 E. FRONTAGE ROAD  
MOVILLE, IA 51039

FOR: RAIL SWITCH FOR AN INDUSTRIAL CONVEYOR ASSEMBLY COMPRISING STRAIGHT AND CURVED RAILS, UPRIGHT BRIDGE FRAMEWORK AND PIVOTING GATES FOR THE TRANSFER OF PRODUCT FROM ONE RAIL TO ANOTHER, IN CLASS 7 (U.S. CLS. 13, 19, 21, 23, 31, 34 AND 35).

FIRST USE 3-1-2007; IN COMMERCE 3-15-2007.

THE MARK CONSISTS OF STANDARD CHARACTERS WITHOUT CLAIM TO ANY PARTICULAR FONT, STYLE, SIZE, OR COLOR.

SER. NO. 77-138,874, FILED 3-23-2007.

IRA J. GOODSaid, EXAMINING ATTORNEY



**Int. Cls.: 9, 35, 37, 38 and 42**

**Prior U.S. Cls.: 21, 23, 26, 36, 38, 100, 101, 102, 103,  
104 and 106**

**Reg. No. 3,465,301**

**United States Patent and Trademark Office**

**Registered July 15, 2008**

**TRADEMARK  
SERVICE MARK  
PRINCIPAL REGISTER**

# SER SOLUTIONS

SER SOLUTIONS, INC. (VIRGINIA CORPORATION)  
LOUDOUN TECH CENTER  
21680 RIDGETOP CIRCLE  
DULLES, VA 20166

FOR: COMPUTER SOFTWARE AND HARDWARE FOR USE IN CALL CENTER AUTOMATION AND MANAGEMENT; COMPUTER SOFTWARE, HARDWARE AND MANUALS SOLD TOGETHER AS A UNIT FOR AUTOMATIC PROCESSING, MANAGEMENT AND ROUTING OF INBOUND AND OUTBOUND TELEPHONE CALLS; COMPUTER HARDWARE AND SOFTWARE FOR TRANSMISSION AND ROUTING OF VOICE AND DATA FOR USE WITH COMPUTER SYSTEMS, COMPUTER TELEPHONY, CALL CONTACT CENTER OPERATIONS; COMPUTER HARDWARE AND SOFTWARE FOR MANAGING BOTH INBOUND AND OUTBOUND CALLS IN A BLENDED ENVIRONMENT IN CALL CONTACT CENTER OPERATIONS; COMPUTER HARDWARE AND SOFTWARE FOR MANAGING AND CONTROLLING CALL CONTACT CENTER OPERATIONS; COMPUTER HARDWARE AND SOFTWARE FOR CUSTOMER RELATIONSHIP MANAGEMENT AT CALL CONTACT CENTERS OPERATIONS, NAMELY, MANAGING, MONITORING AND TRACKING COMMUNICATIONS AND TRANSACTIONS, ASSESSING THE SKILLS OF EMPLOYEES AND MANAGEMENT OF THE ALLOCATION OF THOSE EMPLOYEES WITHIN THE BUSINESS, STATISTICS REPORTING, PROVIDING MARKETING RESEARCH, PLACING TELEPHONE CALLS FOR DIRECT MARKETING AND FOR SALES CAMPAIGN MANAGEMENT, PROVIDING LISTS OF PURCHASERS INTERESTED IN PURCHASING GOODS AND SERVICES AND MANAGING THOSE LISTS, CONTACT MANAGEMENT, LIABILITY MANAGEMENT, RISK MANAGEMENT, TRACKING THE

AMOUNT OF BUSINESS TRANSACTED DURING A GIVEN PERIOD OF TIME, IN CLASS 9 (U.S. CLS. 21, 23, 26, 36 AND 38).

FIRST USE 1-31-2001; IN COMMERCE 1-31-2001.

FOR: BUSINESS MANAGEMENT AND CONSULTATION SERVICES IN THE FIELD OF CALL CONTACT CENTER OPERATIONS AND CALL CONTACT CENTER APPLICATIONS; PROVIDING CUSTOMER SERVICES IN THE FIELD OF TELEPHONE CALL CENTERS FOR OTHERS; MANAGEMENT OF CALL CONTACT CENTERS FOR OTHERS; PROVIDING CONSULTING SERVICES TO OTHERS IN THE FIELD OF CALL CENTER OPERATIONS, IN CLASS 35 (U.S. CLS. 100, 101 AND 102).

FIRST USE 1-31-2001; IN COMMERCE 1-31-2001.

FOR: INSTALLATION OF COMPUTER HARDWARE; MAINTENANCE OF COMPUTER HARDWARE; INSTALLATION OF COMPUTER AND TELEPHONY NETWORKS, NAMELY, CALL CONTACT CENTERS; MAINTENANCE AND REPAIR OF COMPUTER NETWORKS AND TELEPHONY NETWORKS, NAMELY, CALL CONTACT CENTERS, IN CLASS 37 (U.S. CLS. 100, 103 AND 106).

FIRST USE 1-31-2001; IN COMMERCE 1-31-2001.

FOR: TELECOMMUNICATIONS SERVICES, NAMELY, CONSULTING SERVICES IN THE FIELD OF CUSTOMIZED AUTOMATED DIALING AND CALL CONTACT CENTER SYSTEMS; TELECOMMUNICATIONS SERVICES, NAMELY, PROVIDING TELEPHONIC CALL ROUTING SERVICES FOR CALL CENTER OPERATIONS ALLOWING AUTOMATIC DISTRIBUTION OF INBOUND AND OUT-

BOUND CALLS; CALL CENTER TELECOMMUNICATIONS SERVICES IN THE NATURE OF PROVIDING INBOUND AND OUTBOUND TELESERVICES TO OTHERS, NAMELY, TELEPHONE COMMUNICATIONS SERVICES, IN CLASS 38 (U.S. CLS. 100, 101 AND 104).

FIRST USE 1-31-2001; IN COMMERCE 1-31-2001.

FOR: INSTALLATION AND MAINTENANCE OF COMPUTER SOFTWARE ; DESIGN OF COMPUTER SOFTWARE AND COMPUTER SYSTEMS FOR OTHERS; INTEGRATION OF COMPUTER SYSTEMS AND NETWORKS; COMPUTER CONSULTATION; DEVELOPMENT OF COMPUTER TELEPHONE SYSTEMS INTEGRATING COMPUTER HARDWARE AND SOFTWARE FOR AUTOMATIC PROCESSING OF INBOUND AND OUTBOUND TELEPHONE CALLS FOR OTHERS; COMPUTER CONSULTING CONCERNING SOFTWARE AND HARDWARE FOR TELECOMMUNICATIONS AND

CALL CENTER OPERATIONS; DEVELOPMENT AND DESIGN FOR OTHERS OF COMPUTER HARDWARE AND SOFTWARE SOLUTIONS FOR CALL CENTER OPERATIONS; COMPUTER ENGINEERING; INSTALLATION OF COMPUTER SOFTWARE; MAINTENANCE OF COMPUTER SOFTWARE, IN CLASS 42 (U.S. CLS. 100 AND 101).

FIRST USE 1-31-2001; IN COMMERCE 1-31-2001.

THE MARK CONSISTS OF STANDARD CHARACTERS WITHOUT CLAIM TO ANY PARTICULAR FONT, STYLE, SIZE, OR COLOR.

NO CLAIM IS MADE TO THE EXCLUSIVE RIGHT TO USE "SOLUTIONS", APART FROM THE MARK AS SHOWN.

SER. NO. 77-138,928, FILED 3-23-2007.

CAROLYN GRAY, EXAMINING ATTORNEY

**Int. Cl.: 16**

**Prior U.S. Cls.: 2, 5, 22, 23, 29, 37, 38 and 50**

**Reg. No. 3,465,302**

**United States Patent and Trademark Office**

**Registered July 15, 2008**

---

**TRADEMARK  
PRINCIPAL REGISTER**

**PERSIST**

ECMC FOUNDATION (DELAWARE NON-PROFIT CORPORATION)  
SUITE 103, 123 E. MARCY STREET  
SANTA FE, NM 87501

THE MARK CONSISTS OF STANDARD CHARACTERS WITHOUT CLAIM TO ANY PARTICULAR FONT, STYLE, SIZE, OR COLOR.

FOR: PRINTED GUIDES AND CURRICULA TO HELP STUDENTS ACHIEVE SUCCESS IN HIGHER EDUCATION, IN CLASS 16 (U.S. CLS. 2, 5, 22, 23, 29, 37, 38 AND 50).

SER. NO. 77-138,936, FILED 3-23-2007.

FIRST USE 11-0-2006; IN COMMERCE 11-0-2006.

STEVEN R. FINE, EXAMINING ATTORNEY

**Int. Cl.: 37**

**Prior U.S. Cls.: 100, 103 and 106**

**United States Patent and Trademark Office**

**Reg. No. 3,465,303**

**Registered July 15, 2008**

**SERVICE MARK  
PRINCIPAL REGISTER**

**Community Living Solutions**

COMMUNITY LIVING SOLUTIONS, LLC (WIS-  
CONSIN LTD LIAB CO)  
1439 SEYMOUR COURT  
NEENAH, WI 54957

FOR: CONSTRUCTION PLANNING SERVICES  
AND CONSTRUCTION OF HOUSING FACILITIES  
FOR THE ELDERLY, IN CLASS 37 (U.S. CLS. 100, 103  
AND 106).

FIRST USE 3-12-2007; IN COMMERCE 3-12-2007.

THE MARK CONSISTS OF STANDARD CHAR-  
ACTERS WITHOUT CLAIM TO ANY PARTICULAR  
FONT, STYLE, SIZE, OR COLOR.

NO CLAIM IS MADE TO THE EXCLUSIVE  
RIGHT TO USE "SOLUTIONS", APART FROM  
THE MARK AS SHOWN.

SER. NO. 77-139,104, FILED 3-23-2007.

LINDA POWELL, EXAMINING ATTORNEY

**Int. Cl.: 9**

**Prior U.S. Cls.: 21, 23, 26, 36 and 38**

**Reg. No. 3,465,304**

**United States Patent and Trademark Office**

**Registered July 15, 2008**

---

**TRADEMARK  
PRINCIPAL REGISTER**

**FAST TRACKER**

FIRST TEXAS PRODUCTS, LLC (DELAWARE  
LTD LIAB CO)  
1465-H BRENNAN  
EL PASO, TX 79936

FOR: METAL DETECTORS, IN CLASS 9 (U.S. CLS.  
21, 23, 26, 36 AND 38).

FIRST USE 0-0-1999; IN COMMERCE 0-0-1999.

THE MARK CONSISTS OF STANDARD CHAR-  
ACTERS WITHOUT CLAIM TO ANY PARTICULAR  
FONT, STYLE, SIZE, OR COLOR.

OWNER OF U.S. REG. NO. 2,074,956.

SER. NO. 77-139,135, FILED 3-23-2007.

CORY BOONE, EXAMINING ATTORNEY

**Int. Cl.: 9**

**Prior U.S. Cls.: 21, 23, 26, 36 and 38**

**United States Patent and Trademark Office**

**Reg. No. 3,465,305**

**Registered July 15, 2008**

**TRADEMARK  
PRINCIPAL REGISTER**

**TREASURE TRACKER**

FIRST TEXAS PRODUCTS, LLC (DELAWARE  
LTD LIAB CO)  
1465-H BRENNAN  
EL PASO, TX 79936

FOR: METAL DETECTORS, IN CLASS 9 (U.S. CLS.  
21, 23, 26, 36 AND 38).

FIRST USE 0-0-1994; IN COMMERCE 0-0-1994.

THE MARK CONSISTS OF STANDARD CHAR-  
ACTERS WITHOUT CLAIM TO ANY PARTICULAR  
FONT, STYLE, SIZE, OR COLOR.

OWNER OF U.S. REG. NO. 2,074,956.

SER. NO. 77-139,173, FILED 3-23-2007.

CORY BOONE, EXAMINING ATTORNEY

Int. Cl.: 35

Prior U.S. Cls.: 100, 101 and 102

United States Patent and Trademark Office

Reg. No. 3,465,306

Registered July 15, 2008

**SERVICE MARK  
PRINCIPAL REGISTER**



MCMILLAN, DESHAWN LELITA (UNITED STATES INDIVIDUAL)  
P.O. BOX 48825  
WASHINGTON, DC 20002

FOR: PUBLIC ADVOCACY TO PROMOTE AWARENESS OF THE BENEFITS OF ORGAN AND TISSUE DONATION THROUGH LECTURES, SEMINARS, AND WORKSHOPS, IN CLASS 35 (U.S. CLS. 100, 101 AND 102).

FIRST USE 2-21-2007; IN COMMERCE 2-21-2007.

NO CLAIM IS MADE TO THE EXCLUSIVE RIGHT TO USE "CAMPAIGN", APART FROM THE MARK AS SHOWN.

THE NAME(S), PORTRAIT(S), AND/OR SIGNATURE(S) SHOWN IN THE MARK DOES NOT IDENTIFY A PARTICULAR LIVING INDIVIDUAL.

THE COLOR(S) RED, BLUE AND BROWN IS/ARE CLAIMED AS A FEATURE OF THE MARK.

THE MARK CONSISTS OF THE WORDS "SHEILA'S SAVING A LIFE CAMPAIGN" IN BLUE, WITH BROWN HANDS HOLDING A RED HEART ENCLOSED IN A RED BOX. THE COLOR WHITE CONSTITUTES TRANSPARENT AREAS OR BACKGROUNDS AND IS NOT PART OF THE MARK.

SER. NO. 77-139,633, FILED 3-24-2007.

MARY CRAWFORD, EXAMINING ATTORNEY

**Int. Cl.: 9**

**Prior U.S. Cls.: 21, 23, 26, 36 and 38**

**Reg. No. 3,465,307**

**United States Patent and Trademark Office**

**Registered July 15, 2008**

**TRADEMARK  
PRINCIPAL REGISTER**



**INCONTROL**

INSYT NEW MEDIA, LLC (MAINE LTD LIAB  
CO)  
109 CHURCH STREET COMMONS, SUITE C  
FARMINGTON, ME 04938

FOR: COMPUTER PROGRAMS FOR USE IN  
CLIENT-SIDE MANAGEMENT OF THEIR ONLINE  
WEBSITE; COMPUTER SOFTWARE FOR PROVID-  
ING ON-LINE RETAILER, INCENTIVE-BASED  
TRAINING; COMPUTER SOFTWARE THAT PRO-  
VIDES PRODUCT MANUFACTURERS THE ABIL-  
ITY TO CREATE ONLINE DEALER CATALOGS  
AND MEDIA MANAGEMENT OF IMAGES FOR  
PUBLICATIONS, RETAILERS AND SALES REPRE-

SENTATIVES; COMPUTER SOFTWARE FOR OR-  
GANIZING AND VIEWING DIGITAL IMAGES AND  
PHOTOGRAPHS; WEB SITE DEVELOPMENT SOFT-  
WARE, IN CLASS 9 (U.S. CLS. 21, 23, 26, 36 AND 38).

FIRST USE 1-1-2006; IN COMMERCE 1-1-2006.

THE MARK CONSISTS OF STYLIZED TEXT  
WITH THE "C" SHAPED AS A CRESCENT MOON.

SER. NO. 77-140,280, FILED 3-26-2007.

MICHAEL KAZAZIAN, EXAMINING ATTORNEY



**Int. Cl.: 43**

**Prior U.S. Cls.: 100 and 101**

**United States Patent and Trademark Office**

**Reg. No. 3,465,308**

**Registered July 15, 2008**

**SERVICE MARK  
PRINCIPAL REGISTER**



SALSA CATERERS & SPECIAL EVENTS, INC.  
(NEW YORK CORPORATION)  
4006 THIRD AVENUE  
BRONX., NY 10457

FOR: CATERING; CATERING FOR THE PROVISION OF FOOD AND BEVERAGES; CATERING IN FAST-FOOD CAFETERIAS; CATERING OF FOOD AND DRINKS, IN CLASS 43 (U.S. CLS. 100 AND 101).

FIRST USE 1-1-1997; IN COMMERCE 1-1-1997.

NO CLAIM IS MADE TO THE EXCLUSIVE RIGHT TO USE "CATERERS & SPECIAL EVENTS", APART FROM THE MARK AS SHOWN.

THE MARK CONSISTS OF A PALM TREE WITH PALM LEAVES COMING OUT FROM THE PALM TREE UNDERSCORING BELOW THE WORD "SALSA" & OVERSCORING OVER THE WORD "SALSA".

SER. NO. 77-140,466, FILED 3-26-2007.

PAUL F. GAST, EXAMINING ATTORNEY

Int. Cl.: 20

Prior U.S. Cls.: 2, 13, 22, 25, 32 and 50

United States Patent and Trademark Office

Reg. No. 3,465,309

Registered July 15, 2008

**TRADEMARK  
PRINCIPAL REGISTER**



ANIMALS MATTER, INC. (CALIFORNIA CORPORATION)  
23790 HAWTHORNE BLVD  
TORRANCE, CA 90505

FOR: BEDS FOR HOUSEHOLD PETS; PET CUSHIONS; PET RAMP; PORTABLE BEDS FOR PETS, IN CLASS 20 (U.S. CLS. 2, 13, 22, 25, 32 AND 50).

FIRST USE 12-31-2006; IN COMMERCE 12-31-2006.

NO CLAIM IS MADE TO THE EXCLUSIVE RIGHT TO USE "L.A. DOG COMPANY", APART FROM THE MARK AS SHOWN.

THE COLOR(S) BLACK, WHITE, GOLD IS/ARE CLAIMED AS A FEATURE OF THE MARK.

THE MARK CONSISTS OF BLACK AND WHITE CREST, WITH A DOG FACE IN BLACK AND WHITE, A PALM TREE IN BLACK AND WHITE AGAINST A GOLD BACKGROUND, A HEART IN BLACK AND WHITE AND A SUN IN BLACK AND WHITE AGAINST A GOLD OR BACKGROUND, WITH A CROWN ON TOP, WITH SCROLLS COMING DOWN THE SIDES OF THE SHIELD, IN BLACK AND WHITE.

SER. NO. 77-140,637, FILED 3-26-2007.

GRETTA YAO, EXAMINING ATTORNEY

**Int. Cls.: 6 and 20**

**Prior U.S. Cls.: 2, 12, 13, 14, 22, 23, 25, 32 and 50**

**United States Patent and Trademark Office**

**Reg. No. 3,465,310**

**Registered July 15, 2008**

**TRADEMARK  
PRINCIPAL REGISTER**

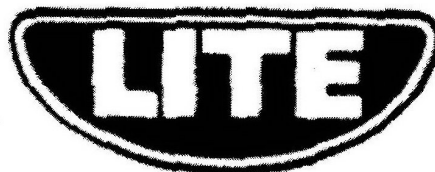

NORTHMAN HOLDINGS, INC. (CANADA CORPORATION)  
UNIT 12  
60 BATHURST DR.  
WATERLOO, CANADA N2V2A9

FOR: METAL LADDERS AND METAL SCAFFOLDING, IN CLASS 6 (U.S. CLS. 2, 12, 13, 14, 23, 25 AND 50).

FOR: NON-METAL LADDERS, IN CLASS 20 (U.S. CLS. 2, 13, 22, 25, 32 AND 50).

OWNER OF CANADA REG. NO. TMA425,349,  
DATED 3-18-1994, EXPIRES 3-18-2009.

OWNER OF U.S. REG. NOS. 2,666,757 AND  
2,785,200.

SER. NO. 77-140,818, FILED 3-26-2007.

GINA HAYES, EXAMINING ATTORNEY

**Int. Cl.: 37**

**Prior U.S. Cls.: 100, 103 and 106**

**United States Patent and Trademark Office**

**Reg. No. 3,465,311**

**Registered July 15, 2008**

**SERVICE MARK  
PRINCIPAL REGISTER**

# DeCrease Laundry

MT COOR LLC (VIRGINIA LTD LIAB CO)  
7016 COMMONS PLAZA  
CHESTERFIELD, VA 23832

FOR: LAUNDRY SERVICES, IN CLASS 37 (U.S.  
CLS. 100, 103 AND 106).

FIRST USE 2-2-2007; IN COMMERCE 2-2-2007.

THE MARK CONSISTS OF STANDARD CHAR-  
ACTERS WITHOUT CLAIM TO ANY PARTICULAR  
FONT, STYLE, SIZE, OR COLOR.

NO CLAIM IS MADE TO THE EXCLUSIVE  
RIGHT TO USE "LAUNDRY", APART FROM THE  
MARK AS SHOWN.

SER. NO. 77-141,977, FILED 3-27-2007.

CAROLINE WOOD, EXAMINING ATTORNEY

**Int. Cl.: 35**

**Prior U.S. Cls.: 100, 101 and 102**

**United States Patent and Trademark Office**

**Reg. No. 3,465,312**

**Registered July 15, 2008**

**SERVICE MARK  
PRINCIPAL REGISTER**

**NICHE RETAIL**

NICHE RETAIL, LLC (MICHIGAN LTD LIAB CO)  
2240 GREER BLVD  
SYLVAN LAKE, MI 48320

FOR: ON-LINE RETAIL STORE SERVICES FEATURING JOGGING STROLLERS, WATCHES, CHILD CAR SEATS, BABY BACK PACKS, CHILD HIGH CHAIRS, INFLATABLE SPEAR BEDS, WATER TRAMPOLINES, RADAR DETECTORS, BICYCLE TRAILERS, TRICYCLES, GOLF TRAVEL BAGS AND PUSH CARTS, TREKKING POLES AND OUTDOOR FURNITURE, IN CLASS 35 (U.S. CLS. 100, 101 AND 102).

FIRST USE 8-31-2001; IN COMMERCE 8-31-2001.

THE MARK CONSISTS OF STANDARD CHARACTERS WITHOUT CLAIM TO ANY PARTICULAR FONT, STYLE, SIZE, OR COLOR.

OWNER OF U.S. REG. NO. 2,913,986.

NO CLAIM IS MADE TO THE EXCLUSIVE RIGHT TO USE "RETAIL", APART FROM THE MARK AS SHOWN.

THE WORDING "NICHE" HAS NO MEANING IN A FOREIGN LANGUAGE.

SEC. 2(F).

SER. NO. 77-142,136, FILED 3-28-2007.

JANET LEE, EXAMINING ATTORNEY

**Int. Cl.: 41**

**Prior U.S. Cls.: 100, 101 and 107**

**United States Patent and Trademark Office**

**Reg. No. 3,465,313**

**Registered July 15, 2008**

**SERVICE MARK  
PRINCIPAL REGISTER**

**COUNT MIDNIGHT**

MONSTER PARTY PRODUCTIONS INC. (ILLINOIS CORPORATION)

#101

2405 ESSINGTON ROAD  
JOLIET, IL 60435

FOR: PRODUCTION OF CABLE TELEVISION PROGRAMS, NAMELY, A CONTINUING PROGRAM WHICH INVOLVES A TALK SHOW VARIETY, NEWS, ENTERTAINMENT AND INTERVIEWS IN THE HORROR AND SCIENCE FICTION GENRE; ENTERTAINMENT IN THE NATURE OF A CONTINUING PROGRAM WHICH INVOLVES A TALK SHOW VARIETY, NEWS, ENTERTAINMENT AND INTERVIEWS IN THE HORROR AND SCIENCE FICTION GENRE, IN CLASS 41 (U.S. CLS. 100, 101 AND 107).

FIRST USE 11-29-2006; IN COMMERCE 11-29-2006.

THE MARK CONSISTS OF STANDARD CHARACTERS WITHOUT CLAIM TO ANY PARTICULAR FONT, STYLE, SIZE, OR COLOR.

"THE NAME(S), PORTRAIT(S), AND/OR SIGNATURE(S) SHOWN IN THE MARK IDENTIFIES KENNETH DIGIULIO, WHOSE CONSENT(S) TO REGISTER IS SUBMITTED."

SER. NO. 77-142,707, FILED 3-28-2007.

GEORGIA CARTY, EXAMINING ATTORNEY

**Int. Cl.: 43**

**Prior U.S. Cls.: 100 and 101**

**United States Patent and Trademark Office**

**Reg. No. 3,465,314**

**Registered July 15, 2008**

**SERVICE MARK  
PRINCIPAL REGISTER**



**blue kangaroo**

BLUE KANGAROO CORPORATION (NEVADA  
CORPORATION)  
P.O. BOX 19400  
RENO, NV 80511

THE MARK CONSISTS OF A KANGAROO AND  
THE WORDS "BLUE KANGAROO".

FOR: CHILDREN'S DAY CARE SERVICES, IN  
CLASS 43 (U.S. CLS. 100 AND 101).

SER. NO. 77-142,944, FILED 3-28-2007.

FIRST USE 3-18-1998; IN COMMERCE 3-18-1998.

TEJBIR SINGH, EXAMINING ATTORNEY

**Int. Cl.: 9**

**Prior U.S. Cls.: 21, 23, 26, 36 and 38**

**Reg. No. 3,465,315**

**United States Patent and Trademark Office**

**Registered July 15, 2008**

**TRADEMARK  
PRINCIPAL REGISTER**

**LX BRIEFING**

AMERICAN SOCIETY FOR TRAINING & DEVELOPMENT (WISCONSIN NON-PROFIT CORPORATION)  
P.O. BOX 1443  
1640 KING STREET  
ALEXANDRIA, VA 22313

FOR: PROVIDING DOWNLOADABLE ELECTRONIC NEWSLETTERS IN THE FIELD OF EMPLOYEE EDUCATION AND TRAINING WRITTEN FOR EXECUTIVES WHO WORK IN THE FIELD OF WORK-PLACE LEARNING AND PERFORMANCE VIA THE INTERNET, IN CLASS 9 (U.S. CLS. 21, 23, 26, 36 AND 38).

FIRST USE 6-0-2006; IN COMMERCE 9-0-2006.

THE MARK CONSISTS OF STANDARD CHARACTERS WITHOUT CLAIM TO ANY PARTICULAR FONT, STYLE, SIZE, OR COLOR.

NO CLAIM IS MADE TO THE EXCLUSIVE RIGHT TO USE "BRIEFING", APART FROM THE MARK AS SHOWN.

SER. NO. 77-143,415, FILED 3-29-2007.

LAURA HAMMEL, EXAMINING ATTORNEY



**Int. Cls.: 25 and 28**

**Prior U.S. Cls.: 22, 23, 38, 39 and 50**

**United States Patent and Trademark Office**

**Reg. No. 3,465,316**

**Registered July 15, 2008**

**TRADEMARK  
PRINCIPAL REGISTER**

**RON FELLOWS**

FELLOWS, RON (CANADA INDIVIDUAL)  
ATTN. GILLIAN RIFKIN  
370 EAST MAPLE ROAD, 4TH FLOOR  
BIRMINGHAM, MI 48009

FOR: CLOTHING, NAMELY, T-SHIRTS, SWEAT-SHIRTS, CAPS, AND BANDANAS, IN CLASS 25 (U.S. CLS. 22 AND 39).

FIRST USE 1-1-1986; IN COMMERCE 1-1-1996.

FOR: TOYS, NAMELY, DIECAST CARS, IN CLASS 28 (U.S. CLS. 22, 23, 38 AND 50).

FIRST USE 1-1-1986; IN COMMERCE 1-1-1996.

THE MARK CONSISTS OF STANDARD CHARACTERS WITHOUT CLAIM TO ANY PARTICULAR FONT, STYLE, SIZE, OR COLOR.

THE NAME(S), PORTRAIT(S), AND/OR SIGNATURE(S) SHOWN IN THE MARK IDENTIFIES "RON FELLOWS", WHOSE CONSENT(S) TO REGISTER IS MADE OF RECORD.

SER. NO. 77-143,947, FILED 3-29-2007.

ALYSSA PALADINO, EXAMINING ATTORNEY

**Int. Cl.: 45**

**Prior U.S. Cls.: 100 and 101**

**United States Patent and Trademark Office**

**Reg. No. 3,465,317**

**Registered July 15, 2008**

**SERVICE MARK  
PRINCIPAL REGISTER**



BLEND IMAGES, LLC (NEVADA LTD LIAB CO)  
774 HOMEWILLOW AVENUE  
LAS VEGAS, NV 89123

FOR: STOCK PHOTOGRAPHY SERVICES,  
NAMELY, LICENSING REPRODUCTION RIGHTS  
OF PHOTOGRAPHIC IMAGES TO OTHERS, IN  
CLASS 45 (U.S. CLS. 100 AND 101).

FIRST USE 1-2-2005; IN COMMERCE 1-2-2005.

THE MARK CONSISTS OF THE WORD BLEND  
IN STYLIZED LETTERING IN THE LOWER RIGHT  
CORNER OF A SOLID RECTANGULAR FIELD.

SER. NO. 77-144,191, FILED 3-29-2007.

DAVID MILLER, EXAMINING ATTORNEY

**Int. Cl.: 33**

**Prior U.S. Cls.: 47 and 49**

**United States Patent and Trademark Office**

**Reg. No. 3,465,318**

**Registered July 15, 2008**

**TRADEMARK  
PRINCIPAL REGISTER**



THE TRUSTEES OF THE COPPOLA FAMILY  
TRUST (CALIFORNIA TRUST)  
1991 ST. HELENA HIGHWAY  
RUTHERFORD, CA 94573

FOR: WINE, IN CLASS 33 (U.S. CLS. 47 AND 49).

FIRST USE 3-9-2007; IN COMMERCE 3-9-2007.

NO CLAIM IS MADE TO THE EXCLUSIVE  
RIGHT TO USE "LABEL" , APART FROM THE  
MARK AS SHOWN.

THE COLOR(S) BRIGHT BLUE-TURQUOISE IS/  
ARE CLAIMED AS A FEATURE OF THE MARK.

THE MARK CONSISTS OF THE WORDS "CELESTIAL BLUE LABEL" IN STYLIZED FORM APPEARING AT THE BOTTOM CENTER OF A RECTANGULAR LABEL TOGETHER WITH THE COLOR BRIGHT BLUE-TURQUOISE APPEARING ON THE RECTANGULAR LABEL AND NECKWRAP OF A WINE BOTTLE. THE SHAPE OF THE BOTTLE IS SHOWN IN DOTTED LINES AND IS NOT CLAIMED AS A FEATURE OF THE MARK. IN ADDITION, THE SHAPE OF THE LABEL AND NECKWRAP IS NOT CLAIMED AS A FEATURE OF THE MARK.

SER. NO. 77-144,225, FILED 3-29-2007.

B. PARADEWELAI, EXAMINING ATTORNEY

**Int. Cl.: 33**

**Prior U.S. Cls.: 47 and 49**

**United States Patent and Trademark Office**

**Reg. No. 3,465,319**

**Registered July 15, 2008**

**TRADEMARK  
PRINCIPAL REGISTER**



THE TRUSTEES OF THE COPPOLA FAMILY  
TRUST (CALIFORNIA TRUST)  
1991 ST. HELENA HIGHWAY  
RUTHERFORD, CA 94573

FOR: WINE, IN CLASS 33 (U.S. CLS. 47 AND 49).

FIRST USE 3-9-2007; IN COMMERCE 3-9-2007.

NO CLAIM IS MADE TO THE EXCLUSIVE  
RIGHT TO USE "LABEL" AND "MALBEC", APART  
FROM THE MARK AS SHOWN.

THE COLOR(S) BRIGHT BLUE-TURQUOISE IS/  
ARE CLAIMED AS A FEATURE OF THE MARK.

THE MARK CONSISTS OF THE WORDS "CELESTIAL BLUE LABEL MALBEC" IN STYLIZED FORM APPEARING AT THE BOTTOM CENTER OF A RECTANGULAR LABEL TOGETHER WITH THE COLOR BRIGHT BLUE-TURQUOISE APPEARING ON THE RECTANGULAR LABEL AND NECKWRAP OF A WINE BOTTLE. THE SHAPE OF THE BOTTLE IS SHOWN IN DOTTED LINES AND IS NOT CLAIMED AS A FEATURE OF THE MARK. IN ADDITION, THE SHAPE OF THE LABEL AND NECKWRAP IS NOT CLAIMED AS A FEATURE OF THE MARK.

SER. NO. 77-144,230, FILED 3-29-2007.

B. PARADEWELAI, EXAMINING ATTORNEY

**Int. Cl.: 9**

**Prior U.S. Cls.: 21, 23, 26, 36 and 38**

**Reg. No. 3,465,320**

**United States Patent and Trademark Office**

**Registered July 15, 2008**

**TRADEMARK  
PRINCIPAL REGISTER**



CDM USA INC. (FLORIDA CORPORATION)  
8065 S.W. 118TH COURT  
MIAMI, FL 33183

THE MARK CONSISTS OF "COUNTMAX" IN  
CAPITAL LETTERS AND STYLIZED UNDERLINE  
AS SHOWN.

FOR: CURRENCY COUNTING MACHINES, IN  
CLASS 9 (U.S. CLS. 21, 23, 26, 36 AND 38).

SER. NO. 77-144,566, FILED 3-30-2007.

FIRST USE 12-1-2006; IN COMMERCE 12-1-2006.

TAMARA FRAZIER, EXAMINING ATTORNEY

**Int. Cl.: 7**

**Prior U.S. Cls.: 13, 19, 21, 23, 31, 34 and 35**

**Reg. No. 3,465,321**

**United States Patent and Trademark Office**

**Registered July 15, 2008**

---

**TRADEMARK  
PRINCIPAL REGISTER**

**WEARHARD**

RICHWOOD INDUSTRIES, INC. (WEST VIRGINIA  
CORPORATION)  
707 7TH STREET WEST  
HUNTINGTON, WV 25714

THE MARK CONSISTS OF STANDARD CHAR-  
ACTERS WITHOUT CLAIM TO ANY PARTICULAR  
FONT, STYLE, SIZE, OR COLOR.

FOR: CAST FORGE TOOLING PARTS, NAMELY,  
UPSET FORGE TOOLING MACHINES AND EX-  
TRUSION DIES, IN CLASS 7 (U.S. CLS. 13, 19, 21, 23,  
31, 34 AND 35).

SER. NO. 77-146,146, FILED 4-2-2007.

FIRST USE 4-24-2007; IN COMMERCE 4-24-2007.

WILLIAM VERHOSEK, EXAMINING ATTORNEY

Int. Cls.: 14, 20 and 35

Prior U.S. Cls.: 2, 13, 22, 25, 27, 28, 32, 50, 100, 101  
and 102

Reg. No. 3,465,322

United States Patent and Trademark Office

Registered July 15, 2008

**TRADEMARK  
SERVICE MARK  
PRINCIPAL REGISTER**

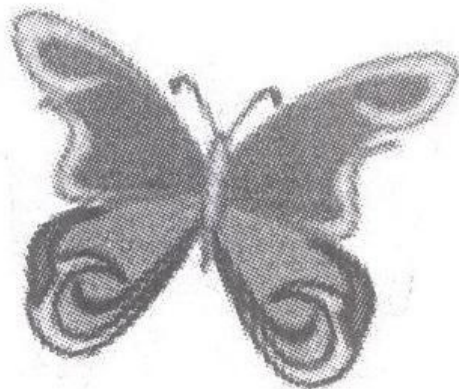

SOUTH WINDOW CORPORATION (NEW YORK CORPORATION)  
SUITE 302  
29 WEST 30TH STREET  
NEW YORK, NY 10001

FOR: JEWELRY, COSTUME JEWELRY; BODY-PIERCING RINGS; WATCHES; CUFF LINKS; PET JEWELRY; AND NON-METAL JEWELRY BOXES, IN CLASS 14 (U.S. CLS. 2, 27, 28 AND 50).

FIRST USE 6-1-2004; IN COMMERCE 6-1-2004.

FOR: JEWELRY DISPLAY CASES; MANNEQUINS, NAMELY, JEWELRY DISPLAY DOLLS; PERSONAL COMPACT MIRRORS; NON-METAL AND NON-LEATHER KEY CHAINS; PLASTIC KEY CHAINS; AND PET CUSHIONS, IN CLASS 20 (U.S. CLS. 2, 13, 22, 25, 32 AND 50).

FIRST USE 6-1-2004; IN COMMERCE 6-1-2004.

FOR: RETAIL STORE SERVICES FEATURING JEWELRY, WATCHES, CUFF LINKS, BODY-PIERCING RINGS, JEWELRY BOXES, JEWELRY DISPLAY CASES, PET JEWELRY, JEWELRY DISPLAY DOLLS, KEY CHAINS, SUNGLASSES, SUNGLASS ACCESSORIES, CASES FOR MINIATURE ELECTRONIC DEVICES, CHARMS FOR CELLULAR PHONES, HANDBAGS, UMBRELLAS, CLOTHING, PET CLOTHING, PET CUSHIONS, PET FEEDING DISHES, PET BRUSHES, PET BLANKETS, PET TOYS, HAIR BANDS AND HAIR PINS, IN CLASS 35 (U.S. CLS. 100, 101 AND 102).

FIRST USE 6-1-2004; IN COMMERCE 6-1-2004.

THE MARK CONSISTS OF BUTTERFLY.

SER. NO. 77-147,491, FILED 4-3-2007.

JANET LEE, EXAMINING ATTORNEY

**Int. Cl.: 9**

**Prior U.S. Cls.: 21, 23, 26, 36 and 38**

**Reg. No. 3,465,323**

**United States Patent and Trademark Office**

**Registered July 15, 2008**

**TRADEMARK  
PRINCIPAL REGISTER**



ADVANCED INTERACTIVE SYSTEMS, INC.  
(WASHINGTON CORPORATION)  
665 ANDOVER PARK WEST, SUITE 201  
SEATTLE, WA 981883321

FOR: SYSTEM FOR TRAINING IN THE USE OF FORCE EMPLOYING SIMULATED LETHAL AND NONLETHAL WEAPONS, CONSISTING OF TRAINING SIMULATOR OPERATING COMPUTER SOFTWARE AND TRAINING SIMULATORS IN WHICH A TRAINEE INTERACTS WITH ADAPTIVE SITUATIONAL ENVIRONMENTS SIMULATED IN THREE-DIMENSIONS, IN CLASS 9 (U.S. CLS. 21, 23, 26, 36 AND 38).

FIRST USE 7-31-2003; IN COMMERCE 7-31-2003.

NO CLAIM IS MADE TO THE EXCLUSIVE RIGHT TO USE "ADVANCED INTERACTIVE SYSTEMS", APART FROM THE MARK AS SHOWN.

THE COLOR(S) BLUE, DARK BLUE, ORANGE, YELLOW, BLACK AND WHITE IS/ARE CLAIMED AS A FEATURE OF THE MARK.

THE MARK CONSISTS OF AN ARTISTIC FLAT REPRESENTATION OF EARTH WITH THE LITERAL ELEMENT "ADVANCED INTERACTIVE SYSTEMS" ABOVE THE GRAPHIC, THE REPRESENTATION BEING A LARGE NEARLY ELLIPTICAL ARC INTERCEPTED BY A SMALL BOTTOM PARTIAL CIRCULAR ARC. THE COLOR BLUE APPEARS IN THE WORDING "ADVANCED INTERACTIVE SYSTEMS" AND IN THE DESIGN OF THE EARTH AS WELL AS IN SEVERAL CONTINENTS WITHIN THE EARTH DESIGN. THE COLORS ORANGE, YELLOW, BLACK AND DARK BLUE ALSO APPEAR WITHIN SEVERAL CONTINENTS IN THE EARTH SHAPED DESIGN. THE COLOR WHITE APPEARS WITHIN THE WORK "AIS", WHICH IS SUPERIMPOSED OVER THE EARTH SHAPED DESIGN.

SER. NO. 77-147,857, FILED 4-3-2007.

DAVID COLLIER, EXAMINING ATTORNEY



**Int. Cls.: 18, 25 and 26**

**Prior U.S. Cls.: 1, 2, 3, 22, 37, 39, 40, 41, 42 and 50**

**United States Patent and Trademark Office**

**Reg. No. 3,465,324**

**Registered July 15, 2008**

**TRADEMARK  
PRINCIPAL REGISTER**

# Fabulous 300

ELAW PRODUCTIONS LIMITED (UNITED  
KINGDOM PRIVATE LIMITED COMPANY)  
LINKS YARD, 29A SPELMAN STREET  
STUDIO 17  
LONDON, UNITED KINGDOM E15LX

FOR: LEATHER BAGS, SUITCASES AND WAL-  
LETS; LEATHER CASES; LEATHER PURSES; LEA-  
THER SHOPPING BAGS; TRAVELLING CASES OF  
LEATHER; IMITATION LEATHER, IN CLASS 18  
(U.S. CLS. 1, 2, 3, 22 AND 41).

FOR: CLOTHING, NAMELY, HEADWEAR,  
BEACHWEAR, FOOTWEAR, LOUNGEWEAR,  
NECKWEAR, SLEEPWEAR, UNDERWEAR, IN-  
FANTWEAR, RAINWEAR, SWIMWEAR, JACKETS,  
COATS, NECKTIES, SHIRTS, T-SHIRTS, SWEAT-  
SHIRTS, PANTS, SWEATPANTS, SOCKS, AND  
BELTS, MEN'S SUITS, TROUSERS, PANTS,

SHORTS, WAISTCOATS, SWEATERS, BLAZERS,  
SCARVES, AND GLOVES; HEADWEAR; FOOT-  
WEAR, IN CLASS 25 (U.S. CLS. 22 AND 39).

FOR: RIBBONS; BRAIDS; BUTTONS, IN CLASS 26  
(U.S. CLS. 37, 39, 40, 42 AND 50).

THE MARK CONSISTS OF STANDARD CHAR-  
ACTERS WITHOUT CLAIM TO ANY PARTICULAR  
FONT, STYLE, SIZE, OR COLOR.

OWNER OF ERPN CMNTY TM OFC REG. NO.  
2445946, DATED 2-7-2007, EXPIRES 2-7-2017.

SER. NO. 77-148,041, FILED 4-4-2007.

DOMINICK J. SALEMI, EXAMINING ATTORNEY

**Int. Cl.: 9**

**Prior U.S. Cls.: 21, 23, 26, 36 and 38**

**Reg. No. 3,465,325**

**United States Patent and Trademark Office**

**Registered July 15, 2008**

**TRADEMARK  
PRINCIPAL REGISTER**



SLINGPOST LLC (CALIFORNIA LTD LIAB CO)  
3 VISTA ALBERI  
NEWPORT COAST, CA 92657

FOR: COMPUTER SOFTWARE FOR USE IN GEOTAGGING SPECIFIC GEOGRAPHIC LOCATIONS ON MAPS ACCESSED THROUGH THE INTERNET, NAMELY, A SYSTEM IN WHICH USERS CREATE AND STORE VOICE MARKS, NAMELY, VOICE MESSAGES CONSISTING OF INFORMATION, OPINIONS, TIPS, WARNINGS AND ADVISE CONCERNING SPECIFIC PHYSICAL LOCATIONS IDENTIFIED BY GLOBAL POSITION SYSTEMS (GPS) WHICH ARE THEN ACCESSED BY OTHERS TO SEARCH, PLAYBACK AND SHARE

THESE MESSAGES OVER A GLOBAL TELECOMMUNICATIONS NETWORK, NAMELY, THE INTERNET AND WIRELESS DEVICES, IN CLASS 9 (U.S. CLS. 21, 23, 26, 36 AND 38).

FIRST USE 11-0-2006; IN COMMERCE 1-0-2007.

NO CLAIM IS MADE TO THE EXCLUSIVE RIGHT TO USE "VOICE" , APART FROM THE MARK AS SHOWN.

SER. NO. 77-148,953, FILED 4-4-2007.

BILL DAWE, EXAMINING ATTORNEY

**Int. Cls.: 35 and 40**

**Prior U.S. Cls.: 100, 101, 102, 103 and 106**

**United States Patent and Trademark Office**

**Reg. No. 3,465,326**

**Registered July 15, 2008**

**SERVICE MARK  
PRINCIPAL REGISTER**



FORTUNE METAL, INC. OF RHODE ISLAND  
(RHODE ISLAND CORPORATION)  
2 CROW POINT RD.  
LINCOLN, RI 02865

FOR: IMPORTING AND EXPORTING OF METALS AND PLASTICS, IN CLASS 35 (U.S. CLS. 100, 101 AND 102).

FIRST USE 4-1-2003; IN COMMERCE 4-1-2003.

FOR: METAL AND PLASTIC RECYCLING, RECYCLING OF ELECTRONIC COMPONENTS, IN CLASS 40 (U.S. CLS. 100, 103 AND 106).

FIRST USE 4-1-2003; IN COMMERCE 4-1-2003.

THE COLOR(S) BLUE AND YELLOW IS/ARE CLAIMED AS A FEATURE OF THE MARK.

THE MARK CONSISTS OF A STYLIZED "F" LOGO AND AN IMAGE OF THE PLANET EARTH. THE "F" LOGO IS BLUE AND OUTLINED IN WHITE. THE PLANET EARTH IMAGE IS BLUE AND YELLOW AND OUTLINED IN WHITE. THE BACKGROUND IS BLUE. THE COLOR WHITE IS FOR OUTLINING PURPOSES ONLY AND IS NOT PART OF THE MARK.

SER. NO. 77-149,402, FILED 4-5-2007.

SCOTT BIBB, EXAMINING ATTORNEY

**Int. Cl.: 35**

**Prior U.S. Cls.: 100, 101 and 102**

**United States Patent and Trademark Office**

**Reg. No. 3,465,327**

**Registered July 15, 2008**

**SERVICE MARK  
PRINCIPAL REGISTER**

**INSIDE DENTISTRY**

AEGIS PUBLICATIONS, LLC (PENNSYLVANIA  
LTD LIAB CO)  
SUITE 105  
104 PHEASANT RUN  
NEWTOWN, PA 18940

FOR: ADVERTISING SERVICES, NAMELY, PRO-  
VIDING ADVERTISING SPACE IN A PERIODICAL;  
ADVERTISING VIA ELECTRONIC MEDIA AND  
SPECIFICALLY THE INTERNET , IN CLASS 35  
(U.S. CLS. 100, 101 AND 102).

FIRST USE 9-1-2005; IN COMMERCE 9-1-2005.

THE MARK CONSISTS OF STANDARD CHAR-  
ACTERS WITHOUT CLAIM TO ANY PARTICULAR  
FONT, STYLE, SIZE, OR COLOR.

NO CLAIM IS MADE TO THE EXCLUSIVE  
RIGHT TO USE "DENTISTRY", APART FROM  
THE MARK AS SHOWN.

SER. NO. 77-149,985, FILED 4-5-2007.

DOMINICK J. SALEMI, EXAMINING ATTORNEY

**Int. Cl.: 42**

**Prior U.S. Cls.: 100 and 101**

**United States Patent and Trademark Office**

**Reg. No. 3,465,328**

**Registered July 15, 2008**

**SERVICE MARK  
PRINCIPAL REGISTER**

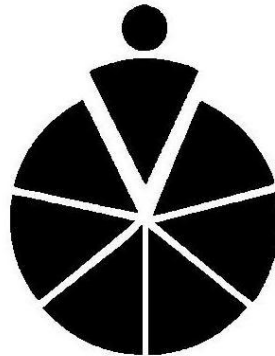

BUSINESS EFFICACY, INC. (MINNESOTA CORPORATION)  
6130 BLUE CIRCLE DRIVE, SUITE 100  
MINNEAPOLIS, MN 55343

FIRST USE 2-1-2006; IN COMMERCE 2-1-2006.

FOR: PROVIDING ON-LINE NON-DOWNLOADABLE SOFTWARE FOR TRACKING, ANALYZING AND PROVIDING FEEDBACK ON SALES PRODUCTIVITY AND PERFORMANCE FOR BUSINESSES; PROVIDING TEMPORARY USE OF ON-LINE NON-DOWNLOADABLE SOFTWARE FOR TRACKING, ANALYZING AND PROVIDING FEEDBACK ON SALES PRODUCTIVITY AND PERFORMANCE FOR BUSINESSES, IN CLASS 42 (U.S. CLS. 100 AND 101).

THE MARK CONSISTS OF A PIE CHART WITH SEVEN SEGMENTS, THE TOP SEGMENT IS SLIGHTLY REMOVED FROM THE CHART AND INCLUDES A ROUND CIRCLE AND SYMBOLIZES A HUMAN FIGURE.

SER. NO. 77-150,223, FILED 4-5-2007.

SARA THOMAS, EXAMINING ATTORNEY

**Int. Cl.: 9**

**Prior U.S. Cls.: 21, 23, 26, 36 and 38**

**Reg. No. 3,465,329**

**United States Patent and Trademark Office**

**Registered July 15, 2008**

---

**TRADEMARK  
PRINCIPAL REGISTER**

**DUAL-LIFE**

TERAMO, CLAY M. (UNITED STATES INDIVIDUAL)  
401 AIRSTREAM COURT  
SCOTTS VALLEY, CA 95066

THE MARK CONSISTS OF STANDARD CHARACTERS WITHOUT CLAIM TO ANY PARTICULAR FONT, STYLE, SIZE, OR COLOR.

FOR: BLANK MAGNETIC COMPUTER TAPES,  
IN CLASS 9 (U.S. CLS. 21, 23, 26, 36 AND 38).

SER. NO. 77-151,094, FILED 4-6-2007.

FIRST USE 3-0-2004; IN COMMERCE 3-0-2004.

DAVID I, EXAMINING ATTORNEY

Int. Cl.: 16

Prior U.S. Cls.: 2, 5, 22, 23, 29, 37, 38 and 50

United States Patent and Trademark Office

Reg. No. 3,465,330

Registered July 15, 2008

TRADEMARK  
PRINCIPAL REGISTER



ECHEVERRIA, KAREN M. (UNITED STATES  
INDIVIDUAL)  
7414 BOUVAIS CIRCLE  
SACRAMENTO, CA 95828

FOR: SCRAPBOOK MATERIALS, NAMELY, A  
KIT COMPRISING A PRINTED GUIDE TO ASSIST  
THE USER IN PREPARING A SCRAPBOOK IN-  
CLUDING SUGGESTIONS FOR JOURNALING  
AND MEMENTOS TO COLLECT AND PLASTIC  
BAGS TO STORE MEMENTOS, PHOTOGRAPHS,  
AND NOTES, IN CLASS 16 (U.S. CLS. 2, 5, 22, 23, 29,  
37, 38 AND 50).

FIRST USE 3-15-2007; IN COMMERCE 3-15-2007.

THE MARK CONSISTS OF CAPITAL LETTER "K"  
IN LARGER FONT, THEN SMALLER CASE LET-  
TERS ECH IN SMALLER FONT.

SER. NO. 77-151,264, FILED 4-7-2007.

JESSICA FATHY, EXAMINING ATTORNEY

**Int. Cl.: 44**

**Prior U.S. Cls.: 100 and 101**

**United States Patent and Trademark Office**

**Reg. No. 3,465,331**

**Registered July 15, 2008**

**SERVICE MARK  
PRINCIPAL REGISTER**



FIRST GLIMPSE 3D IMAGING LLC (GEORGIA  
LTD LIAB CO)  
SUITE D  
4537 FORSYTH RD  
MACON, GA 31210

FOR: MASSAGE; MEDICAL IMAGING SERVICES  
NAMELY, CONSULTING SERVICES IN THE FIELD  
OF USING AND OPERATING MEDICAL IMAGING  
APPARATUS INCLUDING X-RAY, COMPUTED  
TOMOGRAPHY, MAGNETIC RESONANCE IMA-  
GING, ULTRASOUND, AND POSITRON EMISSION  
TOMOGRAPHY APPARATUS, IN CLASS 44 (U.S.  
CLS. 100 AND 101).

FIRST USE 2-14-2007; IN COMMERCE 2-14-2007.

NO CLAIM IS MADE TO THE EXCLUSIVE  
RIGHT TO USE "A PRENATAL EXPERIENCE",  
APART FROM THE MARK AS SHOWN.

THE MARK CONSISTS OF A PREGNANT WO-  
MAN PROFILE. "FIRST GLIMPSE" IS WRITTEN ON  
THE TOP OF THE LOGO AND A "PRENATAL  
EXPERIENCE" IS WRITTEN ON THE BOTTOM.

SER. NO. 77-151,757, FILED 4-9-2007.

HENRY S. ZAK, EXAMINING ATTORNEY



**Int. Cl.: 9**

**Prior U.S. Cls.: 21, 23, 26, 36 and 38**

**Reg. No. 3,465,332**

**United States Patent and Trademark Office**

**Registered July 15, 2008**

---

**TRADEMARK  
PRINCIPAL REGISTER**

**SI-2K**

SILICON IMAGING INC. (NEW YORK COR-  
PORATION)  
25 COVINGTON COURT  
NISKAYUNA, NY 12309

THE MARK CONSISTS OF STANDARD CHAR-  
ACTERS WITHOUT CLAIM TO ANY PARTICULAR  
FONT, STYLE, SIZE, OR COLOR.

FOR: CINEMATOGRAPHIC CAMERAS, IN  
CLASS 9 (U.S. CLS. 21, 23, 26, 36 AND 38).

SER. NO. 77-151,860, FILED 4-9-2007.

FIRST USE 6-15-2006; IN COMMERCE 6-15-2006.

JAMES LOVELACE, EXAMINING ATTORNEY

**Int. Cls.: 5, 10, 29 and 30**

**Prior U.S. Cls.: 6, 18, 26, 39, 44, 46, 51 and 52**

**United States Patent and Trademark Office**

**Reg. No. 3,465,333**

**Registered July 15, 2008**

**TRADEMARK  
PRINCIPAL REGISTER**

# SOUVENAID

N.V. NUTRICIA (NETHERLANDS PUBLIC LIMITED COMPANY (PLC))  
EERSTE STATIONSSTRAAT 186  
ZOETERMEER, NETHERLANDS 2712HM

FOR: PHARMACEUTICAL PRODUCTS FOR USE IN THE TREATMENT OF ALZHEIMER'S DISEASE; DIETETIC SUBSTANCES ADAPTED FOR MEDICAL USE, NAMELY DIETETIC FOODS; FOOD FOR BABIES, INFANTS AND INVALIDS; FOOD SUPPLEMENTS ADAPTED FOR MEDICAL USE; DIETARY NUTRITIONAL SUPPLEMENTS, IN CLASS 5 (U.S. CLS. 6, 18, 44, 46, 51 AND 52).

FOR: MEDICAL APPARATUS AND INSTRUMENTS FOR ADMINISTERING FOOD, NAMELY FOOD DISPENSER PUMPS, ENTERAL FEEDING TUBES, CATHETERS, AND PARTS AND FITTINGS THEREOF, IN CLASS 10 (U.S. CLS. 26, 39 AND 44).

FOR: MEAT, FISH, POULTRY AND GAME; MEAT EXTRACTS; PRESERVED, DRIED AND COOKED FRUITS AND VEGETABLES; JELLIES, JAMS; FRUIT SAUCES, NAMELY CRANBERRY SAUCE AND APPLE SAUCE; EGGS; MILK; MILK PRODUCTS, EXCLUDING ICE CREAM, ICE MILK AND FROZEN YOGURT; EDIBLE OILS AND FATS, IN CLASS 29 (U.S. CL. 46).

FOR: FRUIT SAUCES EXCLUDING CRANBERRY SAUCE AND APPLESAUCE; MILK PRODUCTS, NAMELY ICE MILK, ICE CREAM AND FROZEN YOGURT; NUTRITIONAL ADDITIVES, NOT FOR MEDICAL USE, NAMELY FOOD ADDITIVES FOR FLAVOR, INGREDIENT OR FILLER; COFFEE, TEA, COCOA, SUGAR, RICE, TAPIOCA, SAGO, COFFEE SUBSTITUTES, NAMELY ARTIFICIAL COFFEE; FLOUR; PREPARATIONS MADE FROM CEREALS, NAMELY CEREAL-BASED SNACK FOODS; BREAD; PASTRIES; CONFECTIONERY, NAMELY CAKES, COOKIES; ICES, NAMELY FRUIT ICES, FLAVORED ICES; HONEY, TREACLE; YEAST, BAKING POWDER; SALT, MUSTARD; VINEGAR, SAUCES; CONDIMENTS, NAMELY KETCHUP, MAYONNAISE; SPICES; ICE, IN CLASS 30 (U.S. CL. 46).

THE MARK CONSISTS OF STANDARD CHARACTERS WITHOUT CLAIM TO ANY PARTICULAR FONT, STYLE, SIZE, OR COLOR.

OWNER OF BENELUX REG. NO. 0819690, DATED 3-20-2007, EXPIRES 3-6-2017.

SER. NO. 77-152,687, FILED 4-10-2007.

MARY CRAWFORD, EXAMINING ATTORNEY

**Int. Cl.: 28**

**Prior U.S. Cls.: 22, 23, 38 and 50**

**United States Patent and Trademark Office**

**Reg. No. 3,465,334**

**Registered July 15, 2008**

**TRADEMARK  
PRINCIPAL REGISTER**

**IMPACT BALL**

STEWART, GLENN (UNITED STATES INDIVIDUAL)  
3736 POTAMAC AVE.  
DALLAS, TX 75206

FOR: EXERCISE EQUIPMENT, NAMELY, STRENGTH BALLS AND WEIGHTED BALLS FOR STRENGTHENING PROPER MUSCLES FOR A BETTER GOLF SWING, IN CLASS 28 (U.S. CLS. 22, 23, 38 AND 50).

FIRST USE 4-1-2005; IN COMMERCE 4-1-2005.

THE MARK CONSISTS OF STANDARD CHARACTERS WITHOUT CLAIM TO ANY PARTICULAR FONT, STYLE, SIZE, OR COLOR.

NO CLAIM IS MADE TO THE EXCLUSIVE RIGHT TO USE "BALL", APART FROM THE MARK AS SHOWN.

SER. NO. 77-153,180, FILED 4-10-2007.

DAVID MILLER, EXAMINING ATTORNEY

**Int. Cl.: 35**

**Prior U.S. Cls.: 100, 101 and 102**

**United States Patent and Trademark Office**

**Reg. No. 3,465,335**

**Registered July 15, 2008**

**SERVICE MARK  
PRINCIPAL REGISTER**



STAFFORD SPORTS, INC. (MONTANA CORPORATION)  
1748 SOUTH AVE. WEST  
MISSOULA, MT 59801

FOR: RETAIL STORE SERVICES FEATURING EXERCISE MACHINES, IN CLASS 35 (U.S. CLS. 100, 101 AND 102).

FIRST USE 5-1-2007; IN COMMERCE 5-1-2007.

NO CLAIM IS MADE TO THE EXCLUSIVE RIGHT TO USE "FITNESS OUTFITTERS", APART FROM THE MARK AS SHOWN.

THE COLOR(S) YELLOW AND BLACK IS/ARE CLAIMED AS A FEATURE OF THE MARK.

THE MARK CONSISTS OF THE WORDS "STAFFORD FITNESS OUTFITTERS" IN BLACK LETTERS ON A RECTANGULAR BACKGROUND IN YELLOW.

SEC. 2(F) STAFFORD.

SER. NO. 77-153,396, FILED 4-10-2007.

MICHAEL LITZAU, EXAMINING ATTORNEY

**Int. Cl.: 28**

**Prior U.S. Cls.: 22, 23, 38 and 50**

**United States Patent and Trademark Office**

**Reg. No. 3,465,336**

**Registered July 15, 2008**

**TRADEMARK  
PRINCIPAL REGISTER**

**QUIETSHAPE**

ERIC ARMIN INC. D/B/A EAI EDUCATION  
(NEW JERSEY CORPORATION)  
P.O. BOX 7046  
118 BAUER DRIVE  
OAKLAND, NJ 07436

FOR: EDUCATIONAL TEACHING AIDS, NAME-  
LY, TOY BUILDING BLOCKS AND STACKING  
TOY SHAPES, IN CLASS 28 (U.S. CLS. 22, 23, 38  
AND 50).

FIRST USE 8-1-2002; IN COMMERCE 8-1-2002.

THE MARK CONSISTS OF STANDARD CHAR-  
ACTERS WITHOUT CLAIM TO ANY PARTICULAR  
FONT, STYLE, SIZE, OR COLOR.

SER. NO. 77-153,951, FILED 4-11-2007.

KELLEY WELLS, EXAMINING ATTORNEY

Int. Cl.: 35

Prior U.S. Cls.: 100, 101 and 102

United States Patent and Trademark Office

Reg. No. 3,465,337

Registered July 15, 2008

**SERVICE MARK  
PRINCIPAL REGISTER**



SOLE DESIRES, LLC (UTAH LTD LIAB CO)  
126 SOUTH 630 EAST  
LINDON, UT 84042

FOR: FRANCHISING, NAMELY, OFFERING TECHNICAL ASSISTANCE IN THE ESTABLISHMENT AND/OR OPERATION OF SHOE PARTY TRAILERS FOR USE WITH RETAIL SHOP-AT-HOME PARTY SERVICES IN THE FIELD OF SHOES, BOOTS AND FOOTWEAR, IN CLASS 35 (U.S. CLS. 100, 101 AND 102).

FIRST USE 11-8-2006; IN COMMERCE 11-8-2006.

THE COLOR(S) PINK, YELLOW, BLUE, GREEN IS/ARE CLAIMED AS A FEATURE OF THE MARK.

THE MARK CONSISTS OF BLUE WORD SOLE OVER GREEN WORD DESIRES WITH PINK WORDING ON TAGLINE WHERE SHOPPING IS ALWAYS A PARTY IN STYLIZED FONT FOUR SQUARE BOXES TO THE LEFT UPPER LEFT CORNER PINK BOX WITH HIGH HEEL WOMAN'S SHOE, UPPER RIGHT YELLOW BOX WITH LOW HEEL WOMAN'S SHOE, LOWER LEFT BLUE BOX WITH WOMAN'S ATHLETIC SHOE AND LOWER RIGHT GREEN BOX WITH HIGH HEELED WOMAN'S BOOT.

SER. NO. 77-154,234, FILED 4-11-2007.

KALIE KUNG, EXAMINING ATTORNEY

**Int. Cl.: 11**

**Prior U.S. Cls.: 13, 21, 23, 31 and 34**

**United States Patent and Trademark Office**

**Reg. No. 3,465,338**

**Registered July 15, 2008**

**TRADEMARK  
PRINCIPAL REGISTER**

**COMFORT COMMAND**

SPA LOGIC INC. (CANADA CORPORATION)  
4549 52 STREET  
THORSBY, CANADA T0C2P0

FOR: MOLDED SEATS SOLD AS INTEGRAL  
COMPONENTS OF HOT TUBS AND SPAS, IN CLASS  
11 (U.S. CLS. 13, 21, 23, 31 AND 34).

THE MARK CONSISTS OF STANDARD CHAR-  
ACTERS WITHOUT CLAIM TO ANY PARTICULAR  
FONT, STYLE, SIZE, OR COLOR.

PRIORITY CLAIMED UNDER SEC. 44(D) ON  
CANADA APPLICATION NO. 1342589, FILED 4-10-  
2007, REG. NO. TMA707683, DATED 2-19-2008, EX-  
PIRES 2-19-2023.

SER. NO. 77-154,709, FILED 4-12-2007.

RONALD MCMORROW, EXAMINING ATTORNEY

**Int. Cl.: 17**

**Prior U.S. Cls.: 1, 5, 12, 13, 35 and 50**

**United States Patent and Trademark Office**

**Reg. No. 3,465,339**

**Registered July 15, 2008**

**TRADEMARK  
PRINCIPAL REGISTER**

**MYLAVAC**

SPA LOGIC INC. (CANADA CORPORATION)  
4549 52 STREET  
THORSBY, CANADA T0C2P0

FOR: POLYURETHANE FILM FOR USE AS A  
MOISTURE BARRIER, IN CLASS 17 (U.S. CLS. 1, 5,  
12, 13, 35 AND 50).

THE MARK CONSISTS OF STANDARD CHAR-  
ACTERS WITHOUT CLAIM TO ANY PARTICULAR  
FONT, STYLE, SIZE, OR COLOR.

PRIORITY CLAIMED UNDER SEC. 44(D) ON  
CANADA APPLICATION NO. 1342627, FILED 4-10-  
2007, REG. NO. TMA707696, DATED 2-19-2008, EX-  
PIRES 2-19-2023.

SER. NO. 77-154,712, FILED 4-12-2007.

RONALD MCMORROW, EXAMINING ATTORNEY



**Int. Cl.: 11**

**Prior U.S. Cls.: 13, 21, 23, 31 and 34**

**United States Patent and Trademark Office**

**Reg. No. 3,465,340**

**Registered July 15, 2008**

**TRADEMARK  
PRINCIPAL REGISTER**

**IMAGINE-IT CABINETS**

SPA LOGIC INC. (CANADA CORPORATION)  
4549 52 STREET  
THORSBY, CANADA T0C2P0

FOR: CUSTOMIZED CABINETS SOLD AS AN  
INTEGRAL COMPONENT OF SPAS AND HOT  
TUBS, IN CLASS 11 (U.S. CLS. 13, 21, 23, 31 AND 34).

THE MARK CONSISTS OF STANDARD CHAR-  
ACTERS WITHOUT CLAIM TO ANY PARTICULAR  
FONT, STYLE, SIZE, OR COLOR.

PRIORITY CLAIMED UNDER SEC. 44(D) ON  
CANADA APPLICATION NO. 1342602, FILED 4-10-  
2007, REG. NO. TMA707711, DATED 2-19-2008, EX-  
PIRES 2-19-2023.

NO CLAIM IS MADE TO THE EXCLUSIVE  
RIGHT TO USE "CABINETS", APART FROM THE  
MARK AS SHOWN.

SER. NO. 77-154,714, FILED 4-12-2007.

RONALD MCMORROW, EXAMINING ATTORNEY

**Int. Cl.: 43**

**Prior U.S. Cls.: 100 and 101**

**United States Patent and Trademark Office**

**Reg. No. 3,465,341**

**Registered July 15, 2008**

**SERVICE MARK  
PRINCIPAL REGISTER**

**MADRAS CHETTINAAD**

ASHT VINAYAK, INC. (GEORGIA CORPORATION)

2244 HUNTCREST WAY

LAWRENCEVILLE, GA 300438150

FOR: RESTAURANTS, IN CLASS 43 (U.S. CLS. 100 AND 101).

FIRST USE 3-31-2007; IN COMMERCE 3-31-2007.

THE MARK CONSISTS OF STANDARD CHARACTERS WITHOUT CLAIM TO ANY PARTICULAR FONT, STYLE, SIZE, OR COLOR.

NO CLAIM IS MADE TO THE EXCLUSIVE RIGHT TO USE "CHETTINAAD", APART FROM THE MARK AS SHOWN.

SER. NO. 77-154,845, FILED 4-12-2007.

ANDREA SAUNDERS, EXAMINING ATTORNEY

**Int. Cls.: 26 and 40**

**Prior U.S. Cls.: 37, 39, 40, 42, 50, 100, 103 and 106**

**Reg. No. 3,465,342**

**United States Patent and Trademark Office**

**Registered July 15, 2008**

**TRADEMARK  
SERVICE MARK  
PRINCIPAL REGISTER**

**SHEVYpro**

SHEVY'S CUSTOM WIGS INC. (NEW YORK CORPORATION)  
1884 CONEY ISLAND AVENUE  
NEW YORK, NY 11230

FOR: WIGS; WIGS, HAIRPIECES, AND ADD-IN AND ADD-ON HAIR ACCESSORIES CONSTRUCTED PRIMARILY OF SYNTHETIC AND/OR HUMAN HAIR, IN CLASS 26 (U.S. CLS. 37, 39, 40, 42 AND 50).

FIRST USE 10-1-2006; IN COMMERCE 10-1-2006.

FOR: CUSTOM MANUFACTURE AND FITTING OF WIGS, IN CLASS 40 (U.S. CLS. 100, 103 AND 106).

FIRST USE 10-1-2006; IN COMMERCE 10-1-2006.

THE MARK CONSISTS OF STANDARD CHARACTERS WITHOUT CLAIM TO ANY PARTICULAR FONT, STYLE, SIZE, OR COLOR.

OWNER OF U.S. REG. NO. 3,085,344.

SER. NO. 77-154,943, FILED 4-12-2007.

STEVEN PEREZ, EXAMINING ATTORNEY

**Int. Cl.: 25**

**Prior U.S. Cls.: 22 and 39**

**United States Patent and Trademark Office**

**Reg. No. 3,465,343**

**Registered July 15, 2008**

**TRADEMARK  
PRINCIPAL REGISTER**

# Cali Nation

NACK, ANDREW DUANE (UNITED STATES  
INDIVIDUAL)

561 WEST STREET

SALINAS, CA 93901

FOR: SHORT-SLEEVED OR LONG-SLEEVED T-  
SHIRTS, IN CLASS 25 (U.S. CLS. 22 AND 39).

FIRST USE 1-1-2003; IN COMMERCE 1-1-2003.

THE MARK CONSISTS OF STANDARD CHAR-  
ACTERS WITHOUT CLAIM TO ANY PARTICULAR  
FONT, STYLE, SIZE, OR COLOR.

NO CLAIM IS MADE TO THE EXCLUSIVE  
RIGHT TO USE "CALI", APART FROM THE MARK  
AS SHOWN.

SER. NO. 77-155,308, FILED 4-12-2007.

RENEE MCCRAY, EXAMINING ATTORNEY

**Int. Cl.: 41**

**Prior U.S. Cls.: 100, 101 and 107**

**United States Patent and Trademark Office**

**Reg. No. 3,465,344**

**Registered July 15, 2008**

**SERVICE MARK  
PRINCIPAL REGISTER**

# DigElog

KUSS, DUANE A (MINNESOTA SOLE PROPRIETORSHIP)  
911 3RD ST. S.  
COLD SPRING, MN 56320

FOR: BOOK AND REVIEW PUBLISHING; DESKTOP PUBLISHING FOR OTHERS; ELECTRONIC PUBLISHING SERVICES, NAMELY, PUBLICATION OF TEXT AND GRAPHIC WORKS OF OTHERS ON ONLINE, DVD AND OTHER DIGITAL FORMS FEATURING COMMUNITY AND BUSINESS; MAGAZINE PUBLISHING; MULTIMEDIA PUBLISHING OF BOOKS, MAGAZINES, JOURNALS, SOFTWARE, GAMES, MUSIC, AND ELECTRONIC PUBLICATIONS; MUSIC PUBLISHING SERVICES; NEWSPAPER PUBLISHING; PUBLISHING OF

BOOKS AND REVIEWS; PUBLISHING OF BOOKS, MAGAZINES; PUBLISHING OF ELECTRONIC PUBLICATIONS; PUBLISHING OF REVIEWS; PUBLISHING OF WEB MAGAZINES, IN CLASS 41 (U.S. CLS. 100, 101 AND 107).

FIRST USE 8-1-2005; IN COMMERCE 9-1-2005.

THE MARK CONSISTS OF STANDARD CHARACTERS WITHOUT CLAIM TO ANY PARTICULAR FONT, STYLE, SIZE, OR COLOR.

SER. NO. 77-155,805, FILED 4-13-2007.

KIMBERLY PERRY, EXAMINING ATTORNEY

**Int. Cl.: 25**

**Prior U.S. Cls.: 22 and 39**

**United States Patent and Trademark Office**

**Reg. No. 3,465,345**

**Registered July 15, 2008**

**TRADEMARK  
PRINCIPAL REGISTER**



GIORGIO MORANDI, INC. (NEW YORK CORPORATION)  
1375 BROADWAY, SUITE 707  
NEW YORK, NY 10018

THE MARK CONSISTS OF A BARE FOOT WITH THE NAME FOOTZIES INSIDE THE BODY OF THE FOOT.

FOR: FOOTWEAR MADE OF WOOD; FOOTWEAR FOR MEN AND WOMEN, IN CLASS 25 (U.S. CLS. 22 AND 39).

SER. NO. 77-156,215, FILED 4-13-2007.

FIRST USE 3-1-2007; IN COMMERCE 4-1-2007.

BERNICE MIDDLETON, EXAMINING ATTORNEY

**Int. Cl.: 35**

**Prior U.S. Cls.: 100, 101 and 102**

**United States Patent and Trademark Office**

**Reg. No. 3,465,346**

**Registered July 15, 2008**

**SERVICE MARK  
PRINCIPAL REGISTER**

**SAFFRON**

SAFFRON BRAND CONSULTANTS, S.A. (SPAIN  
CORPORATION)  
C/ZURBANO, 23, BAJO IZDA  
28010 MADRID, SPAIN

OWNER OF ERPN CMNTY TM OFC REG. NO.  
002660108, DATED 7-18-2003, EXPIRES 4-19-2012.

FOR: ADVERTISING SERVICES, BUSINESS CON-  
SULTING SERVICES, BUSINESS MARKETING SER-  
VICES, IN CLASS 35 (U.S. CLS. 100, 101 AND 102).

OWNER OF SPAIN REG. NO. 2392833, DATED 10-  
5-2001, EXPIRES 10-5-2011.

FIRST USE 1-1-2007; IN COMMERCE 1-1-2007.

SER. NO. 77-156,597, FILED 4-13-2007.

THE MARK CONSISTS OF STANDARD CHAR-  
ACTERS WITHOUT CLAIM TO ANY PARTICULAR  
FONT, STYLE, SIZE, OR COLOR.

HEATHER SAPP, EXAMINING ATTORNEY

**Int. Cl.: 44**

**Prior U.S. Cls.: 100 and 101**

**United States Patent and Trademark Office**

**Reg. No. 3,465,347**

**Registered July 15, 2008**

**SERVICE MARK  
PRINCIPAL REGISTER**

**FACE MAPPING**

INTERNATIONAL DERMAL INSTITUTE, INC.  
(CALIFORNIA CORPORATION)  
1535 BEACHEY PLACE  
CARSON, CA 90746

FOR: SKIN AND FACIAL CARE SERVICES,  
NAMELY, SKIN ANALYSIS AND CONSULTATION  
RENDERED IN CONNECTION THEREWITH, IN  
CLASS 44 (U.S. CLS. 100 AND 101).

FIRST USE 2-28-2000; IN COMMERCE 2-28-2000.

THE MARK CONSISTS OF STANDARD CHAR-  
ACTERS WITHOUT CLAIM TO ANY PARTICULAR  
FONT, STYLE, SIZE, OR COLOR.

OWNER OF U.S. REG. NO. 3,113,266.

NO CLAIM IS MADE TO THE EXCLUSIVE  
RIGHT TO USE "MAPPING", APART FROM THE  
MARK AS SHOWN.

SEC. 2(F).

SER. NO. 77-156,755, FILED 4-13-2007.

RAUL CORDOVA, EXAMINING ATTORNEY



**Int. Cl.: 35**

**Prior U.S. Cls.: 100, 101 and 102**

**United States Patent and Trademark Office**

**Reg. No. 3,465,348**

**Registered July 15, 2008**

---

**SERVICE MARK  
PRINCIPAL REGISTER**

**Linking People, Strategy,  
and Performance**

HUSELID, MARK (UNITED STATES INDIVIDUAL)  
58 DANVILLE DRIVE  
PRINCETON JUNCTION, NJ 08550

THE MARK CONSISTS OF STANDARD CHARACTERS WITHOUT CLAIM TO ANY PARTICULAR FONT, STYLE, SIZE, OR COLOR.

FOR: BUSINESS CONSULTATION, IN CLASS 35 (U.S. CLS. 100, 101 AND 102).

SER. NO. 77-156,899, FILED 4-14-2007.

FIRST USE 3-1-2007; IN COMMERCE 3-1-2007.

MICHELE SWAIN, EXAMINING ATTORNEY

Int. Cl.: 35

Prior U.S. Cls.: 100, 101 and 102

United States Patent and Trademark Office

Reg. No. 3,465,349

Registered July 15, 2008

**SERVICE MARK  
PRINCIPAL REGISTER**



OPEN LISTINGS, INC. (CALIFORNIA CORPORATION)  
P.O. BOX 111570  
CAMPBELL, CA 95011

FOR: PROVIDING AN ON-LINE SEARCHABLE DATABASE FEATURING CLASSIFIED AD LISTINGS AND EMPLOYMENT OPPORTUNITIES, IN CLASS 35 (U.S. CLS. 100, 101 AND 102).

FIRST USE 2-18-2007; IN COMMERCE 2-18-2007.

NO CLAIM IS MADE TO THE EXCLUSIVE RIGHT TO USE "OPENLISTINGS", APART FROM THE MARK AS SHOWN.

THE COLOR(S) DARK RED, YELLOW, BLUE, YELLOW GREEN, GREY, LIGHT GREY, WHITE IS/ ARE CLAIMED AS A FEATURE OF THE MARK.

THE MARK CONSISTS OF STYLIZED LETTERS OF "OPEN" IN GREY; STYLIZED LETTERS OF "LISTINGS" IN LIGHT GREY; 11 GREY HORIZONTAL LINES ARE CENTERED IN GREY STYLIZED LETTER O; THE COLOR WHITE APPEARS IN THE CENTER OF THE GREY LETTER O; 1 DARK RED STYLIZED LETTER O; 1 YELLOW STYLIZED LETTER O; 1 YELLOW GREEN STYLIZED LETTER O; 1 BLUE STYLIZED LETTER O; WHICH ARE LOCATED BEHIND THE GREY STYLIZED O AT DIFFERENT DEGREES. .

SER. NO. 77-156,946, FILED 4-14-2007.

ANGELA M. MICHELI, EXAMINING ATTORNEY

**Int. Cl.: 25**

**Prior U.S. Cls.: 22 and 39**

**United States Patent and Trademark Office**

**Reg. No. 3,465,350**

**Registered July 15, 2008**

**TRADEMARK  
PRINCIPAL REGISTER**



PHILLIP JAMES MONTVILLE (UNITED STATES  
INDIVIDUAL)

95 BIRCH BLUFF ROAD

TONKA BAY, MN 55331

FOR: THONGS; TIPS FOR FOOTWEAR; ATHLETIC FOOTWEAR; BEACH FOOTWEAR; FLIP FLOPS; FOOTWEAR; FOOTWEAR; FOOTWEAR FOR MEN; FOOTWEAR FOR MEN AND WOMEN; FOOTWEAR FOR TRACK AND FIELD ATHLETICS; FOOTWEAR FOR WOMEN; FOOTWEAR MADE OF WOOD; FOOTWEAR NOT FOR SPORTS; FOOTWEAR, NAMELY, PUMPS; FOOTWEAR, NAMELY, RUBBERS; JAPANESE FOOTWEAR OF RICE STRAW (WARAJI); JAPANESE SPLIT-TOED WORK FOOTWEAR (JIKATABI); PUMPS; BELTS; LEATHER BELTS, IN CLASS 25 (U.S. CLS. 22 AND 39).

FIRST USE 8-2-2006; IN COMMERCE 1-4-2007.

NO CLAIM IS MADE TO THE EXCLUSIVE RIGHT TO USE "MOCCASINS", APART FROM THE MARK AS SHOWN.

THE COLOR(S) BLACK, WHITE, GREY, BLUE, YELLOW AND GREEN IS/ARE CLAIMED AS A FEATURE OF THE MARK.

THE COLOR WHITE APPEARS IN THE CLOUDS ON THE GLOBE AND THE WORDS "PEACE MOCCASINS", THE COLOR BLACK APPEARS IN THE PEACE SYMBOL, THE COLOR GREY APPEARS IN THE OUTLINE AROUND THE PEACE SYMBOL, THE COLOR BLUE APPEARS IN THE GLOBE, AND THE COLORS GREEN AND YELLOW APPEAR IN THE CONTINENTS ON THE GLOBE.

SER. NO. 77-156,947, FILED 4-14-2007.

ANGELA M. MICHELI, EXAMINING ATTORNEY

**Int. Cls.: 6, 9, 14, 16, 21, 25, 35 and 41**

**Prior U.S. Cls.: 2, 5, 12, 13, 14, 21, 22, 23, 25, 26, 27, 28, 29, 30, 33, 36, 37, 38, 39, 40, 50, 100, 101, 102 and 107**

**Reg. No. 3,465,351**

**United States Patent and Trademark Office**

**Registered July 15, 2008**

**TRADEMARK  
SERVICE MARK  
PRINCIPAL REGISTER**



DELTA SIGMA THETA SORORITY, INCORPORATED (D.C. CORPORATION)  
1707 NEW HAMPSHIRE AVENUE, NW  
WASHINGTON, DC 20009

FOR: METAL KEY CHAINS AND METAL LICENSE PLATES, IN CLASS 6 (U.S. CLS. 2, 12, 13, 14, 23, 25 AND 50).

FIRST USE 1-1-1970; IN COMMERCE 1-1-1970.

FOR: COMPUTER MOUSE PADS, IN CLASS 9 (U.S. CLS. 21, 23, 26, 36 AND 38).

FIRST USE 1-1-1995; IN COMMERCE 1-1-1995.

FOR: JEWELRY, NAMELY, BRACELETS, CHARMS, PINS, WATCHES AND EARRINGS, IN CLASS 14 (U.S. CLS. 2, 27, 28 AND 50).

FIRST USE 1-1-1970; IN COMMERCE 1-1-1970.

FOR: PRINTED PRODUCTS, NAMELY, NEWSLETTERS IN THE FIELD OF ECONOMIC DEVELOPMENT, EDUCATIONAL DEVELOPMENT, INTERNATIONAL AWARENESS AND INVOLVEMENT, PHYSICAL AND MENTAL HEALTH, POLITICAL AWARENESS AND INVOLVEMENT, AND COMMUNITY SERVICE DIRECTED PRIMARILY TOWARD AFRICAN AMERICAN FEMALES; PAPER PRODUCTS, NAMELY, STATIONERY, PRINTED CERTIFICATES, GREETING CARDS;

BROCHURES IN THE FIELD OF ECONOMIC DEVELOPMENT, EDUCATIONAL DEVELOPMENT, INTERNATIONAL AWARENESS AND INVOLVEMENT, PHYSICAL AND MENTAL HEALTH, POLITICAL AWARENESS AND INVOLVEMENT, AND COMMUNITY SERVICE; EDUCATIONAL BOOKS IN THE FIELD OF ECONOMIC DEVELOPMENT, EDUCATIONAL DEVELOPMENT, INTERNATIONAL AWARENESS AND INVOLVEMENT, PHYSICAL AND MENTAL HEALTH, POLITICAL AWARENESS AND INVOLVEMENT, AND COMMUNITY SERVICE; MAGAZINES FEATURING THE FIELDS OF ECONOMIC DEVELOPMENT, EDUCATIONAL DEVELOPMENT, INTERNATIONAL AWARENESS AND INVOLVEMENT, PHYSICAL AND MENTAL HEALTH, POLITICAL AWARENESS AND INVOLVEMENT, AND COMMUNITY SERVICE; EVENT PROGRAMMES; MANUALS IN THE FIELD OF ECONOMIC DEVELOPMENT, EDUCATIONAL DEVELOPMENT, INTERNATIONAL AWARENESS AND INVOLVEMENT, PHYSICAL AND MENTAL HEALTH, POLITICAL AWARENESS AND INVOLVEMENT, AND COMMUNITY SERVICE; AND DECORATIVE LABELS OF PAPER OR CARDBOARD AND STICKERS, DIRECTED PRIMARILY TOWARD AFRICAN AMERICAN FEMALES, IN CLASS 16 (U.S. CLS. 2, 5, 22, 23, 29, 37, 38 AND 50).

FIRST USE 1-1-1970; IN COMMERCE 1-1-1970.

FOR: DINNERWARE, NAMELY, PLATES, BOWLS, DRINKING GLASSES, CUPS, SAUCERS

AND COASTERS NOT MADE OF PAPER AND NOT BEING TABLE LINEN, IN CLASS 21 (U.S. CLS. 2, 13, 23, 29, 30, 33, 40 AND 50).

FIRST USE 1-1-1970; IN COMMERCE 1-1-1970.

FOR: CLOTHING, NAMELY, T-SHIRTS, SWEAT-SHIRTS, TANK TOPS, JACKETS, HATS, SHORTS, PANTS, SHOES, SOCKS, JOGGING SUITS, SWEAT SUITS, POLO SHIRTS, SWEAT PANTS, UNDERWEAR, SWIM WEAR, COATS, LEATHER COATS, BANDANNAS, SWEAT BANDS, BOOTS, GYM SHOES, TENNIS SHOES, AEROBIC SHOES, WALKING SHOES, IN CLASS 25 (U.S. CLS. 22 AND 39).

FIRST USE 1-1-1960; IN COMMERCE 1-1-1960.

FOR: CHARITABLE SERVICES, NAMELY, ORGANIZING AND CONDUCTING VOLUNTEER PROGRAMS AND COMMUNITY SERVICE PROJECTS AND PROVIDING RELATED INFORMATION OVER A GLOBAL COMPUTER NETWORK, IN CLASS 35 (U.S. CLS. 100, 101 AND 102).

FIRST USE 1-1-2000; IN COMMERCE 1-1-2000.

FOR: ARRANGING AND CONDUCTING CONFERENCES, SYMPOSIA, EDUCATIONAL COURSES AND WORKSHOPS IN THE FIELDS OF ECONOMIC DEVELOPMENT, EDUCATIONAL DEVELOPMENT, INTERNATIONAL AWARENESS AND INVOLVEMENT, PHYSICAL AND MENTAL HEALTH, POLITICAL AWARENESS AND INVOLVEMENT, AND COMMUNITY SERVICE AND THE PUBLICATION OF ELECTRONIC NEWSLETTERS AND PRINTED MATERIALS IN CONJUNCTION THEREWITH; AUDIO RECORDING AND PRODUCTION WHEREIN THE RECORDINGS ARE USED IN CONJUNCTION WITH THE CONFERENCES, SYMPOSIA, EDUCATIONAL COURSES AND WORKSHOPS IN THE FIELDS OF ECONOMIC DEVELOPMENT, EDUCATIONAL DEVELOPMENT, INTERNATIONAL AWARENESS AND INVOLVEMENT, PHYSICAL AND MENTAL HEALTH, POLITICAL AWARENESS

AND INVOLVEMENT, AND COMMUNITY SERVICE; PRODUCTION OF VIDEOTAPES WHEREIN THE VIDEOTAPES ARE USED IN CONJUNCTION WITH THE CONFERENCES, SYMPOSIA, EDUCATIONAL COURSES AND WORKSHOPS IN THE FIELDS OF ECONOMIC DEVELOPMENT, EDUCATIONAL DEVELOPMENT, INTERNATIONAL AWARENESS AND INVOLVEMENT, PHYSICAL AND MENTAL HEALTH, POLITICAL AWARENESS AND INVOLVEMENT, AND COMMUNITY SERVICE, IN CLASS 41 (U.S. CLS. 100, 101 AND 107).

FIRST USE 1-1-1970; IN COMMERCE 1-1-1970.

OWNER OF U.S. REG. NOS. 2,199,609, 2,201,178 AND OTHERS.

THE MARK CONSISTS OF AN OVAL-SHAPED CREST CONSISTING OF FRONDS ALONG THE LEFT AND RIGHT BORDERS, A BANNER WITH THE GREEK WORDS "DELTA SIGMA THETA" ALONG THE BOTTOM, AND A REPRESENTATION OF THE GODDESS MINERVA PROFILED ON THE TOP. THE CENTER OF THE CREST, WITHIN THE OUTLINE OF A SHIELD, CONTAINS A TORCH, SUPERIMPOSED DIAGONALLY WITH THE GREEK LETTERS "DELTA", "SIGMA", AND "THETA". BEHIND THE TORCH IS A CHEVRON DESIGN, PARTIALLY COVERING A SWORD AND A STAFF.

THE FOREIGN WORDING IN THE MARK TRANSLATES INTO ENGLISH AS "DELTA SIGMA THETA".

THE NON-LATIN CHARACTER(S) IN THE MARK TRANSLITERATE INTO "DELTA SIGMA THETA", AND THIS MEANS "DELTA SIGMA THETA" IN ENGLISH.

SER. NO. 77-157,144, FILED 4-16-2007.

THOMAS MANOR, EXAMINING ATTORNEY

**Int. Cl.: 36**

**Prior U.S. Cls.: 100, 101 and 102**

**United States Patent and Trademark Office**

**Reg. No. 3,465,352**

**Registered July 15, 2008**

**SERVICE MARK  
PRINCIPAL REGISTER**

**KELSO**

KELSO & COMPANY, L.P. (DELAWARE LIMITED PARTNERSHIP)  
320 PARK AVENUE  
NEW YORK, NY 10022

FOR: FINANCIAL INVESTMENT, NAMELY, THE PURCHASE AND SALE OF PRIVATE AND PUBLIC EQUITY AND DEBT; ORGANIZING INVESTMENT PARTNERSHIPS AND OBTAINING COMMITMENTS FROM INVESTORS TO PROVIDE CAPITAL; FINANCIAL MANAGEMENT, NAMELY, MANAGEMENT OF EQUITY CAPITAL AND OTHER ASSETS ON BEHALF OF INVESTMENT FUNDS AND PORTFOLIO COMPANIES; FINANCIAL CONSULTATION, NAMELY, ASSISTING PORTFOLIO COMPANIES WITH CAPITAL MARKETS OR

OTHER FINANCING TRANSACTIONS; FINANCIAL CONSULTING AND ADVISORY SERVICES, IN CLASS 36 (U.S. CLS. 100, 101 AND 102).

FIRST USE 6-9-1980; IN COMMERCE 6-9-1980.

THE MARK CONSISTS OF STANDARD CHARACTERS WITHOUT CLAIM TO ANY PARTICULAR FONT, STYLE, SIZE, OR COLOR.

SEC. 2(F).

SER. NO. 77-157,257, FILED 4-16-2007.

STEVEN R. FINE, EXAMINING ATTORNEY

**Int. Cl.: 9**

**Prior U.S. Cls.: 21, 23, 26, 36 and 38**

**Reg. No. 3,465,353**

**United States Patent and Trademark Office**

**Registered July 15, 2008**

---

**TRADEMARK  
PRINCIPAL REGISTER**

**CLUSTER DEVELOPMENT KIT**

THE PORTLAND GROUP, INCORPORATED  
(OREGON CORPORATION)  
2 CENTERPOINTE DRIVE, SUITE 320  
LAKE OSWEGO, OR 97035

FOR: COMPUTER SOFTWARE AND MANUALS  
SOLD TOGETHER AS A UNIT THAT ENABLES  
BUILDING, OPERATING AND PROGRAMMING  
COMPUTER SYSTEMS COMPRISED OF MULTIPLE  
SERVERS OR WORKSTATIONS ATTACHED VIA A  
COMPUTER NETWORK, IN CLASS 9 (U.S. CLS. 21,  
23, 26, 36 AND 38).

FIRST USE 9-25-1998; IN COMMERCE 9-25-1998.

THE MARK CONSISTS OF STANDARD CHAR-  
ACTERS WITHOUT CLAIM TO ANY PARTICULAR  
FONT, STYLE, SIZE, OR COLOR.

OWNER OF U.S. REG. NO. 2,447,202.

NO CLAIM IS MADE TO THE EXCLUSIVE  
RIGHT TO USE "KIT", APART FROM THE MARK  
AS SHOWN.

SEC. 2(F).

SER. NO. 77-157,856, FILED 4-16-2007.

KIMBERLY FRYE, EXAMINING ATTORNEY

**Int. Cl.: 41**

**Prior U.S. Cls.: 100, 101 and 107**

**United States Patent and Trademark Office**

**Reg. No. 3,465,354**

**Registered July 15, 2008**

---

**SERVICE MARK  
PRINCIPAL REGISTER**

**THE WORLD IS WATCHING**

VERILOGIX, INC. (CALIFORNIA CORPORATION)  
23705 CRENSHAW BLVD, SUITE 101  
TORRANCE, CA 90505

FOR: VIDEO PRODUCTION SERVICES FOR CREATING INTERACTIVE E-LEARNING COURSES, WEB PRESENTATIONS OR WEBCASTS, TESTS AND SURVEYS FOR DATA COLLECTION, INTERNET ADVERTISING, AND FOR TRAINING AND COMMUNICATION WITH TEXT, VOICE, AND GRAPHICS, IN THE HEAVY MANUFACTURING, AEROSPACE, AUTOMOTIVE, HIGH TECH, RETAIL, FINANCIAL, INSURANCE, HEALTHCARE,

GOVERNMENT, UTILITIES, TRANSPORTATION, AND SECURITY INDUSTRIES, IN CLASS 41 (U.S. CLS. 100, 101 AND 107).

FIRST USE 11-0-2006; IN COMMERCE 11-0-2006.

THE MARK CONSISTS OF STANDARD CHARACTERS WITHOUT CLAIM TO ANY PARTICULAR FONT, STYLE, SIZE, OR COLOR.

SER. NO. 77-157,963, FILED 4-16-2007.

CARYN GLASSER, EXAMINING ATTORNEY



**Int. Cl.: 45**

**Prior U.S. Cls.: 100 and 101**

**United States Patent and Trademark Office**

**Reg. No. 3,465,355**

**Registered July 15, 2008**

**SERVICE MARK  
PRINCIPAL REGISTER**

**BEZAIRE, LEDWITZ &  
ASSOCIATES, A PROFESSIONAL  
CORPORATION**

BEZAIRE, LEDWITZ & ASSOCIATES, APC (CALIFORNIA CORPORATION)

970 WEST 190TH STREET, SUITE 275

TORRANCE, CA 90502

FOR: LEGAL SERVICES AND LEGAL CONSULTING SERVICES, IN CLASS 45 (U.S. CLS. 100 AND 101).

FIRST USE 4-2-2007; IN COMMERCE 4-2-2007.

THE MARK CONSISTS OF STANDARD CHARACTERS WITHOUT CLAIM TO ANY PARTICULAR FONT, STYLE, SIZE, OR COLOR.

NO CLAIM IS MADE TO THE EXCLUSIVE RIGHT TO USE "ASSOCIATES, A PROFESSIONAL CORPORATION", APART FROM THE MARK AS SHOWN.

SER. NO. 77-158,172, FILED 4-17-2007.

JASON TURNER, EXAMINING ATTORNEY

**Int. Cl.: 9**

**Prior U.S. Cls.: 21, 23, 26, 36 and 38**

**Reg. No. 3,465,356**

**United States Patent and Trademark Office**

**Registered July 15, 2008**

---

**TRADEMARK  
PRINCIPAL REGISTER**

**PALACE SCRIPT**

THE MONOTYPE CORPORATION (DELAWARE  
CORPORATION)  
ONE MICROSOFT WAY  
REDMOND, WA 980526399

FOR: COMPUTER SOFTWARE FOR USE IN DIS-  
PLAYING AND PRINTING DIGITAL TYPEFACE  
DESIGNS, TYPOGRAPHICAL ORNAMENTS AND  
CHARACTER FONTS, IN CLASS 9 (U.S. CLS. 21, 23,  
26, 36 AND 38).

FIRST USE 1-31-2002; IN COMMERCE 1-31-2002.

THE MARK CONSISTS OF STANDARD CHAR-  
ACTERS WITHOUT CLAIM TO ANY PARTICULAR  
FONT, STYLE, SIZE, OR COLOR.

NO CLAIM IS MADE TO THE EXCLUSIVE  
RIGHT TO USE "SCRIPT", APART FROM THE  
MARK AS SHOWN.

SER. NO. 77-158,755, FILED 4-17-2007.

BARBARA A. GOLD, EXAMINING ATTORNEY

**Int. Cl.: 37**

**Prior U.S. Cls.: 100, 103 and 106**

**United States Patent and Trademark Office**

**Reg. No. 3,465,357**

**Registered July 15, 2008**

**SERVICE MARK  
PRINCIPAL REGISTER**

**White House Painting &  
Decorating**

MIHALYI, ZOLTAN (HUNGARY INDIVIDUAL)  
117-01 PARK LANE SOUTH, D3E  
RICHMOND HILL, NY 11418

FOR: PAINTING IN THE FIELD OF RESIDENTIAL AND COMMERCIAL PROPERTIES, IN CLASS 37 (U.S. CLS. 100, 103 AND 106).

FIRST USE 10-26-2005; IN COMMERCE 10-26-2005.

THE MARK CONSISTS OF STANDARD CHARACTERS WITHOUT CLAIM TO ANY PARTICULAR FONT, STYLE, SIZE, OR COLOR.

NO CLAIM IS MADE TO THE EXCLUSIVE RIGHT TO USE "HOUSE PAINTING AND DECORATING", APART FROM THE MARK AS SHOWN.

SER. NO. 77-159,459, FILED 4-18-2007.

EMILY CARLSEN, EXAMINING ATTORNEY

**Int. Cls.: 3 and 44**

**Prior U.S. Cls.: 1, 4, 6, 50, 51, 52, 100 and 101**

**United States Patent and Trademark Office**

**Reg. No. 3,465,358**

**Registered July 15, 2008**

**TRADEMARK  
SERVICE MARK  
PRINCIPAL REGISTER**

**NUBIAN KINKS**

KIMBERLY WOODALL-BROWN (NEW YORK CORPORATION)  
STE. 4K  
385 E. 18TH STREET  
BROOKLYN, NY 11226

FOR: OILS FOR HAIR CONDITIONING; HAIR CONDITIONERS; HAIR GELS; HAIR OILS; HAIR POMADES; HAIR SHAMPOO; HAIR SPRAY; MOUSSE FOR HAIR , IN CLASS 3 (U.S. CLS. 1, 4, 6, 50, 51 AND 52).

FIRST USE 5-1-2001; IN COMMERCE 3-1-2002.

FOR: HAIR SALON SERVICES, NAMELY, TREATMENTS TO PROTECT HAIR FROM AF-

FACTS OF EXPOSURE TO SUNLIGHT, HEAT, HUMIDITY AND CHLORINATED WATER; HAIR STYLING; HAIR REPLACEMENT, HAIR ADDITION, AND HAIR EXTENSION SERVICES, IN CLASS 44 (U.S. CLS. 100 AND 101).

FIRST USE 5-1-2001; IN COMMERCE 3-1-2002.

THE MARK CONSISTS OF STANDARD CHARACTERS WITHOUT CLAIM TO ANY PARTICULAR FONT, STYLE, SIZE, OR COLOR.

SER. NO. 77-159,516, FILED 4-18-2007.

ANNE FARRELL, EXAMINING ATTORNEY

**Int. Cls.: 41 and 43**

**Prior U.S. Cls.: 100, 101 and 107**

**United States Patent and Trademark Office**

**Reg. No. 3,465,359**

**Registered July 15, 2008**

**SERVICE MARK  
PRINCIPAL REGISTER**

**PRACTICAL WHIMSY**

PRACTICAL WHIMSY, INC. (CALIFORNIA CORPORATION)  
4712 ADMIRALTY WAY, SUITE 354  
MARINA DEL REY, CA 90292

FOR: ENTERTAINMENT SERVICES, NAMELY, PROVIDING A WEB SITE FEATURING INFORMATION, PHOTOGRAPHS, AND MULTI-MEDIA MATERIALS IN THE FIELD OF ENTERTAINING, NAMELY, PARTY PLANNING; PROVIDING A WEB SITE FEATURING INFORMATION, PHOTOGRAPHS, AND MULTI-MEDIA MATERIALS IN THE FIELD OF PARENTING, CONCERNING EDUCATION OF CHILDREN, IN CLASS 41 (U.S. CLS. 100, 101 AND 107).

FIRST USE 5-31-2005; IN COMMERCE 5-31-2005.

FOR: PROVIDING A WEB SITE FEATURING INFORMATION, PHOTOGRAPHS, AND MULTI-MEDIA MATERIALS IN THE FIELD OF COOKING, IN CLASS 43 (U.S. CLS. 100 AND 101).

FIRST USE 5-31-2005; IN COMMERCE 5-31-2005.

THE MARK CONSISTS OF STANDARD CHARACTERS WITHOUT CLAIM TO ANY PARTICULAR FONT, STYLE, SIZE, OR COLOR.

SER. NO. 77-159,637, FILED 4-18-2007.

RICHARD WHITE, EXAMINING ATTORNEY

**Int. Cl.: 41**

**Prior U.S. Cls.: 100, 101 and 107**

**United States Patent and Trademark Office**

**Reg. No. 3,465,360**

**Registered July 15, 2008**

**SERVICE MARK  
PRINCIPAL REGISTER**

**CALIFORNIA CLAW**

REAL PRO WRESTLING, INC. (TENNESSEE  
CORPORATION)  
1495 BIG MARROWBONE ROAD  
ASHLAND, TN 37015

FOR: ENTERTAINMENT SERVICES, NAMELY,  
LIVE WRESTLING EXHIBITIONS; ENTERTAIN-  
MENT IN THE NATURE OF ON-GOING TELEVI-  
SION PROGRAMS IN THE FIELD OF WRESTLING  
EXHIBITIONS; ENTERTAINMENT SERVICES,  
NAMELY, PROVIDING A RADIO PROGRAM IN  
THE FIELD OF WRESTLING EXHIBITIONS; EN-  
TERTAINMENT SERVICES, NAMELY, PROVIDING  
WEBCASTS IN THE FIELD OF WRESTLING EXHI-  
BITIONS VIA A GLOBAL COMPUTER NETWORK,  
IN CLASS 41 (U.S. CLS. 100, 101 AND 107).

FIRST USE 10-0-2004; IN COMMERCE 10-0-2004.

THE MARK CONSISTS OF STANDARD CHAR-  
ACTERS WITHOUT CLAIM TO ANY PARTICULAR  
FONT, STYLE, SIZE, OR COLOR.

NO CLAIM IS MADE TO THE EXCLUSIVE  
RIGHT TO USE "CALIFORNIA", APART FROM  
THE MARK AS SHOWN.

SER. NO. 77-159,705, FILED 4-18-2007.

LINDA M. KING, EXAMINING ATTORNEY

**Int. Cl.: 7**

**Prior U.S. Cls.: 13, 19, 21, 23, 31, 34 and 35**

**Reg. No. 3,465,361**

**United States Patent and Trademark Office**

**Registered July 15, 2008**

---

**TRADEMARK  
PRINCIPAL REGISTER**

**SILVER SHIELD**

KEM PARTS, LLC (NEVADA LTD LIAB CO)  
18-35 RIVER ROAD  
FAIRLAWN, NJ 07410

THE MARK CONSISTS OF STANDARD CHAR-  
ACTERS WITHOUT CLAIM TO ANY PARTICULAR  
FONT, STYLE, SIZE, OR COLOR.

FOR: AUTOMOTIVE PARTS, NAMELY, IGNI-  
TION WIRE, IN CLASS 7 (U.S. CLS. 13, 19, 21, 23, 31,  
34 AND 35).

SER. NO. 77-159,938, FILED 4-18-2007.

FIRST USE 1-31-1995; IN COMMERCE 1-31-1995.

ARETHA SOMERVILLE, EXAMINING ATTORNEY

**Int. Cl.: 25**

**Prior U.S. Cls.: 22 and 39**

**United States Patent and Trademark Office**

**Reg. No. 3,465,362**

**Registered July 15, 2008**

**TRADEMARK  
PRINCIPAL REGISTER**

**MAGGY BOUTIQUE**

MAGGY BOUTIQUE, LTD. (NEW YORK CORPORATION)

530 SEVENTH AVENUE, 16TH FLOOR

NEW YORK, NY 10018

FOR: DRESSES, IN CLASS 25 (U.S. CLS. 22 AND 39).

FIRST USE 11-25-1982; IN COMMERCE 11-25-1982.

THE MARK CONSISTS OF STANDARD CHARACTERS WITHOUT CLAIM TO ANY PARTICULAR FONT, STYLE, SIZE, OR COLOR.

NO CLAIM IS MADE TO THE EXCLUSIVE RIGHT TO USE "BOUTIQUE", APART FROM THE MARK AS SHOWN.

SER. NO. 77-160,064, FILED 4-18-2007.

ANNE E. GUSTASON, EXAMINING ATTORNEY



**Int. Cl.: 9**

**Prior U.S. Cls.: 21, 23, 26, 36 and 38**

**United States Patent and Trademark Office**

**Reg. No. 3,465,363**

**Registered July 15, 2008**

**TRADEMARK  
PRINCIPAL REGISTER**

# DATA911

HUBB SYSTEMS, LLC (CALIFORNIA LTD LIAB  
CO)  
2021 CHALLENGER DRIVE  
ALAMEDA, CA 94501

FOR: MOBILE COMPUTER SYSTEMS, COMPUTER DISPLAY SCREENS, NAMELY, FLAT-PANEL DISPLAY SCREENS, COMPUTER MONITORS, COMPUTER KEYBOARDS, COMPUTER POWER SUPPLY MODULES, COMPUTER PROCESSORS, NAMELY, CENTRAL PROCESSING UNITS, COMPUTER POWER CONTROL MODULES, NAMELY, POWER MANAGEMENT DEVICES FOR PREVENTING POWER LOSS AND ENSURING SAFE SHUT-DOWN, LAPTOP INTERFACE SYSTEMS, NAMELY, COMPUTER INTERFACE BOARDS, MOBILE DIGITAL VIDEO SYSTEMS, NAMELY, DIGITAL VIDEO RECORDERS, GLOBAL POSITIONING SYSTEMS (GPS), HAND-HELD COMPUTING DEVICES,

NAMELY, PERSONAL DIGITAL ASSISTANTS ALL IN THE FIELD OF PUBLIC SAFETY, IN CLASS 9 (U.S. CLS. 21, 23, 26, 36 AND 38).

FIRST USE 10-0-1989; IN COMMERCE 10-0-1989.

THE MARK CONSISTS OF STANDARD CHARACTERS WITHOUT CLAIM TO ANY PARTICULAR FONT, STYLE, SIZE, OR COLOR.

OWNER OF U.S. REG. NO. 2,546,009.

SEC. 2(F).

SER. NO. 77-160,091, FILED 4-18-2007.

SANI KHOURI, EXAMINING ATTORNEY

**Int. Cl.: 35**

**Prior U.S. Cls.: 100, 101 and 102**

**United States Patent and Trademark Office**

**Reg. No. 3,465,364**

**Registered July 15, 2008**

**SERVICE MARK  
PRINCIPAL REGISTER**

**1099DAQ**

LLOYD CLARK LLC (MARYLAND LTD LIAB  
CO)  
6217 FAIRBOURNE COURT  
HANOVER, MD 21076

FOR: BUSINESS SERVICES, NAMELY, REGIS-  
TERING, SCREENING, CREDENTIALING, AND  
ORGANIZING THIRD-PARTY VENDORS, SUPPLI-  
ERS, AND CONTRACTORS, AND DOCUMENTA-  
TION AND INFORMATION ON BEHALF OF  
OTHERS, IN CLASS 35 (U.S. CLS. 100, 101 AND 102).

FIRST USE 4-1-2007; IN COMMERCE 4-1-2007.

THE MARK CONSISTS OF STANDARD CHAR-  
ACTERS WITHOUT CLAIM TO ANY PARTICULAR  
FONT, STYLE, SIZE, OR COLOR.

SER. NO. 77-160,151, FILED 4-18-2007.

CHRISIE B. KING, EXAMINING ATTORNEY

**Int. Cl.: 14**

**Prior U.S. Cls.: 2, 27, 28 and 50**

**United States Patent and Trademark Office**

**Reg. No. 3,465,365**

**Registered July 15, 2008**

**TRADEMARK  
PRINCIPAL REGISTER**

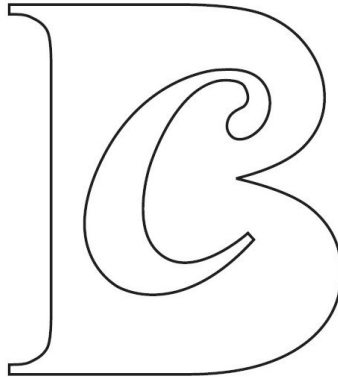

E.B. CLASSICS, INC. (PENNSYLVANIA CORPORATION), DBA BRIANA CHRISTIANA  
HANDBAGS & ACCESSORIES  
201 SCHOOLEY AVENUE  
EXETER, PA 18643

THE MARK CONSISTS OF A LETTER "C" INSIDE  
OF A LETTER "B".

FOR: JEWELRY, IN CLASS 14 (U.S. CLS. 2, 27, 28  
AND 50).

SER. NO. 77-160,208, FILED 4-18-2007.

FIRST USE 0-0-2006; IN COMMERCE 0-0-2006.

JEAN IM, EXAMINING ATTORNEY

**Int. Cl.: 35**

**Prior U.S. Cls.: 100, 101 and 102**

**United States Patent and Trademark Office**

**Reg. No. 3,465,366**

**Registered July 15, 2008**

**SERVICE MARK  
PRINCIPAL REGISTER**

**BIZ PERKS**

NORTHWEST AIRLINES, INC. (MINNESOTA  
CORPORATION)  
DEPARTMENT A1180  
2700 LONE OAK PARKWAY  
EAGAN, MN 55121

FOR: INCENTIVE AWARD PROGRAMS, NAME-  
LY, PROMOTING THE SALE OF GOODS AND  
SERVICES OF OTHERS BY AWARDED FRE-  
QUENT FLYER POINTS, IN CLASS 35 (U.S. CLS.  
100, 101 AND 102).

FIRST USE 3-1-2001; IN COMMERCE 3-1-2001.

THE MARK CONSISTS OF STANDARD CHAR-  
ACTERS WITHOUT CLAIM TO ANY PARTICULAR  
FONT, STYLE, SIZE, OR COLOR.

OWNER OF U.S. REG. NOS. 2,535,120 AND  
2,538,709.

SEC. 2(F).

SER. NO. 77-160,383, FILED 4-19-2007.

TINA BROWN, EXAMINING ATTORNEY

**Int. Cls.: 35 and 41**

**Prior U.S. Cls.: 100, 101, 102 and 107**

**United States Patent and Trademark Office**

**Reg. No. 3,465,367**

**Registered July 15, 2008**

**SERVICE MARK  
PRINCIPAL REGISTER**

**ACCESS INVENTORS**

PRACTICAL ENTERPRISES, INC. (NEW JERSEY CORPORATION)  
SUITE 14  
435 HOLLYWOOD AVE.  
FAIRFIELD, NJ 07004

FOR: ON-LINE RETAIL STORE SERVICES FEATURING GOODS CREATED BY INDEPENDENT INVENTORS; PROMOTING THE GOODS AND SERVICES OF OTHERS BY PREPARING AND PLACING ADVERTISEMENTS ON A GLOBAL COMMUNICATIONS NETWORK, IN CLASS 35 (U.S. CLS. 100, 101 AND 102).

FIRST USE 2-7-2006; IN COMMERCE 5-8-2006.

FOR: EDUCATION SERVICES, NAMELY, PROVIDING INSTRUCTION IN THE FIELD OF PA-

TENTING AND MARKETING INVENTIONS, IN CLASS 41 (U.S. CLS. 100, 101 AND 107).

FIRST USE 2-7-2006; IN COMMERCE 5-8-2006.

THE MARK CONSISTS OF STANDARD CHARACTERS WITHOUT CLAIM TO ANY PARTICULAR FONT, STYLE, SIZE, OR COLOR.

NO CLAIM IS MADE TO THE EXCLUSIVE RIGHT TO USE "INVENTORS", APART FROM THE MARK AS SHOWN.

SER. NO. 77-160,519, FILED 4-19-2007.

GIANCARLO CASTRO, EXAMINING ATTORNEY

**Int. Cl.: 35**

**Prior U.S. Cls.: 100, 101 and 102**

**United States Patent and Trademark Office**

**Reg. No. 3,465,368**

**Registered July 15, 2008**

**SERVICE MARK  
PRINCIPAL REGISTER**

**Marti's**

MARTIS, S.A. (MEXICO CORPORATION)  
P.O. BOX 441  
LAREDO, TX 78040

THE MARK CONSISTS OF STANDARD CHARACTERS WITHOUT CLAIM TO ANY PARTICULAR FONT, STYLE, SIZE, OR COLOR.

FOR: ON-LINE RETAIL STORE SERVICES FEATURING ART, JEWELRY, APPAREL, CLOTHING, FURNITURE, GIFTS, HOUSEWARES, AND WEDDING DRESSES, IN CLASS 35 (U.S. CLS. 100, 101 AND 102).

OWNER OF U.S. REG. NO. 1,866,585.

SER. NO. 77-160,816, FILED 4-19-2007.

FIRST USE 9-28-2003; IN COMMERCE 9-28-2003.

SHAILA SETTLES, EXAMINING ATTORNEY

**Int. Cl.: 35**

**Prior U.S. Cls.: 100, 101 and 102**

**United States Patent and Trademark Office**

**Reg. No. 3,465,369**

**Registered July 15, 2008**

**SERVICE MARK  
PRINCIPAL REGISTER**

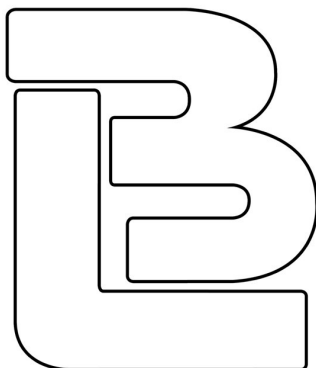

BOTTOMLINE PRODUCTIONS (NEW YORK  
LTD LIAB CO)  
1020 EAST 57TH STREET  
BROOKLYN, NY 11234

FOR: PROVIDING A WEB SITE WHERE USERS CAN POST RATINGS, REVIEWS AND RECOMMENDATIONS ON PRODUCTS AND SERVICES; PROVIDING A WEB SITE WHEREBY BUYERS OF GOODS OR SERVICES LOCATE AND RECEIVE QUOTATIONS FROM MULTIPLE COMPETITIVE SOURCES AND SELLERS OF GOODS OR SERVICES IDENTIFY AND BID ON MULTIPLE NEW SALES OPPORTUNITIES; PROVIDING A WEB SITE WHICH FEATURES ADVERTISEMENTS FOR THE GOODS AND SERVICES OF OTHERS ON A GLOBAL COMPUTER NETWORK; PROVIDING AN ON-LINE COMPUTER WEB SITE THAT LISTS HEALTHCARE PERSONNEL AND OTHER INDIVIDUALS WHO HAVE TAKEN AND PASSED COURSES AND FIELD WORKSHOPS IN ORDER TO PROVIDE A LISTING OF QUALIFIED INDIVIDUALS THAT CAN EFFECTIVELY RESPOND TO A NATURAL OR MANMADE DISASTER OR ACT OF TERRORISM; PROVIDING ON-LINE DIRECTORY INFORMATION SERVICES ALSO FEATURING HYPERLINKS TO OTHER WEB SITES; PROVIDING SPACE AT A WEB SITE FOR THE ADVERTISEMENT OF THE GOODS AND SERVICES OF OTHERS; RENTAL OF ADVERTISING SPACE ON WEB

SITES; BUSINESS MONITORING SERVICES, NAMELY, TRACKING WEBSITES OF OTHERS TO PROVIDE DETAILS ABOUT USER CLICK TRAFFIC OR VISITS TO THE WEBSITE; COOPERATIVE ADVERTISING AND MARKETING SERVICES BY WAY OF SOLICITATION, CUSTOMER SERVICE AND PROVIDING MARKETING INFORMATION VIA WEBSITES ON A GLOBAL COMPUTER NETWORK; PROMOTING, ADVERTISING AND MARKETING OF THE ON-LINE WEBSITES OF OTHERS; PROMOTION, ADVERTISING AND MARKETING OF ON-LINE WEBSITES; PROVIDING A WEBSITE THAT PROVIDES SPORTS LEAGUE MANAGEMENT; PROVIDING AN INTERACTIVE WEBSITE FOR PERSONS TO REGISTER COMPLAINTS AGAINST COMPANIES AND/OR SERVICES OF ALL TYPES, IN CLASS 35 (U.S. CLS. 100, 101 AND 102).

FIRST USE 8-6-2003; IN COMMERCE 8-6-2003.

THE MARK CONSISTS OF COMBINED LETTERS "B" AND "L".

SER. NO. 77-161,272, FILED 4-19-2007.

KATHERINE M. DUBRAY, EXAMINING ATTORNEY

**Int. Cl.: 39**

**Prior U.S. Cls.: 100 and 105**

**United States Patent and Trademark Office**

**Reg. No. 3,465,370**

**Registered July 15, 2008**

**SERVICE MARK  
PRINCIPAL REGISTER**

**eLocker**

ETECH GROUPINTERNATIONAL LTD (AUSTRALIA COMPANY)  
21 VICTORIA ST  
LEVEL 3  
MELBOURNE, AUSTRALIA 3000

FOR: PROVIDING ONLINE ELECTRONIC DATA STORAGE EMBEDDED IN AN ONLINE LEARNING COMPUTER PLATFORM FOR APPLICATION IN EDUCATION, TERTIARY PROGRAMS AND COMMERCIAL APPLICATIONS, IN CLASS 39 (U.S. CLS. 100 AND 105).

FIRST USE 8-0-2006; IN COMMERCE 8-0-2006.

THE MARK CONSISTS OF STANDARD CHARACTERS WITHOUT CLAIM TO ANY PARTICULAR FONT, STYLE, SIZE, OR COLOR.

SER. NO. 77-161,300, FILED 4-19-2007.

ERNEST SHOSHO, EXAMINING ATTORNEY



**Int. Cl.: 36**

**Prior U.S. Cls.: 100, 101 and 102**

**United States Patent and Trademark Office**

**Reg. No. 3,465,371**

**Registered July 15, 2008**

**SERVICE MARK  
PRINCIPAL REGISTER**



NOAH, MILDRED DILLON (UNITED STATES  
INDIVIDUAL)  
1701 APPLEBY LANE  
HARVEY, LA 70058

FOR: FINANCIAL PLANNING CONSULTATION;  
FINANCIAL PLANNING; FINANCIAL PLANNING  
FOR RETIREMENT; FINANCIAL PLANNING,  
NAMELY, THE CREATION OF PERSONALIZED

STRATEGIES TO ACHIEVE FINANCIAL INDEPEN-  
DENCE, IN CLASS 36 (U.S. CLS. 100, 101 AND 102).

FIRST USE 5-28-2006; IN COMMERCE 5-28-2006.

SER. NO. 77-161,430, FILED 4-20-2007.

JAMES MACFARLANE, EXAMINING ATTORNEY

**Int. Cl.: 41**

**Prior U.S. Cls.: 100, 101 and 107**

**United States Patent and Trademark Office**

**Reg. No. 3,465,372**

**Registered July 15, 2008**

**SERVICE MARK  
PRINCIPAL REGISTER**



CHICAGO BEARS FOOTBALL CLUB, INC. (DE-  
LAWARE CORPORATION)  
1000 FOOTBALL DRIVE  
LAKE FOREST, IL 60045

FOR: EDUCATION AND ENTERTAINMENT SERVICES IN THE NATURE OF PROFESSIONAL FOOTBALL GAMES AND EXHIBITIONS; PROVIDING SPORTS AND ENTERTAINMENT INFORMATION VIA A GLOBAL COMPUTER NETWORK OR A COMMERCIAL ON-LINE COMPUTER SERVICE OR BY CABLE, SATELLITE, TELEVISION AND RADIO; ARRANGING AND CONDUCTING ATHLETIC COMPETITIONS, NAMELY, PROFESSIONAL FOOTBALL GAMES AND EXHIBITIONS; FOOTBALL FAN CLUB SERVICES; ENTERTAINMENT SERVICES, NAMELY, MUSICAL AND DANCE PERFORMANCES PROVIDED DURING INTERVALS AT SPORTS EVENTS; EDUCATIONAL SERVICES, NAMELY, PHYSICAL EDUCATION

PROGRAMS; PRODUCTION OF RADIO AND TELEVISION PROGRAMS; LIVE SHOWS FEATURING FOOTBALL GAMES, EXHIBITIONS, COMPETITIONS, MUSIC AND DANCE PERFORMANCES, SPORTING AND CULTURAL ACTIVITIES; PUBLICATION OF TEXTS OTHER THAN PUBLICITY TEXTS, IN CLASS 41 (U.S. CLS. 100, 101 AND 107).

FIRST USE 9-0-1973; IN COMMERCE 9-0-1973.

OWNER OF U.S. REG. NOS. 952,439, 3,222,967 AND OTHERS.

THE MARK CONSISTS OF A STYLIZED DESIGN OF THE LETTER "C".

SER. NO. 77-161,505, FILED 4-20-2007.

JAMES MACFARLANE, EXAMINING ATTORNEY

**Int. Cl.: 30**

**Prior U.S. Cl.: 46**

**United States Patent and Trademark Office**

**Reg. No. 3,465,373**

**Registered July 15, 2008**

**TRADEMARK  
PRINCIPAL REGISTER**

# Cappuccine

CAPPUCCINE, INC. (CALIFORNIA CORPORATION)  
1285 VALDIVIA WAY  
PALM SPRINGS, CA 92262

THE MARK CONSISTS OF STANDARD CHARACTERS WITHOUT CLAIM TO ANY PARTICULAR FONT, STYLE, SIZE, OR COLOR.

FOR: INSTANT COFFEE BEVERAGE MIX, POWDERED HOT CHOCOLATE BEVERAGE MIX, AND POWDERED FOOD FLAVORINGS, IN CLASS 30 (U.S. CL. 46).

SER. NO. 77-161,675, FILED 4-20-2007.

FIRST USE 8-10-1994; IN COMMERCE 9-29-1994.

MARILYN IZZI, EXAMINING ATTORNEY

**Int. Cl.: 9**

**Prior U.S. Cls.: 21, 23, 26, 36 and 38**

**Reg. No. 3,465,374**

**United States Patent and Trademark Office**

**Registered July 15, 2008**

**TRADEMARK  
PRINCIPAL REGISTER**

**AGI**

LEADERTECH SYSTEMS OF CHICAGO, INC.  
(ILLINOIS CORPORATION)  
210 MITTEL DR.  
WOOD DALE, IL 60191

FIRST USE 1-18-1996; IN COMMERCE 1-18-1996.

FOR: COMPUTERS AND BUILDING SECURITY SYSTEMS AND COMPONENTS THEREFOR, NAMELY, COMPUTER CHASSIS, COMPUTER POWER SUPPLIES, COMPUTER MOUSE, KEYBOARDS, COMPUTER CABLES AND SECURITY CAMERAS, IN CLASS 9 (U.S. CLS. 21, 23, 26, 36 AND 38).

THE MARK CONSISTS OF STANDARD CHARACTERS WITHOUT CLAIM TO ANY PARTICULAR FONT, STYLE, SIZE, OR COLOR.

SER. NO. 77-161,753, FILED 4-20-2007.

TAMARA FRAZIER, EXAMINING ATTORNEY

**Int. Cl.: 16**

**Prior U.S. Cls.: 2, 5, 22, 23, 29, 37, 38 and 50**

**Reg. No. 3,465,375**

**United States Patent and Trademark Office**

**Registered July 15, 2008**

**TRADEMARK  
PRINCIPAL REGISTER**

**THE BOOK BUTLER**

DANLEY, NANCY (UNITED STATES INDIVIDUAL)  
36552 DOWLING CT.  
LIVONIA, MI 48150

FOR: A BOOK MARKER THAT INCORPORATES A POCKET TO HOLD A PENCIL, PEN, OR HIGHLIGHTER THAT WRAPS SECURELY AROUND A BOOK USING HOOK AND LOOP, IN CLASS 16 (U.S. CLS. 2, 5, 22, 23, 29, 37, 38 AND 50).

FIRST USE 5-24-1999; IN COMMERCE 10-0-1999.

THE MARK CONSISTS OF STANDARD CHARACTERS WITHOUT CLAIM TO ANY PARTICULAR FONT, STYLE, SIZE, OR COLOR.

NO CLAIM IS MADE TO THE EXCLUSIVE RIGHT TO USE "BOOK", APART FROM THE MARK AS SHOWN.

SER. NO. 77-161,791, FILED 4-20-2007.

COLLEEN KEARNEY, EXAMINING ATTORNEY

**Int. Cl.: 9**

**Prior U.S. Cls.: 21, 23, 26, 36 and 38**

**Reg. No. 3,465,376**

**United States Patent and Trademark Office**

**Registered July 15, 2008**

---

**TRADEMARK  
PRINCIPAL REGISTER**

**DESIGNFOIL**

DREESE, JOHN, J (UNITED STATES INDIVIDUAL)  
604 BABBLING BROOK DRIVE  
SAGINAW, TX 76179

FOR: COMPUTER SOFTWARE PLATFORMS  
FOR DESIGNING AND ANALYZING AIRFOILS,  
IN CLASS 9 (U.S. CLS. 21, 23, 26, 36 AND 38).

FIRST USE 1-5-2001; IN COMMERCE 1-18-2002.

THE MARK CONSISTS OF STANDARD CHARACTERS WITHOUT CLAIM TO ANY PARTICULAR FONT, STYLE, SIZE, OR COLOR.

SEC. 2(F).

SER. NO. 77-161,793, FILED 4-20-2007.

COLLEEN KEARNEY, EXAMINING ATTORNEY

**Int. Cl.: 28**

**Prior U.S. Cls.: 22, 23, 38 and 50**

**United States Patent and Trademark Office**

**Reg. No. 3,465,377**

**Registered July 15, 2008**

**TRADEMARK  
PRINCIPAL REGISTER**

**WOODY**

CTG ATHLETICS, LLC (DELAWARE LTD LIAB  
CO)  
2417 3RD AVENUE, SUITE 207  
BRONX, NY 10451

THE MARK CONSISTS OF STANDARD CHAR-  
ACTERS WITHOUT CLAIM TO ANY PARTICULAR  
FONT, STYLE, SIZE, OR COLOR.

FOR: SPORTING GOODS, NAMELY, BASEBALL  
BATS, IN CLASS 28 (U.S. CLS. 22, 23, 38 AND 50).

SER. NO. 77-161,903, FILED 4-20-2007.

FIRST USE 7-6-2006; IN COMMERCE 7-6-2006.

MICHAEL SOUDERS, EXAMINING ATTORNEY

**Int. Cl.: 41**

**Prior U.S. Cls.: 100, 101 and 107**

**United States Patent and Trademark Office**

**Reg. No. 3,465,378**

**Registered July 15, 2008**

**SERVICE MARK  
PRINCIPAL REGISTER**

# BET AWARDS

BLACK ENTERTAINMENT TELEVISION LLC  
(D.C. LTD LIAB CO)  
LEGAL AFFAIRS  
ONE BET PLAZA, 1235 W STREET, N.E.  
WASHINGTON, DC 20018

FOR: ENTERTAINMENT IN THE NATURE OF  
TELEVISED MUSIC AWARDS PROGRAMS; AN  
ANNUAL AWARDS PROGRAM FOR THE PRESEN-  
TATION OF AWARDS IN RECOGNITION OF DIS-  
TINGUISHED ACHIEVEMENT IN THE FIELD OF  
MUSIC, VIDEO ARTS, SPORTS, LIFESTYLE, POLI-  
TICS AND EDUCATION; ENTERTAINMENT SER-  
VICES, NAMELY, LIVE PERFORMANCES BY  
MUSICAL ARTISTS AND MUSICAL GROUPS; EDU-  
CATIONAL SERVICES, NAMELY, PROVIDING IN-  
CENTIVES TO ENCOURAGE INDIVIDUALS TO  
DEMONSTRATE EXCELLENCE IN THE FIELD OF  
MUSIC, VIDEO ARTS, SPORTS, LIFESTYLE, POLI-  
TICS AND EDUCATION THROUGH THE ISSU-

ANCE OF AWARDS, IN CLASS 41 (U.S. CLS. 100,  
101 AND 107).

FIRST USE 6-19-2001; IN COMMERCE 6-19-2001.

THE MARK CONSISTS OF STANDARD CHAR-  
ACTERS WITHOUT CLAIM TO ANY PARTICULAR  
FONT, STYLE, SIZE, OR COLOR.

OWNER OF U.S. REG. NOS. 1,511,259, 2,603,399  
AND OTHERS.

NO CLAIM IS MADE TO THE EXCLUSIVE  
RIGHT TO USE "AWARDS", APART FROM THE  
MARK AS SHOWN.

SER. NO. 77-162,026, FILED 4-20-2007.

JANET LEE, EXAMINING ATTORNEY



**Int. Cl.: 39**

**Prior U.S. Cls.: 100 and 105**

**United States Patent and Trademark Office**

**Reg. No. 3,465,379**

**Registered July 15, 2008**

**SERVICE MARK  
PRINCIPAL REGISTER**

**LACKLAND SELF STORAGE**

STORAGE ASSETS, LLC (NEW JERSEY LTD  
LIAB CO)  
290 U.S. HIGHWAY 22 WEST  
GREEN BROOK, NJ 08812

FOR: PROVIDING SELF-STORAGE FACILITIES  
FOR OTHERS CONTAINING PERMANENT SELF-  
STORAGE UNIT SPACES OF VARYING SIZES FOR  
LEASE TO INDIVIDUALS AND BUSINESSES, IN  
CLASS 39 (U.S. CLS. 100 AND 105).

FIRST USE 1-1-1978; IN COMMERCE 1-1-1978.

THE MARK CONSISTS OF STANDARD CHAR-  
ACTERS WITHOUT CLAIM TO ANY PARTICULAR  
FONT, STYLE, SIZE, OR COLOR.

NO CLAIM IS MADE TO THE EXCLUSIVE  
RIGHT TO USE "SELF STORAGE", APART FROM  
THE MARK AS SHOWN.

SER. NO. 77-162,185, FILED 4-20-2007.

LA TONIA FISHER, EXAMINING ATTORNEY

**Int. Cl.: 39**

**Prior U.S. Cls.: 100 and 105**

**United States Patent and Trademark Office**

**Reg. No. 3,465,380**

**Registered July 15, 2008**

**SERVICE MARK  
PRINCIPAL REGISTER**

**storage solutions for  
life's challenges**

STORAGE ASSETS, LLC (NEW JERSEY LTD  
LIAB CO)  
290 U.S. HIGHWAY 22 WEST  
GREEN BROOK, NJ 08812

FOR: PROVIDING SELF-STORAGE FACILITIES  
FOR OTHERS CONTAINING PERMANENT SELF-  
STORAGE UNIT SPACES OF VARYING SIZES FOR  
LEASE TO INDIVIDUALS AND BUSINESSES, IN  
CLASS 39 (U.S. CLS. 100 AND 105).

FIRST USE 3-15-2006; IN COMMERCE 5-1-2006.

THE MARK CONSISTS OF STANDARD CHAR-  
ACTERS WITHOUT CLAIM TO ANY PARTICULAR  
FONT, STYLE, SIZE, OR COLOR.

NO CLAIM IS MADE TO THE EXCLUSIVE  
RIGHT TO USE "STORAGE SOLUTIONS", APART  
FROM THE MARK AS SHOWN.

SER. NO. 77-162,238, FILED 4-20-2007.

LA TONIA FISHER, EXAMINING ATTORNEY

**Int. Cl.: 39**

**Prior U.S. Cls.: 100 and 105**

**United States Patent and Trademark Office**

**Reg. No. 3,465,381**

**Registered July 15, 2008**

**SERVICE MARK  
PRINCIPAL REGISTER**

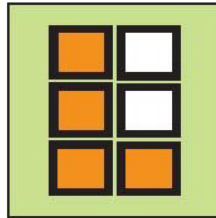

STORAGE ASSETS, LLC (NEW JERSEY LTD  
LIAB CO)  
290 U.S. HIGHWAY 22 WEST  
GREEN BROOK, NJ 08812

FOR: PROVIDING SELF-STORAGE FACILITIES  
FOR OTHERS CONTAINING PERMANENT SELF-  
STORAGE UNIT SPACES OF VARYING SIZES FOR  
LEASE TO INDIVIDUALS AND BUSINESSES, IN  
CLASS 39 (U.S. CLS. 100 AND 105).

FIRST USE 3-15-2006; IN COMMERCE 5-1-2006.

THE COLOR(S) ORANGE, WHITE, GREEN AND  
BLACK IS/ARE CLAIMED AS A FEATURE OF THE  
MARK.

THE MARK CONSISTS OF SIX BOXES WITH  
BLACK OUTLINES, WITH FOUR OF THE BOXES  
BEING ORANGE AND TWO OF THE BOXES BEING  
WHITE, AND WITH A GREEN BACKGROUND  
AROUND THE BOXES, ALL FORMING A LETTER  
"L".

SER. NO. 77-162,268, FILED 4-20-2007.

LA TONIA FISHER, EXAMINING ATTORNEY

**Int. Cl.: 41**

**Prior U.S. Cls.: 100, 101 and 107**

**United States Patent and Trademark Office**

**Reg. No. 3,465,382**

**Registered July 15, 2008**

**SERVICE MARK  
PRINCIPAL REGISTER**

**Learning Built To Last**

CLUB Z!, INC. (FLORIDA CORPORATION)  
SUITE 185  
15310 AMBERLY DRIVE  
TAMPA, FL 33647

FOR: IN-HOME TUTORING SERVICES FOR STUDENTS IN PRE-KINDERGARTEN, ELEMENTARY, MIDDLE AND HIGH SCHOOL, IN CLASS 41 (U.S. CLS. 100, 101 AND 107).

FIRST USE 6-1-2006; IN COMMERCE 6-1-2006.

THE MARK CONSISTS OF STANDARD CHARACTERS WITHOUT CLAIM TO ANY PARTICULAR FONT, STYLE, SIZE, OR COLOR.

SER. NO. 77-162,451, FILED 4-21-2007.

JENNIFER MARTIN, EXAMINING ATTORNEY

**Int. Cl.: 26**

**Prior U.S. Cls.: 37, 39, 40, 42 and 50**

**United States Patent and Trademark Office**

**Reg. No. 3,465,383**

**Registered July 15, 2008**

**TRADEMARK  
PRINCIPAL REGISTER**

# The Original Wigsite

ACE WIGS (NEVADA SOLE PROPRIETORSHIP)  
930 TAHOE BLVD STE 802-401  
INCLINE VILLAGE, NV 89451

FOR: WIGS, IN CLASS 26 (U.S. CLS. 37, 39, 40, 42  
AND 50).

FIRST USE 10-1-1996; IN COMMERCE 10-1-1996.

THE MARK CONSISTS OF STANDARD CHAR-  
ACTERS WITHOUT CLAIM TO ANY PARTICULAR  
FONT, STYLE, SIZE, OR COLOR.

NO CLAIM IS MADE TO THE EXCLUSIVE  
RIGHT TO USE "ORIGINAL", APART FROM THE  
MARK AS SHOWN.

SER. NO. 77-162,654, FILED 4-22-2007.

SHANNON TWOHIG, EXAMINING ATTORNEY

Int. Cls.: 35 and 42

Prior U.S. Cls.: 100, 101 and 102

United States Patent and Trademark Office

Reg. No. 3,465,384

Registered July 15, 2008

SERVICE MARK  
PRINCIPAL REGISTER



TOOLBOX  
STUDIOS

TOOLBOX STUDIOS, INC. (TEXAS CORPORATION)  
454 SOLEDAD STREET, SUITE 100  
SAN ANTONIO, TX 78205

FOR: PROVIDING CONCEPT AND BRAND DEVELOPMENT SERVICES FOR OTHERS IN THE FIELDS OF CHEMICALS, PAINTS, COSMETICS, LUBRICANTS, FUELS, PHARMACEUTICALS, METAL GOODS, MACHINERY, HAND TOOLS, ELECTRICAL AND SCIENTIFIC APPARATUS, MEDICAL APPARATUS, ENVIRONMENTAL CONTROL APPARATUS, VEHICLES, FIREARMS, JEWELRY, MUSICAL INSTRUMENTS, PAPER GOODS AND PRINTED MATTER, RUBBER GOODS, LEATHER GOODS, NON-METALLIC BUILDING MATERIALS, FURNITURE, HOUSEWARES AND GLASS, CORRAGE AND FIBERS, YARNS AND THREADS, FABRICS, CLOTHING, FLOOR COVERINGS, TOYS AND SPORTING GOODS, MEATS AND PROCESSED FOODS, STAPLE FOODS, NATURAL AGRICULTURAL PRODUCTS, LIGHT BEVERAGES, WINES AND SPIRITS, SMOKERS' ARTICLES, ADVERTISING AND BUSINESS SERVICES, INSURANCE AND FINANCIAL SERVICES, BUILDING CONSTRUCTION AND REPAIR SERVICES, TELECOMMUNICATIONS SERVICES, TRANSPORTATION AND STORAGE SERVICES, MATERIAL TREATMENT SERVICES, EDUCATION AND ENTERTAINMENT SERVICES, COMPUTER AND SCIENTIFIC SERVICES, HOTELS AND RESTAURANTS, AGRICULTURAL SERVICES, AND LEGAL SERVICES; ADVERTISING SERVICES, NAMELY, CREATING CORPORATE AND BRAND IDENTITY FOR OTHERS; BUSINESS DEVELOPMENT SERVICES, NAMELY, PROVIDING START-UP SUPPORT FOR BUSINESSES OF OTHERS; BUSINESS LEADERSHIP DEVELOPMENT SERVICES; DEVELOPMENT OF MARKETING STRATEGIES AND CONCEPTS; CONSULTANCY SERVICES REGARDING BUSINESS STRATEGIES; CREATION OF MARKETING TOOLS DESIGNED TO INCREASE A

CLIENT COMPANY'S KNOWLEDGE OF CUSTOMER NEEDS, AND ITS COMPETITORS' PRODUCTS AND SERVICES, PRICING, ADVERTISING STRATEGY AND SALES STRATEGY; ADVERTISING AND MARKETING; PREPARING ADVERTISEMENTS FOR OTHERS; DEVELOPMENT OF ADVERTISING CAMPAIGNS FOR RADIO, TELEVISION, PRINT, E-MAIL, WEBSITES AND OTHER DIGITAL AND ONLINE TRANSMISSION MEDIUMS; DESIGN OF INTERNET ADVERTISING; COPYING OF DOCUMENTS FOR OTHERS; DESIGN OF POINT OF SALE ADVERTISING MATERIALS FOR OTHERS; PRODUCING PROMOTIONAL VIDEOTAPES, VIDEO DISCS, AND AUDIO VISUAL RECORDINGS, IN CLASS 35 (U.S. CLS. 100, 101 AND 102).

FIRST USE 4-2-2007; IN COMMERCE 4-2-2007.

FOR: ENVIRONMENTAL DESIGN, NAMELY, THE DESIGN OF SPECIALTY INTERIOR AND EXTERIOR ENVIRONMENT SETTINGS; INTERACTIVE COMPUTER SOFTWARE DEVELOPMENT; SEARCH ENGINE OPTIMIZATION, NAMELY, DEVELOPMENT, MAINTENANCE AND UPDATING OF A TELECOMMUNICATION NETWORK SEARCH ENGINE; DESIGN, CREATION, HOSTING, MAINTENANCE OF WEBSITES FOR OTHERS; GRAPHIC ART DESIGN; COMMERCIAL ART DESIGN; GRAPHIC DESIGN SERVICES; GRAPHIC ILLUSTRATION SERVICES FOR OTHERS, IN CLASS 42 (U.S. CLS. 100 AND 101).

FIRST USE 4-2-2007; IN COMMERCE 4-2-2007.

NO CLAIM IS MADE TO THE EXCLUSIVE RIGHT TO USE "STUDIOS", APART FROM THE MARK AS SHOWN.

SER. NO. 77-162,668, FILED 4-22-2007.

JASON BLAIR, EXAMINING ATTORNEY

**Int. Cl.: 42**

**Prior U.S. Cls.: 100 and 101**

**United States Patent and Trademark Office**

**Reg. No. 3,465,385**

**Registered July 15, 2008**

**SERVICE MARK  
PRINCIPAL REGISTER**

# Where Ideas Work

TOOLBOX STUDIOS, INC. (TEXAS CORPORATION)  
SUITE 100  
454 SOLEDAD STREET  
SAN ANTONIO, TX 78205

FOR: GRAPHIC ART DESIGN; COMMERCIAL ART DESIGN; GRAPHIC DESIGN SERVICES; GRAPHIC ILLUSTRATION SERVICES FOR OTHERS, IN CLASS 42 (U.S. CLS. 100 AND 101).

FIRST USE 4-2-2007; IN COMMERCE 4-2-2007.

THE MARK CONSISTS OF STANDARD CHARACTERS WITHOUT CLAIM TO ANY PARTICULAR FONT, STYLE, SIZE, OR COLOR.

SER. NO. 77-162,669, FILED 4-22-2007.

JASON BLAIR, EXAMINING ATTORNEY

**Int. Cls.: 35 and 42**

**Prior U.S. Cls.: 100, 101 and 102**

**United States Patent and Trademark Office**

**Reg. No. 3,465,386**

**Registered July 15, 2008**

**SERVICE MARK  
PRINCIPAL REGISTER**



TOOLBOX STUDIOS, INC. (TEXAS CORPORATION)

454 SOLEDAD STREET, SUITE 100  
SAN ANTONIO, TX 78205

FOR: PROVIDING CONCEPT AND BRAND DEVELOPMENT SERVICES FOR OTHERS IN THE FIELDS OF CHEMICALS, PAINTS, COSMETICS, LUBRICANTS, FUELS, PHARMACEUTICALS, METAL GOODS, MACHINERY, HAND TOOLS, ELECTRICAL AND SCIENTIFIC APPARATUS, MEDICAL APPARATUS, ENVIRONMENTAL CONTROL APPARATUS, VEHICLES, FIREARMS, JEWELRY, MUSICAL INSTRUMENTS, PAPER GOODS AND PRINTED MATTER, RUBBER GOODS, LEATHER GOODS, NON-METALLIC BUILDING MATERIALS, FURNITURE, HOUSEWARES AND GLASS, CORRUGATED AND FIBERS, YARNS AND THREADS, FABRICS, CLOTHING, FLOOR COVERINGS, TOYS AND SPORTING GOODS, MEATS AND PROCESSED FOODS, STAPLE FOODS, NATURAL AGRICULTURAL PRODUCTS, LIGHT BEVERAGES, WINES AND SPIRITS, SMOKERS' ARTICLES, ADVERTISING AND BUSINESS SERVICES, INSURANCE AND FINANCIAL SERVICES, BUILDING CONSTRUCTION AND REPAIR SERVICES, TELECOMMUNICATIONS SERVICES, TRANSPORTATION AND STORAGE SERVICES, MATERIAL TREATMENT SERVICES, EDUCATION AND ENTERTAINMENT SERVICES, COMPUTER AND SCIENTIFIC SERVICES, HOTELS AND RESTAURANTS, AGRICULTURAL SERVICES, AND LEGAL SERVICES; ADVERTISING SERVICES, NAMELY, CREATING CORPORATE AND BRAND IDENTITY FOR OTHERS; BUSINESS DEVELOPMENT SERVICES, NAMELY, PROVIDING START-

UP SUPPORT FOR BUSINESSES OF OTHERS; BUSINESS LEADERSHIP DEVELOPMENT SERVICES; DEVELOPMENT OF MARKETING STRATEGIES AND CONCEPTS; CONSULTANCY SERVICES REGARDING BUSINESS STRATEGIES; CREATION OF MARKETING TOOLS DESIGNED TO INCREASE A CLIENT COMPANY'S KNOWLEDGE OF CUSTOMER NEEDS, AND ITS COMPETITORS' PRODUCTS AND SERVICES, PRICING, ADVERTISING STRATEGY AND SALES STRATEGY; ADVERTISING AND MARKETING; PREPARING ADVERTISEMENTS FOR OTHERS; DEVELOPMENT OF ADVERTISING CAMPAIGNS FOR RADIO, TELEVISION, PRINT, E-MAIL, WEBSITES AND OTHER DIGITAL AND ONLINE TRANSMISSION MEDIUMS; DESIGN OF INTERNET ADVERTISING; COPYING OF DOCUMENTS FOR OTHERS; DESIGN OF POINT OF SALE ADVERTISING MATERIALS FOR OTHERS; PRODUCING PROMOTIONAL VIDEOTAPES, VIDEO DISCS, AND AUDIO VISUAL RECORDINGS, IN CLASS 35 (U.S. CLS. 100, 101 AND 102).

FIRST USE 4-2-2007; IN COMMERCE 4-2-2007.

FOR: ENVIRONMENTAL DESIGN, NAMELY, THE DESIGN OF SPECIALTY INTERIOR AND EXTERIOR ENVIRONMENT SETTINGS; INTERACTIVE COMPUTER SOFTWARE DEVELOPMENT; SEARCH ENGINE OPTIMIZATION, NAMELY, DEVELOPMENT, MAINTENANCE AND UPDATING OF A TELECOMMUNICATION NETWORK SEARCH ENGINE; DESIGN, CREATION, HOSTING, MAINTENANCE OF WEBSITES FOR OTHERS; GRAPHIC ART DESIGN; COMMERCIAL ART DESIGN; GRAPHIC DESIGN SERVICES; GRAPHIC



ILLUSTRATION SERVICES FOR OTHERS, IN  
CLASS 42 (U.S. CLS. 100 AND 101).

SER. NO. 77-162,671, FILED 4-22-2007.

FIRST USE 4-2-2007; IN COMMERCE 4-2-2007.

JASON BLAIR, EXAMINING ATTORNEY

**Int. Cl.: 41**

**Prior U.S. Cls.: 100, 101 and 107**

**United States Patent and Trademark Office**

**Reg. No. 3,465,387**

**Registered July 15, 2008**

**SERVICE MARK  
PRINCIPAL REGISTER**

**DAY TRAK**

VIRTUAL PRESS OFFICE, INC. (NEW JERSEY CORPORATION)  
94 VALLEY ROAD  
MONTCLAIR, NJ 07042

FOR: NEWS PRESS AGENCY SERVICES, NAME-  
LY, GATHERING AND DISSEMINATING CORPO-  
RATE PRESS RELEASES FOR OTHERS VIA A  
GLOBAL COMPUTER NETWORK AND DISSEMI-  
NATING REPORTS ON NEWS MEDIA INTEREST  
IN PRESS RELEASES; PUBLICATION OF CORPO-  
RATE PRESS RELEASES FOR OTHERS; NEWS AND

PRESS RELEASE WIRES SERVICES, IN CLASS 41  
(U.S. CLS. 100, 101 AND 107).

FIRST USE 11-1-1996; IN COMMERCE 11-1-1996.

THE MARK CONSISTS OF STANDARD CHAR-  
ACTERS WITHOUT CLAIM TO ANY PARTICULAR  
FONT, STYLE, SIZE, OR COLOR.

SER. NO. 77-162,837, FILED 4-23-2007.

JANICE KIM, EXAMINING ATTORNEY

**Int. Cl.: 40**

**Prior U.S. Cls.: 100, 103 and 106**

**United States Patent and Trademark Office**

**Reg. No. 3,465,388**

**Registered July 15, 2008**

**SERVICE MARK  
PRINCIPAL REGISTER**

**RECYCLES MART**

GRAND TRAVERSE COUNTY RESOURCE RE-  
COVERY DEPARTMENT (MICHIGAN AN  
AGENCY OF THE STATE OF MICHIGAN)  
2650 LAFRANIER RD  
TRAVERSE CITY, MI 49686

THE MARK CONSISTS OF STANDARD CHAR-  
ACTERS WITHOUT CLAIM TO ANY PARTICULAR  
FONT, STYLE, SIZE, OR COLOR.

FOR: RECYCLING, IN CLASS 40 (U.S. CLS. 100,  
103 AND 106).

SER. NO. 77-163,084, FILED 4-23-2007.

FIRST USE 1-23-2006; IN COMMERCE 1-23-2006.

SIMON TENG, EXAMINING ATTORNEY

**Int. Cls.: 25 and 39**

**Prior U.S. Cls.: 22, 39, 100 and 105**

**United States Patent and Trademark Office**

**Reg. No. 3,465,389**

**Registered July 15, 2008**

**TRADEMARK  
SERVICE MARK  
PRINCIPAL REGISTER**



BIKE NEW YORK INC. (NEW YORK CORPORATION)  
891 AMSTERDAM AVENUE  
NEW YORK, NY 10025

FOR: CLOTHING, NAMELY, T-SHIRTS, IN CLASS 25 (U.S. CLS. 22 AND 39).

FIRST USE 9-30-2004; IN COMMERCE 9-30-2004.

FOR: ARRANGING TRAVEL TOURS, NAMELY, BIKE TOURS, IN CLASS 39 (U.S. CLS. 100 AND 105).

FIRST USE 6-30-2004; IN COMMERCE 6-30-2004.

NO CLAIM IS MADE TO THE EXCLUSIVE RIGHT TO USE "TWIN LIGHTS RIDE", APART FROM THE MARK AS SHOWN.

"THE MARK CONSISTS OF THE WORDING TWIN LIGHTS RIDE AND A DESIGN OF A SPOKED WHEEL AND ABSTRACT LIGHTHOUSE."

SER. NO. 77-163,808, FILED 4-24-2007.

TERESA M. RUPP, EXAMINING ATTORNEY

**Int. Cl.: 29**

**Prior U.S. Cl.: 46**

**United States Patent and Trademark Office**

**Reg. No. 3,465,390**

**Registered July 15, 2008**

**TRADEMARK  
PRINCIPAL REGISTER**

**PIPIL RED BEANS**

GOTERA, INC (TEXAS CORPORATION), DBA  
PRODUCTOS MAMA LYCHA

4422 W. 12TH STREET

HOUSTON, TX 77055

FOR: DRIED RED BEANS, IN CLASS 29 (U.S. CL.  
46).

FIRST USE 4-5-2003; IN COMMERCE 4-5-2003.

THE MARK CONSISTS OF STANDARD CHAR-  
ACTERS WITHOUT CLAIM TO ANY PARTICULAR  
FONT, STYLE, SIZE, OR COLOR.

NO CLAIM IS MADE TO THE EXCLUSIVE  
RIGHT TO USE "RED BEANS", APART FROM  
THE MARK AS SHOWN.

SER. NO. 77-164,337, FILED S.R. 4-24-2007 AM. P.R.  
2-13-2008.

ELLEN PERKINS, EXAMINING ATTORNEY

**Int. Cl.: 1**

**Prior U.S. Cls.: 1, 5, 6, 10, 26 and 46**

**Reg. No. 3,465,391**

**United States Patent and Trademark Office**

**Registered July 15, 2008**

**TRADEMARK  
PRINCIPAL REGISTER**

**ZMM**

ZEOX CORPORATION (CANADA CORPORATION)  
6459 MACK ROAD  
PEACHLAND, CANADA V0H1X8

FOR: ZEOLITES, NAMELY, A FAMILY OF HYDROUS ALUMINUM SILICATE MINERALS USED CHIEFLY AS MOLECULAR FILTERS AND ION EXCHANGE AGENTS, IN CLASS 1 (U.S. CLS. 1, 5, 6, 10, 26 AND 46).

FIRST USE 1-31-2007; IN COMMERCE 1-31-2007.

THE MARK CONSISTS OF STANDARD CHARACTERS WITHOUT CLAIM TO ANY PARTICULAR FONT, STYLE, SIZE, OR COLOR.

PRIORITY CLAIMED UNDER SEC. 44(D) ON CANADA APPLICATION NO. 1321863, FILED 10-27-2006, REG. NO. TMA701568, DATED 11-23-2007, EXPIRES 11-23-2022.

SER. NO. 77-164,635, FILED 4-24-2007.

RICHARD A. STRASER, EXAMINING ATTORNEY

**Int. Cls.: 9, 16 and 41**

**Prior U.S. Cls.: 2, 5, 21, 22, 23, 26, 29, 36, 37, 38, 50,  
100, 101 and 107**

**Reg. No. 3,465,392**

**United States Patent and Trademark Office**

**Registered July 15, 2008**

**TRADEMARK  
SERVICE MARK  
PRINCIPAL REGISTER**

# Untie the Knots

INSPIRAGEN INSTITUTE, INC. (MARYLAND CORPORATION)  
SUITE 134  
6400 BALTIMORE NATIONAL PIKE  
BALTIMORE, MD 21228

FOR: PRE-RECORDED CDS, VIDEO TAPES, LASER DISKS, AUDIO TAPES, DOWNLOADABLE AUDIO AND VIDEO FILES, AND DVDS FEATURING MOTIVATIONAL SPEAKERS, AND SELF-IMPROVEMENT, NAMELY, ADVICE ON PERSONAL, PROFESSIONAL AND BUSINESS DEVELOPMENT, IN CLASS 9 (U.S. CLS. 21, 23, 26, 36 AND 38).

FIRST USE 1-1-1998; IN COMMERCE 1-1-2000.

FOR: WORKBOOKS DIRECTED TO MOTIVATIONAL SPEAKERS, AND SELF-IMPROVEMENT, NAMELY, ADVICE ON PERSONAL, PROFESSIONAL AND BUSINESS DEVELOPMENT; MAGAZINES FEATURING MOTIVATIONAL SPEAKERS, AND SELF-IMPROVEMENT, NAMELY, ADVICE ON PERSONAL, PROFESSIONAL AND BUSINESS DEVELOPMENT; SERIES OF NON-FICTION BOOKS, IN THE FIELD OF MOTIVATIONAL SPEAKERS,

AND SELF-IMPROVEMENT, NAMELY, ADVICE ON PERSONAL, PROFESSIONAL AND BUSINESS DEVELOPMENT, IN CLASS 16 (U.S. CLS. 2, 5, 22, 23, 29, 37, 38 AND 50).

FIRST USE 1-1-1998; IN COMMERCE 1-1-2000.

FOR: EDUCATION SERVICES, NAMELY, PROVIDING CLASSES, SEMINARS, LECTURES AND WORKSHOPS IN THE FIELD OF MOTIVATIONAL SPEAKERS, AND SELF-IMPROVEMENT, NAMELY, ADVICE ON PERSONAL, PROFESSIONAL AND BUSINESS DEVELOPMENT, IN CLASS 41 (U.S. CLS. 100, 101 AND 107).

FIRST USE 1-1-1998; IN COMMERCE 1-1-2000.

THE MARK CONSISTS OF STANDARD CHARACTERS WITHOUT CLAIM TO ANY PARTICULAR FONT, STYLE, SIZE, OR COLOR.

SER. NO. 77-164,669, FILED 4-24-2007.

SUNG IN, EXAMINING ATTORNEY

**Int. Cls.: 35 and 42**

**Prior U.S. Cls.: 100, 101 and 102**

**United States Patent and Trademark Office**

**Reg. No. 3,465,393**

**Registered July 15, 2008**

**SERVICE MARK  
PRINCIPAL REGISTER**

# ACCUSTAT

ACCUSTAT EMR (SOUTH CAROLINA LTD LIAB  
CO)  
2556 WILD GAME TRAIL  
MYRTLE BEACH, SC 29588

FOR: BUSINESS CONSULTING AND INFORMATION SERVICES; INFORMATION, ADVISORY AND CONSULTANCY SERVICES RELATING TO BUSINESS AND MANAGEMENT OR BUSINESS ADMINISTRATION, INCLUDING SUCH SERVICES PROVIDED ON LINE OR VIA THE INTERNET, IN CLASS 35 (U.S. CLS. 100, 101 AND 102).

FIRST USE 1-15-2004; IN COMMERCE 1-15-2004.

FOR: DESIGN OF COMPUTER NETWORKS AND SOFTWARE FOR OTHERS FOR THE MEDICAL INDUSTRY; APPLICATION SERVICE PROVIDER, NAMELY, PROVIDING, HOSTING, MANAGING, DEVELOPING, AND MAINTAINING APPLICATIONS, SOFTWARE, WEBSITES, AND DATABASES IN THE FIELDS OF PERSONAL PRODUCTIVITY, WIRELESS COMMUNICATION, MOBILE INFOR-

MATION ACCESS, AND REMOTE DATA MANAGEMENT FOR WIRELESS DELIVERY OF CONTENT TO HANDHELD COMPUTERS, LAPTOPS AND MOBILE ELECTRONIC DEVICES; TECHNICAL SUPPORT SERVICES, NAMELY, TROUBLESHOOTING OF COMPUTER HARDWARE AND SOFTWARE PROBLEMS; TECHNICAL SUPPORT SERVICES, NAMELY, TROUBLESHOOTING OF INDUSTRIAL PROCESS CONTROL COMPUTER SOFTWARE PROBLEMS; TECHNICAL SUPPORT, NAMELY, MONITORING OF NETWORK SYSTEMS, IN CLASS 42 (U.S. CLS. 100 AND 101).

FIRST USE 1-15-2004; IN COMMERCE 1-15-2004.

THE MARK CONSISTS OF STANDARD CHARACTERS WITHOUT CLAIM TO ANY PARTICULAR FONT, STYLE, SIZE, OR COLOR.

SER. NO. 77-164,797, FILED 4-24-2007.

BRENDAN REGAN, EXAMINING ATTORNEY



**Int. Cl.: 41**

**Prior U.S. Cls.: 100, 101 and 107**

**United States Patent and Trademark Office**

**Reg. No. 3,465,394**

**Registered July 15, 2008**

**SERVICE MARK  
PRINCIPAL REGISTER**

**2ND STORY GUYS**

HARDRIVE PRODUCTIONS, INC. (FLORIDA  
CORPORATION)  
4085 L.B. MCLEOD ROAD, SUITE F1  
ORLANDO, FL 32811

FOR: ENTERTAINMENT SERVICES IN THE  
NATURE OF PERFORMANCES INVOLVING INDI-  
VIDUALS PERFORMING VARIOUS THEATRICAL  
AND ATHLETIC MANEUVERS AND STUNTS ON  
STILTS , IN CLASS 41 (U.S. CLS. 100, 101 AND 107).

FIRST USE 10-1-1994; IN COMMERCE 10-1-1994.

THE MARK CONSISTS OF STANDARD CHAR-  
ACTERS WITHOUT CLAIM TO ANY PARTICULAR  
FONT, STYLE, SIZE, OR COLOR.

SER. NO. 77-164,976, FILED 4-25-2007.

B. PARADEWELAI, EXAMINING ATTORNEY

**Int. Cl.: 9**

**Prior U.S. Cls.: 21, 23, 26, 36 and 38**

**Reg. No. 3,465,395**

**United States Patent and Trademark Office**

**Registered July 15, 2008**

**TRADEMARK  
PRINCIPAL REGISTER**

**ID SHIELD**

EXTRACT SYSTEMS, LLC (WISCONSIN LTD  
LIAB CO)  
SUITE 200  
6418 NORMANDY LANE  
MADISON, WI 53719

FOR: COMPUTER SOFTWARE FOR AUTOMA-  
TED REDACTION FOR USE IN SANITIZING PUB-  
LICLY AVAILABLE DOCUMENTS, IN CLASS 9 (U.S.  
CLS. 21, 23, 26, 36 AND 38).

FIRST USE 1-1-2005; IN COMMERCE 1-1-2005.

THE MARK CONSISTS OF STANDARD CHAR-  
ACTERS WITHOUT CLAIM TO ANY PARTICULAR  
FONT, STYLE, SIZE, OR COLOR.

NO CLAIM IS MADE TO THE EXCLUSIVE  
RIGHT TO USE "ID", APART FROM THE MARK  
AS SHOWN.

SER. NO. 77-165,118, FILED 4-25-2007.

RAUL CORDOVA, EXAMINING ATTORNEY

**Int. Cl.: 35**

**Prior U.S. Cls.: 100, 101 and 102**

**United States Patent and Trademark Office**

**Reg. No. 3,465,396**

**Registered July 15, 2008**

**SERVICE MARK  
PRINCIPAL REGISTER**

**CustoMark**  
**distributor** 

EDGE TECH CORPORATION (OKLAHOMA  
CORPORATION)  
1310 NORTH HILLS CENTRE  
ADA, OK 74820

FOR: DISTRIBUTORSHIP SERVICES FEATUR-  
ING CUSTOMIZED PRINTED PRODUCTS BEAR-  
ING CORPORATE NAMES AND LOGOS FOR  
PROMOTIONAL AND ADVERTISING PURPOSES,  
NAMELY, HARD DRIVES, FLASH DRIVES, INK  
PEN PLUS FLASH DRIVES, AND DIGITAL PIC-  
TURE FRAMES, IN CLASS 35 (U.S. CLS. 100, 101  
AND 102).

FIRST USE 3-1-2007; IN COMMERCE 3-1-2007.

NO CLAIM IS MADE TO THE EXCLUSIVE  
RIGHT TO USE "DISTRIBUTOR", APART FROM  
THE MARK AS SHOWN.

SER. NO. 77-165,398, FILED 4-25-2007.

DAWN HAN, EXAMINING ATTORNEY

**Int. Cl.: 35**

**Prior U.S. Cls.: 100, 101 and 102**

**United States Patent and Trademark Office**

**Reg. No. 3,465,397**

**Registered July 15, 2008**

**SERVICE MARK  
PRINCIPAL REGISTER**



ONE ACTION (D.C. NON-PROFIT CORPORATION)  
SUITE 601  
1400 EYE STREET, N.W.  
WASHINGTON, DC 20005

FOR: PROMOTING PUBLIC AWARENESS ABOUT THE GLOBAL AIDS EPIDEMIC AND POVERTY WORLDWIDE; PUBLIC ADVOCACY TO PROMOTE AWARENESS ABOUT THE GLOBAL AIDS EPIDEMIC AND POVERTY WORLDWIDE, IN CLASS 35 (U.S. CLS. 100, 101 AND 102).

FIRST USE 3-31-2005; IN COMMERCE 3-31-2005.

OWNER OF U.S. REG. NOS. 3,069,885, 3,069,886, AND 3,069,887.

THE MARK CONSISTS OF "ONE" WITHIN A CIRCLE AND THE WORDING "THE CAMPAIGN TO MAKE POVERTY HISTORY" AND "WWW.ONE.ORG".

SER. NO. 77-165,509, FILED 4-25-2007.

AMY MCMENAMIN, EXAMINING ATTORNEY

**Int. Cl.: 35**

**Prior U.S. Cls.: 100, 101 and 102**

**United States Patent and Trademark Office**

**Reg. No. 3,465,398**

**Registered July 15, 2008**

**SERVICE MARK  
PRINCIPAL REGISTER**



CHANNEL INTELLIGENCE, INC. (DELAWARE CORPORATION)  
SUITE 101  
1180 CELEBRATION BOULEVARD  
CELEBRATION, FL 34747

FOR: ONLINE SERVICES, NAMELY, PROVIDING MANUFACTURERS AND RETAILERS WITH INFORMATION ON THE SALES AND PRODUCT DISTRIBUTION OF THEIR PRODUCTS; PROMOTING THE GOODS AND SERVICES OF OTHERS BY MEANS OF OPERATING A WEBSITE WITH LINKS TO RETAIL STORE WEBSITES OF OTHERS; PROVIDING LINKS TO WEBSITES OF OTHERS FEATURING MANUFACTURED GOODS FOR RETAIL

AND WHOLESALE STORE SERVICES, IN CLASS 35 (U.S. CLS. 100, 101 AND 102).

FIRST USE 5-27-2002; IN COMMERCE 5-27-2002.

THE MARK CONSISTS OF THE STYLIZED LETTERS "CI" WITHIN A BOX DIVIDED IN THE MIDDLE BY A CURVED LINE.

SEC. 2(F).

SER. NO. 77-165,642, FILED 4-25-2007.

LOURDES AYALA, EXAMINING ATTORNEY

**Int. Cl.: 35**

**Prior U.S. Cls.: 100, 101 and 102**

**United States Patent and Trademark Office**

**Reg. No. 3,465,399**

**Registered July 15, 2008**

**SERVICE MARK  
PRINCIPAL REGISTER**

**All your favorite stores.  
OneCart convenience.**

SHOP.COM (CALIFORNIA CORPORATION)  
BUILDING 1, SUITE 210  
1 LOWER RAGSDALE DRIVE  
MONTEREY, CA 93940

FOR: ON-LINE RETAIL STORE SERVICES FEATURING A WIDE VARIETY OF CONSUMER GOODS OF OTHERS; ON-LINE ORDERING SERVICES FEATURING A WIDE VARIETY OF CONSUMER GOODS OF OTHERS; PROVISION OF WEB SITES FEATURING INFORMATION IN THE FIELDS OF SHOPPING, RETAILING, ELECTRONIC COMMERCE, AND ORDER FULFILLMENT; PROVISION OF WEB SITES FEATURING REFERRALS TO WEB SITES IN THE FIELDS OF SHOPPING, RETAILING, ELECTRONIC COMMERCE, AND ORDER FULFILLMENT; PROVISION OF WEB SITES FEATURING POLLS AND SURVEYS FOR USERS

TO SHARE OPINIONS CONCERNING THE FIELDS OF SHOPPING, RETAILING, ELECTRONIC COMMERCE, AND ORDER FULFILLMENT; DISSEMINATION OF ADVERTISING FOR OTHERS VIA THE INTERNET AND OTHER COMPUTER AND COMMUNICATION NETWORKS, IN CLASS 35 (U.S. CLS. 100, 101 AND 102).

FIRST USE 4-24-2007; IN COMMERCE 4-24-2007.

THE MARK CONSISTS OF STANDARD CHARACTERS WITHOUT CLAIM TO ANY PARTICULAR FONT, STYLE, SIZE, OR COLOR.

SER. NO. 77-165,728, FILED 4-25-2007.

KAPIL BHANOT, EXAMINING ATTORNEY

**Int. Cls.: 18 and 25**

**Prior U.S. Cls.: 1, 2, 3, 22, 39 and 41**

**United States Patent and Trademark Office**

**Reg. No. 3,465,400**

**Registered July 15, 2008**

**TRADEMARK  
PRINCIPAL REGISTER**

**CRYSTALISHIOUS**

SIDLES, JEFFREY (UNITED STATES INDIVIDUAL)  
6924 E. MARIPOSA DRIVE  
SCOTTSDALE, AZ 85251

FOR: HANDBAGS, IN CLASS 18 (U.S. CLS. 1, 2, 3, 22 AND 41).

FIRST USE 7-29-2005; IN COMMERCE 8-12-2005.

FOR: BELTS; SHOES; WRISTBANDS, IN CLASS 25 (U.S. CLS. 22 AND 39).

FIRST USE 7-29-2005; IN COMMERCE 8-12-2005.

THE MARK CONSISTS OF STANDARD CHARACTERS WITHOUT CLAIM TO ANY PARTICULAR FONT, STYLE, SIZE, OR COLOR.

SER. NO. 77-165,806, FILED 4-25-2007.

CHRISTINE COOPER, EXAMINING ATTORNEY

**Int. Cl.: 42**

**Prior U.S. Cls.: 100 and 101**

**United States Patent and Trademark Office**

**Reg. No. 3,465,401**

**Registered July 15, 2008**

**SERVICE MARK  
PRINCIPAL REGISTER**

**READSCAPE**

READSCAPE INC. (WASHINGTON CORPORATION)  
SUITE 231  
4111 E. MADISON STREET  
SEATTLE, WA 98112

FOR: DEVELOPMENT OF COMPUTER SOFTWARE FOR READING DOCUMENTS; DEVELOPMENT OF PRODUCTIVITY SOFTWARE IN THE FIELD OF ERGONOMICS, IN CLASS 42 (U.S. CLS. 100 AND 101).

FIRST USE 5-8-2006; IN COMMERCE 5-8-2006.

THE MARK CONSISTS OF STANDARD CHARACTERS WITHOUT CLAIM TO ANY PARTICULAR FONT, STYLE, SIZE, OR COLOR.

SER. NO. 77-165,878, FILED 4-25-2007.

KATHRYN COWARD, EXAMINING ATTORNEY



**Int. Cl.: 37**

**Prior U.S. Cls.: 100, 103 and 106**

**United States Patent and Trademark Office**

**Reg. No. 3,465,402**

**Registered July 15, 2008**

**SERVICE MARK  
PRINCIPAL REGISTER**

**GREEN FUEL TECHNOLOGIES**

GREEN FUEL TECHNOLOGIES L.L.C. (ARIZONA LTD LIAB CO)  
4209 W VILLA LINDA DR  
GLENDALE, AZ 85310

FOR: INSTALLATION, MAINTENANCE AND REPAIR OF SOLAR ENERGY OR RENEWABLE ENERGY EQUIPMENT OR INSTALLATIONS FOR COMMERCIAL AND RESIDENTIAL BUILDINGS AND HOMES; RESIDENTIAL AND BUILDING CONSTRUCTION CONSULTING; CONSTRUCTION OF COMMERCIAL AND RESIDENTIAL BUILDINGS THAT MAKE USE OF SOLAR ENERGY OR RENEWABLE ENERGY EQUIPMENT OR INSTALLATIONS; RENOVATION IN THE FIELD OF COMMERCIAL AND RESIDENTIAL BUILDINGS THAT

MAKE USE OF SOLAR ENERGY OR RENEWABLE ENERGY EQUIPMENT OR INSTALLATIONS, IN CLASS 37 (U.S. CLS. 100, 103 AND 106).

FIRST USE 1-0-2000; IN COMMERCE 1-0-2000.

THE MARK CONSISTS OF STANDARD CHARACTERS WITHOUT CLAIM TO ANY PARTICULAR FONT, STYLE, SIZE, OR COLOR.

SEC. 2(F).

SER. NO. 77-165,921, FILED 4-25-2007.

PAUL E. FAHRENKOPF, EXAMINING ATTORNEY

**Int. Cls.: 2, 6 and 19**

**Prior U.S. Cls.: 1, 2, 6, 11, 12, 13, 14, 16, 23, 25, 33 and 50**

**Reg. No. 3,465,403**

**United States Patent and Trademark Office**

**Registered July 15, 2008**

**TRADEMARK  
PRINCIPAL REGISTER**

 **CONSERVAGLASS+**

FOUR SEASONS SOLAR PRODUCTS LLC (NEW YORK LTD LIAB CO)  
5005 VETERANS MEMORIAL HIGHWAY  
HOLBROOK, NY 11741

FOR: GLAZING SYSTEMS CONSISTING OF GLASS COATINGS, NAMELY, PROTECTIVE COATINGS AND LACQUERS THAT ARE IN THE NATURE OF A COATING, IN CLASS 2 (U.S. CLS. 6, 11 AND 16).

FIRST USE 1-22-2007; IN COMMERCE 1-22-2007.

FOR: CONSERVATORY GLAZING SYSTEMS CONSISTING OF WALL PANELS OF METAL, CEILING PANELS OF METAL, ROOF PANELS OF METAL; GLAZING SYSTEMS CONSISTING OF WALL PANELS OF METAL, CEILING PANELS OF METAL, ROOF PANELS OF METAL, AND COMPONENTS PARTS FOR RECEIVING GLAZING; METAL CONSERVATORIES; METAL GLASSHOUSES/GREENHOUSES; METAL WINDOW FRAMES; METAL DOOR FRAMES; METAL GLAZING BARS; METAL RIDGE BEAMS; METAL EAVES; METAL BEAMS; METAL GUTTERS; AND METAL DECORATIVE MOULDINGS, CRESTINGS, AND FINIALS; METAL WINDOWS; METAL GLAZED WINDOWS; CASEMENT WINDOWS OF METAL; CONSERVATORY ROOFING SYSTEMS CONSISTING OF METAL ROOFING, METAL ROOFING TILES, METAL SKYLIGHTS THAT UTILIZE STRUCTURAL INSULATED PANELS, CONNECTORS, CORNERS AND OTHER COMPONENTS SOLD AS A UNIT, IN CLASS 6 (U.S. CLS. 2, 12, 13, 14, 23, 25 AND 50).

FIRST USE 1-22-2007; IN COMMERCE 1-22-2007.

FOR: CONSERVATORY GLAZING SYSTEMS AND GLAZING SYSTEMS HAVING A COATING ACTIVATED BY UV RAYS THAT ENABLES THE GLASS TO CLEAN ITSELF; BOTH CONSISTING OF WALL PANELS OF NON-METAL, CEILING PANELS OF NON-METAL, ROOF PANELS OF NON-METAL, AND COMPONENTS PARTS FOR RECEIVING GLAZING; NON-METAL CONSERVATORIES, NON-METAL WINDOW FRAMES, NON-METAL GLAZING BARS; NON-METAL RIDGE BEAMS; NON-METAL EAVES; NON-METAL BEAMS; NON-METAL GUTTERS; NON-METAL GLAZED WINDOWS; WINDOW CASEMENTS NOT OF METAL; AND NON-METAL DECORATIVE MOULDINGS, CRESTINGS, AND FINIALS; GLASS FOR BUILDINGS; GLASS FOR WINDOWS; GLASS FOR DOORS; PLASTIC ROOFING PANELS AND TRANSLUCENT PLASTICS ROOFING PANELS, NON-METAL SKYLIGHTS THAT UTILIZE STRUCTURAL INSULATED PANELS, CONNECTORS, CORNERS AND OTHER COMPONENTS SOLD AS A UNIT, IN CLASS 19 (U.S. CLS. 1, 12, 33 AND 50).

FIRST USE 1-22-2007; IN COMMERCE 1-22-2007.

SER. NO. 77-166,097, FILED 4-26-2007.

KARANENDRA S. CHHINA, EXAMINING ATTORNEY

**Int. Cl.: 1**

**Prior U.S. Cls.: 1, 5, 6, 10, 26 and 46**

**Reg. No. 3,465,404**

**United States Patent and Trademark Office**

**Registered July 15, 2008**

---

**TRADEMARK  
PRINCIPAL REGISTER**

**POR-A-THANE**

PATHWAY POLYMERS, INC. (DELAWARE CORPORATION)  
2003 AMNICOLA HIGHWAY  
CHATTANOOGA, TN 37406

FOR: POLYURETHANES, NAMELY, A RANGE OF TWO OR MORE COMPONENT POLYURETHANE COMPOUNDS WHICH WHEN COMBINED TOGETHER REACT TO FORM A SOLID URETHANE ELASTOMER OR FOAM, IN CLASS 1 (U.S. CLS. 1, 5, 6, 10, 26 AND 46).

FIRST USE 4-15-2007; IN COMMERCE 4-15-2007.

THE MARK CONSISTS OF STANDARD CHARACTERS WITHOUT CLAIM TO ANY PARTICULAR FONT, STYLE, SIZE, OR COLOR.

SER. NO. 77-166,233, FILED 4-26-2007.

CARYN GLASSER, EXAMINING ATTORNEY

**Int. Cl.: 41**

**Prior U.S. Cls.: 100, 101 and 107**

**United States Patent and Trademark Office**

**Reg. No. 3,465,405**

**Registered July 15, 2008**

**SERVICE MARK  
PRINCIPAL REGISTER**

**CIRCLE FINANCIAL GROUP**

CIRCLE FINANCIAL GROUP, LLC (DELAWARE  
LTD LIAB CO)  
660 MADISON AVENUE, 17TH FLOOR  
NEW YORK, NY 10022

FOR: EDUCATIONAL SERVICES FOR WOMEN,  
NAMELY, SEMINARS, WORKSHIPS, CONFEREN-  
CES AND AN INTERNET OR GLOBAL COMPUTER  
NETWORK WEBSITE PROVIDING TRAINING IN  
THE FIELDS OF BEST PRACTICES IN INVEST-  
MENT EXECUTION, TAX PLANNING, PHILAN-  
THROPY, ESTATE PLANNING AND PERSONAL  
WELLNESS FOR WOMEN; PROVIDING MEMBER-  
SHIP ORGANIZATION SERVICES FOR WOMEN,  
NAMELY, PROVIDING TRAINING IN THE FIELDS  
OF INVESTMENT EXECUTION, TAX PLANNING,  
PHILANTHROPY, ESTATE PLANNING AND PER-

SONAL WELLNESS FOR WOMEN, IN CLASS 41  
(U.S. CLS. 100, 101 AND 107).

FIRST USE 8-31-2002; IN COMMERCE 8-31-2002.

THE MARK CONSISTS OF STANDARD CHAR-  
ACTERS WITHOUT CLAIM TO ANY PARTICULAR  
FONT, STYLE, SIZE, OR COLOR.

NO CLAIM IS MADE TO THE EXCLUSIVE  
RIGHT TO USE "FINANCIAL GROUP", APART  
FROM THE MARK AS SHOWN.

SER. NO. 77-166,304, FILED 4-26-2007.

AMOS T. MATTHEWS, JR., EXAMINING ATTOR-  
NEY

**Int. Cl.: 42**

**Prior U.S. Cls.: 100 and 101**

**United States Patent and Trademark Office**

**Reg. No. 3,465,406**

**Registered July 15, 2008**

**SERVICE MARK  
PRINCIPAL REGISTER**

**AustarPharma**

AUSTAR INTERNATIONAL LIMITED (HONG  
KONG LTD LIAB CO)  
UNIT 6, 1/F., BLOCK B, NEW TRADE PLAZA  
6 ON PING STREET  
SHATIN, N.T., HONG KONG

FOR: RESEARCH AND DEVELOPMENT AND  
CONSULTATION RELATED THERETO IN THE  
FIELD OF PHARMACEUTICALS, NAMELY GEN-  
ERIC DRUG PRODUCTS, IN CLASS 42 (U.S. CLS. 100  
AND 101).

FIRST USE 7-12-2004; IN COMMERCE 7-18-2004.

THE MARK CONSISTS OF STANDARD CHAR-  
ACTERS WITHOUT CLAIM TO ANY PARTICULAR  
FONT, STYLE, SIZE, OR COLOR.

SER. NO. 77-166,321, FILED 4-26-2007.

EMILY CARLSEN, EXAMINING ATTORNEY

**Int. Cls.: 7 and 24**

**Prior U.S. Cls.: 13, 19, 21, 23, 31, 34, 35, 42 and 50**

**United States Patent and Trademark Office**

**Reg. No. 3,465,407**

**Registered July 15, 2008**

**TRADEMARK  
PRINCIPAL REGISTER**

**FENNER PRECISION**

FENNER U.S., INC. (DELAWARE CORPORATION)  
SUITE 200  
103 FOULK ROAD  
WILMINGTON, DE 19803

FOR: MACHINE PARTS, NAMELY, TIMING BELTS, POWER TRANSMISSION BELTS, PULLEYS, TIRES AND ROLLERS FOR USE IN PAPER CONVEYING MACHINES, ALL FOR MACHINES USED IN INDUSTRIAL APPLICATIONS, IN CLASS 7 (U.S. CLS. 13, 19, 21, 23, 31, 34 AND 35).

FIRST USE 9-1-2006; IN COMMERCE 9-1-2006.

FOR: CHEMICAL FIBER FABRIC REINFORCED WITH RESINS OR ELASTOMERS, IN CLASS 24 (U.S. CLS. 42 AND 50).

FIRST USE 9-1-2006; IN COMMERCE 9-1-2006.

THE MARK CONSISTS OF STANDARD CHARACTERS WITHOUT CLAIM TO ANY PARTICULAR FONT, STYLE, SIZE, OR COLOR.

OWNER OF U.S. REG. NOS. 1,171,971 AND 2,461,466.

NO CLAIM IS MADE TO THE EXCLUSIVE RIGHT TO USE "PRECISION", APART FROM THE MARK AS SHOWN.

SER. NO. 77-166,415, FILED 4-26-2007.

LINDA M. KING, EXAMINING ATTORNEY

**Int. Cl.: 42**

**Prior U.S. Cls.: 100 and 101**

**United States Patent and Trademark Office**

**Reg. No. 3,465,408**

**Registered July 15, 2008**

**SERVICE MARK  
PRINCIPAL REGISTER**

**GO QUOTE!**

GRANGE INSURANCE ASSOCIATION (WA-  
SHINGTON CORPORATION)  
200 CEDAR STREET  
SEATTLE, WA 981211223

FOR: PROVIDING ON-LINE NON-DOWNLOAD-  
ABLE SOFTWARE FOR USE IN PROVIDING  
QUOTES AND MAKING POLICY SUBMISSIONS  
IN THE FIELD OF AUTOMOBILE INSURANCE, IN  
CLASS 42 (U.S. CLS. 100 AND 101).

FIRST USE 2-27-2007; IN COMMERCE 2-27-2007.

THE MARK CONSISTS OF STANDARD CHAR-  
ACTERS WITHOUT CLAIM TO ANY PARTICULAR  
FONT, STYLE, SIZE, OR COLOR.

NO CLAIM IS MADE TO THE EXCLUSIVE  
RIGHT TO USE "QUOTE", APART FROM THE  
MARK AS SHOWN.

SER. NO. 77-166,455, FILED 4-26-2007.

TINA BROWN, EXAMINING ATTORNEY

**Int. Cls.: 1 and 17**

**Prior U.S. Cls.: 1, 5, 6, 10, 12, 13, 26, 35, 46 and 50**

**United States Patent and Trademark Office**

**Reg. No. 3,465,409**

**Registered July 15, 2008**

**TRADEMARK  
PRINCIPAL REGISTER**

**CONTEGA**

BIOLOGISCHE INSEL LOTHAR MOLL GMBH &  
CO. KG (FED REP GERMANY CORPORATION)  
RHEINTALSTRASSE 35-43  
SCHWETZINGEN, FED REP GERMANY 68723

FOR: ADHESIVES FOR BUILDING MATERIALS OF WOOD, PAPER OR PLASTIC; GLUE IN THE NATURE OF ADHESIVES FOR BUILDING MATERIALS OF WOOD, PAPER OR PLASTIC; AIRTIGHT SEALING ADHESIVES FOR WOOD, PAPER OR PLASTIC, IN CLASS 1 (U.S. CLS. 1, 5, 6, 10, 26 AND 46).

FIRST USE 2-28-2007; IN COMMERCE 2-28-2007.

FOR: PLASTER BOND TAPE AND ADHESIVE BANDS FOR GLUING FILMS, CARDBOARD, BOARDS, PAPER MATTER AND BUILDING MATERIALS, INCLUDING WOOD, STONE, CONCRETE AND PLASTER; AND DOUBLE-LAYERED OR MULTILAYERED ADHESIVE TAPES, ALL FOR USE IN THE BUILDING INDUSTRY; SEALANTS FOR BUILDINGS, NAMELY, AIRTIGHT SEALING

WEBS USED IN THE BUILDING INDUSTRY, FOR FLOORS AND WALL COVERINGS, FOR FOILS AND ROOF UNDERLAY, NAMELY, ADHESIVE CORDS, SEALING CORDS, HOT MELTS, SEALING COMPOUNDS, SEALANTS, BUTYL RUBBER, IN CLASS 17 (U.S. CLS. 1, 5, 12, 13, 35 AND 50).

FIRST USE 2-28-2007; IN COMMERCE 2-28-2007.

THE MARK CONSISTS OF STANDARD CHARACTERS WITHOUT CLAIM TO ANY PARTICULAR FONT, STYLE, SIZE, OR COLOR.

OWNER OF ERPN CMNTY TM OFC REG. NO. 003848074, DATED 8-30-2005, EXPIRES 5-21-2014.

THE WORDING "CONTEGA" HAS NO MEANING IN A FOREIGN LANGUAGE.

SER. NO. 77-166,677, FILED 4-26-2007.

ELISSA GARBER KON, EXAMINING ATTORNEY



**Int. Cl.: 19**

**Prior U.S. Cls.: 1, 12, 33 and 50**

**United States Patent and Trademark Office**

**Reg. No. 3,465,410**

**Registered July 15, 2008**

**TRADEMARK  
PRINCIPAL REGISTER**

# Happy Hues

CHROMASAND LLC (OHIO LTD LIAB CO)  
P.O. BOX 31883  
INDEPENDENCE, OH 44131

THE MARK CONSISTS OF STANDARD CHAR-  
ACTERS WITHOUT CLAIM TO ANY PARTICULAR  
FONT, STYLE, SIZE, OR COLOR.

FOR: COLORED SAND, IN CLASS 19 (U.S. CLS. 1,  
12, 33 AND 50).

SER. NO. 77-166,701, FILED 4-26-2007.

FIRST USE 9-30-2002; IN COMMERCE 9-30-2002.

MARGARET POWER, EXAMINING ATTORNEY

**Int. Cls.: 1, 7, 8, 11 and 21**

**Prior U.S. Cls.: 1, 2, 5, 6, 10, 13, 19, 21, 23, 26, 28, 29, 30, 31, 33, 34, 35, 40, 44, 46 and 50**

**Reg. No. 3,465,411**

**United States Patent and Trademark Office**

**Registered July 15, 2008**

**TRADEMARK  
PRINCIPAL REGISTER**

**ALWAYS MOVING FORWARD**

THE ERASER COMPANY, INC. (NEW YORK CORPORATION)  
OLIVA DRIVE  
P.O. BOX 4961  
SYRACUSE, NY 13221

FOR: LIQUID CHEMICAL USED ON SWITCHES, RELAYS, CONNECTORS, BATTERIES, IC PINS AND SOCKETS, WIRES AND OTHER COPPER OR METAL ELECTRICAL OR ELECTRONIC CONTACTS FOR THE REMOVAL OF OXIDATION AND PROTECTION AGAINST OXIDATION, IN CLASS 1 (U.S. CLS. 1, 5, 6, 10, 26 AND 46).

FIRST USE 0-0-1999; IN COMMERCE 0-0-1999.

FOR: INDUSTRIAL MACHINES FOR CUTTING, BENDING AND FORMING THE LEADS OF ELECTRICAL COMPONENTS AND STRIPPING THE INSULATION FROM ELECTRICAL LEADS TO EXPOSE AN UNDERLYING CURRENT CARRYING ELEMENT; INDUSTRIAL MACHINES FOR CUTTING CABLES TO SPECIFIED LENGTHS, IN CLASS 7 (U.S. CLS. 13, 19, 21, 23, 31, 34 AND 35).

FIRST USE 0-0-1999; IN COMMERCE 0-0-1999.

FOR: MANUALLY OPERATED, HAND HELD TOOL IN THE NATURE OF A RETRACTABLE BRUSH EXTENDER USED WITH INDUSTRIAL

BRUSHES FOR CLEANING AND BURNISHING, IN CLASS 8 (U.S. CLS. 23, 28 AND 44).

FIRST USE 0-0-1999; IN COMMERCE 0-0-1999.

FOR: INFRARED HEATERS FOR SHRINKING HIGH AND LOW TEMPERATURE SHRINKABLE MATERIAL, SOLDERING ELECTRICAL CONNECTIONS, HEATING PARTS FOR BENDING, EXPANDING, SEALING OR THAWING THE PART, IN CLASS 11 (U.S. CLS. 13, 21, 23, 31 AND 34).

FIRST USE 0-0-1999; IN COMMERCE 0-0-1999.

FOR: HAND HELD INDUSTRIAL BRUSHES USED FOR BURNISHING AND CLEANING METALS, GLASS, CERAMICS AND PLASTICS USED IN ELECTRICAL OR ELECTRONIC COMPONENTS AND SYSTEMS, IN CLASS 21 (U.S. CLS. 2, 13, 23, 29, 30, 33, 40 AND 50).

FIRST USE 0-0-1999; IN COMMERCE 0-0-1999.

THE MARK CONSISTS OF STANDARD CHARACTERS WITHOUT CLAIM TO ANY PARTICULAR FONT, STYLE, SIZE, OR COLOR.

SER. NO. 77-167,215, FILED 4-27-2007.

ELISSA GARBER KON, EXAMINING ATTORNEY

**Int. Cl.: 33**

**Prior U.S. Cls.: 47 and 49**

**United States Patent and Trademark Office**

**Reg. No. 3,465,412**

**Registered July 15, 2008**

**TRADEMARK  
PRINCIPAL REGISTER**

**BORN FROM PURITY**

FINLANDIA VODKA WORLDWIDE LTD. (FIN-  
LAND CORPORATION)  
PORKKALANKATU 24  
HELSINKI, FINLAND 00180

THE MARK CONSISTS OF STANDARD CHAR-  
ACTERS WITHOUT CLAIM TO ANY PARTICULAR  
FONT, STYLE, SIZE, OR COLOR.

FOR: DISTILLED SPIRITS, IN CLASS 33 (U.S. CLS.  
47 AND 49).

SER. NO. 77-167,619, FILED 4-27-2007.

FIRST USE 5-1-2007; IN COMMERCE 5-1-2007.

STEVEN R. FINE, EXAMINING ATTORNEY

**Int. Cl.: 35**

**Prior U.S. Cls.: 100, 101 and 102**

**United States Patent and Trademark Office**

**Reg. No. 3,465,413**

**Registered July 15, 2008**

**SERVICE MARK  
PRINCIPAL REGISTER**

**GETMYFREELAPTOP.COM**

WORLD AVENUE IP, LLC (DELAWARE LTD  
LIAB CO)  
6001 BROKEN SOUND PARKWAY, SUITE 200  
BOCA RATON, FL 33487

FOR: ADVERTISING SERVICES, SOLELY, AD-  
VERTISING AND PROMOTIONS OF LAPTOPS AND  
OTHER ELECTRONIC GOODS VIA INTERNET,  
RADIO, TV AND OTHER METHODS INCLUDING  
BUT NOT LIMITED TO PRINT MEDIA, DIRECT  
MARKETING AND TELEMARKETING; PREPAR-  
ING AND PLACING ADVERTISEMENTS FOR OTH-  
ERS, NAMELY, BANNER ADS, LANDING PAGES

AND MARKETING CREATIVE'S VIA THE INTER-  
NET, IN CLASS 35 (U.S. CLS. 100, 101 AND 102).

FIRST USE 11-22-2006; IN COMMERCE 11-22-2006.

THE MARK CONSISTS OF STANDARD CHAR-  
ACTERS WITHOUT CLAIM TO ANY PARTICULAR  
FONT, STYLE, SIZE, OR COLOR.

SER. NO. 77-167,640, FILED 4-27-2007.

JENNIFER VASQUEZ, EXAMINING ATTORNEY

**Int. Cls.: 35 and 36**

**Prior U.S. Cls.: 100, 101 and 102**

**United States Patent and Trademark Office**

**Reg. No. 3,465,414**

**Registered July 15, 2008**

**SERVICE MARK  
PRINCIPAL REGISTER**

SILVER SUMMIT PROPERTIES,  
LLC

SILVER SUMMIT PROPERTIES, LLC (GEORGIA  
LTD LIAB CO)  
SUITE 304  
11780 NORTHFALL LANE  
ALPHARETTA, GA 30004

FOR: REAL ESTATE SALES MANAGEMENT, IN  
CLASS 35 (U.S. CLS. 100, 101 AND 102).

FIRST USE 7-30-2004; IN COMMERCE 12-14-2004.

FOR: REAL ESTATE BROKERAGE, IN CLASS 36  
(U.S. CLS. 100, 101 AND 102).

FIRST USE 7-30-2004; IN COMMERCE 3-15-2005.

THE MARK CONSISTS OF STANDARD CHAR-  
ACTERS WITHOUT CLAIM TO ANY PARTICULAR  
FONT, STYLE, SIZE, OR COLOR.

OWNER OF U.S. REG. NO. 3,298,797.

NO CLAIM IS MADE TO THE EXCLUSIVE  
RIGHT TO USE "PROPERTIES, LLC", APART FROM  
THE MARK AS SHOWN.

SER. NO. 77-167,764, FILED 4-27-2007.

JENNIFER VASQUEZ, EXAMINING ATTORNEY

**Int. Cls.: 35 and 41**

**Prior U.S. Cls.: 100, 101, 102 and 107**

**United States Patent and Trademark Office**

**Reg. No. 3,465,415**

**Registered July 15, 2008**

**SERVICE MARK  
PRINCIPAL REGISTER**

**VCN**

BREAKDOWN SERVICES, LTD. (CALIFORNIA CORPORATION)  
2140 COTNER AVENUE, THIRD FLOOR  
LOS ANGELES, CA 90025

FOR: PROVIDING A JOB PLACEMENT WEBSITE WHERE VIDEO AUDITIONS, CREATED BY ENTERTAINMENT INDUSTRY RELATED COMPANIES, AND PHOTOGRAPHS AND RESUMES OF ACTORS APPEARING IN THE VIDEO AUDITIONS, ARE MADE AVAILABLE FOR VIEWING BY AGENTS, DIRECTORS, PRODUCERS AND ADVERTISING AGENCIES, IN CLASS 35 (U.S. CLS. 100, 101 AND 102).

FIRST USE 9-20-2007; IN COMMERCE 9-20-2007.

FOR: ENTERTAINMENT SERVICES, NAMELY, PROVIDING A WEB SITE FEATURING VARIOUS TELEVISION PROGRAMS IN THE FIELD OF COMEDY AND DRAMA WHERE ORIGINAL VIDEO CONTENT IS BROADCAST VIA THE INTERNET, IN CLASS 41 (U.S. CLS. 100, 101 AND 107).

FIRST USE 9-20-2007; IN COMMERCE 9-20-2007.

THE MARK CONSISTS OF STANDARD CHARACTERS WITHOUT CLAIM TO ANY PARTICULAR FONT, STYLE, SIZE, OR COLOR.

SER. NO. 77-167,787, FILED 4-27-2007.

COLLEEN DOMBROW, EXAMINING ATTORNEY

Int. Cl.: 30

Prior U.S. Cl.: 46

United States Patent and Trademark Office

Reg. No. 3,465,416

Registered July 15, 2008

TRADEMARK  
PRINCIPAL REGISTER



SUSTAINABLE SOURCING, LLC (MASSACHUSETTS LTD LIAB CO)  
15 CASTLE HILL AVENUE  
GREAT BARRINGTON, MA 01230

FOR: SALT, IN CLASS 30 (U.S. CL. 46).

FIRST USE 1-1-2006; IN COMMERCE 5-1-2006.

NO CLAIM IS MADE TO THE EXCLUSIVE RIGHT TO USE "SUSTAINABLE", APART FROM THE MARK AS SHOWN.

THE COLOR(S) GREEN AND YELLOW IS/ARE CLAIMED AS A FEATURE OF THE MARK.

THE MARK CONSISTS OF THE WORD "SUSTAINABLE" ABOVE THE WORD "SOURCING" WITH ABSTRACT DESIGNS INSIDE OF A SQUARE. THE COLOR GREEN APPEARS IN THE WORDING "SOURCING" AND THE BACKGROUND OF THE SQUARE. THE COLOR YELLOW APPEARS IN THE WORDING "SUSTAINABLE", THE ABSTRACT DESIGNS AND THE BORDER OF THE SQUARE.

THE WORDING "SUSTAINABLE SOURCING" AND NON-LATIN CHARACTERS HAS NO MEANING IN A FOREIGN LANGUAGE.

SER. NO. 77-167,946, FILED 4-27-2007.

TINA BROWN, EXAMINING ATTORNEY

Int. Cls.: 12 and 28

Prior U.S. Cls.: 19, 21, 22, 23, 31, 35, 38, 44 and 50

United States Patent and Trademark Office

Reg. No. 3,465,417

Registered July 15, 2008

TRADEMARK  
PRINCIPAL REGISTER



COURREGES DESIGN (FRANCE JOINT STOCK COMPANY)

40 RUE FRANCOIS 1ER  
PARIS, FRANCE 75008

FOR: LAND VEHICLES, NAMELY, ELECTRIC CARS, IN CLASS 12 (U.S. CLS. 19, 21, 23, 31, 35 AND 44).

FOR: TOY VEHICLES, IN CLASS 28 (U.S. CLS. 22, 23, 38 AND 50).

OWNER OF FRANCE REG. NO. 023185457, DATED 9-23-2002, EXPIRES 9-23-2012.

THE COLOR(S) BLACK AND BLUE IS/ARE CLAIMED AS A FEATURE OF THE MARK.

THE MARK CONSISTS OF THE LETTERS "AC" IN STYLIZED LETTERING AND ABOVE THE LETTERS "AC" IS THE WORD "COURREGES" IN STYLIZED LETTERING AND WRITTEN VERTICALLY, "AC COURREGES" ARE IN BLACK; ON THE RIGHT HAND SIDE THERE APPEARS THE LETTER "R" IN STYLIZED FORM, ABOVE THE LETTER "R" IS A CIRCLE AND ON THE LOWER LEFT HAND SIDE OF THE LETTER ARE IS THE WORD "BULLE" IN STYLIZED FORM. THE WORD "BULLE", THE LETTER "R" AND THE CIRCLE ABOVE IT ARE IN BLUE.

THE ENGLISH TRANSLATION OF THE WORD "BULLE" IS BUBBLE.

SER. NO. 77-168,132, FILED 4-27-2007.

DAVID I, EXAMINING ATTORNEY



**Int. Cl.: 30**

**Prior U.S. Cl.: 46**

**United States Patent and Trademark Office**

**Reg. No. 3,465,418**

**Registered July 15, 2008**

**TRADEMARK  
PRINCIPAL REGISTER**

**GRANNY'S FAMOUS BBQ**

AUNT SALLY'S KITCHEN INC. (NEW YORK  
CORPORATION)

71 BLACK WALNUT DRIVE

ROCHESTER, NY 14615

FOR: BARBECUE SAUCE, IN CLASS 30 (U.S. CL.  
46).

FIRST USE 4-5-2007; IN COMMERCE 4-24-2007.

THE MARK CONSISTS OF STANDARD CHAR-  
ACTERS WITHOUT CLAIM TO ANY PARTICULAR  
FONT, STYLE, SIZE, OR COLOR.

NO CLAIM IS MADE TO THE EXCLUSIVE  
RIGHT TO USE "FAMOUS BBQ", APART FROM  
THE MARK AS SHOWN.

SER. NO. 77-168,189, FILED 4-27-2007.

ANGELA M. MICHELI, EXAMINING ATTORNEY

**Int. Cls.: 35, 36 and 41**

**Prior U.S. Cls.: 100, 101, 102 and 107**

**United States Patent and Trademark Office**

**Reg. No. 3,465,419**

**Registered July 15, 2008**

**SERVICE MARK  
PRINCIPAL REGISTER**

**THOUGHTFUL CHOICES**

MINERVINO, RICHARD SR. (UNITED STATES INDIVIDUAL)  
1 BARNES PARK SOUTH  
WALLINGFORD, CT 06492

FOR: PROVIDING INFORMATION ONLINE IN THE FIELD OF TAXES, NAMELY, TAX INFORMATION SERVICES; ADMINISTRATION OF A PROGRAM FOR ENABLING PARTICIPANTS TO OBTAIN DISCOUNTS ON GOODS AND RECEIVE IMPROVED SERVICES; MEMBERSHIP CLUB SERVICES PROVIDING DISCOUNTS AND PROCESSING REBATES FOR THE SERVICES OF OTHERS, IN CLASS 35 (U.S. CLS. 100, 101 AND 102).

FIRST USE 10-23-2006; IN COMMERCE 10-23-2006.

FOR: FUND INVESTMENT CONSULTATION; INVESTMENT ADVICE; INVESTMENT BROKERAGE; INVESTMENT CLUBS; PROVIDING INFORMATION ONLINE IN THE FIELD OF INVESTMENT ADVICE, INSURANCE MATTERS, AND FINANCIAL PLANNING FOR RETIREMENT; INVESTMENT CONSULTATION; FINANCIAL

CONSULTATION IN THE FIELD OF RETIREMENT, SAVING FOR RETIREMENT, INSURANCE AND INVESTING, IN CLASS 36 (U.S. CLS. 100, 101 AND 102).

FIRST USE 10-23-2006; IN COMMERCE 10-23-2006.

FOR: EDUCATIONAL SERVICES, NAMELY PROVIDING ONLINE AND LIVE WORKSHOPS, SEMINARS AND LECTURES IN THE FIELDS OF RETIREMENT, FINANCIAL SERVICES AND INVESTING, IN CLASS 41 (U.S. CLS. 100, 101 AND 107).

FIRST USE 10-23-2006; IN COMMERCE 10-23-2006.

THE MARK CONSISTS OF STANDARD CHARACTERS WITHOUT CLAIM TO ANY PARTICULAR FONT, STYLE, SIZE, OR COLOR.

SER. NO. 77-169,028, FILED 4-30-2007.

JOHN DWYER, EXAMINING ATTORNEY

**Int. Cl.: 41**

**Prior U.S. Cls.: 100, 101 and 107**

**United States Patent and Trademark Office**

**Reg. No. 3,465,420**

**Registered July 15, 2008**

**SERVICE MARK  
PRINCIPAL REGISTER**

**FLYFF**

AEONSOFT, INC. (REPUBLIC OF KOREA COR-  
PORATION)  
SEOKHO BLDG 3RD FLOOR  
YEOKSAM-DONG  
GANGNAM-GU, SEOUL, REPUBLIC OF KOREA  
135-080

FOR: ENTERTAINMENT SERVICES, NAMELY,  
PROVIDING ON-LINE COMPUTER GAMES AND  
INTERACTIVE GAMES, IN CLASS 41 (U.S. CLS. 100,  
101 AND 107).

FIRST USE 11-11-2005; IN COMMERCE 12-22-2005.

THE MARK CONSISTS OF STANDARD CHAR-  
ACTERS WITHOUT CLAIM TO ANY PARTICULAR  
FONT, STYLE, SIZE, OR COLOR.

SER. NO. 77-169,224, FILED 4-30-2007.

TASHIA BUNCH, EXAMINING ATTORNEY

Int. Cl.: 30

Prior U.S. Cl.: 46

United States Patent and Trademark Office

Reg. No. 3,465,421

Registered July 15, 2008

TRADEMARK  
PRINCIPAL REGISTER



SNOWBERRY USA, INC. (CALIFORNIA CORPORATION)  
SUITE 1904  
3550 WILSHIRE BOULEVARD  
LOS ANGELES, CA 90010

THE MARK CONSISTS OF A STYLIZED HAPPY FACE WITH SCATTERED HAIR WITH WORD "SNOWBERRY" UNDERNEATH.

FOR: FROZEN YOGURT, IN CLASS 30 (U.S. CL. 46).

SER. NO. 77-169,394, FILED 4-30-2007.

FIRST USE 7-25-2006; IN COMMERCE 7-25-2006.

FRED MANDIR, EXAMINING ATTORNEY

**Int. Cl.: 37**

**Prior U.S. Cls.: 100, 103 and 106**

**United States Patent and Trademark Office**

**Reg. No. 3,465,422**

**Registered July 15, 2008**

**SERVICE MARK  
PRINCIPAL REGISTER**

**SETTING THE PACE**

SOUTHLAND CONCRETE CORPORATION (VIRGINIA CORPORATION)  
44330 MERCURE CIRCLE, SUITE 100  
DULLES, VA 20166

FOR: BUILDING CONSTRUCTION AND RENOVATION AND REPAIR; RESIDENTIAL AND COMMERCIAL BUILDING CONSTRUCTION AND RENOVATION AND REPAIR; CONSTRUCTION MANAGEMENT; CONSTRUCTION SUPERVISION, IN CLASS 37 (U.S. CLS. 100, 103 AND 106).

FIRST USE 3-15-2000; IN COMMERCE 3-15-2000.

THE MARK CONSISTS OF STANDARD CHARACTERS WITHOUT CLAIM TO ANY PARTICULAR FONT, STYLE, SIZE, OR COLOR.

SER. NO. 77-169,697, FILED 5-1-2007.

REBECCA POVARCHUK, EXAMINING ATTORNEY

**Int. Cl.: 36**

**Prior U.S. Cls.: 100, 101 and 102**

**United States Patent and Trademark Office**

**Reg. No. 3,465,423**

**Registered July 15, 2008**

**SERVICE MARK  
PRINCIPAL REGISTER**

**HUBPRO**

HUB INTERNATIONAL CANADA WEST CO.  
(CANADA CORPORATION)  
SUITE 900  
1959 UPPER WATER STREET  
HALIFAX, NOVA SCOTIA, CANADA B3J 3N2

FOR: INSURANCE SERVICES, NAMELY, INSURANCE BROKERAGE SERVICES, INSURANCE CONSULTING SERVICES, INSURANCE RISK MANAGEMENT SERVICES, IN CLASS 36 (U.S. CLS. 100, 101 AND 102).

FIRST USE 5-6-2007; IN COMMERCE 5-6-2007.

THE MARK CONSISTS OF STANDARD CHARACTERS WITHOUT CLAIM TO ANY PARTICULAR FONT, STYLE, SIZE, OR COLOR.

OWNER OF U.S. REG. NOS. 2,900,083, 3,270,884, AND 3,270,885.

SER. NO. 77-170,066, FILED 5-1-2007.

DANNEAN HETZEL, EXAMINING ATTORNEY

Int. Cls.: 35 and 36

Prior U.S. Cls.: 100, 101 and 102

United States Patent and Trademark Office

Reg. No. 3,465,424

Registered July 15, 2008

SERVICE MARK  
PRINCIPAL REGISTER



TONY LARUSSA'S ANIMAL RESCUE FOUNDATION (CALIFORNIA NON-PROFIT CORPORATION)  
P. O. BOX 30215  
WALNUT CREEK, CA 94598

FOR: PROMOTING PUBLIC AWARENESS OF THE NEED FOR ANIMAL THERAPY, NAMELY, HUMAN-ANIMAL RELATIONSHIPS FOR SENIOR CITIZENS, HOSPITAL PATIENTS, CHILDREN AND YOUTH, IN CLASS 35 (U.S. CLS. 100, 101 AND 102).

FIRST USE 5-1-2007; IN COMMERCE 5-1-2007.

FOR: CHARITABLE FUNDRAISING SERVICES, NAMELY, PROVIDING GRANTS AND DONATIONS TO ORGANIZATIONS FOR USE IN THE FIELD OF PROMOTING AND PROVIDING ANIMAL THERAPY, NAMELY, HUMAN-ANIMAL RE-

LATIONSHIPS FOR SENIOR CITIZENS, HOSPITAL PATIENTS, CHILDREN AND YOUTH, IN CLASS 36 (U.S. CLS. 100, 101 AND 102).

FIRST USE 5-1-2007; IN COMMERCE 5-1-2007.

NO CLAIM IS MADE TO THE EXCLUSIVE RIGHT TO USE "FUND", APART FROM THE MARK AS SHOWN.

THE MARK CONSISTS OF A DOG, A GIRL AND A CAT WITH THE WORDS "PET HUG FUND SOOTHING MINDS. OPENING HEARTS".

SER. NO. 77-170,499, FILED 5-1-2007.

GINA HAYES, EXAMINING ATTORNEY

**Int. Cl.: 9**

**Prior U.S. Cls.: 21, 23, 26, 36 and 38**

**United States Patent and Trademark Office**

**Reg. No. 3,465,425**

**Registered July 15, 2008**

**TRADEMARK  
PRINCIPAL REGISTER**

**STAR 1000**

VALOR COMPUTERIZED SYSTEMS, LTD (IS-  
RAEL CORPORATION)  
42 KACHLIT STREET  
YAVNE, ISRAEL 81511

FOR: COMPUTER SOFTWARE FOR COMPUTER  
SOFTWARE USED FOR DATA MANAGEMENT  
SYSTEMS FOR PRINTED CIRCUIT BOARDS THAT  
ARCHIVES MANUFACTURING DATA ON OPTI-  
CAL DISK JUKEBOX AND DIGITAL AUDIO TAPE  
FOR DISTRIBUTION AND GRAPHICAL VIEWING  
THROUGHOUT A COMPANY, IN CLASS 9 (U.S.  
CLS. 21, 23, 26, 36 AND 38).

FIRST USE 6-1-1993; IN COMMERCE 6-1-1993.

THE MARK CONSISTS OF STANDARD CHAR-  
ACTERS WITHOUT CLAIM TO ANY PARTICULAR  
FONT, STYLE, SIZE, OR COLOR.

SER. NO. 77-170,517, FILED 5-1-2007.

GINA HAYES, EXAMINING ATTORNEY



Int. Cl.: 42

Prior U.S. Cls.: 100 and 101

United States Patent and Trademark Office

Reg. No. 3,465,426

Registered July 15, 2008

SERVICE MARK  
PRINCIPAL REGISTER



REALCE, CATHERINE LORENZO (CALIFORNIA  
SOLE PROPRIETORSHIP)  
PO BOX 3415  
LONG BEACH, CA 90803

FOR: GRAPHIC DESIGN SERVICES, IN CLASS 42  
(U.S. CLS. 100 AND 101).

FIRST USE 2-7-2007; IN COMMERCE 2-7-2007.

THE COLOR(S) BROWN, MAGENTA, WHITE  
AND ORANGE IS/ARE CLAIMED AS A FEATURE  
OF THE MARK.

THE MARK CONSISTS OF THE NAME "VISUAL-  
CHEMIST" IN THE COLOR BROWN, A MAGENTA  
TAGLINE OF "EXPERIMENTS. SOLUTIONS. REAC-  
TIONS." AND A MAGENTA COLORED CHEMIS-  
TRY FLASK SITTING ON TOP OF A BROWN AND  
WHITE CIRCULAR RUG, THE DESIGN OF 3 GRA-  
PHIC FLOWERS WITH 5 ORANGE PETALS,  
BROWN STEMS AND MAGENTA CENTERS ARE  
INSIDE THE FLASK.

SER. NO. 77-170,562, FILED 5-2-2007.

DOMINIC FATHY, EXAMINING ATTORNEY

**Int. Cl.: 41**

**Prior U.S. Cls.: 100, 101 and 107**

**United States Patent and Trademark Office**

**Reg. No. 3,465,427**

**Registered July 15, 2008**

**SERVICE MARK  
PRINCIPAL REGISTER**

# HDCandy

MAXDEF LLC (CALIFORNIA LTD LIAB CO)  
524 SAN ANSELMO AVE SUITE 212  
SAN ANSELMO, CA 94960

FOR: PRODUCTION OF HIGH DEFINITION VIDEO AND CREATION OF HIGH DEFINITION VISUAL EFFECTS FOR OTHERS FOR USE IN DVDS, TELEVISION PROGRAMS AND ON WEBSITES; PRODUCTION OF HIGH DEFINITION VISUAL EFFECTS FOR VIDEOS, DVDS, TELEVISION AND FOR INTERNET WEBSITES; ENTERTAINMENT SERVICES, NAMELY, PROVIDING A WEB SITE FEATURING MUSICAL PERFORMANCES, MUSICAL VIDEOS, RELATED FILM CLIPS, PHOTOGRAPHS, AND OTHER MULTIMEDIA MATERIALS, SOME OF WHICH ARE IN HIGH DEFINITION;

MULTIMEDIA ENTERTAINMENT SERVICES IN THE NATURE OF HIGH DEFINITION RECORDING, PRODUCTION AND POST-PRODUCTION SERVICES IN THE FIELDS OF MUSIC, VIDEO, AND FILMS, IN CLASS 41 (U.S. CLS. 100, 101 AND 107).

FIRST USE 3-1-2007; IN COMMERCE 4-1-2007.

THE MARK CONSISTS OF STANDARD CHARACTERS WITHOUT CLAIM TO ANY PARTICULAR FONT, STYLE, SIZE, OR COLOR.

SER. NO. 77-170,637, FILED 5-2-2007.

PAUL E. FAHRENKOPF, EXAMINING ATTORNEY

**Int. Cl.: 9**

**Prior U.S. Cls.: 21, 23, 26, 36 and 38**

**Reg. No. 3,465,428**

**United States Patent and Trademark Office**

**Registered July 15, 2008**

---

**TRADEMARK  
PRINCIPAL REGISTER**

**TORION**

TORION TECHNOLOGIES, INC. (UTAH CORPORATION)  
2400 NORTH 180 WEST  
PLEASANT GROVE, UT 84062

THE MARK CONSISTS OF STANDARD CHARACTERS WITHOUT CLAIM TO ANY PARTICULAR FONT, STYLE, SIZE, OR COLOR.

FOR: CHEMICAL ANALYSIS EQUIPMENT, NAMELY, MASS SPECTROMETERS, IN CLASS 9 (U.S. CLS. 21, 23, 26, 36 AND 38).

SER. NO. 77-170,776, FILED 5-2-2007.

FIRST USE 2-28-2007; IN COMMERCE 2-28-2007.

YONG KIM, EXAMINING ATTORNEY

**Int. Cl.: 25**

**Prior U.S. Cls.: 22 and 39**

**United States Patent and Trademark Office**

**Reg. No. 3,465,429**

**Registered July 15, 2008**

**TRADEMARK  
PRINCIPAL REGISTER**



PILOTI, INC. (CALIFORNIA CORPORATION)  
1863 FALLVIEW ROAD  
WESTLAKE VILLAGE, CA 91361

FOR: DRIVING SHOES, WALKING SHOES;  
CLOTHING, NAMELY, T-SHIRTS, SHIRTS, PANTS,  
JACKETS, SWEATERS, SOCKS, HATS AND CAPS,  
IN CLASS 25 (U.S. CLS. 22 AND 39).

FIRST USE 3-1-1999; IN COMMERCE 3-18-1999.

THE MARK CONSISTS OF THE LETTER P IN  
STYLIZED FORM.

SER. NO. 77-171,332, FILED 5-2-2007.

YAT SYE, LEE, EXAMINING ATTORNEY

Int. Cl.: 30

Prior U.S. Cl.: 46

United States Patent and Trademark Office

Reg. No. 3,465,430

Registered July 15, 2008

TRADEMARK  
PRINCIPAL REGISTER



TRISTAR FOOD WHOLESALE CO., INC. (NEW JERSEY CORPORATION)  
115 AMITY STREET  
JERSEY CITY, NJ 07304

FOR: MOON CAKES, IN CLASS 30 (U.S. CL. 46).

FIRST USE 8-22-2006; IN COMMERCE 8-22-2006.

NO CLAIM IS MADE TO THE EXCLUSIVE RIGHT TO USE "TIỆM BÁNH" AND THE TRANSLITERATED NON-LATIN CHARACTERS OF "BINH GIA" AND "VIETNAM", APART FROM THE MARK AS SHOWN.

THE ENGLISH TRANSLATION OF THE WORD "TIỆM BÁNH ÔNG KHÁNH" IN THE MARK IS "ENJOY TOGETHER BAKERY STORE."

THE NON-LATIN CHARACTERS IN THE CIRCLE TRANSLITERATES INTO "BINH GIA DONG KHANH VIETNAM", AND THIS MEANS "MOON CAKE STORE, ENJOY TOGETHER, VIETNAM" IN ENGLISH. THE NON-LATIN CHARACTERS IN THE VERTICAL COLUMN TRANSLITERATE TO "LUONG THIN MY CANH ÔNG KHÁNH BINH GIA" AND THIS MEANS "LUCKY DAY, BEAUTIFUL VIEW, MOON CAKE STORE". THE NON-LATIN CHARACTERS IN THE POEM TRANSLITERATES TO "MING YUE JI SHI YOU, BA JIAO WAN QING TIAN, BU ZHI TIAN SHENG GONG QUE, JIN JI SHI HE NIEN, WO YU CHENG FENG GUI QU, WEI KUNG CHUNG LOU YU YU, GAO QU BU XING HAN, CHI WU LONG QING YING, HE XI JAI REN JIAN, JUEN ZHU GE, DI YI HU, JIAO WU

MIAN, BU YING YOU HEN, HE SHI CHENG XIANG BIE SHI YUAN, REN YOU BEI HUAN LI HE, YUE YOU YIN QING YUAN QUE, CHI SHI GU NAN QUAN, DAN YUAN RAN CHENG JIAO, QIN LI GONG CHAN JUEN, SONG - SU, DONG PO (SHUI DIAO GE TOU)" AND THIS TRANSLATES TO "BRIGHT MOON, WHEN WILL YOU APPEAR, LIFTING MY WINE, I QUESTION THE DARK-BLUE SKY, DON'T KNOW IN THE CELESTIAL PALACES AND HALLS, TONIGHT IS WHAT YEAR, I'D LIKE TO RIDE THE WIND THERE, BUT I'M AFRAID THE POSH BUILDINGS AND JADE MANSIONS, IN HIGH PLACES ARE TOO COLD TO BEAR, SO I RISE AND DANCE AND PLAY WITH THE SHADOWS, HOW CAN THAT COMPARE WITH OUR HUMAN WORLD, (YOU) GO AROUND THE RED CHAMBERS, GO BELOW THE CURTAINED DOORWAY, SHINE ON THE SLEEPLESS, SURELY YOU BEAR US NO ILL WILL, WHY THEN MUST YOU BE SO ROUND WHEN WE HUMANS PART, PEOPLE HAVE THEIR SORROWS, JOYS, SEPARATIONS AND GET TOGETHERS, THE MOON CAN BE FOUND SHADED OR CLEAR, WAXED OR WANED, THIS HAD NEVER BEEN PERFECT SINCE ANCIENT TIMES, I ONLY HOPE THAT WE WILL LAST LONG, AND SHARE THE MOON'S BEAUTY EVEN IF WE ARE A THOUSAND MILES APART, SONG - SU, DONGPO (WATER TONE SONG BEGINNING)" IN ENGLISH.

SER. NO. 77-172,079, FILED 5-3-2007.

WILLIAM VERHOSEK, EXAMINING ATTORNEY

**Int. Cls.: 35 and 36**

**Prior U.S. Cls.: 100, 101 and 102**

**United States Patent and Trademark Office**

**Reg. No. 3,465,431**

**Registered July 15, 2008**

**SERVICE MARK  
PRINCIPAL REGISTER**



SEED CORP. (INDIANA CORPORATION)  
SUITE 106  
501 N. MORTON ST.  
BLOOMINGTON, IN 47404

FOR: RENTAL OF OFFICE MACHINERY AND  
EQUIPMENT, NAMELY, COPYING MACHINES, IN  
CLASS 35 (U.S. CLS. 100, 101 AND 102).

FIRST USE 6-15-2004; IN COMMERCE 6-15-2004.

FOR: SERVICES IN THE FIELD OF BUSINESS  
INCUBATION, NAMELY, RENTAL OF OFFICE

SPACE, CONFERENCE ROOMS AND TRAINING  
ROOMS, AND RENTAL OF SHARED DATA CEN-  
TER FACILITIES, NAMELY, CLIMATE-CONTROL-  
LED COMPUTERIZED SERVER STORAGE ROOMS,  
FOR START-UP BUSINESSES, IN CLASS 36 (U.S.  
CLS. 100, 101 AND 102).

FIRST USE 6-15-2004; IN COMMERCE 6-15-2004.

SER. NO. 77-172,301, FILED 5-3-2007.

JAMES LOVELACE, EXAMINING ATTORNEY

**Int. Cl.: 9**

**Prior U.S. Cls.: 21, 23, 26, 36 and 38**

**Reg. No. 3,465,432**

**United States Patent and Trademark Office**

**Registered July 15, 2008**

---

**TRADEMARK  
PRINCIPAL REGISTER**

**TOR**

THE TOR PROJECT, INC. (MASSACHUSETTS  
NON-PROFIT CORPORATION)  
56 WATERHOUSE ST., SUITE #1  
SOMERVILLE, MA 02144

THE MARK CONSISTS OF STANDARD CHAR-  
ACTERS WITHOUT CLAIM TO ANY PARTICULAR  
FONT, STYLE, SIZE, OR COLOR.

FOR: COMPUTER SOFTWARE FOR ANON-  
YMOUS TRANSMISSION AND DELIVERY OF IN-  
FORMATION AND DATA OVER THE INTERNET,  
IN CLASS 9 (U.S. CLS. 21, 23, 26, 36 AND 38).

SER. NO. 77-172,360, FILED 5-3-2007.

FIRST USE 10-8-2003; IN COMMERCE 10-8-2003.

MARCIE MILONE, EXAMINING ATTORNEY

**Int. Cl.: 9**

**Prior U.S. Cls.: 21, 23, 26, 36 and 38**

**Reg. No. 3,465,433**

**United States Patent and Trademark Office**

**Registered July 15, 2008**

**TRADEMARK  
PRINCIPAL REGISTER**

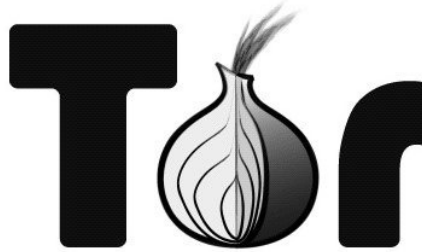

THE TOR PROJECT, INC. (MASSACHUSETTS  
NON-PROFIT CORPORATION)  
56 WATERHOUSE ST., SUITE #1  
SOMERVILLE, MA 02144

THE MARK CONSISTS OF THE LETTERS "T"  
AND "R" WITH A DESIGN OF AN ONION IN-  
BETWEEN THE TWO LETTERS REPRESENTING  
THE LETTER "O".

FOR: COMPUTER SOFTWARE FOR ANON-  
YMOUS TRANSMISSION AND DELIVERY OF IN-  
FORMATION AND DATA OVER THE INTERNET,  
IN CLASS 9 (U.S. CLS. 21, 23, 26, 36 AND 38).

SER. NO. 77-172,363, FILED 5-3-2007.

FIRST USE 10-8-2003; IN COMMERCE 10-8-2003.

MARCIE MILONE, EXAMINING ATTORNEY



**Int. Cls.: 35 and 45**

**Prior U.S. Cls.: 100, 101 and 102**

**United States Patent and Trademark Office**

**Reg. No. 3,465,434**

**Registered July 15, 2008**

**SERVICE MARK  
PRINCIPAL REGISTER**

**YOUR GEORGIA LAW FIRM**

KAINE & JONES, LLC (GEORGIA LTD LIAB CO)  
SUITE 850  
3355 LENOX ROAD  
ATLANTA, GA 30326

FOR: BUSINESS CONSULTING SERVICES, NAMELY, ASSISTING LEGAL PROFESSIONALS IN ORGANIZING AND SETTING UP THEIR PRACTICES FOR OFFERING DIVORCE PLANNING AND FACILITATION AND LEGAL DOCUMENT SERVICES TO THEIR CLIENTS, IN CLASS 35 (U.S. CLS. 100, 101 AND 102).

FIRST USE 5-3-2007; IN COMMERCE 5-3-2007.

FOR: LEGAL DOCUMENT PREPARATION AND RESEARCH SERVICES FOR ATTORNEYS; LEGAL SERVICES, IN CLASS 45 (U.S. CLS. 100 AND 101).

FIRST USE 5-3-2007; IN COMMERCE 5-3-2007.

THE MARK CONSISTS OF STANDARD CHARACTERS WITHOUT CLAIM TO ANY PARTICULAR FONT, STYLE, SIZE, OR COLOR.

NO CLAIM IS MADE TO THE EXCLUSIVE RIGHT TO USE "GEORGIA LAW FIRM" , APART FROM THE MARK AS SHOWN.

SER. NO. 77-172,689, FILED 5-4-2007.

ROBIN CHOSID, EXAMINING ATTORNEY

**Int. Cl.: 33**

**Prior U.S. Cls.: 47 and 49**

**United States Patent and Trademark Office**

**Reg. No. 3,465,435**

**Registered July 15, 2008**

**TRADEMARK  
PRINCIPAL REGISTER**

**TASTE A DIFFERENT SHADE OF  
BLACK**

DIAGEO BRANDS B.V. (NETHERLANDS PRIVATE LIMITED COMPANY)  
MOLENWERF 10-12  
AMSTERDAM 1014 BG, NETHERLANDS

THE MARK CONSISTS OF STANDARD CHARACTERS WITHOUT CLAIM TO ANY PARTICULAR FONT, STYLE, SIZE, OR COLOR.

FOR: ALCOHOLIC BEVERAGES, NAMELY, DISTILLED SPIRITS, IN CLASS 33 (U.S. CLS. 47 AND 49).

SER. NO. 77-172,692, FILED 5-4-2007.

FIRST USE 10-31-2005; IN COMMERCE 10-31-2005.

NAKIA HENRY, EXAMINING ATTORNEY

Int. Cl.: 35

Prior U.S. Cls.: 100, 101 and 102

United States Patent and Trademark Office

Reg. No. 3,465,436

Registered July 15, 2008

**SERVICE MARK  
PRINCIPAL REGISTER**



TIRES FIRST, INC. (GEORGIA CORPORATION)  
5454 MILLER ROAD  
COLUMBUS, GA 31909

FOR: RETAIL TIRE STORES, IN CLASS 35 (U.S. CLS. 100, 101 AND 102).

FIRST USE 11-4-2002; IN COMMERCE 11-4-2002.

NO CLAIM IS MADE TO THE EXCLUSIVE RIGHT TO USE "TIRES" AND "MILLER ROAD", APART FROM THE MARK AS SHOWN.

THE COLOR(S) YELLOW, RED, BLACK AND WHITE IS/ARE CLAIMED AS A FEATURE OF THE MARK.

THE MARK CONSISTS OF AN IMAGE OF A BLACK TIRE WITH THE WORD "TIRES" IN YELLOW ALONG AND OVERLAPPING THE TOP LEFT PORTION, THE WORDS "OF MILLER ROAD" IN WHITE OVERLAYING THE BOTTOM RIDE PORTION OF THE TIRE AND THE WORD "1ST" IN YELLOW AND OUTLINED IN RED ARISING THROUGH THE MIDDLE OF THE TIRE AND OVERLAYING PORTIONS OF THE TIRE. THE TIRE ALSO HAS A CONCENTRIC BLACK CIRCLE IN THE MIDDLE.

SER. NO. 77-172,770, FILED 5-4-2007.

SARA THOMAS, EXAMINING ATTORNEY

Int. Cl.: 35

Prior U.S. Cls.: 100, 101 and 102

United States Patent and Trademark Office

Reg. No. 3,465,437

Registered July 15, 2008

SERVICE MARK  
PRINCIPAL REGISTER

parts city

O'REILLY AUTOMOTIVE, INC. (MISSOURI  
CORPORATION)  
233 S. PATTERSON  
SPRINGFIELD, MO 65802

FOR: RETAIL OUTLETS FEATURING AUTOMO-  
TIVE PARTS, IN CLASS 35 (U.S. CLS. 100, 101 AND  
102).

FIRST USE 10-0-1973; IN COMMERCE 10-0-1973.

THE MARK CONSISTS OF STANDARD CHAR-  
ACTERS WITHOUT CLAIM TO ANY PARTICULAR  
FONT, STYLE, SIZE, OR COLOR.

NO CLAIM IS MADE TO THE EXCLUSIVE  
RIGHT TO USE "PARTS", APART FROM THE  
MARK AS SHOWN.

SER. NO. 77-172,910, FILED 5-4-2007.

WENDY GOODMAN, EXAMINING ATTORNEY

**Int. Cl.: 5**

**Prior U.S. Cls.: 6, 18, 44, 46, 51 and 52**

**United States Patent and Trademark Office**

**Reg. No. 3,465,438**

**Registered July 15, 2008**

**TRADEMARK  
PRINCIPAL REGISTER**

**SCOUT BLUE CHEMISTRY**

SCOUT SYSTEMS, LLC (DELAWARE LTD LIAB  
CO)  
P.O. BOX 3483  
DURANGO, CO 813023483

FOR: CARPET DEODORIZERS; CARPET FRESH-  
ENERS AND ODOR ELIMINATORS; ODOR NEU-  
TRALIZING PREPARATIONS FOR USE ON  
CARPETS; CHEMICAL PREPARATIONS FOR SA-  
NITARY PURPOSES; ALL PURPOSE DISINFECT-  
ING AND DEODORIZING PREPARATIONS;  
DEODORIZING PRODUCTS, NAMELY, ALL PUR-  
POSE DEODORIZER PREPARATIONS FOR HOUSE-

HOLD, COMMERCIAL AND INDUSTRIAL USE, IN  
CLASS 5 (U.S. CLS. 6, 18, 44, 46, 51 AND 52).

FIRST USE 2-17-2004; IN COMMERCE 12-4-2004.

THE MARK CONSISTS OF STANDARD CHAR-  
ACTERS WITHOUT CLAIM TO ANY PARTICULAR  
FONT, STYLE, SIZE, OR COLOR.

SER. NO. 77-173,033, FILED 5-4-2007.

DEZMONA MIZELLE, EXAMINING ATTORNEY

**Int. Cls.: 5 and 30**

**Prior U.S. Cls.: 6, 18, 44, 46, 51 and 52**

**United States Patent and Trademark Office**

**Reg. No. 3,465,439**

**Registered July 15, 2008**

**TRADEMARK  
PRINCIPAL REGISTER**

**SEMPER**

SEMPER AB (SWEDEN CORPORATION)  
BOX 1101  
SUNDBYBERG, SWEDEN 17222

FOR: BABY FOOD; PROTEIN REDUCED AND GLUTEN FREE FOOD FOR MEDICAL PURPOSES; DIETETIC FOODS ADAPTED FOR MEDICAL USE, IN CLASS 5 (U.S. CLS. 6, 18, 44, 46, 51 AND 52).

FOR: PROTEIN REDUCED AND GLUTEN FREE FLOUR AND BREAD; BREAD; PASTRIES; ALMOND PASTE; CHOCOLATE SYRUP; CHOCOLATE PASTES; CHOCOLATE TOPPING; CHEESE SAUCE; CHOCOLATE-BASED FILLINGS FOR CAKES AND PIES; CUSTARD-BASED FILLINGS FOR CAKES AND PIES; FLOUR; BREAKFAST CEREALS; CEREAL BASED SNACK FOOD; PROCESSED CEREALS;

READY TO EAT, CEREAL DERIVED FOOD BARS, IN CLASS 30 (U.S. CL. 46).

THE MARK CONSISTS OF STANDARD CHARACTERS WITHOUT CLAIM TO ANY PARTICULAR FONT, STYLE, SIZE, OR COLOR.

OWNER OF ERPN CMNTY TM OFC REG. NO. 136499, DATED 5-1-1999, EXPIRES 4-1-2016.

OWNER OF U.S. REG. NOS. 1,045,531, 2,056,690, AND 2,675,990.

SER. NO. 77-173,215, FILED 5-4-2007.

COLLEEN KEARNEY, EXAMINING ATTORNEY

Int. Cl.: 16

Prior U.S. Cls.: 2, 5, 22, 23, 29, 37, 38 and 50

United States Patent and Trademark Office

Reg. No. 3,465,440

Registered July 15, 2008

TRADEMARK  
PRINCIPAL REGISTER



PACON CORPORATION (WISCONSIN CORPORATION)  
2525 NORTH CASALOMA DRIVE  
APPELTON, WI 54913

FOR: PAPER GOODS, NAMELY, PAPER FOR BULLETIN BOARD BACKGROUNDS, MURALS, BANNER PAPER, AND DISPLAY PAPER, IN CLASS 16 (U.S. CLS. 2, 5, 22, 23, 29, 37, 38 AND 50).

FIRST USE 6-19-2002; IN COMMERCE 6-19-2002.

OWNER OF U.S. REG. NO. 2,849,839.

THE MARK CONSISTS OF A CIRCLE OF FLAMES WITH A MULTI-LINEAR DESIGN BISECTING THE "FLAMES" WHERE THE FLAMES APPEAR UNDERNEATH THE "LESS" PORTION OF THE WORD "FLAMELESS."

SEC. 2(F) AS TO "FLAMELESS".

SER. NO. 77-173,251, FILED 5-4-2007.

AISHA SALEM, EXAMINING ATTORNEY

**Int. Cl.: 41**

**Prior U.S. Cls.: 100, 101 and 107**

**United States Patent and Trademark Office**

**Reg. No. 3,465,441**

**Registered July 15, 2008**

**SERVICE MARK  
PRINCIPAL REGISTER**



**Petit Appetit**

BARNES, LISA L. (UNITED STATES INDIVIDUAL), DBA PETIT APPETIT  
75 MARIN AVE.  
SAUSALITO, CA 94965

FOR: EDUCATION SERVICES, NAMELY, PROVIDING CLASSES IN THE FIELD OF CHILDREN'S FOOD, COOKING AND NUTRITION AND DISTRIBUTION OF COURSE MATERIAL IN CONNECTION THEREWITH, IN CLASS 41 (U.S. CLS. 100, 101 AND 107).

FIRST USE 8-1-2001; IN COMMERCE 1-1-2002.

THE ENGLISH TRANSLATION OF FOREIGN WORDING "PETIT APPETIT" IN THE MARK IS SMALL APPETITE.

SER. NO. 77-173,420, FILED 5-4-2007.

AISHA SALEM, EXAMINING ATTORNEY



**Int. Cl.: 36**

**Prior U.S. Cls.: 100, 101 and 102**

**United States Patent and Trademark Office**

**Reg. No. 3,465,442**

**Registered July 15, 2008**

**SERVICE MARK  
PRINCIPAL REGISTER**

**EZ OR FREE GUARANTEE**

INVESTATE HOLDINGS CO. (INDIANA CORPORATION)

#200

6302 ILLINOIS ROAD  
FORT WAYNE, IN 46804

FOR: REAL ESTATE ACQUISITION SERVICES; REAL ESTATE PROCUREMENT FOR OTHERS; INVESTMENT SERVICES, NAMELY, ASSET ACQUISITION, CONSULTATION, DEVELOPMENT AND MANAGEMENT SERVICES; LOAN FINANCING; REAL ESTATE VALUATION SERVICES; PROVIDING INFORMATION IN THE FIELD OF REAL ESTATE VIA THE INTERNET; REAL ESTATE

BROKERAGE, IN CLASS 36 (U.S. CLS. 100, 101 AND 102).

FIRST USE 12-23-2003; IN COMMERCE 12-23-2003.

THE MARK CONSISTS OF STANDARD CHARACTERS WITHOUT CLAIM TO ANY PARTICULAR FONT, STYLE, SIZE, OR COLOR.

SER. NO. 77-173,450, FILED 5-4-2007.

DAVID TOOLEY, EXAMINING ATTORNEY

**Int. Cl.: 35**

**Prior U.S. Cls.: 100, 101 and 102**

**United States Patent and Trademark Office**

**Reg. No. 3,465,443**

**Registered July 15, 2008**

**SERVICE MARK  
PRINCIPAL REGISTER**



DEALER BASICS, LLC (TEXAS LTD LIAB CO)  
SUITE 900  
3625 N. HALL STREET  
DALLAS, TX 75219

FOR: PROVIDING BUSINESS CONSULTING SERVICES FOR AUTO DEALERSHIPS RELATING TO DATA ANALYSIS; AND BUSINESS DATA ACQUISITION SERVICES WHICH COLLECT AND ARRANGE AUTOMOTIVE INFORMATION, IN CLASS 35 (U.S. CLS. 100, 101 AND 102).

FIRST USE 2-1-2007; IN COMMERCE 2-1-2007.

THE COLOR(S) RED, WHITE, AND ORANGE IS/ ARE CLAIMED AS A FEATURE OF THE MARK.

THE MARK CONSISTS OF BULLS-EYE WITH A SUPERIMPOSED ARROW. THE ARROW IS IN WHITE, AND THE CONCENTRIC CIRCLES FROM THE INSIDE TO THE OUTSIDE ARE IN RED, WHITE, ORANGE, WHITE, AND RED.

SER. NO. 77-173,464, FILED 5-4-2007.

EDWARD NELSON, EXAMINING ATTORNEY

**Int. Cls.: 35, 41, 43 and 45**

**Prior U.S. Cls.: 100, 101, 102 and 107**

**United States Patent and Trademark Office**

**Reg. No. 3,465,444**

**Registered July 15, 2008**

**SERVICE MARK  
PRINCIPAL REGISTER**

**GABRIEL PROJECT**

ARCHDIOCESE OF GALVESTON-HOUSTON  
(TEXAS SECTION 501(C)(3) RELIGIOUS ORGANIZATION)  
ATTN: JOHN A. SIEGER, GENERAL COUNSEL  
1700 SAN JACINTO STREET  
HOUSTON, TX 77002

FOR: PARISH BASED PASTORAL CARE, NAME-  
LY, REFERRALS IN THE FIELD OF MEDICAL  
CARE, ADOPTION, AND FOSTER CARE FOR WO-  
MEN IN DIFFICULT OR CRISIS PREGNANCY  
CIRCUMSTANCES, IN CLASS 35 (U.S. CLS. 100, 101  
AND 102).

FIRST USE 12-31-1993; IN COMMERCE 12-31-1995.

FOR: PARISH BASED PASTORAL CARE, NAME-  
LY, EDUCATION IN THE FIELD OF PRE-NATAL  
CARE, CHILD CARE, AND NATURAL FAMILY  
PLANNING FOR WOMEN IN DIFFICULT OR CRI-  
SIS PREGNANCY CIRCUMSTANCES PROVIDED  
VIA ONE ON ONE MENTORING, IN CLASS 41 (U.S.  
CLS. 100, 101 AND 107).

FIRST USE 12-31-1993; IN COMMERCE 12-31-1995.

FOR: PARISH BASED PASTORAL CARE, NAME-  
LY, SUPPORT FOR WOMEN IN DIFFICULT OR  
CRISIS PREGNANCY CIRCUMSTANCES, NAME-  
LY, PROVIDING FOOD AND TEMPORARY HOUS-  
ING, IN CLASS 43 (U.S. CLS. 100 AND 101).

FIRST USE 12-31-1993; IN COMMERCE 12-31-1995.

FOR: PARISH BASED PASTORAL CARE, NAME-  
LY, SUPPORT FOR WOMEN IN DIFFICULT OR  
CRISIS PREGNANCY CIRCUMSTANCES, NAME-  
LY, PROVIDING CLOTHING, IN CLASS 45 (U.S.  
CLS. 100 AND 101).

FIRST USE 12-31-1993; IN COMMERCE 12-31-1995.

THE MARK CONSISTS OF STANDARD CHAR-  
ACTERS WITHOUT CLAIM TO ANY PARTICULAR  
FONT, STYLE, SIZE, OR COLOR.

SER. NO. 77-173,572, FILED 5-4-2007.

EUGENIA MARTIN, EXAMINING ATTORNEY

**Int. Cl.: 25**

**Prior U.S. Cls.: 22 and 39**

**United States Patent and Trademark Office**

**Reg. No. 3,465,445**

**Registered July 15, 2008**

**TRADEMARK  
PRINCIPAL REGISTER**

**MAMACOAT**

JAPANESE WEEKEND MATERNITY, INC. (CALIFORNIA CORPORATION)  
222 DORE STREET  
SAN FRANCISCO, CA 94103

THE MARK CONSISTS OF STANDARD CHARACTERS WITHOUT CLAIM TO ANY PARTICULAR FONT, STYLE, SIZE, OR COLOR.

FOR: CLOTHING, NAMELY CONVERTIBLE JACKETS AND COATS, IN CLASS 25 (U.S. CLS. 22 AND 39).

SER. NO. 77-173,605, FILED 5-4-2007.

FIRST USE 1-1-1996; IN COMMERCE 1-1-1996.

LESLEY LAMOTHE, EXAMINING ATTORNEY

**Int. Cl.: 41**

**Prior U.S. Cls.: 100, 101 and 107**

**United States Patent and Trademark Office**

**Reg. No. 3,465,446**

**Registered July 15, 2008**

**SERVICE MARK  
PRINCIPAL REGISTER**

# Change Lab

BG MULCONREY, INC. (TEXAS CORPORATION)  
6315 BIG CAT COVE  
AUSTIN, TX 78750

FOR: ENTERTAINMENT SERVICES IN THE NATURE OF AN ON-GOING REALITY BASED TELEVISION PROGRAM; ENTERTAINMENT SERVICES, NAMELY, PROVIDING A RADIO PROGRAM IN THE FIELD OF CHANGE CONSULTING VIA A GLOBAL COMPUTER NETWORK, IN CLASS 41 (U.S. CLS. 100, 101 AND 107).

FIRST USE 5-5-2007; IN COMMERCE 5-5-2007.

THE MARK CONSISTS OF STANDARD CHARACTERS WITHOUT CLAIM TO ANY PARTICULAR FONT, STYLE, SIZE, OR COLOR.

NO CLAIM IS MADE TO THE EXCLUSIVE RIGHT TO USE "CHANGE", APART FROM THE MARK AS SHOWN.

SER. NO. 77-173,746, FILED 5-5-2007.

KARANENDRA S. CHHINA, EXAMINING ATTORNEY

Int. Cl.: 25

Prior U.S. Cls.: 22 and 39

United States Patent and Trademark Office

Reg. No. 3,465,447

Registered July 15, 2008

TRADEMARK  
PRINCIPAL REGISTER



VÉLEZ GONZÁLEZ, FEDERICO (COLOMBIA INDIVIDUAL)  
CALLE 41 # 73-18  
MEDELLÍN, COLOMBIA

FOR: ATHLETIC UNIFORMS; BANDANAS; BASEBALL CAPS; BERMUDA SHORTS; BICYCLE GLOVES; BIKINIS; CAPRI PANTS; CAP VISORS; CAPS; CLOTHING, NAMELY, ARM WARMERS; CULOTTES; CYCLISTS' JERSEYS; VESTS; FLEECE PULLOVERS; GLOVES; GOLF CAPS; GYM SHORTS; GYM SUITS; JACKETS; JERSEYS; JOGGING PANTS; JOGGING SUITS; KNICKERS; KNIT SHIRTS; KNITTED CAPS; LEG WARMERS; LONG JACKETS; MEN AND WOMEN JACKETS, COATS, TROUSERS, VESTS; PULLOVERS; RAIN JACKETS; SHORT-SLEEVED OR LONG-SLEEVED T-SHIRTS; SHORTS; SOCKS; SPORTS JACKETS; SPORTS JERSEYS; SUSPENDERS; SWEAT BANDS; SWEATERS; SWIM WEAR; SWIMMING CAPS; SWIMSUITS; TIGHTS; TOPS; T-SHIRTS; TRAINING SUITS; UNDER GARMENTS; UNDERCLOTHES; UNIFORMS; WATERPROOF JACKETS AND PANTS; WIND RESISTANT JACKETS; WIND-JACKETS; WIND VESTS, IN CLASS 25 (U.S. CLS. 22 AND 39).

FIRST USE 6-18-2004; IN COMMERCE 10-31-2005.

THE COLOR(S) GREEN, YELLOW, BLUE, PINK, BLACK, RED, WHITE, GRAY, AND ORANGE IS/ ARE CLAIMED AS A FEATURE OF THE MARK.

THE MARK CONSISTS OF A STANDING NUN WITH A SAD LOOK ON HER FACE, WEARING TENNIS SHOES AND CARRYING A SUITCASE IN HER LEFT HAND AND A PARTIALLY FILLED FOOTBALL IN HER RIGHT HAND. THE COLORS GREEN AND YELLOW APPEAR IN THE SUITCASE. THE COLOR BLUE APPEARS JUST AROUND THE YELLOW STRIPE ON THE SUITCASE, ON THE EYE GLASSES HANGING FROM THE NUN'S NECK, AND ON THE NUN'S WARDROBE. THE COLOR PINK APPEARS ON THE NUN'S SOCKS. THE COLOR RED APPEARS ON THE NUN'S TENNIS SHOES, ON THE SUITCASE, ON THE EYE GLASSES SHE IS WEARING, AS A RED DOT ON HER DRESS, AND ON THE STICKER ATTACHED TO THE SUITCASE. THE COLOR WHITE APPEARS ON THE FOOTBALL, SOCKS, TENNIS SHOES, AND ON THE NUN'S WARDROBE. THE COLOR GREY APPEARS ON THE FOOTBALL. THE COLOR BLACK APPEARS ON THE NUN'S WARDROBE AND IN THE FOOTBALL. THE COLOR ORANGE APPEARS ON THE NUN'S FACE, CALVES AND HANDS.

SER. NO. 77-173,840, FILED 5-6-2007.

JIM RINGLE, EXAMINING ATTORNEY

Int. Cl.: 42

Prior U.S. Cls.: 100 and 101

United States Patent and Trademark Office

Reg. No. 3,465,448

Registered July 15, 2008

SERVICE MARK  
PRINCIPAL REGISTER



DIGITAL BURRO, INC. (CALIFORNIA CORPORATION)  
4354 HEREFORD WAY  
ANDERSON, CA 96007

FOR: APPLICATION SERVICE PROVIDER (ASP) FEATURING SOFTWARE FOR USE IN MANAGING DIGITAL VIDEO, AUDIO, IMAGE AND TEXT CONTENT; COMPUTER SERVICE, NAMELY, ACTING AS AN APPLICATION SERVICE PROVIDER IN THE FIELD OF KNOWLEDGE MANAGEMENT TO HOST COMPUTER APPLICATION SOFTWARE FOR CREATING SEARCHABLE DATABASES OF INFORMATION AND DATA; COMPUTER SERVICE, NAMELY, ACTING AS AN APPLICATION SERVICE PROVIDER IN THE FIELD OF KNOWLEDGE MANAGEMENT TO HOST COMPUTER APPLICATION SOFTWARE FOR SEARCHING AND RETRIEVING INFORMATION FROM DATABASES AND COMPUTER NETWORKS; COMPUTER SER-

VICE, NAMELY, ACTING AS AN APPLICATION SERVICE PROVIDER IN THE FIELD OF KNOWLEDGE MANAGEMENT TO HOST COMPUTER APPLICATION SOFTWARE FOR THE COLLECTION, EDITING, ORGANIZING, MODIFYING, BOOK MARKING, TRANSMISSION, STORAGE AND SHARING OF DATA AND INFORMATION, IN CLASS 42 (U.S. CLS. 100 AND 101).

FIRST USE 1-19-2007; IN COMMERCE 1-19-2007.

NO CLAIM IS MADE TO THE EXCLUSIVE RIGHT TO USE ".COM", APART FROM THE MARK AS SHOWN.

SER. NO. 77-173,913, FILED 5-6-2007.

JASON BLAIR, EXAMINING ATTORNEY

**Int. Cl.: 41**

**Prior U.S. Cls.: 100, 101 and 107**

**United States Patent and Trademark Office**

**Reg. No. 3,465,449**

**Registered July 15, 2008**

**SERVICE MARK  
PRINCIPAL REGISTER**

IEEE MENTORING CONNECTION

THE INSTITUTE OF ELECTRICAL AND ELECTRONICS ENGINEERS, INC. (NEW YORK CORPORATION)

445 HOES LANE  
PISCATAWAY, NJ 08855

FOR: EDUCATION SERVICES, NAMELY, MENTORING IN THE FIELD OF CAREER PLANNING AND PROFESSIONAL DEVELOPMENT, IN CLASS 41 (U.S. CLS. 100, 101 AND 107).

FIRST USE 7-13-2006; IN COMMERCE 7-13-2006.

THE MARK CONSISTS OF STANDARD CHARACTERS WITHOUT CLAIM TO ANY PARTICULAR FONT, STYLE, SIZE, OR COLOR.

OWNER OF U.S. REG. NOS. 1,770,511 AND 2,862,848.

NO CLAIM IS MADE TO THE EXCLUSIVE RIGHT TO USE "MENTORING", APART FROM THE MARK AS SHOWN.

SER. NO. 77-174,119, FILED 5-7-2007.

GISELLE AGOSTO, EXAMINING ATTORNEY



**Int. Cl.: 5**

**Prior U.S. Cls.: 6, 18, 44, 46, 51 and 52**

**United States Patent and Trademark Office**

**Reg. No. 3,465,450**

**Registered July 15, 2008**

**TRADEMARK  
PRINCIPAL REGISTER**

**REJUVA**

1-800-HEALTHY.COM, INC. (DELAWARE CORPORATION)  
834 WILSON DRIVE, SUITE B  
RIDGELAND, MS 39157

THE MARK CONSISTS OF STANDARD CHARACTERS WITHOUT CLAIM TO ANY PARTICULAR FONT, STYLE, SIZE, OR COLOR.

FOR: DIETARY SUPPLEMENTS, IN CLASS 5 (U.S. CLS. 6, 18, 44, 46, 51 AND 52).

SER. NO. 77-174,134, FILED 5-7-2007.

FIRST USE 6-0-2005; IN COMMERCE 6-0-2005.

ELLEN B. AWRICH, EXAMINING ATTORNEY

Int. Cls.: 35, 41 and 44

Prior U.S. Cls.: 100, 101, 102 and 107

United States Patent and Trademark Office

Reg. No. 3,465,451

Registered July 15, 2008

**SERVICE MARK  
PRINCIPAL REGISTER**



NOVARTIS AG (SWITZERLAND CORPORATION)  
CH-4002  
BASEL, SWITZERLAND

FOR: BUSINESS AND CONSUMER PRODUCT CONSULTATION SERVICES IN THE FIELDS OF EYE CARE, CONTACT LENSES, AND LENS CARE, IN CLASS 35 (U.S. CLS. 100, 101 AND 102).

FIRST USE 7-1-2007; IN COMMERCE 7-1-2007.

FOR: EDUCATIONAL SERVICES, NAMELY, PROVIDING CLASSES, SEMINARS, WORKSHOPS, PROGRAMS, CONFERENCES, AND COURSES IN THE FIELDS OF EYE CARE, CONTACT LENSES, AND LENS CARE, AND DISTRIBUTION OF COURSE MATERIAL IN CONNECTION THEREWITH, IN CLASS 41 (U.S. CLS. 100, 101 AND 107).

FIRST USE 7-1-2007; IN COMMERCE 7-1-2007.

FOR: PROVIDING MEDICAL INFORMATION IN THE FIELDS OF EYE CARE, CONTACT LENSES, AND LENS CARE, IN CLASS 44 (U.S. CLS. 100 AND 101).

FIRST USE 7-1-2007; IN COMMERCE 7-1-2007.

OWNER OF U.S. REG. NO. 1,611,014.

NO CLAIM IS MADE TO THE EXCLUSIVE RIGHT TO USE "VISION" AND "PARTNERS", APART FROM THE MARK AS SHOWN.

THE MARK CONSISTS OF THE WORDS "CIBA VISION VISIONARY PARTNERS YOUR PATIENTS. YOUR PRACTICE. OUR PASSION" AND A SERIES OF CIRCLES.

SER. NO. 77-174,577, FILED 5-7-2007.

KAELIE KUNG, EXAMINING ATTORNEY

**Int. Cls.: 35, 41 and 44**

**Prior U.S. Cls.: 100, 101, 102 and 107**

**United States Patent and Trademark Office**

**Reg. No. 3,465,452**

**Registered July 15, 2008**

**SERVICE MARK  
PRINCIPAL REGISTER**

**CIBA VISION VISIONARY  
PARTNERS YOUR PATIENTS.  
YOUR PRACTICE. OUR PASSION.**

NOVARTIS AG (SWITZERLAND CORPORATION)  
CH-4002  
BASEL, SWITZERLAND

FOR: BUSINESS AND CONSUMER PRODUCT CONSULTATION SERVICES IN THE FIELDS OF EYE CARE, CONTACT LENSES, AND LENS CARE, IN CLASS 35 (U.S. CLS. 100, 101 AND 102).

FIRST USE 7-1-2007; IN COMMERCE 7-1-2007.

FOR: EDUCATIONAL SERVICES, NAMELY, PROVIDING CLASSES, SEMINARS, WORKSHOPS, PROGRAMS, CONFERENCES, AND COURSES IN THE FIELDS OF EYE CARE, CONTACT LENSES, AND LENS CARE, AND DISTRIBUTION OF COURSE MATERIAL IN CONNECTION THEREWITH, IN CLASS 41 (U.S. CLS. 100, 101 AND 107).

FIRST USE 7-1-2007; IN COMMERCE 7-1-2007.

FOR: PROVIDING MEDICAL INFORMATION IN THE FIELDS OF EYE CARE, CONTACT LENSES, AND LENS CARE, IN CLASS 44 (U.S. CLS. 100 AND 101).

FIRST USE 7-1-2007; IN COMMERCE 7-1-2007.

THE MARK CONSISTS OF STANDARD CHARACTERS WITHOUT CLAIM TO ANY PARTICULAR FONT, STYLE, SIZE, OR COLOR.

OWNER OF U.S. REG. NO. 1,611,014.

NO CLAIM IS MADE TO THE EXCLUSIVE RIGHT TO USE "VISION" AND "PARTNERS", APART FROM THE MARK AS SHOWN.

SER. NO. 77-174,627, FILED 5-7-2007.

KAELIE KUNG, EXAMINING ATTORNEY

**Int. Cl.: 41**

**Prior U.S. Cls.: 100, 101 and 107**

**United States Patent and Trademark Office**

**Reg. No. 3,465,453**

**Registered July 15, 2008**

**SERVICE MARK  
PRINCIPAL REGISTER**

**CAMP BOCA**

PANTHERS BRHC, LLC (DELAWARE LTD LIAB  
CO)

345 PARK AVENUE

NEW YORK, NY 10154

FOR: DAY CAMP SERVICES NAMELY, ACTIV-  
ITIES IN THE NATURE OF BEACH TRIPS, NATURE  
WALKS, SWIMMING TRIPS, PICNICS AND RE-  
CREATIONAL CAMP SERVICES FOR HOTEL  
AND RESORT GUESTS , IN CLASS 41 (U.S. CLS.  
100, 101 AND 107).

FIRST USE 1-1-1993; IN COMMERCE 1-1-1999.

THE MARK CONSISTS OF STANDARD CHAR-  
ACTERS WITHOUT CLAIM TO ANY PARTICULAR  
FONT, STYLE, SIZE, OR COLOR.

OWNER OF U.S. REG. NO. 2,358,805.

NO CLAIM IS MADE TO THE EXCLUSIVE  
RIGHT TO USE "CAMP", APART FROM THE  
MARK AS SHOWN.

SEC. 2(F).

SER. NO. 77-174,629, FILED 5-7-2007.

CAROLINE WOOD, EXAMINING ATTORNEY

**Int. Cl.: 41**

**Prior U.S. Cls.: 100, 101 and 107**

**United States Patent and Trademark Office**

**Reg. No. 3,465,454**

**Registered July 15, 2008**

**SERVICE MARK  
PRINCIPAL REGISTER**

**HORSEGIRLTV**

HORSEGIRLTV LLC (OREGON LTD LIAB CO)  
C234  
2305 ASHLAND STREET  
ASHLAND, OR 97520

FOR: ENTERTAINMENT SERVICES, NAMELY,  
PROVIDING AN ON-LINE WEB LOG FEATURING  
INTERVIEWS, PRODUCT REVIEWS, NEWS AND  
INFORMATION AND COMMENTARY RELATING  
TO EQUESTRIAN EVENTS AND SPORTING  
EVENTS RELATING TO HORSES AND PROVIDING  
INFORMATION ON ISSUES RELATING TO THE  
CARE, OWNERSHIP AND HANDLING OF HORSES

VIA A GLOBAL COMPUTER NETWORK, IN CLASS  
41 (U.S. CLS. 100, 101 AND 107).

FIRST USE 4-20-2007; IN COMMERCE 4-20-2007.

THE MARK CONSISTS OF STANDARD CHAR-  
ACTERS WITHOUT CLAIM TO ANY PARTICULAR  
FONT, STYLE, SIZE, OR COLOR.

SER. NO. 77-174,909, FILED 5-7-2007.

EDWARD NELSON, EXAMINING ATTORNEY

**Int. Cl.: 41**

**Prior U.S. Cls.: 100, 101 and 107**

**United States Patent and Trademark Office**

**Reg. No. 3,465,455**

**Registered July 15, 2008**

**SERVICE MARK  
PRINCIPAL REGISTER**

**TUNE IN.TACK UP.**

HORSEGIRLTV LLC (OREGON LTD LIAB CO)  
C234  
2305 ASHLAND STREET  
ASHLAND, OR 97520

FOR: ENTERTAINMENT SERVICES, NAMELY,  
PROVIDING AN ON-LINE WEB LOG FEATURING  
INTERVIEWS, PRODUCT REVIEWS, NEWS AND  
INFORMATION AND COMMENTARY RELATING  
TO EQUESTRIAN EVENTS AND SPORTING  
EVENTS RELATING TO HORSES AND PROVIDING  
INFORMATION ON ISSUES RELATING TO THE  
CARE, OWNERSHIP AND HANDLING OF HORSES

VIA A GLOBAL COMPUTER NETWORK, IN CLASS  
41 (U.S. CLS. 100, 101 AND 107).

FIRST USE 4-20-2007; IN COMMERCE 4-20-2007.

THE MARK CONSISTS OF STANDARD CHAR-  
ACTERS WITHOUT CLAIM TO ANY PARTICULAR  
FONT, STYLE, SIZE, OR COLOR.

SER. NO. 77-174,918, FILED 5-7-2007.

EDWARD NELSON, EXAMINING ATTORNEY

**Int. Cl.: 41**

**Prior U.S. Cls.: 100, 101 and 107**

**United States Patent and Trademark Office**

**Reg. No. 3,465,456**

**Registered July 15, 2008**

**SERVICE MARK  
PRINCIPAL REGISTER**

**FLY FOR FUN**

AEONSOFT, INC. (REPUBLIC OF KOREA COR-  
PORATION)  
SEOKHO BLDG 3RD FLOOR  
YEOKSAM-DONG  
GANGNAM-GU, SEOUL, REPUBLIC OF KOREA  
135-080

FOR: ENTERTAINMENT SERVICES, NAMELY,  
PROVIDING ON-LINE COMPUTER GAMES AND  
INTERACTIVE GAMES, IN CLASS 41 (U.S. CLS. 100,  
101 AND 107).

FIRST USE 11-11-2005; IN COMMERCE 12-22-2005.

THE MARK CONSISTS OF STANDARD CHAR-  
ACTERS WITHOUT CLAIM TO ANY PARTICULAR  
FONT, STYLE, SIZE, OR COLOR.

SER. NO. 77-174,969, FILED 5-7-2007.

TASHIA BUNCH, EXAMINING ATTORNEY

**Int. Cl.: 35**

**Prior U.S. Cls.: 100, 101 and 102**

**United States Patent and Trademark Office**

**Reg. No. 3,465,457**

**Registered July 15, 2008**

**SERVICE MARK  
PRINCIPAL REGISTER**



SYMX CORPORATION (FLORIDA CORPORATION)  
6320 NW 84TH AVENUE  
MIAMI, FL 33166

FOR: BUSINESS CONSULTING SERVICES, NAMELY, THE TRACKING, MANAGEMENT AND ALLOCATION OF EQUIPMENT, STAFF AND PEOPLE WITHIN A FACILITY, AND THE COORDINATION OF THE SELECTION, PURCHASE, INSTALLATION AND OPERATION OF EQUIP-

MENT WITHIN A MEDICAL FACILITY, IN CLASS 35 (U.S. CLS. 100, 101 AND 102).

FIRST USE 11-1-2006; IN COMMERCE 11-1-2006.

THE MARK CONSISTS OF STYLIZED "S" AND WORD MARK "SYMX".

SER. NO. 77-175,095, FILED 5-8-2007.

CHARLES L. JENKINS, EXAMINING ATTORNEY



**Int. Cls.: 9 and 42**

**Prior U.S. Cls.: 21, 23, 26, 36, 38, 100 and 101**

**United States Patent and Trademark Office**

**Reg. No. 3,465,458**

**Registered July 15, 2008**

**TRADEMARK  
SERVICE MARK  
PRINCIPAL REGISTER**

**ALWAYS ON, AVAILABLE,  
ACCESSIBLE**

TENEROS, INC. (DELAWARE CORPORATION)  
321 E. EVELYN AVENUE, 2ND FLOOR  
MOUNTAIN VIEW, CA 94041

FOR: COMPUTER SOFTWARE AND HARDWARE, NAMELY, NETWORK, SERVER AND DESK-TOP APPLIANCES AND APPLICATIONS WHICH MONITOR, MANAGE AND PROVIDE DATA BACK-UP, CONTINUITY, PROTECTION, RECOVERY AND SECURITY AND NOT UNINTERUP-TABLE POWER SUPPLIES, IN CLASS 9 (U.S. CLS. 21, 23, 26, 36 AND 38).

FIRST USE 6-30-2004; IN COMMERCE 6-30-2004.

FOR: COMPUTER SOFTWARE AND HARDWARE SERVICES, NAMELY, ACTING AS AN APPLICATION SERVICE PROVIDER PROVIDING DATA BACK-UP, CONTINUITY, PROTECTION, RECOVERY AND SECURITY, IN CLASS 42 (U.S. CLS. 100 AND 101).

FIRST USE 6-30-2004; IN COMMERCE 6-30-2004.

THE MARK CONSISTS OF STANDARD CHARACTERS WITHOUT CLAIM TO ANY PARTICULAR FONT, STYLE, SIZE, OR COLOR.

SER. NO. 77-175,193, FILED 5-8-2007.

BENJAMIN ALLEN, EXAMINING ATTORNEY

**Int. Cl.: 3**

**Prior U.S. Cls.: 1, 4, 6, 50, 51 and 52**

**United States Patent and Trademark Office**

**Reg. No. 3,465,459**

**Registered July 15, 2008**

**TRADEMARK  
PRINCIPAL REGISTER**

**HEALTHY MOUTH**

JASON NATURAL PRODUCTS, INC. (CALIFORNIA CORPORATION)  
3515 EASTHAM DRIVE  
CULVER CITY, CA 90232

FOR: TOOTHPASTE; TOOTH GEL; TOOTH POLISH; MOUTHWASH, IN CLASS 3 (U.S. CLS. 1, 4, 6, 50, 51 AND 52).

FIRST USE 1-0-2001; IN COMMERCE 1-0-2001.

THE MARK CONSISTS OF STANDARD CHARACTERS WITHOUT CLAIM TO ANY PARTICULAR FONT, STYLE, SIZE, OR COLOR.

OWNER OF U.S. REG. NO. 2,548,636.

SEC. 2(F).

SER. NO. 77-175,304, FILED 5-8-2007.

MICHAEL GAAFAR, EXAMINING ATTORNEY

**Int. Cl.: 41**

**Prior U.S. Cls.: 100, 101 and 107**

**United States Patent and Trademark Office**

**Reg. No. 3,465,460**

**Registered July 15, 2008**

---

**SERVICE MARK  
PRINCIPAL REGISTER**

# The Downey Profile

DOWNEY, JAMES RICHARD (UNITED STATES  
INDIVIDUAL)  
1320 EDGEWOOD AVENUE  
BOWLING GREEN, KY 42103

FOR: HANDICAPPING FOR SPORTING EVENTS,  
IN CLASS 41 (U.S. CLS. 100, 101 AND 107).

FIRST USE 2-4-2003; IN COMMERCE 2-4-2003.

THE MARK CONSISTS OF STANDARD CHAR-  
ACTERS WITHOUT CLAIM TO ANY PARTICULAR  
FONT, STYLE, SIZE, OR COLOR.

SEC. 2(F).

SER. NO. 77-175,341, FILED 5-8-2007.

ERIN FALK, EXAMINING ATTORNEY

**Int. Cls.: 9 and 42**

**Prior U.S. Cls.: 21, 23, 26, 36, 38, 100 and 101**

**Reg. No. 3,465,461**

**United States Patent and Trademark Office**

**Registered July 15, 2008**

**TRADEMARK  
SERVICE MARK  
PRINCIPAL REGISTER**

# CLINICALSENSE

INFORSENSE LIMITED (UNITED KINGDOM CORPORATION)  
COLET COURT, 100 HAMMERSMITH ROAD  
LONDON, UNITED KINGDOM W67JP

FOR: COMPUTER SOFTWARE, NAMELY, COMPUTER SOFTWARE FOR THE ANALYSIS, DATABASE MANAGEMENT, DIGITIZING, TRANSFORMATION, INTEGRATION, MINING, RETRIEVAL, WAREHOUSING, STORING, MANIPULATION, VISUALIZATION, AND FORMATTING OF DATA, NAMELY, TEXTUAL OR NUMERIC OR NUMERIC/TEXTUAL INFORMATION, OR INFORMATION PRESENTED IN TEXTUAL, NUMERIC OR GRAPHIC FORM, IN THE FIELDS OF MANUFACTURING, COMMUNICATIONS, PHARMACEUTICALS, HEALTHCARE, GOVERNMENT, FINANCE, AND BUSINESS; KNOWLEDGE MANAGEMENT SOFTWARE IN THE FIELDS OF MANUFACTURING, COMMUNICATIONS, PHARMACEUTICALS, HEALTHCARE, GOVERNMENT, FINANCE, AND BUSINESS; COMPUTER GRAPHICS SOFTWARE; COMPUTER SOFTWARE DOWNLOADED FROM THE INTERNET FOR THE ANALYSIS, DATABASE MANAGEMENT, DIGITIZING, TRANSFORMATION, MANIPULATION, INTEGRATION, MINING, RETRIEVAL, WAREHOUSING, STORING, VISUALIZATION, AND FORMATTING OF DATA, NAMELY, TEXTUAL OR NUMERIC OR NUMERIC/TEXTUAL INFORMATION, OR INFORMATION PRESENTED IN TEXTUAL, NUMERIC OR GRAPHIC FORM; COMPUTER SOFTWARE FOR ANALYZING AND PROCESSING IMAGES, GRAPHICS, AND TEXT IN CONNECTION WITH MARKET INFORMATION IN THE FIELDS OF MANUFACTURING, COMMUNICATIONS, PHARMACEUTICALS, HEALTHCARE, GOVERNMENT, FINANCE, AND BUSINESS; COMPUTER SOFTWARE FOR BUSINESS PURPOSES, NAMELY, THE ANALYSIS, DATABASE MANAGEMENT, DIGITIZING, TRANSFORMATION, INTE-

GRATION, MANIPULATION, MINING, RETRIEVAL, WAREHOUSING, STORING, VISUALIZATION AND FORMATTING OF DATA RELATED TO MARKETING, HUMAN RESOURCES, RESEARCH, AND SALES, IN THE FIELDS OF MANUFACTURING, COMMUNICATIONS, PHARMACEUTICALS, HEALTHCARE, GOVERNMENT, FINANCE, AND BUSINESS; COMPUTER SOFTWARE FOR THE VISUALIZATION OF MARKET INFORMATION IN THE FIELDS OF MANUFACTURING, COMMUNICATIONS, PHARMACEUTICALS, HEALTHCARE, GOVERNMENT, FINANCE, AND BUSINESS; COMPUTER SOFTWARE FOR THE VISUALIZATION OF LIFE SCIENCE DATA; COMPUTER SOFTWARE FOR THE VISUALIZATION AND ANALYSIS OF SCIENTIFIC EXPLORATION DATA; DATA PROCESSING SOFTWARE, NAMELY, PROGRAMS FOR ANALYSIS, DATABASE MANAGEMENT, DIGITIZING, TRANSFORMATION, INTEGRATION, MINING, RETRIEVAL, WAREHOUSING, STORING, MANIPULATION, VISUALIZATION, AND FORMATTING OF DATA IN THE FIELDS OF MANUFACTURING, COMMUNICATIONS, PHARMACEUTICALS, HEALTHCARE, GOVERNMENT, FINANCE, AND BUSINESS; DATA PROCESSING WORKFLOW SOFTWARE, NAMELY, PROGRAMS FOR ANALYSIS, DATABASE MANAGEMENT, DIGITIZING, TRANSFORMATION, INTEGRATION, MINING, RETRIEVAL, WAREHOUSING, STORING, MANIPULATION, VISUALIZATION, AND FORMATTING OF DATA IN THE FIELDS OF MANUFACTURING, COMMUNICATIONS, PHARMACEUTICALS, HEALTHCARE, GOVERNMENT, FINANCE, AND BUSINESS; SOFTWARE FOR INTERNET-BASED SERVICES, NAMELY, PROGRAMS FOR ANALYSIS, DATABASE MANAGEMENT, DIGITIZING, TRANSFORMATION, INTEGRATION, MINING, RETRIEVAL, WAREHOUSING, STORING, MANIPULATION, VISUALIZATION, AND FORMATTING OF DATA IN THE FIELDS OF MANUFACTURING, COMMUNI-

CATIONS, PHARMACEUTICALS, HEALTHCARE, GOVERNMENT, FINANCE, AND BUSINESS; DATA VISUALIZATION SOFTWARE, NAMELY, PROGRAMS FOR ANALYSIS, DATABASE MANAGEMENT, DIGITIZING, TRANSFORMATION, INTEGRATION, MINING, RETRIEVAL, WAREHOUSING, STORING, MANIPULATION, VISUALIZATION, AND FORMATTING OF DATA IN THE FIELDS OF MANUFACTURING, COMMUNICATIONS, PHARMACEUTICALS, HEALTHCARE, GOVERNMENT, FINANCE, AND BUSINESS; COMPUTER SOFTWARE FOR THE ANALYSIS AND PROCESSING OF GENE EXPRESSION DATA, GENE SEQUENCE DATA RELATING TO OR DERIVING FROM THE LIFE SCIENCES AND RESEARCH IN RELATION TO LIFE SCIENCES AND DRUG DISCOVERY; COMPUTERIZED DOWNLOADABLE AND RECORDED DATABASES, NAMELY, DATABASES FEATURING BIOLOGICAL, CHEMICAL, LIFE SCIENCE, AND SCIENTIFIC EXPLORATION INFORMATION; COMPUTER HARDWARE AND FIRMWARE FOR ANALYSIS, DATABASE MANAGEMENT, DIGITIZING, TRANSFORMATION, INTEGRATION, MINING, RETRIEVAL, WAREHOUSING, STORING, MANIPULATION, VISUALIZATION, AND FORMATTING OF DATA IN THE FIELDS OF MANUFACTURING, COMMUNICATIONS, PHARMACEUTICALS, HEALTHCARE, GOVERNMENT, FINANCE, AND BUSINESS; BLANK RECORDING DISCS, IN CLASS 9 (U.S. CLS. 21, 23, 26, 36 AND 38).

FOR: SCIENTIFIC RESEARCH; SCIENTIFIC AND TECHNOLOGICAL DESIGN FOR OTHERS IN THE FIELDS OF MEDICINE, BIOLOGY, AND GENETICS; TECHNOLOGICAL RESEARCH THE FIELDS OF MEDICINE, BIOLOGY, AND GENETICS; IN-

DUSTRIAL ANALYSIS AND RESEARCH IN THE FIELDS OF MEDICINE, BIOLOGY, AND GENETICS; DESIGN AND DEVELOPMENT OF COMPUTER HARDWARE AND SOFTWARE; DEVELOPMENT OF COMPUTER HARDWARE AND SOFTWARE FOR USE IN RELATION TO COMMERCIAL OR SCIENTIFIC RESEARCH; COMPUTERIZED ANALYSIS OF DATA, NAMELY, DATA RELATED TO MEDICAL, CLINICAL, BIOLOGICAL, AND GENETIC INFORMATION; COMPUTERIZED MINING OF DATA; DEVELOPMENT OF COMPUTER PROGRAMS FOR THE VISUALIZATION OF DATA; SOFTWARE ENGINEERING; SOFTWARE DEVELOPMENT; SOFTWARE PROGRAMMING; PROFESSIONAL CONSULTANCY RELATING TO COMPUTER SOFTWARE; SCIENTIFIC DATA ANALYSIS, NAMELY, ANALYSIS OF MEDICAL, CLINICAL, BIOLOGICAL, AND GENETIC INFORMATION; COMPUTERIZED NON-DOWNLOADABLE DATABASES, NAMELY, DATABASES FEATURING BIOLOGICAL, CHEMICAL, LIFE SCIENCE, AND SCIENTIFIC EXPLORATION INFORMATION; CONSULTANCY AND INFORMATION SERVICES RELATING TO ALL THE ABOVE SERVICES, IN CLASS 42 (U.S. CLS. 100 AND 101).

THE MARK CONSISTS OF STANDARD CHARACTERS WITHOUT CLAIM TO ANY PARTICULAR FONT, STYLE, SIZE, OR COLOR.

PRIORITY CLAIMED UNDER SEC. 44(D) ON UNITED KINGDOM APPLICATION NO. 2454145, FILED 4-30-2007, REG. NO. 2454145, DATED 4-30-2007, EXPIRES 4-30-2017.

SER. NO. 77-175,411, FILED 5-8-2007.

SUSAN STIGLITZ, EXAMINING ATTORNEY

**Int. Cl.: 42**

**Prior U.S. Cls.: 100 and 101**

**United States Patent and Trademark Office**

**Reg. No. 3,465,462**

**Registered July 15, 2008**

**SERVICE MARK  
PRINCIPAL REGISTER**



SPRAYROQ, INC. (FLORIDA CORPORATION)  
4707 ALTON COURT  
BIRMINGHAM, AL 35210

THE COLOR(S) RED AND TAN IS/ARE CLAIMED  
AS A FEATURE OF THE MARK.

FOR: DESIGN OF PROTECTIVE LINING SYSTEMS IN THE NATURE OF RESINOUS COATINGS FOR PROTECTING AND WATERPROOFING MANHOLES, CABLE VAULTS, WET WELLS, PIPES AND TANKS, IN CLASS 42 (U.S. CLS. 100 AND 101).

THE MARK CONSISTS OF THE WORD "SPRAYROQ" IN RED, WITH TAN SPHERES OF VARYING HUE ARRANGED IN A CIRCLE AROUND THE LETTERS "RAY" IN "SPRAYROQ".

SER. NO. 77-175,431, FILED 5-8-2007.

FIRST USE 2-23-2005; IN COMMERCE 2-23-2005.

JAY FLOWERS, EXAMINING ATTORNEY

**Int. Cl.: 17**

**Prior U.S. Cls.: 1, 5, 12, 13, 35 and 50**

**United States Patent and Trademark Office**

**Reg. No. 3,465,463**

**Registered July 15, 2008**

**TRADEMARK  
PRINCIPAL REGISTER**

**ACTIV-POLYMER**

CSP TECHNOLOGIES, INC., A DE (DELAWARE  
CORPORATION)  
1030 RIVERFRONT CENTER  
P.O. BOX 710  
AMSTERDAM, NY 12010

FOR: PLASTIC FILMS, TAPES AND SHEETS FOR  
APPLICATIONS REQUIRING CONTROLLED EN-  
VIRONMENTS IN THE COMMERCIAL, INDUS-  
TRIAL AND PHARMACEUTICAL FIELDS , IN  
CLASS 17 (U.S. CLS. 1, 5, 12, 13, 35 AND 50).

FIRST USE 1-4-1999; IN COMMERCE 1-7-1999.

THE MARK CONSISTS OF STANDARD CHAR-  
ACTERS WITHOUT CLAIM TO ANY PARTICULAR  
FONT, STYLE, SIZE, OR COLOR.

SER. NO. 77-175,586, FILED 5-8-2007.

JAY FLOWERS, EXAMINING ATTORNEY

**Int. Cl.: 17**

**Prior U.S. Cls.: 1, 5, 12, 13, 35 and 50**

**United States Patent and Trademark Office**

**Reg. No. 3,465,464**

**Registered July 15, 2008**

**TRADEMARK  
PRINCIPAL REGISTER**

**SMARTPIPE**

TELSCO INDUSTRIES, INC. (TEXAS CORPORATION)  
3301 W. KINGSLEY ROAD  
GARLAND, TX 75041

FOR: FLEXIBLE IRRIGATION PLUMBING PIPES, NOT OF METAL, NAMELY, FLEXIBLE IRRIGATION PIPES AND FLEXIBLE IRRIGATION RISERS; FLEXIBLE PLASTIC PIPES FOR IRRIGATION PURPOSES; FLEXIBLE IRRIGATION PIPES OF PLASTIC, IN CLASS 17 (U.S. CLS. 1, 5, 12, 13, 35 AND 50).

FIRST USE 4-12-2007; IN COMMERCE 4-12-2007.

THE MARK CONSISTS OF STANDARD CHARACTERS WITHOUT CLAIM TO ANY PARTICULAR FONT, STYLE, SIZE, OR COLOR.

SER. NO. 77-175,847, FILED 5-8-2007.

LINDA ORNDORFF, EXAMINING ATTORNEY



**Int. Cl.: 9**

**Prior U.S. Cls.: 21, 23, 26, 36 and 38**

**United States Patent and Trademark Office**

**Reg. No. 3,465,465**

**Registered July 15, 2008**

**TRADEMARK  
PRINCIPAL REGISTER**



SWITCHVOX SYSTEMS, LLC (DELAWARE LTD  
LIAB CO)  
445 JAN DAVIS DRIVE  
HUNTSVILLE, AL 35806

THE MARK CONSISTS OF THE WORD "SWITCH-  
VOX" CONTAINING A SOLID "O" WITH ECHO  
LINES RADIATING DIAGONALLY FROM THE  
LETTER "O".

FOR: COMPUTER TELEPHONY SOFTWARE, IN  
CLASS 9 (U.S. CLS. 21, 23, 26, 36 AND 38).

SER. NO. 77-175,957, FILED 5-8-2007.

FIRST USE 2-1-2005; IN COMMERCE 2-1-2005.

JOHN GARTNER, EXAMINING ATTORNEY

**Int. Cls.: 16, 41, 44 and 45**

**Prior U.S. Cls.: 2, 5, 22, 23, 29, 37, 38, 50, 100, 101 and 107**

**Reg. No. 3,465,466**

**United States Patent and Trademark Office**

**Registered July 15, 2008**

**TRADEMARK  
SERVICE MARK  
PRINCIPAL REGISTER**

# SALUBRIS

ORCHARD VILLAGE (ILLINOIS CORPORATION)  
7670 MARMORA MANOR  
SKOKIE, IL 60077

FOR: RECIPES, CURRICULUM GUIDES IN THE FIELD OF NUTRITION, COOKING, LIFE STYLE, INTERPERSONAL AND SOCIAL SKILLS, DEVELOPMENTAL DISABILITIES, ASSISTED LIVING, AND CARE OF DISABLED INDIVIDUALS, INSTRUCTION SHEETS AND BOOKLETS IN THE FIELD OF NUTRITION, COOKING, LIFE STYLE, INTERPERSONAL AND SOCIAL SKILLS, DEVELOPMENTAL DISABILITIES, ASSISTED LIVING, AND CARE OF DISABLED INDIVIDUALS, IN CLASS 16 (U.S. CLS. 2, 5, 22, 23, 29, 37, 38 AND 50).

FIRST USE 1-1-2004; IN COMMERCE 8-1-2005.

FOR: CLASSES, SEMINARS, WORKSHOPS, AND TUTORIALS FOCUSED ON NUTRITION, COOKING, LIFE STYLE, INTERPERSONAL AND SOCIAL SKILLS, DEVELOPMENTAL DISABILITIES, ASSISTED LIVING, AND CARE OF DISABLED INDIVIDUALS, IN CLASS 41 (U.S. CLS. 100, 101 AND 107).

FIRST USE 1-1-2004; IN COMMERCE 8-1-2005.

FOR: PROVIDING INFORMATION VIA A COMPUTER NETWORK IN THE FIELD OF NUTRITION, LONG TERM ASSISTED CARE, DEVELOPMENTAL DISABILITIES, AND CARE OF DISABLED INDIVIDUALS, IN CLASS 44 (U.S. CLS. 100 AND 101).

FIRST USE 1-1-2006; IN COMMERCE 1-1-2006.

FOR: PROVIDING INFORMATION VIA A COMPUTER NETWORK IN THE FIELD OF LIFE STYLE, INTERPERSONAL AND SOCIAL SKILLS; PROVIDING INFORMATION IN THE FIELD OF PERSONAL CARE OF MENTALLY OR PHYSICALLY CHALLENGED PEOPLE TO PERFORM DAILY ACTIVITIES, SUCH AS BATHING, GROOMING, AND PERSONAL MOBILITY, IN CLASS 45 (U.S. CLS. 100 AND 101).

FIRST USE 1-1-2006; IN COMMERCE 1-1-2006.

THE MARK CONSISTS OF STANDARD CHARACTERS WITHOUT CLAIM TO ANY PARTICULAR FONT, STYLE, SIZE, OR COLOR.

SER. NO. 77-175,982, FILED 5-8-2007.

ELLEN PERKINS, EXAMINING ATTORNEY

**Int. Cl.: 35**

**Prior U.S. Cls.: 100, 101 and 102**

**United States Patent and Trademark Office**

**Reg. No. 3,465,467**

**Registered July 15, 2008**

**SERVICE MARK  
PRINCIPAL REGISTER**

WHERE PERSONAL SERVICE IS  
STILL THE BEST MEDICINE

RAL AND ASSOCIATES LLC (MARYLAND LTD  
LIAB CO)  
4 BALLYBUNION COURT  
TIMONIUM, MD 21093

FOR: PROCURING OF CONTRACTS FOR THE  
PURCHASE AND SALE OF GOODS, NAMELY,  
BODY IMPLANT PROSTHESES, IN CLASS 35 (U.S.  
CLS. 100, 101 AND 102).

FIRST USE 6-12-1989; IN COMMERCE 6-12-1989.

THE MARK CONSISTS OF STANDARD CHAR-  
ACTERS WITHOUT CLAIM TO ANY PARTICULAR  
FONT, STYLE, SIZE, OR COLOR.

SER. NO. 77-176,027, FILED 5-8-2007.

DEZMONA MIZELLE, EXAMINING ATTORNEY

**Int. Cls.: 9 and 28**

**Prior U.S. Cls.: 21, 22, 23, 26, 36, 38 and 50**

**United States Patent and Trademark Office**

**Reg. No. 3,465,468**

**Registered July 15, 2008**

---

**TRADEMARK  
PRINCIPAL REGISTER**

**U.B.FUNKEYS**

MATTEL, INC. (DELAWARE CORPORATION)  
M1-1518  
333 CONTINENTAL BLVD.  
EL SEGUNDO, CA 90245

FOR: ELECTRONICS, NAMELY, COMPUTER GAMES, COMPUTER GAME HARDWARE, COMPUTER GAME SOFTWARE, IN CLASS 9 (U.S. CLS. 21, 23, 26, 36 AND 38).

FIRST USE 6-20-2007; IN COMMERCE 6-20-2007.

FOR: TOYS, GAMES AND PLAYTHINGS, NAMELY, TOY FIGURES, TOY FIGURE PLAYSETS, AND

ACCESSORIES FOR ALL OF THE FOREGOING, IN CLASS 28 (U.S. CLS. 22, 23, 38 AND 50).

FIRST USE 6-20-2007; IN COMMERCE 6-20-2007.

THE MARK CONSISTS OF STANDARD CHARACTERS WITHOUT CLAIM TO ANY PARTICULAR FONT, STYLE, SIZE, OR COLOR.

SER. NO. 77-176,204, FILED 5-9-2007.

KAPIL BHANOT, EXAMINING ATTORNEY

**Int. Cl.: 12**

**Prior U.S. Cls.: 19, 21, 23, 31, 35 and 44**

**United States Patent and Trademark Office**

**Reg. No. 3,465,469**

**Registered July 15, 2008**

**TRADEMARK  
PRINCIPAL REGISTER**

**Street Legal... But Just  
Barely.**

LUCRE, INC. (COLORADO CORPORATION)  
#100  
1705 14TH STREET  
BOULDER, CO 80302

THE MARK CONSISTS OF STANDARD CHAR-  
ACTERS WITHOUT CLAIM TO ANY PARTICULAR  
FONT, STYLE, SIZE, OR COLOR.

FOR: AUTOMOBILES, IN CLASS 12 (U.S. CLS. 19,  
21, 23, 31, 35 AND 44).

SER. NO. 77-176,472, FILED 5-9-2007.

FIRST USE 1-1-2007; IN COMMERCE 1-1-2007.

MICHAEL WIENER, EXAMINING ATTORNEY

**Int. Cl.: 37**

**Prior U.S. Cls.: 100, 103 and 106**

**United States Patent and Trademark Office**

**Reg. No. 3,465,470**

**Registered July 15, 2008**

---

**SERVICE MARK  
PRINCIPAL REGISTER**

**GOLD MEDAL**

GOLD MEDAL PLUMBING, HEATING, COOL-  
ING, ELECTRIC INC. (NEW JERSEY COR-  
PORATION)  
11 COTTERS LN  
EAST BRUNSWICK, NJ 08816

FOR: PLUMBING SERVICES, IN CLASS 37 (U.S.  
CLS. 100, 103 AND 106).

FIRST USE 5-1-2003; IN COMMERCE 5-1-2003.

THE MARK CONSISTS OF STANDARD CHAR-  
ACTERS WITHOUT CLAIM TO ANY PARTICULAR  
FONT, STYLE, SIZE, OR COLOR.

SER. NO. 77-176,582, FILED 5-9-2007.

BARBARA GAYNOR, EXAMINING ATTORNEY

**Int. Cl.: 9**

**Prior U.S. Cls.: 21, 23, 26, 36 and 38**

**United States Patent and Trademark Office**

**Reg. No. 3,465,471**

**Registered July 15, 2008**

**TRADEMARK  
PRINCIPAL REGISTER**

**SMARTCLICK**

OMRON CORPORATION (JAPAN CORPORATION)

801, MINAMIFUDO-CHO, HORIKAWAHIGASHIRU

SHIOKOJIDORI, SHIMOGYO-KU, KYOTO-SHI  
KYOTO, JAPAN 600-8530

FOR: CONNECTORS FOR ELECTRIC WIRES AND CABLES, ELECTRIC WIRES AND CABLES, ELECTRICAL CONNECTORS, IN CLASS 9 (U.S. CLS. 21, 23, 26, 36 AND 38).

THE MARK CONSISTS OF STANDARD CHARACTERS WITHOUT CLAIM TO ANY PARTICULAR FONT, STYLE, SIZE, OR COLOR.

PRIORITY CLAIMED UNDER SEC. 44(D) ON JAPAN APPLICATION NO. 2007-22033, FILED 3-14-2007, REG. NO. 5096472, DATED 12-7-2007, EXPIRES 12-7-2017.

SER. NO. 77-176,658, FILED 5-9-2007.

CAROLYN GRAY, EXAMINING ATTORNEY

**Int. Cl.: 9**

**Prior U.S. Cls.: 21, 23, 26, 36 and 38**

**United States Patent and Trademark Office**

**Reg. No. 3,465,472**

**Registered July 15, 2008**

**TRADEMARK  
PRINCIPAL REGISTER**



OMRON CORPORATION (JAPAN CORPORATION)  
801, MINAMIFUDO-CHO, HORIKAWAHIGASHIIRU  
SHIOKOJIDORI, SHIMOGYO-KU, KYOTO-SHI  
KYOTO, JAPAN 600-8530

FOR: CONNECTORS FOR ELECTRIC WIRES AND CABLES, ELECTRIC WIRES AND CABLES, ELECTRICAL CONNECTORS, IN CLASS 9 (U.S. CLS. 21, 23, 26, 36 AND 38).

PRIORITY CLAIMED UNDER SEC. 44(D) ON JAPAN APPLICATION NO. 2007-22033, FILED 3-14-2007, REG. NO. 5096473, DATED 12-7-2007, EXPIRES 12-7-2017.

THE MARK CONSISTS OF THE WORD "SMARTCLICK" WITH A BLACK CIRCLE ENCOMPASSING THE LETTER "S" IN "SMART".

SER. NO. 77-176,671, FILED 5-9-2007.

CAROLYN GRAY, EXAMINING ATTORNEY



**Int. Cl.: 41**

**Prior U.S. Cls.: 100, 101 and 107**

**United States Patent and Trademark Office**

**Reg. No. 3,465,473**

**Registered July 15, 2008**

**SERVICE MARK  
PRINCIPAL REGISTER**



AEONSOFT, INC. (REPUBLIC OF KOREA CORPORATION)  
SEOKHO BLDG 3RD FLOOR  
YEOKSAM-DONG  
GANGNAM-GU, SEOUL, REPUBLIC OF KOREA  
135-080

FIRST USE 11-11-2005; IN COMMERCE 12-22-2005.

OWNER OF REPUBLIC OF KOREA REG. NO. 0106947, DATED 10-12-2004, EXPIRES 10-12-2014.

FOR: ENTERTAINMENT SERVICES, NAMELY, PROVIDING ON-LINE COMPUTER GAMES AND INTERACTIVE GAMES; PROVIDING A WEBSITE FEATURING COMPUTER GAMES, COMPUTER GAME STRATEGY, GAMES, ON-LINE GAMES, VIDEO GAMES, INTERACTIVE GAMES, AVATARS, REALITY SIMULATION, CONTESTS, AND COMPETITIONS, IN CLASS 41 (U.S. CLS. 100, 101 AND 107).

THE MARK CONSISTS OF THE LETTERS "F", "L", "Y", "F", "F" IN STYLIZED FORM WITH A SMALL STAR ABOVE THE LETTER "Y".

SER. NO. 77-176,764, FILED 5-9-2007.

TASHIA BUNCH, EXAMINING ATTORNEY

**Int. Cl.: 2**

**Prior U.S. Cls.: 6, 11 and 16**

**United States Patent and Trademark Office**

**Reg. No. 3,465,474**

**Registered July 15, 2008**

**TRADEMARK  
PRINCIPAL REGISTER**

**SPEEDSKIM**

FREEMAN PRODUCTS, INC. (OKLAHOMA  
CORPORATION)  
1912 W. KENOSHA  
BROKEN ARROW, OK 74012

THE MARK CONSISTS OF STANDARD CHAR-  
ACTERS WITHOUT CLAIM TO ANY PARTICULAR  
FONT, STYLE, SIZE, OR COLOR.

FOR: COATING COMPOSITION IN THE NAT-  
URE OF ACRYLIC WALL AND CEILING SKIM  
PAINT, IN CLASS 2 (U.S. CLS. 6, 11 AND 16).

SER. NO. 77-177,252, FILED 5-10-2007.

FIRST USE 1-23-2007; IN COMMERCE 1-23-2007.

LESLEY LAMOTHE, EXAMINING ATTORNEY

**Int. Cl.: 19**

**Prior U.S. Cls.: 1, 12, 33 and 50**

**United States Patent and Trademark Office**

**Reg. No. 3,465,475**

**Registered July 15, 2008**

**TRADEMARK  
PRINCIPAL REGISTER**

**SONOSECUR**

MATERIAUX SPECIALISES LOUISEVILLE INC.  
(CANADA CORPORATION)

161, RUE SAINT-PAUL

LOUISEVILLE, QUEBEC, CANADA J5V2G9

FOR: FIRE RESISTANT ACOUSTICAL WOOD  
FIBER PANELS FOR WALLS AND CEILINGS, IN  
CLASS 19 (U.S. CLS. 1, 12, 33 AND 50).

FIRST USE 4-0-1998; IN COMMERCE 4-0-1998.

THE MARK CONSISTS OF STANDARD CHAR-  
ACTERS WITHOUT CLAIM TO ANY PARTICULAR  
FONT, STYLE, SIZE, OR COLOR.

PRIORITY CLAIMED UNDER SEC. 44(D) ON  
CANADA APPLICATION NO. 1324006, FILED 11-14-  
2006, REG. NO. 697190, DATED 9-25-2007, EXPIRES 9-  
25-2022.

SER. NO. 77-177,293, FILED 5-10-2007.

MICHAEL WEBSTER, EXAMINING ATTORNEY

**Int. Cl.: 41**

**Prior U.S. Cls.: 100, 101 and 107**

**United States Patent and Trademark Office**

**Reg. No. 3,465,476**

**Registered July 15, 2008**

**SERVICE MARK  
PRINCIPAL REGISTER**

**TOMAHAWK FALL RIDE**

RANDALL TROUTMAN (UNITED STATES INDIVIDUAL)

5816 WEST THEISEN ROAD  
TOMAHAWK, WI 54487 AND

ROBERT TROUTMAN (UNITED STATES INDIVIDUAL)

5816 WEST THEISEN ROAD  
TOMAHAWK, WI 54487

FOR: CONDUCTING AND ORGANIZING COMMUNITY MOTORCYCLE FESTIVALS FEATURING MOTORCYCLE DISPLAYS AND MUSICAL PERFORMANCES BY BANDS AND INDIVIDUAL PERFORMERS, IN CLASS 41 (U.S. CLS. 100, 101 AND 107).

FIRST USE 9-1-1990; IN COMMERCE 9-1-1990.

THE MARK CONSISTS OF STANDARD CHARACTERS WITHOUT CLAIM TO ANY PARTICULAR FONT, STYLE, SIZE, OR COLOR.

NO CLAIM IS MADE TO THE EXCLUSIVE RIGHT TO USE "FALL RIDE", APART FROM THE MARK AS SHOWN.

SER. NO. 77-177,357, FILED 5-10-2007.

HENRY S. ZAK, EXAMINING ATTORNEY

**Int. Cl.: 14**

**Prior U.S. Cls.: 2, 27, 28 and 50**

**United States Patent and Trademark Office**

**Reg. No. 3,465,477**

**Registered July 15, 2008**

**TRADEMARK  
PRINCIPAL REGISTER**

**DESTINATION**

MONTESINO INTERNATIONAL CORP. (FLORIDA CORPORATION)  
1816 N. DIXIE HWY, SUITE C-2, BOX 6  
FORT LAUDERDALE, FL 33305

THE MARK CONSISTS OF STANDARD CHARACTERS WITHOUT CLAIM TO ANY PARTICULAR FONT, STYLE, SIZE, OR COLOR.

FOR: JEWELRY, IN CLASS 14 (U.S. CLS. 2, 27, 28 AND 50).

SER. NO. 77-177,562, FILED 5-10-2007.

FIRST USE 4-25-2005; IN COMMERCE 4-25-2005.

JENNIFER HETU, EXAMINING ATTORNEY

**Int. Cl.: 3**

**Prior U.S. Cls.: 1, 4, 6, 50, 51 and 52**

**United States Patent and Trademark Office**

**Reg. No. 3,465,478**

**Registered July 15, 2008**

**TRADEMARK  
PRINCIPAL REGISTER**

**T'FIVVE**

NEOPHARM CO., LTD. (REPUBLIC OF KOREA CORPORATION)  
BVC-203 KRIBB, 52 OEUN-DONG  
YUSEONG-GU  
DAJEON-CITY, REPUBLIC OF KOREA 305-806

FOR: COSMETICS, NAMELY, NOURISHING COSMETIC CREAMS; BEAUTY MASKS; BADIAN ESSENCE OIL FOR PERSONAL USE; BATH OIL; BABY OIL; NON-MEDICATED DANDRUFF LOTIONS; NON-MEDICATED DANDRUFF CREAMS; SKIN MILK LOTIONS; SKIN TONERS; NON-MEDICATED LIP PROTECTOR; COLD CREAMS; CLEANSING CREAM; FOUNDATION CREAMS; SKIN WHITENING CREAMS; MEDICATED SOAP; CREAM SOAPS, IN CLASS 3 (U.S. CLS. 1, 4, 6, 50, 51 AND 52).

THE MARK CONSISTS OF STANDARD CHARACTERS WITHOUT CLAIM TO ANY PARTICULAR FONT, STYLE, SIZE, OR COLOR.

PRIORITY CLAIMED UNDER SEC. 44(D) ON REPUBLIC OF KOREA APPLICATION NO. 40200657262, FILED 11-13-2006, REG. NO. 0716644, DATED 7-10-2007, EXPIRES 7-10-2017.

THE WORDING "T'FIVVE" HAS NO MEANING IN A FOREIGN LANGUAGE.

SER. NO. 77-177,640, FILED 5-10-2007.

JAMES LOVELACE, EXAMINING ATTORNEY

**Int. Cl.: 5**

**Prior U.S. Cls.: 6, 18, 44, 46, 51 and 52**

**United States Patent and Trademark Office**

**Reg. No. 3,465,479**

**Registered July 15, 2008**

**TRADEMARK  
PRINCIPAL REGISTER**

**T'FIVVE**

NEOPHARM CO., LTD. (REPUBLIC OF KOREA CORPORATION)  
BVC-203 KRIBB, 52 OEUN-DONG, YUSEONG-GU  
DAJEON-CITY, REPUBLIC OF KOREA 305-806

FOR: PHARMACEUTICAL PREPARATIONS FOR THE PREVENTION AND TREATMENT OF DISORDERS OF THE IMMUNE SYSTEM, NAMELY, AGENTS FOR IMMUNITY ADJUSTMENT; PHARMACEUTICAL PREPARATIONS FOR TREATING DANDRUFF; MEDICATED SUNBURN LOTIONS; CELLULAR FUNCTION ACTIVATING AGENTS; PHARMACEUTICAL ANTI-ALLERGIC PREPARATIONS AND SUBSTANCES; UNIT DOES CAPSULES SOLD EMPTY FOR PHARMACEUTICAL USE; MEDICINAL HAIR GROWTH PREPARATIONS; DIETETIC FOODS ADAPTED FOR MEDICAL USE; ENZYME PREPARATIONS FOR MEDICAL PURPOSES; PHARMACEUTICAL SKIN LOTIONS; ANTI-BIOTIC OINTMENTS FOR PHARMACEUTICAL PURPOSES; FERMENTS FOR PHARMACEUTICAL

PURPOSES; PHARMACEUTICAL PREPARATIONS FOR THE TREATMENT OF BURNS; PHARMACEUTICAL PREPARATIONS FOR SKIN CARE, IN CLASS 5 (U.S. CLS. 6, 18, 44, 46, 51 AND 52).

THE MARK CONSISTS OF STANDARD CHARACTERS WITHOUT CLAIM TO ANY PARTICULAR FONT, STYLE, SIZE, OR COLOR.

PRIORITY CLAIMED UNDER SEC. 44(D) ON REPUBLIC OF KOREA APPLICATION NO. 40200657263, FILED 11-13-2006, REG. NO. 0716645, DATED 7-10-2007, EXPIRES 7-10-2017.

THE WORDING "T'FIVVE" HAS NO MEANING IN A FOREIGN LANGUAGE.

SER. NO. 77-177,656, FILED 5-10-2007.

JAMES LOVELACE, EXAMINING ATTORNEY

**Int. Cl.: 14**

**Prior U.S. Cls.: 2, 27, 28 and 50**

**United States Patent and Trademark Office**

**Reg. No. 3,465,480**

**Registered July 15, 2008**

---

**TRADEMARK  
PRINCIPAL REGISTER**

**Coquette**

GLENN MILLER (CALIFORNIA SOLE PROPRIETORSHIP)  
4909 LAKEWOOD BLVD. STE. 501  
LAKEWOOD, CA 90712

THE MARK CONSISTS OF STANDARD CHARACTERS WITHOUT CLAIM TO ANY PARTICULAR FONT, STYLE, SIZE, OR COLOR.

FOR: JEWELRY, IN CLASS 14 (U.S. CLS. 2, 27, 28 AND 50).

SER. NO. 77-177,673, FILED 5-10-2007.

FIRST USE 3-1-2007; IN COMMERCE 3-1-2007.

DEIRDRE ROBERTSON, EXAMINING ATTORNEY



**Int. Cl.: 9**

**Prior U.S. Cls.: 21, 23, 26, 36 and 38**

**Reg. No. 3,465,481**

**United States Patent and Trademark Office**

**Registered July 15, 2008**

**TRADEMARK  
PRINCIPAL REGISTER**

**iLab Solutions**

ILAB SOLUTIONS, LLC (MASSACHUSETTS LTD  
LIAB CO)  
177 HUDSON STREET  
SOMERVILLE, MA 02144

FOR: COMPUTER SOFTWARE FOR USE IN THE  
LABORATORY FOR ORGANIZING REQUISITIONS  
AND ORDERS, IN CLASS 9 (U.S. CLS. 21, 23, 26, 36  
AND 38).

FIRST USE 7-19-2006; IN COMMERCE 7-19-2006.

THE MARK CONSISTS OF STANDARD CHAR-  
ACTERS WITHOUT CLAIM TO ANY PARTICULAR  
FONT, STYLE, SIZE, OR COLOR.

NO CLAIM IS MADE TO THE EXCLUSIVE  
RIGHT TO USE "SOLUTIONS", APART FROM  
THE MARK AS SHOWN.

SER. NO. 77-177,710, FILED 5-10-2007.

STEVEN R. FOSTER, EXAMINING ATTORNEY

**Int. Cl.: 6**

**Prior U.S. Cls.: 2, 12, 13, 14, 23, 25 and 50**

**Reg. No. 3,465,482**

**United States Patent and Trademark Office**

**Registered July 15, 2008**

**TRADEMARK  
PRINCIPAL REGISTER**

**CARNIT**

KÖPPERNTWICKLUNGS -GMBH (FED REP  
GERMANY CORPORATION)  
KÖNIGSTEINER STR. 2  
HATTINGEN, FED REP GERMANY 45529

PRIORITY CLAIMED UNDER SEC. 44(D) ON  
ERPN CMNTY TM OFC APPLICATION NO.  
005471354, FILED 11-15-2006, REG. NO. 5471354,  
DATED 12-20-2007, EXPIRES 11-15-2016.

FOR: COMMON METALS, IN PARTICULAR  
HIGH-TENSILE METAL ALLOYS UNWROUGHT  
AND SEMI WORKED FOR FURTHER MANUFAC-  
TURE; HIGH STRENGTH, STAINLESS AUSTENI-  
TIC STEEL NOT USED IN JEWELRY OR CLOCKS,  
IN CLASS 6 (U.S. CLS. 2, 12, 13, 14, 23, 25 AND 50).

THE WORDING "CARNIT" HAS NO MEANING  
IN A FOREIGN LANGUAGE.

SER. NO. 77-177,881, FILED 5-10-2007.

THE MARK CONSISTS OF STANDARD CHAR-  
ACTERS WITHOUT CLAIM TO ANY PARTICULAR  
FONT, STYLE, SIZE, OR COLOR.

CYNTHIA SLOAN, EXAMINING ATTORNEY

**Int. Cl.: 3**

**Prior U.S. Cls.: 1, 4, 6, 50, 51 and 52**

**United States Patent and Trademark Office**

**Reg. No. 3,465,483**

**Registered July 15, 2008**

**TRADEMARK  
PRINCIPAL REGISTER**

**MAGNIFICILS**

LANCOME PARFUMS ET BEAUTE & CIE  
(FRANCE SOCIETE EN NOM COLLECTIF)  
29, RUE DU FAUBOURG SAINT-HONORE  
PARIS, FRANCE 75008

OWNER OF FRANCE REG. NO. 2402667, DATED  
11-12-1998, EXPIRES 11-12-2008.

FOR: MASCARAS, IN CLASS 3 (U.S. CLS. 1, 4, 6, 50,  
51 AND 52).

SER. NO. 77-177,976, FILED 5-10-2007.

THE MARK CONSISTS OF STANDARD CHAR-  
ACTERS WITHOUT CLAIM TO ANY PARTICULAR  
FONT, STYLE, SIZE, OR COLOR.

KEVIN CORWIN, EXAMINING ATTORNEY

**Int. Cls.: 35, 40 and 42**

**Prior U.S. Cls.: 100, 101, 102, 103 and 106**

**Reg. No. 3,465,484**

**United States Patent and Trademark Office**

**Registered July 15, 2008**

**SERVICE MARK  
PRINCIPAL REGISTER**

# AMMUNITION

THE BRAND COALITION LIMITED (UNITED  
KINGDOM LIMITED COMPANY (LTD.))  
BROOKMANS PARK  
1A GREEN CLOSE  
HERTFORDSHIRE, UNITED KINGDOM AL97ST

FOR: ADVERTISING SERVICES, INCLUDING ADVERTISING AND PUBLICITY SERVICES, NAMELY, PROMOTING THE GOODS, SERVICES, BRAND IDENTITY AND COMMERCIAL INFORMATION AND NEWS OF THIRD PARTIES THROUGH PRINT, AUDIO, VIDEO, DIGITAL AND ON-LINE MEDIUMS; BUSINESS MANAGEMENT AND BUSINESS ADMINISTRATION ADVISORY SERVICES; BUSINESS ADVISORY SERVICES, NAMELY, PROVIDING ADVICE TO OTHERS RELATING TO MARKETING ACTIVITIES AND LAUNCHING OF NEW PRODUCTS; ADVERTISING AGENCY SERVICES; RENTAL OF ADVERTISING SPACE; PROFESSIONAL BUSINESS MANAGEMENT CONSULTANCY; PUBLIC RELATIONS; PRODUCTION AND DISTRIBUTION OF RADIO AND TELEVISION COMMERCIALS; TELEVISION ADVERTISING AGENCIES; PLANNING AND CONDUCTING OF TRADE FAIRS, EXHIBITIONS AND PRESENTATIONS FOR ECONOMIC OR ADVERTISING PURPOSES, IN CLASS 35 (U.S. CLS. 100, 101 AND 102).

FOR: PRINTING AND TYPESETTING SERVICES, IN CLASS 40 (U.S. CLS. 100, 103 AND 106).

FOR: GRAPHIC DESIGN SERVICES; DESIGN SERVICES, NAMELY, DESIGN OF NEW PRODUCTS FOR OTHERS, COMMERCIAL ART DESIGN, PACKAGING DESIGN FOR OTHERS AND GRAPHIC ART DESIGN; WEBSITE DESIGN FOR OTHERS; COMPUTER SOFTWARE DESIGN FOR OTHERS; PACKAGE DESIGN FOR OTHERS; PROVIDING INFORMATION IN THE FIELD OF BRAND CONSULTANCY, GRAPHIC DESIGN, AND PRODUCT DESIGN, VIA THE INTERNET; ENGINEERING SERVICES, NAMELY, DRAWING OF TECHNICAL PLANS AND SPECIFICATIONS FOR OTHERS, IN CLASS 42 (U.S. CLS. 100 AND 101).

THE MARK CONSISTS OF STANDARD CHARACTERS WITHOUT CLAIM TO ANY PARTICULAR FONT, STYLE, SIZE, OR COLOR.

OWNER OF UNITED KINGDOM REG. NO. 2257533, DATED 3-29-2002, EXPIRES 1-10-2011.

SER. NO. 77-178,013, FILED 5-10-2007.

JAMES MACFARLANE, EXAMINING ATTORNEY

**Int. Cl.: 20**

**Prior U.S. Cls.: 2, 13, 22, 25, 32 and 50**

**United States Patent and Trademark Office**

**Reg. No. 3,465,485**

**Registered July 15, 2008**

**TRADEMARK  
PRINCIPAL REGISTER**



HAPPY2EZ INC. (CALIFORNIA CORPORATION)  
14211 BEACH BLVD.  
WESTMINSTER, CA, CA 92683

THE MARK CONSISTS OF THE LETTERS "HAP-  
PY2EZ" WITH THE "2" POSITIONED ON AN OPEN  
LEFT HAND.

FOR: MATTRESSES; PILLOWS; CUSHIONS, IN  
CLASS 20 (U.S. CLS. 2, 13, 22, 25, 32 AND 50).

SER. NO. 77-178,068, FILED 5-10-2007.

FIRST USE 9-30-2002; IN COMMERCE 9-30-2002.

SETH A. RAPPAPORT, EXAMINING ATTORNEY

**Int. Cl.: 16**

**Prior U.S. Cls.: 2, 5, 22, 23, 29, 37, 38 and 50**

**United States Patent and Trademark Office**

**Reg. No. 3,465,486**

**Registered July 15, 2008**

**TRADEMARK  
PRINCIPAL REGISTER**

**CONNECT**

LUMIN PUBLISHING, INC. (UTAH CORPORATION)  
6183 S. PRAIRIE VIEW DRIVE, SUITE 103  
SALT LAKE CITY, UT 84118

THE MARK CONSISTS OF STANDARD CHARACTERS WITHOUT CLAIM TO ANY PARTICULAR FONT, STYLE, SIZE, OR COLOR.

FOR: MAGAZINES FEATURING BUSINESS AND ENTREPRENEURISM, IN CLASS 16 (U.S. CLS. 2, 5, 22, 23, 29, 37, 38 AND 50).

SER. NO. 77-178,112, FILED 5-10-2007.

FIRST USE 4-30-2003; IN COMMERCE 4-30-2003.

SALLY SHIH, EXAMINING ATTORNEY

Int. Cl.: 35

Prior U.S. Cls.: 100, 101 and 102

United States Patent and Trademark Office

Reg. No. 3,465,487

Registered July 15, 2008

**SERVICE MARK  
PRINCIPAL REGISTER**



ITC TOURS WORLDWIDE (JAMAICA) LIMITED  
(JAMAICA CORPORATION)  
2331 N. SR. 7., SUITE 210  
SUNRISE, FL 33313

FOR: TRAVEL MANAGEMENT, NAMELY, BUSINESS CONSULTING AND MANAGEMENT SERVICES IN THE FIELD OF TRAVEL, TRAVEL PLANNING AND THE OPERATION OF TRAVEL RELATED BUSINESS; ON-LINE RETAIL STORE SERVICES FEATURING TRAVEL RELATED GOODS AND SERVICES; RETAIL STORE SERVICES

FEATURING TRAVEL RELATED GOODS AND SERVICES, IN CLASS 35 (U.S. CLS. 100, 101 AND 102).

FIRST USE 1-1-1990; IN COMMERCE 1-1-1990.

NO CLAIM IS MADE TO THE EXCLUSIVE RIGHT TO USE "TOURS WORLDWIDE", APART FROM THE MARK AS SHOWN.

SER. NO. 77-178,144, FILED 5-10-2007.

PAUL F. GAST, EXAMINING ATTORNEY

**Int. Cl.: 41**

**Prior U.S. Cls.: 100, 101 and 107**

**Reg. No. 3,465,488**

**United States Patent and Trademark Office**

**Registered July 15, 2008**

---

**SERVICE MARK  
PRINCIPAL REGISTER**

**YMC YOURMUSICCHANNEL**

WDMG, LLC (TEXAS LTD LIAB CO)  
SUITE 100  
2601 MOCKINGBIRD LANE  
DALLAS, TX 75235

THE MARK CONSISTS OF STANDARD CHARACTERS WITHOUT CLAIM TO ANY PARTICULAR FONT, STYLE, SIZE, OR COLOR.

FOR: PRODUCTION OF TELEVISION AND AUDIO SHOWS, SPECIFICALLY MUSIC SHOWS TO BE PROVIDED BY MEANS OF CABLE AND SATELLITE TELEVISION, INCLUDING BY INTERNET AND DIGITAL DOWNLOADS , IN CLASS 41 (U.S. CLS. 100, 101 AND 107).

NO CLAIM IS MADE TO THE EXCLUSIVE RIGHT TO USE "YOURMUSICCHANNEL", APART FROM THE MARK AS SHOWN.

SER. NO. 77-178,208, FILED 5-10-2007.

FIRST USE 11-1-2005; IN COMMERCE 11-1-2005.

SHAUNIA CARLYLE, EXAMINING ATTORNEY



**Int. Cl.: 41**

**Prior U.S. Cls.: 100, 101 and 107**

**United States Patent and Trademark Office**

**Reg. No. 3,465,489**

**Registered July 15, 2008**

**SERVICE MARK  
PRINCIPAL REGISTER**

**YMC RECORDS**

WDMG, LLC (TEXAS LTD LIAB CO)  
SUITE 100  
2601 MOCKINGBIRD LANE  
DALLAS, TX 75235

FOR: MUSIC PRODUCTION SERVICES AND  
PRODUCTION OF MUSIC VIDEO RECORDING  
SERVICES, IN CLASS 41 (U.S. CLS. 100, 101 AND 107).

FIRST USE 9-1-2005; IN COMMERCE 9-1-2005.

THE MARK CONSISTS OF STANDARD CHAR-  
ACTERS WITHOUT CLAIM TO ANY PARTICULAR  
FONT, STYLE, SIZE, OR COLOR.

NO CLAIM IS MADE TO THE EXCLUSIVE  
RIGHT TO USE "RECORDS", APART FROM THE  
MARK AS SHOWN.

SER. NO. 77-178,209, FILED 5-10-2007.

SHAUNIA CARLYLE, EXAMINING ATTORNEY

**Int. Cl.: 3**

**Prior U.S. Cls.: 1, 4, 6, 50, 51 and 52**

**United States Patent and Trademark Office**

**Reg. No. 3,465,490**

**Registered July 15, 2008**

**TRADEMARK  
PRINCIPAL REGISTER**

**MAP-15 REGENERATOR**

INTERNATIONAL DERMAL INSTITUTE, INC.  
(CALIFORNIA CORPORATION)

1535 BEACHEY PLACE

CARSON, CA 90746

FOR: NON-MEDICATED SKIN CARE PREPARA-  
TIONS, IN CLASS 3 (U.S. CLS. 1, 4, 6, 50, 51 AND 52).

FIRST USE 10-0-2007; IN COMMERCE 10-0-2007.

THE MARK CONSISTS OF STANDARD CHAR-  
ACTERS WITHOUT CLAIM TO ANY PARTICULAR  
FONT, STYLE, SIZE, OR COLOR.

NO CLAIM IS MADE TO THE EXCLUSIVE  
RIGHT TO USE "REGENERATOR", APART FROM  
THE MARK AS SHOWN.

SER. NO. 77-178,233, FILED 5-10-2007.

JENNY PARK, EXAMINING ATTORNEY

**Int. Cl.: 44**

**Prior U.S. Cls.: 100 and 101**

**United States Patent and Trademark Office**

**Reg. No. 3,465,491**

**Registered July 15, 2008**

**SERVICE MARK  
PRINCIPAL REGISTER**

# MicroZone

INTERNATIONAL DERMAL INSTITUTE, INC.  
(CALIFORNIA CORPORATION)  
1535 BEACHEY PLACE  
CARSON, CA 90746

THE MARK CONSISTS OF STANDARD CHAR-  
ACTERS WITHOUT CLAIM TO ANY PARTICULAR  
FONT, STYLE, SIZE, OR COLOR.

FOR: SKIN CARE SERVICES; SKIN CARE SER-  
VICES PROVIDED AT A SKIN CARE SALON, IN  
CLASS 44 (U.S. CLS. 100 AND 101).

SER. NO. 77-178,272, FILED 5-10-2007.

FIRST USE 1-0-2008; IN COMMERCE 1-0-2008.

JENNY PARK, EXAMINING ATTORNEY

**Int. Cls.: 35, 41 and 42**

**Prior U.S. Cls.: 100, 101, 102 and 107**

**United States Patent and Trademark Office**

**Reg. No. 3,465,492**

**Registered July 15, 2008**

**SERVICE MARK  
PRINCIPAL REGISTER**



online home of  
**The Society for Protective Coatings**

SSPC: THE SOCIETY FOR PROTECTIVE COATINGS (PENNSYLVANIA NON-PROFIT CORPORATION)

SSPC: THE SOCIETY FOR PROTECTIVE COATING  
40 24TH STREET, 6TH FLOOR  
PITTSBURGH, PA 15222

FOR: PROVIDING INFORMATION FOR MEMBERS AND OTHERS ABOUT BUSINESS MEETINGS AND BUSINESS CONFERENCES IN THE FIELD OF PROTECTIVE COATINGS VIA A WEBSITE, IN CLASS 35 (U.S. CLS. 100, 101 AND 102).

FIRST USE 1-1-2007; IN COMMERCE 1-1-2007.

FOR: PROVIDING INFORMATION FOR MEMBERS AND OTHERS IN THE FIELD OF TRAINING SERVICES IN THE FIELD OF APPLICATION OF PROTECTIVE COATINGS, PROTECTIVE COATING EDUCATIONAL CERTIFICATION CLASSES, TECHNICAL PROTECTIVE COATING PUBLICATION OF BOOKS, AND PAINTING CONTRACTOR EDUCATIONAL CERTIFICATION CLASSES VIA A WEBSITE, IN CLASS 41 (U.S. CLS. 100, 101 AND 107).

FIRST USE 1-1-2007; IN COMMERCE 1-1-2007.

FOR: PROVIDING INFORMATION FOR MEMBERS AND OTHERS IN THE FIELD OF DEVELOPING VOLUNTARY PROTECTIVE COATING INDUSTRY STANDARDS VIA A WEBSITE, IN CLASS 42 (U.S. CLS. 100 AND 101).

FIRST USE 1-1-2007; IN COMMERCE 1-1-2007.

OWNER OF U.S. REG. NO. 3,229,224.

NO CLAIM IS MADE TO THE EXCLUSIVE RIGHT TO USE "ONLINE HOME OF THE SOCIETY FOR PROTECTIVE COATINGS", APART FROM THE MARK AS SHOWN.

SER. NO. 77-178,623, FILED 5-11-2007.

SIMON TENG, EXAMINING ATTORNEY

Int. Cl.: 33

Prior U.S. Cls.: 47 and 49

**United States Patent and Trademark Office**

**Reg. No. 3,465,493**

Registered July 15, 2008

**TRADEMARK  
PRINCIPAL REGISTER**

The word "Backus" is written in a highly stylized, cursive script. The letters are interconnected, with a large, flowing 'B' at the beginning and a long, sweeping tail on the 's'.

JOSEPH PHELPS VINEYARDS LLC (CALIFOR-  
NIA LTD LIAB CO)  
200 TAPLIN ROAD  
ST. HELENA, CA 94574

FOR: WINE, IN CLASS 33 (U.S. CLS. 47 AND 49).

FIRST USE 10-31-2002; IN COMMERCE 10-31-2002.

OWNER OF U.S. REG. NO. 2,516,943.

THE MARK CONSISTS OF THE WORD  
"BACKUS" IS STYLIZED LETTERING.

SEC. 2(F).

SER. NO. 77-178,635, FILED 5-11-2007.

JACLYN KIDWELL, EXAMINING ATTORNEY

**Int. Cls.: 35, 41 and 42**

**Prior U.S. Cls.: 100, 101, 102 and 107**

**United States Patent and Trademark Office**

**Reg. No. 3,465,494**

**Registered July 15, 2008**

**SERVICE MARK  
PRINCIPAL REGISTER**



SSPC: THE SOCIETY FOR PROTECTIVE COATINGS (PENNSYLVANIA NON-PROFIT CORPORATION)

SSPC: THE SOCIETY FOR PROTECTIVE COATING  
40 24TH STREET, 6TH FLOOR  
PITTSBURGH, PA 15222

FOR: PROVIDING INFORMATION FOR MEMBERS AND OTHERS ABOUT BUSINESS MEETINGS AND BUSINESS CONFERENCES IN THE FIELD OF PROTECTIVE COATINGS VIA A WEBSITE, IN CLASS 35 (U.S. CLS. 100, 101 AND 102).

FIRST USE 1-1-2007; IN COMMERCE 1-1-2007.

FOR: PROVIDING INFORMATION FOR MEMBERS AND OTHERS IN THE FIELD OF TRAINING SERVICES IN THE FIELD OF APPLICATION OF PROTECTIVE COATINGS, PROTECTIVE COATING EDUCATIONAL CERTIFICATION CLASSES, PUBLICATION OF BOOKS IN THE FIELD OF TECHNICAL

PROTECTIVE COATING, AND PAINTING CONTRACTOR EDUCATIONAL CERTIFICATION CLASSES VIA A WEBSITE, IN CLASS 41 (U.S. CLS. 100, 101 AND 107).

FIRST USE 1-1-2007; IN COMMERCE 1-1-2007.

FOR: PROVIDING INFORMATION FOR MEMBERS AND OTHERS IN THE FIELD OF DEVELOPING VOLUNTARY PROTECTIVE COATING INDUSTRY STANDARDS VIA A WEBSITE, IN CLASS 42 (U.S. CLS. 100 AND 101).

FIRST USE 1-1-2007; IN COMMERCE 1-1-2007.

OWNER OF U.S. REG. NO. 3,229,224.

SER. NO. 77-178,647, FILED 5-11-2007.

SIMON TENG, EXAMINING ATTORNEY

**Int. Cl.: 41**

**Prior U.S. Cls.: 100, 101 and 107**

**United States Patent and Trademark Office**

**Reg. No. 3,465,495**

**Registered July 15, 2008**

**SERVICE MARK  
PRINCIPAL REGISTER**



SSPC: THE SOCIETY FOR PROTECTIVE COATINGS (PENNSYLVANIA NON-PROFIT CORPORATION)

SSPC: THE SOCIETY FOR PROTECTIVE COATING  
40 24TH STREET, 6TH FLOOR  
PITTSBURGH, PA 15222

FOR: TRAINING SERVICES FOR CERTIFICATION AS INDUSTRIAL PROTECTIVE COATINGS SPECIALISTS , IN CLASS 41 (U.S. CLS. 100, 101 AND 107).

FIRST USE 2-11-2007; IN COMMERCE 2-11-2007.

OWNER OF U.S. REG. NO. 3,229,224.

NO CLAIM IS MADE TO THE EXCLUSIVE RIGHT TO USE "THE SOCIETY FOR PROTECTIVE COATINGS", APART FROM THE MARK AS SHOWN.

SER. NO. 77-178,722, FILED 5-11-2007.

SIMON TENG, EXAMINING ATTORNEY

**Int. Cl.: 25**

**Prior U.S. Cls.: 22 and 39**

**United States Patent and Trademark Office**

**Reg. No. 3,465,496**

**Registered July 15, 2008**

**TRADEMARK  
PRINCIPAL REGISTER**

**MAGIC-ALLS**

CASEY, DAVINA (AUSTRALIA INDIVIDUAL)

15 PATRICK STREET

AITKENVALE, AUSTRALIA 4814

FOR: BABY AND INFANT DIAPERS OF TEXTILE AND CLOTH; LINERS FOR INFANT DIAPERS OF TEXTILE AND CLOTH; DIAPER PANTS OF TEXTILE AND CLOTH; TEXTILE WATERPROOF DIAPER COVERS , IN CLASS 25 (U.S. CLS. 22 AND 39).

THE MARK CONSISTS OF STANDARD CHARACTERS WITHOUT CLAIM TO ANY PARTICULAR FONT, STYLE, SIZE, OR COLOR.

PRIORITY CLAIMED UNDER SEC. 44(D) ON AUSTRALIA APPLICATION NO. 1167854, FILED 3-23-2007, REG. NO. 1167854, DATED 3-23-2007, EXPIRES 3-23-2017.

SER. NO. 77-178,919, FILED 5-11-2007.

LOURDES AYALA, EXAMINING ATTORNEY



**Int. Cls.: 19 and 35**

**Prior U.S. Cls.: 1, 12, 33, 50, 100, 101 and 102**

**United States Patent and Trademark Office**

**Reg. No. 3,465,497**

**Registered July 15, 2008**

**TRADEMARK  
SERVICE MARK  
PRINCIPAL REGISTER**



CLAYTON HOLDINGS LIMITED (NEW ZEALAND COMPANY)  
10-24 VAUGHAN ROAD  
ROTORUA, NEW ZEALAND

FOR: NON-METALLIC BUILDING MATERIALS, NAMELY, BUILDING TIMBER, MANUFACTURED TIMBER, SAWN TIMBER AND WORKED TIMBER, IN CLASS 19 (U.S. CLS. 1, 12, 33 AND 50).

FOR: RETAIL AND WHOLESALE STORES FEATURING BUILDING MATERIALS, INCLUDING BUILDING TIMBER, MANUFACTURED TIMBER, SAWN TIMBER AND WORK TIMBER, IN CLASS 35 (U.S. CLS. 100, 101 AND 102).

PRIORITY CLAIMED UNDER SEC. 44(D) ON NEW ZEALAND APPLICATION NO. 767261, FILED 4-23-2007, REG. NO. 767261, DATED 10-25-2007, EXPIRES 10-25-2017.

THE COLOR(S) BROWN AND GREEN IS/ARE CLAIMED AS A FEATURE OF THE MARK.

THE MARK CONSISTS OF A TRIPLE BROWN AND GREEN SEMI-CIRCLE SURROUNDING A TRIPLE GREEN CHECK MARK.

SER. NO. 77-179,127, FILED 5-11-2007.

SUSAN LESLIE DUBOIS, EXAMINING ATTORNEY

**Int. Cls.: 19 and 35**

**Prior U.S. Cls.: 1, 12, 33, 50, 100, 101 and 102**

**United States Patent and Trademark Office**

**Reg. No. 3,465,498**

**Registered July 15, 2008**

**TRADEMARK  
SERVICE MARK  
PRINCIPAL REGISTER**

**INGRAINED PRECISION**

CLAYTON HOLDINGS LIMITED (NEW ZEAL-  
AND COMPANY)  
10-24 VAUGHAN ROAD  
ROTORUA, NEW ZEALAND

FOR: NON-METALLIC BUILDING MATERIALS,  
NAMELY, BUILDING TIMBER, MANUFACTURED  
TIMBER, SAWN TIMBER AND WORKED TIMBER,  
IN CLASS 19 (U.S. CLS. 1, 12, 33 AND 50).

FOR: RETAIL AND WHOLESALE STORES FEAT-  
URING BUILDING MATERIALS, INCLUDING  
BUILDING TIMBER, MANUFACTURED TIMBER,

SAWN TIMBER AND WORK TIMBER, IN CLASS 35  
(U.S. CLS. 100, 101 AND 102).

THE MARK CONSISTS OF STANDARD CHAR-  
ACTERS WITHOUT CLAIM TO ANY PARTICULAR  
FONT, STYLE, SIZE, OR COLOR.

OWNER OF NEW ZEALAND REG. NO. 767264,  
DATED 10-25-2007, EXPIRES 10-25-2017.

SER. NO. 77-179,141, FILED 5-11-2007.

SUSAN LESLIE DUBOIS, EXAMINING ATTORNEY

**Int. Cls.: 9, 16, 35 and 41**

**Prior U.S. Cls.: 2, 5, 21, 22, 23, 26, 29, 36, 37, 38, 50,  
100, 101, 102 and 107**

**Reg. No. 3,465,499**

**United States Patent and Trademark Office**

**Registered July 15, 2008**

**TRADEMARK  
SERVICE MARK  
PRINCIPAL REGISTER**



GENERALITAT DE CATALUNYA (SPAIN AU-  
TONOMOUS COMMUNITY)

PALAU ROBERT

PASSEIG DE GRACIA, 107, 3R.

BARCELONA, SPAIN 08008

FOR: DOWNLOADABLE ELECTRONIC PUBLICATIONS, NAMELY, ARTICLES AND NEWSLETTERS FEATURING THE GENERALITAT OF CATALUNYA'S NEWS, PROJECTS, ACHIEVEMENTS AND INITIATIVES; COMPACT DISCS, CD-ROMS, DVDS AND VIDEO CASSETTES FEATURING GENERALITAT OF CATALUNYA'S NEWS, PROJECTS, ACHIEVEMENTS AND INITIATIVES, IN CLASS 9 (U.S. CLS. 21, 23, 26, 36 AND 38).

FOR: BOOKS AND MAGAZINES FEATURING THE GENERALITAT OF CATALUNYA'S NEWS, PROJECTS, ACHIEVEMENTS AND INITIATIVES; PUBLICATIONS AND PRINTED MATTER, NAMELY, NEWSLETTERS AND NEWSPAPERS FEATURING THE GENERALITAT OF CATALUNYA'S NEWS, PROJECTS, ACHIEVEMENTS AND INITIATIVES, PRINTED FORMS, CATALOGS IN THE FIELD OF SOUVENIRS FEATURING THE GOVERNMENT OF CATALUNYA, ENVELOPES, GREETING CARDS, NOTE CARDS, DIARIES, POSTERS, PHOTOGRAPHS, PAPER AND CARDBOARD; SCHOOL SUPPLIES, NAMELY, PENS, NOTEBOOKS AND PENCILS, OFFICE REQUISITES, NAMELY, RUBBER BANDS, STAPLER, ADHESIVE TAPE DISPENSERS; STATIONERY, IN CLASS 16 (U.S. CLS. 2, 5, 22, 23, 29, 37, 38 AND 50).

FOR: ADVERTISEMENT SERVICES; ORGANIZATION OF TRADE FAIRS AND EXHIBITIONS FOR COMMERCIAL OR ADVERTISING PURPOSES; SALES PROMOTION FOR OTHERS; PROMOTION

OF TOURISM IN THE CATALUNYA GEOGRAPHIC REGION AREA; COMMERCIAL RETAIL STORES AND ONLINE RETAIL STORES VIA GLOBAL COMPUTER NETWORKS FEATURING DOWNLOADABLE ELECTRONIC PUBLICATIONS, COMPACT DISCS, CD-ROMS, DVDS, VIDEO CASSETTES, BOOKS, MAGAZINES, PUBLICATIONS, PRINTED MATTER, FORMS, CATALOGUES, ENVELOPES, LETTERS, INVOICES, CARDS, DIARIES, POSTERS, PHOTOGRAPHS, PAPER, CARDBOARD AND GOODS MADE FROM THESE MATERIALS, SCHOOL SUPPLIES, INSTRUCTIONAL AND TEACHING MATERIAL, OFFICE REQUISITES EXCEPT FURNITURE AND STATIONERY; STATISTICAL-INFORMATION SERVICES; MARKET SURVEYS; COMPUTERIZED FILE MANAGEMENT; PUBLICATION OF PUBLICITY TEXTS, IN CLASS 35 (U.S. CLS. 100, 101 AND 102).

FOR: ORGANIZING SPORTING AND CULTURAL ACTIVITIES; ARRANGING AND CONDUCTING OF COURSES, CONFERENCES, COLLOQUIUMS, SEMINARS, SYMPOSIUMS AND TRAINING WORKSHOPS IN THE FIELDS OF CATALUNYA'S CULTURAL AND TOURIST ATTRACTIONS; ORGANIZATION OF TRADE FAIRS AND EXHIBITIONS FOR EDUCATIONAL, CULTURAL AND TRAINING PURPOSES; EDITING OF WRITTEN TEXTS AND PUBLICATION OF BOOKS; ELECTRONIC PUBLICATION OF BOOKS AND ONLINE PERIODICALS, IN CLASS 41 (U.S. CLS. 100, 101 AND 107).

OWNER OF ERPN CMNTY TM OFC REG. NO. 5498415, DATED 11-14-2007, EXPIRES 11-24-2016.

NO CLAIM IS MADE TO THE EXCLUSIVE RIGHT TO USE "GENERALITAT DE CATALUNYA

CATALUNYA", APART FROM THE MARK AS SHOWN.

THE COLOR(S) RED, BLACK AND WHITE IS/ ARE CLAIMED AS A FEATURE OF THE MARK.

THE MARK CONSISTS OF A SQUARE INSIDE OF WHICH THERE IS A CIRCLE AND INSIDE THE CIRCLE THERE ARE FOR VERTICAL LINES THAT CROSS IT FROM TOP TO BOTTOM, FOLLOWED BY

THE WORDS "GENERALITAT DE CATALUNYA CATALUNYA" IN STYLIZED LETTERS. THE COLORS RED AND WHITE APPEAR IN THE DESIGN ELEMENT, NAMELY, IN THE SQUARE, CIRCLE AND VERTICAL LINES. THE COLOR BLACK APPEARS IN THE WORDS "GENERALITAT DE CATALUNYA CATALUNYA".

SER. NO. 77-179,268, FILED 5-11-2007.

BARBARA BROWN, EXAMINING ATTORNEY

**Int. Cl.: 35**

**Prior U.S. Cls.: 100, 101 and 102**

**United States Patent and Trademark Office**

**Reg. No. 3,465,500**

**Registered July 15, 2008**

**SERVICE MARK  
PRINCIPAL REGISTER**



TRAIGALO.COM,CORP (FLORIDA CORPORATION)  
AMHOUSTON5@AOL.COM  
8881S.W 131 STREET  
MIAMI, FL 33176 AND  
TRAIGALO.COM (FLORIDA CORPORATION)  
8881 S.W. 131 STREET  
MIAMI, FL 33176

FOR: OPERATING AN ONLINE SHOPPING SITE  
IN THE FIELD OF ELECTRONICS AND AUTO  
PARTS, IN CLASS 35 (U.S. CLS. 100, 101 AND 102).

FIRST USE 4-1-2007; IN COMMERCE 4-1-2007.

THE COLOR(S) BLUE, GREEN, YELLOW, RED,  
ORANGE AND BLACK IS/ARE CLAIMED AS A  
FEATURE OF THE MARK.

THE MARK CONSISTS OF AN A PATTERN OF  
OVALS OVER THE WORDING "TRAIGALO.COM".  
THE UPPER LEFT OVAL IN THE MARK IS SHA-

DED COMPLETELY IN THE COLOR BLUE. THE  
LOWER LEFT OVAL IN THE MARK IS SHADED  
COMPLETELY IN THE COLOR GREEN. THE UP-  
PER RIGHT OVAL IS SHADED COMPLETELY IN  
THE COLOR RED. THE LOWER LEFT OVAL IS  
SHADED COMPLETELY IN THE COLOR YELLOW.  
THE SECOND LETTER "O" IN THE WORDING  
"TRAIGALO.COM" APPEARS IN THE COLOR OR-  
ANGE. THE REMAINING LETTERS ARE IN  
BLACK. THE COLOR BLACK ALSO APPEARS IN  
THE OUTER PORTIONS OF THE TWO OVALS IN  
THE CENTER OF THE DESIGN ELEMENT OF THE  
MARK, AND THE COLOR WHITE AS IT APPEARS  
IN THE CENTER OF THE SECOND LETTER "O" IN  
THE TERM "TRAIGALO.COM" INDICATES  
TRANSPARENT AREAS AND ARE NOT PART OF  
THE MARK.

SER. NO. 77-179,275, FILED 5-11-2007.

CHRIS DONINGER, EXAMINING ATTORNEY

**Int. Cl.: 4**

**Prior U.S. Cls.: 1, 6 and 15**

**United States Patent and Trademark Office**

**Reg. No. 3,465,501**

**Registered July 15, 2008**

**TRADEMARK  
PRINCIPAL REGISTER**

# HyperDiamond

ARNOLD, CHRISTOPHER J. (UNITED STATES  
INDIVIDUAL)  
1041 S. STATE ROAD 53  
LOMBARD, IL 60148

FOR: NON-CHEMICAL LUBRICANT ADDI-  
TIVES, AGENTS, AND TREATMENTS FOR EN-  
HANCING THE PERFORMANCE OF  
LUBRICATING OILS, GREASES, AND INTERNAL  
COMBUSTION ENGINES FUELS; NON-CHEMICAL  
ADDITIVES, AGENTS, AND TREATMENTS FOR  
IMPROVING TRIBOLOGY OF METAL AND RUB-  
BER MATERIALS, GENERAL LUBRICATION  
GREASES AND OILS; ALL PURPOSE LUBRICANTS  
TO REDUCE FRICTION, WEAR, AND TEMPERA-

TURE RISE IN CONTACTING PARTS, IN CLASS 4  
(U.S. CLS. 1, 6 AND 15).

FIRST USE 5-0-2007; IN COMMERCE 5-0-2007.

THE MARK CONSISTS OF STANDARD CHAR-  
ACTERS WITHOUT CLAIM TO ANY PARTICULAR  
FONT, STYLE, SIZE, OR COLOR.

SER. NO. 77-179,280, FILED 5-11-2007.

LEIGH CAROLINE CASE, EXAMINING ATTOR-  
NEY

**Int. Cl.: 37**

**Prior U.S. Cls.: 100, 103 and 106**

**Reg. No. 3,465,502**

**United States Patent and Trademark Office**

**Registered July 15, 2008**

---

**SERVICE MARK  
PRINCIPAL REGISTER**

**TVW**

TENNESSEE VALLEY WATERPROOFING, INC.  
(TENNESSEE CORPORATION)  
2404 EAST GALLAHER FERRY ROAD  
KNOXVILLE, TN 37932

THE MARK CONSISTS OF STANDARD CHARACTERS WITHOUT CLAIM TO ANY PARTICULAR FONT, STYLE, SIZE, OR COLOR.

FOR: WATERPROOFING OF ARTICLES OF MASONRY, WOOD AND OTHER BUILDING AND CONSTRUCTION SURFACES, NAMELY, BASEMENTS, IN CLASS 37 (U.S. CLS. 100, 103 AND 106).

SER. NO. 77-179,506, FILED 5-12-2007.

FIRST USE 1-0-1994; IN COMMERCE 1-0-1994.

EMILY CHUO, EXAMINING ATTORNEY

**Int. Cls.: 3 and 35**

**Prior U.S. Cls.: 1, 4, 6, 50, 51, 52, 100, 101 and 102**

**Reg. No. 3,465,503**

**United States Patent and Trademark Office**

**Registered July 15, 2008**

**TRADEMARK  
SERVICE MARK  
PRINCIPAL REGISTER**

# Sister Sage

SISTER SAGE (NEW HAMPSHIRE LTD LIAB CO)  
41 CHENEY AVENUE  
PETERBOROUGH, NH 03458

FOR: HOUSE MARK FOR PERSONAL CARE PRODUCTS, NAMELY, BODY SPRAYS, BODY OILS, SKIN CLEANSING BODY BARS, BATH SALTS, SCENTED ROOM SPRAYS, INCENSE STICKS AND SMUDGE BURNED FOR ROOM FRAGRANCE, ESSENTIAL OILS FOR PERSONAL USE, IN CLASS 3 (U.S. CLS. 1, 4, 6, 50, 51 AND 52).

FIRST USE 6-8-2003; IN COMMERCE 9-15-2004.

FOR: ON-LINE, MAIL ORDER AND RETAIL STORE SERVICES FEATURING BOOKS, GREETING CARDS, JEWELRY, CLOTHING, CANDLES,

INCENSE, ESSENTIAL OILS, HERBS, GIFTS AND SUPPLIES USED FOR RELIGIOUS PURPOSES, IN CLASS 35 (U.S. CLS. 100, 101 AND 102).

FIRST USE 6-8-2003; IN COMMERCE 7-15-2004.

THE MARK CONSISTS OF STANDARD CHARACTERS WITHOUT CLAIM TO ANY PARTICULAR FONT, STYLE, SIZE, OR COLOR.

NO CLAIM IS MADE TO THE EXCLUSIVE RIGHT TO USE "SAGE", APART FROM THE MARK AS SHOWN.

SER. NO. 77-179,565, FILED 5-12-2007.

ELLEN BURNS, EXAMINING ATTORNEY



**Int. Cl.: 41**

**Prior U.S. Cls.: 100, 101 and 107**

**United States Patent and Trademark Office**

**Reg. No. 3,465,504**

**Registered July 15, 2008**

**SERVICE MARK  
PRINCIPAL REGISTER**

**UNIVERSITY OF NEW JERSEY**

RUTGERS, THE STATE UNIVERSITY OF NEW  
JERSEY (NEW JERSEY INSTRUMENTALITY)  
7 COLLEGE AVENUE, WINANTS HALL, RM 401  
NEW BRUNSWICK, NJ 08903

FOR: EDUCATIONAL SERVICES IN THE NAT-  
URE OF COURSES, IN THE FIELDS OF POST-  
SECONDARY AND CONTINUING EDUCATION,  
IN CLASS 41 (U.S. CLS. 100, 101 AND 107).

FIRST USE 9-8-1998; IN COMMERCE 9-8-1998.

THE MARK CONSISTS OF STANDARD CHAR-  
ACTERS WITHOUT CLAIM TO ANY PARTICULAR  
FONT, STYLE, SIZE, OR COLOR.

OWNER OF U.S. REG. NO. 2,450,289.

NO CLAIM IS MADE TO THE EXCLUSIVE  
RIGHT TO USE "UNIVERSITY", APART FROM  
THE MARK AS SHOWN.

SEC. 2(F).

SER. NO. 77-179,881, FILED 5-14-2007.

JORDAN BAKER, EXAMINING ATTORNEY

**Int. Cl.: 28**

**Prior U.S. Cls.: 22, 23, 38 and 50**

**Reg. No. 3,465,505**

**United States Patent and Trademark Office**

**Registered July 15, 2008**

---

**TRADEMARK  
PRINCIPAL REGISTER**

**DSG**

ROGER CLEVELAND GOLF COMPANY, INC.  
(CALIFORNIA CORPORATION)  
5601 SKYLAB ROAD  
HUNTINGTON BEACH, CA 92647

THE MARK CONSISTS OF STANDARD CHAR-  
ACTERS WITHOUT CLAIM TO ANY PARTICULAR  
FONT, STYLE, SIZE, OR COLOR.

FOR: IRON-TYPE GOLF CLUBS, NAMELY, WED-  
GES, IN CLASS 28 (U.S. CLS. 22, 23, 38 AND 50).

SER. NO. 77-179,996, FILED 5-14-2007.

FIRST USE 1-23-2006; IN COMMERCE 1-23-2006.

LYDIA BELZER, EXAMINING ATTORNEY

**Int. Cl.: 35**

**Prior U.S. Cls.: 100, 101 and 102**

**United States Patent and Trademark Office**

**Reg. No. 3,465,506**

**Registered July 15, 2008**

**SERVICE MARK  
PRINCIPAL REGISTER**

**ERMENEGILDO ZEGNA**

ERMENEGILDO ZEGNA CORPORATION (NEW  
YORK CORPORATION)

UNIT A

100 WEST FOREST AVENUE

ENGLEWOOD, NJ 07631

FOR: ON-LINE RETAIL STORE SERVICES FEATURING MEN'S CLOTHING, ACCESSORIES AND TOILETRIES, IN CLASS 35 (U.S. CLS. 100, 101 AND 102).

FIRST USE 2-0-2006; IN COMMERCE 3-0-2006.

THE MARK CONSISTS OF STANDARD CHARACTERS WITHOUT CLAIM TO ANY PARTICULAR FONT, STYLE, SIZE, OR COLOR.

OWNER OF U.S. REG. NOS. 3,122,182, 3,237,896 AND OTHERS.

THE NAME(S), PORTRAIT(S), AND/OR SIGNATURE(S) SHOWN IN THE MARK DOES NOT IDENTIFY A PARTICULAR LIVING INDIVIDUAL.

SER. NO. 77-180,364, FILED 5-14-2007.

BRENDAN REGAN, EXAMINING ATTORNEY

**Int. Cl.: 35**

**Prior U.S. Cls.: 100, 101 and 102**

**United States Patent and Trademark Office**

**Reg. No. 3,465,507**

**Registered July 15, 2008**

**SERVICE MARK  
PRINCIPAL REGISTER**

**M/RESEARCH**

MODERN SURVEY, INC. (MINNESOTA CORPORATION)  
SUITE 202, 701 NORTH THIRD STREET  
MINNEAPOLIS, MN 55401

FOR: CONDUCTING CUSTOMIZABLE ON-LINE  
BUSINESS MANAGEMENT RESEARCH SURVEYS,  
IN CLASS 35 (U.S. CLS. 100, 101 AND 102).

FIRST USE 1-29-2007; IN COMMERCE 1-29-2007.

THE MARK CONSISTS OF STANDARD CHARACTERS WITHOUT CLAIM TO ANY PARTICULAR FONT, STYLE, SIZE, OR COLOR.

SER. NO. 77-180,396, FILED 5-14-2007.

DORITT L. CARROLL, EXAMINING ATTORNEY

**Int. Cls.: 1 and 4**

**Prior U.S. Cls.: 1, 5, 6, 10, 15, 26 and 46**

**United States Patent and Trademark Office**

**Reg. No. 3,465,508**

**Registered July 15, 2008**

**TRADEMARK  
PRINCIPAL REGISTER**

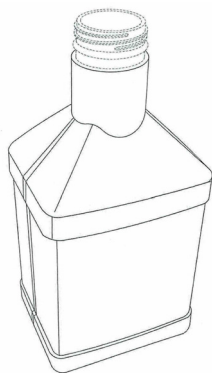

AMSOIL INC. (DELAWARE CORPORATION)  
AMSOIL BUILDING  
925 TOWER AVENUE  
SUPERIOR, WI 54880

FOR: TRANSMISSION FLUID, IN CLASS 1 (U.S. CLS. 1, 5, 6, 10, 26 AND 46).

FIRST USE 6-0-1995; IN COMMERCE 6-0-1995.

FOR: LUBRICANTS, OILS AND GREASES FOR AUTOMOTIVE, INDUSTRIAL AND COMMERCIAL USE, IN CLASS 4 (U.S. CLS. 1, 6 AND 15).

FIRST USE 6-0-1995; IN COMMERCE 6-0-1995.

THE MARK CONSISTS OF A THREE-DIMENSIONAL BOTTLE CONFIGURATION FOR THE

GOODS. THE BOTTLE FEATURES A WIDE BOTTLE NECK THAT FLARES OUT TO CREATE A RECTANGULAR CONTAINER. THE BOTTOM AND TOP PORTIONS OF THE RECTANGULAR SHAPE OF THE BOTTLE ARE SLIGHTLY FLARED, AND THE LINES GOING DOWN THE CENTER OF THE LEFT SIDE OF THE BOTTLE PORTRAY A VIEW STRIP. THE THREADED NECK CLOSURE IS PORTRAYED IN DOTTED LINES AND IS NOT CLAIMED AS A FEATURE OF THE MARK.

SEC. 2(F).

SER. NO. 77-180,416, FILED 5-14-2007.

SUSAN LESLIE DUBOIS, EXAMINING ATTORNEY

**Int. Cls.: 9, 10 and 28**

**Prior U.S. Cls.: 21, 22, 23, 26, 36, 38, 39, 44 and 50**

**United States Patent and Trademark Office**

**Reg. No. 3,465,509**

**Registered July 15, 2008**

**TRADEMARK  
PRINCIPAL REGISTER**

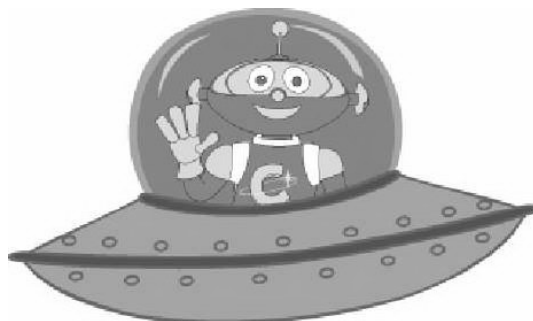

AT KIDSYSTEMS INC. (MARYLAND CORPORATION)  
8737 COLESVILLE ROAD  
SILVER SPRING, MD 20910

FOR: MULTI-FUNCTION COMPUTER INPUT DEVICES, NAMELY, COMPUTER PERIPHERALS; INTERACTIVE COMPUTER SOFTWARE FOR USE AS A GAME, VIDEO GAME OR VIRTUAL REALITY GAME FOR USE IN PHYSICAL THERAPY, EDUCATION, REHABILITATION, ENTERTAINMENT, AND CHILD DEVELOPMENT; MECHANICAL AND VIRTUAL ROBOTS FOR PERSONAL USE DESIGNED TO MIMIC HUMAN ACTION FOR USE IN EDUCATION, ENTERTAINMENT, AND CHILD DEVELOPMENT, IN CLASS 9 (U.S. CLS. 21, 23, 26, 36 AND 38).

FIRST USE 3-31-2006; IN COMMERCE 3-31-2006.

FOR: MECHANICAL AND VIRTUAL APPARATUS FOR PHYSICAL TRAINING FOR MEDICAL USE DESIGNED TO MIMIC HUMAN ACTION FOR USE IN PHYSICAL THERAPY, REHABILITATION, AND CHILD DEVELOPMENT; MECHANICAL AND VIRTUAL MEDICAL INSTRUMENTS FOR USE IN

PHYSICAL THERAPY, REHABILITATION, AND CHILD DEVELOPMENT TO PROMOTE PHYSICAL INTERACTION, IN CLASS 10 (U.S. CLS. 26, 39 AND 44).

FIRST USE 3-31-2006; IN COMMERCE 3-31-2006.

FOR: EDUCATIONAL LEARNING TOYS, NAMELY, MECHANICAL AND VIRTUAL CHARACTER FOR USE IN PHYSICAL THERAPY, EDUCATION, REHABILITATION, ENTERTAINMENT, AND CHILD DEVELOPMENT TO PROMOTE PHYSICAL INTERACTION, IN CLASS 28 (U.S. CLS. 22, 23, 38 AND 50).

FIRST USE 3-31-2006; IN COMMERCE 3-31-2006.

THE MARK CONSISTS OF A ROBOT WITHIN A FLYING SAUCER, WITH THE LITERAL ELEMENT CONTAINED ON THE ROBOTIC FIGURE.

SER. NO. 77-180,486, FILED 5-14-2007.

ANNE MADDEN, EXAMINING ATTORNEY

**Int. Cl.: 3**

**Prior U.S. Cls.: 1, 4, 6, 50, 51 and 52**

**United States Patent and Trademark Office**

**Reg. No. 3,465,510**

**Registered July 15, 2008**

**TRADEMARK  
PRINCIPAL REGISTER**

**PHYTO-BLACK LIFT**

L'OREAL (FRANCE SOCIETE ANONYME)  
14 RUE ROYALE  
PARIS, FRANCE 75008

FOR: PERFUME, TOILET WATER; GELS, SALTS FOR THE BATH AND THE SHOWER NOT FOR MEDICAL PURPOSE; TOILET SOAPS, BODY DEODORANTS; COSMETICS, NAMELY, CREAMS, MILKS, LOTIONS, GELS AND POWDERS FOR THE FACE, THE BODY AND THE HANDS; NON-MEDICATED SUN CARE PREPARATIONS; MAKE-UP PREPARATIONS; SHAMPOOS; GELS, SPRAYS, MOUSSES AND BALMS FOR THE HAIR STYLING AND HAIR CARE; HAIR LACQUERS; HAIR COLOURING AND HAIR DECOLORANT PREPARATIONS; PERMANENT WAVING AND CURLING PREPARATIONS; ESSENTIAL OILS FOR PERSO-

NAL USE, IN CLASS 3 (U.S. CLS. 1, 4, 6, 50, 51 AND 52).

THE MARK CONSISTS OF STANDARD CHARACTERS WITHOUT CLAIM TO ANY PARTICULAR FONT, STYLE, SIZE, OR COLOR.

PRIORITY CLAIMED UNDER SEC. 44(D) ON FRANCE APPLICATION NO. 073499828, FILED 5-11-2007, REG. NO. 073499828, DATED 5-11-2007, EXPIRES 5-11-2017.

OWNER OF U.S. REG. NOS. 2,930,297 AND 2,945,671.

SER. NO. 77-180,559, FILED 5-14-2007.

CHRIS DONINGER, EXAMINING ATTORNEY

**Int. Cl.: 3**

**Prior U.S. Cls.: 1, 4, 6, 50, 51 and 52**

**Reg. No. 3,465,511**

**United States Patent and Trademark Office**

**Registered July 15, 2008**

**TRADEMARK  
PRINCIPAL REGISTER**

# Ovation

BELL, ROBERT D. (UNITED STATES INDIVIDUAL)  
7549 GREENVALLEY LANE  
FRISCO, TX 75034 AND  
BELL, ANN (UNITED STATES INDIVIDUAL)  
7549 GREENVALLEY LANE  
FRISCO, TX 75034

FOR: BATH OILS FOR COSMETIC PURPOSES; BODY AND BEAUTY CARE COSMETICS; CLEANSING CREAMS; COCOA BUTTER FOR COSMETIC PURPOSES; COLORING PREPARATIONS FOR COSMETIC PURPOSES; COSMETIC CREAMS; COSMETIC CREAMS FOR SKIN CARE; COSMETIC OILS; COSMETIC OILS FOR THE EPIDERMIS; COSMETIC PREPARATIONS AGAINST SUNBURN; COSMETIC PREPARATIONS FOR BODY CARE; COSMETIC PREPARATIONS FOR EYE LASHES; COSMETIC PREPARATIONS FOR SKIN RENEWAL; COSMETIC PRODUCTS IN THE FORM OF AEROSOLS FOR SKIN CARE; COSMETIC PRODUCTS IN THE FORM OF AEROSOLS FOR SKINCARE; COSMETIC ROUGES; COSMETIC SOAPS; COSMETIC SUN-PROTECTING PREPARATIONS; COSMETIC SUN-TANNING PREPARATIONS; COSMETIC SUNTAN LOTIONS; COSMETICS; COSMETICS, NAMELY, COMPACTS; COSMETICS, NAMELY, LIP PRIMER; COSMETICS, NAMELY, LIP REPAIRERS; FACE

CREAMS FOR COSMETIC USE; FOAMS CONTAINING COSMETICS AND SUNSCREENS; NUTRITIONAL OILS FOR COSMETIC PURPOSES; PENCILS FOR COSMETIC PURPOSES; PERFUME OILS FOR THE MANUFACTURE OF COSMETIC PREPARATIONS; PRE-MOISTENED COSMETIC TOWELETTES; PRE-MOISTENED COSMETIC WIPES; ROSE OIL FOR COSMETIC PURPOSES; SKIN AND BODY TOPICAL LOTIONS, CREAMS AND OILS FOR COSMETIC USE; SOAPS; TISSUES IMPREGNATED WITH COSMETIC LOTIONS; TONERS; TOPICAL SKIN SPRAYS FOR COSMETIC PURPOSES, IN CLASS 3 (U.S. CLS. 1, 4, 6, 50, 51 AND 52).

FIRST USE 5-27-1954; IN COMMERCE 5-27-1954.

THE MARK CONSISTS OF STANDARD CHARACTERS WITHOUT CLAIM TO ANY PARTICULAR FONT, STYLE, SIZE, OR COLOR.

SEC. 2(F).

SER. NO. 77-180,816, FILED 5-14-2007.

SOPHIA S. KIM, EXAMINING ATTORNEY



**Int. Cls.: 9, 35 and 42**

**Prior U.S. Cls.: 21, 23, 26, 36, 38, 100, 101 and 102**

**United States Patent and Trademark Office**

**Reg. No. 3,465,512**

**Registered July 15, 2008**

**TRADEMARK  
SERVICE MARK  
PRINCIPAL REGISTER**



PREFIXA VISION SYSTEMS S.A. DE C.V. (MEXICO CORPORATION)  
3 PONIENTE 911-8  
SAN PEDRO CHOLULA, MEXICO 72760

FOR: SOFTWARE FOR PROCESSING IMAGES, GRAPHICS AND TEXT; SOFTWARE FOR PROCESSING DIGITAL IMAGES OF THE ANATOMY FOR DIAGNOSIS AND TREATMENT; INFRARED CAMERAS; DIGITAL CAMERAS; ELECTRIC AND ELECTRONIC VIDEO SURVEILLANCE INSTALLATIONS; SCANNERS; MEDICAL SOFTWARE FOR PROCESSING AND DISPLAYING OF DIGITAL IMAGES; PRINTED CIRCUIT BOARDS, IN CLASS 9 (U.S. CLS. 21, 23, 26, 36 AND 38).

FIRST USE 8-1-2006; IN COMMERCE 8-1-2006.

FOR: ON-LINE RETAIL STORE SERVICES FEATURING SOFTWARE, DIGITAL CAMERAS, INFRARED CAMERAS, VIDEO SURVEILLANCE EQUIPMENT, SCANNERS AND PRINTED CIRCUIT BOARDS, IN CLASS 35 (U.S. CLS. 100, 101 AND 102).

FIRST USE 8-1-2006; IN COMMERCE 8-1-2006.

FOR: COMPUTER SOFTWARE CONSULTANCY; COMPUTER SOFTWARE CONSULTATION; CONSULTATION SERVICES IN THE FIELDS OF SELEC-

TION, IMPLEMENTATION AND USE OF COMPUTER HARDWARE AND SOFTWARE SYSTEMS FOR OTHERS; COMPUTER SOFTWARE DESIGN FOR OTHERS; COMPUTER SOFTWARE DEVELOPMENT; COMPUTER SOFTWARE DESIGN, COMPUTER PROGRAMMING, OR MAINTENANCE OF COMPUTER SOFTWARE; CONSULTANCY IN THE FIELD OF SOFTWARE DESIGN; CONSULTING SERVICES IN THE FIELD OF DESIGN, SELECTION, IMPLEMENTATION AND USE OF COMPUTER HARDWARE AND SOFTWARE SYSTEMS FOR OTHERS; IMAGE PROCESSING SOFTWARE DESIGN; DESIGN OF COMPUTER HARDWARE, INTEGRATED CIRCUITS, COMMUNICATIONS HARDWARE AND SOFTWARE AND COMPUTER NETWORKS FOR OTHERS, IN CLASS 42 (U.S. CLS. 100 AND 101).

FIRST USE 8-1-2006; IN COMMERCE 8-1-2006.

THE MARK CONSISTS OF A SINGLE RIGHT-POINTING ANGLE QUOTE OVERLAPPED BY A SEMICIRCLE, A DOT AND THE WORDING OF THE MARK, "PREFIXA" IN STANDARD CHARACTERS.

SER. NO. 77-180,881, FILED 5-15-2007.

KAREN BRACEY, EXAMINING ATTORNEY

**Int. Cl.: 36**

**Prior U.S. Cls.: 100, 101 and 102**

**United States Patent and Trademark Office**

**Reg. No. 3,465,513**

**Registered July 15, 2008**

**SERVICE MARK  
PRINCIPAL REGISTER**

**UATP INSIDER'S CLUB**

UNIVERSAL AIR TRAVEL PLAN, INC. (DELA-  
WARE CORPORATION)  
1301 PENNSYLVANIA AVENUE, N.W.  
WASHINGTON, DC 20004

FOR: INSURANCE BROKERAGE SERVICES IN  
CONNECTION WITH TRAVEL-RELATED INSUR-  
ANCE, NAMELY, TRAVEL ACCIDENT, BAGGAGE  
DAMAGE, DELAY OR LOSS, PRIMARY RENTAL  
CAR LOSS AND DAMAGE COVERAGE, RENTAL  
CAR PERSONAL ACCIDENT COVERAGE, EXCESS  
MEDICAL EXPENSES, AND WORLDWIDE EMER-  
GENCY ASSISTANCE, IN CLASS 36 (U.S. CLS. 100,  
101 AND 102).

FIRST USE 1-0-1994; IN COMMERCE 1-0-1994.

THE MARK CONSISTS OF STANDARD CHAR-  
ACTERS WITHOUT CLAIM TO ANY PARTICULAR  
FONT, STYLE, SIZE, OR COLOR.

OWNER OF U.S. REG. NO. 2,446,091.

NO CLAIM IS MADE TO THE EXCLUSIVE  
RIGHT TO USE "INSIDER'S CLUB", APART FROM  
THE MARK AS SHOWN.

SER. NO. 77-180,960, FILED 5-15-2007.

CAROLYN CATALDO, EXAMINING ATTORNEY

Int. Cls.: 16 and 39

Prior U.S. Cls.: 2, 5, 22, 23, 29, 37, 38, 50, 100 and 105

United States Patent and Trademark Office

Reg. No. 3,465,514

Registered July 15, 2008

TRADEMARK  
SERVICE MARK  
PRINCIPAL REGISTER



QATAR AIRWAYS (QATAR CORPORATION)  
P.O. BOX 22550  
QATAR AIRWAYS TOWER  
DOHA, QATAR

FOR: BROCHURES, PRINTED TIMETABLES  
AND MAPS, ALL RELATING TO AIR TRANSPORT,  
IN CLASS 16 (U.S. CLS. 2, 5, 22, 23, 29, 37, 38 AND 50).

FOR: AIR TRANSPORT SERVICES; PACKAGING  
ARTICLES FOR TRANSPORTATION; AIR TRANS-  
PORT AND STORAGE OF GOODS; TRAVEL AR-  
RANGEMENT, IN CLASS 39 (U.S. CLS. 100 AND 105).

OWNER OF QATAR REG. NO. 22350, DATED 9-9-  
2003, EXPIRES 2-16-2010.

THE MARK CONSISTS IN PART OF THE WORD-  
ING "QMILES", THE ARABIC CHARACTERS  
WHICH TRANSLITERATE INTO "QMILES" AND  
A REPRESENTATION OF AN AIRPLANE.

SER. NO. 77-180,974, FILED 5-15-2007.

EDWARD NELSON, EXAMINING ATTORNEY

**Int. Cl.: 3**

**Prior U.S. Cls.: 1, 4, 6, 50, 51 and 52**

**United States Patent and Trademark Office**

**Reg. No. 3,465,515**

**Registered July 15, 2008**

**TRADEMARK  
PRINCIPAL REGISTER**

**FULL SHIMMER**

L'OREAL (FRANCE SOCIETE ANONYME)  
14 RUE ROYALE  
PARIS, FRANCE 75008

FOR: SHAMPOOS; GELS, SPRAYS, MOUSSES  
AND BALMS FOR THE HAIR STYLING AND HAIR  
CARE; HAIR LACQUERS; HAIR COLOURING AND  
HAIR DECOLORANT PREPARATIONS; PERMA-  
NENT WAVING AND CURLING PREPARATIONS;  
ESSENTIAL OILS FOR PERSONAL USE, IN CLASS 3  
(U.S. CLS. 1, 4, 6, 50, 51 AND 52).

THE MARK CONSISTS OF STANDARD CHAR-  
ACTERS WITHOUT CLAIM TO ANY PARTICULAR  
FONT, STYLE, SIZE, OR COLOR.

PRIORITY CLAIMED UNDER SEC. 44(D) ON  
FRANCE APPLICATION NO. 063464195, FILED 11-  
21-2006, REG. NO. 063464195, DATED 11-21-2006,  
EXPIRES 11-21-2016.

SER. NO. 77-181,028, FILED 5-15-2007.

MARK SPARACINO, EXAMINING ATTORNEY

**Int. Cl.: 19**

**Prior U.S. Cls.: 1, 12, 33 and 50**

**United States Patent and Trademark Office**

**Reg. No. 3,465,516**

**Registered July 15, 2008**

---

**TRADEMARK  
PRINCIPAL REGISTER**

**CONPAC**

AGGREGATE INDUSTRIES MANAGEMENT,  
INC. (DELAWARE CORPORATION)  
13900 PINEY MEETINGHOUSE ROAD  
ROCKVILLE, MD 20850

THE MARK CONSISTS OF STANDARD CHAR-  
ACTERS WITHOUT CLAIM TO ANY PARTICULAR  
FONT, STYLE, SIZE, OR COLOR.

FOR: RECYCLED CONCRETE BASE USED FOR  
STRUCTURAL FILL, CONCRETE SIDEWALK SUB-  
BASE, AND OTHER APPLICATIONS, IN CLASS 19  
(U.S. CLS. 1, 12, 33 AND 50).

SER. NO. 77-181,058, FILED 5-15-2007.

FIRST USE 5-16-2005; IN COMMERCE 5-16-2005.

ELLEN B. AWRICH, EXAMINING ATTORNEY

Int. Cl.: 43

Prior U.S. Cls.: 100 and 101

United States Patent and Trademark Office

Reg. No. 3,465,517

Registered July 15, 2008

**SERVICE MARK  
PRINCIPAL REGISTER**



BONEHEADS SEAFOOD, INC. (GEORGIA CORPORATION)  
1935 PEACHTREE RD., N.E.  
ATLANTA, GA 30305

FOR: RESTAURANT SERVICES, IN CLASS 43  
(U.S. CLS. 100 AND 101).

FIRST USE 1-31-2004; IN COMMERCE 1-31-2004.

OWNER OF U.S. REG. NOS. 3,001,026 AND  
3,275,790.

NO CLAIM IS MADE TO THE EXCLUSIVE  
RIGHT TO USE "GRILLED FISH PIRI PIRI CHICKEN",  
APART FROM THE MARK AS SHOWN.

THE COLOR(S) BLUE, BLACK, AND YELLOW IS/  
ARE CLAIMED AS A FEATURE OF THE MARK.

THE MARK CONSISTS OF THE MARK CONSISTS  
OF THE WORD "BONEHEADS", WHICH APPEARS  
IN BLUE WITH BLACK SHADING. THE LETTER  
"A" IN THE WORD "BONEHEADS" APPEARS AS A  
FISH HEAD. BELOW "BONEHEADS" ARE THE  
WORDS "GRILLED FISH PIRI PIRI CHICKEN"  
THAT APPEAR IN YELLOW. THE PHRASE "GRIL-  
LED FISH" IS SEPARATED FROM "PIRI PIRI  
CHICKEN" WITH A YELLOW DOT.

SER. NO. 77-181,116, FILED 5-15-2007.

ROSELLE HERRERA, EXAMINING ATTORNEY

**Int. Cl.: 9**

**Prior U.S. Cls.: 21, 23, 26, 36 and 38**

**Reg. No. 3,465,518**

**United States Patent and Trademark Office**

**Registered July 15, 2008**

**TRADEMARK  
PRINCIPAL REGISTER**

**HI-G-WAY**

HI-G-TEK INC. (DELAWARE CORPORATION)  
5410 EDSON LANE, SUITE 320A  
NORTH BETHESDA, MD 20852

FOR: AUTOMATIC REMOTE MONITORING SYSTEMS FOR VEHICLE REFUELING, NAMELY, AUTOMATIC REFUELING SYSTEMS, COMPRISED OF AN ELECTRONIC TAG AFFIXED TO A VEHICLE NEAR THE OPENING OF THE FUEL TANK BY MEANS OF A SEALING WIRE, A READING HEAD PLACED ON THE REFUELING NOZZLE AND A READER CONNECTED TO A MAIN COMPUTER, FOR PURPOSES OF PROVIDING AUTOMATIC REFUELING CAPABILITY BY MEANS OF SECURE, NO-MONEY TRANSACTIONS AND GENERATING

SIGNIFICANT TIME SAVINGS, IN CLASS 9 (U.S. CLS. 21, 23, 26, 36 AND 38).

THE MARK CONSISTS OF STANDARD CHARACTERS WITHOUT CLAIM TO ANY PARTICULAR FONT, STYLE, SIZE, OR COLOR.

OWNER OF ISRAEL REG. NO. 114101, DATED 11-4-1998, EXPIRES 11-4-2008.

OWNER OF U.S. REG. NO. 2,376,471.

SER. NO. 77-181,124, FILED 5-15-2007.

SHANNON TWOHIG, EXAMINING ATTORNEY

**Int. Cl.: 41**

**Prior U.S. Cls.: 100, 101 and 107**

**United States Patent and Trademark Office**

**Reg. No. 3,465,519**

**Registered July 15, 2008**

**SERVICE MARK  
PRINCIPAL REGISTER**

# Creative Kids Yoga

MOVING SPIRIT LLC (NEW HAMPSHIRE LTD  
LIAB CO)  
32 DANIEL WEBSTER HIGHWAY  
MERRIMACK, NH 03054

FOR: EDUCATIONAL SERVICES, NAMELY,  
TRAINING TEACHERS IN THE FIELD OF YOGA  
AND MOVEMENTS FOR CHILDREN; YOGA AND  
MOVEMENT WORKSHOPS, CLASSES AND CAMPS  
FOR CHILDREN AND DISTRIBUTION OF COURSE  
MANUALS IN CONNECTION THEREWITH, IN  
CLASS 41 (U.S. CLS. 100, 101 AND 107).

FIRST USE 10-1-2006; IN COMMERCE 10-1-2006.

THE MARK CONSISTS OF STANDARD CHAR-  
ACTERS WITHOUT CLAIM TO ANY PARTICULAR  
FONT, STYLE, SIZE, OR COLOR.

NO CLAIM IS MADE TO THE EXCLUSIVE  
RIGHT TO USE "KIDS YOGA", APART FROM  
THE MARK AS SHOWN.

SER. NO. 77-181,211, FILED 5-15-2007.

LINDA E. BLOHM, EXAMINING ATTORNEY



**Int. Cl.: 41**

**Prior U.S. Cls.: 100, 101 and 107**

**United States Patent and Trademark Office**

**Reg. No. 3,465,520**

**Registered July 15, 2008**

**SERVICE MARK  
PRINCIPAL REGISTER**

# CDO Focus

FOCUS POINT PRESS, INC. (NEW YORK CORPORATION)  
10 EAST 38TH STREET  
NEW YORK, NY 10016

FOR: PROVIDING ONLINE MAGAZINES FEATURING ARTICLES RELATING TO COLLATERALIZED DEBT OBLIGATIONS, IN CLASS 41 (U.S. CLS. 100, 101 AND 107).

FIRST USE 10-16-2007; IN COMMERCE 10-16-2007.

THE MARK CONSISTS OF STANDARD CHARACTERS WITHOUT CLAIM TO ANY PARTICULAR FONT, STYLE, SIZE, OR COLOR.

NO CLAIM IS MADE TO THE EXCLUSIVE RIGHT TO USE "CDO", APART FROM THE MARK AS SHOWN.

SER. NO. 77-181,219, FILED 5-15-2007.

AHSEN KHAN, EXAMINING ATTORNEY

**Int. Cl.: 16**

**Prior U.S. Cls.: 2, 5, 22, 23, 29, 37, 38 and 50**

**United States Patent and Trademark Office**

**Reg. No. 3,465,521**

**Registered July 15, 2008**

**TRADEMARK  
PRINCIPAL REGISTER**

**PARKER URBAN**

PARKER PEN PRODUCTS (ENGLAND CORPORATION)  
PARKER HOUSE, ESTATE ROAD  
NEWHAVEN, EAST SUSSEX, UNITED KINGDOM  
BN90AU

FOR: WRITING INSTRUMENTS, IN CLASS 16  
(U.S. CLS. 2, 5, 22, 23, 29, 37, 38 AND 50).

THE MARK CONSISTS OF STANDARD CHARACTERS WITHOUT CLAIM TO ANY PARTICULAR FONT, STYLE, SIZE, OR COLOR.

PRIORITY CLAIMED UNDER SEC. 44(D) ON ERPN CMNTY TM OFC APPLICATION NO. 005481205, FILED 11-20-2006, REG. NO. 005481205, DATED 11-20-2006, EXPIRES 11-20-2016.

OWNER OF U.S. REG. NOS. 165,783, 1,842,892 AND OTHERS.

SER. NO. 77-181,461, FILED 5-15-2007.

REBECCA EISINGER, EXAMINING ATTORNEY

**Int. Cl.: 5**

**Prior U.S. Cls.: 6, 18, 44, 46, 51 and 52**

**United States Patent and Trademark Office**

**Reg. No. 3,465,522**

**Registered July 15, 2008**

**TRADEMARK  
PRINCIPAL REGISTER**



INKO SPORT AMERICA LLC (FLORIDA LTD  
LIAB CO)  
SUITE 607  
2200 SOUTH DIXIE HIGHWAY  
MIAMI, FL 33133

FOR: DIETARY AND NUTRITIONAL SUPPLE-  
MENTS, IN CLASS 5 (U.S. CLS. 6, 18, 44, 46, 51 AND  
52).

FIRST USE 12-8-2006; IN COMMERCE 12-8-2006.

NO CLAIM IS MADE TO THE EXCLUSIVE  
RIGHT TO USE "SUPERIOR SPORTS NUTRITION",  
APART FROM THE MARK AS SHOWN.

THE COLOR(S) RED, WHITE AND BLUE IS/ARE  
CLAIMED AS A FEATURE OF THE MARK.

THE MARK CONSISTS OF AN ARBITRARY DE-  
SIGN THAT IS BLUE ON THE LOWER RIGHT AND  
RED ON THE UPPER LEFT AND SURROUNDED  
BY THE RED OUTLINE OF A BOX AND THEN AN  
OUTLINE OF A BLUE BOX. TO THE RIGHT OF THE  
BOX THE LETTERS "EUROSPOR" ARE BLUE AND  
THE "T" AT THE END OF "EUROSPORT" IS RED.  
THE WORDS "SUPERIOR SPORTS NUTRITION"  
ARE IN RED. THE COLOR WHITE APPEARS IN  
THE WORDING BACKGROUND OF THE SQUARE  
CONTAIN THE ARBITRARY DESIGNS.

SER. NO. 77-181,533, FILED 5-15-2007.

ALICE BENMAMAN, EXAMINING ATTORNEY

**Int. Cls.: 9 and 42**

**Prior U.S. Cls.: 21, 23, 26, 36, 38, 100 and 101**

**United States Patent and Trademark Office**

**Reg. No. 3,465,523**

**Registered July 15, 2008**

**TRADEMARK  
SERVICE MARK  
PRINCIPAL REGISTER**



AVAILINK, INC. (DELAWARE CORPORATION)  
20201 CENTURY BOULEVARD, SUITE 160  
GERMANTOWN, MD 20874

FOR: SEMICONDUCTOR CHIPS; INTEGRATED CIRCUITS; SEMICONDUCTOR DEVICES FOR USE IN TELECOMMUNICATIONS, NAMELY, MODEMS, CABLE AND WIRELESS TUNERS, DEMODULATORS, GATEWAYS, NAMELY, COMPUTERS, NODES AND NETWORKS THAT ALLOW AND CONTROL ACCESS TO OTHER COMPUTERS AND NETWORKS, AND MULTIPLEXERS; SEMICONDUCTOR DEVICES FOR USE IN DATA PROCESSING DEVICES FOR COMMUNICATIONS APPLICATIONS; CABLE, SATELLITE, AND DIGITAL TERRESTRIAL TELEVISION AND COMMUNITY ANTENNAE TELEVISION SYSTEMS COMPRISED OF CABLE BOXES, SET-TOP BOXES, CABLE CONNECTORS, ELECTRICAL CONNECTORS, OPTICAL CONNECTORS, MODULATORS, AND DEMODULATORS; WIRELESS COMMUNICATION DEVICES, NAMELY, TELEVISION TRANSMITTERS, DIGITAL LOCAL LOOP TRANSMITTERS, CELL PHONES, PDAS, PERSONAL MEDIA PLAYERS, TELEVISION RECEIVERS, PORTABLE COMPUTER GAME PLAYERS, ENCODERS, AND DECODERS, NAMELY, CHANNEL DECODERS AND DIGITAL MULTIMEDIA DECODERS, IN CLASS 9 (U.S. CLS. 21, 23, 26, 36 AND 38).

FIRST USE 3-30-2007; IN COMMERCE 3-30-2007.

FOR: ENGINEERING SERVICES, NAMELY, ENGINEERING FOR THE TELECOMMUNICATIONS INDUSTRY; ENGINEERING SERVICES IN THE FIELDS OF SEMICONDUCTOR CHIP DESIGN AND COMPUTER HARDWARE; SEMICONDUCTOR CHIP DESIGN SERVICES; CONSULTING SERVICES IN THE FIELDS OF SEMICONDUCTOR CHIP DESIGN AND COMPUTER HARDWARE, IN CLASS 42 (U.S. CLS. 100 AND 101).

FIRST USE 3-30-2007; IN COMMERCE 3-30-2007.

SER. NO. 77-181,567, FILED 5-15-2007.

JOHN GARTNER, EXAMINING ATTORNEY

**Int. Cl.: 35**

**Prior U.S. Cls.: 100, 101 and 102**

**United States Patent and Trademark Office**

**Reg. No. 3,465,524**

**Registered July 15, 2008**

**SERVICE MARK  
PRINCIPAL REGISTER**



VELOCITY EXPRESS, INC. (DELAWARE CORPORATION)  
BUILDING B SUITE 300  
1 MORNINGSIDE DRIVE NORTH  
WESTPORT, CT 06880

FOR: MONITORING AND TRACKING OF PACKAGE SHIPMENTS, IN CLASS 35 (U.S. CLS. 100, 101 AND 102).

FIRST USE 7-21-2006; IN COMMERCE 7-21-2006.

NO CLAIM IS MADE TO THE EXCLUSIVE RIGHT TO USE "REAL TIME DELIVERY", APART FROM THE MARK AS SHOWN.

THE COLOR(S) RED, BLACK, WHITE AND GRAY IS/ARE CLAIMED AS A FEATURE OF THE MARK.

THE MARK CONSISTS OF A RED RECTANGLE CONTAINING THE WORDS "REAL TIME" IN BLACK STYLIZED LETTERING DIRECTLY TO THE LEFT OF A BLACK RECTANGLE CONTAINING THE WORD "DELIVERY". IN WHITE STYLIZED LETTERING, BOTH OF WHICH ARE SURROUNDED BY A WHITE BORDER OUTLINED IN DARK GRAY.

SER. NO. 77-181,694, FILED 5-15-2007.

CHRISIE B. KING, EXAMINING ATTORNEY

**Int. Cl.: 25**

**Prior U.S. Cls.: 22 and 39**

**United States Patent and Trademark Office**

**Reg. No. 3,465,525**

**Registered July 15, 2008**

**TRADEMARK  
PRINCIPAL REGISTER**

**URBAN EDEN**

CHERYL LYNNE SWADE (UNITED STATES IN-  
DIVIDUAL)  
5136 THE TOLEDO  
LONG BEACH, CA 90803

FOR: BELTS; CAPS; CHILDREN'S AND INFANTS'  
CLOTH BIBS; CHILDREN'S CLOTH EATING BIBS;  
CLOTH BIBS; CLOTH DIAPERS; CLOTHING FOR  
WEAR IN WRESTLING GAMES; CLOTHING,  
NAMELY, HAND-WARMERS; CLOTHING, NAME-  
LY, WRAP-AROUNDS; CORSETS; HOODS; INFANT  
AND TODDLER ONE PIECE CLOTHING; INFANT  
CLOTH DIAPERS; JERSEYS; LEATHER BELTS;  
SHIFTS; SHORT SETS; SHOULDER WRAPS; SWAD-

DLING CLOTHES; TIES; TOPS; WRAPS, IN CLASS 25  
(U.S. CLS. 22 AND 39).

FIRST USE 1-1-2001; IN COMMERCE 1-1-2001.

THE MARK CONSISTS OF STANDARD CHAR-  
ACTERS WITHOUT CLAIM TO ANY PARTICULAR  
FONT, STYLE, SIZE, OR COLOR.

OWNER OF U.S. REG. NO. 2,802,896.

SER. NO. 77-181,787, FILED 5-15-2007.

JIM RINGLE, EXAMINING ATTORNEY

**Int. Cl.: 41**

**Prior U.S. Cls.: 100, 101 and 107**

**United States Patent and Trademark Office**

**Reg. No. 3,465,526**

**Registered July 15, 2008**

**SERVICE MARK  
PRINCIPAL REGISTER**



JETT, KAREN (UNITED STATES INDIVIDUAL)  
87 RIDGE ROAD  
TELFORD, PA 18969

FOR: EDUCATION SERVICES, NAMELY, PROVIDING LIVE AND ON-LINE SEMINARS, WORKSHOPS AND COACHING IN THE FIELD OF MANAGEMENT AND LEADERSHIP AND DISTRIBUTING COURSE MATERIALS IN CONNECTION HERewith, IN CLASS 41 (U.S. CLS. 100, 101 AND 107).

FIRST USE 9-1-2006; IN COMMERCE 10-1-2006.

NO CLAIM IS MADE TO THE EXCLUSIVE RIGHT TO USE "ETHICS", APART FROM THE MARK AS SHOWN.

THE MARK CONSISTS OF STYLIZED LETTERING FEATURING A "Q" AND AN "E" SUPERIMPOSED ON A BAR FEATURING REVERSE STYLIZED LETTERING "QUESTIONING ETHICS" .

SER. NO. 77-182,103, FILED 5-16-2007.

JENNY PARK, EXAMINING ATTORNEY

**Int. Cl.: 41**

**Prior U.S. Cls.: 100, 101 and 107**

**United States Patent and Trademark Office**

**Reg. No. 3,465,527**

**Registered July 15, 2008**

**SERVICE MARK  
PRINCIPAL REGISTER**

**MUCHAS CULTURAS, ONE  
COMMUNITY**

JOYCE PRESCHOOL (MINNESOTA NON-PROFIT  
CORPORATION)  
1219 W. 31ST STREET  
MINNEAPOLIS, MN 55408

FOR: EDUCATIONAL SERVICES IN THE NAT-  
URE OF EARLY CHILDHOOD EDUCATION AND  
LANGUAGE IMMERSION SCHOOLS, IN CLASS 41  
(U.S. CLS. 100, 101 AND 107).

FIRST USE 1-16-2007; IN COMMERCE 1-16-2007.

THE MARK CONSISTS OF STANDARD CHAR-  
ACTERS WITHOUT CLAIM TO ANY PARTICULAR  
FONT, STYLE, SIZE, OR COLOR.

THE ENGLISH TRANSLATION OF THE WORD  
"MUCHAS CULTURAS" IN THE MARK IS MANY  
CULTURES.

SER. NO. 77-182,158, FILED 5-16-2007.

MIDGE BUTLER, EXAMINING ATTORNEY



**Int. Cl.: 14**

**Prior U.S. Cls.: 2, 27, 28 and 50**

**Reg. No. 3,465,528**

**United States Patent and Trademark Office**

**Registered July 15, 2008**

---

**TRADEMARK  
PRINCIPAL REGISTER**

**NEWCOMB**

THE ADMINISTRATORS OF THE TULANE EDUCATIONAL FUND (LOUISIANA NON-PROFIT CORPORATION)  
300 GIBSON HALL  
6823 ST. CHARLES AVENUE  
NEW ORLEANS, LA 70118

THE MARK CONSISTS OF STANDARD CHARACTERS WITHOUT CLAIM TO ANY PARTICULAR FONT, STYLE, SIZE, OR COLOR.

SEC. 2(F).

FOR: JEWELRY, IN CLASS 14 (U.S. CLS. 2, 27, 28 AND 50).

SER. NO. 77-182,572, FILED 5-16-2007.

FIRST USE 1-1-1910; IN COMMERCE 1-1-1910.

LINDA M. KING, EXAMINING ATTORNEY

**Int. Cl.: 35**

**Prior U.S. Cls.: 100, 101 and 102**

**United States Patent and Trademark Office**

**Reg. No. 3,465,529**

**Registered July 15, 2008**

**SERVICE MARK  
PRINCIPAL REGISTER**

**ASSOCIATION OF INDEPENDENT  
COMMERCIAL PRODUCERS**

ASSOCIATION OF INDEPENDENT COMMERCIAL PRODUCERS INC. (NEW YORK CORPORATION)

100 EAST 42ND STREET  
NEW YORK, NY 10017

FOR: ASSOCIATION SERVICES, NAMELY, PROMOTING THE INTERESTS OF TELEVISION AND FILM ADVERTISING AND COMMERCIAL PRODUCERS, IN CLASS 35 (U.S. CLS. 100, 101 AND 102).

FIRST USE 0-0-1972; IN COMMERCE 0-0-1972.

THE MARK CONSISTS OF STANDARD CHARACTERS WITHOUT CLAIM TO ANY PARTICULAR FONT, STYLE, SIZE, OR COLOR.

NO CLAIM IS MADE TO THE EXCLUSIVE RIGHT TO USE "ASSOCIATION", APART FROM THE MARK AS SHOWN.

SEC. 2(F).

SER. NO. 77-182,623, FILED 5-16-2007.

SUSAN LESLIE DUBOIS, EXAMINING ATTORNEY

**Int. Cl.: 25**

**Prior U.S. Cls.: 22 and 39**

**United States Patent and Trademark Office**

**Reg. No. 3,465,530**

**Registered July 15, 2008**

**TRADEMARK  
PRINCIPAL REGISTER**

**NEWCOMB**

THE ADMINISTRATORS OF THE TULANE EDUCATIONAL FUND (LOUISIANA NON-PROFIT CORPORATION)  
300 GIBSON HALL  
6823 ST. CHARLES AVENUE  
NEW ORLEANS, LA 70118

FOR: CLOTHING, NAMELY, T-SHIRTS, SWEAT-SHIRTS, CAPS, SHORTS, IN CLASS 25 (U.S. CLS. 22 AND 39).

FIRST USE 1-1-1960; IN COMMERCE 1-1-1960.

THE MARK CONSISTS OF STANDARD CHARACTERS WITHOUT CLAIM TO ANY PARTICULAR FONT, STYLE, SIZE, OR COLOR.

SEC. 2(F).

SER. NO. 77-182,672, FILED 5-16-2007.

LINDA M. KING, EXAMINING ATTORNEY

**Int. Cls.: 6, 14, 37, 40 and 42**

**Prior U.S. Cls.: 2, 12, 13, 14, 23, 25, 27, 28, 50, 100,  
101, 103 and 106**

**Reg. No. 3,465,531**

**United States Patent and Trademark Office**

**Registered July 15, 2008**

**TRADEMARK  
SERVICE MARK  
PRINCIPAL REGISTER**



**DETOUR GOLD**

DETOUR GOLD CORPORATION (CANADA  
CORPORATION)  
ROYAL BANK PLAZA, NORTH TOWER SUITE 2040  
200 BAY STREET  
TORONTO, CANADA M5J2J1

FOR: COMMON METALS AND THEIR ALLOYS  
FOR FURTHER MANUFACTURING , IN CLASS 6  
(U.S. CLS. 2, 12, 13, 14, 23, 25 AND 50).

FOR: GOLD; PRECIOUS METALS AND THEIR  
ALLOYS, IN CLASS 14 (U.S. CLS. 2, 27, 28 AND 50).

FOR: MINING EXTRACTION OF MINERALS,  
NAMELY, GOLD, AND PRECIOUS AND BASE  
METALS, IN CLASS 37 (U.S. CLS. 100, 103 AND 106).

FOR: REFINING AND PROCESSING OF MINER-  
ALS, NAMELY, GOLD, AND PRECIOUS AND BASE  
METALS, IN CLASS 40 (U.S. CLS. 100, 103 AND 106).

FOR: MINING AND MINERAL EXPLORATION  
SERVICES; MINERAL ASSAYING SERVICES;  
MINING AND MINERAL EXPLORATION AND  
EVALUATION SERVICES, IN CLASS 42 (U.S. CLS.  
100 AND 101).

OWNER OF CANADA REG. NO. TMA702665,  
DATED 12-7-2007, EXPIRES 12-7-2022.

NO CLAIM IS MADE TO THE EXCLUSIVE  
RIGHT TO USE "GOLD", APART FROM THE  
MARK AS SHOWN.

SER. NO. 77-182,686, FILED 5-16-2007.

ASMAT KHAN, EXAMINING ATTORNEY

**Int. Cl.: 21**

**Prior U.S. Cls.: 2, 13, 23, 29, 30, 33, 40 and 50**

**Reg. No. 3,465,532**

**United States Patent and Trademark Office**

**Registered July 15, 2008**

---

**TRADEMARK  
PRINCIPAL REGISTER**

**NEWCOMB**

THE ADMINISTRATORS OF THE TULANE EDUCATIONAL FUND (LOUISIANA NON-PROFIT CORPORATION)  
300 GIBSON HALL  
6823 ST. CHARLES AVENUE  
NEW ORLEANS, LA 70118

FOR: HOUSEWARES, NAMELY, CUPS, MUGS, BEVERAGeware, IN CLASS 21 (U.S. CLS. 2, 13, 23, 29, 30, 33, 40 AND 50).

FIRST USE 1-1-1960; IN COMMERCE 1-1-1960.

THE MARK CONSISTS OF STANDARD CHARACTERS WITHOUT CLAIM TO ANY PARTICULAR FONT, STYLE, SIZE, OR COLOR.

SEC. 2(F).

SER. NO. 77-182,712, FILED 5-16-2007.

LINDA M. KING, EXAMINING ATTORNEY

**Int. Cl.: 7**

**Prior U.S. Cls.: 13, 19, 21, 23, 31, 34 and 35**

**United States Patent and Trademark Office**

**Reg. No. 3,465,533**

**Registered July 15, 2008**

**TRADEMARK  
PRINCIPAL REGISTER**

**EZ-Glide**

GLOBE FOOD EQUIPMENT COMPANY (OHIO  
CORPORATION)  
2153 DRYDEN RD  
DAYTON, OH 45439

THE MARK CONSISTS OF STANDARD CHAR-  
ACTERS WITHOUT CLAIM TO ANY PARTICULAR  
FONT, STYLE, SIZE, OR COLOR.

FOR: ELECTRIC FOOD SLICERS, IN CLASS 7  
(U.S. CLS. 13, 19, 21, 23, 31, 34 AND 35).

SER. NO. 77-182,729, FILED 5-16-2007.

FIRST USE 7-5-2007; IN COMMERCE 7-5-2007.

ELLEN BURNS, EXAMINING ATTORNEY

**Int. Cl.: 10**

**Prior U.S. Cls.: 26, 39 and 44**

**United States Patent and Trademark Office**

**Reg. No. 3,465,534**

**Registered July 15, 2008**

**TRADEMARK  
PRINCIPAL REGISTER**

**Quest HF**

QUANTUM MEDICAL IMAGING (NEW YORK  
LTD LIAB CO)  
2002 ORVILLE DRIVE NORTH  
RONKONKOMA, NY 11705

FOR: ELECTROMAGNETIC MEDICAL DIAG-  
NOSTIC IMAGING APPARATUS, IN CLASS 10  
(U.S. CLS. 26, 39 AND 44).

FIRST USE 2-1-2000; IN COMMERCE 2-1-2000.

THE MARK CONSISTS OF STANDARD CHAR-  
ACTERS WITHOUT CLAIM TO ANY PARTICULAR  
FONT, STYLE, SIZE, OR COLOR.

NO CLAIM IS MADE TO THE EXCLUSIVE  
RIGHT TO USE "HF", APART FROM THE MARK  
AS SHOWN.

SER. NO. 77-182,849, FILED 5-16-2007.

PETER B. BROMAGHIM, EXAMINING ATTORNEY

**Int. Cl.: 41**

**Prior U.S. Cls.: 100, 101 and 107**

**United States Patent and Trademark Office**

**Reg. No. 3,465,535**

**Registered July 15, 2008**

**SERVICE MARK  
PRINCIPAL REGISTER**



TOYOTA MOTOR MANUFACTURING KENTUCKY, INC. (KENTUCKY CORPORATION)  
1001 CHERRY BLOSSOM WAY  
GEORGETOWN, KY 40324

FOR: ARRANGING AND CONDUCTING EDUCATIONAL CONFERENCES IN THE FIELD OF WOMEN'S ISSUES, IN CLASS 41 (U.S. CLS. 100, 101 AND 107).

FIRST USE 4-1-2006; IN COMMERCE 4-1-2006.

NO CLAIM IS MADE TO THE EXCLUSIVE RIGHT TO USE "WOMEN", APART FROM THE MARK AS SHOWN.

THE COLOR(S) GREEN AND BLACK IS/ARE CLAIMED AS A FEATURE OF THE MARK.

THE MARK CONSISTS OF TWO LARGE GREEN LEAVES WITH AN OVERLAY OF THREE SMALLER AND DARKER SHADED GREEN LEAVES. THE COLOR BLACK APPEARS IN THE LITERAL ELEMENT OF THE MARK WHICH CONSISTS OF THE WORDING "IN THE INTEREST OF WOMEN" AND IS DEPICTED IN TWO STACKED ROWS TO THE RIGHT OF THE LEAVES, WITH THE TOP ROW CONTAINING THE WORDS "IN THE INTEREST OF" AND THE BOTTOM ROW CONTAINING THE WORD "WOMEN", ALL IN TITLE CASE.

SER. NO. 77-182,854, FILED 5-16-2007.

ROBERT C. CLARK JR., EXAMINING ATTORNEY



**Int. Cl.: 10**

**Prior U.S. Cls.: 26, 39 and 44**

**United States Patent and Trademark Office**

**Reg. No. 3,465,536**

**Registered July 15, 2008**

**TRADEMARK  
PRINCIPAL REGISTER**

**Quiet Lift**

QUANTUM MEDICAL IMAGING (NEW YORK  
LTD LIAB CO)  
2002 ORVILLE DRIVE NORTH  
RONKONKOMA, NY 11779

FOR: ELECTROMAGNETIC MEDICAL DIAG-  
NOSTIC IMAGING APPARATUS, IN CLASS 10  
(U.S. CLS. 26, 39 AND 44).

FIRST USE 3-1-2000; IN COMMERCE 3-1-2000.

THE MARK CONSISTS OF STANDARD CHAR-  
ACTERS WITHOUT CLAIM TO ANY PARTICULAR  
FONT, STYLE, SIZE, OR COLOR.

NO CLAIM IS MADE TO THE EXCLUSIVE  
RIGHT TO USE "LIFT", APART FROM THE MARK  
AS SHOWN.

SER. NO. 77-182,938, FILED 5-16-2007.

PETER B. BROMAGHIM, EXAMINING ATTORNEY

**Int. Cls.: 11 and 12**

**Prior U.S. Cls.: 13, 19, 21, 23, 31, 34, 35 and 44**

**United States Patent and Trademark Office**

**Reg. No. 3,465,537**

**Registered July 15, 2008**

**TRADEMARK  
PRINCIPAL REGISTER**

**LUXMARK**

OSTLER INTERNATIONAL, INC. (UTAH CORPORATION)  
3170 SOUTH 900 WEST  
SALT LAKE CITY, UT 84119

FOR: AUTOMOTIVE AFTERMARKET PARTS, NAMELY, LIGHTS, IN CLASS 11 (U.S. CLS. 13, 21, 23, 31 AND 34).

FIRST USE 12-0-2001; IN COMMERCE 12-0-2001.

FOR: AUTOMOTIVE AFTERMARKET PARTS, NAMELY, STRUCTURAL PARTS FOR AUTOMOBILES, BUMPERS, GRILLES, HOODS, DOORS, PANELS, REAR VIEW MIRRORS, SIDE VIEW MIRRORS, VANITY MIRRORS, FENDERS, TURN

SIGNALS, DIRECTIONAL SIGNALS, SPOILERS, FITTED COVERS FOR BUMPERS, MOULDINGS, SUPPORTS AND ASSEMBLIES THEREOF, ALL FOR VEHICLES, IN CLASS 12 (U.S. CLS. 19, 21, 23, 31, 35 AND 44).

FIRST USE 12-0-2001; IN COMMERCE 12-0-2001.

THE MARK CONSISTS OF STANDARD CHARACTERS WITHOUT CLAIM TO ANY PARTICULAR FONT, STYLE, SIZE, OR COLOR.

SER. NO. 77-182,987, FILED 5-16-2007.

BARBARA BROWN, EXAMINING ATTORNEY

**Int. Cl.: 38**

**Prior U.S. Cls.: 100, 101 and 104**

**United States Patent and Trademark Office**

**Reg. No. 3,465,538**

**Registered July 15, 2008**

**SERVICE MARK  
PRINCIPAL REGISTER**

# NOTIFYALL

SELECTPATH, INC. (NEW MEXICO CORPORATION)  
5801 MENAUL N.E.  
ALBUQUERQUE, NM 87110

FOR: DELIVERY OF MESSAGES BY ELECTRONIC TRANSMISSION, NAMELY, ELECTRONIC MESSAGING SYSTEM IN THE NATURE OF A GROUP TEXT MESSAGING SERVICE WHEREBY TEXT MESSAGES ARE SENT TO CELL PHONES, PAGERS, OR EMAIL ADDRESSES OF SUBSCRIBERS, IN CLASS 38 (U.S. CLS. 100, 101 AND 104).

FIRST USE 4-4-2006; IN COMMERCE 4-4-2006.

THE MARK CONSISTS OF STANDARD CHARACTERS WITHOUT CLAIM TO ANY PARTICULAR FONT, STYLE, SIZE, OR COLOR.

SER. NO. 77-183,048, FILED 5-16-2007.

KAELIE KUNG, EXAMINING ATTORNEY

**Int. Cls.: 11 and 12**

**Prior U.S. Cls.: 13, 19, 21, 23, 31, 34, 35 and 44**

**United States Patent and Trademark Office**

**Reg. No. 3,465,539**

**Registered July 15, 2008**

**TRADEMARK  
PRINCIPAL REGISTER**

# CERTIFIT

OSTLER INTERNATIONAL, INC. (UTAH CORPORATION)  
3170 SOUTH 900 WEST  
SALT LAKE CITY, UT 84119

FOR: AUTOMOTIVE AFTERMARKET PARTS, NAMELY, LIGHTS, IN CLASS 11 (U.S. CLS. 13, 21, 23, 31 AND 34).

FIRST USE 10-0-1995; IN COMMERCE 10-0-1995.

FOR: AUTOMOTIVE AFTERMARKET PARTS, NAMELY, STRUCTURAL PARTS FOR AUTOMOBILES, BUMPERS, GRILLES, HOODS, DOORS, PANELS, REAR VIEW MIRRORS, SIDE VIEW MIRRORS, VANITY MIRRORS, FENDERS, TURN

SIGNALS, DIRECTIONAL SIGNALS, SPOILERS, FITTED COVERS FOR BUMPERS, MOULDINGS, SUPPORTS AND ASSEMBLIES THEREOF, ALL FOR VEHICLES, IN CLASS 12 (U.S. CLS. 19, 21, 23, 31, 35 AND 44).

FIRST USE 10-0-1995; IN COMMERCE 10-0-1995.

THE MARK CONSISTS OF STANDARD CHARACTERS WITHOUT CLAIM TO ANY PARTICULAR FONT, STYLE, SIZE, OR COLOR.

SER. NO. 77-183,060, FILED 5-16-2007.

BARBARA BROWN, EXAMINING ATTORNEY

**Int. Cl.: 28**

**Prior U.S. Cls.: 22, 23, 38 and 50**

**Reg. No. 3,465,540**

**United States Patent and Trademark Office**

**Registered July 15, 2008**

---

**TRADEMARK  
PRINCIPAL REGISTER**

**SWING PERFECT!**

SWING PERFECT, LLC (TENNESSEE LTD LIAB  
CO)  
SUITE 106  
3555 KEITH STREET  
CLEVELAND, TN 37312

FOR: GOLF CLUB SWING AIDS, NAMELY, A  
TRAINING DEVICE THAT ATTACHES TEMPORA-  
RILY TO THE SHAFT OF A GOLF CLUB TO  
PROVIDE FEEDBACK OF INCORRECT CLUB PO-  
SITIONING IN THE BACKSWING AND FORWARD  
SWING, IN CLASS 28 (U.S. CLS. 22, 23, 38 AND 50).

FIRST USE 7-19-2002; IN COMMERCE 7-19-2002.

THE MARK CONSISTS OF STANDARD CHAR-  
ACTERS WITHOUT CLAIM TO ANY PARTICULAR  
FONT, STYLE, SIZE, OR COLOR.

NO CLAIM IS MADE TO THE EXCLUSIVE  
RIGHT TO USE "SWING", APART FROM THE  
MARK AS SHOWN.

SER. NO. 77-183,221, FILED 5-17-2007.

MELVIN AXILBUND, EXAMINING ATTORNEY

**Int. Cl.: 25**

**Prior U.S. Cls.: 22 and 39**

**United States Patent and Trademark Office**

**Reg. No. 3,465,541**

**Registered July 15, 2008**

**TRADEMARK  
PRINCIPAL REGISTER**

**BODY TRAININGSYSTEMS**

THE STEP COMPANY (GEORGIA CORPORATION)  
2130 NEWMARKET PARKWAY  
MARIETTA, GA 30067

FOR: CLOTHING, NAMELY, T-SHIRTS, SWEAT-SHIRTS, JACKETS, HATS, PANTS, HEAD SCARVES AND SHORTS, IN CLASS 25 (U.S. CLS. 22 AND 39).

FIRST USE 5-1-2005; IN COMMERCE 5-1-2005.

THE MARK CONSISTS OF STANDARD CHARACTERS WITHOUT CLAIM TO ANY PARTICULAR FONT, STYLE, SIZE, OR COLOR.

OWNER OF U.S. REG. NOS. 2,489,730, 2,509,128, AND 2,524,359.

SER. NO. 77-183,312, FILED 5-17-2007.

MARY BOAGNI, EXAMINING ATTORNEY

**Int. Cls.: 14 and 24**

**Prior U.S. Cls.: 2, 27, 28, 42 and 50**

**United States Patent and Trademark Office**

**Reg. No. 3,465,542**

**Registered July 15, 2008**

**TRADEMARK  
PRINCIPAL REGISTER**

**HEARTBREAKER**

GUEVEN DESIGN SCHMUCK GMBH (FED REP  
GERMANY LTD LIAB CO)  
LESSINGSTRASSE 16  
PFORZHEIM, FED REP GERMANY 75175

FOR: JEWELRY; RINGS; PENDANTS, EARRINGS  
AND BRACELETS; LEATHER AND FABRIC  
STRAPS USED AS A COMPONENT OF JEWELRY,  
IN CLASS 14 (U.S. CLS. 2, 27, 28 AND 50).

FOR: TEXTILES AND TEXTILE GOODS, NAME-  
LY, BED SKIRTS, BED SHEETS, BEDSPREADS;  
FABRIC TABLE CLOTHES, IN CLASS 24 (U.S. CLS.  
42 AND 50).

THE MARK CONSISTS OF STANDARD CHAR-  
ACTERS WITHOUT CLAIM TO ANY PARTICULAR  
FONT, STYLE, SIZE, OR COLOR.

OWNER OF FED REP GERMANY REG. NO.  
30447307, DATED 1-12-2005, EXPIRES 8-31-2014.

SER. NO. 77-183,373, FILED 5-17-2007.

MATTHEW EINSTEIN, EXAMINING ATTORNEY

**Int. Cl.: 9**

**Prior U.S. Cls.: 21, 23, 26, 36 and 38**

**United States Patent and Trademark Office**

**Reg. No. 3,465,543**

**Registered July 15, 2008**

**TRADEMARK  
PRINCIPAL REGISTER**

**REINVERTING OPERATING LENS  
SYSTEM**

VOLK OPTICAL INC. (OHIO CORPORATION)  
7893 ENTERPRISE DRIVE  
MENTOR, OH 44060

FOR: OPHTHALMOSCOPY LENSES, IN CLASS 9  
(U.S. CLS. 21, 23, 26, 36 AND 38).

FIRST USE 10-0-1994; IN COMMERCE 10-0-1994.

THE MARK CONSISTS OF STANDARD CHAR-  
ACTERS WITHOUT CLAIM TO ANY PARTICULAR  
FONT, STYLE, SIZE, OR COLOR.

OWNER OF U.S. REG. NO. 2,110,065.

NO CLAIM IS MADE TO THE EXCLUSIVE  
RIGHT TO USE "LENS SYSTEM", APART FROM  
THE MARK AS SHOWN.

SEC. 2(F).

SER. NO. 77-183,378, FILED 5-17-2007.

LOURDES AYALA, EXAMINING ATTORNEY



**Int. Cl.: 1**

**Prior U.S. Cls.: 1, 5, 6, 10, 26 and 46**

**Reg. No. 3,465,544**

**United States Patent and Trademark Office**

**Registered July 15, 2008**

---

**TRADEMARK  
PRINCIPAL REGISTER**

**FlexiCote**

COMPO GMBH & CO KG (FED REP GERMANY  
KOMMANDITGESELLSCHAFT (KG))  
GILDENSTRASSE 38  
MUNSTER, FED REP GERMANY 48157

OWNER OF FED REP GERMANY REG. NO.  
30739037, DATED 8-20-2007, EXPIRES 6-30-2017.

FOR: FERTILIZERS, IN CLASS 1 (U.S. CLS. 1, 5, 6,  
10, 26 AND 46).

SER. NO. 77-183,496, FILED 5-17-2007.

THE MARK CONSISTS OF STANDARD CHAR-  
ACTERS WITHOUT CLAIM TO ANY PARTICULAR  
FONT, STYLE, SIZE, OR COLOR.

CHRISTINA SOBRAL, EXAMINING ATTORNEY

**Int. Cl.: 28**

**Prior U.S. Cls.: 22, 23, 38 and 50**

**United States Patent and Trademark Office**

**Reg. No. 3,465,545**

**Registered July 15, 2008**

**TRADEMARK  
PRINCIPAL REGISTER**

**Bad Call!**

TUTM ENTERTAINMENT, INC. (NEW JERSEY  
CORPORATION)  
45 FERNWOOD AVENUE  
EDISON, NJ 08837

FOR: NOVELTY ITEMS, NAMELY, FAUX  
SPORTING EQUIPMENT IN THE NATURE OF  
PENALTY FLAGS, FOAM BRICKS, AND INFLATA-  
BLE REFEREE DOLLS, IN CLASS 28 (U.S. CLS. 22, 23,  
38 AND 50).

FIRST USE 1-1-2007; IN COMMERCE 1-1-2007.

THE MARK CONSISTS OF STANDARD CHAR-  
ACTERS WITHOUT CLAIM TO ANY PARTICULAR  
FONT, STYLE, SIZE, OR COLOR.

SER. NO. 77-183,647, FILED 5-17-2007.

RAMONA ORTIGA, EXAMINING ATTORNEY

**Int. Cl.: 36**

**Prior U.S. Cls.: 100, 101 and 102**

**United States Patent and Trademark Office**

**Reg. No. 3,465,546**

**Registered July 15, 2008**

**SERVICE MARK  
PRINCIPAL REGISTER**

**SYNAPSE INVESTMENT  
MANAGEMENT**

SYNAPSE INVESTMENT MANAGEMENT LLP  
(ENGLAND LIMITED CORPORATION)  
3RD FLOOR  
24 CORNHILL  
LONDON, ENGLAND EC3V3ND

FOR: FINANCIAL SERVICES, NAMELY INVEST-  
MENT ADVISORY SERVICES, INVESTMENT MAN-  
AGEMENT SERVICES AND ASSET  
MANAGEMENT SERVICES, IN CLASS 36 (U.S.  
CLS. 100, 101 AND 102).

FIRST USE 4-2-2007; IN COMMERCE 4-2-2007.

THE MARK CONSISTS OF STANDARD CHAR-  
ACTERS WITHOUT CLAIM TO ANY PARTICULAR  
FONT, STYLE, SIZE, OR COLOR.

NO CLAIM IS MADE TO THE EXCLUSIVE  
RIGHT TO USE "INVESTMENT MANAGEMENT",  
APART FROM THE MARK AS SHOWN.

SER. NO. 77-183,654, FILED 5-17-2007.

ANNE E. GUSTASON, EXAMINING ATTORNEY

**Int. Cl.: 11**

**Prior U.S. Cls.: 13, 21, 23, 31 and 34**

**United States Patent and Trademark Office**

**Reg. No. 3,465,547**

**Registered July 15, 2008**

**TRADEMARK  
PRINCIPAL REGISTER**

**ARMALIGHT**

ORIENT8 LIMITED (HONG KONG LTD LIAB  
CO)  
10A SEAPOWER INDUSTRIAL CENTRE  
177 HOI BUN ROAD  
KWUN TONG, KOWLOON, HONG KONG

FOR: PORTABLE LIGHTING APPARATUS,  
NAMELY, ELECTRIC TORCHES FOR LIGHTING;  
FLASHLIGHTS; SPOTLIGHTS; LED LIGHT FIX-

TURES; PARTS AND FITTINGS THEREFORE, IN  
CLASS 11 (U.S. CLS. 13, 21, 23, 31 AND 34).

OWNER OF HONG KONG REG. NO. 300425808,  
DATED 5-24-2005, EXPIRES 5-23-2015.

SER. NO. 77-183,825, FILED 5-17-2007.

INGRID C. EULIN, EXAMINING ATTORNEY

**Int. Cl.: 25**

**Prior U.S. Cls.: 22 and 39**

**United States Patent and Trademark Office**

**Reg. No. 3,465,548**

**Registered July 15, 2008**

**TRADEMARK  
PRINCIPAL REGISTER**



THE STEP COMPANY (GEORGIA CORPORATION)  
2130 NEWMARKET PARKWAY  
MARIETTA, GA 30067

FOR: CLOTHING, NAMELY, T-SHIRTS, SWEAT-SHIRTS, JACKETS, HATS, PANTS, HEAD SCARVES AND SHORTS, IN CLASS 25 (U.S. CLS. 22 AND 39).

FIRST USE 5-1-2005; IN COMMERCE 5-1-2005.

OWNER OF U.S. REG. NOS. 2,489,730, 2,509,128, AND 2,524,359.

"THE MARK CONSISTS IN PART OF A STYLIZED DESIGN OF HAND WEIGHTS."

SER. NO. 77-183,841, FILED 5-17-2007.

MARY BOAGNI, EXAMINING ATTORNEY

**Int. Cls.: 42 and 44**

**Prior U.S. Cls.: 100 and 101**

**United States Patent and Trademark Office**

**Reg. No. 3,465,549**

**Registered July 15, 2008**

**SERVICE MARK  
PRINCIPAL REGISTER**



LABORATORIO CLINICO BORINQUEN, INC.  
(PUERTO RICO CORPORATION)  
BALDORIOTY 2, ESQ. GOYCO  
CAGUAS, PUERTO RICO 00725

FOR: MEDICAL ANALYSIS SERVICES FOR PERSONS, NAMELY, MEDICAL LABORATORIES, IN CLASS 42 (U.S. CLS. 100 AND 101).

FIRST USE 9-1-1971; IN COMMERCE 9-1-1971.

FOR: MEDICAL ANALYSIS SERVICES FOR PERSONS, NAMELY, MEDICAL TESTING, IN CLASS 44 (U.S. CLS. 100 AND 101).

FIRST USE 9-1-1971; IN COMMERCE 9-1-1971.

NO CLAIM IS MADE TO THE EXCLUSIVE RIGHT TO USE "LABORATORIO CLINICO", APART FROM THE MARK AS SHOWN.

THE COLOR(S) GREEN IS/ARE CLAIMED AS A FEATURE OF THE MARK.

THE MARK CONSISTS OF A HORIZONTAL LINE WITH THE WORD "LABORATORIO" UNDERNEATH IT. BELOW "LABORATORIO" IS THE WORD "CLINICO". UNDERNEATH IT IS AN OVAL/CIRCLE WITH THE LETTERS "L" AND "B" INTERTWINED. BENEATH THE OVAL/CIRCLE IS THE WORD "BORINQUEN" UNDERLINED. THE COLOR GREEN APPEARS IN THE WORDING "LABORATORIO CLINICO BORINQUEN", IN THE INTERTWINED LETTERS "LB", IN THE OVAL/CIRCLE AROUND "LB", AND IN LINES ABOVE "LABORATORIO CLINICO" AND BELOW "BORINQUEN". THE COLOR WHITE APPEARS IN THE DRAWING TO INDICATE A TRANSPARENT BACKGROUND.

THE FOREIGN WORDING IN THE MARK TRANSLATES INTO ENGLISH AS BORINQUEN CLINICAL LABORATORY.

SER. NO. 77-183,933, FILED 5-17-2007.

REBECCA EISINGER, EXAMINING ATTORNEY

Int. Cl.: 9

Prior U.S. Cls.: 21, 23, 26, 36 and 38

Reg. No. 3,465,550

United States Patent and Trademark Office

Registered July 15, 2008

TRADEMARK  
PRINCIPAL REGISTER



CONVOY OF HOPE (CALIFORNIA CORPORATION)  
330 S. PATTERSON AVENUE  
SPRINGFIELD, MO 65802

FOR: DVDS FEATURING INFORMATION PERTAINING TO CHARITABLE FUND-RAISING, HUNGER RELIEF, AND CHRISTIANITY AND RELIGION, IN CLASS 9 (U.S. CLS. 21, 23, 26, 36 AND 38).

FIRST USE 5-10-2004; IN COMMERCE 5-10-2004.

OWNER OF U.S. REG. NO. 2,392,514.

THE MARK CONSISTS OF THE WORDS "ONE DAY TO FEED THE WORLD CONVOY OF HOPE", A LARGER NUMERAL "1" SUPERIMPOSED OVER THE LETTER "E" IN THE WORD "ONE", AND AN OUTLINE OF A GLOBE DESIGN IN THE BACKGROUND.

SER. NO. 77-184,000, FILED 5-17-2007.

EVELYN BRADLEY, EXAMINING ATTORNEY

Int. Cl.: 16

Prior U.S. Cls.: 2, 5, 22, 23, 29, 37, 38 and 50

United States Patent and Trademark Office

Reg. No. 3,465,551

Registered July 15, 2008

TRADEMARK  
PRINCIPAL REGISTER



CONVOY OF HOPE (CALIFORNIA CORPORATION)  
330 S. PATTERSON AVENUE  
SPRINGFIELD, MO 65802

FOR: PUBLICATIONS AND OTHER PRINTED MATERIALS, NAMELY, BOOKLETS, PAMPHLETS, BROCHURES, REPORTS, AND PRINTED EDUCATIONAL MATERIALS ALL PERTAINING TO CHARITABLE FUND-RAISING, HUNGER RELIEF, AND CHRISTIANITY AND RELIGION, IN CLASS 16 (U.S. CLS. 2, 5, 22, 23, 29, 37, 38 AND 50).

FIRST USE 1-15-2003; IN COMMERCE 1-15-2003.

OWNER OF U.S. REG. NO. 2,392,514.

THE MARK CONSISTS OF THE WORDS "ONE DAY TO FEED THE WORLD CONVOY OF HOPE", A LARGER NUMERAL "1" SUPERIMPOSED OVER THE LETTER "E" IN THE WORD "ONE", AND AN OUTLINE OF A GLOBE DESIGN IN THE BACKGROUND.

SER. NO. 77-184,011, FILED 5-17-2007.

EVELYN BRADLEY, EXAMINING ATTORNEY



Int. Cl.: 36

Prior U.S. Cls.: 100, 101 and 102

United States Patent and Trademark Office

Reg. No. 3,465,552

Registered July 15, 2008

SERVICE MARK  
PRINCIPAL REGISTER



CONVOY OF HOPE (CALIFORNIA CORPORATION)  
330 S. PATTERSON AVENUE  
SPRINGFIELD, MO 65802

FOR: CHARITABLE FUND RAISING SERVICES,  
IN CLASS 36 (U.S. CLS. 100, 101 AND 102).

FIRST USE 10-2-2002; IN COMMERCE 10-2-2002.

OWNER OF U.S. REG. NO. 2,392,514.

THE MARK CONSISTS OF THE WORDS "ONE DAY TO FEED THE WORLD CONVOY OF HOPE", A LARGER NUMERAL "1" SUPERIMPOSED OVER THE LETTER "E" IN THE WORD "ONE", AND AN OUTLINE OF A GLOBE DESIGN IN THE BACKGROUND .

SER. NO. 77-184,017, FILED 5-17-2007.

EVELYN BRADLEY, EXAMINING ATTORNEY

**Int. Cl.: 35**

**Prior U.S. Cls.: 100, 101 and 102**

**United States Patent and Trademark Office**

**Reg. No. 3,465,553**

**Registered July 15, 2008**

**SERVICE MARK  
PRINCIPAL REGISTER**

**INTELITURE**

LOVELESS, BECTON (UNITED STATES INDIVIDUAL)  
4077 CLIPPER STREET  
SARATOGA SPRINGS, UT 84043

FOR: INTERNET MARKETING CONSULTING SERVICES, SEARCH ENGINE MARKETING SERVICES, COMPILATION OF WEBSITE STATISTICS FOR BUSINESS PURPOSES, WEB ANALYTICS REGARDING SUCCESS OF MARKETING CAMPAIGNS, IN CLASS 35 (U.S. CLS. 100, 101 AND 102).

FIRST USE 12-1-2003; IN COMMERCE 12-1-2003.

THE MARK CONSISTS OF STANDARD CHARACTERS WITHOUT CLAIM TO ANY PARTICULAR FONT, STYLE, SIZE, OR COLOR.

SER. NO. 77-184,129, FILED 5-17-2007.

ANDREA K. NADELMAN, EXAMINING ATTORNEY

**Int. Cl.: 36**

**Prior U.S. Cls.: 100, 101 and 102**

**United States Patent and Trademark Office**

**Reg. No. 3,465,554**

**Registered July 15, 2008**

**SERVICE MARK  
PRINCIPAL REGISTER**

**DCI**

DIVERSIFIED CREDIT INVESTMENTS, LLC  
(DELAWARE LTD LIAB CO)  
201 SPEAR STREET, SUITE 250  
SAN FRANCISCO, CA 94105

FOR: INVESTMENT MANAGEMENT AND INVESTMENT ADVISORY SERVICES, NEITHER OF WHICH USES STRATEGIES EMPHASIZING TAX-DEDUCTIBLE CUMULATIVE TIER I REGULATORY CAPITAL SECURITIES FOR BANKS, IN CLASS 36 (U.S. CLS. 100, 101 AND 102).

FIRST USE 0-0-2004; IN COMMERCE 0-0-2004.

THE MARK CONSISTS OF STANDARD CHARACTERS WITHOUT CLAIM TO ANY PARTICULAR FONT, STYLE, SIZE, OR COLOR.

SER. NO. 77-184,132, FILED 5-17-2007.

JASON ROTH, EXAMINING ATTORNEY

**Int. Cl.: 41**

**Prior U.S. Cls.: 100, 101 and 107**

**United States Patent and Trademark Office**

**Reg. No. 3,465,555**

**Registered July 15, 2008**

**SERVICE MARK  
PRINCIPAL REGISTER**

**American Association for  
the Study of Headache**

AMERICAN HEADACHE SOCIETY (MISSOURI  
NON-PROFIT CORPORATION)

19 MANTUA ROAD

MOUNT ROYAL, NJ 08061

FOR: DEVELOPMENT AND DISSEMINATION  
OF EDUCATIONAL MATERIALS OF OTHERS IN  
THE FIELD OF PAIN ASSOCIATED WITH THE  
HEAD, FACE AND NECK, IN CLASS 41 (U.S. CLS.  
100, 101 AND 107).

FIRST USE 4-8-1959; IN COMMERCE 4-8-1959.

THE MARK CONSISTS OF STANDARD CHAR-  
ACTERS WITHOUT CLAIM TO ANY PARTICULAR  
FONT, STYLE, SIZE, OR COLOR.

NO CLAIM IS MADE TO THE EXCLUSIVE  
RIGHT TO USE "ASSOCIATION FOR THE STUDY  
OF HEADACHE", APART FROM THE MARK AS  
SHOWN.

SEC. 2(F).

SER. NO. 77-184,246, FILED 5-18-2007.

TINA KUAN, EXAMINING ATTORNEY

Int. Cl.: 37

Prior U.S. Cls.: 100, 103 and 106

United States Patent and Trademark Office

Reg. No. 3,465,556

Registered July 15, 2008

**SERVICE MARK  
PRINCIPAL REGISTER**



PHOENIX AUTO GLASS, INC. (NEW YORK CORPORATION)  
929-7 LINCOLN AVENUE  
HOLBROOK, NY 11741

FOR: INSTALLATION, MAINTENANCE AND REPAIR OF AUTOMOBILE GLASS, WINDOWS, AND WINDSHIELDS, IN CLASS 37 (U.S. CLS. 100, 103 AND 106).

FIRST USE 1-1-2007; IN COMMERCE 1-1-2007.

NO CLAIM IS MADE TO THE EXCLUSIVE RIGHT TO USE "AUTO GLASS", APART FROM THE MARK AS SHOWN.

THE COLOR(S) RED AND BLACK IS/ARE CLAIMED AS A FEATURE OF THE MARK.

THE MARK CONSISTS OF A STYLIZED PHOENIX IN RED AND THE TEXT "PHOENIX AUTO GLASS" IN BLACK LETTERING.

SER. NO. 77-184,283, FILED 5-18-2007.

PAM WILLIS, EXAMINING ATTORNEY

**Int. Cl.: 28**

**Prior U.S. Cls.: 22, 23, 38 and 50**

**United States Patent and Trademark Office**

**Reg. No. 3,465,557**

**Registered July 15, 2008**

**TRADEMARK  
PRINCIPAL REGISTER**

**RIP DRIVE**

KEE ACTION SPORTS I LLC (DELAWARE LTD  
LIAB CO)

570 MANTUA BOULEVARD

SEWELL, NJ 08080

FOR: PAINTBALL GUN FEEDER ASSIST ME-  
CHANISM, IN CLASS 28 (U.S. CLS. 22, 23, 38 AND 50).

FIRST USE 5-0-2005; IN COMMERCE 5-0-2005.

THE MARK CONSISTS OF STANDARD CHAR-  
ACTERS WITHOUT CLAIM TO ANY PARTICULAR  
FONT, STYLE, SIZE, OR COLOR.

NO CLAIM IS MADE TO THE EXCLUSIVE  
RIGHT TO USE "DRIVE", APART FROM THE  
MARK AS SHOWN.

SER. NO. 77-184,298, FILED 5-18-2007.

EDWARD FENNESSY, EXAMINING ATTORNEY

**Int. Cl.: 28**

**Prior U.S. Cls.: 22, 23, 38 and 50**

**United States Patent and Trademark Office**

**Reg. No. 3,465,558**

**Registered July 15, 2008**

**TRADEMARK  
PRINCIPAL REGISTER**

**WOBBLESMART**

JUNCKER, BO (DENMARK INDIVIDUAL)  
INGERSLEVS BOULEVARD 4 4. TH  
AARHUS, DENMARK 8000

OWNER OF DENMARK REG. NO. VR200700687,  
DATED 3-15-2007, EXPIRES 3-15-2017.

FOR: GYMNAS TIC APPARATUS, IN CLASS 28  
(U.S. CLS. 22, 23, 38 AND 50).

SER. NO. 77-184,303, FILED 5-18-2007.

THE MARK CONSISTS OF STANDARD CHAR-  
ACTERS WITHOUT CLAIM TO ANY PARTICULAR  
FONT, STYLE, SIZE, OR COLOR.

AMY HELLA, EXAMINING ATTORNEY

**Int. Cl.: 21**

**Prior U.S. Cls.: 2, 13, 23, 29, 30, 33, 40 and 50**

**Reg. No. 3,465,559**

**United States Patent and Trademark Office**

**Registered July 15, 2008**

---

**TRADEMARK  
PRINCIPAL REGISTER**

**FOLEY MARTENS**

COLUMBIAN HOME PRODUCTS, L.L.C. (ILLI-  
NOIS LTD LIAB CO)  
1536 BEECH STREET  
TERRE HAUTE, IN 47804

THE MARK CONSISTS OF STANDARD CHAR-  
ACTERS WITHOUT CLAIM TO ANY PARTICULAR  
FONT, STYLE, SIZE, OR COLOR.

FOR: CUTTING BOARDS, IN CLASS 21 (U.S. CLS.  
2, 13, 23, 29, 30, 33, 40 AND 50).

SER. NO. 77-184,304, FILED 5-18-2007.

FIRST USE 0-0-1989; IN COMMERCE 0-0-1989.

ANNE E. GUSTASON, EXAMINING ATTORNEY



**Int. Cl.: 21**

**Prior U.S. Cls.: 2, 13, 23, 29, 30, 33, 40 and 50**

**Reg. No. 3,465,560**

**United States Patent and Trademark Office**

**Registered July 15, 2008**

**TRADEMARK  
PRINCIPAL REGISTER**



COLUMBIAN HOME PRODUCTS, L.L.C. (ILLI-  
NOIS LTD LIAB CO)  
1536 BEECH STREET  
TERRE HAUTE, IN 47804

THE MARK CONSISTS OF "FOLEY MARTENS"  
IN HEXAGON.

FOR: CUTTING BOARDS, IN CLASS 21 (U.S. CLS.  
2, 13, 23, 29, 30, 33, 40 AND 50).

SER. NO. 77-184,308, FILED 5-18-2007.

FIRST USE 0-0-1989; IN COMMERCE 0-0-1989.

ANNE E. GUSTASON, EXAMINING ATTORNEY

**Int. Cl.: 16**

**Prior U.S. Cls.: 2, 5, 22, 23, 29, 37, 38 and 50**

**United States Patent and Trademark Office**

**Reg. No. 3,465,561**

**Registered July 15, 2008**

**TRADEMARK  
PRINCIPAL REGISTER**

# IgniteCard

DIMPLEDOUGH INC. (DELAWARE CORPORATION)  
STE 240  
4807 ROCKSIDE RD.  
INDEPENDENCE, OH 44131

THE MARK CONSISTS OF STANDARD CHARACTERS WITHOUT CLAIM TO ANY PARTICULAR FONT, STYLE, SIZE, OR COLOR.

FOR: GIFT CARDS, IN CLASS 16 (U.S. CLS. 2, 5, 22, 23, 29, 37, 38 AND 50).

SER. NO. 77-184,336, FILED 5-18-2007.

FIRST USE 9-15-2006; IN COMMERCE 12-1-2006.

LINDA E. BLOHM, EXAMINING ATTORNEY

**Int. Cl.: 10**

**Prior U.S. Cls.: 26, 39 and 44**

**United States Patent and Trademark Office**

**Reg. No. 3,465,562**

**Registered July 15, 2008**

**TRADEMARK  
PRINCIPAL REGISTER**

**LFN**

SYNTHES (U.S.A.) (PENNSYLVANIA PARTNER-  
SHIP)  
1302 WRIGHTS LANE EAST  
WEST CHESTER, PA 19380

FOR: SURGICAL IMPLANTS, NAMELY, IM-  
PLANTABLE NAILS AND NAILING SYSTEMS  
MADE OF METAL, CERAMICS OR ARTIFICIAL  
TISSUE FOR OSTEOSYNTHESIS, IN CLASS 10 (U.S.  
CLS. 26, 39 AND 44).

FIRST USE 9-29-2006; IN COMMERCE 9-29-2006.

THE MARK CONSISTS OF STANDARD CHAR-  
ACTERS WITHOUT CLAIM TO ANY PARTICULAR  
FONT, STYLE, SIZE, OR COLOR.

THE WORDING "LFN" HAS NO MEANING IN A  
FOREIGN LANGUAGE.

SER. NO. 77-184,360, FILED 5-18-2007.

ALICE BENMAMAN, EXAMINING ATTORNEY

**Int. Cl.: 16**

**Prior U.S. Cls.: 2, 5, 22, 23, 29, 37, 38 and 50**

**United States Patent and Trademark Office**

**Reg. No. 3,465,563**

**Registered July 15, 2008**

---

**TRADEMARK  
PRINCIPAL REGISTER**

**It's not just business.  
It's personal.**

DIMPLEDOUGH INC. (DELAWARE CORPORATION)  
STE 240  
4807 ROCKSIDE RD.  
INDEPENDENCE, OH 44131

THE MARK CONSISTS OF STANDARD CHARACTERS WITHOUT CLAIM TO ANY PARTICULAR FONT, STYLE, SIZE, OR COLOR.

FOR: GIFT CARDS, IN CLASS 16 (U.S. CLS. 2, 5, 22, 23, 29, 37, 38 AND 50).

SER. NO. 77-184,380, FILED 5-18-2007.

FIRST USE 1-10-2007; IN COMMERCE 2-1-2007.

LINDA E. BLOHM, EXAMINING ATTORNEY

**Int. Cl.: 38**

**Prior U.S. Cls.: 100, 101 and 104**

**United States Patent and Trademark Office**

**Reg. No. 3,465,564**

**Registered July 15, 2008**

**SERVICE MARK  
PRINCIPAL REGISTER**

**BLUE NATION**

CENTENNIAL COMMUNICATIONS CORP. (DE-  
LAWARE CORPORATION)  
3349 RTE. 138, BLDG. A  
WALL, NJ 07719

FOR: WIRELESS TELEPHONE TELECOMMUNI-  
CATION SERVICES, NAMELY, WIRELESS MOBILE  
TELEPHONE CALLING PLANS, IN CLASS 38 (U.S.  
CLS. 100, 101 AND 104).

FIRST USE 4-19-2007; IN COMMERCE 4-19-2007.

THE MARK CONSISTS OF STANDARD CHAR-  
ACTERS WITHOUT CLAIM TO ANY PARTICULAR  
FONT, STYLE, SIZE, OR COLOR.

OWNER OF U.S. REG. NO. 3,120,186.

NO CLAIM IS MADE TO THE EXCLUSIVE  
RIGHT TO USE "NATION", APART FROM THE  
MARK AS SHOWN.

SER. NO. 77-184,387, FILED 5-18-2007.

JOHN SCHUYLER YARD, EXAMINING ATTOR-  
NEY

**Int. Cl.: 19**

**Prior U.S. Cls.: 1, 12, 33 and 50**

**United States Patent and Trademark Office**

**Reg. No. 3,465,565**

**Registered July 15, 2008**

**TRADEMARK  
PRINCIPAL REGISTER**

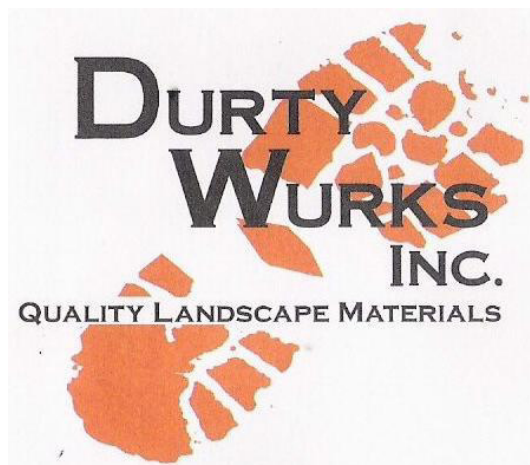

DURTY WURKS, INC. (GEORGIA CORPORATION)  
5200 HAMILTON ROAD  
COLUMBUS, GA 31904

FOR: SAND; PAVING STONES; STONE FOR BUILDING AND CONSTRUCTION, IN CLASS 19 (U.S. CLS. 1, 12, 33 AND 50).

FIRST USE 4-2-2001; IN COMMERCE 4-2-2001.

NO CLAIM IS MADE TO THE EXCLUSIVE RIGHT TO USE "INC." AND "QUALITY LANDSCAPE MATERIALS", APART FROM THE MARK AS SHOWN.

THE COLOR(S) ORANGE, BLACK AND WHITE IS/ARE CLAIMED AS A FEATURE OF THE MARK.

THE MARK CONSISTS OF ORANGE WORK BOOT TREAD PRINT WITH WHITE IN BETWEEN TREAD MARKS. BLACK LETTERING OF "DURTY WURKS QUALITY LANDSCAPE MATERIALS" OVER THE WORK BOOT TREAD PRINT.

SER. NO. 77-184,461, FILED 5-18-2007.

GIANCARLO CASTRO, EXAMINING ATTORNEY

**Int. Cl.: 8**

**Prior U.S. Cls.: 23, 28 and 44**

**United States Patent and Trademark Office**

**Reg. No. 3,465,566**

**Registered July 15, 2008**

**TRADEMARK  
PRINCIPAL REGISTER**

**INFI**

BUSSE KNIFE CO. (OHIO CORPORATION)  
11651 COUNTY ROAD 12  
WAUSEON, OH 43567

THE MARK CONSISTS OF STANDARD CHAR-  
ACTERS WITHOUT CLAIM TO ANY PARTICULAR  
FONT, STYLE, SIZE, OR COLOR.

FOR: KNIFE BLADES SOLD AS INTEGRAL  
COMPONENTS OF MULTI-FUNCTION FIXED  
BLADE SPORT KNIVES, IN CLASS 8 (U.S. CLS. 23,  
28 AND 44).

SER. NO. 77-184,661, FILED 5-18-2007.

FIRST USE 0-0-1996; IN COMMERCE 0-0-1996.

MAUREEN DALL, EXAMINING ATTORNEY

**Int. Cls.: 14 and 35**

**Prior U.S. Cls.: 2, 27, 28, 50, 100, 101 and 102**

**United States Patent and Trademark Office**

**Reg. No. 3,465,567**

**Registered July 15, 2008**

**TRADEMARK  
SERVICE MARK  
PRINCIPAL REGISTER**

**GUY DAVID**

GASSAN DIAMONDS B.V. (NETHERLANDS LTD  
LIAB CO)  
NIEUWE UILENBURGERSTRAAT 173/175  
AMSTERDAM, NETHERLANDS 1011LN

FOR: PRECIOUS METALS AND THEIR ALLOYS;  
JEWELRY, PRECIOUS STONES, HOROLOGICAL  
AND CHRONOMETRIC INSTRUMENTS, IN CLASS  
14 (U.S. CLS. 2, 27, 28 AND 50).

FOR: RETAIL STORE SERVICES IN THE FIELD  
OF PRECIOUS METALS AND THEIR ALLOYS AND  
GOODS IN PRECIOUS METALS OR COATED  
THEREWITH, NOT INCLUDED IN OTHER CLAS-  
SES, JEWELRY, PRECIOUS STONES, AND HORO-  
LOGICAL AND CHRONOMETRIC INSTRUMENTS,  
IN CLASS 35 (U.S. CLS. 100, 101 AND 102).

THE MARK CONSISTS OF STANDARD CHAR-  
ACTERS WITHOUT CLAIM TO ANY PARTICULAR  
FONT, STYLE, SIZE, OR COLOR.

PRIORITY CLAIMED UNDER SEC. 44(D) ON  
BENELUX APPLICATION NO. 1127696, FILED 1-25-  
2007, REG. NO. 0816618, DATED 7-5-2007, EXPIRES 7-  
25-2017.

THE MARK DOES NOT IDENTIFY A PARTICU-  
LAR LIVING INDIVIDUAL.

SER. NO. 77-184,706, FILED 5-18-2007.

JAMES GRIFFIN, EXAMINING ATTORNEY



Int. Cl.: 36

Prior U.S. Cls.: 100, 101 and 102

United States Patent and Trademark Office

Reg. No. 3,465,568

Registered July 15, 2008

SERVICE MARK  
PRINCIPAL REGISTER



MONITOR CLIPPER  
PARTNERS

MONITOR CLIPPER PARTNERS, LLC (DELA-  
WARE LTD LIAB CO)  
4TH FLOOR  
TWO CANAL PARK  
CAMBRIDGE, MA 02141

FOR: FINANCIAL AND INVESTMENT SERVI-  
CES, SPECIFICALLY PRIVATE EQUITY INVEST-  
MENT, IN CLASS 36 (U.S. CLS. 100, 101 AND 102).

FIRST USE 3-0-2007; IN COMMERCE 3-0-2007.

NO CLAIM IS MADE TO THE EXCLUSIVE  
RIGHT TO USE "PARTNERS", APART FROM THE  
MARK AS SHOWN.

THE MARK CONSISTS OF A COMPASS DESIGN  
ABOVE THE WORDS "MONITOR CLIPPER PART-  
NERS".

SER. NO. 77-184,723, FILED 5-18-2007.

SAMUEL E. SHARPER JR., EXAMINING ATTOR-  
NEY

**Int. Cls.: 6 and 9**

**Prior U.S. Cls.: 2, 12, 13, 14, 21, 23, 25, 26, 36, 38 and 50**

**United States Patent and Trademark Office**

**Reg. No. 3,465,569**

**Registered July 15, 2008**

**TRADEMARK  
PRINCIPAL REGISTER**

**OK BRAND**

OKLAHOMA STEEL & WIRE CO., INC. (OKLAHOMA CORPORATION)  
P.O BOX 220  
HIGHWAY 70 SOUTH  
MADILL, OK 73446

FOR: FENCING PRODUCTS, NAMELY, BARBED WIRE, WOVEN WIRE, METAL BARBLESS NON-ELECTRIC CABLE, AND METAL FENCE STAYS, IN CLASS 6 (U.S. CLS. 2, 12, 13, 14, 23, 25 AND 50).

FIRST USE 2-20-1985; IN COMMERCE 2-20-1985.

FOR: ELECTRIC FENCE WIRE, IN CLASS 9 (U.S. CLS. 21, 23, 26, 36 AND 38).

FIRST USE 3-1-1985; IN COMMERCE 3-1-1985.

THE MARK CONSISTS OF STANDARD CHARACTERS WITHOUT CLAIM TO ANY PARTICULAR FONT, STYLE, SIZE, OR COLOR.

OWNER OF U.S. REG. NO. 1,437,702.

NO CLAIM IS MADE TO THE EXCLUSIVE RIGHT TO USE "BRAND", APART FROM THE MARK AS SHOWN.

SER. NO. 77-184,825, FILED 5-18-2007.

APRIL ROACH, EXAMINING ATTORNEY

**Int. Cl.: 3**

**Prior U.S. Cls.: 1, 4, 6, 50, 51 and 52**

**United States Patent and Trademark Office**

**Reg. No. 3,465,570**

**Registered July 15, 2008**

**TRADEMARK  
PRINCIPAL REGISTER**

**SPA SCENT**

FRAGRANCES OF IRELAND LIMITED (IRE-  
LAND COMPANY)  
JAMESON'S CORNER, KILMACANOGUE  
BRAY, CO. WICKLOW, IRELAND

FOR: PERFUMES; HAND SOAP; BODY SOAP;  
DEODORANT SOAP; BODY LOTIONS; BATH GEL;  
HAIR SHAMPOO; COLOGNE; AFTER SHAVE; TAL-  
CUM POWDER; COSMETIC CREAMS; SHAVING  
CREAMS AND GELS; BUBBLE BATH; BATH OIL;  
BATH SALTS; MAKE-UP; LIPSTICKS; COSMETICS;  
SOAPS; ESSENTIAL OILS; HAIR LOTIONS; DENTI-  
FRICES, IN CLASS 3 (U.S. CLS. 1, 4, 6, 50, 51 AND 52).

THE MARK CONSISTS OF STANDARD CHAR-  
ACTERS WITHOUT CLAIM TO ANY PARTICULAR  
FONT, STYLE, SIZE, OR COLOR.

PRIORITY CLAIMED UNDER SEC. 44(D) ON  
IRELAND APPLICATION NO. 2006/02674, FILED  
11-28-2006, REG. NO. 235623, DATED 11-28-2006,  
EXPIRES 11-28-2013.

NO CLAIM IS MADE TO THE EXCLUSIVE  
RIGHT TO USE "SCENT" , APART FROM THE  
MARK AS SHOWN.

SER. NO. 77-184,867, FILED 5-18-2007.

ANDREA K. NADELMAN, EXAMINING ATTOR-  
NEY

Int. Cl.: 40

Prior U.S. Cls.: 100, 103 and 106

United States Patent and Trademark Office

Reg. No. 3,465,571

Registered July 15, 2008

SERVICE MARK  
PRINCIPAL REGISTER



AIR ADVANTAGE, LLC (VIRGINIA LTD LIAB  
CO)  
25 ISLAND VIEW DRIVE  
NEWPORT NEWS, VA 23602

THE MARK CONSISTS OF THE WORDS "HEALTHY  
GUARD" ABOVE A SWORD AND THE WORDS  
"ENVIRONMENTAL ARMOR" BELOW.

FOR: MOLD REMEDIATION SERVICES USING  
AN ELECTROSTATIC SPRAYER TO PREVENT  
GROWTH OF MOLD AND BACTERIA, IN CLASS  
40 (U.S. CLS. 100, 103 AND 106).

SER. NO. 77-184,937, FILED 5-18-2007.

FIRST USE 4-12-2007; IN COMMERCE 4-12-2007.

MARK SPARACINO, EXAMINING ATTORNEY

**Int. Cl.: 35**

**Prior U.S. Cls.: 100, 101 and 102**

**United States Patent and Trademark Office**

**Reg. No. 3,465,572**

**Registered July 15, 2008**

**SERVICE MARK  
PRINCIPAL REGISTER**

LARRY MILLER NO RISK USED  
CARS

LANDCAR MANAGEMENT LTD. (UTAH LIMITED PARTNERSHIP)  
9350 SOUTH 150 EAST, SUITE 1000  
SANDY, UT 84070

FOR: USED CAR DEALERSHIPS, IN CLASS 35  
(U.S. CLS. 100, 101 AND 102).

FIRST USE 3-0-2007; IN COMMERCE 4-0-2007.

THE MARK CONSISTS OF STANDARD CHARACTERS WITHOUT CLAIM TO ANY PARTICULAR FONT, STYLE, SIZE, OR COLOR.

NO CLAIM IS MADE TO THE EXCLUSIVE RIGHT TO USE "USED CARS", APART FROM THE MARK AS SHOWN.

THE NAME "LARRY MILLER" IDENTIFIES A LIVING INDIVIDUAL WHOSE CONSENT IS OF RECORD.

SER. NO. 77-185,007, FILED 5-18-2007.

ELLEN PERKINS, EXAMINING ATTORNEY

**Int. Cl.: 25**

**Prior U.S. Cls.: 22 and 39**

**United States Patent and Trademark Office**

**Reg. No. 3,465,573**

**Registered July 15, 2008**

**TRADEMARK  
PRINCIPAL REGISTER**

**TANOSHINDE**

AMEMIYA, SHOICHI (JAPAN INDIVIDUAL)  
341 WEST 47TH STREET #3R  
NEW YORK, NY 10036

FOR: T-SHIRTS; SWEATERS; PANTS; SHORTS;  
SHIRTS; JACKETS; FLEECE PULLOVERS, IN  
CLASS 25 (U.S. CLS. 22 AND 39).

FIRST USE 8-24-2006; IN COMMERCE 8-24-2006.

THE MARK CONSISTS OF STANDARD CHAR-  
ACTERS WITHOUT CLAIM TO ANY PARTICULAR  
FONT, STYLE, SIZE, OR COLOR.

THE FOREIGN WORDING IN THE MARK  
TRANSLATES INTO ENGLISH AS "ENJOY".

SER. NO. 77-185,077, FILED 5-18-2007.

JACQUELINE A. LAVINE, EXAMINING ATTOR-  
NEY

**Int. Cls.: 41 and 42**

**Prior U.S. Cls.: 100, 101 and 107**

**United States Patent and Trademark Office**

**Reg. No. 3,465,574**

**Registered July 15, 2008**

**SERVICE MARK  
PRINCIPAL REGISTER**

**SUCCESS MEASURES**

NEIGHBORHOOD REINVESTMENT CORP. (D.C.  
CORPORATION)  
1325 G STREET, N.W.  
SUITE 800  
WASHINGTON, DC 20005

FOR: TRAINING AND COACHING SERVICES IN  
THE FIELD OF DATA COLLECTION, DOCUMENT-  
ING, AND EVALUATING THE OUTCOME OF  
COMMUNITY DEVELOPMENT AND REVITALIZA-  
TION PROGRAMS, IN CLASS 41 (U.S. CLS. 100, 101  
AND 107).

FIRST USE 1-0-2001; IN COMMERCE 1-0-2001.

FOR: PROVIDING TEMPORARY USE OF ON-  
LINE NON-DOWNLOADABLE SOFTWARE FOR  
MEASURING THE IMPACT OF COMMUNITY DE-

VELOPMENT ACTIVITIES THROUGH SURVEY  
DATA AND EVALUATION DATA AND PROVID-  
ING TECHNICAL ASSISTANCE AND SUPPORT  
SERVICES TO USERS IN CONNECTION WITH  
THE ON-LINE NON-DOWNLOADABLE SOFT-  
WARE, IN CLASS 42 (U.S. CLS. 100 AND 101).

FIRST USE 1-0-2001; IN COMMERCE 1-0-2001.

THE MARK CONSISTS OF STANDARD CHAR-  
ACTERS WITHOUT CLAIM TO ANY PARTICULAR  
FONT, STYLE, SIZE, OR COLOR.

SER. NO. 77-185,111, FILED 5-18-2007.

RICHARD A. STRASER, EXAMINING ATTORNEY

**Int. Cls.: 9, 16 and 41**

**Prior U.S. Cls.: 2, 5, 21, 22, 23, 26, 29, 36, 37, 38, 50,  
100, 101 and 107**

**Reg. No. 3,465,575**

**United States Patent and Trademark Office**

**Registered July 15, 2008**

**TRADEMARK  
SERVICE MARK  
PRINCIPAL REGISTER**

## Brilliant Book House

COOKE, C. GRAHAM (UNITED KINGDOM INDIVIDUAL)  
6391 LEISURE TOWN ROAD  
VACAVILLE, CA 95687

FOR: DOWNLOADABLE MP3 FILES, MP3 RECORDINGS, ONLINE DISCUSSION BOARDS, WEB CASTS, POD CASTS FEATURING MUSIC, AUDIO BOOKS AND NEWS BROADCASTS; ELECTRONIC PUBLICATIONS, NAMELY, ELECTRONIC BOOKS (E-BOOKS) FEATURING BOOKS AND MANUSCRIPTS RECORDED ON COMPUTER MEDIA, IN CLASS 9 (U.S. CLS. 21, 23, 26, 36 AND 38).

FIRST USE 3-5-2007; IN COMMERCE 3-5-2007.

FOR: BOOKS IN THE FIELD OF THEOLOGY, RELIGION, SELF-HELP AND GENERAL NON-FICTION; NON-FICTION BOOKS ON A VARIETY OF TOPICS; NON-FICTION BOOKS ON A VARIETY OF TOPICS; REFERENCE BOOKS IN THE FIELD OF THEOLOGY, RELIGION, SELF-HELP AND LIFESTYLE; SCHOLARLY BOOKS ON VARIOUS TOPICS, NAMELY, THEOLOGY, RELIGION, SELF-HELP AND LIFESTYLE; SERIES OF FICTION AND NON-FICTION BOOKS ON A VARIETY OF TOPICS; SERIES OF FICTION AND NON-FICTION BOOKS ON A VARIETY OF TOPICS; SERIES OF NON-

FICTION BOOKS IN THE FIELD OF THEOLOGY, RELIGION, SELF-HELP AND LIFESTYLE, IN CLASS 16 (U.S. CLS. 2, 5, 22, 23, 29, 37, 38 AND 50).

FIRST USE 3-5-2007; IN COMMERCE 3-5-2007.

FOR: BOOK AND REVIEW PUBLISHING; MULTIMEDIA PUBLISHING OF BOOKS, MAGAZINES, JOURNALS, SOFTWARE, GAMES, MUSIC, AND ELECTRONIC PUBLICATIONS; PUBLICATION OF BOOKS; PUBLISHING OF BOOKS AND REVIEWS, IN CLASS 41 (U.S. CLS. 100, 101 AND 107).

FIRST USE 3-5-2007; IN COMMERCE 3-5-2007.

THE MARK CONSISTS OF STANDARD CHARACTERS WITHOUT CLAIM TO ANY PARTICULAR FONT, STYLE, SIZE, OR COLOR.

NO CLAIM IS MADE TO THE EXCLUSIVE RIGHT TO USE "BOOK", APART FROM THE MARK AS SHOWN.

SER. NO. 77-185,157, FILED 5-18-2007.

ALEXANDER L. POWERS, EXAMINING ATTORNEY



**Int. Cls.: 40 and 42**

**Prior U.S. Cls.: 100, 101, 103 and 106**

**United States Patent and Trademark Office**

**Reg. No. 3,465,576**

**Registered July 15, 2008**

**SERVICE MARK  
PRINCIPAL REGISTER**

**AUTOPILOT**



AUTOPILOT, INC. (MONTANA CORPORATION)  
3917 SOURDOUGH ROAD  
BOZEMAN, MT 59715

FOR: MACHINE SHOP SERVICES, NAME-  
LY, MACHINING PARTS AND PRODUCTS FOR OTH-  
ERS, IN CLASS 40 (U.S. CLS. 100, 103 AND 106).

FIRST USE 1-4-2006; IN COMMERCE 1-4-2006.

FOR: CONSULTATION, DESIGN, RESEARCH,  
DEVELOPMENT AND TESTING FOR NEW PRO-  
DUCT DEVELOPMENT; CONSULTATION, DE-  
SIGN, RESEARCH, DEVELOPMENT AND  
TESTING FOR NEW PRODUCT DEVELOPMENT  
FOR OTHERS; ENGINEERING SERVICES, NAME-  
LY, ENGINEERING FOR NEW PRODUCT DEVEL-  
OPMENT FOR THE CONSUMER MARKET;  
DEVELOPMENT OF COMPUTER PROGRAMS RE-

CORDED ON CAD, CAM OR SIMILAR SOFTWARE  
DESIGNED FOR USE IN CONSTRUCTION AND  
AUTOMATED MANUFACTURING, IN CLASS 42  
(U.S. CLS. 100 AND 101).

FIRST USE 1-4-2006; IN COMMERCE 1-4-2006.

THE MARK CONSISTS OF THE SINGLE WORD  
"AUTOPILOT" IN A SANS SERIF SCRIPT DIS-  
PLAYED IN CAPS AND UNDERLINED WITH A  
SINGLE BOLD LINE WHICH DROPS TO FORM A  
BROKEN 90 DEGREE ANGLE BENEATH THE  
CENTER OF THE WORD. A PINWHEEL IS INSET  
WITHIN THE ANGLE.

SER. NO. 77-185,160, FILED 5-18-2007.

CHRISTINA SOBRAL, EXAMINING ATTORNEY

**Int. Cl.: 30**

**Prior U.S. Cl.: 46**

**United States Patent and Trademark Office**

**Reg. No. 3,465,577**

**Registered July 15, 2008**

**TRADEMARK  
PRINCIPAL REGISTER**

**TESTAROASTA  
ITALIAN ROAST  
FOR THE LOVE OF COFFEE**

BABY'S COFFEE LLC (FLORIDA LTD LIAB CO)  
3180 US1 AND MM15  
KEY WEST, FL 33040

FOR: COFFEE; READY TO DRINK COFFEE;  
WHOLE COFFEE BEANS; DARK ROASTED COFFEE BEANS; GROUND COFFEE, IN CLASS 30 (U.S. CL. 46).

FIRST USE 4-18-2003; IN COMMERCE 4-18-2003.

THE MARK CONSISTS OF STANDARD CHARACTERS WITHOUT CLAIM TO ANY PARTICULAR FONT, STYLE, SIZE, OR COLOR.

NO CLAIM IS MADE TO THE EXCLUSIVE RIGHT TO USE "ITALIAN ROAST", APART FROM THE MARK AS SHOWN.

SER. NO. 77-185,167, FILED 5-18-2007.

RICHARD WHITE, EXAMINING ATTORNEY

**Int. Cl.: 35**

**Prior U.S. Cls.: 100, 101 and 102**

**United States Patent and Trademark Office**

**Reg. No. 3,465,578**

**Registered July 15, 2008**

**SERVICE MARK  
PRINCIPAL REGISTER**

# Inner Media Vision

INNER MEDIA VISION, INC. (CALIFORNIA CORPORATION)  
87 CASTLE HILL COURT  
VALLEJO, CA 94591

FOR: ADVERTISING SERVICES, NAMELY, CREATING BRAND IDENTITY FOR OTHERS; BUSINESS CONSULTATION SERVICES TO ASSIST ORGANIZATIONS IN PLANNING, MANAGING, AND CONDUCTING FUND RAISING ACTIVITIES; BUSINESS LEADERSHIP DEVELOPMENT; MARKETING CONSULTING, IN CLASS 35 (U.S. CLS. 100, 101 AND 102).

FIRST USE 1-31-2007; IN COMMERCE 4-30-2007.

THE MARK CONSISTS OF STANDARD CHARACTERS WITHOUT CLAIM TO ANY PARTICULAR FONT, STYLE, SIZE, OR COLOR.

NO CLAIM IS MADE TO THE EXCLUSIVE RIGHT TO USE "MEDIA", APART FROM THE MARK AS SHOWN.

SER. NO. 77-185,193, FILED 5-18-2007.

ERNEST SHOSHO, EXAMINING ATTORNEY

**Int. Cl.: 38**

**Prior U.S. Cls.: 100, 101 and 104**

**United States Patent and Trademark Office**

**Reg. No. 3,465,579**

**Registered July 15, 2008**

**SERVICE MARK  
PRINCIPAL REGISTER**

**sidekick** 

T-MOBILE USA, INC. (DELAWARE CORPORATION)

12920 S.E. 38TH STREET  
BELLEVUE, WA 98006

FOR: TELECOMMUNICATIONS SERVICES, NAMELY, WIRELESS VOICE AND DATA TRANSMISSION, TWO WAY WIRELESS TRANSMISSION OF EMAIL AND TEXT BETWEEN WIRELESS TELECOMMUNICATIONS TERMINALS AND COMPUTERS, AND PROVIDING MULTIPLE-USER ACCESS TO A GLOBAL COMPUTER NETWORK, IN CLASS 38 (U.S. CLS. 100, 101 AND 104).

FIRST USE 4-13-2007; IN COMMERCE 4-13-2007.

OWNER OF U.S. REG. NOS. 3,012,845, 3,062,057 AND OTHERS.

THE COLOR(S) GRAY, WHITE, AND PINK IS/ARE CLAIMED AS A FEATURE OF THE MARK.

THE MARK CONSISTS OF THE WORD "SIDEKICK" IN GRAY WITH THE SECOND "I" DISPLAYED UPSIDE DOWN TO THE LEFT OF THE LETTERS "ID" IN WHITE IN A PINK SQUARE BOX WITH ROUNDED EDGES.

SER. NO. 77-185,293, FILED 5-18-2007.

DAVID TOOLEY, EXAMINING ATTORNEY

**Int. Cl.: 25**

**Prior U.S. Cls.: 22 and 39**

**United States Patent and Trademark Office**

**Reg. No. 3,465,580**

**Registered July 15, 2008**

**TRADEMARK  
PRINCIPAL REGISTER**

**A CHICK'S LIFE**

A CHICK'S LIFE, LLC (NEW JERSEY LTD LIAB  
CO)  
1006 RIVERVIEW DRIVE  
BRIELLE, NJ 08730

FOR: CLOTHING, NAMELY, SHIRTS, TOPS, T-  
SHIRTS, SWEAT SHIRTS, PAJAMAS, BELTS, AND  
HEADGEAR, NAMELY, CAPS, HATS, AND VISORS,  
IN CLASS 25 (U.S. CLS. 22 AND 39).

FIRST USE 4-26-2007; IN COMMERCE 6-22-2007.

THE MARK CONSISTS OF STANDARD CHAR-  
ACTERS WITHOUT CLAIM TO ANY PARTICULAR  
FONT, STYLE, SIZE, OR COLOR.

SER. NO. 77-185,523, FILED 5-20-2007.

JASON ROTH, EXAMINING ATTORNEY

**Int. Cl.: 9**

**Prior U.S. Cls.: 21, 23, 26, 36 and 38**

**United States Patent and Trademark Office**

**Reg. No. 3,465,581**

**Registered July 15, 2008**

**TRADEMARK  
PRINCIPAL REGISTER**

# Informance

RODENSTOCK GMBH (FED REP GERMANY  
GMBH)  
ISARTALSTR. 43  
MÜNCHEN, FED REP GERMANY 80469

PRIORITY CLAIMED UNDER SEC. 44(D) ON FED  
REP GERMANY APPLICATION NO. 30679426.8,  
FILED 12-22-2006, REG. NO. 30679426, DATED 3-22-  
2007, EXPIRES 12-31-2016.

FOR: SPECTACLES, IN PARTICULAR SPECTA-  
CLES WITH HEAD MOUNTED DISPLAY FUNC-  
TION, IN CLASS 9 (U.S. CLS. 21, 23, 26, 36 AND 38).

SER. NO. 77-185,719, FILED 5-21-2007.

THE MARK CONSISTS OF STANDARD CHAR-  
ACTERS WITHOUT CLAIM TO ANY PARTICULAR  
FONT, STYLE, SIZE, OR COLOR.

DARRYL SPRUILL, EXAMINING ATTORNEY

Int. Cl.: 31

Prior U.S. Cls.: 1 and 46

United States Patent and Trademark Office

Reg. No. 3,465,582

Registered July 15, 2008

TRADEMARK  
PRINCIPAL REGISTER



AARDBARK, INC. (VERMONT CORPORATION)  
P.O. BOX 803  
DORSET, VT 05251

FOR: EDIBLE DOG TREATS AND DOG FOOD, IN  
CLASS 31 (U.S. CLS. 1 AND 46).

FIRST USE 1-23-2007; IN COMMERCE 1-23-2007.

THE COLOR(S) BEIGE, GREY, BLACK, WHITE,  
AND GREEN IS/ARE CLAIMED AS A FEATURE OF  
THE MARK.

THE MARK CONSISTS OF THE WORD "WAGA-  
THA'S" APPEARING ABOVE A DESIGN OF A DOG

STANDING ON ONE PAW ON A STYLIZED VER-  
SION OF AN EDIBLE DOG BONE. THE TERM  
"WAGATHA'S" APPEARS IN BLACK SOLID LET-  
TERS. THE DOG IS WHITE AND OUTLINED IN  
BLACK WITH GREY SPOTS ON ITS LEFT EYE,  
RIGHT ABDOMEN, LEFT FOREARM, AND LEFT  
SHIN. THE DOG IS WEARING A SCARF AROUND  
ITS NECK IN THE COLOR GREEN WITH WHITE  
BONES ON IT. THE EDIBLE DOG BONE APPEARS  
IN THE COLOR BEIGE.

SER. NO. 77-185,725, FILED 5-21-2007.

ZHALEH DELANEY, EXAMINING ATTORNEY

**Int. Cl.: 9**

**Prior U.S. Cls.: 21, 23, 26, 36 and 38**

**United States Patent and Trademark Office**

**Reg. No. 3,465,583**

**Registered July 15, 2008**

**TRADEMARK  
PRINCIPAL REGISTER**



NINTENDO OF AMERICA INC. (WASHINGTON CORPORATION)  
4820 150TH AVENUE NE  
REDMOND, WA 98052

FOR: COMPUTER SOFTWARE AND PROGRAMS FOR TRANSMITTING, ACCESSING, BROWSING, RECEIVING, DOWNLOADING, SELECTING, REVIEWING, SEARCHING, MANIPULATING, MANAGING, ARRANGING AND ORGANIZING TEXT, DATA, IMAGES, AUDIO, AND VIDEO FILES; COMPUTER SOFTWARE AND PROGRAMS FOR TRANSMITTING, ACCESSING, BROWSING, SELECTING, RECEIVING, REVIEWING, DOWNLOADING, SEARCHING, MANIPULATING, MANAGING, ARRANGING AND ORGANIZING DIGITAL MEDIA CONTENT TO OR WITH PORTABLE RECEIVING AND VIEWING DEVICES; COMPUTER SOFTWARE AND PROGRAMS FOR ORDERING FOOD AND DRINK FROM VENDORS, RESTAURANTS AND PROVIDERS VIA COMPUTER NETWORK; ELECTRONIC GAME PROGRAMS AND SOFTWARE; INTERACTIVE VIDEO GAME PROGRAMS AND SOFTWARE, IN CLASS 9 (U.S. CLS. 21, 23, 26, 36 AND 38).

FIRST USE 1-27-2007; IN COMMERCE 5-1-2007.

OWNER OF U.S. REG. NOS. 1,497,674, 3,130,821 AND OTHERS.

NO CLAIM IS MADE TO THE EXCLUSIVE RIGHT TO USE "NETWORK", APART FROM THE MARK AS SHOWN.

THE COLOR(S) BLUE, WHITE, GRAY AND BLACK IS/ARE CLAIMED AS A FEATURE OF THE MARK.

THE MARK CONSISTS OF AN OVAL SHAPED SEAL WITH A DEPICTION OF A GRAY PORTABLE GAME CONSOLE WITH BLUE SCREENS IN THE CENTER OF THE OVAL. THE BACKGROUND BEHIND THE PORTABLE GAME CONSOLE IS WHITE WITH GRAY VERTICAL AND HORIZONTAL LINES, RESEMBLING THE LATITUDE AND LONGITUDE LINES OF A MAP OR GLOBE. THE BORDER AROUND THE GAME CONSOLE IS A THICK BLUE OVAL SHAPED BORDER WITH THE TERMS IN THE BORDER, ON THE TOP PORTION, IN WHITE, "NINTENDO". ON THE BOTTOM PORTION, THE TERMS, IN WHITE, "FAN NETWORK". OUTSIDE OF THE BLUE BORDER, IS A THIN WHITE BORDER, FOLLOWED BY A THIN GRAY BORDER, FOLLOWED BY A THICKER BLACK OUTSIDE BORDER.

SER. NO. 77-185,781, FILED 5-21-2007.

MARLENE BELL, EXAMINING ATTORNEY



**Int. Cl.: 30**

**Prior U.S. Cl.: 46**

**United States Patent and Trademark Office**

**Reg. No. 3,465,584**

**Registered July 15, 2008**

**TRADEMARK  
PRINCIPAL REGISTER**

**WILLPOWDER**

WILL THOMAS GOLDFARB (UNITED STATES  
INDIVIDUAL)  
72 17 34TH AVENUE, 1K  
JACKSON HEIGHTS, NY 11372

FOR: FOOD ADDITIVES FOR NON-NUTRITION-  
AL PURPOSES FOR USE AS A FLAVORING, IN-  
GREDIENT OR FILLER, IN CLASS 30 (U.S. CL. 46).

FIRST USE 1-1-2006; IN COMMERCE 1-1-2006.

THE MARK CONSISTS OF STANDARD CHAR-  
ACTERS WITHOUT CLAIM TO ANY PARTICULAR  
FONT, STYLE, SIZE, OR COLOR.

THE WORDING "WILLPOWDER" HAS NO  
MEANING IN A FOREIGN LANGUAGE.

SER. NO. 77-185,819, FILED 5-21-2007.

SEAN CROWLEY, EXAMINING ATTORNEY

**Int. Cl.: 36**

**Prior U.S. Cls.: 100, 101 and 102**

**United States Patent and Trademark Office**

**Reg. No. 3,465,585**

**Registered July 15, 2008**

**SERVICE MARK  
PRINCIPAL REGISTER**

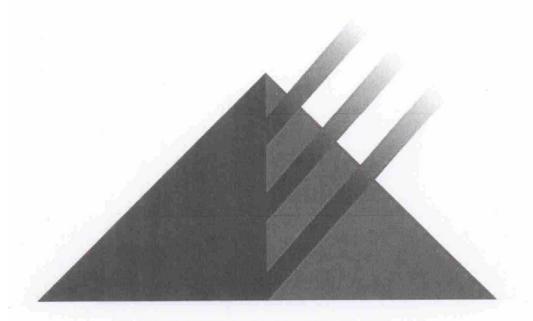

TRAFELET & COMPANY LLC (DELAWARE LTD  
LIAB CO)  
590 MADISON AVENUE  
39TH FLOOR  
NEW YORK, NY 10022

THE MARK CONSISTS OF A TRIANGLE WITH  
THREE HORIZONTAL LINES EXTENDING FROM  
IT.

FOR: HEDGE FUND INVESTMENT SERVICES,  
IN CLASS 36 (U.S. CLS. 100, 101 AND 102).

SER. NO. 77-185,849, FILED 5-21-2007.

FIRST USE 10-31-2005; IN COMMERCE 10-31-2005.

GISELLE AGOSTO, EXAMINING ATTORNEY

**Int. Cls.: 18 and 25**

**Prior U.S. Cls.: 1, 2, 3, 22, 39 and 41**

**United States Patent and Trademark Office**

**Reg. No. 3,465,586**

**Registered July 15, 2008**

**TRADEMARK  
PRINCIPAL REGISTER**

**SWIMS**

SWIMS AS (NORWAY CORPORATION)  
PRESIDENT HARBITZ GATE 4  
0259 OSLO, NORWAY

FOR: HANDBAGS; ALL-PURPOSE CARRYING  
BAGS; SPORTS BAGS, IN CLASS 18 (U.S. CLS. 1, 2, 3,  
22 AND 41).

FOR: GALOSHES; RAINWEAR, IN CLASS 25 (U.S.  
CLS. 22 AND 39).

PRIORITY CLAIMED UNDER SEC. 44(D) ON  
NORWAY APPLICATION NO. 200701913, FILED 2-  
16-2007, REG. NO. 243348, DATED 1-2-2008, EXPIRES  
1-2-2018.

SER. NO. 77-185,921, FILED 5-21-2007.

NORA BUCHANAN WILL, EXAMINING ATTOR-  
NEY

**Int. Cl.: 16**

**Prior U.S. Cls.: 2, 5, 22, 23, 29, 37, 38 and 50**

**United States Patent and Trademark Office**

**Reg. No. 3,465,587**

**Registered July 15, 2008**

**TRADEMARK  
PRINCIPAL REGISTER**



**THE OPEN CITY**

THE OPEN CITY INTERNATIONAL FOUNDATION, INC. (NEW JERSEY CORPORATION)  
1070-H HIGHWAY 34, #207  
MATAWAN, NJ 07747

FOR: PRINTED EDUCATIONAL MATERIALS IN THE FIELD OF ECONOMIC DEVELOPMENT PROMOTION OF LOW INCOME RURAL AND URBAN AREAS THROUGHOUT THE WORLD THROUGH THE DEVELOPMENT OF PROGRAMS AND PROJECTS BY A NOT-FOR-PROFIT ORGANIZATION, IN CLASS 16 (U.S. CLS. 2, 5, 22, 23, 29, 37, 38 AND 50).

THE MARK CONSISTS OF A DESIGN OF A FIGURE WITHIN A CIRCLE AND ARCH WITHIN A LARGER CIRCLE WITH THE WORDS "THE PLACE TO BUILD CIVIC VALUES" WITHIN THE OUTER CIRCLE AND THE WORDS "THE OPEN CITY" BELOW THE CIRCLE.

SER. NO. 77-186,078, FILED 5-21-2007.

FIRST USE 8-20-2004; IN COMMERCE 8-20-2004.

WILLIAM ROSSMAN, EXAMINING ATTORNEY

**Int. Cl.: 35**

**Prior U.S. Cls.: 100, 101 and 102**

**United States Patent and Trademark Office**

**Reg. No. 3,465,588**

**Registered July 15, 2008**

**SERVICE MARK  
PRINCIPAL REGISTER**

**CERAVIEW**

CAMBRIDGE ENERGY RESEARCH ASSOCIATES, INC. (MASSACHUSETTS CORPORATION)  
55 CAMBRIDGE STREET  
CAMBRIDGE, MA 02142

FOR: ECONOMIC FORECASTING AND ANALYSIS OF ENERGY MARKETS AND BUSINESS STRATEGIES; BUSINESS MANAGEMENT CONSULTATION IN THE ENERGY, NATURAL RESOURCE AND ENVIRONMENT INDUSTRIES; CONSULTING SERVICES RELATING TO ONLINE BUSINESS IN ENERGY-RELATED FIELDS, PROVIDING BUSINESS INFORMATION IN THE ENERGY, NATURAL RESOURCE AND ENVIRONMENTAL INDUSTRIES; ARRANGING AND CONDUCTING BUSINESS CONFERENCES;

PROVIDING AN ACCESSIBLE WEBSITE FOR ENERGY AND ECONOMIC BUSINESS ISSUES; AND CONSULTING AND RESEARCH SERVICES IN THE FIELD OF WORLD ENERGY TRENDS, DEVELOPMENTS, ISSUES AND RESOURCES, IN CLASS 35 (U.S. CLS. 100, 101 AND 102).

FIRST USE 10-0-2004; IN COMMERCE 10-0-2004.

THE MARK CONSISTS OF STANDARD CHARACTERS WITHOUT CLAIM TO ANY PARTICULAR FONT, STYLE, SIZE, OR COLOR.

SER. NO. 77-186,079, FILED 5-21-2007.

FLORENTINA BLANDU, EXAMINING ATTORNEY

**Int. Cls.: 9 and 41**

**Prior U.S. Cls.: 21, 23, 26, 36, 38, 100, 101 and 107**

**Reg. No. 3,465,589**

**United States Patent and Trademark Office**

**Registered July 15, 2008**

**TRADEMARK  
SERVICE MARK  
PRINCIPAL REGISTER**

# Spiderfingers

MEEKER, JARED Z. (UNITED STATES INDIVIDUAL)  
26065 CHARONNE CT.  
VALENCIA, CA 91355

FOR: DOWNLOADABLE MP3 FILES, MP3 RECORDINGS, ONLINE DISCUSSION BOARDS, WEB CASTS, POD CASTS FEATURING MUSIC, AUDIO BOOKS AND NEWS BROADCASTS; DOWNLOADABLE MUSICAL SOUND RECORDINGS; DOWNLOADABLE RING TONES, GRAPHICS AND MUSIC VIA A GLOBAL COMPUTER NETWORK AND WIRELESS DEVICES; DOWNLOADABLE VIDEO RECORDINGS FEATURING MUSIC; SOUND RECORDINGS FEATURING MUSIC; VIDEO RECORDINGS FEATURING MUSIC; VISUAL RECORDINGS AND AUDIO VISUAL RECORDINGS FEATURING MUSIC AND ANIMATION, IN CLASS 9 (U.S. CLS. 21, 23, 26, 36 AND 38).

FIRST USE 1-1-2001; IN COMMERCE 1-1-2001.

FOR: BOOK AND REVIEW PUBLISHING; COMPOSITION OF MUSIC FOR OTHERS; EDUCATION IN THE FIELD OF MUSIC RENDERED THROUGH CORRESPONDENCE COURSES; EDUCATION IN THE FIELD OF MUSIC RENDERED THROUGH VIDEO CONFERENCE; ELECTRONIC PUBLISHING SERVICES, NAMELY, PUBLICATION OF TEXT AND GRAPHIC WORKS OF OTHERS ON CD, DVD AND ONLINE FEATURING MUSIC; ENTERTAINMENT IN THE NATURE OF VISUAL AND AUDIO PERFORMANCES, NAMELY, MUSICAL BAND, ROCK GROUP, GYMNASTIC, DANCE, AND BALLET PERFORMANCES; ENTERTAINMENT, NAMELY, LIVE PERFORMANCES BY A MUSICAL BAND; ENTERTAINMENT SERVICES, NAMELY, AN ON-

LINE ACTIVITY WHERE YOU CREATE YOUR OWN MUSIC VIDEOS; ENTERTAINMENT SERVICES, NAMELY, NON-DOWNLOADABLE RING-TONES, PRE-RECORDED MUSIC, VIDEO AND GRAPHICS PRESENTED TO MOBILE COMMUNICATIONS DEVICES VIA A GLOBAL COMPUTER NETWORK AND WIRELESS NETWORKS; ENTERTAINMENT SERVICES, NAMELY, PROVIDING A WEB SITE FEATURING MUSICAL PERFORMANCES, MUSICAL VIDEOS, RELATED FILM CLIPS, PHOTOGRAPHS, AND OTHER MULTIMEDIA MATERIALS; INSTRUCTION IN THE FIELD OF MUSIC; MULTIMEDIA ENTERTAINMENT SERVICES IN THE NATURE OF RECORDING, PRODUCTION AND POST-PRODUCTION SERVICES IN THE FIELDS OF MUSIC, VIDEO, AND FILMS; MUSIC COMPOSITION FOR OTHERS; MUSIC PRODUCTION SERVICES; PUBLISHING OF BOOKS, MAGAZINES; PUBLISHING OF ELECTRONIC PUBLICATIONS; MULTIMEDIA PUBLISHING OF BOOKS, MAGAZINES, JOURNALS, SOFTWARE, GAMES, MUSIC, AND ELECTRONIC PUBLICATIONS; MUSIC PUBLISHING SERVICES; PRODUCTION OF SOUND AND MUSIC VIDEO RECORDINGS; PUBLICATION OF MUSICAL TEXTS, IN CLASS 41 (U.S. CLS. 100, 101 AND 107).

FIRST USE 1-1-2001; IN COMMERCE 1-1-2001.

THE MARK CONSISTS OF STANDARD CHARACTERS WITHOUT CLAIM TO ANY PARTICULAR FONT, STYLE, SIZE, OR COLOR.

SER. NO. 77-186,181, FILED 5-21-2007.

MARY ROSSMAN, EXAMINING ATTORNEY

**Int. Cl.: 35**

**Prior U.S. Cls.: 100, 101 and 102**

**United States Patent and Trademark Office**

**Reg. No. 3,465,590**

**Registered July 15, 2008**

**SERVICE MARK  
PRINCIPAL REGISTER**

**THE NEXT WAVE IN PAYMENTS**

CRONE CONSULTING LLC (CALIFORNIA LTD  
LIAB CO)  
148 GLASGOW LANE  
SAN CARLOS, CA 94070

FOR: BUSINESS CONSULTATION, NAMELY, STRATEGIC PLANNING, BUSINESS DEVELOPMENT, SALES, MARKETING, IMPLEMENTATION AND OPERATIONAL MANAGEMENT AND OTHER BUSINESS ADVISORY SERVICES TO FINANCIAL INSTITUTIONS, MERCHANTS, BILLERS, TELECOMMUNICATIONS CARRIERS, INVESTORS, DATA AND PAYMENT PROCESSORS ON THE SELECTION AND IMPLEMENTATION OF VARIOUS EXISTING AND EMERGING FORMS OF ELECTRONIC COMMERCE, MOBILE BANKING, MOBILE PAYMENT AND MOBILE MARKETING, INITIATED, VERIFIED, PROCESSED OR CONSUMMATED THROUGH MOBILE PHONES AND DEVICES; MARKETING SERVICES, NAMELY,

MARKETING OFFERS, COUPONS, LOYALTY AND REWARD PROGRAMS ACCESSED VIA MOBILE PHONES, IN CLASS 35 (U.S. CLS. 100, 101 AND 102).

FIRST USE 10-11-2006; IN COMMERCE 10-11-2006.

THE MARK CONSISTS OF STANDARD CHARACTERS WITHOUT CLAIM TO ANY PARTICULAR FONT, STYLE, SIZE, OR COLOR.

NO CLAIM IS MADE TO THE EXCLUSIVE RIGHT TO USE "PAYMENTS", APART FROM THE MARK AS SHOWN.

SER. NO. 77-186,571, FILED 5-21-2007.

BARBARA BROWN, EXAMINING ATTORNEY

Prior U.S. Cl.: 200

United States Patent and Trademark Office

Reg. No. 3,465,591

Registered July 15, 2008

COLLECTIVE MEMBERSHIP  
PRINCIPAL REGISTER

CHRIST'S SANCTIFIED HOLY  
CHURCH

BOARD NO. 1 OF CHRIST'S SANCTIFIED HOLY  
CHURCH, INC. (GEORGIA CORPORATION)  
129 GREAT OAK DRIVE  
HAMPSTEAD, NC 28443

FOR: INDICATING MEMBERSHIP IN A(N)  
CHURCH, IN CLASS 200 (U.S. CL. 200).

FIRST USE 2-14-1892; IN COMMERCE 2-14-1892.

THE MARK CONSISTS OF STANDARD CHAR-  
ACTERS WITHOUT CLAIM TO ANY PARTICULAR  
FONT, STYLE, SIZE, OR COLOR.

NO CLAIM IS MADE TO THE EXCLUSIVE  
RIGHT TO USE "CHURCH", APART FROM THE  
MARK AS SHOWN.

SEC. 2(F).

SER. NO. 77-186,604, FILED 5-21-2007.

JENNY PARK, EXAMINING ATTORNEY



**Int. Cls.: 35 and 41**

**Prior U.S. Cls.: 100, 101, 102 and 107**

**United States Patent and Trademark Office**

**Reg. No. 3,465,592**

**Registered July 15, 2008**

**SERVICE MARK  
PRINCIPAL REGISTER**

**DEALER R.E.P.P.**

MOTORCYCLE TRAINING INSTITUTE, INC.  
(FLORIDA CORPORATION)  
3330 NORTHWEST 125TH STREET  
MIAMI, FL 33167

FOR: PROMOTING GOODS AND SERVICES OF  
OTHERS BY ARRANGING FOR SPONSORS TO  
AFFILIATE THEIR GOODS AND SERVICES WITH  
MOTORCYCLE RIDER EDUCATION SERVICES, IN  
CLASS 35 (U.S. CLS. 100, 101 AND 102).

FIRST USE 10-16-2006; IN COMMERCE 10-16-2006.

FOR: EDUCATIONAL SERVICES, NAMELY, IN-  
STRUCTIONAL SERVICES FOR MOTORCYCLE  
RIDERS, IN CLASS 41 (U.S. CLS. 100, 101 AND 107).

FIRST USE 10-16-2006; IN COMMERCE 10-16-2006.

THE MARK CONSISTS OF STANDARD CHAR-  
ACTERS WITHOUT CLAIM TO ANY PARTICULAR  
FONT, STYLE, SIZE, OR COLOR.

NO CLAIM IS MADE TO THE EXCLUSIVE  
RIGHT TO USE "DEALER", APART FROM THE  
MARK AS SHOWN.

SER. NO. 77-186,748, FILED 5-22-2007.

LINDA POWELL, EXAMINING ATTORNEY

**Int. Cl.: 16**

**Prior U.S. Cls.: 2, 5, 22, 23, 29, 37, 38 and 50**

**United States Patent and Trademark Office**

**Reg. No. 3,465,593**

**Registered July 15, 2008**

**TRADEMARK  
PRINCIPAL REGISTER**

**THE QUILTER MAGAZINE**

ALL AMERICAN CRAFTS, INC. (NEW JERSEY  
CORPORATION)  
7 WATERLOO ROAD  
STANHOPE, NJ 07874

FOR: MAGAZINE IN THE FIELD OF ARTS AND  
CRAFTS, IN CLASS 16 (U.S. CLS. 2, 5, 22, 23, 29, 37, 38  
AND 50).

FIRST USE 9-30-2000; IN COMMERCE 9-30-2000.

THE MARK CONSISTS OF STANDARD CHAR-  
ACTERS WITHOUT CLAIM TO ANY PARTICULAR  
FONT, STYLE, SIZE, OR COLOR.

OWNER OF U.S. REG. NO. 2,489,676.

NO CLAIM IS MADE TO THE EXCLUSIVE  
RIGHT TO USE "MAGAZINE", APART FROM THE  
MARK AS SHOWN.

SEC. 2(F).

SER. NO. 77-186,937, FILED 5-22-2007.

ANDREA HACK, EXAMINING ATTORNEY

**Int. Cl.: 41**

**Prior U.S. Cls.: 100, 101 and 107**

**United States Patent and Trademark Office**

**Reg. No. 3,465,594**

**Registered July 15, 2008**

**SERVICE MARK  
PRINCIPAL REGISTER**

MOHEGAN SUN AT POCONO DOWNS

DOWNS RACING, L.P. (PENNSYLVANIA PART-  
NERSHIP)

1280 HIGHWAY 315

WILKES-BARRE, PA 18702

FOR: PROVIDING CASINO FACILITIES AND  
SERVICES, IN CLASS 41 (U.S. CLS. 100, 101 AND 107).

FIRST USE 11-14-2006; IN COMMERCE 11-14-2006.

THE MARK CONSISTS OF STANDARD CHAR-  
ACTERS WITHOUT CLAIM TO ANY PARTICULAR  
FONT, STYLE, SIZE, OR COLOR.

NO CLAIM IS MADE TO THE EXCLUSIVE  
RIGHT TO USE "POCONO DOWNS", APART FROM  
THE MARK AS SHOWN.

SER. NO. 77-187,007, FILED 5-22-2007.

KATHY DE JONGE, EXAMINING ATTORNEY

**Int. Cl.: 28**

**Prior U.S. Cls.: 22, 23, 38 and 50**

**United States Patent and Trademark Office**

**Reg. No. 3,465,595**

**Registered July 15, 2008**

**TRADEMARK  
PRINCIPAL REGISTER**

**RAD RED RUBY**

MATTEL, INC. (DELAWARE CORPORATION)  
M1-1518  
333 CONTINENTAL BLVD.  
EL SEGUNDO, CA 90245

FOR: TOYS, GAMES AND PLAYTHINGS, NAME-  
LY, TOY VEHICLES, TOY FIGURES, AND ACCES-  
SORIES FOR ALL OF THE FOREGOING, IN CLASS  
28 (U.S. CLS. 22, 23, 38 AND 50).

FIRST USE 1-14-2008; IN COMMERCE 1-14-2008.

THE MARK CONSISTS OF STANDARD CHAR-  
ACTERS WITHOUT CLAIM TO ANY PARTICULAR  
FONT, STYLE, SIZE, OR COLOR.

SER. NO. 77-187,057, FILED 5-22-2007.

MONIQUE MILLER, EXAMINING ATTORNEY

**Int. Cl.: 41**

**Prior U.S. Cls.: 100, 101 and 107**

**United States Patent and Trademark Office**

**Reg. No. 3,465,596**

**Registered July 15, 2008**

**SERVICE MARK  
PRINCIPAL REGISTER**

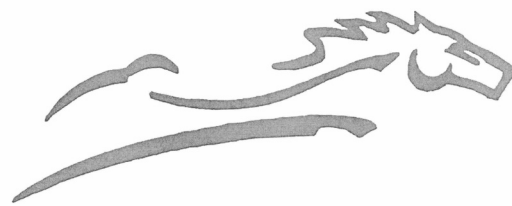

DOWNS RACING, L.P. (PENNSYLVANIA PART-  
NERSHIP)  
1280 HIGHWAY 315  
WILKES-BARRE, PA 18702

THE MARK CONSISTS OF A STYLIZED OUT-  
LINE OF A HORSE.

FOR: PROVIDING CASINO FACILITIES AND  
SERVICES, IN CLASS 41 (U.S. CLS. 100, 101 AND 107).

SER. NO. 77-187,088, FILED 5-22-2007.

FIRST USE 11-14-2006; IN COMMERCE 11-14-2006.

DANIEL CAPSHAW, EXAMINING ATTORNEY

**Int. Cl.: 6**

**Prior U.S. Cls.: 2, 12, 13, 14, 23, 25 and 50**

**Reg. No. 3,465,597**

**United States Patent and Trademark Office**

**Registered July 15, 2008**

**TRADEMARK  
PRINCIPAL REGISTER**

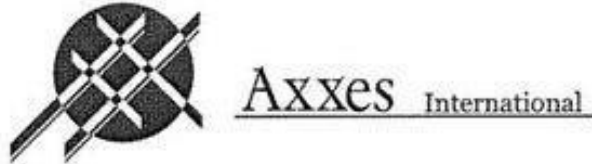

AXXES INTERNATIONAL INC. (PANAMA CORPORATION)

EDIFICIO UNIVERSAL

CALLE 50 #102

PLANTA BAJA, PANAMA

FOR: MATERIALS OF METAL FOR RAILWAY CONSTRUCTION, IN CLASS 6 (U.S. CLS. 2, 12, 13, 14, 23, 25 AND 50).

OWNER OF PANAMA REG. NO. 11480101, DATED 5-24-2001, EXPIRES 5-24-2011.

NO CLAIM IS MADE TO THE EXCLUSIVE RIGHT TO USE "INTERNATIONAL", APART FROM THE MARK AS SHOWN.

SER. NO. 77-187,317, FILED 5-22-2007.

ERNEST SHOSHO, EXAMINING ATTORNEY

**Int. Cl.: 19**

**Prior U.S. Cls.: 1, 12, 33 and 50**

**United States Patent and Trademark Office**

**Reg. No. 3,465,598**

**Registered July 15, 2008**

**TRADEMARK  
PRINCIPAL REGISTER**

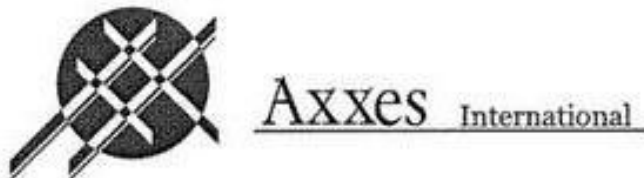

AXXES INTERNATIONAL INC. (PANAMA CORPORATION)  
EDIFICIO UNIVERSAL  
CALLE 50 #102  
PLANTA BAJA, PANAMA

FOR: CEMENT MIXES; CONCRETE; GRAVEL;  
AGGREGATE MATERIAL COMPOSED OF ROCK,  
CEMENT, LIME, MORTAR, PLASTER FOR ROAD-  
WAY CONSTRUCTION , IN CLASS 19 (U.S. CLS. 1,  
12, 33 AND 50).

OWNER OF PANAMA REG. NO. 11480001, DATED 5-24-2001, EXPIRES 5-24-2011.

NO CLAIM IS MADE TO THE EXCLUSIVE RIGHT TO USE "INTERNATIONAL", APART FROM THE MARK AS SHOWN.

SER. NO. 77-187,322, FILED 5-22-2007.

ERNEST SHOSHO, EXAMINING ATTORNEY

**Int. Cl.: 5**

**Prior U.S. Cls.: 6, 18, 44, 46, 51 and 52**

**Reg. No. 3,465,599**

**United States Patent and Trademark Office**

**Registered July 15, 2008**

---

**TRADEMARK  
PRINCIPAL REGISTER**

**POWER RITUAL COMBO**

EBLEECE ENTERTAINMENT, INC. (CALIFORNIA CORPORATION)  
SUITE # 286A  
468 NORTH CAMDEN DRIVE  
BEVERLY HILLS, CA 90210

FOR: THERAPEUTIC SPELL KITS COMPRISING POTIONS AND HERBS USED FOR LOVE PROBLEMS, MONEY PROBLEMS, IN CLASS 5 (U.S. CLS. 6, 18, 44, 46, 51 AND 52).

FIRST USE 1-1-2001; IN COMMERCE 1-1-2001.

THE MARK CONSISTS OF STANDARD CHARACTERS WITHOUT CLAIM TO ANY PARTICULAR FONT, STYLE, SIZE, OR COLOR.

SEC. 2(F).

SER. NO. 77-187,342, FILED 5-22-2007.

LINDA E. BLOHM, EXAMINING ATTORNEY



**Int. Cls.: 16, 25 and 41**

**Prior U.S. Cls.: 2, 5, 22, 23, 29, 37, 38, 39, 50, 100, 101  
and 107**

**Reg. No. 3,465,600**

**United States Patent and Trademark Office**

**Registered July 15, 2008**

**TRADEMARK  
SERVICE MARK  
PRINCIPAL REGISTER**

**AMERICA'S PLACE TO RACE**

IOWA SPEEDWAY (IOWA CORPORATION)  
3333 RUSTY WALLACE DRIVE  
NEWTON, IA 50208

FOR: PUBLICATIONS AND OTHER PRINTED MATERIAL, NAMELY, PROGRAMS, MEDIA GUIDES, BUMPER STICKERS, BROCHURES AND BOOKS, ALL THE FOREGOING IN THE FIELD OF AUTO RACING AND POSTERS, IN CLASS 16 (U.S. CLS. 2, 5, 22, 23, 29, 37, 38 AND 50).

FIRST USE 10-0-2006; IN COMMERCE 3-0-2007.

FOR: WEARING APPAREL, NAMELY, JACKETS, SHIRTS, PANTS AND HATS, CAPS, T-SHIRTS, SHORTS, SWEATSHIRTS, AND HEADWEAR, IN CLASS 25 (U.S. CLS. 22 AND 39).

FIRST USE 10-0-2006; IN COMMERCE 3-0-2007.

FOR: ENTERTAINMENT SERVICE—NAMELY, ORGANIZING AND CONDUCTING MOTOR VEHICLE RACES, COMPETITIONS, AND EXHIBITIONS; EDUCATIONAL SERVICES, NAMELY, PROVIDING CLASSES AND COURSES OF INSTRUCTION IN THE FIELD OF VEHICLE DRIVING, IN CLASS 41 (U.S. CLS. 100, 101 AND 107).

FIRST USE 10-0-2006; IN COMMERCE 11-0-2006.

THE MARK CONSISTS OF STANDARD CHARACTERS WITHOUT CLAIM TO ANY PARTICULAR FONT, STYLE, SIZE, OR COLOR.

NO CLAIM IS MADE TO THE EXCLUSIVE RIGHT TO USE "AMERICA'S" AND "RACE", APART FROM THE MARK AS SHOWN.

SER. NO. 77-187,347, FILED 5-22-2007.

ELLEN PERKINS, EXAMINING ATTORNEY

**Int. Cls.: 35 and 36**

**Prior U.S. Cls.: 100, 101 and 102**

**United States Patent and Trademark Office**

**Reg. No. 3,465,601**

**Registered July 15, 2008**

**SERVICE MARK  
PRINCIPAL REGISTER**

**WASHINGTON, DC MARTIN  
LUTHER KING, JR. NATIONAL  
MEMORIAL PROJECT  
FOUNDATION, INC.**

WASHINGTON, DC MARTIN LUTHER KING,  
JR. NATIONAL MEMORIAL PROJECT FOUN-  
DATION, INC. (MARYLAND CORPORATION)  
SUITE 334  
401 F STREET, NW  
WASHINGTON, DC 20001

FOR: PROMOTING THE PUBLIC AWARENESS  
OF THE EFFORTS TO FUND A PUBLIC MEMOR-  
IAL TO DR. MARTIN LUTHER KING, JR.; PRO-  
MOTING THE PUBLIC AWARENESS OF DR.  
MARTIN LUTHER KING'S LIFE, WORK AND  
VISION OF FREEDOM, OPPORTUNITY AND JUST-  
ICE AND ACHIEVING SOCIAL CHANGE  
THROUGH NON-VIOLENT MEANS, IN CLASS 35  
(U.S. CLS. 100, 101 AND 102).

FIRST USE 5-29-1998; IN COMMERCE 5-29-1998.

FOR: CHARITABLE FUND RAISING SERVICES,  
IN CLASS 36 (U.S. CLS. 100, 101 AND 102).

FIRST USE 5-29-1998; IN COMMERCE 5-29-1998.

THE MARK CONSISTS OF STANDARD CHAR-  
ACTERS WITHOUT CLAIM TO ANY PARTICULAR  
FONT, STYLE, SIZE, OR COLOR.

NO CLAIM IS MADE TO THE EXCLUSIVE  
RIGHT TO USE "FOUNDATION, INC.", APART  
FROM THE MARK AS SHOWN.

THE NAME(S), PORTRAIT(S), AND/OR SIGNA-  
TURE(S) SHOWN IN THE MARK DOES NOT IDEN-  
TIFY A PARTICULAR LIVING INDIVIDUAL.

SEC. 2(F).

SER. NO. 77-187,351, FILED 5-22-2007.

ELISSA GARBER KON, EXAMINING ATTORNEY

**Int. Cl.: 43**

**Prior U.S. Cls.: 100 and 101**

**United States Patent and Trademark Office**

**Reg. No. 3,465,602**

**Registered July 15, 2008**

**SERVICE MARK  
PRINCIPAL REGISTER**

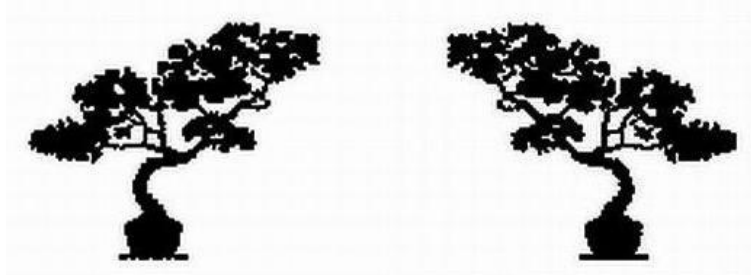

PFCCB ADMINISTRATION, INC. (DELAWARE CORPORATION)  
7676 EAST PINNACLE PEAK ROAD  
SCOTTSDALE, AZ 85255

FOR: RESTAURANT AND BAR SERVICES; CARRY-OUT RESTAURANT SERVICES, IN CLASS 43 (U.S. CLS. 100 AND 101).

FIRST USE 7-20-1993; IN COMMERCE 7-20-1993.

OWNER OF U.S. REG. NO. 1,847,107.

THE MARK CONSISTS OF THE DESIGN OF TWO TREES.

SER. NO. 77-187,510, FILED 5-22-2007.

DARRYL SPRUILL, EXAMINING ATTORNEY

**Int. Cl.: 41**

**Prior U.S. Cls.: 100, 101 and 107**

**United States Patent and Trademark Office**

**Reg. No. 3,465,603**

**Registered July 15, 2008**

**SERVICE MARK  
PRINCIPAL REGISTER**

**HIP HOP OFFICIAL**

GOTV NETWORKS, INC. (CALIFORNIA CORPORATION)  
14144 VENTURA BOULEVARD  
SUITE 300  
SHERMAN OAKS, CA 91423

FOR: ENTERTAINMENT SERVICES, NAMELY, PROVIDING TELEVISION PROGRAMS THROUGH MOBILE AND BROADBAND PLATFORMS IN THE FIELDS OF ENTERTAINMENT, NEWS, LIFESTYLE, CURRENT EVENTS, COMEDY, VARIETY, MUSIC, DOCUMENTARIES, GAMES, ANIMATION, SHOPPING, COMMENTARY IN THE FIELDS OF ENTERTAINMENT, NEWS, LIFESTYLE, CULTURE, CURRENT EVENTS, COMEDY, POLITICS AND MUSIC, REVIEWS IN THE FIELDS OF ENTERTAINMENT, NEWS, LIFESTYLE, CULTURE, CURRENT EVENTS, COMEDY, POLITICS AND MUSIC, AND POLLING/VOTING IN THE FIELDS

OF ENTERTAINMENT, NEWS, LIFESTYLE, CULTURE, CURRENT EVENTS, COMEDY, POLITICS AND MUSIC, IN CLASS 41 (U.S. CLS. 100, 101 AND 107).

FIRST USE 2-23-2006; IN COMMERCE 2-23-2006.

THE MARK CONSISTS OF STANDARD CHARACTERS WITHOUT CLAIM TO ANY PARTICULAR FONT, STYLE, SIZE, OR COLOR.

NO CLAIM IS MADE TO THE EXCLUSIVE RIGHT TO USE "HIP HOP", APART FROM THE MARK AS SHOWN.

SER. NO. 77-187,655, FILED 5-22-2007.

ANDREA SAUNDERS, EXAMINING ATTORNEY

**Int. Cls.: 38 and 41**

**Prior U.S. Cls.: 100, 101, 104 and 107**

**United States Patent and Trademark Office**

**Reg. No. 3,465,604**

**Registered July 15, 2008**

**SERVICE MARK  
PRINCIPAL REGISTER**

**COLORAUDIO**

LEHMAN COMMUNICATIONS CORPORATION  
(COLORADO CORPORATION)  
P.O. BOX 299  
LONGMONT, CO 80502

FOR: TELECOMMUNICATION SERVICES,  
NAMELY, TRANSMISSION OF PODCASTS AND  
WEBCASTS, IN CLASS 38 (U.S. CLS. 100, 101 AND  
104).

FIRST USE 3-14-2007; IN COMMERCE 3-14-2007.

FOR: ENTERTAINMENT SERVICES, NAMELY,  
PROVIDING PODCASTS AND WEBCASTS IN THE

FIELD OF WEEKLY NEWS, IN CLASS 41 (U.S. CLS.  
100, 101 AND 107).

FIRST USE 3-14-2007; IN COMMERCE 3-14-2007.

THE MARK CONSISTS OF STANDARD CHAR-  
ACTERS WITHOUT CLAIM TO ANY PARTICULAR  
FONT, STYLE, SIZE, OR COLOR.

SER. NO. 77-187,673, FILED 5-22-2007.

KATHERINE CHANG, EXAMINING ATTORNEY

**Int. Cl.: 44**

**Prior U.S. Cls.: 100 and 101**

**United States Patent and Trademark Office**

**Reg. No. 3,465,605**

**Registered July 15, 2008**

**SERVICE MARK  
PRINCIPAL REGISTER**



FUENTES, JAMES (UNITED STATES INDIVIDUAL)  
1950 JENNIE LANE  
LA HABRA, CA 90631

FOR: WEIGHT REDUCTION DIET PLANNING AND SUPERVISION; DIETARY AND NUTRITIONAL GUIDANCE; NUTRITION COUNSELING; PROVIDING INFORMATION ABOUT DIETARY SUPPLEMENTS AND NUTRITION , IN CLASS 44 (U.S. CLS. 100 AND 101).

FIRST USE 5-1-2007; IN COMMERCE 5-1-2007.

THE MARK CONSISTS OF A TORTOISE WITHOUT ITS SHELL STANDING ON ITS HIND LEGS IN A BIKINI AND WITH A TAPE MEASURE AROUND ITS WAIST.

SER. NO. 77-187,685, FILED 5-22-2007.

JILL C. ALT, EXAMINING ATTORNEY

**Int. Cl.: 28**

**Prior U.S. Cls.: 22, 23, 38 and 50**

**United States Patent and Trademark Office**

**Reg. No. 3,465,606**

**Registered July 15, 2008**

**TRADEMARK  
PRINCIPAL REGISTER**

**BONEHEDZ**

HOPPIN HYDROS, INC. (CALIFORNIA CORPORATION)  
P.O. BOX 3333  
CERRITOS, CA 90703

THE MARK CONSISTS OF STANDARD CHARACTERS WITHOUT CLAIM TO ANY PARTICULAR FONT, STYLE, SIZE, OR COLOR.

FOR: TOY FIGURES, IN CLASS 28 (U.S. CLS. 22, 23, 38 AND 50).

SER. NO. 77-187,686, FILED 5-22-2007.

FIRST USE 7-0-2006; IN COMMERCE 7-0-2006.

MARY ROSSMAN, EXAMINING ATTORNEY

**Int. Cl.: 44**

**Prior U.S. Cls.: 100 and 101**

**United States Patent and Trademark Office**

**Reg. No. 3,465,607**

**Registered July 15, 2008**

**SERVICE MARK  
PRINCIPAL REGISTER**

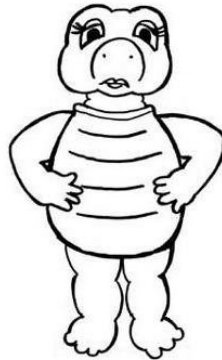

FUENTES, JAMES (UNITED STATES INDIVIDUAL)  
1950 JENNIE LANE  
LA HABRA, CA 90631

FOR: WEIGHT REDUCTION DIET PLANNING AND SUPERVISION; DIETARY AND NUTRITIONAL GUIDANCE; PROVIDING INFORMATION ABOUT DIETARY SUPPLEMENTS AND NUTRITION; NUTRITION COUNSELING , IN CLASS 44 (U.S. CLS. 100 AND 101).

FIRST USE 5-1-2007; IN COMMERCE 5-1-2007.

THE MARK CONSISTS OF A TORTOISE STANDING ON ITS HIND LEGS.

SER. NO. 77-187,746, FILED 5-22-2007.

JILL C. ALT, EXAMINING ATTORNEY



**Int. Cl.: 6**

**Prior U.S. Cls.: 2, 12, 13, 14, 23, 25 and 50**

**Reg. No. 3,465,608**

**United States Patent and Trademark Office**

**Registered July 15, 2008**

---

**TRADEMARK  
PRINCIPAL REGISTER**



MAXLOK CORPORATION (TEXAS CORPORATION)  
6100 CORPORATE DR SUITE 588  
HOUSTON, TX 77036

FIRST USE 2-1-2007; IN COMMERCE 3-8-2007.

SER. NO. 77-187,853, FILED 5-23-2007.

FOR: MANUALLY OPERATED METAL VALVES,  
IN CLASS 6 (U.S. CLS. 2, 12, 13, 14, 23, 25 AND 50).

KATHERINE CONNOLLY, EXAMINING ATTORNEY

**Int. Cl.: 35**

**Prior U.S. Cls.: 100, 101 and 102**

**United States Patent and Trademark Office**

**Reg. No. 3,465,609**

**Registered July 15, 2008**

**SERVICE MARK  
PRINCIPAL REGISTER**

**CULTURETOUR**

NOBLE COMMUNICATIONS COMPANY (MISSOURI CORPORATION)  
2155 WEST CHESTERFIELD BOULEVARD  
SPRINGFIELD, MO 65807

FOR: BUSINESS MARKETING AND BUSINESS CONSULTING SERVICES; MARKET RESEARCH; MARKET SERVICES, NAMELY, CONDUCTING CONSUMER TRACKING BEHAVIOR RESEARCH AND CONSUMER TREND ANALYSIS; COMMERCIALIZATION STRATEGY SERVICES, NAMELY, CREATING CORPORATE AND BRANDING IDENTITY FOR OTHERS; MARKETING, ADVERTISING AND PROMOTION OF THE GOODS AND SERVI-

CES OF OTHERS, IN CLASS 35 (U.S. CLS. 100, 101 AND 102).

FIRST USE 7-9-2004; IN COMMERCE 7-9-2004.

THE MARK CONSISTS OF STANDARD CHARACTERS WITHOUT CLAIM TO ANY PARTICULAR FONT, STYLE, SIZE, OR COLOR.

SER. NO. 77-188,042, FILED 5-23-2007.

JIM RINGLE, EXAMINING ATTORNEY

**Int. Cl.: 35**

**Prior U.S. Cls.: 100, 101 and 102**

**United States Patent and Trademark Office**

**Reg. No. 3,465,610**

**Registered July 15, 2008**

**SERVICE MARK  
PRINCIPAL REGISTER**

**BRANDALIZM**

NOBLE COMMUNICATIONS COMPANY (MISSOURI CORPORATION)  
2155 WEST CHESTERFIELD BOULEVARD  
SPRINGFIELD, MO 65807

FOR: BUSINESS MARKETING AND BUSINESS CONSULTING SERVICES; MARKET RESEARCH; MARKET SERVICES, NAMELY, CONDUCTING CONSUMER TRACKING BEHAVIOR RESEARCH AND CONSUMER TREND ANALYSIS; COMMERCIALIZATION STRATEGY SERVICES, NAMELY, CREATING CORPORATE AND BRANDING IDENTITY FOR OTHERS; MARKETING, ADVERTISING AND PROMOTION OF THE GOODS AND SERVI-

CES OF OTHERS, IN CLASS 35 (U.S. CLS. 100, 101 AND 102).

FIRST USE 9-20-2005; IN COMMERCE 9-20-2005.

THE MARK CONSISTS OF STANDARD CHARACTERS WITHOUT CLAIM TO ANY PARTICULAR FONT, STYLE, SIZE, OR COLOR.

SER. NO. 77-188,147, FILED 5-23-2007.

JIM RINGLE, EXAMINING ATTORNEY

**Int. Cl.: 10**

**Prior U.S. Cls.: 26, 39 and 44**

**United States Patent and Trademark Office**

**Reg. No. 3,465,611**

**Registered July 15, 2008**

**TRADEMARK  
PRINCIPAL REGISTER**

**ROBODOC**

CUREXO MEDICAL, INC. (CALIFORNIA CORPORATION)  
1433 N. MARKET BLVD., #1  
SACRAMENTO, CA 95834

FOR: SURGICAL AND MEDICAL APPARATUS, NAMELY, A ROBOTIC SURGICAL APPARATUS, COMPRISING COMPUTERS, ROBOTIC ARMS, FORCE SENSORS, CUTTING INSTRUMENTS, AND COMPUTER PROGRAMS, USED FOR ORTHOPEDIC AND OTHER SURGICAL PROCEDURES, IN CLASS 10 (U.S. CLS. 26, 39 AND 44).

FIRST USE 2-23-1994; IN COMMERCE 2-23-1994.

THE MARK CONSISTS OF STANDARD CHARACTERS WITHOUT CLAIM TO ANY PARTICULAR FONT, STYLE, SIZE, OR COLOR.

SER. NO. 77-188,485, FILED 5-23-2007.

GEOFFREY FOSDICK, EXAMINING ATTORNEY

**Int. Cl.: 40**

**Prior U.S. Cls.: 100, 103 and 106**

**United States Patent and Trademark Office**

**Reg. No. 3,465,612**

**Registered July 15, 2008**

**SERVICE MARK  
PRINCIPAL REGISTER**

**PAINTSQUARE**

SOUTHSIDE HOLDINGS, INC. (PENNSYLVANIA  
CORPORATION)  
SUITE 310  
2100 WHARTON STREET  
PITTSBURGH, PA 15203

FOR: PROVIDING A WEBSITE FEATURING IN-  
FORMATION ON THE PROTECTIVE COATINGS  
INDUSTRY, IN CLASS 40 (U.S. CLS. 100, 103 AND  
106).

FIRST USE 10-31-2000; IN COMMERCE 10-31-2000.

THE MARK CONSISTS OF STANDARD CHAR-  
ACTERS WITHOUT CLAIM TO ANY PARTICULAR  
FONT, STYLE, SIZE, OR COLOR.

SER. NO. 77-188,495, FILED 5-23-2007.

JANICE KIM, EXAMINING ATTORNEY

**Int. Cl.: 10**

**Prior U.S. Cls.: 26, 39 and 44**

**United States Patent and Trademark Office**

**Reg. No. 3,465,613**

**Registered July 15, 2008**

**TRADEMARK  
PRINCIPAL REGISTER**

**INTEGRATED SURGICAL SYSTEMS**

CUREXO MEDICAL, INC. (CALIFORNIA CORPORATION)  
1433 N. MARKET BLVD., #1  
SACRAMENTO, CA 95834

FOR: SURGICAL AND MEDICAL APPARATUS, NAMELY, A ROBOTIC SURGICAL APPARATUS, COMPRISING COMPUTERS, ROBOTIC ARMS, FORCE SENSORS, CUTTING INSTRUMENTS, AND COMPUTER PROGRAMS, USED FOR ORTHOPEDIC AND OTHER SURGICAL PROCEDURES, IN CLASS 10 (U.S. CLS. 26, 39 AND 44).

FIRST USE 2-0-1991; IN COMMERCE 2-0-1991.

THE MARK CONSISTS OF STANDARD CHARACTERS WITHOUT CLAIM TO ANY PARTICULAR FONT, STYLE, SIZE, OR COLOR.

NO CLAIM IS MADE TO THE EXCLUSIVE RIGHT TO USE "SURGICAL SYSTEMS", APART FROM THE MARK AS SHOWN.

SEC. 2(F).

SER. NO. 77-188,528, FILED 5-23-2007.

GEOFFREY FOSDICK, EXAMINING ATTORNEY

**Int. Cl.: 35**

**Prior U.S. Cls.: 100, 101 and 102**

**United States Patent and Trademark Office**

**Reg. No. 3,465,614**

**Registered July 15, 2008**

**SERVICE MARK  
PRINCIPAL REGISTER**

**ADALYST**

NOBLE COMMUNICATIONS COMPANY (MISSOURI CORPORATION)  
2155 WEST CHESTERFIELD BOULEVARD  
SPRINGFIELD, MO 65807

FOR: BUSINESS MARKETING AND BUSINESS CONSULTING SERVICES; MARKET RESEARCH; MARKET SERVICES, NAMELY, CONDUCTING CONSUMER TRACKING BEHAVIOR RESEARCH AND CONSUMER TREND ANALYSIS; COMMERCIALIZATION STRATEGY SERVICES, NAMELY, CREATING CORPORATE AND BRANDING IDENTITY FOR OTHERS; MARKETING, ADVERTISING AND PROMOTION OF THE GOODS AND SERVI-

CES OF OTHERS, IN CLASS 35 (U.S. CLS. 100, 101 AND 102).

FIRST USE 12-0-2006; IN COMMERCE 12-0-2006.

THE MARK CONSISTS OF STANDARD CHARACTERS WITHOUT CLAIM TO ANY PARTICULAR FONT, STYLE, SIZE, OR COLOR.

SER. NO. 77-188,578, FILED 5-23-2007.

JIM RINGLE, EXAMINING ATTORNEY

**Int. Cl.: 10**

**Prior U.S. Cls.: 26, 39 and 44**

**United States Patent and Trademark Office**

**Reg. No. 3,465,615**

**Registered July 15, 2008**

**TRADEMARK  
PRINCIPAL REGISTER**



CUREXO MEDICAL, INC. (CALIFORNIA CORPORATION)  
1433 N. MARKET BLVD., #1  
SACRAMENTO, CA 95834

FOR: SURGICAL AND MEDICAL APPARATUS, NAMELY, A ROBOTIC SURGICAL APPARATUS, COMPRISING COMPUTERS, ROBOTIC ARMS, FORCE SENSORS, CUTTING INSTRUMENTS, AND COMPUTER PROGRAMS, USED FOR ORTHOPEDIC AND SURGICAL PROCEDURES, IN CLASS 10 (U.S. CLS. 26, 39 AND 44).

FIRST USE 2-0-1991; IN COMMERCE 2-0-1991.

THE MARK CONSISTS OF A FANCIFUL DESIGN OF A PHYSICIAN'S FACE.

SER. NO. 77-188,662, FILED 5-23-2007.

GEOFFREY FOSDICK, EXAMINING ATTORNEY



**Int. Cl.: 28**

**Prior U.S. Cls.: 22, 23, 38 and 50**

**United States Patent and Trademark Office**

**Reg. No. 3,465,616**

**Registered July 15, 2008**

**TRADEMARK  
PRINCIPAL REGISTER**

**LADDER BAGS**

LADDER GOLF LLC (CALIFORNIA LTD LIAB  
CO)  
PO BOX 478  
EL CAJON, CA 92022

FOR: ACTION TYPE TARGET GAMES; ACTION  
SKILL GAMES; EQUIPMENT SOLD AS A UNIT FOR  
PLAYING ACTION TYPE TARGET GAMES; EQUIP-  
MENT SOLD AS A UNIT FOR PLAYING ACTION  
SKILL GAMES; OUTDOOR ACTIVITY GAMES IN  
THE NATURE OF GAME THROWING DEVICES,  
WITH TARGETS AND INSTRUCTIONS, IN CLASS  
28 (U.S. CLS. 22, 23, 38 AND 50).

FIRST USE 5-18-2007; IN COMMERCE 5-18-2007.

THE MARK CONSISTS OF STANDARD CHAR-  
ACTERS WITHOUT CLAIM TO ANY PARTICULAR  
FONT, STYLE, SIZE, OR COLOR.

OWNER OF U.S. REG. NO. 2,984,720.

NO CLAIM IS MADE TO THE EXCLUSIVE  
RIGHT TO USE "BAGS", APART FROM THE MARK  
AS SHOWN.

SER. NO. 77-188,787, FILED 5-23-2007.

KAREN BRACEY, EXAMINING ATTORNEY

**Int. Cl.: 35**

**Prior U.S. Cls.: 100, 101 and 102**

**United States Patent and Trademark Office**

**Reg. No. 3,465,617**

**Registered July 15, 2008**

---

**SERVICE MARK  
PRINCIPAL REGISTER**



AUTONATION HOLDING CORP. (DELAWARE  
CORPORATION)  
110 S.E. 6TH STREET, 20TH FLOOR  
FT. LAUDERDALE, FL 33301

FIRST USE 4-9-2007; IN COMMERCE 4-9-2007.

SER. NO. 77-188,859, FILED 5-23-2007.

FOR: AUTOMOBILE DEALERSHIP SERVICES, IN  
CLASS 35 (U.S. CLS. 100, 101 AND 102).

JAY FLOWERS, EXAMINING ATTORNEY

**Int. Cl.: 9**

**Prior U.S. Cls.: 21, 23, 26, 36 and 38**

**Reg. No. 3,465,618**

**United States Patent and Trademark Office**

**Registered July 15, 2008**

---

**TRADEMARK  
PRINCIPAL REGISTER**

# Mindsoul

MARK D HINDS (UNITED STATES INDIVIDUAL)  
774 MAYS BLVD 10-373  
INCLINE VILLAGE, NV 89451

THE MARK CONSISTS OF STANDARD CHARACTERS WITHOUT CLAIM TO ANY PARTICULAR FONT, STYLE, SIZE, OR COLOR.

FOR: PRE-RECORDED CDS FEATURING INSPIRATIONAL SPEAKING, IN CLASS 9 (U.S. CLS. 21, 23, 26, 36 AND 38).

SER. NO. 77-188,878, FILED 5-23-2007.

FIRST USE 10-1-2006; IN COMMERCE 10-1-2006.

JAY FLOWERS, EXAMINING ATTORNEY

**Int. Cl.: 16**

**Prior U.S. Cls.: 2, 5, 22, 23, 29, 37, 38 and 50**

**United States Patent and Trademark Office**

**Reg. No. 3,465,619**

**Registered July 15, 2008**

**TRADEMARK  
PRINCIPAL REGISTER**

**A GIRL NAMED PANTS**

A GIRL NAMED PANTS, INC. (NEW YORK  
CORPORATION)  
8954 STONEBRIAR DRIVE  
CLARENCE CENTER, NY 14032

THE MARK CONSISTS OF STANDARD CHAR-  
ACTERS WITHOUT CLAIM TO ANY PARTICULAR  
FONT, STYLE, SIZE, OR COLOR.

FOR: CHILDREN'S BOOKS AND POSTERS, IN  
CLASS 16 (U.S. CLS. 2, 5, 22, 23, 29, 37, 38 AND 50).

SER. NO. 77-189,133, FILED 5-24-2007.

FIRST USE 11-23-2004; IN COMMERCE 12-14-2004.

SIMON TENG, EXAMINING ATTORNEY

**Int. Cl.: 41**

**Prior U.S. Cls.: 100, 101 and 107**

**United States Patent and Trademark Office**

**Reg. No. 3,465,620**

**Registered July 15, 2008**

**SERVICE MARK  
PRINCIPAL REGISTER**

**MESDA**

OLD SALEM, INC. (NORTH CAROLINA CORPORATION)  
BOX F, SALEM STATION  
WINSTON-SALEM, NC 27108

FOR: EDUCATION AND ENTERTAINMENT SERVICES, NAMELY, MUSEUMS FEATURING ARTISTIC EXHIBITS AND HISTORIC EXHIBITS RENDERED TO DEVELOP KNOWLEDGE OF EARLY AMERICAN ART, CRAFTS, LANDSCAPE, AND CULTURE; CONDUCTING DISPLAYS AND INTERACTIVE EXHIBITS IN THE FIELD OF EARLY AMERICAN ART, CRAFTS, LANDSCAPE AND CULTURE; GUIDED GROUP TOURS OF MUSEUMS FEATURING KNOWLEDGE OF EARLY AMERICAN ART, CRAFTS, LANDSCAPE, AND

CULTURE; CONDUCTING INFORMAL LECTURE PROGRAMS AND MUSEUM CLASSES IN THE FIELDS OF EARLY AMERICAN ART, CRAFTS, LANDSCAPE, AND CULTURE, IN CLASS 41 (U.S. CLS. 100, 101 AND 107).

FIRST USE 0-0-1965; IN COMMERCE 0-0-1965.

THE MARK CONSISTS OF STANDARD CHARACTERS WITHOUT CLAIM TO ANY PARTICULAR FONT, STYLE, SIZE, OR COLOR.

SER. NO. 77-189,149, FILED 5-24-2007.

HANNO RITTNER, EXAMINING ATTORNEY

**Int. Cl.: 3**

**Prior U.S. Cls.: 1, 4, 6, 50, 51 and 52**

**United States Patent and Trademark Office**

**Reg. No. 3,465,621**

**Registered July 15, 2008**

**TRADEMARK  
PRINCIPAL REGISTER**

**FERIA**

L'OREAL (FRANCE SOCIETE ANONYME)  
14 RUE ROYALE  
PARIS, FRANCE 75008

OWNER OF U.S. REG. NOS. 2,644,044, 3,142,693  
AND OTHERS.

FOR: HAIR COLOR PREPARATIONS, IN CLASS 3  
(U.S. CLS. 1, 4, 6, 50, 51 AND 52).

THE FOREIGN WORDING IN THE MARK  
TRANSLATES INTO ENGLISH AS FAIR.

FIRST USE 7-1-1998; IN COMMERCE 7-1-1998.

SER. NO. 77-189,252, FILED 5-24-2007.

THE MARK CONSISTS OF STANDARD CHAR-  
ACTERS WITHOUT CLAIM TO ANY PARTICULAR  
FONT, STYLE, SIZE, OR COLOR.

MARK SPARACINO, EXAMINING ATTORNEY

**Int. Cl.: 43**

**Prior U.S. Cls.: 100 and 101**

**United States Patent and Trademark Office**

**Reg. No. 3,465,622**

**Registered July 15, 2008**

**SERVICE MARK  
PRINCIPAL REGISTER**

**NEW START**

WESTINGHOUSE ELECTRIC COMPANY LLC  
(DELAWARE LTD LIAB CO)  
WESTINGHOUSE LEGAL - IP  
4350 NORTHERN PIKE  
MONROEVILLE, PA 151462866

THE MARK CONSISTS OF STANDARD CHAR-  
ACTERS WITHOUT CLAIM TO ANY PARTICULAR  
FONT, STYLE, SIZE, OR COLOR.

FOR: RESTAURANT SERVICES, IN CLASS 43  
(U.S. CLS. 100 AND 101).

SER. NO. 77-189,257, FILED 5-24-2007.

FIRST USE 5-24-2007; IN COMMERCE 5-24-2007.

KIMBERLY FRYE, EXAMINING ATTORNEY

**Int. Cl.: 30**

**Prior U.S. Cl.: 46**

**United States Patent and Trademark Office**

**Reg. No. 3,465,623**

**Registered July 15, 2008**

**TRADEMARK  
PRINCIPAL REGISTER**



CHOTAI, SHRI DIPAKKUMAR KANTILAL (INDIA INDIVIDUAL)  
MAHIYAL, TALOD-383 215  
8/9A, PURSHOTTAM INDUSTRIAL ESTATE  
GUJARAT STATE, INDIA

FOR: INSTANT FOOD MIXES FOR MAKING VEGETABLE-BASED AND MEAT-BASED DISHES, NAMELY, INSTANT KHAMAN MIX, INSTANT GOTA MIX, INSTANT DHOKLA MIX, INSTANT HANDWA MIX, INSTANT IDLY MIX, INSTANT DHOSA MIX, INSTANT DALWADA MIX, INSTANT DAHIWADA MIX, INSTANT UPMA MIX, INSTANT KNICHU MIX, INSTANT BATATAWADA MIX, INSTANT MASALA MIX, INSTANT GULAB JAMUN MIX, INSTANT BATAKA POHA MIX, INSTANT

CHOLAFALI MIX, AND INSTANT MATHIA MIX, IN CLASS 30 (U.S. CL. 46).

FIRST USE 0-0-1988; IN COMMERCE 7-5-2005.

NO CLAIM IS MADE TO THE EXCLUSIVE RIGHT TO USE "TALOD", APART FROM THE MARK AS SHOWN.

THE MARK CONSISTS OF THE WORD "TALOD" WRITTEN ACROSS THE WINGS OF A BIRD.

SER. NO. 77-189,259, FILED 5-24-2007.

NAKIA HENRY, EXAMINING ATTORNEY



**Int. Cls.: 1 and 40**

**Prior U.S. Cls.: 1, 5, 6, 10, 26, 46, 100, 103 and 106**

**United States Patent and Trademark Office**

**Reg. No. 3,465,624**

**Registered July 15, 2008**

**TRADEMARK  
SERVICE MARK  
PRINCIPAL REGISTER**

**WISCONSINBIOPRODUCTS**

MOLECULAR BIOLOGY RESOURCES INC. (WIS-  
CONSIN CORPORATION)  
6143 N. 60TH STREET  
MILWAUKEE, WI 53218

FOR: BACTERIA FOR USE IN FOOD MANUFACTURE;  
CHEMICAL PREPARATIONS IN THE NATURE OF  
FILTERING MATERIALS IN THE BIOTECH INDUSTRY;  
EMULSIFIERS FOR USE IN THE MANUFACTURE OF  
FOODS, IN CLASS 1 (U.S. CLS. 1, 5, 6, 10, 26 AND 46).

FIRST USE 6-1-2000; IN COMMERCE 6-1-2000.

FOR: CONTRACT MANUFACTURING IN THE FIELD OF  
FERMENTATION, IN CLASS 40 (U.S. CLS. 100, 103 AND 106).

FIRST USE 6-1-2000; IN COMMERCE 6-1-2000.

THE MARK CONSISTS OF STANDARD CHARACTERS  
WITHOUT CLAIM TO ANY PARTICULAR FONT, STYLE,  
SIZE, OR COLOR.

OWNER OF U.S. REG. NO. 2,537,473.

SEC. 2(F).

SER. NO. 77-189,293, FILED 5-24-2007.

BRIAN CALLAGHAN, EXAMINING ATTORNEY

**Int. Cl.: 5**

**Prior U.S. Cls.: 6, 18, 44, 46, 51 and 52**

**Reg. No. 3,465,625**

**United States Patent and Trademark Office**

**Registered July 15, 2008**

**TRADEMARK  
PRINCIPAL REGISTER**



DELTA SPORTS SUPPLEMENTS, LLC (ARIZONA  
LTD LIAB CO)

2440 W. 12TH STREET, #3

TEMPE, AZ 85281

FOR: NUTRITIONAL SUPPLEMENTS, IN CLASS  
5 (U.S. CLS. 6, 18, 44, 46, 51 AND 52).

FIRST USE 7-1-2005; IN COMMERCE 7-1-2005.

NO CLAIM IS MADE TO THE EXCLUSIVE  
RIGHT TO USE "STIMULANT" AND "ENERGY &  
FAT LOSS TECHNOLOGY", APART FROM THE  
MARK AS SHOWN.

THE COLOR(S) YELLOW, RED, SILVER AND  
BLACK IS/ARE CLAIMED AS A FEATURE OF THE  
MARK.

THE COLOR YELLOW APPEARS IN THE "X".  
THE COLOR RED APPEARS IN THE "X". THE  
COLOR SILVER APPEARS IN THE BORDER  
AROUND THE "X" AND IN THE WORDING "STI-  
MULANT XTREME ENERGY & FAT LOSS TECH-  
NOLOGY". THE COLOR BLACK APPEARS IN THE  
BACKGROUND.

SER. NO. 77-189,379, FILED 5-24-2007.

ROBERT STRUCK, EXAMINING ATTORNEY

**Int. Cl.: 40**

**Prior U.S. Cls.: 100, 103 and 106**

**United States Patent and Trademark Office**

**Reg. No. 3,465,626**

**Registered July 15, 2008**

**SERVICE MARK  
PRINCIPAL REGISTER**

**UNITED**

UNITED FOUNDRIES, INC. (DELAWARE CORPORATION)  
1400 GRACE AVENUE N.E.  
CANTON, OH 44705

THE MARK CONSISTS OF STANDARD CHARACTERS WITHOUT CLAIM TO ANY PARTICULAR FONT, STYLE, SIZE, OR COLOR.

FOR: CUSTOM MANUFACTURE OF ROLLING MILL ROLLS FOR USE IN ROLLING MILLS, IN CLASS 40 (U.S. CLS. 100, 103 AND 106).

SER. NO. 77-189,495, FILED 5-24-2007.

FIRST USE 1-1-2007; IN COMMERCE 1-1-2007.

ELLEN PERKINS, EXAMINING ATTORNEY

**Int. Cls.: 20 and 35**

**Prior U.S. Cls.: 2, 13, 22, 25, 32, 50, 100, 101 and 102**

**United States Patent and Trademark Office**

**Reg. No. 3,465,627**

**Registered July 15, 2008**

**TRADEMARK  
SERVICE MARK  
PRINCIPAL REGISTER**

**They've Slammed It.  
You've Pounded It.  
Now Own It.**

DISTINGUISHED SPORTS, INC. (NEW YORK CORPORATION)

3RD FLOOR

1375 BROADWAY

NEW YORK, NY 10018

FOR: NOVELTY ITEMS, NAMELY, GAME USED SYNTHETIC GLASS WALL BOARD FROM HOCKEY RINKS, IN CLASS 20 (U.S. CLS. 2, 13, 22, 25, 32 AND 50).

FIRST USE 4-0-2007; IN COMMERCE 4-0-2007.

FOR: RETAIL STORE SERVICES FEATURING SPORTS MEMORABILIA, IN CLASS 35 (U.S. CLS. 100, 101 AND 102).

FIRST USE 4-0-2007; IN COMMERCE 4-0-2007.

THE MARK CONSISTS OF STANDARD CHARACTERS WITHOUT CLAIM TO ANY PARTICULAR FONT, STYLE, SIZE, OR COLOR.

SER. NO. 77-189,513, FILED 5-24-2007.

ALEXANDER L. POWERS, EXAMINING ATTORNEY

**Int. Cl.: 40**

**Prior U.S. Cls.: 100, 103 and 106**

**United States Patent and Trademark Office**

**Reg. No. 3,465,628**

**Registered July 15, 2008**

---

**SERVICE MARK  
PRINCIPAL REGISTER**

**SARCO**

UNITED FOUNDRIES, INC. (DELAWARE COR-  
PORATION)  
1400 GRACE AVENUE N.E.  
CANTON, OH 44705

THE MARK CONSISTS OF STANDARD CHAR-  
ACTERS WITHOUT CLAIM TO ANY PARTICULAR  
FONT, STYLE, SIZE, OR COLOR.

FOR: CUSTOM MANUFACTURE OF ROLLING  
MILL ROLLS FOR USE IN ROLLING MILLS, IN  
CLASS 40 (U.S. CLS. 100, 103 AND 106).

SER. NO. 77-189,519, FILED 5-24-2007.

FIRST USE 1-1-2007; IN COMMERCE 1-1-2007.

ELLEN PERKINS, EXAMINING ATTORNEY

**Int. Cl.: 43**

**Prior U.S. Cls.: 100 and 101**

**United States Patent and Trademark Office**

**Reg. No. 3,465,629**

**Registered July 15, 2008**

**SERVICE MARK  
PRINCIPAL REGISTER**

**STICKY RICE**

GUMBO'S CREOLE CAFÉ, L.C (VIRGINIA LTD  
LIAB CO)  
2232 WEST MAIN STREET  
RICHMOND, VA 23220

THE MARK CONSISTS OF STANDARD CHAR-  
ACTERS WITHOUT CLAIM TO ANY PARTICULAR  
FONT, STYLE, SIZE, OR COLOR.

FOR: RESTAURANTS, IN CLASS 43 (U.S. CLS. 100  
AND 101).

SER. NO. 77-189,682, FILED 5-24-2007.

FIRST USE 9-1-1999; IN COMMERCE 9-1-1999.

ELLEN B. AWRICH, EXAMINING ATTORNEY

Int. Cl.: 35

Prior U.S. Cls.: 100, 101 and 102

United States Patent and Trademark Office

Reg. No. 3,465,630

Registered July 15, 2008

SERVICE MARK  
PRINCIPAL REGISTER



culturewaves

BE FIRST FASTER

NOBLE COMMUNICATIONS COMPANY (MISSOURI CORPORATION)  
2155 WEST CHESTERFIELD BOULEVARD  
SPRINGFIELD, MO 65807

FOR: BUSINESS MARKETING AND BUSINESS CONSULTING SERVICES; MARKET RESEARCH; MARKET SERVICES, NAMELY, CONDUCTING CONSUMER TRACKING BEHAVIOR RESEARCH AND CONSUMER TREND ANALYSIS; COMMERCIALIZATION STRATEGY SERVICES, NAMELY, CREATING CORPORATE AND BRANDING IDENTITY FOR OTHERS; MARKETING, ADVERTISING

AND PROMOTION OF THE GOODS AND SERVICES OF OTHERS, IN CLASS 35 (U.S. CLS. 100, 101 AND 102).

FIRST USE 5-18-2007; IN COMMERCE 5-18-2007.

THE MARK CONSISTS OF WORD ELEMENTS WITH WAVES OFF OF THE LETTER "T".

SER. NO. 77-189,719, FILED 5-24-2007.

JIM RINGLE, EXAMINING ATTORNEY

Int. Cl.: 33

Prior U.S. Cls.: 47 and 49

**United States Patent and Trademark Office**

**Reg. No. 3,465,631**

Registered July 15, 2008

---

**TRADEMARK  
PRINCIPAL REGISTER**

**CASK NO. 16**

DIAGEO NORTH AMERICA, INC. (CONNECTI-  
CUT CORPORATION)

801 MAIN AVENUE

NORWALK, CT 06851

FOR: ALCOHOLIC BEVERAGES, NAMELY,  
WHISKY, IN CLASS 33 (U.S. CLS. 47 AND 49).

FIRST USE 9-30-2007; IN COMMERCE 9-30-2007.

THE MARK CONSISTS OF STANDARD CHAR-  
ACTERS WITHOUT CLAIM TO ANY PARTICULAR  
FONT, STYLE, SIZE, OR COLOR.

NO CLAIM IS MADE TO THE EXCLUSIVE  
RIGHT TO USE "CASK", APART FROM THE MARK  
AS SHOWN.

SER. NO. 77-189,752, FILED 5-24-2007.

LESLEY LAMOTHE, EXAMINING ATTORNEY



Int. Cl.: 35

Prior U.S. Cls.: 100, 101 and 102

United States Patent and Trademark Office

Reg. No. 3,465,632

Registered July 15, 2008

**SERVICE MARK  
PRINCIPAL REGISTER**

Spend 10 minutes

**1** File Taxes



In as little as 24 hours

**2** Get Money\*



FAMKE HOLDINGS CORPORATION (DELAWARE CORPORATION)  
230 PARK AVENUE STE 864  
NEW YORK, NY 10169

FOR: TAX FILING SERVICES, IN CLASS 35 (U.S. CLS. 100, 101 AND 102).

FIRST USE 1-18-2005; IN COMMERCE 1-18-2005.

NO CLAIM IS MADE TO THE EXCLUSIVE RIGHT TO USE "SPEND 10 MINUTES 1 FILE TAXES" OR "IN AS LITTLE AS 24 HOURS 2 GET MONEY", APART FROM THE MARK AS SHOWN.

THE COLOR(S) BLUE, BLACK AND WHITE IS/ARE CLAIMED AS A FEATURE OF THE MARK.

THE COLOR BLUE APPEARS IN THE CIRCLE AROUND THE NUMBER "1" AND THE CIRCLE

AROUND THE NUMBER "2" AND AS SHADING IN THE TWO CLOCK FACES. THE COLOR BLACK APPEARS IN THE WORDING "SPEND 10 MINUTES", "FILE TAXES", "IN AS LITTLE AS 24 HOURS", "GET MONEY" IN THE OUTLINE, NUMBERS, NOTCHES AND HANDS IN THE DESIGN OF THE CLOCKS AND IN THE DESIGN OF THE LAP TOP COMPUTER AND DOLLAR SIGNS ON THE FACES OF THE CLOCKS. THE COLOR WHITE APPEARS IN THE NUMBERS "1" AND "2", IN THE FACE OF THE CLOCKS AND IN THE DESIGN OF THE LAP TOP COMPUTER ON THE FACE OF THE CLOCK.

SER. NO. 77-190,096, FILED 5-24-2007.

KATHERINE CONNOLLY, EXAMINING ATTORNEY

**Int. Cl.: 25**

**Prior U.S. Cls.: 22 and 39**

**United States Patent and Trademark Office**

**Reg. No. 3,465,633**

**Registered July 15, 2008**

**TRADEMARK  
PRINCIPAL REGISTER**

**PEECE LUV CHIKIN**

CFA PROPERTIES, INC. (DELAWARE CORPORATION)  
1105 NORTH MARKET STREET, SUITE 928  
WILMINGTON, DE 19801

THE MARK CONSISTS OF STANDARD CHARACTERS WITHOUT CLAIM TO ANY PARTICULAR FONT, STYLE, SIZE, OR COLOR.

FOR: T-SHIRTS, IN CLASS 25 (U.S. CLS. 22 AND 39).

SER. NO. 77-190,136, FILED 5-24-2007.

FIRST USE 7-0-1999; IN COMMERCE 7-0-1999.

JOHN E. MICHOS, EXAMINING ATTORNEY

**Int. Cl.: 29**

**Prior U.S. Cl.: 46**

**United States Patent and Trademark Office**

**Reg. No. 3,465,634**

**Registered July 15, 2008**

**TRADEMARK  
PRINCIPAL REGISTER**

**RESTAURANT SAVER**

JETRO HOLDINGS, INC. (DELAWARE COR-  
PORATION)  
15-24 132ND STREET  
FLUSHING, NY 11356

THE MARK CONSISTS OF STANDARD CHAR-  
ACTERS WITHOUT CLAIM TO ANY PARTICULAR  
FONT, STYLE, SIZE, OR COLOR.

FOR: FROZEN VEGETABLES, IN CLASS 29 (U.S.  
CL. 46).

SER. NO. 77-190,156, FILED 5-24-2007.

FIRST USE 6-0-2006; IN COMMERCE 6-0-2006.

LINDA M. KING, EXAMINING ATTORNEY

**Int. Cl.: 29**

**Prior U.S. Cl.: 46**

**United States Patent and Trademark Office**

**Reg. No. 3,465,635**

**Registered July 15, 2008**

**TRADEMARK  
PRINCIPAL REGISTER**

**MAMA ISABELLA**

JETRO HOLDINGS, INC. (DELAWARE CORPORATION)  
15-24 132ND STREET  
FLUSHING, NY 11356

THE MARK CONSISTS OF STANDARD CHARACTERS WITHOUT CLAIM TO ANY PARTICULAR FONT, STYLE, SIZE, OR COLOR.

FOR: SAUSAGE, SLICED PEPPERONI PIZZA TOPPING AND DELI MEATS, IN CLASS 29 (U.S. CL. 46).

SER. NO. 77-190,159, FILED 5-25-2007.

FIRST USE 5-0-2004; IN COMMERCE 5-0-2004.

LINDA M. KING, EXAMINING ATTORNEY

**Int. Cl.: 38**

**Prior U.S. Cls.: 100, 101 and 104**

**United States Patent and Trademark Office**

**Reg. No. 3,465,636**

**Registered July 15, 2008**

**SERVICE MARK  
PRINCIPAL REGISTER**

**WHAT I KNOW NOW**

SPRAGINS, ELLYN (UNITED STATES INDIVIDUAL)  
322 SOUTH MAIN STREET  
PENNINGTON, NJ 08534

FOR: PROVIDING ONLINE LIST SERVERS FOR TRANSMISSION OF MESSAGES AMONG COMPUTER USERS CONCERNING MOTIVATION AND PERSONAL DEVELOPMENT; PROVIDING ONLINE ELECTRONIC BULLETIN BOARDS FOR TRANSMISSION OF MESSAGES AMONG COMPUTER USERS CONCERNING MOTIVATION AND PERSONAL DEVELOPMENT; PROVIDING ONLINE CHAT ROOMS FOR TRANSMISSION OF MESSAGES AMONG USERS IN THE FIELD OF GENERAL INTEREST; PROVIDING ONLINE COMMUNICATIONS LINKS WHICH TRANSFER THE WEBSITE USER TO OTHER LOCAL AND GLOBAL WEB PAGES; TRANSMISSION OF INFORMATION BY ELECTRONIC COMMUNICATIONS NETWORKS; TRANSMISSION OF MESSAGES OVER ELECTRONIC MEDIA; AUDIO BROADCASTING; BROADCASTING PROGRAMS VIA A GLOBAL COMPUTER NETWORK; COMMUNICATIONS BY COMPUTER TERMINALS; COMMUNICATIONS SERVICES, NAMELY, TRANSMITTING STREAMED SOUND AND AUDIO-VISUAL RECORDINGS VIA THE IN-

TERNET; VIDEO BROADCASTING; WEBCASTING SERVICES; ELECTRONIC MESSAGE SENDING; ONLINE DOCUMENT DELIVERY VIA A GLOBAL COMPUTER NETWORK; PROVIDING ACCESS TO DATABASES; PROVIDING ONLINE CHAT ROOMS AND ELECTRONIC BULLETIN BOARDS FOR TRANSMISSION OF MESSAGES AMONG USERS IN THE FIELD OF GENERAL INTEREST; PROVIDING ONLINE FORUMS FOR TRANSMISSION OF MESSAGES AMONG COMPUTER USERS CONCERNING MOTIVATION, PERSONAL AND PROFESSIONAL DEVELOPMENT; STREAMING OF AUDIO MATERIAL ON THE INTERNET; STREAMING OF VIDEO MATERIAL ON THE INTERNET; WEB CONFERENCING SERVICES; WEB MESSAGING, IN CLASS 38 (U.S. CLS. 100, 101 AND 104).

FIRST USE 4-30-2006; IN COMMERCE 4-30-2006.

THE MARK CONSISTS OF STANDARD CHARACTERS WITHOUT CLAIM TO ANY PARTICULAR FONT, STYLE, SIZE, OR COLOR.

SER. NO. 77-190,238, FILED 5-25-2007.

SHAUNIA CARLYLE, EXAMINING ATTORNEY

Int. Cl.: 25

Prior U.S. Cls.: 22 and 39

**United States Patent and Trademark Office**

**Reg. No. 3,465,637**

Registered July 15, 2008

**TRADEMARK  
PRINCIPAL REGISTER**



A CHICK'S LIFE, LLC (NEW JERSEY LTD LIAB  
CO)  
1006 RIVERVIEW DRIVE  
BRIELLE, NJ 08730

FOR: CLOTHING, NAMELY, SHIRTS, TOPS, T-  
SHIRTS, SWEAT SHIRTS, PAJAMAS, BELTS, AND  
HEADGEAR, NAMELY, CAPS, HATS, AND VISORS,  
IN CLASS 25 (U.S. CLS. 22 AND 39).

FIRST USE 4-26-2007; IN COMMERCE 6-22-2007.

THE MARK CONSISTS OF A CHICK WEARING  
SUNGLASSES.

SER. NO. 77-190,339, FILED 5-25-2007.

JASON ROTH, EXAMINING ATTORNEY

**Int. Cls.: 7 and 9**

**Prior U.S. Cls.: 13, 19, 21, 23, 26, 31, 34, 35, 36 and 38**

**United States Patent and Trademark Office**

**Reg. No. 3,465,638**

**Registered July 15, 2008**

**TRADEMARK  
PRINCIPAL REGISTER**

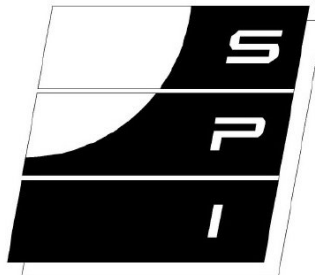

SOLAR POWER INDUSTRIES, INC. (DELAWARE CORPORATION)  
13 AIRPORT ROAD  
BELLE VERNON, PA 15012

FOR: ELECTRIC GENERATORS USING SOLAR POWER, IN CLASS 7 (U.S. CLS. 13, 19, 21, 23, 31, 34 AND 35).

FIRST USE 4-6-2004; IN COMMERCE 4-6-2004.

FOR: SOLAR CELLS AND SOLAR CELL MODULES, IN CLASS 9 (U.S. CLS. 21, 23, 26, 36 AND 38).

FIRST USE 4-6-2004; IN COMMERCE 4-6-2004.

SER. NO. 77-190,506, FILED 5-25-2007.

JASON LOTT, EXAMINING ATTORNEY

**Int. Cls.: 7 and 9**

**Prior U.S. Cls.: 13, 19, 21, 23, 26, 31, 34, 35, 36 and 38**

**Reg. No. 3,465,639**

**United States Patent and Trademark Office**

**Registered July 15, 2008**

**TRADEMARK  
PRINCIPAL REGISTER**

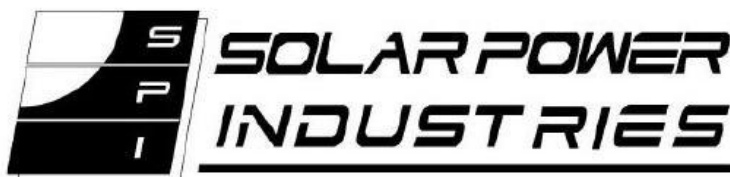

SOLAR POWER INDUSTRIES, INC. (DELAWARE CORPORATION)  
13 AIRPORT ROAD  
BELLE VERNON, PA 15012

FIRST USE 4-6-2004; IN COMMERCE 4-6-2004.

FOR: ELECTRIC GENERATORS USING SOLAR POWER, IN CLASS 7 (U.S. CLS. 13, 19, 21, 23, 31, 34 AND 35).

NO CLAIM IS MADE TO THE EXCLUSIVE RIGHT TO USE "SOLAR POWER INDUSTRIES", APART FROM THE MARK AS SHOWN.

FIRST USE 4-6-2004; IN COMMERCE 4-6-2004.

SER. NO. 77-190,518, FILED 5-25-2007.

FOR: SOLAR CELLS AND SOLAR CELL MODULES, IN CLASS 9 (U.S. CLS. 21, 23, 26, 36 AND 38).

JASON LOTT, EXAMINING ATTORNEY



**Int. Cl.: 9**

**Prior U.S. Cls.: 21, 23, 26, 36 and 38**

**Reg. No. 3,465,640**

**United States Patent and Trademark Office**

**Registered July 15, 2008**

**TRADEMARK  
PRINCIPAL REGISTER**



XPEC ENTERTAINMENT INC. (TAIWAN CORPORATION)  
5F, NO. 53, NANJING E. RD. SEC. 2  
TAIPEI, TAIWAN

FOR: COMPUTER GAME SOFTWARE AND VIDEO GAME SOFTWARE, IN CLASS 9 (U.S. CLS. 21, 23, 26, 36 AND 38).

FIRST USE 5-1-2006; IN COMMERCE 5-1-2006.

THE COLOR(S) RED AND WHITE IS/ARE CLAIMED AS A FEATURE OF THE MARK.

THE MARK CONSISTS OF THE MARK "XPEC" IN WHITE WITHIN A RED HORIZONTAL BOX.

SER. NO. 77-190,543, FILED 5-25-2007.

ANTHONY RINKER, EXAMINING ATTORNEY

**Int. Cls.: 35 and 42**

**Prior U.S. Cls.: 100, 101 and 102**

**United States Patent and Trademark Office**

**Reg. No. 3,465,641**

**Registered July 15, 2008**

**SERVICE MARK  
PRINCIPAL REGISTER**



**HAVI Global Solutions**

THE HAVI GROUP LIMITED PARTNERSHIP  
(DELAWARE LIMITED PARTNERSHIP)  
SUITE 400  
3010 HIGHLAND PARKWAY  
DOWNERS GROVE, IL 60515

FOR: BUSINESS MANAGEMENT SERVICES IN THE FIELD OF PROJECT MANAGEMENT FOR OTHERS; SUPPLY CHAIN MANAGEMENT SERVICES; BUSINESS CONSULTING SERVICES RELATED TO PRODUCT DISTRIBUTION, OPERATIONS MANAGEMENT SERVICES, LOGISTICS, REVERSE LOGISTICS, SUPPLY CHAIN, PRODUCTION SYSTEMS, DISTRIBUTION SOLUTIONS AND SOURCING STRATEGIES FOR OTHERS; INVENTORY CONTROL; AND PROMOTION AND MARKETING SERVICES AND RELATED CONSULTING, IN CLASS 35 (U.S. CLS. 100, 101 AND 102).

FIRST USE 1-1-2006; IN COMMERCE 1-1-2006.

FOR: PACKAGING DESIGN FOR OTHERS, IN CLASS 42 (U.S. CLS. 100 AND 101).

FIRST USE 1-1-2006; IN COMMERCE 1-1-2006.

NO CLAIM IS MADE TO THE EXCLUSIVE RIGHT TO USE "GLOBAL SOLUTIONS", APART FROM THE MARK AS SHOWN.

THE MARK CONSISTS OF A GLOBE THAT HAS A FRAME TO THE LEFT OF IT. THE WORDS "HAVI GLOBAL SOLUTIONS" APPEAR TO THE RIGHT OF THE GLOBE.

SER. NO. 77-190,584, FILED 5-25-2007.

ELLEN B. AWRICH, EXAMINING ATTORNEY

**Int. Cl.: 9**

**Prior U.S. Cls.: 21, 23, 26, 36 and 38**

**United States Patent and Trademark Office**

**Reg. No. 3,465,642**

**Registered July 15, 2008**

**TRADEMARK  
PRINCIPAL REGISTER**

*UltimateScale*

KABUSHIKI KAISHA TANITA (JAPAN CORPORATION)  
14-2, 1-CHOME, MAENOCHO  
ITABASHI-KU, TOKYO, JAPAN

OWNER OF U.S. REG. NO. 2,505,610.

SEC. 2(F).

FOR: BODY WEIGHT SCALES ALSO HAVING A  
BODY FAT MEASURING FUNCTION, IN CLASS 9  
(U.S. CLS. 21, 23, 26, 36 AND 38).

SER. NO. 77-190,723, FILED 5-25-2007.

FIRST USE 2-18-1999; IN COMMERCE 2-18-1999.

EVELYN BRADLEY, EXAMINING ATTORNEY

**Int. Cl.: 9**

**Prior U.S. Cls.: 21, 23, 26, 36 and 38**

**Reg. No. 3,465,643**

**United States Patent and Trademark Office**

**Registered July 15, 2008**

**TRADEMARK  
PRINCIPAL REGISTER**

**IDRUNA**

IDRUNA SOFTWARE, INC. (CALIFORNIA CORPORATION)  
40312 BALBOA DRIVE  
TEMECULA, CA 92591

PHOTOGRAPHS, IN CLASS 9 (U.S. CLS. 21, 23, 26, 36 AND 38).

FIRST USE 6-0-2001; IN COMMERCE 6-0-2001.

FOR: COMPUTER SOFTWARE FOR REMOTE EDITING OF GRAPHICS AND PHOTOGRAPHS; COMPUTER SOFTWARE FOR EDITING AND TRANSMISSION OF GRAPHICS AND PHOTOGRAPHS; COMPUTER SOFTWARE FOR EDITING, PAINTING AND ILLUMINATING GRAPHICS AND PHOTOGRAPHS FROM FILM AND DIGITAL CAMERAS; COMPUTER SOFTWARE FOR THREE DIMENSIONAL RENDERING OF GRAPHICS AND

THE MARK CONSISTS OF STANDARD CHARACTERS WITHOUT CLAIM TO ANY PARTICULAR FONT, STYLE, SIZE, OR COLOR.

SER. NO. 77-190,730, FILED 5-25-2007.

EVELYN BRADLEY, EXAMINING ATTORNEY

**Int. Cls.: 32 and 43**

**Prior U.S. Cls.: 45, 46, 48, 100 and 101**

**United States Patent and Trademark Office**

**Reg. No. 3,465,644**

**Registered July 15, 2008**

**TRADEMARK  
SERVICE MARK  
PRINCIPAL REGISTER**

**AMERICA'S DOG**

TAG RESTAURANTS, LLC (ILLINOIS LTD LIAB  
CO)  
C/O AMERICA'S DOG NAVY PIER, SUITE 121  
700 E GRAND AVE  
CHICAGO, IL 60611

FOR: CARBONATED AND NONCARBONATED  
SOFT DRINKS FOR CONSUMPTION ON AND OFF  
THE PREMISES, IN CLASS 32 (U.S. CLS. 45, 46 AND  
48).

FIRST USE 12-0-1995; IN COMMERCE 12-0-1995.

FOR: RESTAURANT SERVICES, IN CLASS 43  
(U.S. CLS. 100 AND 101).

FIRST USE 12-0-1995; IN COMMERCE 12-0-1995.

THE MARK CONSISTS OF STANDARD CHAR-  
ACTERS WITHOUT CLAIM TO ANY PARTICULAR  
FONT, STYLE, SIZE, OR COLOR.

SEC. 2(F).

SER. NO. 77-190,837, FILED 5-25-2007.

KATHLEEN LORENZO, EXAMINING ATTORNEY

**Int. Cl.: 41**

**Prior U.S. Cls.: 100, 101 and 107**

**United States Patent and Trademark Office**

**Reg. No. 3,465,645**

**Registered July 15, 2008**

**SERVICE MARK  
PRINCIPAL REGISTER**

**ALLIANCE OF IRANIAN  
AMERICANS**

ALLIANCE OF IRANIAN AMERICANS (CALIFORNIA CHARITABLE, NON-PROFIT CORPORATION)  
5 HUTTON CENTRE DR., STE 860  
SANTA ANA, CA 92707

FOR: EDUCATIONAL SERVICES, NAMELY, CONDUCTING SEMINARS, CONFERENCES AND INFORMAL ON-LINE PROGRAMS IN THE FIELD OF ANTI-DISCRIMINATION, CIVIL RIGHTS AND THE EVILS OF PREJUDICE, AND DISSEMINATION OF COURSE MATERIALS AND/OR PRINTABLE EDUCATIONAL MATERIALS IN CONNECTION THEREWITH; TELEVISION PROGRAM PRODUCTION SERVICES; RADIO PROGRAM PRODUCTION SERVICES IN THE FIELDS OF ANTI-

DISCRIMINATION AND CIVIL RIGHTS, IN CLASS 41 (U.S. CLS. 100, 101 AND 107).

FIRST USE 10-1-2001; IN COMMERCE 11-8-2001.

THE MARK CONSISTS OF STANDARD CHARACTERS WITHOUT CLAIM TO ANY PARTICULAR FONT, STYLE, SIZE, OR COLOR.

SEC. 2(F).

SER. NO. 77-190,931, FILED 5-25-2007.

KATHLEEN M. VANSTON, EXAMINING ATTORNEY

**Int. Cl.: 11**

**Prior U.S. Cls.: 13, 21, 23, 31 and 34**

**United States Patent and Trademark Office**

**Reg. No. 3,465,646**

**Registered July 15, 2008**

**TRADEMARK  
PRINCIPAL REGISTER**

**TRAVIS INDUSTRIES**

TRAVIS INDUSTRIES, INC. (WASHINGTON CORPORATION)  
4800 HARBOUR POINT BLVD. SW  
MUKILTEO, WA 98275

FOR: WOOD, GAS, AND PELLET BURNING FIREPLACE INSERTS IN THE NATURE OF HEAT EXCHANGERS AND SOLID AND GAS FUEL BURNERS; WOOD, GAS, AND PELLET BURNING FIREPLACES; WOOD, GAS, AND PELLET BURNING STOVES; ELECTRIC FIREPLACES AND FIREPLACE INSERTS IN THE NATURE OF HEAT EXCHANGERS, SOLID FUEL BURNERS, STOVES; REPLACEMENT PARTS FOR ALL OF THE AFOREMENTIONED GOODS; BURNER ASSEMBLIES FOR GAS-BURNING STOVES AND GAS FIREPLACE INSERTS; DECORATIVE WATER AND FLAME

FOUNTAINS, IN CLASS 11 (U.S. CLS. 13, 21, 23, 31 AND 34).

FIRST USE 3-14-1988; IN COMMERCE 3-14-1988.

THE MARK CONSISTS OF STANDARD CHARACTERS WITHOUT CLAIM TO ANY PARTICULAR FONT, STYLE, SIZE, OR COLOR.

NO CLAIM IS MADE TO THE EXCLUSIVE RIGHT TO USE "INDUSTRIES", APART FROM THE MARK AS SHOWN.

SER. NO. 77-190,952, FILED 5-25-2007.

LINDA LAVACHE, EXAMINING ATTORNEY

Int. Cl.: 9

Prior U.S. Cls.: 21, 23, 26, 36 and 38

Reg. No. 3,465,647

United States Patent and Trademark Office

Registered July 15, 2008

---

TRADEMARK  
PRINCIPAL REGISTER

VISIONS

EDUCATIONAL BROADCASTING CORPORATION  
(NEW YORK CORPORATION)  
450 WEST 33RD STREET  
NEW YORK, NY 10001

FOR: PRE-RECORDED VIDEO TAPES, COMPACT DISKS, DVDS, AND OTHER OPTICALLY AND MAGNETICALLY ENCODED ELECTRONIC MEDIA, ALL FEATURING AERIAL SCENIC PHOTOGRAPHY OF DOMESTIC AND FOREIGN DESTINATIONS, IN CLASS 9 (U.S. CLS. 21, 23, 26, 36 AND 38).

FIRST USE 12-8-1997; IN COMMERCE 12-8-1997.

THE MARK CONSISTS OF STANDARD CHARACTERS WITHOUT CLAIM TO ANY PARTICULAR FONT, STYLE, SIZE, OR COLOR.

SER. NO. 77-190,965, FILED 5-25-2007.

KAREN SEVERSON, EXAMINING ATTORNEY



**Int. Cl.: 36**

**Prior U.S. Cls.: 100, 101 and 102**

**United States Patent and Trademark Office**

**Reg. No. 3,465,648**

**Registered July 15, 2008**

**SERVICE MARK  
PRINCIPAL REGISTER**

**ALLIANCE OF IRANIAN  
AMERICANS**

ALLIANCE OF IRANIAN AMERICANS (CALIFORNIA CHARITABLE, NON-PROFIT CORPORATION)  
5 HUTTON CENTRE DR., STE 860  
SANTA ANA, CA 92707

FOR: CHARITABLE FUND RAISING FOR THE SUPPORT OF PROGRAMS CONCERNING INTER-ETHNIC RELATIONS, HATE CRIME VICTIM SUPPORT AND RELATED PROGRAMS ADDRESSING SOCIETAL ISSUES PERTAINING TO EQUALITY AND FAIRNESS OF TREATMENT FOR ALL PEOPLE, IN CLASS 36 (U.S. CLS. 100, 101 AND 102).

FIRST USE 10-1-2001; IN COMMERCE 11-8-2001.

THE MARK CONSISTS OF STANDARD CHARACTERS WITHOUT CLAIM TO ANY PARTICULAR FONT, STYLE, SIZE, OR COLOR.

SEC. 2(F).

SER. NO. 77-190,971, FILED 5-25-2007.

KATHLEEN M. VANSTON, EXAMINING ATTORNEY

**Int. Cl.: 42**

**Prior U.S. Cls.: 100 and 101**

**United States Patent and Trademark Office**

**Reg. No. 3,465,649**

**Registered July 15, 2008**

**SERVICE MARK  
PRINCIPAL REGISTER**



LOCKLINK COMMUNICATIONS INC (NEVADA CORPORATION)  
PO BOX 610607  
SAN JOSE, CA 95161

FOR: APPLICATION SERVICE PROVIDER (ASP) FEATURING SOFTWARE FOR USE IN FACILITATING SECURE COMMUNICATIONS WITH APPLICATIONS AND WEB SITES OF OTHERS HOSTED ON A COMPUTER SERVER FOR A GLOBAL COM-

PUTER NETWORK, IN CLASS 42 (U.S. CLS. 100 AND 101).

FIRST USE 8-8-1997; IN COMMERCE 8-8-1997.

OWNER OF U.S. REG. NO. 2,499,405.

SER. NO. 77-191,000, FILED 5-25-2007.

STEVEN PEREZ, EXAMINING ATTORNEY

**Int. Cl.: 9**

**Prior U.S. Cls.: 21, 23, 26, 36 and 38**

**United States Patent and Trademark Office**

**Reg. No. 3,465,650**

**Registered July 15, 2008**

**TRADEMARK  
PRINCIPAL REGISTER**

# HORKOS

HORKOS CORP (JAPAN CORPORATION)  
2-24-20, KUSADO-CHO  
FUKUYAMA-SHI, JAPAN 720-8650

FOR: MEASURING MACHINES AND INSTRUMENTS, NAMELY, APPARATUS FOR MEASURING THE VOLUME, CONDITION AND QUALITY OF CUTTING FLUID OR COOLANT USED FOR MACHINE TOOLS; AIR QUALITY MEASUREMENT APPARATUS, NAMELY, PARTICLE COUNTERS; TEMPERATURE INDICATORS; PRESSURE GAUGES; LEVEL INDICATORS; ACCELEROMETERS; ILLUMINOMETERS; CONCENTRATION METERS; AND FLOWMETERS, IN CLASS 9 (U.S. CLS. 21, 23, 26, 36 AND 38).

PRIORITY CLAIMED UNDER SEC. 44(D) ON JAPAN APPLICATION NO. T2007-045964, FILED 5-9-2007, REG. NO. 5106162, DATED 1-18-2008, EXPIRES 1-18-2018.

OWNER OF U.S. REG. NOS. 2,351,888, 2,424,435, AND 2,641,445.

THE FOREIGN WORDING IN THE MARK TRANSLATES INTO ENGLISH AS AGREEMENT OR OBJECT OF AN AGREEMENT.

SER. NO. 77-191,084, FILED 5-25-2007.

ESTHER BELENKER, EXAMINING ATTORNEY

**Int. Cl.: 9**

**Prior U.S. Cls.: 21, 23, 26, 36 and 38**

**United States Patent and Trademark Office**

**Reg. No. 3,465,651**

**Registered July 15, 2008**

**TRADEMARK  
PRINCIPAL REGISTER**



HORKOS CORP (JAPAN CORPORATION)  
2-24-20, KUSADO-CHO  
FUKUYAMA-SHI, JAPAN 720-8650

FOR: MEASURING MACHINES AND INSTRUMENTS, NAMELY, APPARATUS FOR MEASURING THE VOLUME, CONDITION AND QUALITY OF CUTTING FLUID OR COOLANT USED FOR MACHINE TOOLS; AIR QUALITY MEASUREMENT APPARATUS, NAMELY, PARTICLE COUNTERS; TEMPERATURE INDICATORS; PRESSURE GAUGES; LEVEL INDICATORS; ACCELEROMETERS; ILLUMINOMETERS; CONCENTRATION METERS; AND FLOWMETERS, IN CLASS 9 (U.S. CLS. 21, 23, 26, 36 AND 38).

PRIORITY CLAIMED UNDER SEC. 44(D) ON JAPAN APPLICATION NO. T2007-045966, FILED 5-

9-2007, REG. NO. 5106164, DATED 1-18-2008, EXPIRES 1-18-2018.

OWNER OF U.S. REG. NOS. 2,351,888, 2,424,435, AND 2,641,445.

THE MARK CONSISTS OF TWO RECTANGLES FORMING THE VERTICAL ELEMENTS OF THE CHARACTER H WITH THE LITERAL ELEMENT HORKOS FORMING THE CROSSBAR OF THE H.

THE FOREIGN WORDING IN THE MARK TRANSLATES INTO ENGLISH AS AGREEMENT OR OBJECT OF AN AGREEMENT.

SER. NO. 77-191,090, FILED 5-25-2007.

ESTHER BELENKER, EXAMINING ATTORNEY

**Int. Cl.: 10**

**Prior U.S. Cls.: 26, 39 and 44**

**Reg. No. 3,465,652**

**United States Patent and Trademark Office**

**Registered July 15, 2008**

---

**TRADEMARK  
PRINCIPAL REGISTER**

**PVAC**

ABLATION FRONTIERS, INC. (DELAWARE  
CORPORATION)  
6354 CORTE DEL ABETO, SUITE A  
CARLSBAD, CA 92011

THE MARK CONSISTS OF STANDARD CHAR-  
ACTERS WITHOUT CLAIM TO ANY PARTICULAR  
FONT, STYLE, SIZE, OR COLOR.

FOR: ELECTROPHYSIOLOGY CATHETERS FOR  
ABLATION TREATMENTS IN THE HEART, IN  
CLASS 10 (U.S. CLS. 26, 39 AND 44).

SER. NO. 77-191,160, FILED 5-26-2007.

FIRST USE 9-11-2006; IN COMMERCE 9-11-2006.

MICHAEL WEBSTER, EXAMINING ATTORNEY

**Int. Cl.: 10**

**Prior U.S. Cls.: 26, 39 and 44**

**United States Patent and Trademark Office**

**Reg. No. 3,465,653**

**Registered July 15, 2008**

**TRADEMARK  
PRINCIPAL REGISTER**

**MASC**

ABLATION FRONTIERS, INC. (DELAWARE  
CORPORATION)  
6354 CORTE DEL ABETO, SUITE A  
CARLSBAD, CA 92011

THE MARK CONSISTS OF STANDARD CHAR-  
ACTERS WITHOUT CLAIM TO ANY PARTICULAR  
FONT, STYLE, SIZE, OR COLOR.

FOR: ELECTROPHYSIOLOGY CATHETERS FOR  
ABLATION TREATMENTS IN THE HEART, IN  
CLASS 10 (U.S. CLS. 26, 39 AND 44).

SER. NO. 77-191,161, FILED 5-26-2007.

FIRST USE 9-11-2006; IN COMMERCE 9-11-2006.

MICHAEL WEBSTER, EXAMINING ATTORNEY

**Int. Cl.: 10**

**Prior U.S. Cls.: 26, 39 and 44**

**Reg. No. 3,465,654**

**United States Patent and Trademark Office**

**Registered July 15, 2008**

---

**TRADEMARK  
PRINCIPAL REGISTER**

**MAAC**

ABLATION FRONTIERS, INC. (DELAWARE  
CORPORATION)  
6354 CORTE DEL ABETO, SUITE A  
CARLSBAD, CA 92011

THE MARK CONSISTS OF STANDARD CHAR-  
ACTERS WITHOUT CLAIM TO ANY PARTICULAR  
FONT, STYLE, SIZE, OR COLOR.

FOR: ELECTROPHYSIOLOGY CATHETERS FOR  
ABLATION TREATMENTS IN THE HEART, IN  
CLASS 10 (U.S. CLS. 26, 39 AND 44).

SER. NO. 77-191,162, FILED 5-26-2007.

FIRST USE 9-11-2006; IN COMMERCE 9-11-2006.

MICHAEL WEBSTER, EXAMINING ATTORNEY

**Int. Cl.: 19**

**Prior U.S. Cls.: 1, 12, 33 and 50**

**United States Patent and Trademark Office**

**Reg. No. 3,465,655**

**Registered July 15, 2008**

**TRADEMARK  
PRINCIPAL REGISTER**

WISCONSIN CEMENT COMPANY

EAGLE MATERIALS IP LLC (DELAWARE LTD  
LIAB CO)  
3811 TURTLE CREEK BLVD., SUITE 1100  
DALLAS, TX 75219

NO CLAIM IS MADE TO THE EXCLUSIVE  
RIGHT TO USE "CEMENT COMPANY", APART  
FROM THE MARK AS SHOWN.

FOR: CONSTRUCTION PRODUCTS, NAMELY,  
HYDRAULIC CEMENT, IN CLASS 19 (U.S. CLS. 1, 12,  
33 AND 50).

SEC. 2(F).

FIRST USE 5-0-1982; IN COMMERCE 5-0-1982.

SER. NO. 77-191,327, FILED 5-27-2007.

THE MARK CONSISTS OF STANDARD CHAR-  
ACTERS WITHOUT CLAIM TO ANY PARTICULAR  
FONT, STYLE, SIZE, OR COLOR.

MICHAEL WEBSTER, EXAMINING ATTORNEY



**Int. Cl.: 41**

**Prior U.S. Cls.: 100, 101 and 107**

**United States Patent and Trademark Office**

**Reg. No. 3,465,656**

**Registered July 15, 2008**

**SERVICE MARK  
PRINCIPAL REGISTER**

**Enhance Your Chance**

KATEN, LAURA J (UNITED STATES INDIVIDUAL)  
221 FRANK AVE  
MAMARONECK, NY 10543

FOR: WORKSHOPS AND SEMINARS IN THE FIELD OF CAREER DEVELOPMENT, PROFESSIONAL DEVELOPMENT, JOB PREPARATION AND WORKPLACE READINESS, IN CLASS 41 (U.S. CLS. 100, 101 AND 107).

FIRST USE 6-25-2005; IN COMMERCE 6-25-2005.

THE MARK CONSISTS OF STANDARD CHARACTERS WITHOUT CLAIM TO ANY PARTICULAR FONT, STYLE, SIZE, OR COLOR.

OWNER OF U.S. REG. NO. 3,090,964.

SER. NO. 77-191,495, FILED 5-28-2007.

YAT SYE, LEE, EXAMINING ATTORNEY

**Int. Cl.: 41**

**Prior U.S. Cls.: 100, 101 and 107**

**United States Patent and Trademark Office**

**Reg. No. 3,465,657**

**Registered July 15, 2008**

**SERVICE MARK  
PRINCIPAL REGISTER**

**COURT SOLUTIONS**

NATIONAL CENTER FOR STATE COURTS (VIR-  
GINIA NON-STOCK CORPORATION)  
300 NEWPORT AVENUE  
WILLIAMSBURG, VA 23185

FOR: EDUCATIONAL SERVICES, NAMELY,  
CONDUCTING CONFERENCES IN THE FIELD OF  
COURT ADMINISTRATION AND DISTRIBUTION  
OF COURSE MATERIAL IN CONNECTION THERE-  
WITH , IN CLASS 41 (U.S. CLS. 100, 101 AND 107).

FIRST USE 0-0-2005; IN COMMERCE 0-0-2005.

THE MARK CONSISTS OF STANDARD CHAR-  
ACTERS WITHOUT CLAIM TO ANY PARTICULAR  
FONT, STYLE, SIZE, OR COLOR.

NO CLAIM IS MADE TO THE EXCLUSIVE  
RIGHT TO USE "COURT", APART FROM THE  
MARK AS SHOWN.

SER. NO. 77-191,556, FILED 5-28-2007.

RICHARD WHITE, EXAMINING ATTORNEY

**Int. Cl.: 41**

**Prior U.S. Cls.: 100, 101 and 107**

**United States Patent and Trademark Office**

**Reg. No. 3,465,658**

**Registered July 15, 2008**

**SERVICE MARK  
PRINCIPAL REGISTER**

**High School for Recording  
Arts**

STUDIO 4 ENTERPRISES INC. (MINNESOTA  
CORPORATION)  
550 VANDALIA STREET  
SAINT PAUL, MN 55114

NO CLAIM IS MADE TO THE EXCLUSIVE  
RIGHT TO USE "HIGH SCHOOL", APART FROM  
THE MARK AS SHOWN.

FOR: PROVIDING COURSES OF INSTRUCTION  
AT THE HIGH SCHOOL LEVEL, IN CLASS 41 (U.S.  
CLS. 100, 101 AND 107).

SEC. 2(F).

FIRST USE 0-0-1998; IN COMMERCE 0-0-1998.

SER. NO. 77-191,559, FILED 5-28-2007.

THE MARK CONSISTS OF STANDARD CHAR-  
ACTERS WITHOUT CLAIM TO ANY PARTICULAR  
FONT, STYLE, SIZE, OR COLOR.

JEAN IM, EXAMINING ATTORNEY

Int. Cl.: 29

Prior U.S. Cl.: 46

United States Patent and Trademark Office

Reg. No. 3,465,659

Registered July 15, 2008

TRADEMARK  
PRINCIPAL REGISTER



QINQIN INCORPORATED CO., LTD (FUJIAN)  
(CHINA CORPORATION)  
WULI INDUSTRIAL ZONE, JINJIANG CITY  
FUJIAN PROVINCE, CHINA

FOR: EGGS; FRUIT SALADS; FRUIT JELLIES  
PRESERVES; BEAN CURD PRODUCTS, NAMELY,  
PROCESSED BEAN CURD, FRESH BEAN CURD  
SHEETS; EDIBLE OILS; CORN OIL; DRIED MUSH-  
ROOMS; DRIED EDIBLE FUNGUS, IN CLASS 29  
(U.S. CL. 46).

OWNER OF CHINA REG. NO. 3293585, DATED 2-  
7-2004, EXPIRES 2-6-2014.

OWNER OF U.S. REG. NO. 2,526,697.

THE MARK CONSISTS OF CHINESE CHARAC-  
TERS WITH THE WORDING "QINQIN" APPEAR-  
ING BELOW IN STYLIZED LETTERING, THE  
CHINESE CHARACTERS WITHIN AN OVAL WITH  
A DOUBLE BORDER AND "QINQIN" WITHIN AN  
ASYMMETRICAL RECTANGLE WITH A BORDER  
ON TWO SIDES, INTERLOCKED WITH THE OVAL.

THE NON-LATIN CHARACTERS IN THE MARK  
TRANSLITERATE TO QIN WHICH MEANS INTI-  
MATE IN ENGLISH.

SER. NO. 77-191,578, FILED 5-29-2007.

CARYN GLASSER, EXAMINING ATTORNEY

**Int. Cl.: 35**

**Prior U.S. Cls.: 100, 101 and 102**

**United States Patent and Trademark Office**

**Reg. No. 3,465,660**

**Registered July 15, 2008**

**SERVICE MARK  
PRINCIPAL REGISTER**

**WORLD OF DIAMONDS**

WRM JEWELRY, INC. (ARIZONA CORPORATION)  
SUITE 1050  
6900 E. CAMELBACK  
SCOTTSDALE, AZ 85251

FOR: ON-LINE RETAIL AND WHOLESALE STORE SERVICES FEATURING DIAMONDS, PRECIOUS GEMSTONES, SEMI-PRECIOUS GEMSTONES, JEWELRY, WATCHES, WEDDING BANDS, BRACELETS, NECKLACES, EARRINGS, AND RINGS, IN CLASS 35 (U.S. CLS. 100, 101 AND 102).

FIRST USE 12-2-2005; IN COMMERCE 12-2-2005.

THE MARK CONSISTS OF STANDARD CHARACTERS WITHOUT CLAIM TO ANY PARTICULAR FONT, STYLE, SIZE, OR COLOR.

NO CLAIM IS MADE TO THE EXCLUSIVE RIGHT TO USE "DIAMONDS", APART FROM THE MARK AS SHOWN.

SER. NO. 77-191,582, FILED 5-29-2007.

ESTHER BELENKER, EXAMINING ATTORNEY

**Int. Cl.: 2**

**Prior U.S. Cls.: 6, 11 and 16**

**United States Patent and Trademark Office**

**Reg. No. 3,465,661**

**Registered July 15, 2008**

**TRADEMARK  
PRINCIPAL REGISTER**

**AMBASSADOR**

KWAL-HOWELLS, INC. (COLORADO CORPORATION)  
3900 JOLIET STREET  
DENVER, CO 80239

THE MARK CONSISTS OF STANDARD CHARACTERS WITHOUT CLAIM TO ANY PARTICULAR FONT, STYLE, SIZE, OR COLOR.

FOR: ACRYLIC-BASED PAINTS FOR INTERIOR AND EXTERIOR USE, IN CLASS 2 (U.S. CLS. 6, 11 AND 16).

SER. NO. 77-191,662, FILED 5-29-2007.

FIRST USE 7-1-1950; IN COMMERCE 7-1-1950.

BARBARA BROWN, EXAMINING ATTORNEY

**Int. Cl.: 41**

**Prior U.S. Cls.: 100, 101 and 107**

**United States Patent and Trademark Office**

**Reg. No. 3,465,662**

**Registered July 15, 2008**

**SERVICE MARK  
PRINCIPAL REGISTER**

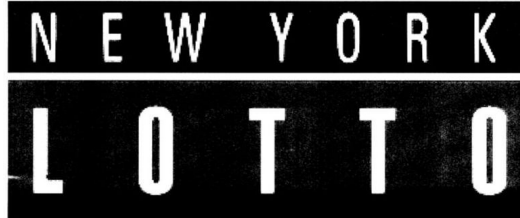

NEW YORK STATE DIVISION OF THE LOT-  
TERY (NEW YORK STATE AGENCY)  
ONE BROADWAY CENTER  
SCHENECTADY, NY 12301

THE MARK CONSISTS OF RECTANGULAR DE-  
SIGN WITH THE WORDS "NEW YORK LOTTO".

FOR: LOTTERY SERVICES AND LOTTO GAME  
SERVICES, IN CLASS 41 (U.S. CLS. 100, 101 AND 107).

SEC. 2(F).

FIRST USE 2-18-1996; IN COMMERCE 2-18-1996.

SER. NO. 77-191,962, FILED 5-29-2007.

NO CLAIM IS MADE TO THE EXCLUSIVE  
RIGHT TO USE "LOTTO", APART FROM THE  
MARK AS SHOWN.

TRICIA SONNEBORN, EXAMINING ATTORNEY

Int. Cl.: 33

Prior U.S. Cls.: 47 and 49

United States Patent and Trademark Office

Reg. No. 3,465,663

Registered July 15, 2008

TRADEMARK  
PRINCIPAL REGISTER

d•abbatis

MIURA VINEYARDS, LLC (CALIFORNIA LTD  
LIAB CO)  
PO BOX 801  
PETALUMA, CA 94953

THE FOREIGN WORDING IN THE MARK  
TRANSLATES INTO ENGLISH AS FROM THE  
ABBEY.

FOR: WINES, IN CLASS 33 (U.S. CLS. 47 AND 49).

FIRST USE 6-1-2003; IN COMMERCE 6-1-2003.

SER. NO. 77-191,979, FILED 5-29-2007.

THE MARK CONSISTS OF THE LETTER "D"  
AND THE TERM "ABBATIS" WITH A CIRCLE  
BETWEEN THE TWO.

JEFFERY COWARD, EXAMINING ATTORNEY



**Int. Cl.: 33**

**Prior U.S. Cls.: 47 and 49**

**United States Patent and Trademark Office**

**Reg. No. 3,465,664**

**Registered July 15, 2008**

**TRADEMARK  
PRINCIPAL REGISTER**



TERRA LIMITED (IRELAND LTD LIAB CO)  
BAILIEBORO  
INSTITUTE ROAD  
COUNTY CAVAN, IRELAND

THE MARK CONSISTS OF THE WORD "MAL-  
ONEY'S", CELTIC KNOT, AND BANNER.

FOR: LIQUEURS, WINES, AND WINE-BASED  
BEVERAGES, IN CLASS 33 (U.S. CLS. 47 AND 49).

SER. NO. 77-191,983, FILED 5-29-2007.

FIRST USE 8-21-2006; IN COMMERCE 8-21-2006.

PAUL F. GAST, EXAMINING ATTORNEY

**Int. Cl.: 41**

**Prior U.S. Cls.: 100, 101 and 107**

**United States Patent and Trademark Office**

**Reg. No. 3,465,665**

**Registered July 15, 2008**

**SERVICE MARK  
PRINCIPAL REGISTER**

**RAISING BILLIONS TO  
EDUCATE MILLIONS**

NEW YORK STATE DIVISION OF THE LOT-  
TERY (NEW YORK STATE AGENCY)  
ONE BROADWAY CENTER  
SCHENECTADY, NY 12301

THE MARK CONSISTS OF STANDARD CHAR-  
ACTERS WITHOUT CLAIM TO ANY PARTICULAR  
FONT, STYLE, SIZE, OR COLOR.

FOR: LOTTERY SERVICES AND LOTTO GAME  
SERVICES, IN CLASS 41 (U.S. CLS. 100, 101 AND 107).

SER. NO. 77-191,989, FILED 5-29-2007.

FIRST USE 3-31-2006; IN COMMERCE 3-31-2006.

TRICIA SONNEBORN, EXAMINING ATTORNEY

**Int. Cls.: 41 and 43**

**Prior U.S. Cls.: 100, 101 and 107**

**United States Patent and Trademark Office**

**Reg. No. 3,465,666**

**Registered July 15, 2008**

**SERVICE MARK  
PRINCIPAL REGISTER**



SONESTA INTERNATIONAL HOTELS COR-  
PORATION (NEW YORK CORPORATION)  
116 HUNTINGTON AVENUE  
BOSTON, MA 02216

FOR: CABARET AND NIGHT CLUB SERVICES,  
IN CLASS 41 (U.S. CLS. 100, 101 AND 107).

FIRST USE 8-11-1969; IN COMMERCE 8-11-1969.

FOR: RESTAURANT AND BAR SERVICES, IN  
CLASS 43 (U.S. CLS. 100 AND 101).

FIRST USE 8-11-1969; IN COMMERCE 8-11-1969.

THE MARK CONSISTS OF THE WORDS "MY-  
STICK DEN" IN A STYLIZED PRINT, SURROUND-  
ED BY A FANCIFUL DESIGN .

SER. NO. 77-192,066, FILED 5-29-2007.

ANNE E. GUSTASON, EXAMINING ATTORNEY

**Int. Cl.: 5**

**Prior U.S. Cls.: 6, 18, 44, 46, 51 and 52**

**Reg. No. 3,465,667**

**United States Patent and Trademark Office**

**Registered July 15, 2008**

**TRADEMARK  
PRINCIPAL REGISTER**



CHARLES L. CRIST M.D. (UNITED STATES  
INDIVIDUAL)  
SUITE C  
1824 S. LONE PINE AVENUE  
SPRINGFIELD, MO 65804

AND VITAMIN SUPPLEMENTS, IN CLASS 5 (U.S.  
CLS. 6, 18, 44, 46, 51 AND 52).

FIRST USE 8-13-2004; IN COMMERCE 8-13-2004.

SER. NO. 77-192,091, FILED 5-29-2007.

FOR: DIETARY AND NUTRITIONAL SUPPLE-  
MENTS; NUTRITIONAL HEALTH SUPPLEMENTS

HOWARD B. LEVINE, EXAMINING ATTORNEY

**Int. Cl.: 43**

**Prior U.S. Cls.: 100 and 101**

**United States Patent and Trademark Office**

**Reg. No. 3,465,668**

**Registered July 15, 2008**

**SERVICE MARK  
PRINCIPAL REGISTER**



SONESTA INTERNATIONAL HOTELS COR-  
PORATION (NEW YORK CORPORATION)  
116 HUNTINGTON AVENUE  
BOSTON, MA 02216

THE MARK CONSISTS OF THE WORDS "LE  
BOOZE" WITH AN ACCENT OVER THE FINAL "E".

FOR: RESTAURANT AND BAR SERVICES, IN  
CLASS 43 (U.S. CLS. 100 AND 101).

SER. NO. 77-192,101, FILED 5-29-2007.

FIRST USE 8-31-1972; IN COMMERCE 8-31-1972.

ANNE E. GUSTASON, EXAMINING ATTORNEY

**Int. Cl.: 41**

**Prior U.S. Cls.: 100, 101 and 107**

**United States Patent and Trademark Office**

**Reg. No. 3,465,669**

**Registered July 15, 2008**

**SERVICE MARK  
PRINCIPAL REGISTER**

**T. HARV EKER**

TRUE POWER INTERNATIONAL, LTD. (WASHINGTON CORPORATION)  
300 NORTH COMMERCIAL STREET  
BELLINGHAM, WA 98225

FOR: EDUCATIONAL SERVICES, NAMELY, CONDUCTING LIVE SEMINARS, WORKSHOPS, SEMINARS VIA LIVE AUDIO AND VIDEO STREAMING OVER THE INTERNET, ALL IN THE FIELDS OF WEALTH ACCUMULATION, BUSINESS MANAGEMENT, ENTREPRENEURIAL SKILLS, REAL ESTATE, FINANCE AND INVESTMENTS, PERSONAL AND PROFESSIONAL DEVELOPMENT, MOTIVATIONAL IMPROVEMENTS, AND SELF-IMAGE IMPROVEMENT; ARRANGING TRAINING COURSES IN TEACHING INSTITUTES, ARRANGING WORKSHOP AND TRAINING COURSES; PROVIDING EDUCATIONAL AND SEMINAR COURSES, ALL IN THE FIELDS OF WEALTH ACCUMULATION, BUSINESS MANAGEMENT, ENTREPRENEURIAL SKILLS, REAL ES-

TATE, FINANCE AND INVESTMENTS, PERSONAL AND PROFESSIONAL DEVELOPMENT, MOTIVATIONAL IMPROVEMENTS, AND SELF-IMAGE IMPROVEMENT, IN CLASS 41 (U.S. CLS. 100, 101 AND 107).

FIRST USE 12-31-1999; IN COMMERCE 12-31-1999.

THE MARK CONSISTS OF STANDARD CHARACTERS WITHOUT CLAIM TO ANY PARTICULAR FONT, STYLE, SIZE, OR COLOR.

THE NAME "T. HARV EKER" IDENTIFIES A LIVING INDIVIDUAL WHOSE CONSENT IS OF RECORD.

SER. NO. 77-192,149, FILED 5-29-2007.

SHARON MEIER, EXAMINING ATTORNEY

**Int. Cl.: 9**

**Prior U.S. Cls.: 21, 23, 26, 36 and 38**

**United States Patent and Trademark Office**

**Reg. No. 3,465,670**

**Registered July 15, 2008**

**TRADEMARK  
PRINCIPAL REGISTER**

**NODESTAR**

METRON, INC. (VIRGINIA CORPORATION)  
11911 FREEDOM DRIVE  
RESTON, VA 201905602

THE MARK CONSISTS OF STANDARD CHAR-  
ACTERS WITHOUT CLAIM TO ANY PARTICULAR  
FONT, STYLE, SIZE, OR COLOR.

FOR: COMPUTER SOFTWARE FOR DATA FU-  
SION AND OBJECT TRACKING, IN CLASS 9 (U.S.  
CLS. 21, 23, 26, 36 AND 38).

SER. NO. 77-192,158, FILED 5-29-2007.

FIRST USE 8-25-2003; IN COMMERCE 8-25-2003.

INGA ERVIN, EXAMINING ATTORNEY

**Int. Cl.: 9**

**Prior U.S. Cls.: 21, 23, 26, 36 and 38**

**United States Patent and Trademark Office**

**Reg. No. 3,465,671**

**Registered July 15, 2008**

**TRADEMARK  
PRINCIPAL REGISTER**

**NODESTARPLUS**

METRON, INC. (VIRGINIA CORPORATION)  
11911 FREEDOM DRIVE  
RESTON, VA 201905602

THE MARK CONSISTS OF STANDARD CHAR-  
ACTERS WITHOUT CLAIM TO ANY PARTICULAR  
FONT, STYLE, SIZE, OR COLOR.

FOR: COMPUTER SOFTWARE FOR DATA FU-  
SION AND OBJECT TRACKING, IN CLASS 9 (U.S.  
CLS. 21, 23, 26, 36 AND 38).

SER. NO. 77-192,183, FILED 5-29-2007.

FIRST USE 10-10-2007; IN COMMERCE 10-10-2007.

INGA ERVIN, EXAMINING ATTORNEY



**Int. Cl.: 36**

**Prior U.S. Cls.: 100, 101 and 102**

**United States Patent and Trademark Office**

**Reg. No. 3,465,672**

**Registered July 15, 2008**

**SERVICE MARK  
PRINCIPAL REGISTER**

**POR SER MEXICANO ES EL  
AUTENTICO ENLACE DE LAS  
FAMILIAS MEXICANOS**

BANCO MERCANTIL DEL NORTE, S.A. (MEX-  
ICO CORPORATION)  
ZARAGOZA 920 SUR  
MONTERREY, MEXICO 64000

FOR: BANKING AND ONLINE BANKING SERVICES; AUTOMATED TELLER MACHINE SERVICES; BILL PAYMENT SERVICES; BROKERAGE SERVICES IN THE FIELDS OF STOCKS, COMMODITIES, INSURANCE AND FUTURES; BUSINESS BROKERAGE SERVICES; BUSINESS FINANCE PROCUREMENT SERVICES; CAPITAL INVESTMENT CONSULTATION; CASH MANAGEMENT; CHECK CASHING; CHECK PROCESSING; CHECKING ACCOUNT SERVICES; COMMERCIAL LENDING SERVICES; COMMODITY INVESTMENT ADVISE; CONSUMER LENDING SERVICES; CURRENCY EXCHANGE AND ADVISE; ELECTRONIC FUNDS TRANSFER; ELECTRONIC PAYMENT, NAMELY ELECTRONIC PROCESSING AND TRANSMISSION OF BILL PAYMENT DATA; EQUIPMENT FINANCING SERVICES; FIDUCIARY REPRESENTATIVES; FINANCIAL SERVICES IN THE FIELD OF MONEY LENDING; FINANCIAL VALUATION OF REAL ESTATE; FINANCING SERVICES; HOME EQUITY LOANS; INSTALLMENT LOANS; INSURANCE ADMINISTRATION; INSURANCE BROKERAGE; INVESTMENT BANKING

SERVICES; INVESTMENT MANAGEMENT SERVICES; LOAN FINANCING; MONEY ORDER SERVICES; MORTGAGE LENDING; MORTGAGE BANKING; ONLINE BANKING SERVICES; BANKING SERVICES; PROVIDING BANK ACCOUNT INFORMATION BY TELEPHONE; REAL ESTATE MANAGEMENT; SAVINGS ACCOUNT SERVICES; SAVINGS AND LOAN SERVICES; SAVINGS BANK SERVICES; STOCK BROKERAGE; TRUST SERVICES, NAMELY, INVESTMENT AND TRUST COMPANY SERVICES, IN CLASS 36 (U.S. CLS. 100, 101 AND 102).

FIRST USE 6-1-2006; IN COMMERCE 6-1-2006.

THE MARK CONSISTS OF STANDARD CHARACTERS WITHOUT CLAIM TO ANY PARTICULAR FONT, STYLE, SIZE, OR COLOR.

THE ENGLISH TRANSLATION OF "POR SER MEXICANO ES EL AUTENTICO ENLACE DE LAS FAMILIAS MEXICANOS" IS "BEING MEXICAN IS THE AUTHENTIC LINK OF MEXICAN FAMILIES".

SER. NO. 77-192,206, FILED S.R. 5-29-2007 AM. P.R. 3-7-2008.

CHRISTINA SOBRAL, EXAMINING ATTORNEY

Int. Cl.: 35

Prior U.S. Cls.: 100, 101 and 102

United States Patent and Trademark Office

Reg. No. 3,465,673

Registered July 15, 2008

SERVICE MARK  
PRINCIPAL REGISTER



MANAGEMENT HEALTH SYSTEMS, INC.  
(GEORGIA CORPORATION)  
5608 PRINCETON AVENUE  
COLUMBUS, GA 31904

OWNER OF U.S. REG. NO. 2,481,701.

FOR: STAFFING SERVICES, NAMELY, PROVIDING PLACEMENT OF MEDICAL AND DENTAL PERSONNEL, ADMINISTRATORS AND SUPPORT STAFF WITH HEALTH CARE PROVIDERS, IN CLASS 35 (U.S. CLS. 100, 101 AND 102).

THE MARK CONSISTS OF A STYLIZED IMAGE OF TWO PEOPLE IN AN EMBRACE FORMING THE IMAGE OF A HEART.

SER. NO. 77-192,300, FILED 5-29-2007.

FIRST USE 3-31-2002; IN COMMERCE 3-31-2002.

DAWN HAN, EXAMINING ATTORNEY

**Int. Cl.: 37**

**Prior U.S. Cls.: 100, 103 and 106**

**United States Patent and Trademark Office**

**Reg. No. 3,465,674**

**Registered July 15, 2008**

**SERVICE MARK  
PRINCIPAL REGISTER**

**FLOORGEN**

FLOORCARE HOLDINGS, LLC (NEW YORK  
LTD LIAB CO)  
777 SOUTH STREET  
PO BOX 2310  
NEWBURGH, NY 12550

FOR: PROVIDING CONCRETE FLOOR TREAT-  
MENT AND FINISHING SERVICES FOR OTHERS,  
NAMELY, APPLICATION OF EPOXY, URETHANE,  
HARDENERS, DENSIFIERS, PENETRATORS, SUR-  
FACTANTS, CLEANERS AND PROTECTANT  
COATINGS TO CONCRETE FLOORS AND POLISH-  
ING THEREOF WITH POLISHING TOOLS, BRU-

SHES AND PADS, IN CLASS 37 (U.S. CLS. 100, 103  
AND 106).

FIRST USE 3-31-2004; IN COMMERCE 3-31-2004.

THE MARK CONSISTS OF STANDARD CHAR-  
ACTERS WITHOUT CLAIM TO ANY PARTICULAR  
FONT, STYLE, SIZE, OR COLOR.

SER. NO. 77-192,315, FILED 5-29-2007.

YONG KIM, EXAMINING ATTORNEY

**Int. Cls.: 3 and 30**

**Prior U.S. Cls.: 1, 4, 6, 46, 50, 51 and 52**

**United States Patent and Trademark Office**

**Reg. No. 3,465,675**

**Registered July 15, 2008**

**TRADEMARK  
PRINCIPAL REGISTER**

**SMART MOUTH**

TRIUMPH PHARMACEUTICALS INC. (COLOR-  
ADO CORPORATION)  
SUITE A  
10403 BAUR BOULEVARD  
ST. LOUIS, MO 63132

FOR: NON-MEDICAL MOUTH RINSE, TOOTH-  
PASTE, IN CLASS 3 (U.S. CLS. 1, 4, 6, 50, 51 AND 52).

FIRST USE 11-15-2004; IN COMMERCE 11-15-2004.

FOR: CHEWING GUM, CANDY BREATH MINTS,  
IN CLASS 30 (U.S. CL. 46).

FIRST USE 5-19-2006; IN COMMERCE 5-19-2006.

THE MARK CONSISTS OF STANDARD CHAR-  
ACTERS WITHOUT CLAIM TO ANY PARTICULAR  
FONT, STYLE, SIZE, OR COLOR.

OWNER OF U.S. REG. NO. 3,143,142.

SER. NO. 77-192,391, FILED 5-29-2007.

ESTHER A. BORSUK, EXAMINING ATTORNEY

**Int. Cl.: 35**

**Prior U.S. Cls.: 100, 101 and 102**

**United States Patent and Trademark Office**

**Reg. No. 3,465,676**

**Registered July 15, 2008**

**SERVICE MARK  
PRINCIPAL REGISTER**

**BPLAN**

BRINTECH, INC. (FLORIDA CORPORATION)  
63 HIGHWAY 515  
BLAIRSVILLE, GA 30512

FOR: ONLINE BUSINESS RISK MANAGEMENT;  
INTERACTIVE RECORD-KEEPING SERVICES FOR  
USE IN RISK MANAGEMENT AND REGULATORY  
COMPLIANCE FOR BANK, THRIFT, CREDIT, AND  
FINANCIAL INSTITUTIONS , IN CLASS 35 (U.S.  
CLS. 100, 101 AND 102).

FIRST USE 12-25-2005; IN COMMERCE 3-28-2006.

THE MARK CONSISTS OF STANDARD CHAR-  
ACTERS WITHOUT CLAIM TO ANY PARTICULAR  
FONT, STYLE, SIZE, OR COLOR.

SER. NO. 77-192,440, FILED 5-29-2007.

ARETHA SOMERVILLE, EXAMINING ATTORNEY

**Int. Cl.: 35**

**Prior U.S. Cls.: 100, 101 and 102**

**United States Patent and Trademark Office**

**Reg. No. 3,465,677**

**Registered July 15, 2008**

**SERVICE MARK  
PRINCIPAL REGISTER**

**BTRAC**

BRINTECH, INC. (FLORIDA CORPORATION)  
63 HIGHWAY 515  
BLAIRSVILLE, GA 30512

FOR: ONLINE BUSINESS RISK MANAGEMENT;  
INTERACTIVE RECORD-KEEPING SERVICES FOR  
USE IN RISK MANAGEMENT AND REGULATORY  
COMPLIANCE FOR BANK, THRIFT, CREDIT, AND  
FINANCIAL INSTITUTIONS , IN CLASS 35 (U.S.  
CLS. 100, 101 AND 102).

FIRST USE 1-3-2004; IN COMMERCE 9-14-2004.

THE MARK CONSISTS OF STANDARD CHAR-  
ACTERS WITHOUT CLAIM TO ANY PARTICULAR  
FONT, STYLE, SIZE, OR COLOR.

SER. NO. 77-192,451, FILED 5-29-2007.

ARETHA SOMERVILLE, EXAMINING ATTORNEY

**Int. Cl.: 35**

**Prior U.S. Cls.: 100, 101 and 102**

**United States Patent and Trademark Office**

**Reg. No. 3,465,678**

**Registered July 15, 2008**

**SERVICE MARK  
PRINCIPAL REGISTER**

**BTAP**

BRINTECH, INC. (FLORIDA CORPORATION)  
63 HIGHWAY 515  
BLAIRSVILLE, GA 30512

FOR: ONLINE BUSINESS RISK MANAGEMENT;  
INTERACTIVE RECORD-KEEPING SERVICES FOR  
USE IN RISK MANAGEMENT AND REGULATORY  
COMPLIANCE FOR BANK, THRIFT, CREDIT, AND  
FINANCIAL INSTITUTIONS , IN CLASS 35 (U.S.  
CLS. 100, 101 AND 102).

FIRST USE 1-3-2005; IN COMMERCE 3-15-2005.

THE MARK CONSISTS OF STANDARD CHAR-  
ACTERS WITHOUT CLAIM TO ANY PARTICULAR  
FONT, STYLE, SIZE, OR COLOR.

SER. NO. 77-192,468, FILED 5-29-2007.

ARETHA SOMERVILLE, EXAMINING ATTORNEY

**Int. Cl.: 35**

**Prior U.S. Cls.: 100, 101 and 102**

**United States Patent and Trademark Office**

**Reg. No. 3,465,679**

**Registered July 15, 2008**

**SERVICE MARK  
PRINCIPAL REGISTER**

**BCOMPLY**

BRINTECH, INC. (FLORIDA CORPORATION)  
63 HIGHWAY 515  
BLAIRSVILLE, GA 30512

FOR: ONLINE BUSINESS RISK MANAGEMENT;  
INTERACTIVE RECORD-KEEPING SERVICES FOR  
USE IN RISK MANAGEMENT AND REGULATORY  
COMPLIANCE FOR BANK, THRIFT, CREDIT, AND  
FINANCIAL INSTITUTIONS , IN CLASS 35 (U.S.  
CLS. 100, 101 AND 102).

FIRST USE 12-2-2006; IN COMMERCE 2-13-2007.

THE MARK CONSISTS OF STANDARD CHAR-  
ACTERS WITHOUT CLAIM TO ANY PARTICULAR  
FONT, STYLE, SIZE, OR COLOR.

SER. NO. 77-192,476, FILED 5-29-2007.

ARETHA SOMERVILLE, EXAMINING ATTORNEY



**Int. Cl.: 35**

**Prior U.S. Cls.: 100, 101 and 102**

**United States Patent and Trademark Office**

**Reg. No. 3,465,680**

**Registered July 15, 2008**

**SERVICE MARK  
PRINCIPAL REGISTER**

**BAUDIT**

BRINTECH, INC. (FLORIDA CORPORATION)  
63 HIGHWAY 515  
BLAIRSVILLE, GA 30512

FOR: ONLINE BUSINESS RISK MANAGEMENT;  
INTERACTIVE RECORD-KEEPING SERVICES FOR  
USE IN RISK MANAGEMENT AND REGULATORY  
COMPLIANCE FOR BANK, THRIFT, CREDIT, AND  
FINANCIAL INSTITUTIONS , IN CLASS 35 (U.S.  
CLS. 100, 101 AND 102).

FIRST USE 12-12-2006; IN COMMERCE 2-13-2007.

THE MARK CONSISTS OF STANDARD CHAR-  
ACTERS WITHOUT CLAIM TO ANY PARTICULAR  
FONT, STYLE, SIZE, OR COLOR.

SER. NO. 77-192,485, FILED 5-29-2007.

ARETHA SOMERVILLE, EXAMINING ATTORNEY

**Int. Cl.: 35**

**Prior U.S. Cls.: 100, 101 and 102**

**United States Patent and Trademark Office**

**Reg. No. 3,465,681**

**Registered July 15, 2008**

**SERVICE MARK  
PRINCIPAL REGISTER**

**BSACOMPLY**

BRINTECH, INC. (FLORIDA CORPORATION)  
63 HIGHWAY 515  
BLAIRSVILLE, GA 30512

FOR: ONLINE BUSINESS RISK MANAGEMENT;  
INTERACTIVE RECORD-KEEPING SERVICES FOR  
USE IN RISK MANAGEMENT AND REGULATORY  
COMPLIANCE FOR BANK, THRIFT, CREDIT, AND  
FINANCIAL INSTITUTIONS , IN CLASS 35 (U.S.  
CLS. 100, 101 AND 102).

FIRST USE 12-12-2006; IN COMMERCE 2-13-2007.

THE MARK CONSISTS OF STANDARD CHAR-  
ACTERS WITHOUT CLAIM TO ANY PARTICULAR  
FONT, STYLE, SIZE, OR COLOR.

SER. NO. 77-192,491, FILED 5-29-2007.

ARETHA SOMERVILLE, EXAMINING ATTORNEY

**Int. Cl.: 35**

**Prior U.S. Cls.: 100, 101 and 102**

**United States Patent and Trademark Office**

**Reg. No. 3,465,682**

**Registered July 15, 2008**

**SERVICE MARK  
PRINCIPAL REGISTER**

**BSECURE**

BRINTECH, INC. (FLORIDA CORPORATION)  
63 HIGHWAY 515  
BLAIRSVILLE, GA 30512

FIRST USE 12-12-2006; IN COMMERCE 2-13-2007.

FOR: ONLINE BUSINESS RISK MANAGEMENT;  
INTERACTIVE RECORD-KEEPING SERVICES FOR  
USE IN RISK MANAGEMENT AND REGULATORY  
COMPLIANCE FOR BANK, THRIFT, CREDIT, AND  
FINANCIAL INSTITUTIONS , IN CLASS 35 (U.S.  
CLS. 100, 101 AND 102).

THE MARK CONSISTS OF STANDARD CHAR-  
ACTERS WITHOUT CLAIM TO ANY PARTICULAR  
FONT, STYLE, SIZE, OR COLOR.

SER. NO. 77-192,498, FILED 5-29-2007.

ARETHA SOMERVILLE, EXAMINING ATTORNEY

**Int. Cl.: 35**

**Prior U.S. Cls.: 100, 101 and 102**

**United States Patent and Trademark Office**

**Reg. No. 3,465,683**

**Registered July 15, 2008**

**SERVICE MARK  
PRINCIPAL REGISTER**

**BSOX**

BRINTECH, INC. (FLORIDA CORPORATION)  
63 HIGHWAY 515  
BLAIRSVILLE, GA 30512

FOR: ONLINE BUSINESS RISK MANAGEMENT;  
INTERACTIVE RECORD-KEEPING SERVICES FOR  
USE IN RISK MANAGEMENT AND REGULATORY  
COMPLIANCE FOR BANK, THRIFT, CREDIT, AND  
FINANCIAL INSTITUTIONS , IN CLASS 35 (U.S.  
CLS. 100, 101 AND 102).

FIRST USE 12-12-2006; IN COMMERCE 2-13-2007.

THE MARK CONSISTS OF STANDARD CHAR-  
ACTERS WITHOUT CLAIM TO ANY PARTICULAR  
FONT, STYLE, SIZE, OR COLOR.

SER. NO. 77-192,502, FILED 5-29-2007.

ARETHA SOMERVILLE, EXAMINING ATTORNEY

**Int. Cl.: 35**

**Prior U.S. Cls.: 100, 101 and 102**

**United States Patent and Trademark Office**

**Reg. No. 3,465,684**

**Registered July 15, 2008**

**SERVICE MARK  
PRINCIPAL REGISTER**

**BTRACAUDIT**

BRINTECH, INC. (FLORIDA CORPORATION)  
63 HIGHWAY 515  
BLAIRSVILLE, GA 30512

FOR: ONLINE BUSINESS RISK MANAGEMENT;  
INTERACTIVE RECORD-KEEPING SERVICES FOR  
USE IN RISK MANAGEMENT AND REGULATORY  
COMPLIANCE FOR BANK, THRIFT, CREDIT, AND  
FINANCIAL INSTITUTIONS , IN CLASS 35 (U.S.  
CLS. 100, 101 AND 102).

FIRST USE 12-12-2006; IN COMMERCE 2-13-2007.

THE MARK CONSISTS OF STANDARD CHAR-  
ACTERS WITHOUT CLAIM TO ANY PARTICULAR  
FONT, STYLE, SIZE, OR COLOR.

SER. NO. 77-192,506, FILED 5-29-2007.

ARETHA SOMERVILLE, EXAMINING ATTORNEY

**Int. Cl.: 35**

**Prior U.S. Cls.: 100, 101 and 102**

**United States Patent and Trademark Office**

**Reg. No. 3,465,685**

**Registered July 15, 2008**

**SERVICE MARK  
PRINCIPAL REGISTER**

**HICKEY AND ASSOCIATES**

HICKEY & ASSOCIATES (MINNESOTA LTD  
LIAB CO)  
2375 ARCHER LN N  
PLYMOUTH, MN 55447

FOR: BUSINESS CONSULTING, MANAGEMENT,  
PLANNING AND SUPERVISION; BUSINESS RELO-  
CATION CONSULTING; AND BUSINESS CON-  
SULTING SERVICES IN THE FIELDS OF SITE  
SELECTION AND PUBLIC INCENTIVES MANAGE-  
MENT, IN CLASS 35 (U.S. CLS. 100, 101 AND 102).

FIRST USE 11-1-1986; IN COMMERCE 11-1-1986.

THE MARK CONSISTS OF STANDARD CHAR-  
ACTERS WITHOUT CLAIM TO ANY PARTICULAR  
FONT, STYLE, SIZE, OR COLOR.

NO CLAIM IS MADE TO THE EXCLUSIVE  
RIGHT TO USE "ASSOCIATES", APART FROM  
THE MARK AS SHOWN.

SER. NO. 77-192,736, FILED 5-30-2007.

ELI HELLMAN, EXAMINING ATTORNEY

**Int. Cl.: 35**

**Prior U.S. Cls.: 100, 101 and 102**

**United States Patent and Trademark Office**

**Reg. No. 3,465,686**

**Registered July 15, 2008**

**SERVICE MARK  
PRINCIPAL REGISTER**



HICKEY & ASSOCIATES (MINNESOTA LTD  
LIAB CO)  
2375 ARCHER LN N  
PLYMOUTH, MN 55447

FOR: BUSINESS CONSULTING, MANAGEMENT,  
PLANNING AND SUPERVISION; BUSINESS RELO-  
CATION CONSULTING; AND BUSINESS CON-  
SULTING SERVICES IN THE FIELDS OF SITE  
SELECTION AND PUBLIC INCENTIVES MANAGE-  
MENT, IN CLASS 35 (U.S. CLS. 100, 101 AND 102).

FIRST USE 11-1-1986; IN COMMERCE 11-1-1986.

NO CLAIM IS MADE TO THE EXCLUSIVE  
RIGHT TO USE ASSOCIATES, APART FROM THE  
MARK AS SHOWN.

THE MARK CONSISTS OF A RELATIVELY LAR-  
GER LETTER H, WITH A BAR AND THE WORD  
"HICKEY" ABOVE THE H, A BAR AND THE WORD  
"ASSOCIATES" BELOW THE H, AND AN "&" SIGN  
OVER THE CENTER OF THE H.

SER. NO. 77-192,765, FILED 5-30-2007.

ELI HELLMAN, EXAMINING ATTORNEY

**Int. Cl.: 5**

**Prior U.S. Cls.: 6, 18, 44, 46, 51 and 52**

**Reg. No. 3,465,687**

**United States Patent and Trademark Office**

**Registered July 15, 2008**

**TRADEMARK  
PRINCIPAL REGISTER**

**EDOROVE**

GLAXO GROUP LIMITED (ENGLAND CORPORATION)  
GLAXO WELLCOME HOUSE  
BERKELEY AVENUE  
GREENFORD, MIDDLESEX, ENGLAND UB60NN

FOR: PHARMACEUTICAL PREPARATIONS AND SUBSTANCES FOR THE TREATMENT OF INFECTIOUS DISEASES, BLOOD DISORDERS, PAIN, INFLAMMATION, SEPSIS, ALOPECIA AND OBESITY, AND FOR THE TREATMENT OF VIRAL, METABOLIC, ENDOCRINE, MUSCULOSKELETAL, CARDIOVASCULAR, CARDIOPULMONARY, GENITOURINARY, SEXUAL DYSFUNCTION, ONCOLOGICAL, HEPATOLOGICAL, OPHTHALMOLOGICAL, RESPIRATORY, NEUROLOGICAL, GASTROINTESTINAL, HORMONAL, DERMATOLOGICAL AND PSYCHIATRIC RELA-

TED DISEASES AND DISORDERS, AND FOR THE TREATMENT OF DAMAGED SKIN AND TISSUE; AND FOR VACCINES, IN CLASS 5 (U.S. CLS. 6, 18, 44, 46, 51 AND 52).

THE MARK CONSISTS OF STANDARD CHARACTERS WITHOUT CLAIM TO ANY PARTICULAR FONT, STYLE, SIZE, OR COLOR.

PRIORITY CLAIMED UNDER SEC. 44(D) ON UNITED KINGDOM APPLICATION NO. 2448953, FILED 3-9-2007, REG. NO. 2448953, DATED 3-9-2007, EXPIRES 3-9-2017.

SER. NO. 77-192,851, FILED 5-30-2007.

ANNE MADDEN, EXAMINING ATTORNEY



**Int. Cl.: 5**

**Prior U.S. Cls.: 6, 18, 44, 46, 51 and 52**

**Reg. No. 3,465,688**

**United States Patent and Trademark Office**

**Registered July 15, 2008**

---

**TRADEMARK  
PRINCIPAL REGISTER**

**SERGEANT'S**

SERGEANT'S PET CARE PRODUCTS, INC. (NE-  
VADA CORPORATION)  
2625 S 158TH PLAZA  
OMAHA, NE 681301770

FOR: HAIRBALL REMEDY FOR CATS, IN CLASS  
5 (U.S. CLS. 6, 18, 44, 46, 51 AND 52).

FIRST USE 12-0-1965; IN COMMERCE 12-0-1965.

THE MARK CONSISTS OF STANDARD CHAR-  
ACTERS WITHOUT CLAIM TO ANY PARTICULAR  
FONT, STYLE, SIZE, OR COLOR.

OWNER OF U.S. REG. NO. 3,270,277.

SER. NO. 77-192,901, FILED 5-30-2007.

MATTHEW PAPPAS, EXAMINING ATTORNEY

**Int. Cls.: 9, 38 and 42**

**Prior U.S. Cls.: 21, 23, 26, 36, 38, 100, 101 and 104**

**United States Patent and Trademark Office**

**Reg. No. 3,465,689**

**Registered July 15, 2008**

**TRADEMARK  
SERVICE MARK  
PRINCIPAL REGISTER**

# INGENITECH

INGENITECH LIMITED (NEW ZEALAND COMPANY)  
65 SEYMOUR STREET  
C/-LESLIE & O'DONNELL LIMITED  
BLLENHEIM, NEW ZEALAND

FOR: COMPUTER SOFTWARE FOR USE IN DIAGNOSING MALFUNCTIONS IN THE OPERATION OF INDUSTRIAL AUTOMATION MACHINERY AND EQUIPMENT; COMPUTER SOFTWARE FOR USE IN OPERATING TELEMETRIC AND TELECOMMUNICATIONS SYSTEMS, IN CLASS 9 (U.S. CLS. 21, 23, 26, 36 AND 38).

FOR: TELECOMMUNICATION AND TELEMETRY SERVICES, NAMELY, ISDN SERVICES, LOCAL AND LONG DISTANCE TRANSMISSION OF VOICE, DATA, GRAPHICS BY MEANS OF TELEPHONE, TELEGRAPHIC, WIRELESS, CABLE AND SATELLITE TRANSMISSIONS, IN CLASS 38 (U.S. CLS. 100, 101 AND 104).

FOR: DESIGN OF COMPUTER SOFTWARE DIAGNOSTIC PROGRAMS FOR INDUSTRIAL, ENVIRONMENTAL AND MECHANICAL PROCESSES;

DIAGNOSTIC SERVICES IN THE FIELD OF COMPUTER SOFTWARE FOR INDUSTRIAL AUTOMATION MACHINERY AND EQUIPMENT; MACHINERY AND ENVIRONMENTAL PERFORMANCE ASSESSMENT DIAGNOSTIC SERVICES IN THE FIELD OF TRANSPORTATION OF VEHICLES, MACHINERY AND TECHNOLOGY EQUIPMENT PROVIDED BY COMPUTER, AND OTHER ELECTRONIC MEANS, IN CLASS 42 (U.S. CLS. 100 AND 101).

THE MARK CONSISTS OF STANDARD CHARACTERS WITHOUT CLAIM TO ANY PARTICULAR FONT, STYLE, SIZE, OR COLOR.

PRIORITY CLAIMED UNDER SEC. 44(D) ON NEW ZEALAND APPLICATION NO. 768900, FILED 5-23-2007, REG. NO. 768902, DATED 2-19-2008, EXPIRES 5-23-2017.

SER. NO. 77-192,946, FILED 5-30-2007.

RENEE MCCRAY, EXAMINING ATTORNEY

**Int. Cls.: 9, 38 and 42**

**Prior U.S. Cls.: 21, 23, 26, 36, 38, 100, 101 and 104**

**United States Patent and Trademark Office**

**Reg. No. 3,465,690**

**Registered July 15, 2008**

**TRADEMARK  
SERVICE MARK  
PRINCIPAL REGISTER**



INGENITECH LIMITED (NEW ZEALAND COMPANY)  
65 SEYMOUR STREET  
C/-LESLIE & O'DONNELL LIMITED  
BLENHEIM, NEW ZEALAND

FOR: COMPUTER SOFTWARE FOR USE IN DIAGNOSING MALFUNCTIONS IN THE OPERATION OF INDUSTRIAL AUTOMATION MACHINERY AND EQUIPMENT; COMPUTER SOFTWARE FOR USE IN OPERATING TELEMETRIC AND TELECOMMUNICATIONS SYSTEMS, IN CLASS 9 (U.S. CLS. 21, 23, 26, 36 AND 38).

FOR: TELECOMMUNICATION AND TELEMETRY SERVICES, NAMELY, ISDN SERVICES, LOCAL AND LONG DISTANCE TRANSMISSION OF VOICE, DATA, GRAPHICS BY MEANS OF TELEPHONE, TELEGRAPHIC, WIRELESS, CABLE AND SATELLITE TRANSMISSIONS, IN CLASS 38 (U.S. CLS. 100, 101 AND 104).

FOR: DESIGN OF COMPUTER SOFTWARE DIAGNOSTIC PROGRAMS FOR INDUSTRIAL, ENVIRONMENTAL AND MECHANICAL PROCESSES; DIAGNOSTIC SERVICES IN THE FIELD OF COMPUTER SOFTWARE FOR INDUSTRIAL AUTOMATION MACHINERY AND EQUIPMENT; MACHINERY AND ENVIRONMENTAL PERFORMANCE ASSESSMENT DIAGNOSTIC SERVICES IN THE FIELD OF TRANSPORTATION OF VEHICLES, MACHINERY AND TECHNOLOGY EQUIPMENT PROVIDED BY COMPUTER, AND OTHER ELECTRONIC MEANS, IN CLASS 42 (U.S. CLS. 100 AND 101).

PRIORITY CLAIMED UNDER SEC. 44(D) ON NEW ZEALAND APPLICATION NO. 768902, FILED 5-23-2007, REG. NO. 768902, DATED 2-19-2008, EXPIRES 5-23-2017.

SER. NO. 77-193,000, FILED 5-30-2007.

RENEE MCCRAY, EXAMINING ATTORNEY

**Int. Cls.: 35 and 42**

**Prior U.S. Cls.: 100, 101 and 102**

**United States Patent and Trademark Office**

**Reg. No. 3,465,691**

**Registered July 15, 2008**

**SERVICE MARK  
PRINCIPAL REGISTER**

**RED PIXEL STUDIOS**

RED PIXEL STUDIOS, INC. (KENTUCKY CORPORATION)  
319 EAST 2ND STREET  
OWENSBORO, KY 42303

FOR: ADVERTISING, MARKETING AND PROMOTION; DEVELOPING CUSTOMIZED PRESENTATIONS AND EXHIBITIONS FOR USE IN ADVERTISING; DEVELOPING PROMOTIONAL CAMPAIGNS FOR BUSINESS; CREATING CORPORATE AND BRAND IDENTITIES FOR OTHERS; PUBLISHING OF ADVERTISING TEXTS; AND BUSINESS MARKETING CONSULTING SERVICES, IN CLASS 35 (U.S. CLS. 100, 101 AND 102).

FIRST USE 4-12-2001; IN COMMERCE 4-12-2001.

FOR: COMPUTER SERVICES, NAMELY, DESIGNING AND IMPLEMENTING WEB SITES FOR OTHERS; MAINTENANCE OF WEB SITES FOR OTHERS; GRAPHIC ILLUSTRATION SERVICES

FOR OTHERS; DATABASE DEVELOPMENT; AND CONSULTING SERVICES IN THE FIELDS OF NETWORKING, COMPUTER TECHNOLOGY AND WEB SITE MAINTENANCE, IN CLASS 42 (U.S. CLS. 100 AND 101).

FIRST USE 4-12-2001; IN COMMERCE 4-12-2001.

THE MARK CONSISTS OF STANDARD CHARACTERS WITHOUT CLAIM TO ANY PARTICULAR FONT, STYLE, SIZE, OR COLOR.

NO CLAIM IS MADE TO THE EXCLUSIVE RIGHT TO USE "STUDIOS", APART FROM THE MARK AS SHOWN.

SER. NO. 77-193,118, FILED 5-30-2007.

RONALD AIKENS, EXAMINING ATTORNEY

**Int. Cl.: 41**

**Prior U.S. Cls.: 100, 101 and 107**

**United States Patent and Trademark Office**

**Reg. No. 3,465,692**

**Registered July 15, 2008**

**SERVICE MARK  
PRINCIPAL REGISTER**



BARNES, WILLIE L. (UNITED STATES INDIVIDUAL)  
NO. 1  
1137 NORTH BEACHWOOD DRIVE  
LOS ANGELES, CA 90038

THE MARK CONSISTS OF A RISING AFRO INSTEAD OF THE SUN, WITH A PICK IN IT, OVER THE COMPANY NAME, "AFROTECH".

FOR: POST-PRODUCTION EDITING SERVICES IN THE FIELD OF MUSIC, VIDEOS AND FILMS, IN CLASS 41 (U.S. CLS. 100, 101 AND 107).

SER. NO. 77-193,220, FILED 5-30-2007.

FIRST USE 10-1-2006; IN COMMERCE 10-1-2006.

JASON TURNER, EXAMINING ATTORNEY

**Int. Cl.: 14**

**Prior U.S. Cls.: 2, 27, 28 and 50**

**United States Patent and Trademark Office**

**Reg. No. 3,465,693**

**Registered July 15, 2008**

**TRADEMARK  
PRINCIPAL REGISTER**

**STEINER**

REPRESENTACIONES ALBIS, S.A. DE C.V.  
(MEXICO PARTNERSHIP)  
AV. HERMANOS SERDAN 689-A  
COLONIA SAN RAFAEL PONIENTE  
PUEBLA, PUEBLA, MEXICO 72029

FOR: WATCHES, CLOCKS AND CHRONOMET-  
RIC INSTRUMENTS; PRECIOUS METALS AND  
THEIR ALLOYS; JEWELRY, IMITATION JEWELRY  
AND PRECIOUS STONES, IN CLASS 14 (U.S. CLS. 2,  
27, 28 AND 50).

THE MARK CONSISTS OF STANDARD CHAR-  
ACTERS WITHOUT CLAIM TO ANY PARTICULAR  
FONT, STYLE, SIZE, OR COLOR.

OWNER OF MEXICO REG. NO. 869256, DATED 2-  
24-2005, EXPIRES 12-7-2014.

OWNER OF U.S. REG. NO. 3,077,843.

SEC. 2(F).

SER. NO. 77-193,287, FILED 5-30-2007.

CAROLYN CATALDO, EXAMINING ATTORNEY

**Int. Cls.: 21 and 27**

**Prior U.S. Cls.: 2, 13, 19, 20, 23, 29, 30, 33, 37, 40, 42  
and 50**

**Reg. No. 3,465,694**

**United States Patent and Trademark Office**

**Registered July 15, 2008**

---

**TRADEMARK  
PRINCIPAL REGISTER**

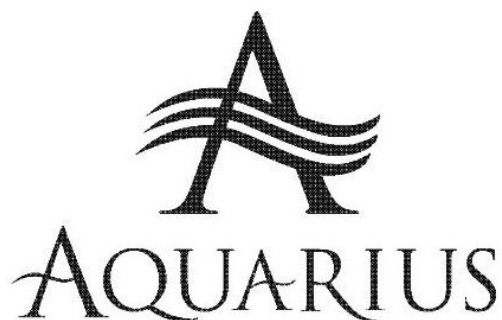

KENNEY MANUFACTURING COMPANY  
(RHODE ISLAND CORPORATION)  
1000 JEFFERSON BOULEVARD  
WARWICK, RI 02886

FIRST USE 2-28-2004; IN COMMERCE 3-31-2007.

OWNER OF U.S. REG. NO. 2,086,617.

FOR: SHOWER CADDIES, IN CLASS 21 (U.S. CLS.  
2, 13, 23, 29, 30, 33, 40 AND 50).

THE MARK CONSISTS OF A STYLIZED LETTER  
"A" OVER THE WORD "AQUARIUS".

FIRST USE 2-28-2004; IN COMMERCE 5-30-2007.

SER. NO. 77-193,408, FILED 5-30-2007.

FOR: BATH MATS, IN CLASS 27 (U.S. CLS. 19, 20,  
37, 42 AND 50).

LESLIE RICHARDS, EXAMINING ATTORNEY

**Int. Cl.: 16**

**Prior U.S. Cls.: 2, 5, 22, 23, 29, 37, 38 and 50**

**Reg. No. 3,465,695**

**United States Patent and Trademark Office**

**Registered July 15, 2008**

**TRADEMARK  
PRINCIPAL REGISTER**

**EM+C**

NORTH AMERICAN PUBLISHING COMPANY  
(PENNSYLVANIA CORPORATION)  
SUITE 1200  
1500 SPRING GARDEN STREET  
PHILADELPHIA, PA 191304094

THE MARK CONSISTS OF STANDARD CHAR-  
ACTERS WITHOUT CLAIM TO ANY PARTICULAR  
FONT, STYLE, SIZE, OR COLOR.

FOR: MAGAZINES IN THE FIELD OF ONLINE  
MARKETING, IN CLASS 16 (U.S. CLS. 2, 5, 22, 23, 29,  
37, 38 AND 50).

SER. NO. 77-193,567, FILED 5-30-2007.

FIRST USE 8-20-2007; IN COMMERCE 10-31-2007.

FLORENTINA BLANDU, EXAMINING ATTORNEY



Int. Cl.: 35

Prior U.S. Cls.: 100, 101 and 102

United States Patent and Trademark Office

Reg. No. 3,465,696

Registered July 15, 2008

**SERVICE MARK  
PRINCIPAL REGISTER**



P & K NEW YORK CORP. (NEW YORK CORPORATION)  
35-19 157TH STREET  
FLUSHING, NY 11354

FOR: WHOLESALE DISTRIBUTORSHIPS FEATURING BEAUTY CARE PRODUCTS, BEAUTY SUPPLIES AND BEAUTY CARE EQUIPMENTS; WHOLESALE STORES FEATURING BEAUTY CARE PRODUCTS, BEAUTY SUPPLIES AND BEAUTY CARE EQUIPMENTS, IN CLASS 35 (U.S. CLS. 100, 101 AND 102).

FIRST USE 9-20-2006; IN COMMERCE 9-20-2006.

NO CLAIM IS MADE TO THE EXCLUSIVE RIGHT TO USE "N.Y.", APART FROM THE MARK AS SHOWN.

THE MARK CONSISTS OF THE WORDS "BADA" AND "FROM N.Y." WRITTEN IN A SOLID BLACK SQUARE SURROUNDED BY A WHITE RECTAN-

GLE OUTLINED IN BLACK. THE OUTER RECTANGLE IS SLIGHTLY TALLER THAN IT IS WIDE. "BADA" IS WRITTEN IN WHITE FONT INSIDE THE INNER BLACK SQUARE BOX; THE LETTER "B" IS STRETCHED VERTICALLY SO THAT IT TAKES UP ALMOST THE FULL HEIGHT OF THE BLACK BOX, FOLLOWED BY A FLOATING "A" THAT HOVERS NEXT TO THE UPPER PORTION OF THE LETTER "B"; THE LETTER "D" IS ALSO STRETCHED VERTICALLY SO THAT IT IS THE SAME HEIGHT AS THE LETTER "B"; THE SECOND "A" IS GROUND-ED BY THE BOTTOM OF "D". "FROM N.Y." IS WRITTEN IN BLACK UNDERNEATH THE INNER BLACK BOX, ON THE LOWER SIDE OF THE SURROUNDING WHITE RECTANGLE AND IS STRETCHED HORIZONTALLY TO FIT THE WIDTH OF THE INNER BLACK BOX.

SER. NO. 77-193,581, FILED 5-30-2007.

FLORENTINA BLANDU, EXAMINING ATTORNEY

Int. Cl.: 41

Prior U.S. Cls.: 100, 101 and 107

United States Patent and Trademark Office

Reg. No. 3,465,697

Registered July 15, 2008

SERVICE MARK  
PRINCIPAL REGISTER



INCFUSION CORPORATION (CALIFORNIA CORPORATION)  
407 N. MAPLE DRIVE  
BEVERLY HILLS, CA 90210

FOR: ENTERTAINMENT SERVICES, NAMELY, PROVIDING REVIEWS, NEWS AND INFORMATION IN THE FIELD OF MOTION PICTURE FILMS, PRE-RECORDED DVDS FEATURING ENTERTAINMENT AND ENTERTAINMENT-RELATED TOPICS VIA THE INTERNET; PROVIDING AN ONLINE COMPUTER DATABASE FEATURING REVIEWS, NEWS, INFORMATION AND CONTENT IN THE FIELD OF MOTION PICTURE FILMS, PRE-RECORDED DVDS FEATURING ENTERTAINMENT AND ENTERTAINMENT-RELATED TOPICS; PROVID-

ING NEWSLETTERS FEATURING REVIEWS, NEWS AND INFORMATION IN THE FIELD OF MOTION PICTURE FILMS, PRE-RECORDED DVDS FEATURING ENTERTAINMENT AND ENTERTAINMENT-RELATED TOPICS VIA THE INTERNET, IN CLASS 41 (U.S. CLS. 100, 101 AND 107).

FIRST USE 3-31-2004; IN COMMERCE 3-31-2004.

OWNER OF U.S. REG. NO. 2,492,006.

SER. NO. 77-193,663, FILED 5-30-2007.

MATTHEW PAPPAS, EXAMINING ATTORNEY

Int. Cl.: 41

Prior U.S. Cls.: 100, 101 and 107

United States Patent and Trademark Office

Reg. No. 3,465,698

Registered July 15, 2008

SERVICE MARK  
PRINCIPAL REGISTER



INCFUSION CORPORATION (CALIFORNIA CORPORATION)  
407 N. MAPLE DRIVE  
BEVERLY HILLS, CA 90210

FOR: ENTERTAINMENT SERVICES, NAMELY, PROVIDING REVIEWS, NEWS AND INFORMATION IN THE FIELD OF MOTION PICTURE FILMS, PRE-RECORDED DVDS FEATURING ENTERTAINMENT, GAMES AND ENTERTAINMENT-RELATED TOPICS VIA THE INTERNET; PROVIDING AN ONLINE COMPUTER DATABASE FEATURING REVIEWS, NEWS, INFORMATION AND CONTENT IN THE FIELD MOTION PICTURE FILMS, PRE-RECORDED DVDS FEATURING ENTERTAINMENT, GAMES AND ENTERTAINMENT-RELATED TOPICS; MOVIE SCHEDULE AND LOCATION INFORMATION SERVICES; ENTERTAINMENT IN THE NATURE OF CONDUCTING CONTESTS, COMPETITIONS AND GAMES IN THE FIELD OF ENTERTAINMENT; ENTERTAINMENT SERVICES, NAMELY, PROVIDING ON-LINE PUB-

LISHING SERVICES, NAMELY, PUBLISHING JOURNALS AND BLOGS FEATURING PERSONAL INFORMATION AND OPINIONS IN THE FIELD OF ENTERTAINMENT; PROVIDING ON-LINE NEWSLETTERS FEATURING REVIEWS, NEWS AND INFORMATION IN THE FIELD OF MOTION PICTURE FILMS, PRE-RECORDED DVDS FEATURING ENTERTAINMENT, PRE-RECORDED VIDEOTAPES FEATURING ENTERTAINMENT, GAMES AND ENTERTAINMENT-RELATED TOPICS VIA THE INTERNET, IN CLASS 41 (U.S. CLS. 100, 101 AND 107).

FIRST USE 8-31-1998; IN COMMERCE 8-31-1998.

OWNER OF U.S. REG. NO. 2,492,006.

SER. NO. 77-193,768, FILED 5-30-2007.

MATTHEW PAPPAS, EXAMINING ATTORNEY

Int. Cl.: 38

Prior U.S. Cls.: 100, 101 and 104

United States Patent and Trademark Office

Reg. No. 3,465,699

Registered July 15, 2008

SERVICE MARK  
PRINCIPAL REGISTER



INCFUSION CORPORATION (CALIFORNIA CORPORATION)  
407 N. MAPLE DRIVE  
BEVERLY HILLS, CA 90210

FOR: PROVIDING ON-LINE CHAT ROOMS AND ELECTRONIC BULLETIN BOARDS FOR TRANSMISSION OF MESSAGES AMONG USERS IN THE FIELD OF MOTION PICTURE FILMS, PRE-RECORDED DVDS FEATURING ENTERTAINMENT, PRE-RECORDED VIDEOTAPES FEATURING ENTERTAINMENT, GAMES AND ENTERTAINMENT RELATED TOPICS; PROVIDING MULTIPLE-USER ACCESS TO A GLOBAL COMPUTER NETWORK FOR THE TRANSFER AND DISSEMINATION OF A WIDE RANGE OF INFORMATION AND SERVICES, AND FOR ACCESSING THIRD PARTY AND PROPRIETARY WEB SITES; ELECTRONIC TRANSMIS-

SION OF DATA AND DOCUMENTS VIA A GLOBAL COMPUTER NETWORK; PROVIDING IN-LINE FACILITIES FOR REAL-TIME INTERACTION WITH OTHER COMPUTER USERS CONCERNING MOTION PICTURE FILMS, PRE-RECORDED DVDS FEATURING ENTERTAINMENT, PRE-RECORDED VIDEOTAPES FEATURING ENTERTAINMENT, GAMES AND ENTERTAINMENT RELATED TOPICS, IN CLASS 38 (U.S. CLS. 100, 101 AND 104).

FIRST USE 8-31-1998; IN COMMERCE 8-31-1998.

OWNER OF U.S. REG. NO. 2,492,006.

SER. NO. 77-193,774, FILED 5-30-2007.

MATTHEW PAPPAS, EXAMINING ATTORNEY

Int. Cl.: 42

Prior U.S. Cls.: 100 and 101

United States Patent and Trademark Office

Reg. No. 3,465,700

Registered July 15, 2008

SERVICE MARK  
PRINCIPAL REGISTER



INCFUSION CORPORATION (CALIFORNIA CORPORATION)  
407 N. MAPLE DRIVE  
BEVERLY HILLS, CA 90210

FOR: COMPUTER SERVICES, NAMELY, HOSTING ONLINE WEB FACILITIES FOR OTHERS FOR ORGANIZING AND CONDUCTING ONLINE MEETINGS, GATHERINGS, AND INTERACTIVE DISCUSSIONS; COMPUTER SERVICES IN THE NATURE OF CUSTOMIZED WEB PAGES FEATURING USER-DEFINED INFORMATION, PERSONAL PROFILES AND INFORMATION; PROVIDING SEARCH ENGINES FOR OBTAINING DATA ON A WIDE VARIETY OF TOPICS AND FIELDS OF GENERAL INTEREST VIA THE INTERNET; HOST-

ING OF DIGITAL CONTENT ON THE INTERNET, NAMELY, ONLINE JOURNALS AND BLOGS; PROVIDING TEMPORARY USE OF NON-DOWNLOADABLE COMPUTER SOFTWARE FOR USE IN THE CREATION AND PUBLICATION OF ONLINE JOURNALS AND BLOGS, IN CLASS 42 (U.S. CLS. 100 AND 101).

FIRST USE 8-31-1998; IN COMMERCE 8-31-1998.

OWNER OF U.S. REG. NO. 2,492,006.

SER. NO. 77-193,775, FILED 5-30-2007.

MATTHEW PAPPAS, EXAMINING ATTORNEY

Int. Cl.: 35

Prior U.S. Cls.: 100, 101 and 102

United States Patent and Trademark Office

Reg. No. 3,465,701

Registered July 15, 2008

SERVICE MARK  
PRINCIPAL REGISTER



INCFUSION CORPORATION (CALIFORNIA CORPORATION)  
407 N. MAPLE DRIVE  
BEVERLY HILLS, CA 90210

FOR: ON-LINE RETAIL STORE SERVICES FEATURING PRE-RECORDED COMPACT DISCS, DVDS, COMPUTER GAMES, POSTERS AND PRINTED MATERIALS RELATED TO MOTION PICTURE FILM, VIDEO AND TELEVISION ENTERTAINMENT; PROMOTING THE GOODS AND SERVICES OF OTHERS BY MEANS OF OPERATING AN ON-LINE SHOPPING MALL WITH LINKS TO THE WEBSITES OF OTHERS; DISSEMINATION OF ADVERTISING FOR OTHERS VIA A

GLOBAL COMPUTER NETWORK; ON-LINE ADVERTISING AND MARKETING SERVICES; PROVIDING AND RENTAL OF ADVERTISING SPACE ON THE INTERNET; COMPARISON SHOPPING SERVICES, IN CLASS 35 (U.S. CLS. 100, 101 AND 102).

FIRST USE 8-31-1998; IN COMMERCE 8-31-1998.

OWNER OF U.S. REG. NO. 2,492,006.

SER. NO. 77-193,778, FILED 5-30-2007.

MATTHEW PAPPAS, EXAMINING ATTORNEY

**Int. Cl.: 10**

**Prior U.S. Cls.: 26, 39 and 44**

**United States Patent and Trademark Office**

**Reg. No. 3,465,702**

**Registered July 15, 2008**

**TRADEMARK  
PRINCIPAL REGISTER**

**e100 NeuroRobotic System**

MYOMO, INC. (MASSACHUSETTS CORPORATION)  
SUITE 205, THE SCHRAFF CENTER  
529 MAIN STREET  
BOSTON, MA 02129

FOR: BRACES FOR LIMBS AND JOINTS, FOR MEDICAL USE, IN CLASS 10 (U.S. CLS. 26, 39 AND 44).

FIRST USE 9-5-2006; IN COMMERCE 12-1-2006.

THE MARK CONSISTS OF STANDARD CHARACTERS WITHOUT CLAIM TO ANY PARTICULAR FONT, STYLE, SIZE, OR COLOR.

NO CLAIM IS MADE TO THE EXCLUSIVE RIGHT TO USE "NEUROROBOTIC SYSTEM", APART FROM THE MARK AS SHOWN.

SER. NO. 77-193,816, FILED 5-30-2007.

ROBERT LAVACHE, EXAMINING ATTORNEY

**Int. Cl.: 35**

**Prior U.S. Cls.: 100, 101 and 102**

**United States Patent and Trademark Office**

**Reg. No. 3,465,703**

**Registered July 15, 2008**

**SERVICE MARK  
PRINCIPAL REGISTER**



WALKER ADVERTISING, INC. (CALIFORNIA CORPORATION)  
1010 SOUTH CABRILLO AVENUE  
SAN PEDRO, CA 90731

FOR: LEGAL SERVICE ADVERTISING SERVICES, NAMELY, PREPARING AND PLACING RADIO, NEWSPAPER, TELEVISION AND INTERNET ADVERTISING OF LEGAL SERVICES FOR OTHERS, IN CLASS 35 (U.S. CLS. 100, 101 AND 102).

FIRST USE 11-1-1992; IN COMMERCE 6-1-2003.

OWNER OF U.S. REG. NO. 1,823,099.

NO CLAIM IS MADE TO THE EXCLUSIVE RIGHT TO USE "ADVERTISING", APART FROM THE MARK AS SHOWN.

THE MARK CONSISTS OF A GRAPHIC OF A TELEVISION SCREEN WITH THE LETTER "W" ON THE SCREEN OF THE TELEVISION. TO THE RIGHT OF THE TELEVISION ARE THE WORDS "WALKER ADVERTISING" ABOVE A SOLID HORIZONTAL LINE.

SER. NO. 77-193,871, FILED 5-31-2007.

KATHLEEN M. VANSTON, EXAMINING ATTORNEY



**Int. Cl.: 28**

**Prior U.S. Cls.: 22, 23, 38 and 50**

**United States Patent and Trademark Office**

**Reg. No. 3,465,704**

**Registered July 15, 2008**

**TRADEMARK  
PRINCIPAL REGISTER**

**EASY SHOT LAUNCHER**

MATTEL, INC. (DELAWARE CORPORATION)  
M1-1518  
333 CONTINENTAL BLVD.  
EL SEGUNDO, CA 90245

THE MARK CONSISTS OF STANDARD CHAR-  
ACTERS WITHOUT CLAIM TO ANY PARTICULAR  
FONT, STYLE, SIZE, OR COLOR.

FOR: TOYS, GAMES AND PLAYTHINGS, NAME-  
LY, TOY VEHICLE ACCESSORIES, IN CLASS 28  
(U.S. CLS. 22, 23, 38 AND 50).

SER. NO. 77-193,976, FILED 5-31-2007.

FIRST USE 3-6-2008; IN COMMERCE 3-6-2008.

JAMES MACFARLANE, EXAMINING ATTORNEY

**Int. Cl.: 8**

**Prior U.S. Cls.: 23, 28 and 44**

**United States Patent and Trademark Office**

**Reg. No. 3,465,705**

**Registered July 15, 2008**

**TRADEMARK  
PRINCIPAL REGISTER**

**SERGEANT'S**

SERGEANT'S PET CARE PRODUCTS, INC. (NE-  
VADA CORPORATION)  
2625 S 158TH PLAZA  
OMAHA, NE 68124

FOR: NAIL CLIPPERS FOR PETS, IN CLASS 8  
(U.S. CLS. 23, 28 AND 44).

FIRST USE 12-0-1970; IN COMMERCE 12-0-1970.

THE MARK CONSISTS OF STANDARD CHAR-  
ACTERS WITHOUT CLAIM TO ANY PARTICULAR  
FONT, STYLE, SIZE, OR COLOR.

OWNER OF U.S. REG. NOS. 3,081,652, 3,109,005,  
AND 3,270,277.

SER. NO. 77-193,978, FILED 5-31-2007.

STEVEN JACKSON, EXAMINING ATTORNEY

**Int. Cl.: 28**

**Prior U.S. Cls.: 22, 23, 38 and 50**

**United States Patent and Trademark Office**

**Reg. No. 3,465,706**

**Registered July 15, 2008**

**TRADEMARK  
PRINCIPAL REGISTER**

**CROSSROAD CRASH**

MATTEL, INC. (DELAWARE CORPORATION)  
333 CONTINENTAL BLVD.  
M1-1518  
EL SEGUNDO, CA 90245

FOR: TOYS, GAMES AND PLAYTHINGS, NAME-  
LY, TOY VEHICLE PLAYSETS AND ACCESSORIES  
THEREFOR, IN CLASS 28 (U.S. CLS. 22, 23, 38 AND  
50).

FIRST USE 2-20-2008; IN COMMERCE 2-20-2008.

THE MARK CONSISTS OF STANDARD CHAR-  
ACTERS WITHOUT CLAIM TO ANY PARTICULAR  
FONT, STYLE, SIZE, OR COLOR.

SER. NO. 77-193,981, FILED 5-31-2007.

DAVID COLLIER, EXAMINING ATTORNEY

**Int. Cls.: 6 and 24**

**Prior U.S. Cls.: 2, 12, 13, 14, 23, 25, 42 and 50**

**United States Patent and Trademark Office**

**Reg. No. 3,465,707**

**Registered July 15, 2008**

**TRADEMARK  
PRINCIPAL REGISTER**

**ACADASPAN**

S & S STRUCTURES, INC. (CALIFORNIA CORPORATION)  
20530 BIG SPRINGS ROAD  
WEED, CA 96094

FOR: METAL PREFABRICATED BUILDING MATERIALS FOR CONSTRUCTING RELOCATABLE, ENCLOSED TENSIONED FABRIC BUILDING STRUCTURES, NAMELY, METAL STRUCTURAL BEAMS , IN CLASS 6 (U.S. CLS. 2, 12, 13, 14, 23, 25 AND 50).

FIRST USE 0-0-1999; IN COMMERCE 0-0-1999.

FOR: PREFABRICATED BUILDING MATERIALS, NAMELY, TENT FABRIC FOR CONSTRUCT-

ING RELOCATABLE, ENCLOSED TENSIONED FABRIC BUILDING STRUCTURES AND ROPES SOLELY FOR USE IN CONNECTION THEREWITH, IN CLASS 24 (U.S. CLS. 42 AND 50).

FIRST USE 0-0-1999; IN COMMERCE 0-0-1999.

THE MARK CONSISTS OF STANDARD CHARACTERS WITHOUT CLAIM TO ANY PARTICULAR FONT, STYLE, SIZE, OR COLOR.

SER. NO. 77-194,181, FILED 5-31-2007.

RICHARD A. STRASER, EXAMINING ATTORNEY

**Int. Cl.: 24**

**Prior U.S. Cls.: 42 and 50**

**United States Patent and Trademark Office**

**Reg. No. 3,465,708**

**Registered July 15, 2008**

**TRADEMARK  
PRINCIPAL REGISTER**

**SHASTA SHELTER**

S & S STRUCTURES, INC. (CALIFORNIA CORPORATION)  
20530 BIG SPRINGS ROAD  
WEED, CA 96094

FOR: PREFABRICATED BUILDING MATERIALS, NAMELY, TENT FABRIC FOR CONSTRUCTING RELOCATABLE, ENCLOSED TENSIONED FABRIC BUILDING STRUCTURES AND ROPES SOLELY FOR USE IN CONNECTION THEREWITH, IN CLASS 24 (U.S. CLS. 42 AND 50).

FIRST USE 10-18-2002; IN COMMERCE 10-18-2002.

THE MARK CONSISTS OF STANDARD CHARACTERS WITHOUT CLAIM TO ANY PARTICULAR FONT, STYLE, SIZE, OR COLOR.

OWNER OF U.S. REG. NO. 3,026,369.

NO CLAIM IS MADE TO THE EXCLUSIVE RIGHT TO USE "SHELTER", APART FROM THE MARK AS SHOWN.

SER. NO. 77-194,213, FILED 5-31-2007.

RICHARD A. STRASER, EXAMINING ATTORNEY

**Int. Cls.: 6 and 24**

**Prior U.S. Cls.: 2, 12, 13, 14, 23, 25, 42 and 50**

**United States Patent and Trademark Office**

**Reg. No. 3,465,709**

**Registered July 15, 2008**

**TRADEMARK  
PRINCIPAL REGISTER**

**SHASTA PEAK**

S & S STRUCTURES, INC. (CALIFORNIA CORPORATION)  
20530 BIG SPRINGS ROAD  
WEED, CA 96094

FOR: METAL PREFABRICATED BUILDING MATERIALS FOR CONSTRUCTING RELOCATABLE, ENCLOSED TENSIONED FABRIC BUILDING STRUCTURES, NAMELY, METAL STRUCTURAL BEAMS , IN CLASS 6 (U.S. CLS. 2, 12, 13, 14, 23, 25 AND 50).

FIRST USE 2-0-2005; IN COMMERCE 2-0-2005.

FOR: PREFABRICATED BUILDING MATERIALS, NAMELY, TENT FABRIC FOR CONSTRUCTING RELOCATABLE, ENCLOSED TENSIONED FABRIC BUILDING STRUCTURES AND ROPES

SOLELY FOR USE IN CONNECTION THEREWITH, IN CLASS 24 (U.S. CLS. 42 AND 50).

FIRST USE 2-0-2005; IN COMMERCE 2-0-2005.

THE MARK CONSISTS OF STANDARD CHARACTERS WITHOUT CLAIM TO ANY PARTICULAR FONT, STYLE, SIZE, OR COLOR.

OWNER OF U.S. REG. NO. 3,026,369.

SEC. 2(F) AS TO "SHASTA".

SER. NO. 77-194,241, FILED 5-31-2007.

RICHARD A. STRASER, EXAMINING ATTORNEY

**Int. Cl.: 30**

**Prior U.S. Cl.: 46**

**United States Patent and Trademark Office**

**Reg. No. 3,465,710**

**Registered July 15, 2008**

**TRADEMARK  
PRINCIPAL REGISTER**

**FORBIDDEN APPLE**

MTR GAMING GROUP, INC. (DELAWARE CORPORATION)  
P.O.BOX 356  
ROUTE 2  
CHESTER, WV 26034

FOR: DESSERT FOODS, NAMELY, A FROZEN APPLE INFUSED WITH COFFEE LIQUOR AND SERVED ON A HEATED APPLE TART PASTRY, IN CLASS 30 (U.S. CL. 46).

FIRST USE 8-19-2003; IN COMMERCE 8-19-2003.

THE MARK CONSISTS OF STANDARD CHARACTERS WITHOUT CLAIM TO ANY PARTICULAR FONT, STYLE, SIZE, OR COLOR.

NO CLAIM IS MADE TO THE EXCLUSIVE RIGHT TO USE "APPLE", APART FROM THE MARK AS SHOWN.

SER. NO. 77-194,260, FILED 5-31-2007.

DANNAN HETZEL, EXAMINING ATTORNEY

**Int. Cls.: 6 and 24**

**Prior U.S. Cls.: 2, 12, 13, 14, 23, 25, 42 and 50**

**United States Patent and Trademark Office**

**Reg. No. 3,465,711**

**Registered July 15, 2008**

**TRADEMARK  
PRINCIPAL REGISTER**

**QWIKTRAC**

S & S STRUCTURES, INC. (CALIFORNIA CORPORATION)  
20530 BIG SPRINGS ROAD  
WEED, CA 96094

FOR: METAL PREFABRICATED BUILDING MATERIALS FOR CONSTRUCTING RELOCATABLE, ENCLOSED TENSIONED FABRIC BUILDING STRUCTURES, NAMELY, METAL STRUCTURAL BEAMS , IN CLASS 6 (U.S. CLS. 2, 12, 13, 14, 23, 25 AND 50).

FIRST USE 2-0-2001; IN COMMERCE 2-0-2001.

FOR: PREFABRICATED BUILDING MATERIALS, NAMELY, TENT FABRIC FOR CONSTRUCTING RELOCATABLE, ENCLOSED TENSIONED

FABRIC BUILDING STRUCTURES AND ROPES SOLELY FOR USE IN CONNECTION THEREWITH, IN CLASS 24 (U.S. CLS. 42 AND 50).

FIRST USE 2-0-2001; IN COMMERCE 2-0-2001.

THE MARK CONSISTS OF STANDARD CHARACTERS WITHOUT CLAIM TO ANY PARTICULAR FONT, STYLE, SIZE, OR COLOR.

OWNER OF U.S. REG. NO. 2,439,956.

SER. NO. 77-194,262, FILED 5-31-2007.

RICHARD A. STRASER, EXAMINING ATTORNEY



**Int. Cls.: 6 and 24**

**Prior U.S. Cls.: 2, 12, 13, 14, 23, 25, 42 and 50**

**United States Patent and Trademark Office**

**Reg. No. 3,465,712**

**Registered July 15, 2008**

**TRADEMARK  
PRINCIPAL REGISTER**

**FASTRACK**

S & S STRUCTURES, INC. (CALIFORNIA CORPORATION)  
20530 BIG SPRINGS ROAD  
WEED, CA 96094

FOR: METAL PREFABRICATED BUILDING MATERIALS FOR CONSTRUCTING RELOCATABLE, ENCLOSED TENSIONED FABRIC BUILDING STRUCTURES, NAMELY, METAL STRUCTURAL BEAMS , IN CLASS 6 (U.S. CLS. 2, 12, 13, 14, 23, 25 AND 50).

FIRST USE 2-0-2001; IN COMMERCE 2-0-2001.

FOR: PREFABRICATED BUILDING MATERIALS, NAMELY, TENT FABRIC FOR CONSTRUCTING RELOCATABLE, ENCLOSED TENSIONED

FABRIC BUILDING STRUCTURES AND ROPES SOLELY FOR USE IN CONNECTION THEREWITH, IN CLASS 24 (U.S. CLS. 42 AND 50).

FIRST USE 2-0-2001; IN COMMERCE 2-0-2001.

THE MARK CONSISTS OF STANDARD CHARACTERS WITHOUT CLAIM TO ANY PARTICULAR FONT, STYLE, SIZE, OR COLOR.

OWNER OF U.S. REG. NO. 2,518,560.

SER. NO. 77-194,282, FILED 5-31-2007.

RICHARD A. STRASER, EXAMINING ATTORNEY

**Int. Cl.: 19**

**Prior U.S. Cls.: 1, 12, 33 and 50**

**United States Patent and Trademark Office**

**Reg. No. 3,465,713**

**Registered July 15, 2008**

**TRADEMARK  
PRINCIPAL REGISTER**

**MADURO**

AGGREGATE INDUSTRIES MANAGEMENT,  
INC. (DELAWARE CORPORATION)  
13900 PINEY MEETINGHOUSE ROAD  
ROCKVILLE, MD 20850

FOR: CONCRETE BLOCK PAVERS, IN CLASS 19  
(U.S. CLS. 1, 12, 33 AND 50).

FIRST USE 2-22-2005; IN COMMERCE 4-21-2005.

THE MARK CONSISTS OF STANDARD CHAR-  
ACTERS WITHOUT CLAIM TO ANY PARTICULAR  
FONT, STYLE, SIZE, OR COLOR.

THE FOREIGN WORDING IN THE MARK  
TRANSLATES INTO ENGLISH AS MATURE.

SER. NO. 77-194,355, FILED 5-31-2007.

ELLEN B. AWRICH, EXAMINING ATTORNEY

**Int. Cl.: 16**

**Prior U.S. Cls.: 2, 5, 22, 23, 29, 37, 38 and 50**

**Reg. No. 3,465,714**

**United States Patent and Trademark Office**

**Registered July 15, 2008**

**TRADEMARK  
PRINCIPAL REGISTER**

# Rue Mentor Connection

RUE EDUCATIONAL PUBLISHERS INC. (FLORIDA CORPORATION)  
150 MCMULLEN BOOTH ROAD SOUTH  
CLEARWATER, FL 33759

FOR: EDUCATIONAL PUBLICATIONS, NAME-  
LY, TRAINING MANUALS IN THE FIELD OF  
NURSING, IN CLASS 16 (U.S. CLS. 2, 5, 22, 23, 29,  
37, 38 AND 50).

FIRST USE 1-1-2006; IN COMMERCE 1-1-2006.

THE MARK CONSISTS OF STANDARD CHAR-  
ACTERS WITHOUT CLAIM TO ANY PARTICULAR  
FONT, STYLE, SIZE, OR COLOR.

NO CLAIM IS MADE TO THE EXCLUSIVE  
RIGHT TO USE "MENTOR", APART FROM THE  
MARK AS SHOWN.

SER. NO. 77-194,503, FILED 5-31-2007.

VIVIAN MICZNIK FIRST, EXAMINING ATTOR-  
NEY

**Int. Cl.: 21**

**Prior U.S. Cls.: 2, 13, 23, 29, 30, 33, 40 and 50**

**United States Patent and Trademark Office**

**Reg. No. 3,465,715**

**Registered July 15, 2008**

**TRADEMARK  
PRINCIPAL REGISTER**

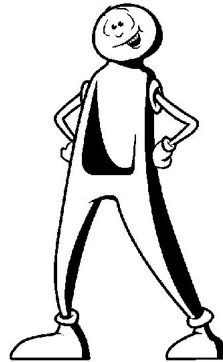

E-Z FLOSS (CALIFORNIA PARTNERSHIP)  
P.O. BOX 2292  
PALM SPRINGS, CA 92263

FOR: DENTAL FLOSS HOLDER, IN CLASS 21  
(U.S. CLS. 2, 13, 23, 29, 30, 33, 40 AND 50).

FIRST USE 10-16-2006; IN COMMERCE 3-6-2008.

THE MARK CONSISTS OF A CARTOON CHARACTER RENDERING WITH THE SHAPE AND GENERAL CHARACTERISTICS OF THE "E-Z FLOSS" DENTAL FLOSS HOLDER, A PLASTIC DEVICE FOR HOLDING DENTAL FLOSS.

SER. NO. 77-194,969, FILED 5-31-2007.

ROBIN CHOSID, EXAMINING ATTORNEY

**Int. Cl.: 3**

**Prior U.S. Cls.: 1, 4, 6, 50, 51 and 52**

**United States Patent and Trademark Office**

**Reg. No. 3,465,716**

**Registered July 15, 2008**

**TRADEMARK  
PRINCIPAL REGISTER**



AMERICAN INTERNATIONAL INDUSTRIES  
(CALIFORNIA PARTNERSHIP)  
2220 GASPAR AVENUE  
LOS ANGELES, CA 90040

FOR: NAIL POLISH, NAIL POLISH BASE COAT,  
FALSE NAILS, NAIL CARE PREPARATIONS, NAIL  
CREAM, NAIL GROOMING PRODUCTS, NAMELY,  
TIPS, GLUE, LACQUER AND GLITTER; NAIL  
STRENGTHENERS, NAIL-POLISH REMOVERS,  
NAIL GROWTH ENHANCER, NAIL GELS, NAIL  
GLUE REMOVER, NAIL LOTIONS, PARAFFIN  
NAIL TREATMENT, NAIL PREPARATION, NAME-  
LY, ACRYLIC LIQUID AND POWDER, AND NAIL

CLEANSER, IN CLASS 3 (U.S. CLS. 1, 4, 6, 50, 51 AND  
52).

FIRST USE 8-0-2001; IN COMMERCE 8-0-2001.

THE MARK CONSISTS OF A SHAPE OF THE  
LETTER "C" TO THE LEFT OF A CURLED LINE  
WHICH RESEMBLES THE NUMBER "9".

SER. NO. 77-195,008, FILED 5-31-2007.

JESSICA FATHY, EXAMINING ATTORNEY

Int. Cl.: 16

Prior U.S. Cls.: 2, 5, 22, 23, 29, 37, 38 and 50

United States Patent and Trademark Office

Reg. No. 3,465,717

Registered July 15, 2008

TRADEMARK  
PRINCIPAL REGISTER



A HOT MAMA (CALIFORNIA CORPORATION)  
11655 LAURELCREST DRIVE  
STUDIO CITY, CA 91604

FOR: POCKET CALENDARS; PRINTED CALENDARS; WALL CALENDARS, IN CLASS 16 (U.S. CLS. 2, 5, 22, 23, 29, 37, 38 AND 50).

FIRST USE 0-0-2007; IN COMMERCE 0-0-2007.

THE COLOR(S) PINK, PURPLE, BROWN, AND WHITE IS/ARE CLAIMED AS A FEATURE OF THE MARK.

THE MARK CONSISTS OF A PINK BANNER WITH BROWN TEXT READING "HOT MAMA" AND PURPLE, BROWN, PINK AND WHITE STRIPES ON THE UNDERSIDE OF THE BANNER ABOVE A PINK HEART WITH BROWN SCROLLWORK AND A BROWN FLEUR DE LIS. A SMALLER PINK BANNER WITH BROWN TEXT READING "SMART," "STYLISH," "STRONG" SEPARATED BY TWO WHITE STARS IS LOCATED BENEATH THE PINK HEART. PURPLE, BROWN, PINK AND WHITE STRIPES ARE LOCATED ON THE UNDERSIDE OF THE BANNER.

SER. NO. 77-195,013, FILED 5-31-2007.

JESSICA FATHY, EXAMINING ATTORNEY

**Int. Cl.: 42**

**Prior U.S. Cls.: 100 and 101**

**United States Patent and Trademark Office**

**Reg. No. 3,465,718**

**Registered July 15, 2008**

**SERVICE MARK  
PRINCIPAL REGISTER**



NATIONAL RECYCLING COALITION, INC.  
(NEW YORK CORPORATION)  
SUITE 425  
805 15TH STREET, NW  
WASHINGTON, DC 20005

FOR: PROVIDING TECHNICAL INFORMATION REGARDING THE BENEFICIAL USE OF INDUSTRIAL BYPRODUCTS IN LIEU OF OTHER COMPARABLE MATERIALS, IN CLASS 42 (U.S. CLS. 100 AND 101).

FIRST USE 8-0-2006; IN COMMERCE 8-0-2006.

NO CLAIM IS MADE TO THE EXCLUSIVE RIGHT TO USE "INDUSTRIAL RESOURCES COUNCIL", APART FROM THE MARK AS SHOWN.

THE COLOR(S) BLACK, BLUE, LIGHT BLUE, AND GREEN IS/ARE CLAIMED AS A FEATURE OF THE MARK.

THE MARK CONSISTS OF A RECTANGULAR SHAPE HAVING TWO HALVES, WHEREBY THE RIGHT HALF CONTAINS THE WORDS "INDUSTRIAL RESOURCES COUNCIL" IN LIGHT BLUE FONT AGAINST A BLACK BACKGROUND, AND THE LEFT HALF CONSISTS OF A CIRCULAR DESIGN EXHIBITING BLACK, BLUE, LIGHT BLUE, AND GREEN COLORS. THE CIRCULAR DESIGN CONSISTS OF A LIGHT BLUE SPHERE, SURROUNDED BY GREEN ARROW-SHAPED OBJECTS, WHICH IS SURROUNDED BY A LIGHT BLUE AND BLACK BARRIER. THE CIRCULAR DESIGN IS PRESENTED AGAINST A BLUE BACKGROUND.

SER. NO. 77-195,050, FILED 5-31-2007.

CAROL SPILS, EXAMINING ATTORNEY

**Int. Cl.: 41**

**Prior U.S. Cls.: 100, 101 and 107**

**United States Patent and Trademark Office**

**Reg. No. 3,465,719**

**Registered July 15, 2008**

**SERVICE MARK  
PRINCIPAL REGISTER**

**CHEFS' NIGHT OUT**

THE JAMES BEARD FOUNDATION, INC. (NEW  
YORK CORPORATION)  
167 WEST 12TH STREET  
NEW YORK, NY 10011

FOR: CONDUCTING ENTERTAINMENT EXHI-  
BITIONS IN THE NATURE OF AN ANNUAL CU-  
LINARY AND BEVERAGE FESTIVAL, IN CLASS 41  
(U.S. CLS. 100, 101 AND 107).

FIRST USE 6-0-1990; IN COMMERCE 6-0-1990.

THE MARK CONSISTS OF STANDARD CHAR-  
ACTERS WITHOUT CLAIM TO ANY PARTICULAR  
FONT, STYLE, SIZE, OR COLOR.

SER. NO. 77-195,579, FILED 6-1-2007.

BARBARA A. GOLD, EXAMINING ATTORNEY



**Int. Cl.: 43**

**Prior U.S. Cls.: 100 and 101**

**United States Patent and Trademark Office**

**Reg. No. 3,465,720**

**Registered July 15, 2008**

**SERVICE MARK  
PRINCIPAL REGISTER**

**TINY KITCHEN**

MEDVED, DENISE SULLIVAN (UNITED STATES  
INDIVIDUAL)  
5115 RAVENSWORTH ROAD  
ANNANDALE, VA 22003

OWNER OF U.S. REG. NO. 2,856,694.

FOR: PROVIDING A WEB SITE FEATURING  
INFORMATION ON COOKING AND ENTERTAIN-  
ING, IN CLASS 43 (U.S. CLS. 100 AND 101).

NO CLAIM IS MADE TO THE EXCLUSIVE  
RIGHT TO USE "KITCHEN", APART FROM THE  
MARK AS SHOWN.

FIRST USE 12-0-2007; IN COMMERCE 12-0-2007.

SER. NO. 77-195,625, FILED 6-1-2007.

THE MARK CONSISTS OF STANDARD CHAR-  
ACTERS WITHOUT CLAIM TO ANY PARTICULAR  
FONT, STYLE, SIZE, OR COLOR.

JILL C. ALT, EXAMINING ATTORNEY

**Int. Cls.: 35 and 41**

**Prior U.S. Cls.: 100, 101, 102 and 107**

**United States Patent and Trademark Office**

**Reg. No. 3,465,721**

**Registered July 15, 2008**

**SERVICE MARK  
PRINCIPAL REGISTER**

**THE METROPOLITAN COOKING &  
ENTERTAINING SHOW**

MEDVED, DENISE SULLIVAN (UNITED STATES  
INDIVIDUAL)  
5115 RAVENSWORTH ROAD  
ANNANDALE, VA 22003

FOR: ARRANGING AND CONDUCTING TRADE  
SHOW EXHIBITIONS IN THE FIELDS OF COOK-  
ING, ENTERTAINING AND HOME IMPROVE-  
MENT, IN CLASS 35 (U.S. CLS. 100, 101 AND 102).

FIRST USE 11-0-2006; IN COMMERCE 11-0-2006.

FOR: ARRANGING AND CONDUCTING EDU-  
CATIONAL CONFERENCES, NAMELY, LEC-  
TURES, DEMONSTRATIONS AND EXHIBITS IN  
THE FIELDS OF COOKING, ENTERTAINING AND

HOME IMPROVEMENT, IN CLASS 41 (U.S. CLS. 100,  
101 AND 107).

FIRST USE 11-0-2006; IN COMMERCE 11-0-2006.

THE MARK CONSISTS OF STANDARD CHAR-  
ACTERS WITHOUT CLAIM TO ANY PARTICULAR  
FONT, STYLE, SIZE, OR COLOR.

NO CLAIM IS MADE TO THE EXCLUSIVE  
RIGHT TO USE "COOKING & ENTERTAINING  
SHOW" , APART FROM THE MARK AS SHOWN.

SER. NO. 77-195,653, FILED 6-1-2007.

JILL C. ALT, EXAMINING ATTORNEY

**Int. Cls.: 12, 20, 35, 37, 39 and 40**

**Prior U.S. Cls.: 2, 13, 19, 21, 22, 23, 25, 31, 32, 35, 44,  
50, 100, 101, 102, 103, 105 and 106**

**Reg. No. 3,465,722**

**United States Patent and Trademark Office**

**Registered July 15, 2008**

**TRADEMARK  
SERVICE MARK  
PRINCIPAL REGISTER**

# RENTACRATE

RENTACRATE LLC (DELAWARE LTD LIAB CO)  
124 PROSPECT STREET  
WALTHAM, MA 02453

FOR: DOLLIES AND NON-MOTORIZED CARTS,  
NAMELY, HANDCARTS AND CARTS FOR MOV-  
ING COMPUTERS, BOOKS BOXES AND PICTURES  
FOR COMMERCIAL USE, IN CLASS 12 (U.S. CLS. 19,  
21, 23, 31, 35 AND 44).

FIRST USE 8-1-2004; IN COMMERCE 8-1-2004.

FOR: NON-METAL CRATES AND BINS FOR  
COMMERCIAL USE, IN CLASS 20 (U.S. CLS. 2, 13,  
22, 25, 32 AND 50).

FIRST USE 8-1-2004; IN COMMERCE 8-1-2004.

FOR: ONLINE RETAIL STORE AND RETAIL  
STORE SERVICES FEATURING MOVING SUP-  
PLIES, IN CLASS 35 (U.S. CLS. 100, 101 AND 102).

FIRST USE 8-1-2004; IN COMMERCE 8-1-2004.

FOR: ELECTRONIC EQUIPMENT COLLECTION  
FOR RECYCLING, IN CLASS 37 (U.S. CLS. 100, 103  
AND 106).

FIRST USE 8-1-2004; IN COMMERCE 8-1-2004.

FOR: RENTAL OF CARTS, BINS, DOLLIES AND  
HAND TRUCKS, IN CLASS 39 (U.S. CLS. 100 AND  
105).

FIRST USE 8-1-2004; IN COMMERCE 8-1-2004.

FOR: DOCUMENT SHREDDING SERVICES;  
AND ELECTRONIC EQUIPMENT RECYCLING  
AND DISPOSAL SERVICES, NAMELY, THE DISAS-  
SEMBLY AND DESTRUCTION OF DATA STORED  
ON ELECTRONIC EQUIPMENT PERFORMED IN  
PREPARATION FOR RECYCLING, IN CLASS 40  
(U.S. CLS. 100, 103 AND 106).

FIRST USE 12-1-2002; IN COMMERCE 12-1-2002.

THE MARK CONSISTS OF STANDARD CHAR-  
ACTERS WITHOUT CLAIM TO ANY PARTICULAR  
FONT, STYLE, SIZE, OR COLOR.

SER. NO. 77-195,860, FILED 6-1-2007.

BILL DAWE, EXAMINING ATTORNEY

**Int. Cl.: 33**

**Prior U.S. Cls.: 47 and 49**

**United States Patent and Trademark Office**

**Reg. No. 3,465,723**

**Registered July 15, 2008**

**TRADEMARK  
PRINCIPAL REGISTER**

**CHASING VENUS**

CREW WINE COMPANY, LLC (CALIFORNIA  
LTD LIAB CO)  
3632 EAST LINCOLN AVENUE  
SACRAMENTO, CA 95818

THE MARK CONSISTS OF STANDARD CHAR-  
ACTERS WITHOUT CLAIM TO ANY PARTICULAR  
FONT, STYLE, SIZE, OR COLOR.

FOR: WINE, IN CLASS 33 (U.S. CLS. 47 AND 49).

SER. NO. 77-195,902, FILED 6-1-2007.

FIRST USE 2-15-2007; IN COMMERCE 2-15-2007.

BARBARA GAYNOR, EXAMINING ATTORNEY

Int. Cl.: 17

Prior U.S. Cls.: 1, 5, 12, 13, 35 and 50

United States Patent and Trademark Office

Reg. No. 3,465,724

Registered July 15, 2008

TRADEMARK  
PRINCIPAL REGISTER



LG VERWALTUNGS, GMBH (FED REP GERMA-  
NY LTD LIAB CO)  
KRONPRINZENSTRASSE 53-57  
DORTMUND, FED REP GERMANY 44135

FOR: SYNTHETIC RUBBER; SYNTHETIC RUBBER FOR USE IN THE MANUFACTURE OF TIRES; UNCURED SYNTHETIC RUBBER FOR USE IN THE MANUFACTURE OF A WIDE VARIETY OF GOODS; CHLORINATED RUBBER; CRUDE RUBBER; CUSHIONING OF RUBBER IN THE NATURE OF STUFFING; ELECTRICAL INSULATING RUBBER PRODUCTS; FIGURINES MADE OF RUBBER; FLUORO RUBBER; FOAM RUBBER; GENERAL PURPOSE SILICONE RUBBER SEALANT; HYDROCHLORINATED RUBBER; INDUSTRIAL PACKAGING CONTAINERS OF RUBBER; ISOBUTYLENE-ISOPRENE RUBBER; LIQUID RUBBER; NATURAL RUBBER; PACKING AND PADDING OF RUBBER FOR SHIPPING CONTAINERS; PADDING OF RUBBER FOR SHIPPING CONTAINERS; POLYSULFIDE RUBBER; RECLAIMED RUBBER; RAW RUBBER; SEMI-WORKED RUBBER; RUBBER BANDS FOR COMMERCIAL AND INDUSTRIAL USES; RUBBER BARS AND RODS; RUBBER BOTTLE STOPPERS; RUBBER BUMPERS FOR LOADING DOCKS; RUBBER DERIVATIVES; RUBBER PACKING FOR SHIPPING CONTAINERS; RUBBER SHEETS; RUBBER SHOCK ABSORBERS FOR INDUSTRIAL MACHINERY; RUBBER SLEEVES FOR PROTECTING PARTS OF MACHINERY; RUBBER SOLUTIONS; RUBBER STOPPERS FOR INDUSTRIAL PACKAGING CONTAINERS; RUBBER THREAD NOT FOR TEXTILE

USE; RUBBER TUBES AND PIPES; RUBBER WHEEL CHOCKS; SEALING PLUGS MADE PRIMARILY FROM RUBBER; SHOCK ABSORBING RUBBER BUFFERS FOR INDUSTRIAL MACHINERY; SHOCK BUFFERS OF RUBBER FOR INDUSTRIAL MACHINERY; SILICONE RUBBER; SLEEVES OF RUBBER FOR PROTECTING PARTS OF MACHINERY; STUFFING OF RUBBER; STYRENE-BUTADIENE RUBBER; VALVES OF RUBBER OR VULCANIZED FIBER; GUM AND GUTTAPERCHA, IN PELLET AND GRANULE FORM, FOR USE IN THE MANUFACTURE OF INDUSTRIAL PRODUCTS, PADDING MATERIAL AND CUSHIONING, AND TIRES; ASBESTOS BOARDS, CORDS, STRINGS AND FELT; ASBESTOS FABRIC FOR USE AS CABLE INSULATION; ASBESTOS FIRE CURTAINS; ASBESTOS FOR USE IN THE MANUFACTURE OF BRAKE LININGS; ASBESTOS NETS; ASBESTOS PACKING FOR VALVES AND PISTONS; ASBESTOS PAPER, POWDER AND YARN; PACKING, STOPPING AND INSULATING MATERIALS, NAMELY, GRAPHITE PACKING FOR GASKETS; GRAPHITE PACKING FOR PUMPS, GASKETS, AND VALVES; MOLDABLE COMPOUNDS FOR USE IN PACKING; MOLDED FOAM INSULATED CONTAINER PACKING FOR COMMERCIAL TRANSPORTATION; PACKING FOAM IN SHEET FORM; PACKING MATERIAL FOR FORMING SEALS; PACKING PADDING OF PLASTIC FOR SHIPPING CONTAINERS; PACKING PADDING OF RUBBER FOR SHIPPING CONTAINERS; PLASTIC PACKING FOR SHIPPING CONTAINERS; RUBBER

PACKING FOR SHIPPING CONTAINERS; ELECTRICAL INSULATING TAPE; ELECTRICAL INSULATING MICA PRODUCTS; ELECTRICAL INSULATING RUBBER PRODUCTS; INSULATING AND PROTECTIVE INTERLAYER DIELECTRIC MATERIALS AND COATINGS FOR USE IN INTEGRATED CIRCUITS, SEMICONDUCTOR DEVICES, COMPUTER DISK DRIVES AND OTHER COMPUTER HARDWARE; INSULATING BLANKETS FOR HOT WATER HEATERS; INSULATING BLANKETS MADE OF SILICA FIBERS, INSULATING FILM FOR USE IN THE MANUFACTURE OF SEMICONDUCTORS; INSULATING GLOVES; POLYURETHANE FOAM AND POLYETHYLENE FOAM; INSULATING OIL FOR TRANSFORMERS; INSULATING PAINT; INSULATING PLASTER; INSULATING REFRACTORY MATERIALS; INSULATING SLEEVES FOR POWER LINES; INSULATING SLEEVES FOR WATER HEATERS; INSULATING SPLICE COVER FOR ELECTRICAL CABLE; INSULATING STRUCTURAL PANELS FOR PLACEMENT ON EDIFICES; INSULATING TILES; INSULATING WATER PROOFING MEMBRANES; INSULATING WATER PROOFING TILES; AND POLYURETHANE FILM FOR USE IN SEALING AND INSULATING BUILDINGS; MICA; RAW

MICA; PARTLY PROCESSED MICA; PLASTICS IN EXTRUDED FORM FOR USE IN MANUFACTURING; FLEXIBLE PIPES, NOT OF METAL; NON-METAL TUBING AND TUBING COUPLINGS FOR JOINING AND TERMINATING PIPES, IN CLASS 17 (U.S. CLS. 1, 5, 12, 13, 35 AND 50).

OWNER OF FED REP GERMANY REG. NO. 30674165, DATED 12-12-2006, EXPIRES 12-31-2016.

THE COLOR(S) DARK PURPLE, LIGHT PURPLE, DARK GREY, LIGHT GREY, AND WHITE IS/ARE CLAIMED AS A FEATURE OF THE MARK.

THE MARK CONSISTS OF THE COLOR DARK PURPLE OUTLINED WITH LIGHT PURPLE AND DARK GREY APPEARS IN THE INTERIOR "E" SHAPED DESIGN; THE COLOR LIGHT GRAY OUTLINED WITH DARK GREY AND WHITE APPEARS IN THE EXTERIOR CIRCULAR DESIGN.

SER. NO. 77-195,928, FILED 6-1-2007.

ELLEN PERKINS, EXAMINING ATTORNEY

**Int. Cl.: 5**

**Prior U.S. Cls.: 6, 18, 44, 46, 51 and 52**

**United States Patent and Trademark Office**

**Reg. No. 3,465,725**

**Registered July 15, 2008**

**TRADEMARK  
PRINCIPAL REGISTER**



LG VERWALTUNGS, GMBH (FED REP GERMA-  
NY LTD LIAB CO)

KRONPRINZENSTRASSE 53-57

DORTMUND, FED REP GERMANY 44135

FOR: NUTRITIONAL SUPPLEMENTS, NOT FOR  
MEDICAL PURPOSES, IN CLASS 5 (U.S. CLS. 6, 18,  
44, 46, 51 AND 52).

PRIORITY CLAIMED UNDER SEC. 44(D) ON FED  
REP GERMANY APPLICATION NO. 30674165.2/3,  
FILED 12-2-2006, REG. NO. 30674165, DATED 12-12-  
2006, EXPIRES 12-12-2016.

THE COLOR(S) DARK PURPLE, LIGHT PURPLE,  
DARK GREY, LIGHT GREY, AND WHITE IS/ARE  
CLAIMED AS A FEATURE OF THE MARK.

THE MARK CONSISTS OF THE COLOR DARK  
PURPLE OUTLINED WITH LIGHT PURPLE AND  
DARK GREY APPEARS IN THE INTERIOR "E"  
SHAPED DESIGN; THE COLOR LIGHT GRAY OUT-  
LINED WITH DARK GREY AND WHITE APPEARS  
IN THE EXTERIOR CIRCULAR DESIGN.

SER. NO. 77-195,939, FILED 6-1-2007.

ELLEN PERKINS, EXAMINING ATTORNEY

**Int. Cl.: 40**

**Prior U.S. Cls.: 100, 103 and 106**

**United States Patent and Trademark Office**

**Reg. No. 3,465,726**

**Registered July 15, 2008**

**SERVICE MARK  
PRINCIPAL REGISTER**



LG VERWALTUNGS, GMBH (FED REP GERMA-  
NY LTD LIAB CO)  
KRONPRINZENSTRASSE 53-57  
DORTMUND, FED REP GERMANY 44135

FOR: TREATMENT OF CHEMICALS, NAMELY,  
PURIFICATION OF SILICON-BASED AND/OR  
CHLORINE-BASED CHEMICALS; APPLICATION  
OF PROTECTIVE COATINGS TO OPTICAL FIBERS  
AND SEMICONDUCTORS; METAL TREATMENT;  
WASTE TREATMENT; WATER TREATMENT; SOIL  
TREATMENT; PAPER TREATMENT; AND TREAT-  
MENT OF RUBBERS AND POLYMERS; BOOK-  
BINDING; FILM DEVELOPMENT AND  
REPRODUCTION OF PHOTOGRAPHS; WOOD-  
WORKING; SURFACE REFINEMENT OR ANODI-  
ZATION; ENAMELING, GALVANIZATION, PHOS-  
PHATISING, CHROMIUM-PLATING, ZINC-  
PLATING, TEXTILE FIREPROOFING, EDGING,  
SHRINKING AND FINISHING; BLEACHING OF  
CLOTH, CLOTHING, FABRIC AND TEXTILES;  
DYEING OF CLOTHING, FABRIC AND FUR; RE-  
CYCLING OF RESIDUE FROM FOSSIL FUEL POW-  
ER PLANTS AND OF WASTE; INCINERATION OF  
RESIDUE FROM FOSSIL FUEL POWER PLANTS

AND OF WASTE; PRODUCTION OF ENERGY AND  
PRODUCTION OF HEAT BY GENERATING ELEC-  
TRICITY; DEMOLITION SERVICES; SAND BLAST-  
ING; CUSTOM MANUFACTURE OF INSULATION  
FOR THE CONSTRUCTION INDUSTRY, IN CLASS  
40 (U.S. CLS. 100, 103 AND 106).

OWNER OF FED REP GERMANY REG. NO.  
30674165, DATED 12-12-2006, EXPIRES 12-31-2016.

THE COLOR(S) DARK PURPLE, LIGHT PURPLE,  
DARK GREY, LIGHT GREY, AND WHITE IS/ARE  
CLAIMED AS A FEATURE OF THE MARK.

THE MARK CONSISTS OF THE COLOR DARK  
PURPLE OUTLINED WITH LIGHT PURPLE AND  
DARK GREY APPEARS IN THE INTERIOR "E"  
SHAPED DESIGN; THE COLOR LIGHT GRAY OUT-  
LINED WITH DARK GREY AND WHITE APPEARS  
IN THE EXTERIOR CIRCULAR DESIGN.

SER. NO. 77-195,984, FILED 6-1-2007.

ELLEN PERKINS, EXAMINING ATTORNEY



**Int. Cl.: 41**

**Prior U.S. Cls.: 100, 101 and 107**

**United States Patent and Trademark Office**

**Reg. No. 3,465,727**

**Registered July 15, 2008**

**SERVICE MARK  
PRINCIPAL REGISTER**



LG VERWALTUNGS, GMBH (FED REP GERMA-  
NY LTD LIAB CO)  
KRONPRINZENSTRASSE 53-57  
DORTMUND, FED REP GERMANY 44135

FOR: TRAINING IN THE FIELD OF ANIMAL NUTRITION, AND CHEMICALS; PROVIDING INSTRUCTION, NAMELY, PROVIDING COURSES OF INSTRUCTION AT THE COLLEGE LEVEL OR ABOVE; VEHICLE DRIVING INSTRUCTION; EDUCATION RENDERED THROUGH CORRESPONDENCE COURSES IN THE FIELDS OF CHEMICALS, NUTRITION, ANIMAL NUTRITION AND ELECTRONICS; EDUCATION RENDERED THROUGH CORRESPONDENCE COURSES IN THE FIELDS OF LANGUAGE OR TUITION; PROVIDING CONTINUING EDUCATION COURSES IN THE FORM OF FURTHER TRAINING IN THE FIELD OF CHEMICALS, NUTRITION AND ANIMAL NUTRITION; PERSONNEL TRAINING IN THE FIELDS OF POWER PLANTS, WASTE INCINERATION PLANTS, WASTE DISPOSAL PLANTS, AND WATER TREATMENT PLANTS; PUBLICA-

TION OF BOOKS, PERIODICALS AND NEWSPAPERS; ORGANIZATION OF EXHIBITIONS FOR CULTURAL OR EDUCATIONAL PURPOSES, IN CLASS 41 (U.S. CLS. 100, 101 AND 107).

OWNER OF FED REP GERMANY REG. NO. 30674165, DATED 12-12-2006, EXPIRES 12-31-2016.

THE COLOR(S) DARK PURPLE, LIGHT PURPLE, DARK GREY, LIGHT GREY, AND WHITE IS/ARE CLAIMED AS A FEATURE OF THE MARK.

THE MARK CONSISTS OF THE COLOR DARK PURPLE OUTLINED WITH LIGHT PURPLE AND DARK GREY APPEARS IN THE INTERIOR "E" SHAPED DESIGN; THE COLOR LIGHT GRAY OUTLINED WITH DARK GREY AND WHITE APPEARS IN THE EXTERIOR CIRCULAR DESIGN.

SER. NO. 77-195,993, FILED 6-1-2007.

ELLEN PERKINS, EXAMINING ATTORNEY

**Int. Cls.: 31 and 44**

**Prior U.S. Cls.: 1, 46, 100 and 101**

**United States Patent and Trademark Office**

**Reg. No. 3,465,728**

**Registered July 15, 2008**

**TRADEMARK  
SERVICE MARK  
PRINCIPAL REGISTER**

# LEGEND CAT

BREWER, CAROL ANN (UNITED STATES INDIVIDUAL)  
1225 E SUNSET DRIVE, SUITE 145  
SUNSET POSTAL BOX 395  
BELLINGHAM, WA 98226

FOR: LIVE ANIMALS, NAMELY, FELINES, IN CLASS 31 (U.S. CLS. 1 AND 46).

FIRST USE 10-30-1993; IN COMMERCE 1-30-1996.

FOR: BREEDING AND STUD SERVICES FOR SHOW, BREEDER, AND PET QUALITY ANIMALS, NAMELY, FELINES, IN CLASS 44 (U.S. CLS. 100 AND 101).

FIRST USE 10-30-1993; IN COMMERCE 1-30-1996.

THE MARK CONSISTS OF STANDARD CHARACTERS WITHOUT CLAIM TO ANY PARTICULAR FONT, STYLE, SIZE, OR COLOR.

NO CLAIM IS MADE TO THE EXCLUSIVE RIGHT TO USE "CAT", APART FROM THE MARK AS SHOWN.

SEC. 2(F).

SER. NO. 77-196,038, FILED 6-1-2007.

JUSTINE D. PARKER, EXAMINING ATTORNEY

**Int. Cl.: 39**

**Prior U.S. Cls.: 100 and 105**

**United States Patent and Trademark Office**

**Reg. No. 3,465,729**

**Registered July 15, 2008**

**SERVICE MARK  
PRINCIPAL REGISTER**

**Hooves & Paws Animal Rescue**

HOOVES & PAWS ANIMAL RESCUE, INC. (CALIFORNIA CORPORATION)  
7806 EAST AVE. U  
LITTLE ROCK, CA 93543

FOR: ANIMAL RESCUE SERVICES; PET RESCUE SERVICES; RESCUE SERVICES, IN CLASS 39 (U.S. CLS. 100 AND 105).

FIRST USE 3-14-2002; IN COMMERCE 3-14-2002.

THE MARK CONSISTS OF STANDARD CHARACTERS WITHOUT CLAIM TO ANY PARTICULAR FONT, STYLE, SIZE, OR COLOR.

NO CLAIM IS MADE TO THE EXCLUSIVE RIGHT TO USE "ANIMAL RESCUE", APART FROM THE MARK AS SHOWN.

SER. NO. 77-196,366, FILED 6-3-2007.

DARRYL SPRUILL, EXAMINING ATTORNEY

**Int. Cls.: 9, 16, 35, 41 and 45**

**Prior U.S. Cls.: 2, 5, 21, 22, 23, 26, 29, 36, 37, 38, 50,  
100, 101, 102 and 107**

**Reg. No. 3,465,730**

**United States Patent and Trademark Office**

**Registered July 15, 2008**

**TRADEMARK  
SERVICE MARK  
PRINCIPAL REGISTER**

**NATIONAL ARBITRATION FORUM**

NATIONAL ARBITRATION FORUM (MINNESOTA CORPORATION)  
6465 WAYZATA BLVD.  
SUITE 500  
MINNEAPOLIS, MN 55426

FOR: DOWNLOADABLE ELECTRONIC PUBLICATIONS IN THE NATURE OF NEWSLETTERS, BROCHURES, PAMPHLETS, WHITE PAPERS, HANDBOOKS, AND JOURNALS IN THE FIELD OF ALTERNATIVE DISPUTE RESOLUTION, IN CLASS 9 (U.S. CLS. 21, 23, 26, 36 AND 38).

FIRST USE 3-27-1997; IN COMMERCE 3-27-1997.

FOR: PUBLICATIONS, NAMELY, NEWSLETTERS, BROCHURES, PAMPHLETS, WHITE PAPERS, AND BOOKS IN THE FIELD OF ALTERNATIVE DISPUTE RESOLUTION, IN CLASS 16 (U.S. CLS. 2, 5, 22, 23, 29, 37, 38 AND 50).

FIRST USE 8-1-1986; IN COMMERCE 8-1-1986.

FOR: ADMINISTRATION OF ALTERNATIVE DISPUTE RESOLUTION BUSINESSES, IN CLASS 35 (U.S. CLS. 100, 101 AND 102).

FIRST USE 11-0-1992; IN COMMERCE 11-0-1992.

FOR: EDUCATIONAL SERVICES, NAMELY, PROVIDING SEMINARS, LECTURES, AND COURSES IN THE FIELD OF ALTERNATIVE DISPUTE RESOLUTION, IN CLASS 41 (U.S. CLS. 100, 101 AND 107).

FIRST USE 0-0-1990; IN COMMERCE 0-0-1990.

FOR: ALTERNATIVE DISPUTE RESOLUTION SERVICES IN THE NATURE OF ARBITRATION AND MEDIATION SERVICES, IN CLASS 45 (U.S. CLS. 100 AND 101).

FIRST USE 8-1-1986; IN COMMERCE 8-1-1986.

THE MARK CONSISTS OF STANDARD CHARACTERS WITHOUT CLAIM TO ANY PARTICULAR FONT, STYLE, SIZE, OR COLOR.

OWNER OF U.S. REG. NOS. 2,484,009, 2,501,544, AND 3,158,544.

SEC. 2(F).

SER. NO. 77-196,430, FILED 6-4-2007.

SHANNON TWOHIG, EXAMINING ATTORNEY

**Int. Cls.: 9, 16, 41 and 45**

**Prior U.S. Cls.: 2, 5, 21, 22, 23, 26, 29, 36, 37, 38, 50,  
100, 101 and 107**

**Reg. No. 3,465,731**

**United States Patent and Trademark Office**

**Registered July 15, 2008**

**TRADEMARK  
SERVICE MARK  
PRINCIPAL REGISTER**



NATIONAL ARBITRATION FORUM (MINNESOTA CORPORATION)  
6465 WAYZATA BLVD.  
SUITE 500  
MINNEAPOLIS, MN 55426

FOR: DOWNLOADABLE ELECTRONIC PUBLICATIONS IN THE NATURE OF NEWSLETTERS, BROCHURES, PAMPHLETS, WHITE PAPERS, HANDBOOKS, AND JOURNALS IN THE FIELD OF ALTERNATIVE DISPUTE RESOLUTION, IN CLASS 9 (U.S. CLS. 21, 23, 26, 36 AND 38).

FIRST USE 6-1-2005; IN COMMERCE 6-1-2005.

FOR: PUBLICATIONS, NAMELY, NEWSLETTERS, BROCHURES, PAMPHLETS, WHITE PAPERS, AND BOOKS IN THE FIELD OF ALTERNATIVE DISPUTE RESOLUTION, IN CLASS 16 (U.S. CLS. 2, 5, 22, 23, 29, 37, 38 AND 50).

FIRST USE 6-1-2005; IN COMMERCE 6-1-2005.

FOR: EDUCATIONAL SERVICES, NAMELY, PROVIDING SEMINARS, LECTURES, AND COUR-

SES IN THE FIELD OF ALTERNATIVE DISPUTE RESOLUTION, IN CLASS 41 (U.S. CLS. 100, 101 AND 107).

FIRST USE 6-1-2005; IN COMMERCE 6-1-2005.

FOR: ALTERNATIVE DISPUTE RESOLUTION SERVICES IN THE NATURE OF ARBITRATION AND MEDIATION SERVICES, IN CLASS 45 (U.S. CLS. 100 AND 101).

FIRST USE 6-1-2005; IN COMMERCE 6-1-2005.

OWNER OF U.S. REG. NOS. 2,484,009, 2,501,544, AND 3,158,544.

SEC. 2(F) AS TO "NATIONAL ARBITRATION FORUM".

SER. NO. 77-196,433, FILED 6-4-2007.

SHANNON TWOHIG, EXAMINING ATTORNEY

**Int. Cl.: 12**

**Prior U.S. Cls.: 19, 21, 23, 31, 35 and 44**

**Reg. No. 3,465,732**

**United States Patent and Trademark Office**

**Registered July 15, 2008**

**TRADEMARK  
PRINCIPAL REGISTER**



CAPCO, LLC (INDIANA LTD LIAB CO)  
1349 ARCADIA DRIVE  
COLUMBUS, IN 47201

FIRST USE 4-1-1997; IN COMMERCE 4-1-1997.

FOR: PARTS FOR AUTOMOBILE SEAT BELTS, NAMELY, ADJUSTERS, CENERATOR CAPS, ANCHOR PLATES, ANCHORS, STAYS, ANCHOR STRAPS, AND COVER PLATES; INFLATOR COMPONENTS FOR AUTOMOBILE AIRBAGS, NAMELY, CLOSURES AND DIFFUSERS, IN CLASS 12 (U.S. CLS. 19, 21, 23, 31, 35 AND 44).

THE MARK CONSISTS OF STYLIZED LETTER "C" WITH THE WORD "CAPCO".

SER. NO. 77-196,439, FILED 6-4-2007.

CYNTHIA SLOAN, EXAMINING ATTORNEY

**Int. Cl.: 10**

**Prior U.S. Cls.: 26, 39 and 44**

**United States Patent and Trademark Office**

**Reg. No. 3,465,733**

**Registered July 15, 2008**

**TRADEMARK  
PRINCIPAL REGISTER**

**ESSENCE**

CALIFORNIA EXOTIC NOVELTIES LLC (CALI-  
FORNIA LTD LIAB CO)  
14235 RAMONA AVENUE  
CHINO, CA 91710

THE MARK CONSISTS OF STANDARD CHAR-  
ACTERS WITHOUT CLAIM TO ANY PARTICULAR  
FONT, STYLE, SIZE, OR COLOR.

FOR: ADULT SEXUAL AIDS, NAMELY, VIBRA-  
TORS, IN CLASS 10 (U.S. CLS. 26, 39 AND 44).

SER. NO. 77-196,541, FILED 6-4-2007.

FIRST USE 3-1-2007; IN COMMERCE 3-1-2007.

JOHN DALIER, EXAMINING ATTORNEY

**Int. Cls.: 7, 9 and 37**

**Prior U.S. Cls.: 13, 19, 21, 23, 26, 31, 34, 35, 36, 38,  
100, 103 and 106**

**Reg. No. 3,465,734**

**United States Patent and Trademark Office**

**Registered July 15, 2008**

**TRADEMARK  
SERVICE MARK  
PRINCIPAL REGISTER**

# IDAB WAMAC

HEIDELBERGER DRUCKMASCHINEN AG (FED  
REP GERMANY CORPORATION)  
KURFUERSTEN-ANLAGE 52-60  
HEIDELBERG, FED REP GERMANY 69115

FOR: PRINT SHOP MACHINES FOR THE NEWS-  
PAPER INDUSTRY, NAMELY, PRINTING MA-  
CHINES, AND MACHINES AND DEVICES FOR  
THE FURTHER PROCESSING OF PRINT SHOP  
PRODUCTS IN BINDERIES AND MAIL ROOMS,  
NAMELY, BINDING MACHINES, CUTTING MA-  
CHINES, PACKAGING MACHINES, WRAPPING  
MACHINES, STITCHING MACHINES, FOLDING  
MACHINES; PRESS ROOM MACHINES, NAMELY,  
INSERTING MACHINES FOR INSERTING PRINT-  
ED PRODUCTS, IN PARTICULAR LEAFLETS,  
ADVERTISEMENT, FLYERS, TV MAGAZINES  
AND SECTIONS OF NEWSPAPERS PRINTED IN  
ADVANCE, INTO OTHER PRINTED PRODUCTS, IN  
PARTICULAR NEWSPAPERS, IN A MAILROOM  
FOR PRESS ROOM PRODUCTS; MAILROOM MA-  
CHINES FOR THE NEWSPAPER INDUSTRY,  
NAMELY, MACHINES FOR BINDING, CUTTING,  
FOLDING, STAPLING, STACKING, WRAPPING  
AND CONVEYING PRINTED MATTER, IN CLASS  
7 (U.S. CLS. 13, 19, 21, 23, 31, 34 AND 35).

FOR: COMPUTER SOFTWARE AND ELECTRO-  
NIC CONTROLLERS FOR CONTROLLING PRINT-  
ING MACHINES, INSERTING MACHINES,

MAILROOM MACHINES, BINDING MACHINES,  
CUTTING MACHINES, PACKAGING MACHINES,  
WRAPPING MACHINES, STITCHING MACHINES,  
AND FOLDING MACHINES IN THE NEWSPAPER  
INDUSTRY , IN CLASS 9 (U.S. CLS. 21, 23, 26, 36 AND  
38).

FOR: MAINTENANCE AND SERVICING OF IN-  
SERTING MACHINES AND MAILROOM MA-  
CHINES FOR THE NEWSPAPER INDUSTRY, IN  
CLASS 37 (U.S. CLS. 100, 103 AND 106).

THE MARK CONSISTS OF STANDARD CHAR-  
ACTERS WITHOUT CLAIM TO ANY PARTICULAR  
FONT, STYLE, SIZE, OR COLOR.

PRIORITY CLAIMED UNDER SEC. 44(D) ON  
ERPNTY CMNTY TM OFC APPLICATION NO.  
005637913, FILED 1-24-2007, REG. NO. 005637913,  
DATED 2-4-2008, EXPIRES 1-24-2017.

THE WORDING "IDAB", "WAMAC" NOR " IDAB  
WAMAC" HAS NO MEANING IN A FOREIGN  
LANGUAGE.

SER. NO. 77-196,597, FILED 6-4-2007.

ESTHER BELENKER, EXAMINING ATTORNEY



**Int. Cl.: 9**

**Prior U.S. Cls.: 21, 23, 26, 36 and 38**

**Reg. No. 3,465,735**

**United States Patent and Trademark Office**

**Registered July 15, 2008**

**TRADEMARK  
PRINCIPAL REGISTER**

# PAN MANAGER

EGENERA, INC. (DELAWARE CORPORATION)  
165 FOREST STREET  
MARLBOROUGH, MA 01752

FOR: ENTERPRISE SERVER APPLICATION SOFTWARE USED ACROSS LOCAL AREA NETWORKS AND DATA CENTER ENVIRONMENTS; COMPUTER SOFTWARE TO ENABLE AUTOMATION, INTEGRATION, AND ALLOCATION OF DATA CENTER RESOURCES; COMPUTER SOFTWARE TO CONFIGURE MULTI-TIER TOPOLOGIES; COMPUTER SOFTWARE FOR SERVER CONSOLIDATION; COMPUTER SOFTWARE FOR DATA CENTER RESOURCES VIRTUALIZATION; COMPUTER SOFTWARE TO ENABLE OPTIMIZATION OF DATA CENTER RESOURCES, NAMELY, COMPUTER HARDWARE AND DATA CENTER APPLICATIONS; COMPUTER SOFTWARE FOR DEPLOYMENT, AUTOMATION, INTEGRATION, ADMINISTRATION, CONSOLIDATION AND MONITORING OF DATA CENTER INFRASTRUCTURE APPLICATIONS, DATABASES, WEB SERVERS, APPLICATION CLUSTERS, APPLICATION SERVERS AND SECURITY APPLICATIONS, AND DISASTER RECOVERY APPLICATIONS; COMPUTER SOFTWARE FOR ENABLING COMPUTING

ON DEMAND CAPABILITIES TO DATA CENTER APPLICATION CLUSTERS; COMPUTER SOFTWARE PLATFORMS FOR CREATING AND HOSTING APPLIANCE SERVERS; COMPUTER SOFTWARE TO CREATE AND ENABLE ADMINISTRATION OF DATA CENTER APPLICATIONS; COMPUTER SOFTWARE TO CREATE AND ADMINISTER DATA CENTER HARDWARE TECHNOLOGIES; COMPUTER SOFTWARE TO ENABLE SECURE DATA CENTER RESOURCE PARTITIONING, IN CLASS 9 (U.S. CLS. 21, 23, 26, 36 AND 38).

FIRST USE 4-0-2001; IN COMMERCE 12-0-2001.

THE MARK CONSISTS OF STANDARD CHARACTERS WITHOUT CLAIM TO ANY PARTICULAR FONT, STYLE, SIZE, OR COLOR.

NO CLAIM IS MADE TO THE EXCLUSIVE RIGHT TO USE "MANAGER", APART FROM THE MARK AS SHOWN.

SER. NO. 77-196,689, FILED 6-4-2007.

KEVIN DINALLO, EXAMINING ATTORNEY

**Int. Cl.: 7**

**Prior U.S. Cls.: 13, 19, 21, 23, 31, 34 and 35**

**Reg. No. 3,465,736**

**United States Patent and Trademark Office**

**Registered July 15, 2008**

**TRADEMARK  
PRINCIPAL REGISTER**

**BIJUR DELIMON**

INDUSTRIAL MANUFACTURING COMPANY  
INTERNATIONAL LLC (DELAWARE LTD  
LIAB CO)  
6950 SOUTH EDGERTON ROAD  
BRECKSVILLE, OH 44141

FOR: LUBRICATORS, NAMELY, POWER-OPER-  
ATED LUBRICANT DISPENSERS FOR INDUS-  
TRIAL MACHINES, IN CLASS 7 (U.S. CLS. 13, 19,  
21, 23, 31, 34 AND 35).

FIRST USE 6-1-2007; IN COMMERCE 6-1-2007.

THE MARK CONSISTS OF STANDARD CHAR-  
ACTERS WITHOUT CLAIM TO ANY PARTICULAR  
FONT, STYLE, SIZE, OR COLOR.

OWNER OF U.S. REG. NOS. 535,491, 928,552 AND  
OTHERS.

SER. NO. 77-196,716, FILED 6-4-2007.

GINA FINK, EXAMINING ATTORNEY

**Int. Cl.: 16**

**Prior U.S. Cls.: 2, 5, 22, 23, 29, 37, 38 and 50**

**United States Patent and Trademark Office**

**Reg. No. 3,465,737**

**Registered July 15, 2008**

**TRADEMARK  
PRINCIPAL REGISTER**

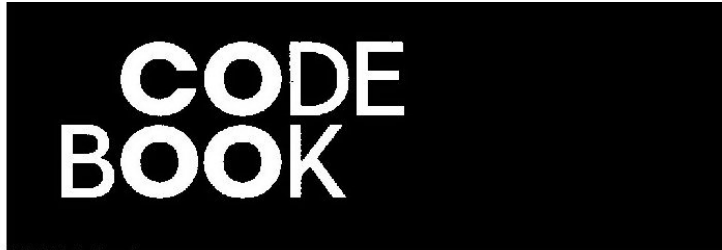

NEVER DONE, INC. (NEW YORK CORPORATION)  
SUITE 1A  
910 WEST END AVENUE  
NEW YORK, NY 10025

NO CLAIM IS MADE TO THE EXCLUSIVE  
RIGHT TO USE "BOOK", APART FROM THE  
MARK AS SHOWN.

FOR: CALENDARS, DATE BOOKS, ADDRESS  
BOOKS, PERSONAL ORGANIZERS, AGENDAS, IN  
CLASS 16 (U.S. CLS. 2, 5, 22, 23, 29, 37, 38 AND 50).

SER. NO. 77-196,735, FILED 6-4-2007.

FIRST USE 2-0-2007; IN COMMERCE 9-0-2007.

KEVON CHISOLM, EXAMINING ATTORNEY

**Int. Cls.: 35 and 42**

**Prior U.S. Cls.: 100, 101 and 102**

**United States Patent and Trademark Office**

**Reg. No. 3,465,738**

**Registered July 15, 2008**

**SERVICE MARK  
PRINCIPAL REGISTER**

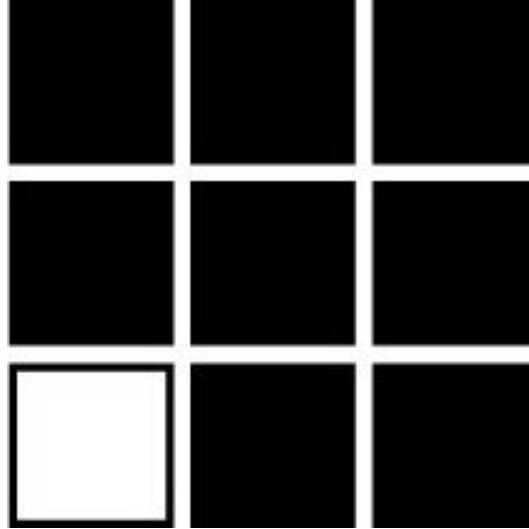

RED PIXEL STUDIOS, INC. (KENTUCKY CORPORATION)  
P.O. BOX 931  
OWENSBORO, KY 42302

FOR: ADVERTISING, MARKETING AND PROMOTION; DEVELOPING CUSTOMIZED PRESENTATIONS AND EXHIBITIONS FOR USE IN ADVERTISING; DEVELOPING PROMOTIONAL CAMPAIGNS FOR BUSINESS; CREATING CORPORATE AND BRAND IDENTITIES FOR OTHERS; AND PUBLISHING OF ADVERTISING TEXTS, IN CLASS 35 (U.S. CLS. 100, 101 AND 102).

FIRST USE 4-12-2001; IN COMMERCE 4-12-2001.

FOR: COMPUTER SERVICES, NAMELY, DESIGNING AND IMPLEMENTING WEB SITES FOR OTHERS; MAINTENANCE OF WEB SITES FOR OTHERS; GRAPHIC ILLUSTRATION SERVICES FOR OTHERS; DATABASE DEVELOPMENT; AND CONSULTING SERVICES IN THE FIELD OF WEB SITE MAINTENANCE, IN CLASS 42 (U.S. CLS. 100 AND 101).

FIRST USE 4-12-2001; IN COMMERCE 4-12-2001.

SER. NO. 77-196,810, FILED 6-4-2007.

RONALD AIKENS, EXAMINING ATTORNEY

**Int. Cl.: 35**

**Prior U.S. Cls.: 100, 101 and 102**

**United States Patent and Trademark Office**

**Reg. No. 3,465,739**

**Registered July 15, 2008**

**SERVICE MARK  
PRINCIPAL REGISTER**



AURORA PHOTOS, INC. (MAINE CORPORATION)  
20-36 DANFORTH STREET #216  
PORTLAND, ME 04101

FOR: TALENT AGENCIES, IN CLASS 35 (U.S. CLS. 100, 101 AND 102).

FIRST USE 10-1-2007; IN COMMERCE 10-1-2007.

NO CLAIM IS MADE TO THE EXCLUSIVE RIGHT TO USE "SELECT" , APART FROM THE MARK AS SHOWN.

THE COLOR(S) BLACK AND YELLOW IS/ARE CLAIMED AS A FEATURE OF THE MARK.

THE MARK CONSISTS OF THE WORD "SELECT" IN BLACK WITH STYLIZED YELLOW SUN RAYS EMANATING FROM THE "S" IN "SELECT".

SER. NO. 77-196,929, FILED 6-4-2007.

CHRISTINE COOPER, EXAMINING ATTORNEY

**Int. Cls.: 6 and 19**

**Prior U.S. Cls.: 1, 2, 12, 13, 14, 23, 25, 33 and 50**

**United States Patent and Trademark Office**

**Reg. No. 3,465,740**

**Registered July 15, 2008**

**TRADEMARK  
PRINCIPAL REGISTER**

WHERE LIGHT MEETS DESIGN

J.R. FOUR LTD. DBA TECHNICAL GLASS PRODUCTS (WASHINGTON CORPORATION)  
2425 CARILLON POINT  
KIRKLAND, WA 98033

FOR: METAL FRAMING FOR WALLS, DOORS, WINDOWS AND BUILDINGS, IN CLASS 6 (U.S. CLS. 2, 12, 13, 14, 23, 25 AND 50).

FIRST USE 5-3-2007; IN COMMERCE 5-3-2007.

FOR: GLASS BUILDING PRODUCTS, NAMELY, ARCHITECTURAL GLASS, STRUCTURAL GLASS, DECORATIVE GLASS, FIRE-RATED GLASS, IMPACT SAFETY-RATED GLASS, BULLET-RESIS-

TANT GLASS, SECURITY GLASS, WIRED GLASS, SIDELIGHTS, WINDOWS, TRANSOMS; GLASS CHANNELS, IN CLASS 19 (U.S. CLS. 1, 12, 33 AND 50).

FIRST USE 5-3-2007; IN COMMERCE 5-3-2007.

THE MARK CONSISTS OF STANDARD CHARACTERS WITHOUT CLAIM TO ANY PARTICULAR FONT, STYLE, SIZE, OR COLOR.

SER. NO. 77-197,179, FILED 6-4-2007.

CAROLYN CATALDO, EXAMINING ATTORNEY

**Int. Cl.: 8**

**Prior U.S. Cls.: 23, 28 and 44**

**United States Patent and Trademark Office**

**Reg. No. 3,465,741**

**Registered July 15, 2008**

**TRADEMARK  
PRINCIPAL REGISTER**

**MASTERFORCE**

MENARD, INC. (WISCONSIN CORPORATION)  
4777 MENARD DRIVE  
EAU CLAIRE, WI 54703

FOR: HAND OPERATED LAWN AND GARDEN TOOLS, NAMELY, HOES, SPADES, AERATORS, EDGERS, ICE CHOPPERS, CHISELS, WEEDERS, RAKES CULTIVATORS, TILLERS, PRUNERS, SAWS, POLE PRUNERS AND SAWS, TRANSPLANTERS, SHEARS, FRUIT PICKERS, TROWELS, GRASS WHIPS; LONG HANDLED ROUND POINT SHOVELS WITH FIBERGLASS HANDLES, LONG HANDLED ROUND POINT SHOVELS WITH WOOD HANDLES, D-HANDLE ROUND POINT SHOVELS WITH WOOD HANDLES, D-HANDLE SPADE POINT SHOVELS WITH WOOD HANDLES, SPECIALTY SHOVELS IN THE NATURE OF LONG HAN-

DLE TRENCHERS WITH WOOD HANDLES, POST HOLE DIGGERS WITH FIBERGLASS HANDLES, FORKS WITH 5-TINES AND FIBERGLASS HANDLES, AND SOD LIFTERS WITH WOOD HANDLES, IN CLASS 8 (U.S. CLS. 23, 28 AND 44).

FIRST USE 4-0-2007; IN COMMERCE 4-0-2007.

THE MARK CONSISTS OF STANDARD CHARACTERS WITHOUT CLAIM TO ANY PARTICULAR FONT, STYLE, SIZE, OR COLOR.

SER. NO. 77-197,291, FILED 6-4-2007.

KATHERINE CONNOLLY, EXAMINING ATTORNEY

Int. Cl.: 41

Prior U.S. Cls.: 100, 101 and 107

United States Patent and Trademark Office

Reg. No. 3,465,742

Registered July 15, 2008

SERVICE MARK  
PRINCIPAL REGISTER



JETTER, KIMBERLY, P. (UNITED STATES INDIVIDUAL)

1-D

3051 EDWIN AVE.  
FORT LEE, NJ 07024

FOR: COMPOSITION OF MUSIC FOR OTHERS; ENTERTAINMENT IN THE NATURE OF VISUAL AND AUDIO PERFORMANCES, NAMELY, MUSICAL BAND, ROCK GROUP, GYMNASTIC, DANCE, AND BALLET PERFORMANCES; ENTERTAINMENT IN THE NATURE OF MUSIC; ENTERTAINMENT, NAMELY, LIVE PERFORMANCES BY A MUSICAL BAND; ENTERTAINMENT SERVICES, NAMELY, AN ONLINE ACTIVITY WHERE YOU CREATE YOUR OWN MUSIC VIDEOS; ENTERTAINMENT SERVICES, NAMELY, NON-DOWNLOADABLE RINGTONES, PRE-RECORDED MUSIC, VIDEO AND GRAPHICS PRESENTED TO MOBILE COMMUNICATIONS DEVICES VIA A GLOBAL COMPUTER NETWORK AND WIRELESS NETWORKS; ENTERTAINMENT SERVICES, NAMELY, PROVIDING A WEB SITE FEATURING MUSICAL PERFORMANCES, MUSICAL VIDEOS, RELATED FILM CLIPS, PHOTOGRAPHS, AND OTHER MULTIMEDIA MATERIALS; ENTERTAINMENT SERVICES, NAMELY, PROVIDING PRERECORDED MUSIC, INFORMATION IN THE FIELD OF MUSIC, AND COMMENTARY AND ARTICLES ABOUT MUSIC, ALL ON-LINE VIA A GLOBAL

COMPUTER NETWORK; ENTERTAINMENT, NAMELY, LIVE MUSIC CONCERTS; ENTERTAINMENT, NAMELY, LIVE PERFORMANCES BY MUSICAL BANDS; MULTIMEDIA ENTERTAINMENT SERVICES IN THE NATURE OF RECORDING, PRODUCTION AND POST-PRODUCTION SERVICES IN THE FIELDS OF MUSIC, VIDEO, AND FILMS; MUSIC COMPOSITION AND TRANSCRIPTION FOR OTHERS; MUSIC COMPOSITION FOR OTHERS; MUSIC PRODUCTION SERVICES; MUSIC PUBLISHING SERVICES; MUSIC TRANSCRIPTION FOR OTHERS; POST-PRODUCTION EDITING SERVICES IN THE FIELD OF MUSIC, VIDEOS AND FILMS; PRESENTATION OF MUSICAL PERFORMANCE; PRODUCTION OF SOUND AND MUSIC VIDEO RECORDINGS; RENTAL OF PHONOGRAPHIC AND MUSIC RECORDINGS, IN CLASS 41 (U.S. CLS. 100, 101 AND 107).

FIRST USE 1-21-2006; IN COMMERCE 1-21-2006.

THE MARK CONSISTS OF THE WORD HUSSY WITH A TAIL EXTENDED FROM THE BOTTOM OF THE "Y" AND TINY NICKS ON THE LETTERS TO LOOK LIKE FUR.

SER. NO. 77-197,428, FILED 6-5-2007.

HANNO RITTNER, EXAMINING ATTORNEY



**Int. Cl.: 16**

**Prior U.S. Cls.: 2, 5, 22, 23, 29, 37, 38 and 50**

**United States Patent and Trademark Office**

**Reg. No. 3,465,743**

**Registered July 15, 2008**

**TRADEMARK  
PRINCIPAL REGISTER**

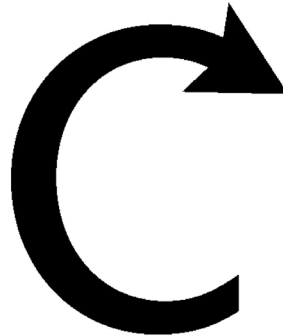

THE CATERING CONSULTANTS, INC. (GEORGIA CORPORATION)  
SUITE 102-498  
931 MONROE DR.  
ATLANTA, GA 30308

FOR: MAGAZINE, NEWSLETTERS AND BROCHURES IN THE NATURE OF CITY GUIDES FEATURING LOCAL AND REGIONAL ENTERTAINMENT, SHOPPING, DINING AND TRAVEL EVENT LISTINGS, INFORMATION AND ARTI-

CLES, IN CLASS 16 (U.S. CLS. 2, 5, 22, 23, 29, 37, 38 AND 50).

FIRST USE 6-10-2005; IN COMMERCE 6-10-2005.

THE MARK CONSISTS OF AN ARROW IN THE SHAPE OF THE LETTER "C."

SER. NO. 77-197,435, FILED 6-5-2007.

HANNO RITTNER, EXAMINING ATTORNEY

**Int. Cl.: 28**

**Prior U.S. Cls.: 22, 23, 38 and 50**

**United States Patent and Trademark Office**

**Reg. No. 3,465,744**

**Registered July 15, 2008**

**TRADEMARK  
PRINCIPAL REGISTER**



K.S. TOYS LTD. (HONG KONG LTD LIAB CO)  
RM 312-315, PENINSULA CENTRE 67 MODY RD.  
KOWLOON, HONG KONG

FOR: BABY MULTIPLE ACTIVITY TOYS; BATH TOYS; BATHTUB TOYS; CHILDREN'S MULTIPLE ACTIVITY TOYS; CRIB TOYS; INFANT TOYS; LEVER ACTION TOYS; MECHANICAL ACTION TOYS; MECHANICAL TOYS; POP UP TOYS, IN CLASS 28 (U.S. CLS. 22, 23, 38 AND 50).

FIRST USE 5-15-2005; IN COMMERCE 5-15-2005.

OWNER OF U.S. REG. NO. 3,055,966.

THE COLOR(S) PINK, SALMON PINK, BROWN, ORANGE, WHITE, BLACK, RED, YELLOW, GREEN AND BLUE IS/ARE CLAIMED AS A FEATURE OF THE MARK.

THE MARK CONSISTS OF A STYLIZED BABY'S HEAD RISING OUT OF FLOWER, WHEREIN THE BABY'S HAT IS YELLOW WITH ORANGE DOTS, THE FACE IS SALMON PINK FLESH TONE WITH BLUE EYES AND BLACK PUPILS AND RED LIPS, THE FLOWER PETALS ARE RED, THE LEAVES ARE GREEN, BELOW WHICH APPEARS A BROWN BORDER, THE WORD, THE WORDS "FLOWER BABY" APPEAR ON A WHITE FIELD SURROUNDED BY A YELLOW BORDER, WHERE THE WORD "BABY" IS GREEN AND THE WORD "FLOWER" APPEARS IN RED AND ORANGE, THE WORD "KS" IS BLUE WITH WHITE HIGHLIGHTS, AND THE BACKGROUND IS PINK.

SER. NO. 77-197,447, FILED 6-5-2007.

HANNO RITTNER, EXAMINING ATTORNEY

**Int. Cl.: 41**

**Prior U.S. Cls.: 100, 101 and 107**

**United States Patent and Trademark Office**

**Reg. No. 3,465,745**

**Registered July 15, 2008**

**SERVICE MARK  
PRINCIPAL REGISTER**

**TAKE HOME HANDYMAN**

DISCOVERY COMMUNICATIONS, LLC (MARY-  
LAND LTD LIAB CO)  
ONE DISCOVERY PLACE  
SILVER SPRING, MD 20910

FOR: ENTERTAINMENT SERVICES IN THE  
NATURE OF A CONTINUING NONFICTION PRO-  
GRAM ABOUT HOME IMPROVEMENT AND RE-  
NOVATION PROJECTS, ACCESSIBLE BY  
TELEVISION, SATELLITE, BROADBAND, MOBILE,  
WIRELESS, FIBER OPTICS, CABLE, RADIO AND A  
GLOBAL COMPUTER NETWORK; INFORMATION  
REGARDING SAME PROVIDED VIA A GLOBAL  
COMPUTER NETWORK, IN CLASS 41 (U.S. CLS. 100,  
101 AND 107).

FIRST USE 4-7-2007; IN COMMERCE 4-7-2007.

THE MARK CONSISTS OF STANDARD CHAR-  
ACTERS WITHOUT CLAIM TO ANY PARTICULAR  
FONT, STYLE, SIZE, OR COLOR.

NO CLAIM IS MADE TO THE EXCLUSIVE  
RIGHT TO USE "HANDYMAN", APART FROM  
THE MARK AS SHOWN.

SER. NO. 77-197,540, FILED 6-5-2007.

SANI KHOURI, EXAMINING ATTORNEY

**Int. Cl.: 18**

**Prior U.S. Cls.: 1, 2, 3, 22 and 41**

**United States Patent and Trademark Office**

**Reg. No. 3,465,746**

**Registered July 15, 2008**

**TRADEMARK  
PRINCIPAL REGISTER**

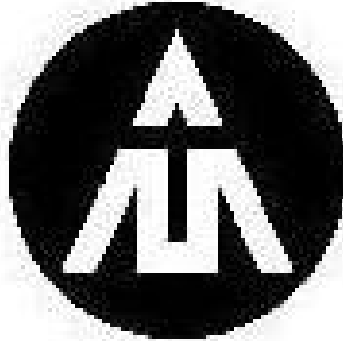

TAIYO KOGYO CORPORATION (JAPAN CORPORATION)  
4-8-4, KIKAWA-HIGASHI, YODOGAWA-KU  
OSAKA-SHI, OSAKA, JAPAN 532-0012

FOR: BAGS AND POUCHES, NAMELY, ALL-PURPOSE CARRYING BAGS, CARRY-ALL BAGS, MESSENGER BAGS, SCHOOL BAGS, SLING BAGS, TOTE BAGS, TRAVEL BAGS, DRAWSTRING POUCHES, AND ZIPPERED POUCHES, IN CLASS 18 (U.S. CLS. 1, 2, 3, 22 AND 41).

PRIORITY CLAIMED UNDER SEC. 44(D) ON JAPAN APPLICATION NO. 2007-18746, FILED 3-5-2007, REG. NO. 5071467, DATED 8-17-2007, EXPIRES 8-17-2017.

THE MARK CONSISTS OF A STYLIZED DESIGN ELEMENT.

SER. NO. 77-197,643, FILED 6-5-2007.

ANNE FARRELL, EXAMINING ATTORNEY

**Int. Cl.: 9**

**Prior U.S. Cls.: 21, 23, 26, 36 and 38**

**United States Patent and Trademark Office**

**Reg. No. 3,465,747**

**Registered July 15, 2008**

**TRADEMARK  
PRINCIPAL REGISTER**

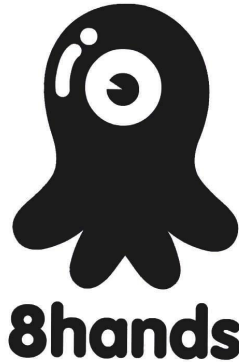

S.M.B.P. IGLOO LTD. (ISRAEL CORPORATION)  
3 HASADNAOT STREET  
HERZLIA, ISRAEL 46728

FOR: COMPUTER SOFTWARE IN THE FIELD OF SOCIAL NETWORKING FOR MANAGING, ANALYZING, ORGANIZING AND OPTIMIZING CONTENT FROM WEBSITES OF OTHERS THAT FEATURE BLOGS, MESSAGING SERVICES, IMAGES, MUSIC AND VIDEO CONTENT; COMPUTER SOFTWARE FOR ENABLING COMMUNICATION FOR USE IN CONNECTING COMPUTER NET-

WORK USERS, IN CLASS 9 (U.S. CLS. 21, 23, 26, 36 AND 38).

FIRST USE 8-1-2006; IN COMMERCE 4-15-2007.

THE MARK CONSISTS OF A FOUR-LEGGED OCTOPUS SHAPED-FIGURE WITH A SINGLE EYE.

SER. NO. 77-197,700, FILED 6-5-2007.

LINDA M. KING, EXAMINING ATTORNEY

**Int. Cl.: 9**

**Prior U.S. Cls.: 21, 23, 26, 36 and 38**

**Reg. No. 3,465,748**

**United States Patent and Trademark Office**

**Registered July 15, 2008**

**TRADEMARK  
PRINCIPAL REGISTER**

**GMS**

LIQUID CONTROLS, LLC (DELAWARE CORPORATION)  
105 ALBRECHT DRIVE  
LAKE BLUFF, IL 60044

FOR: WIRELESS FLUID FLOW IN-FLOW, OUT-FLOW MEASUREMENT DISPLAY AND GLOBAL POSITION LOCATOR FOR USE IN IN-CAB MOUNTING FOR TANKER TRUCKS, IN CLASS 9 (U.S. CLS. 21, 23, 26, 36 AND 38).

FIRST USE 5-21-2005; IN COMMERCE 5-21-2005.

THE MARK CONSISTS OF STANDARD CHARACTERS WITHOUT CLAIM TO ANY PARTICULAR FONT, STYLE, SIZE, OR COLOR.

THE WORDING "GMS" HAS NO MEANING IN A FOREIGN LANGUAGE.

SER. NO. 77-197,705, FILED 6-5-2007.

LINDA M. KING, EXAMINING ATTORNEY

**Int. Cls.: 9, 40 and 42**

**Prior U.S. Cls.: 21, 23, 26, 36, 38, 100, 101, 103 and 106**

**Reg. No. 3,465,749**

**United States Patent and Trademark Office**

**Registered July 15, 2008**

**TRADEMARK  
SERVICE MARK  
PRINCIPAL REGISTER**



OMRON CORPORATION (JAPAN CORPORATION)  
801, MINAMIFUDO-CHO, HORIKAWAHIGASHIIRU  
SHIOKOJIDORI, SHIMOGYO-KU, KYOTO-SHI  
KYOTO, JAPAN 600-8530

FOR: INTEGRATED CIRCUITS; INTEGRATED CIRCUIT ELEMENTS, NAMELY, INTEGRATED CIRCUIT MODULES; LARGE SCALE INTEGRATED CIRCUITS; INTEGRATED CIRCUIT CHIPS; SEMICONDUCTORS; SEMICONDUCTOR ELEMENTS, NAMELY, SEMICONDUCTOR CHIPS AND DEVICES; WAFERS, NAMELY, WAFERS FOR SEMICONDUCTOR INTEGRATED CIRCUITS, IN CLASS 9 (U.S. CLS. 21, 23, 26, 36 AND 38).

FOR: CUSTOM MANUFACTURING OF ELECTRONIC CIRCUITS AND COMPUTERS; CUSTOM MANUFACTURING OF PRINTED CIRCUIT BOARDS; AND CUSTOM MANUFACTURING OF SEMICONDUCTOR ELEMENTS, IN CLASS 40 (U.S. CLS. 100, 103 AND 106).

FOR: DESIGNING OF ELECTRONIC CIRCUITS, SEMICONDUCTOR ELEMENTS, INTEGRATED CIRCUITS AND LARGE SCALE INTEGRATED CIRCUITS; CONSULTANCY FOR DESIGNING OF ELECTRONIC CIRCUITS, SEMICONDUCTOR ELEMENTS, INTEGRATED CIRCUITS AND LARGE SCALE INTEGRATED CIRCUITS; PROVIDING INFORMATION ON DESIGNING OF ELECTRONIC CIRCUITS, SEMICONDUCTOR ELEMENTS, INTEGRATED CIRCUITS AND LARGE SCALE INTEGRATED CIRCUITS; TESTING AND RESEARCH ON ELECTRONIC CIRCUITS, SEMICONDUCTOR ELEMENTS, INTEGRATED CIRCUITS AND

LARGE SCALE INTEGRATED CIRCUITS; CONSULTANCY FOR TESTING AND RESEARCH ON ELECTRONIC CIRCUITS, SEMICONDUCTOR ELEMENTS, INTEGRATED CIRCUITS AND LARGE SCALE INTEGRATED CIRCUITS; PROVIDING INFORMATION ON TESTING AND RESEARCH ON ELECTRONIC CIRCUITS, SEMICONDUCTOR ELEMENTS, INTEGRATED CIRCUITS AND LARGE SCALE INTEGRATED CIRCUITS; AND TESTING AND RESEARCH ON MACHINES, APPARATUS AND INSTRUMENTS, IN CLASS 42 (U.S. CLS. 100 AND 101).

OWNER OF JAPAN REG. NO. 5106831, DATED 1-25-2008, EXPIRES 1-25-2018.

NO CLAIM IS MADE TO THE EXCLUSIVE RIGHT TO USE "SEMICONDUCTOR", APART FROM THE MARK AS SHOWN.

THE COLOR(S) ORANGE, GREEN AND GRAY IS/ARE CLAIMED AS A FEATURE OF THE MARK.

THE MARK CONSISTS OF THE WORD "BEYOND" IN THE COLOR ORANGE ABOVE THE WORDS "THE SEMICONDUCTOR" IN THE COLOR GRAY, WITH ALL WORDING TO THE RIGHT OF A SEMI-CIRCLE COMPRISED OF FOUR DIFFERENT SHADES OF ORANGE CIRCLES AND TWO DIFFERENT SHADES OF GREEN SQUARES.

SER. NO. 77-197,810, FILED 6-5-2007.

CAROLYN GRAY, EXAMINING ATTORNEY

**Int. Cls.: 9, 40 and 42**

**Prior U.S. Cls.: 21, 23, 26, 36, 38, 100, 101, 103 and 106**

**United States Patent and Trademark Office**

**Reg. No. 3,465,750**

**Registered July 15, 2008**

**TRADEMARK  
SERVICE MARK  
PRINCIPAL REGISTER**



OMRON CORPORATION (JAPAN CORPORATION)  
801, MINAMIFUDO-CHO, HORIKAWAHIGASHIRU  
SHIOKOJIDORI, SHIMOGYO-KU, KYOTO-SHI  
KYOTO, JAPAN 600-8530

FOR: INTEGRATED CIRCUITS; INTEGRATED CIRCUIT ELEMENTS, NAMELY, INTEGRATED CIRCUIT MODULES; LARGE SCALE INTEGRATED CIRCUITS; INTEGRATED CIRCUIT CHIPS; SEMICONDUCTORS; SEMICONDUCTOR ELEMENTS, NAMELY, SEMICONDUCTOR CHIPS AND DEVICES; WAFERS, NAMELY, WAFERS FOR SEMICONDUCTOR INTEGRATED CIRCUITS, IN CLASS 9 (U.S. CLS. 21, 23, 26, 36 AND 38).

FOR: CUSTOM MANUFACTURING OF ELECTRONIC CIRCUITS AND COMPUTERS; CUSTOM MANUFACTURING OF PRINTED CIRCUIT BOARDS; AND CUSTOM MANUFACTURING OF SEMICONDUCTOR ELEMENTS, IN CLASS 40 (U.S. CLS. 100, 103 AND 106).

FOR: DESIGNING OF ELECTRONIC CIRCUITS, SEMICONDUCTOR ELEMENTS, INTEGRATED CIRCUITS AND LARGE SCALE INTEGRATED CIRCUITS; CONSULTANCY FOR DESIGNING OF ELECTRONIC CIRCUITS, SEMICONDUCTOR ELEMENTS, INTEGRATED CIRCUITS AND LARGE SCALE INTEGRATED CIRCUITS; PROVIDING INFORMATION ON DESIGNING OF ELECTRONIC CIRCUITS, SEMICONDUCTOR ELEMENTS, INTEGRATED CIRCUITS AND LARGE SCALE INTEGRATED CIRCUITS; TESTING AND RESEARCH ON ELECTRONIC CIRCUITS, SEMICONDUCTOR ELEMENTS, INTEGRATED CIRCUITS AND

LARGE SCALE INTEGRATED CIRCUITS; CONSULTANCY FOR TESTING AND RESEARCH ON ELECTRONIC CIRCUITS, SEMICONDUCTOR ELEMENTS, INTEGRATED CIRCUITS AND LARGE SCALE INTEGRATED CIRCUITS; PROVIDING INFORMATION ON TESTING AND RESEARCH ON ELECTRONIC CIRCUITS, SEMICONDUCTOR ELEMENTS, INTEGRATED CIRCUITS AND LARGE SCALE INTEGRATED CIRCUITS; AND TESTING AND RESEARCH ON MACHINES, APPARATUS AND INSTRUMENTS, IN CLASS 42 (U.S. CLS. 100 AND 101).

OWNER OF JAPAN REG. NO. 5106832, DATED 1-25-2008, EXPIRES 1-25-2018.

NO CLAIM IS MADE TO THE EXCLUSIVE RIGHT TO USE "SEMICONDUCTOR", APART FROM THE MARK AS SHOWN.

THE COLOR(S) ORANGE, GREEN AND GRAY IS/ARE CLAIMED AS A FEATURE OF THE MARK.

THE MARK CONSISTS OF THE WORD "BEYOND" IN THE COLOR ORANGE AND THE WORDS "THE SEMICONDUCTOR" IN THE COLOR GRAY, WITH ALL WORDING TO THE RIGHT OF A SEMI-CIRCLE COMPRISED OF FOUR DIFFERENT SHADES OF ORANGE CIRCLES AND TWO DIFFERENT SHADES OF GREEN SQUARES.

SER. NO. 77-197,825, FILED 6-5-2007.

CAROLYN GRAY, EXAMINING ATTORNEY



**Int. Cl.: 45**

**Prior U.S. Cls.: 100 and 101**

**Reg. No. 3,465,751**

**United States Patent and Trademark Office**

**Registered July 15, 2008**

**SERVICE MARK  
PRINCIPAL REGISTER**



NOKR, INC. (CALIFORNIA CORPORATION)  
P.O. BOX 900461  
SAN DIEGO, CA 921900461

NO CLAIM IS MADE TO THE EXCLUSIVE RIGHT TO USE "NEXT OF KIN REGISTRY" AND "EMERGENCY INFORMATION LINK", APART FROM THE MARK AS SHOWN.

FOR: DISASTER RECOVERY SERVICES, NAME-  
LY, REGISTRATION OF PERSONAL EMERGENCY  
CONTACTS, NEXT OF KIN AND VITAL MEDICAL  
INFORMATION WHICH CAN BE ACCESSED BY  
PUBLIC EMERGENCY RESPONSE AGENCIES;  
MISSING PERSON RECOVERY SERVICE, NAME-  
LY, AN EMERGENCY CONTACT SYSTEM TO  
ASSIST PEOPLE IN FINDING A MISSING, INJURED  
OR DECEASED FAMILY MEMBER FROM MAN  
MADE DISASTERS, DISEASE PANDEMIC, TER-  
RORISM, NATURAL DISASTERS, AND DAILY  
EMERGENCIES, IN CLASS 45 (U.S. CLS. 100 AND  
101).

THE MARK CONSISTS OF A THREE-SIDED LINE  
WITH A DOWNWARD FACING ARROW FORM-  
ING THE TOP PORTION OF A RECTANGLE,  
BELOW THIS ARE THE LETTERS "NOKR" FOL-  
LOWED BY A DEPICTION OF A GLOBE, BELOW  
THIS ARE THE WORDS "NEXT OF KIN REGIS-  
TRY", BELOW THIS IS ANOTHER THREE-SIDED  
LINE WITH AN UPWARD FACING ARROW FORM-  
ING THE BOTTOM PORTION OF A RECTANGLE,  
BELOW THIS ARE THE WORDS "EMERGENCY  
INFORMATION LINK".

SER. NO. 77-197,862, FILED 6-5-2007.

FIRST USE 1-1-2004; IN COMMERCE 1-1-2004.

SUSAN RICHARDS, EXAMINING ATTORNEY

**Int. Cl.: 42**

**Prior U.S. Cls.: 100 and 101**

**United States Patent and Trademark Office**

**Reg. No. 3,465,752**

**Registered July 15, 2008**

**SERVICE MARK  
PRINCIPAL REGISTER**



**AuraPortal**

AURA DIFUSION S.L. (SPAIN LTD LIAB CO)  
VELAZQUEZ, 61  
MADRID, SPAIN

FOR: COMPUTER SOFTWARE DEVELOPMENT,  
IN CLASS 42 (U.S. CLS. 100 AND 101).

OWNER OF ERPN CMNTY TM OFC REG. NO.  
005425939, DATED 10-15-2006, EXPIRES 10-30-2016.

THE COLOR(S) NAVY BLUE, LIGHT BLUE,  
GREY, AND BLACK IS/ARE CLAIMED AS A FEAT-  
TURE OF THE MARK.

THE MARK CONSISTS OF CONSISTS OF THE  
TERM "AURAPORTAL" IN NAVY BLUE LETTERS  
BELOW THE REPRESENTATION OF A LION'S  
HEAD WITH A LIGHT AND DARK BLUE MANE,  
A GREY FACE AND BLACK EARS, EYES, MOUTH  
AND NOSE.

SER. NO. 77-197,924, FILED 6-5-2007.

JAMES A. RAUEN, EXAMINING ATTORNEY

**Int. Cl.: 43**

**Prior U.S. Cls.: 100 and 101**

**United States Patent and Trademark Office**

**Reg. No. 3,465,753**

**Registered July 15, 2008**

**SERVICE MARK  
PRINCIPAL REGISTER**

**MAKING YOU LOOK GOOD, BY  
DESIGN**

**CORT FURNITURE RENTAL CORPORATION  
(DELAWARE CORPORATION)  
11250 WAPLES MILL ROAD  
FAIRFAX, VA 22030**

**THE MARK CONSISTS OF STANDARD CHAR-  
ACTERS WITHOUT CLAIM TO ANY PARTICULAR  
FONT, STYLE, SIZE, OR COLOR.**

**FOR: RENTAL OF FURNITURE, IN CLASS 43  
(U.S. CLS. 100 AND 101).**

**SER. NO. 77-198,004, FILED 6-5-2007.**

**FIRST USE 12-31-2004; IN COMMERCE 12-31-2004.**

**JEAN IM, EXAMINING ATTORNEY**

**Int. Cl.: 38**

**Prior U.S. Cls.: 100, 101 and 104**

**United States Patent and Trademark Office**

**Reg. No. 3,465,754**

**Registered July 15, 2008**

**SERVICE MARK  
PRINCIPAL REGISTER**

**CONNECTMAIL**

HOOVER'S, INC. (DELAWARE CORPORATION)  
5800 AIRPORT BOULEVARD  
AUSTIN, TX 78752

FOR: EMAIL RETRIEVAL, IDENTIFICATION  
AND VERIFICATION SERVICES, IN CLASS 38  
(U.S. CLS. 100, 101 AND 104).

FIRST USE 6-5-2007; IN COMMERCE 6-5-2007.

THE MARK CONSISTS OF STANDARD CHAR-  
ACTERS WITHOUT CLAIM TO ANY PARTICULAR  
FONT, STYLE, SIZE, OR COLOR.

SER. NO. 77-198,025, FILED 6-5-2007.

KARANENDRA S. CHHINA, EXAMINING ATTOR-  
NEY

**Int. Cl.: 28**

**Prior U.S. Cls.: 22, 23, 38 and 50**

**United States Patent and Trademark Office**

**Reg. No. 3,465,755**

**Registered July 15, 2008**

**TRADEMARK  
PRINCIPAL REGISTER**

**WEAVING OUTSIDE THE BOX**

BOENDIER DESIGNS, LLC (GEORGIA LTD LIAB  
CO)  
4646 CHIMNEY ROCK DRIVE  
LILBURN, GA 30047

FOR: HOBBY CRAFT KITS COMPRISING WEAV-  
ING INSTRUCTIONS AND WEAVING MATERIAL  
FOR MAKING SMALL FASHION CONTAINERS  
SUCH AS PURSES, ELECTRONIC COMPONENT  
CASES, OR SMALL BAGS , IN CLASS 28 (U.S. CLS.  
22, 23, 38 AND 50).

FIRST USE 3-8-2007; IN COMMERCE 3-8-2007.

THE MARK CONSISTS OF STANDARD CHAR-  
ACTERS WITHOUT CLAIM TO ANY PARTICULAR  
FONT, STYLE, SIZE, OR COLOR.

SER. NO. 77-198,084, FILED 6-5-2007.

JANICE KIM, EXAMINING ATTORNEY

**Int. Cl.: 35**

**Prior U.S. Cls.: 100, 101 and 102**

**United States Patent and Trademark Office**

**Reg. No. 3,465,756**

**Registered July 15, 2008**

**SERVICE MARK  
PRINCIPAL REGISTER**

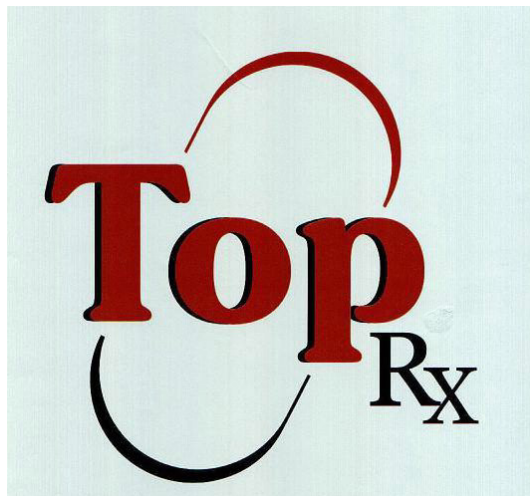

TOPRX, INC. (TENNESSEE CORPORATION)  
2950 BROTHER BLVD.  
BARTLETT, TN 38133

FOR: WHOLESALE DISTRIBUTORSHIP FEATURING PHARMACEUTICALS, IN CLASS 35 (U.S. CLS. 100, 101 AND 102).

FIRST USE 4-16-2007; IN COMMERCE 4-16-2007.

OWNER OF U.S. REG. NO. 2,812,886.

NO CLAIM IS MADE TO THE EXCLUSIVE RIGHT TO USE "RX", APART FROM THE MARK AS SHOWN.

THE COLOR(S) RED AND BLACK IS/ARE CLAIMED AS A FEATURE OF THE MARK.

THE MARK CONSISTS OF A STYLIZED PILL WITH THE WORD "TOPRX" WRITTEN ACROSS IT. THE COLOR RED APPEARS IN THE TOP HALF OF THE PILL DESIGN AND IN THE WORDING "TOP". THE COLOR BLACK APPEARS IN THE BOTTOM HALF OF THE PILL DESIGN AND IN THE LETTERS "RX".

SER. NO. 77-198,248, FILED 6-5-2007.

LESLIE RICHARDS, EXAMINING ATTORNEY

**Int. Cl.: 21**

**Prior U.S. Cls.: 2, 13, 23, 29, 30, 33, 40 and 50**

**United States Patent and Trademark Office**

**Reg. No. 3,465,757**

**Registered July 15, 2008**

**TRADEMARK  
PRINCIPAL REGISTER**

**Bearier**

COMPUMERIC ENGINEERING, INC. (CALIFORNIA CORPORATION)  
1390 S. MILLIKEN AVENUE  
ONTARIO, CA 91761

THE MARK CONSISTS OF STANDARD CHARACTERS WITHOUT CLAIM TO ANY PARTICULAR FONT, STYLE, SIZE, OR COLOR.

FOR: TRASH CONTAINERS FOR HOUSEHOLD USE, IN CLASS 21 (U.S. CLS. 2, 13, 23, 29, 30, 33, 40 AND 50).

SER. NO. 77-198,267, FILED 6-5-2007.

FIRST USE 6-1-1999; IN COMMERCE 6-1-1999.

LINDA POWELL, EXAMINING ATTORNEY

**Int. Cls.: 1, 7, 11 and 35**

**Prior U.S. Cls.: 1, 5, 6, 10, 13, 19, 21, 23, 26, 31, 34, 35,  
46, 100, 101 and 102**

**Reg. No. 3,465,758**

**United States Patent and Trademark Office**

**Registered July 15, 2008**

**TRADEMARK  
SERVICE MARK  
PRINCIPAL REGISTER**



RUSSELL, JOHN A. (UNITED STATES INDIVIDUAL)

523-C

16541 REDMOND WAY

REDMOND, WA 98052 AND

RUSSELL, PAMELA E. (UNITED STATES INDIVIDUAL)

523-C

16541 REDMOND WAY

REDMOND, WA 98052 AND

ODYSSEY HOLDINGS L.L.C. (WASHINGTON LTD LIAB CO)

436-C

16541 REDMOND WAY

REDMOND, WA 98052

FOR: WATER TREATMENT CHEMICALS FOR USE IN FRESH WATER PONDS, IN CLASS 1 (U.S. CLS. 1, 5, 6, 10, 26 AND 46).

FIRST USE 3-30-2001; IN COMMERCE 6-20-2001.

FOR: WATER PUMPS FOR USE IN FRESH WATER PONDS; AERATORS, IN CLASS 7 (U.S. CLS. 13, 19, 21, 23, 31, 34 AND 35).

FIRST USE 3-30-2001; IN COMMERCE 6-20-2001.

FOR: WATER FILTERS; FRESH WATER POND CLEANING DEVICES, NAMELY, SKIMMERS; UNDERWATER LIGHTING FIXTURES; WATER PURIFYING APPARATUS, NAMELY, UV CLARIFIERS, IN CLASS 11 (U.S. CLS. 13, 21, 23, 31 AND 34).

FIRST USE 3-30-2001; IN COMMERCE 6-20-2001.

FOR: RETAIL STORE SERVICES FEATURING FRESH WATER POND KITS, CLEANING SUPPLIES AND MAINTENANCE KITS, IN CLASS 35 (U.S. CLS. 100, 101 AND 102).

FIRST USE 3-30-2001; IN COMMERCE 6-20-2001.

NO CLAIM IS MADE TO THE EXCLUSIVE RIGHT TO USE "WATERGARDENS", APART FROM THE MARK AS SHOWN.

THE MARK CONSISTS OF TWO FISH SWIMMING IN A POND WITH WATER FLOWERS AND THE WORDS "RUSSELL WATERGARDENS".

SER. NO. 77-198,361, FILED 6-5-2007.

CYNTHIA SLOAN, EXAMINING ATTORNEY



**Int. Cl.: 28**

**Prior U.S. Cls.: 22, 23, 38 and 50**

**United States Patent and Trademark Office**

**Reg. No. 3,465,759**

**Registered July 15, 2008**

**TRADEMARK  
PRINCIPAL REGISTER**

**MDGOLF**

GOLF NETWORK (NORTHERN IRELAND  
PARTNERSHIP)  
UNIT 6, RATHENRAW INDUSTRIAL ESTATE  
ANTRIM, UNITED KINGDOM BT412SJ

FOR: GOLF CLUBS; COVERS FOR GOLF CLUBS;  
GOLF BALLS, GOLF GLOVES; GOLF CLUB BAGS;  
GOLF CLUB GRIPS; GOLF CLUB HEADS; GOLF  
CLUB SHAFTS; GOLF MATS; GOLF PUTTERS;  
STANDS FOR GOLF BAGS; AND TROLLEY BAGS  
FOR GOLF EQUIPMENT, IN CLASS 28 (U.S. CLS. 22,  
23, 38 AND 50).

FIRST USE 1-1-1999; IN COMMERCE 6-1-2005.

THE MARK CONSISTS OF STANDARD CHAR-  
ACTERS WITHOUT CLAIM TO ANY PARTICULAR  
FONT, STYLE, SIZE, OR COLOR.

SER. NO. 77-198,725, FILED 6-6-2007.

TINA L. SNAPP, EXAMINING ATTORNEY

**Int. Cl.: 41**

**Prior U.S. Cls.: 100, 101 and 107**

**United States Patent and Trademark Office**

**Reg. No. 3,465,760**

**Registered July 15, 2008**

**SERVICE MARK  
PRINCIPAL REGISTER**

**TOTAL HOCKEY**

TOTAL HOCKEY WORLDWIDE, LLC (MINNE-  
SOTA LTD LIAB CO)  
SUITE 175  
2015 SILVER BELL ROAD  
EAGAN, MN 55122

FOR: HOCKEY INSTRUCTION; HOCKEY  
CAMPS, IN CLASS 41 (U.S. CLS. 100, 101 AND 107).

FIRST USE 11-0-2002; IN COMMERCE 11-0-2002.

THE MARK CONSISTS OF STANDARD CHAR-  
ACTERS WITHOUT CLAIM TO ANY PARTICULAR  
FONT, STYLE, SIZE, OR COLOR.

NO CLAIM IS MADE TO THE EXCLUSIVE  
RIGHT TO USE HOCKEY, APART FROM THE  
MARK AS SHOWN.

SER. NO. 77-198,899, FILED 6-6-2007.

WANDA KAY PRICE, EXAMINING ATTORNEY

**Int. Cl.: 41**

**Prior U.S. Cls.: 100, 101 and 107**

**United States Patent and Trademark Office**

**Reg. No. 3,465,761**

**Registered July 15, 2008**

**SERVICE MARK  
PRINCIPAL REGISTER**

**TOTAL HOCKEY TRAINING  
SYSTEMS**

TOTAL HOCKEY WORLDWIDE, LLC (MINNE-  
SOTA LTD LIAB CO)  
SUITE 175  
2015 SILVER BELL ROAD  
EAGAN, MN 55122

FOR: HOCKEY INSTRUCTION; HOCKEY  
CAMPS, IN CLASS 41 (U.S. CLS. 100, 101 AND 107).

FIRST USE 1-0-2004; IN COMMERCE 1-0-2004.

THE MARK CONSISTS OF STANDARD CHAR-  
ACTERS WITHOUT CLAIM TO ANY PARTICULAR  
FONT, STYLE, SIZE, OR COLOR.

NO CLAIM IS MADE TO THE EXCLUSIVE  
RIGHT TO USE "HOCKEY TRAINING SYSTEMS",  
APART FROM THE MARK AS SHOWN.

SER. NO. 77-199,031, FILED 6-6-2007.

WANDA KAY PRICE, EXAMINING ATTORNEY

**Int. Cl.: 29**

**Prior U.S. Cl.: 46**

**United States Patent and Trademark Office**

**Reg. No. 3,465,762**

**Registered July 15, 2008**

**TRADEMARK  
PRINCIPAL REGISTER**



LIBERTY BRAND PRODUCTS INC./LES PRO-  
DUCTS DE MARQUE LIBERTE INC. (CANA-  
DA CORPORATION)

1 LIBERTE AVENUE

CANDIAC, QUEBEC, CANADA J5R3X8

FOR: YOGURT, IN CLASS 29 (U.S. CL. 46).

FIRST USE 5-4-2007; IN COMMERCE 5-4-2007.

NO CLAIM IS MADE TO THE EXCLUSIVE  
RIGHT TO USE "PEAR", APART FROM THE MARK  
AS SHOWN.

THE MARK CONSISTS OF A "PEAR" IN FRONT  
OF A SHAFT OF WHEAT WITH THE WORD "PEAR"  
IN A BANNER IN FRONT OF A "PEAR".

SER. NO. 77-199,180, FILED 6-6-2007.

JENNIFER VASQUEZ, EXAMINING ATTORNEY

**Int. Cls.: 35 and 36**

**Prior U.S. Cls.: 100, 101 and 102**

**United States Patent and Trademark Office**

**Reg. No. 3,465,763**

**Registered July 15, 2008**

**SERVICE MARK  
PRINCIPAL REGISTER**



THE HAVI GROUP LIMITED PARTNERSHIP  
(DELAWARE LIMITED PARTNERSHIP)  
SUITE 400  
3010 HIGHLAND PARKWAY  
DOWNERS GROVE, IL 60515

FOR: BUSINESS MANAGEMENT SERVICES IN THE FIELD OF PROJECT MANAGEMENT FOR OTHERS; BUSINESS CONSULTING SERVICES RELATING TO BUDGETING, SUPPLY PLANNING, LOGISTICS, INVENTORY MONITORING, ORDERS AND PRODUCT ALLOCATION; PROMOTION AND MARKETING SERVICES AND RELATED CONSULTING, IN CLASS 35 (U.S. CLS. 100, 101 AND 102).

FIRST USE 1-1-2006; IN COMMERCE 1-1-2006.

FOR: FINANCIAL ANALYSIS AND CONSULTATION, IN CLASS 36 (U.S. CLS. 100, 101 AND 102).

FIRST USE 1-1-2006; IN COMMERCE 1-1-2006.

NO CLAIM IS MADE TO THE EXCLUSIVE RIGHT TO USE "GLOBAL SOLUTIONS", APART FROM THE MARK AS SHOWN.

THE MARK CONSISTS OF A GLOBE THAT HAS A FRAME TO THE LEFT OF IT. THE WORDS "IPL" APPEAR TO THE RIGHT OF THE GLOBE. THE WORDS "HAVI GLOBAL SOLUTIONS" APPEAR UNDER "IPL."

SER. NO. 77-199,242, FILED 6-6-2007.

ELLEN B. AWRICH, EXAMINING ATTORNEY

Int. Cl.: 3

Prior U.S. Cls.: 1, 4, 6, 50, 51 and 52

United States Patent and Trademark Office

Reg. No. 3,465,764

Registered July 15, 2008

TRADEMARK  
PRINCIPAL REGISTER



TA YANG BUSINESS STORE (TAIWAN CORPORATION)  
HAN-SHENG EAST RD., BAAN CHYAU CITY  
5F, NO. 18, ALLEY 17, LANE 193  
TAIPEI HSIEN, TAIWAN

FOR: FUMIGATING INCENSES, INCENSE, INCENSE STICKS, IN CLASS 3 (U.S. CLS. 1, 4, 6, 50, 51 AND 52).

FIRST USE 7-10-1997; IN COMMERCE 7-10-1997.

NO CLAIM IS MADE TO THE EXCLUSIVE RIGHT TO USE THE CHINESE CHARACTER THAT MEANS "INCENSE", APART FROM THE MARK AS SHOWN.

THE COLOR(S) GREEN, YELLOW, RED, ORANGE, BLACK AND WHITE IS/ARE CLAIMED AS A FEATURE OF THE MARK.

THE MARK CONSISTS OF THE COLOR GREEN IS APPLIED TO GENERALLY SQUARE BACKGROUND, THE COLOR YELLOW IS APPLIED TO

THE THREE CHINESE CHARACTERS, THE COLORS RED AND ORANGE ARE APPLIED TO THE DESIGN OF FLAMES, THE COLOR BLACK IS APPLIED TO THE OBJECTS IN THE FLAMES AND BEHIND THE FLAMES, AND THE COLOR WHITE IS APPLIED TO THE SKY BEHIND THE FLAMES.

THE TOP TWO CHARACTERS, FROM TOP TO BOTTOM, TAKEN TOGETHER MAY BE TRANSLATED AS "TO REMOVE OBSTRUCTION; TO SAVE FROM MISFORTUNE OR DISASTER; TO REMIT SIN OR PUNISHMENT; TO DO AWAY WITH EVIL; TO EXORCIZE; EVIL MUST BE COMPLETELY ERADICATED" IN ENGLISH. THE THIRD AND LAST CHARACTER TRANSLATES AS "INCENSE" IN ENGLISH.

THE NON-LATIN CHARACTERS IN THE MARK TRANSLITERATE TO "CHU ZHANG XIANG."

SER. NO. 77-199,272, FILED 6-6-2007.

ATTIYA MALIK, EXAMINING ATTORNEY

**Int. Cl.: 36**

**Prior U.S. Cls.: 100, 101 and 102**

**United States Patent and Trademark Office**

**Reg. No. 3,465,765**

**Registered July 15, 2008**

**SERVICE MARK  
PRINCIPAL REGISTER**

**STERLING MONEY-ONLY**

STERLING NATIONAL BANK (UNITED STATES  
CHARTERED BANK)

650 FIFTH AVENUE, 4TH FLOOR

NEW YORK, NY 10019

FOR: PAYROLL FUNDING SERVICES, IN CLASS  
36 (U.S. CLS. 100, 101 AND 102).

FIRST USE 3-1-2007; IN COMMERCE 3-1-2007.

THE MARK CONSISTS OF STANDARD CHAR-  
ACTERS WITHOUT CLAIM TO ANY PARTICULAR  
FONT, STYLE, SIZE, OR COLOR.

NO CLAIM IS MADE TO THE EXCLUSIVE  
RIGHT TO USE "MONEY-ONLY", APART FROM  
THE MARK AS SHOWN.

SER. NO. 77-199,462, FILED 6-6-2007.

JENNIFER MARTIN, EXAMINING ATTORNEY

**Int. Cl.: 7**

**Prior U.S. Cls.: 13, 19, 21, 23, 31, 34 and 35**

**United States Patent and Trademark Office**

**Reg. No. 3,465,766**

**Registered July 15, 2008**

**TRADEMARK  
PRINCIPAL REGISTER**



THE REDD GROUP LLC. (CALIFORNIA LTD  
LIAB CO)  
3685 MT. DIABLO BLVD SUITE 255  
LAFAYETTE, CA 94549

FOR: POWER-OPERATED TOOLS, NAMELY,  
BUFFERS; POWER-OPERATED TOOLS, NAMELY,  
GRINDERS; GRINDING TOOLS FOR GRINDING  
MACHINES, IN CLASS 7 (U.S. CLS. 13, 19, 21, 23, 31, 34  
AND 35).

FIRST USE 0-0-2006; IN COMMERCE 0-0-2006.

NO CLAIM IS MADE TO THE EXCLUSIVE  
RIGHT TO USE "GLASS", APART FROM THE  
MARK AS SHOWN.

THE COLOR(S) BLACK, WHITE AND BLUE IS/  
ARE CLAIMED AS A FEATURE OF THE MARK.

THE WORD "GLASS" IS BLACK. THE WORD  
"RENU" IS WHITE. THE RECTANGLE IS BLUE.  
THE STAR IS WHITE. THE MARK APPEARS ON A  
TRANSPARENT BACKGROUND, AND NO OTHER  
COLOR IS CLAIMED AS A FEATURE OF THE  
MARK.

SER. NO. 77-199,693, FILED 6-6-2007.

DAVID MILLER, EXAMINING ATTORNEY



**Int. Cl.: 7**

**Prior U.S. Cls.: 13, 19, 21, 23, 31, 34 and 35**

**Reg. No. 3,465,767**

**United States Patent and Trademark Office**

**Registered July 15, 2008**

---

**TRADEMARK  
PRINCIPAL REGISTER**

**MONSOON**

P.E.P. TECHNOLOGIES, INTERNATIONAL, LLC  
(FLORIDA LTD LIAB CO), AKA PROACTIVE  
ENVIRONMENTAL PRODUCTS  
1787 LAKEWOOD RANCH BLVD., SUITE 113  
BRADENTON, FL 34211

THE MARK CONSISTS OF STANDARD CHAR-  
ACTERS WITHOUT CLAIM TO ANY PARTICULAR  
FONT, STYLE, SIZE, OR COLOR.

FOR: SUBMERSIBLE ELECTRIC WATER PUMPS  
FOR GROUNDWATER TESTING, IN CLASS 7 (U.S.  
CLS. 13, 19, 21, 23, 31, 34 AND 35).

SER. NO. 77-199,955, FILED 6-7-2007.

FIRST USE 1-0-2005; IN COMMERCE 1-0-2005.

MIDGE BUTLER, EXAMINING ATTORNEY

**Int. Cls.: 9 and 42**

**Prior U.S. Cls.: 21, 23, 26, 36, 38, 100 and 101**

**United States Patent and Trademark Office**

**Reg. No. 3,465,768**

**Registered July 15, 2008**

**TRADEMARK  
SERVICE MARK  
PRINCIPAL REGISTER**

**54WARD**

5 4WARD INTEGRATED SOLUTIONS LLC (DE-  
LAWARE LTD LIAB CO)  
527 ROUTE 303  
ORANGEBURG, NY 10962

FOR: INTEGRATED AUTOMOTIVE ELECTRO-  
NIC INTERFACE SYSTEMS COMPRISED OF  
HARDWARE, SOFTWARE AND COMPONENTS  
THEREOF, AND CONTAINERS AND HOUSINGS  
THEREFORE, FOR USE IN OPERATING ON-  
BOARD DEVICES, SOFTWARE AND SYSTEMS,  
AND INSTRUCTIONAL MANUALS PROVIDED  
THERewith, IN CLASS 9 (U.S. CLS. 21, 23, 26, 36  
AND 38).

FIRST USE 7-31-2006; IN COMMERCE 7-31-2006.

FOR: TECHNICAL CONSULTING, CUSTOMIZA-  
TION OF COMPUTER HARDWARE AND SOFT-

WARE, DESIGN SERVICES, TECHNICAL SUPPORT  
SERVICES, AND MAINTENANCE AND REPAIR  
SERVICES OF COMPUTER SOFTWARE, IN THE  
FIELD OF INTEGRATED AUTOMOTIVE ELEC-  
TRONIC INTERFACE SYSTEMS FOR USE IN OP-  
ERATING ONBOARD DEVICES, SOFTWARE AND  
SYSTEMS, IN CLASS 42 (U.S. CLS. 100 AND 101).

FIRST USE 7-31-2006; IN COMMERCE 7-31-2006.

THE MARK CONSISTS OF STANDARD CHAR-  
ACTERS WITHOUT CLAIM TO ANY PARTICULAR  
FONT, STYLE, SIZE, OR COLOR.

SER. NO. 77-200,083, FILED 6-7-2007.

ANGELA M. MICHELI, EXAMINING ATTORNEY

**Int. Cl.: 35**

**Prior U.S. Cls.: 100, 101 and 102**

**United States Patent and Trademark Office**

**Reg. No. 3,465,769**

**Registered July 15, 2008**

**SERVICE MARK  
PRINCIPAL REGISTER**

**I NEED A TRUCK**

INTERSTATE ONLINE SOFTWARE, INC. (OHIO  
CORPORATION)  
P.O. BOX 2303  
HEATH, OH 43056

THE MARK CONSISTS OF STANDARD CHAR-  
ACTERS WITHOUT CLAIM TO ANY PARTICULAR  
FONT, STYLE, SIZE, OR COLOR.

FOR: ADVERTISING SERVICES, NAMELY, PRO-  
VIDING INFORMATION AS TO THE AVAILABIL-  
ITY OF TRUCKS FOR PURCHASE, IN CLASS 35  
(U.S. CLS. 100, 101 AND 102).

SER. NO. 77-200,205, FILED 6-7-2007.

FIRST USE 4-4-1997; IN COMMERCE 4-4-1997.

BERNICE MIDDLETON, EXAMINING ATTORNEY

**Int. Cl.: 41**

**Prior U.S. Cls.: 100, 101 and 107**

**United States Patent and Trademark Office**

**Reg. No. 3,465,770**

**Registered July 15, 2008**

**SERVICE MARK  
PRINCIPAL REGISTER**

# Professional Nobodies

MENDEZ, PAUL M (UNITED STATES INDIVIDUAL)  
804 SAM CALLOWAY RD  
FORT WORTH, TX 76114 AND  
MENDEZ, MARK A (UNITED STATES INDIVIDUAL)  
3405 BINYON ST.  
FORT WORTH, TX 76133

FOR: ENTERTAINMENT, NAMELY, LIVE PERFORMANCES BY A MUSICAL BAND, IN CLASS 41 (U.S. CLS. 100, 101 AND 107).

FIRST USE 7-1-2004; IN COMMERCE 7-1-2005.

THE MARK CONSISTS OF STANDARD CHARACTERS WITHOUT CLAIM TO ANY PARTICULAR FONT, STYLE, SIZE, OR COLOR.

SER. NO. 77-200,235, FILED 6-7-2007.

SUZANNE BLANE, EXAMINING ATTORNEY

**Int. Cls.: 9 and 15**

**Prior U.S. Cls.: 2, 21, 23, 26, 36 and 38**

**United States Patent and Trademark Office**

**Reg. No. 3,465,771**

**Registered July 15, 2008**

**TRADEMARK  
PRINCIPAL REGISTER**

**MOOG**

MOOG MUSIC, INC. (NORTH CAROLINA CORPORATION)  
2004-E RIVERSIDE DRIVE  
ASHEVILLE, NC 28804

FOR: SOUND FREQUENCY FILTERS FOR CONTROLLING AUDIO PARAMETERS BY RAISING OR LOWERING THE GAIN OF SPECIFIC AUDIO FREQUENCIES USING A MULTIPLE RESONANT FILTER ARRAY AND ANIMATING THOSE FREQUENCIES USING A BUILT-IN PATTERN GENERATOR, IN CLASS 9 (U.S. CLS. 21, 23, 26, 36 AND 38).

FIRST USE 8-31-2002; IN COMMERCE 8-31-2002.

FOR: ELECTRONIC MUSICAL KEYBOARDS; MUSIC SYNTHESIZERS; THEREMINS AND MUSI-

CAL INSTRUMENTS IN GENERAL, IN CLASS 15 (U.S. CLS. 2, 21 AND 36).

FIRST USE 8-31-2002; IN COMMERCE 8-31-2002.

THE MARK CONSISTS OF STANDARD CHARACTERS WITHOUT CLAIM TO ANY PARTICULAR FONT, STYLE, SIZE, OR COLOR.

OWNER OF U.S. REG. NOS. 2,339,224, 2,473,815 AND OTHERS.

SEC. 2(F).

SER. NO. 77-200,300, FILED 6-7-2007.

KELLY MCCOY, EXAMINING ATTORNEY

**Int. Cls.: 35 and 36**

**Prior U.S. Cls.: 100, 101 and 102**

**United States Patent and Trademark Office**

**Reg. No. 3,465,772**

**Registered July 15, 2008**

**SERVICE MARK  
PRINCIPAL REGISTER**

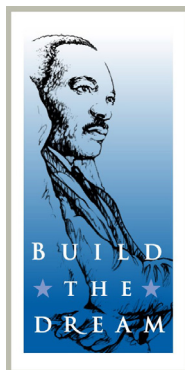

WASHINGTON, DC MARTIN LUTHER KING,  
JR. NATIONAL MEMORIAL PROJECT FOUN-  
DATION, INC. (MARYLAND CORPORATION)  
SUITE 334  
401 F STREET, NW  
WASHINGTON, DC 20001

FOR: PROMOTING THE PUBLIC AWARENESS  
OF THE EFFORTS TO FUND A PUBLIC MEMOR-  
IAL TO DR MARTIN LUTHER KING, JR, PROMOT-  
ING THE PUBLIC AWARENESS OF DR MARTIN  
LUTHER KING'S LIFE, WORK AND VISION OF  
FREEDOM, OPPORTUNITY AND JUSTICE AND  
ACHIEVING SOCIAL CHANGE THROUGH NON-  
VIOLENT MEANS, IN CLASS 35 (U.S. CLS. 100, 101  
AND 102).

FIRST USE 5-0-2003; IN COMMERCE 5-0-2003.

FOR: CHARITABLE FUND RAISING SERVICES,  
IN CLASS 36 (U.S. CLS. 100, 101 AND 102).

FIRST USE 5-0-2003; IN COMMERCE 5-0-2003.

THE NAME(S), PORTRAIT(S), AND/OR SIGNA-  
TURE(S) SHOWN IN THE MARK DOES NOT IDENTI-  
FY A PARTICULAR LIVING INDIVIDUAL.

THE COLOR(S) BLUE, BLACK AND WHITE IS/  
ARE CLAIMED AS A FEATURE OF THE MARK.

"THE MARK CONSISTS OF A PORTRAIT OF THE  
PROFILE OF DR. MARTIN LUTHER KING, JR. AS  
DEPICTED IN THE MONUMENT, IN BLACK, ON  
TOP OF THE LITERAL ELEMENT "BUILD THE  
DREAM" IN WHITE, WHERE THE WORD THE IS  
PRECEDED AND FOLLOWED BY A FIVE-POIN-  
TED STAR IN BLUE. ALL OF THE AFOREMEN-  
TIONED ELEMENTS ARE ENCLOSED WITHIN A  
RECTANGULAR SHAPED WHITE BORDER WITH  
A BLUE BACKGROUND."

SER. NO. 77-200,322, FILED 6-7-2007.

ELISSA GARBER KON, EXAMINING ATTORNEY

Int. Cl.: 42

Prior U.S. Cls.: 100 and 101

United States Patent and Trademark Office

Reg. No. 3,465,773

Registered July 15, 2008

SERVICE MARK  
PRINCIPAL REGISTER



JB+A, INC. (GEORGIA CORPORATION)  
SUITE 400  
700 GALLERIA PARKWAY  
ATLANTA, GA 30339

FOR: LANDSCAPE ARCHITECTURAL DESIGN,  
IN CLASS 42 (U.S. CLS. 100 AND 101).

FIRST USE 9-1-2004; IN COMMERCE 9-1-2004.

NO CLAIM IS MADE TO THE EXCLUSIVE  
RIGHT TO USE "PLANNING" AND "LANDSCAPE

ARCHITECTURE", APART FROM THE MARK AS  
SHOWN.

THE MARK CONSISTS OF LOWER CASE "J",  
UPPER CASE "B", PLUS SYMBOL AND LOWER  
CASE "A" AT THE UPPER RIGHT, ENCLOSED  
WITHIN A STYLIZED SQUARE AND FOLLOWED  
BY THE WORDS "PLANNING + LANDSCAPE  
ARCHITECTURE".

SER. NO. 77-200,470, FILED 6-7-2007.

RUSS HERMAN, EXAMINING ATTORNEY

**Int. Cl.: 25**

**Prior U.S. Cls.: 22 and 39**

**United States Patent and Trademark Office**

**Reg. No. 3,465,774**

**Registered July 15, 2008**

**TRADEMARK  
PRINCIPAL REGISTER**

**MAYU**

MAYU LLC (ILLINOIS LTD LIAB CO)  
211 DENNIS LANE  
GLENCOE, IL 60022

FOR: KNITTED CLOTHING, NAMELY, SWEATERS, SHAWLS, HOODED SHAWLS, SCARVES; HATS, IN CLASS 25 (U.S. CLS. 22 AND 39).

FIRST USE 1-10-2006; IN COMMERCE 2-17-2006.

THE MARK CONSISTS OF STANDARD CHARACTERS WITHOUT CLAIM TO ANY PARTICULAR FONT, STYLE, SIZE, OR COLOR.

THE FOREIGN WORDING IN THE MARK TRANSLATES INTO ENGLISH AS RIVER.

SER. NO. 77-200,528, FILED 6-7-2007.

WILLIAM ROSSMAN, EXAMINING ATTORNEY



**Int. Cl.: 45**

**Prior U.S. Cls.: 100 and 101**

**United States Patent and Trademark Office**

**Reg. No. 3,465,775**

**Registered July 15, 2008**

**SERVICE MARK  
PRINCIPAL REGISTER**



GET US IMMIGRATION HELP.COM (WASHINGTON LTD LIAB CO)  
4684 LOST CREEK LANE  
BELLINGHAM, WA 98229

FOR: PARALEGAL SERVICES, IN CLASS 45 (U.S. CLS. 100 AND 101).

FIRST USE 5-31-2007; IN COMMERCE 5-31-2007.

THE COLOR(S) RED, GREY, AND BLUE IS/ARE CLAIMED AS A FEATURE OF THE MARK.

THE MARK CONSISTS OF THREE STARS ARE LOCATED AT THE TOP OF THE LOGO AND ARE

COLORED AS FOLLOWS: RED, GREY, AND BLUE. USING AKZIDENZ GROTESK EXTRA BOLD CONDENSED TYPE FACE IN ALL CAPS, THE WORD "GET" IS COLORED IN RED; "US" IS COLORED GREY WITH A RED VERTICAL LINE DIVIDING THE TWO LETTERS. "IMMIGRATION" IS COLORED IN BLUE FOLLOWED BY "HELP" COLORED IN RED. "IMMIGRATION" AND "HELP" IS SEPERATED BY A RED VERTICAL LINE. NEXT, ".COM" IS GREY IN COLOR.

SER. NO. 77-200,554, FILED 6-7-2007.

RUDY R. SINGLETON, EXAMINING ATTORNEY

**Int. Cl.: 42**

**Prior U.S. Cls.: 100 and 101**

**United States Patent and Trademark Office**

**Reg. No. 3,465,776**

**Registered July 15, 2008**

**SERVICE MARK  
PRINCIPAL REGISTER**



JB+A, INC. (GEORGIA CORPORATION)  
SUITE 400  
700 GALLERIA PARKWAY  
ATLANTA, GA 30339

FOR: LANDSCAPE ARCHITECTURAL DESIGN,  
IN CLASS 42 (U.S. CLS. 100 AND 101).

FIRST USE 6-1-2007; IN COMMERCE 6-1-2007.

NO CLAIM IS MADE TO THE EXCLUSIVE  
RIGHT TO USE "CITYPARKS" AND "CITYPLA-  
ZAS", APART FROM THE MARK AS SHOWN.

THE MARK CONSISTS OF LOWERCASE "J",  
UPPERCASE "B", PLUS SYMBOL, LOWERCASE  
"A" SURROUNDED BY SQUARE WITH TWO OFF-  
SET RECTANGLES EACH CONTAINING WORDS  
"CITY PARKS" IN ONE "CITY PLAZAS" IN THE  
OTHER RECTANGLE WITH CITY PARKS IS CAP-  
PED WITH A SILLOUETTE OF FAMILIES WALK-  
ING WITH THE WORDS "CELEBRATING YOU  
COMMUNITY" BELOW.

SER. NO. 77-200,557, FILED 6-7-2007.

RUSS HERMAN, EXAMINING ATTORNEY

**Int. Cl.: 9**

**Prior U.S. Cls.: 21, 23, 26, 36 and 38**

**Reg. No. 3,465,777**

**United States Patent and Trademark Office**

**Registered July 15, 2008**

---

**TRADEMARK  
PRINCIPAL REGISTER**

**iPlan**

SOLUTION SYSTEMS INCORPORATED (PENNSYLVANIA CORPORATION)  
SUITE 500  
201 SABINE AVENUE  
NARBERTH, PA 19072

FOR: COMPUTER SOFTWARE FOR PROJECT MANAGEMENT, ONLINE PROJECT MANAGEMENT AND WEB BASED PROJECT MANAGEMENT, IN CLASS 9 (U.S. CLS. 21, 23, 26, 36 AND 38).

FIRST USE 4-24-2007; IN COMMERCE 4-24-2007.

THE MARK CONSISTS OF STANDARD CHARACTERS WITHOUT CLAIM TO ANY PARTICULAR FONT, STYLE, SIZE, OR COLOR.

SER. NO. 77-200,884, FILED 6-7-2007.

BARBARA BROWN, EXAMINING ATTORNEY

**Int. Cl.: 34**

**Prior U.S. Cls.: 2, 8, 9 and 17**

**United States Patent and Trademark Office**

**Reg. No. 3,465,778**

**Registered July 15, 2008**

**TRADEMARK  
PRINCIPAL REGISTER**

**MARLBORO SNUS**

PHILIP MORRIS USA INC. (VIRGINIA CORPORATION)  
6601 WEST BROAD STREET  
RICHMOND, VA 23230

OWNER OF U.S. REG. NOS. 68,502, 938,510 AND OTHERS.

FOR: TOBACCO, RAW OR MANUFACTURED, NAMELY, SNUS TOBACCO, IN CLASS 34 (U.S. CLS. 2, 8, 9 AND 17).

NO CLAIM IS MADE TO THE EXCLUSIVE RIGHT TO USE "SNUS", APART FROM THE MARK AS SHOWN.

FIRST USE 8-6-2007; IN COMMERCE 8-6-2007.

SER. NO. 77-201,264, FILED 6-8-2007.

THE MARK CONSISTS OF STANDARD CHARACTERS WITHOUT CLAIM TO ANY PARTICULAR FONT, STYLE, SIZE, OR COLOR.

DANNEAN HETZEL, EXAMINING ATTORNEY

**Int. Cl.: 41**

**Prior U.S. Cls.: 100, 101 and 107**

**United States Patent and Trademark Office**

**Reg. No. 3,465,779**

**Registered July 15, 2008**

**SERVICE MARK  
PRINCIPAL REGISTER**

**TIME WARNER PRODUCTIONS  
KANSAS CITY**

TIME WARNER CABLE INC. (DELAWARE COR-  
PORATION)  
290 HARBOR DRIVE  
STAMFORD, CT 06902

FOR: PRODUCTION OF VIDEOS FOR OTHERS,  
NAMELY VIDEOTAPES AND DVDS, IN CLASS 41  
(U.S. CLS. 100, 101 AND 107).

FIRST USE 7-1-1998; IN COMMERCE 7-1-1998.

THE MARK CONSISTS OF STANDARD CHAR-  
ACTERS WITHOUT CLAIM TO ANY PARTICULAR  
FONT, STYLE, SIZE, OR COLOR.

NO CLAIM IS MADE TO THE EXCLUSIVE  
RIGHT TO USE "PRODUCTIONS KANSAS CITY",  
APART FROM THE MARK AS SHOWN.

SER. NO. 77-201,357, FILED 6-8-2007.

LA TONIA FISHER, EXAMINING ATTORNEY

**Int. Cl.: 41**

**Prior U.S. Cls.: 100, 101 and 107**

**Reg. No. 3,465,780**

**United States Patent and Trademark Office**

**Registered July 15, 2008**

**SERVICE MARK  
PRINCIPAL REGISTER**



TIME WARNER CABLE INC. (DELAWARE CORPORATION)  
290 HARBOR DRIVE  
STAMFORD, CT 06902

FOR: PRODUCTION OF VIDEOS FOR OTHERS, NAMELY VIDEOTAPES AND DVDS, IN CLASS 41 (U.S. CLS. 100, 101 AND 107).

FIRST USE 7-1-1998; IN COMMERCE 7-1-1998.

NO CLAIM IS MADE TO THE EXCLUSIVE RIGHT TO USE "PRODUCTIONS KANSAS CITY", APART FROM THE MARK AS SHOWN.

THE MARK CONSISTS OF SPIRAL SYMBOL TO LEFT OF WORKS "TIME WARNER PRODUCTIONS KANSAS CITY."

SER. NO. 77-201,381, FILED 6-8-2007.

LA TONIA FISHER, EXAMINING ATTORNEY

**Int. Cl.: 35**

**Prior U.S. Cls.: 100, 101 and 102**

**United States Patent and Trademark Office**

**Reg. No. 3,465,781**

**Registered July 15, 2008**

**SERVICE MARK  
PRINCIPAL REGISTER**

## Reviewing the Reviews

ABOUT, INC. (DELAWARE CORPORATION)  
249 W. 17TH STREET  
NEW YORK, NY 10011

FOR: PROVIDING CONSUMER INFORMATION THROUGH META-REVIEWS FEATURING CONSUMER REVIEWS OF PRODUCTS AND SERVICES AND COMPILATION AND COMMENTS OF REVIEWS OF PRODUCTS AND SERVICES VIA THE INTERNET; PROMOTING THE GOODS AND SERVICES OF OTHERS BY PROVIDING A WEBSITE FEATURING PRICE-COMPARISON INFORMATION, PRODUCT REVIEWS, LINKS TO THE RETAIL WEBSITES OF OTHERS, AND DISCOUNT INFORMATION; PROMOTING THE GOODS AND

SERVICES OF OTHERS BY MEANS OF OPERATING AN ON-LINE SHOPPING MALL WITH LINKS TO THE RETAIL WEB SITES OF OTHERS, IN CLASS 35 (U.S. CLS. 100, 101 AND 102).

FIRST USE 6-0-2000; IN COMMERCE 6-0-2000.

THE MARK CONSISTS OF STANDARD CHARACTERS WITHOUT CLAIM TO ANY PARTICULAR FONT, STYLE, SIZE, OR COLOR.

SER. NO. 77-201,416, FILED 6-8-2007.

ALLISON HOLTZ, EXAMINING ATTORNEY

**Int. Cl.: 41**

**Prior U.S. Cls.: 100, 101 and 107**

**United States Patent and Trademark Office**

**Reg. No. 3,465,782**

**Registered July 15, 2008**

**SERVICE MARK  
PRINCIPAL REGISTER**



REO SPEEDWAGON, INC. (CALIFORNIA CORPORATION)  
AZOFF MUSIC MGT, 1100 GLENDON AVE, #2000  
LOS ANGELES, CA 90024

FOR: ENTERTAINMENT SERVICES IN THE NAME OF LIVE PERFORMANCES AND PERSONAL APPEARANCES BY A MUSICAL ARTIST; AUDIO AND VIDEO RECORDING SERVICES; ENTERTAINMENT IN THE NATURE OF CONTINUING TELEVISION AND RADIO PROGRAMS IN THE FIELD OF VARIETY, COMEDY AND MUSIC; ENTERTAINMENT, NAMELY, PRODUCTION OF LIVE THEATRICAL SHOWS, LIVE MUSICAL SHOWS, CONCERTS AND RADIO AND TELEVISION PROGRAMS; PRODUCTION OF MUSICAL AUDIO RECORDINGS AND MUSICAL VIDEO RECORDINGS; FILM AND TELEVISION STUDIOS AND RECORDING STUDIOS; MUSIC PUBLISHING SERVICES; PRODUCTION AND DISTRIBUTION OF MOTION PICTURES; EDUCATIONAL SERVICES, NAMELY, CONDUCTING SEMINARS AND CONFERENCES IN THE FIELD OF ENTERTAINMENT

AND MUSIC; CONDUCTING ENTERTAINMENT EXHIBITIONS IN THE NATURE OF MUSICAL SHOWS; PUBLICATION OF BOOKS AND MAGAZINES, IN CLASS 41 (U.S. CLS. 100, 101 AND 107).

FIRST USE 12-1-1969; IN COMMERCE 12-1-1969.

OWNER OF U.S. REG. NOS. 1,431,535, 1,453,266, AND 1,454,967.

THE MARK CONSISTS OF THREE CONCENTRIC CIRCLES WITH THE STYLIZED LETTERS "REO" IN THE CENTER CIRCLE. THE TERM "SPEED" APPEARS ABOVE THE CENTER CIRCLE AND THE TERM "WAGON" APPEARS BELOW IT. A PAIR OF WINGS APPEARS ON EITHER SIDE OF THE CENTER CIRCLE NEXT TO THE "R" AND THE "O" OF "REO".

SER. NO. 77-201,427, FILED 6-8-2007.

SONYA STEPHENS, EXAMINING ATTORNEY



**Int. Cl.: 35**

**Prior U.S. Cls.: 100, 101 and 102**

**United States Patent and Trademark Office**

**Reg. No. 3,465,783**

**Registered July 15, 2008**

**SERVICE MARK  
PRINCIPAL REGISTER**

## Reviewing the Reviewers

ABOUT, INC. (DELAWARE CORPORATION)  
249 W. 17TH STREET  
NEW YORK, NY 10011

FOR: PROVIDING CONSUMER INFORMATION THROUGH META-REVIEWS FEATURING CONSUMER REVIEWS OF PRODUCTS AND SERVICES AND COMPILATION AND COMMENTS OF REVIEWS OF PRODUCTS AND SERVICES VIA THE INTERNET; PROMOTING THE GOODS AND SERVICES OF OTHERS BY PROVIDING A WEBSITE FEATURING PRICE-COMPARISON INFORMATION, PRODUCT REVIEWS, LINKS TO THE RETAIL WEBSITES OF OTHERS, AND DISCOUNT INFORMATION; PROMOTING THE GOODS AND

SERVICES OF OTHERS BY MEANS OF OPERATING AN ON-LINE SHOPPING MALL WITH LINKS TO THE RETAIL WEB SITES OF OTHERS, IN CLASS 35 (U.S. CLS. 100, 101 AND 102).

FIRST USE 6-0-2000; IN COMMERCE 6-0-2000.

THE MARK CONSISTS OF STANDARD CHARACTERS WITHOUT CLAIM TO ANY PARTICULAR FONT, STYLE, SIZE, OR COLOR.

SER. NO. 77-201,454, FILED 6-8-2007.

ALLISON HOLTZ, EXAMINING ATTORNEY

**Int. Cl.: 16**

**Prior U.S. Cls.: 2, 5, 22, 23, 29, 37, 38 and 50**

**Reg. No. 3,465,784**

**United States Patent and Trademark Office**

**Registered July 15, 2008**

**TRADEMARK  
PRINCIPAL REGISTER**

**THE WAY OF PILGRIMAGE**

THE UPPER ROOM (TENNESSEE NON-PROFIT CORPORATION)  
P.O. BOX 340004  
1908 GRAND AVENUE  
NASHVILLE, TN 372030004

FORMATION, PRAYER, RELIGION, RELIGIOUS CONGREGATIONS, RELIGIOUS EDUCATION, SPIRITUALITY, AND SPIRITUAL GROWTH; PENS, IN CLASS 16 (U.S. CLS. 2, 5, 22, 23, 29, 37, 38 AND 50).

FOR: PRINTED PUBLICATIONS, NAMELY, BOOKLETS, GUIDEBOOKS, STUDY GUIDES, TRAINING AND INSTRUCTIONAL MATERIALS, AND WORKBOOKS, IN THE FIELDS OF CHRISTIANITY, CHRISTIAN, RELIGIOUS AND SPIRITUAL DEVELOPMENT, CHRISTIAN, RELIGIOUS AND SPIRITUAL MINISTRY, CONGREGATIONAL, INSPIRATIONAL AND RELIGIOUS PROGRAMS, DEVOTIONAL TOPICS, PERSONAL DEVELOPMENT, PERSONAL PIETY, PERSONAL TRANS-

FIRST USE 3-0-2007; IN COMMERCE 3-0-2007.

THE MARK CONSISTS OF STANDARD CHARACTERS WITHOUT CLAIM TO ANY PARTICULAR FONT, STYLE, SIZE, OR COLOR.

SER. NO. 77-201,499, FILED 6-8-2007.

DAVID TAYLOR, EXAMINING ATTORNEY

**Int. Cl.: 12**

**Prior U.S. Cls.: 19, 21, 23, 31, 35 and 44**

**Reg. No. 3,465,785**

**United States Patent and Trademark Office**

**Registered July 15, 2008**

---

**TRADEMARK  
PRINCIPAL REGISTER**

**ROCKER FLARES**

CRE PRODUCTS, LLC (UTAH LTD LIAB CO)  
SUITE 17  
255 NORTH 950 WEST  
LOGAN, UT 84321

FOR: GUARDS FOR PROTECTING ROCKER  
PANELS OF VEHICLES, IN CLASS 12 (U.S. CLS. 19,  
21, 23, 31, 35 AND 44).

FIRST USE 1-1-1989; IN COMMERCE 1-1-1989.

THE MARK CONSISTS OF STANDARD CHAR-  
ACTERS WITHOUT CLAIM TO ANY PARTICULAR  
FONT, STYLE, SIZE, OR COLOR.

NO CLAIM IS MADE TO THE EXCLUSIVE  
RIGHT TO USE "ROCKER", APART FROM THE  
MARK AS SHOWN.

SER. NO. 77-201,967, FILED 6-8-2007.

RONALD AIKENS, EXAMINING ATTORNEY

**Int. Cl.: 40**

**Prior U.S. Cls.: 100, 103 and 106**

**United States Patent and Trademark Office**

**Reg. No. 3,465,786**

**Registered July 15, 2008**

**SERVICE MARK  
PRINCIPAL REGISTER**



ENTENTE SPIRITS, LLC (MICHIGAN LTD LIAB  
CO)  
10983 HILLS ROAD  
BARODA, MI 49101

FOR: WINERY SERVICES, IN CLASS 40 (U.S. CLS.  
100, 103 AND 106).

FIRST USE 10-17-2002; IN COMMERCE 8-15-2003.

NO CLAIM IS MADE TO THE EXCLUSIVE  
RIGHT TO USE "WINERY" , APART FROM THE  
MARK AS SHOWN.

THE MARK CONSISTS OF A STYLIZED DESIGN  
OF A ROUND BUILDING ABOVE THE WORDING  
THE ROUND BARN WINERY.

SER. NO. 77-202,192, FILED 6-9-2007.

ALEXANDER L. POWERS, EXAMINING ATTOR-  
NEY

Int. Cl.: 44

Prior U.S. Cls.: 100 and 101

United States Patent and Trademark Office

Reg. No. 3,465,787

Registered July 15, 2008

**SERVICE MARK  
PRINCIPAL REGISTER**



DELAMAR, LINDA M. (UNITED STATES INDIVIDUAL)

109 WOOLMANS LANE

MOUNT LAUREL, NJ 08054

FOR: HYPNOSIS; REIKI; NAMELY PROVIDING IN-PERSON ENERGY HEALING SERVICES, IN CLASS 44 (U.S. CLS. 100 AND 101).

FIRST USE 6-1-2007; IN COMMERCE 6-1-2007.

THE COLOR(S) PURPLE AND BLACK IS/ARE CLAIMED AS A FEATURE OF THE MARK.

THE MARK CONSISTS OF THE WORDS "THE MINDFUL CORNER" IN PURPLE AND CHINESE CHARACTERS IN BLACK.

THE NON-LATIN CHARACTERS IN THE MARK transliterate to "ZHENG NIAN" AND "LING QI," AND THIS MEANS "RIGHT THOUGHT, RIGHT IDEA, RIGHT INTENTION, MINDFULNESS, UNIVERSAL LIFE FORCE ENERGY, AND BEST ENERGY" IN ENGLISH.

SER. NO. 77-202,269, FILED 6-10-2007.

SANI KHOURI, EXAMINING ATTORNEY

Int. Cl.: 36

Prior U.S. Cls.: 100, 101 and 102

United States Patent and Trademark Office

Reg. No. 3,465,788

Registered July 15, 2008

**SERVICE MARK  
PRINCIPAL REGISTER**

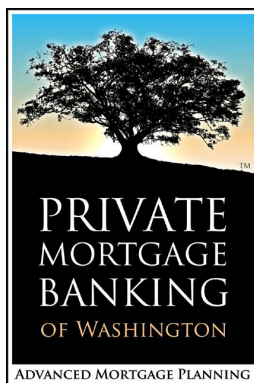

RIELLY, GREGORY D. (UNITED STATES INDIVIDUAL)  
1516 RUCKER AVENUE  
EVERETT, WA 98201

FOR: FINANCIAL SERVICES, NAMELY, MORTGAGE PLANNING, IN CLASS 36 (U.S. CLS. 100, 101 AND 102).

FIRST USE 5-15-2007; IN COMMERCE 5-15-2007.

NO CLAIM IS MADE TO THE EXCLUSIVE RIGHT TO USE "PRIVATE MORTGAGE BANKING OF WASHINGTON AND ADVANCED MORTGAGE PLANNING", APART FROM THE MARK AS SHOWN.

THE COLOR(S) BLACK, BLUE, ORANGE, YELLOW AND WHITE IS/ARE CLAIMED AS A FEATURE OF THE MARK.

THE MARK CONSISTS OF A RECTANGLE WITH A BLACK OUTSIDE BORDER AND A WHITE INSIDE BORDER, A SMALLER RECTANGLE APPEARS INSIDE THE BORDER WITH THE TOP THIRD OF THE RECTANGLE ILLUSTRATING A BLACK TREE SILHOUETTED AGAINST A BLUE SKY TURNING INTO ORANGE WITH A YELLOW SUN, THE LOWER TWO-THIRDS OF THE INSIDE RECTANGLE IS A BLACK FOREGROUND WITH THE WORDING "PRIVATE MORTGAGE BANKING" IN WHITE AND "OF WASHINGTON" IN ORANGE, BELOW THE INSIDE RECTANGLE APPEARS A SMALL WHITE RECTANGLE WITH THE WORDING "ADVANCED MORTGAGE PLANNING" IN BLACK.

SER. NO. 77-202,342, FILED 6-11-2007.

JEFF DEFORD, EXAMINING ATTORNEY

**Int. Cl.: 35**

**Prior U.S. Cls.: 100, 101 and 102**

**United States Patent and Trademark Office**

**Reg. No. 3,465,789**

**Registered July 15, 2008**

**SERVICE MARK  
PRINCIPAL REGISTER**



QCORPS RESIDENTIAL, INC. (DELAWARE CORPORATION)  
5333 WESTHEIMER ROAD, SUITE 1000  
HOUSTON, TX 770565411

FOR: ELECTRONIC FACILITATION OF BUSINESS FUNCTIONS IN THE AREAS OF INITIATION, TERMINATION, TRANSFER AND PURCHASE OF UTILITIES AND OTHER SERVICES AND PRODUCTS, NAMELY, ELECTRICITY, NATURAL GAS, METERED WATER, LOCAL TELEPHONE, LONG DISTANCE TELEPHONE, CABLE TELEVISION, SATELLITE TELEVISION, DIAL-UP INTERNET ACCESS, CABLE INTERNET ACCESS, BROADBAND, WIRELESS AND CELLULAR TELEPHONE, SECURITY SYSTEM MONITORING, CHANGE OF ADDRESS, POST OFFICE BOX RENTAL, FURNITURE, FURNITURE RENTAL, APPLIANCE, APPLIANCE RENTALS, STORAGE FACILITY RENTAL, MOVING COMPANY SERVICES, PET CARE, CHILD CARE, BOTTLED WATER, MAGAZINES, LOCAL NEWSPAPERS, NATIONAL NEWSPAPERS, GENERAL DELIVERY SERVICES, GROCERY DELIVERY, PARKING, CLUB MEMBERSHIPS, AUTOMOBILE AND TRUCK RENTAL, DRY CLEANING, PREPARED FOOD DELIVERY, INSURANCE, HOUSEKEEPING SERVICES, DRIVER'S LICENSE RENEWAL, AUTOMOBILE

REGISTRATION, AUTOMOBILE TOLL ROAD PASSES, VOTER REGISTRATION, FINANCIAL SERVICES, BANKING SERVICES, WAKE UP/REMINDER SERVICES, REPAIR AND MAINTENANCE, TOGETHER WITH ANY SUBSETS AND COMBINATIONS OF SUCH SERVICES, ALL OF WHICH ARE PROVIDED VIA THE GLOBAL COMPUTER NETWORK TO RESIDENTS AND PERSONS INTENDING TO BECOME RESIDENTS OF MULTI-FAMILY RESIDENTIAL HOUSING COMMUNITIES, COOPERATIVES, CONDOMINIUMS AND OTHER SIMILAR FACILITIES, AND RESIDENTS AND PERSONS INTENDING TO BECOME RESIDENTS OF SINGLE FAMILY RESIDENCES, IN CLASS 35 (U.S. CLS. 100, 101 AND 102).

FIRST USE 3-9-2007; IN COMMERCE 3-9-2007.

OWNER OF U.S. REG. NO. 3,143,443.

THE MARK CONSISTS OF A HOUSE WITH A FENCE IN FRONT INSIDE A CIRCLE, BESIDE THE PICTURE ARE THE WORDS "WHITEFENCE".

SER. NO. 77-202,427, FILED 6-11-2007.

EUGENIA MARTIN, EXAMINING ATTORNEY

Int. Cl.: 35

Prior U.S. Cls.: 100, 101 and 102

United States Patent and Trademark Office

Reg. No. 3,465,790

Registered July 15, 2008

SERVICE MARK  
PRINCIPAL REGISTER



QCORPS RESIDENTIAL, INC. (DELAWARE CORPORATION)  
5333 WESTHEIMER ROAD, SUITE 1000  
HOUSTON, TX 770565411

FOR: ELECTRONIC FACILITATION OF BUSINESS FUNCTIONS IN THE AREAS OF INITIATION, TERMINATION, TRANSFER AND PURCHASE OF UTILITIES AND OTHER SERVICES AND PRODUCTS, NAMELY, ELECTRICITY, NATURAL GAS, METERED WATER, LOCAL TELEPHONE, LONG DISTANCE TELEPHONE, CABLE TELEVISION, SATELLITE TELEVISION, DIAL-UP INTERNET ACCESS, CABLE INTERNET ACCESS, BROADBAND, WIRELESS AND CELLULAR TELEPHONE, SECURITY SYSTEM MONITORING, CHANGE OF ADDRESS, POST OFFICE BOX RENTAL, FURNITURE, FURNITURE RENTAL, APPLIANCE, APPLIANCE RENTALS, STORAGE FACILITY RENTAL, MOVING COMPANY SERVICES, PET CARE, CHILD CARE, BOTTLED WATER, MAGAZINES, LOCAL NEWSPAPERS, NATIONAL NEWSPAPERS, GENERAL DELIVERY SERVICES, GROCERY DELIVERY, PARKING, CLUB MEMBERSHIPS, AUTOMOBILE AND TRUCK RENTAL, DRY CLEANING, PREPARED FOOD DELIVERY, INSURANCE, HOUSEKEEPING SERVICES, DRIVER'S LICENSE RENEWAL, AUTOMOBILE REGISTRATION, AUTOMOBILE TOLL ROAD PASSES,

VOTER REGISTRATION, FINANCIAL SERVICES, BANKING SERVICES, WAKE UP/REMINDER SERVICES, REPAIR AND MAINTENANCE, TOGETHER WITH ANY SUBSETS AND COMBINATIONS OF SUCH SERVICES, ALL OF WHICH ARE PROVIDED VIA THE GLOBAL COMPUTER NETWORK TO RESIDENTS AND PERSONS INTENDING TO BECOME RESIDENTS OF MULTI-FAMILY RESIDENTIAL HOUSING COMMUNITIES, COOPERATIVES, CONDOMINIUMS AND OTHER SIMILAR FACILITIES, AND RESIDENTS AND PERSONS INTENDING TO BECOME RESIDENTS OF SINGLE FAMILY RESIDENCES, IN CLASS 35 (U.S. CLS. 100, 101 AND 102).

FIRST USE 3-9-2007; IN COMMERCE 3-9-2007.

OWNER OF U.S. REG. NO. 3,143,443.

THE MARK CONSISTS OF A HOUSE WITH A FENCE IN FRONT INSIDE A CIRCLE, BESIDE THE PICTURE ARE THE WORDS "WHITE FENCE" WITH THE WORDS "YOUR HOME. YOUR LIFE. CONNECTED." BELOW IT.

SER. NO. 77-202,434, FILED 6-11-2007.

EUGENIA MARTIN, EXAMINING ATTORNEY



**Int. Cl.: 1**

**Prior U.S. Cls.: 1, 5, 6, 10, 26 and 46**

**Reg. No. 3,465,791**

**United States Patent and Trademark Office**

**Registered July 15, 2008**

**TRADEMARK  
PRINCIPAL REGISTER**



HENAN HONGYE CHEMICAL COMPANY LTD.  
(CHINA CORPORATION)  
2KM TO THE NORTH OF NANLE COUNTY  
PUYANG CITY, HENAN, CHINA

FOR: THIOUREA; ORGANIC BLEACHING CHEMICALS FOR USE IN THE TEXTILE AND PAPER MAKING INDUSTRY; CHEMICAL AGENTS FOR MANUFACTURING DYESTUFF; SODIUM HYDROSULFITE; THIOUREA DIOXIDE; FORMAMIDINESULFINIC ACID; AMINO IMINO METHANESULFINIC ACID; SODIUM PERBORATE; SODIUM PERCARBONATE; TETRA ACETYL ETHYLENE DIAMINE; FURFURYL ALCOHOL;

FURFURAL; FURAN RESIN; MELAMINE; 2-ETHYL ANTHRAQUINONE; CHEMICAL PULP BLEACHING AGENT FAS, IN CLASS 1 (U.S. CLS. 1, 5, 6, 10, 26 AND 46).

FIRST USE 3-10-2007; IN COMMERCE 3-10-2007.

THE MARK CONSISTS OF THE WORD "HONYE" IN STYLIZED FORM WITH TWO SEMI CIRCLES.

SER. NO. 77-202,507, FILED 6-11-2007.

SHAUNIA CARLYLE, EXAMINING ATTORNEY

**Int. Cl.: 11**

**Prior U.S. Cls.: 13, 21, 23, 31 and 34**

**United States Patent and Trademark Office**

**Reg. No. 3,465,792**

**Registered July 15, 2008**

**TRADEMARK  
PRINCIPAL REGISTER**

**AIDIA**

AIDIA INC. (MICHIGAN CORPORATION)  
5858 NILES DRIVE  
TROY, MI 48098

THE MARK CONSISTS OF STANDARD CHAR-  
ACTERS WITHOUT CLAIM TO ANY PARTICULAR  
FONT, STYLE, SIZE, OR COLOR.

FOR: LAMPS, IN CLASS 11 (U.S. CLS. 13, 21, 23, 31  
AND 34).

SER. NO. 77-202,791, FILED 6-11-2007.

FIRST USE 6-8-2007; IN COMMERCE 6-8-2007.

RUDY R. SINGLETON, EXAMINING ATTORNEY

**Int. Cl.: 35**

**Prior U.S. Cls.: 100, 101 and 102**

**United States Patent and Trademark Office**

**Reg. No. 3,465,793**

**Registered July 15, 2008**

**SERVICE MARK  
PRINCIPAL REGISTER**



COMMONWEALTH EDISON COMPANY (ILLINOIS CORPORATION)  
10 SOUTH DEARBORN STREET  
CHICAGO, IL 60603

FOR: PROMOTING PUBLIC AWARENESS OF THE NEED FOR ENERGY CONSERVATION, ENERGY EFFICIENCY, AND RENEWABLE ENERGY; PROVIDING CUSTOMER INFORMATION IN THE FIELDS OF ENERGY CONSERVATION, ENERGY EFFICIENCY, AND RENEWABLE ENERGY; PROVIDING FINANCIAL ASSISTANCE TO LOW INCOME AND SENIOR UTILITY CUSTOMERS AND PROMOTIONAL EFFORTS DIRECTED THERETO, IN CLASS 35 (U.S. CLS. 100, 101 AND 102).

FIRST USE 7-3-2006; IN COMMERCE 7-3-2006.

NO CLAIM IS MADE TO THE EXCLUSIVE RIGHT TO USE "ENERGY", APART FROM THE MARK AS SHOWN.

THE MARK CONSISTS OF REPRESENTATION OF A LIGHT BULB CONTAINING THE WORD "CARE," AND THE WORDS "CUSTOMERS" AND "RELIABLE" TO THE LEFT SIDE OF THE LIGHT BULB, AND THE WORDS "AFFORDABLE" AND "ENERGY" TO THE RIGHT SIDE OF THE LIGHT BULB.

SER. NO. 77-202,871, FILED 6-11-2007.

PATRICIA EVANKO, EXAMINING ATTORNEY

**Int. Cl.: 35**

**Prior U.S. Cls.: 100, 101 and 102**

**United States Patent and Trademark Office**

**Reg. No. 3,465,794**

**Registered July 15, 2008**

**SERVICE MARK  
PRINCIPAL REGISTER**



COMMONWEALTH EDISON COMPANY (ILLINOIS CORPORATION)  
10 SOUTH DEARBORN STREET  
CHICAGO, IL 60603

FOR: PROMOTING PUBLIC AWARENESS OF THE NEED FOR ENERGY CONSERVATION, ENERGY EFFICIENCY, AND RENEWABLE ENERGY; PROVIDING CUSTOMER INFORMATION IN THE FIELDS OF ENERGY CONSERVATION, ENERGY EFFICIENCY, AND RENEWABLE ENERGY; PROVIDING FINANCIAL ASSISTANCE TO LOW INCOME AND SENIOR UTILITY CUSTOMERS AND PROMOTIONAL EFFORTS DIRECTED THERETO, IN CLASS 35 (U.S. CLS. 100, 101 AND 102).

FIRST USE 7-3-2006; IN COMMERCE 7-3-2006.

NO CLAIM IS MADE TO THE EXCLUSIVE RIGHT TO USE "ENERGY", APART FROM THE MARK AS SHOWN.

THE MARK CONSISTS OF REPRESENTATION OF A LIGHT BULB CONTAINING THE WORD "CARE."

SER. NO. 77-202,896, FILED 6-11-2007.

PATRICIA EVANKO, EXAMINING ATTORNEY

**Int. Cl.: 41**

**Prior U.S. Cls.: 100, 101 and 107**

**United States Patent and Trademark Office**

**Reg. No. 3,465,795**

**Registered July 15, 2008**

**SERVICE MARK  
PRINCIPAL REGISTER**

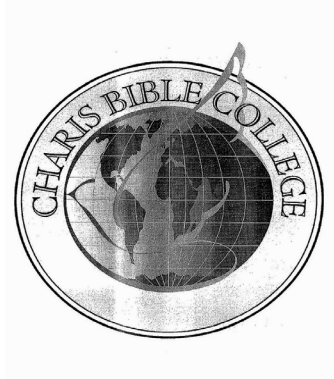

ANDREW WOMMACK MINISTRIES, INC. (COL-  
ORADO CORPORATION)  
850 ELKTON DRIVE  
COLORADO SPRINGS, CO 80907

FOR: EDUCATIONAL SERVICES, NAMELY,  
CONDUCTING CLASSES, SEMINARS, CONFEREN-  
CES, WORKSHOPS AND TRAINING IN THE  
FIELDS OF THE BIBLE AND CHRISTIAN MINIS-  
TRY AND DISTRIBUTION OF COURSE MATERI-  
ALS IN CONNECTION THEREWITH, IN CLASS 41  
(U.S. CLS. 100, 101 AND 107).

FIRST USE 8-13-2002; IN COMMERCE 8-13-2002.

NO CLAIM IS MADE TO THE EXCLUSIVE  
RIGHT TO USE "BIBLE COLLEGE", APART FROM  
THE MARK AS SHOWN.

THE MARK CONSISTS OF AN OUTLINE OF A  
DOVE SUPERIMPOSED OVER AN IMAGE OF THE  
EARTH IN THE CENTER A CIRCULAR SEAL WITH  
THE WORDS "CHARIS BIBLE COLLEGE".

SER. NO. 77-202,946, FILED 6-11-2007.

GIANCARLO CASTRO, EXAMINING ATTORNEY

**Int. Cl.: 39**

**Prior U.S. Cls.: 100 and 105**

**United States Patent and Trademark Office**

**Reg. No. 3,465,796**

**Registered July 15, 2008**

**SERVICE MARK  
PRINCIPAL REGISTER**

The logo consists of the letters "ITLX" in a bold, sans-serif font. The letter "X" is stylized with a white diagonal line running from the top-left to the bottom-right, and a white dotted line running from the top-right to the bottom-left, intersecting at the center of the "X".

INTEGRATED TRANSPORTATION LOGISTICS,  
L.L.C. (MICHIGAN LTD LIAB CO)  
P.O. BOX 7155  
BLOOMFIELD HILLS, MI 48302

FOR: TRANSPORTATION SERVICES EXCLUDING RAILWAY SERVICE, NAMELY, TRANSPORTATION OF GOODS BY LAND VEHICLES; WAREHOUSING SERVICES, IN CLASS 39 (U.S. CLS. 100 AND 105).

FIRST USE 4-17-2000; IN COMMERCE 4-17-2000.

THE MARK CONSISTS OF THE LETTERS "I", "T", "L", "X." THE STYLIZED LETTER "X" CONTAINS A DOTTED LINE IN THE LETTER.

SER. NO. 77-202,964, FILED 6-11-2007.

SHANNON TWOHIG, EXAMINING ATTORNEY

**Int. Cl.: 41**

**Prior U.S. Cls.: 100, 101 and 107**

**United States Patent and Trademark Office**

**Reg. No. 3,465,797**

**Registered July 15, 2008**

**SERVICE MARK  
PRINCIPAL REGISTER**

# Manolay

3 GUY PRODUCTIONS, LLC (NEVADA LTD  
LIAB CO)  
4001 S. DECATUR BLVD., SUITE 37-442  
LAS VEGAS, NV 89103

THE MARK CONSISTS OF STANDARD CHAR-  
ACTERS WITHOUT CLAIM TO ANY PARTICULAR  
FONT, STYLE, SIZE, OR COLOR.

FOR: ENTERTAINMENT SERVICES, NAMELY,  
PROVIDING AN INTERNET WEBSITE FEATUR-  
ING ADULT MOVIES AND ADULT VIDEO CLIPS,  
IN CLASS 41 (U.S. CLS. 100, 101 AND 107).

SER. NO. 77-203,015, FILED 6-11-2007.

FIRST USE 6-1-2007; IN COMMERCE 6-1-2007.

CORY BOONE, EXAMINING ATTORNEY

**Int. Cl.: 41**

**Prior U.S. Cls.: 100, 101 and 107**

**United States Patent and Trademark Office**

**Reg. No. 3,465,798**

**Registered July 15, 2008**

**SERVICE MARK  
PRINCIPAL REGISTER**

**SNEAKER BALL**

GROSS, AL (UNITED STATES INDIVIDUAL)  
PO BOX 9500  
ASPEN, CO 816129500

OWNER OF U.S. REG. NO. 2,460,546.

FOR: CONDUCTING ENTERTAINMENT EXHIBITIONS IN THE NATURE OF BALLROOM DANCES FEATURING FASHION SHOWS, IN CLASS 41 (U.S. CLS. 100, 101 AND 107).

NO CLAIM IS MADE TO THE EXCLUSIVE RIGHT TO USE "BALL", APART FROM THE MARK AS SHOWN.

SEC. 2(F).

FIRST USE 1-1-1988; IN COMMERCE 3-2-1998.

SER. NO. 77-203,452, FILED 6-11-2007.

THE MARK CONSISTS OF STANDARD CHARACTERS WITHOUT CLAIM TO ANY PARTICULAR FONT, STYLE, SIZE, OR COLOR.

REBECCA SMITH, EXAMINING ATTORNEY



**Int. Cl.: 41**

**Prior U.S. Cls.: 100, 101 and 107**

**United States Patent and Trademark Office**

**Reg. No. 3,465,799**

**Registered July 15, 2008**

**SERVICE MARK  
PRINCIPAL REGISTER**

MOHEGAN SUN AT POCONO DOWNS

DOWNS RACING, L.P. (PENNSYLVANIA LIMITED PARTNERSHIP)  
1280 HIGHWAY 315  
WILKES-BARRE, PA 18702

FOR: ENTERTAINMENT, NAMELY, CONDUCTING HORSE RACES AND BETTING SERVICES, IN CLASS 41 (U.S. CLS. 100, 101 AND 107).

FIRST USE 11-14-2006; IN COMMERCE 11-14-2006.

THE MARK CONSISTS OF STANDARD CHARACTERS WITHOUT CLAIM TO ANY PARTICULAR FONT, STYLE, SIZE, OR COLOR.

NO CLAIM IS MADE TO THE EXCLUSIVE RIGHT TO USE "POCONO DOWNS", APART FROM THE MARK AS SHOWN.

SER. NO. 77-203,589, FILED 6-12-2007.

KATHY DE JONGE, EXAMINING ATTORNEY

**Int. Cl.: 35**

**Prior U.S. Cls.: 100, 101 and 102**

**United States Patent and Trademark Office**

**Reg. No. 3,465,800**

**Registered July 15, 2008**

**SERVICE MARK  
PRINCIPAL REGISTER**



FITCARE, LLC (OKLAHOMA LTD LIAB CO)  
6710 N. CLASSEN BLVD.  
OKLAHOMA CITY, OK 73116

THE COLOR(S) BLACK, GREEN, AND RED IS/  
ARE CLAIMED AS A FEATURE OF THE MARK.

FOR: PROVIDING ASSISTANCE, FITNESS EVALUATION AND CONSULTATION TO CORPORATE CLIENTS TO HELP THEIR EMPLOYEES MAKE HEALTH, WELLNESS AND NUTRITIONAL CHANGES IN THEIR DAILY LIVING TO INCREASE PRODUCTIVITY AND LOWER HEALTH CARE COSTS, IN CLASS 35 (U.S. CLS. 100, 101 AND 102).

THE MARK CONSISTS OF THE WORDING "FIT-CARE YOUR CORPORATE WELLNESS SPECIALISTS" IN BLACK, AND IN WHICH THE LETTER "C" IS MADE OF A RED APPLE WITH A GREEN LEAF. THE MARK APPEARS ON A TRANSPARENT BACKGROUND AND NO OTHER COLORS ARE CLAIMED

FIRST USE 4-0-2007; IN COMMERCE 4-0-2007.

NO CLAIM IS MADE TO THE EXCLUSIVE RIGHT TO USE "YOUR CORPORATE WELLNESS SPECIALISTS", APART FROM THE MARK AS SHOWN.

SER. NO. 77-203,681, FILED 6-12-2007.

JASON LOTT, EXAMINING ATTORNEY

**Int. Cl.: 11**

**Prior U.S. Cls.: 13, 21, 23, 31 and 34**

**Reg. No. 3,465,801**

**United States Patent and Trademark Office**

**Registered July 15, 2008**

---

**TRADEMARK  
PRINCIPAL REGISTER**

**AVILA**

VOLUME INTERNATIONAL CORP. (TEXAS  
CORPORATION)  
21160 IMPERIAL VALLEY DR.  
HOUSTON, TX 77073

THE MARK CONSISTS OF STANDARD CHAR-  
ACTERS WITHOUT CLAIM TO ANY PARTICULAR  
FONT, STYLE, SIZE, OR COLOR.

FOR: ELECTRIC LIGHTING FIXTURES, IN  
CLASS 11 (U.S. CLS. 13, 21, 23, 31 AND 34).

SER. NO. 77-203,770, FILED 6-12-2007.

FIRST USE 4-19-2002; IN COMMERCE 1-10-2003.

PAM WILLIS, EXAMINING ATTORNEY

Int. Cl.: 41

Prior U.S. Cls.: 100, 101 and 107

United States Patent and Trademark Office

Reg. No. 3,465,802

Registered July 15, 2008

**SERVICE MARK  
PRINCIPAL REGISTER**

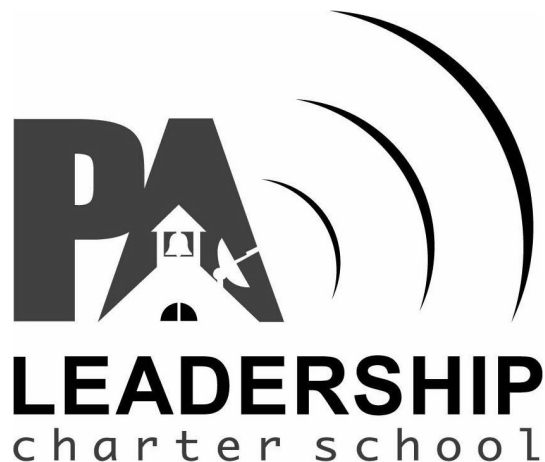

PENNSYLVANIA LEADERSHIP CHARTER  
SCHOOL, INC. (PENNSYLVANIA TAX EX-  
EMPT CORPORATION)  
1332 ENTERPRISE DRIVE  
WEST CHESTER, PA 19380

FOR: EDUCATIONAL SERVICES, NAMELY,  
PROVIDING CHARTER SCHOOL EDUCATIONAL  
SERVICES IN GRADES KINDERGARTEN  
THROUGH 12, IN CLASS 41 (U.S. CLS. 100, 101  
AND 107).

FIRST USE 6-1-2004; IN COMMERCE 6-1-2004.

NO CLAIM IS MADE TO THE EXCLUSIVE  
RIGHT TO USE "PENNSYLVANIA LEADERSHIP  
CHARTER SCHOOL", APART FROM THE MARK  
AS SHOWN.

THE MARK CONSISTS OF THE ROOF OF AN  
OLD SCHOOLHOUSE WITH A BELL IN A CUPOLA  
AND A SATELLITE DISH WITH SIGNAL WAVES.

SER. NO. 77-203,816, FILED 6-12-2007.

LINDA MICKLEBURGH, EXAMINING ATTORNEY

**Int. Cl.: 28**

**Prior U.S. Cls.: 22, 23, 38 and 50**

**Reg. No. 3,465,803**

**United States Patent and Trademark Office**

**Registered July 15, 2008**

---

**TRADEMARK  
PRINCIPAL REGISTER**

**UAV**

MATTEL, INC. (DELAWARE CORPORATION)  
M1-1518  
333 CONTINENTAL BLVD.  
EL SEGUNDO, CA 90245

THE MARK CONSISTS OF STANDARD CHAR-  
ACTERS WITHOUT CLAIM TO ANY PARTICULAR  
FONT, STYLE, SIZE, OR COLOR.

FOR: TOYS, GAMES AND PLAYTHINGS, NAME-  
LY, TOY VEHICLES AND ACCESSORIES THERE-  
FOR, IN CLASS 28 (U.S. CLS. 22, 23, 38 AND 50).

SER. NO. 77-203,856, FILED 6-12-2007.

FIRST USE 2-20-2008; IN COMMERCE 2-20-2008.

CAROL SPILS, EXAMINING ATTORNEY

**Int. Cl.: 28**

**Prior U.S. Cls.: 22, 23, 38 and 50**

**United States Patent and Trademark Office**

**Reg. No. 3,465,804**

**Registered July 15, 2008**

**TRADEMARK  
PRINCIPAL REGISTER**

**DREAD HEAD**

MATTEL, INC. (DELAWARE CORPORATION)  
M1-1518  
333 CONTINENTAL BLVD.  
EL SEGUNDO, CA 90245

THE MARK CONSISTS OF STANDARD CHAR-  
ACTERS WITHOUT CLAIM TO ANY PARTICULAR  
FONT, STYLE, SIZE, OR COLOR.

FOR: TOYS, GAMES AND PLAYTHINGS, NAME-  
LY, TOY VEHICLES AND ACCESSORIES THERE-  
FOR, IN CLASS 28 (U.S. CLS. 22, 23, 38 AND 50).

SER. NO. 77-203,857, FILED 6-12-2007.

FIRST USE 2-19-2008; IN COMMERCE 2-19-2008.

CAROL SPILS, EXAMINING ATTORNEY

**Int. Cl.: 41**

**Prior U.S. Cls.: 100, 101 and 107**

**United States Patent and Trademark Office**

**Reg. No. 3,465,805**

**Registered July 15, 2008**

**SERVICE MARK  
PRINCIPAL REGISTER**

**CHINIAN**

EEC KOREA CO., LTD. (REPUBLIC OF KOREA CORPORATION)  
448-13, SEONGNAE-DONG, GANGDONG-GU  
SEOUL, REPUBLIC OF KOREA

FOR: PUBLICATION OF TEXTS OTHER THAN PUBLICITY TEXTS, PUBLICATION OF BOOKS, PUBLICATION OF ELECTRONIC BOOKS AND JOURNALS ON-LINE, PROVIDING ON-LINE ELECTRONIC PUBLICATIONS IN THE FIELD OF CHINESE LANGUAGE INSTRUCTION THAT ARE NOT DOWNLOADABLE, ELECTRONIC DESKTOP PUBLISHING FOR OTHERS, TUTORING IN THE FIELD OF ENGLISH, CHINESE, JAPANESE AND KOREAN, PROVIDING STUDY HALL TUITION IN THE FIELD OF SCIENCE, TEACHING IN THE FIELD OF ENGLISH, CHINESE, JAPANESE AND KOREAN, EDUCATIONAL EXAMINATION, EDUCATION INFORMATION, INSTRUCTION SERVICES IN THE FIELD OF ENGLISH, CHINESE, JAPANESE AND KOREAN, LIBRARY MANAGEMENT, LENDING LIBRARIES, ORGANIZATION OF MUSEUM EXHIBITIONS FOR CULTURAL OR EDUCATIONAL

PURPOSES, PROVIDING MUSEUM FACILITIES, NURSERY SCHOOLS, HISTORICAL SITE MANAGEMENT, ARRANGING OF OVERSEAS STUDY, MOBILE LIBRARY SERVICES, STUDY ROOM MANAGEMENT, KINDERGARTEN SERVICES, ACADEMIES OF ENGLISH, ACADEMIES OF CHINESE, ACADEMIES OF JAPANESE, ACADEMIES OF KOREAN, IN CLASS 41 (U.S. CLS. 100, 101 AND 107).

THE MARK CONSISTS OF STANDARD CHARACTERS WITHOUT CLAIM TO ANY PARTICULAR FONT, STYLE, SIZE, OR COLOR.

PRIORITY CLAIMED UNDER SEC. 44(D) ON REPUBLIC OF KOREA APPLICATION NO. 2007-0010267, FILED 4-13-2007, REG. NO. 160061, DATED 1-23-2008, EXPIRES 1-23-2018.

SER. NO. 77-203,938, FILED 6-12-2007.

KATHY DE JONGE, EXAMINING ATTORNEY

**Int. Cl.: 31**

**Prior U.S. Cls.: 1 and 46**

**United States Patent and Trademark Office**

**Reg. No. 3,465,806**

**Registered July 15, 2008**

**TRADEMARK  
PRINCIPAL REGISTER**

**WOODSTRAW**

FOREST CONCEPTS, LLC (WASHINGTON LTD  
LIAB CO)  
3320 WEST VALLEY HWY N, SUITE D-110  
AUBURN, WA 980012457

THE MARK CONSISTS OF STANDARD CHAR-  
ACTERS WITHOUT CLAIM TO ANY PARTICULAR  
FONT, STYLE, SIZE, OR COLOR.

FOR: MULCH, IN CLASS 31 (U.S. CLS. 1 AND 46).

SER. NO. 77-203,988, FILED 6-12-2007.

FIRST USE 9-2-1998; IN COMMERCE 2-4-2004.

CAROL SPILS, EXAMINING ATTORNEY



**Int. Cl.: 42**

**Prior U.S. Cls.: 100 and 101**

**United States Patent and Trademark Office**

**Reg. No. 3,465,807**

**Registered July 15, 2008**

**SERVICE MARK  
PRINCIPAL REGISTER**

**COSTCO CONCIERGE SERVICES**

COSTCO WHOLESALE MEMBERSHIP, INC. (CALIFORNIA CORPORATION)  
999 LAKE DRIVE  
ISSAQUAH, WA 98027

FOR: TECHNICAL SUPPORT, NAMELY, PROVIDING TROUBLESHOOTING SERVICES FOR WAREHOUSE CLUB SHOPPERS WITH RESPECT TO PROBLEMS RELATING TO CONSUMER ELECTRONICS, COMPUTERS AND COMPUTER PERIPHERALS, IN CLASS 42 (U.S. CLS. 100 AND 101).

FIRST USE 2-28-2007; IN COMMERCE 2-28-2007.

THE MARK CONSISTS OF STANDARD CHARACTERS WITHOUT CLAIM TO ANY PARTICULAR FONT, STYLE, SIZE, OR COLOR.

OWNER OF U.S. REG. NOS. 1,318,685, 2,989,385 AND OTHERS.

NO CLAIM IS MADE TO THE EXCLUSIVE RIGHT TO USE "SERVICES", APART FROM THE MARK AS SHOWN.

SER. NO. 77-204,059, FILED 6-12-2007.

LINDA M. KING, EXAMINING ATTORNEY

**Int. Cl.: 41**

**Prior U.S. Cls.: 100, 101 and 107**

**United States Patent and Trademark Office**

**Reg. No. 3,465,808**

**Registered July 15, 2008**

**SERVICE MARK  
PRINCIPAL REGISTER**



REGENT UNIVERSITY (VIRGINIA CORPORATION)  
1000 REGENT UNIVERSITY DRIVE  
VIRGINIA BEACH, VA 234649800

FOR: EDUCATIONAL SERVICES, NAMELY, PROVIDING COURSES OF INSTRUCTION AT THE UNIVERSITY LEVEL AND DISTRIBUTION OF COURSE MATERIAL IN CONNECTION THEREWITH, IN CLASS 41 (U.S. CLS. 100, 101 AND 107).

FIRST USE 5-1-2007; IN COMMERCE 5-1-2007.

OWNER OF U.S. REG. NOS. 1,682,259 AND 3,111,799.

NO CLAIM IS MADE TO THE EXCLUSIVE RIGHT TO USE "UNIVERSITY", APART FROM THE MARK AS SHOWN.

THE MARK CONSISTS OF A GRAPHIC DEPICTION OF A CROWN FOLLOWED BY THE WORDS "REGENT UNIVERSITY".

SER. NO. 77-204,144, FILED 6-12-2007.

MICHELLE DUBOIS, EXAMINING ATTORNEY

**Int. Cl.: 35**

**Prior U.S. Cls.: 100, 101 and 102**

**United States Patent and Trademark Office**

**Reg. No. 3,465,809**

**Registered July 15, 2008**

**SERVICE MARK  
PRINCIPAL REGISTER**

**eat well guide**

SUSTAINABLE TABLE (DELAWARE NON-PROFIT CORPORATION)  
215 LEXINGTON AVENUE, SUITE 1001  
NEW YORK, NY 100166023

FOR: OPERATING A WEBSITE FEATURING A FREE ONLINE SEARCHABLE DATABASE OF INFORMATION DESIGNED TO ASSIST CONSUMERS IN LOCATING SUPPLIERS OF SUSTAINABLE FOOD INCLUDING SUSTAINABLY-RAISED MEAT, POULTRY, DAIRY AND EGGS, AND PROVIDING AN ONLINE DIRECTORY OF SUSTAINABLE FOOD PRODUCERS AND DISTRIBUTORS, INCLUDING BAKERS, FARMERS, BUTCHERS, CATERERS, PERSONAL CHEFS, RETAIL AND ONLINE OUTLETS, RESTAURANTS, AND BED-AND-

BREAKFAST LODGING, IN CLASS 35 (U.S. CLS. 100, 101 AND 102).

FIRST USE 11-3-2003; IN COMMERCE 11-3-2003.

THE MARK CONSISTS OF STANDARD CHARACTERS WITHOUT CLAIM TO ANY PARTICULAR FONT, STYLE, SIZE, OR COLOR.

NO CLAIM IS MADE TO THE EXCLUSIVE RIGHT TO USE "GUIDE", APART FROM THE MARK AS SHOWN.

SER. NO. 77-204,196, FILED 6-12-2007.

ALICE BENMAMAN, EXAMINING ATTORNEY

**Int. Cl.: 9**

**Prior U.S. Cls.: 21, 23, 26, 36 and 38**

**United States Patent and Trademark Office**

**Reg. No. 3,465,810**

**Registered July 15, 2008**

**TRADEMARK  
PRINCIPAL REGISTER**



UNIEA CORPORATION (CALIFORNIA CORPORATION)  
317 W MAIN STREET, SUITE 327  
ALHAMBRA, CA 91801

FOR: ABS, ALSO KNOWN AS ACRYLONITRILE BUTADIENE STYRENE, PLASTIC COMPUTER CARRYING CASE COVERED BY PADDED LEATHER FOR 13 INCH COMPUTERS; LEATHER COMPUTER CARRYING CASE FOR 13 INCH LAPTOP COMPUTER IN THE COLORS GREY, WHITE, BLUE; LEATHER COMPUTER CARRYING CASE FOR 15 INCH LAPTOP COMPUTER IN THE COLORS RED, GREY, WHITE AND BLUE; PROTECTIVE CARRYING CASES FOR 30 GIGABYTES MP3 PLAYERS IN THE COLORS RED, BLACK AND WHITE; PROTECTIVE CARRYING CASES FOR 60 AND 80 GIGABYTES MP3 PLAYERS IN THE COLORS RED, BLACK AND WHITE; PROTECTIVE CARRYING CASES FOR 30 GIGABYTES VIDEO MP3 PLAYERS;

SPECIALLY DESIGNED PROTECTIVE COVERS FOR LAPTOP COMPUTER KEYBOARDS IN THE COLORS RED, BLUE, PINK AND TRANSPARENT; PROTECTIVE LEATHER CARRYING CASES FOR 2 GIGABYTES MP3 PLAYERS THAT FEATURE CARRYING STRAPS IN THE COLORS BLUE, TRANSPARENT, RED, PINK, GREY AND GREEN, IN CLASS 9 (U.S. CLS. 21, 23, 26, 36 AND 38).

FIRST USE 3-1-2006; IN COMMERCE 8-29-2006.

THE MARK CONSISTS OF CURVED LINE THAT APPEARS SIMILAR TO AN INCOMPLETE TEAR DROP WITH TWO CRESCENT SHAPES TO THE LEFT OF THE CURVED LINE.

SER. NO. 77-204,201, FILED 6-12-2007.

TANYA AMOS, EXAMINING ATTORNEY

**Int. Cls.: 9, 25 and 41**

**Prior U.S. Cls.: 21, 22, 23, 26, 36, 38, 39, 100, 101 and 107**

**Reg. No. 3,465,811**

**United States Patent and Trademark Office**

**Registered July 15, 2008**

**TRADEMARK  
SERVICE MARK  
PRINCIPAL REGISTER**

# THE RETROFITS

THE RETROFITS, LLC (OREGON LTD LIAB CO)  
1211 SE 37TH AVENUE  
PORTLAND, OR 97214

FOR: COMPACT DISCS FEATURING MUSICAL RECORDINGS BY THE RETROFITS, IN CLASS 9 (U.S. CLS. 21, 23, 26, 36 AND 38).

FIRST USE 6-13-2003; IN COMMERCE 2-0-2004.

FOR: SHORT-SLEEVED OR LONG-SLEEVED T-SHIRTS; T-SHIRTS, IN CLASS 25 (U.S. CLS. 22 AND 39).

FIRST USE 6-13-2003; IN COMMERCE 12-0-2004.

FOR: ENTERTAINMENT SERVICES NAMELY, PROVIDING A WEBSITE FEATURING, PHOTOGRAPHIC, AUDIO, VIDEO AND PROSE PRESENTATIONS FEATURING THE RETROFITS;

ENTERTAINMENT IN THE NATURE OF LIVE PERFORMANCES BY THE RETROFITS; ENTERTAINMENT IN THE NATURE OF VISUAL AND AUDIO PERFORMANCES, NAMELY, MUSICAL BAND, ROCK GROUP, GYMNASTIC, DANCE, AND BALLET PERFORMANCES; ENTERTAINMENT, NAMELY, LIVE PERFORMANCES BY MUSICAL BANDS; ENTERTAINMENT, NAMELY, LIVE PERFORMANCES BY ROCK GROUPS, IN CLASS 41 (U.S. CLS. 100, 101 AND 107).

FIRST USE 6-13-2003; IN COMMERCE 1-19-2004.

THE MARK CONSISTS OF STANDARD CHARACTERS WITHOUT CLAIM TO ANY PARTICULAR FONT, STYLE, SIZE, OR COLOR.

SER. NO. 77-204,207, FILED 6-12-2007.

MELVIN AXILBUND, EXAMINING ATTORNEY

**Int. Cl.: 5**

**Prior U.S. Cls.: 6, 18, 44, 46, 51 and 52**

**Reg. No. 3,465,812**

**United States Patent and Trademark Office**

**Registered July 15, 2008**

---

**TRADEMARK  
PRINCIPAL REGISTER**

**DRNATURA**

HARDY, LEONARD (CANADA INDIVIDUAL)  
P.O. BOX 9  
GHARB, MALTA GRB100

THE MARK CONSISTS OF STANDARD CHARACTERS WITHOUT CLAIM TO ANY PARTICULAR FONT, STYLE, SIZE, OR COLOR.

FOR: NUTRITIONAL AND HERBAL SUPPLEMENTS FOR COLON CLEANSING, DIGESTIVE HEALTH, PARASITE CLEANSING AND DETOXIFICATION OF THE BODY, IN CLASS 5 (U.S. CLS. 6, 18, 44, 46, 51 AND 52).

"DRNATURA" DOES NOT IDENTIFY A LIVING INDIVIDUAL.

SER. NO. 77-204,267, FILED 6-12-2007.

FIRST USE 1-13-2001; IN COMMERCE 9-6-2001.

JAY BESCH, EXAMINING ATTORNEY

**Int. Cl.: 33**

**Prior U.S. Cls.: 47 and 49**

**United States Patent and Trademark Office**

**Reg. No. 3,465,813**

**Registered July 15, 2008**

**TRADEMARK  
PRINCIPAL REGISTER**



UNITED BRANDS COMPANY (CALIFORNIA CORPORATION)  
10940 WILSHIRE BLVD., SUITE 1600  
LOS ANGELES, CA 90024

FOR: ALCOHOLIC BEVERAGES PRODUCED FROM A BREWED MALT BASE WITH NATURAL JUICE FLAVORINGS, IN CLASS 33 (U.S. CLS. 47 AND 49).

FIRST USE 6-11-2006; IN COMMERCE 12-8-2006.

OWNER OF U.S. REG. NO. 3,263,454.

NO CLAIM IS MADE TO THE EXCLUSIVE RIGHT TO USE JUICE, APART FROM THE MARK AS SHOWN.

THE MARK CONSISTS OF THE STYLIZED WORDING JOOSE INSIDE OF A STYLIZED BORDER.

SER. NO. 77-204,432, FILED 6-12-2007.

LA TONIA FISHER, EXAMINING ATTORNEY

**Int. Cl.: 35**

**Prior U.S. Cls.: 100, 101 and 102**

**United States Patent and Trademark Office**

**Reg. No. 3,465,814**

**Registered July 15, 2008**

**SERVICE MARK  
PRINCIPAL REGISTER**

# Mr. Deal

HEITHAUS, MICHAEL W. (UNITED STATES  
INDIVIDUAL)  
SUITE D  
5723 TILDEN AVENUE  
VAN NUYS, CA 91401

FOR: ADVERTISING SERVICES, NAMELY, PROMOTING AND MARKETING THE GOODS AND SERVICES OF OTHERS THROUGH ALL PUBLIC COMMUNICATION MEANS, IN CLASS 35 (U.S. CLS. 100, 101 AND 102).

FIRST USE 12-6-2006; IN COMMERCE 12-6-2006.

THE MARK CONSISTS OF STANDARD CHARACTERS WITHOUT CLAIM TO ANY PARTICULAR FONT, STYLE, SIZE, OR COLOR.

SER. NO. 77-204,595, FILED 6-13-2007.

ANNE FARRELL, EXAMINING ATTORNEY



**Int. Cl.: 3**

**Prior U.S. Cls.: 1, 4, 6, 50, 51 and 52**

**Reg. No. 3,465,815**

**United States Patent and Trademark Office**

**Registered July 15, 2008**

---

**TRADEMARK  
PRINCIPAL REGISTER**

**LSA COMPLEX**

LINDI, LLC (PENNSYLVANIA LTD LIAB CO)  
355 W. LANCASTER AVENUE  
HAVERFORD, PA 19041

THE MARK CONSISTS OF STANDARD CHARACTERS WITHOUT CLAIM TO ANY PARTICULAR FONT, STYLE, SIZE, OR COLOR.

FOR: BOTANICAL EXTRACTS SOLD AS AN INTEGRAL COMPONENT OF COSMETICS AND NON-MEDICATED HAIR AND SKIN CARE PREPARATIONS, IN CLASS 3 (U.S. CLS. 1, 4, 6, 50, 51 AND 52).

NO CLAIM IS MADE TO THE EXCLUSIVE RIGHT TO USE "COMPLEX", APART FROM THE MARK AS SHOWN.

SER. NO. 77-204,632, FILED 6-13-2007.

FIRST USE 5-0-2004; IN COMMERCE 5-0-2004.

KATHERINE CHANG, EXAMINING ATTORNEY

**Int. Cl.: 5**

**Prior U.S. Cls.: 6, 18, 44, 46, 51 and 52**

**Reg. No. 3,465,816**

**United States Patent and Trademark Office**

**Registered July 15, 2008**

---

**TRADEMARK  
PRINCIPAL REGISTER**

**ARTHRID-IT MAX**

GARCOA, INC. (OHIO CORPORATION)  
24007 VENTURA BOULEVARD, SUITE 135  
CALABASAS, CA 91302

THE MARK CONSISTS OF STANDARD CHAR-  
ACTERS WITHOUT CLAIM TO ANY PARTICULAR  
FONT, STYLE, SIZE, OR COLOR.

FOR: ANALGESIC PREPARATIONS, IN CLASS 5  
(U.S. CLS. 6, 18, 44, 46, 51 AND 52).

SER. NO. 77-204,727, FILED 6-13-2007.

FIRST USE 4-29-2007; IN COMMERCE 4-29-2007.

MONIQUE MILLER, EXAMINING ATTORNEY

**Int. Cl.: 30**

**Prior U.S. Cl.: 46**

**United States Patent and Trademark Office**

**Reg. No. 3,465,817**

**Registered July 15, 2008**

**TRADEMARK  
PRINCIPAL REGISTER**

**CACTUS JOE**

MEDALLION FOODS, INC. (ARKANSAS CORPORATION)  
3636 MEDALLION AVENUE  
NEWPORT, AR 72112

FOR: CORN-BASED SNACK FOODS; CORN CHIPS; TORTILLA CHIPS; EXTRUDED CORN SNACKS, NAMELY, CHEESE FLAVORED CORN PUFFS, CORN CURLS; EXTRUDED CORN SNACKS IN THE NATURE OF HOT FRIES, IN CLASS 30 (U.S. CL. 46).

FIRST USE 2-15-2008; IN COMMERCE 2-15-2008.

THE MARK CONSISTS OF STANDARD CHARACTERS WITHOUT CLAIM TO ANY PARTICULAR FONT, STYLE, SIZE, OR COLOR.

SER. NO. 77-204,780, FILED 6-13-2007.

JACQUELINE A. LAVINE, EXAMINING ATTORNEY

**Int. Cl.: 41**

**Prior U.S. Cls.: 100, 101 and 107**

**United States Patent and Trademark Office**

**Reg. No. 3,465,818**

**Registered July 15, 2008**

**SERVICE MARK  
PRINCIPAL REGISTER**

**ZAGHAREET!**

ZAGHAREET! TRIBAL BELLY DANCE COMPAN-  
NY (CANADA CORPORATION)  
11727 111 AVENUE  
EDMONTON, CANADA T5G0E3

FOR: ENTERTAINMENT SERVICES, NAMELY,  
THEATER PRODUCTIONS, LIVE PERFORMANCES  
BY BELLY DANCERS, LIVE DANCE AND BELLY  
DANCE PERFORMANCES; EDUCATION IN THE  
NATURE OF PRIVATE AND GROUP DANCE AND  
BELLY DANCE LESSONS; DANCE INSTRUCTION;  
EDUCATION IN THE FIELD OF DANCE PERFOR-  
MANCES, THEATER PERFORMANCES, AND BEL-  
LY DANCE PERFORMANCES, IN CLASS 41 (U.S.  
CLS. 100, 101 AND 107).

FIRST USE 10-2-2004; IN COMMERCE 8-3-2006.

THE MARK CONSISTS OF STANDARD CHAR-  
ACTERS WITHOUT CLAIM TO ANY PARTICULAR  
FONT, STYLE, SIZE, OR COLOR.

PRIORITY CLAIMED UNDER SEC. 44(D) ON  
CANADA APPLICATION NO. 1328311, FILED 12-15-  
2006, REG. NO. TMA701761, DATED 11-27-2007, EX-  
PIRES 11-27-2022.

THE ENGLISH TRANSLATION OF "ZAGHAR-  
EET" IN THE MARK IS A VOCALIZATION, SOME-  
TIMES CALLED ULULATION.

SER. NO. 77-204,856, FILED 6-13-2007.

BARBARA A. GOLD, EXAMINING ATTORNEY

**Int. Cl.: 28**

**Prior U.S. Cls.: 22, 23, 38 and 50**

**United States Patent and Trademark Office**

**Reg. No. 3,465,819**

**Registered July 15, 2008**

**TRADEMARK  
PRINCIPAL REGISTER**

**BEAST BASH**

MATTEL, INC. (DELAWARE CORPORATION)  
M1-1518  
333 CONTINENTAL BLVD.  
EL SEGUNDO, CA 90245

FOR: TOYS, GAMES AND PLAYTHINGS, NAME-  
LY, TOY VEHICLE PLAYSETS AND ACCESSORIES  
THEREFOR, IN CLASS 28 (U.S. CLS. 22, 23, 38 AND  
50).

FIRST USE 2-19-2008; IN COMMERCE 2-19-2008.

THE MARK CONSISTS OF STANDARD CHAR-  
ACTERS WITHOUT CLAIM TO ANY PARTICULAR  
FONT, STYLE, SIZE, OR COLOR.

SER. NO. 77-204,914, FILED 6-13-2007.

JUSTINE D. PARKER, EXAMINING ATTORNEY

**Int. Cl.: 25**

**Prior U.S. Cls.: 22 and 39**

**United States Patent and Trademark Office**

**Reg. No. 3,465,820**

**Registered July 15, 2008**

**TRADEMARK  
PRINCIPAL REGISTER**

**ALABAMA GIRL**

EAGLE CREST, INC. (FLORIDA CORPORATION)  
5353-1 RAMONA BOULEVARD  
JACKSONVILLE, FL 32205

FOR: CLOTHING , NAMELY, HATS, SHIRTS,  
UNDERGARMENTS, SWIMSUITS, SWEATSHIRTS,  
SWEATERS, JACKETS, COATS, GLOVES, SCARVES,  
BELTS, HEADBANDS, WRISTBANDS, PANTS,  
SHORTS, SKIRTS, DRESSES, OVERALLS, SOCKS,  
STOCKINGS, AND LEGGINGS, IN CLASS 25 (U.S.  
CLS. 22 AND 39).

FIRST USE 4-4-2007; IN COMMERCE 4-4-2007.

THE MARK CONSISTS OF STANDARD CHAR-  
ACTERS WITHOUT CLAIM TO ANY PARTICULAR  
FONT, STYLE, SIZE, OR COLOR.

SER. NO. 77-204,935, FILED 6-13-2007.

RONALD MCMORROW, EXAMINING ATTORNEY

**Int. Cl.: 35**

**Prior U.S. Cls.: 100, 101 and 102**

**United States Patent and Trademark Office**

**Reg. No. 3,465,821**

**Registered July 15, 2008**

**SERVICE MARK  
PRINCIPAL REGISTER**

# Don't Say What?

STARKEY LABORATORIES, INC. (MINNESOTA CORPORATION)  
6700 WASHINGTON AVENUE SOUTH  
EDEN PRAIRIE, MN 55344

FOR: PROMOTING PUBLIC AWARENESS OF HEARING LOSS, IN CLASS 35 (U.S. CLS. 100, 101 AND 102).

FIRST USE 4-18-2007; IN COMMERCE 4-18-2007.

THE MARK CONSISTS OF STANDARD CHARACTERS WITHOUT CLAIM TO ANY PARTICULAR FONT, STYLE, SIZE, OR COLOR.

SER. NO. 77-204,965, FILED 6-13-2007.

WARREN L. OLANDRIA, EXAMINING ATTORNEY

**Int. Cl.: 30**

**Prior U.S. Cl.: 46**

**United States Patent and Trademark Office**

**Reg. No. 3,465,822**

**Registered July 15, 2008**

**TRADEMARK  
PRINCIPAL REGISTER**



VENTANA HEALTH INC. (CALIFORNIA CORPORATION)  
927 CALLE NEGOCIO  
SUITE J  
SAN CLEMENTE, CA 92673

FOR: SUGAR SUBSTITUTES, IN CLASS 30 (U.S. CL. 46).

FIRST USE 12-18-2005; IN COMMERCE 12-18-2005.

OWNER OF U.S. REG. NO. 3,088,570.

NO CLAIM IS MADE TO THE EXCLUSIVE RIGHT TO USE "SWEET", APART FROM THE MARK AS SHOWN.

THE COLOR(S) ORANGE, BLACK AND WHITE IS/ARE CLAIMED AS A FEATURE OF THE MARK.

THE MARK DISPLAYS THE WORD "Z SWEET" IN STACKED FORMAT. THE BACKGROUND COLOR IS ORANGE AND THE "Z" IS DISPLAYED IN WHITE WITH BLACK OUTLINE. THE WORD "SWEET" IS BLACK. THE LOGO DESIGN IS RECTANGULAR WITH ROUNDED EDGES.

SER. NO. 77-205,056, FILED 6-13-2007.

MARCIE MILONE, EXAMINING ATTORNEY



**Int. Cl.: 7**

**Prior U.S. Cls.: 13, 19, 21, 23, 31, 34 and 35**

**Reg. No. 3,465,823**

**United States Patent and Trademark Office**

**Registered July 15, 2008**

**TRADEMARK  
PRINCIPAL REGISTER**

**SWAMPER**

DEERE & COMPANY (DELAWARE CORPORATION)  
TRADEMARK LAW GROUP  
ONE JOHN DEERE PLACE  
MOLINE, IL 61265

THE MARK CONSISTS OF STANDARD CHARACTERS WITHOUT CLAIM TO ANY PARTICULAR FONT, STYLE, SIZE, OR COLOR.

FOR: BUCKET TEETH FOR CONSTRUCTION EQUIPMENT, IN CLASS 7 (U.S. CLS. 13, 19, 21, 23, 31, 34 AND 35).

SER. NO. 77-205,063, FILED 6-13-2007.

FIRST USE 4-30-2002; IN COMMERCE 4-30-2002.

JOHN KELLY, EXAMINING ATTORNEY

**Int. Cl.: 41**

**Prior U.S. Cls.: 100, 101 and 107**

**United States Patent and Trademark Office**

**Reg. No. 3,465,824**

**Registered July 15, 2008**

**SERVICE MARK  
PRINCIPAL REGISTER**



3 GUY PRODUCTIONS, LLC (NEVADA LTD  
LIAB CO)  
4001 S. DECATUR BLVD., SUITE 37-442  
LAS VEGAS, NV 89103

THE MARK CONSISTS OF AN IMAGE OF A CD  
WITH THE WORD MANOLAY PRINTED NEXT TO  
IT.

FOR: ENTERTAINMENT SERVICES, NAMELY,  
PROVIDING AN INTERNET WEBSITE FEATUR-  
ING ADULT MOVIES AND ADULT VIDEO CLIPS,  
IN CLASS 41 (U.S. CLS. 100, 101 AND 107).

SER. NO. 77-205,069, FILED 6-13-2007.

FIRST USE 6-1-2007; IN COMMERCE 6-1-2007.

CORY BOONE, EXAMINING ATTORNEY

**Int. Cl.: 35**

**Prior U.S. Cls.: 100, 101 and 102**

**United States Patent and Trademark Office**

**Reg. No. 3,465,825**

**Registered July 15, 2008**

**SERVICE MARK  
PRINCIPAL REGISTER**

**QUALITY HEALTH FIRST**

INDIANA HEALTH INFORMATION EX-  
CHANGE, INC. (INDIANA CORPORATION)  
SUITE 300  
846 N. SENATE AVE.  
INDIANAPOLIS, IN 46202

FOR: BUSINESS SERVICES, NAMELY, BUSINESS  
MANAGEMENT CONSULTING FOR HEALTH  
CARE PROVIDERS DESIGNED TO PROVIDE CLIN-  
ICAL DATA AND QUALITY STANDARDS TO  
ASSIST THE PROVIDERS AND OTHER RELEVANT  
PARTIES IN ACHIEVING THE HIGHEST QUALITY  
PATIENT CARE, IN CLASS 35 (U.S. CLS. 100, 101  
AND 102).

FIRST USE 7-31-2006; IN COMMERCE 7-31-2006.

THE MARK CONSISTS OF STANDARD CHAR-  
ACTERS WITHOUT CLAIM TO ANY PARTICULAR  
FONT, STYLE, SIZE, OR COLOR.

NO CLAIM IS MADE TO THE EXCLUSIVE  
RIGHT TO USE "QUALITY HEALTH", APART  
FROM THE MARK AS SHOWN.

SER. NO. 77-205,186, FILED 6-13-2007.

NAAKWAMA ANKRAH, EXAMINING ATTORNEY

**Int. Cl.: 28**

**Prior U.S. Cls.: 22, 23, 38 and 50**

**United States Patent and Trademark Office**

**Reg. No. 3,465,826**

**Registered July 15, 2008**

**TRADEMARK  
PRINCIPAL REGISTER**

**1-2-3 CHECK-UP!**

MATTEL, INC. (DELAWARE CORPORATION)  
M1-1518  
333 CONTINENTAL BLVD.  
EL SEGUNDO, CA 90245

FOR: TOYS, GAMES AND PLAYTHINGS, NAME-  
LY, TOY FIGURE PLAYSETS AND ACCESSORIES  
THEREFOR, IN CLASS 28 (U.S. CLS. 22, 23, 38 AND  
50).

FIRST USE 1-30-2008; IN COMMERCE 1-30-2008.

THE MARK CONSISTS OF STANDARD CHAR-  
ACTERS WITHOUT CLAIM TO ANY PARTICULAR  
FONT, STYLE, SIZE, OR COLOR.

SER. NO. 77-205,272, FILED 6-13-2007.

JUSTINE D. PARKER, EXAMINING ATTORNEY

**Int. Cl.: 7**

**Prior U.S. Cls.: 13, 19, 21, 23, 31, 34 and 35**

**United States Patent and Trademark Office**

**Reg. No. 3,465,827**

**Registered July 15, 2008**

**TRADEMARK  
PRINCIPAL REGISTER**



THE REDD GROUP LLC. (CALIFORNIA LTD  
LIAB CO)  
3685 MT. DIABLO BLVD SUITE 255  
LAFAYETTE, CA 94549

FOR: GRINDING TOOLS FOR GRINDING MA-  
CHINES; GRINDING MACHINES FOR GLASS;  
ABRASIVE DISKS FOR POWER-OPERATED GRIN-  
DERS; ABRASIVE DISKS FOR POWER-OPERATED  
SANDERS.; POWER-OPERATED POLISHERS, IN  
CLASS 7 (U.S. CLS. 13, 19, 21, 23, 31, 34 AND 35).

FIRST USE 0-0-2006; IN COMMERCE 0-0-2006.

NO CLAIM IS MADE TO THE EXCLUSIVE  
RIGHT TO USE "DISK", APART FROM THE MARK  
AS SHOWN.

THE COLOR(S) BLACK, WHITE AND BLUE IS/  
ARE CLAIMED AS A FEATURE OF THE MARK.

THE WORD "RENU" IS BLACK. THE WORD  
"DISK" IS WHITE. THE CIRCLE IS BLUE. THE  
CIRCULAR STREAKS ABOVE AND BELOW THE  
WORD "DISK" ARE WHITE. THE MARK APPEARS  
ON A TRANSPARENT BACKGROUND, AND NO  
OTHER COLOR IS CLAIMED AS A FEATURE OF  
THE MARK.

SER. NO. 77-205,428, FILED 6-13-2007.

DAVID MILLER, EXAMINING ATTORNEY

**Int. Cl.: 33**

**Prior U.S. Cls.: 47 and 49**

**United States Patent and Trademark Office**

**Reg. No. 3,465,828**

**Registered July 15, 2008**

**TRADEMARK  
PRINCIPAL REGISTER**

**BROKEN ROCK VINEYARD**

HILL, WILLIAM H. (UNITED STATES INDIVIDUAL)  
P.O. BOX 3989  
NAPA, CA 94558

NO CLAIM IS MADE TO THE EXCLUSIVE RIGHT TO USE "VINEYARD", APART FROM THE MARK AS SHOWN.

FOR: WINE, IN CLASS 33 (U.S. CLS. 47 AND 49).

FIRST USE 0-0-2005; IN COMMERCE 0-0-2005.

SER. NO. 77-205,491, FILED 6-13-2007.

THE MARK CONSISTS OF STANDARD CHARACTERS WITHOUT CLAIM TO ANY PARTICULAR FONT, STYLE, SIZE, OR COLOR.

CHARISMA HAMPTON, EXAMINING ATTORNEY

**Int. Cl.: 25**

**Prior U.S. Cls.: 22 and 39**

**United States Patent and Trademark Office**

**Reg. No. 3,465,829**

**Registered July 15, 2008**

**TRADEMARK  
PRINCIPAL REGISTER**

**TKS**

SEARS BRANDS, LLC (ILLINOIS LTD LIAB CO)  
3333 BEVERLY ROAD  
HOFFMAN ESTATES, IL 60179

FOR: CLOTHING AND WEARING APPAREL,  
NAMELY, SHIRTS, TOPS, DRESSES, JUMPERS,  
JACKETS, SHORTS, PANTS, CAPRIS, JEANS,  
SKIRTS, SKORTS, UNDERWEAR, SOCKS, TIGHTS  
AND FOOTWEAR FOR INFANTS, TODDLERS,  
GIRLS AND BOYS, IN CLASS 25 (U.S. CLS. 22 AND  
39).

FIRST USE 1-0-1998; IN COMMERCE 1-0-1998.

THE MARK CONSISTS OF STANDARD CHAR-  
ACTERS WITHOUT CLAIM TO ANY PARTICULAR  
FONT, STYLE, SIZE, OR COLOR.

OWNER OF U.S. REG. NO. 2,261,451.

SER. NO. 77-205,552, FILED 6-13-2007.

DARRYL SPRUILL, EXAMINING ATTORNEY

**Int. Cl.: 9**

**Prior U.S. Cls.: 21, 23, 26, 36 and 38**

**Reg. No. 3,465,830**

**United States Patent and Trademark Office**

**Registered July 15, 2008**

**TRADEMARK  
PRINCIPAL REGISTER**

**EWOO**

HARRON SA (SWITZERLAND CORPORATION)  
C/O POWER DATA SA  
LE TRESI 6B  
1028 PREVERENGES, SWITZERLAND

FOR: APPARATUS FOR RECORDING, DOWN-LOADING OR REPRODUCTION OF SOUND AND/OR IMAGES; PLAYERS FOR DIGITALLY RECORDED MUSIC AND/OR SOUND, COMPRESSED OR NON-COMPRESSED; TRANSMITTER-RECEIVER STATION INTENDED TO COOPERATE BY RADIO WITH A REMOTE CONTROL AND TO OPERATE WITH A MUSIC AND/OR SOUND PLAYER, AS WELL AS TO RECHARGE THE BATTERIES OF THE PLAYER AND/OR OF THE REMOTE CONTROL AND FINALLY TO BE CONNECTED, VIA CABLE OR NOT, WITH APPARATUS FOR REPRODUCTION OF SOUND, IMAGES AND WITH APPARATUS FOR THE TREATMENT OF DATA AND SIGNALS; PORTABLE AND RECHARGEABLE REMOTE CONTROL INTENDED TO COOPERATE

WITH THE SAID STATION; ELECTRIC SUPPLY CABLES AND CONNECTION CABLES; ELECTRIC CONNECTORS, IN CLASS 9 (U.S. CLS. 21, 23, 26, 36 AND 38).

THE MARK CONSISTS OF STANDARD CHARACTERS WITHOUT CLAIM TO ANY PARTICULAR FONT, STYLE, SIZE, OR COLOR.

PRIORITY CLAIMED UNDER SEC. 44(D) ON SWITZERLAND APPLICATION NO. 02579/2006, FILED 12-28-2006, REG. NO. 556080, DATED 3-6-2007, EXPIRES 12-27-2016.

THE WORDING "EWOO" HAS NO MEANING IN A FOREIGN LANGUAGE.

SER. NO. 77-205,808, FILED 6-14-2007.

MARIAM MAHMOUDI, EXAMINING ATTORNEY



**Int. Cl.: 9**

**Prior U.S. Cls.: 21, 23, 26, 36 and 38**

**Reg. No. 3,465,831**

**United States Patent and Trademark Office**

**Registered July 15, 2008**

---

**TRADEMARK  
PRINCIPAL REGISTER**

**GOLDEN CHALLENGE**

ARISTOCRAT TECHNOLOGIES AUSTRALIA  
PTY LTD (AUSTRALIA CORPORATION)  
71 LONGUEVILLE ROAD  
LANE COVE, NSW, AUSTRALIA 2066

PRIORITY CLAIMED UNDER SEC. 44(D) ON  
AUSTRALIA APPLICATION NO. 1152065, FILED  
12-14-2006, REG. NO. 1152065, DATED 12-14-2006,  
EXPIRES 12-14-2016.

FOR: GAMING MACHINES; COMPUTER HARD-  
WARE; DOWNLOADABLE GAME SOFTWARE;  
ELECTRONIC GAME SOFTWARE, IN CLASS 9  
(U.S. CLS. 21, 23, 26, 36 AND 38).

SER. NO. 77-206,092, FILED 6-14-2007.

THE MARK CONSISTS OF STANDARD CHAR-  
ACTERS WITHOUT CLAIM TO ANY PARTICULAR  
FONT, STYLE, SIZE, OR COLOR.

WILLIAM ROSSMAN, EXAMINING ATTORNEY

**Int. Cl.: 6**

**Prior U.S. Cls.: 2, 12, 13, 14, 23, 25 and 50**

**Reg. No. 3,465,832**

**United States Patent and Trademark Office**

**Registered July 15, 2008**

**TRADEMARK  
PRINCIPAL REGISTER**



**RAIL-K-ING**

COAST SUNDECKS WATERPROOFING, LIM-  
ITED (WASHINGTON CORPORATION)  
1124 FIR AVENUE #110  
BLAINE, WA 98230

FIRST USE 1-31-2007; IN COMMERCE 1-31-2007.

OWNER OF U.S. REG. NO. 2,674,711.

FOR: ALUMINUM METAL RAILINGS FOR FEN-  
CES, BALCONIES, BRIDGES, SUNDECKS, POOLS,  
AND STAIRS, IN CLASS 6 (U.S. CLS. 2, 12, 13, 14, 23,  
25 AND 50).

SER. NO. 77-206,104, FILED 6-14-2007.

SIMON TENG, EXAMINING ATTORNEY

**Int. Cl.: 14**

**Prior U.S. Cls.: 2, 27, 28 and 50**

**United States Patent and Trademark Office**

**Reg. No. 3,465,833**

**Registered July 15, 2008**

**TRADEMARK  
PRINCIPAL REGISTER**



RICHLINE GROUP, INC (DELAWARE CORPORATION)  
516 FIFTH AVENUE  
NEW YORK, NY 10036

FOR: JEWELRY MADE WHOLLY OR SUBSTANTIALLY IN PART OF GOLD, IN CLASS 14 (U.S. CLS. 2, 27, 28 AND 50).

FIRST USE 5-0-2001; IN COMMERCE 5-0-2001.

OWNER OF U.S. REG. NOS. 1,473,068, 1,741,201 AND OTHERS.

NO CLAIM IS MADE TO THE EXCLUSIVE RIGHT TO USE "OR", APART FROM THE MARK AS SHOWN.

THE MARK CONSISTS OF "OR" FOLLOWED BY A HEART DESIGN.

THE FOREIGN WORDING IN THE MARK TRANSLATES INTO ENGLISH AS GOLD.

SER. NO. 77-206,178, FILED 6-14-2007.

JENNIFER DIXON, EXAMINING ATTORNEY

**Int. Cls.: 6, 9, 16, 19, 21 and 24**

**Prior U.S. Cls.: 1, 2, 5, 12, 13, 14, 21, 22, 23, 25, 26, 29, 30, 33, 36, 37, 38, 40, 42 and 50**

**Reg. No. 3,465,834**

**United States Patent and Trademark Office**

**Registered July 15, 2008**

**TRADEMARK  
PRINCIPAL REGISTER**

**JÄGER BOMB**

MAST-JAEGERMEISTER AG (FED REP GERMA-  
NY CORPORATION)  
MAST-JAEGERMEISTERSTRASSE 7-15  
38296 WOLFENBUETTEL, FED REP GERMANY

FOR: NON-LUMINOUS, NON-MECHANICAL  
TIN SIGNS, IN CLASS 6 (U.S. CLS. 2, 12, 13, 14, 23,  
25 AND 50).

FIRST USE 4-30-2007; IN COMMERCE 4-30-2007.

FOR: MAGNETS, COLD BOX CLINGS BEING  
AKIN TO REFRIGERATOR MAGNETS, IN CLASS 9  
(U.S. CLS. 21, 23, 26, 36 AND 38).

FIRST USE 4-30-2007; IN COMMERCE 4-30-2007.

FOR: CARDBOARD, PHOTOGRAPHS, STICK-  
ERS, IN CLASS 16 (U.S. CLS. 2, 5, 22, 23, 29, 37, 38  
AND 50).

FIRST USE 2-23-2007; IN COMMERCE 2-23-2007.

FOR: NON-LUMINOUS, NON-MECHANICAL  
SIGNS NOT OF METAL, NAMELY, ACRYLIC  
PRICE SIGNS, ACRYLIC BAR SIGNS, IN CLASS 19  
(U.S. CLS. 1, 12, 33 AND 50).

FIRST USE 4-30-2007; IN COMMERCE 4-30-2007.

FOR: PLASTIC CUPS, IN CLASS 21 (U.S. CLS. 2, 13,  
23, 29, 30, 33, 40 AND 50).

FIRST USE 4-30-2007; IN COMMERCE 4-30-2007.

FOR: BANNERS OF CLOTH, IN CLASS 24 (U.S.  
CLS. 42 AND 50).

FIRST USE 4-30-2007; IN COMMERCE 4-30-2007.

THE MARK CONSISTS OF STANDARD CHAR-  
ACTERS WITHOUT CLAIM TO ANY PARTICULAR  
FONT, STYLE, SIZE, OR COLOR.

OWNER OF U.S. REG. NO. 3,008,995.

THE FOREIGN WORDING IN THE MARK  
TRANSLATES INTO ENGLISH AS HUNTER.

SER. NO. 77-206,302, FILED 6-14-2007.

BRENDAN REGAN, EXAMINING ATTORNEY

Int. Cl.: 37

Prior U.S. Cls.: 100, 103 and 106

United States Patent and Trademark Office

Reg. No. 3,465,835

Registered July 15, 2008

SERVICE MARK  
PRINCIPAL REGISTER



ASPEN DRILLING, LLC (COLORADO LTD LIAB  
CO)  
2040 W HAMILTON PLACE  
SHERIDAN, CO 80110

FOR: OIL AND GAS DRILLING, IN CLASS 37  
(U.S. CLS. 100, 103 AND 106).

FIRST USE 2-12-2007; IN COMMERCE 2-28-2007.

NO CLAIM IS MADE TO THE EXCLUSIVE  
RIGHT TO USE "COMPANIES", APART FROM  
THE MARK AS SHOWN.

THE COLOR(S) WHITE, BLACK AND RED IS/  
ARE CLAIMED AS A FEATURE OF THE MARK.

THE BLACK AND WHITE COLOR IS LOCATED  
IN THE MOUNTAINS BEHIND THE RED "ASPEN"  
LETTERING THAT HAS A BLACK BORDER. ALSO,  
THE LETTERING COMPANIES IS BLACK AND  
LOCATED UNDER THE RED "ASPEN" LETTER-  
ING.

SER. NO. 77-206,387, FILED 6-14-2007.

MARTHA FROMM, EXAMINING ATTORNEY

**Int. Cl.: 43**

**Prior U.S. Cls.: 100 and 101**

**United States Patent and Trademark Office**

**Reg. No. 3,465,836**

**Registered July 15, 2008**

**SERVICE MARK  
PRINCIPAL REGISTER**



KATSE, INC. (CALIFORNIA CORPORATION)  
2335 CASA GRANDE  
PASADENA, CA 91104

FOR: RESTAURANT SERVICES, IN CLASS 43  
(U.S. CLS. 100 AND 101).

FIRST USE 8-1-2005; IN COMMERCE 9-1-2005.

NO CLAIM IS MADE TO THE EXCLUSIVE  
RIGHT TO USE "CALIFORNIA SKEWERS", APART  
FROM THE MARK AS SHOWN.

THE COLOR(S) GRAY, RED, YELLOW, WHITE,  
BLUE, ORANGE AND BLACK IS/ARE CLAIMED AS  
A FEATURE OF THE MARK.

THE MARK CONSIST OF THE BACKGROUND IS  
WHITE, THE WORDING "CALIFORNIA" IS RED,  
THE WORDING "SKEWERS" IS BLUE, THE  
SCREWS ARE GRAY, THE SUN DESIGN AND  
HORIZONTAL LINES ARE YELLOW, THE GRILL  
DESIGN IS BLACK WITH BLACK LINES, THE  
KABOBS ARE BLACK, THE FLAMES ARE RED  
AND THE FIRE DESIGN IS RED, ORANGE, AND  
YELLOW.

SER. NO. 77-206,456, FILED 6-14-2007.

MICHELE SWAIN, EXAMINING ATTORNEY

**Int. Cl.: 35**

**Prior U.S. Cls.: 100, 101 and 102**

**United States Patent and Trademark Office**

**Reg. No. 3,465,837**

**Registered July 15, 2008**

**SERVICE MARK  
PRINCIPAL REGISTER**

**NETRITION**

NETRITION, INC. (NEW YORK CORPORATION)  
20 PETRA LANE  
ALBANY, NY 12205

FOR: COMPUTERIZED ON-LINE RETAIL STORE  
SERVICES IN THE FIELD OF NUTRITIONAL PRO-  
DUCTS, IN CLASS 35 (U.S. CLS. 100, 101 AND 102).

FIRST USE 2-19-1997; IN COMMERCE 2-19-1997.

THE MARK CONSISTS OF STANDARD CHAR-  
ACTERS WITHOUT CLAIM TO ANY PARTICULAR  
FONT, STYLE, SIZE, OR COLOR.

OWNER OF U.S. REG. NO. 2,476,963.

SER. NO. 77-206,573, FILED 6-14-2007.

JULIE GUTTADAURO, EXAMINING ATTORNEY

**Int. Cl.: 9**

**Prior U.S. Cls.: 21, 23, 26, 36 and 38**

**Reg. No. 3,465,838**

**United States Patent and Trademark Office**

**Registered July 15, 2008**

**TRADEMARK  
PRINCIPAL REGISTER**

# vPatrol

ISECURITECH COMPANY LIMITED (HONG  
KONG LTD LIAB CO)  
BLK 1, 16A, THE BELCHER'S, POKFULAM ROAD  
1A, 10 NAM FUNG SUN CHUEN, QUARRY BAY, -  
HONGKONG  
HONG KONG, HONG KONG

FOR: BUILDING SECURITY SYSTEMS COM-  
PRISING SOFTWARE AND HARDWARE FOR PRO-  
VIDING PICTURE, VIDEO, ALARM STATUS,  
BUILDING PLANS, AND OTHER INFORMATION  
TO A REMOTE STATION; ENTRY/EXIT SECURITY  
PORTAL COMPRISED OF AN ELECTRONIC PAS-  
SAGEWAY EQUIPPED WITH BIOMETRIC DEVI-  
CES FOR IDENTIFICATION VERIFICATION AND  
DETECTION OF IMPERMISSIBLE ITEMS BEING  
CARRIED THROUGH; ELECTRIC AND ELECTRO-

NIC VIDEO SURVEILLANCE INSTALLATIONS;  
FACILITIES MANAGEMENT SOFTWARE, NAME-  
LY, SOFTWARE TO CONTROL BUILDING ENVIR-  
ONMENTAL, ACCESS AND SECURITY SYSTEMS,  
IN CLASS 9 (U.S. CLS. 21, 23, 26, 36 AND 38).

FIRST USE 12-15-2006; IN COMMERCE 12-15-2006.

THE MARK CONSISTS OF STANDARD CHAR-  
ACTERS WITHOUT CLAIM TO ANY PARTICULAR  
FONT, STYLE, SIZE, OR COLOR.

SER. NO. 77-206,828, FILED 6-15-2007.

ALEXANDER L. POWERS, EXAMINING ATTOR-  
NEY



**Int. Cl.: 35**

**Prior U.S. Cls.: 100, 101 and 102**

**United States Patent and Trademark Office**

**Reg. No. 3,465,839**

**Registered July 15, 2008**

**SERVICE MARK  
PRINCIPAL REGISTER**

**The Professional Car  
Society**

THE PROFESSIONAL CAR SOCIETY (NEW JERSEY NON-PROFIT CORPORATION)  
201 GLENSIDE TRAIL  
SPARTA, NJ 07871

FOR: ASSOCIATION SERVICES FEATURING THE ORGANIZING AND MAINTAINING GROUPS AND CHAPTERS TO PROMOTE THE INTERESTS OF ANTIQUE PROFESSIONAL CAR OWNERS; BUSINESS MANAGEMENT AND ADMINISTRATION OF ASSOCIATION SERVICES IN THE FIELD OF ANTIQUE PROFESSIONAL CARS; PROMOTING PUBLIC AWARENESS OF THE PRESERVATION OF ANTIQUE PROFESSIONAL CARS, IN CLASS 35 (U.S. CLS. 100, 101 AND 102).

FIRST USE 3-1-1981; IN COMMERCE 3-1-1981.

THE MARK CONSISTS OF STANDARD CHARACTERS WITHOUT CLAIM TO ANY PARTICULAR FONT, STYLE, SIZE, OR COLOR.

NO CLAIM IS MADE TO THE EXCLUSIVE RIGHT TO USE "SOCIETY", APART FROM THE MARK AS SHOWN.

SEC. 2(F).

SER. NO. 77-206,900, FILED 6-15-2007.

SUE LAWRENCE, EXAMINING ATTORNEY

**Int. Cl.: 35**

**Prior U.S. Cls.: 100, 101 and 102**

**United States Patent and Trademark Office**

**Reg. No. 3,465,840**

**Registered July 15, 2008**

**SERVICE MARK  
PRINCIPAL REGISTER**

**GOLDRING GULF DISTRIBUTING**

N GOLDRING CORPORATION (ALABAMA CORPORATION)  
809 JEFFERSON HIGHWAY  
NEW ORLEANS, LA 70121

FOR: WHOLESALE DISTRIBUTORSHIP SERVICES FEATURING ALCOHOLIC AND NON-ALCOHOLIC BEVERAGES, IN CLASS 35 (U.S. CLS. 100, 101 AND 102).

FIRST USE 7-14-2001; IN COMMERCE 7-14-2001.

THE MARK CONSISTS OF STANDARD CHARACTERS WITHOUT CLAIM TO ANY PARTICULAR FONT, STYLE, SIZE, OR COLOR.

NO CLAIM IS MADE TO THE EXCLUSIVE RIGHT TO USE "DISTRIBUTING", APART FROM THE MARK AS SHOWN.

SER. NO. 77-207,032, FILED 6-15-2007.

ROBERT C. CLARK JR., EXAMINING ATTORNEY

**Int. Cl.: 35**

**Prior U.S. Cls.: 100, 101 and 102**

**United States Patent and Trademark Office**

**Reg. No. 3,465,841**

**Registered July 15, 2008**

---

**SERVICE MARK  
PRINCIPAL REGISTER**

**COW HALLOWEEN**

COW, INC. (INDIANA CORPORATION)  
3479 S. KENTUCKY AVENUE  
INDIANAPOLIS, IN 46221

FIRST USE 9-25-1998; IN COMMERCE 9-25-1998.

FOR: RETAIL STORES FEATURING HOLIDAY COSTUMES AND RELATED ACCESSORIES, HOLIDAY DECORATIONS, HOLIDAY PARTY SUPPLIES, HOLIDAY MERCHANDISE, AND OTHER HOLIDAY RELATED ITEMS, IN CLASS 35 (U.S. CLS. 100, 101 AND 102).

THE MARK CONSISTS OF STANDARD CHARACTERS WITHOUT CLAIM TO ANY PARTICULAR FONT, STYLE, SIZE, OR COLOR.

SER. NO. 77-207,036, FILED 6-15-2007.

BILL DAWE, EXAMINING ATTORNEY

Int. Cl.: 35

Prior U.S. Cls.: 100, 101 and 102

United States Patent and Trademark Office

Reg. No. 3,465,842

Registered July 15, 2008

SERVICE MARK  
PRINCIPAL REGISTER



N GOLDRING CORPORATION (ALABAMA CORPORATION)  
809 JEFFERSON HIGHWAY  
NEW ORLEANS, LA 70121

FOR: WHOLESALE DISTRIBUTORSHIP SERVICES FEATURING ALCOHOLIC AND NON-ALCOHOLIC BEVERAGES, IN CLASS 35 (U.S. CLS. 100, 101 AND 102).

FIRST USE 7-14-2001; IN COMMERCE 7-14-2001.

NO CLAIM IS MADE TO THE EXCLUSIVE RIGHT TO USE "DISTRIBUTING", APART FROM THE MARK AS SHOWN.

SER. NO. 77-207,124, FILED 6-15-2007.

ROBERT C. CLARK JR., EXAMINING ATTORNEY

**Int. Cl.: 9**

**Prior U.S. Cls.: 21, 23, 26, 36 and 38**

**Reg. No. 3,465,843**

**United States Patent and Trademark Office**

**Registered July 15, 2008**

---

**TRADEMARK  
PRINCIPAL REGISTER**

**Casinfo**

CASINFO (NEVADA LTD LIAB CO)  
5019 QUIET FALLS CT  
LAS VEGAS, NV 89141

THE MARK CONSISTS OF STANDARD CHAR-  
ACTERS WITHOUT CLAIM TO ANY PARTICULAR  
FONT, STYLE, SIZE, OR COLOR.

FOR: COMPUTER SOFTWARE FOR USE IN  
ACCOUNTING, PLAYER TRACKING AND PLAY-  
ER SERVICES IN THE GAMING INDUSTRY, IN  
CLASS 9 (U.S. CLS. 21, 23, 26, 36 AND 38).

SER. NO. 77-207,128, FILED 6-15-2007.

FIRST USE 7-31-2003; IN COMMERCE 7-31-2003.

SHANNON TWOHIG, EXAMINING ATTORNEY

Int. Cl.: 35

Prior U.S. Cls.: 100, 101 and 102

United States Patent and Trademark Office

Reg. No. 3,465,844

Registered July 15, 2008

**SERVICE MARK  
PRINCIPAL REGISTER**



THE PROFESSIONAL CAR SOCIETY (NEW JERSEY NON-PROFIT CORPORATION)  
201 GLENSIDE TRAIL  
SPARTA, NJ 07871

FOR: ASSOCIATION SERVICES FEATURING THE ORGANIZING AND MAINTAINING GROUPS AND CHAPTERS TO PROMOTE THE INTERESTS OF ANTIQUE PROFESSIONAL CAR OWNERS; BUSINESS MANAGEMENT AND ADMINISTRATION OF ASSOCIATION SERVICES IN THE FIELD OF ANTIQUE PROFESSIONAL CARS; PROMOTING PUBLIC AWARENESS OF THE PRESERVATION OF ANTIQUE PROFESSIONAL CARS, IN CLASS 35 (U.S. CLS. 100, 101 AND 102).

FIRST USE 3-1-1981; IN COMMERCE 3-1-1981.

NO CLAIM IS MADE TO THE EXCLUSIVE RIGHT TO USE "PROFESSIONAL CAR SOCIETY", APART FROM THE MARK AS SHOWN.

THE COLOR(S) RED, YELLOW, WHITE AND BLACK IS/ARE CLAIMED AS A FEATURE OF THE MARK.

THE MARK CONSISTS OF CIRCULAR DESIGN WITH A WHITE CROSS DESIGN WITHIN A RED CIRCLE; INSIDE THE WHITE CROSS IS A BLACK COACH, THE WHITE CROSS IS OUTLINED IN BLACK, THE RED CIRCLE IS OUTLINED IN WHITE; THE NEXT CIRCULAR BAND IS IN BLACK WITH WHITE RADIATING LINES, AND THE OUTER MOST BORDER IS IN YELLOW WITH A BLACK OUTER BORDER, AND THE WORDING "PROFESSIONAL CAR SOCIETY" IN BLACK.

SER. NO. 77-207,178, FILED 6-15-2007.

SUE LAWRENCE, EXAMINING ATTORNEY

**Int. Cl.: 43**

**Prior U.S. Cls.: 100 and 101**

**United States Patent and Trademark Office**

**Reg. No. 3,465,845**

**Registered July 15, 2008**

**SERVICE MARK  
PRINCIPAL REGISTER**

**MISAKI**

KYOTO OF KNOXVILLE, INC. (TENNESSEE  
CORPORATION)

8207 KINGSTON PIKE

KNOXVILLE, TN 37919

FOR: RESTAURANT SERVICES, IN CLASS 43  
(U.S. CLS. 100 AND 101).

FIRST USE 3-27-2007; IN COMMERCE 3-27-2007.

THE MARK CONSISTS OF STANDARD CHAR-  
ACTERS WITHOUT CLAIM TO ANY PARTICULAR  
FONT, STYLE, SIZE, OR COLOR.

THE FOREIGN WORDING IN THE MARK  
TRANSLATES INTO ENGLISH AS BLOOMING  
TASTE / BLOOMING FLAVOR.

SER. NO. 77-207,331, FILED 6-15-2007.

ODESSA BIBBINS, EXAMINING ATTORNEY

**Int. Cl.: 14**

**Prior U.S. Cls.: 2, 27, 28 and 50**

**United States Patent and Trademark Office**

**Reg. No. 3,465,846**

**Registered July 15, 2008**

**TRADEMARK  
PRINCIPAL REGISTER**

**UNCONDITIONAL LOVE**

MICHAEL ANTHONY JEWELERS LLC (NEW  
YORK LTD LIAB CO)  
115 SOUTH MACQUESTEN PARKWAY  
MOUNT VERNON, NY 10550

THE MARK CONSISTS OF STANDARD CHAR-  
ACTERS WITHOUT CLAIM TO ANY PARTICULAR  
FONT, STYLE, SIZE, OR COLOR.

FOR: JEWELRY, IN CLASS 14 (U.S. CLS. 2, 27, 28  
AND 50).

SER. NO. 77-207,599, FILED 6-15-2007.

FIRST USE 6-1-2007; IN COMMERCE 6-1-2007.

CHARLOTTE CORWIN, EXAMINING ATTORNEY



**Int. Cl.: 9**

**Prior U.S. Cls.: 21, 23, 26, 36 and 38**

**United States Patent and Trademark Office**

**Reg. No. 3,465,847**

**Registered July 15, 2008**

**TRADEMARK  
PRINCIPAL REGISTER**



COMPUTER TELEPHONY SOLUTIONS, INC.  
(ARIZONA CORPORATION), DBA OAISYS  
7965 S. PRIEST DRIVE #105  
TEMPE, AZ 85284

FOR: TELEPHONE CALL RECORDING SYSTEM  
COMPRISED PRIMARILY OF COMPUTER HARD-  
WARE AND COMPUTER SOFTWARE PROGRAMS  
FOR THE RECORDING OF CONVERSATIONS,  
DICTATIONS, AND VERBAL MESSAGES AND  
THE INTEGRATION OF TEXT, ASSOCIATED  
DATA, HYPERLINKS AND AUDIO RECORDINGS

INTO A SINGLE FILE, IN CLASS 9 (U.S. CLS. 21, 23,  
26, 36 AND 38).

FIRST USE 1-10-2007; IN COMMERCE 1-10-2007.

THE MARK CONSISTS OF A CIRCLE OVERLAY-  
ING A "T".

SER. NO. 77-207,764, FILED 6-15-2007.

RONALD MCMORROW, EXAMINING ATTORNEY

Int. Cl.: 25

Prior U.S. Cls.: 22 and 39

United States Patent and Trademark Office

Reg. No. 3,465,848

Registered July 15, 2008

TRADEMARK  
PRINCIPAL REGISTER

*il cocco di mamma* 

BOTTARI, DONNA M. (UNITED STATES INDIVIDUAL)  
13 STOWERS STREET  
REVERE, MA 02151

FOR: CUSTOM DESIGNED PRODUCTS, NAME-  
LY, INFANTWEAR, CHILDREN'S CLOTHING,  
NAMELY, BIBS, SHIRTS, INFANT AND TODDLER  
ONE-PIECE CLOTHING, HATS, SOCKS, SHOES,  
DRESSES, PANTS, JACKETS, AND SWEATERS,  
AND ADULT SHIRTS, IN CLASS 25 (U.S. CLS. 22  
AND 39).

FIRST USE 6-17-2006; IN COMMERCE 6-17-2006.

THE COLOR(S) BLUE IS/ARE CLAIMED AS A  
FEATURE OF THE MARK.

THE MARK CONSISTS OF STYLIZED BLUE  
CURSIVE LOWERCASE LETTERS "IL COCCO DI  
MAMMA" IN THE SHAPE OF A WAVE. A SOLID  
BLUE HEART FOLLOWS THE WORD "MAMMA".

THE FOREIGN WORDING IN THE MARK  
TRANSLATES INTO ENGLISH AS MAMA'S BOY.

SER. NO. 77-207,809, FILED 6-15-2007.

MARTHA SANTOMARTINO, EXAMINING ATTOR-  
NEY

**Int. Cl.: 41**

**Prior U.S. Cls.: 100, 101 and 107**

**United States Patent and Trademark Office**

**Reg. No. 3,465,849**

**Registered July 15, 2008**

**SERVICE MARK  
PRINCIPAL REGISTER**

**TEAM INTELLIGENCE**

CALDWELL CONSULTING GROUP, LLC. (ILLINOIS LIMITED LIABILITY CORPORATION)  
1482 WHITE OAK LANE  
WOODSTOCK, IL 60098

FOR: TRAINING AND COACHING SERVICES FOR TEAM BUILDING, IN CLASS 41 (U.S. CLS. 100, 101 AND 107).

FIRST USE 6-10-1996; IN COMMERCE 1-12-2007.

THE MARK CONSISTS OF STANDARD CHARACTERS WITHOUT CLAIM TO ANY PARTICULAR FONT, STYLE, SIZE, OR COLOR.

NO CLAIM IS MADE TO THE EXCLUSIVE RIGHT TO USE "TEAM", APART FROM THE MARK AS SHOWN.

SER. NO. 77-207,960, FILED 6-16-2007.

ERNEST SHOSHO, EXAMINING ATTORNEY

**Int. Cl.: 3**

**Prior U.S. Cls.: 1, 4, 6, 50, 51 and 52**

**Reg. No. 3,465,850**

**United States Patent and Trademark Office**

**Registered July 15, 2008**

---

**TRADEMARK  
PRINCIPAL REGISTER**

# Black Gardenia

BERGMAN, MICHELE (UNITED STATES INDIVIDUAL)

1531 N. SIERRA BONITA

LOS ANGELES, CA 90046

FOR: PERFUME OILS, IN CLASS 3 (U.S. CLS. 1, 4, 6, 50, 51 AND 52).

FIRST USE 9-1-2001; IN COMMERCE 9-1-2001.

THE MARK CONSISTS OF STANDARD CHARACTERS WITHOUT CLAIM TO ANY PARTICULAR FONT, STYLE, SIZE, OR COLOR.

NO CLAIM IS MADE TO THE EXCLUSIVE RIGHT TO USE "GARDENIA", APART FROM THE MARK AS SHOWN.

SER. NO. 77-208,085, FILED 6-17-2007.

EDWARD FENNESSY, EXAMINING ATTORNEY

Int. Cl.: 25

Prior U.S. Cls.: 22 and 39

Reg. No. 3,465,851

United States Patent and Trademark Office

Registered July 15, 2008

TRADEMARK  
PRINCIPAL REGISTER

SUSEXFUL

BRACKINS, CRAIG L (UNITED STATES INDIVIDUAL)  
3794 ASHWOOD AVE  
LOS ANGELES, CA 90066

FOR: SPORTS SHIRTS; SPORTS SHIRTS WITH SHORT SLEEVES; SWEAT SHIRTS; T-SHIRTS; WIND SHIRTS; YOGA SHIRTS; A-SHIRTS; BUTTON-FRONT ALOHA SHIRTS; CAMP SHIRTS; DRESS SHIRTS; GOLF SHIRTS; KNIT SHIRTS; NIGHT SHIRTS; OPEN-NECKED SHIRTS; PIQUE SHIRTS; POLO SHIRTS; SHIRT FRONTS; SHIRT YOKES; SHIRTS; SHIRTS FOR SUITS; SHORT-SLEEVED OR LONG-SLEEVED T-SHIRTS; SHORT-SLEEVED SHIRTS; SLEEP SHIRTS; SPORT SHIRTS; BALLOON PANTS; CAPRI PANTS; CARGO PANTS; DENIMS; JOGGING PANTS; LEATHER PANTS; LOUNGE PANTS; NON-DISPOSABLE CLOTH TRAINING PANTS; NURSE PANTS; PANTS; PETTI-PANTS; SKI PANTS; SNOW PANTS; SNOWBOARD PANTS; SWEAT PANTS; TAP PANTS; TOBOGGAN HATS, PANTS AND CAPS; TRACK PANTS; WATERPROOF JACKETS AND PANTS; YOGA PANTS; LINGERIE; LINGERIE ACCESSORIES, NAMELY, REMOVABLE SILICONE BREAST ENHANCER PADS USED IN A BRA; MATERNITY LINGERIE; BRIEFS; DISPOSABLE UNDERWEAR; KNITTED UNDERWEAR; LADIES' UNDERWEAR; PARTS OF CLOTHING, NAMELY, GUSSETS FOR TIGHTS, GUSSETS FOR STOCKINGS, GUSSETS FOR BATHING SUITS, GUSSETS FOR UNDERWEAR, GUSSETS FOR LEOTARDS AND GUSSETS FOR FOOTLETS; PERSPIRATION ABSORBENT UNDERWEAR CLOTHING; THERMAL UNDERWEAR; THONGS; UNDERWEAR; UNDERWEAR, NAMELY, BOY SHORTS; WOMEN'S UNDERWEAR; WOMEN OR KNITTED UNDERWEAR; DRESS SHIELDS; DRESS SUITS; DRESSES; DRESSES

MADE FROM SKINS; DRESSING GOWNS; EVENING DRESSES; NURSE DRESSES; SKIRTS AND DRESSES; WEDDING DRESSES; WOMEN'S CEREMONIAL DRESSES; COATS; COATS FOR MEN AND WOMEN; COATS MADE OF COTTON; COATS OF DENIM; DUST COATS; FUR COATS; FUR COATS AND JACKETS; LAB COATS; LEATHER COATS; LIGHT-REFLECTING COATS; MEN AND WOMEN JACKETS, COATS, TROUSERS, VESTS; MORNING COATS; OVER COATS; RAIN COATS; RIDING COATS; SPORT COATS; SUIT COATS; TOP COATS; TRENCH COATS; WIND COATS; DENIM JACKETS; DOWN JACKETS; FISHERMEN'S JACKETS; FUR JACKETS; HEAVY JACKETS; JACKET LINERS; JACKETS; LEATHER JACKETS; LIGHT-REFLECTING JACKETS; LONG JACKETS; RAIN JACKETS; RAINPROOF JACKETS; SKI JACKETS; SLEEVED OR SLEEVELESS JACKETS; SMOKING JACKETS; SPORTS JACKETS; STUFF JACKETS; SUEDE JACKETS; WIND RESISTANT JACKETS; WIND-JACKETS; FISHING VESTS; HUNTING VESTS; LONG SLEEVED VESTS; QUILTED VESTS; VEST EXTENDERS; VESTED SUITS; VESTS; WIND VESTS; FUR HATS; HAT BANDS; HATS; SMALL HATS; WOOLLY HATS, IN CLASS 25 (U.S. CLS. 22 AND 39).

FIRST USE 9-13-1996; IN COMMERCE 9-13-1996.

THE MARK CONSISTS OF STANDARD CHARACTERS WITHOUT CLAIM TO ANY PARTICULAR FONT, STYLE, SIZE, OR COLOR.

SER. NO. 77-208,113, FILED 6-18-2007.

ALEXANDER L. POWERS, EXAMINING ATTORNEY

Int. Cls.: 35, 37 and 45

Prior U.S. Cls.: 100, 101, 102, 103 and 106

United States Patent and Trademark Office

Reg. No. 3,465,852

Registered July 15, 2008

SERVICE MARK  
PRINCIPAL REGISTER



UNIFIRST CORPORATION (MASSACHUSETTS CORPORATION)  
68 JONSPIN ROAD  
WILMINGTON, MA 01887

FOR: ONLINE RETAIL STORE SERVICES IN THE FIELD OF UNIFORMS, FACILITY SERVICES PRODUCTS, NAMELY, FLOOR MATS, JANITORIAL CLEANING PRODUCTS, RESTROOM PRODUCTS INCLUDING HAND SOAP, SANITIZERS, AIR FRESHENERS, DISPOSABLE TOWELS AND TOWEL DISPENSERS AND DISPOSABLE TISSUE, AND PROTECTIVE CLOTHING, IN CLASS 35 (U.S. CLS. 100, 101 AND 102).

FIRST USE 4-30-2006; IN COMMERCE 4-30-2006.

FOR: JANITORIAL SERVICES; RENTAL OF MOPS, TEXTILE TOWELS FOR USE IN RESTROOM AND FLOOR CARE; RENTAL OF FACILITY SERVICES PRODUCTS, NAMELY, MATS AND JANITORIAL PRODUCTS, LAUNDRY SERVICES FOR

UNIFORMS AND PROTECTIVE CLOTHING, IN CLASS 37 (U.S. CLS. 100, 103 AND 106).

FIRST USE 4-30-2006; IN COMMERCE 4-30-2006.

FOR: RENTAL SERVICES, NAMELY, THE RENTAL OF UNIFORMS AND PROTECTIVE CLOTHING, IN CLASS 45 (U.S. CLS. 100 AND 101).

FIRST USE 4-30-2006; IN COMMERCE 4-30-2006.

OWNER OF U.S. REG. NOS. 1,320,087 AND 3,058,815.

THE MARK CONSISTS OF "UNIFIRST U1ST" AND RECTANGLE DESIGN.

SER. NO. 77-208,173, FILED 6-18-2007.

MICHAEL WEBSTER, EXAMINING ATTORNEY

**Int. Cls.: 18 and 24**

**Prior U.S. Cls.: 1, 2, 3, 22, 41, 42 and 50**

**United States Patent and Trademark Office**

**Reg. No. 3,465,853**

**Registered July 15, 2008**

**TRADEMARK  
PRINCIPAL REGISTER**

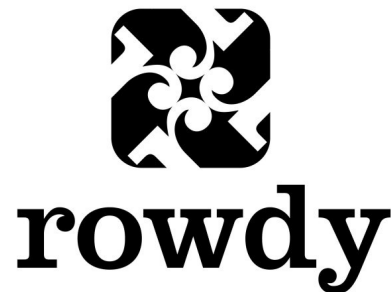

ROWDY PRODUCTS, LLC (IDAHO LTD LIAB  
CO)  
2231 W. DIVIDE CREEK STREET  
MERIDIAN, ID 83646

FOR: INFANT CARRIERS WORN ON THE BODY  
AND SLINGS FOR CARRYING INFANTS; DIAPER  
BAGS, AND HAND BAGS, IN CLASS 18 (U.S. CLS. 1,  
2, 3, 22 AND 41).

FIRST USE 4-1-2007; IN COMMERCE 4-1-2007.

FOR: INFANT AND TODDLER BEDDING,  
NAMELY, BLANKETS, LINENS, BED PADS, MAT-

TRESS PADS AND CRIB BUMPER PADS, IN CLASS  
24 (U.S. CLS. 42 AND 50).

FIRST USE 4-1-2007; IN COMMERCE 4-1-2007.

THE MARK CONSISTS OF THE WORD "ROW-  
DY" WITH A REPRESENTATION IMAGE OF A  
PINWHEEL MADE OUT OF THE LETTER "R".

SER. NO. 77-208,218, FILED 6-18-2007.

ELIZABETH HUGHITT, EXAMINING ATTORNEY

**Int. Cl.: 2**

**Prior U.S. Cls.: 6, 11 and 16**

**United States Patent and Trademark Office**

**Reg. No. 3,465,854**

**Registered July 15, 2008**

**TRADEMARK  
PRINCIPAL REGISTER**

**AWX**

THE SHERWIN-WILLIAMS COMPANY (DELA-  
WARE CORPORATION)  
300 DELAWARE AVENUE  
SUITE 522  
WILMINGTON, FED REP GERMANY 198011607

FOR: PAINTS, IN CLASS 2 (U.S. CLS. 6, 11 AND 16).

FIRST USE 9-29-2006; IN COMMERCE 9-29-2006.

THE MARK CONSISTS OF STANDARD CHAR-  
ACTERS WITHOUT CLAIM TO ANY PARTICULAR  
FONT, STYLE, SIZE, OR COLOR.

SER. NO. 77-208,405, FILED 6-18-2007.

LINDA ORNDORFF, EXAMINING ATTORNEY



**Int. Cl.: 25**

**Prior U.S. Cls.: 22 and 39**

**United States Patent and Trademark Office**

**Reg. No. 3,465,855**

**Registered July 15, 2008**

**TRADEMARK  
PRINCIPAL REGISTER**

**KENTUCKY THOROUGHBRED**

EAGLE CREST, INC. (FLORIDA CORPORATION)  
5353-1 RAMONA BOULEVARD  
JACKSONVILLE, FL 32205

FIRST USE 4-4-2007; IN COMMERCE 4-4-2007.

FOR: CLOTHING, NAMELY, HATS, SHIRTS,  
UNDERGARMENTS, SWIMSUITS, SWEATSHIRTS,  
SWEATERS, JACKETS, COATS, GLOVES, SCARVES,  
BELTS, HEADBANDS, WRISTBANDS, PANTS,  
SHORTS, SKIRTS, DRESSES, OVERALLS, SOCKS,  
STOCKINGS, AND LEGGINGS, IN CLASS 25 (U.S.  
CLS. 22 AND 39).

THE MARK CONSISTS OF STANDARD CHAR-  
ACTERS WITHOUT CLAIM TO ANY PARTICULAR  
FONT, STYLE, SIZE, OR COLOR.

SER. NO. 77-208,522, FILED 6-18-2007.

RONALD MCMORROW, EXAMINING ATTORNEY

**Int. Cl.: 2**

**Prior U.S. Cls.: 6, 11 and 16**

**United States Patent and Trademark Office**

**Reg. No. 3,465,856**

**Registered July 15, 2008**

**TRADEMARK  
PRINCIPAL REGISTER**

**ZIPSET**

TOKYO PRINTING INK CORPORATION, U.S.A.  
(CALIFORNIA CORPORATION)  
18710 S. WILMINGTON AVE., SUITE 101  
RANCHO DOMINGUEZ, CA 90220

FOR: PRINTING INKS, COATINGS, PIGMENTS  
AND DISPERSIONS FOR USE IN THE GRAPHIC  
ARTS INDUSTRY, IN CLASS 2 (U.S. CLS. 6, 11 AND  
16).

FIRST USE 0-0-1944; IN COMMERCE 10-1-1990.

THE MARK CONSISTS OF STANDARD CHAR-  
ACTERS WITHOUT CLAIM TO ANY PARTICULAR  
FONT, STYLE, SIZE, OR COLOR.

SER. NO. 77-208,561, FILED 6-18-2007.

ESTHER BELENKER, EXAMINING ATTORNEY

**Int. Cl.: 11**

**Prior U.S. Cls.: 13, 21, 23, 31 and 34**

**United States Patent and Trademark Office**

**Reg. No. 3,465,857**

**Registered July 15, 2008**

**TRADEMARK  
PRINCIPAL REGISTER**

**ACCUFLECT**

ACCURATUS CORPORATION (DELAWARE  
CORPORATION)  
35 HOWARD STREET  
PHILLIPSBURG, NJ 08865

THE MARK CONSISTS OF STANDARD CHAR-  
ACTERS WITHOUT CLAIM TO ANY PARTICULAR  
FONT, STYLE, SIZE, OR COLOR.

FOR: LAMP REFLECTORS; LIGHT REFLEC-  
TORS, IN CLASS 11 (U.S. CLS. 13, 21, 23, 31 AND 34).

SER. NO. 77-208,827, FILED 6-18-2007.

FIRST USE 1-1-2000; IN COMMERCE 1-1-2000.

JIM RINGLE, EXAMINING ATTORNEY

Int. Cl.: 35

Prior U.S. Cls.: 100, 101 and 102

United States Patent and Trademark Office

Reg. No. 3,465,858

Registered July 15, 2008

SERVICE MARK  
PRINCIPAL REGISTER

The logo features the words "Tide Report" in a bold, hand-drawn, sans-serif font. The word "Tide" is positioned above "Report". A thick, solid black horizontal line is drawn underneath the word "Report", extending across its width and slightly beyond.

NOBLE COMMUNICATIONS COMPANY (MISSOURI CORPORATION)  
2155 WEST CHESTERFIELD BOULEVARD  
SPRINGFIELD, MO 65807

FOR: BUSINESS MARKETING AND BUSINESS CONSULTING SERVICES; MARKET RESEARCH; MARKET SERVICES, NAMELY CONDUCTING CONSUMER TRACKING BEHAVIOR RESEARCH AND CONSUMER TREND ANALYSIS; COMMERCIALIZATION STRATEGY SERVICES, NAMELY CREATING CORPORATE AND BRANDING IDENTITY FOR OTHERS; MARKETING, ADVERTISING AND PROMOTION OF THE GOODS AND SERVICES OF OTHERS, IN CLASS 35 (U.S. CLS. 100, 101 AND 102).

FIRST USE 5-23-2007; IN COMMERCE 5-23-2007.

NO CLAIM IS MADE TO THE EXCLUSIVE RIGHT TO USE "REPORT", APART FROM THE MARK AS SHOWN.

THE MARK CONSISTS OF THE TERM "TIDE REPORT" WRITTEN IN A STYLIZED MANNER WITH A LINE UNDER THE WORD "REPORT".

SER. NO. 77-208,846, FILED 6-18-2007.

JIM RINGLE, EXAMINING ATTORNEY

**Int. Cls.: 16, 35 and 41**

**Prior U.S. Cls.: 2, 5, 22, 23, 29, 37, 38, 50, 100, 101, 102  
and 107**

**Reg. No. 3,465,859**

**United States Patent and Trademark Office**

**Registered July 15, 2008**

**TRADEMARK  
SERVICE MARK  
PRINCIPAL REGISTER**

AMERICAN HEADACHE SOCIETY

AMERICAN HEADACHE SOCIETY (MISSOURI  
NON-PROFIT CORPORATION)  
19 MANTUA ROAD  
MOUNT ROYAL, NJ 08061

FOR: NEWSLETTERS IN THE SUBJECTS OF  
DIAGNOSIS AND TREATMENT OF HEADACHE,  
IN CLASS 16 (U.S. CLS. 2, 5, 22, 23, 29, 37, 38 AND 50).

FIRST USE 10-24-1999; IN COMMERCE 10-24-1999.

FOR: REFERRAL SERVICES IN THE NATURE  
OF REFERRING PATIENTS TO PHYSICIANS, IN  
CLASS 35 (U.S. CLS. 100, 101 AND 102).

FIRST USE 10-24-1999; IN COMMERCE 10-24-1999.

FOR: DEVELOPMENT AND DISSEMINATION  
OF EDUCATIONAL MATERIALS OF OTHERS IN  
THE FIELD OF PAIN ASSOCIATED WITH THE  
HEAD, FACE AND NECK; EDUCATIONAL SERVI-

CES IN THE NATURE OF CONDUCTING SEMI-  
NARS RELATING TO HEADACHE DIAGNOSIS  
AND TREATMENT, IN CLASS 41 (U.S. CLS. 100,  
101 AND 107).

FIRST USE 10-24-1999; IN COMMERCE 10-24-1999.

THE MARK CONSISTS OF STANDARD CHAR-  
ACTERS WITHOUT CLAIM TO ANY PARTICULAR  
FONT, STYLE, SIZE, OR COLOR.

NO CLAIM IS MADE TO THE EXCLUSIVE  
RIGHT TO USE "HEADACHE SOCIETY", APART  
FROM THE MARK AS SHOWN.

SEC. 2(F).

SER. NO. 77-209,037, FILED 6-18-2007.

TINA KUAN, EXAMINING ATTORNEY

**Int. Cl.: 35**

**Prior U.S. Cls.: 100, 101 and 102**

**United States Patent and Trademark Office**

**Reg. No. 3,465,860**

**Registered July 15, 2008**

**SERVICE MARK  
PRINCIPAL REGISTER**

# The Best Wurst

THE MONKEY'S DOG, LLC (TEXAS LTD LIAB  
CO)  
2400 WILSON STREET  
AUSTIN, TX 78704

NO CLAIM IS MADE TO THE EXCLUSIVE  
RIGHT TO USE "WURST", APART FROM THE  
MARK AS SHOWN.

FOR: STREET VENDOR SERVICES FEATURING  
FOOD, IN CLASS 35 (U.S. CLS. 100, 101 AND 102).

SEC. 2(F).

FIRST USE 3-31-1997; IN COMMERCE 3-31-1997.

SER. NO. 77-209,044, FILED 6-18-2007.

THE MARK CONSISTS OF STANDARD CHAR-  
ACTERS WITHOUT CLAIM TO ANY PARTICULAR  
FONT, STYLE, SIZE, OR COLOR.

GISELLE AGOSTO, EXAMINING ATTORNEY

**Int. Cl.: 25**

**Prior U.S. Cls.: 22 and 39**

**United States Patent and Trademark Office**

**Reg. No. 3,465,861**

**Registered July 15, 2008**

**TRADEMARK  
PRINCIPAL REGISTER**

**ITALIC**

LIAO, YUE (CHINA INDIVIDUAL)  
49 KUNLUN ROAD  
LUCHENG INDUSTRIAL DEVELOPMENT DIS-  
TRICT  
WENZHOU, ZHEJIANG, CHINA

FOR: GLOVES; HEADWEAR; LEATHER SHOES;  
SHIRTS; SHOE SOLES; SHOES; T-SHIRTS; HOSIERY;  
NECKTIES; TROUSERS; UNDERWEAR; BELTS  
MADE OF LEATHER; JACKETS , IN CLASS 25  
(U.S. CLS. 22 AND 39).

FIRST USE 10-20-2005; IN COMMERCE 2-1-2007.

THE MARK CONSISTS OF STANDARD CHAR-  
ACTERS WITHOUT CLAIM TO ANY PARTICULAR  
FONT, STYLE, SIZE, OR COLOR.

SER. NO. 77-209,192, FILED 6-19-2007.

GIANCARLO CASTRO, EXAMINING ATTORNEY

**Int. Cl.: 35**

**Prior U.S. Cls.: 100, 101 and 102**

**United States Patent and Trademark Office**

**Reg. No. 3,465,862**

**Registered July 15, 2008**

**SERVICE MARK  
PRINCIPAL REGISTER**

**THE LOVE OF THE LAND**

RIO VISTA, LIMITED (CALIFORNIA PARTNER-  
SHIP)  
P. O. BOX 21218  
LOS ANGELES, CA 90021

THE MARK CONSISTS OF STANDARD CHAR-  
ACTERS WITHOUT CLAIM TO ANY PARTICULAR  
FONT, STYLE, SIZE, OR COLOR.

FOR: DISTRIBUTORSHIPS IN THE FIELD OF  
FRESH PRODUCE, IN CLASS 35 (U.S. CLS. 100, 101  
AND 102).

SER. NO. 77-209,394, FILED 6-19-2007.

FIRST USE 10-20-2003; IN COMMERCE 11-1-2003.

BARBARA BROWN, EXAMINING ATTORNEY



**Int. Cl.: 9**

**Prior U.S. Cls.: 21, 23, 26, 36 and 38**

**Reg. No. 3,465,863**

**United States Patent and Trademark Office**

**Registered July 15, 2008**

---

**TRADEMARK  
PRINCIPAL REGISTER**

**iTALK**

LOCATION BASED TECHNOLOGIES, INC. (NE-  
VADA CORPORATION)  
4989 E. LA PALMA AVENUE  
ANAHEIM, CA 92807

FOR: CASES FOR MOBILE PHONES; CELL  
PHONE COVERS; CELL PHONES; CELLULAR  
PHONES; DIGITAL CELLULAR PHONES; DIGITAL  
PHONES; PAGERS, IN CLASS 9 (U.S. CLS. 21, 23, 26,  
36 AND 38).

FIRST USE 10-1-1997; IN COMMERCE 10-1-1997.

THE MARK CONSISTS OF STANDARD CHAR-  
ACTERS WITHOUT CLAIM TO ANY PARTICULAR  
FONT, STYLE, SIZE, OR COLOR.

SER. NO. 77-209,849, FILED 6-19-2007.

KRISTINA MORRIS, EXAMINING ATTORNEY

**Int. Cl.: 4**

**Prior U.S. Cls.: 1, 6 and 15**

**United States Patent and Trademark Office**

**Reg. No. 3,465,864**

**Registered July 15, 2008**

**TRADEMARK  
PRINCIPAL REGISTER**



CONOCOPHILLIPS COMPANY (DELAWARE  
CORPORATION)  
ML 1106  
600 NORTH DAIRY ASHFORD  
HOUSTON, TX 770791175

FOR: LUBRICANTS, NAMELY, OILS FOR MO-  
TOR VEHICLES, IN CLASS 4 (U.S. CLS. 1, 6 AND 15).

FIRST USE 7-10-2006; IN COMMERCE 9-28-2006.

NO CLAIM IS MADE TO THE EXCLUSIVE  
RIGHT TO USE "CLASSIC ATF", APART FROM  
THE MARK AS SHOWN.

THE MARK CONSISTS OF THE WORD "CLAS-  
SIC" WITH A STAR ABOVE THE "I" AND "ATF"  
BELOW. THE STIPPLING ABOVE THE "I" IN THE  
UPPER RIGHT PORTION IS USED TO SHOW THE  
STAR PATTERN. THE STIPPLING IS NOT  
CLAIMED AS PART OF THE MARK. THE OTHER  
GRAY TONES OF THE MARK ARE NOT CLAIMED  
AS COLOR.

SER. NO. 77-209,924, FILED 6-19-2007.

MARY CRAWFORD, EXAMINING ATTORNEY

**Int. Cl.: 36**

**Prior U.S. Cls.: 100, 101 and 102**

**United States Patent and Trademark Office**

**Reg. No. 3,465,865**

**Registered July 15, 2008**

**SERVICE MARK  
PRINCIPAL REGISTER**

**PRO PHARMA**

PRO PHARMA PHARMACEUTICAL CONSULTANTS, INC. (CALIFORNIA CORPORATION)  
SUITE 150  
9221 CORBIN AVENUE  
NORTHRIDGE, CA 91324

FOR: PHARMACY BENEFIT CONSULTING, MANAGEMENT AND DATA ANALYSIS SERVICES, IN CLASS 36 (U.S. CLS. 100, 101 AND 102).

FIRST USE 12-31-1985; IN COMMERCE 12-31-1985.

THE MARK CONSISTS OF STANDARD CHARACTERS WITHOUT CLAIM TO ANY PARTICULAR FONT, STYLE, SIZE, OR COLOR.

NO CLAIM IS MADE TO THE EXCLUSIVE RIGHT TO USE "PHARMA", APART FROM THE MARK AS SHOWN.

SER. NO. 77-210,096, FILED 6-19-2007.

MARK SPARACINO, EXAMINING ATTORNEY

**Int. Cl.: 35**

**Prior U.S. Cls.: 100, 101 and 102**

**United States Patent and Trademark Office**

**Reg. No. 3,465,866**

**Registered July 15, 2008**

**SERVICE MARK  
PRINCIPAL REGISTER**

**CIRCLE OF EXCELLENCE**

COMPRESSION MANAGEMENT SERVICES, INC.  
(PENNSYLVANIA CORPORATION)  
SUITE 420  
580 SOUTH AIKEN AVENUE  
PITTSBURGH, PA 15232

FOR: RETAIL STORE SERVICES FEATURING  
GOODS FOR WOMEN CANCER PATIENTS AND  
SURVIVORS, NAMELY, WIGS, BREAST PROSTHE-  
SES, BRAS AND COMPRESSION GARMENTS, IN  
CLASS 35 (U.S. CLS. 100, 101 AND 102).

FIRST USE 9-1-2006; IN COMMERCE 5-1-2007.

THE MARK CONSISTS OF STANDARD CHAR-  
ACTERS WITHOUT CLAIM TO ANY PARTICULAR  
FONT, STYLE, SIZE, OR COLOR.

SER. NO. 77-210,513, FILED 6-20-2007.

MARY I. SPARROW, EXAMINING ATTORNEY

**Int. Cl.: 9**

**Prior U.S. Cls.: 21, 23, 26, 36 and 38**

**Reg. No. 3,465,867**

**United States Patent and Trademark Office**

**Registered July 15, 2008**

**TRADEMARK  
PRINCIPAL REGISTER**

**ADVENT SOFTWARE**

ADVENT SOFTWARE, INC. (DELAWARE CORPORATION)  
5TH FLOOR  
600 TOWNSEND ST.  
SAN FRANCISCO, CA 94103

FOR: COMPUTER SOFTWARE, AND MANUALS SOLD AS A UNIT, FOR USE IN THE FIELDS OF FINANCIAL MANAGEMENT, INVESTMENT TRACKING, PORTFOLIO ANALYSIS, PORTFOLIO MANAGEMENT, INVESTMENT REPORTING, INVESTMENT PERFORMANCE MEASUREMENT AND ANALYSIS, FINANCIAL INSTRUMENT TRADES TRACKING, ACCOUNT RECONCILIATION AND ACCOUNTING, INVESTMENT REVENUE MANAGEMENT, INVESTMENT BILLING MANAGEMENT, AND INVESTMENT ACCOUNT BILLING, RECEIVABLES TRACKING, REVENUE DISTRIBUTION AND REPORTING, IN CLASS 9 (U.S. CLS. 21, 23, 26, 36 AND 38).

FIRST USE 9-30-2005, THE MARK WAS FIRST USED ANYWHERE IN A DIFFERENT FORM

OTHER THAN THAT SOUGHT TO BE REGISTERED ON 01/15/1983.; IN COMMERCE 9-30-2005, THE MARK WAS FIRST USED IN COMMERCE IN A DIFFERENT FORM OTHER THAN THAT SOUGHT TO BE REGISTERED ON 01/15/1983..

THE MARK CONSISTS OF STANDARD CHARACTERS WITHOUT CLAIM TO ANY PARTICULAR FONT, STYLE, SIZE, OR COLOR.

OWNER OF U.S. REG. NOS. 1,490,606, 2,793,737 AND OTHERS.

NO CLAIM IS MADE TO THE EXCLUSIVE RIGHT TO USE "SOFTWARE", APART FROM THE MARK AS SHOWN.

SER. NO. 77-210,560, FILED 6-20-2007.

JOHN KELLY, EXAMINING ATTORNEY

**Int. Cl.: 41**

**Prior U.S. Cls.: 100, 101 and 107**

**United States Patent and Trademark Office**

**Reg. No. 3,465,868**

**Registered July 15, 2008**

**SERVICE MARK  
PRINCIPAL REGISTER**

# The Glamazons

FINGER, MERYL (UNITED STATES INDIVIDUAL)  
31-28 47TH STREET  
ASTORIA, NY 11103

FOR: ENTERTAINMENT IN THE NATURE OF LIVE PERFORMANCES BY SINGING AND DANCING GROUP; ENTERTAINMENT IN THE NATURE OF VISUAL AND AUDIO PERFORMANCES, AND MUSICAL, VARIETY, NEWS AND COMEDY SHOWS; ENTERTAINMENT IN THE NATURE OF VISUAL AND AUDIO PERFORMANCES, NAMELY, MUSICAL BAND, ROCK GROUP, GYMNASTIC, DANCE, AND BALLET PERFORMANCES; ENTERTAINMENT NAMELY, LIVE PERFORMANCES BY A MUSICAL BAND; ENTERTAINMENT SERVICES, NAMELY, PROVIDING A WEB SITE FEATURING

MUSICAL PERFORMANCES, MUSICAL VIDEOS, RELATED FILM CLIPS, PHOTOGRAPHS, AND OTHER MULTIMEDIA MATERIALS; ENTERTAINMENT, NAMELY, LIVE PERFORMANCES BY ROCK GROUPS, IN CLASS 41 (U.S. CLS. 100, 101 AND 107).

FIRST USE 1-1-2002; IN COMMERCE 1-1-2002.

THE MARK CONSISTS OF STANDARD CHARACTERS WITHOUT CLAIM TO ANY PARTICULAR FONT, STYLE, SIZE, OR COLOR.

SER. NO. 77-210,670, FILED 6-20-2007.

SUE LAWRENCE, EXAMINING ATTORNEY

**Int. Cl.: 29**

**Prior U.S. Cl.: 46**

**United States Patent and Trademark Office**

**Reg. No. 3,465,869**

**Registered July 15, 2008**

**TRADEMARK  
PRINCIPAL REGISTER**

Serve Your Family the Very  
Best ...

BIRDS EYE FOODS, INC. (DELAWARE COR-  
PORATION)  
90 LINDEN OAKS  
ROCHESTER, NY 14625

THE MARK CONSISTS OF STANDARD CHAR-  
ACTERS WITHOUT CLAIM TO ANY PARTICULAR  
FONT, STYLE, SIZE, OR COLOR.

FOR: FROZEN VEGETABLES, IN CLASS 29 (U.S.  
CL. 46).

SER. NO. 77-210,694, FILED 6-20-2007.

FIRST USE 11-0-2005; IN COMMERCE 11-0-2005.

ASMAT KHAN, EXAMINING ATTORNEY

**Int. Cl.: 44**

**Prior U.S. Cls.: 100 and 101**

**United States Patent and Trademark Office**

**Reg. No. 3,465,870**

**Registered July 15, 2008**

**SERVICE MARK  
PRINCIPAL REGISTER**

ALLENTOWN WOMEN'S CENTER

ALLENTOWN WOMEN'S CENTER, INC. (PENNSYLVANIA CORPORATION)  
1409 UNION BOULEVARD, REAR  
ALLENTOWN, PA 18109

FOR: MEDICAL SERVICES, NAMELY, PROVIDING BIRTH CONTROL COUNSELING, PREGNANCY TESTING AND COUNSELING, CONTRACEPTION, GYNECOLOGICAL SERVICES, REPRODUCTIVE HEALTH AND COUNSELING SERVICES, ABORTION SERVICES, PERFORMING OUTPATIENT SURGERY, DIAGNOSIS AND TREATMENT OF SEXUALLY TRANSMITTED DISEASES INCLUDING HIV, COLPOSCOPY AND CRYOSURGERY; PROVIDING MEDICAL INFORMATION, CONSULTANCY AND ADVISORY SERVICES; GYNECOLOGICAL PAP EXAMINATION, IN CLASS 44 (U.S. CLS. 100 AND 101).

FIRST USE 0-0-1978; IN COMMERCE 0-0-1980.

THE MARK CONSISTS OF STANDARD CHARACTERS WITHOUT CLAIM TO ANY PARTICULAR FONT, STYLE, SIZE, OR COLOR.

NO CLAIM IS MADE TO THE EXCLUSIVE RIGHT TO USE "WOMEN'S CENTER", APART FROM THE MARK AS SHOWN.

SEC. 2(F).

SER. NO. 77-210,725, FILED 6-20-2007.

TERESA M. RUPP, EXAMINING ATTORNEY



**Int. Cls.: 35 and 37**

**Prior U.S. Cls.: 100, 101, 102, 103 and 106**

**United States Patent and Trademark Office**

**Reg. No. 3,465,871**

**Registered July 15, 2008**

**SERVICE MARK  
PRINCIPAL REGISTER**

**SCHNUCKS EXPRESS**

SCHNUCK MARKET, INC. (MISSOURI CORPORATION)  
11420 LACKLAND AVE.  
ST. LOUIS, MO 631463561

FOR: RETAIL STORE SERVICES FEATURING CONVENIENCE STORE ITEMS, IN CLASS 35 (U.S. CLS. 100, 101 AND 102).

FIRST USE 7-14-1999; IN COMMERCE 7-14-1999.

FOR: VEHICLE SERVICE STATIONS FOR REFUELING; CAR AND TRUCK WASHING SERVICES, IN CLASS 37 (U.S. CLS. 100, 103 AND 106).

FIRST USE 6-0-2002; IN COMMERCE 6-0-2002.

THE MARK CONSISTS OF STANDARD CHARACTERS WITHOUT CLAIM TO ANY PARTICULAR FONT, STYLE, SIZE, OR COLOR.

OWNER OF U.S. REG. NOS. 1,352,203, 1,904,841 AND OTHERS.

SER. NO. 77-210,950, FILED 6-20-2007.

RONALD AIKENS, EXAMINING ATTORNEY

**Int. Cls.: 21 and 41**

**Prior U.S. Cls.: 2, 13, 23, 29, 30, 33, 40, 50, 100, 101  
and 107**

**Reg. No. 3,465,872**

**United States Patent and Trademark Office**

**Registered July 15, 2008**

**TRADEMARK  
SERVICE MARK  
PRINCIPAL REGISTER**

**THE ROAD ENDS HERE**

THE NATIONAL COLLEGIATE ATHLETIC AS-  
SOCIATION (INDIANA UNINC. ASSOCIA-  
TION)

P.O. BOX 6222  
INDIANAPOLIS, IN 46206

FOR: CUPS, IN CLASS 21 (U.S. CLS. 2, 13, 23, 29, 30,  
33, 40 AND 50).

FIRST USE 4-0-2005; IN COMMERCE 4-0-2005.

FOR: ENTERTAINMENT SERVICES IN THE  
NATURE OF ATHLETIC CONTESTS, GAMES,  
TOURNAMENTS, COMPETITIONS, EXHIBITIONS

AND EVENTS, IN CLASS 41 (U.S. CLS. 100, 101 AND  
107).

FIRST USE 4-0-2005; IN COMMERCE 4-0-2005.

THE MARK CONSISTS OF STANDARD CHAR-  
ACTERS WITHOUT CLAIM TO ANY PARTICULAR  
FONT, STYLE, SIZE, OR COLOR.

SER. NO. 77-211,093, FILED 6-20-2007.

NELSON SNYDER, EXAMINING ATTORNEY

**Int. Cl.: 3**

**Prior U.S. Cls.: 1, 4, 6, 50, 51 and 52**

**United States Patent and Trademark Office**

**Reg. No. 3,465,873**

**Registered July 15, 2008**

**TRADEMARK  
PRINCIPAL REGISTER**

**REV-ER UPPER**

BARE ESSENTUALS BEAUTY, INC. (DELA-  
WARE CORPORATION)  
22ND FLOOR  
71 STEVENSON STREET  
SAN FRANCISCO, CA 94105

FOR: NON-MEDICATED SKIN CARE PREPARA-  
TIONS; SKIN CARE PRODUCTS, NAMELY, NON-  
MEDICATED SKIN SERUM; NON-MEDICATED  
LIP CARE PREPARATIONS , IN CLASS 3 (U.S. CLS.  
1, 4, 6, 50, 51 AND 52).

FIRST USE 1-0-2005; IN COMMERCE 1-0-2005.

THE MARK CONSISTS OF STANDARD CHAR-  
ACTERS WITHOUT CLAIM TO ANY PARTICULAR  
FONT, STYLE, SIZE, OR COLOR.

OWNER OF U.S. REG. NO. 3,237,824.

SER. NO. 77-211,326, FILED 6-20-2007.

PAUL E. FAHRENKOPF, EXAMINING ATTORNEY

**Int. Cl.: 7**

**Prior U.S. Cls.: 13, 19, 21, 23, 31, 34 and 35**

**Reg. No. 3,465,874**

**United States Patent and Trademark Office**

**Registered July 15, 2008**

---

**TRADEMARK  
PRINCIPAL REGISTER**

**PreciseEdge**

GLOBE FOOD EQUIPMENT COMPANY (OHIO  
CORPORATION)  
2153 DRYDEN RD  
DAYTON, OH 45439

THE MARK CONSISTS OF STANDARD CHAR-  
ACTERS WITHOUT CLAIM TO ANY PARTICULAR  
FONT, STYLE, SIZE, OR COLOR.

FOR: ELECTRIC FOOD SLICERS, IN CLASS 7  
(U.S. CLS. 13, 19, 21, 23, 31, 34 AND 35).

SER. NO. 77-211,557, FILED 6-21-2007.

FIRST USE 7-5-2007; IN COMMERCE 7-5-2007.

ELLEN BURNS, EXAMINING ATTORNEY

**Int. Cl.: 28**

**Prior U.S. Cls.: 22, 23, 38 and 50**

**United States Patent and Trademark Office**

**Reg. No. 3,465,875**

**Registered July 15, 2008**

**TRADEMARK  
PRINCIPAL REGISTER**

**AFFINITY**

W.C. BRADLEY/ZEBCO HOLDINGS, INC.  
(GEORGIA CORPORATION)  
6101 EAST APACHE STREET  
TULSA, OK 74115

THE MARK CONSISTS OF STANDARD CHAR-  
ACTERS WITHOUT CLAIM TO ANY PARTICULAR  
FONT, STYLE, SIZE, OR COLOR.

FOR: FISHING RODS, IN CLASS 28 (U.S. CLS. 22,  
23, 38 AND 50).

SER. NO. 77-211,588, FILED 6-21-2007.

FIRST USE 7-1-2002; IN COMMERCE 7-1-2002.

CHRISTINE COOPER, EXAMINING ATTORNEY

**Int. Cl.: 41**

**Prior U.S. Cls.: 100, 101 and 107**

**United States Patent and Trademark Office**

**Reg. No. 3,465,876**

**Registered July 15, 2008**

**SERVICE MARK  
PRINCIPAL REGISTER**



CATCH MINISTRY, INC. (TENNESSEE CORPORATION)  
268 COTTONWOOD BEND  
CLEVELAND, TN 37312

FOR: CHARITABLE SERVICES, NAMELY, CONDUCTING RECREATIONAL FISHING EVENTS AND TOURNAMENTS FOR CHRISTIAN MINISTRY PURPOSES, IN CLASS 41 (U.S. CLS. 100, 101 AND 107).

FIRST USE 7-22-2006; IN COMMERCE 7-22-2006.

NO CLAIM IS MADE TO THE EXCLUSIVE RIGHT TO USE "CHRISTIAN FISH SYMBOL", APART FROM THE MARK AS SHOWN.

THE COLOR(S) COPPER, PLATINUM, SILVER, GOLD, BRONZE, PEWTER, ONYX, BRASS, BLACK AND WHITE IS/ARE CLAIMED AS A FEATURE OF THE MARK.

THE MARK CONSISTS OF THE OUTLINE OF THE CHRISTIAN FISH SYMBOL WITH THE WORD "CATCH" IN THE INTERIOR OUTLINE, DEPICTED IN METALLIC COLORS WITH REFLECTIVE COLORATION.

SER. NO. 77-211,813, FILED 6-21-2007.

JULIE GUTTADAURO, EXAMINING ATTORNEY

**Int. Cl.: 35**

**Prior U.S. Cls.: 100, 101 and 102**

**United States Patent and Trademark Office**

**Reg. No. 3,465,877**

**Registered July 15, 2008**

**SERVICE MARK  
PRINCIPAL REGISTER**



BAY N BAY, INC. (CALIFORNIA CORPORATION)  
5580 BANDINI BLVD.  
BELL, CA 90201

FOR: DISTRIBUTORSHIP SERVICES IN THE FIELD OF CLOTHING; GOODS IMPORT-EXPORT AGENCY IN THE FIELD OF CLOTHING; WHOLESALE DISTRIBUTORSHIPS AND ORDERING SERVICES IN THE FIELD OF CLOTHING , IN CLASS 35 (U.S. CLS. 100, 101 AND 102).

THE MARK CONSISTS OF THE WORDING "BAY N BAY" BELOW A BLOCK FIGURE. THE LETTERS "N", "B", AND "B" APPEAR ON THE SIDES OF THE BLOCK FIGURE. THE LETTER "N" APPEARS AT THE TOP OF THE BLOCK FIGURES AND THE TWO "B'S" APPEARS ON THE RIGHT AND LEFT OF THE BLOCK FIGURE.

SER. NO. 77-211,976, FILED 6-21-2007.

FIRST USE 6-10-2006; IN COMMERCE 6-10-2006.

SETH A. RAPPAPORT, EXAMINING ATTORNEY

**Int. Cl.: 35**

**Prior U.S. Cls.: 100, 101 and 102**

**United States Patent and Trademark Office**

**Reg. No. 3,465,878**

**Registered July 15, 2008**

---

**SERVICE MARK  
PRINCIPAL REGISTER**

**TURRET**

TURRET STEEL INDUSTRIES, INC. (PENNSYLVANIA CORPORATION)  
100 LEETSDALE INDUSTRIAL PARK DR.  
LEETSDALE, PA 15056

THE MARK CONSISTS OF STANDARD CHARACTERS WITHOUT CLAIM TO ANY PARTICULAR FONT, STYLE, SIZE, OR COLOR.

FOR: DISTRIBUTORSHIP SERVICES IN THE FIELD OF STAINLESS, CARBON AND ALLOY STEEL BARS AND BILLETS, IN CLASS 35 (U.S. CLS. 100, 101 AND 102).

SER. NO. 77-212,154, FILED 6-21-2007.

FIRST USE 4-10-1970; IN COMMERCE 5-30-1970.

B. PARADEWELAI, EXAMINING ATTORNEY



**Int. Cls.: 7, 9 and 12**

**Prior U.S. Cls.: 13, 19, 21, 23, 26, 31, 34, 35, 36, 38 and 44**

**Reg. No. 3,465,879**

**United States Patent and Trademark Office**

**Registered July 15, 2008**

**TRADEMARK  
PRINCIPAL REGISTER**

# MOROSO

MOROSO PERFORMANCE PRODUCTS, INC.  
(CONNECTICUT CORPORATION)  
80 CARTER DRIVE  
GUILFORD, CT 064372116

FOR: LAND VEHICLE CARBURETION SYSTEMS AND COMPONENTS THEREFORE, NAMELY, CARBURETOR SPACERS; CARBURETOR WEDGE PLATES, ANTI-REVERSION PLATES, CARBURETOR AIRPANS AND PARTS THEREFORE; ALTERNATOR PULLEYS; INSULATED SPARK PLUG WIRE SLEEVES; HIGH ENERGY IGNITION (HEI) DISTRIBUTOR BOOT UNITS COMPRISED OF BOOTS AND CLIPS FOR INSTALLATION ON THE ENDS OF DISTRIBUTOR CABLES, SPARK PLUG BOOT UNITS COMPRISED OF BOOTS AND CLIPS FOR INSTALLATION ON THE ENDS OF SPARK PLUG WIRES, DISTRIBUTOR BOOTS, SPARK PLUG WIRE GIRDLES; RACING SPARK PLUG WIRES, AND SPIRAL CORE SPARK PLUG WIRES, ALTERNATOR MOUNTING BRACKETS; AND ADVANCE WIRE UNITS TO MODIFY A DISTRIBUTOR SO AS TO CHANGE THE SPARK ADVANCE CURVE OF A STANDARD DISTRIBUTOR; INTAKE MANIFOLD BOLTS AND PARTS THEREFORE; VEHICLE IGNITION PARTS AND PARTS THEREFORE, NAMELY, IGNITION DISTRIBUTORS, DISTRIBUTOR TIMING INDICATORS; DISTRIBUTOR SHIMS AND PARTS THEREFORE; DISTRIBUTOR HOLD-DOWN CLAMPS; TIMING COVER BOLTS; FUEL PUMP PARTS, NAMELY, FUEL PUMP BLOCK-OFF PLATES AND FUEL PUMP PUSH RODS FOR LAND VEHICLES; OIL PUMPS AND PARTS THEREFORE, NAMELY, OIL PUMP SHAFTS, AND OIL PUMP HIGH-PRESSURE RELIEF SPRINGS, OIL PUMP EXTENSIONS, EXTENDED OIL PUMP PICKUPS, OIL PUMP PICKUPS, OIL PUMP PICKUP ASSEMBLIES, OIL RETURN GALLERY SCREEN AND PARTS THEREFORE, OIL RESERVE COMPENSATORS AND COMPENSATOR MOUNTS; AUTOMOBILE OIL PANS AND MOTOR VEHICLE OILING

SYSTEMS AND COMPONENTS COMPRISING OIL PANS, OIL RESTRICTORS AND PARTS THEREFORE, OIL PAN BAFFLES, OIL PAN STUDS AND PARTS THEREFORE, OIL PAN BOLTS; CRANK SHAFTS FOR LAND VEHICLES; DRY SUMP PUMPS AND EXTERNAL OIL PUMP DRIVES AND PARTS THEREFORE; OIL FILTER ADAPTERS, OIL FILTER BY-PASSES, REMOTE OIL FILTER MOUNTS, OIL FILTER BLOCK-OFF PLATES, OIL PUMP BLOCK-OFF PLATES, DRY SUMP OIL TANKS, DRY SUMP OIL TANK MOUNTS, OIL FILTERS; VALVE LIFTER OIL BAFFLES; AUTOMOTIVE PARTS, NAMELY, ENGINE SEALS; PUMPS FOR COOLING LAND VEHICLE ENGINES, VEHICLE COOLING SYSTEMS AND PARTS THEREFORE, NAMELY, WATER OUTLET RESTRICTORS AND PARTS THEREFORE; RADIATOR PARTS, NAMELY, RADIATOR HOSE QUICK DISCONNECTS, WATER OUTLET FILLER NECKS; WATER PUMPS FOR LAND VEHICLES AND PARTS THEREFORE, NAMELY, ELECTRICAL WATER PUMP DRIVES, WATER PUMP IMPELLERS, WATER PUMP BLOCK-OFF PLATES AND FILLER NECKS AND PLATE AND NECK UNITS COMPRISING A FILLER NECK, GASKETS, BOLTS, AND AN ADAPTER CASTING; WATER PUMPS AND SPACERS FOR LAND VEHICLES; VEHICLE ENGINE PARTS, NAMELY, COOLING SYSTEM EXPANSION TANKS, Y-BLOCK BY-PASSES AND PARTS THEREFORE, FANS FOR MACHINE ENGINES; VEHICLE ENGINE PARTS, NAMELY, CRANK SHAFT PULLEYS PARTS THEREFORE, NAMELY, AND CRANK SHAFT PULLEY DRIVE MANDRELS; INSULATED COOL CANS, COMPRISING A CONTAINER FOR COOLANT WITH A HOLLOW COIL THEREIN THROUGH WHICH FUEL MAY BE PASSED AND COOLED; VEHICLE PARTS, NAMELY, VALVE COVERS AND PARTS THEREFORE; AIR FILTERS FOR LAND VEHICLE ENGINES, NAMELY, STREET AIR CLEANERS; ALL OF THE ABOVE BEING PARTS FOR LAND

VEHICLES; LAND VEHICLE ENGINE PARTS, NAMELY, ENGINE CYLINDER PARTS CONSISTING OF CYLINDER HEAD BOLTS AND PARTS THEREFORE, ENGINE HEAD PARTS CONSISTING OF ENGINE HEAD BOLT WASHERS AND HEADER BOLTS; ENGINE MANIFOLD PARTS CONSISTING OF VACUUM LINE CAPS; LAND VEHICLE ENGINE FUEL SYSTEM PARTS, NAMELY, FUEL BLOCKS FOR CONNECTING A SINGLE FUEL LINE TO MULTIPLE FUEL LINES AND PARTS THEREFORE, METAL FUEL LINES FOR CONNECTING DIFFERENT COMPONENTS OF FUEL SYSTEMS AND METAL FUEL HOSES; LAND VEHICLE ENGINE PARTS CONSISTING OF AIR FILTERS AND AIR FILTER ELEMENTS AND STUD GIRDLES FOR CONNECTING CARBURETORS TO AIR FILTERS; LAND VEHICLE ENGINE PARTS CONSISTING OF EXHAUST HEADER FLANGE PLATES AND PARTS THEREFORE, ROCKER ARM STUDS, PUSHROD GUIDE PLATES; WINDAGE TRAYS FOR OIL PANS; LAND VEHICLE ENGINE CRANKSHAFT PARTS, NAMELY, METAL WIPERS FOR REMOVING DEBRIS FROM CRANK-SHAFTS, VENTILATORS FOR REMOVING EXCESS HEAT FROM CRANK-SHAFTS AND MAIN BEARING CAP STUDS; LAND VEHICLE ENGINE PARTS CONSISTING OF DRIVE TRAINS AND PARTS, NAMELY, MAGNETIC FILTER DRAIN PLUGS; STANDS FOR MACHINES, NAMELY, WORK STANDS FOR SUPPORTING VEHICLE PARTS TO ALLOW STABLE ACCESS DURING REPAIR AND MAINTENANCE, NAMELY, DIAL INDICATOR WORK STANDS AND CAR-

BURETOR WORK STANDS, IN CLASS 7 (U.S. CLS. 13, 19, 21, 23, 31, 34 AND 35).

FIRST USE 2-0-1972; IN COMMERCE 2-0-1972.

FOR: FUEL PRESSURE GAUGE FERRULES AND BUSHINGS, IN CLASS 9 (U.S. CLS. 21, 23, 26, 36 AND 38).

FIRST USE 2-0-1968; IN COMMERCE 2-0-1968.

FOR: LAND VEHICLE PARTS, NAMELY, QUICK HOOD RELEASES, SPHERICAL BEARING ROD ENDS; HOOD PIN SETS; LAND VEHICLE WHEEL PARTS, NAMELY, WHEEL STUDS, WHEEL RIM SCREWS, TIRES, AND WHEEL ROLLER PILOT BEARINGS; LAND VEHICLE PARTS, NAMELY, TRANSMISSION PARTS, NAMELY, AUTOMATIC TRANSMISSION OIL COOLERS AND FILTERS, IN CLASS 12 (U.S. CLS. 19, 21, 23, 31, 35 AND 44).

FIRST USE 2-0-1968; IN COMMERCE 2-0-1968.

THE MARK CONSISTS OF STANDARD CHARACTERS WITHOUT CLAIM TO ANY PARTICULAR FONT, STYLE, SIZE, OR COLOR.

OWNER OF U.S. REG. NOS. 2,136,866 AND 2,327,517.

SER. NO. 77-212,165, FILED 6-21-2007.

LOURDES AYALA, EXAMINING ATTORNEY

**Int. Cl.: 35**

**Prior U.S. Cls.: 100, 101 and 102**

**United States Patent and Trademark Office**

**Reg. No. 3,465,880**

**Registered July 15, 2008**

**SERVICE MARK  
PRINCIPAL REGISTER**



HAJOCA CORPORATION (MAINE CORPORATION)  
127 COULTER AVENUE  
ARDMORE, PA 19003

FOR: WHOLESALE STORES FEATURING  
PLUMBING SUPPLIES, IN CLASS 35 (U.S. CLS. 100,  
101 AND 102).

FIRST USE 2-0-1997; IN COMMERCE 2-0-1997.

NO CLAIM IS MADE TO THE EXCLUSIVE  
RIGHT TO USE THE PLUMBING WAREHOUSE,  
APART FROM THE MARK AS SHOWN.

THE MARK CONSISTS OF A STAR WHICH DOTS  
THE "I" IN THE WORD "PLUMBING", THE WORD  
"WAREHOUSE" IS UNDERLINED, AND A SUPER-  
SCRIPT STAR IS BETWEEN THE LETTERS "L" AND  
"C".

SER. NO. 77-212,433, FILED 6-21-2007.

KAREN K. BUSH, EXAMINING ATTORNEY

**Int. Cl.: 9**

**Prior U.S. Cls.: 21, 23, 26, 36 and 38**

**United States Patent and Trademark Office**

**Reg. No. 3,465,881**

**Registered July 15, 2008**

**TRADEMARK  
PRINCIPAL REGISTER**

**FreeSign**

RODENSTOCK GMBH (FED REP GERMANY  
GMBH)  
ISARTALSTR. 43  
MUNCHEN, FED REP GERMANY 80469

PRIORITY CLAIMED UNDER SEC. 44(D) ON FED  
REP GERMANY APPLICATION NO. 30701607.2,  
FILED 1-5-2007, REG. NO. 30701607.2, DATED 3-13-  
2007, EXPIRES 3-13-2017.

FOR: SPECTACLE LENSES, IN PARTICULAR  
PROGRESSIVE SPECTACLE LENSES, IN CLASS 9  
(U.S. CLS. 21, 23, 26, 36 AND 38).

SER. NO. 77-212,449, FILED 6-21-2007.

THE MARK CONSISTS OF STANDARD CHAR-  
ACTERS WITHOUT CLAIM TO ANY PARTICULAR  
FONT, STYLE, SIZE, OR COLOR.

DARRYL SPRUILL, EXAMINING ATTORNEY

**Int. Cl.: 16**

**Prior U.S. Cls.: 2, 5, 22, 23, 29, 37, 38 and 50**

**Reg. No. 3,465,882**

**United States Patent and Trademark Office**

**Registered July 15, 2008**

---

**TRADEMARK  
PRINCIPAL REGISTER**

**METHODS IN MOLECULAR  
BIOLOGY**

SPRINGER SCIENCE AND BUSINESS MEDIA,  
LLC (MASSACHUSETTS LTD LIAB CO)  
101 PHILIP DRIVE  
NORWELL, MA 02061

NO CLAIM IS MADE TO THE EXCLUSIVE  
RIGHT TO USE "MOLECULAR BIOLOGY", APART  
FROM THE MARK AS SHOWN.

FOR: SERIES OF NON-FICTION BOOKS IN THE  
FIELD OF BIOLOGY, IN CLASS 16 (U.S. CLS. 2, 5, 22,  
23, 29, 37, 38 AND 50).

SEC. 2(F).

FIRST USE 0-0-1984; IN COMMERCE 0-0-1984.

SER. NO. 77-212,710, FILED 6-22-2007.

THE MARK CONSISTS OF STANDARD CHAR-  
ACTERS WITHOUT CLAIM TO ANY PARTICULAR  
FONT, STYLE, SIZE, OR COLOR.

EVELYN BRADLEY, EXAMINING ATTORNEY

**Int. Cl.: 16**

**Prior U.S. Cls.: 2, 5, 22, 23, 29, 37, 38 and 50**

**Reg. No. 3,465,883**

**United States Patent and Trademark Office**

**Registered July 15, 2008**

**TRADEMARK  
PRINCIPAL REGISTER**

**METHODS IN MOLECULAR  
MEDICINE**

SPRINGER SCIENCE AND BUSINESS MEDIA,  
LLC (MASSACHUSETTS LTD LIAB CO)  
101 PHILIP DRIVE  
NORWELL, MA 02061

NO CLAIM IS MADE TO THE EXCLUSIVE  
RIGHT TO USE "MOLECULAR MEDICINE",  
APART FROM THE MARK AS SHOWN.

FOR: SERIES OF NON-FICTION BOOKS IN THE  
FIELD OF MEDICINE, IN CLASS 16 (U.S. CLS. 2, 5,  
22, 23, 29, 37, 38 AND 50).

SEC. 2(F).

FIRST USE 0-0-1996; IN COMMERCE 0-0-1996.

SER. NO. 77-212,712, FILED 6-22-2007.

THE MARK CONSISTS OF STANDARD CHAR-  
ACTERS WITHOUT CLAIM TO ANY PARTICULAR  
FONT, STYLE, SIZE, OR COLOR.

EVELYN BRADLEY, EXAMINING ATTORNEY

**Int. Cl.: 16**

**Prior U.S. Cls.: 2, 5, 22, 23, 29, 37, 38 and 50**

**Reg. No. 3,465,884**

**United States Patent and Trademark Office**

**Registered July 15, 2008**

**TRADEMARK  
PRINCIPAL REGISTER**

**METHODS IN BIOTECHNOLOGY**

SPRINGER SCIENCE AND BUSINESS MEDIA,  
LLC (MASSACHUSETTS LTD LIAB CO)  
101 PHILIP DRIVE  
NORWELL, MA 02061

NO CLAIM IS MADE TO THE EXCLUSIVE  
RIGHT TO USE "BIOTECHNOLOGY", APART  
FROM THE MARK AS SHOWN.

FOR: SERIES OF NON-FICTION BOOKS IN THE  
FIELD OF BIOTECHNOLOGY, IN CLASS 16 (U.S.  
CLS. 2, 5, 22, 23, 29, 37, 38 AND 50).

SEC. 2(F).

FIRST USE 0-0-1996; IN COMMERCE 0-0-1996.

SER. NO. 77-212,716, FILED 6-22-2007.

THE MARK CONSISTS OF STANDARD CHAR-  
ACTERS WITHOUT CLAIM TO ANY PARTICULAR  
FONT, STYLE, SIZE, OR COLOR.

EVELYN BRADLEY, EXAMINING ATTORNEY

**Int. Cl.: 16**

**Prior U.S. Cls.: 2, 5, 22, 23, 29, 37, 38 and 50**

**Reg. No. 3,465,885**

**United States Patent and Trademark Office**

**Registered July 15, 2008**

**TRADEMARK  
PRINCIPAL REGISTER**

**METHODS IN PHARMACOLOGY  
AND TOXICOLOGY**

SPRINGER SCIENCE AND BUSINESS MEDIA,  
LLC (MASSACHUSETTS LTD LIAB CO)  
101 PHILIP DRIVE  
NORWELL, MA 02061

NO CLAIM IS MADE TO THE EXCLUSIVE  
RIGHT TO USE "PHARMACOLOGY AND TOXI-  
COLOGY", APART FROM THE MARK AS SHOWN.

FOR: SERIES OF NON-FICTION BOOKS IN THE  
FIELD OF PHARMACOLOGY, IN CLASS 16 (U.S.  
CLS. 2, 5, 22, 23, 29, 37, 38 AND 50).

SEC. 2(F).

FIRST USE 0-0-2001; IN COMMERCE 0-0-2001.

SER. NO. 77-212,719, FILED 6-22-2007.

THE MARK CONSISTS OF STANDARD CHAR-  
ACTERS WITHOUT CLAIM TO ANY PARTICULAR  
FONT, STYLE, SIZE, OR COLOR.

EVELYN BRADLEY, EXAMINING ATTORNEY



**Int. Cl.: 16**

**Prior U.S. Cls.: 2, 5, 22, 23, 29, 37, 38 and 50**

**Reg. No. 3,465,886**

**United States Patent and Trademark Office**

**Registered July 15, 2008**

---

**TRADEMARK  
PRINCIPAL REGISTER**

**NEUROMETHODS**

SPRINGER SCIENCE AND BUSINESS MEDIA,  
LLC (MASSACHUSETTS LTD LIAB CO)  
101 PHILIP DRIVE  
NORWELL, MA 02061

FOR: SERIES OF NON-FICTION BOOKS IN THE  
FIELD OF NEUROSCIENCE, IN CLASS 16 (U.S. CLS.  
2, 5, 22, 23, 29, 37, 38 AND 50).

FIRST USE 0-0-1986; IN COMMERCE 0-0-1986.

THE MARK CONSISTS OF STANDARD CHAR-  
ACTERS WITHOUT CLAIM TO ANY PARTICULAR  
FONT, STYLE, SIZE, OR COLOR.

SEC. 2(F).

SER. NO. 77-212,720, FILED 6-22-2007.

EVELYN BRADLEY, EXAMINING ATTORNEY

**Int. Cl.: 28**

**Prior U.S. Cls.: 22, 23, 38 and 50**

**United States Patent and Trademark Office**

**Reg. No. 3,465,887**

**Registered July 15, 2008**

**TRADEMARK  
PRINCIPAL REGISTER**

**FIRE COMMANDER ADVENTURES**

MATTEL, INC. (DELAWARE CORPORATION)  
MI-1518  
333 CONTINENTAL BLVD.  
EL SEGUNDO, CA 90245

FOR: TOYS, GAMES AND PLAYTHINGS, NAME-  
LY, ROLE PLAYING GAMES AND ACCESSORIES  
THEREFOR, IN CLASS 28 (U.S. CLS. 22, 23, 38 AND  
50).

FIRST USE 2-20-2008; IN COMMERCE 2-20-2008.

THE MARK CONSISTS OF STANDARD CHAR-  
ACTERS WITHOUT CLAIM TO ANY PARTICULAR  
FONT, STYLE, SIZE, OR COLOR.

SER. NO. 77-212,859, FILED 6-22-2007.

ANNE MADDEN, EXAMINING ATTORNEY

**Int. Cl.: 42**

**Prior U.S. Cls.: 100 and 101**

**United States Patent and Trademark Office**

**Reg. No. 3,465,888**

**Registered July 15, 2008**

**SERVICE MARK  
PRINCIPAL REGISTER**

**ASSETWISE DIRECT**

GMAC MORTGAGE GROUP, LLC (DELAWARE  
LTD LIAB CO)  
P.O. BOX 200  
200 RENAISSANCE CENTER  
DETROIT, MI 482652000

FOR: PROVIDING ON-LINE NON-DOWNLOAD-  
ABLE SOFTWARE USED BY CUSTOMERS FOR  
AUTOMATED LOAN EVALUATION, IN CLASS 42  
(U.S. CLS. 100 AND 101).

FIRST USE 12-0-1998; IN COMMERCE 12-0-1998.

THE MARK CONSISTS OF STANDARD CHAR-  
ACTERS WITHOUT CLAIM TO ANY PARTICULAR  
FONT, STYLE, SIZE, OR COLOR.

OWNER OF U.S. REG. NO. 2,707,254.

NO CLAIM IS MADE TO THE EXCLUSIVE  
RIGHT TO USE "DIRECT", APART FROM THE  
MARK AS SHOWN.

SER. NO. 77-213,035, FILED 6-22-2007.

JEAN IM, EXAMINING ATTORNEY

Int. Cl.: 36

Prior U.S. Cls.: 100, 101 and 102

United States Patent and Trademark Office

Reg. No. 3,465,889

Registered July 15, 2008

SERVICE MARK  
PRINCIPAL REGISTER



savings  
rev.o.lu.tion

GECU (TEXAS CORPORATION)  
N/A  
7227 VISCOUNT BLVD  
EL PASO, TX 79925

FOR: FINANCIAL SERVICES, NAMELY, SAVINGS PROGRAMS FOR CREDIT UNION MEMBERS, IN CLASS 36 (U.S. CLS. 100, 101 AND 102).

FIRST USE 7-0-2006; IN COMMERCE 7-0-2006.

NO CLAIM IS MADE TO THE EXCLUSIVE RIGHT TO USE "SAVINGS", APART FROM THE MARK AS SHOWN.

THE COLOR(S) BLUE AND GREEN IS/ARE CLAIMED AS A FEATURE OF THE MARK.

THE MARK CONSISTS OF THE WORD "SAVINGS" IN BLUE ON TOP OF THE WORD "REVOLUTION" IN GREEN BROKEN UP IN SYLLABLES BY GREEN DOTS/PERIODS.

SER. NO. 77-213,262, FILED 6-22-2007.

RONALD MCMORROW, EXAMINING ATTORNEY

Int. Cl.: 41

Prior U.S. Cls.: 100, 101 and 107

United States Patent and Trademark Office

Reg. No. 3,465,890

Registered July 15, 2008

SERVICE MARK  
PRINCIPAL REGISTER



SOLIS, RAFAEL (MEXICO INDIVIDUAL)  
621 PINWOOD DRIVE  
ELKGROVE, IL 60007 AND  
RODRIGUEZ, ARMANDO JAVIER (UNITED  
STATES INDIVIDUAL)  
621 PINWOOD DRIVE  
ELKGROVE, IL 60007 AND  
NAVA, JOSE C. GAMBOA (MEXICO INDIVIDUAL)  
621 PINWOOD DRIVE  
ELKGROVE, IL 60007 AND  
SOLIS, LUIS HUMBERTO VIDALES (MEXICO IN-  
DIVIDUAL)  
621 PINWOOD DRIVE  
ELKGROVE, IL 60007 AND

GALLARDO, GERARDO RAMIREZ (MEXICO IN-  
DIVIDUAL)  
621 PINWOOD DRIVE  
ELKGROVE, IL 60007

FOR: ENTERTAINMENT SERVICES, NAMELY,  
LIVE PERFORMANCE BY A MUSICAL GROUP, IN  
CLASS 41 (U.S. CLS. 100, 101 AND 107).

OWNER OF MEXICO REG. NO. 1002499, DATED  
9-17-2007, EXPIRES 6-20-2017.

SER. NO. 77-213,439, FILED 6-22-2007.

JAMES A. RAUEN, EXAMINING ATTORNEY

**Int. Cl.: 41**

**Prior U.S. Cls.: 100, 101 and 107**

**United States Patent and Trademark Office**

**Reg. No. 3,465,891**

**Registered July 15, 2008**

**SERVICE MARK  
PRINCIPAL REGISTER**



SOLIS, RAFAEL (MEXICO INDIVIDUAL)  
621 PINWOOD DRIVE  
ELKGROVE, IL 60007 AND  
RODRIGUEZ, ARMANDO JAVIER (UNITED  
STATES INDIVIDUAL)  
621 PINWOOD DRIVE  
ELKGROVE, IL 60007 AND  
NAVA, JOSE C. GAMBOA (MEXICO INDIVIDUAL)  
621 PINWOOD DRIVE  
ELKGROVE, IL 60007 AND  
SOLIS, LUIS HUMBERTO VIDALES (MEXICO IN-  
DIVIDUAL)  
621 PINWOOD DRIVE  
ELKGROVE, IL 60007 AND

GALLARDO, GERARDO RAMIREZ (MEXICO IN-  
DIVIDUAL)  
621 PINWOOD DRIVE  
ELKGROVE, IL 60007

FOR: ENTERTAINMENT SERVICES, NAMELY,  
LIVE PERFORMANCE BY A MUSICAL GROUP, IN  
CLASS 41 (U.S. CLS. 100, 101 AND 107).

OWNER OF MEXICO REG. NO. 1002500, DATED  
9-17-2007, EXPIRES 6-20-2017.

SER. NO. 77-213,519, FILED 6-22-2007.

JAMES A. RAUEN, EXAMINING ATTORNEY

**Int. Cl.: 44**

**Prior U.S. Cls.: 100 and 101**

**United States Patent and Trademark Office**

**Reg. No. 3,465,892**

**Registered July 15, 2008**

**SERVICE MARK  
PRINCIPAL REGISTER**



ABSOLUTE TREE & STUMP, INC. (FLORIDA CORPORATION)  
2287 DARK BAY DRIVE  
MIDDLEBURG, FL 32068 AND  
LEWIS, MICHAEL SHANE (UNITED STATES INDIVIDUAL)  
2287 DARK BAY DRIVE  
MIDDLEBURG, FL 32068

FOR: TREE CARE SERVICES; TREE REMOVAL SERVICES; TREE SURGERY , IN CLASS 44 (U.S. CLS. 100 AND 101).

FIRST USE 0-0-2000; IN COMMERCE 0-0-2000.

THE MARK CONSISTS OF A MAN CARRYING A TREE.

SER. NO. 77-213,776, FILED 6-22-2007.

MONIQUE MILLER, EXAMINING ATTORNEY

**Int. Cl.: 7**

**Prior U.S. Cls.: 13, 19, 21, 23, 31, 34 and 35**

**Reg. No. 3,465,893**

**United States Patent and Trademark Office**

**Registered July 15, 2008**

---

**TRADEMARK  
PRINCIPAL REGISTER**

**ABYSS**

P.E.P. TECHNOLOGIES, INTERNATIONAL, LLC  
(FLORIDA LTD LIAB CO), AKA PROACTIVE  
ENVIRONMENTAL PRODUCTS  
1767 LAKEWOOD RANCH BOULEVARD, SUITE 113  
BRADENTON, FL 34211

THE MARK CONSISTS OF STANDARD CHAR-  
ACTERS WITHOUT CLAIM TO ANY PARTICULAR  
FONT, STYLE, SIZE, OR COLOR.

FOR: SUBMERSIBLE ELECTRIC WATER PUMPS  
FOR GROUNDWATER TESTING, IN CLASS 7 (U.S.  
CLS. 13, 19, 21, 23, 31, 34 AND 35).

SER. NO. 77-213,871, FILED 6-23-2007.

FIRST USE 5-0-2006; IN COMMERCE 5-0-2006.

MIDGE BUTLER, EXAMINING ATTORNEY



**Int. Cl.: 7**

**Prior U.S. Cls.: 13, 19, 21, 23, 31, 34 and 35**

**Reg. No. 3,465,894**

**United States Patent and Trademark Office**

**Registered July 15, 2008**

---

**TRADEMARK  
PRINCIPAL REGISTER**

**MINI-MONSOON**

P.E.P. TECHNOLOGIES, INTERNATIONAL, LLC  
(FLORIDA LTD LIAB CO), AKA PROACTIVE  
ENVIRONMENTAL PRODUCTS  
1767 LAKEWOOD RANCH BOULEVARD, SUITE 113  
BRADENTON, FL 34211

THE MARK CONSISTS OF STANDARD CHAR-  
ACTERS WITHOUT CLAIM TO ANY PARTICULAR  
FONT, STYLE, SIZE, OR COLOR.

FOR: SUBMERSIBLE ELECTRIC WATER PUMPS  
FOR GROUNDWATER TESTING, IN CLASS 7 (U.S.  
CLS. 13, 19, 21, 23, 31, 34 AND 35).

SER. NO. 77-213,880, FILED 6-23-2007.

FIRST USE 1-0-2005; IN COMMERCE 1-0-2005.

MIDGE BUTLER, EXAMINING ATTORNEY

**Int. Cl.: 7**

**Prior U.S. Cls.: 13, 19, 21, 23, 31, 34 and 35**

**Reg. No. 3,465,895**

**United States Patent and Trademark Office**

**Registered July 15, 2008**

---

**TRADEMARK  
PRINCIPAL REGISTER**

**MEGA-MONSOON**

P.E.P. TECHNOLOGIES, INTERNATIONAL, LLC  
(FLORIDA LTD LIAB CO), AKA PROACTIVE  
ENVIRONMENTAL PRODUCTS  
1767 LAKEWOOD RANCH BOULEVARD, SUITE 113  
BRADENTON, FL 34211

THE MARK CONSISTS OF STANDARD CHAR-  
ACTERS WITHOUT CLAIM TO ANY PARTICULAR  
FONT, STYLE, SIZE, OR COLOR.

FOR: SUBMERSIBLE ELECTRIC WATER PUMPS  
FOR GROUNDWATER TESTING, IN CLASS 7 (U.S.  
CLS. 13, 19, 21, 23, 31, 34 AND 35).

SER. NO. 77-213,882, FILED 6-23-2007.

FIRST USE 1-0-2005; IN COMMERCE 1-0-2005.

MIDGE BUTLER, EXAMINING ATTORNEY

**Int. Cls.: 9 and 41**

**Prior U.S. Cls.: 21, 23, 26, 36, 38, 100, 101 and 107**

**United States Patent and Trademark Office**

**Reg. No. 3,465,896**

**Registered July 15, 2008**

**TRADEMARK  
SERVICE MARK  
PRINCIPAL REGISTER**



TM WILLIAMS, LLC (CALIFORNIA LTD LIAB  
CO)  
STE. 400  
433 N. CAMDEN DR.  
BEVERLY HILLS, CA 90210

FOR: AUDIO AND VIDEO RECORDINGS FEATURING SELF IMPROVEMENT, IN CLASS 9 (U.S. CLS. 21, 23, 26, 36 AND 38).

FIRST USE 7-1-2004; IN COMMERCE 7-1-2004.

FOR: EDUCATIONAL SERVICES, NAMELY, CONDUCTING CLASSES, SEMINARS, WORK-

SHOPS, TUTORING, AND MENTORING IN THE FIELD OF PERSONAL IMPROVEMENT, IN CLASS 41 (U.S. CLS. 100, 101 AND 107).

FIRST USE 7-1-2004; IN COMMERCE 7-1-2004.

THE MARK CONSISTS OF FOUR VERTICAL BARS OVERLAIN BY A FIFTH SLASH EXTENDING FROM THE TOP RIGHT TO THE BOTTOM LEFT.

SER. NO. 77-214,098, FILED 6-25-2007.

BRIAN CALLAGHAN, EXAMINING ATTORNEY

**Int. Cls.: 10 and 44**

**Prior U.S. Cls.: 26, 39, 44, 100 and 101**

**United States Patent and Trademark Office**

**Reg. No. 3,465,897**

**Registered July 15, 2008**

**TRADEMARK  
SERVICE MARK  
PRINCIPAL REGISTER**

**PROSOMNO**

HERBERGER, BERNHARD (FED REP GERMA-  
NY INDIVIDUAL)  
KAULBACHSTRASSE 96  
80802 MUNICH, FED REP GERMANY

FOR: MEDICAL APPARATUS AND INSTRU-  
MENTS, NAMELY, FOR THE THERAPY OF IN-  
SOMNIA, IN CLASS 10 (U.S. CLS. 26, 39 AND 44).

FOR: MEDICAL SERVICES, IN PARTICULAR IN  
THE SECTOR OF INSOMNIA THERAPY; SERVICES  
OF A HOSPITAL, IN CLASS 44 (U.S. CLS. 100 AND  
101).

THE MARK CONSISTS OF STANDARD CHAR-  
ACTERS WITHOUT CLAIM TO ANY PARTICULAR  
FONT, STYLE, SIZE, OR COLOR.

PRIORITY CLAIMED UNDER SEC. 44(D) ON FED  
REP GERMANY APPLICATION NO. 30700332.9,  
FILED 1-3-2007, REG. NO. 30700332, DATED 10-30-  
2007, EXPIRES 1-3-2017.

SER. NO. 77-214,333, FILED 6-25-2007.

LINDA E. BLOHM, EXAMINING ATTORNEY

**Int. Cl.: 24**

**Prior U.S. Cls.: 42 and 50**

**United States Patent and Trademark Office**

**Reg. No. 3,465,898**

**Registered July 15, 2008**

**TRADEMARK  
PRINCIPAL REGISTER**

**LitePro**

LATHAM MANUFACTURING CORP. (DELA-  
WARE CORPORATION)  
787 WATERVLIET-SHAKER ROAD  
LATHAM, NY 12110

THE MARK CONSISTS OF STANDARD CHAR-  
ACTERS WITHOUT CLAIM TO ANY PARTICULAR  
FONT, STYLE, SIZE, OR COLOR.

FOR: FABRICS FOR THE MANUFACTURE OF  
SWIMMING POOL COVERS, IN CLASS 24 (U.S. CLS.  
42 AND 50).

SER. NO. 77-214,680, FILED 6-25-2007.

FIRST USE 6-18-2007; IN COMMERCE 7-5-2007.

ASMAT KHAN, EXAMINING ATTORNEY

Int. Cl.: 35

Prior U.S. Cls.: 100, 101 and 102

United States Patent and Trademark Office

Reg. No. 3,465,899

Registered July 15, 2008

SERVICE MARK  
PRINCIPAL REGISTER



SERVICEMAGIC, INC. (DELAWARE CORPORATION)  
SUITE 200  
14023 DENVER WEST PARKWAY  
GOLDEN, CO 80401

FIRST USE 6-1-2007; IN COMMERCE 6-1-2007.

OWNER OF U.S. REG. NOS. 2,678,084, 2,727,527,  
AND 2,881,371.

FOR: PROVIDING ONLINE DIRECTORY INFORMATION SERVICES IN THE FIELDS OF HOME IMPROVEMENT, HOME MAINTENANCE AND HOME REPAIR; OPERATING ONLINE MARKETPLACES FOR BUYERS AND SELLERS OF HOME IMPROVEMENT, HOME MAINTENANCE AND HOME REPAIR SERVICES, AS WELL AS COMMERCIAL INFORMATIONAL CONTENT RELATED TO SUCH GOODS AND SERVICES, IN CLASS 35 (U.S. CLS. 100, 101 AND 102).

THE MARK CONSISTS OF THE LETTER "M" FORMED BY TWO STICK-LIKE FIGURES ALONG WITH THE NAME "SERVICEMAGIC.COM".

SER. NO. 77-214,961, FILED 6-25-2007.

KELLY BOULTON, EXAMINING ATTORNEY

**Int. Cl.: 40**

**Prior U.S. Cls.: 100, 103 and 106**

**United States Patent and Trademark Office**

**Reg. No. 3,465,900**

**Registered July 15, 2008**

**SERVICE MARK  
PRINCIPAL REGISTER**

**IC GROUP**

IC SECURITY PRINTERS, INC. - MANUFACTURING (UTAH CORPORATION)  
4080 SOUTH 500 WEST  
SALT LAKE CITY, UT 84123

FOR: CUSTOM PRINTING OF CHECKS, FORMS AND PLASTIC CARDS, IN CLASS 40 (U.S. CLS. 100, 103 AND 106).

FIRST USE 9-1-1997; IN COMMERCE 9-1-1997.

THE MARK CONSISTS OF STANDARD CHARACTERS WITHOUT CLAIM TO ANY PARTICULAR FONT, STYLE, SIZE, OR COLOR.

NO CLAIM IS MADE TO THE EXCLUSIVE RIGHT TO USE "GROUP", APART FROM THE MARK AS SHOWN.

SER. NO. 77-215,050, FILED 6-25-2007.

JOHN GARTNER, EXAMINING ATTORNEY

**Int. Cl.: 25**

**Prior U.S. Cls.: 22 and 39**

**United States Patent and Trademark Office**

**Reg. No. 3,465,901**

**Registered July 15, 2008**

**TRADEMARK  
PRINCIPAL REGISTER**

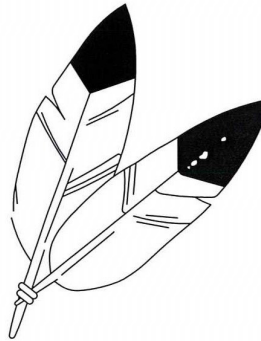

THE COLLEGE OF WILLIAM AND MARY (VIR-  
GINIA CORPORATION)  
P.O. BOX 8795  
WILLIAMSBURG, VA 231878795

FOR: CLOTHING, NAMELY, SWEATSHIRTS,  
SWEAT PANTS, CAPS, BOXER SHORTS, SPORTS-  
HIRTS, JACKETS, SWEATERS, JERSEYS, SUN VI-  
SORS, HATS, NECKTIES, WRISTBANDS,  
HEADBANDS, RAIN PONCHOS, CLOTH BABY  
BIBS, AND T-SHIRTS, IN CLASS 25 (U.S. CLS. 22  
AND 39).

FIRST USE 9-0-2006; IN COMMERCE 9-0-2006.

OWNER OF U.S. REG. NO. 1,646,897.

THE MARK CONSISTS OF FEATHERS.

SER. NO. 77-215,317, FILED 6-26-2007.

ANNE E. GUSTASON, EXAMINING ATTORNEY



**Int. Cl.: 3**

**Prior U.S. Cls.: 1, 4, 6, 50, 51 and 52**

**Reg. No. 3,465,902**

**United States Patent and Trademark Office**

**Registered July 15, 2008**

**TRADEMARK  
PRINCIPAL REGISTER**

**FANTASTIC FOR MEN**

FANTASTIC SAMS FRANCHISE CORPORATION  
(DELAWARE CORPORATION)  
3RD FLOOR  
50 DUNHAM ROAD  
BEVERLY, MA 01915

FOR: HAIR CARE LOTIONS; HAIR CARE PREPARATIONS; HAIR CONDITIONERS; HAIR DRESSINGS FOR MEN; HAIR GELS; HAIR POMADES; HAIR SHAMPOO; HAIR STYLING GEL; HAIR STYLING PREPARATIONS; HAIR STYLING SPRAY; HAIR STYLING FIXATIVE IN THE NATURE OF HAIR WAX; SHAMPOO-CONDITIONERS, IN CLASS 3 (U.S. CLS. 1, 4, 6, 50, 51 AND 52).

FIRST USE 6-18-2007; IN COMMERCE 6-18-2007.

THE MARK CONSISTS OF STANDARD CHARACTERS WITHOUT CLAIM TO ANY PARTICULAR FONT, STYLE, SIZE, OR COLOR.

OWNER OF U.S. REG. NOS. 1,611,636, 3,112,968 AND OTHERS.

NO CLAIM IS MADE TO THE EXCLUSIVE RIGHT TO USE "FOR MEN", APART FROM THE MARK AS SHOWN.

SER. NO. 77-215,360, FILED 6-26-2007.

RONALD AIKENS, EXAMINING ATTORNEY

**Int. Cls.: 36 and 45**

**Prior U.S. Cls.: 100, 101 and 102**

**United States Patent and Trademark Office**

**Reg. No. 3,465,903**

**Registered July 15, 2008**

**SERVICE MARK  
PRINCIPAL REGISTER**

# Ergovention

WINDHAM INJURY MANAGEMENT GROUP  
(NEW HAMPSHIRE CORPORATION)  
500 COMMERCIAL ST.  
MANCHESTER, NH 03101

FOR: CONSULTING SERVICES IN THE FIELD  
OF WORKERS COMPENSATION POLICY RATES,  
INSURANCE SERVICES IN THE NATURE OF LOSS  
CONTROL, FINANCIAL RISK REDUCTION , IN  
CLASS 36 (U.S. CLS. 100, 101 AND 102).

FIRST USE 2-1-2000; IN COMMERCE 2-1-2000.

FOR: CONSULTING SERVICES IN THE FIELD  
OF WORKPLACE SAFETY, IN CLASS 45 (U.S. CLS.  
100 AND 101).

FIRST USE 2-1-2000; IN COMMERCE 2-1-2000.

THE MARK CONSISTS OF STANDARD CHAR-  
ACTERS WITHOUT CLAIM TO ANY PARTICULAR  
FONT, STYLE, SIZE, OR COLOR.

SER. NO. 77-215,445, FILED 6-26-2007.

SARA THOMAS, EXAMINING ATTORNEY

**Int. Cl.: 41**

**Prior U.S. Cls.: 100, 101 and 107**

**Reg. No. 3,465,904**

**United States Patent and Trademark Office**

**Registered July 15, 2008**

---

**SERVICE MARK  
PRINCIPAL REGISTER**

**CORPS PRODUCTIONS**

CORPS PRODUCTIONS (CALIFORNIA PART-  
NERSHIP)  
3811 PARK DRIVE  
EL DORADO HILLS, CA 95762

FOR: PUBLISHING SERVICES, NAMELY, PUB-  
LICATION OF BOOKS, MAGAZINES, JOURNALS,  
MUSIC; ELECTRONIC PUBLISHING SERVICES,  
NAMELY, PUBLICATION OF TEXT AND GRAPHIC  
WORKS OF OTHERS ON CDS, DVDS, CD-ROMS,  
AND DVD-ROMS ON A VARIETY OF TOPICS,  
NAMELY HISTORY, LITERATURE, AND TOPICS  
OF GENERAL INTEREST, IN CLASS 41 (U.S. CLS.  
100, 101 AND 107).

FIRST USE 6-11-2003; IN COMMERCE 6-11-2003.

THE MARK CONSISTS OF STANDARD CHAR-  
ACTERS WITHOUT CLAIM TO ANY PARTICULAR  
FONT, STYLE, SIZE, OR COLOR.

NO CLAIM IS MADE TO THE EXCLUSIVE  
RIGHT TO USE "PRODUCTIONS", APART FROM  
THE MARK AS SHOWN.

SER. NO. 77-215,508, FILED 6-26-2007.

SUNG IN, EXAMINING ATTORNEY

**Int. Cl.: 25**

**Prior U.S. Cls.: 22 and 39**

**United States Patent and Trademark Office**

**Reg. No. 3,465,905**

**Registered July 15, 2008**

**TRADEMARK  
PRINCIPAL REGISTER**

**ARETINA COMPANY**

JAVIER RIVERA RUIZ, DOMINGO (MEXICO  
INDIVIDUAL)

PASEO DEL MORAL 321, JARDINES DEL MORAL  
LEÓN, MEXICO 37160

FOR: SHOES; BOOTS; SANDALS; TENNIS SHOES,  
IN CLASS 25 (U.S. CLS. 22 AND 39).

FIRST USE 7-1-1998; IN COMMERCE 7-1-1998.

THE MARK CONSISTS OF STANDARD CHAR-  
ACTERS WITHOUT CLAIM TO ANY PARTICULAR  
FONT, STYLE, SIZE, OR COLOR.

NO CLAIM IS MADE TO THE EXCLUSIVE  
RIGHT TO USE "COMPANY", APART FROM THE  
MARK AS SHOWN.

SER. NO. 77-215,566, FILED 6-26-2007.

BARBARA GAYNOR, EXAMINING ATTORNEY

Int. Cl.: 35

Prior U.S. Cls.: 100, 101 and 102

United States Patent and Trademark Office

Reg. No. 3,465,906

Registered July 15, 2008

SERVICE MARK  
PRINCIPAL REGISTER



FIDELITONE, INC. (DELAWARE CORPORATION)  
1260 KARL COURT  
WAUCONDA, IL 60084

FOR: PARTS SUPPLY SERVICES, NAMELY WHOLESALE AND RETAIL STORE SERVICES FEATURING REPLACEMENT AND REFURBISHED PARTS FOR CONSUMER ELECTRONIC GOODS AND APPLIANCES AND THIRD PARTY LOGISTICS, NAMELY DATABASE MANAGEMENT, ELECTRONIC ORDER PROCESSING FOR OTHERS, IN CLASS 35 (U.S. CLS. 100, 101 AND 102).

FIRST USE 3-13-2007; IN COMMERCE 3-13-2007.

OWNER OF U.S. REG. NOS. 3,101,285 AND 3,133,906.

NO CLAIM IS MADE TO THE EXCLUSIVE RIGHT TO USE "LOGISTICS", APART FROM THE MARK AS SHOWN.

THE COLOR(S) BLACK, WHITE IS/ARE CLAIMED AS A FEATURE OF THE MARK.

THE MARK CONSISTS OF BLACK LETTERS FOR "FIDELITONE LOGISTICS" WITH A RED DOT OVER THE FIRST "I" ON A WHITE BACKGROUND, A WHITE ARROW OUTLINED WITH A RED CIRCLE, ONE SOLUTION IN RED LETTERS BELOW THE ARROW, PART OF A RED GLOBE OUTLINE ON THE WHITE BACKGROUND ABOVE THE "FIDELITONE".

SER. NO. 77-215,838, FILED 6-26-2007.

ELIZABETH KAJUBI, EXAMINING ATTORNEY

**Int. Cl.: 1**

**Prior U.S. Cls.: 1, 5, 6, 10, 26 and 46**

**Reg. No. 3,465,907**

**United States Patent and Trademark Office**

**Registered July 15, 2008**

**TRADEMARK  
PRINCIPAL REGISTER**

**DIRT BLOCKER**

PRESTONE PRODUCTS CORPORATION (DELA-  
WARE CORPORATION)

39 OLD RIDGEBURY ROAD

DANBURY, CT 06810

FOR: WINDSHIELD DEICER FLUID; CHEMICAL  
ADDITIVES FOR WINDSHIELD DEICER FLUID, IN  
CLASS 1 (U.S. CLS. 1, 5, 6, 10, 26 AND 46).

FIRST USE 8-31-2006; IN COMMERCE 8-31-2006.

THE MARK CONSISTS OF STANDARD CHAR-  
ACTERS WITHOUT CLAIM TO ANY PARTICULAR  
FONT, STYLE, SIZE, OR COLOR.

NO CLAIM IS MADE TO THE EXCLUSIVE  
RIGHT TO USE "DIRT", APART FROM THE MARK  
AS SHOWN.

SER. NO. 77-216,456, FILED 6-27-2007.

KATHLEEN M. VANSTON, EXAMINING ATTOR-  
NEY

**Int. Cl.: 3**

**Prior U.S. Cls.: 1, 4, 6, 50, 51 and 52**

**Reg. No. 3,465,908**

**United States Patent and Trademark Office**

**Registered July 15, 2008**

---

**TRADEMARK  
PRINCIPAL REGISTER**

**DIRT BLOCKER**

PRESTONE PRODUCTS CORPORATION (DELA-  
WARE CORPORATION)  
39 OLD RIDGEBURY ROAD  
DANBURY, CT 06810

NO CLAIM IS MADE TO THE EXCLUSIVE  
RIGHT TO USE "DIRT", APART FROM THE MARK  
AS SHOWN.

FOR: WINDSHIELD WASHING FLUID, IN CLASS  
3 (U.S. CLS. 1, 4, 6, 50, 51 AND 52).

SER. NO. 77-216,472, FILED 6-27-2007.

FIRST USE 8-31-2006; IN COMMERCE 8-31-2006.

THE MARK CONSISTS OF STANDARD CHAR-  
ACTERS WITHOUT CLAIM TO ANY PARTICULAR  
FONT, STYLE, SIZE, OR COLOR.

KATHLEEN M. VANSTON, EXAMINING ATTOR-  
NEY

**Int. Cl.: 3**

**Prior U.S. Cls.: 1, 4, 6, 50, 51 and 52**

**Reg. No. 3,465,909**

**United States Patent and Trademark Office**

**Registered July 15, 2008**

**TRADEMARK  
PRINCIPAL REGISTER**

**TOP SKIN**

LABORATOIRE BIPLUS INC. (NEW YORK  
CORPORATION)  
P.O. BOX 737303  
ELMHURST, NY 11373

FOR: COSMETICS FOR MEN AND WOMEN,  
NAMELY, SKIN CREAMS AND LOTIONS, BODY  
LOTIONS, SKIN MOISTURIZERS, SOAPS, SHAM-  
POO AND CONDITIONER, OILS FOR THE BODY,  
BODY MILKS, IN CLASS 3 (U.S. CLS. 1, 4, 6, 50, 51  
AND 52).

FIRST USE 1-17-2007; IN COMMERCE 1-17-2007.

THE MARK CONSISTS OF STANDARD CHAR-  
ACTERS WITHOUT CLAIM TO ANY PARTICULAR  
FONT, STYLE, SIZE, OR COLOR.

NO CLAIM IS MADE TO THE EXCLUSIVE  
RIGHT TO USE "SKIN", APART FROM THE MARK  
AS SHOWN.

SER. NO. 77-216,496, FILED 6-27-2007.

JEFFERY COWARD, EXAMINING ATTORNEY



**Int. Cl.: 9**

**Prior U.S. Cls.: 21, 23, 26, 36 and 38**

**Reg. No. 3,465,910**

**United States Patent and Trademark Office**

**Registered July 15, 2008**

**TRADEMARK  
PRINCIPAL REGISTER**

**CLEAN POWER**

MONSTER, LLC (NEVADA LTD LIAB CO)  
7251 LAKE MEAD BLVD., WEST, 3RD FLOOR  
LAS VEGAS, NV 89128

FOR: AUDIO EQUIPMENT AND ACCESSORIES, NAMELY, POWER AMPLIFIERS; AUDIO SIGNAL EQUALIZERS; ELECTRICAL CONTROL COMPONENTS AND ACCESSORIES, NAMELY, POWER CONDITIONERS, POWER AMPLIFIERS, VOLTAGE STABILIZERS, CURRENT STABILIZERS, ELECTRICAL SURGE PROTECTORS, CIRCUIT CHARGERS AND CIRCUIT BREAKERS, IN CLASS 9 (U.S. CLS. 21, 23, 26, 36 AND 38).

FIRST USE 12-30-1998; IN COMMERCE 12-30-1998.

THE MARK CONSISTS OF STANDARD CHARACTERS WITHOUT CLAIM TO ANY PARTICULAR FONT, STYLE, SIZE, OR COLOR.

NO CLAIM IS MADE TO THE EXCLUSIVE RIGHT TO USE "POWER", APART FROM THE MARK AS SHOWN.

SER. NO. 77-216,662, FILED 6-27-2007.

AMOS T. MATTHEWS, JR., EXAMINING ATTORNEY

**Int. Cl.: 11**

**Prior U.S. Cls.: 13, 21, 23, 31 and 34**

**United States Patent and Trademark Office**

**Reg. No. 3,465,911**

**Registered July 15, 2008**

**TRADEMARK  
PRINCIPAL REGISTER**

**HALLMARK LIGHTING**

HALLMARK LIGHTING, LLC (CALIFORNIA  
LTD LIAB CO)  
9631 DESOTO AVENUE  
CHATSWORTH, CA 91311

FOR: ELECTRIC LIGHTING FIXTURES; ELECTRIC LIGHTING FIXTURES, NAMELY, SCONCES; ELECTRIC TORCHES FOR LIGHTING; ELECTRIC TRACK LIGHTING UNITS; FIXTURES FOR INCANDESCENT LIGHT BULBS; LED AND HID LIGHT FIXTURES; LIGHTING FIXTURES; WALL LIGHTS, IN CLASS 11 (U.S. CLS. 13, 21, 23, 31 AND 34).

FIRST USE 4-1-1978; IN COMMERCE 6-1-1978.

THE MARK CONSISTS OF STANDARD CHARACTERS WITHOUT CLAIM TO ANY PARTICULAR FONT, STYLE, SIZE, OR COLOR.

NO CLAIM IS MADE TO THE EXCLUSIVE RIGHT TO USE "LIGHTING", APART FROM THE MARK AS SHOWN.

SER. NO. 77-216,711, FILED 6-27-2007.

CHARLOTTE CORWIN, EXAMINING ATTORNEY

**Int. Cl.: 35**

**Prior U.S. Cls.: 100, 101 and 102**

**United States Patent and Trademark Office**

**Reg. No. 3,465,912**

**Registered July 15, 2008**

**SERVICE MARK  
PRINCIPAL REGISTER**

**FIND YOUR SHINE**

SNAP LOCK INDUSTRIES, INC. (UTAH CORPORATION)  
2330 WEST CALIFORNIA AVENUE  
SALT LAKE CITY, UT 84104

FOR: ONLINE RETAIL STORE SERVICES FEATURING AUTOMOBILE CARE PRODUCTS, NAMELY, AUTOMOBILE WAXES, SOAPS, AND POLISHES, IN CLASS 35 (U.S. CLS. 100, 101 AND 102).

FIRST USE 6-5-2007; IN COMMERCE 6-5-2007.

THE MARK CONSISTS OF STANDARD CHARACTERS WITHOUT CLAIM TO ANY PARTICULAR FONT, STYLE, SIZE, OR COLOR.

SER. NO. 77-216,722, FILED 6-27-2007.

MICHAEL GAAFAR, EXAMINING ATTORNEY

**Int. Cl.: 11**

**Prior U.S. Cls.: 13, 21, 23, 31 and 34**

**United States Patent and Trademark Office**

**Reg. No. 3,465,913**

**Registered July 15, 2008**

**TRADEMARK  
PRINCIPAL REGISTER**

**NORTH BAY COLLECTIONS**

HALLMARK LIGHTING, LLC (CALIFORNIA  
LTD LIAB CO)  
9631 DESOTO AVENUE  
CHATSWORTH, CA 91311

FOR: ELECTRIC LIGHTING FIXTURES; ELECTRIC LIGHTING FIXTURES, NAMELY, SCONCES; ELECTRIC TORCHES FOR LIGHTING; ELECTRIC TRACK LIGHTING UNITS; FIXTURES FOR INCANDESCENT LIGHT BULBS; LED AND HID LIGHT FIXTURES; LIGHTING FIXTURES; WALL LIGHTS, IN CLASS 11 (U.S. CLS. 13, 21, 23, 31 AND 34).

FIRST USE 4-1-1995; IN COMMERCE 5-1-1995.

THE MARK CONSISTS OF STANDARD CHARACTERS WITHOUT CLAIM TO ANY PARTICULAR FONT, STYLE, SIZE, OR COLOR.

NO CLAIM IS MADE TO THE EXCLUSIVE RIGHT TO USE "COLLECTIONS", APART FROM THE MARK AS SHOWN.

"NORTH BAY" APPEARING IN THE MARK HAS NO SIGNIFICANCE IN THE RELEVANT TRADE OR INDUSTRY OR AS APPLIED TO THE GOODS/SERVICES LISTED IN THE APPLICATION, NO GEOGRAPHICAL SIGNIFICANCE, NOR ANY MEANING IN A FOREIGN LANGUAGE.

SER. NO. 77-216,865, FILED 6-27-2007.

CHARLOTTE CORWIN, EXAMINING ATTORNEY

**Int. Cls.: 16 and 39**

**Prior U.S. Cls.: 2, 5, 22, 23, 29, 37, 38, 50, 100 and 105**

**United States Patent and Trademark Office**

**Reg. No. 3,465,914**

**Registered July 15, 2008**

**TRADEMARK  
SERVICE MARK  
PRINCIPAL REGISTER**

**順豐**

SF (IP) LIMITED (HONG KONG LTD LIAB CO)  
38-42 KWAI FUNG CRESCENT, KWAI CHUNG,  
14TH FLOOR, YOO HOO TOWER,  
NEW TERRITORIES, HONG KONG

FOR: PAPER BAGS; PAPER BAGS FOR PACKAGING; PAPER POUCHES FOR PACKAGING; PLASTIC BAGS FOR PACKAGING; BOXES OF PAPER OR CARDBOARD; PLASTIC BUBBLE PACKS FOR WRAPPING OR PACKAGING; ENVELOPES; PRINTED FORMS; PAPER FOR WRAPPING AND PACKAGING; PACKING PAPER; PRINTED TIME-TABLES; SEALING STAMPS; STICKERS; STICKERS; PARAFFINED PAPER; PLASTIC WRAP, IN CLASS 16 (U.S. CLS. 2, 5, 22, 23, 29, 37, 38 AND 50).

FOR: AIR TRANSPORT; BARGE TRANSPORT; CAR TRANSPORT; MARINE TRANSPORT; RAILWAY TRANSPORT; RIVER TRANSPORT BY BOAT; WAREHOUSING SERVICES, NAMELY, STORAGE, DISTRIBUTION, PICK-UP, PACKING, AND SHIPPING OF LETTERS, PARCELS, PAPER GOODS, PRINTED MATTERS AND PACKAGING MATERIALS; COURIER SERVICES; DELIVERY OF GOODS BY AIR, BARGE, RAILWAY, RIVER AND MARINE TRANSPORT; TRUCK HAULING; PACKAGING

ARTICLES FOR TRANSPORTATION; PARCEL DELIVERY, IN CLASS 39 (U.S. CLS. 100 AND 105).

PRIORITY CLAIMED UNDER SEC. 44(D) ON HONG KONG APPLICATION NO. 300892855, FILED 3-9-2007.

OWNER OF HONG KONG REG. NO. 300892855, DATED 6-15-2007, EXPIRES 6-15-2017.

THE MARK CONSISTS OF TWO CHINESE CHARACTERS IDENTIFIED AS "SHUN" AND "FUNG" AS SHOWN IN THE TRADITIONAL STYLE.

THE FOREIGN WORDING IN THE MARK TRANSLATES INTO ENGLISH AS SMOOTH, RICH.

THE NON-LATIN CHARACTER(S) IN THE MARK TRANSLITERATES INTO SHUN AND FUNG, AND THIS MEANS SMOOTH AND RICH IN ENGLISH.

SER. NO. 77-216,910, FILED 6-27-2007.

RON FAIRBANKS, EXAMINING ATTORNEY

**Int. Cl.: 38**

**Prior U.S. Cls.: 100, 101 and 104**

**United States Patent and Trademark Office**

**Reg. No. 3,465,915**

**Registered July 15, 2008**

**SERVICE MARK  
PRINCIPAL REGISTER**

# Idealogue

IDEALOGUE INC. (MASSACHUSETTS CORPORATION)  
15 CRAFTS STREET  
WALTHAM, MA 02453

FOR: PROVIDING ON-LINE FORUMS FOR TRANSMISSION OF MESSAGES AMONG COMPUTER USERS CONCERNING POLITICAL AND GLOBAL TOPICS; PROVIDING ON-LINE CHAT ROOMS AND ELECTRONIC BULLETIN BOARDS FOR TRANSMISSION OF MESSAGES AMONG USERS IN THE FIELD OF GENERAL INTEREST; PROVIDING ON-LINE CHAT ROOMS FOR TRANSMISSION OF MESSAGES AMONG COMPUTER USERS CONCERNING POLITICAL AND GLOBAL TOPICS; PROVIDING ON-LINE ELECTRONIC BULLETIN

BOARDS FOR TRANSMISSION OF MESSAGES AMONG COMPUTER USERS CONCERNING POLITICAL AND GLOBAL TOPICS, IN CLASS 38 (U.S. CLS. 100, 101 AND 104).

FIRST USE 12-15-2006; IN COMMERCE 12-15-2006.

THE MARK CONSISTS OF STANDARD CHARACTERS WITHOUT CLAIM TO ANY PARTICULAR FONT, STYLE, SIZE, OR COLOR.

SER. NO. 77-217,002, FILED 6-27-2007.

STEVEN JACKSON, EXAMINING ATTORNEY

**Int. Cls.: 16 and 39**

**Prior U.S. Cls.: 2, 5, 22, 23, 29, 37, 38, 50, 100 and 105**

**United States Patent and Trademark Office**

**Reg. No. 3,465,916**

**Registered July 15, 2008**

**TRADEMARK  
SERVICE MARK  
PRINCIPAL REGISTER**

顺丰

SF (IP) LIMITED (HONG KONG LTD LIAB CO)  
38-42 KWAI FUNG CRESCENT, KWAI CHUNG  
14TH FLOOR, YOO HOO TOWER  
NEW TERRITORIES, HONG KONG

FOR: PAPER BAGS; PAPER BAGS FOR PACKAGING; PLASTIC BAGS FOR PACKAGING; PAPER POUCHES FOR PACKAGING; BOXES OF PAPER OR CARDBOARD; PLASTIC BUBBLE PACKS FOR WRAPPING OR PACKAGING; ENVELOPES; PRINTED FORMS; PAPER FOR WRAPPING AND PACKAGING; PACKING PAPER; PRINTED TIMETABLES; SEALING STAMPS; STICKERS; STICKERS; PARAFFINED PAPER; PLASTIC WRAP, IN CLASS 16 (U.S. CLS. 2, 5, 22, 23, 29, 37, 38 AND 50).

FOR: RAILWAY TRANSPORT; AIR TRANSPORT; BARGE TRANSPORT; CAR TRANSPORT; COURIER SERVICES; DELIVERY OF GOODS BY AIR, BARGE, RAILWAY, RIVER AND MARINE TRANSPORT; WAREHOUSING SERVICES, NAMELY, STORAGE, DISTRIBUTION, PICK-UP, PACKING, AND SHIPPING OF LETTERS, PARCELS, PAPER GOODS, PRINTED MATERIALS AND PACKAGING MATERIALS; TRUCK HAULING; MARINE TRANSPORT; PACKAGING ARTICLES FOR TRANSPORTATION;

PARCEL DELIVERY; RIVER TRANSPORT BY BOAT, IN CLASS 39 (U.S. CLS. 100 AND 105).

PRIORITY CLAIMED UNDER SEC. 44(D) ON HONG KONG APPLICATION NO. 300892855, FILED 3-9-2007.

OWNER OF HONG KONG REG. NO. 300892855, DATED 6-15-2007, EXPIRES 6-15-2017.

THE MARK CONSISTS OF TWO CHINESE CHARACTERS IDENTIFIED AS "SHUN" AND "FUNG" AS SHOWN IN THE SIMPLIFIED STYLE.

THE FOREIGN WORDING IN THE MARK TRANSLATES INTO ENGLISH AS SMOOTH AND RICH.

THE NON-LATIN CHARACTER(S) IN THE MARK TRANSLITERATES INTO SHUN AND FUNG, AND THIS MEANS SMOOTH AND RICH IN ENGLISH.

SER. NO. 77-217,098, FILED 6-27-2007.

RON FAIRBANKS, EXAMINING ATTORNEY

**Int. Cl.: 35**

**Prior U.S. Cls.: 100, 101 and 102**

**United States Patent and Trademark Office**

**Reg. No. 3,465,917**

**Registered July 15, 2008**

**SERVICE MARK  
PRINCIPAL REGISTER**

**CONTEXTWEB**

CONTEXTWEB, INC. (DELAWARE CORPORATION)  
9TH FLOOR  
22 CORTLANDT STREET  
NEW YORK, NY 10007

FOR: ADVERTISING AND ADVERTISEMENT SERVICES; ADVERTISING SERVICES, NAMELY, ADVERTISING FOR OTHERS VIA THE INTERNET; INTERACTIVE AND CONTEXTUAL ADVERTISING FOR OTHERS; ADVERTISING AND PROMOTIONAL SERVICES FOR OTHERS, NAMELY, ONLINE ADVERTISING SERVICES IN THE NATURE OF PROVIDING AN AUTOMATED SYSTEM

OF CONTEXTUAL PRODUCT OR AD PLACEMENT, IN CLASS 35 (U.S. CLS. 100, 101 AND 102).

FIRST USE 5-11-2000; IN COMMERCE 7-0-2000.

THE MARK CONSISTS OF STANDARD CHARACTERS WITHOUT CLAIM TO ANY PARTICULAR FONT, STYLE, SIZE, OR COLOR.

SER. NO. 77-217,177, FILED 6-27-2007.

JOHN GARTNER, EXAMINING ATTORNEY



**Int. Cl.: 31**

**Prior U.S. Cls.: 1 and 46**

**United States Patent and Trademark Office**

**Reg. No. 3,465,918**

**Registered July 15, 2008**

**TRADEMARK  
PRINCIPAL REGISTER**



ALABAMA FARMERS COOPERATIVE, INC.  
(ALABAMA CORPORATION)  
POST OFFICE BOX 2227  
DECATUR, AL 35609

FOR: LIVE PLANTS, NAMELY, VEGETABLES,  
FRUIT PLANTS AND HERB PLANTS, IN CLASS 31  
(U.S. CLS. 1 AND 46).

FIRST USE 1-0-2007; IN COMMERCE 1-0-2007.

OWNER OF U.S. REG. NO. 1,097,653.

NO CLAIM IS MADE TO THE EXCLUSIVE  
RIGHT TO USE "PLANTS", APART FROM THE  
MARK AS SHOWN.

THE MARK CONSISTS OF A BERET WITH THE  
WORDS "BONNIE PLANTS" PRINTED INSIDE.

SER. NO. 77-217,274, FILED 6-27-2007.

BILL DAWE, EXAMINING ATTORNEY

**Int. Cl.: 31**

**Prior U.S. Cls.: 1 and 46**

**United States Patent and Trademark Office**

**Reg. No. 3,465,919**

**Registered July 15, 2008**

**TRADEMARK  
PRINCIPAL REGISTER**

**BONNIE PLANTS**

ALABAMA FARMERS COOPERATIVE, INC.  
(ALABAMA CORPORATION)  
POST OFFICE BOX 2227  
DECATUR, AL 35609

OWNER OF U.S. REG. NO. 1,097,653.

FOR: LIVE PLANTS, NAMELY, VEGETABLES,  
FRUIT PLANTS AND HERB PLANTS, IN CLASS 31  
(U.S. CLS. 1 AND 46).

NO CLAIM IS MADE TO THE EXCLUSIVE  
RIGHT TO USE "PLANTS", APART FROM THE  
MARK AS SHOWN.

FIRST USE 1-0-2007; IN COMMERCE 1-0-2007.

SER. NO. 77-217,283, FILED 6-27-2007.

THE MARK CONSISTS OF STANDARD CHAR-  
ACTERS WITHOUT CLAIM TO ANY PARTICULAR  
FONT, STYLE, SIZE, OR COLOR.

BILL DAWE, EXAMINING ATTORNEY

**Int. Cls.: 16 and 39**

**Prior U.S. Cls.: 2, 5, 22, 23, 29, 37, 38, 50, 100 and 105**

**Reg. No. 3,465,920**

**United States Patent and Trademark Office**

**Registered July 15, 2008**

**TRADEMARK  
SERVICE MARK  
PRINCIPAL REGISTER**



**EXPRESS**

**順豐速運**

SF (IP) LIMITED (HONG KONG LTD LIAB CO)  
38-42 KWAI FUNG CRESCENT, KWAI CHUNG  
14TH FLOOR, YOO HOO TOWER  
NEW TERRITORIES, HONG KONG

PRIORITY CLAIMED UNDER SEC. 44(D) ON  
HONG KONG APPLICATION NO. 300828036, FILED  
3-9-2007, REG. NO. 300828036, DATED 3-9-2007, EX-  
PIRES 3-9-2017.

FOR: PAPER BAGS; PAPER BAGS FOR PACKA-  
GING; PAPER POUCHES FOR PACKAGING; PLAS-  
TIC BAGS FOR PACKAGING; BOXES OF PAPER OR  
CARDBOARD; PLASTIC BUBBLE PACKS FOR  
WRAPPING OR PACKAGING; ENVELOPES; PRIN-  
TED FORMS; PAPER FOR WRAPPING AND  
PACKAGING; PACKING PAPER; PRINTED TIME-  
TABLES; SEALING STAMPS; STICKERS; STICKERS;  
PARAFFINED PAPER; PLASTIC WRAP, IN CLASS  
16 (U.S. CLS. 2, 5, 22, 23, 29, 37, 38 AND 50).

NO CLAIM IS MADE TO THE EXCLUSIVE  
RIGHT TO USE "EXPRESS" AND THE NON-LATIN  
CHARACTERS THAT MEAN "EXPRESS DELIV-  
ERY", APART FROM THE MARK AS SHOWN.

THE MARK CONSISTS OF THE STYLIZED LET-  
TERS "S" AND "F" ABOVE AN UPWARD BENDING  
ARCH ABOVE THE WORD "EXPRESS" ABOVE  
FOUR TRADITIONAL CHINESE CHARACTERS.

FOR: RAILWAY TRANSPORT; AIR TRANSPORT;  
BARGE TRANSPORT; CAR TRANSPORT; COURI-  
ER SERVICES; DELIVERY OF GOODS BY AIR,  
BARGE, RAILWAY, RIVER AND MARINE TRANS-  
PORT; WAREHOUSING SERVICES, NAMELY, STO-  
RAGE, DISTRIBUTION, PICK-UP, PACKING, AND  
SHIPPING OF LETTERS, PARCELS, PAPER GOODS,  
PRINTED MATERIALS AND PACKAGING MATE-  
RIALS; TRUCK HAULING; MARINE TRANSPORT;  
PACKAGING ARTICLES FOR TRANSPORTATION;  
PARCEL DELIVERY; RIVER TRANSPORT BY  
BOAT, IN CLASS 39 (U.S. CLS. 100 AND 105).

THE FOREIGN WORDING IN THE MARK  
TRANSLATES INTO ENGLISH AS "SMOOTH, RICH,  
EXPRESS AND DELIVERY".

"THE NON-LATIN CHARACTER(S) IN THE  
MARK TRANSLITERATES INTO SHUN, FUNG,  
CHUK AND WANG , AND THIS MEANS SMOOTH,  
RICH EXPRESS AND DELIVERY IN ENGLISH."

SER. NO. 77-217,365, FILED 6-27-2007.

RON FAIRBANKS, EXAMINING ATTORNEY

**Int. Cl.: 25**

**Prior U.S. Cls.: 22 and 39**

**United States Patent and Trademark Office**

**Reg. No. 3,465,921**

**Registered July 15, 2008**

**TRADEMARK  
PRINCIPAL REGISTER**

**Ann Michell**

FAJAS CHAROL'S & ANN MICHELL CORP.  
(FLORIDA CORPORATION)  
6995 NW 82 AVE BAY # 31  
MIAMI, FL 33166

FOR: GIRDLES; SHAPEWEAR, NAMELY, BODY  
SUITS, VESTS AND CINCHES IN THE NATURE OF  
CORSETS, IN CLASS 25 (U.S. CLS. 22 AND 39).

FIRST USE 11-15-2006; IN COMMERCE 11-15-2006.

THE MARK CONSISTS OF STANDARD CHAR-  
ACTERS WITHOUT CLAIM TO ANY PARTICULAR  
FONT, STYLE, SIZE, OR COLOR.

THE NAME(S), PORTRAIT(S), AND/OR SIGNA-  
TURE(S) SHOWN IN THE MARK DOES NOT IDENTI-  
FY A PARTICULAR LIVING INDIVIDUAL.

SER. NO. 77-217,636, FILED 6-28-2007.

MATTHEW PAPPAS, EXAMINING ATTORNEY

**Int. Cl.: 16**

**Prior U.S. Cls.: 2, 5, 22, 23, 29, 37, 38 and 50**

**Reg. No. 3,465,922**

**United States Patent and Trademark Office**

**Registered July 15, 2008**

**TRADEMARK  
PRINCIPAL REGISTER**

**MEET YOUR MATCH**

AMERICAN SOCIETY FOR THE PREVENTION  
OF CRUELTY TO ANIMALS, THE (NEW  
YORK CORPORATION)  
424 E. 92ND STREET  
NEW YORK, NY 10128

FOR: PRINTED MATERIALS, NAMELY, POS-  
TERS, BOOKLETS, STICKERS, POSTCARDS, CAGE  
CARDS IN THE NATURE OF PAPER CARDS FOR  
ANIMALS TO BE PLACED ON CAGES THAT DE-  
SCRIBE THE PERSONALITY OF THE ANIMALS TO  
PROSPECTIVE ADOPTERS, AND GUEST PASSES IN  
THE NATURE OF PAPER IDENTIFICATION TAGS  
FOR PROSPECTIVE ADOPTERS OF ANIMALS, IN  
THE FIELD OF BEHAVIOR MODIFICATION, EN-  
VIRONMENTAL ENRICHMENT, COMPANION AN-

IMAL ADOPTION FACILITATION INCLUDING  
COMPATIBILITY, ASSESSMENT, TRAINING, AND  
RECOMMENDATIONS, IN CLASS 16 (U.S. CLS. 2, 5,  
22, 23, 29, 37, 38 AND 50).

FIRST USE 10-1-2003; IN COMMERCE 10-1-2003.

THE MARK CONSISTS OF STANDARD CHAR-  
ACTERS WITHOUT CLAIM TO ANY PARTICULAR  
FONT, STYLE, SIZE, OR COLOR.

SER. NO. 77-217,751, FILED 6-28-2007.

MATTHEW MCDOWELL, EXAMINING ATTOR-  
NEY

**Int. Cl.: 9**

**Prior U.S. Cls.: 21, 23, 26, 36 and 38**

**United States Patent and Trademark Office**

**Reg. No. 3,465,923**

**Registered July 15, 2008**

**TRADEMARK  
PRINCIPAL REGISTER**

**BANNED FROM TELEVISION**

GGW MARKETING, LLC (DELAWARE LTD  
LIAB CO)

1601 CLOVERFIELD BLVD., SUITE 420 SOUTH

SANTA MONICA, CA 90404

FOR: PRERECORDED VIDEOTAPES AND DVDS  
FEATURING ADULT ENTERTAINMENT, IN  
CLASS 9 (U.S. CLS. 21, 23, 26, 36 AND 38).

FIRST USE 10-31-1997; IN COMMERCE 10-31-1997.

THE MARK CONSISTS OF STANDARD CHAR-  
ACTERS WITHOUT CLAIM TO ANY PARTICULAR  
FONT, STYLE, SIZE, OR COLOR.

OWNER OF U.S. REG. NOS. 2,420,336 AND  
2,611,100.

SEC. 2(F).

SER. NO. 77-217,774, FILED 6-28-2007.

DARRYL SPRUILL, EXAMINING ATTORNEY

**Int. Cls.: 16 and 39**

**Prior U.S. Cls.: 2, 5, 22, 23, 29, 37, 38, 50, 100 and 105**

**United States Patent and Trademark Office**

**Reg. No. 3,465,924**

**Registered July 15, 2008**

**TRADEMARK  
SERVICE MARK  
PRINCIPAL REGISTER**



**EXPRESS**

**顺丰速运**

SF (IP) LIMITED (HONG KONG LTD LIAB CO)  
38-42 KWAI FUNG CRESCENT, KWAI CHUNG  
14TH FLOOR, YOO HOO TOWER  
NEW TERRITORIES, HONG KONG

FOR: PAPER BAGS; PAPER BAGS FOR PACKAGING; PAPER POUCHES FOR PACKAGING; PLASTIC BAGS FOR PACKAGING; BOXES OF PAPER OR CARDBOARD; PLASTIC BUBBLE PACKS FOR WRAPPING OR PACKAGING; ENVELOPES; PRINTED FORMS; PAPER FOR WRAPPING AND PACKAGING; PACKING PAPER; PRINTED TIMETABLES; SEALING STAMPS; STICKERS; STICKERS; PARAFFINED PAPER; PLASTIC WRAP, IN CLASS 16 (U.S. CLS. 2, 5, 22, 23, 29, 37, 38 AND 50).

FOR: RAILWAY TRANSPORT; AIR TRANSPORT; BARGE TRANSPORT; CAR TRANSPORT; MARINE TRANSPORT; RIVER TRANSPORT BY BOAT; COURIER SERVICES; DELIVERY OF GOODS BY AIR, BARGE, RAILWAY, RIVER AND MARINE TRANSPORT; WAREHOUSING SERVICES, NAMELY, STORAGE, DISTRIBUTION, PICK-UP, PACKING, AND SHIPPING OF LETTERS, PARCELS, PAPER GOODS, PRINTED MATERIALS AND PACKAGING MATERIALS; TRUCK HAULING; PACKAGING ARTICLES FOR TRANSPORTATION; PARCEL DELIVERY, IN CLASS 39 (U.S. CLS. 100 AND 105).

PRIORITY CLAIMED UNDER SEC. 44(D) ON HONG KONG APPLICATION NO. 300828036, FILED 3-9-2007, REG. NO. 300828036, DATED 3-9-2007, EXPIRES 3-9-2017.

NO CLAIM IS MADE TO THE EXCLUSIVE RIGHT TO USE "EXPRESS" AND NON-LATIN CHARACTERS THAT MEAN "EXPRESS DELIVERY", APART FROM THE MARK AS SHOWN.

THE MARK CONSISTS OF THE STYLIZED LETTERS "S" AND "F" ABOVE AN UPWARD BENDING ARCH ABOVE THE WORD "EXPRESS" ABOVE FOUR TRADITIONAL CHINESE CHARACTERS.

THE FOREIGN WORDING IN THE MARK TRANSLATES INTO ENGLISH AS SMOOTH, RICH, EXPRESS AND DELIVERY.

THE NON-LATIN CHARACTER(S) IN THE MARK TRANSLITERATES INTO "SHUN, FUNG, CHUK" AND "WAN", AND THIS MEANS RICH, SMOOTH, EXPRESS AND DELIVERY IN ENGLISH.

SER. NO. 77-218,001, FILED 6-28-2007.

RON FAIRBANKS, EXAMINING ATTORNEY

Int. Cls.: 9 and 41

Prior U.S. Cls.: 21, 23, 26, 36, 38, 100, 101 and 107

Reg. No. 3,465,925

United States Patent and Trademark Office

Registered July 15, 2008

TRADEMARK  
SERVICE MARK  
PRINCIPAL REGISTER



THE HINMAN DENTAL SOCIETY OF ATLANTA, INC. (GEORGIA CORPORATION)  
33 LENOX POINTE  
ATLANTA, GA 30324

FOR: PRE-RECORDED AUDIO CASSETTES AND CD'S IN THE FIELD OF DENTAL EDUCATION, IN CLASS 9 (U.S. CLS. 21, 23, 26, 36 AND 38).

FIRST USE 3-0-1991; IN COMMERCE 3-0-1991.

FOR: EDUCATIONAL SERVICES, NAMELY, CONDUCTING SEMINARS, CLINICS, MEETINGS, WORKSHOPS AND TECHNICAL PROGRAMS UTILIZING SPEAKERS, FILMS, COURSE MATERIALS AND VIDEO AND AUDIO CASSETTES AND CD'S IN THE FIELD OF DENTISTRY, IN CLASS 41 (U.S. CLS. 100, 101 AND 107).

FIRST USE 9-0-1990; IN COMMERCE 9-0-1990.

OWNER OF U.S. REG. NOS. 1,172,600 AND 1,173,658.

NO CLAIM IS MADE TO THE EXCLUSIVE RIGHT TO USE "DENTAL MEETING" , APART FROM THE MARK AS SHOWN.

THE MARK CONSISTS OF SHADED SQUARE WITH A CIRCLE AND A TRIANGLE SUPERIMPOSED ON THE TOP OF IT. OVER THE TRIANGLE AND CIRCLE ARE A DESIGN OF THE SINGLE SERPENT OF AESCULAPIUS, THE FATHER OF MEDICINE, ENTERTAINED AROUND AN ARABIAN CAUTERY, AN ANCIENT SEARING IRON USED TO SEAL WOUNDS, AND TWO SHEAVES OF WHEAT. AROUND THE PERIPHERY ARE THE WORDS "THOMAS P. HINMAN DENTAL MEETING" AND THE WORDS "MAGNA EST VERITAS ET PRAEVALEBIT". IN THE TOP LEFT CORNER IS THE GREEK LETTER DELTA FOR DENTISTRY, AND IN THE BOTTOM RIGHT CORNER, THE OMICRON FOR ADDEND OR TOOTH. IN THE TOP RIGHT CORNER ARE THE SAME SHEAVES OF WHEAT AND IN THE BOTTOM LEFT CORNER, A SMALL CADUCEUS.

THE FOREIGN WORDING IN THE MARK TRANSLATES INTO ENGLISH AS TRUTH IS GREAT AND WILL PREVAIL.

SER. NO. 77-218,022, FILED 6-28-2007.

EUGENIA MARTIN, EXAMINING ATTORNEY



**Int. Cl.: 42**

**Prior U.S. Cls.: 100 and 101**

**United States Patent and Trademark Office**

**Reg. No. 3,465,926**

**Registered July 15, 2008**

**SERVICE MARK  
PRINCIPAL REGISTER**

**NLIGN**

NLIGN, INC (MISSOURI CORPORATION)  
2875 BONDESSON STREET  
OMAHA, NE 68112

FOR: ENGINEERING SERVICES, NAMELY, ENGINEERING AND TECHNICAL CONSULTING SERVICES FOR MECHANICAL ENGINEERING, MANUFACTURING ENGINEERING, AND FACILITIES MANAGEMENT, IN CLASS 42 (U.S. CLS. 100 AND 101).

FIRST USE 4-0-2005; IN COMMERCE 4-0-2005.

THE MARK CONSISTS OF STANDARD CHARACTERS WITHOUT CLAIM TO ANY PARTICULAR FONT, STYLE, SIZE, OR COLOR.

SER. NO. 77-218,033, FILED 6-28-2007.

STEVEN R. FINE, EXAMINING ATTORNEY

**Int. Cls.: 16 and 39**

**Prior U.S. Cls.: 2, 5, 22, 23, 29, 37, 38, 50, 100 and 105**

**United States Patent and Trademark Office**

**Reg. No. 3,465,927**

**Registered July 15, 2008**

**TRADEMARK  
SERVICE MARK  
PRINCIPAL REGISTER**



SF (IP) LIMITED (HONG KONG LTD LIAB CO)  
38-42 KWAI FUNG CRESCENT, KWAI CHUNG,  
14TH FLOOR, YOO HOO TOWER,  
NEW TERRITORIES, HONG KONG

PRIORITY CLAIMED UNDER SEC. 44(D) ON  
HONG KONG APPLICATION NO. 300828045, FILED  
3-9-2007, REG. NO. 300828045, DATED 3-9-2007, EX-  
PIRES 3-9-2017.

FOR: PAPER BAGS; PAPER BAGS FOR PACKA-  
GING; PAPER POUCHES FOR PACKAGING; PLAS-  
TIC BAGS FOR PACKAGING; BOXES OF PAPER OR  
CARDBOARD; PLASTIC BUBBLE PACKS FOR  
WRAPPING OR PACKAGING; ENVELOPES; PRIN-  
TED FORMS; PAPER FOR WRAPPING AND  
PACKAGING; PACKING PAPER; PRINTED TIME-  
TABLES; SEALING STAMPS; STICKERS; STICKERS;  
PARAFFINED PAPER; PLASTIC WRAP, IN CLASS  
16 (U.S. CLS. 2, 5, 22, 23, 29, 37, 38 AND 50).

NO CLAIM IS MADE TO THE EXCLUSIVE  
RIGHT TO USE "EXPRESS" AND NON-LATIN  
CHARACTERS THAT MEAN "EXPRESS DELIV-  
ERY", APART FROM THE MARK AS SHOWN.

THE MARK CONSISTS OF THE STYLIZED LET-  
TERS "S" AND "F" ABOVE AN UPWARD ARCH  
BESIDE THE WORD "EXPRESS" ABOVE FOUR  
CHINESE CHARACTERS.

FOR: AIR TRANSPORT; BARGE TRANSPORT;  
CAR TRANSPORT; MARINE TRANSPORT; RAIL-  
WAY TRANSPORT; RIVER TRANSPORT BY BOAT;  
COURIER SERVICES; DELIVERY OF GOODS BY  
AIR, BARGE, RAILWAY, RIVER AND MARINE  
TRANSPORT; WAREHOUSING SERVICES, NAME-  
LY, STORAGE, DISTRIBUTION, PICK-UP, PACK-  
ING, AND SHIPPING OF LETTERS, PARCELS,  
PAPER GOODS, PRINTED MATERIALS AND  
PACKAGING MATERIALS; TRUCK HAULING;  
PACKAGING ARTICLES FOR TRANSPORTATION;  
PARCEL DELIVERY, IN CLASS 39 (U.S. CLS. 100  
AND 105).

THE FOREIGN WORDING IN THE MARK  
TRANSLATES INTO ENGLISH AS "SMOOTH, RICH,  
EXPRESS AND DELIVERY".

THE NON-LATIN CHARACTER(S) IN THE  
MARK TRANSLITERATES INTO "SHUN, FUNG,  
CHUK & WAN", AND THIS MEANS "SMOOTH,  
RICH, EXPRESS AND DELIVERY" IN ENGLISH."

SER. NO. 77-218,115, FILED 6-28-2007.

RON FAIRBANKS, EXAMINING ATTORNEY

**Int. Cls.: 16 and 39**

**Prior U.S. Cls.: 2, 5, 22, 23, 29, 37, 38, 50, 100 and 105**

**United States Patent and Trademark Office**

**Reg. No. 3,465,928**

**Registered July 15, 2008**

**TRADEMARK  
SERVICE MARK  
PRINCIPAL REGISTER**



SF (IP) LIMITED (HONG KONG LTD LIAB CO)  
38-42 KWAI FUNG CRESCENT, KWAI CHUNG  
14TH FLOOR, YOO HOO TOWER  
NEW TERRITORIES, HONG KONG

PRIORITY CLAIMED UNDER SEC. 44(D) ON  
HONG KONG APPLICATION NO. 300828045, FILED  
3-9-2007, REG. NO. 300828045, DATED 3-9-2007, EX-  
PIRES 3-9-2017.

FOR: PLASTIC WRAP; PAPER BAGS; PAPER  
BAGS FOR PACKAGING; PLASTIC BAGS FOR  
PACKAGING; BOXES OF PAPER OR CARDBOARD;  
ENVELOPES; PRINTED FORMS; PAPER FOR  
WRAPPING AND PACKAGING; PACKING PAPER;  
PRINTED TIMETABLES; SEALING STAMPS;  
STICKERS; STICKERS; PARAFFINED PAPER; PA-  
PER POUCHES FOR PACKAGING; PLASTIC BUB-  
BLE PACKS FOR WRAPPING OR PACKAGING, IN  
CLASS 16 (U.S. CLS. 2, 5, 22, 23, 29, 37, 38 AND 50).

NO CLAIM IS MADE TO THE EXCLUSIVE  
RIGHT TO USE "EXPRESS" AND NON-LATIN  
CHARACTERS THAT MEAN "EXPRESS DELIV-  
ERY", APART FROM THE MARK AS SHOWN.

THE MARK CONSISTS OF THE STYLIZED LET-  
TERS "S" AND "F" ABOVE AN UPWARD ARCH  
BESIDE THE WORD "EXPRESS" ABOVE FOUR  
DIFFERENT CHINESE CHARACTERS.

FOR: AIR TRANSPORT; BARGE TRANSPORT;  
CAR TRANSPORT; MARINE TRANSPORT; RAIL-  
WAY TRANSPORT; RIVER TRANSPORT BY BOAT;  
COURIER SERVICES; DELIVERY OF GOODS BY  
AIR, BARGE, RAILWAY, RIVER AND MARINE  
TRANSPORT; WAREHOUSING SERVICES, NAME-  
LY, STORAGE, DISTRIBUTION, PICK-UP, PACK-  
ING, AND SHIPPING OF LETTERS, PARCELS,  
PAPER GOODS, PRINTED MATERIALS AND  
PACKAGING MATERIALS; TRUCK HAULING;  
PACKAGING ARTICLES FOR TRANSPORTATION;  
PARCEL DELIVERY, IN CLASS 39 (U.S. CLS. 100  
AND 105).

THE FOREIGN WORDING IN THE MARK  
TRANSLATES INTO ENGLISH AS "SMOOTH, RICH,  
EXPRESS AND DELIVERY".

THE NON-LATIN CHARACTER(S) IN THE  
MARK TRANSLITERATES INTO SHUN, FUNG ,  
CHUK & WAN, AND THIS MEANS SMOOTH, RICH,  
EXPRESS AND DELIVERY IN ENGLISH.

SER. NO. 77-218,332, FILED 6-28-2007.

RON FAIRBANKS, EXAMINING ATTORNEY

**Int. Cls.: 16 and 39**

**Prior U.S. Cls.: 2, 5, 22, 23, 29, 37, 38, 50, 100 and 105**

**United States Patent and Trademark Office**

**Reg. No. 3,465,929**

**Registered July 15, 2008**

**TRADEMARK  
SERVICE MARK  
PRINCIPAL REGISTER**



SF (IP) LIMITED (HONG KONG LTD LIAB CO)  
38-42 KWAI FUNG CRESCENT, KWAI CHUNG  
14TH FLOOR, YOO HOO TOWER  
NEW TERRITORIES, HONG KONG

FOR: PAPER BAGS; PAPER BAGS FOR PACKAGING; PAPER POUCHES FOR PACKAGING; PLASTIC BAGS FOR PACKAGING; BOXES OF PAPER OR CARDBOARD; PLASTIC BUBBLE PACKS FOR WRAPPING OR PACKAGING; ENVELOPES; PRINTED FORMS; PAPER FOR WRAPPING AND PACKAGING; PACKING PAPER; PRINTED TIMETABLES; SEALING STAMPS; STICKERS; STICKERS; PARAFFINED PAPER; PLASTIC WRAP, IN CLASS 16 (U.S. CLS. 2, 5, 22, 23, 29, 37, 38 AND 50).

FOR: COURIER SERVICES; AIR TRANSPORT; BARGE TRANSPORT; CAR TRANSPORT; MARINE TRANSPORT; RAILWAY TRANSPORT; RIVER TRANSPORT BY BOAT; DELIVERY OF GOODS BY AIR, BARGE, RAILWAY, RIVER AND MARINE TRANSPORT; WAREHOUSING SERVICES, NAME-

LY, STORAGE, DISTRIBUTION, PICK-UP, PACKING, AND SHIPPING OF LETTERS, PARCELS, PAPER GOODS, PRINTED MATERIALS AND PACKAGING MATERIALS; TRUCK HAULING; PACKAGING ARTICLES FOR TRANSPORTATION; PARCEL DELIVERY, IN CLASS 39 (U.S. CLS. 100 AND 105).

PRIORITY CLAIMED UNDER SEC. 44(D) ON HONG KONG APPLICATION NO. 300828018, FILED 3-9-2007, REG. NO. 300828018, DATED 3-9-2007, EXPIRES 3-9-2017.

THE MARK CONSISTS OF THE STYLIZED IMAGE OF THE LETTERS "S" AND "F" WITH AN UPWARD BENDING ARCH BENEATH THE LETTERS.

SER. NO. 77-218,585, FILED 6-29-2007.

RON FAIRBANKS, EXAMINING ATTORNEY

**Int. Cls.: 9 and 42**

**Prior U.S. Cls.: 21, 23, 26, 36, 38, 100 and 101**

**United States Patent and Trademark Office**

**Reg. No. 3,465,930**

**Registered July 15, 2008**

**TRADEMARK  
SERVICE MARK  
PRINCIPAL REGISTER**

**SYNTHASITE**

SYNTHASITE (PTY) LTD. (SOUTH AFRICA CORPORATION)  
GARDENS  
4 GORDON STREET  
CAPE TOWN, SOUTH AFRICA 800

FOR: SOFTWARE FOR DESIGNING, CREATING, IMPLEMENTING, MAINTAINING, RECONFIGURING, AND OPTIMIZING THE PERFORMANCE OF WEB SITES FOR OTHERS, IN CLASS 9 (U.S. CLS. 21, 23, 26, 36 AND 38).

FIRST USE 6-10-2004; IN COMMERCE 9-23-2005.

FOR: COMPUTER SERVICES, NAMELY, DESIGNING, CREATING, IMPLEMENTING, MAIN-

TAINING, RECONFIGURING, AND OPTIMIZING THE PERFORMANCE OF WEB SITES FOR OTHERS, IN CLASS 42 (U.S. CLS. 100 AND 101).

FIRST USE 6-10-2004; IN COMMERCE 8-29-2004.

THE MARK CONSISTS OF STANDARD CHARACTERS WITHOUT CLAIM TO ANY PARTICULAR FONT, STYLE, SIZE, OR COLOR.

SER. NO. 77-218,597, FILED 6-29-2007.

MARY ROSSMAN, EXAMINING ATTORNEY

**Int. Cls.: 16 and 39**

**Prior U.S. Cls.: 2, 5, 22, 23, 29, 37, 38, 50, 100 and 105**

**Reg. No. 3,465,931**

**United States Patent and Trademark Office**

**Registered July 15, 2008**

**TRADEMARK  
SERVICE MARK  
PRINCIPAL REGISTER**



SF (IP) LIMITED (HONG KONG LTD LIAB CO)  
38-42 KWAI FUNG CRESCENT, KWAI CHUNG  
14TH FLOOR, YOO HOO TOWER  
NEW TERRITORIES, HONG KONG

FOR: PAPER BAGS; PAPER BAGS FOR PACKAGING; PAPER POUCHES FOR PACKAGING; PLASTIC BAGS FOR PACKAGING; BOXES OF PAPER OR CARDBOARD; PLASTIC BUBBLE PACKS FOR WRAPPING OR PACKAGING; ENVELOPES; PRINTED FORMS; PAPER FOR WRAPPING AND PACKAGING; PACKING PAPER; PRINTED TIME-TABLES; SEALING STAMPS; STICKERS; STICKERS; PARAFFINED PAPER; PLASTIC WRAP, IN CLASS 16 (U.S. CLS. 2, 5, 22, 23, 29, 37, 38 AND 50).

FOR: PARCEL DELIVERY; AIR TRANSPORT; BARGE TRANSPORT; CAR TRANSPORT; MARINE TRANSPORT; RAILWAY TRANSPORT; RIVER TRANSPORT BY BOAT; COURIER SERVICES; DELIVERY OF GOODS BY AIR, BARGE, RAILWAY, RIVER AND MARINE TRANSPORT; WAREHOUSING SERVICES, NAMELY, STORAGE, DISTRIBUTION,

PICK-UP, PACKING, AND SHIPPING OF LETTERS, PARCELS, PAPER GOODS, PRINTED MATERIALS AND PACKAGING MATERIALS; TRUCK HAULING; PACKAGING ARTICLES FOR TRANSPORTATION, IN CLASS 39 (U.S. CLS. 100 AND 105).

PRIORITY CLAIMED UNDER SEC. 44(D) ON HONG KONG APPLICATION NO. 300828027, FILED 3-9-2007, REG. NO. 300828027, DATED 3-9-2007, EXPIRES 3-9-2017.

NO CLAIM IS MADE TO THE EXCLUSIVE RIGHT TO USE "EXPRESS" , APART FROM THE MARK AS SHOWN.

THE MARK CONSISTS OF THE STYLIZED LETTERS "S" AND "F" AND AN ARCH UNDERNEATH, BESIDE THE WORD "EXPRESS".

SER. NO. 77-218,603, FILED 6-29-2007.

RON FAIRBANKS, EXAMINING ATTORNEY

**Int. Cl.: 1**

**Prior U.S. Cls.: 1, 5, 6, 10, 26 and 46**

**Reg. No. 3,465,932**

**United States Patent and Trademark Office**

**Registered July 15, 2008**

**TRADEMARK  
PRINCIPAL REGISTER**



HUNAN JINGSHI GROUP CO.,LTD. (CHINA CORPORATION)  
XIANGSHI WESTERN ROAD, SHIFENG DISTRICT  
ZHUZHOU, CHINA 421005

FOR: ZINC OXIDE; ZINC SULPHATE; BISMUTH;  
ADHESIVES FOR INDUSTRIAL PURPOSES; ADHESIVES,  
OTHER THAN FOR STATIONERY OR HOUSEHOLD PURPOSES ,  
IN CLASS 1 (U.S. CLS. 1, 5, 6, 10, 26 AND 46).

FIRST USE 11-27-2000; IN COMMERCE 10-20-2006.

THE MARK CONSISTS OF "JING SHI" AND LOGO..

THE CHINESE CHARACTERS IN THE MARK ARE TRANSLITERATED INTO "JING SHI" AND HAVE NO MEANING IN ENGLISH.

SER. NO. 77-218,627, FILED 6-29-2007.

MARTHA SANTOMARTINO, EXAMINING ATTORNEY

**Int. Cls.: 16 and 39**

**Prior U.S. Cls.: 2, 5, 22, 23, 29, 37, 38, 50, 100 and 105**

**Reg. No. 3,465,933**

**United States Patent and Trademark Office**

**Registered July 15, 2008**

**TRADEMARK  
SERVICE MARK  
PRINCIPAL REGISTER**

**S. F. EXPRESS**

SF (IP) LIMITED (HONG KONG LTD LIAB CO)  
38-42 KWAI FUNG CRESCENT, KWAI CHUNG  
14TH FLOOR, YOO HOO TOWER  
NEW TERRITORIES, HONG KONG

FOR: PAPER BAGS; PAPER BAGS FOR PACKAGING; PAPER POUCHES FOR PACKAGING; BOXES OF PAPER OR CARDBOARD; PLASTIC BAGS FOR PACKAGING; PLASTIC BUBBLE PACKS FOR WRAPPING OR PACKAGING; ENVELOPES; PAPER FOR WRAPPING AND PACKAGING; PRINTED FORMS; PACKING PAPER; PRINTED TIME-TABLES; SEALING STAMPS; PARAFFINED PAPER; PLASTIC WRAP; STICKERS, IN CLASS 16 (U.S. CLS. 2, 5, 22, 23, 29, 37, 38 AND 50).

FOR: PARCEL DELIVERY; AIR TRANSPORT; BARGE TRANSPORT; CAR TRANSPORT; MARINE TRANSPORT; RAILWAY TRANSPORT; RIVER TRANSPORT BY BOAT; DELIVERY OF GOODS BY AIR, BARGE, RAILWAY, RIVER AND MARINE TRANSPORT; WAREHOUSING SERVICES, NAMELY, STORAGE, DISTRIBUTION, PICK-UP, PACK-

ING, AND SHIPPING OF LETTERS, PARCELS, PAPER GOODS, PRINTED MATERIALS AND PACKAGING MATERIALS; TRUCK HAULING; PACKAGING ARTICLES FOR TRANSPORTATION; COURIER SERVICES, IN CLASS 39 (U.S. CLS. 100 AND 105).

THE MARK CONSISTS OF STANDARD CHARACTERS WITHOUT CLAIM TO ANY PARTICULAR FONT, STYLE, SIZE, OR COLOR.

PRIORITY CLAIMED UNDER SEC. 44(D) ON HONG KONG APPLICATION NO. 300828009, FILED 3-9-2007, REG. NO. 77218639, DATED 3-9-2007, EXPIRES 3-9-2017.

NO CLAIM IS MADE TO THE EXCLUSIVE RIGHT TO USE "EXPRESS", APART FROM THE MARK AS SHOWN.

SER. NO. 77-218,639, FILED 6-29-2007.

RON FAIRBANKS, EXAMINING ATTORNEY



**Int. Cls.: 35 and 41**

**Prior U.S. Cls.: 100, 101, 102 and 107**

**United States Patent and Trademark Office**

**Reg. No. 3,465,934**

**Registered July 15, 2008**

**SERVICE MARK  
PRINCIPAL REGISTER**

**LIVING FORWARD**

WEST HOLLYWOOD MARKETING & VISITORS  
BUREAU (CALIFORNIA CORPORATION)  
8687 MELROSE AVENUE, SUITE M-38  
WEST HOLLYWOOD, CA 90069

FOR: PROMOTIONAL SERVICES, NAMELY, PROMOTING THE ECONOMIC AND BUSINESS DEVELOPMENT OF THE WEST HOLLYWOOD, LOS ANGELES AND SOUTHERN CALIFORNIA REGIONS; ORGANIZING EXHIBITIONS FOR THE PURPOSE OF PROMOTING THE ECONOMIC AND BUSINESS DEVELOPMENT OF THE WEST HOLLYWOOD, LOS ANGELES AND SOUTHERN CALIFORNIA REGIONS; PROVIDING AN ONLINE BUSINESS DIRECTORY FOR BUSINESSES OF THE WEST HOLLYWOOD, LOS ANGELES AND SOUTHERN CALIFORNIA REGIONS AND PROMOTING THE GOODS AND SERVICES OF BUSINESSES LOCATED WITHIN THE WEST HOLLYWOOD, LOS ANGELES AND SOUTHERN CALIFORNIA REGIONS THROUGH ADVERTISING AND PROVIDING INFORMATION; DISTRIBUTION AND DISSEMINATION OF ADVERTISING MATERIALS, NAMELY, PROMOTIONAL CDS, DVDS, TAPES, AND DISCS, MERCHANDISE AND PRINTED MATERIAL, IN CLASS 35 (U.S. CLS. 100, 101 AND 102).

FIRST USE 6-15-2007; IN COMMERCE 6-15-2007.

FOR: ENTERTAINMENT SERVICES, NAMELY, THE PRODUCTION OF TELEVISION PROGRAMS, DOCUMENTARIES AND RADIO PROGRAMS IN ALL MEDIA FEATURING LIVE ACTION, ACTION ADVENTURE, COMEDY OR ANIMATION; ORGANIZING COMMUNITY FESTIVALS AND EXHIBITIONS FEATURING A VARIETY OF ACTIVITIES, NAMELY, CULTURAL, EDUCATIONAL AND ENTERTAINMENT AND SPORTING EVENTS, ART EXHIBITIONS AND PICTORIAL DISPLAYS OF SUBJECT MATTER WHICH CULTURALLY OR HISTORICALLY CORRELATES TO THE WEST HOLLYWOOD, LOS ANGELES AND SOUTHERN CALIFORNIA COMMUNITIES; PROVIDING INFORMATION ON ENTERTAINMENT, ACTIVITIES EVENTS IN WEST HOLLYWOOD, LOS ANGELES AND SOUTHERN CALIFORNIA REGIONS, IN CLASS 41 (U.S. CLS. 100, 101 AND 107).

FIRST USE 6-15-2007; IN COMMERCE 6-15-2007.

THE MARK CONSISTS OF STANDARD CHARACTERS WITHOUT CLAIM TO ANY PARTICULAR FONT, STYLE, SIZE, OR COLOR.

SER. NO. 77-219,170, FILED 6-29-2007.

MATTHEW MCDOWELL, EXAMINING ATTORNEY

**Int. Cl.: 25**

**Prior U.S. Cls.: 22 and 39**

**United States Patent and Trademark Office**

**Reg. No. 3,465,935**

**Registered July 15, 2008**

**TRADEMARK  
PRINCIPAL REGISTER**

**AXIS**

PEI LICENSING, INC. (DELAWARE CORPORATION)  
3000 N.W. 107 AVENUE  
MIAMI, FL 33172

FOR: CLOTHING, NAMELY, SHIRTS, DRESS SHIRTS, T-SHIRTS, PANTS, SHORTS, SLACKS, JEANS, SWEATERS, JACKETS, COATS, TIES, HATS AND CAPS, IN CLASS 25 (U.S. CLS. 22 AND 39).

FIRST USE 7-26-1984; IN COMMERCE 7-26-1984.

THE MARK CONSISTS OF STANDARD CHARACTERS WITHOUT CLAIM TO ANY PARTICULAR FONT, STYLE, SIZE, OR COLOR.

OWNER OF U.S. REG. NOS. 1,348,121, 1,443,640, AND 3,197,650.

SER. NO. 77-219,345, FILED 6-29-2007.

ANN E. SAPPENFIELD, EXAMINING ATTORNEY

**Int. Cl.: 35**

**Prior U.S. Cls.: 100, 101 and 102**

**United States Patent and Trademark Office**

**Reg. No. 3,465,936**

**Registered July 15, 2008**

**SERVICE MARK  
PRINCIPAL REGISTER**

# Brilliance Marketing

TICER, CATHERINE RAFTREY (UNITED STATES INDIVIDUAL)

1199 WAKEFIELD STREET

BIRMINGHAM, MI 48009

FOR: PUBLIC RELATIONS; PROMOTION AND MARKETING SERVICES AND RELATED CONSULTING, IN CLASS 35 (U.S. CLS. 100, 101 AND 102).

FIRST USE 10-7-1995; IN COMMERCE 10-7-1995.

THE MARK CONSISTS OF STANDARD CHARACTERS WITHOUT CLAIM TO ANY PARTICULAR FONT, STYLE, SIZE, OR COLOR.

NO CLAIM IS MADE TO THE EXCLUSIVE RIGHT TO USE "MARKETING", APART FROM THE MARK AS SHOWN.

SER. NO. 77-219,383, FILED 6-29-2007.

MARTHA SANTOMARTINO, EXAMINING ATTORNEY

Int. Cl.: 35

Prior U.S. Cls.: 100, 101 and 102

**United States Patent and Trademark Office**

**Reg. No. 3,465,937**

Registered July 15, 2008

---

**SERVICE MARK  
PRINCIPAL REGISTER**

# Puppy Love

SILVERMAN, NANCY (UNITED STATES INDIVIDUAL)

10 BURKHARDT WAY

GAYLORDSVILLE, CT 06755

FOR: RETAIL PET STORE, IN CLASS 35 (U.S. CLS. 100, 101 AND 102).

FIRST USE 9-1-1998; IN COMMERCE 9-1-1998.

THE MARK CONSISTS OF STANDARD CHARACTERS WITHOUT CLAIM TO ANY PARTICULAR FONT, STYLE, SIZE, OR COLOR.

NO CLAIM IS MADE TO THE EXCLUSIVE RIGHT TO USE "PUPPY", APART FROM THE MARK AS SHOWN.

SER. NO. 77-220,019, FILED S.R. 7-1-2007 AM. P.R. 3-25-2008.

MELVIN AXILBUND, EXAMINING ATTORNEY

**Int. Cl.: 5**

**Prior U.S. Cls.: 6, 18, 44, 46, 51 and 52**

**Reg. No. 3,465,938**

**United States Patent and Trademark Office**

**Registered July 15, 2008**

**TRADEMARK  
PRINCIPAL REGISTER**



PRUGEN, INC. (ARIZONA CORPORATION)  
P.M.B. 225  
8711 EAST PINNACLE PEAK ROAD  
SCOTTSDALE, AZ 85255

FOR: MEDICATED SHAMPOO; TOPICAL DERMATOLOGY PRODUCTS, NAMELY, DERMATOLOGICALS, IN CLASS 5 (U.S. CLS. 6, 18, 44, 46, 51 AND 52).

FIRST USE 12-13-2007; IN COMMERCE 12-13-2007.

NO CLAIM IS MADE TO THE EXCLUSIVE RIGHT TO USE "INC." AND "PHARMACEUTICALS", APART FROM THE MARK AS SHOWN.

THE MARK CONSISTS OF THE WORDS "PRUGEN, INC. PHARMACEUTICALS" AND A BEAKER.

SER. NO. 77-220,300, FILED 7-2-2007.

TEJBIR SINGH, EXAMINING ATTORNEY

**Int. Cl.: 10**

**Prior U.S. Cls.: 26, 39 and 44**

**United States Patent and Trademark Office**

**Reg. No. 3,465,939**

**Registered July 15, 2008**

**TRADEMARK  
PRINCIPAL REGISTER**

**DIGIMATCH**

CUREXO MEDICAL, INC. (CALIFORNIA CORPORATION)  
1433 N. MARKET BLVD., #1  
SACRAMENTO, CA 95834

FOR: SURGICAL AND MEDICAL APPARATUS, NAMELY, A ROBOTIC SURGICAL APPARATUS, COMPRISING COMPUTERS, ROBOTIC ARMS, FORCE SENSORS, CUTTING INSTRUMENTS, AND COMPUTER PROGRAMS, USED FOR ORTHOPEDIC AND OTHER SURGICAL PROCEDURES, IN CLASS 10 (U.S. CLS. 26, 39 AND 44).

FIRST USE 11-25-1998; IN COMMERCE 11-25-1998.

THE MARK CONSISTS OF STANDARD CHARACTERS WITHOUT CLAIM TO ANY PARTICULAR FONT, STYLE, SIZE, OR COLOR.

SER. NO. 77-220,427, FILED 7-2-2007.

GEOFFREY FOSDICK, EXAMINING ATTORNEY

**Int. Cl.: 35**

**Prior U.S. Cls.: 100, 101 and 102**

**United States Patent and Trademark Office**

**Reg. No. 3,465,940**

**Registered July 15, 2008**

**SERVICE MARK  
PRINCIPAL REGISTER**

**The Presidio Group A  
Partnership to Manage Risk**

PRESIDIO INSURANCE AGENCY, LLC (UTAH  
LTD LIAB CO)

#550

5295 S. 300 W.

SALT LAKE CITY, UT 84107

FOR: BUSINESS RISK MANAGEMENT, IN  
CLASS 35 (U.S. CLS. 100, 101 AND 102).

FIRST USE 1-1-2000; IN COMMERCE 1-1-2000.

THE MARK CONSISTS OF STANDARD CHAR-  
ACTERS WITHOUT CLAIM TO ANY PARTICULAR  
FONT, STYLE, SIZE, OR COLOR.

NO CLAIM IS MADE TO THE EXCLUSIVE  
RIGHT TO USE "GROUP" AND "A PARTNERSHIP  
TO MANAGE RISK", APART FROM THE MARK AS  
SHOWN.

SER. NO. 77-220,950, FILED 7-2-2007.

ANDREW RHIM, EXAMINING ATTORNEY

**Int. Cl.: 37**

**Prior U.S. Cls.: 100, 103 and 106**

**United States Patent and Trademark Office**

**Reg. No. 3,465,941**

**Registered July 15, 2008**

**SERVICE MARK  
PRINCIPAL REGISTER**

**ECS**

ELECTRONIC CONTROL SYSTEMS, INC. (CALIFORNIA CORPORATION)  
12575 KIRKHAM COURT, SUITE 1  
POWAY, CA 92064

FOR: INSTALLATION, MAINTENANCE, AND REPAIR OF BUILDING SYSTEMS, NAMELY, HEATING, VENTILATION, AIR CONDITIONING, AND TEMPERATURE CONTROL SYSTEMS, FIRE ALARM SYSTEMS, COMMUNICATION SYSTEMS, ACCESS CONTROL SYSTEMS, AND BUILDING MECHANICAL SYSTEMS NOT TO INCLUDE LIGHTING SYSTEMS, IN CLASS 37 (U.S. CLS. 100, 103 AND 106).

FIRST USE 3-12-1997; IN COMMERCE 4-30-1997.

THE MARK CONSISTS OF STANDARD CHARACTERS WITHOUT CLAIM TO ANY PARTICULAR FONT, STYLE, SIZE, OR COLOR.

OWNER OF U.S. REG. NO. 339,453.

SER. NO. 77-221,085, FILED 7-3-2007.

DAVID MURRAY, EXAMINING ATTORNEY



**Int. Cl.: 36**

**Prior U.S. Cls.: 100, 101 and 102**

**United States Patent and Trademark Office**

**Reg. No. 3,465,942**

**Registered July 15, 2008**

**SERVICE MARK  
PRINCIPAL REGISTER**

**AT HOME IN THE COUNTRY**

AGSTAR FINANCIAL SERVICES, ACA (UNITED STATES FEDERALLY CHARTERED CORPORATION)  
1921 PREMIER DRIVE  
MANKATO, MN 560024249

FOR: REAL ESTATE FINANCING FEATURING MORTGAGE LENDING, HOME EQUITY LOANS AND COMMERCIAL EQUITY FINANCING; BANKING AND FINANCIAL SERVICES, NAMELY, CONSUMER, CONSTRUCTION AND CORPORATE/BUSINESS LOANS AND LINES OF CREDIT, NAMELY, PROVIDING LINES OF CREDIT; MORTGAGE BANKING AND BROKERAGE SERVICES; AND

INSURANCE AGENCY SERVICES, IN CLASS 36 (U.S. CLS. 100, 101 AND 102).

FIRST USE 1-31-2006; IN COMMERCE 1-31-2006.

THE MARK CONSISTS OF STANDARD CHARACTERS WITHOUT CLAIM TO ANY PARTICULAR FONT, STYLE, SIZE, OR COLOR.

SER. NO. 77-221,596, FILED 7-3-2007.

WANDA KAY PRICE, EXAMINING ATTORNEY

**Int. Cl.: 25**

**Prior U.S. Cls.: 22 and 39**

**United States Patent and Trademark Office**

**Reg. No. 3,465,943**

**Registered July 15, 2008**

**TRADEMARK  
PRINCIPAL REGISTER**

**HI-TEC**

HI-TEC SPORTS PLC (UNITED KINGDOM PUBLIC LIMITED COMPANY (PLC))  
AVIATION WAY, SOUTHBEND-ON-SEA  
ESSEX, ENGLAND SS26GH

FOR: GOLF SHOES; GOLF CLOTHING, NAME-  
LY, TROUSERS, SHIRTS, POLO SHIRTS, SWEA-  
TERS, AND RAIN WEAR; GOLF HEADGEAR,  
NAMELY, CAPS AND VISORS; GLOVES, IN CLASS  
25 (U.S. CLS. 22 AND 39).

FIRST USE 0-0-1996; IN COMMERCE 0-0-1996.

THE MARK CONSISTS OF STANDARD CHAR-  
ACTERS WITHOUT CLAIM TO ANY PARTICULAR  
FONT, STYLE, SIZE, OR COLOR.

OWNER OF U.S. REG. NOS. 1,173,423, 1,869,704  
AND OTHERS.

SER. NO. 77-221,923, FILED 7-3-2007.

MATTHEW PAPPAS, EXAMINING ATTORNEY

**Int. Cl.: 10**

**Prior U.S. Cls.: 26, 39 and 44**

**United States Patent and Trademark Office**

**Reg. No. 3,465,944**

**Registered July 15, 2008**

**TRADEMARK  
PRINCIPAL REGISTER**

**4DDOME**

COUSIN BIOTECH (FRANCE LTD LIAB CO)  
8 RUE DE L'ABBÉ BONPAIN  
WERVICQ-SUD, FRANCE 59117

OWNER OF ERPN CMNTY TM OFC REG. NO.  
004058608, DATED 5-12-2006, EXPIRES 10-1-2014.

FOR: SURGICAL TEXTILE IMPLANT, IN CLASS  
10 (U.S. CLS. 26, 39 AND 44).

SER. NO. 77-222,044, FILED 7-4-2007.

THE MARK CONSISTS OF STANDARD CHAR-  
ACTERS WITHOUT CLAIM TO ANY PARTICULAR  
FONT, STYLE, SIZE, OR COLOR.

JULIE WATSON, EXAMINING ATTORNEY

**Int. Cl.: 42**

**Prior U.S. Cls.: 100 and 101**

**United States Patent and Trademark Office**

**Reg. No. 3,465,945**

**Registered July 15, 2008**

**SERVICE MARK  
PRINCIPAL REGISTER**

# The Doc Signers

CANTIN, MICHAEL, JAMES (UNITED STATES  
INDIVIDUAL)  
P. O. BOX 71457  
4360 E. SACK DRIVE, PHOENIX, AZ 85050  
PHOENIX, AZ 85050

FOR: NOTARY PUBLIC SERVICES, IN CLASS 42  
(U.S. CLS. 100 AND 101).

FIRST USE 4-3-1998; IN COMMERCE 4-3-1998.

THE MARK CONSISTS OF STANDARD CHAR-  
ACTERS WITHOUT CLAIM TO ANY PARTICULAR  
FONT, STYLE, SIZE, OR COLOR.

SEC. 2(F).

SER. NO. 77-222,105, FILED 7-4-2007.

MARK T. MULLEN, EXAMINING ATTORNEY

Int. Cl.: 35

Prior U.S. Cls.: 100, 101 and 102

United States Patent and Trademark Office

Reg. No. 3,465,946

Registered July 15, 2008

**SERVICE MARK  
PRINCIPAL REGISTER**



SPIO (GEORGIA LTD LIAB CO)  
SUITE 300  
5830 BOND STREET  
CUMMING, GA 30040

FOR: ADVERTISING, MARKETING AND PROMOTION SERVICES; DIRECT MARKETING ADVERTISING FOR OTHERS; DIRECT MARKETING SERVICES, IN CLASS 35 (U.S. CLS. 100, 101 AND 102).

FIRST USE 6-25-2007; IN COMMERCE 6-25-2007.

NO CLAIM IS MADE TO THE EXCLUSIVE RIGHT TO USE "DIRECT TO CONSUMER", APART FROM THE MARK AS SHOWN.

THE COLOR(S) BLACK, WHITE, MAROON IS/ ARE CLAIMED AS A FEATURE OF THE MARK.

THE MARK CONSISTS OF MAROON SQUARE, STYLIZED, CAPITAL, WHITE AND OUTLINED IN BLACK "S", "P", "I", "O" LETTERS INSIDE MAROON SQUARE, UNDER SQUARE READS "SPIO" IN MAROON, UNDERNEATH "SPIO" IN MAROON IS A BLACK LINE, UNDERNEATH THE LINE READS "DIRECT TO CONSUMER" IN BLACK.

SER. NO. 77-222,329, FILED 7-5-2007.

BERNICE MIDDLETON, EXAMINING ATTORNEY

**Int. Cls.: 35 and 41**

**Prior U.S. Cls.: 100, 101, 102 and 107**

**United States Patent and Trademark Office**

**Reg. No. 3,465,947**

**Registered July 15, 2008**

**SERVICE MARK  
PRINCIPAL REGISTER**

**STUDY HALL INC.**

STUDY HALL INC. (MASSACHUSETTS CORPORATION)  
SUITE 402  
45 MAIN STREET  
HUDSON, MA 01749

FOR: EMPLOYMENT AGENCY SERVICES PROVIDING QUALIFIED CLINICAL RESEARCH PROFESSIONALS TO THE BIOPHARMACEUTICAL AND MEDICAL DEVICE INDUSTRIES , IN CLASS 35 (U.S. CLS. 100, 101 AND 102).

FIRST USE 10-25-2002; IN COMMERCE 10-25-2002.

FOR: CONTINUING EDUCATIONAL SERVICES, PROVIDING CONTINUING CLINICAL RESEARCH RELATED EDUCATION COURSES AND SEMINARS TO THE DRUG AND MEDICAL DEVICE

DEVELOPMENT INDUSTRY AWARDING PROFESSIONAL CONTINUING EDUCATION UNITS, IN CLASS 41 (U.S. CLS. 100, 101 AND 107).

FIRST USE 7-0-2005; IN COMMERCE 7-0-2005.

THE MARK CONSISTS OF STANDARD CHARACTERS WITHOUT CLAIM TO ANY PARTICULAR FONT, STYLE, SIZE, OR COLOR.

NO CLAIM IS MADE TO THE EXCLUSIVE RIGHT TO USE "INC.", APART FROM THE MARK AS SHOWN.

SER. NO. 77-222,438, FILED 7-5-2007.

DAVID MILLER, EXAMINING ATTORNEY

**Int. Cl.: 28**

**Prior U.S. Cls.: 22, 23, 38 and 50**

**Reg. No. 3,465,948**

**United States Patent and Trademark Office**

**Registered July 15, 2008**

**TRADEMARK  
PRINCIPAL REGISTER**

# Body Champ

HUPA INTERNATIONAL, INC (CALIFORNIA CORPORATION)  
21717 FERRERO PKWY  
WALNUT, CA 91789

THE MARK CONSISTS OF STANDARD CHARACTERS WITHOUT CLAIM TO ANY PARTICULAR FONT, STYLE, SIZE, OR COLOR.

FOR: EXERCISE EQUIPMENT, NAMELY, TRAMPOLINES, STAIR STEPPING MACHINES, STATIONARY MANUAL TREADMILLS, MANUALLY OPERATED MULTI-PURPOSE HOME GYM EXERCISE EQUIPMENT, WEIGHT LIFTING BENCHES AND BENCH ACCESSORIES, AND STATIONARY EXERCISE BICYCLES, IN CLASS 28 (U.S. CLS. 22, 23, 38 AND 50).

NO CLAIM IS MADE TO THE EXCLUSIVE RIGHT TO USE "BODY", APART FROM THE MARK AS SHOWN.

SER. NO. 77-222,538, FILED 7-5-2007.

FIRST USE 1-1-1996; IN COMMERCE 1-1-1996.

HENRY S. ZAK, EXAMINING ATTORNEY

**Int. Cl.: 11**

**Prior U.S. Cls.: 13, 21, 23, 31 and 34**

**Reg. No. 3,465,949**

**United States Patent and Trademark Office**

**Registered July 15, 2008**

---

**TRADEMARK  
PRINCIPAL REGISTER**

**I SHOWER**

JAPIN INTERNATIONAL, INC. (TAIWAN CORPORATION)  
57, SEC. 2, JIAO-TAN RD.  
FONG YUAN, TAICHUNG, TAIWAN

FOR: WATER FILTRATION UNIT FOR DOMESTIC AND COMMERCIAL USE, FILTERS, PARTS AND FITTINGS FOR ALL THE AFORESAID GOODS, IN CLASS 11 (U.S. CLS. 13, 21, 23, 31 AND 34).

FIRST USE 7-3-2006; IN COMMERCE 7-3-2006.

THE MARK CONSISTS OF STANDARD CHARACTERS WITHOUT CLAIM TO ANY PARTICULAR FONT, STYLE, SIZE, OR COLOR.

NO CLAIM IS MADE TO THE EXCLUSIVE RIGHT TO USE "SHOWER", APART FROM THE MARK AS SHOWN.

SER. NO. 77-222,546, FILED 7-5-2007.

MIDGE BUTLER, EXAMINING ATTORNEY



**Int. Cl.: 35**

**Prior U.S. Cls.: 100, 101 and 102**

**United States Patent and Trademark Office**

**Reg. No. 3,465,950**

**Registered July 15, 2008**

---

**SERVICE MARK  
PRINCIPAL REGISTER**

**Designing Bows to Make  
Your Hunt Count**

ROSS ARCHERY, INC. (KANSAS CORPORATION)  
4280 MAIN STREET  
GRANDVIEW, MO 64030

THE MARK CONSISTS OF STANDARD CHARACTERS WITHOUT CLAIM TO ANY PARTICULAR FONT, STYLE, SIZE, OR COLOR.

FOR: RETAIL STORE SERVICES FEATURING ARCHERY EQUIPMENT, IN CLASS 35 (U.S. CLS. 100, 101 AND 102).

SER. NO. 77-222,905, FILED 7-5-2007.

FIRST USE 12-0-2004; IN COMMERCE 12-0-2004.

AMY GEARIN, EXAMINING ATTORNEY

Int. Cl.: 9

Prior U.S. Cls.: 21, 23, 26, 36 and 38

Reg. No. 3,465,951

United States Patent and Trademark Office

Registered July 15, 2008

TRADEMARK  
PRINCIPAL REGISTER



AERO-INSTRUMENTS CO., LLC (OHIO LTD  
LIAB CO)  
14901 EMERY AVE.  
CLEVELAND, OH 44135

NO CLAIM IS MADE TO THE EXCLUSIVE  
RIGHT TO USE "INSTRUMENTS", APART FROM  
THE MARK AS SHOWN.

FOR: AIR DATA SENSORS, NAMELY, PITOT  
PROBES, PITOT STATIC PROBES, STATIC PRES-  
SURE PORTS, IN CLASS 9 (U.S. CLS. 21, 23, 26, 36  
AND 38).

SER. NO. 77-223,165, FILED 7-6-2007.

FIRST USE 8-0-2001; IN COMMERCE 8-0-2001.

ALEXANDER L. POWERS, EXAMINING ATTOR-  
NEY

**Int. Cl.: 5**

**Prior U.S. Cls.: 6, 18, 44, 46, 51 and 52**

**Reg. No. 3,465,952**

**United States Patent and Trademark Office**

**Registered July 15, 2008**

**TRADEMARK  
PRINCIPAL REGISTER**

**COSULO**

TAKEDA PHARMACEUTICAL COMPANY LIMITED (JAPAN CORPORATION)  
1-1, DOSHOMACHI 4-CHOME  
CHUO-KU, OSAKA, JAPAN

PRIORITY CLAIMED UNDER SEC. 44(D) ON JAPAN APPLICATION NO. 2007-076312, FILED 7-6-2007, REG. NO. 5103479, DATED 1-11-2008, EXPIRES 1-11-2018.

FOR: PHARMACEUTICAL PREPARATIONS FOR THE TREATMENT AND PREVENTION OF DIABETIC DISEASES, IN CLASS 5 (U.S. CLS. 6, 18, 44, 46, 51 AND 52).

THE TERM "COSULO" DOES NOT HAVE ANY SIGNIFICANCE.

THE MARK CONSISTS OF STANDARD CHARACTERS WITHOUT CLAIM TO ANY PARTICULAR FONT, STYLE, SIZE, OR COLOR.

SER. NO. 77-223,187, FILED 7-6-2007.

MATTHEW PAPPAS, EXAMINING ATTORNEY

**Int. Cl.: 5**

**Prior U.S. Cls.: 6, 18, 44, 46, 51 and 52**

**Reg. No. 3,465,953**

**United States Patent and Trademark Office**

**Registered July 15, 2008**

**TRADEMARK  
PRINCIPAL REGISTER**

**EBNIA**

TAKEDA PHARMACEUTICAL COMPANY LIMITED (JAPAN CORPORATION)  
1-1, DOSHOMACHI 4-CHOME  
CHUO-KU, OSAKA, JAPAN

PRIORITY CLAIMED UNDER SEC. 44(D) ON JAPAN APPLICATION NO. 2007-076313, FILED 7-6-2007, REG. NO. 5103480, DATED 1-11-2008, EXPIRES 1-11-2018.

FOR: PHARMACEUTICAL PREPARATIONS FOR THE TREATMENT AND PREVENTION OF DIABETIC DISEASES, IN CLASS 5 (U.S. CLS. 6, 18, 44, 46, 51 AND 52).

THE TERM "EBNIA" DOES NOT HAVE ANY SIGNIFICANCE.

THE MARK CONSISTS OF STANDARD CHARACTERS WITHOUT CLAIM TO ANY PARTICULAR FONT, STYLE, SIZE, OR COLOR.

SER. NO. 77-223,196, FILED 7-6-2007.

MATTHEW PAPPAS, EXAMINING ATTORNEY

**Int. Cl.: 36**

**Prior U.S. Cls.: 100, 101 and 102**

**United States Patent and Trademark Office**

**Reg. No. 3,465,954**

**Registered July 15, 2008**

**SERVICE MARK  
PRINCIPAL REGISTER**

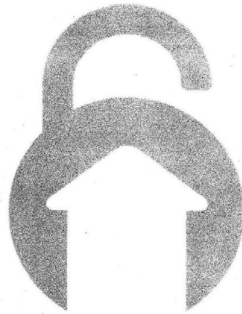

EQUITYKEY LLC (DELAWARE CORPORATION)  
4TH FLOOR  
8880 RIO SAN DIEGO  
SAN DIEGO, CA 92018

FOR: FINANCIAL SERVICES, NAMELY, REAL  
ESTATE INVESTMENT, IN CLASS 36 (U.S. CLS. 100,  
101 AND 102).

FIRST USE 11-1-2006; IN COMMERCE 11-1-2006.

THE MARK CONSISTS OF LOCK AND HOUSE.

SER. NO. 77-223,322, FILED 7-6-2007.

GEOFFREY FOSDICK, EXAMINING ATTORNEY

**Int. Cl.: 9**

**Prior U.S. Cls.: 21, 23, 26, 36 and 38**

**Reg. No. 3,465,955**

**United States Patent and Trademark Office**

**Registered July 15, 2008**

---

**TRADEMARK  
PRINCIPAL REGISTER**

**CELLMACH**

CELLMACH SA DE CV (MEXICO LTD LIAB CO)  
COLONIA REFORMA SOCIAL  
AV. TECAMACHALCO 163 DEPTO 2  
MEXICO CITY, MEXICO 11650

FIRST USE 7-10-2003; IN COMMERCE 7-10-2003.

FOR: TELECOMMUNICATIONS AND DATA  
NETWORKING HARDWARE, NAMELY, DEVICES  
FOR TRANSPORTING AND AGGREGATING  
VOICE, DATA, AND VIDEO COMMUNICATIONS  
ACROSS MULTIPLE NETWORK INFRASTRUC-  
TURES AND COMMUNICATIONS PROTOCOLS,  
IN CLASS 9 (U.S. CLS. 21, 23, 26, 36 AND 38).

THE MARK CONSISTS OF STANDARD CHAR-  
ACTERS WITHOUT CLAIM TO ANY PARTICULAR  
FONT, STYLE, SIZE, OR COLOR.

SER. NO. 77-223,323, FILED 7-6-2007.

MICHELE SWAIN, EXAMINING ATTORNEY

**Int. Cl.: 41**

**Prior U.S. Cls.: 100, 101 and 107**

**United States Patent and Trademark Office**

**Reg. No. 3,465,956**

**Registered July 15, 2008**

**SERVICE MARK  
PRINCIPAL REGISTER**

**CARIBBEAN CRUISINE**

BUNDAVAGA, LLC (FLORIDA LTD LIAB CO)  
PO BOX 493  
BOCA RATON, FL 33429

FOR: ENTERTAINMENT SERVICES, NAMELY, A CONTINUING PROGRAM ABOUT CARIBBEAN LIFESTYLE, FOOD, MUSIC, CRUISES, NEWS UPDATES AND INTERVIEWS ALL ACCESSIBLE BY RADIO, TELEVISION, SATELLITE, AUDIO, VIDEO AND INTERNET, IN CLASS 41 (U.S. CLS. 100, 101 AND 107).

FIRST USE 6-1-2004; IN COMMERCE 12-28-2006.

THE MARK CONSISTS OF STANDARD CHARACTERS WITHOUT CLAIM TO ANY PARTICULAR FONT, STYLE, SIZE, OR COLOR.

NO CLAIM IS MADE TO THE EXCLUSIVE RIGHT TO USE "CARIBBEAN", APART FROM THE MARK AS SHOWN.

SER. NO. 77-223,351, FILED 7-6-2007.

MICHAEL SOUDERS, EXAMINING ATTORNEY

**Int. Cl.: 11**

**Prior U.S. Cls.: 13, 21, 23, 31 and 34**

**United States Patent and Trademark Office**

**Reg. No. 3,465,957**

**Registered July 15, 2008**

**TRADEMARK  
PRINCIPAL REGISTER**

# Visual Lighting Technologies

HAYDT, DANIEL K. (UNITED STATES INDIVIDUAL)  
9 RANCHO CIRCLE  
LAKE FOREST, CA 92630

FOR: LIGHTING FIXTURES THAT INTEGRATE FIBER OPTICS AND/OR LED, IN CLASS 11 (U.S. CLS. 13, 21, 23, 31 AND 34).

FIRST USE 1-1-2000; IN COMMERCE 1-1-2000.

THE MARK CONSISTS OF STANDARD CHARACTERS WITHOUT CLAIM TO ANY PARTICULAR FONT, STYLE, SIZE, OR COLOR.

NO CLAIM IS MADE TO THE EXCLUSIVE RIGHT TO USE "LIGHTING TECHNOLOGIES", APART FROM THE MARK AS SHOWN.

SER. NO. 77-223,455, FILED 7-6-2007.

B. PARADEWELAI, EXAMINING ATTORNEY



**Int. Cl.: 11**

**Prior U.S. Cls.: 13, 21, 23, 31 and 34**

**United States Patent and Trademark Office**

**Reg. No. 3,465,958**

**Registered July 15, 2008**

**TRADEMARK  
PRINCIPAL REGISTER**

**MegoFlex**

HAYDT, DANIEL K. (UNITED STATES INDIVIDUAL)  
9 RANCHO CIRCLE  
LAKE FOREST, CA 92630

THE MARK CONSISTS OF STANDARD CHARACTERS WITHOUT CLAIM TO ANY PARTICULAR FONT, STYLE, SIZE, OR COLOR.

FOR: LIGHTING FIXTURES THAT INTEGRATE FIBERS OPTICS AND/OR LED, IN CLASS 11 (U.S. CLS. 13, 21, 23, 31 AND 34).

SER. NO. 77-223,587, FILED 7-6-2007.

FIRST USE 7-1-2006; IN COMMERCE 7-1-2006.

B. PARADEWELAI, EXAMINING ATTORNEY

**Int. Cl.: 11**

**Prior U.S. Cls.: 13, 21, 23, 31 and 34**

**United States Patent and Trademark Office**

**Reg. No. 3,465,959**

**Registered July 15, 2008**

**TRADEMARK  
PRINCIPAL REGISTER**

# Diamond Line

HAYDT, DANIEL, K. (UNITED STATES INDIVIDUAL)  
9 RANCHO CIRCLE  
LAKE FOREST, CA 92630

FOR: LIGHTING FIXTURES THAT INTEGRATE FIBER OPTICS AND/OR LEDS, IN CLASS 11 (U.S. CLS. 13, 21, 23, 31 AND 34).

FIRST USE 2-1-2005; IN COMMERCE 2-1-2005.

THE MARK CONSISTS OF STANDARD CHARACTERS WITHOUT CLAIM TO ANY PARTICULAR FONT, STYLE, SIZE, OR COLOR.

THE WORDING "LINE" HAS NO MEANING IN A FOREIGN LANGUAGE.

SER. NO. 77-223,602, FILED 7-6-2007.

B. PARADEWELAI, EXAMINING ATTORNEY

Int. Cl.: 11

Prior U.S. Cls.: 13, 21, 23, 31 and 34

United States Patent and Trademark Office

Reg. No. 3,465,960

Registered July 15, 2008

TRADEMARK  
PRINCIPAL REGISTER



HAYDT, DANIEL, K. (UNITED STATES INDIVIDUAL)  
9 RANCHO CIRCLE  
LAKE FOREST, CA 92630

FOR: LIGHTING FIXTURES THAT INTEGRATE FIBER OPTICS AND/OR LED, IN CLASS 11 (U.S. CLS. 13, 21, 23, 31 AND 34).

FIRST USE 1-1-2000; IN COMMERCE 1-1-2000.

NO CLAIM IS MADE TO THE EXCLUSIVE RIGHT TO USE "LIGHTING TECHNOLOGIES", APART FROM THE MARK AS SHOWN.

THE COLOR(S) BLUE, YELLOW, ORANGE, AND RED IS/ARE CLAIMED AS A FEATURE OF THE MARK.

THE MARK CONSISTS OF THE COLOR BLUE APPEARS IN THE WORDING "VISUAL LIGHTING TECHNOLOGIES" AND THE EYEBROW DESIGN; THE COLORS YELLOW, ORANGE AND RED APPEAR IN THE EYE DESIGN. THE LEFT SIDE OF THE EYE DESIGN IS MORE YELLOW AND THE LOWER RIGHT SIDE OF THE EYE IS MORE RED WITH THE TWO COLORS BLENDING AND/OR SHADING IN THE REMAINING AREAS TO FORM ORANGE.

THE WORDING "VISUAL" HAS NO MEANING IN A FOREIGN LANGUAGE.

SER. NO. 77-223,667, FILED 7-6-2007.

B. PARADEWELAI, EXAMINING ATTORNEY

**Int. Cl.: 25**

**Prior U.S. Cls.: 22 and 39**

**United States Patent and Trademark Office**

**Reg. No. 3,465,961**

**Registered July 15, 2008**

**TRADEMARK  
PRINCIPAL REGISTER**

**POSSESS**

MIKOLAJCZYK, DAVID, J (UNITED STATES  
INDIVIDUAL)  
768 BRAYTON AVE., UP  
CLEVELAND, OH 44113

FOR: CLOTHING, NAMELY, T SHIRTS, SWEAT-  
SHIRTS, SCARVES, HOODED SWEATSHIRTS,  
SOCKS, BANDANAS, HATS, PAJAMAS, LONG  
SLEEVE T SHIRTS, LINGERIE, TIES, UNDER-  
WEAR, DISPOSABLE UNDERWEAR, PANTIES,  
THONGS, SHORTS AND BRIEFS, BOXER BRIEFS,  
SWIMWEAR FOR GENTLEMEN AND LADIES,  
SWEAT SUITS, SWEAT SUITS WITH HOODS, HEAD  
SWEATBANDS, SWEATBANDS, SWEAT SHORTS,  
FABRIC BELTS, BELTS MADE OF LEATHER,  
MONEY BELTS, SUSPENDER BELTS FOR MEN,  
SUSPENDER BELTS FOR WOMEN, ADHESIVE

BRAS, BRAS, FITTED SWIMMING COSTUMES  
WITH BRA CUPS, SPORTS BRA, SHOES, DRESS  
SHIRTS, SKIRTS AND DRESSES, CORSETS,  
TIGHTS, STOCKINGS, GARTER BELTS, IN CLASS  
25 (U.S. CLS. 22 AND 39).

FIRST USE 6-4-2001; IN COMMERCE 6-4-2002.

THE MARK CONSISTS OF STANDARD CHAR-  
ACTERS WITHOUT CLAIM TO ANY PARTICULAR  
FONT, STYLE, SIZE, OR COLOR.

SER. NO. 77-223,778, FILED 7-6-2007.

AHSEN KHAN, EXAMINING ATTORNEY

**Int. Cl.: 35**

**Prior U.S. Cls.: 100, 101 and 102**

**United States Patent and Trademark Office**

**Reg. No. 3,465,962**

**Registered July 15, 2008**

**SERVICE MARK  
PRINCIPAL REGISTER**

**CHAMPIONS CARD**

ACCESS VG, LLC (UTAH LTD LIAB CO)  
1012 W. BEARDSLEY  
SALT LAKE CITY, UT 84119

FOR: PROMOTING THE GOODS AND SERVICES OF OTHERS THROUGH DISTRIBUTION OF CONSUMER DISCOUNT AND REWARDS CARDS SOLD BY ORGANIZATIONS TO RAISE MONEY IN SUPPORT OF GROUP-RELATED OPERATIONS , IN CLASS 35 (U.S. CLS. 100, 101 AND 102).

FIRST USE 6-30-2006; IN COMMERCE 6-30-2006.

THE MARK CONSISTS OF STANDARD CHARACTERS WITHOUT CLAIM TO ANY PARTICULAR FONT, STYLE, SIZE, OR COLOR.

NO CLAIM IS MADE TO THE EXCLUSIVE RIGHT TO USE "CARD", APART FROM THE MARK AS SHOWN.

SER. NO. 77-223,972, FILED 7-6-2007.

ATTIYA MALIK, EXAMINING ATTORNEY

**Int. Cl.: 41**

**Prior U.S. Cls.: 100, 101 and 107**

**United States Patent and Trademark Office**

**Reg. No. 3,465,963**

**Registered July 15, 2008**

**SERVICE MARK  
PRINCIPAL REGISTER**

# Creatics

TRENOS, HELEN (AUSTRALIA INDIVIDUAL)  
17 RENDALL CLOSE  
MARGARET RIVER, AUSTRALIA 6285

FOR: ARRANGEMENT OF TRAINING COURSES IN TEACHING INSTITUTES; ARRANGING PROFESSIONAL WORKSHOP AND TRAINING COURSES; EDUCATING AT UNIVERSITY OR COLLEGES; EDUCATION SERVICES IN THE NATURE OF COURSES AT THE UNIVERSITY LEVEL; EDUCATION SERVICES, NAMELY, PROVIDING MENTORING, WORKSHOPS, CLASSES IN THE FIELD OF ACTING; EDUCATIONAL RESEARCH; EDUCATIONAL SERVICES, NAMELY, DEVELOPING CURRICULUM FOR OTHERS IN THE FIELD OF ACTING; PROVIDING COURSES OF INSTRU-

TION AT THE GRADUATE AND POST-GRADUATE LEVEL, IN CLASS 41 (U.S. CLS. 100, 101 AND 107).

THE MARK CONSISTS OF STANDARD CHARACTERS WITHOUT CLAIM TO ANY PARTICULAR FONT, STYLE, SIZE, OR COLOR.

PRIORITY CLAIMED UNDER SEC. 44(D) ON AUSTRALIA APPLICATION NO. 079466505, FILED 6-28-2007, REG. NO. 1184167, DATED 6-28-2007, EXPIRES 6-28-2017.

SER. NO. 77-224,046, FILED 7-7-2007.

ALYSSA PALADINO, EXAMINING ATTORNEY

**Int. Cl.: 18**

**Prior U.S. Cls.: 1, 2, 3, 22 and 41**

**United States Patent and Trademark Office**

**Reg. No. 3,465,964**

**Registered July 15, 2008**

**TRADEMARK  
PRINCIPAL REGISTER**



BELIKA, INC. (CALIFORNIA CORPORATION)  
6933 LONGFELLOW CT.  
SAN JOSE,, CA 95129

FOR: ALL PURPOSE SPORT BAGS; ALL-PURPOSE CARRYING BAGS; BAGS AND HOLDALLS FOR SPORTS CLOTHING; GENERAL PURPOSE BAGS FOR CARRYING YOGA EQUIPMENT; GYM BAGS; OVERNIGHT BAGS; SCHOOL BAGS; SCHOOL BOOK BAGS; TOTE BAGS; WINE BAGS WITH HANDLES FOR CARRYING OR HOLDING WINE; SHOPPING BAGS MADE OF SKIN, IN CLASS 18 (U.S. CLS. 1, 2, 3, 22 AND 41).

FIRST USE 3-23-2005; IN COMMERCE 10-31-2005.

THE NAME "BELIKA" DOES NOT IDENTIFY A LIVING INDIVIDUAL.

THE COLOR(S) YELLOW, GREEN, WHITE IS/ ARE CLAIMED AS A FEATURE OF THE MARK.

THE MARK CONSISTS OF THE NAME BELIKA IN YELLOW. THE LEAVE IS WHITE. THE FRAME AROUND THE LEAF IS GREEN.

SER. NO. 77-224,118, FILED 7-7-2007.

STEVEN JACKSON, EXAMINING ATTORNEY

**Int. Cl.: 36**

**Prior U.S. Cls.: 100, 101 and 102**

**United States Patent and Trademark Office**

**Reg. No. 3,465,965**

**Registered July 15, 2008**

**SERVICE MARK  
PRINCIPAL REGISTER**

**EQUITYKEY**

EQUITYKEY LLC (DELAWARE LTD LIAB CO)  
4TH FLOOR  
8880 RIO SAN DIEGO  
SAN DIEGO, CA 92018

THE MARK CONSISTS OF STANDARD CHAR-  
ACTERS WITHOUT CLAIM TO ANY PARTICULAR  
FONT, STYLE, SIZE, OR COLOR.

FOR: FINANCIAL SERVICES, NAMELY, REAL  
ESTATE INVESTMENT, IN CLASS 36 (U.S. CLS. 100,  
101 AND 102).

SER. NO. 77-224,397, FILED 7-9-2007.

FIRST USE 11-1-2006; IN COMMERCE 11-1-2006.

GEOFFREY FOSDICK, EXAMINING ATTORNEY



Int. Cl.: 36

Prior U.S. Cls.: 100, 101 and 102

**United States Patent and Trademark Office**

**Reg. No. 3,465,966**

Registered July 15, 2008

**SERVICE MARK  
PRINCIPAL REGISTER**

EQUITY KEY

EQUITYKEY LLC (DELAWARE LTD LIAB CO)  
4TH FLOOR  
8880 RIO SAN DIEGO  
SAN DIEGO, CA 92018

NO CLAIM IS MADE TO THE EXCLUSIVE  
RIGHT TO USE "EQUITY", APART FROM THE  
MARK AS SHOWN.

FOR: FINANCIAL SERVICES, NAMELY, REAL  
ESTATE INVESTMENT, IN CLASS 36 (U.S. CLS. 100,  
101 AND 102).

SER. NO. 77-224,404, FILED 7-9-2007.

FIRST USE 11-1-2006; IN COMMERCE 11-1-2006.

GEOFFREY FOSDICK, EXAMINING ATTORNEY

Int. Cl.: 35

Prior U.S. Cls.: 100, 101 and 102

**United States Patent and Trademark Office**

**Reg. No. 3,465,967**

Registered July 15, 2008

**SERVICE MARK  
PRINCIPAL REGISTER**

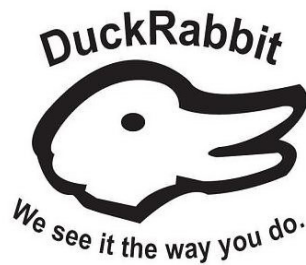

DUCKRABBIT LLC (DELAWARE LTD LIAB CO)  
7509-G CONNELLEY DRIVE  
HANOVER, MD 21076

FOR: ADVERTISING, MARKETING AND PRO-  
MOTION SERVICES; ARRANGING AND CON-  
DUCTING MARKETING PROMOTIONAL EVENTS  
FOR OTHERS, IN CLASS 35 (U.S. CLS. 100, 101 AND  
102).

THE MARK CONSISTS OF IMAGE OF DUCK  
AND/OR RABBIT HEAD WITH WORDS: "DUCK-  
RABBIT WE SEE IT THE WAY YOU DO." AND A  
PERIOD AFTER THE WORD "DO".

SER. NO. 77-224,615, FILED 7-9-2007.

FIRST USE 5-26-2005; IN COMMERCE 5-26-2005.

SHANNON TWOHIG, EXAMINING ATTORNEY

Int. Cls.: 9 and 40

Prior U.S. Cls.: 21, 23, 26, 36, 38, 100, 103 and 106

United States Patent and Trademark Office

Reg. No. 3,465,968

Registered July 15, 2008

TRADEMARK  
SERVICE MARK  
PRINCIPAL REGISTER

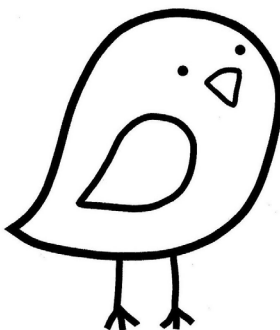

PHOENIX KIOSK, INC. (NEVADA CORPORATION)  
1155 W. RIO SALADO PARKWAY, STE. 202  
TEMPE, AZ 85281

FOR: INTERACTIVE COMPUTER KIOSKS COMPRISING COMPUTERS, COMPUTER HARDWARE, COMPUTER PERIPHERALS, AND COMPUTER OPERATING SOFTWARE, FOR USE IN CUSTOMER ASSISTANCE, INFORMATION SERVICES, MONETARY TRANSACTIONS AND GENERAL PURPOSE, IN CLASS 9 (U.S. CLS. 21, 23, 26, 36 AND 38).

FIRST USE 5-1-2007; IN COMMERCE 5-1-2007.

FOR: MANUFACTURE OF KIOSKS TO ORDER AND/OR SPECIFICATION OF OTHERS; MANUFACTURING SERVICES FOR OTHERS IN THE FIELD OF KIOSKS; CUSTOM MANUFACTURE OF KIOSKS, IN CLASS 40 (U.S. CLS. 100, 103 AND 106).

FIRST USE 5-30-2007; IN COMMERCE 5-30-2007.

THE MARK CONSISTS OF BIRD.

SER. NO. 77-224,789, FILED 7-9-2007.

DEZMONA MIZELLE, EXAMINING ATTORNEY

**Int. Cl.: 41**

**Prior U.S. Cls.: 100, 101 and 107**

**United States Patent and Trademark Office**

**Reg. No. 3,465,969**

**Registered July 15, 2008**

**SERVICE MARK  
PRINCIPAL REGISTER**

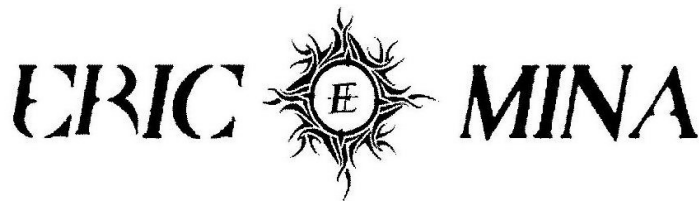

ERIC MINA (UNITED STATES INDIVIDUAL)  
167 WILSONVILLE ROAD  
HAWLEY, PA 18428

"THE NAME(S), PORTRAIT(S), AND/OR SIGNATURE(S) SHOWN IN THE MARK IDENTIFIES ERIC MINA, WHOSE CONSENT(S) TO REGISTER IS SUBMITTED."

FOR: ENTERTAINMENT SERVICES, NAMELY, PERFORMANCES INVOLVING HYPNOSIS, COMEDY, MAGIC AND CRAZY STUNTS, IN CLASS 41 (U.S. CLS. 100, 101 AND 107).

THE MARK CONSISTS OF THE WORDS ERIC MINA WITH A DESIGN IN BETWEEN ERIC AND MINA..

SER. NO. 77-224,805, FILED 7-9-2007.

FIRST USE 6-30-2006; IN COMMERCE 6-30-2006.

KYLE PEETE, EXAMINING ATTORNEY

**Int. Cl.: 39**

**Prior U.S. Cls.: 100 and 105**

**United States Patent and Trademark Office**

**Reg. No. 3,465,970**

**Registered July 15, 2008**

**SERVICE MARK  
PRINCIPAL REGISTER**

**LIMORES.NET**

QLIMO, INC. (NEW YORK CORPORATION)  
SUITE 2A  
245 WEST 72ND STREET  
NEW YORK, NY 10023

FOR: LIMOUSINE SERVICE; TRANSPORTATION  
RESERVATION SERVICES FOR LIMOUSINE  
TRANSPORTATION, IN CLASS 39 (U.S. CLS. 100  
AND 105).

FIRST USE 9-15-2006; IN COMMERCE 9-15-2006.

THE MARK CONSISTS OF STANDARD CHAR-  
ACTERS WITHOUT CLAIM TO ANY PARTICULAR  
FONT, STYLE, SIZE, OR COLOR.

SER. NO. 77-224,989, FILED 7-9-2007.

HENRY S. ZAK, EXAMINING ATTORNEY

**Int. Cl.: 45**

**Prior U.S. Cls.: 100 and 101**

**United States Patent and Trademark Office**

**Reg. No. 3,465,971**

**Registered July 15, 2008**

**SERVICE MARK  
PRINCIPAL REGISTER**



AWARENESS TECHNOLOGIES, INC. (DELA-  
WARE CORPORATION)  
SUITE 1140  
4640 ADMIRALTY WAY  
MARINA DEL REY, CA 90292

FOR: LICENSING OF COMPUTER SOFTWARE,  
IN CLASS 45 (U.S. CLS. 100 AND 101).

FIRST USE 3-27-2004; IN COMMERCE 3-27-2004.

NO CLAIM IS MADE TO THE EXCLUSIVE  
RIGHT TO USE "AWARENESS TECHNOLOGIES",  
APART FROM THE MARK AS SHOWN.

THE COLOR(S) RED AND BLACK IS/ARE  
CLAIMED AS A FEATURE OF THE MARK.

THE MARK CONSISTS OF A RED CIRCLE AT  
THE LEFT DIVIDED BY BLACK INTERSECTING  
(HORIZONTAL AND VERTICAL) LINES. THE HOR-  
IZONTAL BLACK LINE CONTINUES TO THE  
RIGHT OF THE CIRCLE WITH THE WORD  
"AWARENESS" ABOVE THE LINE AND THE  
WORD "TECHNOLOGIES" BELOW THE LINE.  
THE WORD "AWARENESS" IS IN BLACK AND  
OVERLAPS THE TOP RIGHT QUADRANT OF THE  
DIVIDED CIRCLE. THE WORD "TECHNOLOGIES"  
IS IN RED AND BEGINS TO THE RIGHT OF THE  
CIRCLE .

SER. NO. 77-225,708, FILED 7-10-2007.

RICHARD WHITE, EXAMINING ATTORNEY

**Int. Cl.: 42**

**Prior U.S. Cls.: 100 and 101**

**United States Patent and Trademark Office**

**Reg. No. 3,465,972**

**Registered July 15, 2008**

**SERVICE MARK  
PRINCIPAL REGISTER**



NGP SOFTWARE, INC. (D.C. CORPORATION)  
1225 EYE STREET NW, SUITE 1225  
WASHINGTON, DC 20005

FOR: APPLICATION SERVICE PROVIDER (ASP) FEATURING SOFTWARE FOR USE IN FUND RAISING, DATABASE MANAGEMENT AND COMPLIANCE REPORTING FOR POLITICAL FUNDRAISERS, POLITICAL CAMPAIGNS AND COMMITTEES, CAMPAIGN FUND TRACKING ORGANIZATIONS, LOBBYISTS, NON-PROFIT ORGANIZATIONS AND OTHER INTEREST GROUPS; DESIGNING AND MAINTAINING COMPUTER SOFTWARE APPLICATIONS AND WEB SITES FOR POLITICAL FUNDRAISERS, POLITICAL CAMPAIGNS AND COMMITTEES, CAMPAIGN FUND TRACKING ORGANIZATIONS, LOBBYISTS, NON-PROFIT ORGANIZATIONS AND OTHER INTEREST GROUPS; CONSULTANCY IN THE FIELD OF INFORMATION TECHNOLOGIES, NAMELY COM-

PUTER HARDWARE AND SOFTWARE FOR FUND RAISING AND POLITICAL CAMPAIGN MANAGEMENT; DATA CONVERSION SERVICES, NAMELY, THE CONVERSION AND ENHANCEMENT OF DATA FOR USE IN FUND RAISING AND POLITICAL CAMPAIGN MANAGEMENT; AND PROVIDING TECHNICAL SUPPORT SERVICES, NAMELY, TROUBLESHOOTING OF HARDWARE AND SOFTWARE PROBLEMS AND MONITORING OF COMPUTER NETWORK SYSTEMS, IN CLASS 42 (U.S. CLS. 100 AND 101).

FIRST USE 9-24-1999; IN COMMERCE 9-24-1999.

THE MARK CONSISTS OF THE STYLIZED LETTERS "N", "G" AND "P".

SER. NO. 77-226,234, FILED 7-10-2007.

GINA FINK, EXAMINING ATTORNEY

**Int. Cl.: 19**

**Prior U.S. Cls.: 1, 12, 33 and 50**

**United States Patent and Trademark Office**

**Reg. No. 3,465,973**

**Registered July 15, 2008**

**TRADEMARK  
PRINCIPAL REGISTER**

**GREEN MODERN KITS**  
**green building for the rest of us!**

COPELAND CASATI MEDIA (VIRGINIA CORPORATION)  
6902 PARK AVE  
RICHMOND, VA 23226

FOR: GREEN BUILDING KITS COMPRISED OF EXTERIOR NONMETAL COMPOSITE PANELS INTENDED TO MAKE A PERSON'S HOUSE MORE ENVIRONMENTALLY FRIENDLY AND CONSTRUCTION DESIGNS FOR USE WITH THE PANELS , IN CLASS 19 (U.S. CLS. 1, 12, 33 AND 50).

FIRST USE 1-1-2007; IN COMMERCE 1-1-2007.

THE MARK CONSISTS OF STANDARD CHARACTERS WITHOUT CLAIM TO ANY PARTICULAR FONT, STYLE, SIZE, OR COLOR.

NO CLAIM IS MADE TO THE EXCLUSIVE RIGHT TO USE "GREEN MODERN KITS" AND "GREEN BUILDING", APART FROM THE MARK AS SHOWN.

SER. NO. 77-226,335, FILED 7-10-2007.

SUNG IN, EXAMINING ATTORNEY



**Int. Cl.: 35**

**Prior U.S. Cls.: 100, 101 and 102**

**United States Patent and Trademark Office**

**Reg. No. 3,465,974**

**Registered July 15, 2008**

**SERVICE MARK  
PRINCIPAL REGISTER**

# Beowoof

WRAZEL, LAURA J. (UNITED STATES INDIVIDUAL)  
105 7TH ST., APT. 2  
HOBOKEN, NJ 070305058 AND  
GERSTNER, KARL L. (UNITED STATES INDIVIDUAL)  
105 7TH ST., APT. 2  
HOBOKEN, NJ 070305058

FOR: COMPUTER SERVICES, NAMELY, PROVIDING CONSUMER INFORMATION IN THE FIELD OF ANIMALS AND PETS RELATING TO PET PRODUCTS, PET TREATS AND PET TOYS; COMPUTERIZED ON-LINE RETAIL STORE SERVICES IN THE FIELD OF PET SUPPLIES; RETAIL PET STORES; RETAIL STORE SERVICES FEATURING PET SUPPLIES; RETAIL STORE SERVICES IN THE FIELD OF PET SUPPLIES FEATURING A BONUS

INCENTIVE PROGRAM FOR CUSTOMERS; RETAIL STORE SERVICES, AVAILABLE THROUGH COMPUTER COMMUNICATIONS AND INTERACTIVE TELEVISION, FEATURING PET SUPPLIES; RETAIL PET SUPPLY STORES, IN CLASS 35 (U.S. CLS. 100, 101 AND 102).

FIRST USE 5-11-2003; IN COMMERCE 6-24-2003.

THE MARK CONSISTS OF STANDARD CHARACTERS WITHOUT CLAIM TO ANY PARTICULAR FONT, STYLE, SIZE, OR COLOR.

SER. NO. 77-226,453, FILED 7-10-2007.

LINDA E. BLOHM, EXAMINING ATTORNEY

**Int. Cl.: 42**

**Prior U.S. Cls.: 100 and 101**

**United States Patent and Trademark Office**

**Reg. No. 3,465,975**

**Registered July 15, 2008**

**SERVICE MARK  
PRINCIPAL REGISTER**

**RADIXX AIR ENTERPRISE**

RADIXX SOLUTIONS INTERNATIONAL, INC.  
(DELAWARE CORPORATION)  
6310 HAZELTINE NATIONAL DRIVE  
ORLANDO, FL 32822

FOR: DESIGN, DEVELOPMENT AND IMPLEMENTATION OF COMPUTER SOFTWARE USED IN THE TRAVEL RESERVATION AND TRAVEL TICKET INVENTORY MANAGEMENT FIELDS; HOSTING THE WEBSITES OF OTHERS ON A COMPUTER SERVER FOR A GLOBAL COMPUTER NETWORK IN THE TRAVEL RESERVATION AND TRAVEL TICKET INVENTORY MANAGEMENT FIELDS, IN CLASS 42 (U.S. CLS. 100 AND 101).

FIRST USE 12-14-2004; IN COMMERCE 12-14-2004.

THE MARK CONSISTS OF STANDARD CHARACTERS WITHOUT CLAIM TO ANY PARTICULAR FONT, STYLE, SIZE, OR COLOR.

NO CLAIM IS MADE TO THE EXCLUSIVE RIGHT TO USE "AIR ENTERPRISE", APART FROM THE MARK AS SHOWN.

SER. NO. 77-226,663, FILED 7-11-2007.

MIDGE BUTLER, EXAMINING ATTORNEY

**Int. Cl.: 9**

**Prior U.S. Cls.: 21, 23, 26, 36 and 38**

**Reg. No. 3,465,976**

**United States Patent and Trademark Office**

**Registered July 15, 2008**

**TRADEMARK  
PRINCIPAL REGISTER**

**RADIXX AIR ENTERPRISE**

RADIXX SOLUTIONS INTERNATIONAL, INC.  
(DELAWARE CORPORATION)  
6310 HAZELTINE NATIONAL DRIVE  
ORLANDO, FL 32822

THE MARK CONSISTS OF STANDARD CHARACTERS WITHOUT CLAIM TO ANY PARTICULAR FONT, STYLE, SIZE, OR COLOR.

FOR: COMPUTER APPLICATION SOFTWARE FOR USE IN THE TRAVEL RELATED RESERVATIONS AND TRAVEL RELATED INVENTORY MANAGEMENT FIELDS; AND DATABASE MANAGEMENT SOFTWARE FOR USE IN THE TRAVEL-RELATED RESERVATIONS FIELD AND THE TRAVEL-RELATED INVENTORY MANAGEMENT FIELD, IN CLASS 9 (U.S. CLS. 21, 23, 26, 36 AND 38).

NO CLAIM IS MADE TO THE EXCLUSIVE RIGHT TO USE "AIR ENTERPRISE", APART FROM THE MARK AS SHOWN.

SER. NO. 77-226,689, FILED 7-11-2007.

FIRST USE 12-14-2004; IN COMMERCE 12-14-2004.

MIDGE BUTLER, EXAMINING ATTORNEY

**Int. Cl.: 9**

**Prior U.S. Cls.: 21, 23, 26, 36 and 38**

**United States Patent and Trademark Office**

**Reg. No. 3,465,977**

**Registered July 15, 2008**

**TRADEMARK  
PRINCIPAL REGISTER**

**SPIRIT HD**

THOMSON (FRANCE SOCIETE ANONYME)  
46 QUAI ALPHONSE LE GALLO  
BOULOGNE-BILLANCOURT, FRANCE 92100

FOR: FILM SCANNERS AND TELECINES USED  
TO TRANSFER MOTION PICTURE FILMS TO A  
DIGITAL FORMAT FOR PROFESSIONAL FILM  
AND VIDEO APPLICATIONS FOR HIGH-DEFINI-  
TION TELEVISION AND HIGH-DEFINITION MO-  
VIES, IN CLASS 9 (U.S. CLS. 21, 23, 26, 36 AND 38).

THE MARK CONSISTS OF STANDARD CHAR-  
ACTERS WITHOUT CLAIM TO ANY PARTICULAR  
FONT, STYLE, SIZE, OR COLOR.

PRIORITY CLAIMED UNDER SEC. 44(D) ON  
FRANCE APPLICATION NO. 073482260, FILED 2-  
13-2007, REG. NO. 073482260, DATED 2-13-2007, EX-  
PIRES 2-13-2017.

OWNER OF U.S. REG. NO. 3,010,515.

NO CLAIM IS MADE TO THE EXCLUSIVE  
RIGHT TO USE "HD", APART FROM THE MARK  
AS SHOWN.

SER. NO. 77-226,709, FILED 7-11-2007.

DANNEAN HETZEL, EXAMINING ATTORNEY

**Int. Cl.: 9**

**Prior U.S. Cls.: 21, 23, 26, 36 and 38**

**Reg. No. 3,465,978**

**United States Patent and Trademark Office**

**Registered July 15, 2008**

---

**TRADEMARK  
PRINCIPAL REGISTER**

**HATTERAS**

EATON CORPORATION (OHIO CORPORATION)  
1111 SUPERIOR AVENUE  
CLEVELAND, OH 44114

FIRST USE 10-7-1994; IN COMMERCE 10-7-1994.

FOR: ELECTRICAL DISTRIBUTION SYSTEMS  
CONSISTING OF POWER DISTRIBUTION PANELS,  
ELECTRICAL SWITCHES, AND ELECTRICAL  
POWER CONNECTORS FOR MARINAS, PRIVATE  
DOCKS, POOLS, AND DECK AREAS , IN CLASS 9  
(U.S. CLS. 21, 23, 26, 36 AND 38).

THE MARK CONSISTS OF STANDARD CHAR-  
ACTERS WITHOUT CLAIM TO ANY PARTICULAR  
FONT, STYLE, SIZE, OR COLOR.

SER. NO. 77-226,883, FILED 7-11-2007.

TEJBIR SINGH, EXAMINING ATTORNEY

**Int. Cl.: 9**

**Prior U.S. Cls.: 21, 23, 26, 36 and 38**

**Reg. No. 3,465,979**

**United States Patent and Trademark Office**

**Registered July 15, 2008**

**TRADEMARK  
PRINCIPAL REGISTER**

**SAGE Metering, Inc. Prime**

SAGE METERING, INC. (CALIFORNIA CORPORATION)  
BUILDING D-1  
8 HARRIS COURT  
MONTEREY, CA 93940

NO CLAIM IS MADE TO THE EXCLUSIVE RIGHT TO USE "METERING, INC.", APART FROM THE MARK AS SHOWN.

FOR: THERMAL MASS FLOWMETERS, IN CLASS 9 (U.S. CLS. 21, 23, 26, 36 AND 38).

SEC. 2(F).

FIRST USE 3-23-2007; IN COMMERCE 4-16-2007.

SER. NO. 77-226,921, FILED 7-11-2007.

THE MARK CONSISTS OF STANDARD CHARACTERS WITHOUT CLAIM TO ANY PARTICULAR FONT, STYLE, SIZE, OR COLOR.

BRENDAN REGAN, EXAMINING ATTORNEY

**Int. Cl.: 9**

**Prior U.S. Cls.: 21, 23, 26, 36 and 38**

**Reg. No. 3,465,980**

**United States Patent and Trademark Office**

**Registered July 15, 2008**

---

**TRADEMARK  
PRINCIPAL REGISTER**

**ELAN**

GRIFFIN TECHNOLOGY, INC. (TENNESSEE  
CORPORATION)  
1930 AIR LANE DRIVE  
NASHVILLE, TN 37210

FOR: PROTECTIVE CARRYING CASES FOR  
PORTABLE ELECTRONIC DEVICES, NAMELY,  
MOBILE PHONES, MP3 PLAYERS, DIGITAL MED-  
IA PLAYERS, PERSONAL DATA ASSISTANTS, IN  
CLASS 9 (U.S. CLS. 21, 23, 26, 36 AND 38).

FIRST USE 4-10-2007; IN COMMERCE 4-10-2007.

THE MARK CONSISTS OF STANDARD CHAR-  
ACTERS WITHOUT CLAIM TO ANY PARTICULAR  
FONT, STYLE, SIZE, OR COLOR.

SER. NO. 77-227,487, FILED 7-11-2007.

ERNEST SHOSHO, EXAMINING ATTORNEY

**Int. Cl.: 45**

**Prior U.S. Cls.: 100 and 101**

**United States Patent and Trademark Office**

**Reg. No. 3,465,981**

**Registered July 15, 2008**

**SERVICE MARK  
PRINCIPAL REGISTER**

# Caregiving Solutions

UNITY CARE, INC. (CALIFORNIA CORPORATION)  
5455 WILSHIRE BLVD., SUITE 810  
LOS ANGELES, CA 90036

FOR: PERSONAL CARE ASSISTANCE OF DAILY LIVING ACTIVITIES SUCH AS BATHING, GROOMING AND PERSONAL MOBILITY BY IN-HOME NON-MEDICAL PRIVATE ATTENDANTS, COMPANIONS AND PRIVATE DUTY INDIVIDUALS TO ASSIST THE ELDERLY, FRAIL OR THOSE REQUESTING ASSISTANCE, IN CLASS 45 (U.S. CLS. 100 AND 101).

FIRST USE 3-20-2007; IN COMMERCE 3-20-2007.

THE MARK CONSISTS OF STANDARD CHARACTERS WITHOUT CLAIM TO ANY PARTICULAR FONT, STYLE, SIZE, OR COLOR.

NO CLAIM IS MADE TO THE EXCLUSIVE RIGHT TO USE "CAREGIVING", APART FROM THE MARK AS SHOWN.

SER. NO. 77-227,673, FILED 7-12-2007.

COLLEEN DOMBROW, EXAMINING ATTORNEY



**Int. Cl.: 3**

**Prior U.S. Cls.: 1, 4, 6, 50, 51 and 52**

**Reg. No. 3,465,982**

**United States Patent and Trademark Office**

**Registered July 15, 2008**

---

**TRADEMARK  
PRINCIPAL REGISTER**

**SMARTMOUTH**

TRIUMPH PHARMACEUTICALS INC. (COLOR-  
ADO CORPORATION)  
10403 BAUR BLVD., SUITE A  
ST. LOUIS, MO 63132

THE MARK CONSISTS OF STANDARD CHAR-  
ACTERS WITHOUT CLAIM TO ANY PARTICULAR  
FONT, STYLE, SIZE, OR COLOR.

FOR: NON-MEDICATED MOUTH RINSE,  
TOOTHPASTE, BREATH-FRESHENING BREATH  
MINTS AND BREATH-FRESHENING GUM, IN  
CLASS 3 (U.S. CLS. 1, 4, 6, 50, 51 AND 52).

SER. NO. 77-228,064, FILED 7-12-2007.

FIRST USE 1-15-2005; IN COMMERCE 2-15-2005.

ESTHER A. BORSUK, EXAMINING ATTORNEY

**Int. Cl.: 42**

**Prior U.S. Cls.: 100 and 101**

**United States Patent and Trademark Office**

**Reg. No. 3,465,983**

**Registered July 15, 2008**

**SERVICE MARK  
PRINCIPAL REGISTER**



AUSTAR INTERNATIONAL LIMITED (HONG  
KONG LTD LIAB CO)  
UNIT 6, 1/F, BLOCK B, NEW TRADE PLAZA  
6 ON PING STREET  
SHATIN, N.T., HONG KONG

FOR: RESEARCH AND DEVELOPMENT AND  
CONSULTATION RELATED THERETO IN THE  
FIELD OF PHARMACEUTICALS, NAMELY, GEN-  
ERIC DRUG PRODUCTS, IN CLASS 42 (U.S. CLS. 100  
AND 101).

FIRST USE 9-13-2005; IN COMMERCE 9-13-2005.

THE COLOR(S) RED AND BLUE IS/ARE  
CLAIMED AS A FEATURE OF THE MARK.

THE MARK CONSISTS OF INTERLOCKING  
STYLIZED LETTERS "A" IN RED AND "P" IN BLUE  
FOLLOWED BY THE WORD "AUSTARPHARMA"  
IN BLUE.

SER. NO. 77-228,393, FILED 7-12-2007.

CAROLYN CATALDO, EXAMINING ATTORNEY

**Int. Cl.: 42**

**Prior U.S. Cls.: 100 and 101**

**United States Patent and Trademark Office**

**Reg. No. 3,465,984**

**Registered July 15, 2008**

**SERVICE MARK  
PRINCIPAL REGISTER**



**WATERMARK**  
Research Partners, LLC

WATERMARK RESEARCH PARTNERS, LLC (IN-  
DIANA LTD LIAB CO)  
9190 CORPORATION DRIVE  
SUITE 105  
INDIANAPOLIS, IN 46256

FOR: INDEPENDENT SAFETY MONITORING  
OF CLINICAL DATA, NAMELY, SAFETY RE-  
LATED VARIABLES, FOR THE PHARMACEUTICAL,  
BIOTECH, AND DEVICE INDUSTRY , IN CLASS 42  
(U.S. CLS. 100 AND 101).

FIRST USE 4-20-2003; IN COMMERCE 4-20-2003.

NO CLAIM IS MADE TO THE EXCLUSIVE  
RIGHT TO USE "RESEARCH PARTNERS, LLC",  
APART FROM THE MARK AS SHOWN.

THE COLOR(S) BLACK AND DARK BLUE IS/  
ARE CLAIMED AS A FEATURE OF THE MARK.

THE MARK CONSISTS OF 3 COLORS; BLACK,  
GREY AND DARK BLUE. THE MARK IS A DOU-  
BLE CIRCLE IN DARK BLUE WITH A SECOND  
DOUBLE CIRCLE AS A SHADOW OF THE OTHER  
IN GREY. BENEATH THE CIRCLES IS THE STY-  
LIZED BLACK TEXT "WATERMARK RESEARCH  
PARTNERS, LLC". THE TEXT IS ARRANGED SO  
THAT "WATERMARK" IS ONE LINE DIRECTLY  
BENEATH THE CIRCLES AND "RESEARCH PART-  
NERS, LLC" IS A SECOND LINE BENEATH THE  
CIRCLES.

SEC. 2(F).

SER. NO. 77-228,633, FILED 7-12-2007.

ESTHER A. BORSUK, EXAMINING ATTORNEY

Int. Cl.: 44

Prior U.S. Cls.: 100 and 101

United States Patent and Trademark Office

Reg. No. 3,465,985

Registered July 15, 2008

**SERVICE MARK  
PRINCIPAL REGISTER**



JUDY CASPER OF CHICAGO LLC (NEVADA  
LTD LIAB CO)  
612 RIO DEL SOL DRIVE  
NORTH LAS VEGAS, NV 89031

FOR: HAIR REPLACEMENT, IN CLASS 44 (U.S.  
CLS. 100 AND 101).

FIRST USE 10-1-2005; IN COMMERCE 10-1-2005.

NO CLAIM IS MADE TO THE EXCLUSIVE  
RIGHT TO USE "CHICAGO HAIR", APART FROM  
THE MARK AS SHOWN.

THE MARK CONSISTS OF A TALL BUILDING  
DESIGN AFTER OUR NAME "JC" AND THE  
WORDS "HAIR CREATORS" ARE ENCLOSED IN  
AN OVAL BACKGROUND. ALL LETTERS ARE  
BOLDED.

SER. NO. 77-228,636, FILED 7-12-2007.

ESTHER A. BORSUK, EXAMINING ATTORNEY

**Int. Cl.: 33**

**Prior U.S. Cls.: 47 and 49**

**United States Patent and Trademark Office**

**Reg. No. 3,465,986**

**Registered July 15, 2008**

**TRADEMARK  
PRINCIPAL REGISTER**

**WORLD VINEYARD**

WINEXPERT INC. (CANADA CORPORATION)  
27 SCOTT STREET WEST  
ST. CATHARINES, CANADA L2R1E1

FOR: KITS FOR MAKING WINE, IN CLASS 33  
(U.S. CLS. 47 AND 49).

FIRST USE 10-12-2006; IN COMMERCE 10-12-2006.

THE MARK CONSISTS OF STANDARD CHAR-  
ACTERS WITHOUT CLAIM TO ANY PARTICULAR  
FONT, STYLE, SIZE, OR COLOR.

SER. NO. 77-228,905, FILED 7-13-2007.

TRACY WHITTAKER-BROWN, EXAMINING AT-  
TORNEY

**Int. Cl.: 25**

**Prior U.S. Cls.: 22 and 39**

**United States Patent and Trademark Office**

**Reg. No. 3,465,987**

**Registered July 15, 2008**

**TRADEMARK  
PRINCIPAL REGISTER**

# Yoga Sandals

TRENBERTH, GAYLE I. (UNITED STATES INDIVIDUAL)  
5486 MCFADDEN AVE.  
HUNTINGTON BEACH, CA 92649

NO CLAIM IS MADE TO THE EXCLUSIVE RIGHT TO USE "SANDALS", APART FROM THE MARK AS SHOWN.

FOR: FOOTWEAR USED FOR YOGA TRAINING, FOOT DISORDERS, PEDICURES AND EVERYDAY WEAR, IN CLASS 25 (U.S. CLS. 22 AND 39).

SEC. 2(F).

FIRST USE 1-11-2002; IN COMMERCE 1-17-2002.

SER. NO. 77-229,046, FILED 7-13-2007.

THE MARK CONSISTS OF STANDARD CHARACTERS WITHOUT CLAIM TO ANY PARTICULAR FONT, STYLE, SIZE, OR COLOR.

KYLE PEETE, EXAMINING ATTORNEY

**Int. Cl.: 25**

**Prior U.S. Cls.: 22 and 39**

**United States Patent and Trademark Office**

**Reg. No. 3,465,988**

**Registered July 15, 2008**

**TRADEMARK  
PRINCIPAL REGISTER**



TRIUMPH PHARMACEUTICALS INC. (COLOR-  
ADO CORPORATION)  
10403 BAUR BLVD., SUITE A  
ST. LOUIS, MO 63132

THE MARK CONSISTS OF THE WORDS "SMART  
MOUTH" IN STANDARD CHARACTERS.

FOR: CLOTHING, NAMELY, SHIRTS, PANTS,  
JACKETS, FOOTWEAR AND HEADWEAR, IN  
CLASS 25 (U.S. CLS. 22 AND 39).

SER. NO. 77-229,462, FILED 7-13-2007.

FIRST USE 6-15-2005; IN COMMERCE 9-15-2005.

ESTHER A. BORSUK, EXAMINING ATTORNEY

**Int. Cl.: 20**

**Prior U.S. Cls.: 2, 13, 22, 25, 32 and 50**

**United States Patent and Trademark Office**

**Reg. No. 3,465,989**

**Registered July 15, 2008**

**TRADEMARK  
PRINCIPAL REGISTER**

**Fake The Cake**

CHAVEZ, STEPHANIE K (UNITED STATES IN-  
DIVIDUAL)  
1380 N. 3RD AVE.  
UPLAND, CA 91786

THE MARK CONSISTS OF STANDARD CHAR-  
ACTERS WITHOUT CLAIM TO ANY PARTICULAR  
FONT, STYLE, SIZE, OR COLOR.

FOR: IMITATION CAKES FOR RENTAL MADE  
OF STYROFOAM AND DISPLAY ICING, IN CLASS  
20 (U.S. CLS. 2, 13, 22, 25, 32 AND 50).

SER. NO. 77-229,514, FILED 7-13-2007.

FIRST USE 6-11-2006; IN COMMERCE 6-11-2006.

ELLEN B. AWRICH, EXAMINING ATTORNEY



**Int. Cl.: 9**

**Prior U.S. Cls.: 21, 23, 26, 36 and 38**

**Reg. No. 3,465,990**

**United States Patent and Trademark Office**

**Registered July 15, 2008**

**TRADEMARK  
PRINCIPAL REGISTER**



NETDEVIL, LTD. (COLORADO CORPORATION)  
DOGWOOD ST, SUITE 240  
LOUISVILLE, CO 80027

OF VIRTUAL REALITY COMPRISED OF COMPUTER HARDWARE AND SOFTWARE, IN CLASS 9 (U.S. CLS. 21, 23, 26, 36 AND 38).

FOR: COMPUTER GAME SOFTWARE; INTERACTIVE MULTIMEDIA COMPUTER GAME PROGRAMS; COMPUTER GAME SOFTWARE THAT MAY BE DOWNLOADED FROM A GLOBAL COMPUTER NETWORK; COMPUTER GAME CARTRIDGES TO BE USED IN COMPUTER GAME MACHINES ADAPTED FOR USE WITH TELEVISION RECEIVERS; INTERACTIVE VIDEO GAMES

FIRST USE 12-5-2006; IN COMMERCE 12-15-2006.

THE MARK CONSISTS OF STYLIZED ANIMAL SKULL, CIRCLE AND WORDS "WARMONGER".

SER. NO. 77-229,651, FILED 7-13-2007.

LESLEY LAMOTHE, EXAMINING ATTORNEY

**Int. Cl.: 9**

**Prior U.S. Cls.: 21, 23, 26, 36 and 38**

**Reg. No. 3,465,991**

**United States Patent and Trademark Office**

**Registered July 15, 2008**

**TRADEMARK  
PRINCIPAL REGISTER**



NETDEVIL, LTD. (COLORADO CORPORATION)  
1795 DOGWOOD ST, SUITE 240  
LOUISVILLE, CO 80027

FOR: COMPUTER GAME SOFTWARE; INTERACTIVE MULTIMEDIA COMPUTER GAME PROGRAMS; COMPUTER GAME SOFTWARE THAT MAY BE DOWNLOADED FROM A GLOBAL COMPUTER NETWORK; COMPUTER GAME CARTRIDGES TO BE USED IN COMPUTER GAME MACHINES ADAPTED FOR USE WITH TELEVISION RECEIVERS; INTERACTIVE VIDEO GAMES OF VIRTUAL REALITY COMPRISED OF COMPU-

TER HARDWARE AND SOFTWARE, IN CLASS 9 (U.S. CLS. 21, 23, 26, 36 AND 38).

FIRST USE 12-5-2006; IN COMMERCE 12-15-2006.

THE MARK CONSISTS OF STYLIZED ANIMAL SKULL, CIRCLE AND WORDS "WARMONGER OPERATION: DOWNTOWN DESTRUCTION".

SER. NO. 77-229,667, FILED 7-13-2007.

LESLEY LAMOTHE, EXAMINING ATTORNEY

**Int. Cl.: 29**

**Prior U.S. Cl.: 46**

**United States Patent and Trademark Office**

**Reg. No. 3,465,992**

**Registered July 15, 2008**

**TRADEMARK  
PRINCIPAL REGISTER**



VAN ECUADOR SEA FOODS, INC. (NEW YORK  
CORPORATION)  
9TH FLOOR  
445 PARK AVENUE  
NEW YORK, NY 10022

THE MARK CONSISTS OF THE STYLIZED  
WORDS "VAN ECUADOR".

SER. NO. 77-229,791, FILED 7-14-2007.

FOR: TUNA FISH, IN CLASS 29 (U.S. CL. 46).

FIRST USE 6-0-2007; IN COMMERCE 6-0-2007.

EVELYN BRADLEY, EXAMINING ATTORNEY

**Int. Cl.: 9**

**Prior U.S. Cls.: 21, 23, 26, 36 and 38**

**Reg. No. 3,465,993**

**United States Patent and Trademark Office**

**Registered July 15, 2008**

**TRADEMARK  
PRINCIPAL REGISTER**

**POWERDOCK**

GRIFFIN TECHNOLOGY, INC. (TENNESSEE  
CORPORATION)  
1930 AIR LANE DRIVE  
NASHVILLE, TN 37210

THE MARK CONSISTS OF STANDARD CHAR-  
ACTERS WITHOUT CLAIM TO ANY PARTICULAR  
FONT, STYLE, SIZE, OR COLOR.

FOR: BATTERY CHARGERS FOR PORTABLE  
ELECTRONIC DEVICES, IN CLASS 9 (U.S. CLS. 21,  
23, 26, 36 AND 38).

SER. NO. 77-230,000, FILED 7-15-2007.

FIRST USE 11-30-2006; IN COMMERCE 11-30-2006.

ERNEST SHOSHO, EXAMINING ATTORNEY

**Int. Cls.: 9 and 41**

**Prior U.S. Cls.: 21, 23, 26, 36, 38, 100, 101 and 107**

**Reg. No. 3,465,994**

**United States Patent and Trademark Office**

**Registered July 15, 2008**

**TRADEMARK  
SERVICE MARK  
PRINCIPAL REGISTER**



ROWLAND, NIAMBI K (ILLINOIS JOINT VENTURE)  
1612 SOUTH 7TH ST.  
SPRINGFIELD, IL 62703 AND  
ROWLAND, AYANNA K (ILLINOIS JOINT VENTURE), DBA AZ ONE  
1612 SOUTH 7TH ST.  
SPRINGFIELD, IL 62703

FOR: MUSICAL SOUND RECORDINGS, IN CLASS 9 (U.S. CLS. 21, 23, 26, 36 AND 38).

FIRST USE 8-31-1999; IN COMMERCE 12-31-1999.

FOR: ENTERTAINMENT IN THE NATURE OF LIVE PERFORMANCES BY A MUSICAL GROUP, IN CLASS 41 (U.S. CLS. 100, 101 AND 107).

FIRST USE 8-31-1999; IN COMMERCE 8-31-1999.

SER. NO. 77-230,058, FILED 7-16-2007.

RONALD MCMORROW, EXAMINING ATTORNEY

**Int. Cl.: 12**

**Prior U.S. Cls.: 19, 21, 23, 31, 35 and 44**

**Reg. No. 3,465,995**

**United States Patent and Trademark Office**

**Registered July 15, 2008**

**TRADEMARK  
PRINCIPAL REGISTER**

# Toddler Teams

TODDLER TEAMS (CONNECTICUT LTD LIAB  
CO)  
5 SOUTHWOOD DRIVE  
NEW CANAAN, CT 06840

FOR: CHILD RESTRAINTS FOR VEHICLE  
SEATS; CHILDREN'S CAR SEATS; CHILDREN'S  
SAFETY SEATS FOR CARS; CHILDREN'S SAFETY  
SEATS FOR VEHICLES, IN CLASS 12 (U.S. CLS. 19,  
21, 23, 31, 35 AND 44).

FIRST USE 1-1-2006; IN COMMERCE 2-1-2006.

THE MARK CONSISTS OF STANDARD CHAR-  
ACTERS WITHOUT CLAIM TO ANY PARTICULAR  
FONT, STYLE, SIZE, OR COLOR.

NO CLAIM IS MADE TO THE EXCLUSIVE  
RIGHT TO USE TODDLER, APART FROM THE  
MARK AS SHOWN.

SER. NO. 77-230,113, FILED 7-16-2007.

JANET LEE, EXAMINING ATTORNEY

**Int. Cls.: 9 and 35**

**Prior U.S. Cls.: 21, 23, 26, 36, 38, 100, 101 and 102**

**Reg. No. 3,465,996**

**United States Patent and Trademark Office**

**Registered July 15, 2008**

**TRADEMARK  
SERVICE MARK  
PRINCIPAL REGISTER**

**ZOTEC**

ZOTEC PARTNERS, LLC (INDIANA LTD LIAB  
CO)  
11460 NORTH MERIDIAN  
CARMEL, IN 46032

FOR: COMPUTER SOFTWARE FOR MEDICAL  
BILLING THAT MAY BE DOWNLOADED FROM A  
GLOBAL COMPUTER NETWORK, IN CLASS 9 (U.S.  
CLS. 21, 23, 26, 36 AND 38).

FIRST USE 12-31-1998; IN COMMERCE 12-31-1998.

FOR: MEDICAL BILLING SUPPORT SERVICES,  
IN CLASS 35 (U.S. CLS. 100, 101 AND 102).

FIRST USE 12-31-1998; IN COMMERCE 12-31-1998.

THE MARK CONSISTS OF STANDARD CHAR-  
ACTERS WITHOUT CLAIM TO ANY PARTICULAR  
FONT, STYLE, SIZE, OR COLOR.

SER. NO. 77-230,117, FILED 7-16-2007.

BERNICE MIDDLETON, EXAMINING ATTORNEY

**Int. Cl.: 24**

**Prior U.S. Cls.: 42 and 50**

**United States Patent and Trademark Office**

**Reg. No. 3,465,997**

**Registered July 15, 2008**

**TRADEMARK  
PRINCIPAL REGISTER**

**ZenDixie**

CONATSER, VICTORIA ANNE (UNITED STATES  
INDIVIDUAL)  
125 CLINE AVENUE  
HENDERSONVILLE, TN 370753213

FOR: WORKS OF FOLK AND FINE ART MADE  
FROM TEXTILES, NAMELY, WALLHANGINGS,  
BANNERS; BEDDING, NAMELY, BED SHEETS,  
BED SPREADS; QUILTS; SCULPTURES, IN CLASS  
24 (U.S. CLS. 42 AND 50).

FIRST USE 7-6-2007; IN COMMERCE 7-12-2007.

THE MARK CONSISTS OF STANDARD CHAR-  
ACTERS WITHOUT CLAIM TO ANY PARTICULAR  
FONT, STYLE, SIZE, OR COLOR.

SER. NO. 77-230,129, FILED 7-16-2007.

BERNICE MIDDLETON, EXAMINING ATTORNEY



**Int. Cls.: 35 and 42**

**Prior U.S. Cls.: 100, 101 and 102**

**United States Patent and Trademark Office**

**Reg. No. 3,465,998**

**Registered July 15, 2008**

**SERVICE MARK  
PRINCIPAL REGISTER**

# ASK PEACHY

GANNETT CO., INC. (DELAWARE CORPORATION)  
7950 JONES BRANCH DRIVE  
MCLEAN, VA 22107

FOR: DISSEMINATION OF ADVERTISING FOR OTHERS VIA THE INTERNET, IN CLASS 35 (U.S. CLS. 100, 101 AND 102).

FIRST USE 2-28-2007; IN COMMERCE 2-28-2007.

FOR: COMPUTER SERVICES, NAMELY, PROVIDING A SEARCH ENGINE FOR OBTAINING INFORMATION ABOUT GENERAL AND LOCAL, NATIONAL AND INTERNATIONAL NEWS, DIRECTORY LISTINGS, CLASSIFIEDS, LOCAL EVENTS,

SHOPPING, RESTAURANTS, BARS AND HOTELS, AND OTHER INFORMATION OF INTEREST TO RESIDENTS AND VISITORS TO THE ATLANTA, GEORGIA METROPOLITAN AREA, VIA THE INTERNET, IN CLASS 42 (U.S. CLS. 100 AND 101).

FIRST USE 2-28-2007; IN COMMERCE 2-28-2007.

THE MARK CONSISTS OF STANDARD CHARACTERS WITHOUT CLAIM TO ANY PARTICULAR FONT, STYLE, SIZE, OR COLOR.

SER. NO. 77-230,348, FILED 7-16-2007.

JENNY PARK, EXAMINING ATTORNEY

**Int. Cl.: 29**

**Prior U.S. Cl.: 46**

**United States Patent and Trademark Office**

**Reg. No. 3,465,999**

**Registered July 15, 2008**

**TRADEMARK  
PRINCIPAL REGISTER**



KEY GLOBAL FOODS, LLC (FLORIDA LTD  
LIAB CO)  
P.O. BOX 880373  
BOCA RATON, FL 33433

FOR: DRIED VEGETABLES, IN CLASS 29 (U.S.  
CL. 46).

FIRST USE 6-11-2007; IN COMMERCE 6-11-2007.

THE COLOR(S) GREEN AND ORANGE IS/ARE  
CLAIMED AS A FEATURE OF THE MARK.

THE MARK CONSISTS OF THE WORDING  
"GRANUSCA" WITH STYLIZED GREEN LETTERS.

THE WORDING APPEARS IN AN ORANGE OVAL-  
ARCH SHAPE ATTACHED TO A SERIES OF OR-  
ANGE TRIANGLES. BELOW THE ORANGE SHAPE  
IS A HALF-OVAL IN GREEN WITH A CUTOUT  
DESIGN OF A SERIES OF ORANGE LEAVES. THE  
WHITE IN THE DRAWING AROUND THE LET-  
TERS IN "GRANUSCA" AND AROUND THE  
LEAVES REPRESENTS A TRANSPARENT BACK-  
GROUND, AND DOES NOT INDICATE A CLAIM  
OF THE COLOR WHITE AS A FEATURE OF THE  
MARK.

SER. NO. 77-230,523, FILED 7-16-2007.

LYDIA BELZER, EXAMINING ATTORNEY

**Int. Cls.: 35 and 41**

**Prior U.S. Cls.: 100, 101, 102 and 107**

**United States Patent and Trademark Office**

**Reg. No. 3,466,000**

**Registered July 15, 2008**

**SERVICE MARK  
PRINCIPAL REGISTER**



NATIONAL CARE CONNECTION, LLC (COLOR-  
ADO LTD LIAB CO)  
429 SHOREHAM CIRCLE  
CASTLE ROCK, CO 80108

FOR: PROVIDING BUSINESS, COMMERCIAL  
AND CONSUMER INFORMATION IN THE FIELD  
OF CAREGIVING TO IMPROVE THE CARE AND  
QUALITY OF LIFE FOR INDIVIDUALS WITH  
COMPREHENSIVE CARE NEEDS, IN CLASS 35  
(U.S. CLS. 100, 101 AND 102).

FIRST USE 1-15-2007; IN COMMERCE 1-15-2007.

FOR: PROVIDING EDUCATIONAL AND TRAIN-  
ING SERVICES IN THE FORM OF LIVE COURSE  
INSTRUCTION AND INTERACTIVE WEB-DELIV-  
ERED COURSE INSTRUCTION IN THE FIELD OF  
CAREGIVING, WHICH IS DESIGNED TO MEET  
GOVERNMENT- AND BUSINESS-MANDATED  
TRAINING REQUIREMENTS, AND TO TEACH  
CLIENTS HOW TO IMPROVE THE CARE AND  
QUALITY OF LIFE FOR INDIVIDUALS WITH  
COMPREHENSIVE CARE NEEDS, IN CLASS 41  
(U.S. CLS. 100, 101 AND 107).

FIRST USE 1-15-2007; IN COMMERCE 1-15-2007.

NO CLAIM IS MADE TO THE EXCLUSIVE  
RIGHT TO USE "CAREGIVER", APART FROM  
THE MARK AS SHOWN.

THE MARK CONSISTS OF FOUR SEPARATE,  
CURVED LINES WHICH ARE THICK ON ONE END  
AND THINNER ON THE OTHER END AND WHICH  
MAKE UP THE OUTLINE OF A CIRCLE. INSIDE  
THE CIRCLE JUST OFF-CENTER TO THE RIGHT  
AND NEAR THE TOP LINE IS A GEOMETRIC  
FIGURE OF A PERSON WHOSE LEFT ARM AP-  
PEARS TO BE CROSSING THE THICK SIDE OF THE  
TOP LINE. BEHIND THE PERSON AND ALSO  
WITHIN THE CIRCLE ARE CLOUDS AND SKY.  
THE WORD "CAREGIVER" RUN THROUGH THE  
BOTTOM PART OF THE CIRCLE ABOVE THE  
BOTTOM CURVED LINE AND BELOW EACH OF  
THE TWO SIDE CURVED LINES OF THE CIRCLE  
WITH THE WORD "CARE" CENTERED IN THE  
BOTTOM OF THE CIRCLE AND THE "G" OF  
"GIVER" BETWEEN THE BOTTOM TWO CURVED  
LINES ON THE RIGHT SIDE OF THE IMAGE. "360"  
APPEARS BELOW "GIVER". THE "FEET" OF THE  
GEOMETRIC PERSON ARE JUST ABOVE THE "A"  
AND THE "E" OF "CARE."

SER. NO. 77-230,534, FILED 7-16-2007.

EDWARD NELSON, EXAMINING ATTORNEY

**Int. Cl.: 24**

**Prior U.S. Cls.: 42 and 50**

**United States Patent and Trademark Office**

**Reg. No. 3,466,001**

**Registered July 15, 2008**

**TRADEMARK  
PRINCIPAL REGISTER**

**ROBERT KAUFMAN FABRICS**

ROBERT KAUFMAN CO., INC. (CALIFORNIA  
CORPORATION)  
P.O. BOX 59266  
GREENMEAD STATION  
LOS ANGELES, CA 900590266

FOR: FABRICS AND TEXTILES FOR USE IN THE  
MANUFACTURE OF CLOTHING, CLOTHING AC-  
CESSORIES, HOUSEHOLD ITEMS, QUILTING AND  
CRAFTS, IN CLASS 24 (U.S. CLS. 42 AND 50).

FIRST USE 0-0-1991; IN COMMERCE 0-0-1991.

THE MARK CONSISTS OF STANDARD CHAR-  
ACTERS WITHOUT CLAIM TO ANY PARTICULAR  
FONT, STYLE, SIZE, OR COLOR.

NO CLAIM IS MADE TO THE EXCLUSIVE  
RIGHT TO USE "FABRICS", APART FROM THE  
MARK AS SHOWN.

THE NAME(S), PORTRAIT(S), AND/OR SIGNA-  
TURE(S) SHOWN IN THE MARK DOES NOT IDEN-  
TIFY A PARTICULAR LIVING INDIVIDUAL.

SER. NO. 77-230,735, FILED 7-16-2007.

JOHN KELLY, EXAMINING ATTORNEY

**Int. Cl.: 24**

**Prior U.S. Cls.: 42 and 50**

**United States Patent and Trademark Office**

**Reg. No. 3,466,002**

**Registered July 15, 2008**

**TRADEMARK  
PRINCIPAL REGISTER**

**ROBERT KAUFMAN**

ROBERT KAUFMAN CO., INC. (CALIFORNIA  
CORPORATION)  
P.O. BOX 59266  
GREENMEAD STATION  
LOS ANGELES, CA 900590266

FOR: FABRICS AND TEXTILES FOR USE IN THE  
MANUFACTURE OF CLOTHING, CLOTHING AC-  
CESSORIES, HOUSEHOLD ITEMS, QUILTING AND  
CRAFTS, IN CLASS 24 (U.S. CLS. 42 AND 50).

FIRST USE 0-0-1942; IN COMMERCE 0-0-1942.

THE MARK CONSISTS OF STANDARD CHAR-  
ACTERS WITHOUT CLAIM TO ANY PARTICULAR  
FONT, STYLE, SIZE, OR COLOR.

THE NAME(S), PORTRAIT(S), AND/OR SIGNA-  
TURE(S) SHOWN IN THE MARK DOES NOT IDENT-  
IFY A PARTICULAR LIVING INDIVIDUAL.

SER. NO. 77-230,774, FILED 7-16-2007.

JOHN KELLY, EXAMINING ATTORNEY

**Int. Cls.: 38 and 41**

**Prior U.S. Cls.: 100, 101, 104 and 107**

**United States Patent and Trademark Office**

**Reg. No. 3,466,003**

**Registered July 15, 2008**

**SERVICE MARK  
PRINCIPAL REGISTER**



TORQUE TV, LLC (DELAWARE LTD LIAB CO)  
7 SULLIVAN ROAD  
GOLDENS BRIDGE, NY 105261423

FOR: INTERNET BROADCASTING SERVICES,  
NAMELY, THE STREAMING OF AUDIO-VISUAL  
MATERIALS RELATED TO THE AUTOMOBILE,  
TRUCK, AND MOTORCYCLE INDUSTRIES VIA  
THE INTERNET, IN CLASS 38 (U.S. CLS. 100, 101  
AND 104).

FIRST USE 7-7-2006; IN COMMERCE 4-21-2007.

FOR: PRODUCTION AND DISTRIBUTION OF  
PROGRAMMING RELATED TO THE AUTOMO-

BILE, TRUCK, AND MOTORCYCLE INDUSTRIES  
VIA THE INTERNET, IN CLASS 41 (U.S. CLS. 100, 101  
AND 107).

FIRST USE 7-7-2006; IN COMMERCE 4-21-2007.

THE MARK CONSISTS OF THE WORDS "TOR-  
QUE.TV" IN A STYLIZED TEXT. THE LETTER "Q"  
IN THE WORD "TORQUE" CONSISTS OF GEARS.

SER. NO. 77-230,938, FILED 7-16-2007.

HENRY S. ZAK, EXAMINING ATTORNEY

**Int. Cl.: 41**

**Prior U.S. Cls.: 100, 101 and 107**

**United States Patent and Trademark Office**

**Reg. No. 3,466,004**

**Registered July 15, 2008**

**SERVICE MARK  
PRINCIPAL REGISTER**

**TOO REAL FOR TV**

MAROY, MICHAEL (UNITED STATES INDIVIDUAL)  
4933 WEST CRAIG ROAD, SUITE 369  
LAS VEGAS, NV 89130

FOR: PRODUCTION OF VIDEO DISCS AND TAPES; PRODUCTION OF VIDEO DISCS FOR OTHERS; PRODUCTION OF VIDEO CASSETTES; VIDEOTAPE PRODUCTION, IN CLASS 41 (U.S. CLS. 100, 101 AND 107).

FIRST USE 1-1-2001; IN COMMERCE 1-1-2003.

THE MARK CONSISTS OF STANDARD CHARACTERS WITHOUT CLAIM TO ANY PARTICULAR FONT, STYLE, SIZE, OR COLOR.

NO CLAIM IS MADE TO THE EXCLUSIVE RIGHT TO USE "TV", APART FROM THE MARK AS SHOWN.

SER. NO. 77-231,071, FILED 7-17-2007.

REBECCA EISINGER, EXAMINING ATTORNEY

**Int. Cl.: 35**

**Prior U.S. Cls.: 100, 101 and 102**

**United States Patent and Trademark Office**

**Reg. No. 3,466,005**

**Registered July 15, 2008**

**SERVICE MARK  
PRINCIPAL REGISTER**

**GLOBAL BEST PRACTICES**

PRICEWATERHOUSECOOPERS LLP (DELA-  
WARE LIMITED LIABILITY PARTNERSHIP)  
300 MADISON AVENUE  
NEW YORK, NY 10017

FOR: PROVIDING AN INTERACTIVE DATA-  
BASE OF BUSINESS OPERATIONAL AND BUSI-  
NESS MANAGEMENT INFORMATION, IN CLASS  
35 (U.S. CLS. 100, 101 AND 102).

FIRST USE 1-1-1995; IN COMMERCE 1-1-1995.

THE MARK CONSISTS OF STANDARD CHAR-  
ACTERS WITHOUT CLAIM TO ANY PARTICULAR  
FONT, STYLE, SIZE, OR COLOR.

OWNER OF U.S. REG. NO. 2,078,361.

NO CLAIM IS MADE TO THE EXCLUSIVE  
RIGHT TO USE "BEST PRACTICES", APART FROM  
THE MARK AS SHOWN.

SEC. 2(F).

SER. NO. 77-231,348, FILED 7-17-2007.

LYDIA BELZER, EXAMINING ATTORNEY



**Int. Cl.: 41**

**Prior U.S. Cls.: 100, 101 and 107**

**United States Patent and Trademark Office**

**Reg. No. 3,466,006**

**Registered July 15, 2008**

**SERVICE MARK  
PRINCIPAL REGISTER**

# MOVIE QUEST

TRIBUNE MEDIA SERVICES, INC. (DELAWARE CORPORATION)  
435 N. MICHIGAN AVENUE  
CHICAGO, IL 60611

FOR: PROVIDING AN ONLINE INTERACTIVE GUIDE FOR MOVIES, THEATER LISTINGS, THEATER LOCATIONS, MOVIE REVIEWS, INDUSTRY NEWS, MOVIE SUMMARIES, TRAILERS AND ACTOR PROFILES, VIA THE INTERNET, IN CLASS 41 (U.S. CLS. 100, 101 AND 107).

FIRST USE 6-24-1998; IN COMMERCE 6-24-1998.

THE MARK CONSISTS OF STANDARD CHARACTERS WITHOUT CLAIM TO ANY PARTICULAR FONT, STYLE, SIZE, OR COLOR.

OWNER OF U.S. REG. NO. 2,420,452.

NO CLAIM IS MADE TO THE EXCLUSIVE RIGHT TO USE "MOVIE", APART FROM THE MARK AS SHOWN.

SER. NO. 77-231,727, FILED 7-17-2007.

ELLEN B. AWRICH, EXAMINING ATTORNEY

**Int. Cl.: 36**

**Prior U.S. Cls.: 100, 101 and 102**

**United States Patent and Trademark Office**

**Reg. No. 3,466,007**

**Registered July 15, 2008**

**SERVICE MARK  
PRINCIPAL REGISTER**

**YOUR SUCCESS. OUR FOCUS.**

ONEAMERICA FINANCIAL PARTNERS, INC.  
(INDIANA CORPORATION)  
P.O. BOX 368  
ONE AMERICAN SQUARE  
INDIANAPOLIS, IN 462060368

FOR: INSURANCE BROKERAGE; INSURANCE UNDERWRITING IN THE FIELD OF LIFE INSURANCE; ANNUITY UNDERWRITING; ISSUANCE AND ADMINISTRATION OF ANNUITIES; INSURANCE ADMINISTRATION IN THE FIELD OF LIFE INSURANCE; FINANCIAL ANALYSIS AND CONSULTATION; FINANCIAL ADMINISTRATION OF RETIREMENT PLANS; FINANCIAL PLANNING

CONSULTATION, IN CLASS 36 (U.S. CLS. 100, 101 AND 102).

FIRST USE 4-0-2007; IN COMMERCE 4-0-2007.

THE MARK CONSISTS OF STANDARD CHARACTERS WITHOUT CLAIM TO ANY PARTICULAR FONT, STYLE, SIZE, OR COLOR.

SER. NO. 77-231,833, FILED 7-17-2007.

SARA THOMAS, EXAMINING ATTORNEY

Int. Cl.: 35

Prior U.S. Cls.: 100, 101 and 102

United States Patent and Trademark Office

Reg. No. 3,466,008

Registered July 15, 2008

SERVICE MARK  
PRINCIPAL REGISTER

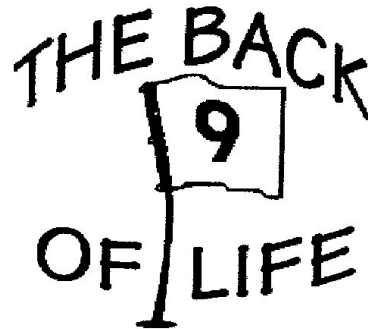

THE BACK 9 OF LIFE (CALIFORNIA LTD LIAB  
CO)  
538 W NAOMI AVE  
ARCADIA, CA 91007

FIRST USE 4-0-2007; IN COMMERCE 4-0-2007.

FOR: ON-LINE RETAIL STORE SERVICES FEATURING HATS, SHIRTS, TOWELS, GOLF BALLS, AND BAGS, IN CLASS 35 (U.S. CLS. 100, 101 AND 102).

SER. NO. 77-232,024, FILED 7-17-2007.

DAVID TOOLEY, EXAMINING ATTORNEY

**Int. Cls.: 25 and 35**

**Prior U.S. Cls.: 22, 39, 100, 101 and 102**

**United States Patent and Trademark Office**

**Reg. No. 3,466,009**

**Registered July 15, 2008**

**TRADEMARK  
SERVICE MARK  
PRINCIPAL REGISTER**



WICKED WEASEL PTY. LTD. (AUSTRALIA LTD  
LIAB CO)  
4/10 BRIGANTINE ST.  
BYRON BAY, AUSTRALIA NSW2481

FOR: CLOTHING, NAMELY, HATS, CAPS, BEANIE CAPS, VISORS, SHIRTS, SPORT SHIRTS, SWEATSHIRTS, T-SHIRTS, TANK TOPS, BLOUSES, SWEATERS, CARDIGANS, JACKETS, PANTS, SWEAT PANTS, SHORTS, SKIRTS, DRESSES, JUMPERS, OVERALLS, BATHROBES, LINGERIE, PAJAMAS, SWIMSUITS, BEACHWEAR, BELTS, UNDERWEAR, SOCKS AND FOOTWEAR, IN CLASS 25 (U.S. CLS. 22 AND 39).

FIRST USE 6-7-2004; IN COMMERCE 6-7-2004.

FOR: ON-LINE RETAIL STORE FEATURING CLOTHING, INCLUDING, HATS, CAPS, BEANIE CAPS, VISORS, SHIRTS, SPORT SHIRTS, SWEATSHIRTS, T-SHIRTS, TANK TOPS, BLOUSES, SWEATERS, CARDIGANS, JACKETS, PANTS, SWEAT PANTS, SHORTS, SKIRTS, DRESSES, JUMPERS, OVERALLS, BATHROBES, LINGERIE, PAJAMAS,

SWIMSUITS, BEACHWEAR, BELTS, UNDERWEAR, SOCKS AND FOOTWEAR, IN CLASS 35 (U.S. CLS. 100, 101 AND 102).

FIRST USE 6-7-2004; IN COMMERCE 6-7-2004.

OWNER OF U.S. REG. NO. 2,753,364.

THE COLOR(S) BLACK AND RED IS/ARE CLAIMED AS A FEATURE OF THE MARK.

THE MARK CONSISTS OF TWO BLACK "W'S" HORIZONTALLY ADJACENT AND JOINED TO ONE ANOTHER. A BLACK HORIZONTAL LINE INTERSECTS THE MIDPOINT OF EACH VALLEY OF THE LETTERS FORMING FOUR INVERTED TRIANGLES EACH OF WHICH IS COLORED RED.

SER. NO. 77-232,296, FILED 7-18-2007.

YONG KIM, EXAMINING ATTORNEY

**Int. Cl.: 31**

**Prior U.S. Cls.: 1 and 46**

**United States Patent and Trademark Office**

**Reg. No. 3,466,010**

**Registered July 15, 2008**

**TRADEMARK  
PRINCIPAL REGISTER**

**HORSE HAVEN**

GRASSLAND OREGON, INC. (OREGON CORPORATION)

5825 SHOREVIEW LANE, SUITE A

KEIZER, OR 97303

FOR: SEEDS, NAMELY, GRASS SEEDS, IN CLASS 31 (U.S. CLS. 1 AND 46).

FIRST USE 6-18-2007; IN COMMERCE 6-18-2007.

THE MARK CONSISTS OF STANDARD CHARACTERS WITHOUT CLAIM TO ANY PARTICULAR FONT, STYLE, SIZE, OR COLOR.

NO CLAIM IS MADE TO THE EXCLUSIVE RIGHT TO USE "HORSE", APART FROM THE MARK AS SHOWN.

SER. NO. 77-232,447, FILED 7-18-2007.

THEODORE MCBRIDE, EXAMINING ATTORNEY

**Int. Cls.: 29 and 35**

**Prior U.S. Cls.: 46, 100, 101 and 102**

**United States Patent and Trademark Office**

**Reg. No. 3,466,011**

**Registered July 15, 2008**

**TRADEMARK  
SERVICE MARK  
PRINCIPAL REGISTER**



SCHNUCK MARKET, INC. (MISSOURI CORPORATION)  
11420 LACKLAND AVE.  
ST. LOUIS, MO 631463561

FOR: MEAT, PORK, AND POULTRY, IN CLASS 29 (U.S. CL. 46).

FIRST USE 1-23-2007; IN COMMERCE 1-23-2007.

FOR: RETAIL GROCERY STORE SERVICES, IN CLASS 35 (U.S. CLS. 100, 101 AND 102).

FIRST USE 1-6-2007; IN COMMERCE 1-6-2007.

NO CLAIM IS MADE TO THE EXCLUSIVE RIGHT TO USE "NATURAL", APART FROM THE MARK AS SHOWN.

THE COLOR(S) GREEN, LIGHT GREEN, WHITE, BLACK, BLUE, YELLOW, AND RED IS/ARE CLAIMED AS A FEATURE OF THE MARK.

THE MARK CONSISTS OF A WHITE "NATURAL" OUTLINED IN BLACK OVER ALTERNATING GREEN AND LIGHT GREEN LINES IN A QUADRILATERAL WITH CURVED LINES OUTLINED IN BLACK WITH A SEMI-CIRCLE IN BLUE ABOVE THE LETTERS "NAT" AND BELOW THE LETTERS "RAL" WITH A RED CIRCLE UNDER A YELLOW SWIRL ABOVE THE LETTER "A".

SER. NO. 77-232,749, FILED 7-18-2007.

RONALD AIKENS, EXAMINING ATTORNEY

**Int. Cl.: 6**

**Prior U.S. Cls.: 2, 12, 13, 14, 23, 25 and 50**

**Reg. No. 3,466,012**

**United States Patent and Trademark Office**

**Registered July 15, 2008**

**TRADEMARK  
PRINCIPAL REGISTER**

**HIGH SPEED**

SIDEL PARTICIPATIONS (FRANCE SOCIETE  
PAR ACTIONS SIMPLIFIEE)  
AVENUE DE LA PATROUILLE DE FRANCE  
OCTEVILLE SUR MER, FRANCE 76930

FOR: MOULDS OF METAL FOR THE MANU-  
FACTURE OF FORMS, HOLLOW BODIES AND  
CONTAINERS, IN CLASS 6 (U.S. CLS. 2, 12, 13, 14,  
23, 25 AND 50).

THE MARK CONSISTS OF STANDARD CHAR-  
ACTERS WITHOUT CLAIM TO ANY PARTICULAR  
FONT, STYLE, SIZE, OR COLOR.

OWNER OF ERPN CMNTY TM OFC REG. NO.  
005343827, DATED 1-8-2008, EXPIRES 9-28-2016.

SER. NO. 77-232,872, FILED 7-18-2007.

ANNE E. GUSTASON, EXAMINING ATTORNEY

**Int. Cl.: 37**

**Prior U.S. Cls.: 100, 103 and 106**

**United States Patent and Trademark Office**

**Reg. No. 3,466,013**

**Registered July 15, 2008**

**SERVICE MARK  
PRINCIPAL REGISTER**



RICKS, CHUCK (UNITED STATES INDIVIDUAL)  
1805 CEDAR ST.  
NEWBERG, OR 97132

NO CLAIM IS MADE TO THE EXCLUSIVE  
RIGHT TO USE "WALLPAPER PRO", APART FROM  
THE MARK AS SHOWN.

FOR: WALLCOVERING INSTALLATION AND  
REMOVAL SERVICES, IN CLASS 37 (U.S. CLS. 100,  
103 AND 106).

SER. NO. 77-233,137, FILED 7-18-2007.

FIRST USE 11-15-1999; IN COMMERCE 1-13-2000.

COLLEEN KEARNEY, EXAMINING ATTORNEY



**Int. Cl.: 3**

**Prior U.S. Cls.: 1, 4, 6, 50, 51 and 52**

**United States Patent and Trademark Office**

**Reg. No. 3,466,014**

**Registered July 15, 2008**

**TRADEMARK  
PRINCIPAL REGISTER**

**CELLEBIOTIC**

L'OREAL (FRANCE SOCIETE ANONYME)  
14 RUE ROYALE  
PARIS, FRANCE 75008

FOR: PERFUME, TOILET WATER; BATH AND SHOWER GELS AND SALTS NOT FOR MEDICAL PURPOSE; TOILET SOAPS, BODY DEODORANTS; COSMETICS, NAMELY, CREAMS, MILKS, LOTIONS, GELS AND POWDERS FOR THE FACE, THE BODY AND THE HANDS; NON-MEDICATED SUN CARE PREPARATIONS; MAKEUP PREPARATIONS; SHAMPOOS; GELS, SPRAYS, MOUSSES AND BALMS FOR THE HAIR STYLING AND HAIR CARE; HAIR LACQUERS; HAIR COLOURING AND HAIR DECOLORANT PREPARATIONS; PERMANENT WAVING AND CURLING PREPARATIONS;

ESSENTIAL OILS FOR PERSONAL USE, IN CLASS 3 (U.S. CLS. 1, 4, 6, 50, 51 AND 52).

THE MARK CONSISTS OF STANDARD CHARACTERS WITHOUT CLAIM TO ANY PARTICULAR FONT, STYLE, SIZE, OR COLOR.

PRIORITY CLAIMED UNDER SEC. 44(D) ON FRANCE APPLICATION NO. 073514044, FILED 7-17-2007, REG. NO. 073514044, DATED 7-17-2007, EXPIRES 7-17-2017.

SER. NO. 77-233,306, FILED 7-19-2007.

KATHY DE JONGE, EXAMINING ATTORNEY

**Int. Cls.: 1 and 3**

**Prior U.S. Cls.: 1, 4, 5, 6, 10, 26, 46, 50, 51 and 52**

**United States Patent and Trademark Office**

**Reg. No. 3,466,015**

**Registered July 15, 2008**

**TRADEMARK  
PRINCIPAL REGISTER**

# BIOFIBRINE

BIOTHERM (MONACO SOCIETE ANONYME  
MONEGASQUE)  
11 AVENUE ALBERT II  
LE NEPTUNE  
MONACO, MONACO 98000

FOR: CHEMICAL INGREDIENT FOR USE IN  
THE MANUFACTURE OF COSMETIC PRODUCTS,  
IN CLASS 1 (U.S. CLS. 1, 5, 6, 10, 26 AND 46).

FOR: PERFUME, TOILET WATER; GELS, SALTS  
FOR THE BATH AND THE SHOWER NOT FOR  
MEDICAL PURPOSE; TOILET SOAPS, BODY DEO-  
DORANTS; COSMETICS, NAMELY, CREAMS,  
MILKS, LOTIONS, GELS AND POWDERS FOR  
THE FACE, THE BODY AND THE HANDS; NON-  
MEDICATED SUN CARE PREPARATIONS; MAKE-  
UP PREPARATIONS; SHAMPOOS; GELS, SPRAYS,  
MOUSSES AND BALMS FOR THE HAIR STYLING  
AND HAIR CARE; HAIR LACQUERS; HAIR COL-

OURING AND HAIR DECOLORANT PREPARA-  
TIONS; PERMANENT WAVING AND CURING  
PREPARATIONS; ESSENTIAL OILS FOR PERSON-  
AL USE , IN CLASS 3 (U.S. CLS. 1, 4, 6, 50, 51 AND  
52).

THE MARK CONSISTS OF STANDARD CHAR-  
ACTERS WITHOUT CLAIM TO ANY PARTICULAR  
FONT, STYLE, SIZE, OR COLOR.

PRIORITY CLAIMED UNDER SEC. 44(D) ON  
MONACO APPLICATION NO. 0725982, FILED 4-10-  
2007, REG. NO. 0725982, DATED 4-10-2007, EXPIRES  
4-10-2017.

SER. NO. 77-233,308, FILED 7-19-2007.

RONALD AIKENS, EXAMINING ATTORNEY

**Int. Cl.: 37**

**Prior U.S. Cls.: 100, 103 and 106**

**United States Patent and Trademark Office**

**Reg. No. 3,466,016**

**Registered July 15, 2008**

**SERVICE MARK  
PRINCIPAL REGISTER**



EINSTEINS PLUMBING & HEATING INC. (NEW  
YORK CORPORATION)  
38 BLENHEIM RD.  
MANALAPAN, NJ 07726

FOR: INSTALLATION, MAINTENANCE AND  
REPAIR OF PLUMBING AND HEATING SYSTEMS,  
IN CLASS 37 (U.S. CLS. 100, 103 AND 106).

FIRST USE 9-7-2004; IN COMMERCE 10-21-2004.

NO CLAIM IS MADE TO THE EXCLUSIVE  
RIGHT TO USE "PLUMBING & HEATING INC.",  
APART FROM THE MARK AS SHOWN.

THE MARK CONSISTS OF A DESIGN OF A BIG  
CAPITAL LETTER "E" WITH A MAN'S HEAD AND  
BODY HOLDING A WRENCH COMING OUT OF  
THE LETTER "E" AND THE WORDS EINSTEIN'S  
PLUMBING AND HEATING, INC. FEATURED TO  
THE RIGHT OF THE DESIGN.

SER. NO. 77-233,486, FILED 7-19-2007.

CHARISMA HAMPTON, EXAMINING ATTORNEY

**Int. Cl.: 18**

**Prior U.S. Cls.: 1, 2, 3, 22 and 41**

**United States Patent and Trademark Office**

**Reg. No. 3,466,017**

**Registered July 15, 2008**

**TRADEMARK  
PRINCIPAL REGISTER**



2K6 LLC (NEW YORK LTD LIAB CO)  
285 LAFAYETTE STREET, APT. 6D  
NEW YORK, NY 10012

FOR: LEATHER GOODS, NAMELY, PURSES  
AND HANDBAG TOTES, IN CLASS 18 (U.S. CLS. 1,  
2, 3, 22 AND 41).

FIRST USE 9-1-2006; IN COMMERCE 9-1-2006.

THE MARK CONSISTS OF A CONFIGURATION  
OF A SERIES OF KNOTS LOCATED AT THE

BOTTOM OF HANDBAGS. THE MATTER APPEAR-  
ING IN DOTTED LINES IS NOT PART OF THE  
MARK, BUT ONLY SHOWS THE POSITION OF THE  
MARK ON THE GOODS

SEC. 2(F).

SER. NO. 77-233,539, FILED 7-19-2007.

JENNIFER VASQUEZ, EXAMINING ATTORNEY

**Int. Cls.: 38, 42 and 45**

**Prior U.S. Cls.: 100, 101 and 104**

**United States Patent and Trademark Office**

**Reg. No. 3,466,018**

**Registered July 15, 2008**

**SERVICE MARK  
PRINCIPAL REGISTER**

**SERVINT**

SERVINT INTERNET SERVICES (VIRGINIA CORPORATION)  
6861 ELM STREET, SUITE 4E  
MCLEAN, VA 22101

FOR: PROVIDING MULTIPLE USER ACCESS TO A GLOBAL COMPUTER INFORMATION NETWORK FOR THE TRANSFER AND DISSEMINATION OF INFORMATION , IN CLASS 38 (U.S. CLS. 100, 101 AND 104).

FIRST USE 11-30-1995; IN COMMERCE 11-30-1995.

FOR: MAINTAINING AND HOSTING THE WEB SITES OF OTHERS ON A COMPUTER SERVER FOR A GLOBAL COMPUTER NETWORK; TECHNICAL SUPPORT SERVICES, NAMELY, MONITORING OF NETWORK SYSTEMS, TROUBLESHOOTING OF COMPUTER HARDWARE AND SOFTWARE PROBLEMS, IN CLASS 42 (U.S. CLS. 100 AND 101).

FIRST USE 11-30-1995; IN COMMERCE 11-30-1995.

FOR: REGISTRATION OF DOMAIN NAMES FOR IDENTIFICATION OF USERS ON A GLOBAL COMPUTER NETWORK AND WORLD WIDE WEB, IN CLASS 45 (U.S. CLS. 100 AND 101).

FIRST USE 2-0-1995; IN COMMERCE 2-0-1995.

THE MARK CONSISTS OF STANDARD CHARACTERS WITHOUT CLAIM TO ANY PARTICULAR FONT, STYLE, SIZE, OR COLOR.

SER. NO. 77-233,564, FILED 7-19-2007.

SANDRA MANIOS, EXAMINING ATTORNEY

Int. Cls.: 41, 43, 44 and 45

Prior U.S. Cls.: 100, 101 and 107

United States Patent and Trademark Office

Reg. No. 3,466,019

Registered July 15, 2008

SERVICE MARK  
PRINCIPAL REGISTER



REMED RECOVERY CARE CENTERS, LLC  
(PENNSYLVANIA LTD LIAB CO)  
16 INDUSTRIAL BLVD, SUITE 203  
PAOLI, PA 19301

FOR: VOCATIONAL TRAINING REHABILITATION SERVICES FOR INDIVIDUALS WITH ACQUIRED BRAIN INJURY, IN CLASS 41 (U.S. CLS. 100, 101 AND 107).

FIRST USE 10-1-2007; IN COMMERCE 10-1-2007.

FOR: FLEXIBLE INTERACTIVE ADULT DAY CARE SERVICES FOR INDIVIDUALS WITH ACQUIRED BRAIN INJURY, IN CLASS 43 (U.S. CLS. 100 AND 101).

FIRST USE 10-1-2007; IN COMMERCE 10-1-2007.

FOR: HEALTHCARE SERVICES, NAMELY, REHABILITATION OF INDIVIDUALS WITH ACQUIRED BRAIN INJURY; COMPREHENSIVE MEDICAL AND PHYSICAL EVALUATION OF INDIVIDUALS WITH ACQUIRED BRAIN INJURY; FORMULATING MEDICAL TREATMENT PLANS FOR INDIVIDUALS WITH ACQUIRED BRAIN INJURY; CUSTOMIZED POST-ACUTE MEDICAL AND PHYSICAL REHABILITATION AND TREAT-

MENT OF INDIVIDUALS WITH ACQUIRED BRAIN INJURY; INTENSIVE SHORT- AND LONG-TERM NEUROBEHAVIORAL REHABILITATION AND TREATMENT OF INDIVIDUALS WITH ACQUIRED BRAIN INJURY; SHORT- AND LONG-TERM OUTPATIENT MEDICAL AND PHYSICAL REHABILITATION OF INDIVIDUALS WITH ACQUIRED BRAIN INJURY, IN CLASS 44 (U.S. CLS. 100 AND 101).

FIRST USE 10-1-2007; IN COMMERCE 10-1-2007.

FOR: CASE MANAGEMENT SERVICES, NAMELY, THE COORDINATION OF NECESSARY MEDICAL SERVICES, VOCATIONAL ISSUES AND EDUCATIONAL SERVICES TO INDIVIDUALS WITH ACQUIRED BRAIN INJURY, IN CLASS 45 (U.S. CLS. 100 AND 101).

FIRST USE 10-1-2007; IN COMMERCE 10-1-2007.

OWNER OF U.S. REG. NOS. 1,703,919 AND 2,463,204.

SER. NO. 77-233,709, FILED 7-19-2007.

MATTHEW PAPPAS, EXAMINING ATTORNEY

**Int. Cls.: 41, 43, 44 and 45**

**Prior U.S. Cls.: 100, 101 and 107**

**United States Patent and Trademark Office**

**Reg. No. 3,466,020**

**Registered July 15, 2008**

**SERVICE MARK  
PRINCIPAL REGISTER**

**REMED**

REMED RECOVERY CARE CENTERS, LLC  
(PENNSYLVANIA LTD LIAB CO)  
16 INDUSTRIAL BLVD, SUITE 203  
PAOLI, PA 19301

FOR: VOCATIONAL TRAINING REHABILITATION SERVICES FOR INDIVIDUALS WITH ACQUIRED BRAIN INJURY, IN CLASS 41 (U.S. CLS. 100, 101 AND 107).

FIRST USE 1-1-1985; IN COMMERCE 1-1-1985.

FOR: FLEXIBLE INTERACTIVE ADULT DAY CARE SERVICES FOR INDIVIDUALS WITH ACQUIRED BRAIN INJURY, IN CLASS 43 (U.S. CLS. 100 AND 101).

FIRST USE 1-1-1985; IN COMMERCE 1-1-1985.

FOR: HEALTHCARE SERVICES, NAMELY, REHABILITATION OF INDIVIDUALS WITH ACQUIRED BRAIN INJURY; COMPREHENSIVE MEDICAL AND PHYSICAL EVALUATION OF INDIVIDUALS WITH ACQUIRED BRAIN INJURY; FORMULATING MEDICAL TREATMENT PLANS FOR INDIVIDUALS WITH ACQUIRED BRAIN INJURY; CUSTOMIZED POST-ACUTE MEDICAL AND PHYSICAL REHABILITATION AND TREATMENT OF INDIVIDUALS WITH ACQUIRED BRAIN INJURY; INTENSIVE SHORT- AND LONG-TERM

NEUROBEHAVIORAL REHABILITATION AND TREATMENT OF INDIVIDUALS WITH ACQUIRED BRAIN INJURY; SHORT- AND LONG-TERM OUTPATIENT MEDICAL AND PHYSICAL REHABILITATION OF INDIVIDUALS WITH ACQUIRED BRAIN INJURY, IN CLASS 44 (U.S. CLS. 100 AND 101).

FIRST USE 1-1-1985; IN COMMERCE 1-1-1985.

FOR: CASE MANAGEMENT SERVICES, NAMELY, THE COORDINATION OF NECESSARY MEDICAL SERVICES, VOCATIONAL ISSUES AND EDUCATIONAL SERVICES TO INDIVIDUALS WITH ACQUIRED BRAIN INJURY, IN CLASS 45 (U.S. CLS. 100 AND 101).

FIRST USE 1-1-1985; IN COMMERCE 1-1-1985.

THE MARK CONSISTS OF STANDARD CHARACTERS WITHOUT CLAIM TO ANY PARTICULAR FONT, STYLE, SIZE, OR COLOR.

OWNER OF U.S. REG. NOS. 1,703,919 AND 2,463,204.

SER. NO. 77-233,714, FILED 7-19-2007.

MATTHEW PAPPAS, EXAMINING ATTORNEY

**Int. Cls.: 41, 43, 44 and 45**

**Prior U.S. Cls.: 100, 101 and 107**

**United States Patent and Trademark Office**

**Reg. No. 3,466,021**

**Registered July 15, 2008**

**SERVICE MARK  
PRINCIPAL REGISTER**

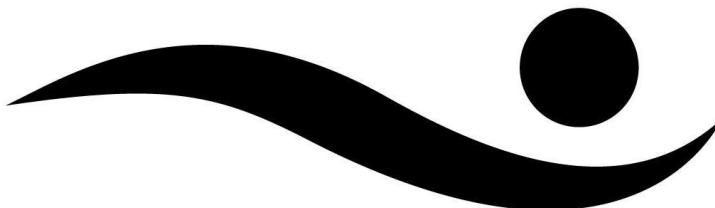

REMED RECOVERY CARE CENTERS, LLC  
(PENNSYLVANIA LTD LIAB CO)  
16 INDUSTRIAL BLVD, SUITE 203  
PAOLI, PA 19301

FOR: VOCATIONAL TRAINING REHABILITATION SERVICES FOR INDIVIDUALS WITH ACQUIRED BRAIN INJURY, IN CLASS 41 (U.S. CLS. 100, 101 AND 107).

FIRST USE 10-1-2007; IN COMMERCE 10-1-2007.

FOR: FLEXIBLE INTERACTIVE ADULT DAY CARE SERVICES FOR INDIVIDUALS WITH ACQUIRED BRAIN INJURY, IN CLASS 43 (U.S. CLS. 100 AND 101).

FIRST USE 10-1-2007; IN COMMERCE 10-1-2007.

FOR: HEALTHCARE SERVICES, NAMELY, REHABILITATION OF INDIVIDUALS WITH ACQUIRED BRAIN INJURY; COMPREHENSIVE MEDICAL AND PHYSICAL EVALUATION OF INDIVIDUALS WITH ACQUIRED BRAIN INJURY; FORMULATING MEDICAL TREATMENT PLANS FOR INDIVIDUALS WITH ACQUIRED BRAIN INJURY; CUSTOMIZED POST-ACUTE MEDICAL

AND PHYSICAL REHABILITATION AND TREATMENT OF INDIVIDUALS WITH ACQUIRED BRAIN INJURY; INTENSIVE SHORT- AND LONG-TERM NEUROBEHAVIORAL REHABILITATION AND TREATMENT OF INDIVIDUALS WITH ACQUIRED BRAIN INJURY; SHORT- AND LONG-TERM OUTPATIENT MEDICAL AND PHYSICAL REHABILITATION OF INDIVIDUALS WITH ACQUIRED BRAIN INJURY, IN CLASS 44 (U.S. CLS. 100 AND 101).

FIRST USE 10-1-2007; IN COMMERCE 10-1-2007.

FOR: CASE MANAGEMENT SERVICES, NAMELY, THE COORDINATION OF NECESSARY MEDICAL SERVICES, VOCATIONAL ISSUES AND EDUCATIONAL SERVICES TO INDIVIDUALS WITH ACQUIRED BRAIN INJURY, IN CLASS 45 (U.S. CLS. 100 AND 101).

FIRST USE 10-1-2007; IN COMMERCE 10-1-2007.

SER. NO. 77-233,721, FILED 7-19-2007.

MATTHEW PAPPAS, EXAMINING ATTORNEY



Int. Cl.: 30

Prior U.S. Cl.: 46

United States Patent and Trademark Office

Reg. No. 3,466,022

Registered July 15, 2008

TRADEMARK  
PRINCIPAL REGISTER



YANAKOPULOS, NIKITA (UNITED STATES IN-  
DIVIDUAL)

165 MAIN ST.

MEDFORD, MA 02155

FOR: PIZZA, IN CLASS 30 (U.S. CL. 46).

FIRST USE 11-17-2004; IN COMMERCE 11-17-2004.

NO CLAIM IS MADE TO THE EXCLUSIVE  
RIGHT TO USE "FAMOUS PIZZA", APART FROM  
THE MARK AS SHOWN.

THE MARK CONSISTS OF THE WORD "PINKY'S  
FAMOUS PIZZA" ON A RECTANGULAR SIGN.

SER. NO. 77-234,061, FILED 7-19-2007.

JANET LEE, EXAMINING ATTORNEY

**Int. Cl.: 25**

**Prior U.S. Cls.: 22 and 39**

**United States Patent and Trademark Office**

**Reg. No. 3,466,023**

**Registered July 15, 2008**

**TRADEMARK  
PRINCIPAL REGISTER**

**C FOR YOU**

CERTIFIED/BRANCHING HABIT INC. (WA-  
SHINGTON CORPORATION)  
8821 RENTON AVE. S.  
SEATTLE, WA 98118

THE MARK CONSISTS OF STANDARD CHAR-  
ACTERS WITHOUT CLAIM TO ANY PARTICULAR  
FONT, STYLE, SIZE, OR COLOR.

FOR: PANTS; JEANS, IN CLASS 25 (U.S. CLS. 22  
AND 39).

SER. NO. 77-234,222, FILED 7-19-2007.

FIRST USE 6-21-2007; IN COMMERCE 6-21-2007.

JENNIFER VASQUEZ, EXAMINING ATTORNEY

**Int. Cl.: 18**

**Prior U.S. Cls.: 1, 2, 3, 22 and 41**

**United States Patent and Trademark Office**

**Reg. No. 3,466,024**

**Registered July 15, 2008**

**TRADEMARK  
PRINCIPAL REGISTER**



SIMPLYSHE, INC. (DELAWARE CORPORATION)  
1020 KEARNY STREET  
SAN FRANCISCO, CA 94133

FOR: CLOTHING FOR DOMESTIC PETS; COLLARS FOR PETS; COLLARS FOR PETS BEARING MEDICAL INFORMATION; DISPOSABLE PET DIAPERS; ELECTRONIC PET COLLARS; GARMENTS FOR PETS; PET ACCESSORIES, NAMELY, CANVAS, VINYL AND LEATHER POUCHES FOR HOLDING DISPOSABLE BAGS TO PLACE PET WASTE IN; PET CLOTHING; PET COLLAR ACCESSORIES, NAMELY, BOWS AND CHARMS; PET PRODUCTS IN THE NATURE OF A RESTRAINING DEVICE, NAMELY, TIE-OUT STAKES AND TIE-OUT CHAINS, IN CLASS 18 (U.S. CLS. 1, 2, 3, 22 AND 41).

FIRST USE 1-1-2007; IN COMMERCE 2-1-2007.

THE LINING IS A FEATURE OF THE MARK AND DOES NOT INDICATE COLOR.

THE MARK CONSISTS OF A LITERAL ELEMENT "MM" AND "MAX-A-MILLION" AND DESIGN ELEMENT COMPRISING A DOG. THE LETTERS "MM" ARE STYLIZED, AND PLACED UNDERNEATH A CROWN, BOTH SET AGAINST A BACKGROUND IN THE SHAPE OF A DOG WITH A BORDER. THE WORD "MAX-A-MILLION" IS PLACED BENEATH THE DOG. ALL THE FOREGOING ELEMENTS ARE SET AGAINST A BACKGROUND WITH VERTICAL STRIPES, IN THE SHAPE OF A RECTANGLE.

SER. NO. 77-234,339, FILED 7-20-2007.

WANDA KAY PRICE, EXAMINING ATTORNEY

**Int. Cl.: 5**

**Prior U.S. Cls.: 6, 18, 44, 46, 51 and 52**

**United States Patent and Trademark Office**

**Reg. No. 3,466,025**

**Registered July 15, 2008**

**TRADEMARK  
PRINCIPAL REGISTER**

# Future Formulations

MINE MIND (ARIZONA LTD LIAB CO)  
6558 E COOPER STREET  
TUCSON, AZ 85710

FOR: ANIMAL FEED ADDITIVE FOR USE AS A NUTRITIONAL SUPPLEMENT FOR MEDICAL PURPOSES; ANIMAL FEED SUPPLEMENTS; CALCIUM SUPPLEMENTS; DIETARY AND NUTRITIONAL SUPPLEMENTS; DIETARY DRINK MIX FOR USE AS A MEAL REPLACEMENT; DIETARY FIBER AS AN ADDITIVE FOR FOOD PRODUCTS; DIETARY FOOD SUPPLEMENTS; DIETARY SUPPLEMENTAL DRINKS; DIETARY SUPPLEMENTS; DIETARY SUPPLEMENTS FOR ANIMALS; DIETARY SUPPLEMENTS FOR HUMAN CONSUMPTION; FEED SUPPLEMENTS FOR CATS, DOGS AND HOUSEHOLD PETS; FOOD SUPPLEMENTS; FOOD SUPPLEMENTS, NAMELY, ANTI-OXIDANTS; HERBAL SUPPLEMENTS; HOMEOPATHIC SUPPLEMENTS; MEAL REPLACEMENT AND DIETARY SUPPLEMENT DRINK MIXES; MINERAL NUTRITIONAL SUPPLEMENTS; MINERAL SUPPLEMENTS; NUTRACEUTICALS FOR USE AS A DIETARY SUPPLEMENT; NUTRITIONAL ADDITIVES FOR MEDICAL PURPOSES FOR USE IN FOODS AND DIETARY SUPPLEMENTS FOR HU-

MAN CONSUMPTION; NUTRITIONAL SUPPLEMENTS; NUTRITIONAL SUPPLEMENTS IN LOTION FORM SOLD AS A COMPONENT OF NUTRITIONAL SKIN CARE PRODUCTS; POWDERED FRUIT-FLAVORED DIETARY SUPPLEMENT DRINK MIX; POWDERED NUTRITIONAL SUPPLEMENT DRINK MIX; VITAMIN AND MINERAL SUPPLEMENTS; VITAMIN SUPPLEMENT IN TABLET FORM FOR USE IN MAKING AN EFFERVESCENT BEVERAGE WHEN ADDED TO WATER; VITAMIN SUPPLEMENTS, IN CLASS 5 (U.S. CLS. 6, 18, 44, 46, 51 AND 52).

FIRST USE 2-27-1992; IN COMMERCE 2-27-1992.

THE MARK CONSISTS OF STANDARD CHARACTERS WITHOUT CLAIM TO ANY PARTICULAR FONT, STYLE, SIZE, OR COLOR.

NO CLAIM IS MADE TO THE EXCLUSIVE RIGHT TO USE "FORMULATIONS", APART FROM THE MARK AS SHOWN.

SER. NO. 77-234,537, FILED 7-20-2007.

SHANNON TWOHIG, EXAMINING ATTORNEY

Int. Cl.: 28

Prior U.S. Cls.: 22, 23, 38 and 50

United States Patent and Trademark Office

Reg. No. 3,466,026

Registered July 15, 2008

TRADEMARK  
PRINCIPAL REGISTER

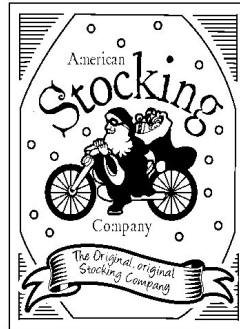

EXPANSION, LLC (TEXAS LTD LIAB CO)  
2023 WILBUR  
DALLAS, TX 75224

FOR: CHRISTMAS STOCKINGS, IN CLASS 28  
(U.S. CLS. 22, 23, 38 AND 50).

FIRST USE 1-2-2007; IN COMMERCE 6-7-2007.

NO CLAIM IS MADE TO THE EXCLUSIVE  
RIGHT TO USE "AMERICAN STOCKING COMPA-  
NY" AND "THE ORIGINAL, ORIGINAL STOCKING

COMPANY", APART FROM THE MARK AS  
SHOWN.

THE MARK CONSISTS OF A SANTA ON A  
BICYCLE WITH A GIANT CHRISTMAS STOCKING  
ON HIS SHOULDER WITH THE WORDS "AMER-  
ICAN STOCKING COMPANY" AND "THE ORIGI-  
NAL, ORIGINAL STOCKING COMPANY" IN A  
STYLIZED TEXT.

SER. NO. 77-234,588, FILED 7-20-2007.

LINDA M. KING, EXAMINING ATTORNEY

**Int. Cl.: 16**

**Prior U.S. Cls.: 2, 5, 22, 23, 29, 37, 38 and 50**

**United States Patent and Trademark Office**

**Reg. No. 3,466,027**

**Registered July 15, 2008**

**TRADEMARK  
PRINCIPAL REGISTER**

**FLO**

S.D. WARREN COMPANY (PENNSYLVANIA  
CORPORATION)  
225 FRANKLIN STREET  
BOSTON, MA 021102804

FOR: PRINTING PAPER, IN CLASS 16 (U.S. CLS. 2,  
5, 22, 23, 29, 37, 38 AND 50).

FIRST USE 5-11-2007; IN COMMERCE 5-11-2007.

THE MARK CONSISTS OF STANDARD CHAR-  
ACTERS WITHOUT CLAIM TO ANY PARTICULAR  
FONT, STYLE, SIZE, OR COLOR.

SER. NO. 77-234,756, FILED 7-20-2007.

AMOS T. MATTHEWS, JR., EXAMINING ATTOR-  
NEY

**Int. Cl.: 40**

**Prior U.S. Cls.: 100, 103 and 106**

**United States Patent and Trademark Office**

**Reg. No. 3,466,028**

**Registered July 15, 2008**

**SERVICE MARK  
PRINCIPAL REGISTER**

**Explo-Dynamics**

EXPLO-DYNAMICS, LLC. (KENTUCKY LTD  
LIAB CO)  
WWW.EXPLO-DYNAMICS.COM  
330 LITTLEFOOT LANE  
MADISONVILLE, KY 42431

THE MARK CONSISTS OF STANDARD CHAR-  
ACTERS WITHOUT CLAIM TO ANY PARTICULAR  
FONT, STYLE, SIZE, OR COLOR.

FOR: GENERATION OF ENERGY, IN CLASS 40  
(U.S. CLS. 100, 103 AND 106).

SER. NO. 77-235,420, FILED 7-21-2007.

FIRST USE 7-12-2006; IN COMMERCE 7-31-2006.

DOMINICK J. SALEMI, EXAMINING ATTORNEY

Int. Cl.: 43

Prior U.S. Cls.: 100 and 101

United States Patent and Trademark Office

Reg. No. 3,466,029

Registered July 15, 2008

SERVICE MARK  
PRINCIPAL REGISTER



PHILLY GIRL, LLC (COLORADO LTD LIAB CO)  
7243 S. YARROW WAY LITTLETON  
LITTLETON, CO 80128

FOR: RESTAURANT SERVICES, IN CLASS 43  
(U.S. CLS. 100 AND 101).

FIRST USE 7-9-2007; IN COMMERCE 7-9-2007.

NO CLAIM IS MADE TO THE EXCLUSIVE  
RIGHT TO USE "PHILLY'S CHEESESTEAK GRILL",  
APART FROM THE MARK AS SHOWN.

THE MARK CONSISTS OF ONE OVAL WITH 13  
STARS AND THE WORDS "CHEESESTEAK GRILL".  
"CHEESESTEAK GRILL" IS CENTERED AT THE  
BOTTOM OF THE OVAL. THERE IS ANOTHER  
SMALLER OVAL INSIDE THE OUTER OVAL WITH  
THE WORD "PHILLY'S". THE DOT OVER THE "I"  
IN "PHILLY'S" IS A SOLID STAR.

SER. NO. 77-236,547, FILED 7-23-2007.

WENDY JUN, EXAMINING ATTORNEY



**Int. Cl.: 31**

**Prior U.S. Cls.: 1 and 46**

**United States Patent and Trademark Office**

**Reg. No. 3,466,030**

**Registered July 15, 2008**

**TRADEMARK  
PRINCIPAL REGISTER**

**ECO APPLES**

RED TOMATO, INC. (MASSACHUSETTS NON-  
PROFIT CORPORATION)

1033 TURNPIKE STREET

CANTON, MA 02021

FOR: FRESH FRUITS AND FRESH VEGETA-  
BLES, IN CLASS 31 (U.S. CLS. 1 AND 46).

FIRST USE 12-31-2004; IN COMMERCE 12-31-2004.

THE MARK CONSISTS OF STANDARD CHAR-  
ACTERS WITHOUT CLAIM TO ANY PARTICULAR  
FONT, STYLE, SIZE, OR COLOR.

NO CLAIM IS MADE TO THE EXCLUSIVE  
RIGHT TO USE "APPLES", APART FROM THE  
MARK AS SHOWN.

SER. NO. 77-236,805, FILED 7-24-2007.

MICHAEL KEATING, EXAMINING ATTORNEY

**Int. Cl.: 35**

**Prior U.S. Cls.: 100, 101 and 102**

**United States Patent and Trademark Office**

**Reg. No. 3,466,031**

**Registered July 15, 2008**

**SERVICE MARK  
PRINCIPAL REGISTER**

**ECO APPLES**

RED TOMATO, INC. (MASSACHUSETTS NON-  
PROFIT CORPORATION)  
1033 TURNPIKE STREET  
CANTON, MA 02021

FOR: CONSULTING REGARDING THE MAR-  
KETING OF AGRICULTURAL PRODUCTS; ASSIST-  
ING OTHERS WITH THE MARKETING OF  
AGRICULTURAL PRODUCTS; ADVERTISING  
SERVICES, NAMELY, PROVIDING OTHERS WITH  
PROMOTIONAL MATERIALS FOR AGRICULTUR-  
AL PRODUCTS, IN CLASS 35 (U.S. CLS. 100, 101 AND  
102).

FIRST USE 12-31-2004; IN COMMERCE 12-31-2004.

THE MARK CONSISTS OF STANDARD CHAR-  
ACTERS WITHOUT CLAIM TO ANY PARTICULAR  
FONT, STYLE, SIZE, OR COLOR.

NO CLAIM IS MADE TO THE EXCLUSIVE  
RIGHT TO USE "APPLES", APART FROM THE  
MARK AS SHOWN.

SER. NO. 77-236,807, FILED 7-24-2007.

MICHAEL KEATING, EXAMINING ATTORNEY

**Int. Cl.: 36**

**Prior U.S. Cls.: 100, 101 and 102**

**United States Patent and Trademark Office**

**Reg. No. 3,466,032**

**Registered July 15, 2008**

**SERVICE MARK  
PRINCIPAL REGISTER**



PAUL CAPITAL ADVISORS, LLC (DELAWARE  
LTD LIAB CO)  
50 CALIFORNIA STREET  
SAN FRANCISCO, CA 94111

FOR: FINANCIAL SERVICES, NAMELY, PRIVATE EQUITY CAPITAL INVESTMENT MANAGEMENT AND ADVISORY SERVICES, IN CLASS 36 (U.S. CLS. 100, 101 AND 102).

FIRST USE 11-0-1990; IN COMMERCE 2-0-1991.

THE MARK CONSISTS OF TWO COLUMNS SUPPORTING AN ARCH, WITH HALF AN ARCHED OPENING APPEARING BEHIND THE COLUMN ON THE LEFT, ALL CONTAINED WITHIN A SQUARE.

SER. NO. 77-236,905, FILED 7-24-2007.

CHRISTOPHER BUONGIORNO, EXAMINING ATTORNEY

**Int. Cl.: 36**

**Prior U.S. Cls.: 100, 101 and 102**

**United States Patent and Trademark Office**

**Reg. No. 3,466,033**

**Registered July 15, 2008**

**SERVICE MARK  
PRINCIPAL REGISTER**

**PAUL CAPITAL PARTNERS**

PAUL CAPITAL ADVISORS, LLC (DELAWARE  
LTD LIAB CO)  
50 CALIFORNIA STREET  
SAN FRANCISCO, CA 94111

FOR: FINANCIAL SERVICES, NAMELY, PRIVATE EQUITY CAPITAL INVESTMENT MANAGEMENT AND ADVISORY SERVICES, IN CLASS 36 (U.S. CLS. 100, 101 AND 102).

FIRST USE 11-0-1990; IN COMMERCE 2-0-1991.

THE MARK CONSISTS OF STANDARD CHARACTERS WITHOUT CLAIM TO ANY PARTICULAR FONT, STYLE, SIZE, OR COLOR.

NO CLAIM IS MADE TO THE EXCLUSIVE RIGHT TO USE "CAPITAL PARTNERS", APART FROM THE MARK AS SHOWN.

SER. NO. 77-236,910, FILED 7-24-2007.

CHRISTOPHER BUONGIORNO, EXAMINING ATTORNEY

**Int. Cl.: 33**

**Prior U.S. Cls.: 47 and 49**

**United States Patent and Trademark Office**

**Reg. No. 3,466,034**

**Registered July 15, 2008**

**TRADEMARK  
PRINCIPAL REGISTER**

**Dungeness**

LIGHTNING RIDGE INVESTMENTS LLC, DBA  
OLYMPIC CELLARS WINERY AND OLYMPIC  
CELLARS (NEVADA LTD LIAB CO)  
255410 HIGHWAY 101  
PORT ANGELES, WA 98362

FOR: WINES, IN CLASS 33 (U.S. CLS. 47 AND 49).

FIRST USE 12-1-1981; IN COMMERCE 12-1-1981.

THE MARK CONSISTS OF STANDARD CHAR-  
ACTERS WITHOUT CLAIM TO ANY PARTICULAR  
FONT, STYLE, SIZE, OR COLOR.

SEC. 2(F).

SER. NO. 77-237,225, FILED 7-24-2007.

MARK SPARACINO, EXAMINING ATTORNEY

**Int. Cls.: 35 and 36**

**Prior U.S. Cls.: 100, 101 and 102**

**United States Patent and Trademark Office**

**Reg. No. 3,466,035**

**Registered July 15, 2008**

**SERVICE MARK  
PRINCIPAL REGISTER**

**PACIFIC BRIDGE**

THE PACIFIC BRIDGE COMPANIES, INC. (NE-  
VADA CORPORATION)  
825 SOUTH PRIMROSE AVENUE, SUITE C  
MONROVIA, CA 91016

FOR: INSURANCE CLAIMS AUDITING SERVI-  
CES; INVESTMENT ADVICE SERVICES; BUSINESS  
RISK MANAGEMENT SERVICES, IN CLASS 35 (U.S.  
CLS. 100, 101 AND 102).

FIRST USE 12-31-1997; IN COMMERCE 4-9-2004.

FOR: INVESTMENT ADVISORY SERVICES; FI-  
NANCIAL AND ESTATE PLANNING; LIFE INSUR-

ANCE BROKERAGE AND UNDERWRITING  
SERVICES, IN CLASS 36 (U.S. CLS. 100, 101 AND 102).

FIRST USE 12-31-1997; IN COMMERCE 4-9-2004.

THE MARK CONSISTS OF STANDARD CHAR-  
ACTERS WITHOUT CLAIM TO ANY PARTICULAR  
FONT, STYLE, SIZE, OR COLOR.

SER. NO. 77-237,239, FILED 7-24-2007.

KAREN K. BUSH, EXAMINING ATTORNEY

**Int. Cl.: 36**

**Prior U.S. Cls.: 100, 101 and 102**

**United States Patent and Trademark Office**

**Reg. No. 3,466,036**

**Registered July 15, 2008**

**SERVICE MARK  
PRINCIPAL REGISTER**

**KISS YOUR BRANCH GOODBYE**

PENNSYLVANIA STATE EMPLOYEES CREDIT  
UNION (PENNSYLVANIA CORPORATION)  
ONE CREDIT UNION PLACE  
HARRISBURG, PA 17110

THE MARK CONSISTS OF STANDARD CHAR-  
ACTERS WITHOUT CLAIM TO ANY PARTICULAR  
FONT, STYLE, SIZE, OR COLOR.

FOR: CREDIT UNIONS, IN CLASS 36 (U.S. CLS.  
100, 101 AND 102).

SER. NO. 77-237,335, FILED 7-24-2007.

FIRST USE 2-1-2007; IN COMMERCE 2-1-2007.

THOMAS MANOR, EXAMINING ATTORNEY

**Int. Cl.: 9**

**Prior U.S. Cls.: 21, 23, 26, 36 and 38**

**United States Patent and Trademark Office**

**Reg. No. 3,466,037**

**Registered July 15, 2008**

---

**TRADEMARK  
PRINCIPAL REGISTER**

**SONG**

JIAYI.SONG, JOHNNY (UNITED STATES INDIVIDUAL)  
104-45 43RD AVE  
CORONA, NY 11368

FIRST USE 5-1-2007; IN COMMERCE 5-1-2007.

SER. NO. 77-237,725, FILED 7-24-2007.

FOR: CARRYING CASES FOR CELL PHONES AND PORTABLE MUSIC PLAYERS, NAMELY, MP3 PLAYERS, IN CLASS 9 (U.S. CLS. 21, 23, 26, 36 AND 38).

TIMOTHY FINNEGAN, EXAMINING ATTORNEY



**Int. Cl.: 9**

**Prior U.S. Cls.: 21, 23, 26, 36 and 38**

**Reg. No. 3,466,038**

**United States Patent and Trademark Office**

**Registered July 15, 2008**

---

**TRADEMARK  
PRINCIPAL REGISTER**

**LifeOnRecord**

EL GHATIT, ALAA A (UNITED STATES INDIVIDUAL), DBA LIFEONRECORD  
1509 OLD BARN CIRCLE  
LIBERTYVILLE, IL 60048

FOR: AUDIO AND VIDEO RECORDINGS FEATURING THE VOICES AND/OR IMAGES OF PEOPLE CONTRIBUTING TO INDIVIDUAL AND EVENT-BASED JOURNALS AND DIARIES , IN CLASS 9 (U.S. CLS. 21, 23, 26, 36 AND 38).

FIRST USE 3-12-2006; IN COMMERCE 11-17-2006.

THE MARK CONSISTS OF STANDARD CHARACTERS WITHOUT CLAIM TO ANY PARTICULAR FONT, STYLE, SIZE, OR COLOR.

SER. NO. 77-237,834, FILED 7-24-2007.

KELLEY WELLS, EXAMINING ATTORNEY

**Int. Cl.: 25**

**Prior U.S. Cls.: 22 and 39**

**United States Patent and Trademark Office**

**Reg. No. 3,466,039**

**Registered July 15, 2008**

**TRADEMARK  
PRINCIPAL REGISTER**

**DANCLOG**

EURO-DAN SKO A/S (DENMARK CORPORATION)  
KROGSAGERVEJ 50  
7000 FREDERICIA, DENMARK

FOR: SHOES AND FOOTWEAR, IN CLASS 25 (U.S. CLS. 22 AND 39).

THE MARK CONSISTS OF STANDARD CHARACTERS WITHOUT CLAIM TO ANY PARTICULAR FONT, STYLE, SIZE, OR COLOR.

OWNER OF DENMARK REG. NO. VR199301135,  
DATED 2-5-1993, EXPIRES 2-5-2013.

"DANCLOG" APPEARING IN THE MARK HAS  
NO MEANING IN A FOREIGN LANGUAGE.

SER. NO. 77-237,963, FILED 7-25-2007.

MICHAEL WIENER, EXAMINING ATTORNEY

**Int. Cl.: 41**

**Prior U.S. Cls.: 100, 101 and 107**

**United States Patent and Trademark Office**

**Reg. No. 3,466,040**

**Registered July 15, 2008**

**SERVICE MARK  
PRINCIPAL REGISTER**

**GRAMMAR GRATER**

MINNESOTA PUBLIC RADIO (MINNESOTA  
NON-PROFIT CORPORATION)  
480 CEDAR STREET  
ST. PAUL, MN 55101

FOR: INTERNET RADIO SERVICES, NAMELY,  
PROVIDING PODCASTS IN THE FIELD OF ENGLISH  
WORDS, GRAMMAR AND USAGE; PROVIDING  
INFORMATION ABOUT ENGLISH WORDS,  
GRAMMAR AND USAGE FOR DOWNLOADING  
TO COMPUTERS, PORTABLE MEDIA PLAYERS,  
TELEPHONES, CELLULAR TELEPHONES, PERSONAL  
DIGITAL ASSISTANTS, RADIOS, MINI DISC  
PLAYERS AND MP3 PLAYERS, IN CLASS 41 (U.S.  
CLS. 100, 101 AND 107).

FIRST USE 7-23-2007; IN COMMERCE 7-23-2007.

THE MARK CONSISTS OF STANDARD CHARACTERS  
WITHOUT CLAIM TO ANY PARTICULAR FONT,  
STYLE, SIZE, OR COLOR.

NO CLAIM IS MADE TO THE EXCLUSIVE  
RIGHT TO USE "GRAMMAR", APART FROM THE  
MARK AS SHOWN.

SER. NO. 77-238,018, FILED 7-25-2007.

DOMINICK J. SALEMI, EXAMINING ATTORNEY

**Int. Cls.: 41 and 42**

**Prior U.S. Cls.: 100, 101 and 107**

**United States Patent and Trademark Office**

**Reg. No. 3,466,041**

**Registered July 15, 2008**

**SERVICE MARK  
PRINCIPAL REGISTER**

DESIGNED BY CAR PEOPLE FOR  
CAR PEOPLE

AUTO/MATE, INC. (NEW YORK CORPORATION)  
4 CORPORATE DRIVE  
CLIFTON PARK, NY 12065

FOR: TRAINING IN THE USE AND OPERATION  
OF COMPUTER PROGRAMS AND SYSTEMS FOR  
AUTOMOBILE DEALERSHIPS, IN CLASS 41 (U.S.  
CLS. 100, 101 AND 107).

FIRST USE 1-30-2007; IN COMMERCE 1-30-2007.

FOR: DEVELOPMENT OF COMPUTER PRO-  
GRAMS AND COMPUTER SYSTEMS FOR AUTO-  
MOBILE DEALERSHIPS AND TECHNICAL

SUPPORT THEREFORE, NAMELY, TROUBLE-  
SHOOTING OF COMPUTER HARDWARE AND  
SOFTWARE PROBLEMS, IN CLASS 42 (U.S. CLS.  
100 AND 101).

FIRST USE 1-30-2007; IN COMMERCE 1-30-2007.

THE MARK CONSISTS OF STANDARD CHAR-  
ACTERS WITHOUT CLAIM TO ANY PARTICULAR  
FONT, STYLE, SIZE, OR COLOR.

SER. NO. 77-238,105, FILED 7-25-2007.

BRIAN CALLAGHAN, EXAMINING ATTORNEY

**Int. Cl.: 9**

**Prior U.S. Cls.: 21, 23, 26, 36 and 38**

**United States Patent and Trademark Office**

**Reg. No. 3,466,042**

**Registered July 15, 2008**

**TRADEMARK  
PRINCIPAL REGISTER**

**SEE AND HEAR. LOUD AND  
CLEAR.**

THOMSON (FRANCE SOCIETE ANONYME)  
46 QUAI ALPHONSE LE GALLO  
BOULOGNE-BILLANCOURT, FRANCE 92100

FOR: TELEPHONES; DIGITAL PHONES; MOBILE  
TELEPHONES, IN CLASS 9 (U.S. CLS. 21, 23, 26, 36  
AND 38).

THE MARK CONSISTS OF STANDARD CHAR-  
ACTERS WITHOUT CLAIM TO ANY PARTICULAR  
FONT, STYLE, SIZE, OR COLOR.

PRIORITY CLAIMED UNDER SEC. 44(D) ON  
FRANCE APPLICATION NO. 07/3487858, FILED 3-  
12-2007, REG. NO. 07/3487858, DATED 3-12-2007,  
EXPIRES 3-12-2017.

SER. NO. 77-238,140, FILED 7-25-2007.

DANNEAN HETZEL, EXAMINING ATTORNEY

**Int. Cl.: 43**

**Prior U.S. Cls.: 100 and 101**

**United States Patent and Trademark Office**

**Reg. No. 3,466,043**

**Registered July 15, 2008**

**SERVICE MARK  
PRINCIPAL REGISTER**



FLIRT PRODUCTIONS INCORPORATED (NEW JERSEY CORPORATION)  
140 WEST ALLENDALE AVENUE  
ALLENDALE, NJ 07401

FOR: RESTAURANTS; SUSHI LOUNGE SERVICES; TAKE-OUT RESTAURANT SERVICES, IN CLASS 43 (U.S. CLS. 100 AND 101).

FIRST USE 6-30-2002; IN COMMERCE 6-30-2002.

OWNER OF U.S. REG. NO. 3,098,055.

NO CLAIM IS MADE TO THE EXCLUSIVE RIGHT TO USE "SUSHI LOUNGE", APART FROM THE MARK AS SHOWN.

THE COLOR(S) RED, WHITE AND BLACK IS/ ARE CLAIMED AS A FEATURE OF THE MARK.

THE MARK CONSISTS OF THE WORD "FLIRT" STYLIZED PLACED ABOVE THE WORDS "SUSHI LOUNGE" WITH BLACK CHOP STICKS BENEATH THE WORDS, ALL WITHIN A RED CIRCLE WITH A WHITE CONCENTRIC OUTER RIM. THE COLOR BLACK APPEARS IN THE WORDING "FLIRT SUSHI LOUNGE" AND IN THE CHOPSTICKS DESIGN. THE COLOR RED APPEARS IN THE BACKGROUND OF THE CIRCLE DESIGN. THE COLOR WHITE APPEARS IN THE CONCENTRIC OUTER RIM OF THE CIRCLE DESIGN.

SER. NO. 77-238,143, FILED 7-25-2007.

SETH A. RAPPAPORT, EXAMINING ATTORNEY

**Int. Cl.: 12**

**Prior U.S. Cls.: 19, 21, 23, 31, 35 and 44**

**Reg. No. 3,466,044**

**United States Patent and Trademark Office**

**Registered July 15, 2008**

---

**TRADEMARK  
PRINCIPAL REGISTER**

**RGATOR**

DEERE & COMPANY (DELAWARE CORPORATION)  
TRADEMARK LAW GROUP  
ONE JOHN DEERE PLACE  
MOLINE, IL 61265

FOR: ALL-TERRAIN VEHICLES, IN CLASS 12  
(U.S. CLS. 19, 21, 23, 31, 35 AND 44).

FIRST USE 8-15-2005; IN COMMERCE 8-15-2005.

THE MARK CONSISTS OF STANDARD CHARACTERS WITHOUT CLAIM TO ANY PARTICULAR FONT, STYLE, SIZE, OR COLOR.

OWNER OF U.S. REG. NOS. 1,798,626 AND 2,853,350.

SER. NO. 77-238,472, FILED 7-25-2007.

JOHN KELLY, EXAMINING ATTORNEY

**Int. Cl.: 41**

**Prior U.S. Cls.: 100, 101 and 107**

**United States Patent and Trademark Office**

**Reg. No. 3,466,045**

**Registered July 15, 2008**

**SERVICE MARK  
PRINCIPAL REGISTER**

**Hostess with the Mostess**

HOSTESS WITH THE MOSTESS, INC. (CALIFORNIA CORPORATION)  
11624 CANDY ROSE WAY  
SAN DIEGO, CA 92131

FOR: PROVIDING A WEBSITE THAT FEATURES INFORMAL INSTRUCTION ON SOCIAL ENTERTAINING AND PARTY PLANNING, IN CLASS 41 (U.S. CLS. 100, 101 AND 107).

FIRST USE 4-26-2006; IN COMMERCE 4-26-2006.

THE MARK CONSISTS OF STANDARD CHARACTERS WITHOUT CLAIM TO ANY PARTICULAR FONT, STYLE, SIZE, OR COLOR.

SER. NO. 77-238,923, FILED 7-25-2007.

VIVIAN MICZNIK FIRST, EXAMINING ATTORNEY



**Int. Cl.: 41**

**Prior U.S. Cls.: 100, 101 and 107**

**United States Patent and Trademark Office**

**Reg. No. 3,466,046**

**Registered July 15, 2008**

**SERVICE MARK  
PRINCIPAL REGISTER**



HISPANO USA, LLC (FLORIDA LTD LIAB CO)  
SUITE 200  
4115 MEDICAL DRIVE  
SAN ANTONIO, TX 78229

FOR: FILM DISTRIBUTION; ENTERTAINMENT SERVICES, NAMELY, PLANNING AND CONDUCTING A SERIES OF FILM FESTIVALS, IN CLASS 41 (U.S. CLS. 100, 101 AND 107).

FIRST USE 12-1-2003; IN COMMERCE 12-1-2003.

OWNER OF U.S. REG. NO. 3,306,778.

NO CLAIM IS MADE TO THE EXCLUSIVE RIGHT TO USE "HISPANO MOVIES", APART FROM THE MARK AS SHOWN.

THE FOREIGN WORDING IN THE MARK TRANSLATES INTO ENGLISH AS "HISPANIC".

SER. NO. 77-239,068, FILED 7-26-2007.

CIMMERIAN COLEMAN, EXAMINING ATTORNEY

**Int. Cls.: 35 and 41**

**Prior U.S. Cls.: 100, 101, 102 and 107**

**United States Patent and Trademark Office**

**Reg. No. 3,466,047**

**Registered July 15, 2008**

**SERVICE MARK  
PRINCIPAL REGISTER**



HISPANO USA, LLC (FLORIDA LTD LIAB CO)  
SUITE 200  
4115 MEDICAL DRIVE  
SAN ANTONIO, TX 78229

FOR: ADVERTISING AND MARKETING, ARRANGING AND CONDUCTING MARKETING PROMOTIONAL EVENTS FOR OTHERS, IN CLASS 35 (U.S. CLS. 100, 101 AND 102).

FIRST USE 12-1-2003; IN COMMERCE 12-1-2003.

FOR: ORGANIZING COMMUNITY FESTIVALS FEATURING A VARIETY OF ACTIVITIES, NAMELY, SPORTING EVENTS, ART EXHIBITIONS, FLEA MARKETS, ETHNIC DANCES AND THE LIKE, IN CLASS 41 (U.S. CLS. 100, 101 AND 107).

FIRST USE 12-1-2003; IN COMMERCE 12-1-2003.

OWNER OF U.S. REG. NO. 3,306,778.

NO CLAIM IS MADE TO THE EXCLUSIVE RIGHT TO USE "HISPANO EVENTS", APART FROM THE MARK AS SHOWN.

THE FOREIGN WORDING IN THE MARK TRANSLATES INTO ENGLISH AS "HISPANIC".

SER. NO. 77-239,070, FILED 7-26-2007.

CIMMERIAN COLEMAN, EXAMINING ATTORNEY

Int. Cls.: 35 and 41

Prior U.S. Cls.: 100, 101, 102 and 107

United States Patent and Trademark Office

Reg. No. 3,466,048

Registered July 15, 2008

SERVICE MARK  
PRINCIPAL REGISTER



HISPANO USA, LLC (FLORIDA LTD LIAB CO)  
SUITE 200  
4115 MEDICAL DRIVE  
SAN ANTONIO, TX 78229

FOR: ADVERTISING AND BUSINESS MANAGEMENT CONSULTANCY, IN CLASS 35 (U.S. CLS. 100, 101 AND 102).

FIRST USE 12-1-2003; IN COMMERCE 12-1-2003.

FOR: CONDUCTING EXHIBITIONS IN THE NATURE OF TRADITIONAL HISPANIC FAIRS AND MUSIC FESTIVALS, IN CLASS 41 (U.S. CLS. 100, 101 AND 107).

FIRST USE 12-1-2003; IN COMMERCE 12-1-2003.

OWNER OF U.S. REG. NO. 3,306,778.

NO CLAIM IS MADE TO THE EXCLUSIVE RIGHT TO USE "FESTIVAL HISPANO USA", APART FROM THE MARK AS SHOWN.

THE FOREIGN WORDING IN THE MARK TRANSLATES INTO ENGLISH AS "HISPANIC".

SER. NO. 77-239,073, FILED 7-26-2007.

CIMMERIAN COLEMAN, EXAMINING ATTORNEY

**Int. Cl.: 7**

**Prior U.S. Cls.: 13, 19, 21, 23, 31, 34 and 35**

**United States Patent and Trademark Office**

**Reg. No. 3,466,049**

**Registered July 15, 2008**

**TRADEMARK  
PRINCIPAL REGISTER**

**BOAT LIFT U.S.**

BOAT LIFT, U.S., INC. (FLORIDA CORPORATION)  
10290 STRINGFELLOW ROAD  
SAINT JAMES CITY, FL 33956

FOR: POWER-OPERATED BOAT LIFTS, IN CLASS 7 (U.S. CLS. 13, 19, 21, 23, 31, 34 AND 35).

FIRST USE 6-15-1998; IN COMMERCE 6-15-1998.

THE MARK CONSISTS OF STANDARD CHARACTERS WITHOUT CLAIM TO ANY PARTICULAR FONT, STYLE, SIZE, OR COLOR.

NO CLAIM IS MADE TO THE EXCLUSIVE RIGHT TO USE "BOAT LIFT", APART FROM THE MARK AS SHOWN.

SEC. 2(F) AS TO "U.S.".

SER. NO. 77-239,345, FILED 7-26-2007.

CARRIE GENOVESE, EXAMINING ATTORNEY

Int. Cl.: 25

Prior U.S. Cls.: 22 and 39

United States Patent and Trademark Office

Reg. No. 3,466,050

Registered July 15, 2008

TRADEMARK  
PRINCIPAL REGISTER

sandía

WATTS DE TEICHER, CAROL (FED REP GER-  
MANY INDIVIDUAL)  
VOHENSTRAUSSER STR. 68  
92637 WEIDEN, FED REP GERMANY

THE ENGLISH TRANSLATION OF THE WORD  
"SANDIA" IN THE MARK IS WATERMELON.

FOR: SWIM AND BEACH WEAR, IN CLASS 25  
(U.S. CLS. 22 AND 39).

SER. NO. 77-239,553, FILED 7-26-2007.

FIRST USE 12-31-2005; IN COMMERCE 5-31-2007.

LAURA HAMMEL, EXAMINING ATTORNEY

**Int. Cl.: 16**

**Prior U.S. Cls.: 2, 5, 22, 23, 29, 37, 38 and 50**

**Reg. No. 3,466,051**

**United States Patent and Trademark Office**

**Registered July 15, 2008**

**TRADEMARK  
PRINCIPAL REGISTER**

**Talking to the Top Brass**

BOOHER CONSULTANTS, INC. (TEXAS CORPORATION)  
2051 HUGHES ROAD  
GRAPEVINE, TX 76051 AND  
BOOHER, DIANNA (UNITED STATES INDIVIDUAL)  
5208 NORMANDY DRIVE  
COLLEYVILLE, TX 76034

FOR: EDUCATIONAL PUBLICATIONS, NAME-  
LY, EDUCATIONAL LEARNING CARDS, FLASH  
CARDS, ACTIVITY CARDS, WORKBOOKS, TEXT-  
BOOKS, ACTIVITY BOOKS, STORY BOOKS, PUZZLE  
BOOKS, PUZZLES, TEACHER GUIDES,  
MANUALS, POSTERS, EDUCATIONAL CARD

GAMES AND EDUCATIONAL BOOKLETS IN THE  
FIELD OF COMMUNICATION; MANUALS IN THE  
FIELD OF COMMUNICATION, IN CLASS 16 (U.S.  
CLS. 2, 5, 22, 23, 29, 37, 38 AND 50).

FIRST USE 1-15-2007; IN COMMERCE 1-15-2007.

THE MARK CONSISTS OF STANDARD CHAR-  
ACTERS WITHOUT CLAIM TO ANY PARTICULAR  
FONT, STYLE, SIZE, OR COLOR.

SER. NO. 77-239,581, FILED 7-26-2007.

MARK PILARO, EXAMINING ATTORNEY

**Int. Cl.: 5**

**Prior U.S. Cls.: 6, 18, 44, 46, 51 and 52**

**Reg. No. 3,466,052**

**United States Patent and Trademark Office**

**Registered July 15, 2008**

---

**TRADEMARK  
PRINCIPAL REGISTER**

**ARTRIHELP**

NATURAL HEALTH CORPORATION (FLORIDA  
CORPORATION)  
22003 S.W. 100 PLACE  
MIAMI, FL 33190

THE MARK CONSISTS OF STANDARD CHAR-  
ACTERS WITHOUT CLAIM TO ANY PARTICULAR  
FONT, STYLE, SIZE, OR COLOR.

FOR: DIETARY SUPPLEMENT, IN CLASS 5 (U.S.  
CLS. 6, 18, 44, 46, 51 AND 52).

SER. NO. 77-239,673, FILED 7-26-2007.

FIRST USE 4-1-2007; IN COMMERCE 4-1-2007.

ELLEN B. AWRICH, EXAMINING ATTORNEY

**Int. Cl.: 41**

**Prior U.S. Cls.: 100, 101 and 107**

**United States Patent and Trademark Office**

**Reg. No. 3,466,053**

**Registered July 15, 2008**

**SERVICE MARK  
PRINCIPAL REGISTER**

**JET STREAMING**

MINNESOTA PUBLIC RADIO (MINNESOTA  
NON-PROFIT CORPORATION)  
480 CEDAR STREET  
ST. PAUL, MN 55101

FOR: INTERNET RADIO SERVICES, NAMELY,  
PROVIDING PODCASTS IN THE FIELD OF  
WEATHER AND CLIMATOLOGY; PROVIDING IN-  
FORMATION ABOUT WEATHER AND CLIMA-  
TOLOGY FOR DOWNLOADING TO COMPUTERS,  
PORTABLE MEDIA PLAYERS, TELEPHONES, CEL-  
LULAR TELEPHONES, PERSONAL DIGITAL AS-  
SISTANTS, RADIOS, MINI DISC PLAYERS AND

MP3 PLAYERS, IN CLASS 41 (U.S. CLS. 100, 101 AND  
107).

FIRST USE 3-28-2007; IN COMMERCE 3-28-2007.

THE MARK CONSISTS OF STANDARD CHAR-  
ACTERS WITHOUT CLAIM TO ANY PARTICULAR  
FONT, STYLE, SIZE, OR COLOR.

SER. NO. 77-239,767, FILED 7-26-2007.

DOMINICK J. SALEMI, EXAMINING ATTORNEY



**Int. Cl.: 16**

**Prior U.S. Cls.: 2, 5, 22, 23, 29, 37, 38 and 50**

**Reg. No. 3,466,054**

**United States Patent and Trademark Office**

**Registered July 15, 2008**

---

**TRADEMARK  
PRINCIPAL REGISTER**

**KEYS**

CENTER FOR CREATIVE LEADERSHIP (NORTH  
CAROLINA CORPORATION)  
ONE LEADERSHIP PLACE  
GREENSBORO, NC 27410

THE MARK CONSISTS OF STANDARD CHAR-  
ACTERS WITHOUT CLAIM TO ANY PARTICULAR  
FONT, STYLE, SIZE, OR COLOR.

FOR: QUESTIONNAIRE TO EVALUATE AN OR-  
GANIZATION'S WORK ENVIRONMENT FOR STI-  
MULANTS AND OBSTACLES TO CREATIVITY  
THEREIN, IN CLASS 16 (U.S. CLS. 2, 5, 22, 23, 29, 37,  
38 AND 50).

OWNER OF U.S. REG. NO. 2,029,311.

SER. NO. 77-239,812, FILED 7-26-2007.

FIRST USE 7-1-1995; IN COMMERCE 7-1-1995.

PAUL CROWLEY, EXAMINING ATTORNEY

**Int. Cls.: 9 and 16**

**Prior U.S. Cls.: 2, 5, 21, 22, 23, 26, 29, 36, 37, 38 and 50**

**United States Patent and Trademark Office**

**Reg. No. 3,466,055**

**Registered July 15, 2008**

**TRADEMARK  
PRINCIPAL REGISTER**

**BRINGING HEALTHCARE  
TECHNOLOGY INTO PRACTICE**

INTELLISPHERE, LLC (DELAWARE LTD LIAB  
CO)  
666 PLAINSBORO ROAD  
PLAINSBORO, NJ 08536

FOR: ELECTRONIC PUBLICATIONS, NAMELY,  
MAGAZINES FOR PHYSICIANS AND HEALTH-  
CARE PROFESSIONALS, DOWNLOADABLE ELEC-  
TRONIC PUBLICATIONS IN THE NATURE OF  
TECHNOLOGY INFORMATION FOR HEALTH-  
CARE, IN CLASS 9 (U.S. CLS. 21, 23, 26, 36 AND 38).

FIRST USE 1-0-2006; IN COMMERCE 1-0-2006.

FOR: MAGAZINES FOR PHYSICIANS AND  
HEALTHCARE PROFESSIONALS, IN CLASS 16  
(U.S. CLS. 2, 5, 22, 23, 29, 37, 38 AND 50).

FIRST USE 1-0-2006; IN COMMERCE 1-0-2006.

THE MARK CONSISTS OF STANDARD CHAR-  
ACTERS WITHOUT CLAIM TO ANY PARTICULAR  
FONT, STYLE, SIZE, OR COLOR.

NO CLAIM IS MADE TO THE EXCLUSIVE  
RIGHT TO USE "HEALTHCARE TECHNOLOGY",  
APART FROM THE MARK AS SHOWN.

SER. NO. 77-239,830, FILED 7-26-2007.

CAROLYN GRAY, EXAMINING ATTORNEY

**Int. Cl.: 9**

**Prior U.S. Cls.: 21, 23, 26, 36 and 38**

**United States Patent and Trademark Office**

**Reg. No. 3,466,056**

**Registered July 15, 2008**

**TRADEMARK  
PRINCIPAL REGISTER**

**ULTIMATE STYLIST**

MATTEL, INC. (DELAWARE CORPORATION)  
M1-1518  
333 CONTINENTAL BLVD.  
EL SEGUNDO, CA 90245

FOR: TOYS, GAMES AND PLAYTHINGS, NAME-  
LY, COMPUTER GAME HARDWARE, NAMELY,  
COMPUTER HARDWARE FOR GAMING; COMPU-  
TER GAME SOFTWARE; COMPUTER GAME CON-  
TROLLERS, KEYBOARD AND SCREEN FOR  
COMPUTER GAMES; AND CARD READING

EQUIPMENT, IN CLASS 9 (U.S. CLS. 21, 23, 26, 36  
AND 38).

FIRST USE 12-13-2007; IN COMMERCE 12-13-2007.

THE MARK CONSISTS OF STANDARD CHAR-  
ACTERS WITHOUT CLAIM TO ANY PARTICULAR  
FONT, STYLE, SIZE, OR COLOR.

SER. NO. 77-240,037, FILED 7-26-2007.

CYNTHIA SLOAN, EXAMINING ATTORNEY

**Int. Cl.: 28**

**Prior U.S. Cls.: 22, 23, 38 and 50**

**United States Patent and Trademark Office**

**Reg. No. 3,466,057**

**Registered July 15, 2008**

**TRADEMARK  
PRINCIPAL REGISTER**

**SLIDE 2 STYLE**

MATTEL, INC. (DELAWARE CORPORATION)  
M1-1518  
333 CONTINENTAL BLVD.  
EL SEGUNDO, CA 90245

FOR: TOYS, GAMES AND PLAYTHINGS, NAME-  
LY, A MECHANICAL CARD GAME COMPRISING  
CARDS AND A CARD VIEWER, PACKAGED AS A  
UNIT, IN CLASS 28 (U.S. CLS. 22, 23, 38 AND 50).

FIRST USE 12-13-2007; IN COMMERCE 12-13-2007.

THE MARK CONSISTS OF STANDARD CHAR-  
ACTERS WITHOUT CLAIM TO ANY PARTICULAR  
FONT, STYLE, SIZE, OR COLOR.

OWNER OF U.S. REG. NO. 3,111,831.

SER. NO. 77-240,039, FILED 7-26-2007.

CYNTHIA SLOAN, EXAMINING ATTORNEY

**Int. Cl.: 36**

**Prior U.S. Cls.: 100, 101 and 102**

**United States Patent and Trademark Office**

**Reg. No. 3,466,058**

**Registered July 15, 2008**

**SERVICE MARK  
PRINCIPAL REGISTER**

**PARSEC FINANCIAL**

PARSEC FINANCIAL MANAGEMENT, INC.  
(NORTH CAROLINA CORPORATION)  
6 WALL STREET  
ASHEVILLE, NC 28801

FOR: FINANCIAL PLANNING AND ASSET  
MANAGEMENT, IN CLASS 36 (U.S. CLS. 100, 101  
AND 102).

FIRST USE 0-0-1992; IN COMMERCE 0-0-1992.

THE MARK CONSISTS OF STANDARD CHAR-  
ACTERS WITHOUT CLAIM TO ANY PARTICULAR  
FONT, STYLE, SIZE, OR COLOR.

NO CLAIM IS MADE TO THE EXCLUSIVE  
RIGHT TO USE "FINANCIAL", APART FROM  
THE MARK AS SHOWN.

SER. NO. 77-240,328, FILED 7-27-2007.

MELISSA VALLILLO, EXAMINING ATTORNEY

**Int. Cl.: 16**

**Prior U.S. Cls.: 2, 5, 22, 23, 29, 37, 38 and 50**

**Reg. No. 3,466,059**

**United States Patent and Trademark Office**

**Registered July 15, 2008**

---

**TRADEMARK  
PRINCIPAL REGISTER**

**TUFF GUY**

ILLINOIS TOOL WORKS INC. (DELAWARE  
CORPORATION)  
3600 WEST LAKE AVENUE  
GLENVIEW, IL 60026

FOR: ALL PURPOSE HEAVY DUTY PERMA-  
NENT INK MARKER FOR USE IN INDUSTRIAL  
APPLICATIONS AND DESIGNED FOR THE INDUS-  
TRIAL MARKET, IN CLASS 16 (U.S. CLS. 2, 5, 22, 23,  
29, 37, 38 AND 50).

FIRST USE 7-16-2007; IN COMMERCE 7-16-2007.

THE MARK CONSISTS OF STANDARD CHAR-  
ACTERS WITHOUT CLAIM TO ANY PARTICULAR  
FONT, STYLE, SIZE, OR COLOR.

SER. NO. 77-240,479, FILED 7-27-2007.

MICHAEL KEATING, EXAMINING ATTORNEY

Int. Cls.: 41, 43, 44 and 45

Prior U.S. Cls.: 100, 101 and 107

United States Patent and Trademark Office

Reg. No. 3,466,060

Registered July 15, 2008

SERVICE MARK  
PRINCIPAL REGISTER



REMED RECOVERY CARE CENTERS, LLC  
(PENNSYLVANIA LTD LIAB CO)  
16 INDUSTRIAL BLVD, SUITE 203  
PAOLI, PA 19301

FOR: VOCATIONAL TRAINING REHABILITATION SERVICES FOR INDIVIDUALS WITH ACQUIRED BRAIN INJURY, IN CLASS 41 (U.S. CLS. 100, 101 AND 107).

FIRST USE 10-1-2007; IN COMMERCE 10-1-2007.

FOR: FLEXIBLE INTERACTIVE ADULT DAY CARE SERVICES FOR INDIVIDUALS WITH ACQUIRED BRAIN INJURY, IN CLASS 43 (U.S. CLS. 100 AND 101).

FIRST USE 10-1-2007; IN COMMERCE 10-1-2007.

FOR: HEALTHCARE SERVICES, NAMELY, REHABILITATION OF INDIVIDUALS WITH ACQUIRED BRAIN INJURY; COMPREHENSIVE MEDICAL AND PHYSICAL EVALUATION OF INDIVIDUALS WITH ACQUIRED BRAIN INJURY; FORMULATING MEDICAL TREATMENT PLANS FOR INDIVIDUALS WITH ACQUIRED BRAIN INJURY; CUSTOMIZED POST-ACUTE MEDICAL AND PHYSICAL REHABILITATION AND TREAT-

MENT OF INDIVIDUALS WITH ACQUIRED BRAIN INJURY; INTENSIVE SHORT- AND LONG-TERM NEUROBEHAVIORAL REHABILITATION AND TREATMENT OF INDIVIDUALS WITH ACQUIRED BRAIN INJURY; SHORT- AND LONG-TERM OUTPATIENT MEDICAL AND PHYSICAL REHABILITATION OF INDIVIDUALS WITH ACQUIRED BRAIN INJURY, IN CLASS 44 (U.S. CLS. 100 AND 101).

FIRST USE 10-1-2007; IN COMMERCE 10-1-2007.

FOR: CASE MANAGEMENT SERVICES, NAMELY, THE COORDINATION OF NECESSARY MEDICAL SERVICES, VOCATIONAL ISSUES AND EDUCATIONAL SERVICES TO INDIVIDUALS WITH ACQUIRED BRAIN INJURY, IN CLASS 45 (U.S. CLS. 100 AND 101).

FIRST USE 10-1-2007; IN COMMERCE 10-1-2007.

OWNER OF U.S. REG. NOS. 1,703,919 AND 2,463,204.

SER. NO. 77-240,572, FILED 7-27-2007.

MATTHEW PAPPAS, EXAMINING ATTORNEY

**Int. Cls.: 41, 43, 44 and 45**

**Prior U.S. Cls.: 100, 101 and 107**

**United States Patent and Trademark Office**

**Reg. No. 3,466,061**

**Registered July 15, 2008**

**SERVICE MARK  
PRINCIPAL REGISTER**

**SUPPORTING EVEN THE  
LONGEST JOURNEY**

REMED RECOVERY CARE CENTERS, LLC  
(PENNSYLVANIA LTD LIAB CO)  
16 INDUSTRIAL BLVD, SUITE 203  
PAOLI, PA 19301

FOR: VOCATIONAL TRAINING REHABILITATION SERVICES FOR INDIVIDUALS WITH ACQUIRED BRAIN INJURY, IN CLASS 41 (U.S. CLS. 100, 101 AND 107).

FIRST USE 10-1-2007; IN COMMERCE 10-1-2007.

FOR: FLEXIBLE INTERACTIVE ADULT DAY CARE SERVICES FOR INDIVIDUALS WITH ACQUIRED BRAIN INJURY, IN CLASS 43 (U.S. CLS. 100 AND 101).

FIRST USE 10-1-2007; IN COMMERCE 10-1-2007.

FOR: HEALTHCARE SERVICES, NAMELY, REHABILITATION OF INDIVIDUALS WITH ACQUIRED BRAIN INJURY; COMPREHENSIVE MEDICAL AND PHYSICAL EVALUATION OF INDIVIDUALS WITH ACQUIRED BRAIN INJURY; FORMULATING MEDICAL TREATMENT PLANS FOR INDIVIDUALS WITH ACQUIRED BRAIN INJURY; CUSTOMIZED POST-ACUTE MEDICAL AND PHYSICAL REHABILITATION AND TREATMENT OF INDIVIDUALS WITH ACQUIRED BRAIN

INJURY; INTENSIVE SHORT- AND LONG-TERM NEUROBEHAVIORAL REHABILITATION AND TREATMENT OF INDIVIDUALS WITH ACQUIRED BRAIN INJURY; SHORT- AND LONG-TERM OUTPATIENT MEDICAL AND PHYSICAL REHABILITATION OF INDIVIDUALS WITH ACQUIRED BRAIN INJURY, IN CLASS 44 (U.S. CLS. 100 AND 101).

FIRST USE 10-1-2007; IN COMMERCE 10-1-2007.

FOR: CASE MANAGEMENT SERVICES, NAMELY, THE COORDINATION OF NECESSARY MEDICAL SERVICES, VOCATIONAL ISSUES AND EDUCATIONAL SERVICES TO INDIVIDUALS WITH ACQUIRED BRAIN INJURY, IN CLASS 45 (U.S. CLS. 100 AND 101).

FIRST USE 10-1-2007; IN COMMERCE 10-1-2007.

THE MARK CONSISTS OF STANDARD CHARACTERS WITHOUT CLAIM TO ANY PARTICULAR FONT, STYLE, SIZE, OR COLOR.

SER. NO. 77-240,579, FILED 7-27-2007.

MATTHEW PAPPAS, EXAMINING ATTORNEY



**Int. Cl.: 36**

**Prior U.S. Cls.: 100, 101 and 102**

**United States Patent and Trademark Office**

**Reg. No. 3,466,062**

**Registered July 15, 2008**

**SERVICE MARK  
PRINCIPAL REGISTER**

**SENTINEL FUNDS**

NATIONAL LIFE INSURANCE COMPANY (VER-  
MONT CORPORATION)  
NATIONAL LIFE DRIVE  
MONTPELIER, VT 05604

OWNER OF U.S. REG. NOS. 1,303,067, 2,880,399  
AND OTHERS.

FOR: INVESTMENT OF FUNDS FOR OTHERS;  
MUTUAL FUND INVESTMENT SERVICES; IN-  
VESTMENT MANAGEMENT SERVICES, IN CLASS  
36 (U.S. CLS. 100, 101 AND 102).

NO CLAIM IS MADE TO THE EXCLUSIVE  
RIGHT TO USE "FUNDS", APART FROM THE  
MARK AS SHOWN.

FIRST USE 11-30-2003; IN COMMERCE 11-30-2003.

SER. NO. 77-240,620, FILED 7-27-2007.

THE MARK CONSISTS OF STANDARD CHAR-  
ACTERS WITHOUT CLAIM TO ANY PARTICULAR  
FONT, STYLE, SIZE, OR COLOR.

LINDA ESTRADA, EXAMINING ATTORNEY

Int. Cl.: 29

Prior U.S. Cl.: 46

United States Patent and Trademark Office

Reg. No. 3,466,063

Registered July 15, 2008

TRADEMARK  
PRINCIPAL REGISTER



LINK SNACKS, INC. (WISCONSIN CORPORATION)  
ONE SNACK FOOD LANE  
MINONG, WI 548594405

FOR: PROCESSED MEAT, NAMELY, JERKY, IN CLASS 29 (U.S. CL. 46).

FIRST USE 7-31-2003; IN COMMERCE 12-16-2003.

OWNER OF U.S. REG. NO. 2,993,708.

NO CLAIM IS MADE TO THE EXCLUSIVE RIGHT TO USE "QUALITY MEATS", APART FROM THE MARK AS SHOWN.

THE MARK CONSISTS OF THE WORDS "WORLD KITCHENS" IN A STYLIZED FONT AND GRAPHICAL FORM, PLACED ABOVE AND PARTLY BEHIND AN OVAL DEPICTION OF THE WORLD, WITH A GRAPHICAL RENDITION OF THE WORLD LAND MASSES DEPICTED IN THE OVAL RENDERING OF THE WORLD, WITH GRAPHICAL LATITUDE AND LONGITUDE LINES DEPICTED IN THE OVAL OF THE WORLD, AND WITH A RIBBON CONTAINING THE WORDS "QUALITY AND MEATS" SUPERIMPOSED OVER THE LOWER PORTION OF THE WORLD.

SER. NO. 77-240,774, FILED 7-27-2007.

JORDAN BAKER, EXAMINING ATTORNEY

Int. Cl.: 29

Prior U.S. Cl.: 46

United States Patent and Trademark Office

Reg. No. 3,466,064

Registered July 15, 2008

TRADEMARK  
PRINCIPAL REGISTER



LINK SNACKS, INC. (WISCONSIN CORPORATION)  
ONE SNACK FOOD LANE  
MINONG, WI 548594405

FOR: PROCESSED MEAT, NAMELY, BEEF; BEEF PATTIES; CHICKEN; CORNED BEEF; HAM; HAMBURGER; JERKY; LUNCHEON MEATS; PREPARED OR PACKAGED MEALS CONSISTING OF MEAT OR POULTRY; MEAT; POULTRY; PROCESSED MEAT, NAMELY, BEEF, CHICKEN, TURKEY, PORK, ROAST BEEF; AND TURKEY, IN CLASS 29 (U.S. CL. 46).

FIRST USE 5-28-2003; IN COMMERCE 5-28-2003.

OWNER OF U.S. REG. NO. 2,993,708.

NO CLAIM IS MADE TO THE EXCLUSIVE RIGHT TO USE "QUALITY MEATS", APART FROM THE MARK AS SHOWN.

THE MARK CONSISTS OF THE WORDS "WORLD KITCHENS" IN A STYLIZED FONT AND GRAPHICAL FORM, SUPERIMPOSED OVER A MULTI-BAND HORIZONTAL RIBBON, AND PLACED OVER AN OVAL DEPICTION OF THE WORLD, WITH A GRAPHICAL RENDITION OF THE WORLD LAND MASSES DEPICTED IN THE OVAL RENDERING OF THE WORLD, WITH GRAPHICAL LATITUDE AND LONGITUDE LINES DEPICTED IN THE OVAL OF THE WORLD, WITH A RIBBON CONTAINING THE WORDS "QUALITY AND MEATS" SUPERIMPOSED OVER THE LOWER PORTION OF THE WORLD.

SER. NO. 77-240,795, FILED 7-27-2007.

JORDAN BAKER, EXAMINING ATTORNEY

Int. Cl.: 29

Prior U.S. Cl.: 46

United States Patent and Trademark Office

Reg. No. 3,466,065

Registered July 15, 2008

TRADEMARK  
PRINCIPAL REGISTER



LINK SNACKS, INC. (WISCONSIN CORPORATION)

ONE SNACK FOOD LANE  
MINONG, WI 548594405

FOR: PROCESSED MEAT, NAMELY, BEEF; BEEF PATTIES; CHICKEN; CORNED BEEF; HAM; HAMBURGER; JERKY; LUNCHEON MEATS; PREPARED OR PACKAGED MEALS CONSISTING OF MEAT OR POULTRY; MEAT; PORK; POULTRY; PROCESSED MEAT, NAMELY, BEEF, CHICKEN, TURKEY, PORK, ROAST BEEF; AND TURKEY, IN CLASS 29 (U.S. CL. 46).

FIRST USE 5-29-1998; IN COMMERCE 1-13-2003.

OWNER OF U.S. REG. NO. 2,993,708.

NO CLAIM IS MADE TO THE EXCLUSIVE RIGHT TO USE "QUALITY MEATS", APART FROM THE MARK AS SHOWN.

THE MARK CONSISTS OF THE WORDS "WORLD KITCHENS" IN A STYLIZED FONT AND GRAPHICAL FORM, PLACED OVER AN OVAL DEPICTION OF THE WORLD, WITH A GRAPHICAL RENDITION OF THE WORLD LAND MASSES DEPICTED IN THE OVAL RENDERING OF THE WORLD, WITH GRAPHICAL RENDERING OF LATITUDE AND LONGITUDE LINES DEPICTED IN THE OVAL OF THE WORLD, WITH A RIBBON CONTAINING THE WORDS "QUALITY AND MEATS" SUPERIMPOSED OVER THE LOWER PORTION OF THE WORLD, AND WITH A MULTIBAND HORIZONTAL RIBBON APPEARING BEHIND THE MID-POINT OF THE WORLD.

SER. NO. 77-240,802, FILED 7-27-2007.

JORDAN BAKER, EXAMINING ATTORNEY

**Int. Cls.: 36 and 44**

**Prior U.S. Cls.: 100, 101 and 102**

**United States Patent and Trademark Office**

**Reg. No. 3,466,066**

**Registered July 15, 2008**

**SERVICE MARK  
PRINCIPAL REGISTER**

**THE DESTINY HEALTH  
EMPOWERMENT PLAN**

DESTINY HEALTH, INC. (DELAWARE CORPORATION)  
SUITE 410  
1801 ROCKVILLE PIKE  
BETHESDA, MD 20852

FOR: HEALTH RELATED INSURANCE SERVICES AND PRODUCTS, NAMELY, UNDERWRITING, ADMINISTERING, MANAGING, AND PROVIDING TRADITIONAL AND PRE-PAID HEALTH INSURANCE PLANS, CONSUMER DRIVEN HEALTH CARE PLANS, HEALTH REIMBURSEMENT ARRANGEMENTS, MEDICAL SAVINGS ACCOUNT SERVICES, HEALTH BENEFIT PLAN MANAGEMENT SERVICES AND PRE-PAID HEALTH INSURANCE PLANS FOR THE BENEFIT OF OTHERS, IN CLASS 36 (U.S. CLS. 100, 101 AND 102).

FIRST USE 6-5-2007; IN COMMERCE 6-7-2007.

FOR: HEALTH CARE RELATED SERVICES, NAMELY, WELLNESS PROGRAMS AND PROVID-

ING HEALTH AND MEDICAL CARE INFORMATION AND BENEFIT SERVICES INFORMATION BY MEANS OF A GLOBAL COMPUTER NETWORK, IN CLASS 44 (U.S. CLS. 100 AND 101).

FIRST USE 6-5-2007; IN COMMERCE 6-7-2007.

THE MARK CONSISTS OF STANDARD CHARACTERS WITHOUT CLAIM TO ANY PARTICULAR FONT, STYLE, SIZE, OR COLOR.

OWNER OF U.S. REG. NOS. 3,134,588 AND 3,139,745.

NO CLAIM IS MADE TO THE EXCLUSIVE RIGHT TO USE "HEALTH" AND "PLAN", APART FROM THE MARK AS SHOWN.

SER. NO. 77-240,887, FILED 7-27-2007.

WENDY GOODMAN, EXAMINING ATTORNEY

**Int. Cl.: 42**

**Prior U.S. Cls.: 100 and 101**

**United States Patent and Trademark Office**

**Reg. No. 3,466,067**

**Registered July 15, 2008**

**SERVICE MARK  
PRINCIPAL REGISTER**



ABRAHAMIAN, MARY (UNITED STATES INDIVIDUAL)  
2218 RIDGEWIND WAY  
WINDERMERE, FL 34786

FOR: HOME STAGING CONSULTATION, NAME-  
LY, TEMPORARY INTERIOR AND EXTERIOR  
HOME DECORATION CONSULTATION FOR THE  
PURPOSE OF MAKING HOMES MORE APPEAL-  
ING TO PROSPECTIVE BUYERS ; TEMPORARY  
INTERIOR AND EXTERIOR HOME DECORATION  
CONSULTATION, NAMELY, HOME STAGING  
CONSULTATION FOR THE PURPOSE OF MAKING  
HOMES MORE APPEALING TO PROSPECTIVE  
BUYERS, IN CLASS 42 (U.S. CLS. 100 AND 101).

FIRST USE 5-18-2006; IN COMMERCE 5-18-2006.

THE MARK CONSISTS OF INSIDE OF A BOX,  
TOP HALF, LETTERS ON A BACKGROUND, "RE-  
DESIGN", LOWER CASE "RE"CAPITAL "D" LOW-  
ER CASE, "ESIGN" IN THE LOWER HALF OF BOX,  
LOWERCASE LETTERS ON A BACKGROUND,  
"MY SPACE".

SER. NO. 77-241,248, FILED 7-27-2007.

ALICE BENMAMAN, EXAMINING ATTORNEY

**Int. Cl.: 9**

**Prior U.S. Cls.: 21, 23, 26, 36 and 38**

**Reg. No. 3,466,068**

**United States Patent and Trademark Office**

**Registered July 15, 2008**

**TRADEMARK  
PRINCIPAL REGISTER**

The logo for "Light Scoop" features the word "Light" in a large, bold, italicized sans-serif font. Below it, the word "SCOOP" is written in a smaller, bold, all-caps sans-serif font. A thick horizontal line runs through the middle of the "Light" text, extending slightly beyond the left and right edges of the letters.

KEN KOBRE PHOTOGRAPHY (CALIFORNIA  
SOLE PROPRIETORSHIP)  
4 MCCORMICK ST.  
SAN FRANCISCO, CA 94109

FOR: CAMERA FLASHES; PORTABLE PHOTO-  
GRAPHY EQUIPMENT, NAMELY, REFLECTORS,  
TRIPODS, LIGHT STANDS AND SUPPORTS AND  
BAGS SPECIALLY ADAPTED FOR THESE GOODS,  
IN CLASS 9 (U.S. CLS. 21, 23, 26, 36 AND 38).

FIRST USE 8-1-2005; IN COMMERCE 7-19-2007.

THE MARK CONSISTS OF THE WORD "LIGHT-  
SCOOP" ON TWO LINES. "LIGHT" IS ON THE TOP  
LINE, AND "SCOOP" IS ON THE BOTTOM LINE,  
WITH THE BOTTOM OF THE LETTER "L" EX-  
TENDING OVER THE ENTIRE WORD "SCOOP".

SER. NO. 77-241,338, FILED 7-28-2007.

WENDY JUN, EXAMINING ATTORNEY

Int. Cl.: 25

Prior U.S. Cls.: 22 and 39

United States Patent and Trademark Office

Reg. No. 3,466,069

Registered July 15, 2008

TRADEMARK  
PRINCIPAL REGISTER



FORENSICS 101, INC (NORTH CAROLINA CORPORATION)  
PO BOX 681691  
CHARLOTTE, NC 28216

FOR: PIQUE SHIRTS; POLO SHIRTS; SHIRT FRONTS; SHIRT YOKES; SHIRTS; SHIRTS FOR SUITS; SHORT-SLEEVED OR LONG-SLEEVED T-SHIRTS; SHORT-SLEEVED SHIRTS; SLEEP SHIRTS; SPORT SHIRTS; SPORTS SHIRTS; SPORTS SHIRTS WITH SHORT SLEEVES; SWEAT SHIRTS; T-SHIRTS; TEE SHIRTS; WIND SHIRTS; YOGA SHIRTS; JOGGING PANTS; PANTS; SWEAT PANTS; TRACK PANTS; HATS; SMALL HATS; TOBOGGAN HATS, PANTS AND CAPS; WOOLLY HATS; INFANT AND TODDLER ONE PIECE CLOTHING; JERSEYS; LEA-

TER BELTS; SHORT SETS; TIES, IN CLASS 25 (U.S. CLS. 22 AND 39).

FIRST USE 1-11-2007; IN COMMERCE 3-7-2007.

THE MARK CONSISTS OF THE LETTERS AND NUMBERS "FORENSICS 101" WITH A FINGERPRINT AS THE LETTER "O" IN "FORENSICS" WITH A GRADUATION CAP ON TOP OF THE SECOND NUMBER "1" AND A MAGNIFYING GLASS BEHIND THE LETTERS "NSI".

SER. NO. 77-241,378, FILED 7-28-2007.

BARBARA BROWN, EXAMINING ATTORNEY



**Int. Cl.: 18**

**Prior U.S. Cls.: 1, 2, 3, 22 and 41**

**United States Patent and Trademark Office**

**Reg. No. 3,466,070**

**Registered July 15, 2008**

**TRADEMARK  
PRINCIPAL REGISTER**



HEPLER, BRENDA ANDERSON (UNITED STATES INDIVIDUAL)  
12 PARK GATE  
LAFAYETTE, CA 04549

FOR: LUGGAGE TAG, IN CLASS 18 (U.S. CLS. 1, 2, 3, 22 AND 41).

FIRST USE 12-21-2006; IN COMMERCE 7-20-2007.

THE MARK CONSISTS OF A DAISY-LIKE FLOWER WITH SIX PETALS, ONE OF WHICH IS FALLING. THERE ARE NO LEAVES AND NO STEMS. THE WORD "TASSATAG" IS WRITTEN TO THE RIGHT OF THE FALLING PETAL.

SER. NO. 77-241,387, FILED 7-28-2007.

DAVID HOFFMAN, EXAMINING ATTORNEY

**Int. Cl.: 41**

**Prior U.S. Cls.: 100, 101 and 107**

**United States Patent and Trademark Office**

**Reg. No. 3,466,071**

**Registered July 15, 2008**

**SERVICE MARK  
PRINCIPAL REGISTER**

**JIM CATHCART**

CATHCART, JIM (UNITED STATES INDIVIDUAL)  
2324 CROMBIE COURT  
LAKE SHERWOOD, CA 91361

FOR: CONDUCTING WORKSHOPS AND SEMINARS IN THE FIELDS OF BUSINESS, SALES, LEADERSHIP, MOTIVATION, AND COMMUNICATIONS SKILLS, IN CLASS 41 (U.S. CLS. 100, 101 AND 107).

FIRST USE 12-31-1976; IN COMMERCE 12-31-1976.

THE MARK CONSISTS OF STANDARD CHARACTERS WITHOUT CLAIM TO ANY PARTICULAR FONT, STYLE, SIZE, OR COLOR.

SER. NO. 77-241,552, FILED 7-29-2007.

GISELLE AGOSTO, EXAMINING ATTORNEY

**Int. Cl.: 5**

**Prior U.S. Cls.: 6, 18, 44, 46, 51 and 52**

**Reg. No. 3,466,072**

**United States Patent and Trademark Office**

**Registered July 15, 2008**

**TRADEMARK  
PRINCIPAL REGISTER**



VITALIZE LABS, LLC (NEW YORK LTD LIAB  
CO)  
151 MERCER STREET  
NEW YORK, NY 10012

FOR: DIETARY AND NUTRITIONAL SUPPLEMENTS; DIETARY DRINK MIX FOR USE AS A MEAL REPLACEMENT; DIETARY FOOD SUPPLEMENTS; DIETARY SUPPLEMENTS; FOOD SUPPLEMENTS; FOOD SUPPLEMENTS, NAMELY, ANTI-OXIDANTS; HERBAL SUPPLEMENTS; MEAL REPLACEMENT AND DIETARY SUPPLEMENT DRINK MIXES; MINERAL NUTRITIONAL SUPPLEMENTS; POWDERED NUTRITIONAL SUPPLEMENT DRINK MIX; VITAMIN AND MINERAL SUPPLEMENTS; VITAMIN SUPPLEMENT IN TABLET FORM FOR USE IN MAKING AN EFFER-

VESCENT BEVERAGE WHEN ADDED TO WATER; VITAMIN SUPPLEMENTS; NUTRITIONAL DRINK MIX FOR USE AS A MEAL REPLACEMENT; NUTRITIONAL SUPPLEMENTS, IN CLASS 5 (U.S. CLS. 6, 18, 44, 46, 51 AND 52).

FIRST USE 11-1-2005; IN COMMERCE 12-1-2006.

THE MARK CONSISTS OF TWO LETTER E'S, FACING EACH OTHER, THE SECOND REVERSED, AND CONNECTED BY A BACKSLASH IN THE MIDDLE, WITH THE TEXT "EBOOST" BELOW.

SER. NO. 77-241,597, FILED 7-30-2007.

AMY HELLA, EXAMINING ATTORNEY

**Int. Cl.: 35**

**Prior U.S. Cls.: 100, 101 and 102**

**United States Patent and Trademark Office**

**Reg. No. 3,466,073**

**Registered July 15, 2008**

**SERVICE MARK  
PRINCIPAL REGISTER**

**Authentic Leadership  
Institute**

AUTHENTIC LEADERSHIP INSTITUTE, INC.  
(MASSACHUSETTS CORPORATION)  
4 QUARRY LANE  
HARVARD, MA 01451

FOR: BUSINESS MANAGEMENT CONSULTATION IN THE FIELD OF EXECUTIVE AND LEADERSHIP DEVELOPMENT, IN CLASS 35 (U.S. CLS. 100, 101 AND 102).

FIRST USE 3-11-2007; IN COMMERCE 4-24-2007.

THE MARK CONSISTS OF STANDARD CHARACTERS WITHOUT CLAIM TO ANY PARTICULAR FONT, STYLE, SIZE, OR COLOR.

NO CLAIM IS MADE TO THE EXCLUSIVE RIGHT TO USE "LEADERSHIP INSTITUTE", APART FROM THE MARK AS SHOWN.

SER. NO. 77-242,076, FILED 7-30-2007.

PAUL E. FAHRENKOPF, EXAMINING ATTORNEY

**Int. Cl.: 36**

**Prior U.S. Cls.: 100, 101 and 102**

**United States Patent and Trademark Office**

**Reg. No. 3,466,074**

**Registered July 15, 2008**

**SERVICE MARK  
PRINCIPAL REGISTER**

**CAMBRIDGE Realty Capital  
Companies**

CAMBRIDGE REALTY CAPITAL, LLC (ILLINOIS  
LTD LIAB CO), DBA CAMBRIDGE REALTY  
CAPITAL COMPANIES  
125 SOUTH WACKER DRIVE, SUITE 1800  
CHICAGO, IL 60606

FOR: MORTGAGE LENDING; MORTGAGE  
BANKING SERVICES, NAMELY, ORIGATION,  
ACQUISITION, SERVICING, SECURITIZATION  
AND BROKERAGE OF MORTGAGE LOANS, IN  
CLASS 36 (U.S. CLS. 100, 101 AND 102).

FIRST USE 5-3-1999; IN COMMERCE 5-3-1999.

THE MARK CONSISTS OF STANDARD CHAR-  
ACTERS WITHOUT CLAIM TO ANY PARTICULAR  
FONT, STYLE, SIZE, OR COLOR.

NO CLAIM IS MADE TO THE EXCLUSIVE  
RIGHT TO USE "REALTY CAPITAL COMPANIES",  
APART FROM THE MARK AS SHOWN.

SER. NO. 77-242,229, FILED 7-30-2007.

MICHAEL LEWIS, EXAMINING ATTORNEY

**Int. Cl.: 36**

**Prior U.S. Cls.: 100, 101 and 102**

**United States Patent and Trademark Office**

**Reg. No. 3,466,075**

**Registered July 15, 2008**

**SERVICE MARK  
PRINCIPAL REGISTER**



**CAMBRIDGE**  
Realty Capital Companies

CAMBRIDGE REALTY CAPITAL, LLC (ILLINOIS  
LTD LIAB CO), DBA CAMBRIDGE REALTY  
CAPITAL COMPANIES

SUITE 1800  
125 S. WACKER DRIVE  
CHICAGO, IL 60606

FOR: MORTGAGE BANKING SERVICES, NAME-  
LY, ORIGINATION, ACQUISITION, SERVICING,  
SECURITIZATION AND BROKERAGE OF MORT-  
GAGE LOANS; MORTGAGE LENDING, IN CLASS  
36 (U.S. CLS. 100, 101 AND 102).

FIRST USE 5-3-1999; IN COMMERCE 5-3-1999.

NO CLAIM IS MADE TO THE EXCLUSIVE  
RIGHT TO USE "REALTY CAPITAL COMPANIES",  
APART FROM THE MARK AS SHOWN.

THE MARK CONSISTS OF A DESIGN ELEMENT  
CONSISTING OF A STYLIZED DEPICTION OF THE  
CAPITAL, OR UPPER PORTION, OF A BURGUNDY  
DORIC COLUMN, ENCLOSED IN A CIRCLE ON A  
WHITE BACKGROUND, AND THE TEXT ELE-  
MENT "CAMBRIDGE REALTY CAPITAL COMPA-  
NIES" APPEARS IN BLACK BELOW THE DESIGN  
ELEMENT.

SER. NO. 77-242,294, FILED 7-30-2007.

MICHAEL LEWIS, EXAMINING ATTORNEY

**Int. Cl.: 40**

**Prior U.S. Cls.: 100, 103 and 106**

**United States Patent and Trademark Office**

**Reg. No. 3,466,076**

**Registered July 15, 2008**

**SERVICE MARK  
PRINCIPAL REGISTER**



FOCUS MARKETING, LLC (MICHIGAN LTD  
LIAB CO)  
2495 112TH AVE.  
HOLLAND, MI 49424

THE MARK CONSISTS OF SCIENCE LAB LIKE  
WITH BEAKERS AND BUBBLES.

FOR: DESIGN PRINTING FOR OTHERS, IN  
CLASS 40 (U.S. CLS. 100, 103 AND 106).

SER. NO. 77-242,556, FILED 7-30-2007.

FIRST USE 6-19-2007; IN COMMERCE 6-19-2007.

MICHELE SWAIN, EXAMINING ATTORNEY

**Int. Cl.: 25**

**Prior U.S. Cls.: 22 and 39**

**United States Patent and Trademark Office**

**Reg. No. 3,466,077**

**Registered July 15, 2008**

**TRADEMARK  
PRINCIPAL REGISTER**

# Local Kine Hawaii

COFER, MICHAEL S (UNITED STATES INDIVIDUAL), DBA LOCAL KINE HAWAII  
211 21ST ST.  
HOQUIAM, WA 98550

NO CLAIM IS MADE TO THE EXCLUSIVE RIGHT TO USE "HAWAII", APART FROM THE MARK AS SHOWN.

FOR: T-SHIRTS, IN CLASS 25 (U.S. CLS. 22 AND 39).

THE ENGLISH TRANSLATION OF "KINE" IS KIND.

FIRST USE 7-15-2007; IN COMMERCE 7-15-2007.

SER. NO. 77-242,563, FILED 7-30-2007.

THE MARK CONSISTS OF STANDARD CHARACTERS WITHOUT CLAIM TO ANY PARTICULAR FONT, STYLE, SIZE, OR COLOR.

TRACY CROSS, EXAMINING ATTORNEY



**Int. Cl.: 41**

**Prior U.S. Cls.: 100, 101 and 107**

**United States Patent and Trademark Office**

**Reg. No. 3,466,078**

**Registered July 15, 2008**

**SERVICE MARK  
PRINCIPAL REGISTER**



CAMBRIDGE REALTY CAPITAL, LLC (ILLINOIS  
LTD LIAB CO), DBA CAMBRIDGE REALTY  
CAPITAL COMPANIES  
SUITE 1800  
125 S. WACKER DRIVE  
CHICAGO, IL 60606

FOR: PROVIDING NEWSLETTERS IN THE  
FIELD OF FINANCIAL SERVICES FOR OWNERS  
OF NURSING HOMES AND HEALTH CARE FA-  
CILITIES VIA E-MAIL, IN CLASS 41 (U.S. CLS. 100,  
101 AND 107).

FIRST USE 9-9-2004; IN COMMERCE 9-9-2004.

THE COLOR(S) RED IS/ARE CLAIMED AS A  
FEATURE OF THE MARK.

THE MARK CONSISTS OF A TEXT ELEMENT,  
"E-PULSE!" APPEARING IN THE COLOR RED,  
AND A DESIGN ELEMENT CONSISTING OF A  
STYLIZED DEPICTION OF A RED ELECTROCAR-  
DIOGRAM DISPLAY FLOWING INTO A RED  
FIELD.

SER. NO. 77-242,778, FILED 7-31-2007.

MICHAEL LEWIS, EXAMINING ATTORNEY

**Int. Cl.: 9**

**Prior U.S. Cls.: 21, 23, 26, 36 and 38**

**United States Patent and Trademark Office**

**Reg. No. 3,466,079**

**Registered July 15, 2008**

**TRADEMARK  
PRINCIPAL REGISTER**

**DIGISOURCE**

GENERAL COUNCIL FOR THE ASSEMBLIES OF  
GOD (MISSOURI CORPORATION), DBA GOS-  
PEL PUBLISHING HOUSE  
1445 N. BOONVILLE AVENUE  
SPRINGFIELD, MO 658021894

FOR: MULTIMEDIA SOFTWARE RECORDED  
ON CD-ROM FEATURING INFORMATION AND  
FORMS FOR RELIGIOUS MINISTRIES PERTAIN-  
ING TO LEGAL RIGHTS, HOW TO COACH STU-  
DENT CLUBS, CAMPUS MISSIONARY TRAINING,  
STRATEGIES FOR REACHING MEMBERS, WEB  
LINKS TO OTHER CAMPUS MINISTRY SITES,  
AND OTHER RELIGIOUS MINISTRY RELATED

INFORMATION, IN CLASS 9 (U.S. CLS. 21, 23, 26, 36  
AND 38).

FIRST USE 12-31-2006; IN COMMERCE 12-31-2006.

THE MARK CONSISTS OF STANDARD CHAR-  
ACTERS WITHOUT CLAIM TO ANY PARTICULAR  
FONT, STYLE, SIZE, OR COLOR.

SER. NO. 77-242,935, FILED 7-31-2007.

MATTHEW PAPPAS, EXAMINING ATTORNEY

**Int. Cl.: 1**

**Prior U.S. Cls.: 1, 5, 6, 10, 26 and 46**

**Reg. No. 3,466,080**

**United States Patent and Trademark Office**

**Registered July 15, 2008**

---

**TRADEMARK  
PRINCIPAL REGISTER**

# Biomile

FIRST WORLD TRADE CORP. (CANADA CORPORATION)  
194 MCMORRAN CRESCENT  
THORNHILL, CANADA L4J3S6

FOR: CHEMICAL ADDITIVES FOR ENHANCING THE PERFORMANCE OF LUBRICATING OILS, GREASES AND INTERNAL COMBUSTION ENGINE FUELS; CHEMICAL ADDITIVES FOR FUEL TREATMENT; CHEMICAL ADDITIVES FOR USE WITH INTERNAL COMBUSTION ENGINE FUELS; OCTANE BOOSTER FUEL CHEMICAL ADDITIVE, IN CLASS 1 (U.S. CLS. 1, 5, 6, 10, 26 AND 46).

FIRST USE 2-1-2006; IN COMMERCE 2-1-2006.

THE MARK CONSISTS OF STANDARD CHARACTERS WITHOUT CLAIM TO ANY PARTICULAR FONT, STYLE, SIZE, OR COLOR.

PRIORITY CLAIMED UNDER SEC. 44(D) ON CANADA APPLICATION NO. 1356942, FILED 7-25-2007.

SER. NO. 77-243,019, FILED 7-31-2007.

DAVID COLLIER, EXAMINING ATTORNEY

**Int. Cl.: 5**

**Prior U.S. Cls.: 6, 18, 44, 46, 51 and 52**

**Reg. No. 3,466,081**

**United States Patent and Trademark Office**

**Registered July 15, 2008**

---

**TRADEMARK  
PRINCIPAL REGISTER**

**INNER BLISS**

JAMES J. MATTIODA (UNITED STATES INDIVIDUAL)  
P.O. BOX 1126  
DEL MAR, CA 92014

THE MARK CONSISTS OF STANDARD CHARACTERS WITHOUT CLAIM TO ANY PARTICULAR FONT, STYLE, SIZE, OR COLOR.

FOR: DIETARY AND NUTRITIONAL SUPPLEMENTS; HERBAL SUPPLEMENTS, IN CLASS 5 (U.S. CLS. 6, 18, 44, 46, 51 AND 52).

SER. NO. 77-243,234, FILED 7-31-2007.

FIRST USE 6-1-2006; IN COMMERCE 6-1-2006.

MARLENE BELL, EXAMINING ATTORNEY

**Int. Cl.: 41**

**Prior U.S. Cls.: 100, 101 and 107**

**United States Patent and Trademark Office**

**Reg. No. 3,466,082**

**Registered July 15, 2008**

**SERVICE MARK  
PRINCIPAL REGISTER**

# EvolutionHealth

BLUE DUNN (CALIFORNIA SOLE PROPRIETORSHIP), DBA EVOLUTION HEALTH  
5024 ALIBI TERRACE  
NORTH PORT, FL 34286

FOR: PHYSICAL EDUCATION SERVICES; PHYSICAL FITNESS INSTRUCTION; PROVIDING ASSISTANCE, PERSONAL TRAINING AND PHYSICAL FITNESS CONSULTATION TO INDIVIDUALS TO HELP THEM MAKE PHYSICAL FITNESS, STRENGTH, CONDITIONING, AND EXERCISE IMPROVEMENT IN THEIR DAILY LIVING; HEALTH CLUB SERVICES, NAMELY, PROVIDING INSTRUCTION AND EQUIPMENT IN THE

FIELD OF PHYSICAL EXERCISE, IN CLASS 41 (U.S. CLS. 100, 101 AND 107).

FIRST USE 3-8-1999; IN COMMERCE 3-8-1999.

THE MARK CONSISTS OF STANDARD CHARACTERS WITHOUT CLAIM TO ANY PARTICULAR FONT, STYLE, SIZE, OR COLOR.

SER. NO. 77-243,355, FILED 7-31-2007.

KATINA MISTER, EXAMINING ATTORNEY

**Int. Cl.: 35**

**Prior U.S. Cls.: 100, 101 and 102**

**United States Patent and Trademark Office**

**Reg. No. 3,466,083**

**Registered July 15, 2008**

**SERVICE MARK  
PRINCIPAL REGISTER**

# Web 'n' Walk Box

DEUTSCHE TELEKOM AG (FED REP GERMA-  
NY CORPORATION)  
FRIEDRICH-EBERT-ALLEE 140  
BONN, FED REP GERMANY 53113

FOR: ADVERTISING SERVICES, NAMELY, PREPARING AND PLACING ADVERTISEMENTS FOR OTHERS PROMOTING THE GOODS AND SERVICES OF OTHERS THROUGH PRINTED ADVERTISING, PRINTED DIRECTORIES, THROUGH ENCODED MEDIA, THROUGH THE DISSEMINATION OF PROMOTIONAL MATERIALS, THROUGH DIRECT MAIL ADVERTISING, THROUGH ELECTRONIC BILLBOARD ADVERTISING, PREPARING AUDIO-VISUAL PRESENTATIONS FOR USE IN ADVERTISING; BUSINESS MANAGEMENT SERVICES, NAMELY, BUSINESS APPRAISALS, BUSINESS AUDITING, PROVIDING BUSINESS INFORMATION, NAMELY, PREPARING BUSINESS REPORTS AND CONDUCTING BUSINESS RESEARCH, ANALYSIS AND SURVEYS, BUSINESS MANAGEMENT PLANNING, BUSINESS MANAGEMENT CONSULTATION, BUSINESS MANAGEMENT SUPERVISION, CONDUCTING BUSINESS NETWORKING FOR OTHERS; BUSINESS MANAGEMENT AND CONSULTING SERVICES, EXCLUDING AGRICULTURAL BUSINESS MANAGEMENT AND CONSULTING SERVICES;

PROVIDING INFORMATION VIA THE TELEPHONE AND THE GLOBAL COMMUNICATION NETWORKS IN THE FIELD OF ADVERTISING AND BUSINESS MARKETING; PROFESSIONAL CONSULTANCY IN THE FIELD OF DATA PROCESSING; ORGANIZING JOB FAIRS, IN CLASS 35 (U.S. CLS. 100, 101 AND 102).

THE MARK CONSISTS OF STANDARD CHARACTERS WITHOUT CLAIM TO ANY PARTICULAR FONT, STYLE, SIZE, OR COLOR.

PRIORITY CLAIMED UNDER SEC. 44(D) ON FED REP GERMANY APPLICATION NO. 30710013.8/3, FILED 2-12-2007, REG. NO. 30710013, DATED 3-27-2007, EXPIRES 2-28-2017.

OWNER OF U.S. REG. NOS. 3,250,718, 3,257,839 AND OTHERS.

NO CLAIM IS MADE TO THE EXCLUSIVE RIGHT TO USE "WEB", APART FROM THE MARK AS SHOWN.

SER. NO. 77-243,659, FILED 7-31-2007.

STEPHEN AQUILA, EXAMINING ATTORNEY

**Int. Cl.: 36**

**Prior U.S. Cls.: 100, 101 and 102**

**United States Patent and Trademark Office**

**Reg. No. 3,466,084**

**Registered July 15, 2008**

**SERVICE MARK  
PRINCIPAL REGISTER**

# Web 'n' Walk Box

DEUTSCHE TELEKOM AG (FED REP GERMA-  
NY CORPORATION)  
FRIEDRICH-EBERT-ALLEE 140  
BONN, FED REP GERMANY 53113

FOR: INSURANCE SERVICES, NAMELY, INSURANCE BROKERAGE, INSURANCE CLAIMS PROCESSING; FINANCIAL SERVICES, NAMELY, CLEARING OF SECURE FINANCIAL TRANSACTIONS THROUGH ONLINE SERVICES; FINANCIAL ANALYSIS AND CONSULTATION; FINANCIAL INFORMATION PROVIDED BY ELECTRONIC MEANS; FINANCIAL INFORMATION PROCESSING; FINANCIAL PORTFOLIO MANAGEMENT; FINANCIAL SERVICES, NAMELY, FINANCIAL CONSULTATION IN THE FIELD OF FINANCIAL SECURITIES; SAFE DEPOSIT BOX SERVICES FOR THE SAFEKEEPING OF SECURITIES; FINANCIAL SPONSORSHIP OF SPORTS, EDUCATIONAL AND ENTERTAINMENT PROGRAMS AND EVENTS; COMMERCIAL LENDING SERVICES; MONETARY EXCHANGE; CREDIT CARD SERVICES; TELEPHONE CALLING CARD SERVICES; ELECTRONIC COMMERCE SERVICES, NAMELY, ELECTRONIC DEBIT AND CREDIT CARD TRANSACTION PROCESSING SERVICES, FUNDS TRANSFER AND BILL PAYMENT-PROCESSING SERVICES; DISCOUNT BROKERAGE SERVICES; SECURITY BROKERAGE; BROKERAGE IN THE FIELD OF INSURANCE, STOCKS, COMMODITIES; CUSTOM BROKERAGE FOR THIRD PARTIES IN THE FIELD OF INSURANCE, STOCKS, COMMODITIES; BROKERAGE OF SHARES AND VENTURE CAPITAL FUNDING SERVICES TO START-UP COMPANIES; BROKERAGE OF FUND SHARES; BROKERAGE OF PRO-

DUCTIVE INVESTMENT OF FUNDS; REAL ESTATE SERVICES, NAMELY, BROKERAGE, MANAGEMENT, LEASING, AND APPRAISAL OF REAL PROPERTY; CONSULTING SERVICES RELATING TO INSURANCE SERVICES, NAMELY, PROVIDING INFORMATION AND BROKERAGE OF INSURANCES IN THE FIELD OF HOME INSURANCE, ACCIDENT INSURANCE AND HEALTH INSURANCE; CONSULTING SERVICES RELATING TO BANK SERVICES; PROVIDING INFORMATION VIA THE TELEPHONE AND THE GLOBAL COMMUNICATION NETWORKS IN THE FIELD OF FINANCE, IN CLASS 36 (U.S. CLS. 100, 101 AND 102).

THE MARK CONSISTS OF STANDARD CHARACTERS WITHOUT CLAIM TO ANY PARTICULAR FONT, STYLE, SIZE, OR COLOR.

PRIORITY CLAIMED UNDER SEC. 44(D) ON FED REP GERMANY APPLICATION NO. 30710013.8/3, FILED 2-12-2007, REG. NO. 30710013, DATED 3-27-2007, EXPIRES 2-28-2017.

OWNER OF U.S. REG. NOS. 3,250,718, 3,257,839 AND OTHERS.

NO CLAIM IS MADE TO THE EXCLUSIVE RIGHT TO USE "WEB", APART FROM THE MARK AS SHOWN.

SER. NO. 77-243,666, FILED 7-31-2007.

STEPHEN AQUILA, EXAMINING ATTORNEY

**Int. Cl.: 41**

**Prior U.S. Cls.: 100, 101 and 107**

**United States Patent and Trademark Office**

**Reg. No. 3,466,085**

**Registered July 15, 2008**

**SERVICE MARK  
PRINCIPAL REGISTER**

**UNSPOKEN**

GOMEZ MICHAEL (PENNSYLVANIA PARTNER-  
SHIP)  
184 JOYA CIR  
HARRISBURG, PA 17112

THE MARK CONSISTS OF STANDARD CHAR-  
ACTERS WITHOUT CLAIM TO ANY PARTICULAR  
FONT, STYLE, SIZE, OR COLOR.

FOR: ENTERTAINMENT, NAMELY, LIVE PER-  
FORMANCES BY A MUSICAL BAND, IN CLASS 41  
(U.S. CLS. 100, 101 AND 107).

SER. NO. 77-243,975, FILED 8-1-2007.

FIRST USE 9-16-2006; IN COMMERCE 9-16-2006.

LINDA ORNDORFF, EXAMINING ATTORNEY



Int. Cls.: 25 and 41

Prior U.S. Cls.: 22, 39, 100, 101 and 107

United States Patent and Trademark Office

Reg. No. 3,466,086

Registered July 15, 2008

**TRADEMARK  
SERVICE MARK  
PRINCIPAL REGISTER**

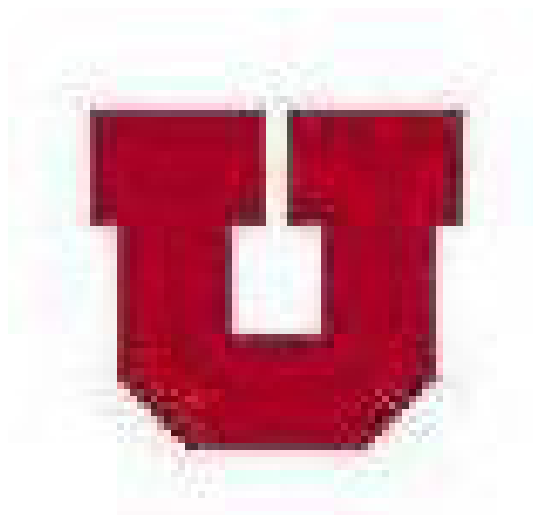

THE UNIVERSITY OF UTAH (UTAH CORPORATION)  
270 S. 1500 E. UNIVERSITY BOOKSTORE  
SALT LAKE CITY, UT 841120670

FOR: CLOTHING, NAMELY, T-SHIRTS, SWEAT-SHIRTS, BASEBALL CAPS, AND TIES, IN CLASS 25 (U.S. CLS. 22 AND 39).

FIRST USE 0-0-1890; IN COMMERCE 0-0-1890.

FOR: EDUCATIONAL AND ENTERTAINMENT SERVICES, NAMELY, PROVIDING COURSES OF INSTRUCTION AT THE UNIVERSITY LEVEL; EDUCATIONAL RESEARCH; ARRANGING AND CONDUCTING ATHLETIC COMPETITIONS, EVENTS,

TOURNAMENTS, AND EXHIBITIONS, IN CLASS 41 (U.S. CLS. 100, 101 AND 107).

FIRST USE 0-0-1890; IN COMMERCE 0-0-1890.

THE COLOR(S) RED IS/ARE CLAIMED AS A FEATURE OF THE MARK.

THE MARK CONSISTS OF SOLID RED U IN BLOCK FORM.

SER. NO. 77-244,187, FILED 8-1-2007.

MICHAEL KAZAZIAN, EXAMINING ATTORNEY

Int. Cls.: 25 and 41

Prior U.S. Cls.: 22, 39, 100, 101 and 107

United States Patent and Trademark Office

Reg. No. 3,466,087

Registered July 15, 2008

**TRADEMARK  
SERVICE MARK  
PRINCIPAL REGISTER**



THE UNIVERSITY OF UTAH (UTAH CORPORATION)  
270 S. 1500 E. UNIVERSITY BOOKSTORE  
SALT LAKE CITY, UT 841120670

FOR: CLOTHING, NAMELY, T-SHIRTS, SWEAT-SHIRTS, SHORTS, TANK TOPS, BASEBALL CAPS, AND TIES, IN CLASS 25 (U.S. CLS. 22 AND 39).

FIRST USE 0-0-1890; IN COMMERCE 0-0-1890.

FOR: EDUCATIONAL AND ENTERTAINMENT SERVICES, NAMELY, PROVIDING COURSES OF INSTRUCTION AT THE UNIVERSITY LEVEL; EDU-

CATIONAL RESEARCH; ARRANGING AND CONDUCTING ATHLETIC COMPETITIONS, EVENTS, TOURNAMENTS, AND EXHIBITIONS, IN CLASS 41 (U.S. CLS. 100, 101 AND 107).

FIRST USE 0-0-1890; IN COMMERCE 0-0-1890.

THE MARK CONSISTS OF THE LETTER U IN BLOCK FORM.

SER. NO. 77-244,206, FILED 8-1-2007.

MICHAEL KAZAZIAN, EXAMINING ATTORNEY

**Int. Cl.: 30**

**Prior U.S. Cl.: 46**

**United States Patent and Trademark Office**

**Reg. No. 3,466,088**

**Registered July 15, 2008**

**TRADEMARK  
PRINCIPAL REGISTER**

**York Castle Tropical Ice  
Cream**

YORK CASTLE ICE CREAM COMPANY, INC.  
(MARYLAND CORPORATION), DBA YORK  
CASTLE ICE CREAM COMPANY, INC

6771 MID CITIES AVENUE

BELTSVILLE, MD 20705

FOR: ICE CREAM, IN CLASS 30 (U.S. CL. 46).

FIRST USE 8-1-1985; IN COMMERCE 8-1-1985.

THE MARK CONSISTS OF STANDARD CHAR-  
ACTERS WITHOUT CLAIM TO ANY PARTICULAR  
FONT, STYLE, SIZE, OR COLOR.

NO CLAIM IS MADE TO THE EXCLUSIVE  
RIGHT TO USE "TROPICAL ICE CREAM", APART  
FROM THE MARK AS SHOWN.

SER. NO. 77-244,417, FILED 8-1-2007.

JANICE KIM, EXAMINING ATTORNEY

**Int. Cl.: 8**

**Prior U.S. Cls.: 23, 28 and 44**

**United States Patent and Trademark Office**

**Reg. No. 3,466,089**

**Registered July 15, 2008**

**TRADEMARK  
PRINCIPAL REGISTER**



ZAPTRON (HK) LIMITED (HONG KONG LIMITED COMPANY)  
2ND FLOOR  
91-97 JERVOIS STREET  
SHEUNG WAN, HONG KONG

NO CLAIM IS MADE TO THE EXCLUSIVE RIGHT TO USE "DELUXE TOOLS", APART FROM THE MARK AS SHOWN.

FOR: HAND TOOLS, NAMELY, PUTTY KNIVES; AND DRILL BITS FOR HAND DRILLS, IN CLASS 8 (U.S. CLS. 23, 28 AND 44).

SER. NO. 77-245,272, FILED 8-2-2007.

FIRST USE 6-20-2007; IN COMMERCE 7-15-2007.

BILL DAWE, EXAMINING ATTORNEY

**Int. Cls.: 37 and 42**

**Prior U.S. Cls.: 100, 101, 103 and 106**

**United States Patent and Trademark Office**

**Reg. No. 3,466,090**

**Registered July 15, 2008**

**SERVICE MARK  
PRINCIPAL REGISTER**



HEEREMA GROUP SERVICES S.A. (LUXEMBOURG SOCIETE ANONYME)  
GRAND RUE 31-33, 1661  
LUXEMBOURG, LUXEMBOURG

FOR: BUILDING, REPAIR, INSTALLATION, DISMANTLING AND MAINTENANCE SERVICES OF APPARATUS AND INSTALLATIONS AT OFFSHORE LOCATIONS ON AND UNDER WATER, SHIPS AND OTHER VESSELS, DRY DOCKS AND DRY DOCK FACILITIES, DOCKYARDS, WHARFS, PANELING, DAMS, PIERS, BRIDGES, DRAINAGE SYSTEMS, OIL AND GAS PRODUCING FACILITIES, FLOATING OFFSHORE EQUIPMENT, PIPELINES, STEEL CONSTRUCTIONS AND OTHER CIVIL ENGINEERING CONSTRUCTIONS AND INDUSTRIAL INSTALLATIONS AND MACHINES; CONSTRUCTIONS OF PILINGS ON LAND AND AT SEA; MINING EXTRACTION; PUMPING AND EXTRACTION OF OIL, GAS AND OTHER ENERGY PRODUCTS; WELL DRILLING AND BORING AIMED AT EXTRACTING ENERGY PRODUCTS; RENTAL OF MACHINERY AND TOOLS FOR THE EXTRACTION OF OIL, GAS AND OTHER ENERGY PRODUCTS; CONSTRUCTION PLANNING AND CONSULTATION; CONSULTANCY IN THE FIELD OF TECHNOLOGIES AND TECHNIQUES FOR MINING EXTRACTION OF RAW MATERIALS, RELATED CONSULTATION AND INFORMATION IN THE FIELD OF ALL AFOREMENTIONED SERVICES, IN CLASS 37 (U.S. CLS. 100, 103 AND 106).

FIRST USE 4-30-2007; IN COMMERCE 4-30-2007.

FOR: ENGINEERING; ARCHITECTURAL DESIGN AND CONSULTATION FOR CONSTRUCTION

PURPOSES; DESIGN FOR OTHERS, OF APPARATUS AND INSTALLATIONS FOR OFFSHORE LOCATIONS ON AND UNDER WATER, SHIPS AND OTHER VESSELS, DRY DOCKS AND DRY DOCK FACILITIES, DOCKYARDS, WHARFS, PANELING, DAMS, PIERS, BRIDGES, DRAINAGE SYSTEMS, OIL AND GAS PRODUCTION FACILITIES, FLOATING OFFSHORE EQUIPMENT, PIPELINES, STEEL CONSTRUCTIONS AND OTHER CIVIL ENGINEERING CONSTRUCTIONS AND INDUSTRIAL INSTALLATIONS AND MACHINERY; SCIENTIFIC AND INDUSTRIAL RESEARCH IN THE FIELD OF CONSTRUCTION, REPAIR, MAINTENANCE, TRANSPORT, STORAGE, RESEARCH, EXPLOITATION AND EXTRACTION OF OIL, GAS AND OTHER ENERGY PRODUCTS; TECHNICAL RESEARCH IN THE FIELD OF CONSTRUCTION, REPAIR, MAINTENANCE, TRANSPORT, STORAGE, RESEARCH, EXPLOITATION AND EXTRACTION OF OIL, GAS AND OTHER ENERGY PRODUCTS; TECHNICAL DESIGN FOR OTHERS IN THE OFFSHORE INDUSTRY; TECHNOLOGY SUPERVISION, RESEARCH AND INSPECTION IN THE FIELD OF GEOLOGICAL AND OCEANOGRAPHIC MINING; EXPLORATION AND RESEARCH OF NATURAL GAS AND OIL WELLS, BITUMEN, MINERALS AND OTHER ENERGY PRODUCTS; CONSULTANCY IN THE FIELD OF TECHNOLOGIES AND TECHNIQUES FOR EXPLORATION OF RAW MATERIALS; TECHNICAL RESEARCH AND RELATED CONSULTATION FOR COMPANIES AND PARTICIPANTS IN THE FIELD OF CONSTRUCTION, REPAIR, MAINTENANCE, TRANSPORT, STORAGE, RESEARCH, EXPLOITATION AND EXTRACTION OF OIL, GAS AND OTHER ENERGY PRODUCTS; DESIGN AND DE-

VELOPMENT OF COMPUTERS AND SOFTWARE;  
RELATED CONSULTATION AND INFORMATION  
SERVICES IN THE FIELD OF ALL AFOREMEN-  
TIONED SERVICES, IN CLASS 42 (U.S. CLS. 100 AND  
101).

FIRST USE 4-30-2007; IN COMMERCE 4-30-2007.

NO CLAIM IS MADE TO THE EXCLUSIVE  
RIGHT TO USE "ENGINEERING", APART FROM  
THE MARK AS SHOWN.

THE COLOR(S) BLUE, YELLOW AND WHITE IS/  
ARE CLAIMED AS A FEATURE OF THE MARK.

THE MARK CONSISTS OF A YELLOW SQUARE;  
INSIDE THE YELLOW SQUARE IS A WHITE CIR-  
CLE. THE WHITE CIRCLE CONTAINS THE CAPI-  
TAL LETTER "H" IN BLUE. THE LITERAL  
ELEMENT "HFG" IN BLUE IS DIRECTLY CEN-  
TERED UNDERNEATH THE SQUARE DESIGN  
AND BELOW "HFG" IS THE LITERAL ELEMENT  
"ENGINEERING" ALSO IN THE COLOR BLUE.

SER. NO. 77-245,383, FILED 8-2-2007.

TRACY CROSS, EXAMINING ATTORNEY

Int. Cls.: 37, 39 and 40

Prior U.S. Cls.: 100, 103, 105 and 106

United States Patent and Trademark Office

Reg. No. 3,466,091

Registered July 15, 2008

SERVICE MARK  
PRINCIPAL REGISTER



SPOT ENTERPRISES, LLC (DELAWARE LTD  
LIAB CO)  
242 WASHINGTON STREET  
WEYMOUTH, MA 02188

FOR: CARPET AND RUG CLEANING; CLEAN-  
ING OF CLOTHING; DRY CLEANING, IN CLASS 37  
(U.S. CLS. 100, 103 AND 106).

FIRST USE 4-28-2006; IN COMMERCE 4-28-2006.

FOR: STORAGE OF CLOTHES, IN CLASS 39 (U.S.  
CLS. 100 AND 105).

FIRST USE 4-28-2006; IN COMMERCE 4-28-2006.

FOR: TAILORING, IN CLASS 40 (U.S. CLS. 100, 103  
AND 106).

FIRST USE 4-28-2006; IN COMMERCE 4-28-2006.

NO CLAIM IS MADE TO THE EXCLUSIVE  
RIGHT TO USE "DRYCLEANING", "SHIRTS",  
AND "TAILORING", APART FROM THE MARK  
AS SHOWN.

THE COLOR(S) BLACK, LAVENDER, AND  
WHITE IS/ARE CLAIMED AS A FEATURE OF  
THE MARK.

THE MARK CONSISTS OF THE WORDS: THE  
(ALL LOWER-CASE BLACK LETTERS ABOVE THE  
"C" IN "CLEANERSPOT"), "CLEANERSPOT" (ONE  
WORD, IN BLACK TYPE, ONLY THE C AND S ARE  
UPPER-CASE). UNDERNEATH CLEANERSPOT  
ARE WRITTEN THE WORDS, "DRYCLEANING",  
"SHIRTS", AND "TAILORING". THESE THREE  
WORDS ARE ALL UPPER-CASE BLACK TYPE  
AND ARE SEPARATED BY LAVENDER DOTS.  
AROUND THE "O" IN "SPOT" IS A LAVENDER  
CURVILINEAR SHAPE THAT EXTENDS OUT-  
WARD IN SIX CURVILINEAR POINTS AND THAT  
RESEMBLES A DROP OF WATER. THIS LARGE  
SHAPE HAS THREE SMALL LAVENDER DOTS  
AROUND IT. THE LAVENDER USED IN THE  
MARK IS PANTONE 272.

SER. NO. 77-246,233, FILED 8-3-2007.

SANJEEV VOHRA, EXAMINING ATTORNEY

**Int. Cl.: 9**

**Prior U.S. Cls.: 21, 23, 26, 36 and 38**

**United States Patent and Trademark Office**

**Reg. No. 3,466,092**

**Registered July 15, 2008**

---

**TRADEMARK  
PRINCIPAL REGISTER**

**Clearly The Best**

TAW<sup>^</sup>GLOBAL, LLC (MICHIGAN LTD LIAB CO)  
556 ARTHUR ST.  
KALAMAZOO, MI 49048

THE MARK CONSISTS OF STANDARD CHAR-  
ACTERS WITHOUT CLAIM TO ANY PARTICULAR  
FONT, STYLE, SIZE, OR COLOR.

FOR: RADIO TRANSMITTERS, IN CLASS 9 (U.S.  
CLS. 21, 23, 26, 36 AND 38).

SER. NO. 77-246,362, FILED 8-3-2007.

FIRST USE 4-1-2001; IN COMMERCE 4-1-2001.

DAVID H. STINE, EXAMINING ATTORNEY



**Int. Cl.: 9**

**Prior U.S. Cls.: 21, 23, 26, 36 and 38**

**Reg. No. 3,466,093**

**United States Patent and Trademark Office**

**Registered July 15, 2008**

---

**TRADEMARK  
PRINCIPAL REGISTER**

**CENTRIS**

CSAV, INC. (MASSACHUSETTS CORPORATION)  
8401 EAGLE CREEK PARKWAY, SUITE 700  
SAVAGE, MN 55378

FOR: MECHANICAL MOUNTING SYSTEMS,  
NAMELY, MOUNTING ARMS FOR LIQUID CRYSTAL  
DISPLAYS, PLASMA DISPLAYS, AND CATHODE RAY  
TUBE DISPLAYS, IN CLASS 9 (U.S. CLS. 21, 23, 26, 36 AND 38).

FIRST USE 4-30-2005; IN COMMERCE 4-30-2005.

THE MARK CONSISTS OF STANDARD CHARACTERS  
WITHOUT CLAIM TO ANY PARTICULAR FONT, STYLE,  
SIZE, OR COLOR.

SER. NO. 77-246,730, FILED 8-3-2007.

DAVID I, EXAMINING ATTORNEY

**Int. Cl.: 10**

**Prior U.S. Cls.: 26, 39 and 44**

**United States Patent and Trademark Office**

**Reg. No. 3,466,094**

**Registered July 15, 2008**

**TRADEMARK  
PRINCIPAL REGISTER**

**CHILL-OUT CHAIR**

FREEDOM CONCEPTS INC. (CANADA CORPORATION)  
1565 INKSTER BOULEVARD  
WINNIPEG, MANITOBA, CANADA R2X1R2

FOR: MEDICAL DEVICE, NAMELY, A CHAIR WITH MULTI-POSITIONAL OTTOMAN THAT FACILITATES ALTERNATIVE SEATING POSITIONS, IN CLASS 10 (U.S. CLS. 26, 39 AND 44).

FIRST USE 6-5-2005; IN COMMERCE 6-5-2005.

THE MARK CONSISTS OF STANDARD CHARACTERS WITHOUT CLAIM TO ANY PARTICULAR FONT, STYLE, SIZE, OR COLOR.

PRIORITY CLAIMED UNDER SEC. 44(D) ON CANADA APPLICATION NO. 1337458, FILED 2-21-2007.

NO CLAIM IS MADE TO THE EXCLUSIVE RIGHT TO USE "CHAIR", APART FROM THE MARK AS SHOWN.

SER. NO. 77-246,886, FILED 8-3-2007.

STEVEN R. FINE, EXAMINING ATTORNEY

**Int. Cl.: 9**

**Prior U.S. Cls.: 21, 23, 26, 36 and 38**

**United States Patent and Trademark Office**

**Reg. No. 3,466,095**

**Registered July 15, 2008**

**TRADEMARK  
PRINCIPAL REGISTER**

**JEWELCITY**

STUDIO JOONTOON (NEW JERSEY LTD LIAB  
CO)  
SUITE 5E  
185 PROSPECT AVE.  
HACKENSACK, NJ 07601

FOR: ELECTRONIC GAME SOFTWARE FOR  
CELLULAR TELEPHONES, IN CLASS 9 (U.S. CLS.  
21, 23, 26, 36 AND 38).

FIRST USE 3-24-2007; IN COMMERCE 8-1-2007.

THE MARK CONSISTS OF STANDARD CHAR-  
ACTERS WITHOUT CLAIM TO ANY PARTICULAR  
FONT, STYLE, SIZE, OR COLOR.

SER. NO. 77-247,255, FILED 8-4-2007.

ALICE SUE CARRUTHERS, EXAMINING ATTOR-  
NEY

**Int. Cl.: 45**

**Prior U.S. Cls.: 100 and 101**

**United States Patent and Trademark Office**

**Reg. No. 3,466,096**

**Registered July 15, 2008**

**SERVICE MARK  
PRINCIPAL REGISTER**

Cornell D.M. Judge Cornish

Downpat

CORNISH, CORNELL D.M. JUDGE (UNITED STATES INDIVIDUAL), DBA CORNISH, CORNELL D.

1101 NEW HAMPSHIRE AVE., NW, SUITE 301  
WASHINGTON, DC 200371502

FOR: LEGAL SERVICES, NAMELY, TRADE-MARK SEARCHING AND CLEARANCE SERVICES, IN CLASS 45 (U.S. CLS. 100 AND 101).

FIRST USE 9-13-1990; IN COMMERCE 9-13-1990.

THE MARK CONSISTS OF STANDARD CHARACTERS WITHOUT CLAIM TO ANY PARTICULAR FONT, STYLE, SIZE, OR COLOR.

THE NAME "CORNELL D.M. JUDGE CORNISH" IDENTIFIES A LIVING INDIVIDUAL WHOSE CONSENT IS OF RECORD.

SER. NO. 77-247,319, FILED 8-4-2007.

JENNIFER VASQUEZ, EXAMINING ATTORNEY

**Int. Cl.: 12**

**Prior U.S. Cls.: 19, 21, 23, 31, 35 and 44**

**Reg. No. 3,466,097**

**United States Patent and Trademark Office**

**Registered July 15, 2008**

**TRADEMARK  
PRINCIPAL REGISTER**

**FORGETMENOT**

MORNINGSTAR, JAMES (UNITED STATES IN-  
DIVIDUAL)  
3661 VICTORIA DRIVE  
WEST PALM BEACH, FL 33406

THE MARK CONSISTS OF STANDARD CHAR-  
ACTERS WITHOUT CLAIM TO ANY PARTICULAR  
FONT, STYLE, SIZE, OR COLOR.

FOR: CHILDREN'S SAFETY SEATS FOR VEHI-  
CLES, IN CLASS 12 (U.S. CLS. 19, 21, 23, 31, 35 AND  
44).

SER. NO. 77-247,339, FILED 8-4-2007.

FIRST USE 9-17-2002; IN COMMERCE 8-1-2007.

CAROLINE WOOD, EXAMINING ATTORNEY

**Int. Cl.: 35**

**Prior U.S. Cls.: 100, 101 and 102**

**United States Patent and Trademark Office**

**Reg. No. 3,466,098**

**Registered July 15, 2008**

**SERVICE MARK  
PRINCIPAL REGISTER**

**CHOOSE THE RIGHT NANNY**

CHOOSE THE RIGHT NANNY, LLC (TEXAS LTD  
LIAB CO)  
STE.102 PMB #374  
6804 STONY HILL RD.  
MCKINNEY, TX 75070

FOR: REFERRAL AND PLACEMENT OF CANDI-  
DATES EXPERIENCED IN DOMESTIC AND  
HOUSEHOLD SERVICES, IN CLASS 35 (U.S. CLS.  
100, 101 AND 102).

FIRST USE 3-0-2005; IN COMMERCE 3-0-2005.

THE MARK CONSISTS OF STANDARD CHAR-  
ACTERS WITHOUT CLAIM TO ANY PARTICULAR  
FONT, STYLE, SIZE, OR COLOR.

SER. NO. 77-247,803, FILED 8-6-2007.

TIMOTHY FINNEGAN, EXAMINING ATTORNEY

**Int. Cl.: 35**

**Prior U.S. Cls.: 100, 101 and 102**

**United States Patent and Trademark Office**

**Reg. No. 3,466,099**

**Registered July 15, 2008**

**SERVICE MARK  
PRINCIPAL REGISTER**

# BUZZmakers

GAUL ADVERTISING, INC. (PENNSYLVANIA CORPORATION), DBA GAUL ADVERTISING, INC  
SUITE 106  
485 DEVON PARK DRIVE  
WAYNE, PA 19087

FOR: ADVERTISING AND PUBLICITY SERVICES; ADVERTISING THROUGH ALL PUBLIC COMMUNICATION MEANS; PLANNING AND CONDUCTING OF TRADE FAIRS, EXHIBITIONS AND PRESENTATIONS FOR ECONOMIC OR ADVERTISING PURPOSES; PREPARING SPEECHES AND ORAL PRESENTATIONS FOR OTHERS FOR USE IN ADVERTISING; PROMOTING THE GOODS

AND SERVICES OF OTHERS BY DISTRIBUTING ADVERTISING MATERIALS THROUGH A VARIETY OF METHODS, IN CLASS 35 (U.S. CLS. 100, 101 AND 102).

FIRST USE 8-23-2006; IN COMMERCE 9-1-2006.

THE MARK CONSISTS OF STANDARD CHARACTERS WITHOUT CLAIM TO ANY PARTICULAR FONT, STYLE, SIZE, OR COLOR.

SER. NO. 77-247,880, FILED 8-6-2007.

WENDY GOODMAN, EXAMINING ATTORNEY

**Int. Cl.: 29**

**Prior U.S. Cl.: 46**

**United States Patent and Trademark Office**

**Reg. No. 3,466,100**

**Registered July 15, 2008**

**TRADEMARK  
PRINCIPAL REGISTER**

**RON SON**

RON SON FOODS, INC. (NEW JERSEY CORPORATION)  
81 LOCKE AVE.  
SWEDESBORO, NJ 08085

FOR: PROCESSED OLIVE OILS, PROCESSED ANCHOVIES, PROCESSED FRUITS AND VEGETABLES, NAMELY, MUSHROOMS, OLIVES, ARTICHOKES AND PEPPERS, IN CLASS 29 (U.S. CL. 46).

FIRST USE 3-26-1985; IN COMMERCE 3-26-1985.

THE MARK CONSISTS OF STANDARD CHARACTERS WITHOUT CLAIM TO ANY PARTICULAR FONT, STYLE, SIZE, OR COLOR.

THE NAME(S), PORTRAIT(S), AND/OR SIGNATURE(S) SHOWN IN THE MARK DOES NOT IDENTIFY A PARTICULAR LIVING INDIVIDUAL.

SER. NO. 77-247,895, FILED 8-6-2007.

JOHN GARTNER, EXAMINING ATTORNEY



**Int. Cl.: 35**

**Prior U.S. Cls.: 100, 101 and 102**

**United States Patent and Trademark Office**

**Reg. No. 3,466,101**

**Registered July 15, 2008**

**SERVICE MARK  
PRINCIPAL REGISTER**



ECONOMIC MODELING SPECIALIST, INC.  
(IDAHO CORPORATION), DBA A/K/A CCBE-  
NEFITS INC.

ATTN: FRANK L. HILL  
1187 ALTURAS DRIVE  
MOSCOW, ID 83843

FOR: ECONOMIC CONSULTING AND INFOR-  
MATION FOR THE INDUSTRIAL AND COMMER-  
CIAL SECTORS FOR PLANNING, ORGANIZING,  
MONITORING AND CARRYING OUT UNIQUE  
AND COMPLEX PROJECTS IN DIFFERENT SEC-  
TORS OF ONE OR SEVERAL COMPANIES; ECO-

NOMIC FORECASTING AND ANALYSIS, IN CLASS  
35 (U.S. CLS. 100, 101 AND 102).

FIRST USE 6-15-2005; IN COMMERCE 6-15-2005.

NO CLAIM IS MADE TO THE EXCLUSIVE  
RIGHT TO USE "ECONOMIC MODELING SPECIA-  
LISTS INC.", APART FROM THE MARK AS  
SHOWN.

SER. NO. 77-247,905, FILED 8-6-2007.

WENDY GOODMAN, EXAMINING ATTORNEY

**Int. Cl.: 35**

**Prior U.S. Cls.: 100, 101 and 102**

**United States Patent and Trademark Office**

**Reg. No. 3,466,102**

**Registered July 15, 2008**

---

**SERVICE MARK  
PRINCIPAL REGISTER**

**Our Giving Community**

NATIONAL ALLIANCE FOR CHOICE IN GIVING (MINNESOTA CORPORATION)  
101 STATE STREET  
PORTLAND, ME 04101

FOR: ASSOCIATION SERVICES, NAMELY, PROMOTING THE INTERESTS OF NONPROFIT ORGANIZATIONS, IN CLASS 35 (U.S. CLS. 100, 101 AND 102).

FIRST USE 12-1-2005; IN COMMERCE 12-1-2005.

THE MARK CONSISTS OF STANDARD CHARACTERS WITHOUT CLAIM TO ANY PARTICULAR FONT, STYLE, SIZE, OR COLOR.

SER. NO. 77-247,968, FILED 8-6-2007.

JASON BLAIR, EXAMINING ATTORNEY

**Int. Cl.: 36**

**Prior U.S. Cls.: 100, 101 and 102**

**United States Patent and Trademark Office**

**Reg. No. 3,466,103**

**Registered July 15, 2008**

**SERVICE MARK  
PRINCIPAL REGISTER**

**THE SMART WAY TO SELL,  
FIND & FINANCE YOUR HOME**

HOUSESAVVY USA, LLC (MASSACHUSETTS  
LTD LIAB CO)  
320 WASHINGTON STREET  
NORWELL, MA 02061

FOR: OPERATING MARKETPLACES FOR SELLERS OF REAL ESTATE; REAL ESTATE LISTING SERVICES; REAL ESTATE BROKERAGE SERVICES; CONSULTING SERVICES FOR BUYERS AND SELLERS OF REAL ESTATE; MORTGAGE LENDING SERVICES; MORTGAGE COUNSELING SERVICES, IN CLASS 36 (U.S. CLS. 100, 101 AND 102).

FIRST USE 4-15-2007; IN COMMERCE 4-15-2007.

THE MARK CONSISTS OF STANDARD CHARACTERS WITHOUT CLAIM TO ANY PARTICULAR FONT, STYLE, SIZE, OR COLOR.

SER. NO. 77-248,048, FILED 8-6-2007.

BENJAMIN OKEKE, EXAMINING ATTORNEY

**Int. Cl.: 25**

**Prior U.S. Cls.: 22 and 39**

**United States Patent and Trademark Office**

**Reg. No. 3,466,104**

**Registered July 15, 2008**

**TRADEMARK  
PRINCIPAL REGISTER**

**JUSRAMINC**

OKUMOTO, KYLE (UNITED STATES INDIVIDUAL)  
2733 HENRY STREET  
HONOLULU, HI 96817

THE MARK CONSISTS OF STANDARD CHARACTERS WITHOUT CLAIM TO ANY PARTICULAR FONT, STYLE, SIZE, OR COLOR.

FOR: SHIRTS; SHORTS; PANTS; LADIES' UNDERWEAR; UNDERWEAR; HATS; SWIM WEAR FOR GENTLEMEN AND LADIES; SKIRTS; SWEATERS; JACKETS, IN CLASS 25 (U.S. CLS. 22 AND 39).

SER. NO. 77-248,142, FILED 8-6-2007.

FIRST USE 1-1-2007; IN COMMERCE 5-1-2007.

AMY GEARIN, EXAMINING ATTORNEY

**Int. Cls.: 35, 41 and 42**

**Prior U.S. Cls.: 100, 101, 102 and 107**

**United States Patent and Trademark Office**

**Reg. No. 3,466,105**

**Registered July 15, 2008**

**SERVICE MARK  
PRINCIPAL REGISTER**



SUCCESSFACTORS, INC. (DELAWARE CORPORATION)  
1500 FASHION ISLAND BLVD. SUITE 300  
SAN MATEO, CA 94404

FOR: BUSINESS CONSULTATION TO ASSIST IN BUSINESS PERFORMANCE, NAMELY, ON THE SUBJECTS OF WORKFORCE DEVELOPMENT AND PLANNING, MANAGEMENT OF CHANGES IN THE WORKFORCE, CAREER DEVELOPMENT AND PLANNING, EMPLOYEE TRAINING AND EDUCATION, COMPENSATION PLANNING, HUMAN RESOURCES, WORKFORCE RECRUITING, WORKFORCE ATTRIBUTES, WORKFORCE PERFORMANCE, AND THE EVALUATION OF PERSONNEL, IN CLASS 35 (U.S. CLS. 100, 101 AND 102).

FIRST USE 7-20-2007; IN COMMERCE 7-20-2007.

FOR: OFFERING ONLINE EDUCATIONAL CLASSES, SEMINARS AND WORKSHOPS TO ASSIST IN BUSINESS PERFORMANCE, NAMELY, EMPLOYMENT TRAINING AND TRAINING ON THE SUBJECTS OF WORKFORCE PLANNING AND DEVELOPMENT, MANAGEMENT OF CHANGES IN THE WORKFORCE, EMPLOYEE CAREER DEVELOPMENT AND PLANNING, COMPENSATION PLANNING, WORKFORCE RECRUITING, EVALUATION OF PERSONNEL, DATA ANALYSIS AND REPORTING IN THE FIELDS OF HUMAN RESOURCES, WORKFORCE ATTRIBUTES, AND WORKFORCE PERFORMANCE; PROVIDING ONLINE JOURNALS, NAMELY, BLOGS, ON THE SUBJECTS OF BUSINESS PERFORMANCE, NAMELY, WORKFORCE PLANNING AND DEVELOPMENT, CAREER DEVELOPMENT AND PLANNING, EM-

PLOYEE TRAINING AND EDUCATION, COMPENSATION PLANNING, WORKFORCE RECRUITING, DATA ANALYSIS AND REPORTING IN THE FIELDS OF HUMAN RESOURCES, WORKFORCE ATTRIBUTES, AND WORKFORCE PERFORMANCE, AND THE EVALUATION OF PERSONNEL, IN CLASS 41 (U.S. CLS. 100, 101 AND 107).

FIRST USE 7-20-2007; IN COMMERCE 7-20-2007.

FOR: PROVIDING TEMPORARY USE OF ONLINE NON-DOWNLOADABLE SOFTWARE TO ASSIST IN BUSINESS PERFORMANCE, NAMELY, FOR WORKFORCE PLANNING AND DEVELOPMENT, MANAGEMENT OF CHANGES IN THE WORKFORCE, EMPLOYEE CAREER DEVELOPMENT AND PLANNING, COMPENSATION PLANNING, WORKFORCE RECRUITING, DATA ANALYSIS AND REPORTING IN THE FIELDS OF HUMAN RESOURCES, WORKFORCE ATTRIBUTES, AND WORKFORCE PERFORMANCE, AND FOR EVALUATION OF PERSONNEL; TECHNICAL SUPPORT SERVICES, NAMELY, TROUBLESHOOTING COMPUTER SOFTWARE PROBLEMS IN THE FIELD OF ASSISTING IN BUSINESS PERFORMANCE AND EVALUATION OF PERSONNEL, IN CLASS 42 (U.S. CLS. 100 AND 101).

FIRST USE 7-20-2007; IN COMMERCE 7-20-2007.

THE MARK CONSISTS OF PERSON DESIGN IN A SQUARE.

SER. NO. 77-248,286, FILED 8-6-2007.

LA TONIA FISHER, EXAMINING ATTORNEY

**Int. Cls.: 35 and 36**

**Prior U.S. Cls.: 100, 101 and 102**

**United States Patent and Trademark Office**

**Reg. No. 3,466,106**

**Registered July 15, 2008**

**SERVICE MARK  
PRINCIPAL REGISTER**

# EQUITIUM

THE EQUITIUM GROUP, LLC (FLORIDA LTD  
LIAB CO)  
1001 BRICKELL BAY DRIVE, SUITE 2414  
MIAMI, FL 33131

FOR: BUSINESS CONSULTING, MANAGEMENT,  
PLANNING AND SUPERVISION SERVICES, IN  
CLASS 35 (U.S. CLS. 100, 101 AND 102).

FIRST USE 2-0-2006; IN COMMERCE 2-0-2006.

FOR: FINANCIAL ANALYSIS AND CONSULTA-  
TION; VENTURE CAPITAL INVESTING SERVICES;  
PRIVATE EQUITY INVESTING SERVICES; MAN-

AGEMENT SERVICES FOR ASSETS, NAMELY,  
BANK INVESTMENT SERVICES, IN CLASS 36 (U.S.  
CLS. 100, 101 AND 102).

FIRST USE 2-0-2006; IN COMMERCE 2-0-2006.

THE MARK CONSISTS OF STANDARD CHAR-  
ACTERS WITHOUT CLAIM TO ANY PARTICULAR  
FONT, STYLE, SIZE, OR COLOR.

SER. NO. 77-249,732, FILED 8-8-2007.

JULIE GUTTADAURO, EXAMINING ATTORNEY

**Int. Cl.: 9**

**Prior U.S. Cls.: 21, 23, 26, 36 and 38**

**United States Patent and Trademark Office**

**Reg. No. 3,466,107**

**Registered July 15, 2008**

**TRADEMARK  
PRINCIPAL REGISTER**

**EZ TYPER**

GENETIC TESTING INSTITUTE, INC. (WISCONSIN CORPORATION), DBA GTI DIAGNOSTICS  
20925 CROSSROADS CIRCLE  
WAUKESHA, WI 53186

FOR: CD CONTAINING SCIENTIFIC INSTRUCTIONS, METHODS AND OTHER SCIENTIFIC INFORMATION FOR USE WITH A MOLECULAR DETECTION KIT, IN CLASS 9 (U.S. CLS. 21, 23, 26, 36 AND 38).

FIRST USE 10-1-2006; IN COMMERCE 10-1-2006.

THE MARK CONSISTS OF STANDARD CHARACTERS WITHOUT CLAIM TO ANY PARTICULAR FONT, STYLE, SIZE, OR COLOR.

SER. NO. 77-249,788, FILED 8-8-2007.

KIMBERLY PERRY, EXAMINING ATTORNEY

**Int. Cl.: 33**

**Prior U.S. Cls.: 47 and 49**

**United States Patent and Trademark Office**

**Reg. No. 3,466,108**

**Registered July 15, 2008**

**TRADEMARK  
PRINCIPAL REGISTER**

**LITTLE LAKES CELLARS**

HOUDINI, INC. (CALIFORNIA CORPORATION)  
4225 N. PALM STREET  
FULLERTON, CA 92835

NO CLAIM IS MADE TO THE EXCLUSIVE  
RIGHT TO USE "CELLARS", APART FROM THE  
MARK AS SHOWN.

FOR: WINE, IN CLASS 33 (U.S. CLS. 47 AND 49).

FIRST USE 11-29-2007; IN COMMERCE 11-29-2007.

SER. NO. 77-250,766, FILED 8-8-2007.

THE MARK CONSISTS OF STANDARD CHAR-  
ACTERS WITHOUT CLAIM TO ANY PARTICULAR  
FONT, STYLE, SIZE, OR COLOR.

BERYL GARDNER, EXAMINING ATTORNEY



**Int. Cl.: 6**

**Prior U.S. Cls.: 2, 12, 13, 14, 23, 25 and 50**

**Reg. No. 3,466,109**

**United States Patent and Trademark Office**

**Registered July 15, 2008**

---

**TRADEMARK  
PRINCIPAL REGISTER**

**MARKIN**

MARKIN TUBING, LP (DELAWARE LIMITED  
PARTNERSHIP)  
1 MARKIN LANE  
WYOMING, WY 14591

FOR: STEEL AND METAL TUBING, IN CLASS 6  
(U.S. CLS. 2, 12, 13, 14, 23, 25 AND 50).

FIRST USE 0-0-1958; IN COMMERCE 0-0-1958.

THE MARK CONSISTS OF STANDARD CHAR-  
ACTERS WITHOUT CLAIM TO ANY PARTICULAR  
FONT, STYLE, SIZE, OR COLOR.

SEC. 2(F).

SER. NO. 77-250,876, FILED 8-9-2007.

KAPIL BHANOT, EXAMINING ATTORNEY

**Int. Cl.: 9**

**Prior U.S. Cls.: 21, 23, 26, 36 and 38**

**Reg. No. 3,466,110**

**United States Patent and Trademark Office**

**Registered July 15, 2008**

---

**TRADEMARK  
PRINCIPAL REGISTER**

**THREAD DETECTIVE**

INNOVATIVE COMPONENTS, INC. (ILLINOIS  
CORPORATION)  
1050 NATIONAL PARKWAY  
SCHAUMBURG, IL 601734519

FOR: A MEASURING APPARATUS FOR IDENTIFYING  
THREADS IN NUTS AND BOLTS, IN CLASS  
9 (U.S. CLS. 21, 23, 26, 36 AND 38).

FIRST USE 5-9-2007; IN COMMERCE 5-9-2007.

THE MARK CONSISTS OF STANDARD CHARACTERS  
WITHOUT CLAIM TO ANY PARTICULAR  
FONT, STYLE, SIZE, OR COLOR.

NO CLAIM IS MADE TO THE EXCLUSIVE  
RIGHT TO USE "THREAD", APART FROM THE  
MARK AS SHOWN.

SER. NO. 77-250,913, FILED 8-9-2007.

AISHA SALEM, EXAMINING ATTORNEY

**Int. Cl.: 41**

**Prior U.S. Cls.: 100, 101 and 107**

**United States Patent and Trademark Office**

**Reg. No. 3,466,111**

**Registered July 15, 2008**

**SERVICE MARK  
PRINCIPAL REGISTER**

**BRONZE TROPHY**

UNITED STATES POLO ASSOCIATION (ILLI-  
NOIS CORPORATION)  
STE. 430  
771 CORPORATE DRIVE  
LEXINGTON, KY 40503

FOR: ENTERTAINMENT SERVICES, NAMELY,  
ORGANIZING AND CONDUCTING POLO EVENTS  
AND TOURNAMENTS, IN CLASS 41 (U.S. CLS. 100,  
101 AND 107).

FIRST USE 0-0-1980; IN COMMERCE 0-0-1980.

THE MARK CONSISTS OF STANDARD CHAR-  
ACTERS WITHOUT CLAIM TO ANY PARTICULAR  
FONT, STYLE, SIZE, OR COLOR.

SEC. 2(F).

SER. NO. 77-251,042, FILED 8-9-2007.

ALICE BENMAMAN, EXAMINING ATTORNEY

**Int. Cl.: 41**

**Prior U.S. Cls.: 100, 101 and 107**

**United States Patent and Trademark Office**

**Reg. No. 3,466,112**

**Registered July 15, 2008**

**SERVICE MARK  
PRINCIPAL REGISTER**

**NATIONAL COPPER CUP**

UNITED STATES POLO ASSOCIATION (ILLI-  
NOIS CORPORATION)  
STE. 430  
771 CORPORATE DRIVE  
LEXINGTON, KY 40503

FOR: ENTERTAINMENT SERVICES, NAMELY,  
ORGANIZING AND CONDUCTING POLO EVENTS  
AND TOURNAMENTS, IN CLASS 41 (U.S. CLS. 100,  
101 AND 107).

FIRST USE 0-0-1975; IN COMMERCE 0-0-1975.

THE MARK CONSISTS OF STANDARD CHAR-  
ACTERS WITHOUT CLAIM TO ANY PARTICULAR  
FONT, STYLE, SIZE, OR COLOR.

SEC. 2(F).

SER. NO. 77-251,066, FILED 8-9-2007.

ALICE BENMAMAN, EXAMINING ATTORNEY

**Int. Cls.: 29 and 30**

**Prior U.S. Cl.: 46**

**United States Patent and Trademark Office**

**Reg. No. 3,466,113**

**Registered July 15, 2008**

**TRADEMARK  
PRINCIPAL REGISTER**

# San Giuseppe

STANISLAUS PARTNERS (CALIFORNIA LIMITED PARTNERSHIP)  
ATTN: ELIZABETH CHATFIELD  
P.O. BOX 3951  
MODESTO, CA 95352

FOR: PROCESSED VEGETABLES; CANNED VEGETABLES; CANNED TOMATOES; VEGETABLE PASTE; VEGETABLE PUREE; TOMATO PASTE; TOMATO PUREE, IN CLASS 29 (U.S. CL. 46).

FIRST USE 10-30-2005; IN COMMERCE 10-30-2005.

FOR: SAUCES; TOMATO-BASED SAUCES; READY-MADE SAUCES; TOMATO SAUCE; CANNED TOMATO SAUCE; PIZZA SAUCE; SPAGHETTI

AND PASTA SAUCE; MARINARA SAUCE; SALSA, IN CLASS 30 (U.S. CL. 46).

FIRST USE 10-30-2005; IN COMMERCE 10-30-2005.

THE MARK CONSISTS OF STANDARD CHARACTERS WITHOUT CLAIM TO ANY PARTICULAR FONT, STYLE, SIZE, OR COLOR.

THE FOREIGN WORDING IN THE MARK TRANSLATES INTO ENGLISH AS "SAINT JOSEPH."

SER. NO. 77-251,186, FILED 8-9-2007.

CHRISTINA SOBRAL, EXAMINING ATTORNEY

**Int. Cl.: 11**

**Prior U.S. Cls.: 13, 21, 23, 31 and 34**

**United States Patent and Trademark Office**

**Reg. No. 3,466,114**

**Registered July 15, 2008**

---

**TRADEMARK  
PRINCIPAL REGISTER**

**CROSSOVER**

LSI INDUSTRIES INC. (OHIO CORPORATION)  
P.O. BOX 42728  
10000 ALLIANCE RD.  
CINCINNATI, OH 45242

THE MARK CONSISTS OF STANDARD CHAR-  
ACTERS WITHOUT CLAIM TO ANY PARTICULAR  
FONT, STYLE, SIZE, OR COLOR.

FOR: ELECTRIC LIGHTING FIXTURES, IN  
CLASS 11 (U.S. CLS. 13, 21, 23, 31 AND 34).

SER. NO. 77-251,216, FILED 8-9-2007.

FIRST USE 11-0-2007; IN COMMERCE 2-1-2008.

BONNIE LUKEN, EXAMINING ATTORNEY

Int. Cl.: 33

Prior U.S. Cls.: 47 and 49

United States Patent and Trademark Office

Reg. No. 3,466,115

Registered July 15, 2008

**TRADEMARK  
PRINCIPAL REGISTER**



BACARDI & COMPANY LIMITED (LIECHTEN-  
STEIN CORPORATION)  
AEULESTRASSE 5  
VADUZ, LIECHTENSTEIN FL-9490

FOR: ALCOHOLIC BEVERAGES, NAMELY, TE-  
QUILA, IN CLASS 33 (U.S. CLS. 47 AND 49).

FIRST USE 8-7-2007; IN COMMERCE 8-7-2007.

NO CLAIM IS MADE TO THE EXCLUSIVE  
RIGHT TO USE THE REPRESENTATION OF THE  
SHAPE OF THE BOTTLE, "REPOSADO" AND "100%  
AGAVE", APART FROM THE MARK AS SHOWN.

THE COLOR(S) YELLOW, RED, GOLD, BLACK,  
BROWN AND WHITE IS/ARE CLAIMED AS A  
FEATURE OF THE MARK.

THE MARK CONSISTS OF A BOTTLE WITH A  
YELLOW CAP AND RED STRIPE IN WHICH THE  
WORDING "REPOSADO" APPEARS IN YELLOW,  
THE WORDING "100% AGAVE" IN RED, A GOLD  
"C" ON THE NECK OF THE BOTTLE, A YELLOW  
LABEL EDGED IN GOLD AND RED, THE WORD  
"CAZADORES" IN RED AND BLACK, A BROWN  
DEER WITH BROWN ANTLERS AND A WHITE  
MARK AT THE NECK, AN AGAVE PLANT IN  
WHITE ON A BROWN CIRCLE AND A GOLD  
SCROLL BANNER.

THE FOREIGN WORDING IN THE MARK  
TRANSLATES INTO ENGLISH AS RESTED AND  
LIGHT INFANTRY.

SER. NO. 77-251,251, FILED 8-9-2007.

HEATHER THOMPSON, EXAMINING ATTORNEY

**Int. Cl.: 25**

**Prior U.S. Cls.: 22 and 39**

**United States Patent and Trademark Office**

**Reg. No. 3,466,116**

**Registered July 15, 2008**

**TRADEMARK  
PRINCIPAL REGISTER**



**HENRY JACOBSON**

HENRY JACOBSON, LLC (CALIFORNIA LTD  
LIAB CO)  
880 HARBOUR WAY SOUTH  
RICHMOND, CA 94804

OWNER OF U.S. REG. NO. 2,860,191.

THE NAME "HENRY JACOBSON" IDENTIFIES A  
LIVING INDIVIDUAL WHOSE CONSENT IS OF  
RECORD.

FOR: MEN'S TAILORED CLOTHING, NAMELY,  
PANTS, SHIRTS, AND JACKETS; FOOTWEAR;  
HEADWEAR; OUTERWEAR; AND NECKWEAR;  
WOMEN'S CLOTHING, NAMELY, DRESSES,  
SKIRTS, SHIRTS, PANTS, AND COATS; FOOT-  
WEAR; UNDERGARMENTS; HEADWEAR; AND  
NECKWEAR, IN CLASS 25 (U.S. CLS. 22 AND 39).

THE MARK CONSISTS OF THE LETTERS "HJ"  
ON A SHIELD DESIGN AND THE WORDS "HENRY  
JACOBSON" TO THE RIGHT OF THE SHIELD.

SER. NO. 77-251,373, FILED 8-9-2007.

FIRST USE 7-20-2005; IN COMMERCE 7-20-2005.

SUSAN LESLIE DUBOIS, EXAMINING ATTORNEY



**Int. Cl.: 19**

**Prior U.S. Cls.: 1, 12, 33 and 50**

**United States Patent and Trademark Office**

**Reg. No. 3,466,117**

**Registered July 15, 2008**

**TRADEMARK  
PRINCIPAL REGISTER**

# SolaRay

RADIANT MANUFACTURING (WYOMING  
CORPORATION)  
1248 DEWAR DRIVE  
ROCK SPRINGS, WY 82901

THE MARK CONSISTS OF STANDARD CHAR-  
ACTERS WITHOUT CLAIM TO ANY PARTICULAR  
FONT, STYLE, SIZE, OR COLOR.

FOR: PLASTIC POSTS WITH REFLECTIVE UV  
COATED DISCS ATTACHED, IN CLASS 19 (U.S.  
CLS. 1, 12, 33 AND 50).

SER. NO. 77-251,383, FILED 8-9-2007.

FIRST USE 5-1-2007; IN COMMERCE 5-1-2007.

ALYSSA PALADINO, EXAMINING ATTORNEY

**Int. Cl.: 7**

**Prior U.S. Cls.: 13, 19, 21, 23, 31, 34 and 35**

**Reg. No. 3,466,118**

**United States Patent and Trademark Office**

**Registered July 15, 2008**

**TRADEMARK  
PRINCIPAL REGISTER**

**AIR BLADE**

ILLINOIS TOOL WORKS INC. (DELAWARE  
CORPORATION)  
3600 WEST LAKE AVENUE  
GLENVIEW, IL 600261215

FOR: SPRAYING DEVICES, NAMELY, AIR BRUSHES AND AIR COMPRESSORS FOR APPLYING COATINGS SUCH AS PAINT, IN CLASS 7 (U.S. CLS. 13, 19, 21, 23, 31, 34 AND 35).

FIRST USE 3-16-2007; IN COMMERCE 3-16-2007.

THE MARK CONSISTS OF STANDARD CHARACTERS WITHOUT CLAIM TO ANY PARTICULAR FONT, STYLE, SIZE, OR COLOR.

NO CLAIM IS MADE TO THE EXCLUSIVE RIGHT TO USE "AIR", APART FROM THE MARK AS SHOWN.

SER. NO. 77-251,543, FILED 8-9-2007.

STEPHEN AQUILA, EXAMINING ATTORNEY

**Int. Cl.: 16**

**Prior U.S. Cls.: 2, 5, 22, 23, 29, 37, 38 and 50**

**United States Patent and Trademark Office**

**Reg. No. 3,466,119**

**Registered July 15, 2008**

**TRADEMARK  
PRINCIPAL REGISTER**

**DEW DROP**

TSUKINEKO CO., LTD. (JAPAN CORPORATION)  
5-11-10 ARAKAWA, ARAKAWA-KU  
TOKYO, JAPAN 116

THE MARK CONSISTS OF STANDARD CHAR-  
ACTERS WITHOUT CLAIM TO ANY PARTICULAR  
FONT, STYLE, SIZE, OR COLOR.

FOR: STAMP PADS AND CONTAINERS THERE-  
FOR, IN CLASS 16 (U.S. CLS. 2, 5, 22, 23, 29, 37, 38  
AND 50).

SER. NO. 77-251,644, FILED 8-9-2007.

FIRST USE 1-31-2006; IN COMMERCE 1-31-2006.

DARRYL SPRUILL, EXAMINING ATTORNEY

**Int. Cl.: 16**

**Prior U.S. Cls.: 2, 5, 22, 23, 29, 37, 38 and 50**

**Reg. No. 3,466,120**

**United States Patent and Trademark Office**

**Registered July 15, 2008**

**TRADEMARK  
PRINCIPAL REGISTER**

**THE ESSENTIAL GLUE PAD**

TSUKINEKO CO., LTD. (JAPAN CORPORATION)  
5-11-10 ARAKAWA, ARAKAWA-KU  
TOKYO, JAPAN 116

FOR: GLUE FOR STATIONARY OR HOUSE-  
HOLD USE; GLUE PADS AND CONTAINERS  
THEREFOR; GLUE FOR IMPREGNATING GLUE  
PADS, IN CLASS 16 (U.S. CLS. 2, 5, 22, 23, 29, 37, 38  
AND 50).

FIRST USE 1-31-2006; IN COMMERCE 1-31-2006.

THE MARK CONSISTS OF STANDARD CHAR-  
ACTERS WITHOUT CLAIM TO ANY PARTICULAR  
FONT, STYLE, SIZE, OR COLOR.

NO CLAIM IS MADE TO THE EXCLUSIVE  
RIGHT TO USE "GLUE PAD", APART FROM THE  
MARK AS SHOWN.

SER. NO. 77-251,646, FILED 8-9-2007.

DARRYL SPRUILL, EXAMINING ATTORNEY

**Int. Cl.: 29**

**Prior U.S. Cl.: 46**

**United States Patent and Trademark Office**

**Reg. No. 3,466,121**

**Registered July 15, 2008**

**TRADEMARK  
PRINCIPAL REGISTER**

**Cosecha del Verano**

STANISLAUS PARTNERS (CALIFORNIA LIMITED PARTNERSHIP)  
ATTN: ELIZABETH CHATFIELD  
P.O. BOX 3951  
MODESTO, CA 95352

FOR: PROCESSED VEGETABLES; CANNED VEGETABLES; CANNED TOMATOES; VEGETABLE PASTE; VEGETABLE PUREE; TOMATO PASTE; TOMATO PUREE, IN CLASS 29 (U.S. CL. 46).

FIRST USE 8-19-2005; IN COMMERCE 8-19-2005.

THE MARK CONSISTS OF STANDARD CHARACTERS WITHOUT CLAIM TO ANY PARTICULAR FONT, STYLE, SIZE, OR COLOR.

THE ENGLISH TRANSLATION OF THE WORD "COSECHA DEL VERANO" IN THE MARK IS SUMMER HARVEST.

SER. NO. 77-251,752, FILED 8-9-2007.

CHRISTINA SOBRAL, EXAMINING ATTORNEY

**Int. Cls.: 29 and 30**

**Prior U.S. Cl.: 46**

**United States Patent and Trademark Office**

**Reg. No. 3,466,122**

**Registered July 15, 2008**

**TRADEMARK  
PRINCIPAL REGISTER**

# Tomate Bonita

STANISLAUS PARTNERS (CALIFORNIA LIMITED PARTNERSHIP)  
P.O. BOX 3951  
MODESTO, CA 95352

FOR: PROCESSED VEGETABLES; CANNED VEGETABLES; CANNED TOMATOES; VEGETABLE PASTE; VEGETABLE PUREE; TOMATO PASTE; TOMATO PUREE, IN CLASS 29 (U.S. CL. 46).

FIRST USE 12-1-2006; IN COMMERCE 12-1-2006.

FOR: SAUCES; TOMATO-BASED SAUCES; READY-MADE SAUCES; TOMATO SAUCE; CANNED TOMATO SAUCE; PIZZA SAUCE; SPAGHETTI AND PASTA SAUCE; MARINARA SAUCE; SALSA, IN CLASS 30 (U.S. CL. 46).

FIRST USE 12-1-2006; IN COMMERCE 12-1-2006.

THE MARK CONSISTS OF STANDARD CHARACTERS WITHOUT CLAIM TO ANY PARTICULAR FONT, STYLE, SIZE, OR COLOR.

NO CLAIM IS MADE TO THE EXCLUSIVE RIGHT TO USE "TOMATE", APART FROM THE MARK AS SHOWN.

THE FOREIGN WORDING IN THE MARK TRANSLATES INTO ENGLISH AS "PRETTY TOMATO".

SER. NO. 77-251,862, FILED 8-9-2007.

CHRISTINA SOBRAL, EXAMINING ATTORNEY

**Int. Cl.: 29**

**Prior U.S. Cl.: 46**

**United States Patent and Trademark Office**

**Reg. No. 3,466,123**

**Registered July 15, 2008**

**TRADEMARK  
PRINCIPAL REGISTER**

# Ponte Vecchio

STANISLAUS PARTNERS (CALIFORNIA LIMITED PARTNERSHIP)  
P.O. BOX 3951  
MODESTO, CA 95352

FOR: PROCESSED VEGETABLES; CANNED VEGETABLES; CANNED TOMATOES; VEGETABLE PASTE; VEGETABLE PUREE; TOMATO PASTE; TOMATO PUREE, IN CLASS 29 (U.S. CL. 46).

FIRST USE 11-13-2005; IN COMMERCE 11-13-2005.

THE MARK CONSISTS OF STANDARD CHARACTERS WITHOUT CLAIM TO ANY PARTICULAR FONT, STYLE, SIZE, OR COLOR.

THE ENGLISH TRANSLATION OF THE WORD "PONTE VECCHIO" IN THE MARK IS OLD BRIDGE.

SER. NO. 77-251,876, FILED 8-9-2007.

CHRISTINA SOBRAL, EXAMINING ATTORNEY

**Int. Cl.: 30**

**Prior U.S. Cl.: 46**

**United States Patent and Trademark Office**

**Reg. No. 3,466,124**

**Registered July 15, 2008**

**TRADEMARK  
PRINCIPAL REGISTER**

# Monseratto

STANISLAUS PARTNERS (CALIFORNIA LIMITED PARTNERSHIP)  
ATTN: ELIZABETH CHATFIELD  
P.O. BOX 3951  
MODESTO, CA 95352

FOR: SAUCES; TOMATO-BASED SAUCES; READY-MADE SAUCES; TOMATO SAUCE; CANNED TOMATO SAUCE; PIZZA SAUCE; SPAGHETTI AND PASTA SAUCE; MARINARA SAUCE; SALSA, IN CLASS 30 (U.S. CL. 46).

FIRST USE 12-19-2006; IN COMMERCE 12-19-2006.

THE MARK CONSISTS OF STANDARD CHARACTERS WITHOUT CLAIM TO ANY PARTICULAR FONT, STYLE, SIZE, OR COLOR.

SER. NO. 77-251,878, FILED 8-9-2007.

CHRISTINA SOBRAL, EXAMINING ATTORNEY



**Int. Cl.: 29**

**Prior U.S. Cl.: 46**

**United States Patent and Trademark Office**

**Reg. No. 3,466,125**

**Registered July 15, 2008**

**TRADEMARK  
PRINCIPAL REGISTER**

# Exquisito

STANISLAUS PARTNERS (CALIFORNIA LIMITED PARTNERSHIP)  
ATTN: ELIZABETH CHATFIELD  
P.O. BOX 3951  
MODESTO, CA 95352

FOR: PROCESSED VEGETABLES; CANNED VEGETABLES; CANNED TOMATOES; VEGETABLE PASTE; VEGETABLE PUREE; TOMATO PASTE; TOMATO PUREE, IN CLASS 29 (U.S. CL. 46).

FIRST USE 12-1-2006; IN COMMERCE 12-1-2006.

THE MARK CONSISTS OF STANDARD CHARACTERS WITHOUT CLAIM TO ANY PARTICULAR FONT, STYLE, SIZE, OR COLOR.

THE ENGLISH TRANSLATION OF THE WORD "EXQUISITO" IN THE MARK IS EXQUISITE.

SER. NO. 77-251,882, FILED 8-9-2007.

CHRISTINA SOBRAL, EXAMINING ATTORNEY

**Int. Cls.: 35 and 45**

**Prior U.S. Cls.: 100, 101 and 102**

**United States Patent and Trademark Office**

**Reg. No. 3,466,126**

**Registered July 15, 2008**

**SERVICE MARK  
PRINCIPAL REGISTER**

**COLLEGE TONIGHT**

COLLEGE TONIGHT, INC. (CALIFORNIA CORPORATION)  
SUITE 208  
12747 RIVERSIDE DRIVE  
VALLEY VILLAGE, CA 91607

FOR: PROVIDING AN ONLINE DIRECTORY SERVICE FEATURING INFORMATION REGARDING, PERSONAL PROFILES, CLASSIFIED ADVERTISEMENTS AND SOCIAL NETWORKING FOR REGISTERED USERS WHO ARE PRIMARILY STUDENTS, FORMER STUDENTS AND ALUMNI IN ORDER TO PARTICIPATE IN COMPETITIONS, GET FEEDBACK AND OTHER INFORMATION ABOUT CAMPUS LIFE AND SOCIAL EVENTS FROM THEIR PEERS AND OTHERS, AND FORM VIRTUAL COMMUNITIES AMONG STUDENTS, FORMER STUDENTS AND ALUMNI OF COLLEGES AND UNIVERSITIES, IN CLASS 35 (U.S. CLS. 100, 101 AND 102).

FIRST USE 5-13-2007; IN COMMERCE 8-8-2007.

FOR: PROVIDING INTERNET BASED SOCIAL NETWORKING AMONG COLLEGE STUDENTS, FORMER COLLEGE STUDENTS AND COLLEGE ALUMNI ON, AROUND AND IN CONNECTION WITH COLLEGE AND UNIVERSITY CAMPUS LIFE, IN CLASS 45 (U.S. CLS. 100 AND 101).

FIRST USE 5-13-2007; IN COMMERCE 8-8-2007.

THE MARK CONSISTS OF STANDARD CHARACTERS WITHOUT CLAIM TO ANY PARTICULAR FONT, STYLE, SIZE, OR COLOR.

NO CLAIM IS MADE TO THE EXCLUSIVE RIGHT TO USE "COLLEGE", APART FROM THE MARK AS SHOWN.

SER. NO. 77-252,466, FILED 8-10-2007.

FRANK LATTUCA, EXAMINING ATTORNEY

**Int. Cl.: 12**

**Prior U.S. Cls.: 19, 21, 23, 31, 35 and 44**

**Reg. No. 3,466,127**

**United States Patent and Trademark Office**

**Registered July 15, 2008**

---

**TRADEMARK  
PRINCIPAL REGISTER**

**UTPRO**

CUSTOM FIBREGLASS MANUFACTURING CO.  
(CALIFORNIA CORPORATION)  
1711 HARBOR AVE.  
LONG BEACH, CA 90801

THE MARK CONSISTS OF STANDARD CHAR-  
ACTERS WITHOUT CLAIM TO ANY PARTICULAR  
FONT, STYLE, SIZE, OR COLOR.

FOR: PICKUP TRUCK CAPS, IN CLASS 12 (U.S.  
CLS. 19, 21, 23, 31, 35 AND 44).

SER. NO. 77-252,959, FILED 8-10-2007.

FIRST USE 10-5-2006; IN COMMERCE 10-5-2006.

WILLIAM ROSSMAN, EXAMINING ATTORNEY

Int. Cl.: 29

Prior U.S. Cl.: 46

United States Patent and Trademark Office

Reg. No. 3,466,128

Registered July 15, 2008

TRADEMARK  
PRINCIPAL REGISTER



PRODUCTOS ALIMENTICIOS DIANA, S.A. DE  
C.V. (EL SALVADOR CORPORATION)  
COLONIA GUADALUPE Y SOYAPANGO  
12 AVENIDA SUR, NÚMERO 11  
SAN SALVADOR, EL SALVADOR

FOR: PLANTAIN CHIPS; YUCCA CHIPS; PRO-  
CESSED EDIBLE SEEDS, IN CLASS 29 (U.S. CL. 46).

FIRST USE 12-31-1951; IN COMMERCE 7-31-2005.

OWNER OF U.S. REG. NOS. 1,883,773 AND  
2,933,050.

THE COLOR(S) RED, BLACK, YELLOW AND  
ORANGE IS/ARE CLAIMED AS A FEATURE OF  
THE MARK.

THE MARK CONSISTS OF THE WORD "DIANA"  
IN STYLIZED YELLOW CAPITAL LETTERS INSIDE  
A RED BOWL-SHAPED FIGURE SURROUNDED  
BY A THIN BLACK BORDER. BELOW THIS FIG-  
URE APPEAR THE WORDS "TODO MUNDO" IN  
STYLIZED LOWER CASE LETTERS DRAWN IN A  
CURVED MANNER AS IF FLOATING OVER THE  
BACKGROUND. THE LETTERS ARE COLORED  
RED, GRADUALLY TURNING ORANGE AND  
THEN YELLOW FROM LEFT TO RIGHT AND  
ARE OUTLINED IN BLACK.

THE FOREIGN WORDING IN THE MARK  
TRANSLATES INTO ENGLISH AS ALL WORLD.

SER. NO. 77-253,153, FILED 8-12-2007.

LINDA LAVACHE, EXAMINING ATTORNEY

**Int. Cls.: 41 and 45**

**Prior U.S. Cls.: 100, 101 and 107**

**United States Patent and Trademark Office**

**Reg. No. 3,466,129**

**Registered July 15, 2008**

**SERVICE MARK  
PRINCIPAL REGISTER**



GRAVES, KARIN (UNITED STATES INDIVIDUAL)  
FIRST FLOOR, NBCOFC  
1470 JAMBOREE ROAD  
NEWPORT BEACH, CA 92660

FOR: BIBLICAL INSTRUCTION, IN CLASS 41 (U.S. CLS. 100, 101 AND 107).

FIRST USE 10-2-2005; IN COMMERCE 10-2-2005.

FOR: MINISTERIAL SERVICES INCLUDING, BUT NOT LIMITED TO, SOCIAL SUPPORT, ORGANIZING, IMPLEMENTING, AND CONDUCTING OF CHRISTIAN BASED PROGRAMS AND EVENTS, OVERSEEING OF SUCH MINISTERIAL SERVICES, IN CLASS 45 (U.S. CLS. 100 AND 101).

FIRST USE 10-2-2005; IN COMMERCE 10-2-2005.

OWNER OF U.S. REG. NO. 3,223,968.

NO CLAIM IS MADE TO THE EXCLUSIVE RIGHT TO USE "MINISTRIES", APART FROM THE MARK AS SHOWN.

THE COLOR(S) BLUE IS/ARE CLAIMED AS A FEATURE OF THE MARK.

THE MARK CONSISTS OF "WING" IS ALL IN CAPITAL LETTERS, "MINISTRIES" IS BELOW "WING" AND IS JUSTIFIED TO THE LENGTH OF "WING" ABOVE. THERE ARE TWO BLUE STYLIZED SEAGULLS BEHIND THE ENTIRE NAME "WING MINISTRIES WOMEN IMPARTING TO THE NEXT GENERATION" THE ENTIRE TEXT IS IN BLUE.

SER. NO. 77-253,281, FILED 8-13-2007.

JAMES GRIFFIN, EXAMINING ATTORNEY

Int. Cl.: 7

Prior U.S. Cls.: 13, 19, 21, 23, 31, 34 and 35

United States Patent and Trademark Office

Reg. No. 3,466,130

Registered July 15, 2008

TRADEMARK  
PRINCIPAL REGISTER



GUANGZHOU AQUILA PRECISE TOOLS LIMITED (CHINA LTD LIAB CO)  
DACHONGKOU  
IND. ZONE, SHAWAN TOWN, PAN YU DISTRICT  
GUANG-ZHOU CITY, CHINA

FOR: POWER OPERATED TOOLS FOR WOOD WORKING, NAMELY, SOLID CARBIDE DRILL BITS, ROUTER BITS, END MILLS, TUNGSTEN CARBIDE TIPPED FINGER JOINT CUTTERS, EDGE-BANDING CUTTERS BEING MACHINES, QUICK CHANGE CHUCKS FOR POWER DRILLS; CUSTOM-MADE MACHINE TOOLS, NAMELY, SOLID CARBIDE DRILL BITS, ROUTER BITS, END MILLS, TUNGSTEN CARBIDE TIPPED FINGER JOINT CUTTERS, EDGE-BANDING CUTTERS BEING MACHINES, QUICK CHANGE CHUCKS FOR POWER DRILLS, FOR PRECISION MACHIN-

ING APPLICATIONS, IN CLASS 7 (U.S. CLS. 13, 19, 21, 23, 31, 34 AND 35).

FIRST USE 3-1-2001; IN COMMERCE 11-29-2006.

THE MARK CONSISTS OF THE WORD "AQUILA" WITH CHINESE CHARACTERS AND A DEPICTION OF AN EAGLE WITHIN A SEMI-CIRCLE.

THE NON-LATIN CHARACTERS IN THE MARK TRANSLITERATE INTO "TIAN YING", AND THIS MEANS SKY AND EAGLE IN ENGLISH.

SER. NO. 77-253,294, FILED 8-13-2007.

EVELYN BRADLEY, EXAMINING ATTORNEY

Int. Cl.: 30

Prior U.S. Cl.: 46

United States Patent and Trademark Office

Reg. No. 3,466,131

Registered July 15, 2008

TRADEMARK  
PRINCIPAL REGISTER



LORRAINE T. GUERRIERO (UNITED STATES  
INDIVIDUAL)  
24 HEATHWOOD AVENUE  
JACKSON, NJ 08527

FOR: CHOCOLATE-COVERED POTATO CHIPS;  
PRETZELS, IN CLASS 30 (U.S. CL. 46).

FIRST USE 12-15-1995; IN COMMERCE 12-15-1995.

THE MARK CONSISTS OF THE PHRASE "HASH AND BROEDIE'S CHOCOLATE CHIPPS" IN SCRIPTED LETTERS, INSIDE A SQUARE (WHICH IS DIAMOND SHAPED, HEREINAFTER REFERRED TO AS "SQUARE"), FORMED BY A PAIR OF PARALLEL LINES, WITH A CAPITAL LETTER "H" IN "HASH", A CAPITAL LETTER "A" IN "AND," AND A CAPITAL LETTER "B" IN "BROEDIE'S", WITH THE WORD "AND" ALIGNED ACROSS AN INSIDE CORNER OF THE SQUARE, AND THE WORD "HASH" ALIGNED PARALLEL TO AN INSIDE SIDE OF THE SQUARE, NEXT TO AND BEFORE THE WORD "AND", AND THE WORD

"BROEDIE'S" ALIGNED PARALLEL TO AN INSIDE SIDE OF THE SQUARE, NEXT TO AND AFTER THE WORD "AND", AND THE WORDS "CHOCOLATE CHIPPS" LOCATED IN THE MIDDLE OF THE SQUARE, WITH THE COMMON CAPITAL LETTER "C" USED FOR BOTH WORDS "CHOCOLATE" AND "CHIPPS" AS A LARGE LETTER "C" ENCLOSING THE FIRST TWO LETTERS "HO" AND "HI" OF THE REMAINING LETTERS FORMING WORD PORTIONS "HOCOLATE" AND "HIPPS", AND THE SMALL LETTER "H" IN THE WORD PORTION "HOCOLATE" IS ALIGNED DIRECTLY ABOVE THE SMALL LETTER "H" IN THE WORD PORTION "HIPPS", AND A PAIR OF PARALLEL LINES UNDERLINE THE WORD PORTION "HOCOLATE", SO AS TO ALIGN THE WORDS PORTIONS "HOCOLATE" AND "HIPPS" DIRECTLY IN THE MIDDLE OF THE CAPITAL LETTER "C".

SER. NO. 77-253,884, FILED 8-13-2007.

RAUL CORDOVA, EXAMINING ATTORNEY

**Int. Cl.: 35**

**Prior U.S. Cls.: 100, 101 and 102**

**United States Patent and Trademark Office**

**Reg. No. 3,466,132**

**Registered July 15, 2008**

**SERVICE MARK  
PRINCIPAL REGISTER**

**Creaser Jewelers  
Jewelry to Fall in Love  
With**

INTERGALACTIC MINING, CORP. (MAINE CORPORATION), DBA (DBA) CREASER JEWELERS

138 MAINE STREET  
SOUTH PARIS, ME 04281

FOR: RETAIL JEWELRY STORES, IN CLASS 35 (U.S. CLS. 100, 101 AND 102).

FIRST USE 8-1-1999; IN COMMERCE 8-1-1999.

THE MARK CONSISTS OF STANDARD CHARACTERS WITHOUT CLAIM TO ANY PARTICULAR FONT, STYLE, SIZE, OR COLOR.

NO CLAIM IS MADE TO THE EXCLUSIVE RIGHT TO USE "JEWELERS" AND "JEWELRY", APART FROM THE MARK AS SHOWN.

SER. NO. 77-253,968, FILED 8-13-2007.

BARBARA GAYNOR, EXAMINING ATTORNEY



**Int. Cl.: 25**

**Prior U.S. Cls.: 22 and 39**

**United States Patent and Trademark Office**

**Reg. No. 3,466,133**

**Registered July 15, 2008**

**TRADEMARK  
PRINCIPAL REGISTER**

**SPIEGEL**

SPIEGEL CATALOG HOLDINGS CORPORATION  
(DELAWARE CORPORATION)  
711 THIRD AVENUE, 4TH FLOOR  
NEW YORK, NY 10017

FOR: CLOTHING, NAMELY, SWEATSHIRTS,  
LEGGINGS, SWEATPANTS, SHOES, SWIMSUITS  
AND COVER-UPS, IN CLASS 25 (U.S. CLS. 22 AND  
39).

FIRST USE 1-0-2001; IN COMMERCE 1-0-2001.

THE MARK CONSISTS OF STANDARD CHAR-  
ACTERS WITHOUT CLAIM TO ANY PARTICULAR  
FONT, STYLE, SIZE, OR COLOR.

OWNER OF U.S. REG. NOS. 1,339,154, 1,840,600  
AND OTHERS.

SEC. 2(F).

SER. NO. 77-253,973, FILED 8-13-2007.

ANN E. SAPPENFIELD, EXAMINING ATTORNEY

**Int. Cl.: 5**

**Prior U.S. Cls.: 6, 18, 44, 46, 51 and 52**

**Reg. No. 3,466,134**

**United States Patent and Trademark Office**

**Registered July 15, 2008**

**TRADEMARK  
PRINCIPAL REGISTER**

**KELDRO**

GLAXO GROUP LIMITED (ENGLAND CORPORATION)  
BERKELEY AVENUE  
GLAXO WELLCOME HOUSE  
GREENFORD, MIDDLESEX, ENGLAND UB60NN

FOR: PHARMACEUTICAL PREPARATIONS AND SUBSTANCES FOR THE TREATMENT OF INFECTIOUS DISEASES, BLOOD DISORDERS, PAIN, INFLAMMATION, SEPSIS, ALOPECIA AND OBESITY, AND FOR THE TREATMENT OF VIRAL, METABOLIC, ENDOCRINE, MUSCULOSKELETAL, CARDIOVASCULAR, CARDIOPULMONARY, GENITOURINARY, SEXUAL DYSFUNCTION, ONCOLOGICAL, HEPATOLOGICAL, OPHTHALMOLOGICAL, RESPIRATORY, NEUROLOGICAL, GASTROINTESTINAL, HORMONAL, DERMATOLOGICAL AND PSYCHIATRIC RELA-

TED DISEASES AND DISORDERS, AND FOR THE TREATMENT OF DAMAGED SKIN AND TISSUE; AND FOR VACCINES, IN CLASS 5 (U.S. CLS. 6, 18, 44, 46, 51 AND 52).

THE MARK CONSISTS OF STANDARD CHARACTERS WITHOUT CLAIM TO ANY PARTICULAR FONT, STYLE, SIZE, OR COLOR.

PRIORITY CLAIMED UNDER SEC. 44(D) ON UNITED KINGDOM APPLICATION NO. 2463350, FILED 8-6-2007, REG. NO. 2463350, DATED 8-6-2007, EXPIRES 8-6-2017.

SER. NO. 77-254,858, FILED 8-14-2007.

SETH A. RAPPAPORT, EXAMINING ATTORNEY

**Int. Cl.: 5**

**Prior U.S. Cls.: 6, 18, 44, 46, 51 and 52**

**Reg. No. 3,466,135**

**United States Patent and Trademark Office**

**Registered July 15, 2008**

**TRADEMARK  
PRINCIPAL REGISTER**

# ELECTROVE

GLAXO GROUP LIMITED (ENGLAND CORPORATION)  
BERKELEY AVENUE  
GLAXO WELLCOME HOUSE  
GREENFORD, MIDDLESEX, ENGLAND UB60NN

FOR: PHARMACEUTICAL PREPARATIONS AND SUBSTANCES FOR THE TREATMENT OF INFECTIOUS DISEASES, BLOOD DISORDERS, PAIN, INFLAMMATION, SEPSIS, ALOPECIA AND OBESITY, AND FOR THE TREATMENT OF VIRAL, METABOLIC, ENDOCRINE, MUSCULOSKELETAL, CARDIOVASCULAR, CARDIOPULMONARY, GENITOURINARY, SEXUAL DYSFUNCTION, ONCOLOGICAL, HEPATOLOGICAL, OPHTHALMOLOGICAL, RESPIRATORY, NEUROLOGICAL, GASTROINTESTINAL, HORMONAL, DERMATOLOGICAL AND PSYCHIATRIC RELA-

TED DISEASES AND DISORDERS, AND FOR THE TREATMENT OF DAMAGED SKIN AND TISSUE; AND FOR VACCINES, IN CLASS 5 (U.S. CLS. 6, 18, 44, 46, 51 AND 52).

THE MARK CONSISTS OF STANDARD CHARACTERS WITHOUT CLAIM TO ANY PARTICULAR FONT, STYLE, SIZE, OR COLOR.

PRIORITY CLAIMED UNDER SEC. 44(D) ON UNITED KINGDOM APPLICATION NO. 2463352, FILED 8-6-2007, REG. NO. 2463352, DATED 8-6-2007, EXPIRES 8-6-2017.

SER. NO. 77-254,870, FILED 8-14-2007.

SETH A. RAPPAPORT, EXAMINING ATTORNEY

**Int. Cl.: 5**

**Prior U.S. Cls.: 6, 18, 44, 46, 51 and 52**

**Reg. No. 3,466,136**

**United States Patent and Trademark Office**

**Registered July 15, 2008**

**TRADEMARK  
PRINCIPAL REGISTER**

# ZENJOYCE

GLAXO GROUP LIMITED (ENGLAND CORPORATION)  
BERKELEY AVENUE  
GLAXO WELLCOME HOUSE  
GREENFORD, MIDDLESEX, ENGLAND UB60NN

FOR: PHARMACEUTICAL PREPARATIONS AND SUBSTANCES FOR THE TREATMENT OF INFECTIOUS DISEASES, BLOOD DISORDERS, PAIN, INFLAMMATION, SEPSIS, ALOPECIA AND OBESITY, AND FOR THE TREATMENT OF VIRAL, METABOLIC, ENDOCRINE, MUSCULOSKELETAL, CARDIOVASCULAR, CARDIOPULMONARY, GENITOURINARY, SEXUAL DYSFUNCTION, ONCOLOGICAL, HEPATOLOGICAL, OPHTHALMOLOGICAL, RESPIRATORY, NEUROLOGICAL, GASTROINTESTINAL, HORMONAL, DERMATOLOGICAL AND PSYCHIATRIC RELA-

TED DISEASES AND DISORDERS, AND FOR THE TREATMENT OF DAMAGED SKIN AND TISSUE; AND FOR VACCINES, IN CLASS 5 (U.S. CLS. 6, 18, 44, 46, 51 AND 52).

THE MARK CONSISTS OF STANDARD CHARACTERS WITHOUT CLAIM TO ANY PARTICULAR FONT, STYLE, SIZE, OR COLOR.

PRIORITY CLAIMED UNDER SEC. 44(D) ON UNITED KINGDOM APPLICATION NO. 2463355, FILED 8-6-2007, REG. NO. 2463355, DATED 8-6-2007, EXPIRES 8-6-2017.

SER. NO. 77-254,872, FILED 8-14-2007.

SETH A. RAPPAPORT, EXAMINING ATTORNEY

**Int. Cl.: 6**

**Prior U.S. Cls.: 2, 12, 13, 14, 23, 25 and 50**

**Reg. No. 3,466,137**

**United States Patent and Trademark Office**

**Registered July 15, 2008**

**TRADEMARK  
PRINCIPAL REGISTER**

**SKUNKWORTH**

THE NOVITA GROUP PTY LTD (AUSTRALIA  
CORPORATION)  
4 HOGG AVENUE  
SALTER POINT, AUSTRALIA 6152

PRIORITY CLAIMED UNDER SEC. 44(D) ON  
AUSTRALIA APPLICATION NO. 1161837, FILED 2-  
19-2007, REG. NO. 1161837, DATED 2-19-2007, EX-  
PIRES 2-19-2017.

FOR: CANTILEVERED BRACKETS OF METAL,  
IN CLASS 6 (U.S. CLS. 2, 12, 13, 14, 23, 25 AND 50).

SER. NO. 77-255,114, FILED 8-14-2007.

THE MARK CONSISTS OF STANDARD CHAR-  
ACTERS WITHOUT CLAIM TO ANY PARTICULAR  
FONT, STYLE, SIZE, OR COLOR.

MATTHEW PAPPAS, EXAMINING ATTORNEY

**Int. Cl.: 25**

**Prior U.S. Cls.: 22 and 39**

**United States Patent and Trademark Office**

**Reg. No. 3,466,138**

**Registered July 15, 2008**

**TRADEMARK  
PRINCIPAL REGISTER**



PRIETO, VIRGINIA (MEXICO INDIVIDUAL)  
1238 CUYAMACA AVE.  
CHULA VISTA, CA 91911

NO CLAIM IS MADE TO THE EXCLUSIVE  
RIGHT TO USE "BRAZIL", APART FROM THE  
MARK AS SHOWN.

FOR: JEANS; TOPS; PANTS; CAPRI PANTS;  
SHIRTS; SHORTS; BATHING SUITS; BELTS CLOTH-  
ING, IN CLASS 25 (U.S. CLS. 22 AND 39).

SER. NO. 77-255,422, FILED 8-15-2007.

FIRST USE 4-4-2006; IN COMMERCE 10-20-2006.

MARCIE MILONE, EXAMINING ATTORNEY

**Int. Cl.: 41**

**Prior U.S. Cls.: 100, 101 and 107**

**United States Patent and Trademark Office**

**Reg. No. 3,466,139**

**Registered July 15, 2008**

**SERVICE MARK  
PRINCIPAL REGISTER**

**MOVEMENT & WELLNESS**

MOVEMENT AND WELLNESS, LLC (NEW  
YORK LTD LIAB CO)  
71 LINDA AVE.  
WHITE PLAINS, NY 10605

FOR: PHYSICAL FITNESS INSTRUCTION, IN-  
CLUDING INDIVIDUAL AND GROUP INSTRU-  
TION IN PILATES, GYROTONIC, DANCE, YOGA,  
STRETCHING, FITNESS, MOVEMENT, BALANCE,  
ALIGNMENT AND CORE STRENGTH, IN CLASS 41  
(U.S. CLS. 100, 101 AND 107).

FIRST USE 10-1-2003; IN COMMERCE 10-1-2003.

THE MARK CONSISTS OF STANDARD CHAR-  
ACTERS WITHOUT CLAIM TO ANY PARTICULAR  
FONT, STYLE, SIZE, OR COLOR.

SER. NO. 77-255,656, FILED 8-15-2007.

SHAUNIA CARLYLE, EXAMINING ATTORNEY

**Int. Cl.: 44**

**Prior U.S. Cls.: 100 and 101**

**United States Patent and Trademark Office**

**Reg. No. 3,466,140**

**Registered July 15, 2008**

**SERVICE MARK  
PRINCIPAL REGISTER**

**In Pain? We'll See You  
Today!**

AUSTIN CHIROPRACTIC CENTER, P.C. (TEXAS  
CORPORATION)  
6800 WESTGATE BLVD., SUITE 117  
AUSTIN, TX 78745

THE MARK CONSISTS OF STANDARD CHAR-  
ACTERS WITHOUT CLAIM TO ANY PARTICULAR  
FONT, STYLE, SIZE, OR COLOR.

FOR: CHIROPRACTIC SERVICES, IN CLASS 44  
(U.S. CLS. 100 AND 101).

SER. NO. 77-255,765, FILED 8-15-2007.

FIRST USE 10-1-2005; IN COMMERCE 11-1-2005.

STEVEN R. FINE, EXAMINING ATTORNEY



**Int. Cl.: 35**

**Prior U.S. Cls.: 100, 101 and 102**

**United States Patent and Trademark Office**

**Reg. No. 3,466,141**

**Registered July 15, 2008**

**SERVICE MARK  
PRINCIPAL REGISTER**



PROFESSIONAL RETAIL STORE MAINTENANCE ASSOCIATION (TEXAS UNINC. ASSOCIATION)

SUITE 160  
14285 MIDWAY ROAD  
ADDISON, TX 75001

FOR: ASSOCIATION SERVICES, NAMELY, PROMOTING THE IMPROVEMENT OF BUSINESS CONDITIONS, PROMOTING IMPLEMENTING UNIFORM AND HIGHER BUSINESS STANDARDS IN THE RETAIL STORE MAINTENANCE INDUSTRY, PROMOTING THE CREATION OF AN ENVIRONMENT TO CONTINUALLY IMPROVE THE BUSINESS PROCESSES, PROMOTING ACTIVE PARTICIPATION IN INDUSTRY AFFAIRS AND ADVANCING AWARENESS OF RETAIL FACILITIES FOR ALL INDUSTRIES, IN CLASS 35 (U.S. CLS. 100, 101 AND 102).

FIRST USE 9-1-1995; IN COMMERCE 9-1-1995.

THE MARK CONSISTS OF, IN PART, CIRCLES ON TOP OF PRISMS TO FORM A REPRESENTATION OF PERSONS. THE WORDS "PRSM PROFESSIONAL RETAIL STORE MAINTENANCE" SURROUNDS THE REPRESENTATION OF PERSONS.

SEC. 2(F) PROFESSIONAL RETAIL STORE MAINTENANCE.

SER. NO. 77-256,215, FILED 8-15-2007.

TRACY CROSS, EXAMINING ATTORNEY

**Int. Cl.: 28**

**Prior U.S. Cls.: 22, 23, 38 and 50**

**United States Patent and Trademark Office**

**Reg. No. 3,466,142**

**Registered July 15, 2008**

**TRADEMARK  
PRINCIPAL REGISTER**

**WIDOWMAKER**

HARD CORE DECOYS, LTD. (OHIO LTD LIAB  
CO)  
1614 EAST 40TH STREET  
CLEVELAND, OH 44103

THE MARK CONSISTS OF STANDARD CHAR-  
ACTERS WITHOUT CLAIM TO ANY PARTICULAR  
FONT, STYLE, SIZE, OR COLOR.

FOR: HUNTING DECOYS, NAMELY, TURKEY  
DECOYS, IN CLASS 28 (U.S. CLS. 22, 23, 38 AND 50).

SER. NO. 77-256,276, FILED 8-15-2007.

FIRST USE 11-0-2006; IN COMMERCE 11-0-2006.

BRIAN PINO, EXAMINING ATTORNEY

Int. Cls.: 16 and 21

Prior U.S. Cls.: 2, 5, 13, 22, 23, 29, 30, 33, 37, 38, 40  
and 50

Reg. No. 3,466,143

United States Patent and Trademark Office

Registered July 15, 2008

TRADEMARK  
PRINCIPAL REGISTER



ANOUSH HENDIAZAD (UNITED STATES INDIVIDUAL)  
23 SOUTHWOOD DRIVE  
MORRIS PLAINS, NJ 07950

FOR: FRAMED WALL PAINTINGS, IN CLASS 16  
(U.S. CLS. 2, 5, 22, 23, 29, 37, 38 AND 50).

FIRST USE 7-1-2004; IN COMMERCE 7-1-2004.

FOR: PORCELAIN AND CRYSTAL FIGURINES;  
PORCELAIN AND CRYSTAL DINNERWARE,  
NAMELY, VASES, BOWLS, CANDLESTICKS, IN  
CLASS 21 (U.S. CLS. 2, 13, 23, 29, 30, 33, 40 AND 50).

FIRST USE 7-1-2004; IN COMMERCE 7-1-2004.

THE MARK CONSISTS OF "SORELLE" INSIDE A  
DOUBLE OVAL CAPPED WITH A CROWN.

THE FOREIGN WORDING IN THE MARK  
TRANSLATES INTO ENGLISH AS "SISTERS".

SER. NO. 77-256,306, FILED 8-15-2007.

JANET LEE, EXAMINING ATTORNEY

**Int. Cl.: 25**

**Prior U.S. Cls.: 22 and 39**

**United States Patent and Trademark Office**

**Reg. No. 3,466,144**

**Registered July 15, 2008**

**TRADEMARK  
PRINCIPAL REGISTER**



DTL DOWN THE LINE SPORTSWEAR, INC.  
(TEXAS CORPORATION)  
SUITE 230, BOX 224 6700 WOODLANDS PKWY  
THE WOODLANDS, TX 77382

FOR: CLOTHING, NAMELY, SPORTSWEAR IN  
THE NATURE OF TENNIS APPAREL, PANTS,  
SHIRTS, SKIRTS, SHORTS, WARM UP SUITS,  
SWEATSUITS, TEAM UNIFORMS, HATS, AND VI-  
SORS, IN CLASS 25 (U.S. CLS. 22 AND 39).

FIRST USE 10-4-2007; IN COMMERCE 1-7-2008.

THE MARK CONSISTS OF AN OVAL WITH TWO  
CIRCULAR INSERTS ON EITHER END OF THE  
OVAL WITH A LINE BETWEEN (RESEMBLING A  
DUMBELL) WITH THE LETTERS "DTL" BELOW.

SER. NO. 77-256,328, FILED 8-15-2007.

TRACY WHITTAKER-BROWN, EXAMINING AT-  
TORNEY

**Int. Cl.: 10**

**Prior U.S. Cls.: 26, 39 and 44**

**United States Patent and Trademark Office**

**Reg. No. 3,466,145**

**Registered July 15, 2008**

**TRADEMARK  
PRINCIPAL REGISTER**

# MiniMuffs

NATUS MEDICAL, INC. (CALIFORNIA CORPORATION)  
1501 INDUSTRIAL ROAD  
SAN CARLOS, CA 94070

FOR: NEONATAL NOISE ATTENUATORS, IN CLASS 10 (U.S. CLS. 26, 39 AND 44).

FIRST USE 1-29-1992; IN COMMERCE 1-29-1992.

THE MARK CONSISTS OF STANDARD CHARACTERS WITHOUT CLAIM TO ANY PARTICULAR FONT, STYLE, SIZE, OR COLOR.

SEC. 2(F).

SER. NO. 77-256,444, FILED 8-15-2007.

PAUL CROWLEY, EXAMINING ATTORNEY

**Int. Cl.: 10**

**Prior U.S. Cls.: 26, 39 and 44**

**United States Patent and Trademark Office**

**Reg. No. 3,466,146**

**Registered July 15, 2008**

**TRADEMARK  
PRINCIPAL REGISTER**

**NEOBLUE**

NATUS MEDICAL, INC. (CALIFORNIA CORPORATION)  
1501 INDUSTRIAL ROAD  
SAN CARLOS, CA 94070

FOR: MOBILE MEDICAL EQUIPMENT, NAME-  
LY, PHOTOTHERAPY UNITS, TO PROVIDE  
TREATMENT FOR NEONATAL HYPERBILIRUBI-  
NEMIA, IN CLASS 10 (U.S. CLS. 26, 39 AND 44).

FIRST USE 10-18-2002; IN COMMERCE 10-18-2002.

THE MARK CONSISTS OF STANDARD CHAR-  
ACTERS WITHOUT CLAIM TO ANY PARTICULAR  
FONT, STYLE, SIZE, OR COLOR.

OWNER OF U.S. REG. NO. 2,927,693.

SER. NO. 77-256,448, FILED 8-15-2007.

PAUL CROWLEY, EXAMINING ATTORNEY

**Int. Cl.: 9**

**Prior U.S. Cls.: 21, 23, 26, 36 and 38**

**Reg. No. 3,466,147**

**United States Patent and Trademark Office**

**Registered July 15, 2008**

---

**TRADEMARK  
PRINCIPAL REGISTER**

**TOP 10 PROOFS**

DUTKO, ROBERT A. (MICHIGAN SOLE PROPRIETORSHIP)  
20731 COVENTRY  
CLINTON TOWNSHIP, MI 48035

THE MARK CONSISTS OF STANDARD CHARACTERS WITHOUT CLAIM TO ANY PARTICULAR FONT, STYLE, SIZE, OR COLOR.

FOR: RELIGIOUS EDUCATIONAL MATERIALS IN THE FORM OF A SERIES COLLECTION OF AUDIO CDS, IN CLASS 9 (U.S. CLS. 21, 23, 26, 36 AND 38).

SER. NO. 77-257,284, FILED 8-16-2007.

FIRST USE 11-3-2006; IN COMMERCE 11-3-2006.

ALEXANDER L. POWERS, EXAMINING ATTORNEY

**Int. Cls.: 3, 5, 35 and 44**

**Prior U.S. Cls.: 1, 4, 6, 18, 44, 46, 50, 51, 52, 100, 101  
and 102**

**Reg. No. 3,466,148**

**United States Patent and Trademark Office**

**Registered July 15, 2008**

**TRADEMARK  
SERVICE MARK  
PRINCIPAL REGISTER**

# DERMALOGICA

INTERNATIONAL DERMAL INSTITUTE, INC.  
(CALIFORNIA CORPORATION)  
1535 BEACHEY PLACE  
CARSON, CA 90746

FOR: AROMATHERAPY OILS; BATH SALTS; BODY CREAMS; BODY OILS; BODY SCRUBS; BODY WASHES; DEODORANT FOR PERSONAL USE; EXFOLIANTS FOR THE SKIN; FOUNDATION; HAIR CARE PREPARATIONS; HAIR CONDITIONERS; MAKE-UP REMOVERS; NON-MEDICATED SKIN CARE PREPARATIONS; PRE-MOISTENED COSMETIC WIPES; SHAMPOOS; SHAVING PREPARATIONS; SKIN CARE BOOSTERS, NAMELY, CONCENTRATED NON-MEDICATED SKIN CARE PREPARATIONS FOR TREATMENT OF A VARIETY OF SKIN CONDITIONS; SKIN CLEANSERS; SKIN CONDITIONERS; SKIN CREAMS; SKIN MASQUES; SKIN MOISTURIZERS; SKIN SCRUBS; SUN BLOCK PREPARATIONS; SUN CARE LOTIONS; AND SUN SCREEN PREPARATIONS, IN CLASS 3 (U.S. CLS. 1, 4, 6, 50, 51 AND 52).

FIRST USE 0-0-1986; IN COMMERCE 0-0-1986.

FOR: ACNE MEDICATIONS; ANTIBACTERIAL SKIN WASH; DIETARY SUPPLEMENTS; MEDICATED SKIN CLEARING GEL; MEDICATED PRE-MOISTENED WIPES; AND MEDICATED SKIN CARE PREPARATIONS, IN CLASS 5 (U.S. CLS. 6, 18, 44, 46, 51 AND 52).

FIRST USE 3-1-1997; IN COMMERCE 3-1-1997.

FOR: RETAIL STORE SERVICES IN THE FIELD OF SKIN CARE PRODUCTS, IN CLASS 35 (U.S. CLS. 100, 101 AND 102).

FIRST USE 3-0-2004; IN COMMERCE 3-0-2004.

FOR: SKIN CARE SERVICES; SKIN ANALYSIS AND CONSULTATION SERVICES RENDERED IN CONNECTION THEREWITH, IN CLASS 44 (U.S. CLS. 100 AND 101).

FIRST USE 3-0-2004; IN COMMERCE 3-0-2004.

THE MARK CONSISTS OF STANDARD CHARACTERS WITHOUT CLAIM TO ANY PARTICULAR FONT, STYLE, SIZE, OR COLOR.

OWNER OF U.S. REG. NO. 1,539,948.

THE WORDING "DERMALOGICA" HAS NO MEANING IN ENGLISH.

SER. NO. 77-257,593, FILED 8-16-2007.

MAUREEN DALL, EXAMINING ATTORNEY



Int. Cl.: 25

Prior U.S. Cls.: 22 and 39

United States Patent and Trademark Office

Reg. No. 3,466,149

Registered July 15, 2008

TRADEMARK  
PRINCIPAL REGISTER

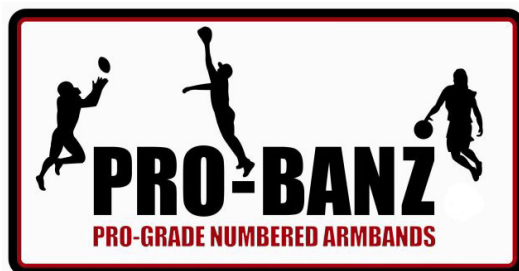

E-SOLARSTORM LLC (NEW JERSEY LTD LIAB  
CO), DBA E-SOLARSTORM LLC  
8 LINCOLN PLACE APT I  
NORTH BRUNSWICK, NJ 08902

FOR: SWEATBANDS, IN CLASS 25 (U.S. CLS. 22  
AND 39).

FIRST USE 1-1-2007; IN COMMERCE 1-1-2007.

NO CLAIM IS MADE TO THE EXCLUSIVE  
RIGHT TO USE "PRO-GRADE NUMBERED ARM-  
BANDS", APART FROM THE MARK AS SHOWN.

THE COLOR(S) BLACK AND RED IS/ARE  
CLAIMED AS A FEATURE OF THE MARK.

THE COLOR BLACK APPEARS ON THE OUT-  
SIDE OF THE RECTANGLE, IN THE TERM "PRO-

BANZ" AND IN THE DESIGN OF THE ATHLETES  
ENGAGED IN RESPECTIVE SPORTS, LEFT, CEN-  
TER AND RIGHT. THE COLOR RED APPEARS ON  
THE INSIDE OF THE RECTANGLE AND IN THE  
WORDING "PRO-GRADE NUMBERED ARM-  
BANDS". THE MARK CONSISTS OF ATHLETES  
ENGAGED IN RESPECTIVE SPORTS, IN LEFT,  
CENTER AND RIGHT. THE ACTUAL BRAND  
PRO-BANZ IS LOCATED IN THE CENTER, AND A  
DESCRIPTION OF THE COMPANY'S PRIMARY  
PRODUCT PRO-GRADE NUMBERED ARM BANDS  
IS UNDERNEATH THE BRAND NAME, IN THE  
CENTER.

SEC. 2(F).

SER. NO. 77-257,776, FILED 8-17-2007.

CAROLINE WOOD, EXAMINING ATTORNEY

**Int. Cl.: 11**

**Prior U.S. Cls.: 13, 21, 23, 31 and 34**

**Reg. No. 3,466,150**

**United States Patent and Trademark Office**

**Registered July 15, 2008**

**TRADEMARK  
PRINCIPAL REGISTER**



CARRIER CORPORATION (DELAWARE CORPORATION)  
ONE CARRIER PLACE  
FARMINGTON, CT 06034

FOR: RESIDENTIAL AIR CONDITIONING AND HEATING UNITS, AND STRUCTURAL OR REPLACEMENT PARTS THEREFOR; FURNACES, COMPONENTS FOR AIR CONDITIONING AND COOLING SYSTEMS, NAMELY, BLOWERS AND AIR COOLERS; GAS AND ELECTRIC FURNACES, HEATERS AND DEHUMIDIFIERS FOR RESIDENTIAL AND LIGHT COMMERCIAL USE; HEATING

AND COOLING EQUIPMENT, NAMELY, FURNACES, AIR CONDITIONERS, AND HEAT PUMPS AND REPLACEMENT PARTS THEREFOR, IN CLASS 11 (U.S. CLS. 13, 21, 23, 31 AND 34).

FIRST USE 8-1-2007; IN COMMERCE 8-1-2007.

SER. NO. 77-258,214, FILED 8-17-2007.

MARIA-VICTORIA SUAREZ, EXAMINING ATTORNEY

**Int. Cl.: 29**

**Prior U.S. Cl.: 46**

**United States Patent and Trademark Office**

**Reg. No. 3,466,151**

**Registered July 15, 2008**

**TRADEMARK  
PRINCIPAL REGISTER**

**JACKPACK!**

LINK SNACKS, INC. (WISCONSIN CORPORATION)  
ONE SNACKFOOD LANE  
MINONG, WI 54859

THE MARK CONSISTS OF STANDARD CHARACTERS WITHOUT CLAIM TO ANY PARTICULAR FONT, STYLE, SIZE, OR COLOR.

FOR: MEAT SNACKS, IN CLASS 29 (U.S. CL. 46).

SER. NO. 77-258,324, FILED 8-17-2007.

FIRST USE 0-0-2005; IN COMMERCE 0-0-2005.

MONIQUE MILLER, EXAMINING ATTORNEY

**Int. Cl.: 1**

**Prior U.S. Cls.: 1, 5, 6, 10, 26 and 46**

**United States Patent and Trademark Office**

**Reg. No. 3,466,152**

**Registered July 15, 2008**

**TRADEMARK  
PRINCIPAL REGISTER**

# FRX Polymers

FRX POLYMERS, LLLP (MARYLAND LTD LIAB  
CO)  
200 TURNPIKE ROAD  
CHELMSFORD, MA 01824

FOR: CATALYSTS FOR USE IN THE MANUFACTURE OF SYNTHETICS, RUBBERS AND POLYMERS; POLYMER BASE COMPOSITIONS USED IN THE MANUFACTURE OF COMMERCIAL, INDUSTRIAL AND DOMESTIC GOODS; POLYMER BEADS FOR USE IN MANUFACTURING; POLYMER COMPOSITIONS USED IN THE MANUFACTURE OF COMMERCIAL AND INDUSTRIAL GOODS, IN CLASS 1 (U.S. CLS. 1, 5, 6, 10, 26 AND 46).

FIRST USE 1-1-2007; IN COMMERCE 1-1-2007.

THE MARK CONSISTS OF STANDARD CHARACTERS WITHOUT CLAIM TO ANY PARTICULAR FONT, STYLE, SIZE, OR COLOR.

NO CLAIM IS MADE TO THE EXCLUSIVE RIGHT TO USE "POLYMERS", APART FROM THE MARK AS SHOWN.

SER. NO. 77-258,580, FILED 8-17-2007.

RONALD AIKENS, EXAMINING ATTORNEY

**Int. Cl.: 14**

**Prior U.S. Cls.: 2, 27, 28 and 50**

**United States Patent and Trademark Office**

**Reg. No. 3,466,153**

**Registered July 15, 2008**

**TRADEMARK  
PRINCIPAL REGISTER**



CLIFFORD, SHARON (UTAH SOLE PROPRIETORSHIP), DBA SASSY TOE  
2988 KINGS COURT LANE  
WASHINGTON, UT 84780

FOR: RINGS BEING JEWELRY; EARRINGS; LEATHER JEWELRY AND ACCESSORY BOXES; JEWELRY CHAINS, IN CLASS 14 (U.S. CLS. 2, 27, 28 AND 50).

FIRST USE 7-1-2007; IN COMMERCE 7-1-2007.

THE COLOR(S) PINK, PURPLE, RED AND FLESH IS/ARE CLAIMED AS A FEATURE OF THE MARK.

THE MARK CONSISTS OF TWO FLESH-COLORED FEET WITH PINK PAINTED TOE NAILS, WITH PURPLE AND RED FLOWER ANKLETS ON BOTH ANKLES, A RED FLOWER TOE RING ON ONE TOE AND A PINK BAND TOE RING ON ONE TOE. THE LETTERING IS DARK PINK.

SER. NO. 77-258,659, FILED 8-18-2007.

SUSAN STIGLITZ, EXAMINING ATTORNEY

**Int. Cls.: 35 and 43**

**Prior U.S. Cls.: 100, 101 and 102**

**United States Patent and Trademark Office**

**Reg. No. 3,466,154**

**Registered July 15, 2008**

**SERVICE MARK  
PRINCIPAL REGISTER**



LIBORIO MARKET, INC. (CALIFORNIA CORPORATION)  
171 S. HUDSON AVE.  
PASADENA, CA 91101

FOR: RETAIL GROCERY STORES, RETAIL SUPERMARKETS, IN-STORE RETAIL DELICATESSEN, IN-STORE TAKE-OUT BAKERY SERVICES, IN-STORE BUTCHER SERVICES, IN STORE BAKERY SERVICES, FEATURING TORTILLA MAKING, IN STORE BUTCHER SERVICES, FEATURING POULTRY PROCESSING, IN CLASS 35 (U.S. CLS. 100, 101 AND 102).

FIRST USE 12-31-1984; IN COMMERCE 12-31-1984.

FOR: IN STORE RESTAURANT, IN CLASS 43 (U.S. CLS. 100 AND 101).

FIRST USE 12-31-1984; IN COMMERCE 12-31-1984.

NO CLAIM IS MADE TO THE EXCLUSIVE RIGHT TO USE "MARKETS" AND "EST. 1966", APART FROM THE MARK AS SHOWN.

THE COLOR(S) RED, WHITE AND BLUE IS/ARE CLAIMED AS A FEATURE OF THE MARK.

THE MARK CONSISTS OF A BLUE OVAL SHAPE THAT ENTIRELY ENCIRCLES RED AND BLUE LETTERING WHICH COLLECTIVELY SPELLS OUT THE ENTIRE LITERAL ELEMENT, "LIBORIO MARKETS". THE RED LITERAL ELEMENT SPELLING "LIBORIO" APPEARS IN CURSIVE TEXT. THE BLUE LITERAL ELEMENT SPELLING "MARKETS" APPEARS IN STANDARD BLOCK TEXT BELOW THE RED CURSIVE LITERAL ELEMENT. ALL OF THE AFOREMENTIONED DESCRIPTION IS PLACED ON A WHITE BACKGROUND.

THE ENGLISH TRANSLATION OF THE WORD "LIBORIO" IN THE MARK IS A PEASANT FROM A RURAL AREA.

SER. NO. 77-258,701, FILED 8-18-2007.

CHERYL CLAYTON, EXAMINING ATTORNEY

Int. Cl.: 36

Prior U.S. Cls.: 100, 101 and 102

United States Patent and Trademark Office

Reg. No. 3,466,155

Registered July 15, 2008

SERVICE MARK  
PRINCIPAL REGISTER



REST, HILLARD C (UNITED STATES INDIVIDUAL), DBA HILLARD REST ASSOCIATES  
137 OLD TOLL RD/PO BOX 1419  
LAKE ARROWHEAD, CA 926521419

FOR: FINANCIAL CONSULTATION IN THE FIELD OF INVESTMENTS AND INSURANCE, IN CLASS 36 (U.S. CLS. 100, 101 AND 102).

FIRST USE 3-1-1990; IN COMMERCE 3-1-1990.

NO CLAIM IS MADE TO THE EXCLUSIVE RIGHT TO USE "FINANCE", APART FROM THE MARK AS SHOWN.

THE MARK CONSISTS OF BLACK, GREY AND WHITE TEXT ON BLACK AND WHITE BACKGROUND WITH A BLACK BORDER.

SER. NO. 77-258,724, FILED 8-18-2007.

JAY FLOWERS, EXAMINING ATTORNEY

**Int. Cl.: 9**

**Prior U.S. Cls.: 21, 23, 26, 36 and 38**

**Reg. No. 3,466,156**

**United States Patent and Trademark Office**

**Registered July 15, 2008**

**TRADEMARK  
PRINCIPAL REGISTER**

**TRAX  
RECORDS**

RACHAEL CAIN (ILLINOIS CORPORATION),  
DBA PHUTURE TRAX RECORDS  
540 N. LAKESHORE DR. #716  
CHICAGO, IL 60611

FOR: MUSICAL SOUND RECORDINGS, IN  
CLASS 9 (U.S. CLS. 21, 23, 26, 36 AND 38).

FIRST USE 8-2-1985; IN COMMERCE 8-2-1988.

NO CLAIM IS MADE TO THE EXCLUSIVE  
RIGHT TO USE "RECORDS", APART FROM THE  
MARK AS SHOWN.

SEC. 2(F).

SER. NO. 77-258,902, FILED 8-20-2007.

DANIEL CAPSHAW, EXAMINING ATTORNEY



**Int. Cl.: 41**

**Prior U.S. Cls.: 100, 101 and 107**

**United States Patent and Trademark Office**

**Reg. No. 3,466,157**

**Registered July 15, 2008**

**SERVICE MARK  
PRINCIPAL REGISTER**

**SPLASH**

MYRTLE BEACH PELICANS LP (PENNSYLVANIA LIMITED PARTNERSHIP)  
1251 21ST AVE. N  
MYRTLE BEACH, SC 29577

THE MARK CONSISTS OF STANDARD CHARACTERS WITHOUT CLAIM TO ANY PARTICULAR FONT, STYLE, SIZE, OR COLOR.

FOR: ENTERTAINMENT SERVICES NAMELY, LIVE APPEARANCES BY A BASEBALL MASCOT, IN CLASS 41 (U.S. CLS. 100, 101 AND 107).

SER. NO. 77-259,664, FILED 8-20-2007.

FIRST USE 3-1-1999; IN COMMERCE 3-1-1999.

KIMBERLY FRYE, EXAMINING ATTORNEY

Int. Cl.: 35

Prior U.S. Cls.: 100, 101 and 102

United States Patent and Trademark Office

Reg. No. 3,466,158

Registered July 15, 2008

**SERVICE MARK  
PRINCIPAL REGISTER**

P R O F E S S I O N A L  
**RETAIL STORE**  
M A I N T E N A N C E

PROFESSIONAL RETAIL STORE MAINTENANCE ASSOCIATION (TEXAS UNINC. ASSOCIATION)

SUITE 160  
14285 MIDWAY ROAD  
ADDISON, TX 75001

FOR: ASSOCIATION SERVICES, NAMELY, PROMOTING THE IMPROVEMENT OF BUSINESS CONDITIONS, PROMOTING IMPLEMENTING UNIFORM AND HIGHER BUSINESS STANDARDS IN THE RETAIL STORE MAINTENANCE INDUSTRY, PROMOTING THE CREATION OF AN ENVIRONMENT TO CONTINUALLY IMPROVE THE BUSINESS PROCESS, PROMOTING ACTIVE PARTICIPATION IN INDUSTRY AFFAIRS AND ADVANCING AWARENESS OF RETAIL FACILITIES

FOR ALL INDUSTRIES, IN CLASS 35 (U.S. CLS. 100, 101 AND 102).

FIRST USE 4-1-1998; IN COMMERCE 4-1-1998.

THE MARK CONSISTS OF , IN PART, THE WORDING "PROFESSIONAL RETAIL STORE MAINTENANCE" WITH THE "O" IN "STORE" ENCIRCLING A GROUPING OF PRISMS WITH CIRCLES ABOVE REPRESENTING PERSONS.

SEC. 2(F) AS TO "PROFESSIONAL RETAIL STORE MAINTENANCE".

SER. NO. 77-259,709, FILED 8-20-2007.

TRACY CROSS, EXAMINING ATTORNEY

**Int. Cl.: 41**

**Prior U.S. Cls.: 100, 101 and 107**

**United States Patent and Trademark Office**

**Reg. No. 3,466,159**

**Registered July 15, 2008**

**SERVICE MARK  
PRINCIPAL REGISTER**

**BRAIN WORKOUT CENTER**

SOI DENVER, LLC (COLORADO LTD LIAB CO)  
#30  
8006 E ARAPAHOE RD.  
CENTENNIAL, CO 80112

FOR: EDUCATIONAL SERVICES, NAMELY,  
PROVIDING CLASSES OF INSTRUCTION IN CON-  
DITIONING TO IMPROVE A PERSON'S COGNI-  
TIVE LEARNING STYLE AND THEREBY  
REMEDiate THE PERSON'S LEARNING DISOR-  
DERS, IN CLASS 41 (U.S. CLS. 100, 101 AND 107).

FIRST USE 6-30-2003; IN COMMERCE 6-30-2003.

THE MARK CONSISTS OF STANDARD CHAR-  
ACTERS WITHOUT CLAIM TO ANY PARTICULAR  
FONT, STYLE, SIZE, OR COLOR.

NO CLAIM IS MADE TO THE EXCLUSIVE  
RIGHT TO USE "BRAIN AND CENTER", APART  
FROM THE MARK AS SHOWN.

SER. NO. 77-259,894, FILED 8-20-2007.

MICHAEL WEBSTER, EXAMINING ATTORNEY

**Int. Cl.: 35**

**Prior U.S. Cls.: 100, 101 and 102**

**United States Patent and Trademark Office**

**Reg. No. 3,466,160**

**Registered July 15, 2008**

**SERVICE MARK  
PRINCIPAL REGISTER**

**FUEL FRENZY**

THE KROGER CO. OF MICHIGAN (MICHIGAN CORPORATION)  
18334 LAUREL PARK DRIVE NORTH  
LIVONIA, MI 481522686

FOR: GASOLINE DISCOUNT PROGRAM OFFERING PARTICIPANTS DISCOUNTS ON GASOLINE THROUGH STORE PURCHASES, IN CLASS 35 (U.S. CLS. 100, 101 AND 102).

FIRST USE 12-0-2004; IN COMMERCE 12-0-2004.

THE MARK CONSISTS OF STANDARD CHARACTERS WITHOUT CLAIM TO ANY PARTICULAR FONT, STYLE, SIZE, OR COLOR.

NO CLAIM IS MADE TO THE EXCLUSIVE RIGHT TO USE "FUEL", APART FROM THE MARK AS SHOWN.

SER. NO. 77-260,442, FILED 8-21-2007.

ARETHA SOMERVILLE, EXAMINING ATTORNEY

**Int. Cls.: 25 and 41**

**Prior U.S. Cls.: 22, 39, 100, 101 and 107**

**United States Patent and Trademark Office**

**Reg. No. 3,466,161**

**Registered July 15, 2008**

**TRADEMARK  
SERVICE MARK  
PRINCIPAL REGISTER**



THE EQUINE ASSISTED LEARNING CENTER,  
LLC (CALIFORNIA LTD LIAB CO)  
830 ORANGE AVE., STE. G  
CORONADO, CA 92118, CA 92118

FOR: CLOTHING, NAMELY, T-SHIRTS, JACKETS, SHORTS, SLACKS AND SKIRTS; CLOTHING ACCESSORIES, NAMELY, HATS, GLOVES, SCARVES AND HEADBANDS, IN CLASS 25 (U.S. CLS. 22 AND 39).

FIRST USE 2-15-2007; IN COMMERCE 2-15-2007.

FOR: EDUCATIONAL SERVICES, NAMELY, CONDUCTING CLASSES, SEMINARS, CONFERENCES, WORKSHOPS AND PROVIDING TRAINING IN THE FIELD OF EQUINE ASSISTED PSYCHOTHERAPY EDUCATION, AND DISTRIBUTION OF COURSE MATERIALS IN CONNECTION THEREWITH, IN CLASS 41 (U.S. CLS. 100, 101 AND 107).

FIRST USE 2-15-2007; IN COMMERCE 2-15-2007.

NO CLAIM IS MADE TO THE EXCLUSIVE RIGHT TO USE "ZHI" AND THE NON LATIN CHARACTERS WHICH MEAN KNOWLEDGE OR WISDOM AS TO CLASS 41, APART FROM THE MARK AS SHOWN.

THE MARK CONSISTS OF HORSE SHOE LOGO AROUND CHINESE SYMBOL WITH "ZHI" UNDERNEATH.

THE ENGLISH TRANSLATION OF THE WORD "ZHI" IN THE MARK IS "KNOWLEDGE" OR "WISDOM".

THE NON-LATIN CHARACTER(S) IN THE MARK TRANSLITERATES INTO "GEE", AND THIS MEANS KNOWLEDGE OR WISDOM IN ENGLISH.

SER. NO. 77-260,663, FILED 8-21-2007.

JIM RINGLE, EXAMINING ATTORNEY

**Int. Cl.: 41**

**Prior U.S. Cls.: 100, 101 and 107**

**United States Patent and Trademark Office**

**Reg. No. 3,466,162**

**Registered July 15, 2008**

**SERVICE MARK  
PRINCIPAL REGISTER**



CONTRERAS, JOSE DURON (MEXICO INDIVIDUAL), DBA LOS COCINEROS DEL NORTE  
5086 E. BELMONT AVE  
FRESNO, CA 93727

FOR: ENTERTAINMENT IN THE NATURE OF A MUSICAL GROUP, IN CLASS 41 (U.S. CLS. 100, 101 AND 107).

FIRST USE 8-1-2006; IN COMMERCE 8-1-2006.

THE MARK CONSISTS OF THE WORD "COCINEROS" WHEREIN THE "I" AND "O" ARE IN THE DESIGN OF LABORATORY FLASKS.

THE ENGLISH TRANSLATION OF "COCINEROS" IS COOKS.

SER. NO. 77-260,718, FILED 8-21-2007.

KEVIN DINALLO, EXAMINING ATTORNEY

Int. Cl.: 13

Prior U.S. Cls.: 2 and 9

United States Patent and Trademark Office

Reg. No. 3,466,163

Registered July 15, 2008

**TRADEMARK  
PRINCIPAL REGISTER**

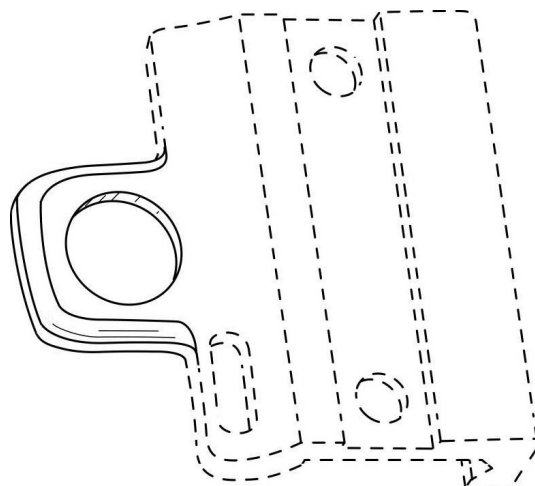

SWAN, RICHARD E. (UNITED STATES INDIVIDUAL)  
171 WEST STREET  
EAST BRIDGEWATER, MA 02379

FOR: GUN MOUNTS FOR USE IN ATTACHING OPTICAL LENS SIGHTS, HOLOGRAPHIC LENS SIGHTS, LASER SIGHTS, AND NIGHT VISION DEVICES IN THE NATURE OF INFRARED DETECTORS, INVISIBLE LIGHT PROJECTORS AND SCOPES, TO WEAPON PLATFORMS, IN CLASS 13 (U.S. CLS. 2 AND 9).

FIRST USE 1-1-1987; IN COMMERCE 1-1-1987.

THE MARK CONSISTS OF THE CONFIGURATION OF AN ACTUATOR PLATFORM OF A GUN ACCESSORY MOUNT IN THE FORM OF A SUBSTANTIALLY SEMI-CIRCULAR BOSS CONTAINING A CIRCULAR HOLE IN ITS CENTER AND EXTENDING FROM ONE SIDE OF THE MOUNT. THE MARK DOES NOT INCLUDE THE PORTION OF THE DRAWING SHOWN IN DOTTED LINES.

SEC. 2(F).

SER. NO. 77-260,751, FILED 8-21-2007.

JIM RINGLE, EXAMINING ATTORNEY

**Int. Cl.: 16**

**Prior U.S. Cls.: 2, 5, 22, 23, 29, 37, 38 and 50**

**Reg. No. 3,466,164**

**United States Patent and Trademark Office**

**Registered July 15, 2008**

---

**TRADEMARK  
PRINCIPAL REGISTER**

**HEILMAN DESIGNS**

HEILMAN, JOHN H. (CALIFORNIA SOLE PROPRIETORSHIP), DBA DBA: HEILMAN DESIGNS  
P.O. BOX 786  
LEWISTON, CA 96052

NO CLAIM IS MADE TO THE EXCLUSIVE RIGHT TO USE "DESIGNS", APART FROM THE MARK AS SHOWN.

FOR: PASTEL BOXES, IN CLASS 16 (U.S. CLS. 2, 5, 22, 23, 29, 37, 38 AND 50).

SEC. 2(F).

FIRST USE 8-12-2001; IN COMMERCE 10-5-2001.

SER. NO. 77-260,989, FILED 8-21-2007.

THE MARK CONSISTS OF STANDARD CHARACTERS WITHOUT CLAIM TO ANY PARTICULAR FONT, STYLE, SIZE, OR COLOR.

KEVON CHISOLM, EXAMINING ATTORNEY



**Int. Cl.: 35**

**Prior U.S. Cls.: 100, 101 and 102**

**United States Patent and Trademark Office**

**Reg. No. 3,466,165**

**Registered July 15, 2008**

**SERVICE MARK  
PRINCIPAL REGISTER**

**WAVETRACK**

WAVETRACK INTERNATIONAL LIMITED  
(HONG KONG CORPORATION)  
UNIT A, 13 /F., EIB CENTRE  
40-44 BONHAM STRAND  
SHEUNG WAN, HONG KONG

FOR: BUSINESS CONSULTANCY, ADVISORY,  
RESEARCH AND INFORMATION SERVICES, IN  
CLASS 35 (U.S. CLS. 100, 101 AND 102).

THE MARK CONSISTS OF STANDARD CHAR-  
ACTERS WITHOUT CLAIM TO ANY PARTICULAR  
FONT, STYLE, SIZE, OR COLOR.

OWNER OF HONG KONG REG. NO. 300192726,  
DATED 4-7-2004, EXPIRES 4-6-2014.

OWNER OF U.S. REG. NOS. 2,943,115, 3,141,263,  
AND 3,330,336.

SER. NO. 77-261,042, FILED 8-21-2007.

DOMINIC FATHY, EXAMINING ATTORNEY

**Int. Cl.: 9**

**Prior U.S. Cls.: 21, 23, 26, 36 and 38**

**United States Patent and Trademark Office**

**Reg. No. 3,466,166**

**Registered July 15, 2008**

**TRADEMARK  
PRINCIPAL REGISTER**

**BARISTA**

BASIS INTERNATIONAL, LTD. (NEW MEXICO  
CORPORATION)  
5901 JEFFERSON NE  
ALBUQUERQUE, NM 871093432

FOR: COMPUTER SOFTWARE, NAMELY, SOFTWARE PROVIDING TOOLS AND PROGRAMMING LANGUAGE TO ENABLE SOFTWARE DEVELOPERS TO PREPARE BUSINESS APPLICATIONS, IN CLASS 9 (U.S. CLS. 21, 23, 26, 36 AND 38).

FIRST USE 7-1-1999; IN COMMERCE 7-1-1999.

THE MARK CONSISTS OF STANDARD CHARACTERS WITHOUT CLAIM TO ANY PARTICULAR FONT, STYLE, SIZE, OR COLOR.

SER. NO. 77-261,996, FILED 8-22-2007.

JENNIFER HETU, EXAMINING ATTORNEY

**Int. Cl.: 38**

**Prior U.S. Cls.: 100, 101 and 104**

**United States Patent and Trademark Office**

**Reg. No. 3,466,167**

**Registered July 15, 2008**

**SERVICE MARK  
PRINCIPAL REGISTER**

# FaveOtron

DEUTSCHE TELEKOM AG (FED REP GERMA-  
NY CORPORATION)  
FRIEDRICH-EBERT-ALLEE 140  
BONN, FED REP GERMANY 53113

FOR: TELECOMMUNICATION AND INFORMATION TECHNOLOGY SERVICES, NAMELY, ELECTRIC, DIGITAL, CELLULAR AND WIRELESS TRANSMISSION OF VOICE, DATA, INFORMATION IMAGES, SIGNALS AND MESSAGES AND TRANSMISSION OF VOICE, DATA, IMAGES, AUDIO, VIDEO AND INFORMATION VIA TELEPHONE, TELEVISION AND GLOBAL COMMUNICATION NETWORKS; PROVIDING TELECOMMUNICATIONS CONNECTIONS OVER A GLOBAL COMMUNICATIONS NETWORK, ELECTRONIC STORE-AND-FORWARD MESSAGING; RENTAL OF TELECOMMUNICATIONS EQUIPMENT, NAMELY, EQUIPMENT FOR ELECTRONIC ACCESS TO GLOBAL TELECOMMUNICATIONS NETWORK, EQUIPMENT FOR TRANSMITTING, RECEIVING, RECORDING AND MONITORING VOICE, DATA, INFORMATION IMAGES, SIGNALS, MESSAGES COMPRISED OF DATA AND WORD PROCESSORS, AND TELECOMMUNICATIONS HARDWARE COMPONENTS AND PERIPHERALS THEREOF FOR USE IN THE TELECOMMUNICATIONS INDUSTRY, AND RENTAL OF EQUIPMENT FOR TRANSMITTING, RECEIVING, RECORDING AND MONITORING COMPU-

TER PROGRAMS FOR USE IN OPERATING AND ACCESSING TELECOMMUNICATIONS SYSTEMS; AUDIO AND VIDEO BROADCASTING; PROVIDING MULTIPLE-USER DIAL-UP AND DEDICATED ACCESS TO THE INTERNET; PERSONAL COMMUNICATIONS SERVICES; PAGER SERVICES; TRANSMISSION AND BROADCAST OF AUDIO AND VIDEO PROGRAMMING; LEASING OF TELECOMMUNICATIONS EQUIPMENT, COMPONENTS AND SYSTEMS; PROVIDING INFORMATION VIA THE TELEPHONE AND THE GLOBAL COMMUNICATION NETWORKS IN THE FIELD OF TELECOMMUNICATIONS; CONSULTING IN THE FIELD OF TELECOMMUNICATIONS, IN CLASS 38 (U.S. CLS. 100, 101 AND 104).

THE MARK CONSISTS OF STANDARD CHARACTERS WITHOUT CLAIM TO ANY PARTICULAR FONT, STYLE, SIZE, OR COLOR.

PRIORITY CLAIMED UNDER SEC. 44(D) ON FED REP GERMANY APPLICATION NO. 30715447538, FILED 3-6-2007, REG. NO. 30715447, DATED 4-18-2007, EXPIRES 3-31-2017.

SER. NO. 77-262,013, FILED 8-22-2007.

KATHERINE STOIDES, EXAMINING ATTORNEY

**Int. Cl.: 36**

**Prior U.S. Cls.: 100, 101 and 102**

**United States Patent and Trademark Office**

**Reg. No. 3,466,168**

**Registered July 15, 2008**

**SERVICE MARK  
PRINCIPAL REGISTER**

**REAL CASH. REAL CREDIT.  
REAL PEOPLE.**

PURPOSE INTELLECTUAL PROPERTY MAN-  
AGEMENT II, INC. (NEVADA CORPORA-  
TION)

SUITE 850-15C  
101 CONVENTION CENTER DRIVE  
LAS VEGAS, NV 89109

FOR: PAYDAY LOANS; CASH ADVANCES,  
SHORT-TERM LOANS; INSTALLMENT LOANS;  
CAR TITLE LOANS; CREDIT CARD SERVICES, IN  
CLASS 36 (U.S. CLS. 100, 101 AND 102).

FIRST USE 2-6-2007; IN COMMERCE 2-6-2007.

THE MARK CONSISTS OF STANDARD CHAR-  
ACTERS WITHOUT CLAIM TO ANY PARTICULAR  
FONT, STYLE, SIZE, OR COLOR.

SER. NO. 77-262,063, FILED 8-22-2007.

MORGAN WYNNE, EXAMINING ATTORNEY

Prior U.S. Cl.: 200

United States Patent and Trademark Office

Reg. No. 3,466,169

Registered July 15, 2008

**COLLECTIVE MEMBERSHIP  
PRINCIPAL REGISTER**



CHOWDHURY, DHIMAN DEB (CALIFORNIA CHARITABLE, NON-PROFIT CORPORATION), DBA HUMAN RIGHTS CONGRESS FOR BANGLADESH MINORITIES (HRCBM)  
519 GILES WAY  
SAN JOSE, CA 95136

FOR: INDICATING MEMBERSHIP IN A HUMAN RIGHTS AND HUMANITARIAN ORGANIZATION DEDICATED TO UPHOLD HUMAN RIGHTS FOR MINORITIES IN BANGLADESH AND PROVIDE LEGAL ADVOCACY AND REHABILITATION SERVICES TO DESTITUTE WITH SPECIAL ATTENTION TO WOMEN AND CHILDREN, IN CLASS 200 (U.S. CL. 200).

FIRST USE 8-8-2000; IN COMMERCE 8-8-2000.

NO CLAIM IS MADE TO THE EXCLUSIVE RIGHT TO USE THE REPRESENTATION OF THE

MAP OF BANGLADESH, APART FROM THE MARK AS SHOWN.

THE COLOR(S) BLUE AND WHITE IS/ARE CLAIMED AS A FEATURE OF THE MARK.

THE COLOR BLUE APPEARS IN THE LETTERS "HRCBM" AND IN THE DESIGN OF THE MAP OF BANGLADESH, THE SURROUNDING CONCENTRIC CIRCLES AND LEAVES DESIGN, AND THE COLOR WHITE APPEARS IN THE BACKGROUND OF THE CIRCLE.

SER. NO. 77-262,172, FILED 8-22-2007.

BARBARA BROWN, EXAMINING ATTORNEY

**Int. Cl.: 38**

**Prior U.S. Cls.: 100, 101 and 104**

**United States Patent and Trademark Office**

**Reg. No. 3,466,170**

**Registered July 15, 2008**

**SERVICE MARK  
PRINCIPAL REGISTER**

**KNOXTUBE**

BAKER, DOUGLAS D (UNITED STATES INDIVIDUAL)  
1147 TREYMOUR WAY  
KNOXVILLE, TN 37922

THE MARK CONSISTS OF STANDARD CHARACTERS WITHOUT CLAIM TO ANY PARTICULAR FONT, STYLE, SIZE, OR COLOR.

FOR: STREAMING OF VIDEO MATERIAL ON THE INTERNET, IN CLASS 38 (U.S. CLS. 100, 101 AND 104).

SER. NO. 77-262,264, FILED 8-22-2007.

FIRST USE 11-15-2007; IN COMMERCE 11-15-2007.

KIMBERLY FRYE, EXAMINING ATTORNEY

**Int. Cl.: 1**

**Prior U.S. Cls.: 1, 5, 6, 10, 26 and 46**

**United States Patent and Trademark Office**

**Reg. No. 3,466,171**

**Registered July 15, 2008**

**TRADEMARK  
PRINCIPAL REGISTER**

**KAYSER**

KAYSER BERNDORF AG (AUSTRIA JOINT  
STOCK COMPANY)  
26, LEOBERSDORFER STRASSE  
BERNDORF, AUSTRIA

FOR: GAS CARTRIDGES FILLED WITH CAR-  
BON DIOXIDE OR NITROUS OXIDE FOR GAS  
PRESSURIZED BEVERAGE SIPHON CONTAINERS,  
NAMELY, CREAM WHIPPERS, CREAM PITCHERS  
AND SODA WATER HOLDERS, IN CLASS 1 (U.S.  
CLS. 1, 5, 6, 10, 26 AND 46).

FIRST USE 0-0-1986; IN COMMERCE 0-0-1986.

THE MARK CONSISTS OF STANDARD CHAR-  
ACTERS WITHOUT CLAIM TO ANY PARTICULAR  
FONT, STYLE, SIZE, OR COLOR.

OWNER OF U.S. REG. NO. 3,324,728.

SEC. 2(F).

SER. NO. 77-262,404, FILED 8-23-2007.

JANET LEE, EXAMINING ATTORNEY

**Int. Cl.: 6**

**Prior U.S. Cls.: 2, 12, 13, 14, 23, 25 and 50**

**United States Patent and Trademark Office**

**Reg. No. 3,466,172**

**Registered July 15, 2008**

**TRADEMARK  
PRINCIPAL REGISTER**

**FAN-E-FLAG**

ROBINSON, BILL (UNITED STATES INDIVIDUAL)  
4106 STONEBROOK FARMS ROAD  
GREENSBORO, NC 27406

THE MARK CONSISTS OF STANDARD CHARACTERS WITHOUT CLAIM TO ANY PARTICULAR FONT, STYLE, SIZE, OR COLOR.

FOR: METAL BRACKET FOR DISPLAYING FLAGS, IN CLASS 6 (U.S. CLS. 2, 12, 13, 14, 23, 25 AND 50).

SER. NO. 77-262,473, FILED 8-23-2007.

FIRST USE 6-29-2007; IN COMMERCE 7-7-2007.

MONIQUE MILLER, EXAMINING ATTORNEY



**Int. Cls.: 35 and 36**

**Prior U.S. Cls.: 100, 101 and 102**

**United States Patent and Trademark Office**

**Reg. No. 3,466,173**

**Registered July 15, 2008**

**SERVICE MARK  
PRINCIPAL REGISTER**



INTERACTIVE REALTY, INC. (FLORIDA CORPORATION)  
540 MONTREAL AVENUE  
MELBOURNE, FL 32935

FOR: REAL ESTATE SALES MANAGEMENT; REAL ESTATE MARKETING SERVICES IN THE FIELD OF HOMES, CONDOMINIUMS AND INVESTMENT PROPERTIES, IN CLASS 35 (U.S. CLS. 100, 101 AND 102).

FIRST USE 3-1-2002; IN COMMERCE 3-1-2002.

FOR: LEASING OF REAL ESTATE; PROVIDING INFORMATION IN THE FIELD OF REAL ESTATE VIA THE INTERNET; PROVIDING REAL ESTATE LISTINGS AND REAL ESTATE INFORMATION VIA THE INTERNET; REAL ESTATE AGENCIES; REAL ESTATE BROKERAGE; REAL ESTATE CONSULTATION; REAL ESTATE LISTING; REAL ESTATE MANAGEMENT, IN CLASS 36 (U.S. CLS. 100, 101 AND 102).

FIRST USE 3-1-2002; IN COMMERCE 3-1-2002.

THE COLOR(S) BLACK AND YELLOW IS/ARE CLAIMED AS A FEATURE OF THE MARK.

THE MARK CONSISTS OF A YELLOW HOUSE OUTLINED IN BLACK. A SOLID BLACK CHIMNEY AND BLACK LETTERING OF "INTERACTIVE REALTY". A BLACK, RECTANGULAR BOX IS IN THE LOWER RIGHT-HAND CORNER OF THE HOUSE. THE BOX INCLUDES A YELLOW COMPUTER MOUSE AND YELLOW CORD. THE YELLOW CORD EXTENDS FROM THE BLACK BOX AND THROUGH THE WORDS "INTERACTIVE" AND "REALTY."

SER. NO. 77-262,687, FILED 8-23-2007.

DAYNA BROWNE, EXAMINING ATTORNEY

**Int. Cl.: 40**

**Prior U.S. Cls.: 100, 103 and 106**

**United States Patent and Trademark Office**

**Reg. No. 3,466,174**

**Registered July 15, 2008**

**SERVICE MARK  
PRINCIPAL REGISTER**



PHOENIX MOTORCARS, INC. (CALIFORNIA CORPORATION)  
SUITE 104-197  
9668 MILLIKEN AVENUE  
RANCHO CUCAMONGA, CA 91730

FIRST USE 1-24-2002; IN COMMERCE 1-24-2002.

THE MARK CONSISTS OF A BIRD.

FOR: MANUFACTURE AND ASSEMBLY OF GENERAL PRODUCT LINES IN THE FIELD OF AUTOMOBILES TO THE ORDER AND SPECIFICATION OF OTHERS, IN CLASS 40 (U.S. CLS. 100, 103 AND 106).

SER. NO. 77-262,984, FILED 8-23-2007.

WILLIAM VERHOSEK, EXAMINING ATTORNEY

**Int. Cl.: 41**

**Prior U.S. Cls.: 100, 101 and 107**

**United States Patent and Trademark Office**

**Reg. No. 3,466,175**

**Registered July 15, 2008**

**SERVICE MARK  
PRINCIPAL REGISTER**

# Scholarpedia

IZHIKEVICH, EUGENE M. (CALIFORNIA SOLE PROPRIETORSHIP), DBA SCHOLARPIDIA  
10844 CORTE DE MARIN  
SAN DIEGO, CA 92130

FOR: BOOK AND REVIEW PUBLISHING; ELECTRONIC PUBLISHING SERVICES, NAMELY, PUBLICATION OF TEXT AND GRAPHIC WORKS OF OTHERS ON ON-LINE FEATURING SCIENCE, TECHNOLOGY, ENCYCLOPEDIA ARTICLES; MAGAZINE PUBLISHING; MULTIMEDIA PUBLISHING OF BOOKS, MAGAZINES, JOURNALS, SOFTWARE, GAMES, MUSIC, AND ELECTRONIC PUBLICATIONS; PUBLISHING AND ISSUING SCIENTIFIC PAPERS IN RELATION TO MEDICAL TECHNOLOGY; PUBLISHING OF WEB MAGAZINES; PUBLISHING OF BOOKS AND REVIEWS;

PUBLISHING OF BOOKS, MAGAZINES; PUBLISHING OF ELECTRONIC PUBLICATIONS; PUBLISHING OF JOURNALS, BOOKS AND HANDBOOKS IN THE FIELD OF MEDICINE; PUBLISHING OF REVIEWS, IN CLASS 41 (U.S. CLS. 100, 101 AND 107).

FIRST USE 12-26-2005; IN COMMERCE 12-26-2005.

THE MARK CONSISTS OF STANDARD CHARACTERS WITHOUT CLAIM TO ANY PARTICULAR FONT, STYLE, SIZE, OR COLOR.

SER. NO. 77-263,306, FILED 8-24-2007.

MICHELLE DUBOIS, EXAMINING ATTORNEY

**Int. Cl.: 5**

**Prior U.S. Cls.: 6, 18, 44, 46, 51 and 52**

**Reg. No. 3,466,176**

**United States Patent and Trademark Office**

**Registered July 15, 2008**

**TRADEMARK  
PRINCIPAL REGISTER**

**INCRUSE**

GLAXO GROUP LIMITED (ENGLAND CORPORATION)  
GLAXO WELLCOME HOUSE  
BERKELEY AVENUE  
GREENFORD, MIDDLESEX, ENGLAND UB60NN

FOR: PHARMACEUTICAL PREPARATIONS AND SUBSTANCES FOR THE TREATMENT OF INFECTIOUS DISEASES, BLOOD DISORDERS, PAIN, INFLAMMATION, SEPSIS, ALOPECIA AND OBESITY, AND FOR THE TREATMENT OF VIRAL, METABOLIC, ENDOCRINE, MUSCULOSKELETAL, CARDIOVASCULAR, CARDIOPULMONARY, GENITOURINARY, SEXUAL DYSFUNCTION, ONCOLOGICAL, HEPATOLOGICAL, OPHTHALMOLOGICAL, RESPIRATORY, NEUROLOGICAL, GASTROINTESTINAL, HORMONAL, DERMATOLOGICAL AND PSYCHIATRIC RELA-

TED DISEASES AND DISORDERS, AND FOR THE TREATMENT OF DAMAGED SKIN AND TISSUE; AND FOR VACCINES, IN CLASS 5 (U.S. CLS. 6, 18, 44, 46, 51 AND 52).

THE MARK CONSISTS OF STANDARD CHARACTERS WITHOUT CLAIM TO ANY PARTICULAR FONT, STYLE, SIZE, OR COLOR.

PRIORITY CLAIMED UNDER SEC. 44(D) ON UNITED KINGDOM APPLICATION NO. 2463047, FILED 8-2-2007, REG. NO. 2463047, DATED 8-2-2007, EXPIRES 8-2-2017.

SER. NO. 77-263,434, FILED 8-24-2007.

SETH A. RAPPAPORT, EXAMINING ATTORNEY

**Int. Cl.: 5**

**Prior U.S. Cls.: 6, 18, 44, 46, 51 and 52**

**Reg. No. 3,466,177**

**United States Patent and Trademark Office**

**Registered July 15, 2008**

**TRADEMARK  
PRINCIPAL REGISTER**

**INCRUZE**

GLAXO GROUP LIMITED (ENGLAND CORPORATION)  
GLAXO WELLCOME HOUSE  
BERKELEY AVENUE  
GREENFORD, MIDDLESEX, ENGLAND UB60NN

FOR: PHARMACEUTICAL PREPARATIONS AND SUBSTANCES FOR THE TREATMENT OF INFECTIOUS DISEASES, BLOOD DISORDERS, PAIN, INFLAMMATION, SEPSIS, ALOPECIA AND OBESITY, AND FOR THE TREATMENT OF VIRAL, METABOLIC, ENDOCRINE, MUSCULOSKELETAL, CARDIOVASCULAR, CARDIOPULMONARY, GENITOURINARY, SEXUAL DYSFUNCTION, ONCOLOGICAL, HEPATOLOGICAL, OPHTHALMOLOGICAL, RESPIRATORY, NEUROLOGICAL, GASTROINTESTINAL, HORMONAL, DERMATOLOGICAL AND PSYCHIATRIC RELA-

TED DISEASES AND DISORDERS, AND FOR THE TREATMENT OF DAMAGED SKIN AND TISSUE; AND FOR VACCINES, IN CLASS 5 (U.S. CLS. 6, 18, 44, 46, 51 AND 52).

THE MARK CONSISTS OF STANDARD CHARACTERS WITHOUT CLAIM TO ANY PARTICULAR FONT, STYLE, SIZE, OR COLOR.

PRIORITY CLAIMED UNDER SEC. 44(D) ON UNITED KINGDOM APPLICATION NO. 2463049, FILED 8-2-2007, REG. NO. 2463049, DATED 8-2-2007, EXPIRES 8-2-2017.

SER. NO. 77-263,436, FILED 8-24-2007.

SETH A. RAPPAPORT, EXAMINING ATTORNEY

**Int. Cls.: 6, 14, 16 and 21**

**Prior U.S. Cls.: 2, 5, 12, 13, 14, 22, 23, 25, 27, 28, 29,  
30, 33, 37, 38, 40 and 50**

**Reg. No. 3,466,178**

**United States Patent and Trademark Office**

**Registered July 15, 2008**

**TRADEMARK  
PRINCIPAL REGISTER**

# Kuhapilis

BUZALI, SOFIA MERCADO (MEXICO INDIVIDUAL)  
7616 R. W. EMERSON LOOP  
LAREDO, TX 78041

FOR: FIGURINES OF COMMON METAL AND PEWTER FIGURINES, IN CLASS 6 (U.S. CLS. 2, 12, 13, 14, 23, 25 AND 50).

FIRST USE 1-1-2007; IN COMMERCE 8-1-2007.

FOR: JEWELRY, ORNAMENTAL PINS, CHARMS, AND FIGURINES OF PRECIOUS METAL, NAMELY, GOLD, SILVER AND PLATINUM, IN CLASS 14 (U.S. CLS. 2, 27, 28 AND 50).

FIRST USE 1-1-2007; IN COMMERCE 8-1-2007.

FOR: PAPER STATIONERY, DECALS, STICKERS, GREETING CARDS, STORY BOOKS, COASTERS MADE OF PAPER, PAPER BOXES, AND BOOK-

MARKS, IN CLASS 16 (U.S. CLS. 2, 5, 22, 23, 29, 37, 38 AND 50).

FIRST USE 1-1-2007; IN COMMERCE 8-1-2007.

FOR: MUGS, VASES, CANDLE HOLDERS, INCENSE BURNERS, DECORATIVE CERAMIC TILES NOT FOR USE AS BUILDING MATERIALS, CERAMIC FIGURINES, PORCELAIN FIGURINES, PLASTIC COASTERS, IN CLASS 21 (U.S. CLS. 2, 13, 23, 29, 30, 33, 40 AND 50).

FIRST USE 1-1-2007; IN COMMERCE 8-1-2007.

THE MARK CONSISTS OF STANDARD CHARACTERS WITHOUT CLAIM TO ANY PARTICULAR FONT, STYLE, SIZE, OR COLOR.

SER. NO. 77-263,911, FILED 8-24-2007.

SCOTT BIBB, EXAMINING ATTORNEY

**Int. Cl.: 35**

**Prior U.S. Cls.: 100, 101 and 102**

**United States Patent and Trademark Office**

**Reg. No. 3,466,179**

**Registered July 15, 2008**

**SERVICE MARK  
PRINCIPAL REGISTER**



SYAC CORPORATION (CALIFORNIA CORPORATION), DBA PINK LILY  
1748 HAIGHT ST.  
SAN FRANCISCO, CA 94117

FOR: RETAIL CLOTHING BOUTIQUES, IN CLASS 35 (U.S. CLS. 100, 101 AND 102).

FIRST USE 5-10-2007; IN COMMERCE 5-10-2007.

THE COLOR(S) PINK, LIGHT PINK, AND DARK PINK IS/ARE CLAIMED AS A FEATURE OF THE MARK.

THE MARK CONSISTS OF A SILHOUETTE DRAWING OF A PINK LILY FLOWER OUTLINED IN LIGHT PINK AND THE WORDING "PINK LILY" IN DARK PINK. THE COLOR WHITE IS FOR BACKGROUND ONLY.

SER. NO. 77-264,023, FILED 8-24-2007.

JANET LEE, EXAMINING ATTORNEY

**Int. Cl.: 25**

**Prior U.S. Cls.: 22 and 39**

**United States Patent and Trademark Office**

**Reg. No. 3,466,180**

**Registered July 15, 2008**

**TRADEMARK  
PRINCIPAL REGISTER**

**POPATU**

POSH INTERNATIONAL (CALIFORNIA CORPORATION)  
2436 E. 8TH ST.  
LOS ANGELES, CA 90021

FOR: CLOTHING, NAMELY, COSTUMES FOR USE IN ROLE-PLAYING GAMES, DRESSES, SKIRTS, LEOTARDS, T-SHIRTS, KNIT PANTS, JUMPSUITS, JUMPERS, ROMPERS, TANK TOPS, VESTS, SWEATERS, KNIT SHIRTS, KNIT SKIRTS, KNIT SWEATERS, CARDIGANS, JACKETS, SHORTS, BLOUSES AND SKIRTS IN THE NATURE OF TUTUS; FLIP FLOPS; SHOES; SLIPPERS; FOOTWEAR, IN CLASS 25 (U.S. CLS. 22 AND 39).

FIRST USE 8-1-2007; IN COMMERCE 8-1-2007.

THE MARK CONSISTS OF STANDARD CHARACTERS WITHOUT CLAIM TO ANY PARTICULAR FONT, STYLE, SIZE, OR COLOR.

THE FOREIGN WORDING IN THE MARK TRANSLATES INTO ENGLISH AS "BUTTERFLY".

SER. NO. 77-264,364, FILED 8-25-2007.

KAPIL BHANOT, EXAMINING ATTORNEY



**Int. Cl.: 30**

**Prior U.S. Cl.: 46**

**United States Patent and Trademark Office**

**Reg. No. 3,466,181**

**Registered July 15, 2008**

**TRADEMARK  
PRINCIPAL REGISTER**



QUALITY VEGAN, LLC (OREGON LTD LIAB  
CO)  
3214 NE 16TH AVE  
PORTLAND, OR 97212

THE MARK CONSISTS OF SIX STEMMED FLOW-  
ERS AROUND THE WORD "EVERYDAYCAKE".

FOR: CAKE, IN CLASS 30 (U.S. CL. 46).

SER. NO. 77-264,551, FILED 8-26-2007.

FIRST USE 7-31-2007; IN COMMERCE 8-15-2007.

DAVID TOOLEY, EXAMINING ATTORNEY

**Int. Cl.: 35**

**Prior U.S. Cls.: 100, 101 and 102**

**Reg. No. 3,466,182**

**United States Patent and Trademark Office**

**Registered July 15, 2008**

---

**SERVICE MARK  
PRINCIPAL REGISTER**

**Professional Retail Store  
Maintenance**

PROFESSIONAL RETAIL STORE MAINTENANCE ASSOCIATION (TEXAS UNINC. ASSOCIATION)  
SUITE 160  
14285 MIDWAY ROAD  
ADDISON, TX 75001

FOR: ASSOCIATION SERVICES, NAMELY, PROMOTING THE IMPROVEMENT OF BUSINESS CONDITIONS, PROMOTING IMPLEMENTING UNIFORM AND HIGHER BUSINESS STANDARDS IN THE RETAIL STORE MAINTENANCE INDUSTRY, PROMOTING THE CREATION OF AN ENVIRONMENT TO CONTINUALLY IMPROVE THE BUSINESS PROCESSES, PROMOTING ACTIVE PARTICIPATION IN INDUSTRY AFFAIRS AND

ADVANCING AWARENESS OF RETAIL FACILITIES FOR ALL INDUSTRIES, IN CLASS 35 (U.S. CLS. 100, 101 AND 102).

FIRST USE 9-1-1995; IN COMMERCE 9-1-1995.

THE MARK CONSISTS OF STANDARD CHARACTERS WITHOUT CLAIM TO ANY PARTICULAR FONT, STYLE, SIZE, OR COLOR.

SEC. 2(F).

SER. NO. 77-264,756, FILED 8-27-2007.

TRACY CROSS, EXAMINING ATTORNEY

**Int. Cls.: 35 and 41**

**Prior U.S. Cls.: 100, 101, 102 and 107**

**United States Patent and Trademark Office**

**Reg. No. 3,466,183**

**Registered July 15, 2008**

**SERVICE MARK  
PRINCIPAL REGISTER**

**HSAR**

HUNTERDON/SOMERSET ASSOCIATION OF  
REALTORS (NEW JERSEY NON-PROFIT  
CORPORATION)

BUILDING B

3461 ROUTE 22 EAST

BRANCHBURG, NJ 08876

FOR: TRADE ASSOCIATION SERVICES, NAME-  
LY, PROMOTING THE INTERESTS OF COMMER-  
CIAL AND RESIDENTIAL REAL ESTATE  
BROKERS, SALESPEOPLE, REAL ESTATE  
AGENTS, PROPERTY MANAGERS, APPRAISERS,  
COUNSELORS, AND REAL ESTATE PROFESSION-  
ALS, IN CLASS 35 (U.S. CLS. 100, 101 AND 102).

FIRST USE 2-25-1997; IN COMMERCE 2-25-1997.

FOR: CONDUCTING LECTURES, SEMINARS,  
AND WORKSHOPS IN THE FIELD OF REAL ESTATE,  
IN CLASS 41 (U.S. CLS. 100, 101 AND 107).

FIRST USE 2-25-1997; IN COMMERCE 2-25-1997.

THE MARK CONSISTS OF STANDARD CHAR-  
ACTERS WITHOUT CLAIM TO ANY PARTICULAR  
FONT, STYLE, SIZE, OR COLOR.

SER. NO. 77-264,792, FILED 8-27-2007.

JESSICA A. POWERS, EXAMINING ATTORNEY

**Int. Cl.: 9**

**Prior U.S. Cls.: 21, 23, 26, 36 and 38**

**Reg. No. 3,466,184**

**United States Patent and Trademark Office**

**Registered July 15, 2008**

---

**TRADEMARK  
PRINCIPAL REGISTER**

# Risky Business

NATIONAL COUNCIL ON ECONOMIC EDUCATION, INC. (D.C. CORPORATION)  
1140 AVENUE OF THE AMERICAS  
NEW YORK, NY 10036

FOR: ELECTRONIC EDUCATIONAL MATERIALS, NAMELY, DVDS, DOWNLOADABLE VIDEO FILES, AND DOWNLOADABLE LESSON PLANS PERTAINING TO EDUCATIONAL COURSES ON PERSONAL FINANCE, ECONOMICS, AND LIFE SKILLS, FOR USE BY HIGH SCHOOL TEACHERS AND THEIR STUDENTS AND BY TEENAGERS AND YOUNG ADULTS ENGAGED IN NON-SCHOOL-BASED EDUCATIONAL PROGRAMS,

AND PRINTED SUPPORT MATERIALS SOLD TOGETHER THEREWITH, IN CLASS 9 (U.S. CLS. 21, 23, 26, 36 AND 38).

FIRST USE 12-19-2006; IN COMMERCE 12-19-2006.

THE MARK CONSISTS OF STANDARD CHARACTERS WITHOUT CLAIM TO ANY PARTICULAR FONT, STYLE, SIZE, OR COLOR.

SER. NO. 77-265,694, FILED 8-28-2007.

KIMBERLY FRYE, EXAMINING ATTORNEY

**Int. Cls.: 33 and 40**

**Prior U.S. Cls.: 47, 49, 100, 103 and 106**

**Reg. No. 3,466,185**

**United States Patent and Trademark Office**

**Registered July 15, 2008**

---

**TRADEMARK  
SERVICE MARK  
PRINCIPAL REGISTER**

# Chester Gap Cellars

CHESTER GAP CELLARS, INC. (VIRGINIA CORPORATION)  
PO BOX 108  
FRONT ROYAL, VA 22630

THE MARK CONSISTS OF STANDARD CHARACTERS WITHOUT CLAIM TO ANY PARTICULAR FONT, STYLE, SIZE, OR COLOR.

FOR: WINE; WINES, IN CLASS 33 (U.S. CLS. 47 AND 49).

NO CLAIM IS MADE TO THE EXCLUSIVE RIGHT TO USE "CELLARS", APART FROM THE MARK AS SHOWN.

FIRST USE 6-0-2006; IN COMMERCE 6-0-2006.

FOR: WINERY SERVICES, IN CLASS 40 (U.S. CLS. 100, 103 AND 106).

SER. NO. 77-265,892, FILED 8-28-2007.

FIRST USE 6-0-2006; IN COMMERCE 6-0-2006.

SHANNON TWOHIG, EXAMINING ATTORNEY

**Int. Cl.: 7**

**Prior U.S. Cls.: 13, 19, 21, 23, 31, 34 and 35**

**Reg. No. 3,466,186**

**United States Patent and Trademark Office**

**Registered July 15, 2008**

**TRADEMARK  
PRINCIPAL REGISTER**



INDUSTRIAL MANUFACTURING COMPANY  
INTERNATIONAL LLC (DELAWARE LTD  
LIAB CO)

6950 SOUTH EDGERTON ROAD  
BRECKSVILLE, OH 44141

FOR: LUBRICATORS, NAMELY, POWER-OPER-  
ATED LUBRICANT DISPENSERS FOR INDUS-  
TRIAL MACHINES, IN CLASS 7 (U.S. CLS. 13, 19,  
21, 23, 31, 34 AND 35).

FIRST USE 6-1-2007; IN COMMERCE 6-1-2007.

OWNER OF U.S. REG. NOS. 535,491, 928,552 AND  
OTHERS.

THE MARK CONSISTS OF "BIJUR DELIMON"  
AND DESIGN.

THE WORDING "BIJUR DELIMON" HAS NO  
MEANING IN A FOREIGN LANGUAGE.

SER. NO. 77-266,367, FILED 8-28-2007.

GINA FINK, EXAMINING ATTORNEY

Int. Cl.: 35

Prior U.S. Cls.: 100, 101 and 102

United States Patent and Trademark Office

Reg. No. 3,466,187

Registered July 15, 2008

**SERVICE MARK  
PRINCIPAL REGISTER**



SANDSTORM DESIGN, INC. (ILLINOIS CORPORATION)  
1802 W. BERTEAU AVE., SUITE 209  
4619 N. RAVENSWOOD  
CHICAGO, IL 60613

FOR: ADVERTISING AND MARKETING, IN CLASS 35 (U.S. CLS. 100, 101 AND 102).

FIRST USE 10-1-1998; IN COMMERCE 10-1-1998.

OWNER OF U.S. REG. NO. 3,347,301.

NO CLAIM IS MADE TO THE EXCLUSIVE RIGHT TO USE "DESIGN INC.", APART FROM THE MARK AS SHOWN.

THE COLOR(S) BLUE AND GRAY IS/ARE CLAIMED AS A FEATURE OF THE MARK.

THE MARK CONSISTS OF THE WORDS "SANDSTORM DESIGN INC" IN BLUE AND THE WORD "DESIGN" IN BOLD LETTERING ENCASED WITHIN PART OF A GRAY SWIRL.

SER. NO. 77-266,906, FILED 8-29-2007.

ANDREA BUTLER, EXAMINING ATTORNEY

**Int. Cl.: 35**

**Prior U.S. Cls.: 100, 101 and 102**

**United States Patent and Trademark Office**

**Reg. No. 3,466,188**

**Registered July 15, 2008**

**SERVICE MARK  
PRINCIPAL REGISTER**

**The Heart of Utah's Dixie**

WASHINGTON CITY (UTAH MUNICIPAL COR-  
PORATION)  
111 NORTH 100 EAST  
WASHINGTON CITY, UT 84780

FOR: MUNICIPAL SERVICES, NAMELY, BUSI-  
NESS MARKETING AND PROMOTING ECONOM-  
IC DEVELOPMENT AND GROWTH OF  
WASHINGTON CITY, IN CLASS 35 (U.S. CLS. 100,  
101 AND 102).

FIRST USE 3-27-2007; IN COMMERCE 3-27-2007.

THE MARK CONSISTS OF STANDARD CHAR-  
ACTERS WITHOUT CLAIM TO ANY PARTICULAR  
FONT, STYLE, SIZE, OR COLOR.

SER. NO. 77-267,174, FILED 8-29-2007.

DOMINIC J. FERRAIUOLO, EXAMINING ATTOR-  
NEY



**Int. Cl.: 35**

**Prior U.S. Cls.: 100, 101 and 102**

**United States Patent and Trademark Office**

**Reg. No. 3,466,189**

**Registered July 15, 2008**

**SERVICE MARK  
PRINCIPAL REGISTER**

# Celebrate Life

WASHINGTON CITY (UTAH MUNICIPAL CORPORATION)  
111 NORTH 100 EAST  
WASHINGTON CITY, UT 84780

FOR: MUNICIPAL SERVICES, NAMELY, BUSINESS MARKETING AND PROMOTING ECONOMIC DEVELOPMENT AND GROWTH OF WASHINGTON CITY, IN CLASS 35 (U.S. CLS. 100, 101 AND 102).

FIRST USE 3-27-2007; IN COMMERCE 3-27-2007.

THE MARK CONSISTS OF STANDARD CHARACTERS WITHOUT CLAIM TO ANY PARTICULAR FONT, STYLE, SIZE, OR COLOR.

SER. NO. 77-267,183, FILED 8-29-2007.

DOMINIC J. FERRAIUOLO, EXAMINING ATTORNEY

**Int. Cl.: 35**

**Prior U.S. Cls.: 100, 101 and 102**

**United States Patent and Trademark Office**

**Reg. No. 3,466,190**

**Registered July 15, 2008**

**SERVICE MARK  
PRINCIPAL REGISTER**

**Got Sunscreen?**

WASHINGTON CITY (UTAH MUNICIPAL CORPORATION)  
111 NORTH 100 EAST  
WASHINGTON CITY, UT 84780

FOR: MUNICIPAL SERVICES, NAMELY, BUSINESS MARKETING AND PROMOTING ECONOMIC DEVELOPMENT AND GROWTH OF WASHINGTON CITY, IN CLASS 35 (U.S. CLS. 100, 101 AND 102).

FIRST USE 3-27-2007; IN COMMERCE 3-27-2007.

THE MARK CONSISTS OF STANDARD CHARACTERS WITHOUT CLAIM TO ANY PARTICULAR FONT, STYLE, SIZE, OR COLOR.

SER. NO. 77-267,196, FILED 8-29-2007.

DOMINIC J. FERRAIUOLO, EXAMINING ATTORNEY

Int. Cl.: 16

Prior U.S. Cls.: 2, 5, 22, 23, 29, 37, 38 and 50

Reg. No. 3,466,191

United States Patent and Trademark Office

Registered July 15, 2008

TRADEMARK  
PRINCIPAL REGISTER



ERIC CHRISTENSEN FINE ART & EDITIONS,  
INC. (CALIFORNIA CORPORATION)  
3883 WOODFORD DRIVE  
SAN JOSE, CA 95124

THE NAME(S), PORTRAIT(S), AND/OR SIGNATURE(S) SHOWN IN THE MARK IDENTIFIES "ERIC CHRISTENSEN", WHOSE CONSENT(S) TO REGISTER IS SUBMITTED.

FOR: PAPER GOODS, NAMELY, PAINTINGS ON PAPER OR CANVAS AND GICLEES ON PAPER OR CANVAS; PRINTED MATTER, NAMELY, POSTERS, PRINTS, GICLEES, POSTCARDS, BROCHURES ABOUT ART, CATALOGS IN THE FIELD OF ART, PRINTED VISUALS IN THE NATURE OF PROMOTIONAL MATERIALS; PHOTOGRAPHS, IN CLASS 16 (U.S. CLS. 2, 5, 22, 23, 29, 37, 38 AND 50).

THE MARK CONSISTS OF A SQUARE IMAGE CONTAINING A GLASS OF WINE IN THE FOREGROUND AND OUTLINE OF A FIG TREE IN THE BACKGROUND. THE WORDS "ERIC CHRISTENSEN" ARE STYLIZED AND ARE TO THE RIGHT OF THE SQUARE IMAGE. THE WORDS "FINE ART & EDITIONS" ARE BELOW "ERIC CHRISTENSEN" AND IN A SMALLER FONT.

FIRST USE 1-15-2007; IN COMMERCE 2-28-2007.

SER. NO. 77-267,310, FILED 8-29-2007.

NO CLAIM IS MADE TO THE EXCLUSIVE RIGHT TO USE "FINE ART AND EDITIONS", APART FROM THE MARK AS SHOWN.

DANIEL BRODY, EXAMINING ATTORNEY

**Int. Cl.: 9**

**Prior U.S. Cls.: 21, 23, 26, 36 and 38**

**Reg. No. 3,466,192**

**United States Patent and Trademark Office**

**Registered July 15, 2008**

---

**TRADEMARK  
PRINCIPAL REGISTER**

**NIK**

NIK SOFTWARE, INC. (NEVADA CORPORATION), DBA NIK MULTIMEDIA, INC.  
7588 METROPOLITAN DRIVE  
SAN DIEGO, CA 92108

FOR: COMPUTER SOFTWARE FOR USE IN IMAGE PROCESSING, AND DIGITAL IMAGE ENHANCEMENT AND MODIFICATION, IN CLASS 9 (U.S. CLS. 21, 23, 26, 36 AND 38).

FIRST USE 12-28-1999; IN COMMERCE 12-28-1999.

THE MARK CONSISTS OF STANDARD CHARACTERS WITHOUT CLAIM TO ANY PARTICULAR FONT, STYLE, SIZE, OR COLOR.

THE NAME "NIK" SHOWN IN THE MARK DOES NOT IDENTIFY A PARTICULAR LIVING INDIVIDUAL.

SER. NO. 77-267,654, FILED 8-29-2007.

WENDY GOODMAN, EXAMINING ATTORNEY

**Int. Cl.: 20**

**Prior U.S. Cls.: 2, 13, 22, 25, 32 and 50**

**United States Patent and Trademark Office**

**Reg. No. 3,466,193**

**Registered July 15, 2008**

**TRADEMARK  
PRINCIPAL REGISTER**

# The Orator

OKLAHOMA SOUND CORPORATION (NEW  
JERSEY CORPORATION)  
149 ENTIN RD.  
CLIFTON, NJ 07014

FOR: LECTERNS, IN CLASS 20 (U.S. CLS. 2, 13, 22,  
25, 32 AND 50).

FIRST USE 1-8-1988; IN COMMERCE 1-8-1988.

THE MARK CONSISTS OF STANDARD CHAR-  
ACTERS WITHOUT CLAIM TO ANY PARTICULAR  
FONT, STYLE, SIZE, OR COLOR.

SEC. 2(F).

SER. NO. 77-267,671, FILED 8-29-2007.

RAMONA ORTIGA, EXAMINING ATTORNEY

**Int. Cl.: 40**

**Prior U.S. Cls.: 100, 103 and 106**

**Reg. No. 3,466,194**

**United States Patent and Trademark Office**

**Registered July 15, 2008**

---

**SERVICE MARK  
PRINCIPAL REGISTER**

**COUNSEL PRESS**

DOLAN MEDIA COMPANY (DELAWARE CORPORATION)  
706 SECOND AVENUE SOUTH  
1200 BAKER BUILDING  
MINNEAPOLIS, MN 55402

FOR: PRINTING SERVICES, NAMELY, PRINTING OF LEGAL AND BUSINESS DOCUMENTS AND RELATED CONSULTING SERVICES FOR CONFORMING DOCUMENTS TO THE RULES OF COURTS AND ADMINISTRATIVE AGENCIES, IN CLASS 40 (U.S. CLS. 100, 103 AND 106).

FIRST USE 0-0-1967; IN COMMERCE 0-0-1967.

THE MARK CONSISTS OF STANDARD CHARACTERS WITHOUT CLAIM TO ANY PARTICULAR FONT, STYLE, SIZE, OR COLOR.

NO CLAIM IS MADE TO THE EXCLUSIVE RIGHT TO USE "PRESS", APART FROM THE MARK AS SHOWN.

SER. NO. 77-268,071, FILED 8-30-2007.

NAKIA HENRY, EXAMINING ATTORNEY

**Int. Cl.: 10**

**Prior U.S. Cls.: 26, 39 and 44**

**United States Patent and Trademark Office**

**Reg. No. 3,466,195**

**Registered July 15, 2008**

**TRADEMARK  
PRINCIPAL REGISTER**

**CONCEPTION KIT**

MELROCK, LTD. (JERSEY CORPORATION)  
BERESFORD HOUSE, BELLOZANE ROAD  
ST. HELIER, UNITED KINGDOM JE23JW

FOR: MEDICAL DEVICES IN THE FIELD OF  
REPRODUCTION, IN CLASS 10 (U.S. CLS. 26, 39  
AND 44).

FIRST USE 4-26-2006; IN COMMERCE 4-26-2006.

THE MARK CONSISTS OF STANDARD CHAR-  
ACTERS WITHOUT CLAIM TO ANY PARTICULAR  
FONT, STYLE, SIZE, OR COLOR.

NO CLAIM IS MADE TO THE EXCLUSIVE  
RIGHT TO USE "KIT", APART FROM THE MARK  
AS SHOWN.

SER. NO. 77-268,516, FILED 8-30-2007.

GIANCARLO CASTRO, EXAMINING ATTORNEY

**Int. Cl.: 31**

**Prior U.S. Cls.: 1 and 46**

**United States Patent and Trademark Office**

**Reg. No. 3,466,196**

**Registered July 15, 2008**

**TRADEMARK  
PRINCIPAL REGISTER**



INTERNATIONAL STOCK FOOD CORPORATION (NEW YORK CORPORATION)  
P.O. BOX 29  
WAVERLY, NY 14892

FOR: ANIMAL FOOD AND NON-MEDICATED ADDITIVES FOR ANIMAL FOOD AND FOOD GRADE ADDITIVES AS PRESERVATIVES FOR ANIMAL FOOD, IN CLASS 31 (U.S. CLS. 1 AND 46).

FIRST USE 1-3-1955; IN COMMERCE 1-3-1955.

THE MARK CONSISTS OF THE LETTERS "ISF" WITH GLOBE DESIGN.

SER. NO. 77-269,134, FILED 8-31-2007.

EDWARD FENNESSY, EXAMINING ATTORNEY



**Int. Cl.: 45**

**Prior U.S. Cls.: 100 and 101**

**United States Patent and Trademark Office**

**Reg. No. 3,466,197**

**Registered July 15, 2008**

**SERVICE MARK  
PRINCIPAL REGISTER**

**I NEED AN ANGEL**

I NEED AN ANGEL, INC. (ARIZONA CORPORATION)  
SUITE 103  
4408 NORTH MILLER ROAD  
SCOTTSDALE, AZ 85251

FOR: HOME CARE SERVICES, NAMELY, PROVIDING IN-HOME NON-MEDICAL ASSISTED LIVING SERVICES IN THE NATURE OF COMPANIONSHIP SERVICES FOR THE ELDERLY AND OTHER INDIVIDUALS WHO NEED ASSISTANCE TO ENABLE THEM TO CONTINUE LIVING AT HOME, IN CLASS 45 (U.S. CLS. 100 AND 101).

FIRST USE 10-1-2004; IN COMMERCE 10-1-2004.

THE MARK CONSISTS OF STANDARD CHARACTERS WITHOUT CLAIM TO ANY PARTICULAR FONT, STYLE, SIZE, OR COLOR.

SER. NO. 77-269,234, FILED 8-31-2007.

ROBERT LAVACHE, EXAMINING ATTORNEY

**Int. Cl.: 41**

**Prior U.S. Cls.: 100, 101 and 107**

**United States Patent and Trademark Office**

**Reg. No. 3,466,198**

**Registered July 15, 2008**

**SERVICE MARK  
PRINCIPAL REGISTER**

# SHOUTFEST

JEFF ROBERTS PRODUCTIONS, INC. (TENNESSEE CORPORATION)  
SUITE 301  
3050 BUSINESS PARK  
GOODLETTSVILLE, TN 37072

FOR: ARRANGING AND CONDUCTING A NATIONAL TOUR OF CONCERTS FEATURING MULTIPLE MUSICAL GROUPS; ARRANGING AND CONDUCTING FESTIVALS FEATURING MULTIPLE MUSICAL GROUPS; PROVIDING A WEBSITE ON GLOBAL COMPUTER NETWORKS FEATURING INFORMATION ON MUSICAL PERFORMANCES, MUSICAL PERFORMERS AND TICKET

INFORMATION FOR EVENTS, IN CLASS 41 (U.S. CLS. 100, 101 AND 107).

FIRST USE 7-1-2002; IN COMMERCE 8-1-2002.

THE MARK CONSISTS OF STANDARD CHARACTERS WITHOUT CLAIM TO ANY PARTICULAR FONT, STYLE, SIZE, OR COLOR.

SER. NO. 77-269,691, FILED 8-31-2007.

ERIN FALK, EXAMINING ATTORNEY

**Int. Cl.: 11**

**Prior U.S. Cls.: 13, 21, 23, 31 and 34**

**United States Patent and Trademark Office**

**Reg. No. 3,466,199**

**Registered July 15, 2008**

**TRADEMARK  
PRINCIPAL REGISTER**



SILESIA ESPAÑA, S.A. (SPAIN JOINT STOCK COMPANY)  
CALLE OSONA, 6 BAJOS  
BARCELONA, SPAIN 08023

FOR: ELECTRIC COOKING GRILLS FOR COMMERCIAL USE, IN CLASS 11 (U.S. CLS. 13, 21, 23, 31 AND 34).

FIRST USE 10-1-2006; IN COMMERCE 10-1-2006.

NO CLAIM IS MADE TO THE EXCLUSIVE RIGHT TO USE "GRILLS OR WORLDWIDE", APART FROM THE MARK AS SHOWN.

THE COLOR(S) BLUE AND WHITE IS/ARE CLAIMED AS A FEATURE OF THE MARK.

THE MARK CONSISTS OF A GLOBE AND DESIGN. THE COLOR BLUE APPEARS ON THE ENTIRE BACKGROUND OF THE MARK, AND THE COLOR WHITE IS USED ON PART OF THE GLOBE IMAGE AND DESIGN ELEMENTS, AS WELL AS FOR ALL LETTERING.

SER. NO. 77-269,805, FILED 8-31-2007.

ANNE MADDEN, EXAMINING ATTORNEY

**Int. Cl.: 1**

**Prior U.S. Cls.: 1, 5, 6, 10, 26 and 46**

**Reg. No. 3,466,200**

**United States Patent and Trademark Office**

**Registered July 15, 2008**

---

**TRADEMARK  
PRINCIPAL REGISTER**

# Intercept

INTELAGARD, INC. (COLORADO CORPORATION)  
590 BURBANK ST., SUITE 220  
BROOMFIELD, CO 80020

FOR: MANUALLY OPERATED COMPRESSED AIR FOAM (CAF) DISPENSING APPARATUS FOR USE IN DISPENSING A VARIETY OF FOAMS AND FORMULAS FOR FIRE SUPPRESSION AND PROTECTION, HAZARDOUS MATERIALS REMEDIATION, AND BIOCHEMICAL DECONTAMINATION, IN CLASS 1 (U.S. CLS. 1, 5, 6, 10, 26 AND 46).

FIRST USE 12-1-2006; IN COMMERCE 12-1-2006.

THE MARK CONSISTS OF STANDARD CHARACTERS WITHOUT CLAIM TO ANY PARTICULAR FONT, STYLE, SIZE, OR COLOR.

SER. NO. 77-269,846, FILED 8-31-2007.

GEORGIA CARTY, EXAMINING ATTORNEY

**Int. Cl.: 25**

**Prior U.S. Cls.: 22 and 39**

**United States Patent and Trademark Office**

**Reg. No. 3,466,201**

**Registered July 15, 2008**

**TRADEMARK  
PRINCIPAL REGISTER**

**BAILEY MARIE DESIGNS**

WESTERN INDUSTRIES ASSOCIATES LLC (NE-  
VADA LTD LIAB CO)  
SUITE D  
297 KINGSBURY GRADE  
LAKE TAHOE (STATELINE), NV 894494470

FOR: WEDDING GOWNS; BRIDESMAID DRESSES, IN CLASS 25 (U.S. CLS. 22 AND 39).

FIRST USE 6-15-2007; IN COMMERCE 6-15-2007.

THE MARK CONSISTS OF STANDARD CHARACTERS WITHOUT CLAIM TO ANY PARTICULAR FONT, STYLE, SIZE, OR COLOR.

NO CLAIM IS MADE TO THE EXCLUSIVE RIGHT TO USE "DESIGNS", APART FROM THE MARK AS SHOWN.

THE MARK DOES NOT IDENTIFY A PARTICULAR LIVING INDIVIDUAL.

SER. NO. 77-270,019, FILED 8-31-2007.

H. M. FISHER, EXAMINING ATTORNEY

**Int. Cls.: 35 and 43**

**Prior U.S. Cls.: 100, 101 and 102**

**United States Patent and Trademark Office**

**Reg. No. 3,466,202**

**Registered July 15, 2008**

**SERVICE MARK  
PRINCIPAL REGISTER**



CANTALOOP INTERNATIONAL INC. (CALIFORNIA CORPORATION)  
UNIT 280  
7083 HOLLYWOOD BLVD.  
LOS ANGELES, CA 90028

FOR: ASSOCIATION SERVICES, NAMELY, PROMOTING DIVERSITY IN THE RESTAURANT AND HOTEL INDUSTRIES ON BEHALF OF EMPLOYEES, VENDORS, MANAGEMENT, AND OWNERS; FRANCHISING, NAMELY, OFFERING TECHNICAL ASSISTANCE IN THE ESTABLISHMENT AND/OR OPERATION OF FROZEN YOGURT RETAIL LOCATIONS; OFFERING TECHNICAL ASSISTANCE IN THE ESTABLISHMENT AND/OR OPERATION OF RESTAURANTS; ON-LINE BUSINESS DIRECTORIES FEATURING FROZEN YOGURT RETAIL LOCATIONS ON-LINE LISTING, NOT ON-LINE PUBLICATION; ON-LINE ORDERING SERVICES IN THE FIELD OF RESTAURANT TAKE-OUT AND DELIVERY; RESTAURANT FRANCHISING; RESTAURANT MANAGEMENT FOR OTHERS, IN CLASS 35 (U.S. CLS. 100, 101 AND 102).

FIRST USE 9-18-2006; IN COMMERCE 9-18-2006.

FOR: CAFE-RESTAURANTS; CARRY-OUT RESTAURANTS; DELICATESSENS; FAST FOOD AND NON-STOP RESTAURANT SERVICES; FAST-FOOD RESTAURANTS; FAST-FOOD RESTAURANTS AND SNACKBARS; HOTEL, BAR AND RESTAURANT SERVICES; PROVIDING ADVICE TO TOUR-

ISTS AND BUSINESS TRAVELERS ON HOTEL AND RESTAURANT DESTINATIONS; PROVIDING ON-LINE REVIEWS OF RESTAURANTS AND HOTELS; PROVIDING PROGRESSIVE DINNER EVENTS WHERE PARTICIPANTS SAMPLE MEALS AND DRINKS AT A SERIES OF RESTAURANTS; PROVIDING REVIEWS OF RESTAURANTS; RESERVATION OF RESTAURANTS; RESTAURANT AND BAR SERVICES; RESTAURANT SERVICES; RESTAURANT SERVICES FEATURING SANDWICHES; RESTAURANTS; RESTAURANTS FEATURING HOME DELIVERY; SELF SERVICE RESTAURANTS; SELF-SERVICE RESTAURANTS; TAKE-OUT RESTAURANT SERVICES; TRAVEL AGENCY SERVICES, NAMELY, MAKING RESERVATIONS AND BOOKINGS FOR RESTAURANTS AND MEALS, IN CLASS 43 (U.S. CLS. 100 AND 101).

FIRST USE 9-18-2006; IN COMMERCE 9-18-2006.

NO CLAIM IS MADE TO THE EXCLUSIVE RIGHT TO USE "NATURAL FROZEN YOGURT", APART FROM THE MARK AS SHOWN.

THE PATTERN IS ON A CROSS SECTION OF AN ORANGE SLICE NEXT TO THE WORD "CANTALOOP".

SER. NO. 77-270,185, FILED 9-1-2007.

ZACHARY BELLO, EXAMINING ATTORNEY

**Int. Cl.: 30**

**Prior U.S. Cl.: 46**

**United States Patent and Trademark Office**

**Reg. No. 3,466,203**

**Registered July 15, 2008**

**TRADEMARK  
PRINCIPAL REGISTER**



**SOLAR ROAST COFFEE**

SOLAR ROAST COFFEE LLC (OREGON LTD  
LIAB CO)

226 NORTH MAIN STREET

PUEBLO, CO 81003

FOR: ROASTED COFFEE BEANS, IN CLASS 30  
(U.S. CL. 46).

FIRST USE 7-4-2004; IN COMMERCE 7-4-2004.

NO CLAIM IS MADE TO THE EXCLUSIVE  
RIGHT TO USE "ROAST COFFEE", APART FROM  
THE MARK AS SHOWN.

THE MARK CONSISTS OF THE GREEK GOD  
HELIOS, HAVING RAYS OF LIGHT EMANATING  
FROM HIS HEAD, DRIVING A CHARIOT PULLED  
BY A WINGED HORSE.

SER. NO. 77-270,288, FILED 9-2-2007.

TINA KUAN, EXAMINING ATTORNEY

**Int. Cl.: 16**

**Prior U.S. Cls.: 2, 5, 22, 23, 29, 37, 38 and 50**

**Reg. No. 3,466,204**

**United States Patent and Trademark Office**

**Registered July 15, 2008**

**TRADEMARK  
PRINCIPAL REGISTER**

**INTRO MAGAZINE**

EASTER, LAURA AVIANA (UNITED STATES  
INDIVIDUAL)  
PO BOX 202252  
SHAKER HEIGHTS, OH 44120

FOR: MAGAZINES FEATURING HIP HOP, RAP,  
RANDB, SOUL, ROCK, POP, MODELS, FASHION,  
AND URBAN ENTERTAINMENT, IN CLASS 16 (U.S.  
CLS. 2, 5, 22, 23, 29, 37, 38 AND 50).

FIRST USE 5-5-2007; IN COMMERCE 5-5-2007.

THE MARK CONSISTS OF STANDARD CHAR-  
ACTERS WITHOUT CLAIM TO ANY PARTICULAR  
FONT, STYLE, SIZE, OR COLOR.

NO CLAIM IS MADE TO THE EXCLUSIVE  
RIGHT TO USE "MAGAZINE", APART FROM THE  
MARK AS SHOWN.

SER. NO. 77-270,325, FILED 9-3-2007.

RONALD MCMORROW, EXAMINING ATTORNEY



**Int. Cl.: 41**

**Prior U.S. Cls.: 100, 101 and 107**

**United States Patent and Trademark Office**

**Reg. No. 3,466,205**

**Registered July 15, 2008**

**SERVICE MARK  
PRINCIPAL REGISTER**

**TRAX ENTERTAINMENT**

FISHMAN, JEFFREY CHARLES (UNITED STATES INDIVIDUAL), DBA TRAX ENTERTAINMENT  
P.O. BOX 903  
KAPAA, HI 96746

FOR: ENTERTAINMENT IN THE NATURE OF VISUAL AND AUDIO PERFORMANCES, AND MUSICAL, VARIETY, NEWS AND COMEDY SHOWS; ENTERTAINMENT IN THE NATURE OF LIVE PERFORMANCES BY DISC JOCKEY OR MULTIMEDIA ARTIST, IN CLASS 41 (U.S. CLS. 100, 101 AND 107).

FIRST USE 4-1-1985; IN COMMERCE 4-1-1985.

THE MARK CONSISTS OF STANDARD CHARACTERS WITHOUT CLAIM TO ANY PARTICULAR FONT, STYLE, SIZE, OR COLOR.

NO CLAIM IS MADE TO THE EXCLUSIVE RIGHT TO USE "ENTERTAINMENT", APART FROM THE MARK AS SHOWN.

SER. NO. 77-270,387, FILED 9-3-2007.

BRENDAN REGAN, EXAMINING ATTORNEY

**Int. Cls.: 9 and 11**

**Prior U.S. Cls.: 13, 21, 23, 26, 31, 34, 36 and 38**

**United States Patent and Trademark Office**

**Reg. No. 3,466,206**

**Registered July 15, 2008**

---

**TRADEMARK  
PRINCIPAL REGISTER**

**STEALTH**

RAB LIGHTING, INC. (NEW YORK CORPORATION)  
170 LUDLOW AVENUE  
NORTHVALE, NJ 07647

FOR: MOTION ACTIVATED ELECTRIC LIGHTING FIXTURES USED FOR SECURITY PURPOSES, IN CLASS 9 (U.S. CLS. 21, 23, 26, 36 AND 38).

FIRST USE 7-15-1995; IN COMMERCE 7-15-1995.

FOR: MOTION ACTIVATED ELECTRIC LIGHTING FIXTURES NOT USED FOR SECURITY PURPOSES, IN CLASS 11 (U.S. CLS. 13, 21, 23, 31 AND 34).

FIRST USE 7-15-1995; IN COMMERCE 7-15-1995.

THE MARK CONSISTS OF STANDARD CHARACTERS WITHOUT CLAIM TO ANY PARTICULAR FONT, STYLE, SIZE, OR COLOR.

SER. NO. 77-270,979, FILED 9-4-2007.

ROBERT LAVACHE, EXAMINING ATTORNEY

**Int. Cl.: 45**

**Prior U.S. Cls.: 100 and 101**

**United States Patent and Trademark Office**

**Reg. No. 3,466,207**

**Registered July 15, 2008**

**SERVICE MARK  
PRINCIPAL REGISTER**

**THE POWER OF LOVE**

CORPORATE MUTUAL RESOURCES INCORPORATED (DELAWARE CORPORATION)  
50 GRANDVIEW BOULEVARD  
WYOMISSING HILLS, PA 19609

FOR: NON-MEDICAL SOCIAL CARE, NAMELY, COMPANIONSHIP SERVICES FOR THE ELDERLY, HANDICAPPED, AND HOME-BOUND; PERSONAL SHOPPING FOR OTHERS; AND PERSONAL CARE AND HOUSEHOLD ASSISTANCE OF ACTIVITIES OF DAILY LIVING FOR THE ELDERLY, HANDICAPPED, AND HOME-BOUND, NAMELY, IN-HOME COOKING FOR OTHERS AND IN-HOME

RESPITE CARE, IN CLASS 45 (U.S. CLS. 100 AND 101).

FIRST USE 6-4-2005; IN COMMERCE 6-4-2005.

THE MARK CONSISTS OF STANDARD CHARACTERS WITHOUT CLAIM TO ANY PARTICULAR FONT, STYLE, SIZE, OR COLOR.

SER. NO. 77-271,186, FILED 9-4-2007.

C. DIONNE CLYBURN, EXAMINING ATTORNEY

**Int. Cls.: 9 and 11**

**Prior U.S. Cls.: 13, 21, 23, 26, 31, 34, 36 and 38**

**United States Patent and Trademark Office**

**Reg. No. 3,466,208**

**Registered July 15, 2008**

---

**TRADEMARK  
PRINCIPAL REGISTER**

**SUPER STEALTH**

RAB LIGHTING, INC. (NEW YORK CORPORATION)  
170 LUDLOW AVENUE  
NORTHVALE, NJ 07647

FOR: MOTION ACTIVATED ELECTRIC LIGHTING FIXTURES USED FOR SECURITY PURPOSES, IN CLASS 9 (U.S. CLS. 21, 23, 26, 36 AND 38).

FIRST USE 10-0-2005; IN COMMERCE 10-0-2005.

FOR: MOTION ACTIVATED ELECTRIC LIGHTING FIXTURES NOT USED FOR SECURITY PURPOSES, IN CLASS 11 (U.S. CLS. 13, 21, 23, 31 AND 34).

FIRST USE 10-0-2005; IN COMMERCE 10-0-2005.

THE MARK CONSISTS OF STANDARD CHARACTERS WITHOUT CLAIM TO ANY PARTICULAR FONT, STYLE, SIZE, OR COLOR.

SER. NO. 77-271,246, FILED 9-4-2007.

ROBERT LAVACHE, EXAMINING ATTORNEY

**Int. Cl.: 35**

**Prior U.S. Cls.: 100, 101 and 102**

**United States Patent and Trademark Office**

**Reg. No. 3,466,209**

**Registered July 15, 2008**

**SERVICE MARK  
PRINCIPAL REGISTER**

# CaptainU

CAPTAINU, LLC (ILLINOIS LTD LIAB CO)  
1439 S. MICHIGAN AVE #201  
CHICAGO, IL 60605

FIRST USE 3-10-2007; IN COMMERCE 8-1-2007.

FOR: PROVIDING INFORMATION IN THE  
FIELD OF SPORTS RECRUITING SERVICES FOR  
HIGH SCHOOL AND COLLEGE ATHLETES VIA A  
GLOBAL COMPUTER NETWORK, IN CLASS 35  
(U.S. CLS. 100, 101 AND 102).

THE MARK CONSISTS OF STANDARD CHAR-  
ACTERS WITHOUT CLAIM TO ANY PARTICULAR  
FONT, STYLE, SIZE, OR COLOR.

SER. NO. 77-271,579, FILED 9-5-2007.

ROBERT LAVACHE, EXAMINING ATTORNEY

**Int. Cl.: 8**

**Prior U.S. Cls.: 23, 28 and 44**

**United States Patent and Trademark Office**

**Reg. No. 3,466,210**

**Registered July 15, 2008**

**TRADEMARK  
PRINCIPAL REGISTER**

**TRI-LOCK**

CHAPIN MANUFACTURING, INC. (NEW YORK CORPORATION)  
700 ELLICOTT STREET  
BATAVIA, NY 14021

FOR: TANK CLOSURE DEVICE FOR USE IN CONNECTION WITH HAND OPERATED LIQUID SPRAYERS CONSISTING OF A LIQUID RECEPTACLE AND PUMP CYLINDER AND A REMOVABLE PUMP PLUNGER TO PERMIT PLACING LIQUID IN THE RECEPTACLE, IN CLASS 8 (U.S. CLS. 23, 28 AND 44).

FIRST USE 8-15-2007; IN COMMERCE 8-15-2007.

THE MARK CONSISTS OF STANDARD CHARACTERS WITHOUT CLAIM TO ANY PARTICULAR FONT, STYLE, SIZE, OR COLOR.

SER. NO. 77-271,935, FILED 9-5-2007.

BARBARA A. GOLD, EXAMINING ATTORNEY

**Int. Cl.: 8**

**Prior U.S. Cls.: 23, 28 and 44**

**United States Patent and Trademark Office**

**Reg. No. 3,466,211**

**Registered July 15, 2008**

**TRADEMARK  
PRINCIPAL REGISTER**



CHAPIN MANUFACTURING, INC. (NEW YORK CORPORATION)  
700 ELLICOTT STREET  
BATAVIA, NY 14021

FOR: TANK CLOSURE DEVICE FOR USE IN CONNECTION WITH HAND OPERATED LIQUID SPRAYERS CONSISTING OF A LIQUID RECEPTACLE AND PUMP CYLINDER AND A REMOVABLE PUMP PLUNGER TO PERMIT PLACING LIQUID IN THE RECEPTACLE, IN CLASS 8 (U.S. CLS. 23, 28 AND 44).

FIRST USE 8-15-2007; IN COMMERCE 8-15-2007.

NO CLAIM IS MADE TO THE EXCLUSIVE RIGHT TO USE "PUMP", APART FROM THE MARK AS SHOWN.

THE MARK CONSISTS OF A TRIANGLE WITH A CIRCULAR CENTER OPENING AND TRUNCATED ENDS OVER A CIRCLE.

SER. NO. 77-271,991, FILED 9-5-2007.

BARBARA A. GOLD, EXAMINING ATTORNEY

**Int. Cl.: 3**

**Prior U.S. Cls.: 1, 4, 6, 50, 51 and 52**

**United States Patent and Trademark Office**

**Reg. No. 3,466,212**

**Registered July 15, 2008**

**TRADEMARK  
PRINCIPAL REGISTER**

The logo for MEDTOX Wipe. The word "MEDTOX" is written in a bold, black, sans-serif font. The word "Wipe" is written in a red, cursive script font, positioned to the right and slightly below "MEDTOX".

MEDTOX DIAGNOSTICS, INC. (DELAWARE CORPORATION)  
1238 ANTHONY ROAD  
BURLINGTON, NC 27215

THE COLOR(S) BLACK AND RED IS/ARE CLAIMED AS A FEATURE OF THE MARK.

FOR: DISPOSABLE WIPES IMPREGNATED WITH CHEMICALS OR COMPOUNDS FOR THE REMOVAL OF METAL CONTAMINATION FROM SURFACES INCLUDING DERMAL SURFACES FOR PERSONAL AND COMMERCIAL USE, IN CLASS 3 (U.S. CLS. 1, 4, 6, 50, 51 AND 52).

THE MARK CONSISTS OF THE TERMS "MED-TOX WIPE" WITH THE TERM "MED" APPEARING IN BLACK, AND THE TERMS "TOX" AND "WIPE" APPEARING IN RED.

FIRST USE 9-5-2007; IN COMMERCE 9-5-2007.

SER. NO. 77-271,992, FILED 9-5-2007.

NO CLAIM IS MADE TO THE EXCLUSIVE RIGHT TO USE "WIPE", APART FROM THE MARK AS SHOWN.

BARBARA A. GOLD, EXAMINING ATTORNEY



Int. Cl.: 41

Prior U.S. Cls.: 100, 101 and 107

United States Patent and Trademark Office

Reg. No. 3,466,213

Registered July 15, 2008

SERVICE MARK  
PRINCIPAL REGISTER



TRAIN WITH CHARLIE (TEXAS LTD LIAB CO)  
1411 ELKTON CT.  
COLLEGE STATION, TX 77845

FOR: PERSONAL TRAINER SERVICES, IN CLASS  
41 (U.S. CLS. 100, 101 AND 107).

FIRST USE 2-0-2006; IN COMMERCE 2-0-2006.

THE NAME "CHARLIE" IDENTIFIES A LIVING  
INDIVIDUAL WHOSE CONSENT IS OF RECORD.

THE MARK CONSISTS OF THE TEXT "TWC"  
AND THE "W" IS A BODY FIGURE HOLDING  
WEIGHTS ON A BAR BELL.

SER. NO. 77-272,536, FILED 9-5-2007.

SOPHIA S. KIM, EXAMINING ATTORNEY

Int. Cls.: 25 and 35

Prior U.S. Cls.: 22, 39, 100, 101 and 102

United States Patent and Trademark Office

Reg. No. 3,466,214

Registered July 15, 2008

TRADEMARK  
SERVICE MARK  
PRINCIPAL REGISTER

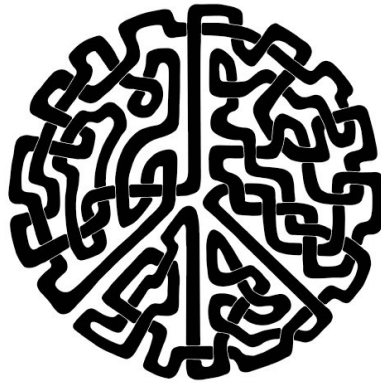

SMITH, ANDREAS B. (UNITED STATES INDIVIDUAL), DBA P.E.A.C.E. FITS  
2215 CARROLL STREET # 201  
OAKLAND, CA 94606

FOR: HOODS; INFANT AND TODDLER ONE PIECE CLOTHING; JERSEYS; SHORT SETS; TOPS; SHORT-SLEEVED OR LONG-SLEEVED T-SHIRTS; T-SHIRTS; DENIM JACKETS; JACKETS; WATER-PROOF JACKETS AND PANTS; MEN AND WOMEN JACKETS, COATS, TROUSERS, VESTS; SKIRTS; SKIRTS AND DRESSES; CAPRI PANTS; CARGO PANTS; DENIMS; JOGGING PANTS; LOUNGE PANTS; PANTS; SWEAT PANTS; TRACK PANTS; LONG-SLEEVED SHIRTS; OPEN-NECKED SHIRTS; SHORT-SLEEVED SHIRTS; SWEAT SHIRTS; TEE SHIRTS; YOGA SHIRTS; JEANS; BODY SUITS; JOGGING OUTFITS; BASEBALL CAPS; CAPS; HATS; YOGA PANTS, IN CLASS 25 (U.S. CLS. 22 AND 39).

FIRST USE 6-15-2006; IN COMMERCE 10-15-2006.

FOR: MAIL ORDER CATALOG SERVICES FEATURING CLOTHING; MAIL ORDER SERVICES FEATURING CLOTHING; ONLINE RETAIL CONSIGNMENT STORES FEATURING CLOTHING; RETAIL CLOTHING BOUTIQUES; RETAIL

CLOTHING STORES; RETAIL CONSIGNMENT STORES FEATURING CLOTHING; RETAIL CONSIGNMENT STORES IN THE FIELD OF CLOTHING; RETAIL DISCOUNT STORE SERVICES IN THE FIELD OF CLOTHING; RETAIL STORES FEATURING CLOTHING; RETAIL CLOTHING STORES; WHOLESALE DISTRIBUTORSHIPS FEATURING CLOTHING; WHOLESALE STORES FEATURING CLOTHING, IN CLASS 35 (U.S. CLS. 100, 101 AND 102).

FIRST USE 6-15-2006; IN COMMERCE 10-15-2006.

THE MARK CONSISTS OF AN ECLECTIC ART PIECE INCORPORATING CELTIC KNOT-WORK AND OTHER TRIBAL ART. CIRCULAR IN SHAPE INCLUDES THE LINES OF A CLASSIC "PEACE SIGN", SURROUNDED BY A NETWORK OF INTERWOVEN LINES, FORMED BY ONE CONTINUOUS STRAND.

SEC. 2(F).

SER. NO. 77-272,589, FILED 9-5-2007.

LAURA KOVALSKY, EXAMINING ATTORNEY

**Int. Cls.: 40 and 42**

**Prior U.S. Cls.: 100, 101, 103 and 106**

**United States Patent and Trademark Office**

**Reg. No. 3,466,215**

**Registered July 15, 2008**

**SERVICE MARK  
PRINCIPAL REGISTER**

**AIRCRAFTED, INSIDE & OUT**

YANKEE PACIFIC AEROSPACE, INC. (DELA-  
WARE CORPORATION)  
500 BRACKETT ROAD  
RYE, NH 03870

FOR: MANUFACTURING SERVICES FOR OTH-  
ERS IN THE FIELD OF AIRCRAFT, IN CLASS 40  
(U.S. CLS. 100, 103 AND 106).

FIRST USE 9-25-2007; IN COMMERCE 9-25-2007.

FOR: AIRCRAFT STRUCTURAL DESIGN SERVI-  
CES, IN CLASS 42 (U.S. CLS. 100 AND 101).

FIRST USE 1-31-2007; IN COMMERCE 1-31-2007.

THE MARK CONSISTS OF STANDARD CHAR-  
ACTERS WITHOUT CLAIM TO ANY PARTICULAR  
FONT, STYLE, SIZE, OR COLOR.

SER. NO. 77-272,725, FILED 9-6-2007.

KEVON CHISOLM, EXAMINING ATTORNEY

**Int. Cls.: 7 and 37**

**Prior U.S. Cls.: 13, 19, 21, 23, 31, 34, 35, 100, 103 and 106**

**United States Patent and Trademark Office**

**Reg. No. 3,466,216**

**Registered July 15, 2008**

**TRADEMARK  
SERVICE MARK  
PRINCIPAL REGISTER**



TMI, LLC (ILLINOIS LTD LIAB CO)  
101 E. STATE PARKWAY  
SCHAUMBURG, IL 60173

FOR: PACKAGING MACHINES, PACKING MACHINES, AUTOMATION PACKAGING AND ASSEMBLING MACHINES AND REPLACEMENT PARTS THEREFOR, IN CLASS 7 (U.S. CLS. 13, 19, 21, 23, 31, 34 AND 35).

FIRST USE 3-0-2006; IN COMMERCE 3-0-2006.

FOR: REPAIR AND MAINTENANCE OF PACKAGING AND PACKING MACHINES AND AUTOMA-

TION DEVICES FOR PACKAGING AND PACKING, IN CLASS 37 (U.S. CLS. 100, 103 AND 106).

FIRST USE 3-0-2006; IN COMMERCE 3-0-2006.

THE MARK CONSISTS OF THE STYLIZED LETTERS "TT" IN A CUBE WITH DIAGONAL LINES COMING OUT OF THE BOTTOM OF THE CUBE.

SER. NO. 77-272,996, FILED 9-6-2007.

PRISCILLA MILTON, EXAMINING ATTORNEY

Int. Cl.: 43

Prior U.S. Cls.: 100 and 101

United States Patent and Trademark Office

Reg. No. 3,466,217

Registered July 15, 2008

**SERVICE MARK  
PRINCIPAL REGISTER**



SAFI, GHASSAN, A. (JORDAN INDIVIDUAL),  
DBA HIP HOP FISH AND CHICKEN  
HIPHOPFISH1@AOL.COM  
825 WEST CENTRAL AVE  
MOULTRIE, GA 32304

FOR: FAST FOOD RESTAURANT, IN CLASS 43  
(U.S. CLS. 100 AND 101).

FIRST USE 8-20-2004; IN COMMERCE 8-20-2004.

NO CLAIM IS MADE TO THE EXCLUSIVE  
RIGHT TO USE "FISH & CHICKEN," CHICAGO  
CUISINE," AND "WE FRY FRESH FISH", APART  
FROM THE MARK AS SHOWN.

THE COLOR(S) RED, YELLOW, GRAY, ORANGE,  
BLACK, BLUE, SALMON, AND WHITE IS/ARE  
CLAIMED AS A FEATURE OF THE MARK.

THE MARK CONSISTS OF A FISH WITH A  
GRAY BODY AND BLUE TAIL-FIN. A CHICKEN  
WITH A YELLOW BODY THE COLOR RED AP-  
PEARS IN THE WORDING HIP HOP, CHICAGO  
CUISINE AND WE FRY FRESH FISH, AS WELL AS  
IN THE CHICKEN'S COMB. THE COLOR YELLOW  
APPEARS IN THE CHICKEN'S BODY. THE COLOR  
GRAY APPEARS IN THE FISH'S BODY. THE COL-  
OR ORANGE APPEARS IN THE CHICKEN'S BEAK.  
THE COLOR BLACK APPEARS IN THE WORDING  
FISH & CHICKEN AND IN THE MUSIC NOTES.  
THE COLOR SALMON APPEARS IN THE CHICK-  
EN'S FEET. THE WHITE APPEARS IN THE FISH'S  
EYES.

SER. NO. 77-273,324, FILED 9-6-2007.

DORITT L. CARROLL, EXAMINING ATTORNEY

**Int. Cl.: 9**

**Prior U.S. Cls.: 21, 23, 26, 36 and 38**

**Reg. No. 3,466,218**

**United States Patent and Trademark Office**

**Registered July 15, 2008**

**TRADEMARK  
PRINCIPAL REGISTER**

**FIDAMAT**

SIEMENS AKTIENGESELLSCHAFT (FED REP  
GERMANY AKTIENGESELLSCHAFT)  
WITTELSBACHERPLATZ 2 80333  
MÜNCHEN, FED REP GERMANY

THE MARK CONSISTS OF STANDARD CHAR-  
ACTERS WITHOUT CLAIM TO ANY PARTICULAR  
FONT, STYLE, SIZE, OR COLOR.

FOR: GAS TESTING INSTRUMENTS, IN CLASS 9  
(U.S. CLS. 21, 23, 26, 36 AND 38).

SER. NO. 77-273,428, FILED 9-6-2007.

FIRST USE 12-31-1981; IN COMMERCE 12-31-1981.

VERNA BETH RIRIE, EXAMINING ATTORNEY

**Int. Cl.: 9**

**Prior U.S. Cls.: 21, 23, 26, 36 and 38**

**Reg. No. 3,466,219**

**United States Patent and Trademark Office**

**Registered July 15, 2008**

**TRADEMARK  
PRINCIPAL REGISTER**



BASIS INTERNATIONAL, LTD. (NEW MEXICO CORPORATION)  
5901 JEFFERSON NE  
ALBUQUERQUE, NM 87109

FIRST USE 7-1-1999; IN COMMERCE 7-1-1999.

FOR: COMPUTER SOFTWARE, NAMELY, SOFTWARE PROVIDING TOOLS AND PROGRAMMING LANGUAGE TO ENABLE SOFTWARE DEVELOPERS TO PREPARE BUSINESS APPLICATIONS, IN CLASS 9 (U.S. CLS. 21, 23, 26, 36 AND 38).

THE MARK CONSISTS OF THE LETTER "A" WITH THE CONNECTING LINE IN THE MIDDLE REPLACED BY A SWIVEL LINE.

SER. NO. 77-273,477, FILED 9-6-2007.

JENNIFER HETU, EXAMINING ATTORNEY

**Int. Cl.: 16**

**Prior U.S. Cls.: 2, 5, 22, 23, 29, 37, 38 and 50**

**Reg. No. 3,466,220**

**United States Patent and Trademark Office**

**Registered July 15, 2008**

**TRADEMARK  
PRINCIPAL REGISTER**

**RENEWED & READY**

PACIFIC PRESS PUBLISHING ASSOCIATION  
(IDAHO CORPORATION)  
PO BOX 5353  
NAMPA, ID 836535353

FOR: PRINTED PERIODICAL PROMOTING THE INTERESTS OF MATURE INDIVIDUALS AND IN THE FIELDS OF RETIREMENT, MATURE OR RETIRED LIFESTYLES, FINANCE, HEALTH, INSURANCE, MEDICINE, TRAVEL, HEALTH, TRAVEL, VOLUNTEER ACTIVITIES, SPIRITUAL LIFE, RELATIONSHIPS, SERVICE, HUMOR, AGING AND

FAMILY RELATIONSHIPS, IN CLASS 16 (U.S. CLS. 2, 5, 22, 23, 29, 37, 38 AND 50).

FIRST USE 5-1-2007; IN COMMERCE 5-1-2007.

THE MARK CONSISTS OF STANDARD CHARACTERS WITHOUT CLAIM TO ANY PARTICULAR FONT, STYLE, SIZE, OR COLOR.

SER. NO. 77-273,836, FILED 9-7-2007.

SOPHIA S. KIM, EXAMINING ATTORNEY



**Int. Cl.: 35**

**Prior U.S. Cls.: 100, 101 and 102**

**United States Patent and Trademark Office**

**Reg. No. 3,466,221**

**Registered July 15, 2008**

**SERVICE MARK  
PRINCIPAL REGISTER**

**REDBERI**

LANGSTON PARTNERS LLC (NEW YORK LTD  
LIAB CO)  
339 FLATBUSH AVENUE  
BROOKLYN, NY 11217

THE MARK CONSISTS OF STANDARD CHAR-  
ACTERS WITHOUT CLAIM TO ANY PARTICULAR  
FONT, STYLE, SIZE, OR COLOR.

FOR: RETAIL STORE SERVICES FEATURING  
WOMEN'S CLOTHING, JEWELRY, BEAUTY AND  
SKIN CARE PRODUCTS, AND ACCESSORIES, IN  
CLASS 35 (U.S. CLS. 100, 101 AND 102).

SER. NO. 77-273,846, FILED 9-7-2007.

FIRST USE 8-27-2003; IN COMMERCE 8-27-2003.

SOPHIA S. KIM, EXAMINING ATTORNEY

**Int. Cl.: 25**

**Prior U.S. Cls.: 22 and 39**

**United States Patent and Trademark Office**

**Reg. No. 3,466,222**

**Registered July 15, 2008**

**TRADEMARK  
PRINCIPAL REGISTER**

**COTTONSHOP**

MAN SUM TRADING COMPANY LIMITED  
(HONG KONG LTD LIAB CO)  
UNIT 105, 1/F ELITE INDUSTRIAL CENTRE  
883 CHEUNG SHA WAN ROAD  
KOWLOON, HONG KONG

FOR: CLOTHING MADE IN WHOLE OR IN  
SIGNIFICANT PART OF COTTON, NAMELY, UN-  
DERWEAR, TROUSERS, SHORTS, PANTS, PAJA-  
MAS, T-SHIRTS, JERSEYS, SOCKS, BABY  
ROMPERS, CAMISOLES, AND BABY BIBS NOT OF  
PAPER, IN CLASS 25 (U.S. CLS. 22 AND 39).

FIRST USE 3-31-2000; IN COMMERCE 6-16-2001.

THE MARK CONSISTS OF STANDARD CHAR-  
ACTERS WITHOUT CLAIM TO ANY PARTICULAR  
FONT, STYLE, SIZE, OR COLOR.

OWNER OF U.S. REG. NO. 2,652,287.

SEC. 2(F).

SER. NO. 77-273,986, FILED 9-7-2007.

STEVEN R. FINE, EXAMINING ATTORNEY

**Int. Cl.: 2**

**Prior U.S. Cls.: 6, 11 and 16**

**United States Patent and Trademark Office**

**Reg. No. 3,466,223**

**Registered July 15, 2008**

**TRADEMARK  
PRINCIPAL REGISTER**

**ARMORCLAD**

SPECIALTY COATINGS, INC (NEW JERSEY  
CORPORATION)  
784 MORRIS TURNPIKE SUITE 316  
SHORT HILLS, NJ 07078, NJ 07078

THE MARK CONSISTS OF STANDARD CHAR-  
ACTERS WITHOUT CLAIM TO ANY PARTICULAR  
FONT, STYLE, SIZE, OR COLOR.

FOR: PAINT AND EPOXY COATINGS FOR USE  
ON FLOORS, IN CLASS 2 (U.S. CLS. 6, 11 AND 16).

SER. NO. 77-274,085, FILED 9-7-2007.

FIRST USE 8-15-2007; IN COMMERCE 8-15-2007.

REBECCA SMITH, EXAMINING ATTORNEY

**Int. Cls.: 16 and 26**

**Prior U.S. Cls.: 2, 5, 22, 23, 29, 37, 38, 39, 40, 42 and 50**

**United States Patent and Trademark Office**

**Reg. No. 3,466,224**

**Registered July 15, 2008**

**TRADEMARK  
PRINCIPAL REGISTER**

**A BREATH OF FRESH 'HAIR'**

NANO CORPORATION LIMITED (HONG KONG CORPORATION)  
ROOM 502, TUNG MING BUILDING, 40 DES VOEUX, ROAD CENTRAL  
HONG KONG, HONG KONG

FOR: PRINTED TECHNICAL GUIDE FOR APPLICATION OF HAIR EXTENSIONS, IN CLASS 16 (U.S. CLS. 2, 5, 22, 23, 29, 37, 38 AND 50).

FIRST USE 3-5-2007; IN COMMERCE 3-5-2007.

FOR: HAIR EXTENSIONS, IN CLASS 26 (U.S. CLS. 37, 39, 40, 42 AND 50).

FIRST USE 3-5-2007; IN COMMERCE 3-5-2007.

THE MARK CONSISTS OF STANDARD CHARACTERS WITHOUT CLAIM TO ANY PARTICULAR FONT, STYLE, SIZE, OR COLOR.

PRIORITY CLAIMED UNDER SEC. 44(D) ON CANADA APPLICATION NO. 1338649, FILED 3-9-2007.

NO CLAIM IS MADE TO THE EXCLUSIVE RIGHT TO USE "HAIR", APART FROM THE MARK AS SHOWN.

SER. NO. 77-274,271, FILED 9-7-2007.

MATTHEW MCDOWELL, EXAMINING ATTORNEY

**Int. Cl.: 41**

**Prior U.S. Cls.: 100, 101 and 107**

**United States Patent and Trademark Office**

**Reg. No. 3,466,225**

**Registered July 15, 2008**

**SERVICE MARK  
PRINCIPAL REGISTER**

**ASHEBA**

WILSON, DAVID ASHEBA (UNITED STATES  
INDIVIDUAL)  
149 MONTECITO AVE #103  
OAKLAND, CA 94610

FOR: ENTERTAINMENT SERVICES, NAMELY,  
PERSONAL APPEARANCES BY A SINGER SONG-  
WRITER AND MUSICIAN; ENTERTAINMENT  
SERVICES, NAMELY, PROVIDING A WEB SITE  
FEATURING MUSICAL PERFORMANCES, MUSI-  
CAL VIDEOS, RELATED FILM CLIPS, PHOTO-  
GRAPHS, AND OTHER MULTIMEDIA  
MATERIALS, IN CLASS 41 (U.S. CLS. 100, 101 AND  
107).

FIRST USE 1-1-1997; IN COMMERCE 4-1-2002.

THE MARK CONSISTS OF STANDARD CHAR-  
ACTERS WITHOUT CLAIM TO ANY PARTICULAR  
FONT, STYLE, SIZE, OR COLOR.

THE FOREIGN WORDING IN THE MARK  
TRANSLATES INTO ENGLISH AS CREATIVE ONE  
FROM SWAHILI LANGUAGE.

SER. NO. 77-274,351, FILED 9-7-2007.

VIVIAN MICZNIK FIRST, EXAMINING ATTOR-  
NEY

Int. Cl.: 3

Prior U.S. Cls.: 1, 4, 6, 50, 51 and 52

United States Patent and Trademark Office

Reg. No. 3,466,226

Registered July 15, 2008

TRADEMARK  
PRINCIPAL REGISTER



FACES EUROPEAN SKIN CARE, INC. (CALIFORNIA CORPORATION)  
8110 WEST 3RD ST.  
LOS ANGELES, CA 90048

FOR: BODY AND BEAUTY CARE COSMETICS AND HAIR-CARE PRODUCTS, NAMELY, SHAMPOOS AND HAIR CONDITIONERS; SKIN-CARE PRODUCTS, NAMELY, SKIN CLEANSERS, BODY AND FACIAL SCRUBS, SKIN TONERS, SKIN MASQUES, NON-MEDICATED SKIN PEELS, SKIN MOISTURIZERS AND HYDRATORS, SKIN CREAMS, NON-MEDICATED SKIN GELS; SUN-TANNING AND SUN-CARE PREPARATIONS, NAMELY, SKIN LIGHTENERS, SKIN BRIGHTENERS FOR CLEARING ACNE PIGMENTATIONS, AND SUN TAN LOTIONS; MAKE-UP REMOVERS, MAKE UP, IN CLASS 3 (U.S. CLS. 1, 4, 6, 50, 51 AND 52).

FIRST USE 9-9-2007; IN COMMERCE 9-9-2007.

THE COLOR(S) BLACK, WHITE, AND BROWN IS/ARE CLAIMED AS A FEATURE OF THE MARK.

THE MARK CONSISTS OF CAPITAL "B" THAT IS ITALIZED BETWEEN TWO PARALLELL LINES IN BROWN COLOR ABOVE THE WORD "BELLOR". IN THE WORD "BELLOR" THE LETTERS "B", "E", "O", AND "R" ARE ALL IN BLACK COLOR . THE LETTERS "LL" IN THE WORD "BELLOR" ARE IN BROWN COLOR.

SER. NO. 77-275,146, FILED 9-10-2007.

RICHARD A. STRASER, EXAMINING ATTORNEY

**Int. Cl.: 28**

**Prior U.S. Cls.: 22, 23, 38 and 50**

**United States Patent and Trademark Office**

**Reg. No. 3,466,227**

**Registered July 15, 2008**

**TRADEMARK  
PRINCIPAL REGISTER**

**EASY GRIP**

CRUSH, ROY DAVID (UNITED STATES INDIVIDUAL)  
4631 F.M. 811  
CENTERVILLE, TX 75833

FOR: OUTDOOR ACTIVITY GAMES IN THE NATURE OF A LIGHT WEIGHT SYNTHETIC WEBBING WITH HAND LOOPS FOR PLAYING THE GAME OF TUG OF WAR PULLING GAME, IN CLASS 28 (U.S. CLS. 22, 23, 38 AND 50).

FIRST USE 3-3-1985; IN COMMERCE 5-7-1985.

THE MARK CONSISTS OF STANDARD CHARACTERS WITHOUT CLAIM TO ANY PARTICULAR FONT, STYLE, SIZE, OR COLOR.

NO CLAIM IS MADE TO THE EXCLUSIVE RIGHT TO USE "GRIP", APART FROM THE MARK AS SHOWN.

SER. NO. 77-275,951, FILED 9-10-2007.

RAUL CORDOVA, EXAMINING ATTORNEY

**Int. Cl.: 35**

**Prior U.S. Cls.: 100, 101 and 102**

**United States Patent and Trademark Office**

**Reg. No. 3,466,228**

**Registered July 15, 2008**

**SERVICE MARK  
PRINCIPAL REGISTER**



SEB SA (FRANCE SOCIÉTÉ ANONYME (SA))  
4 CHEMIN DU PETIT BOIS  
ECULLY, FRANCE 69130

FOR: RETAIL STORE SERVICES AND ONLINE  
RETAIL STORE SERVICES FEATURING HOUSE-  
HOLD ELECTRICAL APPLIANCES, TABLEWARE  
AND KITCHEN UTENSILS, IN CLASS 35 (U.S. CLS.  
100, 101 AND 102).

PRIORITY CLAIMED UNDER SEC. 44(D) ON  
FRANCE APPLICATION NO. 073490131, FILED 3-

23-2007, REG. NO. 073490131, DATED 3-23-2007, EX-  
PIRES 3-22-2017.

NO CLAIM IS MADE TO THE EXCLUSIVE  
RIGHT TO USE "HOME & COOK", APART FROM  
THE MARK AS SHOWN.

THE MARK CONSISTS OF "HOME & COOK"  
AND A DESIGN ELEMENT.

SER. NO. 77-276,111, FILED 9-11-2007.

LOURDES AYALA, EXAMINING ATTORNEY



**Int. Cl.: 41**

**Prior U.S. Cls.: 100, 101 and 107**

**United States Patent and Trademark Office**

**Reg. No. 3,466,229**

**Registered July 15, 2008**

**SERVICE MARK  
PRINCIPAL REGISTER**

**DAMS OF DISTINCTION**

AMERICAN HEREFORD ASSOCIATION, INC.  
(ARIZONA CORPORATION)  
1501 WYANDOTTE STREET  
KANSAS CITY, MO 641081222

FOR: PROVIDING RECOGNITION AND INCENTIVES BY THE WAY OF AWARDS TO DEMONSTRATE EXCELLENCE IN THE FIELD OF COWS AND CATTLE BREEDING , IN CLASS 41 (U.S. CLS. 100, 101 AND 107).

FIRST USE 0-0-1986; IN COMMERCE 0-0-1986.

THE MARK CONSISTS OF STANDARD CHARACTERS WITHOUT CLAIM TO ANY PARTICULAR FONT, STYLE, SIZE, OR COLOR.

NO CLAIM IS MADE TO THE EXCLUSIVE RIGHT TO USE "DAMS", APART FROM THE MARK AS SHOWN.

SER. NO. 77-276,581, FILED 9-11-2007.

LINDA ORNDORFF, EXAMINING ATTORNEY

Int. Cls.: 25 and 35

Prior U.S. Cls.: 22, 39, 100, 101 and 102

United States Patent and Trademark Office

Reg. No. 3,466,230

Registered July 15, 2008

TRADEMARK  
SERVICE MARK  
PRINCIPAL REGISTER

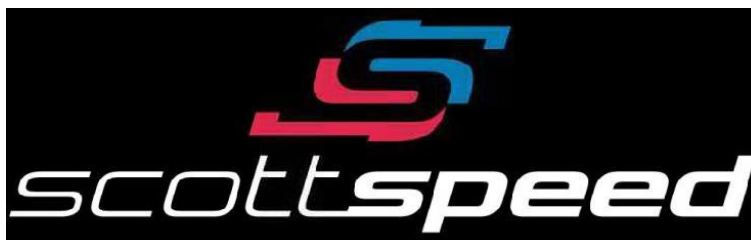

SCOTTSPEED, INC. (ARIZONA CORPORATION)  
SUITE D101  
9376 EAST BAHIA DRIVE  
SCOTTSDALE, AZ 85260

FOR: CLOTHING AND APPAREL, NAMELY, HATS, CAPS, VISORS, JACKETS, POLO SHIRTS, PULLOVERS, SHIRTS, SHORTS, NON-MEDICAL COMPRESSION SHIRTS AND SHORTS, SWEATSHIRTS, HOODED SWEATSHIRTS, TANK TOPS, T-SHIRTS, AND BLOUSES, IN CLASS 25 (U.S. CLS. 22 AND 39).

FIRST USE 12-31-2005; IN COMMERCE 12-31-2005.

FOR: ON-LINE RETAIL STORE SERVICES FEATURING CLOTHING AND APPAREL, NAMELY, HATS, CAPS, VISORS, JACKETS, POLO SHIRTS, PULLOVERS, SHIRTS, SHORTS, NON-MEDICAL COMPRESSION SHIRTS AND SHORTS, SWEATSHIRTS, HOODED SWEATSHIRTS, TANK TOPS, T-SHIRTS, AND BLOUSES, IN CLASS 35 (U.S. CLS. 100, 101 AND 102).

FIRST USE 12-31-2005; IN COMMERCE 12-31-2005.

THE NAME(S), PORTRAIT(S), AND/OR SIGNATURE(S) SHOWN IN THE MARK IDENTIFIES "SCOTT SPEED", WHOSE CONSENT(S) TO REGISTER IS SUBMITTED.

THE COLOR(S) BLUE, RED, AND WHITE IS/ARE CLAIMED AS A FEATURE OF THE MARK.

THE MARK CONSISTS OF A DOUBLE "S" STYLIZED DESIGN CONTAINING BLUE IN THE TOP PORTION, RED IN THE BOTTOM PORTION. "SCOTTSPEED" APPEARS IN WHITE LETTERING BELOW THE DOUBLE S STYLIZED DESIGN. "SPEED" APPEARS IN BOLD LETTERING. THE COLOR BLACK IS NOT CLAIMED AS A FEATURE OF THE MARK AND IS MERELY BACKGROUND.

SER. NO. 77-276,618, FILED 9-11-2007.

SHAILA SETTLES, EXAMINING ATTORNEY

Int. Cls.: 25 and 35

Prior U.S. Cls.: 22, 39, 100, 101 and 102

United States Patent and Trademark Office

Reg. No. 3,466,231

Registered July 15, 2008

TRADEMARK  
SERVICE MARK  
PRINCIPAL REGISTER



SCOTTSPEED, INC. (ARIZONA CORPORATION)  
SUITE D101  
9376 EAST BAHIA DRIVE  
SCOTTSDALE, AZ 85260

FOR: CLOTHING AND APPAREL, NAMELY, HATS, CAPS, VISORS, JACKETS, POLO SHIRTS, PULLOVERS, SHIRTS, SHORTS, NON-MEDICAL COMPRESSION SHIRTS AND SHORTS, SWEATSHIRTS, HOODED SWEATSHIRTS, TANK TOPS, T-SHIRTS, AND BLOUSES, IN CLASS 25 (U.S. CLS. 22 AND 39).

FIRST USE 12-31-2005; IN COMMERCE 12-31-2005.

FOR: ON-LINE RETAIL STORE SERVICES FEATURING CLOTHING AND APPAREL, NAMELY, HATS, CAPS, VISORS, JACKETS, POLO SHIRTS, PULLOVERS, SHIRTS, SHORTS, NON-MEDICAL COMPRESSION SHIRTS AND SHORTS, SWEAT-

SHIRTS, HOODED SWEATSHIRTS, TANK TOPS, T-SHIRTS, AND BLOUSES, IN CLASS 35 (U.S. CLS. 100, 101 AND 102).

FIRST USE 12-31-2005; IN COMMERCE 12-31-2005.

THE NAME(S), PORTRAIT(S), AND/OR SIGNATURE(S) SHOWN IN THE MARK IDENTIFIES "SCOTT SPEED", WHOSE CONSENT(S) TO REGISTER IS SUBMITTED.

THE MARK CONSISTS OF A DOUBLE S STYLIZED DESIGN. SCOTTSPEED APPEARS BELOW THE DOUBLE S STYLIZED DESIGN. SPEED APPEARS IN BOLD LETTERING.

SER. NO. 77-276,716, FILED 9-11-2007.

SHAILA SETTLES, EXAMINING ATTORNEY

**Int. Cls.: 25 and 35**

**Prior U.S. Cls.: 22, 39, 100, 101 and 102**

**United States Patent and Trademark Office**

**Reg. No. 3,466,232**

**Registered July 15, 2008**

**TRADEMARK  
SERVICE MARK  
PRINCIPAL REGISTER**



SCOTTSPEED, INC. (ARIZONA CORPORATION)  
SUITE D101  
9376 EAST BAHIA DRIVE  
SCOTTSDALE, AZ 85260

FOR: CLOTHING AND APPAREL, NAMELY, HATS, CAPS, VISORS, JACKETS, POLO SHIRTS, PULLOVERS, SHIRTS, SHORTS, NON-MEDICAL COMPRESSION SHIRTS AND SHORTS, SWEATSHIRTS, HOODED SWEATSHIRTS, TANK TOPS, T-SHIRTS, AND BLOUSES, IN CLASS 25 (U.S. CLS. 22 AND 39).

FIRST USE 12-31-2005; IN COMMERCE 12-31-2005.

FOR: ON-LINE RETAIL STORE SERVICES FEATURING CLOTHING AND APPAREL, NAMELY, HATS, CAPS, VISORS, JACKETS, POLO SHIRTS, PULLOVERS, SHIRTS, SHORTS, NON-MEDICAL COMPRESSION SHIRTS AND SHORTS, SWEAT-

SHIRTS, HOODED SWEATSHIRTS, TANK TOPS, T-SHIRTS, AND BLOUSES, IN CLASS 35 (U.S. CLS. 100, 101 AND 102).

FIRST USE 12-31-2005; IN COMMERCE 12-31-2005.

THE COLOR(S) BLUE AND RED IS/ARE CLAIMED AS A FEATURE OF THE MARK.

THE MARK CONSISTS OF A DOUBLE "S" STYLIZED DESIGN CONTAINING BLUE IN THE TOP PORTION, RED IN THE BOTTOM PORTION. THE COLOR WHITE IS NOT CLAIMED AS A FEATURE OF THE MARK AND SERVES MERELY AS BACKGROUND.

SER. NO. 77-276,723, FILED 9-11-2007.

SHAILA SETTLES, EXAMINING ATTORNEY

Int. Cl.: 30

Prior U.S. Cl.: 46

United States Patent and Trademark Office

Reg. No. 3,466,233

Registered July 15, 2008

TRADEMARK  
PRINCIPAL REGISTER

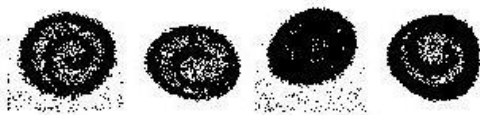

Ice Milan  
Gelateria



ICE MILAN (NEW JERSEY LTD LIAB CO)  
PINE PLAZA #43  
831 ROUTE 10 EAST  
WHIPPANY, NJ 07981

FOR: GELATO; ITALIAN ICE, IN CLASS 30 (U.S. CL. 46).

FIRST USE 7-1-2006; IN COMMERCE 7-1-2006.

NO CLAIM IS MADE TO THE EXCLUSIVE RIGHT TO USE "ICE MILAN GELATERIA", APART FROM THE MARK AS SHOWN.

THE STIPPLING IS FOR SHADING PURPOSES ONLY.

THE MARK CONSISTS OF SWIRLY MARKS WITH THE STYLIZED TEXT "ICE MILAN GELATERIA".

THE FOREIGN WORDING IN THE MARK TRANSLATES INTO ENGLISH AS "ICE CREAM STORE".

SEC. 2(F).

SER. NO. 77-277,063, FILED 9-11-2007.

LAURIE MAYES, EXAMINING ATTORNEY

**Int. Cl.: 6**

**Prior U.S. Cls.: 2, 12, 13, 14, 23, 25 and 50**

**Reg. No. 3,466,234**

**United States Patent and Trademark Office**

**Registered July 15, 2008**

**TRADEMARK  
PRINCIPAL REGISTER**



YIEH CORP. (TAIWAN CORPORATION)  
1F., NO. 69-6, JIA SHIN EAST ROAD  
KANG SHAN TOWN  
KAOHSIUNG HSIEN, TAIWAN

FOR: IRON, STEEL, IN CLASS 6 (U.S. CLS. 2, 12, 13,  
14, 23, 25 AND 50).

FIRST USE 4-1-2004; IN COMMERCE 4-1-2004.

THE COLOR(S) BLUE AND WHITE IS/ARE  
CLAIMED AS A FEATURE OF THE MARK.

THE MARK CONSISTS OF A SQUARE CONTAIN-  
ING TWO PARALLELOGRAMS RUNNING DIAG-  
ONALLY UPWARD FROM THE WORDING "YIEH,"  
WHICH APPEARS IN THE LOWER LEFT CORNER  
OF THE SQUARE. THE COLOR BLUE APPEARS AS  
THE BACKGROUND COLOR OF THE SQUARE,  
AND THE COLOR WHITE APPEARS AS THE  
WORDING "YIEH" AND AS THE COLOR OF THE  
TWO PARALLELOGRAMS.

SER. NO. 77-277,953, FILED 9-12-2007.

ANDREA HACK, EXAMINING ATTORNEY

**Int. Cl.: 3**

**Prior U.S. Cls.: 1, 4, 6, 50, 51 and 52**

**United States Patent and Trademark Office**

**Reg. No. 3,466,235**

**Registered July 15, 2008**

**TRADEMARK  
PRINCIPAL REGISTER**

**HAUTE BODY CUISINE**

DONNA BAYLES WALLACE, (UNITED STATES  
INDIVIDUAL), DBA DBA/BAYLISS RANCH  
P.O. BOX 367  
BIGGS, CA 95917

FOR: BATH SALTS; BODY CREAM; BODY LO-  
TION; BODY SPRAYS; BODY WASHES; EXFOLI-  
ANTS FOR THE BODY; SHAMPOOS; HAIR  
CONDITIONER; SKIN CONDITIONERS , IN CLASS  
3 (U.S. CLS. 1, 4, 6, 50, 51 AND 52).

FIRST USE 9-1-2002; IN COMMERCE 9-1-2002.

THE MARK CONSISTS OF STANDARD CHAR-  
ACTERS WITHOUT CLAIM TO ANY PARTICULAR  
FONT, STYLE, SIZE, OR COLOR.

NO CLAIM IS MADE TO THE EXCLUSIVE  
RIGHT TO USE "BODY", APART FROM THE  
MARK AS SHOWN.

SER. NO. 77-278,156, FILED 9-12-2007.

HEATHER THOMPSON, EXAMINING ATTORNEY

**Int. Cl.: 21**

**Prior U.S. Cls.: 2, 13, 23, 29, 30, 33, 40 and 50**

**United States Patent and Trademark Office**

**Reg. No. 3,466,236**

**Registered July 15, 2008**

**TRADEMARK  
PRINCIPAL REGISTER**



**LOCK & LOCK GLASS**

LOCK & LOCK CO., LTD. (REPUBLIC OF KOREA CORPORATION)  
386 GASAN-LI, SEONJANG-MYUN, ASAN  
CHUNGNAM, REPUBLIC OF KOREA

FOR: PLASTIC CUPS; BOWLS; TRAYS, NOT OF PRECIOUS METAL; CRUETS, NOT OF PRECIOUS METAL; HOUSEHOLD CONTAINERS FOR FOOD; BOTTLES FOR BEVERAGES AND FOOD, SOLD EMPTY; DISHES; BUCKETS; NON-ELECTRIC KETTLES; PLASTIC WATER BOTTLES, SOLD EMPTY, IN CLASS 21 (U.S. CLS. 2, 13, 23, 29, 30, 33, 40 AND 50).

OWNER OF REPUBLIC OF KOREA REG. NO. 40-0685153, DATED 11-10-2006, EXPIRES 11-10-2016.

NO CLAIM IS MADE TO THE EXCLUSIVE RIGHT TO USE "GLASS", APART FROM THE MARK AS SHOWN.

SER. NO. 77-278,268, FILED 9-12-2007.

KAREN K. BUSH, EXAMINING ATTORNEY



**Int. Cl.: 28**

**Prior U.S. Cls.: 22, 23, 38 and 50**

**United States Patent and Trademark Office**

**Reg. No. 3,466,237**

**Registered July 15, 2008**

**TRADEMARK  
PRINCIPAL REGISTER**

**TOUJOURS COUTURE**

MATTEL, INC. (DELAWARE CORPORATION)  
M1-1518  
333 CONTINENTAL BLVD.  
EL SEGUNDO, CA 90245

FOR: TOYS, GAMES AND PLAYTHINGS, NAME-  
LY, DOLLS, DOLL CLOTHING AND DOLL ACCES-  
SORIES, TOY FIGURES AND ACCESSORIES  
THEREFOR, IN CLASS 28 (U.S. CLS. 22, 23, 38 AND  
50).

FIRST USE 2-22-2008; IN COMMERCE 2-22-2008.

THE MARK CONSISTS OF STANDARD CHAR-  
ACTERS WITHOUT CLAIM TO ANY PARTICULAR  
FONT, STYLE, SIZE, OR COLOR.

NO CLAIM IS MADE TO THE EXCLUSIVE  
RIGHT TO USE "COUTURE", APART FROM THE  
MARK AS SHOWN.

THE ENGLISH TRANSLATION OF "TOUJOURS"  
IS ALWAYS.

SER. NO. 77-278,583, FILED 9-13-2007.

JOHN GARTNER, EXAMINING ATTORNEY

**Int. Cl.: 41**

**Prior U.S. Cls.: 100, 101 and 107**

**United States Patent and Trademark Office**

**Reg. No. 3,466,238**

**Registered July 15, 2008**

**SERVICE MARK  
PRINCIPAL REGISTER**



HAMER, RYKE GEERD (FED REP GERMANY  
INDIVIDUAL)  
SUITE 2306  
1150 JERVIS STREET  
VANCOUVER, CANADA V6E2C8

FOR: ORGANIZATION OF SEMINARS, WORK-  
ING GROUPS, RESEARCH GROUPS AND CON-  
VENTIONS, IN THE FIELD OF MEDICINE, IN  
CLASS 41 (U.S. CLS. 100, 101 AND 107).

FIRST USE 1-1-2005; IN COMMERCE 1-1-2005.

PRIORITY CLAIMED UNDER SEC. 44(D) ON  
CANADA APPLICATION NO. 1363444, FILED 9-13-  
2007.

NO CLAIM IS MADE TO THE EXCLUSIVE  
RIGHT TO USE "GERMAN NEW MEDICINE",  
APART FROM THE MARK AS SHOWN.

THE COLOR(S) YELLOW, ORANGE, WHITE  
AND RED IS/ARE CLAIMED AS A FEATURE OF  
THE MARK.

THE MARK CONSISTS OF THREE FREE-STAND-  
ING CIRCLES, PARTIALLY OVERLAPPING. THE  
LEFTMOST CIRCLE HAS THE LETTER "G" IN ITS  
CENTER AND IS YELLOW, THE MIDDLE HAS THE  
LETTER "N" IN ITS CENTER AND IS ORANGE,  
AND THE RIGHTMOST CIRCLE HAS THE LETTER  
"M" IN ITS CENTER AND IS RED. THE TYPEFACE  
OF THE CENTERING LETTERS IS TAHOMA WITH  
DROP SHADOW. THE WORDS "GERMAN NEW  
MEDICINE" ARE WRITTEN BENEATH THE  
THREE CIRCLES. THE COLOR OF THESE WORDS  
IS DARK BLUE, TYPEFACE TAHOMA, WITH A  
DROP SHADOW. THE COLOR WHITE APPEARS IN  
THE LETTERS "GNM".

SEC. 2(F).

SER. NO. 77-278,598, FILED 9-13-2007.

NAAKWAMA ANKRAH, EXAMINING ATTORNEY

Int. Cl.: 25

Prior U.S. Cls.: 22 and 39

**United States Patent and Trademark Office**

**Reg. No. 3,466,239**

Registered July 15, 2008

**TRADEMARK  
PRINCIPAL REGISTER**



CAMPILLO, JIMI (UNITED STATES INDIVIDUAL)  
269 S. BEVERLY DRIVE #249  
BEVERLY HILLS, CA 90212

FOR: SWIM CAPS; SWIM TRUNKS; SWIM WEAR;  
SWIM WEAR FOR GENTLEMEN AND LADIES;  
SWIMMING CAPS; SWIMMING CAPS; SWIMMING

COSTUMES; SWIMMING TRUNKS; SWIMSUITS, IN  
CLASS 25 (U.S. CLS. 22 AND 39).

FIRST USE 9-13-2006; IN COMMERCE 9-13-2006.

SER. NO. 77-278,925, FILED 9-13-2007.

JACLYN KIDWELL, EXAMINING ATTORNEY

**Int. Cl.: 18**

**Prior U.S. Cls.: 1, 2, 3, 22 and 41**

**United States Patent and Trademark Office**

**Reg. No. 3,466,240**

**Registered July 15, 2008**

**TRADEMARK  
PRINCIPAL REGISTER**

Port•a•bra

PINK DIAMOND INTERNATIONAL, INC.  
(FLORIDA CORPORATION)  
SUITE 313  
12864 BISCAYNE BOULEVARD  
NORTH MIAMI BEACH, FL 33181

FOR: VALISES, COFFERS IN THE NATURE OF TRAVELING TRUNKS, TRAVEL BAGS, LUGGAGE AND BOXES FOR TRAVEL NOT MADE OF PAPER TO CARRY AND PROTECT ARTICLES OF CLOTHING, NAMELY, UNDERGARMENTS, IN CLASS 18 (U.S. CLS. 1, 2, 3, 22 AND 41).

PRIORITY CLAIMED UNDER SEC. 44(D) ON COLOMBIA APPLICATION NO. 07-26878, FILED 3-16-2007, REG. NO. 339691, DATED 9-26-2007, EXPIRES 9-26-2017.

THE MARK CONSISTS OF THE WORDS "PORT"; "A"; AND "BRA". EACH WORD IS SPACED EVENLY APART WITH A DOT BETWEEN EACH WORD.

SER. NO. 77-279,046, FILED 9-13-2007.

MONIQUE MILLER, EXAMINING ATTORNEY

**Int. Cl.: 9**

**Prior U.S. Cls.: 21, 23, 26, 36 and 38**

**United States Patent and Trademark Office**

**Reg. No. 3,466,241**

**Registered July 15, 2008**

**TRADEMARK  
PRINCIPAL REGISTER**

**SEO-CART**

CIRKUIT NETWORKS, INC. (INDIANA CORPORATION)  
1004 W. 900 N.  
LUCERNE, IN 46950

THE MARK CONSISTS OF STANDARD CHARACTERS WITHOUT CLAIM TO ANY PARTICULAR FONT, STYLE, SIZE, OR COLOR.

FOR: ON-LINE SHOPPING AND ORDERING SYSTEM SOFTWARE, IN CLASS 9 (U.S. CLS. 21, 23, 26, 36 AND 38).

SER. NO. 77-279,373, FILED 9-14-2007.

FIRST USE 9-1-2004; IN COMMERCE 9-1-2004.

HOWARD B. LEVINE, EXAMINING ATTORNEY

**Int. Cls.: 35 and 41**

**Prior U.S. Cls.: 100, 101, 102 and 107**

**United States Patent and Trademark Office**

**Reg. No. 3,466,242**

**Registered July 15, 2008**

**SERVICE MARK  
PRINCIPAL REGISTER**

**International Wireless  
Communications Expo**

PENTON BUSINESS MEDIA, INC. (DELAWARE CORPORATION)  
4TH FLOOR  
249 WEST 17TH STREET  
NEW YORK, NY 10011

FOR: ARRANGING AND CONDUCTING TRADE SHOW EXHIBITIONS IN THE FIELD OF WIRELESS AND MOBILE COMMUNICATIONS TECHNOLOGIES; ARRANGING AND CONDUCTING TRADE SHOWS IN THE FIELD OF WIRELESS AND MOBILE COMMUNICATIONS TECHNOLOGIES, IN CLASS 35 (U.S. CLS. 100, 101 AND 102).

FIRST USE 0-0-1977; IN COMMERCE 0-0-1977.

FOR: EDUCATIONAL SERVICES, NAMELY, CONDUCTING CLASSES, SEMINARS, WORKSHOPS, AND CONFERENCES IN THE FIELD OF WIRELESS AND MOBILE COMMUNICATIONS

TECHNOLOGIES AND THE DISTRIBUTION OF COURSE MATERIALS IN CONNECTION THEREWITH, IN CLASS 41 (U.S. CLS. 100, 101 AND 107).

FIRST USE 0-0-1977; IN COMMERCE 0-0-1977.

THE MARK CONSISTS OF STANDARD CHARACTERS WITHOUT CLAIM TO ANY PARTICULAR FONT, STYLE, SIZE, OR COLOR.

NO CLAIM IS MADE TO THE EXCLUSIVE RIGHT TO USE "EXPO", APART FROM THE MARK AS SHOWN.

SEC. 2(F).

SER. NO. 77-279,916, FILED 9-14-2007.

ANGELA GAW, EXAMINING ATTORNEY

Int. Cl.: 28

Prior U.S. Cls.: 22, 23, 38 and 50

Reg. No. 3,466,243

United States Patent and Trademark Office

Registered July 15, 2008

TRADEMARK  
PRINCIPAL REGISTER

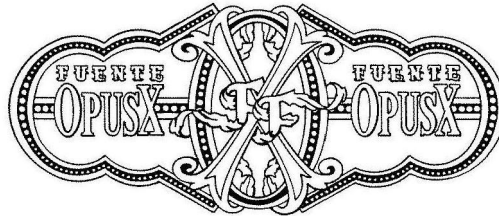

FUENTE MARKETING LTD. (BR.VIRGIN ISLANDS CORPORATION)  
PALM GROVE HOUSE, P.O. BOX 438 ROAD TOWN  
TORTOLA, BR.VIRGIN ISLANDS

FOR: GOLF BALLS, IN CLASS 28 (U.S. CLS. 22, 23, 38 AND 50).

FIRST USE 9-30-2004; IN COMMERCE 9-30-2004.

OWNER OF U.S. REG. NOS. 2,364,801, 2,949,372, AND 3,146,101.

THE MARK CONSISTS OF THE WORDS "FUENTE OPUSX" ON EACH SIDE OF A CENTER DESIGN CONSISTING OF THE LETTER "O" CONTAINING THE LETTERS "FF" INTERTWINED WITH THE LETTER "X".

THE FOREIGN WORDING IN THE MARK TRANSLATES INTO ENGLISH AS "FUENTE" IS FOUNTAIN.

SER. NO. 77-279,989, FILED 9-14-2007.

Laurie Mayes, Examining Attorney

**Int. Cls.: 35 and 40**

**Prior U.S. Cls.: 100, 101, 102, 103 and 106**

**United States Patent and Trademark Office**

**Reg. No. 3,466,244**

**Registered July 15, 2008**

**SERVICE MARK  
PRINCIPAL REGISTER**

# French Press

BRONSON, MICHELLE K. (UNITED STATES  
INDIVIDUAL)  
2495 MAIN STREET, SUITE 507  
BUFFALO, NY 14214

FOR: DESIGN OF MARKETING AND PUBLICI-  
TY MATERIALS FOR OTHERS, IN CLASS 35 (U.S.  
CLS. 100, 101 AND 102).

FIRST USE 6-1-2006; IN COMMERCE 6-1-2006.

FOR: PRINTING SERVICES; PRINTING OF STA-  
TIONERY AND MARKETING AND PUBLICITY

MATERIALS FOR OTHERS, IN CLASS 40 (U.S.  
CLS. 100, 103 AND 106).

FIRST USE 6-1-2006; IN COMMERCE 6-1-2006.

THE MARK CONSISTS OF STANDARD CHAR-  
ACTERS WITHOUT CLAIM TO ANY PARTICULAR  
FONT, STYLE, SIZE, OR COLOR.

SER. NO. 77-280,155, FILED 9-14-2007.

JASON LOTT, EXAMINING ATTORNEY



**Int. Cls.: 36 and 42**

**Prior U.S. Cls.: 100, 101 and 102**

**United States Patent and Trademark Office**

**Reg. No. 3,466,245**

**Registered July 15, 2008**

**SERVICE MARK  
PRINCIPAL REGISTER**



CMARKET, INC. (DELAWARE CORPORATION)  
125 CAMBRIDGE PARK DRIVE  
CAMBRIDGE, MA 02140

FOR: FUND RAISING SERVICES FOR CHARITABLE OR NONPROFIT ENTITIES, CONSULTING SERVICES TO FACILITATE FUND RAISING ACTIVITIES FOR CHARITABLE OR NONPROFIT ENTITIES, ON-LINE FUND RAISING ACTIVITIES FOR CHARITABLE OR NONPROFIT ENTITIES, AND PROVIDING INFORMATION ON THE SUBJECT OF FUND RAISING ACTIVITIES FOR CHARITABLE OR NONPROFIT ENTITIES, IN CLASS 36 (U.S. CLS. 100, 101 AND 102).

FIRST USE 9-1-2006; IN COMMERCE 9-1-2006.

FOR: HOSTING THE ON-LINE CHARITABLE FUND RAISING AUCTION WEBSITES OF OTHERS OVER GLOBAL COMPUTER NETWORKS, IN CLASS 42 (U.S. CLS. 100 AND 101).

FIRST USE 9-1-2006; IN COMMERCE 9-1-2006.

OWNER OF U.S. REG. NOS. 2,927,803, 3,031,369, AND 3,173,117.

THE COLOR(S) RED AND YELLOW IS/ARE CLAIMED AS A FEATURE OF THE MARK.

THE MARK CONSISTS OF THE WORDING "CMARKET" AND A STYLIZED SPIRAL GRAPHIC ELEMENT. THE COLOR RED APPEARS IN THE WORDING "CMARKET" AND IN THE DARKER SHADED AREA OF THE STYLIZED SPIRAL GRAPHIC ELEMENT; THE COLOR YELLOW APPEARS IN THE LIGHTER SHADED AREA OF THE STYLIZED SPIRAL GRAPHIC ELEMENT.

SER. NO. 77-280,263, FILED 9-14-2007.

MICHAEL GAAFAR, EXAMINING ATTORNEY

**Int. Cls.: 25 and 28**

**Prior U.S. Cls.: 22, 23, 38, 39 and 50**

**United States Patent and Trademark Office**

**Reg. No. 3,466,246**

**Registered July 15, 2008**

**TRADEMARK  
PRINCIPAL REGISTER**

# Tokoro Surfboards

WADE TOKORO SURFBOARDS, INC. (HAWAII CORPORATION)  
PO BOX 6404  
KANEIOHE, HI 96744

FOR: T-SHIRTS, IN CLASS 25 (U.S. CLS. 22 AND 39).

FIRST USE 0-0-1991; IN COMMERCE 0-0-2000.

FOR: SURFBOARDS, IN CLASS 28 (U.S. CLS. 22, 23, 38 AND 50).

FIRST USE 0-0-1991; IN COMMERCE 0-0-2000.

THE MARK CONSISTS OF STANDARD CHARACTERS WITHOUT CLAIM TO ANY PARTICULAR FONT, STYLE, SIZE, OR COLOR.

NO CLAIM IS MADE TO THE EXCLUSIVE RIGHT TO USE "SURFBOARDS", APART FROM THE MARK AS SHOWN.

SEC. 2(F).

SER. NO. 77-280,421, FILED 9-14-2007.

JENNIFER MARTIN, EXAMINING ATTORNEY

**Int. Cl.: 35**

**Prior U.S. Cls.: 100, 101 and 102**

**United States Patent and Trademark Office**

**Reg. No. 3,466,247**

**Registered July 15, 2008**

**SERVICE MARK  
PRINCIPAL REGISTER**

**WE CAN HELP AS LITTLE OR  
AS MUCH AS YOU LIKE.**

ETHAN ALLEN GLOBAL, INC. (DELAWARE  
CORPORATION)  
ETHAN ALLEN DRIVE  
DANBURY, CT 06813

THE MARK CONSISTS OF STANDARD CHAR-  
ACTERS WITHOUT CLAIM TO ANY PARTICULAR  
FONT, STYLE, SIZE, OR COLOR.

FOR: RETAIL FURNITURE STORES, IN CLASS 35  
(U.S. CLS. 100, 101 AND 102).

SER. NO. 77-280,456, FILED 9-15-2007.

FIRST USE 7-9-2007; IN COMMERCE 7-9-2007.

KATHLEEN LORENZO, EXAMINING ATTORNEY

Int. Cl.: 25

Prior U.S. Cls.: 22 and 39

United States Patent and Trademark Office

Reg. No. 3,466,248

Registered July 15, 2008

TRADEMARK  
PRINCIPAL REGISTER



TLCARE WEAR, INC. (RHODE ISLAND CORPORATION)  
1050 TOLLGATE ROAD  
WARWICK, RI 02886

FOR: SCRUBS NOT FOR MEDICAL PURPOSES,  
IN CLASS 25 (U.S. CLS. 22 AND 39).

FIRST USE 9-3-2007; IN COMMERCE 9-14-2007.

NO CLAIM IS MADE TO THE EXCLUSIVE  
RIGHT TO USE "SCRUBS" , APART FROM THE  
MARK AS SHOWN.

THE COLOR(S) BLUE IS/ARE CLAIMED AS A  
FEATURE OF THE MARK.

THE COLOR BLUE APPEARS IN THE WORDING  
"COOL"; THE BLACK AND WHITE IN THE DRAW-  
ING REPRESENTS BACKGROUND, OUTLINING,  
SHADING, AND/OR TRANSPARENT AREAS AND  
ARE NOT PART OF THE MARK.

SER. NO. 77-281,054, FILED 9-17-2007.

AISHA SALEM, EXAMINING ATTORNEY

**Int. Cl.: 41**

**Prior U.S. Cls.: 100, 101 and 107**

**United States Patent and Trademark Office**

**Reg. No. 3,466,249**

**Registered July 15, 2008**

**SERVICE MARK  
PRINCIPAL REGISTER**

# Teach613

TEACH613 (NEW JERSEY NON-PROFIT ASSOCIATION)  
25 LANTERN LANE  
CHERRY HILL, NJ 08002

FOR: DEVELOPMENT AND DISSEMINATION OF EDUCATIONAL MATERIALS OF OTHERS IN THE FIELD OF JEWISH EDUCATION; EDUCATION SERVICES, NAMELY, PROVIDING LIVE AND ON-LINE CLASSES, SEMINARS, WORKSHOPS, AND CONFERENCES IN THE FIELD OF JUDAIC STUDIES AND THOUGHT; EDUCATION SERVICES, NAMELY, PROVIDING CLASSES, SEMINARS, WORKSHOPS, AND CONFERENCES IN THE FIELD OF JUDAIC STUDIES; EDUCATIONAL SERVICES, NAMELY, CONDUCTING INFORMAL PROGRAMS IN THE FIELDS OF JUDAIC STUDIES, USING ON-LINE ACTIVITIES AND INTERACTIVE EXHIBITS, AND PRINTABLE MATERIALS DISTRIBUTED THEREWITH; EDUCATIONAL SERVICES, NAME-

LY, CONDUCTING CLASSES, SEMINARS, WORKSHOPS, AND CONFERENCES IN THE FIELD OF JUDAIC STUDIES AND DISTRIBUTION OF COURSE MATERIAL IN CONNECTION THEREWITH; PROVIDING ADVICE AND INFORMATION IN THE FIELD OF EDUCATIONAL AND ENTERTAINMENT ACTIVITIES AND EVENTS FOR CHILDREN, IN CLASS 41 (U.S. CLS. 100, 101 AND 107).

FIRST USE 1-1-2003; IN COMMERCE 1-1-2004.

THE MARK CONSISTS OF STANDARD CHARACTERS WITHOUT CLAIM TO ANY PARTICULAR FONT, STYLE, SIZE, OR COLOR.

SER. NO. 77-281,270, FILED 9-17-2007.

LINDSEY RUBIN, EXAMINING ATTORNEY

**Int. Cl.: 35**

**Prior U.S. Cls.: 100, 101 and 102**

**United States Patent and Trademark Office**

**Reg. No. 3,466,250**

**Registered July 15, 2008**

**SERVICE MARK  
PRINCIPAL REGISTER**

**ACHIEVING BRAND INTEGRITY**

BRAND INTEGRITY, INC. (NEW YORK CORPORATION)  
60 PARK AVENUE  
ROCHESTER, NY 14607

FOR: BUSINESS CONSULTANCY SERVICES, NAMELY, MANAGEMENT STRATEGY DEVELOPMENT AND IMPLEMENTATION PROCESS AND PROGRAMS THAT ENABLE ALIGNMENT BETWEEN EMPLOYEE BEHAVIORS AND COMPANY GOALS AND OBJECTIVES, IMPLEMENTED THROUGH EMPLOYEE PERFORMANCE AND RECOGNITION PROGRAMS; BUSINESS MANAGEMENT CONSULTANCY AS WELL AS DEVELOPMENT OF PROCESSES FOR THE ANALYSIS AND THE IMPLEMENTATION OF STRAT-

EGY PLANS AND MANAGEMENT PROJECTS, IN CLASS 35 (U.S. CLS. 100, 101 AND 102).

FIRST USE 5-1-2002; IN COMMERCE 5-1-2002.

THE MARK CONSISTS OF STANDARD CHARACTERS WITHOUT CLAIM TO ANY PARTICULAR FONT, STYLE, SIZE, OR COLOR.

NO CLAIM IS MADE TO THE EXCLUSIVE RIGHT TO USE "BRAND INTEGRITY" , APART FROM THE MARK AS SHOWN.

SER. NO. 77-281,287, FILED 9-17-2007.

MARK T. MULLEN, EXAMINING ATTORNEY

**Int. Cl.: 25**

**Prior U.S. Cls.: 22 and 39**

**United States Patent and Trademark Office**

**Reg. No. 3,466,251**

**Registered July 15, 2008**

**TRADEMARK  
PRINCIPAL REGISTER**

**JEAN'S CAMISOLES**

MINECONZO, JEAN (UNITED STATES INDIVIDUAL)  
525 HARRISON AVENUE  
SCHENECTADY, NY 12306

FOR: CLOTHING, NAMELY, UNDERGARMENTS, IN CLASS 25 (U.S. CLS. 22 AND 39).

FIRST USE 2-0-2006; IN COMMERCE 2-0-2006.

THE MARK CONSISTS OF STANDARD CHARACTERS WITHOUT CLAIM TO ANY PARTICULAR FONT, STYLE, SIZE, OR COLOR.

NO CLAIM IS MADE TO THE EXCLUSIVE RIGHT TO USE "CAMISOLES", APART FROM THE MARK AS SHOWN.

THE NAME "JEAN" IDENTIFIES A LIVING INDIVIDUAL WHOSE CONSENT IS OF RECORD.

SER. NO. 77-281,804, FILED 9-18-2007.

SAMUEL E. SHARPER JR., EXAMINING ATTORNEY

**Int. Cl.: 39**

**Prior U.S. Cls.: 100 and 105**

**United States Patent and Trademark Office**

**Reg. No. 3,466,252**

**Registered July 15, 2008**

**SERVICE MARK  
PRINCIPAL REGISTER**

**yipeetravel.biz**

HOLZ, PETER B. (UNITED STATES INDIVIDUAL)  
2215 BURCHAM DRIVE  
EAST LANSING, MI 48823

FOR: PROVIDING AN ON-LINE COMPUTER DATABASE IN THE FIELD OF TRAVEL INFORMATION SERVICES; PROVIDING AUTOMATED CHECK-IN AND TICKETING SERVICES FOR AIR TRAVELERS; PROVIDING INFORMATION, NEWS AND COMMENTARY IN THE FIELD OF TRAVEL; PROVIDING LINKS TO WEB SITES OF OTHERS FEATURING TRAVEL; TRAVEL AGENCY SERVICES, NAMELY, MAKING RESERVATIONS AND BOOKINGS FOR TRANSPORTATION; TRAVEL AND TOUR INFORMATION SERVICE; TRAVEL AND TOUR TICKET RESERVATION SERVICE;

TRAVEL BOOKING AGENCIES; TRAVEL, EXCURSION AND CRUISE ARRANGEMENT, IN CLASS 39 (U.S. CLS. 100 AND 105).

FIRST USE 8-1-2007; IN COMMERCE 8-1-2007.

THE MARK CONSISTS OF "YIPEETRavel.BIZ" WITH THE WORD "YIPEE" BEING IN "PORKY'S" FONT AND THE TEXT "TRAVEL.BIZ" BEING IN ARIAL FONT.

SER. NO. 77-281,902, FILED 9-18-2007.

ALEXANDER L. POWERS, EXAMINING ATTORNEY



**Int. Cl.: 19**

**Prior U.S. Cls.: 1, 12, 33 and 50**

**Reg. No. 3,466,253**

**United States Patent and Trademark Office**

**Registered July 15, 2008**

---

**TRADEMARK  
PRINCIPAL REGISTER**

**WE LAY IT RIGHT. THE FIRST  
TIME.**

T3 BUSINESS CONSULTANTS (ILLINOIS SOLE  
PROPRIETORSHIP)  
3318 OREGON TRAIL  
OLYMPIA FIELDS, IL 60461 AND  
CHICAGO AREA TILE & STONE (ILLINOIS SOLE  
PROPRIETORSHIP)  
11601 S. LONGWOOD  
CHICAGO, IL 60643

FIRST USE 8-1-2007; IN COMMERCE 8-1-2007.

THE MARK CONSISTS OF STANDARD CHAR-  
ACTERS WITHOUT CLAIM TO ANY PARTICULAR  
FONT, STYLE, SIZE, OR COLOR.

SER. NO. 77-282,180, FILED 9-18-2007.

FOR: CERAMIC TILES, IN CLASS 19 (U.S. CLS. 1,  
12, 33 AND 50).

WILLIAM ROSSMAN, EXAMINING ATTORNEY

**Int. Cl.: 41**

**Prior U.S. Cls.: 100, 101 and 107**

**United States Patent and Trademark Office**

**Reg. No. 3,466,254**

**Registered July 15, 2008**

**SERVICE MARK  
PRINCIPAL REGISTER**

**OOSI ORANGE OSCEOLA SAFETY  
INSTITUTE**

ORANGE OSCEOLA SAFETY INSTITUTE, LLC  
(FLORIDA LTD LIAB CO)  
SUITE 102  
1637 EAST VINE STREET  
KISSIMMEE, FL 34744

FOR: PROVIDING COURSES OF EDUCATION,  
NAMELY, DRIVER IMPROVEMENT AND MOTOR-  
CYCLE SAFETY TRAINING, IN CLASS 41 (U.S. CLS.  
100, 101 AND 107).

FIRST USE 9-30-2000; IN COMMERCE 9-30-2000.

THE MARK CONSISTS OF STANDARD CHAR-  
ACTERS WITHOUT CLAIM TO ANY PARTICULAR  
FONT, STYLE, SIZE, OR COLOR.

NO CLAIM IS MADE TO THE EXCLUSIVE  
RIGHT TO USE "ORANGE OSCEOLA SAFETY  
INSTITUTE", APART FROM THE MARK AS  
SHOWN.

SER. NO. 77-282,210, FILED 9-18-2007.

JANET LEE, EXAMINING ATTORNEY

**Int. Cls.: 36, 41 and 42**

**Prior U.S. Cls.: 100, 101, 102 and 107**

**United States Patent and Trademark Office**

**Reg. No. 3,466,255**

**Registered July 15, 2008**

**SERVICE MARK  
PRINCIPAL REGISTER**

**HARVARD UNIVERSITY  
GRADUATE SCHOOL OF DESIGN**

PRESIDENT AND FELLOWS OF HARVARD  
COLLEGE (MASSACHUSETTS CORPORATION)  
124 MOUNT AUBURN STREET, SUITE 570-N  
CAMBRIDGE, MA 02138

FOR: PROVIDING EDUCATIONAL RESEARCH  
FELLOWSHIPS AND FINANCIAL FUNDING IN  
THE FIELDS OF ARCHITECTURE, LANDSCAPE  
ARCHITECTURE, URBAN PLANNING AND DE-  
SIGN, REAL ESTATE, DIGITAL MEDIA, HOUSING  
AND RELATED FIELDS, IN CLASS 36 (U.S. CLS. 100,  
101 AND 102).

FIRST USE 12-31-1986; IN COMMERCE 12-31-1986.

FOR: EDUCATIONAL SERVICES, NAMELY,  
PROVIDING COURSES OF INSTRUCTION AT  
THE UNIVERSITY LEVEL, INCLUDING THOSE IN  
THE FIELDS OF ARCHITECTURE, LANDSCAPE  
ARCHITECTURE, URBAN PLANNING AND DE-  
SIGN, REAL ESTATE, DIGITAL MEDIA, HOUSING  
AND RELATED FIELDS AND TRAINING IN THE  
FIELDS OF ARCHITECTURE, LANDSCAPE AR-  
CHITECTURE, URBAN PLANNING AND DESIGN,  
REAL ESTATE, DIGITAL MEDIA, HOUSING AND  
RELATED FIELDS, IN CLASS 41 (U.S. CLS. 100, 101  
AND 107).

FIRST USE 12-31-1936; IN COMMERCE 12-31-1936.

FOR: RESEARCH IN THE FIELDS OF ARCHI-  
TECTURE, LANDSCAPE ARCHITECTURE, URBAN  
PLANNING AND DESIGN, REAL ESTATE, DIGI-  
TAL MEDIA, HOUSING, AND DESIGN STUDIES,  
IN CLASS 42 (U.S. CLS. 100 AND 101).

FIRST USE 12-31-2000; IN COMMERCE 12-31-2000.

THE MARK CONSISTS OF STANDARD CHAR-  
ACTERS WITHOUT CLAIM TO ANY PARTICULAR  
FONT, STYLE, SIZE, OR COLOR.

OWNER OF U.S. REG. NOS. 1,578,190, 1,608,533  
AND OTHERS.

NO CLAIM IS MADE TO THE EXCLUSIVE  
RIGHT TO USE "UNIVERSITY GRADUATE  
SCHOOL OF DESIGN", APART FROM THE MARK  
AS SHOWN.

SER. NO. 77-282,276, FILED 9-18-2007.

KATHLEEN LORENZO, EXAMINING ATTORNEY

**Int. Cl.: 16**

**Prior U.S. Cls.: 2, 5, 22, 23, 29, 37, 38 and 50**

**Reg. No. 3,466,256**

**United States Patent and Trademark Office**

**Registered July 15, 2008**

**TRADEMARK  
PRINCIPAL REGISTER**

# Wichacaba

TRIPLETT, LYDIA L. (UNITED STATES INDIVIDUAL)  
P.O. BOX 600324  
NEWTON, MA 02460 AND  
TRIPLETT, HUNTER R. (UNITED STATES INDIVIDUAL)  
P.O. BOX 600324  
NEWTON, MA 02460

FOR: CARTOON PRINTS; CARTOON STRIPS; NEWSPAPER CARTOONS; CALENDARS; CROSS-WORD PUZZLES; EDUCATIONAL PUBLICATIONS, NAMELY, EDUCATIONAL LEARNING CARDS, FLASH CARDS, ACTIVITY CARDS, WORKBOOKS, TEXTBOOKS, ACTIVITY BOOKS, STORY BOOKS, PUZZLE BOOKS, PUZZLES, TEACHER GUIDES, MANUALS, POSTERS, EDUCATIONAL CARD GAMES AND EDUCATIONAL BOOKLETS IN THE FIELD OF SELF AWARENESS; GREETING CARDS;

FABRIC GIFT BAGS; PLASTIC OR PAPER BAGS FOR MERCHANDISE PACKAGING; WRITING PADS; POSTCARDS; BUMPER STICKERS; DECORATIVE STICKERS FOR HELMETS; STICKERS; PAPER PLACE MATS; COMIC BOOKS, IN CLASS 16 (U.S. CLS. 2, 5, 22, 23, 29, 37, 38 AND 50).

FIRST USE 12-7-2005; IN COMMERCE 12-7-2005.

THE MARK CONSISTS OF STANDARD CHARACTERS WITHOUT CLAIM TO ANY PARTICULAR FONT, STYLE, SIZE, OR COLOR.

SER. NO. 77-282,977, FILED 9-19-2007.

JOHN SCHUYLER YARD, EXAMINING ATTORNEY

**Int. Cls.: 4, 37 and 39**

**Prior U.S. Cls.: 1, 6, 15, 100, 103, 105 and 106**

**United States Patent and Trademark Office**

**Reg. No. 3,466,257**

**Registered July 15, 2008**

**TRADEMARK  
SERVICE MARK  
PRINCIPAL REGISTER**

**SIPPIN**

SIPPIN BROTHERS OIL COMPANY, INCORPORATED (CONNECTICUT CORPORATION)  
234 MAIN STREET  
MONROE, CT 06468

FOR: HEATING FUEL AND DIESEL FUEL, IN CLASS 4 (U.S. CLS. 1, 6 AND 15).

FIRST USE 0-0-1919; IN COMMERCE 0-0-1999.

FOR: HVAC INSTALLATION, REPAIR AND MAINTENANCE SERVICES, IN CLASS 37 (U.S. CLS. 100, 103 AND 106).

FIRST USE 0-0-1978; IN COMMERCE 0-0-1978.

FOR: HEATING FUEL AND DIESEL FUEL DELIVERY SERVICES, IN CLASS 39 (U.S. CLS. 100 AND 105).

FIRST USE 0-0-1919; IN COMMERCE 0-0-1999.

THE MARK CONSISTS OF STANDARD CHARACTERS WITHOUT CLAIM TO ANY PARTICULAR FONT, STYLE, SIZE, OR COLOR.

SEC. 2(F).

SER. NO. 77-283,000, FILED 9-19-2007.

JEFFERY COWARD, EXAMINING ATTORNEY

**Int. Cl.: 9**

**Prior U.S. Cls.: 21, 23, 26, 36 and 38**

**Reg. No. 3,466,258**

**United States Patent and Trademark Office**

**Registered July 15, 2008**

**TRADEMARK  
PRINCIPAL REGISTER**

**ORPHEUS**

IRIS MUSIC GROUP (NEW YORK CORPORATION)  
414 EAST 52ND STREET  
C/O B. WOLPE, CPA  
NEW YORK, NY 10022

FOR: PRERECORDED PHONOGRAPHIC, PRERECORDED COMPACT DISCS AND DVDS, PRERECORDED AUDIOTAPE AND AUDIO TAPE CASSETTES, VIDEO DISCS AND VIDEO TAPE CASSETTES ALL FEATURING INSTRUMENTAL MUSIC, SONGS AND SPOKEN WORDS IN THE FIELD OF POETRY, DRAMA AND POPULAR MUSIC; CD-ROMS FEATURING INSTRUMENTAL MUSIC, SONGS AND SPOKEN WORDS IN THE FIELD OF POETRY, DRAMA AND POPULAR MUSIC; AUDIO CASSETTES, AUDIO DISCS, PRERECORDED DIGITAL AUDIO TAPE, PRERECORDED DIGITAL VIDEO DISKS, PRERECORDED AUDIO

DIGITAL TAPES, AUDIO DIGITAL DISCS, DOWNLOADABLE MP3 FILES, MP3 RECORDINGS, ONLINE DISCUSSION BOARDS, WEB CASTS AND POD CASTS, ALL FEATURING MUSIC AND/OR WORDS IN THE FIELD OF POETRY, DRAMA POPULAR MUSIC, IN CLASS 9 (U.S. CLS. 21, 23, 26, 36 AND 38).

FIRST USE 10-1-1967; IN COMMERCE 10-1-1967.

THE MARK CONSISTS OF STANDARD CHARACTERS WITHOUT CLAIM TO ANY PARTICULAR FONT, STYLE, SIZE, OR COLOR.

SER. NO. 77-283,006, FILED 9-19-2007.

EDWARD FENNESSY, EXAMINING ATTORNEY

**Int. Cl.: 3**

**Prior U.S. Cls.: 1, 4, 6, 50, 51 and 52**

**United States Patent and Trademark Office**

**Reg. No. 3,466,259**

**Registered July 15, 2008**

**TRADEMARK  
PRINCIPAL REGISTER**

**SARA'S beauty bar**

BEAUTY BAR, LLC (OHIO LTD LIAB CO)  
2919 W. CENTRAL AVE.  
TOLEDO, OH 43606

FOR: BODY CREAMS; HAND CREAMS; PERFUMED CREAMS; SKIN CREAMS; 3-IN-1 HAIR SHAMPOOS; HAIR SHAMPOO; BODY WASHES; BUBBLE BATH, IN CLASS 3 (U.S. CLS. 1, 4, 6, 50, 51 AND 52).

FIRST USE 6-21-2007; IN COMMERCE 6-21-2007.

THE MARK CONSISTS OF STANDARD CHARACTERS WITHOUT CLAIM TO ANY PARTICULAR FONT, STYLE, SIZE, OR COLOR.

NO CLAIM IS MADE TO THE EXCLUSIVE RIGHT TO USE "BEAUTY BAR", APART FROM THE MARK AS SHOWN.

"THE NAME(S), PORTRAIT(S), AND/OR SIGNATURE(S) SHOWN IN THE MARK IDENTIFIES SARA SPALLINO, WHOSE CONSENT(S) TO REGISTER IS SUBMITTED."

SER. NO. 77-283,041, FILED 9-19-2007.

CHERYL CLAYTON, EXAMINING ATTORNEY

**Int. Cl.: 10**

**Prior U.S. Cls.: 26, 39 and 44**

**United States Patent and Trademark Office**

**Reg. No. 3,466,260**

**Registered July 15, 2008**

**TRADEMARK  
PRINCIPAL REGISTER**



**In the Groove**

IN THE GROOVE L.L.C. (MICHIGAN LTD LIAB  
CO)  
7600 MADELINE STREET  
SAGINAW, MI 486094991

FIRST USE 2-0-2006; IN COMMERCE 2-0-2006.

SER. NO. 77-283,208, FILED 9-19-2007.

FOR: MEDICAL BRACES FOR KNEES, IN CLASS  
10 (U.S. CLS. 26, 39 AND 44).

DEIRDRE ROBERTSON, EXAMINING ATTORNEY



**Int. Cl.: 35**

**Prior U.S. Cls.: 100, 101 and 102**

**United States Patent and Trademark Office**

**Reg. No. 3,466,261**

**Registered July 15, 2008**

**SERVICE MARK  
PRINCIPAL REGISTER**

**megagps**

GUARANTEED MERCHANDISE, INC (UTAH  
CORPORATION)  
134 EAST 200 NORTH  
ALPINE, UT 84004

FOR: WHOLESALE DISTRIBUTORSHIPS FEATURING GPS UNITS, GPS ACCESSORIES AND GPS RELATED SOFTWARE; ON-LINE RETAIL STORE SERVICES FEATURING GPS UNITS, GPS ACCESSORIES AND GPS RELATED SOFTWARE, IN CLASS 35 (U.S. CLS. 100, 101 AND 102).

FIRST USE 9-7-2004; IN COMMERCE 9-7-2004.

THE MARK CONSISTS OF STANDARD CHARACTERS WITHOUT CLAIM TO ANY PARTICULAR FONT, STYLE, SIZE, OR COLOR.

SER. NO. 77-283,243, FILED 9-19-2007.

RAMONA ORTIGA, EXAMINING ATTORNEY

**Int. Cl.: 35**

**Prior U.S. Cls.: 100, 101 and 102**

**United States Patent and Trademark Office**

**Reg. No. 3,466,262**

**Registered July 15, 2008**

**SERVICE MARK  
PRINCIPAL REGISTER**

**BENCH CRAFT**

TRANSPORTATION MEDIA, INC. (OREGON  
CORPORATION), DBA BENCH CRAFT COM-  
PANY

P.O. BOX 6343  
PORTLAND, OR 97228

FOR: PREPARING AND PLACING OUTDOOR  
GOLF COURSE ADVERTISEMENTS FOR OTHERS  
THROUGH THE USE OF FIXTURES SUCH AS  
BENCHES AND DISPLAY BOARDS AND TEE  
SIGNS AND THE LIKE, IN CLASS 35 (U.S. CLS. 100,  
101 AND 102).

FIRST USE 12-31-1982; IN COMMERCE 12-31-1982.

THE MARK CONSISTS OF STANDARD CHAR-  
ACTERS WITHOUT CLAIM TO ANY PARTICULAR  
FONT, STYLE, SIZE, OR COLOR.

SER. NO. 77-283,574, FILED 9-19-2007.

NICHOLAS ALTREE, EXAMINING ATTORNEY

**Int. Cl.: 28**

**Prior U.S. Cls.: 22, 23, 38 and 50**

**United States Patent and Trademark Office**

**Reg. No. 3,466,263**

**Registered July 15, 2008**

---

**TRADEMARK  
PRINCIPAL REGISTER**

**ULTIMATE EXTROYER**

MATTEL, INC. (DELAWARE CORPORATION)  
M1-1518  
333 CONTINENTAL BLVD.  
EL SEGUNDO, CA 90245

FOR: TOYS, GAMES AND PLAYTHINGS, NAME-  
LY, TOY ACTION FIGURES, TOY FIGURES, AND  
ACCESSORIES FOR ALL OF THE FOREGOING, IN  
CLASS 28 (U.S. CLS. 22, 23, 38 AND 50).

FIRST USE 2-20-2008; IN COMMERCE 2-20-2008.

THE MARK CONSISTS OF STANDARD CHAR-  
ACTERS WITHOUT CLAIM TO ANY PARTICULAR  
FONT, STYLE, SIZE, OR COLOR.

SER. NO. 77-283,790, FILED 9-19-2007.

JOHN GARTNER, EXAMINING ATTORNEY

**Int. Cls.: 16, 35, 36 and 41**

**Prior U.S. Cls.: 2, 5, 22, 23, 29, 37, 38, 50, 100, 101, 102  
and 107**

**Reg. No. 3,466,264**

**United States Patent and Trademark Office**

**Registered July 15, 2008**

**TRADEMARK  
SERVICE MARK  
PRINCIPAL REGISTER**



DOBERMAN PINSCHER CLUB OF AMERICA  
(MICHIGAN NON-PROFIT CORPORATION),  
DBA DPCA  
12419 6TH AVE. CT. NW  
GIG HARBOR, WA 98332

FOR: EDUCATIONAL BOOKS FEATURING THE DOBERMAN PINSCHER; PRINTED INSTRUCTIONAL, EDUCATIONAL, AND TEACHING MATERIALS IN THE FIELD OF BREEDER, EXHIBITOR AND JUDGES' EDUCATION WITH RESPECT TO THE DOBERMAN PINSCHER, IN CLASS 16 (U.S. CLS. 2, 5, 22, 23, 29, 37, 38 AND 50).

FIRST USE 4-30-1977; IN COMMERCE 4-30-1977.

FOR: PUBLIC ADVOCACY TO PROMOTE AWARENESS OF THE HISTORIC ROLE PLAYED BY THE DOBERMAN PINSCHER, THE ROLE PLAYED BY THE DOBERMAN PINSCHER IN SOCIETY TODAY, AND THE INCREASING THREAT TO THE RIGHT TO OWN AND BREED DOBERMAN PINSCHERS SPECIFICALLY AND DOGS IN GENERAL BECAUSE OF LEGISLATIVE EFFORTS ADOPTED THROUGHOUT THE UNITED STATES, IN CLASS 35 (U.S. CLS. 100, 101 AND 102).

FIRST USE 4-30-1977; IN COMMERCE 4-30-1977.

FOR: CHARITABLE FUND RAISING, IN CLASS 36 (U.S. CLS. 100, 101 AND 102).

FIRST USE 4-30-1977; IN COMMERCE 4-30-1977.

FOR: DOG SHOWS; EDUCATION SERVICES, NAMELY, CLASSES, SEMINARS, WORKSHOPS, AND CONFERENCES IN THE FIELD OF BREEDING, OWNING AND CARING FOR THE DOBERMAN PINSCHER; EDUCATIONAL SERVICES, NAMELY, CONDUCTING PROGRAMS IN THE FIELD OF BREEDING, OWNING, JUDGING, EXHIBITING, AND CARING FOR THE DOBERMAN PINSCHER, IN CLASS 41 (U.S. CLS. 100, 101 AND 107).

FIRST USE 4-30-1977; IN COMMERCE 4-30-1977.

NO CLAIM IS MADE TO THE EXCLUSIVE RIGHT TO USE "CLUB", APART FROM THE MARK AS SHOWN.

THE COLOR(S) BLACK AND RUST IS/ARE CLAIMED AS A FEATURE OF THE MARK.

THE COLOR BLACK APPEARS IN THE WORDING "DOBERMAN PINSCHER CLUB OF AMERICA," IN THE BODY OF THE DOBERMAN PINSCHER ILLUSTRATION, AND IN THE CIRCLE THAT ENCOMPASSES THE MARK; THE COLOR RUST APPEARS IN THE BODY OF THE DOBERMAN PINSCHER ILLUSTRATION

SEC. 2(F).

SER. NO. 77-283,965, FILED 9-19-2007.

JORDAN BAKER, EXAMINING ATTORNEY

**Int. Cl.: 45**

**Prior U.S. Cls.: 100 and 101**

**United States Patent and Trademark Office**

**Reg. No. 3,466,265**

**Registered July 15, 2008**

**SERVICE MARK  
PRINCIPAL REGISTER**

**Skypalz  
Connecting the Airline  
Community**

SKYPALZ,LLC (GUAM LTD LIAB CO), DBA  
SKYPALZ.COM

PO BOX 23216 GMF

BARRIGADA, GUAM 96921

FOR: INTERNET BASED SOCIAL NETWORK-  
ING, INTRODUCTION, AND DATING SERVICES,  
IN CLASS 45 (U.S. CLS. 100 AND 101).

FIRST USE 5-6-2007; IN COMMERCE 9-9-2007.

THE MARK CONSISTS OF STANDARD CHAR-  
ACTERS WITHOUT CLAIM TO ANY PARTICULAR  
FONT, STYLE, SIZE, OR COLOR.

NO CLAIM IS MADE TO THE EXCLUSIVE  
RIGHT TO USE "CONNECTING THE AIRLINE  
COMMUNITY", APART FROM THE MARK AS  
SHOWN.

SER. NO. 77-284,436, FILED 9-20-2007.

MARY ROSSMAN, EXAMINING ATTORNEY

**Int. Cl.: 31**

**Prior U.S. Cls.: 1 and 46**

**United States Patent and Trademark Office**

**Reg. No. 3,466,266**

**Registered July 15, 2008**

**TRADEMARK  
PRINCIPAL REGISTER**

**EUROPEAN TREE**

NURSERYMEN'S EXCHANGE, INC. (CALIFORNIA CORPORATION)  
2651 N. CABRILLO HWY.  
HALF MOON BAY, CA 94019

NO CLAIM IS MADE TO THE EXCLUSIVE RIGHT TO USE "TREE", APART FROM THE MARK AS SHOWN.

FOR: LIVE PLANTS, IN CLASS 31 (U.S. CLS. 1 AND 46).

SEC. 2(F).

FIRST USE 9-1-1996; IN COMMERCE 9-1-1996.

SER. NO. 77-284,490, FILED 9-20-2007.

THE MARK CONSISTS OF STANDARD CHARACTERS WITHOUT CLAIM TO ANY PARTICULAR FONT, STYLE, SIZE, OR COLOR.

SKYE YOUNG, EXAMINING ATTORNEY

**Int. Cl.: 17**

**Prior U.S. Cls.: 1, 5, 12, 13, 35 and 50**

**United States Patent and Trademark Office**

**Reg. No. 3,466,267**

**Registered July 15, 2008**

**TRADEMARK  
PRINCIPAL REGISTER**

**SILCO ROPE**

DAVLYN MANUFACTURING CO., INC. (PENNSYLVANIA CORPORATION)

P.O. BOX 49

85 MENNONITE CHURCH ROAD

SPRING CITY, PA 19475

FOR: FIBERGLASS FABRICS FOR INSULATION, NAMELY, SILICONE RUBBER COATED WOVEN FIBERGLASS MATTING USED AS A SEAL, IN CLASS 17 (U.S. CLS. 1, 5, 12, 13, 35 AND 50).

FIRST USE 6-1-2007; IN COMMERCE 6-1-2007.

THE MARK CONSISTS OF STANDARD CHARACTERS WITHOUT CLAIM TO ANY PARTICULAR FONT, STYLE, SIZE, OR COLOR.

OWNER OF U.S. REG. NOS. 1,562,162, 3,160,728 AND OTHERS.

NO CLAIM IS MADE TO THE EXCLUSIVE RIGHT TO USE "ROPE", APART FROM THE MARK AS SHOWN.

SER. NO. 77-284,799, FILED 9-20-2007.

TIMOTHY FINNEGAN, EXAMINING ATTORNEY

**Int. Cl.: 30**

**Prior U.S. Cl.: 46**

**United States Patent and Trademark Office**

**Reg. No. 3,466,268**

**Registered July 15, 2008**

**TRADEMARK  
PRINCIPAL REGISTER**

**ELEGANT ASSORTMENT**

RUSSELL STOVER CANDIES, INC. (MISSOURI  
CORPORATION)  
4900 OAK STREET  
KANSAS CITY, MO 641122702

OWNER OF U.S. REG. NO. 2,145,499.

FOR: CHOCOLATE CANDY, IN CLASS 30 (U.S.  
CL. 46).

NO CLAIM IS MADE TO THE EXCLUSIVE  
RIGHT TO USE "ASSORTMENT", APART FROM  
THE MARK AS SHOWN.

FIRST USE 3-0-2007; IN COMMERCE 3-0-2007.

SER. NO. 77-285,017, FILED 9-20-2007.

THE MARK CONSISTS OF STANDARD CHAR-  
ACTERS WITHOUT CLAIM TO ANY PARTICULAR  
FONT, STYLE, SIZE, OR COLOR.

REBECCA EISINGER, EXAMINING ATTORNEY



**Int. Cl.: 42**

**Prior U.S. Cls.: 100 and 101**

**United States Patent and Trademark Office**

**Reg. No. 3,466,269**

**Registered July 15, 2008**

**SERVICE MARK  
PRINCIPAL REGISTER**

**NUTSHELL**

WEBASSIST.COM CORPORATION (CALIFORNIA CORPORATION)  
SUITE 204  
227 N. EL CAMINO REAL  
ENCINITAS, CA 92024

FOR: INTERNET-BASED COMPUTER SERVICES, NAMELY, PROVIDE AN ON-LINE NON-DOWNLOADABLE REPORTING ENGINE THAT ALLOWS FOR THE MONITORING AND REPORTING ON THE SOFTWARE USAGE OF OTHERS, IN CLASS 42 (U.S. CLS. 100 AND 101).

FIRST USE 5-15-2007; IN COMMERCE 5-15-2007.

THE MARK CONSISTS OF STANDARD CHARACTERS WITHOUT CLAIM TO ANY PARTICULAR FONT, STYLE, SIZE, OR COLOR.

SER. NO. 77-285,075, FILED 9-20-2007.

RONALD AIKENS, EXAMINING ATTORNEY

**Int. Cl.: 16**

**Prior U.S. Cls.: 2, 5, 22, 23, 29, 37, 38 and 50**

**United States Patent and Trademark Office**

**Reg. No. 3,466,270**

**Registered July 15, 2008**

**TRADEMARK  
PRINCIPAL REGISTER**



SCOTTSPEED, INC. (ARIZONA CORPORATION)  
SUITE D101  
9376 EAST BAHIA DRIVE  
SCOTTSDALE, AZ 85260

FOR: PAPER GOODS AND PRINTED MATTER,  
NAMELY, POSTERS AND PHOTOGRAPHS DIREC-  
TED TO AUTOMOBILE RACING, IN CLASS 16 (U.S.  
CLS. 2, 5, 22, 23, 29, 37, 38 AND 50).

FIRST USE 12-31-2005; IN COMMERCE 12-31-2005.

THE NAME(S), PORTRAIT(S), AND/OR SIGNA-  
TURE(S) SHOWN IN THE MARK IDENTIFIES  
"SCOTT SPEED", WHOSE CONSENT(S) TO REGIS-  
TER IS SUBMITTED.

THE MARK CONSISTS OF STYLIZED SIGNA-  
TURE OF THE NAME SCOTT SPEED.

SER. NO. 77-285,093, FILED 9-20-2007.

SHAILA SETTLES, EXAMINING ATTORNEY

**Int. Cl.: 9**

**Prior U.S. Cls.: 21, 23, 26, 36 and 38**

**United States Patent and Trademark Office**

**Reg. No. 3,466,271**

**Registered July 15, 2008**

**TRADEMARK  
PRINCIPAL REGISTER**



DONG HUA (CHINA INDIVIDUAL)  
2312 TROY AVE  
SOUTH EL MONTE, CA 91733

FIRST USE 8-15-2007; IN COMMERCE 8-15-2007.

FOR: CASES FOR SPECTACLES AND SUNGLASSES; FRAMES FOR SPECTACLES AND SUNGLASSES; LENSES FOR SUNGLASSES; SUNGLASS LENSES; SUNGLASSES, IN CLASS 9 (U.S. CLS. 21, 23, 26, 36 AND 38).

THE MARK CONSISTS OF THE WORDING "FERRA," STYLIZED.

SER. NO. 77-285,129, FILED 9-20-2007.

WANDA KAY PRICE, EXAMINING ATTORNEY

**Int. Cl.: 35**

**Prior U.S. Cls.: 100, 101 and 102**

**United States Patent and Trademark Office**

**Reg. No. 3,466,272**

**Registered July 15, 2008**

**SERVICE MARK  
PRINCIPAL REGISTER**

**RYDESMART**

RYDER SYSTEM, INC. (FLORIDA CORPORATION)  
11690 NW 105TH STREET  
MIAMI, FL 33178

FOR: PROVIDING AN ONLINE COMPUTER DATABASE FEATURING REAL TIME VEHICLE DATA FOR THE REPORTING OF TRUCK FLEET DATA AND TRACKING OF TRUCK FLEET LOCATION FOR COMMERCIAL PURPOSES , IN CLASS 35 (U.S. CLS. 100, 101 AND 102).

FIRST USE 5-31-2006; IN COMMERCE 5-31-2006.

THE MARK CONSISTS OF STANDARD CHARACTERS WITHOUT CLAIM TO ANY PARTICULAR FONT, STYLE, SIZE, OR COLOR.

OWNER OF U.S. REG. NOS. 1,123,006, 1,575,603 AND OTHERS.

SER. NO. 77-285,491, FILED 9-21-2007.

MICHAEL KAZAZIAN, EXAMINING ATTORNEY

**Int. Cl.: 41**

**Prior U.S. Cls.: 100, 101 and 107**

**United States Patent and Trademark Office**

**Reg. No. 3,466,273**

**Registered July 15, 2008**

**SERVICE MARK  
PRINCIPAL REGISTER**

**STEP BY STEP COLLEGE  
PLANNING**

NEXT STEP PUBLISHING, INC. (NEW YORK CORPORATION)

86 WEST MAIN STREET

VICTOR, NY 14564

FOR: CAREER AND COLLEGE PLANNING SERVICES, IN CLASS 41 (U.S. CLS. 100, 101 AND 107).

FIRST USE 10-11-2007; IN COMMERCE 10-11-2007.

THE MARK CONSISTS OF STANDARD CHARACTERS WITHOUT CLAIM TO ANY PARTICULAR FONT, STYLE, SIZE, OR COLOR.

NO CLAIM IS MADE TO THE EXCLUSIVE RIGHT TO USE "COLLEGE PLANNING", APART FROM THE MARK AS SHOWN.

SER. NO. 77-285,720, FILED 9-21-2007.

RONALD AIKENS, EXAMINING ATTORNEY

**Int. Cls.: 35 and 42**

**Prior U.S. Cls.: 100, 101 and 102**

**United States Patent and Trademark Office**

**Reg. No. 3,466,274**

**Registered July 15, 2008**

**SERVICE MARK  
PRINCIPAL REGISTER**

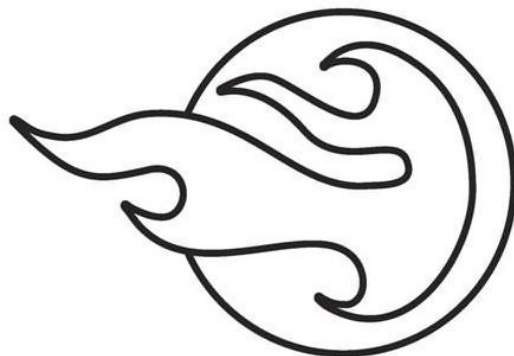

SHOPZILLA, INC. (CALIFORNIA CORPORATION)  
12200 W OLYMPIC BLVD, STE 300  
LOS ANGELES, CA 90064

FOR: PROMOTING THE SALE OF GOODS AND SERVICES OF OTHERS BY PROVIDING HYPERTEXT LINKS TO THE WEB SITE OF OTHERS, AND THROUGH ON-LINE ORDERING AND CATALOGING OF THOSE GOODS AND SERVICES; INTERNET CONSUMER COMPARISON SHOPPING SERVICES; PROVIDING RATINGS AND REVIEWS OF BUSINESSES AND PRODUCTS AND SERVICES FOR USE BY CONSUMERS; PROVIDING DATABASES CONTAINING COMMERCIAL INFORMATION RELATING TO PRODUCTS AND MERCHANTS; PROVIDING DATABASES FEATURING CONSUMER PRODUCTS AND MERCHANTS INFORMATION; RATING SERVICES, NAMELY, REAL TIME ON-LINE CUSTOMIZED RATING OF BUSINESSES WHO OFFER GOODS AND SERVICES ON A GLOBAL COMPUTER NETWORK; PROVIDING BUSI-

NESS RATINGS FOR CONSUMERS AND BUSINESSES; PROVIDING ONLINE BUSINESS RATINGS FOR CONSUMERS AND BUSINESSES, IN CLASS 35 (U.S. CLS. 100, 101 AND 102).

FIRST USE 5-5-2007; IN COMMERCE 5-5-2007.

FOR: PROVIDING A SEARCH ENGINE ON THE INTERNET FOR OBTAINING INFORMATION ON CONSUMER PRODUCTS AND MERCHANTS, IN CLASS 42 (U.S. CLS. 100 AND 101).

FIRST USE 5-5-2007; IN COMMERCE 5-5-2007.

THE MARK CONSISTS OF A STYLIZED HORIZONTAL FLAME PARTIALLY WITHIN A CIRCLE.

SER. NO. 77-285,736, FILED 9-21-2007.

ATTIYA MALIK, EXAMINING ATTORNEY

**Int. Cl.: 41**

**Prior U.S. Cls.: 100, 101 and 107**

**United States Patent and Trademark Office**

**Reg. No. 3,466,275**

**Registered July 15, 2008**

**SERVICE MARK  
PRINCIPAL REGISTER**

**¡CLUB PAPI!**

AWAD, JAMIE (CALIFORNIA SOLE PROPRIETORSHIP), DBA CLUB PAPI PRODUCTIONS  
272 ADDISON STREET  
SAN FRANCISCO, CA 94131

FOR: ENTERTAINMENT SERVICES, NAMELY, PROVIDING AN ON-LINE SUBSCRIPTION SERVICE FEATURING IMAGES AND VIDEO RECORDINGS IN THE NATURE OF ADULT ENTERTAINMENT AND PROVIDING A WEB SITE FEATURING IMAGES AND VIDEO RECORDINGS IN THE NATURE OF ADULT ENTERTAINMENT, IN CLASS 41 (U.S. CLS. 100, 101 AND 107).

FIRST USE 5-20-2006; IN COMMERCE 5-23-2006.

THE MARK CONSISTS OF STANDARD CHARACTERS WITHOUT CLAIM TO ANY PARTICULAR FONT, STYLE, SIZE, OR COLOR.

OWNER OF U.S. REG. NO. 2,535,869.

THE FOREIGN WORDING IN THE MARK TRANSLATES INTO ENGLISH AS "PAPI" IS SPANISH FOR FATHER.

SER. NO. 77-285,805, FILED 9-21-2007.

SUNG IN, EXAMINING ATTORNEY

**Int. Cls.: 16 and 41**

**Prior U.S. Cls.: 2, 5, 22, 23, 29, 37, 38, 50, 100, 101 and 107**

**United States Patent and Trademark Office**

**Reg. No. 3,466,276**

**Registered July 15, 2008**

**TRADEMARK  
SERVICE MARK  
PRINCIPAL REGISTER**

**THE FRED FACTOR**

SANBORN & ASSOCIATES, INC. (COLORADO CORPORATION)  
818 SUMMER DRIVE  
HIGHLANDS RANCH, CA 80126

FOR: BOOKS IN THE FIELDS OF LEADERSHIP, TEAM BUILDING, CHANGE MANAGEMENT AND CUSTOMER SERVICE, IN CLASS 16 (U.S. CLS. 2, 5, 22, 23, 29, 37, 38 AND 50).

FIRST USE 0-0-1988; IN COMMERCE 0-0-1988.

FOR: EDUCATIONAL SERVICES, NAMELY, PROVIDING KEYNOTE PRESENTATIONS AND PROFESSIONAL SEMINARS IN THE FIELDS OF LEADERSHIP, TEAM BUILDING, CHANGE MANAGEMENT AND CUSTOMER SERVICES, AND

PROVIDING COURSE MATERIALS IN CONNECTION THEREWITH, IN CLASS 41 (U.S. CLS. 100, 101 AND 107).

FIRST USE 0-0-1988; IN COMMERCE 0-0-1988.

THE MARK CONSISTS OF STANDARD CHARACTERS WITHOUT CLAIM TO ANY PARTICULAR FONT, STYLE, SIZE, OR COLOR.

THE NAME "FRED" IDENTIFIES A LIVING INDIVIDUAL WHOSE CONSENT IS OF RECORD.

SER. NO. 77-286,417, FILED 9-22-2007.

LINDA M. KING, EXAMINING ATTORNEY



Int. Cl.: 42

Prior U.S. Cls.: 100 and 101

United States Patent and Trademark Office

Reg. No. 3,466,277

Registered July 15, 2008

**SERVICE MARK  
PRINCIPAL REGISTER**



DITTON, FRANCINE (UNITED STATES INDIVIDUAL)  
P.O. BOX 1265  
CLEARWATER, FL 337571265

FOR: DESIGN OF CUSTOM PAINTINGS; GRAPHIC ART DESIGN; GRAPHIC ILLUSTRATION SERVICES FOR OTHERS, IN CLASS 42 (U.S. CLS. 100 AND 101).

FIRST USE 6-28-2007; IN COMMERCE 9-20-2007.

THE COLOR(S) BLACK, WHITE, GREY, RED, LAVENDER, BLUE, PINK, PURPLE, RED, ORANGE, AND YELLOW. IS/ARE CLAIMED AS A FEATURE OF THE MARK.

THE MARK CONSISTS OF THE COLOR BLACK WHICH APPEARS IN THE WORDING "THUNDER-

BOLT", THE WORD "LOTUS", AND IN THE RECTANGLE WITH THE LIGHTNING BOLT. THE COLOR WHITE APPEARS IN THE LIGHTNING BOLT AND AS A BORDER SURROUNDING ALL THE ELEMENTS IN THE IMAGE. THE COLOR WHITE WILL BE TRANSPARENT WHEN PRINTED ON ANY LIGHT COLORED BACKGROUNDS. THE COLOR GREY APPEARS IN THE RECTANGLE WITH THE LIGHTNING BOLT. THE COLOR RED APPEARS AS AN OUTLINE AROUND THE LETTERS "T" AND "L", THE TOP PORTION OF THE LETTER "L", AND IN THE CENTER OF THE FLOWER. THE COLORS LAVENDER, BLUE, PINK, PURPLE, ORANGE, AND YELLOW ALL APPEAR IN THE FLOWER.

SER. NO. 77-286,498, FILED 9-22-2007.

LINDA M. KING, EXAMINING ATTORNEY

**Int. Cl.: 44**

**Prior U.S. Cls.: 100 and 101**

**United States Patent and Trademark Office**

**Reg. No. 3,466,278**

**Registered July 15, 2008**

**SERVICE MARK  
PRINCIPAL REGISTER**

HEALTHMARK FOOT AND ANKLE  
ASSOCIATES

HEALTHMARK FOOT AND ANKLE ASSOCI-  
ATES, P.C. (PENNSYLVANIA CORPORATION)  
101 NORTH MONROE STREET  
MEDIA, PA 19063

FOR: MEDICAL SERVICES, IN CLASS 44 (U.S.  
CLS. 100 AND 101).

FIRST USE 10-16-1987; IN COMMERCE 10-16-1987.

THE MARK CONSISTS OF STANDARD CHAR-  
ACTERS WITHOUT CLAIM TO ANY PARTICULAR  
FONT, STYLE, SIZE, OR COLOR.

NO CLAIM IS MADE TO THE EXCLUSIVE  
RIGHT TO USE "FOOT" AND "ANKLE ASSOCI-  
ATES", APART FROM THE MARK AS SHOWN.

SER. NO. 77-286,711, FILED 9-24-2007.

MARGERY A. TIERNEY, EXAMINING ATTORNEY

**Int. Cl.: 36**

**Prior U.S. Cls.: 100, 101 and 102**

**United States Patent and Trademark Office**

**Reg. No. 3,466,279**

**Registered July 15, 2008**

**SERVICE MARK  
PRINCIPAL REGISTER**

**Pacesetters Motorcycle Club**

PACESETTERS MOTORCYCLE CLUB (ALABA-  
MA CORPORATION)

3812 RIVER PLACE

MOBILE, AL 36605

FOR: CHARITABLE FUND RAISING, IN CLASS  
36 (U.S. CLS. 100, 101 AND 102).

FIRST USE 3-26-2006; IN COMMERCE 3-26-2006.

THE MARK CONSISTS OF STANDARD CHAR-  
ACTERS WITHOUT CLAIM TO ANY PARTICULAR  
FONT, STYLE, SIZE, OR COLOR.

NO CLAIM IS MADE TO THE EXCLUSIVE  
RIGHT TO USE "MOTORCYCLE CLUB", APART  
FROM THE MARK AS SHOWN.

SER. NO. 77-286,841, FILED 9-24-2007.

JENNIFER VASQUEZ, EXAMINING ATTORNEY

**Int. Cl.: 35**

**Prior U.S. Cls.: 100, 101 and 102**

**United States Patent and Trademark Office**

**Reg. No. 3,466,280**

**Registered July 15, 2008**

**SERVICE MARK  
PRINCIPAL REGISTER**

**T<sup>6</sup> H<sup>R</sup> E<sup>0</sup> O<sup>U</sup> R<sup>P</sup> Y<sup>Q</sup>**

THEORY GROUP (CALIFORNIA LTD LIAB CO)  
1292 DEERFIELD PLACE  
DIAMOND BAR, CA 91765

FOR: ADVERTISING SERVICES, NAMELY,  
CREATING CORPORATE AND BRAND IDENTITY  
FOR OTHERS; ORGANIZING EXHIBITIONS FOR  
COMMERCIAL OR ADVERTISING PURPOSES;  
LAYOUT SERVICES FOR ADVERTISING PURPOSES,  
IN CLASS 35 (U.S. CLS. 100, 101 AND 102).

FIRST USE 1-22-2007; IN COMMERCE 1-22-2007.

THE MARK CONSISTS OF THE WORDS "THEORY  
GROUP" IN STYLIZED TEXT.

SER. NO. 77-287,576, FILED 9-24-2007.

ALEXANDER L. POWERS, EXAMINING ATTORNEY

**Int. Cl.: 38**

**Prior U.S. Cls.: 100, 101 and 104**

**United States Patent and Trademark Office**

**Reg. No. 3,466,281**

**Registered July 15, 2008**

**SERVICE MARK  
PRINCIPAL REGISTER**

**One World. No Borders.**

WIRELESS INK CORPORATION (DELAWARE CORPORATION)  
606 JOHNSON AVE. SUITE 23  
BOHEMIA, NY 11716

FOR: WIRELESS BROADBAND COMMUNICATION SERVICES; COMMUNICATIONS BY MEANS OF MOBILE PHONES; WIRELESS BROADBAND COMMUNICATION SERVICES AND COMMUNICATIONS BY MEANS OF MOBILE PHONES, NAMELY, MOBILE MEDIA SERVICES IN THE NATURE OF ELECTRONIC TRANSMISSION OF ENTERTAINMENT MEDIA CONTENT, PROVIDING ON-LINE COMMUNICATIONS LINKS WHICH TRANSFER THE WEBSITE USER TO OTHER LOCAL AND GLOBAL WEB PAGES, PROVISION OF ACCESS TO ELECTRONIC SITES, WIRELESS ELECTRONIC TRANSMISSION OF VOICE SIGNALS, DATA, FACSIMILES, IMAGES AND INFORMATION, PROVIDING ON-LINE CHAT ROOMS FOR TRANSMISSION

OF MESSAGES AMONG COMPUTER USERS CONCERNING COMMUNITY AND NEWS, PROVIDING ON-LINE ELECTRONIC BULLETIN BOARDS FOR TRANSMISSION OF MESSAGES AMONG COMPUTER USERS CONCERNING COMMUNITY AND NEWS, AND PROVIDING ON-LINE FORUMS FOR TRANSMISSION OF MESSAGES AMONG COMPUTER USERS CONCERNING COMMUNITY AND NEWS, IN CLASS 38 (U.S. CLS. 100, 101 AND 104).

FIRST USE 1-31-2005; IN COMMERCE 1-31-2005.

THE MARK CONSISTS OF STANDARD CHARACTERS WITHOUT CLAIM TO ANY PARTICULAR FONT, STYLE, SIZE, OR COLOR.

SER. NO. 77-287,919, FILED 9-25-2007.

DAVID HOFFMAN, EXAMINING ATTORNEY

**Int. Cl.: 38**

**Prior U.S. Cls.: 100, 101 and 104**

**United States Patent and Trademark Office**

**Reg. No. 3,466,282**

**Registered July 15, 2008**

**SERVICE MARK  
PRINCIPAL REGISTER**

**Your Life. Your Friends.  
Your World.**

WIRELESS INK CORPORATION (DELAWARE CORPORATION)  
606 JOHNSON AVE. SUITE 23  
BOHEMIA, NY 11716

FOR: COMMUNICATIONS BY MEANS OF MOBILE PHONES; WIRELESS BROADBAND COMMUNICATION SERVICES; WIRELESS BROADBAND COMMUNICATION SERVICES AND COMMUNICATIONS BY MEANS OF MOBILE PHONES, NAMELY, MOBILE MEDIA SERVICES IN THE NATURE OF ELECTRONIC TRANSMISSION OF ENTERTAINMENT MEDIA CONTENT, PROVIDING ON-LINE COMMUNICATIONS LINKS WHICH TRANSFER THE WEBSITE USER TO OTHER LOCAL AND GLOBAL WEB PAGES, PROVISION OF ACCESS TO ELECTRONIC SITES, WIRELESS ELECTRONIC TRANSMISSION OF VOICE SIGNALS, DATA, FACSIMILES, IMAGES AND INFORMATION, PROVIDING ON-LINE CHAT ROOMS FOR TRANSMISSION

OF MESSAGES AMONG COMPUTER USERS CONCERNING COMMUNITY AND NEWS, PROVIDING ON-LINE ELECTRONIC BULLETIN BOARDS FOR TRANSMISSION OF MESSAGES AMONG COMPUTER USERS CONCERNING COMMUNITY AND NEWS, AND PROVIDING ON-LINE FORUMS FOR TRANSMISSION OF MESSAGES AMONG COMPUTER USERS CONCERNING COMMUNITY AND NEWS, IN CLASS 38 (U.S. CLS. 100, 101 AND 104).

FIRST USE 11-7-2004; IN COMMERCE 1-31-2005.

THE MARK CONSISTS OF STANDARD CHARACTERS WITHOUT CLAIM TO ANY PARTICULAR FONT, STYLE, SIZE, OR COLOR.

SER. NO. 77-287,952, FILED 9-25-2007.

DAVID HOFFMAN, EXAMINING ATTORNEY

Int. Cl.: 36

Prior U.S. Cls.: 100, 101 and 102

United States Patent and Trademark Office

Reg. No. 3,466,283

Registered July 15, 2008

**SERVICE MARK  
PRINCIPAL REGISTER**



TRS, INC. (TEXAS CORPORATION)  
9977 NORTH 90TH STREET, #150  
SCOTTSDALE, AZ 85258

FOR: LEASE PURCHASE SERVICES IN THE NATURE OF PROVIDING RENT-TO-OWN LEASE PURCHASE AGREEMENTS USED TO OBTAIN HOME FURNISHINGS, IN CLASS 36 (U.S. CLS. 100, 101 AND 102).

FIRST USE 4-15-2006; IN COMMERCE 8-15-2006.

NO CLAIM IS MADE TO THE EXCLUSIVE RIGHT TO USE "EASY PAY", APART FROM THE MARK AS SHOWN.

SER. NO. 77-287,981, FILED 9-25-2007.

AHSEN KHAN, EXAMINING ATTORNEY

**Int. Cl.: 45**

**Prior U.S. Cls.: 100 and 101**

**United States Patent and Trademark Office**

**Reg. No. 3,466,284**

**Registered July 15, 2008**

**SERVICE MARK  
PRINCIPAL REGISTER**



HANSEN, FRANCINE M. (UNITED STATES INDIVIDUAL)  
12708 SE STEPHENS STREET  
PORTLAND, OR 97233 AND  
ORR, ANNA M. (UNITED STATES INDIVIDUAL)  
12708 SE STEPHENS STREET  
PORTLAND, OR 97233

FOR: CHARITABLE SERVICES, NAMELY, GRANTING WISHES OF TERMINALLY ILL CANCER PATIENTS BASED ON THEIR EXPRESSED WISHES AND REQUESTS, IN CLASS 45 (U.S. CLS. 100 AND 101).

FIRST USE 12-27-1997; IN COMMERCE 7-10-1999.

THE COLOR(S) PINK AND DARK BROWN IS/ ARE CLAIMED AS A FEATURE OF THE MARK.

THE MARK CONSISTS OF A CIRCLE WITH AN OUTSIDE BORDER IN BROWN AND AN INSIDE BORDER IN PINK, INSIDE THE CIRCLE ARE TWO PINK RIBBONS TOUCHING SIDE BY SIDE ON A BROWN BACKGROUND.

SER. NO. 77-288,141, FILED 9-25-2007.

JEFF DEFORD, EXAMINING ATTORNEY



**Int. Cl.: 36**

**Prior U.S. Cls.: 100, 101 and 102**

**United States Patent and Trademark Office**

**Reg. No. 3,466,285**

**Registered July 15, 2008**

**SERVICE MARK  
PRINCIPAL REGISTER**

# Southern Exposure

SNOWBIRD MEDI-QUOTE INC. (CANADA CORPORATION)

205 - 259 MIDPARK WAY SE

CALGARY, AB, CANADA T2X1M2

FOR: INSURANCE BROKERAGE IN THE FIELD OF HEALTH INSURANCE, IN CLASS 36 (U.S. CLS. 100, 101 AND 102).

THE MARK CONSISTS OF STANDARD CHARACTERS WITHOUT CLAIM TO ANY PARTICULAR FONT, STYLE, SIZE, OR COLOR.

OWNER OF CANADA REG. NO. TMA706,885, DATED 2-8-2008, EXPIRES 2-8-2023.

SER. NO. 77-288,951, FILED 9-26-2007.

BARNEY CHARLON, EXAMINING ATTORNEY

**Int. Cl.: 9**

**Prior U.S. Cls.: 21, 23, 26, 36 and 38**

**Reg. No. 3,466,286**

**United States Patent and Trademark Office**

**Registered July 15, 2008**

**TRADEMARK  
PRINCIPAL REGISTER**



MESQUEUE, DAVID (UNITED STATES INDIVIDUAL)  
PO BOX 191369  
SAN JUAN, PUERTO RICO 009191369

FOR: (BASED ON USE IN COMMERCE) CASES FOR SPECTACLES AND SUNGLASSES; FRAMES FOR SPECTACLES AND SUNGLASSES; LENSES FOR SUNGLASSES; NOSE GUARDS WHICH CAN BE WORN BY ATTACHMENT TO EYEWEAR SUCH AS SUNGLASSES AND SKI GOGGLES; SUNGLASS LENSES; SUNGLASSES; EYEWEAR; EYEWEAR ACCESSORIES, NAMELY, STRAPS, NECK CORDS AND HEAD STRAPS WHICH RESTRAIN EYEWEAR FROM MOVEMENT ON A WEARER; PROTECTIVE EYEWEAR; PROTECTIVE EYEWEAR AND COMPONENT PARTS THEREOF; SAFETY EYEWEAR; SPORTS EYEWEAR(BASED ON 44(E)) CASES FOR SPECTACLES AND SUNGLASSES; FRAMES FOR SPECTACLES AND SUNGLASSES; LENSES FOR SUNGLASSES; NOSE GUARDS WHICH CAN BE WORN BY ATTACHMENT TO

EYEWEAR SUCH AS SUNGLASSES AND SKI GOGGLES; SUNGLASS LENSES; SUNGLASSES; EYEWEAR; EYEWEAR ACCESSORIES, NAMELY, STRAPS, NECK CORDS AND HEAD STRAPS WHICH RESTRAIN EYEWEAR FROM MOVEMENT ON A WEARER; PROTECTIVE EYEWEAR; PROTECTIVE EYEWEAR AND COMPONENT PARTS THEREOF; SAFETY EYEWEAR; SPORTS EYEWEAR, IN CLASS 9 (U.S. CLS. 21, 23, 26, 36 AND 38).

FIRST USE 7-11-2002; IN COMMERCE 9-18-2002.

OWNER OF PUERTO RICO REG. NO. 54147, DATED 7-11-2002, EXPIRES 7-11-2012.

THE MARK CONSISTS OF A STYLIZED LETTER "Z".

SER. NO. 77-289,044, FILED 9-26-2007.

REGINA DRUMMOND, EXAMINING ATTORNEY

**Int. Cl.: 9**

**Prior U.S. Cls.: 21, 23, 26, 36 and 38**

**Reg. No. 3,466,287**

**United States Patent and Trademark Office**

**Registered July 15, 2008**

---

**TRADEMARK  
PRINCIPAL REGISTER**

**TADPRO**

PEGASUS VERTEX, INC. (TEXAS CORPORATION)  
SUITE 448  
6100 CORPORATE DR.  
HOUSTON, TX 77036

FOR: INDUSTRIAL PROCESS CONTROL SOFTWARE, IN CLASS 9 (U.S. CLS. 21, 23, 26, 36 AND 38).

FIRST USE 6-1-2004; IN COMMERCE 6-1-2004.

THE MARK CONSISTS OF STANDARD CHARACTERS WITHOUT CLAIM TO ANY PARTICULAR FONT, STYLE, SIZE, OR COLOR.

SER. NO. 77-289,184, FILED 9-26-2007.

ALEXANDER L. POWERS, EXAMINING ATTORNEY

**Int. Cl.: 9**

**Prior U.S. Cls.: 21, 23, 26, 36 and 38**

**Reg. No. 3,466,288**

**United States Patent and Trademark Office**

**Registered July 15, 2008**

**TRADEMARK  
PRINCIPAL REGISTER**

**CEMPRO**

PEGASUS VERTEX, INC. (TEXAS CORPORATION)  
SUITE 448  
6100 CORPORATE DR.  
HOUSTON, TX 77036

FOR: INDUSTRIAL PROCESS CONTROL SOFTWARE, IN CLASS 9 (U.S. CLS. 21, 23, 26, 36 AND 38).

FIRST USE 6-1-2004; IN COMMERCE 6-1-2004.

THE MARK CONSISTS OF STANDARD CHARACTERS WITHOUT CLAIM TO ANY PARTICULAR FONT, STYLE, SIZE, OR COLOR.

SER. NO. 77-289,231, FILED 9-26-2007.

ALEXANDER L. POWERS, EXAMINING ATTORNEY

Int. Cl.: 35

Prior U.S. Cls.: 100, 101 and 102

United States Patent and Trademark Office

Reg. No. 3,466,289

Registered July 15, 2008

SERVICE MARK  
PRINCIPAL REGISTER



BAND AGAINST MS, INC. (DELAWARE NOT-  
FOR-PROFIT CORPORATION)  
SUITE 102  
2409 21ST AVENUE S.  
NASHVILLE, TN 37212

FOR: PROMOTING PUBLIC AWARENESS  
ABOUT MULTIPLE SCLEROSIS, IN CLASS 35 (U.S.  
CLS. 100, 101 AND 102).

FIRST USE 2-0-2007; IN COMMERCE 2-0-2007.

OWNER OF U.S. REG. NOS. 3,000,713 AND  
3,000,746.

NO CLAIM IS MADE TO THE EXCLUSIVE  
RIGHT TO USE "MS", APART FROM THE MARK  
AS SHOWN.

THE NAME(S), PORTRAIT(S), AND/OR SIGNA-  
TURE(S) SHOWN IN THE MARK IDENTIFIES  
"CLAY WALKER", WHOSE CONSENT(S) TO REG-  
ISTER IS SUBMITTED.

THE MARK CONSISTS OF THE PHRASE "BAMS  
BAND AGAINST MS" TOGETHER WITH AN IL-  
LUSTRATION OF A MAN IN A HAT AND A  
HUMAN HAND ON A GUITAR WITH THE NAME  
"CLAY WALKER" ON THE GUITAR.

SER. NO. 77-289,313, FILED 9-26-2007.

TIMOTHY FINNEGAN, EXAMINING ATTORNEY

Int. Cl.: 36

Prior U.S. Cls.: 100, 101 and 102

United States Patent and Trademark Office

Reg. No. 3,466,290

Registered July 15, 2008

SERVICE MARK  
PRINCIPAL REGISTER



BAND AGAINST MS, INC. (DELAWARE NOT-  
FOR-PROFIT CORPORATION)  
SUITE 102  
2409 21ST AVENUE S.  
NASHVILLE, TN 37212

FOR: CHARITABLE FUND RAISING SERVICES  
TO SUPPORT RESEARCH PROGRAMS SEEKING A  
CURE FOR THE DISEASE AND FOR PROGRAMS  
PROVIDING ASSISTANCE TO PEOPLE LIVING  
WITH MULTIPLE SCLEROSIS, IN CLASS 36 (U.S.  
CLS. 100, 101 AND 102).

FIRST USE 2-0-2007; IN COMMERCE 2-0-2007.

OWNER OF U.S. REG. NOS. 3,000,713 AND  
3,000,746.

NO CLAIM IS MADE TO THE EXCLUSIVE  
RIGHT TO USE "MS", APART FROM THE MARK  
AS SHOWN.

THE NAME(S), PORTRAIT(S), AND/OR SIGNA-  
TURE(S) SHOWN IN THE MARK IDENTIFIES  
"CLAY WALKER", WHOSE CONSENT(S) TO REG-  
ISTER IS SUBMITTED.

THE MARK CONSISTS OF THE PHRASE "BAMS  
BAND AGAINST MS" TOGETHER WITH AN IL-  
LUSTRATION OF A MAN IN A HAT AND A  
HUMAN HAND ON A GUITAR WITH THE NAME  
"CLAY WALKER" ON THE GUITAR.

SER. NO. 77-289,318, FILED 9-26-2007.

TIMOTHY FINNEGAN, EXAMINING ATTORNEY

**Int. Cl.: 40**

**Prior U.S. Cls.: 100, 103 and 106**

**Reg. No. 3,466,291**

**United States Patent and Trademark Office**

**Registered July 15, 2008**

**SERVICE MARK  
PRINCIPAL REGISTER**

**FLAME TECH**

FLAME TECHNOLOGIES, INC. (TEXAS CORPORATION)  
703 CYPRESS CREEK  
CEDAR PARK, TX 78613

FOR: MANUFACTURING SERVICES FOR OTHERS IN THE FIELD OF CUTTING AND GAS WELDING APPARATUS, IN CLASS 40 (U.S. CLS. 100, 103 AND 106).

FIRST USE 1-1-1980; IN COMMERCE 1-1-1980.

NO CLAIM IS MADE TO THE EXCLUSIVE RIGHT TO USE "TECH", APART FROM THE MARK AS SHOWN.

THE MARK CONSISTS OF THE WORDS "FLAME TECH" IN STYLIZED TEXT ALONG WITH FLAMES FROM THE LETTER "F".

SER. NO. 77-289,354, FILED 9-26-2007.

DAVID TAYLOR, EXAMINING ATTORNEY

Int. Cl.: 3

Prior U.S. Cls.: 1, 4, 6, 50, 51 and 52

United States Patent and Trademark Office

Reg. No. 3,466,292

Registered July 15, 2008

TRADEMARK  
PRINCIPAL REGISTER

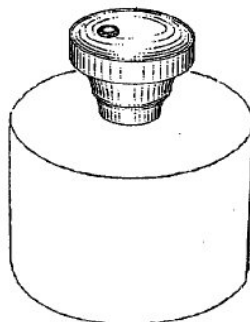

PRL USA HOLDINGS, INC. (DELAWARE CORPORATION)  
SUITE 201  
103 FOULK ROAD  
WILMINGTON, DE 19803

FOR: EAU DE PERFUME AND EAU DE TOILETTE, IN CLASS 3 (U.S. CLS. 1, 4, 6, 50, 51 AND 52).

FIRST USE 8-12-2001; IN COMMERCE 8-12-2001.

OWNER OF U.S. REG. NO. 2,566,338.

THE STIPPLING IS FOR SHADING PURPOSES ONLY.

THE MARK CONSISTS OF THE CONFIGURATION OF A CYLINDER ROUND BOTTLE WITH A CRIMPED NECK AND CAP THEREFORE, THE CAP IS A CYLINDRICAL DOMED METALLIC CAP WITH A SINGLE DIAMOND-LIKE STONE PROTRUDING FROM THE TOP.

SEC. 2(F).

SER. NO. 77-289,357, FILED 9-26-2007.

CAROL SPILS, EXAMINING ATTORNEY



**Int. Cl.: 35**

**Prior U.S. Cls.: 100, 101 and 102**

**United States Patent and Trademark Office**

**Reg. No. 3,466,293**

**Registered July 15, 2008**

**SERVICE MARK  
PRINCIPAL REGISTER**

**AMOUR**

PEEKAY, INC. (WASHINGTON CORPORATION)  
901 W. MAIN "A"  
AUBURN, WA 980015280

FOR: ONLINE RETAIL STORE SERVICES FEATURING LINGERIE, STOCKINGS, DRESSES, SKIRTS, CORSETS, SHOES, SLIPPERS, AND MEN'S UNDERWEAR, IN CLASS 35 (U.S. CLS. 100, 101 AND 102).

FIRST USE 1-15-2001; IN COMMERCE 1-15-2001.

THE MARK CONSISTS OF STANDARD CHARACTERS WITHOUT CLAIM TO ANY PARTICULAR FONT, STYLE, SIZE, OR COLOR.

OWNER OF U.S. REG. NO. 2,623,551.

SER. NO. 77-289,442, FILED 9-26-2007.

JOHN SCHUYLER YARD, EXAMINING ATTORNEY

**Int. Cl.: 20**

**Prior U.S. Cls.: 2, 13, 22, 25, 32 and 50**

**Reg. No. 3,466,294**

**United States Patent and Trademark Office**

**Registered July 15, 2008**

---

**TRADEMARK  
PRINCIPAL REGISTER**

**DecoDots**

WALLS, JILL S. (TEXAS LTD LIAB CO)  
3105 NATIVE OAK DRIVE  
FLOWER MOUND, TX 75022

FIRST USE 9-24-2007; IN COMMERCE 9-24-2007.

FOR: METAL DISCS, NAMELY, PHOTO FRAMES  
DESIGNED TO HOLD DECORATIVE IMAGES OR  
PHOTOS FOR CRAFT EMBELLISHMENTS, IN  
CLASS 20 (U.S. CLS. 2, 13, 22, 25, 32 AND 50).

THE MARK CONSISTS OF STYLIZED LETTERS  
USING THE CURLZ MT FONT.

SER. NO. 77-289,605, FILED 9-26-2007.

DARRYL SPRUILL, EXAMINING ATTORNEY

**Int. Cl.: 35**

**Prior U.S. Cls.: 100, 101 and 102**

**United States Patent and Trademark Office**

**Reg. No. 3,466,295**

**Registered July 15, 2008**

**SERVICE MARK  
PRINCIPAL REGISTER**



CAR GUY GARAGE, INC. (ILLINOIS CORPORATION)  
SUITE 150  
4740 N. CUMBERLAND AVE  
CHICAGO, IL 60656

FOR: ON-LINE RETAIL STORE SERVICES FEATURING GARAGE STORAGE AND ORGANIZATION, IN CLASS 35 (U.S. CLS. 100, 101 AND 102).

FIRST USE 5-25-2006; IN COMMERCE 5-25-2006.

NO CLAIM IS MADE TO THE EXCLUSIVE RIGHT TO USE "GARAGE", APART FROM THE MARK AS SHOWN.

THE COLOR(S) BLUE AND BLACK IS/ARE CLAIMED AS A FEATURE OF THE MARK.

THE MARK CONSISTS OF AN OUTLINE OF A BLUE CAR WITH BLACK SHADOWS CONTAINING THE TEXT IN BLACK.

SER. NO. 77-289,668, FILED 9-26-2007.

RONALD AIKENS, EXAMINING ATTORNEY

**Int. Cls.: 41 and 45**

**Prior U.S. Cls.: 100, 101 and 107**

**United States Patent and Trademark Office**

**Reg. No. 3,466,296**

**Registered July 15, 2008**

**SERVICE MARK  
PRINCIPAL REGISTER**

# Soompi

SOOMPI MEDIA LLC (CALIFORNIA LTD LIAB  
CO)  
SUITE 100  
ONE LAGOON DRIVES  
REDWOOD SHORES, CA 94065

FOR: ENTERTAINMENT SERVICES, NAMELY;  
PROVIDING AN INTERACTIVE WEBSITE FEATURING INFORMATION IN THE FIELDS OF MUSIC, MOVIES, TELEVISION PROGRAMS, AND MUSIC VIDEOS; ENTERTAINMENT SERVICES, NAMELY, PROVIDING AN INTERACTIVE WEBSITE FEATURING MUSICAL VIDEOS, MOVIES, TELEVISION PROGRAMS; ENTERTAINMENT SERVICES, NAMELY, PROVIDING ON-LINE REVIEWS, COMMENTARY, PODCASTS, VIDEO CASTS, TEXT MESSAGES, AND PHOTOS ABOUT CELEBRITIES, PRODUCERS, MUSIC, MOVIES, TELEVISION PROGRAMS, AND THE GENERAL

ENTERTAINMENT INDUSTRY, IN CLASS 41 (U.S. CLS. 100, 101 AND 107).

FIRST USE 3-27-1998; IN COMMERCE 3-27-1998.

FOR: ONLINE SOCIAL NETWORKING SERVICES, IN CLASS 45 (U.S. CLS. 100 AND 101).

FIRST USE 7-10-2000; IN COMMERCE 7-10-2000.

THE MARK CONSISTS OF STANDARD CHARACTERS WITHOUT CLAIM TO ANY PARTICULAR FONT, STYLE, SIZE, OR COLOR.

SER. NO. 77-290,162, FILED 9-27-2007.

TIMOTHY FINNEGAN, EXAMINING ATTORNEY

**Int. Cl.: 30**

**Prior U.S. Cl.: 46**

**United States Patent and Trademark Office**

**Reg. No. 3,466,297**

**Registered July 15, 2008**

**TRADEMARK  
PRINCIPAL REGISTER**

**The Sweet Cow**

MACIOCH, CHRISTOPHER (UNITED STATES  
INDIVIDUAL)  
580 PATTEN AVE  
LONG BRANCH, NJ 07740

THE MARK CONSISTS OF STANDARD CHAR-  
ACTERS WITHOUT CLAIM TO ANY PARTICULAR  
FONT, STYLE, SIZE, OR COLOR.

FOR: ICE CREAM, IN CLASS 30 (U.S. CL. 46).

SER. NO. 77-290,314, FILED 9-27-2007.

FIRST USE 0-0-1989; IN COMMERCE 0-0-1989.

SUNG IN, EXAMINING ATTORNEY

**Int. Cl.: 9**

**Prior U.S. Cls.: 21, 23, 26, 36 and 38**

**United States Patent and Trademark Office**

**Reg. No. 3,466,298**

**Registered July 15, 2008**

**TRADEMARK  
PRINCIPAL REGISTER**

# Event Magic Pro

FROGWARE, LLC (TEXAS LTD LIAB CO)  
P.O. BOX 537  
CYPRESS, TX 77410

OWNER OF U.S. REG. NO. 3,258,325.

FOR: COMPUTER SOFTWARE FOR EVENT  
PLANNING, IN CLASS 9 (U.S. CLS. 21, 23, 26, 36  
AND 38).

NO CLAIM IS MADE TO THE EXCLUSIVE  
RIGHT TO USE "EVENT", APART FROM THE  
MARK AS SHOWN.

FIRST USE 6-1-1997; IN COMMERCE 7-1-1997.

SER. NO. 77-290,340, FILED 9-27-2007.

THE MARK CONSISTS OF STANDARD CHAR-  
ACTERS WITHOUT CLAIM TO ANY PARTICULAR  
FONT, STYLE, SIZE, OR COLOR.

NAPOLEON SHARMA, EXAMINING ATTORNEY

**Int. Cl.: 42**

**Prior U.S. Cls.: 100 and 101**

**United States Patent and Trademark Office**

**Reg. No. 3,466,299**

**Registered July 15, 2008**

**SERVICE MARK  
PRINCIPAL REGISTER**

**WORK SPACE TO GO**

LANGATE CORP. (NEW JERSEY CORPORATION)  
1150 HARVARD PLACE  
FORT LEE, NJ 07024

FOR: COMPUTER SERVICE, NAMELY, ACTING AS AN APPLICATION SERVICE PROVIDER IN THE FIELD OF KNOWLEDGE MANAGEMENT TO HOST COMPUTER APPLICATION SOFTWARE FOR THE COLLECTION, EDITING, ORGANIZING, MODIFYING, BOOK MARKING, TRANSMISSION, STORAGE AND SHARING OF DATA AND INFORMATION, IN CLASS 42 (U.S. CLS. 100 AND 101).

FIRST USE 8-15-2007; IN COMMERCE 8-15-2007.

THE MARK CONSISTS OF STANDARD CHARACTERS WITHOUT CLAIM TO ANY PARTICULAR FONT, STYLE, SIZE, OR COLOR.

NO CLAIM IS MADE TO THE EXCLUSIVE RIGHT TO USE "WORK SPACE", APART FROM THE MARK AS SHOWN.

SER. NO. 77-291,067, FILED 9-28-2007.

JOHN GARTNER, EXAMINING ATTORNEY

**Int. Cl.: 9**

**Prior U.S. Cls.: 21, 23, 26, 36 and 38**

**United States Patent and Trademark Office**

**Reg. No. 3,466,300**

**Registered July 15, 2008**

**TRADEMARK  
PRINCIPAL REGISTER**

**UVEX IGNITE**

SPERIAN EYE & FACE PROTECTION, INC.  
(DELAWARE CORPORATION)  
900 DOUGLAS PIKE  
SMITHFIELD, RI 02917

FOR: PROTECTIVE EYEWEAR; SAFETY EYE-  
WEAR, IN CLASS 9 (U.S. CLS. 21, 23, 26, 36 AND 38).

FIRST USE 3-19-2007; IN COMMERCE 3-19-2007.

THE MARK CONSISTS OF STANDARD CHAR-  
ACTERS WITHOUT CLAIM TO ANY PARTICULAR  
FONT, STYLE, SIZE, OR COLOR.

OWNER OF U.S. REG. NOS. 1,410,203, 3,032,724  
AND OTHERS.

SER. NO. 77-291,139, FILED 9-28-2007.

B. PARADEWELAI, EXAMINING ATTORNEY



**Int. Cl.: 44**

**Prior U.S. Cls.: 100 and 101**

**United States Patent and Trademark Office**

**Reg. No. 3,466,301**

**Registered July 15, 2008**

**SERVICE MARK  
PRINCIPAL REGISTER**

**DISPENSARY OF HOPE**

SAINT THOMAS HEALTH SERVICES (TENNESSEE CORPORATION)  
4220 HARDING ROAD  
NASHVILLE, TN 37205

FOR: PREPARATION AND DISPENSING OF MEDICATIONS, IN CLASS 44 (U.S. CLS. 100 AND 101).

FIRST USE 12-31-2004; IN COMMERCE 12-31-2004.

THE MARK CONSISTS OF STANDARD CHARACTERS WITHOUT CLAIM TO ANY PARTICULAR FONT, STYLE, SIZE, OR COLOR.

NO CLAIM IS MADE TO THE EXCLUSIVE RIGHT TO USE "DISPENSARY", APART FROM THE MARK AS SHOWN.

SER. NO. 77-291,596, FILED 9-28-2007.

THOMAS MANOR, EXAMINING ATTORNEY

**Int. Cl.: 35**

**Prior U.S. Cls.: 100, 101 and 102**

**United States Patent and Trademark Office**

**Reg. No. 3,466,302**

**Registered July 15, 2008**

**SERVICE MARK  
PRINCIPAL REGISTER**

**DISPENSARY OF HOPE**

SAINT THOMAS HEALTH SERVICES (TENNESSEE CORPORATION)  
4220 HARDING ROAD  
NASHVILLE, TN 37205

FOR: COORDINATING THE COLLECTION OF PHARMACEUTICALS FOR DISTRIBUTION TO CLINICS, PHYSICIANS, AND PHARMACIES SERVING INDIGENT OR UNINSURED PATIENTS, IN CLASS 35 (U.S. CLS. 100, 101 AND 102).

FIRST USE 12-31-2004; IN COMMERCE 12-31-2004.

THE MARK CONSISTS OF STANDARD CHARACTERS WITHOUT CLAIM TO ANY PARTICULAR FONT, STYLE, SIZE, OR COLOR.

NO CLAIM IS MADE TO THE EXCLUSIVE RIGHT TO USE "DISPENSARY", APART FROM THE MARK AS SHOWN.

SER. NO. 77-291,619, FILED 9-28-2007.

THOMAS MANOR, EXAMINING ATTORNEY

**Int. Cl.: 9**

**Prior U.S. Cls.: 21, 23, 26, 36 and 38**

**Reg. No. 3,466,303**

**United States Patent and Trademark Office**

**Registered July 15, 2008**

**TRADEMARK  
PRINCIPAL REGISTER**



BROWN, KENNETH (UNITED STATES INDIVIDUAL), DBA CHEK RECORDS  
P.O.BOX 96003  
HOUSTON, TX 77213

NO CLAIM IS MADE TO THE EXCLUSIVE RIGHT TO USE "RECORDS", APART FROM THE MARK AS SHOWN.

FOR: DOWNLOADABLE MUSICAL SOUND RECORDINGS; MUSICAL SOUND RECORDINGS, IN CLASS 9 (U.S. CLS. 21, 23, 26, 36 AND 38).

SER. NO. 77-291,869, FILED 9-28-2007.

FIRST USE 6-22-2005; IN COMMERCE 6-22-2005.

SALLY SHIH, EXAMINING ATTORNEY

**Int. Cls.: 36, 37, 38, 39, 40, 42 and 44**

**Prior U.S. Cls.: 100, 101, 102, 103, 104, 105 and 106**

**United States Patent and Trademark Office**

**Reg. No. 3,466,304**

**Registered July 15, 2008**

**SERVICE MARK  
PRINCIPAL REGISTER**

# Be an ICON

ICON CAPITAL CORP. (DELAWARE CORPORATION)  
100 FIFTH AVE, 4TH FLOOR  
NEW YORK, NY 10011

FOR: FUNDS INVESTMENT, NAMELY, OFFERING INVESTMENTS IN LIMITED PARTNERSHIPS AND DIRECT PARTICIPATION PROGRAMS, IN CLASS 36 (U.S. CLS. 100, 101 AND 102).

FIRST USE 7-19-2007; IN COMMERCE 7-19-2007.

FOR: LEASING CONSTRUCTION EQUIPMENT, IN CLASS 37 (U.S. CLS. 100, 103 AND 106).

FIRST USE 7-19-2007; IN COMMERCE 7-19-2007.

FOR: LEASING OF TELECOMMUNICATION EQUIPMENT, IN CLASS 38 (U.S. CLS. 100, 101 AND 104).

FIRST USE 7-19-2007; IN COMMERCE 7-19-2007.

FOR: LEASING AIRCRAFTS AND VESSELS, IN CLASS 39 (U.S. CLS. 100 AND 105).

FIRST USE 7-19-2007; IN COMMERCE 7-19-2007.

FOR: LEASING OF ENERGY GENERATING EQUIPMENT, NAMELY, LEASING PHOTOGRAPHIC EQUIPMENT, LEASING MANUFACTURING EQUIPMENT AND PATTERN PRINTING EQUIPMENT, IN CLASS 40 (U.S. CLS. 100, 103 AND 106).

FIRST USE 7-19-2007; IN COMMERCE 7-19-2007.

FOR: LEASING COMPUTER EQUIPMENT, NOT FOR PHOTOGRAPHIC OR PATTERN PRINTING, IN CLASS 42 (U.S. CLS. 100 AND 101).

FIRST USE 7-19-2007; IN COMMERCE 7-19-2007.

FOR: LEASING MEDICAL EQUIPMENT, NOT FOR PHOTOGRAPHIC OR PATTERN PRINTING, IN CLASS 44 (U.S. CLS. 100 AND 101).

FIRST USE 7-19-2007; IN COMMERCE 7-19-2007.

THE MARK CONSISTS OF STANDARD CHARACTERS WITHOUT CLAIM TO ANY PARTICULAR FONT, STYLE, SIZE, OR COLOR.

SER. NO. 77-292,023, FILED 9-28-2007.

CHARISMA HAMPTON, EXAMINING ATTORNEY

**Int. Cl.: 36**

**Prior U.S. Cls.: 100, 101 and 102**

**United States Patent and Trademark Office**

**Reg. No. 3,466,305**

**Registered July 15, 2008**

**SERVICE MARK  
PRINCIPAL REGISTER**

**AGCAROLINA FINANCIAL**

EAST CAROLINA FARM CREDIT, ACA (UNITED STATES COOPERATIVE ASSOCIATION)  
4000 POOLE ROAD  
RALEIGH, NC 27610

FOR: AGRICULTURAL LENDING AND FINANCIAL SERVICES, NAMELY, PROVIDING FARM REAL ESTATE AND HOME LOANS, FARM OPERATING AND BUSINESS LOANS, FARM EQUIPMENT LOANS, PERSONAL LOANS, AUTOMOBILE LOANS, INSURANCE ADMINISTRATION IN THE FIELD OF CROPS AND LIFE INSURANCE, FINANCIAL PLANNING SERVICES, AND FARM EQUIPMENT AND AUTOMOBILE LEASE FINANCING, IN CLASS 36 (U.S. CLS. 100, 101 AND 102).

FIRST USE 12-1-2007; IN COMMERCE 12-1-2007.

THE MARK CONSISTS OF STANDARD CHARACTERS WITHOUT CLAIM TO ANY PARTICULAR FONT, STYLE, SIZE, OR COLOR.

NO CLAIM IS MADE TO THE EXCLUSIVE RIGHT TO USE "FINANCIAL", APART FROM THE MARK AS SHOWN.

SER. NO. 77-292,404, FILED 9-30-2007.

ANGELA GAW, EXAMINING ATTORNEY

**Int. Cls.: 16 and 20**

**Prior U.S. Cls.: 2, 5, 13, 22, 23, 25, 29, 32, 37, 38 and 50**

**United States Patent and Trademark Office**

**Reg. No. 3,466,306**

**Registered July 15, 2008**

**TRADEMARK  
PRINCIPAL REGISTER**

# UR1 International

UR1 INTERNATIONAL PTY LTD (AUSTRALIA  
CORPORATION)  
215 BROWNS ROAD, NOBLE PARK  
MELBOURNE, AUSTRALIA 3174

FOR: ALBUMS, NAMELY, BOOKS IN WHICH  
PHOTOGRAPHS ARE STORED, CARDBOARD  
MOUNTS FOR PHOTOGRAPHS, PHOTOGRAPH  
MOUNTS, AND STATIONERY, IN CLASS 16 (U.S.  
CLS. 2, 5, 22, 23, 29, 37, 38 AND 50).

FIRST USE 11-1-1991; IN COMMERCE 3-1-2002.

FOR: FRAMES, NAMELY, PICTURE FRAMES  
AND PHOTOGRAPHIC FRAMES, IN CLASS 20 (U.S.  
CLS. 2, 13, 22, 25, 32 AND 50).

FIRST USE 11-1-1991; IN COMMERCE 3-1-2002.

THE MARK CONSISTS OF STANDARD CHAR-  
ACTERS WITHOUT CLAIM TO ANY PARTICULAR  
FONT, STYLE, SIZE, OR COLOR.

NO CLAIM IS MADE TO THE EXCLUSIVE  
RIGHT TO USE "INTERNATIONAL", APART  
FROM THE MARK AS SHOWN.

SER. NO. 77-292,490, FILED 10-1-2007.

ROBIN CHOSID, EXAMINING ATTORNEY

Int. Cl.: 9

Prior U.S. Cls.: 21, 23, 26, 36 and 38

United States Patent and Trademark Office

Reg. No. 3,466,307

Registered July 15, 2008

TRADEMARK  
PRINCIPAL REGISTER



LET'S GO ROBOTICS INCORPORATED (CALIFORNIA CORPORATION)  
5431 AVENIDA ENCINAS, SUITE K  
CALRSBAD, CA 92008

FOR: LABORATORY ROBOTS, IN CLASS 9 (U.S. CLS. 21, 23, 26, 36 AND 38).

FIRST USE 9-1-2007; IN COMMERCE 9-15-2007.

NO CLAIM IS MADE TO THE EXCLUSIVE RIGHT TO USE "ROBOTICS", APART FROM THE MARK AS SHOWN.

THE COLOR(S) BLUE, YELLOW, RED, GRAY, LIGHT GRAY, BLACK IS/ARE CLAIMED AS A FEATURE OF THE MARK.

THE MARK CONSISTS OF AN IMAGE OF A SMALL ROBOT WITH RED HANDS, TWO GRAY ARMS, TWO LEGS WITH BLUE FEET, A SQUARE GRAY BODY, YELLOW EYES, A LIGHT BLUE DOME ON THE TOP, THE BLUE LETTERS "LGR" WITH THE WORDS IN BLACK LETTERS "LET'S GO ROBOTICS" IN THE LOGO.

SER. NO. 77-292,737, FILED 10-1-2007.

STEVEN R. FINE, EXAMINING ATTORNEY

Int. Cl.: 35

Prior U.S. Cls.: 100, 101 and 102

United States Patent and Trademark Office

Reg. No. 3,466,308

Registered July 15, 2008

SERVICE MARK  
PRINCIPAL REGISTER



CAMPBELL, DAN (UNITED STATES INDIVIDUAL)  
5013 CALLE PRINCESA  
LAS CRUCES, NM 88012

FOR: PROVIDING A WEB SITE THAT ENABLES USERS TO POST ITEMS FOR SALE THROUGH ON-LINE CLASSIFIED ADVERTISEMENTS; PROVIDING AN ON-LINE SEARCHABLE DATABASE FEATURING CLASSIFIED AD LISTINGS AND EMPLOYMENT OPPORTUNITIES, IN CLASS 35 (U.S. CLS. 100, 101 AND 102).

FIRST USE 9-21-2007; IN COMMERCE 9-21-2007.

NO CLAIM IS MADE TO THE EXCLUSIVE RIGHT TO USE "LAS CRUCES TRADING POST YOUR CLASSIFIED COMMUNITY NEWSPAPER", APART FROM THE MARK AS SHOWN.

THE COLOR(S) BLUE, GREEN, RED, BLACK, WHITE AND BURNT RED IS/ARE CLAIMED AS A FEATURE OF THE MARK.

THE MARK CONSISTS OF THE WORDING "LAS CRUCES TRADING POST" POSITIONED IN FRONT

OF AN OUTLINE OF MOUNTAINS, A SUN AND AN IMAGE OF THREE CROSSES POSITIONED ON ADDITIONAL, SMALLER MOUNTAINS IN THE BACKGROUND, WITH THE WORDS "YOUR CLASSIFIED COMMUNITY NEWSPAPER" BELOW. THE COLOR BLUE APPEARS IN THE BACKGROUND OF THE UPPER 2/3 OF THE MARK AND IN THE WORDING "YOUR CLASSIFIED COMMUNITY NEWSPAPER". THE COLOR GREEN APPEARS IN THE LOWER 1/3 OF THE MARK. THE COLOR RED APPEARS IN A DOTTED LINE SEPARATING THE UPPER AND LOWER PORTIONS OF THE MARK AND IN THE IMAGE OF A SUN. THE COLOR BLACK APPEARS IN THE BORDER OF THE ENTIRE MARK AND THE IMAGE OF THE SMALLER MOUNTAINS FEATURED IN THE BACKGROUND. THE COLOR WHITE APPEARS IN THE WORDING "LAS CRUCES TRADING POST", IN THE THREE CROSSES AND IN THE DOTTED LINE SEPARATING THE UPPER AND LOWER PORTIONS OF THE MARK. THE COLOR BURNT RED APPEARS IN THE LARGER MOUNTAINS.

SER. NO. 77-293,019, FILED 10-1-2007.

SALLY SHIH, EXAMINING ATTORNEY



**Int. Cls.: 16, 35 and 41**

**Prior U.S. Cls.: 2, 5, 22, 23, 29, 37, 38, 50, 100, 101, 102  
and 107**

**Reg. No. 3,466,309**

**United States Patent and Trademark Office**

**Registered July 15, 2008**

**TRADEMARK  
SERVICE MARK  
PRINCIPAL REGISTER**

# Westrends

THE COUNCIL OF STATE GOVERNMENTS  
(KENTUCKY UNINC. ASSOCIATION)  
2760 RESEARCH PARK DRIVE  
LEXINGTON, KY 40511

FOR: PRINTED REPORTS, NEWSLETTERS,  
PAMPHLETS, BOOKS AND BOOKLETS COVERING  
TOPICS OF INTEREST TO STATE LEGISLATORS  
AND OFFICIALS FROM THE WESTERN STATES,  
IN CLASS 16 (U.S. CLS. 2, 5, 22, 23, 29, 37, 38 AND 50).

FIRST USE 1-1-1987; IN COMMERCE 1-1-1989.

FOR: PUBLIC POLICY RESEARCH SERVICES,  
NAMELY, IDENTIFYING THE DEMOGRAPHIC,  
ECONOMIC, AND CULTURAL TRENDS THAT  
ARE SHAPING THE WESTERN STATES, IN CLASS  
35 (U.S. CLS. 100, 101 AND 102).

FIRST USE 1-1-1987; IN COMMERCE 1-1-1989.

FOR: EDUCATIONAL RESEARCH AND EDUCA-  
TION SERVICES, NAMELY, CONDUCTING PRE-  
SENTATIONS, SEMINARS, CONFERENCES AND  
WORKSHOPS COVERING TOPICS OF INTEREST  
TO STATE LEGISLATORS AND OFFICIALS FROM  
THE WESTERN STATES, AND DISTRIBUTING  
COURSE MATERIALS IN CONNECTION THERE-  
WITH, IN CLASS 41 (U.S. CLS. 100, 101 AND 107).

FIRST USE 1-1-1987; IN COMMERCE 1-1-1989.

THE MARK CONSISTS OF STANDARD CHAR-  
ACTERS WITHOUT CLAIM TO ANY PARTICULAR  
FONT, STYLE, SIZE, OR COLOR.

SER. NO. 77-293,538, FILED 10-2-2007.

JASON BLAIR, EXAMINING ATTORNEY

**Int. Cl.: 28**

**Prior U.S. Cls.: 22, 23, 38 and 50**

**United States Patent and Trademark Office**

**Reg. No. 3,466,310**

**Registered July 15, 2008**

**TRADEMARK  
PRINCIPAL REGISTER**

**THESE GIRLS ROCK**

LADIES PROFESSIONAL GOLF ASSOCIATION  
(OHIO NON-PROFIT CORPORATION)  
100 INTERNATIONAL GOLF DRIVE  
DAYTONA BEACH, FL 32124

FOR: GOLF SPORTING GOODS AND RELATED  
GOLF EQUIPMENT, NAMELY, GOLF CLUBS,  
GOLF BAGS, GOLF GLOVES, GOLF BAG TAGS,  
DIVOT REPAIR TOOLS, GOLF BALL MARKERS IN  
THE FORM OF A CLIP FOR ATTACHMENT TO  
HATS, GOLF BALL MARKERS, GOLF CLUB HEAD-  
COVERS, GOLF BALLS, GOLF BALL RETRIEVERS,  
GOLF BAG ACCESSORY POUCHES, GOLF CLUB  
REPAIR KITS, GOLF CLUB GRIPS, GOLF SHOE  
BAG COVERS, AND GOLF TEES, IN CLASS 28 (U.S.  
CLS. 22, 23, 38 AND 50).

FIRST USE 5-30-2007; IN COMMERCE 5-30-2007.

THE MARK CONSISTS OF STANDARD CHAR-  
ACTERS WITHOUT CLAIM TO ANY PARTICULAR  
FONT, STYLE, SIZE, OR COLOR.

OWNER OF U.S. REG. NOS. 3,147,914 AND  
3,258,121.

SER. NO. 77-293,583, FILED 10-2-2007.

JULIE GUTTADAURO, EXAMINING ATTORNEY

**Int. Cl.: 15**

**Prior U.S. Cls.: 2, 21 and 36**

**United States Patent and Trademark Office**

**Reg. No. 3,466,311**

**Registered July 15, 2008**

**TRADEMARK  
PRINCIPAL REGISTER**

**DGT**

PAUL REED SMITH GUITARS, LIMITED PART-  
NERSHIP (MARYLAND LIMITED PARTNER-  
SHIP)  
380 LOG CANOE CIRCLE  
STEVENSVILLE, MD 21666

THE MARK CONSISTS OF STANDARD CHAR-  
ACTERS WITHOUT CLAIM TO ANY PARTICULAR  
FONT, STYLE, SIZE, OR COLOR.

FOR: GUITARS, IN CLASS 15 (U.S. CLS. 2, 21 AND  
36).

SER. NO. 77-293,759, FILED 10-2-2007.

FIRST USE 7-20-2007; IN COMMERCE 7-20-2007.

ELLEN PERKINS, EXAMINING ATTORNEY

**Int. Cls.: 37, 39 and 45**

**Prior U.S. Cls.: 100, 101, 103, 105 and 106**

**United States Patent and Trademark Office**

**Reg. No. 3,466,312**

**Registered July 15, 2008**

**SERVICE MARK  
PRINCIPAL REGISTER**



FALCONTRUST AIR HOLDINGS, LLC. (FLORIDA LTD LIAB CO)  
14150 SW 129 STREET  
MIAMI, FL 33186

FOR: AIRCRAFT GROUND SUPPORT EQUIPMENT MAINTENANCE AND REPAIR; AIRCRAFT BUILDING FACILITIES AND MAINTENANCE AND REPAIR; AIRCRAFT ENGINE AND AIRFRAME MAINTENANCE; AVIONICS INSTALLATION AND REPAIR; GROUND SUPPORT EQUIPMENT MAINTENANCE; AIRCRAFT CLEANING SERVICES, IN CLASS 37 (U.S. CLS. 100, 103 AND 106).

FIRST USE 11-28-2004; IN COMMERCE 11-28-2004.

FOR: AIRCRAFT TOWING, PUSHBACK AND TAXI SERVICES; RAMP HANDLING AND CARGO SERVICES; AIRCRAFT LOADING AND UNLOADING PASSENGER OF LUGGAGE; AIRCRAFT LOADING AND UNLOADING OF CARGO; PROVIDING GROUND TRANSPORTATION SERVICES FOR PASSENGERS AND CARGO VIA CAR, VAN, BUS, TRAIN, LIMO; AIRPORT BAGGAGE HANDLING; CAR AND VEHICLE PARKING, PARKING LOT SERVICES, SCHEDULING AND TRANSPORTATION RESERVATION SERVICES; RENTAL OF CARS IN THE FIELD OF AVIATION AND FIXED BASE OPERATIONS, IN CLASS 39 (U.S. CLS. 100 AND 105).

FIRST USE 11-28-2004; IN COMMERCE 11-28-2004.

FOR: CONCIERGE SERVICES FOR OTHERS COMPRISING MAKING REQUESTED PERSONAL ARRANGEMENTS AND RESERVATIONS AND PROVIDING CUSTOMER-SPECIFIC INFORMATION TO MEET INDIVIDUAL NEEDS RENDERED TOGETHER IN AN AIRPORT FACILITY, IN CLASS 45 (U.S. CLS. 100 AND 101).

FIRST USE 11-28-2004; IN COMMERCE 11-28-2004.

NO CLAIM IS MADE TO THE EXCLUSIVE RIGHT TO USE "AIR", APART FROM THE MARK AS SHOWN.

THE COLOR(S) CLAIMED ARE YELLOW, BLACK, AND RED IS/ARE CLAIMED AS A FEATURE OF THE MARK.

THE MARK CONSISTS OF ON THE LEFT SIDE OF THE DESIGN A YELLOW SQUARE IS FOUND. WITHIN THE SQUARE IS AN EAGLE-LIKE POINTED HEAD AND BODY WHICH IS OUTLINED TO MAKE THE BODY OF AN EAGLE WHICH HAS A STYLIZED AND CAPITALIZED BLOCK LETTER "F" FOUND WITHIN THE SQUARE. THE EAGLE-LIKE BODY INCLUDES LINES FROM ONE CORNER TO ANOTHER; THE LETTER "F" DOES NOT HAVE THESE LINES AS A FILL. DIRECTLY TO THE RIGHT OF SAID DESIGN, STYLIZED AND CAPITALIZED BLOCK LETTERS ARE FOUND READING THE NAME "FALCONTRUST" IN BLACK. BELOW THE LAST LETTER "T" IN "FALCONTRUST" YOU WILL FIND THE BEGINNING OF THE NEXT WORD, "AIR", IN RED, WHICH IS ALSO IN STYLIZED AND CAPITALIZED BLOCK LETTERS. A YELLOW LINE IS THEN DRAWN FROM THE BOTTOM RIGHT CORNER OF THE SQUARE, BEGINNING UNDER THE LETTER "F" FOR "FALCONTRUST" AND GOING THROUGH THE WORD "AIR", ENDING AFTER THE WORD. THE LINE IS DRAWN UPWARDS IN A SLOPE-LIKE FORM.

SER. NO. 77-293,938, FILED 10-2-2007.

ANNE E. GUSTASON, EXAMINING ATTORNEY

**Int. Cl.: 31**

**Prior U.S. Cls.: 1 and 46**

**United States Patent and Trademark Office**

**Reg. No. 3,466,313**

**Registered July 15, 2008**

**TRADEMARK  
PRINCIPAL REGISTER**

**"BREED FOR GENETICS, FEED  
FOR PERFORMANCE"**

NUTRI-PLUS, INC. (IDAHO CORPORATION)  
PO BOX 1145  
BELLEVUE, ID 83313

THE MARK CONSISTS OF STANDARD CHAR-  
ACTERS WITHOUT CLAIM TO ANY PARTICULAR  
FONT, STYLE, SIZE, OR COLOR.

FOR: HORSE FEED, IN CLASS 31 (U.S. CLS. 1  
AND 46).

SER. NO. 77-294,214, FILED 10-2-2007.

FIRST USE 1-1-2007; IN COMMERCE 1-1-2007.

REBECCA GILBERT, EXAMINING ATTORNEY

**Int. Cl.: 35**

**Prior U.S. Cls.: 100, 101 and 102**

**United States Patent and Trademark Office**

**Reg. No. 3,466,314**

**Registered July 15, 2008**

**SERVICE MARK  
PRINCIPAL REGISTER**

**RETURN ON INSPIRATION**

ROI VENTURES, LLC (ILLINOIS LTD LIAB CO)  
C/O SUZANNE MUCHIN  
191 N WACKER DRIVE, SUITE 1800  
CHICAGO, IL 60606

FOR: BUSINESS CONSULTING SERVICES,  
NAMELY, CONSULTING BUSINESSES AND EN-  
TREPRENEURS TO DEVELOP AND LAUNCH  
BUSINESS VENTURES, IDEAS, PRODUCTS AND  
SERVICES IN NON-PROFIT AND FOR-PROFIT, IN  
CLASS 35 (U.S. CLS. 100, 101 AND 102).

FIRST USE 8-0-2006; IN COMMERCE 8-0-2006.

THE MARK CONSISTS OF STANDARD CHAR-  
ACTERS WITHOUT CLAIM TO ANY PARTICULAR  
FONT, STYLE, SIZE, OR COLOR.

SER. NO. 77-294,311, FILED 10-2-2007.

WON TEAK OH, EXAMINING ATTORNEY

**Int. Cl.: 9**

**Prior U.S. Cls.: 21, 23, 26, 36 and 38**

**United States Patent and Trademark Office**

**Reg. No. 3,466,315**

**Registered July 15, 2008**

**TRADEMARK  
PRINCIPAL REGISTER**

**ALIS**

CARL ZEISS NTS GMBH (FED REP GERMANY  
LTD LIAB CO)  
CARL-ZEISS-STRASSE 56  
73447 OBERKOCHEN, FED REP GERMANY

PRIORITY CLAIMED UNDER SEC. 44(D) ON FED  
REP GERMANY APPLICATION NO. 30741847.2/0,  
FILED 6-27-2007, REG. NO. 30741847, DATED 9-5-  
2007, EXPIRES 9-5-2017.

FOR: ELECTRON MICROSCOPES AND PARTS  
THEREOF, IN CLASS 9 (U.S. CLS. 21, 23, 26, 36 AND  
38).

SER. NO. 77-294,342, FILED 10-2-2007.

THE MARK CONSISTS OF STANDARD CHAR-  
ACTERS WITHOUT CLAIM TO ANY PARTICULAR  
FONT, STYLE, SIZE, OR COLOR.

KATHLEEN LORENZO, EXAMINING ATTORNEY

**Int. Cl.: 3**

**Prior U.S. Cls.: 1, 4, 6, 50, 51 and 52**

**United States Patent and Trademark Office**

**Reg. No. 3,466,316**

**Registered July 15, 2008**

**TRADEMARK  
PRINCIPAL REGISTER**

**HERBAX**

GUTIERREZ, ENRIQUE GARZA (MEXICO INDIVIDUAL)  
COL. LATINOAMERICANA  
BOLIVIA NO. 563  
SALTILLO, COAHUILA, MEXICO 25270

FOR: FACE AND BODY CREAMS; SKIN WHITENING PREPARATIONS; COSMETICS; NON-MEDICATED SUNCARE PREPARATIONS FOR FACE AND BODY; EXFOLIANTS FOR SKIN; HAIR COLORANTS; HAIR CARE PREPARATIONS; FACE, BODY AND HAIR SOAPS AND SHAMPOOS; MASSAGE OILS; PERFUMERY; DENTIFRICES, IN CLASS 3 (U.S. CLS. 1, 4, 6, 50, 51 AND 52).

THE MARK CONSISTS OF STANDARD CHARACTERS WITHOUT CLAIM TO ANY PARTICULAR FONT, STYLE, SIZE, OR COLOR.

OWNER OF MEXICO REG. NO. 892781, DATED 7-27-2005, EXPIRES 6-13-2015.

THE TERM "HERBAX" HAS NO MEANING IN A FOREIGN LANGUAGE.

SER. NO. 77-294,706, FILED 10-3-2007.

JAMES A. RAUEN, EXAMINING ATTORNEY



Int. Cl.: 44

Prior U.S. Cls.: 100 and 101

United States Patent and Trademark Office

Reg. No. 3,466,317

Registered July 15, 2008

SERVICE MARK  
PRINCIPAL REGISTER



ERIKSEN, WILLIAM C., DC (UNITED STATES  
INDIVIDUAL)  
415 CARDINAL DRIVE  
ELIZABETHTOWN, KY 42701 AND  
ERIKSEN SERVICES, LLC (KENTUCKY LTD LIAB  
CO)  
415 CARDINAL DRIVE  
ELIZABETHTOWN, KY 42701

FOR: CHIROPRACTIC SERVICES, IN CLASS 44  
(U.S. CLS. 100 AND 101).

FIRST USE 3-17-2007; IN COMMERCE 3-17-2007.

NO CLAIM IS MADE TO THE EXCLUSIVE  
RIGHT TO USE "KID'S", APART FROM THE MARK  
AS SHOWN.

THE COLOR(S) LIGHT TAN, DARK TAN, WHITE,  
AND BLACK IS/ARE CLAIMED AS A FEATURE OF  
THE MARK.

THE MARK CONSISTS OF A BEAR, CHIRO'S,  
HEAD, WITH LIGHT TAN MOUTH AREA, BLACK  
MOUTH, DARK TAN FACE, WHITE EYES WITH  
BLACK PUPILS, BLACK NOSE, AND BLACK EYE-  
LASHES, AND BLACK LETTERS OUTLINED IN  
WHITE AND BLACK.

SER. NO. 77-294,721, FILED 10-3-2007.

LOURDES AYALA, EXAMINING ATTORNEY

**Int. Cl.: 41**

**Prior U.S. Cls.: 100, 101 and 107**

**United States Patent and Trademark Office**

**Reg. No. 3,466,318**

**Registered July 15, 2008**

---

**SERVICE MARK  
PRINCIPAL REGISTER**

# Skid School

STEVENS ADVANCED DRIVER TRAINING  
(NEW HAMPSHIRE PARTNERSHIP)

57 SOUTH RIVER ROAD

BEDFORD, NH 03110

FOR: DRIVER SAFETY TRAINING, IN CLASS 41  
(U.S. CLS. 100, 101 AND 107).

FIRST USE 1-1-1979; IN COMMERCE 1-1-2001.

THE MARK CONSISTS OF STANDARD CHARACTERS WITHOUT CLAIM TO ANY PARTICULAR FONT, STYLE, SIZE, OR COLOR.

NO CLAIM IS MADE TO THE EXCLUSIVE RIGHT TO USE "SCHOOL", APART FROM THE MARK AS SHOWN.

SER. NO. 77-294,830, FILED 10-3-2007.

REBECCA SMITH, EXAMINING ATTORNEY

**Int. Cl.: 5**

**Prior U.S. Cls.: 6, 18, 44, 46, 51 and 52**

**United States Patent and Trademark Office**

**Reg. No. 3,466,319**

**Registered July 15, 2008**

**TRADEMARK  
PRINCIPAL REGISTER**

**QUICK BOOST**

TOTALLY SLIM, INC. (FLORIDA CORPORATION)  
4350 W. SUNRISE BLVD, SUITE 122  
PLANTATION, FL 33313

FOR: VITAMINS; NUTRITIONAL SUPPLEMENTS; DIETARY AND MINERAL SUPPLEMENTS; DIETARY AND MINERAL SUPPLEMENT DRINK MIXES FOR ENERGY AND IMMUNITY; MEDICINAL HERBS; AND HEALTH FOOD PRODUCTS, NAMELY, DIETARY SUPPLEMENT DRINK MIXES FOR ENERGY AND IMMUNITY, IN CLASS 5 (U.S. CLS. 6, 18, 44, 46, 51 AND 52).

FIRST USE 6-1-2006; IN COMMERCE 6-1-2006.

THE MARK CONSISTS OF STANDARD CHARACTERS WITHOUT CLAIM TO ANY PARTICULAR FONT, STYLE, SIZE, OR COLOR.

SER. NO. 77-295,048, FILED 10-3-2007.

BARBARA GAYNOR, EXAMINING ATTORNEY

**Int. Cl.: 25**

**Prior U.S. Cls.: 22 and 39**

**United States Patent and Trademark Office**

**Reg. No. 3,466,320**

**Registered July 15, 2008**

**TRADEMARK  
PRINCIPAL REGISTER**

**Paddle Stronger Surf  
Longer**

HILTS, DAVID (UNITED STATES INDIVIDUAL)  
39563 BONAIRE WAY  
MURRIETA, CA 92563

FOR: TRAINING SUITS; WET SUIT GLOVES;  
WET SUITS; WET SUITS FOR WATER-SKIING  
AND SUB-AQUA; BATHING SUITS; BATHING  
SUITS FOR MEN; SURF WEAR, IN CLASS 25 (U.S.  
CLS. 22 AND 39).

FIRST USE 4-4-2004; IN COMMERCE 4-30-2004.

THE MARK CONSISTS OF STANDARD CHAR-  
ACTERS WITHOUT CLAIM TO ANY PARTICULAR  
FONT, STYLE, SIZE, OR COLOR.

NO CLAIM IS MADE TO THE EXCLUSIVE  
RIGHT TO USE "SURF", APART FROM THE MARK  
AS SHOWN.

SER. NO. 77-295,481, FILED 10-3-2007.

INGA ERVIN, EXAMINING ATTORNEY

**Int. Cl.: 9**

**Prior U.S. Cls.: 21, 23, 26, 36 and 38**

**Reg. No. 3,466,321**

**United States Patent and Trademark Office**

**Registered July 15, 2008**

**TRADEMARK  
PRINCIPAL REGISTER**



PERFORMANCE RC PRODUCTS INC. (WASHINGTON CORPORATION)  
149 PETWORTH DRIVE  
VICTORIA, B.C., CANADA V9E1J4

FOR: BATTERIES FOR RADIO CONTROLLED MODEL VEHICLES; ACCESSORIES FOR BATTERIES, NAMELY, VOLTAGE REGULATORS, POWER SWITCHES, BATTERY CHARGERS, BATTERY VOLT METERS BATTERY TESTERS, FOR RADIO CONTROLLED MODEL VEHICLES; POWER PACKS, COMPRISING LITHIUM ION TYPE BATTERIES, LITHIUM POLYMER TYPE BATTERIES, AND LITHIUM MANGANESE TYPE BATTERIES FOR RADIO CONTROLLED MODEL VEHICLES; ACCESSORIES FOR POWER PACKS, NAMELY, VOLTAGE REGULATORS, POWER SWITCHES, BATTERY CHARGERS, BATTERY VOLT METERS, AND BATTERY TESTERS, FOR RADIO CONTROLLED MODEL VEHICLES; ACCESSORIES FOR LITHIUM ION, LITHIUM POLYMER AND LITHIUM MANGANESE BATTERIES, NAMELY, VOLTAGE REGULATORS, POWER SWITCHES, BATTERY CHARGERS, BATTERY VOLT METERS, BATTERY TESTERS, FOR RADIO CONTROLLED MODEL

VEHICLES SUCH AS AIRCRAFT, HELICOPTERS, CARS, AND ROBOTS, IN CLASS 9 (U.S. CLS. 21, 23, 26, 36 AND 38).

FIRST USE 7-15-2002; IN COMMERCE 7-15-2002.

THE COLOR(S) TEAL GREEN, BLUE, PURPLE, RED, ORANGE, AND YELLOW IS/ARE CLAIMED AS A FEATURE OF THE MARK.

THE MARK CONSISTS OF DIAGONAL COLORED BARS SEPARATED BY WHITE SPACES. THE COLOR TEAL GREEN STARTS IN THE FIRST RECTANGLE TO THE LEFT AND GRADUALLY CHANGES THROUGH THE RECTANGLES TO BLUE TO PURPLE TO RED TO ORANGE AND FINALLY TO YELLOW IN THE LAST RECTANGLE AT THE FAR RIGHT.

SER. NO. 77-295,553, FILED 10-3-2007.

MICHAEL WEBSTER, EXAMINING ATTORNEY

**Int. Cl.: 44**

**Prior U.S. Cls.: 100 and 101**

**United States Patent and Trademark Office**

**Reg. No. 3,466,322**

**Registered July 15, 2008**

**SERVICE MARK  
PRINCIPAL REGISTER**

**PREMIER PACIFIC VINEYARDS**

PREMIER PACIFIC VINEYARDS, L.P. (CALIFORNIA LIMITED PARTNERSHIP)

P.O. BOX 3989

NAPA, CA 94558

FOR: VINEYARD SERVICES, NAMELY, CULTIVATION OF GRAPES TO THE ORDER AND SPECIFICATION OF OTHERS, IN CLASS 44 (U.S. CLS. 100 AND 101).

FIRST USE 3-1-1999; IN COMMERCE 3-1-1999.

THE MARK CONSISTS OF STANDARD CHARACTERS WITHOUT CLAIM TO ANY PARTICULAR FONT, STYLE, SIZE, OR COLOR.

NO CLAIM IS MADE TO THE EXCLUSIVE RIGHT TO USE "VINEYARDS", APART FROM THE MARK AS SHOWN.

SEC. 2(F).

SER. NO. 77-295,565, FILED 10-3-2007.

DAVID MILLER, EXAMINING ATTORNEY

**Int. Cl.: 41**

**Prior U.S. Cls.: 100, 101 and 107**

**United States Patent and Trademark Office**

**Reg. No. 3,466,323**

**Registered July 15, 2008**

**SERVICE MARK  
PRINCIPAL REGISTER**

**TIM AND ERIC AWESOME SHOW  
GREAT JOB!**

THE CARTOON NETWORK, INC. (DELAWARE CORPORATION)  
C/O TURNER BROADCASTING SYSTEM, INC.  
ONE CNN CENTER, 13 NORTH  
ATLANTA, GA 30303

FOR: ENTERTAINMENT SERVICES, NAMELY, A COMEDY, DRAMA, ACTION, ADVENTURE PROGRAM SERIES PROVIDED THROUGH CABLE TELEVISION, BROADCAST TELEVISION, INTERNET, AND VIDEO-ON-DEMAND, IN CLASS 41 (U.S. CLS. 100, 101 AND 107).

FIRST USE 2-11-2007; IN COMMERCE 2-11-2007.

THE MARK CONSISTS OF STANDARD CHARACTERS WITHOUT CLAIM TO ANY PARTICULAR FONT, STYLE, SIZE, OR COLOR.

NO CLAIM IS MADE TO THE EXCLUSIVE RIGHT TO USE "SHOW", APART FROM THE MARK AS SHOWN.

SER. NO. 77-295,930, FILED 10-4-2007.

MICHAEL WEBSTER, EXAMINING ATTORNEY

**Int. Cl.: 35**

**Prior U.S. Cls.: 100, 101 and 102**

**United States Patent and Trademark Office**

**Reg. No. 3,466,324**

**Registered July 15, 2008**

**SERVICE MARK  
PRINCIPAL REGISTER**

SIS INTERNATIONAL RESEARCH

SIS INTERNATIONAL, INC. (NEW YORK CORPORATION)  
FLOOR 2  
11 EAST 22ND STREET  
NEW YORK, NY 10010

FOR: BUSINESS SERVICES, NAMELY, THE COLLECTION, MANAGEMENT, ANALYSIS AND REPORTING OF COMPANY, BUSINESS SECTOR AND INDUSTRY DATA AND RESEARCH; CUSTOM GLOBAL MARKET INTELLIGENCE RESEARCH AND ANALYSIS; CONSULTATION SERVICES IN THE FIELD OF BUSINESS SECTOR AND INDUSTRY DATA, RESEARCH AND ANALYSIS, IN CLASS 35 (U.S. CLS. 100, 101 AND 102).

FIRST USE 3-1-1984; IN COMMERCE 3-1-1984.

THE MARK CONSISTS OF STANDARD CHARACTERS WITHOUT CLAIM TO ANY PARTICULAR FONT, STYLE, SIZE, OR COLOR.

NO CLAIM IS MADE TO THE EXCLUSIVE RIGHT TO USE "INTERNATIONAL RESEARCH", APART FROM THE MARK AS SHOWN.

SER. NO. 77-295,989, FILED 10-4-2007.

PAUL F. GAST, EXAMINING ATTORNEY



**Int. Cls.: 41 and 45**

**Prior U.S. Cls.: 100, 101 and 107**

**United States Patent and Trademark Office**

**Reg. No. 3,466,325**

**Registered July 15, 2008**

**SERVICE MARK  
PRINCIPAL REGISTER**



FREE ARTIST NETWORK.COM, INC. (NEW YORK CORPORATION)  
8 MOORING DRIVE  
BELLPORT, NY 11713

FOR: ENTERTAINMENT SERVICES, NAMELY, PROVIDING PRERECORDED MUSIC, INFORMATION IN THE FIELD OF MUSIC, AND COMMENTARY AND ARTICLES ABOUT MUSIC, ALL ONLINE VIA A GLOBAL COMPUTER NETWORK, IN CLASS 41 (U.S. CLS. 100, 101 AND 107).

FIRST USE 9-7-2007; IN COMMERCE 9-7-2007.

FOR: ONLINE SOCIAL NETWORKING SERVICES, IN CLASS 45 (U.S. CLS. 100 AND 101).

FIRST USE 9-7-2007; IN COMMERCE 9-7-2007.

NO CLAIM IS MADE TO THE EXCLUSIVE RIGHT TO USE "FREE ARTIST NETWORK" AND ".COM", APART FROM THE MARK AS SHOWN.

THE COLOR(S) PURPLE, GREEN, BLUE, DARK RED, ORANGE, WHITE AND BLACK IS/ARE CLAIMED AS A FEATURE OF THE MARK.

THE MARK CONSISTS OF THE STYLIZED WORDING "FAN" INSIDE THE DESIGN OF AN OVAL, AND THE STYLIZED WORDING "THE-FREEARTISTNETWORK.COM" TO THE RIGHT OF THE OVAL. THE COLOR WHITE APPEARS IN THE STYLIZED WORDING "FAN". THE COLOR BLACK APPEARS IN THE OUTLINE OF AN OVAL. THE COLOR ORANGE APPEARS IN THE FILL OF THE OVAL. THE COLOR BLUE APPEARS IN THE LETTERS "THE" AND "NET" IN THE WORDING "THEFREEARTISTNETWORK.COM". THE COLOR PURPLE APPEARS IN THE LETTERS "FREE" IN THE WORDING "THEFREEARTISTNETWORK.COM". THE COLOR DARK RED APPEARS IN THE LETTERS "ARTIST" IN THE WORDING "THE-FREEARTISTNETWORK.COM". THE COLOR ORANGE APPEARS IN THE LETTERS "WORK" IN THE WORDING "THEFREEARTISTNETWORK.COM". THE COLOR GREEN APPEARS IN THE LETTERS ".COM" IN THE WORDING "THE-FREEARTISTNETWORK.COM".

SER. NO. 77-295,996, FILED 10-4-2007.

JAY BESCH, EXAMINING ATTORNEY

**Int. Cl.: 38**

**Prior U.S. Cls.: 100, 101 and 104**

**United States Patent and Trademark Office**

**Reg. No. 3,466,326**

**Registered July 15, 2008**

**SERVICE MARK  
PRINCIPAL REGISTER**

**VOXANT**

VOXANT, INC. (DELAWARE CORPORATION)  
1851 ALEXANDER BELL DR., SUITE 350  
RESTON, VA 20191

FIRST USE 12-0-2005; IN COMMERCE 12-0-2005.

FOR: TRANSMISSION AND ELECTRONIC DISTRIBUTION OF FULLY LICENSED ONLINE INFORMATION AND NEWS IN THE FORM OF VIDEO, AUDIO, PRINT AND STILL PHOTOGRAPHS TO CONTENT PROVIDERS, PUBLISHERS, WEBSITES, BLOGS, AND ADVERTISERS, IN CLASS 38 (U.S. CLS. 100, 101 AND 104).

THE MARK CONSISTS OF STANDARD CHARACTERS WITHOUT CLAIM TO ANY PARTICULAR FONT, STYLE, SIZE, OR COLOR.

SER. NO. 77-296,349, FILED 10-4-2007.

CYNTHIA SLOAN, EXAMINING ATTORNEY

**Int. Cl.: 38**

**Prior U.S. Cls.: 100, 101 and 104**

**United States Patent and Trademark Office**

**Reg. No. 3,466,327**

**Registered July 15, 2008**

**SERVICE MARK  
PRINCIPAL REGISTER**



VOXANT, INC. (DELAWARE CORPORATION)  
1851 ALEXANDER BELL DR., SUITE 350  
RESTON, VA 20191

FIRST USE 12-0-2005; IN COMMERCE 12-0-2005.

FOR: TRANSMISSION AND ELECTRONIC DISTRIBUTION OF FULLY LICENSED ONLINE INFORMATION AND NEWS IN THE FORM OF VIDEO, AUDIO, PRINT AND STILL PHOTOGRAPHS TO CONTENT PROVIDERS, PUBLISHERS, WEBSITES, BLOGS, AND ADVERTISERS, IN CLASS 38 (U.S. CLS. 100, 101 AND 104).

THE MARK CONSISTS OF THE TERM VOXANT WITH THREE CURVED LINES STACKED VERTICALLY ABOVE THE LETTER "O".

SER. NO. 77-296,381, FILED 10-4-2007.

CYNTHIA SLOAN, EXAMINING ATTORNEY

**Int. Cls.: 35, 36 and 45**

**Prior U.S. Cls.: 100, 101 and 102**

**United States Patent and Trademark Office**

**Reg. No. 3,466,328**

**Registered July 15, 2008**

**SERVICE MARK  
PRINCIPAL REGISTER**

**MPA**

MEDICAL PARTNERS OF AMERICA, INC. (DE-  
LAWARE CORPORATION)  
SUITE 310  
822 HIGHWAY A1A NORTH  
PONTE VEDRA BEACH, FL 32082

FOR: COST CONTAINMENT, REVIEW AND UTI-  
LIZATION ANALYSIS IN THE FIELD OF HEALTH-  
CARE SERVICES; INTERACTIVE MEDICAL  
RECORDKEEPING SERVICES FOR USE IN RISK  
MANAGEMENT, CLAIMS PAYMENT, ADMINIS-  
TRATION AND REGULATORY COMPLIANCE, IN  
CLASS 35 (U.S. CLS. 100, 101 AND 102).

FIRST USE 11-9-2006; IN COMMERCE 11-9-2006.

FOR: MEDICAL HEALTH PLAN AND CLAIMS  
ADMINISTRATION; ORGANIZATION AND AD-  
MINISTRATION OF PREFERRED PROVIDER

PLANS IN THE MEDICAL FIELD, IN CLASS 36  
(U.S. CLS. 100, 101 AND 102).

FIRST USE 11-9-2006; IN COMMERCE 11-9-2006.

FOR: VERIFYING AND MONITORING THE  
CREDENTIALS OF DOCTORS AND OTHER MED-  
ICAL PROFESSIONALS, IN CLASS 45 (U.S. CLS. 100  
AND 101).

FIRST USE 9-1-2007; IN COMMERCE 9-1-2007.

THE MARK CONSISTS OF STANDARD CHAR-  
ACTERS WITHOUT CLAIM TO ANY PARTICULAR  
FONT, STYLE, SIZE, OR COLOR.

SER. NO. 77-296,437, FILED 10-4-2007.

ESTHER BELENKER, EXAMINING ATTORNEY

**Int. Cls.: 41, 44 and 45**

**Prior U.S. Cls.: 100, 101 and 107**

**United States Patent and Trademark Office**

**Reg. No. 3,466,329**

**Registered July 15, 2008**

**SERVICE MARK  
PRINCIPAL REGISTER**

**SMOOCHES 4 POOCHES**

CHRISTINE L. DAVIS (UNITED STATES INDIVIDUAL)  
6009 RYLAND DRIVE  
BETHESDA, MD 20817

FOR: PET SERVICES, NAMELY, OBEDIENCE TRAINING, IN CLASS 41 (U.S. CLS. 100, 101 AND 107).

FIRST USE 1-15-2002; IN COMMERCE 1-15-2002.

FOR: PET SERVICES, NAMELY, DOG WALKING, IN CLASS 44 (U.S. CLS. 100 AND 101).

FIRST USE 1-15-2002; IN COMMERCE 1-15-2002.

FOR: PET SITTING, IN CLASS 45 (U.S. CLS. 100 AND 101).

FIRST USE 1-15-2002; IN COMMERCE 1-15-2002.

THE MARK CONSISTS OF STANDARD CHARACTERS WITHOUT CLAIM TO ANY PARTICULAR FONT, STYLE, SIZE, OR COLOR.

SER. NO. 77-296,531, FILED 10-4-2007.

ODESSA BIBBINS, EXAMINING ATTORNEY

**Int. Cl.: 1**

**Prior U.S. Cls.: 1, 5, 6, 10, 26 and 46**

**Reg. No. 3,466,330**

**United States Patent and Trademark Office**

**Registered July 15, 2008**

---

**TRADEMARK  
PRINCIPAL REGISTER**

**BARRICURE**

CARLISLE INTANGIBLE COMPANY (DELA-  
WARE CORPORATION)  
SUITE 201  
250 SOUTH CLINTON STREET  
SYRACUSE, NY 13202

THE MARK CONSISTS OF STANDARD CHAR-  
ACTERS WITHOUT CLAIM TO ANY PARTICULAR  
FONT, STYLE, SIZE, OR COLOR.

FOR: CURING AGENT DISPERSION FOR THE  
PREPARATION OF COATINGS FOR WALLS AND  
FOUNDATIONS, IN CLASS 1 (U.S. CLS. 1, 5, 6, 10, 26  
AND 46).

SER. NO. 77-296,662, FILED 10-4-2007.

FIRST USE 4-30-2007; IN COMMERCE 4-30-2007.

JOHN SCHUYLER YARD, EXAMINING ATTOR-  
NEY

**Int. Cl.: 36**

**Prior U.S. Cls.: 100, 101 and 102**

**United States Patent and Trademark Office**

**Reg. No. 3,466,331**

**Registered July 15, 2008**

**SERVICE MARK  
PRINCIPAL REGISTER**

**FINANCIAL SECURITY FOR THE  
LONG RUN**

SECURIAN FINANCIAL GROUP, INC. (DELA-  
WARE CORPORATION)  
400 ROBERT STREET NORTH  
ST. PAUL, MN 55101

FOR: BROKERAGE AND UNDERWRITING OF  
MUTUAL FUNDS, ANNUITIES AND INSURANCE;  
INSURANCE, BROKERAGE AND UNDERWRIT-  
ING SERVICES, NAMELY, PROPERTY, CASUAL-  
TY, LIFE, HEALTH AND DISABILITY INSURANCE,  
INSURANCE ADMINISTRATION, INSURANCE  
CLAIMS ADJUSTMENT SERVICES, IN CLASS 36  
(U.S. CLS. 100, 101 AND 102).

FIRST USE 9-25-2007; IN COMMERCE 9-25-2007.

THE MARK CONSISTS OF STANDARD CHAR-  
ACTERS WITHOUT CLAIM TO ANY PARTICULAR  
FONT, STYLE, SIZE, OR COLOR.

SER. NO. 77-296,904, FILED 10-5-2007.

HANNO RITTNER, EXAMINING ATTORNEY

Int. Cl.: 11

Prior U.S. Cls.: 13, 21, 23, 31 and 34

United States Patent and Trademark Office

Reg. No. 3,466,332

Registered July 15, 2008

TRADEMARK  
PRINCIPAL REGISTER



SOCIETE INDUSTRIELLE DE LACANCHE  
(FRANCE SOCIETE ANONYME (SA))  
LACANCHE  
ARNAY LE DUC, FRANCE 21230

FOR: ELECTRIC SLOW COOKERS; ELECTRIC  
PRESSURE COOKERS; GAS COOKERS; ELECTRO-  
MAGNETIC INDUCTION COOKERS FOR HOUSE-  
HOLD PURPOSES, IN CLASS 11 (U.S. CLS. 13, 21, 23,  
31 AND 34).

OWNER OF FRANCE REG. NO. 99795283, DATED  
5-26-1999, EXPIRES 5-25-2009.

OWNER OF U.S. REG. NO. 1,861,743.

NO CLAIM IS MADE TO THE EXCLUSIVE  
RIGHT TO USE "FOURNEAUX DE FRANCE",  
APART FROM THE MARK AS SHOWN.

THE MARK CONSISTS OF "LACANCHE" FOUR-  
NEAUX DE FRANCE AND A DESIGN ELEMENT.

THE FOREIGN WORDING IN THE MARK  
TRANSLATES INTO ENGLISH AS "COOKER FROM  
FRANCE".

SER. NO. 77-296,908, FILED 10-5-2007.

RUSS HERMAN, EXAMINING ATTORNEY



**Int. Cl.: 29**

**Prior U.S. Cl.: 46**

**United States Patent and Trademark Office**

**Reg. No. 3,466,333**

**Registered July 15, 2008**

**TRADEMARK  
PRINCIPAL REGISTER**

# Steakhouse Angus

WMK HOLDINGS, INC. (DELAWARE CORPORATION)  
SUITE 1249  
300 DELAWARE AVENUE  
WILMINGTON, DE 19801

FOR: ANGUS MEAT, IN CLASS 29 (U.S. CL. 46).

FIRST USE 1-1-2007; IN COMMERCE 1-1-2007.

THE MARK CONSISTS OF STANDARD CHARACTERS WITHOUT CLAIM TO ANY PARTICULAR FONT, STYLE, SIZE, OR COLOR.

OWNER OF U.S. REG. NO. 3,314,554.

NO CLAIM IS MADE TO THE EXCLUSIVE RIGHT TO USE "ANGUS", APART FROM THE MARK AS SHOWN.

SER. NO. 77-297,126, FILED 10-5-2007.

RONALD AIKENS, EXAMINING ATTORNEY

**Int. Cl.: 37**

**Prior U.S. Cls.: 100, 103 and 106**

**United States Patent and Trademark Office**

**Reg. No. 3,466,334**

**Registered July 15, 2008**

**SERVICE MARK  
PRINCIPAL REGISTER**



KACZMAREK, J G (UNITED STATES INDIVIDUAL)  
PO BOX 10  
ATHOL SPRINGS, NY 14010

FOR: CONSTRUCTION PLANNING AND CONSTRUCTION CONSULTATION IN THE FIELD OF RESIDENTIAL AND COMMERCIAL DWELLINGS AND MODULAR HOMES; REMODELING AND RENOVATION OF RESIDENTIAL AND COMMERCIAL DWELLINGS, IN CLASS 37 (U.S. CLS. 100, 103 AND 106).

FIRST USE 1-1-2007; IN COMMERCE 1-1-2007.

NO CLAIM IS MADE TO THE EXCLUSIVE RIGHT TO USE "INNOVATIVE DWELLINGS", APART FROM THE MARK AS SHOWN.

THE COLOR(S) GREEN AND BLACK IS/ARE CLAIMED AS A FEATURE OF THE MARK.

THE COLOR GREEN APPEARS IN THE DESIGN ELEMENT, WHICH CONSISTS OF AN INCOMPLETE BUILDING COMPRISING A ROOF LINE, LEFT SIDE, AND A HORIZONTAL LINE REPRESENTING GROUND. THE COLOR BLACK APPEARS IN THE WORDING "INNOVATIVE DWELLINGS".

SER. NO. 77-297,198, FILED 10-5-2007.

LINDA LAVACHE, EXAMINING ATTORNEY

**Int. Cl.: 16**

**Prior U.S. Cls.: 2, 5, 22, 23, 29, 37, 38 and 50**

**United States Patent and Trademark Office**

**Reg. No. 3,466,335**

**Registered July 15, 2008**

**TRADEMARK  
PRINCIPAL REGISTER**

**KING'S CROSS**

KING'S CROSS GREETING CARDS LLC (UTAH  
LTD LIAB CO)  
1112 EAST 920 NORTH  
OREM, UT 84097

FOR: PAPER GOODS, NAMELY, GREETING  
CARDS, NOTE CARDS, PAPER STATIONARY  
AND ENVELOPES, DECORATIVE WRITING PA-  
PERS, WRAPPING PAPER, PAPER EMBELLISH-  
MENTS FOR USE IN MAKING SCRAPBOOKS, IN  
CLASS 16 (U.S. CLS. 2, 5, 22, 23, 29, 37, 38 AND 50).

FIRST USE 10-1-2007; IN COMMERCE 10-1-2007.

THE MARK CONSISTS OF STANDARD CHAR-  
ACTERS WITHOUT CLAIM TO ANY PARTICULAR  
FONT, STYLE, SIZE, OR COLOR.

SER. NO. 77-297,327, FILED 10-5-2007.

DANIEL CAPSHAW, EXAMINING ATTORNEY

Int. Cl.: 16

Prior U.S. Cls.: 2, 5, 22, 23, 29, 37, 38 and 50

United States Patent and Trademark Office

Reg. No. 3,466,336

Registered July 15, 2008

TRADEMARK  
PRINCIPAL REGISTER



1

KING'S CROSS GREETING CARDS LLC (UTAH  
LTD LIAB CO)  
1112 EAST 920 NORTH  
OREM, UT 84097

FOR: PAPER GOODS, NAMELY, GREETING  
CARDS, NOTE CARDS, PAPER STATIONARY  
AND ENVELOPES, DECORATIVE WRITING PA-  
PERS, WRAPPING PAPER, CALENDARS, PAPER  
EMBELLISHMENTS FOR USE IN MAKING SCRAP-  
BOOKS, IN CLASS 16 (U.S. CLS. 2, 5, 22, 23, 29, 37, 38  
AND 50).

FIRST USE 10-1-2007; IN COMMERCE 10-1-2007.

THE COLOR(S) RED, WHITE, BLACK, TAN IS/  
ARE CLAIMED AS A FEATURE OF THE MARK.

THE MARK CONSISTS OF STYLIZED UPPER  
CASE LETTER "K", WHITE WITH BLACK TRIM IN  
A RED BOX, DETAILED WITH TAN BRAID SCOL-  
LING INSIDE THE LETTER.

SER. NO. 77-297,364, FILED 10-5-2007.

DANIEL CAPSHAW, EXAMINING ATTORNEY

**Int. Cl.: 9**

**Prior U.S. Cls.: 21, 23, 26, 36 and 38**

**Reg. No. 3,466,337**

**United States Patent and Trademark Office**

**Registered July 15, 2008**

---

**TRADEMARK  
PRINCIPAL REGISTER**

**EZ-SCAN**

SPX CORPORATION (DELAWARE CORPORATION)  
13515 BALLANTYNE CORPORATE PLACE  
CHARLOTTE, ND 28277

THE MARK CONSISTS OF STANDARD CHARACTERS WITHOUT CLAIM TO ANY PARTICULAR FONT, STYLE, SIZE, OR COLOR.

FOR: VEHICLE DIAGNOSTIC TOOLS, NAMELY, HAND HELD COMPUTERS FOR TROUBLE SHOOTING VEHICLE OPERATING SYSTEMS, IN CLASS 9 (U.S. CLS. 21, 23, 26, 36 AND 38).

SER. NO. 77-297,968, FILED 10-6-2007.

FIRST USE 11-30-2002; IN COMMERCE 11-30-2002.

ROBERT C. CLARK JR., EXAMINING ATTORNEY

**Int. Cls.: 16, 35 and 43**

**Prior U.S. Cls.: 2, 5, 22, 23, 29, 37, 38, 50, 100, 101 and 102**

**Reg. No. 3,466,338**

**United States Patent and Trademark Office**

**Registered July 15, 2008**

**TRADEMARK  
SERVICE MARK  
PRINCIPAL REGISTER**

# AP Printing

AP PRINTING CORPORATION (CALIFORNIA CORPORATION), DBA A&P PRINTING  
3400 DE LA CRUZ BLVD., SUITE #X  
SANTA CLARA, CA 95054

FOR: INVITATION CARDS; PRINTED INVITATIONS; BUSINESS CARD PAPER; BUSINESS CARDS; BUSINESS FORMS; PAPER FOR USE IN THE GRAPHIC ARTS INDUSTRY; PAPERS FOR USE IN THE GRAPHIC ARTS INDUSTRY; PRINTED MENUS; ENVELOPES FOR STATIONERY USE; STATIONERY WRITING PAPER AND ENVELOPES, IN CLASS 16 (U.S. CLS. 2, 5, 22, 23, 29, 37, 38 AND 50).

FIRST USE 1-9-1996; IN COMMERCE 1-9-1996.

FOR: BUSINESS CARD DESIGN SERVICES; CREATIVE MARKETING DESIGN SERVICES; DESIGN OF ADVERTISING FLYERS FOR OTHERS; DESIGN OF ADVERTISING MATERIALS FOR OTHERS; DESIGN OF INTERNET ADVERTISING, IN CLASS 35 (U.S. CLS. 100, 101 AND 102).

FIRST USE 1-9-1996; IN COMMERCE 1-9-1996.

FOR: CONSULTANCY SERVICES IN THE FIELD OF MENU PLANNING FOR OTHERS, IN CLASS 43 (U.S. CLS. 100 AND 101).

FIRST USE 1-9-1996; IN COMMERCE 1-9-1996.

THE MARK CONSISTS OF STANDARD CHARACTERS WITHOUT CLAIM TO ANY PARTICULAR FONT, STYLE, SIZE, OR COLOR.

NO CLAIM IS MADE TO THE EXCLUSIVE RIGHT TO USE "PRINTING", APART FROM THE MARK AS SHOWN.

SER. NO. 77-297,995, FILED 10-6-2007.

ROBERT C. CLARK JR., EXAMINING ATTORNEY

**Int. Cl.: 7**

**Prior U.S. Cls.: 13, 19, 21, 23, 31, 34 and 35**

**Reg. No. 3,466,339**

**United States Patent and Trademark Office**

**Registered July 15, 2008**

**TRADEMARK  
PRINCIPAL REGISTER**

**BOM-DigiMotor**

ZHONGSHAN BROAD-OCEAN MOTOR CO.,LTD  
(CHINA LTD LIAB CO)  
3RD IND DISTRICT, SHA LANG WEST DISTRICT  
ZHONGSHAN, GUANGDONG, CHINA

FOR: ELECTRIC MOTORS FOR MACHINES,  
NAMELY, MOTORS FOR WIND GENERATORS,  
MOTORS FOR ELECTRIC FANS, MOTORS FOR  
AIR-CONDITIONERS, MOTORS FOR WASHING  
MACHINES FOR CLOTHS, MOTORS FOR  
CLOTHES DRYING MACHINES, MOTORS FOR  
KITCHEN FOOD MIXERS, MOTORS FOR DISH  
WASHING MACHINES; ENGINES AND MOTORS  
FOR GENERATION OF ELECTRICITY; IGNITION

DEVICES FOR MOTORS OF LAND VEHICLES, IN  
CLASS 7 (U.S. CLS. 13, 19, 21, 23, 31, 34 AND 35).

FIRST USE 6-7-2007; IN COMMERCE 6-7-2007.

THE MARK CONSISTS OF STANDARD CHAR-  
ACTERS WITHOUT CLAIM TO ANY PARTICULAR  
FONT, STYLE, SIZE, OR COLOR.

SER. NO. 77-298,182, FILED 10-8-2007.

LAURIE MAYES, EXAMINING ATTORNEY

**Int. Cl.: 41**

**Prior U.S. Cls.: 100, 101 and 107**

**United States Patent and Trademark Office**

**Reg. No. 3,466,340**

**Registered July 15, 2008**

**SERVICE MARK  
PRINCIPAL REGISTER**

MOTÍVATE. EDÚCATE. ELÉVATE.

QWEST COMMUNICATIONS INTERNATIONAL  
INC. (DELAWARE CORPORATION)  
1801 CALIFORNIA STREET  
DENVER, CO 80202

FOR: EDUCATIONAL SERVICES, NAMELY,  
PROVIDING A WEBSITE THAT FEATURES IN-  
STRUCTION REGARDING IDENTITY THEFT PRE-  
VENTION AND ONLINE SAFETY TRAINING  
THROUGH COMMUNITY INVOLVEMENT, AND  
PROVIDING NON-DOWNLOADABLE INSTRU-  
CTIONAL BROCHURES IN CONNECTION THERE-  
WITH, IN CLASS 41 (U.S. CLS. 100, 101 AND 107).

FIRST USE 9-30-2007; IN COMMERCE 9-30-2007.

THE MARK CONSISTS OF STANDARD CHAR-  
ACTERS WITHOUT CLAIM TO ANY PARTICULAR  
FONT, STYLE, SIZE, OR COLOR.

NO CLAIM IS MADE TO THE EXCLUSIVE  
RIGHT TO USE "EDÚCATE", APART FROM THE  
MARK AS SHOWN.

THE ENGLISH TRANSLATION OF THE SPANISH  
WORDING "MOTÍVATE EDÚCATE ELÉVATE" MO-  
TIVATE EDUCATE ELEVATE.

SER. NO. 77-298,431, FILED 10-8-2007.

BARBARA A. GOLD, EXAMINING ATTORNEY



**Int. Cl.: 45**

**Prior U.S. Cls.: 100 and 101**

**United States Patent and Trademark Office**

**Reg. No. 3,466,341**

**Registered July 15, 2008**

**SERVICE MARK  
PRINCIPAL REGISTER**

**boomerage club**

BOOMERAGE CLUB, INC. (PENNSYLVANIA  
CORPORATION)  
RR #1 BOX 1263  
HALLSTEAD, PA 18822

FOR: ONLINE SOCIAL CLUB SERVICES, NAME-  
LY, SOCIAL INTRODUCTION SERVICES, IN CLASS  
45 (U.S. CLS. 100 AND 101).

FIRST USE 6-5-2007; IN COMMERCE 6-5-2007.

THE MARK CONSISTS OF STANDARD CHAR-  
ACTERS WITHOUT CLAIM TO ANY PARTICULAR  
FONT, STYLE, SIZE, OR COLOR.

NO CLAIM IS MADE TO THE EXCLUSIVE  
RIGHT TO USE "CLUB", APART FROM THE MARK  
AS SHOWN.

SER. NO. 77-298,459, FILED 10-8-2007.

JOHN E. MICHOS, EXAMINING ATTORNEY

**Int. Cl.: 10**

**Prior U.S. Cls.: 26, 39 and 44**

**United States Patent and Trademark Office**

**Reg. No. 3,466,342**

**Registered July 15, 2008**

**TRADEMARK  
PRINCIPAL REGISTER**

**PLANE (& SIMPLE) DENTURE  
ARTICULATION SYSTEM**

PAUL D. RASKIN, D.D.S. (UNITED STATES  
INDIVIDUAL)  
SUITE C-2  
2344 BUTANO DRIVE  
SACRAMENTO, CA 95825

FOR: DENTURE ARTICULATORS; DENTURE  
ARTICULATION SYSTEM COMPRISED PRIMAR-  
ILY OF A DENTURE ARTICULATOR AND A  
COMPENSATING SCRIBER TO DETERMINE  
TEETH PLACEMENT, IN CLASS 10 (U.S. CLS. 26,  
39 AND 44).

FIRST USE 2-6-2008; IN COMMERCE 2-6-2008.

THE MARK CONSISTS OF STANDARD CHAR-  
ACTERS WITHOUT CLAIM TO ANY PARTICULAR  
FONT, STYLE, SIZE, OR COLOR.

NO CLAIM IS MADE TO THE EXCLUSIVE  
RIGHT TO USE DENTURE ARTICULATION SYS-  
TEM, APART FROM THE MARK AS SHOWN.

SER. NO. 77-298,994, FILED 10-9-2007.

DAVID ELTON, EXAMINING ATTORNEY

**Int. Cl.: 7**

**Prior U.S. Cls.: 13, 19, 21, 23, 31, 34 and 35**

**United States Patent and Trademark Office**

**Reg. No. 3,466,343**

**Registered July 15, 2008**

**TRADEMARK  
PRINCIPAL REGISTER**

**MAGMO**

SPX CORPORATION (DELAWARE CORPORATION)  
13515 BALLANTYNE CORPORATE PLACE  
CHARLOTTE, NC 28277

THE MARK CONSISTS OF STANDARD CHARACTERS WITHOUT CLAIM TO ANY PARTICULAR FONT, STYLE, SIZE, OR COLOR.

FOR: INDUSTRIAL PUMPS, NAMELY, POSITIVE DISPLACEMENT PUMPS, IN CLASS 7 (U.S. CLS. 13, 19, 21, 23, 31, 34 AND 35).

SER. NO. 77-299,028, FILED 10-9-2007.

FIRST USE 8-8-1972; IN COMMERCE 1-1-1976.

ROBERT C. CLARK JR., EXAMINING ATTORNEY

**Int. Cl.: 35**

**Prior U.S. Cls.: 100, 101 and 102**

**United States Patent and Trademark Office**

**Reg. No. 3,466,344**

**Registered July 15, 2008**

**SERVICE MARK  
PRINCIPAL REGISTER**



ALDIA NEWSPAPERS INCORPORATED (PENNSYLVANIA CORPORATION)  
1500 JFK BLVD.  
PHILADELPHIA, PA 19102

FOR: BUSINESS NETWORKING, IN CLASS 35  
(U.S. CLS. 100, 101 AND 102).

FIRST USE 9-1-2006; IN COMMERCE 9-1-2006.

NO CLAIM IS MADE TO THE EXCLUSIVE RIGHT TO USE "LATINO PROFESSIONAL NETWORK", APART FROM THE MARK AS SHOWN.

THE MARK CONSISTS OF STYLIZED LETTERS.

SER. NO. 77-299,272, FILED 10-9-2007.

CAROLYN CATALDO, EXAMINING ATTORNEY

Int. Cl.: 35

Prior U.S. Cls.: 100, 101 and 102

United States Patent and Trademark Office

Reg. No. 3,466,345

Registered July 15, 2008

SERVICE MARK  
PRINCIPAL REGISTER



LOYALTY AWARD SERVICES (TEXAS LTD  
LIAB CO)  
TWO GALLERIA TOWER CENTER, SUITE 1000  
13455 NOEL ROAD  
DALLAS, TX 75240

FOR: BUSINESS AND MARKETING MANAGE-  
MENT SERVICES, NAMELY, THE REGISTRATION  
AND COMPILATION OF STATISTICAL DATA PRO-  
MOTING THE SALE OF GOODS AND SERVICES OF  
OTHERS BY AWARDED PURCHASE POINTS FOR  
THE CUSTOMER'S USE OF SPECIFIED VENDORS  
FOR THE FINANCING OR REFINANCING OF A  
HOME, PURCHASE OF A HOME, OR THE USE OF A  
PARTICULAR MOVING COMPANY, HOME WAR-  
RANTY FIRM FOUNDATION REPAIR COMPANY,

HOME PROTECTION FIRM OR SIMILAR BUSI-  
NESS ENTITY OR SERVICE, IN CLASS 35 (U.S. CLS.  
100, 101 AND 102).

FIRST USE 9-11-2006; IN COMMERCE 9-11-2006.

NO CLAIM IS MADE TO THE EXCLUSIVE  
RIGHT TO USE "MILES", APART FROM THE  
MARK AS SHOWN.

THE MARK CONSISTS OF "EASY MILES".

SER. NO. 77-299,301, FILED 10-9-2007.

CAROLYN CATALDO, EXAMINING ATTORNEY

Int. Cl.: 35

Prior U.S. Cls.: 100, 101 and 102

United States Patent and Trademark Office

Reg. No. 3,466,346

Registered July 15, 2008

SERVICE MARK  
PRINCIPAL REGISTER

Network with *Sabor*

ALDIA NEWSPAPERS INCORPORATED (PENN-  
SYLVANIA CORPORATION)  
SUITE 525  
1500 JFK BLVD.  
PHILADELPHIA, PA 19102

FOR: BUSINESS NETWORKING, IN CLASS 35  
(U.S. CLS. 100, 101 AND 102).

FIRST USE 9-1-2006; IN COMMERCE 9-1-2006.

NO CLAIM IS MADE TO THE EXCLUSIVE  
RIGHT TO USE "NETWORK", APART FROM THE  
MARK AS SHOWN.

THE MARK CONSISTS OF STYLIZED LETTERS.

SER. NO. 77-299,312, FILED 10-9-2007.

CAROLYN CATALDO, EXAMINING ATTORNEY

**Int. Cl.: 9**

**Prior U.S. Cls.: 21, 23, 26, 36 and 38**

**Reg. No. 3,466,347**

**United States Patent and Trademark Office**

**Registered July 15, 2008**

**TRADEMARK  
PRINCIPAL REGISTER**

**LUXO**

TNS INTERNATIONAL CORP. (FLORIDA CORPORATION)  
SUITE NO. 118  
2051 NW 112TH AVENUE  
MIAMI, FL 33172

FOR: HOLSTER FOR CARRYING MOBILE PHONES, PAGERS AND PERSONAL DIGITAL ASSISTANTS; CARRYING CASES FOR MOBILE PHONES; ACCESSORIES FOR MOBILE PHONES, NAMELY NECK STRAPS, HAND STRAPS AND LANYARDS; CARRYING BAGS AND CASES, NAMELY BAGS AND CASES FOR CARRYING CAMERAS, CELL PHONES, LAPTOPS, GAME CONSOLE, PAGERS, MUSIC DEVICES NAMELY MP3

AND MP4 PLAYERS, IN CLASS 9 (U.S. CLS. 21, 23, 26, 36 AND 38).

FIRST USE 6-10-2005; IN COMMERCE 6-10-2005.

THE MARK CONSISTS OF STANDARD CHARACTERS WITHOUT CLAIM TO ANY PARTICULAR FONT, STYLE, SIZE, OR COLOR.

"THE FOREIGN WORDING IN THE MARK TRANSLATES INTO ENGLISH AS LUXURY."

SER. NO. 77-299,764, FILED 10-9-2007.

REBECCA SMITH, EXAMINING ATTORNEY

**Int. Cl.: 39**

**Prior U.S. Cls.: 100 and 105**

**United States Patent and Trademark Office**

**Reg. No. 3,466,348**

**Registered July 15, 2008**

**SERVICE MARK  
PRINCIPAL REGISTER**



ACADEMIC TRAVEL ABROAD, INC. (D.C. CORPORATION)  
1920 N STREET, NW  
WASHINGTON, DC 20036

OWNER OF U.S. REG. NO. 1,470,089.

FOR: ORGANIZATION OF EXCURSIONS, SIGHTSEEING TOURS, HOLIDAY TOURS AND TRAVEL; AND TOUR CONDUCTING, IN CLASS 39 (U.S. CLS. 100 AND 105).

THE MARK CONSISTS OF THE WORD "GRAND-TRAVEL" AND THE DESIGN OF AN AIRPLANE.

SER. NO. 77-299,842, FILED 10-9-2007.

FIRST USE 12-10-1996; IN COMMERCE 12-10-1996.

JOHN GARTNER, EXAMINING ATTORNEY



**Int. Cl.: 28**

**Prior U.S. Cls.: 22, 23, 38 and 50**

**United States Patent and Trademark Office**

**Reg. No. 3,466,349**

**Registered July 15, 2008**

**TRADEMARK  
PRINCIPAL REGISTER**

**SUPER CLIFF HANGERS**

MATTEL, INC. (DELAWARE CORPORATION)  
333 CONTINENTAL BLVD.  
MI-1518  
EL SEGUNDO, CA 90245

OWNER OF U.S. REG. NO. 1,346,434.

FOR: TOYS, GAMES AND PLAYTHINGS, IN  
CLASS 28 (U.S. CLS. 22, 23, 38 AND 50).

NO CLAIM IS MADE TO THE EXCLUSIVE  
RIGHT TO USE "SUPER", APART FROM THE  
MARK AS SHOWN.

FIRST USE 3-3-2008; IN COMMERCE 3-3-2008.

SER. NO. 77-299,848, FILED 10-9-2007.

THE MARK CONSISTS OF STANDARD CHAR-  
ACTERS WITHOUT CLAIM TO ANY PARTICULAR  
FONT, STYLE, SIZE, OR COLOR.

JACLYN KIDWELL, EXAMINING ATTORNEY

**Int. Cl.: 39**

**Prior U.S. Cls.: 100 and 105**

**United States Patent and Trademark Office**

**Reg. No. 3,466,350**

**Registered July 15, 2008**

**SERVICE MARK  
PRINCIPAL REGISTER**

**AROMA TOURS**

AROMA TOURS - JAMES LLEWELLYN AND  
ROBBI ZECK (AUSTRALIA PARTNERSHIP)

PO BOX 55N

BALLARAT NORTH, AUSTRALIA

FOR: ARRANGING TRAVEL TOURS; CON-  
DUCTING SIGHTSEEING TOURS FOR OTHERS;  
TOUR CONDUCTING OR ESCORTING, IN CLASS  
39 (U.S. CLS. 100 AND 105).

FIRST USE 4-0-1994; IN COMMERCE 3-6-1995.

THE MARK CONSISTS OF STANDARD CHAR-  
ACTERS WITHOUT CLAIM TO ANY PARTICULAR  
FONT, STYLE, SIZE, OR COLOR.

OWNER OF U.S. REG. NO. 2,349,881.

NO CLAIM IS MADE TO THE EXCLUSIVE  
RIGHT TO USE "TOURS", APART FROM THE  
MARK AS SHOWN.

SER. NO. 77-300,081, FILED 10-9-2007.

RAUL CORDOVA, EXAMINING ATTORNEY

**Int. Cl.: 36**

**Prior U.S. Cls.: 100, 101 and 102**

**United States Patent and Trademark Office**

**Reg. No. 3,466,351**

**Registered July 15, 2008**

**SERVICE MARK  
PRINCIPAL REGISTER**

**DISTINCTIVE REALTY**

DISTINCTIVE REALTY, INC. (MASSACHUSETTS  
CORPORATION)  
19B MAPLE STREET  
MARLBOROUGH, MA 01752

FOR: RESIDENTIAL REAL ESTATE BROKER-  
AGE AND RENTAL SERVICES, IN CLASS 36 (U.S.  
CLS. 100, 101 AND 102).

FIRST USE 11-1-2002; IN COMMERCE 11-1-2002.

THE MARK CONSISTS OF STANDARD CHAR-  
ACTERS WITHOUT CLAIM TO ANY PARTICULAR  
FONT, STYLE, SIZE, OR COLOR.

NO CLAIM IS MADE TO THE EXCLUSIVE  
RIGHT TO USE "REALTY", APART FROM THE  
MARK AS SHOWN.

SER. NO. 77-300,177, FILED 10-10-2007.

KIMBERLY FRYE, EXAMINING ATTORNEY

**Int. Cl.: 12**

**Prior U.S. Cls.: 19, 21, 23, 31, 35 and 44**

**Reg. No. 3,466,352**

**United States Patent and Trademark Office**

**Registered July 15, 2008**

---

**TRADEMARK  
PRINCIPAL REGISTER**

**SUPERDUMPS**

STRONG, BROOKS (UNITED STATES INDIVIDUAL)  
13617 RALPH CULVER RD.  
HOUSTON, TN 77086

THE MARK CONSISTS OF STANDARD CHARACTERS WITHOUT CLAIM TO ANY PARTICULAR FONT, STYLE, SIZE, OR COLOR.

FOR: DUMP TRUCKS EQUIPPED WITH A PATENTED STRONG ARM TRAILING AXLE, IN CLASS 12 (U.S. CLS. 19, 21, 23, 31, 35 AND 44).

SER. NO. 77-300,415, FILED 10-10-2007.

FIRST USE 12-15-1994; IN COMMERCE 12-15-1994.

DAVID YONTEF, EXAMINING ATTORNEY

Int. Cl.: 16

Prior U.S. Cls.: 2, 5, 22, 23, 29, 37, 38 and 50

United States Patent and Trademark Office

Reg. No. 3,466,353

Registered July 15, 2008

TRADEMARK  
PRINCIPAL REGISTER



KING'S CROSS GREETING CARDS LLC (UTAH  
LTD LIAB CO)  
1112 EAST 920 NORTH  
OREM, UT 84097

FOR: PAPER GOODS, NAMELY, GREETING  
CARDS, NOTE CARDS, PAPER STATIONARY  
AND ENVELOPES, DECORATIVE WRITING PA-  
PERS, WRAPPING PAPER, CALENDARS, PAPER  
EMBELLISHMENTS FOR USE IN MAKING SCRAP-  
BOOKS, IN CLASS 16 (U.S. CLS. 2, 5, 22, 23, 29, 37, 38  
AND 50).

FIRST USE 10-1-2007; IN COMMERCE 10-1-2007.

NO CLAIM IS MADE TO THE EXCLUSIVE  
RIGHT TO USE GREETING CARDS, APART FROM  
THE MARK AS SHOWN.

THE COLOR(S) RED, BLACK, WHITE, TAN IS/  
ARE CLAIMED AS A FEATURE OF THE MARK.

"THE MARK CONSISTS OF A RED BLOCK CON-  
TAINING A WHITE STYLIZED UPPER-CASE LET-  
TER "K" TRIMMED IN BLACK WITH TAN  
BRAIDED SCROLLING IN THE INTERIOR OF  
THE LETTER, THE WORDING "GREETING  
CARDS" IN BLACK AND THE REMAINDER OF  
THE MARK IN RED STYLIZED LETTERING.."

SER. NO. 77-300,459, FILED 10-10-2007.

DANIEL CAPSHAW, EXAMINING ATTORNEY

**Int. Cl.: 16**

**Prior U.S. Cls.: 2, 5, 22, 23, 29, 37, 38 and 50**

**Reg. No. 3,466,354**

**United States Patent and Trademark Office**

**Registered July 15, 2008**

**TRADEMARK  
PRINCIPAL REGISTER**

**LEARN 'N FOLDER**

PURYEAR, SHARON B (UNITED STATES INDIVIDUAL)

2804 PEBBLEBROOK DRIVE  
SANFORD, NC 27330 AND

JACKSON, DEBORA M (UNITED STATES INDIVIDUAL)

2804 PEBBLEBROOK DRIVE  
SANFORD, NC 27330

FOR: FOLDERS IN THE NATURE OF FOLDABLE GRAPHIC ORGANIZERS FORMATTED FOR UNIT STUDIES FOR CHILDREN, PRESCHOOL THROUGH HIGH SCHOOL, IN CLASS 16 (U.S. CLS. 2, 5, 22, 23, 29, 37, 38 AND 50).

FIRST USE 3-19-2008; IN COMMERCE 3-19-2008.

THE MARK CONSISTS OF STANDARD CHARACTERS WITHOUT CLAIM TO ANY PARTICULAR FONT, STYLE, SIZE, OR COLOR.

NO CLAIM IS MADE TO THE EXCLUSIVE RIGHT TO USE "FOLDER", APART FROM THE MARK AS SHOWN.

SER. NO. 77-300,881, FILED 10-10-2007.

GENE MACIOL, EXAMINING ATTORNEY

**Int. Cls.: 41 and 45**

**Prior U.S. Cls.: 100, 101 and 107**

**United States Patent and Trademark Office**

**Reg. No. 3,466,355**

**Registered July 15, 2008**

**SERVICE MARK  
PRINCIPAL REGISTER**

# MAGNUM PHOTOS

MAGNUM PHOTOS INTERNATIONAL, INC.  
(DELAWARE CORPORATION)

151 WEST 25TH STREET  
NEW YORK, NY 10001

FOR: ENTERTAINMENT SERVICES, NAMELY, PROVIDING A WEBSITE FEATURING PHOTOGRAPHIC, AUDIO, VIDEO AND PROSE PRESENTATIONS FEATURING DOCUMENTARY PHOTOGRAPHY; PHOTOGRAPHIC AND VIDEO SERVICES, NAMELY, PHOTOGRAPHIC AND VIDEO CAPTURE; PHOTOGRAPHIC COMPOSITION FOR OTHERS; PHOTOGRAPHIC REPORTING; PHOTOGRAPHY SERVICES, IN CLASS 41 (U.S. CLS. 100, 101 AND 107).

FIRST USE 12-1-1947; IN COMMERCE 12-1-1947.

FOR: STOCK PHOTOGRAPHY SERVICES, NAMELY, LEASING REPRODUCTION RIGHTS OF PHOTOGRAPHS AND TRANSPARENCIES TO OTHERS, IN CLASS 45 (U.S. CLS. 100 AND 101).

FIRST USE 12-1-1947; IN COMMERCE 12-1-1947.

THE MARK CONSISTS OF STANDARD CHARACTERS WITHOUT CLAIM TO ANY PARTICULAR FONT, STYLE, SIZE, OR COLOR.

NO CLAIM IS MADE TO THE EXCLUSIVE RIGHT TO USE "PHOTOS", APART FROM THE MARK AS SHOWN.

SER. NO. 77-301,018, FILED 10-10-2007.

ALYSSA PALADINO, EXAMINING ATTORNEY

Prior U.S. Cl.: 200

United States Patent and Trademark Office

Reg. No. 3,466,356

Registered July 15, 2008

COLLECTIVE MEMBERSHIP  
PRINCIPAL REGISTER



TERRI WOOD (UNITED STATES INDIVIDUAL)  
2225 BEAR VALLEY TERRACE  
SILVER SPRING, MD 20906

FOR: INDICATING MEMBERSHIP IN A MOTORCYCLE CLUB, IN CLASS 200 (U.S. CL. 200).

FIRST USE 4-28-2007; IN COMMERCE 4-28-2007.

NO CLAIM IS MADE TO THE EXCLUSIVE RIGHT TO USE "M/C" AND "SILVER SPRING, MD", APART FROM THE MARK AS SHOWN.

THE COLOR(S) BLACK, SILVER, PURPLE, YELLOW, GOLD AND YELLOW GOLD IS/ARE CLAIMED AS A FEATURE OF THE MARK.

THE MARK CONSISTS OF A BLACK SHIELD WITH THREE POINTS AT THE TOP AND ONE POINT AT THE BOTTOM OUTLINED WITH A GOLD BORDER. ONE PURPLE RIBBON IS LOCATED AT THE TOP OF THE SHIELD AND ANOTHER PURPLE RIBBON IS LOCATED AT THE BOTTOM OF THE SHIELD. THE TOP RIBBON IS OUTLINED IN YELLOW GOLD AND IT CONTAINS THE CAPITAL LETTERS "MAXIMUM SOUND" WHICH ARE YELLOW AND OUTLINED IN BLACK. THE BOT-

TOM RIBBON IS ALSO OUTLINED IN YELLOW GOLD AND IT CONTAINS CAPITAL LETTERS "SILVER SPRING, MD" WHICH ARE YELLOW AND OUTLINED IN BLACK. FURTHERMORE THE BACK OF A MOTORCYCLE TIRE IS LOCATED BETWEEN THE TOP AND BOTTOM RIBBONS. THIS MOTORCYCLE TIRE IS IN VARIANT SHADES OF SILVER AND THE TIRE CONTAINS A PATTERN OF SILVER TREADS. ALSO LOCATED DIRECTLY TO THE RIGHT OF THE TIRE ARE SILVER TWIN PIPES; SILVER AND BLACK RIMS; AND A SILVER AND BLACK MUFFLER. THEN LOCATED DIRECTLY ABOVE THE TIRE IS A SILVER BACK FENDER. THE OUTLINE OF THREE CITY BUILDINGS IS LOCATED TO THE LEFT OF THE TIRE IN SILVER. SILVER SMOKE IS LOCATED ON BOTH THE RIGHT AND LEFT-HAND SIDES OF THE TIRE. THE TIRE IS CENTERED BETWEEN TWO STREET LINES WHICH ARE OUTLINED IN SILVER. FINALLY THE CAPITAL LETTERS "M/C" ARE LOCATED UNDERNEATH THE TIRE IN YELLOW. THE "M/C" ABBREVIATION STAND FOR THE WORDS MOTORCYCLE CLUB.

SER. NO. 77-301,228, FILED 10-10-2007.

KATINA MISTER, EXAMINING ATTORNEY



**Int. Cl.: 9**

**Prior U.S. Cls.: 21, 23, 26, 36 and 38**

**United States Patent and Trademark Office**

**Reg. No. 3,466,357**

**Registered July 15, 2008**

**TRADEMARK  
PRINCIPAL REGISTER**



ERIS MEDICAL TECHNOLOGIES, LLC. (OHIO  
LTD LIAB CO)

3227 LINDEN PLACE

CANFIELD, OH 44406

FOR: COMPUTER SOFTWARE FOR USE IN  
IDENTIFYING MEDICAL CHARGE CAPTURE  
AND IN IDENTIFYING COMPLIANCE OPPORTU-  
NITIES FOR HOSPITALS, IN CLASS 9 (U.S. CLS. 21,  
23, 26, 36 AND 38).

FIRST USE 6-14-2007; IN COMMERCE 6-18-2007.

NO CLAIM IS MADE TO THE EXCLUSIVE  
RIGHT TO USE "RX", APART FROM THE MARK  
AS SHOWN.

THE COLOR(S) INDIGO BLUE AND BLACK IS/  
ARE CLAIMED AS A FEATURE OF THE MARK.

THE MARK CONSISTS OF LOWER CASE "ERIS",  
UPPER CASE "RX" ENCASED IN A CIRCLE.

SER. NO. 77-301,372, FILED 10-11-2007.

KIMBERLY PERRY, EXAMINING ATTORNEY

**Int. Cl.: 33**

**Prior U.S. Cls.: 47 and 49**

**United States Patent and Trademark Office**

**Reg. No. 3,466,358**

**Registered July 15, 2008**

**TRADEMARK  
PRINCIPAL REGISTER**

# Whipps Cream

MOON TOWER LTD. (OHIO LTD LIAB CO)  
20600 CHAGRIN BLVD SUITE#450  
SHAKER HEIGHTS, OH 44122

FOR: ALCOHOLIC BEVERAGES, NAMELY, A  
WHIPPED CREAM COMBINED WITH FLAVORING  
AND ALCOHOL, IN CLASS 33 (U.S. CLS. 47 AND 49).

FIRST USE 1-15-2002; IN COMMERCE 1-15-2002.

THE MARK CONSISTS OF STANDARD CHAR-  
ACTERS WITHOUT CLAIM TO ANY PARTICULAR  
FONT, STYLE, SIZE, OR COLOR.

NO CLAIM IS MADE TO THE EXCLUSIVE  
RIGHT TO USE "CREAM", APART FROM THE  
MARK AS SHOWN.

SER. NO. 77-301,458, FILED 10-11-2007.

RONALD MCMORROW, EXAMINING ATTORNEY

**Int. Cls.: 41 and 45**

**Prior U.S. Cls.: 100, 101 and 107**

**United States Patent and Trademark Office**

**Reg. No. 3,466,359**

**Registered July 15, 2008**

**SERVICE MARK  
PRINCIPAL REGISTER**

**POWER IN PARENTING**

BEECH ACRES (OHIO CORPORATION)  
6881 BEECHMONT AVENUE  
CINCINNATI, OH 45202

FOR: EDUCATIONAL SERVICES, NAMELY, CLASSES, SEMINARS AND WORKSHOPS IN GROUPS OR ONE-ON-ONE, TO ENHANCE THE SOCIAL, EMOTIONAL AND INTELLECTUAL DEVELOPMENT OF CHILDREN, AND PRINTED MATERIALS AND DOWNLOADABLE DIGITAL FILES FEATURING PRINTABLE MATERIALS DISTRIBUTED THEREWITH; EDUCATIONAL SERVICES, NAMELY, CONDUCTING IN-PERSON, TELEPHONIC AND ON-LINE TRAINING CLASSES FOR FAMILIES IN THE FIELD OF CHILD DEVELOPMENT, AND PRINTED MATERIALS AND DOWNLOADABLE DIGITAL FILES FEATURING PRINTABLE MATERIALS DISTRIBUTED THEREWITH, IN CLASS 41 (U.S. CLS. 100, 101 AND 107).

FIRST USE 8-15-2007; IN COMMERCE 2-1-2008.

FOR: SUPPORT SERVICES, NAMELY, ORGANIZING AND CONDUCTING PARENTING SUPPORT GROUPS AND MENTOR RELATIONSHIPS TO ENHANCE THE SOCIAL, EMOTIONAL AND INTEL-

LECTUAL DEVELOPMENT OF CHILDREN; PROVIDING PARENT AND CHILD INTRAFAMILY PERSONAL RELATIONSHIP ASSESSMENTS AND CASE MANAGEMENT, NAMELY, COORDINATION OF LEGAL, SOCIAL AND PSYCHOLOGICAL SERVICES FOR FAMILIES AND REFERRALS TO COMMUNITY SERVICES RELATED TO CHILD DEVELOPMENT; ORGANIZING AND CONDUCTING SUPPORT GROUPS FOR FAMILIES TO ENHANCE CHILD DEVELOPMENT, IN CLASS 45 (U.S. CLS. 100 AND 101).

FIRST USE 8-15-2007; IN COMMERCE 2-1-2008.

THE MARK CONSISTS OF STANDARD CHARACTERS WITHOUT CLAIM TO ANY PARTICULAR FONT, STYLE, SIZE, OR COLOR.

NO CLAIM IS MADE TO THE EXCLUSIVE RIGHT TO USE "PARENTING", APART FROM THE MARK AS SHOWN.

SER. NO. 77-301,532, FILED 10-11-2007.

KATHY DE JONGE, EXAMINING ATTORNEY

**Int. Cls.: 9 and 16**

**Prior U.S. Cls.: 2, 5, 21, 22, 23, 26, 29, 36, 37, 38 and 50**

**Reg. No. 3,466,360**

**United States Patent and Trademark Office**

**Registered July 15, 2008**

**TRADEMARK  
PRINCIPAL REGISTER**



EVERY BODY'S YOGA, INC. (NORTH CAROLINA CORPORATION)  
7508 HAYMARKET LANE  
RALEIGH, NC 27615

FOR: PRE-RECORDED DIGITAL VIDEO DISKS FEATURING FITNESS INSTRUCTION, IN CLASS 9 (U.S. CLS. 21, 23, 26, 36 AND 38).

FIRST USE 7-24-2007; IN COMMERCE 7-24-2007.

FOR: PRINTED MATTER, NAMELY, INSTRUCTIONAL MANUALS IN THE FIELD OF YOGA AND FITNESS, IN CLASS 16 (U.S. CLS. 2, 5, 22, 23, 29, 37, 38 AND 50).

FIRST USE 7-24-2007; IN COMMERCE 7-24-2007.

NO CLAIM IS MADE TO THE EXCLUSIVE RIGHT TO USE YOGA, APART FROM THE MARK AS SHOWN.

THE MARK CONSISTS OF A SILHOUETTE IMAGE OF A WOMAN AND A MAN POSING IN STRETCH POSITIONS WITH AN IMAGE IN THE BACKGROUND OF A SUN WITH OUTREACHED ARMS AND THE WORDS YOU CALL THIS ARCHING OVER THE TOP OF THE SAME AND WITH THE WORD YOGA AT THE BASE OF THE DESIGN.

SER. NO. 77-301,540, FILED 10-11-2007.

GINA FINK, EXAMINING ATTORNEY

**Int. Cls.: 9 and 16**

**Prior U.S. Cls.: 2, 5, 21, 22, 23, 26, 29, 36, 37, 38 and 50**

**Reg. No. 3,466,361**

**United States Patent and Trademark Office**

**Registered July 15, 2008**

---

**TRADEMARK  
PRINCIPAL REGISTER**

**YOU CALL THIS YOGA**

EVERY BODY'S YOGA, INC. (NORTH CAROLINA CORPORATION)  
7508 HAYMARKET LANE  
RALEIGH, NC 27615

FOR: PRE-RECORDED DIGITAL VIDEO DISKS FEATURING FITNESS INSTRUCTION, IN CLASS 9 (U.S. CLS. 21, 23, 26, 36 AND 38).

FIRST USE 5-29-2007; IN COMMERCE 5-29-2007.

FOR: PRINTED MATTER, NAMELY, INSTRUCTIONAL MANUALS IN THE FIELD OF YOGA AND FITNESS, IN CLASS 16 (U.S. CLS. 2, 5, 22, 23, 29, 37, 38 AND 50).

FIRST USE 7-15-2007; IN COMMERCE 7-15-2007.

THE MARK CONSISTS OF STANDARD CHARACTERS WITHOUT CLAIM TO ANY PARTICULAR FONT, STYLE, SIZE, OR COLOR.

NO CLAIM IS MADE TO THE EXCLUSIVE RIGHT TO USE YOGA, APART FROM THE MARK AS SHOWN.

SER. NO. 77-301,565, FILED 10-11-2007.

GINA FINK, EXAMINING ATTORNEY

**Int. Cl.: 42**

**Prior U.S. Cls.: 100 and 101**

**United States Patent and Trademark Office**

**Reg. No. 3,466,362**

**Registered July 15, 2008**

**SERVICE MARK  
PRINCIPAL REGISTER**

**BRITTENFORD**  
— S Y S T E M S

BRITTENFORD SYSTEMS, INC. (DELAWARE CORPORATION)  
12359 SUNRISE VALLEY DR. STE 130  
RESTON, VA 20191

FOR: CONSULTING SERVICES IN THE FIELD OF DESIGN, SELECTION, IMPLEMENTATION AND USE OF COMPUTER HARDWARE AND SOFTWARE SYSTEMS FOR OTHERS, IN CLASS 42 (U.S. CLS. 100 AND 101).

FIRST USE 6-10-2005; IN COMMERCE 6-10-2005.

NO CLAIM IS MADE TO THE EXCLUSIVE RIGHT TO USE "SYSTEMS", APART FROM THE MARK AS SHOWN.

THE COLOR(S) RED, AND BLACK IS/ARE CLAIMED AS A FEATURE OF THE MARK.

THE MARK CONSISTS OF "BRITTENFORD" IS IN A BOLD RED, WITH THE "T'S" JOINED TOGETHER AND WITH A STYLIZED LETTER "O." A THIN RED HORIZONTAL LINE APPEARS UNDER "BRITTENFORD," EXTENDING FROM THE "B" THROUGH THE "E". "SYSTEMS" IS IN BLACK.

SER. NO. 77-301,641, FILED 10-11-2007.

ROBIN CHOSID, EXAMINING ATTORNEY

**Int. Cl.: 14**

**Prior U.S. Cls.: 2, 27, 28 and 50**

**United States Patent and Trademark Office**

**Reg. No. 3,466,363**

**Registered July 15, 2008**

**TRADEMARK  
PRINCIPAL REGISTER**



VICTOR'S THREE D, INC. (NEW JERSEY CORPORATION)  
25 BROOK AVENUE  
MAYWOOD, NJ 07607

THE MARK CONSISTS OF STYLIZED "V" WITH  
A CROWN ON TOP.

FOR: JEWELRY FINDINGS; RINGS, IN CLASS 14  
(U.S. CLS. 2, 27, 28 AND 50).

SER. NO. 77-301,961, FILED 10-11-2007.

FIRST USE 10-18-1960; IN COMMERCE 10-18-1960.

MICHAEL WIENER, EXAMINING ATTORNEY

**Int. Cl.: 35**

**Prior U.S. Cls.: 100, 101 and 102**

**United States Patent and Trademark Office**

**Reg. No. 3,466,364**

**Registered July 15, 2008**

**SERVICE MARK  
PRINCIPAL REGISTER**

# NDT Central

NDT CENTRAL LLC (TEXAS LTD LIAB CO)  
SUITE 100  
1014 WHITESTONE LN.  
HOUSTON, TX 77073

FOR: EMPLOYMENT HIRING, RECRUITING,  
PLACEMENT, STAFFING AND CAREER NET-  
WORKING SERVICES, IN CLASS 35 (U.S. CLS. 100,  
101 AND 102).

FIRST USE 10-15-2002; IN COMMERCE 10-15-2002.

THE MARK CONSISTS OF STANDARD CHAR-  
ACTERS WITHOUT CLAIM TO ANY PARTICULAR  
FONT, STYLE, SIZE, OR COLOR.

NO CLAIM IS MADE TO THE EXCLUSIVE  
RIGHT TO USE "NDT", APART FROM THE MARK  
AS SHOWN.

SER. NO. 77-302,154, FILED 10-11-2007.

GEORGE LORENZO, EXAMINING ATTORNEY



**Int. Cl.: 11**

**Prior U.S. Cls.: 13, 21, 23, 31 and 34**

**United States Patent and Trademark Office**

**Reg. No. 3,466,365**

**Registered July 15, 2008**

**TRADEMARK  
PRINCIPAL REGISTER**

**BioStream**

HELLET INVENTIONS, INC (CALIFORNIA CORPORATION)  
1539 SAN RAFAEL WAY  
CAMARILLO, CA 93012

THE MARK CONSISTS OF STANDARD CHARACTERS WITHOUT CLAIM TO ANY PARTICULAR FONT, STYLE, SIZE, OR COLOR.

FOR: AQUARIUM FILTRATION APPARATUS,  
IN CLASS 11 (U.S. CLS. 13, 21, 23, 31 AND 34).

SER. NO. 77-302,230, FILED 10-11-2007.

FIRST USE 2-12-2007; IN COMMERCE 2-12-2007.

KATHERINE STOIDES, EXAMINING ATTORNEY

**Int. Cl.: 9**

**Prior U.S. Cls.: 21, 23, 26, 36 and 38**

**Reg. No. 3,466,366**

**United States Patent and Trademark Office**

**Registered July 15, 2008**

---

**TRADEMARK  
PRINCIPAL REGISTER**

**VRED**

LAS VEGAS GAMING, INC. (NEVADA CORPORATION)  
4000 WEST ALI BABA LANE, SUITE D  
LAS VEGAS, NV 89118

THE MARK CONSISTS OF STANDARD CHARACTERS WITHOUT CLAIM TO ANY PARTICULAR FONT, STYLE, SIZE, OR COLOR.

FOR: COMPUTER GAME SOFTWARE; GAMING MACHINES, IN CLASS 9 (U.S. CLS. 21, 23, 26, 36 AND 38).

SER. NO. 77-302,265, FILED 10-11-2007.

FIRST USE 10-3-2007; IN COMMERCE 10-3-2007.

MONIQUE MILLER, EXAMINING ATTORNEY

**Int. Cls.: 29 and 30**

**Prior U.S. Cl.: 46**

**United States Patent and Trademark Office**

**Reg. No. 3,466,367**

**Registered July 15, 2008**

**TRADEMARK  
PRINCIPAL REGISTER**

**Yummies Inside**

CHUKAR CHERRIES (WASHINGTON COR-  
PORATION)  
PO BOX 510  
PROSSER, WA 99350

FOR: DRIED FRUITS, IN CLASS 29 (U.S. CL. 46).

FIRST USE 5-15-2001; IN COMMERCE 5-15-2001.

FOR: CHOCOLATE CANDIES, IN CLASS 30 (U.S.  
CL. 46).

FIRST USE 5-15-2001; IN COMMERCE 5-15-2001.

THE MARK CONSISTS OF STANDARD CHAR-  
ACTERS WITHOUT CLAIM TO ANY PARTICULAR  
FONT, STYLE, SIZE, OR COLOR.

SER. NO. 77-302,271, FILED 10-11-2007.

PETER B. BROMAGHIM, EXAMINING ATTORNEY

**Int. Cl.: 35**

**Prior U.S. Cls.: 100, 101 and 102**

**United States Patent and Trademark Office**

**Reg. No. 3,466,368**

**Registered July 15, 2008**

**SERVICE MARK  
PRINCIPAL REGISTER**

**BALSAM HILL**

RED SLATE BRANDS, INC. (BR.VIRGIN ISLANDS CORPORATION)  
TRINITY CHAMBERS, P.O. BOX 4301  
ROAD TOWN, BR.VIRGIN ISLANDS

FOR: ON-LINE RETAIL STORE SERVICES FEATURING HOUSEHOLD DECORATIONS, DECORATING ACCESSORIES, AND HOLIDAY DECORATIONS, CONSISTING OF ARTIFICIAL TREES AND PLANTS, ARTIFICIAL CHRISTMAS TREES, GARLAND, WREATHS, ORNAMENTS AND HOLIDAY LIGHTS; RETAIL STORE SERVICES FEATURING HOUSEHOLD DECORATIONS, DECORATING ACCESSORIES, AND HOLIDAY DECORATIONS, CONSISTING OF ARTIFICIAL TREES AND PLANTS, ARTIFICIAL CHRISTMAS TREES, GARLAND, WREATHS, ORNAMENTS

AND HOLIDAY LIGHTS, IN CLASS 35 (U.S. CLS. 100, 101 AND 102).

FIRST USE 10-1-2006; IN COMMERCE 10-1-2006.

THE MARK CONSISTS OF STANDARD CHARACTERS WITHOUT CLAIM TO ANY PARTICULAR FONT, STYLE, SIZE, OR COLOR.

NO CLAIM IS MADE TO THE EXCLUSIVE RIGHT TO USE "BALSAM", APART FROM THE MARK AS SHOWN.

SER. NO. 77-302,628, FILED 10-12-2007.

MARIAM MAHMOUDI, EXAMINING ATTORNEY

**Int. Cl.: 40**

**Prior U.S. Cls.: 100, 103 and 106**

**United States Patent and Trademark Office**

**Reg. No. 3,466,369**

**Registered July 15, 2008**

**SERVICE MARK  
PRINCIPAL REGISTER**

**CASTLE METALS**

A.M. CASTLE & CO. (MARYLAND CORPORATION)

3400 NORTH WOLF RD.

FRANKLIN PARK, IL 60131

FOR: METAL TREATMENT, FABRICATION, AND FINISHING SERVICES IN THE AEROSPACE, MANUFACTURING, AND OIL AND GAS INDUSTRY EQUIPMENT FIELDS, IN CLASS 40 (U.S. CLS. 100, 103 AND 106).

FIRST USE 1-1-1891; IN COMMERCE 10-12-1991.

THE MARK CONSISTS OF STANDARD CHARACTERS WITHOUT CLAIM TO ANY PARTICULAR FONT, STYLE, SIZE, OR COLOR.

OWNER OF U.S. REG. NOS. 1,009,462, 2,130,876 AND OTHERS.

NO CLAIM IS MADE TO THE EXCLUSIVE RIGHT TO USE "METALS", APART FROM THE MARK AS SHOWN.

SER. NO. 77-302,911, FILED 10-12-2007.

MICHAEL GAAFAR, EXAMINING ATTORNEY

**Int. Cl.: 40**

**Prior U.S. Cls.: 100, 103 and 106**

**United States Patent and Trademark Office**

**Reg. No. 3,466,370**

**Registered July 15, 2008**

**SERVICE MARK  
PRINCIPAL REGISTER**

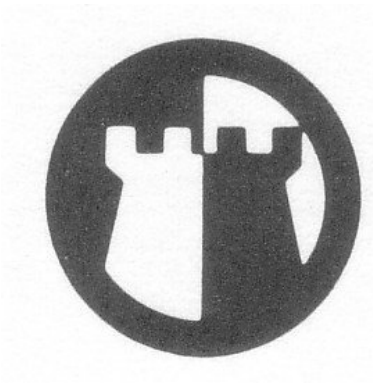

A.M. CASTLE & CO. (MARYLAND CORPORATION)  
3400 NORTH WOLF ROAD  
FRANKLIN PARK, IL 60131

OWNER OF U.S. REG. NOS. 1,009,462, 1,509,629  
AND OTHERS.

FOR: METAL TREATMENT, FABRICATION,  
AND FINISHING SERVICES IN THE AEROSPACE,  
MANUFACTURING, AND OIL AND GAS INDUSTRY  
EQUIPMENT FIELDS, IN CLASS 40 (U.S. CLS.  
100, 103 AND 106).

THE MARK CONSISTS OF IMAGE OF A CASTLE  
TURRET OR 'ROOK' CHESS PIECE.

SER. NO. 77-303,050, FILED 10-12-2007.

FIRST USE 8-16-1976; IN COMMERCE 10-12-1991.

MICHAEL GAAFAR, EXAMINING ATTORNEY

**Int. Cl.: 32**

**Prior U.S. Cls.: 45, 46 and 48**

**United States Patent and Trademark Office**

**Reg. No. 3,466,371**

**Registered July 15, 2008**

**TRADEMARK  
PRINCIPAL REGISTER**

**CAPTAIN MORGAN**

DIAGEO NORTH AMERICA, INC. (CONNECTI-  
CUT CORPORATION)  
801 MAIN AVENUE  
NORWALK, CT 06851

FOR: BREWED MALT-BASED ALCOHOLIC BEV-  
ERAGE IN THE NATURE OF A BEER, IN CLASS 32  
(U.S. CLS. 45, 46 AND 48).

FIRST USE 4-1-2006; IN COMMERCE 4-1-2006.

THE MARK CONSISTS OF STANDARD CHAR-  
ACTERS WITHOUT CLAIM TO ANY PARTICULAR  
FONT, STYLE, SIZE, OR COLOR.

OWNER OF U.S. REG. NOS. 972,985, 3,159,948 AND  
OTHERS.

THE NAME(S), PORTRAIT(S), AND/OR SIGNA-  
TURE(S) SHOWN IN THE MARK DOES NOT IDENTI-  
FY A PARTICULAR LIVING INDIVIDUAL.

SER. NO. 77-303,060, FILED 10-12-2007.

RON FAIRBANKS, EXAMINING ATTORNEY

**Int. Cl.: 9**

**Prior U.S. Cls.: 21, 23, 26, 36 and 38**

**United States Patent and Trademark Office**

**Reg. No. 3,466,372**

**Registered July 15, 2008**

**TRADEMARK  
PRINCIPAL REGISTER**



ZINWELL CORPORATION (TAIWAN CORPORATION)  
7F, NO. 512  
YUAN SHAN ROAD, CHUNG HO CITY  
TAIPEI HSIEN, TAIWAN

FOR: LIQUID CRYSTAL DISPLAY; FIBER OPTICAL SIGNAL RECEIVER; SET-TOP-BOX FOR TV (INTERNET/TV BOX), IN CLASS 9 (U.S. CLS. 21, 23, 26, 36 AND 38).

FIRST USE 4-2-2007; IN COMMERCE 4-14-2007.

THE COLOR(S) RED, GREEN, YELLOW AND BLUE IS/ARE CLAIMED AS A FEATURE OF THE MARK.

THE MARK CONSISTS OF THE STYLIZED LETTERS "ZINTV" HAVING A RED DOT OVER THE "I" AND FOUR SQUARE LIKE CONTOURS ADJACENT THE STYLIZED "V", WITH THE SQUARE CONTOURS HAVING THE COLORS GREEN, YELLOW, BLUE, AND RED.

SER. NO. 77-303,209, FILED 10-12-2007.

JANICE L. MCMORROW, EXAMINING ATTORNEY



**Int. Cl.: 41**

**Prior U.S. Cls.: 100, 101 and 107**

**United States Patent and Trademark Office**

**Reg. No. 3,466,373**

**Registered July 15, 2008**

**SERVICE MARK  
PRINCIPAL REGISTER**



LEROY'S HORSE AND SPORTS PLACE (NEVADA CORPORATION)  
675 GRIER DRIVE  
LAS VEGAS, NV 89119

FOR: ENTERTAINMENT SERVICES, NAMELY, AN ON-GOING SERIES FEATURING SPORTS AND BETTING INFORMATION PROVIDED THROUGH WEBCASTS, RADIO BROADCASTS AND PODCASTS, IN CLASS 41 (U.S. CLS. 100, 101 AND 107).

FIRST USE 7-0-2006; IN COMMERCE 7-0-2006.

OWNER OF U.S. REG. NOS. 2,143,897 AND 2,148,537.

NO CLAIM IS MADE TO THE EXCLUSIVE RIGHT TO USE "SPORTS HOUR", APART FROM THE MARK AS SHOWN.

THE MARK CONSISTS OF THE WORD "LEROY'S" WITH HORIZONTAL LINES SUGGESTING MOVEMENT OVER THE WORDS "SPORTS HOUR!" SUPERIMPOSED OVER A MICROPHONE.

SER. NO. 77-303,278, FILED 10-12-2007.

MARLENE BELL, EXAMINING ATTORNEY

Int. Cls.: 25 and 28

Prior U.S. Cls.: 22, 23, 38, 39 and 50

Reg. No. 3,466,374

United States Patent and Trademark Office

Registered July 15, 2008

TRADEMARK  
PRINCIPAL REGISTER



PURIK LTD. (SAMOA CORPORATION)  
PORTCULLIS TRUSTNET CHAMBERS  
P.O. BOX 1225  
APIA, SAMOA

FOR: ATHLETIC UNIFORMS; BABUSHKAS; BELTS; BELTS OF TEXTILE; BLOUSONS; BODY SHAPERS; BODY SUITS; BOTTOMS; CAMISOLES; CAPELETS; CAPES; CAPS; CARGO PANTS; COATS; COATS FOR MEN AND WOMEN; COATS MADE OF COTTON; COATS OF DENIM; COMBINATIONS; DRESS SHIRTS; DRESS SUITS; DRESSES; FABRIC BELTS; FLIP FLOPS; FOAM PEDICURE SLIPPERS; FOOTWEAR; FOOTWEAR FOR MEN; FOOTWEAR FOR TRACK AND FIELD ATHLETICS; FOOTWEAR FOR WOMEN; GIRDLES; GLOVES; GYM SHORTS; GYM SUITS; GYMNASTIC SHOES; HEAD SWEAT-BANDS; HEADBANDS; HEADBANDS AGAINST SWEATING; HEADWEAR; HOSIERY; JACKETS; JERSEYS; JOGGING OUTFITS; JOGGING PANTS; JOGGING SUITS; LADIES' SUITS; LEOTARDS; LEOTARDS AND TIGHTS FOR WOMEN, MEN AND CHILDREN OF NYLON, COTTON OR OTHER TEXTILE FIBERS; LIVERIES; LONG JACKETS; LONG SLEEVED VESTS; LONG-SLEEVED SHIRTS; LOUNGE PANTS; LOUNGEWEAR; MAILLOTS; MEN AND WOMEN JACKETS, COATS, TROUSERS, VESTS; MEN'S SOCKS; MEN'S SUITS; WOMEN'S SUITS; NEGLIGEEES; ONE-PIECE PLAY SUITS; OVER COATS; OVERALLS; OVERCOATS; PANTALOONS; PANTIES, SHORTS AND BRIEFS; PANTS; PANTSUITS; PANTYHOSE; PARKAS; PARTS OF CLOTHING, NAMELY, GUSSETS FOR TIGHTS, GUSSETS FOR STOCKINGS, GUSSETS FOR BATHING SUITS, GUSSETS FOR UNDERWEAR, GUSSETS FOR LEOTARDS AND GUSSETS FOR

FOOTLETS; PEDAL PUSHERS; PLAY SUITS; POLO SHIRTS; PONCHOS; PULLOVERS; ROBES; ROMPERS; RUBBERS; SASHES; SCARVES; SCHOOL UNIFORMS; SERAPES; SHAWLS; SHAWLS AND HEADSCARVES; SHAWLS AND STOLEES; SHIRTS; SHIRTS FOR SUITS; SHORT TROUSERS; SHORTS; SHORT-SLEEVED OR LONG-SLEEVED T-SHIRTS; SHORT-SLEEVED SHIRTS; SHOULDER SCARVES; SHOULDER WRAPS; SHOWER CAPS; SHRUGS; SLACKS; SLEEVED OR SLEEVELESS JACKETS; SLEEVELESS JERSEYS; SMOCKS; SOCKS; SOCKS AND STOCKINGS; SPORT COATS; SPORT SHIRTS; SPORTS BRA; SPORTS JACKETS; SPORTS JERSEYS; SPORTS JERSEYS AND BREECHES FOR SPORTS; SPORTS OVERUNIFORMS; SPORTS SHIRTS; SPORTS SHIRTS WITH SHORT SLEEVES; STOCKINGS; STOLEES; SWEAT BANDS; SWEAT PANTS; SWEAT SHIRTS; SWEAT SHORTS; SWEAT SUITS; SWEATBANDS; SWEATSOCKS; TANK TOPS; TEDDIES; TEE SHIRTS; TIGHTS; TOPCOATS; TOPS; TRACK PANTS; TRACK SUITS; TRAINING SUITS; TROUSERS; TROUSERS FOR SWEATING; TRUNKS; TUNICS; T-SHIRTS; UNIFORMS; UNITARDS; VESTS; WAIST BELTS; WAISTBANDS; WAISTCOATS; WALKING SHORTS; WARM UP SUITS; YOGA PANTS; YOGA SHIRTS; CLOTHING, NAMELY, BLOUSES, COVER-UPS, JUMP SUITS, LEG WARMERS, LEGGINGS, PAJAMAS, PANTS, SKIRTS, SWEATERS, UNDERWEAR, VESTS, ARM WARMERS, HAND-WARMERS, KNEE WARMERS AND WRAP-AROUNDS; GLOVES FOR MEN, WOMEN, AND CHILDREN; CLOTHING ACCESSORIES, NAMELY, EAR MUFFS AND GAITERS; HEADGEAR, NAMELY, BANDANAS, BERETS, HATS, TOQUES AND VISORS; FOOTWEAR, NAMELY, BOOTS, CASUAL SHOES, DANCE

SHOES, SANDALS, SHOES, SLIPPERS AND SPORTS SHOES, IN CLASS 25 (U.S. CLS. 22 AND 39).

FIRST USE 4-27-2005; IN COMMERCE 4-26-2007.

FOR: ANKLE AND WRIST WEIGHTS FOR EXERCISE; ATHLETIC EQUIPMENT, NAMELY TRAINING DEVICES TO BE WORN ON THE BODY FOR SUPPORT; ATHLETIC SPORTING GOODS, NAMELY, ATHLETIC WRIST AND JOINT SUPPORTS; BAGS SPECIALLY ADAPTED FOR SPORTS EQUIPMENT; BALLS FOR GAMES; BARBELLS; BAR-BELLS FOR WEIGHT LIFTING; BOXING GLOVES; DUMBBELL SETS; DUMBBELLS; DUMBBELLS FOR WEIGHT LIFTING; EXERCISE BALLS; EXERCISE BARS; EXERCISE EQUIPMENT, NAMELY, CHEST EXPANDERS, CHEST PULLS, SHOULDER STRETCHER USING RESISTANCE CABLES, SHOULDER STRETCHER USING A CABLE AND PULLEYS; EXERCISE WEIGHT CUFFS; EXERCISE WEIGHTS; EXERCISE WRIST WEIGHTS; EXERCISING PULLEYS; JUMP ROPES; PERSONAL EXERCISE MATS; RUBBER ACTION BALLS; RUBBER BALLS; SHIN PADS FOR ATHLETIC USE; SPORT BALLS; STRESS RELIEF BALLS FOR HAND EX-

ERCISE; WORK-OUT GLOVES; WRIST AND ANKLE WEIGHTS FOR EXERCISE; YOGA MATS, IN CLASS 28 (U.S. CLS. 22, 23, 38 AND 50).

FIRST USE 4-27-2005; IN COMMERCE 4-26-2007.

NO CLAIM IS MADE TO THE EXCLUSIVE RIGHT TO USE "YOGA", APART FROM THE MARK AS SHOWN.

THE COLOR(S) BLACK, GREY, NAVY BLUE, BLUE, GREEN, YELLOW, ORANGE, RED IS/ARE CLAIMED AS A FEATURE OF THE MARK.

THE MARK CONSISTS OF THE WORDING "AGGY" WHEREIN THE LETTERS "A", "G" AND "Y" ARE IN BLACK AND THE LETTER "O" IS REPRESENTED BY A GREEN CIRCLE AND A COLUMN OF CIRCLES IN GREY, NAVY BLUE, BLUE, YELLOW, ORANGE AND RED.

SER. NO. 77-303,400, FILED 10-12-2007.

MELISSA VALLILLO, EXAMINING ATTORNEY

**Int. Cl.: 36**

**Prior U.S. Cls.: 100, 101 and 102**

**United States Patent and Trademark Office**

**Reg. No. 3,466,375**

**Registered July 15, 2008**

**SERVICE MARK  
PRINCIPAL REGISTER**



SANFORD HEALTH (SOUTH DAKOTA NON-  
PROFIT CORPORATION)  
1305 W. 18TH STREET  
SIOUX FALLS, SD 571175039

FOR: HEALTH INSURANCE IN THE NATURE  
OF HEALTH CARE INDEMNITY INSURANCE;  
INSURANCE CLAIMS ADMINISTRATION, IN  
CLASS 36 (U.S. CLS. 100, 101 AND 102).

FIRST USE 0-0-1998; IN COMMERCE 0-0-1998.

OWNER OF U.S. REG. NO. 2,627,383.

THE MARK CONSISTS OF A DESIGN OF A  
HEART WITH AN EMBEDDED LORRAINE CROSS  
AND A CHEVRON BENEATH IT.

SER. NO. 77-303,467, FILED 10-13-2007.

MICHAEL WIENER, EXAMINING ATTORNEY

**Int. Cl.: 39**

**Prior U.S. Cls.: 100 and 105**

**United States Patent and Trademark Office**

**Reg. No. 3,466,376**

**Registered July 15, 2008**

**SERVICE MARK  
PRINCIPAL REGISTER**



SANFORD HEALTH (SOUTH DAKOTA NON-  
PROFIT CORPORATION)  
1305 W. 18TH STREET  
SIOUX FALLS, SD 571175039

FOR: ELECTRONIC STORAGE AND RETRIEVAL  
OF PERSONAL HEALTH DATA AND MEDICAL  
RECORDS, IN CLASS 39 (U.S. CLS. 100 AND 105).

FIRST USE 0-0-2004; IN COMMERCE 0-0-2004.

OWNER OF U.S. REG. NO. 2,627,383.

THE MARK CONSISTS OF A DESIGN OF A  
HEART WITH AN EMBEDDED LORRAINE CROSS  
AND A CHEVRON BENEATH IT.

SER. NO. 77-303,468, FILED 10-13-2007.

MICHAEL WIENER, EXAMINING ATTORNEY

Int. Cl.: 31

Prior U.S. Cls.: 1 and 46

United States Patent and Trademark Office

Reg. No. 3,466,377

Registered July 15, 2008

TRADEMARK  
PRINCIPAL REGISTER



LENTZ, KIRK, L. (UNITED STATES INDIVIDUAL)

310 S. TWIN OAKS VALLEY RD.  
SAN MARCOS, CA 92078

FOR: DOGS, IN CLASS 31 (U.S. CLS. 1 AND 46).

FIRST USE 9-14-2007; IN COMMERCE 9-14-2007.

NO CLAIM IS MADE TO THE EXCLUSIVE RIGHT TO USE "DOG" AND "PROFESSIONAL PET PRODUCT SERVICES", APART FROM THE MARK AS SHOWN.

THE COLOR(S) RED, WHITE, BLUE, BLACK AND BROWN IS/ARE CLAIMED AS A FEATURE OF THE MARK.

THE MARK CONSISTS OF ALL LETTERING IS IN BLACK, TOP LINE IS RED, BOTTOM LINE IS BLUE, DOG IS BROWN WITH A RED TONGUE, WITH A BLACK NOSE AND BLACK HIGHLIGHTS, ALL ON A WHITE BACK DROP.

SER. NO. 77-303,595, FILED S.R. 10-14-2007 AM.  
P.R. 2-15-2008.

ADA HAN, EXAMINING ATTORNEY

**Int. Cl.: 39**

**Prior U.S. Cls.: 100 and 105**

**United States Patent and Trademark Office**

**Reg. No. 3,466,378**

**Registered July 15, 2008**

**SERVICE MARK  
PRINCIPAL REGISTER**

# LateralG

SPROUSE, MICHAEL J (UNITED STATES INDIVIDUAL)  
3823 MARWICK AVE.  
LONG BEACH, CA 90808

FOR: PROVIDING ROAD AND TRAFFIC INFORMATION; PROVIDING AN ON-LINE COMPUTER DATABASE IN THE FIELD OF TRAVEL INFORMATION SERVICES, IN CLASS 39 (U.S. CLS. 100 AND 105).

FIRST USE 2-1-2003; IN COMMERCE 8-1-2007.

THE MARK CONSISTS OF STANDARD CHARACTERS WITHOUT CLAIM TO ANY PARTICULAR FONT, STYLE, SIZE, OR COLOR.

SER. NO. 77-303,622, FILED 10-14-2007.

KATHERINE E. HALMEN, EXAMINING ATTORNEY

**Int. Cl.: 16**

**Prior U.S. Cls.: 2, 5, 22, 23, 29, 37, 38 and 50**

**Reg. No. 3,466,379**

**United States Patent and Trademark Office**

**Registered July 15, 2008**

**TRADEMARK  
PRINCIPAL REGISTER**

**AMERICA'S #1 SERIES FOR  
MAXIMUM CHILLS!**

AUDIOCRAFT PUBLISHING, INC. (MICHIGAN  
CORPORATION)  
P.O. BOX 281  
TOPINABEE ISLAND, MI 49791

THE MARK CONSISTS OF STANDARD CHAR-  
ACTERS WITHOUT CLAIM TO ANY PARTICULAR  
FONT, STYLE, SIZE, OR COLOR.

FOR: PUBLICATIONS, NAMELY, BOOKS FEATURING FICTION STORIES IN THE FIELD OF MYSTERIES, IN CLASS 16 (U.S. CLS. 2, 5, 22, 23, 29, 37, 38 AND 50).

SER. NO. 77-303,926, FILED 10-15-2007.

FIRST USE 12-1-2003; IN COMMERCE 12-1-2003.

JUSTINE D. PARKER, EXAMINING ATTORNEY



**Int. Cls.: 35 and 36**

**Prior U.S. Cls.: 100, 101 and 102**

**United States Patent and Trademark Office**

**Reg. No. 3,466,380**

**Registered July 15, 2008**

**SERVICE MARK  
PRINCIPAL REGISTER**

# One Person Group

LEVY, JOEL (UNITED STATES INDIVIDUAL)  
APT. 15C  
401 EAST 80TH STREET  
NEW YORK, NY 10075

FOR: BUSINESS ADMINISTRATION SERVICES PROVIDED TO SELF-EMPLOYED PERSONS, SMALL BUSINESSES, INDIVIDUALS AND LIKE OTHERS, NAMELY, ADMINISTRATION OF HUMAN RESOURCES, IN CLASS 35 (U.S. CLS. 100, 101 AND 102).

FIRST USE 7-1-2007; IN COMMERCE 7-1-2007.

FOR: INSURANCE BROKERAGE, NAMELY, BROKERAGE OF GROUP MEDICAL INSURANCE FOR SELF-EMPLOYED PERSONS, SMALL BUSINESSES, INDIVIDUALS AND LIKE OTHERS, THROUGH CONSOLIDATION OF SUCH PEOPLE AND BUSINESSES SO THAT THEY QUALIFY FOR GROUP MEDICAL INSURANCE BENEFITS; AND PROVISION OF OTHER GROUP BENEFITS, NAMELY, ADMINISTRATION OF DISABILITY INSUR-

ANCE, ADMINISTRATION OF 401K PLANS AND FLEXIBLE SPENDING ACCOUNTS, ALL FOR SELF-EMPLOYED PERSONS, SMALL BUSINESSES, INDIVIDUALS AND LIKE OTHERS, THROUGH CONSOLIDATION OF SUCH PEOPLE AND BUSINESSES SO THAT THEY QUALIFY FOR GROUP BENEFITS, IN CLASS 36 (U.S. CLS. 100, 101 AND 102).

FIRST USE 7-1-2007; IN COMMERCE 7-1-2007.

THE MARK CONSISTS OF STANDARD CHARACTERS WITHOUT CLAIM TO ANY PARTICULAR FONT, STYLE, SIZE, OR COLOR.

NO CLAIM IS MADE TO THE EXCLUSIVE RIGHT TO USE "GROUP", APART FROM THE MARK AS SHOWN.

SER. NO. 77-303,973, FILED 10-15-2007.

ANDREA K. NADELMAN, EXAMINING ATTORNEY

**Int. Cl.: 39**

**Prior U.S. Cls.: 100 and 105**

**United States Patent and Trademark Office**

**Reg. No. 3,466,381**

**Registered July 15, 2008**

**SERVICE MARK  
PRINCIPAL REGISTER**



PARACO GAS CORPORATION (NEW YORK CORPORATION)  
2975 WESTCHESTER AVENUE  
PURCHASE, NY 10577

FOR: GAS SUPPLYING, IN CLASS 39 (U.S. CLS. 100 AND 105).

FIRST USE 8-30-1999; IN COMMERCE 8-30-1999.

NO CLAIM IS MADE TO THE EXCLUSIVE RIGHT TO USE "GAS" , APART FROM THE MARK AS SHOWN.

THE COLOR(S) RED, WHITE AND BLUE IS/ARE CLAIMED AS A FEATURE OF THE MARK.

THE MARK CONSISTS OF A STYLIZED LETTER "P," WHICH HAS A BLUE UPPER PORTION WITH A WHITE STAR FORMING THE OPENING IN THE UPPER PORTION OF THE "P," AND A LOWER PORTION FORMED BY CURVED RED AND WHITE STRIPES; FOLLOWED BY "PARACO" IN FORWARD SLANTING BLUE BLOCK LETTERS; BELOW THE "CO" IN "PARACO" IS THE WORD "GAS" IN SMALLER FORWARD SLANTING BLUE BLOCK LETTERS; A RED HORIZONTAL LINE RUNS UNDER THE "P PARA" PORTION OF THE MARK AND ENDS JUST BEFORE THE "CO" IN "PARACO" AND JUST BEFORE IT MEETS THE WORD, "GAS" .

SER. NO. 77-304,128, FILED 10-15-2007.

STEVEN PEREZ, EXAMINING ATTORNEY

Int. Cl.: 25

Prior U.S. Cls.: 22 and 39

United States Patent and Trademark Office

Reg. No. 3,466,382

Registered July 15, 2008

TRADEMARK  
PRINCIPAL REGISTER

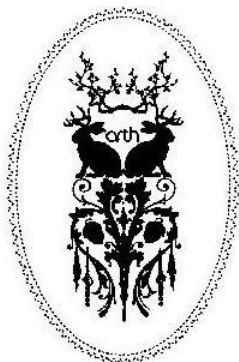

SUNRIC USA, INC. (CALIFORNIA CORPORATION)  
SUITE #A108  
THE LAB 2930 BRISTOL STREET  
COSTA MESA, CA 92626

FOR: KNITWEAR, NAMELY, KNIT SHIRTS, KNITTED CAPS, KNITTED HATS, KNITTED UNDERWEAR; T-SHIRTS; JERSEYS; SPORT COATS; SPORT SHIRTS; POLO SHIRTS; SWEAT SHIRTS; SWEAT PANTS; SWEAT SUITS; BANDANAS; MUFFLERS; EAR MUFFS; GLOVES; SOCKS; HEADGEAR, NAMELY, HATS AND CAPS; BERETS; VISORS; SUN VISORS; HEADBANDS, IN CLASS 25 (U.S. CLS. 22 AND 39).

FIRST USE 6-1-2007; IN COMMERCE 6-5-2007.

OWNER OF U.S. REG. NO. 3,294,436.

THE MARK CONSISTS OF THE DESIGN OF TWO JACKALOPES WITH ANTLERS PROTRUDING FROM THEIR HEADS THAT ARE FACING AWAY FROM EACH OTHER. THE WORDING "ARTH" APPEARS BETWEEN THE JACKALOPES AND THE JACKALOPES APPEAR ABOVE A HEART-SHAPED DESIGN THAT IS FORMED BY LEAVES AND BRANCHES WITH TWO ACORNS APPEARING INSIDE OF THE HEART DESIGN. ALL OF THE AFOREMENTIONED APPEAR WITHIN A DECORATIVE OVAL BORDER.

SER. NO. 77-304,307, FILED 10-15-2007.

AMY MCMENAMIN, EXAMINING ATTORNEY

**Int. Cl.: 5**

**Prior U.S. Cls.: 6, 18, 44, 46, 51 and 52**

**Reg. No. 3,466,383**

**United States Patent and Trademark Office**

**Registered July 15, 2008**

---

**TRADEMARK  
PRINCIPAL REGISTER**

**STAT-PREP**

BIOMED PACKAGING SYSTEMS, INC (DELA-  
WARE CORPORATION)  
100 PEARL STREET  
NORWALK, CT 06850

THE MARK CONSISTS OF STANDARD CHAR-  
ACTERS WITHOUT CLAIM TO ANY PARTICULAR  
FONT, STYLE, SIZE, OR COLOR.

FOR: PRE-OPERATIVE APPLICATORS IMPREG-  
NATED WITH ANTISEPTIC SOLUTION FOR PRE-  
PARATION OF SKIN PRIOR TO SURGERY, IN  
CLASS 5 (U.S. CLS. 6, 18, 44, 46, 51 AND 52).

SER. NO. 77-304,416, FILED 10-15-2007.

FIRST USE 4-3-2007; IN COMMERCE 4-3-2007.

PATRICIA EVANKO, EXAMINING ATTORNEY

**Int. Cl.: 3**

**Prior U.S. Cls.: 1, 4, 6, 50, 51 and 52**

**Reg. No. 3,466,384**

**United States Patent and Trademark Office**

**Registered July 15, 2008**

**TRADEMARK  
PRINCIPAL REGISTER**

**SEWER SOLVE**

COMMERCIAL MAINTENANCE CHEMICAL  
(NEW YORK CORPORATION)  
4190 SUNRISE HWY  
MASSAPEQUA, NY 11758

FOR: CHEMICAL USED TO CLEAN OUT AND  
DEGREASE DRAIN LINES AND SEWER LINES, IN  
CLASS 3 (U.S. CLS. 1, 4, 6, 50, 51 AND 52).

FIRST USE 12-1-2006; IN COMMERCE 12-1-2006.

THE MARK CONSISTS OF STANDARD CHAR-  
ACTERS WITHOUT CLAIM TO ANY PARTICULAR  
FONT, STYLE, SIZE, OR COLOR.

NO CLAIM IS MADE TO THE EXCLUSIVE  
RIGHT TO USE "SEWER", APART FROM THE  
MARK AS SHOWN.

SER. NO. 77-304,630, FILED 10-15-2007.

KYLE PEETE, EXAMINING ATTORNEY

**Int. Cl.: 5**

**Prior U.S. Cls.: 6, 18, 44, 46, 51 and 52**

**Reg. No. 3,466,385**

**United States Patent and Trademark Office**

**Registered July 15, 2008**

---

**TRADEMARK  
PRINCIPAL REGISTER**

**IMMUNE SOOTHERS**

JARROW FORMULAS, INC. (CALIFORNIA CORPORATION)  
1824 SOUTH ROBERTSON BLVD.  
LOS ANGELES, CA 900354317

FOR: DIETARY AND NUTRITIONAL SUPPLEMENTS, IN CLASS 5 (U.S. CLS. 6, 18, 44, 46, 51 AND 52).

FIRST USE 11-30-2007; IN COMMERCE 11-30-2007.

THE MARK CONSISTS OF STANDARD CHARACTERS WITHOUT CLAIM TO ANY PARTICULAR FONT, STYLE, SIZE, OR COLOR.

NO CLAIM IS MADE TO THE EXCLUSIVE RIGHT TO USE "IMMUNE", APART FROM THE MARK AS SHOWN.

SER. NO. 77-304,654, FILED 10-15-2007.

JAMES STEIN, EXAMINING ATTORNEY

**Int. Cl.: 45**

**Prior U.S. Cls.: 100 and 101**

**United States Patent and Trademark Office**

**Reg. No. 3,466,386**

**Registered July 15, 2008**

**SERVICE MARK  
PRINCIPAL REGISTER**



GKL RESIDENT AGENTS/FILINGS, INC. (NEVADA CORPORATION)  
1000 E WILLIAM STREET, SUITE 204  
CARSON CITY, NV 89701

FOR: PUBLIC DOCUMENT FILING, SEARCH AND RETRIEVAL; PROVIDING INFORMATION ON PUBLIC DOCUMENT FILING, SEARCHING AND RETRIEVAL VIA A WEB SITE; AUTHENTICATION AND CERTIFICATION OF ANNUAL PUBLICLY FILED DOCUMENTS, POWERS OF ATTORNEY, GOVERNMENT DOCUMENTS AND STATUTORY CORPORATE COMPLIANCE DOCUMENTS; PROVIDING INFORMATION ABOUT AUTHENTICATION AND CERTIFICATION OF ANNUAL PUBLICLY FILED DOCUMENTS, POWERS OF ATTORNEY, GOVERNMENT DOCUMENTS AND STATUTORY CORPORATE COMPLIANCE DOCUMENTS; REGISTRATION OF DOMAIN NAMES FOR IDENTIFICATION OF BUSINESS USERS ON A GLOBAL COMPUTER NETWORK; RESIDENT AGENT REPRESENTATION SERVICES, NAMELY, ACTING AS AGENTS FOR

RECEIPT OF PROCESS SERVICE; PROVIDING REGISTRATION OF DOMAIN NAMES FOR IDENTIFICATION OF BUSINESS USERS ON A GLOBAL COMPUTER NETWORK VIA A WEB SITE; RESIDENT AGENT REPRESENTATION SERVICES, NAMELY, ACTING AS AGENTS FOR RECEIPT OF PROCESS SERVICES VIA A WEB SITE, IN CLASS 45 (U.S. CLS. 100 AND 101).

FIRST USE 2-28-2006; IN COMMERCE 2-28-2006.

OWNER OF U.S. REG. NOS. 3,275,059 AND 3,288,161.

THE MARK CONSISTS OF THE LETTERS "GKL" WITHIN A RECTANGLE BORDER AND INCLUDES A STYLIZED PAPER DESIGN ELEMENT.

SER. NO. 77-304,962, FILED 10-16-2007.

MARILYN IZZI, EXAMINING ATTORNEY

**Int. Cl.: 16**

**Prior U.S. Cls.: 2, 5, 22, 23, 29, 37, 38 and 50**

**United States Patent and Trademark Office**

**Reg. No. 3,466,387**

**Registered July 15, 2008**

**TRADEMARK  
PRINCIPAL REGISTER**

# Humanbook

HUMANBOOK, INC. (DELAWARE CORPORATION)  
PO BOX 81362  
WELLESLEY HILLS, MA 02481

FOR: PRINTED DIRECTORIES, NAMELY, PEOPLE LOCATOR DIRECTORIES, CONTACT DIRECTORIES OF CLASSMATES AND CONTACT DIRECTORIES OF CO-WORKERS; ADDRESS BOOKS, NOTE BOOKS, DIARIES, PHOTOGRAPH ALBUMS, IN CLASS 16 (U.S. CLS. 2, 5, 22, 23, 29, 37, 38 AND 50).

FIRST USE 3-14-2001; IN COMMERCE 3-14-2001.

THE MARK CONSISTS OF STANDARD CHARACTERS WITHOUT CLAIM TO ANY PARTICULAR FONT, STYLE, SIZE, OR COLOR.

SER. NO. 77-304,966, FILED 10-16-2007.

DAYNA BROWNE, EXAMINING ATTORNEY



**Int. Cl.: 35**

**Prior U.S. Cls.: 100, 101 and 102**

**United States Patent and Trademark Office**

**Reg. No. 3,466,388**

**Registered July 15, 2008**

**SERVICE MARK  
PRINCIPAL REGISTER**



ROBERT GANGER (UNITED STATES INDIVIDUAL)  
578 WASHINGTON BLVD., P.O. BOX 274  
MARINA DEL REY, CA 902925442

FOR: FASHION SHOW EXHIBITIONS FOR COMMERCIAL PURPOSES; ARRANGING AND CONDUCTING TRADE SHOW EXHIBITIONS IN THE FIELD OF FASHION, IN CLASS 35 (U.S. CLS. 100, 101 AND 102).

FIRST USE 8-1-2007; IN COMMERCE 8-1-2007.

NO CLAIM IS MADE TO THE EXCLUSIVE RIGHT TO USE "ECO", APART FROM THE MARK AS SHOWN.

THE COLOR(S) GREEN, WHITE, GREY AND PURPLE IS/ARE CLAIMED AS A FEATURE OF THE MARK.

THE MARK CONSISTS OF A GREEN LEAF WITH THE LETTERS "ECO" AND "NOUVEAU" IN PURPLE AGAINST A GREY AND WHITE BACKGROUND.

THE ENGLISH TRANSLATION OF THE WORD "NOUVEAU" IN THE MARK IS "NEW".

SER. NO. 77-304,982, FILED 10-16-2007.

STEVEN R. FINE, EXAMINING ATTORNEY

**Int. Cl.: 39**

**Prior U.S. Cls.: 100 and 105**

**United States Patent and Trademark Office**

**Reg. No. 3,466,389**

**Registered July 15, 2008**

**SERVICE MARK  
PRINCIPAL REGISTER**

**WE FLY FOR YOUR SMILE**

AUSTRIAN AIRLINES AG (AUSTRIA CORPORATION)  
OFFICE PARK 2  
1300 WIEN-FLUGHAFEN  
VIENNA, AUSTRIA

THE MARK CONSISTS OF STANDARD CHARACTERS WITHOUT CLAIM TO ANY PARTICULAR FONT, STYLE, SIZE, OR COLOR.

FOR: TRANSPORTATION OF PASSENGERS AND/OR GOODS BY AIR, IN CLASS 39 (U.S. CLS. 100 AND 105).

SER. NO. 77-305,461, FILED 10-16-2007.

FIRST USE 6-1-2007; IN COMMERCE 10-10-2007.

ALLISON HOLTZ, EXAMINING ATTORNEY

**Int. Cl.: 35**

**Prior U.S. Cls.: 100, 101 and 102**

**United States Patent and Trademark Office**

**Reg. No. 3,466,390**

**Registered July 15, 2008**

**SERVICE MARK  
PRINCIPAL REGISTER**

# The Leads King

RJR COMPUTING SOLUTIONS, INC. (ILLINOIS CORPORATION)  
12102 S. 70TH CT.  
PALOS HEIGHTS, IL 60463

FOR: ADVERTISING AND MARKETING; ADVERTISING, MARKETING AND PROMOTION SERVICES; ADVICE IN THE FIELD OF BUSINESS MANAGEMENT AND MARKETING; BUSINESS CONSULTATION AND MANAGEMENT REGARDING MARKETING ACTIVITIES AND LAUNCHING OF NEW PRODUCTS; BUSINESS MARKETING CONSULTING SERVICES; BUSINESS MARKETING SERVICES; COOPERATIVE ADVERTISING AND MARKETING; COOPERATIVE ADVERTISING AND MARKETING SERVICES BY WAY OF SOLICITATION, CUSTOMER SERVICE AND PROVIDING MARKETING INFORMATION VIA WEBSITES ON A GLOBAL COMPUTER NETWORK; CREATIVE MARKETING DESIGN SERVICES; DEVELOPMENT OF MARKETING STRATEGIES AND CONCEPTS; DIRECT MARKETING ADVERTISING FOR OTHERS; DIRECT MARKETING CONSULTING SERVICES; DIRECT MARKETING SERVICES; MARKETING CONSULTING; MARKETING PLAN

DEVELOPMENT; MARKETING SERVICES, NAMELY PROVIDING INFORMATIONAL WEB PAGES DESIGNED TO GENERATE SALES TRAFFIC VIA HYPERLINKS TO OTHER WEB SITES; ON-LINE ADVERTISING AND MARKETING SERVICES; PROMOTION AND MARKETING SERVICES AND RELATED CONSULTING; PROMOTION, ADVERTISING AND MARKETING OF ON-LINE WEBSITES; PROVIDING BUSINESS MARKETING INFORMATION; PROVIDING INFORMATION IN THE FIELD OF MARKETING AND ON-LINE MARKETING MEDIA VIA THE INTERNET, IN CLASS 35 (U.S. CLS. 100, 101 AND 102).

FIRST USE 10-27-2006; IN COMMERCE 10-27-2006.

THE MARK CONSISTS OF STANDARD CHARACTERS WITHOUT CLAIM TO ANY PARTICULAR FONT, STYLE, SIZE, OR COLOR.

SER. NO. 77-305,642, FILED 10-16-2007.

HOWARD SMIGA, EXAMINING ATTORNEY

**Int. Cl.: 14**

**Prior U.S. Cls.: 2, 27, 28 and 50**

**United States Patent and Trademark Office**

**Reg. No. 3,466,391**

**Registered July 15, 2008**

**TRADEMARK  
PRINCIPAL REGISTER**

**BARELY IN THE BODY**

KIZYS, GINTARE (UNITED STATES INDIVIDUAL)

#311

1112 MONTANA AVENUE  
SANTA MONICA, CA 90403

FOR: BRACELETS; BROOCHES; CHOKERS; COSTUME JEWELRY; DIAMOND JEWELRY; EARRINGS; GEMSTONE JEWELRY; JEWEL PENDANTS; JEWELRY; NECKLACES; PENDANTS; PINS; RINGS, IN CLASS 14 (U.S. CLS. 2, 27, 28 AND 50).

FIRST USE 8-20-2007; IN COMMERCE 8-20-2007.

THE MARK CONSISTS OF STANDARD CHARACTERS WITHOUT CLAIM TO ANY PARTICULAR FONT, STYLE, SIZE, OR COLOR.

SER. NO. 77-305,664, FILED 10-16-2007.

LYDIA BELZER, EXAMINING ATTORNEY

**Int. Cl.: 7**

**Prior U.S. Cls.: 13, 19, 21, 23, 31, 34 and 35**

**Reg. No. 3,466,392**

**United States Patent and Trademark Office**

**Registered July 15, 2008**

---

**TRADEMARK  
PRINCIPAL REGISTER**

**VACULOADER**

MIDWEST INTERNATIONAL STANDARD PRO-  
DUCTS, INC. (DELAWARE CORPORATION)  
105 STOVER ROAD  
CHARLEVOIX, MI 497200438

THE MARK CONSISTS OF STANDARD CHAR-  
ACTERS WITHOUT CLAIM TO ANY PARTICULAR  
FONT, STYLE, SIZE, OR COLOR.

FOR: BULK LOADING MACHINES, NAMELY,  
DUST REMOVAL MACHINE FOR BULK LOADING  
SOLIDS THAT REMOVES DUST, IN CLASS 7 (U.S.  
CLS. 13, 19, 21, 23, 31, 34 AND 35).

SER. NO. 77-305,738, FILED 10-17-2007.

FIRST USE 11-2-1993; IN COMMERCE 11-2-1993.

DANIEL CAPSHAW, EXAMINING ATTORNEY

**Int. Cl.: 35**

**Prior U.S. Cls.: 100, 101 and 102**

**United States Patent and Trademark Office**

**Reg. No. 3,466,393**

**Registered July 15, 2008**

**SERVICE MARK  
PRINCIPAL REGISTER**

**CAVENDER'S WESTERN  
OUTFITTER**

CAVENDER INVESTMENT PROPERTIES, LTD.  
(TEXAS PARTNERSHIP)  
2019 WSW LOOP 323  
TYLER, TX 75701

FOR: RETAIL STORES FEATURING CLOTHING,  
BOOTS, HATS, BELTS AND ACCESSORIES, IN  
CLASS 35 (U.S. CLS. 100, 101 AND 102).

FIRST USE 7-30-1998; IN COMMERCE 7-30-1998.

THE MARK CONSISTS OF STANDARD CHAR-  
ACTERS WITHOUT CLAIM TO ANY PARTICULAR  
FONT, STYLE, SIZE, OR COLOR.

OWNER OF U.S. REG. NO. 3,209,200.

NO CLAIM IS MADE TO THE EXCLUSIVE  
RIGHT TO USE "WESTERN OUTFITTER", APART  
FROM THE MARK AS SHOWN.

SEC. 2(F).

SER. NO. 77-305,811, FILED 10-17-2007.

RICHARD WHITE, EXAMINING ATTORNEY

**Int. Cl.: 36**

**Prior U.S. Cls.: 100, 101 and 102**

**United States Patent and Trademark Office**

**Reg. No. 3,466,394**

**Registered July 15, 2008**

**SERVICE MARK  
PRINCIPAL REGISTER**

**BENESOLV**

NEACE & ASSOCIATES INSURANCE AGENCY  
OF OHIO, INC. (OHIO CORPORATION)  
SUITE 1100  
895 CENTRAL AVENUE  
CINCINNATI, OH 45202

THE MARK CONSISTS OF STANDARD CHAR-  
ACTERS WITHOUT CLAIM TO ANY PARTICULAR  
FONT, STYLE, SIZE, OR COLOR.

FOR: ADMINISTRATION OF EMPLOYEE BENE-  
FIT PLANS, NAMELY, HEALTHCARE BENEFIT  
PLANS, IN CLASS 36 (U.S. CLS. 100, 101 AND 102).

SER. NO. 77-305,817, FILED 10-17-2007.

FIRST USE 10-0-2006; IN COMMERCE 10-0-2006.

ROBERT C. CLARK JR., EXAMINING ATTORNEY

**Int. Cl.: 9**

**Prior U.S. Cls.: 21, 23, 26, 36 and 38**

**Reg. No. 3,466,395**

**United States Patent and Trademark Office**

**Registered July 15, 2008**

**TRADEMARK  
PRINCIPAL REGISTER**

# MilMetrix

PELLERIN MILNOR CORPORATION (LOUISIANA CORPORATION)  
700 JACKSON STREET  
KENNER, LA 70062

FOR: COMPUTER SOFTWARE FOR MONITORING REAL TIME OF LAUNDRY EQUIPMENT SYSTEM PERFORMANCE, MEASURING ACTUAL PERFORMANCE AGAINST BENCHMARKS AND PROVIDING A GRAPHICAL DISPLAY FOR INSTANT VIEW OF ENTIRE PRODUCTION SYSTEM STATUS AND PERFORMANCE, IN CLASS 9 (U.S. CLS. 21, 23, 26, 36 AND 38).

FIRST USE 5-9-2007; IN COMMERCE 5-9-2007.

THE MARK CONSISTS OF STANDARD CHARACTERS WITHOUT CLAIM TO ANY PARTICULAR FONT, STYLE, SIZE, OR COLOR.

"MILMETRIX" HAS NO MEANING IN A FOREIGN LANGUAGE.

SER. NO. 77-305,828, FILED 10-17-2007.

ROBERT C. CLARK JR., EXAMINING ATTORNEY



**Int. Cls.: 35, 39, 41 and 43**

**Prior U.S. Cls.: 100, 101, 102, 105 and 107**

**Reg. No. 3,466,396**

**United States Patent and Trademark Office**

**Registered July 15, 2008**

**SERVICE MARK  
PRINCIPAL REGISTER**



SMARTER TRAVEL MEDIA LLC (NEVADA LTD  
LIAB CO)  
465 MEDFORD STREET, SUITE 400  
BOSTON, MA 02129

FOR: PRICE COMPARISON SERVICES IN THE FIELD OF TRAVEL FOR USE BY CONSUMERS IN DETERMINING THE COST OF TRANSPORTATION, LODGING, HOSPITALITY SERVICES, RESTAURANT AND BAR SERVICES AVAILABLE ELECTRONICALLY VIA COMPUTER NETWORKS, GLOBAL INFORMATION NETWORKS, AND WIRELESS NETWORKS, IN CLASS 35 (U.S. CLS. 100, 101 AND 102).

FIRST USE 6-8-2006; IN COMMERCE 6-8-2006.

FOR: TRAVEL INFORMATION SERVICES; TRAVEL INFORMATION SERVICES, NAMELY, PROVIDING TRAVEL-RELATED INFORMATION, TRAVEL NEWS, AND INFORMATION ON TRAVEL-RELATED TOPICS; PROVIDING INFORMATION FOR OTHERS ABOUT TRANSPORTATION; PROVIDING AIRLINE, CAR RENTAL, CRUISE, TOUR, TRAIN, AND TRAVEL INFORMATION; ALL AVAILABLE ELECTRONICALLY VIA COMPUTER NETWORKS, GLOBAL INFORMATION NETWORKS, AND WIRELESS NETWORKS, IN CLASS 39 (U.S. CLS. 100 AND 105).

FIRST USE 6-8-2006; IN COMMERCE 6-8-2006.

FOR: PROVIDING NEWSLETTERS IN THE FIELD OF TRAVEL VIA E-MAIL, IN CLASS 41 (U.S. CLS. 100, 101 AND 107).

FIRST USE 6-8-2006; IN COMMERCE 6-8-2006.

FOR: TRAVEL INFORMATION SERVICES, NAMELY, PROVIDING INFORMATION CONCERNING HOTELS, RESORTS, INNS, TEMPORARY LODGINGS, HOSPITALITY SERVICES, RESTAURANT, AND BAR SERVICES; PROVIDING ONLINE INFORMATION IN THE FIELD OF HOSPITALITY SERVICES; ALL AVAILABLE ELECTRONICALLY VIA COMPUTER NETWORKS, GLOBAL INFORMATION NETWORKS, AND WIRELESS NETWORKS, IN CLASS 43 (U.S. CLS. 100 AND 101).

FIRST USE 6-8-2006; IN COMMERCE 6-8-2006.

OWNER OF U.S. REG. NOS. 2,966,035 AND 2,969,377.

THE COLOR(S) BLUE AND LIGHT GREEN IS/ ARE CLAIMED AS A FEATURE OF THE MARK.

THE COLOR BLUE APPEARS IN THE WORD "BOOKING" AND THE COLOR GREEN APPEARS IN THE WORD "BUDDY". THE COLOR WHITE IN THE AIRPLANE DESIGN ELEMENT MERELY REPRESENTS BACKGROUND AREA AND THE COLOR WHITE IS NOT CLAIMED AS A FEATURE OF THE MARK.

SER. NO. 77-305,977, FILED 10-17-2007.

MARTHA FROMM, EXAMINING ATTORNEY

**Int. Cl.: 17**

**Prior U.S. Cls.: 1, 5, 12, 13, 35 and 50**

**Reg. No. 3,466,397**

**United States Patent and Trademark Office**

**Registered July 15, 2008**

**TRADEMARK  
PRINCIPAL REGISTER**

**MASCOAT**

MASCORP, LTD. (TEXAS LIMITED PARTNER-  
SHIP)  
4310 CAMPBELL ROAD  
HOUSTON, TX 77041

FOR: INSULATING COATINGS FOR MARINE,  
COMMERCIAL, INDUSTRIAL, AND RESIDENTIAL  
USE, NAMELY, CERAMIC INSULATING COAT-  
INGS IN THE NATURE OF PAINT OR LACQUER  
WITH ANTI-CONDENSATION, HEAT RESISTANCE  
FOR THE PURPOSE OF PERSONNEL PROTEC-  
TION, ANTI-CORROSION, SOUND DAMPENING,  
HEAT RETENTION, ENERGY SAVINGS, VAPOR  
BARRIERS, AND ULTRA-VIOLET RADIATION

PROTECTION PROPERTIES, IN CLASS 17 (U.S.  
CLS. 1, 5, 12, 13, 35 AND 50).

FIRST USE 1-31-1995; IN COMMERCE 6-30-1995.

THE MARK CONSISTS OF STANDARD CHAR-  
ACTERS WITHOUT CLAIM TO ANY PARTICULAR  
FONT, STYLE, SIZE, OR COLOR.

SER. NO. 77-306,121, FILED 10-17-2007.

STEPHEN AQUILA, EXAMINING ATTORNEY

**Int. Cl.: 36**

**Prior U.S. Cls.: 100, 101 and 102**

**United States Patent and Trademark Office**

**Reg. No. 3,466,398**

**Registered July 15, 2008**

**SERVICE MARK  
PRINCIPAL REGISTER**

**BOCA CENTER**

485 PROPERTIES, LLC (DELAWARE LTD LIAB  
CO)  
8500 ANDREW CARNEGIE BLVD MAIL STOP C308  
C/O TEACHERS INSURANCE & ANNUITY ASSOC.  
CHARLOTTE, NC 28262

FOR: SHOPPING CENTER AND MIXED USE  
DEVELOPMENT SERVICES, NAMELY, RENTAL  
OF SHOPPING CENTER SPACE , IN CLASS 36 (U.S.  
CLS. 100, 101 AND 102).

FIRST USE 11-0-1994; IN COMMERCE 11-0-1994.

THE MARK CONSISTS OF STANDARD CHAR-  
ACTERS WITHOUT CLAIM TO ANY PARTICULAR  
FONT, STYLE, SIZE, OR COLOR.

NO CLAIM IS MADE TO THE EXCLUSIVE  
RIGHT TO USE "CENTER", APART FROM THE  
MARK AS SHOWN.

SEC. 2(F).

SER. NO. 77-306,442, FILED 10-17-2007.

GINA HAYES, EXAMINING ATTORNEY

**Int. Cl.: 12**

**Prior U.S. Cls.: 19, 21, 23, 31, 35 and 44**

**United States Patent and Trademark Office**

**Reg. No. 3,466,399**

**Registered July 15, 2008**

**TRADEMARK  
PRINCIPAL REGISTER**

**GO ANYWHERE TOY HAULERS**

RV ANYWHERE INC (CALIFORNIA CORPORATION)  
41451 LOS ALAMOS RD.  
MURRIETA, CA 92562

FOR: RECREATIONAL VEHICLES, NAMELY, TOY HAULERS, IN CLASS 12 (U.S. CLS. 19, 21, 23, 31, 35 AND 44).

FIRST USE 1-1-2006; IN COMMERCE 1-1-2006.

THE MARK CONSISTS OF STANDARD CHARACTERS WITHOUT CLAIM TO ANY PARTICULAR FONT, STYLE, SIZE, OR COLOR.

NO CLAIM IS MADE TO THE EXCLUSIVE RIGHT TO USE "TOY HAULERS", APART FROM THE MARK AS SHOWN.

SER. NO. 77-306,639, FILED 10-17-2007.

SUSAN RICHARDS, EXAMINING ATTORNEY

**Int. Cl.: 35**

**Prior U.S. Cls.: 100, 101 and 102**

**United States Patent and Trademark Office**

**Reg. No. 3,466,400**

**Registered July 15, 2008**

---

**SERVICE MARK  
PRINCIPAL REGISTER**

**ESAS**

CLAIM TECHNOLOGIES INCORPORATED  
(IOWA CORPORATION)  
100 COURT AVENUE, SUITE 306  
DES MOINES, IA 50309

THE MARK CONSISTS OF STANDARD CHAR-  
ACTERS WITHOUT CLAIM TO ANY PARTICULAR  
FONT, STYLE, SIZE, OR COLOR.

FOR: INSURANCE CLAIMS AUDITING SERVI-  
CES, IN CLASS 35 (U.S. CLS. 100, 101 AND 102).

SER. NO. 77-307,599, FILED 10-18-2007.

FIRST USE 7-1-1993; IN COMMERCE 7-1-1993.

MARK SPARACINO, EXAMINING ATTORNEY

**Int. Cls.: 10, 41 and 44**

**Prior U.S. Cls.: 26, 39, 44, 100, 101 and 107**

**United States Patent and Trademark Office**

**Reg. No. 3,466,401**

**Registered July 15, 2008**

**TRADEMARK  
SERVICE MARK  
PRINCIPAL REGISTER**

**BIO-RSA**

TORNIER (FRANCE SOCIÉTÉ PAR ACTIONS  
SIMPLIFIÉE (SAS))  
RUE DOYEN GOSSE  
SAINT ISMIER, FRANCE 38330

FOR: SURGICAL IMPLANTS COMPRISING ARTIFICIAL MATERIAL, SHOULDER PROSTHESES, AND SURGICAL INSTRUMENTS FOR FITTING THESE GOODS, IN CLASS 10 (U.S. CLS. 26, 39 AND 44).

FOR: TRAINING IN THE FIELD OF SURGERY AND IN PARTICULAR IN THE CONTEXT OF THE FITTING OF A COMPLETE REVERSED SHOULDER PROSTHESIS, IN CLASS 41 (U.S. CLS. 100, 101 AND 107).

FOR: INFORMATION IN THE FIELD OF SURGERY AND IN PARTICULAR IN THE CONTEXT

OF THE FITTING OF A COMPLETE REVERSED SHOULDER PROSTHESIS, IN CLASS 44 (U.S. CLS. 100 AND 101).

THE MARK CONSISTS OF STANDARD CHARACTERS WITHOUT CLAIM TO ANY PARTICULAR FONT, STYLE, SIZE, OR COLOR.

PRIORITY CLAIMED UNDER SEC. 44(D) ON FRANCE APPLICATION NO. 073496762, FILED 4-24-2007, REG. NO. 073496762, DATED 4-24-2007, EXPIRES 4-23-2017.

SER. NO. 77-308,131, FILED 10-19-2007.

DAVID ELTON, EXAMINING ATTORNEY

**Int. Cl.: 35**

**Prior U.S. Cls.: 100, 101 and 102**

**United States Patent and Trademark Office**

**Reg. No. 3,466,402**

**Registered July 15, 2008**

**SERVICE MARK  
PRINCIPAL REGISTER**

# The Horse Studio

HORSE STUDIO INC, THE (NEW YORK COR-  
PORATION)  
P.O. BOX 404  
STAMFORD, NY 121670404

FOR: OPERATING AN ONLINE SHOPPING SITE  
IN THE FIELD OF HORSE AND EQUESTRIAN  
PRODUCTS, IN CLASS 35 (U.S. CLS. 100, 101 AND  
102).

FIRST USE 4-1-2006; IN COMMERCE 4-1-2006.

THE MARK CONSISTS OF STANDARD CHAR-  
ACTERS WITHOUT CLAIM TO ANY PARTICULAR  
FONT, STYLE, SIZE, OR COLOR.

NO CLAIM IS MADE TO THE EXCLUSIVE  
RIGHT TO USE "HORSE", APART FROM THE  
MARK AS SHOWN.

SER. NO. 77-308,248, FILED 10-19-2007.

DAVID COLLIER, EXAMINING ATTORNEY

Int. Cl.: 33

Prior U.S. Cls.: 47 and 49

United States Patent and Trademark Office

Reg. No. 3,466,403

Registered July 15, 2008

TRADEMARK  
PRINCIPAL REGISTER



KABUSHIKI KAISHA MIYAZAKIHONTEN (JAPAN CORPORATION)  
972 MINAMI-GOMIZUKA, KUSU-CHO  
YOKKAICHI CITY, MIE, JAPAN

FOR: DISTILLED SPIRITS OF RICE, IN CLASS 33  
(U.S. CLS. 47 AND 49).

FIRST USE 2-9-2007; IN COMMERCE 2-9-2007.

OWNER OF U.S. REG. NO. 3,358,686.

NO CLAIM IS MADE TO THE EXCLUSIVE RIGHT TO USE "SHOCHU, HONKAKU KOME SHOCHU AND SPIRITS DISTILLED FROM RICE", APART FROM THE MARK AS SHOWN.

THE COLOR(S) BLACK AND RED IS/ARE CLAIMED AS A FEATURE OF THE MARK.

THE LARGER NON-LATIN CHARACTERS ON THE RIGHT SIDE OF THE MARK ARE IN THE COLOR BLACK; THE COLOR RED APPEARS IN THE INSIDE OF BOTH LETTER "OS" IN THE WORD SHIROCHIDORI, AND IN THE INSIDE OF THE ELONGATED CHARACTER OF THE LARGER NON-LATIN CHARACTERS ON THE RIGHT SIDE;

THE TERM "SHIROCHIDORI" IS IN THE COLOR BLACK AND THE WORDING UNDERNEATH IT "DISTILLED FROM RICE SHOCHU" IS IN THE COLOR BLACK; THE SMALLER NON-LATIN CHARACTERS IN A HORIZONTAL POSITION ARE IN THE COLOR BLACK LOCATED ABOVE THE TERM "SHOCHU" THAT IS ALSO BLACK.

THE WORD "SHIROCHIDORI" MEANS SNOWY PLOVER OR KENTISH PLOVER IN ENGLISH. THE WORDS "HONKAKU KOME SHOCHU" MEAN AUTHENTIC SPIRITS DISTILLED FROM RICE IN ENGLISH. THE WORD "SHOCHU" MEANS SPIRITS.

THE LARGER NON-LATIN CHARACTERS ON THE RIGHT SIDE OF THE MARK TRANSLITERATE TO "SHIROCHIDORI". THE SMALLER NON-LATIN CHARACTERS IN A HORIZONTAL POSITION IN THE MARK TRANSLITERATE TO "HONKAKU KOME SHOCHU".

SER. NO. 77-308,358, FILED 10-19-2007.

CHRISTOPHER BUONGIORNO, EXAMINING ATTORNEY



**Int. Cl.: 45**

**Prior U.S. Cls.: 100 and 101**

**United States Patent and Trademark Office**

**Reg. No. 3,466,404**

**Registered July 15, 2008**

**SERVICE MARK  
PRINCIPAL REGISTER**

**GET VISAS**

FROMAN, DAVID (UNITED STATES INDIVIDUAL)  
9820 WILLOW CREEK ROAD, STE. 275  
SAN DIEGO, CA 92131

FOR: LEGAL SERVICES RELATED TO IMMIGRATION, IN CLASS 45 (U.S. CLS. 100 AND 101).

FIRST USE 3-20-2000; IN COMMERCE 9-5-2001.

THE MARK CONSISTS OF STANDARD CHARACTERS WITHOUT CLAIM TO ANY PARTICULAR FONT, STYLE, SIZE, OR COLOR.

OWNER OF U.S. REG. NO. 2,633,715.

NO CLAIM IS MADE TO THE EXCLUSIVE RIGHT TO USE "VISAS", APART FROM THE MARK AS SHOWN.

SEC. 2(F).

SER. NO. 77-308,405, FILED 10-19-2007.

BRIAN NEVILLE, EXAMINING ATTORNEY

**Int. Cl.: 14**

**Prior U.S. Cls.: 2, 27, 28 and 50**

**United States Patent and Trademark Office**

**Reg. No. 3,466,405**

**Registered July 15, 2008**

**TRADEMARK  
PRINCIPAL REGISTER**



SHE BEADS COMPANY (ILLINOIS CORPORATION)  
1824 JOHNS DR.  
GLENVIEW, IL 60025

THE MARK CONSISTS OF THE LETTERS "SB" IN THE MIDDLE OF A WREATH OF STYLIZED AND OVERLAPPING LETTERS "S" AND "B".

FOR: HAND-ROLLED CLAY BEAD JEWELRY,  
IN CLASS 14 (U.S. CLS. 2, 27, 28 AND 50).

SER. NO. 77-308,566, FILED 10-19-2007.

FIRST USE 2-28-2006; IN COMMERCE 2-28-2006.

OWNER OF U.S. REG. NO. 2,662,829.

CARYN GLASSER, EXAMINING ATTORNEY

**Int. Cl.: 35**

**Prior U.S. Cls.: 100, 101 and 102**

**United States Patent and Trademark Office**

**Reg. No. 3,466,406**

**Registered July 15, 2008**

**SERVICE MARK  
PRINCIPAL REGISTER**

# Queer the Air

HOWARD BROWN HEALTH CENTER (ILLINOIS  
CORPORATION)  
LCCP  
4025 N. SHERIDAN  
CHICAGO, IL 60613

FOR: PUBLIC ADVOCACY TO PROMOTE  
AWARENESS OF SMOKE-FREE LESBIAN, GAY,  
BISEXUAL, AND TRANSGENDER BARS AND PUB-  
LIC SPACES, IN CLASS 35 (U.S. CLS. 100, 101 AND  
102).

FIRST USE 12-0-2005; IN COMMERCE 12-0-2005.

THE MARK CONSISTS OF STANDARD CHAR-  
ACTERS WITHOUT CLAIM TO ANY PARTICULAR  
FONT, STYLE, SIZE, OR COLOR.

SER. NO. 77-308,631, FILED 10-19-2007.

KAREN BRACEY, EXAMINING ATTORNEY

**Int. Cl.: 41**

**Prior U.S. Cls.: 100, 101 and 107**

**United States Patent and Trademark Office**

**Reg. No. 3,466,407**

**Registered July 15, 2008**

**SERVICE MARK  
PRINCIPAL REGISTER**

# Terpsikhore

TERPSIKHORE INC. (NORTH CAROLINA CORPORATION)  
2213 KILBURN ROAD  
RALEIGH, NC 27604

FOR: MULTIMEDIA ENTERTAINMENT SERVICES IN THE NATURE OF RECORDING, PRODUCTION AND POST-PRODUCTION SERVICES IN THE FIELDS OF MUSIC, VIDEO, AND FILMS, IN CLASS 41 (U.S. CLS. 100, 101 AND 107).

FIRST USE 10-6-2007; IN COMMERCE 10-6-2007.

THE MARK CONSISTS OF STANDARD CHARACTERS WITHOUT CLAIM TO ANY PARTICULAR FONT, STYLE, SIZE, OR COLOR.

SER. NO. 77-308,727, FILED 10-19-2007.

MICHAEL ENGEL, EXAMINING ATTORNEY

**Int. Cl.: 25**

**Prior U.S. Cls.: 22 and 39**

**United States Patent and Trademark Office**

**Reg. No. 3,466,408**

**Registered July 15, 2008**

**TRADEMARK  
PRINCIPAL REGISTER**

**Omoroi**

DCTY CO., LTD (REPUBLIC OF KOREA CORPORATION)

943-1, DOGOK-DONG, GANGNAM-GU

SEOUL, REPUBLIC OF KOREA

FOR: CHILDREN'S CLOTHING, NAMELY, PANTS, SHIRTS, JUMPERS, JACKETS AND HEADWEAR; CLOTHING, NAMELY, ANORAKS, JACKETS, JEANS, SPORTS SHIRTS, T-SHIRTS, HEADWEAR, WORKING OVERALLS, POLO SHIRTS AND COMBINATIONS, IN CLASS 25 (U.S. CLS. 22 AND 39).

THE MARK CONSISTS OF STANDARD CHARACTERS WITHOUT CLAIM TO ANY PARTICULAR FONT, STYLE, SIZE, OR COLOR.

OWNER OF REPUBLIC OF KOREA REG. NO. 0533571, DATED 10-28-2002, EXPIRES 10-28-2012.

THE ENGLISH TRANSLATION OF THE WORD "OMOROI" IN THE MARK IS FUNNY OR INTERESTING.

SER. NO. 77-308,949, FILED 10-19-2007.

ANDREW RHIM, EXAMINING ATTORNEY

**Int. Cl.: 9**

**Prior U.S. Cls.: 21, 23, 26, 36 and 38**

**Reg. No. 3,466,409**

**United States Patent and Trademark Office**

**Registered July 15, 2008**

**TRADEMARK  
PRINCIPAL REGISTER**

# Music Band-It

YC CABLE (EAST), INC. (NEW JERSEY CORPORATION)  
STE 5A  
121 ETHEL RD W  
PISCATAWAY, NJ 088545952

FOR: AUDIO-VISUAL ACCESSORIES, NAMELY, WEARABLE AND CARRYING CASES FEATURING WIRE MANAGEMENT FOR RETRACTABLE AND NON-RETRACTABLE CABLES AND JACKS SPECIFICALLY ADAPTED FOR PORTABLE VIDEO OR AUDIO DEVICES INCLUDING BUT NOT LIMITED TO MP3 PLAYERS; SIGNAL BAND SEPARATORS, ELECTRIC TRANSFORMERS, ACOUSTIC COUPLERS, SOLAR BATTERY CHARGERS, VIDEO SPLITTERS, HEADPHONES AND EARPHONES FEATURING WIRE MANAGEMENT FOR RETRACTABLE AND NON-RETRACTABLE CABLES

SPECIFICALLY ADAPTED FOR PORTABLE VIDEO DEVICES, AUDIO DEVICES AND CELL PHONES, IN CLASS 9 (U.S. CLS. 21, 23, 26, 36 AND 38).

FIRST USE 9-2-2007; IN COMMERCE 9-25-2007.

THE MARK CONSISTS OF STANDARD CHARACTERS WITHOUT CLAIM TO ANY PARTICULAR FONT, STYLE, SIZE, OR COLOR.

NO CLAIM IS MADE TO THE EXCLUSIVE RIGHT TO USE "MUSIC", APART FROM THE MARK AS SHOWN.

SER. NO. 77-308,985, FILED 10-19-2007.

PATRICIA EVANKO, EXAMINING ATTORNEY

**Int. Cl.: 9**

**Prior U.S. Cls.: 21, 23, 26, 36 and 38**

**Reg. No. 3,466,410**

**United States Patent and Trademark Office**

**Registered July 15, 2008**

---

**TRADEMARK  
PRINCIPAL REGISTER**



TONY VICTORY FITNESS, LLC (CALIFORNIA  
LTD LIAB CO)  
8014 ANTWERP AVE.  
LOS ANGELES, CA 90001

FIRST USE 11-1-2002; IN COMMERCE 11-1-2002.

SER. NO. 77-309,132, FILED 10-19-2007.

FOR: SERIES OF PRERECORDED VIDEOTAPES  
AND DVD'S FEATURING EXERCISES SET TO  
MUSIC, IN CLASS 9 (U.S. CLS. 21, 23, 26, 36 AND 38).

ADA HAN, EXAMINING ATTORNEY

**Int. Cls.: 30 and 43**

**Prior U.S. Cls.: 46, 100 and 101**

**United States Patent and Trademark Office**

**Reg. No. 3,466,411**

**Registered July 15, 2008**

**TRADEMARK  
SERVICE MARK  
PRINCIPAL REGISTER**

**PIZZA KNIGHT**

ROUND TABLE FRANCHISE CORPORATION,  
THE (CALIFORNIA CORPORATION)  
1320 WILLOW PASS ROAD, SUITE 600  
CONCORD, CA 94520

FOR: PIZZA FOR CONSUMPTION ON AND OFF  
PREMISES, IN CLASS 30 (U.S. CL. 46).

FIRST USE 9-6-2007; IN COMMERCE 9-6-2007.

FOR: RESTAURANT SERVICES; RESTAURANTS  
FEATURING TAKE OUT AND DELIVERY SERVI-  
CES, IN CLASS 43 (U.S. CLS. 100 AND 101).

FIRST USE 9-6-2007; IN COMMERCE 9-6-2007.

THE MARK CONSISTS OF STANDARD CHAR-  
ACTERS WITHOUT CLAIM TO ANY PARTICULAR  
FONT, STYLE, SIZE, OR COLOR.

NO CLAIM IS MADE TO THE EXCLUSIVE  
RIGHT TO USE "PIZZA", APART FROM THE  
MARK AS SHOWN.

SER. NO. 77-309,753, FILED 10-22-2007.

GIANCARLO CASTRO, EXAMINING ATTORNEY



**Int. Cl.: 41**

**Prior U.S. Cls.: 100, 101 and 107**

**United States Patent and Trademark Office**

**Reg. No. 3,466,412**

**Registered July 15, 2008**

**SERVICE MARK  
PRINCIPAL REGISTER**

# Clay Cafe Studios

CLAY CAFE STUDIOS OF VIRGINIA, INC. (VIRGINIA CORPORATION)  
101 NORTH MAPLE AVE.  
FALLS CHURCH, VA 22046

FOR: PROVIDING FACILITIES IN THE NATURE OF PAINT-IT-YOURSELF CERAMICS STUDIOS PROVIDING USE OF VARIOUS SUPPLIES AND EQUIPMENT, NAMELY, UNPAINTED CERAMIC PLATES, BOWLS, MUGS, FIGURINES, HOUSEHOLD ITEMS, PICTURE FRAMES, SALT AND PEPPER SHAKERS, ALL IN A VARIETY OF SIZES, PLUS PAINTS, GLAZES AND FIRING MATERIALS, IN CLASS 41 (U.S. CLS. 100, 101 AND 107).

FIRST USE 11-1-1997; IN COMMERCE 4-1-1998.

THE MARK CONSISTS OF STANDARD CHARACTERS WITHOUT CLAIM TO ANY PARTICULAR FONT, STYLE, SIZE, OR COLOR.

NO CLAIM IS MADE TO THE EXCLUSIVE RIGHT TO USE "CLAY" AND "STUDIO", APART FROM THE MARK AS SHOWN.

SER. NO. 77-309,803, FILED 10-22-2007.

CHRISTINE COOPER, EXAMINING ATTORNEY

**Int. Cl.: 30**

**Prior U.S. Cl.: 46**

**United States Patent and Trademark Office**

**Reg. No. 3,466,413**

**Registered July 15, 2008**

**TRADEMARK  
PRINCIPAL REGISTER**

**GIO-BELLA'S SWEET SHOPPE**

NINA C. OWEN (UNITED STATES INDIVIDUAL)  
980 COUNTY HOME ROAD  
PARIS, TN 38242

NO CLAIM IS MADE TO THE EXCLUSIVE  
RIGHT TO USE "SWEET SHOPPE", APART FROM  
THE MARK AS SHOWN.

FOR: CANDY, IN CLASS 30 (U.S. CL. 46).

FIRST USE 2-8-2007; IN COMMERCE 3-6-2007.

SER. NO. 77-310,056, FILED 10-22-2007.

THE MARK CONSISTS OF STANDARD CHAR-  
ACTERS WITHOUT CLAIM TO ANY PARTICULAR  
FONT, STYLE, SIZE, OR COLOR.

GEOFFREY FOSDICK, EXAMINING ATTORNEY

Int. Cl.: 41

Prior U.S. Cls.: 100, 101 and 107

United States Patent and Trademark Office

Reg. No. 3,466,414

Registered July 15, 2008

SERVICE MARK  
PRINCIPAL REGISTER



FERMIN DORADO (UNITED STATES INDIVIDUAL), DBA FIESTA DE LAS FLORES  
2717 E. YANDELL STREET  
EL PASO, TX 79903

FOR: ENTERTAINMENT IN THE NATURE OF LIVE MUSIC CONCERTS; ORGANIZING COMMUNITY FESTIVALS FEATURING A VARIETY OF ACTIVITIES, NAMELY, ART EXHIBITIONS, HERITAGE MARKETS, ETHNIC DANCES, AND THE LIKE, IN CLASS 41 (U.S. CLS. 100, 101 AND 107).

FIRST USE 7-15-1999; IN COMMERCE 7-15-1999.

NO CLAIM IS MADE TO THE EXCLUSIVE RIGHT TO USE "FIESTA DE LAS FLORES" AND "EL PASO TEXAS", APART FROM THE MARK AS SHOWN.

THE COLOR(S) BLUE, PURPLE, YELLOW, RED, PINK, ORANGE, GREEN, AND TURQUOISE IS/ARE CLAIMED AS A FEATURE OF THE MARK.

THE MARK CONSISTS OF THE WORDS "FIESTA DE LAS FLORES" IN PURPLE. "FIESTA" AND "FLORES" ARE OUTLINED IN YELLOW AND RED. NEXT TO "FIESTA" ARE THREE FLOWERS

OUTLINED IN PINK AND COLORED IN ORANGE. THE CENTER PORTION OF THE FLOWERS IS IN YELLOW AND RED. THREE GREEN LEAVES ARE ATTACHED TO THE FLOWERS. SURROUNDING THE FLOWERS ARE STREAMERS AND CONFETTI. THE STREAMERS ARE IN PURPLE, GREEN, AND TURQUOISE COLOR. THE CONFETTI ARE IN ORANGE, PINK, PURPLE, TURQUOISE, YELLOW, AND GREEN. A BLUE SEAL IS LOCATED IN THE CURVE PORTION OF THE LETTER 'S' IN THE WORD "FIESTA". INSIDE THE SEAL IN STYLIZED FORM ARE THE WORDS "FIESTA DE LAS FLORES" AND "EL PASO TEXAS" IN BLUE. IN THE CENTER OF THE SEAL IS A BROWN GUITAR, BROWN SOMBRERO, AND THREE FLOWERS WITH A GREEN STEM AND GREEN LEAF. THE CENTER OF THE FLOWERS ARE IN YELLOW. THE TWO LEFT FLOWERS ARE PINK, WHILE THE RIGHT FLOWER IS IN PURPLE.

THE FOREIGN WORDING IN THE MARK TRANSLATES INTO ENGLISH AS "FESTIVAL OF THE FLOWERS".

SER. NO. 77-310,192, FILED 10-22-2007.

SIMON TENG, EXAMINING ATTORNEY

**Int. Cl.: 33**

**Prior U.S. Cls.: 47 and 49**

**United States Patent and Trademark Office**

**Reg. No. 3,466,415**

**Registered July 15, 2008**

**TRADEMARK  
PRINCIPAL REGISTER**

**CENTURY CELLARS**

DIAGEO NORTH AMERICA, INC. (CONNECTI-  
CUT CORPORATION)  
801 MAIN AVENUE  
NORWALK, CT 06851

FOR: WINES, IN CLASS 33 (U.S. CLS. 47 AND 49).

FIRST USE 4-30-2003; IN COMMERCE 4-30-2003.

THE MARK CONSISTS OF STANDARD CHAR-  
ACTERS WITHOUT CLAIM TO ANY PARTICULAR  
FONT, STYLE, SIZE, OR COLOR.

OWNER OF U.S. REG. NO. 3,272,769.

NO CLAIM IS MADE TO THE EXCLUSIVE  
RIGHT TO USE "CELLARS", APART FROM THE  
MARK AS SHOWN.

SER. NO. 77-310,198, FILED 10-22-2007.

RON FAIRBANKS, EXAMINING ATTORNEY

**Int. Cl.: 33**

**Prior U.S. Cls.: 47 and 49**

**United States Patent and Trademark Office**

**Reg. No. 3,466,416**

**Registered July 15, 2008**

**TRADEMARK  
PRINCIPAL REGISTER**

**CENTURY  
CELLARS**

DIAGEO NORTH AMERICA, INC. (CONNECTI-  
CUT CORPORATION)  
801 MAIN AVENUE  
NORWALK, CT 06851

FOR: WINES, IN CLASS 33 (U.S. CLS. 47 AND 49).

FIRST USE 4-30-2003; IN COMMERCE 4-30-2003.

OWNER OF U.S. REG. NO. 3,272,769.

NO CLAIM IS MADE TO THE EXCLUSIVE  
RIGHT TO USE "CELLARS", APART FROM THE  
MARK AS SHOWN.

THE MARK CONSISTS OF THE WORD "CENTU-  
RY" OVER THE WORD "CELLARS" IN STYLIZED  
FORMAT.

SER. NO. 77-310,206, FILED 10-22-2007.

RON FAIRBANKS, EXAMINING ATTORNEY

**Int. Cl.: 9**

**Prior U.S. Cls.: 21, 23, 26, 36 and 38**

**Reg. No. 3,466,417**

**United States Patent and Trademark Office**

**Registered July 15, 2008**

**TRADEMARK  
PRINCIPAL REGISTER**

**GOOD ENOUGH**

GRANDON TECHNOLOGY CORP. (TAIWAN CORPORATION), DBA GRANDON TECHNOLOGY CORP.  
13F., NO.159, SEC.1, KEELUNG RD.  
TAIPEI CITY, TAIWAN 110

FOR: ELECTRIC BATTERIES FOR VEHICLES, ACCUMULATORS FOR VEHICLES, BATTERIES, BATTERY CHARGERS, ELECTRODES, BATTERY JARS, BATTERY BOXES, ELECTRIC BATTERIES, HIGH VOLTAGE BATTERIES, ACCUMULATORS, ACCUMULATOR BOXES, ACCUMULATORS JARS, CATHODES, LITHIUM BATTERIES, SOLAR BATTERIES, FUEL CELLS, AND BATTERIES FOR MO-

BILE PHONES, IN CLASS 9 (U.S. CLS. 21, 23, 26, 36 AND 38).

FIRST USE 7-6-2007; IN COMMERCE 8-28-2007.

THE MARK CONSISTS OF STANDARD CHARACTERS WITHOUT CLAIM TO ANY PARTICULAR FONT, STYLE, SIZE, OR COLOR.

SER. NO. 77-310,274, FILED 10-22-2007.

BERYL GARDNER, EXAMINING ATTORNEY

**Int. Cl.: 9**

**Prior U.S. Cls.: 21, 23, 26, 36 and 38**

**Reg. No. 3,466,418**

**United States Patent and Trademark Office**

**Registered July 15, 2008**

**TRADEMARK  
PRINCIPAL REGISTER**

**ICREALTIME**

IC REALTIME (DELAWARE LTD LIAB CO)  
5811 N ANDREWS WAY  
FT. LAUDERDALE, FL 33309

FOR: SECURITY AND SURVEILLANCE PRODUCTS AND ACCESSORIES, NAMELY, SECURITY CAMERAS, DIGITAL VIDEO APPARATUS FOR RECORDING, TRANSMISSION OR REPRODUCTION OF SOUND AND IMAGES, SUCH AS DVRS (DIGITAL VIDEO RECORDERS), CLOSED CIRCUIT TELEVISION MONITORS, UTP (UNSHIELDED TWISTED PAIR) VIDEO AND AUDIO TRANSMISSION DEVICES, NAMELY, APPARATUS FOR RECORDING, TRANSMITTING AND REPRODUCING SOUND AND IMAGES; CABLES, NAMELY ELEC-

TRIC CABLES, CONNECTION CABLE, COAXIAL CABLE; CONNECTORS, NAMELY, CABLE CONNECTORS, PLUG CONNECTORS, ELECTRIC CONNECTORS, IN CLASS 9 (U.S. CLS. 21, 23, 26, 36 AND 38).

FIRST USE 11-1-2005; IN COMMERCE 1-18-2006.

THE MARK CONSISTS OF STANDARD CHARACTERS WITHOUT CLAIM TO ANY PARTICULAR FONT, STYLE, SIZE, OR COLOR.

SER. NO. 77-310,364, FILED 10-22-2007.

JANICE KIM, EXAMINING ATTORNEY

**Int. Cl.: 9**

**Prior U.S. Cls.: 21, 23, 26, 36 and 38**

**Reg. No. 3,466,419**

**United States Patent and Trademark Office**

**Registered July 15, 2008**

**TRADEMARK  
PRINCIPAL REGISTER**

**VOICES OF EXPERIENCE**

NATIONAL SPEAKERS ASSOCIATION (ARIZONA NON-PROFIT CORPORATION)  
1500 SOUTH PRIEST DRIVE  
TEMPE, AZ 85281

FOR: PRE-RECORDED CDS FEATURING TRAINING, TEACHING, AND EDUCATIONAL SUBJECT MATTER IN THE FIELD OF PUBLIC SPEAKING, IN CLASS 9 (U.S. CLS. 21, 23, 26, 36 AND 38).

FIRST USE 12-31-2001; IN COMMERCE 12-31-2001.

THE MARK CONSISTS OF STANDARD CHARACTERS WITHOUT CLAIM TO ANY PARTICULAR FONT, STYLE, SIZE, OR COLOR.

SER. NO. 77-310,371, FILED 10-22-2007.

HEATHER BIDDULPH, EXAMINING ATTORNEY



**Int. Cl.: 42**

**Prior U.S. Cls.: 100 and 101**

**United States Patent and Trademark Office**

**Reg. No. 3,466,420**

**Registered July 15, 2008**

**SERVICE MARK  
PRINCIPAL REGISTER**

# Online Life

LOH ENTERPRISES PTY LTD (AUSTRALIA LTD  
LIAB CO)  
PO BOX 900  
GLEN WAVERLEY, AUSTRALIA 3150

FOR: COMPUTER SERVICES IN THE NATURE OF CUSTOMIZED WEB PAGES FEATURING USER-DEFINED INFORMATION, PERSONAL PROFILES AND INFORMATION; PROVIDING A WEBSITE THAT GIVES COMPUTER USERS THE ABILITY TO UPLOAD, EXCHANGE AND SHARE PHOTOS, VIDEOS AND VIDEO LOGS; COMPUTER SERVICES, NAMELY, CREATING AN ONLINE COMMUNITY FOR REGISTERED USERS TO PARTICIPATE IN COMPETITIONS, SHOWCASE THEIR SKILLS, GET FEEDBACK FROM THEIR PEERS, FORM VIRTUAL COMMUNITIES, ENGAGE IN SOCIAL NETWORKING AND IMPROVE THEIR TALENT; COMPUTER SERVICES, NAMELY, HOSTING ONLINE WEB FACILITIES FOR OTHERS FOR ORGANIZING AND CONDUCTING ONLINE MEETINGS,

GATHERINGS, AND INTERACTIVE DISCUSSIONS; HOSTING AN ONLINE COMMUNITY WEBSITE FEATURING GENERAL INTEREST; COMPUTER SERVICES, NAMELY, UPLOADING MUSIC TO THE INTERNET FOR OTHERS, IN CLASS 42 (U.S. CLS. 100 AND 101).

FIRST USE 10-20-2007; IN COMMERCE 10-20-2007.

THE MARK CONSISTS OF STANDARD CHARACTERS WITHOUT CLAIM TO ANY PARTICULAR FONT, STYLE, SIZE, OR COLOR.

NO CLAIM IS MADE TO THE EXCLUSIVE RIGHT TO USE "ONLINE", APART FROM THE MARK AS SHOWN.

SER. NO. 77-310,560, FILED 10-23-2007.

DAWN HAN, EXAMINING ATTORNEY

**Int. Cl.: 5**

**Prior U.S. Cls.: 6, 18, 44, 46, 51 and 52**

**Reg. No. 3,466,421**

**United States Patent and Trademark Office**

**Registered July 15, 2008**

---

**TRADEMARK  
PRINCIPAL REGISTER**

**CHLOR-O-FLAGE**

HUNTING SCIENCE, LLC (WISCONSIN LTD  
LIAB CO)  
P.O. BOX 236  
ANTIGO, WI 54409

THE MARK CONSISTS OF STANDARD CHAR-  
ACTERS WITHOUT CLAIM TO ANY PARTICULAR  
FONT, STYLE, SIZE, OR COLOR.

FOR: PHARMACEUTICAL PREPARATIONS,  
NAMELY, SCENT ELIMINATION GEL TABLETS  
FOR HUNTERS, IN CLASS 5 (U.S. CLS. 6, 18, 44, 46, 51  
AND 52).

SER. NO. 77-310,700, FILED 10-23-2007.

FIRST USE 8-9-2005; IN COMMERCE 8-9-2005.

BRENDAN REGAN, EXAMINING ATTORNEY

**Int. Cls.: 35 and 41**

**Prior U.S. Cls.: 100, 101, 102 and 107**

**United States Patent and Trademark Office**

**Reg. No. 3,466,422**

**Registered July 15, 2008**

**SERVICE MARK  
PRINCIPAL REGISTER**



ONWARD EDUCATION & TRAINING, LLC  
(NEW JERSEY LTD LIAB CO)  
ONE GREENTREE CENTRE, SUITE 201  
MARLTON, NJ 08053

FOR: CONSULTING AND MARKETING SERVICES RENDERED TO COLLEGES AND UNIVERSITIES FOR THE CREATION AND DEVELOPMENT OF ONLINE ADULT DISTANCE LEARNING OFF-CAMPUS DEGREE PROGRAMS FOR WORKING ADULTS, INCLUDING CONSULTING ON WEB-BASED RECRUITMENT, ENROLLMENT SERVICES, ASSISTANCE IN ADMISSIONS, AND MARKETING, IN CLASS 35 (U.S. CLS. 100, 101 AND 102).

FIRST USE 9-27-2007; IN COMMERCE 9-27-2007.

FOR: CAREER COUNSELING AND TRAINING SERVICES FOR THE PUBLIC FEATURING CAREER ASSESSMENT, JOB SEARCH, INTERVIEW

TRAINING, RESUME DEVELOPMENT AND PREPARATION, AND COUNSELING ON EMPLOYMENT RESOURCES; EDUCATIONAL AND TRAINING SERVICES IN THE AREA OF CORPORATE HUMAN RESOURCES, NAMELY, CONDUCTING ONLINE DISTANCE LEARNING COURSES ON BEHALF OF BUSINESS ORGANIZATIONS FOR EMPLOYEES AND STAFF IN THE AREAS OF CAREER COUNSELING, RESUME DEVELOPMENT AND PREPARATION, INTERVIEW TRAINING AND TECHNIQUES, AND LEADERSHIP AND TEAM BUILDING TRAINING, IN CLASS 41 (U.S. CLS. 100, 101 AND 107).

FIRST USE 9-27-2007; IN COMMERCE 9-27-2007.

SER. NO. 77-310,843, FILED 10-23-2007.

RON FAIRBANKS, EXAMINING ATTORNEY

**Int. Cl.: 5**

**Prior U.S. Cls.: 6, 18, 44, 46, 51 and 52**

**United States Patent and Trademark Office**

**Reg. No. 3,466,423**

**Registered July 15, 2008**

**TRADEMARK  
PRINCIPAL REGISTER**

**BETAFLORA**

ADVANCED LIFE RESEARCH, INC. (NEVADA  
CORPORATION)  
PO BOX 27740  
LAS VEGAS, NV 89126

THE MARK CONSISTS OF STANDARD CHAR-  
ACTERS WITHOUT CLAIM TO ANY PARTICULAR  
FONT, STYLE, SIZE, OR COLOR.

FOR: DIETARY SUPPLEMENT, IN CLASS 5 (U.S.  
CLS. 6, 18, 44, 46, 51 AND 52).

SER. NO. 77-310,935, FILED 10-23-2007.

FIRST USE 2-22-2007; IN COMMERCE 2-22-2007.

KEVIN DINALLO, EXAMINING ATTORNEY

**Int. Cls.: 41 and 45**

**Prior U.S. Cls.: 100, 101 and 107**

**United States Patent and Trademark Office**

**Reg. No. 3,466,424**

**Registered July 15, 2008**

**SERVICE MARK  
PRINCIPAL REGISTER**



CLERGY, TAX & LAW, INC. (TENNESSEE CORPORATION)  
SUITE 500  
5746 MARLIN ROAD  
CHATTANOOGA, TN 374114061

FOR: EDUCATIONAL SERVICES, NAMELY, CONDUCTING CLASSES, LECTURES AND SEMINARS IN THE FIELD OF CHURCH MANAGEMENT, TAXES AND FINANCES; ARRANGING AND CONDUCTING EDUCATIONAL CONFERENCES IN THE FIELD OF CHURCH MANAGEMENT, TAXES AND FINANCES, IN CLASS 41 (U.S. CLS. 100, 101 AND 107).

FIRST USE 12-15-2006; IN COMMERCE 12-15-2006.

FOR: RELIGIOUS COUNSELING FOR FAMILIES; MINISTERIAL SERVICES, NAMELY, ORDINATION OF MINISTERS, IN CLASS 45 (U.S. CLS. 100 AND 101).

FIRST USE 12-15-2006; IN COMMERCE 12-15-2006.

OWNER OF U.S. REG. NO. 3,263,805.

NO CLAIM IS MADE TO THE EXCLUSIVE RIGHT TO USE "INTERNATIONAL CONGRESS OF CHURCHES & MINISTERS", APART FROM THE MARK AS SHOWN.

THE COLOR(S) BLACK, WHITE, GOLD AND RED IS/ARE CLAIMED AS A FEATURE OF THE MARK.

THE MARK CONSISTS OF THE LETTERS "ICCM" AND THE WORDS "INTERNATIONAL CONGRESS OF CHURCHES & MINISTERS" IN WHITE WITH THE LETTERS "ICCM" SET AGAINST A BLACK NEARLY RECTANGULAR FIGURE OUTLINED IN WHITE WHICH ALSO CONTAINS TWO (2) TORCH DESIGNS IN WHICH THE TORCHES ARE GOLD AND WHITE AND THE FLAMES ARE RED, GOLD AND WHITE APPEARING ON EITHER SIDE OF THE LETTERS WITH THE BLACK NEARLY RECTANGULAR FIGURE IN TURN APPEARING AGAINST A BLACK CIRCLE WITH GOLD RAYS PROTRUDING THEREFROM AND HAVING WITHIN THE BLACK CIRCLE A RED SERRATED FIGURE OUTLINED IN WHITE WITHIN WHICH IS A GLOBE DESIGN IN WHITE, WITH WHITE HORIZONTAL AND VERTICAL LINES, THAT APPEARS AGAINST A GOLD BACKGROUND.

SER. NO. 77-311,023, FILED 10-23-2007.

Laurie Mayes, Examining Attorney

**Int. Cl.: 35**

**Prior U.S. Cls.: 100, 101 and 102**

**United States Patent and Trademark Office**

**Reg. No. 3,466,425**

**Registered July 15, 2008**

**SERVICE MARK  
PRINCIPAL REGISTER**

NAVIGATE THE GLOBAL ECONOMY

SIS INTERNATIONAL, INC. (NEW YORK CORPORATION)  
FLOOR 2  
11 EAST 22ND STREET  
NEW YORK, NY 10010

FOR: BUSINESS SERVICES, NAMELY, THE COLLECTION, MANAGEMENT, ANALYSIS AND REPORTING OF COMPANY, BUSINESS SECTOR AND INDUSTRY DATA AND RESEARCH; CUSTOM GLOBAL MARKET INTELLIGENCE RESEARCH AND ANALYSIS; CONSULTATION SERVICES IN THE FIELD OF BUSINESS SECTOR AND INDUSTRY DATA, RESEARCH AND ANALYSIS, IN CLASS 35 (U.S. CLS. 100, 101 AND 102).

FIRST USE 9-15-2007; IN COMMERCE 9-15-2007.

THE MARK CONSISTS OF STANDARD CHARACTERS WITHOUT CLAIM TO ANY PARTICULAR FONT, STYLE, SIZE, OR COLOR.

NO CLAIM IS MADE TO THE EXCLUSIVE RIGHT TO USE "GLOBAL ECONOMY", APART FROM THE MARK AS SHOWN.

SER. NO. 77-311,121, FILED 10-23-2007.

PAUL F. GAST, EXAMINING ATTORNEY

**Int. Cls.: 35 and 41**

**Prior U.S. Cls.: 100, 101, 102 and 107**

**United States Patent and Trademark Office**

**Reg. No. 3,466,426**

**Registered July 15, 2008**

**SERVICE MARK  
PRINCIPAL REGISTER**

**ONWARD**

ONWARD EDUCATION & TRAINING, LLC  
(NEW JERSEY LTD LIAB CO)  
ONE GREENTREE CENTRE, SUITE 201  
MARLTON, NJ 08053

FOR: CONSULTING AND MARKETING SERVICES RENDERED TO COLLEGES AND UNIVERSITIES FOR THE CREATION AND DEVELOPMENT OF ONLINE ADULT DISTANCE LEARNING OFF-CAMPUS DEGREE PROGRAMS FOR WORKING ADULTS, INCLUDING CONSULTING ON WEB-BASED RECRUITMENT, ENROLLMENT SERVICES, ASSISTANCE IN ADMISSIONS, AND MARKETING, IN CLASS 35 (U.S. CLS. 100, 101 AND 102).

FIRST USE 9-27-2007; IN COMMERCE 9-27-2007.

FOR: CAREER COUNSELING AND TRAINING SERVICES FOR THE PUBLIC FEATURING CAREER ASSESSMENT, JOB SEARCH, INTERVIEW TRAINING, RESUME DEVELOPMENT AND PREPARATION, AND COUNSELING ON EMPLOY-

MENT RESOURCES; EDUCATIONAL AND TRAINING SERVICES IN THE AREA OF CORPORATE HUMAN RESOURCES, NAMELY, CONDUCTING ONLINE DISTANCE LEARNING COURSES ON BEHALF OF BUSINESS ORGANIZATIONS FOR EMPLOYEES AND STAFF IN THE AREAS OF CAREER COUNSELING, RESUME DEVELOPMENT AND PREPARATION, INTERVIEW TRAINING AND TECHNIQUES, AND LEADERSHIP AND TEAM BUILDING TRAINING, IN CLASS 41 (U.S. CLS. 100, 101 AND 107).

FIRST USE 9-27-2007; IN COMMERCE 9-27-2007.

THE MARK CONSISTS OF STANDARD CHARACTERS WITHOUT CLAIM TO ANY PARTICULAR FONT, STYLE, SIZE, OR COLOR.

SER. NO. 77-311,248, FILED 10-23-2007.

RON FAIRBANKS, EXAMINING ATTORNEY

**Int. Cl.: 35**

**Prior U.S. Cls.: 100, 101 and 102**

**United States Patent and Trademark Office**

**Reg. No. 3,466,427**

**Registered July 15, 2008**

**SERVICE MARK  
PRINCIPAL REGISTER**

**SOJERN**

SOJERN, INC. (NEVADA CORPORATION)  
2323 SOUTH 171ST STREET, SUITE 200  
OMAHA, NE 68130

THE MARK CONSISTS OF STANDARD CHAR-  
ACTERS WITHOUT CLAIM TO ANY PARTICULAR  
FONT, STYLE, SIZE, OR COLOR.

FOR: ADVERTISING AND COMMERCIAL IN-  
FORMATION SERVICES, VIA THE INTERNET, IN  
CLASS 35 (U.S. CLS. 100, 101 AND 102).

SER. NO. 77-311,416, FILED 10-23-2007.

FIRST USE 10-9-2007; IN COMMERCE 10-9-2007.

IRA J. GOODSaid, EXAMINING ATTORNEY



**Int. Cl.: 3**

**Prior U.S. Cls.: 1, 4, 6, 50, 51 and 52**

**Reg. No. 3,466,428**

**United States Patent and Trademark Office**

**Registered July 15, 2008**

**TRADEMARK  
PRINCIPAL REGISTER**

**col-pure**

COLORADO HEALTH AND BEAUTY PRO-  
DUCTS (COLORADO LTD LIAB CO)  
PO BOX 270628  
LOUISVILLE, CO 80027

FOR: BEAUTY CREAMS; BEAUTY CREAMS FOR  
BODY CARE; BEAUTY GELS; BEAUTY LOTIONS;  
BEAUTY MASKS; BEAUTY MILKS; BEAUTY SER-  
UMS; BODY AND BEAUTY CARE COSMETICS;  
FACE AND BODY BEAUTY CREAMS; FACIAL  
BEAUTY MASKS; AGE SPOT REDUCING CREAMS;  
ANTI-AGING CREAM; ANTI-AGING CREAMS;  
ANTI-FRECKLE CREAMS; COSMETIC CREAMS  
FOR SKIN CARE; COSMETIC PREPARATIONS  
FOR SKIN RENEWAL; EXFOLIANTS FOR DAILY  
SKINCARE; LOTIONS FOR DAILY SKINCARE;  
MOUSSE FOR DAILY SKINCARE; NON-MEDICA-  
TED SKIN CARE PREPARATIONS; NON-MEDICA-  
TED SKIN CARE PREPARATIONS, NAMELY,  
CREAMS, LOTIONS, GELS, TONERS, CLEANERS  
AND PEELS; NON-MEDICATED SKIN CREAMS;

NON-MEDICATED STIMULATING LOTIONS FOR  
THE SKIN; PATCHES CONTAINING SUN SCREEN  
AND SUN BLOCK FOR USE ON THE SKIN; SKIN  
ABRASIVE PREPARATIONS; SKIN AND BODY  
TOPICAL LOTIONS, CREAMS AND OILS FOR  
COSMETIC USE; SKIN BRONZER; SKIN BRONZ-  
ING CREAMS; SKIN CARE PREPARATION, NAME-  
LY, BODY POLISH, IN CLASS 3 (U.S. CLS. 1, 4, 6, 50,  
51 AND 52).

FIRST USE 11-1-2005; IN COMMERCE 11-1-2005.

THE MARK CONSISTS OF STANDARD CHAR-  
ACTERS WITHOUT CLAIM TO ANY PARTICULAR  
FONT, STYLE, SIZE, OR COLOR.

SER. NO. 77-311,441, FILED 10-23-2007.

APRIL ROACH, EXAMINING ATTORNEY

**Int. Cl.: 9**

**Prior U.S. Cls.: 21, 23, 26, 36 and 38**

**Reg. No. 3,466,429**

**United States Patent and Trademark Office**

**Registered July 15, 2008**

---

**TRADEMARK  
PRINCIPAL REGISTER**

**NETVM**

D3DATA, LLC (WASHINGTON LTD LIAB CO)  
6920 220TH STREET SW  
SUITE 109  
MOUNTLAKE TERRACE, WA 98043

WARE TO CONTROL AND MONITOR MULTIPLE  
VIDEO CAMERAS, IN CLASS 9 (U.S. CLS. 21, 23, 26,  
36 AND 38).

FIRST USE 9-1-2002; IN COMMERCE 9-1-2002.

FOR: DOWNLOADABLE BROWSER-BASED  
SOFTWARE FOR SECURITY VIDEO, HOSTED VI-  
DEO MANAGEMENT, AND REMOTE VERIFICA-  
TION; SOFTWARE FOR REMOTE MANAGEMENT  
AND MONITORING OF SECURITY VIDEO CAM-  
ERAS; NETWORK VIDEO MANAGEMENT SOFT-  
WARE; SOFTWARE FOR VIDEO SECURITY  
SYSTEMS; TELEVISION SURVEILLANCE SOFT-

THE MARK CONSISTS OF STANDARD CHAR-  
ACTERS WITHOUT CLAIM TO ANY PARTICULAR  
FONT, STYLE, SIZE, OR COLOR.

SER. NO. 77-311,540, FILED 10-23-2007.

CHRISTINA SOBRAL, EXAMINING ATTORNEY

**Int. Cl.: 9**

**Prior U.S. Cls.: 21, 23, 26, 36 and 38**

**Reg. No. 3,466,430**

**United States Patent and Trademark Office**

**Registered July 15, 2008**

---

**TRADEMARK  
PRINCIPAL REGISTER**

**D3DATA**

D3DATA, LLC (WASHINGTON LTD LIAB CO)  
6920 220TH STREET SW  
SUITE 109  
MOUNTLAKE TERRACE, WA 98043

WARE TO CONTROL AND MONITOR MULTIPLE  
VIDEO CAMERAS, IN CLASS 9 (U.S. CLS. 21, 23, 26,  
36 AND 38).

FIRST USE 9-1-2002; IN COMMERCE 9-1-2002.

FOR: DOWNLOADABLE BROWSER-BASED  
SOFTWARE FOR SECURITY VIDEO, HOSTED VI-  
DEO MANAGEMENT, AND REMOTE VERIFICA-  
TION; SOFTWARE FOR REMOTE MANAGEMENT  
AND MONITORING OF SECURITY VIDEO CAM-  
ERAS; NETWORK VIDEO MANAGEMENT SOFT-  
WARE; SOFTWARE FOR VIDEO SECURITY  
SYSTEMS; TELEVISION SURVEILLANCE SOFT-

THE MARK CONSISTS OF STANDARD CHAR-  
ACTERS WITHOUT CLAIM TO ANY PARTICULAR  
FONT, STYLE, SIZE, OR COLOR.

SER. NO. 77-311,541, FILED 10-23-2007.

CHRISTINA SOBRAL, EXAMINING ATTORNEY

**Int. Cl.: 35**

**Prior U.S. Cls.: 100, 101 and 102**

**United States Patent and Trademark Office**

**Reg. No. 3,466,431**

**Registered July 15, 2008**

**SERVICE MARK  
PRINCIPAL REGISTER**



**lawlolawl**

E19 INDUSTRIES LLC (FLORIDA LTD LIAB CO)  
1812 SE 31ST LANE  
OCALA, FL 34471

FOR: ON-LINE RETAIL STORE SERVICES FEATURING T-SHIRTS, WALLPAPER, MOUSE PADS, PLUSH TOYS, AND DOWNLOADABLE ANIMATION FILES, DOWNLOADABLE GRAPHIC ART, DOWNLOADABLE AUDIO FILES, AND DOWNLOADABLE ELECTRONIC BOOKS, IN CLASS 35 (U.S. CLS. 100, 101 AND 102).

FIRST USE 4-4-2007; IN COMMERCE 5-17-2007.

THE MARK CONSISTS OF THREE SMILING FACES WITH THE STYLIZED TEXT "LAWLOLAWL" UNDERNEATH THE FACES.

SER. NO. 77-311,568, FILED 10-23-2007.

MICHAEL SOUDERS, EXAMINING ATTORNEY

**Int. Cl.: 37**

**Prior U.S. Cls.: 100, 103 and 106**

**United States Patent and Trademark Office**

**Reg. No. 3,466,432**

**Registered July 15, 2008**

**SERVICE MARK  
PRINCIPAL REGISTER**

**COLLISYS**

COLLINS ELECTRICAL SYSTEMS, INC. (MINNESOTA CORPORATION)  
4990 NORTH HIGHWAY 169  
NEW HOPE, MN 55428

FOR: ELECTRICAL SYSTEM INSTALLATION, CONSTRUCTION, MAINTENANCE AND TECHNICAL SUPPORT SERVICES IN THE NATURE OF TECHNICAL ADVICE IN THE FIELD OF INSTALLATION, CONSTRUCTION, MAINTENANCE, OVERHAUL AND REPAIR OF LOW VOLTAGE COMMUNICATIONS SYSTEMS AND HIGH VOLTAGE POWER LINES FOR CITIES, MUNICIPALITIES, GOVERNMENTAL APPLICATIONS, SPORTS FACILITIES, COMMERCIAL BUSINESS, PARKING AREAS, HIGH RISE HOUSING, INDUSTRIAL PLANTS, MEDICAL FACILITIES, OFFICES AND RETAIL FACILITIES; INSTALLATION AND MAIN-

TENANCE OF HIGHWAY LIGHTING, TRAFFIC SIGNALS, TUNNEL LIGHTING, CLOSED-CIRCUIT TELEVISION AND SOPHISTICATED FIBER INTEGRATED TRAFFIC MANAGEMENT AND EMERGENCY VEHICLE PREEMPTION SYSTEMS, IN CLASS 37 (U.S. CLS. 100, 103 AND 106).

FIRST USE 10-4-1991; IN COMMERCE 10-4-1991.

THE MARK CONSISTS OF STANDARD CHARACTERS WITHOUT CLAIM TO ANY PARTICULAR FONT, STYLE, SIZE, OR COLOR.

SER. NO. 77-311,841, FILED 10-24-2007.

TOBY BULLOFF, EXAMINING ATTORNEY

**Int. Cl.: 31**

**Prior U.S. Cls.: 1 and 46**

**United States Patent and Trademark Office**

**Reg. No. 3,466,433**

**Registered July 15, 2008**

**TRADEMARK  
PRINCIPAL REGISTER**

**GOLD RUSH**

CARGILL, INCORPORATED (DELAWARE CORPORATION)  
15407 MCGINTY ROAD WEST  
WAYZATA, MN 55391

THE MARK CONSISTS OF STANDARD CHARACTERS WITHOUT CLAIM TO ANY PARTICULAR FONT, STYLE, SIZE, OR COLOR.

FOR: ANIMAL FEED, IN CLASS 31 (U.S. CLS. 1 AND 46).

SER. NO. 77-311,983, FILED 10-24-2007.

FIRST USE 8-24-2000; IN COMMERCE 8-24-2000.

WILLIAM VERHOSEK, EXAMINING ATTORNEY

**Int. Cl.: 35**

**Prior U.S. Cls.: 100, 101 and 102**

**United States Patent and Trademark Office**

**Reg. No. 3,466,434**

**Registered July 15, 2008**

**SERVICE MARK  
PRINCIPAL REGISTER**



**& c o m p a n y**

TAMPA BAY CONVENTION & VISITORS BU-  
REAU, INC. (FLORIDA CORPORATION), DBA  
TAMPA BAY & COMPANY  
401 EAST JACKSON STREET  
TAMPA, FL 33602

FOR: PROMOTING TOURISM, TRAVEL, BUSI-  
NESS, AND ECONOMIC DEVELOPMENT IN THE  
TAMPA BAY REGION OF FLORIDA, IN CLASS 35  
(U.S. CLS. 100, 101 AND 102).

FIRST USE 10-1-2007; IN COMMERCE 10-1-2007.

NO CLAIM IS MADE TO THE EXCLUSIVE  
RIGHT TO USE "TAMPA BAY & COMPANY",  
APART FROM THE MARK AS SHOWN.

SER. NO. 77-312,088, FILED 10-24-2007.

KAREN SEVERSON, EXAMINING ATTORNEY

**Int. Cls.: 38, 41 and 45**

**Prior U.S. Cls.: 100, 101, 104 and 107**

**United States Patent and Trademark Office**

**Reg. No. 3,466,435**

**Registered July 15, 2008**

**SERVICE MARK  
PRINCIPAL REGISTER**

**POWNCE**

MEGATECHTRONIUM, INC. (DELAWARE CORPORATION)  
1459 18TH STREET, SUITE 142  
SAN FRANCISCO, CA 94107

FOR: TELECOMMUNICATION SERVICES, NAMELY, PROVIDING DATA TRANSFER SERVICES BY ONLINE AND TELECOMMUNICATION MEANS FOR THE TRANSMISSION, VIEWING, AND DOWNLOADING OF TEXT, WEBLINKS, IMAGES, AUDIO, AND VIDEO CONTENT AMONG USERS, IN CLASS 38 (U.S. CLS. 100, 101 AND 104).

FIRST USE 6-27-2007; IN COMMERCE 6-27-2007.

FOR: ONLINE JOURNALS, NAMELY, BLOGS FEATURING TOPICS OF GENERAL INTEREST, IN CLASS 41 (U.S. CLS. 100, 101 AND 107).

FIRST USE 6-27-2007; IN COMMERCE 6-27-2007.

FOR: INTERNET BASED SOCIAL NETWORKING SERVICES ALLOWING USERS TO COMMUNICATE AND SHARE, TRANSMIT, VIEW, AND DOWNLOAD TEXT, IMAGES, AUDIO AND VIDEO CONTENT, IN CLASS 45 (U.S. CLS. 100 AND 101).

FIRST USE 6-27-2007; IN COMMERCE 6-27-2007.

THE MARK CONSISTS OF STANDARD CHARACTERS WITHOUT CLAIM TO ANY PARTICULAR FONT, STYLE, SIZE, OR COLOR.

SER. NO. 77-312,473, FILED 10-24-2007.

LYDIA BELZER, EXAMINING ATTORNEY



**Int. Cls.: 35 and 44**

**Prior U.S. Cls.: 100, 101 and 102**

**United States Patent and Trademark Office**

**Reg. No. 3,466,436**

**Registered July 15, 2008**

**SERVICE MARK  
PRINCIPAL REGISTER**



LITTER INDUSTRIES, INC. (OHIO CORPORATION)  
524 EASTERN AVENUE  
CHILLICOTHE, OH 45601

FOR: DISTRIBUTORSHIP SERVICES IN THE FIELD OF PROPANE GAS; WHOLESALE DISTRIBUTORSHIP SERVICES IN THE AREA OF BEER AND ALE, IN CLASS 35 (U.S. CLS. 100, 101 AND 102).

FIRST USE 1-1-1952; IN COMMERCE 1-1-1953.

FOR: AGRICULTURAL FARMING, IN CLASS 44 (U.S. CLS. 100 AND 101).

FIRST USE 1-1-1952; IN COMMERCE 1-1-1953.

THE MARK CONSISTS OF A STYLIZED BUFFALO WITH THE TERM "LITTER" SUPERIMPOSED OVER IT ALL ENCIRCLED BY A ROPE.

SER. NO. 77-312,570, FILED 10-24-2007.

GENE MACIOL, EXAMINING ATTORNEY

**Int. Cl.: 44**

**Prior U.S. Cls.: 100 and 101**

**United States Patent and Trademark Office**

**Reg. No. 3,466,437**

**Registered July 15, 2008**

**SERVICE MARK  
PRINCIPAL REGISTER**



**Health  
Dimensions**

HEALTH DIMENSIONS, LLC (CALIFORNIA LTD  
LIAB CO), DBA HEALTH DIMENSIONS  
2942 HARDING STREET  
CARLSBAD, CA 92008

FOR: MEDICAL SERVICES, NAMELY, PROVID-  
ING MEDICAL BIOMETRIC SCREENINGS AND  
VACCINATIONS EITHER DIRECTLY OR  
THROUGH A THIRD PARTY, FOR INDIVIDUALS  
OR ANY TYPE OF ORGANIZED GROUP, INCLUD-  
ING EMPLOYERS, BROKERS OR THIRD PARTY  
ADMINISTRATORS, IN CLASS 44 (U.S. CLS. 100  
AND 101).

FIRST USE 11-11-1992; IN COMMERCE 1-2-1993.

NO CLAIM IS MADE TO THE EXCLUSIVE  
RIGHT TO USE "HEALTH", APART FROM THE  
MARK AS SHOWN.

THE COLOR(S) BLACK AND RED IS/ARE  
CLAIMED AS A FEATURE OF THE MARK.

THE MARK CONSISTS OF A BLACK LETTER "D"  
STYLIZED INSIDE A BLACK LETTER "H" SUR-  
ROUNDED WITH A RED BACKGROUND AND  
THE WORDS "HEALTH DIMENSIONS" SPELLED  
OUT IN BLACK BELOW.

SER. NO. 77-312,699, FILED 10-24-2007.

CIMMERIAN COLEMAN, EXAMINING ATTOR-  
NEY

Int. Cl.: 3

Prior U.S. Cls.: 1, 4, 6, 50, 51 and 52

United States Patent and Trademark Office

Reg. No. 3,466,438

Registered July 15, 2008

TRADEMARK  
PRINCIPAL REGISTER



BAILEY, STEVEN M. (CANADA INDIVIDUAL)  
BOX 1585  
3592 APPLETON SIDE ROAD  
CARLETON PLACE, CANADA K7C4M3

FOR: PERFUME, COLOGNE, EAU DE TOILETTE,  
PERFUME OIL, BODY SPRAY, AFTERSHAVE,  
AFTERSHAVE BALM, DEODORANT, SHAMPOO,  
SOAP, IN CLASS 3 (U.S. CLS. 1, 4, 6, 50, 51 AND 52).

FIRST USE 8-6-1999; IN COMMERCE 8-6-1999.

PRIORITY CLAIMED UNDER SEC. 44(D) ON  
CANADA APPLICATION NO. 1366870, FILED 10-9-  
2007.

OWNER OF U.S. REG. NO. 1,804,019.

NO CLAIM IS MADE TO THE EXCLUSIVE  
RIGHT TO USE "POUR HOMME", APART FROM  
THE MARK AS SHOWN.

THE MARK CONSISTS OF THE STYLIZED  
WORD "SEXUAL" FEATURING ACCENTS ON  
THE LETTERS "X" AND "U" ABOVE THE WORDS  
"POUR HOMME".

THE FOREIGN WORDING IN THE MARK  
TRANSLATES INTO ENGLISH AS FOR MAN.

SER. NO. 77-312,830, FILED 10-24-2007.

RAUL CORDOVA, EXAMINING ATTORNEY

**Int. Cl.: 9**

**Prior U.S. Cls.: 21, 23, 26, 36 and 38**

**Reg. No. 3,466,439**

**United States Patent and Trademark Office**

**Registered July 15, 2008**

---

**TRADEMARK  
PRINCIPAL REGISTER**

**Yogen**

EASY ENERGY, INC (NEVADA CORPORATION)  
POB 6409  
49 HA'AROSHET ST.  
KARMIEL, ISRAEL 20100

FOR: BATTERY CHARGERS, NAMELY, MANU-  
ALLY OPERATED BATTERY CHARGERS, IN  
CLASS 9 (U.S. CLS. 21, 23, 26, 36 AND 38).

FIRST USE 10-22-2007; IN COMMERCE 10-22-2007.

THE MARK CONSISTS OF STANDARD CHAR-  
ACTERS WITHOUT CLAIM TO ANY PARTICULAR  
FONT, STYLE, SIZE, OR COLOR.

THE FOREIGN WORDING IN THE MARK  
TRANSLATES INTO ENGLISH AS "PREMONI-  
TION".

SER. NO. 77-312,995, FILED 10-25-2007.

KAPIL BHANOT, EXAMINING ATTORNEY

**Int. Cl.: 35**

**Prior U.S. Cls.: 100, 101 and 102**

**United States Patent and Trademark Office**

**Reg. No. 3,466,440**

**Registered July 15, 2008**

**SERVICE MARK  
PRINCIPAL REGISTER**

The logo for uBid.com features the text "uBid.com" in a bold, sans-serif font. The letter "u" is red, while "Bid" and ".com" are blue. The letters are slightly shadowed, giving them a 3D appearance as if they are floating above a white surface.

UBID, INC. (DELAWARE CORPORATION)  
8725 W. HIGGINS, 9TH FLOOR  
CHICAGO, IL 60631

OWNER OF U.S. REG. NOS. 2,229,515, 2,991,806  
AND OTHERS.

FOR: ONLINE TRADING SERVICES IN WHICH THE SELLER POSTS PRODUCTS TO BE AUCTIONED AND BIDDING IS DONE VIA THE INTERNET; ONLINE RETAIL STORE SERVICES FEATURING CONSUMER ELECTRONICS, COMPUTER-RELATED PRODUCTS, HOME APPLIANCES, HOME IMPROVEMENT, AUTOMOTIVE, SPORTS AND RECREATIONAL, MULTIMEDIA ENTERTAINMENT, TOYS, JEWELRY, FRAGRANCES, SKIN CARE, COSMETICS, PURSES, HAND BAGS, WALLETS, SUNGLASSES, HATS, TOOLS, ART, FURNITURE, STORAGE, ORGANIZATION, PET SUPPLIES, CRAFTS, FOOD AND WINE, GARDENING AND PLANTING SUPPLIES, AND LAWN AND GARDEN DECOR, IN CLASS 35 (U.S. CLS. 100, 101 AND 102).

NO CLAIM IS MADE TO THE EXCLUSIVE RIGHT TO USE ".COM", APART FROM THE MARK AS SHOWN.

THE COLOR(S) RED AND BLUE IS/ARE CLAIMED AS A FEATURE OF THE MARK.

THE COLOR RED APPEARS IN THE WORDING AS THE LETTER "U" AS WELL AS ON THE DOT; THE COLOR BLUE APPEARS IN THE WORDING AS THE LETTERS "BID" AND "COM".

SER. NO. 77-313,267, FILED 10-25-2007.

FIRST USE 1-1-1997; IN COMMERCE 1-1-1997.

STEVEN JACKSON, EXAMINING ATTORNEY

Int. Cl.: 20

Prior U.S. Cls.: 2, 13, 22, 25, 32 and 50

Reg. No. 3,466,441

United States Patent and Trademark Office

Registered July 15, 2008

TRADEMARK  
PRINCIPAL REGISTER



NATIONAL OFFICE SERVICES, INC. (OHIO CORPORATION)  
15655 BROOKPARK ROAD  
BROOK PARK, OH 44142

FOR: OFFICE FURNITURE MANUFACTURED WITH RECYCLED OR USED ELEMENTS AND IS RE-MANUFACTURED TOGETHER WITH NEW REPLACEMENT PARTS AND TRIM ELEMENTS , IN CLASS 20 (U.S. CLS. 2, 13, 22, 25, 32 AND 50).

FIRST USE 12-15-2006; IN COMMERCE 12-15-2006.

OWNER OF U.S. REG. NO. 3,292,985.

NO CLAIM IS MADE TO THE EXCLUSIVE RIGHT TO USE "HYBRID OFFICE FURNITURE", APART FROM THE MARK AS SHOWN.

THE MARK CONSISTS OF THE STYLIZED WORDS "GEN2 HYBRID OFFICE FURNITURE". NEXT TO THE WORD "GEN" IS AN IMAGE OF A LEAF. THE NUMBER "2" IS UNDERLINED AND THE LETTER "G" IS DISPLAYED IN LARGER STYLIZED LETTERING AGAINST A PARTIALLY SHADED INCOMPLETE RECTANGLE. ONE SIDE OF THE RECTANGLE FORMS A CURVE AND OUTLINES THE LETTER "E" IN "GEN".

SER. NO. 77-313,811, FILED 10-25-2007.

RENEE SERVANCE, EXAMINING ATTORNEY

**Int. Cl.: 16**

**Prior U.S. Cls.: 2, 5, 22, 23, 29, 37, 38 and 50**

**Reg. No. 3,466,442**

**United States Patent and Trademark Office**

**Registered July 15, 2008**

---

**TRADEMARK  
PRINCIPAL REGISTER**

# GO GUIDE

GOVERNMENT SOLUTIONS GROUP, INC. (CALIFORNIA CORPORATION)  
456 EAST ORANGE GROVE BLVD., SUITE 302  
PASADENA, CA 91104

FOR: PRINTED MATERIALS, NAMELY, INFORMATION BROCHURE ABOUT PUBLIC PARKS, IN CLASS 16 (U.S. CLS. 2, 5, 22, 23, 29, 37, 38 AND 50).

FIRST USE 5-30-2007; IN COMMERCE 5-30-2007.

THE MARK CONSISTS OF STANDARD CHARACTERS WITHOUT CLAIM TO ANY PARTICULAR FONT, STYLE, SIZE, OR COLOR.

NO CLAIM IS MADE TO THE EXCLUSIVE RIGHT TO USE "GUIDE", APART FROM THE MARK AS SHOWN.

SER. NO. 77-313,858, FILED 10-25-2007.

ELISSA GARBER KON, EXAMINING ATTORNEY

**Int. Cls.: 41 and 42**

**Prior U.S. Cls.: 100, 101 and 107**

**United States Patent and Trademark Office**

**Reg. No. 3,466,443**

**Registered July 15, 2008**

**SERVICE MARK  
PRINCIPAL REGISTER**

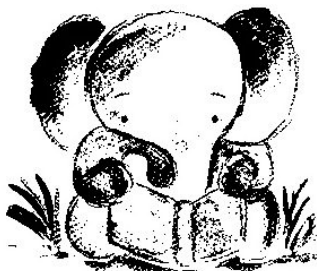

**Blue Elephant Books**

*What Does Your Imagination Look Like?*

BLUE ELEPHANT BOOKS, INC. (CALIFORNIA CORPORATION)  
28982 SAM PLACE  
CANYON COUNTRY, CA 91387

FOR: EDITORIAL CONSULTATION; EDITING OF PRINTED MATTER; EDUCATIONAL AND ENTERTAINMENT SERVICES, NAMELY, PROVIDING MOTIVATIONAL AND EDUCATIONAL SPEAKERS, IN CLASS 41 (U.S. CLS. 100, 101 AND 107).

FIRST USE 9-0-2006; IN COMMERCE 10-0-2006.

FOR: GRAPHIC ART DESIGN; GRAPHIC DESIGN SERVICES; GRAPHIC ILLUSTRATION SERVICES FOR OTHERS; DESIGN AND DEVELOPMENT OF BOOKS, IN CLASS 42 (U.S. CLS. 100 AND 101).

FIRST USE 9-0-2006; IN COMMERCE 10-0-2006.

NO CLAIM IS MADE TO THE EXCLUSIVE RIGHT TO USE "BOOKS", APART FROM THE MARK AS SHOWN.

THE MARK CONSISTS OF AN ELEPHANT HOLDING A BOOK, ABSTRACT DESIGNS IN THE FORM OF GRASS TO THE LEFT AND RIGHT SIDE OF THE ELEPHANT, AND A SOLID HORIZONTAL LINE SEPARATING THE STYLIZED TEXT "BLUE ELEPHANT BOOKS" AND "WHAT DOES YOUR IMAGINATION LOOK LIKE?".

SER. NO. 77-313,990, FILED 10-25-2007.

MICHELLE DUBOIS, EXAMINING ATTORNEY



**Int. Cl.: 36**

**Prior U.S. Cls.: 100, 101 and 102**

**United States Patent and Trademark Office**

**Reg. No. 3,466,444**

**Registered July 15, 2008**

**SERVICE MARK  
PRINCIPAL REGISTER**



VALIANT INSURANCE GROUP, INC. (DELA-  
WARE CORPORATION)  
30TH FLOOR  
100 WILLIAM STREET  
NEW YORK, NY 10038

FOR: INSURANCE SERVICES, NAMELY, WRIT-  
ING PROPERTY AND CASUALTY INSURANCE, IN  
CLASS 36 (U.S. CLS. 100, 101 AND 102).

FIRST USE 10-1-2007; IN COMMERCE 10-1-2007.

NO CLAIM IS MADE TO THE EXCLUSIVE  
RIGHT TO USE "INSURANCE", APART FROM  
THE MARK AS SHOWN.

THE COLOR(S) PURPLE AND GOLD IS/ARE  
CLAIMED AS A FEATURE OF THE MARK.

THE MARK CONSISTS OF A STYLIZED "V" AS  
PART OF A SQUARE SPLIT INTO THREE PARTS:  
FIRST PART IS GOLD, MIDDLE PART IS PURPLE,  
AND THIRD PART IS GOLD; "VALIANT" IS PUR-  
PLE; "INSURANCE" IS GOLD.

SER. NO. 77-314,240, FILED 10-26-2007.

PAUL E. FAHRENKOPF, EXAMINING ATTORNEY

**Int. Cls.: 29 and 31**

**Prior U.S. Cls.: 1 and 46**

**United States Patent and Trademark Office**

**Reg. No. 3,466,445**

**Registered July 15, 2008**

**TRADEMARK  
PRINCIPAL REGISTER**

**HINES PEANUTS**

HINES NUT COMPANY LTD. (TEXAS LIMITED PARTNERSHIP), AKA HINES NUT COMPANY  
990 SOUTH SAINT PAUL STREET  
DALLAS, TX 75201

FOR: ROASTED NUTS; SHELLED NUTS, IN CLASS 29 (U.S. CL. 46).

FIRST USE 1-1-1970; IN COMMERCE 1-1-1970.

FOR: RAW NUTS , IN CLASS 31 (U.S. CLS. 1 AND 46).

FIRST USE 1-1-1970; IN COMMERCE 1-1-1970.

THE MARK CONSISTS OF STANDARD CHARACTERS WITHOUT CLAIM TO ANY PARTICULAR FONT, STYLE, SIZE, OR COLOR.

NO CLAIM IS MADE TO THE EXCLUSIVE RIGHT TO USE "PEANUTS", APART FROM THE MARK AS SHOWN.

SEC. 2(F).

SER. NO. 77-314,292, FILED 10-26-2007.

MICHAEL KEATING, EXAMINING ATTORNEY

Int. Cl.: 29

Prior U.S. Cl.: 46

United States Patent and Trademark Office

Reg. No. 3,466,446

Registered July 15, 2008

TRADEMARK  
PRINCIPAL REGISTER



NANTUCKET ACQUISITION, LLC (MASSACHUSETTS LTD LIAB CO)  
300 WEST 1ST STREET  
BOSTON, MA 021271207

FOR: POTATO CHIPS, IN CLASS 29 (U.S. CL. 46).

FIRST USE 5-25-2005; IN COMMERCE 5-25-2005.

NO CLAIM IS MADE TO THE EXCLUSIVE RIGHT TO USE "HAND COOKED NANTUCKET POTATO CHIPS NO PRESERVATIVES AND THE OUTLINE OF THE MAP OF NANTUCKET", APART FROM THE MARK AS SHOWN.

THE COLOR(S) RED, WHITE AND NAVY BLUE IS/ARE CLAIMED AS A FEATURE OF THE MARK.

THE MARK CONSISTS OF THE COLORS RED, WHITE AND NAVY BLUE, WHICH ARE CLAIMED AS A DISTINCTIVE FEATURE OF THE MARK. THE WORDS "ANNE'S HAND COOKED" APPEAR AT THE TOP OF THE MARK IN NAVY BLUE, WITH A WHITE BACKGROUND. THE WORD "NANTUCKET" APPEARS IN RED IN LARGER LETTERS BELOW "ANNE'S HAND COOKED", AND IS FLANKED BY A NAVY BLUE-OVER-RED STRIPE ON EITHER SIDE, BOWED IN A DOWNWARD DIRECTION. IN THE MIDDLE OF THE MARK IS A DRAWING WHICH CONSISTS OF THE FOLLOWING: A DRAWING, OUTLINED IN NAVY BLUE,

WITH A WHITE BACKGROUND, OF NANTUCKET ISLAND, WITH THE WORD "NANTUCKET" IN THE LEFT-CENTER SECTION OF THE ISLAND, SURROUNDED BY HORIZONTAL PEAKED LINES IN THE SHAPE OF WAVES. TO THE LEFT OF THE ISLAND IS AN ILLUSTRATION OF A "SCHOONER" SHIP WITH MULTIPLE SAILS, FACING TOWARDS THE ISLAND. TO THE RIGHT OF THE ISLAND IS AN ILLUSTRATION OF A WHALE WITH ITS TAIL OUT OF THE WATER AND BLOWING WATER OUT OF ITS BLOWHOLE. ON THE TOP RIGHT HAND SECTION OF THE ISLAND IS AN ILLUSTRATION OF A FISHERMAN DRESSED IN FISHERMAN'S SLICKERS HOLDING A FISHING POLE WITH A LINE IN THE WATER. ON THE BOTTOM-RIGHT SECTION OF THE ISLAND IS AN ILLUSTRATION OF A LOBSTER, OUTLINED IN NAVY BLUE. BELOW THE DRAWING ARE THE WORDS "POTATO CHIPS" IN RED LETTERING SLIGHTLY SMALLER THAN THE WORD "NANTUCKET" ABOVE THE DRAWING. THE WORDS "NO PRESERVATIVES" APPEAR BELOW "POTATO CHIPS" IN SMALLER CAPITAL NAVY BLUE LETTERS. BELOW THE WORDS "NO PRESERVATIVES" IS A RED-OVER-NAVY BLUE STRIPE BOWED IN AN UPWARD DIRECTION.

SER. NO. 77-314,302, FILED 10-26-2007.

ELISSA GARBER KON, EXAMINING ATTORNEY

**Int. Cl.: 35**

**Prior U.S. Cls.: 100, 101 and 102**

**United States Patent and Trademark Office**

**Reg. No. 3,466,447**

**Registered July 15, 2008**

**SERVICE MARK  
PRINCIPAL REGISTER**

# Pool Kids

POOLMASTER, INC. (CALIFORNIA CORPORATION)  
770 W. DEL PASO ROAD  
SACRAMENTO, CA 95834

FOR: WHOLESALE DISTRIBUTORSHIPS FEATURING INFLATABLES, NAMELY, BALLS, MATTRESS, AND TUBES, AND TOYS, NAMELY, BASKETBALL HOOPS, SOCCER NETS AND BALLS, VOLLEYBALL NETS AND BALLS , IN CLASS 35 (U.S. CLS. 100, 101 AND 102).

FIRST USE 9-1-1994; IN COMMERCE 9-1-1994.

THE MARK CONSISTS OF STANDARD CHARACTERS WITHOUT CLAIM TO ANY PARTICULAR FONT, STYLE, SIZE, OR COLOR.

NO CLAIM IS MADE TO THE EXCLUSIVE RIGHT TO USE "POOL", APART FROM THE MARK AS SHOWN.

SER. NO. 77-314,554, FILED 10-26-2007.

KIMBERLY FRYE, EXAMINING ATTORNEY

**Int. Cl.: 35**

**Prior U.S. Cls.: 100, 101 and 102**

**United States Patent and Trademark Office**

**Reg. No. 3,466,448**

**Registered July 15, 2008**

**SERVICE MARK  
PRINCIPAL REGISTER**

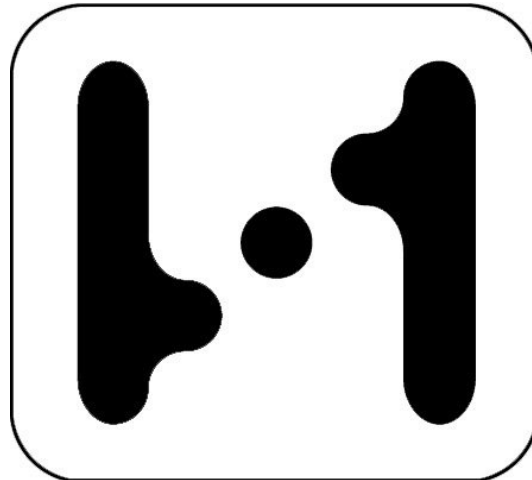

ONE-TO-ONE INSTITUTE (MICHIGAN NON-  
PROFIT CORPORATION)  
P.O. BOX 16307  
LANSING, MI 489016307

FOR: BUSINESS ADVISORY AND CONSULTING  
SERVICES TO SCHOOL DISTRICTS AND EDUCA-  
TION DEPARTMENTS, IN THE FIELD OF DEVEL-  
OPING, BUILDING, LAUNCHING, AND  
SUSTAINING ONE TO ONE WIRELESS LEARNING  
AND TEACHING; PROMOTING PUBLIC AWARE-  
NESS OF THE IMPORTANCE OF ONE TO ONE  
WIRELESS LEARNING AND TEACHING IN  
SCHOOLS, IN CLASS 35 (U.S. CLS. 100, 101 AND 102).

FIRST USE 3-8-2006; IN COMMERCE 3-8-2006.

THE MARK CONSISTS OF TWO STYLIZED NU-  
MERAL "ONE'S" FACING EACH OTHER ACROSS A  
CENTRAL DOT; THE LEFTMOST NUMERAL IS  
UPSIDE DOWN.

SER. NO. 77-314,766, FILED 10-26-2007.

ADA HAN, EXAMINING ATTORNEY

**Int. Cl.: 41**

**Prior U.S. Cls.: 100, 101 and 107**

**United States Patent and Trademark Office**

**Reg. No. 3,466,449**

**Registered July 15, 2008**

**SERVICE MARK  
PRINCIPAL REGISTER**

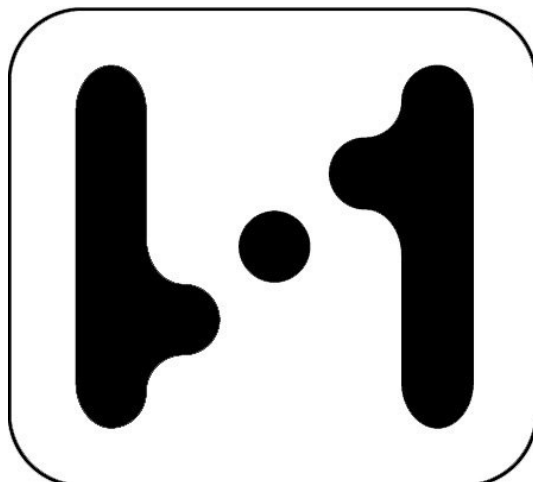

ONE-TO-ONE INSTITUTE (MICHIGAN NON-PROFIT CORPORATION)  
P.O. BOX 16307  
LANSING, MI 489016307

FOR: EDUCATIONAL SERVICES, NAMELY, PROMOTING A PROGRAM TO PROMOTE TEACHING METHODS OF ONE TO ONE WIRELESS LEARNING AND TEACHING IN SCHOOLS; EDUCATIONAL SERVICES, NAMELY, DEVELOPING CURRICULA FOR OTHERS IN THE FIELD OF WIRELESS LEARNING AND TEACHING, NAMELY, DEVELOPING PROGRAM MODELS; AND EDUCATIONAL SERVICES, NAMELY, ORGANIZING, PROMOTING, CONDUCTING, AND ADMINISTERING EDUCATION PROGRAMS AND

ACTIVITIES FOR SCHOOL DISTRICTS AND EDUCATION DEPARTMENTS IN THE FIELD OF WIRELESS LEARNING AND TEACHING, IN CLASS 41 (U.S. CLS. 100, 101 AND 107).

FIRST USE 3-8-2006; IN COMMERCE 3-8-2006.

THE MARK CONSISTS OF TWO STYLIZED NUMERAL ONE'S FACING EACH OTHER ACROSS A CENTRAL DOT; THE LEFTMOST NUMERAL IS UPSIDE DOWN.

SER. NO. 77-314,804, FILED 10-26-2007.

ADA HAN, EXAMINING ATTORNEY

**Int. Cl.: 44**

**Prior U.S. Cls.: 100 and 101**

**United States Patent and Trademark Office**

**Reg. No. 3,466,450**

**Registered July 15, 2008**

**SERVICE MARK  
PRINCIPAL REGISTER**

**The choice is yours.  
Choose to know.**

LIFECHOICES MEDICAL CLINIC & RESOURCE  
CENTER BOARD OF DIRECTORS (MISSOURI  
CORPORATION)  
531 EAST 7TH STREET  
JOPLIN, MO 64801

THE MARK CONSISTS OF STANDARD CHAR-  
ACTERS WITHOUT CLAIM TO ANY PARTICULAR  
FONT, STYLE, SIZE, OR COLOR.

FOR: OBSTETRIC AND GYNECOLOGY SERVI-  
CES, IN CLASS 44 (U.S. CLS. 100 AND 101).

SER. NO. 77-314,810, FILED 10-26-2007.

FIRST USE 1-1-2001; IN COMMERCE 1-1-2001.

DARRYL SPRUILL, EXAMINING ATTORNEY

**Int. Cl.: 45**

**Prior U.S. Cls.: 100 and 101**

**United States Patent and Trademark Office**

**Reg. No. 3,466,451**

**Registered July 15, 2008**

**SERVICE MARK  
PRINCIPAL REGISTER**

**The Raw Divas**

THE RAW DIVAS (WYOMING CORPORATION)  
11747 PUERTO BANUS AVE.  
LAS VEGAS, NV 89138

FOR: PERSONAL GROWTH AND MOTIVATION  
CONSULTING SERVICES, IN CLASS 45 (U.S. CLS.  
100 AND 101).

FIRST USE 5-5-2007; IN COMMERCE 8-9-2007.

NO CLAIM IS MADE TO THE EXCLUSIVE  
RIGHT TO USE "RAW", APART FROM THE MARK  
AS SHOWN.

THE MARK CONSISTS OF THE STYLIZED  
WORDS "THE RAW DIVAS". THE DOT ON THE  
LETTER "I" IN THE WORD "DIVAS" IS AN IMAGE  
OF A RASPBERRY WITH LEAVES.

SER. NO. 77-314,903, FILED 10-26-2007.

BONNIE LUKEN, EXAMINING ATTORNEY



**Int. Cl.: 41**

**Prior U.S. Cls.: 100, 101 and 107**

**United States Patent and Trademark Office**

**Reg. No. 3,466,452**

**Registered July 15, 2008**

**SERVICE MARK  
PRINCIPAL REGISTER**

**Gianna Michaels**

WICKER, TERAH (UNITED STATES INDIVIDUAL)  
6345 BALBOA BLVD. STE. 370  
ENCINO, CA 91316

FOR: ENTERTAINMENT SERVICES IN THAT NATURE OF LIVE ACTING, DANCING PERFORMANCES AND MODELING FOR ADULT PERFORMANCES AND PUBLIC PERFORMANCES OF A STAR OF ADULT MOVIES; ENTERTAINMENT SERVICES, NAMELY, PROVIDING ADULT ENTERTAINMENT VISUAL IMAGES AND LIVE ADULT ORIENTED ENTERTAINMENT VIA A GLOBAL COMPUTER NETWORK; ENTERTAINMENT SERVICES, NAMELY, LIVE AND RECORDED ADULT ENTERTAINMENT PERFORMANCES VIA BROADCAST TELEVISION, SATELLITE, CABLE, RADIO,

BROADBAND AND GLOBAL COMPUTER NETWORKS, IN CLASS 41 (U.S. CLS. 100, 101 AND 107).

FIRST USE 12-1-2004; IN COMMERCE 12-1-2004.

THE MARK CONSISTS OF STANDARD CHARACTERS WITHOUT CLAIM TO ANY PARTICULAR FONT, STYLE, SIZE, OR COLOR.

THE NAME SHOWN IN THE MARK IDENTIFIES "TERAH WICKER," WHOSE CONSENT TO REGISTER IS SUBMITTED.

SER. NO. 77-314,968, FILED 10-26-2007.

MARIA-VICTORIA SUAREZ, EXAMINING ATTORNEY

**Int. Cl.: 9**

**Prior U.S. Cls.: 21, 23, 26, 36 and 38**

**Reg. No. 3,466,453**

**United States Patent and Trademark Office**

**Registered July 15, 2008**

**TRADEMARK  
PRINCIPAL REGISTER**

**CONSUMER CREDIT 101**

THE CREDIT COLLEGE (NORTH CAROLINA  
LTD LIAB CO)  
1959 N. PEACE HAVEN ROAD, STE. 109  
WINSTON SALEM, NC 27106

FOR: COMPUTER PROGRAMS FOR PRE-RECORDED GAMES; PRE-RECORDED CDS, VIDEO TAPES, LASER DISKS AND DVDS FEATURING INFORMATION AND EDUCATIONAL PROGRAMS ON UNDERSTANDING AND IMPROVING ONE'S CONSUMER CREDIT; PRE-RECORDED DIGITAL MEDIA FEATURING CONSUMER CREDIT INFORMATION AND LESSONS ABOUT IMPROVING ONE'S CREDIT; PRE-RECORDED ELECTRONIC MEDIA FEATURING INFORMATION AND EDUCATIONAL PROGRAMS ABOUT UNDERSTAND-

ING AND IMPROVING ONE'S CONSUMER CREDIT, IN CLASS 9 (U.S. CLS. 21, 23, 26, 36 AND 38).

FIRST USE 1-20-2004; IN COMMERCE 7-10-2007.

THE MARK CONSISTS OF STANDARD CHARACTERS WITHOUT CLAIM TO ANY PARTICULAR FONT, STYLE, SIZE, OR COLOR.

NO CLAIM IS MADE TO THE EXCLUSIVE RIGHT TO USE "CONSUMER CREDIT", APART FROM THE MARK AS SHOWN.

SER. NO. 77-314,989, FILED 10-26-2007.

GINA FINK, EXAMINING ATTORNEY

**Int. Cl.: 41**

**Prior U.S. Cls.: 100, 101 and 107**

**United States Patent and Trademark Office**

**Reg. No. 3,466,454**

**Registered July 15, 2008**

**SERVICE MARK  
PRINCIPAL REGISTER**

# Vanessa Blue

FAULKNER, TANYA (UNITED STATES INDIVIDUAL)  
6345 BALBOA BLVD. STE. 370  
ENCINO, CA 91316

FOR: ENTERTAINMENT SERVICES IN THE NATURE OF LIVE ACTING, DANCING PERFORMANCES AND MODELING FOR ADULT PERFORMANCES AND PUBLIC PERFORMANCES OF A STAR OF ADULT MOVIES; ENTERTAINMENT SERVICES, NAMELY, PROVIDING ADULT ENTERTAINMENT VISUAL IMAGES AND LIVE ADULT ORIENTED ENTERTAINMENT VIA A GLOBAL COMPUTER NETWORK; ENTERTAINMENT SERVICES, NAMELY, LIVE AND RECORDED ADULT ENTERTAINMENT PERFORMANCES VIA BROADCAST TELEVISION, SATELLITE, CABLE, RADIO,

BROADBAND AND GLOBAL COMPUTER NETWORKS, IN CLASS 41 (U.S. CLS. 100, 101 AND 107).

FIRST USE 12-30-1996; IN COMMERCE 12-30-1996.

THE MARK CONSISTS OF STANDARD CHARACTERS WITHOUT CLAIM TO ANY PARTICULAR FONT, STYLE, SIZE, OR COLOR.

THE NAME(S), PORTRAIT(S), AND/OR SIGNATURE(S) SHOWN IN THE MARK IDENTIFIES "TANYA FAULKNER", WHOSE CONSENT(S) TO REGISTER IS SUBMITTED.

SER. NO. 77-314,994, FILED 10-26-2007.

GINA FINK, EXAMINING ATTORNEY

**Int. Cl.: 35**

**Prior U.S. Cls.: 100, 101 and 102**

**United States Patent and Trademark Office**

**Reg. No. 3,466,455**

**Registered July 15, 2008**

**SERVICE MARK  
PRINCIPAL REGISTER**



U.S. SUPERIOR STONE & TILE, INC. (CALIFORNIA CORPORATION), DBA SUPERIOR HARDWARE SUPPLY  
1201 14TH AVENUE  
OAKLAND, CA 94606

FIRST USE 2-22-2005; IN COMMERCE 2-22-2005.

THE MARK CONSISTS OF TWO STYLIZED "S"'S ABOVE A STYLIZED "C".

FOR: RETAIL AND WHOLESALE STORE SERVICES FEATURING A VARIETY OF KITCHEN AND BATHROOM REMODELING MATERIALS, NAMELY, FLOORING, MARBLE, GRANITE, TILE, CABINETS, SINKS, AND PLUMBING SUPPLIES, IN CLASS 35 (U.S. CLS. 100, 101 AND 102).

SER. NO. 77-315,060, FILED 10-26-2007.

ROBIN CHOSID, EXAMINING ATTORNEY

**Int. Cl.: 26**

**Prior U.S. Cls.: 37, 39, 40, 42 and 50**

**United States Patent and Trademark Office**

**Reg. No. 3,466,456**

**Registered July 15, 2008**

**TRADEMARK  
PRINCIPAL REGISTER**



LDG FRANCHISE CO., LTD. (CHINA CORPORATION)  
2FL., BLOCK 9  
NO.1040, AIGUO ROAD, LUOHU DISTRICT  
SHEN ZHEN, CHINA

FOR: HAIR BANDS, BARRETTES, BELT BUCKLES FOR CLOTHING, BELT BUCKLES OF PRECIOUS METAL FOR CLOTHING, BROOCHES, BUCKLES FOR CLOTHING, BUTTONS FOR CLOTHING, CLASPS FOR CLOTHING, CLOTH PATCHES FOR CLOTHING, CLOTHING HOOKS, EMBROIDERED PATCHES FOR CLOTHING, EYELETS FOR CLOTHING, LOOPS FOR CLOTHING, SHOULDER PADS FOR CLOTHING, SWEATER GUARDS, HAT ORNAMENTS NOT OF PRECIOUS

METAL, EMBROIDERY, HAIR ORNAMENTS, BELT CLASPS AND ARTIFICIAL FLOWERS, IN CLASS 26 (U.S. CLS. 37, 39, 40, 42 AND 50).

FIRST USE 1-6-2006; IN COMMERCE 1-1-2007.

THE MARK CONSISTS OF A CARICATURE OF A BUTTERFLY LIKE DESIGN ADJACENT TO THE STYLIZED LETTERING "MISS Q".

SER. NO. 77-315,248, FILED 10-27-2007.

CHRISTOPHER BUONGIORNO, EXAMINING ATTORNEY

**Int. Cl.: 41**

**Prior U.S. Cls.: 100, 101 and 107**

**United States Patent and Trademark Office**

**Reg. No. 3,466,457**

**Registered July 15, 2008**

---

**SERVICE MARK  
PRINCIPAL REGISTER**

**SlotFest**

FROMM, RANDALL A. (UNITED STATES INDIVIDUAL), DBA SLOT TECH MAGAZINE  
1944 FALMOUTH DR.  
EL CAJON, CA 920202827

THE MARK CONSISTS OF STANDARD CHARACTERS WITHOUT CLAIM TO ANY PARTICULAR FONT, STYLE, SIZE, OR COLOR.

FOR: ARRANGING PROFESSIONAL WORKSHOP AND TRAINING COURSES, IN CLASS 41 (U.S. CLS. 100, 101 AND 107).

SER. NO. 77-315,286, FILED 10-27-2007.

FIRST USE 10-1-2007; IN COMMERCE 10-1-2007.

DAWN HAN, EXAMINING ATTORNEY

**Int. Cl.: 25**

**Prior U.S. Cls.: 22 and 39**

**United States Patent and Trademark Office**

**Reg. No. 3,466,458**

**Registered July 15, 2008**

**TRADEMARK  
PRINCIPAL REGISTER**

Modern styles for the  
petite, carefree  
fashionista who lives life  
large.

LE, TERESA M. (UNITED STATES INDIVIDUAL), DBA TLE DESIGNS  
1716 BROADVIEW DRIVE  
HIXSON, TN 37343

FOR: CLOTHING FOR WOMEN, NAMELY, DRESSES, SHIRTS, TOPS, BLOUSES, CAMISOLES, TANK-TOPS, JACKETS, COATS, PANTS, SHORTS, SKIRTS, SUITS, HEADBANDS, BELTS, SCARFS, IN CLASS 25 (U.S. CLS. 22 AND 39).

FIRST USE 7-0-2007; IN COMMERCE 7-0-2007.

THE MARK CONSISTS OF STANDARD CHARACTERS WITHOUT CLAIM TO ANY PARTICULAR FONT, STYLE, SIZE, OR COLOR.

SER. NO. 77-315,319, FILED 10-27-2007.

DARRYL SPRUILL, EXAMINING ATTORNEY

**Int. Cl.: 9**

**Prior U.S. Cls.: 21, 23, 26, 36 and 38**

**United States Patent and Trademark Office**

**Reg. No. 3,466,459**

**Registered July 15, 2008**

**TRADEMARK  
PRINCIPAL REGISTER**

**TRAX RECORDS**

CAIN RACHAEL (UNITED STATES INDIVIDUAL), DBA PHUTURE TRAX RECORDS  
540 N. LAKESHORE DR. #716  
CHICAGO, IL 60611

FOR: AUDIO AND VIDEO RECORDINGS FEATURING MUSIC AND DOCUMENTARIES, DRAMAS, COMEDIES, AND CARTOONS, BASED ON THE INSPIRATION, AND UNITY, CREATED BY DANCE, AND THE UNIQUE SOUND AND UNITY AMONG PEOPLE OF ALL NATIONS THROUGH A HOUSE MUSIC SOUND, IN CLASS 9 (U.S. CLS. 21, 23, 26, 36 AND 38).

FIRST USE 0-0-1984; IN COMMERCE 8-2-1985.

THE MARK CONSISTS OF STANDARD CHARACTERS WITHOUT CLAIM TO ANY PARTICULAR FONT, STYLE, SIZE, OR COLOR.

NO CLAIM IS MADE TO THE EXCLUSIVE RIGHT TO USE "RECORDS", APART FROM THE MARK AS SHOWN.

SEC. 2(F).

SER. NO. 77-315,356, FILED 10-28-2007.

TRACY CROSS, EXAMINING ATTORNEY



**Int. Cl.: 36**

**Prior U.S. Cls.: 100, 101 and 102**

**United States Patent and Trademark Office**

**Reg. No. 3,466,460**

**Registered July 15, 2008**

**SERVICE MARK  
PRINCIPAL REGISTER**

**Blue Ridge ESOP Associates  
The Leader in Professional  
ESOP Administration**

TRANSITION FINANCE STRATEGIES, LLC  
(VIRGINIA LTD LIAB CO), DBA BLUE RIDGE  
ESOP ASSOCIATES  
154 HANSEN RD.  
CHARLOTTESVILLE, VA 22911

THE MARK CONSISTS OF STANDARD CHAR-  
ACTERS WITHOUT CLAIM TO ANY PARTICULAR  
FONT, STYLE, SIZE, OR COLOR.

FOR: ADMINISTRATION OF EMPLOYEE PEN-  
SION PLANS, IN CLASS 36 (U.S. CLS. 100, 101 AND  
102).

SER. NO. 77-315,450, FILED 10-28-2007.

FIRST USE 1-1-2005; IN COMMERCE 1-1-2005.

ELIZABETH KAJUBI, EXAMINING ATTORNEY

**Int. Cl.: 41**

**Prior U.S. Cls.: 100, 101 and 107**

**United States Patent and Trademark Office**

**Reg. No. 3,466,461**

**Registered July 15, 2008**

**SERVICE MARK  
PRINCIPAL REGISTER**

# Snacktivity

BERRY, DEBORAH G. (UNITED STATES INDIVIDUAL)  
23 DEWEY AVENUE  
WINDSOR, CT 06095

FOR: ENTERTAINMENT SERVICES, NAMELY, PROVIDING INSTRUCTION IN CRAFT PROJECTS ON THE NATURE OF ASSEMBLING FOOD INTO EDIBLE ARRANGEMENTS, IN CLASS 41 (U.S. CLS. 100, 101 AND 107).

FIRST USE 9-30-1990; IN COMMERCE 9-30-1990.

THE MARK CONSISTS OF STANDARD CHARACTERS WITHOUT CLAIM TO ANY PARTICULAR FONT, STYLE, SIZE, OR COLOR.

SER. NO. 77-315,813, FILED 10-29-2007.

HENRY S. ZAK, EXAMINING ATTORNEY

**Int. Cl.: 41**

**Prior U.S. Cls.: 100, 101 and 107**

**United States Patent and Trademark Office**

**Reg. No. 3,466,462**

**Registered July 15, 2008**

**SERVICE MARK  
PRINCIPAL REGISTER**

# Snacktivities

BERRY, DEBORAH G. (UNITED STATES INDIVIDUAL)  
23 DEWEY DRIVE  
WINDSOR, CT 06095

FOR: ENTERTAINMENT SERVICES, NAMELY, PROVIDING INSTRUCTION IN CRAFT PROJECTS ON THE NATURE OF ASSEMBLING FOOD INTO EDIBLE ARRANGEMENTS, IN CLASS 41 (U.S. CLS. 100, 101 AND 107).

FIRST USE 9-30-1990; IN COMMERCE 9-30-1990.

THE MARK CONSISTS OF STANDARD CHARACTERS WITHOUT CLAIM TO ANY PARTICULAR FONT, STYLE, SIZE, OR COLOR.

SER. NO. 77-315,841, FILED 10-29-2007.

HENRY S. ZAK, EXAMINING ATTORNEY

**Int. Cl.: 16**

**Prior U.S. Cls.: 2, 5, 22, 23, 29, 37, 38 and 50**

**United States Patent and Trademark Office**

**Reg. No. 3,466,463**

**Registered July 15, 2008**

**TRADEMARK  
PRINCIPAL REGISTER**



NORSKE SKOGINDUSTRIER ASA (NORWAY  
LTD LIAB CO)  
OKSENOYVEIEN 80  
1326 LYSAKER, NORWAY

FOR: PAPER; MAGAZINE PAPER; PRINTING  
PAPER, IN CLASS 16 (U.S. CLS. 2, 5, 22, 23, 29, 37, 38  
AND 50).

FIRST USE 12-31-2002, THE MARK WAS FIRST  
USED ANYWHERE IN A DIFFERENT FORM  
OTHER THAN THAT SOUGHT TO BE

REGISTERED ON 00/00/1987.; IN COMMERCE  
10-24-2006.

OWNER OF U.S. REG. NOS. 1,871,276 AND  
2,821,094.

THE MARK CONSISTS OF THE STYLIZED LET-  
TERS "NORSC."

SER. NO. 77-315,862, FILED 10-29-2007.

HENRY S. ZAK, EXAMINING ATTORNEY

**Int. Cl.: 11**

**Prior U.S. Cls.: 13, 21, 23, 31 and 34**

**United States Patent and Trademark Office**

**Reg. No. 3,466,464**

**Registered July 15, 2008**

**TRADEMARK  
PRINCIPAL REGISTER**

**AquaC**

AQUAC, INC. (CALIFORNIA CORPORATION)  
7949 STROMESA COURT, STE. E  
SAN DIEGO, CA 92126

THE MARK CONSISTS OF STANDARD CHAR-  
ACTERS WITHOUT CLAIM TO ANY PARTICULAR  
FONT, STYLE, SIZE, OR COLOR.

FOR: WATER FILTER SYSTEMS FOR AQUA-  
RIUMS, NAMELY, PROTEIN SKIMMERS AND  
CALCIUM REACTORS, IN CLASS 11 (U.S. CLS. 13,  
21, 23, 31 AND 34).

SER. NO. 77-315,953, FILED 10-29-2007.

FIRST USE 12-15-1998; IN COMMERCE 12-15-1998.

MARLENE BELL, EXAMINING ATTORNEY

**Int. Cl.: 11**

**Prior U.S. Cls.: 13, 21, 23, 31 and 34**

**Reg. No. 3,466,465**

**United States Patent and Trademark Office**

**Registered July 15, 2008**

---

**TRADEMARK  
PRINCIPAL REGISTER**

**REMORA**

AQUAC, INC. (CALIFORNIA CORPORATION)  
7949 STROMESA COURT, STE. E  
SAN DIEGO, CA 92126

THE MARK CONSISTS OF STANDARD CHAR-  
ACTERS WITHOUT CLAIM TO ANY PARTICULAR  
FONT, STYLE, SIZE, OR COLOR.

FOR: WATER FILTER SYSTEMS FOR AQUA-  
RIUMS, NAMELY, PROTEIN SKIMMERS, IN CLASS  
11 (U.S. CLS. 13, 21, 23, 31 AND 34).

SER. NO. 77-315,957, FILED 10-29-2007.

FIRST USE 1-15-2000; IN COMMERCE 1-15-2000.

MARLENE BELL, EXAMINING ATTORNEY

**Int. Cl.: 9**

**Prior U.S. Cls.: 21, 23, 26, 36 and 38**

**Reg. No. 3,466,466**

**United States Patent and Trademark Office**

**Registered July 15, 2008**

---

**TRADEMARK  
PRINCIPAL REGISTER**

**EXPEDITIONDI**

QUANTUM3D (CALIFORNIA CORPORATION)  
6330 SAN IGNACIO AVE  
SAN JOSE, CA 95119

SAFTEY VEST AND HELMET, IN CLASS 9 (U.S. CLS.  
21, 23, 26, 36 AND 38).

FIRST USE 2-15-2005; IN COMMERCE 2-15-2005.

FOR: A COMPUTER HARDWARE AND SOFTWARE PLATFORM WITH WIRELESS NETWORKING CAPABILITY TO PROVIDE SYNTHETIC VIRTUAL ENVIRONMENT TRAINING AND MISSION REHEARSAL EXERCISES FOR INDIVIDUAL AND COLLECTIVE MOUNTED AND DISMOUNTED INFANTRY AND FIRST RESPONDERS WHICH IS SELF-CONTAINED ON A WEARABLE

THE MARK CONSISTS OF STANDARD CHARACTERS WITHOUT CLAIM TO ANY PARTICULAR FONT, STYLE, SIZE, OR COLOR.

SER. NO. 77-316,088, FILED 10-29-2007.

CHERYL CLAYTON, EXAMINING ATTORNEY

**Int. Cl.: 9**

**Prior U.S. Cls.: 21, 23, 26, 36 and 38**

**United States Patent and Trademark Office**

**Reg. No. 3,466,467**

**Registered July 15, 2008**

**TRADEMARK  
PRINCIPAL REGISTER**

**GEOSCAPESE**

QUANTUM3D (CALIFORNIA CORPORATION)  
6330 SAN IGNACIO AVE  
SAN JOSE, CA 95119

SOFTWARE, IN CLASS 9 (U.S. CLS. 21, 23, 26, 36 AND 38).

FIRST USE 12-7-2004; IN COMMERCE 12-7-2004.

FOR: DIGITAL MEDIA DATA FILES AND DATABASES, NAMELY, TERRAIN DATA, CULTURAL FEATURES AND IMAGERY THAT PROVIDE A VIRTUAL WORLD OR SYNTHETIC ENVIRONMENT FOR USE IN SYNTHETIC ENVIRONMENT VISUAL AND SENSOR SIMULATION TRAINING, MISSION PLANNING AND MISSION REHEARSAL APPLICATIONS THAT EMPLOY VISUALIZATION

THE MARK CONSISTS OF STANDARD CHARACTERS WITHOUT CLAIM TO ANY PARTICULAR FONT, STYLE, SIZE, OR COLOR.

SER. NO. 77-316,139, FILED 10-29-2007.

CHERYL CLAYTON, EXAMINING ATTORNEY



**Int. Cl.: 35**

**Prior U.S. Cls.: 100, 101 and 102**

**United States Patent and Trademark Office**

**Reg. No. 3,466,468**

**Registered July 15, 2008**

**SERVICE MARK  
PRINCIPAL REGISTER**

**SHADYBROOK POA**

SHADYBROOK PROPERTY OWNERS ASSOCIATION (TEXAS CORPORATION)  
175 CAROLINE LANE  
BULLARD, TX 75757

FOR: ASSOCIATION SERVICES, NAMELY, PROMOTING THE INTERESTS OF SHADYBROOK PROPERTY OWNERS ASSOCIATION, IN CLASS 35 (U.S. CLS. 100, 101 AND 102).

FIRST USE 7-0-1975; IN COMMERCE 1-1-1976.

THE MARK CONSISTS OF STANDARD CHARACTERS WITHOUT CLAIM TO ANY PARTICULAR FONT, STYLE, SIZE, OR COLOR.

NO CLAIM IS MADE TO THE EXCLUSIVE RIGHT TO USE "POA", APART FROM THE MARK AS SHOWN.

SER. NO. 77-316,212, FILED 10-29-2007.

MONIQUE MILLER, EXAMINING ATTORNEY

**Int. Cl.: 16**

**Prior U.S. Cls.: 2, 5, 22, 23, 29, 37, 38 and 50**

**United States Patent and Trademark Office**

**Reg. No. 3,466,469**

**Registered July 15, 2008**

**TRADEMARK  
PRINCIPAL REGISTER**

**#1 Commercial Paper Source**

8 NET, INC. (CALIFORNIA CORPORATION)  
13140 ALONDRA BLVD.  
CERRITOS, CA 90703

FOR: PRINTING PAPER; PRINTING PAPERS, IN  
CLASS 16 (U.S. CLS. 2, 5, 22, 23, 29, 37, 38 AND 50).

FIRST USE 8-1-2001; IN COMMERCE 8-1-2001.

THE MARK CONSISTS OF STANDARD CHAR-  
ACTERS WITHOUT CLAIM TO ANY PARTICULAR  
FONT, STYLE, SIZE, OR COLOR.

SEC. 2(F).

SER. NO. 77-316,260, FILED 10-29-2007.

DAWN FELDMAN, EXAMINING ATTORNEY

**Int. Cl.: 41**

**Prior U.S. Cls.: 100, 101 and 107**

**United States Patent and Trademark Office**

**Reg. No. 3,466,470**

**Registered July 15, 2008**

**SERVICE MARK  
PRINCIPAL REGISTER**

**The Redheads  
Britta-N-Brooke**

RED LIGHTNING ENTERTAINMENT, LLC  
(TENNESSEE LTD LIAB CO)  
SUITE 202  
11 MUSIC CIRCLE SOUTH  
NASHVILLE, TN 37203

FOR: ENTERTAINMENT IN THE NATURE OF  
LIVE PERFORMANCES BY A VOCAL DUO, IN  
CLASS 41 (U.S. CLS. 100, 101 AND 107).

FIRST USE 7-4-2005; IN COMMERCE 3-28-2007.

THE MARK CONSISTS OF STANDARD CHAR-  
ACTERS WITHOUT CLAIM TO ANY PARTICULAR  
FONT, STYLE, SIZE, OR COLOR.

THE NAMES "BRITTA" AND "BROOKE" IN THE  
MARK IDENTIFY LIVING INDIVIDUALS WHOSE  
CONSENTS ARE OF RECORD.

SER. NO. 77-316,304, FILED 10-29-2007.

DAVID MILLER, EXAMINING ATTORNEY

**Int. Cl.: 16**

**Prior U.S. Cls.: 2, 5, 22, 23, 29, 37, 38 and 50**

**Reg. No. 3,466,471**

**United States Patent and Trademark Office**

**Registered July 15, 2008**

---

**TRADEMARK  
PRINCIPAL REGISTER**

**IRISHCONNECTIONS**

PATRICK MCCARTHY (UNITED STATES INDIVIDUAL)  
89 PRINCETON STREET  
WILLISTON PARK, NY 11596

FOR: MAGAZINE OF INTEREST TO THE GENERAL PUBLIC AND IRISH AMERICAN COMMUNITY, IN CLASS 16 (U.S. CLS. 2, 5, 22, 23, 29, 37, 38 AND 50).

FIRST USE 2-29-2000; IN COMMERCE 2-29-2000.

THE MARK CONSISTS OF STANDARD CHARACTERS WITHOUT CLAIM TO ANY PARTICULAR FONT, STYLE, SIZE, OR COLOR.

OWNER OF U.S. REG. NO. 3,168,765.

SER. NO. 77-316,502, FILED 10-30-2007.

DOMINIC FATHY, EXAMINING ATTORNEY

**Int. Cl.: 9**

**Prior U.S. Cls.: 21, 23, 26, 36 and 38**

**United States Patent and Trademark Office**

**Reg. No. 3,466,472**

**Registered July 15, 2008**

**TRADEMARK  
PRINCIPAL REGISTER**

**DIGITAL CHECK**

DIGITAL CHECK CORPORATION (DELAWARE  
CORPORATION)  
SUITE 31  
466 CENTRAL AVENUE  
NORTHFIELD, IL 60093

FOR: COUNTERTOP CHECK SCANNERS, IN  
CLASS 9 (U.S. CLS. 21, 23, 26, 36 AND 38).

FIRST USE 6-0-1995; IN COMMERCE 6-0-1995.

THE MARK CONSISTS OF STANDARD CHAR-  
ACTERS WITHOUT CLAIM TO ANY PARTICULAR  
FONT, STYLE, SIZE, OR COLOR.

SEC. 2(F).

SER. NO. 77-316,574, FILED 10-30-2007.

ALLISON HOLTZ, EXAMINING ATTORNEY

**Int. Cl.: 35**

**Prior U.S. Cls.: 100, 101 and 102**

**United States Patent and Trademark Office**

**Reg. No. 3,466,473**

**Registered July 15, 2008**

**SERVICE MARK  
PRINCIPAL REGISTER**

**CBIZ Performance Connection**

CBIZ BENEFITS & INSURANCE SERVICES, INC.  
(MISSOURI CORPORATION)  
11440 TOMAHAWK CREEK PKWY  
LEAWOOD, KS 66211

FOR: CONSULTING SERVICES IN THE FIELD  
OF HUMAN RESOURCES DEVELOPMENT, NAME-  
LY, UTILIZING TECHNOLOGY FOR THE PROMO-  
TION OF EMPLOYEE RETENTION, CAREER  
GROWTH AND INCREASED PRODUCTIVITY  
FOR EMPLOYEES AND EMPLOYERS, IN CLASS  
35 (U.S. CLS. 100, 101 AND 102).

FIRST USE 9-10-2007; IN COMMERCE 9-10-2007.

THE MARK CONSISTS OF STANDARD CHAR-  
ACTERS WITHOUT CLAIM TO ANY PARTICULAR  
FONT, STYLE, SIZE, OR COLOR.

SER. NO. 77-316,624, FILED 10-30-2007.

ODESSA BIBBINS, EXAMINING ATTORNEY

**Int. Cl.: 37**

**Prior U.S. Cls.: 100, 103 and 106**

**United States Patent and Trademark Office**

**Reg. No. 3,466,474**

**Registered July 15, 2008**

**SERVICE MARK  
PRINCIPAL REGISTER**

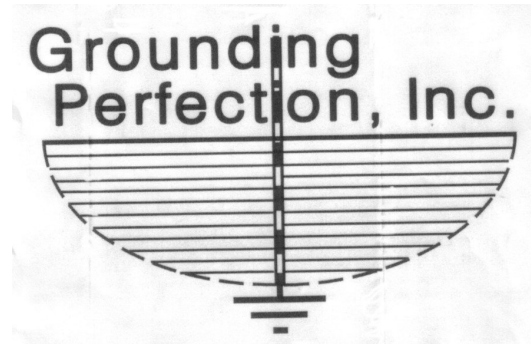

GROUNDING PERFECTION, INC. (NEBRASKA CORPORATION)  
2630 N. YAGER ROAD #201  
FREMONT, NE 680257800

NO CLAIM IS MADE TO THE EXCLUSIVE RIGHT TO USE "GROUNDING" AND "INC.", APART FROM THE MARK AS SHOWN.

FOR: INSTALLATION OF DEEP EARTH LOW RESISTANCE ELECTRICAL GROUNDING SYSTEMS, IN CLASS 37 (U.S. CLS. 100, 103 AND 106).

SER. NO. 77-316,935, FILED 10-30-2007.

FIRST USE 1-1-1989; IN COMMERCE 1-1-1989.

WENDY GOODMAN, EXAMINING ATTORNEY

**Int. Cl.: 35**

**Prior U.S. Cls.: 100, 101 and 102**

**United States Patent and Trademark Office**

**Reg. No. 3,466,475**

**Registered July 15, 2008**

**SERVICE MARK  
PRINCIPAL REGISTER**

**BLOOMING EDIBLES**

BLOOMING EDIBLES, INC. (NEW JERSEY CORPORATION)  
675 WHITE HORSE PIKE  
ATCO, NJ 08004

FOR: ON-LINE RETAIL STORE SERVICES FEATURING EDIBLE ARRANGEMENTS OF CUT AND SCULPTURED FRUITS AND VEGETABLES, FRUIT BASKETS, PARTY TRAYS, ANTIPASTOS, FLOWER ARRANGEMENTS, CANDY AND BALLOONS.; RETAIL STORE SERVICES FEATURING EDIBLE ARRANGEMENTS OF CUT AND SCULPTURED FRUITS AND VEGETABLES, FRUIT BASKETS, PARTY TRAYS, ANTIPASTOS, FLOWER ARRANGEMENTS, CANDY AND BALLOONS.; CATALOG ORDERING SERVICE FEATURING EDIBLE ARRANGEMENTS OF CUT AND SCULPTURED FRUITS AND VEGETABLES, FRUIT BASKETS,

PARTY TRAYS, ANTIPASTOS, FLOWER ARRANGEMENTS, CANDY AND BALLOONS, IN CLASS 35 (U.S. CLS. 100, 101 AND 102).

FIRST USE 2-0-1990; IN COMMERCE 2-0-1992.

THE MARK CONSISTS OF STANDARD CHARACTERS WITHOUT CLAIM TO ANY PARTICULAR FONT, STYLE, SIZE, OR COLOR.

NO CLAIM IS MADE TO THE EXCLUSIVE RIGHT TO USE "EDIBLES", APART FROM THE MARK AS SHOWN.

SER. NO. 77-316,998, FILED 10-30-2007.

EMILY CARLSEN, EXAMINING ATTORNEY



**Int. Cl.: 36**

**Prior U.S. Cls.: 100, 101 and 102**

**United States Patent and Trademark Office**

**Reg. No. 3,466,476**

**Registered July 15, 2008**

**SERVICE MARK  
PRINCIPAL REGISTER**

**UPMC Health Plan Small  
Business Advantage**

UNIVERSITY OF PITTSBURGH - OF THE COMMONWEALTH SYSTEM OF HIGHER EDUCATION (PENNSYLVANIA CORPORATION)  
1710 CATHEDRAL OF LEARNING, 4200 5TH AVE  
PITTSBURGH, PA 15260

FOR: ADMINISTRATION OF EMPLOYEE BENEFIT PLANS CONCERNING INSURANCE AND FINANCE, IN CLASS 36 (U.S. CLS. 100, 101 AND 102).

FIRST USE 10-1-2007; IN COMMERCE 10-1-2007.

THE MARK CONSISTS OF STANDARD CHARACTERS WITHOUT CLAIM TO ANY PARTICULAR FONT, STYLE, SIZE, OR COLOR.

OWNER OF U.S. REG. NOS. 2,174,963, 3,153,897, AND 3,271,900.

NO CLAIM IS MADE TO THE EXCLUSIVE RIGHT TO USE "HEALTH PLAN SMALL BUSINESS", APART FROM THE MARK AS SHOWN.

SER. NO. 77-317,060, FILED 10-30-2007.

HEATHER BIDDULPH, EXAMINING ATTORNEY

**Int. Cl.: 36**

**Prior U.S. Cls.: 100, 101 and 102**

**United States Patent and Trademark Office**

**Reg. No. 3,466,477**

**Registered July 15, 2008**

**SERVICE MARK  
PRINCIPAL REGISTER**

**BRISTOL WEST**

BRISTOL WEST HOLDINGS, INC. (DELAWARE CORPORATION)  
5701 STIRLING ROAD  
DAVIE, FL 33314

FOR: INSURANCE SERVICES, NAMELY, UNDERWRITING IN THE FIELD OF PROPERTY AND CASUALTY INSURANCE, INSURANCE ADMINISTRATION, CLAIMS ADMINISTRATION, AND AGENCY SERVICES; AND PROVIDING INFORMATION ABOUT INSURANCE AND UNDERWRITING SERVICES VIA THE INTERNET, IN CLASS 36 (U.S. CLS. 100, 101 AND 102).

FIRST USE 1-1-1998; IN COMMERCE 1-1-1998.

THE MARK CONSISTS OF STANDARD CHARACTERS WITHOUT CLAIM TO ANY PARTICULAR FONT, STYLE, SIZE, OR COLOR.

OWNER OF U.S. REG. NOS. 2,967,924 AND 2,977,782.

SER. NO. 77-317,190, FILED 10-30-2007.

NAAKWAMA ANKRAH, EXAMINING ATTORNEY

**Int. Cl.: 36**

**Prior U.S. Cls.: 100, 101 and 102**

**United States Patent and Trademark Office**

**Reg. No. 3,466,478**

**Registered July 15, 2008**

**SERVICE MARK  
PRINCIPAL REGISTER**

**BRISTOL WEST INSURANCE  
GROUP**

BRISTOL WEST HOLDINGS, INC. (DELAWARE CORPORATION)  
5701 STIRLING ROAD  
DAVIE, FL 33314

FOR: INSURANCE SERVICES, NAMELY, UNDERWRITING IN THE FIELD OF PROPERTY AND CASUALTY INSURANCE, INSURANCE ADMINISTRATION, CLAIMS ADMINISTRATION, AND AGENCY SERVICES; AND PROVIDING INFORMATION ABOUT INSURANCE AND UNDERWRITING SERVICES VIA THE INTERNET, IN CLASS 36 (U.S. CLS. 100, 101 AND 102).

FIRST USE 1-1-1998; IN COMMERCE 1-1-1998.

THE MARK CONSISTS OF STANDARD CHARACTERS WITHOUT CLAIM TO ANY PARTICULAR FONT, STYLE, SIZE, OR COLOR.

OWNER OF U.S. REG. NOS. 2,967,924 AND 2,977,782.

NO CLAIM IS MADE TO THE EXCLUSIVE RIGHT TO USE "INSURANCE GROUP", APART FROM THE MARK AS SHOWN.

SER. NO. 77-317,204, FILED 10-30-2007.

NAAKWAMA ANKRAH, EXAMINING ATTORNEY

**Int. Cl.: 36**

**Prior U.S. Cls.: 100, 101 and 102**

**United States Patent and Trademark Office**

**Reg. No. 3,466,479**

**Registered July 15, 2008**

**SERVICE MARK  
PRINCIPAL REGISTER**



BRISTOL WEST HOLDINGS, INC. (DELAWARE CORPORATION)  
5701 STIRLING ROAD  
DAVIE, FL 33314

FOR: INSURANCE SERVICES, NAMELY, UNDERWRITING IN THE FIELD OF PROPERTY AND CASUALTY INSURANCE, INSURANCE ADMINISTRATION, CLAIMS ADMINISTRATION, AND AGENCY SERVICES; AND PROVIDING INFORMATION ABOUT INSURANCE AND UNDERWRITING SERVICES VIA THE INTERNET, IN CLASS 36 (U.S. CLS. 100, 101 AND 102).

FIRST USE 1-1-1998; IN COMMERCE 1-1-1998.

OWNER OF U.S. REG. NOS. 2,967,924 AND 2,977,782.

NO CLAIM IS MADE TO THE EXCLUSIVE RIGHT TO USE "INSURANCE GROUP", APART FROM THE MARK AS SHOWN.

SER. NO. 77-317,211, FILED 10-30-2007.

NAAKWAMA ANKRAH, EXAMINING ATTORNEY

**Int. Cl.: 36**

**Prior U.S. Cls.: 100, 101 and 102**

**United States Patent and Trademark Office**

**Reg. No. 3,466,480**

**Registered July 15, 2008**

**SERVICE MARK  
PRINCIPAL REGISTER**

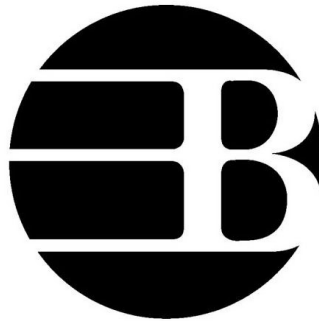

BRISTOL WEST HOLDINGS, INC. (DELAWARE CORPORATION)  
5701 STIRLING ROAD  
DAVIE, FL 33314

FOR: INSURANCE SERVICES, NAMELY, UNDERWRITING IN THE FIELD OF PROPERTY AND CASUALTY INSURANCE, INSURANCE ADMINISTRATION, CLAIMS ADMINISTRATION, AND AGENCY SERVICES; AND PROVIDING IN-

FORMATION ABOUT INSURANCE AND UNDERWRITING SERVICES VIA THE INTERNET, IN CLASS 36 (U.S. CLS. 100, 101 AND 102).

FIRST USE 1-1-1998; IN COMMERCE 1-1-1998.

SER. NO. 77-317,215, FILED 10-30-2007.

NAAKWAMA ANKRAH, EXAMINING ATTORNEY

**Int. Cl.: 29**

**Prior U.S. Cl.: 46**

**United States Patent and Trademark Office**

**Reg. No. 3,466,481**

**Registered July 15, 2008**

**TRADEMARK  
PRINCIPAL REGISTER**

**BUON GUSTO**

COLUMBUS MANUFACTURING, INC. (DELA-  
WARE CORPORATION)  
30977 SAN ANTONIO STREET  
HAYWARD, CA 94544

FOR: SALAMI, IN CLASS 29 (U.S. CL. 46).

FIRST USE 12-31-1926; IN COMMERCE 12-31-1960.

THE MARK CONSISTS OF STANDARD CHAR-  
ACTERS WITHOUT CLAIM TO ANY PARTICULAR  
FONT, STYLE, SIZE, OR COLOR.

THE ENGLISH TRANSLATION OF THE WORD  
"BUON GUSTO" IN THE MARK IS GOOD TASTE.

SEC. 2(F).

SER. NO. 77-317,217, FILED 10-30-2007.

COLLEEN DOMBROW, EXAMINING ATTORNEY

**Int. Cl.: 9**

**Prior U.S. Cls.: 21, 23, 26, 36 and 38**

**Reg. No. 3,466,482**

**United States Patent and Trademark Office**

**Registered July 15, 2008**

**TRADEMARK  
PRINCIPAL REGISTER**

**hdr**

HDR (CALIFORNIA PARTNERSHIP)  
P.O. BOX 1984  
VENICE, CA 90294

MUSIC AND MUSIC-BASED ENTERTAINMENT,  
IN CLASS 9 (U.S. CLS. 21, 23, 26, 36 AND 38).

FIRST USE 11-1-2000; IN COMMERCE 2-1-2001.

FOR: MUSICAL SOUND RECORDINGS; DOWN-  
LOADABLE MUSICAL SOUND RECORDINGS;  
DOWNLOADABLE RING TONES, GRAPHICS AND  
MUSIC VIA A GLOBAL COMPUTER NETWORK  
AND WIRELESS DEVICES; MUSICAL VIDEO RE-  
CORDINGS; VIDEO RECORDINGS FEATURING  
MUSIC AND DRAMATIC AND NON-DRAMATIC  
PERFORMANCES OF MUSICAL WORKS; DOWN-  
LOADABLE VIDEO RECORDINGS FEATURING

THE MARK CONSISTS OF STANDARD CHAR-  
ACTERS WITHOUT CLAIM TO ANY PARTICULAR  
FONT, STYLE, SIZE, OR COLOR.

SER. NO. 77-317,474, FILED 10-30-2007.

LINDA LAVACHE, EXAMINING ATTORNEY

**Int. Cl.: 2**

**Prior U.S. Cls.: 6, 11 and 16**

**United States Patent and Trademark Office**

**Reg. No. 3,466,483**

**Registered July 15, 2008**

**TRADEMARK  
PRINCIPAL REGISTER**

**ARCADIAN'S AUTO-BOND**

ARCADIAN SERVICES, INC. (ALABAMA CORPORATION)  
3109 NORTHINGTON COURT  
FLORENCE, AL 35630

FOR: CLEAR COATING SURFACE PROTECTANT FOR AUTOMOBILES, IN CLASS 2 (U.S. CLS. 6, 11 AND 16).

FIRST USE 3-23-2007; IN COMMERCE 3-23-2007.

THE MARK CONSISTS OF STANDARD CHARACTERS WITHOUT CLAIM TO ANY PARTICULAR FONT, STYLE, SIZE, OR COLOR.

OWNER OF U.S. REG. NO. 3,284,543.

SER. NO. 77-317,482, FILED 10-30-2007.

MICHELE SWAIN, EXAMINING ATTORNEY



**Int. Cls.: 35 and 41**

**Prior U.S. Cls.: 100, 101, 102 and 107**

**United States Patent and Trademark Office**

**Reg. No. 3,466,484**

**Registered July 15, 2008**

**SERVICE MARK  
PRINCIPAL REGISTER**

**CLIENTMAGNET**

MARKETADVANTAGE, INC. (MINNESOTA CORPORATION)  
8829 STANLEY TRAIL  
EDEN PRAIRIE, MN 55347

FOR: BUSINESS CONSULTING SERVICES IN THE FIELD OF MARKETING, SALES AND MANAGEMENT, IN CLASS 35 (U.S. CLS. 100, 101 AND 102).

FIRST USE 4-30-2002; IN COMMERCE 4-30-2002.

FOR: EDUCATIONAL SERVICES, NAMELY, CONDUCTING CLASSES, SEMINARS AND WORKSHOPS IN THE FIELD OF CONSULTING, MARKETING, PUBLIC SPEAKING, AND DISTRIBUTING COURSE MATERIALS AND PRODUCTS IN CONNECTION THEREWITH; PRESENTING MOTIVA-

TIONAL SEMINARS AND EDUCATIONAL SEMINARS, CLASSES AND WORKSHOPS IN THE FIELD OF MARKETING, SALES AND MANAGEMENT, AND DISTRIBUTING COURSE MATERIALS AND PRODUCTS IN CONNECTION THEREWITH, IN CLASS 41 (U.S. CLS. 100, 101 AND 107).

FIRST USE 4-30-2002; IN COMMERCE 4-30-2002.

THE MARK CONSISTS OF STANDARD CHARACTERS WITHOUT CLAIM TO ANY PARTICULAR FONT, STYLE, SIZE, OR COLOR.

SER. NO. 77-317,544, FILED 10-31-2007.

SANI KHOURI, EXAMINING ATTORNEY

Int. Cls.: 37 and 39

Prior U.S. Cls.: 100, 103, 105 and 106

United States Patent and Trademark Office

Reg. No. 3,466,485

Registered July 15, 2008

SERVICE MARK  
PRINCIPAL REGISTER

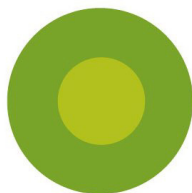

sfgreenclean

ALBER, WILLIAM F. (UNITED STATES INDIVIDUAL)

222 HELLECK STREET

SAN FRANCISCO, CA 94129 AND

SPERLING, JOHN (UNITED STATES INDIVIDUAL)

C/O 222 HELLECK STREET

SAN FRANCISCO, CA 94129

FOR: DRY CLEANING; LAUNDRY SERVICES; CLEANING OF CLOTHING, IN CLASS 37 (U.S. CLS. 100, 103 AND 106).

FIRST USE 11-1-2006; IN COMMERCE 2-1-2007.

FOR: LAUNDRY PICK-UP AND DELIVERY SERVICES, IN CLASS 39 (U.S. CLS. 100 AND 105).

FIRST USE 11-1-2006; IN COMMERCE 2-1-2007.

NO CLAIM IS MADE TO THE EXCLUSIVE RIGHT TO USE "SF GREEN CLEAN", APART FROM THE MARK AS SHOWN.

THE COLOR(S) GREEN AND LIGHT GREEN IS/ARE CLAIMED AS A FEATURE OF THE MARK.

THE MARK CONSISTS OF THE WORD "SFGREENCLEAN" AND TWO CONCENTRIC CIRCLES CENTERED ABOVE IT. THE COLOR GREEN APPEARS IN THE OUTER MOST CIRCLE AND IN THE LETTERS "GREENCLEAN". THE COLOR LIGHT GREEN APPEARS IN THE INNER MOST CIRCLE AND IN THE LETTERS "SF".

SER. NO. 77-317,557, FILED 10-31-2007.

PATRICIA EVANKO, EXAMINING ATTORNEY

**Int. Cl.: 3**

**Prior U.S. Cls.: 1, 4, 6, 50, 51 and 52**

**Reg. No. 3,466,486**

**United States Patent and Trademark Office**

**Registered July 15, 2008**

---

**TRADEMARK  
PRINCIPAL REGISTER**

**PHO FINISH**

BUBBLES, INC. (VIRGINIA CORPORATION)  
1577 SPRING HILL ROAD, SUITE 500  
VIENNA, VA 22182

FIRST USE 10-5-2005; IN COMMERCE 10-5-2005.

FOR: HAIR SALON PRODUCTS, NAMELY,  
SHAMPOOS, CONDITIONERS, STYLING PRE-  
PARATIONS, SOAPS, TOILET WATER, SKIN  
CREAMS AND BODY LOTIONS, IN CLASS 3 (U.S.  
CLS. 1, 4, 6, 50, 51 AND 52).

THE MARK CONSISTS OF STANDARD CHAR-  
ACTERS WITHOUT CLAIM TO ANY PARTICULAR  
FONT, STYLE, SIZE, OR COLOR.

SER. NO. 77-318,014, FILED 10-31-2007.

KELLY MCCOY, EXAMINING ATTORNEY

**Int. Cls.: 35 and 36**

**Prior U.S. Cls.: 100, 101 and 102**

**United States Patent and Trademark Office**

**Reg. No. 3,466,487**

**Registered July 15, 2008**

**SERVICE MARK  
PRINCIPAL REGISTER**

**7 W NEW YORK**

MERCHANDISE MART PROPERTIES, INC. (DE-  
LAWARE CORPORATION)  
SUITE 470  
222 MERCHANDISE MART PLAZA  
CHICAGO, IL 60654

FOR: ADVERTISING AND PROMOTING TRA-  
DESHOWS, IN CLASS 35 (U.S. CLS. 100, 101 AND 102).

FIRST USE 3-2-2005; IN COMMERCE 3-2-2005.

FOR: LEASING WHOLESALE SHOWROOM  
SPACE, IN CLASS 36 (U.S. CLS. 100, 101 AND 102).

FIRST USE 3-2-2005; IN COMMERCE 3-2-2005.

THE MARK CONSISTS OF STANDARD CHAR-  
ACTERS WITHOUT CLAIM TO ANY PARTICULAR  
FONT, STYLE, SIZE, OR COLOR.

NO CLAIM IS MADE TO THE EXCLUSIVE  
RIGHT TO USE "NEW YORK", APART FROM THE  
MARK AS SHOWN.

SER. NO. 77-318,038, FILED 10-31-2007.

KATINA MISTER, EXAMINING ATTORNEY

**Int. Cl.: 25**

**Prior U.S. Cls.: 22 and 39**

**United States Patent and Trademark Office**

**Reg. No. 3,466,488**

**Registered July 15, 2008**

**TRADEMARK  
PRINCIPAL REGISTER**

# PAVEMENT

CALMEX SPORTS, INC. (CALIFORNIA CORPORATION)  
10922 KLINGERMAN ST. #1  
SO. EL MONTE, CA 91733

FOR: MEN'S, WOMEN'S, BOY'S, GIRL'S, INFANT'S, TODDLER'S WEARING APPAREL, NAME-  
LY, T-SHIRT, SWEATSHIRTS, TANK TOP, SHIRTS,  
SWEATERS, VESTS, JACKETS, PANTS, SHORTS,  
SWEATPANTS, COATS, UNDERWEAR, BIBS,  
SOCKS, SHOES, BATHROBES, ATHLETIC UNI-  
FORMS, BEACHWEAR, BODYSUITS, BELTS, HATS  
AND CAPS, IN CLASS 25 (U.S. CLS. 22 AND 39).

FIRST USE 10-4-2000; IN COMMERCE 10-4-2000.

THE MARK CONSISTS OF STANDARD CHAR-  
ACTERS WITHOUT CLAIM TO ANY PARTICULAR  
FONT, STYLE, SIZE, OR COLOR.

OWNER OF U.S. REG. NO. 2,491,338.

SER. NO. 77-318,193, FILED 10-31-2007.

SAIMA MAKHDOOM, EXAMINING ATTORNEY

Int. Cl.: 41

Prior U.S. Cls.: 100, 101 and 107

United States Patent and Trademark Office

Reg. No. 3,466,489

Registered July 15, 2008

SERVICE MARK  
PRINCIPAL REGISTER



BLUE GOOSE INK (WISCONSIN SOLE PROPRIETORSHIP)  
N10907 MCDONAH LANE  
TREMPEALEAU, WI 54661

FOR: CUSTOM WRITING SERVICES; WRITTEN TEXT EDITING, IN CLASS 41 (U.S. CLS. 100, 101 AND 107).

FIRST USE 4-11-2007; IN COMMERCE 4-11-2007.

THE COLOR(S) STANDARD BLACK AND PMS 281 BLUE IS/ARE CLAIMED AS A FEATURE OF THE MARK.

THE MARK CONSISTS OF "BLUE GOOSE INK" IN BLACK, DRAGONFLY FONT; "WRITING, NATURALLY" BENEATH, IN BLUE, CAVALIER FONT; ALL UNDERLINED WITH A BLUE SQUIGGLE AND BORDERED ON THE RIGHT BY A BLUE QUILL PEN.

SER. NO. 77-318,318, FILED 10-31-2007.

TAMARA FRAZIER, EXAMINING ATTORNEY

**Int. Cl.: 1**

**Prior U.S. Cls.: 1, 5, 6, 10, 26 and 46**

**Reg. No. 3,466,490**

**United States Patent and Trademark Office**

**Registered July 15, 2008**

---

**TRADEMARK  
PRINCIPAL REGISTER**

**NOVACAT**

NOVA CHEMICALS INC. (DELAWARE COR-  
PORATION)  
1550 CORAOPOLIS HEIGHTS ROAD  
MOON TOWNSHIP, PA 15108

THE MARK CONSISTS OF STANDARD CHAR-  
ACTERS WITHOUT CLAIM TO ANY PARTICULAR  
FONT, STYLE, SIZE, OR COLOR.

FOR: POLYMERIZATION CATALYSTS, IN  
CLASS 1 (U.S. CLS. 1, 5, 6, 10, 26 AND 46).

SER. NO. 77-318,333, FILED 10-31-2007.

FIRST USE 2-10-2004; IN COMMERCE 2-10-2004.

MATTHEW EINSTEIN, EXAMINING ATTORNEY

**Int. Cl.: 45**

**Prior U.S. Cls.: 100 and 101**

**United States Patent and Trademark Office**

**Reg. No. 3,466,491**

**Registered July 15, 2008**

**SERVICE MARK  
PRINCIPAL REGISTER**

**HIM**

HARVEST INTERNATIONAL MINISTRY (CALIFORNIA CORPORATION)  
1539 E. HOWARD ST.  
PASADENA, CA 90010

FOR: PREACHING THE BIBLE, PRAYING FOR PEOPLE, AND PASTORAL COUNSELING, NAMELY, PROVIDING MINISTERIAL SERVICES, IN CLASS 45 (U.S. CLS. 100 AND 101).

FIRST USE 10-1-1996; IN COMMERCE 10-1-1996.

THE MARK CONSISTS OF STANDARD CHARACTERS WITHOUT CLAIM TO ANY PARTICULAR FONT, STYLE, SIZE, OR COLOR.

OWNER OF U.S. REG. NO. 2,382,679.

SER. NO. 77-318,570, FILED 10-31-2007.

SEAN CROWLEY, EXAMINING ATTORNEY



**Int. Cl.: 9**

**Prior U.S. Cls.: 21, 23, 26, 36 and 38**

**Reg. No. 3,466,492**

**United States Patent and Trademark Office**

**Registered July 15, 2008**

---

**TRADEMARK  
PRINCIPAL REGISTER**

**Voicent**

VOICENT COMMUNICATIONS INCORPORATED (CALIFORNIA CORPORATION)  
19925 STEVENS CREEK BLVD  
CUPERTINO, CA 95014

FIRST USE 1-1-2002; IN COMMERCE 1-1-2002.

FOR: COMPUTER SOFTWARE FOR USE IN CUSTOMER RELATIONSHIP MANAGEMENT (CRM); AUTOMATIC TELEPHONE DIALERS; COMPUTER DATABASE MANAGEMENT SOFTWARE FOR USE IN PERSONALIZING THE CONTENT OF EMAIL COMMUNICATIONS; COMPUTER TELEPHONY SOFTWARE, IN CLASS 9 (U.S. CLS. 21, 23, 26, 36 AND 38).

THE MARK CONSISTS OF STANDARD CHARACTERS WITHOUT CLAIM TO ANY PARTICULAR FONT, STYLE, SIZE, OR COLOR.

SER. NO. 77-318,589, FILED 10-31-2007.

LINDA LAVACHE, EXAMINING ATTORNEY

Int. Cl.: 41

Prior U.S. Cls.: 100, 101 and 107

United States Patent and Trademark Office

Reg. No. 3,466,493

Registered July 15, 2008

SERVICE MARK  
PRINCIPAL REGISTER



SOUTHEAST WOMEN'S HERBAL CONFERENCE, INC. (NORTH CAROLINA CORPORATION)

1039 CAMP ELLIOT RD.  
BLACK MOUNTAIN, NC 28711

FOR: EDUCATIONAL SERVICES, NAMELY, CONDUCTING CONFERENCES FOR WOMEN IN THE FIELD OF HERBS IN THE SOUTHEAST U.S. IN CLASS 41 (U.S. CLS. 100, 101 AND 107).

FIRST USE 10-0-2004; IN COMMERCE 10-0-2004.

NO CLAIM IS MADE TO THE EXCLUSIVE RIGHT TO USE "SOUTHEAST WOMEN'S HERBAL

CONFERENCE", APART FROM THE MARK AS SHOWN.

THE MARK CONSISTS OF THREE WOMEN WITH THEIR ARMS UP, SURROUNDED BY LEAVES, WITH A MOON ABOVE, AND THE STYLIZED TEXT "SOUTHEAST WOMEN'S HERBAL CONFERENCE".

SER. NO. 77-318,672, FILED 11-1-2007.

EMILY CARLSEN, EXAMINING ATTORNEY

**Int. Cls.: 35 and 43**

**Prior U.S. Cls.: 100, 101 and 102**

**United States Patent and Trademark Office**

**Reg. No. 3,466,494**

**Registered July 15, 2008**

**SERVICE MARK  
PRINCIPAL REGISTER**

**manic inn**

SLAPP, NOEL ROBERT (AUSTRALIA INDIVIDUAL)  
P.O. BOX 5003 CHR  
SAIPAN, NORTHERN MARIANA ISLANDS, MICRONESIA 96950

FOR: RETAIL CLOTHING BOUTIQUES, IN CLASS 35 (U.S. CLS. 100, 101 AND 102).

FIRST USE 1-10-2005; IN COMMERCE 3-20-2005.

FOR: BAR SERVICES; CAFE-RESTAURANTS, IN CLASS 43 (U.S. CLS. 100 AND 101).

FIRST USE 1-10-2005; IN COMMERCE 3-20-2005.

THE MARK CONSISTS OF STANDARD CHARACTERS WITHOUT CLAIM TO ANY PARTICULAR FONT, STYLE, SIZE, OR COLOR.

SER. NO. 77-318,683, FILED 11-1-2007.

BRENDAN REGAN, EXAMINING ATTORNEY

**Int. Cl.: 28**

**Prior U.S. Cls.: 22, 23, 38 and 50**

**United States Patent and Trademark Office**

**Reg. No. 3,466,495**

**Registered July 15, 2008**

**TRADEMARK  
PRINCIPAL REGISTER**

THE MIND OF A TREADMILL IN  
THE BODY OF AN ELLIPTICAL

AEROBICS, INC. (DELAWARE CORPORATION)  
34 FAIRFIELD PLACE  
WEST CALDWELL, NJ 07006

THE MARK CONSISTS OF STANDARD CHAR-  
ACTERS WITHOUT CLAIM TO ANY PARTICULAR  
FONT, STYLE, SIZE, OR COLOR.

FOR: EXERCISE MACHINES, IN CLASS 28 (U.S.  
CLS. 22, 23, 38 AND 50).

SER. NO. 77-318,892, FILED 11-1-2007.

FIRST USE 12-18-2007; IN COMMERCE 12-18-2007.

LINDA MICKLEBURGH, EXAMINING ATTORNEY

Int. Cl.: 25

Prior U.S. Cls.: 22 and 39

**United States Patent and Trademark Office**

**Reg. No. 3,466,496**

Registered July 15, 2008

**TRADEMARK  
PRINCIPAL REGISTER**

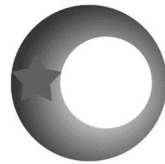

*Leo Star*

LEO STAR ATHLETIC CO. LTD. (CANADA CORPORATION)

1445 WEST BROADWAY

VANCOUVER, CANADA V6H1H6

FOR: DRESS SHIRTS; JACKETS; MEN AND WOMEN JACKETS, COATS, TROUSERS, VESTS; PANTS; SHORT-SLEEVED OR LONG-SLEEVED T-SHIRTS; SWEAT SHIRTS; T-SHIRTS, IN CLASS 25 (U.S. CLS. 22 AND 39).

OWNER OF CANADA REG. NO. TMA685998, DATED 4-13-2007, EXPIRES 4-13-2022.

THE MARK CONSISTS OF ONE STAR, ONE CIRCLE OR ELLIPSE CONTAINING REPRESENTATIONS OF HEAVENLY BODIES OR NATURAL PHENOMENA.

SER. NO. 77-318,976, FILED 11-1-2007.

CAROLYN GRAY, EXAMINING ATTORNEY

**Int. Cl.: 19**

**Prior U.S. Cls.: 1, 12, 33 and 50**

**United States Patent and Trademark Office**

**Reg. No. 3,466,497**

**Registered July 15, 2008**

**TRADEMARK  
PRINCIPAL REGISTER**



AZEK BUILDING PRODUCTS, INC. (DELA-  
WARE CORPORATION)  
801 COREY STREET  
SCRANTON, PA 18505

FOR: BUILDING MATERIALS, NAMELY, DECK-  
ING BOARDS, IN CLASS 19 (U.S. CLS. 1, 12, 33 AND  
50).

FIRST USE 8-31-2007; IN COMMERCE 8-31-2007.

OWNER OF U.S. REG. NOS. 2,696,724 AND  
3,068,158.

NO CLAIM IS MADE TO THE EXCLUSIVE  
RIGHT TO USE "DECK", APART FROM THE  
MARK AS SHOWN.

THE COLOR(S) DARK BLUE (PANTONE PMS  
2945) AND PURPLE (PANTONE PMS 242) IS/ARE  
CLAIMED AS A FEATURE OF THE MARK.

THE MARK CONSISTS OF THE WORD "AZEK"  
IN DARK BLUE ABOVE THE WORD "DECK" IN  
PURPLE AND AN ARROW IN PURPLE TO THE  
RIGHT OF THE WORDS "AZEK" AND "DECK."

SER. NO. 77-319,059, FILED 11-1-2007.

ROBIN MITTLER, EXAMINING ATTORNEY

**Int. Cl.: 35**

**Prior U.S. Cls.: 100, 101 and 102**

**United States Patent and Trademark Office**

**Reg. No. 3,466,498**

**Registered July 15, 2008**

---

**SERVICE MARK  
PRINCIPAL REGISTER**

**826**

826 NATIONAL, INC. (CALIFORNIA NON-PROFIT CORPORATION)  
826 VALENCIA ST.  
SAN FRANCISCO, CA 94110

THE MARK CONSISTS OF STANDARD CHARACTERS WITHOUT CLAIM TO ANY PARTICULAR FONT, STYLE, SIZE, OR COLOR.

FOR: RETAIL STORE SERVICES IN THE FIELD OF GENERAL CONSUMER MERCHANDISE AND GIFTS; RETAIL VARIETY STORES; RETAIL GIFT SHOPS, IN CLASS 35 (U.S. CLS. 100, 101 AND 102).

SER. NO. 77-319,128, FILED 11-1-2007.

FIRST USE 4-10-2002; IN COMMERCE 4-10-2002.

BARBARA GAYNOR, EXAMINING ATTORNEY

**Int. Cl.: 41**

**Prior U.S. Cls.: 100, 101 and 107**

**United States Patent and Trademark Office**

**Reg. No. 3,466,499**

**Registered July 15, 2008**

**SERVICE MARK  
PRINCIPAL REGISTER**

**826**

826 NATIONAL, INC. (CALIFORNIA NON-PROFIT CORPORATION)  
826 VALENCIA ST.  
SAN FRANCISCO, CA 94110

FOR: EDUCATION SERVICES, NAMELY, PROVIDING TUTORING IN THE FIELD OF WRITING; PUBLISHING OF BOOKS, PAMPHLETS, AND JOURNALS ON A VARIETY OF TOPICS, IN CLASS 41 (U.S. CLS. 100, 101 AND 107).

FIRST USE 4-10-2002; IN COMMERCE 4-10-2002.

THE MARK CONSISTS OF STANDARD CHARACTERS WITHOUT CLAIM TO ANY PARTICULAR FONT, STYLE, SIZE, OR COLOR.

SER. NO. 77-319,133, FILED 11-1-2007.

BARBARA GAYNOR, EXAMINING ATTORNEY



**Int. Cl.: 41**

**Prior U.S. Cls.: 100, 101 and 107**

**United States Patent and Trademark Office**

**Reg. No. 3,466,500**

**Registered July 15, 2008**

**SERVICE MARK  
PRINCIPAL REGISTER**

**THE CURRENT MUSIC BLOG**

MINNESOTA PUBLIC RADIO (MINNESOTA  
NON-PROFIT CORPORATION)  
480 CEDAR STREET  
ST. PAUL, MN 55101

FOR: COMPUTER SERVICES, NAMELY, HOST-  
ING AND MAINTAINING AN ONLINE WEBSITE  
FOR POSTING BLOGS AFFILIATED WITH A  
RADIO BROADCASTER FEATURING COMMEN-  
TARY AND INFORMATION IN THE FIELD OF  
MUSIC PERFORMANCES, MUSICIANS, NEWS  
AND EVENTS, IN CLASS 41 (U.S. CLS. 100, 101  
AND 107).

FIRST USE 8-8-2006; IN COMMERCE 8-8-2006.

THE MARK CONSISTS OF STANDARD CHAR-  
ACTERS WITHOUT CLAIM TO ANY PARTICULAR  
FONT, STYLE, SIZE, OR COLOR.

OWNER OF U.S. REG. NOS. 3,301,681 AND  
3,312,531.

NO CLAIM IS MADE TO THE EXCLUSIVE  
RIGHT TO USE "MUSIC BLOG", APART FROM  
THE MARK AS SHOWN.

SEC. 2(F).

SER. NO. 77-319,136, FILED 11-1-2007.

JOHN E. MICHOS, EXAMINING ATTORNEY

**Int. Cl.: 43**

**Prior U.S. Cls.: 100 and 101**

**United States Patent and Trademark Office**

**Reg. No. 3,466,501**

**Registered July 15, 2008**

**SERVICE MARK  
PRINCIPAL REGISTER**

**TIMBERMIST**

RZEPECKI, KAREN R. AND RZEPECKI, STEPHEN G. (PENNSYLVANIA PARTNERSHIP),  
DBA TIMBERMIST  
11050 BACKUS ROAD  
WATERFORD, PA 16442

THE MARK CONSISTS OF STANDARD CHARACTERS WITHOUT CLAIM TO ANY PARTICULAR FONT, STYLE, SIZE, OR COLOR.

FOR: RESORT LODGING SERVICES, IN CLASS 43 (U.S. CLS. 100 AND 101).

SER. NO. 77-319,222, FILED 11-1-2007.

FIRST USE 1-15-1998; IN COMMERCE 1-15-1998.

HEATHER BIDDULPH, EXAMINING ATTORNEY

**Int. Cl.: 9**

**Prior U.S. Cls.: 21, 23, 26, 36 and 38**

**Reg. No. 3,466,502**

**United States Patent and Trademark Office**

**Registered July 15, 2008**

**TRADEMARK  
PRINCIPAL REGISTER**

**SCUM OF THE EARTH**

13 FREAKS, LLC (ARKANSAS LTD LIAB CO),  
AKA RIGGS  
277 CR 1076  
MOUNTAIN HOME, AR 72653

TURING MUSICAL SOUND RECORDINGS AND  
PERFORMANCES; LASER DISCS FEATURING MU-  
SICAL SOUND RECORDINGS AND PERFORMAN-  
CES, IN CLASS 9 (U.S. CLS. 21, 23, 26, 36 AND 38).

FIRST USE 10-24-2004; IN COMMERCE 10-24-2004.

THE MARK CONSISTS OF STANDARD CHAR-  
ACTERS WITHOUT CLAIM TO ANY PARTICULAR  
FONT, STYLE, SIZE, OR COLOR.

SER. NO. 77-319,436, FILED 11-1-2007.

FOR: PHONOGRAPH RECORDS FEATURING  
MUSICAL SOUND RECORDINGS AND PERFOR-  
MANCES; AUDIO CASSETTES FEATURING MUSI-  
C A L S O U N D R E C O R D I N G S A N D  
PERFORMANCES; COMPACT DISCS FEATURING  
MUSICAL SOUND RECORDINGS AND PERFOR-  
MANCES; DIGITAL MEDIA, NAMELY, PRE-RE-  
CORDED VIDEO CASSETTES, DIGITAL VIDEO  
DISCS, DIGITAL VERSATILE DISCS, DOWNLOAD-  
ABLE AUDIO AND VIDEO RECORDINGS, DVDS,  
AND HIGH DEFINITION DIGITAL DISKS FEA-

JOHN HWANG, EXAMINING ATTORNEY

**Int. Cl.: 37**

**Prior U.S. Cls.: 100, 103 and 106**

**United States Patent and Trademark Office**

**Reg. No. 3,466,503**

**Registered July 15, 2008**

**SERVICE MARK  
PRINCIPAL REGISTER**

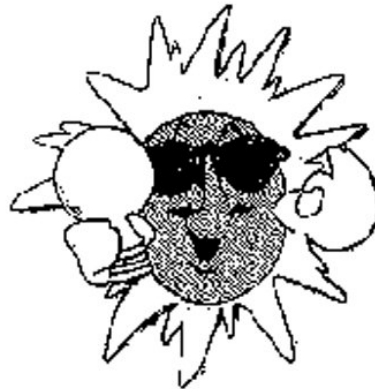

ARIZONA SUN ELECTRICAL CONTRACTORS,  
INC. (ARIZONA CORPORATION)  
9205 N 10TH AVE.  
PHOENIX, AZ 85021

THE MARK CONSISTS OF A SUN, WITH RAYS,  
WEARING FRAMED GLASSES AND HOLDING A  
LIGHT BULB.

FOR: RESIDENTIAL ELECTRICAL CONTRACT-  
ING, IN CLASS 37 (U.S. CLS. 100, 103 AND 106).

SER. NO. 77-319,563, FILED 11-1-2007.

FIRST USE 7-1-1992; IN COMMERCE 7-1-1992.

ALLISON HOLTZ, EXAMINING ATTORNEY

**Int. Cl.: 42**

**Prior U.S. Cls.: 100 and 101**

**United States Patent and Trademark Office**

**Reg. No. 3,466,504**

**Registered July 15, 2008**

**SERVICE MARK  
PRINCIPAL REGISTER**

**Spherexx.com**

SPHEREXX.COM (OKLAHOMA CORPORATION), DBA SPHEREXX LLC DBA SPHEREXX.COM  
6401 S SANDUSKY AVENUE  
TULSA, OK 74136

THE MARK CONSISTS OF STANDARD CHARACTERS WITHOUT CLAIM TO ANY PARTICULAR FONT, STYLE, SIZE, OR COLOR.

FOR: WEBSITE DEVELOPMENT FOR OTHERS,  
IN CLASS 42 (U.S. CLS. 100 AND 101).

SER. NO. 77-319,598, FILED 11-1-2007.

FIRST USE 1-1-2002; IN COMMERCE 1-1-2005.

KEVON CHISOLM, EXAMINING ATTORNEY

Int. Cl.: 41

Prior U.S. Cls.: 100, 101 and 107

United States Patent and Trademark Office

Reg. No. 3,466,505

Registered July 15, 2008

SERVICE MARK  
PRINCIPAL REGISTER



PIZZA HUT, INC. (CALIFORNIA CORPORATION)  
LEGAL  
14841 N. DALLAS PARKWAY  
DALLAS, TX 75254

THE COLOR(S) RED, YELLOW, BLACK, WHITE, AND GREEN IS/ARE CLAIMED AS A FEATURE OF THE MARK.

FOR: PROVIDING STADIUM AND FIELD FACILITY SERVICES FOR ATHLETIC AND ENTERTAINMENT EVENTS AND COMPETITIONS, CONCERTS, EXPOSITIONS, AND COMMUNITY EVENTS; PROVIDING ONLINE INFORMATION RELATING TO STADIUM SERVICES AND SPORTING EVENTS, CONCERTS, EXPOSITIONS, AND COMMUNITY EVENTS, IN CLASS 41 (U.S. CLS. 100, 101 AND 107).

THE MARK CONSISTS OF A RED CUPOLA STYLED ROOF DESIGN WITH A YELLOW UNDERLINE AND THE WORDS PIZZA HUT PARK. THE COLOR WHITE APPEARS IN THE WORDING "PIZZA HUT" AND IN THE INNER OUTLINE OF THE WORDING "PARK"; THE COLOR RED APPEARS IN THE DESIGN OF THE CUPOLA; THE COLOR YELLOW APPEARS IN THE HORIZONTAL LINE UNDER THE CUPOLA; THE COLOR GREEN APPEARS IN THE DOT ABOVE THE LETTER "I" IN "PIZZA"; AND THE COLOR BLACK APPEARS IN THE OUTLINE OF THE ENTIRE MARK.

FIRST USE 8-6-2005; IN COMMERCE 8-6-2005.

OWNER OF U.S. REG. NOS. 729,847, 3,206,923 AND OTHERS.

SER. NO. 77-319,769, FILED 11-2-2007.

NO CLAIM IS MADE TO THE EXCLUSIVE RIGHT TO USE "PARK", APART FROM THE MARK AS SHOWN.

SIMON TENG, EXAMINING ATTORNEY

**Int. Cl.: 42**

**Prior U.S. Cls.: 100 and 101**

**United States Patent and Trademark Office**

**Reg. No. 3,466,506**

**Registered July 15, 2008**

**SERVICE MARK  
PRINCIPAL REGISTER**

**JILL LYNN DESIGN**

ANDERSON, JILL (UNITED STATES INDIVIDUAL)  
400 17TH STREET N.W., UNIT 1335  
ATLANTA, GA 30363

FOR: GRAPHIC DESIGN SERVICES; DESIGN OF HOMEPAGES AND WEBSITES, IN CLASS 42 (U.S. CLS. 100 AND 101).

FIRST USE 6-17-2003; IN COMMERCE 6-17-2003.

THE MARK CONSISTS OF STANDARD CHARACTERS WITHOUT CLAIM TO ANY PARTICULAR FONT, STYLE, SIZE, OR COLOR.

NO CLAIM IS MADE TO THE EXCLUSIVE RIGHT TO USE "DESIGN", APART FROM THE MARK AS SHOWN.

THE NAME "JILL LYNN" SHOWN IN THE MARK IDENTIFIES JILL LYNN ANDERSON, WHOSE CONSENT IS OF RECORD.

SER. NO. 77-319,898, FILED 11-2-2007.

AHSEN KHAN, EXAMINING ATTORNEY

**Int. Cl.: 35**

**Prior U.S. Cls.: 100, 101 and 102**

**United States Patent and Trademark Office**

**Reg. No. 3,466,507**

**Registered July 15, 2008**

**SERVICE MARK  
PRINCIPAL REGISTER**

**DIDGEBRIDGE**

DIDGEBRIDGE, LLC (DELAWARE LTD LIAB  
CO)  
SUITE 300  
10401 NORTH MERIDIAN STREET  
INDIANAPOLIS, IN 46290

FOR: ADVERTISING SERVICES, NAMELY, PROMOTING THE GOODS AND SERVICES OF OTHERS BY PROVIDING DIGITAL OR PRINT ADVERTISING THAT ALLOWS FOR THE TRACKING OF CUSTOMER RESPONSES TO EACH ADVERTISEMENT TO MEASURE THE SUCCESS OF ADVERTISING

TISING CAMPAIGNS, IN CLASS 35 (U.S. CLS. 100, 101 AND 102).

FIRST USE 11-10-2006; IN COMMERCE 11-10-2006.

THE MARK CONSISTS OF STANDARD CHARACTERS WITHOUT CLAIM TO ANY PARTICULAR FONT, STYLE, SIZE, OR COLOR.

SER. NO. 77-319,903, FILED 11-2-2007.

AHSEN KHAN, EXAMINING ATTORNEY



**Int. Cls.: 37 and 42**

**Prior U.S. Cls.: 100, 101, 103 and 106**

**United States Patent and Trademark Office**

**Reg. No. 3,466,508**

**Registered July 15, 2008**

**SERVICE MARK  
PRINCIPAL REGISTER**

**architelligent**

CYAN PLANNING & CONSULTING CORP (NEW  
YORK CORPORATION)  
19245C 71 CRESCENT SUITE 3C  
FRESH MEADOWS, NY 11365

FOR: CONSULTING AND PLANNING SERVICES  
FOR THE ARCHITECTURE AND CONSTRUCTION  
INDUSTRY, NAMELY, PLANNING AND LAYING  
OUT OF FACILITY BUILDINGS, CONSTRUCTION  
PLANNING, CONSTRUCTION MANAGEMENT, IN  
CLASS 37 (U.S. CLS. 100, 103 AND 106).

FIRST USE 10-21-2007; IN COMMERCE 10-21-2007.

FOR: CONSULTING SERVICES IN THE FIELD  
OF ARCHITECTURAL DESIGN VIA COMPUTER  
AIDED DESIGN (CAD) ILLUSTRATIVE MAPPING,  
IN CLASS 42 (U.S. CLS. 100 AND 101).

FIRST USE 10-21-2007; IN COMMERCE 10-21-2007.

THE MARK CONSISTS OF STANDARD CHAR-  
ACTERS WITHOUT CLAIM TO ANY PARTICULAR  
FONT, STYLE, SIZE, OR COLOR.

SER. NO. 77-320,098, FILED 11-2-2007.

STEVEN JACKSON, EXAMINING ATTORNEY

**Int. Cl.: 41**

**Prior U.S. Cls.: 100, 101 and 107**

**United States Patent and Trademark Office**

**Reg. No. 3,466,509**

**Registered July 15, 2008**

**SERVICE MARK  
PRINCIPAL REGISTER**

**THE COLOR CODE**

HARTMAN INTERNATIONAL, LLC (UTAH LTD  
LIAB CO)  
145 W. CRYSTAL AVE.  
SALT LAKE CITY, UT 84115

FOR: EDUCATIONAL SERVICES, NAMELY,  
PROVIDING TRAINING, COACHING, TRAINER  
CERTIFICATION COURSES, WORKSHOPS, SEMI-  
NARS, RETREATS IN THE NATURE OF COURSES,  
AND LECTURES IN THE FIELDS OF PERSONAL-  
ITY, PERSONALITY PROFILES, PERSONALITY  
TRAITS, CHARACTER TRAITS, INTERPERSONAL  
COMMUNICATION, COMMUNICATION IM-  
PROVEMENT, PERSONAL RELATIONSHIPS, PRO-  
FESSIONAL RELATIONSHIPS, EMPLOYEE  
RELATIONSHIPS, EMPLOYEE MANAGEMENT,  
WORKPLACE DIVERSITY, TEAM WORK, BUSI-  
NESS INTERACTION, LEADERSHIP, HUMAN BE-  
HAVIOR, CARING, SHARING, COMPASSION,  
INTEGRITY, CREATIVITY, HONESTY, LOYALTY,

VALUES, MOTIVES, MOTIVATION, POSITIVE AF-  
FIRMATIONS, PASSION FOR LIFE, SUCCESS IN  
LIFE, ENJOYMENT OF LIFE, STRESS REDUCTION,  
CONFLICT REDUCTION, INTERPERSONAL  
SKILLS, INTERPERSONAL SKILLS DEVELOP-  
MENT, PRODUCTIVITY, SALES, PERSONAL EF-  
FECTIVENESS, AND PERSONAL IMPROVEMENT,  
IN CLASS 41 (U.S. CLS. 100, 101 AND 107).

FIRST USE 12-31-1990; IN COMMERCE 12-31-1990.

THE MARK CONSISTS OF STANDARD CHAR-  
ACTERS WITHOUT CLAIM TO ANY PARTICULAR  
FONT, STYLE, SIZE, OR COLOR.

SER. NO. 77-320,162, FILED 11-2-2007.

RENEE SERVANCE, EXAMINING ATTORNEY

**Int. Cls.: 35, 38 and 42**

**Prior U.S. Cls.: 100, 101, 102 and 104**

**United States Patent and Trademark Office**

**Reg. No. 3,466,510**

**Registered July 15, 2008**

**SERVICE MARK  
PRINCIPAL REGISTER**

# RCONNECTION

REGISTER.COM, INC. (DELAWARE CORPORATION)  
11TH FLOOR  
575 EIGHTH AVENUE  
NEW YORK, NY 10018

FOR: ON-LINE ADVERTISING AND MARKETING SERVICES FOR OTHERS, IN CLASS 35 (U.S. CLS. 100, 101 AND 102).

FIRST USE 1-15-2006; IN COMMERCE 1-15-2006.

FOR: PROVIDING MULTIPLE USER-ACCESS TO A GLOBAL COMPUTER INFORMATION NETWORK; EMAIL AND WEBSITE FORWARDING SERVICES; PROVIDING PRIVATE AND SECURE REAL TIME ELECTRONIC COMMUNICATION OVER A COMPUTER NETWORK; ELECTRONIC MAIL SERVICES, IN CLASS 38 (U.S. CLS. 100, 101 AND 104).

FIRST USE 1-15-2006; IN COMMERCE 1-15-2006.

FOR: DESIGN, CREATION, HOSTING, MAINTENANCE OF WEB SITES FOR OTHERS; PROVIDING TEMPORARY USE OF ON-LINE NON-DOWNLOADABLE COMPUTER SOFTWARE DEVELOPMENT TOOLS FOR CREATING WEB SITES; WEB SITE MONITORING, SECURITY, AND BACKUP SERVICES, NAMELY, MONITORING APPLICATION USAGE BY OTHERS, PROVIDING NOTIFICATION TO BUSINESSES ABOUT COMPUTER FIREWALL OR OTHER COMPUTER SECURITY

VIOLATIONS OR THREATS; COMPUTER SERVICES, NAMELY, FILTERING OF UNWANTED E-MAILS; COMPUTER SERVICES, NAMELY, MONITORING AND REPORTING OF WEB SITE TRAFFIC; COMPUTER WEBSITE DESIGN AND DATABASE DEVELOPMENT FOR OTHERS AND CONSULTATION IN CONNECTION THEREWITH; COMPUTER SERVICES, NAMELY, HOSTING ON-LINE INTERACTIVE WEB FACILITIES FOR OTHERS TO REGISTER DOMAIN NAMES INDIVIDUALLY OR IN BULK, MAINTAIN AND ADMINISTER INFORMATION RELATED TO REGISTERED DOMAIN NAMES, AND MANAGE DOMAIN NAMES BY FACILITATING THE TRANSFER AND RENEWAL OF DOMAIN NAMES; COMPUTER SERVICES IN THE FIELD OF DATA ENCRYPTION, NAMELY PROVIDING A WEBSITE FOR OTHERS TO OBTAIN AND ADMINISTER DIGITAL CERTIFICATES; PROVIDING INFORMATION REGARDING WEBSITE AND DATABASE DEVELOPMENT, IN CLASS 42 (U.S. CLS. 100 AND 101).

FIRST USE 1-15-2006; IN COMMERCE 1-15-2006.

THE MARK CONSISTS OF STANDARD CHARACTERS WITHOUT CLAIM TO ANY PARTICULAR FONT, STYLE, SIZE, OR COLOR.

SER. NO. 77-320,280, FILED 11-2-2007.

JAY FLOWERS, EXAMINING ATTORNEY

**Int. Cl.: 35**

**Prior U.S. Cls.: 100, 101 and 102**

**United States Patent and Trademark Office**

**Reg. No. 3,466,511**

**Registered July 15, 2008**

**SERVICE MARK  
PRINCIPAL REGISTER**

**HAWTHORNE DIRECT**

HAWTHORNE DIRECT INC. (IOWA CORPORATION)  
300 NORTH 16TH STREET  
FAIRFIELD, IA 52556

FOR: ADVERTISING AND MARKETING, IN CLASS 35 (U.S. CLS. 100, 101 AND 102).

FIRST USE 9-0-1998; IN COMMERCE 9-0-1998.

THE MARK CONSISTS OF STANDARD CHARACTERS WITHOUT CLAIM TO ANY PARTICULAR FONT, STYLE, SIZE, OR COLOR.

OWNER OF U.S. REG. NO. 2,311,993.

NO CLAIM IS MADE TO THE EXCLUSIVE RIGHT TO USE "DIRECT", APART FROM THE MARK AS SHOWN.

SER. NO. 77-320,335, FILED 11-2-2007.

GEOFFREY FOSDICK, EXAMINING ATTORNEY

**Int. Cls.: 35, 39 and 41**

**Prior U.S. Cls.: 100, 101, 102, 105 and 107**

**United States Patent and Trademark Office**

**Reg. No. 3,466,512**

**Registered July 15, 2008**

**SERVICE MARK  
PRINCIPAL REGISTER**

**STORETRIEVE OPTICAL  
SOLUTIONS (SOS)**

STORETRIEVE, INC. (CALIFORNIA CORPORATION)  
1150 SOUTH TAYLOR AVENUE  
MONTEBELLO, CA 90640

FOR: RECORDS MANAGEMENT SERVICES, NAMELY, DOCUMENT INDEXING FOR OTHERS; MANAGEMENT OF COMPUTERIZED FILES; DOCUMENT REPRODUCTION, IN CLASS 35 (U.S. CLS. 100, 101 AND 102).

FIRST USE 2-1-2007; IN COMMERCE 2-1-2007.

FOR: PHYSICAL STORAGE OF ELECTRONICALLY-STORED DATA OR DOCUMENTS; ELECTRONIC STORAGE OF DOCUMENTS AND FILES, IN CLASS 39 (U.S. CLS. 100 AND 105).

FIRST USE 2-1-2007; IN COMMERCE 2-1-2007.

FOR: DIGITAL IMAGING SERVICES, IN CLASS 41 (U.S. CLS. 100, 101 AND 107).

FIRST USE 2-1-2007; IN COMMERCE 2-1-2007.

THE MARK CONSISTS OF STANDARD CHARACTERS WITHOUT CLAIM TO ANY PARTICULAR FONT, STYLE, SIZE, OR COLOR.

NO CLAIM IS MADE TO THE EXCLUSIVE RIGHT TO USE "OPTICAL", APART FROM THE MARK AS SHOWN.

SER. NO. 77-320,416, FILED 11-2-2007.

JIM RINGLE, EXAMINING ATTORNEY

**Int. Cl.: 16**

**Prior U.S. Cls.: 2, 5, 22, 23, 29, 37, 38 and 50**

**United States Patent and Trademark Office**

**Reg. No. 3,466,513**

**Registered July 15, 2008**

**TRADEMARK  
PRINCIPAL REGISTER**



LIVE IN LOVE, INC. (FLORIDA CORPORATION)  
A3  
3400 S.W. 26TH TERRACE  
FORT LAUDERDALE, FL 33312

THE MARK CONSISTS OF "GUARANTEED TO  
DELIVER A SMILE" SURROUNDING A DOG  
HEAD.

FOR: STATIONERY, IN CLASS 16 (U.S. CLS. 2, 5,  
22, 23, 29, 37, 38 AND 50).

SER. NO. 77-320,491, FILED 11-2-2007.

FIRST USE 7-1-2002; IN COMMERCE 7-1-2002.

MARLENE BELL, EXAMINING ATTORNEY

Int. Cl.: 20

Prior U.S. Cls.: 2, 13, 22, 25, 32 and 50

United States Patent and Trademark Office

Reg. No. 3,466,514

Registered July 15, 2008

TRADEMARK  
PRINCIPAL REGISTER



TREHARNE, SALLY, W. (UNITED STATES IN-  
DIVIDUAL), DBA NEXTO YOU  
290 NELSON SIDING ROAD  
CLE ELUM, WA 98922

FOR: NECK-SUPPORTING PILLOWS; BACK SUP-  
PORT CUSHIONS NOT FOR MEDICAL PURPOSES;  
PORTABLE BACK SUPPORT FOR USE WITH  
CHAIRS, IN CLASS 20 (U.S. CLS. 2, 13, 22, 25, 32  
AND 50).

FIRST USE 10-1-2002; IN COMMERCE 8-1-2007.

THE MARK CONSISTS OF STYLIZED LETTERS  
"NEXTO YOU".

SER. NO. 77-320,539, FILED 11-2-2007.

KEVIN CORWIN, EXAMINING ATTORNEY

**Int. Cl.: 43**

**Prior U.S. Cls.: 100 and 101**

**United States Patent and Trademark Office**

**Reg. No. 3,466,515**

**Registered July 15, 2008**

**SERVICE MARK  
PRINCIPAL REGISTER**

**Seafood is Brain Food**

HOQUE ENTERPRISES LLC (TEXAS LTD LIAB  
CO)  
10821 COMPOSITE DRIVE  
DALLAS, TX 75220

THE MARK CONSISTS OF STANDARD CHAR-  
ACTERS WITHOUT CLAIM TO ANY PARTICULAR  
FONT, STYLE, SIZE, OR COLOR.

FOR: RESTAURANT SERVICES, IN CLASS 43  
(U.S. CLS. 100 AND 101).

SER. NO. 77-320,575, FILED 11-2-2007.

FIRST USE 1-1-2007; IN COMMERCE 1-1-2007.

AHSEN KHAN, EXAMINING ATTORNEY



**Int. Cl.: 30**

**Prior U.S. Cl.: 46**

**United States Patent and Trademark Office**

**Reg. No. 3,466,516**

**Registered July 15, 2008**

**TRADEMARK  
PRINCIPAL REGISTER**



**KOMACHI**

FAR WEST RICE, INC. (CALIFORNIA CORPORATION)  
P.O. BOX 370  
DURHAM, CA 95938

FOR: RICE, IN CLASS 30 (U.S. CL. 46).

FIRST USE 10-30-2007; IN COMMERCE 10-30-2007.

THE MARK CONSISTS OF NON-LATIN CHARACTERS AND THE WORDING, "KOMACHI" REPEATED WITHIN AND BENEATH AN OVAL WITH RICE PLANTS.

THE FOREIGN WORDING IN THE MARK TRANSLATES INTO ENGLISH AS "BEAUTY SPECIAL SELECT RICE".

THE NON-LATIN CHARACTER(S) IN THE MARK TRANSLITERATES INTO "KO MA CHI TOKU SEN MAI" , AND THIS MEANS "BEAUTY SPECIAL SELECT RICE" IN ENGLISH.

SER. NO. 77-320,598, FILED 11-2-2007.

GILBERT SWIFT, EXAMINING ATTORNEY

Int. Cl.: 25

Prior U.S. Cls.: 22 and 39

United States Patent and Trademark Office

Reg. No. 3,466,517

Registered July 15, 2008

TRADEMARK  
PRINCIPAL REGISTER



LIVIN' LIFE CLOTHING CO., LLC (GEORGIA  
LTD LIAB CO)  
1885 HARPER DRIVE APT. 15A  
MORROW, GA 30260

FOR: A-SHIRTS; BUTTON-FRONT ALOHA SHIRTS; CAMP SHIRTS; DRESS SHIRTS; GOLF SHIRTS; KNIT SHIRTS; LONG-SLEEVED SHIRTS; NIGHT SHIRTS; OPEN-NECKED SHIRTS; PIQUE SHIRTS; POLO SHIRTS; RUGBY SHIRTS; SHIRT FRONTS; SHIRT YOKES; SHIRTS; SHIRTS FOR SUITS; SHORT-SLEEVED OR LONG-SLEEVED T-SHIRTS; SHORT-SLEEVED SHIRTS; SLEEP SHIRTS; SPORT SHIRTS; SPORTS SHIRTS; SPORTS SHIRTS WITH SHORT SLEEVES; SWEAT SHIRTS; T-SHIRTS; TEE SHIRTS; TRIATHLON CLOTHING, NAMELY, TRIATHLON TIGHTS, TRIATHLON SHORTS, TRIATHLON SINGLET, TRIATHLON SHIRTS, TRIATHLON SUITS; WIND SHIRTS; YOGA SHIRTS; BALLOON PANTS; CAPRI PANTS; CARGO PANTS; DENIMS; JOGGING PANTS; LEATHER PANTS; LOUNGE PANTS; NON-DISPOSABLE CLOTH TRAINING PANTS; NURSE PANTS; PANTS; PETTI-PANTS; SKI PANTS; SNOW PANTS; SNOWBOARD PANTS; STRETCH PANTS; SWEAT PANTS; TAP PANTS; TOBOGGAN HATS, PANTS AND CAPS; TRACK PANTS; WATERPROOF JACKETS AND PANTS; WIND PANTS; YOGA PANTS;

COATS; COATS FOR MEN AND WOMEN; COATS MADE OF COTTON; COATS OF DENIM; DUST COATS; FUR COATS; FUR COATS AND JACKETS; SPORT COATS; SUIT COATS; BED JACKETS; DENIM JACKETS; DOWN JACKETS; FISHERMEN'S JACKETS; FUR JACKETS; HEAVY JACKETS; JACKET LINERS; JACKETS; LEATHER JACKETS; WIND RESISTANT JACKETS; JEANS; ATHLETIC SHOES; CANVAS SHOES; DECK-SHOES; LEATHER SHOES; RUNNING SHOES; TENNIS SHOES; BATHING SUITS; BATHING SUITS FOR MEN; BODY SUITS; DRESS SUITS; JOGGING SUITS; MEN'S SUITS; WOMEN'S SUITS; SUITS; SWEAT SUITS; HATS; WOOLLY HATS; BASEBALL CAPS; KNITTED CAPS; SKULL CAPS, IN CLASS 25 (U.S. CLS. 22 AND 39).

FIRST USE 10-19-2006; IN COMMERCE 11-2-2007.

NO CLAIM IS MADE TO THE EXCLUSIVE RIGHT TO USE "CLOTHING CO.", APART FROM THE MARK AS SHOWN.

SER. NO. 77-320,760, FILED 11-3-2007.

KATHERINE E. HALMEN, EXAMINING ATTORNEY

**Int. Cl.: 9**

**Prior U.S. Cls.: 21, 23, 26, 36 and 38**

**Reg. No. 3,466,518**

**United States Patent and Trademark Office**

**Registered July 15, 2008**

---

**TRADEMARK  
PRINCIPAL REGISTER**

**S.A.F.E.**

SOFTWARE ANALYSIS AND FORENSIC ENGINEERING CORPORATION (CALIFORNIA CORPORATION), DBA SAFE  
15565 SWISS CREEK LANE  
CUPERTINO, CA 95014

THE MARK CONSISTS OF STANDARD CHARACTERS WITHOUT CLAIM TO ANY PARTICULAR FONT, STYLE, SIZE, OR COLOR.

FOR: COMPUTER SOFTWARE FOR ANALYZING AND COMPARING SOFTWARE, IN CLASS 9 (U.S. CLS. 21, 23, 26, 36 AND 38).

SER. NO. 77-320,825, FILED 11-3-2007.

FIRST USE 8-16-2007; IN COMMERCE 9-1-2007.

KATINA MISTER, EXAMINING ATTORNEY

**Int. Cl.: 35**

**Prior U.S. Cls.: 100, 101 and 102**

**United States Patent and Trademark Office**

**Reg. No. 3,466,519**

**Registered July 15, 2008**

**SERVICE MARK  
PRINCIPAL REGISTER**

**GALILEO LAW DIRECTORY**

FITZ, CATHERINE R (UNITED STATES INDIVIDUAL)  
233 LUZ PL.  
DAVIS, CA 95616

FOR: ON-LINE BUSINESS DIRECTORIES FEATURING LAWYERS, LAW OFFICES, "ADR" (ALTERNATIVE DISPUTE RESOLUTION SERVICES), FACILITIES USED IN THE PROVISION OF LEGAL SERVICES, ASSOCIATIONS INCLUDING BAR ASSOCIATIONS AND STUDENT GROUPS, BUSINESS ASSOCIATIONS, EDUCATIONAL GROUPS RELATED TO LAW, AND GROUPS OF INDIVIDUALS INTERESTED IN ROLEPLAYING COURTROOM SCENARIOS.; PROVIDING AN ON-LINE COMMERCIAL INFORMATION DIRECTORY ON THE INTERNET; PROVIDING AN ONLINE DIRECTORY INFORMATION SERVICE FEATURING INFORMATION REGARDING LAWYERS, LAW OFFICES, "ADR" (ALTERNATIVE DISPUTE RESOLUTION SERVICES), FACILITIES USED IN THE PROVISION OF LEGAL SERVICES, ASSOCIATIONS INCLUDING BAR ASSOCIATIONS AND STUDENT

GROUPS, BUSINESS ASSOCIATIONS, EDUCATIONAL GROUPS RELATED TO LAW, AND GROUPS OF INDIVIDUALS INTERESTED IN ROLEPLAYING COURTROOM SCENARIOS.; PROVIDING ON-LINE DIRECTORY INFORMATION SERVICES ALSO FEATURING HYPERLINKS TO OTHER WEB SITES, IN CLASS 35 (U.S. CLS. 100, 101 AND 102).

FIRST USE 6-9-2007; IN COMMERCE 6-9-2007.

THE MARK CONSISTS OF STANDARD CHARACTERS WITHOUT CLAIM TO ANY PARTICULAR FONT, STYLE, SIZE, OR COLOR.

NO CLAIM IS MADE TO THE EXCLUSIVE RIGHT TO USE "LAW DIRECTORY" , APART FROM THE MARK AS SHOWN.

SER. NO. 77-320,838, FILED 11-4-2007.

VERNA BETH RIRIE, EXAMINING ATTORNEY

Int. Cls.: 41 and 44

Prior U.S. Cls.: 100, 101 and 107

United States Patent and Trademark Office

Reg. No. 3,466,520

Registered July 15, 2008

SERVICE MARK  
PRINCIPAL REGISTER



THE HILARIOUS HAIRDRESSOR, L.L.C. (TEXAS  
LTD LIAB CO)  
724 PECAN ROW  
NEW BRAUNFELS, TX 78132

THE COLOR(S) PINK, PURPLE, BLACK, WHITE,  
GREY AND TEAL IS/ARE CLAIMED AS A FEAT-  
URE OF THE MARK.

FOR: ENTERTAINMENT IN THE NATURE OF  
LIVE VISUAL AND AUDIO PERFORMANCES AND  
COMEDY SHOWS, IN CLASS 41 (U.S. CLS. 100, 101  
AND 107).

FIRST USE 3-2-2007; IN COMMERCE 3-2-2007.

FOR: SALON SERVICES, NAMELY, HAIR CUT-  
TING, STYLING, COLORING, STRAIGHTENING,  
WAXING AND MANICURES, IN CLASS 44 (U.S.  
CLS. 100 AND 101).

FIRST USE 3-2-2006; IN COMMERCE 3-2-2006.

NO CLAIM IS MADE TO THE EXCLUSIVE  
RIGHT TO USE "HAIRDRESSER", APART FROM  
THE MARK AS SHOWN.

THE MARK CONSISTS OF THE WORD "THE" IN  
PURPLE, THE WORD "HILARIOUS" IN PINK LET-  
TERS WITH A PURPLE SHADOW EFFECT; THE  
WORD "HAIRDRESSER" IN WHITE APPEARING  
ON A BLACK BANNER DESIGN; SCISSOR DESIGN  
APPEARING WITH GREY BLADES AND BLACK  
HANDLE WITH TEAL FINGER HOLES; BLACK  
MICROPHONE ON A STAND WITH A PURPLE  
WIRE; AND A HAIR BLOW DRYER APPEARING IN  
GREY AND WHITE WITH A BLACK HANDLES,  
BUTTON AND NOZZLE OPENING.

SER. NO. 77-320,853, FILED 11-4-2007.

RON FAIRBANKS, EXAMINING ATTORNEY

**Int. Cls.: 9 and 35**

**Prior U.S. Cls.: 21, 23, 26, 36, 38, 100, 101 and 102**

**Reg. No. 3,466,521**

**United States Patent and Trademark Office**

**Registered July 15, 2008**

---

**TRADEMARK  
SERVICE MARK  
PRINCIPAL REGISTER**

**TALENTZONE**

TALENT ZONE, LLC (DELAWARE LTD LIAB  
CO), DBA R. W. ROOK CONSULTING, LLC  
1133 ST. WILLIAM DR.  
LIBERTYVILLE, IL 60048

FOR: COMPUTER SOFTWARE PLATFORMS  
FOR HUMAN RESOURCES CONSULTING, IN  
CLASS 9 (U.S. CLS. 21, 23, 26, 36 AND 38).

FIRST USE 1-1-2004; IN COMMERCE 1-1-2004.

FOR: HUMAN RESOURCES CONSULTATION, IN  
CLASS 35 (U.S. CLS. 100, 101 AND 102).

FIRST USE 1-1-2004; IN COMMERCE 1-1-2004.

THE MARK CONSISTS OF STANDARD CHAR-  
ACTERS WITHOUT CLAIM TO ANY PARTICULAR  
FONT, STYLE, SIZE, OR COLOR.

SER. NO. 77-320,865, FILED 11-4-2007.

ANN E. SAPPENFIELD, EXAMINING ATTORNEY

**Int. Cl.: 36**

**Prior U.S. Cls.: 100, 101 and 102**

**United States Patent and Trademark Office**

**Reg. No. 3,466,522**

**Registered July 15, 2008**

**SERVICE MARK  
PRINCIPAL REGISTER**

IT'S OUR POLICY TO PROTECT

HM INSURANCE GROUP, INC. (PENNSYLVANIA CORPORATION)  
SUITE 2180  
120 FIFTH AVENUE  
PITTSBURGH, PA 152223099

FOR: GROUP INSURANCE AND RE-INSURANCE SERVICES, NAMELY, UNDERWRITING, ISSUING AND ADMINISTERING VOLUNTARY ACCIDENT, SUPPLEMENTAL HOSPITAL INDEMNITY, CRITICAL ILLNESS, SHORT-TERM DISABILITY AND WHOLE LIFE INSURANCE; INSURANCE SERVICES, NAMELY, UNDERWRITING, ISSUING AND ADMINISTERING LIMITED BENEFIT MEDICAL, EXCESS OF LOSS, EMPLOYER STOP LOSS, HMO RE-INSURANCE, PROVIDER

EXCESS AND WORKERS' COMPENSATION COVERAGE INSURANCE; INSURANCE ADMINISTRATION FOR THIRD PARTIES, IN CLASS 36 (U.S. CLS. 100, 101 AND 102).

FIRST USE 4-4-2007; IN COMMERCE 4-4-2007.

THE MARK CONSISTS OF STANDARD CHARACTERS WITHOUT CLAIM TO ANY PARTICULAR FONT, STYLE, SIZE, OR COLOR.

SER. NO. 77-321,061, FILED 11-5-2007.

KATHY DE JONGE, EXAMINING ATTORNEY

**Int. Cl.: 41**

**Prior U.S. Cls.: 100, 101 and 107**

**United States Patent and Trademark Office**

**Reg. No. 3,466,523**

**Registered July 15, 2008**

**SERVICE MARK  
PRINCIPAL REGISTER**



NEXT STEP PUBLISHING, INC. (NEW YORK CORPORATION)  
86 WEST MAIN STREET  
VICTOR, NY 14564

FOR: CAREER AND COLLEGE PLANNING SERVICES, IN CLASS 41 (U.S. CLS. 100, 101 AND 107).

FIRST USE 10-11-2007; IN COMMERCE 10-11-2007.

NO CLAIM IS MADE TO THE EXCLUSIVE RIGHT TO USE "COLLEGE PLANNING", APART FROM THE MARK AS SHOWN.

THE MARK CONSISTS OF THE WORDS "STEP BY STEP" NEXT TO AN IMAGE OF A FOOT, WITH THE WORD "BY" WITHIN A CIRCULAR DESIGN ELEMENT, AND THE WORDS "COLLEGE PLANNING" UNDERNEATH.

SER. NO. 77-321,066, FILED 11-5-2007.

RONALD AIKENS, EXAMINING ATTORNEY



Int. Cl.: 35

Prior U.S. Cls.: 100, 101 and 102

United States Patent and Trademark Office

Reg. No. 3,466,524

Registered July 15, 2008

**SERVICE MARK  
PRINCIPAL REGISTER**

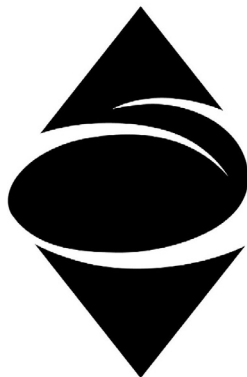

OTTER TAIL CORPORATION (MINNESOTA CORPORATION)  
P.O. BOX 496  
215 SOUTH CASCADE STREET  
FERGUS FALLS, MN 565380496

FOR: ACCOUNTING SERVICES; BUSINESS ACQUISITION AND MERGER CONSULTATION; ADVERTISING AND PUBLICITY SERVICES, NAMELY, PROMOTING AND MARKETING THE GOODS AND SERVICES OF OTHERS THROUGH ALL PUBLIC COMMUNICATIONS MEANS; HUMAN RESOURCES CONSULTATION AND MANAGEMENT; SHAREHOLDER AND BUSINESS RECORDS MANAGEMENT AND FINANCIAL RECORDS MANAGEMENT; SHAREHOLDER SERVICES, NAMELY, ANNUAL SHAREHOLDER MEETING PLANNING, PROXY TABULATION,

PREPARING BUSINESS REPORTS, AND PROVIDING CONSUMER INFORMATION AND RELATED NEWS TO INVESTORS IN THE FIELD OF COMPANY FINANCIAL INFORMATION AND BUSINESS DEVELOPMENTS AND EVENTS, IN CLASS 35 (U.S. CLS. 100, 101 AND 102).

FIRST USE 6-30-2001; IN COMMERCE 6-30-2001.

THE MARK CONSISTS OF A VERTICAL DIAMOND SHAPE INTERSECTED HORIZONTALLY BY AN OVAL-SHAPED SWIRL.

SER. NO. 77-321,086, FILED 11-5-2007.

BRENDAN REGAN, EXAMINING ATTORNEY

**Int. Cls.: 35 and 37**

**Prior U.S. Cls.: 100, 101, 102, 103 and 106**

**United States Patent and Trademark Office**

**Reg. No. 3,466,525**

**Registered July 15, 2008**

---

**SERVICE MARK  
PRINCIPAL REGISTER**

**ALT**

ALL ERECTION & CRANE RENTAL CORP.  
(OHIO CORPORATION)

7809 OLD ROCKSIDE ROAD

CLEVELAND, OH 441312315

FOR: RETAIL STORE SERVICES FEATURING  
CONSTRUCTION EQUIPMENT, NAMELY,  
CRANES, BOOMS AND LIFTS, IN CLASS 35 (U.S.  
CLS. 100, 101 AND 102).

FIRST USE 5-3-1984; IN COMMERCE 5-3-1984.

FOR: RENTAL OF CONSTRUCTION EQUIP-  
MENT, NAMELY, CRANES, BOOMS AND LIFTS,  
IN CLASS 37 (U.S. CLS. 100, 103 AND 106).

FIRST USE 5-3-1984; IN COMMERCE 5-3-1984.

THE MARK CONSISTS OF STANDARD CHAR-  
ACTERS WITHOUT CLAIM TO ANY PARTICULAR  
FONT, STYLE, SIZE, OR COLOR.

SER. NO. 77-321,097, FILED 11-5-2007.

KIMBERLY PERRY, EXAMINING ATTORNEY

**Int. Cl.: 35**

**Prior U.S. Cls.: 100, 101 and 102**

**United States Patent and Trademark Office**

**Reg. No. 3,466,526**

**Registered July 15, 2008**

**SERVICE MARK  
PRINCIPAL REGISTER**

**artHEALS**

FAMILY SERVICE CENTERS, INC. (FLORIDA  
CORPORATION)  
2960 ROOSEVELT BLVD.  
CLEARWATER, FL 33760

FOR: ORGANIZING AND CONDUCTING CHAR-  
ITY AUCTIONS FOR CHARITABLE FUNDRAIS-  
ING PURPOSES, IN CLASS 35 (U.S. CLS. 100, 101  
AND 102).

FIRST USE 2-0-2006; IN COMMERCE 3-0-2006.

THE MARK CONSISTS OF STANDARD CHAR-  
ACTERS WITHOUT CLAIM TO ANY PARTICULAR  
FONT, STYLE, SIZE, OR COLOR.

SER. NO. 77-321,105, FILED 11-5-2007.

GINA HAYES, EXAMINING ATTORNEY

**Int. Cl.: 16**

**Prior U.S. Cls.: 2, 5, 22, 23, 29, 37, 38 and 50**

**United States Patent and Trademark Office**

**Reg. No. 3,466,527**

**Registered July 15, 2008**

**TRADEMARK  
PRINCIPAL REGISTER**

# Snoozmark

READ2SLEEP, LLC (OKLAHOMA LTD LIAB CO)  
#345  
1611 S. UTICA AVE  
TULSA, OK 74104

THE MARK CONSISTS OF STANDARD CHAR-  
ACTERS WITHOUT CLAIM TO ANY PARTICULAR  
FONT, STYLE, SIZE, OR COLOR.

FOR: BOOKMARKS, IN CLASS 16 (U.S. CLS. 2, 5,  
22, 23, 29, 37, 38 AND 50).

SER. NO. 77-321,222, FILED 11-5-2007.

FIRST USE 6-1-2005; IN COMMERCE 4-1-2006.

BENJAMIN ALLEN, EXAMINING ATTORNEY

Int. Cl.: 33

Prior U.S. Cls.: 47 and 49

United States Patent and Trademark Office

Reg. No. 3,466,528

Registered July 15, 2008

TRADEMARK  
PRINCIPAL REGISTER



PINK GIRL WINES, LLC (CALIFORNIA LTD  
LIAB CO)

PO BOX 854

NAPA, CA 94559

FOR: WINES; SPIRITS, IN CLASS 33 (U.S. CLS. 47  
AND 49).

FIRST USE 12-0-2006; IN COMMERCE 12-0-2006.

NO CLAIM IS MADE TO THE EXCLUSIVE  
RIGHT TO USE "PINK", APART FROM THE MARK  
AS SHOWN.

THE MARK CONSISTS OF A STYLIZED CREST  
WITH THE STYLIZED WORDS "PINK GIRL" IN  
THE CENTER OF THE CREST.

SER. NO. 77-321,304, FILED 11-5-2007.

BRIAN NEVILLE, EXAMINING ATTORNEY

**Int. Cl.: 36**

**Prior U.S. Cls.: 100, 101 and 102**

**United States Patent and Trademark Office**

**Reg. No. 3,466,529**

**Registered July 15, 2008**

**SERVICE MARK  
PRINCIPAL REGISTER**



BUSINESS PARTNERS ALLIANCE (MAINE CORPORATION)  
16 HEMLOCK DRIVE  
SACO, ME 04072

FOR: CREDIT AND FINANCIAL CONSULTATION; FINANCIAL ANALYSIS AND CONSULTATION; FINANCIAL CONSULTATION; FINANCIAL CONSULTATION IN THE FIELD OF COMMERCIAL LOANS; FINANCIAL CONSULTING; FINANCIAL FORECASTING; FINANCIAL INFORMATION PROCESSING; FINANCIAL LOAN CONSULTATION; FINANCIAL MANAGEMENT; FINANCIAL PLANNING; FINANCIAL PLANNING CONSULTATION; FINANCIAL PORTFOLIO ANALYSIS SERVICES; FINANCIAL PORTFOLIO MANAGEMENT; FINANCIAL RESEARCH; FINANCIAL RISK MANAGEMENT; FINANCIAL RISK MANAGEMENT CONSULTATION; FINANCIAL SERVICES, NAMELY, MONEY LENDING, IN CLASS 36 (U.S. CLS. 100, 101 AND 102).

FIRST USE 2-0-2007; IN COMMERCE 2-0-2007.

NO CLAIM IS MADE TO THE EXCLUSIVE RIGHT TO USE "BUSINESS PARTNERS ALLIANCE", APART FROM THE MARK AS SHOWN.

THE MARK CONSISTS OF TRIANGLE SHAPE WITH STYLIZED LETTERS "B", "P" AND "A" EMBEDDED IN DIAGONAL LINE FROM LEFT TO RIGHT. WITHIN THE TRIANGLE THERE ARE THREE OTHER TRIANGLES. UNDERNEATH THE TRIANGLE ARE THE STYLIZED WORDS "BUSINESS PARTNERS ALLIANCE".

SER. NO. 77-321,350, FILED 11-5-2007.

KATHERINE M. DUBRAY, EXAMINING ATTORNEY

**Int. Cls.: 35 and 37**

**Prior U.S. Cls.: 100, 101, 102, 103 and 106**

**United States Patent and Trademark Office**

**Reg. No. 3,466,530**

**Registered July 15, 2008**

**SERVICE MARK  
PRINCIPAL REGISTER**

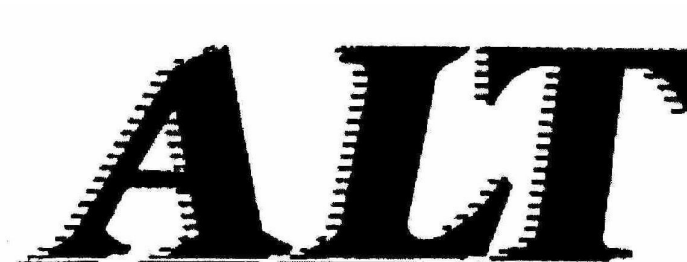

ALL ERECTION & CRANE RENTAL CORP.  
(OHIO CORPORATION)  
7809 OLD ROCKSIDE ROAD  
CLEVELAND, OH 441312315

FOR: RETAIL STORE SERVICES FEATURING  
CONSTRUCTION EQUIPMENT, NAMELY,  
CRANES, BOOMS AND LIFTS, IN CLASS 35 (U.S.  
CLS. 100, 101 AND 102).

FIRST USE 12-31-1992; IN COMMERCE 12-31-1992.

FOR: RENTAL OF CONSTRUCTION EQUIP-  
MENT, NAMELY, CRANES, BOOMS AND LIFTS,  
IN CLASS 37 (U.S. CLS. 100, 103 AND 106).

FIRST USE 12-31-1992; IN COMMERCE 12-31-1992.

THE MARK CONSISTS OF THE STYLIZED LET-  
TERS "ALT".

SER. NO. 77-321,393, FILED 11-5-2007.

KIMBERLY PERRY, EXAMINING ATTORNEY

**Int. Cl.: 35**

**Prior U.S. Cls.: 100, 101 and 102**

**United States Patent and Trademark Office**

**Reg. No. 3,466,531**

**Registered July 15, 2008**

**SERVICE MARK  
PRINCIPAL REGISTER**

**OTTER TAIL CORPORATION**

OTTER TAIL CORPORATION (MINNESOTA CORPORATION)  
P.O. BOX 496  
215 SOUTH CASCADE STREET  
FERGUS FALLS, MN 565380496

FOR: ACCOUNTING SERVICES; BUSINESS ACQUISITION AND MERGER CONSULTATION; ADVERTISING AND PUBLICITY SERVICES, NAMELY, PROMOTING AND MARKETING THE GOODS AND SERVICES OF OTHERS THROUGH ALL PUBLIC COMMUNICATIONS MEANS; HUMAN RESOURCES CONSULTATION AND MANAGEMENT; SHAREHOLDER AND BUSINESS RECORDS MANAGEMENT AND FINANCIAL RECORDS MANAGEMENT; SHAREHOLDER SERVICES, NAMELY, ANNUAL SHAREHOLDER MEETING PLANNING, PROXY TABULATION, PREPARING BUSINESS REPORTS, AND PROVIDING CONSUMER INFORMATION AND RELATED NEWS TO INVESTORS IN THE FIELD OF COMPA-

NY FINANCIAL INFORMATION AND BUSINESS DEVELOPMENTS AND EVENTS, IN CLASS 35 (U.S. CLS. 100, 101 AND 102).

FIRST USE 6-30-2001; IN COMMERCE 6-30-2001.

THE MARK CONSISTS OF STANDARD CHARACTERS WITHOUT CLAIM TO ANY PARTICULAR FONT, STYLE, SIZE, OR COLOR.

OWNER OF U.S. REG. NOS. 2,624,849 AND 2,624,866.

NO CLAIM IS MADE TO THE EXCLUSIVE RIGHT TO USE "CORPORATION", APART FROM THE MARK AS SHOWN.

SER. NO. 77-321,512, FILED 11-5-2007.

BRENDAN REGAN, EXAMINING ATTORNEY



**Int. Cls.: 16 and 35**

**Prior U.S. Cls.: 2, 5, 22, 23, 29, 37, 38, 50, 100, 101 and 102**

**Reg. No. 3,466,532**

**United States Patent and Trademark Office**

**Registered July 15, 2008**

**TRADEMARK  
SERVICE MARK  
PRINCIPAL REGISTER**

**ORGANIZATIONAL  
EFFECTIVENESS INVENTORY**

APPLIED RESEARCH CENTER, INC. (ILLINOIS CORPORATION)  
21 S. EVERGREEN AVE, SUITE 100  
ARLINGTON HEIGHTS, IL 60005

FOR: BOOKLETS IN THE FIELD OF PSYCHOLOGICAL TESTING, PERSONAL DEVELOPMENT, TEAM BUILDING, AND ORGANIZATIONAL CHANGE AND DEVELOPMENT; BROCHURES ABOUT PSYCHOLOGICAL TESTING, PERSONAL DEVELOPMENT, TEAM BUILDING, AND ORGANIZATIONAL CHANGE AND DEVELOPMENT; CATALOGS IN THE FIELD OF PSYCHOLOGICAL TESTING, PERSONAL DEVELOPMENT, TEAM BUILDING, AND ORGANIZATIONAL CHANGE AND DEVELOPMENT; MANUALS IN THE FIELD OF PSYCHOLOGICAL TESTING, PERSONAL DEVELOPMENT, TEAM BUILDING, AND ORGANIZATIONAL CHANGE AND DEVELOPMENT; PAMPHLETS IN THE FIELD OF PSYCHOLOGICAL TESTING, PERSONAL DEVELOPMENT, TEAM BUILDING, AND ORGANIZATIONAL CHANGE AND DEVELOPMENT; PRINTED ANSWER SHEETS IN THE FIELD OF PSYCHOLOGICAL TESTING, PERSONAL DEVELOPMENT, TEAM BUILDING, AND ORGANIZATIONAL CHANGE AND DEVELOPMENT; PRINTED SURVEY ANSWER SHEETS; QUESTIONNAIRES ON THE MEASUREMENT OF INDIVIDUAL AND GROUP LEADERSHIP AND ORGANIZATIONAL FACTORS RELATED TO ORGANIZATIONAL EFFECTIVENESS; RESEARCH REPORTS FEATURING PSYCHOLOGICAL TESTING, PERSONAL DEVELOPMENT, TEAM BUILDING, AND ORGANIZATIONAL CHANGE AND DEVELOPMENT, IN CLASS 16 (U.S. CLS. 2, 5, 22, 23, 29, 37, 38 AND 50).

FIRST USE 9-15-1994; IN COMMERCE 9-15-1994.

FOR: ANALYSES AND APPRAISALS OF ENTERPRISES; BUSINESS APPRAISALS; BUSINESS INFORMATION SERVICES AND APPRAISALS; BUSINESS INVESTIGATIONS, EVALUATIONS, EXPERT APPRAISALS, INFORMATION AND RESEARCH; BUSINESS MANAGEMENT CONSULTANCY SERVICES; BUSINESS ORGANIZATIONAL CONSULTATION; BUSINESS PLANNING; BUSINESS RESEARCH AND SURVEYS; BUSINESS RESEARCH CONSULTATION; CONDUCTING BUSINESS RESEARCH AND SURVEYS; CONDUCTING ON-LINE BUSINESS MANAGEMENT RESEARCH SURVEYS; CORPORATE MANAGEMENT ASSISTANCE; EMPLOYEE RELATIONS INFORMATION SERVICES; PREPARING BUSINESS REPORTS; PROVIDING AN ON-LINE COMPUTER DATABASE FEATURING TRADE INFORMATION IN THE FIELD OF PSYCHOLOGICAL TESTING, PERSONAL DEVELOPMENT, TEAM BUILDING, AND ORGANIZATIONAL CHANGE AND DEVELOPMENT, IN CLASS 35 (U.S. CLS. 100, 101 AND 102).

FIRST USE 9-15-1994; IN COMMERCE 9-15-1994.

THE MARK CONSISTS OF STANDARD CHARACTERS WITHOUT CLAIM TO ANY PARTICULAR FONT, STYLE, SIZE, OR COLOR.

SEC. 2(F).

SER. NO. 77-321,754, FILED 11-5-2007.

TIMOTHY FINNEGAN, EXAMINING ATTORNEY

**Int. Cl.: 43**

**Prior U.S. Cls.: 100 and 101**

**United States Patent and Trademark Office**

**Reg. No. 3,466,533**

**Registered July 15, 2008**

**SERVICE MARK  
PRINCIPAL REGISTER**

**PRAIRIE TAP**

HMSHOST CORPORATION (DELAWARE CORPORATION)

6905 ROCKLEDGE DRIVE MS 7-1

BETHESDA, MD 20817

FOR: RESTAURANT SERVICES, IN CLASS 43  
(U.S. CLS. 100 AND 101).

FIRST USE 5-16-2001; IN COMMERCE 5-16-2001.

THE MARK CONSISTS OF STANDARD CHARACTERS WITHOUT CLAIM TO ANY PARTICULAR FONT, STYLE, SIZE, OR COLOR.

NO CLAIM IS MADE TO THE EXCLUSIVE RIGHT TO USE "TAP", APART FROM THE MARK AS SHOWN.

SER. NO. 77-321,840, FILED 11-5-2007.

SUSAN RICHARDS, EXAMINING ATTORNEY

**Int. Cl.: 5**

**Prior U.S. Cls.: 6, 18, 44, 46, 51 and 52**

**Reg. No. 3,466,534**

**United States Patent and Trademark Office**

**Registered July 15, 2008**

---

**TRADEMARK  
PRINCIPAL REGISTER**

**AgriTec**

EARTH SCIENCE LABORATORIES, INC. (NEVADA CORPORATION)  
113 SE 22ND STREET, SUITE 1  
BENTONVILLE, AR 72712

FOR: COPPER-BASED ALGAECIDE FOR AGRICULTURAL USE IN LAKES, PONDS, SEWER LAGOONS AND WATER RESERVOIRS; COPPER-BASED BACTERICIDE FOR USE IN LAKES, PONDS, SEWER LAGOONS AND WATER RESERVOIRS, IN CLASS 5 (U.S. CLS. 6, 18, 44, 46, 51 AND 52).

FIRST USE 5-1-1998; IN COMMERCE 5-1-1998.

THE MARK CONSISTS OF STANDARD CHARACTERS WITHOUT CLAIM TO ANY PARTICULAR FONT, STYLE, SIZE, OR COLOR.

SER. NO. 77-321,905, FILED 11-5-2007.

GILBERT SWIFT, EXAMINING ATTORNEY

**Int. Cl.: 12**

**Prior U.S. Cls.: 19, 21, 23, 31, 35 and 44**

**United States Patent and Trademark Office**

**Reg. No. 3,466,535**

**Registered July 15, 2008**

**TRADEMARK  
PRINCIPAL REGISTER**

# Falcon Motorcycles

AMARYLLIS SALIMA KNIGHT (UNITED STATES INDIVIDUAL)

11900 WEST OLYMPIC BLVD SUITE #650

LOS ANGELES, CA 90064

FOR: MOTORCYCLES, IN CLASS 12 (U.S. CLS. 19, 21, 23, 31, 35 AND 44).

FIRST USE 11-1-2007; IN COMMERCE 11-1-2007.

THE MARK CONSISTS OF STANDARD CHARACTERS WITHOUT CLAIM TO ANY PARTICULAR FONT, STYLE, SIZE, OR COLOR.

NO CLAIM IS MADE TO THE EXCLUSIVE RIGHT TO USE "MOTORCYCLES", APART FROM THE MARK AS SHOWN.

SER. NO. 77-321,946, FILED 11-5-2007.

HEATHER BIDDULPH, EXAMINING ATTORNEY

**Int. Cl.: 40**

**Prior U.S. Cls.: 100, 103 and 106**

**United States Patent and Trademark Office**

**Reg. No. 3,466,536**

**Registered July 15, 2008**

**SERVICE MARK  
PRINCIPAL REGISTER**

**RED TIE STUDIOS**

RED TIE STUDIOS (TEXAS PARTNERSHIP)  
11906 BARRINGTON WAY  
AUSTIN, TX 78759

FOR: CREATION OF CUSTOM PORTRAITS AND  
PAINTINGS BASED ON PHOTOGRAPHS, SNAP-  
SHOTS OR IMAGES PROVIDED BY THE CUSTO-  
MER, IN CLASS 40 (U.S. CLS. 100, 103 AND 106).

FIRST USE 3-1-2006; IN COMMERCE 6-1-2006.

THE MARK CONSISTS OF STANDARD CHAR-  
ACTERS WITHOUT CLAIM TO ANY PARTICULAR  
FONT, STYLE, SIZE, OR COLOR.

NO CLAIM IS MADE TO THE EXCLUSIVE  
RIGHT TO USE "STUDIO", APART FROM THE  
MARK AS SHOWN.

SER. NO. 77-322,177, FILED 11-6-2007.

COLLEEN KEARNEY, EXAMINING ATTORNEY

**Int. Cl.: 41**

**Prior U.S. Cls.: 100, 101 and 107**

**United States Patent and Trademark Office**

**Reg. No. 3,466,537**

**Registered July 15, 2008**

**SERVICE MARK  
PRINCIPAL REGISTER**

**ROCKY MOUNTAIN COLLEGE OF  
ART + DESIGN**

ROCKY MOUNTAIN SCHOOL OF ART, INC.  
(COLORADO CORPORATION)  
1600 PIERCE STREET  
LAKEWOOD, CO 80214

FOR: EDUCATIONAL SERVICES, NAMELY, OFFERING COURSES OF INSTRUCTION IN THE FIELDS OF ART, ANIMATION, FINE ARTS, GRAPHIC DESIGN, ART EDUCATION, ILLUSTRATION AND FOUNDATION STUDIES, IN CLASS 41 (U.S. CLS. 100, 101 AND 107).

FIRST USE 0-0-1984; IN COMMERCE 0-0-1984.

THE MARK CONSISTS OF STANDARD CHARACTERS WITHOUT CLAIM TO ANY PARTICULAR FONT, STYLE, SIZE, OR COLOR.

NO CLAIM IS MADE TO THE EXCLUSIVE RIGHT TO USE "COLLEGE OF ART + DESIGN", APART FROM THE MARK AS SHOWN.

SEC. 2(F).

SER. NO. 77-322,534, FILED 11-6-2007.

KAREN BRACEY, EXAMINING ATTORNEY

**Int. Cl.: 9**

**Prior U.S. Cls.: 21, 23, 26, 36 and 38**

**Reg. No. 3,466,538**

**United States Patent and Trademark Office**

**Registered July 15, 2008**

---

**TRADEMARK  
PRINCIPAL REGISTER**

**PRODUCTIONCENTRE**

ROCKWELL AUTOMATION (DELAWARE CORPORATION)  
1201 SOUTH SECOND STREET  
MILWAUKEE, WI 53204

FOR: COMPUTER SOFTWARE FOR USE IN INDUSTRIAL AUTOMATION AND MANUFACTURING; COMPUTER SOFTWARE THAT DELIVERS REAL-TIME INFORMATION ACROSS MANUFACTURING PROCESS INDUSTRIES TO ASSIST WITH OPERATIONAL IMPROVEMENT, BUSINESS RISK MANAGEMENT AND QUALITY ASSURANCE; COMPUTER SOFTWARE FOR USE IN THE OPERATION AND MAINTENANCE OF INDUSTRIAL AUTOMATION PROCESSES; AND COMPUTER SOFTWARE FOR COLLECTING AND DISTRIBUT-

ING DATA WITHIN COMPUTER NETWORKS, INCLUDING THE INTERNET, AND ENABLING DATA COMMUNICATION BETWEEN APPLICATION PROGRAMS, IN CLASS 9 (U.S. CLS. 21, 23, 26, 36 AND 38).

FIRST USE 10-25-2006; IN COMMERCE 10-26-2006.

THE MARK CONSISTS OF STANDARD CHARACTERS WITHOUT CLAIM TO ANY PARTICULAR FONT, STYLE, SIZE, OR COLOR.

SER. NO. 77-322,563, FILED 11-6-2007.

DAVID MURRAY, EXAMINING ATTORNEY

**Int. Cl.: 9**

**Prior U.S. Cls.: 21, 23, 26, 36 and 38**

**Reg. No. 3,466,539**

**United States Patent and Trademark Office**

**Registered July 15, 2008**

**TRADEMARK  
PRINCIPAL REGISTER**

**FACTORYTALK  
PRODUCTIONCENTRE**

ROCKWELL AUTOMATION (DELAWARE CORPORATION)  
1201 SOUTH SECOND STREET  
MILWAUKEE, WI 53204

FOR: COMPUTER SOFTWARE FOR USE IN INDUSTRIAL AUTOMATION AND MANUFACTURING; COMPUTER SOFTWARE THAT DELIVERS REAL-TIME INFORMATION ACROSS MANUFACTURING PROCESS INDUSTRIES TO ASSIST WITH OPERATIONAL IMPROVEMENT, BUSINESS RISK MANAGEMENT AND QUALITY ASSURANCE; COMPUTER SOFTWARE FOR USE IN THE OPERATION AND MAINTENANCE OF INDUSTRIAL AUTOMATION PROCESSES; AND COMPUTER SOFTWARE FOR COLLECTING AND DISTRIBUT-

ING DATA WITHIN COMPUTER NETWORKS, INCLUDING THE INTERNET, AND ENABLING DATA COMMUNICATION BETWEEN APPLICATION PROGRAMS, IN CLASS 9 (U.S. CLS. 21, 23, 26, 36 AND 38).

FIRST USE 10-25-2006; IN COMMERCE 10-25-2006.

THE MARK CONSISTS OF STANDARD CHARACTERS WITHOUT CLAIM TO ANY PARTICULAR FONT, STYLE, SIZE, OR COLOR.

SER. NO. 77-322,579, FILED 11-6-2007.

DAVID MURRAY, EXAMINING ATTORNEY



**Int. Cl.: 7**

**Prior U.S. Cls.: 13, 19, 21, 23, 31, 34 and 35**

**Reg. No. 3,466,540**

**United States Patent and Trademark Office**

**Registered July 15, 2008**

---

**TRADEMARK  
PRINCIPAL REGISTER**

**MTX**

TOSHIBA INTERNATIONAL CORPORATION  
(CALIFORNIA CORPORATION)  
13131 WEST LITTLE YORK ROAD  
HOUSTON, TX 77041

THE MARK CONSISTS OF STANDARD CHAR-  
ACTERS WITHOUT CLAIM TO ANY PARTICULAR  
FONT, STYLE, SIZE, OR COLOR.

FOR: ADJUSTABLE SPEED DRIVES, IN CLASS 7  
(U.S. CLS. 13, 19, 21, 23, 31, 34 AND 35).

SER. NO. 77-322,583, FILED 11-6-2007.

FIRST USE 8-0-2006; IN COMMERCE 8-0-2006.

SUE LAWRENCE, EXAMINING ATTORNEY

**Int. Cl.: 1**

**Prior U.S. Cls.: 1, 5, 6, 10, 26 and 46**

**Reg. No. 3,466,541**

**United States Patent and Trademark Office**

**Registered July 15, 2008**

---

**TRADEMARK  
PRINCIPAL REGISTER**

**SYNDOL**

SCIENTIFIC DESIGN COMPANY, INC. (DELA-  
WARE CORPORATION)  
49 INDUSTRIAL AVENUE  
LITTLE FERRY, NJ 076431901

THE MARK CONSISTS OF STANDARD CHAR-  
ACTERS WITHOUT CLAIM TO ANY PARTICULAR  
FONT, STYLE, SIZE, OR COLOR.

FOR: CATALYSTS FOR USE IN THE MANUFAC-  
TURE OF INDUSTRIAL CHEMICALS, IN CLASS 1  
(U.S. CLS. 1, 5, 6, 10, 26 AND 46).

SER. NO. 77-322,663, FILED 11-6-2007.

FIRST USE 12-31-1988; IN COMMERCE 12-31-1988.

KIMBERLY PERRY, EXAMINING ATTORNEY

**Int. Cl.: 14**

**Prior U.S. Cls.: 2, 27, 28 and 50**

**United States Patent and Trademark Office**

**Reg. No. 3,466,542**

**Registered July 15, 2008**

**TRADEMARK  
PRINCIPAL REGISTER**

**TECHNO COM.**

KC JEWELRY, INC. (CALIFORNIA CORPORATION)  
550 S HILL STREET #825  
LOS ANGELES, CA 90013

THE MARK CONSISTS OF STANDARD CHARACTERS WITHOUT CLAIM TO ANY PARTICULAR FONT, STYLE, SIZE, OR COLOR.

FOR: HOROLOGICAL AND CHRONOMETRIC INSTRUMENTS, NAMELY WATCHES, IN CLASS 14 (U.S. CLS. 2, 27, 28 AND 50).

SER. NO. 77-322,744, FILED S.R. 11-6-2007 AM. P.R. 3-11-2008.

FIRST USE 2-16-2004; IN COMMERCE 2-16-2004.

PATRICIA EVANKO, EXAMINING ATTORNEY

**Int. Cls.: 41 and 45**

**Prior U.S. Cls.: 100, 101 and 107**

**United States Patent and Trademark Office**

**Reg. No. 3,466,543**

**Registered July 15, 2008**

**SERVICE MARK  
PRINCIPAL REGISTER**

**STYLE SOCIAL**

DANA MICHELE, LLC (NEW YORK LTD LIAB  
CO)  
3 EAST 84TH STREET  
NEW YORK, NY 10018

FOR: PLANNING SOCIAL EVENTS FOR OTHERS; CONSULTATION SERVICES REGARDING SOCIAL EVENTS; PROVIDING INFORMATION IN THE FIELD OF PLANNING SOCIAL EVENTS; ORGANIZATION OF FASHION SHOWS, IN CLASS 41 (U.S. CLS. 100, 101 AND 107).

FIRST USE 4-29-2007; IN COMMERCE 4-29-2007.

FOR: PROVIDING PERSONAL FASHION INFORMATION; CONSULTATION SERVICES REGARDING PERSONAL FASHION, IN CLASS 45 (U.S. CLS. 100 AND 101).

FIRST USE 4-29-2007; IN COMMERCE 4-29-2007.

THE MARK CONSISTS OF STANDARD CHARACTERS WITHOUT CLAIM TO ANY PARTICULAR FONT, STYLE, SIZE, OR COLOR.

SER. NO. 77-322,795, FILED 11-6-2007.

MELVIN AXILBUND, EXAMINING ATTORNEY

**Int. Cls.: 9 and 42**

**Prior U.S. Cls.: 21, 23, 26, 36, 38, 100 and 101**

**United States Patent and Trademark Office**

**Reg. No. 3,466,544**

**Registered July 15, 2008**

**TRADEMARK  
SERVICE MARK  
PRINCIPAL REGISTER**

# RELATIVITY

KCURA CORPORATION (ILLINOIS CORPORATION)  
333 WEST WACKER DRIVE  
SUITE 1430  
CHICAGO, IL 60606

FOR: COMPUTER SOFTWARE, NAMELY, DOWNLOADABLE LITIGATION SOFTWARE FOR COLLECTING, STORING, SHARING, REVIEWING, SEARCHING, MANAGING, CATEGORIZING AND CODING DOCUMENTS, IN CLASS 9 (U.S. CLS. 21, 23, 26, 36 AND 38).

FIRST USE 1-0-2005; IN COMMERCE 1-0-2005.

FOR: COMPUTER SERVICES, NAMELY, COMPUTER SOFTWARE APPLICATION DEVELOPMENT FOR OTHERS IN THE FIELD OF LITIGATION SOFTWARE; COMPUTER SYSTEM DESIGN FOR OTHERS IN THE FIELD OF LITIGATION SOFTWARE; COMPUTER SOFTWARE DEPLOYMENT FOR OTHERS IN THE FIELD OF LITIGATION SOFTWARE; COMPUTER SYSTEM

AND COMPUTER SOFTWARE INTEGRATION AND TECHNICAL CONSULTING IN THE FIELD OF LITIGATION SOFTWARE; HOSTING ONLINE WEB FACILITIES FOR OTHERS IN THE FIELD OF LITIGATION SOFTWARE; APPLICATION SERVICE PROVIDER FEATURING WEB-BASED LITIGATION SOFTWARE FOR COLLECTING, STORING, SHARING, REVIEWING, SEARCHING, MANAGING, CATEGORIZING AND CODING DOCUMENTS, IN CLASS 42 (U.S. CLS. 100 AND 101).

FIRST USE 1-0-2005; IN COMMERCE 1-0-2005.

THE MARK CONSISTS OF STANDARD CHARACTERS WITHOUT CLAIM TO ANY PARTICULAR FONT, STYLE, SIZE, OR COLOR.

SER. NO. 77-322,807, FILED 11-6-2007.

KARANENDRA S. CHHINA, EXAMINING ATTORNEY

**Int. Cl.: 36**

**Prior U.S. Cls.: 100, 101 and 102**

**United States Patent and Trademark Office**

**Reg. No. 3,466,545**

**Registered July 15, 2008**

**SERVICE MARK  
PRINCIPAL REGISTER**

# Scholar Shares

PATRO MEDIA, LLC (IOWA LTD LIAB CO)  
1200 FOX TRAIL DRIVE  
CEDAR RAPIDS, IA 52402

FOR: CHARITABLE FUNDRAISING SERVICES, NAMELY, SCRIP-BASED FUNDRAISING FOR K-12 PUBLIC AND PRIVATE SCHOOLS BY ISSUING SCRIP CERTIFICATES TO SCHOOLS AT A SUBSTANTIALLY DISCOUNTED PRICE FROM RETAILERS TO BE SOLD TO PARENTS AND OTHER SCHOOL SUPPORTERS, ALLOWING PROFITS TO GO TO THE SCHOOLS, IN CLASS 36 (U.S. CLS. 100, 101 AND 102).

FIRST USE 2-10-2002; IN COMMERCE 3-1-2006.

THE MARK CONSISTS OF STANDARD CHARACTERS WITHOUT CLAIM TO ANY PARTICULAR FONT, STYLE, SIZE, OR COLOR.

NO CLAIM IS MADE TO THE EXCLUSIVE RIGHT TO USE "SCHOLAR", APART FROM THE MARK AS SHOWN.

SER. NO. 77-322,873, FILED 11-6-2007.

BRIAN PINO, EXAMINING ATTORNEY

**Int. Cl.: 25**

**Prior U.S. Cls.: 22 and 39**

**United States Patent and Trademark Office**

**Reg. No. 3,466,546**

**Registered July 15, 2008**

**TRADEMARK  
PRINCIPAL REGISTER**



ALLIANCE LACROSSE LLC. (NEW JERSEY LTD  
LIAB CO)  
19 EASTLICK RD  
EDISON, NJ 08817

FOR: BELTS; CAPS; JERSEYS; TIES; KNIT  
SHIRTS; PIQUE SHIRTS; POLO SHIRTS; SHORT-  
SLEEVED OR LONG-SLEEVED T-SHIRTS; T-  
SHIRTS; SHIRTS; SWEAT BANDS; SWEAT PANTS;  
SWEAT SHIRTS; SWEAT SHORTS; SWEAT SUITS;  
BOARD SHORTS; SHORTS; UNDERWEAR, NAME-  
LY, BOY SHORTS; JACKETS; HATS; BEANIES;  
ATHLETIC FOOTWEAR; FLIP FLOPS; FOOTWEAR;  
SNEAKERS; SWIMWEAR; GLOVES; UNDERGAR-

MENTS; HEADBANDS; PANTS; SOCKS; THERMAL  
UNDERWEAR, IN CLASS 25 (U.S. CLS. 22 AND 39).

FIRST USE 7-1-2007; IN COMMERCE 8-1-2007.

NO CLAIM IS MADE TO THE EXCLUSIVE  
RIGHT TO USE "LACROSSE", APART FROM THE  
MARK AS SHOWN.

SER. NO. 77-322,897, FILED 11-6-2007.

DAVID YONTEF, EXAMINING ATTORNEY

**Int. Cl.: 44**

**Prior U.S. Cls.: 100 and 101**

**United States Patent and Trademark Office**

**Reg. No. 3,466,547**

**Registered July 15, 2008**

**SERVICE MARK  
PRINCIPAL REGISTER**

**THE COLOR CODE**

HARTMAN INTERNATIONAL, LLC (UTAH LTD  
LIAB CO)  
145 W. CRYSTAL AVE.  
SALT LAKE CITY, UT 84115

FOR: PSYCHOLOGICAL TESTING, ANALYZING,  
CONSULTING, ADVISING, COUNSELING AND  
PROVIDING PSYCHOLOGICAL ASSESSMENTS IN  
THE FIELDS OF PERSONALITY, PERSONALITY  
PROFILES, PERSONALITY TRAITS, CHARACTER  
TRAITS, INTERPERSONAL COMMUNICATION,  
COMMUNICATION IMPROVEMENT, PERSONAL  
RELATIONSHIPS, PROFESSIONAL RELATION-  
SHIPS, PROMOTING POSITIVE EMPLOYEE RELA-  
TIONSHIPS, WORKPLACE DIVERSITY, TEAM  
WORK, BUSINESS INTERACTION, LEADERSHIP,  
HUMAN BEHAVIOR, CARING, SHARING, COM-  
PASSION, INTEGRITY, CREATIVITY, HONESTY,  
LOYALTY, VALUES, MOTIVES, MOTIVATION, PO-

SITIVE AFFIRMATIONS, PASSION FOR LIFE, SUC-  
CESS IN LIFE, ENJOYMENT OF LIFE, STRESS  
REDUCTION, CONFLICT REDUCTION, INTER-  
PERSONAL SKILLS, INTERPERSONAL SKILLS DE-  
VELOPMENT, PRODUCTIVITY, SALES,  
PERSONAL EFFECTIVENESS, AND PERSONAL  
IMPROVEMENT, IN CLASS 44 (U.S. CLS. 100 AND  
101).

FIRST USE 12-31-1985; IN COMMERCE 12-31-1985.

THE MARK CONSISTS OF STANDARD CHAR-  
ACTERS WITHOUT CLAIM TO ANY PARTICULAR  
FONT, STYLE, SIZE, OR COLOR.

SER. NO. 77-323,016, FILED 11-6-2007.

RENEE SERVANCE, EXAMINING ATTORNEY



**Int. Cl.: 6**

**Prior U.S. Cls.: 2, 12, 13, 14, 23, 25 and 50**

**Reg. No. 3,466,548**

**United States Patent and Trademark Office**

**Registered July 15, 2008**

**TRADEMARK  
PRINCIPAL REGISTER**

**PIC-FIX**

BELLEHUMEUR, ALEX R. (UNITED STATES  
INDIVIDUAL)  
6242 NAPOLI COURT  
LONG BEACH, CA 90803

FIRST USE 11-18-1996; IN COMMERCE 11-18-1996.

FOR: METAL BRACKETS WITH ADHESIVE FOR  
ATTACHMENT TO THE BASE OF A PICTURE  
FRAME TO SECURE THE FRAME IN A HORIZON-  
TAL OR DESIRED POSITION, IN CLASS 6 (U.S. CLS.  
2, 12, 13, 14, 23, 25 AND 50).

THE MARK CONSISTS OF STANDARD CHAR-  
ACTERS WITHOUT CLAIM TO ANY PARTICULAR  
FONT, STYLE, SIZE, OR COLOR.

SER. NO. 77-323,044, FILED 11-6-2007.

CHARLES L. JENKINS, EXAMINING ATTORNEY

**Int. Cls.: 35, 39 and 41**

**Prior U.S. Cls.: 100, 101, 102, 105 and 107**

**United States Patent and Trademark Office**

**Reg. No. 3,466,549**

**Registered July 15, 2008**

**SERVICE MARK  
PRINCIPAL REGISTER**

**CORPORATE RECORDS  
ORGANIZATIONAL STRUCTURE  
SOFTWARE (CROSS)**

STORETRIEVE, INC. (CALIFORNIA CORPORATION)  
1150 SOUTH TAYLOR AVENUE  
MONTEBELLO, CA 90640

FOR: RECORDS MANAGEMENT SERVICES, NAMELY, DOCUMENT INDEXING FOR OTHERS; MANAGEMENT OF COMPUTERIZED FILES; DOCUMENT REPRODUCTION, IN CLASS 35 (U.S. CLS. 100, 101 AND 102).

FIRST USE 2-1-2007; IN COMMERCE 2-1-2007.

FOR: PHYSICAL STORAGE OF ELECTRONICALLY-STORED DATA OR DOCUMENTS; ELECTRONIC STORAGE OF DOCUMENTS AND FILES, IN CLASS 39 (U.S. CLS. 100 AND 105).

FIRST USE 2-1-2007; IN COMMERCE 2-1-2007.

FOR: DIGITAL IMAGING SERVICES, IN CLASS 41 (U.S. CLS. 100, 101 AND 107).

FIRST USE 2-1-2007; IN COMMERCE 2-1-2007.

THE MARK CONSISTS OF STANDARD CHARACTERS WITHOUT CLAIM TO ANY PARTICULAR FONT, STYLE, SIZE, OR COLOR.

NO CLAIM IS MADE TO THE EXCLUSIVE RIGHT TO USE "CORPORATE RECORDS ORGANIZATIONAL STRUCTURE SOFTWARE", APART FROM THE MARK AS SHOWN.

SER. NO. 77-323,067, FILED 11-6-2007.

JIM RINGLE, EXAMINING ATTORNEY

**Int. Cl.: 35**

**Prior U.S. Cls.: 100, 101 and 102**

**United States Patent and Trademark Office**

**Reg. No. 3,466,550**

**Registered July 15, 2008**

**SERVICE MARK  
PRINCIPAL REGISTER**

**VIDCENTIVE**

DIDGEBRIDGE, LLC (DELAWARE LTD LIAB  
CO)  
SUITE 300  
10401 NORTH MERIDIAN STREET  
INDIANAPOLIS, IN 46290

FOR: ADVERTISING SERVICES, NAMELY, PROMOTING THE GOODS AND SERVICES OF OTHERS BY PROVIDING VIDEO ADVERTISING VIEWED OVER LAPTOPS, HAND-HELD DEVICES, DESKTOPS, TVS, IPTV (INTERNET PROTOCOL TELEVISION), DIGITAL SET-TOP BOXES AND PUBLIC DIGITAL SCREEN DISPLAYS THAT ALLOWS FOR THE TRACKING OF CUSTOMER RESPONSES

TO EACH ADVERTISEMENT IN ORDER TO MEASURE THE SUCCESS OF THE ADVERTISING CAMPAIGNS, IN CLASS 35 (U.S. CLS. 100, 101 AND 102).

FIRST USE 5-5-2007; IN COMMERCE 7-1-2007.

THE MARK CONSISTS OF STANDARD CHARACTERS WITHOUT CLAIM TO ANY PARTICULAR FONT, STYLE, SIZE, OR COLOR.

SER. NO. 77-323,082, FILED 11-6-2007.

AHSEN KHAN, EXAMINING ATTORNEY

Int. Cl.: 3

Prior U.S. Cls.: 1, 4, 6, 50, 51 and 52

United States Patent and Trademark Office

Reg. No. 3,466,551

Registered July 15, 2008

TRADEMARK  
PRINCIPAL REGISTER



WE'RE NO ANGELS SOAP CO. (ALASKA CORPORATION)

P.O. BOX 83

HEALY, AK 99743

FOR: SOAPS FOR BODY CARE; BAR SOAP; BATH SOAPS; BATH SOAPS IN LIQUID, SOLID OR GEL FORM; COCOA BUTTER FOR COSMETIC PURPOSES; COSMETIC SOAPS; HAND SOAPS; PERFUMED SOAPS; SKIN SOAP; SOAPS FOR PERSONAL USE; SOAPS, IN CLASS 3 (U.S. CLS. 1, 4, 6, 50, 51 AND 52).

FIRST USE 9-1-2007; IN COMMERCE 10-26-2007.

NO CLAIM IS MADE TO THE EXCLUSIVE RIGHT TO USE "SOAP CO.", APART FROM THE MARK AS SHOWN.

THE MARK CONSISTS OF A CURVED BANNER WITH STYLIZED ANGEL WINGS AND CURVED DEVIL'S TAILS ON THE SIDES AND BOTTOM OF THE BANNER, THE WORDING "WE'RE NO ANGELS" INSIDE THE BANNER, AND THE WORDING "SOAP CO." AND "GETTING DIRTY JUST GOT FUN" ON SEPARATE LINES BELOW THE BANNER.

SER. NO. 77-323,145, FILED 11-6-2007.

KATHY DE JONGE, EXAMINING ATTORNEY

**Int. Cl.: 35**

**Prior U.S. Cls.: 100, 101 and 102**

**United States Patent and Trademark Office**

**Reg. No. 3,466,552**

**Registered July 15, 2008**

**SERVICE MARK  
PRINCIPAL REGISTER**

**GREAT DESIGN. EVERY DAY.  
FOR EVERYONE.**

TARGET BRANDS, INC. (MINNESOTA COR-  
PORATION)  
TPS-3165  
1000 NICOLLET MALL  
MINNEAPOLIS, MN 55403

THE MARK CONSISTS OF STANDARD CHAR-  
ACTERS WITHOUT CLAIM TO ANY PARTICULAR  
FONT, STYLE, SIZE, OR COLOR.

FOR: RETAIL DEPARTMENT STORE SERVICES;  
RETAIL ONLINE DEPARTMENT STORE SERVI-  
CES, IN CLASS 35 (U.S. CLS. 100, 101 AND 102).

SER. NO. 77-323,228, FILED 11-7-2007.

FIRST USE 1-16-2005; IN COMMERCE 1-16-2005.

ROBERT C. CLARK JR., EXAMINING ATTORNEY

**Int. Cl.: 36**

**Prior U.S. Cls.: 100, 101 and 102**

**United States Patent and Trademark Office**

**Reg. No. 3,466,553**

**Registered July 15, 2008**

**SERVICE MARK  
PRINCIPAL REGISTER**

# ICE iMpact

INTERCONTINENTALEXCHANGE, INC. (DELA-  
WARE CORPORATION)  
2100 RIVEREDGE PARKWAY, 5TH FLOOR  
ATLANTA, GA 30328

FOR: PROVIDING INFORMATION RELATING TO COMMODITIES, COMMODITY DERIVATIVES, AND/OR OPTIONS ON COMMODITIES AND COMMODITY DERIVATIVES; PROVIDING ONLINE REAL-TIME AND HISTORIC FINANCIAL INFORMATION RELATING TO THE PURCHASING AND/OR SELLING OF COMMODITIES, COMMODITY DERIVATIVES, OPTIONS ON COMMODITIES AND/OR OPTIONS ON COMMODITY DERIVATIVES; DISSEMINATING REAL-TIME AND HISTORIC INFORMATION RELATING TO THE PURCHASING, SELLING, ADMINISTERING, MANAGING, MONITORING, EVALUATING, AND/OR TRACKING OF COMMODITIES, COMMODITY DERIVATIVES, AND/OR OPTIONS THEREON; PROVIDING INFORMATION IN THE NATURE OF PRODUCT,

MARKET, VOLUME, PRICING, SETTLEMENT, ORDER, QUANTITY, DATE/TIME, TRADE-TYPE, STATUS, CONTRACT SYMBOL, OPTION, AND/OR RELATED FINANCIAL INFORMATION; PROVIDING FINANCIAL INFORMATION VIA INTERCONNECTED COMPUTER SYSTEMS, NETWORKING INFRASTRUCTURES, THE INTERNET, AND/OR MESSAGING SYSTEMS, IN CLASS 36 (U.S. CLS. 100, 101 AND 102).

FIRST USE 9-25-2006; IN COMMERCE 9-25-2006.

THE MARK CONSISTS OF STANDARD CHARACTERS WITHOUT CLAIM TO ANY PARTICULAR FONT, STYLE, SIZE, OR COLOR.

SER. NO. 77-323,302, FILED 11-7-2007.

MARK T. MULLEN, EXAMINING ATTORNEY

**Int. Cl.: 37**

**Prior U.S. Cls.: 100, 103 and 106**

**United States Patent and Trademark Office**

**Reg. No. 3,466,554**

**Registered July 15, 2008**

**SERVICE MARK  
PRINCIPAL REGISTER**



**RICHFIELD INVESTMENT CORPORATION  
(TEXAS CORPORATION)  
10001 WESTHEIMER RD., SUITE 2888  
HOUSTON, TX 77042**

FOR: HOUSING SERVICES, NAMELY, DEVELOPMENT OF REAL PROPERTY, NAMELY, REPAIR, IMPROVEMENT, AND NEW CONSTRUCTION; LAND DEVELOPMENT SERVICES, NAMELY, PLANNING AND LAYING OUT OF RESIDENTIAL AND/OR COMMERCIAL COMMUNITIES; REAL ESTATE DEVELOPMENT; CONSTRUCTION MANAGEMENT; CONSTRUCTION, MAINTENANCE AND RENOVATION OF PROPERTY; HOUSING SERVICES, NAMELY, REPAIR, IMPROVEMENT, AND CONSTRUCTION OF RESIDENTIAL REAL PROPERTY, IN CLASS 37 (U.S. CLS. 100, 103 AND 106).

FIRST USE 1-1-2003; IN COMMERCE 1-1-2003.

NO CLAIM IS MADE TO THE EXCLUSIVE RIGHT TO USE "INVESTMENTS", APART FROM THE MARK AS SHOWN.

"THE COLOR(S) BLUE, GREEN AND WHITE IS/ ARE CLAIMED AS A FEATURE OF THE MARK."

"THE MARK CONSISTS OF A RECTANGLE WITH THE UPPER AND LEFT PORTION IN BLUE, WITH A WHITE LINE ACROSS IT FROM THE LOWER LEFT TO THE MIDDLE RIGHT SIDE, AND WITH THE RIGHT PORTION BELOW THE LINE IN GREEN. THE WORDS RICHFIELD INVESTMENT APPEAR IN BLUE BENEATH THE RECTANGLE."

SER. NO. 77-323,309, FILED 11-7-2007.

ELISSA GARBER KON, EXAMINING ATTORNEY

**Int. Cl.: 19**

**Prior U.S. Cls.: 1, 12, 33 and 50**

**United States Patent and Trademark Office**

**Reg. No. 3,466,555**

**Registered July 15, 2008**

**TRADEMARK  
PRINCIPAL REGISTER**

**No Fall-A-Particle Board**

REEDS FERRY SMALL BUILDINGS, INC. (NEW HAMPSHIRE CORPORATION), DBA REEDS FERRY

3 INDUSTRIAL DRIVE  
HUDSON, NH 03051

FOR: NON-METAL STORAGE SHEDS AND GAZEBOS, IN CLASS 19 (U.S. CLS. 1, 12, 33 AND 50).

FIRST USE 3-20-2006; IN COMMERCE 3-20-2006.

THE MARK CONSISTS OF STANDARD CHARACTERS WITHOUT CLAIM TO ANY PARTICULAR FONT, STYLE, SIZE, OR COLOR.

NO CLAIM IS MADE TO THE EXCLUSIVE RIGHT TO USE "BOARD", APART FROM THE MARK AS SHOWN.

SER. NO. 77-323,322, FILED 11-7-2007.

KATHERINE CHANG, EXAMINING ATTORNEY



**Int. Cl.: 45**

**Prior U.S. Cls.: 100 and 101**

**United States Patent and Trademark Office**

**Reg. No. 3,466,556**

**Registered July 15, 2008**

**SERVICE MARK  
PRINCIPAL REGISTER**



PROTEGEMOS TUS IDEAS, S.C. (MEXICO CORPORATION)  
MONTECITO 38, PISO 38, OF. 29  
MEXICO, MEXICO 03810

FOR: LEGAL SERVICES, IN CLASS 45 (U.S. CLS. 100 AND 101).

FIRST USE 12-16-2004; IN COMMERCE 12-16-2004.

NO CLAIM IS MADE TO THE EXCLUSIVE RIGHT TO USE "CANADA" , APART FROM THE MARK AS SHOWN.

THE MARK CONSISTS OF A MAPLE LEAF ON TOP OF A CONVEX LINE AND THE WORDING "OPCIÓN CANADÁ" UNDERNEATH ON STANDARD CHARACTERS.

THE FOREIGN WORDING IN THE MARK TRANSLATES INTO ENGLISH AS OPTION.

SER. NO. 77-323,336, FILED 11-7-2007.

TAMARA FRAZIER, EXAMINING ATTORNEY

**Int. Cl.: 16**

**Prior U.S. Cls.: 2, 5, 22, 23, 29, 37, 38 and 50**

**Reg. No. 3,466,557**

**United States Patent and Trademark Office**

**Registered July 15, 2008**

**TRADEMARK  
PRINCIPAL REGISTER**

**SNOW LIFE LIFTS LUXURY**

BONNIER CORPORATION (DELAWARE CORPORATION)  
ATTN: MIA SYKES  
460 N. ORLANDO AVENUE, SUITE 200  
WINTER PARK, FL 32789

FOR: PRINTED PUBLICATIONS, NAMELY, MAGAZINES FEATURING THE HIGH-END ALPINE EXPERIENCE, INCLUDING SNOW-SPORTS, SNOW-SPORTS EQUIPMENT, UPSCALE SERVICES AND SNOW-RELATED EVENTS, IN CLASS 16 (U.S. CLS. 2, 5, 22, 23, 29, 37, 38 AND 50).

FIRST USE 11-1-2007; IN COMMERCE 11-1-2007.

THE MARK CONSISTS OF STANDARD CHARACTERS WITHOUT CLAIM TO ANY PARTICULAR FONT, STYLE, SIZE, OR COLOR.

NO CLAIM IS MADE TO THE EXCLUSIVE RIGHT TO USE "SNOW", APART FROM THE MARK AS SHOWN.

SER. NO. 77-323,337, FILED 11-7-2007.

TAMARA FRAZIER, EXAMINING ATTORNEY

**Int. Cl.: 41**

**Prior U.S. Cls.: 100, 101 and 107**

**United States Patent and Trademark Office**

**Reg. No. 3,466,558**

**Registered July 15, 2008**

**SERVICE MARK  
PRINCIPAL REGISTER**

**Dr. Ajrawat's Air Pulse  
Autonomic Meditation  
Therapy**

AJRAWAT, PARAMJIT SINGH (UNITED STATES  
INDIVIDUAL)  
12101 STONEY CREEK ROAD  
POTOMAC, MD 20854

FOR: MEDITATION TRAINING, IN CLASS 41  
(U.S. CLS. 100, 101 AND 107).

FIRST USE 6-4-1994; IN COMMERCE 6-5-1996.

THE MARK CONSISTS OF STANDARD CHAR-  
ACTERS WITHOUT CLAIM TO ANY PARTICULAR  
FONT, STYLE, SIZE, OR COLOR.

SEC. 2(F) AS TO "AIR PULSE AUTONOMIC  
MEDITATION THERAPY".

SER. NO. 77-323,419, FILED 11-7-2007.

KAREN BRACEY, EXAMINING ATTORNEY

**Int. Cls.: 36 and 42**

**Prior U.S. Cls.: 100, 101 and 102**

**United States Patent and Trademark Office**

**Reg. No. 3,466,559**

**Registered July 15, 2008**

**SERVICE MARK  
PRINCIPAL REGISTER**



U-BUILD EQUITY 2 INCORPORATED (CALI-  
FORNIA CORPORATION)

# 5

10055 WOLF RD.  
GRASS VALLEY, CA 95949

FOR: FINANCING SERVICES ; CONSULTATION  
SERVICES IN THE FIELD OF FINANCING, IN  
CLASS 36 (U.S. CLS. 100, 101 AND 102).

FIRST USE 3-28-1992; IN COMMERCE 3-28-1992.

FOR: CONSTRUCTION DRAFTING ; DESIGN  
FOR OTHERS IN THE FIELD OF CONSTRUCTION  
; CONSULTATION SERVICES IN THE FIELD OF  
DRAFTING, IN CLASS 42 (U.S. CLS. 100 AND 101).

FIRST USE 3-28-1992; IN COMMERCE 3-28-1992.

THE MARK CONSISTS OF THE STYLIZED  
WORDS "UBUILD EQUITY QUALITY". THERE  
ARE MULTIPLE HAMMERS COMMING DOWN  
ON THE LETTER "I" IN THE WORD "EQUITY".  
THE LETTER "I" IN THE WORD "EQUITY" IS  
PORTRAIED AS A NAIL.

SER. NO. 77-323,486, FILED 11-7-2007.

SHARON MEIER, EXAMINING ATTORNEY

**Int. Cls.: 16, 35, 41 and 42**

**Prior U.S. Cls.: 2, 5, 22, 23, 29, 37, 38, 50, 100, 101, 102  
and 107**

**Reg. No. 3,466,560**

**United States Patent and Trademark Office**

**Registered July 15, 2008**

**TRADEMARK  
SERVICE MARK  
PRINCIPAL REGISTER**

The logo for DEX features the word "DEX" in a bold, sans-serif font. A diagonal line extends from the top right of the letter "X" upwards and to the right, ending in an arrowhead.

DEX MEDIA, INC. (DELAWARE CORPORATION)  
198 INVERNESS DRIVE WEST  
ENGLEWOOD, CO 80112

FOR: PRINTED TELEPHONE DIRECTORIES, IN CLASS 16 (U.S. CLS. 2, 5, 22, 23, 29, 37, 38 AND 50).

FIRST USE 1-0-2004; IN COMMERCE 1-0-2004.

FOR: TELEPHONE DIRECTORY AND ADVERTISING SERVICES, NAMELY, PROMOTING THE GOODS AND SERVICES OF OTHERS VIA THE PREPARATION AND DISSEMINATION OF ADVERTISEMENTS AND LISTINGS AND VIA CONSULTING SERVICES RELATED THERETO, AND PLACING SUCH ADVERTISEMENTS AND LISTINGS IN PRINTED PUBLICATIONS AND DIRECTORIES, AND IN ON-LINE PUBLICATIONS AND DIRECTORIES; COMPUTER SERVICES, NAMELY, PROVIDING ON-LINE TELEPHONE DIRECTORIES AND SHOPPER INFORMATION GUIDES VIA THE GLOBAL COMPUTER NETWORK; BUSINESS MARKETING AND DIRECT MAIL CONSULTING SERVICES, IN CLASS 35 (U.S. CLS. 100, 101 AND 102).

FIRST USE 1-0-2004; IN COMMERCE 1-0-2004.

FOR: PUBLICATION OF TELEPHONE DIRECTORIES, IN CLASS 41 (U.S. CLS. 100, 101 AND 107).

FIRST USE 1-0-2004; IN COMMERCE 1-0-2004.

FOR: COMPUTER SERVICES AND WEBSITE CONSULTING SERVICES, NAMELY, DESIGNING, DEVELOPING, HOSTING AND MAINTAINING THE WEBSITES OF OTHERS ON A COMPUTER SERVER FOR A GLOBAL COMPUTER NETWORK; CONSULTING AND ADVICE IN THE FIELD OF DESIGNING, DEVELOPING, HOSTING, MAINTAINING, AND MANAGING ONLINE COMMERCE WEBSITES; CREATING INDEXES OF SEARCHABLE INFORMATION, WEBSITES, KEY WORDS AND OTHER RESOURCES AVAILABLE ON A GLOBAL COMPUTER NETWORK, IN CLASS 42 (U.S. CLS. 100 AND 101).

FIRST USE 1-0-2004; IN COMMERCE 1-0-2004.

OWNER OF U.S. REG. NOS. 2,561,784, 3,268,025 AND OTHERS.

SER. NO. 77-323,487, FILED 11-7-2007.

MATTHEW PAPPAS, EXAMINING ATTORNEY

**Int. Cls.: 35 and 37**

**Prior U.S. Cls.: 100, 101, 102, 103 and 106**

**United States Patent and Trademark Office**

**Reg. No. 3,466,561**

**Registered July 15, 2008**

**SERVICE MARK  
PRINCIPAL REGISTER**



BLAKESLEE, RYAN P (UNITED STATES INDIVIDUAL), DBA VERTIGO SYSTEMS  
848 SCHUYLKILL MALL  
FRACKVILLE, PA 17931

FOR: RETAIL COMPUTER AND ELECTRONIC STORES, IN CLASS 35 (U.S. CLS. 100, 101 AND 102).

FIRST USE 9-20-2003; IN COMMERCE 9-20-2003.

FOR: COMPUTER INSTALLATION AND REPAIR, IN CLASS 37 (U.S. CLS. 100, 103 AND 106).

FIRST USE 0-0-1997; IN COMMERCE 9-20-2003.

NO CLAIM IS MADE TO THE EXCLUSIVE RIGHT TO USE "SYSTEMS", APART FROM THE MARK AS SHOWN.

THE MARK CONSISTS OF STYLIZED WORDING OF THE WORDS VERTIGO AND SYSTEMS WITH A STYLIZED SWIRL INSIDE A BORDER.

SER. NO. 77-323,631, FILED 11-7-2007.

CAROLYN CATALDO, EXAMINING ATTORNEY

**Int. Cl.: 42**

**Prior U.S. Cls.: 100 and 101**

**United States Patent and Trademark Office**

**Reg. No. 3,466,562**

**Registered July 15, 2008**

**SERVICE MARK  
PRINCIPAL REGISTER**

**SIMPLE SCHEDULE**

DUNCAN, LLC (DELAWARE LTD LIAB CO)  
200 INDUSTRIAL PARKWAY  
CHAGRIN FALLS, OH 44022

FOR: PROVIDING TEMPORARY USE OF ON-  
LINE NON-DOWNLOADABLE SOFTWARE FOR  
SCHEDULING DATABASE MANAGEMENT AND  
ARCHIVING IN THE FIELD OF HUMAN WORK  
FORCE AND PROJECT MANAGEMENT , IN CLASS  
42 (U.S. CLS. 100 AND 101).

FIRST USE 1-0-2006; IN COMMERCE 1-0-2006.

THE MARK CONSISTS OF STANDARD CHAR-  
ACTERS WITHOUT CLAIM TO ANY PARTICULAR  
FONT, STYLE, SIZE, OR COLOR.

NO CLAIM IS MADE TO THE EXCLUSIVE  
RIGHT TO USE "SCHEDULE", APART FROM THE  
MARK AS SHOWN.

SER. NO. 77-323,739, FILED 11-7-2007.

EMILY CHUO, EXAMINING ATTORNEY

Int. Cl.: 37

Prior U.S. Cls.: 100, 103 and 106

United States Patent and Trademark Office

Reg. No. 3,466,563

Registered July 15, 2008

**SERVICE MARK  
PRINCIPAL REGISTER**



SPRINKLER ONE, L.L.C. (MICHIGAN LTD LIAB  
CO)  
5460 GRATIOT  
ST.CLAIR, MI 48079

FOR: INSTALLATION AND MAINTENANCE OF  
SPRINKLERS AND LAWN IRRIGATION SYSTEMS,  
IN CLASS 37 (U.S. CLS. 100, 103 AND 106).

FIRST USE 10-1-2007; IN COMMERCE 10-1-2007.

NO CLAIM IS MADE TO THE EXCLUSIVE  
RIGHT TO USE "SPRINKLER", APART FROM  
THE MARK AS SHOWN.

THE COLOR(S) YELLOW ,BLACK ,SILVER, IS/  
ARE CLAIMED AS A FEATURE OF THE MARK.

THE WORDING " SPRINKLER ONE" APPEARS  
IN SILVER; THE BODY OF THE STYLIZED NU-  
MERAL "1" FIGURE APPEARS IN YELLOW; AND  
THE EYES, LEGS, AND FEET OF THE FIGURE  
AND LINES ABOVE AND ADJACENT TO THE  
FIGURE APPEAR IN BLACK.

SER. NO. 77-323,891, FILED 11-7-2007.

RONALD MCMORROW, EXAMINING ATTORNEY



Int. Cl.: 42

Prior U.S. Cls.: 100 and 101

United States Patent and Trademark Office

Reg. No. 3,466,564

Registered July 15, 2008

**SERVICE MARK  
PRINCIPAL REGISTER**



THOMAS & THOMAS TECHNOLOGIES, LLC  
(TEXAS LTD LIAB CO), DBA PROGRAMMERS ON CALL  
10149 ARAGON DR  
WACO, TX 76708

FOR: COMPUTER SOFTWARE DESIGN, COMPUTER PROGRAMMING, OR MAINTENANCE OF COMPUTER SOFTWARE, IN CLASS 42 (U.S. CLS. 100 AND 101).

FIRST USE 5-1-2007; IN COMMERCE 5-1-2007.

NO CLAIM IS MADE TO THE EXCLUSIVE RIGHT TO USE "PROGRAMMERS", APART FROM THE MARK AS SHOWN.

THE MARK CONSISTS OF A SHADOW FIGURE OF A PERSON SITTING IN A CHAIR WITH HANDS ON A KEYBOARD, THE HEAD OF THE PERSON MAKES THE LETTER "O" IN THE WORD "PROGRAMMERS". THE DESK HAS A COMPUTER FLAT SCREEN MONITOR AND KEYBOARD ON TOP A TELEPHONE HANDSET WITH COILED WIRE FLOATS AROUND THE WORDS "ON CALL".

SER. NO. 77-323,923, FILED 11-7-2007.

FRED CARL, EXAMINING ATTORNEY

**Int. Cls.: 14, 18 and 25**

**Prior U.S. Cls.: 1, 2, 3, 22, 27, 28, 39, 41 and 50**

**United States Patent and Trademark Office**

**Reg. No. 3,466,565**

**Registered July 15, 2008**

**TRADEMARK  
PRINCIPAL REGISTER**

**loyalty & blood**

LOYALTY & BLOOD INC. (NEW YORK CORPORATION), DBA LOYALTY & LOVE INC.  
209 JACKSON ST APT 1  
BROOKLYN, NY 11211

FOR: JEWELRY, IN CLASS 14 (U.S. CLS. 2, 27, 28 AND 50).

FIRST USE 10-24-2007; IN COMMERCE 11-5-2007.

FOR: TOTE BAGS; PURSES; HANDBAGS, IN CLASS 18 (U.S. CLS. 1, 2, 3, 22 AND 41).

FIRST USE 10-24-2007; IN COMMERCE 11-5-2007.

FOR: SHIRTS; TOPS, IN CLASS 25 (U.S. CLS. 22 AND 39).

FIRST USE 10-24-2007; IN COMMERCE 11-5-2007.

THE MARK CONSISTS OF STANDARD CHARACTERS WITHOUT CLAIM TO ANY PARTICULAR FONT, STYLE, SIZE, OR COLOR.

SER. NO. 77-323,984, FILED 11-7-2007.

REGINA DRUMMOND, EXAMINING ATTORNEY

**Int. Cl.: 41**

**Prior U.S. Cls.: 100, 101 and 107**

**United States Patent and Trademark Office**

**Reg. No. 3,466,566**

**Registered July 15, 2008**

**SERVICE MARK  
PRINCIPAL REGISTER**

**A SIP OF INSPIRATION**

STEPHANIE E. WILSON-COLEMAN (UNITED STATES INDIVIDUAL)  
7258 S. HALSTED  
CHICAGO, IL 60621

FOR: PERSONAL APPEARANCES BY AN INSPIRATIONAL AND MOTIVATIONAL SPEAKER; EDUCATIONAL SERVICES, NAMELY, PROVIDING WORKSHOPS, SEMINARS AND TRAINING IN THE FIELD OF SELF IMPROVEMENT, SELF-EMPOWERMENT AND SELF-RELIANCE; MEETING FACILITATOR, NAMELY, ARRANGING WORKSHOPS, SEMINARS AND TRAINING COURSES IN THE FIELD OF SELF IMPROVEMENT,

SELF-EMPOWERMENT, AND SELF-RELIANCE FOR BUSINESSES AND INDIVIDUALS, IN CLASS 41 (U.S. CLS. 100, 101 AND 107).

FIRST USE 9-1-2004; IN COMMERCE 9-1-2004.

THE MARK CONSISTS OF STANDARD CHARACTERS WITHOUT CLAIM TO ANY PARTICULAR FONT, STYLE, SIZE, OR COLOR.

SER. NO. 77-324,227, FILED 11-7-2007.

KAREN K. BUSH, EXAMINING ATTORNEY

**Int. Cl.: 41**

**Prior U.S. Cls.: 100, 101 and 107**

**United States Patent and Trademark Office**

**Reg. No. 3,466,567**

**Registered July 15, 2008**

**SERVICE MARK  
PRINCIPAL REGISTER**

# Flava Invasion

GUTHRIE, GORDON N (UNITED STATES INDIVIDUAL)  
468 HEATHROW WAY  
STONE MOUNTAIN, GA 30087

FOR: ENTERTAINMENT IN THE NATURE OF DANCE PERFORMANCES; ENTERTAINMENT IN THE NATURE OF LIVE PERFORMANCES BY DANCE GROUPS, DANCE COMPANIES, DANCERS, MUSICAL BANDS; ENTERTAINMENT IN THE NATURE OF VISUAL AND AUDIO PERFORMANCES, AND MUSICAL, VARIETY, NEWS AND COMEDY SHOWS; ENTERTAINMENT IN THE NATURE OF VISUAL AND AUDIO PERFORMAN-

CES, NAMELY, MUSICAL BAND, ROCK GROUP, GYMNASTIC, DANCE, AND BALLET PERFORMANCES, IN CLASS 41 (U.S. CLS. 100, 101 AND 107).

FIRST USE 12-20-2005; IN COMMERCE 12-21-2005.

THE MARK CONSISTS OF STANDARD CHARACTERS WITHOUT CLAIM TO ANY PARTICULAR FONT, STYLE, SIZE, OR COLOR.

SER. NO. 77-324,249, FILED 11-8-2007.

ANN E. SAPPENFIELD, EXAMINING ATTORNEY

**Int. Cl.: 11**

**Prior U.S. Cls.: 13, 21, 23, 31 and 34**

**United States Patent and Trademark Office**

**Reg. No. 3,466,568**

**Registered July 15, 2008**

**TRADEMARK  
PRINCIPAL REGISTER**

**EVERHOT**

BRADFORD WHITE CORPORATION (DELA-  
WARE CORPORATION)  
725 TALAMORE DRIVE  
AMBLER, PA 190021815

FOR: INSTANT HOT WATER HEATERS; IN-  
STANT HOT WATER HEATING SYSTEMS COM-  
PRISED OF A TANK AND A DISPENSER, IN CLASS  
11 (U.S. CLS. 13, 21, 23, 31 AND 34).

FIRST USE 0-0-1983; IN COMMERCE 0-0-1983.

THE MARK CONSISTS OF STANDARD CHAR-  
ACTERS WITHOUT CLAIM TO ANY PARTICULAR  
FONT, STYLE, SIZE, OR COLOR.

OWNER OF U.S. REG. NOS. 500,197, 1,056,545,  
AND 2,989,441.

SER. NO. 77-324,276, FILED 11-8-2007.

ANN E. SAPPENFIELD, EXAMINING ATTORNEY

**Int. Cl.: 36**

**Prior U.S. Cls.: 100, 101 and 102**

**United States Patent and Trademark Office**

**Reg. No. 3,466,569**

**Registered July 15, 2008**

**SERVICE MARK  
PRINCIPAL REGISTER**

**MAR VISTA INVESTMENT  
PARTNERS**

MAR VISTA INVESTMENT PARTNERS, LLC  
(DELAWARE LTD LIAB CO)  
SUITE 1000  
100 WILSHIRE BLVD.  
SANTA MONICA, CA 90401

FOR: INVESTMENT MANAGEMENT, IN CLASS  
36 (U.S. CLS. 100, 101 AND 102).

FIRST USE 11-0-2007; IN COMMERCE 11-0-2007.

THE MARK CONSISTS OF STANDARD CHAR-  
ACTERS WITHOUT CLAIM TO ANY PARTICULAR  
FONT, STYLE, SIZE, OR COLOR.

NO CLAIM IS MADE TO THE EXCLUSIVE  
RIGHT TO USE "INVESTMENT PARTNERS",  
APART FROM THE MARK AS SHOWN.

SER. NO. 77-324,316, FILED 11-8-2007.

FRED CARL, EXAMINING ATTORNEY

**Int. Cl.: 6**

**Prior U.S. Cls.: 2, 12, 13, 14, 23, 25 and 50**

**Reg. No. 3,466,570**

**United States Patent and Trademark Office**

**Registered July 15, 2008**

**TRADEMARK  
PRINCIPAL REGISTER**

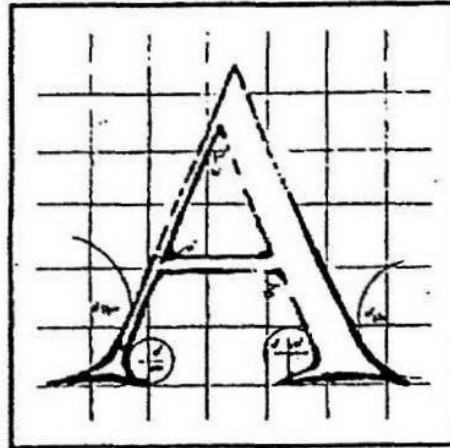

TREFIMETAUX S.A. (FRANCE CORPORATION)  
11 BIS RUE DE L'HOTEL DE VILLE  
92400 COURBEVOIE, FRANCE

FOR: FINISHED AND UNFINISHED COPPER  
AND COPPER ALLOY SHEETS, RODS AND BARS  
FOR USE IN THE ARCHITECTURE AND INTER-  
IOR DECORATION OF COMMERCIAL AND PRI-

VATE BUILDINGS, IN CLASS 6 (U.S. CLS. 2, 12, 13,  
14, 23, 25 AND 50).

OWNER OF FRANCE REG. NO. 99/781518, DA-  
TED 3-18-1999, EXPIRES 3-17-2009.

SER. NO. 77-324,386, FILED 11-8-2007.

BARBARA RUTLAND, EXAMINING ATTORNEY

**Int. Cl.: 42**

**Prior U.S. Cls.: 100 and 101**

**United States Patent and Trademark Office**

**Reg. No. 3,466,571**

**Registered July 15, 2008**

**SERVICE MARK  
PRINCIPAL REGISTER**

# Quantalux

QUANTALUX, LLC (MICHIGAN LTD LIAB CO)  
1005 LINCOLN AVE  
ANN ARBOR, MI 48104

THE MARK CONSISTS OF STANDARD CHAR-  
ACTERS WITHOUT CLAIM TO ANY PARTICULAR  
FONT, STYLE, SIZE, OR COLOR.

FOR: PRODUCT RESEARCH & DEVELOPMENT,  
IN CLASS 42 (U.S. CLS. 100 AND 101).

SER. NO. 77-324,394, FILED 11-8-2007.

FIRST USE 10-30-2007; IN COMMERCE 10-30-2007.

ROBIN MITTLER, EXAMINING ATTORNEY



**Int. Cl.: 35**

**Prior U.S. Cls.: 100, 101 and 102**

**United States Patent and Trademark Office**

**Reg. No. 3,466,572**

**Registered July 15, 2008**

**SERVICE MARK  
PRINCIPAL REGISTER**

**ALL ABOUT SENIORS**

ALL ABOUT SENIORS, LLC (INDIANA LTD  
LIAB CO)  
521 PELLSTON DRIVE  
FORT WAYNE, IN 46825

FOR: PERSONNEL RELOCATION; MOVING  
AND RELOCATION SERVICES, NAMELY, PLAN-  
NING AND IMPLEMENTING MOVES OF HOMES  
AND OFFICES, IN CLASS 35 (U.S. CLS. 100, 101 AND  
102).

FIRST USE 3-1-2007; IN COMMERCE 3-1-2007.

THE MARK CONSISTS OF STANDARD CHAR-  
ACTERS WITHOUT CLAIM TO ANY PARTICULAR  
FONT, STYLE, SIZE, OR COLOR.

NO CLAIM IS MADE TO THE EXCLUSIVE  
RIGHT TO USE "SENIORS", APART FROM THE  
MARK AS SHOWN.

SER. NO. 77-324,402, FILED 11-8-2007.

KHANH LE, EXAMINING ATTORNEY

**Int. Cl.: 33**

**Prior U.S. Cls.: 47 and 49**

**United States Patent and Trademark Office**

**Reg. No. 3,466,573**

**Registered July 15, 2008**

**TRADEMARK  
PRINCIPAL REGISTER**

**REAL STONES**

HAND PICKED SELECTIONS, INC. (VIRGINIA  
CORPORATION)  
226 EAST LEE ST.  
WARRENTON, VA 22186

THE MARK CONSISTS OF STANDARD CHAR-  
ACTERS WITHOUT CLAIM TO ANY PARTICULAR  
FONT, STYLE, SIZE, OR COLOR.

FOR: WINES, IN CLASS 33 (U.S. CLS. 47 AND 49).

SER. NO. 77-324,446, FILED 11-8-2007.

FIRST USE 8-16-2007; IN COMMERCE 8-16-2007.

BENJAMIN OKEKE, EXAMINING ATTORNEY

**Int. Cls.: 35, 37 and 41**

**Prior U.S. Cls.: 100, 101, 102, 103, 106 and 107**

**United States Patent and Trademark Office**

**Reg. No. 3,466,574**

**Registered July 15, 2008**

**SERVICE MARK  
PRINCIPAL REGISTER**

# PIRATE DIVERS

PIRATE DIVERS, LLC (FLORIDA LTD LIAB CO)  
2679 TREANOR TERRACE  
WELLINGTON, FL 33414

FOR: RETAIL STORE SERVICES, BOTH ONLINE AND OFFLINE, FEATURING WATER-SPORT AND DIVING-RELATED MATTER, NAMELY, DIVING GASES, DIVING GAS COMPRESSORS, SPEAR GUNS AND ALL RELATED PARTS AND GEAR, ALL TYPES OF DIVING AND SCUBA EQUIPMENT AND SUPPLIES INCLUDING MASKS, FINS, KNIVES, SNORKELS, LIGHTS, BUOYANCY COMPENSATORS, REGULATORS, TANKS, WETSUITS, DRY SUITS, GLOVES, HOODS, AND UNDERGARMENTS, SUPPLIES AND COURSE MATERIALS FOR SCUBA CERTIFICATION, DIVE-RELATED CLOTHING INCLUDING T-SHIRTS, HATS, MUGS, HOOKS, CLIPS, NOTEBOOKS, LICENSE PLATES, AND DIVE-RELATED TOOLS AND PARTS, RE-BREATHERS, AND DIVE AND SCUBA-RELATED BOOKS AND PERIODICALS, IN CLASS 35 (U.S. CLS. 100, 101 AND 102).

FIRST USE 7-1-2007; IN COMMERCE 7-1-2007.

FOR: REPAIR AND MAINTENANCE SERVICES OF WATER SPORT AND DIVING EQUIPMENT,

MACHINES AND APPARATUS, IN CLASS 37 (U.S. CLS. 100, 103 AND 106).

FIRST USE 7-1-2007; IN COMMERCE 7-1-2007.

FOR: EDUCATIONAL SERVICES, NAMELY, PROVIDING WATER SPORT AND DIVING INSTRUCTION; ENTERTAINMENT SERVICES, NAMELY, CONDUCTING DIVING EXHIBITIONS AND EXCURSIONS, IN CLASS 41 (U.S. CLS. 100, 101 AND 107).

FIRST USE 7-1-2007; IN COMMERCE 7-1-2007.

THE MARK CONSISTS OF STANDARD CHARACTERS WITHOUT CLAIM TO ANY PARTICULAR FONT, STYLE, SIZE, OR COLOR.

NO CLAIM IS MADE TO THE EXCLUSIVE RIGHT TO USE "DIVERS", APART FROM THE MARK AS SHOWN.

SER. NO. 77-324,459, FILED 11-8-2007.

BRENDAN REGAN, EXAMINING ATTORNEY

**Int. Cl.: 16**

**Prior U.S. Cls.: 2, 5, 22, 23, 29, 37, 38 and 50**

**United States Patent and Trademark Office**

**Reg. No. 3,466,575**

**Registered July 15, 2008**

**TRADEMARK  
PRINCIPAL REGISTER**

**PAGEPLUS**

START WIRELESS GROUP, INC. (OHIO CORPORATION)  
1615 TIMBERWOLF DRIVE  
HOLLAND, OH 43528

THE MARK CONSISTS OF STANDARD CHARACTERS WITHOUT CLAIM TO ANY PARTICULAR FONT, STYLE, SIZE, OR COLOR.

FOR: NON-MAGNETICALLY ENCODED PREPAID PURCHASE CARDS FOR CELLULAR TELEPHONES, IN CLASS 16 (U.S. CLS. 2, 5, 22, 23, 29, 37, 38 AND 50).

SER. NO. 77-324,640, FILED 11-8-2007.

FIRST USE 12-31-1998; IN COMMERCE 12-31-1998.

JUDITH HELFMAN, EXAMINING ATTORNEY

**Int. Cls.: 35, 37 and 41**

**Prior U.S. Cls.: 100, 101, 102, 103, 106 and 107**

**United States Patent and Trademark Office**

**Reg. No. 3,466,576**

**Registered July 15, 2008**

**SERVICE MARK  
PRINCIPAL REGISTER**



PIRATE DIVERS, LLC (FLORIDA LTD LIAB CO)  
2679 TREANOR TERRACE  
WELLINGTON, FL 33414

FOR: RETAIL STORE SERVICES, BOTH ONLINE AND OFFLINE, FEATURING WATER-SPORT AND DIVING-RELATED MATTER, NAMELY, DIVING GASES, DIVING GAS COMPRESSORS, SPEAR GUNS AND ALL RELATED PARTS AND GEAR, ALL TYPES OF DIVING AND SCUBA EQUIPMENT AND SUPPLIES INCLUDING MASKS, FINS, KNIVES, SNORKELS, LIGHTS, BUOYANCY COMPENSATORS, REGULATORS, TANKS, WETSUITS, DRY SUITS, GLOVES, HOODS, AND UNDERGARMENTS, SUPPLIES AND COURSE MATERIALS FOR SCUBA CERTIFICATION, DIVE-RELATED CLOTHING INCLUDING T-SHIRTS, HATS, MUGS, HOOKS, CLIPS, NOTEBOOKS, LICENSE PLATES, AND DIVE-RELATED TOOLS AND PARTS, RE-BREATHERS, AND DIVE- AND SCUBA-RELATED BOOKS AND PERIODICALS, IN CLASS 35 (U.S. CLS. 100, 101 AND 102).

FIRST USE 7-1-2007; IN COMMERCE 7-1-2007.

FOR: REPAIR AND MAINTENANCE SERVICES OF WATER SPORT AND DIVING EQUIPMENT, MACHINES AND APPARATUS, IN CLASS 37 (U.S. CLS. 100, 103 AND 106).

FIRST USE 7-1-2007; IN COMMERCE 7-1-2007.

FOR: EDUCATIONAL SERVICES, NAMELY, PROVIDING WATER SPORT AND DIVING INSTRUCTION; ENTERTAINMENT SERVICES, NAMELY, CONDUCTING DIVING EXHIBITIONS AND EXCURSIONS, IN CLASS 41 (U.S. CLS. 100, 101 AND 107).

FIRST USE 7-1-2007; IN COMMERCE 7-1-2007.

THE MARK CONSISTS OF HUMAN SKULL WITH A CAP DISPLAYING A DIAGONAL STRIPE ON THE LEFT SIDE AND TWO SPEAR GUNS CROSSED BEHIND THE SKULL.

SER. NO. 77-324,642, FILED 11-8-2007.

BRENDAN REGAN, EXAMINING ATTORNEY

**Int. Cl.: 3**

**Prior U.S. Cls.: 1, 4, 6, 50, 51 and 52**

**Reg. No. 3,466,577**

**United States Patent and Trademark Office**

**Registered July 15, 2008**

**TRADEMARK  
PRINCIPAL REGISTER**

**HONEYBEE GARDENS**

HONEYBEE GARDENS, INC. (PENNSYLVANIA CORPORATION)  
1082 PALISADES DRIVE  
LEESPORT, PA 19533

FOR: ASTRINGENTS FOR COSMETIC PURPOSES; BATH OILS FOR COSMETIC PURPOSES; BODY AND BEAUTY CARE COSMETICS; CLEANSING CREAMS; COSMETIC CREAMS; COSMETIC PENCILS; COSMETIC PREPARATIONS; COSMETIC PREPARATIONS FOR BODY CARE; COSMETIC PREPARATIONS FOR EYE LASHES; COSMETIC ROUGES; COSMETIC SOAPS; COSMETICS AND MAKE-UP; LIP BALM; BODY POWDER; LIP GLOSS; AFTER-SHAVE; EYE LINER; EYE MAKE-UP; EYE SHADOW; MASCARA; BATH AND SHOWER GELS AND SALTS NOT FOR MEDICAL PURPOSES; BATH

SOAPS; SKIN TONERS; NAIL CARE PREPARATIONS; NAIL POLISH; NAIL POLISH REMOVER; NAIL-POLISH REMOVERS; DEODORANT FOR PERSONAL USE, IN CLASS 3 (U.S. CLS. 1, 4, 6, 50, 51 AND 52).

FIRST USE 12-31-1995; IN COMMERCE 12-31-1995.

THE MARK CONSISTS OF STANDARD CHARACTERS WITHOUT CLAIM TO ANY PARTICULAR FONT, STYLE, SIZE, OR COLOR.

SER. NO. 77-324,650, FILED 11-8-2007.

BENJAMIN ALLEN, EXAMINING ATTORNEY

**Int. Cl.: 16**

**Prior U.S. Cls.: 2, 5, 22, 23, 29, 37, 38 and 50**

**United States Patent and Trademark Office**

**Reg. No. 3,466,578**

**Registered July 15, 2008**

**TRADEMARK  
PRINCIPAL REGISTER**



START WIRELESS GROUP, INC. (OHIO CORPORATION)  
1615 TIMBERWOLF DRIVE  
HOLLAND, OH 45328

FOR: NON-MAGNETICALLY ENCODED PRE-PAID PURCHASE CARDS FOR CELLULAR TELEPHONES, IN CLASS 16 (U.S. CLS. 2, 5, 22, 23, 29, 37, 38 AND 50).

FIRST USE 9-1-2007; IN COMMERCE 9-1-2007.

THE MARK CONSISTS OF THE DESIGN OF AN OWL.

SER. NO. 77-324,651, FILED 11-8-2007.

JUDITH HELFMAN, EXAMINING ATTORNEY

**Int. Cl.: 16**

**Prior U.S. Cls.: 2, 5, 22, 23, 29, 37, 38 and 50**

**United States Patent and Trademark Office**

**Reg. No. 3,466,579**

**Registered July 15, 2008**

**TRADEMARK  
PRINCIPAL REGISTER**

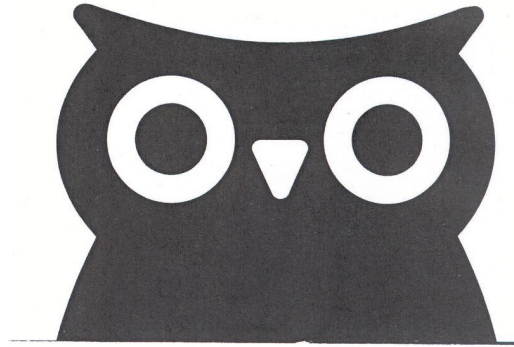

START WIRELESS GROUP, INC. (OHIO CORPORATION)  
1615 TIMBERWOLF DRIVE  
HOLLAND, OH 43528

FOR: NON-MAGNETICALLY ENCODED PREPAID PURCHASE CARDS FOR CELLULAR TELEPHONES, IN CLASS 16 (U.S. CLS. 2, 5, 22, 23, 29, 37, 38 AND 50).

FIRST USE 9-1-2007; IN COMMERCE 9-1-2007.

THE MARK CONSISTS OF THE DESIGN OF AN OWL.

SER. NO. 77-324,667, FILED 11-8-2007.

JUDITH HELFMAN, EXAMINING ATTORNEY



**Int. Cl.: 35**

**Prior U.S. Cls.: 100, 101 and 102**

**United States Patent and Trademark Office**

**Reg. No. 3,466,580**

**Registered July 15, 2008**

---

**SERVICE MARK  
PRINCIPAL REGISTER**

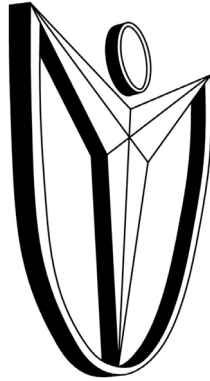

R3GLOBAL, LLC (FLORIDA LTD LIAB CO)  
6767 PHILLIPS INDUSTRIAL BOULEVARD  
JACKSONVILLE, FL 32256

FIRST USE 1-1-2007; IN COMMERCE 1-1-2007.

FOR: ON-LINE RETAIL STORE SERVICES FEATURING BOOKS AND TRAINING MANUALS AND TRAINING DVDS AND CDS, IN CLASS 35 (U.S. CLS. 100, 101 AND 102).

SER. NO. 77-324,834, FILED 11-8-2007.

JENNIFER HETU, EXAMINING ATTORNEY

**Int. Cl.: 35**

**Prior U.S. Cls.: 100, 101 and 102**

**United States Patent and Trademark Office**

**Reg. No. 3,466,581**

**Registered July 15, 2008**

**SERVICE MARK  
PRINCIPAL REGISTER**

**GoWaterCooler.com**

GOWATERCOOLER, LLC (CALIFORNIA LTD  
LIAB CO)  
SUITE 1820  
915 WILSHIRE BLVD.  
LOS ANGELES, CA 90017

FOR: ADVERTISING, INCLUDING PROMOTION  
RELATING TO THE SALE OF ARTICLES AND  
SERVICES FOR THIRD PARTIES BY THE TRANS-  
MISSION OF ADVERTISING MATERIAL AND THE  
DISSEMINATION OF ADVERTISING MESSAGES  
ON COMPUTER NETWORKS; DISSEMINATION OF  
ADVERTISING FOR OTHERS VIA AN ON-LINE  
COMMUNICATIONS NETWORK ON THE INTER-  
NET; EMPLOYMENT HIRING, RECRUITING, PLA-  
CEMENT, STAFFING AND CAREER  
NETWORKING SERVICES; PROMOTING THE  
GOODS AND SERVICES OF OTHERS VIA A GLO-

BAL COMPUTER NETWORK; PROVIDING A WEB  
SITE WHICH FEATURES ADVERTISEMENTS FOR  
THE GOODS AND SERVICES OF OTHERS ON A  
GLOBAL COMPUTER NETWORK; EMPLOYEE RE-  
LATIONS INFORMATION SERVICES, IN CLASS 35  
(U.S. CLS. 100, 101 AND 102).

FIRST USE 2-6-2007; IN COMMERCE 3-1-2007.

THE MARK CONSISTS OF STANDARD CHAR-  
ACTERS WITHOUT CLAIM TO ANY PARTICULAR  
FONT, STYLE, SIZE, OR COLOR.

SER. NO. 77-324,843, FILED 11-8-2007.

ANTHONY RINKER, EXAMINING ATTORNEY

**Int. Cl.: 35**

**Prior U.S. Cls.: 100, 101 and 102**

**United States Patent and Trademark Office**

**Reg. No. 3,466,582**

**Registered July 15, 2008**

**SERVICE MARK  
PRINCIPAL REGISTER**

**PHARMASTANCE**

TGAS CONSULTING LLC (NEW JERSEY LTD  
LIAB CO)  
301 EAST GERMANTOWN PIKE  
EAST NORRITON, PA 19403

FOR: BUSINESS CONSULTING SERVICES,  
NAMELY, DATA COLLECTION AND AGGREGA-  
TION, RESEARCH, ANALYSIS OF BUSINESS MAR-  
KETS, BUSINESS BENCHMARKING, PREPARING  
BUSINESS REPORTS, PLANNING AND MANAGE-  
MENT IN CONNECTION WITH SALES AND MAR-  
KETING OPERATIONS FUNCTIONS IN THE  
PHARMACEUTICAL INDUSTRY; PROVIDING A  
DATABASE OF BENCHMARK BUSINESS INFOR-  
MATION TO EVALUATE OPERATING PRACTICES

AND STRATEGIES AGAINST PHARMACEUTICAL  
INDUSTRY STANDARDS, IN CLASS 35 (U.S. CLS.  
100, 101 AND 102).

FIRST USE 3-14-2007; IN COMMERCE 3-14-2007.

THE MARK CONSISTS OF STANDARD CHAR-  
ACTERS WITHOUT CLAIM TO ANY PARTICULAR  
FONT, STYLE, SIZE, OR COLOR.

SER. NO. 77-324,858, FILED 11-8-2007.

TASHIA BUNCH, EXAMINING ATTORNEY

**Int. Cl.: 41**

**Prior U.S. Cls.: 100, 101 and 107**

**United States Patent and Trademark Office**

**Reg. No. 3,466,583**

**Registered July 15, 2008**

**SERVICE MARK  
PRINCIPAL REGISTER**

**VIRTUAL L**

CENTERSTAGE MEDIA, LLC (ILLINOIS LTD  
LIAB CO)  
350 NORTH ORLEANS STREET  
CHICAGO, IL 60654

FOR: ONLINE PUBLICATION IN THE NATURE  
OF AN ON-LINE CITY GUIDE FEATURING GEN-  
ERAL INFORMATION RELATING TO ENTER-  
TAINMENT, ARTS AND LEISURE, IN CLASS 41  
(U.S. CLS. 100, 101 AND 107).

FIRST USE 0-0-1994; IN COMMERCE 0-0-1994.

THE MARK CONSISTS OF STANDARD CHAR-  
ACTERS WITHOUT CLAIM TO ANY PARTICULAR  
FONT, STYLE, SIZE, OR COLOR.

NO CLAIM IS MADE TO THE EXCLUSIVE  
RIGHT TO USE "VIRTUAL", APART FROM THE  
MARK AS SHOWN.

SER. NO. 77-324,859, FILED 11-8-2007.

DAYNA BROWNE, EXAMINING ATTORNEY

**Int. Cls.: 18, 20, 21, 22 and 25**

**Prior U.S. Cls.: 1, 2, 3, 7, 13, 19, 22, 23, 25, 29, 30, 32, 33, 39, 40, 41, 42 and 50**

**Reg. No. 3,466,584**

**United States Patent and Trademark Office**

**Registered July 15, 2008**

**TRADEMARK  
PRINCIPAL REGISTER**



PYUNG AN TEXTILE CO., LTD. (REPUBLIC OF KOREA CORPORATION)  
281 HWIKYUNG-DONG, DONGDAEMUN-KU  
SEOUL, REPUBLIC OF KOREA

FOR: BACKPACKS; RUCKSACKS; MOUNTAIN-NEERING STICKS; WALKING STICKS , IN CLASS 18 (U.S. CLS. 1, 2, 3, 22 AND 41).

FIRST USE 9-24-2005; IN COMMERCE 11-1-2007.

FOR: NON-METAL PEGS; SLEEPING BAGS, IN CLASS 20 (U.S. CLS. 2, 13, 22, 25, 32 AND 50).

FIRST USE 12-1-2005; IN COMMERCE 11-1-2007.

FOR: MUGS; PLASTIC CUPS; BUCKETS; VACUUM BOTTLES; THERMAL INSULATED BAGS FOR FOOD OR BEVERAGES; INSULATED FLASKS; PORTABLE COOKING KITS FOR OUTDOOR USE, IN CLASS 21 (U.S. CLS. 2, 13, 23, 29, 30, 33, 40 AND 50).

FIRST USE 9-24-2005; IN COMMERCE 11-1-2007.

FOR: TENTS; ROPES, IN CLASS 22 (U.S. CLS. 1, 2, 7, 19, 22, 42 AND 50).

FIRST USE 11-1-2007; IN COMMERCE 11-1-2007.

FOR: BOOTS; INNER SOLES; ANORAKS; SUITS; JACKETS; JUMPERS; JEANS; PARKAS; SHIRTS; BRAS; SHIRT FRONTS; UNDERWEAR; DRAWERS; UNDERSHIRTS; UNDERPANTS; SWEATERS; UNIFORMS; VESTS; TANK TOPS; MUFFLERS; MUFFS; GLOVES; SOCKS; TIGHTS; CAPS; HOODS; WATER-PROOF JACKETS AND PANTS, IN CLASS 25 (U.S. CLS. 22 AND 39).

FIRST USE 9-24-2005; IN COMMERCE 10-3-2007.

OWNER OF U.S. REG. NO. 2,275,308.

NO CLAIM IS MADE TO THE EXCLUSIVE RIGHT TO USE "ITALY", APART FROM THE MARK AS SHOWN.

THE MARK CONSISTS OF A RHINO IMAGE HORN WITH STYLIZED LETTERS "ITALY NEPA".

SER. NO. 77-324,879, FILED 11-8-2007.

ARETHA SOMERVILLE, EXAMINING ATTORNEY

**Int. Cls.: 40 and 42**

**Prior U.S. Cls.: 100, 101, 103 and 106**

**United States Patent and Trademark Office**

**Reg. No. 3,466,585**

**Registered July 15, 2008**

**SERVICE MARK  
PRINCIPAL REGISTER**

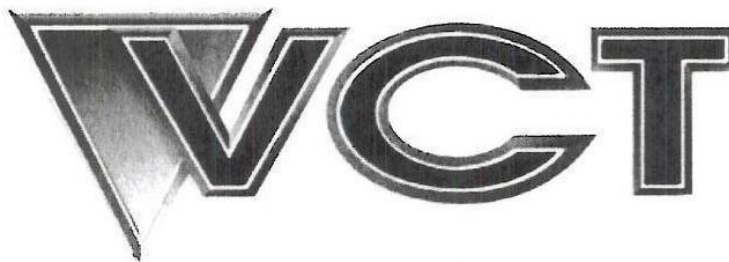

VERSATILE CARD TECHNOLOGY, INC. (ILLINOIS CORPORATION)  
5200 THATCHER ROAD  
DOWNERS GROVE, IL 60515

FOR: CUSTOM MANUFACTURE OF THERMOPLASTIC CARDS, NAMELY, SECURE AND NON-SECURE BANKING CARDS, SMART CARDS, SMART BLANK CONTACTLESS CARDS, GIFT CARDS, ATM CARDS, DEBIT CARDS, RETAIL STORE ISSUED CARDS, PHONE CARDS, ID CARDS, PROMOTIONAL CARDS, KEY CARDS, PLASTIC COATED CARDS, SCRATCH OFF AND LAMINATED CARDS TO THE ORDER AND SPECIFICATION OF OTHERS; CONTRACT MANUFACTURING IN THE FIELD OF THERMOPLASTIC CARDS, NAMELY, SECURE AND NON-SECURE BANKING CARDS, SMART CARDS, SMART BLANK CONTACTLESS CARDS, GIFT CARDS, ATM CARDS, DEBIT CARDS, RETAIL STORE ISSUED CARDS, PHONE CARDS, ID CARDS, PROMOTIONAL CARDS, KEY CARDS, PLASTIC COATED CARDS, SCRATCH OFF AND LAMINA-

TED CARDS, IN CLASS 40 (U.S. CLS. 100, 103 AND 106).

FIRST USE 1-1-1997; IN COMMERCE 1-1-1997.

FOR: CUSTOM DESIGN SERVICES, NAMELY, GRAPHICAL DESIGN OF SECURE AND NON-SECURE BANKING CARDS, SMART CARDS, SMART BLANK CONTACTLESS CARDS, GIFT CARDS, ATM CARDS, DEBIT CARDS, RETAIL STORE ISSUED CARDS, PHONE CARDS, ID CARDS, PROMOTIONAL CARDS, KEY CARDS, PLASTIC COATED CARDS, SCRATCH OFF AND LAMINATED CARDS FOR OTHERS, IN CLASS 42 (U.S. CLS. 100 AND 101).

FIRST USE 1-1-1997; IN COMMERCE 1-1-1997.

SER. NO. 77-324,914, FILED 11-8-2007.

MICHAEL TANNER, EXAMINING ATTORNEY

**Int. Cl.: 37**

**Prior U.S. Cls.: 100, 103 and 106**

**United States Patent and Trademark Office**

**Reg. No. 3,466,586**

**Registered July 15, 2008**

**SERVICE MARK  
PRINCIPAL REGISTER**



**Simply  
Green<sup>LLC</sup>**

SIMPLY GREEN A BIOFUELS COMPANY, LLC  
(NEW HAMPSHIRE LTD LIAB CO)  
74 UNION ROAD  
STRATHAM, NH 03885

FOR: BIODIESEL FUELING SERVICES FOR RESIDENTIAL, COMMERCIAL, INDUSTRIAL, MARINE, AGRICULTURAL, CONSTRUCTION AND GOLF COURSE MARKETS , IN CLASS 37 (U.S. CLS. 100, 103 AND 106).

FIRST USE 3-18-2007; IN COMMERCE 4-12-2007.

NO CLAIM IS MADE TO THE EXCLUSIVE RIGHT TO USE "GREEN LLC", APART FROM THE MARK AS SHOWN.

THE MARK CONSISTS OF THE WORDS "SIMPLY GREEN LLC" WITH THE LETTER "I" IN THE WORD "SIMPLY" REPRESENTED BY A GRAPHIC LEAF-TYPE ELEMENT.

SER. NO. 77-324,966, FILED 11-8-2007.

KATHLEEN LORENZO, EXAMINING ATTORNEY

**Int. Cl.: 16**

**Prior U.S. Cls.: 2, 5, 22, 23, 29, 37, 38 and 50**

**United States Patent and Trademark Office**

**Reg. No. 3,466,587**

**Registered July 15, 2008**

**TRADEMARK  
PRINCIPAL REGISTER**

**POULTRY SCIENCE**

POULTRY SCIENCE ASSOCIATION (TEXAS  
CORPORATION)  
1111 N. DUNLAP AVENUE  
SAVOY, IL 61874

FOR: PERIODIC JOURNALS IN THE FIELD OF  
POULTRY RESEARCH, IN CLASS 16 (U.S. CLS. 2, 5,  
22, 23, 29, 37, 38 AND 50).

FIRST USE 0-0-1921; IN COMMERCE 0-0-1921.

THE MARK CONSISTS OF STANDARD CHAR-  
ACTERS WITHOUT CLAIM TO ANY PARTICULAR  
FONT, STYLE, SIZE, OR COLOR.

SEC. 2(F).

SER. NO. 77-325,041, FILED 11-8-2007.

MICHAEL LITZAU, EXAMINING ATTORNEY



Int. Cls.: 25 and 34

Prior U.S. Cls.: 2, 8, 9, 17, 22 and 39

United States Patent and Trademark Office

Reg. No. 3,466,588

Registered July 15, 2008

TRADEMARK  
PRINCIPAL REGISTER

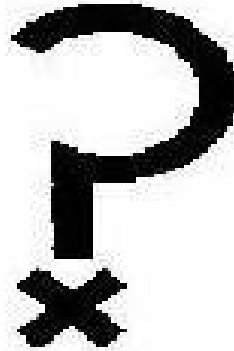

VIPER ROOM DEVELOPMENT, LLC (DELA-  
WARE LTD LIAB CO)  
510 N. ROBERTSON BLVD.  
LOS ANGELES, CA 90048

FOR: T-SHIRTS, IN CLASS 25 (U.S. CLS. 22 AND  
39).

FIRST USE 8-17-1994; IN COMMERCE 8-17-1994.

FOR: MATCHES, IN CLASS 34 (U.S. CLS. 2, 8, 9  
AND 17).

FIRST USE 6-6-1994; IN COMMERCE 6-6-1994.

THE MARK CONSISTS OF QUESTION MARK  
DESIGN.

SER. NO. 77-325,049, FILED 11-8-2007.

WON TEAK OH, EXAMINING ATTORNEY

**Int. Cl.: 35**

**Prior U.S. Cls.: 100, 101 and 102**

**United States Patent and Trademark Office**

**Reg. No. 3,466,589**

**Registered July 15, 2008**

**SERVICE MARK  
PRINCIPAL REGISTER**



THE YARN LOUNGE, INC. (VIRGINIA CORPORATION)  
3003 WEST CARY ST  
RICHMOND, VA 23221

THE MARK CONSISTS OF CHAIR WITH BALL OF YARN IN SEAT.

FOR: RETAIL STORES FEATURING KNITTING YARN AND KNITTING ACCESSORIES, IN CLASS 35 (U.S. CLS. 100, 101 AND 102).

SER. NO. 77-325,148, FILED 11-8-2007.

FIRST USE 3-12-2005; IN COMMERCE 3-12-2005.

WENDY GOODMAN, EXAMINING ATTORNEY

**Int. Cl.: 37**

**Prior U.S. Cls.: 100, 103 and 106**

**United States Patent and Trademark Office**

**Reg. No. 3,466,590**

**Registered July 15, 2008**

**SERVICE MARK  
PRINCIPAL REGISTER**

**CAM Cleaning Services**

CAM CLEANING SERVICES, INC. (TEXAS CORPORATION)  
1330-A HUGH ROAD  
HOUSTON, TX 77067

FOR: CLEANING OF COMMERCIAL BUILDINGS, CHURCHES, SCHOOLS, RETAIL STORES, WAREHOUSES, NEW CONSTRUCTION FACILITIES, BANKS, HEALTH CARE LOCATIONS, FACTORIES, IN CLASS 37 (U.S. CLS. 100, 103 AND 106).

FIRST USE 5-9-1991; IN COMMERCE 5-9-1991.

THE MARK CONSISTS OF STANDARD CHARACTERS WITHOUT CLAIM TO ANY PARTICULAR FONT, STYLE, SIZE, OR COLOR.

NO CLAIM IS MADE TO THE EXCLUSIVE RIGHT TO USE "CLEANING SERVICES", APART FROM THE MARK AS SHOWN.

SER. NO. 77-325,167, FILED 11-8-2007.

COLLEEN DOMBROW, EXAMINING ATTORNEY

**Int. Cl.: 41**

**Prior U.S. Cls.: 100, 101 and 107**

**United States Patent and Trademark Office**

**Reg. No. 3,466,591**

**Registered July 15, 2008**

**SERVICE MARK  
PRINCIPAL REGISTER**

**HARVARD STUDENT AGENCIES,  
INC. TRANSLATION SERVICES**

PRESIDENT AND FELLOWS OF HARVARD  
COLLEGE (MASSACHUSETTS CORPORATION)  
124 MT. AUBURN ST., SUITE 570-N  
CAMBRIDGE, MA 02138

FOR: TRANSLATION SERVICES, IN CLASS 41  
(U.S. CLS. 100, 101 AND 107).

FIRST USE 11-7-2007; IN COMMERCE 11-7-2007.

THE MARK CONSISTS OF STANDARD CHAR-  
ACTERS WITHOUT CLAIM TO ANY PARTICULAR  
FONT, STYLE, SIZE, OR COLOR.

OWNER OF U.S. REG. NOS. 1,608,533, 1,624,908  
AND OTHERS.

NO CLAIM IS MADE TO THE EXCLUSIVE  
RIGHT TO USE "STUDENT AGENCIES, INC.  
TRANSLATION SERVICES", APART FROM THE  
MARK AS SHOWN.

SER. NO. 77-325,209, FILED 11-8-2007.

BRENDAN REGAN, EXAMINING ATTORNEY

**Int. Cl.: 43**

**Prior U.S. Cls.: 100 and 101**

**United States Patent and Trademark Office**

**Reg. No. 3,466,592**

**Registered July 15, 2008**

**SERVICE MARK  
PRINCIPAL REGISTER**

**FLATBREADZ A FRESH  
APPROACH TO SANDWICHES**

HMSHOST CORPORATION (DELAWARE COR-  
PORATION)

6905 ROCKLEDGE DRIVE MS 7-1

BETHESDA, MD 20817

FOR: RESTAURANT SERVICES, IN CLASS 43  
(U.S. CLS. 100 AND 101).

FIRST USE 11-0-2000; IN COMMERCE 11-0-2000.

THE MARK CONSISTS OF STANDARD CHAR-  
ACTERS WITHOUT CLAIM TO ANY PARTICULAR  
FONT, STYLE, SIZE, OR COLOR.

NO CLAIM IS MADE TO THE EXCLUSIVE  
RIGHT TO USE "FLATBREADS", APART FROM  
THE MARK AS SHOWN.

SER. NO. 77-325,271, FILED 11-8-2007.

SUSAN RICHARDS, EXAMINING ATTORNEY

**Int. Cl.: 36**

**Prior U.S. Cls.: 100, 101 and 102**

**United States Patent and Trademark Office**

**Reg. No. 3,466,593**

**Registered July 15, 2008**

**SERVICE MARK  
PRINCIPAL REGISTER**

**FUELED BY THE FALLEN**

SCOTT, CODY (UNITED STATES INDIVIDUAL)  
375 HONEY HILL LOOP  
SEARCY, AR 72143

THE MARK CONSISTS OF STANDARD CHAR-  
ACTERS WITHOUT CLAIM TO ANY PARTICULAR  
FONT, STYLE, SIZE, OR COLOR.

FOR: CHARITABLE FUNDRAISING SERVICES  
BY MEANS OF AN ENTERTAINMENT EVENT, IN  
CLASS 36 (U.S. CLS. 100, 101 AND 102).

SER. NO. 77-325,277, FILED 11-8-2007.

FIRST USE 5-28-2007; IN COMMERCE 5-28-2007.

SAIMA MAKHDOOM, EXAMINING ATTORNEY

**Int. Cl.: 42**

**Prior U.S. Cls.: 100 and 101**

**United States Patent and Trademark Office**

**Reg. No. 3,466,594**

**Registered July 15, 2008**

**SERVICE MARK  
PRINCIPAL REGISTER**

**STAGEAGENT**

ESTAGE ENTERPRISES, INC. (CALIFORNIA  
CORPORATION)  
P.O. BOX 672  
PALO ALTO, CA 94302

FOR: HOSTING AN ONLINE COMMUNITY WEBSITE FEATURING SERVICES FOR THE ENTERTAINMENT INDUSTRY INCLUDING SOCIAL NETWORKING, CASTING CALLS, LISTINGS OF LOCAL PRODUCTIONS, A DIRECTORY OF CLASSES AND TEACHERS AND RESOURCES FOR ACTORS, PRODUCERS AND FANS, IN CLASS 42 (U.S. CLS. 100 AND 101).

FIRST USE 12-0-2000; IN COMMERCE 12-0-2000.

THE MARK CONSISTS OF STANDARD CHARACTERS WITHOUT CLAIM TO ANY PARTICULAR FONT, STYLE, SIZE, OR COLOR.

SER. NO. 77-325,314, FILED 11-8-2007.

BRIAN CALLAGHAN, EXAMINING ATTORNEY

**Int. Cl.: 3**

**Prior U.S. Cls.: 1, 4, 6, 50, 51 and 52**

**United States Patent and Trademark Office**

**Reg. No. 3,466,595**

**Registered July 15, 2008**

**TRADEMARK  
PRINCIPAL REGISTER**

**MSINGI ORGANICS**

DENYCE MOODY (WASHINGTON SOLE PROPRIETORSHIP), DBA MSINGI ORGANICS  
26519 NE 34TH ST  
CAMAS, WA 98607

FOR: BAR SOAP; BATH SOAPS IN LIQUID, SOLID OR GEL FORM; HAND SOAPS; HAND LOTIONS; SKIN LOTIONS; FACE AND BODY LOTIONS; BATH SALTS; BODY SCRUB; LIP BALM; SKIN CARE PREPARATIONS, NAMELY, BODY BALM; FACE AND BODY CREAMS; BODY SPRAYS, IN CLASS 3 (U.S. CLS. 1, 4, 6, 50, 51 AND 52).

FIRST USE 5-1-2007; IN COMMERCE 10-1-2007.

THE MARK CONSISTS OF STANDARD CHARACTERS WITHOUT CLAIM TO ANY PARTICULAR FONT, STYLE, SIZE, OR COLOR.

NO CLAIM IS MADE TO THE EXCLUSIVE RIGHT TO USE "ORGANICS", APART FROM THE MARK AS SHOWN.

THE FOREIGN WORDING IN THE MARK TRANSLATES INTO ENGLISH AS FOUNDATION OR ESSENCE.

SER. NO. 77-325,319, FILED 11-8-2007.

MICHAEL GAAFAR, EXAMINING ATTORNEY



**Int. Cl.: 21**

**Prior U.S. Cls.: 2, 13, 23, 29, 30, 33, 40 and 50**

**United States Patent and Trademark Office**

**Reg. No. 3,466,596**

**Registered July 15, 2008**

**TRADEMARK  
PRINCIPAL REGISTER**



HICKS, NEIL (UNITED STATES INDIVIDUAL)  
26 MAIN STREET  
GOLDENS BRIDGE, NY 10526

FOR: CLOTHES DRYING RACKS, IN CLASS 21  
(U.S. CLS. 2, 13, 23, 29, 30, 33, 40 AND 50).

FIRST USE 11-2-2007; IN COMMERCE 11-2-2007.

THE COLOR(S) BLUE, GOLD AND WHITE IS/  
ARE CLAIMED AS A FEATURE OF THE MARK.

THE MARK CONSISTS OF A BLUE SILHOUETTE  
OF A GLOVE ABOVE A GOLD TRIANGLE WITH  
WHITE FLAME SHAPES INSIDE THE TRIANGLE  
USED TO REPRESENT HEAT.

SER. NO. 77-325,369, FILED 11-8-2007.

RENEE SERVANCE, EXAMINING ATTORNEY

**Int. Cl.: 14**

**Prior U.S. Cls.: 2, 27, 28 and 50**

**Reg. No. 3,466,597**

**United States Patent and Trademark Office**

**Registered July 15, 2008**

**TRADEMARK  
PRINCIPAL REGISTER**

**JEWELS ET JIM**

JEWELS ET JIM, LLC (NEW YORK LTD LIAB  
CO)  
437 MADISON AVENUE, 32ND FLOOR  
NEW YORK, NY 10022

FOR: BRACELETS; BRACELETS OF PRECIOUS  
METAL; IDENTIFICATION BRACELETS; CHARMS;  
JEWEL PENDANTS; PENDANTS; JEWELRY, IN  
CLASS 14 (U.S. CLS. 2, 27, 28 AND 50).

FIRST USE 6-15-2006; IN COMMERCE 10-25-2006.

THE MARK CONSISTS OF STANDARD CHAR-  
ACTERS WITHOUT CLAIM TO ANY PARTICULAR  
FONT, STYLE, SIZE, OR COLOR.

NO CLAIM IS MADE TO THE EXCLUSIVE  
RIGHT TO USE "JEWELS", APART FROM THE  
MARK AS SHOWN.

SER. NO. 77-325,377, FILED 11-8-2007.

CORY BOONE, EXAMINING ATTORNEY

Int. Cl.: 41

Prior U.S. Cls.: 100, 101 and 107

United States Patent and Trademark Office

Reg. No. 3,466,598

Registered July 15, 2008

SERVICE MARK  
PRINCIPAL REGISTER



CLUB SAVANA BANANAS (MISSISSIPPI LTD  
LIAB CO)  
304 WEST CANAL STREET STE A  
PICAYUNE, MS 39466

FOR: ENTERTAINMENT SERVICES, NAMELY,  
CONDUCTING PARTIES, IN CLASS 41 (U.S. CLS.  
100, 101 AND 107).

FIRST USE 6-17-2007; IN COMMERCE 6-17-2007.

NO CLAIM IS MADE TO THE EXCLUSIVE  
RIGHT TO USE "DIVA FOR A DAY BIRTHDAY  
PARTIES PRIVATE PARTIES GIFT APPAREL AND  
ACCESSORIES 304 W CANAL ST, STE A PICAYUNE,  
MS 39466 601.749.5059 601.347.6464", APART FROM  
THE MARK AS SHOWN.

THE COLOR(S) PINK, YELLOW, GREEN, BLUE,  
WHITE, AND BROWN IS/ARE CLAIMED AS A  
FEATURE OF THE MARK.

THE MARK CONSISTS OF WORDING AND DE-  
SIGNS. THE WORDING "CLUB SAVANA BANA-  
NAS" APPEARS IN DARK PINK AT THE TOP OF  
THE DRAWING, WITH HEART SHAPES WITHIN  
THE FIRST LETTERS OF EACH WORD. IN THE  
CENTER OF THE DRAWING, THE FOLLOWING  
WORDING APPEARS IN GREEN: "A FUN PLACE

FOR GIRLS' DIVA FOR A DAY BIRTHDAY PAR-  
TIES PRIVATE PARTIES GIFT APPAREL AND  
ACCESSORIES". BEHIND THIS WORDING, THERE  
IS A STYLIZED PINK DESIGN OF LIPS. AT THE  
BOTTOM LEFT OF THE DRAWING, THE FOLLO-  
WING WORDING APPEARS IN DARK PINK: "304 W  
CANAL ST, STE A PICAYUNE, MS 39466." AT THE  
BOTTOM RIGHT OF THE DRAWING, THE FOL-  
LOWING WORDING ALSO APPEARS IN DARK  
PINK: "601.749.5059 601.347.6464." ON THE LEFT  
SIDE OF THE DRAWING, THERE IS A DESIGN  
OF A PERFUME SPRAYER IN BLUE, GREEN, AND  
WHITE, CASTING A BLUE SHADOW, AND PRE-  
SENTED IN FRONT OF A YELLOW FIELD WITH  
PINK HEARTS FLOATING IN THE FIELD. ON THE  
RIGHT SIDE OF THE DRAWING, THERE IS A  
DESIGN OF A SITTING GIRL IN YELLOW, BLUE,  
AND WHITE LOOKING INTO A BLUE AND WHITE  
MIRROR AND APPLYING PINK LIPSTICK. AT THE  
BOTTOM CENTER OF THE DRAWING, THERE IS A  
DESIGN OF A MAKEUP KIT AND BRUSHES IN  
YELLOW, GREEN, BLUE, WHITE, AND BROWN.  
THE BACKGROUND OF THE ENTIRE MARK IS  
LIGHT PINK.

SER. NO. 77-325,378, FILED 11-8-2007.

CORY BOONE, EXAMINING ATTORNEY

**Int. Cl.: 35**

**Prior U.S. Cls.: 100, 101 and 102**

**United States Patent and Trademark Office**

**Reg. No. 3,466,599**

**Registered July 15, 2008**

**SERVICE MARK  
PRINCIPAL REGISTER**

**ParentPreneur**

KIRK, JULIE LENZER (UNITED STATES INDIVIDUAL)  
23505 PURITAN PLACE  
DAMASCUS, MD 20872

THE MARK CONSISTS OF STANDARD CHARACTERS WITHOUT CLAIM TO ANY PARTICULAR FONT, STYLE, SIZE, OR COLOR.

FOR: PROFESSIONAL BUSINESS CONSULTATION, IN CLASS 35 (U.S. CLS. 100, 101 AND 102).

SER. NO. 77-325,603, FILED 11-9-2007.

FIRST USE 7-31-2007; IN COMMERCE 7-31-2007.

NATALIE POLZER, EXAMINING ATTORNEY

**Int. Cl.: 9**

**Prior U.S. Cls.: 21, 23, 26, 36 and 38**

**Reg. No. 3,466,600**

**United States Patent and Trademark Office**

**Registered July 15, 2008**

---

**TRADEMARK  
PRINCIPAL REGISTER**

**PHPX**

MEINZER, RYAN (UNITED STATES INDIVIDUAL)  
9112 BRINSON DRIVE  
KELLER, TX 76248

THE MARK CONSISTS OF STANDARD CHARACTERS WITHOUT CLAIM TO ANY PARTICULAR FONT, STYLE, SIZE, OR COLOR.

FOR: COMPUTER SOFTWARE FOR USE IN MANAGING INTERNET CONTENT AND CREATING WEB PORTALS, IN CLASS 9 (U.S. CLS. 21, 23, 26, 36 AND 38).

SER. NO. 77-325,650, FILED 11-9-2007.

FIRST USE 2-0-1998; IN COMMERCE 2-0-1998.

RENEE SERVANCE, EXAMINING ATTORNEY

**Int. Cl.: 35**

**Prior U.S. Cls.: 100, 101 and 102**

**United States Patent and Trademark Office**

**Reg. No. 3,466,601**

**Registered July 15, 2008**

**SERVICE MARK  
PRINCIPAL REGISTER**

# RightTarget

LEAPFROG ONLINE (ILLINOIS LTD LIAB CO)  
807 GREENWOOD  
EVANSTON, IL 60201

FOR: ON-LINE ADVERTISING AND MARKET-  
ING SERVICES, IN CLASS 35 (U.S. CLS. 100, 101 AND  
102).

FIRST USE 3-1-2005; IN COMMERCE 3-1-2005.

THE MARK CONSISTS OF STANDARD CHAR-  
ACTERS WITHOUT CLAIM TO ANY PARTICULAR  
FONT, STYLE, SIZE, OR COLOR.

SER. NO. 77-325,697, FILED S.R. 11-9-2007 AM. P.R.  
2-26-2008.

FRED CARL, EXAMINING ATTORNEY

**Int. Cl.: 35**

**Prior U.S. Cls.: 100, 101 and 102**

**United States Patent and Trademark Office**

**Reg. No. 3,466,602**

**Registered July 15, 2008**

**SERVICE MARK  
PRINCIPAL REGISTER**



PS ENERGY GROUP, INC. (GEORGIA CORPORATION)  
SUITE 500  
2987 CLAIRMONT ROAD  
ATLANTA, GA 30329

FOR: CONSULTATION SERVICES IN BUSINESS MANAGEMENT RELATING TO FUELS; WHOLESALE ORDERING, WHOLESALE STORE AND WHOLESALE DISTRIBUTORSHIP SERVICES RELATING TO ENERGY PRODUCTS, NAMELY, FOSSIL FUELS, SUCH AS NATURAL GAS, DIESEL FUEL, GASOLINE AND ALTERNATIVE FUELS, IN CLASS 35 (U.S. CLS. 100, 101 AND 102).

FIRST USE 4-28-1998; IN COMMERCE 4-28-1998.

NO CLAIM IS MADE TO THE EXCLUSIVE RIGHT TO USE "ENERGY GROUP INC.", APART FROM THE MARK AS SHOWN.

THE MARK CONSISTS OF A GLOBE WITH LATITUDE AND LONGITUDE LINES AND A FLAME INSIDE THE GLOBE, OVER THE WORDS "PS ENERGY GROUP INC."

SER. NO. 77-325,739, FILED 11-9-2007.

ELLEN PERKINS, EXAMINING ATTORNEY

**Int. Cl.: 35**

**Prior U.S. Cls.: 100, 101 and 102**

**United States Patent and Trademark Office**

**Reg. No. 3,466,603**

**Registered July 15, 2008**

**SERVICE MARK  
PRINCIPAL REGISTER**



BETE INVESTMENTS, LLC (FLORIDA LTD LIAB  
CO)  
1990 MAIN STREET, SUITE 750  
SARASOTA, FL 34236

FOR: INFOMEDIARY SERVICES, NAMELY, FACILITATING TRANSACTIONS BETWEEN BUYERS AND SELLERS THROUGH PROVIDING BUYERS WITH INFORMATION ABOUT SELLERS, GOODS, AND/OR SERVICES; PROVIDING INFORMATION ABOUT THE GOODS AND SERVICES OF OTHERS VIA THE GLOBAL COMPUTER NETWORK; MATCHING CONSUMERS WITH SERVICE PROVIDERS IN THE FIELD OF RESIDENTIAL AND

COMMERCIAL SERVICES VIA THE GLOBAL COMPUTER NETWORK, IN CLASS 35 (U.S. CLS. 100, 101 AND 102).

FIRST USE 9-8-2007; IN COMMERCE 9-8-2007.

THE MARK CONSISTS OF A BEE HOLDING A PIECE OF PAPER AND A PENCIL.

SER. NO. 77-325,776, FILED 11-9-2007.

DARRYL SPRUILL, EXAMINING ATTORNEY



**Int. Cl.: 38**

**Prior U.S. Cls.: 100, 101 and 104**

**United States Patent and Trademark Office**

**Reg. No. 3,466,604**

**Registered July 15, 2008**

**SERVICE MARK  
PRINCIPAL REGISTER**

**PEOPLECAST**

NETWORK FOUNDATION TECHNOLOGIES,  
LLC (CALIFORNIA LTD LIAB CO)  
SUITE 2062  
10250 CENSTELLATION BOULEVARD  
CENTURY CITY, CA 90067

FOR: ONLINE STREAMING OF AUDIO AND  
VIDEO MATERIAL, ENABLING WEBCASTING  
SERVICES FOR OTHERS, IN CLASS 38 (U.S. CLS.  
100, 101 AND 104).

FIRST USE 2-0-2005; IN COMMERCE 2-0-2005.

THE MARK CONSISTS OF STANDARD CHAR-  
ACTERS WITHOUT CLAIM TO ANY PARTICULAR  
FONT, STYLE, SIZE, OR COLOR.

SER. NO. 77-325,814, FILED 11-9-2007.

YAT SYE, LEE, EXAMINING ATTORNEY

**Int. Cl.: 16**

**Prior U.S. Cls.: 2, 5, 22, 23, 29, 37, 38 and 50**

**Reg. No. 3,466,605**

**United States Patent and Trademark Office**

**Registered July 15, 2008**

---

**TRADEMARK  
PRINCIPAL REGISTER**

**Hidden Secrets Book Covers**

MIZE, ROBERT, T (UNITED STATES INDIVIDUAL), DBA HIDDEN SECRETS BOOK COVERS

7952 SARTAN WAY NE

ALBUQUERQUE, NM 871093128

FOR: BOOK COVERS, IN CLASS 16 (U.S. CLS. 2, 5, 22, 23, 29, 37, 38 AND 50).

FIRST USE 2-1-2004; IN COMMERCE 2-1-2004.

THE MARK CONSISTS OF STANDARD CHARACTERS WITHOUT CLAIM TO ANY PARTICULAR FONT, STYLE, SIZE, OR COLOR.

NO CLAIM IS MADE TO THE EXCLUSIVE RIGHT TO USE "BOOK COVERS", APART FROM THE MARK AS SHOWN.

SER. NO. 77-325,939, FILED 11-9-2007.

CAROLINE WOOD, EXAMINING ATTORNEY

**Int. Cl.: 4**

**Prior U.S. Cls.: 1, 6 and 15**

**United States Patent and Trademark Office**

**Reg. No. 3,466,606**

**Registered July 15, 2008**

**TRADEMARK  
PRINCIPAL REGISTER**

**BOTANI ORGANICS**

BRIGHT LIGHTS CANDLE COMPANY (CALI-  
FORNIA CORPORATION)  
P.O. BOX 539  
LOWER LAKE, CA 95457

FOR: CANDLES, IN CLASS 4 (U.S. CLS. 1, 6 AND  
15).

FIRST USE 10-15-2007; IN COMMERCE 11-1-2007.

THE MARK CONSISTS OF STANDARD CHAR-  
ACTERS WITHOUT CLAIM TO ANY PARTICULAR  
FONT, STYLE, SIZE, OR COLOR.

OWNER OF U.S. REG. NOS. 3,211,241 AND  
3,236,805.

NO CLAIM IS MADE TO THE EXCLUSIVE  
RIGHT TO USE "ORGANICS", APART FROM THE  
MARK AS SHOWN.

SER. NO. 77-326,071, FILED 11-9-2007.

ALYSSA PALADINO, EXAMINING ATTORNEY

**Int. Cls.: 35 and 37**

**Prior U.S. Cls.: 100, 101, 102, 103 and 106**

**United States Patent and Trademark Office**

**Reg. No. 3,466,607**

**Registered July 15, 2008**

**SERVICE MARK  
PRINCIPAL REGISTER**



FIBROWATT, LLC (DELAWARE LTD LIAB CO)  
SUITE 201  
6 PENNS TRAIL  
NEWTOWN, PA 18940

FIRST USE 12-14-2004; IN COMMERCE 12-14-2004.

FOR: OPERATION OF A BUSINESS FOR OTHERS, NAMELY, OPERATION OF POWER PLANTS THAT USE POULTRY LITTER AS FUEL, IN CLASS 35 (U.S. CLS. 100, 101 AND 102).

THE MARK IS COMPRISED OF A SHADED RECTANGLE WITH SLANTED SIDES CONTAINING A REPRESENTATION OF AN ELECTRIC BOLT INTERSECTING WITH THE LETTER "F" IN THE WORD "FIBROWATT".

FIRST USE 6-1-2007; IN COMMERCE 6-1-2007.

SER. NO. 77-326,091, FILED 11-9-2007.

FOR: CONSTRUCTION OF POWER PLANTS THAT USE POULTRY LITTER AS FUEL, IN CLASS 37 (U.S. CLS. 100, 103 AND 106).

ODESSA BIBBINS, EXAMINING ATTORNEY

**Int. Cls.: 9 and 41**

**Prior U.S. Cls.: 21, 23, 26, 36, 38, 100, 101 and 107**

**United States Patent and Trademark Office**

**Reg. No. 3,466,608**

**Registered July 15, 2008**

**TRADEMARK  
SERVICE MARK  
PRINCIPAL REGISTER**

# TOADIES

LEWIS, VADEN TODD (UNITED STATES INDIVIDUAL)

4213 MARY'S CREEK DRIVE

BENBROOK, TX 76116

FOR: DIGITAL MATERIALS, NAMELY, CDS AND DOWNLOADABLE AUDIO FILES FEATURING MUSIC; DOWNLOADABLE MUSICAL SOUND RECORDINGS; MUSICAL SOUND RECORDINGS, IN CLASS 9 (U.S. CLS. 21, 23, 26 AND 38).

FIRST USE 8-0-1987; IN COMMERCE 2-0-1990.

FOR: ENTERTAINMENT, NAMELY LIVE MUSIC CONCERTS, IN CLASS 41 (U.S. CLS. 100, 101 AND 107).

FIRST USE 8-0-1987; IN COMMERCE 2-0-1990.

THE MARK CONSISTS OF STANDARD CHARACTERS WITHOUT CLAIM TO ANY PARTICULAR FONT, STYLE, SIZE, OR COLOR.

SER. NO. 77-326,143, FILED 11-9-2007.

ANGELA GAW, EXAMINING ATTORNEY

**Int. Cls.: 40 and 42**

**Prior U.S. Cls.: 100, 101, 103 and 106**

**United States Patent and Trademark Office**

**Reg. No. 3,466,609**

**Registered July 15, 2008**

**SERVICE MARK  
PRINCIPAL REGISTER**

**VERSATILE CARD TECHNOLOGY**

VERSATILE CARD TECHNOLOGY, INC. (ILLINOIS CORPORATION)  
5200 THATCHER ROAD  
DOWNERS GROVE, IL 60515

FOR: CUSTOM MANUFACTURE OF THERMOPLASTIC CARDS, NAMELY, SECURE AND NON-SECURE BANKING CARDS, SMART CARDS, SMART BLANK CONTACTLESS CARDS, GIFT CARDS, ATM CARDS, DEBIT CARDS, RETAIL STORE ISSUED CARDS, PHONE CARDS, ID CARDS, PROMOTIONAL CARDS, KEY CARDS, PLASTIC COATED CARDS, SCRATCH OFF AND LAMINATED CARDS TO THE ORDER AND SPECIFICATION OF OTHERS; CONTRACT MANUFACTURING IN THE FIELD OF THERMOPLASTIC CARDS, NAMELY, SECURE AND NON-SECURE BANKING CARDS, SMART CARDS, SMART BLANK CONTACTLESS CARDS, GIFT CARDS, ATM CARDS, DEBIT CARDS, RETAIL STORE ISSUED CARDS, PHONE CARDS, ID CARDS, PROMOTIONAL CARDS, KEY CARDS, PLASTIC COATED CARDS, SCRATCH OFF AND LAMINATED CARDS, IN CLASS 40 (U.S. CLS. 100, 103 AND 106).

FIRST USE 1-1-1997; IN COMMERCE 1-1-1997.

FOR: CUSTOM DESIGN SERVICES, NAMELY, GRAPHICAL DESIGN OF SECURE AND NON-SECURE BANKING CARDS, SMART CARDS, SMART BLANK CONTACTLESS CARDS, GIFT CARDS, ATM CARDS, DEBIT CARDS, RETAIL STORE ISSUED CARDS, PHONE CARDS, ID CARDS, PROMOTIONAL CARDS, KEY CARDS, PLASTIC COATED CARDS, SCRATCH OFF AND LAMINATED CARDS FOR OTHERS, IN CLASS 42 (U.S. CLS. 100 AND 101).

FIRST USE 1-1-1997; IN COMMERCE 1-1-1997.

THE MARK CONSISTS OF STANDARD CHARACTERS WITHOUT CLAIM TO ANY PARTICULAR FONT, STYLE, SIZE, OR COLOR.

NO CLAIM IS MADE TO THE EXCLUSIVE RIGHT TO USE "CARD TECHNOLOGY", APART FROM THE MARK AS SHOWN.

SER. NO. 77-326,164, FILED 11-9-2007.

MICHAEL TANNER, EXAMINING ATTORNEY

**Int. Cl.: 28**

**Prior U.S. Cls.: 22, 23, 38 and 50**

**United States Patent and Trademark Office**

**Reg. No. 3,466,610**

**Registered July 15, 2008**

**TRADEMARK  
PRINCIPAL REGISTER**

**CRYSTAL CRAFTS**

LISA FRANK, INC. (ARIZONA CORPORATION)  
6760 S. LISA FRANK AVE.  
TUSCON, AZ 85706

FOR: CHILDREN'S HOBBY CRAFT KIT COM-  
PRISING VARIOUSLY SHAPED DIE-CAST METAL  
FRAMES, PLASTIC BEAD CRYSTALS IN ASSOR-  
TED COLORS, MAGNETS AND CORDING, IN  
CLASS 28 (U.S. CLS. 22, 23, 38 AND 50).

FIRST USE 12-31-2000; IN COMMERCE 12-31-2000.

THE MARK CONSISTS OF STANDARD CHAR-  
ACTERS WITHOUT CLAIM TO ANY PARTICULAR  
FONT, STYLE, SIZE, OR COLOR.

NO CLAIM IS MADE TO THE EXCLUSIVE  
RIGHT TO USE "CRAFTS", APART FROM THE  
MARK AS SHOWN.

SEC. 2(F).

SER. NO. 77-326,206, FILED 11-9-2007.

JAMES STEIN, EXAMINING ATTORNEY

**Int. Cl.: 25**

**Prior U.S. Cls.: 22 and 39**

**United States Patent and Trademark Office**

**Reg. No. 3,466,611**

**Registered July 15, 2008**

**TRADEMARK  
PRINCIPAL REGISTER**

**KORKERS**

KORKERS PRODUCTS LLC (OREGON LTD  
LIAB CO)  
1239 SE 12TH AVE  
PORTLAND, OR 97230

FOR: CLOTHING, NAMELY, FOOTWEAR AND  
HEADWEAR; REPLACEABLE SOLE UNITS AND  
OTHER COMPONENTS FOR FOOTWEAR, NAME-  
LY, SPIKES, IN CLASS 25 (U.S. CLS. 22 AND 39).

FIRST USE 9-10-1959; IN COMMERCE 9-10-1959.

THE MARK CONSISTS OF STANDARD CHAR-  
ACTERS WITHOUT CLAIM TO ANY PARTICULAR  
FONT, STYLE, SIZE, OR COLOR.

OWNER OF U.S. REG. NO. 839,616.

SER. NO. 77-326,250, FILED 11-9-2007.

ZACHARY BELLO, EXAMINING ATTORNEY



**Int. Cl.: 29**

**Prior U.S. Cl.: 46**

**United States Patent and Trademark Office**

**Reg. No. 3,466,612**

**Registered July 15, 2008**

**TRADEMARK  
PRINCIPAL REGISTER**

**Healthy Community Harvest**

HUNGER ACTION NETWORK OF NEW YORK  
STATE (NEW YORK CORPORATION)  
275 STATE STREET  
ALBANY, NY 12210

FOR: FRUIT-BASED SPREADS; GARLIC-BASED  
SPREAD; JELLIES; VEGETABLE-BASED SPREADS,  
IN CLASS 29 (U.S. CL. 46).

FIRST USE 11-9-2007; IN COMMERCE 11-9-2007.

THE MARK CONSISTS OF STANDARD CHAR-  
ACTERS WITHOUT CLAIM TO ANY PARTICULAR  
FONT, STYLE, SIZE, OR COLOR.

NO CLAIM IS MADE TO THE EXCLUSIVE  
RIGHT TO USE "HEALTHY", APART FROM THE  
MARK AS SHOWN.

SER. NO. 77-326,257, FILED 11-9-2007.

TRACY CROSS, EXAMINING ATTORNEY

**Int. Cl.: 44**

**Prior U.S. Cls.: 100 and 101**

**United States Patent and Trademark Office**

**Reg. No. 3,466,613**

**Registered July 15, 2008**

**SERVICE MARK  
PRINCIPAL REGISTER**

**PEBBLE BEACH**

PEBBLE BEACH COMPANY (CALIFORNIA  
PARTNERSHIP)  
2700 17-MILE DRIVE  
PEBBLE BEACH, CA 93953

FOR: HEALTH SPA SERVICES, NAMELY, COS-  
METIC BODY CARE SERVICES; SALON SERVICES,  
NAMELY, PROVIDING FACIALS, MANICURES  
AND MASSAGES, IN CLASS 44 (U.S. CLS. 100 AND  
101).

FIRST USE 0-0-2000; IN COMMERCE 0-0-2000.

THE MARK CONSISTS OF STANDARD CHAR-  
ACTERS WITHOUT CLAIM TO ANY PARTICULAR  
FONT, STYLE, SIZE, OR COLOR.

OWNER OF U.S. REG. NOS. 1,065,027, 1,884,513  
AND OTHERS.

SER. NO. 77-326,270, FILED 11-9-2007.

AMY GEARIN, EXAMINING ATTORNEY

Int. Cl.: 36

Prior U.S. Cls.: 100, 101 and 102

United States Patent and Trademark Office

Reg. No. 3,466,614

Registered July 15, 2008

**SERVICE MARK  
PRINCIPAL REGISTER**



AMERICAN LUNG ASSOCIATION OF THE CENTRAL STATES (MISSOURI NON-PROFIT CORPORATION)  
1118 HAMPTON AVENUE  
ST. LOUIS, MO 63139

FOR: CHARITABLE FUNDRAISING SERVICES, NAMELY, RAISING MONEY FOR THE PREVENTION OF LUNG DISEASE, IN CLASS 36 (U.S. CLS. 100, 101 AND 102).

FIRST USE 11-1-2007; IN COMMERCE 11-1-2007.

NO CLAIM IS MADE TO THE EXCLUSIVE RIGHT TO USE "THE MET", APART FROM THE MARK AS SHOWN.

THE COLOR(S) GRAY, GREEN AND WHITE IS/ ARE CLAIMED AS A FEATURE OF THE MARK.

THE MARK CONSISTS OF A GRAY BUILDING WITH A GREEN ROOF, THE BUILDING IS SHOWN WITH FIVE COLUMNS OF WHITE WINDOWS; UNDER THE BUILDING IS A GRAY LINE WITH THE WORD "MASTER" SHOWN IN GRAY UNDER THE LINE AND THE WORDS "THE MET" SHOWN IN GREEN UNDER THE WORD "MASTER".

SER. NO. 77-326,291, FILED 11-9-2007.

ASMAT KHAN, EXAMINING ATTORNEY

**Int. Cl.: 33**

**Prior U.S. Cls.: 47 and 49**

**United States Patent and Trademark Office**

**Reg. No. 3,466,615**

**Registered July 15, 2008**

**TRADEMARK  
PRINCIPAL REGISTER**

**BOUNTY HUNTER**

WINE SCOUT INTERNATIONAL (CALIFORNIA  
CORPORATION)  
975 FIRST STREET  
NAPA, CA 94559

FOR: WINE, IN CLASS 33 (U.S. CLS. 47 AND 49).

FIRST USE 8-31-1999; IN COMMERCE 8-31-1999.

THE MARK CONSISTS OF STANDARD CHAR-  
ACTERS WITHOUT CLAIM TO ANY PARTICULAR  
FONT, STYLE, SIZE, OR COLOR.

OWNER OF U.S. REG. NO. 2,311,360.

SER. NO. 77-326,413, FILED 11-9-2007.

PAUL CROWLEY, EXAMINING ATTORNEY

**Int. Cl.: 14**

**Prior U.S. Cls.: 2, 27, 28 and 50**

**United States Patent and Trademark Office**

**Reg. No. 3,466,616**

**Registered July 15, 2008**

**TRADEMARK  
PRINCIPAL REGISTER**

**Linear Expressions The  
happy you wear!**

ELTON, LAURA (UNITED STATES INDIVIDUAL)  
28 CASTLE COURT  
RANDOLPH, NJ 07869

THE MARK CONSISTS OF STANDARD CHARACTERS WITHOUT CLAIM TO ANY PARTICULAR FONT, STYLE, SIZE, OR COLOR.

FOR: JEWELRY, NAMELY, BRACELETS, NECKLACES, EARRINGS AND RINGS, IN CLASS 14 (U.S. CLS. 2, 27, 28 AND 50).

SER. NO. 77-326,475, FILED 11-9-2007.

FIRST USE 12-23-2007; IN COMMERCE 12-23-2007.

FLORENTINA BLANDU, EXAMINING ATTORNEY

**Int. Cl.: 36**

**Prior U.S. Cls.: 100, 101 and 102**

**United States Patent and Trademark Office**

**Reg. No. 3,466,617**

**Registered July 15, 2008**

**SERVICE MARK  
PRINCIPAL REGISTER**

**E CASHIER**

NELNET BUSINESS SOLUTIONS, INC. (NEBRASKA CORPORATION)  
SUITE 306  
100 N. 56TH STREET  
LINCOLN, NE 68504

FOR: ELECTRONIC PAYMENT, NAMELY, ELECTRONIC PROCESSING AND TRANSMISSION OF TUITION, FEES AND OTHER BILL PAYMENT DATA ON BEHALF OF SCHOOLS AND COLLEGES, STUDENTS AND PARENTS, IN CLASS 36 (U.S. CLS. 100, 101 AND 102).

FIRST USE 6-1-1999; IN COMMERCE 6-1-1999.

THE MARK CONSISTS OF STANDARD CHARACTERS WITHOUT CLAIM TO ANY PARTICULAR FONT, STYLE, SIZE, OR COLOR.

OWNER OF U.S. REG. NO. 2,490,411.

NO CLAIM IS MADE TO THE EXCLUSIVE RIGHT TO USE "E", APART FROM THE MARK AS SHOWN.

SER. NO. 77-326,514, FILED 11-10-2007.

NAPOLEON SHARMA, EXAMINING ATTORNEY

**Int. Cl.: 9**

**Prior U.S. Cls.: 21, 23, 26, 36 and 38**

**United States Patent and Trademark Office**

**Reg. No. 3,466,618**

**Registered July 15, 2008**

**TRADEMARK  
PRINCIPAL REGISTER**

**FlipSide**

ELECTRIC POCKET LTD (UNITED KINGDOM  
LTD LIAB CO)  
ALPHA, LOWERLEIGH RD  
PONTNEWYNYDD, UNITED KINGDOM NP84LG

THE MARK CONSISTS OF STANDARD CHAR-  
ACTERS WITHOUT CLAIM TO ANY PARTICULAR  
FONT, STYLE, SIZE, OR COLOR.

FOR: COMPUTER SOFTWARE FOR PROCES-  
SING DIGITAL MUSIC FILES, IN CLASS 9 (U.S.  
CLS. 21, 23, 26, 36 AND 38).

SER. NO. 77-326,529, FILED 11-10-2007.

FIRST USE 10-4-2007; IN COMMERCE 11-9-2007.

MICHAEL SOUDERS, EXAMINING ATTORNEY

**Int. Cls.: 9 and 11**

**Prior U.S. Cls.: 13, 21, 23, 26, 31, 34, 36 and 38**

**United States Patent and Trademark Office**

**Reg. No. 3,466,619**

**Registered July 15, 2008**

**TRADEMARK  
PRINCIPAL REGISTER**

# Luxxor

GRADIENT LENS CORPORATION (NEW YORK CORPORATION)  
207 TREMONT STREET  
ROCHESTER, NY 14608

FOR: LIGHTS FOR BORESCOPES, MICROSCOPES, VIDEO INSPECTION VIDEO CAMERAS, VIDEO INSPECTION VIDEOSCOPIES, AND VIDEO INSPECTION MICROSCOPES; LIGHT GUIDES FOR BORESCOPES, MICROSCOPES, VIDEO INSPECTION VIDEO CAMERAS, VIDEO INSPECTION VIDEOSCOPIES, AND VIDEO INSPECTION MICROSCOPES; VIDEO COUPLER LENSES FOR BORESCOPES, MICROSCOPES, VIDEO INSPECTION VIDEO CAMERAS, VIDEO INSPECTION VIDEOSCOPIES, AND VIDEO INSPECTION MICROSCOPES; DIGITAL CAMERA COUPLERS FOR BORESCOPES, MICROSCOPES, VIDEO INSPECTION VIDEO CAMERAS, VIDEO INSPECTION VIDEOSCOPIES, AND VIDEO INSPECTION MICROSCOPES; BATTERY PACKS FOR BORESCOPE, MICROSCOPE, AND VIDEO INSPECTION LIGHTING; BATTERY PACKS FOR BORESCOPE, MICRO-

SCOPE, AND VIDEO INSPECTION VIDEO SYSTEMS; AND VIDEO CAMERAS FOR BORESCOPES, MICROSCOPES, VIDEO INSPECTION VIDEOSCOPIES, AND VIDEO INSPECTION MICROSCOPES, IN CLASS 9 (U.S. CLS. 21, 23, 26, 36 AND 38).

FIRST USE 7-28-1999; IN COMMERCE 7-28-1999.

FOR: LIGHTS, NAMELY, ARC LAMPS FOR USE IN VIDEO INSPECTION, IN CLASS 11 (U.S. CLS. 13, 21, 23, 31 AND 34).

FIRST USE 7-28-1999; IN COMMERCE 7-28-1999.

THE MARK CONSISTS OF STANDARD CHARACTERS WITHOUT CLAIM TO ANY PARTICULAR FONT, STYLE, SIZE, OR COLOR.

SER. NO. 77-326,538, FILED 11-10-2007.

JENNIFER MARTIN, EXAMINING ATTORNEY



Int. Cl.: 41

Prior U.S. Cls.: 100, 101 and 107

United States Patent and Trademark Office

Reg. No. 3,466,620

Registered July 15, 2008

SERVICE MARK  
PRINCIPAL REGISTER



TORIBIO, JULIO R. (UNITED STATES INDIVIDUAL)  
636 LIGHTHOUSE AVENUE  
MONTEREY, CA 93940

FOR: MARTIAL ARTS INSTRUCTION, IN CLASS 41 (U.S. CLS. 100, 101 AND 107).

FIRST USE 6-1-1993; IN COMMERCE 6-1-1993.

NO CLAIM IS MADE TO THE EXCLUSIVE RIGHT TO USE "SEIBUKAN JUJUTSU", APART FROM THE MARK AS SHOWN.

THE COLOR(S) PURPLE, GOLD, GREEN, RED, BROWN, BLACK AND WHITE IS/ARE CLAIMED AS A FEATURE OF THE MARK.

THE MARK CONSISTS OF A WHITE CIRCLE APPEARS IN THE CENTER OF THE MARK. FOUR BLACK DIAMOND SHAPES APPEAR IN THE CENTER OF THE WHITE CIRCLE WITH THE COLOR WHITE APPEARING AS SMALLER DIAMOND SHAPES IN THE CENTER OF THE FOUR BLACK DIAMOND SHAPES. A BROWN CIRCLE OUTLINES THE WHITE CIRCLE. A GREEN TRIANGLE SURROUNDS THE WHITE CIRCLE. THE COLOR BROWN APPEARS IN THE GREEN TRIANGLE AS

OUTLINING THREE GREEN TRIANGLES ON EACH OF THE THREE CORNERS OF THE GREEN TRIANGLE. A WHITE CIRCLE SURROUNDS THE GREEN TRIANGLE. A RED CIRCLE SURROUNDS THE WHITE CIRCLE. ANOTHER WHITE CIRCLE SURROUNDS THE RED CIRCULAR LINE. A PURPLE CIRCLE SURROUNDS THE IMMEDIATELY REFERENCED WHITE CIRCLE, THE GREEN TRIANGLE AND THE REMAINING ELEMENTS. THE COLOR GOLD APPEARS ON THE PURPLE CIRCLE IN THE FORM OF TEXT "SEIBUKAN JUJUTSU" AND JAPANESE CHARACTERS. A GOLD DOT APPEARS BEFORE THE WORDS "SEIBUKAN JUJUTSU" AND AFTER.

THE FOREIGN WORDING IN THE MARK TRANSLATES INTO ENGLISH AS "HOUSE OF CORRECT MARTIAL ART".

THE NON-LATIN CHARACTERS IN THE MARK TRANSLITERATE INTO "SEI" "BU" "CAN" "JU" "JUTSU" WHICH MEANS "HOUSE OF CORRECT MARTIAL ARTS FLEXIBLE ARTS" IN ENGLISH.

SER. NO. 77-326,557, FILED 11-10-2007.

BILL DAWE, EXAMINING ATTORNEY

**Int. Cl.: 28**

**Prior U.S. Cls.: 22, 23, 38 and 50**

**United States Patent and Trademark Office**

**Reg. No. 3,466,621**

**Registered July 15, 2008**

**TRADEMARK  
PRINCIPAL REGISTER**

# Bustin Boards

BUSTIN BOARDS LLC (NEW JERSEY LTD LIAB  
CO)  
721 GRAND STREET, UNIT 2L  
HOBOKEN, NJ 07030

FOR: SKATEBOARDS; BAGS FOR SKATE-  
BOARDS; BALL BEARINGS FOR SKATEBOARDS;  
NUTS AND BOLTS FOR SKATEBOARDS; SKATE-  
BOARD DECKS; SKATEBOARD GRIP TAPES; SKA-  
TEBOARD RAILS; SKATEBOARD RISER PADS;  
SKATEBOARD TRUCKS; SKATEBOARD WHEELS,  
IN CLASS 28 (U.S. CLS. 22, 23, 38 AND 50).

FIRST USE 8-1-2001; IN COMMERCE 9-1-2001.

THE MARK CONSISTS OF STANDARD CHAR-  
ACTERS WITHOUT CLAIM TO ANY PARTICULAR  
FONT, STYLE, SIZE, OR COLOR.

NO CLAIM IS MADE TO THE EXCLUSIVE  
RIGHT TO USE "BOARDS", APART FROM THE  
MARK AS SHOWN.

SER. NO. 77-326,560, FILED 11-10-2007.

GEORGE LORENZO, EXAMINING ATTORNEY

Int. Cl.: 30

Prior U.S. Cl.: 46

United States Patent and Trademark Office

Reg. No. 3,466,622

Registered July 15, 2008

TRADEMARK  
PRINCIPAL REGISTER



TRISTARS INDUSTRIAS SA DE CV (MEXICO CORPORATION)  
SENDERO SAN JERÓNIMO  
PIERRE LOTI NO. 110  
MONTERREY, MEXICO 64630

FOR: FLAVOURINGS FOR SOUPS; PROCESSED HERBS; SEASONINGS; VEGETABLE CONCENTRATES USED FOR SEASONING; BAKING SPICES, IN CLASS 30 (U.S. CL. 46).

FIRST USE 5-1-2006; IN COMMERCE 5-1-2006.

NO CLAIM IS MADE TO THE EXCLUSIVE RIGHT TO USE "MOJO CRIOLLO", APART FROM THE MARK AS SHOWN.

THE MARK CONSISTS OF THE WORDS "MOJO CRIOLLO DON FIDEL" IN STYLIZED LETTERS, THE WORDS "DON FIDEL" APPEARING IN MUCH BIGGER SIZED LETTERS, NEXT TO THE FACE OF A SMILING CHEF WITH A LONG MUSTACHE.

THE FOREIGN WORDING IN THE MARK TRANSLATES INTO ENGLISH AS "CREOLE SEASONINGS MR. FIDEL".

SER. NO. 77-326,592, FILED 11-10-2007.

AISHA CLARKE, EXAMINING ATTORNEY

**Int. Cl.: 41**

**Prior U.S. Cls.: 100, 101 and 107**

**United States Patent and Trademark Office**

**Reg. No. 3,466,623**

**Registered July 15, 2008**

**SERVICE MARK  
PRINCIPAL REGISTER**

# Trax2

LAM, WILLIAM (AUSTRALIA INDIVIDUAL)  
32 PINE ST  
SURREY HILLS, AUSTRALIA 3127

FOR: MULTIMEDIA PUBLISHING OF BOOKS, MAGAZINES, JOURNALS, SOFTWARE, GAMES, MUSIC, AND ELECTRONIC PUBLICATIONS; NEWSPAPER PUBLICATION; ON-LINE PUBLICATION OF BOOKS AND MAPS; PROVIDING ON-LINE PUBLICATIONS IN THE NATURE OF BOOKS AND MAPS IN THE FIELD OF TRAVEL; PUBLICATION AND EDITING OF PRINTED MATTER; PUBLICATION OF BOOKS; PUBLICATION OF BOOKS, MAGAZINES, ALMANACS AND JOURNALS; PUBLICATION OF BOOKS, OF MAGAZINES, OF JOURNALS, OF NEWSPAPERS, OF PERIODICALS, OF CATALOGS, OF BROCHURES; PUBLICATION OF BOOKS, REVIEWS; PUBLICATION OF BROCHURES; PUBLICATION OF ELECTRONIC MAGAZINES; PUBLICATION OF ELECTRONIC NEWSPAPERS ACCESSIBLE VIA A GLOBAL COMPUTER NETWORK; PUBLICATION OF JOURNALS; PUBLICATION OF LEAFLETS; PUBLICATION OF MAGAZINES; PUBLICATION OF MANUALS; PUBLICATION OF MUSICAL TEXTS; PUBLICATION OF PERIODICALS; PUBLICATION OF PRINTED MATTER; PUBLICATION OF TEXT BOOKS; PUBLICATION OF TEXTS, BOOKS, JOURNALS;

PUBLICATION OF TEXTS, BOOKS, MAGAZINES AND OTHER PRINTED MATTER; PUBLICATION OF THE EDITORIAL CONTENT OF SITES ACCESSIBLE VIA A GLOBAL COMPUTER NETWORK; PUBLICATION OF MAPS AND TRAVEL BOOKS; PUBLISHING OF ELECTRONIC PUBLICATIONS; EDUCATION COURSES RELATING TO THE TRAVEL INDUSTRY; BOOK AND REVIEW PUBLISHING; DESKTOP PUBLISHING FOR OTHERS; DIGITAL VIDEO, AUDIO, AND MULTIMEDIA PUBLISHING SERVICES; MAGAZINE PUBLISHING; MUSIC PUBLISHING SERVICES; NEWSPAPER PUBLISHING; ONLINE ELECTRONIC PUBLISHING OF BOOKS AND PERIODICALS; PUBLISHING OF BOOKS AND REVIEWS; PUBLISHING OF BOOKS, MAGAZINES; PUBLISHING OF REVIEWS; PUBLISHING OF WEB MAGAZINES, IN CLASS 41 (U.S. CLS. 100, 101 AND 107).

FIRST USE 1-1-2001; IN COMMERCE 1-1-2004.

THE MARK CONSISTS OF STANDARD CHARACTERS WITHOUT CLAIM TO ANY PARTICULAR FONT, STYLE, SIZE, OR COLOR.

SER. NO. 77-326,617, FILED 11-10-2007.

MORGAN WYNNE, EXAMINING ATTORNEY

**Int. Cl.: 41**

**Prior U.S. Cls.: 100, 101 and 107**

**United States Patent and Trademark Office**

**Reg. No. 3,466,624**

**Registered July 15, 2008**

---

**SERVICE MARK  
PRINCIPAL REGISTER**

# Atomic Playground

HILL, JERRE A. (UNITED STATES INDIVIDUAL)  
803 W BLUE SPRINGS AVE  
ORANGE CITY, FL 32763

THE MARK CONSISTS OF STANDARD CHAR-  
ACTERS WITHOUT CLAIM TO ANY PARTICULAR  
FONT, STYLE, SIZE, OR COLOR.

FOR: ENTERTAINMENT, NAMELY, LIVE PER-  
FORMANCES BY ROCK GROUPS, IN CLASS 41  
(U.S. CLS. 100, 101 AND 107).

SER. NO. 77-326,661, FILED 11-11-2007.

FIRST USE 8-31-2006; IN COMMERCE 11-1-2007.

B. PARADEWELAI, EXAMINING ATTORNEY

**Int. Cl.: 35**

**Prior U.S. Cls.: 100, 101 and 102**

**United States Patent and Trademark Office**

**Reg. No. 3,466,625**

**Registered July 15, 2008**

---

**SERVICE MARK  
PRINCIPAL REGISTER**

**JONESBEACH.COM**

MICHAEL J. DEFINA (NEW YORK SOLE PROPRIETORSHIP)  
21 INDIANA STREET  
HICKSVILLE, NY 118012526

FOR: ADVERTISING AND COMMERCIAL INFORMATION SERVICES, VIA THE INTERNET, IN CLASS 35 (U.S. CLS. 100, 101 AND 102).

FIRST USE 4-1-1999; IN COMMERCE 4-1-1999.

THE MARK CONSISTS OF STANDARD CHARACTERS WITHOUT CLAIM TO ANY PARTICULAR FONT, STYLE, SIZE, OR COLOR.

OWNER OF U.S. REG. NO. 2,486,368.

SEC. 2(F).

SER. NO. 77-326,745, FILED 11-11-2007.

DAVID ELTON, EXAMINING ATTORNEY

**Int. Cls.: 9, 10 and 21**

**Prior U.S. Cls.: 2, 13, 21, 23, 26, 29, 30, 33, 36, 38, 39,  
40, 44 and 50**

**Reg. No. 3,466,626**

**United States Patent and Trademark Office**

**Registered July 15, 2008**

**TRADEMARK  
PRINCIPAL REGISTER**

**NITRILE-PERFECT**

PREVENTIVE CARE, INC. (MINNESOTA CORPORATION)  
15215 BOULDER TRAIL  
ROSEMOUNT, MN 55068

FOR: DISPOSABLE SYNTHETIC PROTECTIVE WORK GLOVES FOR SCIENTIFIC LABORATORY, INDUSTRIAL, AND AGRICULTURAL USE, IN CLASS 9 (U.S. CLS. 21, 23, 26, 36 AND 38).

FIRST USE 5-1-1999; IN COMMERCE 5-1-1999.

FOR: DISPOSABLE SYNTHETIC GLOVES FOR MEDICAL, DENTAL, AND VETERINARY USE, IN CLASS 10 (U.S. CLS. 26, 39 AND 44).

FIRST USE 5-1-1999; IN COMMERCE 5-1-1999.

FOR: DISPOSABLE SYNTHETIC GLOVES FOR USE IN CLEANING AND GENERAL USE AND THE FOOD SERVICE INDUSTRY, IN CLASS 21 (U.S. CLS. 2, 13, 23, 29, 30, 33, 40 AND 50).

FIRST USE 5-1-1999; IN COMMERCE 5-1-1999.

THE MARK CONSISTS OF STANDARD CHARACTERS WITHOUT CLAIM TO ANY PARTICULAR FONT, STYLE, SIZE, OR COLOR.

OWNER OF U.S. REG. NO. 2,506,272.

SER. NO. 77-326,927, FILED 11-12-2007.

JOHN HWANG, EXAMINING ATTORNEY

**Int. Cl.: 42**

**Prior U.S. Cls.: 100 and 101**

**United States Patent and Trademark Office**

**Reg. No. 3,466,627**

**Registered July 15, 2008**

**SERVICE MARK  
PRINCIPAL REGISTER**

**We Manage Your Servers.  
You Manage Your Business.**

INETU MANAGED HOSTING (PENNSYLVANIA CORPORATION)  
744 ROBLE RD SUITE 70  
ALLENTOWN, PA 18109

FOR: APPLICATION SERVICE PROVIDER (ASP), NAMELY, HOSTING COMPUTER SOFTWARE APPLICATIONS OF OTHERS; APPLICATION SERVICE PROVIDER, NAMELY, PROVIDING, HOSTING, MANAGING, DEVELOPING, AND MAINTAINING APPLICATIONS, SOFTWARE, WEBSITES, AND DATABASES IN THE FIELDS OF PERSONAL PRODUCTIVITY, WIRELESS COMMUNICATION, MOBILE INFORMATION ACCESS, AND REMOTE DATA MANAGEMENT FOR WIRELESS DELIVERY OF CONTENT TO HANDHELD COMPUTERS, LAPTOPS AND MOBILE ELECTRONIC DEVICES; COMPUTER SERVICE, ACTING AS AN APPLICATION SERVICE PROVIDER IN THE FIELD OF KNOWLEDGE MANAGEMENT TO HOST COMPUTER APPLICATION SOFTWARE FOR CREATING SEARCHABLE DATABASES OF INFORMATION AND DATA TO ALLOW USERS TO PERFORM, ON-LINE, THE COLLECTING AND ANALYZING OF DIFFERENT TYPES OF OPINION SURVEYS; COMPUTER SERVICE, NAMELY, ACTING AS AN APPLICATION SERVICE PROVIDER IN THE FIELD OF KNOWLEDGE MANAGEMENT TO HOST COMPUTER APPLICATION SOFTWARE FOR CREATING SEARCHABLE DATABASES OF INFORMATION AND DATA; COMPUTER SERVICE, NAMELY, ACTING AS AN APPLICATION SERVICE PROVIDER IN THE FIELD OF KNOWLEDGE MANAGEMENT TO HOST COMPUTER APPLICATION SOFTWARE FOR SEARCHING AND RETRIEVING INFORMATION FROM DATABASES AND COMPUTER NETWORKS; COMPUTER SERVICE, NAMELY, ACTING AS AN APPLICATION SERVICE PROVIDER IN THE FIELD OF KNOWLEDGE

MANAGEMENT TO HOST COMPUTER APPLICATION SOFTWARE FOR THE COLLECTION, EDITING, ORGANIZING, MODIFYING, BOOK MARKING, TRANSMISSION, STORAGE AND SHARING OF DATA AND INFORMATION; COMPUTER SERVICES, NAMELY, HOSTING ON-LINE INTERACTIVE PUBLIC CALENDARS THAT ALLOW MULTIPLE PARTICIPANTS TO SHARE EVENT SCHEDULES, FACILITY RESERVATIONS, AND TRANSPORTATION REQUESTS; COMPUTER SERVICES, NAMELY, HOSTING ON-LINE WEB FACILITIES FOR OTHERS FOR ORGANIZING AND CONDUCTING ONLINE MEETINGS, GATHERINGS, AND INTERACTIVE DISCUSSIONS; DESIGN, CREATION, HOSTING AND MAINTENANCE OF INTERNET SITES FOR THIRD PARTIES; DESIGN, CREATION, HOSTING, MAINTENANCE OF WEBSITES FOR OTHERS; HOSTING OF DIGITAL CONTENT ON THE INTERNET; HOSTING THE DIGITAL AUDIO AND VIDEO CONTENT OF OTHERS FOR THE PURPOSE OF ENABLING HOTEL, INN, AND OTHER LODGING ESTABLISHMENT GUESTS TO DOWNLOAD THE CONTENT ON A PAY PER VIEW BASIS; HOSTING THE WEB SITES OF OTHERS ON A COMPUTER SERVER FOR A GLOBAL COMPUTER NETWORK; WEB SITE HOSTING SERVICES, IN CLASS 42 (U.S. CLS. 100 AND 101).

FIRST USE 4-1-2007; IN COMMERCE 4-1-2007.

THE MARK CONSISTS OF STANDARD CHARACTERS WITHOUT CLAIM TO ANY PARTICULAR FONT, STYLE, SIZE, OR COLOR.

SER. NO. 77-326,948, FILED 11-12-2007.

DAVID TAYLOR, EXAMINING ATTORNEY



Int. Cl.: 42

Prior U.S. Cls.: 100 and 101

United States Patent and Trademark Office

Reg. No. 3,466,628

Registered July 15, 2008

SERVICE MARK  
PRINCIPAL REGISTER

# Server Smarts

INETU MANAGED HOSTING (PENNSYLVANIA CORPORATION)  
744 ROBLE RD SUITE 70  
ALLENTOWN, PA 18109

FOR: APPLICATION SERVICE PROVIDER (ASP), NAMELY, HOSTING COMPUTER SOFTWARE APPLICATIONS OF OTHERS; APPLICATION SERVICE PROVIDER, NAMELY, PROVIDING, HOSTING, MANAGING, DEVELOPING, AND MAINTAINING APPLICATIONS, SOFTWARE, WEBSITES, AND DATABASES IN THE FIELDS OF PERSONAL PRODUCTIVITY, WIRELESS COMMUNICATION, MOBILE INFORMATION ACCESS, AND REMOTE DATA MANAGEMENT FOR WIRELESS DELIVERY OF CONTENT TO HANDHELD COMPUTERS, LAPTOPS AND MOBILE ELECTRONIC DEVICES; COMPUTER SERVICE, ACTING AS AN APPLICATION SERVICE PROVIDER IN THE FIELD OF KNOWLEDGE MANAGEMENT TO HOST COMPUTER APPLICATION SOFTWARE FOR CREATING SEARCHABLE DATABASES OF INFORMATION AND DATA TO ALLOW USERS TO PERFORM, ON-LINE, THE COLLECTING AND ANALYZING OF DIFFERENT TYPES OF OPINION SURVEYS; COMPUTER SERVICE, NAMELY, ACTING AS AN APPLICATION SERVICE PROVIDER IN THE FIELD OF KNOWLEDGE MANAGEMENT TO HOST COMPUTER APPLICATION SOFTWARE FOR CREATING SEARCHABLE DATABASES OF INFORMATION AND DATA; COMPUTER SERVICE, NAMELY, ACTING AS AN APPLICATION SERVICE PROVIDER IN THE FIELD OF KNOWLEDGE MANAGEMENT TO HOST COMPUTER APPLICATION SOFTWARE FOR SEARCHING AND RETRIEVING INFORMATION FROM DATABASES AND COMPUTER NETWORKS; COMPUTER SERVICE, NAMELY, ACTING AS AN APPLICATION SERVICE PROVIDER IN THE FIELD OF KNOWLEDGE MANAGEMENT TO HOST COMPUTER APPLICATION SOFTWARE FOR THE COLLECTION,

EDITING, ORGANIZING, MODIFYING, BOOK MARKING, TRANSMISSION, STORAGE AND SHARING OF DATA AND INFORMATION; COMPUTER SERVICES, NAMELY, HOSTING ON-LINE INTERACTIVE PUBLIC CALENDARS THAT ALLOW MULTIPLE PARTICIPANTS TO SHARE EVENT SCHEDULES, FACILITY RESERVATIONS, AND TRANSPORTATION REQUESTS; COMPUTER SERVICES, NAMELY, HOSTING ON-LINE WEB FACILITIES FOR OTHERS FOR ORGANIZING AND CONDUCTING ONLINE MEETINGS, GATHERINGS, AND INTERACTIVE DISCUSSIONS; DESIGN, CREATION, HOSTING AND MAINTENANCE OF INTERNET SITES FOR THIRD PARTIES; DESIGN, CREATION, HOSTING, MAINTENANCE OF WEBSITES FOR OTHERS; HOSTING OF DIGITAL CONTENT ON THE INTERNET; HOSTING THE DIGITAL AUDIO AND VIDEO CONTENT OF OTHERS FOR THE PURPOSE OF ENABLING HOTEL, INN, AND OTHER LODGING ESTABLISHMENT GUESTS TO DOWNLOAD THE CONTENT ON A PAY PER VIEW BASIS; HOSTING THE WEB SITES OF OTHERS ON A COMPUTER SERVER FOR A GLOBAL COMPUTER NETWORK; WEB SITE HOSTING SERVICES, IN CLASS 42 (U.S. CLS. 100 AND 101).

FIRST USE 11-12-2007; IN COMMERCE 11-12-2007.

THE MARK CONSISTS OF STANDARD CHARACTERS WITHOUT CLAIM TO ANY PARTICULAR FONT, STYLE, SIZE, OR COLOR.

NO CLAIM IS MADE TO THE EXCLUSIVE RIGHT TO USE "SERVER", APART FROM THE MARK AS SHOWN.

SER. NO. 77-326,964, FILED 11-12-2007.

DAVID TAYLOR, EXAMINING ATTORNEY

**Int. Cl.: 35**

**Prior U.S. Cls.: 100, 101 and 102**

**United States Patent and Trademark Office**

**Reg. No. 3,466,629**

**Registered July 15, 2008**

**SERVICE MARK  
PRINCIPAL REGISTER**

**Zen Master of Exercise,  
Health and Fitness**

FUREY, MATT (UNITED STATES INDIVIDUAL)  
10339 BIRDWATCH DRIVE  
TAMPA, FL 33647

FOR: ON-LINE RETAIL STORE SERVICES FEATURING EDUCATIONAL MATERIALS, WORKBOOKS, PRINTED LITERATURE, DVDS, CDS AND VIDEOS ALL IN THE FIELD OF MARKETING, HEALTH, WELLNESS, FITNESS AND MAKING MONEY ON THE INTERNET; BUSINESS INFORMATION IN THE FIELD OF MARKETING, HEALTH, WELLNESS, FITNESS AND MAKING MONEY ON THE INTERNET; PROVIDING INFORMATION ABOUT THE GOODS AND SERVICES OF OTHERS VIA THE GLOBAL COMPUTER NETWORK; PROVIDING ON-LINE DIRECTORY INFORMATION SERVICES ALSO FEATURING

HYPERLINKS TO OTHER WEB SITES, IN CLASS 35 (U.S. CLS. 100, 101 AND 102).

FIRST USE 10-0-2007; IN COMMERCE 10-0-2007.

THE MARK CONSISTS OF STANDARD CHARACTERS WITHOUT CLAIM TO ANY PARTICULAR FONT, STYLE, SIZE, OR COLOR.

OWNER OF U.S. REG. NO. 3,148,734.

NO CLAIM IS MADE TO THE EXCLUSIVE RIGHT TO USE "EXERCISE, HEALTH AND FITNESS", APART FROM THE MARK AS SHOWN.

SER. NO. 77-326,975, FILED 11-12-2007.

LINDA M. KING, EXAMINING ATTORNEY

**Int. Cl.: 37**

**Prior U.S. Cls.: 100, 103 and 106**

**United States Patent and Trademark Office**

**Reg. No. 3,466,630**

**Registered July 15, 2008**

**SERVICE MARK  
PRINCIPAL REGISTER**

**Art-Faux Design & Painting  
Inc.**

ART-FAUX DESIGN & PAINTING INC. (FLOR-  
IDA CORPORATION)

2965 WOODSIDE AVE.

NAPLES, FL 34112

FOR: DECORATIVE PAINTING SERVICES, IN  
CLASS 37 (U.S. CLS. 100, 103 AND 106).

FIRST USE 5-1-2002; IN COMMERCE 5-1-2002.

THE MARK CONSISTS OF STANDARD CHAR-  
ACTERS WITHOUT CLAIM TO ANY PARTICULAR  
FONT, STYLE, SIZE, OR COLOR.

NO CLAIM IS MADE TO THE EXCLUSIVE  
RIGHT TO USE "DESIGN & PAINTING INC.",  
APART FROM THE MARK AS SHOWN.

SER. NO. 77-326,978, FILED 11-12-2007.

MARY CRAWFORD, EXAMINING ATTORNEY

**Int. Cl.: 43**

**Prior U.S. Cls.: 100 and 101**

**United States Patent and Trademark Office**

**Reg. No. 3,466,631**

**Registered July 15, 2008**

**SERVICE MARK  
PRINCIPAL REGISTER**

**IT'S MEXCELLENT!**

BROWNCROFT ENTERPRISES, INC. (NEW  
YORK CORPORATION)  
70 QUENTIN ROAD  
ROCHESTER, NY 14609

THE MARK CONSISTS OF STANDARD CHAR-  
ACTERS WITHOUT CLAIM TO ANY PARTICULAR  
FONT, STYLE, SIZE, OR COLOR.

FOR: RESTAURANTS, IN CLASS 43 (U.S. CLS. 100  
AND 101).

SER. NO. 77-326,994, FILED 11-12-2007.

FIRST USE 10-9-2007; IN COMMERCE 10-9-2007.

LAURA KOVALSKY, EXAMINING ATTORNEY

**Int. Cls.: 9, 16, 41 and 42**

**Prior U.S. Cls.: 2, 5, 21, 22, 23, 26, 29, 36, 37, 38, 50,  
100, 101 and 107**

**Reg. No. 3,466,632**

**United States Patent and Trademark Office**

**Registered July 15, 2008**

**TRADEMARK  
SERVICE MARK  
PRINCIPAL REGISTER**

**SPINE 3D**

SPINESTUDIOS, INC. (FLORIDA CORPORATION), DBA SPINE3D  
1395 BRICKELL AVENUE, 14TH FLOOR  
C/O FOWLER WHITE BURNETT, P.A. - JHF  
MIAMI, FL 331313302

FOR: PHOTOGRAPHIC AND CINEMATOGRAPHIC RECORDINGS, NAMELY, ANIMATED FILMS ON THE SUBJECT OF ARCHITECTURAL MODELS, PLANS, AND SPECIFICATIONS FOR ALL TYPES OF EDIFICES, INTERIORS AND LANDSCAPING AND ELECTRONIC PHOTOGRAPHS STORED AS DIGITAL MEDIA FILES ON CD AND DVD, IN CLASS 9 (U.S. CLS. 21, 23, 26, 36 AND 38).

FIRST USE 3-1-2000; IN COMMERCE 3-1-2000.

FOR: ARCHITECTURAL MODELS, PLANS AND SPECIFICATIONS FOR ALL TYPES OF EDIFICES, INTERIORS, AND LANDSCAPING, IN CLASS 16 (U.S. CLS. 2, 5, 22, 23, 29, 37, 38 AND 50).

FIRST USE 3-1-2000; IN COMMERCE 3-1-2000.

FOR: ANIMATION PRODUCTION SERVICES, IN CLASS 41 (U.S. CLS. 100, 101 AND 107).

FIRST USE 3-1-2000; IN COMMERCE 3-1-2000.

FOR: ARCHITECTURAL DESIGN SERVICES, NAMELY, CREATING ARCHITECTURAL ANIMATION VISUALIZATIONS, DIGITAL AND 3D MODELS, IMAGES, 3D RENDERINGS, PLANS AND SPECIFICATIONS, IN CLASS 42 (U.S. CLS. 100 AND 101).

FIRST USE 3-1-2000; IN COMMERCE 3-1-2000.

THE MARK CONSISTS OF STANDARD CHARACTERS WITHOUT CLAIM TO ANY PARTICULAR FONT, STYLE, SIZE, OR COLOR.

NO CLAIM IS MADE TO THE EXCLUSIVE RIGHT TO USE "3D", APART FROM THE MARK AS SHOWN.

SER. NO. 77-327,033, FILED 11-12-2007.

MIDGE BUTLER, EXAMINING ATTORNEY

**Int. Cl.: 41**

**Prior U.S. Cls.: 100, 101 and 107**

**United States Patent and Trademark Office**

**Reg. No. 3,466,633**

**Registered July 15, 2008**

**SERVICE MARK  
PRINCIPAL REGISTER**



COHEN, REBECCA RICHMAN (UNITED STATES  
INDIVIDUAL)  
C/O MARVIN COHEN  
807 DAVIS ST. - UNIT 2305  
EVANSTON, IL 60201

OWNER OF U.S. REG. NO. 3,348,345.

FOR: MOTION PICTURE FILM PRODUCTION  
ON THE SUBJECT OF FILMS WHICH COVER  
VARIOUS SUBJECTS, EXCEPT HORSES, IN CLASS  
41 (U.S. CLS. 100, 101 AND 107).

THE MARK CONSISTS OF FOUR SECTIONS OF  
A FILM STRIP. EACH SECTION DEPICTS A DIF-  
FERENT POSE OF A RUNNING HORSE AND  
RIDER WITH A GRIDLINE BACKGROUND.

SER. NO. 77-327,052, FILED 11-12-2007.

FIRST USE 11-5-2007; IN COMMERCE 11-5-2007.

LA TONIA FISHER, EXAMINING ATTORNEY

**Int. Cl.: 45**

**Prior U.S. Cls.: 100 and 101**

**United States Patent and Trademark Office**

**Reg. No. 3,466,634**

**Registered July 15, 2008**

**SERVICE MARK  
PRINCIPAL REGISTER**

**Safe Harbor Eldercare**

CAPE COD ELDERCARE, LLC (MASSACHU-  
SETTS LTD LIAB CO)

#323

775 E. FALMOUTH HIGHWAY  
EAST FALMOUTH, MA 02536

FOR: SOCIAL SERVICES, NAMELY, COMPANIONSHIP FOR THE ELDERLY; ASSISTED LIVING SERVICE FOR PERSONAL PURPOSES, NAMELY, ASSISTANCE IN SORTING AND ORGANIZATION OF MAIL AND MANAGING OF APPOINTMENT CALENDAR; PERSONAL CARE ASSISTANCE OF ACTIVITIES OF DAILY LIVING SUCH AS BATHING, GROOMING AND PERSONAL MOBILITY FOR ELDERLY PEOPLE, IN CLASS 45 (U.S. CLS. 100 AND 101).

FIRST USE 10-31-2007; IN COMMERCE 10-31-2007.

THE MARK CONSISTS OF STANDARD CHARACTERS WITHOUT CLAIM TO ANY PARTICULAR FONT, STYLE, SIZE, OR COLOR.

NO CLAIM IS MADE TO THE EXCLUSIVE RIGHT TO USE "ELDERCARE", APART FROM THE MARK AS SHOWN.

SER. NO. 77-327,161, FILED 11-12-2007.

MELISSA VALLILLO, EXAMINING ATTORNEY

Int. Cl.: 45

Prior U.S. Cls.: 100 and 101

United States Patent and Trademark Office

Reg. No. 3,466,635

Registered July 15, 2008

SERVICE MARK  
PRINCIPAL REGISTER



CAPE COD ELDERCARE, LLC (MASSACHUSETTS LTD LIAB CO)

#323

775 E. FALMOUTH HIGHWAY  
EAST FALMOUTH, MA 02536

FOR: SOCIAL SERVICES, NAMELY, COMPANIONSHIP FOR THE ELDERLY; ASSISTED LIVING SERVICE FOR PERSONAL PURPOSES, NAMELY, ASSISTANCE IN SORTING AND ORGANIZATION OF MAIL AND MANAGING OF APPOINTMENT CALENDAR; PERSONAL CARE ASSISTANCE OF ACTIVITIES OF DAILY LIVING SUCH AS BATHING, GROOMING AND PERSONAL MOBILITY FOR ELDERLY PEOPLE, IN CLASS 45 (U.S. CLS. 100 AND 101).

FIRST USE 10-31-2007; IN COMMERCE 10-31-2007.

NO CLAIM IS MADE TO THE EXCLUSIVE RIGHT TO USE "ELDERCARE", APART FROM THE MARK AS SHOWN.

THE MARK CONSISTS OF A LIGHTHOUSE WITH LIGHT RAYS, THE WORDING "SAFE HARBOR ELDERCARE" AND AN OCEAN WAVE.

SER. NO. 77-327,195, FILED 11-12-2007.

MELISSA VALLILLO, EXAMINING ATTORNEY



**Int. Cl.: 3**

**Prior U.S. Cls.: 1, 4, 6, 50, 51 and 52**

**United States Patent and Trademark Office**

**Reg. No. 3,466,636**

**Registered July 15, 2008**

**TRADEMARK  
PRINCIPAL REGISTER**

**MEDI SCIENCE**

SIXSA SPA, LLC (ILLINOIS LTD LIAB CO)  
3775 W. ARTHUR STREET  
LINCOLNWOOD, IL 60712

THE MARK CONSISTS OF STANDARD CHAR-  
ACTERS WITHOUT CLAIM TO ANY PARTICULAR  
FONT, STYLE, SIZE, OR COLOR.

FOR: ANTI-AGING CREAM; COSMETIC  
CREAMS FOR SKIN CARE, IN CLASS 3 (U.S. CLS.  
1, 4, 6, 50, 51 AND 52).

SER. NO. 77-327,216, FILED 11-12-2007.

FIRST USE 10-1-2007; IN COMMERCE 10-1-2007.

ELIZABETH KAJUBI, EXAMINING ATTORNEY

**Int. Cl.: 35**

**Prior U.S. Cls.: 100, 101 and 102**

**United States Patent and Trademark Office**

**Reg. No. 3,466,637**

**Registered July 15, 2008**

**SERVICE MARK  
PRINCIPAL REGISTER**

**MARKETING-SHERPA**

DIGITAL TRUST, INC. (FLORIDA CORPORATION)  
412 FIRST STREET NORTH  
JACKSONVILLE BEACH, FL 32250

THE MARK CONSISTS OF STANDARD CHARACTERS WITHOUT CLAIM TO ANY PARTICULAR FONT, STYLE, SIZE, OR COLOR.

FOR: MARKET RESEARCH, IN CLASS 35 (U.S. CLS. 100, 101 AND 102).

SER. NO. 77-327,222, FILED 11-12-2007.

FIRST USE 0-0-2000; IN COMMERCE 0-0-2000.

PRISCILLA MILTON, EXAMINING ATTORNEY

**Int. Cl.: 43**

**Prior U.S. Cls.: 100 and 101**

**United States Patent and Trademark Office**

**Reg. No. 3,466,638**

**Registered July 15, 2008**

**SERVICE MARK  
PRINCIPAL REGISTER**

**HAYWOOD PARK**

FIRC MANAGEMENT, INC. (FLORIDA CORPORATION)  
SUITE 302  
2665 SOUTH BAYSHORE DRIVE  
COCONUT GROVE, FL 33133

FOR: HOTEL SERVICES, IN CLASS 43 (U.S. CLS. 100 AND 101).

FIRST USE 0-0-1984; IN COMMERCE 0-0-1984.

THE MARK CONSISTS OF STANDARD CHARACTERS WITHOUT CLAIM TO ANY PARTICULAR FONT, STYLE, SIZE, OR COLOR.

NO CLAIM IS MADE TO THE EXCLUSIVE RIGHT TO USE "PARK", APART FROM THE MARK AS SHOWN.

SER. NO. 77-327,226, FILED 11-12-2007.

SEAN CROWLEY, EXAMINING ATTORNEY

Int. Cl.: 14

Prior U.S. Cls.: 2, 27, 28 and 50

**United States Patent and Trademark Office**

**Reg. No. 3,466,639**

Registered July 15, 2008

**TRADEMARK  
PRINCIPAL REGISTER**

The image shows the word "MOSSIMO" written in a highly stylized, cursive script. The letters are interconnected and have a fluid, handwritten appearance. The 'M' and 'O's are particularly prominent and rounded.

MOSSIMO HOLDINGS, LLC (DELAWARE LTD  
LIAB CO)  
103 FOULK ROAD  
WILMINGTON, DE 19803

FOR: JEWELRY, IN CLASS 14 (U.S. CLS. 2, 27, 28  
AND 50).

FIRST USE 8-13-1996; IN COMMERCE 8-13-1996.

OWNER OF U.S. REG. NOS. 1,551,068 AND  
2,051,272.

THE MARK CONSISTS OF "MOSSIMO" IN A  
STYLIZED SCRIPT.

SER. NO. 77-327,228, FILED 11-12-2007.

STEVEN R. FINE, EXAMINING ATTORNEY

**Int. Cl.: 36**

**Prior U.S. Cls.: 100, 101 and 102**

**United States Patent and Trademark Office**

**Reg. No. 3,466,640**

**Registered July 15, 2008**

**SERVICE MARK  
PRINCIPAL REGISTER**

**HAYWOOD PARK**

FIRC MANAGEMENT, INC. (FLORIDA CORPORATION)  
SUITE 302  
2665 SOUTH BAYSHORE DRIVE  
COCONUT GROVE, FL 33133

FOR: SHOPPING CENTER SERVICES, NAMELY, RENTAL OF SHOPPING CENTER SPACE; AND LEASING OFFICE SPACE, IN CLASS 36 (U.S. CLS. 100, 101 AND 102).

FIRST USE 0-0-1984; IN COMMERCE 0-0-1984.

THE MARK CONSISTS OF STANDARD CHARACTERS WITHOUT CLAIM TO ANY PARTICULAR FONT, STYLE, SIZE, OR COLOR.

NO CLAIM IS MADE TO THE EXCLUSIVE RIGHT TO USE "PARK", APART FROM THE MARK AS SHOWN.

SER. NO. 77-327,256, FILED 11-12-2007.

SEAN CROWLEY, EXAMINING ATTORNEY

**Int. Cl.: 43**

**Prior U.S. Cls.: 100 and 101**

**United States Patent and Trademark Office**

**Reg. No. 3,466,641**

**Registered July 15, 2008**

**SERVICE MARK  
PRINCIPAL REGISTER**

**TATTERED COVER**

TATTERED COVER, INC. (COLORADO CORPORATION)  
1628 16TH STREET  
DENVER, CO 80202

FOR: SERVING OF FOOD AND DRINK/BEVERAGES; COFFEE-HOUSE AND SNACK-BAR SERVICES; TEA ROOMS; PROVIDING OF FOOD AND DRINK, IN CLASS 43 (U.S. CLS. 100 AND 101).

FIRST USE 10-10-1994; IN COMMERCE 10-10-1994.

THE MARK CONSISTS OF STANDARD CHARACTERS WITHOUT CLAIM TO ANY PARTICULAR FONT, STYLE, SIZE, OR COLOR.

OWNER OF U.S. REG. NO. 1,747,525.

SER. NO. 77-327,323, FILED 11-12-2007.

B. PARADEWELAI, EXAMINING ATTORNEY

**Int. Cl.: 9**

**Prior U.S. Cls.: 21, 23, 26, 36 and 38**

**United States Patent and Trademark Office**

**Reg. No. 3,466,642**

**Registered July 15, 2008**

**TRADEMARK  
PRINCIPAL REGISTER**



IMPEX CO. LLC (UTAH LTD LIAB CO)  
1015 SOUTH STATE ST.  
OREM, UT 84606

FOR: MESSENGER BAGS ESPECIALLY ADAP-  
TED FOR HOLDING LAPTOPS; BACKPACKS ESPE-  
CIALLY ADAPTED FOR HOLDING LAPTOPS;  
BACKPACKS ESPECIALLY ADAPTED FOR HOLD-  
ING LAPTOPS AND NOTEBOOK COMPUTERS;  
LAPTOP CARRYING CASES; PROTECTIVE  
SLEEVES FOR LAPTOP COMPUTERS, IN CLASS 9  
(U.S. CLS. 21, 23, 26, 36 AND 38).

FIRST USE 5-26-2006; IN COMMERCE 12-29-2006.

OWNER OF U.S. REG. NO. 3,356,375.

THE MARK CONSISTS OF AN ISIS BIRD.

SER. NO. 77-327,329, FILED 11-12-2007.

MICHAEL KAZAZIAN, EXAMINING ATTORNEY

**Int. Cl.: 41**

**Prior U.S. Cls.: 100, 101 and 107**

**United States Patent and Trademark Office**

**Reg. No. 3,466,643**

**Registered July 15, 2008**

**SERVICE MARK  
PRINCIPAL REGISTER**

**CATALOOCHEE**

PHOENIX SKI CORPORATION (NORTH CAROLINA CORPORATION)  
1080 SKI LODGE ROAD  
MAGGIE VALLEY, NC 28751

FOR: SKI RESORT SERVICES NOT INCLUDING LODGING, IN CLASS 41 (U.S. CLS. 100, 101 AND 107).

FIRST USE 12-0-1961; IN COMMERCE 12-0-1961.

THE MARK CONSISTS OF STANDARD CHARACTERS WITHOUT CLAIM TO ANY PARTICULAR FONT, STYLE, SIZE, OR COLOR.

SEC. 2(F).

SER. NO. 77-327,336, FILED 11-12-2007.

MELVIN AXILBUND, EXAMINING ATTORNEY



**Int. Cl.: 19**

**Prior U.S. Cls.: 1, 12, 33 and 50**

**United States Patent and Trademark Office**

**Reg. No. 3,466,644**

**Registered July 15, 2008**

**TRADEMARK  
PRINCIPAL REGISTER**

**AVIANO**

SAROYAN LUMBER COMPANY, INC. (CALI-  
FORNIA CORPORATION)  
6230 SO. ALAMEDA ST.  
HUNTINGTON PARK, CA 90255

THE MARK CONSISTS OF STANDARD CHAR-  
ACTERS WITHOUT CLAIM TO ANY PARTICULAR  
FONT, STYLE, SIZE, OR COLOR.

FOR: FLOOR BOARDS, WOODEN FLOORING,  
HARDWOOD FLOORING; NON-METAL ARCHI-  
TECTURAL MOULDINGS AND FINISH TRIM, IN  
CLASS 19 (U.S. CLS. 1, 12, 33 AND 50).

SER. NO. 77-327,345, FILED 11-12-2007.

FIRST USE 11-8-2007; IN COMMERCE 11-8-2007.

DEIRDRE ROBERTSON, EXAMINING ATTORNEY

**Int. Cls.: 16 and 41**

**Prior U.S. Cls.: 2, 5, 22, 23, 29, 37, 38, 50, 100, 101 and 107**

**United States Patent and Trademark Office**

**Reg. No. 3,466,645**

**Registered July 15, 2008**

**TRADEMARK  
SERVICE MARK  
PRINCIPAL REGISTER**

**EDITOR & PUBLISHER**

NIELSEN BUSINESS MEDIA, INC. (DELAWARE CORPORATION)  
770 BROADWAY  
NEW YORK, NY 100039595

FOR: PRINTED PERIODICALS IN THE FIELDS OF PRINT AND ONLINE JOURNALISM, IN CLASS 16 (U.S. CLS. 2, 5, 22, 23, 29, 37, 38 AND 50).

FIRST USE 8-17-1918; IN COMMERCE 8-17-1918.

FOR: PROVIDING ON-LINE PUBLICATIONS, NAMELY, PERIODICALS IN THE FIELD OF PRINT AND ON-LINE JOURNALISM, IN CLASS 41 (U.S. CLS. 100, 101 AND 107).

FIRST USE 6-30-1998; IN COMMERCE 6-30-1998.

THE MARK CONSISTS OF STANDARD CHARACTERS WITHOUT CLAIM TO ANY PARTICULAR FONT, STYLE, SIZE, OR COLOR.

OWNER OF U.S. REG. NOS. 234,944, 243,753 AND OTHERS.

SEC. 2(F).

SER. NO. 77-327,352, FILED 11-12-2007.

ANNE E. GUSTASON, EXAMINING ATTORNEY

**Int. Cl.: 35**

**Prior U.S. Cls.: 100, 101 and 102**

**United States Patent and Trademark Office**

**Reg. No. 3,466,646**

**Registered July 15, 2008**

**SERVICE MARK  
PRINCIPAL REGISTER**

**GALLERYWATCH**

GALLERYWATCH.COM, INC. (TEXAS CORPORATION)  
50 F STREET, N.W.  
WASHINGTON, DC 20001

FOR: ONLINE TRACKING OF DOCUMENTS, REPORTS, AND NEWSLETTERS FEATURING NEWS AND INFORMATION REGARDING LEGISLATION, GOVERNMENT AGENCIES, LEGISLATIVE, POLITICAL, AND OTHER GOVERNMENT ACTIVITIES OVER A GLOBAL COMPUTER NETWORK, IN CLASS 35 (U.S. CLS. 100, 101 AND 102).

FIRST USE 5-1-1996; IN COMMERCE 5-1-1996.

THE MARK CONSISTS OF STANDARD CHARACTERS WITHOUT CLAIM TO ANY PARTICULAR FONT, STYLE, SIZE, OR COLOR.

SER. NO. 77-327,384, FILED 11-12-2007.

ALEX KEAM, EXAMINING ATTORNEY

**Int. Cl.: 7**

**Prior U.S. Cls.: 13, 19, 21, 23, 31, 34 and 35**

**United States Patent and Trademark Office**

**Reg. No. 3,466,647**

**Registered July 15, 2008**

**TRADEMARK  
PRINCIPAL REGISTER**

**LPA**

HYSAVE LIMITED (UNITED KINGDOM LTD  
LIAB CO)  
MIDSOMER NORTON  
ENTERPRISE HOUSE, WESTFIELD IND. ESTATE  
BATH BA3 4BH, UNITED KINGDOM

THE MARK CONSISTS OF STANDARD CHAR-  
ACTERS WITHOUT CLAIM TO ANY PARTICULAR  
FONT, STYLE, SIZE, OR COLOR.

FOR: ENERGY EFFICIENT LIQUID REFRIG-  
ERATION PUMPS, IN CLASS 7 (U.S. CLS. 13, 19, 21,  
23, 31, 34 AND 35).

SER. NO. 77-327,385, FILED 11-12-2007.

FIRST USE 1-1-1988; IN COMMERCE 1-1-1988.

ALEX KEAM, EXAMINING ATTORNEY

Int. Cls.: 9, 25 and 28

Prior U.S. Cls.: 21, 22, 23, 26, 36, 38, 39 and 50

United States Patent and Trademark Office

Reg. No. 3,466,648

Registered July 15, 2008

TRADEMARK  
PRINCIPAL REGISTER



MASTERGRIP, INC. (TEXAS CORPORATION)  
3410 CENTURY CIRCLE  
IRVING, TX 75062

FOR: CORRECTIVE GLASSES, SUNGLASSES  
AND SPORT GLASSES, IN CLASS 9 (U.S. CLS. 21,  
23, 26, 36 AND 38).

FIRST USE 4-1-2007; IN COMMERCE 4-1-2007.

FOR: GOLF CLOTHING NAMELY, GOLF  
GLOVES, HATS, SOCKS, SHOES, SWEATERS AND  
SHIRTS, IN CLASS 25 (U.S. CLS. 22 AND 39).

FIRST USE 1-1-2007; IN COMMERCE 1-1-2007.

FOR: GOLF CLUBS; GOLF BALLS; GOLF CLUB  
COMPONENTS, NAMELY, GOLF GRIPS, GOLF  
SHAFTS AND GOLF CLUB HEADS; GOLF BAGS;  
GOLF TEES; AND A GOLF CLUB SWING TRAINER,

NAMELY, A WEIGHTED GOLF CLUB WITH A  
TRAINING GRIP TO ENSURE PROPER HAND  
PLACEMENTT, IN CLASS 28 (U.S. CLS. 22, 23, 38  
AND 50).

FIRST USE 4-1-2007; IN COMMERCE 4-1-2007.

OWNER OF U.S. REG. NO. 2,654,224.

NO CLAIM IS MADE TO THE EXCLUSIVE  
RIGHT TO USE "GOLF", APART FROM THE MARK  
AS SHOWN.

THE MARK CONSISTS OF LOWERCASE LET-  
TERS "MG" INSIDE CIRCLE WITH WORD "GOLF"  
BELOW..

SER. NO. 77-327,389, FILED 11-12-2007.

MICHAEL KEATING, EXAMINING ATTORNEY

**Int. Cl.: 37**

**Prior U.S. Cls.: 100, 103 and 106**

**United States Patent and Trademark Office**

**Reg. No. 3,466,649**

**Registered July 15, 2008**

**SERVICE MARK  
PRINCIPAL REGISTER**



WALL EXPRESSIONS, INC. (GEORGIA CORPORATION)

# 215

9876 MAIN ST.  
WOODSTOCK, GA 30188

FOR: PAINTING IN THE FIELD OF FAUX FINISHES AND MURALS ON PAINTABLE SURFACES FOR HOMES OR OFFICES, IN CLASS 37 (U.S. CLS. 100, 103 AND 106).

FIRST USE 9-0-2006; IN COMMERCE 10-0-2006.

THE MARK CONSISTS IN PART OF THE HIGHLY STYLIZED LETTERS "WE".

SER. NO. 77-327,432, FILED 11-12-2007.

STEVEN R. FOSTER, EXAMINING ATTORNEY

**Int. Cls.: 29, 30, 35 and 43**

**Prior U.S. Cls.: 46, 100, 101 and 102**

**United States Patent and Trademark Office**

**Reg. No. 3,466,650**

**Registered July 15, 2008**

**TRADEMARK  
SERVICE MARK  
PRINCIPAL REGISTER**



KOSHER VENDING INDUSTRIES, LLC (NEW YORK LTD LIAB CO)  
711 EXECUTIVE BLVD., SUITE B  
VALLEY COTTAGE, NY 10989

FOR: ONION RINGS, VEGETABLE CUTLETS, MOZZARELLA STICKS, IN CLASS 29 (U.S. CL. 46).

FIRST USE 2-0-2007; IN COMMERCE 2-0-2007.

FOR: HOT DOG SANDWICHES, KNISHES AND PIZZA, IN CLASS 30 (U.S. CL. 46).

FIRST USE 2-0-2007; IN COMMERCE 2-0-2007.

FOR: VENDING MACHINE SERVICES IN THE NATURE OF FOOD PRODUCTS, IN CLASS 35 (U.S. CLS. 100, 101 AND 102).

FIRST USE 2-0-2007; IN COMMERCE 2-0-2007.

FOR: FOOD PREPARATION; CONTRACT FOOD SERVICES, NAMELY, PROVIDING FOODS FOR OTHERS TO BE SOLD IN VENDING MACHINES, IN CLASS 43 (U.S. CLS. 100 AND 101).

FIRST USE 2-0-2007; IN COMMERCE 2-0-2007.

NO CLAIM IS MADE TO THE EXCLUSIVE RIGHT TO USE "HOT NOSH", APART FROM THE MARK AS SHOWN.

THE MARK CONSISTS OF A SEMICIRCLE SURROUND CONTAINING THE TEXT "HOT NOSH 24/6" AND THE TERM "HOT" CONTAINS FLAMES.

SER. NO. 77-327,539, FILED 11-12-2007.

CURTIS FRENCH, EXAMINING ATTORNEY

**Int. Cl.: 19**

**Prior U.S. Cls.: 1, 12, 33 and 50**

**United States Patent and Trademark Office**

**Reg. No. 3,466,651**

**Registered July 15, 2008**

**TRADEMARK  
PRINCIPAL REGISTER**

**Palassé**

SAROYAN LUMBER COMPANY, INC. (CALI-  
FORNIA CORPORATION)  
6230 SO. ALAMEDA ST.  
HUNTINGTON PARK, CA 90255

THE MARK CONSISTS OF STANDARD CHAR-  
ACTERS WITHOUT CLAIM TO ANY PARTICULAR  
FONT, STYLE, SIZE, OR COLOR.

FOR: FLOOR BOARDS, WOODEN FLOORING,  
HARDWOOD FLOORING; NON-METAL ARCHI-  
TECTURAL MOULDINGS AND FINISH TRIM, IN  
CLASS 19 (U.S. CLS. 1, 12, 33 AND 50).

SER. NO. 77-327,579, FILED 11-12-2007.

FIRST USE 4-18-2006; IN COMMERCE 4-18-2006.

JEAN IM, EXAMINING ATTORNEY



**Int. Cl.: 19**

**Prior U.S. Cls.: 1, 12, 33 and 50**

**United States Patent and Trademark Office**

**Reg. No. 3,466,652**

**Registered July 15, 2008**

**TRADEMARK  
PRINCIPAL REGISTER**

**Torino**

SAROYAN LUMBER COMPANY, INC. (CALI-  
FORNIA CORPORATION)  
6230 SO. ALAMEDA ST.  
HUNTINGTON PARK, CA 90255

FOR: FLOOR BOARDS, WOODEN FLOORING,  
HARDWOOD FLOORING; NON-METAL ARCHI-  
TECTURAL MOULDINGS AND FINISH TRIM, IN  
CLASS 19 (U.S. CLS. 1, 12, 33 AND 50).

FIRST USE 4-18-2006; IN COMMERCE 4-18-2006.

THE MARK CONSISTS OF STANDARD CHAR-  
ACTERS WITHOUT CLAIM TO ANY PARTICULAR  
FONT, STYLE, SIZE, OR COLOR.

THE ENGLISH TRANSLATION OF "TORINO" IN  
THE MARK IS TURIN, AN ITALIAN CITY.

SER. NO. 77-327,594, FILED 11-12-2007.

JEAN IM, EXAMINING ATTORNEY

**Int. Cl.: 19**

**Prior U.S. Cls.: 1, 12, 33 and 50**

**United States Patent and Trademark Office**

**Reg. No. 3,466,653**

**Registered July 15, 2008**

**TRADEMARK  
PRINCIPAL REGISTER**

**SAN AGATA**

SAROYAN LUMBER COMPANY, INC. (CALI-  
FORNIA CORPORATION)  
6230 SO. ALAMEDA ST.  
HUNTINGTON PARK, CA 90255

FOR: FLOOR BOARDS, WOODEN FLOORING,  
HARDWOOD FLOORING; NON-METAL ARCHI-  
TECTURAL MOULDINGS AND FINISH TRIM, IN  
CLASS 19 (U.S. CLS. 1, 12, 33 AND 50).

FIRST USE 4-18-2006; IN COMMERCE 4-18-2006.

THE MARK CONSISTS OF STANDARD CHAR-  
ACTERS WITHOUT CLAIM TO ANY PARTICULAR  
FONT, STYLE, SIZE, OR COLOR.

THE WORDING "SAN AGATA" HAS NO MEAN-  
ING IN A FOREIGN LANGUAGE.

SER. NO. 77-327,605, FILED 11-12-2007.

JEAN IM, EXAMINING ATTORNEY

**Int. Cl.: 19**

**Prior U.S. Cls.: 1, 12, 33 and 50**

**United States Patent and Trademark Office**

**Reg. No. 3,466,654**

**Registered July 15, 2008**

**TRADEMARK  
PRINCIPAL REGISTER**

**ROSSA CORSA**

SAROYAN LUMBER COMPANY, INC. (CALIFORNIA CORPORATION)  
6230 SO. ALAMEDA ST.  
HUNTINGTON PARK, CA 90255

FOR: FLOOR BOARDS, WOODEN FLOORING, HARDWOOD FLOORING; NON-METAL ARCHITECTURAL MOULDINGS AND FINISH TRIM, IN CLASS 19 (U.S. CLS. 1, 12, 33 AND 50).

FIRST USE 4-18-2006; IN COMMERCE 4-18-2006.

THE MARK CONSISTS OF STANDARD CHARACTERS WITHOUT CLAIM TO ANY PARTICULAR FONT, STYLE, SIZE, OR COLOR.

THE ENGLISH TRANSLATION OF "ROSSA CORSA" IN THE MARK IS RED RACE.

SER. NO. 77-327,633, FILED 11-12-2007.

JEAN IM, EXAMINING ATTORNEY

**Int. Cl.: 9**

**Prior U.S. Cls.: 21, 23, 26, 36 and 38**

**Reg. No. 3,466,655**

**United States Patent and Trademark Office**

**Registered July 15, 2008**

---

**TRADEMARK  
PRINCIPAL REGISTER**

**3D EVOLUTION**

CT CORE TECHNOLOGIES, INC. (OHIO CORPORATION)  
SUITE 346  
1690 WOODLANDS DRIVE  
MAUMEE, OH 43537

FOR: COMPUTER INTERFACE SOFTWARE FOR ALLOWING COMPUTERS RUNNING DIFFERENT CAD/CAM PROGRAMS TO COMMUNICATE, IN CLASS 9 (U.S. CLS. 21, 23, 26, 36 AND 38).

FIRST USE 8-31-2005; IN COMMERCE 8-31-2005.

THE MARK CONSISTS OF STANDARD CHARACTERS WITHOUT CLAIM TO ANY PARTICULAR FONT, STYLE, SIZE, OR COLOR.

OWNER OF U.S. REG. NO. 3,386,258.

NO CLAIM IS MADE TO THE EXCLUSIVE RIGHT TO USE "3D", APART FROM THE MARK AS SHOWN.

SER. NO. 77-327,643, FILED 11-12-2007.

ALYSSA PALADINO, EXAMINING ATTORNEY

**Int. Cls.: 35 and 44**

**Prior U.S. Cls.: 100, 101 and 102**

**United States Patent and Trademark Office**

**Reg. No. 3,466,656**

**Registered July 15, 2008**

**SERVICE MARK  
PRINCIPAL REGISTER**



**hemalife**

HEMALIFE MEDICAL, LLC (MISSOURI LTD  
LIAB CO)  
2824 WESTRIDGE OAKS COURT  
WILDWOOD, MO 630401129

FOR: DISTRIBUTORSHIP SERVICES IN THE  
FIELD OF MEDICAL PRODUCTS, IN CLASS 35  
(U.S. CLS. 100, 101 AND 102).

FIRST USE 10-14-2006; IN COMMERCE 10-24-2006.

FOR: MEDICAL SERVICES, NAMELY, AUTOLO-  
GOUS BLOOD COMPONENT PROCESSING; MED-  
ICAL SERVICES, NAMELY, COLLECTION OF  
AUTOLOGOUS BLOOD, IN CLASS 44 (U.S. CLS.  
100 AND 101).

FIRST USE 10-14-2006; IN COMMERCE 10-24-2006.

THE MARK CONSISTS OF THE WORD "HEMA-  
LIFE" IN LOWER CASE ARIAL ROUND MT BOLD  
FONT WITH A SHADOW EFFECT. THE ACCOM-  
PANYING LOGO IS TO THE LEFT OF THE WORD  
"HEMALIFE" AND CONSISTS OF FIVE (5) HEXA-  
GONS LOCATED IN CLOSE PROXIMITY WITH  
ONE HEXAGON CENTRALLY LOCATED WITH  
FOUR HEXAGONS BORDERING FOUR INDIVI-  
DUAL SIDES.

SER. NO. 77-327,661, FILED 11-12-2007.

ESTHER A. BORSUK, EXAMINING ATTORNEY

Int. Cl.: 43

Prior U.S. Cls.: 100 and 101

United States Patent and Trademark Office

Reg. No. 3,466,657

Registered July 15, 2008

**SERVICE MARK  
PRINCIPAL REGISTER**



SAFFRON BISTRO, LLC (VIRGINIA LTD LIAB  
CO)  
SUITE 200  
8300 BOONE BLVD.  
VIENNA, VA 22218

FOR: WINE BARS; PROVISION OF FOOD AND  
DRINK IN RESTAURANTS; RESTAURANT AND  
BAR SERVICES; RESTAURANT SERVICES; RES-  
TAURANTS, IN CLASS 43 (U.S. CLS. 100 AND 101).

FIRST USE 6-5-2007; IN COMMERCE 9-2-2007.

THE MARK CONSISTS OF A BUNCH OF GRAPES  
TURNED 45 DEGREES COUNTER-CLOCKWISE ON  
A DIAGONAL. A LEAF APPEARS IN THE TOP LEFT

OF THE IMAGE AND IS ATTACHED TO FULL AND  
PARTIAL CIRCLES REPRESENTING THE SEVEN  
INDIVIDUAL GRAPES. THERE IS VARIATION IN  
THE SIZE OF THE SEVEN GRAPES AS WELL AS  
THE THICKNESS OF THE LINES REPRESENTING  
THE OUTSIDE OF SAID GRAPES. A SMALL SPIR-  
ALED STEM APPEARS TO THE RIGHT OF THE  
LEAF AND ABOVE THE BUNCH OF GRAPES AND  
IS ORIENTED VERTICALLY BUT TRAILS OFF TO  
THE TOP RIGHT .

SER. NO. 77-327,679, FILED 11-12-2007.

PAUL E. FAHRENKOPF, EXAMINING ATTORNEY

**Int. Cl.: 8**

**Prior U.S. Cls.: 23, 28 and 44**

**United States Patent and Trademark Office**

**Reg. No. 3,466,658**

**Registered July 15, 2008**

---

**TRADEMARK  
PRINCIPAL REGISTER**

# Hot Wax Art

RIBA, S D (UNITED STATES INDIVIDUAL)

P O BOX 4517

CLEARWATER, FL 34695

FOR: SPATULAS FOR SPREADING HOT WAX,  
IN CLASS 8 (U.S. CLS. 23, 28 AND 44).

FIRST USE 10-22-2007; IN COMMERCE 10-22-2007.

THE MARK CONSISTS OF STANDARD CHAR-  
ACTERS WITHOUT CLAIM TO ANY PARTICULAR  
FONT, STYLE, SIZE, OR COLOR.

NO CLAIM IS MADE TO THE EXCLUSIVE  
RIGHT TO USE "HOT WAX", APART FROM THE  
MARK AS SHOWN.

SER. NO. 77-327,718, FILED 11-12-2007.

ADA HAN, EXAMINING ATTORNEY

Int. Cl.: 41

Prior U.S. Cls.: 100, 101 and 107

United States Patent and Trademark Office

Reg. No. 3,466,659

Registered July 15, 2008

SERVICE MARK  
PRINCIPAL REGISTER

# Identity Crisis

SUMMERS, JOHN ROBERT (UNITED STATES INDIVIDUAL), DBA SUMATYME  
13818 N. SAGUARO BLVD. #101  
FOUNTAIN HILLS, AZ 85268 AND  
CALBERT, JAMES CARY BYRON EPHRAIM (UNITED STATES INDIVIDUAL), DBA CTX  
13818 N. SAGUARO BLVD. #101  
FOUNTAIN HILLS, AZ 85268

FOR: COMPOSITION OF MUSIC FOR OTHERS; ENTERTAINMENT IN THE NATURE OF VISUAL AND AUDIO PERFORMANCES, AND MUSICAL, VARIETY, NEWS AND COMEDY SHOWS; ENTERTAINMENT IN THE NATURE OF VISUAL AND AUDIO PERFORMANCES, NAMELY, MUSICAL BAND, ROCK GROUP, GYMNASTIC, DANCE, AND BALLET PERFORMANCES; ENTERTAINMENT IN THE NATURE OF MUSICAL GROUP; ENTERTAINMENT, NAMELY, LIVE PERFORMANCES BY A MUSICAL BAND; ENTERTAINMENT SERVICES, NAMELY, AN ONLINE ACTIVITY WHERE YOU CREATE YOUR OWN MUSIC VIDEOS; ENTERTAINMENT SERVICES, NAMELY, NON-DOWNLOADABLE RING TONES, PRE-RE-

CORDED MUSIC, VIDEO AND GRAPHICS PRESENTED TO MOBILE COMMUNICATIONS DEVICES VIA A GLOBAL COMPUTER NETWORK AND WIRELESS NETWORKS; ENTERTAINMENT SERVICES, NAMELY, PROVIDING A WEB SITE FEATURING MUSICAL PERFORMANCES, MUSICAL VIDEOS, RELATED FILM CLIPS, PHOTOGRAPHS, AND OTHER MULTIMEDIA MATERIALS; ENTERTAINMENT, NAMELY, LIVE MUSIC CONCERTS; ENTERTAINMENT, NAMELY, LIVE PERFORMANCES BY MUSICAL BANDS; PRESENTATION OF MUSICAL PERFORMANCE, IN CLASS 41 (U.S. CLS. 100, 101 AND 107).

FIRST USE 7-1-2004; IN COMMERCE 7-1-2004.

THE MARK CONSISTS OF STANDARD CHARACTERS WITHOUT CLAIM TO ANY PARTICULAR FONT, STYLE, SIZE, OR COLOR.

SER. NO. 77-327,746, FILED 11-13-2007.

MARIAM MAHMOUDI, EXAMINING ATTORNEY



**Int. Cl.: 36**

**Prior U.S. Cls.: 100, 101 and 102**

**United States Patent and Trademark Office**

**Reg. No. 3,466,660**

**Registered July 15, 2008**

**SERVICE MARK  
PRINCIPAL REGISTER**

**"Our Employees Are Our  
Future"**

RM CN CREDIT SERVICES, INC. (TEXAS COR-  
PORATION), DBA RM CN CREDIT SERVICES  
STE B  
1611 WILMETH RD  
MCKINNEY, TX 75069

FOR: CONSUMER CREDIT CONSULTATION, IN  
CLASS 36 (U.S. CLS. 100, 101 AND 102).

FIRST USE 8-30-2007; IN COMMERCE 8-30-2007.

THE MARK CONSISTS OF STANDARD CHAR-  
ACTERS WITHOUT CLAIM TO ANY PARTICULAR  
FONT, STYLE, SIZE, OR COLOR.

SER. NO. 77-327,801, FILED 11-13-2007.

DOMINIC J. FERRAIUOLO, EXAMINING ATTOR-  
NEY

**Int. Cl.: 14**

**Prior U.S. Cls.: 2, 27, 28 and 50**

**United States Patent and Trademark Office**

**Reg. No. 3,466,661**

**Registered July 15, 2008**

**TRADEMARK  
PRINCIPAL REGISTER**

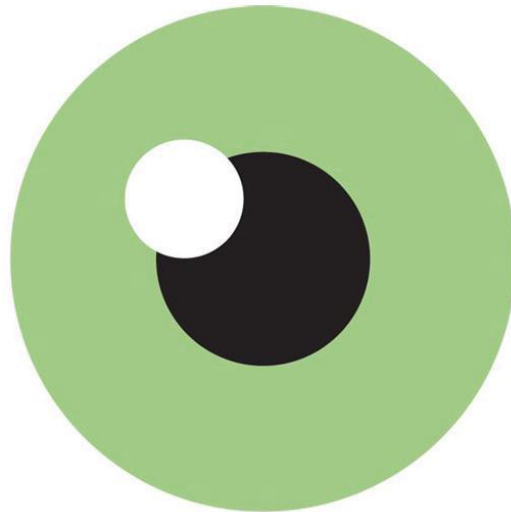

VERRAS, ILIAS (UNITED STATES INDIVIDUAL)  
107 VALENCIA ST APT 7  
COND TORRE BLANCA, PUERTO RICO 00907

FOR: JEWELRY, IN CLASS 14 (U.S. CLS. 2, 27, 28  
AND 50).

FIRST USE 8-5-2005; IN COMMERCE 8-5-2005.

THE COLOR(S) GREEN, BLACK AND WHITE IS/  
ARE CLAIMED AS A FEATURE OF THE MARK.

THE MARK CONSISTS OF THREE CIRCLES. THE  
OUTER CIRCLE IS GREEN, THE INNER CIRCLE IS  
BLACK WITH A WHITE CIRCLE OFF TO THE LEFT  
OF THE INNER CIRCLE.

SER. NO. 77-327,848, FILED 11-13-2007.

JASON ROTH, EXAMINING ATTORNEY

Int. Cl.: 37

Prior U.S. Cls.: 100, 103 and 106

United States Patent and Trademark Office

Reg. No. 3,466,662

Registered July 15, 2008

**SERVICE MARK  
PRINCIPAL REGISTER**



BODDY, PAUL L. (UNITED STATES INDIVIDUAL)

4371 ANGUS CIRCLE

DOYLESTOWN, PA 18901

FOR: BUILDING CONSTRUCTION AND REPAIR, IN CLASS 37 (U.S. CLS. 100, 103 AND 106).

FIRST USE 9-8-2003; IN COMMERCE 9-8-2003.

NO CLAIM IS MADE TO THE EXCLUSIVE RIGHT TO USE "GREEN SYSTEMS", APART FROM THE MARK AS SHOWN.

THE COLOR(S) GREY AND GREEN IS/ARE CLAIMED AS A FEATURE OF THE MARK.

THE MARK CONSISTS OF THE IMAGE OF A BUILDING MADE UP OF GREY RECTANGULAR BLOCKS. UNDERNEATH THE BUILDING ARE THE WORDS "GREEN SYSTEMS". THE WORD "GREEN" IS THE COLOR GREEN AND THE WORD "SYSTEMS" IS THE COLOR GREY.

SER. NO. 77-327,885, FILED 11-13-2007.

PAULA MAHONEY, EXAMINING ATTORNEY

**Int. Cl.: 10**

**Prior U.S. Cls.: 26, 39 and 44**

**United States Patent and Trademark Office**

**Reg. No. 3,466,663**

**Registered July 15, 2008**

**TRADEMARK  
PRINCIPAL REGISTER**



CLUFFY BIOMEDICAL, LLC (MONTANA LTD  
LIAB CO)  
3700 HUCKLEBERRY DRIVE  
GREAT FALLS, MT 59404

FOR: ORTHOPEDIC SUPPORTS; SUPPORTS FOR  
THE FOOT FOR USE INSIDE OF FOOTWEAR,  
BOOTS, AND SHOES; ORTHOTIC DEVICES, NAME-  
LY, ORTHOPEDIC CORRECTIVE PADS, IN CLASS  
10 (U.S. CLS. 26, 39 AND 44).

FIRST USE 6-0-2003; IN COMMERCE 10-0-2003.

THE MARK CONSISTS OF A TRIANGULAR  
SHAPE AND A PARTIALLY SUPERIMPOSED CIR-  
CULAR SHAPE, WHEREIN A LIGHT SEMI-CIRC-  
ULAR PORTION OF THE CIRCLE OVERLAPS THE  
TRIANGLE AND A DARK SEMI-CIRCULAR POR-  
TION COMPLETES THE CIRCULAR SHAPE OUT-  
SIDE OF THE TRIANGULAR SHAPE.

SER. NO. 77-327,887, FILED 11-13-2007.

PAULA MAHONEY, EXAMINING ATTORNEY

**Int. Cl.: 5**

**Prior U.S. Cls.: 6, 18, 44, 46, 51 and 52**

**United States Patent and Trademark Office**

**Reg. No. 3,466,664**

**Registered July 15, 2008**

**TRADEMARK  
PRINCIPAL REGISTER**

***Qualigen***

QUALIGEN, INC. (DELAWARE CORPORATION)  
2042 CORTE DEL NOGAL, SUITE A/B  
CARLSBAD, CA 92011

FIRST USE 6-1-2000; IN COMMERCE 6-1-2000.

FOR: AUTOMATED DIAGNOSTIC KITS COM-  
PRISED OF DIAGNOSTIC REAGENTS AND AS-  
SAYS FOR TESTING BODY FLUIDS, IN CLASS 5  
(U.S. CLS. 6, 18, 44, 46, 51 AND 52).

SER. NO. 77-327,911, FILED 11-13-2007.

GISELLE AGOSTO, EXAMINING ATTORNEY

**Int. Cl.: 35**

**Prior U.S. Cls.: 100, 101 and 102**

**United States Patent and Trademark Office**

**Reg. No. 3,466,665**

**Registered July 15, 2008**

**SERVICE MARK  
PRINCIPAL REGISTER**

**FOOD IS LIFE, MAKE IT GOOD**

APPLIED EDACITY, INC. (VIRGINIA CORPORATION)  
1606 SIMMONS COURT  
MCLEAN, VA 22101

THE MARK CONSISTS OF STANDARD CHARACTERS WITHOUT CLAIM TO ANY PARTICULAR FONT, STYLE, SIZE, OR COLOR.

FOR: OFFERING TECHNICAL ASSISTANCE IN THE ESTABLISHMENT AND OPERATION OF RESTAURANTS, IN CLASS 35 (U.S. CLS. 100, 101 AND 102).

SER. NO. 77-327,920, FILED 11-13-2007.

FIRST USE 11-9-2007; IN COMMERCE 11-9-2007.

MICHAEL ENGEL, EXAMINING ATTORNEY

Int. Cl.: 41

Prior U.S. Cls.: 100, 101 and 107

United States Patent and Trademark Office

Reg. No. 3,466,666

Registered July 15, 2008

SERVICE MARK  
PRINCIPAL REGISTER



ARKADIUM, INC. (NEW YORK CORPORATION)  
37 W. 20TH STREET, SUITE 809  
NEW YORK, NY 10011

FOR: ENTERTAINMENT SERVICES, NAMELY,  
PROVIDING ON-LINE COMPUTER GAMES, IN  
CLASS 41 (U.S. CLS. 100, 101 AND 107).

FIRST USE 2-1-2006; IN COMMERCE 2-1-2006.

THE COLOR(S) BLUE, WHITE, YELLOW, OR-  
ANGE AND RED IS/ARE CLAIMED AS A FEATURE  
OF THE MARK.

THE MARK CONSISTS OF A YELLOW AND  
ORANGE CIRCLE BEHIND THE WORDING  
"GREAT DAY GAMES" WHICH APPEARS IN RED  
AND IS OUTLINED IN WHITE. ABOVE THE "ES" IN  
"GAMES" APPEARS THE WORD "ARKADIUM'S"  
IN WHITE. BELOW THE WORDING IS THE SEN-  
TENCE "YOUR DAY JUST WENT FROM GOOD...-  
TO GREAT" IN WHITE. THE BACKGROUND OF  
THE MARK IS BLUE.

SER. NO. 77-327,922, FILED 11-13-2007.

RICHARD WHITE, EXAMINING ATTORNEY

**Int. Cl.: 43**

**Prior U.S. Cls.: 100 and 101**

**United States Patent and Trademark Office**

**Reg. No. 3,466,667**

**Registered July 15, 2008**

**SERVICE MARK  
PRINCIPAL REGISTER**



FRESH 'N FIT CUISINE, LLC (GEORGIA LTD  
LIAB CO)  
6080 PARKWAY NORTH DRIVE, SUITE # 200  
CUMMING, GA 30040

FOR: FOOD PREPARATION SERVICES IN THE  
NATURE OF PREPARING CALORIE CONTROL-  
LED HEALTHY EATING MEAL PLANS FOR CUS-  
TOMERS, FEATURING HOME DELIVERY OF THE  
PREPARED FOODS, IN CLASS 43 (U.S. CLS. 100  
AND 101).

FIRST USE 7-17-2006; IN COMMERCE 7-17-2006.

NO CLAIM IS MADE TO THE EXCLUSIVE  
RIGHT TO USE "CUISINE", APART FROM THE  
MARK AS SHOWN.

THE COLOR(S) ORANGE, BLUE, BLACK AND  
CREAM IS/ARE CLAIMED AS A FEATURE OF THE  
MARK.

THE COLOR CREAM APPEARS IN THE FORK  
DESIGN, IN THE BACKGROUND OF THE REC-

TANGLE BEHIND THE WORDS "FRESH N FIT", IN  
THE WORD "CUISINE" AND IN THE DOTS ON  
EITHER SIDE OF THIS WORD, THE COLOR BLUE  
APPEARS IN THE BACKGROUND OF THE OVAL  
DESIGN FEATURING ANGLED LINES IN ALTER-  
NATING LIGHT AND DARK BLUE, THE COLOR  
ORANGE APPEARS IN THE RECTANGULAR  
BACKGROUND AROUND THE ENTIRE MARK,  
IN A DARKER SHADE OF ORANGE IN THE OUT-  
LINING AROUND THE OVAL DESIGN AND IN  
THE OUTLINE AROUND THE RECTANGULAR  
SHAPE CONTAINING THE WORDS "FRESH N  
FIT" AND THE COLOR BLACK APPEARS IN THE  
WORDS "FRESH N FIT", IN THE DOTS ON EITHER  
SIDE OF THE "N", IN THE WORDS "FOOD TO DIET  
FOR!", IN THE SHADOW BEHIND THE WORD  
"CUISINE", IN BETWEEN THE TINES OF THE  
FORK DESIGN, AND IN THE CENTER OF THE  
FORK HANDLE.

SER. NO. 77-327,935, FILED 11-13-2007.

CHARLOTTE CORWIN, EXAMINING ATTORNEY



Int. Cl.: 43

Prior U.S. Cls.: 100 and 101

United States Patent and Trademark Office

Reg. No. 3,466,668

Registered July 15, 2008

**SERVICE MARK  
PRINCIPAL REGISTER**



THE LAZY CHICKEN CORPORATION (SOUTH  
CAROLINA CORPORATION)

1099 EAST BUTLER ROAD

GREENVILLE, SC 29607

FOR: RESTAURANT SERVICES, IN CLASS 43  
(U.S. CLS. 100 AND 101).

FIRST USE 5-1-2007; IN COMMERCE 5-1-2007.

NO CLAIM IS MADE TO THE EXCLUSIVE  
RIGHT TO USE "CHICKEN ROTISSERIE", APART  
FROM THE MARK AS SHOWN.

THE MARK CONSISTS OF THE DEPICTION OF A  
CHICKEN ON A HAMMOCK BETWEEN TWO  
PALM TREES.

SER. NO. 77-327,949, FILED 11-13-2007.

MARY BOAGNI, EXAMINING ATTORNEY

**Int. Cl.: 43**

**Prior U.S. Cls.: 100 and 101**

**United States Patent and Trademark Office**

**Reg. No. 3,466,669**

**Registered July 15, 2008**

**SERVICE MARK  
PRINCIPAL REGISTER**

**Black's**

I.T.B. EIGHT, LLC (MARYLAND LTD LIAB CO)  
SUITE 210  
7752 WOODMONT AVENUE  
BETHESDA, MD 20814

FOR: RESTAURANT AND BAR SERVICES, IN  
CLASS 43 (U.S. CLS. 100 AND 101).

FIRST USE 3-31-1999; IN COMMERCE 3-31-1999.

THE MARK CONSISTS OF STANDARD CHAR-  
ACTERS WITHOUT CLAIM TO ANY PARTICULAR  
FONT, STYLE, SIZE, OR COLOR.

SEC. 2(F).

SER. NO. 77-328,019, FILED 11-13-2007.

KIMBERLY FRYE, EXAMINING ATTORNEY

**Int. Cl.: 41**

**Prior U.S. Cls.: 100, 101 and 107**

**United States Patent and Trademark Office**

**Reg. No. 3,466,670**

**Registered July 15, 2008**

---

**SERVICE MARK  
PRINCIPAL REGISTER**

**Flavor Highway**

STEPHEN TAYLOR GIBBS (UNITED STATES  
INDIVIDUAL)  
2325 3RD STREET, SUITE 330  
SAN FRANCISCO, CA 94107

THE MARK CONSISTS OF STANDARD CHAR-  
ACTERS WITHOUT CLAIM TO ANY PARTICULAR  
FONT, STYLE, SIZE, OR COLOR.

FOR: ENTERTAINMENT IN THE NATURE OF  
ON-GOING TELEVISION PROGRAMS IN THE  
FIELD OF FOOD AND COOKING, IN CLASS 41  
(U.S. CLS. 100, 101 AND 107).

SER. NO. 77-328,072, FILED 11-13-2007.

FIRST USE 5-2-2005; IN COMMERCE 2-24-2006.

EMILY CHUO, EXAMINING ATTORNEY

**Int. Cls.: 25 and 35**

**Prior U.S. Cls.: 22, 39, 100, 101 and 102**

**United States Patent and Trademark Office**

**Reg. No. 3,466,671**

**Registered July 15, 2008**

**TRADEMARK  
SERVICE MARK  
PRINCIPAL REGISTER**

# Christa Taylor

EMPOWERED TRADITIONALIST, LLC (WA-SHINGTON LTD LIAB CO)  
6910 NE 151ST CIRCLE  
VANCOUVER, WA 98686

FOR: WOMEN'S CLOTHING, NAMELY, SHIRTS, PANTS, SKIRTS, DRESSES, COATS, JACKETS, SWIMWEAR, SCARVES, BELTS, AND HATS, IN CLASS 25 (U.S. CLS. 22 AND 39).

FIRST USE 1-5-2007; IN COMMERCE 1-5-2007.

FOR: RETAIL AND ONLINE RETAIL STORE SERVICES FEATURING WOMEN'S CLOTHING AND ACCESSORIES, IN CLASS 35 (U.S. CLS. 100, 101 AND 102).

FIRST USE 1-5-2007; IN COMMERCE 1-5-2007.

THE MARK CONSISTS OF STANDARD CHARACTERS WITHOUT CLAIM TO ANY PARTICULAR FONT, STYLE, SIZE, OR COLOR.

THE NAME "CHRISTA TAYLOR" IDENTIFIES A LIVING INDIVIDUAL WHOSE CONSENT IS OF RECORD.

SER. NO. 77-328,100, FILED 11-13-2007.

EMILY CHUO, EXAMINING ATTORNEY

**Int. Cl.: 42**

**Prior U.S. Cls.: 100 and 101**

**United States Patent and Trademark Office**

**Reg. No. 3,466,672**

**Registered July 15, 2008**

**SERVICE MARK  
PRINCIPAL REGISTER**

**TITLETEC**

TITLE TECHNOLOGIES, INC. (MISSISSIPPI CORPORATION)  
P.O. BOX 690  
INDIANOLA, MS 38751

THE MARK CONSISTS OF STANDARD CHARACTERS WITHOUT CLAIM TO ANY PARTICULAR FONT, STYLE, SIZE, OR COLOR.

FOR: PROVIDING ON-LINE NON-DOWNLOADABLE SOFTWARE FOR STREAMLINING THE AUTOMOBILE TITLE AND REGISTRATION PROCESS, IN CLASS 42 (U.S. CLS. 100 AND 101).

SER. NO. 77-328,115, FILED 11-13-2007.

FIRST USE 8-0-2007; IN COMMERCE 8-0-2007.

MONIQUE MILLER, EXAMINING ATTORNEY

**Int. Cls.: 42, 43 and 44**

**Prior U.S. Cls.: 100 and 101**

**United States Patent and Trademark Office**

**Reg. No. 3,466,673**

**Registered July 15, 2008**

**SERVICE MARK  
PRINCIPAL REGISTER**



VICAR OPERATING, INC. (CALIFORNIA CORPORATION)  
12401 WEST OLYMPIC BOULEVARD  
LOS ANGELES, CA 900641022

FOR: VETERINARY CLINICAL LABORATORY SERVICES, IN CLASS 42 (U.S. CLS. 100 AND 101).

FIRST USE 1-0-2002; IN COMMERCE 1-0-2002.

FOR: PET BOARDING SERVICES, IN CLASS 43 (U.S. CLS. 100 AND 101).

FIRST USE 1-0-2002; IN COMMERCE 1-0-2002.

FOR: VETERINARY CARE SERVICES, ANIMAL HOSPITAL SERVICES AND ANIMAL GROOMING, IN CLASS 44 (U.S. CLS. 100 AND 101).

FIRST USE 1-0-2002; IN COMMERCE 1-0-2002.

OWNER OF U.S. REG. NOS. 2,725,544, 2,847,530, AND 3,316,327.

THE COLOR(S) BLUE AND WHITE IS/ARE CLAIMED AS A FEATURE OF THE MARK.

THE MARK CONSISTS OF THE LETTERS "VCA" WHICH ARE BLUE AND A MAP OF THE UNITED STATES WHICH IS WHITE AND OUTLINED IN BLUE.

SER. NO. 77-328,237, FILED 11-13-2007.

GEORGE LORENZO, EXAMINING ATTORNEY

**Int. Cls.: 9, 10 and 21**

**Prior U.S. Cls.: 2, 13, 21, 23, 26, 29, 30, 33, 36, 38, 39,  
40, 44 and 50**

**Reg. No. 3,466,674**

**United States Patent and Trademark Office**

**Registered July 15, 2008**

**TRADEMARK  
PRINCIPAL REGISTER**

**SYNTHO-PERFECT**

PREVENTIVE CARE, INC. (MINNESOTA CORPORATION)  
15215 BOULDER TRAIL  
ROSEMOUNT, MN 55068

FOR: DISPOSABLE SYNTHETIC PROTECTIVE WORK GLOVES FOR SCIENTIFIC LABORATORY, INDUSTRIAL, AND AGRICULTURAL USE, IN CLASS 9 (U.S. CLS. 21, 23, 26, 36 AND 38).

FIRST USE 9-1-1996; IN COMMERCE 9-1-1996.

FOR: DISPOSABLE SYNTHETIC GLOVES FOR MEDICAL, DENTAL, AND VETERINARY USE, IN CLASS 10 (U.S. CLS. 26, 39 AND 44).

FIRST USE 9-1-1996; IN COMMERCE 9-1-1996.

FOR: DISPOSABLE SYNTHETIC GLOVES FOR USE IN CLEANING AND GENERAL USE AND THE FOOD SERVICES INDUSTRY, IN CLASS 21 (U.S. CLS. 2, 13, 23, 29, 30, 33, 40 AND 50).

FIRST USE 9-1-1996; IN COMMERCE 9-1-1996.

THE MARK CONSISTS OF STANDARD CHARACTERS WITHOUT CLAIM TO ANY PARTICULAR FONT, STYLE, SIZE, OR COLOR.

OWNER OF U.S. REG. NO. 2,506,273.

SER. NO. 77-328,273, FILED 11-13-2007.

JOHN HWANG, EXAMINING ATTORNEY

**Int. Cls.: 42, 43 and 44**

**Prior U.S. Cls.: 100 and 101**

**United States Patent and Trademark Office**

**Reg. No. 3,466,675**

**Registered July 15, 2008**

**SERVICE MARK  
PRINCIPAL REGISTER**



VICAR OPERATING, INC. (CALIFORNIA CORPORATION)  
12401 WEST OLYMPIC BOULEVARD  
LOS ANGELES, CA 900641022

FOR: VETERINARY CLINICAL LABORATORY SERVICES, IN CLASS 42 (U.S. CLS. 100 AND 101).

FIRST USE 1-0-2002; IN COMMERCE 1-0-2002.

FOR: PET BOARDING SERVICES, IN CLASS 43 (U.S. CLS. 100 AND 101).

FIRST USE 1-0-2002; IN COMMERCE 1-0-2002.

FOR: VETERINARY CARE SERVICES, ANIMAL HOSPITAL SERVICES AND ANIMAL GROOMING, IN CLASS 44 (U.S. CLS. 100 AND 101).

FIRST USE 1-0-2002; IN COMMERCE 1-0-2002.

OWNER OF U.S. REG. NOS. 2,725,544, 2,874,530, AND 3,316,327.

THE COLOR(S) BLUE AND WHITE IS/ARE CLAIMED AS A FEATURE OF THE MARK.

THE MARK CONSISTS OF THE LETTERS "VCA" WHICH ARE WHITE AND OUTLINED IN BLUE AND A MAP OF THE UNITED STATES WHICH IS BLUE AND OUTLINED IN WHITE.

SER. NO. 77-328,284, FILED 11-13-2007.

GEORGE LORENZO, EXAMINING ATTORNEY



**Int. Cl.: 9**

**Prior U.S. Cls.: 21, 23, 26, 36 and 38**

**Reg. No. 3,466,676**

**United States Patent and Trademark Office**

**Registered July 15, 2008**

**TRADEMARK  
PRINCIPAL REGISTER**

**spectraplus**

PATTEE, JOHN T. (WASHINGTON SOLE PROPRIETORSHIP), DBA PIONEER HILL SOFTWARE  
24460 MASON RD. NW  
POULSBO, WA 98370

FIRST USE 1-1-1996; IN COMMERCE 1-1-1996.

FOR: ELECTRONIC PRODUCTS FOR THE GENERATION, MEASUREMENT, AND ANALYSIS OF AUDIO SIGNALS, NAMELY, AUDIO ANALYZERS; ELECTRONIC PRODUCTS FOR THE MANIPULATION OF THE FREQUENCY, TIME, AND AMPLITUDE CHARACTERISTICS OF AUDIO SIGNALS, NAMELY, AUDIO PROCESSORS, IN CLASS 9 (U.S. CLS. 21, 23, 26, 36 AND 38).

THE MARK CONSISTS OF STANDARD CHARACTERS WITHOUT CLAIM TO ANY PARTICULAR FONT, STYLE, SIZE, OR COLOR.

SER. NO. 77-328,303, FILED 11-13-2007.

JACQUELINE A. LAVINE, EXAMINING ATTORNEY

**Int. Cl.: 9**

**Prior U.S. Cls.: 21, 23, 26, 36 and 38**

**Reg. No. 3,466,677**

**United States Patent and Trademark Office**

**Registered July 15, 2008**

**TRADEMARK  
PRINCIPAL REGISTER**

**CKS**

CKS HOLDINGS LIMITED (UNITED KINGDOM CORPORATION)  
WELWYN GARDEN CITY  
SWALLOW END, SWALLOWFIELDS  
HERTFORDSHIRE AL7 1JA, UNITED KINGDOM

FOR: DATA PROCESSING AND COMPUTERS, AND PERIPHERALS THEREFOR NAMELY, INPUT, INTERFACE HARDWARE AND DEVICES, KEYBOARDS AND KEYPADS; SOFTWARE, WHETHER EMBEDDED IN ANOTHER PRODUCT OR ON A STAND-ALONE BASIS, FOR CONTROLLING THE AFORESAID PERIPHERALS; SOFTWARE DRIVERS AND INTERFACE SOFTWARE, WHETHER EMBEDDED IN ANOTHER PRODUCT OR ON A STAND-ALONE BASIS, FOR INTERFACING THE AFORESAID PERIPHERALS TO DATA PROCESSORS AND COMPUTERS; CUSTOM DESIGN SOFTWARE FOR ASSISTING OTHERS IN DESIGNING AND CREATING THE AFORESAID PERIPHERALS FOR THEIR OWN REQUIREMENTS; OPTICAL AND MAGNETIC DISCS AND CD ROMS CARRYING SOFTWARE FOR CONTROLLING SUCH PERIPHERALS, INTERFACE SOFTWARE, AND CUSTOM DESIGN SOFTWARE FOR ASSISTING

OTHERS IN DESIGNING AND CREATING THE AFORESAID PERIPHERALS FOR THEIR OWN REQUIREMENTS; ENCODED ROMS AND EPROMS, AND ELECTRONIC MEMORY CARDS AND CHIP CARDS CONTAINING SOFTWARE FOR CONTROLLING SUCH PERIPHERALS, INTERFACE SOFTWARE, AND CUSTOM DESIGN SOFTWARE FOR ASSISTING OTHERS IN DESIGNING AND CREATING THE AFORESAID PERIPHERALS FOR THEIR OWN REQUIREMENT, IN CLASS 9 (U.S. CLS. 21, 23, 26, 36 AND 38).

FIRST USE 7-27-1985; IN COMMERCE 12-11-1992.

THE MARK CONSISTS OF STANDARD CHARACTERS WITHOUT CLAIM TO ANY PARTICULAR FONT, STYLE, SIZE, OR COLOR.

OWNER OF U.S. REG. NO. 2,772,814.

SER. NO. 77-328,305, FILED 11-13-2007.

JACQUELINE A. LAVINE, EXAMINING ATTORNEY

**Int. Cl.: 3**

**Prior U.S. Cls.: 1, 4, 6, 50, 51 and 52**

**Reg. No. 3,466,678**

**United States Patent and Trademark Office**

**Registered July 15, 2008**

**TRADEMARK  
PRINCIPAL REGISTER**

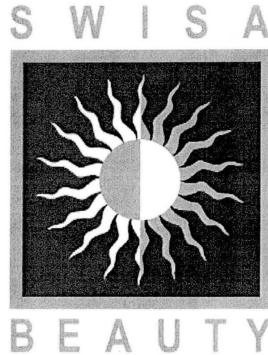

SWISA, INC. (TEXAS CORPORATION)  
525 INTERNATIONAL PARKWAY, SUITE 601  
RICHARDSON, TX 75081

FOR: COSMETIC AND BEAUTY ITEMS, NAME-  
LY, CREAMS, FACIAL PEELS, LOTIONS, BODY  
BUTTER, BATH OILS, BATH WASHES, SERUMS,  
CELLULITE GELS, MUD MASKS, BAR SOAPS,  
CLEANSING GELS, SKIN TONERS, MOISTURI-  
ZERS, SHAMPOO, CONDITIONER, HAIR MASKS,  
STYLING GELS AND SALT AND MINERAL  
TREATMENTS, IN CLASS 3 (U.S. CLS. 1, 4, 6, 50, 51  
AND 52).

FIRST USE 11-16-2001; IN COMMERCE 11-16-2001.

NO CLAIM IS MADE TO THE EXCLUSIVE  
RIGHT TO USE "BEAUTY", APART FROM THE  
MARK AS SHOWN.

THE STIPLING IS FOR SHADING PURPOSES.

THE MARK CONSISTS OF A SUN IN A SQUARE  
BOX WITH THE WORD "SWISA" ABOVE THE BOX  
AND THE WORD "BEAUTY" BELOW THE BOX.

SER. NO. 77-328,322, FILED 11-13-2007.

KELLEY WELLS, EXAMINING ATTORNEY

**Int. Cl.: 37**

**Prior U.S. Cls.: 100, 103 and 106**

**United States Patent and Trademark Office**

**Reg. No. 3,466,679**

**Registered July 15, 2008**

**SERVICE MARK  
PRINCIPAL REGISTER**

YOU'LL FEEL GOOD SAVING  
GREEN WHILE YOU KEEP THE  
EARTH CLEAN

VAN'S HEATING & AIR CONDITIONING, INC.  
(WISCONSIN CORPORATION)  
525 BUTLER STREET  
DE PERE, WI 54115

THE MARK CONSISTS OF STANDARD CHAR-  
ACTERS WITHOUT CLAIM TO ANY PARTICULAR  
FONT, STYLE, SIZE, OR COLOR.

FOR: REPAIR, MAINTENANCE AND INSTALLA-  
TION OF PLUMBING, HEATING, VENTILATION  
AND AIR CONDITIONING APPARATUS, IN CLASS  
37 (U.S. CLS. 100, 103 AND 106).

SER. NO. 77-328,331, FILED 11-13-2007.

FIRST USE 11-1-2007; IN COMMERCE 12-9-2007.

PAM WILLIS, EXAMINING ATTORNEY

Int. Cl.: 33

Prior U.S. Cls.: 47 and 49

United States Patent and Trademark Office

Reg. No. 3,466,680

Registered July 15, 2008

TRADEMARK  
PRINCIPAL REGISTER

# X Cream

MOON TOWER LTD. (OHIO LTD LIAB CO)  
20600 CHAGRIN BLVD. SUITE#450  
SHAKER HEIGHTS, OH 44122

FOR: ALCOHOLIC BEVERAGES, NAMELY, A  
WHIPPED CREAM COMBINED WITH FLAVORING  
AND ALCOHOL, IN CLASS 33 (U.S. CLS. 47 AND 49).

FIRST USE 10-8-2007; IN COMMERCE 11-1-2007.

THE MARK CONSISTS OF STANDARD CHAR-  
ACTERS WITHOUT CLAIM TO ANY PARTICULAR  
FONT, STYLE, SIZE, OR COLOR.

NO CLAIM IS MADE TO THE EXCLUSIVE  
RIGHT TO USE "CREAM", APART FROM THE  
MARK AS SHOWN.

SER. NO. 77-328,353, FILED 11-13-2007.

RONALD MCMORROW, EXAMINING ATTORNEY

Int. Cl.: 41

Prior U.S. Cls.: 100, 101 and 107

United States Patent and Trademark Office

Reg. No. 3,466,681

Registered July 15, 2008

**SERVICE MARK  
PRINCIPAL REGISTER**



REVEREND ANTHONY PALAZZOLO (UNITED STATES INDIVIDUAL)  
101 MARSH COVE LANE  
PONTE VEDRA BEACH, FL 32082

FOR: SOCIAL CLUB SERVICES, NAMELY, ARRANGING, ORGANIZING AND HOSTING SOCIAL EVENTS, GET-TOGETHERS, AND PARTIES FOR CLUB MEMBERS, IN CLASS 41 (U.S. CLS. 100, 101 AND 107).

FIRST USE 10-19-2007; IN COMMERCE 10-19-2007.

NO CLAIM IS MADE TO THE EXCLUSIVE RIGHT TO USE "CATHOLIC SINGLES NETWORK", APART FROM THE MARK AS SHOWN.

THE COLOR(S) GREEN, BLUE AND WHITE IS/ARE CLAIMED AS A FEATURE OF THE MARK.

THE MARK CONSISTS OF A PICTURE OF A CROSS IN WHITE SEPARATING A GREEN FIELD TO THE LEFT AND A BLUE FIELD TO THE RIGHT WITH THE WORDS "IT'S JUST FUN" IN THE BLUE FIELD AND THE PHRASE "CATHOLIC SINGLES NETWORK" ON THE BOTTOM OF THE MARK.

SER. NO. 77-328,386, FILED 11-13-2007.

DOMINIC J. FERRAIUOLO, EXAMINING ATTORNEY

**Int. Cl.: 37**

**Prior U.S. Cls.: 100, 103 and 106**

**United States Patent and Trademark Office**

**Reg. No. 3,466,682**

**Registered July 15, 2008**

**SERVICE MARK  
PRINCIPAL REGISTER**

**US SEWER & DRAIN**

US SEWER & DRAIN, INC. (PENNSYLVANIA  
CORPORATION)  
1100 WOOD LANE  
LANGHORNE, PA 19047

FOR: CONSTRUCTION, INSTALLATION, RE-  
PAIR AND MAINTENANCE OF SEWERS, DRAINS  
AND PIPELINES; INSTALLATION OF PIPE LINING  
COMPRISED OF SEWER LINER AND EPOXY RE-  
SIN; REPAIR AND MAINTENANCE OF INSTAL-  
LED AND INACCESSIBLE SEWER PIPES AND  
CONDUITS, IN CLASS 37 (U.S. CLS. 100, 103 AND  
106).

FIRST USE 1-0-1995; IN COMMERCE 1-0-1995.

THE MARK CONSISTS OF STANDARD CHAR-  
ACTERS WITHOUT CLAIM TO ANY PARTICULAR  
FONT, STYLE, SIZE, OR COLOR.

OWNER OF U.S. REG. NO. 3,212,876.

NO CLAIM IS MADE TO THE EXCLUSIVE  
RIGHT TO USE "SEWER & DRAIN", APART FROM  
THE MARK AS SHOWN.

SEC. 2(F).

SER. NO. 77-328,396, FILED 11-13-2007.

DOMINIC J. FERRAIUOLO, EXAMINING ATTOR-  
NEY

**Int. Cl.: 41**

**Prior U.S. Cls.: 100, 101 and 107**

**United States Patent and Trademark Office**

**Reg. No. 3,466,683**

**Registered July 15, 2008**

**SERVICE MARK  
PRINCIPAL REGISTER**

**SMART REPORTS**

KAPLAN, INC. (DELAWARE CORPORATION)  
888 SEVENTH AVENUE  
NEW YORK, NY 10106

FOR: EDUCATION SERVICES, NAMELY, PROVIDING ONLINE INDIVIDUALIZED COMPUTER ANALYSIS OF STUDENTS' ACADEMIC PERFORMANCE ON PRACTICE STANDARDIZED ADMISSION OR LICENSING TESTS AND INDIVIDUALIZED STUDY PLANS FOR IMPROVEMENT, IN CLASS 41 (U.S. CLS. 100, 101 AND 107).

FIRST USE 5-21-2007; IN COMMERCE 5-21-2007.

THE MARK CONSISTS OF STANDARD CHARACTERS WITHOUT CLAIM TO ANY PARTICULAR FONT, STYLE, SIZE, OR COLOR.

NO CLAIM IS MADE TO THE EXCLUSIVE RIGHT TO USE "REPORTS", APART FROM THE MARK AS SHOWN.

SER. NO. 77-328,406, FILED 11-13-2007.

DOMINIC J. FERRAIUOLO, EXAMINING ATTORNEY



**Int. Cl.: 36**

**Prior U.S. Cls.: 100, 101 and 102**

**United States Patent and Trademark Office**

**Reg. No. 3,466,684**

**Registered July 15, 2008**

**SERVICE MARK  
PRINCIPAL REGISTER**



CORE, DAVID (UNITED STATES INDIVIDUAL)  
FIRST FLOOR  
1177 HYPOLUXO ROAD  
LANTANA, FL 33462

FOR: FINANCIAL SERVICES, NAMELY, RETIREMENT ACCOUNT DISTRIBUTION MANAGEMENT AND CONSULTATION, IN CLASS 36 (U.S. CLS. 100, 101 AND 102).

FIRST USE 9-1-2007; IN COMMERCE 9-1-2007.

NO CLAIM IS MADE TO THE EXCLUSIVE RIGHT TO USE "RETIREMENT MANAGEMENT", APART FROM THE MARK AS SHOWN.

SER. NO. 77-328,420, FILED 11-13-2007.

BARBARA RUTLAND, EXAMINING ATTORNEY

**Int. Cl.: 41**

**Prior U.S. Cls.: 100, 101 and 107**

**United States Patent and Trademark Office**

**Reg. No. 3,466,685**

**Registered July 15, 2008**

**SERVICE MARK  
PRINCIPAL REGISTER**

**68's INSIDE SPORTS**

INSIDE SPORTS AND FITNESS LLC (KANSAS  
LTD LIAB CO)  
6807 W. 295TH STREET  
LOUISBURG, KS 66053

FOR: GYM AND FITNESS FACILITY OFFERING  
EXERCISE, WEIGHT TRAINING, AND ATHLETIC  
TRAINING, IN CLASS 41 (U.S. CLS. 100, 101 AND  
107).

FIRST USE 6-1-2007; IN COMMERCE 6-1-2007.

THE MARK CONSISTS OF STANDARD CHAR-  
ACTERS WITHOUT CLAIM TO ANY PARTICULAR  
FONT, STYLE, SIZE, OR COLOR.

NO CLAIM IS MADE TO THE EXCLUSIVE  
RIGHT TO USE "SPORTS", APART FROM THE  
MARK AS SHOWN.

SER. NO. 77-328,436, FILED 11-13-2007.

ALYSSA PALADINO, EXAMINING ATTORNEY

**Int. Cls.: 16 and 40**

**Prior U.S. Cls.: 2, 5, 22, 23, 29, 37, 38, 50, 100, 103 and 106**

**Reg. No. 3,466,686**

**United States Patent and Trademark Office**

**Registered July 15, 2008**

**TRADEMARK  
SERVICE MARK  
PRINCIPAL REGISTER**



ENNIS, INC. (TEXAS CORPORATION)  
2441 PRESIDENTIAL PARKWAY  
MIDLOTHIAN, TX 76065

FOR: PRINTED MATTER, NAMELY, CUSTOM FORMS PRINTED TO CUSTOMER SPECIFICATIONS, IN CLASS 16 (U.S. CLS. 2, 5, 22, 23, 29, 37, 38 AND 50).

FIRST USE 11-17-2004; IN COMMERCE 11-17-2004.

FOR: PRINTING CUSTOM FORMS TO CUSTOMER SPECIFICATIONS, IN CLASS 40 (U.S. CLS. 100, 103 AND 106).

FIRST USE 11-17-2004; IN COMMERCE 11-17-2004.

THE MARK CONSISTS OF THE WORD GENFORMS. ABOVE THE "GEN" PORTION ARE THE LETTERS "GF", TILTED SIDEWAYS, IN A BOX.

SER. NO. 77-328,443, FILED 11-13-2007.

GENE MACIOL, EXAMINING ATTORNEY

**Int. Cl.: 41**

**Prior U.S. Cls.: 100, 101 and 107**

**United States Patent and Trademark Office**

**Reg. No. 3,466,687**

**Registered July 15, 2008**

**SERVICE MARK  
PRINCIPAL REGISTER**

**EHAP**

TREE CARE INDUSTRY ASSOCIATION, INC.  
(OHIO CORPORATION)  
3 PERIMETER ROAD, UNIT 1  
MANCHESTER, NH 03103

FOR: EDUCATIONAL SERVICES, NAMELY,  
CONDUCTING SEMINARS, CLASSES, WORK-  
SHOPS, AND CONFERENCES IN THE FIELD OF  
ELECTRICAL HAZARDS AWARENESS AND DIS-  
TRIBUTING COURSE MATERIALS IN CONNEC-  
TION THEREWITH, IN CLASS 41 (U.S. CLS. 100, 101  
AND 107).

FIRST USE 3-3-2007; IN COMMERCE 3-3-2007.

THE MARK CONSISTS OF STANDARD CHAR-  
ACTERS WITHOUT CLAIM TO ANY PARTICULAR  
FONT, STYLE, SIZE, OR COLOR.

SER. NO. 77-328,466, FILED 11-13-2007.

GENE MACIOL, EXAMINING ATTORNEY

**Int. Cl.: 3**

**Prior U.S. Cls.: 1, 4, 6, 50, 51 and 52**

**United States Patent and Trademark Office**

**Reg. No. 3,466,688**

**Registered July 15, 2008**

**TRADEMARK  
PRINCIPAL REGISTER**

**TaKnow**

DEBORAH ANN FOSTER BUSBY (OHIO SOLE  
PROPRIETORSHIP)  
9640 SIMSBURY COURT  
TWINSBURG, OH 44087

THE MARK CONSISTS OF STANDARD CHAR-  
ACTERS WITHOUT CLAIM TO ANY PARTICULAR  
FONT, STYLE, SIZE, OR COLOR.

FOR: COLOGNES, PERFUMES AND COSMET-  
ICS; LIQUID PERFUMES; PERFUMED CREAMS;  
PERFUMED SOAP, IN CLASS 3 (U.S. CLS. 1, 4, 6, 50,  
51 AND 52).

SER. NO. 77-328,553, FILED 11-13-2007.

FIRST USE 1-28-2003; IN COMMERCE 1-28-2003.

ALYSSA PALADINO, EXAMINING ATTORNEY

**Int. Cl.: 20**

**Prior U.S. Cls.: 2, 13, 22, 25, 32 and 50**

**United States Patent and Trademark Office**

**Reg. No. 3,466,689**

**Registered July 15, 2008**

**TRADEMARK  
PRINCIPAL REGISTER**

**ROLLEASE**

ROLLEASE, INC. (DELAWARE CORPORATION)  
200 HARVARD AVENUE  
STAMFORD, CT 06902

FOR: COMPONENTS FOR USE IN MANUFACTURING AND FABRICATING WINDOW COVERINGS, NAMELY, CLUTCHES, END PLUGS AND BOTTOM PLUGS; BRACKETS; CONNECTORS; TUBING AND SHAFTS; FASCIA, HEADRAILS AND HEM BARS; BEAD CHAINS AND OPERATING DRIVE LOOPS, IN CLASS 20 (U.S. CLS. 2, 13, 22, 25, 32 AND 50).

FIRST USE 11-16-1982; IN COMMERCE 11-16-1982.

THE MARK CONSISTS OF STANDARD CHARACTERS WITHOUT CLAIM TO ANY PARTICULAR FONT, STYLE, SIZE, OR COLOR.

OWNER OF U.S. REG. NO. 1,512,317.

SER. NO. 77-328,574, FILED 11-13-2007.

ALLISON HOLTZ, EXAMINING ATTORNEY

**Int. Cl.: 20**

**Prior U.S. Cls.: 2, 13, 22, 25, 32 and 50**

**United States Patent and Trademark Office**

**Reg. No. 3,466,690**

**Registered July 15, 2008**

**TRADEMARK  
PRINCIPAL REGISTER**

ENGINEERED TO BE ESSENTIAL

ROLLEASE, INC. (DELAWARE CORPORATION)  
200 HARVARD AVENUE  
STAMFORD, CT 06902

FOR: COMPONENTS FOR USE IN MANUFACTURING AND FABRICATING WINDOW COVERINGS, NAMELY, CLUTCHES, END PLUGS AND BOTTOM PLUGS; BRACKETS; CONNECTORS; TUBING AND SHAFTS; FASCIA, HEADRAILS AND HEM BARS; BEAD CHAINS AND OPERATING DRIVE LOOPS, IN CLASS 20 (U.S. CLS. 2, 13, 22, 25, 32 AND 50).

FIRST USE 10-0-2000; IN COMMERCE 10-0-2000.

THE MARK CONSISTS OF STANDARD CHARACTERS WITHOUT CLAIM TO ANY PARTICULAR FONT, STYLE, SIZE, OR COLOR.

OWNER OF U.S. REG. NO. 2,512,773.

SER. NO. 77-328,575, FILED 11-13-2007.

ALLISON HOLTZ, EXAMINING ATTORNEY

**Int. Cl.: 35**

**Prior U.S. Cls.: 100, 101 and 102**

**United States Patent and Trademark Office**

**Reg. No. 3,466,691**

**Registered July 15, 2008**

**SERVICE MARK  
PRINCIPAL REGISTER**

**EXPERIENCE TO BUILD ON**

PACIFIC LUMBER & TRUSS CO. (OREGON  
CORPORATION)  
5895 JEAN ROAD  
LAKE OSWEGO, OR 97035

FOR: WHOLESALE DISTRIBUTORSHIPS FEATURING LUMBER, TRUSSES, ENGINEERED WOOD PRODUCTS, SIDING, FENCING, DECKING, HARDWARE, DOORS, MILLWORK, WINDOWS AND CABINETS; WHOLESALE STORES FEATURING LUMBER, TRUSSES, ENGINEERED WOOD PRODUCTS, SIDING, FENCING, DECKING, HARD-

WARE, DOORS, MILLWORK, WINDOWS AND CABINETS, IN CLASS 35 (U.S. CLS. 100, 101 AND 102).

FIRST USE 5-1-2007; IN COMMERCE 6-19-2007.

THE MARK CONSISTS OF STANDARD CHARACTERS WITHOUT CLAIM TO ANY PARTICULAR FONT, STYLE, SIZE, OR COLOR.

SER. NO. 77-328,590, FILED 11-13-2007.

ALYSSA PALADINO, EXAMINING ATTORNEY



**Int. Cl.: 41**

**Prior U.S. Cls.: 100, 101 and 107**

**United States Patent and Trademark Office**

**Reg. No. 3,466,692**

**Registered July 15, 2008**

**SERVICE MARK  
PRINCIPAL REGISTER**

**YOUR HAND IN MATRIMONY**

STRICTLYWEDDINGS.COM LLC (TEXAS LTD  
LIAB CO)  
SUITE 1125  
3131 TURTLE CREEK BLVD.  
DALLAS, TX 75219

THE MARK CONSISTS OF STANDARD CHAR-  
ACTERS WITHOUT CLAIM TO ANY PARTICULAR  
FONT, STYLE, SIZE, OR COLOR.

FOR: PROVIDING INFORMATION IN THE  
FIELD OF WEDDING PARTY PLANNING, IN  
CLASS 41 (U.S. CLS. 100, 101 AND 107).

SER. NO. 77-328,596, FILED 11-13-2007.

FIRST USE 11-9-2007; IN COMMERCE 11-9-2007.

BRENDAN REGAN, EXAMINING ATTORNEY

**Int. Cl.: 35**

**Prior U.S. Cls.: 100, 101 and 102**

**United States Patent and Trademark Office**

**Reg. No. 3,466,693**

**Registered July 15, 2008**

**SERVICE MARK  
PRINCIPAL REGISTER**

**Timeless jewelry by GOLDEN  
FLAMINGO**

GOLDEN FLAMINGO, LLC (NEW YORK LTD  
LIAB CO)  
1037 BRIGHTON BEACH AVENUE  
BROOKLYN, NY 11235

FOR: ADVERTISING AND MARKETING; ADVERTISING PARTICULARLY SERVICES FOR THE PROMOTION OF GOODS; ARRANGING AND CONDUCTING TRADE SHOWS IN THE FIELD OF JEWELRY AND WATCHES; BUSINESS MANAGEMENT AND CONSULTATION IN THE FIELD OF JEWELRY AND WATCHES WHOLESAL AND RETAIL DISTRIBUTION; COMPUTERIZED ON-LINE ORDERING SERVICES IN THE FIELD OF JEWELRY AND WATCHES; COMPUTERIZED ON-LINE RETAIL STORE SERVICES IN THE FIELD OF JEWELRY AND WATCHES; CONCESSION STANDS FEATURING JEWELRY AND WATCHES; CONDUCTING TRADE SHOWS IN THE FIELD OF JEWELRY AND WATCHES; CONSULTANCY SERVICES REGARDING BUSINESS STRATEGIES; CONSULTATION IN THE FIELD OF COMMERCIALS OR INFOMERCIALS; COOPERATIVE ADVERTISING AND MARKETING; CUSTOMER SERVICE IN THE FIELD OF JEWELRY AND WATCHES WHOLESAL AND RETAIL DISTRIBUTION; DIRECT MAIL ADVERTISING; DISSEMINATION OF ADVERTISING MATTER; DISTRIBUTION AND DISSEMINATION OF ADVERTISING MATERIALS; DISTRIBUTORSHIP SERVICES IN THE FIELD OF JEWELRY AND WATCHES; DISTRIBUTORSHIPS IN THE FIELD OF JEWELRY AND WATCHES; FRANCHISE SERVICES, NAMELY, OFFERING TECHNICAL AND BUSINESS MANAGEMENT ASSISTANCE IN THE ESTABLISHMENT AND OPERATION OF JEWELRY, PRECIOUS STONES AND WATCHES RETAIL DISTRIBUTION; FRANCHISING, NAMELY, CONSULTATION AND ASSISTANCE IN BUSINESS MANAGEMENT, ORGANIZATION AND PROMOTION; FRANCHISING, NAMELY, OFFERING TECHNICAL ASSISTANCE IN THE ESTABLISHMENT AND/OR OPERATION

OF JEWELRY, PRECIOUS STONES AND WATCHES RETAIL DISTRIBUTION; GENERAL BUSINESS MERCHANDISING SERVICES, NAMELY, MARKETING; INVENTORY MANAGEMENT IN THE FIELD OF JEWELRY AND WATCHES RETAIL DISTRIBUTION; INVOICING SERVICES IN THE FIELD OF JEWELRY AND WATCHES RETAIL AND WHOLESAL DISTRIBUTION; MANAGEMENT AND BUSINESS CONSULTING SERVICES IN THE FIELD OF JEWELRY AND WATCHES RETAIL AND WHOLESAL DISTRIBUTION; MANUFACTURER REPRESENTATIVES IN THE FIELD OF JEWELRY AND WATCHES; ON-LINE RETAIL STORE SERVICES FEATURING JEWELRY AND WATCHES; OPERATING AN ONLINE SHOPPING SITE IN THE FIELD OF JEWELRY AND WATCHES; PREPARING AUDIO-VISUAL DISPLAYS IN THE FIELD OF JEWELRY AND WATCHES; PRODUCT DEMONSTRATION; PRODUCTION OF TELEVISION COMMERCIALS; PROFESSIONAL BUSINESS CONSULTATION; PROMOTING AND CONDUCTING TRADE SHOWS IN THE FIELD OF JEWELRY AND WATCHES; PROVIDING AN ON-LINE SHOWROOM FOR THE GOODS OF OTHERS IN THE FIELD OF JEWELRY, PRECIOUS STONES AND WATCHES; PROVIDING TRADE INFORMATION; RETAIL JEWELRY STORES; RETAIL SHOPS FEATURING JEWELRY, PRECIOUS STONES AND WATCHES; RETAIL STORE SERVICES FEATURING JEWELRY, PRECIOUS STONES AND WATCHES; RETAIL STORE SERVICES IN THE FIELD OF JEWELRY, PRECIOUS STONES AND WATCHES FEATURING A BONUS INCENTIVE PROGRAM FOR CUSTOMERS; RETAIL STORE SERVICES IN THE FIELD OF JEWELRY, PRECIOUS STONES AND WATCHES THAT CAN BE PURCHASED UNDER A RENT-TO-OWN CONTRACT; RETAIL STORE SERVICES, AVAILABLE THROUGH COMPUTER COMMUNICATIONS AND INTERACTIVE TELEVISION, FEATURING JEWELRY, PRECIOUS STONES AND WATCHES; RETAIL JEWELRY, PRECIOUS STONES AND

WATCHES STORES, IN CLASS 35 (U.S. CLS. 100, 101 AND 102).

FIRST USE 12-15-2004; IN COMMERCE 2-2-2006.

THE MARK CONSISTS OF STANDARD CHARACTERS WITHOUT CLAIM TO ANY PARTICULAR FONT, STYLE, SIZE, OR COLOR.

NO CLAIM IS MADE TO THE EXCLUSIVE RIGHT TO USE "JEWELRY", APART FROM THE MARK AS SHOWN.

SER. NO. 77-328,600, FILED 11-13-2007.

ALICE BENMAMAN, EXAMINING ATTORNEY

**Int. Cl.: 41**

**Prior U.S. Cls.: 100, 101 and 107**

**United States Patent and Trademark Office**

**Reg. No. 3,466,694**

**Registered July 15, 2008**

**SERVICE MARK  
PRINCIPAL REGISTER**

**MERCANTILE COMMERCIAL  
CAPITAL'S SMALL BUSINESS  
SUCCESS STRATEGIES**

MERCANTILE COMMERCIAL CAPITAL LLC  
(FLORIDA LTD LIAB CO)  
SUITE 3006  
940 CENTRE CIRCLE  
ALTAMONTE SPRINGS, FL 32714

FOR: EDUCATIONAL SERVICES, NAMELY,  
PROVIDING SEMINARS AND TELESEMINARS IN  
THE FIELD OF BUSINESS GROWTH, IN CLASS 41  
(U.S. CLS. 100, 101 AND 107).

FIRST USE 11-1-2007; IN COMMERCE 11-13-2007.

THE MARK CONSISTS OF STANDARD CHAR-  
ACTERS WITHOUT CLAIM TO ANY PARTICULAR  
FONT, STYLE, SIZE, OR COLOR.

NO CLAIM IS MADE TO THE EXCLUSIVE  
RIGHT TO USE "SMALL BUSINESS" AND "STRA-  
TEGIES", APART FROM THE MARK AS SHOWN.

SER. NO. 77-328,602, FILED 11-13-2007.

ANTHONY RINKER, EXAMINING ATTORNEY

Int. Cl.: 30

Prior U.S. Cl.: 46

United States Patent and Trademark Office

Reg. No. 3,466,695

Registered July 15, 2008

TRADEMARK  
PRINCIPAL REGISTER



Vua Trà  
Nature Treats, Inc.

LIN, WENDY YUEH-CHIH (UNITED STATES INDIVIDUAL)  
16482 MONTE CRISTO DRIVE  
HACIENDA HEIGHTS, CA 91745

FOR: JAPANESE GREEN TEA; LIME TEA; MIXES IN THE NATURE OF CONCENTRATES, SYRUPS OR POWDERS USED IN THE PREPARATION OF TEA BASED BEVERAGES; OOLONG TEA; SAGE TEA; TEA; TEA BAGS; TEA FOR INFUSIONS; TEA OF PARCHED POWDER OF BARLEY WITH HUSK (MUGI-CHA); TEA OF SALTY KELP POWDER (KOMBU-CHA); TEA PODS; TEA SUBSTITUTES; TEA-BASED BEVERAGES WITH FRUIT FLAVORING; THEINE-FREE TEA SWEETENED WITH SWEETENERS; BEVERAGES MADE OF TEA; BLACK TEA; FLAVOURINGS OF TEA; FRUIT TEAS; GREEN TEA; HERB TEA; HERBAL TEA; ICED TEA; FLAVOURED VINEGAR; VINEGAR; WINE VINEGAR; GRAIN-BASED BEVERAGES; HERBAL FOOD BEVERAGES; BEVERAGES MADE OF COFFEE; CHOCOLATE FOOD BEVERAGES NOT BEING DAIRY-BASED OR VEGETABLE BASED; COFFEE FLAVORED SYRUP USED IN MAKING FOOD BEVERAGES; COFFEE-BASED BEVERAGE CONTAINING MILK; CORN STARCH BASED DRINK, IN THE NATURE OF A FOOD BEVERAGE CONSISTING PRIMARILY OF MAIZE AND PORRIDGE; FLAVOR ENHANCERS USED IN FOOD AND BEVERAGE PRODUCTS; FLAVOR-

INGS FOR BEVERAGES; GRAIN-BASED FOOD BEVERAGES; PREPARED COCOA AND COCOA-BASED BEVERAGES; PREPARED COFFEE AND COFFEE-BASED BEVERAGES; SCENTED WATER FOR FLAVORING BEVERAGES, IN CLASS 30 (U.S. CL. 46).

FIRST USE 11-13-2007; IN COMMERCE 11-13-2007.

NO CLAIM IS MADE TO THE EXCLUSIVE RIGHT TO USE "NATURE TREATS, INC.", APART FROM THE MARK AS SHOWN.

THE MARK CONSISTS OF VIETNAMESE WORDS "VUA TRA" ON THE TOP AND THE ENGLISH:"NATURE TREATS, INC." ON THE BOTTOM AND THE JAPANESE TRANSLATION ON THE LEFT SIDE.

THE NON-LATIN CHARACTER(S) IN THE MARK TRANSLITERATES INTO "MIDORINO NO IE", AND THIS MEANS "HOUSE IN THE GREEN FIELD" IN ENGLISH.

SER. NO. 77-328,632, FILED 11-13-2007.

HOWARD SMIGA, EXAMINING ATTORNEY

**Int. Cl.: 36**

**Prior U.S. Cls.: 100, 101 and 102**

**United States Patent and Trademark Office**

**Reg. No. 3,466,696**

**Registered July 15, 2008**

**SERVICE MARK  
PRINCIPAL REGISTER**

**Helping Build, Protect and  
Transfer Wealth**

MSN, LLC (MISSOURI LTD LIAB CO), DBA  
CUTTER ADVISORS  
15703 SUMMER RIDGE DR.  
CHESTERFIELD, MO 63017

FOR: COMPREHENSIVE FINANCIAL PLAN-  
NING AND INVESTMENT ADVISORY SERVICES  
FOR ENABLING SUCCESSFUL BUILDING, PRO-  
TECTING AND TRANSFERRING OF FINANCIAL  
ASSETS , IN CLASS 36 (U.S. CLS. 100, 101 AND 102).

FIRST USE 6-1-2004; IN COMMERCE 6-1-2004.

THE MARK CONSISTS OF STANDARD CHAR-  
ACTERS WITHOUT CLAIM TO ANY PARTICULAR  
FONT, STYLE, SIZE, OR COLOR.

SER. NO. 77-328,718, FILED 11-13-2007.

HEATHER THOMPSON, EXAMINING ATTORNEY

**Int. Cl.: 16**

**Prior U.S. Cls.: 2, 5, 22, 23, 29, 37, 38 and 50**

**United States Patent and Trademark Office**

**Reg. No. 3,466,697**

**Registered July 15, 2008**

**TRADEMARK  
PRINCIPAL REGISTER**

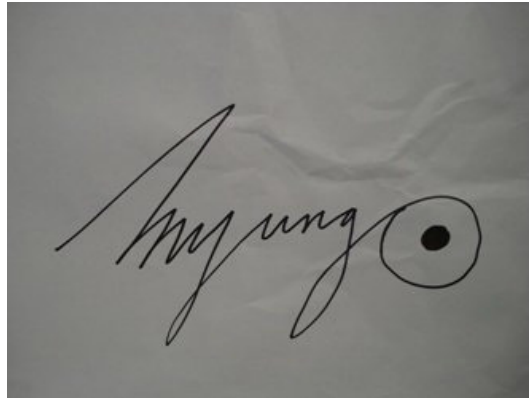

KIM, MYUNG (UNITED STATES INDIVIDUAL)  
16235 MAGNOLIA WAY  
FONTANA, CA 92335

FOR: PAINTINGS, IN CLASS 16 (U.S. CLS. 2, 5, 22,  
23, 29, 37, 38 AND 50).

FIRST USE 1-1-2007; IN COMMERCE 9-1-2007.

THE MARK CONSISTS OF THE MARK IS THE  
SIGNATURE OF THE OWNER/ARTIST, A LIVING  
PERSON, THE NAME "MYUNG" WITH A CIRCLE  
AND A DOT ON THE LAST CHARACTER OF THE  
NAME.

SER. NO. 77-328,777, FILED 11-13-2007.

ANDREA SAUNDERS, EXAMINING ATTORNEY

**Int. Cl.: 35**

**Prior U.S. Cls.: 100, 101 and 102**

**United States Patent and Trademark Office**

**Reg. No. 3,466,698**

**Registered July 15, 2008**

---

**SERVICE MARK  
PRINCIPAL REGISTER**

**glassbooth**

GLASSBOOTH CORPORATION (MASSACHU-  
SETTS CORPORATION)  
73 SCHOOL STREET  
CAMBRIDGE, MA 02139

THE MARK CONSISTS OF STANDARD CHAR-  
ACTERS WITHOUT CLAIM TO ANY PARTICULAR  
FONT, STYLE, SIZE, OR COLOR.

FOR: PROVIDING ONLINE INFORMATION RE-  
LATING TO ISSUES THAT INFORM POLITICAL  
DECISIONS, IN CLASS 35 (U.S. CLS. 100, 101 AND  
102).

SER. NO. 77-328,789, FILED 11-13-2007.

FIRST USE 8-24-2007; IN COMMERCE 11-2-2007.

GINA HAYES, EXAMINING ATTORNEY



**Int. Cl.: 42**

**Prior U.S. Cls.: 100 and 101**

**United States Patent and Trademark Office**

**Reg. No. 3,466,699**

**Registered July 15, 2008**

**SERVICE MARK  
PRINCIPAL REGISTER**

# Shining Stars

ABRAMS GENTILE ENTERTAINMENT, INC.  
(NEW YORK CORPORATION)  
244 WEST 54TH STREET, 9TH FLOOR  
NEW YORK, NY 10019

FOR: COMPUTER SERVICES, NAMELY, HOSTING ONLINE WEB FACILITIES FOR OTHERS FOR CONDUCTING ONLINE GATHERINGS AND INTERACTIVE DISCUSSIONS; AND COMPUTER SERVICES IN THE NATURE OF CUSTOMIZED WEB PAGES FEATURING USER-DEFINED INFORMATION, PERSONAL PROFILES AND INFORMATION, IN CLASS 42 (U.S. CLS. 100 AND 101).

FIRST USE 3-23-2007; IN COMMERCE 3-23-2007.

THE MARK CONSISTS OF STANDARD CHARACTERS WITHOUT CLAIM TO ANY PARTICULAR FONT, STYLE, SIZE, OR COLOR.

SER. NO. 77-328,821, FILED 11-13-2007.

EVELYN BRADLEY, EXAMINING ATTORNEY

**Int. Cl.: 41**

**Prior U.S. Cls.: 100, 101 and 107**

**United States Patent and Trademark Office**

**Reg. No. 3,466,700**

**Registered July 15, 2008**

**SERVICE MARK  
PRINCIPAL REGISTER**

# AcuPractice

VENTRESCA, JAMES, THOMAS (UNITED STATES INDIVIDUAL)  
PO BOX 1291 (8 MOOTS CT)  
TIJERAS, NM 87059

THE MARK CONSISTS OF STANDARD CHARACTERS WITHOUT CLAIM TO ANY PARTICULAR FONT, STYLE, SIZE, OR COLOR.

FOR: EDUCATION SERVICES, NAMELY, PROVIDING SEMINARS IN THE FIELDS OF ACUPUNCTURE AND ORIENTAL MEDICINE, IN CLASS 41 (U.S. CLS. 100, 101 AND 107).

SER. NO. 77-328,919, FILED 11-14-2007.

FIRST USE 9-1-2003; IN COMMERCE 9-1-2003.

RUDY R. SINGLETON, EXAMINING ATTORNEY

**Int. Cl.: 44**

**Prior U.S. Cls.: 100 and 101**

**United States Patent and Trademark Office**

**Reg. No. 3,466,701**

**Registered July 15, 2008**

**SERVICE MARK  
PRINCIPAL REGISTER**



LOGAN, RYAN (UNITED STATES INDIVIDUAL)  
#504  
1250 LINCOLN ROAD  
MIAMI BEACH, FL 33139

FIRST USE 2-15-2007; IN COMMERCE 8-14-2007.

SER. NO. 77-328,924, FILED 11-14-2007.

FOR: MASSAGE THERAPY SERVICES AND HY-  
DRO THERAPY SERVICES, IN CLASS 44 (U.S. CLS.  
100 AND 101).

RUDY R. SINGLETON, EXAMINING ATTORNEY

Int. Cl.: 13

Prior U.S. Cls.: 2 and 9

United States Patent and Trademark Office

Reg. No. 3,466,702

Registered July 15, 2008

TRADEMARK  
PRINCIPAL REGISTER



DEDNUTZ PRODUCTS, LLC (NORTH CAROLINA LTD LIAB CO)  
2710 WILKINS DRIVE  
SANFORD, NC 27330

FOR: SCOPE MOUNT FOR A RIFLE, IN CLASS 13  
(U.S. CLS. 2 AND 9).

FIRST USE 1-0-2007; IN COMMERCE 1-0-2007.

OWNER OF U.S. REG. NO. 3,340,668.

THE COLOR(S) BLACK, WHITE, BROWN, SILVER, AND ORANGE IS/ARE CLAIMED AS A FEATURE OF THE MARK.

THE MARK CONSISTS OF AN ORANGE CIRCULAR BULLSEYE SHAPE WITH A BLACK CROSS HAIR THEREON, A SKULL WITH ANTLERS IN WHITE IS BELOW THE CENTER OF THE CROSS HAIR AND A PAIR OF SICKLES WITH SILVER BLADES AND BROWN HANDLES ARE CROSSED BEHIND THE SKULL IN THE CENTER OF THE BULLSEYE WITH THE WORDS: "GAME REAPER" SEPARATED BY THE BULLSEYE.

SER. NO. 77-328,970, FILED 11-14-2007.

NICHOLAS ALTREE, EXAMINING ATTORNEY

**Int. Cl.: 35**

**Prior U.S. Cls.: 100, 101 and 102**

**United States Patent and Trademark Office**

**Reg. No. 3,466,703**

**Registered July 15, 2008**

---

**SERVICE MARK  
PRINCIPAL REGISTER**

**supportU**

RTM&J INC. (GEORGIA CORPORATION)  
50 RIVERGATE COURT  
MARIETTA, GA 30068

FOR: BUSINESS MARKETING CONSULTING  
SERVICES, IN CLASS 35 (U.S. CLS. 100, 101 AND 102).

FIRST USE 9-1-2007; IN COMMERCE 9-1-2007.

THE MARK CONSISTS OF STANDARD CHAR-  
ACTERS WITHOUT CLAIM TO ANY PARTICULAR  
FONT, STYLE, SIZE, OR COLOR.

SER. NO. 77-329,057, FILED 11-14-2007.

KATHLEEN LORENZO, EXAMINING ATTORNEY

**Int. Cl.: 35**

**Prior U.S. Cls.: 100, 101 and 102**

**United States Patent and Trademark Office**

**Reg. No. 3,466,704**

**Registered July 15, 2008**

---

**SERVICE MARK  
PRINCIPAL REGISTER**

**Ystory**

RTM&J INC. (GEORGIA CORPORATION)  
50 RIVERGATE COURT  
MARIETTA, GA 30068

FOR: BUSINESS MARKETING CONSULTING  
SERVICES, IN CLASS 35 (U.S. CLS. 100, 101 AND 102).

FIRST USE 9-1-2007; IN COMMERCE 9-1-2007.

THE MARK CONSISTS OF STANDARD CHAR-  
ACTERS WITHOUT CLAIM TO ANY PARTICULAR  
FONT, STYLE, SIZE, OR COLOR.

SER. NO. 77-329,076, FILED 11-14-2007.

KATHLEEN LORENZO, EXAMINING ATTORNEY

**Int. Cl.: 35**

**Prior U.S. Cls.: 100, 101 and 102**

**United States Patent and Trademark Office**

**Reg. No. 3,466,705**

**Registered July 15, 2008**

---

**SERVICE MARK  
PRINCIPAL REGISTER**

**WO!mantics**

RTM&J INC. (GEORGIA CORPORATION)  
50 RIVERGATE COURT  
MARIETTA, GA 30068

THE MARK CONSISTS OF STANDARD CHAR-  
ACTERS WITHOUT CLAIM TO ANY PARTICULAR  
FONT, STYLE, SIZE, OR COLOR.

FOR: BUSINESS MARKETING CONSULTING  
SERVICES, IN CLASS 35 (U.S. CLS. 100, 101 AND 102).

SER. NO. 77-329,078, FILED 11-14-2007.

FIRST USE 9-1-2007; IN COMMERCE 9-1-2007.

KATHLEEN LORENZO, EXAMINING ATTORNEY

**Int. Cl.: 35**

**Prior U.S. Cls.: 100, 101 and 102**

**United States Patent and Trademark Office**

**Reg. No. 3,466,706**

**Registered July 15, 2008**

---

**SERVICE MARK  
PRINCIPAL REGISTER**

**hispanicON**

RTM&J INC. (GEORGIA CORPORATION)  
50 RIVERGATE COURT  
MARIETTA, GA 30068

THE MARK CONSISTS OF STANDARD CHAR-  
ACTERS WITHOUT CLAIM TO ANY PARTICULAR  
FONT, STYLE, SIZE, OR COLOR.

FOR: BUSINESS MARKETING CONSULTING  
SERVICES, IN CLASS 35 (U.S. CLS. 100, 101 AND 102).

SER. NO. 77-329,079, FILED 11-14-2007.

FIRST USE 9-1-2007; IN COMMERCE 9-1-2007.

KATHLEEN LORENZO, EXAMINING ATTORNEY



**Int. Cl.: 35**

**Prior U.S. Cls.: 100, 101 and 102**

**United States Patent and Trademark Office**

**Reg. No. 3,466,707**

**Registered July 15, 2008**

---

**SERVICE MARK  
PRINCIPAL REGISTER**

**kaBOOMERS**

RTM&J INC. (GEORGIA CORPORATION)  
50 RIVERGATE COURT  
MARIETTA, GA 30068

FOR: BUSINESS MARKETING CONSULTING  
SERVICES, IN CLASS 35 (U.S. CLS. 100, 101 AND 102).

FIRST USE 9-1-2007; IN COMMERCE 9-1-2007.

THE MARK CONSISTS OF STANDARD CHAR-  
ACTERS WITHOUT CLAIM TO ANY PARTICULAR  
FONT, STYLE, SIZE, OR COLOR.

SER. NO. 77-329,085, FILED 11-14-2007.

KATHLEEN LORENZO, EXAMINING ATTORNEY

Int. Cl.: 35

Prior U.S. Cls.: 100, 101 and 102

United States Patent and Trademark Office

Reg. No. 3,466,708

Registered July 15, 2008

SERVICE MARK  
PRINCIPAL REGISTER



SEASONAL ELEGANCE LLC (FLORIDA LTD  
LIAB CO)  
13018 BERWICKSHIRE DRIVE  
JACKSONVILLE, FL 32224

FOR: ON-LINE RETAIL STORE SERVICES FEATURING ARTIFICIAL SILK FLOWER ARRANGEMENTS AND DESIGNS, ARTIFICIAL SILK PLANTS, ARTIFICIAL SILK TREES, SPECIALTY CRYSTAL, NAMELY, VASES, LANDMARKS AND FIGURINES, SPECIALTY GLASSWARE, NAMELY, FIGURINES, AND HOME FURNISHINGS, NAMELY, TABLE RUNNERS, PLACEMATS, AND CANDLEHOLDERS, IN CLASS 35 (U.S. CLS. 100, 101 AND 102).

FIRST USE 9-0-2007; IN COMMERCE 9-0-2007.

THE MARK CONSISTS OF THE TEXT "SEASONAL ELEGANCE" WRITTEN IN FANCY ITALICS FONT. THERE IS ONE LONG FLOWER STEM

ABOVE THE WORD "SEASONAL" WHICH HAS A STEM AND TWO LEAVES JOINED TO STEM ON EITHER SIDE WITH ONE FLOWER. THE FLOWER IS ABOVE THE "S" IN "SEASONAL" AND THE END OF THE THIN STEM IS ABOVE THE "A" IN THE WORD "SEASONAL". ONE LEAF ABOVE THE "AS" IN THE WORD "SEASONAL" AND SECOND LEAF ABOVE THE "ON" IN THE WORD "SEASONAL". THE SAME LONG FLOWER STEM IS USED BELOW THE WORD "ELEGANCE" WITH THE FLOWER UNDERNEATH THE "CE" OF THE WORD "ELEGANCE" AND THE THIN STEM BEGINS UNDERNEATH THE "EL" IN THE WORD "ELEGANCE". ONE LEAF BELOW "AN" IN THE WORD "ELEGANCE" AND SECOND LEAF BELOW "EG" IN THE WORD "ELEGANCE".

SER. NO. 77-329,087, FILED 11-14-2007.

JUSTINE D. PARKER, EXAMINING ATTORNEY

**Int. Cl.: 35**

**Prior U.S. Cls.: 100, 101 and 102**

**United States Patent and Trademark Office**

**Reg. No. 3,466,709**

**Registered July 15, 2008**

---

**SERVICE MARK  
PRINCIPAL REGISTER**

**enterACTIVES**

RTM&J INC. (GEORGIA CORPORATION)  
50 RIVERGATE COURT  
MARIETTA, GA 30068

THE MARK CONSISTS OF STANDARD CHAR-  
ACTERS WITHOUT CLAIM TO ANY PARTICULAR  
FONT, STYLE, SIZE, OR COLOR.

FOR: BUSINESS MARKETING CONSULTING  
SERVICES, IN CLASS 35 (U.S. CLS. 100, 101 AND 102).

SER. NO. 77-329,093, FILED 11-14-2007.

FIRST USE 9-1-2007; IN COMMERCE 9-1-2007.

KATHLEEN LORENZO, EXAMINING ATTORNEY

**Int. Cl.: 38**

**Prior U.S. Cls.: 100, 101 and 104**

**United States Patent and Trademark Office**

**Reg. No. 3,466,710**

**Registered July 15, 2008**

**SERVICE MARK  
PRINCIPAL REGISTER**

# Talking Metal

TALKING METAL (NEW JERSEY PARTNER-  
SHIP)

#305

39 GREENE STREET  
JERSEY CITY, NJ 07302

FOR: INTERNET BROADCASTING SERVICES;  
PODCASTING SERVICES; SATELLITE TELEVISION  
BROADCASTING; TELEVISION AND RADIO  
BROADCASTING SERVICES, IN CLASS 38 (U.S.  
CLS. 100, 101 AND 104).

FIRST USE 8-4-2005; IN COMMERCE 8-4-2005.

THE MARK CONSISTS OF STANDARD CHAR-  
ACTERS WITHOUT CLAIM TO ANY PARTICULAR  
FONT, STYLE, SIZE, OR COLOR.

SER. NO. 77-329,114, FILED 11-14-2007.

MARGERY A. TIERNEY, EXAMINING ATTORNEY

**Int. Cl.: 12**

**Prior U.S. Cls.: 19, 21, 23, 31, 35 and 44**

**United States Patent and Trademark Office**

**Reg. No. 3,466,711**

**Registered July 15, 2008**

**TRADEMARK  
PRINCIPAL REGISTER**

**FARM DAWG**

EAST BAY TIRE CO. (CALIFORNIA CORPORATION)  
2200 HUNTINGTON DR., UNIT C  
FAIRFIELD, CA 94533

FOR: TIRES FOR VEHICLES NOT FOR HIGHWAY SERVICE, IN CLASS 12 (U.S. CLS. 19, 21, 23, 31, 35 AND 44).

FIRST USE 4-6-2007; IN COMMERCE 4-6-2007.

THE MARK CONSISTS OF STANDARD CHARACTERS WITHOUT CLAIM TO ANY PARTICULAR FONT, STYLE, SIZE, OR COLOR.

OWNER OF U.S. REG. NOS. 3,172,057, 3,221,264 AND OTHERS.

SER. NO. 77-329,148, FILED 11-14-2007.

BILL DAWE, EXAMINING ATTORNEY

**Int. Cl.: 41**

**Prior U.S. Cls.: 100, 101 and 107**

**United States Patent and Trademark Office**

**Reg. No. 3,466,712**

**Registered July 15, 2008**

**SERVICE MARK  
PRINCIPAL REGISTER**

FRANKEL, MARCIA (NEW YORK LTD LIAB CO), DBA EDUCATIONAL SERVICES CENTER, INC

2 LOUIS AVENUE  
MONSEY, NY 10952 AND

FRANKEL, EMANUEL (NEW YORK LTD LIAB CO),  
DBA EDUCATIONAL SERVICES CENTER, INC  
2 LOUIS AVENUE  
MONSEY, NY 10952

FOR: EDUCATION SERVICES, NAMELY, PROVIDING TUTORING IN THE FIELD OF COLLEGE

ENTRANCE EXAMINATION SKILLS, IN CLASS 41 (U.S. CLS. 100, 101 AND 107).

FIRST USE 8-6-1978; IN COMMERCE 8-6-1978.

THE MARK CONSISTS OF THREE LETTERS, "ESC", THAT ARE SLIGHTLY OVERLAPPING AND THE CENTER LETTER, "S", IS RAISED.

SER. NO. 77-329,152, FILED 11-14-2007.

JILL PRATER, EXAMINING ATTORNEY

**Int. Cl.: 43**

**Prior U.S. Cls.: 100 and 101**

**United States Patent and Trademark Office**

**Reg. No. 3,466,713**

**Registered July 15, 2008**

**SERVICE MARK  
PRINCIPAL REGISTER**



I.T.B. EIGHT, LLC (MARYLAND LTD LIAB CO)  
SUITE 210  
7752 WOODMONT AVENUE  
BETHESDA, MD 20814

THE MARK CONSISTS OF A RECTANGLE WITH  
THE WORDS "BLACK'S BAR & KITCHEN" IN THE  
CENTER.

FOR: RESTAURANT AND BAR SERVICES, IN  
CLASS 43 (U.S. CLS. 100 AND 101).

SEC. 2(F).

FIRST USE 3-31-1999; IN COMMERCE 3-31-1999.

SER. NO. 77-329,155, FILED 11-14-2007.

NO CLAIM IS MADE TO THE EXCLUSIVE  
RIGHT TO USE "BAR & KITCHEN", APART FROM  
THE MARK AS SHOWN.

KIMBERLY FRYE, EXAMINING ATTORNEY

**Int. Cl.: 42**

**Prior U.S. Cls.: 100 and 101**

**United States Patent and Trademark Office**

**Reg. No. 3,466,714**

**Registered July 15, 2008**

**SERVICE MARK  
PRINCIPAL REGISTER**

**IHOUSE WEB SOLUTIONS**

CIS DATA SYSTEMS, INC. (CALIFORNIA CORPORATION)  
2030 FRANKLIN ST., STE. 500  
OAKLAND, CA 94612

FOR: COMPUTER SERVICES, NAMELY, MANAGING WEB SITES FOR OTHERS; DISPLAYING THE WEB SITES AND IMAGES OF OTHERS ON A COMPUTER SERVER; E-MAIL SYSTEM DESIGN AND IMPLEMENTATION FOR OTHERS; HOSTING THE WEB SITES OF OTHERS ON A COMPUTER SERVER FOR A GLOBAL COMPUTER NETWORK; PROVIDING TEMPORARY USE OF ON-LINE NON-DOWNLOADABLE SOFTWARE FOR CREATING CUSTOM WEB SITES AND HOME PAGES USING TEMPLATES, IN THE FIELD OF REAL ESTATE MARKETING AND SALES, IN CLASS 42 (U.S. CLS. 100 AND 101).

FIRST USE 1-1-2007; IN COMMERCE 1-1-2007.

THE MARK CONSISTS OF STANDARD CHARACTERS WITHOUT CLAIM TO ANY PARTICULAR FONT, STYLE, SIZE, OR COLOR.

OWNER OF U.S. REG. NO. 3,267,258.

NO CLAIM IS MADE TO THE EXCLUSIVE RIGHT TO USE "WEB SOLUTIONS", APART FROM THE MARK AS SHOWN.

SER. NO. 77-329,186, FILED 11-14-2007.

G. MAYERSCHOFF, EXAMINING ATTORNEY



**Int. Cl.: 36**

**Prior U.S. Cls.: 100, 101 and 102**

**United States Patent and Trademark Office**

**Reg. No. 3,466,715**

**Registered July 15, 2008**

**SERVICE MARK  
PRINCIPAL REGISTER**

**INTELCARE HEALTH**

DIVERSIFIED HEALTH PLANS, INC. (NEVADA CORPORATION)  
861 SW 78TH AVENUE, SUITE 200  
PLANTATION, FL 33324

FOR: INSURANCE AGENCY AND BROKERAGE IN THE FIELD OF HEALTH INSURANCE PLANS, SUCH SERVICES PROVIDED TO CUSTOMERS DIRECTLY, THROUGH USE OF A GLOBAL COMPUTER NETWORK, AND VIA OUTSIDE SALES AGENTS UNAFFILIATED WITH PHARMACIES, IN CLASS 36 (U.S. CLS. 100, 101 AND 102).

FIRST USE 8-16-2007; IN COMMERCE 8-16-2007.

THE MARK CONSISTS OF STANDARD CHARACTERS WITHOUT CLAIM TO ANY PARTICULAR FONT, STYLE, SIZE, OR COLOR.

NO CLAIM IS MADE TO THE EXCLUSIVE RIGHT TO USE "HEALTH", APART FROM THE MARK AS SHOWN.

SER. NO. 77-329,187, FILED 11-14-2007.

JIM RINGLE, EXAMINING ATTORNEY

**Int. Cl.: 28**

**Prior U.S. Cls.: 22, 23, 38 and 50**

**Reg. No. 3,466,716**

**United States Patent and Trademark Office**

**Registered July 15, 2008**

**TRADEMARK  
PRINCIPAL REGISTER**



CHAZPRO MAGIC CO. INC. (WASHINGTON CORPORATION)  
P.O. BOX 108  
JOYCE, WA 98343

THE MARK CONSISTS OF A RAVEN WITH OUTSTRETCHED WINGS IN MIDFLIGHT, AN OPEN BEAK, AND FORWARD OUTSTRETCHED TALONS GRASPING A COIN.

FOR: MAGIC TRICKS, IN CLASS 28 (U.S. CLS. 22, 23, 38 AND 50).

SER. NO. 77-329,195, FILED 11-14-2007.

FIRST USE 1-1-1997; IN COMMERCE 1-1-1997.

JIM RINGLE, EXAMINING ATTORNEY

**Int. Cl.: 11**

**Prior U.S. Cls.: 13, 21, 23, 31 and 34**

**United States Patent and Trademark Office**

**Reg. No. 3,466,717**

**Registered July 15, 2008**

**TRADEMARK  
PRINCIPAL REGISTER**

**RIVET SEALER 3000**

HUGHES, JOSEPH D. (UNITED STATES INDIVIDUAL)  
921 WESTCLIFFE DR.  
WINTER GARDEN, FL 34787

FOR: HEAT GUN ATTACHMENT FOR REMOVING AIR POCKETS FROM VINYL GRAPHICS, IN CLASS 11 (U.S. CLS. 13, 21, 23, 31 AND 34).

FIRST USE 4-20-2007; IN COMMERCE 4-20-2007.

THE MARK CONSISTS OF STANDARD CHARACTERS WITHOUT CLAIM TO ANY PARTICULAR FONT, STYLE, SIZE, OR COLOR.

NO CLAIM IS MADE TO THE EXCLUSIVE RIGHT TO USE "RIVET SEALER", APART FROM THE MARK AS SHOWN.

SER. NO. 77-329,200, FILED 11-14-2007.

JIM RINGLE, EXAMINING ATTORNEY

Int. Cl.: 9

Prior U.S. Cls.: 21, 23, 26, 36 and 38

United States Patent and Trademark Office

Reg. No. 3,466,718

Registered July 15, 2008

TRADEMARK  
PRINCIPAL REGISTER



NETSOLACE, INC. (CONNECTICUT CORPORATION)  
95 BARNES ROAD  
WALLINGFORD, CT 064921800

FOR: COMPUTER SOFTWARE APPLICATION FOR OPERATION OF A DYNAMIC MULTI-SCREEN DIGITAL MENU, IN CLASS 9 (U.S. CLS. 21, 23, 26, 36 AND 38).

FIRST USE 8-20-2007; IN COMMERCE 8-20-2007.

OWNER OF U.S. REG. NO. 3,147,575.

THE COLOR(S) ORANGE, RED, GREEN AND BLUE IS/ARE CLAIMED AS A FEATURE OF THE MARK.

THE MARK CONSISTS OF THE WORDS "NETSOLACE DM" APPEARING IN BLUE, AND THREE RECTANGLES OUTLINED IN BLACK, IN WHICH A SPECTRUM OF THE COLORS ORANGE, RED, GREEN AND BLUE APPEAR.

SER. NO. 77-329,232, FILED 11-14-2007.

ERIN FALK, EXAMINING ATTORNEY

**Int. Cl.: 35**

**Prior U.S. Cls.: 100, 101 and 102**

**United States Patent and Trademark Office**

**Reg. No. 3,466,719**

**Registered July 15, 2008**

**SERVICE MARK  
PRINCIPAL REGISTER**



COMMONWEALTH OF KENTUCKY (KEN-  
TUCKY STATE AGENCY)  
300 W. BROADWAY  
FRANKFORT, KY 40601

FOR: ORGANIZING BUSINESS COMPETITIONS  
AMONG COLLEGE AND UNIVERSITY STUDENTS  
TO ENCOURAGE INNOVATION, IN CLASS 35 (U.S.  
CLS. 100, 101 AND 102).

FIRST USE 2-5-2008; IN COMMERCE 2-5-2008.

THE MARK CONSISTS OF THE WORDS "IDEA  
STATE" IN STYLIZED BLOCK LETTERS FOL-  
LOWED BY A GRAPHIC LETTER "U" HAVING A  
SPRIAL LIGHT BULB IN THE MIDDLE OF THE "U".

SER. NO. 77-329,234, FILED 11-14-2007.

LINDA M. KING, EXAMINING ATTORNEY

**Int. Cl.: 9**

**Prior U.S. Cls.: 21, 23, 26, 36 and 38**

**United States Patent and Trademark Office**

**Reg. No. 3,466,720**

**Registered July 15, 2008**

**TRADEMARK  
PRINCIPAL REGISTER**

**NETSOLACE POP**

NETSOLACE, INC. (CONNECTICUT CORPORATION)  
95 BARNES ROAD  
WALLINGFORD, CT 064921800

FOR: COMPUTER SOFTWARE APPLICATION FOR OPERATION OF A TOUCH SCREEN INTERFACE FOR A POINT OF PURCHASE ELECTRONIC CATALOGUE DELIVERING WEB-BASED CONTENT AND FOR ALLOWING CONSUMERS TO BROWSE PRODUCTS AND SERVICES, IN CLASS 9 (U.S. CLS. 21, 23, 26, 36 AND 38).

FIRST USE 8-20-2007; IN COMMERCE 8-20-2007.

THE MARK CONSISTS OF STANDARD CHARACTERS WITHOUT CLAIM TO ANY PARTICULAR FONT, STYLE, SIZE, OR COLOR.

OWNER OF U.S. REG. NO. 3,147,575.

NO CLAIM IS MADE TO THE EXCLUSIVE RIGHT TO USE POP, APART FROM THE MARK AS SHOWN.

SER. NO. 77-329,247, FILED 11-14-2007.

ERIN FALK, EXAMINING ATTORNEY

**Int. Cl.: 9**

**Prior U.S. Cls.: 21, 23, 26, 36 and 38**

**Reg. No. 3,466,721**

**United States Patent and Trademark Office**

**Registered July 15, 2008**

**TRADEMARK  
PRINCIPAL REGISTER**



NETSOLACE, INC. (CONNECTICUT CORPORATION)  
95 BARNES ROAD  
WALLINGFORD, CT 064921800

THE COLOR(S) BLUE, BLACK, WHITE AND ORANGE IS/ARE CLAIMED AS A FEATURE OF THE MARK.

FOR: COMPUTER SOFTWARE APPLICATION FOR OPERATION OF A TOUCH SCREEN INTERFACE FOR A POINT OF PURCHASE ELECTRONIC CATALOGUE DELIVERING WEB-BASED CONTENT AND FOR ALLOWING CONSUMERS TO BROWSE PRODUCTS AND SERVICES, IN CLASS 9 (U.S. CLS. 21, 23, 26, 36 AND 38).

THE MARK CONSISTS OF THE WORDS "NETSOLACE POP", WITH "NETSOLACE" AND THE "P'S" IN "POP" APPEARING IN THE COLOR BLUE; THE LETTER "O" IN "POP" APPEARING IN THE COLOR ORANGE, AND HAVING A REPRESENTATION OF A CURSOR APPEARING IN THE COLOR WHITE AND OUTLINED IN THE COLOR BLACK.

FIRST USE 8-20-2007; IN COMMERCE 8-20-2007.

SER. NO. 77-329,274, FILED 11-14-2007.

OWNER OF U.S. REG. NO. 3,147,575.

ERIN FALK, EXAMINING ATTORNEY

**Int. Cl.: 40**

**Prior U.S. Cls.: 100, 103 and 106**

**United States Patent and Trademark Office**

**Reg. No. 3,466,722**

**Registered July 15, 2008**

**SERVICE MARK  
PRINCIPAL REGISTER**

**OLIVE STREET TABLE**

OLIVE STREET TABLE, LLC (CALIFORNIA LTD  
LIAB CO)  
817 N. MILPAS ST.  
SANTA BARBARA, CA 93103

FOR: FOOD PROCESSING, NAMELY, THE MAN-  
UFACTURE OF FOOD PRODUCTS FOR SALE TO  
THE GOURMET FOOD RETAIL AND SERVICE  
INDUSTRIES, IN CLASS 40 (U.S. CLS. 100, 103 AND  
106).

FIRST USE 1-0-2004; IN COMMERCE 1-0-2006.

THE MARK CONSISTS OF STANDARD CHAR-  
ACTERS WITHOUT CLAIM TO ANY PARTICULAR  
FONT, STYLE, SIZE, OR COLOR.

SER. NO. 77-329,296, FILED 11-14-2007.

JESSICA A. POWERS, EXAMINING ATTORNEY



**Int. Cl.: 18**

**Prior U.S. Cls.: 1, 2, 3, 22 and 41**

**United States Patent and Trademark Office**

**Reg. No. 3,466,723**

**Registered July 15, 2008**

**TRADEMARK  
PRINCIPAL REGISTER**

**LOLITA**

HEALY, TRACY (UNITED STATES INDIVIDUAL)  
STUDIO # 201  
9100 WHITE BLUFF ROAD  
SAVANNAH, GA 31419

FOR: TOTE BAGS; COSMETIC BAGS SOLD EMPLOY;  
UMBRELLAS, IN CLASS 18 (U.S. CLS. 1, 2, 3, 22  
AND 41).

FIRST USE 1-1-2007; IN COMMERCE 1-1-2007.

THE MARK CONSISTS OF STANDARD CHARACTERS  
WITHOUT CLAIM TO ANY PARTICULAR FONT,  
STYLE, SIZE, OR COLOR.

OWNER OF U.S. REG. NO. 2,522,727.

SER. NO. 77-329,304, FILED 11-14-2007.

LINDSEY RUBIN, EXAMINING ATTORNEY

**Int. Cl.: 5**

**Prior U.S. Cls.: 6, 18, 44, 46, 51 and 52**

**United States Patent and Trademark Office**

**Reg. No. 3,466,724**

**Registered July 15, 2008**

**TRADEMARK  
PRINCIPAL REGISTER**

**SONATA**

AGRAQUEST, INC. (DELAWARE CORPORATION)  
1540 DREW AVENUE  
DAVIS, CA 95618

FOR: PESTICIDES, IN CLASS 5 (U.S. CLS. 6, 18, 44,  
46, 51 AND 52).

FIRST USE 10-3-2000; IN COMMERCE 10-3-2000.

THE MARK CONSISTS OF STANDARD CHARACTERS WITHOUT CLAIM TO ANY PARTICULAR FONT, STYLE, SIZE, OR COLOR.

OWNER OF U.S. REG. NO. 2,485,488.

SER. NO. 77-329,331, FILED 11-14-2007.

NAAKWAMA ANKRAH, EXAMINING ATTORNEY

**Int. Cl.: 40**

**Prior U.S. Cls.: 100, 103 and 106**

**United States Patent and Trademark Office**

**Reg. No. 3,466,725**

**Registered July 15, 2008**

---

**SERVICE MARK  
PRINCIPAL REGISTER**

# Tagless Threads

HUMMEL, KURT (UNITED STATES INDIVIDUAL)  
2120 SEA ISLAND PLACE  
SAN MARCOS, CA 92078

FOR: SILK SCREEN PRINTING SERVICES, IN CLASS 40 (U.S. CLS. 100, 103 AND 106).

FIRST USE 10-1-2006; IN COMMERCE 10-1-2006.

THE MARK CONSISTS OF STANDARD CHARACTERS WITHOUT CLAIM TO ANY PARTICULAR FONT, STYLE, SIZE, OR COLOR.

NO CLAIM IS MADE TO THE EXCLUSIVE RIGHT TO USE "TAGLESS", APART FROM THE MARK AS SHOWN.

SER. NO. 77-329,356, FILED 11-14-2007.

KATHERINE CONNOLLY, EXAMINING ATTORNEY

**Int. Cls.: 25 and 43**

**Prior U.S. Cls.: 22, 39, 100 and 101**

**United States Patent and Trademark Office**

**Reg. No. 3,466,726**

**Registered July 15, 2008**

**TRADEMARK  
SERVICE MARK  
PRINCIPAL REGISTER**

**ONE TASTY BURGER**

BROTHER JIMMY'S NYC RESTAURANT HOLD-  
INGS, LLC (DELAWARE LTD LIAB CO)  
544 WEST 27TH STREET, 2ND FLOOR  
NEW YORK, NY 10001

FOR: CAPS; SHORT-SLEEVED OR LONG-  
SLEEVED T-SHIRTS; T-SHIRTS, IN CLASS 25 (U.S.  
CLS. 22 AND 39).

FIRST USE 10-1-2007; IN COMMERCE 10-1-2007.

FOR: BAR SERVICES; RESTAURANT FEATUR-  
ING BURGERS, IN PART AND BAR SERVICES;  
RESTAURANT SERVICES FEATURING BURGERS,  
IN PART; RESTAURANTS FEATURING BURGERS,  
IN PART, IN CLASS 43 (U.S. CLS. 100 AND 101).

FIRST USE 10-1-2007; IN COMMERCE 10-1-2007.

THE MARK CONSISTS OF STANDARD CHAR-  
ACTERS WITHOUT CLAIM TO ANY PARTICULAR  
FONT, STYLE, SIZE, OR COLOR.

NO CLAIM IS MADE TO THE EXCLUSIVE  
RIGHT TO USE "TASTY BURGER" FOR INTERNA-  
TIONAL CLASS 43 , APART FROM THE MARK AS  
SHOWN.

SER. NO. 77-329,359, FILED 11-14-2007.

JEAN IM, EXAMINING ATTORNEY

**Int. Cl.: 9**

**Prior U.S. Cls.: 21, 23, 26, 36 and 38**

**United States Patent and Trademark Office**

**Reg. No. 3,466,727**

**Registered July 15, 2008**

**TRADEMARK  
PRINCIPAL REGISTER**

*inspiring & informing you*

INTERNATIONAL MASTERS PUBLISHERS AB  
(SWEDEN CORPORATION)  
ANGSBATBRON 1, BOX 803  
MALMO, SWEDEN SE-21120

FOR: SERIES OF PRE-RECORDED DVDS ON  
FEATURING PREDATORS IN THE ANIMAL KING-  
DOM, SPACE EXPLORATION, ANCIENT CIVILIZA-  
TIONS, NATURAL WONDERS AND WEATHER  
PHENOMENON, MILITARY WAR MACHINES, DI-  
GITAL PHOTOGRAPHY AND FAMILY HISTORY  
AND SERIES OF PRE-RECORDED CDS FEATUR-

ING CLASSICAL MUSIC, IN CLASS 9 (U.S. CLS. 21,  
23, 26, 36 AND 38).

FIRST USE 12-1-2005; IN COMMERCE 12-1-2005.

THE MARK CONSISTS OF STANDARD CHAR-  
ACTERS WITHOUT CLAIM TO ANY PARTICULAR  
FONT, STYLE, SIZE, OR COLOR.

SER. NO. 77-329,390, FILED 11-14-2007.

AMY MCMENAMIN, EXAMINING ATTORNEY

Int. Cl.: 43

Prior U.S. Cls.: 100 and 101

United States Patent and Trademark Office

Reg. No. 3,466,728

Registered July 15, 2008

SERVICE MARK  
PRINCIPAL REGISTER



Q SMOKE SHACK, LLC (ILLINOIS LTD LIAB CO), DBA SMOQUE BBQ  
3800 NORTH PULASKI ROAD  
CHICAGO, IL 60641

FOR: CAFE-RESTAURANTS, IN CLASS 43 (U.S. CLS. 100 AND 101).

FIRST USE 9-1-2006; IN COMMERCE 12-18-2006.

NO CLAIM IS MADE TO THE EXCLUSIVE RIGHT TO USE "BBQ SMOKE" AND "LOW AND SLOW", APART FROM THE MARK AS SHOWN.

THE COLOR(S) MAROON, BLACK AND WHITE IS/ARE CLAIMED AS A FEATURE OF THE MARK.

THE MARK CONSISTS OF BLACK CIRCULAR BACKGROUND WITH FRAYED EDGES, WITH AN INSET WHITE RING, FOLLOWED BY AN INSET MAROON RING; THE WORDING "BBQ" APPEARS AT THE TOP OF THE CIRCLE IN WHITE, AND BELOW THAT WORDING IS "SMO" IN BLACK, AND OUTLINED IN WHITE, AND "QUE" IN MAROON, AND OUTLINED IN WHITE; THE WORDING "LOW AND SLOW" APPEAR AT THE BOTTOM OF THE CIRCLE IN WHITE TEXT.

SER. NO. 77-329,487, FILED 11-14-2007.

JORDAN BAKER, EXAMINING ATTORNEY

Int. Cl.: 9

Prior U.S. Cls.: 21, 23, 26, 36 and 38

Reg. No. 3,466,729

United States Patent and Trademark Office

Registered July 15, 2008

TRADEMARK  
PRINCIPAL REGISTER

*JET* SHIELD

NUMA TACTICAL LLC (NEW JERSEY LTD LIAB  
CO)  
107 WOODFIELD DRIVE  
SHORT HILLS, NJ 07078

THE MARK CONSISTS OF THE WORDS JET AND  
SHIELD COMBINED INTO ONE WORD, "JET-  
SHIELD", "JET" IS IN ITALICS AND "SHIELD" IS  
IN BOLD.

FOR: ANTI-REFLECTIVE LENSES; EYEGLOSS  
LENSES; LENSES FOR SUNGLASSES; OPHTHAL-  
MIC LENSES; OPTICAL LENSES; SPECTACLE LEN-  
SES; SUNGLASS LENSES, IN CLASS 9 (U.S. CLS. 21,  
23, 26, 36 AND 38).

SER. NO. 77-329,490, FILED 11-14-2007.

FIRST USE 8-1-2007; IN COMMERCE 8-1-2007.

REBECCA GILBERT, EXAMINING ATTORNEY

**Int. Cls.: 35 and 36**

**Prior U.S. Cls.: 100, 101 and 102**

**United States Patent and Trademark Office**

**Reg. No. 3,466,730**

**Registered July 15, 2008**

**SERVICE MARK  
PRINCIPAL REGISTER**

**LACROSSE GLOBAL FUND  
SERVICES**

LACROSSE GLOBAL FUND SERVICES, LLC  
(DELAWARE LTD LIAB CO)  
12700 WHITEWATER DRIVE  
MINNETONKA, MN 55343

FOR: BUSINESS MANAGEMENT AND ADVICE,  
IN CLASS 35 (U.S. CLS. 100, 101 AND 102).

FIRST USE 5-15-2007; IN COMMERCE 5-15-2007.

FOR: FINANCIAL SERVICES, NAMELY, FUND  
ADMINISTRATION SERVICES FOR INVESTMENT  
MANAGERS; FUND INVESTMENT SERVICES;  
PROVIDING ONLINE INFORMATION IN THE  
FIELDS OF FINANCIAL INVESTMENT, HEDGE  
FUND MANAGEMENT, AND HEDGE FUND PER-

FORMANCE, IN CLASS 36 (U.S. CLS. 100, 101 AND  
102).

FIRST USE 5-15-2007; IN COMMERCE 5-15-2007.

THE MARK CONSISTS OF STANDARD CHAR-  
ACTERS WITHOUT CLAIM TO ANY PARTICULAR  
FONT, STYLE, SIZE, OR COLOR.

NO CLAIM IS MADE TO THE EXCLUSIVE  
RIGHT TO USE "GLOBAL FUND SERVICES",  
APART FROM THE MARK AS SHOWN.

SER. NO. 77-329,518, FILED 11-14-2007.

B. PARADEWELAI, EXAMINING ATTORNEY



**Int. Cl.: 37**

**Prior U.S. Cls.: 100, 103 and 106**

**United States Patent and Trademark Office**

**Reg. No. 3,466,731**

**Registered July 15, 2008**

**SERVICE MARK  
PRINCIPAL REGISTER**

**SAVING NEARBY NATURE**

NORTHERN VIRGINIA CONSERVATION TRUST  
(VIRGINIA NON-STOCK CORPORATION)  
4022 HUMMER ROAD  
ANNANDALE, VA 22003

THE MARK CONSISTS OF STANDARD CHAR-  
ACTERS WITHOUT CLAIM TO ANY PARTICULAR  
FONT, STYLE, SIZE, OR COLOR.

FOR: LAND RECLAMATION SERVICES IN THE  
FIELD OF LAND CONSERVATION AND PRESER-  
VATION, IN CLASS 37 (U.S. CLS. 100, 103 AND 106).

SER. NO. 77-329,554, FILED 11-14-2007.

FIRST USE 2-20-2007; IN COMMERCE 2-20-2007.

JOHN GARTNER, EXAMINING ATTORNEY

**Int. Cl.: 32**

**Prior U.S. Cls.: 45, 46 and 48**

**United States Patent and Trademark Office**

**Reg. No. 3,466,732**

**Registered July 15, 2008**

**TRADEMARK  
PRINCIPAL REGISTER**

**MANHATTAN SPECIAL**

MANHATTAN SPECIAL BOTTLING CORP.  
(NEW YORK CORPORATION)  
342 MANHATTAN AVENUE  
BROOKLYN, NY 11211

OWNER OF U.S. REG. NO. 2,121,274.

FOR: SODAS, SYRUPS AND CONCENTRATES  
FOR MAKING SOFT DRINKS, IN CLASS 32 (U.S.  
CLS. 45, 46 AND 48).

NO CLAIM IS MADE TO THE EXCLUSIVE  
RIGHT TO USE "SPECIAL", APART FROM THE  
MARK AS SHOWN.

FIRST USE 1-2-1923; IN COMMERCE 2-0-1925.

SER. NO. 77-329,670, FILED 11-14-2007.

THE MARK CONSISTS OF STANDARD CHAR-  
ACTERS WITHOUT CLAIM TO ANY PARTICULAR  
FONT, STYLE, SIZE, OR COLOR.

JAMES A. RAUEN, EXAMINING ATTORNEY

Int. Cl.: 3

Prior U.S. Cls.: 1, 4, 6, 50, 51 and 52

United States Patent and Trademark Office

Reg. No. 3,466,733

Registered July 15, 2008

TRADEMARK  
PRINCIPAL REGISTER

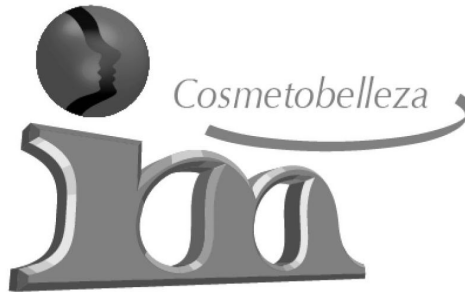

COSMETOBELLEZA NATURAL IM, S.A. DE C.V.  
(MEXICO CORPORATION)  
COL. IZTACIHUATL  
MARTIN LUIS GUZMAN N° 215  
DEL. BENITO JUAREZ, MEXICO 03520

FOR: BODY SOAP WITH KELP AND BOTANICAL EXTRACTS, ASTRINGENT FACIAL SOAP, HAIR SHINING OIL, BLUSH WITH ROSE PETALS, EYELASH MASCARA, COSMETIC CREAM FOR USE ON EYELASHES, SILICONE MASCARA, MASCARA WITH MAMEY OIL, MAKEUP REMOVER, BODY GEL WITH GRAPEFRUIT AND BOTANICAL EXTRACTS, BODY CONTOURING CREAM, MOISTURIZING CREAM, MOISTURIZING CREAM WITH COLLAGEN, RICE FACE POWDER, ROYAL JELLY CREAM WITH COLLAGEN AND VITAMIN E FOR

COSMETIC PURPOSE, COSMETIC CREAM, NAME-  
LY, MOTHER OF PEARL CREAM WITH VITAMIN  
E, IN CLASS 3 (U.S. CLS. 1, 4, 6, 50, 51 AND 52).

FIRST USE 10-10-2007; IN COMMERCE 10-10-2007.

THE MARK CONSISTS OF THE TERM "COSME-  
TOBELLEZA" ABOVE A STYLED IMAGE OF THE  
TERM "IM".

THE WORDING "COSMETOBELLEZA" HAS NO  
MEANING IN A FOREIGN LANGUAGE.

SER. NO. 77-329,671, FILED 11-14-2007.

JAMES A. RAUEN, EXAMINING ATTORNEY

**Int. Cl.: 35**

**Prior U.S. Cls.: 100, 101 and 102**

**United States Patent and Trademark Office**

**Reg. No. 3,466,734**

**Registered July 15, 2008**

**SERVICE MARK  
PRINCIPAL REGISTER**



CITYBOYS INTERNATIONAL MANAGEMENT  
GROUP, LLC (PENNSYLVANIA LTD LIAB  
CO)  
28 BEECHWOOD ROAD  
PARKSIDE, PA 19015

FOR: ON-LINE RETAIL STORE SERVICES FEATURING MUSICAL CDS, DOWNLOADABLE MUSIC, T-SHIRTS, HATS, STICKERS, AND FOAM DRINK HOLDERS , IN CLASS 35 (U.S. CLS. 100, 101 AND 102).

FIRST USE 9-1-2003; IN COMMERCE 12-15-2004.

THE MARK CONSISTS OF A DIAMOND-SHAPE OF A ROAD SIGN WITH A COW'S HEAD WEARING HEADPHONES. THE STYLIZED WORD "MOOZIKOO" IS LOCATED TO THE RIGHT OF THE DIAMOND.

THE WORD "MOOZIKOO" HAS NO MEANING IN ENGLISH.

SER. NO. 77-329,673, FILED 11-14-2007.

MARY ROSSMAN, EXAMINING ATTORNEY

Int. Cl.: 3

Prior U.S. Cls.: 1, 4, 6, 50, 51 and 52

United States Patent and Trademark Office

Reg. No. 3,466,735

Registered July 15, 2008

TRADEMARK  
PRINCIPAL REGISTER

t.a.l.k.  
beauty...

MOBU, L.L.P. (OKLAHOMA LIMITED PART-  
NERSHIP)  
7646 N. WESTERN  
OKLAHOMA CITY, OK 73116

FOR: BODY AND BEAUTY CARE COSMETICS;  
COLOGNES, PERFUMES AND COSMETICS; COS-  
METIC PENCILS; COSMETIC ROUGES; COSMET-  
ICS; COSMETICS AND COSMETIC  
PREPARATIONS; COSMETICS AND MAKE-UP;  
COSMETICS IN GENERAL, INCLUDING PER-  
FUMES; EYEBROW COSMETICS; MAKE-UP KITS  
COMPRISED OF COSMETICS; NAIL VARNISH FOR  
COSMETIC PURPOSES; PENCILS FOR COSMETIC  
PURPOSES, IN CLASS 3 (U.S. CLS. 1, 4, 6, 50, 51 AND  
52).

FIRST USE 11-1-2007; IN COMMERCE 11-1-2007.

NO CLAIM IS MADE TO THE EXCLUSIVE  
RIGHT TO USE "BEAUTY", APART FROM THE  
MARK AS SHOWN.

THE MARK CONSISTS OF THE STYLIZED LOW-  
ERCASE WORDS "T.A.L.K. BEAUTY ...", NOTING  
THE STYLIZED PERIODS BETWEEN THE LETTERS  
"T" "A" "L" AND "K" AS WELL AS THE STYLIZED  
ELLIPSIS AT THE END.

SER. NO. 77-329,711, FILED 11-14-2007.

ALEX KEAM, EXAMINING ATTORNEY

**Int. Cl.: 41**

**Prior U.S. Cls.: 100, 101 and 107**

**United States Patent and Trademark Office**

**Reg. No. 3,466,736**

**Registered July 15, 2008**

**SERVICE MARK  
PRINCIPAL REGISTER**



FREMANTLE MEDIA NORTH AMERICA, INC.  
(DELAWARE CORPORATION)  
4000 W. ALAMEDA AVENUE, 3RD FLOOR  
BURBANK, CA 91505

FOR: ENTERTAINMENT SERVICES IN THE  
NATURE OF A TELEVISION GAME SHOW; PRO-  
VIDING A WEBSITE FEATURING INFORMATION

ON TELEVISION GAME SHOWS, IN CLASS 41 (U.S.  
CLS. 100, 101 AND 107).

FIRST USE 9-5-2007; IN COMMERCE 9-5-2007.

SER. NO. 77-329,732, FILED 11-14-2007.

MARY BOAGNI, EXAMINING ATTORNEY

Int. Cl.: 40

Prior U.S. Cls.: 100, 103 and 106

United States Patent and Trademark Office

Reg. No. 3,466,737

Registered July 15, 2008

SERVICE MARK  
PRINCIPAL REGISTER



OSLO PRESS INC. (NORTH CAROLINA CORPORATION)

616 GLASCOCK ST

RALEIGH, NC 27604

FOR: ENGRAVING; PRINTING, IN CLASS 40  
(U.S. CLS. 100, 103 AND 106).

FIRST USE 3-15-2007; IN COMMERCE 7-17-2007.

NO CLAIM IS MADE TO THE EXCLUSIVE  
RIGHT TO USE "PRESS" , APART FROM THE  
MARK AS SHOWN.

THE MARK CONSISTS OF SILHOUETTE OF A  
SITTING CAT WITH A SWOOPING TAIL, WITH  
THE STYLIZED TEXT "OSLO PRESS".

SER. NO. 77-329,749, FILED 11-14-2007.

THOMAS MANOR, EXAMINING ATTORNEY

Int. Cl.: 25

Prior U.S. Cls.: 22 and 39

United States Patent and Trademark Office

Reg. No. 3,466,738

Registered July 15, 2008

TRADEMARK  
PRINCIPAL REGISTER



JAY MARTINEZ (UNITED STATES INDIVIDUAL)  
7475 E. TIMBERLANE COURT  
SCOTTSDALE, AZ 85258

FOR: A-SHIRTS; BUTTON-FRONT ALOHA SHIRTS; CAMP SHIRTS; DRESS SHIRTS; GOLF SHIRTS; KNIT SHIRTS; LONG-SLEEVED SHIRTS; NIGHT SHIRTS; OPEN-NECKED SHIRTS; PIQUE SHIRTS; POLO SHIRTS; RUGBY SHIRTS; SHIRT FRONTS; SHIRT YOKES; SHIRTS; SHIRTS FOR SUITS; SHORT-SLEEVED OR LONG-SLEEVED T-SHIRTS; SHORT-SLEEVED SHIRTS; SWIMWEAR; ANKLE SOCKS; ANKLETS; ANTI-PERSPIRANT SOCKS; JAPANESE STYLE SOCKS (TABI COVERS); JAPANESE STYLE SOCKS (TABI); MEN'S SOCKS; SOCKS; THERMAL SOCKS; WATER SOCKS; WOOLLEN SOCKS; LINGERIE; BALLOON PANTS; CAPRI PANTS; CARGO PANTS; DENIMS; JOGGING PANTS; LEATHER PANTS; LOUNGE PANTS; NON-DISPOSABLE CLOTH TRAINING PANTS; NURSE PANTS; PANTS; PETTI-PANTS; SKI PANTS; SNOW PANTS; SNOWBOARD PANTS; STRETCH PANTS; SWEAT PANTS; TAP PANTS; TOBOGGAN HATS, PANTS AND CAPS; BERMUDA SHORTS; BOARD SHORTS; BOXER SHORTS; FLEECE SHORTS; GYM SHORTS; PANTIES, SHORTS AND BRIEFS; RUGBY SHORTS; SHORT OVERCOAT FOR KIMONO (HAORI); SHORT PETTICOATS; SHORT SETS; SHORT TROUSERS; SHORTS; SLIDING SHORTS; SPORTS SHIRTS WITH SHORT SLEEVES; SWEAT SHORTS; TRIATHLON CLOTHING, NAMELY, TRIATHLON TIGHTS, TRIATH-

LON SHORTS, TRIATHLON SINGLET, TRIATHLON SHIRTS, TRIATHLON SUITS; BRIEFS; DISPOSABLE UNDERWEAR; KNITTED UNDERWEAR; LADIES' UNDERWEAR; LONG UNDERWEAR; PARTS OF CLOTHING, NAMELY, GUSSETS FOR TIGHTS, GUSSETS FOR STOCKINGS, GUSSETS FOR BATHING SUITS, GUSSETS FOR UNDERWEAR, GUSSETS FOR LEOTARDS AND GUSSETS FOR FOOTLETS; PERSPIRATION ABSORBENT UNDERWEAR CLOTHING; THERMAL UNDERWEAR; THONGS; UNDERWEAR; UNDERWEAR, NAMELY, BOY SHORTS; WOMEN'S UNDERWEAR; WOVEN OR KNITTED UNDERWEAR; DENIM JACKETS; DOWN JACKETS; JACKETS; SKIRTS; SKIRTS AND DRESSES, IN CLASS 25 (U.S. CLS. 22 AND 39).

FIRST USE 5-11-1998; IN COMMERCE 9-13-2000.

THE COLOR(S) BLACK AND BLUE IS/ARE CLAIMED AS A FEATURE OF THE MARK.

THE COLOR BLACK APPEARS ON THE WORDING "ADRNLN". THE COLOR BLUE APPEARS ON THE STYLIZED DESIGN OF THE TRIANGLE WITH CURVED EDGES.

SER. NO. 77-329,761, FILED 11-14-2007.

COLLEEN DOMBROW, EXAMINING ATTORNEY



**Int. Cl.: 9**

**Prior U.S. Cls.: 21, 23, 26, 36 and 38**

**United States Patent and Trademark Office**

**Reg. No. 3,466,739**

**Registered July 15, 2008**

**TRADEMARK  
PRINCIPAL REGISTER**



FAST FORWARD VIDEO, INC. (CALIFORNIA  
CORPORATION)  
18200-B WEST MCDURMOTT  
IRVINE, CA 92614

THE MARK CONSISTS OF CONSIST OF STY-  
LIZED TEXT "FFV" STANDING FOR OUR COMPA-  
NY'S NAME FAST FORWARD VIDEO.

FOR: DIGITAL VIDEO RECORDERS, IN CLASS 9  
(U.S. CLS. 21, 23, 26, 36 AND 38).

SER. NO. 77-329,767, FILED 11-14-2007.

FIRST USE 3-0-2006; IN COMMERCE 3-0-2006.

CORY BOONE, EXAMINING ATTORNEY

**Int. Cl.: 37**

**Prior U.S. Cls.: 100, 103 and 106**

**United States Patent and Trademark Office**

**Reg. No. 3,466,740**

**Registered July 15, 2008**

**SERVICE MARK  
PRINCIPAL REGISTER**



**WELBRO  
BUILDING CORPORATION**

WELBRO BUILDING CORPORATION (FLORIDA CORPORATION)  
2301 MAITLAND CENTER PARKWAY STE 250  
MAITLAND, FL 32751

FOR: CONSTRUCTION MANAGEMENT; CONSTRUCTION SUPERVISION; BUILDING CONSTRUCTION AND REPAIR, IN CLASS 37 (U.S. CLS. 100, 103 AND 106).

FIRST USE 3-21-1979; IN COMMERCE 2-6-1986.

NO CLAIM IS MADE TO THE EXCLUSIVE RIGHT TO USE "BUILDING CORPORATION", APART FROM THE MARK AS SHOWN.

THE COLOR(S) YELLOW AND BLACK IS/ARE CLAIMED AS A FEATURE OF THE MARK.

THE STYLIZED LETTERS "WB" ARE YELLOW WITH BLACK OUTLINE, WHILE THE REMAINING WORDING IS BLACK.

SER. NO. 77-329,778, FILED 11-14-2007.

MATTHEW PAPPAS, EXAMINING ATTORNEY

**Int. Cls.: 13 and 28**

**Prior U.S. Cls.: 2, 9, 22, 23, 38 and 50**

**United States Patent and Trademark Office**

**Reg. No. 3,466,741**

**Registered July 15, 2008**

**TRADEMARK  
PRINCIPAL REGISTER**

**TIBERIUS**

TIBERIUS ARMS, LLC (INDIANA LTD LIAB CO)  
2727 FERGUSON ROAD  
FORT WAYNE, IN 46809

FOR: NON-LETHAL TACTICAL GUNS; AIR  
GUNS; AND GUNS THAT OPERATE BY UTILIZING  
COMPRESSED GAS, IN CLASS 13 (U.S. CLS. 2 AND  
9).

FIRST USE 12-31-2005; IN COMMERCE 12-31-2005.

FOR: SPORTING GOODS, NAMELY, PAINTBALL  
GUNS, IN CLASS 28 (U.S. CLS. 22, 23, 38 AND 50).

FIRST USE 12-31-2005; IN COMMERCE 12-31-2005.

THE MARK CONSISTS OF STANDARD CHAR-  
ACTERS WITHOUT CLAIM TO ANY PARTICULAR  
FONT, STYLE, SIZE, OR COLOR.

SER. NO. 77-329,793, FILED 11-14-2007.

RICHARD WHITE, EXAMINING ATTORNEY

**Int. Cl.: 19**

**Prior U.S. Cls.: 1, 12, 33 and 50**

**United States Patent and Trademark Office**

**Reg. No. 3,466,742**

**Registered July 15, 2008**

**TRADEMARK  
PRINCIPAL REGISTER**

**MARBELLA**

SAROYAN LUMBER COMPANY, INC. (CALI-  
FORNIA CORPORATION)  
6230 SO. ALAMEDA ST.  
HUNTINGTON PARK, CA 90255

THE MARK CONSISTS OF STANDARD CHAR-  
ACTERS WITHOUT CLAIM TO ANY PARTICULAR  
FONT, STYLE, SIZE, OR COLOR.

FOR: FLOOR BOARDS, WOODEN FLOORING,  
HARDWOOD FLOORING; NON-METAL ARCHI-  
TECTURAL MOULDINGS AND FINISH TRIM, IN  
CLASS 19 (U.S. CLS. 1, 12, 33 AND 50).

SER. NO. 77-329,836, FILED 11-14-2007.

FIRST USE 4-18-2006; IN COMMERCE 4-18-2006.

JEAN IM, EXAMINING ATTORNEY

**Int. Cl.: 36**

**Prior U.S. Cls.: 100, 101 and 102**

**United States Patent and Trademark Office**

**Reg. No. 3,466,743**

**Registered July 15, 2008**

**SERVICE MARK  
PRINCIPAL REGISTER**

**Creative Financial  
Resources, LLC**

CREATIVE FINANCIAL RESOURCES (MARY-  
LAND LTD LIAB CO)  
P.O. BOX 237  
12975 HIGHLAND ROAD  
HIGHLAND, MD 20777

FOR: PROVIDING WORKING CAPITAL FINAN-  
CING TO SMALL BUSINESSES AND SMALL BUSI-  
NESS OWNERS, IN CLASS 36 (U.S. CLS. 100, 101 AND  
102).

FIRST USE 3-0-2006; IN COMMERCE 3-1-2007.

THE MARK CONSISTS OF STANDARD CHAR-  
ACTERS WITHOUT CLAIM TO ANY PARTICULAR  
FONT, STYLE, SIZE, OR COLOR.

NO CLAIM IS MADE TO THE EXCLUSIVE  
RIGHT TO USE "FINANCIAL RESOURCES, LLC",  
APART FROM THE MARK AS SHOWN.

SER. NO. 77-329,844, FILED 11-14-2007.

ANDREA SAUNDERS, EXAMINING ATTORNEY

**Int. Cl.: 42**

**Prior U.S. Cls.: 100 and 101**

**United States Patent and Trademark Office**

**Reg. No. 3,466,744**

**Registered July 15, 2008**

**SERVICE MARK  
PRINCIPAL REGISTER**

**ALEXICON**

ALEXICON, INC. (CALIFORNIA CORPORATION)  
34249 CAMINO CAPISTRANO  
CAPISTRANO BEACH, CA 92624

FOR: CONSULTATION SERVICES IN THE  
FIELDS OF SELECTION, IMPLEMENTATION  
AND USE OF COMPUTER HARDWARE AND  
SOFTWARE SYSTEMS FOR OTHERS, IN CLASS 42  
(U.S. CLS. 100 AND 101).

FIRST USE 6-1-1999; IN COMMERCE 6-1-1999.

THE MARK CONSISTS OF STANDARD CHARACTERS WITHOUT CLAIM TO ANY PARTICULAR FONT, STYLE, SIZE, OR COLOR.

SER. NO. 77-329,851, FILED 11-14-2007.

TIMOTHY FINNEGAN, EXAMINING ATTORNEY

**Int. Cl.: 41**

**Prior U.S. Cls.: 100, 101 and 107**

**United States Patent and Trademark Office**

**Reg. No. 3,466,745**

**Registered July 15, 2008**

**SERVICE MARK  
PRINCIPAL REGISTER**

# Chili's Karaoke

ASAP ENTERTAINMENT, INC. (ILLINOIS CORPORATION)  
12224 S. SPRINGFIELD AVE.  
ALSIP, IL 60803

FOR: MOBILE ENTERTAINMENT SERVICES, NAMELY, PROVIDING DISC JOCKEYS AND KARAOKE, IN CLASS 41 (U.S. CLS. 100, 101 AND 107).

FIRST USE 6-1-2003; IN COMMERCE 6-1-2003.

THE MARK CONSISTS OF STANDARD CHARACTERS WITHOUT CLAIM TO ANY PARTICULAR FONT, STYLE, SIZE, OR COLOR.

NO CLAIM IS MADE TO THE EXCLUSIVE RIGHT TO USE "KARAOKE", APART FROM THE MARK AS SHOWN.

SER. NO. 77-329,854, FILED 11-14-2007.

ALLISON SCHRODY, EXAMINING ATTORNEY

**Int. Cl.: 16**

**Prior U.S. Cls.: 2, 5, 22, 23, 29, 37, 38 and 50**

**United States Patent and Trademark Office**

**Reg. No. 3,466,746**

**Registered July 15, 2008**

**TRADEMARK  
PRINCIPAL REGISTER**

**Road Tested**

DTG MAPS INC. (MONTANA CORPORATION)  
44 E JULIE CT.  
BOZEMAN, MT 59718

THE MARK CONSISTS OF STANDARD CHAR-  
ACTERS WITHOUT CLAIM TO ANY PARTICULAR  
FONT, STYLE, SIZE, OR COLOR.

FOR: MAPS, IN CLASS 16 (U.S. CLS. 2, 5, 22, 23, 29,  
37, 38 AND 50).

SER. NO. 77-329,858, FILED 11-14-2007.

FIRST USE 2-1-2007; IN COMMERCE 7-1-2007.

TIMOTHY FINNEGAN, EXAMINING ATTORNEY



**Int. Cl.: 41**

**Prior U.S. Cls.: 100, 101 and 107**

**United States Patent and Trademark Office**

**Reg. No. 3,466,747**

**Registered July 15, 2008**

**SERVICE MARK  
PRINCIPAL REGISTER**

**CELADON YOUTH**

LIN, ANCHI (UNITED STATES INDIVIDUAL)  
19 RIVERSIDE LANE  
HOLMDEL, NJ 07733

FOR: RECREATION AND ENTERTAINMENT SERVICES, NAMELY, LIVE MUSICAL CONCERTS; ENTERTAINMENT SERVICES IN THE NATURE OF LIVE PERFORMANCES BY ORCHESTRA AND INDIVIDUAL MUSICIANS; ARRANGING AND CONDUCTING EDUCATIONAL CONFERENCES; ORGANIZING OF MUSIC ACTIVITIES, NAMELY, LIVE MUSICAL PERFORMANCES AND OF MUSIC COMPETITIONS, IN CLASS 41 (U.S. CLS. 100, 101 AND 107).

FIRST USE 9-23-2007; IN COMMERCE 9-29-2007.

THE MARK CONSISTS OF STANDARD CHARACTERS WITHOUT CLAIM TO ANY PARTICULAR FONT, STYLE, SIZE, OR COLOR.

NO CLAIM IS MADE TO THE EXCLUSIVE RIGHT TO USE "YOUTH", APART FROM THE MARK AS SHOWN.

THE WORDING "CELADON" HAS NO MEANING IN A FOREIGN LANGUAGE.

SER. NO. 77-329,859, FILED 11-14-2007.

TIMOTHY FINNEGAN, EXAMINING ATTORNEY

**Int. Cl.: 41**

**Prior U.S. Cls.: 100, 101 and 107**

**United States Patent and Trademark Office**

**Reg. No. 3,466,748**

**Registered July 15, 2008**

**SERVICE MARK  
PRINCIPAL REGISTER**



DAVIS, MARK (UNITED STATES INDIVIDUAL)  
834 CONGO STREET  
SAN FRANCISCO, CA 941312811

FIRST USE 6-24-2001; IN COMMERCE 6-24-2001.

FOR: PROVIDING ASSISTANCE, PERSONAL TRAINING AND PHYSICAL FITNESS CONSULTATION TO INDIVIDUALS TO HELP THEM MAKE PHYSICAL FITNESS, STRENGTH, CONDITIONING, AND EXERCISE IMPROVEMENT IN THEIR DAILY LIVING, IN CLASS 41 (U.S. CLS. 100, 101 AND 107).

THE MARK CONSISTS OF AN OVAL WITH THE STYLIZED WORDS "XBIGMAN".

SER. NO. 77-329,860, FILED 11-14-2007.

ALLISON SCHRODY, EXAMINING ATTORNEY

**Int. Cl.: 44**

**Prior U.S. Cls.: 100 and 101**

**United States Patent and Trademark Office**

**Reg. No. 3,466,749**

**Registered July 15, 2008**

**SERVICE MARK  
PRINCIPAL REGISTER**



SHEER BALANCE, INC. (DELAWARE CORPORATION)

# 726

10 MUSEUM WAY  
CAMBRIDGE, MA 02141

FOR: PROVIDING A WEBSITE FEATURING INFORMATION ABOUT HEALTH AND WELLNESS, NUTRITION, SPA, MIND (MENTAL HEALTH) AND BEAUTY, IN CLASS 44 (U.S. CLS. 100 AND 101).

FIRST USE 7-18-2007; IN COMMERCE 10-27-2007.

THE MARK CONSISTS OF THREE OVALS WITH THE STYLIZED WORDS "SHEER BALANCE" TO THE RIGHT OF THEM.

SER. NO. 77-329,869, FILED 11-14-2007.

TRICIA SONNEBORN, EXAMINING ATTORNEY

**Int. Cl.: 19**

**Prior U.S. Cls.: 1, 12, 33 and 50**

**United States Patent and Trademark Office**

**Reg. No. 3,466,750**

**Registered July 15, 2008**

**TRADEMARK  
PRINCIPAL REGISTER**

**DONTRE**

SAROYAN LUMBER COMPANY, INC. (CALI-  
FORNIA CORPORATION)  
6230 SO. ALAMEDA ST.  
HUNTINGTON PARK, CA 90255

THE MARK CONSISTS OF STANDARD CHAR-  
ACTERS WITHOUT CLAIM TO ANY PARTICULAR  
FONT, STYLE, SIZE, OR COLOR.

FOR: FLOOR BOARDS, WOODEN FLOORING,  
HARDWOOD FLOORING; NON-METAL ARCHI-  
TECTURAL MOULDINGS AND FINISH TRIM, IN  
CLASS 19 (U.S. CLS. 1, 12, 33 AND 50).

SER. NO. 77-329,883, FILED 11-14-2007.

FIRST USE 4-18-2006; IN COMMERCE 4-18-2006.

JEAN IM, EXAMINING ATTORNEY

Int. Cl.: 35

Prior U.S. Cls.: 100, 101 and 102

United States Patent and Trademark Office

Reg. No. 3,466,751

Registered July 15, 2008

SERVICE MARK  
PRINCIPAL REGISTER

technofacing

FORE, HEIDI A (UNITED STATES INDIVIDUAL)  
6312 TRANSYLVANIA BEACH RD  
PROSPECT, KY 40059

FOR: ADVERTISING AND BUSINESS MANAGEMENT CONSULTANCY; ADVICE IN THE FIELD OF BUSINESS MANAGEMENT AND MARKETING; ADVICE RELATING TO THE ORGANISATION AND MANAGEMENT OF BUSINESS; ADVISORY SERVICE FOR ORGANIZATIONAL ISSUES AND BUSINESS ADMINISTRATION, WITH AND WITHOUT THE HELP OF ELECTRONIC DATA BASES; ADVISORY SERVICES RELATING TO BUSINESS MANAGEMENT AND BUSINESS OPERATIONS; BUSINESS ADVICE AND ANALYSIS OF MARKETS; BUSINESS ADVICE AND INFORMATION; BUSINESS ADVISORY SERVICES, CONSULTANCY AND INFORMATION; BUSINESS CONSULTATION; BUSINESS CONSULTATION AND MANAGEMENT REGARDING MARKETING ACTIVITIES AND LAUNCHING OF NEW PRODUCTS; BUSINESS CONSULTATION SERVICES; BUSINESS CONSULTING AND INFORMATION SERVICES; BUSINESS CONSULTING, MANAGEMENT, PLANNING AND SUPERVISION; BUSINESS MANAGEMENT AND ADVICE; BUSINESS MANAGEMENT CONSULT-

ING WITH RELATION TO STRATEGY, MARKETING, PRODUCTION, PERSONNEL AND RETAIL SALE MATTERS; BUSINESS MANAGEMENT INFORMATION ON A WIDE VARIETY OF TOPICS TO SERVICE PROVIDING PROFESSIONALS; BUSINESS MARKETING AND DIRECT MAIL CONSULTING SERVICES; BUSINESS MARKETING CONSULTING SERVICES; BUSINESS NETWORKING; BUSINESS ORGANISATION AND MANAGEMENT CONSULTING SERVICES; DEVELOPING PROMOTIONAL CAMPAIGNS FOR BUSINESS; PROVIDING BUSINESS MARKETING INFORMATION; CONCEPT AND BRAND DEVELOPMENT IN THE REAL ESTATE INDUSTRY, IN CLASS 35 (U.S. CLS. 100, 101 AND 102).

FIRST USE 1-10-2007; IN COMMERCE 1-10-2007.

THE MARK CONSISTS OF STANDARD CHARACTERS WITHOUT CLAIM TO ANY PARTICULAR FONT, STYLE, SIZE, OR COLOR.

SER. NO. 77-329,884, FILED 11-14-2007.

MICHAEL WIENER, EXAMINING ATTORNEY

**Int. Cl.: 19**

**Prior U.S. Cls.: 1, 12, 33 and 50**

**Reg. No. 3,466,752**

**United States Patent and Trademark Office**

**Registered July 15, 2008**

**TRADEMARK  
PRINCIPAL REGISTER**

**NUOVA**

SAROYAN LUMBER COMPANY, INC. (CALI-  
FORNIA CORPORATION)  
6230 SO. ALAMEDA ST.  
HUNTINGTON PARK, CA 90255

FOR: FLOOR BOARDS, WOODEN FLOORING,  
HARDWOOD FLOORING; NON-METAL ARCHI-  
TECTURAL MOULDINGS AND FINISH TRIM, IN  
CLASS 19 (U.S. CLS. 1, 12, 33 AND 50).

FIRST USE 5-11-2006; IN COMMERCE 5-11-2006.

THE MARK CONSISTS OF STANDARD CHAR-  
ACTERS WITHOUT CLAIM TO ANY PARTICULAR  
FONT, STYLE, SIZE, OR COLOR.

THE ENGLISH TRANSLATION OF "NUOVA" IS  
"NEWS" OR "NEW".

SER. NO. 77-329,891, FILED 11-14-2007.

KELLEY WELLS, EXAMINING ATTORNEY

**Int. Cl.: 35**

**Prior U.S. Cls.: 100, 101 and 102**

**United States Patent and Trademark Office**

**Reg. No. 3,466,753**

**Registered July 15, 2008**

**SERVICE MARK  
PRINCIPAL REGISTER**

**SimplyONE**

VOICENATION, LLC (GEORGIA LTD LIAB CO),  
DBA VOICEPLUS COMMUNICATIONS  
SUITE C  
5089 BRISTOL INDUSTRIAL WAY  
BUFORD, GA 30518

THE MARK CONSISTS OF STANDARD CHAR-  
ACTERS WITHOUT CLAIM TO ANY PARTICULAR  
FONT, STYLE, SIZE, OR COLOR.

FOR: TELEPHONE ANSWERING SERVICE, IN  
CLASS 35 (U.S. CLS. 100, 101 AND 102).

SER. NO. 77-329,907, FILED 11-14-2007.

FIRST USE 11-14-2007; IN COMMERCE 11-14-2007.

THOMAS MANOR, EXAMINING ATTORNEY

**Int. Cl.: 35**

**Prior U.S. Cls.: 100, 101 and 102**

**United States Patent and Trademark Office**

**Reg. No. 3,466,754**

**Registered July 15, 2008**

**SERVICE MARK  
PRINCIPAL REGISTER**

The logo for AXONICS is a stylized, serif font where the letters are interconnected. The 'A' and 'X' overlap, the 'O' and 'N' overlap, and the 'I' and 'C' overlap. The 'S' is separate but overlaps with the 'C'.

AXONICS, INC. (NEW YORK CORPORATION)  
20 POST LANE NORTH  
SUFFERN, NY 10901

THE MARK CONSISTS OF THE WORD "AXONICS" WITH EACH LETTER TOUCHING EACH OTHER AND THE "O" AND "X" OVERLAPPING.

FOR: ADVERTISING, MARKETING AND PROMOTION SERVICES, IN CLASS 35 (U.S. CLS. 100, 101 AND 102).

SER. NO. 77-329,931, FILED 11-14-2007.

FIRST USE 6-11-2007; IN COMMERCE 6-11-2007.

BARBARA BROWN, EXAMINING ATTORNEY



**Int. Cl.: 45**

**Prior U.S. Cls.: 100 and 101**

**United States Patent and Trademark Office**

**Reg. No. 3,466,755**

**Registered July 15, 2008**

**SERVICE MARK  
PRINCIPAL REGISTER**

**A Wealthy Place**

HOLMAN SR, MICHAEL (UNITED STATES IN-  
DIVIDUAL)  
P O BOX 3097 CHURCH STREET STATION  
NEW YORK, NY 10008

THE MARK CONSISTS OF STANDARD CHAR-  
ACTERS WITHOUT CLAIM TO ANY PARTICULAR  
FONT, STYLE, SIZE, OR COLOR.

FOR: EVANGELISTIC AND MINISTERIAL SER-  
VICES, IN CLASS 45 (U.S. CLS. 100 AND 101).

SER. NO. 77-329,945, FILED 11-14-2007.

FIRST USE 11-14-2007; IN COMMERCE 11-14-2007.

BARBARA BROWN, EXAMINING ATTORNEY

**Int. Cl.: 9**

**Prior U.S. Cls.: 21, 23, 26, 36 and 38**

**United States Patent and Trademark Office**

**Reg. No. 3,466,756**

**Registered July 15, 2008**

**TRADEMARK  
PRINCIPAL REGISTER**

**PERSONALEFFECT**

XMPIE INC. (DELAWARE CORPORATION)  
767 THIRD AVENUE  
NEW YORK, NY 10017

THE MARK CONSISTS OF STANDARD CHAR-  
ACTERS WITHOUT CLAIM TO ANY PARTICULAR  
FONT, STYLE, SIZE, OR COLOR.

FOR: SOFTWARE FOR CREATING MARKETING  
MATERIALS, IN CLASS 9 (U.S. CLS. 21, 23, 26, 36  
AND 38).

SER. NO. 77-329,954, FILED 11-14-2007.

FIRST USE 4-0-2002; IN COMMERCE 10-28-2003.

MICHAEL WIENER, EXAMINING ATTORNEY

**Int. Cl.: 42**

**Prior U.S. Cls.: 100 and 101**

**United States Patent and Trademark Office**

**Reg. No. 3,466,757**

**Registered July 15, 2008**

**SERVICE MARK  
PRINCIPAL REGISTER**

# Baymotion

BAYMOTION, INC. (CALIFORNIA CORPORATION)  
2601 BLANDING AVENUE #402  
ALAMEDA, CA 94501

FOR: TECHNICAL SUPPORT SERVICES, NAME-  
LY, TROUBLESHOOTING OF COMPUTER HARD-  
WARE AND SOFTWARE PROBLEMS; TECHNICAL  
SUPPORT SERVICES, NAMELY, TROUBLESHOOT-  
ING OF COMPUTER SOFTWARE PROBLEMS;  
TECHNICAL SUPPORT SERVICES, NAMELY,  
TROUBLESHOOTING OF INDUSTRIAL PROCESS

CONTROL COMPUTER SOFTWARE PROBLEMS,  
IN CLASS 42 (U.S. CLS. 100 AND 101).

FIRST USE 10-9-2001; IN COMMERCE 10-9-2001.

THE MARK CONSISTS OF STANDARD CHAR-  
ACTERS WITHOUT CLAIM TO ANY PARTICULAR  
FONT, STYLE, SIZE, OR COLOR.

SER. NO. 77-329,955, FILED 11-14-2007.

MARY BOAGNI, EXAMINING ATTORNEY

**Int. Cls.: 35 and 41**

**Prior U.S. Cls.: 100, 101, 102 and 107**

**United States Patent and Trademark Office**

**Reg. No. 3,466,758**

**Registered July 15, 2008**

**SERVICE MARK  
PRINCIPAL REGISTER**

**Technofacing your Business**

FORE, HEIDI A (UNITED STATES INDIVIDUAL)  
6312 TRANSYLVANIA BEACH RD  
PROSPECT, KY 40059

FIRST USE 1-10-2007; IN COMMERCE 1-10-2007.

FOR: BUSINESS ADVICE AND INFORMATION;  
BUSINESS MARKETING CONSULTING SERVICES,  
IN CLASS 35 (U.S. CLS. 100, 101 AND 102).

THE MARK CONSISTS OF STANDARD CHAR-  
ACTERS WITHOUT CLAIM TO ANY PARTICULAR  
FONT, STYLE, SIZE, OR COLOR.

FIRST USE 1-10-2007; IN COMMERCE 1-10-2007.

SER. NO. 77-329,956, FILED 11-14-2007.

FOR: BUSINESS TRAINING, IN CLASS 41 (U.S.  
CLS. 100, 101 AND 107).

MICHAEL WIENER, EXAMINING ATTORNEY

**Int. Cl.: 42**

**Prior U.S. Cls.: 100 and 101**

**United States Patent and Trademark Office**

**Reg. No. 3,466,759**

**Registered July 15, 2008**

**SERVICE MARK  
PRINCIPAL REGISTER**

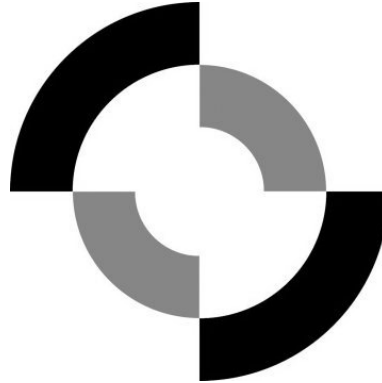

BAYMOTION, INC. (CALIFORNIA CORPORATION)  
2601 BLANDING AVENUE #402  
ALAMEDA, CA 94501

FOR: TECHNICAL SUPPORT SERVICES, NAME-  
LY, TROUBLESHOOTING OF COMPUTER HARD-  
WARE AND SOFTWARE PROBLEMS; TECHNICAL  
SUPPORT SERVICES, NAMELY, TROUBLESHOOT-  
ING OF COMPUTER SOFTWARE PROBLEMS;  
TECHNICAL SUPPORT SERVICES, NAMELY,  
TROUBLESHOOTING OF INDUSTRIAL PROCESS  
CONTROL COMPUTER SOFTWARE PROBLEMS,  
IN CLASS 42 (U.S. CLS. 100 AND 101).

FIRST USE 10-9-2001; IN COMMERCE 10-9-2001.

THE MARK CONSISTS OF CIRCLES WITHIN  
CIRCLES CUT IN QUARTERS WHERE ONLY THE  
OPPOSITE QUARTER IS SHOWING FOR EACH  
CIRCLE .

SER. NO. 77-329,965, FILED 11-14-2007.

MARY BOAGNI, EXAMINING ATTORNEY

**Int. Cl.: 16**

**Prior U.S. Cls.: 2, 5, 22, 23, 29, 37, 38 and 50**

**Reg. No. 3,466,760**

**United States Patent and Trademark Office**

**Registered July 15, 2008**

**TRADEMARK  
PRINCIPAL REGISTER**

**"Understand"ards**

MARKARIAN, BRIAN S (CALIFORNIA SOLE PROPRIETORSHIP), DBA OUTPOST LEARNING COMPANY  
45 10TH COURT, UNIT A  
HERMOSA BEACH, CA 90254

GUAGE ARTS, IN CLASS 16 (U.S. CLS. 2, 5, 22, 23, 29, 37, 38 AND 50).

FIRST USE 6-26-2006; IN COMMERCE 3-1-2007.

FOR: EDUCATIONAL PUBLICATIONS, NAME-  
LY, EDUCATIONAL LEARNING CARDS, FLASH  
CARDS, ACTIVITY CARDS, WORKBOOKS, TEXT-  
BOOKS, ACTIVITY BOOKS, STORY BOOKS, PUZ-  
ZLE BOOKS, PUZZLES, TEACHER GUIDES,  
MANUALS, POSTERS, EDUCATIONAL CARD  
GAMES AND EDUCATIONAL BOOKLETS IN THE  
FIELD OF MATHEMATICS AND ENGLISH-LAN-

THE MARK CONSISTS OF STANDARD CHAR-  
ACTERS WITHOUT CLAIM TO ANY PARTICULAR  
FONT, STYLE, SIZE, OR COLOR.

SER. NO. 77-329,991, FILED 11-15-2007.

CHERYL CLAYTON, EXAMINING ATTORNEY

**Int. Cl.: 1**

**Prior U.S. Cls.: 1, 5, 6, 10, 26 and 46**

**Reg. No. 3,466,761**

**United States Patent and Trademark Office**

**Registered July 15, 2008**

---

**TRADEMARK  
PRINCIPAL REGISTER**

**WINDCHECK**

WINFIELD SOLUTIONS LLC. (DELAWARE LTD  
LIAB CO)  
1080 COUNTY ROAD F WEST  
SHOREVIEW, MN 55126

THE MARK CONSISTS OF STANDARD CHAR-  
ACTERS WITHOUT CLAIM TO ANY PARTICULAR  
FONT, STYLE, SIZE, OR COLOR.

FOR: DRIFT RETARDANT FOR USE WITH IN-  
SECTICIDES, IN CLASS 1 (U.S. CLS. 1, 5, 6, 10, 26  
AND 46).

SER. NO. 77-330,019, FILED 11-15-2007.

FIRST USE 3-31-1994; IN COMMERCE 3-31-1994.

RONALD AIKENS, EXAMINING ATTORNEY

**Int. Cl.: 20**

**Prior U.S. Cls.: 2, 13, 22, 25, 32 and 50**

**United States Patent and Trademark Office**

**Reg. No. 3,466,762**

**Registered July 15, 2008**

**TRADEMARK  
PRINCIPAL REGISTER**

# Stay-Put Stakes

TEKNOR APEX COMPANY (DELAWARE CORPORATION)  
505 CENTRAL AVE  
PAWTUCKET, RI 02861

FOR: NON-METAL GARDEN STAKES, IN CLASS 20 (U.S. CLS. 2, 13, 22, 25, 32 AND 50).

FIRST USE 8-0-2000; IN COMMERCE 8-0-2000.

THE MARK CONSISTS OF STANDARD CHARACTERS WITHOUT CLAIM TO ANY PARTICULAR FONT, STYLE, SIZE, OR COLOR.

OWNER OF U.S. REG. NO. 2,513,590.

NO CLAIM IS MADE TO THE EXCLUSIVE RIGHT TO USE "STAKES", APART FROM THE MARK AS SHOWN.

SEC. 2(F).

SER. NO. 77-330,030, FILED 11-15-2007.

KATHY DE JONGE, EXAMINING ATTORNEY



**Int. Cl.: 1**

**Prior U.S. Cls.: 1, 5, 6, 10, 26 and 46**

**United States Patent and Trademark Office**

**Reg. No. 3,466,763**

**Registered July 15, 2008**

**TRADEMARK  
PRINCIPAL REGISTER**

**Kippisil**

ESSENTIAL INGREDIENTS (GEORGIA CORPORATION)  
4544 ATWATER COURT SUITE 110  
BUFORD, GA 30518

FOR: FUNCTIONALIZED SILICONES FOR USE IN THE MANUFACTURE OF PERSONAL CARE AND COSMETIC COMPOSITIONS; SILICONE RESINS FOR USE IN THE MANUFACTURE OF PERSONAL CARE AND COSMETIC COMPOSITIONS; SILICONES FOR USE IN THE MANUFACTURE OF PERSONAL CARE AND COSMETIC COMPOSITIONS, IN CLASS 1 (U.S. CLS. 1, 5, 6, 10, 26 AND 46).

FIRST USE 8-24-2007; IN COMMERCE 9-15-2007.

THE MARK CONSISTS OF STANDARD CHARACTERS WITHOUT CLAIM TO ANY PARTICULAR FONT, STYLE, SIZE, OR COLOR.

SER. NO. 77-330,045, FILED 11-15-2007.

BARBARA RUTLAND, EXAMINING ATTORNEY

**Int. Cl.: 43**

**Prior U.S. Cls.: 100 and 101**

**United States Patent and Trademark Office**

**Reg. No. 3,466,764**

**Registered July 15, 2008**

**SERVICE MARK  
PRINCIPAL REGISTER**



WEINBERG, ELI (UNITED STATES INDIVIDUAL)  
3500 MYSTIC POINT DRIVE  
AVENTURA, FL 33180

FOR: CAFE-RESTAURANTS, IN CLASS 43 (U.S. CLS. 100 AND 101).

FIRST USE 6-0-2005; IN COMMERCE 7-0-2006.

THE COLOR(S) RED IS/ARE CLAIMED AS A FEATURE OF THE MARK.

THE MARK CONSISTS OF THE WORD "LUL", WITH THE LETTERS IN RED.

THE MARK HAS NO MEANING IN A FOREIGN LANGUAGE.

SER. NO. 77-330,047, FILED 11-15-2007.

ROBERT STRUCK, EXAMINING ATTORNEY

**Int. Cl.: 36**

**Prior U.S. Cls.: 100, 101 and 102**

**United States Patent and Trademark Office**

**Reg. No. 3,466,765**

**Registered July 15, 2008**

**SERVICE MARK  
PRINCIPAL REGISTER**

**CHARGE ANYWHERE**

CHARGE ANYWHERE, LLC (DELAWARE LTD  
LIAB CO)  
SUITE A  
9693 GERWIG LANE  
COLUMBIA, MD 21046

FOR: PROVIDING ELECTRONIC PROCESSING  
OF ELECTRONIC FUNDS TRANSFER, ACH, CRED-  
IT CARD, DEBIT CARD, ELECTRONIC CHECK  
AND ELECTRONIC PAYMENTS, IN CLASS 36  
(U.S. CLS. 100, 101 AND 102).

FIRST USE 8-15-2001; IN COMMERCE 8-15-2001.

THE MARK CONSISTS OF STANDARD CHAR-  
ACTERS WITHOUT CLAIM TO ANY PARTICULAR  
FONT, STYLE, SIZE, OR COLOR.

OWNER OF U.S. REG. NO. 2,670,586.

SEC. 2(F).

SER. NO. 77-330,083, FILED 11-15-2007.

MARK PILARO, EXAMINING ATTORNEY

**Int. Cl.: 42**

**Prior U.S. Cls.: 100 and 101**

**United States Patent and Trademark Office**

**Reg. No. 3,466,766**

**Registered July 15, 2008**

**SERVICE MARK  
PRINCIPAL REGISTER**

**OBSERVERA**

OBSERVERA, INC. (VIRGINIA CORPORATION)  
SUITE I  
3856 DULLES SOUTH COURT  
CHANTILLY, VA 20151

FOR: TECHNOLOGY CONSULTATION IN THE  
FIELD OF REMOTE SENSING, IN CLASS 42 (U.S.  
CLS. 100 AND 101).

FIRST USE 6-21-1995; IN COMMERCE 6-21-1995.

THE MARK CONSISTS OF STANDARD CHAR-  
ACTERS WITHOUT CLAIM TO ANY PARTICULAR  
FONT, STYLE, SIZE, OR COLOR.

THE FOREIGN WORDING IN THE MARK  
TRANSLATES INTO ENGLISH AS WILL OBSERVE.

SER. NO. 77-330,107, FILED 11-15-2007.

JASON ROTH, EXAMINING ATTORNEY

**Int. Cl.: 44**

**Prior U.S. Cls.: 100 and 101**

**United States Patent and Trademark Office**

**Reg. No. 3,466,767**

**Registered July 15, 2008**

**SERVICE MARK  
PRINCIPAL REGISTER**



THE INDIANA HAND CENTER (INDIANA CORPORATION), DBA HAND SURGERY ASSOCIATES - MANUS  
MANAGING PARTNER, COO, MEDICAL ILLUSTRATION  
8501 HARCOURT ROAD, P.O. BOX 80434  
INDIANAPOLIS, IN 462800434

FOR: SURGERY, IN CLASS 44 (U.S. CLS. 100 AND 101).

FIRST USE 6-1-2007; IN COMMERCE 6-1-2007.

NO CLAIM IS MADE TO THE EXCLUSIVE RIGHT TO USE "INDIANA SHOULDER AND ELBOW INSTITUTE" AND "A DIVISION OF THE

INDIANA HAND CENTER", APART FROM THE MARK AS SHOWN.

THE MARK CONSISTS OF THE LETTERING "INDIANA SHOULDER & ELBOW INSTITUTE" PLUS THE GRAPHIC ELEMENT OF A BOX CONTAINING 2 CURVED ARCS AND A CIRCLE (REPRESENTING TWO ARMS AND A PERSON'S HEAD)..

SER. NO. 77-330,150, FILED 11-15-2007.

RICHARD WHITE, EXAMINING ATTORNEY

Int. Cl.: 35

Prior U.S. Cls.: 100, 101 and 102

United States Patent and Trademark Office

Reg. No. 3,466,768

Registered July 15, 2008

SERVICE MARK  
PRINCIPAL REGISTER



KABUSHIKI KAISHA TANITA (JAPAN CORPORATION)  
14-2, 1-CHOME, MAENOCHO  
ITABASHI-KU, TOKYO, JAPAN

FOR: RETAIL STORE SERVICES, ONLINE RETAIL STORE SERVICES AND WHOLESALE DISTRIBUTORSHIPS FEATURING SCALES, IN CLASS 35 (U.S. CLS. 100, 101 AND 102).

FIRST USE 10-1-2007; IN COMMERCE 10-1-2007.

NO CLAIM IS MADE TO THE EXCLUSIVE RIGHT TO USE "MINISCALE.US", APART FROM THE MARK AS SHOWN.

THE MARK CONSISTS OF A STYLIZED DEPICTION OF A SCALE POSITIONED TO THE LEFT OF THE TERM "MINISCALE.US".

SER. NO. 77-330,254, FILED 11-15-2007.

LEIGH CAROLINE CASE, EXAMINING ATTORNEY

**Int. Cls.: 2 and 17**

**Prior U.S. Cls.: 1, 5, 6, 11, 12, 13, 16, 35 and 50**

**United States Patent and Trademark Office**

**Reg. No. 3,466,769**

**Registered July 15, 2008**

**TRADEMARK  
PRINCIPAL REGISTER**

**QUICK MENDER**

VERSAFLEX INCORPORATED (KANSAS CORPORATION)  
87 SHAWNEE AVENUE  
KANSAS CITY, KS 66105

FOR: COATINGS IN THE NATURE OF INDUSTRIAL SEALANTS FOR WATERPROOFING AND SURFACE HARDENING; CONCRETE MOISTURE BARRIER COATING; RESIN-BASED COATINGS FOR USE ON ROOFS, WALLS AND PAVEMENTS; SEALER COATINGS FOR USE IN INDUSTRIAL AND COMMERCIAL WOOD AND CONCRETE FLOORING, IN CLASS 2 (U.S. CLS. 6, 11 AND 16).

FIRST USE 8-18-2000; IN COMMERCE 8-18-2000.

FOR: ADHESIVE SEALANT AND CAULKING COMPOUND; DUST PROOFING SEALANTS; RESIN-BASED SEALANTS FOR USE ON ROOFS,

WALLS AND PAVEMENTS; SEALANTS FOR BUILDINGS; SEALANTS FOR PAVEMENT JOINTS; WATERPROOF SEALANTS, IN CLASS 17 (U.S. CLS. 1, 5, 12, 13, 35 AND 50).

FIRST USE 8-18-2000; IN COMMERCE 8-18-2000.

THE MARK CONSISTS OF STANDARD CHARACTERS WITHOUT CLAIM TO ANY PARTICULAR FONT, STYLE, SIZE, OR COLOR.

SEC. 2(F).

SER. NO. 77-330,255, FILED 11-15-2007.

AMOS T. MATTHEWS, JR., EXAMINING ATTORNEY

**Int. Cl.: 9**

**Prior U.S. Cls.: 21, 23, 26, 36 and 38**

**United States Patent and Trademark Office**

**Reg. No. 3,466,770**

**Registered July 15, 2008**

**TRADEMARK  
PRINCIPAL REGISTER**

**SAVE THE CAT!**

SNYDER, BLAKE (UNITED STATES INDIVIDUAL)  
441 NORTH MANSFIELD AVENUE  
LOS ANGELES, CA 90036

THE MARK CONSISTS OF STANDARD CHARACTERS WITHOUT CLAIM TO ANY PARTICULAR FONT, STYLE, SIZE, OR COLOR.

FOR: EDUCATIONAL SOFTWARE FEATURING INSTRUCTION IN WRITING SCREENPLAYS, IN CLASS 9 (U.S. CLS. 21, 23, 26, 36 AND 38).

SER. NO. 77-330,268, FILED 11-15-2007.

FIRST USE 10-27-2006; IN COMMERCE 10-27-2006.

BARNEY CHARLON, EXAMINING ATTORNEY



**Int. Cl.: 9**

**Prior U.S. Cls.: 21, 23, 26, 36 and 38**

**Reg. No. 3,466,771**

**United States Patent and Trademark Office**

**Registered July 15, 2008**

---

**TRADEMARK  
PRINCIPAL REGISTER**

# Project Insight

METAFUSE INCORPORATED (CALIFORNIA CORPORATION)  
SUITE 270  
17320 RED HILL AVENUE  
IRVINE, CA 92614

FOR: COMPUTER SOFTWARE FOR PROJECT MANAGEMENT, IN CLASS 9 (U.S. CLS. 21, 23, 26, 36 AND 38).

FIRST USE 12-13-2001; IN COMMERCE 1-1-2002.

THE MARK CONSISTS OF STANDARD CHARACTERS WITHOUT CLAIM TO ANY PARTICULAR FONT, STYLE, SIZE, OR COLOR.

NO CLAIM IS MADE TO THE EXCLUSIVE RIGHT TO USE "PROJECT", APART FROM THE MARK AS SHOWN.

SER. NO. 77-330,317, FILED 11-15-2007.

INGA ERVIN, EXAMINING ATTORNEY

**Int. Cl.: 44**

**Prior U.S. Cls.: 100 and 101**

**United States Patent and Trademark Office**

**Reg. No. 3,466,772**

**Registered July 15, 2008**

**SERVICE MARK  
PRINCIPAL REGISTER**

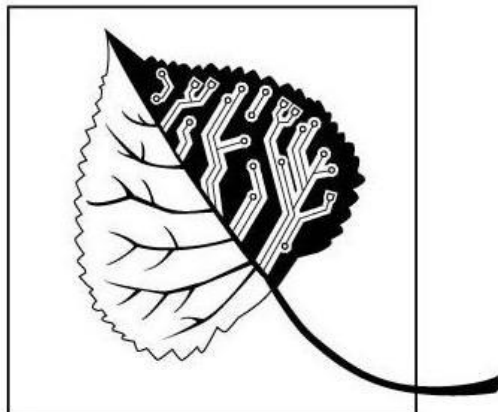

ALLERTEK SYSTEMS, LLC (VIRGINIA LTD  
LIAB CO)  
43730 STONE FENCE TERRACE  
LEESBURG, VA 20175

FOR: HEALTH CARE; HEALTH CARE SERVICES, NAMELY, WELLNESS PROGRAMS; PROVIDING A DATABASE IN THE FIELD OF ASTHMA AND ALLERGY INFORMATION AND ALSO ALLOWS INPUTTING AND COLLECTION OF DATA AND INFORMATION ALL FOR RESEARCH PURPOSES; PROVIDING A DATABASE IN THE FIELD OF ASTHMA AND ALLERGY INFORMATION AND ALSO ALLOWS INPUTTING AND COLLECTION OF DATA AND INFORMATION ALL FOR TREATMENT AND DIAGNOSTIC PURPOSES, IN CLASS 44 (U.S. CLS. 100 AND 101).

FIRST USE 4-1-2007; IN COMMERCE 4-1-2007.

NO CLAIM IS MADE TO THE EXCLUSIVE RIGHT TO USE "A LEAF IN A SQUARE", APART FROM THE MARK AS SHOWN.

THE MARK CONSISTS OF A LEAF CENTERED WITHIN A SQUARE AT AN ANGLE, BUT WITH THE LOWER PORTION OF THE STEM OF SUCH LEAF EXTENDING BEYOND THE RIGHT LOWER PERIMETER OF THE SQUARE; THE MAIN PORTION OF THE LEAF IS DIVIDED IN TWO PARTS WITH THE LEFT LOWER PORTION REFLECTING THE VEINS OF THE LEAF IN BLACK AGAINST A LIGHT BACKGROUND, AND THE RIGHT UPPER PORTION REFLECTING DIGITAL CIRCUITS AGAINST A DARK BACKGROUND.

SER. NO. 77-330,326, FILED 11-15-2007.

JENNIFER HETU, EXAMINING ATTORNEY

**Int. Cls.: 43 and 44**

**Prior U.S. Cls.: 100 and 101**

**United States Patent and Trademark Office**

**Reg. No. 3,466,773**

**Registered July 15, 2008**

**SERVICE MARK  
PRINCIPAL REGISTER**



PETS & COMPANY (MISSOURI CORPORATION)  
# 104  
17701 EDISON AVENUE  
CHESTERFIELD, MO 63005

FOR: PET BOARDING SERVICES, IN CLASS 43  
(U.S. CLS. 100 AND 101).

FIRST USE 3-1-2005; IN COMMERCE 2-25-2006.

FOR: ANIMAL GROOMING, IN CLASS 44 (U.S.  
CLS. 100 AND 101).

FIRST USE 3-1-2005; IN COMMERCE 2-25-2006.

THE MARK CONSISTS OF THE SYLIZED  
WORDS "PETS & COMPANY" WITH A SMALL  
HOUSE WITH A FENCE LOCATED BELOW THE  
WORDS.

SER. NO. 77-330,327, FILED 11-15-2007.

JENNIFER HETU, EXAMINING ATTORNEY

**Int. Cl.: 7**

**Prior U.S. Cls.: 13, 19, 21, 23, 31, 34 and 35**

**Reg. No. 3,466,774**

**United States Patent and Trademark Office**

**Registered July 15, 2008**

**TRADEMARK  
PRINCIPAL REGISTER**

**JIFFY**

JIFFY MIXER ENTERPRISES, INC. (CALIFORNIA CORPORATION)  
4120 TIGRIS WAY  
RIVERSIDE, CA 925034843

FIRST USE 1-1-1955; IN COMMERCE 1-1-1955.

FOR: POWER TOOL ACCESSORIES, NAMELY, MECHANICAL MIXING ATTACHMENT IN THE NATURE OF A MIXER FOR MIXING INDUSTRIAL AND COMMERCIAL LIQUIDS AND DRY MATERIALS AND LIQUID AND DRY MATERIALS COMBINED OR MULTIPLE COMPONENT MATERIALS, IN CLASS 7 (U.S. CLS. 13, 19, 21, 23, 31, 34 AND 35).

THE MARK CONSISTS OF STANDARD CHARACTERS WITHOUT CLAIM TO ANY PARTICULAR FONT, STYLE, SIZE, OR COLOR.

SER. NO. 77-330,338, FILED 11-15-2007.

JAMES LOVELACE, EXAMINING ATTORNEY

**Int. Cl.: 12**

**Prior U.S. Cls.: 19, 21, 23, 31, 35 and 44**

**Reg. No. 3,466,775**

**United States Patent and Trademark Office**

**Registered July 15, 2008**

---

**TRADEMARK  
PRINCIPAL REGISTER**

**IRONKING**

ROBERT E. KING EQUIPMENT INCORPORATED (FLORIDA CORPORATION)  
6814 US 27 SOUTH  
SEBRING, FL 33870

THE MARK CONSISTS OF STANDARD CHARACTERS WITHOUT CLAIM TO ANY PARTICULAR FONT, STYLE, SIZE, OR COLOR.

FOR: TRAILERS, IN CLASS 12 (U.S. CLS. 19, 21, 23, 31, 35 AND 44).

SER. NO. 77-330,362, FILED 11-15-2007.

FIRST USE 11-21-1998; IN COMMERCE 11-21-2007.

JOHN E. MICHOS, EXAMINING ATTORNEY

**Int. Cl.: 35**

**Prior U.S. Cls.: 100, 101 and 102**

**United States Patent and Trademark Office**

**Reg. No. 3,466,776**

**Registered July 15, 2008**

**SERVICE MARK  
PRINCIPAL REGISTER**

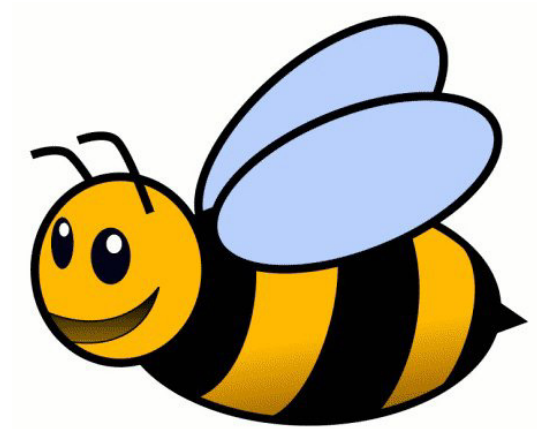

BRAD CURRY (ILLINOIS SOLE PROPRIETOR-  
SHIP), DBA BEE ACTIVE TOYS  
204 WEST WASHINGTON  
MONTICELLO, IL 61856

THE MARK CONSISTS OF A STYLIZED BEE  
HAVING A BLACK AND YELLOW BODY, YELLOW  
HEAD, BLACK STINGER, EYES, AND ANTENNAE,  
AND LIGHT BLUE WINGS.

FOR: RETAIL TOY STORES, IN CLASS 35 (U.S.  
CLS. 100, 101 AND 102).

FIRST USE 3-0-2007; IN COMMERCE 5-0-2007.

SER. NO. 77-330,367, FILED 11-15-2007.

THE COLOR(S) YELLOW, BLACK, WHITE, AND  
LIGHT BLUE IS/ARE CLAIMED AS A FEATURE OF  
THE MARK.

STEVEN PEREZ, EXAMINING ATTORNEY

**Int. Cl.: 25**

**Prior U.S. Cls.: 22 and 39**

**United States Patent and Trademark Office**

**Reg. No. 3,466,777**

**Registered July 15, 2008**

**TRADEMARK  
PRINCIPAL REGISTER**

 **CT CROWDED TEETH**

ROMO, MICHELLE (UNITED STATES INDIVIDUAL)  
4416 CAMERO AVE.  
LOS ANGELES, CA 90027

THE MARK CONSISTS OF THE STYLIZED WORDS "CT CROWDED TEETH". THERE ARE TWO LEAFS BELOW "CT".

FOR: MITTENS; SCARVES; SOCKS; SWEAT SHIRTS; T-SHIRTS; TANK TOPS; UNDERGARMENTS, IN CLASS 25 (U.S. CLS. 22 AND 39).

SER. NO. 77-330,371, FILED 11-15-2007.

FIRST USE 10-1-2004; IN COMMERCE 10-1-2004.

STEVEN PEREZ, EXAMINING ATTORNEY

**Int. Cl.: 7**

**Prior U.S. Cls.: 13, 19, 21, 23, 31, 34 and 35**

**Reg. No. 3,466,778**

**United States Patent and Trademark Office**

**Registered July 15, 2008**

**TRADEMARK  
PRINCIPAL REGISTER**

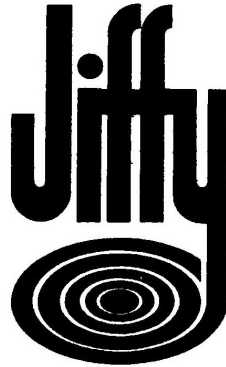

JIFFY MIXER ENTERPRISES, INC. (CALIFORNIA CORPORATION)  
4120 TIGRIS WAY  
RIVERSIDE, CA 925034843

FIRST USE 1-1-1955; IN COMMERCE 1-1-1955.

FOR: POWER TOOL ACCESSORIES, NAMELY, MECHANICAL MIXING ATTACHMENT IN THE NATURE OF A MIXER FOR MIXING INDUSTRIAL AND COMMERCIAL LIQUIDS AND DRY MATERIALS AND LIQUID AND DRY MATERIALS COMBINED OR MULTIPLE COMPONENT MATERIALS, IN CLASS 7 (U.S. CLS. 13, 19, 21, 23, 31, 34 AND 35).

THE MARK CONSISTS OF THE WORD "JIFFY" WITH THE "Y" ENDING IN CONCENTRIC CIRCLES UNDER "JIFFY".

SER. NO. 77-330,397, FILED 11-15-2007.

JAMES LOVELACE, EXAMINING ATTORNEY



**Int. Cl.: 37**

**Prior U.S. Cls.: 100, 103 and 106**

**United States Patent and Trademark Office**

**Reg. No. 3,466,779**

**Registered July 15, 2008**

**SERVICE MARK  
PRINCIPAL REGISTER**

VENTURE PROFESSIONAL CENTER

VENTURE DEVELOPMENT CORPORATION  
(CALIFORNIA CORPORATION)  
THIRD FLOOR  
125 EAST SIR FRANCIS DRAKE BOULEVARD  
LARKSPUR, CA 94939

FOR: REAL ESTATE DEVELOPMENT, NAMELY,  
PLANNING AND DEVELOPMENT OF COMMERCIAL  
CONDOMINIUMS, IN CLASS 37 (U.S. CLS. 100,  
103 AND 106).

FIRST USE 5-31-2005; IN COMMERCE 4-30-2007.

THE MARK CONSISTS OF STANDARD CHARACTERS WITHOUT CLAIM TO ANY PARTICULAR FONT, STYLE, SIZE, OR COLOR.

NO CLAIM IS MADE TO THE EXCLUSIVE RIGHT TO USE "PROFESSIONAL CENTER", APART FROM THE MARK AS SHOWN.

SER. NO. 77-330,401, FILED 11-15-2007.

LINDSEY RUBIN, EXAMINING ATTORNEY

**Int. Cls.: 9 and 41**

**Prior U.S. Cls.: 21, 23, 26, 36, 38, 100, 101 and 107**

**United States Patent and Trademark Office**

**Reg. No. 3,466,780**

**Registered July 15, 2008**

**TRADEMARK  
SERVICE MARK  
PRINCIPAL REGISTER**

**STRAIGHT GUYS FOR GAY EYES**

EKRA GROUP, INC. (CALIFORNIA CORPORATION)  
5650 FULCHER AVENUE  
NORTH HOLLYWOOD, CA 91601

FOR: DIGITAL MATERIALS, NAMELY, PRE-RECORDED VIDEOTAPES, COMPACT DISCS, CD-ROMS, DVDS, VIDEOTAPES, DOWNLOADABLE PRE-RECORDED VIDEO, AND DIGITAL PHOTOGRAPHS AND IMAGES FEATURING SEXUALLY ORIENTED ADULT ENTERTAINMENT; DOWNLOADABLE VIDEO RECORDINGS FEATURING SEXUALLY ORIENTED ADULT ENTERTAINMENT; PRE-RECORDED CDS, VIDEO TAPES, LASER DISKS AND DVDS FEATURING SEXUALLY ORIENTED ADULT ENTERTAINMENT; DOWNLOADABLE FILMS AND TV PROGRAMS FEATURING SEXUALLY ORIENTED ADULT ENTERTAINMENT PROVIDED VIA A VIDEO-ON-DEMAND SERVICE, IN CLASS 9 (U.S. CLS. 21, 23, 26, 36 AND 38).

FIRST USE 7-29-2005; IN COMMERCE 7-29-2005.

FOR: ENTERTAINMENT SERVICES, NAMELY, PROVIDING A WEBSITE FEATURING PHOTOGRAPHIC, AUDIO, VIDEO AND PROSE PRESENTATIONS FEATURING ADULT ENTERTAINMENT, IN CLASS 41 (U.S. CLS. 100, 101 AND 107).

FIRST USE 7-29-2005; IN COMMERCE 7-29-2005.

THE MARK CONSISTS OF STANDARD CHARACTERS WITHOUT CLAIM TO ANY PARTICULAR FONT, STYLE, SIZE, OR COLOR.

SER. NO. 77-330,435, FILED 11-15-2007.

MARK PILARO, EXAMINING ATTORNEY

**Int. Cl.: 35**

**Prior U.S. Cls.: 100, 101 and 102**

**United States Patent and Trademark Office**

**Reg. No. 3,466,781**

**Registered July 15, 2008**

**SERVICE MARK  
PRINCIPAL REGISTER**

EXACTLY LIKE NOBODY ELSE

YH INC. (MICHIGAN CORPORATION), DBA YH  
COMMUNICATIONS  
SUITE 213  
233 WASHINGTON AVE  
GRAND HAVEN, MI 49417

THE MARK CONSISTS OF STANDARD CHAR-  
ACTERS WITHOUT CLAIM TO ANY PARTICULAR  
FONT, STYLE, SIZE, OR COLOR.

FOR: ADVERTISING, MARKETING AND PRO-  
MOTION SERVICES, IN CLASS 35 (U.S. CLS. 100, 101  
AND 102).

SER. NO. 77-330,437, FILED 11-15-2007.

FIRST USE 11-1-2005; IN COMMERCE 11-1-2005.

ELLEN PERKINS, EXAMINING ATTORNEY

**Int. Cl.: 42**

**Prior U.S. Cls.: 100 and 101**

**United States Patent and Trademark Office**

**Reg. No. 3,466,782**

**Registered July 15, 2008**

**SERVICE MARK  
PRINCIPAL REGISTER**

# GAMEPLAN

MPACT ENVIRONMENTAL SOLUTIONS, LLC  
(SOUTH CAROLINA LTD LIAB CO)  
P O BOX 1385  
FOUNTAIN INN, SC 29644

FOR: MICROBIAL AND FUNGI CONTAMINATION ABATEMENT AND PREVENTION SERVICES, NAMELY, TESTING INDOOR ENVIRONMENTAL QUALITY, TREATMENT AND PREVENTION OF INDOOR MICROBIAL AND FUNGI CONTAMINATION, AND MAINTENANCE OF INDOOR ENVIRONMENTAL QUALITY, IN CLASS 42 (U.S. CLS. 100 AND 101).

FIRST USE 10-1-2007; IN COMMERCE 10-1-2007.

THE MARK CONSISTS OF STANDARD CHARACTERS WITHOUT CLAIM TO ANY PARTICULAR FONT, STYLE, SIZE, OR COLOR.

SER. NO. 77-330,439, FILED 11-15-2007.

WENDY JUN, EXAMINING ATTORNEY

**Int. Cl.: 29**

**Prior U.S. Cl.: 46**

**United States Patent and Trademark Office**

**Reg. No. 3,466,783**

**Registered July 15, 2008**

**TRADEMARK  
PRINCIPAL REGISTER**

**SWEET FREEDOM**

WELLS' DAIRY, INC. (IOWA CORPORATION)  
P.O. BOX 1310  
ONE BLUE BUNNY DRIVE  
LE MARS, IA 51031

FOR: YOGURT, IN CLASS 29 (U.S. CL. 46).

FIRST USE 1-18-2007; IN COMMERCE 1-18-2007.

THE MARK CONSISTS OF STANDARD CHARACTERS WITHOUT CLAIM TO ANY PARTICULAR FONT, STYLE, SIZE, OR COLOR.

OWNER OF U.S. REG. NOS. 2,884,475, 2,903,452, AND 3,225,795.

SER. NO. 77-330,484, FILED 11-15-2007.

SONYA STEPHENS, EXAMINING ATTORNEY

**Int. Cl.: 11**

**Prior U.S. Cls.: 13, 21, 23, 31 and 34**

**Reg. No. 3,466,784**

**United States Patent and Trademark Office**

**Registered July 15, 2008**

**TRADEMARK  
PRINCIPAL REGISTER**



LOCAL TRANSPORTATION ALTERNATIVES,  
INC. (CALIFORNIA CORPORATION)

7878 E. MARGARET COURT  
ANAHEIM HILLS, CA 92808

FOR: AQUARIUM LIGHTS; BOOK LIGHTS; CARRYING CASES SPECIALLY ADAPTED FOR DJ LIGHTING GEAR AND ELECTRIC LIGHTS; CEILING LIGHTS; CHEMICALLY-ACTIVATED LIGHT STICKS; COLOR FILTERS FOR USE IN LIGHTING INSTRUMENTS; DIVING LIGHTS; ELECTRIC HOLIDAY LIGHTS; ELECTRIC LIGHT BULBS; ELECTRIC LIGHTING FIXTURES; ELECTRIC LIGHTING FIXTURES, NAMELY, POWER FAILURE BACKUP SAFETY LIGHTING; ELECTRIC LIGHTING FIXTURES, NAMELY, SCONCES; ELECTRIC LIGHTS FOR CHRISTMAS TREES; ELECTRIC NIGHT LIGHTS; ELECTRIC TORCHES FOR LIGHTING; ELECTRIC TRACK LIGHTING UNITS; ELECTRICAL MAGNIFYING LIGHT FIXTURES; FIBER OPTIC LIGHTING FIXTURES USED IN CONJUNCTION WITH ELECTRICAL ILLUMINATORS; FILTERS FOR PHOTOGRAPHIC, CINEMATOGRAPHIC, VIDEO AND PERFORMING ARTS LIGHTING; FIXTURES FOR INCANDESCENT LIGHT BULBS; FLASHING STROBE LIGHT APPARATUS; FLASHLIGHT POINTERS; FLASHLIGHTS; FLOURESCENT ELECTRIC LIGHT BULBS; FLUORESCENT LIGHTING TUBES; FRAGRANCE DISPENSING UNIT WHICH ALSO FEATURES A NIGHT LIGHT; HALOGEN LIGHT BULBS; HIGH INTENSITY SEARCH LIGHTS; INCANDESCENT LIGHT BULBS; INFRARED LIGHTING FIXTURES; KLIEG LIGHTS; LED (LIGHT EMITTING DIODES) LIGHTING FIXTURES FOR USE IN DISPLAY, COMMERCIAL, INDUSTRIAL, RESIDENTIAL, AND ARCHITECTURAL ACCENT LIGHTING APPLICATIONS; LED AND HID LIGHT FIXTURES; LED LIGHT BULBS; LAMP WHOSE LIGHT CAN BE TURNED IN ALL DIRECTIONS;

LANDSCAPE LIGHTING INSTALLATIONS; LASER LIGHT PROJECTORS; LIGHT BULBS; LIGHT DIFFUSERS; LIGHT POST LUMINAIRES; LIGHT REFLECTORS; LIGHTED DISCO BALLS; LIGHTED OUTDOOR HOLIDAY SCULPTURES AND WIRE FRAME STATUES; LIGHTED PARTY-THEMED DECORATIONS, ELECTRIC LIGHT DECORATIVE STRINGS; LIGHTERS PRIMARILY FOR LIGHTING GRILLS, FIREPLACES AND CANDLES; LIGHTING APPARATUS FOR VEHICLES; LIGHTING DEVICES FOR SHOWCASES; LIGHTING FIXTURES; LIGHTING FIXTURES FOR USE IN PARKING DECKS AND GARAGES; LIGHTING FIXTURES FOR USE IN PARKING LOTS AND WALKWAYS; LIGHTING FIXTURES THAT INTEGRATE NATURAL DAYLIGHT AND FLUORESCENT LIGHTING INTO THE FIXTURE; LIGHTING SYSTEM FOR USE DURING SURGERY COMPRISING A LENS MODULE, AN ADJUSTABLE CONDUIT FOR SUPPORTING A FIBER OPTIC CABLE OPERATIVELY ATTACHED TO THE LENS MODULE AND A MOUNTING BRACKET; LIGHTING TRACKS; LIGHTING TUBES; LIGHTS FOR FIREARMS; LIGHTS FOR USE IN ILLUMINATING SIGNS AND DISPLAYS; LIGHTS FOR VEHICLES; MINIATURE LIGHT BULBS; MOBILE LIGHT TOWERS; OUTDOOR LIGHTED CHRISTMAS ORNAMENTS; OUTDOOR LIGHTING, NAMELY, PAVER LIGHTS; OXYGEN CONCENTRATORS FOR USE WITH FUEL CELLS USED IN HEATING, VENTILATION, AIR CONDITIONING, LIGHTING, AND POWER SYSTEMS FOR BUILDINGS; PEN LIGHTS; POCKET SEARCH LIGHTS; PORTABLE BATTERY-OPERATED LIGHTS THAT CAN BE PLACED ON SURFACES WHERE OTHER LIGHT SOURCES ARE UNAVAILABLE; RADIATORS USING VISIBLE LIGHT NOT FOR MOTORS AND ENGINES; REAR LIGHTS FOR VEHICLES; RUNNING LIGHTS FOR LAND VEHICLES; RUNNING LIGHTS FOR SHOES AND BAGS; SCONCE LIGHTING FIXTURES; SOCKETS FOR

ELECTRIC LIGHTS; SOLAR LIGHT FIXTURES, NAMELY, INDOOR AND OUTDOOR SOLAR POWERED LIGHTING UNITS AND FIXTURES; TAIL LIGHTS FOR LAND VEHICLES; TAIL LIGHTS FOR VEHICLES; VEHICLE TURN-SIGNAL LIGHT BULBS; WALL LIGHTS, IN CLASS 11 (U.S. CLS. 13, 21, 23, 31 AND 34).

FIRST USE 12-12-2006; IN COMMERCE 12-12-2006.

THE COLOR(S) RED, GREEN IS/ARE CLAIMED AS A FEATURE OF THE MARK.

THE COLOR RED APPEARS IN THE LETTERS "LTA", AND THE COLOR GREEN APPEARS IN THE SEMI-CIRCLE UNDERNEATH THE LETTERING.

SER. NO. 77-330,507, FILED 11-15-2007.

ANNE E. GUSTASON, EXAMINING ATTORNEY

**Int. Cls.: 9 and 41**

**Prior U.S. Cls.: 21, 23, 26, 36, 38, 100, 101 and 107**

**Reg. No. 3,466,785**

**United States Patent and Trademark Office**

**Registered July 15, 2008**

**TRADEMARK  
SERVICE MARK  
PRINCIPAL REGISTER**

# JAKE CRUISE

EKRA GROUP, INC. (CALIFORNIA CORPORATION)  
5650 FULCHER AVENUE  
NORTH HOLLYWOOD, CA 91601

FOR: DIGITAL MATERIALS, NAMELY, PRE-RECORDED VIDEOTAPES, COMPACT DISCS, CD-ROMS, DVDS, VIDEOTAPES, DOWNLOADABLE PRE-RECORDED VIDEO, AND DIGITAL PHOTOGRAPHS AND IMAGES FEATURING SEXUALLY ORIENTED ADULT ENTERTAINMENT; DOWNLOADABLE VIDEO RECORDINGS FEATURING SEXUALLY ORIENTED ADULT ENTERTAINMENT; PRE-RECORDED CDS, VIDEO TAPES, LASER DISKS AND DVDS FEATURING SEXUALLY ORIENTED ADULT ENTERTAINMENT; DOWNLOADABLE FILMS AND TV PROGRAMS FEATURING SEXUALLY ORIENTED ADULT ENTERTAINMENT PROVIDED VIA A VIDEO-ON-DEMAND SERVICE, IN CLASS 9 (U.S. CLS. 21, 23, 26, 36 AND 38).

FIRST USE 3-18-2002; IN COMMERCE 3-18-2002.

FOR: ENTERTAINMENT SERVICES, NAMELY, PROVIDING A WEBSITE FEATURING PHOTOGRAPHIC, AUDIO, VIDEO AND PROSE PRESENTATIONS FEATURING ADULT ENTERTAINMENT, IN CLASS 41 (U.S. CLS. 100, 101 AND 107).

FIRST USE 3-18-2002; IN COMMERCE 3-18-2002.

THE MARK CONSISTS OF STANDARD CHARACTERS WITHOUT CLAIM TO ANY PARTICULAR FONT, STYLE, SIZE, OR COLOR.

THE NAME(S), PORTRAIT(S), AND/OR SIGNATURE(S) SHOWN IN THE MARK DOES NOT IDENTIFY A PARTICULAR LIVING INDIVIDUAL.

SER. NO. 77-330,515, FILED 11-15-2007.

MARK PILARO, EXAMINING ATTORNEY



Int. Cl.: 36

Prior U.S. Cls.: 100, 101 and 102

United States Patent and Trademark Office

Reg. No. 3,466,786

Registered July 15, 2008

SERVICE MARK  
PRINCIPAL REGISTER



SINCERELY YOURS REALTY, LLC (NORTH  
CAROLINA LTD LIAB CO)  
5554 ROBMONT DRIVE  
FAYETTEVILLE, NC 28306

NO CLAIM IS MADE TO THE EXCLUSIVE  
RIGHT TO USE "REALTY", APART FROM THE  
MARK AS SHOWN.

FOR: REAL ESTATE BROKERAGE, INVEST-  
MENT, AND MANAGEMENT, IN CLASS 36 (U.S.  
CLS. 100, 101 AND 102).

SER. NO. 77-330,561, FILED 11-15-2007.

FIRST USE 10-9-2007; IN COMMERCE 10-9-2007.

MICHAEL KAZAZIAN, EXAMINING ATTORNEY

**Int. Cl.: 3**

**Prior U.S. Cls.: 1, 4, 6, 50, 51 and 52**

**United States Patent and Trademark Office**

**Reg. No. 3,466,787**

**Registered July 15, 2008**

**TRADEMARK  
PRINCIPAL REGISTER**

**PERFORMANCE TIPS**

CREATIVE NAIL DESIGN, INC. (CALIFORNIA  
CORPORATION)  
1125 JOSHUA WAY  
VISTA, CA 92083

THE MARK CONSISTS OF STANDARD CHAR-  
ACTERS WITHOUT CLAIM TO ANY PARTICULAR  
FONT, STYLE, SIZE, OR COLOR.

FOR: ARTIFICIAL FINGERNAILS; NAIL TIPS, IN  
CLASS 3 (U.S. CLS. 1, 4, 6, 50, 51 AND 52).

SER. NO. 77-330,581, FILED 11-15-2007.

FIRST USE 12-1-2006; IN COMMERCE 12-1-2006.

TINA KUAN, EXAMINING ATTORNEY

**Int. Cl.: 9**

**Prior U.S. Cls.: 21, 23, 26, 36 and 38**

**Reg. No. 3,466,788**

**United States Patent and Trademark Office**

**Registered July 15, 2008**

**TRADEMARK  
PRINCIPAL REGISTER**

# ClearCheck21

INLITE RESEARCH INC (CALIFORNIA CORPORATION)  
615 TEMPLETON COURT  
SUNNYVALE, CA 94087

FOR: ACCOUNTING SOFTWARE FOR USE IN THE CONSTRUCTION INDUSTRY FOR CONTRACT BIDDING AND JOB ACCOUNTING; COMPUTER COMMUNICATIONS SOFTWARE TO ALLOW CUSTOMERS TO ACCESS BANK ACCOUNT INFORMATION AND TRANSACT BANK BUSINESS; COMPUTER E-COMMERCE SOFTWARE TO ALLOW USERS TO PERFORM ELECTRONIC BUSINESS TRANSACTIONS VIA A GLOBAL COMPUTER NETWORK; COMPUTER SOFTWARE DEVELOPMENT TOOLS; COMPUTER SOFTWARE FOR APPLICATION AND DATABASE INTEGRATION; COMPUTER SOFTWARE FOR COMPUTER SYSTEM AND APPLICATION DEVELOPMENT, DEPLOYMENT AND MANAGEMENT; COMPUTER SOFTWARE FOR CREATING SEARCHABLE DATABASES OF INFORMATION

AND DATA; COMPUTER SOFTWARE FOR USE IN PROGRAMMING FACSIMILE MACHINES; COMPUTER SOFTWARE FOR OBTAINING, MODIFYING, INTERPRETING, AND PROCESSING IMAGES OF BANK CHECKS AND RELATED REMITTANCE AND INVOICING DOCUMENTS; SOFTWARE FOR PROCESSING IMAGES, GRAPHICS AND TEXT; TAX MANAGEMENT DATA COLLECTION SOFTWARE, IN CLASS 9 (U.S. CLS. 21, 23, 26, 36 AND 38).

FIRST USE 11-15-2007; IN COMMERCE 11-15-2007.

THE MARK CONSISTS OF STANDARD CHARACTERS WITHOUT CLAIM TO ANY PARTICULAR FONT, STYLE, SIZE, OR COLOR.

SER. NO. 77-330,618, FILED 11-15-2007.

ANDREA SAUNDERS, EXAMINING ATTORNEY

**Int. Cl.: 43**

**Prior U.S. Cls.: 100 and 101**

**United States Patent and Trademark Office**

**Reg. No. 3,466,789**

**Registered July 15, 2008**

**SERVICE MARK  
PRINCIPAL REGISTER**



ARAMARK CORPORATION (DELAWARE CORPORATION)  
29TH FLOOR  
1101 MARKET STREET  
PHILADELPHIA, PA 19107

FOR: CONTRACT FOOD SERVICES; RESTAURANT SERVICES; RESTAURANTS, IN CLASS 43 (U.S. CLS. 100 AND 101).

FIRST USE 9-0-2006; IN COMMERCE 9-0-2006.

THE MARK CONSISTS OF LITERAL ELEMENT STYLIZED WITH ACCENT.

THE FOREIGN WORDING IN THE MARK TRANSLATES INTO ENGLISH AS "LEFT-HANDED".

SER. NO. 77-330,623, FILED 11-15-2007.

SUSAN LESLIE DUBOIS, EXAMINING ATTORNEY

**Int. Cl.: 35**

**Prior U.S. Cls.: 100, 101 and 102**

**United States Patent and Trademark Office**

**Reg. No. 3,466,790**

**Registered July 15, 2008**

**SERVICE MARK  
PRINCIPAL REGISTER**

**AMERICAN RESPIRATORY  
ALLIANCE OF WESTERN  
PENNSYLVANIA**

AMERICAN RESPIRATORY ALLIANCE OF  
WESTERN PENNSYLVANIA (PENNSYLVANIA  
CORPORATION)  
AMERICAN RESPIRATORY ALLIANCE OF WESTERN  
201 SMITH DRIVE SUITE E  
CRANBERRY, PA 16066

FOR: PROMOTING THE INTERESTS OF THE  
PUBLIC IN THE PREVENTION AND CONTROL OF  
LUNG AND RESPIRATORY DISEASES, IN CLASS  
35 (U.S. CLS. 100, 101 AND 102).

FIRST USE 1-4-1999; IN COMMERCE 1-4-1999.

THE MARK CONSISTS OF STANDARD CHARACTERS WITHOUT CLAIM TO ANY PARTICULAR FONT, STYLE, SIZE, OR COLOR.

OWNER OF U.S. REG. NOS. 2,568,526 AND 2,568,542.

SEC. 2(F).

SER. NO. 77-330,631, FILED 11-15-2007.

MARY ROSSMAN, EXAMINING ATTORNEY

**Int. Cl.: 41**

**Prior U.S. Cls.: 100, 101 and 107**

**United States Patent and Trademark Office**

**Reg. No. 3,466,791**

**Registered July 15, 2008**

**SERVICE MARK  
PRINCIPAL REGISTER**

**SCORE ON DEMAND**

QUAD INT'L., INCORPORATED (FLORIDA CORPORATION), DBA THE SCORE GROUP  
1629 NW 84TH AVENUE  
DORAL, FL 33126

FOR: ENTERTAINMENT SERVICES, NAMELY, PROVIDING ADULT MATERIAL AND VIEWING THEREOF, NAMELY, PROVIDING IMAGES, VIDEO AND EDITORIAL CONTENT IN THE FIELD OF ADULT ENTERTAINMENT VIA A GLOBAL COMPUTER NETWORK, IN CLASS 41 (U.S. CLS. 100, 101 AND 107).

FIRST USE 7-9-2007; IN COMMERCE 9-18-2007.

THE MARK CONSISTS OF STANDARD CHARACTERS WITHOUT CLAIM TO ANY PARTICULAR FONT, STYLE, SIZE, OR COLOR.

OWNER OF U.S. REG. NOS. 2,515,292, 2,810,589 AND OTHERS.

NO CLAIM IS MADE TO THE EXCLUSIVE RIGHT TO USE "ON DEMAND", APART FROM THE MARK AS SHOWN.

SER. NO. 77-330,643, FILED 11-15-2007.

NELSON SNYDER, EXAMINING ATTORNEY

**Int. Cl.: 35**

**Prior U.S. Cls.: 100, 101 and 102**

**United States Patent and Trademark Office**

**Reg. No. 3,466,792**

**Registered July 15, 2008**

**SERVICE MARK  
PRINCIPAL REGISTER**



YTB INTERNATIONAL, INC. (DELAWARE CORPORATION)  
1901 EAST EDWARDSVILLE ROAD  
WOOD RIVER, IL 62095

FOR: ONLINE AUTOMOTIVE INDUSTRY SERVICES FOR OTHERS, NAMELY, PROVIDING INTERNET WEBPAGES AND LINKS FOR CONSUMERS TO FIND NEW AND PRE-OWNED VEHICLE PRICE QUOTES, PURCHASE NEW AND PRE-OWNED VEHICLES, AND FINANCE THE PURCHASE OF NEW AND PRE-OWNED VEHICLES FROM AUTOMOBILE DEALERS, PROFESSIONALS AND RETAIL PROVIDERS, IN CLASS 35 (U.S. CLS. 100, 101 AND 102).

FIRST USE 6-26-2007; IN COMMERCE 6-26-2007.

NO CLAIM IS MADE TO THE EXCLUSIVE RIGHT TO USE "CARS", APART FROM THE MARK AS SHOWN.

THE MARK CONSISTS OF THE STYLIZED WORDS "YTB CARS" AND AN OUTLINE OF A PORTION OF A VEHICLE.

SER. NO. 77-330,664, FILED 11-15-2007.

KEVON CHISOLM, EXAMINING ATTORNEY

**Int. Cl.: 9**

**Prior U.S. Cls.: 21, 23, 26, 36 and 38**

**Reg. No. 3,466,793**

**United States Patent and Trademark Office**

**Registered July 15, 2008**

**TRADEMARK  
PRINCIPAL REGISTER**

**VIRTUAL HOLD**

VIRTUAL HOLD TECHNOLOGY, LLC (DELAWARE LTD LIAB CO)  
137 HERITAGE WOODS DRIVE  
AKRON, OH 44321

FOR: QUEUING SOFTWARE, NAMELY, SOFTWARE FOR USE IN MANAGING AND COORDINATING QUEUE POSITION, CALL BACK, AND COMMUNICATION ROUTING BETWEEN RESOURCES; COMMUNICATION SCHEDULING SOFTWARE, NAMELY, SOFTWARE FOR AUTOMATING, COORDINATING AND MANAGING CALL BACK FUNCTIONS BETWEEN RESOURCES; AND INTERNET AND SMS (SHORT MESSAGING SERVICE) QUEUE MANAGEMENT SOFTWARE, NAMELY, SOFTWARE FOR COORDINATING AND MANAGING INCOMING COMMUNICATION REQUESTS INTO QUEUES VIA INTERNET AND

SMS NETWORKS, IN CLASS 9 (U.S. CLS. 21, 23, 26, 36 AND 38).

FIRST USE 1-2-1997; IN COMMERCE 10-28-1997.

THE MARK CONSISTS OF STANDARD CHARACTERS WITHOUT CLAIM TO ANY PARTICULAR FONT, STYLE, SIZE, OR COLOR.

OWNER OF U.S. REG. NO. 2,137,640.

NO CLAIM IS MADE TO THE EXCLUSIVE RIGHT TO USE "VITRUAL", APART FROM THE MARK AS SHOWN.

SER. NO. 77-330,691, FILED 11-15-2007.

ROBIN CHOSID, EXAMINING ATTORNEY



**Int. Cl.: 42**

**Prior U.S. Cls.: 100 and 101**

**United States Patent and Trademark Office**

**Reg. No. 3,466,794**

**Registered July 15, 2008**

**SERVICE MARK  
PRINCIPAL REGISTER**

# MediaLogic

MEDIALOGIC, INC. (TEXAS CORPORATION)  
3320 BERING DRIVE  
HOUSTON, TX 77057

FOR: APPLICATION SERVICE PROVIDER (ASP)  
FEATURING SOFTWARE FOR USE IN MANAGE-  
MENT AND STORAGE OF OPERATING DOCU-  
MENTS AND THE MANAGEMENT OF VENDORS  
THAT PRODUCED THE DOCUMENTS , IN CLASS  
42 (U.S. CLS. 100 AND 101).

FIRST USE 6-4-2007; IN COMMERCE 6-4-2007.

THE MARK CONSISTS OF STANDARD CHAR-  
ACTERS WITHOUT CLAIM TO ANY PARTICULAR  
FONT, STYLE, SIZE, OR COLOR.

SER. NO. 77-330,696, FILED S.R. 11-15-2007 AM.  
P.R. 3-3-2008.

PRISCILLA MILTON, EXAMINING ATTORNEY

**Int. Cl.: 43**

**Prior U.S. Cls.: 100 and 101**

**United States Patent and Trademark Office**

**Reg. No. 3,466,795**

**Registered July 15, 2008**

**SERVICE MARK  
PRINCIPAL REGISTER**

**We've Got Huevos**

BYC, INC. (CALIFORNIA CORPORATION)  
1851 GARNET AVE.  
SAN DIEGO, CA 92109

FOR: CAFE-RESTAURANTS; PROVISION OF  
FOOD AND DRINK IN RESTAURANTS; RESTAU-  
RANT AND BAR SERVICES; RESTAURANT SER-  
VICES; RESTAURANTS, IN CLASS 43 (U.S. CLS. 100  
AND 101).

FIRST USE 1-1-1979; IN COMMERCE 1-1-2006.

THE MARK CONSISTS OF STANDARD CHAR-  
ACTERS WITHOUT CLAIM TO ANY PARTICULAR  
FONT, STYLE, SIZE, OR COLOR.

THE FOREIGN WORDING IN THE MARK  
TRANSLATES INTO ENGLISH AS EGGS.

SER. NO. 77-330,760, FILED 11-15-2007.

VIVIAN MICZNIK FIRST, EXAMINING ATTOR-  
NEY

**Int. Cl.: 3**

**Prior U.S. Cls.: 1, 4, 6, 50, 51 and 52**

**United States Patent and Trademark Office**

**Reg. No. 3,466,796**

**Registered July 15, 2008**

**TRADEMARK  
PRINCIPAL REGISTER**



CREATIVE NAIL DESIGN (CALIFORNIA CORPORATION)  
1125 JOSHUA WAY  
VISTA, CA 92083

FOR: ARTIFICIAL AND NATURAL NAIL CARE PREPARATIONS, NAMELY, NAIL STRENGTHENERS, NAIL POLISH REMOVERS, NAIL ENAMEL, LIQUIDS AND POWDERS FOR SCULPTING ARTIFICIAL FINGERNAILS, ARTIFICIAL FINGERNAIL TIPS AND FORMS, ADHESIVES FOR ATTACHING ARTIFICIAL FINGERNAILS IN LIQUID AND POWDER FORM; CUTICLE PREPARATIONS, NAMELY, CREAMS, LOTIONS AND OILS; HAND CREAMS, LOTIONS AND CLEANSERS; FOOT CREAMS, LO-

TIONS, AND CLEANSERS, IN CLASS 3 (U.S. CLS. 1, 4, 6, 50, 51 AND 52).

FIRST USE 7-17-2007; IN COMMERCE 7-17-2007.

OWNER OF U.S. REG. NO. 1,491,840.

THE MARK CONSISTS IN PART OF A STYLIZED LETTER C WITHIN A SQUARE.

SER. NO. 77-330,794, FILED 11-15-2007.

PRISCILLA MILTON, EXAMINING ATTORNEY

**Int. Cl.: 41**

**Prior U.S. Cls.: 100, 101 and 107**

**United States Patent and Trademark Office**

**Reg. No. 3,466,797**

**Registered July 15, 2008**

**SERVICE MARK  
PRINCIPAL REGISTER**

**Get a Brand or Die a  
Generic**

BROWN, MICHAEL (UNITED STATES INDIVIDUAL)  
7674 CONTINENTAL PLACE  
RANCHO CUCAMONGA, CA 91730

FOR: EDUCATIONAL SERVICES, NAMELY, CONDUCTING LECTURES, SEMINARS, AND TRAINING IN THE FIELD OF CAREER AND PERSONAL DEVELOPMENT AND DISTRIBUTION OF COURSE MATERIAL IN CONNECTION THEREWITH, IN CLASS 41 (U.S. CLS. 100, 101 AND 107).

FIRST USE 2-5-2000; IN COMMERCE 5-10-2002.

THE MARK CONSISTS OF STANDARD CHARACTERS WITHOUT CLAIM TO ANY PARTICULAR FONT, STYLE, SIZE, OR COLOR.

SER. NO. 77-330,804, FILED 11-15-2007.

JOHN DALIER, EXAMINING ATTORNEY

**Int. Cl.: 5**

**Prior U.S. Cls.: 6, 18, 44, 46, 51 and 52**

**United States Patent and Trademark Office**

**Reg. No. 3,466,798**

**Registered July 15, 2008**

**TRADEMARK  
PRINCIPAL REGISTER**

# Joint Magic

BEHR, JEFFREY L (UNITED STATES INDIVIDUAL)  
11 ROBIN HOOD WAY  
WAYNE, NJ 07470

NO CLAIM IS MADE TO THE EXCLUSIVE RIGHT TO USE "JOINT", APART FROM THE MARK AS SHOWN.

FOR: PREPARATION FOR THE RELIEF OF PAIN, IN CLASS 5 (U.S. CLS. 6, 18, 44, 46, 51 AND 52).

SER. NO. 77-330,821, FILED 11-15-2007.

FIRST USE 10-10-2007; IN COMMERCE 10-10-2007.

THE MARK CONSISTS OF STANDARD CHARACTERS WITHOUT CLAIM TO ANY PARTICULAR FONT, STYLE, SIZE, OR COLOR.

VIVIAN MICZNIK FIRST, EXAMINING ATTORNEY

**Int. Cl.: 35**

**Prior U.S. Cls.: 100, 101 and 102**

**United States Patent and Trademark Office**

**Reg. No. 3,466,799**

**Registered July 15, 2008**

**SERVICE MARK  
PRINCIPAL REGISTER**

**ONE ASS TO KICK**

KANTOR + WASSINK AGENCY LLC (MICHIGAN LTD LIAB CO)  
251 STATE ST SE  
GRAND RAPIDS, MI 49503

FOR: ADVERTISING, MARKETING AND PROMOTION SERVICES, IN CLASS 35 (U.S. CLS. 100, 101 AND 102).

FIRST USE 11-7-2007; IN COMMERCE 11-7-2007.

THE MARK CONSISTS OF STANDARD CHARACTERS WITHOUT CLAIM TO ANY PARTICULAR FONT, STYLE, SIZE, OR COLOR.

SER. NO. 77-330,827, FILED 11-15-2007.

MATTHEW MCDOWELL, EXAMINING ATTORNEY

**Int. Cl.: 36**

**Prior U.S. Cls.: 100, 101 and 102**

**United States Patent and Trademark Office**

**Reg. No. 3,466,800**

**Registered July 15, 2008**

**SERVICE MARK  
PRINCIPAL REGISTER**



CONTINENTAL PROPERTIES, INC. (FLORIDA CORPORATION)  
2240 PALM BEACH LAKES BLVD. SUITE 400  
WEST PALM BEACH, FL 33409

FOR: LAND ACQUISITION, NAMELY, REAL ESTATE BROKERAGE; PROVIDING INFORMATION IN THE FIELD OF REAL ESTATE VIA THE INTERNET; PROVIDING REAL ESTATE LISTINGS AND REAL ESTATE INFORMATION VIA THE INTERNET; REAL ESTATE ACQUISITION SERVICES; REAL ESTATE AGENCIES; REAL ESTATE CONSULTATION; REAL ESTATE INVESTMENT; REAL ESTATE LISTING; REAL ESTATE MANAGEMENT; REAL ESTATE MANAGEMENT CONSULTATION; REAL ESTATE MULTIPLE LISTING SERVICES, IN CLASS 36 (U.S. CLS. 100, 101 AND 102).

FIRST USE 6-20-1990; IN COMMERCE 6-20-1990.

THE COLOR(S) GOLD AND BLACK IS/ARE CLAIMED AS A FEATURE OF THE MARK.

THE MARK CONSISTS OF THE STYLIZED LETTERS "CP" IN GOLD WITHIN A BLACK CIRCLE.

SER. NO. 77-330,828, FILED 11-15-2007.

MATTHEW MCDOWELL, EXAMINING ATTORNEY

**Int. Cl.: 38**

**Prior U.S. Cls.: 100, 101 and 104**

**United States Patent and Trademark Office**

**Reg. No. 3,466,801**

**Registered July 15, 2008**

**SERVICE MARK  
PRINCIPAL REGISTER**

**NEWSVETTER**

ANDREW FOWLER (UNITED STATES INDIVIDUAL)  
4380 SW CRESTWOOD DRIVE  
PORTLAND, OR 97225

FOR: AN INTERACTIVE WEBSITE THAT PROVIDES AN ONLINE FORUM TO CREATE, DELIVER, EVALUATE, AND DISCUSS CONTENT FOR THE MEDIA, IN CLASS 38 (U.S. CLS. 100, 101 AND 104).

FIRST USE 6-22-2007; IN COMMERCE 10-4-2007.

THE MARK CONSISTS OF STANDARD CHARACTERS WITHOUT CLAIM TO ANY PARTICULAR FONT, STYLE, SIZE, OR COLOR.

SER. NO. 77-330,853, FILED 11-15-2007.

DAYNA BROWNE, EXAMINING ATTORNEY



**Int. Cl.: 33**

**Prior U.S. Cls.: 47 and 49**

**United States Patent and Trademark Office**

**Reg. No. 3,466,802**

**Registered July 15, 2008**

**TRADEMARK  
PRINCIPAL REGISTER**

**EFFEN IS A FIVE-LETTER WORD**

CONSTELLATION SPIRITS INC. (DELAWARE  
CORPORATION)  
1 SOUTH DEARBORN, SUITE 1700  
CHICAGO, IL 60603

FOR: DISTILLED SPIRITS, IN CLASS 33 (U.S. CLS.  
47 AND 49).

FIRST USE 8-0-2007; IN COMMERCE 8-0-2007.

THE MARK CONSISTS OF STANDARD CHAR-  
ACTERS WITHOUT CLAIM TO ANY PARTICULAR  
FONT, STYLE, SIZE, OR COLOR.

OWNER OF U.S. REG. NOS. 2,788,499, 3,252,791  
AND OTHERS.

THE FOREIGN WORDING IN THE MARK  
TRANSLATES INTO ENGLISH AS "EVEN" OR  
"SMOOTH".

SER. NO. 77-330,957, FILED 11-15-2007.

KHANH LE, EXAMINING ATTORNEY

**Int. Cl.: 42**

**Prior U.S. Cls.: 100 and 101**

**United States Patent and Trademark Office**

**Reg. No. 3,466,803**

**Registered July 15, 2008**

**SERVICE MARK  
PRINCIPAL REGISTER**



VISISTAT, INC. (CALIFORNIA CORPORATION)  
P.O. BOX 320546  
LOS GATOS, CA 95032

FOR: COMPUTER AND WEBSITE DIAGNOSTIC  
SERVICES, NAMELY, TRACKING, ANALYZING,  
EVALUATING AND ADVISING WEBSITE OPERA-  
TORS CONCERNING IMPLEMENTATION, US-  
ABILITY, FUNCTIONING, PERFORMANCE AND

OPTIMIZATION OF THEIR WEBSITES, IN CLASS 42  
(U.S. CLS. 100 AND 101).

FIRST USE 9-21-2001; IN COMMERCE 3-1-2002.

SER. NO. 77-330,961, FILED 11-15-2007.

MORGAN WYNNE, EXAMINING ATTORNEY

**Int. Cl.: 35**

**Prior U.S. Cls.: 100, 101 and 102**

**United States Patent and Trademark Office**

**Reg. No. 3,466,804**

**Registered July 15, 2008**

**SERVICE MARK  
PRINCIPAL REGISTER**



BELLAGIO, LLC (NEVADA LTD LIAB CO)  
3600 LAS VEGAS BOULEVARD SOUTH  
LAS VEGAS, NV 89109

OWNER OF U.S. REG. NOS. 2,514,690, 2,915,992  
AND OTHERS.

FOR: ART GALLERIES; ISSUING GIFT CERTIFI-  
CATES WHICH MAY THEN BE REDEEMED FOR  
GOODS OR SERVICES; PROVIDING FACILITIES  
FOR BUSINESS MEETINGS; PROVIDING INFOR-  
MATION IN THE FIELD OF SHOPPING VIA THE  
INTERNET, IN CLASS 35 (U.S. CLS. 100, 101 AND  
102).

THE FOREIGN WORDING IN THE MARK  
TRANSLATES INTO ENGLISH AS "BEAUTIFUL  
LAKE".

SER. NO. 77-330,984, FILED 11-15-2007.

FIRST USE 10-15-1998; IN COMMERCE 10-15-1998.

KEVIN DINALLO, EXAMINING ATTORNEY

**Int. Cl.: 41**

**Prior U.S. Cls.: 100, 101 and 107**

**United States Patent and Trademark Office**

**Reg. No. 3,466,805**

**Registered July 15, 2008**

**SERVICE MARK  
PRINCIPAL REGISTER**



BELLAGIO, LLC (NEVADA LTD LIAB CO)  
3600 LAS VEGAS BOULEVARD SOUTH  
LAS VEGAS, NV 89109

FOR: CONDUCTING AND PROVIDING FACILITIES FOR SPECIAL EVENTS FEATURING CASINO AND GAMING CONTESTS AND TOURNAMENTS; BOTANICAL GARDENS; HEALTH CLUB SERVICES; BOOKING OF THEATRE TICKETS; SPECIAL EVENT PLANNING; CABARETS; NIGHT CLUBS; AMUSEMENT ARCADES; BEACH AND POOL CLUBS, NAMELY, PROVIDING FITNESS AND EXERCISE FACILITIES FEATURING POOLS AND BATHING AND SHOWERING FACILITIES; PROVIDING INFORMATION IN THE FIELD OF GAM-

ING AND ENTERTAINMENT VIA THE INTERNET, IN CLASS 41 (U.S. CLS. 100, 101 AND 107).

FIRST USE 10-15-1998; IN COMMERCE 10-15-1998.

OWNER OF U.S. REG. NOS. 2,514,690, 2,915,992 AND OTHERS.

THE FOREIGN WORDING IN THE MARK TRANSLATES INTO ENGLISH AS "BEAUTIFUL LAKE".

SER. NO. 77-330,988, FILED 11-15-2007.

KEVIN DINALLO, EXAMINING ATTORNEY

**Int. Cl.: 17**

**Prior U.S. Cls.: 1, 5, 12, 13, 35 and 50**

**United States Patent and Trademark Office**

**Reg. No. 3,466,806**

**Registered July 15, 2008**

**TRADEMARK  
PRINCIPAL REGISTER**



CHAEI HSIN ENTERPRISE CO., LTD. (TAIWAN CORPORATION)  
NO.208-20, JHONGCING RD., SITUN DISTRICT  
TAICHUNG CITY 407, TAIWAN

FOR: PLASTIC FILM FOR USE IN MANUFACTURE TO FORM PARTS OF SHOES, HATS, LUGGAGE AND PURSES AND NOT FOR USE IN WRAPPING, IN CLASS 17 (U.S. CLS. 1, 5, 12, 13, 35 AND 50).

FIRST USE 10-1-2007; IN COMMERCE 10-1-2007.

THE MARK CONSISTS OF "TWO HORN LIKE ARCUATE CONTOURS CONTIGUOUSLY POSITIONED IN OPPOSING DIRECTIONS".

SER. NO. 77-330,996, FILED 11-15-2007.

DAVID TAYLOR, EXAMINING ATTORNEY

**Int. Cl.: 41**

**Prior U.S. Cls.: 100, 101 and 107**

**United States Patent and Trademark Office**

**Reg. No. 3,466,807**

**Registered July 15, 2008**

**SERVICE MARK  
PRINCIPAL REGISTER**

Your best is our business

BECKER, MARC (CANADA INDIVIDUAL)  
5 CHEMIN DU BOIS D'OPIO  
OPIO, FRANCE 06650

FOR: PERSONAL COACHING SERVICES IN THE  
FIELD OF LIFESTYLE, TRIATHLON; TRAINING  
SERVICES IN THE FIELD OF FITNESS, TRIATH-  
LON, IN CLASS 41 (U.S. CLS. 100, 101 AND 107).

FIRST USE 7-0-2006; IN COMMERCE 7-0-2006.

THE MARK CONSISTS OF STANDARD CHAR-  
ACTERS WITHOUT CLAIM TO ANY PARTICULAR  
FONT, STYLE, SIZE, OR COLOR.

SER. NO. 77-331,034, FILED 11-15-2007.

LINDA MICKLEBURGH, EXAMINING ATTORNEY

Int. Cl.: 16

Prior U.S. Cls.: 2, 5, 22, 23, 29, 37, 38 and 50

United States Patent and Trademark Office

Reg. No. 3,466,808

Registered July 15, 2008

TRADEMARK  
PRINCIPAL REGISTER

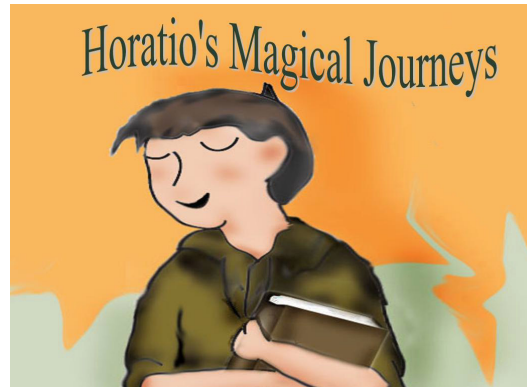

PENTZ, JANE A. (UNITED STATES INDIVIDUAL)  
111-1 GROVE ST.  
WEST ROXBURY, MA 02132

FOR: CHILDREN'S INTERACTIVE EDUCATIONAL BOOKS, IN CLASS 16 (U.S. CLS. 2, 5, 22, 23, 29, 37, 38 AND 50).

FIRST USE 2-22-2007; IN COMMERCE 10-15-2007.

THE COLOR(S) ORANGE, DARK GREEN, BROWN AND LIGHT GREEN IS/ARE CLAIMED AS A FEATURE OF THE MARK.

THE MARK CONSISTS OF BACKGROUND COLORS ARE ORANGE ON TOP AND A LIGHT GREEN ON THE BOTTOM. THERE IS A BOY WITH A DARK GREEN SHIRT AND BROWN HAIR HOLDING A BROWN BOOK.

SER. NO. 77-331,035, FILED 11-15-2007.

KYLE PEETE, EXAMINING ATTORNEY

**Int. Cl.: 25**

**Prior U.S. Cls.: 22 and 39**

**United States Patent and Trademark Office**

**Reg. No. 3,466,809**

**Registered July 15, 2008**

**TRADEMARK  
PRINCIPAL REGISTER**

**Grand Canyon Boots and  
Belts**

ALEX TRACHTER (UNITED STATES INDIVIDUAL)

877 FOREST WILLOW

EL PASO, TX 79922

FOR: BOOTS; BELTS MADE OF LEATHER, IN CLASS 25 (U.S. CLS. 22 AND 39).

FIRST USE 6-1-2006; IN COMMERCE 1-1-2007.

THE MARK CONSISTS OF STANDARD CHARACTERS WITHOUT CLAIM TO ANY PARTICULAR FONT, STYLE, SIZE, OR COLOR.

NO CLAIM IS MADE TO THE EXCLUSIVE RIGHT TO USE "BOOTS AND BELTS", APART FROM THE MARK AS SHOWN.

SER. NO. 77-331,053, FILED 11-15-2007.

JOHN WILKE, EXAMINING ATTORNEY



**Int. Cl.: 35**

**Prior U.S. Cls.: 100, 101 and 102**

**United States Patent and Trademark Office**

**Reg. No. 3,466,810**

**Registered July 15, 2008**

**SERVICE MARK  
PRINCIPAL REGISTER**



ROYAL NETWORKING, LLC (CALIFORNIA  
LTD LIAB CO)  
SUITE 700  
1875 CENTURY PARK EAST  
LOS ANGELES, CA 90067

FOR: ADVERTISING, MARKETING AND PRO-  
MOTION SERVICES, IN CLASS 35 (U.S. CLS. 100, 101  
AND 102).

FIRST USE 8-8-2007; IN COMMERCE 8-8-2007.

NO CLAIM IS MADE TO THE EXCLUSIVE  
RIGHT TO USE "NETWORKING", APART FROM  
THE MARK AS SHOWN.

THE MARK CONSISTS OF A LION'S HEAD  
DRAWN WITH BROAD CURVING STROKES AND  
SHOWN MAINLY FROM THE SIDE VIEW, MOUTH  
AGAPE, WEARING A FIVE-POINTED CROWN ON  
ITS HEAD.

SER. NO. 77-331,071, FILED 11-15-2007.

MICHAEL KEATING, EXAMINING ATTORNEY

**Int. Cl.: 3**

**Prior U.S. Cls.: 1, 4, 6, 50, 51 and 52**

**Reg. No. 3,466,811**

**United States Patent and Trademark Office**

**Registered July 15, 2008**

---

**TRADEMARK  
PRINCIPAL REGISTER**

**LipoLean**

RENEW INFINITY LLC. (FLORIDA LTD LIAB  
CO)  
183 SANTA BARBARA WAY  
PALM BEACH GARDENS, FL 33410

THE MARK CONSISTS OF STANDARD CHAR-  
ACTERS WITHOUT CLAIM TO ANY PARTICULAR  
FONT, STYLE, SIZE, OR COLOR.

FOR: BEAUTY CREAMS FOR BODY CARE;  
FACE AND BODY BEAUTY CREAMS; MASSAGE  
CREAMS; NON-MEDICATED SKIN CREAMS, IN  
CLASS 3 (U.S. CLS. 1, 4, 6, 50, 51 AND 52).

SER. NO. 77-331,099, FILED 11-16-2007.

FIRST USE 11-1-2007; IN COMMERCE 11-1-2007.

JAMES STEIN, EXAMINING ATTORNEY

Int. Cl.: 35

Prior U.S. Cls.: 100, 101 and 102

United States Patent and Trademark Office

Reg. No. 3,466,812

Registered July 15, 2008

SERVICE MARK  
PRINCIPAL REGISTER



DOWNTOWN DIVAS INC. (FLORIDA CORPORATION)  
SUITE 209  
909 E. NEW HAVEN AVE.  
MELBOURNE, FL 32901

THE MARK CONSISTS OF FEMALE CHARACTER IN FRONT OF CITY BUILDINGS WITH "DOWNTOWN DIVAS" IN TEXT UNDERNEATH.

FOR: RETAIL CLOTHING BOUTIQUES, IN CLASS 35 (U.S. CLS. 100, 101 AND 102).

SER. NO. 77-331,104, FILED 11-16-2007.

FIRST USE 9-1-2000; IN COMMERCE 9-1-2000.

JAMES STEIN, EXAMINING ATTORNEY

**Int. Cl.: 9**

**Prior U.S. Cls.: 21, 23, 26, 36 and 38**

**Reg. No. 3,466,813**

**United States Patent and Trademark Office**

**Registered July 15, 2008**

**TRADEMARK  
PRINCIPAL REGISTER**



ENG ELECTRIC CO., LTD. (TAIWAN CORPORATION)  
KWEISHAN HSIANG  
5F, NO. 536, SEC.1, MIN SHENG N. RD.  
TAOYUAN HSIEN, TAIWAN

PHONE BATTERY CHARGERS, UNINTERRUPTIBLE POWER SUPPLIES, ELECTRIC LIGHT SWITCHES, BATTERY CHARGERS, IN CLASS 9 (U.S. CLS. 21, 23, 26, 36 AND 38).

FOR: ELECTRONIC INSTRUMENTS AND APPARATUS, NAMELY, AC/DC CURRENT TRANSFORMERS, CURRENT RECTIFIERS, ELECTRICAL RELAYS, POWER SUPPLY DEVICE, ELECTRONIC PARKING LOT TICKET DISPENSERS, CELL

FIRST USE 12-25-1986; IN COMMERCE 12-25-1986.

SER. NO. 77-331,130, FILED 11-16-2007.

REBECCA EISINGER, EXAMINING ATTORNEY

**Int. Cl.: 27**

**Prior U.S. Cls.: 19, 20, 37, 42 and 50**

**United States Patent and Trademark Office**

**Reg. No. 3,466,814**

**Registered July 15, 2008**

**TRADEMARK  
PRINCIPAL REGISTER**

**ABRIEL**

COLOUR & DESIGN, INC. (ARKANSAS CORPORATION)  
2210 CANTRELL ROAD  
LITTLE ROCK, AR 72202

FOR: WALLPAPER; WALLPAPER IN THE NATURE OF ROOMSIZE DECORATIVE ADHESIVE WALL COVERINGS; NON-TEXTILE WALL COVERINGS; VINYL WALLCOVERINGS, IN CLASS 27 (U.S. CLS. 19, 20, 37, 42 AND 50).

FIRST USE 5-17-2002; IN COMMERCE 5-17-2002.

THE MARK CONSISTS OF STANDARD CHARACTERS WITHOUT CLAIM TO ANY PARTICULAR FONT, STYLE, SIZE, OR COLOR.

SER. NO. 77-331,156, FILED 11-16-2007.

JERI J. FICKES, EXAMINING ATTORNEY

**Int. Cl.: 27**

**Prior U.S. Cls.: 19, 20, 37, 42 and 50**

**United States Patent and Trademark Office**

**Reg. No. 3,466,815**

**Registered July 15, 2008**

**TRADEMARK  
PRINCIPAL REGISTER**

**CALEB**

COLOUR & DESIGN, INC. (ARKANSAS CORPORATION)  
2210 CANTRELL ROAD  
LITTLE ROCK, AR 72202

FOR: WALLPAPER; WALLPAPER IN THE NATURE OF ROOMSIZE DECORATIVE ADHESIVE WALL COVERINGS; NON-TEXTILE WALL COVERINGS; VINYL WALLCOVERINGS, IN CLASS 27 (U.S. CLS. 19, 20, 37, 42 AND 50).

FIRST USE 3-1-2002; IN COMMERCE 3-1-2002.

THE MARK CONSISTS OF STANDARD CHARACTERS WITHOUT CLAIM TO ANY PARTICULAR FONT, STYLE, SIZE, OR COLOR.

SER. NO. 77-331,174, FILED 11-16-2007.

JERI J. FICKES, EXAMINING ATTORNEY

**Int. Cl.: 27**

**Prior U.S. Cls.: 19, 20, 37, 42 and 50**

**United States Patent and Trademark Office**

**Reg. No. 3,466,816**

**Registered July 15, 2008**

**TRADEMARK  
PRINCIPAL REGISTER**

**CALI**

COLOUR & DESIGN, INC. (ARKANSAS CORPORATION)  
2210 CANTRELL ROAD  
LITTLE ROCK, AR 72202

FOR: WALLPAPER; WALLPAPER IN THE NATURE OF ROOMSIZE DECORATIVE ADHESIVE WALL COVERINGS; NON-TEXTILE WALL COVERINGS; VINYL WALLCOVERINGS, IN CLASS 27 (U.S. CLS. 19, 20, 37, 42 AND 50).

FIRST USE 3-28-2003; IN COMMERCE 3-28-2003.

THE MARK CONSISTS OF STANDARD CHARACTERS WITHOUT CLAIM TO ANY PARTICULAR FONT, STYLE, SIZE, OR COLOR.

SER. NO. 77-331,179, FILED 11-16-2007.

JERI J. FICKES, EXAMINING ATTORNEY

**Int. Cl.: 25**

**Prior U.S. Cls.: 22 and 39**

**United States Patent and Trademark Office**

**Reg. No. 3,466,817**

**Registered July 15, 2008**

**TRADEMARK  
PRINCIPAL REGISTER**



MIKE L. MOON (UNITED STATES INDIVIDUAL)  
PO BOX 650  
BUENA VISTA, GA 31803

THE MARK CONSISTS OF A HALF-MOON FOLLOWED BY THE LITERAL ELEMENT "MOON-CRAFT".

FOR: DRESSES; SKIRTS; PANTS; SHIRTS; BLOUSES; JACKETS; SASHES; SCARVES, IN CLASS 25 (U.S. CLS. 22 AND 39).

SER. NO. 77-331,180, FILED 11-16-2007.

FIRST USE 6-28-1988; IN COMMERCE 6-30-1988.

LINDA E. BLOHM, EXAMINING ATTORNEY



**Int. Cl.: 41**

**Prior U.S. Cls.: 100, 101 and 107**

**United States Patent and Trademark Office**

**Reg. No. 3,466,818**

**Registered July 15, 2008**

**SERVICE MARK  
PRINCIPAL REGISTER**

**INSPIREME**

INSPIREME, LLC (MAINE LTD LIAB CO)  
194 FRONT STREET  
BATH, ME 04530

THE MARK CONSISTS OF STANDARD CHAR-  
ACTERS WITHOUT CLAIM TO ANY PARTICULAR  
FONT, STYLE, SIZE, OR COLOR.

FOR: PERSONAL TRAINING SERVICES, NAME-  
LY, STRENGTH AND CONDITIONING TRAINING;  
PHYSICAL FITNESS CONSULTATION, IN CLASS 41  
(U.S. CLS. 100, 101 AND 107).

SER. NO. 77-331,184, FILED 11-16-2007.

FIRST USE 6-30-2004; IN COMMERCE 6-30-2004.

DAVID MURRAY, EXAMINING ATTORNEY

**Int. Cl.: 27**

**Prior U.S. Cls.: 19, 20, 37, 42 and 50**

**United States Patent and Trademark Office**

**Reg. No. 3,466,819**

**Registered July 15, 2008**

**TRADEMARK  
PRINCIPAL REGISTER**

**CHENAL**

COLOUR & DESIGN, INC. (ARKANSAS CORPORATION)  
2210 CANTRELL ROAD  
LITTLE ROCK, AR 72202

FOR: WALLPAPER; WALLPAPER IN THE NATURE OF ROOMSIZE DECORATIVE ADHESIVE WALL COVERINGS; NON-TEXTILE WALL COVERINGS; WALLCOVERINGS, IN CLASS 27 (U.S. CLS. 19, 20, 37, 42 AND 50).

FIRST USE 2-17-2006; IN COMMERCE 2-17-2006.

THE MARK CONSISTS OF STANDARD CHARACTERS WITHOUT CLAIM TO ANY PARTICULAR FONT, STYLE, SIZE, OR COLOR.

SER. NO. 77-331,187, FILED 11-16-2007.

LINDA POWELL, EXAMINING ATTORNEY

**Int. Cl.: 27**

**Prior U.S. Cls.: 19, 20, 37, 42 and 50**

**United States Patent and Trademark Office**

**Reg. No. 3,466,820**

**Registered July 15, 2008**

**TRADEMARK  
PRINCIPAL REGISTER**

**MARIPOSA**

COLOUR & DESIGN, INC. (ARKANSAS CORPORATION)  
2210 CANTRELL ROAD  
LITTLE ROCK, AR 72202

FOR: WALLPAPER; WALLPAPER IN THE NATURE OF ROOMSIZE DECORATIVE ADHESIVE WALL COVERINGS; NON-TEXTILE WALL COVERINGS; WALLCOVERINGS, IN CLASS 27 (U.S. CLS. 19, 20, 37, 42 AND 50).

FIRST USE 9-17-2004; IN COMMERCE 9-17-2004.

THE MARK CONSISTS OF STANDARD CHARACTERS WITHOUT CLAIM TO ANY PARTICULAR FONT, STYLE, SIZE, OR COLOR.

SER. NO. 77-331,200, FILED 11-16-2007.

LINDA POWELL, EXAMINING ATTORNEY

**Int. Cl.: 27**

**Prior U.S. Cls.: 19, 20, 37, 42 and 50**

**United States Patent and Trademark Office**

**Reg. No. 3,466,821**

**Registered July 15, 2008**

**TRADEMARK  
PRINCIPAL REGISTER**

**MARACAY**

COLOUR & DESIGN, INC. (ARKANSAS CORPORATION)  
2210 CANTRELL ROAD  
LITTLE ROCK, AR 72202

FOR: WALLPAPER; WALLPAPER IN THE NATURE OF ROOMSIZE DECORATIVE ADHESIVE WALL COVERINGS; NON-TEXTILE WALL COVERINGS; WALLCOVERINGS, IN CLASS 27 (U.S. CLS. 19, 20, 37, 42 AND 50).

FIRST USE 9-9-2005; IN COMMERCE 9-9-2005.

THE MARK CONSISTS OF STANDARD CHARACTERS WITHOUT CLAIM TO ANY PARTICULAR FONT, STYLE, SIZE, OR COLOR.

SER. NO. 77-331,204, FILED 11-16-2007.

LINDA POWELL, EXAMINING ATTORNEY

**Int. Cl.: 7**

**Prior U.S. Cls.: 13, 19, 21, 23, 31, 34 and 35**

**United States Patent and Trademark Office**

**Reg. No. 3,466,822**

**Registered July 15, 2008**

---

**TRADEMARK  
PRINCIPAL REGISTER**

# Pasture Blaster

FIMCO INC. (IOWA CORPORATION), DBA  
SCHABEN INDUSTRIES  
SUITE DD836  
800 STEVENS PORT DR.  
DAKOTA DUNES, SD 57049

THE MARK CONSISTS OF STANDARD CHAR-  
ACTERS WITHOUT CLAIM TO ANY PARTICULAR  
FONT, STYLE, SIZE, OR COLOR.

FOR: POWER-OPERATED SPRAYERS, IN CLASS  
7 (U.S. CLS. 13, 19, 21, 23, 31, 34 AND 35).

SER. NO. 77-331,205, FILED 11-16-2007.

FIRST USE 0-0-2006; IN COMMERCE 0-0-2006.

DAVID MURRAY, EXAMINING ATTORNEY

**Int. Cl.: 43**

**Prior U.S. Cls.: 100 and 101**

**United States Patent and Trademark Office**

**Reg. No. 3,466,823**

**Registered July 15, 2008**

**SERVICE MARK  
PRINCIPAL REGISTER**

**FOTI'S**

FOTI'S, LLC (VIRGINIA LTD LIAB CO)  
3288 SLATE MILLS ROAD  
SPERRYVILLE, VA 22740

THE MARK CONSISTS OF STANDARD CHAR-  
ACTERS WITHOUT CLAIM TO ANY PARTICULAR  
FONT, STYLE, SIZE, OR COLOR.

FOR: RESTAURANT AND BAR SERVICES, IN  
CLASS 43 (U.S. CLS. 100 AND 101).

SER. NO. 77-331,208, FILED 11-16-2007.

FIRST USE 6-7-2005; IN COMMERCE 6-7-2005.

JAMES STEIN, EXAMINING ATTORNEY

**Int. Cl.: 27**

**Prior U.S. Cls.: 19, 20, 37, 42 and 50**

**Reg. No. 3,466,824**

**United States Patent and Trademark Office**

**Registered July 15, 2008**

---

**TRADEMARK  
PRINCIPAL REGISTER**

**LEILA**

COLOUR & DESIGN, INC. (ARKANSAS CORPORATION)  
2210 CANTRELL ROAD  
LITTLE ROCK, AR 72202

FOR: WALLPAPER; WALLPAPER IN THE NATURE OF ROOMSIZE DECORATIVE ADHESIVE WALL COVERINGS; NON-TEXTILE WALL COVERINGS; WALLCOVERINGS, IN CLASS 27 (U.S. CLS. 19, 20, 37, 42 AND 50).

FIRST USE 2-11-2005; IN COMMERCE 2-11-2005.

THE MARK CONSISTS OF STANDARD CHARACTERS WITHOUT CLAIM TO ANY PARTICULAR FONT, STYLE, SIZE, OR COLOR.

SER. NO. 77-331,209, FILED 11-16-2007.

LINDA POWELL, EXAMINING ATTORNEY

**Int. Cl.: 15**

**Prior U.S. Cls.: 2, 21 and 36**

**Reg. No. 3,466,825**

**United States Patent and Trademark Office**

**Registered July 15, 2008**

**TRADEMARK  
PRINCIPAL REGISTER**

**BRIO!**

GEMEINHARDT COMPANY LLC (DELAWARE  
LTD LIAB CO), DBA GEMSTONE MUSICAL  
INSTRUMENTS  
P.O. BOX 788  
57882 STATE ROAD 19 SOUTH  
ELKHART, IN 46517

FOR: MUSICAL INSTRUMENTS AND ACCES-  
SORIES THEREFORE, NAMELY, FLUTES AND  
FLUTE CASES AND CASE COVERS, IN CLASS 15  
(U.S. CLS. 2, 21 AND 36).

FIRST USE 12-8-2005; IN COMMERCE 12-8-2005.

THE MARK CONSISTS OF STANDARD CHAR-  
ACTERS WITHOUT CLAIM TO ANY PARTICULAR  
FONT, STYLE, SIZE, OR COLOR.

THE FOREIGN WORDING IN THE MARK  
TRANSLATES INTO ENGLISH AS "ENERGY" OR  
"VITALITY."

SER. NO. 77-331,212, FILED 11-16-2007.

JAMES STEIN, EXAMINING ATTORNEY



**Int. Cl.: 6**

**Prior U.S. Cls.: 2, 12, 13, 14, 23, 25 and 50**

**Reg. No. 3,466,826**

**United States Patent and Trademark Office**

**Registered July 15, 2008**

**TRADEMARK  
PRINCIPAL REGISTER**

# Infusion

NEXT INNOVATIONS, LTD. (MINNESOTA CORPORATION)  
PO BOX 999  
WALKER, MN 56484

FOR: PRINT METAL SUBSTRATE, NAMELY, TRANSPARENT, OPAQUE, AND TRANSLUCENT FILMS CONTAINING DYE-SUBLIMATION INK APPLIED BY A HEAT TRANSFER PRESS, IN CLASS 6 (U.S. CLS. 2, 12, 13, 14, 23, 25 AND 50).

FIRST USE 10-18-2007; IN COMMERCE 11-9-2007.

THE MARK CONSISTS OF STANDARD CHARACTERS WITHOUT CLAIM TO ANY PARTICULAR FONT, STYLE, SIZE, OR COLOR.

SER. NO. 77-331,217, FILED 11-16-2007.

KIMBERLY PERRY, EXAMINING ATTORNEY

**Int. Cl.: 41**

**Prior U.S. Cls.: 100, 101 and 107**

**United States Patent and Trademark Office**

**Reg. No. 3,466,827**

**Registered July 15, 2008**

**SERVICE MARK  
PRINCIPAL REGISTER**



SOUTHWESTERN/GREAT AMERICAN, INC.  
(TENNESSEE CORPORATION), DBA THE  
SOUTHWESTERN COMPANY  
2451 ATRIUM WAY  
NASHVILLE, TN 37214

FOR: CONDUCTING WORKSHOPS AND SEMI-  
NARS IN SELF-MOTIVATION, COMMUNICATION  
SKILLS, AND LEADERSHIP TECHNIQUES FOR

PROFESSIONALS, IN CLASS 41 (U.S. CLS. 100, 101  
AND 107).

FIRST USE 3-0-2006; IN COMMERCE 3-0-2006.

SER. NO. 77-331,229, FILED 11-16-2007.

KIMBERLY PERRY, EXAMINING ATTORNEY

**Int. Cl.: 6**

**Prior U.S. Cls.: 2, 12, 13, 14, 23, 25 and 50**

**Reg. No. 3,466,828**

**United States Patent and Trademark Office**

**Registered July 15, 2008**

---

**TRADEMARK  
PRINCIPAL REGISTER**

**InFusion**

NEXT INNOVATIONS, LTD. (MINNESOTA CORPORATION)  
PO BOX 999  
WALKER, MN 56484

FOR: PRINT METAL SUBSTRATE, NAMELY, TRANSPARENT, OPAQUE, AND TRANSLUCENT FILMS CONTAINING DYE-SUBLIMATION INK APPLIED BY A HEAT TRANSFER PRESS, IN CLASS 6 (U.S. CLS. 2, 12, 13, 14, 23, 25 AND 50).

FIRST USE 10-18-2007; IN COMMERCE 11-9-2007.

THE MARK CONSISTS OF STANDARD CHARACTERS WITHOUT CLAIM TO ANY PARTICULAR FONT, STYLE, SIZE, OR COLOR.

SER. NO. 77-331,231, FILED 11-16-2007.

KIMBERLY PERRY, EXAMINING ATTORNEY

**Int. Cl.: 41**

**Prior U.S. Cls.: 100, 101 and 107**

**United States Patent and Trademark Office**

**Reg. No. 3,466,829**

**Registered July 15, 2008**

---

**SERVICE MARK  
PRINCIPAL REGISTER**

**PRINTS IN MOTION**

NEW VISION MARKETING, LLC (SOUTH CAROLINA LTD LIAB CO)  
1110 WEST BUTLER ROAD  
GREENVILLE, SC 29607

THE MARK CONSISTS OF STANDARD CHARACTERS WITHOUT CLAIM TO ANY PARTICULAR FONT, STYLE, SIZE, OR COLOR.

FOR: EDUCATION AND TRAINING SERVICES IN THE FIELD OF PRINTING AND OBJECT WRAPPING, IN CLASS 41 (U.S. CLS. 100, 101 AND 107).

SER. NO. 77-331,235, FILED 11-16-2007.

FIRST USE 8-27-2007; IN COMMERCE 10-18-2007.

KIMBERLY PERRY, EXAMINING ATTORNEY

**Int. Cl.: 27**

**Prior U.S. Cls.: 19, 20, 37, 42 and 50**

**Reg. No. 3,466,830**

**United States Patent and Trademark Office**

**Registered July 15, 2008**

---

**TRADEMARK  
PRINCIPAL REGISTER**

**KOSHI**

COLOUR & DESIGN, INC. (ARKANSAS CORPORATION)  
2210 CANTRELL ROAD  
LITTLE ROCK, AR 72202

FOR: WALLPAPER; WALLPAPER IN THE NATURE OF ROOMSIZE DECORATIVE ADHESIVE WALL COVERINGS; NON-TEXTILE WALL COVERINGS; WALLCOVERINGS, IN CLASS 27 (U.S. CLS. 19, 20, 37, 42 AND 50).

FIRST USE 9-20-2002; IN COMMERCE 9-20-2002.

THE MARK CONSISTS OF STANDARD CHARACTERS WITHOUT CLAIM TO ANY PARTICULAR FONT, STYLE, SIZE, OR COLOR.

SER. NO. 77-331,255, FILED 11-16-2007.

LINDA POWELL, EXAMINING ATTORNEY

**Int. Cl.: 27**

**Prior U.S. Cls.: 19, 20, 37, 42 and 50**

**United States Patent and Trademark Office**

**Reg. No. 3,466,831**

**Registered July 15, 2008**

**TRADEMARK  
PRINCIPAL REGISTER**

**KATIVA**

COLOUR & DESIGN, INC. (ARKANSAS CORPORATION)  
2210 CANTRELL ROAD  
LITTLE ROCK, AR 72202

FOR: WALLPAPER; WALLPAPER IN THE NATURE OF ROOMSIZE DECORATIVE ADHESIVE WALL COVERINGS; NON-TEXTILE WALL COVERINGS; WALLCOVERINGS, IN CLASS 27 (U.S. CLS. 19, 20, 37, 42 AND 50).

FIRST USE 2-17-2006; IN COMMERCE 2-17-2006.

THE MARK CONSISTS OF STANDARD CHARACTERS WITHOUT CLAIM TO ANY PARTICULAR FONT, STYLE, SIZE, OR COLOR.

SER. NO. 77-331,261, FILED 11-16-2007.

LINDA POWELL, EXAMINING ATTORNEY

**Int. Cl.: 21**

**Prior U.S. Cls.: 2, 13, 23, 29, 30, 33, 40 and 50**

**Reg. No. 3,466,832**

**United States Patent and Trademark Office**

**Registered July 15, 2008**

---

**TRADEMARK  
PRINCIPAL REGISTER**

**SEASIDE GOURMET**

THE BEACHCOMBERS INTERNATIONAL, INC.  
(FLORIDA CORPORATION)

P O BOX 250

FORT MYERS, FL 33902

FOR: DISHES AND PLATES, IN CLASS 21 (U.S.  
CLS. 2, 13, 23, 29, 30, 33, 40 AND 50).

FIRST USE 9-7-2007; IN COMMERCE 9-7-2007.

THE MARK CONSISTS OF STANDARD CHAR-  
ACTERS WITHOUT CLAIM TO ANY PARTICULAR  
FONT, STYLE, SIZE, OR COLOR.

NO CLAIM IS MADE TO THE EXCLUSIVE  
RIGHT TO USE "GOURMET", APART FROM THE  
MARK AS SHOWN.

SER. NO. 77-331,264, FILED 11-16-2007.

JAMES STEIN, EXAMINING ATTORNEY

**Int. Cl.: 3**

**Prior U.S. Cls.: 1, 4, 6, 50, 51 and 52**

**United States Patent and Trademark Office**

**Reg. No. 3,466,833**

**Registered July 15, 2008**

**TRADEMARK  
PRINCIPAL REGISTER**

**Smellywasher**

FLYNN, PAUL (UNITED STATES INDIVIDUAL)  
13875 WEBSTER COURT  
SAVAGE, MN 55378

THE MARK CONSISTS OF STANDARD CHARACTERS WITHOUT CLAIM TO ANY PARTICULAR FONT, STYLE, SIZE, OR COLOR.

FOR: CLEANER FOR USE ON WASHING MACHINES, IN CLASS 3 (U.S. CLS. 1, 4, 6, 50, 51 AND 52).

SER. NO. 77-331,266, FILED 11-16-2007.

FIRST USE 1-1-2006; IN COMMERCE 1-1-2006.

CHRISTINE COOPER, EXAMINING ATTORNEY



**Int. Cl.: 9**

**Prior U.S. Cls.: 21, 23, 26, 36 and 38**

**United States Patent and Trademark Office**

**Reg. No. 3,466,834**

**Registered July 15, 2008**

**TRADEMARK  
PRINCIPAL REGISTER**

**BEASTIEBAGS**

BEASTIEBAGS, LLC (VIRGINIA LTD LIAB CO)  
P.O. BOX 684  
MCLEAN, VA 22101

FOR: EYEGLASS CASES, IN CLASS 9 (U.S. CLS. 21,  
23, 26, 36 AND 38).

FIRST USE 10-0-2006; IN COMMERCE 10-0-2006.

THE MARK CONSISTS OF STANDARD CHAR-  
ACTERS WITHOUT CLAIM TO ANY PARTICULAR  
FONT, STYLE, SIZE, OR COLOR.

OWNER OF U.S. REG. NO. 2,637,452.

SER. NO. 77-331,270, FILED 11-16-2007.

MICHAEL TANNER, EXAMINING ATTORNEY

**Int. Cl.: 27**

**Prior U.S. Cls.: 19, 20, 37, 42 and 50**

**Reg. No. 3,466,835**

**United States Patent and Trademark Office**

**Registered July 15, 2008**

**TRADEMARK  
PRINCIPAL REGISTER**

**GALLICA**

COLOUR & DESIGN, INC. (ARKANSAS CORPORATION)  
2210 CANTRELL ROAD  
LITTLE ROCK, AR 72202

FOR: WALLPAPER; WALLPAPER IN THE NATURE OF ROOMSIZE DECORATIVE ADHESIVE WALL COVERINGS; NON-TEXTILE WALL COVERINGS; WALLCOVERINGS, IN CLASS 27 (U.S. CLS. 19, 20, 37, 42 AND 50).

FIRST USE 5-17-2002; IN COMMERCE 5-17-2002.

THE MARK CONSISTS OF STANDARD CHARACTERS WITHOUT CLAIM TO ANY PARTICULAR FONT, STYLE, SIZE, OR COLOR.

SER. NO. 77-331,274, FILED 11-16-2007.

GIANCARLO CASTRO, EXAMINING ATTORNEY

**Int. Cl.: 27**

**Prior U.S. Cls.: 19, 20, 37, 42 and 50**

**United States Patent and Trademark Office**

**Reg. No. 3,466,836**

**Registered July 15, 2008**

**TRADEMARK  
PRINCIPAL REGISTER**

**ELORA**

COLOUR & DESIGN, INC. (ARKANSAS CORPORATION)  
2210 CANTRELL ROAD  
LITTLE ROCK, AR 72202

FOR: WALLPAPER; WALLPAPER IN THE NATURE OF ROOMSIZE DECORATIVE ADHESIVE WALL COVERINGS; NON-TEXTILE WALL COVERINGS; WALLCOVERINGS, IN CLASS 27 (U.S. CLS. 19, 20, 37, 42 AND 50).

FIRST USE 3-1-2002; IN COMMERCE 3-1-2002.

THE MARK CONSISTS OF STANDARD CHARACTERS WITHOUT CLAIM TO ANY PARTICULAR FONT, STYLE, SIZE, OR COLOR.

SER. NO. 77-331,283, FILED 11-16-2007.

GIANCARLO CASTRO, EXAMINING ATTORNEY

**Int. Cl.: 27**

**Prior U.S. Cls.: 19, 20, 37, 42 and 50**

**Reg. No. 3,466,837**

**United States Patent and Trademark Office**

**Registered July 15, 2008**

**TRADEMARK  
PRINCIPAL REGISTER**

**ELISE**

COLOUR & DESIGN, INC. (ARKANSAS CORPORATION)  
2210 CANTRELL ROAD  
LITTLE ROCK, AR 72202

FOR: WALLPAPER; WALLPAPER IN THE NATURE OF ROOMSIZE DECORATIVE ADHESIVE WALL COVERINGS; NON-TEXTILE WALL COVERINGS; WALLCOVERINGS, IN CLASS 27 (U.S. CLS. 19, 20, 37, 42 AND 50).

FIRST USE 9-20-2002; IN COMMERCE 9-20-2002.

THE MARK CONSISTS OF STANDARD CHARACTERS WITHOUT CLAIM TO ANY PARTICULAR FONT, STYLE, SIZE, OR COLOR.

SER. NO. 77-331,293, FILED 11-16-2007.

GIANCARLO CASTRO, EXAMINING ATTORNEY

**Int. Cl.: 27**

**Prior U.S. Cls.: 19, 20, 37, 42 and 50**

**Reg. No. 3,466,838**

**United States Patent and Trademark Office**

**Registered July 15, 2008**

**TRADEMARK  
PRINCIPAL REGISTER**

**EDO**

COLOUR & DESIGN, INC. (ARKANSAS CORPORATION)  
2210 CANTRELL ROAD  
LITTLE ROCK, AR 72202

FOR: WALLPAPER; WALLPAPER IN THE NATURE OF ROOMSIZE DECORATIVE ADHESIVE WALL COVERINGS; NON-TEXTILE WALL COVERINGS; WALLCOVERINGS, IN CLASS 27 (U.S. CLS. 19, 20, 37, 42 AND 50).

FIRST USE 11-19-1999; IN COMMERCE 11-19-1999.

THE MARK CONSISTS OF STANDARD CHARACTERS WITHOUT CLAIM TO ANY PARTICULAR FONT, STYLE, SIZE, OR COLOR.

SER. NO. 77-331,296, FILED 11-16-2007.

GIANCARLO CASTRO, EXAMINING ATTORNEY

**Int. Cl.: 45**

**Prior U.S. Cls.: 100 and 101**

**United States Patent and Trademark Office**

**Reg. No. 3,466,839**

**Registered July 15, 2008**

**SERVICE MARK  
PRINCIPAL REGISTER**

**CHEWBARKA'S TAGS**

FRED RICCI TOOL CO., INC. (RHODE ISLAND  
CORPORATION)  
SUITE 2  
165 DYERVILLE AVE.  
JOHNSTON, RI 02919

FOR: PROVIDING PET IDENTIFICATION TAGS,  
IN CLASS 45 (U.S. CLS. 100 AND 101).

FIRST USE 3-30-2002; IN COMMERCE 3-30-2002.

THE MARK CONSISTS OF STANDARD CHAR-  
ACTERS WITHOUT CLAIM TO ANY PARTICULAR  
FONT, STYLE, SIZE, OR COLOR.

NO CLAIM IS MADE TO THE EXCLUSIVE  
RIGHT TO USE "TAGS", APART FROM THE MARK  
AS SHOWN.

SER. NO. 77-331,300, FILED 11-16-2007.

MICHAEL TANNER, EXAMINING ATTORNEY

**Int. Cl.: 27**

**Prior U.S. Cls.: 19, 20, 37, 42 and 50**

**Reg. No. 3,466,840**

**United States Patent and Trademark Office**

**Registered July 15, 2008**

**TRADEMARK  
PRINCIPAL REGISTER**

**MINDORO**

COLOUR & DESIGN, INC. (ARKANSAS CORPORATION)  
2210 CANTRELL ROAD  
LITTLE ROCK, AR 72202

FOR: WALLPAPER; WALLPAPER IN THE NATURE OF ROOMSIZE DECORATIVE ADHESIVE WALL COVERINGS; NON-TEXTILE WALL COVERINGS; WALLCOVERINGS, IN CLASS 27 (U.S. CLS. 19, 20, 37, 42 AND 50).

FIRST USE 9-9-2005; IN COMMERCE 9-9-2005.

THE MARK CONSISTS OF STANDARD CHARACTERS WITHOUT CLAIM TO ANY PARTICULAR FONT, STYLE, SIZE, OR COLOR.

SER. NO. 77-331,306, FILED 11-16-2007.

GIANCARLO CASTRO, EXAMINING ATTORNEY

**Int. Cl.: 33**

**Prior U.S. Cls.: 47 and 49**

**United States Patent and Trademark Office**

**Reg. No. 3,466,841**

**Registered July 15, 2008**

**TRADEMARK  
PRINCIPAL REGISTER**

**VILLA SAN MAURICE**

KEVIN SHANNON (CALIFORNIA CORPORATION), DBA MOUNTAIN VIEW VINTNERS  
1761 SOUTH NOVATO BLVD  
NOVATO, CA 94947

THE MARK CONSISTS OF STANDARD CHARACTERS WITHOUT CLAIM TO ANY PARTICULAR FONT, STYLE, SIZE, OR COLOR.

FOR: RED WINE; TABLE WINES; WHITE WINE; WINE; WINES, IN CLASS 33 (U.S. CLS. 47 AND 49).

SER. NO. 77-331,309, FILED 11-16-2007.

FIRST USE 7-9-2004; IN COMMERCE 7-19-2004.

DARRYL SPRUILL, EXAMINING ATTORNEY



**Int. Cl.: 42**

**Prior U.S. Cls.: 100 and 101**

**United States Patent and Trademark Office**

**Reg. No. 3,466,842**

**Registered July 15, 2008**

**SERVICE MARK  
PRINCIPAL REGISTER**



INFINITY SOFTWARE DEVELOPMENT, INC.  
(FLORIDA CORPORATION)  
SUITE 200  
3522 THOMASVILLE ROAD  
TALLAHASSEE, FL 32309

FOR: COMPUTER SERVICES FOR OTHERS, NAMELY, CUSTOM COMPUTER SOFTWARE DEVELOPMENT; COMPUTER MAINFRAME PROGRAMMING; MULTIMEDIA DESIGN DEVELOPMENT SERVICES, NAMELY, DESIGN AND DEVELOPMENT OF KIOSKS, SPEAKER SUPPORT PRESENTATIONS, CD-ROM PRESENTATIONS, ELECTRONIC MARKETING AND PROMOTIONAL MATERIALS, COMPUTER-BASED TRAINING MATERIALS, DIGITAL AUDIO/VIDEO PRODUCTION MATERIALS, 3-D AND 2-D ANIMATION, INTERACTIVE GAMES; GRAPHIC ART DE-

SIGN OF PRINT AND ELECTRONIC MEDIA; DESIGN AND DEVELOPMENT OF WEB PAGES AND SITES; AND COMPUTER CONSULTATION SERVICES, IN CLASS 42 (U.S. CLS. 100 AND 101).

FIRST USE 9-15-1998; IN COMMERCE 9-15-1998.

OWNER OF U.S. REG. NOS. 3,063,414 AND 3,100,386.

THE MARK CONSISTS OF THE LITERAL ELEMENT "INFINITY" SUPERIMPOSED OVER THE SYMBOL FOR INFINITY.

SER. NO. 77-331,323, FILED 11-16-2007.

NAAKWAMA ANKRAH, EXAMINING ATTORNEY

**Int. Cl.: 41**

**Prior U.S. Cls.: 100, 101 and 107**

**United States Patent and Trademark Office**

**Reg. No. 3,466,843**

**Registered July 15, 2008**

**SERVICE MARK  
PRINCIPAL REGISTER**

**THE CUSTOMER CONNECTION**

UNLIMITED PERFORMANCE TRAINING, INC.  
(ILLINOIS CORPORATION)  
666 DUNDEE ROAD, SUITE 501  
NORTHBROOK, IL 60062

FOR: ARRANGING AND CONDUCTING WORK-  
SHOPS AND SEMINARS IN THE FIELD OF SALES,  
IN CLASS 41 (U.S. CLS. 100, 101 AND 107).

FIRST USE 7-24-2007; IN COMMERCE 7-24-2007.

THE MARK CONSISTS OF STANDARD CHAR-  
ACTERS WITHOUT CLAIM TO ANY PARTICULAR  
FONT, STYLE, SIZE, OR COLOR.

SER. NO. 77-331,327, FILED 11-16-2007.

NAAKWAMA ANKRAH, EXAMINING ATTORNEY

**Int. Cl.: 39**

**Prior U.S. Cls.: 100 and 105**

**Reg. No. 3,466,844**

**United States Patent and Trademark Office**

**Registered July 15, 2008**

**SERVICE MARK  
PRINCIPAL REGISTER**

**SRI**

STEBICH RIDDER INTERNATIONAL, INC.  
(NEW YORK CORPORATION)  
599 11TH AVENUE  
NEW YORK, NY 10036

FOR: CARGO HANDLING; CARGO SHIP TRANSPORT; CARGO UNLOADING; COURIER SERVICES; DELIVERY OF GOODS BY AIR, RAIL, ROAD AND SEA; EXPRESS DELIVERY OF GOODS BY AIR, RAIL, ROAD AND SEA; FREIGHT FORWARDING; FREIGHT SHIP TRANSPORT; FREIGHT TRAIN TRANSPORT; FREIGHT TRANSPORTATION BY AIR, RAIL, ROAD AND SEA; GLOBAL TRANSPORTATION OF FREIGHT FOR OTHERS BY ALL AVAILABLE MEANS; GUARDED TRANSPORTATION OF VALUABLES AND MONEY BY TRUCK; GUARDED TRUCK TRANSPORT; MOVING VAN SERVICES; MOVING VAN TRANSPORT; PACKAGING ARTICLES FOR TRANSPORTATION; PACKING ARTICLES FOR TRANSPORTATION; PARCEL DELIVERY; PICK UP, DELIVERY AND STORAGE OF PERSONAL PROPERTY; PROVIDING INFORMATION CONCERNING COLLECTION AND DELIVERY OF ASSETS IN TRANSIT, NAMELY, VEHICLES, TRAILERS, DRIVERS, CARGO AND DELIVERY CONTAINERS; RAILWAY TRANSPORT; RENTAL OF WAREHOUSE SPACE; SHIPPING AND DELIVERY SERVICES, NAMELY, PICKUP, TRANSPORTATION, AND DELIVERY OF

PACKAGES AND LETTERS BY VARIOUS MODES OF TRANSPORTATION; TRANSPORT OF GOODS; TRANSPORTATION AND STORAGE OF GOODS; TRANSPORTATION OF HOUSEHOLD GOODS OF OTHERS; TRANSPORTATION OF PASSENGERS AND/OR GOODS BY AIR, RAIL, ROAD AND SEA; TRUCK TRANSPORT; WAREHOUSE STORAGE; WAREHOUSING INFORMATION; WAREHOUSING SERVICES; WAREHOUSING SERVICES, NAMELY, STORAGE, DISTRIBUTION, PICK-UP, AND PACKING FOR SHIPMENT OF DOCUMENTS, PACKAGES, RAW MATERIALS, AND OTHER FREIGHT FOR OTHERS; WAREHOUSING SERVICES, NAMELY, STORAGE, DISTRIBUTION, PICK-UP, PACKING, AND SHIPPING OF FINE ART, INCLUDING BUT NOT LIMITED TO PAINTINGS, DRAWINGS, DOCUMENTS, PHOTOGRAPHS AND SCULPTURES, IN CLASS 39 (U.S. CLS. 100 AND 105).

FIRST USE 8-21-2001; IN COMMERCE 8-21-2001.

THE MARK CONSISTS OF STANDARD CHARACTERS WITHOUT CLAIM TO ANY PARTICULAR FONT, STYLE, SIZE, OR COLOR.

SER. NO. 77-331,329, FILED 11-16-2007.

RENEE MCCRAY, EXAMINING ATTORNEY

**Int. Cl.: 42**

**Prior U.S. Cls.: 100 and 101**

**United States Patent and Trademark Office**

**Reg. No. 3,466,845**

**Registered July 15, 2008**

**SERVICE MARK  
PRINCIPAL REGISTER**



GREGG ALLEN INC. (GEORGIA CORPORATION)  
5289 TIMBO LANE  
MABLETON, GA 30126

FOR: INSPECTIONS OF RESIDENTIAL PROPERTY, IN CLASS 42 (U.S. CLS. 100 AND 101).

FIRST USE 11-4-2002; IN COMMERCE 11-4-2002.

THE MARK CONSISTS OF SILHOUETTE OF A MAN PEERING UNDER AN OPEN ROOF AND INTO A MINIATURIZED HOUSE WITH A FLASHLIGHT.

SER. NO. 77-331,332, FILED 11-16-2007.

DORITT L. CARROLL, EXAMINING ATTORNEY

**Int. Cl.: 36**

**Prior U.S. Cls.: 100, 101 and 102**

**United States Patent and Trademark Office**

**Reg. No. 3,466,846**

**Registered July 15, 2008**

**SERVICE MARK  
PRINCIPAL REGISTER**

**CREATING WEALTH AND  
WELL-BEING**

GRECU CAPITAL MANAGEMENT, INC. (CALIFORNIA CORPORATION)  
SUITE 300  
3017 DOUGLAS BLVD  
ROSEVILLE, CA 95661

FOR: FINANCIAL AND INVESTMENT SERVICES, NAMELY, MANAGEMENT AND BROKERAGE IN THE FIELDS OF STOCKS, BONDS, OPTIONS, COMMODITIES, FUTURES AND OTHER SECURITIES, AND THE INVESTMENT OF FUNDS OF OTHERS; FINANCIAL PLANNING; FINANCIAL PLANNING AND INVESTMENT ADVISORY SERVICES; FINANCIAL PLANNING CONSULTATION; FINANCIAL PLANNING FOR RETIREMENT; FINANCIAL PLANNING, NAMELY, THE CREATION OF PERSONALIZED STRATEGIES TO ACHIEVE FINANCIAL INDEPENDENCE; FINANCIAL PORTFOLIO ANALYSIS SERVICES; FINANCIAL PORTFOLIO MANAGEMENT; FINANCIAL RESEARCH; FINANCIAL RISK MANAGEMENT; FINANCIAL SERVICES IN THE NATURE OF AN INVESTMENT SECURITY; FINANCIAL SERVICES, NAMELY, ASSISTING OTHERS WITH THE COMPLETION OF FINANCIAL TRANSACTIONS FOR STOCKS, BONDS, SECURITIES AND EQUITIES; FINANCIAL SERVICES, NAMELY, A TOTAL PORTFOLIO OFFERING FOR HIGH NET WORTH CLIENTS CONSISTING OF BOTH SEPARATE ACCOUNTS AND MUTUAL FUNDS FOR EQUITY AND FIXED IN-

COME INVESTMENTS; FINANCIAL SERVICES, NAMELY, SAVINGS PROGRAMS FOR YOUTHS; FUND INVESTMENT CONSULTATION; FUNDS INVESTMENT; INVESTMENT ADVICE; INVESTMENT ADVISORY SERVICES; INVESTMENT BROKERAGE; INVESTMENT CLUBS; INVESTMENT CONSULTATION; INVESTMENT MANAGEMENT; INVESTMENT MANAGEMENT OF AND DISTRIBUTION OF ANNUITIES; INVESTMENT MANAGEMENT OF AND DISTRIBUTION OF VARIABLE ANNUITIES; INVESTMENT OF FUNDS FOR OTHERS; MUTUAL FUND INVESTMENT; PRIVATE EQUITY FUND INVESTMENT SERVICES; PROVIDING INFORMATION AND ADVICE IN THE FIELD OF FINANCE, FINANCIAL INVESTMENTS, FINANCIAL VALUATIONS, AND THE FINANCIAL ASPECTS OF RETIREMENT, IN CLASS 36 (U.S. CLS. 100, 101 AND 102).

FIRST USE 10-1-2003; IN COMMERCE 10-1-2003.

THE MARK CONSISTS OF STANDARD CHARACTERS WITHOUT CLAIM TO ANY PARTICULAR FONT, STYLE, SIZE, OR COLOR.

SER. NO. 77-331,341, FILED 11-16-2007.

PAULA MAHONEY, EXAMINING ATTORNEY

**Int. Cl.: 42**

**Prior U.S. Cls.: 100 and 101**

**United States Patent and Trademark Office**

**Reg. No. 3,466,847**

**Registered July 15, 2008**

**SERVICE MARK  
PRINCIPAL REGISTER**

**PerfectBILL\$**

CAREERSUSA, INC. (FLORIDA CORPORATION), DBA CAREERSUSA  
SUITE 200  
6501 CONGRESS AVENUE  
BOCA RATON, FL 33487

FOR: PROVIDING TEMPORARY USE OF NON-DOWNLOADABLE COMPUTER SOFTWARE FOR PREPARING INVOICES OVER COMPUTER NETWORKS, INTRANETS AND THE INTERNET , IN CLASS 42 (U.S. CLS. 100 AND 101).

FIRST USE 3-20-2007; IN COMMERCE 3-20-2007.

THE MARK CONSISTS OF STANDARD CHARACTERS WITHOUT CLAIM TO ANY PARTICULAR FONT, STYLE, SIZE, OR COLOR.

SER. NO. 77-331,344, FILED 11-16-2007.

FLORENTINA BLANDU, EXAMINING ATTORNEY

**Int. Cl.: 27**

**Prior U.S. Cls.: 19, 20, 37, 42 and 50**

**Reg. No. 3,466,848**

**United States Patent and Trademark Office**

**Registered July 15, 2008**

---

**TRADEMARK  
PRINCIPAL REGISTER**

**ZOLA**

COLOUR & DESIGN, INC. (ARKANSAS CORPORATION)  
2210 CANTRELL ROAD  
LITTLE ROCK, AR 72202

FOR: WALLPAPER; WALLPAPER IN THE NATURE OF ROOMSIZE DECORATIVE ADHESIVE WALL COVERINGS; NON-TEXTILE WALL COVERINGS; WALLCOVERINGS, IN CLASS 27 (U.S. CLS. 19, 20, 37, 42 AND 50).

FIRST USE 9-20-2002; IN COMMERCE 9-20-2002.

THE MARK CONSISTS OF STANDARD CHARACTERS WITHOUT CLAIM TO ANY PARTICULAR FONT, STYLE, SIZE, OR COLOR.

SER. NO. 77-331,349, FILED 11-16-2007.

GIANCARLO CASTRO, EXAMINING ATTORNEY

**Int. Cl.: 27**

**Prior U.S. Cls.: 19, 20, 37, 42 and 50**

**Reg. No. 3,466,849**

**United States Patent and Trademark Office**

**Registered July 15, 2008**

---

**TRADEMARK  
PRINCIPAL REGISTER**

**YOSHI**

COLOUR & DESIGN, INC. (ARKANSAS CORPORATION)  
2210 CANTRELL ROAD  
LITTLE ROCK, AR 72202

FOR: WALLPAPER; WALLPAPER IN THE NATURE OF ROOMSIZE DECORATIVE ADHESIVE WALL COVERINGS; NON-TEXTILE WALL COVERINGS; WALLCOVERINGS, IN CLASS 27 (U.S. CLS. 19, 20, 37, 42 AND 50).

FIRST USE 11-19-1999; IN COMMERCE 11-19-1999.

THE MARK CONSISTS OF STANDARD CHARACTERS WITHOUT CLAIM TO ANY PARTICULAR FONT, STYLE, SIZE, OR COLOR.

SER. NO. 77-331,356, FILED 11-16-2007.

GIANCARLO CASTRO, EXAMINING ATTORNEY



**Int. Cl.: 9**

**Prior U.S. Cls.: 21, 23, 26, 36 and 38**

**United States Patent and Trademark Office**

**Reg. No. 3,466,850**

**Registered July 15, 2008**

**TRADEMARK  
PRINCIPAL REGISTER**

**I.D.MATE**

EN-VISION AMERICA, INC. (ILLINOIS CORPORATION)  
1845 WEST HOVEY AVENUE  
NORMAL, IL 61761

FOR: BAR CODE READER, IN CLASS 9 (U.S. CLS. 21, 23, 26, 36 AND 38).

FIRST USE 2-15-1996; IN COMMERCE 7-2-1997.

THE MARK CONSISTS OF STANDARD CHARACTERS WITHOUT CLAIM TO ANY PARTICULAR FONT, STYLE, SIZE, OR COLOR.

OWNER OF U.S. REG. NO. 2,467,022.

NO CLAIM IS MADE TO THE EXCLUSIVE RIGHT TO USE "I.D.", APART FROM THE MARK AS SHOWN.

SER. NO. 77-331,360, FILED 11-16-2007.

DANNEAN HETZEL, EXAMINING ATTORNEY

**Int. Cl.: 27**

**Prior U.S. Cls.: 19, 20, 37, 42 and 50**

**United States Patent and Trademark Office**

**Reg. No. 3,466,851**

**Registered July 15, 2008**

**TRADEMARK  
PRINCIPAL REGISTER**

**TOULON**

COLOUR & DESIGN, INC. (ARKANSAS CORPORATION)  
2210 CANTRELL ROAD  
LITTLE ROCK, AR 72202

FOR: WALLPAPER; WALLPAPER IN THE NATURE OF ROOMSIZE DECORATIVE ADHESIVE WALL COVERINGS; NON-TEXTILE WALL COVERINGS; WALLCOVERINGS, IN CLASS 27 (U.S. CLS. 19, 20, 37, 42 AND 50).

FIRST USE 6-6-2003; IN COMMERCE 6-6-2003.

THE MARK CONSISTS OF STANDARD CHARACTERS WITHOUT CLAIM TO ANY PARTICULAR FONT, STYLE, SIZE, OR COLOR.

SER. NO. 77-331,362, FILED 11-16-2007.

GIANCARLO CASTRO, EXAMINING ATTORNEY

**Int. Cl.: 32**

**Prior U.S. Cls.: 45, 46 and 48**

**United States Patent and Trademark Office**

**Reg. No. 3,466,852**

**Registered July 15, 2008**

**TRADEMARK  
PRINCIPAL REGISTER**

**A Taste of Vermont**

LONG TRAIL BREWING COMPANY (VERMONT CORPORATION)

P.O. BOX 168

JCT. ROUTE 4 & 100A

BRIDGEWATER CORNERS, VT 05035

FOR: BEER; ALE, IN CLASS 32 (U.S. CLS. 45, 46 AND 48).

FIRST USE 0-0-2004; IN COMMERCE 0-0-2004.

THE MARK CONSISTS OF STANDARD CHARACTERS WITHOUT CLAIM TO ANY PARTICULAR FONT, STYLE, SIZE, OR COLOR.

NO CLAIM IS MADE TO THE EXCLUSIVE RIGHT TO USE "VERMONT", APART FROM THE MARK AS SHOWN.

SER. NO. 77-331,367, FILED 11-16-2007.

MICHAEL TANNER, EXAMINING ATTORNEY

**Int. Cl.: 27**

**Prior U.S. Cls.: 19, 20, 37, 42 and 50**

**United States Patent and Trademark Office**

**Reg. No. 3,466,853**

**Registered July 15, 2008**

**TRADEMARK  
PRINCIPAL REGISTER**

**TONGA**

COLOUR & DESIGN, INC. (ARKANSAS CORPORATION)  
2210 CANTRELL ROAD  
LITTLE ROCK, AR 72202

FOR: WALLPAPER; WALLPAPER IN THE NATURE OF ROOMSIZE DECORATIVE ADHESIVE WALL COVERINGS; NON-TEXTILE WALL COVERINGS; WALLCOVERINGS, IN CLASS 27 (U.S. CLS. 19, 20, 37, 42 AND 50).

FIRST USE 5-5-2006; IN COMMERCE 5-5-2006.

THE MARK CONSISTS OF STANDARD CHARACTERS WITHOUT CLAIM TO ANY PARTICULAR FONT, STYLE, SIZE, OR COLOR.

SER. NO. 77-331,372, FILED 11-16-2007.

WENDY GOODMAN, EXAMINING ATTORNEY

**Int. Cl.: 30**

**Prior U.S. Cl.: 46**

**United States Patent and Trademark Office**

**Reg. No. 3,466,854**

**Registered July 15, 2008**

**TRADEMARK  
PRINCIPAL REGISTER**

**Cotton Country**

SMUCKER BRANDS, INC. (DELAWARE CORPORATION)  
ONE STRAWBERRY LANE  
ORRVILLE, OH 446670280

THE MARK CONSISTS OF STANDARD CHARACTERS WITHOUT CLAIM TO ANY PARTICULAR FONT, STYLE, SIZE, OR COLOR.

FOR: CORN BREAD MIX, IN CLASS 30 (U.S. CL. 46).

SER. NO. 77-331,373, FILED 11-16-2007.

FIRST USE 4-1-2006; IN COMMERCE 4-1-2006.

ELI HELLMAN, EXAMINING ATTORNEY

**Int. Cl.: 44**

**Prior U.S. Cls.: 100 and 101**

**United States Patent and Trademark Office**

**Reg. No. 3,466,855**

**Registered July 15, 2008**

**SERVICE MARK  
PRINCIPAL REGISTER**



DESERT INSTITUTE FOR SPINE CARE (ARIZONA CORPORATION)

SUITE 400

1635 E. MYRTLE AVENUE

PHOENIX, AZ 85020

FOR: MEDICAL SERVICES, NAMELY, PROVIDING MEDICAL TREATMENT AND DIAGNOSIS TO PATIENTS WITH BACK AND SPINAL PAIN THAT MAY BE CAUSED BY INJURIES OR DEGENERATIVE CONDITIONS, IN CLASS 44 (U.S. CLS. 100 AND 101).

FIRST USE 5-1-2007; IN COMMERCE 5-1-2007.

NO CLAIM IS MADE TO THE EXCLUSIVE RIGHT TO USE "INSTITUTE FOR SPINE CARE", APART FROM THE MARK AS SHOWN.

THE MARK CONSISTS OF A SWOSH; A CIRCLE MADE UP OF THREE BRUSH STROKES/LINES ON TOP AND THREE BRUSH STROKES/LINES ON THE BOTTOM. FOLLOWING THAT IS THE STYLIZED TEXT "DISC". BELOW THE SWOSH AND "DISC" IS THE TAG LINE "DESERT INSTITUTE FOR SPINE CARE".

SER. NO. 77-331,389, FILED 11-16-2007.

RENEE MCCRAY, EXAMINING ATTORNEY

**Int. Cl.: 27**

**Prior U.S. Cls.: 19, 20, 37, 42 and 50**

**United States Patent and Trademark Office**

**Reg. No. 3,466,856**

**Registered July 15, 2008**

**TRADEMARK  
PRINCIPAL REGISTER**

**TIVOLI**

COLOUR & DESIGN, INC. (ARKANSAS CORPORATION)  
2210 CANTRELL ROAD  
LITTLE ROCK, AR 72202

FOR: WALLPAPER; WALLPAPER IN THE NATURE OF ROOMSIZE DECORATIVE ADHESIVE WALL COVERINGS; NON-TEXTILE WALL COVERINGS; WALLCOVERINGS, IN CLASS 27 (U.S. CLS. 19, 20, 37, 42 AND 50).

FIRST USE 11-22-2002; IN COMMERCE 11-22-2002.

THE MARK CONSISTS OF STANDARD CHARACTERS WITHOUT CLAIM TO ANY PARTICULAR FONT, STYLE, SIZE, OR COLOR.

SER. NO. 77-331,390, FILED 11-16-2007.

WENDY GOODMAN, EXAMINING ATTORNEY

Int. Cl.: 44

Prior U.S. Cls.: 100 and 101

United States Patent and Trademark Office

Reg. No. 3,466,857

Registered July 15, 2008

SERVICE MARK  
PRINCIPAL REGISTER



VIBRAGENE (NEVADA LTD LIAB CO)  
200 EAST ROOSEVELT STREET  
DILLON, SC 29536

FOR: CONVENTIONAL LAB TESTING AND GENETIC TESTING FOR HUMANS AND ANIMALS FOR THE DETECTION, SECURED REPORTING AND POTENTIAL CORRECTION OF ALL TYPES OF DISEASE PROCESSES, IN CLASS 44 (U.S. CLS. 100 AND 101).

FIRST USE 6-27-2007; IN COMMERCE 8-1-2007.

THE MARK CONSISTS OF THE TEXT "VIBRAGENE" IN "BANK GOTHIC LIGHT" FONT; THE "V" OF THE WORD "VIBRAGENE" LOOKS SOME-

WHAT LIKE A "CHECK MARK". THE RIGHT SIDE OF THE "V" IS SLIGHTLY LARGER THAN THAT OF THE LEFT SIDE. THE "G" OF THE WORD "VIBRAGENE" IS SET AT A 45 DEGREE ANGLE WITH 2 "O"S (ALSO AT 45 DEGREE ANGLES) LINKED WITH THE "G" IN A CHAIN FORMAT. THE SLOGAN: "THE BUILDING BLOCKS OF LIFE AND HEALTH." ARE WRITING IN "BANK GOTHIC LIGHT". THE PLACEMENT OF THE SLOGAN IS LOCATED ON THE LEFT, BELOW THE WORD "VIBRA" AND BETWEEN THE "G" AND 2 "O"S LINKED CHAIN.

SER. NO. 77-331,398, FILED 11-16-2007.

KAREN K. BUSH, EXAMINING ATTORNEY



**Int. Cl.: 27**

**Prior U.S. Cls.: 19, 20, 37, 42 and 50**

**United States Patent and Trademark Office**

**Reg. No. 3,466,858**

**Registered July 15, 2008**

**TRADEMARK  
PRINCIPAL REGISTER**

**TANGO**

COLOUR & DESIGN, INC. (ARKANSAS CORPORATION)  
2210 CANTRELL ROAD  
LITTLE ROCK, AR 72202

FOR: WALLPAPER; WALLPAPER IN THE NATURE OF ROOMSIZE DECORATIVE ADHESIVE WALL COVERINGS; NON-TEXTILE WALL COVERINGS; WALLCOVERINGS, IN CLASS 27 (U.S. CLS. 19, 20, 37, 42 AND 50).

FIRST USE 1-10-2003; IN COMMERCE 1-10-2003.

THE MARK CONSISTS OF STANDARD CHARACTERS WITHOUT CLAIM TO ANY PARTICULAR FONT, STYLE, SIZE, OR COLOR.

SER. NO. 77-331,406, FILED 11-16-2007.

WENDY GOODMAN, EXAMINING ATTORNEY

**Int. Cl.: 27**

**Prior U.S. Cls.: 19, 20, 37, 42 and 50**

**United States Patent and Trademark Office**

**Reg. No. 3,466,859**

**Registered July 15, 2008**

**TRADEMARK  
PRINCIPAL REGISTER**

**SHIMA**

COLOUR & DESIGN, INC. (ARKANSAS CORPORATION)  
2210 CANTRELL ROAD  
LITTLE ROCK, AR 72202

FOR: WALLPAPER; WALLPAPER IN THE NATURE OF ROOMSIZE DECORATIVE ADHESIVE WALL COVERINGS; NON-TEXTILE WALL COVERINGS; WALLCOVERINGS, IN CLASS 27 (U.S. CLS. 19, 20, 37, 42 AND 50).

FIRST USE 9-20-2002; IN COMMERCE 9-20-2002.

THE MARK CONSISTS OF STANDARD CHARACTERS WITHOUT CLAIM TO ANY PARTICULAR FONT, STYLE, SIZE, OR COLOR.

THE WORDING "SHIMA" HAS NO MEANING IN ENGLISH.

SER. NO. 77-331,413, FILED 11-16-2007.

WENDY GOODMAN, EXAMINING ATTORNEY

**Int. Cl.: 35**

**Prior U.S. Cls.: 100, 101 and 102**

**United States Patent and Trademark Office**

**Reg. No. 3,466,860**

**Registered July 15, 2008**

**SERVICE MARK  
PRINCIPAL REGISTER**

**NULEGACY**

NULEGACY INTERNATIONAL, LLC (TEXAS  
LTD LIAB CO)  
2031 FAIR OAKS CIRCLE  
CORINTH, TX 76210

FOR: ADMINISTRATION OF A DISCOUNT PRO-  
GRAM FOR ENABLING PARTICIPANTS TO OB-  
TAIN DISCOUNTS ON GOODS AND SERVICES  
THROUGH USE OF A DISCOUNT MEMBERSHIP  
CARD, IN CLASS 35 (U.S. CLS. 100, 101 AND 102).

FIRST USE 9-1-2007; IN COMMERCE 9-1-2007.

THE MARK CONSISTS OF STANDARD CHAR-  
ACTERS WITHOUT CLAIM TO ANY PARTICULAR  
FONT, STYLE, SIZE, OR COLOR.

SER. NO. 77-331,431, FILED 11-16-2007.

RONALD MCMORROW, EXAMINING ATTORNEY

**Int. Cl.: 27**

**Prior U.S. Cls.: 19, 20, 37, 42 and 50**

**Reg. No. 3,466,861**

**United States Patent and Trademark Office**

**Registered July 15, 2008**

---

**TRADEMARK  
PRINCIPAL REGISTER**

**SARDA**

COLOUR & DESIGN, INC. (ARKANSAS CORPORATION)  
2210 CANTRELL ROAD  
LITTLE ROCK, AR 72202

FOR: WALLPAPER; WALLPAPER IN THE NATURE OF ROOMSIZE DECORATIVE ADHESIVE WALL COVERINGS; NON-TEXTILE WALL COVERINGS; WALLCOVERINGS, IN CLASS 27 (U.S. CLS. 19, 20, 37, 42 AND 50).

FIRST USE 8-18-2000; IN COMMERCE 8-18-2000.

THE MARK CONSISTS OF STANDARD CHARACTERS WITHOUT CLAIM TO ANY PARTICULAR FONT, STYLE, SIZE, OR COLOR.

THE MARK HAS NO MEANING IN ENGLISH.

SER. NO. 77-331,445, FILED 11-16-2007.

WENDY GOODMAN, EXAMINING ATTORNEY

**Int. Cl.: 40**

**Prior U.S. Cls.: 100, 103 and 106**

**Reg. No. 3,466,862**

**United States Patent and Trademark Office**

**Registered July 15, 2008**

---

**SERVICE MARK  
PRINCIPAL REGISTER**

YOUR LIFE...YOUR  
FAMILY...CAPTURED IN A WAY  
NEVER SEEN BEFORE

MICHEL SABOURIN PORTRAIT DESIGN, INC.  
(FLORIDA CORPORATION)  
2119 SOUTH U.S. HIGHWAY ONE  
JUPITER, FL 33477

THE MARK CONSISTS OF STANDARD CHAR-  
ACTERS WITHOUT CLAIM TO ANY PARTICULAR  
FONT, STYLE, SIZE, OR COLOR.

FOR: CREATION OF CUSTOM PORTRAITS,  
PAINTINGS AND TAPESTRIES BASED ON PHOTO-  
GRAPHS SHOT BY APPLICANT, IN CLASS 40 (U.S.  
CLS. 100, 103 AND 106).

SER. NO. 77-331,452, FILED 11-16-2007.

FIRST USE 4-15-2006; IN COMMERCE 4-15-2006.

FLORENTINA BLANDU, EXAMINING ATTORNEY

**Int. Cl.: 27**

**Prior U.S. Cls.: 19, 20, 37, 42 and 50**

**United States Patent and Trademark Office**

**Reg. No. 3,466,863**

**Registered July 15, 2008**

**TRADEMARK  
PRINCIPAL REGISTER**

**OBANA**

COLOUR & DESIGN, INC. (ARKANSAS CORPORATION)  
2210 CANTRELL ROAD  
LITTLE ROCK, AR 72202

FOR: WALLPAPER; WALLPAPER IN THE NATURE OF ROOMSIZE DECORATIVE ADHESIVE WALL COVERINGS; NON-TEXTILE WALL COVERINGS; WALLCOVERINGS, IN CLASS 27 (U.S. CLS. 19, 20, 37, 42 AND 50).

FIRST USE 10-17-2003; IN COMMERCE 10-17-2003.

THE MARK CONSISTS OF STANDARD CHARACTERS WITHOUT CLAIM TO ANY PARTICULAR FONT, STYLE, SIZE, OR COLOR.

SER. NO. 77-331,455, FILED 11-16-2007.

WENDY GOODMAN, EXAMINING ATTORNEY

**Int. Cl.: 27**

**Prior U.S. Cls.: 19, 20, 37, 42 and 50**

**United States Patent and Trademark Office**

**Reg. No. 3,466,864**

**Registered July 15, 2008**

**TRADEMARK  
PRINCIPAL REGISTER**

**MONTERRO**

COLOUR & DESIGN, INC. (ARKANSAS CORPORATION)  
2210 CANTRELL ROAD  
LITTLE ROCK, AR 72202

FOR: WALLPAPER; WALLPAPER IN THE NATURE OF ROOMSIZE DECORATIVE ADHESIVE WALL COVERINGS; NON-TEXTILE WALL COVERINGS; WALLCOVERINGS, IN CLASS 27 (U.S. CLS. 19, 20, 37, 42 AND 50).

FIRST USE 9-20-2002; IN COMMERCE 9-20-2002.

THE MARK CONSISTS OF STANDARD CHARACTERS WITHOUT CLAIM TO ANY PARTICULAR FONT, STYLE, SIZE, OR COLOR.

SER. NO. 77-331,473, FILED 11-16-2007.

LINDA POWELL, EXAMINING ATTORNEY

**Int. Cl.: 35**

**Prior U.S. Cls.: 100, 101 and 102**

**United States Patent and Trademark Office**

**Reg. No. 3,466,865**

**Registered July 15, 2008**

**SERVICE MARK  
PRINCIPAL REGISTER**

**PRECO**

PRECO, INC. (ARIZONA CORPORATION)  
SUITE 200A  
7500 E. MCDONALD DRIVE  
SCOTTSDALE, AZ 85250

FOR: CATALOG ORDERING SERVICES AND  
ONLINE RETAIL STORE SERVICES FEATURING  
TELEVISION AND VIDEO PRODUCTS, IN CLASS 35  
(U.S. CLS. 100, 101 AND 102).

FIRST USE 3-3-1993; IN COMMERCE 3-3-1993.

THE MARK CONSISTS OF STANDARD CHAR-  
ACTERS WITHOUT CLAIM TO ANY PARTICULAR  
FONT, STYLE, SIZE, OR COLOR.

SER. NO. 77-331,474, FILED 11-16-2007.

LINDA POWELL, EXAMINING ATTORNEY



Int. Cl.: 41

Prior U.S. Cls.: 100, 101 and 107

United States Patent and Trademark Office

Reg. No. 3,466,866

Registered July 15, 2008

SERVICE MARK  
PRINCIPAL REGISTER



MEDICAL NETWORK ONE  
*Michigan Institute For Health Enhancement*

MICHIGAN INSTITUTE FOR HEALTH EN-  
HANCEMENT, LLC (MICHIGAN LTD LIAB  
CO)  
4986 ADAMS ROAD  
ROCHESTER, MI 48306

FOR: ON SITE AND OFFSITE EDUCATION PRO-  
GRAMS, NAMELY, DESIGNING, DEVELOPING,  
AND PROVIDING CLASSES, SEMINARS, AND  
WORKSHOPS TO PROMOTE HEALTHY LIFE-  
STYLES; EDUCATIONAL PROGRAMS REGARD-  
ING MANAGEMENT OF CHRONIC MEDICAL  
CONDITIONS, DISEASES, DIABETES, WEIGHT DIS-  
ORDERS, STRESS REDUCTION, DEPRESSION,  
AND MENTAL WELLNESS, IN CLASS 41 (U.S. CLS.  
100, 101 AND 107).

FIRST USE 5-1-2006; IN COMMERCE 5-1-2006.

NO CLAIM IS MADE TO THE EXCLUSIVE  
RIGHT TO USE "MEDICAL NETWORK" AND  
"MICHIGAN INSTITUTE FOR HEALTH ENHANCE-  
MENT", APART FROM THE MARK AS SHOWN.

THE MARK CONSISTS OF A TREE WITH THE  
IMAGE OF A BUTTERFLY IN THE TOP OF THE  
TREE WITH A CRESCENT SHAPE AROUND THE  
TREE WITH THE WORDS "MEDICAL NETWORK  
ONE MICHIGAN INSTITUTE FOR HEALTH EN-  
HANCEMENT" UNDERNEATH.

SER. NO. 77-331,523, FILED 11-16-2007.

H. M. FISHER, EXAMINING ATTORNEY

**Int. Cl.: 41**

**Prior U.S. Cls.: 100, 101 and 107**

**United States Patent and Trademark Office**

**Reg. No. 3,466,867**

**Registered July 15, 2008**

**SERVICE MARK  
PRINCIPAL REGISTER**

**BE ACTIVE NOW**

BLUE CROSS BLUE SHIELD OF NORTH CAROLINA (NORTH CAROLINA NON-PROFIT CORPORATION)  
POST OFFICE BOX 2291  
DURHAM, NC 27702

FOR: EDUCATIONAL SERVICES, NAMELY, A PHYSICAL ACTIVITY/FITNESS TRAINING PROGRAM THAT ENCOURAGES MEDICARE MEMBERS TO IMPROVE THEIR QUALITY OF LIFE THROUGH PHYSICAL ACTIVITY AND REDUCE CHRONIC ILLNESSES ASSOCIATED WITH PHYSICAL INACTIVITY, IN CLASS 41 (U.S. CLS. 100, 101 AND 107).

FIRST USE 5-1-2007; IN COMMERCE 5-1-2007.

THE MARK CONSISTS OF STANDARD CHARACTERS WITHOUT CLAIM TO ANY PARTICULAR FONT, STYLE, SIZE, OR COLOR.

OWNER OF U.S. REG. NO. 3,246,020.

SER. NO. 77-331,526, FILED 11-16-2007.

MARY ROSSMAN, EXAMINING ATTORNEY

**Int. Cl.: 36**

**Prior U.S. Cls.: 100, 101 and 102**

**United States Patent and Trademark Office**

**Reg. No. 3,466,868**

**Registered July 15, 2008**

**SERVICE MARK  
PRINCIPAL REGISTER**

plan with  
confidence...enjoy life

EASTERN PLANNING, INC. (NEW YORK COR-  
PORATION)  
33 RT. 304  
NANUET, NY 10954

THE MARK CONSISTS OF STANDARD CHAR-  
ACTERS WITHOUT CLAIM TO ANY PARTICULAR  
FONT, STYLE, SIZE, OR COLOR.

FOR: FINANCIAL PLANNING, IN CLASS 36 (U.S.  
CLS. 100, 101 AND 102).

SER. NO. 77-331,533, FILED 11-16-2007.

FIRST USE 11-1-2005; IN COMMERCE 11-1-2005.

PAULA MAHONEY, EXAMINING ATTORNEY

**Int. Cl.: 9**

**Prior U.S. Cls.: 21, 23, 26, 36 and 38**

**Reg. No. 3,466,869**

**United States Patent and Trademark Office**

**Registered July 15, 2008**

**TRADEMARK  
PRINCIPAL REGISTER**

**CIPHR**

CALAMP DATACOM, INC. (CALIFORNIA CORPORATION)  
1401 NORTH RICE AVENUE  
OXNARD, CA 93030

FOR: COMPUTER HARDWARE, NAMELY, A CELLULAR ROUTER USED TO PROVIDE SECURE WIRELESS COMMUNICATIONS OVER CELLULAR NETWORKS FOR CONNECTING MOBILE DEVICES OR STATIONARY DEVICES AT REMOTE SITES; COMPUTER HARDWARE AND SOFTWARE FOR USE IN TRACKING, MONITORING AND MANAGING VEHICLE LOCATION (AVL) AND ROUTE PLANNING (GPS), FLEET MANAGEMENT AND DISPATCH AS WELL AS OPERATIONS VIA A CELLULAR NETWORK; TRANSPONDER UNITS FOR PROVIDING REMOTE SENSOR INPUT AND

STATUS INFORMATION, TELEMETRY AND SCADA (SUPERVISORY CONTROL AND DATA ACQUISITION) INFORMATION OVER A CELLULAR NETWORK, IN CLASS 9 (U.S. CLS. 21, 23, 26, 36 AND 38).

FIRST USE 2-7-2007; IN COMMERCE 9-18-2007.

THE MARK CONSISTS OF STANDARD CHARACTERS WITHOUT CLAIM TO ANY PARTICULAR FONT, STYLE, SIZE, OR COLOR.

SER. NO. 77-331,552, FILED 11-16-2007.

ANN E. SAPPENFIELD, EXAMINING ATTORNEY

**Int. Cl.: 36**

**Prior U.S. Cls.: 100, 101 and 102**

**United States Patent and Trademark Office**

**Reg. No. 3,466,870**

**Registered July 15, 2008**

**SERVICE MARK  
PRINCIPAL REGISTER**

**COFFEECOUNSEL**

SMITH BEERS YUNKER & COMPANY, INC.  
(OHIO CORPORATION)  
1241 NAGEL ROAD  
CINCINNATI, OH 45255

FOR: CONSULTATION IN COMPREHENSIVE  
FUND RAISING SERVICES FOR CHARITIES AND  
NON-PROFIT ENTITIES, INCLUDING ANNUAL  
GIVING, ENDOWMENT AND CAPITAL CAM-  
PAIGNS, ESTATE-PLANNED GIVING PROGRAMS  
AND SPECIAL EVENTS, IN CLASS 36 (U.S. CLS. 100,  
101 AND 102).

FIRST USE 6-30-1995; IN COMMERCE 6-30-1995.

THE MARK CONSISTS OF STANDARD CHAR-  
ACTERS WITHOUT CLAIM TO ANY PARTICULAR  
FONT, STYLE, SIZE, OR COLOR.

SER. NO. 77-331,565, FILED 11-16-2007.

ANN E. SAPPENFIELD, EXAMINING ATTORNEY

**Int. Cl.: 5**

**Prior U.S. Cls.: 6, 18, 44, 46, 51 and 52**

**Reg. No. 3,466,871**

**United States Patent and Trademark Office**

**Registered July 15, 2008**

**TRADEMARK  
PRINCIPAL REGISTER**

**ISTO**

ISTO TECHNOLOGIES, INC. (DELAWARE CORPORATION)  
SUITE 200  
1155 OLIVETTE EXECUTIVE OFFICE PARKWAY  
ST. LOUIS, MO 63132

FOR: SYNTHETIC BIOMATERIAL FOR MEDICAL USE, NAMELY, THE STIMULATION OF BONE AND CARTILAGE GROWTH; CELL-BASED MATERIAL FOR REPAIR AND REGENERATION OF DISCS IN THE SPINE; CELLULAR TISSUE AND CELLULAR COMPONENTS IN THE NATURE OF BIOLOGICAL TISSUE FOR IMPLANTATION WITHIN CARTILAGE FOR THE REPAIR, REPLACE-

MENT AND GROWTH ENHANCEMENT OF CARTILAGE, IN CLASS 5 (U.S. CLS. 6, 18, 44, 46, 51 AND 52).

FIRST USE 4-16-2007; IN COMMERCE 4-16-2007.

THE MARK CONSISTS OF STANDARD CHARACTERS WITHOUT CLAIM TO ANY PARTICULAR FONT, STYLE, SIZE, OR COLOR.

SER. NO. 77-331,610, FILED 11-16-2007.

JANICE KIM, EXAMINING ATTORNEY

**Int. Cl.: 28**

**Prior U.S. Cls.: 22, 23, 38 and 50**

**Reg. No. 3,466,872**

**United States Patent and Trademark Office**

**Registered July 15, 2008**

**TRADEMARK  
PRINCIPAL REGISTER**



KIDS CROOKED HOUSE, LLC (MAINE LTD  
LIAB CO)  
5 WALTER PARTRIDGE ROAD  
WINDHAM, ME 04062

THE MARK CONSISTS OF THE FANCIFUL DE-  
SIGN OF A CROOKED HOUSE WITHIN THE DE-  
SIGN OF A SHADED OVAL.

FOR: PLAY HOUSES, IN CLASS 28 (U.S. CLS. 22,  
23, 38 AND 50).

SER. NO. 77-331,627, FILED 11-16-2007.

FIRST USE 1-1-2007; IN COMMERCE 1-1-2007.

BARBARA A. GOLD, EXAMINING ATTORNEY

**Int. Cl.: 36**

**Prior U.S. Cls.: 100, 101 and 102**

**United States Patent and Trademark Office**

**Reg. No. 3,466,873**

**Registered July 15, 2008**

**SERVICE MARK  
PRINCIPAL REGISTER**

**BEN HOGAN FOUNDATION**

THE BEN HOGAN FOUNDATION (TEXAS CORPORATION)  
P.O. BOX 121518  
FORT WORTH, TX 761211518

FOR: ACCEPTING AND ADMINISTERING MONETARY CHARITABLE CONTRIBUTIONS, CHARITABLE FUND RAISING, AND CHARITABLE FUNDRAISING BY MEANS OF AN ENTERTAINMENT EVENT, IN CLASS 36 (U.S. CLS. 100, 101 AND 102).

FIRST USE 11-7-2007; IN COMMERCE 11-7-2007.

THE MARK CONSISTS OF STANDARD CHARACTERS WITHOUT CLAIM TO ANY PARTICULAR FONT, STYLE, SIZE, OR COLOR.

NO CLAIM IS MADE TO THE EXCLUSIVE RIGHT TO USE "FOUNDATION", APART FROM THE MARK AS SHOWN.

THE NAME "BEN HOGAN" DOES NOT NAME A PARTICULAR LIVING INDIVIDUAL.

SER. NO. 77-331,628, FILED 11-16-2007.

ESTHER BELENKER, EXAMINING ATTORNEY



**Int. Cl.: 20**

**Prior U.S. Cls.: 2, 13, 22, 25, 32 and 50**

**United States Patent and Trademark Office**

**Reg. No. 3,466,874**

**Registered July 15, 2008**

**TRADEMARK  
PRINCIPAL REGISTER**

**Sky-Marx**

SKY-TRAX INCORPORATED (DELAWARE CORPORATION)  
98 QUIGLEY BLVD.  
NEW CASTLE, DE 197204150

FOR: OVERHEAD BAR-CODE LABELING SYSTEM FOR INVENTORY TRACKING, NAMELY, VINYL BAR CODE LABELS MOUNTED ON CORRUGATED PLASTIC BOARD WHICH FUNCTION AS POSITION MARKERS TO PROVIDE ITEM AND LOCATION DATA, IN CLASS 20 (U.S. CLS. 2, 13, 22, 25, 32 AND 50).

FIRST USE 8-18-2005; IN COMMERCE 8-18-2005.

THE MARK CONSISTS OF STANDARD CHARACTERS WITHOUT CLAIM TO ANY PARTICULAR FONT, STYLE, SIZE, OR COLOR.

SER. NO. 77-331,687, FILED 11-16-2007.

APRIL ROACH, EXAMINING ATTORNEY

**Int. Cl.: 41**

**Prior U.S. Cls.: 100, 101 and 107**

**United States Patent and Trademark Office**

**Reg. No. 3,466,875**

**Registered July 15, 2008**

**SERVICE MARK  
PRINCIPAL REGISTER**

**SLOT MACHINE UNIVERSITY**

WMS GAMING INC. (DELAWARE CORPORATION)  
800 SOUTH NORTHPOINT BOULEVARD  
WAUKEGAN, IL 60085

FOR: EDUCATIONAL SERVICES, NAMELY,  
PROVIDING WEB-BASED TRAINING IN THE  
FIELD OF SLOT MACHINES, IN CLASS 41 (U.S.  
CLS. 100, 101 AND 107).

FIRST USE 11-14-2006; IN COMMERCE 11-14-2006.

THE MARK CONSISTS OF STANDARD CHARACTERS WITHOUT CLAIM TO ANY PARTICULAR FONT, STYLE, SIZE, OR COLOR.

NO CLAIM IS MADE TO THE EXCLUSIVE RIGHT TO USE "SLOT MACHINE", APART FROM THE MARK AS SHOWN.

SER. NO. 77-331,703, FILED 11-16-2007.

MIDGE BUTLER, EXAMINING ATTORNEY

**Int. Cl.: 36**

**Prior U.S. Cls.: 100, 101 and 102**

**United States Patent and Trademark Office**

**Reg. No. 3,466,876**

**Registered July 15, 2008**

**SERVICE MARK  
PRINCIPAL REGISTER**

**A LEGACY OF COURAGE. A  
FOUNDATION OF HOPE.**

THE BEN HOGAN FOUNDATION (TEXAS COR-  
PORATION)  
P.O. BOX 121518  
FORT WORTH, TX 761211518

FOR: ACCEPTING AND ADMINISTERING  
MONETARY CHARITABLE CONTRIBUTIONS,  
CHARITABLE FUND RAISING, AND CHARITA-  
BLE FUNDRAISING BY MEANS OF AN ENTER-  
TAINMENT EVENT, IN CLASS 36 (U.S. CLS. 100, 101  
AND 102).

FIRST USE 11-7-2007; IN COMMERCE 11-7-2007.

THE MARK CONSISTS OF STANDARD CHAR-  
ACTERS WITHOUT CLAIM TO ANY PARTICULAR  
FONT, STYLE, SIZE, OR COLOR.

NO CLAIM IS MADE TO THE EXCLUSIVE  
RIGHT TO USE "FOUNDATION", APART FROM  
THE MARK AS SHOWN.

SER. NO. 77-331,710, FILED 11-16-2007.

ESTHER BELENKER, EXAMINING ATTORNEY

**Int. Cl.: 14**

**Prior U.S. Cls.: 2, 27, 28 and 50**

**United States Patent and Trademark Office**

**Reg. No. 3,466,877**

**Registered July 15, 2008**

**TRADEMARK  
PRINCIPAL REGISTER**

**WORDS TO LIVE BY**

CAROLEE LLC (DELAWARE LTD LIAB CO)  
88 HAMILTON AVE.  
STAMFORD, CT 06902

THE MARK CONSISTS OF STANDARD CHAR-  
ACTERS WITHOUT CLAIM TO ANY PARTICULAR  
FONT, STYLE, SIZE, OR COLOR.

FOR: JEWELRY, NAMELY, STERLING SILVER  
BRACELETS, IN CLASS 14 (U.S. CLS. 2, 27, 28 AND  
50).

SER. NO. 77-331,762, FILED 11-16-2007.

FIRST USE 9-15-2007; IN COMMERCE 9-15-2007.

SEAN CROWLEY, EXAMINING ATTORNEY

**Int. Cls.: 16 and 40**

**Prior U.S. Cls.: 2, 5, 22, 23, 29, 37, 38, 50, 100, 103 and 106**

**Reg. No. 3,466,878**

**United States Patent and Trademark Office**

**Registered July 15, 2008**

**TRADEMARK  
SERVICE MARK  
PRINCIPAL REGISTER**

# GENFORMS

ENNIS, INC. (TEXAS CORPORATION)  
2441 PRESIDENTIAL PARKWAY  
MIDLOTHIAN, TX 76065

FOR: PRINTED MATTER, NAMELY, INTEGRATED FORMS IN THE FORM OF CUSTOMIZED INTEGRATED LABEL PRODUCTS, NAMELY, PAPER FORMS TO THE BACK OF WHICH A LINER AND SUBSTRATE ARE APPLIED AND FROM WHICH LABELS, CARDS, DECALS, AND MAGNETS ARE DIE CUT AND SOLD AS A UNIT, IN CLASS 16 (U.S. CLS. 2, 5, 22, 23, 29, 37, 38 AND 50).

FIRST USE 11-1-1995; IN COMMERCE 11-1-1995.

FOR: PRINTING INTEGRATED FORMS, NAMELY, CUSTOMIZED INTEGRATED LABEL PRO-

DUCTS, NAMELY, PAPER FORMS TO THE BACK OF WHICH A LINER AND SUBSTRATE ARE APPLIED AND FROM WHICH LABELS, CARDS, DECALS, AND MAGNETS ARE DIE CUT AND SOLD AS A UNIT, IN CLASS 40 (U.S. CLS. 100, 103 AND 106).

FIRST USE 11-1-1995; IN COMMERCE 11-1-1995.

THE MARK CONSISTS OF STANDARD CHARACTERS WITHOUT CLAIM TO ANY PARTICULAR FONT, STYLE, SIZE, OR COLOR.

SER. NO. 77-331,800, FILED 11-16-2007.

GENE MACIOL, EXAMINING ATTORNEY

**Int. Cls.: 16 and 40**

**Prior U.S. Cls.: 2, 5, 22, 23, 29, 37, 38, 50, 100, 103 and 106**

**Reg. No. 3,466,879**

**United States Patent and Trademark Office**

**Registered July 15, 2008**

**TRADEMARK  
SERVICE MARK  
PRINCIPAL REGISTER**



ENNIS, INC. (TEXAS CORPORATION)  
2441 PRESIDENTIAL PARKWAY  
MIDLOTHIAN, TX 76065

FOR: PRINTED MATTER, NAMELY, INTEGRATED FORMS IN THE FORM OF CUSTOMIZED INTEGRATED LABEL PRODUCTS, NAMELY, PAPER FORMS TO THE BACK OF WHICH A LINER AND SUBSTRATE ARE APPLIED AND FROM WHICH LABELS, CARDS, DECALS, AND MAGNETS ARE DIE CUT AND SOLD AS A UNIT, IN CLASS 16 (U.S. CLS. 2, 5, 22, 23, 29, 37, 38 AND 50).

FIRST USE 11-17-2004; IN COMMERCE 11-17-2004.

FOR: PRINTING INTEGRATED FORMS, NAMELY, CUSTOMIZED INTEGRATED LABEL PRO-

DUCTS, NAMELY, PAPER FORMS TO THE BACK OF WHICH A LINER AND SUBSTRATE ARE APPLIED AND FROM WHICH LABELS, CARDS, DECALS, AND MAGNETS ARE DIE CUT AND SOLD AS A UNIT, IN CLASS 40 (U.S. CLS. 100, 103 AND 106).

FIRST USE 11-17-2004; IN COMMERCE 11-17-2004.

THE MARK CONSISTS OF THE WORD "GEN-FORMS". ABOVE THE "GEN" PORTION OF THE WORD ARE THE LETTERS "GF", TILTED SIDEWAYS, IN A BOX.

SER. NO. 77-331,837, FILED 11-16-2007.

GENE MACIOL, EXAMINING ATTORNEY

**Int. Cl.: 35**

**Prior U.S. Cls.: 100, 101 and 102**

**United States Patent and Trademark Office**

**Reg. No. 3,466,880**

**Registered July 15, 2008**

**SERVICE MARK  
PRINCIPAL REGISTER**

DOES YOUR DIAMOND SAY THAT?

ALSON JEWELERS, INC. (OHIO CORPORATION)  
28149 CHAGRIN BLVD.  
WOODMERE, OH 44122

THE MARK CONSISTS OF STANDARD CHAR-  
ACTERS WITHOUT CLAIM TO ANY PARTICULAR  
FONT, STYLE, SIZE, OR COLOR.

FOR: RETAIL SHOPS FEATURING JEWELRY,  
GIFTS AND HOME FURNISHINGS, IN CLASS 35  
(U.S. CLS. 100, 101 AND 102).

SER. NO. 77-331,856, FILED 11-16-2007.

FIRST USE 1-0-2007; IN COMMERCE 1-0-2007.

RAMONA ORTIGA, EXAMINING ATTORNEY

**Int. Cl.: 10**

**Prior U.S. Cls.: 26, 39 and 44**

**Reg. No. 3,466,881**

**United States Patent and Trademark Office**

**Registered July 15, 2008**

**TRADEMARK  
PRINCIPAL REGISTER**

# MultiSure

APEX BIOTECHNOLOGY CORP (TAIWAN CORPORATION)  
NO.7, LI-HSIN RD.V, HSINCHU SCIENCE PARK  
HSINCHU CITY 30078, TAIWAN

FOR: BLOOD COMPONENT SEPARATION APPARATUS FOR MEDICAL PURPOSES; APPARATUS FOR CLINICAL DIAGNOSIS; MEDICAL DIAGNOSTIC APPARATUS, ANALYTICAL APPARATUS FOR MEDICAL PURPOSES AND BLOOD PRESSURE MEASURING APPARATUS; APPARATUS FOR BLOOD ANALYSIS; BLOOD URIC ACID MONITORING APPARATUS FOR MEDICAL DIAGNOSTIC USE; BLOOD LACTATE MONITORING APPARATUS FOR MEDICAL DIAGNOSTIC USE;

BLOOD GLUCOSE MONITORING APPARATUS; CHOLESTEROL MONITORING APPARATUS FOR MEDICAL DIAGNOSTIC USE; MULTIPLE FUNCTION BLOOD MONITORING APPARATUS FOR MEDICAL DIAGNOSTIC USE; NEEDLE-BASED AND NEEDLE-FREE INJECTION SYSTEMS; APPARATUS FOR TAKING BLOOD, IN CLASS 10 (U.S. CLS. 26, 39 AND 44).

FIRST USE 8-21-2003; IN COMMERCE 9-10-2004.

SER. NO. 77-331,866, FILED 11-16-2007.

MARCIE MILONE, EXAMINING ATTORNEY



**Int. Cl.: 36**

**Prior U.S. Cls.: 100, 101 and 102**

**United States Patent and Trademark Office**

**Reg. No. 3,466,882**

**Registered July 15, 2008**

**SERVICE MARK  
PRINCIPAL REGISTER**



THE BEN HOGAN FOUNDATION (TEXAS CORPORATION)

P.O. BOX 121518

FORT WORTH, TX 761211518

FOR: ACCEPTING AND ADMINISTERING MONETARY CHARITABLE CONTRIBUTIONS, CHARITABLE FUND RAISING, AND CHARITABLE FUNDRAISING BY MEANS OF AN ENTERTAINMENT EVENT, IN CLASS 36 (U.S. CLS. 100, 101 AND 102).

FIRST USE 11-7-2007; IN COMMERCE 11-7-2007.

NO CLAIM IS MADE TO THE EXCLUSIVE RIGHT TO USE "FOUNDATION", APART FROM THE MARK AS SHOWN.

THE NAME "BEN HOGAN" DOES NOT IDENTIFY A PARTICULAR LIVING INDIVIDUAL.

THE COLOR(S) BLUE AND GRAY IS/ARE CLAIMED AS A FEATURE OF THE MARK.

THE MARK CONSISTS OF THE GRAY SILHOUETTE OF A MAN WEARING A HAT AND SWINGING A GOLF CLUB, TO THE LEFT OF WHICH APPEAR THE WORDS "BEN" AND "HOGAN" IN BLUE ABOVE A GRAY LINE AND THE WORD "FOUNDATION" IN BLUE BELOW SAID GRAY LINE.

SER. NO. 77-331,894, FILED 11-16-2007.

ESTHER BELENKER, EXAMINING ATTORNEY

Int. Cl.: 36

Prior U.S. Cls.: 100, 101 and 102

United States Patent and Trademark Office

Reg. No. 3,466,883

Registered July 15, 2008

SERVICE MARK  
PRINCIPAL REGISTER



OPERATION SUPPORT OUR TROOPS - ILLINOIS, INC. (ILLINOIS NON-PROFIT CORPORATION)  
1593 CLEMSON DRIVE  
NAPERVILLE, IL 60565

FOR: CHARITABLE FUND RAISING SERVICES,  
IN CLASS 36 (U.S. CLS. 100, 101 AND 102).

FIRST USE 1-0-2006; IN COMMERCE 1-0-2006.

NO CLAIM IS MADE TO THE EXCLUSIVE RIGHT TO USE "ILLINOIS, INC.", APART FROM THE MARK AS SHOWN.

THE MARK CONSISTS OF STATE OF ILLINOIS WITH FLAG DESIGN.

SER. NO. 77-331,920, FILED 11-16-2007.

STEPHANIE ALI, EXAMINING ATTORNEY

**Int. Cls.: 38 and 41**

**Prior U.S. Cls.: 100, 101, 104 and 107**

**United States Patent and Trademark Office**

**Reg. No. 3,466,884**

**Registered July 15, 2008**

**SERVICE MARK  
PRINCIPAL REGISTER**



WREAL LLC (FLORIDA LTD LIAB CO)  
SUITE 100  
396 ALHAMBRA CIRCLE  
MIAMI, FL 33134

FOR: STREAMING OF VIDEO MATERIAL ON THE INTERNET; BROADCASTING SERVICES AND PROVISION OF TELECOMMUNICATION ACCESS TO VIDEO AND AUDIO CONTENT PROVIDED VIA A VIDEO-ON-DEMAND SERVICE VIA THE INTERNET; COMMUNICATIONS SERVICES, NAMELY, TRANSMITTING STREAMED SOUND AND AUDIO-VISUAL RECORDINGS VIA THE INTERNET, IN CLASS 38 (U.S. CLS. 100, 101 AND 104).

FIRST USE 11-1-2007; IN COMMERCE 12-27-2007.

FOR: ENTERTAINMENT SERVICES, NAMELY, PROVIDING A WEBSITE FEATURING PHOTO-

GRAPHIC, AUDIO, VIDEO AND PROSE PRESENTATIONS FEATURING ADULT ENTERTAINMENT, IN CLASS 41 (U.S. CLS. 100, 101 AND 107).

FIRST USE 11-1-2007; IN COMMERCE 12-27-2007.

THE COLOR(S) RED IS/ARE CLAIMED AS A FEATURE OF THE MARK.

THE MARK CONSISTS OF A RED FLAME WITH A TRANSPARENT "HOLE" IN THE CENTER.

SER. NO. 77-331,960, FILED 11-16-2007.

SHARON MEIER, EXAMINING ATTORNEY

**Int. Cl.: 36**

**Prior U.S. Cls.: 100, 101 and 102**

**United States Patent and Trademark Office**

**Reg. No. 3,466,885**

**Registered July 15, 2008**

**SERVICE MARK  
PRINCIPAL REGISTER**

**WACHOVIA MOBILE**

WACHOVIA CORPORATION (NORTH CAROLINA CORPORATION)  
ONE WACHOVIA CENTER  
301 S COLLEGE STREET, 30TH FLOOR, NC0630  
CHARLOTTE, NC 282880630

FOR: BANKING SERVICES PROVIDED BY MOBILE TELEPHONE CONNECTIONS, IN CLASS 36 (U.S. CLS. 100, 101 AND 102).

FIRST USE 9-14-2006; IN COMMERCE 9-14-2006.

THE MARK CONSISTS OF STANDARD CHARACTERS WITHOUT CLAIM TO ANY PARTICULAR FONT, STYLE, SIZE, OR COLOR.

NO CLAIM IS MADE TO THE EXCLUSIVE RIGHT TO USE "MOBILE", APART FROM THE MARK AS SHOWN.

SER. NO. 77-331,974, FILED 11-16-2007.

JILL PRATER, EXAMINING ATTORNEY

**Int. Cl.: 9**

**Prior U.S. Cls.: 21, 23, 26, 36 and 38**

**Reg. No. 3,466,886**

**United States Patent and Trademark Office**

**Registered July 15, 2008**

---

**TRADEMARK  
PRINCIPAL REGISTER**

**OPS Man**

SKY-TRAX INCORPORATED (DELAWARE CORPORATION)  
98 QUIGLEY BLVD.  
NEW CASTLE, DE 197204150

FIRST USE 7-15-2006; IN COMMERCE 7-15-2006.

FOR: COMPUTER SOFTWARE FOR REAL TIME MONITORING AND REPORTING OF VEHICLE STATISTICS, NAMELY, MOVEMENT, POSITIONING, LOCATION, TRACKING, AND REMOTE MONITORING OF INDOOR VEHICLES FOR USE WITH A LOCAL AREA NETWORK FOR REMOTE OPERATIONS MONITORING AND MANAGEMENT, IN CLASS 9 (U.S. CLS. 21, 23, 26, 36 AND 38).

THE MARK CONSISTS OF STANDARD CHARACTERS WITHOUT CLAIM TO ANY PARTICULAR FONT, STYLE, SIZE, OR COLOR.

SER. NO. 77-331,988, FILED 11-16-2007.

APRIL ROACH, EXAMINING ATTORNEY

Int. Cl.: 30

Prior U.S. Cl.: 46

United States Patent and Trademark Office

Reg. No. 3,466,887

Registered July 15, 2008

TRADEMARK  
PRINCIPAL REGISTER



ICOFFEE DISTRICT CORPORATION (FLORIDA CORPORATION), DBA ICOFFEE DISTRICT CORPORATION  
4761 NW 5TH CT  
COCONUT CREEK, FL 33063

FOR: ROASTED COFFEE BEANS, IN CLASS 30 (U.S. CL. 46).

FIRST USE 8-30-2007; IN COMMERCE 8-30-2007.

THE COLOR(S) DARK GREEN, GREEN, AND WHITE IS/ARE CLAIMED AS A FEATURE OF THE MARK.

THE MARK CONSISTS OF A DARK GREEN SLIM RECTANGLE FADED INTO A LIGHTER GREEN FROM TOP TO BOTTOM, WITH A "W" IN THE TOP LEFT CORNER AND AN "E" IN THE TOP RIGHT CORNER, AND A WHITE RECTANGULAR LINE FRAMING THE WORDS "ICOFFEE DISTRICT".

SER. NO. 77-332,033, FILED 11-16-2007.

ARETHA SOMERVILLE, EXAMINING ATTORNEY

**Int. Cl.: 3**

**Prior U.S. Cls.: 1, 4, 6, 50, 51 and 52**

**United States Patent and Trademark Office**

**Reg. No. 3,466,888**

**Registered July 15, 2008**

**TRADEMARK  
PRINCIPAL REGISTER**

**SOLARSILK**

CREATIVE NAIL DESIGN, INC. (CALIFORNIA  
CORPORATION)  
1125 JOSHUA WAY  
VISTA, CA 92083

FOR: HAND LOTIONS; BODY LOTION, IN CLASS  
3 (U.S. CLS. 1, 4, 6, 50, 51 AND 52).

FIRST USE 9-30-1984; IN COMMERCE 9-30-1984.

THE MARK CONSISTS OF STANDARD CHAR-  
ACTERS WITHOUT CLAIM TO ANY PARTICULAR  
FONT, STYLE, SIZE, OR COLOR.

OWNER OF U.S. REG. NO. 1,544,112.

SER. NO. 77-332,035, FILED 11-16-2007.

TINA KUAN, EXAMINING ATTORNEY

**Int. Cl.: 41**

**Prior U.S. Cls.: 100, 101 and 107**

**United States Patent and Trademark Office**

**Reg. No. 3,466,889**

**Registered July 15, 2008**

---

**SERVICE MARK  
PRINCIPAL REGISTER**

**SYNDICATED**

SYNPLICITY, INC. (CALIFORNIA CORPORATION)  
600 WEST CALIFORNIA AVENUE  
SUNNYVALE, CA 94086

FOR: PROVIDING NEWSLETTERS IN THE  
FIELD OF ELECTRONIC DESIGN AUTOMATION  
VIA E-MAIL AND GLOBAL COMPUTER NET-  
WORKS, IN CLASS 41 (U.S. CLS. 100, 101 AND 107).

FIRST USE 1-29-2001; IN COMMERCE 2-0-2001.

THE MARK CONSISTS OF STANDARD CHAR-  
ACTERS WITHOUT CLAIM TO ANY PARTICULAR  
FONT, STYLE, SIZE, OR COLOR.

OWNER OF U.S. REG. NO. 2,549,734.

SER. NO. 77-332,036, FILED 11-16-2007.

MAUREEN DALL, EXAMINING ATTORNEY



**Int. Cl.: 42**

**Prior U.S. Cls.: 100 and 101**

**United States Patent and Trademark Office**

**Reg. No. 3,466,890**

**Registered July 15, 2008**

**SERVICE MARK  
PRINCIPAL REGISTER**

**Technically Speaking, We  
Know IT**

HURFF-WEBB, INC. (FLORIDA CORPORATION), DBA ARTIS IT  
#105  
7406 FULLERTON STREET  
JACKSONVILLE, FL 32256

THE MARK CONSISTS OF STANDARD CHARACTERS WITHOUT CLAIM TO ANY PARTICULAR FONT, STYLE, SIZE, OR COLOR.

FOR: INFORMATION TECHNOLOGY CONSULTATION, IN CLASS 42 (U.S. CLS. 100 AND 101).

SER. NO. 77-332,066, FILED 11-16-2007.

FIRST USE 4-1-2007; IN COMMERCE 4-1-2007.

DAVID ELTON, EXAMINING ATTORNEY

**Int. Cl.: 12**

**Prior U.S. Cls.: 19, 21, 23, 31, 35 and 44**

**Reg. No. 3,466,891**

**United States Patent and Trademark Office**

**Registered July 15, 2008**

---

**TRADEMARK  
PRINCIPAL REGISTER**

GO GREEN. GO COACH. GO MCI.

MOTOR COACH INDUSTRIES INTERNATIONAL, INC. (DELAWARE CORPORATION)  
1700 EAST GOLF ROAD  
SCHAUMBURG, IL 60173

THE MARK CONSISTS OF STANDARD CHARACTERS WITHOUT CLAIM TO ANY PARTICULAR FONT, STYLE, SIZE, OR COLOR.

FOR: MOTOR COACHES, IN CLASS 12 (U.S. CLS. 19, 21, 23, 31, 35 AND 44).

SER. NO. 77-332,091, FILED 11-16-2007.

FIRST USE 6-2-2006; IN COMMERCE 6-2-2006.

JUDITH HELFMAN, EXAMINING ATTORNEY

Int. Cl.: 41

Prior U.S. Cls.: 100, 101 and 107

United States Patent and Trademark Office

Reg. No. 3,466,892

Registered July 15, 2008

**SERVICE MARK  
PRINCIPAL REGISTER**

# Kill Henry Sugar

SHARENOW, DEAN (UNITED STATES INDIVIDUAL)  
247 WEST 76TH STREET APT 6  
NEW YORK, NY 10023

FOR: COMPOSITION OF MUSIC FOR OTHERS; ENTERTAINMENT IN THE NATURE OF VISUAL AND AUDIO PERFORMANCES, AND MUSICAL, VARIETY, NEWS AND COMEDY SHOWS; ENTERTAINMENT IN THE NATURE OF VISUAL AND AUDIO PERFORMANCES, NAMELY, MUSICAL BAND, ROCK GROUP, GYMNASTIC, DANCE, AND BALLET PERFORMANCES; ENTERTAINMENT, NAMELY, LIVE PERFORMANCES BY A MUSICAL BAND; ENTERTAINMENT SERVICES, NAMELY, AN ONLINE ACTIVITY WHERE YOU CREATE YOUR OWN MUSIC VIDEOS; ENTERTAINMENT SERVICES, NAMELY, PROVIDING A WEB SITE FEATURING MUSICAL PERFORMANCES, MUSICAL VIDEOS, RELATED FILM CLIPS, PHOTOGRAPHS, AND OTHER MULTIMEDIA MATERIALS; ENTERTAINMENT, NAMELY, LIVE MUSIC CONCERTS; ENTERTAINMENT, NAMELY,

LIVE PERFORMANCES BY MUSICAL BANDS; MULTIMEDIA ENTERTAINMENT SERVICES IN THE NATURE OF RECORDING, PRODUCTION AND POST-PRODUCTION SERVICES IN THE FIELDS OF MUSIC, VIDEO, AND FILMS; MUSIC COMPOSITION AND TRANSCRIPTION FOR OTHERS; MUSIC COMPOSITION FOR OTHERS; MUSIC PRODUCTION SERVICES; MUSIC SELECTION SERVICES FOR USE IN TV, FILM, RADIO AND VIDEO GAMES; PRODUCTION OF SOUND AND MUSIC VIDEO RECORDINGS, IN CLASS 41 (U.S. CLS. 100, 101 AND 107).

FIRST USE 4-10-1999; IN COMMERCE 4-10-1999.

THE MARK CONSISTS OF STANDARD CHARACTERS WITHOUT CLAIM TO ANY PARTICULAR FONT, STYLE, SIZE, OR COLOR.

SER. NO. 77-332,093, FILED 11-16-2007.

ELLEN PERKINS, EXAMINING ATTORNEY

**Int. Cl.: 36**

**Prior U.S. Cls.: 100, 101 and 102**

**United States Patent and Trademark Office**

**Reg. No. 3,466,893**

**Registered July 15, 2008**

---

**SERVICE MARK  
PRINCIPAL REGISTER**

**ACCESS UPTOWN**

CAVENESS, V. GALE (UNITED STATES INDIVIDUAL)  
1921 TREMONT AVENUE  
FORT WORTH, TX 76107

FOR: ASSESSMENT AND MANAGEMENT OF REAL ESTATE; PROVIDING REAL ESTATE LISTINGS AND REAL ESTATE INFORMATION VIA THE INTERNET; REAL ESTATE AGENCIES; REAL ESTATE BROKERAGE; REAL ESTATE CONSULTATION; REAL ESTATE MANAGEMENT; REAL ESTATE MANAGEMENT CONSULTATION; REAL ESTATE PROCUREMENT FOR OTHERS; LEASING

OF REAL ESTATE; LEASING OF REAL PROPERTY, IN CLASS 36 (U.S. CLS. 100, 101 AND 102).

FIRST USE 10-1-2005; IN COMMERCE 11-1-2006.

THE MARK CONSISTS OF STANDARD CHARACTERS WITHOUT CLAIM TO ANY PARTICULAR FONT, STYLE, SIZE, OR COLOR.

SER. NO. 77-332,112, FILED 11-16-2007.

FRANK LATTUCA, EXAMINING ATTORNEY

**Int. Cl.: 7**

**Prior U.S. Cls.: 13, 19, 21, 23, 31, 34 and 35**

**United States Patent and Trademark Office**

**Reg. No. 3,466,894**

**Registered July 15, 2008**

**TRADEMARK  
PRINCIPAL REGISTER**



WEY YII CORP. (TAIWAN CORPORATION)  
409-6, PEI-TON ROAD, PEI-TON DISTRICT  
TAICHUNG, TAIWAN

FOR: METAL PROCESSING LATHES, GRINDING MACHINES FOR METAL PROCESSING, MILLING MACHINES FOR METAL PROCESSING, DRILLING MACHINES FOR METAL PROCESSING, FILLING MACHINES FOR METAL PROCESSING, GEAR HOBGING MACHINES, ELECTRIC SPARK MACHINES, NAMELY, ELECTRIC-SPARK DISCHARGE SHAPING MACHINES, IN CLASS 7 (U.S. CLS. 13, 19, 21, 23, 31, 34 AND 35).

FIRST USE 1-10-1998; IN COMMERCE 9-1-2007.

OWNER OF U.S. REG. NOS. 1,449,309 AND 3,138,244.

THE COLOR(S) LIGHT BLUE, WHITE, BLACK, YELLOW AND DARK BLUE IS/ARE CLAIMED AS A FEATURE OF THE MARK.

THE MARK CONSISTS OF A BLACK STYLIZED WORD "MICROWEILY" ABOVE YELLOW AND DARK BLUE HORIZONTAL LINES AND WITH A YELLOW AND BLACK CIRCULAR SHAPE APPEARING ABOVE THE "W", ALL TO THE RIGHT OF WHITE AND LIGHT BLUE GEOMETRICALLY SHAPED FIGURES.

SER. NO. 77-332,114, FILED 11-16-2007.

FRANK LATTUCA, EXAMINING ATTORNEY

**Int. Cl.: 16**

**Prior U.S. Cls.: 2, 5, 22, 23, 29, 37, 38 and 50**

**United States Patent and Trademark Office**

**Reg. No. 3,466,895**

**Registered July 15, 2008**

**TRADEMARK  
PRINCIPAL REGISTER**

**B&T DUOS**

CABIN CREEK, LLC (UTAH LTD LIAB CO)  
1199 W 700 SOUTH  
PLEASANT GROVE, UT 84062

FOR: PAPERS FOR SCRAPBOOKS, JOURNALS,  
OCCASION CARDS AND GREETING CARDS,  
NAMELY, COLORED PAPERS, CRAFT PAPERS,  
SPECIALTY PAPERS AND BACKGROUND PA-  
PERS, IN CLASS 16 (U.S. CLS. 2, 5, 22, 23, 29, 37, 38  
AND 50).

FIRST USE 7-0-2004; IN COMMERCE 7-0-2004.

THE MARK CONSISTS OF STANDARD CHAR-  
ACTERS WITHOUT CLAIM TO ANY PARTICULAR  
FONT, STYLE, SIZE, OR COLOR.

NO CLAIM IS MADE TO THE EXCLUSIVE  
RIGHT TO USE "DUOS", APART FROM THE MARK  
AS SHOWN.

SER. NO. 77-332,174, FILED 11-16-2007.

JERI J. FICKES, EXAMINING ATTORNEY

**Int. Cl.: 25**

**Prior U.S. Cls.: 22 and 39**

**United States Patent and Trademark Office**

**Reg. No. 3,466,896**

**Registered July 15, 2008**

**TRADEMARK  
PRINCIPAL REGISTER**



L.A. SUPPLY CO., LLC (CALIFORNIA LTD LIAB  
CO)  
13700 E. ROSECRANS AVE.  
SANTA FE SPRINGS, CA 90670

FOR: BLOUSES; SHIRTS; TANK-TOPS; TOPS, IN  
CLASS 25 (U.S. CLS. 22 AND 39).

FIRST USE 9-17-2007; IN COMMERCE 9-17-2007.

NO CLAIM IS MADE TO THE EXCLUSIVE  
RIGHT TO USE "PINK", APART FROM THE MARK  
AS SHOWN.

THE COLOR(S) PINK AND BLACK IS/ARE  
CLAIMED AS A FEATURE OF THE MARK.

THE MARK CONSISTS OF THE WORDS "PINK  
HEAVEN" IN STYLIZED FONT SURROUNDED BY  
A STYLIZED SQUARE BORDER FEATURING  
HEARTS, CURVING LINES AND A CROWN. THE  
COLOR PINK APPEARS IN THE HEARTS AND  
CROWN, AND THE COLOR BLACK APPEARS IN  
THE WORDING "PINK HEAVEN" AND THE STY-  
LIZED BORDER.

SER. NO. 77-332,212, FILED 11-16-2007.

ANDREW RHIM, EXAMINING ATTORNEY

Int. Cl.: 3

Prior U.S. Cls.: 1, 4, 6, 50, 51 and 52

United States Patent and Trademark Office

Reg. No. 3,466,897

Registered July 15, 2008

TRADEMARK  
PRINCIPAL REGISTER



PHILLIPS, DIONNE (UNITED STATES INDIVIDUAL)  
STUDIO 22  
9911 WEST PICO BLVD.  
LOS ANGELES, CA 90035

FOR: COSMETICS; FALSE EYELASHES; ADHESIVES FOR FALSE EYELASHES; AND KITS FOR FALSE EYELASHES CONSISTING PRIMARILY OF FALSE EYELASHES AND ADHESIVES FOR FALSE EYELASHES, ALSO CONTAINING TWEEZERS, IN CLASS 3 (U.S. CLS. 1, 4, 6, 50, 51 AND 52).

FIRST USE 4-27-2007; IN COMMERCE 4-27-2007.

OWNER OF U.S. REG. NO. 3,262,899.

THE COLOR(S) BLUE, BLACK, WHITE, RED, TAN, AND GREY IS/ARE CLAIMED AS A FEATURE OF THE MARK.

THE MARK CONSISTS OF THE WORDS "D'LASHES BY DIONNE PHILLIPS" AND THE DEPICTION OF THE HEAD AND ARMS OF A WOMAN. THE WORD "D'LASHES" AND THE EYES ARE BLUE. THE WORDS "BY DIONNE PHILLIPS" ARE GREY. THE HAIR, EYEBROWS AND EYELASHES ARE BLACK. THE TEETH AND THE EYES ARE WHITE. THE LIPS ARE RED AND THE SKIN IS TAN.

SER. NO. 77-332,224, FILED 11-16-2007.

LEIGH CAROLINE CASE, EXAMINING ATTORNEY



**Int. Cl.: 3**

**Prior U.S. Cls.: 1, 4, 6, 50, 51 and 52**

**United States Patent and Trademark Office**

**Reg. No. 3,466,898**

**Registered July 15, 2008**

**TRADEMARK  
PRINCIPAL REGISTER**

**BLONDA**

UNITE EUROTHERAPY, INC (CALIFORNIA  
CORPORATION)  
SUITE H  
9380 ACTIVITY RD  
SAN DIEGO, CA 92126

THE MARK CONSISTS OF STANDARD CHAR-  
ACTERS WITHOUT CLAIM TO ANY PARTICULAR  
FONT, STYLE, SIZE, OR COLOR.

FOR: SHAMPOO, IN CLASS 3 (U.S. CLS. 1, 4, 6, 50,  
51 AND 52).

SER. NO. 77-332,237, FILED 11-16-2007.

FIRST USE 1-31-2006; IN COMMERCE 1-31-2006.

ROBERT STRUCK, EXAMINING ATTORNEY

**Int. Cl.: 42**

**Prior U.S. Cls.: 100 and 101**

**United States Patent and Trademark Office**

**Reg. No. 3,466,899**

**Registered July 15, 2008**

**SERVICE MARK  
PRINCIPAL REGISTER**



PICKJACK LLC (NEW YORK LTD LIAB CO)  
116 W 23RD ST FL 5  
NEW YORK, NY 10011

FOR: PROVIDING ON-LINE NON-DOWNLOAD-  
ABLE SOFTWARE FOR CREATING, SHARING  
AND ANSWERING ONLINE POLLS ON ANY TO-  
PIC, IN CLASS 42 (U.S. CLS. 100 AND 101).

FIRST USE 8-0-2007; IN COMMERCE 8-0-2007.

THE COLOR(S) BLACK, GRAY AND GREEN IS/  
ARE CLAIMED AS A FEATURE OF THE MARK.

THE MARK CONSISTS OF THE STYLIZED TERM  
"PICKJACK". THE COLOR(S) BLACK APPEARS IN  
THE WORDS "PICKJACK" AND IN THE CIRCLES  
ABOVE THE LETTERS "I" AND "J". THE COLOR  
GRAY APPEARS IN THE UPPER HALF OF THE  
WORDS "PICKJACK". THE COLOR GREEN AP-  
PEARS ON THE INSIDE OF THE CIRCLES ABOVE  
THE LETTERS "I" AND "J".

SER. NO. 77-332,250, FILED 11-17-2007.

KHANH LE, EXAMINING ATTORNEY

**Int. Cl.: 42**

**Prior U.S. Cls.: 100 and 101**

**United States Patent and Trademark Office**

**Reg. No. 3,466,900**

**Registered July 15, 2008**

---

**SERVICE MARK  
PRINCIPAL REGISTER**

We know design. We know  
what works.

JORDAN, NATASHA (UNITED STATES INDIVIDUAL), DBA JORDAN DESIGN STUDIO  
362 BRANTLEY STREET SE  
PALM BAY, FL 32909

THE MARK CONSISTS OF STANDARD CHARACTERS WITHOUT CLAIM TO ANY PARTICULAR FONT, STYLE, SIZE, OR COLOR.

FOR: GRAPHIC DESIGN SERVICES, IN CLASS 42 (U.S. CLS. 100 AND 101).

SER. NO. 77-332,273, FILED 11-17-2007.

FIRST USE 12-3-2004; IN COMMERCE 12-3-2004.

CAROLINE WOOD, EXAMINING ATTORNEY

**Int. Cl.: 42**

**Prior U.S. Cls.: 100 and 101**

**United States Patent and Trademark Office**

**Reg. No. 3,466,901**

**Registered July 15, 2008**

**SERVICE MARK  
PRINCIPAL REGISTER**

**iCentral**

ICLAIM SYSTEMS CORP. (NEW YORK CORPORATION)  
494 EIGHTH AVE. SUITE 500  
NEW YORK, NY 10001

FOR: APPLICATION SERVICE PROVIDER (ASP) FEATURING SOFTWARE FOR USE IN THE CONSOLIDATION AND ORGANIZATION OF DATA, PROCESSES AND FUNCTIONS INTO ONE ON-LINE DATABASE SYSTEM; APPLICATION SERVICE PROVIDER (ASP), NAMELY, HOSTING COMPUTER SOFTWARE APPLICATIONS OF OTHERS; APPLICATION SERVICE PROVIDER FEATURING SOFTWARE FOR PROVIDING AN ON-LINE DATABASE IN THE FIELD OF TRANSACTION PROCESSING TO UPLOAD TRANSACTIONAL DATA, PROVIDE STATISTICAL ANALYSIS, AND PRODUCE NOTIFICATIONS AND REPORTS; APPLICATION SERVICE PROVIDER, NAMELY, PROVIDING, HOSTING, MANAGING, DEVELOP-

ING, AND MAINTAINING APPLICATIONS, SOFTWARE, WEBSITES, AND DATABASES IN THE FIELDS OF PERSONAL PRODUCTIVITY, WIRELESS COMMUNICATION, MOBILE INFORMATION ACCESS, AND REMOTE DATA MANAGEMENT FOR WIRELESS DELIVERY OF CONTENT TO HANDHELD COMPUTERS, LAPTOPS AND MOBILE ELECTRONIC DEVICES, IN CLASS 42 (U.S. CLS. 100 AND 101).

FIRST USE 11-3-2007; IN COMMERCE 11-3-2007.

THE MARK CONSISTS OF STANDARD CHARACTERS WITHOUT CLAIM TO ANY PARTICULAR FONT, STYLE, SIZE, OR COLOR.

SER. NO. 77-332,274, FILED 11-17-2007.

CAROLINE WOOD, EXAMINING ATTORNEY

**Int. Cl.: 45**

**Prior U.S. Cls.: 100 and 101**

**United States Patent and Trademark Office**

**Reg. No. 3,466,902**

**Registered July 15, 2008**

**SERVICE MARK  
PRINCIPAL REGISTER**

**The Growing Tree Program**

GROWING TREE PROGRAM, THE (MICHIGAN  
NON-PROFIT ORGANIZATION)  
319 AIRPORT INDUSTRIAL DRIVE  
YPSILANTI, MI 48198

FOR: ORGANIZING AND CONDUCTING SUP-  
PORT GROUPS IN THE FIELD OF HELPING CHIL-  
DREN COPE WITH SUBSTANCE ABUSE ISSUES, IN  
CLASS 45 (U.S. CLS. 100 AND 101).

FIRST USE 2-23-2006; IN COMMERCE 2-23-2006.

THE MARK CONSISTS OF STANDARD CHAR-  
ACTERS WITHOUT CLAIM TO ANY PARTICULAR  
FONT, STYLE, SIZE, OR COLOR.

NO CLAIM IS MADE TO THE EXCLUSIVE  
RIGHT TO USE "PROGRAM", APART FROM THE  
MARK AS SHOWN.

SER. NO. 77-332,275, FILED 11-17-2007.

CAROLINE WOOD, EXAMINING ATTORNEY

**Int. Cl.: 25**

**Prior U.S. Cls.: 22 and 39**

**United States Patent and Trademark Office**

**Reg. No. 3,466,903**

**Registered July 15, 2008**

**TRADEMARK  
PRINCIPAL REGISTER**



LINO LUCENTE (UNITED STATES INDIVIDUAL)  
2704 LOGAN STREET  
HIGHLAND PARK, IL 60035

FOR: SHIRTS; JEANS; HATS; SHOES; JACKETS,  
IN CLASS 25 (U.S. CLS. 22 AND 39).

FIRST USE 11-16-2007; IN COMMERCE 11-16-2007.

NO CLAIM IS MADE TO THE EXCLUSIVE  
RIGHT TO USE "KITESURFING", APART FROM  
THE MARK AS SHOWN.

THE COLOR(S) BLACK AND REDISH-BROWN  
IS/ARE CLAIMED AS A FEATURE OF THE MARK.

THE MARK CONSISTS OF THE LETTERS "WK"  
IN BLACK IN A BROWN CIRCLE HAVING BLACK  
WINGS ABOVE AND TO THE LEFT OF THE  
WORDS "WINDIGO" IN BROWN AND "KITESURF-  
ING" IN BLACK.

SER. NO. 77-332,276, FILED 11-17-2007.

CAROLINE WOOD, EXAMINING ATTORNEY

**Int. Cl.: 32**

**Prior U.S. Cls.: 45, 46 and 48**

**United States Patent and Trademark Office**

**Reg. No. 3,466,904**

**Registered July 15, 2008**

**TRADEMARK  
PRINCIPAL REGISTER**



PHARM-ALOE, INC. (WISCONSIN CORPORATION)

10743 MAIN STREET

PO BOX 25

WOODFORD, WI 53599

FOR: ALOE VERA JUICES, IN CLASS 32 (U.S. CLS. 45, 46 AND 48).

FIRST USE 8-7-1992; IN COMMERCE 8-7-1992.

NO CLAIM IS MADE TO THE EXCLUSIVE RIGHT TO USE "NATURAL", APART FROM THE MARK AS SHOWN.

THE COLOR(S) BLACK, GREEN AND RED SHADING TO ORANGE IS/ARE CLAIMED AS A FEATURE OF THE MARK.

THE MARK CONSISTS OF THE TERM "PHARM-ALOE" IN BLACK WITH GREEN UNDERLINING BELOW A RISING OR SETTING SUN IN RED SHADING UP TO ORANGE IN FRONT OF A GREEN STYLIZED PLANT, THE WORDS "PHARM-ALOE" ARE ABOVE THE WORDS "A NATURAL ALTERNATIVE" IN GREEN.

SER. NO. 77-332,277, FILED 11-17-2007.

CAROLINE WOOD, EXAMINING ATTORNEY

**Int. Cl.: 41**

**Prior U.S. Cls.: 100, 101 and 107**

**United States Patent and Trademark Office**

**Reg. No. 3,466,905**

**Registered July 15, 2008**

**SERVICE MARK  
PRINCIPAL REGISTER**



GARCIA, DANIEL (UNITED STATES INDIVIDUAL)  
610 NORTH 4TH AVENUE  
MAYWOOD, IL 60153

FOR: ENTERTAINMENT, NAMELY, LIVE MUSIC CONCERTS; ENTERTAINMENT, NAMELY, LIVE PERFORMANCES BY MUSICAL BANDS; ENTERTAINMENT, NAMELY, LIVE PERFORMANCES BY ROCK GROUPS, IN CLASS 41 (U.S. CLS. 100, 101 AND 107).

FIRST USE 5-1-2003; IN COMMERCE 5-1-2003.

NO CLAIM IS MADE TO THE EXCLUSIVE RIGHT TO USE "BAND", APART FROM THE MARK AS SHOWN.

THE COLOR(S) BLACK, GRAY, WHITE AND YELLOW IS/ARE CLAIMED AS A FEATURE OF THE MARK.

THE MARK CONSISTS OF THE WORDS "BANDA LA PONZONOSA" IN GRAY AND WHITE WITH A YELLOW SCORPION WITH A BLACK BODY IN THE MIDDLE OF THE TEXT.

THE ENGLISH TRANSLATION OF THE WORD "BANDA LA PONZONOSA" IN THE MARK IS THE POISONOUS BAND.

SER. NO. 77-332,285, FILED 11-17-2007.

CAROLINE WOOD, EXAMINING ATTORNEY



Int. Cls.: 35 and 36

Prior U.S. Cls.: 100, 101 and 102

United States Patent and Trademark Office

Reg. No. 3,466,906

Registered July 15, 2008

SERVICE MARK  
PRINCIPAL REGISTER



RSJ ENTERPRISES, P.A. (FLORIDA CORPORATION)  
10452 OAKVIEW PT. TERR  
GOTHA, FL 34734

FOR: MATCHING CONSUMERS WITH REAL ESTATE PROFESSIONALS IN THE FIELD OF REAL ESTATE SERVICES VIA COMPUTER NETWORK; PROVIDING REAL ESTATE LEADS FOR PROSPECTIVE PURCHASERS; REAL ESTATE ADVERTISING SERVICES; REAL ESTATE MARKETING SERVICES IN THE FIELD OF HOMES; REAL ESTATE MARKETING SERVICES, NAMELY, ONLINE SERVICES FEATURING THE PROMOTION OF RESIDENTIAL NEW CONSTRUCTION, WHICH ALSO CONTAINS BACK OFFICE SOLUTIONS FOR BUILDERS; REAL ESTATE MARKETING SERVICES, NAMELY, ONLINE SERVICES FEATURING TOURS OF RESIDENTIAL AND COMMERCIAL REAL ESTATE; REAL ESTATE SALES MANAGEMENT, IN CLASS 35 (U.S. CLS. 100, 101 AND 102).

FIRST USE 9-6-2006; IN COMMERCE 9-6-2006.

FOR: LEASING OF REAL ESTATE; LEASING OF REAL PROPERTY; PROVIDING INFORMATION IN THE FIELD OF REAL ESTATE BY MEANS OF LINKING THE WEB SITE TO OTHER WEB SITES FEATURING REAL ESTATE INFORMATION; PROVIDING INFORMATION IN THE FIELD OF REAL ESTATE VIA THE INTERNET; PROVIDING REAL ESTATE LISTINGS AND REAL ESTATE INFORMATION VIA THE INTERNET; REAL ESTATE ACQUISITION SERVICES; REAL ESTATE

CONSULTANCY; REAL ESTATE CONSULTATION; REAL ESTATE INVESTMENT; REAL ESTATE INVESTMENT SERVICES IN THE NATURE OF PURCHASING AND SELLING OF REAL ESTATE FOR OTHERS; REAL ESTATE LISTING; REAL ESTATE MANAGEMENT; REAL ESTATE MULTIPLE LISTING SERVICES; REAL ESTATE PROCUREMENT FOR OTHERS, IN CLASS 36 (U.S. CLS. 100, 101 AND 102).

FIRST USE 9-6-2006; IN COMMERCE 9-6-2006.

NO CLAIM IS MADE TO THE EXCLUSIVE RIGHT TO USE "GROUP", APART FROM THE MARK AS SHOWN.

THE COLOR(S) BLUE IS/ARE CLAIMED AS A FEATURE OF THE MARK.

THE MARK CONSISTS OF A STYLIZED LETTER "J" OVER A SQUARE WITH A ROUNDED TOP. BETWEEN THE LETTER "J" AND THE SQUARE IS A WHITE BAND. THE SQUARE IS DARK BLUE AT THE TOP FADING TO LIGHT BLUE. THE WORDING "THE JACOBSON GROUP" IS IN WHITE, CENTERED IN THE SQUARE. BENEATH THE SQUARE IS THE PHRASE "GREAT AGENTS, GREAT HOMES" IN BLUE.

SER. NO. 77-332,319, FILED 11-17-2007.

MORGAN WYNNE, EXAMINING ATTORNEY

**Int. Cl.: 45**

**Prior U.S. Cls.: 100 and 101**

**United States Patent and Trademark Office**

**Reg. No. 3,466,907**

**Registered July 15, 2008**

**SERVICE MARK  
PRINCIPAL REGISTER**

**EMPI&A**

Erik M Pelton & Associates, PLLC

ERIK M. PELTON & ASSOCIATES, PLLC (VIR-  
GINIA LTD LIAB CO)  
PO BOX 100637  
ARLINGTON, VA 22210

NO CLAIM IS MADE TO THE EXCLUSIVE  
RIGHT TO USE "ASSOCIATES, PLLC", APART  
FROM THE MARK AS SHOWN.

FOR: LEGAL SERVICES, IN CLASS 45 (U.S. CLS.  
100 AND 101).

SER. NO. 77-332,335, FILED 11-17-2007.

FIRST USE 10-1-2007; IN COMMERCE 10-12-2007.

DAVID COLLIER, EXAMINING ATTORNEY

**Int. Cl.: 33**

**Prior U.S. Cls.: 47 and 49**

**United States Patent and Trademark Office**

**Reg. No. 3,466,908**

**Registered July 15, 2008**

**TRADEMARK  
PRINCIPAL REGISTER**



MB VOGELZANG VINEYARDS, LLC (CALIFORNIA LTD LIAB CO)  
226 EAST CANON PERDIDO, SUITE M  
C/O KOENIG & ASSOCIATES  
SANTA BARBARA, CA 93101

THE MARK CONSISTS OF A STYLIZED "V" AND A STYLIZED UPSIDE DOWN "V".

FOR: TABLE WINES; WINE; WINES, IN CLASS 33 (U.S. CLS. 47 AND 49).

SER. NO. 77-332,369, FILED 11-17-2007.

FIRST USE 5-26-2006; IN COMMERCE 5-26-2006.

SEAN CROWLEY, EXAMINING ATTORNEY

**Int. Cl.: 25**

**Prior U.S. Cls.: 22 and 39**

**United States Patent and Trademark Office**

**Reg. No. 3,466,909**

**Registered July 15, 2008**

**TRADEMARK  
PRINCIPAL REGISTER**



IN CHRIST ENTERPRISES (MARYLAND SOLE  
PROPRIETORSHIP)  
63 EDWARD LANE  
LOTHIAN, MD 20711

THE MARK CONSISTS OF ARROW POINTING  
INSIDE OF THE LETTER "C".

FOR: SHIRTS; PANTS; BASEBALL CAPS; ATH-  
LETIC SHOES; JACKETS, IN CLASS 25 (U.S. CLS. 22  
AND 39).

SER. NO. 77-332,392, FILED 11-17-2007.

FIRST USE 8-21-2007; IN COMMERCE 8-21-2007.

INGRID C. EULIN, EXAMINING ATTORNEY

**Int. Cl.: 41**

**Prior U.S. Cls.: 100, 101 and 107**

**United States Patent and Trademark Office**

**Reg. No. 3,466,910**

**Registered July 15, 2008**

**SERVICE MARK  
PRINCIPAL REGISTER**

# AFRICAN PIE

JORGE DAVID JIHA (UNITED STATES INDIVIDUAL)  
10740 S KENDALE BLVD  
MIAMI, FL 33176

FOR: MOTION PICTURE FILM PRODUCTION; PRODUCTION AND DISTRIBUTION OF INDEPENDENT MOTION PICTURES; PRODUCTION AND DISTRIBUTION OF MOTION PICTURES; RENTAL OF MOTION PICTURE FILMS; RENTAL OF MOTION PICTURES, IN CLASS 41 (U.S. CLS. 100, 101 AND 107).

FIRST USE 7-17-2007; IN COMMERCE 7-17-2007.

THE MARK CONSISTS OF STANDARD CHARACTERS WITHOUT CLAIM TO ANY PARTICULAR FONT, STYLE, SIZE, OR COLOR.

NO CLAIM IS MADE TO THE EXCLUSIVE RIGHT TO USE "AFRICAN", APART FROM THE MARK AS SHOWN.

SER. NO. 77-332,401, FILED 11-17-2007.

PAUL CROWLEY, EXAMINING ATTORNEY

**Int. Cl.: 41**

**Prior U.S. Cls.: 100, 101 and 107**

**United States Patent and Trademark Office**

**Reg. No. 3,466,911**

**Registered July 15, 2008**

**SERVICE MARK  
PRINCIPAL REGISTER**

**EUROPEAN PIE**

JORGE DAVID JIHA (UNITED STATES INDIVIDUAL)  
10740 SOUTH KENDALE BLVD  
MIAMI, FL 33176

FOR: MOTION PICTURE FILM PRODUCTION; PRODUCTION AND DISTRIBUTION OF INDEPENDENT MOTION PICTURES; PRODUCTION AND DISTRIBUTION OF MOTION PICTURES; RENTAL OF MOTION PICTURE FILMS; RENTAL OF MOTION PICTURES, IN CLASS 41 (U.S. CLS. 100, 101 AND 107).

FIRST USE 8-21-2007; IN COMMERCE 8-21-2007.

THE MARK CONSISTS OF STANDARD CHARACTERS WITHOUT CLAIM TO ANY PARTICULAR FONT, STYLE, SIZE, OR COLOR.

NO CLAIM IS MADE TO THE EXCLUSIVE RIGHT TO USE "EUROPEAN", APART FROM THE MARK AS SHOWN.

SER. NO. 77-332,404, FILED 11-17-2007.

PAUL CROWLEY, EXAMINING ATTORNEY

**Int. Cl.: 41**

**Prior U.S. Cls.: 100, 101 and 107**

**United States Patent and Trademark Office**

**Reg. No. 3,466,912**

**Registered July 15, 2008**

**SERVICE MARK  
PRINCIPAL REGISTER**

**ASIAN PIE**

JORGE DAVID JIHA (UNITED STATES INDIVIDUAL)  
10740 SOUTH KENDALE BLVD  
MIAMI, FL 33176

FOR: MOTION PICTURE FILM PRODUCTION; PRODUCTION AND DISTRIBUTION OF INDEPENDENT MOTION PICTURES; PRODUCTION AND DISTRIBUTION OF MOTION PICTURES; RENTAL OF MOTION PICTURE FILMS; RENTAL OF MOTION PICTURES, IN CLASS 41 (U.S. CLS. 100, 101 AND 107).

FIRST USE 9-4-2007; IN COMMERCE 9-4-2007.

THE MARK CONSISTS OF STANDARD CHARACTERS WITHOUT CLAIM TO ANY PARTICULAR FONT, STYLE, SIZE, OR COLOR.

NO CLAIM IS MADE TO THE EXCLUSIVE RIGHT TO USE "ASIAN", APART FROM THE MARK AS SHOWN.

SER. NO. 77-332,408, FILED 11-17-2007.

PAUL CROWLEY, EXAMINING ATTORNEY

**Int. Cl.: 41**

**Prior U.S. Cls.: 100, 101 and 107**

**United States Patent and Trademark Office**

**Reg. No. 3,466,913**

**Registered July 15, 2008**

**SERVICE MARK  
PRINCIPAL REGISTER**

**LATIN PIE**

JORGE, DAVID JIHA (UNITED STATES INDIVIDUAL)  
10740 SOUTH KENDALE BLVD  
MIAMI, FL 33176

FOR: MOTION PICTURE FILM PRODUCTION; PRODUCTION AND DISTRIBUTION OF INDEPENDENT MOTION PICTURES; PRODUCTION AND DISTRIBUTION OF MOTION PICTURES; RENTAL OF MOTION PICTURE FILMS; RENTAL OF MOTION PICTURES, IN CLASS 41 (U.S. CLS. 100, 101 AND 107).

FIRST USE 10-16-2007; IN COMMERCE 10-16-2007.

THE MARK CONSISTS OF STANDARD CHARACTERS WITHOUT CLAIM TO ANY PARTICULAR FONT, STYLE, SIZE, OR COLOR.

SER. NO. 77-332,409, FILED 11-17-2007.

PAUL CROWLEY, EXAMINING ATTORNEY



**Int. Cl.: 41**

**Prior U.S. Cls.: 100, 101 and 107**

**United States Patent and Trademark Office**

**Reg. No. 3,466,914**

**Registered July 15, 2008**

**SERVICE MARK  
PRINCIPAL REGISTER**

**PowerHomeBiz**

POWERHOMEBIZ.COM LLC (VIRGINIA LTD  
LIAB CO), DBA POWERHOMEBIZ.COM LLC  
10253 MARSHALL POND ROAD  
BURKE, VA 22015

THE MARK CONSISTS OF STANDARD CHAR-  
ACTERS WITHOUT CLAIM TO ANY PARTICULAR  
FONT, STYLE, SIZE, OR COLOR.

FOR: PUBLISHING OF WEB MAGAZINES, IN  
CLASS 41 (U.S. CLS. 100, 101 AND 107).

SER. NO. 77-332,425, FILED 11-18-2007.

FIRST USE 12-8-1999; IN COMMERCE 12-8-1999.

SOPHIA S. KIM, EXAMINING ATTORNEY

**Int. Cls.: 35 and 42**

**Prior U.S. Cls.: 100, 101 and 102**

**United States Patent and Trademark Office**

**Reg. No. 3,466,915**

**Registered July 15, 2008**

**SERVICE MARK  
PRINCIPAL REGISTER**



SPITBALL, LLC (NEW JERSEY LTD LIAB CO)  
PO BOX 8775  
RED BANK, NJ 07701

FOR: BUSINESS MANAGEMENT CONSULTANCY AS WELL AS DEVELOPMENT OF PROCESSES FOR THE ANALYSIS AND THE IMPLEMENTATION OF STRATEGY PLANS AND MANAGEMENT PROJECTS, BUSINESS MANAGEMENT CONSULTING WITH RELATION TO STRATEGY, MARKETING, PRODUCTION, PERSONNEL, AND RETAIL SALE MATTERS, CONSULTANCY SERVICES REGARDING BUSINESS STRATEGIES, CREATION OF MARKETING TOOLS DESIGNED TO INCREASE A CLIENT COMPANY'S KNOWLEDGE OF CUSTOMER NEEDS, AND ITS COMPETITORS' PRODUCTS AND SERVICES, PRICING, ADVERTISING STRATEGY AND SALES STRATEGY, DEVELOPMENT OF MARKETING STRATEGIES AND CONCEPTS, ADVERTISING SERVICES, NAMELY, PROMOTING AND MARKETING THE GOODS AND SERVICES OF OTHERS THROUGH ALL PUBLIC COMMUNICATION MEANS, IN CLASS 35 (U.S. CLS. 100, 101 AND 102).

FIRST USE 6-1-2007; IN COMMERCE 6-1-2007.

FOR: DESIGN, CREATION, HOSTING, MAINTENANCE OF WEBSITES FOR OTHERS, DESIGN AND DEVELOPMENT OF MULTIMEDIA PRODUCTS, GRAPHIC DESIGN SERVICES, NAMELY, DESIGN OF PRINT ADVERTISEMENTS, BILLBOARDS, BROCHURES, COMMERCIALS, CORPORATE LOGOS, TRADE SHOW BOOTHS, PRINTED COLLATERAL, CD AND DVD PRESENTATIONS, COMPUTER-AIDED DESIGN OF VIDEO GRAPHICS, IN CLASS 42 (U.S. CLS. 100 AND 101).

FIRST USE 6-1-2007; IN COMMERCE 6-1-2007.

THE MARK CONSISTS OF A LOWERCASE "SPITBALL" WITH A SPLAT INSIDE A THOUGHT BUBBLE AS THE DOT IN THE LETTER 'I'.

SER. NO. 77-332,426, FILED 11-18-2007.

SOPHIA S. KIM, EXAMINING ATTORNEY

**Int. Cl.: 35**

**Prior U.S. Cls.: 100, 101 and 102**

**United States Patent and Trademark Office**

**Reg. No. 3,466,916**

**Registered July 15, 2008**

**SERVICE MARK  
PRINCIPAL REGISTER**



QUICK FUNDING, INC. (CALIFORNIA CORPORATION), DBA QUICK FUNDING  
SUITE 210  
1820 EAST GARRY AVE.  
SANTA ANA, CA 92705

THE MARK CONSISTS OF A STYLIZED LETTER "Q" WITH SIX HORIZONTAL LINES REACHING OUT FROM IT AND THE ENTIRE MARK IS COLORED GREEN.

FOR: CONNECTING BUYERS AND SELLERS OF FINANCIAL ASSETS, IN CLASS 35 (U.S. CLS. 100, 101 AND 102).

SEC. 2(F).

FIRST USE 1-3-2001; IN COMMERCE 1-3-2001.

SER. NO. 77-332,438, FILED 11-18-2007.

THE COLOR(S) GREEN IS/ARE CLAIMED AS A FEATURE OF THE MARK.

SOPHIA S. KIM, EXAMINING ATTORNEY

**Int. Cls.: 14, 25 and 26**

**Prior U.S. Cls.: 2, 22, 27, 28, 37, 39, 40, 42 and 50**

**United States Patent and Trademark Office**

**Reg. No. 3,466,917**

**Registered July 15, 2008**

**TRADEMARK  
PRINCIPAL REGISTER**

**DOMANI**

MOSHE BOUSKILA (UNITED STATES INDIVIDUAL)  
2056 EAST 21TH STREET  
BROOKLYN, NY 11229

FOR: SHIRT STUDS, IN CLASS 14 (U.S. CLS. 2, 27, 28 AND 50).

FIRST USE 3-0-1991; IN COMMERCE 3-0-1991.

FOR: DRESS SHIRTS; KNIT SHIRTS; LONG-SLEEVED SHIRTS; POLO SHIRTS; SHIRTS; CAPRI PANTS; CARGO PANTS; DENIMS; JOGGING PANTS; LEATHER PANTS; LOUNGE PANTS; PANTS; SKI PANTS; SNOW PANTS; STRETCH PANTS; SWEAT PANTS; SLACKS; DRESS SUITS; JOGGING SUITS; SWEATERS; BRIEFS; KNITTED UNDERWEAR; LADIES' UNDERWEAR; LONG UNDERWEAR; PARTS OF CLOTHING, NAMELY, GUSSETS FOR TIGHTS, GUSSETS FOR STOCKINGS, GUSSETS FOR BATHING SUITS, GUSSETS FOR UNDERWEAR, GUSSETS FOR LEOTARDS AND GUSSETS FOR FOOTLETS; THERMAL UNDERWEAR; THONGS; UNDERWEAR; UNDERWEAR, NAMELY, BOY SHORTS; WOMEN'S UNDERWEAR; WOVEN OR KNITTED UNDERWEAR; FOOTWEAR FOR MEN AND WOMEN; INFANT AND TODDLER ONE PIECE CLOTHING; MEN AND WOMEN JACKETS, COATS, TROUSERS,

VESTS; MEN'S SOCKS; MEN'S SUITS; MEN'S SUITS, WOMEN'S SUITS; SHORT SETS; TIES; TOPS, IN CLASS 25 (U.S. CLS. 22 AND 39).

FIRST USE 3-0-1991; IN COMMERCE 3-0-1991.

FOR: BELT BUCKLES NOT OF PRECIOUS METAL; BELT BUCKLES OF PRECIOUS METAL; BODY AND CLOTHING TAPE TO HOLD UP STRAPLESS GOWNS; BROOCHES; CHILD RESTRAINING DEVICES IN THE NATURE OF CLOTH CHILD HARNESS FOR HOUSEHOLD CHAIR; CLOTHING BUCKLES; EYELETS FOR CLOTHING; LOOPS FOR CLOTHING; BELT BUCKLES, IN CLASS 26 (U.S. CLS. 37, 39, 40, 42 AND 50).

FIRST USE 3-0-1991; IN COMMERCE 3-0-1991.

THE MARK CONSISTS OF STANDARD CHARACTERS WITHOUT CLAIM TO ANY PARTICULAR FONT, STYLE, SIZE, OR COLOR.

ENGLISH TRANSLATION OF THE WORD "DOMANI" IN THE MARK IS "TOMORROW".

SER. NO. 77-332,455, FILED S.R. 11-18-2007 AM.  
P.R. 3-10-2008.

THEODORE MCBRIDE, EXAMINING ATTORNEY

**Int. Cl.: 25**

**Prior U.S. Cls.: 22 and 39**

**United States Patent and Trademark Office**

**Reg. No. 3,466,918**

**Registered July 15, 2008**

---

**TRADEMARK  
PRINCIPAL REGISTER**

**Skiara**

D'ELLA CASA DESIGN, LLC (NEW JERSEY LTD  
LIAB CO), DBA CHARLENE DEPRIZIO  
139 PULASKI AVENUE  
SAYREVILLE, NJ 08872

THE MARK CONSISTS OF STANDARD CHAR-  
ACTERS WITHOUT CLAIM TO ANY PARTICULAR  
FONT, STYLE, SIZE, OR COLOR.

FOR: HATS, IN CLASS 25 (U.S. CLS. 22 AND 39).

SER. NO. 77-332,461, FILED 11-18-2007.

FIRST USE 11-15-2007; IN COMMERCE 11-15-2007.

EDWARD NELSON, EXAMINING ATTORNEY

**Int. Cl.: 35**

**Prior U.S. Cls.: 100, 101 and 102**

**United States Patent and Trademark Office**

**Reg. No. 3,466,919**

**Registered July 15, 2008**

**SERVICE MARK  
PRINCIPAL REGISTER**

**lemonlot.org**

ASKME GRAPHICS, LLC (NEW MEXICO LTD  
LIAB CO), DBA LOS ALAMOS LEMON LOT  
116 AZTEC AVENUE  
LOS ALAMOS, NM 87544

THE MARK CONSISTS OF STANDARD CHAR-  
ACTERS WITHOUT CLAIM TO ANY PARTICULAR  
FONT, STYLE, SIZE, OR COLOR.

FOR: PROVIDING USED CAR SALES LEADS  
FOR OTHERS, IN CLASS 35 (U.S. CLS. 100, 101  
AND 102).

SER. NO. 77-332,463, FILED 11-18-2007.

FIRST USE 11-8-2004; IN COMMERCE 12-0-2006.

EDWARD NELSON, EXAMINING ATTORNEY

**Int. Cl.: 3**

**Prior U.S. Cls.: 1, 4, 6, 50, 51 and 52**

**Reg. No. 3,466,920**

**United States Patent and Trademark Office**

**Registered July 15, 2008**

**TRADEMARK  
PRINCIPAL REGISTER**



URSULA'S ABOUT PHACE (PENNSYLVANIA  
LTD LIAB CO)  
1700 SANSOM ST., SUITE 201  
PHILADELPHIA, PA 19103

FIRST USE 4-28-2007; IN COMMERCE 4-28-2007.

FOR: BEAUTY CREAMS; BEAUTY CREAMS FOR  
BODY CARE; BEAUTY GELS; BEAUTY LOTIONS;  
BEAUTY MASKS; BEAUTY MILKS; BEAUTY SER-  
UMS; BODY AND BEAUTY CARE COSMETICS;  
FACE AND BODY BEAUTY CREAMS; FACIAL  
BEAUTY MASKS, IN CLASS 3 (U.S. CLS. 1, 4, 6, 50,  
51 AND 52).

THE MARK CONSISTS OF THE FRIUT POD OF A  
LOTUS FLOWER.

SER. NO. 77-332,487, FILED 11-18-2007.

JOHN WILKE, EXAMINING ATTORNEY

**Int. Cl.: 36**

**Prior U.S. Cls.: 100, 101 and 102**

**United States Patent and Trademark Office**

**Reg. No. 3,466,921**

**Registered July 15, 2008**

**SERVICE MARK  
PRINCIPAL REGISTER**

**33RD COMPANY**

33RD COMPANY, INC. (MINNESOTA CORPORATION)

10451 GLEN EAGLE CIRCLE

WOODBURY, MN 55129

FOR: REAL ESTATE AGENCIES, IN CLASS 36  
(U.S. CLS. 100, 101 AND 102).

FIRST USE 9-21-2002; IN COMMERCE 9-21-2002.

THE MARK CONSISTS OF STANDARD CHARACTERS WITHOUT CLAIM TO ANY PARTICULAR FONT, STYLE, SIZE, OR COLOR.

NO CLAIM IS MADE TO THE EXCLUSIVE RIGHT TO USE "COMPANY", APART FROM THE MARK AS SHOWN.

SER. NO. 77-332,495, FILED 11-18-2007.

LOURDES AYALA, EXAMINING ATTORNEY



**Int. Cl.: 9**

**Prior U.S. Cls.: 21, 23, 26, 36 and 38**

**Reg. No. 3,466,922**

**United States Patent and Trademark Office**

**Registered July 15, 2008**

---

**TRADEMARK  
PRINCIPAL REGISTER**

**PHX-KEYPLUS**

PHOENIX SOFTWARE INTERNATIONAL, INC.  
(CALIFORNIA CORPORATION)  
SUITE 800  
5200 WEST CENTURY BOULEVARD  
LOS ANGELES, CA 90045

THE MARK CONSISTS OF STANDARD CHAR-  
ACTERS WITHOUT CLAIM TO ANY PARTICULAR  
FONT, STYLE, SIZE, OR COLOR.

FOR: COMPUTER SOFTWARE FOR DATA AND  
IMAGE ENTRY, IN CLASS 9 (U.S. CLS. 21, 23, 26, 36  
AND 38).

SER. NO. 77-332,507, FILED 11-18-2007.

FIRST USE 10-1-2007; IN COMMERCE 10-1-2007.

MARK T. MULLEN, EXAMINING ATTORNEY

**Int. Cl.: 35**

**Prior U.S. Cls.: 100, 101 and 102**

**United States Patent and Trademark Office**

**Reg. No. 3,466,923**

**Registered July 15, 2008**

**SERVICE MARK  
PRINCIPAL REGISTER**



PROFESSIONAL RESOURCE GROUP, INC.  
(MASSACHUSETTS CORPORATION)  
STE 1409  
20 PARK PLAZA  
BOSTON, MA 02116

FOR: EMPLOYMENT AGENCIES; EMPLOY-  
MENT HIRING, RECRUITING, PLACEMENT,  
STAFFING AND CAREER NETWORKING SERVI-  
CES; TEMPORARY EMPLOYMENT AGENCIES, IN  
CLASS 35 (U.S. CLS. 100, 101 AND 102).

FIRST USE 1-1-1985; IN COMMERCE 1-1-1985.

THE COLOR(S) BLACK AND RED IS/ARE  
CLAIMED AS A FEATURE OF THE MARK.

THE MARK CONSISTS OF THE WORD "FAN-  
NING" IN BLACK ALONGSIDE A RED CIRCLE.

SER. NO. 77-332,509, FILED 11-18-2007.

DAVID YONTEF, EXAMINING ATTORNEY

**Int. Cl.: 36**

**Prior U.S. Cls.: 100, 101 and 102**

**United States Patent and Trademark Office**

**Reg. No. 3,466,924**

**Registered July 15, 2008**

**SERVICE MARK  
PRINCIPAL REGISTER**

**DIESEL**

CASSADAY, STEPHAN Q. (UNITED STATES IN-  
DIVIDUAL)  
8180 GREENSBORO DR., SUITE 1180  
MCLEAN, VA 22102

THE MARK CONSISTS OF STANDARD CHAR-  
ACTERS WITHOUT CLAIM TO ANY PARTICULAR  
FONT, STYLE, SIZE, OR COLOR.

FOR: FINANCIAL SERVICES, NAMELY, RE-  
TIREMENT FUNDING FINANCING AND MAN-  
AGEMENT SERVICES, IN CLASS 36 (U.S. CLS. 100,  
101 AND 102).

SER. NO. 77-332,519, FILED 11-18-2007.

FIRST USE 1-1-2006; IN COMMERCE 1-1-2006.

DANNEAN HETZEL, EXAMINING ATTORNEY

Int. Cl.: 25

Prior U.S. Cls.: 22 and 39

United States Patent and Trademark Office

Reg. No. 3,466,925

Registered July 15, 2008

TRADEMARK  
PRINCIPAL REGISTER



TURNER III, WOODROW WILSON (UNITED STATES INDIVIDUAL)  
SUITE 205  
8812 W. PICO BLVD.  
LOS ANGELES, CA 90035

FOR: ASCOTS; BELTS; BLOUSES; CAPS; DENIM JACKETS; DENIMS; DRESS SHIRTS; DRESS SUITS; DRESSES; FOOTWEAR; HEAD WEAR; JACKETS; JOGGING SUITS; KNIT SHIRTS; LEATHER BELTS; LOUNGEWEAR; MEN'S SUITS; NECKWEAR; PANTS; POCKET SQUARES; POLO SHIRTS; SHIRTS; SHORTS; SKIRTS; SMOKING JACKETS; SOCKS; SUITS; SUITS OF LEATHER; SWEAT SUITS;

T-SHIRTS; TIES; TOPS; TUXEDOS; UNDERGARMENTS; WALKING SHORTS; LADIES' SUITS, IN CLASS 25 (U.S. CLS. 22 AND 39).

FIRST USE 12-20-1997; IN COMMERCE 1-1-1998.

THE MARK CONSISTS OF TWO LETTERS "WW" IN CURSIVE STYLE WITH A SHADOW, ADJACENT TO EACH OTHER AND ONE SLIGHTLY LOWER.

SER. NO. 77-332,541, FILED 11-18-2007.

HOWARD SMIGA, EXAMINING ATTORNEY

**Int. Cl.: 41**

**Prior U.S. Cls.: 100, 101 and 107**

**United States Patent and Trademark Office**

**Reg. No. 3,466,926**

**Registered July 15, 2008**

**SERVICE MARK  
PRINCIPAL REGISTER**

**Life Mastery Ministries**

LIFE MASTERY MINISTRIES, INCORPORATED  
(PENNSYLVANIA CORPORATION)

603 BRADDOCK AVE

TURTLE CREEK, PA 15145

FOR: RELIGIOUS INSTRUCTION SERVICES, IN  
CLASS 41 (U.S. CLS. 100, 101 AND 107).

FIRST USE 1-1-2005; IN COMMERCE 1-1-2005.

THE MARK CONSISTS OF STANDARD CHAR-  
ACTERS WITHOUT CLAIM TO ANY PARTICULAR  
FONT, STYLE, SIZE, OR COLOR.

NO CLAIM IS MADE TO THE EXCLUSIVE  
RIGHT TO USE "MINISTRIES", APART FROM  
THE MARK AS SHOWN.

SER. NO. 77-332,543, FILED 11-18-2007.

HOWARD SMIGA, EXAMINING ATTORNEY

**Int. Cl.: 41**

**Prior U.S. Cls.: 100, 101 and 107**

**United States Patent and Trademark Office**

**Reg. No. 3,466,927**

**Registered July 15, 2008**

**SERVICE MARK  
PRINCIPAL REGISTER**

**Making every child a star!**

KIDDYKEYS LLC (WISCONSIN LTD LIAB CO)  
3967 LEANNA LANE  
GREEN BAY, WI 54311

FOR: EDUCATION SERVICES, NAMELY, PROVIDING EARLY CHILDHOOD AND KINDERGARTEN MUSIC CLASSES AND DISTRIBUTING COURSE MATERIALS IN CONNECTION THEREWITH IN THE FIELD OF MUSIC , IN CLASS 41 (U.S. CLS. 100, 101 AND 107).

FIRST USE 9-4-2004; IN COMMERCE 9-4-2004.

THE MARK CONSISTS OF STANDARD CHARACTERS WITHOUT CLAIM TO ANY PARTICULAR FONT, STYLE, SIZE, OR COLOR.

SER. NO. 77-332,554, FILED 11-18-2007.

ROBERT LAVACHE, EXAMINING ATTORNEY

**Int. Cl.: 5**

**Prior U.S. Cls.: 6, 18, 44, 46, 51 and 52**

**Reg. No. 3,466,928**

**United States Patent and Trademark Office**

**Registered July 15, 2008**

---

**TRADEMARK  
PRINCIPAL REGISTER**

# Cruise Control

LIFE UNLIMITED LLC (DELAWARE LTD LIAB  
CO)  
2602 NORTHWOOD DRIVE  
SAN JOSE, CA 95132

THE MARK CONSISTS OF STANDARD CHAR-  
ACTERS WITHOUT CLAIM TO ANY PARTICULAR  
FONT, STYLE, SIZE, OR COLOR.

FOR: DIETARY SUPPLEMENTS, IN CLASS 5 (U.S.  
CLS. 6, 18, 44, 46, 51 AND 52).

SER. NO. 77-332,564, FILED 11-18-2007.

FIRST USE 2-1-2003; IN COMMERCE 2-1-2003.

BONNIE LUKEN, EXAMINING ATTORNEY

**Int. Cl.: 35**

**Prior U.S. Cls.: 100, 101 and 102**

**United States Patent and Trademark Office**

**Reg. No. 3,466,929**

**Registered July 15, 2008**

**SERVICE MARK  
PRINCIPAL REGISTER**

**Jolly Green Hydroponics**

JOLLY GREEN HYDROPONICS, LLC (TEXAS  
LTD LIAB CO)  
13628 NEUTRON RD.  
FARMERS BRANCH, TX 75244

FOR: ON-LINE RETAIL STORE SERVICES FEATURING HYDROPONIC GREENHOUSE HORTICULTURAL SUPPLIES; RETAIL HYDROPONIC GREENHOUSE HORTICULTURAL SUPPLIES STORES, IN CLASS 35 (U.S. CLS. 100, 101 AND 102).

FIRST USE 11-18-2007; IN COMMERCE 11-18-2007.

THE MARK CONSISTS OF STANDARD CHARACTERS WITHOUT CLAIM TO ANY PARTICULAR FONT, STYLE, SIZE, OR COLOR.

NO CLAIM IS MADE TO THE EXCLUSIVE RIGHT TO USE "HYDROPONICS", APART FROM THE MARK AS SHOWN.

SER. NO. 77-332,582, FILED 11-18-2007.

JAMES LOVELACE, EXAMINING ATTORNEY



**Int. Cl.: 35**

**Prior U.S. Cls.: 100, 101 and 102**

**United States Patent and Trademark Office**

**Reg. No. 3,466,930**

**Registered July 15, 2008**

**SERVICE MARK  
PRINCIPAL REGISTER**



HARDACRE GROUP LLC (OHIO LTD LIAB CO),  
DBA HARDACRE CONSULTING  
SUITE 125  
251 WEST CENTRAL AVE.  
SPRINGBORO, OH 45066

FOR: BUSINESS CONSULTATION; BUSINESS CONSULTATION SERVICES; BUSINESS CONSULTING AND BUSINESS INFORMATION FOR ENTERPRISES; BUSINESS CONSULTING AND INFORMATION SERVICES; BUSINESS CONSULTING SERVICES RELATING TO PRODUCT DISTRIBUTION, OPERATIONS MANAGEMENT SERVICES, LOGISTICS, REVERSE LOGISTICS, SUPPLY CHAIN, AND PRODUCTION SYSTEMS AND DISTRIBUTION SOLUTIONS; BUSINESS CONSULTING, INQUIRIES OR INFORMATION; BUSINESS CONSULTING, MANAGEMENT, PLANNING AND SUPERVISION; PROFESSIONAL BUSINESS CONSULTATION, IN CLASS 35 (U.S. CLS. 100, 101 AND 102).

FIRST USE 11-1-2007; IN COMMERCE 11-7-2007.

NO CLAIM IS MADE TO THE EXCLUSIVE RIGHT TO USE "CONSULTING", APART FROM THE MARK AS SHOWN.

THE COLOR(S) BLACK, BLUE, ORANGE IS/ARE CLAIMED AS A FEATURE OF THE MARK.

THE MARK CONSISTS OF A STYLIZED "HC" WITH THE LETTER "H" IN ORANGE AND THE LETTER "C" IN BLUE, TO THE LEFT OF THE STACKED WORDING "HARDACRE" IN ORANGE AND "CONSULTING" IN BLUE ALL ON A BLACK BACKGROUND.

SER. NO. 77-332,588, FILED 11-18-2007.

JAMES LOVELACE, EXAMINING ATTORNEY

**Int. Cl.: 38**

**Prior U.S. Cls.: 100, 101 and 104**

**United States Patent and Trademark Office**

**Reg. No. 3,466,931**

**Registered July 15, 2008**

**SERVICE MARK  
PRINCIPAL REGISTER**

**MYTVPAL**

BB ENTERTAINMENT LLC (DELAWARE LTD  
LIAB CO)  
P.O. BOX 34062  
SAN FRANCISCO, CA 941340062

FOR: COMMUNICATIONS SERVICES, NAMELY,  
TRANSMITTING STREAMED SOUND AND  
AUDIO-VISUAL RECORDINGS VIA THE INTER-  
NET; STREAMING OF AUDIO MATERIAL ON THE  
INTERNET; STREAMING OF VIDEO MATERIAL  
ON THE INTERNET, IN CLASS 38 (U.S. CLS. 100, 101  
AND 104).

FIRST USE 7-21-2006; IN COMMERCE 7-21-2006.

THE MARK CONSISTS OF STANDARD CHAR-  
ACTERS WITHOUT CLAIM TO ANY PARTICULAR  
FONT, STYLE, SIZE, OR COLOR.

SER. NO. 77-332,612, FILED 11-19-2007.

STEPHEN AQUILA, EXAMINING ATTORNEY

**Int. Cl.: 10**

**Prior U.S. Cls.: 26, 39 and 44**

**Reg. No. 3,466,932**

**United States Patent and Trademark Office**

**Registered July 15, 2008**

---

**TRADEMARK  
PRINCIPAL REGISTER**

**UNI-GRIPAR**

DENTSPLY INTERNATIONAL INC. (DELA-  
WARE CORPORATION)  
221 WEST PHILADELPHIA STREET  
YORK, PA 174050872

FOR: X-RAY APPLIANCES FOR DENTAL AND  
MEDICAL USE, IN CLASS 10 (U.S. CLS. 26, 39 AND  
44).

FIRST USE 5-30-2007; IN COMMERCE 5-30-2007.

THE MARK CONSISTS OF STANDARD CHAR-  
ACTERS WITHOUT CLAIM TO ANY PARTICULAR  
FONT, STYLE, SIZE, OR COLOR.

OWNER OF U.S. REG. NO. 3,306,355.

SER. NO. 77-332,662, FILED 11-19-2007.

AMY ALFIERI, EXAMINING ATTORNEY

**Int. Cl.: 42**

**Prior U.S. Cls.: 100 and 101**

**United States Patent and Trademark Office**

**Reg. No. 3,466,933**

**Registered July 15, 2008**

**SERVICE MARK  
PRINCIPAL REGISTER**

**RADICAL SUPPORT**

ON-LINE NETWORK SERVICES, INC. (GEORGIA CORPORATION), DBA RADICAL SUPPORT  
SUITE 201  
585 COLONIAL PARK DRIVE  
ROSWELL, GA 30075

FOR: INFORMATION TECHNOLOGY CONSULTATION, IN CLASS 42 (U.S. CLS. 100 AND 101).

FIRST USE 12-1-2002; IN COMMERCE 12-1-2002.

THE MARK CONSISTS OF STANDARD CHARACTERS WITHOUT CLAIM TO ANY PARTICULAR FONT, STYLE, SIZE, OR COLOR.

NO CLAIM IS MADE TO THE EXCLUSIVE RIGHT TO USE "SUPPORT", APART FROM THE MARK AS SHOWN.

SER. NO. 77-332,667, FILED 11-19-2007.

TEJBIR SINGH, EXAMINING ATTORNEY

**Int. Cl.: 35**

**Prior U.S. Cls.: 100, 101 and 102**

**United States Patent and Trademark Office**

**Reg. No. 3,466,934**

**Registered July 15, 2008**

**SERVICE MARK  
PRINCIPAL REGISTER**

# Executegic

HALL, CARL L. JR. (UNITED STATES INDIVIDUAL), DBA CHUCK HALL  
35 CEDAR CREST CT  
DOYLESTOWN, PA 18901

FOR: ADVERTISING AND MARKETING; ADVERTISING SERVICES, PUBLIC RELATIONS AND MARKETING SERVICES, NAMELY, PROMOTING AND MARKETING THE GOODS AND SERVICES OF OTHERS THROUGH ALL PUBLIC COMMUNICATION MEANS; ADVICE IN THE FIELD OF BUSINESS MANAGEMENT AND MARKETING; BUSINESS CONSULTATION AND MANAGEMENT REGARDING MARKETING ACTIVITIES AND LAUNCHING OF NEW PRODUCTS; BUSINESS MARKETING CONSULTING SERVICES; CREATION OF MARKETING TOOLS DESIGNED TO INCREASE A CLIENT COMPANY'S KNOWLEDGE

OF CUSTOMER NEEDS, AND ITS COMPETITORS' PRODUCTS AND SERVICES, PRICING, ADVERTISING STRATEGY AND SALES STRATEGY; DEVELOPMENT OF MARKETING STRATEGIES AND CONCEPTS; GENERAL BUSINESS MERCHANDISING SERVICES, NAMELY, MARKETING, IN CLASS 35 (U.S. CLS. 100, 101 AND 102).

FIRST USE 11-14-2007; IN COMMERCE 11-19-2007.

THE MARK CONSISTS OF STANDARD CHARACTERS WITHOUT CLAIM TO ANY PARTICULAR FONT, STYLE, SIZE, OR COLOR.

SER. NO. 77-332,709, FILED 11-19-2007.

ANDREA SAUNDERS, EXAMINING ATTORNEY

**Int. Cl.: 42**

**Prior U.S. Cls.: 100 and 101**

**United States Patent and Trademark Office**

**Reg. No. 3,466,935**

**Registered July 15, 2008**

**SERVICE MARK  
PRINCIPAL REGISTER**



ON-LINE NETWORK SERVICES, INC. (GEORGIA CORPORATION), DBA RADICAL SUPPORT

SUITE 201  
585 COLONIAL PARK DRIVE  
ROSWELL, GA 30075

FOR: INFORMATION TECHNOLOGY CONSULTATION, IN CLASS 42 (U.S. CLS. 100 AND 101).

FIRST USE 12-1-2002; IN COMMERCE 12-1-2002.

NO CLAIM IS MADE TO THE EXCLUSIVE RIGHT TO USE "SUPPORT", APART FROM THE MARK AS SHOWN.

THE COLOR(S) DARK BLUE, LIGHT BLUE, WHITE, AND RED IS/ARE CLAIMED AS A FEATURE OF THE MARK.

THE MARK CONSISTS OF THE TERM "RADICAL SUPPORT" WITH A BULLS EYE AND LIGHTNING BOLT IN BETWEEN THE TERM "RADICAL" AND "SUPPORT". THE TERM "RADICAL SUPPORT" IS IN DARK BLUE, THE BULLS EYE IS IN LIGHT BLUE AND WHITE, AND THE LIGHTING BOLT IS RED.

SER. NO. 77-332,716, FILED 11-19-2007.

TEJBIR SINGH, EXAMINING ATTORNEY

**Int. Cl.: 12**

**Prior U.S. Cls.: 19, 21, 23, 31, 35 and 44**

**United States Patent and Trademark Office**

**Reg. No. 3,466,936**

**Registered July 15, 2008**

**TRADEMARK  
PRINCIPAL REGISTER**

The Happ<sup>e</sup>seat

SCOTT FARRELL MEDIA, LLC (FLORIDA LTD  
LIAB CO)  
2209 E. 5TH AVENUE  
TAMPA, FL 33605

THE MARK CONSISTS OF THE TERM "THE  
HAPPESEAT", WITH A STYLIZED LOWERCASE "E"  
IN THE TERM "HAPPE" THAT CONTAINS TWO  
DOTS FOR EYES.

FOR: VEHICLE SEAT COVERS, NAMELY, TO-  
WEL MATERIAL THAT FITS AROUND AUTOMO-  
BILE SEATS, IN CLASS 12 (U.S. CLS. 19, 21, 23, 31, 35  
AND 44).

SER. NO. 77-332,738, FILED 11-19-2007.

FIRST USE 10-10-2007; IN COMMERCE 10-10-2007.

BILL DAWE, EXAMINING ATTORNEY

**Int. Cl.: 44**

**Prior U.S. Cls.: 100 and 101**

**United States Patent and Trademark Office**

**Reg. No. 3,466,937**

**Registered July 15, 2008**

**SERVICE MARK  
PRINCIPAL REGISTER**

**IDATS**

YELLOW COURTYARD, LLC (FLORIDA LTD  
LIAB CO)  
1688 MERIDIAN AVENUE, 10TH FLOOR  
MIAMI BEACH, FL 33139

FOR: HEALTHCARE SERVICES, NAMELY, PRO-  
VIDING MEDICAL CONSULTATIONS THROUGH  
A NETWORK OF COLLABORATIVE HEALTH  
CARE PROFESSIONALS FOR CLIENTS, IN CLASS  
44 (U.S. CLS. 100 AND 101).

FIRST USE 5-31-2007; IN COMMERCE 5-31-2007.

THE MARK CONSISTS OF STANDARD CHAR-  
ACTERS WITHOUT CLAIM TO ANY PARTICULAR  
FONT, STYLE, SIZE, OR COLOR.

SER. NO. 77-332,742, FILED 11-19-2007.

INGRID C. EULIN, EXAMINING ATTORNEY



**Int. Cl.: 35**

**Prior U.S. Cls.: 100, 101 and 102**

**United States Patent and Trademark Office**

**Reg. No. 3,466,938**

**Registered July 15, 2008**

**SERVICE MARK  
PRINCIPAL REGISTER**



ONTHESIDE INC. (GEORGIA CORPORATION)  
530 MEANS STREET NW, SUITE 150  
ATLANTA, GA 30318

FOR: BUSINESS SERVICES, NAMELY, PROVIDING COMPUTER DATABASES REGARDING THE PURCHASE AND SALE OF A WIDE VARIETY OF PRODUCTS AND SERVICES OF OTHERS, IN CLASS 35 (U.S. CLS. 100, 101 AND 102).

FIRST USE 10-1-2007; IN COMMERCE 10-1-2007.

NO CLAIM IS MADE TO THE EXCLUSIVE RIGHT TO USE ".COM", APART FROM THE MARK AS SHOWN.

THE MARK CONSISTS OF THE LITERAL ELEMENTS OF THE WORDS "ONTHESIDE.COM" WHEREIN THE WORD "SIDE" IS ALIGNED PERPENDICULAR TO THE ALIGNMENT OF THE OTHER WORDS.

SER. NO. 77-332,750, FILED 11-19-2007.

ANDREA SAUNDERS, EXAMINING ATTORNEY

**Int. Cl.: 9**

**Prior U.S. Cls.: 21, 23, 26, 36 and 38**

**Reg. No. 3,466,939**

**United States Patent and Trademark Office**

**Registered July 15, 2008**

---

**TRADEMARK  
PRINCIPAL REGISTER**

**NEGEVTECH**

NEGEVTECH, LTD. (ISRAEL CORPORATION)  
12 HAMADA STREET  
REHOVOT, ISRAEL 76703

FIRST USE 5-31-2001; IN COMMERCE 12-5-2002.

FOR: OPTICAL INSPECTION APPARATUS FOR  
INSPECTION OF SEMICONDUCTOR MATERIALS,  
NAMELY, SEMICONDUCTOR WAFERS, RETI-  
CLES, AND PHOTOMASKS, IN CLASS 9 (U.S. CLS.  
21, 23, 26, 36 AND 38).

THE MARK CONSISTS OF STANDARD CHAR-  
ACTERS WITHOUT CLAIM TO ANY PARTICULAR  
FONT, STYLE, SIZE, OR COLOR.

SER. NO. 77-332,770, FILED 11-19-2007.

LINDA ORNDORFF, EXAMINING ATTORNEY

**Int. Cl.: 43**

**Prior U.S. Cls.: 100 and 101**

**United States Patent and Trademark Office**

**Reg. No. 3,466,940**

**Registered July 15, 2008**

**SERVICE MARK  
PRINCIPAL REGISTER**

**UNEXPECTED COMFORTS ON THE  
ROAD**

MARRIOTT INTERNATIONAL, INC. (DELA-  
WARE CORPORATION)  
10400 FERNWOOD ROAD  
BETHESDA, MD 20817

FOR: HOTEL SERVICES; RESTAURANT SERVI-  
CES; PROVISION OF GENERAL PURPOSE FACIL-  
ITIES IN HOTELS FOR MEETINGS,  
CONFERENCES AND EXHIBITIONS; PROVISION  
OF BANQUET AND SOCIAL FUNCTION FACIL-  
ITIES IN HOTELS FOR SPECIAL OCCASIONS; AND  
RESERVATION SERVICES FOR HOTEL ACCOM-

MODATIONS FOR OTHERS, IN CLASS 43 (U.S. CLS.  
100 AND 101).

FIRST USE 3-6-2007; IN COMMERCE 3-6-2007.

THE MARK CONSISTS OF STANDARD CHAR-  
ACTERS WITHOUT CLAIM TO ANY PARTICULAR  
FONT, STYLE, SIZE, OR COLOR.

SER. NO. 77-332,776, FILED 11-19-2007.

NATALIE POLZER, EXAMINING ATTORNEY

**Int. Cl.: 36**

**Prior U.S. Cls.: 100, 101 and 102**

**United States Patent and Trademark Office**

**Reg. No. 3,466,941**

**Registered July 15, 2008**

**SERVICE MARK  
PRINCIPAL REGISTER**

**OZAUKEE BANK**

OZAUKEE BANK (WISCONSIN CORPORATION)  
W62 N209 WASHINGTON AVE.  
CEDARBURG, WI 53012

FOR: BANKING SERVICES, IN CLASS 36 (U.S.  
CLS. 100, 101 AND 102).

FIRST USE 12-31-1992; IN COMMERCE 12-31-1992.

THE MARK CONSISTS OF STANDARD CHAR-  
ACTERS WITHOUT CLAIM TO ANY PARTICULAR  
FONT, STYLE, SIZE, OR COLOR.

NO CLAIM IS MADE TO THE EXCLUSIVE  
RIGHT TO USE "BANK", APART FROM THE  
MARK AS SHOWN.

SEC. 2(F).

SER. NO. 77-332,780, FILED 11-19-2007.

JOHN WILKE, EXAMINING ATTORNEY

**Int. Cl.: 33**

**Prior U.S. Cls.: 47 and 49**

**United States Patent and Trademark Office**

**Reg. No. 3,466,942**

**Registered July 15, 2008**

**TRADEMARK  
PRINCIPAL REGISTER**

**ALCYONE**

PABLO FALLABRINO (URUGUAY INDIVIDUAL)  
RUTA 1, KM. 162  
CANELONES, URUGUAY

THE MARK CONSISTS OF STANDARD CHARACTERS WITHOUT CLAIM TO ANY PARTICULAR FONT, STYLE, SIZE, OR COLOR.

FOR: WINES, IN CLASS 33 (U.S. CLS. 47 AND 49).

SER. NO. 77-332,854, FILED 11-19-2007.

FIRST USE 11-1-2003; IN COMMERCE 11-1-2003.

KATHERINE STOIDES, EXAMINING ATTORNEY

Int. Cl.: 35

Prior U.S. Cls.: 100, 101 and 102

United States Patent and Trademark Office

Reg. No. 3,466,943

Registered July 15, 2008

**SERVICE MARK  
PRINCIPAL REGISTER**



LITTLE BIG MOUSE, LLC (NEVADA LTD LIAB  
CO)  
2511 N. HAYDEN ISLAND DR  
PORTLAND, OR 97217

FOR: ON-LINE RETAIL STORE SERVICES FEATURING NEW AND REPLACEMENT METAL, NON-METAL VINYL AND WOOD WINDOWS, DOORS AND REPLACEMENT GLASS; RETAIL STORE SERVICES FEATURING NEW AND REPLACEMENT METAL, NON-METAL VINYL AND WOOD WINDOWS, DOORS AND REPLACEMENT GLASS, IN CLASS 35 (U.S. CLS. 100, 101 AND 102).

FIRST USE 4-29-2007; IN COMMERCE 4-29-2007.

NO CLAIM IS MADE TO THE EXCLUSIVE RIGHT TO USE "WINDOW COMPANY", APART FROM THE MARK AS SHOWN.

THE MARK CONSISTS OF LOGO CONSIST OF A HALF ROUND WINDOW WITH SUN BURST GRID PATTERN. "YOUR WINDOW COMPANY" ARCHED ABOVE THE WINDOW FROM LEFT TO RIGHT. "DOING THE RIGHT THING" BELOW AND ACROSS THE ENTIRE WIDTH OF THE WINDOW.

SER. NO. 77-332,861, FILED 11-19-2007.

KATHERINE STOIDES, EXAMINING ATTORNEY

**Int. Cl.: 44**

**Prior U.S. Cls.: 100 and 101**

**United States Patent and Trademark Office**

**Reg. No. 3,466,944**

**Registered July 15, 2008**

**SERVICE MARK  
PRINCIPAL REGISTER**

Come see who you've been  
waiting for.

MIRACLE MOMENT IMAGING, INC. (MINNE-  
SOTA CORPORATION)  
931 MADISON AVENUE  
MANKATO, MN 56001

THE MARK CONSISTS OF STANDARD CHAR-  
ACTERS WITHOUT CLAIM TO ANY PARTICULAR  
FONT, STYLE, SIZE, OR COLOR.

FOR: MEDICAL IMAGING SERVICES, IN CLASS  
44 (U.S. CLS. 100 AND 101).

SER. NO. 77-332,862, FILED 11-19-2007.

FIRST USE 9-27-2007; IN COMMERCE 9-27-2007.

KRISTIN DAHLING, EXAMINING ATTORNEY

**Int. Cl.: 5**

**Prior U.S. Cls.: 6, 18, 44, 46, 51 and 52**

**United States Patent and Trademark Office**

**Reg. No. 3,466,945**

**Registered July 15, 2008**

**TRADEMARK  
PRINCIPAL REGISTER**

# Hemodraulix

AXIS LABS, INC. (COLORADO CORPORATION)  
12835 E ARAPAHOE ROAD TOWER ONE STE 450  
CENTENNIAL, CO 80112

THE MARK CONSISTS OF STANDARD CHAR-  
ACTERS WITHOUT CLAIM TO ANY PARTICULAR  
FONT, STYLE, SIZE, OR COLOR.

FOR: DIETARY FOOD SUPPLEMENTS, IN CLASS  
5 (U.S. CLS. 6, 18, 44, 46, 51 AND 52).

SER. NO. 77-332,889, FILED 11-19-2007.

FIRST USE 11-19-2007; IN COMMERCE 11-19-2007.

KATHERINE STOIDES, EXAMINING ATTORNEY



**Int. Cl.: 36**

**Prior U.S. Cls.: 100, 101 and 102**

**United States Patent and Trademark Office**

**Reg. No. 3,466,946**

**Registered July 15, 2008**

**SERVICE MARK  
PRINCIPAL REGISTER**

**VMG**  
**PARTNERS**

VMG EQUITY PARTNERS, LLC (DELAWARE  
LTD LIAB CO)  
55 FRANCISCO STREET, SUITE 400  
SAN FRANCISCO, CA 94133

FOR: INVESTMENT ADVISORY SERVICES; VENTURE CAPITAL SERVICES, NAMELY, PROVIDING FINANCING TO EMERGING AND START-UP COMPANIES AND PROVIDING MEZZANINE AND SENIOR DEBT FINANCING; PRIVATE EQUITY FUND INVESTMENT SERVICES, IN CLASS 36 (U.S. CLS. 100, 101 AND 102).

FIRST USE 9-28-2007; IN COMMERCE 9-28-2007.

THE MARK CONSISTS OF STANDARD CHARACTERS WITHOUT CLAIM TO ANY PARTICULAR FONT, STYLE, SIZE, OR COLOR.

NO CLAIM IS MADE TO THE EXCLUSIVE RIGHT TO USE "PARTNERS", APART FROM THE MARK AS SHOWN.

SER. NO. 77-332,902, FILED 11-19-2007.

DOMINICK J. SALEMI, EXAMINING ATTORNEY

**Int. Cl.: 12**

**Prior U.S. Cls.: 19, 21, 23, 31, 35 and 44**

**Reg. No. 3,466,947**

**United States Patent and Trademark Office**

**Registered July 15, 2008**

**TRADEMARK  
PRINCIPAL REGISTER**



LIUZHOU WULING MOTORS CO., LTD. (CHINA CORPORATION)  
NO.18, HEXI ROAD, LIUZHOU  
GUANGXI, CHINA

FIRST USE 4-0-1987; IN COMMERCE 11-0-1997.

THE MARK CONSISTS OF FIVE RHOMBUSES IN THE FORM OF A "W".

FOR: AUTOMOBILES; TRACTORS; ELECTRIC CARS; REFRIGERATED TRAILERS; COACHES; MOTOR HOMES; AUTOMOBILE CHASSIS; AUTOMOBILE BODIES; VANS; MOTORS FOR AUTOMOBILES; MOTORCYCLES; AMBULANCES, IN CLASS 12 (U.S. CLS. 19, 21, 23, 31, 35 AND 44).

SER. NO. 77-332,913, FILED 11-19-2007.

MARTHA FROMM, EXAMINING ATTORNEY

**Int. Cl.: 45**

**Prior U.S. Cls.: 100 and 101**

**United States Patent and Trademark Office**

**Reg. No. 3,466,948**

**Registered July 15, 2008**

**SERVICE MARK  
PRINCIPAL REGISTER**

**P.A.W.S. PET ALERT WARNING  
SYSTEM**

GLOBAL PET SEARCH INC. (NEVADA COR-  
PORATION)  
SUITE F  
5795 S. SANDHILL RD.  
LAS VEGAS, NV 891202558

FOR: ASSISTING IN THE LOCATING LOST PETS,  
IN CLASS 45 (U.S. CLS. 100 AND 101).

FIRST USE 5-15-2007; IN COMMERCE 9-1-2007.

THE MARK CONSISTS OF STANDARD CHAR-  
ACTERS WITHOUT CLAIM TO ANY PARTICULAR  
FONT, STYLE, SIZE, OR COLOR.

NO CLAIM IS MADE TO THE EXCLUSIVE  
RIGHT TO USE "PET ALERT WARNING SYSTEM",  
APART FROM THE MARK AS SHOWN.

SER. NO. 77-332,923, FILED 11-19-2007.

ASMAT KHAN, EXAMINING ATTORNEY

**Int. Cl.: 16**

**Prior U.S. Cls.: 2, 5, 22, 23, 29, 37, 38 and 50**

**Reg. No. 3,466,949**

**United States Patent and Trademark Office**

**Registered July 15, 2008**

**TRADEMARK  
PRINCIPAL REGISTER**

**HOPAX**

TAIWAN HOPAX CHEMICALS MFG. CO., LTD.  
(TAIWAN CORPORATION)  
NO. 28, HUA DONG ROAD  
KAOHSIUNG COUNTY  
DALIAO TOWNSHIP, TAIWAN

FIRST USE 1-1-1974; IN COMMERCE 1-1-1997.

FOR: MEMO PADS, WRITING PAPER PADS,  
NOTEPAPERS; NOTE PADS; BOOKMARKERS; IN-  
DEX CARDS; SELF-ADHESIVE NOTE PADS; AD-  
HESIVE TAPES FOR STATIONERY AND  
HOUSEHOLD PURPOSES; PAPER LABELS; MARK-  
ING TABS; SELF-ADHESIVE PAPER LABELS, IN  
CLASS 16 (U.S. CLS. 2, 5, 22, 23, 29, 37, 38 AND 50).

THE MARK CONSISTS OF STANDARD CHAR-  
ACTERS WITHOUT CLAIM TO ANY PARTICULAR  
FONT, STYLE, SIZE, OR COLOR.

SER. NO. 77-332,927, FILED 11-19-2007.

MATTHEW MCDOWELL, EXAMINING ATTOR-  
NEY

**Int. Cl.: 45**

**Prior U.S. Cls.: 100 and 101**

**United States Patent and Trademark Office**

**Reg. No. 3,466,950**

**Registered July 15, 2008**

**SERVICE MARK  
PRINCIPAL REGISTER**

# PAWS ALERT

GLOBAL PET SEARCH INC. (NEVADA CORPORATION)  
SUITE F  
5795 S. SANDHILL RD.  
LAS VEGAS, NV 891202558

FOR: ASSISTING IN THE LOCATING LOST PETS,  
IN CLASS 45 (U.S. CLS. 100 AND 101).

FIRST USE 5-15-2007; IN COMMERCE 9-1-2007.

THE MARK CONSISTS OF STANDARD CHARACTERS WITHOUT CLAIM TO ANY PARTICULAR FONT, STYLE, SIZE, OR COLOR.

NO CLAIM IS MADE TO THE EXCLUSIVE RIGHT TO USE "ALERT", APART FROM THE MARK AS SHOWN.

SER. NO. 77-332,933, FILED 11-19-2007.

ASMAT KHAN, EXAMINING ATTORNEY

**Int. Cl.: 41**

**Prior U.S. Cls.: 100, 101 and 107**

**United States Patent and Trademark Office**

**Reg. No. 3,466,951**

**Registered July 15, 2008**

**SERVICE MARK  
PRINCIPAL REGISTER**

# StateLine Quartet

BIGGS, LARRY D. (UNITED STATES INDIVIDUAL)  
360 NEW DEAL POTTS ROAD  
COTTONTOWN, TN 37048

FOR: ENTERTAINMENT IN THE NATURE OF LIVE PERFORMANCES BY A SINGING QUARTET ACCOMPANIED BY INSTRUMENTAL MUSIC, IN CLASS 41 (U.S. CLS. 100, 101 AND 107).

FIRST USE 6-0-2005; IN COMMERCE 9-0-2005.

THE MARK CONSISTS OF STANDARD CHARACTERS WITHOUT CLAIM TO ANY PARTICULAR FONT, STYLE, SIZE, OR COLOR.

NO CLAIM IS MADE TO THE EXCLUSIVE RIGHT TO USE "QUARTET", APART FROM THE MARK AS SHOWN.

SER. NO. 77-332,944, FILED 11-19-2007.

JOHN KELLY, EXAMINING ATTORNEY

**Int. Cl.: 37**

**Prior U.S. Cls.: 100, 103 and 106**

**United States Patent and Trademark Office**

**Reg. No. 3,466,952**

**Registered July 15, 2008**

**SERVICE MARK  
PRINCIPAL REGISTER**

**Choose Pest Elimination  
Over Pest Control!**

AYESU, KOJO (UNITED STATES INDIVIDUAL)  
495 EAST 178TH STREET, #1G  
BRONX, NY 10457

FOR: PEST CONTROL AND EXTERMINATION  
OTHER THAN FOR AGRICULTURAL PURPOSES,  
IN CLASS 37 (U.S. CLS. 100, 103 AND 106).

FIRST USE 6-11-2007; IN COMMERCE 6-11-2007.

THE MARK CONSISTS OF STANDARD CHAR-  
ACTERS WITHOUT CLAIM TO ANY PARTICULAR  
FONT, STYLE, SIZE, OR COLOR.

SER. NO. 77-332,968, FILED 11-19-2007.

DOMINIC J. FERRAIUOLO, EXAMINING ATTOR-  
NEY

**Int. Cl.: 41**

**Prior U.S. Cls.: 100, 101 and 107**

**United States Patent and Trademark Office**

**Reg. No. 3,466,953**

**Registered July 15, 2008**

**SERVICE MARK  
PRINCIPAL REGISTER**

**WRITINGLABEDGE**

PETERSON'S NELNET, LLC. (NEBRASKA LTD  
LIAB CO)  
SUITE 301  
121 SOUTH 13TH STREET  
LINCOLN, NE 68508

FOR: CUSTOM WRITING SERVICES, IN CLASS  
41 (U.S. CLS. 100, 101 AND 107).

FIRST USE 12-11-2005; IN COMMERCE 12-11-2005.

THE MARK CONSISTS OF STANDARD CHAR-  
ACTERS WITHOUT CLAIM TO ANY PARTICULAR  
FONT, STYLE, SIZE, OR COLOR.

SER. NO. 77-332,971, FILED 11-19-2007.

DOMINIC J. FERRAIUOLO, EXAMINING ATTOR-  
NEY



**Int. Cl.: 36**

**Prior U.S. Cls.: 100, 101 and 102**

**United States Patent and Trademark Office**

**Reg. No. 3,466,954**

**Registered July 15, 2008**

**SERVICE MARK  
PRINCIPAL REGISTER**

**COED**

ESITEBROKERS, LLC (DELAWARE LTD LIAB  
CO)  
977 SEMINOLE TRAIL, #379  
CHARLOTTESVILLE, VA 22901

FOR: FINANCIAL DEBT COUNSELING AND  
CONSUMER LENDING SERVICES; DEBIT, CREDIT  
AND CASH CARD SERVICES, NAMELY, ISSUING  
DEBIT, CREDIT, CASH, GIFT, PREPAID AND  
STORED VALUE CARDS; PREPAID TELEPHONE  
CALLING CARD SERVICES; PROVIDING A WEB  
SITE WHERE USERS CAN POST RATINGS, RE-  
VIEWS AND RECOMMENDATIONS ON STOCKS,  
BONDS, MUTUAL FUNDS AND OTHER FINAN-  
CIAL INSTRUMENTS; PROVIDING ON-LINE FI-  
NANCIAL CALCULATORS; PROVIDING ON-LINE

NEWS IN THE FIELD OF FINANCE; PROVIDING  
STUDENT LOAN INFORMATION, IN CLASS 36  
(U.S. CLS. 100, 101 AND 102).

FIRST USE 11-12-2007; IN COMMERCE 11-12-2007.

THE MARK CONSISTS OF STANDARD CHAR-  
ACTERS WITHOUT CLAIM TO ANY PARTICULAR  
FONT, STYLE, SIZE, OR COLOR.

SER. NO. 77-332,998, FILED 11-19-2007.

JACQUELINE A. LAVINE, EXAMINING ATTOR-  
NEY

**Int. Cl.: 3**

**Prior U.S. Cls.: 1, 4, 6, 50, 51 and 52**

**United States Patent and Trademark Office**

**Reg. No. 3,466,955**

**Registered July 15, 2008**

**TRADEMARK  
PRINCIPAL REGISTER**

**C-SYSTEM**

AMERICAN CREW, INC. (DELAWARE CORPORATION)  
1732 CHAMPA STREET  
DENVER, CO 80202

FOR: HAIR CARE PRODUCTS, NAMELY, SHAMPOO, CONDITIONER; HAIR STYLING PREPARATIONS, NAMELY, HAIR STYLING CREAMS, LOTIONS, GELS, LEAVE-IN CONDITIONING SPRAY, AND HAIR SPRAY, IN CLASS 3 (U.S. CLS. 1, 4, 6, 50, 51 AND 52).

FIRST USE 3-15-2003; IN COMMERCE 3-15-2003.

THE MARK CONSISTS OF STANDARD CHARACTERS WITHOUT CLAIM TO ANY PARTICULAR FONT, STYLE, SIZE, OR COLOR.

OWNER OF U.S. REG. NO. 2,810,408.

SER. NO. 77-333,001, FILED 11-19-2007.

NAKIA HENRY, EXAMINING ATTORNEY

**Int. Cls.: 9 and 40**

**Prior U.S. Cls.: 21, 23, 26, 36, 38, 100, 103 and 106**

**United States Patent and Trademark Office**

**Reg. No. 3,466,956**

**Registered July 15, 2008**

**TRADEMARK  
SERVICE MARK  
PRINCIPAL REGISTER**

**RELIABILITY BY DESIGN**

DB CONTROL (CALIFORNIA CORPORATION)  
1120 AUBURN STREET  
FREMONT, CA 94538

FOR: AUTOMATED PROCESS CONTROL SYSTEM, NAMELY, MICRO-PROCESSOR BASED HARDWARE AND SOFTWARE USED TO MONITOR THE STATUS OF INDUSTRIAL PROCESSES, NAMELY POWER GENERATION, ELECTRICAL DISTRIBUTION AND OIL AND GAS PROCESSING; DC/AC POWER CONVERTERS; ELECTRICAL DISTRIBUTION SYSTEMS, NAMELY, POWER DISTRIBUTION PANELS; ELECTRICAL PLUG DEVICE ENABLING CONNECTION AND DISCONNECTION OF POWER AND/OR CONTROL CABLES; ELECTRICAL POWER CONNECTORS; ELECTRICAL POWER DISTRIBUTION BLOCKS; ELECTRICAL POWER DISTRIBUTION UNITS; HIGH-FREQUENCY SWITCHING POWER SUPPLIES; POWER AMPLIFIERS; POWER CONTROLLERS; POWER DISTRIBUTING BOXES; POWER SUPPLIES; POWER SUPPLY CONNECTORS AND ADAPTORS FOR USE WITH PORTABLE ELECTRONIC DEVICES; POWER TRANSFORMERS FOR AMPLIFICATION; RENEWABLE BATTERY SYSTEM TO PROVIDE BACKUP POWER; VOLTAGE REGULATORS FOR ELECTRIC POWER; VOLTAGE STABILIZING POWER SUPPLY; WAVEGUIDES FOR HIGH POWER BEAM DELIVERY; RADAR RECEIVERS WITH AMPLIFIERS; APPARATUS AND INSTRUMENTS FOR CONVEYING, DISTRIBUTING, TRANSFORMING, STORING, REGULATING OR CONTROLLING ELECTRIC CURRENT; DISTRIBUTION TRANSFORMERS; ELECTRIC TRANSFORMERS; ELECTRIC VOLTAGE TRANSFORMERS; ELECTRICAL TRANSFORMERS; STEP DOWN TRANSFORMERS;

STEP UP TRANSFORMERS; MEDIUM VOLTAGE POWER DISTRIBUTION AND PROTECTION COMPONENT SYSTEM COMPOSED OF BREAKERS AND SWITCHGEARS; VOLTAGE MONITOR MODULES; VOLTAGE REGULATORS; VOLTAGE STABILIZERS; VOLTAGE STABILIZERS; VOLTAGE SURGE PROTECTORS; VOLTAGE SURGE SUPPRESSORS, IN CLASS 9 (U.S. CLS. 21, 23, 26, 36 AND 38).

FIRST USE 0-0-2002; IN COMMERCE 0-0-2002.

FOR: CUSTOM MANUFACTURE OF AMPLIFIERS, TRANSFORMERS, AND POWER SUPPLIES; MANUFACTURE OF GENERAL PRODUCT LINES IN THE FIELD OF AMPLIFIERS, TRANSFORMERS, AND POWER SUPPLIES TO THE ORDER AND SPECIFICATION OF OTHERS; MANUFACTURE OF AMPLIFIERS, TRANSFORMERS, AND POWER SUPPLIES TO ORDER AND/OR SPECIFICATION OF OTHERS; MANUFACTURING SERVICES FOR OTHERS IN THE FIELD OF AMPLIFIERS, TRANSFORMERS, AND POWER SUPPLIES, IN CLASS 40 (U.S. CLS. 100, 103 AND 106).

FIRST USE 0-0-2002; IN COMMERCE 0-0-2002.

THE MARK CONSISTS OF STANDARD CHARACTERS WITHOUT CLAIM TO ANY PARTICULAR FONT, STYLE, SIZE, OR COLOR.

SER. NO. 77-333,006, FILED 11-19-2007.

JACQUELINE A. LAVINE, EXAMINING ATTORNEY

**Int. Cl.: 21**

**Prior U.S. Cls.: 2, 13, 23, 29, 30, 33, 40 and 50**

**Reg. No. 3,466,957**

**United States Patent and Trademark Office**

**Registered July 15, 2008**

---

**TRADEMARK  
PRINCIPAL REGISTER**

**skid out**

THE POND INC. (CALIFORNIA CORPORATION)  
220 TECHNOLOGY DR STE 120  
IRVINE, CA 92618

THE MARK CONSISTS OF STANDARD CHAR-  
ACTERS WITHOUT CLAIM TO ANY PARTICULAR  
FONT, STYLE, SIZE, OR COLOR.

FOR: CLEANING SPONGES, IN CLASS 21 (U.S.  
CLS. 2, 13, 23, 29, 30, 33, 40 AND 50).

SER. NO. 77-333,025, FILED 11-19-2007.

FIRST USE 8-15-2007; IN COMMERCE 8-27-2007.

JAMES A. RAUEN, EXAMINING ATTORNEY

**Int. Cl.: 45**

**Prior U.S. Cls.: 100 and 101**

**United States Patent and Trademark Office**

**Reg. No. 3,466,958**

**Registered July 15, 2008**

**SERVICE MARK  
PRINCIPAL REGISTER**

# JRetroMatch

WOODMERE ASSET MANAGEMENT, INC.  
(NEW YORK CORPORATION), DBA RETRO-  
MATCH  
306 W 93RD STREET #7  
NEW YORK, NY 10025

FOR: A COMPUTER MATCHMAKING SERVICE PROVIDED ONLINE THAT WILL ALLOW MATCHMAKERS TO SET-UP THEIR OWN NETWORK OF MEMBERS AND FACILITATE THE INTRODUCTION OF INDIVIDUALS, IN CLASS 45 (U.S. CLS. 100 AND 101).

FIRST USE 2-9-2006; IN COMMERCE 2-9-2006.

THE MARK CONSISTS OF STANDARD CHARACTERS WITHOUT CLAIM TO ANY PARTICULAR FONT, STYLE, SIZE, OR COLOR.

OWNER OF U.S. REG. NO. 3,202,985.

SER. NO. 77-333,029, FILED 11-19-2007.

DAVID YONTEF, EXAMINING ATTORNEY

**Int. Cl.: 41**

**Prior U.S. Cls.: 100, 101 and 107**

**United States Patent and Trademark Office**

**Reg. No. 3,466,959**

**Registered July 15, 2008**

**SERVICE MARK  
PRINCIPAL REGISTER**

**ALL VANITY NO SHAME**

MERCURY FITNESS, INC. (CALIFORNIA CORPORATION)  
SUITE 1  
1855 TURK STREET  
SAN FRANCISCO, CA 94115

FOR: HEALTH CLUB SERVICES, NAMELY, PROVIDING INSTRUCTION AND EQUIPMENT IN THE FIELD OF PHYSICAL EXERCISE, YOGA AND PILATES, IN CLASS 41 (U.S. CLS. 100, 101 AND 107).

FIRST USE 5-15-2006; IN COMMERCE 5-15-2006.

THE MARK CONSISTS OF STANDARD CHARACTERS WITHOUT CLAIM TO ANY PARTICULAR FONT, STYLE, SIZE, OR COLOR.

SER. NO. 77-333,030, FILED 11-19-2007.

DAVID YONTEF, EXAMINING ATTORNEY

**Int. Cl.: 44**

**Prior U.S. Cls.: 100 and 101**

**United States Patent and Trademark Office**

**Reg. No. 3,466,960**

**Registered July 15, 2008**

**SERVICE MARK  
PRINCIPAL REGISTER**

**Miracle Moment Imaging**

MIRACLE MOMENT IMAGING, INC. (MINNESOTA CORPORATION)

931 MADISON AVENUE

MANKATO, MN 56001

FOR: MEDICAL IMAGING SERVICES, IN CLASS 44 (U.S. CLS. 100 AND 101).

FIRST USE 9-27-2007; IN COMMERCE 9-27-2007.

THE MARK CONSISTS OF STANDARD CHARACTERS WITHOUT CLAIM TO ANY PARTICULAR FONT, STYLE, SIZE, OR COLOR.

NO CLAIM IS MADE TO THE EXCLUSIVE RIGHT TO USE "IMAGING", APART FROM THE MARK AS SHOWN.

SER. NO. 77-333,036, FILED 11-19-2007.

KRISTIN DAHLING, EXAMINING ATTORNEY

**Int. Cl.: 42**

**Prior U.S. Cls.: 100 and 101**

**United States Patent and Trademark Office**

**Reg. No. 3,466,961**

**Registered July 15, 2008**

**SERVICE MARK  
PRINCIPAL REGISTER**

**TerraSpectra Geomatics**

SPECTRUM GIS, INC. (NEVADA CORPORATION), DBA TERRASPECTRA GEOMATICS  
SUITE A-10  
2700 E. SUNSET  
LAS VEGAS, NV 89120

FOR: CARTOGRAPHY AND MAPPING, IN CLASS 42 (U.S. CLS. 100 AND 101).

FIRST USE 2-19-1998; IN COMMERCE 2-19-1998.

THE MARK CONSISTS OF STANDARD CHARACTERS WITHOUT CLAIM TO ANY PARTICULAR FONT, STYLE, SIZE, OR COLOR.

NO CLAIM IS MADE TO THE EXCLUSIVE RIGHT TO USE "GEOMATICS", APART FROM THE MARK AS SHOWN.

SER. NO. 77-333,038, FILED 11-19-2007.

JEFFERY COWARD, EXAMINING ATTORNEY



**Int. Cl.: 36**

**Prior U.S. Cls.: 100, 101 and 102**

**United States Patent and Trademark Office**

**Reg. No. 3,466,962**

**Registered July 15, 2008**

---

**SERVICE MARK  
PRINCIPAL REGISTER**

# Helping Handbags

THE SALVATION ARMY (CALIFORNIA CORPORATION)  
180 EAST OCEAN BOULEVARD  
LONG BEACH, CA 90802

THE MARK CONSISTS OF STANDARD CHARACTERS WITHOUT CLAIM TO ANY PARTICULAR FONT, STYLE, SIZE, OR COLOR.

FOR: CHARITABLE FUND RAISING, IN CLASS 36 (U.S. CLS. 100, 101 AND 102).

SER. NO. 77-333,043, FILED 11-19-2007.

FIRST USE 6-30-2005; IN COMMERCE 6-30-2005.

DOMINICK J. SALEMI, EXAMINING ATTORNEY

**Int. Cl.: 29**

**Prior U.S. Cl.: 46**

**United States Patent and Trademark Office**

**Reg. No. 3,466,963**

**Registered July 15, 2008**

**TRADEMARK  
PRINCIPAL REGISTER**



COACH FARM, INC. (NEW YORK CORPORATION)  
105 MILL HILL ROAD  
PINE PLAINS, NY 12567

FOR: MILK; CHEESE; CHEESE SPREADS; YOGURT; CURD; WHEY, IN CLASS 29 (U.S. CL. 46).

FIRST USE 6-3-1985; IN COMMERCE 6-3-1985.

NO CLAIM IS MADE TO THE EXCLUSIVE RIGHT TO USE "FARM" , APART FROM THE MARK AS SHOWN.

THE MARK CONSISTS OF THE WORDS "COACH FARM" SURROUNDED BY TWO OVALS ON TOP OF WHICH IS A SILHOUETTE OF A GOAT. THE MARK ALSO FEATURES TWO CONCENTRIC CIRCLES, ONE THIN LINE CIRCLE SURROUNDING THE OVALS IN WHICH "COACH FARM" APPEARS AND A LARGER THICKER CIRCLE MADE UP OF A CHECKERBOARD DESIGN SURROUNDING ALL THE OTHER ELEMENTS.

SER. NO. 77-333,044, FILED 11-19-2007.

DOMINICK J. SALEMI, EXAMINING ATTORNEY

**Int. Cl.: 16**

**Prior U.S. Cls.: 2, 5, 22, 23, 29, 37, 38 and 50**

**Reg. No. 3,466,964**

**United States Patent and Trademark Office**

**Registered July 15, 2008**

---

**TRADEMARK  
PRINCIPAL REGISTER**

**MY STICKEASE**

CABIN CREEK, LLC (UTAH LTD LIAB CO)  
1199 WEST 700 SOUTH  
PLEASANT GROVE, UT 84062

THE MARK CONSISTS OF STANDARD CHAR-  
ACTERS WITHOUT CLAIM TO ANY PARTICULAR  
FONT, STYLE, SIZE, OR COLOR.

FOR: PAPER DIE CUT ADHESIVE SHAPES FOR  
DECORATING SCRAPBOOKS, IN CLASS 16 (U.S.  
CLS. 2, 5, 22, 23, 29, 37, 38 AND 50).

SER. NO. 77-333,047, FILED 11-19-2007.

FIRST USE 6-0-2004; IN COMMERCE 6-0-2004.

JERI J. FICKES, EXAMINING ATTORNEY

**Int. Cl.: 37**

**Prior U.S. Cls.: 100, 103 and 106**

**Reg. No. 3,466,965**

**United States Patent and Trademark Office**

**Registered July 15, 2008**

---

**SERVICE MARK  
PRINCIPAL REGISTER**

**DAVE'S MARINE SERVICES**

DAVE'S MARINE SERVICES, LLC (NORTH CAROLINA LTD LIAB CO)

7313 MINE SHAFT ROAD

RALEIGH, NC 276156021

FOR: REPAIR OR MAINTENANCE OF VESSELS,  
IN CLASS 37 (U.S. CLS. 100, 103 AND 106).

FIRST USE 8-1-2007; IN COMMERCE 8-1-2007.

THE MARK CONSISTS OF STANDARD CHARACTERS WITHOUT CLAIM TO ANY PARTICULAR FONT, STYLE, SIZE, OR COLOR.

NO CLAIM IS MADE TO THE EXCLUSIVE RIGHT TO USE "MARINE SERVICES", APART FROM THE MARK AS SHOWN.

SER. NO. 77-333,050, FILED 11-19-2007.

DOMINICK J. SALEMI, EXAMINING ATTORNEY

**Int. Cl.: 36**

**Prior U.S. Cls.: 100, 101 and 102**

**United States Patent and Trademark Office**

**Reg. No. 3,466,966**

**Registered July 15, 2008**

**SERVICE MARK  
PRINCIPAL REGISTER**

**VMG Partners**

VMG EQUITY PARTNERS, LLC (DELAWARE  
LTD LIAB CO)  
55 FRANCISCO STREET, SUITE 400  
SAN FRANCISCO, CA 94133

FOR: INVESTMENT ADVISORY SERVICES; VENTURE CAPITAL SERVICES, NAMELY, PROVIDING FINANCING TO EMERGING AND START-UP COMPANIES AND PROVIDING MEZZANINE AND SENIOR DEBT FINANCING; PRIVATE EQUITY FUND INVESTMENT SERVICES, IN CLASS 36 (U.S. CLS. 100, 101 AND 102).

FIRST USE 9-28-2007; IN COMMERCE 9-28-2007.

THE MARK CONSISTS OF STANDARD CHARACTERS WITHOUT CLAIM TO ANY PARTICULAR FONT, STYLE, SIZE, OR COLOR.

NO CLAIM IS MADE TO THE EXCLUSIVE RIGHT TO USE "PARTNERS", APART FROM THE MARK AS SHOWN.

SER. NO. 77-333,051, FILED 11-19-2007.

DOMINICK J. SALEMI, EXAMINING ATTORNEY

**Int. Cl.: 41**

**Prior U.S. Cls.: 100, 101 and 107**

**United States Patent and Trademark Office**

**Reg. No. 3,466,967**

**Registered July 15, 2008**

**SERVICE MARK  
PRINCIPAL REGISTER**

**SKYWARN**

NATIONAL OCEANIC AND ATMOSPHERIC ADMINISTRATION (UNITED STATES AGENCY OF THE UNITED STATES GOVERNMENT)  
1401 CONSTITUTION AVENUE, NW  
WASHINGTON, DC 20231

FOR: EDUCATIONAL SERVICES, NAMELY, THE CONDUCT OF CLASSES, SEMINARS, WORKSHOPS AND LECTURES PERTAINING TO SEVERE WEATHER, SPOTTING SEVERE WEATHER CONDITIONS, REPORTING METHODS, PREPARATION FOR SEVERE WEATHER, SAFETY TIPS, AND INFORMATION ON WEATHER AND FORECASTING, INCLUDING THE PROVISION OF SAID SER-

VICES BY MEANS OF THE INTERNET, IN CLASS 41 (U.S. CLS. 100, 101 AND 107).

FIRST USE 1-1-1968; IN COMMERCE 1-1-1968.

THE MARK CONSISTS OF STANDARD CHARACTERS WITHOUT CLAIM TO ANY PARTICULAR FONT, STYLE, SIZE, OR COLOR.

SER. NO. 77-333,055, FILED 11-19-2007.

ELISSA GARBER KON, EXAMINING ATTORNEY

**Int. Cl.: 3**

**Prior U.S. Cls.: 1, 4, 6, 50, 51 and 52**

**United States Patent and Trademark Office**

**Reg. No. 3,466,968**

**Registered July 15, 2008**

---

**TRADEMARK  
PRINCIPAL REGISTER**

**subtle butt**

THE POND INC. (CALIFORNIA CORPORATION)  
220 TECHNOLOGY DR STE 120  
IRVINE, CA 92618

THE MARK CONSISTS OF STANDARD CHAR-  
ACTERS WITHOUT CLAIM TO ANY PARTICULAR  
FONT, STYLE, SIZE, OR COLOR.

FOR: PERSONAL DEODORANTS, IN CLASS 3  
(U.S. CLS. 1, 4, 6, 50, 51 AND 52).

SER. NO. 77-333,067, FILED 11-19-2007.

FIRST USE 10-22-2007; IN COMMERCE 11-19-2007.

JAMES A. RAUEN, EXAMINING ATTORNEY

**Int. Cl.: 30**

**Prior U.S. Cl.: 46**

**United States Patent and Trademark Office**

**Reg. No. 3,466,969**

**Registered July 15, 2008**

**TRADEMARK  
PRINCIPAL REGISTER**

**LITTLE BITZ OF ICE CREAM  
FUN!**

KEMPS LLC (DELAWARE LTD LIAB CO)  
1270 ENERGY PARK LANE  
ST. PAUL, MN 55108

THE MARK CONSISTS OF STANDARD CHAR-  
ACTERS WITHOUT CLAIM TO ANY PARTICULAR  
FONT, STYLE, SIZE, OR COLOR.

FOR: ICE CREAM, IN CLASS 30 (U.S. CL. 46).

SER. NO. 77-333,072, FILED 11-19-2007.

FIRST USE 3-21-2007; IN COMMERCE 3-21-2007.

JAMES A. RAUEN, EXAMINING ATTORNEY



**Int. Cl.: 9**

**Prior U.S. Cls.: 21, 23, 26, 36 and 38**

**United States Patent and Trademark Office**

**Reg. No. 3,466,970**

**Registered July 15, 2008**

**TRADEMARK  
PRINCIPAL REGISTER**

**EXACTPOWER\***

ATLANTIS POWER QUALITY SYSTEMS, INC.  
(CALIFORNIA CORPORATION)  
9411 WINNETKA AVENUE  
CHATSWORTH, CA 91311

FIRST USE 7-19-2000; IN COMMERCE 7-19-2000.

FOR: APPARATUS AND INSTRUMENTS FOR CONVEYING, DISTRIBUTING, TRANSFORMING, STORING, REGULATING OR CONTROLLING ELECTRIC CURRENT; VOLTAGE REGULATORS; VOLTAGE STABILIZERS; VOLTAGE SURGE PROTECTORS; VOLTAGE SURGE SUPPRESSORS; VOLTAGE MONITOR MODULES; VOLTAGE REGULATORS FOR ELECTRIC POWER; VOLTAGE STABILIZING POWER SUPPLY; DC/AC POWER CONVERTERS, IN CLASS 9 (U.S. CLS. 21, 23, 26, 36 AND 38).

THE MARK CONSISTS OF THE LITERAL ELEMENT "EXACTPOWER\*" WITH A HORIZONTAL BLANK (WHITE) LINE RUNNING THROUGH THE LETTERS "TPOWER" AND ENDING BEFORE THE EIGHT POINT STAR AT THE RIGHT HAND SIDE OF THE MARK.

SER. NO. 77-333,074, FILED 11-19-2007.

JAMES A. RAUEN, EXAMINING ATTORNEY

**Int. Cl.: 9**

**Prior U.S. Cls.: 21, 23, 26, 36 and 38**

**United States Patent and Trademark Office**

**Reg. No. 3,466,971**

**Registered July 15, 2008**

**TRADEMARK  
PRINCIPAL REGISTER**

**EWALLET**

ILIUM SOFTWARE, INC. (MICHIGAN CORPORATION)  
3759 PROSPECT  
ANN ARBOR, MI 48105

THE MARK CONSISTS OF STANDARD CHARACTERS WITHOUT CLAIM TO ANY PARTICULAR FONT, STYLE, SIZE, OR COLOR.

FOR: COMPUTER SOFTWARE FOR PERSONAL INFORMATION MANAGEMENT, IN CLASS 9 (U.S. CLS. 21, 23, 26, 36 AND 38).

SER. NO. 77-333,087, FILED 11-19-2007.

FIRST USE 10-29-1997; IN COMMERCE 10-29-1997.

PATRICIA EVANKO, EXAMINING ATTORNEY

**Int. Cl.: 37**

**Prior U.S. Cls.: 100, 103 and 106**

**United States Patent and Trademark Office**

**Reg. No. 3,466,972**

**Registered July 15, 2008**

**SERVICE MARK  
PRINCIPAL REGISTER**

**ULTIMATE AIRCRAFT DEICING  
CORPORATION**

ULTIMATE AIRCRAFT APPEARANCE COR-  
PORATION (NEW YORK CORPORATION)  
CARGO BUILDING 79 - JFK INTL. AIRPORT  
JAMAICA, NY 11430

FOR: AIRPLANE DEICING SERVICES, IN CLASS  
37 (U.S. CLS. 100, 103 AND 106).

FIRST USE 8-15-2007; IN COMMERCE 8-15-2007.

THE MARK CONSISTS OF STANDARD CHAR-  
ACTERS WITHOUT CLAIM TO ANY PARTICULAR  
FONT, STYLE, SIZE, OR COLOR.

OWNER OF U.S. REG. NOS. 2,535,308 AND  
2,720,881.

NO CLAIM IS MADE TO THE EXCLUSIVE  
RIGHT TO USE "AIRCRAFT DEICING CORPORA-  
TION", APART FROM THE MARK AS SHOWN.

SER. NO. 77-333,089, FILED 11-19-2007.

PATRICIA EVANKO, EXAMINING ATTORNEY

**Int. Cl.: 6**

**Prior U.S. Cls.: 2, 12, 13, 14, 23, 25 and 50**

**United States Patent and Trademark Office**

**Reg. No. 3,466,973**

**Registered July 15, 2008**

**TRADEMARK  
PRINCIPAL REGISTER**

**A BOX 4 U**

A BOX 4 U, LLC (KANSAS LTD LIAB CO)  
4911 S. MERIDIAN  
WICHITA, KS 67217

THE MARK CONSISTS OF STANDARD CHAR-  
ACTERS WITHOUT CLAIM TO ANY PARTICULAR  
FONT, STYLE, SIZE, OR COLOR.

FOR: PORTABLE METAL OFFICE BUILDINGS;  
BLAST RESISTANT PORTABLE METAL OFFICE  
BUILDINGS, IN CLASS 6 (U.S. CLS. 2, 12, 13, 14, 23, 25  
AND 50).

SER. NO. 77-333,105, FILED 11-19-2007.

FIRST USE 12-0-1989; IN COMMERCE 12-0-1989.

PATRICIA EVANKO, EXAMINING ATTORNEY

**Int. Cl.: 35**

**Prior U.S. Cls.: 100, 101 and 102**

**United States Patent and Trademark Office**

**Reg. No. 3,466,974**

**Registered July 15, 2008**

**SERVICE MARK  
PRINCIPAL REGISTER**

**BRYAH HR STRATEGIES**

BRYAH HR STRATEGIES, INC. (ILLINOIS CORPORATION)  
30 NORTH LASALLE STREET, SUITE 3900  
CHICAGO, IL 60602

FOR: CONSULTING SERVICES IN THE FIELD OF HUMAN RESOURCES DEVELOPMENT, NAMELY, HUMAN RESOURCES STRATEGY DEVELOPMENT AND BRANDING, ORGANIZATIONAL EFFECTIVENESS, TALENT MANAGEMENT, AND LEADERSHIP DEVELOPMENT, IN CLASS 35 (U.S. CLS. 100, 101 AND 102).

FIRST USE 11-8-2007; IN COMMERCE 11-8-2007.

THE MARK CONSISTS OF STANDARD CHARACTERS WITHOUT CLAIM TO ANY PARTICULAR FONT, STYLE, SIZE, OR COLOR.

NO CLAIM IS MADE TO THE EXCLUSIVE RIGHT TO USE "HR STRATEGIES", APART FROM THE MARK AS SHOWN.

SER. NO. 77-333,119, FILED 11-19-2007.

SHAILA SETTLES, EXAMINING ATTORNEY

**Int. Cl.: 14**

**Prior U.S. Cls.: 2, 27, 28 and 50**

**United States Patent and Trademark Office**

**Reg. No. 3,466,975**

**Registered July 15, 2008**

**TRADEMARK  
PRINCIPAL REGISTER**

**VIDUCCI**

CLASSIC CREATIONS (NEW YORK SOLE PROPRIETORSHIP)  
1 LINDEN PLACE, SUITE 409  
GREAT NECK, NY 11021

THE MARK CONSISTS OF STANDARD CHARACTERS WITHOUT CLAIM TO ANY PARTICULAR FONT, STYLE, SIZE, OR COLOR.

FOR: JEWELRY, PRECIOUS STONES, SEMI-PRECIOUS STONES, PRECIOUS METALS, JEWELRY, NAMELY, WATCHES, IN CLASS 14 (U.S. CLS. 2, 27, 28 AND 50).

SER. NO. 77-333,151, FILED 11-19-2007.

FIRST USE 8-1-2007; IN COMMERCE 8-1-2007.

SONYA STEPHENS, EXAMINING ATTORNEY

**Int. Cl.: 37**

**Prior U.S. Cls.: 100, 103 and 106**

**United States Patent and Trademark Office**

**Reg. No. 3,466,976**

**Registered July 15, 2008**

**SERVICE MARK  
PRINCIPAL REGISTER**

QUALITY FROM THE GROUND  
DOWN

GRIFFIN POOLS, INC. (FLORIDA CORPORATION)  
3404 REYNOLDS ROAD  
LAKELAND, FL 33803

THE MARK CONSISTS OF STANDARD CHARACTERS WITHOUT CLAIM TO ANY PARTICULAR FONT, STYLE, SIZE, OR COLOR.

FOR: CONSTRUCTION OF IN-GROUND CONCRETE SWIMMING POOLS, IN CLASS 37 (U.S. CLS. 100, 103 AND 106).

SER. NO. 77-333,167, FILED 11-19-2007.

FIRST USE 11-13-2007; IN COMMERCE 11-13-2007.

SHAUNIA CARLYLE, EXAMINING ATTORNEY

**Int. Cl.: 20**

**Prior U.S. Cls.: 2, 13, 22, 25, 32 and 50**

**United States Patent and Trademark Office**

**Reg. No. 3,466,977**

**Registered July 15, 2008**

**TRADEMARK  
PRINCIPAL REGISTER**

**RACK-N-PAINT**

WHITNEY INNOVATIONS, INC. (WASHINGTON  
CORPORATION)  
2581 COUNTY ROAD 306  
ELK CREEK, CA 95939

THE MARK CONSISTS OF STANDARD CHAR-  
ACTERS WITHOUT CLAIM TO ANY PARTICULAR  
FONT, STYLE, SIZE, OR COLOR.

FOR: DOOR DISPLAY STAND, IN CLASS 20 (U.S.  
CLS. 2, 13, 22, 25, 32 AND 50).

SER. NO. 77-333,179, FILED 11-19-2007.

FIRST USE 8-30-2007; IN COMMERCE 8-30-2007.

KEVIN DINALLO, EXAMINING ATTORNEY



**Int. Cl.: 35**

**Prior U.S. Cls.: 100, 101 and 102**

**United States Patent and Trademark Office**

**Reg. No. 3,466,978**

**Registered July 15, 2008**

**SERVICE MARK  
PRINCIPAL REGISTER**

**BRAND BUILDING THROUGH  
PEOPLE**

BRYAH HR STRATEGIES, INC. (ILLINOIS CORPORATION)  
30 NORTH LASALLE STREET, SUITE 3900  
CHICAGO, IL 60602

FOR: CONSULTING SERVICES IN THE FIELD OF HUMAN RESOURCES DEVELOPMENT, NAME-  
LY, HUMAN RESOURCES STRATEGY DEVELOP-  
MENT AND BRANDING, ORGANIZATIONAL  
EFFECTIVENESS, TALENT MANAGEMENT, AND  
LEADERSHIP DEVELOPMENT, IN CLASS 35 (U.S.  
CLS. 100, 101 AND 102).

FIRST USE 11-8-2007; IN COMMERCE 11-8-2007.

THE MARK CONSISTS OF STANDARD CHAR-  
ACTERS WITHOUT CLAIM TO ANY PARTICULAR  
FONT, STYLE, SIZE, OR COLOR.

SER. NO. 77-333,183, FILED 11-19-2007.

SHAILA SETTLES, EXAMINING ATTORNEY

**Int. Cl.: 14**

**Prior U.S. Cls.: 2, 27, 28 and 50**

**United States Patent and Trademark Office**

**Reg. No. 3,466,979**

**Registered July 15, 2008**

**TRADEMARK  
PRINCIPAL REGISTER**



CYGNET HILL LTD. (ILLINOIS CORPORATION)  
SUITE 205  
736 N. WESTERN AVE.  
LAKE FOREST, IL 60045

THE MARK CONSISTS OF THE TEXT "CYGNET HILL" AND A BACKGROUND SWAN DESIGN.

FOR: JEWELRY, IN CLASS 14 (U.S. CLS. 2, 27, 28 AND 50).

SER. NO. 77-333,199, FILED 11-19-2007.

FIRST USE 4-26-2007; IN COMMERCE 4-26-2007.

CARYN GLASSER, EXAMINING ATTORNEY

**Int. Cl.: 35**

**Prior U.S. Cls.: 100, 101 and 102**

**United States Patent and Trademark Office**

**Reg. No. 3,466,980**

**Registered July 15, 2008**

**SERVICE MARK  
PRINCIPAL REGISTER**

# SolarAnywhere

CLEAN POWER RESEARCH, LLC (CALIFORNIA  
LTD LIAB CO)  
10 GLEN COURT  
NAPA, CA 94558

FOR: PROVIDING AN ON-LINE COMPUTER  
DATABASE FEATURING TRADE INFORMATION  
IN THE FIELD OF IRRADIANCE DATA, IN CLASS  
35 (U.S. CLS. 100, 101 AND 102).

FIRST USE 11-14-2007; IN COMMERCE 11-14-2007.

THE MARK CONSISTS OF STANDARD CHAR-  
ACTERS WITHOUT CLAIM TO ANY PARTICULAR  
FONT, STYLE, SIZE, OR COLOR.

SER. NO. 77-333,212, FILED 11-19-2007.

WARREN L. OLANDRIA, EXAMINING ATTOR-  
NEY

**Int. Cl.: 39**

**Prior U.S. Cls.: 100 and 105**

**United States Patent and Trademark Office**

**Reg. No. 3,466,981**

**Registered July 15, 2008**

**SERVICE MARK  
PRINCIPAL REGISTER**

**UNITS**

MHM GROUP, INC. (SOUTH CAROLINA CORPORATION)  
1773 LABOR CAMP ROAD  
MT. PLEASANT, SC 29464

FOR: TRANSPORTATION BY TRUCK AND RENTAL OF MOBILE STORAGE CONTAINERS FOR HOUSEHOLD GOODS, IN CLASS 39 (U.S. CLS. 100 AND 105).

FIRST USE 3-4-2002; IN COMMERCE 8-31-2004.

THE MARK CONSISTS OF STANDARD CHARACTERS WITHOUT CLAIM TO ANY PARTICULAR FONT, STYLE, SIZE, OR COLOR.

OWNER OF U.S. REG. NO. 3,049,132.

SER. NO. 77-333,218, FILED 11-19-2007.

KATHY DE JONGE, EXAMINING ATTORNEY

Int. Cl.: 44

Prior U.S. Cls.: 100 and 101

United States Patent and Trademark Office

Reg. No. 3,466,982

Registered July 15, 2008

SERVICE MARK  
PRINCIPAL REGISTER



RUBS, INC. (ARIZONA CORPORATION)  
1531 NORTH WILMOT  
TUCSON, AZ 85712

FOR: MESSAGE; HEALTH SPA SERVICES,  
NAMELY, COSMETIC BODY CARE SERVICES, IN  
CLASS 44 (U.S. CLS. 100 AND 101).

FIRST USE 10-1-2007; IN COMMERCE 10-1-2007.

NO CLAIM IS MADE TO THE EXCLUSIVE  
RIGHT TO USE "MESSAGE STUDIO", APART  
FROM THE MARK AS SHOWN.

THE COLOR(S) MAROON, GREEN, ORANGE  
AND BLACK IS/ARE CLAIMED AS A FEATURE  
OF THE MARK.

THE MARK CONSISTS OF THE WORD "RUBS,"  
FOLLOWED BY THREE SOLID FILLED CIRCLES,

WITH THE WORDS "MESSAGE STUDIO" DIRECT-  
LY UNDERNEATH. THE FIRST LETTER IN THE  
MARK IS A STYLIZED LOWERCASE "R" IN MAR-  
OON, FOLLOWED BY A STYLIZED LOWERCASE  
"U" IN MAROON, FOLLOWED BY A STYLIZED  
LOWERCASE "B" IN MAROON, FOLLOWED BY AN  
ELONGATED "S" IN GREEN. TO THE IMMEDIATE  
RIGHT OF THE WORD "RUBS" ARE THREE SOLID  
COLOR FILLED CIRCLES IN A VERTICAL LINE.  
THE TOP CIRCLE IS GREEN COLORED, THE  
MIDDLE CIRCLE IS ORANGE COLORED, AND  
THE BOTTOM CIRCLE IS MAROON COLORED.  
DIRECTLY UNDERNEATH THE WORD "RUBS"  
AND THE THREE SOLID FILLED CIRCLES ARE  
THE WORDS "MESSAGE STUDIO" IN A STYLIZED,  
UPPERCASE BLACK FONT.

SER. NO. 77-333,255, FILED 11-19-2007.

WILLIAM P. SHANAHAN, EXAMINING ATTOR-  
NEY

**Int. Cl.: 25**

**Prior U.S. Cls.: 22 and 39**

**United States Patent and Trademark Office**

**Reg. No. 3,466,983**

**Registered July 15, 2008**

**TRADEMARK  
PRINCIPAL REGISTER**

**CH SPORT**

THE COLLEGE HOUSE, INC. (NEW YORK COR-  
PORATION)  
1400 CHAMBERLAYNE AVENUE  
RICHMOND, VA 23222

FOR: IMPRINTED AND EMBROIDERED  
CLOTHING FOR MEN AND WOMEN, NAMELY,  
T-SHIRTS, SWEAT SHIRTS, SWEAT PANTS,  
SHORTS, LIGHT JACKETS AND COATS, HATS,  
CAPS AND SWIMWEAR, IN CLASS 25 (U.S. CLS. 22  
AND 39).

FIRST USE 6-20-1996; IN COMMERCE 6-20-1996.

THE MARK CONSISTS OF STANDARD CHAR-  
ACTERS WITHOUT CLAIM TO ANY PARTICULAR  
FONT, STYLE, SIZE, OR COLOR.

NO CLAIM IS MADE TO THE EXCLUSIVE  
RIGHT TO USE "SPORT", APART FROM THE  
MARK AS SHOWN.

SER. NO. 77-333,270, FILED 11-19-2007.

CHRISTOPHER BUONGIORNO, EXAMINING AT-  
TORNEY

**Int. Cl.: 18**

**Prior U.S. Cls.: 1, 2, 3, 22 and 41**

**Reg. No. 3,466,984**

**United States Patent and Trademark Office**

**Registered July 15, 2008**

**TRADEMARK  
PRINCIPAL REGISTER**

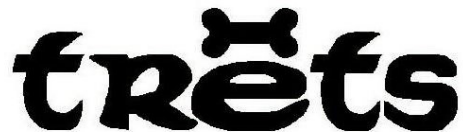

The logo consists of the word "trets" in a bold, lowercase, sans-serif font. The letter "e" is replaced by a stylized bone shape, which is a thick, horizontal bar with a small notch in the center and a slightly curved top edge.

ROSELL, DIANE M. (UNITED STATES INDIVIDUAL)  
106 RIVER STREET  
DOVER-FOXCROFT, ME 04426

FOR: PET ACCESSORIES, NAMELY, CANVAS, NYLON, AND SYNTHETIC MATERIAL POUCHES FOR HOLDING PET TREATS, IN CLASS 18 (U.S. CLS. 1, 2, 3, 22 AND 41).

FIRST USE 7-7-2007; IN COMMERCE 8-23-2007.

THE MARK CONSISTS OF THE LETTERS "TRETTS", WITH THE LETTERS "TETS" IN STYLIZED LOWERCASE AND THE LETTER "R" IN STYLIZED UPPERCASE, WITH A STYLIZED DEPICTION OF A BONE POSITIONED ABOVE THE LETTER "E" (TO INDICATE A LONG VOWEL SOUND).

SER. NO. 77-333,279, FILED 11-19-2007.

PAM WILLIS, EXAMINING ATTORNEY

**Int. Cls.: 29, 30 and 44**

**Prior U.S. Cls.: 46, 100 and 101**

**United States Patent and Trademark Office**

**Reg. No. 3,466,985**

**Registered July 15, 2008**

**TRADEMARK  
SERVICE MARK  
PRINCIPAL REGISTER**

**Dr. Siegal's Cookie Diet**

SM LICENSING CORPORATION (FLORIDA CORPORATION)  
12254 SW 131ST AVE  
MIAMI, FL 33186

FOR: SOUP MIX, IN CLASS 29 (U.S. CL. 46).

FIRST USE 5-1-2007; IN COMMERCE 5-1-2007.

FOR: COOKIES, SHAKE MIX, IN CLASS 30 (U.S. CL. 46).

FIRST USE 5-1-2007; IN COMMERCE 5-1-2007.

FOR: WEIGHT REDUCTION DIET PLANNING AND SUPERVISION SERVICES, IN CLASS 44 (U.S. CLS. 100 AND 101).

FIRST USE 5-1-2007; IN COMMERCE 5-1-2007.

THE MARK CONSISTS OF STANDARD CHARACTERS WITHOUT CLAIM TO ANY PARTICULAR FONT, STYLE, SIZE, OR COLOR.

OWNER OF U.S. REG. NOS. 3,140,979, 3,163,123, AND 3,185,396.

NO CLAIM IS MADE TO THE EXCLUSIVE RIGHT TO USE "COOKIE DIET", APART FROM THE MARK AS SHOWN.

THE NAME(S), PORTRAIT(S), AND/OR SIGNATURE(S) SHOWN IN THE MARK IDENTIFIES DR. SANFORD SIEGAL, WHOSE CONSENT(S) TO REGISTER IS MADE OF RECORD.

SER. NO. 77-333,288, FILED 11-19-2007.

SHAILA SETTLES, EXAMINING ATTORNEY



**Int. Cl.: 18**

**Prior U.S. Cls.: 1, 2, 3, 22 and 41**

**Reg. No. 3,466,986**

**United States Patent and Trademark Office**

**Registered July 15, 2008**

**TRADEMARK  
PRINCIPAL REGISTER**

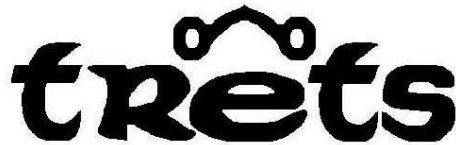

ROSELL, DIANE M. (UNITED STATES INDIVIDUAL)  
106 RIVER STREET  
DOVER-FOXCROFT, ME 04426

FOR: PET ACCESSORIES, NAMELY, CANVAS, NYLON, AND SYNTHETIC MATERIAL POUCHES FOR HOLDING PET TREATS, IN CLASS 18 (U.S. CLS. 1, 2, 3, 22 AND 41).

FIRST USE 7-7-2007; IN COMMERCE 8-23-2007.

THE MARK CONSISTS OF THE LETTERS "TRET'S", WITH THE LETTERS "TETS" IN STYLIZED LOWERCASE AND THE LETTER "R" IN STYLIZED UPPERCASE, WITH A STYLIZED DEPICTION OF A BIT (HORSE) POSITIONED ABOVE THE LETTER "E" (TO INDICATE A LONG VOWEL SOUND).

SER. NO. 77-333,296, FILED 11-19-2007.

PAM WILLIS, EXAMINING ATTORNEY

**Int. Cl.: 31**

**Prior U.S. Cls.: 1 and 46**

**United States Patent and Trademark Office**

**Reg. No. 3,466,987**

**Registered July 15, 2008**

**TRADEMARK  
PRINCIPAL REGISTER**

**ESSENTIAL SPECIALIZED SHOW  
DIETS**

NUTRITION SERVICES, INC. (NEBRASKA CORPORATION)  
P.O. BOX 386  
YORK, NE 68467

FOR: LIVESTOCK FEED, IN CLASS 31 (U.S. CLS. 1 AND 46).

FIRST USE 5-1-2002; IN COMMERCE 5-1-2002.

THE MARK CONSISTS OF STANDARD CHARACTERS WITHOUT CLAIM TO ANY PARTICULAR FONT, STYLE, SIZE, OR COLOR.

OWNER OF U.S. REG. NO. 2,793,272.

NO CLAIM IS MADE TO THE EXCLUSIVE RIGHT TO USE "DIETS", APART FROM THE MARK AS SHOWN.

SEC. 2(F).

SER. NO. 77-333,303, FILED 11-19-2007.

MARK PILARO, EXAMINING ATTORNEY

**Int. Cl.: 25**

**Prior U.S. Cls.: 22 and 39**

**United States Patent and Trademark Office**

**Reg. No. 3,466,988**

**Registered July 15, 2008**

**TRADEMARK  
PRINCIPAL REGISTER**



THE COLLEGE HOUSE, INC. (NEW YORK CORPORATION)

1400 CHAMBERLAYNE AVENUE

RICHMOND, VA 23222

FOR: IMPRINTED AND EMBROIDERED CLOTHING FOR MEN AND WOMEN, NAMELY, T-SHIRTS, SWEAT SHIRTS, SWEAT PANTS, SHORTS, LIGHT JACKETS AND COATS, HATS, CAPS AND SWIMWEAR, IN CLASS 25 (U.S. CLS. 22 AND 39).

FIRST USE 6-20-1996; IN COMMERCE 6-20-1996.

NO CLAIM IS MADE TO THE EXCLUSIVE RIGHT TO USE "SPORT", APART FROM THE MARK AS SHOWN.

THE MARK CONSISTS OF THE LETTERS "CH" ITALICIZED IN ALL CAPS FOLLOWED BY THE WORD "SPORT" IN ALL CAPS INSIDE OF A RECTANGLE DESIGN WITH AN INCOMPLETE OUTLINE AROUND THE EDGE OF THE RECTANGLE.

SER. NO. 77-333,311, FILED 11-19-2007.

CHRISTOPHER BUONGIORNO, EXAMINING ATTORNEY

Int. Cls.: 29, 30 and 44

Prior U.S. Cls.: 46, 100 and 101

United States Patent and Trademark Office

Reg. No. 3,466,989

Registered July 15, 2008

TRADEMARK  
SERVICE MARK  
PRINCIPAL REGISTER

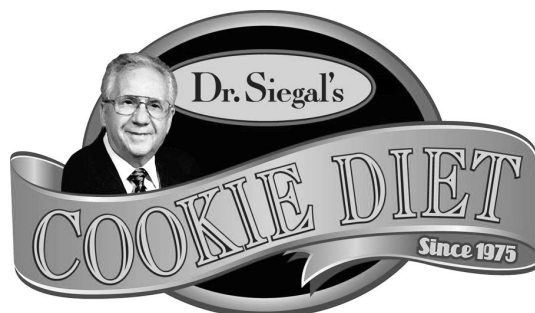

SM LICENSING CORPORATION (FLORIDA CORPORATION)  
12254 SW 131ST AVE  
MIAMI, FL 33186

FOR: SOUP MIX, IN CLASS 29 (U.S. CL. 46).

FIRST USE 5-1-2007; IN COMMERCE 5-1-2007.

FOR: COOKIES, SHAKE MIX, IN CLASS 30 (U.S. CL. 46).

FIRST USE 5-1-2007; IN COMMERCE 5-1-2007.

FOR: WEIGHT REDUCTION DIET PLANNING AND SUPERVISION SERVICES, IN CLASS 44 (U.S. CLS. 100 AND 101).

FIRST USE 5-1-2007; IN COMMERCE 5-1-2007.

OWNER OF U.S. REG. NOS. 3,140,979, 3,163,123, AND 3,185,396.

NO CLAIM IS MADE TO THE EXCLUSIVE RIGHT TO USE "COOKIE DIET" AND "SINCE 1975", APART FROM THE MARK AS SHOWN.

THE NAME(S), PORTRAIT(S), AND/OR SIGNATURE(S) SHOWN IN THE MARK IDENTIFIES DR. SANFORD SIEGAL, WHOSE CONSENT(S) TO REGISTER IS MADE OF RECORD.

THE MARK CONSISTS OF A DARK CIRCULAR BACKGROUND WITH THE WORDS "DR. SIEGAL'S", A SUPERIMPOSED RIBBON BANNER WITH THE WORDS "COOKIE DIET" AND "SINCE 1975", AND AN INSET PHOTOGRAPH OF DR. SANFORD SIEGAL.

SER. NO. 77-333,316, FILED 11-19-2007.

SHAILA SETTLES, EXAMINING ATTORNEY

**Int. Cl.: 9**

**Prior U.S. Cls.: 21, 23, 26, 36 and 38**

**Reg. No. 3,466,990**

**United States Patent and Trademark Office**

**Registered July 15, 2008**

---

**TRADEMARK  
PRINCIPAL REGISTER**

**MIAPLAYER**

MEMCO, INC. (CONNECTICUT CORPORATION)  
25 RUSTIC VIEW ROAD  
GREENWICH, CT 60830

FIRST USE 3-15-2002; IN COMMERCE 3-15-2002.

FOR: SOFTWARE WHICH ENABLES THE USER TO CREATE SPECIAL VIDEO EFFECTS AND ANIMATION AND ENABLES THE USER TO ACCESS SPECIAL VIDEO EFFECTS AND ANIMATION, IN CLASS 9 (U.S. CLS. 21, 23, 26, 36 AND 38).

THE MARK CONSISTS OF STANDARD CHARACTERS WITHOUT CLAIM TO ANY PARTICULAR FONT, STYLE, SIZE, OR COLOR.

SER. NO. 77-333,330, FILED 11-19-2007.

SALLY SHIH, EXAMINING ATTORNEY

**Int. Cl.: 41**

**Prior U.S. Cls.: 100, 101 and 107**

**United States Patent and Trademark Office**

**Reg. No. 3,466,991**

**Registered July 15, 2008**

**SERVICE MARK  
PRINCIPAL REGISTER**

**A CULTURE OF RELIABILITY**

NETEXPRESSUSA, INC. (FLORIDA CORPORATION)  
PO BOX 60075  
FORT MYERS, FL 33906

FOR: PROVIDING ON-LINE INFORMATION IN THE FIELD OF INDUSTRIAL MACHINE MAINTENANCE TO ENSURE RELIABILITY, IN CLASS 41 (U.S. CLS. 100, 101 AND 107).

FIRST USE 6-1-2005; IN COMMERCE 6-1-2005.

THE MARK CONSISTS OF STANDARD CHARACTERS WITHOUT CLAIM TO ANY PARTICULAR FONT, STYLE, SIZE, OR COLOR.

SER. NO. 77-333,355, FILED 11-19-2007.

JASON TURNER, EXAMINING ATTORNEY

**Int. Cl.: 41**

**Prior U.S. Cls.: 100, 101 and 107**

**United States Patent and Trademark Office**

**Reg. No. 3,466,992**

**Registered July 15, 2008**

**SERVICE MARK  
PRINCIPAL REGISTER**

**RELIABILITYWEB.COM**

NETEXPRESSUSA, INC. (FLORIDA CORPORATION)  
PO BOX 60075  
FORT MYERS, FL 33906

THE MARK CONSISTS OF STANDARD CHARACTERS WITHOUT CLAIM TO ANY PARTICULAR FONT, STYLE, SIZE, OR COLOR.

FOR: PROVIDING ON-LINE INFORMATION IN THE FIELD OF INDUSTRIAL MACHINE MAINTENANCE TO ENSURE RELIABILITY, IN CLASS 41 (U.S. CLS. 100, 101 AND 107).

SER. NO. 77-333,377, FILED 11-19-2007.

FIRST USE 11-1-1999; IN COMMERCE 11-1-1999.

JASON TURNER, EXAMINING ATTORNEY

**Int. Cl.: 45**

**Prior U.S. Cls.: 100 and 101**

**United States Patent and Trademark Office**

**Reg. No. 3,466,993**

**Registered July 15, 2008**

**SERVICE MARK  
PRINCIPAL REGISTER**

**SPIEGEL & UTRERA**

SPIEGEL & UTRERA, P.A. (FLORIDA CORPORATION)  
1840 SOUTHWEST 22 STREET, 4TH FLOOR  
MIAMI, FL 33145

THE MARK CONSISTS OF STANDARD CHARACTERS WITHOUT CLAIM TO ANY PARTICULAR FONT, STYLE, SIZE, OR COLOR.

FOR: LEGAL SERVICES, IN CLASS 45 (U.S. CLS. 100 AND 101).

SER. NO. 77-333,378, FILED 11-19-2007.

FIRST USE 10-2-1997; IN COMMERCE 10-2-1997.

ALYSSA PALADINO, EXAMINING ATTORNEY



**Int. Cl.: 10**

**Prior U.S. Cls.: 26, 39 and 44**

**United States Patent and Trademark Office**

**Reg. No. 3,466,994**

**Registered July 15, 2008**

**TRADEMARK  
PRINCIPAL REGISTER**



PROPPER MANUFACTURING CO., INC. (NEW  
YORK CORPORATION)  
36-04 SKILLMAN AVENUE  
LONG ISLAND CITY, NY 11101

FOR: MEDICAL DEVICES, NAMELY, DIAGNOSTIC INSTRUMENT SETS CONSISTING PRIMARILY OF OPHTHALMOSCOPES, OTOSCOPES, SPECULA, RETINOSCOPES, MAGNIFIERS, TONGUE BLADES, ILLUMINATORS AND PEN LIGHTS FOR USE IN THE MEDICAL FIELD, SPHYGMOMANOMETERS, STERILIZATION INDICATORS, MICROSCOPE SLIDES, SURGICAL BLADES AND SCALPELS, FECAL OCCULT BLOOD TEST AND MICROSCOPE

SLIDES, AND LARYNGOSCOPES, IN CLASS 10 (U.S. CLS. 26, 39 AND 44).

FIRST USE 2-1-2007; IN COMMERCE 2-1-2007.

OWNER OF U.S. REG. NO. 1,426,139.

THE MARK CONSISTS OF THE LETTER "P" AND DESIGN.

SER. NO. 77-333,388, FILED 11-19-2007.

HENRY S. ZAK, EXAMINING ATTORNEY

Int. Cls.: 35 and 37

Prior U.S. Cls.: 100, 101, 102, 103 and 106

United States Patent and Trademark Office

Reg. No. 3,466,995

Registered July 15, 2008

SERVICE MARK  
PRINCIPAL REGISTER



REFRESH TO SELL, INC. (FLORIDA CORPORATION)  
2200 CORPORATE DRIVE  
BOYNTON BEACH, FL 33426

FOR: RETAIL SHOP-AT-HOME SERVICES FEATURING HOUSE PAINTS, CARPETING, WINDOW TREATMENTS, CROWN MOULDINGS, ELECTRICAL RECEPTACLES AND SWITCHES, CEILING FANS, BATH FIXTURES, BATHROOM MIRROR FRAMES, TILE, AND GROUT STAINS, IN CLASS 35 (U.S. CLS. 100, 101 AND 102).

FIRST USE 8-20-2007; IN COMMERCE 10-22-2007.

FOR: CONSULTATION SERVICES IN THE FIELD OF REFURBISHING RESIDENTIAL PROPERTIES; HOUSE PAINTING SERVICES; INSTALLATION OF CARPET, WINDOW TREATMENTS, CROWN MOULDINGS, ELECTRICAL RECEPTACLES AND SWITCHES, CEILING FANS, BATH FIXTURES, BATHROOM MIRROR FRAMES, AND TILE; GROUT RECOLORING SERVICES, IN CLASS 37 (U.S. CLS. 100, 103 AND 106).

FIRST USE 8-20-2007; IN COMMERCE 10-22-2007.

THE COLOR(S) BLUE, RED, GREEN, YELLOW, WHITE, BEIGE, BROWN, GOLD, GRAY, AND BLACK IS/ARE CLAIMED AS A FEATURE OF THE MARK.

THE MARK CONSISTS OF THE WORDS "REFRESH TO SELL" AND AN ANTHROPOMORPHIC HOUSE VIEWED FROM THE FRONT HOLDING A SIGN THAT READS "SOLD". THE COLOR BLUE APPEARS IN THE WORD "REFRESH" AND IN THE SHOES. THE COLOR RED APPEARS IN THE WORD "TO", IN THE NOSE AND IN THE "SOLD" SIGN. THE COLOR GREEN APPEARS IN THE WORD "SELL" AND IN THE SCREWDRIVER. THE COLOR YELLOW APPEARS IN THE BRUSH STROKE UNDERSCORING THE WORD "SELL". THE COLOR WHITE APPEARS IN THE SHOES, IN THE GLOVES AND IN THE "SOLD" SIGN. THE COLOR BEIGE APPEARS IN THE FACE OF THE HOUSE AND ON THE HAMMER. THE COLOR BROWN APPEARS IN THE BELT, IN THE HANDLE OF THE "SOLD" SIGN, ON THE SIDING AND ROOF OF THE HOUSE. THE COLOR GOLD APPEARS IN THE BELT BUCKLE. THE COLOR GRAY APPEARS IN THE ARMS, LEGS, SCREWDRIVER, AND HAMMER. THE COLOR BLACK OUTLINES THE WORDS "REFRESH TO SELL" AND HOUSE, "SOLD" SIGN, HAMMER, EYEBROWS, EYES, AND MOUTH.

SER. NO. 77-333,414, FILED 11-19-2007.

ANDREA HACK, EXAMINING ATTORNEY

**Int. Cls.: 35 and 37**

**Prior U.S. Cls.: 100, 101, 102, 103 and 106**

**United States Patent and Trademark Office**

**Reg. No. 3,466,996**

**Registered July 15, 2008**

**SERVICE MARK  
PRINCIPAL REGISTER**

**REFRESH TO SELL**

REFRESH TO SELL, INC. (FLORIDA CORPORATION)  
2200 CORPORATE DRIVE  
BOYNTON BEACH, FL 33426

FOR: RETAIL SHOP-AT-HOME SERVICES FEATURING HOUSE PAINTS, CARPETING, WINDOW TREATMENTS, CROWN MOULDINGS, ELECTRICAL RECEPTACLES AND SWITCHES, CEILING FANS, BATH FIXTURES, BATHROOM MIRROR FRAMES, TILE, AND GROUT STAINS, IN CLASS 35 (U.S. CLS. 100, 101 AND 102).

FIRST USE 8-20-2007; IN COMMERCE 10-22-2007.

FOR: CONSULTATION SERVICES IN THE FIELD OF REFURBISHING RESIDENTIAL PROPERTIES; HOUSE PAINTING SERVICES; INSTALLATION OF

CARPET, WINDOW TREATMENTS, CROWN MOULDINGS, ELECTRICAL RECEPTACLES AND SWITCHES, CEILING FANS, BATH FIXTURES, BATHROOM MIRROR FRAMES, AND TILE; GROUT RECOLORING SERVICES, IN CLASS 37 (U.S. CLS. 100, 103 AND 106).

FIRST USE 8-20-2007; IN COMMERCE 10-22-2007.

THE MARK CONSISTS OF STANDARD CHARACTERS WITHOUT CLAIM TO ANY PARTICULAR FONT, STYLE, SIZE, OR COLOR.

SER. NO. 77-333,420, FILED 11-19-2007.

ANDREA HACK, EXAMINING ATTORNEY

Int. Cl.: 5

Prior U.S. Cls.: 6, 18, 44, 46, 51 and 52

United States Patent and Trademark Office

Reg. No. 3,466,997

Registered July 15, 2008

TRADEMARK  
PRINCIPAL REGISTER



HEALTHMERICA CORPORATION (CALIFORNIA CORPORATION)  
2455 EDWARDS AVE.  
S. EL MONTE, CA 91733

FOR: DIETARY AND NUTRITIONAL SUPPLEMENTS; DIETARY SUPPLEMENTAL DRINKS; DIETARY SUPPLEMENTS; DIETARY SUPPLEMENTS FOR HUMAN CONSUMPTION; HERBAL SUPPLEMENTS; HERBAL TEAS FOR MEDICINAL PURPOSES, IN CLASS 5 (U.S. CLS. 6, 18, 44, 46, 51 AND 52).

FIRST USE 11-1-2007; IN COMMERCE 11-1-2007.

THE COLOR(S) BLACK, WHITE, RED, AND BLUE IS/ARE CLAIMED AS A FEATURE OF THE MARK.

THE MARK CONSISTS OF THE LETTERS "MJ" IN BLUE COLOR LOCATED IN THE MIDDLE OF A RED-OUTLINED BOX, WITH THE WORD "HEALTHMERICA" IN BLUE BOTH ABOVE AND BELOW THE SQUARE. THE WHOLE MARK IS ENCLOSED BY A BLACK OUTLINED BOX.

SER. NO. 77-333,444, FILED 11-19-2007.

MIDGE BUTLER, EXAMINING ATTORNEY

**Int. Cl.: 41**

**Prior U.S. Cls.: 100, 101 and 107**

**United States Patent and Trademark Office**

**Reg. No. 3,466,998**

**Registered July 15, 2008**

**SERVICE MARK  
PRINCIPAL REGISTER**

**iCruise**

LANZ, JEFFERSON (UNITED STATES INDIVIDUAL)  
8033 SUNSET BLVD. #401  
LOS ANGELES, CA 90046

THE MARK CONSISTS OF STANDARD CHARACTERS WITHOUT CLAIM TO ANY PARTICULAR FONT, STYLE, SIZE, OR COLOR.

FOR: DIGITAL VIDEO, AUDIO, AND MULTIMEDIA PUBLISHING SERVICES, IN CLASS 41 (U.S. CLS. 100, 101 AND 107).

SER. NO. 77-333,458, FILED 11-19-2007.

FIRST USE 11-8-2006; IN COMMERCE 11-8-2006.

PAUL F. GAST, EXAMINING ATTORNEY

**Int. Cl.: 41**

**Prior U.S. Cls.: 100, 101 and 107**

**United States Patent and Trademark Office**

**Reg. No. 3,466,999**

**Registered July 15, 2008**

**SERVICE MARK  
PRINCIPAL REGISTER**

**SAVORRA**

SAVORRA COOKING SHOWS, LLC (ILLINOIS  
LTD LIAB CO)  
2025 W. BELMONT AVENUE, #2  
CHICAGO, IL 60618

FOR: ENTERTAINMENT SERVICES, NAMELY,  
CONDUCTING EXHIBITIONS IN THE NATURE OF  
A COOKING SHOW, EDUCATIONAL COOKING  
DEMONSTRATIONS, IN CLASS 41 (U.S. CLS. 100, 101  
AND 107).

FIRST USE 9-15-2007; IN COMMERCE 11-1-2007.

THE MARK CONSISTS OF STANDARD CHAR-  
ACTERS WITHOUT CLAIM TO ANY PARTICULAR  
FONT, STYLE, SIZE, OR COLOR.

SER. NO. 77-333,508, FILED 11-19-2007.

JANICE KIM, EXAMINING ATTORNEY

**Int. Cls.: 16 and 39**

**Prior U.S. Cls.: 2, 5, 22, 23, 29, 37, 38, 50, 100 and 105**

**Reg. No. 3,467,000**

**United States Patent and Trademark Office**

**Registered July 15, 2008**

---

**TRADEMARK  
SERVICE MARK  
PRINCIPAL REGISTER**

**BAD TO THE BEAUNE**

PINE RIDGE WINERY, LLC (DELAWARE LTD  
LIAB CO)  
5901 SILVERADO TRAIL  
NAPA, CA 94558

FOR: NEWSLETTERS IN THE FIELD OF WINE,  
IN CLASS 16 (U.S. CLS. 2, 5, 22, 23, 29, 37, 38 AND 50).

FIRST USE 1-31-1995; IN COMMERCE 1-31-1995.

FOR: WINE CLUB FEATURING PERIODIC SHIP-  
MENT OF WINES TO MEMBERS, IN CLASS 39 (U.S.  
CLS. 100 AND 105).

FIRST USE 1-31-1995; IN COMMERCE 1-31-1995.

THE MARK CONSISTS OF STANDARD CHAR-  
ACTERS WITHOUT CLAIM TO ANY PARTICULAR  
FONT, STYLE, SIZE, OR COLOR.

OWNER OF U.S. REG. NO. 2,130,514.

SER. NO. 77-333,513, FILED 11-19-2007.

JUDITH HELFMAN, EXAMINING ATTORNEY

**Int. Cl.: 42**

**Prior U.S. Cls.: 100 and 101**

**United States Patent and Trademark Office**

**Reg. No. 3,467,001**

**Registered July 15, 2008**

**SERVICE MARK  
PRINCIPAL REGISTER**

# Deadmentalk

IGNIS FORENSICS, LLC (COLORADO LTD LIAB  
CO)  
STE. 445  
200 S. WILCOX ST.  
CASTLE ROCK, CO 80104

THE MARK CONSISTS OF STANDARD CHAR-  
ACTERS WITHOUT CLAIM TO ANY PARTICULAR  
FONT, STYLE, SIZE, OR COLOR.

FOR: CONSULTING SERVICES IN THE FIELD  
OF COLLECTION OF EVIDENCE FOR FORENSIC  
PURPOSES, IN CLASS 42 (U.S. CLS. 100 AND 101).

SER. NO. 77-333,520, FILED 11-19-2007.

FIRST USE 10-24-1994; IN COMMERCE 10-24-1994.

GRETTA YAO, EXAMINING ATTORNEY



**Int. Cl.: 41**

**Prior U.S. Cls.: 100, 101 and 107**

**United States Patent and Trademark Office**

**Reg. No. 3,467,002**

**Registered July 15, 2008**

**SERVICE MARK  
PRINCIPAL REGISTER**



FISH FOR DISH, LLC (ARIZONA LTD LIAB CO)  
507 EAST DESERT HILLS ESTATES DRIVE  
PHOENIX, AZ 85086

FOR: PROVIDING A WEBSITE THAT FEATURES  
INFORMAL INSTRUCTION ON COOKING, IN  
CLASS 41 (U.S. CLS. 100, 101 AND 107).

FIRST USE 10-1-2007; IN COMMERCE 10-1-2007.

THE COLOR(S) ORANGE, YELLOW, WHITE,  
BLACK, BLUE, GRAY AND BROWN IS/ARE  
CLAIMED AS A FEATURE OF THE MARK.

THE MARK CONSISTS OF CARTOON SHARK  
WITH KNIFE AND FORK. THE SHARK'S BODY IS  
ORANGE WITH A YELLOW BELLY. THE TEETH,  
KNIFE AND FORK ARE SHADES OF BLUE AND  
WHITE. THE SHARK'S EYE IS BLACK AND WHITE  
AND ITS EYEBROW DARK BROWN. THE DESIGN  
AS A WHOLE HAS A GRAY SHADOW.

SER. NO. 77-333,523, FILED 11-19-2007.

STEVEN PEREZ, EXAMINING ATTORNEY

**Int. Cl.: 30**

**Prior U.S. Cl.: 46**

**United States Patent and Trademark Office**

**Reg. No. 3,467,003**

**Registered July 15, 2008**

**TRADEMARK  
PRINCIPAL REGISTER**

**HAWAIIAN TRADITION**

LONGS DRUG STORES CALIFORNIA, INC (CALIFORNIA CORPORATION)  
141 NORTH CIVIC DRIVE  
WALNUT CREEK, CA 94596

NO CLAIM IS MADE TO THE EXCLUSIVE RIGHT TO USE "HAWAIIAN", APART FROM THE MARK AS SHOWN.

FOR: COFFEE, IN CLASS 30 (U.S. CL. 46).

FIRST USE 3-0-2000; IN COMMERCE 3-0-2000.

SER. NO. 77-333,535, FILED 11-19-2007.

THE MARK CONSISTS OF STANDARD CHARACTERS WITHOUT CLAIM TO ANY PARTICULAR FONT, STYLE, SIZE, OR COLOR.

MICHAEL WIENER, EXAMINING ATTORNEY

**Int. Cl.: 9**

**Prior U.S. Cls.: 21, 23, 26, 36 and 38**

**Reg. No. 3,467,004**

**United States Patent and Trademark Office**

**Registered July 15, 2008**

**TRADEMARK  
PRINCIPAL REGISTER**



EVER ISLAND ELECTRIC CO., LTD. (CHINA CORPORATION)  
NO1, YIHENG RD., BULONG IND. DIST.  
PUXIN, YANTIAN, FENGGANG, DONGGUAN  
GUANGDONG, CHINA

FOR: ELECTRICAL PLUGS; ELECTRICAL SOCKETS; ELECTRICAL CONNECTORS, AND ELECTRICAL FUSES, IN CLASS 9 (U.S. CLS. 21, 23, 26, 36 AND 38).

FIRST USE 10-31-2002; IN COMMERCE 12-31-2002.

OWNER OF U.S. REG. NO. 2,878,662.

THE MARK CONSISTS OF THE STYLIZED LETTERS "STA" WITHIN A TRIANGULAR CONTOUR WITH THE LETTER "T" HAVING A TOP LINE WHICH EXTENDS OVER THE LETTERS "S" AND "A" AND EXTENDS TO TWO SIDES OF THE TRIANGULAR CONTOUR.

SER. NO. 77-333,537, FILED 11-19-2007.

CHARLES L. JENKINS, EXAMINING ATTORNEY

**Int. Cl.: 19**

**Prior U.S. Cls.: 1, 12, 33 and 50**

**United States Patent and Trademark Office**

**Reg. No. 3,467,005**

**Registered July 15, 2008**

**TRADEMARK  
PRINCIPAL REGISTER**

**ESSROC BLX CEMENT**

TOMAHAWK, INC. (DELAWARE CORPORATION)  
105 NORTH MARKET STREET  
WILMINGTON, DE 19801

OWNER OF U.S. REG. NO. 2,305,722.

FOR: CEMENT USED BY MANUFACTURERS OF  
CEMENT BLOCKS, IN CLASS 19 (U.S. CLS. 1, 12, 33  
AND 50).

NO CLAIM IS MADE TO THE EXCLUSIVE  
RIGHT TO USE "CEMENT", APART FROM THE  
MARK AS SHOWN.

FIRST USE 10-30-1995; IN COMMERCE 10-30-1995.

SER. NO. 77-333,560, FILED 11-19-2007.

THE MARK CONSISTS OF STANDARD CHAR-  
ACTERS WITHOUT CLAIM TO ANY PARTICULAR  
FONT, STYLE, SIZE, OR COLOR.

MORGAN WYNNE, EXAMINING ATTORNEY

**Int. Cl.: 19**

**Prior U.S. Cls.: 1, 12, 33 and 50**

**United States Patent and Trademark Office**

**Reg. No. 3,467,006**

**Registered July 15, 2008**

**TRADEMARK  
PRINCIPAL REGISTER**

**ANTIQUÉ LIMOGÉ**

SAROYAN LUMBER COMPANY, INC. (CALI-  
FORNIA CORPORATION)  
6230 SO. ALAMEDA ST.  
HUNTINGTON PARK, CA 90255

FOR: FLOOR BOARDS, WOODEN FLOORING,  
HARDWOOD FLOORING; NON-METAL ARCHI-  
TECTURAL MOULDINGS AND FINISH TRIM, IN  
CLASS 19 (U.S. CLS. 1, 12, 33 AND 50).

FIRST USE 5-11-2006; IN COMMERCE 5-11-2006.

THE MARK CONSISTS OF STANDARD CHAR-  
ACTERS WITHOUT CLAIM TO ANY PARTICULAR  
FONT, STYLE, SIZE, OR COLOR.

NO CLAIM IS MADE TO THE EXCLUSIVE  
RIGHT TO USE "ANTIQUÉ", APART FROM THE  
MARK AS SHOWN.

THE WORDING "LIMOGÉ" HAS NO MEANING  
IN A FOREIGN LANGUAGE.

SER. NO. 77-333,572, FILED 11-19-2007.

KELLEY WELLS, EXAMINING ATTORNEY

**Int. Cl.: 36**

**Prior U.S. Cls.: 100, 101 and 102**

**United States Patent and Trademark Office**

**Reg. No. 3,467,007**

**Registered July 15, 2008**

**SERVICE MARK  
PRINCIPAL REGISTER**

# SeaCapital

SEACAPITAL LLC (FLORIDA LTD LIAB CO)  
1504 BAY RD. #3007  
MIAMI, FL 33139

FOR: EQUITY CAPITAL INVESTMENT; FUNDS INVESTMENT; INVESTMENT OF FUNDS FOR OTHERS; MANAGEMENT OF A CAPITAL INVESTMENT FUND; MANAGEMENT OF PRIVATE EQUITY FUNDS; PRIVATE EQUITY FUND INVESTMENT SERVICES; PRIVATE PLACEMENTS OF HEDGE FUNDS, PRIVATE EQUITY FUNDS,

SECURITIES AND DERIVATIVES FOR OTHERS, IN CLASS 36 (U.S. CLS. 100, 101 AND 102).

FIRST USE 4-25-2007; IN COMMERCE 7-2-2007.

THE MARK CONSISTS OF STANDARD CHARACTERS WITHOUT CLAIM TO ANY PARTICULAR FONT, STYLE, SIZE, OR COLOR.

SER. NO. 77-333,587, FILED 11-19-2007.

BRIAN NEVILLE, EXAMINING ATTORNEY

**Int. Cl.: 41**

**Prior U.S. Cls.: 100, 101 and 107**

**United States Patent and Trademark Office**

**Reg. No. 3,467,008**

**Registered July 15, 2008**

**SERVICE MARK  
PRINCIPAL REGISTER**

**NAIALANI PRODUCTIONS**

STEELMAN, JULIE (UNITED STATES INDIVIDUAL)  
75-216 MALULANI DRIVE  
KAILUA-KONA, HI 96740

FOR: PHOTOGRAPHY SERVICES; PORTRAIT PHOTOGRAPHY; PRODUCTION OF VIDEO CASSETTES; PRODUCTION OF VIDEO DISCS AND TAPES; PRODUCTION OF VIDEO DISCS FOR OTHERS; VIDEO EDITING; VIDEO MASTERING SERVICES; VIDEO TAPE EDITING; VIDEO TAPE RECORDING FOR OTHERS; PROVIDING FACILITIES FOR PRODUCING VIDEO, CINEMA AND PHOTOGRAPHY PRODUCTIONS; MEDIA PRODUCTION SERVICES, NAMELY, VIDEO AND FILM PRODUCTION; OPERATION OF VIDEO EQUIPMENT OR AUDIO EQUIPMENT ETC. FOR PRODUCTION OF RADIO OR TELEVISION PROGRAMS; PHOTOGRAPHIC AND VIDEO SERVICES, NAMELY, PHOTOGRAPHIC AND VIDEO

CAPTURE; PRODUCTION OF VISUAL EFFECTS FOR VIDEOS, DVDS, TELEVISION AND FOR INTERNET WEBSITES, IN CLASS 41 (U.S. CLS. 100, 101 AND 107).

FIRST USE 10-1-2007; IN COMMERCE 10-1-2007.

THE MARK CONSISTS OF STANDARD CHARACTERS WITHOUT CLAIM TO ANY PARTICULAR FONT, STYLE, SIZE, OR COLOR.

NO CLAIM IS MADE TO THE EXCLUSIVE RIGHT TO USE "PRODUCTIONS", APART FROM THE MARK AS SHOWN.

SER. NO. 77-333,594, FILED 11-19-2007.

ANNE FARRELL, EXAMINING ATTORNEY

**Int. Cl.: 19**

**Prior U.S. Cls.: 1, 12, 33 and 50**

**United States Patent and Trademark Office**

**Reg. No. 3,467,009**

**Registered July 15, 2008**

**TRADEMARK  
PRINCIPAL REGISTER**

**VINTE BLANC**

SAROYAN LUMBER COMPANY, INC. (CALI-  
FORNIA CORPORATION)  
6230 SO. ALAMEDA ST.  
HUNTINGTON PARK, CA 90255

FOR: FLOOR BOARDS, WOODEN FLOORING,  
HARDWOOD FLOORING; NON-METAL ARCHI-  
TECTURAL MOULDINGS AND FINISH TRIM, IN  
CLASS 19 (U.S. CLS. 1, 12, 33 AND 50).

FIRST USE 5-11-2006; IN COMMERCE 5-11-2006.

THE MARK CONSISTS OF STANDARD CHAR-  
ACTERS WITHOUT CLAIM TO ANY PARTICULAR  
FONT, STYLE, SIZE, OR COLOR.

NO CLAIM IS MADE TO THE EXCLUSIVE  
RIGHT TO USE "BLANC", APART FROM THE  
MARK AS SHOWN.

THE ENGLISH TRANSLATION OF "VINTE  
BLANC" IS TWENTY WHITE.

SER. NO. 77-333,606, FILED 11-19-2007.

KELLEY WELLS, EXAMINING ATTORNEY



**Int. Cls.: 9 and 11**

**Prior U.S. Cls.: 13, 21, 23, 26, 31, 34, 36 and 38**

**United States Patent and Trademark Office**

**Reg. No. 3,467,010**

**Registered July 15, 2008**

**TRADEMARK  
PRINCIPAL REGISTER**

**Kooler  
g e n i u s**

HUA BEN WU, (CHINA INDIVIDUAL)  
BEIKENG DEVELOP AREAS, FUCHENG TOWN  
TAISHAN CITY, CHINA

FOR: WATER LEAKAGE DETECTING DEVICE  
CONSISTING OF WATER SENSOR, CONTROL  
UNIT AND ADAPTER, IN CLASS 9 (U.S. CLS. 21,  
23, 26, 36 AND 38).

FIRST USE 4-5-2007; IN COMMERCE 4-5-2007.

FOR: WATER COOLERS AND WATER PURIFY-  
ING APPARATUS, IN CLASS 11 (U.S. CLS. 13, 21, 23,  
31 AND 34).

FIRST USE 4-5-2007; IN COMMERCE 4-5-2007.

NO CLAIM IS MADE TO THE EXCLUSIVE  
RIGHT TO USE "COOLER", APART FROM THE  
MARK AS SHOWN.

THE MARK CONSISTS OF STYLIZED "KOOLER  
GENIUS".

SER. NO. 77-333,613, FILED 11-19-2007.

DORITT L. CARROLL, EXAMINING ATTORNEY

**Int. Cl.: 35**

**Prior U.S. Cls.: 100, 101 and 102**

**United States Patent and Trademark Office**

**Reg. No. 3,467,011**

**Registered July 15, 2008**

**SERVICE MARK  
PRINCIPAL REGISTER**

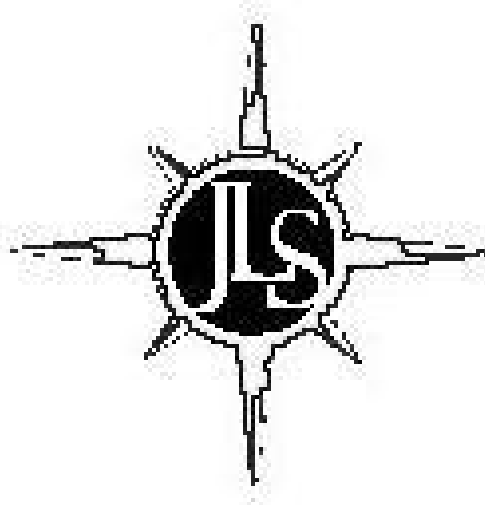

JLS MARKETING CONCEPTS LTD (OHIO LTD  
LIAB CO)  
4884 HIGBEE AVE NW  
CANTON, OH 44718

FOR: BUSINESS MARKETING CONSULTING  
SERVICES; BUSINESS MARKETING SERVICES;  
MARKETING CONSULTING; MARKETING PLAN  
DEVELOPMENT; PROVIDING BUSINESS MAR-  
KETING INFORMATION, IN CLASS 35 (U.S. CLS.  
100, 101 AND 102).

FIRST USE 1-1-2005; IN COMMERCE 1-1-2005.

THE MARK CONSISTS OF THE DESIGN OF A  
NAUTICAL SIGN WITH THE LETTERS "JLS" IN  
THE CENTER.

SER. NO. 77-333,622, FILED 11-19-2007.

ELIZABETH HUGHITT, EXAMINING ATTORNEY

**Int. Cl.: 11**

**Prior U.S. Cls.: 13, 21, 23, 31 and 34**

**Reg. No. 3,467,012**

**United States Patent and Trademark Office**

**Registered July 15, 2008**

---

**TRADEMARK  
PRINCIPAL REGISTER**

**Small Wonder**

SCALEWATCHER NORTH AMERICA INC.  
(PENNSYLVANIA CORPORATION)  
345 LINCOLN STREET  
OXFORD, PA 19363

THE MARK CONSISTS OF STANDARD CHAR-  
ACTERS WITHOUT CLAIM TO ANY PARTICULAR  
FONT, STYLE, SIZE, OR COLOR.

FOR: WATER CONDITIONING UNITS, IN CLASS  
11 (U.S. CLS. 13, 21, 23, 31 AND 34).

SER. NO. 77-333,647, FILED 11-19-2007.

FIRST USE 12-1-2006; IN COMMERCE 12-1-2006.

MELISSA VALLILLO, EXAMINING ATTORNEY

**Int. Cl.: 42**

**Prior U.S. Cls.: 100 and 101**

**United States Patent and Trademark Office**

**Reg. No. 3,467,013**

**Registered July 15, 2008**

**SERVICE MARK  
PRINCIPAL REGISTER**

**LEAFS**

ALCHEMY3, LLC (GEORGIA LTD LIAB CO)  
1725 WINDWARD CONCOURSE, STE 150  
ALPHARETTA, GA 30005

FOR: PROVIDING ON-LINE NON-DOWNLOAD-  
ABLE SOFTWARE FOR USE IN DATABASE MAN-  
AGEMENT OF LICENSED ARTWORK FILES AND  
RELATED COMMENTARY, IN CLASS 42 (U.S. CLS.  
100 AND 101).

FIRST USE 9-20-2007; IN COMMERCE 11-19-2007.

THE MARK CONSISTS OF STANDARD CHAR-  
ACTERS WITHOUT CLAIM TO ANY PARTICULAR  
FONT, STYLE, SIZE, OR COLOR.

SER. NO. 77-333,653, FILED 11-19-2007.

JAY FLOWERS, EXAMINING ATTORNEY

**Int. Cls.: 36 and 37**

**Prior U.S. Cls.: 100, 101, 102, 103 and 106**

**United States Patent and Trademark Office**

**Reg. No. 3,467,014**

**Registered July 15, 2008**

**SERVICE MARK  
PRINCIPAL REGISTER**

**BIXBY**

BIXBY LAND COMPANY (CALIFORNIA CORPORATION)  
SUITE 500  
2211 MICHELSON DRIVE  
IRVINE, CA 92612

FOR: REAL ESTATE INVESTMENT, REAL ESTATE ACQUISITION SERVICES, LEASING OF REAL ESTATE, AND REAL ESTATE MANAGEMENT, IN CLASS 36 (U.S. CLS. 100, 101 AND 102).

FIRST USE 0-0-1896; IN COMMERCE 0-0-1896.

FOR: REAL ESTATE DEVELOPMENT, IN CLASS 37 (U.S. CLS. 100, 103 AND 106).

FIRST USE 0-0-1896; IN COMMERCE 0-0-1896.

THE MARK CONSISTS OF STANDARD CHARACTERS WITHOUT CLAIM TO ANY PARTICULAR FONT, STYLE, SIZE, OR COLOR.

SEC. 2(F).

SER. NO. 77-333,654, FILED 11-19-2007.

MORGAN WYNNE, EXAMINING ATTORNEY

**Int. Cls.: 36 and 37**

**Prior U.S. Cls.: 100, 101, 102, 103 and 106**

**United States Patent and Trademark Office**

**Reg. No. 3,467,015**

**Registered July 15, 2008**

**SERVICE MARK  
PRINCIPAL REGISTER**

**BIXBY LAND COMPANY**

BIXBY LAND COMPANY (CALIFORNIA CORPORATION)  
SUITE 500  
2211 MICHELSON DRIVE  
IRVINE, CA 92612

FOR: REAL ESTATE INVESTMENT, REAL ESTATE ACQUISITION SERVICES, LEASING OF REAL ESTATE, AND REAL ESTATE MANAGEMENT, IN CLASS 36 (U.S. CLS. 100, 101 AND 102).

FIRST USE 0-0-1896; IN COMMERCE 0-0-1896.

FOR: REAL ESTATE DEVELOPMENT, IN CLASS 37 (U.S. CLS. 100, 103 AND 106).

FIRST USE 0-0-1896; IN COMMERCE 0-0-1896.

THE MARK CONSISTS OF STANDARD CHARACTERS WITHOUT CLAIM TO ANY PARTICULAR FONT, STYLE, SIZE, OR COLOR.

NO CLAIM IS MADE TO THE EXCLUSIVE RIGHT TO USE "LAND COMPANY", APART FROM THE MARK AS SHOWN.

SEC. 2(F).

SER. NO. 77-333,658, FILED 11-19-2007.

MORGAN WYNNE, EXAMINING ATTORNEY

**Int. Cl.: 41**

**Prior U.S. Cls.: 100, 101 and 107**

**United States Patent and Trademark Office**

**Reg. No. 3,467,016**

**Registered July 15, 2008**

**SERVICE MARK  
PRINCIPAL REGISTER**

# GHOST WALK

KARLAGE, ROCKY CHARLES (UNITED STATES  
INDIVIDUAL)  
3410 ALTA VISTA AVE  
CINCINNATI, OH 45211

FOR: ARRANGING AND CONDUCTING OF  
CONCERTS; ENTERTAINMENT IN THE NATURE  
OF PROVIDING A WEB SITE FEATURING NAR-  
RATIVE STORIES, RELATED MUSICAL RECORD-  
INGS, RELATED FILM CLIPS, PHOTOGRAPHS,  
AND OTHER MULTIMEDIA MATERIALS; PUBLI-  
CATION OF NARRATIVE STORIES ONLINE; MED-  
IA PRODUCTION SERVICES, NAMELY, VIDEO

AND FILM PRODUCTION, IN CLASS 41 (U.S. CLS.  
100, 101 AND 107).

FIRST USE 11-19-2007; IN COMMERCE 11-19-2007.

THE MARK CONSISTS OF STANDARD CHAR-  
ACTERS WITHOUT CLAIM TO ANY PARTICULAR  
FONT, STYLE, SIZE, OR COLOR.

SER. NO. 77-333,678, FILED 11-19-2007.

SOPHIA S. KIM, EXAMINING ATTORNEY

**Int. Cl.: 37**

**Prior U.S. Cls.: 100, 103 and 106**

**United States Patent and Trademark Office**

**Reg. No. 3,467,017**

**Registered July 15, 2008**

**SERVICE MARK  
PRINCIPAL REGISTER**

**ANGELS UNDERCOVER  
ENTERPRISES**

ANGELS UNDERCOVER ENTERPRISES, INC.  
(NEW YORK CORPORATION)  
PO BOX 1  
GROVELAND, NY 14462

FOR: BUILDING CONSTRUCTION SERVICES;  
EXCAVATION SERVICES; CLEANING OF THE  
PREMISES OF COMMERCIAL AND PRIVATE  
PROPERTIES, IN CLASS 37 (U.S. CLS. 100, 103 AND  
106).

FIRST USE 6-0-2007; IN COMMERCE 6-0-2007.

THE MARK CONSISTS OF STANDARD CHAR-  
ACTERS WITHOUT CLAIM TO ANY PARTICULAR  
FONT, STYLE, SIZE, OR COLOR.

NO CLAIM IS MADE TO THE EXCLUSIVE  
RIGHT TO USE "ENTERPRISES", APART FROM  
THE MARK AS SHOWN.

SER. NO. 77-333,682, FILED 11-20-2007.

SANJEEV VOHRA, EXAMINING ATTORNEY



**Int. Cl.: 42**

**Prior U.S. Cls.: 100 and 101**

**United States Patent and Trademark Office**

**Reg. No. 3,467,018**

**Registered July 15, 2008**

---

**SERVICE MARK  
PRINCIPAL REGISTER**

**GoSee4Me**

BANDOBI, LLC (CALIFORNIA LTD LIAB CO),  
DBA GOSEE4ME  
12401 EVENINGSIDE DRIVE  
SANTA ANA, CA 92705

THE MARK CONSISTS OF STANDARD CHAR-  
ACTERS WITHOUT CLAIM TO ANY PARTICULAR  
FONT, STYLE, SIZE, OR COLOR.

FOR: PROVIDING A WEBSITE THAT GIVES  
COMPUTER USERS THE ABILITY TO UPLOAD,  
EXCHANGE AND SHARE PHOTOS, VIDEOS AND  
VIDEO LOGS, IN CLASS 42 (U.S. CLS. 100 AND 101).

SER. NO. 77-333,683, FILED 11-20-2007.

FIRST USE 11-6-2007; IN COMMERCE 11-6-2007.

STEVEN PEREZ, EXAMINING ATTORNEY

**Int. Cl.: 5**

**Prior U.S. Cls.: 6, 18, 44, 46, 51 and 52**

**Reg. No. 3,467,019**

**United States Patent and Trademark Office**

**Registered July 15, 2008**

**TRADEMARK  
PRINCIPAL REGISTER**



URI INTERNATIONAL, INC. (NEVADA CORPORATION)  
2331 WEST PARK AVENUE  
CEDAR CITY, UT 84720

FOR: DIETARY FOOD SUPPLEMENTS, IN CLASS 5 (U.S. CLS. 6, 18, 44, 46, 51 AND 52).

FIRST USE 12-5-2002; IN COMMERCE 12-5-2002.

THE COLOR(S) LIGHT GREEN, DARK GREEN, AND BLACK IS/ARE CLAIMED AS A FEATURE OF THE MARK.

THE MARK CONSISTS OF A PAIR OF LEAVES, ONE OF WHICH IS LIGHT GREEN, THE OTHER DARK GREEN IN COLOR, FOLLOWED BY THE STYLIZED LETTERS "URI" IN BLACK, WITH THE DOT OVER THE "I" BEING A SMALL DARK-GREEN LEAF.

SER. NO. 77-333,699, FILED 11-20-2007.

SAMUEL E. SHARPER JR., EXAMINING ATTORNEY

**Int. Cl.: 28**

**Prior U.S. Cls.: 22, 23, 38 and 50**

**United States Patent and Trademark Office**

**Reg. No. 3,467,020**

**Registered July 15, 2008**

**TRADEMARK  
PRINCIPAL REGISTER**

**TATUM LANE**

MANKIN, JAMES (UNITED STATES INDIVIDUAL)  
NO. 11  
346 DANSMUIR TERRACE  
SUNNYVALE, CA 94085

THE MARK CONSISTS OF STANDARD CHARACTERS WITHOUT CLAIM TO ANY PARTICULAR FONT, STYLE, SIZE, OR COLOR.

FOR: DOG TOYS, IN CLASS 28 (U.S. CLS. 22, 23, 38 AND 50).

SER. NO. 77-333,701, FILED 11-20-2007.

FIRST USE 10-1-2007; IN COMMERCE 10-1-2007.

HOWARD B. LEVINE, EXAMINING ATTORNEY

**Int. Cl.: 21**

**Prior U.S. Cls.: 2, 13, 23, 29, 30, 33, 40 and 50**

**United States Patent and Trademark Office**

**Reg. No. 3,467,021**

**Registered July 15, 2008**

**TRADEMARK  
PRINCIPAL REGISTER**



SHENZHEN EVERSINING METALWARES CO.,  
LTD. (CHINA CORPORATION)  
20A, INT'L TRADE COMMERCIAL BLDG.  
3005 NANHU RD., LUOHU DISTRICT  
SHENZHEN CITY, CHINA

FOR: COOKING POTS AND PANS; COCKTAIL  
SHAKERS; FRYING PANS; SERVINGWARE FOR  
SERVING FOOD; BEVERAGE GLASSWARE; ME-  
TAL PANS; NON-ELECTRIC KITCHEN CONTAIN-  
ERS NOT MADE OF PRECIOUS METAL; STEAMER  
BASKETS; POTS; TEA SERVICES NOT OF PRE-  
CIOUS METAL, IN CLASS 21 (U.S. CLS. 2, 13, 23, 29,  
30, 33, 40 AND 50).

FIRST USE 10-10-2005; IN COMMERCE 11-20-2006.

THE COLOR(S) GREEN, BLUE AND WHITE IS/  
ARE CLAIMED AS A FEATURE OF THE MARK.

THE MARK CONSISTS OF THE WORD "EVER",  
THE DOTS OF THE TWO ALPHABETS "I", THE  
CIRCLE DEVICE IN THE CENTER OF THE MARK  
AND THE BOUNDARY OF THE CIRCLE DEVICE  
ARE IN THE COLOR GREEN. THE WORD "SHIN-  
ING" AND THE OUTER LAYER OF THE CIRCLE  
DEVICE ARE IN THE COLOR BLUE. THE SMALL  
CIRCLE APPEARING ON THE TOP-LEFT CORNER  
OF THE GREEN CIRCLE IS IN THE COLOR WHITE.

SER. NO. 77-333,702, FILED 11-20-2007.

SAMUEL E. SHARPER JR., EXAMINING ATTOR-  
NEY

**Int. Cl.: 28**

**Prior U.S. Cls.: 22, 23, 38 and 50**

**United States Patent and Trademark Office**

**Reg. No. 3,467,022**

**Registered July 15, 2008**

**TRADEMARK  
PRINCIPAL REGISTER**

**WHERE THERE'S NO SUCH  
THING AS TOO MUCH LOVE**

MANKIN, JAMES (UNITED STATES INDIVIDUAL)  
NO. 11  
346 DANSMUIR TERRACE  
SUNNYVALE, CA 94085

THE MARK CONSISTS OF STANDARD CHARACTERS WITHOUT CLAIM TO ANY PARTICULAR FONT, STYLE, SIZE, OR COLOR.

FOR: DOG TOYS, IN CLASS 28 (U.S. CLS. 22, 23, 38 AND 50).

SER. NO. 77-333,704, FILED 11-20-2007.

FIRST USE 10-1-2007; IN COMMERCE 10-1-2007.

HOWARD B. LEVINE, EXAMINING ATTORNEY

**Int. Cl.: 41**

**Prior U.S. Cls.: 100, 101 and 107**

**United States Patent and Trademark Office**

**Reg. No. 3,467,023**

**Registered July 15, 2008**

**SERVICE MARK  
PRINCIPAL REGISTER**

**Where Turners Turn First**

WOODTURNING ONLINE, LLC (DELAWARE  
LTD LIAB CO)  
PO BOX 186  
SWAMPSCOTT, MA 01907

THE MARK CONSISTS OF STANDARD CHAR-  
ACTERS WITHOUT CLAIM TO ANY PARTICULAR  
FONT, STYLE, SIZE, OR COLOR.

FOR: PUBLISHING OF WEB MAGAZINES, IN  
CLASS 41 (U.S. CLS. 100, 101 AND 107).

SER. NO. 77-333,714, FILED 11-20-2007.

FIRST USE 5-1-2003; IN COMMERCE 11-19-2007.

SANJEEV VOHRA, EXAMINING ATTORNEY

**Int. Cl.: 6**

**Prior U.S. Cls.: 2, 12, 13, 14, 23, 25 and 50**

**Reg. No. 3,467,024**

**United States Patent and Trademark Office**

**Registered July 15, 2008**

---

**TRADEMARK  
PRINCIPAL REGISTER**

**VECTOR**

FARRIER PRODUCT DISTRIBUTION, INC.  
(KENTUCKY CORPORATION)  
361 HAVEN HILL RD.  
P.O. BOX 1328  
SHELBYVILLE, KY 40066

THE MARK CONSISTS OF STANDARD CHARACTERS WITHOUT CLAIM TO ANY PARTICULAR FONT, STYLE, SIZE, OR COLOR.

FOR: HORSE SHOE NAIL, IN CLASS 6 (U.S. CLS. 2, 12, 13, 14, 23, 25 AND 50).

SER. NO. 77-333,727, FILED 11-20-2007.

FIRST USE 6-1-2006; IN COMMERCE 11-1-2006.

CHRISTINA SOBRAL, EXAMINING ATTORNEY

**Int. Cl.: 14**

**Prior U.S. Cls.: 2, 27, 28 and 50**

**United States Patent and Trademark Office**

**Reg. No. 3,467,025**

**Registered July 15, 2008**

**TRADEMARK  
PRINCIPAL REGISTER**

**ADVENTURE TECH**

TIMEX GROUP B.V. (NETHERLANDS COMPAN-  
NY)  
HERENGRACHT 466 1017 CA  
AMSTERDAM, NETHERLANDS

THE MARK CONSISTS OF STANDARD CHAR-  
ACTERS WITHOUT CLAIM TO ANY PARTICULAR  
FONT, STYLE, SIZE, OR COLOR.

FOR: WATCHES, IN CLASS 14 (U.S. CLS. 2, 27, 28  
AND 50).

SER. NO. 77-333,730, FILED 11-20-2007.

FIRST USE 4-0-2005; IN COMMERCE 4-0-2005.

SANJEEV VOHRA, EXAMINING ATTORNEY



**Int. Cl.: 33**

**Prior U.S. Cls.: 47 and 49**

**United States Patent and Trademark Office**

**Reg. No. 3,467,026**

**Registered July 15, 2008**

---

**TRADEMARK  
PRINCIPAL REGISTER**

**BERE**

FQZ LLC (NEW YORK LTD LIAB CO), DBA  
SHERBROOKE CELLARS  
75 SOUTH BROADWAY  
WHITE PLAINS, NY 10601

THE MARK CONSISTS OF STANDARD CHAR-  
ACTERS WITHOUT CLAIM TO ANY PARTICULAR  
FONT, STYLE, SIZE, OR COLOR.

FOR: WINE, IN CLASS 33 (U.S. CLS. 47 AND 49).

SER. NO. 77-333,783, FILED 11-20-2007.

FIRST USE 10-7-2006; IN COMMERCE 10-7-2006.

GIANCARLO CASTRO, EXAMINING ATTORNEY

**Int. Cls.: 35 and 36**

**Prior U.S. Cls.: 100, 101 and 102**

**United States Patent and Trademark Office**

**Reg. No. 3,467,027**

**Registered July 15, 2008**

**SERVICE MARK  
PRINCIPAL REGISTER**

# FTH CAPITAL

AL-SAYRAFI, FAISAL (SAUDI ARABIA INDIVIDUAL)  
P.O. BOX 24368  
AL-ANDALUS ST., 5TH FLOOR, APT. 501  
JEDDAH, SAUDI ARABIA 21446

FOR: BUSINESS ACQUISITION AND MERGER CONSULTATION, BUSINESS CONSULTATION RELATED TO CORPORATE MERGERS, ACQUISITIONS, MANAGEMENT, AND STRUCTURE, IN CLASS 35 (U.S. CLS. 100, 101 AND 102).

FIRST USE 10-0-2007; IN COMMERCE 10-0-2007.

FOR: INVESTMENT BANKING SERVICES; INVESTMENT CONSULTATION; BUSINESS VALUATION SERVICES; FINANCING SERVICES; FACILITATING AND ARRANGING FOR THE FINANCING OF COMMERCIAL CORPORATE

TRANSACTIONS, IN CLASS 36 (U.S. CLS. 100, 101 AND 102).

FIRST USE 10-0-2007; IN COMMERCE 10-0-2007.

THE MARK CONSISTS OF STANDARD CHARACTERS WITHOUT CLAIM TO ANY PARTICULAR FONT, STYLE, SIZE, OR COLOR.

OWNER OF U.S. REG. NOS. 3,173,686 AND 3,331,603.

NO CLAIM IS MADE TO THE EXCLUSIVE RIGHT TO USE "CAPITAL", APART FROM THE MARK AS SHOWN.

SER. NO. 77-333,794, FILED 11-20-2007.

WILLIAM VERHOSEK, EXAMINING ATTORNEY

**Int. Cl.: 36**

**Prior U.S. Cls.: 100, 101 and 102**

**United States Patent and Trademark Office**

**Reg. No. 3,467,028**

**Registered July 15, 2008**

**SERVICE MARK  
PRINCIPAL REGISTER**

**SIGNATURE PERFORMANCE**

SIGNATURE PERFORMANCE, INC. (NEBRASKA CORPORATION)  
SUITE 305  
10330 REGENCY PARKWAY DRIVE  
OMAHA, NE 68114

THE MARK CONSISTS OF STANDARD CHARACTERS WITHOUT CLAIM TO ANY PARTICULAR FONT, STYLE, SIZE, OR COLOR.

FOR: COLLECTION OF DEBTS, IN CLASS 36 (U.S. CLS. 100, 101 AND 102).

SER. NO. 77-333,847, FILED 11-20-2007.

FIRST USE 5-22-2001; IN COMMERCE 5-22-2001.

ROBERT C. CLARK JR., EXAMINING ATTORNEY

**Int. Cl.: 39**

**Prior U.S. Cls.: 100 and 105**

**United States Patent and Trademark Office**

**Reg. No. 3,467,029**

**Registered July 15, 2008**

**SERVICE MARK  
PRINCIPAL REGISTER**

**WE'RE HERTZ. THEY'RE NOT.**

HERTZ SYSTEM, INC. (DELAWARE CORPORATION)  
225 BRAE BOULEVARD  
PARK RIDGE, NJ 07656

THE MARK CONSISTS OF STANDARD CHARACTERS WITHOUT CLAIM TO ANY PARTICULAR FONT, STYLE, SIZE, OR COLOR.

FOR: VEHICLE RENTAL SERVICES, IN CLASS 39 (U.S. CLS. 100 AND 105).

SER. NO. 77-333,856, FILED 11-20-2007.

FIRST USE 2-14-2007; IN COMMERCE 2-14-2007.

ROBERT C. CLARK JR., EXAMINING ATTORNEY

**Int. Cl.: 9**

**Prior U.S. Cls.: 21, 23, 26, 36 and 38**

**Reg. No. 3,467,030**

**United States Patent and Trademark Office**

**Registered July 15, 2008**

---

**TRADEMARK  
PRINCIPAL REGISTER**

**STARGLAS**

STEWART FILMSCREEN CORP. (DELAWARE  
CORPORATION)  
1161 W. SEPULVEDA BLVD.  
TORRENCE, CA 90502

THE MARK CONSISTS OF STANDARD CHAR-  
ACTERS WITHOUT CLAIM TO ANY PARTICULAR  
FONT, STYLE, SIZE, OR COLOR.

FOR: REAR PROJECTION SCREEN, IN CLASS 9  
(U.S. CLS. 21, 23, 26, 36 AND 38).

SER. NO. 77-333,864, FILED 11-20-2007.

FIRST USE 10-25-2005; IN COMMERCE 10-25-2005.

ROBERT C. CLARK JR., EXAMINING ATTORNEY

**Int. Cl.: 43**

**Prior U.S. Cls.: 100 and 101**

**United States Patent and Trademark Office**

**Reg. No. 3,467,031**

**Registered July 15, 2008**

**SERVICE MARK  
PRINCIPAL REGISTER**

**DINGBATS**

TRINITY SELECT GROUPS, LLC (PENNSYLVANIA LTD LIAB CO)  
290 EAST UNION ROAD  
CHESWICK, PA 15024

THE MARK CONSISTS OF STANDARD CHARACTERS WITHOUT CLAIM TO ANY PARTICULAR FONT, STYLE, SIZE, OR COLOR.

FOR: RESTAURANT AND BAR SERVICES, IN CLASS 43 (U.S. CLS. 100 AND 101).

SER. NO. 77-333,865, FILED 11-20-2007.

FIRST USE 8-18-1980; IN COMMERCE 8-18-1980.

ROBERT C. CLARK JR., EXAMINING ATTORNEY

**Int. Cl.: 35**

**Prior U.S. Cls.: 100, 101 and 102**

**United States Patent and Trademark Office**

**Reg. No. 3,467,032**

**Registered July 15, 2008**

**SERVICE MARK  
PRINCIPAL REGISTER**

**adamusmedia**

MAJEWSKI, SYLWIA (POLAND INDIVIDUAL)  
363 FRYERS LANE  
WILLIAMSTOWN, NJ 08094

FOR: ADVERTISING AND BUSINESS MANAGEMENT CONSULTANCY; ADVERTISING AND PUBLICITY SERVICES, NAMELY, PROMOTING THE GOODS, SERVICES, BRAND IDENTITY AND COMMERCIAL INFORMATION AND NEWS OF THIRD PARTIES THROUGH PRINT, AUDIO, VIDEO, DIGITAL AND ON-LINE MEDIUM; ADVERTISING SERVICES, NAMELY, CREATING CORPORATE AND BRAND IDENTITY FOR OTHERS; ADVERTISING SERVICES, NAMELY, CREATING CORPORATE LOGOS FOR OTHERS; ADVERTISING SERVICES, PUBLIC RELATIONS AND MARKETING SERVICES, NAMELY, PROMOTING AND MARKETING THE GOODS AND SERVICES OF OTHERS THROUGH ALL PUBLIC COMMUNICATION MEANS; BUSINESS MARKETING CONSULTING SERVICES; CREATIVE MARKETING DESIGN SERVICES; DESIGN OF ADVERTISING MATERIALS FOR OTHERS; DESIGN OF INTERNET ADVERTISING; DEVELOPMENT OF MARKETING STRATE-

GIES AND CONCEPTS; ON-LINE ADVERTISING AND MARKETING SERVICES; PREPARATION AND REALIZATION OF MEDIA AND ADVERTISING PLANS AND CONCEPTS; PREPARATION OF CUSTOM ADVERTISEMENTS FOR OTHERS; PREPARING AND PLACING ADVERTISEMENTS FOR OTHERS; PREPARING AUDIO-VISUAL PRESENTATIONS FOR USE IN ADVERTISING; PROVIDING ADVERTISING SERVICES USING 3D AND ANIMATION DESIGNS; PROVIDING INFORMATION IN THE FIELD OF MARKETING AND ON-LINE MARKETING MEDIA VIA THE INTERNET, IN CLASS 35 (U.S. CLS. 100, 101 AND 102).

FIRST USE 5-30-2007; IN COMMERCE 5-30-2007.

THE MARK CONSISTS OF STANDARD CHARACTERS WITHOUT CLAIM TO ANY PARTICULAR FONT, STYLE, SIZE, OR COLOR.

SER. NO. 77-333,876, FILED 11-20-2007.

DAVID MILLER, EXAMINING ATTORNEY

**Int. Cl.: 20**

**Prior U.S. Cls.: 2, 13, 22, 25, 32 and 50**

**Reg. No. 3,467,033**

**United States Patent and Trademark Office**

**Registered July 15, 2008**

**TRADEMARK  
PRINCIPAL REGISTER**

**HyVee**



**FUNPAWS**

HY-VEE, INC. (IOWA CORPORATION)  
5820 WESTOWN PARKWAY  
WEST DES MOINES, IA 50266

OWNER OF U.S. REG. NOS. 2,076,819, 3,217,660  
AND OTHERS.

FOR: PET BEDS AND CRATES, IN CLASS 20 (U.S.  
CLS. 2, 13, 22, 25, 32 AND 50).

SER. NO. 77-333,877, FILED 11-20-2007.

FIRST USE 10-14-2006; IN COMMERCE 10-14-2006.

ROBERT LAVACHE, EXAMINING ATTORNEY



**Int. Cls.: 38 and 42**

**Prior U.S. Cls.: 100, 101 and 104**

**United States Patent and Trademark Office**

**Reg. No. 3,467,034**

**Registered July 15, 2008**

**SERVICE MARK  
PRINCIPAL REGISTER**

# COMFLUENT

FRYINGPAN RESOURCES, INC. (COLORADO CORPORATION)  
910 15TH STREET, SUITE 740  
DENVER, CO 80202

FOR: PROVIDING ACCESS TO TELECOMMUNICATION NETWORKS, IN CLASS 38 (U.S. CLS. 100, 101 AND 104).

FIRST USE 1-15-2001; IN COMMERCE 1-15-2001.

FOR: COMPUTER COLOCATION SERVICES, NAMELY, PROVIDING FACILITIES FOR THE LOCATION OF COMPUTER SERVERS WITH THE

EQUIPMENT OF OTHERS, IN CLASS 42 (U.S. CLS. 100 AND 101).

FIRST USE 10-1-1997; IN COMMERCE 10-1-1997.

THE MARK CONSISTS OF STANDARD CHARACTERS WITHOUT CLAIM TO ANY PARTICULAR FONT, STYLE, SIZE, OR COLOR.

SER. NO. 77-333,884, FILED 11-20-2007.

BRIAN NEVILLE, EXAMINING ATTORNEY

**Int. Cls.: 16, 35, 36 and 41**

**Prior U.S. Cls.: 2, 5, 22, 23, 29, 37, 38, 50, 100, 101, 102  
and 107**

**Reg. No. 3,467,035**

**United States Patent and Trademark Office**

**Registered July 15, 2008**

**TRADEMARK  
SERVICE MARK  
PRINCIPAL REGISTER**



THE MCGRAW-HILL COMPANIES, INC. (NEW YORK CORPORATION)  
1221 AVENUE OF THE AMERICAS  
NEW YORK, NY 10020

FOR: PUBLICATION, NAMELY, A MAGAZINE IN THE FIELDS OF COMMERCE, INDUSTRY AND FINANCE, IN CLASS 16 (U.S. CLS. 2, 5, 22, 23, 29, 37, 38 AND 50).

FIRST USE 10-11-2007; IN COMMERCE 10-11-2007.

FOR: COMPUTER SERVICES, NAMELY, PROVIDING NEWS AND INFORMATION ON COMMERCE ALL VIA THE INTERNET, IN CLASS 35 (U.S. CLS. 100, 101 AND 102).

FIRST USE 10-11-2007; IN COMMERCE 10-11-2007.

FOR: COMPUTER SERVICES, NAMELY, PROVIDING NEWS AND INFORMATION ON FINANCE ALL VIA THE INTERNET, IN CLASS 36 (U.S. CLS. 100, 101 AND 102).

FIRST USE 10-11-2007; IN COMMERCE 10-11-2007.

FOR: COMPUTER SERVICES, NAMELY, PROVIDING AN ONLINE MAGAZINE IN THE FIELDS OF COMMERCE, INDUSTRY AND FINANCE VIA THE INTERNET, IN CLASS 41 (U.S. CLS. 100, 101 AND 107).

FIRST USE 10-11-2007; IN COMMERCE 10-11-2007.

OWNER OF U.S. REG. NOS. 549,742, 1,746,837, AND 3,300,772.

THE COLOR(S) RED AND WHITE IS/ARE CLAIMED AS A FEATURE OF THE MARK.

THE MARK CONSISTS OF WORDS IN WHITE WITH A RED BACKGROUND.

SER. NO. 77-333,897, FILED 11-20-2007.

HEATHER SAPP, EXAMINING ATTORNEY

**Int. Cl.: 41**

**Prior U.S. Cls.: 100, 101 and 107**

**United States Patent and Trademark Office**

**Reg. No. 3,467,036**

**Registered July 15, 2008**

**SERVICE MARK  
PRINCIPAL REGISTER**



MAJOR INDOOR LACROSSE LEAGUE, INC.,  
THE (MISSOURI CORPORATION)  
2310 W 75TH STREET  
PRAIRIE VILLAGE, KS 66208

FOR: ENTERTAINMENT SERVICES IN THE  
NATURE OF A PROFESSIONAL BOX LACROSSE  
TEAM, IN CLASS 41 (U.S. CLS. 100, 101 AND 107).

FIRST USE 11-1-2002; IN COMMERCE 11-1-2002.

OWNER OF U.S. REG. NO. 1,466,673.

NO CLAIM IS MADE TO THE EXCLUSIVE  
RIGHT TO USE "PHILADELPHIA", APART FROM  
THE MARK AS SHOWN.

SER. NO. 77-333,915, FILED 11-20-2007.

JAMES A. RAUEN, EXAMINING ATTORNEY

**Int. Cl.: 41**

**Prior U.S. Cls.: 100, 101 and 107**

**United States Patent and Trademark Office**

**Reg. No. 3,467,037**

**Registered July 15, 2008**

**SERVICE MARK  
PRINCIPAL REGISTER**

# LawMapping

COLEMAN, TASHA (UNITED STATES INDIVIDUAL)  
UNIT C4  
91 ROSELAND AVENUE  
CALDWELL, NJ 07006

FOR: EDUCATIONAL SERVICES, NAMELY, CONDUCTING SEMINARS AND WORKSHOPS IN THE FIELD OF PERSONAL AND PROFESSIONAL DEVELOPMENT AND DISTRIBUTION OF COURSE MATERIAL IN CONNECTION THEREWITH; LIFE COACHING SERVICES IN THE FIELD OF PERSONAL AND PROFESSIONAL DEVELOPMENT; PERSONAL COACHING SERVICES IN THE FIELD OF PERSONAL AND PROFESSIONAL DEVELOPMENT; PROFESSIONAL COACHING SERVICES IN

THE FIELD OF PERSONAL AND PROFESSIONAL DEVELOPMENT, IN CLASS 41 (U.S. CLS. 100, 101 AND 107).

FIRST USE 9-0-2007; IN COMMERCE 9-0-2007.

THE MARK CONSISTS OF STANDARD CHARACTERS WITHOUT CLAIM TO ANY PARTICULAR FONT, STYLE, SIZE, OR COLOR.

SER. NO. 77-333,934, FILED 11-20-2007.

MATTHEW MCDOWELL, EXAMINING ATTORNEY

**Int. Cl.: 19**

**Prior U.S. Cls.: 1, 12, 33 and 50**

**United States Patent and Trademark Office**

**Reg. No. 3,467,038**

**Registered July 15, 2008**

---

**TRADEMARK  
PRINCIPAL REGISTER**

**GEMSTONE**

TARKETT INC. (CANADA CORPORATION)  
1001, YAMASKA EAST  
FARNHAM, CANADA J2N1J7

THE MARK CONSISTS OF STANDARD CHAR-  
ACTERS WITHOUT CLAIM TO ANY PARTICULAR  
FONT, STYLE, SIZE, OR COLOR.

FOR: VINYL TILES, IN CLASS 19 (U.S. CLS. 1, 12,  
33 AND 50).

SER. NO. 77-333,949, FILED 11-20-2007.

FIRST USE 9-4-2007; IN COMMERCE 9-4-2007.

TRICIA SONNEBORN, EXAMINING ATTORNEY

**Int. Cl.: 9**

**Prior U.S. Cls.: 21, 23, 26, 36 and 38**

**United States Patent and Trademark Office**

**Reg. No. 3,467,039**

**Registered July 15, 2008**

**TRADEMARK  
PRINCIPAL REGISTER**

**CROSSLOOP**

CROSSLOOP, INC. (CALIFORNIA CORPORATION)  
SUITE D  
170 17TH STREET  
PACIFIC GROVE, CA 93950

FOR: COMPUTER SOFTWARE FOR USE IN ACCESSING, VIEWING AND MANIPULATING DATA, IMAGES, OPERATIONS AND FUNCTIONS ON LOCAL AND REMOTE COMPUTER MONITORS AND DISPLAYS, IN CLASS 9 (U.S. CLS. 21, 23, 26, 36 AND 38).

FIRST USE 11-1-2006; IN COMMERCE 11-1-2006.

THE MARK CONSISTS OF STANDARD CHARACTERS WITHOUT CLAIM TO ANY PARTICULAR FONT, STYLE, SIZE, OR COLOR.

SER. NO. 77-333,950, FILED 11-20-2007.

JENNIFER DIXON, EXAMINING ATTORNEY

**Int. Cl.: 44**

**Prior U.S. Cls.: 100 and 101**

**United States Patent and Trademark Office**

**Reg. No. 3,467,040**

**Registered July 15, 2008**

**SERVICE MARK  
PRINCIPAL REGISTER**

*Planting Your Escape*

MENEFEE, JOHN M. (UNITED STATES INDIVIDUAL)  
P.O. BOX 811  
BELLVILLE, TX 77418

FIRST USE 1-0-2006; IN COMMERCE 1-0-2006.

SER. NO. 77-333,951, FILED 11-20-2007.

FOR: LANDSCAPE GARDENING, IN CLASS 44  
(U.S. CLS. 100 AND 101).

DAVID MILLER, EXAMINING ATTORNEY

**Int. Cls.: 35 and 41**

**Prior U.S. Cls.: 100, 101, 102 and 107**

**United States Patent and Trademark Office**

**Reg. No. 3,467,041**

**Registered July 15, 2008**

**SERVICE MARK  
PRINCIPAL REGISTER**

**EVERYTHING MATERIAL.**

ASM INTERNATIONAL (OHIO CORPORATION)  
9639 KINSMAN ROAD  
MATERIALS PARK, OH 440730002

FOR: ASSOCIATION SERVICES, NAMELY, PROMOTING THE INTERESTS OF MATERIALS SCIENTISTS AND ENGINEERS, IN CLASS 35 (U.S. CLS. 100, 101 AND 102).

FIRST USE 7-31-2007; IN COMMERCE 7-31-2007.

FOR: EDUCATIONAL SERVICES, NAMELY, PROVIDING LIVE AND ON-LINE SEMINARS AND WORKSHOPS IN THE FIELD OF MATERIALS SCIENCES AND DISTRIBUTION OF COURSE MA-

TERIAL IN CONNECTION THEREWITH; ARRANGING AND CONDUCTING EDUCATIONAL CONFERENCES, IN CLASS 41 (U.S. CLS. 100, 101 AND 107).

FIRST USE 7-31-2007; IN COMMERCE 7-31-2007.

THE MARK CONSISTS OF STANDARD CHARACTERS WITHOUT CLAIM TO ANY PARTICULAR FONT, STYLE, SIZE, OR COLOR.

SER. NO. 77-333,956, FILED 11-20-2007.

ALYSSA PALADINO, EXAMINING ATTORNEY



**Int. Cl.: 36**

**Prior U.S. Cls.: 100, 101 and 102**

**United States Patent and Trademark Office**

**Reg. No. 3,467,042**

**Registered July 15, 2008**

**SERVICE MARK  
PRINCIPAL REGISTER**

**GOHEALTH**

NORVAX, INC. (ILLINOIS CORPORATION)  
214 W. HURON STREET  
CHICAGO, IL 606108618

FOR: INFORMATION COLLECTION AND DISSEMINATION SERVICES, NAMELY, GATHERING AND DISSEMINATION OF INFORMATION REGARDING PROSPECTIVE INSURANCE BUYERS, IN CLASS 36 (U.S. CLS. 100, 101 AND 102).

FIRST USE 6-1-2007; IN COMMERCE 6-1-2007.

THE MARK CONSISTS OF STANDARD CHARACTERS WITHOUT CLAIM TO ANY PARTICULAR FONT, STYLE, SIZE, OR COLOR.

SER. NO. 77-333,970, FILED 11-20-2007.

JOHN WILKE, EXAMINING ATTORNEY

**Int. Cl.: 31**

**Prior U.S. Cls.: 1 and 46**

**United States Patent and Trademark Office**

**Reg. No. 3,467,043**

**Registered July 15, 2008**

**TRADEMARK  
PRINCIPAL REGISTER**

**FERMA TECH**

BURKMANN INDUSTRIES, INC. (KENTUCKY  
CORPORATION)

1111 PERRYVILLE ROAD

DANVILLE, KY 40422

FOR: LIVESTOCK FEED, IN CLASS 31 (U.S. CLS. 1  
AND 46).

FIRST USE 10-19-1991; IN COMMERCE 10-19-1991.

THE MARK CONSISTS OF STANDARD CHAR-  
ACTERS WITHOUT CLAIM TO ANY PARTICULAR  
FONT, STYLE, SIZE, OR COLOR.

NO CLAIM IS MADE TO THE EXCLUSIVE  
RIGHT TO USE "TECH", APART FROM THE MARK  
AS SHOWN.

SER. NO. 77-333,999, FILED 11-20-2007.

JENNY PARK, EXAMINING ATTORNEY

**Int. Cls.: 38 and 42**

**Prior U.S. Cls.: 100, 101 and 104**

**United States Patent and Trademark Office**

**Reg. No. 3,467,044**

**Registered July 15, 2008**

**SERVICE MARK  
PRINCIPAL REGISTER**

WHERE THE NETWORKS MEET

FRYINGPAN RESOURCES, INC. (COLORADO CORPORATION)  
910 15TH STREET, SUITE 740  
DENVER, CO 80111

FOR: PROVIDING ACCESS TO TELECOMMUNICATION NETWORKS, IN CLASS 38 (U.S. CLS. 100, 101 AND 104).

FIRST USE 2-1-2003; IN COMMERCE 2-1-2003.

FOR: COMPUTER COLOCATION SERVICES, NAMELY, PROVIDING FACILITIES FOR THE LOCATION OF COMPUTER SERVERS WITH THE

EQUIPMENT OF OTHERS, IN CLASS 42 (U.S. CLS. 100 AND 101).

FIRST USE 2-1-2003; IN COMMERCE 2-1-2003.

THE MARK CONSISTS OF STANDARD CHARACTERS WITHOUT CLAIM TO ANY PARTICULAR FONT, STYLE, SIZE, OR COLOR.

SER. NO. 77-334,003, FILED 11-20-2007.

BRIAN NEVILLE, EXAMINING ATTORNEY

**Int. Cl.: 19**

**Prior U.S. Cls.: 1, 12, 33 and 50**

**United States Patent and Trademark Office**

**Reg. No. 3,467,045**

**Registered July 15, 2008**

**TRADEMARK  
PRINCIPAL REGISTER**

**FRENCH CARRE**

SAROYAN LUMBER COMPANY, INC. (CALI-  
FORNIA CORPORATION)  
6230 SO. ALAMEDA ST.  
HUNTINGTON PARK, CA 90255

FOR: FLOOR BOARDS, WOODEN FLOORING,  
HARDWOOD FLOORING; NON-METAL ARCHI-  
TECTURAL MOULDINGS AND FINISH TRIM, IN  
CLASS 19 (U.S. CLS. 1, 12, 33 AND 50).

FIRST USE 5-11-2006; IN COMMERCE 5-11-2006.

THE MARK CONSISTS OF STANDARD CHAR-  
ACTERS WITHOUT CLAIM TO ANY PARTICULAR  
FONT, STYLE, SIZE, OR COLOR.

THE ENGLISH TRANSLATION OF "CARRE" IS  
"SQUARE".

SER. NO. 77-334,062, FILED 11-20-2007.

KELLEY WELLS, EXAMINING ATTORNEY

**Int. Cl.: 9**

**Prior U.S. Cls.: 21, 23, 26, 36 and 38**

**Reg. No. 3,467,046**

**United States Patent and Trademark Office**

**Registered July 15, 2008**

**TRADEMARK  
PRINCIPAL REGISTER**

**ELEMENT**

L.R. BAGGS CORPORATION (CALIFORNIA  
CORPORATION)  
483 NORTH FRONTAGE  
NIPOMO, CA 93444

THE MARK CONSISTS OF STANDARD CHAR-  
ACTERS WITHOUT CLAIM TO ANY PARTICULAR  
FONT, STYLE, SIZE, OR COLOR.

FOR: ELECTRICAL PICKUPS FOR USE WITH  
MUSICAL INSTRUMENTS, IN CLASS 9 (U.S. CLS.  
21, 23, 26, 36 AND 38).

SER. NO. 77-334,068, FILED 11-20-2007.

FIRST USE 1-16-2003; IN COMMERCE 1-16-2003.

ANTHONY RINKER, EXAMINING ATTORNEY

**Int. Cl.: 45**

**Prior U.S. Cls.: 100 and 101**

**United States Patent and Trademark Office**

**Reg. No. 3,467,047**

**Registered July 15, 2008**

**SERVICE MARK  
PRINCIPAL REGISTER**

**SPACE SMART**

MILBANK, TWEED, HADLEY & MCCLOY LLP  
(NEW YORK LIMITED LIABILITY PARTNER-  
SHIP)

ONE CHASE MANHATTAN PLAZA

NEW YORK, NY 10005

FOR: LEGAL SERVICES, IN CLASS 45 (U.S. CLS.  
100 AND 101).

FIRST USE 3-26-2001; IN COMMERCE 3-26-2001.

THE MARK CONSISTS OF STANDARD CHAR-  
ACTERS WITHOUT CLAIM TO ANY PARTICULAR  
FONT, STYLE, SIZE, OR COLOR.

NO CLAIM IS MADE TO THE EXCLUSIVE  
RIGHT TO USE "SPACE", APART FROM THE  
MARK AS SHOWN.

SER. NO. 77-334,085, FILED 11-20-2007.

MATTHEW MCDOWELL, EXAMINING ATTOR-  
NEY

**Int. Cl.: 6**

**Prior U.S. Cls.: 2, 12, 13, 14, 23, 25 and 50**

**Reg. No. 3,467,048**

**United States Patent and Trademark Office**

**Registered July 15, 2008**

---

**TRADEMARK  
PRINCIPAL REGISTER**

**DC53**

DAIDO STEEL CO., LTD (JAPAN CORPORATION)  
1-10  
HIGASHISAKURA 1-CHOME HIGASHI-KU  
NAGOYA, AICHI, JAPAN

FOR: STEEL, IN CLASS 6 (U.S. CLS. 2, 12, 13, 14, 23,  
25 AND 50).

FIRST USE 4-0-2001; IN COMMERCE 4-0-2001.

THE MARK CONSISTS OF STANDARD CHARACTERS WITHOUT CLAIM TO ANY PARTICULAR FONT, STYLE, SIZE, OR COLOR.

SER. NO. 77-334,088, FILED 11-20-2007.

MATTHEW MCDOWELL, EXAMINING ATTORNEY

**Int. Cl.: 43**

**Prior U.S. Cls.: 100 and 101**

**United States Patent and Trademark Office**

**Reg. No. 3,467,049**

**Registered July 15, 2008**

**SERVICE MARK  
PRINCIPAL REGISTER**

# Sunny Teriyaki

YOON, HENAM (WASHINGTON SOLE PROPRIETORSHIP), DBA SUNNY TERIYAKI  
3416 170TH STREET SW  
LYNNWOOD, WA 98037

FOR: CAFE-RESTAURANTS; CARRY-OUT RESTAURANTS; FAST-FOOD RESTAURANTS; RESTAURANT SERVICES; RESTAURANTS; TAKE-OUT RESTAURANT SERVICES, IN CLASS 43 (U.S. CLS. 100 AND 101).

FIRST USE 10-0-1989; IN COMMERCE 10-0-2007.

THE MARK CONSISTS OF STANDARD CHARACTERS WITHOUT CLAIM TO ANY PARTICULAR FONT, STYLE, SIZE, OR COLOR.

NO CLAIM IS MADE TO THE EXCLUSIVE RIGHT TO USE "TERIYAKI", APART FROM THE MARK AS SHOWN.

SER. NO. 77-334,091, FILED 11-20-2007.

HEATHER THOMPSON, EXAMINING ATTORNEY



**Int. Cl.: 35**

**Prior U.S. Cls.: 100, 101 and 102**

**United States Patent and Trademark Office**

**Reg. No. 3,467,050**

**Registered July 15, 2008**

**SERVICE MARK  
PRINCIPAL REGISTER**

# Leisure Lab

SCHADLER KRAMER GROUP, LLC (NEVADA  
LTD LIAB CO), DBA SK+G, SKG, SKG AD-  
VERTISING, SK+G ADVERTISING  
8912 SPANISH RIDGE AVE  
LAS VEGAS, NV 89148

FOR: ADVERTISING AGENCIES; ADVERTISING  
AGENCIES, NAMELY, PROMOTING THE GOODS  
AND SERVICES OF OTHERS , IN CLASS 35 (U.S.  
CLS. 100, 101 AND 102).

FIRST USE 8-1-2007; IN COMMERCE 8-1-2007.

THE MARK CONSISTS OF STANDARD CHAR-  
ACTERS WITHOUT CLAIM TO ANY PARTICULAR  
FONT, STYLE, SIZE, OR COLOR.

NO CLAIM IS MADE TO THE EXCLUSIVE  
RIGHT TO USE "LEISURE", APART FROM THE  
MARK AS SHOWN.

SER. NO. 77-334,093, FILED 11-20-2007.

MATTHEW MCDOWELL, EXAMINING ATTOR-  
NEY

**Int. Cl.: 44**

**Prior U.S. Cls.: 100 and 101**

**United States Patent and Trademark Office**

**Reg. No. 3,467,051**

**Registered July 15, 2008**

**SERVICE MARK  
PRINCIPAL REGISTER**

**FUNCTION  
HIGHER--PHYSICALLY,  
MENTALLY, SEXUALLY**

SMOKELESS, INC. (FLORIDA CORPORATION)  
649 US HIGHWAY 1, SUITE 1  
N. PALM BEACH, FL 33408

THE MARK CONSISTS OF STANDARD CHAR-  
ACTERS WITHOUT CLAIM TO ANY PARTICULAR  
FONT, STYLE, SIZE, OR COLOR.

FOR: MEDICAL SERVICES, IN CLASS 44 (U.S.  
CLS. 100 AND 101).

SER. NO. 77-334,094, FILED 11-20-2007.

FIRST USE 11-15-2007; IN COMMERCE 11-15-2007.

HEATHER THOMPSON, EXAMINING ATTORNEY

**Int. Cl.: 33**

**Prior U.S. Cls.: 47 and 49**

**United States Patent and Trademark Office**

**Reg. No. 3,467,052**

**Registered July 15, 2008**

**TRADEMARK  
PRINCIPAL REGISTER**

# Primordium Cellars

SWANSON, EDWARD LESLIE (NEBRASKA  
PARTNERSHIP), DBA CUTHILLS VINE-  
YARDS

54663 853 RD.

PIERCE, NE 68767

FOR: WINE, IN CLASS 33 (U.S. CLS. 47 AND 49).

FIRST USE 10-18-2007; IN COMMERCE 11-20-2007.

THE MARK CONSISTS OF STANDARD CHAR-  
ACTERS WITHOUT CLAIM TO ANY PARTICULAR  
FONT, STYLE, SIZE, OR COLOR.

NO CLAIM IS MADE TO THE EXCLUSIVE  
RIGHT TO USE "CELLARS", APART FROM THE  
MARK AS SHOWN.

SER. NO. 77-334,105, FILED 11-20-2007.

HEATHER THOMPSON, EXAMINING ATTORNEY

**Int. Cl.: 35**

**Prior U.S. Cls.: 100, 101 and 102**

**United States Patent and Trademark Office**

**Reg. No. 3,467,053**

**Registered July 15, 2008**

**SERVICE MARK  
PRINCIPAL REGISTER**

**SK+G**

SCHADLER KRAMER GROUP, LLC (NEVADA  
LTD LIAB CO), DBA SK+G, SKG ADVERTIS-  
ING, SK+G ADVERTISING, SKG  
8912 SPANISH RIDGE AVE  
LAS VEGAS, NV 89148

FOR: ADVERTISING AGENCIES; ADVERTISING  
AGENCIES, NAMELY, PROMOTING THE GOODS  
AND SERVICES OF OTHERS , IN CLASS 35 (U.S.  
CLS. 100, 101 AND 102).

FIRST USE 1-1-2007; IN COMMERCE 1-1-2007.

THE MARK CONSISTS OF STANDARD CHAR-  
ACTERS WITHOUT CLAIM TO ANY PARTICULAR  
FONT, STYLE, SIZE, OR COLOR.

SER. NO. 77-334,112, FILED 11-20-2007.

MATTHEW MCDOWELL, EXAMINING ATTOR-  
NEY

**Int. Cl.: 35**

**Prior U.S. Cls.: 100, 101 and 102**

**United States Patent and Trademark Office**

**Reg. No. 3,467,054**

**Registered July 15, 2008**

**SERVICE MARK  
PRINCIPAL REGISTER**



POLY PERFORMANCE, INC. (CALIFORNIA CORPORATION)  
245 TANK FARM ROAD, UNITS L & M  
SAN LUIS OBISPO, CA 93401

FOR: DISTRIBUTORSHIP SERVICES, RETAIL STORE SERVICES, MAIL-ORDER SERVICES AND ONLINE RETAIL STORE SERVICES IN THE FIELD OF PARTS AND ACCESSORIES FOR LAND VEHICLES, IN CLASS 35 (U.S. CLS. 100, 101 AND 102).

FIRST USE 1-1-2002; IN COMMERCE 1-1-2002.

THE COLOR(S) RED, BLACK AND WHITE IS/ARE CLAIMED AS A FEATURE OF THE MARK.

THE MARK CONSISTS OF THE WORD "POLY" IN RED AND OUTLINED IN WHITE, AND THE WORD "PERFORMANCE" IN WHITE SURROUNDED BY A BLACK OVAL WITH A RED SWIRL WITH WHITE LINING ON THE INSIDE ABOVE AND BELOW THE WORDS.

SER. NO. 77-334,137, FILED 11-20-2007.

JEFFERY COWARD, EXAMINING ATTORNEY

**Int. Cl.: 18**

**Prior U.S. Cls.: 1, 2, 3, 22 and 41**

**United States Patent and Trademark Office**

**Reg. No. 3,467,055**

**Registered July 15, 2008**

**TRADEMARK  
PRINCIPAL REGISTER**

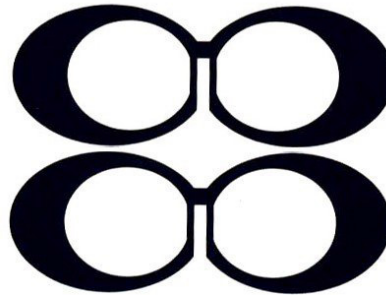

GENERAL TRADING GROUP, INC. (CALIFORNIA CORPORATION)  
2991 E. 46TH ST.  
VERNON, CA 90058

THE MARK CONSISTS OF TWO PAIRS OF HORIZONTALLY CONJOINED LENSES ON TOP OF EACH OTHER.

FOR: HANDBAGS, LUGGAGE, PURSES AND WALLETS, IN CLASS 18 (U.S. CLS. 1, 2, 3, 22 AND 41).

SER. NO. 77-334,144, FILED 11-20-2007.

FIRST USE 11-3-2003; IN COMMERCE 11-3-2003.

CHRISIE B. KING, EXAMINING ATTORNEY

**Int. Cl.: 37**

**Prior U.S. Cls.: 100, 103 and 106**

**United States Patent and Trademark Office**

**Reg. No. 3,467,056**

**Registered July 15, 2008**

**SERVICE MARK  
PRINCIPAL REGISTER**

**ANYTIME ANYWHERE**

HOLDEN, RICHARD E. (UNITED STATES INDIVIDUAL)  
115 OLD STEWART RD, PO BOX 1407  
FORSYTH, GA 310291407

THE MARK CONSISTS OF STANDARD CHARACTERS WITHOUT CLAIM TO ANY PARTICULAR FONT, STYLE, SIZE, OR COLOR.

FOR: VEHICLE REPAIR AND MAINTENANCE,  
IN CLASS 37 (U.S. CLS. 100, 103 AND 106).

SER. NO. 77-334,148, FILED 11-20-2007.

FIRST USE 1-1-1992; IN COMMERCE 1-1-1992.

SUZANNE BLANE, EXAMINING ATTORNEY

**Int. Cl.: 12**

**Prior U.S. Cls.: 19, 21, 23, 31, 35 and 44**

**Reg. No. 3,467,057**

**United States Patent and Trademark Office**

**Registered July 15, 2008**

---

**TRADEMARK  
PRINCIPAL REGISTER**

**POLYPERFORMANCE SYNERGY  
SUSPENSION**

POLY PERFORMANCE, INC. (CALIFORNIA CORPORATION)  
245 TANK FARM ROAD, UNITS L & M  
SAN LUIS OBISPO, CA 93401

FOR: SUSPENSION SYSTEMS FOR LAND VEHICLES, IN CLASS 12 (U.S. CLS. 19, 21, 23, 31, 35 AND 44).

FIRST USE 1-1-2007; IN COMMERCE 1-1-2007.

THE MARK CONSISTS OF STANDARD CHARACTERS WITHOUT CLAIM TO ANY PARTICULAR FONT, STYLE, SIZE, OR COLOR.

NO CLAIM IS MADE TO THE EXCLUSIVE RIGHT TO USE "SUSPENSION", APART FROM THE MARK AS SHOWN.

SER. NO. 77-334,151, FILED 11-20-2007.

JEFFERY COWARD, EXAMINING ATTORNEY



**Int. Cl.: 25**

**Prior U.S. Cls.: 22 and 39**

**United States Patent and Trademark Office**

**Reg. No. 3,467,058**

**Registered July 15, 2008**

---

**TRADEMARK  
PRINCIPAL REGISTER**

**ESKELL**

ESKELL, INC. (ILLINOIS CORPORATION)  
1509 N. MILWAUKEE AVENUE  
CHICAGO, IL 60622

THE MARK CONSISTS OF STANDARD CHAR-  
ACTERS WITHOUT CLAIM TO ANY PARTICULAR  
FONT, STYLE, SIZE, OR COLOR.

FOR: BLOUSES; DRESSES; SLACKS, IN CLASS 25  
(U.S. CLS. 22 AND 39).

SER. NO. 77-334,186, FILED 11-20-2007.

FIRST USE 6-27-2006; IN COMMERCE 6-27-2006.

LINDA ESTRADA, EXAMINING ATTORNEY

**Int. Cl.: 9**

**Prior U.S. Cls.: 21, 23, 26, 36 and 38**

**United States Patent and Trademark Office**

**Reg. No. 3,467,059**

**Registered July 15, 2008**

**TRADEMARK  
PRINCIPAL REGISTER**

**GAZELLE**

DAVID & YOUNG CO., INC. (NEW YORK COR-  
PORATION)  
28 WEST 27TH STREET  
NEW YORK, NY 10001

THE MARK CONSISTS OF STANDARD CHAR-  
ACTERS WITHOUT CLAIM TO ANY PARTICULAR  
FONT, STYLE, SIZE, OR COLOR.

FOR: EYEWEAR, NAMELY, SUNGLASSES AND  
EYEGASSES, IN CLASS 9 (U.S. CLS. 21, 23, 26, 36  
AND 38).

SER. NO. 77-334,193, FILED 11-20-2007.

FIRST USE 7-0-1984; IN COMMERCE 7-0-1984.

CURTIS FRENCH, EXAMINING ATTORNEY

Int. Cl.: 11

Prior U.S. Cls.: 13, 21, 23, 31 and 34

United States Patent and Trademark Office

Reg. No. 3,467,060

Registered July 15, 2008

TRADEMARK  
PRINCIPAL REGISTER



HYDROWORKS LLC (NEW JERSEY LTD LIAB  
CO)  
525 BOULEVARD  
KENILWORTH, NJ 07033

FIRST USE 9-15-2003; IN COMMERCE 11-12-2003.

OWNER OF U.S. REG. NO. 3,096,404.

FOR: STORM WATER FLOOD CONTROL AND  
POLLUTION CONTROL PRODUCTS, NAMELY,  
STORM WATER QUALITY SEPARATORS; STORM  
WATER FLOOD CONTROL AND POLLUTION  
CONTROL PRODUCTS, NAMELY, FILTERS AND  
GROUNDWATER RECHARGERS, IN CLASS 11  
(U.S. CLS. 13, 21, 23, 31 AND 34).

THE MARK CONSISTS OF A WAVE PLACED  
ABOVE THE WORD "HYDROWORKS".

SER. NO. 77-334,203, FILED 11-20-2007.

CURTIS FRENCH, EXAMINING ATTORNEY

**Int. Cl.: 20**

**Prior U.S. Cls.: 2, 13, 22, 25, 32 and 50**

**United States Patent and Trademark Office**

**Reg. No. 3,467,061**

**Registered July 15, 2008**

**TRADEMARK  
PRINCIPAL REGISTER**

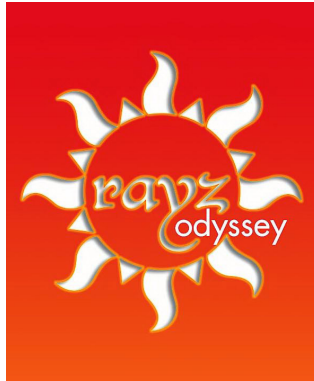

FOGLEMAN, RAYMOND DANIEL (PENNSYLVANIA SOLE PROPRIETORSHIP)  
3 HICKORY ROAD  
HUMMELSTOWN, PA 17036

THE MARK CONSISTS OF THE SUN'S SHAPE IN WHITE AND GREY, THE BACKGROUND IS RED AND ORANGE.

FOR: STATUETTES OF PLASTIC MEN AND WOMEN DOING YOGA POSES, IN CLASS 20 (U.S. CLS. 2, 13, 22, 25, 32 AND 50).

SER. NO. 77-334,235, FILED 11-20-2007.

FIRST USE 10-20-2003; IN COMMERCE 8-15-2007.

THE COLOR(S) RED, ORANGE, WHITE, GREY IS/ARE CLAIMED AS A FEATURE OF THE MARK.

VIVIAN MICZNIK FIRST, EXAMINING ATTORNEY

**Int. Cl.: 16**

**Prior U.S. Cls.: 2, 5, 22, 23, 29, 37, 38 and 50**

**Reg. No. 3,467,062**

**United States Patent and Trademark Office**

**Registered July 15, 2008**

**TRADEMARK  
PRINCIPAL REGISTER**

**MULTISTATE PHARMACY  
JURISPRUDENCE EXAMINATION**

NATIONAL ASSOCIATION OF BOARDS OF  
PHARMACY (KENTUCKY CORPORATION)  
1600 FEEHANVILLE DRIVE  
MOUNT PROSPECT, IL 60056

FOR: PUBLICATIONS; NAMELY, EXAMINATION  
TEXT BOOKLETS, EXAM GUIDES PERTAINING  
TO REGISTRATION IN THE FIELD OF STATE  
PHARMACY LAW , IN CLASS 16 (U.S. CLS. 2, 5, 22,  
23, 29, 37, 38 AND 50).

FIRST USE 8-0-1996; IN COMMERCE 11-2-1998.

THE MARK CONSISTS OF STANDARD CHARACTERS  
WITHOUT CLAIM TO ANY PARTICULAR  
FONT, STYLE, SIZE, OR COLOR.

OWNER OF U.S. REG. NO. 2,523,623.

NO CLAIM IS MADE TO THE EXCLUSIVE  
RIGHT TO USE "EXAMINATION", APART FROM  
THE MARK AS SHOWN.

SEC. 2(F).

SER. NO. 77-334,261, FILED 11-20-2007.

MARIAM MAHMOUDI, EXAMINING ATTORNEY

Int. Cl.: 43

Prior U.S. Cls.: 100 and 101

United States Patent and Trademark Office

Reg. No. 3,467,063

Registered July 15, 2008

SERVICE MARK  
PRINCIPAL REGISTER



RAOUL'S RESTAURANT CORPORATION (NEW  
YORK CORPORATION)  
180 PRINCE STREET  
NEW YORK, NY 10012

FIRST USE 0-0-1975; IN COMMERCE 0-0-1975.

SER. NO. 77-334,262, FILED 11-20-2007.

FOR: RESTAURANT SERVICES, IN CLASS 43  
(U.S. CLS. 100 AND 101).

MARIAM MAHMOUDI, EXAMINING ATTORNEY

**Int. Cl.: 30**

**Prior U.S. Cl.: 46**

**United States Patent and Trademark Office**

**Reg. No. 3,467,064**

**Registered July 15, 2008**

**TRADEMARK  
PRINCIPAL REGISTER**

# Lemon Lust

WILLIAM J. GUTHRIE (UNITED STATES INDIVIDUAL)  
510 NORTH SPRING STREET #A  
PENSACOLA, FL 32501

FOR: BAKERY DESSERTS; BAKERY PRODUCTS, NAMELY, SWEET BAKERY GOODS; CANDIES; SUGAR FREE SWEETS; COOKIES, IN CLASS 30 (U.S. CL. 46).

FIRST USE 1-1-2007; IN COMMERCE 5-1-2007.

THE MARK CONSISTS OF STANDARD CHARACTERS WITHOUT CLAIM TO ANY PARTICULAR FONT, STYLE, SIZE, OR COLOR.

NO CLAIM IS MADE TO THE EXCLUSIVE RIGHT TO USE "LEMON", APART FROM THE MARK AS SHOWN.

SER. NO. 77-334,268, FILED 11-20-2007.

PAUL F. GAST, EXAMINING ATTORNEY

**Int. Cl.: 10**

**Prior U.S. Cls.: 26, 39 and 44**

**United States Patent and Trademark Office**

**Reg. No. 3,467,065**

**Registered July 15, 2008**

**TRADEMARK  
PRINCIPAL REGISTER**

**JORDCO**

JORDCO, INC. (OREGON CORPORATION)  
595 N.W. 167TH AVENUE  
BEAVERTON, OR 97006

FOR: DENTAL INSTRUMENTS, NAMELY, DENTAL ORGANIZER APPARATUS COMPRISED OF A HOUSING CONFIGURED TO RECEIVE A CUSHION, THE HOUSING AND CUSHION BEING USED TO PLACE, STORE, MEASURE AND CLEAN ENDODONTIC FILES AND OTHER INSTRUMENTS AND MEDICAMENTS USED DURING A DENTAL PROCEDURE; DENTAL ORGANIZER DEVICE USED TO SEPARATE, HOLD AND DISPENSE DENTAL PREPARATIONS USED DURING A DENTAL PROCEDURE; DENTAL POLISHING BITS; AND

STERILIZATION CONTAINERS FOR DENTAL AND MEDICAL INSTRUMENTS, IN CLASS 10 (U.S. CLS. 26, 39 AND 44).

FIRST USE 12-1-1994; IN COMMERCE 12-1-1994.

THE MARK CONSISTS OF STANDARD CHARACTERS WITHOUT CLAIM TO ANY PARTICULAR FONT, STYLE, SIZE, OR COLOR.

OWNER OF U.S. REG. NO. 2,349,274.

SER. NO. 77-334,282, FILED 11-20-2007.

KEVIN DINALLO, EXAMINING ATTORNEY



**Int. Cl.: 36**

**Prior U.S. Cls.: 100, 101 and 102**

**United States Patent and Trademark Office**

**Reg. No. 3,467,066**

**Registered July 15, 2008**

**SERVICE MARK  
PRINCIPAL REGISTER**

**AMLI SMART OFFICE**

AMLI RESIDENTIAL PROPERTIES, L.P. (DELA-  
WARE LIMITED PARTNERSHIP)  
SUITE 2200  
200 W. MONROE ST.  
CHICAGO, IL 60606

FOR: LEASING OF APARTMENTS; RENTAL OF  
APARTMENTS, IN CLASS 36 (U.S. CLS. 100, 101 AND  
102).

FIRST USE 5-31-2007; IN COMMERCE 5-31-2007.

THE MARK CONSISTS OF STANDARD CHAR-  
ACTERS WITHOUT CLAIM TO ANY PARTICULAR  
FONT, STYLE, SIZE, OR COLOR.

OWNER OF U.S. REG. NOS. 1,928,116 AND  
1,936,972.

SER. NO. 77-334,305, FILED 11-20-2007.

KEVON CHISOLM, EXAMINING ATTORNEY

Int. Cl.: 5

Prior U.S. Cls.: 6, 18, 44, 46, 51 and 52

Reg. No. 3,467,067

United States Patent and Trademark Office

Registered July 15, 2008

TRADEMARK  
PRINCIPAL REGISTER



BIOPHARM R&D CORPORATION LIMITED  
(GREAT BRITAIN CORPORATION), DBA BIO-  
PHARM  
57 KORNICHE EL NILE STREET, MAADI  
CAIRO, EGYPT 11431

FOR: NUTRACEUTICALS FOR USE DIETARY SUPPLEMENTS; PHARMACEUTICAL AND NUTRACEUTICAL PRODUCTS, NAMELY, ANALGESICS, ANTI-INFLAMMATORY AGENTS, ANTIBIOTIC PREPARATIONS, ANTIFUNGAL PREPARATIONS, ANTIVIRAL PREPARATIONS, AND ANTITUSSIVE PREPARATIONS IN THE FORM OF ELIXIRS, FLUID AND SOLID EXTRACTS, OINTMENTS, PILLS, SOLUTIONS, SYRUPS, TABLETS, TINCTURES, GLOBULES AND WATERS; PHARMACEUTICAL AND NUTRACEUTICAL PREPARATIONS FOR THE PREVENTION AND TREATMENT OF DISORDERS OF THE NERVOUS SYSTEM, THE IMMUNE SYSTEM, THE CARDIO-VASCULAR SYSTEM, THE METABOLIC SYSTEM, THE RESPIRATORY SYSTEM, THE MUSCULO-SKELETAL SYSTEM, AND THE GENITOURINARY SYSTEM; PHARMACEUTICAL AND NUTRACEUTICAL PREPARATIONS FOR USE IN THE TREATMENT OF WOUNDS, SKIN DISORDERS, ALLERGIC DISOR-

DERS, AND INFLAMMATORY DISORDERS; PHARMACEUTICAL AND NUTRACEUTICAL PREPARATIONS FOR USE IN DERMATOLOGY, UROLOGY, GYNECOLOGY, IN CLASS 5 (U.S. CLS. 6, 18, 44, 46, 51 AND 52).

FIRST USE 1-0-1995; IN COMMERCE 1-0-1995.

"THE COLOR(S) GREEN, BLACK AND WHITE IS/ ARE CLAIMED AS A FEATURE OF THE MARK."

"THE MARK CONSISTS OF A HORIZONTAL LINE WITH THE TEXT "BIOPHARM" UNDERNEATH IT AND A DESIGN COMPRISED OF THREE LEAVES ABOVE IT, WHEREIN THE COLOR GREEN APPEARS IN THE LEAF DESIGN, THE COLOR BLACK APPEARS IN THE HORIZONTAL LINES AND PRINTED TERMS AND THE COLOR WHITE APPEARS IN THE BACKGROUND."

SER. NO. 77-334,324, FILED 11-20-2007.

CHRIS WELLS, EXAMINING ATTORNEY

**Int. Cl.: 36**

**Prior U.S. Cls.: 100, 101 and 102**

**United States Patent and Trademark Office**

**Reg. No. 3,467,068**

**Registered July 15, 2008**

**SERVICE MARK  
PRINCIPAL REGISTER**



AMLI RESIDENTIAL PROPERTIES, L.P. (DELA-  
WARE LIMITED PARTNERSHIP)  
SUITE 2200  
200 W. MONROE ST.  
CHICAGO, IL 60606

FOR: LEASING OF APARTMENTS; RENTAL OF  
APARTMENTS, IN CLASS 36 (U.S. CLS. 100, 101 AND  
102).

FIRST USE 5-31-2007; IN COMMERCE 5-31-2007.

OWNER OF U.S. REG. NOS. 1,928,116 AND  
1,936,972.

THE MARK CONSISTS OF THE WORD "SMART"  
ABOVE THE WORD "OFFICE", AND "AMLI", UN-  
DERLINED, OVERLYING THE "M" IN "SMART",  
WITH THREE BLOCKS SEPARATED BY A LINE  
EXTENDING TO THE LEFT OF "SMART" AND  
ALSO TO THE RIGHT OF "SMART".

SER. NO. 77-334,349, FILED 11-20-2007.

KEVON CHISOLM, EXAMINING ATTORNEY

**Int. Cl.: 31**

**Prior U.S. Cls.: 1 and 46**

**United States Patent and Trademark Office**

**Reg. No. 3,467,069**

**Registered July 15, 2008**

**TRADEMARK  
PRINCIPAL REGISTER**

**GLS PLUS**

MOUNTAIN VIEW SEEDS, INC. (OREGON COR-  
PORATION)  
8955 SUNNYVIEW ROAD NE  
SALEM, OR 97305

THE MARK CONSISTS OF STANDARD CHAR-  
ACTERS WITHOUT CLAIM TO ANY PARTICULAR  
FONT, STYLE, SIZE, OR COLOR.

FOR: GRASS SEED, IN CLASS 31 (U.S. CLS. 1 AND  
46).

SER. NO. 77-334,370, FILED 11-20-2007.

FIRST USE 12-1-2006; IN COMMERCE 4-6-2007.

LANA PHAM, EXAMINING ATTORNEY

**Int. Cl.: 9**

**Prior U.S. Cls.: 21, 23, 26, 36 and 38**

**Reg. No. 3,467,070**

**United States Patent and Trademark Office**

**Registered July 15, 2008**

---

**TRADEMARK  
PRINCIPAL REGISTER**

**OBLICORE**

OBLICORE, INC. (DELAWARE CORPORATION)  
700 TECHNOLOGY SQUARE, SUITE 202  
CAMBRIDGE, MA 02139

OPERATIONAL LEVEL AGREEMENTS, IN CLASS 9  
(U.S. CLS. 21, 23, 26, 36 AND 38).

FIRST USE 2-1-2000; IN COMMERCE 2-1-2000.

FOR: SOFTWARE TO AUTHOR, MANAGE,  
MONITOR, REPORT AND TRACK PERFOR-  
MANCE OF SERVICE LEVEL AGREEMENTS, BUSI-  
NESS SERVICE MANAGEMENT AGREEMENTS  
AND INTERNAL OBLIGATION AGREEMENTS,  
NAMELY, CUSTOMER AGREEMENTS, SUPPLIER  
CONTRACTS, UNDERPINNING CONTRACTS AND

THE MARK CONSISTS OF STANDARD CHAR-  
ACTERS WITHOUT CLAIM TO ANY PARTICULAR  
FONT, STYLE, SIZE, OR COLOR.

SER. NO. 77-334,431, FILED 11-20-2007.

KEVON CHISOLM, EXAMINING ATTORNEY

**Int. Cl.: 9**

**Prior U.S. Cls.: 21, 23, 26, 36 and 38**

**Reg. No. 3,467,071**

**United States Patent and Trademark Office**

**Registered July 15, 2008**

---

**TRADEMARK  
PRINCIPAL REGISTER**

**GUARANTEE**

OBLICORE, INC. (DELAWARE CORPORATION)  
700 TECHNOLOGY SQUARE, SUITE 202  
CAMBRIDGE, MA 02139

FOR: SOFTWARE TO AUTHOR, MANAGE,  
MONITOR, REPORT AND TRACK PERFOR-  
MANCE OF SERVICE LEVEL AGREEMENTS, BUSI-  
NESS SERVICE MANAGEMENT AGREEMENTS  
AND INTERNAL OBLIGATION AGREEMENTS,  
NAMELY, CUSTOMER AGREEMENTS, SUPPLIER  
CONTRACTS, UNDERPINNING CONTRACTS AND

OPERATIONAL LEVEL AGREEMENTS, IN CLASS 9  
(U.S. CLS. 21, 23, 26, 36 AND 38).

FIRST USE 8-1-2001; IN COMMERCE 8-1-2001.

THE MARK CONSISTS OF STANDARD CHAR-  
ACTERS WITHOUT CLAIM TO ANY PARTICULAR  
FONT, STYLE, SIZE, OR COLOR.

SER. NO. 77-334,435, FILED 11-20-2007.

KEVON CHISOLM, EXAMINING ATTORNEY

**Int. Cls.: 41 and 44**

**Prior U.S. Cls.: 100, 101 and 107**

**United States Patent and Trademark Office**

**Reg. No. 3,467,072**

**Registered July 15, 2008**

**SERVICE MARK  
PRINCIPAL REGISTER**

# Birth Day Presence

BIRTH DAY PRESENCE, INC. (NEW YORK CORPORATION), DBA BIRTH DAY PRESENCE  
346 WESTMINSTER RD.  
BROOKLYN, NY 11218

FOR: EDUCATION SERVICES, NAMELY, PROVIDING CLASSES AND SEMINARS IN THE FIELD OF CHILDBIRTH EDUCATION, BIRTH DOULA (LABOR ASSISTANT) TRAININGS, AND POSTPARTUM DOULA TRAINING; PHOTOGRAPHY SERVICES, IN CLASS 41 (U.S. CLS. 100, 101 AND 107).

FIRST USE 9-1-2002; IN COMMERCE 9-1-2002.

FOR: DOULA SERVICES FOR BIRTH AND POSTPARTUM, NAMELY, EXPERIENCED LABOR COM-

PANION WHO PROVIDES THE WOMAN AND HER HUSBAND OR PARTNER BOTH EMOTIONAL AND PHYSICAL SUPPORT THROUGHOUT THE ENTIRE LABOR AND DELIVERY, IN CLASS 44 (U.S. CLS. 100 AND 101).

FIRST USE 9-1-2002; IN COMMERCE 9-1-2002.

THE MARK CONSISTS OF STANDARD CHARACTERS WITHOUT CLAIM TO ANY PARTICULAR FONT, STYLE, SIZE, OR COLOR.

SER. NO. 77-334,475, FILED 11-20-2007.

KYLE PEETE, EXAMINING ATTORNEY

**Int. Cl.: 42**

**Prior U.S. Cls.: 100 and 101**

**United States Patent and Trademark Office**

**Reg. No. 3,467,073**

**Registered July 15, 2008**

**SERVICE MARK  
PRINCIPAL REGISTER**



CYAGRA, INC. (DELAWARE CORPORATION)  
197 BOSSLER ROAD  
ELIZABETHTOWN, MA 17022

THE COLOR(S) DARK BLUE, LIGHT BLUE AND WHITE IS/ARE CLAIMED AS A FEATURE OF THE MARK.

FOR: BIOTECHNOLOGY SERVICES, NAMELY, CLONING ANIMALS, MAMMALIAN CLONING, PRODUCING DIFFERENTIATED CELL TYPES WHICH MAY BE TRANSGENIC, PRODUCING EMBRYONIC STEM CELL LINES, TRANSGENIC ANIMALS AND PROTEINS; ALL TO THE SPECIFICATION OF OTHERS FOR RESEARCH, MEDICAL AND AGRICULTURAL USE, IN CLASS 42 (U.S. CLS. 100 AND 101).

THE MARK CONSISTS OF THE WORD CYAGRA IN STYLIZED FORM COMPRISED OF A LARGE "C" WITH A SPHERE IN THE CENTER OF THE "C" AND UPPER CASE BALANCE OF LETTERS WITH A LINE BEHIND THE LETTERS CONNECTED TO THE SPHERE IN DIMINISHING HUE OF BLUE WITH A DARK BLUE BACKGROUND.

SER. NO. 77-334,484, FILED 11-20-2007.

FIRST USE 3-26-1998; IN COMMERCE 3-26-1998.

STEPHANIE ALI, EXAMINING ATTORNEY



**Int. Cl.: 16**

**Prior U.S. Cls.: 2, 5, 22, 23, 29, 37, 38 and 50**

**Reg. No. 3,467,074**

**United States Patent and Trademark Office**

**Registered July 15, 2008**

---

**TRADEMARK  
PRINCIPAL REGISTER**

**SKYWARN**

NATIONAL OCEANIC AND ATMOSPHERIC AD-  
MINISTRATION (UNITED STATES AGENCY  
OF THE UNITED STATES GOVERNMENT)  
1401 CONSTITUTION AVENUE, N.W.  
WASHINGTON, DC 20230

FOR: PRINTED PUBLICATIONS, NAMELY,  
MANUALS, WORKBOOKS, REPORTS, STICKERS,  
BOOKLETS AND GUIDEBOOKS PERTAINING TO  
WEATHER FORECASTING, OBSERVATION, AND  
SEVERE WEATHER PREPARATION AND AWARE-  
NESS, IN CLASS 16 (U.S. CLS. 2, 5, 22, 23, 29, 37, 38  
AND 50).

FIRST USE 1-1-1968; IN COMMERCE 1-1-1968.

THE MARK CONSISTS OF STANDARD CHAR-  
ACTERS WITHOUT CLAIM TO ANY PARTICULAR  
FONT, STYLE, SIZE, OR COLOR.

SER. NO. 77-334,522, FILED 11-20-2007.

ELISSA GARBER KON, EXAMINING ATTORNEY

**Int. Cl.: 25**

**Prior U.S. Cls.: 22 and 39**

**United States Patent and Trademark Office**

**Reg. No. 3,467,075**

**Registered July 15, 2008**

**TRADEMARK  
PRINCIPAL REGISTER**



THE HARKER SCHOOL (CALIFORNIA CORPORATION)  
500 SARATOGA AVENUE  
SARATOGA, CA 95129

THE MARK CONSISTS OF THE LETTER "H"  
WITH A SWIRL INSIDE A SQUARE.

FOR: CLOTHING, NAMELY, T-SHIRTS, JERSEYS, JACKETS AND PANTS, IN CLASS 25 (U.S. CLS. 22 AND 39).

SER. NO. 77-334,541, FILED 11-20-2007.

FIRST USE 11-12-1997; IN COMMERCE 7-17-2006.

KYLE PEETE, EXAMINING ATTORNEY

**Int. Cl.: 39**

**Prior U.S. Cls.: 100 and 105**

**United States Patent and Trademark Office**

**Reg. No. 3,467,076**

**Registered July 15, 2008**

**SERVICE MARK  
PRINCIPAL REGISTER**

**SKY360**

DELTA AIR LINES, INC. (DELAWARE CORPORATION)  
LEGAL DEPT (981/ATG)  
1030 DELTA BLVD  
ATLANTA, GA 303541989

THE MARK CONSISTS OF STANDARD CHARACTERS WITHOUT CLAIM TO ANY PARTICULAR FONT, STYLE, SIZE, OR COLOR.

FOR: AIR TRANSPORTATION, IN CLASS 39 (U.S. CLS. 100 AND 105).

SER. NO. 77-334,545, FILED 11-20-2007.

FIRST USE 10-2-2007; IN COMMERCE 10-2-2007.

KYLE PEETE, EXAMINING ATTORNEY

**Int. Cl.: 36**

**Prior U.S. Cls.: 100, 101 and 102**

**United States Patent and Trademark Office**

**Reg. No. 3,467,077**

**Registered July 15, 2008**

**SERVICE MARK  
PRINCIPAL REGISTER**

**BIGSUR PARTNERS**

BIGSUR PARTNERS LLC (FLORIDA CORPORATION)  
27 DELWOOD LN  
GREENWICH, CT 06830

FOR: FINANCIAL AND INVESTMENT SERVICES, NAMELY, MANAGEMENT AND BROKERAGE IN THE FIELDS OF STOCKS, BONDS, OPTIONS, COMMODITIES, FUTURES AND OTHER SECURITIES, AND THE INVESTMENT OF FUNDS OF OTHERS; FINANCIAL MANAGEMENT; FINANCIAL PLANNING AND INVESTMENT ADVISORY SERVICES; FINANCIAL PLANNING, NAMELY, THE CREATION OF PERSONALIZED STRATEGIES TO ACHIEVE FINANCIAL INDEPENDENCE; FINANCIAL PORTFOLIO MANAGEMENT; FINANCIAL SERVICES, NAMELY, A TOTAL PORTFOLIO OFFERING FOR HIGH NET WORTH CLIENTS CONSISTING OF BOTH SEPARATE ACCOUNTS

AND MUTUAL FUNDS FOR EQUITY AND FIXED INCOME INVESTMENTS, IN CLASS 36 (U.S. CLS. 100, 101 AND 102).

FIRST USE 11-1-2007; IN COMMERCE 11-1-2007.

THE MARK CONSISTS OF STANDARD CHARACTERS WITHOUT CLAIM TO ANY PARTICULAR FONT, STYLE, SIZE, OR COLOR.

NO CLAIM IS MADE TO THE EXCLUSIVE RIGHT TO USE "PARTNERS", APART FROM THE MARK AS SHOWN.

SER. NO. 77-334,558, FILED 11-20-2007.

JEFF DEFORD, EXAMINING ATTORNEY

**Int. Cl.: 39**

**Prior U.S. Cls.: 100 and 105**

**United States Patent and Trademark Office**

**Reg. No. 3,467,078**

**Registered July 15, 2008**

**SERVICE MARK  
PRINCIPAL REGISTER**

**PDT ENRICHMENT PROGRAMS**

PACIFIC DELIGHT TOURS, INC. (NEW YORK CORPORATION)  
38TH FLOOR  
3 PARK AVENUE  
NEW YORK, NY 100165902

FOR: ARRANGING EDUCATIONAL TRAVEL PROGRAMS FOR THE ACADEMIC AND PROFESSIONAL COMMUNITIES, IN CLASS 39 (U.S. CLS. 100 AND 105).

FIRST USE 2-1-2002; IN COMMERCE 2-1-2002.

THE MARK CONSISTS OF STANDARD CHARACTERS WITHOUT CLAIM TO ANY PARTICULAR FONT, STYLE, SIZE, OR COLOR.

OWNER OF U.S. REG. NOS. 2,712,062 AND 2,712,063.

NO CLAIM IS MADE TO THE EXCLUSIVE RIGHT TO USE "ENRICHMENT TOURS", APART FROM THE MARK AS SHOWN.

SER. NO. 77-334,572, FILED 11-20-2007.

JEFF DEFORD, EXAMINING ATTORNEY

**Int. Cl.: 36**

**Prior U.S. Cls.: 100, 101 and 102**

**United States Patent and Trademark Office**

**Reg. No. 3,467,079**

**Registered July 15, 2008**

**SERVICE MARK  
PRINCIPAL REGISTER**

**THE VALUE OF INDEPENDENCE**

BIGSUR PARTNERS LLC (FLORIDA CORPORATION)  
27 DELWOOD LN  
GREENWICH, CT 06830

FOR: FINANCIAL AND INVESTMENT SERVICES, NAMELY, MANAGEMENT AND BROKERAGE IN THE FIELDS OF STOCKS, BONDS, OPTIONS, COMMODITIES, FUTURES AND OTHER SECURITIES, AND THE INVESTMENT OF FUNDS OF OTHERS; FINANCIAL MANAGEMENT; FINANCIAL PLANNING AND INVESTMENT ADVISORY SERVICES; FINANCIAL PLANNING, NAMELY, THE CREATION OF PERSONALIZED STRATEGIES TO ACHIEVE FINANCIAL INDEPENDENCE; FINANCIAL PORTFOLIO MANAGEMENT; FINANCIAL SERVICES, NAMELY, A TOTAL PORTFOLIO

OFFERING FOR HIGH NET WORTH CLIENTS CONSISTING OF BOTH SEPARATE ACCOUNTS AND MUTUAL FUNDS FOR EQUITY AND FIXED INCOME INVESTMENTS, IN CLASS 36 (U.S. CLS. 100, 101 AND 102).

FIRST USE 11-1-2007; IN COMMERCE 11-1-2007.

THE MARK CONSISTS OF STANDARD CHARACTERS WITHOUT CLAIM TO ANY PARTICULAR FONT, STYLE, SIZE, OR COLOR.

SER. NO. 77-334,575, FILED 11-20-2007.

JEFF DEFORD, EXAMINING ATTORNEY

**Int. Cl.: 39**

**Prior U.S. Cls.: 100 and 105**

**United States Patent and Trademark Office**

**Reg. No. 3,467,080**

**Registered July 15, 2008**

**SERVICE MARK  
PRINCIPAL REGISTER**

**UNLEASH ESCAPE EXPLORE**

TRIP DOGS TRAVEL SERVICES, LLC (MINNESOTA LTD LIAB CO), DBA TRIP DOGS TRAVEL  
5165 TRENTON LN N  
PLYMOUTH, MN 55442

FOR: TRAVEL AGENCY SERVICES, NAMELY, MAKING RESERVATIONS AND BOOKINGS FOR TRANSPORTATION; TRAVEL BOOKING AGENCIES; TRAVEL, EXCURSION AND CRUISE ARRANGEMENT, IN CLASS 39 (U.S. CLS. 100 AND 105).

FIRST USE 5-5-2007; IN COMMERCE 5-5-2007.

THE MARK CONSISTS OF STANDARD CHARACTERS WITHOUT CLAIM TO ANY PARTICULAR FONT, STYLE, SIZE, OR COLOR.

SER. NO. 77-334,581, FILED 11-20-2007.

JIM RINGLE, EXAMINING ATTORNEY

**Int. Cl.: 42**

**Prior U.S. Cls.: 100 and 101**

**United States Patent and Trademark Office**

**Reg. No. 3,467,081**

**Registered July 15, 2008**

**SERVICE MARK  
PRINCIPAL REGISTER**

**Safe Harbor Inspections**

SAFE HARBOR INSPECTIONS INC. (NEW YORK CORPORATION)  
82 PRESTON ST  
HUNTINGTON, NY 11743

FOR: INSPECTIONS OF RESIDENTIAL AND COMMERCIAL BUILDINGS, IN CLASS 42 (U.S. CLS. 100 AND 101).

FIRST USE 10-22-2003; IN COMMERCE 10-22-2003.

THE MARK CONSISTS OF STANDARD CHARACTERS WITHOUT CLAIM TO ANY PARTICULAR FONT, STYLE, SIZE, OR COLOR.

NO CLAIM IS MADE TO THE EXCLUSIVE RIGHT TO USE "INSPECTIONS", APART FROM THE MARK AS SHOWN.

SER. NO. 77-334,582, FILED 11-20-2007.

JEFF DEFORD, EXAMINING ATTORNEY



**Int. Cl.: 1**

**Prior U.S. Cls.: 1, 5, 6, 10, 26 and 46**

**Reg. No. 3,467,082**

**United States Patent and Trademark Office**

**Registered July 15, 2008**

---

**TRADEMARK  
PRINCIPAL REGISTER**

**K-FIX**

PARADIGM AGRICULTURAL CONSULTING,  
INC. (CALIFORNIA CORPORATION)  
3703 S. "K" STREET  
TULARE, CA 93274

THE MARK CONSISTS OF STANDARD CHAR-  
ACTERS WITHOUT CLAIM TO ANY PARTICULAR  
FONT, STYLE, SIZE, OR COLOR.

FOR: FERTILIZERS FOR AGRICULTURAL USE,  
IN CLASS 1 (U.S. CLS. 1, 5, 6, 10, 26 AND 46).

SER. NO. 77-334,596, FILED 11-20-2007.

FIRST USE 1-1-1997; IN COMMERCE 1-1-1997.

APRIL ROACH, EXAMINING ATTORNEY

**Int. Cl.: 20**

**Prior U.S. Cls.: 2, 13, 22, 25, 32 and 50**

**Reg. No. 3,467,083**

**United States Patent and Trademark Office**

**Registered July 15, 2008**

---

**TRADEMARK  
PRINCIPAL REGISTER**

**BellagiO Luxury**

FLORIDABEACH, INC. (NEW JERSEY CORPORATION)  
3156 CHELSEA LANE  
LEVITTOWN, NY 11756

FOR: KITCHEN CABINETS AND BATHROOM VANITIES, IN CLASS 20 (U.S. CLS. 2, 13, 22, 25, 32 AND 50).

FIRST USE 1-1-2006; IN COMMERCE 1-1-2006.

THE MARK CONSISTS OF STANDARD CHARACTERS WITHOUT CLAIM TO ANY PARTICULAR FONT, STYLE, SIZE, OR COLOR.

NO CLAIM IS MADE TO THE EXCLUSIVE RIGHT TO USE "LUXURY", APART FROM THE MARK AS SHOWN.

THE ENGLISH TRANSLATION OF THE WORD "BELLAGIO" IN THE MARK IS "BEAUTIFUL LAKE".

SER. NO. 77-334,598, FILED 11-20-2007.

JEFF DEFORD, EXAMINING ATTORNEY

**Int. Cl.: 35**

**Prior U.S. Cls.: 100, 101 and 102**

**United States Patent and Trademark Office**

**Reg. No. 3,467,084**

**Registered July 15, 2008**

**SERVICE MARK  
PRINCIPAL REGISTER**

**SELL MORE SMILES!**

ADVANCED WEB SYSTEMS, LLC (WEST VIRGINIA LTD LIAB CO)  
315 W. MAPLE AVE.  
FAYETTEVILLE, WV 25840

FOR: PROMOTING, ADVERTISING, AND MARKETING OF THE ONLINE WEBSITES OF OTHERS IN THE FIELD OF DENTISTRY; SUBSCRIPTION TO AN INFORMATION MEDIA PACKAGE FOR DENTISTS WANTING TO MAXIMIZE ADVERTISING ONLINE; PROVIDING ADVERTISING, MARKETING AND PROMOTIONAL SERVICES, NAMELY, DEVELOPMENT OF ADVERTISING CAMPAIGNS

FOR WEB DESIGN, IN CLASS 35 (U.S. CLS. 100, 101 AND 102).

FIRST USE 10-7-2003; IN COMMERCE 10-7-2003.

THE MARK CONSISTS OF STANDARD CHARACTERS WITHOUT CLAIM TO ANY PARTICULAR FONT, STYLE, SIZE, OR COLOR.

SER. NO. 77-334,615, FILED 11-20-2007.

JIM RINGLE, EXAMINING ATTORNEY

**Int. Cl.: 39**

**Prior U.S. Cls.: 100 and 105**

**United States Patent and Trademark Office**

**Reg. No. 3,467,085**

**Registered July 15, 2008**

**SERVICE MARK  
PRINCIPAL REGISTER**

**Unleash Your Spirit Escape  
Your Boundaries Explore  
The World**

TRIP DOGS TRAVEL SERVICES, LLC (MINNE-  
SOTA LTD LIAB CO), DBA TRIP DOGS TRA-  
VEL  
5165 TRENTON LN N  
PLYMOUTH, MN 55442

FOR: TRAVEL AGENCY SERVICES, NAMELY,  
MAKING RESERVATIONS AND BOOKINGS FOR  
TRANSPORTATION; TRAVEL AND TOUR TICKET  
RESERVATION SERVICE; TRAVEL, EXCURSION  
AND CRUISE ARRANGEMENT, IN CLASS 39 (U.S.  
CLS. 100 AND 105).

FIRST USE 5-5-2007; IN COMMERCE 5-5-2007.

THE MARK CONSISTS OF STANDARD CHAR-  
ACTERS WITHOUT CLAIM TO ANY PARTICULAR  
FONT, STYLE, SIZE, OR COLOR.

SER. NO. 77-334,620, FILED 11-20-2007.

JIM RINGLE, EXAMINING ATTORNEY

**Int. Cl.: 1**

**Prior U.S. Cls.: 1, 5, 6, 10, 26 and 46**

**Reg. No. 3,467,086**

**United States Patent and Trademark Office**

**Registered July 15, 2008**

---

**TRADEMARK  
PRINCIPAL REGISTER**

**CAL-FIX PLUS**

PARADIGM AGRICULTURAL CONSULTING,  
INC. (CALIFORNIA CORPORATION)  
3073 SOUTH "K" STREET  
TULARE, CA 93274

THE MARK CONSISTS OF STANDARD CHAR-  
ACTERS WITHOUT CLAIM TO ANY PARTICULAR  
FONT, STYLE, SIZE, OR COLOR.

FOR: FERTILIZERS FOR AGRICULTURAL USE,  
IN CLASS 1 (U.S. CLS. 1, 5, 6, 10, 26 AND 46).

SER. NO. 77-334,622, FILED 11-20-2007.

FIRST USE 3-9-2007; IN COMMERCE 3-9-2007.

APRIL ROACH, EXAMINING ATTORNEY

**Int. Cl.: 42**

**Prior U.S. Cls.: 100 and 101**

**United States Patent and Trademark Office**

**Reg. No. 3,467,087**

**Registered July 15, 2008**

**SERVICE MARK  
PRINCIPAL REGISTER**

**ÜberGeekGirl**

STEVENS, JESSICA (UNITED STATES INDIVIDUAL)  
1527 19TH STREET  
SANTA MONICA, CA 90404

FOR: COMPUTER CONSULTATION; COMPUTER NETWORK DESIGN FOR OTHERS; COMPUTER SOFTWARE CONSULTANCY; COMPUTER SOFTWARE DESIGN, COMPUTER PROGRAMMING, OR MAINTENANCE OF COMPUTER SOFTWARE; CONSULTING SERVICES IN THE FIELD OF DESIGN, SELECTION, IMPLEMENTATION AND USE OF COMPUTER HARDWARE AND SOFTWARE SYSTEMS FOR OTHERS; INFORMATION TECHNOLOGY CONSULTATION; INSTALLATION

OF COMPUTER SOFTWARE; INTEGRATION OF COMPUTER SYSTEMS AND NETWORKS, IN CLASS 42 (U.S. CLS. 100 AND 101).

FIRST USE 11-15-2005; IN COMMERCE 11-15-2005.

THE MARK CONSISTS OF STANDARD CHARACTERS WITHOUT CLAIM TO ANY PARTICULAR FONT, STYLE, SIZE, OR COLOR.

SER. NO. 77-334,654, FILED 11-20-2007.

KATHLEEN LORENZO, EXAMINING ATTORNEY

**Int. Cl.: 38**

**Prior U.S. Cls.: 100, 101 and 104**

**United States Patent and Trademark Office**

**Reg. No. 3,467,088**

**Registered July 15, 2008**

---

**SERVICE MARK  
PRINCIPAL REGISTER**

**PV-TV**

LAS VEGAS GAMING, INC. (NEVADA CORPORATION)  
4000 WEST ALI BABA LANE, SUITE D  
LAS VEGAS, NV 89118

FOR: ELECTRONIC, ELECTRIC, AND DIGITAL TRANSMISSION OF VOICE, DATA, IMAGES, SIGNALS, AND MESSAGES TO PLAYERS OF GAMING MACHINES , IN CLASS 38 (U.S. CLS. 100, 101 AND 104).

FIRST USE 5-1-2007; IN COMMERCE 5-1-2007.

THE MARK CONSISTS OF STANDARD CHARACTERS WITHOUT CLAIM TO ANY PARTICULAR FONT, STYLE, SIZE, OR COLOR.

SER. NO. 77-334,655, FILED 11-20-2007.

KATHLEEN LORENZO, EXAMINING ATTORNEY

**Int. Cl.: 9**

**Prior U.S. Cls.: 21, 23, 26, 36 and 38**

**United States Patent and Trademark Office**

**Reg. No. 3,467,089**

**Registered July 15, 2008**

**TRADEMARK  
PRINCIPAL REGISTER**

**ARLink**

PIRACLE, INC. (UTAH CORPORATION)  
SUITE B  
2302 SOUTH PRESIDENTS DRIVE  
SALT LAKE CITY, UT 841202318

FIRST USE 7-10-2007; IN COMMERCE 7-10-2007.

FOR: COMPUTER SOFTWARE WHICH ENABLE THE SECURE MOVEMENT OF FINANCIAL PAYMENT DATA FROM ONE LOCATION TO ANOTHER, AND WHICH CREATES, RECORDS, SHARES AND TRANSMITS PAYMENTS AND PAYMENT INFORMATION, IN CLASS 9 (U.S. CLS. 21, 23, 26, 36 AND 38).

THE MARK CONSISTS OF STYLIZED LETTERS FORMING "ARLINK" WHERE THE FIRST THREE LETTERS ARE CAPITALIZED.

SER. NO. 77-334,658, FILED 11-20-2007.

ANNE MADDEN, EXAMINING ATTORNEY



**Int. Cl.: 19**

**Prior U.S. Cls.: 1, 12, 33 and 50**

**United States Patent and Trademark Office**

**Reg. No. 3,467,090**

**Registered July 15, 2008**

**TRADEMARK  
PRINCIPAL REGISTER**

**For those who appreciate  
the best, and to those who  
accept no less**

SAROYAN LUMBER COMPANY, INC. (CALI-  
FORNIA CORPORATION)  
6230 SO. ALAMEDA ST.  
HUNTINGTON PARK, CA 90255

THE MARK CONSISTS OF STANDARD CHAR-  
ACTERS WITHOUT CLAIM TO ANY PARTICULAR  
FONT, STYLE, SIZE, OR COLOR.

FOR: FLOOR BOARDS, WOODEN FLOORING,  
HARDWOOD FLOORING; NON-METAL ARCHI-  
TECTURAL MOULDINGS AND FINISH TRIM, IN  
CLASS 19 (U.S. CLS. 1, 12, 33 AND 50).

SER. NO. 77-334,661, FILED 11-20-2007.

FIRST USE 7-30-2001; IN COMMERCE 7-30-2001.

ROBERT LAVACHE, EXAMINING ATTORNEY

**Int. Cl.: 16**

**Prior U.S. Cls.: 2, 5, 22, 23, 29, 37, 38 and 50**

**United States Patent and Trademark Office**

**Reg. No. 3,467,091**

**Registered July 15, 2008**

**TRADEMARK  
PRINCIPAL REGISTER**

**PAPER WITH A PAST, AND A  
FUTURE.**

NEW LEAF PAPER, LLC (NEW YORK LTD LIAB  
CO)  
116 NEW MONTGOMERY STREET, SUITE 830  
SAN FRANCISCO, CA 94105

THE MARK CONSISTS OF STANDARD CHAR-  
ACTERS WITHOUT CLAIM TO ANY PARTICULAR  
FONT, STYLE, SIZE, OR COLOR.

FOR: PRINTING PAPER; COPY PAPER; WRIT-  
ING PAPER; DRAWING PAPER, IN CLASS 16 (U.S.  
CLS. 2, 5, 22, 23, 29, 37, 38 AND 50).

SER. NO. 77-334,674, FILED 11-20-2007.

FIRST USE 11-0-1999; IN COMMERCE 11-0-1999.

FLORENTINA BLANDU, EXAMINING ATTORNEY

**Int. Cl.: 19**

**Prior U.S. Cls.: 1, 12, 33 and 50**

**United States Patent and Trademark Office**

**Reg. No. 3,467,092**

**Registered July 15, 2008**

**TRADEMARK  
PRINCIPAL REGISTER**

**Timeless craftsmanship  
that endures**

SAROYAN LUMBER COMPANY, INC. (CALI-  
FORNIA CORPORATION)  
6230 SO. ALAMEDA ST.  
HUNTINGTON PARK, CA 90255

THE MARK CONSISTS OF STANDARD CHAR-  
ACTERS WITHOUT CLAIM TO ANY PARTICULAR  
FONT, STYLE, SIZE, OR COLOR.

FOR: FLOOR BOARDS, WOODEN FLOORING,  
HARDWOOD FLOORING; NON-METAL ARCHI-  
TECTURAL MOULDINGS AND FINISH TRIM, IN  
CLASS 19 (U.S. CLS. 1, 12, 33 AND 50).

SER. NO. 77-334,678, FILED 11-20-2007.

FIRST USE 7-30-2001; IN COMMERCE 7-30-2001.

ROBERT LAVACHE, EXAMINING ATTORNEY

**Int. Cls.: 39 and 41**

**Prior U.S. Cls.: 100, 101, 105 and 107**

**United States Patent and Trademark Office**

**Reg. No. 3,467,093**

**Registered July 15, 2008**

**SERVICE MARK  
PRINCIPAL REGISTER**

**FOGGY BRIDGE**

FOGGY BRIDGE WINERY, LLC (CALIFORNIA  
LTD LIAB CO)  
2929 CAMPUS DRIVE, SUITE 150  
SAN MATEO, CA 94403

FOR: BOAT CRUISES, IN CLASS 39 (U.S. CLS. 100  
AND 105).

FIRST USE 9-7-2007; IN COMMERCE 9-7-2007.

FOR: ENTERTAINMENT SERVICES, NAMELY,  
WINE AND FOOD TASTINGS, IN CLASS 41 (U.S.  
CLS. 100, 101 AND 107).

FIRST USE 9-7-2007; IN COMMERCE 9-7-2007.

THE MARK CONSISTS OF STANDARD CHAR-  
ACTERS WITHOUT CLAIM TO ANY PARTICULAR  
FONT, STYLE, SIZE, OR COLOR.

SER. NO. 77-334,681, FILED 11-20-2007.

MICHAEL ENGEL, EXAMINING ATTORNEY

**Int. Cl.: 24**

**Prior U.S. Cls.: 42 and 50**

**United States Patent and Trademark Office**

**Reg. No. 3,467,094**

**Registered July 15, 2008**

**TRADEMARK  
PRINCIPAL REGISTER**

**WHAT HAPPENS UNDER THE  
BLANKET STAYS UNDER THE  
BLANKET**

SCHOEN, MACEY (UNITED STATES INDIVIDUAL)  
2631 HEATHROW STREET  
LAS VEGAS, NV 89135 AND  
CARTER, ESTHER (UNITED STATES INDIVIDUAL)  
2631 HEATHROW STREET  
LAS VEGAS, NV 89135

FOR: BED BLANKETS; BLANKET THROWS;  
BLANKETS FOR OUTDOOR USE; CHILDREN'S  
BLANKETS, IN CLASS 24 (U.S. CLS. 42 AND 50).

FIRST USE 11-1-2007; IN COMMERCE 11-1-2007.

THE MARK CONSISTS OF STANDARD CHARACTERS WITHOUT CLAIM TO ANY PARTICULAR FONT, STYLE, SIZE, OR COLOR.

SER. NO. 77-334,682, FILED 11-20-2007.

MICHAEL ENGEL, EXAMINING ATTORNEY

**Int. Cl.: 45**

**Prior U.S. Cls.: 100 and 101**

**United States Patent and Trademark Office**

**Reg. No. 3,467,095**

**Registered July 15, 2008**

**SERVICE MARK  
PRINCIPAL REGISTER**

**COMPASS IRB**

COMPASS IRB, LLC (ARIZONA LTD LIAB CO)  
4435 EAST BROADWAY ROAD, SUITE 4  
MESA, AZ 85206

FOR: PROVIDING INDEPENDENT REVIEW OF  
CLINICAL TRIALS INVOLVING HUMAN SUB-  
JECTS, NAMELY, REVIEWING RESEARCH PRO-  
TOCOLS TO ENSURE PROTECTION OF THE  
RIGHTS AND WELFARE OF HUMAN SUBJECTS  
OF RESEARCH, IN CLASS 45 (U.S. CLS. 100 AND  
101).

FIRST USE 10-30-2006; IN COMMERCE 10-30-2006.

THE MARK CONSISTS OF STANDARD CHAR-  
ACTERS WITHOUT CLAIM TO ANY PARTICULAR  
FONT, STYLE, SIZE, OR COLOR.

NO CLAIM IS MADE TO THE EXCLUSIVE  
RIGHT TO USE "IRB", APART FROM THE MARK  
AS SHOWN.

SER. NO. 77-334,683, FILED 11-20-2007.

KEVIN DINALLO, EXAMINING ATTORNEY

**Int. Cl.: 45**

**Prior U.S. Cls.: 100 and 101**

**United States Patent and Trademark Office**

**Reg. No. 3,467,096**

**Registered July 15, 2008**

**SERVICE MARK  
PRINCIPAL REGISTER**

**GUIDING YOU TO SUCCESS**

COMPASS IRB, LLC (ARIZONA LTD LIAB CO)  
4435 EAST BROADWAY ROAD, SUITE 4  
MESA, AZ 85206

FOR: PROVIDING INDEPENDENT REVIEW OF  
CLINICAL TRIALS INVOLVING HUMAN SUB-  
JECTS, NAMELY, REVIEWING RESEARCH PRO-  
TOCOLS TO ENSURE PROTECTION OF THE  
RIGHTS AND WELFARE OF HUMAN SUBJECTS  
OF RESEARCH, IN CLASS 45 (U.S. CLS. 100 AND  
101).

FIRST USE 10-30-2006; IN COMMERCE 10-30-2006.

THE MARK CONSISTS OF STANDARD CHAR-  
ACTERS WITHOUT CLAIM TO ANY PARTICULAR  
FONT, STYLE, SIZE, OR COLOR.

SER. NO. 77-334,689, FILED 11-20-2007.

KEVIN DINALLO, EXAMINING ATTORNEY

**Int. Cl.: 16**

**Prior U.S. Cls.: 2, 5, 22, 23, 29, 37, 38 and 50**

**United States Patent and Trademark Office**

**Reg. No. 3,467,097**

**Registered July 15, 2008**

**TRADEMARK  
PRINCIPAL REGISTER**

**REINCARNATION**

NEW LEAF PAPER, LLC (NEW YORK LTD LIAB  
CO)  
116 NEW MONTGOMERY STREET, SUITE 830  
SAN FRANCISCO, CA 94105

FOR: PRINTING PAPER; COPY PAPER; WRIT-  
ING PAPER; DRAWING PAPER, IN CLASS 16 (U.S.  
CLS. 2, 5, 22, 23, 29, 37, 38 AND 50).

FIRST USE 11-0-1999; IN COMMERCE 11-0-1999.

THE MARK CONSISTS OF STANDARD CHAR-  
ACTERS WITHOUT CLAIM TO ANY PARTICULAR  
FONT, STYLE, SIZE, OR COLOR.

SER. NO. 77-334,692, FILED 11-20-2007.

FLORENTINA BLANDU, EXAMINING ATTORNEY



Int. Cl.: 25

Prior U.S. Cls.: 22 and 39

United States Patent and Trademark Office

Reg. No. 3,467,098

Registered July 15, 2008

TRADEMARK  
PRINCIPAL REGISTER



Blak Oztrich

BLAK OZTRICH INC. (NEW YORK CORPORATION)  
45 COE FARM ROAD  
SUFFERN, NY 10901

FOR: BATH SLIPPERS; SLIPPERS; BASKETBALL SNEAKERS; SNEAKERS; JEANS; CREWNECK SWEATERS; MOCK TURTLE-NECK SWEATERS; TURTLENECK SWEATERS; V-NECK SWEATERS; DRESS SUITS; JOGGING SUITS; LADIES' SUITS; MEN'S SUITS; MEN'S SUITS, WOMEN'S SUITS; SHIRTS FOR SUITS; SKIRT SUITS; SKIRTS; SKIRTS AND DRESSES; SNOW SUITS; SUIT COATS; TRACK SUITS; BLOUSES; BED JACKETS; DENIM JACKETS; DOWN JACKETS; HEAVY JACKETS; JACKET LINERS; JACKETS; LEATHER JACKETS; REVERSIBLE JACKETS; SKI JACKETS; SPORTS JACKETS; ANKLE BOOTS; BOOTS; INFANTS' SHOES AND BOOTS; LACE BOOTS; LADIES' BOOTS; WOMEN'S SHOES; SKI BOOT BAGS; CHILDREN'S HEADWEAR; HEADWEAR; SKULLIES; CHILDREN'S AND INFANTS' CLOTH BIBS; CHILDREN'S CLOTH EATING BIBS; CLOTH BIBS; CLOTH BIBS FOR ADULT DINERS; CLOTH BIBS FOR USE BY SENIOR CITIZENS OR PHYSICALLY- OR MENTALLY-CHALLENGED PERSONS; PLASTIC BABY BIBS; CLOTH DIAPERS; INFANT CLOTH DIAPERS; INFANT DIAPER COVERS; BASEBALL CAPS; CAP VISORS; CAPS; GOLF CAPS; HEADGEAR, NAME- LY, BASEBALL CAPS, DRIVER CAP, FEDORA HAT,-

FITTED CAPS, SKULL CAPS, FATIGUES; KNITTED CAPS; SHOWER CAPS; SKULL CAPS; SWIM CAPS; CAPRI PANTS; CARGO PANTS; DENIMS; JOGGING PANTS; LOUNGE PANTS; NURSE PANTS; PANTS; TRACK PANTS; WATERPROOF JACKETS AND PANTS; YOGA PANTS; LONG JACKETS; MEN AND WOMEN JACKETS, COATS, TROUSERS, VESTS; SLEEVED OR SLEEVELESS JACKETS; HEADBANDS; HEADBANDS AGAINST SWEATING; DANCE COSTUMES; DANCE SHOES; HAT BANDS; NECK BANDS; SASH BANDS FOR KIMONO (OBI); SWEAT BANDS; WRIST BANDS; CLOTHING, NAMELY, WRAP-AROUNDS; HOODS; INFANT AND TODDLER ONE PIECE CLOTHING; JERSEYS; LEATHER BELTS; PERSPIRATION ABSORBENT UNDERWEAR CLOTHING; TIES; TOPS; WRAPS; HATS; SMALL HATS; KNITTED UNDERWEAR, IN CLASS 25 (U.S. CLS. 22 AND 39).

FIRST USE 6-23-2007; IN COMMERCE 6-24-2007.

THE MARK CONSISTS OF OSTRICH LOGO FRAMED IN A VERTICALLY PLACED RECTANGLE WITH AN OVAL CUT OUT.

SER. NO. 77-334,693, FILED 11-20-2007.

MICHAEL ENGEL, EXAMINING ATTORNEY

**Int. Cl.: 16**

**Prior U.S. Cls.: 2, 5, 22, 23, 29, 37, 38 and 50**

**United States Patent and Trademark Office**

**Reg. No. 3,467,099**

**Registered July 15, 2008**

**TRADEMARK  
PRINCIPAL REGISTER**

**PRIMAVERA**

NEW LEAF PAPER, LLC (NEW YORK LTD LIAB  
CO)  
116 NEW MONTGOMERY STREET, SUITE 830  
SAN FRANCISCO, CA 94105

THE MARK CONSISTS OF STANDARD CHAR-  
ACTERS WITHOUT CLAIM TO ANY PARTICULAR  
FONT, STYLE, SIZE, OR COLOR.

FOR: PRINTING PAPER; COPY PAPER; WRIT-  
ING PAPER; DRAWING PAPER, IN CLASS 16 (U.S.  
CLS. 2, 5, 22, 23, 29, 37, 38 AND 50).

SER. NO. 77-334,700, FILED 11-20-2007.

FIRST USE 9-0-2003; IN COMMERCE 4-0-2005.

FLORENTINA BLANDU, EXAMINING ATTORNEY

**Int. Cl.: 38**

**Prior U.S. Cls.: 100, 101 and 104**

**United States Patent and Trademark Office**

**Reg. No. 3,467,100**

**Registered July 15, 2008**

**SERVICE MARK  
PRINCIPAL REGISTER**

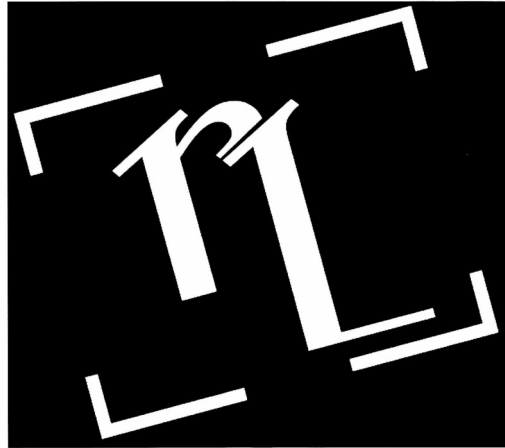

REAL LATINO IMAGES, LLC (ILLINOIS LTD  
LIAB CO)  
2724 N. SACRAMENTO AVE.  
CHICAGO, IL 60647

THE MARK CONSISTS OF THE STYLIZED LET-  
TERS "RL" POSITIONED AT AN ANGLE BETWEEN  
FRAME-LIKE ELEMENTS.

FOR: ELECTRONIC DELIVERY OF IMAGES  
AND PHOTOGRAPHS VIA A GLOBAL COMPUTER  
NETWORK, IN CLASS 38 (U.S. CLS. 100, 101 AND  
104).

SER. NO. 77-334,710, FILED 11-20-2007.

FIRST USE 5-17-2005; IN COMMERCE 10-5-2005.

MYRIAH HABEEB, EXAMINING ATTORNEY

**Int. Cl.: 38**

**Prior U.S. Cls.: 100, 101 and 104**

**United States Patent and Trademark Office**

**Reg. No. 3,467,101**

**Registered July 15, 2008**

**SERVICE MARK  
PRINCIPAL REGISTER**

**REAL LATINO**

REAL LATINO IMAGES, LLC (ILLINOIS LTD  
LIAB CO)  
2724 N. SACRAMENTO AVE.  
CHICAGO, IL 60647

FOR: ELECTRONIC DELIVERY OF IMAGES  
AND PHOTOGRAPHS VIA A GLOBAL COMPUTER  
NETWORK, IN CLASS 38 (U.S. CLS. 100, 101 AND  
104).

FIRST USE 5-17-2005; IN COMMERCE 10-5-2005.

THE MARK CONSISTS OF STANDARD CHAR-  
ACTERS WITHOUT CLAIM TO ANY PARTICULAR  
FONT, STYLE, SIZE, OR COLOR.

NO CLAIM IS MADE TO THE EXCLUSIVE  
RIGHT TO USE "LATINO", APART FROM THE  
MARK AS SHOWN.

SER. NO. 77-334,711, FILED 11-20-2007.

MYRIAH HABEEB, EXAMINING ATTORNEY

**Int. Cl.: 9**

**Prior U.S. Cls.: 21, 23, 26, 36 and 38**

**Reg. No. 3,467,102**

**United States Patent and Trademark Office**

**Registered July 15, 2008**

---

**TRADEMARK  
PRINCIPAL REGISTER**

**SPOTON!**

ALDER TECHNOLOGY, INC. (OREGON CORPORATION)  
SUITE 200  
2100 NW 22ND AVENUE  
PORTLAND, OR 97210

FOR: SOFTWARE FOR EVALUATING THE PRINTING CONDITIONS OF PRINTERS AND PRINT PRESSES, NAMELY, LITHOGRAPHIC PRINTERS, WEB PRESSES, INK JET PROOFERS, SHEET-FED PRESSES, AND DIGITAL PRINTERS, IN CLASS 9 (U.S. CLS. 21, 23, 26, 36 AND 38).

FIRST USE 10-19-2007; IN COMMERCE 10-19-2007.

THE MARK CONSISTS OF STANDARD CHARACTERS WITHOUT CLAIM TO ANY PARTICULAR FONT, STYLE, SIZE, OR COLOR.

SER. NO. 77-334,714, FILED 11-20-2007.

MIDGE BUTLER, EXAMINING ATTORNEY

**Int. Cl.: 35**

**Prior U.S. Cls.: 100, 101 and 102**

**United States Patent and Trademark Office**

**Reg. No. 3,467,103**

**Registered July 15, 2008**

**SERVICE MARK  
PRINCIPAL REGISTER**

NEW AGE PHARMACEUTICALS

MELAMED, HOOTAN (UNITED STATES INDIVIDUAL)  
SUITE 835  
9663 SANTA MONICA BLVD.  
BEVERLY HILLS, CA 90210

FOR: RETAIL PHARMACY SERVICES; RETAIL  
DRUG STORE SERVICES, IN CLASS 35 (U.S. CLS.  
100, 101 AND 102).

FIRST USE 7-0-2007; IN COMMERCE 7-0-2007.

THE MARK CONSISTS OF STANDARD CHARACTERS WITHOUT CLAIM TO ANY PARTICULAR FONT, STYLE, SIZE, OR COLOR.

NO CLAIM IS MADE TO THE EXCLUSIVE RIGHT TO USE "PHARMACEUTICALS", APART FROM THE MARK AS SHOWN.

SER. NO. 77-334,718, FILED 11-20-2007.

RICHARD WHITE, EXAMINING ATTORNEY

**Int. Cl.: 36**

**Prior U.S. Cls.: 100, 101 and 102**

**United States Patent and Trademark Office**

**Reg. No. 3,467,104**

**Registered July 15, 2008**

---

**SERVICE MARK  
PRINCIPAL REGISTER**

**NORTHWESTPHYSICIANS**

THE DOCTORS COMPANY (CALIFORNIA IN-  
TERINSURANCE EXCHANGE)  
185 GREENWOOD ROAD  
NAPA, CA 945580900

FOR: INSURANCE UNDERWRITING IN THE  
FIELD OF MEDICAL LIABILITY, IN CLASS 36  
(U.S. CLS. 100, 101 AND 102).

FIRST USE 2-0-2006; IN COMMERCE 2-0-2006.

THE MARK CONSISTS OF STANDARD CHAR-  
ACTERS WITHOUT CLAIM TO ANY PARTICULAR  
FONT, STYLE, SIZE, OR COLOR.

OWNER OF U.S. REG. NO. 3,223,146.

SER. NO. 77-334,719, FILED 11-20-2007.

DAVID C. REIHNER, EXAMINING ATTORNEY

**Int. Cl.: 29**

**Prior U.S. Cl.: 46**

**United States Patent and Trademark Office**

**Reg. No. 3,467,105**

**Registered July 15, 2008**

**TRADEMARK  
PRINCIPAL REGISTER**



RICKY'S LUCKY NUTS, LLC (COLORADO LTD  
LIAB CO)  
2025 FOREST AVENUE  
DURANGO, CO 81301

FOR: BLANCHED NUTS; CANDIED NUTS; PRO-  
CESSED NUTS; ROASTED NUTS; SNACK MIX  
CONSISTING PRIMARILY OF PROCESSED  
FRUITS, PROCESSED NUTS AND/OR RAISINS, IN  
CLASS 29 (U.S. CL. 46).

FIRST USE 2-21-2007; IN COMMERCE 2-24-2007.

OWNER OF U.S. REG. NO. 3,286,063.

NO CLAIM IS MADE TO THE EXCLUSIVE  
RIGHT TO USE "NUTS", APART FROM THE MARK  
AS SHOWN.

THE MARK CONSISTS OF THREE CONCENTRIC  
CIRCLES WITH A COMMON CENTER BEING A  
GLOBE WITH OUTLINED CONTINENTS AND A  
BODY OF WATER, THE MIDDLE CIRCLE FEAT-  
URING IN-SHELL PEANUTS AND WORDS.

SER. NO. 77-334,720, FILED 11-20-2007.

BILL DAWE, EXAMINING ATTORNEY



**Int. Cl.: 41**

**Prior U.S. Cls.: 100, 101 and 107**

**United States Patent and Trademark Office**

**Reg. No. 3,467,106**

**Registered July 15, 2008**

**SERVICE MARK  
PRINCIPAL REGISTER**



FRIGHTLAND LLC (DELAWARE LTD LIAB CO)  
309 PORT PENN RD.  
MIDDLETOWN, DE 19709

FOR: CONDUCTING ENTERTAINMENT EXHIBITIONS IN THE NATURE OF FALL FESTIVALS; PROVIDING AMUSEMENT PARK RIDES AND ATTRACTIONS, IN CLASS 41 (U.S. CLS. 100, 101 AND 107).

FIRST USE 8-1-1998; IN COMMERCE 9-1-1998.

THE MARK CONSISTS OF THE STYLIZED WORD "FRIGHTLAND". THERE IS A SKULL UNDERNEATH THE "G" AND THE "T" HAS A GUY HANGING FROM THE RIGHT SIDE OF THE "T".

SER. NO. 77-334,742, FILED 11-20-2007.

FLORENTINA BLANDU, EXAMINING ATTORNEY

**Int. Cl.: 35**

**Prior U.S. Cls.: 100, 101 and 102**

**United States Patent and Trademark Office**

**Reg. No. 3,467,107**

**Registered July 15, 2008**

**SERVICE MARK  
PRINCIPAL REGISTER**

# Heritage Distinctive

BUDDYS FLOORING OUTLET, INC (CALIFORNIA CORPORATION)  
3030 INLAND EMPIRE BLVD.  
ONTARIO, CA 91764

FOR: RETAIL STORE SERVICES FEATURING LAMINATE, HARDWOOD, AND TILE FLOORING, IN CLASS 35 (U.S. CLS. 100, 101 AND 102).

FIRST USE 6-1-2006; IN COMMERCE 11-1-2007.

THE MARK CONSISTS OF STANDARD CHARACTERS WITHOUT CLAIM TO ANY PARTICULAR FONT, STYLE, SIZE, OR COLOR.

SER. NO. 77-334,748, FILED 11-20-2007.

DAVID C. REIHNER, EXAMINING ATTORNEY

**Int. Cl.: 35**

**Prior U.S. Cls.: 100, 101 and 102**

**United States Patent and Trademark Office**

**Reg. No. 3,467,108**

**Registered July 15, 2008**

**SERVICE MARK  
PRINCIPAL REGISTER**



THE PRO STYLIST (FLORIDA LTD LIAB CO)  
7362 CARMONA TERRACE #404  
BOCA RATON, FL 33433

THE STIPLING IS FOR SHADING PURPOSES ONLY.

FOR: ON-LINE BUSINESS DIRECTORIES FEATURING BEAUTY SALONS, HAIR STYLISTS AND PRODUCT MANUFACTURERS, IN CLASS 35 (U.S. CLS. 100, 101 AND 102).

THE MARK CONSISTS OF A CHERRY WITH THE STYLIZED WORDS "THE PRO STYLIST WHERE TRUE BEAUTY IS FOUND" TO THE RIGHT OF THE CHERRY.

FIRST USE 9-15-2007; IN COMMERCE 9-15-2007.

SER. NO. 77-334,753, FILED 11-20-2007.

NO CLAIM IS MADE TO THE EXCLUSIVE RIGHT TO USE "STYLIST", APART FROM THE MARK AS SHOWN.

MIDGE BUTLER, EXAMINING ATTORNEY

**Int. Cl.: 12**

**Prior U.S. Cls.: 19, 21, 23, 31, 35 and 44**

**Reg. No. 3,467,109**

**United States Patent and Trademark Office**

**Registered July 15, 2008**

---

**TRADEMARK  
PRINCIPAL REGISTER**



TECTRAN CORPORATION (CALIFORNIA CORPORATION)  
3929 E. GUASTI RD  
ONTARIO, CA 91761

FIRST USE 10-1-2005; IN COMMERCE 1-1-2006.

SER. NO. 77-334,755, FILED 11-20-2007.

FOR: LAND VEHICLE PARTS, NAMELY, WHEELS, IN CLASS 12 (U.S. CLS. 19, 21, 23, 31, 35 AND 44).

APRIL ROACH, EXAMINING ATTORNEY

**Int. Cl.: 35**

**Prior U.S. Cls.: 100, 101 and 102**

**United States Patent and Trademark Office**

**Reg. No. 3,467,110**

**Registered July 15, 2008**

**SERVICE MARK  
PRINCIPAL REGISTER**

**Canton in the City Holiday  
Gift Market**

CANTON IN THE CITY, LLC (TEXAS LTD LIAB  
CO)  
PO BOX 754  
COPPELL, TX 75019

FOR: ARRANGING, PLANNING, ORGANIZING,  
CONDUCTING, MARKETING, PROMOTING AND  
RECRUITING VENDORS FOR TRADE SHOWS  
AND TRADE FAIRS IN THE NATURE OF HOLI-  
DAY GIFT SHOWS AND MARKETS FOR ECONOM-  
IC PURPOSES, IN CLASS 35 (U.S. CLS. 100, 101 AND  
102).

FIRST USE 4-0-2003; IN COMMERCE 10-0-2003.

THE MARK CONSISTS OF STANDARD CHAR-  
ACTERS WITHOUT CLAIM TO ANY PARTICULAR  
FONT, STYLE, SIZE, OR COLOR.

NO CLAIM IS MADE TO THE EXCLUSIVE  
RIGHT TO USE "HOLIDAY GIFT MARKET",  
APART FROM THE MARK AS SHOWN.

SER. NO. 77-334,759, FILED 11-20-2007.

KATHERINE CONNOLLY, EXAMINING ATTOR-  
NEY

**Int. Cl.: 35**

**Prior U.S. Cls.: 100, 101 and 102**

**United States Patent and Trademark Office**

**Reg. No. 3,467,111**

**Registered July 15, 2008**

---

**SERVICE MARK  
PRINCIPAL REGISTER**

**NAPharm**

MELAMED, HOOTAN (UNITED STATES INDIVIDUAL)  
SUITE 835  
9663 SANTA MONICA BLVD.  
BEVERLY HILLS, CA 90210

THE MARK CONSISTS OF STANDARD CHARACTERS WITHOUT CLAIM TO ANY PARTICULAR FONT, STYLE, SIZE, OR COLOR.

FOR: RETAIL PHARMACY SERVICES; RETAIL DRUG STORE SERVICES, IN CLASS 35 (U.S. CLS. 100, 101 AND 102).

SER. NO. 77-334,768, FILED 11-20-2007.

FIRST USE 7-0-2007; IN COMMERCE 7-0-2007.

RICHARD WHITE, EXAMINING ATTORNEY

**Int. Cls.: 35 and 44**

**Prior U.S. Cls.: 100, 101 and 102**

**United States Patent and Trademark Office**

**Reg. No. 3,467,112**

**Registered July 15, 2008**

**SERVICE MARK  
PRINCIPAL REGISTER**



**Spa Bleü**

BLEU'SPA, INC. (ILLINOIS CORPORATION)  
106 N. SECOND STREET  
WEST DUNDEE, IL 60118

FOR: RETAIL STORE SERVICES IN THE FIELD  
OF GROOMING PRODUCTS, IN CLASS 35 (U.S.  
CLS. 100, 101 AND 102).

FIRST USE 5-1-2004; IN COMMERCE 5-1-2004.

FOR: PERSONAL CARE SERVICES, NAMELY,  
DAY SPA SERVICES, NAMELY, PHYSICAL AND  
BEAUTY TREATMENTS, IN CLASS 44 (U.S. CLS. 100  
AND 101).

FIRST USE 5-1-2004; IN COMMERCE 5-1-2004.

NO CLAIM IS MADE TO THE EXCLUSIVE  
RIGHT TO USE "SPA", APART FROM THE MARK  
AS SHOWN.

THE MARK CONSISTS OF A STYLIZED "S" AND  
A STYLIZED "B" OVER THE TERMS "SPA BLEU".

THE TERM "BLEU" TRANSLATES INTO ENG-  
LISH AS "BLUE".

SER. NO. 77-334,783, FILED 11-20-2007.

PAUL F. GAST, EXAMINING ATTORNEY

**Int. Cl.: 35**

**Prior U.S. Cls.: 100, 101 and 102**

**United States Patent and Trademark Office**

**Reg. No. 3,467,113**

**Registered July 15, 2008**

**SERVICE MARK  
PRINCIPAL REGISTER**

**DRIVE ALERT ARRIVE ALIVE**

NATIONAL SLEEP FOUNDATION (MINNESOTA CORPORATION)  
1522 K STREET, NW, SUITE 500  
WASHINGTON, DC 20005

THE MARK CONSISTS OF STANDARD CHARACTERS WITHOUT CLAIM TO ANY PARTICULAR FONT, STYLE, SIZE, OR COLOR.

FOR: PROMOTING PUBLIC AWARENESS OF THE NEED FOR ADEQUATE SLEEP FOR HEALTH AND WELL-BEING, IN CLASS 35 (U.S. CLS. 100, 101 AND 102).

SER. NO. 77-334,786, FILED 11-20-2007.

FIRST USE 11-30-1993; IN COMMERCE 11-30-1993.

JANICE KIM, EXAMINING ATTORNEY



**Int. Cl.: 28**

**Prior U.S. Cls.: 22, 23, 38 and 50**

**United States Patent and Trademark Office**

**Reg. No. 3,467,114**

**Registered July 15, 2008**

**TRADEMARK  
PRINCIPAL REGISTER**

The trademark is a stylized, cursive script of the letters 'MsD'. The 'M' and 's' are connected, and the 'D' is a large, bold letter with a decorative flourish at the top. The entire mark is rendered in a black, elegant script font.

SHENG, LIU (CHINA INDIVIDUAL)  
ROOM 506, NO. 94 ANSHAN 6TH VILLAGE  
YANGPU DISTRICT, SHANGHAI CITY  
200092, CHINA

POOLS; BODY BOARDS; BEACH BALLS, IN CLASS  
28 (U.S. CLS. 22, 23, 38 AND 50).

FIRST USE 6-30-2002; IN COMMERCE 1-31-2004.

SER. NO. 77-334,788, FILED 11-20-2007.

FOR: INFLATABLE TOYS; BALLOONS; INFLA-  
TABLE SWIMMING POOLS; PLAY SWIMMING

JANICE KIM, EXAMINING ATTORNEY

**Int. Cl.: 28**

**Prior U.S. Cls.: 22, 23, 38 and 50**

**United States Patent and Trademark Office**

**Reg. No. 3,467,115**

**Registered July 15, 2008**

**TRADEMARK  
PRINCIPAL REGISTER**



DR. SEUSS ENTERPRISES, L.P. (CALIFORNIA  
LIMITED PARTNERSHIP)  
C/O KARL ZOBELL, ESQ. DLA PIPER US LLP  
1200 PROSPECT STREET, SUITE 575  
LA JOLLA, CA 920373610

THE MARK CONSISTS OF THE IMAGE OF A  
FURRY CREATURE WEARING A TOP HAT AND  
HOLDING A SIGN WITH THE WORDS "SAM I AM"  
IN THE CENTER.

FOR: FINGER PUPPETS, IN CLASS 28 (U.S. CLS.  
22, 23, 38 AND 50).

SER. NO. 77-334,794, FILED 11-20-2007.

FIRST USE 1-0-2002; IN COMMERCE 1-0-2002.

OWNER OF U.S. REG. NO. 2,698,199.

JULIE GUTTADAURO, EXAMINING ATTORNEY

Int. Cl.: 25

Prior U.S. Cls.: 22 and 39

United States Patent and Trademark Office

Reg. No. 3,467,116

Registered July 15, 2008

TRADEMARK  
PRINCIPAL REGISTER



CHEEKS, JR., ROBERT F (UNITED STATES  
INDIVIDUAL)  
9101 TANDOM DRIVE  
FORT WASHINGTON, MD 20744

FOR: GOLF SHIRTS; HATS; KNIT SHIRTS;  
LONG-SLEEVED SHIRTS; POLO SHIRTS; SHIRTS;  
SHORT-SLEEVED OR LONG-SLEEVED T-SHIRTS;  
SHORT-SLEEVED SHIRTS; SWEAT SHIRTS; T-  
SHIRTS; PANTS; SHORTS; CREWNECK SWEA-

TERS; SWEATERS; JACKETS, IN CLASS 25 (U.S.  
CLS. 22 AND 39).

FIRST USE 10-1-2007; IN COMMERCE 10-1-2007.

SER. NO. 77-334,812, FILED 11-20-2007.

KATHERINE CONNOLLY, EXAMINING ATTOR-  
NEY

**Int. Cl.: 41**

**Prior U.S. Cls.: 100, 101 and 107**

**United States Patent and Trademark Office**

**Reg. No. 3,467,117**

**Registered July 15, 2008**

**SERVICE MARK  
PRINCIPAL REGISTER**



PAID 4 ENTERTAINMENT, LLC (US VIRGIN ISLANDS LTD LIAB CO)  
HIDDEN VALLEY 394-150  
ST. THOMAS, US VIRGIN ISLANDS 00802

FOR: ARRANGING AND CONDUCTING OF CONCERTS; CONCERT BOOKING; ENTERTAINMENT, NAMELY, LIVE MUSIC CONCERTS, IN CLASS 41 (U.S. CLS. 100, 101 AND 107).

FIRST USE 6-22-2006; IN COMMERCE 6-22-2006.

NO CLAIM IS MADE TO THE EXCLUSIVE RIGHT TO USE "ENTERTAINMENT", APART FROM THE MARK AS SHOWN.

THE COLOR(S) BLACK, WHITE, GREEN IS/ARE CLAIMED AS A FEATURE OF THE MARK.

THE MARK CONSISTS OF BLACK CIRCLE, GREEN STRIP THRU CENTER OF CIRCLE HORIZONTALLY, STYLIZED WHITE "4" IN CENTER OF CIRCLE, BELOW WHITE "4", THE WORD "ENTERTAINMENT" IN BLACK FONT WITH GREEN OUTLINE, OVERLAYING ON CIRCLE THE WORD "PAID" IN BLACK FONT.

SER. NO. 77-334,863, FILED 11-21-2007.

JOHN WILKE, EXAMINING ATTORNEY

**Int. Cls.: 35 and 42**

**Prior U.S. Cls.: 100, 101 and 102**

**United States Patent and Trademark Office**

**Reg. No. 3,467,118**

**Registered July 15, 2008**

**SERVICE MARK  
PRINCIPAL REGISTER**

**BANKING. TRANSFORMED.**

CGI GROUP INC. (CANADA CORPORATION)  
1130 SHERBROOKE STREET WEST, 6TH FLOOR  
MONTREAL, CANADA H3A2M8

FOR: BUSINESS CONSULTING SERVICES RENDERED TO BANKS, IN CLASS 35 (U.S. CLS. 100, 101 AND 102).

FIRST USE 7-0-2007; IN COMMERCE 7-0-2007.

FOR: INFORMATION TECHNOLOGY CONSULTING SERVICES RENDERED TO BANKS, IN CLASS 42 (U.S. CLS. 100 AND 101).

FIRST USE 7-0-2007; IN COMMERCE 7-0-2007.

THE MARK CONSISTS OF STANDARD CHARACTERS WITHOUT CLAIM TO ANY PARTICULAR FONT, STYLE, SIZE, OR COLOR.

NO CLAIM IS MADE TO THE EXCLUSIVE RIGHT TO USE "BANKING", APART FROM THE MARK AS SHOWN.

SER. NO. 77-334,885, FILED 11-21-2007.

ANDREA SAUNDERS, EXAMINING ATTORNEY

**Int. Cls.: 3 and 5**

**Prior U.S. Cls.: 1, 4, 6, 18, 44, 46, 50, 51 and 52**

**United States Patent and Trademark Office**

**Reg. No. 3,467,119**

**Registered July 15, 2008**

**TRADEMARK  
PRINCIPAL REGISTER**

**EQUINE AMERICA**

W.F. YOUNG, INCORPORATED (MASSACHU-  
SETTS CORPORATION)  
302 BENTON DRIVE  
EAST LONGMEADOW, MA 01028

FOR: NON-MEDICATED ANIMAL HEALTH PRODUCTS FOR LIVESTOCK, INCLUDING HORSES, NAMELY, CLEANING PREPARATIONS IN THE NATURE OF SHAMPOOS, CONDITIONERS, FRAGRANCE SPRAYS, CONDITIONING SPRAYS, TOPICAL HAIRDRESSINGS, HAIR POLISH, MANE AND TAIL CLEANERS; NON-MEDICATED HOOF CARE PRODUCTS, NAMELY, HOOF CONDITIONERS, HOOF POLISH AND HOOF MOISTURIZING CREAM, IN CLASS 3 (U.S. CLS. 1, 4, 6, 50, 51 AND 52).

FIRST USE 5-3-1996; IN COMMERCE 5-3-1996.

FOR: VETERINARY PREPARATIONS, NAMELY, ANIMAL FEED ADDITIVES FOR USE AS NUTRITIONAL DIETARY SUPPLEMENTS; LINIMENTS; MEDICATED SHAMPOOS, CREAMS AND SPRAYS FOR LIVESTOCK, INCLUDING HORSES; MEDICA-

TED HOOF CARE PRODUCTS, NAMELY, HOOF OINTMENTS AND SPRAYS; INSECTICIDES AND INSECT REPELLENTS; ADHESIVE BANDAGES AND WRAPS, IN CLASS 5 (U.S. CLS. 6, 18, 44, 46, 51 AND 52).

FIRST USE 5-3-1996; IN COMMERCE 5-3-1996.

THE MARK CONSISTS OF STANDARD CHARACTERS WITHOUT CLAIM TO ANY PARTICULAR FONT, STYLE, SIZE, OR COLOR.

OWNER OF U.S. REG. NO. 2,207,710.

NO CLAIM IS MADE TO THE EXCLUSIVE RIGHT TO USE "EQUINE", APART FROM THE MARK AS SHOWN.

SER. NO. 77-334,894, FILED 11-21-2007.

MARIA-VICTORIA SUAREZ, EXAMINING ATTORNEY

**Int. Cl.: 35**

**Prior U.S. Cls.: 100, 101 and 102**

**United States Patent and Trademark Office**

**Reg. No. 3,467,120**

**Registered July 15, 2008**

**SERVICE MARK  
PRINCIPAL REGISTER**

**WHO YOU ARE, WHERE YOU'RE  
HEADED**

PEMBERTON WHITEMAN & HILL, LLC (MIS-  
SOURI LTD LIAB CO)  
6320 BROOKSIDE PLAZA, NO. 295  
KANSAS CITY, MO 64113

FOR: EMPLOYMENT HIRING, RECRUITING,  
PLACEMENT AND STAFFING SERVICES; SEARCH  
AND PLACEMENT SERVICES; CONSULTANCY OF  
PERSONNEL RECRUITMENT; JOB AND PERSON-  
NEL PLACEMENT SERVICES, IN CLASS 35 (U.S.  
CLS. 100, 101 AND 102).

FIRST USE 11-20-2007; IN COMMERCE 11-20-2007.

THE MARK CONSISTS OF STANDARD CHAR-  
ACTERS WITHOUT CLAIM TO ANY PARTICULAR  
FONT, STYLE, SIZE, OR COLOR.

SER. NO. 77-334,933, FILED 11-21-2007.

GEORGE LORENZO, EXAMINING ATTORNEY

**Int. Cl.: 9**

**Prior U.S. Cls.: 21, 23, 26, 36 and 38**

**Reg. No. 3,467,121**

**United States Patent and Trademark Office**

**Registered July 15, 2008**

**TRADEMARK  
PRINCIPAL REGISTER**



POWERFUL LEARNING, INC. (NEW JERSEY CORPORATION)

P.O. BOX 225

HILLSDALE, NJ 07642

FOR: EDUCATIONAL SOFTWARE FEATURING INSTRUCTION IN AVIATION, IN CLASS 9 (U.S. CLS. 21, 23, 26, 36 AND 38).

FIRST USE 5-1-2007; IN COMMERCE 5-1-2007.

NO CLAIM IS MADE TO THE EXCLUSIVE RIGHT TO USE "LEARNING", APART FROM THE MARK AS SHOWN.

THE COLOR(S) BLACK, WHITE, BLUE, AND YELLOW IS/ARE CLAIMED AS A FEATURE OF THE MARK.

THE MARK CONSISTS OF AN AIRPLANE OUTLINED IN BLACK AND FILLED IN WITH WHITE. THE AIRCRAFT IS MOVING FROM LEFT TO RIGHT OVER A YELLOW SUN. UNDERNEATH THE AIRCRAFT AND ACROSS THE BOTTOM OF THE YELLOW SUN OUR COMPANY NAME "POWERFUL LEARNING" IS LOCATED IN BLUE.

SER. NO. 77-334,949, FILED 11-21-2007.

MARY ROSSMAN, EXAMINING ATTORNEY



**Int. Cl.: 5**

**Prior U.S. Cls.: 6, 18, 44, 46, 51 and 52**

**Reg. No. 3,467,122**

**United States Patent and Trademark Office**

**Registered July 15, 2008**

---

**TRADEMARK  
PRINCIPAL REGISTER**

**BACTENIX**

NORTH AMERICAN BIOPRODUCTS CORPORATION (GEORGIA CORPORATION)  
SUITE 375  
2180 SATELLITE BOULEVARD  
DULUTH, GA 30097

THE MARK CONSISTS OF STANDARD CHARACTERS WITHOUT CLAIM TO ANY PARTICULAR FONT, STYLE, SIZE, OR COLOR.

FOR: ANTIMICROBIAL AGENTS FOR USE IN ETHANOL PRODUCTION, IN CLASS 5 (U.S. CLS. 6, 18, 44, 46, 51 AND 52).

SER. NO. 77-334,951, FILED 11-21-2007.

FIRST USE 6-15-2007; IN COMMERCE 6-15-2007.

RICHARD A. STRASER, EXAMINING ATTORNEY

**Int. Cl.: 3**

**Prior U.S. Cls.: 1, 4, 6, 50, 51 and 52**

**United States Patent and Trademark Office**

**Reg. No. 3,467,123**

**Registered July 15, 2008**

**TRADEMARK  
PRINCIPAL REGISTER**



HOMECARE LABS, INC. (DELAWARE CORPORATION)  
1735 NORTH BROWN ROAD  
LAWRENCEVILLE, GA 30043

FOR: MULTIPURPOSE CLEANERS AND DEGREASING PREPARATIONS, FOR CLEANING, SHINING, PROTECTING AND FOR THE REMOVAL OF SMOKE RESIDUE, PAINTS, ADHESIVES, LIPSTICKS, BLOOD AND IODINE FROM AUTOMOBILE WHEELS, TIRES, HUBCAPS AND ENGINES, VINYL AND FIBERGLASS CARE AND BOAT SURFACES, PATIOS, MOTORCYCLES, STOVES, GRILLS, SHOWERS, FLOORS, TILE, CONCRETE, AWNINGS, AND STAINLESS STEEL PRODUCTS, IN CLASS 3 (U.S. CLS. 1, 4, 6, 50, 51 AND 52).

FIRST USE 1-3-2005; IN COMMERCE 1-3-2005.

OWNER OF U.S. REG. NOS. 1,418,885, 2,532,198 AND OTHERS.

THE MARK CONSISTS OF THE WORDS "GREASED LIGHTNING" WITH A LIGHTNING BOLT UNDER THE WORDS.

SER. NO. 77-334,956, FILED 11-21-2007.

MARCIE MILONE, EXAMINING ATTORNEY

**Int. Cl.: 41**

**Prior U.S. Cls.: 100, 101 and 107**

**United States Patent and Trademark Office**

**Reg. No. 3,467,124**

**Registered July 15, 2008**

**SERVICE MARK  
PRINCIPAL REGISTER**

# Bishop Secular

WILEY, MARCUS D. (UNITED STATES INDIVIDUAL)  
4001 FANNIN ST. STE. 4342  
HOUSTON, TX 77004

FOR: ENTERTAINMENT IN THE NATURE OF VISUAL AND AUDIO PERFORMANCES, AND MUSICAL, VARIETY, NEWS AND COMEDY SHOWS; ENTERTAINMENT SERVICES, NAMELY, ARRANGING AND CONDUCTING LIVE PERFORMANCES IN THE FIELD OF COMEDY, DRAMA AND MUSIC; PRODUCTION AND DISTRIBUTION TO OTHERS OF TELEVISION, INTERNET AND RADIO PROGRAMS AND MOTION PICTURE FILMS; PUBLISHING SERVICES, NAMELY, PUBLICATION OF NEWSPAPERS, MAGAZINES, PERIODICALS, BOOKS, JOURNALS, EDUCATIONAL MATERIALS; MULTIMEDIA ENTERTAINMENT SOFTWARE PRODUCTION SERVICES, NAMELY, PRODUCTION OF MULTI-MEDIA PUBLICATIONS, CD-

ROMS, DVDS, VIDEOS, VIDEO TAPES AND STREAMING MEDIA CONTENT FEATURING ENTERTAINMENT, IN CLASS 41 (U.S. CLS. 100, 101 AND 107).

FIRST USE 9-1-2002; IN COMMERCE 9-1-2002.

THE MARK CONSISTS OF STANDARD CHARACTERS WITHOUT CLAIM TO ANY PARTICULAR FONT, STYLE, SIZE, OR COLOR.

NO CLAIM IS MADE TO THE EXCLUSIVE RIGHT TO USE "BISHOP", APART FROM THE MARK AS SHOWN.

SER. NO. 77-335,038, FILED 11-21-2007.

VIVIAN MICZNIK FIRST, EXAMINING ATTORNEY

**Int. Cl.: 40**

**Prior U.S. Cls.: 100, 103 and 106**

**United States Patent and Trademark Office**

**Reg. No. 3,467,125**

**Registered July 15, 2008**

**SERVICE MARK  
PRINCIPAL REGISTER**

**FORMULATING INNOVATION**

AAA PHARMACEUTICAL, INC. (NEW JERSEY  
CORPORATION)  
157-160 JEFFERSON STREET  
PAULSBORO, NJ 08066

THE MARK CONSISTS OF STANDARD CHAR-  
ACTERS WITHOUT CLAIM TO ANY PARTICULAR  
FONT, STYLE, SIZE, OR COLOR.

FOR: MANUFACTURING SERVICES FOR OTH-  
ERS IN THE FIELD OF MEDICATIONS, IN CLASS  
40 (U.S. CLS. 100, 103 AND 106).

SER. NO. 77-335,040, FILED 11-21-2007.

FIRST USE 10-31-2007; IN COMMERCE 10-31-2007.

ESTHER BELENKER, EXAMINING ATTORNEY

Int. Cl.: 43

Prior U.S. Cls.: 100 and 101

United States Patent and Trademark Office

Reg. No. 3,467,126

Registered July 15, 2008

SERVICE MARK  
PRINCIPAL REGISTER



CONCEPT ACQUISITIONS, LLC (CALIFORNIA  
LTD LIAB CO)

326 EVANSDALE ROAD  
LAKE MARY, FL 32795

FOR: RESTAURANT SERVICES, IN CLASS 43  
(U.S. CLS. 100 AND 101).

FIRST USE 11-0-2005; IN COMMERCE 11-0-2005.

OWNER OF U.S. REG. NOS. 1,716,962, 1,716,963,  
AND 2,004,536.

THE MARK CONSISTS OF THE WORDS "MOUN-  
TAIN MIKE'S" BORDERING A CIRCLE CONTAIN-  
ING THE LETTER "M" INSIDE.

SER. NO. 77-335,041, FILED 11-21-2007.

VIVIAN MICZNIK FIRST, EXAMINING ATTOR-  
NEY

**Int. Cl.: 5**

**Prior U.S. Cls.: 6, 18, 44, 46, 51 and 52**

**Reg. No. 3,467,127**

**United States Patent and Trademark Office**

**Registered July 15, 2008**

---

**TRADEMARK  
PRINCIPAL REGISTER**



GLOBAL NUTRITIONAL RESEARCH LLC  
(MARYLAND LTD LIAB CO)  
10305 ARMORY AVE.  
KENSINGTON, MD 20895

THE MARK CONSISTS OF THE WORD "CLOTA-  
MIN" WITH A CIRCLE AROUND THE CLOT POR-  
TION OF "CLOTAMIN".

FOR: MULTIVITAMIN DEVELOPED SPECIFI-  
CALLY FOR PEOPLE TAKING BLOOD THINNERS,  
IN CLASS 5 (U.S. CLS. 6, 18, 44, 46, 51 AND 52).

SER. NO. 77-335,053, FILED 11-21-2007.

FIRST USE 8-1-2007; IN COMMERCE 8-15-2007.

SARA THOMAS, EXAMINING ATTORNEY

**Int. Cl.: 35**

**Prior U.S. Cls.: 100, 101 and 102**

**United States Patent and Trademark Office**

**Reg. No. 3,467,128**

**Registered July 15, 2008**

**SERVICE MARK  
PRINCIPAL REGISTER**



**SOUTHWORTH**

SOUTHWORTH TRADING COMPANY (MICHIGAN CORPORATION)  
8101 SAWGRASS TRAIL  
GRAND BLANC, MN 484392410

THE MARK CONSISTS OF THREE SAILS OF A SOLID COLOR AS USED ON A SAILING VESSEL SUCH AS THE MAYFLOWER WITH THE STYLIZED TEXT "SOUTHWORTH".

FOR: EXPORT AND IMPORT AGENCIES, IN CLASS 35 (U.S. CLS. 100, 101 AND 102).

SER. NO. 77-335,064, FILED 11-21-2007.

FIRST USE 8-16-2005; IN COMMERCE 8-16-2005.

SARA THOMAS, EXAMINING ATTORNEY

**Int. Cl.: 9**

**Prior U.S. Cls.: 21, 23, 26, 36 and 38**

**Reg. No. 3,467,129**

**United States Patent and Trademark Office**

**Registered July 15, 2008**

---

**TRADEMARK  
PRINCIPAL REGISTER**

**TAITIEN**

TAITIEN ELECTRONICS CO., LTD (TAIWAN  
CORPORATION)  
5F, 76, PO AI ROAD  
TAIPEI, TAIWAN

FOR: ELECTRONIC COMPONENTS, NAMELY,  
CRYSTAL OSCILLATORS AND CRYSTAL FIL-  
TERS, IN CLASS 9 (U.S. CLS. 21, 23, 26, 36 AND 38).

FIRST USE 9-1-1995; IN COMMERCE 1-15-2002.

THE MARK CONSISTS OF STANDARD CHAR-  
ACTERS WITHOUT CLAIM TO ANY PARTICULAR  
FONT, STYLE, SIZE, OR COLOR.

THE WORDING "TAITIEN" HAS NO MEANING  
IN A FOREIGN LANGUAGE.

SER. NO. 77-335,065, FILED 11-21-2007.

APRIL ROACH, EXAMINING ATTORNEY



**Int. Cl.: 35**

**Prior U.S. Cls.: 100, 101 and 102**

**United States Patent and Trademark Office**

**Reg. No. 3,467,130**

**Registered July 15, 2008**

**SERVICE MARK  
PRINCIPAL REGISTER**

**Send The Flavor of Home**

MARY'S KITCHEN LLC (NEW YORK LTD LIAB  
CO)  
PO BOX 426  
WARWICK, NY 10990

THE MARK CONSISTS OF STANDARD CHAR-  
ACTERS WITHOUT CLAIM TO ANY PARTICULAR  
FONT, STYLE, SIZE, OR COLOR.

FOR: ON-LINE RETAIL STORE SERVICES FEATURING GIFT BASKETS, IN CLASS 35 (U.S. CLS. 100, 101 AND 102).

SER. NO. 77-335,075, FILED 11-21-2007.

FIRST USE 9-0-2006; IN COMMERCE 9-0-2006.

HEATHER BIDDULPH, EXAMINING ATTORNEY

**Int. Cl.: 41**

**Prior U.S. Cls.: 100, 101 and 107**

**United States Patent and Trademark Office**

**Reg. No. 3,467,131**

**Registered July 15, 2008**

**SERVICE MARK  
PRINCIPAL REGISTER**

**ETHICAL MOMENTS**

SAI GLOBAL LIMITED (AUSTRALIA CORPORATION), DBA SAI GLOBAL  
GPO BOX 5420, SYDNEY NSW 2001  
286 SUSSEX STREET, SYDNEY NSW 2000  
SYDNEY, AUSTRALIA 2000

FOR: ONLINE CLASSES FEATURING CORPORATE COMPLIANCE AND BUSINESS ETHICS TRAINING, IN CLASS 41 (U.S. CLS. 100, 101 AND 107).

FIRST USE 12-31-2005; IN COMMERCE 12-31-2005.

THE MARK CONSISTS OF STANDARD CHARACTERS WITHOUT CLAIM TO ANY PARTICULAR FONT, STYLE, SIZE, OR COLOR.

NO CLAIM IS MADE TO THE EXCLUSIVE RIGHT TO USE "ETHICAL", APART FROM THE MARK AS SHOWN.

SER. NO. 77-335,076, FILED 11-21-2007.

APRIL ROACH, EXAMINING ATTORNEY

**Int. Cl.: 36**

**Prior U.S. Cls.: 100, 101 and 102**

**Reg. No. 3,467,132**

**United States Patent and Trademark Office**

**Registered July 15, 2008**

**SERVICE MARK  
PRINCIPAL REGISTER**



DWAYNE SKEEN COMMERCIAL/INDUSTRIAL  
REAL ESTATE, INC. (NORTH CAROLINA  
CORPORATION)  
3929 TINSLEY DRIVE, SUITE 104  
HIGH POINT, NC 27260

NO CLAIM IS MADE TO THE EXCLUSIVE  
RIGHT TO USE "GROUP", APART FROM THE  
MARK AS SHOWN.

FOR: REAL ESTATE BROKERAGE, MANAGE-  
MENT AND CONSULTING SERVICES, IN CLASS 36  
(U.S. CLS. 100, 101 AND 102).

SER. NO. 77-335,081, FILED 11-21-2007.

FIRST USE 1-1-1997; IN COMMERCE 1-1-1997.

MARIAM MAHMOUDI, EXAMINING ATTORNEY

Int. Cl.: 35

Prior U.S. Cls.: 100, 101 and 102

United States Patent and Trademark Office

Reg. No. 3,467,133

Registered July 15, 2008

**SERVICE MARK  
PRINCIPAL REGISTER**



CASTLE INN ENTERPRISES, INC. (ILLINOIS CORPORATION)  
1909 CASTLE AVE.  
BLOOMINGTON, IL 61701

FOR: BUSINESS ORGANIZATION AND MANAGEMENT CONSULTING; BUSINESS ORGANIZATION CONSULTING; MOVING AND RELOCATION SERVICES, NAMELY, PLANNING AND IMPLEMENTING MOVES OF HOMES AND OFFICES, IN CLASS 35 (U.S. CLS. 100, 101 AND 102).

FIRST USE 7-25-2007; IN COMMERCE 7-25-2007.

NO CLAIM IS MADE TO THE EXCLUSIVE RIGHT TO USE "SPECIALISTS" AND "INCORPORATED", APART FROM THE MARK AS SHOWN.

THE COLOR(S) YELLOW AND BLUEISH-GREEN IS/ARE CLAIMED AS A FEATURE OF THE MARK.

THE COLOR BLUEISH-GREEN APPEARS IN: 1) THE WORDS "MOVING, SPECIALISTS AND INCORPORATED", 2) IN THE HOUSE DESIGN AND 3) IN TWO OF THE HEARTS COMING OUT OF THE CHIMNEY. THE COLOR YELLOW APPEARS IN: 1) THE WORD "FORWARD", 2) IN THE SUN DESIGN AND 3) IN THE FIRST HEART COMING OUT OF THE CHIMNEY. THE COLOR WHITE IN THE MARK IS NOT A FEATURE OF THE MARK AND IS MERELY A TRANSPARENT BACKGROUND.

SER. NO. 77-335,105, FILED 11-21-2007.

JENNIFER VASQUEZ, EXAMINING ATTORNEY

**Int. Cl.: 41**

**Prior U.S. Cls.: 100, 101 and 107**

**United States Patent and Trademark Office**

**Reg. No. 3,467,134**

**Registered July 15, 2008**

**SERVICE MARK  
PRINCIPAL REGISTER**

**ASH STREET**

ASH STREET MUSIC, LLC (TENNESSEE LTD  
LIAB CO)  
1508 16TH AVENUE SOUTH  
NASHVILLE, TN 37212

THE MARK CONSISTS OF STANDARD CHAR-  
ACTERS WITHOUT CLAIM TO ANY PARTICULAR  
FONT, STYLE, SIZE, OR COLOR.

FOR: MUSIC PUBLISHING SERVICES, IN CLASS  
41 (U.S. CLS. 100, 101 AND 107).

SER. NO. 77-335,122, FILED 11-21-2007.

FIRST USE 3-17-1993; IN COMMERCE 3-17-1993.

JEFFERY COWARD, EXAMINING ATTORNEY

**Int. Cl.: 40**

**Prior U.S. Cls.: 100, 103 and 106**

**United States Patent and Trademark Office**

**Reg. No. 3,467,135**

**Registered July 15, 2008**

**SERVICE MARK  
PRINCIPAL REGISTER**

# Rememorabilia

BURRIDGE, JEFFREY L (UNITED STATES IN-  
DIVIDUAL)  
105 PARK PLACE DRIVE  
SINKING SPRING, PA 19608

FOR: CUSTOMIZED PRINTING OF COMPANY  
NAMES AND LOGOS FOR PROMOTIONAL AND  
ADVERTISING PURPOSES ON THE GOODS OF  
OTHERS, IN CLASS 40 (U.S. CLS. 100, 103 AND 106).

FIRST USE 11-21-2007; IN COMMERCE 11-21-2007.

THE MARK CONSISTS OF STANDARD CHAR-  
ACTERS WITHOUT CLAIM TO ANY PARTICULAR  
FONT, STYLE, SIZE, OR COLOR.

SER. NO. 77-335,132, FILED 11-21-2007.

CHRISTOPHER BUONGIORNO, EXAMINING AT-  
TORNEY

**Int. Cl.: 44**

**Prior U.S. Cls.: 100 and 101**

**United States Patent and Trademark Office**

**Reg. No. 3,467,136**

**Registered July 15, 2008**

**SERVICE MARK  
PRINCIPAL REGISTER**

**HEALTHYLOOKS**

JEROME LAMB, MD, PC (MISSOURI CORPORATION)  
4820 SOUTH ARROWHEAD DR.  
INDEPENDENCE, MO 64055

FOR: COSMETIC, DERMATOLOGY AND PLASTIC SURGERY; LASER AND IPL (INTENSE PULSE LIGHT) SKIN ENHANCEMENT PROCEDURES; PROVIDING LASER THERAPY FOR TREATING MEDICAL CONDITIONS; MEDICAL HEALTH SPA SERVICES, NAMELY, COSMETIC, FACIAL AND BODY CARE SERVICES; SKIN TREATMENT, NAMELY, THE INJECTION OF DERMAL FILLERS TO REDUCE THE APPEARANCE OF FACIAL FINE LINES, MICRODERMABRASION AND MICRO PEEL; NAMELY, A TOPICAL SKIN TREATMENT INVOLVING ABRASION OF THE SKIN WITH

PRESSURE DRIVEN FLOW OF CRYSTALS OR DERMA PLANING; MEDICAL SERVICE, NAMELY, COSMETIC, DERMATOLOGY OR COSMETIC PLASTIC SURGERY, IN CLASS 44 (U.S. CLS. 100 AND 101).

FIRST USE 11-1-2007; IN COMMERCE 11-1-2007.

THE MARK CONSISTS OF STANDARD CHARACTERS WITHOUT CLAIM TO ANY PARTICULAR FONT, STYLE, SIZE, OR COLOR.

SER. NO. 77-335,137, FILED 11-21-2007.

H. M. FISHER, EXAMINING ATTORNEY

**Int. Cl.: 3**

**Prior U.S. Cls.: 1, 4, 6, 50, 51 and 52**

**Reg. No. 3,467,137**

**United States Patent and Trademark Office**

**Registered July 15, 2008**

**TRADEMARK  
PRINCIPAL REGISTER**

**MEG21**

DYNAMIS THERAPEUTICS, INC. (PENNSYLVANIA CORPORATION)  
4TH FLOOR RESEARCH  
8360 OLD YORK RD.  
ELKINS PARK, PA 190271598

THE MARK CONSISTS OF STANDARD CHARACTERS WITHOUT CLAIM TO ANY PARTICULAR FONT, STYLE, SIZE, OR COLOR.

FOR: FACE AND BODY CREAMS, IN CLASS 3 (U.S. CLS. 1, 4, 6, 50, 51 AND 52).

SER. NO. 77-335,139, FILED 11-21-2007.

FIRST USE 3-3-2006; IN COMMERCE 3-3-2006.

JEFFERY COWARD, EXAMINING ATTORNEY



**Int. Cl.: 36**

**Prior U.S. Cls.: 100, 101 and 102**

**United States Patent and Trademark Office**

**Reg. No. 3,467,138**

**Registered July 15, 2008**

**SERVICE MARK  
PRINCIPAL REGISTER**

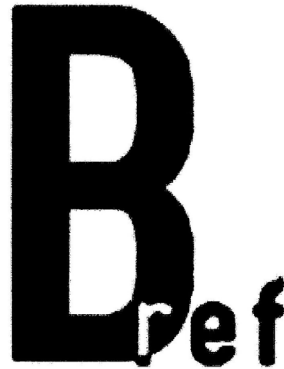

BIOMEDICAL RESEARCH & EDUCATION  
FOUNDATION (PENNSYLVANIA NON-PROF-  
IT CORPORATION)  
SUITE 340  
3701 MARKET STREET  
PHILADELPHIA, PA 19104

FOR: PHILANTHROPIC SERVICES, NAMELY, A  
FOUNDATION FEATURING MONETARY DONA-  
TION IN THE FIELD OF BIOMEDICAL RESEARCH

AND EDUCATION, IN CLASS 36 (U.S. CLS. 100, 101  
AND 102).

FIRST USE 4-30-2004; IN COMMERCE 4-30-2004.

SER. NO. 77-335,140, FILED 11-21-2007.

FRED MANDIR, EXAMINING ATTORNEY

**Int. Cl.: 36**

**Prior U.S. Cls.: 100, 101 and 102**

**United States Patent and Trademark Office**

**Reg. No. 3,467,139**

**Registered July 15, 2008**

**SERVICE MARK  
PRINCIPAL REGISTER**

**DYNAMICONE**

INDYMAC BANK, F.S.B. (UNITED STATES FED-  
ERALLY CHARTERED SAVINGS BANK)  
888 EAST WALNUT STREET  
PASADENA, CA 91101

FOR: FINANCIAL SERVICES, NAMELY, BANK-  
ING AND CREDIT CARD SERVICES; MORTGAGE  
LENDING SERVICES; MORTGAGE AND LOAN  
ORIGINATION; BROKERAGE AND SERVICING  
OF MORTGAGES AND LOANS, IN CLASS 36 (U.S.  
CLS. 100, 101 AND 102).

FIRST USE 11-20-2007; IN COMMERCE 11-20-2007.

THE MARK CONSISTS OF STANDARD CHAR-  
ACTERS WITHOUT CLAIM TO ANY PARTICULAR  
FONT, STYLE, SIZE, OR COLOR.

SER. NO. 77-335,168, FILED 11-21-2007.

EMILY CARLSEN, EXAMINING ATTORNEY

Int. Cl.: 16

Prior U.S. Cls.: 2, 5, 22, 23, 29, 37, 38 and 50

United States Patent and Trademark Office

Reg. No. 3,467,140

Registered July 15, 2008

TRADEMARK  
PRINCIPAL REGISTER



SKATINGISMYLIFE.COM, INC. (VIRGINIA CORPORATION)  
435 E. NELSON AVE.  
ALEXANDRIA, VA 22301

FOR: GREETINGS CARDS AND POSTCARDS; HOLIDAY CARDS; GIFT CARDS; INVITATION CARDS; MOTIVATIONAL CARDS; NOTE CARDS; OCCASION CARDS; GIFT WRAP PAPER; HOLDERS SPECIALLY ADAPTED FOR HOLDING GREETING CARDS, HOLIDAY CARDS, GIFT CARDS, INVITATION CARDS, MOTIVATIONAL CARDS, NOTE CARDS, AND OCCASION CARDS; BLANK JOURNAL BOOKS, PARTICULARLY JOURNALS CONCERNING SKATING; PAPER ORNAMENTS; AND

PAPER BOXES FOR STORING GREETING CARDS, IN CLASS 16 (U.S. CLS. 2, 5, 22, 23, 29, 37, 38 AND 50).

FIRST USE 7-31-2007; IN COMMERCE 7-31-2007.

THE MARK CONSISTS OF THE PHRASE "SKATING IS MY LIFE" PROXIMATE TO A SKATING FIGURE FORGING A VISIBLE ICE SKATING TRAIL CONTACTING SAID PHRASE.

SER. NO. 77-335,185, FILED 11-21-2007.

ALYSSA PALADINO, EXAMINING ATTORNEY

**Int. Cl.: 4**

**Prior U.S. Cls.: 1, 6 and 15**

**United States Patent and Trademark Office**

**Reg. No. 3,467,141**

**Registered July 15, 2008**

**TRADEMARK  
PRINCIPAL REGISTER**

# Sumtech

KL TEXAS, LP (DELAWARE LIMITED PART-  
NERSHIP), DBA SUMMIT INDUSTRIAL PRO-  
DUCTS  
9010 CR 2120  
TYLER, TX 75707

FOR: INDUSTRIAL OILS AND GREASES, LUBRI-  
CATING OILS, LUBRICATING GREASES, LUBRI-  
CANTS, NAMELY, INDUSTRIAL LUBRICANT  
AND LUBRICANT FOR INDUSTRIAL MACHIN-  
ERY, IN CLASS 4 (U.S. CLS. 1, 6 AND 15).

FIRST USE 4-29-2004; IN COMMERCE 11-15-2004.

THE MARK CONSISTS OF STANDARD CHAR-  
ACTERS WITHOUT CLAIM TO ANY PARTICULAR  
FONT, STYLE, SIZE, OR COLOR.

SER. NO. 77-335,206, FILED 11-21-2007.

HEATHER THOMPSON, EXAMINING ATTORNEY

**Int. Cl.: 36**

**Prior U.S. Cls.: 100, 101 and 102**

**United States Patent and Trademark Office**

**Reg. No. 3,467,142**

**Registered July 15, 2008**

**SERVICE MARK  
PRINCIPAL REGISTER**

**RIDE FOR WISHES**

MAKE-A-WISH FOUNDATION OF AMERICA  
(ARIZONA CORPORATION)  
SUITE 300  
3550 NORTH CENTRAL AVENUE  
PHOENIX, AZ 85012

FOR: CHARITABLE FUNDRAISING SERVICES,  
IN CLASS 36 (U.S. CLS. 100, 101 AND 102).

FIRST USE 2-1-2005; IN COMMERCE 2-1-2005.

THE MARK CONSISTS OF STANDARD CHAR-  
ACTERS WITHOUT CLAIM TO ANY PARTICULAR  
FONT, STYLE, SIZE, OR COLOR.

NO CLAIM IS MADE TO THE EXCLUSIVE  
RIGHT TO USE "RIDE", APART FROM THE MARK  
AS SHOWN.

SER. NO. 77-335,217, FILED 11-21-2007.

HEATHER THOMPSON, EXAMINING ATTORNEY

**Int. Cl.: 35**

**Prior U.S. Cls.: 100, 101 and 102**

**United States Patent and Trademark Office**

**Reg. No. 3,467,143**

**Registered July 15, 2008**

**SERVICE MARK  
PRINCIPAL REGISTER**

**AUDIOBOOKSTAND**

BRILLIANCE AUDIO, INC. (MICHIGAN CORPORATION)  
1704 EATON DRIVE, PO BOX 887  
GRAND HAVEN, MI 49417

FOR: MAIL ORDER AND ELECTRONIC CATALOG SERVICES FEATURING AUDIO BOOKS, IN CLASS 35 (U.S. CLS. 100, 101 AND 102).

FIRST USE 7-1-2002; IN COMMERCE 7-1-2002.

THE MARK CONSISTS OF STANDARD CHARACTERS WITHOUT CLAIM TO ANY PARTICULAR FONT, STYLE, SIZE, OR COLOR.

OWNER OF U.S. REG. NO. 3,393,417.

SER. NO. 77-335,224, FILED 11-21-2007.

BRENDAN MCCAULEY, EXAMINING ATTORNEY

Int. Cl.: 5

Prior U.S. Cls.: 6, 18, 44, 46, 51 and 52

Reg. No. 3,467,144

United States Patent and Trademark Office

Registered July 15, 2008

TRADEMARK  
PRINCIPAL REGISTER

The logo features the word "BACTENIX" in a bold, sans-serif font, positioned above the large, stylized number "50". The "V" is a thick, blocky letter that partially overlaps the "5".

NORTH AMERICAN BIOPRODUCTS CORPORATION (GEORGIA CORPORATION)  
SUITE 375  
2180 SATELLITE BOULEVARD  
DULUTH, GA 30097

FIRST USE 6-15-2007; IN COMMERCE 6-15-2007.

THE MARK CONSISTS OF THE WORD "BACTENIX" ABOVE "V50", ALL IN SYLIZED FORM.

FOR: ANTIMICROBIAL AGENTS FOR USE IN ETHANOL PRODUCTION, IN CLASS 5 (U.S. CLS. 6, 18, 44, 46, 51 AND 52).

SER. NO. 77-335,230, FILED 11-21-2007.

RICHARD A. STRASER, EXAMINING ATTORNEY

**Int. Cl.: 25**

**Prior U.S. Cls.: 22 and 39**

**United States Patent and Trademark Office**

**Reg. No. 3,467,145**

**Registered July 15, 2008**

**TRADEMARK  
PRINCIPAL REGISTER**

**ALL MIXED UP!**

HOSIERY NETWORK, INC. (NEW YORK CORPORATION)  
SUITE 1209  
10 WEST 33RD STREET  
NEW YORK, NY 10001

FOR: HOSIERY; ANKLE SOCKS; SOCKS; SOCKS AND STOCKINGS; TIGHTS; LEG WARMERS; LEGGINGS; SLEEPWEAR; PAJAMAS; FLIP FLOPS; LONG UNDERWEAR; UNDERWEAR; FOOTWEAR; SLIPPERS; KNEE HIGHS; KNEE-HIGH STOCKINGS, IN CLASS 25 (U.S. CLS. 22 AND 39).

FIRST USE 11-1-2007; IN COMMERCE 11-20-2007.

THE MARK CONSISTS OF STANDARD CHARACTERS WITHOUT CLAIM TO ANY PARTICULAR FONT, STYLE, SIZE, OR COLOR.

SER. NO. 77-335,233, FILED 11-21-2007.

MICHAEL KEATING, EXAMINING ATTORNEY



**Int. Cl.: 41**

**Prior U.S. Cls.: 100, 101 and 107**

**United States Patent and Trademark Office**

**Reg. No. 3,467,146**

**Registered July 15, 2008**

**SERVICE MARK  
PRINCIPAL REGISTER**

**RADIO RACER**

DILLINGER, DENNIS (UNITED STATES INDIVIDUAL)  
3041 MAPLEWOOD PLACE  
ESCONDIDO, CA 92027

THE MARK CONSISTS OF STANDARD CHARACTERS WITHOUT CLAIM TO ANY PARTICULAR FONT, STYLE, SIZE, OR COLOR.

FOR: ENTERTAINMENT SERVICES, NAMELY, LIVE PERFORMANCES BY A MUSICAL BAND, IN CLASS 41 (U.S. CLS. 100, 101 AND 107).

SER. NO. 77-335,237, FILED 11-21-2007.

FIRST USE 6-10-2005; IN COMMERCE 9-10-2005.

JENNIFER HETU, EXAMINING ATTORNEY

**Int. Cl.: 25**

**Prior U.S. Cls.: 22 and 39**

**United States Patent and Trademark Office**

**Reg. No. 3,467,147**

**Registered July 15, 2008**

**TRADEMARK  
PRINCIPAL REGISTER**

**MIX AND DON'T MATCH!**

HOSIERY NETWORK, INC. (NEW YORK CORPORATION)  
SUITE 1209  
10 WEST 33RD STREET  
NEW YORK, NY 10001

FOR: HOSIERY; ANKLE SOCKS; SOCKS; SOCKS AND STOCKINGS; TIGHTS; LEG WARMERS; LEGGINGS; SLEEPWEAR; PAJAMAS; FLIP FLOPS; LONG UNDERWEAR; UNDERWEAR; FOOTWEAR; SLIPPERS; KNEE HIGHS; KNEE-HIGH STOCKINGS, IN CLASS 25 (U.S. CLS. 22 AND 39).

FIRST USE 11-1-2007; IN COMMERCE 11-20-2007.

THE MARK CONSISTS OF STANDARD CHARACTERS WITHOUT CLAIM TO ANY PARTICULAR FONT, STYLE, SIZE, OR COLOR.

SER. NO. 77-335,248, FILED 11-21-2007.

MICHAEL KEATING, EXAMINING ATTORNEY

**Int. Cl.: 25**

**Prior U.S. Cls.: 22 and 39**

**United States Patent and Trademark Office**

**Reg. No. 3,467,148**

**Registered July 15, 2008**

**TRADEMARK  
PRINCIPAL REGISTER**

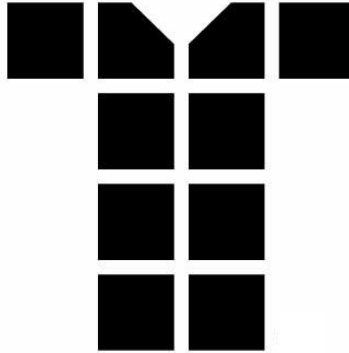

WALTER, STEPHAN (FED REP GERMANY IN-  
DIVIDUAL)  
79 LAIGHT STREET, 5C  
NEW YORK, NY 10013

FOR: ATHLETIC SHOES; BATHING COSTUMES;  
BATHING COSTUMES FOR WOMEN; BATHING  
SUITS; BATHING SUITS FOR MEN; BATHING  
TRUNKS; BEACHWEAR; BIKINIS; CAPS; COATS;  
COATS FOR MEN AND WOMEN; DRESS SHIRTS;  
DRESS SUITS; DRESSES; EVENING DRESSES; EVE-  
NING GOWNS; FOOTWEAR; HATS; HEAD  
SCARVES; HEAD SWEATBANDS; HEAD WEAR;  
HEADWEAR; HEAVY COATS; HEAVY JACKETS;  
HEELS; JACKETS; JEANS; PANTS; SHIRTS; SHOES;  
SKIRTS AND DRESSES; SUITS; SWIM WEAR;

SWIMMING CAPS; TROUSERS; TURBANS; T-  
SHIRTS; UNDERWEAR; UNIFORMS, IN CLASS 25  
(U.S. CLS. 22 AND 39).

FIRST USE 1-1-2001; IN COMMERCE 1-10-2001.

THE MARK CONSISTS OF A SHIRT ICON BRO-  
KEN INTO SEPARATED GEOMETRIC, MOSTLY  
SQUARE BLOCKS, THAT ARE ARRANGED IN A  
GRID.

SER. NO. 77-335,253, FILED 11-21-2007.

STEVEN R. FINE, EXAMINING ATTORNEY

**Int. Cl.: 31**

**Prior U.S. Cls.: 1 and 46**

**United States Patent and Trademark Office**

**Reg. No. 3,467,149**

**Registered July 15, 2008**

**TRADEMARK  
PRINCIPAL REGISTER**

**BED WITH THE BEST!**

MALLARD CREEK, INC. (CALIFORNIA CORPORATION)  
4095 DULUTH AVENUE  
ROCKLIN, CA 95765

THE MARK CONSISTS OF STANDARD CHARACTERS WITHOUT CLAIM TO ANY PARTICULAR FONT, STYLE, SIZE, OR COLOR.

FOR: WOOD SHAVINGS FOR USE AS ANIMAL BEDDING, IN CLASS 31 (U.S. CLS. 1 AND 46).

SER. NO. 77-335,255, FILED 11-21-2007.

FIRST USE 5-1-1990; IN COMMERCE 5-1-1990.

STEVEN R. FINE, EXAMINING ATTORNEY

**Int. Cl.: 5**

**Prior U.S. Cls.: 6, 18, 44, 46, 51 and 52**

**Reg. No. 3,467,150**

**United States Patent and Trademark Office**

**Registered July 15, 2008**

**TRADEMARK  
PRINCIPAL REGISTER**



NORTH AMERICAN BIOPRODUCTS CORPORATION (GEORGIA CORPORATION)  
SUITE 375  
2180 SATELLITE BOULEVARD  
DULUTH, GA 30097

THE MARK CONSISTS OF THE WORD "BACTENIX" ABOVE THE LETTERS "VX", ALL IN STYLED FORM.

FOR: ANTIMICROBIAL AGENTS FOR USE IN ETHANOL PRODUCTION, IN CLASS 5 (U.S. CLS. 6, 18, 44, 46, 51 AND 52).

SER. NO. 77-335,257, FILED 11-21-2007.

FIRST USE 6-15-2007; IN COMMERCE 6-15-2007.

RICHARD A. STRASER, EXAMINING ATTORNEY

**Int. Cl.: 42**

**Prior U.S. Cls.: 100 and 101**

**United States Patent and Trademark Office**

**Reg. No. 3,467,151**

**Registered July 15, 2008**

**SERVICE MARK  
PRINCIPAL REGISTER**

**AMERICAN EXPRESS NETWORK  
INSIDERS**

AMERICAN EXPRESS MARKETING & DEVELOPMENT CORP. (DELAWARE CORPORATION)  
200 VESEY STREET  
NEW YORK, NY 10285

FOR: COMPUTER SERVICES, NAMELY, HOSTING AND MAINTAINING AN ONLINE WEBSITE FOR OTHERS TO PROVIDE FEEDBACK AND INFORMATION WITH RESPECT TO CREDIT CARD OR CHARGE CARD MEMBERSHIP, IN CLASS 42 (U.S. CLS. 100 AND 101).

FIRST USE 11-19-2007; IN COMMERCE 11-19-2007.

THE MARK CONSISTS OF STANDARD CHARACTERS WITHOUT CLAIM TO ANY PARTICULAR FONT, STYLE, SIZE, OR COLOR.

OWNER OF U.S. REG. NOS. 1,024,840, 3,157,593 AND OTHERS.

NO CLAIM IS MADE TO THE EXCLUSIVE RIGHT TO USE "NETWORK", APART FROM THE MARK AS SHOWN.

SER. NO. 77-335,259, FILED 11-21-2007.

PETER B. BROMAGHIM, EXAMINING ATTORNEY

Int. Cls.: 21 and 25

Prior U.S. Cls.: 2, 13, 22, 23, 29, 30, 33, 39, 40 and 50

Reg. No. 3,467,152

United States Patent and Trademark Office

Registered July 15, 2008

TRADEMARK  
PRINCIPAL REGISTER

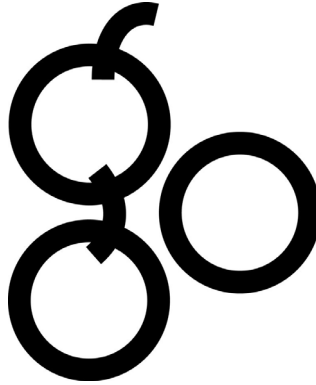

O'DONOHUE, JOHN A. (UNITED STATES INDIVIDUAL)  
624 S. ASHLAND AVE.  
LA GRANGE, IL 60525 AND  
HISCHIER, BRIAN R. (UNITED STATES INDIVIDUAL)  
UNIT 2  
1413 W. ARGYLE  
CHICAGO, IL 60640

FOR: BEER MUGS; COFFEE CUPS, TEA CUPS AND MUGS; CUPS AND MUGS; EARTHENWARE MUGS; GLASS MUGS; MUGS; BATHROOM GLASS HOLDER NOT OF PRECIOUS METAL; CANDLESTICKS OF GLASS; CONTAINERS FOR HOUSEHOLD USE, NAMELY, GLASS BULBS; DRINKING GLASSES; FIGURES OF CHINA, CRYSTAL, EARTHENWARE, GLASS, AND PORCELAIN; FIGURINES OF CHINA, CRYSTAL, EARTHENWARE, GLASS, AND PORCELAIN; FRUIT BOWLS OF GLASS; GLASS BEVERAGeware; GLASS BOWLS; GLASS BOXES; GLASS CARAFES; GLASS DISHES; GLASS JARS; GLASS STORAGE JARS; ORNAMENTAL GLASS SPHERES; ORNAMENTS OF CHINA, CRYSTAL, EARTHENWARE, GLASS, AND PORCELAIN; PILSNER DRINKING GLASSES; SCULPTURES OF CHINA, CRYSTAL, EARTHENWARE, GLASS, AND PORCELAIN; SHOT GLASSES; STAINED GLASS; STAINED GLASS FIGURINES; STATUES OF CHINA, CRYSTAL, EARTHENWARE, GLASS, AND PORCELAIN; STATUETTES OF CHINA, CRYSTAL, EARTHENWARE, GLASS, AND PORCELAIN; WINE GLASSES; WORKS OF ART OF CHINA, CRYSTAL, EARTHENWARE, GLASS, AND PORCELAIN; GOBLETS; PAPER CUPS; PAPER PLATES AND PAPER CUPS; COLD PACKS USED

TO KEEP FOOD AND DRINK COLD; DRINKING CUPS; DRINKING FLASKS; DRINKING FLASKS; DRINKING HORNS; DRINKING STEINS; DRINKING VESSELS; FOAM DRINK HOLDERS; BUCKETS; CANTEENS; COFFEE CUPS; CARDBOARD CUPS; BUSTS OF CHINA, CRYSTAL, EARTHENWARE, GLASS, AND PORCELAIN; COOLERS FOR WINE; PORTABLE BEVERAGE COOLERS; PORTABLE COOLERS; EMPTY SPRAY BOTTLES; DISPOSABLE TABLE PLATES; CONTAINERS FOR ICE; ICE BUCKETS; ICE PAILS; NAPKIN HOLDERS; PITCHERS; PLASTIC WATER BOTTLES SOLD EMPTY; DECANTERS; CARAFES, IN CLASS 21 (U.S. CLS. 2, 13, 23, 29, 30, 33, 40 AND 50).

FIRST USE 11-13-2007; IN COMMERCE 11-19-2007.

FOR: CAMP SHIRTS; DRESS SHIRTS; GOLF SHIRTS; KNIT SHIRTS; LONG-SLEEVED SHIRTS; NIGHT SHIRTS; PIQUE SHIRTS; POLO SHIRTS; RUGBY SHIRTS; SHIRTS; SHORT-SLEEVED OR LONG-SLEEVED T-SHIRTS; SHORT-SLEEVED SHIRTS; SLEEP SHIRTS; SPORT SHIRTS; SPORTS SHIRTS WITH SHORT SLEEVES; SWEAT SHIRTS; T-SHIRTS; TEE SHIRTS; TRIATHLON CLOTHING, NAMELY, TRIATHLON TIGHTS, TRIATHLON SHORTS, TRIATHLON SINGLETs, TRIATHLON SHIRTS, TRIATHLON SUITS; WIND SHIRTS; YOGA SHIRTS; CAPRI PANTS; CARGO PANTS; DENIMS; JOGGING PANTS; LEATHER PANTS; PANTS; SKI PANTS; SNOW PANTS; SNOWBOARD PANTS; SWEAT PANTS; TOBOGGAN HATS, PANTS AND CAPS; TRACK PANTS; WATERPROOF JACKETS AND PANTS; WIND PANTS; YOGA PANTS; BERMUDA SHORTS; BOARD SHORTS; BOXER SHORTS; FLEECE SHORTS; GYM SHORTS; PAN-

TIES, SHORTS AND BRIEFS; RUGBY SHORTS; SHORTS; SWEAT SHORTS; UNDERWEAR, NAME- LY, BOY SHORTS; WALKING SHORTS; BATHING SUITS; BATHING SUITS FOR MEN; BODY SUITS; DRESS SUITS; GYM SUITS; JOGGING SUITS; JUDO SUITS; KARATE SUITS; MEN'S SUITS, WOMEN'S SUITS; SKI SUITS; SNOW SUITS; SUITS; SWEAT SUITS; TRACK SUITS; TRAINING SUITS; WET SUITS; ANKLE SOCKS; ANKLETS; MEN'S SOCKS; SOCKS; SOCKS AND STOCKINGS; THERMAL SOCKS; WATER SOCKS; WOOLLEN SOCKS; APRES-SKI SHOES; ATHLETIC SHOES; BASEBALL SHOES; BEACH SHOES; BOWLING SHOES; BOX- ING SHOES; CANVAS SHOES; CYCLING SHOES; DANCE SHOES; DECK-SHOES; DRIVERS; FOOT- BALL SHOES; GOLF SHOES; GYMNASTIC SHOES; HANDBALL SHOES; HOCKEY SHOES; RUGBY SHOES; RUNNING SHOES; SHOES; SKI AND SNOWBOARD SHOES AND PARTS THEREOF; SKI- ING SHOES; SOCCER SHOES; TENNIS SHOES; TRACK AND FIELD SHOES; TRAINING SHOES; VOLLEYBALL SHOES; WOMEN'S SHOES; WORK SHOES AND BOOTS; BASEBALL CAPS; CAP VI- SORS; CAPS; CAPS WITH VISORS; GOLF CAPS; KNITTED CAPS; SKULL CAPS; SWIM CAPS; SWIM- MING CAPS; FUR HATS; HATS; PAPER HATS FOR USE AS CLOTHING ITEMS; SMALL HATS; WOOL- LY HATS; FLEECE VESTS; LONG SLEEVED VESTS; VESTS; WIND VESTS; BRIEFS; KNITTED UNDER- WEAR; LADIES' UNDERWEAR; LONG UNDER- WEAR; THERMAL UNDERWEAR; THONGS; UNDERWEAR; WOMEN'S UNDERWEAR; WOVEN OR KNITTED UNDERWEAR; BOXER BRIEFS; BRIEFS; HEADBANDS; HEADBANDS AGAINST SWEATING; WRISTBANDS; WRISTBANDS CON- TAINING A COOLING SUBSTANCE TO COOL THE WEARER; SANDALS; BOLO TIES; BOW TIES; TIES; WARM UP SUITS; UNDERSHIRTS; SLEEPING GARMENTS; PANTIES; DRESSES; SPORT COATS; SPORTS BRAS; SPORTS JACKETS; SPORTS JER- SEYS; SPORTS JERSEYS AND BREECHES FOR

SPORTS; SPORTS OVERUNIFORMS; SPORTS SHIRTS; DENIM JACKETS; DOWN JACKETS; FISHERMEN'S JACKETS; FUR COATS AND JACKETS; HEAVY JACKETS; JACKET LINERS; JACKETS; LEATHER JACKETS; LONG JACKETS; RAIN JACK- ETS; RAINPROOF JACKETS; SHELL JACKETS; SKI JACKETS; SLEEVED OR SLEEVELESS JACKETS; SUEDE JACKETS; WIND RESISTANT JACKETS; WIND-JACKETS; COATS; COATS FOR MEN AND WOMEN; COATS MADE OF COTTON; COATS OF DENIM; LIGHT-REFLECTING COATS; OVER COATS; RAIN COATS; RIDING COATS; SUIT COATS; TOP COATS; TRENCH COATS; WIND COATS; BASKETBALL SNEAKERS; SOCCER BOOTS; GOLF TROUSERS; FOOTWEAR FOR TRACK AND FIELD ATHLETICS; SWIM TRUNKS; SWIM WEAR; SWIMMING TRUNKS; FITTED SWIMMING COSTUMES WITH BRA CUPS; BATH- ING COSTUMES; BATHING COSTUMES FOR WO- MEN; BATHING TRUNKS; DRY SUITS; SHIRTS FOR SUITS; SKIRT SUITS; SNOW BOARDING SUITS; BIKINIS; BRAS; ATHLETIC FOOTWEAR; ATHLETIC UNIFORMS; WAIST BELTS; BELTS; BELTS MADE OF LEATHER; BELTS OF TEXTILE; FABRIC BELTS; LEATHER BELTS, IN CLASS 25 (U.S. CLS. 22 AND 39).

FIRST USE 11-13-2007; IN COMMERCE 11-19-2007.

THE MARK CONSISTS OF THREE CIRCLES OF THE SAME SIZE, TWO OF WHICH MAKE UP THE "G" AND ONE FOR THE "O" WITH TWO 1/8 CIRCLE ARCS, ONE ON THE TOP OF THE "G," AND ANGLED TO THE RIGHT, THE OTHER BETWEEN THE TWO CIRCLES THAT MAKE UP THE "G" AND ORIENTED VERTICALLY.

SER. NO. 77-335,264, FILED 11-21-2007.

KAPIL BHANOT, EXAMINING ATTORNEY



**Int. Cl.: 43**

**Prior U.S. Cls.: 100 and 101**

**United States Patent and Trademark Office**

**Reg. No. 3,467,153**

**Registered July 15, 2008**

**SERVICE MARK  
PRINCIPAL REGISTER**

# Tug's Wharf

TUG'S WHARF SEAFOOD RESTAURANT, LLC  
(MISSISSIPPI LTD LIAB CO)  
1458 MAGNOLIA STREET  
GULFPORT, MS 39507

THE MARK CONSISTS OF STANDARD CHAR-  
ACTERS WITHOUT CLAIM TO ANY PARTICULAR  
FONT, STYLE, SIZE, OR COLOR.

FOR: RESTAURANT AND BAR SERVICES, IN  
CLASS 43 (U.S. CLS. 100 AND 101).

SER. NO. 77-335,270, FILED 11-21-2007.

FIRST USE 11-16-2007; IN COMMERCE 11-16-2007.

MICHELE SWAIN, EXAMINING ATTORNEY

**Int. Cl.: 45**

**Prior U.S. Cls.: 100 and 101**

**United States Patent and Trademark Office**

**Reg. No. 3,467,154**

**Registered July 15, 2008**

**SERVICE MARK  
PRINCIPAL REGISTER**

**SPENDALLA**

SPENDALLA, LLC (VIRGINIA LTD LIAB CO)  
54C NORTH BEDFORD STREET  
ARLINGTON, VA 22201

FOR: FASHION CONSULTING SERVICES FOR OTHERS; WARDROBE MANAGEMENT SERVICES FOR OTHERS; PERSONAL IMAGE CONSULTING SERVICES; AND PERSONAL SHOPPING SERVICES FOR OTHERS, IN CLASS 45 (U.S. CLS. 100 AND 101).

FIRST USE 4-1-2007; IN COMMERCE 4-1-2007.

THE MARK CONSISTS OF STANDARD CHARACTERS WITHOUT CLAIM TO ANY PARTICULAR FONT, STYLE, SIZE, OR COLOR.

SER. NO. 77-335,272, FILED 11-21-2007.

STEVEN R. FINE, EXAMINING ATTORNEY

**Int. Cl.: 5**

**Prior U.S. Cls.: 6, 18, 44, 46, 51 and 52**

**United States Patent and Trademark Office**

**Reg. No. 3,467,155**

**Registered July 15, 2008**

**TRADEMARK  
PRINCIPAL REGISTER**



NORTH AMERICAN BIOPRODUCTS CORPORATION (GEORGIA CORPORATION)  
SUITE 375  
2180 SATELLITE BOULEVARD  
DULUTH, GA 30097

FIRST USE 6-15-2007; IN COMMERCE 6-15-2007.

THE MARK CONSISTS OF THE WORD "BACTENIX" ABOVE "V100", ALL IN STYLIZED FORM.

FOR: ANTIMICROBIAL AGENTS FOR USE IN ETHANOL PRODUCTION, IN CLASS 5 (U.S. CLS. 6, 18, 44, 46, 51 AND 52).

SER. NO. 77-335,277, FILED 11-21-2007.

RICHARD A. STRASER, EXAMINING ATTORNEY

**Int. Cl.: 7**

**Prior U.S. Cls.: 13, 19, 21, 23, 31, 34 and 35**

**United States Patent and Trademark Office**

**Reg. No. 3,467,156**

**Registered July 15, 2008**

**TRADEMARK  
PRINCIPAL REGISTER**

**CEKACAN**

Å & R CARTON AB (SWEDEN CORPORATION)  
POST OFFICE BOX 177  
SE-221 00 LUND, SWEDEN

FOR: MACHINES FOR MANUFACTURE, FILL-  
ING AND CLOSING OF PACKAGES OF CARD-  
BOARD, PAPER AND SYNTHETIC RESIN; PARTS  
FOR ALL THE AFORESAID GOODS, IN CLASS 7  
(U.S. CLS. 13, 19, 21, 23, 31, 34 AND 35).

FIRST USE 5-15-1974; IN COMMERCE 3-0-1988.

THE MARK CONSISTS OF STANDARD CHAR-  
ACTERS WITHOUT CLAIM TO ANY PARTICULAR  
FONT, STYLE, SIZE, OR COLOR.

OWNER OF U.S. REG. NO. 1,438,957.

SER. NO. 77-335,287, FILED 11-21-2007.

PATRICIA EVANKO, EXAMINING ATTORNEY

**Int. Cl.: 41**

**Prior U.S. Cls.: 100, 101 and 107**

**United States Patent and Trademark Office**

**Reg. No. 3,467,157**

**Registered July 15, 2008**

**SERVICE MARK  
PRINCIPAL REGISTER**

**THRIVING IVORY**

STROOPE, CLAYTON (UNITED STATES JOINT APPLICANTS)

C/O PRYOR CASHMAN LLP  
410 PARK AVE., 10TH FLOOR  
NEW YORK, NY 10022 AND

JASON, SCOTT (UNITED STATES JOINT APPLICANTS)

C/O PRYOR CASHMAN LLP  
410 PARK AVE., 10TH FLOOR  
NEW YORK, NY 10022

FOR: ENTERTAINMENT IN THE NATURE OF A LIVE MUSICAL PERFORMER, MUSICAL BAND OR MUSICAL GROUP; ENTERTAINMENT IN THE NATURE OF LIVE PERFORMANCES BY A MUSICAL ARTIST, MUSICAL GROUP OR MUSICAL BAND; ENTERTAINMENT IN THE NATURE OF VISUAL AND AUDIO PERFORMANCES BY A MUSICAL ARTIST, MUSICAL GROUP AND MUSICAL BAND; ENTERTAINMENT, NAMELY, LIVE MUSIC CONCERTS; ENTERTAINMENT IN THE NATURE OF LIVE TRAVELING TOURS BY A MUSICAL ARTIST, MUSICAL GROUP OR MUSICAL BAND; ENTERTAINMENT, NAMELY, PERSONAL APPEARANCES BY A MUSICIAN, MUSICAL GROUP OR MUSICAL BAND; ENTERTAINMENT

SERVICES, NAMELY, LIVE, TELEVISED AND MOVIE APPEARANCES BY A PROFESSIONAL ENTERTAINER; ENTERTAINMENT SERVICES, NAMELY, PROVIDING A WEB SITE FEATURING MUSICAL PERFORMANCES, MUSICAL VIDEOS, RELATED FILM CLIPS, PHOTOGRAPHS, AND OTHER MULTIMEDIA MATERIALS; ENTERTAINMENT SERVICES, NAMELY, PROVIDING PRERECORDED MUSIC, INFORMATION IN THE FIELD OF MUSIC, COMMENTARY AND ARTICLES ABOUT MUSIC, ALL ONLINE VIA A GLOBAL COMPUTER NETWORK; MUSIC PUBLISHING SERVICES, IN CLASS 41 (U.S. CLS. 100, 101 AND 107).

FIRST USE 4-0-2002; IN COMMERCE 4-0-2002.

THE MARK CONSISTS OF STANDARD CHARACTERS WITHOUT CLAIM TO ANY PARTICULAR FONT, STYLE, SIZE, OR COLOR.

SER. NO. 77-335,289, FILED 11-21-2007.

AMOS T. MATTHEWS, JR., EXAMINING ATTORNEY

**Int. Cl.: 5**

**Prior U.S. Cls.: 6, 18, 44, 46, 51 and 52**

**Reg. No. 3,467,158**

**United States Patent and Trademark Office**

**Registered July 15, 2008**

**TRADEMARK  
PRINCIPAL REGISTER**



NORTH AMERICAN BIOPRODUCTS CORPORATION (GEORGIA CORPORATION)  
SUITE 375  
2180 SATELLITE BOULEVARD  
DULUTH, GA 30097

FIRST USE 6-15-2007; IN COMMERCE 6-15-2007.

THE MARK CONSISTS OF THE WORD "BACTENIX" ABOVE "V200", ALL IN STYLIZED FORM.

FOR: ANTIMICROBIAL AGENTS FOR USE IN ETHANOL PRODUCTION, IN CLASS 5 (U.S. CLS. 6, 18, 44, 46, 51 AND 52).

SER. NO. 77-335,291, FILED 11-21-2007.

RICHARD A. STRASER, EXAMINING ATTORNEY

**Int. Cl.: 35**

**Prior U.S. Cls.: 100, 101 and 102**

**United States Patent and Trademark Office**

**Reg. No. 3,467,159**

**Registered July 15, 2008**

**SERVICE MARK  
PRINCIPAL REGISTER**

**OPEN**

AMERICAN EXPRESS MARKETING & DEVELOPMENT CORP. (DELAWARE CORPORATION)  
200 VESEY STREET  
NEW YORK, NY 10285

FOR: PROVIDING AN ONLINE DIRECTORY INFORMATION SERVICE FEATURING INFORMATION REGARDING BUSINESSES ACCEPTING THE AMERICAN EXPRESS CARD , IN CLASS 35 (U.S. CLS. 100, 101 AND 102).

FIRST USE 10-1-2006; IN COMMERCE 10-1-2006.

THE MARK CONSISTS OF STANDARD CHARACTERS WITHOUT CLAIM TO ANY PARTICULAR FONT, STYLE, SIZE, OR COLOR.

OWNER OF U.S. REG. NOS. 2,838,377, 3,142,294, AND 3,142,295.

SER. NO. 77-335,295, FILED 11-21-2007.

PETER B. BROMAGHIM, EXAMINING ATTORNEY

**Int. Cl.: 5**

**Prior U.S. Cls.: 6, 18, 44, 46, 51 and 52**

**United States Patent and Trademark Office**

**Reg. No. 3,467,160**

**Registered July 15, 2008**

**TRADEMARK  
PRINCIPAL REGISTER**

**PAINWORXS OTC**

HILL, MIKE (UNITED STATES INDIVIDUAL)

13911 E. STATE HWY 66

ARCADIA, OK 73007

FOR: TOPICAL ANALGESICS, IN CLASS 5 (U.S.  
CLS. 6, 18, 44, 46, 51 AND 52).

FIRST USE 11-0-2006; IN COMMERCE 11-0-2006.

THE MARK CONSISTS OF STANDARD CHAR-  
ACTERS WITHOUT CLAIM TO ANY PARTICULAR  
FONT, STYLE, SIZE, OR COLOR.

NO CLAIM IS MADE TO THE EXCLUSIVE  
RIGHT TO USE "OTC", APART FROM THE MARK  
AS SHOWN.

SER. NO. 77-335,304, FILED 11-21-2007.

ADA HAN, EXAMINING ATTORNEY



**Int. Cl.: 36**

**Prior U.S. Cls.: 100, 101 and 102**

**United States Patent and Trademark Office**

**Reg. No. 3,467,161**

**Registered July 15, 2008**

**SERVICE MARK  
PRINCIPAL REGISTER**

**ZOOM REALTY**

ZOOM REALTY, INC. (CALIFORNIA CORPORATION)

#111

2350 N. CHESTNUT AVE.

FRESNO, CA 93703

FOR: REAL ESTATE BROKERAGE, IN CLASS 36  
(U.S. CLS. 100, 101 AND 102).

FIRST USE 10-24-2007; IN COMMERCE 10-24-2007.

THE MARK CONSISTS OF STANDARD CHARACTERS WITHOUT CLAIM TO ANY PARTICULAR FONT, STYLE, SIZE, OR COLOR.

NO CLAIM IS MADE TO THE EXCLUSIVE RIGHT TO USE "REALTY", APART FROM THE MARK AS SHOWN.

SER. NO. 77-335,307, FILED 11-21-2007.

JANICE KIM, EXAMINING ATTORNEY

**Int. Cl.: 5**

**Prior U.S. Cls.: 6, 18, 44, 46, 51 and 52**

**United States Patent and Trademark Office**

**Reg. No. 3,467,162**

**Registered July 15, 2008**

**TRADEMARK  
PRINCIPAL REGISTER**

***BACTENIX***

NORTH AMERICAN BIOPRODUCTS CORPORATION  
(GEORGIA CORPORATION)  
SUITE 375  
2180 SATELLITE BOULEVARD  
DULUTH, GA 30097

FOR: ANTIMICROBIAL AGENTS FOR USE IN  
ETHANOL PRODUCTION, IN CLASS 5 (U.S. CLS. 6,  
18, 44, 46, 51 AND 52).

FIRST USE 6-15-2007; IN COMMERCE 6-15-2007.

THE MARK CONSISTS OF THE WORD "BACTE-  
NIX" IN STYLIZED FORM.

SER. NO. 77-335,311, FILED 11-21-2007.

RICHARD A. STRASER, EXAMINING ATTORNEY

**Int. Cl.: 17**

**Prior U.S. Cls.: 1, 5, 12, 13, 35 and 50**

**United States Patent and Trademark Office**

**Reg. No. 3,467,163**

**Registered July 15, 2008**

**TRADEMARK  
PRINCIPAL REGISTER**

**SR-2000**

SOUTHEAST RESINS, INC. (GEORGIA CORPORATION)  
2531 BRIARCLIFF RD. STE. 109  
ATLANTA, GA 30329

THE MARK CONSISTS OF STANDARD CHARACTERS WITHOUT CLAIM TO ANY PARTICULAR FONT, STYLE, SIZE, OR COLOR.

FOR: RAPID CURE, HIGH STRENGTH, POLYMER-BASED CONCRETE PATCHING COMPOUND, IN CLASS 17 (U.S. CLS. 1, 5, 12, 13, 35 AND 50).

SER. NO. 77-335,317, FILED 11-21-2007.

FIRST USE 1-1-2002; IN COMMERCE 1-1-2002.

JANICE KIM, EXAMINING ATTORNEY

**Int. Cl.: 35**

**Prior U.S. Cls.: 100, 101 and 102**

**United States Patent and Trademark Office**

**Reg. No. 3,467,164**

**Registered July 15, 2008**

**SERVICE MARK  
PRINCIPAL REGISTER**

**Engage. Assist. Simplify.**

ADVANTEDGE GLOBAL SERVICES, INC.  
(GEORGIA CORPORATION)  
BUILDING F  
309 PIRKLE FERRY ROAD  
CUMMING, GA 30040

THE MARK CONSISTS OF STANDARD CHAR-  
ACTERS WITHOUT CLAIM TO ANY PARTICULAR  
FONT, STYLE, SIZE, OR COLOR.

FOR: OUTSOURCING IN THE FIELD OF LAW,  
IN CLASS 35 (U.S. CLS. 100, 101 AND 102).

SER. NO. 77-335,334, FILED 11-21-2007.

FIRST USE 5-18-2007; IN COMMERCE 9-4-2007.

GEORGE LORENZO, EXAMINING ATTORNEY

**Int. Cls.: 35 and 42**

**Prior U.S. Cls.: 100, 101 and 102**

**United States Patent and Trademark Office**

**Reg. No. 3,467,165**

**Registered July 15, 2008**

**SERVICE MARK  
PRINCIPAL REGISTER**

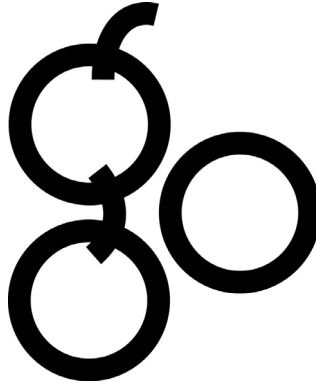

O'DONOHUE, JOHN A. (UNITED STATES INDIVIDUAL)  
624 S. ASHLAND AVE.  
LA GRANGE, IL 60525 AND  
HISCHIER, BRIAN R. (UNITED STATES INDIVIDUAL)  
UNIT 2  
1413 W. ARGYLE  
CHICAGO, IL 60640

FOR: ADVERTISING AND BUSINESS MANAGEMENT CONSULTANCY; ADVERTISING AND PROMOTION SERVICES AND RELATED CONSULTING; ADVERTISING CONSULTATION; ASSISTANCE, ADVISORY SERVICES AND CONSULTANCY WITH REGARD TO BUSINESS PLANNING, BUSINESS ANALYSIS, BUSINESS MANAGEMENT, AND BUSINESS ORGANIZATION; BUSINESS CONSULTATION; BUSINESS MANAGEMENT CONSULTANCY AS WELL AS DEVELOPMENT OF PROCESSES FOR THE ANALYSIS AND THE IMPLEMENTATION OF STRATEGY PLANS AND MANAGEMENT PROJECTS; BUSINESS MARKETING AND DIRECT MAIL CONSULTING SERVICES; BUSINESS MARKETING CONSULTING SERVICES; CONSULTANCY SERVICES REGARDING BUSINESS STRATEGIES; CONSULTATION IN THE FIELD OF COMMERCIALS OR INFOMERCIALS; CONSULTATION RELATING TO TRADE FAIRS; CONSULTATION SERVICES IN THE FIELD OF COMPANY, BUSINESS SECTOR AND INDUSTRY DATA AND RESEARCH; CONSULTING SERVICES RELATING TO PUBLICITY; CORPORATE IMAGE CONSULTING SERVICES; DIRECT MARKETING CONSULTING SERVICES; FRANCHISING, NAMELY CONSULTATION AND

ASSISTANCE IN BUSINESS MANAGEMENT, ORGANIZATION AND PROMOTION; MARKETING CONSULTING; NEW BUSINESS VENTURE DEVELOPMENT AND FORMATION CONSULTING SERVICES; POLITICAL CONSULTANCY; PROFESSIONAL BUSINESS CONSULTATION; PROMOTION AND MARKETING SERVICES AND RELATED CONSULTING; PUBLICITY CONSULTATION; ADVERTISING AGENCY SPECIALIZING IN THE DESIGN AND EXECUTION OF WORD OF MOUTH, VIRAL, BUZZ AND EXPERIENTIAL MARKETING PROGRAMS; BUSINESS CARD DESIGN SERVICES; CREATION OF MARKETING TOOLS DESIGNED TO INCREASE A CLIENT COMPANY'S KNOWLEDGE OF CUSTOMER NEEDS, AND ITS COMPETITORS' PRODUCTS AND SERVICES, PRICING, ADVERTISING STRATEGY AND SALES STRATEGY; CREATIVE MARKETING DESIGN SERVICES; DESIGN OF ADVERTISING FLYERS FOR OTHERS; DESIGN OF ADVERTISING MATERIALS FOR OTHERS; DESIGN OF INTERNET ADVERTISING; MARKETING SERVICES, NAMELY PROVIDING INFORMATIONAL WEB PAGES DESIGNED TO GENERATE SALES TRAFFIC VIA HYPERLINKS TO OTHER WEB SITES; PROMOTING THE ECONOMIC DEVELOPMENT IN THE CITY OF CHICAGO, ILLINOIS; PROVIDING ADVERTISING SERVICES USING 3D AND ANIMATION DESIGNS; PROVIDING ADVERTISING, MARKETING AND PROMOTIONAL SERVICES, NAMELY DEVELOPMENT OF ADVERTISING CAMPAIGNS FOR BUSINESSES, IN CLASS 35 (U.S. CLS. 100, 101 AND 102).

FIRST USE 11-13-2007; IN COMMERCE 11-19-2007.

FOR: GRAPHIC ART DESIGN; GRAPHIC DESIGN SERVICES; GRAPHIC ILLUSTRATION SERVICES FOR OTHERS; ARCHITECTURAL DESIGN; COLOR ANALYSIS FOR PURPOSES OF INTERIOR DESIGN; COMMERCIAL ART DESIGN; COMPUTER AIDED DESIGN FOR OTHERS; COMPUTER SERVICES, NAMELY, DESIGNING AND IMPLEMENTING NETWORK WEB PAGES FOR OTHERS; COMPUTER SERVICES, NAMELY, DESIGNING AND IMPLEMENTING WEB SITES FOR OTHERS; COMPUTER SITE DESIGN; COMPUTER SOFTWARE DESIGN FOR OTHERS; CONSULTING SERVICES IN THE FIELD OF ARCHITECTURAL DESIGN; CONSULTING SERVICES IN THE FIELD OF DESIGN OF NEWSLETTERS; CONSULTING SERVICES IN THE FIELD OF DESIGN, SELECTION, IMPLEMENTATION AND USE OF COMPUTER HARDWARE AND SOFTWARE SYSTEMS FOR OTHERS; CONSULTING SERVICES IN THE FIELD OF THEME PARK ATTRACTION DESIGN; DESIGN OF HOME PAGES; DESIGN OF HOME PAGES, COMPUTER SOFTWARE AND WEB SITES; DESIGN OF HOMEPAGES AND WEB-SITES; DESIGN OF HOMEPAGES AND WEBSITES; DESIGN OF SPECIALTY INTERIOR AND EXTERIOR ENVIRONMENT SETTINGS; DESIGN SKETCHING OF PACKAGING, CONTAINERS, DINNERWARE AND TABLE UTENSILS; DESIGN, CREATION, HOSTING AND MAINTENANCE OF INTERNET SITES FOR THIRD PARTIES; DESIGN, CREATION, HOSTING, MAINTENANCE OF WEBSITES FOR OTHERS; DESIGNING WEBSITES FOR ADVERTISING PURPOSES;

DESIGN AND UPDATING OF HOME PAGES; DRESS DESIGN; FURNITURE DESIGN SERVICES; INDUSTRIAL DESIGN; INTERIOR DESIGN SERVICES; LANDSCAPE ARCHITECTURAL DESIGN; LANDSCAPE LIGHTING DESIGN; PLANNING AND LAYOUT DESIGN FOR THE INTERIOR SPACE OF RETAIL BUSINESS ESTABLISHMENTS; PROVIDING DESIGN SERVICES FOR OTHERS IN THE FIELD OF THEME PARKS, MUSEUMS, AND MINIATURE GOLF COURSES; SHOP INTERIOR DESIGN; THEME PARK ATTRACTION DESIGN SERVICES; PACKAGING DESIGN FOR OTHERS; RESIDENTIAL BUILDING DESIGN; VISUAL DESIGN SERVICES IN THE NATURE OF DESIGNING VISUAL ELEMENTS FOR ONLINE, BROADCAST, PRINT, OUTDOOR AND OTHER COMMUNICATION MEDIA, IN CLASS 42 (U.S. CLS. 100 AND 101).

FIRST USE 11-13-2007; IN COMMERCE 11-19-2007.

THE MARK CONSISTS OF THREE CIRCLES OF THE SAME SIZE, TWO OF WHICH MAKE UP THE "G" AND ONE FOR THE "O" WITH TWO 1/8 CIRCLE ARCS, ONE ON THE TOP OF THE "G," AND ANGLED TO THE RIGHT, THE OTHER BETWEEN THE TWO CIRCLES THAT MAKE UP THE "G" AND ORIENTED VERTICALLY.

SER. NO. 77-335,339, FILED 11-21-2007.

KAPIL BHANOT, EXAMINING ATTORNEY

**Int. Cl.: 11**

**Prior U.S. Cls.: 13, 21, 23, 31 and 34**

**United States Patent and Trademark Office**

**Reg. No. 3,467,166**

**Registered July 15, 2008**

**TRADEMARK  
PRINCIPAL REGISTER**

**JOT**

MAYTAG CORPORATION (DELAWARE CORPORATION)  
403 WEST FOURTH STREET NORTH  
NEWTON, IA 50208

FOR: ELECTRIC REFRIGERATORS; REFRIGERATORS, IN CLASS 11 (U.S. CLS. 13, 21, 23, 31 AND 34).

FIRST USE 11-19-2007; IN COMMERCE 11-19-2007.

THE MARK CONSISTS OF STANDARD CHARACTERS WITHOUT CLAIM TO ANY PARTICULAR FONT, STYLE, SIZE, OR COLOR.

SER. NO. 77-335,344, FILED 11-21-2007.

ANDREA K. NADELMAN, EXAMINING ATTORNEY

**Int. Cl.: 40**

**Prior U.S. Cls.: 100, 103 and 106**

**United States Patent and Trademark Office**

**Reg. No. 3,467,167**

**Registered July 15, 2008**

**SERVICE MARK  
PRINCIPAL REGISTER**

**KATECHO**

KATECHO, INC. (IOWA CORPORATION)  
4020 GANNETT AVENUE  
DES MOINES, IA 50321

THE MARK CONSISTS OF STANDARD CHAR-  
ACTERS WITHOUT CLAIM TO ANY PARTICULAR  
FONT, STYLE, SIZE, OR COLOR.

FOR: CUSTOM MANUFACTURING SERVICES  
OF MEDICAL DEVICES, NAMELY, DISPOSABLE  
ELECTRODES FOR PACING, DEFIBRILLATION,  
PATIENT MONITORING, MUSCLE STIMULATION,  
HYDROGELS, AND ELECTRO-SURGICAL DEVI-  
CES, IN CLASS 40 (U.S. CLS. 100, 103 AND 106).

OWNER OF U.S. REG. NO. 2,617,782.

SER. NO. 77-335,354, FILED 11-21-2007.

FIRST USE 0-0-1986; IN COMMERCE 0-0-1988.

AISHA SALEM, EXAMINING ATTORNEY



**Int. Cl.: 42**

**Prior U.S. Cls.: 100 and 101**

**United States Patent and Trademark Office**

**Reg. No. 3,467,168**

**Registered July 15, 2008**

**SERVICE MARK  
PRINCIPAL REGISTER**

# OpenCircle

ATKINS, PETER (UNITED STATES INDIVIDUAL)

#184

775 E. BLITHEDALE

MILL VALLEY, CA 94941

FOR: COMPUTER PROGRAMMING; COMPUTER PROGRAMMING FOR OTHERS; COMPUTER PROGRAMMING SERVICES; COMPUTER SOFTWARE DESIGN, COMPUTER PROGRAMMING, OR MAINTENANCE OF COMPUTER SOFTWARE; DATA CONVERSION OF COMPUTER PROGRAM DATA OR INFORMATION; DESIGN OF COMPUTER PROGRAMS AND SOFTWARE RELATING TO AIRCRAFT; DEVELOPING COMPUTER PROGRAMS FOR ELECTRONIC CASH REGISTER SYSTEMS; DEVELOPMENT OF COMPUTER PROGRAMS RECORDED ON DATA MEDIA (SOFTWARE) DESIGNED FOR USE IN CONSTRUCTION AND AUTOMATED MANUFACTURING (CAD/CAM); DUPLICATING COMPUTER PROGRAMS; DUPLICATION OF COMPUTER PROGRAMS; MONITORING THE COMPUTER SYSTEMS OF

OTHERS FOR TECHNICAL PURPOSES AND PROVIDING BACK-UP COMPUTER PROGRAMS AND FACILITIES; PROVIDING COMPUTER PROGRAMMING SERVICES TO CUSTOMERS THAT ENABLES THEM TO PROVIDE VIDEO AND AUDIO CONTENT ON THEIR WEBSITES; REPAIR OF DAMAGED COMPUTER PROGRAMS; TECHNICAL SUPPORT, NAMELY, PROVIDING BACK-UP COMPUTER PROGRAMS AND FACILITIES; UPDATING OF COMPUTER PROGRAMS FOR THIRD PARTIES; COMPUTER PROGRAMMING IN THE MEDICAL FIELD, IN CLASS 42 (U.S. CLS. 100 AND 101).

FIRST USE 2-15-2000; IN COMMERCE 2-15-2000.

THE MARK CONSISTS OF STANDARD CHARACTERS WITHOUT CLAIM TO ANY PARTICULAR FONT, STYLE, SIZE, OR COLOR.

SER. NO. 77-335,355, FILED 11-21-2007.

BRIAN NEVILLE, EXAMINING ATTORNEY

Int. Cl.: 43

Prior U.S. Cls.: 100 and 101

United States Patent and Trademark Office

Reg. No. 3,467,169

Registered July 15, 2008

SERVICE MARK  
PRINCIPAL REGISTER



TUG'S WHARF SEAFOOD RESTAURANT, LLC  
(MISSISSIPPI LTD LIAB CO)  
1458 MAGNOLIA STREET  
GULFPORT, MS 39507

FOR: RESTAURANT AND BAR SERVICES, IN  
CLASS 43 (U.S. CLS. 100 AND 101).

FIRST USE 10-16-2007; IN COMMERCE 10-16-2007.

NO CLAIM IS MADE TO THE EXCLUSIVE  
RIGHT TO USE "SEAFOOD RESTAURANT",  
APART FROM THE MARK AS SHOWN.

THE COLOR(S) RED, TAN, WHITE, LIGHT  
GREEN, DARK GREEN, YELLOW, ORANGE,  
BEIGE, BLUE, LIGHT BLUE, AND BROWN IS/ARE  
CLAIMED AS A FEATURE OF THE MARK.

THE MARK CONSISTS OF A WHITE TUGBOAT  
FLOATING ON A BLUE OCEAN. BELOW THE  
TUGBOAT, A BEIGE BEACH, WITH A BLUE INLET.  
TO THE TUGBOAT'S RIGHT AND ON THE BEACH,  
A PALM TREE WITH BROWN TRUNK AND LIGHT  
GREEN PALM FRONDS. BEHIND AND BISECTING

THE PALM TREE, A SMALL, DARK GREEN IS-  
LAND. TO THE TUGBOAT'S LEFT, A LARGER  
DARK GREEN ISLAND. ABOVE AND BEHIND THE  
LARGER ISLAND TO THE TUGBOAT'S LEFT, A  
SEMI-CIRCLE SUN ON THE HORIZON. THE SUN  
BEING YELLOW ON THE BOTTOM THIRD AND  
GRADATING TO ORANGE ON THE TOP TWO  
THIRDS. A LIGHT BLUE SKY ABOVE THE HOR-  
IZON. THE AFOREMENTIONED PICTURE BEING  
CROPPED INSIDE A HORIZONTAL OVAL. ABOVE  
THE HORIZONTAL OVAL CONTAINING THE PIC-  
TURE AND CENTERED, THE WORDS "TUG'S  
WHARF" IN RED AND WRITTEN IN SEPARATED  
SCRIPT. BELOW THE HORIZONTAL OVAL CON-  
TAINING THE PICTURE AND CENTERED, THE  
WORDS "SEAFOOD RESTAURANT" IN RED AND  
WRITTEN IN PRINT. ENCOMPASSING THE HOR-  
IZONTAL OVAL AND THE AFOREMENTIONED  
WORDS AS A BORDER, A TAN HORIZONTAL  
OVAL WITH ONLY THE PERIMETER OUTLINE  
VISIBLE.

SER. NO. 77-335,364, FILED 11-21-2007.

MICHELE SWAIN, EXAMINING ATTORNEY

Int. Cl.: 36

Prior U.S. Cls.: 100, 101 and 102

United States Patent and Trademark Office

Reg. No. 3,467,170

Registered July 15, 2008

SERVICE MARK  
PRINCIPAL REGISTER



CAPSTONE DEVELOPMENT CORP. (ALABAMA CORPORATION)  
431 OFFICE PARK DRIVE  
BIRMINGHAM, AL 35223

FOR: REAL ESTATE SERVICES, NAMELY, MANAGEMENT AND RENTAL OF STUDENT HOUSING FOR COLLEGE STUDENTS, IN CLASS 36 (U.S. CLS. 100, 101 AND 102).

FIRST USE 9-10-2007; IN COMMERCE 9-10-2007.

NO CLAIM IS MADE TO THE EXCLUSIVE RIGHT TO USE "COLUMBIA", "EST", "2007" AND

"COMMUNITY", APART FROM THE MARK AS SHOWN.

THE MARK CONSISTS OF AN OVAL CONTAINING THE FRONT VIEW OF A 2-STORY HOUSE AND THE STYLIZED WORDS "THE COTTAGES OF COLUMBIA A FRONT PORCH COMMUNITY EST. 2007".

SER. NO. 77-335,377, FILED 11-21-2007.

JAY FLOWERS, EXAMINING ATTORNEY

**Int. Cl.: 44**

**Prior U.S. Cls.: 100 and 101**

**United States Patent and Trademark Office**

**Reg. No. 3,467,171**

**Registered July 15, 2008**

**SERVICE MARK  
PRINCIPAL REGISTER**



BLUSH AND BRUSHES LLC (NEW JERSEY LTD  
LIAB CO)  
1643 49TH STREET  
PENNSAUKEN, NJ 08110

FOR: CONSULTATION SERVICES IN THE FIELD  
OF MAKEUP, NAMELY, ON-LINE MAKEUP CON-  
SULTATION SERVICES AND IN-PERSON MAKEUP  
CONSULTATION AND APPLICATION SERVICES;  
SERVICES OF A MAKE-UP ARTIST, IN CLASS 44  
(U.S. CLS. 100 AND 101).

FIRST USE 10-11-2007; IN COMMERCE 10-11-2007.

NO CLAIM IS MADE TO THE EXCLUSIVE  
RIGHT TO USE "BLUSH & BRUSHES", APART  
FROM THE MARK AS SHOWN.

THE COLOR(S) WHITE, CORAL AND GRAY IS/  
ARE CLAIMED AS A FEATURE OF THE MARK.

THE MARK CONTAINS THE PHRASE "BLUSH &  
BRUSHES". THE WORDS "BLUSH" AND "BRU-  
SHES" ARE WRITTEN IN GRAY. A WHITE AM-  
PERSAND WHICH IS USED TO REPRESENT THE  
WORD "AND" IS EMBEDDED IN A STYLIZED  
CORAL-COLORED MAKEUP BRUSH.

SER. NO. 77-335,381, FILED 11-21-2007.

FRED MANDIR, EXAMINING ATTORNEY

**Int. Cl.: 9**

**Prior U.S. Cls.: 21, 23, 26, 36 and 38**

**United States Patent and Trademark Office**

**Reg. No. 3,467,172**

**Registered July 15, 2008**

**TRADEMARK  
PRINCIPAL REGISTER**

**THRIVING IVORY**

STROOPE, CLAYTON (UNITED STATES JOINT APPLICANTS)

C/O PRYOR CASHMAN LLP  
410 PARK AVE., 10TH FLOOR  
NEW YORK, NY 10022 AND

JASON, SCOTT (UNITED STATES JOINT APPLICANTS)

C/O PRYOR CASHMAN LLP  
410 PARK AVE., 10TH FLOOR  
NEW YORK, NY 10022

FOR: MUSICAL SOUND RECORDINGS; AUDIO-VISUAL RECORDINGS, NAMELY, COMPACT DISCS FEATURING MUSIC; DOWNLOADABLE

MUSICAL SOUND RECORDINGS, IN CLASS 9 (U.S. CLS. 21, 23, 26, 36 AND 38).

FIRST USE 5-18-2003; IN COMMERCE 5-18-2003.

THE MARK CONSISTS OF STANDARD CHARACTERS WITHOUT CLAIM TO ANY PARTICULAR FONT, STYLE, SIZE, OR COLOR.

SER. NO. 77-335,390, FILED 11-21-2007.

AMOS T. MATTHEWS, JR., EXAMINING ATTORNEY

Int. Cl.: 36

Prior U.S. Cls.: 100, 101 and 102

United States Patent and Trademark Office

Reg. No. 3,467,173

Registered July 15, 2008

**SERVICE MARK  
PRINCIPAL REGISTER**



CAPSTONE DEVELOPMENT CORP. (ALABAMA CORPORATION)  
431 OFFICE PARK DRIVE  
BIRMINGHAM, AL 35223

FOR: REAL ESTATE SERVICES, NAMELY, MANAGEMENT AND RENTAL OF STUDENT HOUSING FOR COLLEGE STUDENTS, IN CLASS 36 (U.S. CLS. 100, 101 AND 102).

FIRST USE 10-26-2007; IN COMMERCE 10-26-2007.

NO CLAIM IS MADE TO THE EXCLUSIVE RIGHT TO USE "GAINESVILLE", "EST", "2007"

AND "CONDOMINIUM COMMUNITY", APART FROM THE MARK AS SHOWN.

THE MARK CONSISTS OF AN OVAL CONTAINING THE FRONT VIEW OF A 2-STORY HOUSE AND THE STYLIZED WORDS "COTTAGE GROVE AT GAINESVILLE A CONDOMINIUM COMMUNITY EST. 2007".

SER. NO. 77-335,401, FILED 11-21-2007.

JAY FLOWERS, EXAMINING ATTORNEY

**Int. Cls.: 36, 37 and 41**

**Prior U.S. Cls.: 100, 101, 102, 103, 106 and 107**

**United States Patent and Trademark Office**

**Reg. No. 3,467,174**

**Registered July 15, 2008**

**SERVICE MARK  
PRINCIPAL REGISTER**

# Somerby

SOMERBY GOLF CLUB (MINNESOTA NON-PROFIT CORPORATION)  
950 FRONTAGE ROAD NE  
BYRON, MN 55920

FOR: REAL ESTATE ACQUISITION SERVICES; LEASING OF REAL ESTATE; REAL ESTATE MANAGEMENT, IN CLASS 36 (U.S. CLS. 100, 101 AND 102).

FIRST USE 10-1-2001; IN COMMERCE 10-1-2001.

FOR: REAL ESTATE SITE SELECTION; REAL ESTATE DEVELOPMENT, IN CLASS 37 (U.S. CLS. 100, 103 AND 106).

FIRST USE 10-1-2001; IN COMMERCE 10-1-2001.

FOR: GOLF COURSES; GOLF CLUB SERVICES; GOLF INSTRUCTION; PROVIDING GOLF FACILITIES, IN CLASS 41 (U.S. CLS. 100, 101 AND 107).

FIRST USE 10-1-2001; IN COMMERCE 10-1-2001.

THE MARK CONSISTS OF STANDARD CHARACTERS WITHOUT CLAIM TO ANY PARTICULAR FONT, STYLE, SIZE, OR COLOR.

SER. NO. 77-335,437, FILED 11-21-2007.

JESSICA A. POWERS, EXAMINING ATTORNEY

**Int. Cl.: 35**

**Prior U.S. Cls.: 100, 101 and 102**

**United States Patent and Trademark Office**

**Reg. No. 3,467,175**

**Registered July 15, 2008**

**SERVICE MARK  
PRINCIPAL REGISTER**

## Going Beyond the Call

VOICENATION, LLC (GEORGIA LTD LIAB CO),  
DBA VOICEPLUS COMMUNICATIONS  
SUITE C  
5089 BRISTOL INDUSTRIAL WAY  
BUFORD, GA 30518

FOR: TELEPHONE ANSWERING SERVICE, IN  
CLASS 35 (U.S. CLS. 100, 101 AND 102).

FIRST USE 1-1-2007; IN COMMERCE 1-1-2007.

THE MARK CONSISTS OF STANDARD CHAR-  
ACTERS WITHOUT CLAIM TO ANY PARTICULAR  
FONT, STYLE, SIZE, OR COLOR.

SER. NO. 77-335,440, FILED 11-21-2007.

THOMAS MANOR, EXAMINING ATTORNEY



**Int. Cl.: 41**

**Prior U.S. Cls.: 100, 101 and 107**

**United States Patent and Trademark Office**

**Reg. No. 3,467,176**

**Registered July 15, 2008**

**SERVICE MARK  
PRINCIPAL REGISTER**

**PARTNER**

SWANK AUDIO VISUALS, LLC (MISSOURI LTD  
LIAB CO)  
639E GRAVOIS BLUFFS  
ST. LOUIS, MO 63026

FOR: RENTAL OF AUDIO VISUAL EQUIPMENT,  
STAGE LIGHTING AND STAGES; SETUP, RIG-  
GING AND OPERATION OF AUDIO VISUAL  
EQUIPMENT, STAGE LIGHTING AND EVENT  
STAGING FOR OTHERS IN THE HOTEL AND  
CONVENTION INDUSTRY, IN CLASS 41 (U.S. CLS.  
100, 101 AND 107).

FIRST USE 6-15-2000; IN COMMERCE 6-15-2000.

THE MARK CONSISTS OF STANDARD CHAR-  
ACTERS WITHOUT CLAIM TO ANY PARTICULAR  
FONT, STYLE, SIZE, OR COLOR.

OWNER OF U.S. REG. NO. 2,558,551.

SER. NO. 77-335,458, FILED 11-21-2007.

THOMAS MANOR, EXAMINING ATTORNEY

**Int. Cl.: 21**

**Prior U.S. Cls.: 2, 13, 23, 29, 30, 33, 40 and 50**

**United States Patent and Trademark Office**

**Reg. No. 3,467,177**

**Registered July 15, 2008**

**TRADEMARK  
PRINCIPAL REGISTER**

**BEARICUDA**

LACILLA, KEVIN (UNITED STATES INDIVIDUAL)  
119 STONY BROOK LANE  
WATERBURY, CT 06795

THE MARK CONSISTS OF STANDARD CHARACTERS WITHOUT CLAIM TO ANY PARTICULAR FONT, STYLE, SIZE, OR COLOR.

FOR: TRASH CONTAINERS FOR HOUSEHOLD USE, IN CLASS 21 (U.S. CLS. 2, 13, 23, 29, 30, 33, 40 AND 50).

SER. NO. 77-335,467, FILED 11-21-2007.

FIRST USE 10-1-2007; IN COMMERCE 10-1-2007.

JILL C. ALT, EXAMINING ATTORNEY

Int. Cl.: 41

Prior U.S. Cls.: 100, 101 and 107

United States Patent and Trademark Office

Reg. No. 3,467,178

Registered July 15, 2008

SERVICE MARK  
PRINCIPAL REGISTER



BELLIN HEALTH SYSTEMS, INC. (WISCONSIN CORPORATION)  
744 S. WEBSTER AVENUE  
GREEN BAY, WI 54301

FOR: PERSONAL TRAINING SERVICES, NAME-  
LY, STRENGTH AND CONDITIONING TRAINING  
FOR ATHLETIC PERFORMANCE ENHANCE-  
MENT, IN CLASS 41 (U.S. CLS. 100, 101 AND 107).

FIRST USE 8-15-2007; IN COMMERCE 8-15-2007.

OWNER OF U.S. REG. NOS. 3,289,603 AND  
3,289,604.

THE MARK CONSISTS OF THE LETTERS "XL"  
SURROUNDED BY SILHOUETTES OF SPORTS  
FIGURES AND SPORTING GOODS WITH THE  
WORDS "PLAY LARGE" UNDERNEATH.

SER. NO. 77-335,481, FILED 11-21-2007.

HANNO RITTNER, EXAMINING ATTORNEY

**Int. Cl.: 41**

**Prior U.S. Cls.: 100, 101 and 107**

**United States Patent and Trademark Office**

**Reg. No. 3,467,179**

**Registered July 15, 2008**

**SERVICE MARK  
PRINCIPAL REGISTER**

DELIVERING THE SPECTACULAR

SWANK AUDIO VISUALS, LLC (MISSOURI LTD  
LIAB CO)  
639E GRAVOIS BLUFFS  
ST. LOUIS, MO 63026

FOR: RENTAL OF AUDIO VISUAL EQUIPMENT,  
STAGE LIGHTING AND STAGES; SETUP, RIG-  
GING AND OPERATION OF AUDIO VISUAL  
EQUIPMENT, STAGE LIGHTING AND EVENT  
STAGING FOR OTHERS IN THE HOTEL AND  
CONVENTION INDUSTRY, IN CLASS 41 (U.S. CLS.  
100, 101 AND 107).

FIRST USE 11-15-2007; IN COMMERCE 11-15-2007.

THE MARK CONSISTS OF STANDARD CHAR-  
ACTERS WITHOUT CLAIM TO ANY PARTICULAR  
FONT, STYLE, SIZE, OR COLOR.

SER. NO. 77-335,511, FILED 11-21-2007.

THOMAS MANOR, EXAMINING ATTORNEY

**Int. Cl.: 28**

**Prior U.S. Cls.: 22, 23, 38 and 50**

**Reg. No. 3,467,180**

**United States Patent and Trademark Office**

**Registered July 15, 2008**

---

**TRADEMARK  
PRINCIPAL REGISTER**

**THEPLAYFULWORLD**

THE PLAYFUL WORLD LLC (WASHINGTON  
LTD LIAB CO)  
300 N COMMERCIAL ST.  
BELLINGHAM, WA 98225

THE MARK CONSISTS OF STANDARD CHAR-  
ACTERS WITHOUT CLAIM TO ANY PARTICULAR  
FONT, STYLE, SIZE, OR COLOR.

FOR: PLUSH TOYS; PUPPETS, IN CLASS 28 (U.S.  
CLS. 22, 23, 38 AND 50).

SER. NO. 77-335,525, FILED 11-21-2007.

FIRST USE 9-14-2006; IN COMMERCE 9-14-2006.

BARBARA GAYNOR, EXAMINING ATTORNEY

**Int. Cl.: 39**

**Prior U.S. Cls.: 100 and 105**

**United States Patent and Trademark Office**

**Reg. No. 3,467,181**

**Registered July 15, 2008**

**SERVICE MARK  
PRINCIPAL REGISTER**



PARDEEP, KUMAR (UNITED STATES INDIVIDUAL)  
1152 CYPRESS TREE PL  
HERNDON, VA 20190

FOR: CAR TRANSPORT; HIRED CAR TRANSPORT; TAXI TRANSPORT; TAXI TRANSPORT FOR PEOPLE IN WHEELCHAIRS; TRANSPORT BY TWO-WHEELED MOTOR VEHICLES; TRANSPORT BY MOTOR VEHICLE; TRANSPORT OF GOODS; TRANSPORT OF PASSENGERS; TRANSPORTATION AND DELIVERY SERVICES, NAMELY, SAME DAY SHIPMENT SERVICES; TRANSPORTATION AND STORAGE OF GOODS; TRANSPORTATION OF PASSENGERS AND/OR GOODS BY MOTOR VEHICLE; TRANSPORTATION RESERVATION SERVICES; TRAVEL AGENCY SERVICES, NAMELY, MAKING RESERVATIONS AND BOOKINGS FOR TRANSPORTATION, IN CLASS 39 (U.S. CLS. 100 AND 105).

FIRST USE 11-20-2007; IN COMMERCE 11-20-2007.

THE COLOR(S) RED, WHITE, BLUE, BLACK IS/ARE CLAIMED AS A FEATURE OF THE MARK.

THE MARK CONSISTS OF SHIELD WITH OVERLAPPING PICTURES OF THE STATUE OF LIBERTY, THE U.S. CONGRESSIONAL BUILDING, THE WHITE HOUSE, AND THE AMERICAN FLAG, COMPLETELY ENCIRCLED WITH A FRAME OF STARS WITH ADDITIONAL FIVE LARGER RED STARS ON TOP AND FIVE LARGER WHITE STARS ON THE BOTTOM.

SER. NO. 77-335,527, FILED 11-21-2007.

JOHN DALIER, EXAMINING ATTORNEY

**Int. Cl.: 8**

**Prior U.S. Cls.: 23, 28 and 44**

**Reg. No. 3,467,182**

**United States Patent and Trademark Office**

**Registered July 15, 2008**

---

**TRADEMARK  
PRINCIPAL REGISTER**

**JOHN DEERE**

DEERE & COMPANY (DELAWARE CORPORATION)  
TRADEMARK LAW GROUP - WOB  
ONE JOHN DEERE PLACE  
MOLINE, IL 61265

FOR: POCKET KNIVES, IN CLASS 8 (U.S. CLS. 23, 28 AND 44).

FIRST USE 12-1-2000; IN COMMERCE 12-1-2000.

THE MARK CONSISTS OF STANDARD CHARACTERS WITHOUT CLAIM TO ANY PARTICULAR FONT, STYLE, SIZE, OR COLOR.

THE NAME "JOHN DEERE" DOES NOT IDENTIFY A LIVING INDIVIDUAL.

SER. NO. 77-335,538, FILED 11-21-2007.

CHRISTOPHER BUONGIORNO, EXAMINING ATTORNEY

**Int. Cl.: 39**

**Prior U.S. Cls.: 100 and 105**

**United States Patent and Trademark Office**

**Reg. No. 3,467,183**

**Registered July 15, 2008**

**SERVICE MARK  
PRINCIPAL REGISTER**



THE CAR PARK, INC. (IDAHO CORPORATION)  
405 S. 8TH STREET, STE 371  
BOISE, ID 83702

FOR: PARKING LOT SERVICES, IN CLASS 39  
(U.S. CLS. 100 AND 105).

FIRST USE 6-1-2003; IN COMMERCE 6-1-2003.

NO CLAIM IS MADE TO THE EXCLUSIVE  
RIGHT TO USE "CAR PARK" , APART FROM THE  
MARK AS SHOWN.

THE MARK CONSISTS OF A LOGO EMBLEM  
BASED ON A CIRCLE WITH "P" AT ITS CENTER  
AND LEFT AND RIGHT HORIZONTAL SECTIONS  
INCLUDING "CAR" AND "PARK", RESPECTIVE-  
LY.

SER. NO. 77-335,560, FILED 11-21-2007.

MARIA-VICTORIA SUAREZ, EXAMINING ATTOR-  
NEY



**Int. Cl.: 36**

**Prior U.S. Cls.: 100, 101 and 102**

**United States Patent and Trademark Office**

**Reg. No. 3,467,184**

**Registered July 15, 2008**

**SERVICE MARK  
PRINCIPAL REGISTER**



ROSE INTERNATIONAL FUND FOR CHILDREN, THE (WASHINGTON NON-PROFIT CORPORATION)  
14150 NE 20TH STREET - F1  
BELLEVUE, WA 98007

FOR: PROVIDING GRANTS FOR THE ASSISTANCE OF ORPHANED AND DISABLED CHILDREN IN DEVELOPING COUNTRIES; FUNDRAISING SERVICES, NAMELY, RAISING FUNDS FOR THE ASSISTANCE OF ORPHANED

AND DISABLED CHILDREN IN DEVELOPING COUNTRIES, IN CLASS 36 (U.S. CLS. 100, 101 AND 102).

FIRST USE 7-7-2007; IN COMMERCE 7-7-2007.

SER. NO. 77-335,588, FILED 11-21-2007.

LINDSEY RUBIN, EXAMINING ATTORNEY

**Int. Cl.: 9**

**Prior U.S. Cls.: 21, 23, 26, 36 and 38**

**United States Patent and Trademark Office**

**Reg. No. 3,467,185**

**Registered July 15, 2008**

**TRADEMARK  
PRINCIPAL REGISTER**

# **Kong Power**

KONGPOWER TECHNOLOGY CO., LTD. (TAI-  
WAN CORPORATION)  
2F, NO. 501, JHONGSHAN ROAD  
FONGYUAN CITY, TAIWAN

FOR: BATTERIES; ELECTRIC WIRES; ELECTRIC  
CABLES; ELECTRIC SWITCHES; ELECTRIC  
PLUGS; ELECTRIC SOCKETS; VOLTAGE SURGE  
PROTECTORS; ELECTRONIC CONTROLS FOR  
MOTORS; REMOTE CONTROLS FOR TOY MODEL  
CARS, MOTORCYCLES, PLANES, BOATS; BAT-  
TERY CHARGERS; ELECTRICAL CONTROLLERS;

ELECTRIC TRANSDUCERS; ANGULAR GAUGES,  
IN CLASS 9 (U.S. CLS. 21, 23, 26, 36 AND 38).

FIRST USE 1-15-2007; IN COMMERCE 3-28-2007.

NO CLAIM IS MADE TO THE EXCLUSIVE  
RIGHT TO USE "POWER", APART FROM THE  
MARK AS SHOWN.

SER. NO. 77-335,599, FILED 11-21-2007.

JOHN DALIER, EXAMINING ATTORNEY

**Int. Cl.: 41**

**Prior U.S. Cls.: 100, 101 and 107**

**United States Patent and Trademark Office**

**Reg. No. 3,467,186**

**Registered July 15, 2008**

**SERVICE MARK  
PRINCIPAL REGISTER**

**NORTH VS SOUTH SHOOTOUT**

**BAKERSFIELD HEAT GIRLS BASKETBALL  
CLUB (CALIFORNIA NON-PROFIT ORGANI-  
ZATION)**

**P.O. BOX 22345**

**BAKERSFIELD, CA 93390**

**FOR: ENTERTAINMENT IN THE NATURE OF  
AN ANNUAL BASKETBALL TOURNAMENT, IN  
CLASS 41 (U.S. CLS. 100, 101 AND 107).**

**FIRST USE 4-1-1998; IN COMMERCE 6-6-1998.**

**THE MARK CONSISTS OF STANDARD CHAR-  
ACTERS WITHOUT CLAIM TO ANY PARTICULAR  
FONT, STYLE, SIZE, OR COLOR.**

**NO CLAIM IS MADE TO THE EXCLUSIVE  
RIGHT TO USE "SHOOTOUT", APART FROM THE  
MARK AS SHOWN.**

**SER. NO. 77-335,612, FILED 11-21-2007.**

**TRICIA SONNEBORN, EXAMINING ATTORNEY**

**Int. Cl.: 36**

**Prior U.S. Cls.: 100, 101 and 102**

**United States Patent and Trademark Office**

**Reg. No. 3,467,187**

**Registered July 15, 2008**

**SERVICE MARK  
PRINCIPAL REGISTER**

**AMERICYCLE**

AMERICAN NATIONAL PROPERTY AND CA-  
SUALTY COMPANY (MISSOURI CORPORA-  
TION)  
1949 E. SUNSHINE  
SPRINGFIELD, MO 658990001

FOR: INSURANCE UNDERWRITING IN THE  
FIELD OF MOTORCYCLE PROPERTY AND CA-  
SUALTY INSURANCE, IN CLASS 36 (U.S. CLS. 100,  
101 AND 102).

FIRST USE 4-15-1999; IN COMMERCE 4-15-1999.

THE MARK CONSISTS OF STANDARD CHAR-  
ACTERS WITHOUT CLAIM TO ANY PARTICULAR  
FONT, STYLE, SIZE, OR COLOR.

OWNER OF U.S. REG. NOS. 2,391,576 AND  
2,516,320.

SER. NO. 77-335,617, FILED 11-21-2007.

DEZMONA MIZELLE, EXAMINING ATTORNEY

**Int. Cl.: 42**

**Prior U.S. Cls.: 100 and 101**

**United States Patent and Trademark Office**

**Reg. No. 3,467,188**

**Registered July 15, 2008**

**SERVICE MARK  
PRINCIPAL REGISTER**

**HYPERREAL**

MATAMALES INC. (CALIFORNIA CORPORATION)  
5743 CORSA AVE.  
WESTLAKE VILLAGE, CA 91362

FOR: ANIMATION AND SPECIAL-EFFECTS DESIGN FOR OTHERS, IN CLASS 42 (U.S. CLS. 100 AND 101).

FIRST USE 1-0-1999; IN COMMERCE 1-0-1999.

THE MARK CONSISTS OF STANDARD CHARACTERS WITHOUT CLAIM TO ANY PARTICULAR FONT, STYLE, SIZE, OR COLOR.

SER. NO. 77-335,637, FILED 11-21-2007.

LEIGH CAROLINE CASE, EXAMINING ATTORNEY

**Int. Cls.: 35, 39, 40 and 41**

**Prior U.S. Cls.: 100, 101, 102, 103, 105, 106 and 107**

**United States Patent and Trademark Office**

**Reg. No. 3,467,189**

**Registered July 15, 2008**

**SERVICE MARK  
PRINCIPAL REGISTER**

**STORETRIEVE CORPORATE RISK  
AVERSION MANAGEMENT (SCRAM)**

STORETRIEVE, INC. (CALIFORNIA CORPORATION)  
1150 SOUTH TAYLOR AVENUE  
MONTEBELLO, CA 90640

FOR: RECORDS MANAGEMENT SERVICES, NAMELY, DOCUMENT INDEXING FOR OTHERS; MANAGEMENT OF COMPUTERIZED FILES; DOCUMENT REPRODUCTION, IN CLASS 35 (U.S. CLS. 100, 101 AND 102).

FIRST USE 2-1-2007; IN COMMERCE 2-1-2007.

FOR: PHYSICAL STORAGE OF ELECTRONICALLY-STORED DATA OR DOCUMENTS; ELECTRONIC STORAGE OF DOCUMENTS AND FILES, IN CLASS 39 (U.S. CLS. 100 AND 105).

FIRST USE 2-1-2007; IN COMMERCE 2-1-2007.

FOR: SECURED DOCUMENT DESTRUCTION, IN CLASS 40 (U.S. CLS. 100, 103 AND 106).

FIRST USE 2-1-2007; IN COMMERCE 2-1-2007.

FOR: DIGITAL IMAGING SERVICES, IN CLASS 41 (U.S. CLS. 100, 101 AND 107).

FIRST USE 2-1-2007; IN COMMERCE 2-1-2007.

THE MARK CONSISTS OF STANDARD CHARACTERS WITHOUT CLAIM TO ANY PARTICULAR FONT, STYLE, SIZE, OR COLOR.

NO CLAIM IS MADE TO THE EXCLUSIVE RIGHT TO USE "CORPORATE RISK AVERSION MANAGEMENT", APART FROM THE MARK AS SHOWN.

SER. NO. 77-335,668, FILED 11-21-2007.

JIM RINGLE, EXAMINING ATTORNEY

**Int. Cl.: 30**

**Prior U.S. Cl.: 46**

**United States Patent and Trademark Office**

**Reg. No. 3,467,190**

**Registered July 15, 2008**

**TRADEMARK  
PRINCIPAL REGISTER**

**RYE-OLA**

RUBSCHLAGER BAKING CORPORATION (ILLI-  
NOIS CORPORATION)  
3220 WEST GRAND AVENUE  
CHICAGO, IL 60651

THE MARK CONSISTS OF STANDARD CHAR-  
ACTERS WITHOUT CLAIM TO ANY PARTICULAR  
FONT, STYLE, SIZE, OR COLOR.

FOR: BREADS, RYE BREADS, AND RYE BASED  
BREADS, IN CLASS 30 (U.S. CL. 46).

SER. NO. 77-335,687, FILED 11-21-2007.

FIRST USE 4-11-1974; IN COMMERCE 4-11-1974.

BRENDAN MCCAULEY, EXAMINING ATTORNEY

**Int. Cl.: 35**

**Prior U.S. Cls.: 100, 101 and 102**

**United States Patent and Trademark Office**

**Reg. No. 3,467,191**

**Registered July 15, 2008**

**SERVICE MARK  
PRINCIPAL REGISTER**

**iCodify**

MELISSA FERRON HEALTHCARE CONSULTING, LLC (CALIFORNIA LTD LIAB CO),  
DBA MELISSA FERRON HEALTHCARE CONSULTING, LLC  
4347 CANYON VIEW LANE  
PALOS VERDES PENINSULA, CA 90274

FOR: MEDICAL BILLING SUPPORT SERVICES;  
BUSINESS MANAGEMENT AND CONSULTATION  
IN THE FIELD OF HEALTHCARE, IN CLASS 35  
(U.S. CLS. 100, 101 AND 102).

FIRST USE 7-10-2007; IN COMMERCE 9-1-2007.

THE MARK CONSISTS OF STANDARD CHARACTERS WITHOUT CLAIM TO ANY PARTICULAR FONT, STYLE, SIZE, OR COLOR.

SER. NO. 77-335,708, FILED 11-21-2007.

ERNEST SHOSHO, EXAMINING ATTORNEY



**Int. Cl.: 36**

**Prior U.S. Cls.: 100, 101 and 102**

**United States Patent and Trademark Office**

**Reg. No. 3,467,192**

**Registered July 15, 2008**

**SERVICE MARK  
PRINCIPAL REGISTER**

**FAMILIES. BUSINESSES.  
PROMISES KEPT.**

MUTUAL OF ENUMCLAW INSURANCE COM-  
PANY (WASHINGTON CORPORATION)  
1460 WELLS STREET  
ENUMCLAW, WA 98022

FOR: MULTIPLE LINE PROPERTY AND CA-  
SUALTY INSURANCE UNDERWRITING AND  
CLAIMS ADMINISTRATION SERVICES, IN CLASS  
36 (U.S. CLS. 100, 101 AND 102).

FIRST USE 8-30-2007; IN COMMERCE 8-30-2007.

THE MARK CONSISTS OF STANDARD CHAR-  
ACTERS WITHOUT CLAIM TO ANY PARTICULAR  
FONT, STYLE, SIZE, OR COLOR.

SER. NO. 77-335,717, FILED 11-21-2007.

KRISTIN DAHLING, EXAMINING ATTORNEY

**Int. Cl.: 41**

**Prior U.S. Cls.: 100, 101 and 107**

**United States Patent and Trademark Office**

**Reg. No. 3,467,193**

**Registered July 15, 2008**

**SERVICE MARK  
PRINCIPAL REGISTER**

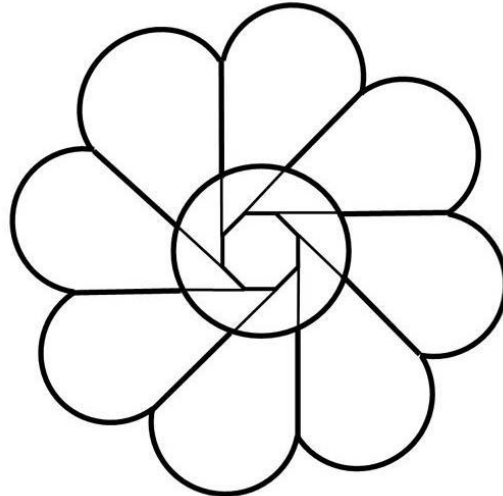

MAHARRY, AYANNA (UNITED STATES INDIVIDUAL)

#307

11929 VENICE BLVD.

LOS ANGELES, CA 90066

THE MARK CONSISTS OF SEVERAL FLOWER PEDAL SHAPES USED TO FORM A FLOWER WITH THE CENTER OF THE FLOWER BEING AN APERTURE AS FROM A CAMERA.

FOR: ENTERTAINMENT, NAMELY, PRODUCTION OF MOTION PICTURES, TELEVISION SHOWS, MUSIC; FILM DISTRIBUTION; FILM STUDIOS, IN CLASS 41 (U.S. CLS. 100, 101 AND 107).

SER. NO. 77-335,734, FILED 11-21-2007.

FIRST USE 1-1-1995; IN COMMERCE 10-1-1998.

JOHN WILKE, EXAMINING ATTORNEY

**Int. Cl.: 35**

**Prior U.S. Cls.: 100, 101 and 102**

**United States Patent and Trademark Office**

**Reg. No. 3,467,194**

**Registered July 15, 2008**

**SERVICE MARK  
PRINCIPAL REGISTER**

# H-Motors Online

ARGUETA, STEVE (UNITED STATES INDIVIDUAL)  
7585 SAN FERNANDO ROAD  
BURBANK, CA 91505

FOR: ON-LINE RETAIL STORE SERVICES FEATURING AUTOMOTIVE ENGINES AND PARTS, IN CLASS 35 (U.S. CLS. 100, 101 AND 102).

FIRST USE 9-1-2002; IN COMMERCE 10-19-2002.

THE MARK CONSISTS OF STANDARD CHARACTERS WITHOUT CLAIM TO ANY PARTICULAR FONT, STYLE, SIZE, OR COLOR.

NO CLAIM IS MADE TO THE EXCLUSIVE RIGHT TO USE "ONLINE", APART FROM THE MARK AS SHOWN.

SER. NO. 77-335,738, FILED 11-21-2007.

PAULA MAHONEY, EXAMINING ATTORNEY

**Int. Cl.: 9**

**Prior U.S. Cls.: 21, 23, 26, 36 and 38**

**Reg. No. 3,467,195**

**United States Patent and Trademark Office**

**Registered July 15, 2008**

**TRADEMARK  
PRINCIPAL REGISTER**

**TRY&DECIDE**

ACRONIS INC (BR.VIRGIN ISLANDS CORPORATION)  
395 OYSTER POINT BLVD  
C/O ACRONIS, INC.  
SOUTH SAN FRANCISCO, CA 94080

SYSTEM TO A PREVIOUS STATE, IN CLASS 9 (U.S. CLS. 21, 23, 26, 36 AND 38).

FIRST USE 11-21-2007; IN COMMERCE 11-21-2007.

FOR: COMPUTER SOFTWARE FOR USE IN BACKUP AND RESTORATION OF HARD DISK DRIVES; COMPUTER SOFTWARE FOR USE IN CREATING A TEMPORARY SECURE ENVIRONMENT WHERE A USER CAN IMPLEMENT CHANGES TO HIS COMPUTER SYSTEM WITHOUT RISKING SYSTEM FAILURE; COMPUTER SOFTWARE FOR USE IN ROLLBACK OF A COMPUTER

THE MARK CONSISTS OF STANDARD CHARACTERS WITHOUT CLAIM TO ANY PARTICULAR FONT, STYLE, SIZE, OR COLOR.

SER. NO. 77-335,743, FILED 11-21-2007.

PAULA MAHONEY, EXAMINING ATTORNEY

**Int. Cl.: 18**

**Prior U.S. Cls.: 1, 2, 3, 22 and 41**

**United States Patent and Trademark Office**

**Reg. No. 3,467,196**

**Registered July 15, 2008**

**TRADEMARK  
PRINCIPAL REGISTER**



RIAN HANDBAGS, LLC (WASHINGTON LTD  
LIAB CO)  
1714 SE 185TH PLACE  
VANCOUVER, WA 98683

FOR: LADIES' HANDBAGS, MEN'S HANDBAGS,  
CHILDREN'S HANDBAGS, SCHOOL BOOK BAGS,  
MESSENGER BAGS, TRAVELING BAGS, OVER-  
NIGHT BAGS, PURSES, WALLETS AND UMBREL-  
LAS, IN CLASS 18 (U.S. CLS. 1, 2, 3, 22 AND 41).

FIRST USE 7-1-2005; IN COMMERCE 7-1-2005.

THE MARK CONSISTS OF THE WORD "RIAN"  
IN STYLIZED LOWERCASE FONT WITH THE  
LETTERS "R", "I" AND "N" FILLED IN AND THE  
LETTER "A" A LINE ABOVE OUTLINED WITH NO  
FILL AND A HORIZONTAL DASH ABOVE WITH A  
STYLIZED DRAWING OF A WOMAN TAKING A  
STEP FORWARD WITH A HANDBAG IN ONE  
HAND.

SER. NO. 77-335,744, FILED 11-21-2007.

STEVEN JACKSON, EXAMINING ATTORNEY

**Int. Cl.: 41**

**Prior U.S. Cls.: 100, 101 and 107**

**United States Patent and Trademark Office**

**Reg. No. 3,467,197**

**Registered July 15, 2008**

**SERVICE MARK  
PRINCIPAL REGISTER**

**Tough Like Wearing  
Dreadlocks**

MAHARRY, AYANNA (UNITED STATES INDIVIDUAL)

#307

11929 VENICE BLVD.  
LOS ANGELES, CA 90066

FOR: ENTERTAINMENT, NAMELY, PRODUCTION OF MOTION PICTURES, TELEVISION SHOWS, MUSIC, IN CLASS 41 (U.S. CLS. 100, 101 AND 107).

FIRST USE 1-1-1999; IN COMMERCE 1-1-2002.

THE MARK CONSISTS OF STANDARD CHARACTERS WITHOUT CLAIM TO ANY PARTICULAR FONT, STYLE, SIZE, OR COLOR.

SER. NO. 77-335,746, FILED 11-21-2007.

JOHN WILKE, EXAMINING ATTORNEY

**Int. Cls.: 41 and 43**

**Prior U.S. Cls.: 100, 101 and 107**

**United States Patent and Trademark Office**

**Reg. No. 3,467,198**

**Registered July 15, 2008**

**SERVICE MARK  
PRINCIPAL REGISTER**

# Just One Plate

KOHAN, NEIL (UNITED STATES INDIVIDUAL)  
2164 SUNSET PLAZA DRIVE  
WEST HOLLYWOOD, CA 90069 AND  
ELLIOTT, MARGAUX (UNITED STATES INDIVIDUAL)  
2164 SUNSET PLAZA DRIVE  
WEST HOLLYWOOD, CA 90069 AND  
WANGER, MAX (UNITED STATES INDIVIDUAL)  
2164 SUNSET PLAZA DRIVE  
WEST HOLLYWOOD, CA 90069

FOR: ENTERTAINMENT SERVICES, NAMELY, PROVIDING A CONTINUING ONLINE COOKING SHOW FEATURING INTERVIEWS, RECIPES AND PHOTOGRAPHIC PRESENTATIONS RELATED TO FOOD AND DINING, IN CLASS 41 (U.S. CLS. 100, 101 AND 107).

FIRST USE 7-25-2007; IN COMMERCE 8-4-2007.

FOR: PROVIDING INFORMATION, NEWS AND COMMENTARY IN THE FIELD OF DINING; PROVIDING AN ONLINE DATABASE FEATURING RECIPES, AND INTERVIEWS AND PHOTOGRAPHS RELATED TO FOOD, DINING, AND COOKING, IN CLASS 43 (U.S. CLS. 100 AND 101).

FIRST USE 7-25-2007; IN COMMERCE 8-4-2007.

THE MARK CONSISTS OF STANDARD CHARACTERS WITHOUT CLAIM TO ANY PARTICULAR FONT, STYLE, SIZE, OR COLOR.

SER. NO. 77-335,749, FILED 11-21-2007.

JOHN E. MICHOS, EXAMINING ATTORNEY

**Int. Cl.: 36**

**Prior U.S. Cls.: 100, 101 and 102**

**United States Patent and Trademark Office**

**Reg. No. 3,467,199**

**Registered July 15, 2008**

**SERVICE MARK  
PRINCIPAL REGISTER**

**Presence with a Purpose**

CAGLE, LOWELL S. "CASEY" (UNITED STATES  
INDIVIDUAL)  
PO BOX 489  
OAKWOOD, GA 30566

FOR: ACCEPTING AND ADMINISTERING  
MONETARY CHARITABLE CONTRIBUTIONS;  
CHARITABLE FUND RAISING; CHARITABLE  
FUNDRAISING SERVICES FOR SENDING UNDER-  
PRIVILEGED CHILDREN TO ONE OF SEVERAL  
CAMPS AROUND THE UNITED STATES WHICH  
ACCEPT THESE CHILDREN AT DISCOUNTED

RATES FOR ONE OR MORE WEEKS, IN CLASS 36  
(U.S. CLS. 100, 101 AND 102).

FIRST USE 5-4-2007; IN COMMERCE 5-4-2007.

THE MARK CONSISTS OF STANDARD CHAR-  
ACTERS WITHOUT CLAIM TO ANY PARTICULAR  
FONT, STYLE, SIZE, OR COLOR.

SER. NO. 77-335,756, FILED 11-21-2007.

KHANH LE, EXAMINING ATTORNEY



**Int. Cl.: 41**

**Prior U.S. Cls.: 100, 101 and 107**

**United States Patent and Trademark Office**

**Reg. No. 3,467,200**

**Registered July 15, 2008**

**SERVICE MARK  
PRINCIPAL REGISTER**

**Can you hit it?**

MAHARRY, AYANNA (UNITED STATES INDIVIDUAL)

#307

11929 VENICE BLVD.

LOS ANGELES, CA 90066

FOR: ORGANIZING SPORTING EVENTS, NAME-  
LY, ORGANIZING AND CONDUCTING TENNIS  
COMPETITIONS; PRODUCTION OF DVDS, VIDEO-  
TAPES AND TELEVISION PROGRAMS FEATUR-  
ING TENNIS AND TENNIS COMPETITIONS;  
PROVIDING FACILITIES FOR RECREATIONAL  
ACTIVITIES IN THE FIELD OF TENNIS AND

TENNIS COMPETITIONS AND TOURNAMENTS,  
IN CLASS 41 (U.S. CLS. 100, 101 AND 107).

FIRST USE 11-1-2007; IN COMMERCE 11-1-2007.

THE MARK CONSISTS OF STANDARD CHAR-  
ACTERS WITHOUT CLAIM TO ANY PARTICULAR  
FONT, STYLE, SIZE, OR COLOR.

SER. NO. 77-335,761, FILED 11-21-2007.

JOHN WILKE, EXAMINING ATTORNEY

**Int. Cl.: 41**

**Prior U.S. Cls.: 100, 101 and 107**

**United States Patent and Trademark Office**

**Reg. No. 3,467,201**

**Registered July 15, 2008**

**SERVICE MARK  
PRINCIPAL REGISTER**

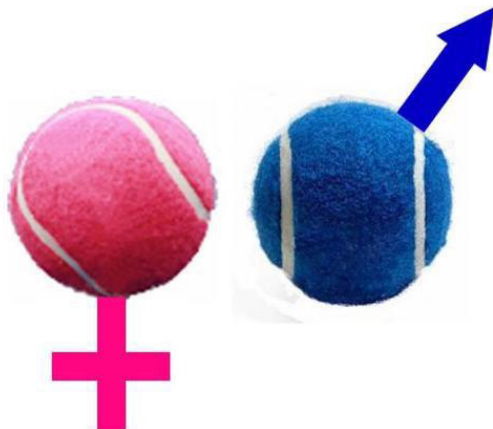

MAHARRY, AYANNA (UNITED STATES INDIVIDUAL)  
#307  
11929 VENICE BLVD.  
LOS ANGELES, CA 90066

FOR: ORGANIZING SPORTING EVENTS, NAME-  
LY, ORGANIZING AND CONDUCTING TENNIS  
COMPETITIONS; PRODUCTION OF DVDS, VIDEO-  
TAPES AND TELEVISION PROGRAMS FEATUR-  
ING TENNIS AND TENNIS COMPETITIONS;  
PROVIDING FACILITIES FOR RECREATIONAL  
ACTIVITIES IN THE FIELD OF TENNIS AND  
TENNIS COMPETITIONS AND TOURNAMENTS,  
IN CLASS 41 (U.S. CLS. 100, 101 AND 107).

FIRST USE 11-1-2007; IN COMMERCE 11-1-2007.

THE COLOR(S) PINK, BLUE, AND WHITE IS/ARE  
CLAIMED AS A FEATURE OF THE MARK.

THE MARK CONSISTS OF A PINK TENNIS BALL  
WITH WHITE MARKINGS AND A PINK CROSS  
EMANATING FROM IT, AND A BLUE TENNIS  
BALL WITH WHITE MARKINGS AND A BLUE  
ARROW EMANATING FROM IT.

SER. NO. 77-335,763, FILED 11-21-2007.

JOHN WILKE, EXAMINING ATTORNEY

**Int. Cl.: 43**

**Prior U.S. Cls.: 100 and 101**

**United States Patent and Trademark Office**

**Reg. No. 3,467,202**

**Registered July 15, 2008**

**SERVICE MARK  
PRINCIPAL REGISTER**

**HILLTOP INN**

JAI SHRI KRISHNA, LLC (CONNECTICUT LTD  
LIAB CO)  
239 FLANDERS ROAD  
NIANTIC, CT 06357

NO CLAIM IS MADE TO THE EXCLUSIVE  
RIGHT TO USE "INN", APART FROM THE MARK  
AS SHOWN.

FOR: HOTELS, IN CLASS 43 (U.S. CLS. 100 AND  
101).

SEC. 2(F).

FIRST USE 11-1-1996; IN COMMERCE 11-1-1996.

SER. NO. 77-335,788, FILED 11-22-2007.

THE MARK CONSISTS OF STANDARD CHAR-  
ACTERS WITHOUT CLAIM TO ANY PARTICULAR  
FONT, STYLE, SIZE, OR COLOR.

HENRY S. ZAK, EXAMINING ATTORNEY

**Int. Cls.: 4 and 11**

**Prior U.S. Cls.: 1, 6, 13, 15, 21, 23, 31 and 34**

**United States Patent and Trademark Office**

**Reg. No. 3,467,203**

**Registered July 15, 2008**

**TRADEMARK  
PRINCIPAL REGISTER**

**ZENSUAL**

ZENSUAL, INC. (CALIFORNIA CORPORATION)  
SUITE 421  
9190 WEST OLYMPIC BLVD.  
BEVERLY HILLS, CA 90212

FOR: CANDLES, IN CLASS 4 (U.S. CLS. 1, 6 AND 15).

FIRST USE 4-18-2006; IN COMMERCE 4-25-2006.

FOR: ROOM FRAGRANCE DIFFUSER COMPRISED OF SCENTED OILS AND RATTAN REEDS IN A CONTAINER USED TO EMIT SCENT

THROUGH CAPILLARY DIFFUSION, IN CLASS 11 (U.S. CLS. 13, 21, 23, 31 AND 34).

FIRST USE 4-18-2006; IN COMMERCE 4-25-2006.

THE MARK CONSISTS OF STANDARD CHARACTERS WITHOUT CLAIM TO ANY PARTICULAR FONT, STYLE, SIZE, OR COLOR.

OWNER OF U.S. REG. NO. 3,314,109.

SER. NO. 77-335,799, FILED 11-22-2007.

APRIL ROACH, EXAMINING ATTORNEY

**Int. Cl.: 38**

**Prior U.S. Cls.: 100, 101 and 104**

**United States Patent and Trademark Office**

**Reg. No. 3,467,204**

**Registered July 15, 2008**

**SERVICE MARK  
PRINCIPAL REGISTER**

**nightwhisper**

COOK, STEVEN M (UNITED STATES INDIVIDUAL), DBA NIGHTWHISPER  
1138 HUNTERS CT.  
ARDEN HILLS, MN 551123710

FOR: BROADCASTING SERVICES AND PROVISION OF TELECOMMUNICATION ACCESS TO VIDEO AND AUDIO CONTENT PROVIDED VIA A VIDEO-ON-DEMAND SERVICE VIA THE INTERNET , IN CLASS 38 (U.S. CLS. 100, 101 AND 104).

FIRST USE 7-3-1999; IN COMMERCE 10-13-2000.

THE MARK CONSISTS OF STANDARD CHARACTERS WITHOUT CLAIM TO ANY PARTICULAR FONT, STYLE, SIZE, OR COLOR.

SER. NO. 77-335,816, FILED 11-22-2007.

SONYA STEPHENS, EXAMINING ATTORNEY

Int. Cl.: 10

Prior U.S. Cls.: 26, 39 and 44

United States Patent and Trademark Office

Reg. No. 3,467,205

Registered July 15, 2008

TRADEMARK  
PRINCIPAL REGISTER

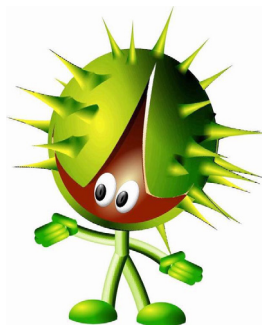

Dr. CHESTNUT

KOMKIN, ANDREY V. (RUSSIAN FED. INDIVIDUAL)  
GEORGIEVA STR 15 - 70  
BARNAUL, RUSSIAN FED. 616057

FOR: ACUPUNCTURE EQUIPMENT; APPARATUS FOR ACUPRESSURE THERAPY; APPARATUS FOR PHYSICAL TRAINING FOR MEDICAL USE; MASSAGING APPARATUS FOR PERSONAL USE; MASSAGE APPARATUS; EXERCISE MACHINES FOR THERAPEUTIC PURPOSES, IN CLASS 10 (U.S. CLS. 26, 39 AND 44).

OWNER OF RUSSIAN FED. REG. NO. 233513,  
DATED 12-26-2002, EXPIRES 3-7-2011.

THE COLOR(S) BLACK, WHITE, LIGHT GREEN, DARK GREEN, LIGHT BROWN, DARK BROWN, YELLOW IS/ARE CLAIMED AS A FEATURE OF THE MARK.

THE MARK CONSISTS OF THE WORDS "DR. CHESTNUT" LOCATED UNDER AN IMAGE OF A FICTIONAL CHARACTER WHICH IS A CARTOON-LIKE LITTLE PERSON. THE CHARACTER HAS SHORT THIN LEGS AND ARMS AND A SIMILARLY THIN BODY. ITS HEAD IS DISPROPORTIONABLY LARGE IN RELATION TO THE BODY AND HAS NARROW POINTED PROJECTIONS. THE CHARACTER'S HEAD RESEMBLES A FRUIT OF HORSE CHESTNUT TREE WHICH HAS BEEN SLIGHTLY CRACKED AND PARTIALLY OPENED. THE OUTSIDE OF CHARACTER'S HEAD IS GREEN; THE SLIGHT OPENING ON THE GREEN SURFACE, WHERE THE EYES ARE DRAWN, IS BROWN.

SER. NO. 77-335,844, FILED 11-22-2007.

JOHN DALIER, EXAMINING ATTORNEY

**Int. Cls.: 35 and 42**

**Prior U.S. Cls.: 100, 101 and 102**

**United States Patent and Trademark Office**

**Reg. No. 3,467,206**

**Registered July 15, 2008**

**SERVICE MARK  
PRINCIPAL REGISTER**

**pageshaping**

CLINTON, KEVIN M. (UNITED STATES INDIVIDUAL)  
20801 SONRISA WAY  
BOCA RATON, FL 33433

FOR: PROMOTION, ADVERTISING AND MARKETING OF ON-LINE WEBSITES; BUSINESS ADVICE AND ANALYSIS OF MARKETS; BUSINESS MANAGEMENT CONSULTANCY AS WELL AS DEVELOPMENT OF PROCESSES FOR THE ANALYSIS AND THE IMPLEMENTATION OF STRATEGY PLANS AND MANAGEMENT PROJECTS; COOPERATIVE ADVERTISING AND MARKETING SERVICES BY WAY OF SOLICITATION, CUSTOMER SERVICE AND PROVIDING MARKETING INFORMATION VIA WEBSITES ON A GLOBAL COMPUTER NETWORK; MARKET STUDY AND ANALYSIS OF MARKET STUDIES, IN CLASS 35 (U.S. CLS. 100, 101 AND 102).

FIRST USE 11-20-2007; IN COMMERCE 11-20-2007.

FOR: COMPUTER SERVICES, NAMELY, DESIGNING AND IMPLEMENTING NETWORK WEB PAGES FOR OTHERS; CREATION AND PROVISION OF WEB PAGES TO AND FOR THIRD PARTIES; PROVIDING CUSTOMIZED ON-LINE WEB PAGES FEATURING USER-DEFINED INFORMATION, WHICH INCLUDES SEARCH ENGINES AND ON-LINE WEB LINKS TO OTHER WEB SITES, IN CLASS 42 (U.S. CLS. 100 AND 101).

FIRST USE 11-20-2007; IN COMMERCE 11-20-2007.

THE MARK CONSISTS OF STANDARD CHARACTERS WITHOUT CLAIM TO ANY PARTICULAR FONT, STYLE, SIZE, OR COLOR.

SER. NO. 77-335,849, FILED 11-22-2007.

JOHN DALIER, EXAMINING ATTORNEY

**Int. Cl.: 7**

**Prior U.S. Cls.: 13, 19, 21, 23, 31, 34 and 35**

**United States Patent and Trademark Office**

**Reg. No. 3,467,207**

**Registered July 15, 2008**

**TRADEMARK  
PRINCIPAL REGISTER**

**EVASHRED**

FV EVANS & SONS LIMITED (NEW ZEALAND  
LTD LIAB CO)

59 MONTGOMERY CRESCENT

UPPER HUTT, NEW ZEALAND

FOR: PAPER SHREDDING MACHINES; SHRED-  
DING MACHINES, IN CLASS 7 (U.S. CLS. 13, 19, 21,  
23, 31, 34 AND 35).

THE MARK CONSISTS OF STANDARD CHAR-  
ACTERS WITHOUT CLAIM TO ANY PARTICULAR  
FONT, STYLE, SIZE, OR COLOR.

OWNER OF NEW ZEALAND REG. NO. 768227,  
DATED 5-11-2007, EXPIRES 5-11-2017.

SER. NO. 77-335,854, FILED 11-22-2007.

HOWARD B. LEVINE, EXAMINING ATTORNEY



**Int. Cl.: 9**

**Prior U.S. Cls.: 21, 23, 26, 36 and 38**

**Reg. No. 3,467,208**

**United States Patent and Trademark Office**

**Registered July 15, 2008**

---

**TRADEMARK  
PRINCIPAL REGISTER**

**CGSim**

SEMICONDUCTOR TECHNOLOGY RESEARCH  
(VIRGINIA CORPORATION)  
SUITE 108  
10404 PATTERSON AVE.  
RICHMOND, VA 23238

THE MARK CONSISTS OF STANDARD CHAR-  
ACTERS WITHOUT CLAIM TO ANY PARTICULAR  
FONT, STYLE, SIZE, OR COLOR.

FOR: COMPUTER SOFTWARE FOR NUMERI-  
CAL SIMULATION OF BULK CRYSTAL GROWTH  
FROM MELTS AND SOLUTIONS, IN CLASS 9 (U.S.  
CLS. 21, 23, 26, 36 AND 38).

SER. NO. 77-335,865, FILED 11-22-2007.

FIRST USE 1-1-1999; IN COMMERCE 5-1-2003.

KATHERINE M. DUBRAY, EXAMINING ATTOR-  
NEY

**Int. Cl.: 45**

**Prior U.S. Cls.: 100 and 101**

**United States Patent and Trademark Office**

**Reg. No. 3,467,209**

**Registered July 15, 2008**

**SERVICE MARK  
PRINCIPAL REGISTER**

**Reaching People. Building  
Lives.**

MILESTONE CHURCH (TEXAS CORPORATION)  
2040 WILLIS LN  
KELLER, TX 76248 AND  
PASTOR JEFF LITTLE (UNITED STATES INDIVI-  
DUAL)  
2040 WILLIS LANE  
KELLER, TX 76248

FOR: RELIGIOUS AND SPIRITUAL SERVICES,  
NAMELY, PROVIDING GATHERINGS AND RE-  
TREATS TO DEVELOP AND ENHANCE THE SPIRI-

TUAL LIVES OF INDIVIDUALS, IN CLASS 45 (U.S.  
CLS. 100 AND 101).

FIRST USE 5-10-2002; IN COMMERCE 5-10-2002.

THE MARK CONSISTS OF STANDARD CHAR-  
ACTERS WITHOUT CLAIM TO ANY PARTICULAR  
FONT, STYLE, SIZE, OR COLOR.

SER. NO. 77-335,895, FILED 11-23-2007.

JAMES A. RAUEN, EXAMINING ATTORNEY

**Int. Cl.: 35**

**Prior U.S. Cls.: 100, 101 and 102**

**United States Patent and Trademark Office**

**Reg. No. 3,467,210**

**Registered July 15, 2008**

**SERVICE MARK  
PRINCIPAL REGISTER**

**DELIGHTFUL TREASURES**

O'LEAR, CYNTHIA (UNITED STATES INDIVIDUAL)  
43 SOUTH BAY AVENUE  
AMITYVILLE, NY 11701

FOR: ON-LINE RETAIL STORE SERVICES FEATURING STATUETTES,GIFT ITEMS;CANDLES AND CANDLE HOLDERS, NOVELTY SIGNS,GREETING CARDS,SERVING PLATES,ARTIFICIAL FLOWERS,VASES,PICTURES,CHRISTMAS ORNAMENTS AND DECORATIONS, DECORATIVE NICK NACKS AND OTHER SIMILAR ITEMS; RETAIL SHOPS FEATURING STATUETTES,GIFT ITEMS;CANDLES AND CANDLE HOLDERS, NOVELTY SIGNS,GREETING CARDS,SERVING PLATES,ARTIFICIAL FLOWERS,VASES,PICTURE-

S, CHRISTMAS ORNAMENTS AND DECORATIONS, DECORATIVE NICK NACKS AND OTHER SIMILAR ITEMS, IN CLASS 35 (U.S. CLS. 100, 101 AND 102).

FIRST USE 2-1-1998; IN COMMERCE 2-1-1998.

THE MARK CONSISTS OF STANDARD CHARACTERS WITHOUT CLAIM TO ANY PARTICULAR FONT, STYLE, SIZE, OR COLOR.

SER. NO. 77-335,900, FILED 11-23-2007.

JAMES A. RAUEN, EXAMINING ATTORNEY

**Int. Cl.: 21**

**Prior U.S. Cls.: 2, 13, 23, 29, 30, 33, 40 and 50**

**United States Patent and Trademark Office**

**Reg. No. 3,467,211**

**Registered July 15, 2008**

**TRADEMARK  
PRINCIPAL REGISTER**



COLLARD, CHRISTOPHER D. (CALIFORNIA CORPORATION)  
101 HENRY ADAMS #380  
SAN FRANCISCO, CA 94103

THE MARK CONSISTS OF THE LOGO "IAP" AND COMPANY NAME "INTERNATIONAL ART PROPERTIES" IS ALL IN ORANGE, "IAP" IS IN LARGE CAPS.

FOR: PLANTERS FOR FLOWERS AND PLANTS,  
IN CLASS 21 (U.S. CLS. 2, 13, 23, 29, 30, 33, 40 AND 50).

SER. NO. 77-335,945, FILED 11-23-2007.

FIRST USE 12-12-1992; IN COMMERCE 12-12-1992.

THE COLOR(S) ORANGE IS/ARE CLAIMED AS A FEATURE OF THE MARK.

JACQUELINE A. LAVINE, EXAMINING ATTORNEY

**Int. Cl.: 1**

**Prior U.S. Cls.: 1, 5, 6, 10, 26 and 46**

**Reg. No. 3,467,212**

**United States Patent and Trademark Office**

**Registered July 15, 2008**

---

**TRADEMARK  
PRINCIPAL REGISTER**

ALPINE SPECIALTY CHEMICALS

M-I L.L.C. (DELAWARE LTD LIAB CO)  
LEGAL DEPT. - TRADEMARKS  
5950 NORTH COURSE DRIVE  
HOUSTON, TX 77072

FOR: CHEMICAL ADDITIVES USED IN MUDS  
FOR OIL AND GAS DRILLING, IN CLASS 1 (U.S.  
CLS. 1, 5, 6, 10, 26 AND 46).

FIRST USE 6-1-2006; IN COMMERCE 6-1-2006.

THE MARK CONSISTS OF STANDARD CHAR-  
ACTERS WITHOUT CLAIM TO ANY PARTICULAR  
FONT, STYLE, SIZE, OR COLOR.

NO CLAIM IS MADE TO THE EXCLUSIVE  
RIGHT TO USE "SPECIALTY CHEMICALS", APART  
FROM THE MARK AS SHOWN.

SER. NO. 77-335,978, FILED 11-23-2007.

KIMBERLY FRYE, EXAMINING ATTORNEY

**Int. Cls.: 3, 4 and 11**

**Prior U.S. Cls.: 1, 4, 6, 13, 15, 21, 23, 31, 34, 50, 51 and 52**

**United States Patent and Trademark Office**

**Reg. No. 3,467,213**

**Registered July 15, 2008**

**TRADEMARK  
PRINCIPAL REGISTER**

**kiss your flame goodbye**

DEVINE, JULIE E. (UNITED STATES INDIVIDUAL)  
1555 FAYE RD.  
AKRON, OH 44306

FOR: ROOM FRAGRANCES; SCENTED ROOM SPRAYS; POTPOURRI; ROOM FRAGRANCE REFILLS FOR NON-ELECTRIC ROOM FRAGRANCE DISPENSERS; FRAGRANCE EMITTING WICKS FOR ROOM FRAGRANCE; SCENTED CERAMIC STONES; SCENTED OILS USED TO PRODUCE AROMAS WHEN HEATED; SCENTED PINE CONES; SCENTED WOOD, IN CLASS 3 (U.S. CLS. 1, 4, 6, 50, 51 AND 52).

FIRST USE 9-1-2007; IN COMMERCE 9-1-2007.

FOR: CANDLES; SCENTED CANDLES; FRAGRANT WAX FOR USE IN POTPOURRI BURNERS, IN CLASS 4 (U.S. CLS. 1, 6 AND 15).

FIRST USE 9-1-2007; IN COMMERCE 9-1-2007.

FOR: FRAGRANCE DISPENSING UNIT WHICH ALSO FEATURES A NIGHT LIGHT; CANDLE LAMPS; ELECTRIC BULBS; ELECTRIC CANDLES; ELECTRIC DISPENSER FOR AIR FRESHENER, IN CLASS 11 (U.S. CLS. 13, 21, 23, 31 AND 34).

FIRST USE 9-1-2007; IN COMMERCE 9-1-2007.

THE MARK CONSISTS OF STANDARD CHARACTERS WITHOUT CLAIM TO ANY PARTICULAR FONT, STYLE, SIZE, OR COLOR.

SER. NO. 77-335,985, FILED 11-23-2007.

KIMBERLY FRYE, EXAMINING ATTORNEY

**Int. Cl.: 1**

**Prior U.S. Cls.: 1, 5, 6, 10, 26 and 46**

**United States Patent and Trademark Office**

**Reg. No. 3,467,214**

**Registered July 15, 2008**

**TRADEMARK  
PRINCIPAL REGISTER**

**NUTRAPATHIC**

PARAMETRIC ASSOCIATES, INC. (MISSOURI  
CORPORATION)  
10934 LIN-VALLE DRIVE  
ST. LOUIS, MO 63123

THE MARK CONSISTS OF STANDARD CHAR-  
ACTERS WITHOUT CLAIM TO ANY PARTICULAR  
FONT, STYLE, SIZE, OR COLOR.

FOR: SOIL CONDITIONERS FOR AGRICULTUR-  
AL USE, IN CLASS 1 (U.S. CLS. 1, 5, 6, 10, 26 AND 46).

SER. NO. 77-336,055, FILED 11-23-2007.

FIRST USE 0-0-1996; IN COMMERCE 0-0-1996.

EMILY CARLSEN, EXAMINING ATTORNEY

**Int. Cl.: 19**

**Prior U.S. Cls.: 1, 12, 33 and 50**

**United States Patent and Trademark Office**

**Reg. No. 3,467,215**

**Registered July 15, 2008**

**TRADEMARK  
PRINCIPAL REGISTER**

**ARMOURTONE**

KNIGHT, ROBIN S. (UNITED STATES INDIVIDUAL)  
12600 OSITO CT. NE  
ALBUQUERQUE, NM 87111

THE MARK CONSISTS OF STANDARD CHARACTERS WITHOUT CLAIM TO ANY PARTICULAR FONT, STYLE, SIZE, OR COLOR.

FOR: PLASTERS, NAMELY, SURFACE PLASTERS, FINISH PLASTERS, IN CLASS 19 (U.S. CLS. 1, 12, 33 AND 50).

SER. NO. 77-336,070, FILED 11-23-2007.

FIRST USE 3-31-2006; IN COMMERCE 3-31-2006.

PAM WILLIS, EXAMINING ATTORNEY



**Int. Cl.: 44**

**Prior U.S. Cls.: 100 and 101**

**United States Patent and Trademark Office**

**Reg. No. 3,467,216**

**Registered July 15, 2008**

**SERVICE MARK  
PRINCIPAL REGISTER**

**Wyld Chyld**

DELUSO, WILLIAM (UNITED STATES INDIVIDUAL)  
1929 SCHERMERHORN STREET  
MERRICK, NY 11566

THE MARK CONSISTS OF STANDARD CHARACTERS WITHOUT CLAIM TO ANY PARTICULAR FONT, STYLE, SIZE, OR COLOR.

FOR: TATTOOING, IN CLASS 44 (U.S. CLS. 100 AND 101).

SER. NO. 77-336,073, FILED 11-23-2007.

FIRST USE 7-1-1989; IN COMMERCE 7-1-1989.

MICHAEL SOUDERS, EXAMINING ATTORNEY

**Int. Cl.: 5**

**Prior U.S. Cls.: 6, 18, 44, 46, 51 and 52**

**United States Patent and Trademark Office**

**Reg. No. 3,467,217**

**Registered July 15, 2008**

**TRADEMARK  
PRINCIPAL REGISTER**

BIOPERFORMA, LLC (UTAH LTD LIAB CO)  
STE 500  
2825 E. COTTONWOOD PARKWAY  
SALT LAKE CITY, UT 84121

FOR: NUTRACEUTICALS FOR USE AS A DIET-  
ARY SUPPLEMENT, IN CLASS 5 (U.S. CLS. 6, 18, 44,  
46, 51 AND 52).

FIRST USE 11-9-2007; IN COMMERCE 11-9-2007.

THE COLOR(S) GREY AND BLUE IS/ARE  
CLAIMED AS A FEATURE OF THE MARK.

THE MARK CONSISTS OF THE WORD "NEURO-  
SAFE", INCLUDING THE COLORS GREY AND  
BLUE. THE LETTERS "NEUR" ARE EXCLUSIVELY  
GREY IN COLOR. THE "O" IS GREY ON THE  
OUTSIDE AND BLUE ON THE INSIDE. THE GREY  
AND BLUE PORTIONS OF THE "O" DO NOT  
TOUCH EACH OTHER. THE LETTERS "SAFE"  
ARE EXCLUSIVELY BLUE IN COLOR.

SER. NO. 77-336,076, FILED 11-23-2007.

HOWARD SMIGA, EXAMINING ATTORNEY

Int. Cl.: 7

Prior U.S. Cls.: 13, 19, 21, 23, 31, 34 and 35

Reg. No. 3,467,218

United States Patent and Trademark Office

Registered July 15, 2008

TRADEMARK  
PRINCIPAL REGISTER

**PROBEL**

PROBELT INDUSTRIAL CORP. (TAIWAN CORPORATION)  
#12, IND. N 5TH RD., NAN KANG IND. ZONE  
NAN TOU COUNTY, TAIWAN

FOR: BELT CONVEYORS; BELTS FOR CONVEYORS; BELTS FOR MACHINES; CONVEYOR BELTS; FAN BELTS FOR MOTORS AND ENGINES; POWER TRANSMISSION BELTS FOR MACHINES; POWER TRANSMISSION BELTS FOR MACHINES, MOTORS AND ENGINES USED IN INDUSTRIAL APPLICA-

TIONS; TIMING BELTS FOR MACHINES, MOTORS AND ENGINES USED IN USED IN INDUSTRIAL APPLICATIONS, IN CLASS 7 (U.S. CLS. 13, 19, 21, 23, 31, 34 AND 35).

FIRST USE 7-31-1991; IN COMMERCE 7-31-1991.

SER. NO. 77-336,093, FILED 11-23-2007.

GEOFFREY FOSDICK, EXAMINING ATTORNEY

**Int. Cl.: 9**

**Prior U.S. Cls.: 21, 23, 26, 36 and 38**

**United States Patent and Trademark Office**

**Reg. No. 3,467,219**

**Registered July 15, 2008**

**TRADEMARK  
PRINCIPAL REGISTER**

# EarthDesk

XERIC DESIGN, LTD. (NEVADA CORPORATION)  
865 TAHOE BLVD, SUITE 214  
INCLINE VILLAGE, NV 89451

FOR: COMPUTER SCREEN SAVER SOFTWARE;  
DOWNLOADABLE COMPUTER SOFTWARE FOR  
DESKTOP, WALLPAPER OR OPERATING SYSTEM  
GRAPHICAL USER INTERFACE ENHANCEMENT;  
COMPUTER SOFTWARE FOR VISUALIZATION IN  
THE NATURE OF GRAPHICAL REPRESENTATION  
AND ANALYSIS OF SATELLITES; COMPUTER  
SOFTWARE FOR DESKTOP, WALLPAPER OR  
OPERATING SYSTEM GRAPHICAL USER INTER-  
FACE ENHANCEMENT THAT MAY BE  
DOWNLOADED FROM A GLOBAL COMPUTER

NETWORK; GRAPHICAL USER INTERFACE SOFTWARE;  
COMPUTER SOFTWARE FOR DESKTOP,  
WALLPAPER OR OPERATING SYSTEM GRAPHICAL  
USER INTERFACE ENHANCEMENT, IN  
CLASS 9 (U.S. CLS. 21, 23, 26, 36 AND 38).

FIRST USE 1-1-2002; IN COMMERCE 3-24-2002.

THE MARK CONSISTS OF STANDARD CHARACTERS  
WITHOUT CLAIM TO ANY PARTICULAR  
FONT, STYLE, SIZE, OR COLOR.

SER. NO. 77-336,120, FILED 11-24-2007.

LINDA LAVACHE, EXAMINING ATTORNEY

**Int. Cl.: 5**

**Prior U.S. Cls.: 6, 18, 44, 46, 51 and 52**

**Reg. No. 3,467,220**

**United States Patent and Trademark Office**

**Registered July 15, 2008**

---

**TRADEMARK  
PRINCIPAL REGISTER**

**SANISTAT**

NEOTEK DEVELOPMENT GROUP, LLC (TEXAS  
LTD LIAB CO)  
1009 SOUTH LINCOLN AVE  
AMARILLO, TX 79101

THE MARK CONSISTS OF STANDARD CHAR-  
ACTERS WITHOUT CLAIM TO ANY PARTICULAR  
FONT, STYLE, SIZE, OR COLOR.

FOR: ALL PURPOSE DISINFECTANTS, IN CLASS  
5 (U.S. CLS. 6, 18, 44, 46, 51 AND 52).

SER. NO. 77-336,155, FILED 11-24-2007.

FIRST USE 8-4-2006; IN COMMERCE 8-4-2006.

MONIQUE MILLER, EXAMINING ATTORNEY

**Int. Cls.: 35 and 44**

**Prior U.S. Cls.: 100, 101 and 102**

**United States Patent and Trademark Office**

**Reg. No. 3,467,221**

**Registered July 15, 2008**

**SERVICE MARK  
PRINCIPAL REGISTER**

# QuadraCare

QUADRACARE, LLC (CALIFORNIA LTD LIAB  
CO)  
981 SOUTH MERIDIAN AVENUE  
ALHAMBRA, CA 918031250

FOR: RETAIL DRUG STORE SERVICES; RETAIL  
PHARMACY SERVICES; RETAIL DRUG STORES,  
IN CLASS 35 (U.S. CLS. 100, 101 AND 102).

FIRST USE 7-11-2005; IN COMMERCE 7-11-2005.

FOR: MEDICAL SERVICES, NAMELY, INFU-  
SION SERVICES, IN CLASS 44 (U.S. CLS. 100 AND  
101).

FIRST USE 7-11-2005; IN COMMERCE 7-11-2005.

THE MARK CONSISTS OF STANDARD CHAR-  
ACTERS WITHOUT CLAIM TO ANY PARTICULAR  
FONT, STYLE, SIZE, OR COLOR.

SER. NO. 77-336,160, FILED 11-24-2007.

MONIQUE MILLER, EXAMINING ATTORNEY

**Int. Cl.: 35**

**Prior U.S. Cls.: 100, 101 and 102**

**United States Patent and Trademark Office**

**Reg. No. 3,467,222**

**Registered July 15, 2008**

**SERVICE MARK  
PRINCIPAL REGISTER**

**ECHODITTO**

ECHODITTO INC (DELAWARE CORPORATION)  
FOURTH FLOOR  
1020 16TH STREET NW  
WASHINGTON, DC 20036

FOR: BUSINESS CONSULTING SERVICES IN  
THE USE OF DEVELOPING INTERNET TOOLS TO  
PROMOTE THE GOODS AND SERVICES OF OTHERS,  
IN CLASS 35 (U.S. CLS. 100, 101 AND 102).

FIRST USE 2-0-2004; IN COMMERCE 2-0-2004.

THE MARK CONSISTS OF STANDARD CHARACTERS  
WITHOUT CLAIM TO ANY PARTICULAR FONT,  
STYLE, SIZE, OR COLOR.

SER. NO. 77-336,173, FILED 11-24-2007.

MONIQUE MILLER, EXAMINING ATTORNEY

**Int. Cl.: 35**

**Prior U.S. Cls.: 100, 101 and 102**

**United States Patent and Trademark Office**

**Reg. No. 3,467,223**

**Registered July 15, 2008**

**SERVICE MARK  
PRINCIPAL REGISTER**



ECHODITTO INC (DELAWARE CORPORATION)  
FOURTH FLOOR  
1020 16TH STREET NW  
WASHINGTON, DC 20036

FOR: BUSINESS CONSULTING SERVICES IN  
THE USE OF DEVELOPING INTERNET TOOLS TO  
PROMOTE THE GOODS AND SERVICES OF OTH-  
ERS, IN CLASS 35 (U.S. CLS. 100, 101 AND 102).

FIRST USE 2-0-2004; IN COMMERCE 2-0-2004.

THE COLOR(S) ORANGE, BLACK AND GRAY IS/  
ARE CLAIMED AS A FEATURE OF THE MARK.

THE MARK CONSISTS OF THE WORD "ECHO"  
IN ORANGE, THE WORD "DITTO" IN BLACK  
WITH AN ORANGE DOT ABOVE THE "I" AND  
REVERBERATION/"ECHO" MARKS AT THE END  
IN GRAY.

SER. NO. 77-336,175, FILED 11-24-2007.

MONIQUE MILLER, EXAMINING ATTORNEY



**Int. Cls.: 35 and 45**

**Prior U.S. Cls.: 100, 101 and 102**

**United States Patent and Trademark Office**

**Reg. No. 3,467,224**

**Registered July 15, 2008**

**SERVICE MARK  
PRINCIPAL REGISTER**

**WeCouldConnect**

SHER, JAYSON (UNITED STATES INDIVIDUAL)  
12324 VENICE BLVD  
LOS ANGELES, CA 90066

FOR: PROVIDING A WEB SITE THAT ENABLES USERS TO POST ITEMS FOR SALE THROUGH ON-LINE CLASSIFIED ADVERTISEMENTS; ADMINISTRATION OF A DISCOUNT PROGRAM FOR ENABLING PARTICIPANTS TO OBTAIN DISCOUNTS ON GOODS AND SERVICES THROUGH USE OF A DISCOUNT MEMBERSHIP CARD; ADVERTISING AND MARKETING, IN CLASS 35 (U.S. CLS. 100, 101 AND 102).

FIRST USE 9-1-2007; IN COMMERCE 9-1-2007.

FOR: INTERNET BASED SOCIAL NETWORKING, INTRODUCTION, AND DATING SERVICES, IN CLASS 45 (U.S. CLS. 100 AND 101).

FIRST USE 9-1-2007; IN COMMERCE 9-1-2007.

THE COLOR(S) GREEN, DARK BLUE AND ORANGE IS/ARE CLAIMED AS A FEATURE OF THE MARK.

THE MARK CONSISTS OF THE STYLIZED LETTERS "WECOULDCONNECT." THE COLOR GREEN APPEARS AS THE COLOR OF THE LETTERING "WE." THE COLOR DARK BLUE APPEARS AS THE COLOR OF THE LETTERING "COULD." THE COLOR ORANGE APPEARS AS THE COLOR OF THE LETTERING "CONNECT".

SER. NO. 77-336,177, FILED 11-24-2007.

KRISTIN DAHLING, EXAMINING ATTORNEY

**Int. Cl.: 12**

**Prior U.S. Cls.: 19, 21, 23, 31, 35 and 44**

**Reg. No. 3,467,225**

**United States Patent and Trademark Office**

**Registered July 15, 2008**

---

**TRADEMARK  
PRINCIPAL REGISTER**

**Alumastryke**

WHEEL SUPPLY SYSTEMS, INC. (NEVADA  
CORPORATION)  
1707 E. DEL AMO BLVD.  
CARSON, CA 90746

THE MARK CONSISTS OF STANDARD CHAR-  
ACTERS WITHOUT CLAIM TO ANY PARTICULAR  
FONT, STYLE, SIZE, OR COLOR.

FOR: WHEEL RIMS, IN CLASS 12 (U.S. CLS. 19, 21,  
23, 31, 35 AND 44).

SER. NO. 77-336,189, FILED 11-24-2007.

FIRST USE 5-1-2007; IN COMMERCE 5-1-2007.

ALLISON HOLTZ, EXAMINING ATTORNEY

**Int. Cl.: 41**

**Prior U.S. Cls.: 100, 101 and 107**

**United States Patent and Trademark Office**

**Reg. No. 3,467,226**

**Registered July 15, 2008**

**SERVICE MARK  
PRINCIPAL REGISTER**

**Nailing Jello To A Tree**

SHENANDOAH FINE ART SCHOLARSHIP OF  
NEW YORK, INC., THE (NEW YORK COR-  
PORATION)  
P.O. BOX 660167  
FLUSHING, NY 11366

FOR: ENTERTAINMENT IN THE NATURE OF  
VISUAL AND AUDIO PERFORMANCES, AND MU-  
SICAL, VARIETY, NEWS AND COMEDY SHOWS,  
IN CLASS 41 (U.S. CLS. 100, 101 AND 107).

FIRST USE 2-1-2007; IN COMMERCE 3-3-2007.

THE MARK CONSISTS OF STANDARD CHAR-  
ACTERS WITHOUT CLAIM TO ANY PARTICULAR  
FONT, STYLE, SIZE, OR COLOR.

SER. NO. 77-336,235, FILED 11-25-2007.

CHRISTINA SOBRAL, EXAMINING ATTORNEY

**Int. Cl.: 25**

**Prior U.S. Cls.: 22 and 39**

**United States Patent and Trademark Office**

**Reg. No. 3,467,227**

**Registered July 15, 2008**

**TRADEMARK  
PRINCIPAL REGISTER**



PERAZZI APPAREL COMPANY, LLC (GEORGIA  
LTD LIAB CO), DBA PZI JEANS  
5050 MEMORIAL DRIVE  
STONE MOUNTAIN, GA 30083

FIRST USE 5-24-2002; IN COMMERCE 5-24-2002.

FOR: NIGHT SHIRTS; OPEN-NECKED SHIRTS;  
PANTS; POLO SHIRTS; SHIRTS; SHIRTS FOR SUITS;  
SHORT-SLEEVED OR LONG-SLEEVED T-SHIRTS;  
SHORT-SLEEVED SHIRTS; SLEEP SHIRTS; SPORTS  
SHIRTS; SPORTS SHIRTS WITH SHORT SLEEVES;  
STRETCH PANTS; SWEAT PANTS; SWEAT SHIRTS;  
T-SHIRTS; TEE SHIRTS; A-SHIRTS; CAPRI PANTS;  
CARGO PANTS; DENIMS; DRESS SHIRTS; GOLF  
SHIRTS; JEANS; JOGGING PANTS; KNIT SHIRTS;  
LEATHER PANTS; LONG-SLEEVED SHIRTS;  
LOUNGE PANTS, IN CLASS 25 (U.S. CLS. 22 AND  
39).

NO CLAIM IS MADE TO THE EXCLUSIVE  
RIGHT TO USE "JEANS", APART FROM THE  
MARK AS SHOWN.

THE MARK CONSISTS OF A STYLIZED LETTER  
"P" IS USED IN CONJUNCTION WITH THE NAME  
AND WORDS "PZI JEANS".

SER. NO. 77-336,242, FILED 11-25-2007.

MARGERY A. TIERNEY, EXAMINING ATTORNEY

**Int. Cl.: 41**

**Prior U.S. Cls.: 100, 101 and 107**

**United States Patent and Trademark Office**

**Reg. No. 3,467,228**

**Registered July 15, 2008**

**SERVICE MARK  
PRINCIPAL REGISTER**

**Pikapet**

FUNKY FRANK, INC. (DELAWARE CORPORATION)  
4500 S. FOUR MILE RUN DR #1133  
ARLINGTON, VA 22204

FOR: ENTERTAINMENT SERVICES NAMELY,  
PROVIDING A WEBSITE FEATURING PHOTOGRAPHIC,  
AUDIO, VIDEO AND PROSE PRESENTATIONS  
FEATURING PETS, IN CLASS 41 (U.S. CLS. 100,  
101 AND 107).

FIRST USE 4-15-2006; IN COMMERCE 4-15-2006.

THE MARK CONSISTS OF STANDARD CHARACTERS  
WITHOUT CLAIM TO ANY PARTICULAR FONT,  
STYLE, SIZE, OR COLOR.

SER. NO. 77-336,261, FILED 11-25-2007.

CAROLINE WOOD, EXAMINING ATTORNEY

**Int. Cl.: 18**

**Prior U.S. Cls.: 1, 2, 3, 22 and 41**

**United States Patent and Trademark Office**

**Reg. No. 3,467,229**

**Registered July 15, 2008**

**TRADEMARK  
PRINCIPAL REGISTER**



cart by cart

CART BY CART, LLC (IOWA LTD LIAB CO)  
425 BELDON AVENUE  
IOWA CITY, IA 52446

FOR: CANVAS SHOPPING BAGS, IN CLASS 18  
(U.S. CLS. 1, 2, 3, 22 AND 41).

FIRST USE 7-1-2007; IN COMMERCE 7-1-2007.

THE MARK CONSISTS OF A 3-DIMENSIONAL  
DRAWING OF A SHOPPING CART ON WHEELS  
WITH THE WORDS "CART BY CART" CENTERED  
UNDERNEATH.

SER. NO. 77-336,268, FILED 11-25-2007.

CAROLINE WOOD, EXAMINING ATTORNEY

**Int. Cl.: 9**

**Prior U.S. Cls.: 21, 23, 26, 36 and 38**

**United States Patent and Trademark Office**

**Reg. No. 3,467,230**

**Registered July 15, 2008**

**TRADEMARK  
PRINCIPAL REGISTER**

**Willitmakeit.com**

WILLITMAKEIT, INC. (ARIZONA CORPORATION)

#760

2550 SOUTH ELLSWORTH RD.

MESA, AZ 85209

FOR: DIGITAL MEDIA, NAMELY, PRE-RECORDED VIDEO CASSETTES, DIGITAL VIDEO DISCS, DIGITAL VERSATILE DISCS, DOWNLOADABLE AUDIO AND VIDEO RECORDINGS, DVDS, AND HIGH DEFINITION DIGITAL DISKS FEATURING AUTOMOBILE STUNTS, AUTOMOBILE CRASHES,

AND RELATED RECORDINGS, IN CLASS 9 (U.S. CLS. 21, 23, 26, 36 AND 38).

FIRST USE 3-13-2005; IN COMMERCE 3-13-2005.

THE MARK CONSISTS OF STANDARD CHARACTERS WITHOUT CLAIM TO ANY PARTICULAR FONT, STYLE, SIZE, OR COLOR.

SER. NO. 77-336,269, FILED 11-25-2007.

CAROLINE WOOD, EXAMINING ATTORNEY

**Int. Cl.: 35**

**Prior U.S. Cls.: 100, 101 and 102**

**United States Patent and Trademark Office**

**Reg. No. 3,467,231**

**Registered July 15, 2008**

**SERVICE MARK  
PRINCIPAL REGISTER**

**K & K Bowling**

K & K BOWLING SERVICES, INC. (NEVADA  
CORPORATION)  
6020 W. FLAMINGO RD. #7  
LAS VEGAS, NV 89103

FOR: RETAIL SPORTING GOODS STORE,  
NAMELY, A BOWLING PRO SHOP OFFERING  
BOWLING RELATED PRODUCTS AND SERVICES,  
IN CLASS 35 (U.S. CLS. 100, 101 AND 102).

FIRST USE 5-1-2000; IN COMMERCE 5-1-2000.

THE MARK CONSISTS OF STANDARD CHAR-  
ACTERS WITHOUT CLAIM TO ANY PARTICULAR  
FONT, STYLE, SIZE, OR COLOR.

NO CLAIM IS MADE TO THE EXCLUSIVE  
RIGHT TO USE "BOWLING", APART FROM THE  
MARK AS SHOWN.

SER. NO. 77-336,288, FILED 11-25-2007.

HANNO RITTNER, EXAMINING ATTORNEY



**Int. Cl.: 9**

**Prior U.S. Cls.: 21, 23, 26, 36 and 38**

**Reg. No. 3,467,232**

**United States Patent and Trademark Office**

**Registered July 15, 2008**

**TRADEMARK  
PRINCIPAL REGISTER**



HRL TECHNOLOGIES, INC. (CALIFORNIA CORPORATION)  
SUITE 930  
5777 W. CENTURY BLVD.  
LOS ANGELES, CA 90045

FOR: COMPUTER HARDWARE AND SOFTWARE USED FOR THE CONTROL OF VOICE CONTROLLED INFORMATION AND COMMUNI-

CATION DEVICES, IN CLASS 9 (U.S. CLS. 21, 23, 26, 36 AND 38).

FIRST USE 10-1-2007; IN COMMERCE 11-5-2007.

SER. NO. 77-336,295, FILED 11-25-2007.

CIMMERIAN COLEMAN, EXAMINING ATTORNEY

**Int. Cl.: 41**

**Prior U.S. Cls.: 100, 101 and 107**

**United States Patent and Trademark Office**

**Reg. No. 3,467,233**

**Registered July 15, 2008**

**SERVICE MARK  
PRINCIPAL REGISTER**

**Lives In Motion**

LIVES IN MOTION, LLC (PENNSYLVANIA LTD  
LIAB CO)  
SUITE 17  
39 IRON HILL ROAD  
NEW BRITAIN, PA 18901

THE MARK CONSISTS OF STANDARD CHAR-  
ACTERS WITHOUT CLAIM TO ANY PARTICULAR  
FONT, STYLE, SIZE, OR COLOR.

FOR: TRAINING SERVICES IN THE FIELD OF  
PSYCHOLOGY, IN CLASS 41 (U.S. CLS. 100, 101 AND  
107).

SER. NO. 77-336,315, FILED 11-25-2007.

FIRST USE 1-1-2007; IN COMMERCE 6-1-2007.

SHAUNIA CARLYLE, EXAMINING ATTORNEY

**Int. Cl.: 5**

**Prior U.S. Cls.: 6, 18, 44, 46, 51 and 52**

**United States Patent and Trademark Office**

**Reg. No. 3,467,234**

**Registered July 15, 2008**

**TRADEMARK  
PRINCIPAL REGISTER**

# THE FEAST

URI INTERNATIONAL, INC. (NEVADA CORPORATION)  
2331 WEST PARK AVENUE  
CEDAR CITY, UT 84720

FOR: DIETARY DRINK MIX FOR USE AS A MEAL REPLACEMENT; DIETARY SUPPLEMENTAL DRINKS; MEAL REPLACEMENT AND DIETARY SUPPLEMENT DRINK MIXES; MEAL REPLACEMENT DRINKS; MEAL REPLACEMENT POWDERS; NUTRITIONAL DRINK MIX FOR USE AS A MEAL REPLACEMENT; POWDERED FRUIT-FLAVORED DIETARY SUPPLEMENT DRINK MIX, IN CLASS 5 (U.S. CLS. 6, 18, 44, 46, 51 AND 52).

FIRST USE 3-31-2006; IN COMMERCE 3-31-2006.

THE MARK CONSISTS OF STANDARD CHARACTERS WITHOUT CLAIM TO ANY PARTICULAR FONT, STYLE, SIZE, OR COLOR.

SER. NO. 77-336,321, FILED 11-25-2007.

SAMUEL E. SHARPER JR., EXAMINING ATTORNEY

**Int. Cl.: 5**

**Prior U.S. Cls.: 6, 18, 44, 46, 51 and 52**

**Reg. No. 3,467,235**

**United States Patent and Trademark Office**

**Registered July 15, 2008**

**TRADEMARK  
PRINCIPAL REGISTER**

**VEGETEIN**

URI INTERNATIONAL, INC. (NEVADA CORPORATION)  
2331 WEST PARK AVENUE  
CEDAR CITY, UT 84720

FIRST USE 7-8-2005; IN COMMERCE 7-8-2005.

FOR: DIETARY DRINK MIX FOR USE AS A MEAL REPLACEMENT; DIETARY SUPPLEMENTAL DRINKS; MEAL REPLACEMENT AND DIETARY SUPPLEMENT DRINK MIXES; MEAL REPLACEMENT DRINKS; MEAL REPLACEMENT POWDERS; NUTRITIONAL DRINK MIX FOR USE AS A MEAL REPLACEMENT; POWDERED NUTRITIONAL SUPPLEMENT DRINK MIX, IN CLASS 5 (U.S. CLS. 6, 18, 44, 46, 51 AND 52).

THE MARK CONSISTS OF STANDARD CHARACTERS WITHOUT CLAIM TO ANY PARTICULAR FONT, STYLE, SIZE, OR COLOR.

SER. NO. 77-336,331, FILED 11-26-2007.

SAMUEL E. SHARPER JR., EXAMINING ATTORNEY

**Int. Cl.: 43**

**Prior U.S. Cls.: 100 and 101**

**United States Patent and Trademark Office**

**Reg. No. 3,467,236**

**Registered July 15, 2008**

**SERVICE MARK  
PRINCIPAL REGISTER**

**IRON HILL BREWERY &  
RESTAURANT**

CHESAPEAKE & DELAWARE BREWING HOLD-  
INGS, LLC (DELAWARE LTD LIAB CO)

2502 W. 6TH STREET

WILMINGTON, DE 19805

FOR: RESTAURANT SERVICES, IN CLASS 43  
(U.S. CLS. 100 AND 101).

FIRST USE 10-1-1996; IN COMMERCE 10-1-1996.

THE MARK CONSISTS OF STANDARD CHAR-  
ACTERS WITHOUT CLAIM TO ANY PARTICULAR  
FONT, STYLE, SIZE, OR COLOR.

NO CLAIM IS MADE TO THE EXCLUSIVE  
RIGHT TO USE "BREWERY & RESTAURANT",  
APART FROM THE MARK AS SHOWN.

SER. NO. 77-336,345, FILED 11-26-2007.

GEORGE LORENZO, EXAMINING ATTORNEY

**Int. Cl.: 43**

**Prior U.S. Cls.: 100 and 101**

**United States Patent and Trademark Office**

**Reg. No. 3,467,237**

**Registered July 15, 2008**

**SERVICE MARK  
PRINCIPAL REGISTER**



CHESAPEAKE & DELAWARE BREWING HOLD-  
INGS, LLC (DELAWARE LTD LIAB CO)  
2502 W. 6TH STREET  
WILMINGTON, DE 19805

FOR: RESTAURANT SERVICES, IN CLASS 43  
(U.S. CLS. 100 AND 101).

FIRST USE 10-1-1996; IN COMMERCE 10-1-1996.

THE MARK CONSISTS OF THE DESIGN OF A  
BIRD IN FLIGHT.

SER. NO. 77-336,346, FILED 11-26-2007.

GEORGE LORENZO, EXAMINING ATTORNEY

**Int. Cl.: 19**

**Prior U.S. Cls.: 1, 12, 33 and 50**

**United States Patent and Trademark Office**

**Reg. No. 3,467,238**

**Registered July 15, 2008**

**TRADEMARK  
PRINCIPAL REGISTER**

**SUPERCAP**

DRYTEK FLOORING SOLUTIONS, LLC (NEW  
HAMPSHIRE LTD LIAB CO)  
195 NEW HAMPSHIRE AVENUE, SUITE 240  
PORTSMOUTH, NH 03801

FOR: SELF-LEVELING CONCRETE CAPPING  
CEMENT, IN CLASS 19 (U.S. CLS. 1, 12, 33 AND 50).

FIRST USE 7-31-2007; IN COMMERCE 7-31-2007.

THE MARK CONSISTS OF STANDARD CHAR-  
ACTERS WITHOUT CLAIM TO ANY PARTICULAR  
FONT, STYLE, SIZE, OR COLOR.

SER. NO. 77-336,374, FILED 11-26-2007.

LEIGH CAROLINE CASE, EXAMINING ATTOR-  
NEY

**Int. Cl.: 35**

**Prior U.S. Cls.: 100, 101 and 102**

**United States Patent and Trademark Office**

**Reg. No. 3,467,239**

**Registered July 15, 2008**

**SERVICE MARK  
PRINCIPAL REGISTER**

**ARE YOU CONNECTED?**

CENTRAL EQUINE, LLC (TENNESSEE LTD  
LIAB CO)  
1579 MONROE DRIVE, SUITE F-242  
ATLANTA, GA 30324

FOR: PROVIDING A WEB SITE THAT ENABLES  
USERS TO POST HORSES FOR SALE THROUGH  
ON-LINE CLASSIFIED ADVERTISEMENTS AND  
DISPLAYING ADVERTISEMENTS FOR OTHERS  
IN THE FIELD OF HORSES AND EQUIPMENT  
RELATED TO THE EQUINE INDUSTRY, IN CLASS  
35 (U.S. CLS. 100, 101 AND 102).

FIRST USE 11-30-2007; IN COMMERCE 11-30-2007.

THE MARK CONSISTS OF STANDARD CHAR-  
ACTERS WITHOUT CLAIM TO ANY PARTICULAR  
FONT, STYLE, SIZE, OR COLOR.

SER. NO. 77-336,384, FILED 11-26-2007.

ANTHONY RINKER, EXAMINING ATTORNEY



**Int. Cl.: 9**

**Prior U.S. Cls.: 21, 23, 26, 36 and 38**

**Reg. No. 3,467,240**

**United States Patent and Trademark Office**

**Registered July 15, 2008**

---

**TRADEMARK  
PRINCIPAL REGISTER**

**JOHN DEERE**

DEERE & COMPANY (DELAWARE CORPORATION)  
TRADEMARK LAW GROUP - WOB  
ONE JOHN DEERE PLACE  
MOLINE, IL 61265

FOR: ELECTRIC LIGHT SWITCH PLATES, MAGNETS, SUNGLASSES, THERMOMETERS; SCIENTIFIC APPARATUS, NAMELY, GRADUATED RULERS, TAPE MEASURES, LEVEL INDICATORS, MOUSE PADS, CALCULATORS, CD CASES, IN CLASS 9 (U.S. CLS. 21, 23, 26, 36 AND 38).

FIRST USE 12-1-2000; IN COMMERCE 12-1-2000.

THE MARK CONSISTS OF STANDARD CHARACTERS WITHOUT CLAIM TO ANY PARTICULAR FONT, STYLE, SIZE, OR COLOR.

THE NAME "JOHN DEERE" DOES NOT IDENTIFY A LIVING INDIVIDUAL.

SER. NO. 77-336,386, FILED 11-26-2007.

CHRISTOPHER BUONGIORNO, EXAMINING ATTORNEY

**Int. Cl.: 35**

**Prior U.S. Cls.: 100, 101 and 102**

**United States Patent and Trademark Office**

**Reg. No. 3,467,241**

**Registered July 15, 2008**

**SERVICE MARK  
PRINCIPAL REGISTER**

**BE PREPARED FOR LIFE**

INTELLIQUOTE INSURANCE SERVICES, INC.  
(CALIFORNIA CORPORATION)  
5170 GOLDEN FOOTHILL PARKWAY  
EL DORADO HILLS, CA 95762

FOR: PROVIDING INSURANCE PRICE QUOTATIONS; PROMOTION OF FINANCIAL AND INSURANCE SERVICES ON BEHALF OF THIRD PARTIES; PROMOTING THE GOODS AND SERVICES OF OTHERS VIA SEARCH ENGINE REFERRAL TRAFFIC ANALYSIS AND REPORTING; PROMOTING THE GOODS AND SERVICES OF OTHERS BY PROVIDING A WEBSITE AT WHICH USERS CAN LINK TO VARIOUS SERVICES RELATED TO THE

INSURANCE INDUSTRY; AND PROVIDING LIFE INSURANCE AGENT REFERRALS, IN CLASS 35 (U.S. CLS. 100, 101 AND 102).

FIRST USE 7-20-2007; IN COMMERCE 7-20-2007.

THE MARK CONSISTS OF STANDARD CHARACTERS WITHOUT CLAIM TO ANY PARTICULAR FONT, STYLE, SIZE, OR COLOR.

SER. NO. 77-336,391, FILED 11-26-2007.

ARETHA SOMERVILLE, EXAMINING ATTORNEY

**Int. Cl.: 11**

**Prior U.S. Cls.: 13, 21, 23, 31 and 34**

**Reg. No. 3,467,242**

**United States Patent and Trademark Office**

**Registered July 15, 2008**

**TRADEMARK  
PRINCIPAL REGISTER**

**JOHN DEERE**

DEERE & COMPANY (DELAWARE CORPORATION)  
TRADEMARK LAW GROUP - WOB  
ONE JOHN DEERE PLACE  
MOLINE, IL 61265

FOR: FLASHLIGHTS, SPOTLIGHTS, LAMP  
SHADES, ELECTRIC POPCORN POPPERS, ELECTRIC  
LIGHTS FOR CHRISTMAS TREES, IN CLASS  
11 (U.S. CLS. 13, 21, 23, 31 AND 34).

FIRST USE 12-1-2000; IN COMMERCE 12-2-2000.

THE MARK CONSISTS OF STANDARD CHARACTERS WITHOUT CLAIM TO ANY PARTICULAR FONT, STYLE, SIZE, OR COLOR.

THE NAME "JOHN DEERE" DOES NOT IDENTIFY A LIVING INDIVIDUAL.

SER. NO. 77-336,397, FILED 11-26-2007.

CHRISTOPHER BUONGIORNO, EXAMINING ATTORNEY

**Int. Cl.: 16**

**Prior U.S. Cls.: 2, 5, 22, 23, 29, 37, 38 and 50**

**United States Patent and Trademark Office**

**Reg. No. 3,467,243**

**Registered July 15, 2008**

**TRADEMARK  
PRINCIPAL REGISTER**

**ROOM100**

THOMPSON HOTELS LLC (DELAWARE LTD  
LIAB CO)  
100 VANDAM STREET, 4TH FLOOR  
NEW YORK, NY 10013

THE MARK CONSISTS OF STANDARD CHAR-  
ACTERS WITHOUT CLAIM TO ANY PARTICULAR  
FONT, STYLE, SIZE, OR COLOR.

FOR: MAGAZINE OF GENERAL NEWS AND  
FEATURES, IN CLASS 16 (U.S. CLS. 2, 5, 22, 23, 29,  
37, 38 AND 50).

SER. NO. 77-336,411, FILED 11-26-2007.

FIRST USE 3-12-2007; IN COMMERCE 3-12-2007.

ELLEN B. AWRICH, EXAMINING ATTORNEY

**Int. Cls.: 36 and 37**

**Prior U.S. Cls.: 100, 101, 102, 103 and 106**

**United States Patent and Trademark Office**

**Reg. No. 3,467,244**

**Registered July 15, 2008**

**SERVICE MARK  
PRINCIPAL REGISTER**

**POKO**

POKO MANAGEMENT CORP. (NEW YORK CORPORATION)  
225 WESTCHESTER AVENUE  
PORT CHESTER, NY 10573

FOR: REAL ESTATE SERVICES, NAMELY, LISTING, LEASING, AND MANAGING COMMERCIAL AND RESIDENTIAL REAL PROPERTY, IN CLASS 36 (U.S. CLS. 100, 101 AND 102).

FIRST USE 0-0-1993; IN COMMERCE 0-0-1993.

FOR: REAL ESTATE DEVELOPMENT OF COMMERCIAL AND RESIDENTIAL PROPERTY; REAL ESTATE CONSTRUCTION SERVICES, NAMELY, PLANNING, LAYING OUT AND CUSTOM CONSTRUCTION OF RESIDENTIAL AND COMMER-

CIAL COMMUNITIES, IN CLASS 37 (U.S. CLS. 100, 103 AND 106).

FIRST USE 0-0-1999; IN COMMERCE 0-0-1999.

THE MARK CONSISTS OF STANDARD CHARACTERS WITHOUT CLAIM TO ANY PARTICULAR FONT, STYLE, SIZE, OR COLOR.

THE WORDING "POKO" HAS NO MEANING IN A FOREIGN LANGUAGE.

SER. NO. 77-336,412, FILED 11-26-2007.

ANDREW RHIM, EXAMINING ATTORNEY

**Int. Cls.: 36 and 37**

**Prior U.S. Cls.: 100, 101, 102, 103 and 106**

**United States Patent and Trademark Office**

**Reg. No. 3,467,245**

**Registered July 15, 2008**

**SERVICE MARK  
PRINCIPAL REGISTER**

**POKO**

POKO MANAGEMENT CORP. (NEW YORK CORPORATION)  
225 WESTCHESTER AVENUE  
PORT CHESTER, NY 10573

FOR: REAL ESTATE SERVICES, NAMELY, LISTING, LEASING, AND MANAGING COMMERCIAL AND RESIDENTIAL REAL PROPERTY, IN CLASS 36 (U.S. CLS. 100, 101 AND 102).

FIRST USE 0-0-1993; IN COMMERCE 0-0-1993.

FOR: REAL ESTATE DEVELOPMENT OF COMMERCIAL AND RESIDENTIAL PROPERTY; REAL ESTATE CONSTRUCTION SERVICES, NAMELY, PLANNING, LAYING OUT AND CUSTOM CON-

STRUCTION OF RESIDENTIAL AND COMMERCIAL COMMUNITIES, IN CLASS 37 (U.S. CLS. 100, 103 AND 106).

FIRST USE 0-0-1999; IN COMMERCE 0-0-1999.

THE MARK CONSISTS OF THE WORD "POKO" IN STYLIZED LETTERING.

THE WORDING "POKO" HAS NO MEANING IN A FOREIGN LANGUAGE.

SER. NO. 77-336,426, FILED 11-26-2007.

ANDREW RHIM, EXAMINING ATTORNEY

**Int. Cl.: 16**

**Prior U.S. Cls.: 2, 5, 22, 23, 29, 37, 38 and 50**

**Reg. No. 3,467,246**

**United States Patent and Trademark Office**

**Registered July 15, 2008**

**TRADEMARK  
PRINCIPAL REGISTER**

**JOHN DEERE**

DEERE & COMPANY (DELAWARE CORPORATION)  
TRADEMARK LAW GROUP - WOB  
ONE JOHN DEERE PLACE  
MOLINE, IL 61265

FOR: PENS, CHECKBOOK COVERS, LETTER OPENERS, GENERAL PURPOSE PLASTIC BAGS, SCRAPBOOKS, ADHESIVE NOTE PAPER, NOTE PADS, NOTE CARDS, DECALS, BUMPER STICKERS, ART PRINTS, IN CLASS 16 (U.S. CLS. 2, 5, 22, 23, 29, 37, 38 AND 50).

FIRST USE 12-1-2000; IN COMMERCE 12-1-2000.

THE MARK CONSISTS OF STANDARD CHARACTERS WITHOUT CLAIM TO ANY PARTICULAR FONT, STYLE, SIZE, OR COLOR.

THE NAME "JOHN DEERE" DOES NOT IDENTIFY A LIVING INDIVIDUAL.

SER. NO. 77-336,433, FILED 11-26-2007.

CHRISTOPHER BUONGIORNO, EXAMINING ATTORNEY

**Int. Cl.: 18**

**Prior U.S. Cls.: 1, 2, 3, 22 and 41**

**Reg. No. 3,467,247**

**United States Patent and Trademark Office**

**Registered July 15, 2008**

**TRADEMARK  
PRINCIPAL REGISTER**

**JOHN DEERE**

DEERE & COMPANY (DELAWARE CORPORATION)  
TRADEMARK LAW GROUP - WOB  
ONE JOHN DEERE PLACE  
MOLINE, IL 61265

FOR: PERSONAL ACCESSORIES, NAMELY, BACKPACKS, BRIEFCASES, BRIEFCASE-TYPE PORTFOLIOS, DUFFEL BAGS, TOTE BAGS, WALLETS AND UMBRELLAS, IN CLASS 18 (U.S. CLS. 1, 2, 3, 22 AND 41).

FIRST USE 12-1-2000; IN COMMERCE 12-1-2000.

THE MARK CONSISTS OF STANDARD CHARACTERS WITHOUT CLAIM TO ANY PARTICULAR FONT, STYLE, SIZE, OR COLOR.

THE NAME "JOHN DEERE" DOES NOT IDENTIFY A LIVING INDIVIDUAL.

SER. NO. 77-336,446, FILED 11-26-2007.

CHRISTOPHER BUONGIORNO, EXAMINING ATTORNEY



**Int. Cl.: 25**

**Prior U.S. Cls.: 22 and 39**

**United States Patent and Trademark Office**

**Reg. No. 3,467,248**

**Registered July 15, 2008**

**TRADEMARK  
PRINCIPAL REGISTER**

**VINTAGE HEM**

VINTAGE HEM, L.C. (UTAH LTD LIAB CO),  
DBA VINTAGE HEM, LLC  
11878 NORTH JUPITER CIRCLE  
HIGHLAND, UT 840033644

THE MARK CONSISTS OF STANDARD CHAR-  
ACTERS WITHOUT CLAIM TO ANY PARTICULAR  
FONT, STYLE, SIZE, OR COLOR.

FOR: SLIPS, IN CLASS 25 (U.S. CLS. 22 AND 39).

SER. NO. 77-336,476, FILED 11-26-2007.

FIRST USE 6-6-2007; IN COMMERCE 6-6-2007.

BENJAMIN ALLEN, EXAMINING ATTORNEY

**Int. Cl.: 43**

**Prior U.S. Cls.: 100 and 101**

**United States Patent and Trademark Office**

**Reg. No. 3,467,249**

**Registered July 15, 2008**

**SERVICE MARK  
PRINCIPAL REGISTER**

# FIRST WATCH

FIRST WATCH RESTAURANTS, INC. (DELA-  
WARE CORPORATION)

9027 TOWN CENTER PARKWAY

BRADENTON, FL 34202

FOR: RESTAURANT SERVICES, IN CLASS 43  
(U.S. CLS. 100 AND 101).

FIRST USE 2-18-1983; IN COMMERCE 2-18-1983.

THE MARK CONSISTS OF STANDARD CHAR-  
ACTERS WITHOUT CLAIM TO ANY PARTICULAR  
FONT, STYLE, SIZE, OR COLOR.

OWNER OF U.S. REG. NOS. 1,551,457, 2,935,978  
AND OTHERS.

SER. NO. 77-336,496, FILED 11-26-2007.

VIVIAN MICZNIK FIRST, EXAMINING ATTOR-  
NEY

**Int. Cl.: 4**

**Prior U.S. Cls.: 1, 6 and 15**

**United States Patent and Trademark Office**

**Reg. No. 3,467,250**

**Registered July 15, 2008**

**TRADEMARK  
PRINCIPAL REGISTER**

**AGLUBE**

WINDECKER INC. (CALIFORNIA CORPORATION)  
940 H. ST.  
LOS BANOS, CA 93635

FOR: ALL PURPOSE LUBRICANTS; AUTOMOTIVE LUBRICANTS; GEAR OILS; HYDRAULIC OILS; INDUSTRIAL GREASES; INDUSTRIAL LUBRICANTS; LUBRICATING GREASES; LUBRICATING OIL FOR MOTOR VEHICLE ENGINES , IN CLASS 4 (U.S. CLS. 1, 6 AND 15).

FIRST USE 1-2-2002; IN COMMERCE 1-2-2002.

THE MARK CONSISTS OF STANDARD CHARACTERS WITHOUT CLAIM TO ANY PARTICULAR FONT, STYLE, SIZE, OR COLOR.

SER. NO. 77-336,529, FILED 11-26-2007.

JACLYN KIDWELL, EXAMINING ATTORNEY

**Int. Cl.: 41**

**Prior U.S. Cls.: 100, 101 and 107**

**United States Patent and Trademark Office**

**Reg. No. 3,467,251**

**Registered July 15, 2008**

**SERVICE MARK  
PRINCIPAL REGISTER**

**CHINESE NEW YEAR  
SPECTACULAR**

UNIVERSAL COMMUNICATIONS NETWORK,  
INC. (NEW JERSEY CORPORATION), DBA  
NEW TANG DYNASTY TELEVISION  
SUITE #1200  
229 W. 28TH STREET  
NEW YORK, NY 10001

FOR: ENTERTAINMENT SERVICES, NAMELY,  
THE PRODUCTION AND PRESENTATION OF  
THEATRICAL AND MUSICAL SHOWS AND TRA-  
DITIONAL CHINESE DANCE PERFORMANCES, IN  
CLASS 41 (U.S. CLS. 100, 101 AND 107).

FIRST USE 9-1-2006; IN COMMERCE 9-1-2006.

THE MARK CONSISTS OF STANDARD CHAR-  
ACTERS WITHOUT CLAIM TO ANY PARTICULAR  
FONT, STYLE, SIZE, OR COLOR.

NO CLAIM IS MADE TO THE EXCLUSIVE  
RIGHT TO USE "CHINESE NEW YEAR", APART  
FROM THE MARK AS SHOWN.

SER. NO. 77-336,538, FILED 11-26-2007.

SHAILA SETTLES, EXAMINING ATTORNEY

**Int. Cl.: 30**

**Prior U.S. Cl.: 46**

**United States Patent and Trademark Office**

**Reg. No. 3,467,252**

**Registered July 15, 2008**

**TRADEMARK  
PRINCIPAL REGISTER**

**FRUISSANT**

EDIBLE ARRANGEMENTS, LLC (CONNECTI-  
CUT LTD LIAB CO)  
95 BARNES ROAD  
WALLINGFORD, CT 094921800

FOR: SANDWICHES; SANDWICHES, NAMELY,  
FRUIT SANDWICHES, FRUIT AND NUT SANDWI-  
CHES AND FRUIT AND CHEESE SANDWICHES, IN  
CLASS 30 (U.S. CL. 46).

FIRST USE 10-4-2007; IN COMMERCE 10-4-2007.

THE MARK CONSISTS OF STANDARD CHAR-  
ACTERS WITHOUT CLAIM TO ANY PARTICULAR  
FONT, STYLE, SIZE, OR COLOR.

SER. NO. 77-336,545, FILED 11-26-2007.

MORGAN WYNNE, EXAMINING ATTORNEY

**Int. Cl.: 36**

**Prior U.S. Cls.: 100, 101 and 102**

**United States Patent and Trademark Office**

**Reg. No. 3,467,253**

**Registered July 15, 2008**

**SERVICE MARK  
PRINCIPAL REGISTER**

**Are You Ready For Life?**

AVELINO & ASSOCIATES, P.C. (NEW YORK  
CORPORATION)  
25TH FLOOR  
225 BROADWAY  
NEW YORK, NY 10007

THE MARK CONSISTS OF STANDARD CHAR-  
ACTERS WITHOUT CLAIM TO ANY PARTICULAR  
FONT, STYLE, SIZE, OR COLOR.

FOR: ESTATE PLANNING, IN CLASS 36 (U.S. CLS.  
100, 101 AND 102).

SER. NO. 77-336,552, FILED 11-26-2007.

FIRST USE 1-1-2006; IN COMMERCE 4-10-2006.

JASON LOTT, EXAMINING ATTORNEY

**Int. Cl.: 30**

**Prior U.S. Cl.: 46**

**United States Patent and Trademark Office**

**Reg. No. 3,467,254**

**Registered July 15, 2008**

**TRADEMARK  
PRINCIPAL REGISTER**

**JOHN DEERE**

DEERE & COMPANY (DELAWARE CORPORATION)  
TRADEMARK LAW GROUP - WOB  
ONE JOHN DEERE PLACE  
MOLINE, IL 61265

FOR: COFFEE; CONFECTIONERY, NAMELY,  
CHEWING GUM AND LOLLIPOPS, IN CLASS 30  
(U.S. CL. 46).

FIRST USE 12-1-2000; IN COMMERCE 12-1-2000.

THE MARK CONSISTS OF STANDARD CHARACTERS WITHOUT CLAIM TO ANY PARTICULAR FONT, STYLE, SIZE, OR COLOR.

THE NAME "JOHN DEERE" DOES NOT IDENTIFY A LIVING INDIVIDUAL.

SER. NO. 77-336,554, FILED 11-26-2007.

CHRISTOPHER BUONGIORNO, EXAMINING ATTORNEY

**Int. Cl.: 35**

**Prior U.S. Cls.: 100, 101 and 102**

**United States Patent and Trademark Office**

**Reg. No. 3,467,255**

**Registered July 15, 2008**

**SERVICE MARK  
PRINCIPAL REGISTER**

**PREMAQUEST**

PREMAQUEST VENTURES (NEVADA CORPORATION)  
2783 ANNANDALE LANE  
SIMI VALLEY, CA 93063

THE MARK CONSISTS OF STANDARD CHARACTERS WITHOUT CLAIM TO ANY PARTICULAR FONT, STYLE, SIZE, OR COLOR.

FOR: EMPLOYMENT HIRING, RECRUITING, PLACEMENT, STAFFING AND CAREER NETWORKING SERVICES, IN CLASS 35 (U.S. CLS. 100, 101 AND 102).

SER. NO. 77-336,555, FILED 11-26-2007.

FIRST USE 9-15-2006; IN COMMERCE 9-15-2006.

CAROL SPILS, EXAMINING ATTORNEY



**Int. Cl.: 41**

**Prior U.S. Cls.: 100, 101 and 107**

**United States Patent and Trademark Office**

**Reg. No. 3,467,256**

**Registered July 15, 2008**

**SERVICE MARK  
PRINCIPAL REGISTER**

CHINESE NEW YEAR SPLENDOR

UNIVERSAL COMMUNICATIONS NETWORK,  
INC. (NEW JERSEY CORPORATION), DBA  
NEW TANG DYNASTY TELEVISION  
SUITE #1200  
229 W. 28TH STREET  
NEW YORK, NY 10001

FOR: ENTERTAINMENT SERVICES, NAMELY,  
THE PRODUCTION AND PRESENTATION OF  
THEATRICAL AND MUSICAL SHOWS AND TRA-  
DITIONAL CHINESE DANCE PERFORMANCES, IN  
CLASS 41 (U.S. CLS. 100, 101 AND 107).

FIRST USE 9-1-2007; IN COMMERCE 9-1-2007.

THE MARK CONSISTS OF STANDARD CHAR-  
ACTERS WITHOUT CLAIM TO ANY PARTICULAR  
FONT, STYLE, SIZE, OR COLOR.

NO CLAIM IS MADE TO THE EXCLUSIVE  
RIGHT TO USE "CHINESE NEW YEAR", APART  
FROM THE MARK AS SHOWN.

SER. NO. 77-336,571, FILED 11-26-2007.

SHAILA SETTLES, EXAMINING ATTORNEY

Int. Cl.: 43

Prior U.S. Cls.: 100 and 101

United States Patent and Trademark Office

Reg. No. 3,467,257

Registered July 15, 2008

SERVICE MARK  
PRINCIPAL REGISTER



SWANKY SHACK (TEXAS LTD LIAB CO)  
2813 RACE STREET  
FORT WORTH, TX 76111

FOR: CATERING; PROVIDING OF FOOD AND  
DRINK; RESTAURANT SERVICES, IN CLASS 43  
(U.S. CLS. 100 AND 101).

FIRST USE 6-20-2006; IN COMMERCE 7-9-2007.

THE MARK CONSISTS OF THE LITERAL TERMS  
"SWANKY SHACK" AND INTEGRATED DESIGN.

THE DESIGN IS AT THE CENTER OF THE MARK  
AND IS A CARTOON IMAGE OF THE HEAD OF A  
CAT WEARING SUNGLASSES AND HOLDING A  
CUP OF COFFEE. THE LITERAL TERMS ARE  
ALONG THE TOP AND BOTTOM OF THE MARK,  
ENCIRCLING THE DESIGN.

SER. NO. 77-336,588, FILED 11-26-2007.

JUDITH HELFMAN, EXAMINING ATTORNEY

**Int. Cl.: 13**

**Prior U.S. Cls.: 2 and 9**

**United States Patent and Trademark Office**

**Reg. No. 3,467,258**

**Registered July 15, 2008**

**TRADEMARK  
PRINCIPAL REGISTER**



FAMARS DI ABBIATICO & SALVINELLI S.R.L.  
(ITALY LIMITED LIABILITY COMPANY)  
VIA VALTROMPIA 16/18  
GARDONE V.T. (BS), ITALY 25063

THE MARK CONSISTS OF A FANCIFUL DESIGN  
OF A COAT OF ARMS THAT INCLUDES THE  
TERM "FAMARS".

FOR: FIREARMS; AMMUNITION AND PROJEC-  
TILES; EXPLOSIVES; FIREWORKS, IN CLASS 13  
(U.S. CLS. 2 AND 9).

SER. NO. 77-336,612, FILED 11-26-2007.

FIRST USE 1-1-1968; IN COMMERCE 1-1-1968.

ALLISON SCHRODY, EXAMINING ATTORNEY

**Int. Cl.: 41**

**Prior U.S. Cls.: 100, 101 and 107**

**United States Patent and Trademark Office**

**Reg. No. 3,467,259**

**Registered July 15, 2008**

**SERVICE MARK  
PRINCIPAL REGISTER**

**OMJIVA**

LEE, SHANNA (UNITED STATES INDIVIDUAL)  
875 THIRD AVENUE  
C/O NORRIS, MCLAUGHLIN & MARCUS  
NEW YORK, NY 10022

THE MARK CONSISTS OF STANDARD CHAR-  
ACTERS WITHOUT CLAIM TO ANY PARTICULAR  
FONT, STYLE, SIZE, OR COLOR.

FOR: YOGA INSTRUCTION, IN CLASS 41 (U.S.  
CLS. 100, 101 AND 107).

SER. NO. 77-336,618, FILED 11-26-2007.

FIRST USE 2-0-2005; IN COMMERCE 5-0-2007.

JUDITH HELFMAN, EXAMINING ATTORNEY

Int. Cl.: 35

Prior U.S. Cls.: 100, 101 and 102

United States Patent and Trademark Office

Reg. No. 3,467,260

Registered July 15, 2008

**SERVICE MARK  
PRINCIPAL REGISTER**



CACTUS MUSIC LLC (TEXAS LTD LIAB CO)  
2110 PORTSMOUTH ST.  
HOUSTON, TX 77098

FOR: RETAIL MUSIC AND RECORD STORES,  
ART GALLERIES, IN CLASS 35 (U.S. CLS. 100, 101  
AND 102).

FIRST USE 11-10-2007; IN COMMERCE 11-10-2007.

NO CLAIM IS MADE TO THE EXCLUSIVE  
RIGHT TO USE "RECORD" AND "HOUSTON  
TEXAS", APART FROM THE MARK AS SHOWN.

THE MARK CONSISTS OF THE STYLIZED  
TERMS "RECORD RANCH" PRECEDING A STY-  
LIZED DEPICTION OF A COWBOY HOLDING TWO  
RECORDS DIRECTLY ABOVE THE TERMS "HOUS-  
TON TEXAS".

SER. NO. 77-336,622, FILED 11-26-2007.

JUDITH HELFMAN, EXAMINING ATTORNEY

**Int. Cl.: 14**

**Prior U.S. Cls.: 2, 27, 28 and 50**

**United States Patent and Trademark Office**

**Reg. No. 3,467,261**

**Registered July 15, 2008**

---

**TRADEMARK  
PRINCIPAL REGISTER**

**Lifetime Mothers**

ROBERT ALEXANDER JEWELERS, INC. (MI-  
CHIGAN CORPORATION)  
SUITE 354  
6632 TELEGRAPH ROAD  
BLOOMFIELD HILLS, MI 48301

THE MARK CONSISTS OF STANDARD CHAR-  
ACTERS WITHOUT CLAIM TO ANY PARTICULAR  
FONT, STYLE, SIZE, OR COLOR.

FOR: JEWELRY; WATCHES, IN CLASS 14 (U.S.  
CLS. 2, 27, 28 AND 50).

SER. NO. 77-336,630, FILED 11-26-2007.

FIRST USE 8-29-2000; IN COMMERCE 10-1-2000.

ALICE BENMAMAN, EXAMINING ATTORNEY

**Int. Cl.: 24**

**Prior U.S. Cls.: 42 and 50**

**United States Patent and Trademark Office**

**Reg. No. 3,467,262**

**Registered July 15, 2008**

**TRADEMARK  
PRINCIPAL REGISTER**

**JOHN DEERE**

DEERE & COMPANY (DELAWARE CORPORATION)  
TRADEMARK LAW GROUP - WOB  
ONE JOHN DEERE PLACE  
MOLINE, IL 61265

FOR: BED BLANKETS, BLANKET THROWS,  
TOWELS, PILLOW CASES, COMFORTERS, BED  
SKIRTS, CURTAINS AND SHOWER CURTAINS,  
IN CLASS 24 (U.S. CLS. 42 AND 50).

FIRST USE 12-1-2000; IN COMMERCE 12-1-2000.

THE MARK CONSISTS OF STANDARD CHARACTERS WITHOUT CLAIM TO ANY PARTICULAR FONT, STYLE, SIZE, OR COLOR.

SER. NO. 77-336,673, FILED 11-26-2007.

CHRISTOPHER BUONGIORNO, EXAMINING ATTORNEY

Int. Cl.: 32

Prior U.S. Cls.: 45, 46 and 48

Reg. No. 3,467,263

United States Patent and Trademark Office

Registered July 15, 2008

TRADEMARK  
PRINCIPAL REGISTER

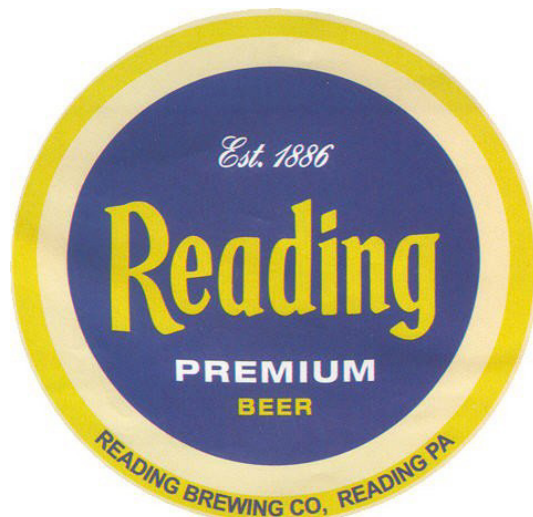

INVESTMENT CAPITAL MANAGEMENT, LLC  
(PENNSYLVANIA LTD LIAB CO)  
850 N WYOMISSING BLVD  
WYOMISSING, PA 19610

FOR: BEER, ALE AND LAGER, IN CLASS 32 (U.S.  
CLS. 45, 46 AND 48).

FIRST USE 8-1-2007; IN COMMERCE 8-1-2007.

NO CLAIM IS MADE TO THE EXCLUSIVE  
RIGHT TO USE "EST. 1886 READING PREMIUM  
BEER READING BREWING CO, READING, PA",  
APART FROM THE MARK AS SHOWN.

THE COLOR(S) BLUE, WHITE AND YELLOW IS/  
ARE CLAIMED AS A FEATURE OF THE MARK.

THE MARK CONSISTS OF A CENTER CIRCLE  
OF DARK BLUE, WITH CONCENTRIC RINGS OF  
YELLOW SURROUNDING IT. THE COLOR BLUE  
APPEARS IN THE WORDING "READING BREW-  
ING CO., READING PA" AND IN THE DESIGN OF  
THE INTERIOR CIRCLE BACKGROUND; THE  
COLOR YELLOW APPEARS IN THE WORDING  
"READING" AND IN THE DESIGN OF THE OUT-  
ERMOST YELLOW RING; THE COLOR WHITE  
APPEARS IN THE WORDING "EST. 1886" AND  
"PREMIUM" AND IN THE DESIGN OF THE MID-  
DLE RING.

SER. NO. 77-336,691, FILED 11-26-2007.

JOHN SCHUYLER YARD, EXAMINING ATTOR-  
NEY



**Int. Cl.: 14**

**Prior U.S. Cls.: 2, 27, 28 and 50**

**United States Patent and Trademark Office**

**Reg. No. 3,467,264**

**Registered July 15, 2008**

**TRADEMARK  
PRINCIPAL REGISTER**

**JOHN DEERE**

DEERE & COMPANY (DELAWARE CORPORATION)  
TRADEMARK LAW GROUP - WOB  
ONE JOHN DEERE PLACE  
MOLINE, IL 61265

FOR: PERSONAL ACCESSORIES, NAMELY, LAP-  
PEL PINS, CLOCKS, WATCHES, IN CLASS 14 (U.S.  
CLS. 2, 27, 28 AND 50).

FIRST USE 12-1-2000; IN COMMERCE 12-1-2000.

THE MARK CONSISTS OF STANDARD CHAR-  
ACTERS WITHOUT CLAIM TO ANY PARTICULAR  
FONT, STYLE, SIZE, OR COLOR.

THE NAME "JOHN DEERE" DOES NOT IDENTI-  
FY A LIVING INDIVIDUAL.

SER. NO. 77-336,701, FILED 11-26-2007.

CHRISTOPHER BUONGIORNO, EXAMINING AT-  
TORNEY

**Int. Cl.: 20**

**Prior U.S. Cls.: 2, 13, 22, 25, 32 and 50**

**Reg. No. 3,467,265**

**United States Patent and Trademark Office**

**Registered July 15, 2008**

**TRADEMARK  
PRINCIPAL REGISTER**

**JOHN DEERE**

DEERE & COMPANY (DELAWARE CORPORATION)  
TRADEMARK LAW GROUP - WOB  
ONE JOHN DEERE PLACE  
MOLINE, IL 61265

FOR: MERCHANDISING ITEMS, NAMELY, VINYL APPLIQUÉS FOR ATTACHMENT TO WINDOWS, MIRRORS AND OTHER SOLID SURFACES, PLASTIC FLAGS, PLASTIC KEY CHAIN TAGS, PILLOWS, FURNITURE, OUTDOOR FURNITURE, WIND CHIMES, IN CLASS 20 (U.S. CLS. 2, 13, 22, 25, 32 AND 50).

FIRST USE 12-1-2000; IN COMMERCE 12-1-2000.

THE MARK CONSISTS OF STANDARD CHARACTERS WITHOUT CLAIM TO ANY PARTICULAR FONT, STYLE, SIZE, OR COLOR.

THE NAME "JOHN DEERE" DOES NOT IDENTIFY A LIVING INDIVIDUAL.

SER. NO. 77-336,735, FILED 11-26-2007.

CHRISTOPHER BUONGIORNO, EXAMINING ATTORNEY

**Int. Cl.: 42**

**Prior U.S. Cls.: 100 and 101**

**United States Patent and Trademark Office**

**Reg. No. 3,467,266**

**Registered July 15, 2008**

**SERVICE MARK  
PRINCIPAL REGISTER**

**HEAT TRAX**

REFINED TECHNOLOGIES, INC. (DELAWARE  
CORPORATION)  
P.O. BOX 132196  
THE WOODLANDS, TX 77393

FOR: TECHNICAL CONSULTING SERVICES,  
NAMELY, TRACKING PERFORMANCE OF PET-  
ROCHEMICAL EQUIPMENT FOR SCHEDULED  
MAINTENANCE, IN CLASS 42 (U.S. CLS. 100 AND  
101).

FIRST USE 11-14-2006; IN COMMERCE 11-14-2006.

THE MARK CONSISTS OF STANDARD CHAR-  
ACTERS WITHOUT CLAIM TO ANY PARTICULAR  
FONT, STYLE, SIZE, OR COLOR.

NO CLAIM IS MADE TO THE EXCLUSIVE  
RIGHT TO USE "HEAT", APART FROM THE MARK  
AS SHOWN.

SER. NO. 77-336,748, FILED 11-26-2007.

MARK PILARO, EXAMINING ATTORNEY

**Int. Cl.: 36**

**Prior U.S. Cls.: 100, 101 and 102**

**United States Patent and Trademark Office**

**Reg. No. 3,467,267**

**Registered July 15, 2008**

**SERVICE MARK  
PRINCIPAL REGISTER**

**CFC**

U.S. OFFICE OF PERSONNEL MANAGEMENT  
(UNITED STATES AGENCY OF THE UNITED  
STATES GOVERNMENT)  
OFFICE OF THE GENERAL COUNSEL  
1900 E STREET NW  
WASHINGTON, DC 20415

FIRST USE 0-0-1964; IN COMMERCE 0-0-1964.

THE MARK CONSISTS OF STANDARD CHAR-  
ACTERS WITHOUT CLAIM TO ANY PARTICULAR  
FONT, STYLE, SIZE, OR COLOR.

FOR: CHARITABLE FUND RAISING PROGRAM  
WITHIN THE FEDERAL GOVERNMENT, IN CLASS  
36 (U.S. CLS. 100, 101 AND 102).

SER. NO. 77-336,750, FILED 11-26-2007.

JENNY PARK, EXAMINING ATTORNEY

**Int. Cl.: 21**

**Prior U.S. Cls.: 2, 13, 23, 29, 30, 33, 40 and 50**

**United States Patent and Trademark Office**

**Reg. No. 3,467,268**

**Registered July 15, 2008**

**TRADEMARK  
PRINCIPAL REGISTER**

**JOHN DEERE**

DEERE & COMPANY (DELAWARE CORPORATION)  
TRADEMARK LAW GROUP - WOB  
ONE JOHN DEERE PLACE  
MOLINE, IL 61265

FOR: BUCKETS, GLASS BEVERAGeware, CUPS, MUGS, THERMAL INSULATED SLEEVE HOLDERS FOR BEVERAGE CANS, PEPPER GRINDERS, SALT AND PEPPER SHAKERS, VACUUM BOTTLES, THERMAL INSULATED CONTAINERS FOR FOOD OR BEVERAGE, AND BARBECUE GRILL ACCESSORIES, NAMELY, SPATULAS, TONGS, COOKING FORKS; BATH ACCESSORIES, NAMELY, TUMBLERS IN THE NATURE OF DRINKING VESSELS, TOOTHBRUSH HOLDERS, SOAP DISHES, WASTEPAPER BASKETS, LOTION

DISPENSERS WITH PUMPS, IN CLASS 21 (U.S. CLS. 2, 13, 23, 29, 30, 33, 40 AND 50).

FIRST USE 12-1-2000; IN COMMERCE 12-1-2000.

THE MARK CONSISTS OF STANDARD CHARACTERS WITHOUT CLAIM TO ANY PARTICULAR FONT, STYLE, SIZE, OR COLOR.

THE NAME "JOHN DEERE" DOES NOT IDENTIFY A LIVING INDIVIDUAL.

SER. NO. 77-336,780, FILED 11-26-2007.

TRICIA SONNEBORN, EXAMINING ATTORNEY

**Int. Cls.: 35, 37, 40, 42 and 45**

**Prior U.S. Cls.: 100, 101, 102, 103 and 106**

**United States Patent and Trademark Office**

**Reg. No. 3,467,269**

**Registered July 15, 2008**

**SERVICE MARK  
PRINCIPAL REGISTER**



BURNS & MCDONNELL ENGINEERING COMPANY (MISSOURI CORPORATION)  
9400 WARD PARKWAY  
KANSAS CITY, MO 64114

FOR: BUSINESS CONSULTING, MANAGEMENT, PLANNING AND SUPERVISION; BUSINESS CONSULTING AND INFORMATION SERVICES, IN CLASS 35 (U.S. CLS. 100, 101 AND 102).

FIRST USE 10-12-1999; IN COMMERCE 1-1-2000.

FOR: CONSTRUCTION MANAGEMENT; CONSTRUCTION CONSULTANCY, IN CLASS 37 (U.S. CLS. 100, 103 AND 106).

FIRST USE 10-12-1999; IN COMMERCE 1-1-2000.

FOR: ENVIRONMENTAL REMEDIATION SERVICES, NAMELY, SOIL, WASTE AND/OR WATER TREATMENT SERVICES, IN CLASS 40 (U.S. CLS. 100, 103 AND 106).

FIRST USE 10-12-1999; IN COMMERCE 1-1-2000.

FOR: ENGINEERING; ARCHITECTURAL DESIGN; CONSULTING SERVICES IN THE FIELD OF ENVIRONMENTAL ASSESSMENT, COMPLIANCE AND PLANNING; CONSULTING IN THE FIELDS OF ENGINEERING AND ARCHITECTURE, IN CLASS 42 (U.S. CLS. 100 AND 101).

FIRST USE 10-12-1999; IN COMMERCE 1-1-2000.

FOR: PERMITTING, NAMELY, OBTAINING ENVIRONMENTAL, DESIGN, ZONING AND OTHER GOVERNMENTAL PERMITS FOR DEVELOPMENT PROJECTS, IN CLASS 45 (U.S. CLS. 100 AND 101).

FIRST USE 10-12-1999; IN COMMERCE 1-1-2000.

NO CLAIM IS MADE TO THE EXCLUSIVE RIGHT TO USE "SINCE 1898", APART FROM THE MARK AS SHOWN.

THE COLOR(S) WHITE AND BLUE IS/ARE CLAIMED AS A FEATURE OF THE MARK.

THE COLOR WHITE APPEARS IN THE WORDING "BURNS & MCDONNELL SINCE 1898", THE LINE FORMING THE INSIDE FRAMING OF THE MARK AND THE TWO HORIZONTAL LINES ACROSS THE MIDDLE OF THE MARK, AND THE COLOR BLUE APPEARS IN THE LINE FORMING THE OUTSIDE FRAMING OF THE MARK AND IN THE BACKGROUND OF THE MARK.

SER. NO. 77-336,785, FILED 11-26-2007.

JOHN GARTNER, EXAMINING ATTORNEY

**Int. Cl.: 41**

**Prior U.S. Cls.: 100, 101 and 107**

**United States Patent and Trademark Office**

**Reg. No. 3,467,270**

**Registered July 15, 2008**

**SERVICE MARK  
PRINCIPAL REGISTER**

**MISS RED HOT**

WINC PROMOTIONS, LLC (CONNECTICUT LTD  
LIAB CO)  
294 STATE STREET  
NORTH HAVEN, CT 06473

THE MARK CONSISTS OF STANDARD CHAR-  
ACTERS WITHOUT CLAIM TO ANY PARTICULAR  
FONT, STYLE, SIZE, OR COLOR.

FOR: ENTERTAINMENT IN THE NATURE OF  
BEAUTY PAGEANTS, IN CLASS 41 (U.S. CLS. 100,  
101 AND 107).

SER. NO. 77-336,791, FILED 11-26-2007.

FIRST USE 8-0-2001; IN COMMERCE 8-0-2001.

TRICIA SONNEBORN, EXAMINING ATTORNEY

**Int. Cl.: 41**

**Prior U.S. Cls.: 100, 101 and 107**

**United States Patent and Trademark Office**

**Reg. No. 3,467,271**

**Registered July 15, 2008**

**SERVICE MARK  
PRINCIPAL REGISTER**

**UNDER GOD**

WASHINGTONPOST.NEWSWEEK INTERACTIVE  
COMPANY, LLC (DELAWARE LTD LIAB CO)  
1515 N. COURTHOUSE ROAD  
ARLINGTON, VA 22201

THE MARK CONSISTS OF STANDARD CHAR-  
ACTERS WITHOUT CLAIM TO ANY PARTICULAR  
FONT, STYLE, SIZE, OR COLOR.

FOR: ONLINE JOURNALS, NAMELY, BLOGS IN  
THE FIELDS OF RELIGION AND CURRENT  
EVENTS, IN CLASS 41 (U.S. CLS. 100, 101 AND 107).

SER. NO. 77-336,805, FILED 11-26-2007.

FIRST USE 12-21-2007; IN COMMERCE 12-21-2007.

VERNA BETH RIRIE, EXAMINING ATTORNEY



**Int. Cl.: 9**

**Prior U.S. Cls.: 21, 23, 26, 36 and 38**

**Reg. No. 3,467,272**

**United States Patent and Trademark Office**

**Registered July 15, 2008**

---

**TRADEMARK  
PRINCIPAL REGISTER**

**Axuality**

BUTLER, BRIAN C. (UNITED STATES INDIVIDUAL)  
APT 326  
716 W GRAND AVE  
EAU CLAIRE, WI 54703

THE MARK CONSISTS OF STANDARD CHARACTERS WITHOUT CLAIM TO ANY PARTICULAR FONT, STYLE, SIZE, OR COLOR.

FOR: DOWNLOADABLE MUSICAL SOUND RECORDINGS; MUSICAL SOUND RECORDINGS, IN CLASS 9 (U.S. CLS. 21, 23, 26, 36 AND 38).

SER. NO. 77-336,813, FILED 11-26-2007.

FIRST USE 8-1-2005; IN COMMERCE 6-1-2007.

KARANENDRA S. CHHINA, EXAMINING ATTORNEY

**Int. Cl.: 32**

**Prior U.S. Cls.: 45, 46 and 48**

**United States Patent and Trademark Office**

**Reg. No. 3,467,273**

**Registered July 15, 2008**

**TRADEMARK  
PRINCIPAL REGISTER**

**DISARMINGLY DRINKABLE**

CAPITAL BREWERY COMPANY, INC. (WISCONSIN CORPORATION)  
7734 TERRACE AVENUE  
MIDDLETON, WI 535620185

THE MARK CONSISTS OF STANDARD CHARACTERS WITHOUT CLAIM TO ANY PARTICULAR FONT, STYLE, SIZE, OR COLOR.

FOR: BEER, IN CLASS 32 (U.S. CLS. 45, 46 AND 48).

SER. NO. 77-336,817, FILED 11-26-2007.

FIRST USE 11-5-2007; IN COMMERCE 11-5-2007.

GIANCARLO CASTRO, EXAMINING ATTORNEY

**Int. Cl.: 42**

**Prior U.S. Cls.: 100 and 101**

**United States Patent and Trademark Office**

**Reg. No. 3,467,274**

**Registered July 15, 2008**

**SERVICE MARK  
PRINCIPAL REGISTER**

# Home Branders

CENTER STAGE HOMES, INC. (ARKANSAS  
CORPORATION)  
8 NOB HILL COVE  
LITTLE ROCK, AR 72205

FOR: HOME STAGING CONSULTATION, NAME-  
LY, TEMPORARY INTERIOR AND EXTERIOR  
HOME DECORATION CONSULTATION FOR THE  
PURPOSE OF MAKING HOMES MORE APPEAL-  
ING TO PROSPECTIVE BUYERS, IN CLASS 42 (U.S.  
CLS. 100 AND 101).

FIRST USE 4-30-2007; IN COMMERCE 9-30-2007.

THE MARK CONSISTS OF STANDARD CHAR-  
ACTERS WITHOUT CLAIM TO ANY PARTICULAR  
FONT, STYLE, SIZE, OR COLOR.

NO CLAIM IS MADE TO THE EXCLUSIVE  
RIGHT TO USE "HOME", APART FROM THE  
MARK AS SHOWN.

SER. NO. 77-336,818, FILED 11-26-2007.

GIANCARLO CASTRO, EXAMINING ATTORNEY

**Int. Cl.: 30**

**Prior U.S. Cl.: 46**

**United States Patent and Trademark Office**

**Reg. No. 3,467,275**

**Registered July 15, 2008**

**TRADEMARK  
PRINCIPAL REGISTER**

**Bob's "Beyond the Bun"  
Chicken Sandwich**

BIG BOY RESTAURANTS INTERNATIONAL  
LLC (MICHIGAN LTD LIAB CO)

ONE BIG BOY DRIVE

WARREN, MI 48091

FOR: SANDWICHES, NAMELY, BREADED  
CHICKEN, IN CLASS 30 (U.S. CL. 46).

FIRST USE 4-1-2007; IN COMMERCE 4-1-2007.

THE MARK CONSISTS OF STANDARD CHAR-  
ACTERS WITHOUT CLAIM TO ANY PARTICULAR  
FONT, STYLE, SIZE, OR COLOR.

NO CLAIM IS MADE TO THE EXCLUSIVE  
RIGHT TO USE "CHICKEN SANDWICH", APART  
FROM THE MARK AS SHOWN.

SER. NO. 77-336,833, FILED 11-26-2007.

GIANCARLO CASTRO, EXAMINING ATTORNEY

**Int. Cl.: 17**

**Prior U.S. Cls.: 1, 5, 12, 13, 35 and 50**

**Reg. No. 3,467,276**

**United States Patent and Trademark Office**

**Registered July 15, 2008**

---

**TRADEMARK  
PRINCIPAL REGISTER**

**TF**

THERMALFIT LLC (NEVADA LTD LIAB CO)  
6295 MCLEOD DR. #13  
LAS VEGAS, NV 89120

THE MARK CONSISTS OF STANDARD CHAR-  
ACTERS WITHOUT CLAIM TO ANY PARTICULAR  
FONT, STYLE, SIZE, OR COLOR.

FOR: PLASTIC PIPE, PIPE FITTINGS, PIPE  
CLAMPS, AND PIPE HANGERS, IN CLASS 17 (U.S.  
CLS. 1, 5, 12, 13, 35 AND 50).

SEC. 2(F).

SER. NO. 77-336,837, FILED 11-26-2007.

FIRST USE 3-0-2006; IN COMMERCE 3-0-2006.

GIANCARLO CASTRO, EXAMINING ATTORNEY

**Int. Cl.: 41**

**Prior U.S. Cls.: 100, 101 and 107**

**United States Patent and Trademark Office**

**Reg. No. 3,467,277**

**Registered July 15, 2008**

**SERVICE MARK  
PRINCIPAL REGISTER**

**DEVAYA YOGA**

LEVIN, BARI, S. (COSTA RICA INDIVIDUAL)  
#34-5361 COBANO  
PUNTARENAS, COSTA RICA

FOR: YOGA INSTRUCTION, IN CLASS 41 (U.S.  
CLS. 100, 101 AND 107).

FIRST USE 1-1-2003; IN COMMERCE 1-1-2003.

THE MARK CONSISTS OF STANDARD CHAR-  
ACTERS WITHOUT CLAIM TO ANY PARTICULAR  
FONT, STYLE, SIZE, OR COLOR.

NO CLAIM IS MADE TO THE EXCLUSIVE  
RIGHT TO USE "YOGA", APART FROM THE  
MARK AS SHOWN.

THE FOREIGN WORDING IN THE MARK  
TRANSLATES INTO ENGLISH AS "LOVER OF  
ANGELS" OR "THE COMPASSIONATE SPIRIT".

SER. NO. 77-336,862, FILED 11-26-2007.

DAVID TAYLOR, EXAMINING ATTORNEY

**Int. Cl.: 35**

**Prior U.S. Cls.: 100, 101 and 102**

**United States Patent and Trademark Office**

**Reg. No. 3,467,278**

**Registered July 15, 2008**

**SERVICE MARK  
PRINCIPAL REGISTER**

**BRAVEHEART MARKETING**

BRAVEHEART PRODUCTIONS, INC. (GEORGIA CORPORATION)  
691 OVERLOOK DRIVE  
CANTON, GA 60114

FOR: ADVERTISING, MARKETING AND PROMOTION SERVICES, IN CLASS 35 (U.S. CLS. 100, 101 AND 102).

FIRST USE 8-1-2007; IN COMMERCE 8-1-2007.

THE MARK CONSISTS OF STANDARD CHARACTERS WITHOUT CLAIM TO ANY PARTICULAR FONT, STYLE, SIZE, OR COLOR.

NO CLAIM IS MADE TO THE EXCLUSIVE RIGHT TO USE "MARKETING", APART FROM THE MARK AS SHOWN.

SER. NO. 77-336,864, FILED 11-26-2007.

ADA HAN, EXAMINING ATTORNEY

**Int. Cl.: 36**

**Prior U.S. Cls.: 100, 101 and 102**

**United States Patent and Trademark Office**

**Reg. No. 3,467,279**

**Registered July 15, 2008**

**SERVICE MARK  
PRINCIPAL REGISTER**



DEBT SETTLEMENT USA, INC. (ARIZONA CORPORATION)  
16430 N. SCOTTSDALE ROAD  
SCOTTSDALE, AZ 85254

FOR: DEBT MANAGEMENT CONSULTATION,  
IN CLASS 36 (U.S. CLS. 100, 101 AND 102).

FIRST USE 12-1-2002; IN COMMERCE 12-1-2002.

NO CLAIM IS MADE TO THE EXCLUSIVE  
RIGHT TO USE "DEBT, SETTLEMENT, OR USA",  
APART FROM THE MARK AS SHOWN.

THE COLOR(S) NAVY AND WHITE IS/ARE  
CLAIMED AS A FEATURE OF THE MARK.

THE MARK CONSISTS OF THE WORDS "DEBT SETTLEMENT USA" WRITTEN AT THE BOTTOM OF THE MARK, "DEBT" IS WRITTEN IN WHITE ON TOP OF A NAVY BUBBLE OF SORTS AS THE BACKGROUND LEANING TOWARDS THE RIGHT AND ATTACHED TO THE BOTTOM OF A STICK FIGURE OF A MAN OUTLINED IN NAVY, THE WORD "SETTLEMENT" FILLED IN NAVY AND THE LETTERS "USA" IN ALL CAPS FILLED IN NAVY. THE STICK FIGURE OF THE MAN STARTS TOWARDS THE END OF THE WORD "SETTLEMENT" AND CONTINUES OVER THE "U".

SER. NO. 77-336,873, FILED 11-26-2007.

DAVID TAYLOR, EXAMINING ATTORNEY



**Int. Cl.: 41**

**Prior U.S. Cls.: 100, 101 and 107**

**United States Patent and Trademark Office**

**Reg. No. 3,467,280**

**Registered July 15, 2008**

**SERVICE MARK  
PRINCIPAL REGISTER**

**EVERY STUDENT LEARNS  
OUTSIDE**

AMERICAN FOREST FOUNDATION (D.C. NON-  
PROFIT CORPORATION)  
1111 NINETEENTH STREET, N.W., SUITE 780  
WASHINGTON, D.C., DC 20036

FOR: ENVIRONMENTAL EDUCATION SERVI-  
CES, NAMELY, CONDUCTING WORKSHOPS ON  
ENVIRONMENTAL TOPICS AND PROVIDING  
TRAINING IN ESTABLISHING AND CONDUCT-  
ING ENVIRONMENTAL ACTION PROJECTS; PRO-  
VIDING EDUCATIONAL INFORMATION IN  
CONJUNCTION WITH THE FOREGOING, IN  
CLASS 41 (U.S. CLS. 100, 101 AND 107).

FIRST USE 7-31-2006; IN COMMERCE 7-31-2006.

THE MARK CONSISTS OF STANDARD CHAR-  
ACTERS WITHOUT CLAIM TO ANY PARTICULAR  
FONT, STYLE, SIZE, OR COLOR.

SER. NO. 77-336,888, FILED 11-26-2007.

MELVIN AXILBUND, EXAMINING ATTORNEY

**Int. Cl.: 42**

**Prior U.S. Cls.: 100 and 101**

**United States Patent and Trademark Office**

**Reg. No. 3,467,281**

**Registered July 15, 2008**

**SERVICE MARK  
PRINCIPAL REGISTER**

**G20**

BURGESS-NORTON MFG. CO., INC. (DELA-  
WARE CORPORATION)  
737 PEYTON STREET  
GENEVA, IL 60134

THE MARK CONSISTS OF STANDARD CHAR-  
ACTERS WITHOUT CLAIM TO ANY PARTICULAR  
FONT, STYLE, SIZE, OR COLOR.

FOR: DESIGN FOR OTHERS IN THE FIELD OF  
POWDER METAL PARTS, IN CLASS 42 (U.S. CLS.  
100 AND 101).

SER. NO. 77-336,897, FILED 11-26-2007.

FIRST USE 1-12-2007; IN COMMERCE 1-12-2007.

BRENDAN MCCAULEY, EXAMINING ATTORNEY

**Int. Cl.: 44**

**Prior U.S. Cls.: 100 and 101**

**United States Patent and Trademark Office**

**Reg. No. 3,467,282**

**Registered July 15, 2008**

**SERVICE MARK  
PRINCIPAL REGISTER**

**LOOK GREAT, NOT FAKE**

BRACCI, STEPHEN P. (UNITED STATES INDIVIDUAL), DBA VERVE  
216 EAST 50TH STREET  
NEW YORK, NY 10022

FOR: MEDICAL SERVICES, NAMELY, MASSAGE, HYDROTHERAPY, HAIR REMOVAL FEATURING COSMETIC AND LASER HAIR REMOVAL, SCLEROTHERAPY TREATMENT OF LEG VEINS, COSMETIC, PLASTIC AND RECONSTRUCTIVE SURGERY, AND LASER WRINKLE REMOVAL, IN CLASS 44 (U.S. CLS. 100 AND 101).

FIRST USE 8-15-2007; IN COMMERCE 8-15-2007.

THE MARK CONSISTS OF STANDARD CHARACTERS WITHOUT CLAIM TO ANY PARTICULAR FONT, STYLE, SIZE, OR COLOR.

SER. NO. 77-336,907, FILED 11-26-2007.

BRENDAN MCCAULEY, EXAMINING ATTORNEY

**Int. Cl.: 18**

**Prior U.S. Cls.: 1, 2, 3, 22 and 41**

**United States Patent and Trademark Office**

**Reg. No. 3,467,283**

**Registered July 15, 2008**

**TRADEMARK  
PRINCIPAL REGISTER**

**MONICA RICH KOSANN**

MONICA RICH KOSANN PHOTOGRAPHY LLC  
(CONNECTICUT LTD LIAB CO)  
97 DOGWOOD LANE  
NEW CANAAN, CT 06840

FOR: HANDBAGS, CLUTCHES, EVENING BAGS,  
AND PURSES MADE FROM PRECIOUS METALS  
OR COATED THEREWITH, IN CLASS 18 (U.S. CLS.  
1, 2, 3, 22 AND 41).

FIRST USE 9-1-2006; IN COMMERCE 9-1-2006.

THE MARK CONSISTS OF STANDARD CHAR-  
ACTERS WITHOUT CLAIM TO ANY PARTICULAR  
FONT, STYLE, SIZE, OR COLOR.

THE NAME "MONICA RICH KOSANN" IDENTI-  
FIES A LIVING INDIVIDUAL WHOSE CONSENT IS  
OF RECORD.

SER. NO. 77-336,908, FILED 11-26-2007.

STEPHANIE ALI, EXAMINING ATTORNEY

Int. Cl.: 32

Prior U.S. Cls.: 45, 46 and 48

United States Patent and Trademark Office

Reg. No. 3,467,284

Registered July 15, 2008

TRADEMARK  
PRINCIPAL REGISTER



EXPERIENCE HENDRIX, L.L.C. (WASHINGTON  
LTD LIAB CO)  
14501 INTERURBAN AVENUE SOUTH  
SEATTLE, WA 98168

FOR: ENERGY DRINKS, IN CLASS 32 (U.S. CLS.  
45, 46 AND 48).

FIRST USE 1-25-2007; IN COMMERCE 5-1-2007.

OWNER OF U.S. REG. NOS. 3,001,464, 3,256,776  
AND OTHERS.

THE NAME(S), PORTRAIT(S), AND/OR SIGNA-  
TURE(S) SHOWN IN THE MARK DOES NOT IDEN-  
TIFY A PARTICULAR LIVING INDIVIDUAL.

THE MARK CONSISTS OF A STYLIZED FORM  
OF THE LITERAL ELEMENT "THE JIMI HENDRIX  
LIQUID EXPERIENCE".

SER. NO. 77-336,912, FILED 11-26-2007.

BRENDAN MCCAULEY, EXAMINING ATTORNEY

**Int. Cl.: 32**

**Prior U.S. Cls.: 45, 46 and 48**

**United States Patent and Trademark Office**

**Reg. No. 3,467,285**

**Registered July 15, 2008**

**TRADEMARK  
PRINCIPAL REGISTER**

**THE JIMI HENDRIX LIQUID  
EXPERIENCE**

EXPERIENCE HENDRIX, L.L.C. (WASHINGTON  
LTD LIAB CO)  
14501 INTERURBAN AVENUE SOUTH  
SEATTLE, WA 98168

FOR: ENERGY DRINKS, IN CLASS 32 (U.S. CLS.  
45, 46 AND 48).

FIRST USE 1-25-2007; IN COMMERCE 5-1-2007.

THE MARK CONSISTS OF STANDARD CHAR-  
ACTERS WITHOUT CLAIM TO ANY PARTICULAR  
FONT, STYLE, SIZE, OR COLOR.

OWNER OF U.S. REG. NOS. 3,001,464, 3,001,465,  
AND 3,256,776.

THE NAME(S), PORTRAIT(S), AND/OR SIGNA-  
TURE(S) SHOWN IN THE MARK DOES NOT IDEN-  
TIFY A PARTICULAR LIVING INDIVIDUAL.

SER. NO. 77-336,917, FILED 11-26-2007.

BRENDAN MCCAULEY, EXAMINING ATTORNEY

**Int. Cl.: 5**

**Prior U.S. Cls.: 6, 18, 44, 46, 51 and 52**

**Reg. No. 3,467,286**

**United States Patent and Trademark Office**

**Registered July 15, 2008**

**TRADEMARK  
PRINCIPAL REGISTER**

**B-L**

W.F. YOUNG, INCORPORATED (MASSACHU-  
SETTS CORPORATION)  
302 BENTON DRIVE  
EAST LONGMEADOW, MA 01028

THE MARK CONSISTS OF STANDARD CHAR-  
ACTERS WITHOUT CLAIM TO ANY PARTICULAR  
FONT, STYLE, SIZE, OR COLOR.

FOR: ANIMAL FEED ADDITIVE FOR USE AS A  
NUTRITIONAL SUPPLEMENT, IN CLASS 5 (U.S.  
CLS. 6, 18, 44, 46, 51 AND 52).

SER. NO. 77-336,918, FILED 11-26-2007.

FIRST USE 12-0-2000; IN COMMERCE 12-0-2000.

FRED CARL, EXAMINING ATTORNEY

**Int. Cl.: 5**

**Prior U.S. Cls.: 6, 18, 44, 46, 51 and 52**

**United States Patent and Trademark Office**

**Reg. No. 3,467,287**

**Registered July 15, 2008**

**TRADEMARK  
PRINCIPAL REGISTER**

**SO-KALM**

W.F. YOUNG, INCORPORATED (MASSACHU-  
SETTS CORPORATION)  
302 BENTON DRIVE  
EAST LONGMEADOW, MA 01028

THE MARK CONSISTS OF STANDARD CHAR-  
ACTERS WITHOUT CLAIM TO ANY PARTICULAR  
FONT, STYLE, SIZE, OR COLOR.

FOR: ANIMAL FEED ADDITIVE FOR USE AS A  
NUTRITIONAL SUPPLEMENT, IN CLASS 5 (U.S.  
CLS. 6, 18, 44, 46, 51 AND 52).

SER. NO. 77-336,946, FILED 11-26-2007.

FIRST USE 8-0-1998; IN COMMERCE 8-0-1998.

FRED CARL, EXAMINING ATTORNEY



**Int. Cl.: 44**

**Prior U.S. Cls.: 100 and 101**

**United States Patent and Trademark Office**

**Reg. No. 3,467,288**

**Registered July 15, 2008**

**SERVICE MARK  
PRINCIPAL REGISTER**

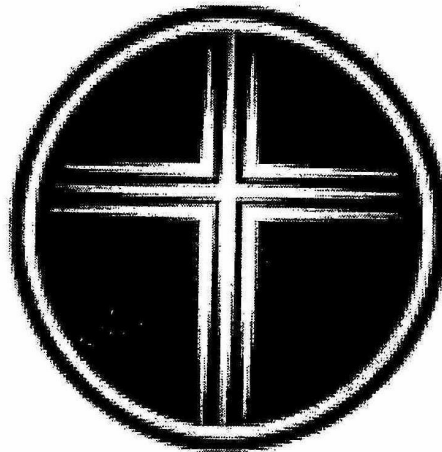

COVENANT MINISTRIES OF BENEVOLENCE  
(ILLINOIS NON-PROFIT CORPORATION)  
5145 CALIFORNIA AVENUE  
CHICAGO, IL 60625

FOR: HOSPITAL SERVICES, NAMELY, PROVIDING MEDICAL AND NURSING CARE FOR PATIENTS; PROVIDING GENERAL HEALTH, WELLNESS, AND MEDICAL INFORMATION TO THE PUBLIC; PHYSICAL THERAPY AND NUTRITIONAL GUIDANCE SERVICES, IN CLASS 44 (U.S. CLS. 100 AND 101).

FIRST USE 11-29-2006; IN COMMERCE 11-29-2006.

OWNER OF U.S. REG. NO. 1,475,472.

THE MARK CONSISTS OF A STYLIZED DESIGN OF A CROSS IN A CIRCLE.

SER. NO. 77-336,953, FILED 11-26-2007.

PAUL F. GAST, EXAMINING ATTORNEY

**Int. Cl.: 41**

**Prior U.S. Cls.: 100, 101 and 107**

**United States Patent and Trademark Office**

**Reg. No. 3,467,289**

**Registered July 15, 2008**

**SERVICE MARK  
PRINCIPAL REGISTER**



RINGLING SCHOOL OF ART & DESIGN (FLOR-  
IDA CORPORATION)  
2700 N. TAMiami TRAIL  
SARASOTA, FL 34234

FOR: EDUCATIONAL SERVICES, NAMELY,  
CONDUCTING CLASSES, SEMINARS, WORK-  
SHOPS, AND CONFERENCES IN THE FIELD OF  
VISUAL ART AND DESIGN, IN CLASS 41 (U.S. CLS.  
100, 101 AND 107).

FIRST USE 4-14-2007; IN COMMERCE 4-14-2007.

THE MARK CONSISTS OF AN OVERALL REC-  
TANGULAR SHAPE AGAINST A BACKGROUND  
OF GEOMETRIC DESIGN COMPRISING VARIOUS  
SUBDIVIDED SQUARES.

SER. NO. 77-336,968, FILED 11-26-2007.

MARIAM MAHMOUDI, EXAMINING ATTORNEY

**Int. Cl.: 30**

**Prior U.S. Cl.: 46**

**United States Patent and Trademark Office**

**Reg. No. 3,467,290**

**Registered July 15, 2008**

**TRADEMARK  
PRINCIPAL REGISTER**



GRUMA CORPORATION (NEVADA CORPORATION)  
SUITE 200  
1159 COTTONWOOD LANE  
IRVING, TX 75038

FOR: TORTILLAS, IN CLASS 30 (U.S. CL. 46).

FIRST USE 1-0-2006; IN COMMERCE 1-0-2006.

OWNER OF U.S. REG. NOS. 1,216,032, 3,178,582  
AND OTHERS.

NO CLAIM IS MADE TO THE EXCLUSIVE  
RIGHT TO USE "TORTILLAS", APART FROM THE  
MARK AS SHOWN.

THE MARK CONSISTS OF A BELL IN A HOUS-  
ING, A RECTANGLE CONTAINING THE WORD  
"MISSION", A RECTANGLE CONTAINING THE  
WORDS "TORTILLAS PLUS!", AND A RIBBON  
DESIGN.

SER. NO. 77-336,993, FILED 11-26-2007.

KELLY MCCOY, EXAMINING ATTORNEY

**Int. Cl.: 41**

**Prior U.S. Cls.: 100, 101 and 107**

**United States Patent and Trademark Office**

**Reg. No. 3,467,291**

**Registered July 15, 2008**

**SERVICE MARK  
PRINCIPAL REGISTER**

# Eggdancer

ALHAMRANI, DANYA M. (UNITED STATES  
INDIVIDUAL)  
P.O. BOX 675185  
RANCHO SANTA FE, CA 92067

FOR: ENTERTAINMENT, NAMELY, LIGHTING PRODUCTION; ENTERTAINMENT, NAMELY, PRODUCTION OF FILMS, TELEVISION PROGRAMS, AND MOTION PICTURES; MEDIA PRODUCTION LOCATION SCOUTING SERVICES FOR ENTERTAINMENT PURPOSES; MEDIA PRODUCTION SERVICES, NAMELY, VIDEO AND FILM PRODUCTION; MOTION PICTURE FILM PRODUCTION; MULTIMEDIA ENTERTAINMENT SERVICES IN THE NATURE OF RECORDING, PRODUCTION AND POST-PRODUCTION SERVICES IN THE FIELDS OF MUSIC, VIDEO, AND FILMS; OPERATION OF VIDEO EQUIPMENT OR AUDIO EQUIPMENT ETC. FOR PRODUCTION OF RADIO OR TELEVISION PROGRAMS; POST-PRODUCTION EDITING SERVICES IN THE FIELD OF MUSIC, VIDEOS AND FILMS; PRODUCTION AND DISTRIBUTION OF INDEPENDENT MOTION PICTURES; PRODUCTION AND DISTRIBUTION OF MOTION PICTURES; PRODUCTION AND DISTRIBUTION OF RADIO PROGRAMS; PRODUCTION AND DISTRIBUTION OF TELEVISION SHOWS AND MOVIES; PRODUCTION OF DVDS, VIDEOTAPES AND TELEVISION PROGRAMS FEATUR-

ING SOCIAL, CULTURE, RELIGION, AND ENTERTAINMENT CONTENT; PRODUCTION OF CABLE TELEVISION PROGRAMS; PRODUCTION OF RADIO OR TELEVISION PROGRAMS; PRODUCTION OF SOUND AND MUSIC VIDEO RECORDINGS; PRODUCTION OF VIDEO AND CREATION OF VISUAL EFFECTS FOR OTHERS FOR USE IN DVDS, TELEVISION PROGRAMS AND ON WEBSITES; PRODUCTION OF VIDEO DISCS AND TAPES; PRODUCTION OF VIDEO DISCS FOR OTHERS; PRODUCTION OF VISUAL EFFECTS FOR VIDEOS, DVDS, TELEVISION AND FOR INTERNET WEBSITES; PROVIDING FACILITIES FOR PRODUCING VIDEO, CINEMA AND PHOTOGRAPHY PRODUCTIONS; TELEVISION PRODUCTION; TELEVISION SHOW PRODUCTION; VIDEOTAPE PRODUCTION, IN CLASS 41 (U.S. CLS. 100, 101 AND 107).

FIRST USE 8-1-2001; IN COMMERCE 8-1-2001.

THE MARK CONSISTS OF STANDARD CHARACTERS WITHOUT CLAIM TO ANY PARTICULAR FONT, STYLE, SIZE, OR COLOR.

SER. NO. 77-337,010, FILED 11-26-2007.

MARY CRAWFORD, EXAMINING ATTORNEY

**Int. Cl.: 42**

**Prior U.S. Cls.: 100 and 101**

**United States Patent and Trademark Office**

**Reg. No. 3,467,292**

**Registered July 15, 2008**

**SERVICE MARK  
PRINCIPAL REGISTER**

**SMARTACUS**

SMARTACUS, INC. (OREGON CORPORATION)  
20710 NW LONGBOW LN  
BEAVERTON, OR 97006

THE MARK CONSISTS OF STANDARD CHAR-  
ACTERS WITHOUT CLAIM TO ANY PARTICULAR  
FONT, STYLE, SIZE, OR COLOR.

FOR: COMPUTER SERVICES, NAMELY, DE-  
SIGNING, INSTALLING AND MAINTAINING,  
AND SUPPORTING COMPUTER NETWORKS, IN  
CLASS 42 (U.S. CLS. 100 AND 101).

SER. NO. 77-337,018, FILED 11-26-2007.

FIRST USE 1-18-2005; IN COMMERCE 2-2-2005.

KELLY MCCOY, EXAMINING ATTORNEY

Int. Cl.: 40

Prior U.S. Cls.: 100, 103 and 106

United States Patent and Trademark Office

Reg. No. 3,467,293

Registered July 15, 2008

**SERVICE MARK  
PRINCIPAL REGISTER**



SUNSTOPPERS INC. (NORTH CAROLINA CORPORATION)  
14105 EAST INDEPENDENCE BOULEVARD  
MATTHEWS, NC 28104

FOR: PROVIDING GLASS TINTING SERVICES FOR AUTOMOBILES, HOMES, AND COMMERCIAL ESTABLISHMENTS, IN CLASS 40 (U.S. CLS. 100, 103 AND 106).

FIRST USE 2-0-2007; IN COMMERCE 2-0-2007.

NO CLAIM IS MADE TO THE EXCLUSIVE RIGHT TO USE "PROFESSIONAL GLASS TINTING", APART FROM THE MARK AS SHOWN.

SER. NO. 77-337,041, FILED 11-26-2007.

TINA BROWN, EXAMINING ATTORNEY

**Int. Cl.: 37**

**Prior U.S. Cls.: 100, 103 and 106**

**United States Patent and Trademark Office**

**Reg. No. 3,467,294**

**Registered July 15, 2008**

**SERVICE MARK  
PRINCIPAL REGISTER**

**CONNECTING AT HOME**

COMMUNICATION CABLES, LLC (COLORADO  
LTD LIAB CO), DBA COMCABLES  
2607 WEST 8TH AVENUE  
DENVER, CO 80204

THE MARK CONSISTS OF STANDARD CHAR-  
ACTERS WITHOUT CLAIM TO ANY PARTICULAR  
FONT, STYLE, SIZE, OR COLOR.

FOR: TELECOMMUNICATION WIRING, IN  
CLASS 37 (U.S. CLS. 100, 103 AND 106).

SER. NO. 77-337,058, FILED 11-26-2007.

FIRST USE 9-30-2007; IN COMMERCE 9-30-2007.

ROBIN CHOSID, EXAMINING ATTORNEY

**Int. Cl.: 41**

**Prior U.S. Cls.: 100, 101 and 107**

**United States Patent and Trademark Office**

**Reg. No. 3,467,295**

**Registered July 15, 2008**

**SERVICE MARK  
PRINCIPAL REGISTER**

**CEESAU**

CEESAU INCORPORATION (CALIFORNIA CORPORATION)  
42 LA FORGE AVENUE  
STATEN ISLAND, NY 10302

FOR: ENTERTAINMENT SERVICES, NAMELY, LIVE, TELEVISED AND MOVIE APPEARANCES BY A PROFESSIONAL ENTERTAINER; ENTERTAINMENT SERVICES, NAMELY, PERSONAL APPEARANCES BY A MUSICIAN AND ACTOR; ENTERTAINMENT SERVICES, NAMELY, PROVIDING A WEB SITE FEATURING MUSICAL PERFORMANCES, MUSICAL VIDEOS, RELATED FILM CLIPS, PHOTOGRAPHS, AND OTHER MULTIMEDIA MATERIALS; MULTIMEDIA ENTERTAINMENT SERVICES IN THE NATURE OF

RECORDING, PRODUCTION AND POST-PRODUCTION SERVICES IN THE FIELDS OF MUSIC, VIDEO, AND FILMS, IN CLASS 41 (U.S. CLS. 100, 101 AND 107).

FIRST USE 6-1-1999; IN COMMERCE 6-1-1999.

THE MARK CONSISTS OF STANDARD CHARACTERS WITHOUT CLAIM TO ANY PARTICULAR FONT, STYLE, SIZE, OR COLOR.

SER. NO. 77-337,079, FILED 11-26-2007.

TAMARA FRAZIER, EXAMINING ATTORNEY



**Int. Cl.: 9**

**Prior U.S. Cls.: 21, 23, 26, 36 and 38**

**Reg. No. 3,467,296**

**United States Patent and Trademark Office**

**Registered July 15, 2008**

**TRADEMARK  
PRINCIPAL REGISTER**

The logo for Secoda features the word "secoda" in a lowercase, sans-serif font. The letters "s", "e", "c", and "d" are in a dark green color. The letter "o" is in a light grey color. A semi-circle in the same dark green color is positioned above the "c" and "o".

SECODA RISK MANAGEMENT, LTD. (UNITED  
KINGDOM LIMITED COMPANY (LTD.))  
TAVERN QUAY BUSINESS CENTRE  
ROPE STREET UNIT 11  
LONDON, ENGLAND SE167TX

FOR: COMPUTER SOFTWARE FOR POLICY  
MANAGEMENT, NAMELY RISK ASSESSMENT  
AND COMPLIANCE IN THE FIELDS OF INFOR-  
MATION SECURITY, FINANCIAL AND LEGAL  
SERVICES, AND HUMAN RESOURCES, IN CLASS  
9 (U.S. CLS. 21, 23, 26, 36 AND 38).

FIRST USE 12-18-2006; IN COMMERCE 12-18-2006.

THE COLOR(S) GREEN, AND GREY IS/ARE  
CLAIMED AS A FEATURE OF THE MARK.

THE MARK CONSISTS OF THE WORD SECODA  
IN GREEN WITH THE LETTER "O" IN GREY, AND  
A GREEN A SEMI- CIRCLE ABOVE THE LETTERS  
"C" AND "O".

SER. NO. 77-337,103, FILED 11-26-2007.

NAKWAMA ANKRAH, EXAMINING ATTORNEY

**Int. Cl.: 9**

**Prior U.S. Cls.: 21, 23, 26, 36 and 38**

**Reg. No. 3,467,297**

**United States Patent and Trademark Office**

**Registered July 15, 2008**

---

**TRADEMARK  
PRINCIPAL REGISTER**

**SLEEK & CHIC**

LIMELIFE, INC. (CALIFORNIA CORPORATION)  
SUITE 230  
4300 BOHANNON DRIVE  
MENLO PARK, CA 94025

THE MARK CONSISTS OF STANDARD CHAR-  
ACTERS WITHOUT CLAIM TO ANY PARTICULAR  
FONT, STYLE, SIZE, OR COLOR.

FOR: DOWNLOADABLE GRAPHICS VIA WIRE-  
LESS DEVICES, IN CLASS 9 (U.S. CLS. 21, 23, 26, 36  
AND 38).

SER. NO. 77-337,136, FILED 11-26-2007.

FIRST USE 2-20-2007; IN COMMERCE 2-20-2007.

PATRICIA EVANKO, EXAMINING ATTORNEY

**Int. Cl.: 45**

**Prior U.S. Cls.: 100 and 101**

**United States Patent and Trademark Office**

**Reg. No. 3,467,298**

**Registered July 15, 2008**

**SERVICE MARK  
PRINCIPAL REGISTER**

**LibertyBell Law Group**

LIBERTYBELL LAW GROUP (CALIFORNIA  
PARTNERSHIP)

245 EAST OLIVE AVENUE, 4TH FLOOR

BURBANK, CA 91502

FOR: ATTORNEY SERVICES, IN CLASS 45 (U.S.  
CLS. 100 AND 101).

FIRST USE 10-1-2007; IN COMMERCE 10-16-2007.

THE MARK CONSISTS OF STANDARD CHAR-  
ACTERS WITHOUT CLAIM TO ANY PARTICULAR  
FONT, STYLE, SIZE, OR COLOR.

NO CLAIM IS MADE TO THE EXCLUSIVE  
RIGHT TO USE "LAW GROUP", APART FROM  
THE MARK AS SHOWN.

SER. NO. 77-337,149, FILED 11-26-2007.

LINDSEY RUBIN, EXAMINING ATTORNEY

**Int. Cl.: 41**

**Prior U.S. Cls.: 100, 101 and 107**

**United States Patent and Trademark Office**

**Reg. No. 3,467,299**

**Registered July 15, 2008**

**SERVICE MARK  
PRINCIPAL REGISTER**

**TRI-DOG**

TRI-DOG SPORTS, TRAVEL & TRAINING, LLC  
(TEXAS LTD LIAB CO)

#1  
607 MASON ST.  
TOMBALL, TX 77375

THE MARK CONSISTS OF STANDARD CHAR-  
ACTERS WITHOUT CLAIM TO ANY PARTICULAR  
FONT, STYLE, SIZE, OR COLOR.

FOR: DOG TRAINING, IN CLASS 41 (U.S. CLS.  
100, 101 AND 107).

SER. NO. 77-337,158, FILED 11-26-2007.

FIRST USE 10-22-2003; IN COMMERCE 6-17-2004.

PAUL CROWLEY, EXAMINING ATTORNEY

**Int. Cl.: 16**

**Prior U.S. Cls.: 2, 5, 22, 23, 29, 37, 38 and 50**

**United States Patent and Trademark Office**

**Reg. No. 3,467,300**

**Registered July 15, 2008**

---

**TRADEMARK  
PRINCIPAL REGISTER**

**Buzzboy**

GALLAGHER, JOHN (UNITED STATES INDIVIDUAL)  
7948 FREEHOLLOW DRIVE  
FALLS CHURCH, VA 22042

THE MARK CONSISTS OF STANDARD CHARACTERS WITHOUT CLAIM TO ANY PARTICULAR FONT, STYLE, SIZE, OR COLOR.

FOR: COMIC BOOKS, IN CLASS 16 (U.S. CLS. 2, 5, 22, 23, 29, 37, 38 AND 50).

SER. NO. 77-337,181, FILED 11-26-2007.

FIRST USE 6-1-1997; IN COMMERCE 10-1-1997.

MICHELE SWAIN, EXAMINING ATTORNEY

**Int. Cl.: 45**

**Prior U.S. Cls.: 100 and 101**

**United States Patent and Trademark Office**

**Reg. No. 3,467,301**

**Registered July 15, 2008**

**SERVICE MARK  
PRINCIPAL REGISTER**

**YOUR GREAT GARAGE**

YOUR GREAT GARAGE, LLC (FLORIDA LTD  
LIAB CO)  
SUITE 302  
13911 WEST HILLSBOROUGH AVENUE  
TAMPA, FL 33635

FOR: ORGANIZATIONAL SERVICES FOR HOME  
OR PERSONAL PURPOSES, NAMELY, ORGANIZ-  
ING GARAGE SPACE, IN CLASS 45 (U.S. CLS. 100  
AND 101).

FIRST USE 1-1-2005; IN COMMERCE 6-1-2006.

THE MARK CONSISTS OF STANDARD CHAR-  
ACTERS WITHOUT CLAIM TO ANY PARTICULAR  
FONT, STYLE, SIZE, OR COLOR.

SER. NO. 77-337,189, FILED 11-26-2007.

ERIN FALK, EXAMINING ATTORNEY

**Int. Cl.: 3**

**Prior U.S. Cls.: 1, 4, 6, 50, 51 and 52**

**Reg. No. 3,467,302**

**United States Patent and Trademark Office**

**Registered July 15, 2008**

**TRADEMARK  
PRINCIPAL REGISTER**

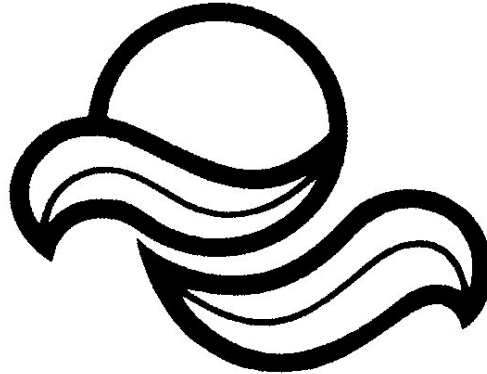

CD&P HEALTH PRODUCTS, INC. (NEW JERSEY CORPORATION)  
86 LACKAWANNA AVENUE  
WEST PATERSON, NJ 07424

BATH FOAM, FACIAL MASKS, BODY MASKS, BEAUTY MASKS, IN CLASS 3 (U.S. CLS. 1, 4, 6, 50, 51 AND 52).

FIRST USE 5-24-1983; IN COMMERCE 5-24-1983.

THE MARK CONSISTS OF TWO STYLIZED WAVES, ONE SUPERIMPOSED OVER A CIRCLE.

SER. NO. 77-337,205, FILED 11-26-2007.

FOR: AROMATHERAPY OILS, BATH OILS, BODY OILS, ESSENTIAL OILS, MASSAGE OILS, BODY LOTION, FACE LOTION, HAND LOTION, FOOT LOTION, BODY CLEANSERS, FACIAL CLEANSERS, BODY SCRUBS, FACIAL SCRUBS, SKIN MOISTURIZERS, BODY SPRAYS, AROMATHERAPY SPRAYS, SKIN CREAM, EYE CREAM, BODY CREAM, BATH GELS, BEAUTY GELS, BATH SALTS, SOAP, BATH POWDER, SHOWER AND

THOMAS MANOR, EXAMINING ATTORNEY

**Int. Cl.: 28**

**Prior U.S. Cls.: 22, 23, 38 and 50**

**United States Patent and Trademark Office**

**Reg. No. 3,467,303**

**Registered July 15, 2008**

---

**TRADEMARK  
PRINCIPAL REGISTER**

**TRAFFIC TREATS**

MICHAEL JAMES CULHANE (UNITED STATES  
INDIVIDUAL)  
4439 SAINT CLAIR AVENUE  
STUDIO CITY, CA 91604

THE MARK CONSISTS OF STANDARD CHAR-  
ACTERS WITHOUT CLAIM TO ANY PARTICULAR  
FONT, STYLE, SIZE, OR COLOR.

FOR: COUNTERS AND MARBLES FOR GAMES,  
IN CLASS 28 (U.S. CLS. 22, 23, 38 AND 50).

SER. NO. 77-337,209, FILED 11-26-2007.

FIRST USE 8-22-2000; IN COMMERCE 11-25-2007.

PAUL CROWLEY, EXAMINING ATTORNEY



**Int. Cl.: 45**

**Prior U.S. Cls.: 100 and 101**

**United States Patent and Trademark Office**

**Reg. No. 3,467,304**

**Registered July 15, 2008**

**SERVICE MARK  
PRINCIPAL REGISTER**

# PreScreen Plus

PRESCREEN AMERICA, INC (TEXAS CORPORATION), DBA PRESCREEN AMERICA  
505 WEST ABRAM STREET  
ARLINGTON, TX 76010

FOR: PRE-EMPLOYMENT BACKGROUND INVESTIGATION SERVICES; PRE-EMPLOYMENT BACKGROUND SCREENING, IN CLASS 45 (U.S. CLS. 100 AND 101).

FIRST USE 7-16-1998; IN COMMERCE 7-16-1998.

THE MARK CONSISTS OF STANDARD CHARACTERS WITHOUT CLAIM TO ANY PARTICULAR FONT, STYLE, SIZE, OR COLOR.

NO CLAIM IS MADE TO THE EXCLUSIVE RIGHT TO USE "PRESCREEN", APART FROM THE MARK AS SHOWN.

SER. NO. 77-337,239, FILED 11-26-2007.

DAVID YONTEF, EXAMINING ATTORNEY

**Int. Cl.: 3**

**Prior U.S. Cls.: 1, 4, 6, 50, 51 and 52**

**Reg. No. 3,467,305**

**United States Patent and Trademark Office**

**Registered July 15, 2008**

**TRADEMARK  
PRINCIPAL REGISTER**

**SHAZBROEK**

BILLEY, SHARON A. (NEW YORK LTD LIAB  
CO), DBA SHAZBROEK, LLC  
9501 CHURCH AVENUE  
BROOKLYN, NY 11212

FOR: SOAPS AND BODY CARE PRODUCTS FOR PERSONAL SKIN CARE, AROMATHERAPY OR COSMETIC USE NAMELY, SCENTED OR UNSCENTED CLEANSING CREAMS, SOAPS, GELS, SCRUBS, MASQUES, TONERS, CONDITIONERS, MOISTURIZERS, SUNSCREEN AND SUNTAN OILS AND CREAMS, SKIN CREAMS, BALMS, LOTIONS, OILS, MILK FOR COSMETIC PURPOSES; SOAPS SCENTED OR UNSCENTED FOR SKIN CARE USE NAMELY BAR SOAPS, LIQUID SOAPS, CREAM SOAPS, GEL SOAPS, SHOWER GELS, SHAVING SOAPS; SCENTED OR UNSCENTED SHAVING PRODUCTS NAMELY, SHAVING CREAMS, SHAVING SOAPS, SHAVING GELS, SHAVING FOAMS, PRESHAVE LOTIONS, TONICS, CREAMS AND BALMS, AFTERSHAVE LOTIONS TONICS, CREAMS AND BALMS FOR SKIN CARE USE AND COSMETIC PURPOSES; SCENTED OR UNSCENTED HAIR CARE PREPARATIONS NAMELY, SHAMPOOS, LOTIONS, TONICS, CONDITIONERS, MASQUES, CREAMS, GELS AND GROOMING PREPARATIONS FOR SKIN CARE AND COSMETIC USE; SCENTED OR UNSCENTED BATH PRODUCTS NAMELY, BATH OILS, BUBBLE BATHS,

FOAM BATHS, BATH MILK, BATH CRYSTALS, BATH SALTS, BATH POWDERS, BATH SOAKS, BATH OILS FOR SKIN CARE AND COSMETIC USE; SCENTED AND UNSCENTED BODY MASSAGE PRODUCTS NAMELY, BODY MASSAGE CREAMS, LOTIONS, OILS AND BALMS FOR SKIN CARE AND COSMETIC USE; PERFUMES, SCENTED OILS, SCENTED OR UNSCENTED BODY SPRAYS AND MISTS, COLOGNES AND ESSENCES, PERSONAL DEODORANTS, BODY POWDERS, NON-MEDICATED LIP CARE PREPARATIONS NAMELY LIP OINTMENTS, LIP STICKS, LIP GELS, LIP CREAMS, LIP BALMS, LIP SCRUBS FOR SKIN CARE AND COSMETIC USE; SINGLE OR BLENDED VEGETABLE BUTTERS FOR SKIN CARE AND COSMETIC USE; SINGLE OR BLENDED ESSENTIAL OILS FOR PERSONAL USE, IN CLASS 3 (U.S. CLS. 1, 4, 6, 50, 51 AND 52).

FIRST USE 10-3-2005; IN COMMERCE 10-14-2005.

THE MARK CONSISTS OF STANDARD CHARACTERS WITHOUT CLAIM TO ANY PARTICULAR FONT, STYLE, SIZE, OR COLOR.

SER. NO. 77-337,255, FILED 11-26-2007.

REBECCA GILBERT, EXAMINING ATTORNEY

**Int. Cl.: 16**

**Prior U.S. Cls.: 2, 5, 22, 23, 29, 37, 38 and 50**

**United States Patent and Trademark Office**

**Reg. No. 3,467,306**

**Registered July 15, 2008**

**TRADEMARK  
PRINCIPAL REGISTER**

**D HOME**

D MAGAZINE PARTNERS, L.P. (TEXAS LIMITED PARTNERSHIP)  
4311 OAK LAWN, FIRST FLOOR  
DALLAS, TX 75219

OWNER OF U.S. REG. NOS. 2,512,363, 2,910,096  
AND OTHERS.

FOR: MAGAZINES FEATURING HOME AND GARDEN CONTENT, IN CLASS 16 (U.S. CLS. 2, 5, 22, 23, 29, 37, 38 AND 50).

NO CLAIM IS MADE TO THE EXCLUSIVE RIGHT TO USE "HOME", APART FROM THE MARK AS SHOWN.

FIRST USE 3-14-2000; IN COMMERCE 3-14-2000.

SER. NO. 77-337,256, FILED 11-26-2007.

THE MARK CONSISTS OF STANDARD CHARACTERS WITHOUT CLAIM TO ANY PARTICULAR FONT, STYLE, SIZE, OR COLOR.

ODESSA BIBBINS, EXAMINING ATTORNEY

**Int. Cl.: 9**

**Prior U.S. Cls.: 21, 23, 26, 36 and 38**

**Reg. No. 3,467,307**

**United States Patent and Trademark Office**

**Registered July 15, 2008**

**TRADEMARK  
PRINCIPAL REGISTER**

**MAXIMALPOWER**

AMERICAN DIGITAL ACCESSORIES CORP.  
(CALIFORNIA CORPORATION)  
16031 ARROW HWY., UNIT H  
IRWINDALE, CA 91706, CA 91706

FOR: BATTERIES, NAMELY, BATTERIES FOR TWO-WAY RADIO DEVICES, DIGITAL CAMERAS, CAMCORDERS, CELLULAR PHONES, GAME SYSTEMS, AND PERSONAL DIGITAL ASSISTANTS (PD); BATTERY CHARGERS; UNIVERSAL BATTERY CHARGERS; TRIPODS; CARRYING CASES FOR DIGITAL DEVICES, NAMELY, TWO-WAY RADIO, DIGITAL CAMERAS, CAMCORDERS, CELLULAR PHONE, GAME SYSTEMS, PERSONAL DI-

GITAL ASSISTANTS (PDA), AND NOTEBOOK COMPUTER, IN CLASS 9 (U.S. CLS. 21, 23, 26, 36 AND 38).

FIRST USE 6-0-2004; IN COMMERCE 6-0-2004.

THE MARK CONSISTS OF STANDARD CHARACTERS WITHOUT CLAIM TO ANY PARTICULAR FONT, STYLE, SIZE, OR COLOR.

SER. NO. 77-337,279, FILED 11-27-2007.

LINDA E. BLOHM, EXAMINING ATTORNEY

**Int. Cl.: 30**

**Prior U.S. Cl.: 46**

**United States Patent and Trademark Office**

**Reg. No. 3,467,308**

**Registered July 15, 2008**

**TRADEMARK  
PRINCIPAL REGISTER**

**TEA, AS IT ONCE WAS**

SOUTHERN SUN TEAS (PRIVATE) LIMITED  
(SRI LANKA LTD LIAB CO)

49/21, FIFE ROAD, COLOMBO 5

COLOMBO - 5, SRI LANKA 50000

FOR: COFFEE AND TEA, IN CLASS 30 (U.S. CL.  
46).

FIRST USE 8-1-2003; IN COMMERCE 8-1-2003.

THE MARK CONSISTS OF STANDARD CHAR-  
ACTERS WITHOUT CLAIM TO ANY PARTICULAR  
FONT, STYLE, SIZE, OR COLOR.

NO CLAIM IS MADE TO THE EXCLUSIVE  
RIGHT TO USE TEA, APART FROM THE MARK  
AS SHOWN.

SER. NO. 77-337,296, FILED 11-27-2007.

JILL PRATER, EXAMINING ATTORNEY

**Int. Cl.: 38**

**Prior U.S. Cls.: 100, 101 and 104**

**United States Patent and Trademark Office**

**Reg. No. 3,467,309**

**Registered July 15, 2008**

**SERVICE MARK  
PRINCIPAL REGISTER**

**VIPgossip**

IDAHO FAMILY HOLDINGS, LLC (IDAHO LTD  
LIAB CO)  
PO BOX 133  
EAGLE, ID 83616

FOR: PROVIDING ON-LINE FORUMS FOR  
TRANSMISSION OF MESSAGES AMONG COMPU-  
TER USERS CONCERNING CELEBRITIES, TELE-  
VISION SHOWS, MOVIES, MUSIC AND OTHER  
ENTERTAINMENT MEDIA, IN CLASS 38 (U.S.  
CLS. 100, 101 AND 104).

FIRST USE 1-6-2006; IN COMMERCE 1-6-2006.

THE MARK CONSISTS OF STANDARD CHAR-  
ACTERS WITHOUT CLAIM TO ANY PARTICULAR  
FONT, STYLE, SIZE, OR COLOR.

SER. NO. 77-337,297, FILED 11-27-2007.

ALICE BENMAMAN, EXAMINING ATTORNEY

**Int. Cl.: 41**

**Prior U.S. Cls.: 100, 101 and 107**

**United States Patent and Trademark Office**

**Reg. No. 3,467,310**

**Registered July 15, 2008**

**SERVICE MARK  
PRINCIPAL REGISTER**

**THE 70'S SHACK**

BURNETT, EDWARD, D (UNITED STATES IN-  
DIVIDUAL)  
15505 BAY RIDGE DRIVE  
OKLAHOMA CITY, OK 73165

FOR: ENTERTAINMENT SERVICES, NAMELY,  
AN ON-GOING SERIES FEATURING POP MUSIC  
OF THE 1970'S PROVIDED THROUGH RADIO  
BROADCAST, IN CLASS 41 (U.S. CLS. 100, 101 AND  
107).

FIRST USE 11-4-2007; IN COMMERCE 11-4-2007.

THE MARK CONSISTS OF STANDARD CHAR-  
ACTERS WITHOUT CLAIM TO ANY PARTICULAR  
FONT, STYLE, SIZE, OR COLOR.

SER. NO. 77-337,314, FILED 11-27-2007.

KAREN K. BUSH, EXAMINING ATTORNEY

**Int. Cl.: 9**

**Prior U.S. Cls.: 21, 23, 26, 36 and 38**

**Reg. No. 3,467,311**

**United States Patent and Trademark Office**

**Registered July 15, 2008**

---

**TRADEMARK  
PRINCIPAL REGISTER**

**PEERLOCK**

PEER SOFTWARE, INC. (NEW YORK CORPORATION)  
SUITE 12  
4155 VETERANS HIGHWAY  
RONKONKOMA, NY 11779

FOR: COMPUTER SOFTWARE, NAMELY COMPUTER SOFTWARE FOR MANAGING ACCESS TO DUPLICATE SETS OF COMPUTER FILES OVER A COMPUTER NETWORK, IN CLASS 9 (U.S. CLS. 21, 23, 26, 36 AND 38).

FIRST USE 6-5-2004; IN COMMERCE 6-5-2004.

THE MARK CONSISTS OF STANDARD CHARACTERS WITHOUT CLAIM TO ANY PARTICULAR FONT, STYLE, SIZE, OR COLOR.

SER. NO. 77-337,317, FILED 11-27-2007.

KYLE PEETE, EXAMINING ATTORNEY



**Int. Cl.: 44**

**Prior U.S. Cls.: 100 and 101**

**United States Patent and Trademark Office**

**Reg. No. 3,467,312**

**Registered July 15, 2008**

**SERVICE MARK  
PRINCIPAL REGISTER**

**EQUIFIT**

EQUINOX HOLDINGS, INC. (DELAWARE CORPORATION)  
895 BROADWAY  
NEW YORK, NY 10003

FOR: PROVIDING ASSISTANCE, FITNESS EVALUATION AND CONSULTATION TO INDIVIDUALS TO HELP THEM MAKE HEALTH, WELLNESS AND NUTRITIONAL CHANGES IN THEIR DAILY LIVING TO IMPROVE HEALTH , IN CLASS 44 (U.S. CLS. 100 AND 101).

FIRST USE 11-30-1993; IN COMMERCE 11-30-1993.

THE MARK CONSISTS OF STANDARD CHARACTERS WITHOUT CLAIM TO ANY PARTICULAR FONT, STYLE, SIZE, OR COLOR.

OWNER OF U.S. REG. NOS. 1,796,108, 1,903,842 AND OTHERS.

SER. NO. 77-337,318, FILED 11-27-2007.

KYLE PEETE, EXAMINING ATTORNEY

**Int. Cl.: 5**

**Prior U.S. Cls.: 6, 18, 44, 46, 51 and 52**

**Reg. No. 3,467,313**

**United States Patent and Trademark Office**

**Registered July 15, 2008**

---

**TRADEMARK  
PRINCIPAL REGISTER**

**EQUI-S&E**

W.F. YOUNG, INCORPORATED (MASSACHU-  
SETTS CORPORATION)  
302 BENTON DRIVE  
EAST LONGMEADOW, MA 01028

THE MARK CONSISTS OF STANDARD CHAR-  
ACTERS WITHOUT CLAIM TO ANY PARTICULAR  
FONT, STYLE, SIZE, OR COLOR.

FOR: ANIMAL FEED ADDITIVE FOR USE AS A  
NUTRITIONAL SUPPLEMENT, IN CLASS 5 (U.S.  
CLS. 6, 18, 44, 46, 51 AND 52).

SER. NO. 77-337,323, FILED 11-27-2007.

FIRST USE 1-0-2001; IN COMMERCE 1-0-2001.

FRED CARL, EXAMINING ATTORNEY

**Int. Cl.: 5**

**Prior U.S. Cls.: 6, 18, 44, 46, 51 and 52**

**Reg. No. 3,467,314**

**United States Patent and Trademark Office**

**Registered July 15, 2008**

---

**TRADEMARK  
PRINCIPAL REGISTER**

**SHED N' SHINE**

W.F. YOUNG, INCORPORATED (MASSACHU-  
SETTS CORPORATION)  
302 BENTON DRIVE  
EAST LONGMEADOW, MA 01028

THE MARK CONSISTS OF STANDARD CHAR-  
ACTERS WITHOUT CLAIM TO ANY PARTICULAR  
FONT, STYLE, SIZE, OR COLOR.

FOR: ANIMAL FEED ADDITIVE FOR USE AS A  
NUTRITIONAL SUPPLEMENT, IN CLASS 5 (U.S.  
CLS. 6, 18, 44, 46, 51 AND 52).

SER. NO. 77-337,330, FILED 11-27-2007.

FIRST USE 1-0-2001; IN COMMERCE 1-0-2001.

FRED CARL, EXAMINING ATTORNEY

**Int. Cl.: 9**

**Prior U.S. Cls.: 21, 23, 26, 36 and 38**

**United States Patent and Trademark Office**

**Reg. No. 3,467,315**

**Registered July 15, 2008**

**TRADEMARK  
PRINCIPAL REGISTER**

**INTEGRATED FRAMER**

COLOR DISPLAY SYSTEMS, INC. (COLORADO  
CORPORATION)  
4600 116TH STREET SW  
MUKILTEO, WA 98275

FOR: COMPUTER SOFTWARE FOR SELECTING  
AND VIEWING FRAMES AND MATTING FOR  
FRAMING ARTWORK AND PHOTOGRAPHS, IN  
CLASS 9 (U.S. CLS. 21, 23, 26, 36 AND 38).

FIRST USE 9-1-1999; IN COMMERCE 9-1-1999.

THE MARK CONSISTS OF STANDARD CHAR-  
ACTERS WITHOUT CLAIM TO ANY PARTICULAR  
FONT, STYLE, SIZE, OR COLOR.

OWNER OF U.S. REG. NO. 2,483,975.

SEC. 2(F).

SER. NO. 77-337,334, FILED 11-27-2007.

KATHLEEN LORENZO, EXAMINING ATTORNEY

**Int. Cl.: 5**

**Prior U.S. Cls.: 6, 18, 44, 46, 51 and 52**

**Reg. No. 3,467,316**

**United States Patent and Trademark Office**

**Registered July 15, 2008**

---

**TRADEMARK  
PRINCIPAL REGISTER**

**FUNGASOL**

W.F. YOUNG, INCORPORATED (MASSACHU-  
SETTS CORPORATION)  
302 BENTON DRIVE  
EAST LONGMEADOW, MA 01028

THE MARK CONSISTS OF STANDARD CHAR-  
ACTERS WITHOUT CLAIM TO ANY PARTICULAR  
FONT, STYLE, SIZE, OR COLOR.

FOR: MEDICATED SHAMPOOS, CREAMS AND  
SPRAYS TO TREAT FUNGAL AND BACTERIAL  
SKIN CONDITIONS ON HORSES, IN CLASS 5 (U.S.  
CLS. 6, 18, 44, 46, 51 AND 52).

SER. NO. 77-337,336, FILED 11-27-2007.

FIRST USE 8-0-1998; IN COMMERCE 8-0-1998.

FRED CARL, EXAMINING ATTORNEY

**Int. Cl.: 36**

**Prior U.S. Cls.: 100, 101 and 102**

**United States Patent and Trademark Office**

**Reg. No. 3,467,317**

**Registered July 15, 2008**

**SERVICE MARK  
PRINCIPAL REGISTER**



AXIAL FINANCIAL NETWORK, LLC (MASSACHUSETTS LTD LIAB CO)  
5 BURLINGTON WOODS, SUITE 102  
BURLINGTON, MA 01803

FOR: FINANCIAL PLANNING AND INVESTMENT ADVISORY SERVICES, IN CLASS 36 (U.S. CLS. 100, 101 AND 102).

FIRST USE 7-24-2007; IN COMMERCE 7-24-2007.

THE COLOR(S) BLUE IS/ARE CLAIMED AS A FEATURE OF THE MARK.

THE MARK CONSISTS OF A STYLIZED LETTER "A", BLUE IN COLOR.

SER. NO. 77-337,375, FILED 11-27-2007.

WILLIAM P. SHANAHAN, EXAMINING ATTORNEY

**Int. Cl.: 33**

**Prior U.S. Cls.: 47 and 49**

**United States Patent and Trademark Office**

**Reg. No. 3,467,318**

**Registered July 15, 2008**

**TRADEMARK  
PRINCIPAL REGISTER**

**SPARTICO**

NATURAL MERCHANTS LLC (OREGON LTD  
LIAB CO)  
100 DEPOT ST / P.O. BOX 1320  
ROGUE RIVER, OR 97537

THE MARK CONSISTS OF STANDARD CHAR-  
ACTERS WITHOUT CLAIM TO ANY PARTICULAR  
FONT, STYLE, SIZE, OR COLOR.

FOR: GRAPE WINE, IN CLASS 33 (U.S. CLS. 47  
AND 49).

SER. NO. 77-337,389, FILED 11-27-2007.

FIRST USE 6-15-2004; IN COMMERCE 10-15-2007.

AMY GEARIN, EXAMINING ATTORNEY

**Int. Cl.: 9**

**Prior U.S. Cls.: 21, 23, 26, 36 and 38**

**Reg. No. 3,467,319**

**United States Patent and Trademark Office**

**Registered July 15, 2008**

**TRADEMARK  
PRINCIPAL REGISTER**

**G900X**

GARMIN INTERNATIONAL, INC. (KANSAS CORPORATION)  
1200 E. 151ST STREET  
OLATHE, KS 66062

FOR: NAVIGATION AND COMMUNICATION SYSTEMS IN THE FIELD OF AVIONICS, NAMELY, GPS RECEIVERS, COMMUNICATION TRANSCEIVERS, TRANSPONDERS, AUDIO PANELS COMPRISING COMPUTER HARDWARE AND SOFTWARE FOR CONTROLLING TRANSMISSION AND RECEPTION OF RADIO SIGNALS, WEATHER RADAR, TERRAIN AWARENESS AND WARNING SYSTEMS (TAWS) COMPRISING COMPUTER HARDWARE AND SOFTWARE FOR DETERMINING WHEN A TERRAIN HAZARD EXISTS AND FOR OUTPUTTING CORRESPONDING ALERTS TO AN AIRCRAFT PILOT OR CREW, ATTITUDE HEADING AND REFERENCE SYSTEMS (AHRS) COMPRISING COMPUTER HARDWARE AND SOFTWARE FOR PROVIDING AIRCRAFT ATTITUDE AND HEADING INFORMATION FOR USE BY A PILOT, FLIGHT CREW OR OTHER AVIONICS,

PRIMARY FLIGHT DISPLAYS (PFDS) COMPRISING COMPUTER HARDWARE AND SOFTWARE FOR DISPLAYING NAVIGATION AND FLIGHT INFORMATION AND FOR CONTROLLING AVIONICS INSTRUMENTS, AND MULTI-FUNCTION FLIGHT DISPLAYS (MFDS) COMPRISING COMPUTER HARDWARE AND SOFTWARE FOR DISPLAYING NAVIGATION AND FLIGHT INFORMATION AND FOR CONTROLLING AVIONICS INSTRUMENTS, IN CLASS 9 (U.S. CLS. 21, 23, 26, 36 AND 38).

FIRST USE 3-0-2007; IN COMMERCE 3-0-2007.

THE MARK CONSISTS OF STANDARD CHARACTERS WITHOUT CLAIM TO ANY PARTICULAR FONT, STYLE, SIZE, OR COLOR.

SER. NO. 77-337,400, FILED 11-27-2007.

SAMUEL E. SHARPER JR., EXAMINING ATTORNEY



**Int. Cl.: 30**

**Prior U.S. Cl.: 46**

**United States Patent and Trademark Office**

**Reg. No. 3,467,320**

**Registered July 15, 2008**

**TRADEMARK  
PRINCIPAL REGISTER**



TRINIDAD BENHAM CORPORATION (COLOR-  
ADO CORPORATION)  
3650 SOUTH YOSEMITE, SUITE 300  
DENVER, CO 80237

FOR: CANDY, IN CLASS 30 (U.S. CL. 46).

FIRST USE 11-13-2007; IN COMMERCE 11-13-2007.

NO CLAIM IS MADE TO THE EXCLUSIVE  
RIGHT TO USE "SNACKS", APART FROM THE  
MARK AS SHOWN.

THE MARK CONSISTS OF THE WORD  
"SNACKS" ENCASED IN A BUBBLE OUTLINE  
WITH THE WORDS "IN A SNAP" IN A BANNER  
BELOW THE BUBBLE, ALL SUPERIMPOSED OVER  
A GRAPHIC REPRESENTATION OF AN EXPLO-  
SION.

SER. NO. 77-337,404, FILED 11-27-2007.

MARGERY A. TIERNEY, EXAMINING ATTORNEY

**Int. Cl.: 45**

**Prior U.S. Cls.: 100 and 101**

**United States Patent and Trademark Office**

**Reg. No. 3,467,321**

**Registered July 15, 2008**

**SERVICE MARK  
PRINCIPAL REGISTER**

**SEWING OUR SUPPORT FOR THE  
TROOPS**

SEW MUCH COMFORT, INC. (MINNESOTA  
CHARITABLE, NON-PROFIT CORPORATION)  
13805 FRONITER LN  
BURNSVILLE, MN 55337

FOR: CHARITABLE SERVICES, NAMELY, PRO-  
VIDING CUSTOM MADE ADAPTIVE CLOTHING,  
FREE OF CHARGE, TO INJURED MILITARY SER-  
VICE MEMBERS , IN CLASS 45 (U.S. CLS. 100 AND  
101).

FIRST USE 1-9-2006; IN COMMERCE 1-9-2006.

THE MARK CONSISTS OF STANDARD CHAR-  
ACTERS WITHOUT CLAIM TO ANY PARTICULAR  
FONT, STYLE, SIZE, OR COLOR.

SER. NO. 77-337,412, FILED 11-27-2007.

SAMUEL E. SHARPER JR., EXAMINING ATTOR-  
NEY

**Int. Cl.: 10**

**Prior U.S. Cls.: 26, 39 and 44**

**United States Patent and Trademark Office**

**Reg. No. 3,467,322**

**Registered July 15, 2008**

**TRADEMARK  
PRINCIPAL REGISTER**



MJ PRODUCTS (TAJIKISTAN LTD LIAB CO),  
DBA O-YES  
2100 NW 22ND ST  
POMPANO, FL 33069

FOR: CONstriction RINGS FOR USE IN  
MAINTAINING PENILE RIGIDITY IN MEN WITH  
ERECTILE DYSFUNCTION, IN CLASS 10 (U.S. CLS.  
26, 39 AND 44).

FIRST USE 8-17-2007; IN COMMERCE 9-3-2007.

THE COLOR(S) BLACK, GRAY AND WHITE IS/  
ARE CLAIMED AS A FEATURE OF THE MARK.

THE MARK CONSISTS OF THE WORDING "MID-  
NIGHT O" IN BLACK LETTERS WITH GREY  
EDGES WITH A SMALL HALF MOON IN WHITE  
WITH BLACK TRIM INSIDE THE LETTER "O".

SER. NO. 77-337,413, FILED S.R. 11-27-2007 AM.  
P.R. 3-10-2008.

SAMUEL E. SHARPER JR., EXAMINING ATTOR-  
NEY

**Int. Cl.: 45**

**Prior U.S. Cls.: 100 and 101**

**United States Patent and Trademark Office**

**Reg. No. 3,467,323**

**Registered July 15, 2008**

**SERVICE MARK  
PRINCIPAL REGISTER**

**SEW MUCH COMFORT**

SEW MUCH COMFORT, INC. (MINNESOTA  
CORPORATION)  
13805 FRONITER LN  
BURNSVILLE, MN 55337

FOR: CHARITABLE SERVICES, NAMELY, PRO-  
VIDING CUSTOM MADE ADAPTIVE CLOTHING,  
FREE OF CHARGE, TO INJURED MILITARY SER-  
VICE MEMBERS, IN CLASS 45 (U.S. CLS. 100 AND  
101).

FIRST USE 1-9-2006; IN COMMERCE 1-9-2006.

THE MARK CONSISTS OF STANDARD CHAR-  
ACTERS WITHOUT CLAIM TO ANY PARTICULAR  
FONT, STYLE, SIZE, OR COLOR.

SER. NO. 77-337,414, FILED 11-27-2007.

SAMUEL E. SHARPER JR., EXAMINING ATTOR-  
NEY

**Int. Cl.: 9**

**Prior U.S. Cls.: 21, 23, 26, 36 and 38**

**Reg. No. 3,467,324**

**United States Patent and Trademark Office**

**Registered July 15, 2008**

**TRADEMARK  
PRINCIPAL REGISTER**

**FOUND IT!**

COMSQUARED SYSTEMS, INC. (GEORGIA CORPORATION)  
5125 PEACHTREE INDUSTRIAL BLVD.  
NORCROSS, GA 30092

THE MARK CONSISTS OF STANDARD CHARACTERS WITHOUT CLAIM TO ANY PARTICULAR FONT, STYLE, SIZE, OR COLOR.

FOR: COMPUTER PROGRAMMES FOR DOCUMENT MANAGEMENT, IN CLASS 9 (U.S. CLS. 21, 23, 26, 36 AND 38).

SER. NO. 77-337,416, FILED 11-27-2007.

FIRST USE 10-31-2007; IN COMMERCE 10-31-2007.

SAMUEL E. SHARPER JR., EXAMINING ATTORNEY

**Int. Cl.: 3**

**Prior U.S. Cls.: 1, 4, 6, 50, 51 and 52**

**United States Patent and Trademark Office**

**Reg. No. 3,467,325**

**Registered July 15, 2008**

---

**TRADEMARK  
PRINCIPAL REGISTER**

**GLOSS & TOSS**

WILLIAM W. LOWE, JR. (UNITED STATES IN-  
DIVIDUAL)  
807 N. ALFRED ST., NO. 1  
LOS ANGELES, CA 90069

THE MARK CONSISTS OF STANDARD CHAR-  
ACTERS WITHOUT CLAIM TO ANY PARTICULAR  
FONT, STYLE, SIZE, OR COLOR.

FOR: HAIR STYLING PREPARATIONS, IN  
CLASS 3 (U.S. CLS. 1, 4, 6, 50, 51 AND 52).

SER. NO. 77-337,449, FILED 11-27-2007.

FIRST USE 10-25-2007; IN COMMERCE 10-25-2007.

TRICIA SONNEBORN, EXAMINING ATTORNEY

**Int. Cls.: 25 and 41**

**Prior U.S. Cls.: 22, 39, 100, 101 and 107**

**United States Patent and Trademark Office**

**Reg. No. 3,467,326**

**Registered July 15, 2008**

**TRADEMARK  
SERVICE MARK  
PRINCIPAL REGISTER**



COLANGELO, MARK (UNITED STATES INDIVIDUAL)  
1126 CATALINA BLVD.  
SAN DIEGO, CA 92107

FOR: MARTIAL ARTS CLOTHING, NAMELY, UNIFORMS, SHIRTS, HATS, AND JACKETS, IN CLASS 25 (U.S. CLS. 22 AND 39).

FIRST USE 10-8-2007; IN COMMERCE 10-8-2007.

FOR: MARTIAL ARTS INSTRUCTION, IN CLASS 41 (U.S. CLS. 100, 101 AND 107).

FIRST USE 10-8-2007; IN COMMERCE 10-8-2007.

THE MARK CONSISTS OF THE FOLLOWING FEATURES. THE MIDDLE OF THE MARK IS A

YIN-YANG SYMBOL WITH THE UNIQUE CHARACTERISTICS OF A RIGHT FIST AND A HEART; THE YIN-YANG SYMBOL IS SURROUNDED BY A SECTION WITH THE WORDS "GO JIU BUJITSU" ARCHED OVER THE TOP HALF OF THE SYMBOL AND WITH 5 STARS ARCHED UNDER THE BOTTOM HALF OF THE SYMBOL; THE SECTION IS THEN SURROUNDED BY AN OCTAGON BORDER WHICH ENCLOSES THE ENTIRE MARK.

THE FOREIGN WORDING IN THE MARK TRANSLATES INTO ENGLISH AS "THE WAY/ART/SCIENCE OF HARD & SOFT MARTIAL ARTS".

SER. NO. 77-337,459, FILED 11-27-2007.

MELVIN AXILBUND, EXAMINING ATTORNEY

**Int. Cls.: 35 and 41**

**Prior U.S. Cls.: 100, 101, 102 and 107**

**United States Patent and Trademark Office**

**Reg. No. 3,467,327**

**Registered July 15, 2008**

**SERVICE MARK  
PRINCIPAL REGISTER**

**TMNK**

PATTERSON, SCOTT A. (UNITED STATES INDIVIDUAL), DBA THE ME NOBODY KNOWS AKA NOBODY AKA TMNK  
P.O. BOX 5185  
PLAINFIELD, NJ 07061

FOR: CHARITABLE SERVICES, NAMELY, ORGANIZING YOUTH GROUPS TO UNDERTAKE PROJECTS TO BENEFIT THE NEEDY AND THE COMMUNITY TO ENCOURAGE LEADERSHIP, CHARACTER, COMPASSION, AND GOOD CITIZENSHIP, IN CLASS 35 (U.S. CLS. 100, 101 AND 102).

FIRST USE 12-1-1992; IN COMMERCE 12-1-1994.

FOR: ART EXHIBITIONS, IN CLASS 41 (U.S. CLS. 100, 101 AND 107).

FIRST USE 12-1-1992; IN COMMERCE 12-1-1994.

THE MARK CONSISTS OF STANDARD CHARACTERS WITHOUT CLAIM TO ANY PARTICULAR FONT, STYLE, SIZE, OR COLOR.

SER. NO. 77-337,474, FILED 11-27-2007.

KATHY DE JONGE, EXAMINING ATTORNEY



**Int. Cl.: 45**

**Prior U.S. Cls.: 100 and 101**

**United States Patent and Trademark Office**

**Reg. No. 3,467,328**

**Registered July 15, 2008**

**SERVICE MARK  
PRINCIPAL REGISTER**

**KEEPUP**

KEEP UP LLC (VIRGINIA LTD LIAB CO)  
21351 RIDGETOP CIRCLE, SUITE 300  
DULLES, VA 20166

THE MARK CONSISTS OF STANDARD CHAR-  
ACTERS WITHOUT CLAIM TO ANY PARTICULAR  
FONT, STYLE, SIZE, OR COLOR.

FOR: SCHEDULING AND REMINDER SERVICES  
IN THE AREA OF IMPORTANT DATES, TASKS  
AND EVENTS, IN CLASS 45 (U.S. CLS. 100 AND 101).

SER. NO. 77-337,495, FILED 11-27-2007.

FIRST USE 9-14-2007; IN COMMERCE 9-14-2007.

TANYA AMOS, EXAMINING ATTORNEY

**Int. Cl.: 38**

**Prior U.S. Cls.: 100, 101 and 104**

**United States Patent and Trademark Office**

**Reg. No. 3,467,329**

**Registered July 15, 2008**

**SERVICE MARK  
PRINCIPAL REGISTER**

**OneButton**

AIRME, INC. (COLORADO CORPORATION)  
SUITE 220  
13710 STRUTHERS ROAD  
COLORADO SPRINGS, CO 80921

THE MARK CONSISTS OF STANDARD CHARACTERS WITHOUT CLAIM TO ANY PARTICULAR FONT, STYLE, SIZE, OR COLOR.

FOR: AUDIO AND VIDEO BROADCASTING SERVICES OVER THE INTERNET; VIDEO BROADCASTING, IN CLASS 38 (U.S. CLS. 100, 101 AND 104).

SER. NO. 77-337,533, FILED 11-27-2007.

FIRST USE 8-15-2007; IN COMMERCE 11-21-2007.

TAMARA FRAZIER, EXAMINING ATTORNEY

**Int. Cl.: 18**

**Prior U.S. Cls.: 1, 2, 3, 22 and 41**

**Reg. No. 3,467,330**

**United States Patent and Trademark Office**

**Registered July 15, 2008**

---

**TRADEMARK  
PRINCIPAL REGISTER**

**ALBA BY CHUNMA**

CHUNMA USA, INC. (CALIFORNIA CORPORATION), DBA ALBA BAGS  
2000 E. 25TH ST.  
VERNON, CA 90058

THE MARK CONSISTS OF STANDARD CHARACTERS WITHOUT CLAIM TO ANY PARTICULAR FONT, STYLE, SIZE, OR COLOR.

FOR: HANDBAGS, TOTE BAGS, BACKPACKS, WALLET, LUGGAGE AND PURSES, IN CLASS 18 (U.S. CLS. 1, 2, 3, 22 AND 41).

SER. NO. 77-337,654, FILED 11-27-2007.

FIRST USE 8-1-2007; IN COMMERCE 9-20-2007.

JENNIFER MARTIN, EXAMINING ATTORNEY

**Int. Cl.: 28**

**Prior U.S. Cls.: 22, 23, 38 and 50**

**United States Patent and Trademark Office**

**Reg. No. 3,467,331**

**Registered July 15, 2008**

**TRADEMARK  
PRINCIPAL REGISTER**

**TackleBoxes2Go**

TACKLE BOXES 2 GO, LLC (WISCONSIN LTD  
LIAB CO)  
SUITE 204  
1035 WEST GLEN OAKS LANE  
MEQUON, WI 53092

THE MARK CONSISTS OF STANDARD CHAR-  
ACTERS WITHOUT CLAIM TO ANY PARTICULAR  
FONT, STYLE, SIZE, OR COLOR.

FOR: FISHING TACKLE; FISHING TACKLE  
BOXES, IN CLASS 28 (U.S. CLS. 22, 23, 38 AND 50).

SER. NO. 77-337,658, FILED 11-27-2007.

FIRST USE 5-1-2007; IN COMMERCE 6-1-2007.

JEFFERY COWARD, EXAMINING ATTORNEY

**Int. Cl.: 36**

**Prior U.S. Cls.: 100, 101 and 102**

**United States Patent and Trademark Office**

**Reg. No. 3,467,332**

**Registered July 15, 2008**

**SERVICE MARK  
PRINCIPAL REGISTER**

**THE ONE PLACE**

BANK MIDWEST, MINNESOTA IOWA, N.A.  
(IOWA CORPORATION)  
1525 18TH STREET  
SPIRIT LAKE, IA 51360

THE MARK CONSISTS OF STANDARD CHAR-  
ACTERS WITHOUT CLAIM TO ANY PARTICULAR  
FONT, STYLE, SIZE, OR COLOR.

FOR: BANKING, INVESTMENT BROKERAGE  
AND INSURANCE AGENCY SERVICES FOR ALL  
TYPES OF INSURANCE, IN CLASS 36 (U.S. CLS. 100,  
101 AND 102).

SER. NO. 77-337,738, FILED 11-27-2007.

FIRST USE 0-0-2002; IN COMMERCE 0-0-2002.

HOWARD B. LEVINE, EXAMINING ATTORNEY

**Int. Cl.: 25**

**Prior U.S. Cls.: 22 and 39**

**United States Patent and Trademark Office**

**Reg. No. 3,467,333**

**Registered July 15, 2008**

**TRADEMARK  
PRINCIPAL REGISTER**

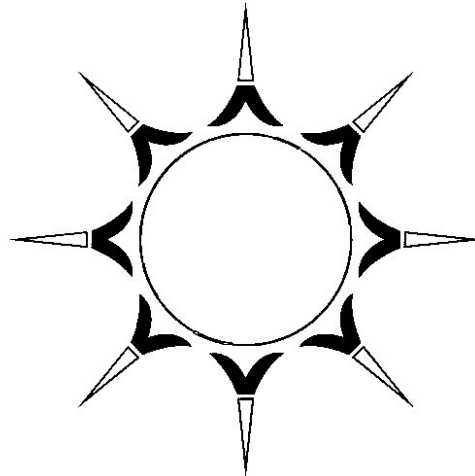

TLORD, INC. (CALIFORNIA CORPORATION)  
5482 WILSHIRE BLVD., SUITE 1915  
LOS ANGELES, CA 90036

THE MARK CONSISTS OF A STYLIZED SUN  
WITH BEAMING LIGHTS THAT RESEMBLE THE  
EIFFEL TOWER.

FOR: SHIRTS; T-SHIRTS; JACKETS; JEANS;  
PANTS; SWEAT PANTS; COATS; UNDERWEAR;  
FOOTWEAR, IN CLASS 25 (U.S. CLS. 22 AND 39).

SER. NO. 77-337,804, FILED 11-27-2007.

FIRST USE 3-15-2007; IN COMMERCE 3-15-2007.

JASON TURNER, EXAMINING ATTORNEY

**Int. Cl.: 24**

**Prior U.S. Cls.: 42 and 50**

**United States Patent and Trademark Office**

**Reg. No. 3,467,334**

**Registered July 15, 2008**

**TRADEMARK  
PRINCIPAL REGISTER**

**Princess Sheet Company**

PRINCESS SHEET CORPORATION (NEW JERSEY CORPORATION)  
75 LEVINE STREET  
PATERSON, NJ 075032731

FOR: BED SHEETS, COMFORTERS, BED BLANKETS, BEDSPREADS, CURTAINS, TABLE CLOTHS NOT OF PAPER, AND BED LINENS, IN CLASS 24 (U.S. CLS. 42 AND 50).

FIRST USE 1-1-2005; IN COMMERCE 1-1-2005.

THE MARK CONSISTS OF STANDARD CHARACTERS WITHOUT CLAIM TO ANY PARTICULAR FONT, STYLE, SIZE, OR COLOR.

NO CLAIM IS MADE TO THE EXCLUSIVE RIGHT TO USE "SHEET COMPANY", APART FROM THE MARK AS SHOWN.

SER. NO. 77-337,855, FILED 11-27-2007.

TARAH HARDY, EXAMINING ATTORNEY

**Int. Cl.: 9**

**Prior U.S. Cls.: 21, 23, 26, 36 and 38**

**Reg. No. 3,467,335**

**United States Patent and Trademark Office**

**Registered July 15, 2008**

---

**TRADEMARK  
PRINCIPAL REGISTER**

# Coyote Bytes

THE CONSERVATION AGENCY (RHODE ISLAND CORPORATION)  
6 SWINBURNE STREET  
JAMESTOWN, RI 02835

FOR: PROVIDING DOWNLOADABLE ELECTRONIC NEWSLETTERS IN THE FIELD OF SCIENTIFIC RESEARCH ON COYOTES, IN CLASS 9 (U.S. CLS. 21, 23, 26, 36 AND 38).

FIRST USE 3-30-2006; IN COMMERCE 3-30-2006.

THE MARK CONSISTS OF STANDARD CHARACTERS WITHOUT CLAIM TO ANY PARTICULAR FONT, STYLE, SIZE, OR COLOR.

NO CLAIM IS MADE TO THE EXCLUSIVE RIGHT TO USE "COYOTE", APART FROM THE MARK AS SHOWN.

SER. NO. 77-337,856, FILED 11-27-2007.

TARAH HARDY, EXAMINING ATTORNEY



**Int. Cls.: 35 and 36**

**Prior U.S. Cls.: 100, 101 and 102**

**United States Patent and Trademark Office**

**Reg. No. 3,467,336**

**Registered July 15, 2008**

**SERVICE MARK  
PRINCIPAL REGISTER**

**FREEDOM FROM THE HIGH  
COST OF INSURANCE**

FREEDOM INSURANCE GROUP, INC. (PENNSYLVANIA CORPORATION)  
3308 GRANT AVE  
PHILADELPHIA, PA 19114

FOR: INSURANCE LEAD COLLECTION AND MATCHING SERVICES, NAMELY, MATCHING CONSUMER REQUESTS FOR INSURANCE POLICY QUOTES COLLECTED OVER THE INTERNET TO PRE-QUALIFIED INSURANCE BROKERS, AGENTS AND AGENCIES INTERESTED IN THOSE REQUESTS, IN CLASS 35 (U.S. CLS. 100, 101 AND 102).

FIRST USE 10-22-2003; IN COMMERCE 10-22-2003.

FOR: ACCIDENT INSURANCE UNDERWRITING; INSURANCE AGENCIES; INSURANCE AGENCY AND BROKERAGE; INSURANCE BROKERAGE; INSURANCE CONSULTANCY; IN-

SURANCE CONSULTATION; INSURANCE INFORMATION; INSURANCE INFORMATION AND CONSULTANCY; INSURANCE PREMIUM RATE COMPUTING; INSURANCE UNDERWRITING SERVICES FOR ALL TYPES OF INSURANCE; PROVIDING INFORMATION IN INSURANCE MATTERS, IN CLASS 36 (U.S. CLS. 100, 101 AND 102).

FIRST USE 6-20-2003; IN COMMERCE 10-1-2003.

THE MARK CONSISTS OF STANDARD CHARACTERS WITHOUT CLAIM TO ANY PARTICULAR FONT, STYLE, SIZE, OR COLOR.

SER. NO. 77-337,876, FILED 11-27-2007.

TARAH HARDY, EXAMINING ATTORNEY

**Int. Cl.: 38**

**Prior U.S. Cls.: 100, 101 and 104**

**United States Patent and Trademark Office**

**Reg. No. 3,467,337**

**Registered July 15, 2008**

**SERVICE MARK  
PRINCIPAL REGISTER**

**WEB-EM**

TELVUE CORPORATION (DELAWARE CORPORATION)  
SUITE 500  
16000 HORIZON WAY  
MT. LAUREL, NJ 08054

FOR: ELECTRONIC, ELECTRIC, AND DIGITAL TRANSMISSION OF VOICE, DATA, IMAGES, SIGNALS, AND MESSAGES; TRANSMISSION OF MESSAGES OVER ELECTRONIC MEDIA; WEB MESSAGING; TELECOMMUNICATION SERVICES, NAMELY, LOCAL AND LONG DISTANCE TRANSMISSION OF VOICE, DATA, GRAPHICS BY MEANS OF TELEPHONE, TELEGRAPHIC, CABLE, AND

SATELLITE TRANSMISSIONS, IN CLASS 38 (U.S. CLS. 100, 101 AND 104).

FIRST USE 1-30-2007; IN COMMERCE 1-30-2007.

THE MARK CONSISTS OF STANDARD CHARACTERS WITHOUT CLAIM TO ANY PARTICULAR FONT, STYLE, SIZE, OR COLOR.

SER. NO. 77-337,894, FILED 11-27-2007.

SALLY SHIH, EXAMINING ATTORNEY

**Int. Cl.: 3**

**Prior U.S. Cls.: 1, 4, 6, 50, 51 and 52**

**Reg. No. 3,467,338**

**United States Patent and Trademark Office**

**Registered July 15, 2008**

**TRADEMARK  
PRINCIPAL REGISTER**

**ABBA PURE PERFORMANCE HAIR  
CARE**

ROUX LABORATORIES, INC. (NEW YORK CORPORATION), DBA COLOMER USA  
5344 OVERMYER DRIVE  
JACKSONVILLE, FL 32254

FOR: HAIR CARE PRODUCTS, NAMELY, SHAMPOO, CONDITIONER; HAIR STYLING PREPARATIONS, NAMELY, STYLING CREAMS, POMADES, LOTIONS, GELS, LEAVE-IN CONDITIONING SPRAY, AND HAIR SPRAY, IN CLASS 3 (U.S. CLS. 1, 4, 6, 50, 51 AND 52).

FIRST USE 12-1-2006; IN COMMERCE 7-1-2007.

THE MARK CONSISTS OF STANDARD CHARACTERS WITHOUT CLAIM TO ANY PARTICULAR FONT, STYLE, SIZE, OR COLOR.

OWNER OF U.S. REG. NOS. 2,309,415, 2,319,398, AND 2,416,439.

NO CLAIM IS MADE TO THE EXCLUSIVE RIGHT TO USE "HAIR CARE", APART FROM THE MARK AS SHOWN.

SER. NO. 77-337,909, FILED 11-27-2007.

JENNY PARK, EXAMINING ATTORNEY

**Int. Cl.: 35**

**Prior U.S. Cls.: 100, 101 and 102**

**United States Patent and Trademark Office**

**Reg. No. 3,467,339**

**Registered July 15, 2008**

**SERVICE MARK  
PRINCIPAL REGISTER**

# Quiphics

GUNZBURG, ARI I (UNITED STATES INDIVIDUAL)  
3830 MENLO DRIVE  
BALTIMORE, MD 21215

FOR: BUSINESS CARD DESIGN SERVICES; CREATIVE MARKETING DESIGN SERVICES; DESIGN OF ADVERTISING FLYERS FOR OTHERS; DESIGN OF ADVERTISING MATERIALS FOR OTHERS; DESIGN OF INTERNET ADVERTISING; ADVERTISING AND MARKETING; BUSINESS MARKETING SERVICES; ON-LINE ADVERTISING AND MARKETING SERVICES; PROMOTION AND MARKETING SERVICES AND RELATED CONSULTING; PROMOTION, ADVERTISING AND MARKETING OF ON-LINE WEBSITES; ADVERTISING SERVICES, NAMELY, CREATING CORPORATE AND BRAND IDENTITY FOR OTHERS; ADVERTISING SERVICES, NAMELY, CREATING

CORPORATE LOGOS FOR OTHERS; ADVERTISING, MARKETING AND PROMOTION SERVICES; CREATING AND UPDATING ADVERTISING MATERIAL; LAYOUT SERVICES FOR ADVERTISING PURPOSES; PREPARING ADVERTISEMENTS FOR OTHERS; PROMOTING, ADVERTISING AND MARKETING OF THE ON-LINE WEBSITES OF OTHERS, IN CLASS 35 (U.S. CLS. 100, 101 AND 102).

FIRST USE 11-27-2007; IN COMMERCE 11-27-2007.

THE MARK CONSISTS OF STANDARD CHARACTERS WITHOUT CLAIM TO ANY PARTICULAR FONT, STYLE, SIZE, OR COLOR.

SER. NO. 77-337,928, FILED 11-27-2007.

SALLY SHIH, EXAMINING ATTORNEY

**Int. Cls.: 9 and 41**

**Prior U.S. Cls.: 21, 23, 26, 36, 38, 100, 101 and 107**

**United States Patent and Trademark Office**

**Reg. No. 3,467,340**

**Registered July 15, 2008**

**TRADEMARK  
SERVICE MARK  
PRINCIPAL REGISTER**

**DERDER**

DER DER PRODUCTIONS, LLC (CALIFORNIA  
LTD LIAB CO)  
4082 PROMONTORY ST.  
SAN DIEGO, CA 92109

FOR: DIGITAL MEDIA, NAMELY, PRE-RECORDED VIDEO CASSETTES, DIGITAL VIDEO DISCS, DIGITAL VERSATILE DISCS, DOWNLOADABLE AUDIO AND VIDEO RECORDINGS, DVDS, AND HIGH DEFINITION DIGITAL DISKS FEATURING PAINTBALL; DOWNLOADABLE MULTIMEDIA FILE CONTAINING ARTWORK, TEXT, AUDIO, VIDEO, GAMES, AND INTERNET WEB LINKS RELATING TO PAINTBALL; DOWNLOADABLE VIDEO RECORDINGS FEATURING PAINTBALL; PRERECORDED DIGITAL VIDEO DISKS FEATURING PAINTBALL; PRERECORDED VIDEO TAPES FEATURING PAINTBALL, IN CLASS 9 (U.S. CLS. 21, 23, 26, 36 AND 38).

FIRST USE 2-0-2003; IN COMMERCE 2-0-2003.

FOR: MEDIA PRODUCTION SERVICES, NAME-  
LY, VIDEO AND FILM PRODUCTION, IN CLASS 41  
(U.S. CLS. 100, 101 AND 107).

FIRST USE 2-0-2003; IN COMMERCE 2-0-2003.

THE MARK CONSISTS OF STANDARD CHAR-  
ACTERS WITHOUT CLAIM TO ANY PARTICULAR  
FONT, STYLE, SIZE, OR COLOR.

SER. NO. 77-337,936, FILED 11-27-2007.

DAVID TAYLOR, EXAMINING ATTORNEY

**Int. Cl.: 16**

**Prior U.S. Cls.: 2, 5, 22, 23, 29, 37, 38 and 50**

**Reg. No. 3,467,341**

**United States Patent and Trademark Office**

**Registered July 15, 2008**

**TRADEMARK  
PRINCIPAL REGISTER**

**CHATTANOOGA SHOWCASING THE  
RENAISSANCE CITY OF THE  
SOUTH**

**WILLIAMS TYPESETTING COMPANY, INC.  
(TENNESSEE CORPORATION)  
6129 AIRWAYS BLVD.  
CHATTANOOGA, TN 37421**

**THE MARK CONSISTS OF STANDARD CHAR-  
ACTERS WITHOUT CLAIM TO ANY PARTICULAR  
FONT, STYLE, SIZE, OR COLOR.**

**FOR: MAGAZINES FEATURING ARTICLES RE-  
LATED TO BUSINESS, SUSTAINABLE DEVELOP-  
MENT, HISTORIC PRESERVATION,  
REEMERGING COMMUNITIES, NONPROFIT IN-  
ITIATIVES, EDUCATION AND CULTURAL ACTIV-  
ITIES IN AND AROUND THE CHATTANOOGA,  
TENNESSEE AREA, IN CLASS 16 (U.S. CLS. 2, 5, 22,  
23, 29, 37, 38 AND 50).**

**NO CLAIM IS MADE TO THE EXCLUSIVE  
RIGHT TO USE "CHATTANOOGA", APART FROM  
THE MARK AS SHOWN.**

**SER. NO. 77-337,942, FILED 11-27-2007.**

**FIRST USE 7-11-2007; IN COMMERCE 7-11-2007.**

**MARY ROSSMAN, EXAMINING ATTORNEY**

**Int. Cl.: 11**

**Prior U.S. Cls.: 13, 21, 23, 31 and 34**

**United States Patent and Trademark Office**

**Reg. No. 3,467,342**

**Registered July 15, 2008**

**TRADEMARK  
PRINCIPAL REGISTER**

**INSTANT SAFETY LIGHTS**

CYALUME TECHNOLOGIES, INC. (DELAWARE CORPORATION)

96 WINDSOR STREET

WEST SPRINGFIELD, MA 01089

FOR: CHEMILUMINESCENT MATERIALS FOR LIGHTING PURPOSES, NAMELY, CHEMILUMINESCENT LIGHT STICKS, IN CLASS 11 (U.S. CLS. 13, 21, 23, 31 AND 34).

FIRST USE 5-10-2007; IN COMMERCE 5-10-2007.

THE MARK CONSISTS OF STANDARD CHARACTERS WITHOUT CLAIM TO ANY PARTICULAR FONT, STYLE, SIZE, OR COLOR.

OWNER OF U.S. REG. NO. 3,379,659.

NO CLAIM IS MADE TO THE EXCLUSIVE RIGHT TO USE "SAFETY LIGHTS", APART FROM THE MARK AS SHOWN.

SER. NO. 77-337,946, FILED 11-27-2007.

JEFFERY COWARD, EXAMINING ATTORNEY

**Int. Cl.: 5**

**Prior U.S. Cls.: 6, 18, 44, 46, 51 and 52**

**United States Patent and Trademark Office**

**Reg. No. 3,467,343**

**Registered July 15, 2008**

**TRADEMARK  
PRINCIPAL REGISTER**

**RX-EYE**

NATURAL ORGANICS INC. (NEW YORK COR-  
PORATION)

548 BROADHOLLOW ROAD

MELVILLE, NY 117473708

FOR: DIETARY SUPPLEMENTS, IN CLASS 5 (U.S.  
CLS. 6, 18, 44, 46, 51 AND 52).

FIRST USE 7-9-2001; IN COMMERCE 7-9-2001.

THE MARK CONSISTS OF STANDARD CHAR-  
ACTERS WITHOUT CLAIM TO ANY PARTICULAR  
FONT, STYLE, SIZE, OR COLOR.

OWNER OF U.S. REG. NO. 2,610,980.

SEC. 2(F).

SER. NO. 77-337,950, FILED 11-27-2007.

GIANCARLO CASTRO, EXAMINING ATTORNEY



**Int. Cl.: 36**

**Prior U.S. Cls.: 100, 101 and 102**

**United States Patent and Trademark Office**

**Reg. No. 3,467,344**

**Registered July 15, 2008**

**SERVICE MARK  
PRINCIPAL REGISTER**

**RICHMOND**

RICHMOND INSURANCE GROUP, LLC (DELA-  
WARE LTD LIAB CO)  
9400 RIDGEWAY  
EVANSTON, IL 60203

FOR: INSURANCE AGENCIES IN THE FIELD OF  
PROFESSIONAL LIABILITY INSURANCE, IN  
CLASS 36 (U.S. CLS. 100, 101 AND 102).

FIRST USE 2-28-2002; IN COMMERCE 2-28-2002.

THE MARK CONSISTS OF STANDARD CHAR-  
ACTERS WITHOUT CLAIM TO ANY PARTICULAR  
FONT, STYLE, SIZE, OR COLOR.

OWNER OF U.S. REG. NO. 2,641,366.

SEC. 2(F).

SER. NO. 77-337,954, FILED 11-27-2007.

JEFFERY COWARD, EXAMINING ATTORNEY

**Int. Cl.: 19**

**Prior U.S. Cls.: 1, 12, 33 and 50**

**United States Patent and Trademark Office**

**Reg. No. 3,467,345**

**Registered July 15, 2008**

**TRADEMARK  
PRINCIPAL REGISTER**

**ATTICTRACKS**

ILLINOIS TOOL WORKS INC. (DELAWARE  
CORPORATION)  
3600 WEST LAKE AVENUE  
GLENVIEW, IL 600261215

FOR: PLASTIC PLATFORM THAT ALLOWS  
HOMEOWNER TO WALK IN THE ATTIC, IN CLASS  
19 (U.S. CLS. 1, 12, 33 AND 50).

FIRST USE 8-5-2000; IN COMMERCE 9-10-2000.

THE MARK CONSISTS OF STANDARD CHAR-  
ACTERS WITHOUT CLAIM TO ANY PARTICULAR  
FONT, STYLE, SIZE, OR COLOR.

OWNER OF U.S. REG. NO. 2,454,084.

SER. NO. 77-337,977, FILED 11-27-2007.

JAY BESCH, EXAMINING ATTORNEY

**Int. Cl.: 37**

**Prior U.S. Cls.: 100, 103 and 106**

**United States Patent and Trademark Office**

**Reg. No. 3,467,346**

**Registered July 15, 2008**

**SERVICE MARK  
PRINCIPAL REGISTER**

**TYBREN HOMES**

TYBREN HOMES, LLC (WASHINGTON LTD  
LIAB CO)  
SUITE 210  
15720 MAIN STREET  
MILL CREEK, WA 98012

FOR: RESIDENTIAL BUILDING CONSTRUCTION AND REAL ESTATE DEVELOPMENT SERVICES, IN CLASS 37 (U.S. CLS. 100, 103 AND 106).

FIRST USE 10-1-2007; IN COMMERCE 10-1-2007.

THE MARK CONSISTS OF STANDARD CHARACTERS WITHOUT CLAIM TO ANY PARTICULAR FONT, STYLE, SIZE, OR COLOR.

NO CLAIM IS MADE TO THE EXCLUSIVE RIGHT TO USE "HOMES", APART FROM THE MARK AS SHOWN.

SER. NO. 77-338,012, FILED 11-27-2007.

JENNY PARK, EXAMINING ATTORNEY

**Int. Cls.: 16 and 41**

**Prior U.S. Cls.: 2, 5, 22, 23, 29, 37, 38, 50, 100, 101 and 107**

**United States Patent and Trademark Office**

**Reg. No. 3,467,347**

**Registered July 15, 2008**

**TRADEMARK  
SERVICE MARK  
PRINCIPAL REGISTER**

# Logistics Today

PENTON MEDIA, INC. (DELAWARE CORPORATION)  
4TH FLOOR  
249 WEST 17TH STREET  
NEW YORK, NY 10011

FOR: MAGAZINES FEATURING INFORMATION IN FIELD OF LOGISTICS AND SUPPLY CHAIN MANAGEMENT; NEWSLETTERS IN THE FIELD OF LOGISTICS AND SUPPLY CHAIN MANAGEMENT, IN CLASS 16 (U.S. CLS. 2, 5, 22, 23, 29, 37, 38 AND 50).

FIRST USE 9-0-2003; IN COMMERCE 9-0-2003.

FOR: PROVIDING NEWSLETTERS IN THE FIELD OF LOGISTICS AND SUPPLY CHAIN MANAGEMENT VIA E-MAIL; PROVIDING ON-LINE PUBLICATIONS IN THE NATURE OF MAGAZINES, NEWSLETTERS, AND GUIDES IN THE FIELD OF

LOGISTICS AND SUPPLY CHAIN MANAGEMENT; ENTERTAINMENT SERVICES, NAMELY, PROVIDING WEBCASTS IN THE FIELD OF LOGISTICS AND SUPPLY CHAIN MANAGEMENT, IN CLASS 41 (U.S. CLS. 100, 101 AND 107).

FIRST USE 9-0-2003; IN COMMERCE 9-0-2003.

THE MARK CONSISTS OF STANDARD CHARACTERS WITHOUT CLAIM TO ANY PARTICULAR FONT, STYLE, SIZE, OR COLOR.

NO CLAIM IS MADE TO THE EXCLUSIVE RIGHT TO USE "LOGISTICS", APART FROM THE MARK AS SHOWN.

SER. NO. 77-338,017, FILED 11-27-2007.

KIMBERLY FRYE, EXAMINING ATTORNEY

**Int. Cl.: 41**

**Prior U.S. Cls.: 100, 101 and 107**

**United States Patent and Trademark Office**

**Reg. No. 3,467,348**

**Registered July 15, 2008**

**SERVICE MARK  
PRINCIPAL REGISTER**

**HUMAN LIFE PROJECT**

RANVILLE, JENNIFER LYNN (UNITED STATES  
INDIVIDUAL)  
1227 W. WEAVER CIR.  
LITTLETON, CO 80120

FIRST USE 11-15-2006; IN COMMERCE 11-15-2006.

FOR: EDUCATIONAL SERVICES, NAMELY,  
LIVE LECTURES IN THE FIELD OF SUSTAINABLE  
LIVING COMMUNITIES, NATURAL RESOURCES,  
URBAN PLANNING, GREEN BUILDING DESIGN,  
THE ROLE OF THE FAMILY IN THE SUSTAIN-  
ABLE COMMUNITY, AND THE DISTRIBUTION OF  
COURSE MATERIAL IN CONNECTION THERE-  
WITH, IN CLASS 41 (U.S. CLS. 100, 101 AND 107).

THE MARK CONSISTS OF STANDARD CHAR-  
ACTERS WITHOUT CLAIM TO ANY PARTICULAR  
FONT, STYLE, SIZE, OR COLOR.

SER. NO. 77-338,094, FILED 11-27-2007.

NANCY CLARKE, EXAMINING ATTORNEY

**Int. Cls.: 41 and 42**

**Prior U.S. Cls.: 100, 101 and 107**

**United States Patent and Trademark Office**

**Reg. No. 3,467,349**

**Registered July 15, 2008**

**SERVICE MARK  
PRINCIPAL REGISTER**

# AnalogX

THOMPSON, MARK (UNITED STATES INDIVIDUAL)

#3555

350 EAST UNIVERSITY DR.  
TEMPE, AZ 85281

FOR: MUSIC PRODUCTION SERVICES, IN CLASS 41 (U.S. CLS. 100, 101 AND 107).

FIRST USE 10-19-1998; IN COMMERCE 10-19-1998.

FOR: COMPUTER SOFTWARE DEVELOPMENT, IN CLASS 42 (U.S. CLS. 100 AND 101).

FIRST USE 10-19-1998; IN COMMERCE 10-19-1998.

THE MARK CONSISTS OF STANDARD CHARACTERS WITHOUT CLAIM TO ANY PARTICULAR FONT, STYLE, SIZE, OR COLOR.

SER. NO. 77-338,098, FILED 11-27-2007.

MELISSA VALLILLO, EXAMINING ATTORNEY

**Int. Cl.: 28**

**Prior U.S. Cls.: 22, 23, 38 and 50**

**United States Patent and Trademark Office**

**Reg. No. 3,467,350**

**Registered July 15, 2008**

**TRADEMARK  
PRINCIPAL REGISTER**

**ECONOGAME**

GARRETT, CARLA YOUNG (UNITED STATES  
INDIVIDUAL)  
110 COLLINS DRIVE  
PLEASANT HILL, CA 94523

THE MARK CONSISTS OF STANDARD CHAR-  
ACTERS WITHOUT CLAIM TO ANY PARTICULAR  
FONT, STYLE, SIZE, OR COLOR.

FOR: EQUIPMENT AND INSTRUCTIONAL MA-  
TERIALS SOLD AS A UNIT FOR PLAYING EDU-  
CATIONAL BOARD GAMES AND EDUCATIONAL  
ROLE PLAYING GAMES, IN CLASS 28 (U.S. CLS. 22,  
23, 38 AND 50).

OWNER OF U.S. REG. NO. 2,512,945.

SER. NO. 77-338,099, FILED 11-27-2007.

FIRST USE 11-30-2000; IN COMMERCE 12-8-2000.

JASON ROTH, EXAMINING ATTORNEY

**Int. Cl.: 11**

**Prior U.S. Cls.: 13, 21, 23, 31 and 34**

**United States Patent and Trademark Office**

**Reg. No. 3,467,351**

**Registered July 15, 2008**

**TRADEMARK  
PRINCIPAL REGISTER**

**MORE THAN JUST A GRILL**

SIKES COOKERS AND GRILLS, INC. (GEORGIA  
CORPORATION)  
337 COMMERCE LOOP  
VIDALIA, GA 30474

THE MARK CONSISTS OF STANDARD CHAR-  
ACTERS WITHOUT CLAIM TO ANY PARTICULAR  
FONT, STYLE, SIZE, OR COLOR.

FOR: GAS COOKERS, IN CLASS 11 (U.S. CLS. 13,  
21, 23, 31 AND 34).

SER. NO. 77-338,120, FILED 11-27-2007.

FIRST USE 10-1-2007; IN COMMERCE 10-1-2007.

MARK T. MULLEN, EXAMINING ATTORNEY



**Int. Cls.: 36 and 37**

**Prior U.S. Cls.: 100, 101, 102, 103 and 106**

**United States Patent and Trademark Office**

**Reg. No. 3,467,352**

**Registered July 15, 2008**

**SERVICE MARK  
PRINCIPAL REGISTER**

**BUILDING VALUE THROUGH  
INTELLIGENT INVESTMENT**

EQUITAS REALTY ADVISORS, L.L.C. (OKLAHOMA LTD LIAB CO)

5801 EAST 41ST STREET, SUITE 101

TULSA, OK 74135

FOR: LAND ACQUISITION, NAMELY, REAL ESTATE BROKERAGE; LEASING OF REAL ESTATE; REAL ESTATE CONSULTATION, IN CLASS 36 (U.S. CLS. 100, 101 AND 102).

FIRST USE 1-16-2007; IN COMMERCE 1-16-2007.

FOR: REAL ESTATE DEVELOPMENT AND REAL ESTATE SITE SELECTION, IN CLASS 37 (U.S. CLS. 100, 103 AND 106).

FIRST USE 1-16-2007; IN COMMERCE 1-16-2007.

THE MARK CONSISTS OF STANDARD CHARACTERS WITHOUT CLAIM TO ANY PARTICULAR FONT, STYLE, SIZE, OR COLOR.

SER. NO. 77-338,152, FILED 11-27-2007.

COLLEEN KEARNEY, EXAMINING ATTORNEY

**Int. Cl.: 25**

**Prior U.S. Cls.: 22 and 39**

**United States Patent and Trademark Office**

**Reg. No. 3,467,353**

**Registered July 15, 2008**

**TRADEMARK  
PRINCIPAL REGISTER**

# TabaJacks

GERMANN, SUMMER (UNITED STATES INDIVIDUAL)

708 MEADOW HILL CT.  
JOHNSBURG, IL 60051 AND

GERMANN, MARGARET (UNITED STATES INDIVIDUAL)

708 MEADOW HILL CT.  
JOHNSBURG, IL 60051

FIRST USE 11-24-2007; IN COMMERCE 11-24-2007.

THE MARK CONSISTS OF STANDARD CHARACTERS WITHOUT CLAIM TO ANY PARTICULAR FONT, STYLE, SIZE, OR COLOR.

SER. NO. 77-338,163, FILED 11-27-2007.

FOR: SOCKS, IN CLASS 25 (U.S. CLS. 22 AND 39).

MELISSA VALLILLO, EXAMINING ATTORNEY

**Int. Cl.: 35**

**Prior U.S. Cls.: 100, 101 and 102**

**United States Patent and Trademark Office**

**Reg. No. 3,467,354**

**Registered July 15, 2008**

**SERVICE MARK  
PRINCIPAL REGISTER**



VALERA, HAZEL (UNITED STATES INDIVIDUAL)  
STE. H187  
1101 S. WINCHESTER BLVD.  
SAN JOSE, CA 95128

FOR: BUSINESS DEVELOPMENT SERVICES, NAMELY, PROVIDING START-UP SUPPORT FOR BUSINESSES OF OTHERS, IN CLASS 35 (U.S. CLS. 100, 101 AND 102).

FIRST USE 8-20-2006; IN COMMERCE 9-1-2006.

NO CLAIM IS MADE TO THE EXCLUSIVE RIGHT TO USE "CORPORATE", APART FROM THE MARK AS SHOWN.

THE MARK CONSISTS OF A CIRCLE WITH 2 ELONGATED CURVED TRIANGLES COMING FROM THE LEFT AND THE STYLIZED LETTERING "CORPORATE GENESIS" IS TO THE RIGHT.

SER. NO. 77-338,169, FILED 11-27-2007.

KATINA MISTER, EXAMINING ATTORNEY

**Int. Cl.: 37**

**Prior U.S. Cls.: 100, 103 and 106**

**United States Patent and Trademark Office**

**Reg. No. 3,467,355**

**Registered July 15, 2008**

**SERVICE MARK  
PRINCIPAL REGISTER**

**THE ICON COMPANIES**

ICON IDENTITY SOLUTIONS (ILLINOIS CORPORATION)  
1418 ELMHURST ROAD  
ELK GROVE VILLAGE, IL 60007

OWNER OF U.S. REG. NOS. 3,005,342, 3,117,816  
AND OTHERS.

FOR: INSTALLATION, REMOVAL, MODIFICATION,  
REPAIR AND MAINTENANCE OF INTERIOR  
AND EXTERIOR SIGN SYSTEMS, IN CLASS 37  
(U.S. CLS. 100, 103 AND 106).

NO CLAIM IS MADE TO THE EXCLUSIVE  
RIGHT TO USE "COMPANIES", APART FROM  
THE MARK AS SHOWN.

FIRST USE 10-29-2007; IN COMMERCE 10-29-2007.

SER. NO. 77-338,170, FILED 11-27-2007.

THE MARK CONSISTS OF STANDARD CHARACTERS  
WITHOUT CLAIM TO ANY PARTICULAR  
FONT, STYLE, SIZE, OR COLOR.

TINA BROWN, EXAMINING ATTORNEY

**Int. Cl.: 40**

**Prior U.S. Cls.: 100, 103 and 106**

**United States Patent and Trademark Office**

**Reg. No. 3,467,356**

**Registered July 15, 2008**

**SERVICE MARK  
PRINCIPAL REGISTER**

**THE ICON COMPANIES**

ICON IDENTITY SOLUTIONS (ILLINOIS CORPORATION)  
1418 ELMHURST ROAD  
ELK GROVE VILLAGE, IL 60007

OWNER OF U.S. REG. NOS. 3,005,342, 3,117,816  
AND OTHERS.

FOR: FABRICATION OF INTERIOR AND EXTERIOR SIGN SYSTEMS TO THE ORDER AND SPECIFICATION OF OTHERS, IN CLASS 40 (U.S. CLS. 100, 103 AND 106).

NO CLAIM IS MADE TO THE EXCLUSIVE RIGHT TO USE "COMPANIES", APART FROM THE MARK AS SHOWN.

FIRST USE 10-29-2007; IN COMMERCE 10-29-2007.

SER. NO. 77-338,173, FILED 11-27-2007.

THE MARK CONSISTS OF STANDARD CHARACTERS WITHOUT CLAIM TO ANY PARTICULAR FONT, STYLE, SIZE, OR COLOR.

TINA BROWN, EXAMINING ATTORNEY

**Int. Cl.: 42**

**Prior U.S. Cls.: 100 and 101**

**United States Patent and Trademark Office**

**Reg. No. 3,467,357**

**Registered July 15, 2008**

**SERVICE MARK  
PRINCIPAL REGISTER**

**THE ICON COMPANIES**

ICON IDENTITY SOLUTIONS (ILLINOIS CORPORATION)  
1418 ELMHURST ROAD  
ELK GROVE VILLAGE, IL 60007

OWNER OF U.S. REG. NOS. 3,005,342, 3,117,816  
AND OTHERS.

FOR: CUSTOM DESIGN AND ENGINEERING OF  
INTERIOR AND EXTERIOR SIGN SYSTEMS FOR  
OTHERS, IN CLASS 42 (U.S. CLS. 100 AND 101).

NO CLAIM IS MADE TO THE EXCLUSIVE  
RIGHT TO USE "COMPANIES", APART FROM  
THE MARK AS SHOWN.

FIRST USE 10-29-2007; IN COMMERCE 10-29-2007.

SER. NO. 77-338,175, FILED 11-27-2007.

THE MARK CONSISTS OF STANDARD CHARACTERS  
WITHOUT CLAIM TO ANY PARTICULAR  
FONT, STYLE, SIZE, OR COLOR.

TINA BROWN, EXAMINING ATTORNEY

Int. Cl.: 36

Prior U.S. Cls.: 100, 101 and 102

United States Patent and Trademark Office

Reg. No. 3,467,358

Registered July 15, 2008

SERVICE MARK  
PRINCIPAL REGISTER



ATLANTIC SOUTHERN BANK (GEORGIA  
CHARTERED BANK)  
4077 FORSYTH ROAD  
MACON, GA 31210

NO CLAIM IS MADE TO THE EXCLUSIVE  
RIGHT TO USE "BANK" , APART FROM THE  
MARK AS SHOWN.

FOR: BANKING SERVICES, IN CLASS 36 (U.S.  
CLS. 100, 101 AND 102).

SER. NO. 77-338,180, FILED 11-27-2007.

FIRST USE 1-1-2006; IN COMMERCE 1-1-2006.

TINA BROWN, EXAMINING ATTORNEY

Int. Cl.: 36

Prior U.S. Cls.: 100, 101 and 102

United States Patent and Trademark Office

Reg. No. 3,467,359

Registered July 15, 2008

SERVICE MARK  
PRINCIPAL REGISTER



YOUNG FAMILY FINANCIAL, LLC (NEW JERSEY LTD LIAB CO)  
153 MOUNT PLEASANT AVENUE  
DOVER, NJ 07807

FOR: ASSISTS CLIENTS IN SECURING THEIR FINANCIAL FUTURE THROUGH VARIOUS FINANCIAL PRODUCTS, NAMELY, BROKERAGE AND ISSUANCE OF LIFE INSURANCE, HEALTH INSURANCE, DISABILITY INSURANCE, LONG-TERM CARE INSURANCE AND INVESTMENT MANAGEMENT OF AND DISTRIBUTION OF FIXED AND INDEXED ANNUITIES, IN CLASS 36 (U.S. CLS. 100, 101 AND 102).

FIRST USE 10-10-2007; IN COMMERCE 11-10-2007.

NO CLAIM IS MADE TO THE EXCLUSIVE RIGHT TO USE "FAMILY FINANCIAL", APART FROM THE MARK AS SHOWN.

THE COLOR(S) BLUE, GRAY AND WHITE IS/ARE CLAIMED AS A FEATURE OF THE MARK.

THE MARK CONSISTS OF TO THE LEFT OF THE IMAGE IS A GRAY BOX. INSIDE A GRAY BOX IS A SOLID BLUE BOX WITH A SCRIPT LETTER "Y" INSIDE. TO THE RIGHT OF THIS BOX ARE LARGE, ALL CAPITAL, BLUE LETTERS THAT SPELL "YOUNG" WITH A THIN GRAY LINE UNDERNEATH THE WORD "YOUNG". WRITTEN IN BLUE SMALL CAPITAL LETTERS, JUST BELOW THE GRAY LINE, ARE THE WORDS "FAMILY FINANCIAL".

SER. NO. 77-338,188, FILED 11-27-2007.

GENE MACIOL, EXAMINING ATTORNEY



**Int. Cl.: 37**

**Prior U.S. Cls.: 100, 103 and 106**

**United States Patent and Trademark Office**

**Reg. No. 3,467,360**

**Registered July 15, 2008**

**SERVICE MARK  
PRINCIPAL REGISTER**

**RIZOS WASH**

IN & OUT CAR WASH, INC. (TEXAS CORPORATION)  
2828 W. NORTHWEST HWY.  
DALLAS, TX 75220

FOR: SELF SERVICE CAR WASHING AND LAUNDRY SERVICES, IN CLASS 37 (U.S. CLS. 100, 103 AND 106).

FIRST USE 1-8-2007; IN COMMERCE 1-8-2007.

THE MARK CONSISTS OF STANDARD CHARACTERS WITHOUT CLAIM TO ANY PARTICULAR FONT, STYLE, SIZE, OR COLOR.

NO CLAIM IS MADE TO THE EXCLUSIVE RIGHT TO USE "WASH", APART FROM THE MARK AS SHOWN.

SER. NO. 77-338,197, FILED 11-27-2007.

GENE MACIOL, EXAMINING ATTORNEY

**Int. Cl.: 5**

**Prior U.S. Cls.: 6, 18, 44, 46, 51 and 52**

**Reg. No. 3,467,361**

**United States Patent and Trademark Office**

**Registered July 15, 2008**

---

**TRADEMARK  
PRINCIPAL REGISTER**

**NIAVIN**

NIAVIN CORPORATION (CALIFORNIA CORPORATION)  
9018 BALBOA BOULEVARD, #305  
NORTHRIDGE, CA 913252610

FOR: PAIN RELIEF MEDICATION, IN CLASS 5  
(U.S. CLS. 6, 18, 44, 46, 51 AND 52).

FIRST USE 8-1-2005; IN COMMERCE 8-1-2005.

THE MARK CONSISTS OF STANDARD CHARACTERS WITHOUT CLAIM TO ANY PARTICULAR FONT, STYLE, SIZE, OR COLOR.

OWNER OF U.S. REG. NO. 3,274,554.

SER. NO. 77-338,203, FILED 11-27-2007.

LANA PHAM, EXAMINING ATTORNEY

**Int. Cl.: 33**

**Prior U.S. Cls.: 47 and 49**

**United States Patent and Trademark Office**

**Reg. No. 3,467,362**

**Registered July 15, 2008**

**TRADEMARK  
PRINCIPAL REGISTER**

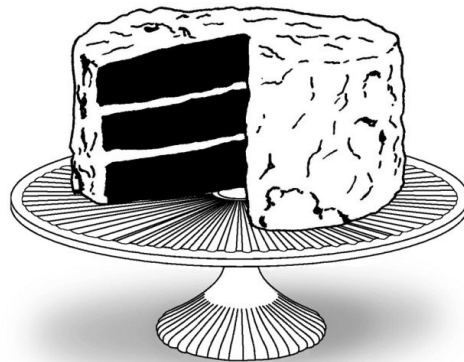

ONE TRUE VINE, LLC (CALIFORNIA LTD LIAB  
CO)  
1104 ADAMS STREET, SUITE 203B  
ST. HELENA, CA 94574

THE MARK CONSISTS OF A DESIGN OF A  
LAYER CAKE DISPLAYED ON TOP OF A RIDGED  
CAKE STAND AND A SHADOW UNDERNEATH.

FOR: WINES, IN CLASS 33 (U.S. CLS. 47 AND 49).

SER. NO. 77-338,206, FILED 11-27-2007.

FIRST USE 7-0-2006; IN COMMERCE 7-0-2006.

APRIL ROACH, EXAMINING ATTORNEY

**Int. Cl.: 33**

**Prior U.S. Cls.: 47 and 49**

**United States Patent and Trademark Office**

**Reg. No. 3,467,363**

**Registered July 15, 2008**

**TRADEMARK  
PRINCIPAL REGISTER**

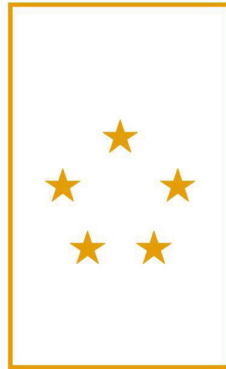

HUNDRED ACRE WINE ESTATE, LLC (CALI-  
FORNIA LTD LIAB CO)  
565 CRYSTAL SPRINGS ROAD  
ST. HELENA, CA 94574

THE MARK CONSISTS OF FIVE GOLD STARS  
DISPLAYED IN A CIRCULAR PATTERN, ALL  
ENCLOSED IN A GOLD RECTANGLE.

FOR: WINES, IN CLASS 33 (U.S. CLS. 47 AND 49).

SER. NO. 77-338,208, FILED 11-27-2007.

FIRST USE 2-0-2003; IN COMMERCE 2-0-2003.

THE COLOR(S) GOLD IS/ARE CLAIMED AS A  
FEATURE OF THE MARK.

ROBIN CHOSID, EXAMINING ATTORNEY

**Int. Cl.: 45**

**Prior U.S. Cls.: 100 and 101**

**United States Patent and Trademark Office**

**Reg. No. 3,467,364**

**Registered July 15, 2008**

**SERVICE MARK  
PRINCIPAL REGISTER**

**THE ICON COMPANIES**

ICON IDENTITY SOLUTIONS (ILLINOIS CORPORATION)  
1418 ELMHURST ROAD  
ELK GROVE VILLAGE, IL 60007

OWNER OF U.S. REG. NOS. 3,005,342, 3,117,816  
AND OTHERS.

FOR: PERMITTING, NAMELY, OBTAINING  
GOVERNMENTAL PERMITS FOR USE IN THE  
FIELD OF FACILITY BRANDING, IN CLASS 45  
(U.S. CLS. 100 AND 101).

NO CLAIM IS MADE TO THE EXCLUSIVE  
RIGHT TO USE "COMPANIES", APART FROM  
THE MARK AS SHOWN.

FIRST USE 10-29-2007; IN COMMERCE 10-29-2007.

SER. NO. 77-338,219, FILED 11-27-2007.

THE MARK CONSISTS OF STANDARD CHAR-  
ACTERS WITHOUT CLAIM TO ANY PARTICULAR  
FONT, STYLE, SIZE, OR COLOR.

TINA BROWN, EXAMINING ATTORNEY

**Int. Cls.: 6, 20, 25, 35, 36 and 37**

**Prior U.S. Cls.: 2, 12, 13, 14, 22, 23, 25, 32, 39, 50, 100, 101, 102, 103 and 106**

**Reg. No. 3,467,365**

**United States Patent and Trademark Office**

**Registered July 15, 2008**

**TRADEMARK  
SERVICE MARK  
PRINCIPAL REGISTER**

**CARL BLACK**

CARL BLACK AUTOMOTIVE GROUP, LLC  
(GEORGIA LTD LIAB CO)  
1110 ROBERTS BOULEVARD NW  
KENNESAW, GA 30144

FOR: METAL LICENSE PLATES, IN CLASS 6 (U.S. CLS. 2, 12, 13, 14, 23, 25 AND 50).

FIRST USE 4-24-1993; IN COMMERCE 4-24-1993.

FOR: PLASTIC KEY CHAIN TAGS, IN CLASS 20 (U.S. CLS. 2, 13, 22, 25, 32 AND 50).

FIRST USE 4-24-1993; IN COMMERCE 4-24-1993.

FOR: JACKETS; SHIRTS; HATS, IN CLASS 25 (U.S. CLS. 22 AND 39).

FIRST USE 4-24-1993; IN COMMERCE 4-24-1993.

FOR: AUTOMOBILE DEALERSHIPS; RETAIL AUTOMOBILE PARTS AND ACCESSORIES STORES, IN CLASS 35 (U.S. CLS. 100, 101 AND 102).

FIRST USE 4-24-1993; IN COMMERCE 4-24-1993.

FOR: FINANCING RELATING TO AUTOMOBILES, IN CLASS 36 (U.S. CLS. 100, 101 AND 102).

FIRST USE 4-24-1993; IN COMMERCE 4-24-1993.

FOR: AUTOMOBILE REPAIR AND MAINTENANCE, IN CLASS 37 (U.S. CLS. 100, 103 AND 106).

FIRST USE 4-24-1993; IN COMMERCE 4-24-1993.

THE MARK CONSISTS OF STANDARD CHARACTERS WITHOUT CLAIM TO ANY PARTICULAR FONT, STYLE, SIZE, OR COLOR.

THE NAME "CARL BLACK" IDENTIFIES A LIVING INDIVIDUAL WHOSE CONSENT IS OF RECORD.

SER. NO. 77-338,224, FILED 11-27-2007.

ALICE SUE CARRUTHERS, EXAMINING ATTORNEY

**Int. Cl.: 41**

**Prior U.S. Cls.: 100, 101 and 107**

**United States Patent and Trademark Office**

**Reg. No. 3,467,366**

**Registered July 15, 2008**

**SERVICE MARK  
PRINCIPAL REGISTER**

**Educational Lectures with  
the Flair of Entertainment  
and Illusion**

GOLDMAN, DAVID (UNITED STATES INDIVIDUAL)  
4000 WESTGATE DRIVE  
SPRINGFIELD, IL 62711

FOR: EDUCATIONAL SERVICES, NAMELY, PROVIDING LECTURES ON THE SUBJECT OF PSYCHIATRY, LAW, AND MEDICOLEGAL TOPICS, IN CLASS 41 (U.S. CLS. 100, 101 AND 107).

FIRST USE 1-1-2001; IN COMMERCE 1-1-2001.

THE MARK CONSISTS OF STANDARD CHARACTERS WITHOUT CLAIM TO ANY PARTICULAR FONT, STYLE, SIZE, OR COLOR.

NO CLAIM IS MADE TO THE EXCLUSIVE RIGHT TO USE "EDUCATIONAL LECTURES", APART FROM THE MARK AS SHOWN.

SER. NO. 77-338,259, FILED 11-27-2007.

MARY MUNSON, EXAMINING ATTORNEY

**Int. Cl.: 42**

**Prior U.S. Cls.: 100 and 101**

**United States Patent and Trademark Office**

**Reg. No. 3,467,367**

**Registered July 15, 2008**

**SERVICE MARK  
PRINCIPAL REGISTER**

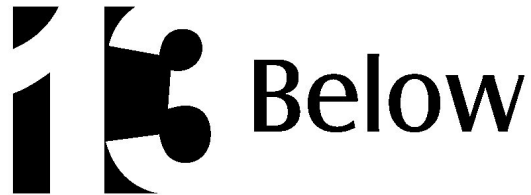

13 BELOW NETWORK, LLC (DELAWARE LTD  
LIAB CO)

#202

8636 EAGLE CREEK CIRCLE  
SAVAGE, MN 55378

FIRST USE 9-20-2007; IN COMMERCE 9-20-2007.

SER. NO. 77-338,264, FILED 11-27-2007.

FOR: INFORMATION TECHNOLOGY CONSUL-  
TATION, IN CLASS 42 (U.S. CLS. 100 AND 101).

COLLEEN KEARNEY, EXAMINING ATTORNEY



**Int. Cl.: 16**

**Prior U.S. Cls.: 2, 5, 22, 23, 29, 37, 38 and 50**

**Reg. No. 3,467,368**

**United States Patent and Trademark Office**

**Registered July 15, 2008**

---

**TRADEMARK  
PRINCIPAL REGISTER**

**The ULTIMATE SPIRITUAL  
SOLUTION**

BENTLEY, KAREN (UNITED STATES INDIVIDUAL)  
P.O. BOX 1209  
44 KNOLL POINT DRIVE  
CENTER HARBOR, NH 03226

FOR: BOOKLETS IN THE FIELD OF LOVE-BASED PROBLEM RESOLUTION; BOOKS IN THE FIELD OF LOVE-BASED PROBLEM RESOLUTION; NEWSLETTERS IN THE FIELD OF LOVE-BASED PROBLEM RESOLUTION, IN CLASS 16 (U.S. CLS. 2, 5, 22, 23, 29, 37, 38 AND 50).

FIRST USE 1-0-1998; IN COMMERCE 1-0-1998.

THE MARK CONSISTS OF STANDARD CHARACTERS WITHOUT CLAIM TO ANY PARTICULAR FONT, STYLE, SIZE, OR COLOR.

SER. NO. 77-338,269, FILED 11-27-2007.

BRENDAN MCCAULEY, EXAMINING ATTORNEY

**Int. Cl.: 35**

**Prior U.S. Cls.: 100, 101 and 102**

**United States Patent and Trademark Office**

**Reg. No. 3,467,369**

**Registered July 15, 2008**

**SERVICE MARK  
PRINCIPAL REGISTER**

**bookies & cookies**

BOOKIES & COOKIES (UTAH CORPORATION)  
486 E 800 S  
PAYSON, UT 84651

THE MARK CONSISTS OF STANDARD CHAR-  
ACTERS WITHOUT CLAIM TO ANY PARTICULAR  
FONT, STYLE, SIZE, OR COLOR.

FOR: CLUB SERVICES, NAMELY, PROMOTING  
THE INTERESTS OF CHILDREN AND BOOKS; ON-  
LINE RETAIL STORE SERVICES FEATURING  
BOOKS, IN CLASS 35 (U.S. CLS. 100, 101 AND 102).

SER. NO. 77-338,276, FILED 11-27-2007.

FIRST USE 8-26-2006; IN COMMERCE 10-0-2006.

DAVID YONTEF, EXAMINING ATTORNEY

**Int. Cl.: 28**

**Prior U.S. Cls.: 22, 23, 38 and 50**

**United States Patent and Trademark Office**

**Reg. No. 3,467,370**

**Registered July 15, 2008**

**TRADEMARK  
PRINCIPAL REGISTER**

**KINGSWOOD**

GLOMCO LIMITED (NEW ZEALAND LTD LIAB  
CO), DBA KINGSWOOD SKIS  
11 COLERIDGE TCE  
LYTTTELTON, NEW ZEALAND 8012

THE MARK CONSISTS OF STANDARD CHAR-  
ACTERS WITHOUT CLAIM TO ANY PARTICULAR  
FONT, STYLE, SIZE, OR COLOR.

FOR: SKI BAGS; SNOW SKIS, IN CLASS 28 (U.S.  
CLS. 22, 23, 38 AND 50).

SER. NO. 77-338,286, FILED 11-27-2007.

FIRST USE 3-1-2005; IN COMMERCE 6-1-2005.

ESTHER BELENKER, EXAMINING ATTORNEY

**Int. Cl.: 35**

**Prior U.S. Cls.: 100, 101 and 102**

**United States Patent and Trademark Office**

**Reg. No. 3,467,371**

**Registered July 15, 2008**

---

**SERVICE MARK  
PRINCIPAL REGISTER**

# WhosFood

WHOSFOOD.COM INC. (NEW YORK CORPORATION)  
1068 EAST 14TH STREET  
BROOKLYN, NY 11230

FOR: PROVIDING A SEARCHABLE ONLINE  
ADVERTISING GUIDE FEATURING THE MENUS  
OF PARTICIPATING RESTAURANTS, IN CLASS 35  
(U.S. CLS. 100, 101 AND 102).

FIRST USE 7-1-2007; IN COMMERCE 7-1-2007.

THE MARK CONSISTS OF STANDARD CHARACTERS WITHOUT CLAIM TO ANY PARTICULAR FONT, STYLE, SIZE, OR COLOR.

SER. NO. 77-338,288, FILED 11-27-2007.

TOBY BULLOFF, EXAMINING ATTORNEY

**Int. Cl.: 36**

**Prior U.S. Cls.: 100, 101 and 102**

**United States Patent and Trademark Office**

**Reg. No. 3,467,372**

**Registered July 15, 2008**

**SERVICE MARK  
PRINCIPAL REGISTER**

**FIRELINE**

F&A FEDERAL CREDIT UNION (CALIFORNIA  
CORPORATION)  
2625 CORPORATE PLACE  
MONTEREY PARK, CA 91754

THE MARK CONSISTS OF STANDARD CHAR-  
ACTERS WITHOUT CLAIM TO ANY PARTICULAR  
FONT, STYLE, SIZE, OR COLOR.

FOR: CREDIT UNION SERVICES; HOME EQUI-  
TY LOANS, IN CLASS 36 (U.S. CLS. 100, 101 AND  
102).

SER. NO. 77-338,298, FILED 11-27-2007.

FIRST USE 4-1-1987; IN COMMERCE 4-1-1987.

HOWARD B. LEVINE, EXAMINING ATTORNEY

**Int. Cl.: 6**

**Prior U.S. Cls.: 2, 12, 13, 14, 23, 25 and 50**

**Reg. No. 3,467,373**

**United States Patent and Trademark Office**

**Registered July 15, 2008**

**TRADEMARK  
PRINCIPAL REGISTER**

**Tsunami Marine**

TSUNAMI MARINE LLC (DELAWARE LTD  
LIAB CO)  
1679 WATERGLEN DRIVE  
WEST CHESTER, PA 19382

FOR: MANUALLY OPERATED STAINLESS  
STEEL 3-WAY VALVES; STAINLESS STEEL 3-WAY  
VALVES NOT BEING PARTS OF MACHINES, IN  
CLASS 6 (U.S. CLS. 2, 12, 13, 14, 23, 25 AND 50).

FIRST USE 5-1-2007; IN COMMERCE 8-15-2007.

THE MARK CONSISTS OF STANDARD CHAR-  
ACTERS WITHOUT CLAIM TO ANY PARTICULAR  
FONT, STYLE, SIZE, OR COLOR.

NO CLAIM IS MADE TO THE EXCLUSIVE  
RIGHT TO USE "MARINE", APART FROM THE  
MARK AS SHOWN.

SER. NO. 77-338,310, FILED 11-27-2007.

CHRISTINE COOPER, EXAMINING ATTORNEY

**Int. Cl.: 42**

**Prior U.S. Cls.: 100 and 101**

**United States Patent and Trademark Office**

**Reg. No. 3,467,374**

**Registered July 15, 2008**

**SERVICE MARK  
PRINCIPAL REGISTER**

# VFR Simulations

VFR SIMULATIONS (PENNSYLVANIA CORPORATION)  
14 HIGHLAND CIRCLE  
STROUDSBURG, PA 18360

FOR: TECHNOLOGICAL CONSULTATION AND PRODUCT RESEARCH IN THE TECHNOLOGY FIELD OF COMPUTER SOFTWARE AND COMPUTER HARDWARE SYSTEMS, IN CLASS 42 (U.S. CLS. 100 AND 101).

FIRST USE 12-7-2006; IN COMMERCE 4-5-2007.

THE MARK CONSISTS OF STANDARD CHARACTERS WITHOUT CLAIM TO ANY PARTICULAR FONT, STYLE, SIZE, OR COLOR.

NO CLAIM IS MADE TO THE EXCLUSIVE RIGHT TO USE "SIMULATIONS", APART FROM THE MARK AS SHOWN.

SER. NO. 77-338,315, FILED 11-27-2007.

CHRISTINE COOPER, EXAMINING ATTORNEY

**Int. Cl.: 30**

**Prior U.S. Cl.: 46**

**United States Patent and Trademark Office**

**Reg. No. 3,467,375**

**Registered July 15, 2008**

**TRADEMARK  
PRINCIPAL REGISTER**

**WINDSOR GARDENS**

SOUTHERN SUN TEAS (PRIVATE) LIMITED  
(SRI LANKA LTD LIAB CO)  
49/21, FIFE ROAD, COLOMBO 5  
COLOMBO - 5, SRI LANKA 50000

THE MARK CONSISTS OF STANDARD CHAR-  
ACTERS WITHOUT CLAIM TO ANY PARTICULAR  
FONT, STYLE, SIZE, OR COLOR.

FOR: COFFEE AND TEA, IN CLASS 30 (U.S. CL.  
46).

SER. NO. 77-338,383, FILED 11-27-2007.

FIRST USE 8-1-2003; IN COMMERCE 8-1-2003.

JILL PRATER, EXAMINING ATTORNEY



**Int. Cl.: 41**

**Prior U.S. Cls.: 100, 101 and 107**

**United States Patent and Trademark Office**

**Reg. No. 3,467,376**

**Registered July 15, 2008**

**SERVICE MARK  
PRINCIPAL REGISTER**

**FUTURE 500**

SHIREMAN, WILLIAM K. (UNITED STATES IN-  
DIVIDUAL)  
412 CORTLAND AV.  
SAN FRANCISCO, CA 94110

THE MARK CONSISTS OF STANDARD CHAR-  
ACTERS WITHOUT CLAIM TO ANY PARTICULAR  
FONT, STYLE, SIZE, OR COLOR.

FOR: EDUCATION SERVICES, NAMELY, PRO-  
VIDING SEMINARS AND WORKSHOPS IN THE  
FIELDS OF ENVIRONMENTAL CONCERNS, IN  
CLASS 41 (U.S. CLS. 100, 101 AND 107).

SER. NO. 77-338,384, FILED 11-27-2007.

FIRST USE 12-20-1995; IN COMMERCE 12-20-1995.

JILL PRATER, EXAMINING ATTORNEY

**Int. Cl.: 35**

**Prior U.S. Cls.: 100, 101 and 102**

**United States Patent and Trademark Office**

**Reg. No. 3,467,377**

**Registered July 15, 2008**

---

**SERVICE MARK  
PRINCIPAL REGISTER**

**TRY-N-BUY**

ROOSTER PRODUCTS INTERNATIONAL, INC.  
(TEXAS CORPORATION)  
ATTN: LEGAL  
17280 N. GREEN MOUNTAIN RD.  
SAN ANTONIO, TX 78247

THE MARK CONSISTS OF STANDARD CHAR-  
ACTERS WITHOUT CLAIM TO ANY PARTICULAR  
FONT, STYLE, SIZE, OR COLOR.

FOR: MERCHANDISE PACKAGING, IN CLASS  
35 (U.S. CLS. 100, 101 AND 102).

SER. NO. 77-338,385, FILED 11-27-2007.

FIRST USE 1-1-2006; IN COMMERCE 3-1-2006.

JILL PRATER, EXAMINING ATTORNEY

**Int. Cl.: 18**

**Prior U.S. Cls.: 1, 2, 3, 22 and 41**

**Reg. No. 3,467,378**

**United States Patent and Trademark Office**

**Registered July 15, 2008**

---

**TRADEMARK  
PRINCIPAL REGISTER**

**PRO TENSION**

ROOSTER PRODUCTS INTERNATIONAL, INC.  
(TEXAS CORPORATION), DBA THE ROOSTER GROUP  
ATTN: LEGAL  
17280 N. GREEN MOUNTAIN RD.  
SAN ANTONIO, TX 78247

FIRST USE 9-1-2007; IN COMMERCE 9-1-2007.

THE MARK CONSISTS OF STANDARD CHARACTERS WITHOUT CLAIM TO ANY PARTICULAR FONT, STYLE, SIZE, OR COLOR.

FOR: TOOL BAGS SOLD EMPTY; TOOL POUCHES SOLD EMPTY, IN CLASS 18 (U.S. CLS. 1, 2, 3, 22 AND 41).

SER. NO. 77-338,391, FILED 11-27-2007.

JILL PRATER, EXAMINING ATTORNEY

**Int. Cl.: 9**

**Prior U.S. Cls.: 21, 23, 26, 36 and 38**

**Reg. No. 3,467,379**

**United States Patent and Trademark Office**

**Registered July 15, 2008**

---

**TRADEMARK  
PRINCIPAL REGISTER**

**PRO FORM X 360**

ROOSTER PRODUCTS INTERNATIONAL, INC.  
(TEXAS CORPORATION), DBA THE ROOSTER GROUP  
ATTN: LEGAL  
17280 N. GREEN MOUNTAIN RD.  
SAN ANTONIO, TX 78247

THE MARK CONSISTS OF STANDARD CHARACTERS WITHOUT CLAIM TO ANY PARTICULAR FONT, STYLE, SIZE, OR COLOR.

FOR: KNEE PADS FOR WORKERS, IN CLASS 9  
(U.S. CLS. 21, 23, 26, 36 AND 38).

SER. NO. 77-338,394, FILED 11-28-2007.

FIRST USE 9-1-2007; IN COMMERCE 9-1-2007.

JILL PRATER, EXAMINING ATTORNEY

**Int. Cl.: 41**

**Prior U.S. Cls.: 100, 101 and 107**

**United States Patent and Trademark Office**

**Reg. No. 3,467,380**

**Registered July 15, 2008**

**SERVICE MARK  
PRINCIPAL REGISTER**

**THE HEALING POWER OF A SONG**

HILL, BENITA (UNITED STATES INDIVIDUAL)  
6861 RIVER RIDGE DRIVE  
NASHVILLE, TN 37221

FOR: ENTERTAINMENT SERVICES, NAMELY, LIVE, TELEVISED AND MOVIE APPEARANCES BY A PROFESSIONAL ENTERTAINER; ENTERTAINMENT SERVICES, NAMELY, AN ON-GOING SERIES FEATURING PERSONAL SURVIVAL STORIES PROVIDED THROUGH CABLE TELEVISION, BROADCAST TELEVISION, WEBCASTS, AND PORTABLE MEDIA, NAMELY, DVDS AND DIGITAL MEDIA FILES; ENTERTAINMENT SERVICES, NAMELY, PROVIDING A TELEVISION PROGRAM IN THE FIELD OF NEWS, REALITY, HEALTH AND SELF-HELP VIA A GLOBAL COMPUTER NETWORK; ENTERTAINMENT SERVICES, NAMELY, PROVIDING PODCASTS IN THE FIELD OF NEWS, REALITY, HEALTH AND SELF-HELP; ENTER-

TAINMENT, NAMELY, A CONTINUING NEWS, REALITY, HEALTH AND SELF-HELP SHOW BROADCAST OVER TELEVISION, SATELLITE, AUDIO, AND VIDEO MEDIA; PRODUCTION AND DISTRIBUTION OF TELEVISION SHOWS AND MOVIES; PRODUCTION OF DVDS, VIDEOTAPES AND TELEVISION PROGRAMS FEATURING NEWS, REALITY, HEALTH AND SELF-HELP, IN CLASS 41 (U.S. CLS. 100, 101 AND 107).

FIRST USE 8-29-2006; IN COMMERCE 8-29-2006.

THE MARK CONSISTS OF STANDARD CHARACTERS WITHOUT CLAIM TO ANY PARTICULAR FONT, STYLE, SIZE, OR COLOR.

SER. NO. 77-338,396, FILED 11-28-2007.

GIANCARLO CASTRO, EXAMINING ATTORNEY

**Int. Cl.: 21**

**Prior U.S. Cls.: 2, 13, 23, 29, 30, 33, 40 and 50**

**United States Patent and Trademark Office**

**Reg. No. 3,467,381**

**Registered July 15, 2008**

**TRADEMARK  
PRINCIPAL REGISTER**

**THROWZINI**

URBAN TREND (H.K.), LTD. (HONG KONG  
CORPORATION)  
31ST FLOOR, SUNSHINE PLAZA  
353 LOCKHART ROAD  
WAN CHAI, HONG KONG

FOR: KNIFE BLOCKS, IN CLASS 21 (U.S. CLS. 2,  
13, 23, 29, 30, 33, 40 AND 50).

FIRST USE 11-13-2007; IN COMMERCE 11-13-2007.

THE MARK CONSISTS OF STANDARD CHAR-  
ACTERS WITHOUT CLAIM TO ANY PARTICULAR  
FONT, STYLE, SIZE, OR COLOR.

SER. NO. 77-338,404, FILED 11-28-2007.

KARANENDRA S. CHHINA, EXAMINING ATTOR-  
NEY

**Int. Cl.: 5**

**Prior U.S. Cls.: 6, 18, 44, 46, 51 and 52**

**United States Patent and Trademark Office**

**Reg. No. 3,467,382**

**Registered July 15, 2008**

**TRADEMARK  
PRINCIPAL REGISTER**

**NEUROPATHYRX**

TERRACEUTICALS, LLC (MICHIGAN LTD LIAB  
CO)  
515 MICHIGAN STREET NE  
GRAND RAPIDS, MI 49503

THE MARK CONSISTS OF STANDARD CHAR-  
ACTERS WITHOUT CLAIM TO ANY PARTICULAR  
FONT, STYLE, SIZE, OR COLOR.

FOR: DIETARY AND NUTRITIONAL SUPPLE-  
MENTS, IN CLASS 5 (U.S. CLS. 6, 18, 44, 46, 51 AND  
52).

SER. NO. 77-338,460, FILED 11-28-2007.

FIRST USE 5-1-2007; IN COMMERCE 5-1-2007.

KEVON CHISOLM, EXAMINING ATTORNEY

**Int. Cl.: 1**

**Prior U.S. Cls.: 1, 5, 6, 10, 26 and 46**

**Reg. No. 3,467,383**

**United States Patent and Trademark Office**

**Registered July 15, 2008**

---

**TRADEMARK  
PRINCIPAL REGISTER**

**VEGELENE**

MICHEL MERCIER PRODUCTS (NEW JERSEY CORPORATION), DBA MMP, INC.  
3470 SOUTH CLINTON AVENUE  
SOUTH PLAINFIELD, NJ 07080

THE MARK CONSISTS OF STANDARD CHARACTERS WITHOUT CLAIM TO ANY PARTICULAR FONT, STYLE, SIZE, OR COLOR.

FOR: CHEMICALS FOR USE IN THE MANUFACTURE OF COSMETIC, PERSONAL CARE AND PHARMACEUTICAL PRODUCTS, IN CLASS 1 (U.S. CLS. 1, 5, 6, 10, 26 AND 46).

SER. NO. 77-338,478, FILED 11-28-2007.

FIRST USE 10-15-2007; IN COMMERCE 10-15-2007.

JASON TURNER, EXAMINING ATTORNEY



**Int. Cl.: 41**

**Prior U.S. Cls.: 100, 101 and 107**

**United States Patent and Trademark Office**

**Reg. No. 3,467,384**

**Registered July 15, 2008**

---

**SERVICE MARK  
PRINCIPAL REGISTER**

# Slapshot

THE NEW YORK TIMES COMPANY (NEW  
YORK CORPORATION)  
620 EIGHTH AVENUE  
NEW YORK, NY 10018

THE MARK CONSISTS OF STANDARD CHAR-  
ACTERS WITHOUT CLAIM TO ANY PARTICULAR  
FONT, STYLE, SIZE, OR COLOR.

FOR: ON-LINE JOURNALS, NAMELY, BLOGS  
FEATURING HOCKEY, IN CLASS 41 (U.S. CLS. 100,  
101 AND 107).

SER. NO. 77-338,480, FILED 11-28-2007.

FIRST USE 11-20-2007; IN COMMERCE 11-20-2007.

BILL DAWE, EXAMINING ATTORNEY

**Int. Cl.: 41**

**Prior U.S. Cls.: 100, 101 and 107**

**United States Patent and Trademark Office**

**Reg. No. 3,467,385**

**Registered July 15, 2008**

**SERVICE MARK  
PRINCIPAL REGISTER**

# Tasteful Temptations

TASTEFUL TEMPTATIONS, INC. (PENNSYLVANIA CORPORATION)  
1123 S. BROAD ST  
PHILADELPHIA, PA 19147

FOR: ENTERTAINMENT SERVICES, NAMELY, LIVE, TELEVISED AND MOVIE APPEARANCES BY A PROFESSIONAL ENTERTAINER; ENTERTAINMENT SERVICES, NAMELY, CONDUCTING PARTIES; ENTERTAINMENT SERVICES, NAMELY, PROVIDING A WEBSITE FEATURING PHOTOGRAPHIC, AUDIO, VIDEO AND PROSE PRESENTATIONS FEATURING ADULT ENTERTAINMENT; MASTER OF CEREMONY SERVICES FOR PARTIES AND SPECIAL EVENTS; PARTY PLANNING; PARTY PLANNING CONSULTATION; PRODUCTION OF DVDS, VIDEOTAPES AND TELEVISION PROGRAMS FEATURING ADULT ENTERTAINMENT;

TURING ADULT ENTERTAINMENT; MULTIMEDIA ENTERTAINMENT SERVICES IN THE NATURE OF RECORDING, PRODUCTION AND POST-PRODUCTION SERVICES IN THE FIELDS OF MUSIC, VIDEO, AND FILMS, IN CLASS 41 (U.S. CLS. 100, 101 AND 107).

FIRST USE 6-1-2001; IN COMMERCE 6-1-2001.

THE MARK CONSISTS OF STANDARD CHARACTERS WITHOUT CLAIM TO ANY PARTICULAR FONT, STYLE, SIZE, OR COLOR.

SER. NO. 77-338,492, FILED 11-28-2007.

JEFFERY COWARD, EXAMINING ATTORNEY

**Int. Cl.: 9**

**Prior U.S. Cls.: 21, 23, 26, 36 and 38**

**Reg. No. 3,467,386**

**United States Patent and Trademark Office**

**Registered July 15, 2008**

---

**TRADEMARK  
PRINCIPAL REGISTER**

**PATHOS**

PATHOS ACOUSTICS S.R.L. (ITALY CORPORATION)  
VIA PALU, 36040 GRUMOLO DELLE ABBADESSE  
VICENZA, ITALY

FIRST USE 9-0-1994; IN COMMERCE 11-0-1999.

SER. NO. 77-338,508, FILED 11-28-2007.

FOR: STEREO AMPLIFIERS, IN CLASS 9 (U.S. CLS. 21, 23, 26, 36 AND 38).

BILL DAWE, EXAMINING ATTORNEY

**Int. Cl.: 36**

**Prior U.S. Cls.: 100, 101 and 102**

**United States Patent and Trademark Office**

**Reg. No. 3,467,387**

**Registered July 15, 2008**

**SERVICE MARK  
PRINCIPAL REGISTER**

**IT'S YOUR HERITAGE. IT'S  
OUR PRIVILEGE.**

HERITAGE BANK & TRUST (TENNESSEE CORPORATION)  
217 S. JAMES M. CAMPBELL BOULEVARD  
COLUMBIA, TN 38401

FOR: BANKING; FINANCIAL SERVICES, NAME-  
LY, MONEY LENDING, SAVINGS ACCOUNTS,  
CHECKING ACCOUNTS, CERTIFICATES OF DE-  
POSIT ACCOUNTS, INDIVIDUAL RETIREMENT  
ACCOUNTS, ISSUING CERTIFICATES OF DEPOS-  
IT, CASH AND ASSET MANAGEMENT SERVICES,  
CREDIT CARD SERVICES, DEBIT CARD SERVI-  
CES, MONEY ORDER SERVICES, AUTOMATIC  
TELLER MACHINE SERVICES, BILL PAYMENT  
SERVICES, FINANCIAL TRUST OPERATIONS, IS-  
SUING PREPAID STORED VALUE CARDS, ELEC-  
TRONIC AND NON-ELECTRONIC BILL PAYMENT  
SERVICES, CURRENCY TRANSFER SERVICES; FI-  
NANCIAL AND INVESTMENT ADVISORY, CON-  
SULTATION, PLANNING, MANAGEMENT, AND  
ADMINISTRATION SERVICES; INVESTMENT  
FUND TRANSFER AND TRANSACTION SERVI-  
CES, ESTATE PLANNING SERVICES, FINANCIAL  
PLANNING; PORTFOLIO MANAGEMENT, IN-

VESTMENT, INSURANCE, AND SECURITIES  
BROKERAGE SERVICES; ASSET ALLOCATION IN  
THE FIELD OF INTEGRATED PENSION SERVICES;  
DISTRIBUTION OF ANNUITIES; CONSUMER  
LENDING SERVICES, MORTGAGE BANKING  
AND MORTGAGE LENDING SERVICES INCLUD-  
ING UNSECURED AND SECURED LENDING FOR  
INDUSTRIAL, COMMERCIAL AND REAL ESTATE  
PROJECTS; AND PROVIDING ALL OF THE FORE-  
GOING SERVICES BY TRADITIONAL ONSITE  
METHODS, BY TELEPHONE, AND VIA THE IN-  
TERNET, IN CLASS 36 (U.S. CLS. 100, 101 AND 102).

FIRST USE 3-6-2006; IN COMMERCE 3-6-2006.

THE MARK CONSISTS OF STANDARD CHAR-  
ACTERS WITHOUT CLAIM TO ANY PARTICULAR  
FONT, STYLE, SIZE, OR COLOR.

SER. NO. 77-338,524, FILED 11-28-2007.

RUDY R. SINGLETON, EXAMINING ATTORNEY

**Int. Cl.: 39**

**Prior U.S. Cls.: 100 and 105**

**United States Patent and Trademark Office**

**Reg. No. 3,467,388**

**Registered July 15, 2008**

**SERVICE MARK  
PRINCIPAL REGISTER**

**DYNAVOL**

LAYERED TECHNOLOGIES, INC. (TEXAS CORPORATION)  
SUITE 700  
5085 W PARK BLVD.  
PLANO, TX 75093

THE MARK CONSISTS OF STANDARD CHARACTERS WITHOUT CLAIM TO ANY PARTICULAR FONT, STYLE, SIZE, OR COLOR.

FOR: PROVIDING A WEBSITE FOR THE ELECTRONIC STORAGE OF DATA OR SERVING STATIC CONTENT, IN CLASS 39 (U.S. CLS. 100 AND 105).

SER. NO. 77-338,531, FILED 11-28-2007.

FIRST USE 6-0-2007; IN COMMERCE 6-0-2007.

ARETHA SOMERVILLE, EXAMINING ATTORNEY

**Int. Cl.: 41**

**Prior U.S. Cls.: 100, 101 and 107**

**United States Patent and Trademark Office**

**Reg. No. 3,467,389**

**Registered July 15, 2008**

**SERVICE MARK  
PRINCIPAL REGISTER**



AMERICAN URBAN RADIO NETWORKS  
(PENNSYLVANIA PARTNERSHIP)  
SUITE 200  
960 PENN AVENUE  
PITTSBURGH, PA 15222

FOR: ENTERTAINMENT SERVICES, NAMELY,  
AN ON-GOING RADIO PROGRAM FEATURING  
MUSIC, NEWS, SPORTS, BUSINESS, ENTERTAIN-  
MENT AND PUBLIC AFFAIRS , IN CLASS 41 (U.S.  
CLS. 100, 101 AND 107).

FIRST USE 6-1-2002; IN COMMERCE 6-1-2002.

NO CLAIM IS MADE TO THE EXCLUSIVE  
RIGHT TO USE "WEEKEND ENTERTAINMENT  
NETWORK", APART FROM THE MARK AS  
SHOWN.

THE MARK CONSISTS OF THE LETTERS "STRZ"  
IN A STYLIZED VERSION AND THE WORDS  
"WEEKEND ENTERTAINMENT NETWORK" AND  
AN OVAL HAVING LEFT AND RIGHT HALVES  
FORMED BY A SERIES OF SPACED APART LINES.

SER. NO. 77-338,623, FILED 11-28-2007.

GEOFFREY FOSDICK, EXAMINING ATTORNEY

**Int. Cl.: 42**

**Prior U.S. Cls.: 100 and 101**

**United States Patent and Trademark Office**

**Reg. No. 3,467,390**

**Registered July 15, 2008**

**SERVICE MARK  
PRINCIPAL REGISTER**

**TRAININGCAMPUS.COM**

HILLICON TECHNOLOGIES CORPORATION  
(TEXAS CORPORATION)  
P.O. BOX 2287  
CEDAR PARK, TX 78630

FOR: PROVIDING TEMPORARY USE OF ON-  
LINE NON-DOWNLOADABLE SOFTWARE FOR  
BUILDING, SELLING, EXCHANGING, AND DIS-  
TRIBUTING EDUCATIONAL MATERIALS IN THE  
FIELD OF HEALTHCARE AND MEDICAL RE-  
SEARCH, IN CLASS 42 (U.S. CLS. 100 AND 101).

FIRST USE 1-1-2003; IN COMMERCE 1-1-2003.

THE MARK CONSISTS OF STANDARD CHAR-  
ACTERS WITHOUT CLAIM TO ANY PARTICULAR  
FONT, STYLE, SIZE, OR COLOR.

SER. NO. 77-338,630, FILED 11-28-2007.

GINA FINK, EXAMINING ATTORNEY

**Int. Cl.: 9**

**Prior U.S. Cls.: 21, 23, 26, 36 and 38**

**United States Patent and Trademark Office**

**Reg. No. 3,467,391**

**Registered July 15, 2008**

**TRADEMARK  
PRINCIPAL REGISTER**

**JustAddCommerce**

RICH MEDIA TECHNOLOGIES, INC. (COLOR-  
ADO CORPORATION)  
1002 LYNES AVE  
SAVANNAH, GA 31415

FOR: COMPUTER SOFTWARE USED TO FACIL-  
ITATE ELECTRONIC COMMERCE, NAMELY,  
DATA EXCHANGE AND SALES TRANSACTIONS,  
ON GLOBAL COMPUTER NETWORKS, IN CLASS 9  
(U.S. CLS. 21, 23, 26, 36 AND 38).

FIRST USE 5-26-1998; IN COMMERCE 5-26-1998.

THE MARK CONSISTS OF STANDARD CHAR-  
ACTERS WITHOUT CLAIM TO ANY PARTICULAR  
FONT, STYLE, SIZE, OR COLOR.

OWNER OF U.S. REG. NO. 2,482,498.

SER. NO. 77-338,640, FILED 11-28-2007.

JEFFERY COWARD, EXAMINING ATTORNEY



**Int. Cl.: 16**

**Prior U.S. Cls.: 2, 5, 22, 23, 29, 37, 38 and 50**

**Reg. No. 3,467,392**

**United States Patent and Trademark Office**

**Registered July 15, 2008**

---

**TRADEMARK  
PRINCIPAL REGISTER**

**PHYSIOLOGICAL GENOMICS**

AMERICAN PHYSIOLOGICAL SOCIETY (MISSOURI CORPORATION)  
9650 ROCKVILLE PIKE  
BETHESDA, MD 20814

FOR: JOURNALS CONCERNING TOPICS IN THE FIELD OF GENOMICS PHYSIOLOGY, IN CLASS 16 (U.S. CLS. 2, 5, 22, 23, 29, 37, 38 AND 50).

FIRST USE 7-15-1999; IN COMMERCE 7-15-1999.

THE MARK CONSISTS OF STANDARD CHARACTERS WITHOUT CLAIM TO ANY PARTICULAR FONT, STYLE, SIZE, OR COLOR.

OWNER OF U.S. REG. NO. 2,637,715.

SEC. 2(F).

SER. NO. 77-338,651, FILED 11-28-2007.

JENNY PARK, EXAMINING ATTORNEY

**Int. Cl.: 28**

**Prior U.S. Cls.: 22, 23, 38 and 50**

**United States Patent and Trademark Office**

**Reg. No. 3,467,393**

**Registered July 15, 2008**

**TRADEMARK  
PRINCIPAL REGISTER**

**MAURICE**

HIGH ENERGY ENTERTAINMENT, LLC (NEW  
JERSEY LTD LIAB CO)  
605 SOUTH WASHINGTON AVE.  
PISCATAWAY, NJ 08854

FOR: PLUSH TOYS AND PUPPETS, IN CLASS 28  
(U.S. CLS. 22, 23, 38 AND 50).

FIRST USE 6-6-2006; IN COMMERCE 6-6-2006.

THE MARK CONSISTS OF STANDARD CHAR-  
ACTERS WITHOUT CLAIM TO ANY PARTICULAR  
FONT, STYLE, SIZE, OR COLOR.

THE NAME "MAURICE" DOES NOT IDENTIFY A  
LIVING INDIVIDUAL.

SER. NO. 77-338,659, FILED 11-28-2007.

LOURDES AYALA, EXAMINING ATTORNEY

**Int. Cl.: 35**

**Prior U.S. Cls.: 100, 101 and 102**

**United States Patent and Trademark Office**

**Reg. No. 3,467,394**

**Registered July 15, 2008**

**SERVICE MARK  
PRINCIPAL REGISTER**

**save a snowman**

SAVE A SNOWMAN (CALIFORNIA CORPORATION)

#113

1133 JUSTIN AVE.  
GLENDALE, CA 91201

FOR: PROMOTING THE PUBLIC AWARENESS OF THE NEED FOR ENVIRONMENTAL PRESERVATION, NAMELY, THE ISSUES RELATED TO CLIMATE CHANGE AND GLOBAL WARMING, PRESERVATION OF OUR ECO-SYSTEMS, PROTECTING THE BALANCE BETWEEN THE OCEANS, FORESTS, CLEAN AIR AND RENEWABLE ENERGY, USING NON-VIOLENT, CREATIVE CONFRONTATION TO EXPOSE GLOBAL ENVIRONMENTAL ISSUES, SUCH AS, CREATING A SUSTAINABLE RENEWABLE, CLEAN AND SUSTAINABLE WORLD, PROTECTING ENDANGERED SPECIES

VICTIMS OF THE EFFECTS OF GLOBAL WARMING, PRESERVING ANCIENT FORESTS, STOPPING GLOBAL WARMING, EXPOSING TOXIC MENACES, PROTECTING OCEANS, INSPIRING CORPORATIONS AND COMPANIES TO BUILD A SAFER WORLD FOR FUTURE GENERATIONS , IN CLASS 35 (U.S. CLS. 100, 101 AND 102).

FIRST USE 4-17-2007; IN COMMERCE 11-7-2007.

THE MARK CONSISTS OF STANDARD CHARACTERS WITHOUT CLAIM TO ANY PARTICULAR FONT, STYLE, SIZE, OR COLOR.

SER. NO. 77-338,661, FILED 11-28-2007.

SANDRA MANIOS, EXAMINING ATTORNEY

**Int. Cl.: 2**

**Prior U.S. Cls.: 6, 11 and 16**

**United States Patent and Trademark Office**

**Reg. No. 3,467,395**

**Registered July 15, 2008**

**TRADEMARK  
PRINCIPAL REGISTER**

**NEROSOL**

KEYSTONE ANILINE CORPORATION (ILLINOIS  
CORPORATION)  
2501 W. FULTON STREET  
CHICAGO, IL 60612

THE MARK CONSISTS OF STANDARD CHAR-  
ACTERS WITHOUT CLAIM TO ANY PARTICULAR  
FONT, STYLE, SIZE, OR COLOR.

FOR: LIQUID DYE CONCENTRATES FOR USE  
IN WOOD, CONCRETE AND LEATHER STAINS, IN  
CLASS 2 (U.S. CLS. 6, 11 AND 16).

SER. NO. 77-338,663, FILED 11-28-2007.

FIRST USE 1-1-1985; IN COMMERCE 1-1-1985.

EDWARD FENNESSY, EXAMINING ATTORNEY

**Int. Cl.: 45**

**Prior U.S. Cls.: 100 and 101**

**United States Patent and Trademark Office**

**Reg. No. 3,467,396**

**Registered July 15, 2008**

**SERVICE MARK  
PRINCIPAL REGISTER**

**WE KNOW NEVADA**

JONES VARGAS, CHARTERED (NEVADA CORPORATION)  
3773 HOWARD HUGHES PARKWAY  
LAS VEGAS, NV 89169

FOR: LEGAL SERVICES, NAMELY, PROVIDING INFORMATION, COUNSELING, ADVICE, DOCUMENT SERVICES AND LITIGATION SERVICES IN THE AREAS OF TRANSACTIONS, GOVERNMENT RELATIONS AND LITIGATION, IN CLASS 45 (U.S. CLS. 100 AND 101).

FIRST USE 11-8-2004; IN COMMERCE 11-8-2004.

THE MARK CONSISTS OF STANDARD CHARACTERS WITHOUT CLAIM TO ANY PARTICULAR FONT, STYLE, SIZE, OR COLOR.

NO CLAIM IS MADE TO THE EXCLUSIVE RIGHT TO USE "NEVADA", APART FROM THE MARK AS SHOWN.

SER. NO. 77-338,666, FILED 11-28-2007.

SANDRA MANIOS, EXAMINING ATTORNEY

**Int. Cls.: 25 and 41**

**Prior U.S. Cls.: 22, 39, 100, 101 and 107**

**United States Patent and Trademark Office**

**Reg. No. 3,467,397**

**Registered July 15, 2008**

**TRADEMARK  
SERVICE MARK  
PRINCIPAL REGISTER**



KELLY, JAMES P. (UNITED STATES INDIVIDUAL)

1128 BTHL-NW RCHMND RD

NEW RICHMOND, OH 45157

FOR: MARTIAL ARTS UNIFORMS, IN CLASS 25 (U.S. CLS. 22 AND 39).

FIRST USE 6-1-2004; IN COMMERCE 6-4-2005.

FOR: MARTIAL ARTS INSTRUCTION; OPERATING OF MARTIAL ARTS' SCHOOLS, IN CLASS 41 (U.S. CLS. 100, 101 AND 107).

FIRST USE 6-1-2004; IN COMMERCE 6-4-2005.

THE MARK CONSISTS OF A BLACK AND WHITE STYLIZED PROFILE OF A LION'S HEAD.

SER. NO. 77-338,680, FILED 11-28-2007.

MIDGE BUTLER, EXAMINING ATTORNEY

**Int. Cl.: 35**

**Prior U.S. Cls.: 100, 101 and 102**

**United States Patent and Trademark Office**

**Reg. No. 3,467,398**

**Registered July 15, 2008**

**SERVICE MARK  
PRINCIPAL REGISTER**

# Pepperjam

KBJ HOLDINGS, LLC (PENNSYLVANIA LTD  
LIAB CO), DBA "PEPPERJAM"  
THIRD FLOOR  
7 SOUTH MAIN STREET  
WILKES-BARRE, PA 18701

THE MARK CONSISTS OF STANDARD CHAR-  
ACTERS WITHOUT CLAIM TO ANY PARTICULAR  
FONT, STYLE, SIZE, OR COLOR.

FOR: PROVIDING INFORMATION IN THE  
FIELD OF MARKETING AND ON-LINE MARKET-  
ING MEDIA VIA THE INTERNET, IN CLASS 35 (U.S.  
CLS. 100, 101 AND 102).

SER. NO. 77-338,684, FILED 11-28-2007.

FIRST USE 8-1-1999; IN COMMERCE 8-1-1999.

ALICE SUE CARRUTHERS, EXAMINING ATTOR-  
NEY

**Int. Cl.: 43**

**Prior U.S. Cls.: 100 and 101**

**United States Patent and Trademark Office**

**Reg. No. 3,467,399**

**Registered July 15, 2008**

**SERVICE MARK  
PRINCIPAL REGISTER**



KBS RESTAURANTS, INC. (MISSOURI CORPORATION), DBA THE FATTED CALF  
155 FOREST CLUB DRIVE  
CLARKSON VALLEY, MO 630057111

THE MARK CONSISTS OF THE STYLIZED LETTERING, "THE FATTED CALF", AND AN IMAGE OF THE HEAD OF A CALF.

FOR: RESTAURANT SERVICES, IN CLASS 43 (U.S. CLS. 100 AND 101).

SER. NO. 77-338,773, FILED 11-28-2007.

FIRST USE 11-29-1965; IN COMMERCE 4-7-1967.

ROSELLE HERRERA, EXAMINING ATTORNEY



**Int. Cl.: 9**

**Prior U.S. Cls.: 21, 23, 26, 36 and 38**

**United States Patent and Trademark Office**

**Reg. No. 3,467,400**

**Registered July 15, 2008**

**TRADEMARK  
PRINCIPAL REGISTER**



MOTOROLA, INC. (DELAWARE CORPORATION)  
1303 EAST ALGONQUIN ROAD  
SCHAUMBURG, IL 60196

FOR: MULTIMEDIA SOFTWARE FOR MOBILE PHONES FOR DELIVERY OF NEWS, SPORTS, ENTERTAINMENT AND WEATHER, IN CLASS 9 (U.S. CLS. 21, 23, 26, 36 AND 38).

FIRST USE 11-30-2005; IN COMMERCE 11-30-2005.

THE STIPPLING IS FOR SHADING PURPOSES ONLY.

THE MARK CONSISTS OF 3 RECTANGLES AND "SCREEN3" LETTERS/NUMBER.

SER. NO. 77-338,818, FILED 11-28-2007.

JULIE WATSON, EXAMINING ATTORNEY

**Int. Cl.: 29**

**Prior U.S. Cl.: 46**

**United States Patent and Trademark Office**

**Reg. No. 3,467,401**

**Registered July 15, 2008**

**TRADEMARK  
PRINCIPAL REGISTER**

**NUTRISYSTEM**

NUTRI/SYSTEM IPHC, INC. (DELAWARE CORPORATION)  
SUITE 1704  
300 DELAWARE AVE  
WILMINGTON, DE 19801

FOR: BREAKFAST, LUNCH AND DINNER ENTREES, AND SNACKS CONTAINING MEAT, FISH AND POULTRY, EGGS, MILK AND MILK PRODUCTS, NAMELY, CREAM CHEESE SPREAD, CHEESE SPREAD, COTTAGE CHEESE, SOUR CREAM, DRIED AND COOKED FRUITS AND VEGETABLES, JELLIES, SAUCES, NAMELY, APPLESAUCE, SNACK DIPS AND SOUPS; PROTEIN

BASED NUTRIENT-DENSE SNACK BARS, YOGURTS, IN CLASS 29 (U.S. CL. 46).

FIRST USE 7-0-1989; IN COMMERCE 7-0-1989.

THE MARK CONSISTS OF STANDARD CHARACTERS WITHOUT CLAIM TO ANY PARTICULAR FONT, STYLE, SIZE, OR COLOR.

SER. NO. 77-338,836, FILED 11-28-2007.

BRIAN NEVILLE, EXAMINING ATTORNEY

**Int. Cl.: 41**

**Prior U.S. Cls.: 100, 101 and 107**

**United States Patent and Trademark Office**

**Reg. No. 3,467,402**

**Registered July 15, 2008**

**SERVICE MARK  
PRINCIPAL REGISTER**

**BLAST**

THE TRUSTEES OF THE CARNEGIE LIBRARY  
OF PITTSBURGH TRUST (PENNSYLVANIA  
TRUST)  
4400 FORBES AVENUE  
PITTSBURGH, PA 15213

FOR: EDUCATIONAL SERVICES, NAMELY,  
PROVIDING LITERACY-BASED OUTREACH PRO-  
GRAMS FOR STUDENTS, IN CLASS 41 (U.S. CLS.  
100, 101 AND 107).

FIRST USE 2-0-2002; IN COMMERCE 6-0-2004.

THE MARK CONSISTS OF STANDARD CHAR-  
ACTERS WITHOUT CLAIM TO ANY PARTICULAR  
FONT, STYLE, SIZE, OR COLOR.

SER. NO. 77-338,848, FILED 11-28-2007.

KATINA MISTER, EXAMINING ATTORNEY

**Int. Cl.: 12**

**Prior U.S. Cls.: 19, 21, 23, 31, 35 and 44**

**United States Patent and Trademark Office**

**Reg. No. 3,467,403**

**Registered July 15, 2008**

---

**TRADEMARK  
PRINCIPAL REGISTER**

**HOODWARE**

LOVE, RICHARD M. (UNITED STATES INDIVIDUAL)  
SUITE 306  
1226 WEST PACES FERRY ROAD  
ATLANTA, GA 30327

THE MARK CONSISTS OF STANDARD CHARACTERS WITHOUT CLAIM TO ANY PARTICULAR FONT, STYLE, SIZE, OR COLOR.

FOR: EXTERNAL ORNAMENTS FOR AUTOMOBILES, IN CLASS 12 (U.S. CLS. 19, 21, 23, 31, 35 AND 44).

SER. NO. 77-338,873, FILED 11-28-2007.

FIRST USE 10-15-2007; IN COMMERCE 10-31-2007.

NAKIA HENRY, EXAMINING ATTORNEY

**Int. Cls.: 30 and 40**

**Prior U.S. Cls.: 46, 100, 103 and 106**

**United States Patent and Trademark Office**

**Reg. No. 3,467,404**

**Registered July 15, 2008**

**TRADEMARK  
SERVICE MARK  
PRINCIPAL REGISTER**

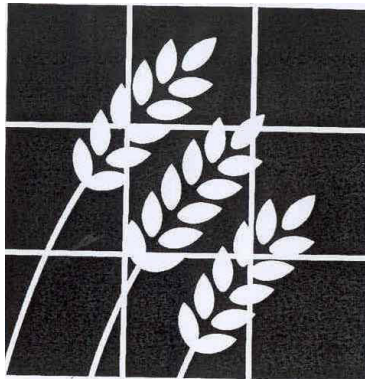

INTERBAKE FOODS, LLC (DELAWARE LTD  
LIAB CO)  
SUITE 210  
2821 EMERYWOOD PARKWAY  
RICHMOND, VA 23294

FOR: COOKIES, CRACKERS, WAFERS FOR ICE  
CREAM SANDWICH NOVELTIES, COOKIE COAT-  
INGS FOR ICE CREAM NOVELTIES, AND CRUM-  
BLED COOKIE BITS USED AS INGREDIENTS IN  
ICE CREAM, IN CLASS 30 (U.S. CL. 46).

FIRST USE 4-1-1990; IN COMMERCE 4-1-1990.

FOR: CONTRACT BAKING SERVICES, IN CLASS  
40 (U.S. CLS. 100, 103 AND 106).

FIRST USE 4-1-1990; IN COMMERCE 4-1-1990.

SER. NO. 77-338,915, FILED 11-28-2007.

WILLIAM VERHOSEK, EXAMINING ATTORNEY

**Int. Cls.: 30 and 40**

**Prior U.S. Cls.: 46, 100, 103 and 106**

**United States Patent and Trademark Office**

**Reg. No. 3,467,405**

**Registered July 15, 2008**

**TRADEMARK  
SERVICE MARK  
PRINCIPAL REGISTER**

**INTERBAKE FOODS**

INTERBAKE FOODS, LLC (DELAWARE LTD  
LIAB CO)  
SUITE 210  
2821 EMERYWOOD PARKWAY  
RICHMOND, VA 23294

FOR: COOKIES, CRACKERS, WAFERS FOR ICE  
CREAM SANDWICH NOVELTIES, COOKIE COAT-  
INGS FOR ICE CREAM NOVELTIES, AND CRUM-  
BLED COOKIE BITS USED AS INGREDIENTS IN  
ICE CREAM, IN CLASS 30 (U.S. CL. 46).

FIRST USE 1-1-1972; IN COMMERCE 1-1-1972.

FOR: CONTRACT BAKING SERVICES, IN CLASS  
40 (U.S. CLS. 100, 103 AND 106).

FIRST USE 1-1-1972; IN COMMERCE 1-1-1972.

THE MARK CONSISTS OF STANDARD CHAR-  
ACTERS WITHOUT CLAIM TO ANY PARTICULAR  
FONT, STYLE, SIZE, OR COLOR.

OWNER OF U.S. REG. NOS. 2,517,824 AND  
2,547,136.

NO CLAIM IS MADE TO THE EXCLUSIVE  
RIGHT TO USE "FOODS", APART FROM THE  
MARK AS SHOWN.

SER. NO. 77-338,919, FILED 11-28-2007.

WILLIAM VERHOSEK, EXAMINING ATTORNEY

**Int. Cl.: 16**

**Prior U.S. Cls.: 2, 5, 22, 23, 29, 37, 38 and 50**

**Reg. No. 3,467,406**

**United States Patent and Trademark Office**

**Registered July 15, 2008**

---

**TRADEMARK  
PRINCIPAL REGISTER**

## Daily Dose of Health

AMERICAN INSTITUTE FOR PREVENTIVE  
MEDICINE (MICHIGAN CORPORATION)  
STE. 350  
30445 NORTHWESTERN HWY.  
FARMINGTON HILLS, MI 48334

FOR: CALENDAR DESK PADS; CALENDARS;  
CALENDARS AND DIARIES; DESK CALENDARS;  
POCKET CALENDARS; PRINTED CALENDARS;  
TEAR-OFF CALENDARS; WALL CALENDARS; A  
SERIES OF BOOKS AND WRITTEN ARTICLES IN  
THE FIELD OF HEALTH; A SERIES OF BOOKS,  
WRITTEN ARTICLES, HANDOUTS AND WORK-

SHEETS IN THE FIELD OF HEALTH, IN CLASS 16  
(U.S. CLS. 2, 5, 22, 23, 29, 37, 38 AND 50).

FIRST USE 12-5-2006; IN COMMERCE 12-5-2006.

THE MARK CONSISTS OF STANDARD CHAR-  
ACTERS WITHOUT CLAIM TO ANY PARTICULAR  
FONT, STYLE, SIZE, OR COLOR.

SER. NO. 77-338,921, FILED 11-28-2007.

ELISSA GARBER KON, EXAMINING ATTORNEY

**Int. Cl.: 22**

**Prior U.S. Cls.: 1, 2, 7, 19, 22, 42 and 50**

**Reg. No. 3,467,407**

**United States Patent and Trademark Office**

**Registered July 15, 2008**

---

**TRADEMARK  
PRINCIPAL REGISTER**

**TY N GRO**

PLANTRA, INC. (MINNESOTA CORPORATION)  
4300 OBISPO ROAD  
ATASCADERO, CA 93422

FOR: SYNTHETIC TIES FOR USE IN AGRICULTURAL APPLICATIONS, IN CLASS 22 (U.S. CLS. 1, 2, 7, 19, 22, 42 AND 50).

FIRST USE 1-31-2007; IN COMMERCE 1-31-2007.

THE MARK CONSISTS OF STANDARD CHARACTERS WITHOUT CLAIM TO ANY PARTICULAR FONT, STYLE, SIZE, OR COLOR.

NO CLAIM IS MADE TO THE EXCLUSIVE RIGHT TO USE "TIE", APART FROM THE MARK AS SHOWN.

SER. NO. 77-338,924, FILED 11-28-2007.

WILLIAM VERHOSEK, EXAMINING ATTORNEY



**Int. Cl.: 43**

**Prior U.S. Cls.: 100 and 101**

**United States Patent and Trademark Office**

**Reg. No. 3,467,408**

**Registered July 15, 2008**

---

**SERVICE MARK  
PRINCIPAL REGISTER**

**ALONTI**

PEPI CORPORATION (TEXAS CORPORATION)  
2444 TIMES BLVD., SUITE 360  
HOUSTON, TX 77005

FOR: RESTAURANT SERVICES; CATERING, IN  
CLASS 43 (U.S. CLS. 100 AND 101).

FIRST USE 7-20-1999; IN COMMERCE 7-20-1999.

THE MARK CONSISTS OF STANDARD CHAR-  
ACTERS WITHOUT CLAIM TO ANY PARTICULAR  
FONT, STYLE, SIZE, OR COLOR.

OWNER OF U.S. REG. NO. 2,536,620.

SER. NO. 77-338,930, FILED 11-28-2007.

FRED MANDIR, EXAMINING ATTORNEY

**Int. Cl.: 35**

**Prior U.S. Cls.: 100, 101 and 102**

**United States Patent and Trademark Office**

**Reg. No. 3,467,409**

**Registered July 15, 2008**

**SERVICE MARK  
PRINCIPAL REGISTER**



GLIDEPATH, INC. (VIRGINIA CORPORATION)  
SUITE 1402  
400 MADISON STREET  
ALEXANDRIA, VA 22314

THE MARK CONSISTS OF AN ANGLED STAR  
AND ITS SHADOW ABOVE THE WORD "GLIDE-  
PATH," WITH ANOTHER STAR OVER THE LET-  
TER "I" IN THE WORD "GLIDEPATH".

FOR: BUSINESS CONSULTING SERVICES, IN  
CLASS 35 (U.S. CLS. 100, 101 AND 102).

SER. NO. 77-338,964, FILED 11-28-2007.

FIRST USE 7-0-1999; IN COMMERCE 7-0-1999.

STEPHANIE ALI, EXAMINING ATTORNEY

**Int. Cl.: 25**

**Prior U.S. Cls.: 22 and 39**

**United States Patent and Trademark Office**

**Reg. No. 3,467,410**

**Registered July 15, 2008**

**TRADEMARK  
PRINCIPAL REGISTER**

**PUTTER WINBROOK**

GOODMAN, JOHN (UNITED STATES INDIVIDUAL)  
6807 SLASH PINE COVE  
MEMPHIS, TN 38119

THE MARK CONSISTS OF STANDARD CHARACTERS WITHOUT CLAIM TO ANY PARTICULAR FONT, STYLE, SIZE, OR COLOR.

FOR: SHIRTS, PANTS, COATS, JACKETS, TIES, HATS, CAPS, SKIRTS, DRESSES, BLOUSES, IN CLASS 25 (U.S. CLS. 22 AND 39).

SER. NO. 77-338,965, FILED 11-28-2007.

FIRST USE 1-19-2007; IN COMMERCE 11-26-2007.

RICHARD WHITE, EXAMINING ATTORNEY

**Int. Cl.: 35**

**Prior U.S. Cls.: 100, 101 and 102**

**United States Patent and Trademark Office**

**Reg. No. 3,467,411**

**Registered July 15, 2008**

**SERVICE MARK  
PRINCIPAL REGISTER**

**THE DUAL SCALE DIFFERENCE**

CENTER FOR ORGANIZATION EFFECTIVENESS, INC. (WISCONSIN CORPORATION),  
DBA SURVEYSBYDESIGN.COM  
6515 GRAND TETON PLAZA, SUITE 145  
MADISON, WI 53719

FOR: CONDUCTING BUSINESS, BUSINESS MANAGEMENT, AND EMPLOYEE SATISFACTION SURVEYS; DESIGN OF BUSINESS, BUSINESS MANAGEMENT, AND EMPLOYEE SATISFACTION SURVEYS FOR OTHERS; MANAGEMENT AND BUSINESS CONSULTING SERVICES IN THE FIELD

OF HUMAN RESOURCES, IN CLASS 35 (U.S. CLS. 100, 101 AND 102).

FIRST USE 8-0-2007; IN COMMERCE 8-0-2007.

THE MARK CONSISTS OF STANDARD CHARACTERS WITHOUT CLAIM TO ANY PARTICULAR FONT, STYLE, SIZE, OR COLOR.

SER. NO. 77-338,973, FILED 11-28-2007.

BARBARA BROWN, EXAMINING ATTORNEY

**Int. Cl.: 9**

**Prior U.S. Cls.: 21, 23, 26, 36 and 38**

**Reg. No. 3,467,412**

**United States Patent and Trademark Office**

**Registered July 15, 2008**

**TRADEMARK  
PRINCIPAL REGISTER**

# Team Skeme

TEAM SKEME ENTERTAINMENT (TEXAS  
PARTNERSHIP)  
4201 MONTEREY OAKS BLVD. #114  
AUSTIN, TX 78749

THE MARK CONSISTS OF STANDARD CHAR-  
ACTERS WITHOUT CLAIM TO ANY PARTICULAR  
FONT, STYLE, SIZE, OR COLOR.

FOR: DOWNLOADABLE MUSICAL SOUND RE-  
CORDINGS, IN CLASS 9 (U.S. CLS. 21, 23, 26, 36 AND  
38).

SER. NO. 77-339,006, FILED 11-28-2007.

FIRST USE 2-4-2006; IN COMMERCE 2-4-2006.

ERIN FALK, EXAMINING ATTORNEY

**Int. Cl.: 15**

**Prior U.S. Cls.: 2, 21 and 36**

**United States Patent and Trademark Office**

**Reg. No. 3,467,413**

**Registered July 15, 2008**

**TRADEMARK  
PRINCIPAL REGISTER**

**PRO-ROUND**

PRO-MARK CORPORATION (TEXAS CORPORATION)  
11550 OLD MAIN STREET LOOP ROAD  
HOUSTON, TX 77025

THE MARK CONSISTS OF STANDARD CHARACTERS WITHOUT CLAIM TO ANY PARTICULAR FONT, STYLE, SIZE, OR COLOR.

FOR: PERCUSSION INSTRUMENTS, IN CLASS 15  
(U.S. CLS. 2, 21 AND 36).

SER. NO. 77-339,013, FILED 11-28-2007.

FIRST USE 11-3-2003; IN COMMERCE 11-3-2003.

BRENDAN MCCAULEY, EXAMINING ATTORNEY

**Int. Cl.: 41**

**Prior U.S. Cls.: 100, 101 and 107**

**United States Patent and Trademark Office**

**Reg. No. 3,467,414**

**Registered July 15, 2008**

**SERVICE MARK  
PRINCIPAL REGISTER**

**RAMP**

HURON CONSULTING GROUP INC. (DELA-  
WARE CORPORATION)  
550 WEST VAN BUREN STREET  
CHICAGO, IL 60607

FOR: EDUCATIONAL SERVICES, NAMELY,  
CLASSES, SEMINARS, MEETINGS IN THE AREA  
OF HIGHER EDUCATION GRANT ADMINISTRA-  
TION AND MATERIALS PROVIDED THEREWITH,  
IN CLASS 41 (U.S. CLS. 100, 101 AND 107).

FIRST USE 4-25-2007; IN COMMERCE 4-25-2007.

THE MARK CONSISTS OF STANDARD CHAR-  
ACTERS WITHOUT CLAIM TO ANY PARTICULAR  
FONT, STYLE, SIZE, OR COLOR.

SER. NO. 77-339,015, FILED 11-28-2007.

WILLIAM VERHOSEK, EXAMINING ATTORNEY

**Int. Cl.: 36**

**Prior U.S. Cls.: 100, 101 and 102**

**United States Patent and Trademark Office**

**Reg. No. 3,467,415**

**Registered July 15, 2008**

**SERVICE MARK  
PRINCIPAL REGISTER**



CONVENIENT CARDS, LLC (MASSACHUSETTS  
LTD LIAB CO)  
540 MEADOW STREET, SUITE 203  
AGAWAM, MA 01001

FOR: DEBIT CARD SERVICES, IN CLASS 36 (U.S.  
CLS. 100, 101 AND 102).

FIRST USE 5-0-2004; IN COMMERCE 5-0-2004.

NO CLAIM IS MADE TO THE EXCLUSIVE  
RIGHT TO USE "CARDS" AND "PREPAID SOLU-  
TIONS", APART FROM THE MARK AS SHOWN.

THE MARK CONSISTS OF INTERLOCKING  
LETTERS - CAPITAL "C".

SER. NO. 77-339,017, FILED 11-28-2007.

WILLIAM VERHOSEK, EXAMINING ATTORNEY



**Int. Cl.: 5**

**Prior U.S. Cls.: 6, 18, 44, 46, 51 and 52**

**United States Patent and Trademark Office**

**Reg. No. 3,467,416**

**Registered July 15, 2008**

**TRADEMARK  
PRINCIPAL REGISTER**

# RiboseOne

WELLNESSONE, INC. (MINNESOTA CORPORATION)  
SUITE 100  
14000 SUNFISH LAKE BLVD NW  
RAMSEY, MN 55303

FOR: DIETARY AND NUTRITIONAL SUPPLEMENTS; DIETARY SUPPLEMENTS; DIETARY SUPPLEMENTS FOR HUMAN CONSUMPTION; NUTRITIONAL SUPPLEMENTS, IN CLASS 5 (U.S. CLS. 6, 18, 44, 46, 51 AND 52).

FIRST USE 10-1-2005; IN COMMERCE 10-1-2005.

THE MARK CONSISTS OF STANDARD CHARACTERS WITHOUT CLAIM TO ANY PARTICULAR FONT, STYLE, SIZE, OR COLOR.

SER. NO. 77-339,026, FILED 11-28-2007.

ALICE BENMAMAN, EXAMINING ATTORNEY

**Int. Cl.: 35**

**Prior U.S. Cls.: 100, 101 and 102**

**United States Patent and Trademark Office**

**Reg. No. 3,467,417**

**Registered July 15, 2008**

**SERVICE MARK  
PRINCIPAL REGISTER**

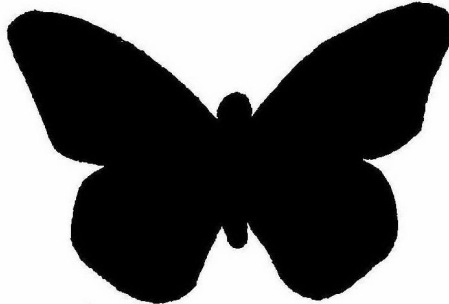

ACT II JEWELRY LLC (DELAWARE LTD LIAB  
CO)  
855 FOSTER AVENUE  
BENSENVILLE, IL 60106

FOR: BUSINESS CONSULTATION AND BUSI-  
NESS ADVISORY SERVICES IN THE FIELD OF  
RETAIL JEWELRY SALES, IN CLASS 35 (U.S. CLS.  
100, 101 AND 102).

FIRST USE 11-27-2007; IN COMMERCE 11-27-2007.

THE MARK CONSISTS OF AN IMAGE OF A  
BUTTERFLY.

SER. NO. 77-339,053, FILED 11-28-2007.

TRICIA SONNEBORN, EXAMINING ATTORNEY

**Int. Cl.: 43**

**Prior U.S. Cls.: 100 and 101**

**United States Patent and Trademark Office**

**Reg. No. 3,467,418**

**Registered July 15, 2008**

**SERVICE MARK  
PRINCIPAL REGISTER**



THOMPSON HOTELS LLC (DELAWARE LTD  
LIAB CO)  
100 VANDAM STREET, 4TH FLOOR  
NEW YORK, NY 10013

FIRST USE 9-30-2002; IN COMMERCE 9-30-2002.

SER. NO. 77-339,056, FILED 11-28-2007.

FOR: HOTEL SERVICES, IN CLASS 43 (U.S. CLS.  
100 AND 101).

ELLEN B. AWRICH, EXAMINING ATTORNEY

**Int. Cl.: 37**

**Prior U.S. Cls.: 100, 103 and 106**

**United States Patent and Trademark Office**

**Reg. No. 3,467,419**

**Registered July 15, 2008**

**SERVICE MARK  
PRINCIPAL REGISTER**

**Rinse Right Carpet Care**

MR. STEAM CARPET CLEANERS (ILLINOIS  
SOLE PROPRIETORSHIP)  
719 EAST BLVD.  
MCHENRY, IL 60051

FOR: CARPET AND RUG CLEANING; CARPET  
CLEANING; CLEANING OF INDUSTRIAL PREMI-  
SES; CLEANING OF RESIDENTIAL HOUSES; RUG  
CLEANING, IN CLASS 37 (U.S. CLS. 100, 103 AND  
106).

FIRST USE 10-22-2007; IN COMMERCE 10-22-2007.

THE MARK CONSISTS OF STANDARD CHAR-  
ACTERS WITHOUT CLAIM TO ANY PARTICULAR  
FONT, STYLE, SIZE, OR COLOR.

NO CLAIM IS MADE TO THE EXCLUSIVE  
RIGHT TO USE "CARPET CARE", APART FROM  
THE MARK AS SHOWN.

SER. NO. 77-339,065, FILED 11-28-2007.

ALLISON SCHRODY, EXAMINING ATTORNEY

**Int. Cl.: 43**

**Prior U.S. Cls.: 100 and 101**

**United States Patent and Trademark Office**

**Reg. No. 3,467,420**

**Registered July 15, 2008**

**SERVICE MARK  
PRINCIPAL REGISTER**

# Fat Sandwiches

ARE YOU HUNGRY LLC (PENNSYLVANIA LTD  
LIAB CO)  
111 SOWERS STREET  
STATE COLLEGE, PA 16801

OWNER OF U.S. REG. NOS. 3,153,825, 3,192,400  
AND OTHERS.

FOR: RESTAURANTS, IN CLASS 43 (U.S. CLS. 100  
AND 101).

NO CLAIM IS MADE TO THE EXCLUSIVE  
RIGHT TO USE "SANDWICHES", APART FROM  
THE MARK AS SHOWN.

FIRST USE 6-20-2005; IN COMMERCE 6-20-2005.

SER. NO. 77-339,106, FILED 11-28-2007.

THE MARK CONSISTS OF STANDARD CHAR-  
ACTERS WITHOUT CLAIM TO ANY PARTICULAR  
FONT, STYLE, SIZE, OR COLOR.

JAY FLOWERS, EXAMINING ATTORNEY

**Int. Cl.: 36**

**Prior U.S. Cls.: 100, 101 and 102**

**United States Patent and Trademark Office**

**Reg. No. 3,467,421**

**Registered July 15, 2008**

**SERVICE MARK  
PRINCIPAL REGISTER**

YOUR PATIENTS TRUST YOUR  
EXPERTISE. YOU CAN TRUST  
OURS.

BANK OF AMERICA CORPORATION (DELA-  
WARE CORPORATION)  
100 NORTH TRYON STREET  
CHARLOTTE, NC 28255

THE MARK CONSISTS OF STANDARD CHAR-  
ACTERS WITHOUT CLAIM TO ANY PARTICULAR  
FONT, STYLE, SIZE, OR COLOR.

FOR: BANKING AND RELATED FINANCIAL  
SERVICES, IN CLASS 36 (U.S. CLS. 100, 101 AND 102).

SER. NO. 77-339,130, FILED 11-28-2007.

FIRST USE 10-1-2006; IN COMMERCE 10-1-2006.

MICHAEL KAZAZIAN, EXAMINING ATTORNEY

**Int. Cls.: 35, 37 and 39**

**Prior U.S. Cls.: 100, 101, 102, 103, 105 and 106**

**United States Patent and Trademark Office**

**Reg. No. 3,467,422**

**Registered July 15, 2008**

**SERVICE MARK  
PRINCIPAL REGISTER**



SAFERIDE MOTOR CLUB, INC. (CALIFORNIA CORPORATION)  
10 UNIVERSAL PLAZA, SUITE 1750  
UNIVERSAL CITY, CA 91608

FOR: AUTOMOTIVE CLUB SERVICES, NAMELY ADMINISTRATION OF A DISCOUNT PROGRAM FOR ENABLING PARTICIPANTS TO OBTAIN DISCOUNTS ON GOODS AND SERVICES THROUGH THE USE OF A MEMBERSHIP CARD; ADMINISTRATION OF A REFERRAL PROGRAM FOR LOCKSMITHING SERVICES FOR OPENING LOCKS FOR PERSONS LOCKED OUT OF VEHICLES, IN CLASS 35 (U.S. CLS. 100, 101 AND 102).

FIRST USE 5-1-2007; IN COMMERCE 5-1-2007.

FOR: AUTOMOTIVE CLUB SERVICES, NAMELY FURNISHING EMERGENCY ROADSIDE SERVICE, IN CLASS 37 (U.S. CLS. 100, 103 AND 106).

FIRST USE 5-1-2007; IN COMMERCE 5-1-2007.

FOR: AUTOMOTIVE CLUB SERVICES, NAMELY, VEHICLE TOWING SERVICE, TRAVEL INFORMATION SERVICES, IN CLASS 39 (U.S. CLS. 100 AND 105).

FIRST USE 5-1-2007; IN COMMERCE 5-1-2007.

NO CLAIM IS MADE TO THE EXCLUSIVE RIGHT TO USE "MOTORCLUB", APART FROM THE MARK AS SHOWN.

THE MARK CONSISTS OF "SAFERIDE MOTOR CLUB" WITHIN THE OUTLINE OF A CAR.

SER. NO. 77-339,133, FILED 11-28-2007.

WENDY JUN, EXAMINING ATTORNEY

**Int. Cl.: 33**

**Prior U.S. Cls.: 47 and 49**

**United States Patent and Trademark Office**

**Reg. No. 3,467,423**

**Registered July 15, 2008**

**TRADEMARK  
PRINCIPAL REGISTER**

**SANFORD & BENEDICT VINEYARD**

S&B VINEYARD, LLC (CALIFORNIA LTD LIAB  
CO)  
900 ARMOUR DRIVE  
LAKE BLUFF, IL 60044

NO CLAIM IS MADE TO THE EXCLUSIVE  
RIGHT TO USE "VINEYARD", APART FROM THE  
MARK AS SHOWN.

FOR: WINE, IN CLASS 33 (U.S. CLS. 47 AND 49).

FIRST USE 12-31-1992; IN COMMERCE 12-31-1992.

SER. NO. 77-339,138, FILED 11-28-2007.

THE MARK CONSISTS OF STANDARD CHAR-  
ACTERS WITHOUT CLAIM TO ANY PARTICULAR  
FONT, STYLE, SIZE, OR COLOR.

GEORGE LORENZO, EXAMINING ATTORNEY



**Int. Cls.: 35, 37 and 39**

**Prior U.S. Cls.: 100, 101, 102, 103, 105 and 106**

**United States Patent and Trademark Office**

**Reg. No. 3,467,424**

**Registered July 15, 2008**

**SERVICE MARK  
PRINCIPAL REGISTER**



SAFERIDE MOTOR CLUB, INC. (CALIFORNIA CORPORATION)  
10 UNIVERSAL PLAZA, SUITE 1750  
UNIVERSAL CITY, CA 91608

FOR: AUTOMOTIVE CLUB SERVICES, NAMELY, ADMINISTRATION OF A DISCOUNT PROGRAM FOR ENABLING PARTICIPANTS TO OBTAIN DISCOUNTS ON GOODS AND SERVICES THROUGH THE USE OF A MEMBERSHIP CARD; ADMINISTRATION OF A REFERRAL PROGRAM FOR LOCKSMITHING SERVICES FOR OPENING LOCKS FOR PERSONS LOCKED OUT OF VEHICLES, IN CLASS 35 (U.S. CLS. 100, 101 AND 102).

FIRST USE 5-1-2007; IN COMMERCE 5-1-2007.

FOR: AUTOMOTIVE CLUB SERVICES, NAMELY, FURNISHING EMERGENCY ROADSIDE SERVICE, IN CLASS 37 (U.S. CLS. 100, 103 AND 106).

FIRST USE 5-1-2007; IN COMMERCE 5-1-2007.

FOR: AUTOMOTIVE CLUB SERVICES, NAMELY, VEHICLE TOWING SERVICE, TRAVEL INFORMATION SERVICES, IN CLASS 39 (U.S. CLS. 100 AND 105).

FIRST USE 5-1-2007; IN COMMERCE 5-1-2007.

NO CLAIM IS MADE TO THE EXCLUSIVE RIGHT TO USE "MOTORCLUB", APART FROM THE MARK AS SHOWN.

THE MARK CONSISTS OF "SAFERIDE MOTOR CLUB" WITHIN THE OUTLINE OF A MOTORCYCLE.

SER. NO. 77-339,172, FILED 11-28-2007.

WENDY JUN, EXAMINING ATTORNEY

**Int. Cl.: 42**

**Prior U.S. Cls.: 100 and 101**

**United States Patent and Trademark Office**

**Reg. No. 3,467,425**

**Registered July 15, 2008**

**SERVICE MARK  
PRINCIPAL REGISTER**

**zoom360**

BRADSHAW, LEONARD (UNITED STATES IN-  
DIVIDUAL)  
945 VILLAGE SQ. N.  
PALM SPRINGS, CA 92262

FOR: CREATION OF INTERNET FILES FOR  
OTHERS THAT WILL ALLOW INDIVIDUAL WEB-  
SITE VIEWERS THE ABILITY TO ROTATE OBJECT  
IMAGES, HORIZONTALLY OR VERTICALLY, AND  
TO ALLOW THEM TO GET A DETAILED VIEW OF  
EACH OF THOSE IMAGES, IN CLASS 42 (U.S. CLS.  
100 AND 101).

FIRST USE 11-1-2007; IN COMMERCE 11-1-2007.

THE MARK CONSISTS OF STANDARD CHAR-  
ACTERS WITHOUT CLAIM TO ANY PARTICULAR  
FONT, STYLE, SIZE, OR COLOR.

OWNER OF U.S. REG. NO. 3,358,555.

SER. NO. 77-339,198, FILED 11-28-2007.

CHRISTOPHER BUONGIORNO, EXAMINING AT-  
TORNEY

**Int. Cl.: 36**

**Prior U.S. Cls.: 100, 101 and 102**

**United States Patent and Trademark Office**

**Reg. No. 3,467,426**

**Registered July 15, 2008**

**SERVICE MARK  
PRINCIPAL REGISTER**

**SANDLOT FUNDING**

SANDLOT FUNDING LLC (DELAWARE LTD  
LIAB CO)  
445 BROAD HOLLOW ROAD, SUITE 239  
MELVILLE, NY 11747

FOR: FINANCIAL SERVICES, NAMELY, ISSU-  
ING ASSET-BACKED, SECURED-LIQUIDITY  
NOTES, IN CLASS 36 (U.S. CLS. 100, 101 AND 102).

FIRST USE 4-19-2007; IN COMMERCE 4-19-2007.

THE MARK CONSISTS OF STANDARD CHAR-  
ACTERS WITHOUT CLAIM TO ANY PARTICULAR  
FONT, STYLE, SIZE, OR COLOR.

NO CLAIM IS MADE TO THE EXCLUSIVE  
RIGHT TO USE "FUNDING", APART FROM THE  
MARK AS SHOWN.

SER. NO. 77-339,200, FILED 11-28-2007.

MICHAEL SOUDERS, EXAMINING ATTORNEY

**Int. Cl.: 42**

**Prior U.S. Cls.: 100 and 101**

**United States Patent and Trademark Office**

**Reg. No. 3,467,427**

**Registered July 15, 2008**

**SERVICE MARK  
PRINCIPAL REGISTER**

**CASAMBA**

CASAMBA, INC. (CALIFORNIA CORPORATION)  
5210 LEWIS ROAD, SUITE 10  
AGOURA HILLS, CA 91301

FOR: COMPUTER SOFTWARE DESIGN FOR OTHERS; COMPUTER SOFTWARE DEVELOPMENT; DESIGN OF COMPUTER NETWORKS AND SOFTWARE FOR OTHERS FOR THE HEALTH CARE INDUSTRY, IN CLASS 42 (U.S. CLS. 100 AND 101).

FIRST USE 3-1-2001; IN COMMERCE 3-1-2001.

THE MARK CONSISTS OF STANDARD CHARACTERS WITHOUT CLAIM TO ANY PARTICULAR FONT, STYLE, SIZE, OR COLOR.

SER. NO. 77-339,205, FILED 11-28-2007.

CHRISTOPHER BUONGIORNO, EXAMINING ATTORNEY

**Int. Cl.: 36**

**Prior U.S. Cls.: 100, 101 and 102**

**United States Patent and Trademark Office**

**Reg. No. 3,467,428**

**Registered July 15, 2008**

**SERVICE MARK  
PRINCIPAL REGISTER**



SANDLOT FUNDING LLC (DELAWARE LTD  
LIAB CO)  
445 BROAD HOLLOW RD., SUITE 239  
MELVILLE, NY 11747

NO CLAIM IS MADE TO THE EXCLUSIVE  
RIGHT TO USE "FUNDING LLC", APART FROM  
THE MARK AS SHOWN.

FOR: FINANCIAL SERVICES, NAMELY, ISSU-  
ING ASSET-BACKED, SECURED-LIQUIDITY  
NOTES, IN CLASS 36 (U.S. CLS. 100, 101 AND 102).

SER. NO. 77-339,206, FILED 11-28-2007.

FIRST USE 4-19-2007; IN COMMERCE 4-19-2007.

MICHAEL SOUDERS, EXAMINING ATTORNEY

**Int. Cl.: 25**

**Prior U.S. Cls.: 22 and 39**

**United States Patent and Trademark Office**

**Reg. No. 3,467,429**

**Registered July 15, 2008**

**TRADEMARK  
PRINCIPAL REGISTER**

**BLUE CANDY**

BLUE PLANET INTERNATIONAL, INC. (CALI-  
FORNIA CORPORATION)  
1526 E. WASHINGTON BLVD.  
LOS ANGELES, CA 90021

FIRST USE 1-10-2007; IN COMMERCE 1-10-2007.

FOR: BELTS; BLAZERS; BLOUSES; BOARD-  
SHORTS; CARDIGANS; DENIMS; DRESSES;  
FLEECE PULLOVERS; FLEECE SHORTS; HATS;  
JACKETS; JEANS; KNIT SHIRTS; POLO SHIRTS;  
SCARVES; SHORT TROUSERS; SHORTS; SLACKS;  
SWEAT SHIRTS; T-SHIRTS; TANK TOPS; THER-  
MAL UNDERWEAR; VESTS, IN CLASS 25 (U.S. CLS.  
22 AND 39).

THE MARK CONSISTS OF STANDARD CHAR-  
ACTERS WITHOUT CLAIM TO ANY PARTICULAR  
FONT, STYLE, SIZE, OR COLOR.

SER. NO. 77-339,217, FILED 11-28-2007.

BARBARA RUTLAND, EXAMINING ATTORNEY

**Int. Cl.: 40**

**Prior U.S. Cls.: 100, 103 and 106**

**United States Patent and Trademark Office**

**Reg. No. 3,467,430**

**Registered July 15, 2008**

---

**SERVICE MARK  
PRINCIPAL REGISTER**

**RXTREME**

OPTICOTE, INC. (ILLINOIS CORPORATION)  
10455 SEYMORE  
FRANKLIN PARK, IL 60191

THE MARK CONSISTS OF STANDARD CHAR-  
ACTERS WITHOUT CLAIM TO ANY PARTICULAR  
FONT, STYLE, SIZE, OR COLOR.

FOR: APPLICATION OF COATINGS TO OPTICAL  
SUBSTRATES INCLUDING OPTICAL LENSES, IN  
CLASS 40 (U.S. CLS. 100, 103 AND 106).

SER. NO. 77-339,223, FILED 11-28-2007.

FIRST USE 10-25-2007; IN COMMERCE 10-25-2007.

JOHN WILKE, EXAMINING ATTORNEY

**Int. Cl.: 28**

**Prior U.S. Cls.: 22, 23, 38 and 50**

**United States Patent and Trademark Office**

**Reg. No. 3,467,431**

**Registered July 15, 2008**

**TRADEMARK  
PRINCIPAL REGISTER**



KIDWISE OUTDOOR PRODUCTS, INC. (GEORGIA CORPORATION)

1869 MCFARLAND ROAD

ALPHARETTA, GA 300058341

FOR: TRAMPOLINES, IN CLASS 28 (U.S. CLS. 22, 23, 38 AND 50).

FIRST USE 5-26-2006; IN COMMERCE 5-26-2006.

NO CLAIM IS MADE TO THE EXCLUSIVE RIGHT TO USE "SPORTS", APART FROM THE MARK AS SHOWN.

THE MARK CONSISTS OF STYLIZED LETTERS WITH A DESIGN MEANT TO CONVEY A BOUNCING MOTION BETWEEN THE LETTERS.

SER. NO. 77-339,227, FILED 11-28-2007.

NANCY CLARKE, EXAMINING ATTORNEY



**Int. Cl.: 6**

**Prior U.S. Cls.: 2, 12, 13, 14, 23, 25 and 50**

**Reg. No. 3,467,432**

**United States Patent and Trademark Office**

**Registered July 15, 2008**

---

**TRADEMARK  
PRINCIPAL REGISTER**

**DETA CLAD**

DYNAMIC MATERIALS CORPORATION (COL-  
ORADO CORPORATION)  
5405 SPINE ROAD  
BOULDER, CO 80301

FOR: EXPLOSION-BONDED CLAD METALS  
SOLD FOR USE IN FABRICATING PROCESS VES-  
SELS, HEAT EXCHANGERS, TUBES, RODS, MA-  
CHINE COMPONENTS AND OTHER STRUCTURES  
FOR GENERALIZED USE IN THE INDUSTRIAL  
ARTS, IN CLASS 6 (U.S. CLS. 2, 12, 13, 14, 23, 25 AND  
50).

FIRST USE 12-8-1964; IN COMMERCE 12-8-1964.

THE MARK CONSISTS OF STANDARD CHAR-  
ACTERS WITHOUT CLAIM TO ANY PARTICULAR  
FONT, STYLE, SIZE, OR COLOR.

OWNER OF U.S. REG. NO. 3,206,528.

SER. NO. 77-339,244, FILED 11-28-2007.

MORGAN WYNNE, EXAMINING ATTORNEY

**Int. Cl.: 36**

**Prior U.S. Cls.: 100, 101 and 102**

**United States Patent and Trademark Office**

**Reg. No. 3,467,433**

**Registered July 15, 2008**

**SERVICE MARK  
PRINCIPAL REGISTER**

**IF YOU'VE GOT THE PINK,  
WE'VE GOT THE GREEN**

PALISADES CAPITAL, LLC (NEVADA LTD LIAB  
CO)  
1919 S. LA CIENEGA BLVD.  
LOS ANGELES, CA 90034

THE MARK CONSISTS OF STANDARD CHAR-  
ACTERS WITHOUT CLAIM TO ANY PARTICULAR  
FONT, STYLE, SIZE, OR COLOR.

FOR: LOAN FINANCING, IN CLASS 36 (U.S. CLS.  
100, 101 AND 102).

SER. NO. 77-339,282, FILED 11-28-2007.

FIRST USE 1-2-2007; IN COMMERCE 2-16-2007.

JUDITH HELFMAN, EXAMINING ATTORNEY

**Int. Cl.: 35**

**Prior U.S. Cls.: 100, 101 and 102**

**United States Patent and Trademark Office**

**Reg. No. 3,467,434**

**Registered July 15, 2008**

**SERVICE MARK  
PRINCIPAL REGISTER**

**QUIKFITNESS**

JENRAY ONLINE, LLC (NEW YORK LTD LIAB  
CO)  
268 WILLOUGHBY AVE.  
BROOKLYN, NY 11205

FOR: ON-LINE RETAIL STORE SERVICES FEATURING DIETARY SUPPLEMENTS, NUTRITIONAL SUPPLEMENTS, VITAMINS AND MINERALS, HERBAL SUPPLEMENTS, HEALTH AND BEAUTY PRODUCTS, COSMETICS, AND HEALTH AND FITNESS PRODUCTS, IN CLASS 35 (U.S. CLS. 100, 101 AND 102).

FIRST USE 2-15-2006; IN COMMERCE 3-15-2006.

THE MARK CONSISTS OF STANDARD CHARACTERS WITHOUT CLAIM TO ANY PARTICULAR FONT, STYLE, SIZE, OR COLOR.

SER. NO. 77-339,287, FILED 11-28-2007.

KATHERINE M. DUBRAY, EXAMINING ATTORNEY

Int. Cl.: 33

Prior U.S. Cls.: 47 and 49

**United States Patent and Trademark Office**

**Reg. No. 3,467,435**

Registered July 15, 2008

**TRADEMARK  
PRINCIPAL REGISTER**



M J MUNDY LIMITED (NEW ZEALAND CORPORATION)  
COUTTS ISLAND ROAD  
CHRISTCHURCH, NEW ZEALAND

FOR: WINES, IN CLASS 33 (U.S. CLS. 47 AND 49).

FIRST USE 10-21-2006; IN COMMERCE 10-21-2006.

THE STIPPLING IS A FEATURE OF THE MARK AND DOES NOT INDICATE COLOR.

THE MARK CONSISTS OF THE WORDS "FLYING KIWI" IN STYLIZED FONT AND THE PICTORIAL DESIGN OF A "FLYING KIWI" BIRD ATTACHED TO A HANG GLIDER.

SER. NO. 77-339,299, FILED 11-28-2007.

MICHAEL SOUDERS, EXAMINING ATTORNEY

**Int. Cl.: 5**

**Prior U.S. Cls.: 6, 18, 44, 46, 51 and 52**

**United States Patent and Trademark Office**

**Reg. No. 3,467,436**

**Registered July 15, 2008**

**TRADEMARK  
PRINCIPAL REGISTER**

**Julguer**

CG JULGUER IMPORTS, INC. (FLORIDA CORPORATION)  
4843 GATEWAY GARDENS DRIVE  
BOYNTON BEACH, FL 33436

THE MARK CONSISTS OF STANDARD CHARACTERS WITHOUT CLAIM TO ANY PARTICULAR FONT, STYLE, SIZE, OR COLOR.

FOR: FOOD, NUTRITIONAL, AND HERBAL SUPPLEMENTS, IN CLASS 5 (U.S. CLS. 6, 18, 44, 46, 51 AND 52).

SER. NO. 77-339,307, FILED 11-28-2007.

FIRST USE 3-1-2007; IN COMMERCE 3-1-2007.

REBECCA EISINGER, EXAMINING ATTORNEY

**Int. Cl.: 30**

**Prior U.S. Cl.: 46**

**United States Patent and Trademark Office**

**Reg. No. 3,467,437**

**Registered July 15, 2008**

**TRADEMARK  
PRINCIPAL REGISTER**

**Arrestingly Delicious**

COOKIE COP, LLC (OHIO LTD LIAB CO)  
2918 CREEKWOOD ESTATES DRIVE  
BLACKLICK, OH 43004

NO CLAIM IS MADE TO THE EXCLUSIVE  
RIGHT TO USE "DELICIOUS", APART FROM THE  
MARK AS SHOWN.

FOR: COOKIES, IN CLASS 30 (U.S. CL. 46).

FIRST USE 10-1-2006; IN COMMERCE 10-1-2006.

SER. NO. 77-339,310, FILED 11-28-2007.

THE MARK CONSISTS OF STANDARD CHAR-  
ACTERS WITHOUT CLAIM TO ANY PARTICULAR  
FONT, STYLE, SIZE, OR COLOR.

PATRICIA EVANKO, EXAMINING ATTORNEY

**Int. Cl.: 35**

**Prior U.S. Cls.: 100, 101 and 102**

**United States Patent and Trademark Office**

**Reg. No. 3,467,438**

**Registered July 15, 2008**

**SERVICE MARK  
PRINCIPAL REGISTER**

**FIXFITNESS**

JENRAY ONLINE, LLC (NEW YORK LTD LIAB  
CO)  
268 WILLOUGHBY AVE.  
BROOKLYN, NY 11205

FOR: ON-LINE RETAIL STORE SERVICES FEATURING DIETARY SUPPLEMENTS, NUTRITIONAL SUPPLEMENTS, VITAMINS AND MINERALS, HERBAL SUPPLEMENTS, HEALTH AND BEAUTY PRODUCTS, COSMETICS, AND HEALTH AND FITNESS PRODUCTS, IN CLASS 35 (U.S. CLS. 100, 101 AND 102).

FIRST USE 5-2-2005; IN COMMERCE 6-1-2005.

THE MARK CONSISTS OF STANDARD CHARACTERS WITHOUT CLAIM TO ANY PARTICULAR FONT, STYLE, SIZE, OR COLOR.

SER. NO. 77-339,326, FILED 11-28-2007.

KATHERINE M. DUBRAY, EXAMINING ATTORNEY

Int. Cl.: 33

Prior U.S. Cls.: 47 and 49

United States Patent and Trademark Office

Reg. No. 3,467,439

Registered July 15, 2008

TRADEMARK  
PRINCIPAL REGISTER



M J MUNDY LIMITED (NEW ZEALAND CORPORATION)  
COUTTS ISLAND ROAD  
CHRISTCHURCH, NEW ZEALAND

FOR: WINES, IN CLASS 33 (U.S. CLS. 47 AND 49).

FIRST USE 9-9-2006; IN COMMERCE 9-9-2006.

THE STIPPLING IS A FEATURE OF THE MARK AND DOES NOT INDICATE COLOR.

THE MARK CONSISTS OF THE WORDS "FLYING KIWI" IN STYLIZED FONT AND THE PICTORIAL DESIGN OF A FLYING KIWI BIRD ATTACHED TO A PARACHUTE.

SER. NO. 77-339,341, FILED 11-28-2007.

MICHAEL SOUDERS, EXAMINING ATTORNEY



**Int. Cl.: 42**

**Prior U.S. Cls.: 100 and 101**

**United States Patent and Trademark Office**

**Reg. No. 3,467,440**

**Registered July 15, 2008**

**SERVICE MARK  
PRINCIPAL REGISTER**

**SDInsight**  
CONSUMER TESTED

STRATEGIC DECISIONS INC (GEORGIA CORPORATION)  
122 EAST JACKSON ST  
THOMASVILLE, GA 31799

FOR: PRODUCT RESEARCH AND DEVELOPMENT FOR OTHERS, IN CLASS 42 (U.S. CLS. 100 AND 101).

FIRST USE 11-8-2007; IN COMMERCE 11-8-2007.

NO CLAIM IS MADE TO THE EXCLUSIVE RIGHT TO USE "CONSUMER TESTED", APART FROM THE MARK AS SHOWN.

THE MARK CONSISTS OF THE LOGO IS IN TRADE GOTHIC FONT. THE "SD" ARE UPPER CASE THE "INSIGHT" ARE UPPER CASE THE "CONSUMER TESTED" IS ALL CAPS BUT SMALLER SIZE FONT .

SER. NO. 77-339,343, FILED 11-28-2007.

JAY FLOWERS, EXAMINING ATTORNEY

**Int. Cl.: 5**

**Prior U.S. Cls.: 6, 18, 44, 46, 51 and 52**

**United States Patent and Trademark Office**

**Reg. No. 3,467,441**

**Registered July 15, 2008**

**TRADEMARK  
PRINCIPAL REGISTER**

**EPHEDRANOL**

JENRAY ONLINE, LLC (NEW YORK LTD LIAB  
CO)  
268 WILLOUGHBY AVE.  
BROOKLYN, NY 11205

FOR: DIETARY AND NUTRITIONAL SUPPLE-  
MENTS; HERBAL SUPPLEMENTS, IN CLASS 5 (U.S.  
CLS. 6, 18, 44, 46, 51 AND 52).

FIRST USE 3-1-2007; IN COMMERCE 3-1-2007.

THE MARK CONSISTS OF STANDARD CHAR-  
ACTERS WITHOUT CLAIM TO ANY PARTICULAR  
FONT, STYLE, SIZE, OR COLOR.

SER. NO. 77-339,351, FILED 11-28-2007.

KATHERINE M. DUBRAY, EXAMINING ATTOR-  
NEY

**Int. Cls.: 25 and 28**

**Prior U.S. Cls.: 22, 23, 38, 39 and 50**

**United States Patent and Trademark Office**

**Reg. No. 3,467,442**

**Registered July 15, 2008**

**TRADEMARK  
PRINCIPAL REGISTER**

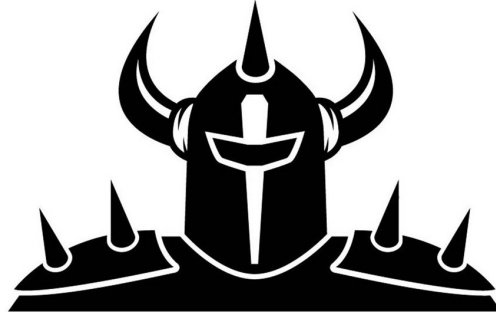

CHOMP, INC. (CALIFORNIA CORPORATION)  
225 S. AVIATION BOULEVARD  
EL SEGUNDO, CA 90245

FOR: CLOTHING, NAMELY, T-SHIRTS AND  
SWEATSHIRTS; HATS AND CAPS; AND BELTS, IN  
CLASS 25 (U.S. CLS. 22 AND 39).

FIRST USE 2-17-1997; IN COMMERCE 4-1-1997.

FOR: SKATEBOARD DECKS, IN CLASS 28 (U.S.  
CLS. 22, 23, 38 AND 50).

FIRST USE 2-17-1997; IN COMMERCE 10-0-1999.

THE MARK CONSISTS OF A DEPICTION OF A  
HELMET WITH THREE HORNS PROTRUDING  
FROM THE HEAD, AND TWO HORNS PROTRUD-  
ING FROM EACH SHOULDER.

SER. NO. 77-339,360, FILED 11-28-2007.

JAY FLOWERS, EXAMINING ATTORNEY

**Int. Cl.: 5**

**Prior U.S. Cls.: 6, 18, 44, 46, 51 and 52**

**Reg. No. 3,467,443**

**United States Patent and Trademark Office**

**Registered July 15, 2008**

---

**TRADEMARK  
PRINCIPAL REGISTER**

**EPHEDRINEX**

JENRAY ONLINE, LLC (NEW YORK LTD LIAB  
CO)  
268 WILLOUGHBY AVE.  
BROOKLYN, NY 11205

THE MARK CONSISTS OF STANDARD CHAR-  
ACTERS WITHOUT CLAIM TO ANY PARTICULAR  
FONT, STYLE, SIZE, OR COLOR.

FOR: DIETARY AND NUTRITIONAL SUPPLE-  
MENTS; HERBAL SUPPLEMENTS, IN CLASS 5 (U.S.  
CLS. 6, 18, 44, 46, 51 AND 52).

SER. NO. 77-339,363, FILED 11-28-2007.

FIRST USE 3-1-2007; IN COMMERCE 3-1-2007.

KATHERINE M. DUBRAY, EXAMINING ATTOR-  
NEY

Int. Cl.: 33

Prior U.S. Cls.: 47 and 49

United States Patent and Trademark Office

Reg. No. 3,467,444

Registered July 15, 2008

TRADEMARK  
PRINCIPAL REGISTER



M J MUNDY LIMITED (NEW ZEALAND CORPORATION)  
COUTTS ISLAND ROAD  
CHRISTCHURCH, NEW ZEALAND

FOR: WINES, IN CLASS 33 (U.S. CLS. 47 AND 49).

FIRST USE 9-9-2006; IN COMMERCE 9-9-2006.

THE STIPPLING IS A FEATURE OF THE MARK  
AND DOES NOT INDICATE COLOR.

THE MARK CONSISTS OF THE WORDS "FLYING KIWI" IN STYLIZED FONT AND THE PICTORIAL DESIGN OF A FLYING KIWI BIRD ATTACHED TO A BALLOON.

SER. NO. 77-339,369, FILED 11-28-2007.

MICHAEL SOUDERS, EXAMINING ATTORNEY

**Int. Cl.: 36**

**Prior U.S. Cls.: 100, 101 and 102**

**United States Patent and Trademark Office**

**Reg. No. 3,467,445**

**Registered July 15, 2008**

**SERVICE MARK  
PRINCIPAL REGISTER**

**STEPPING UP TOGETHER**

WILLIAMS, VELDA A. (UNITED STATES INDIVIDUAL)  
P.O. BOX 2212  
GLOBE, AZ 85502

THE MARK CONSISTS OF STANDARD CHARACTERS WITHOUT CLAIM TO ANY PARTICULAR FONT, STYLE, SIZE, OR COLOR.

FOR: FINANCIAL PLANNING, IN CLASS 36 (U.S. CLS. 100, 101 AND 102).

SER. NO. 77-339,378, FILED 11-28-2007.

FIRST USE 9-4-2007; IN COMMERCE 9-4-2007.

KATHERINE CHANG, EXAMINING ATTORNEY

**Int. Cl.: 9**

**Prior U.S. Cls.: 21, 23, 26, 36 and 38**

**Reg. No. 3,467,446**

**United States Patent and Trademark Office**

**Registered July 15, 2008**

---

**TRADEMARK  
PRINCIPAL REGISTER**

**ELECTRORACK**

ELECTRORACK PRODUCTS COMPANY (CALI-  
FORNIA CORPORATION)  
1443 S. SUNKIST STREET  
ANAHEIM, CA 92806

FOR: RACKS FOR ELECTRONIC EQUIPMENT,  
IN CLASS 9 (U.S. CLS. 21, 23, 26, 36 AND 38).

FIRST USE 8-23-2004; IN COMMERCE 8-23-2004.

THE MARK CONSISTS OF STANDARD CHAR-  
ACTERS WITHOUT CLAIM TO ANY PARTICULAR  
FONT, STYLE, SIZE, OR COLOR.

SER. NO. 77-339,389, FILED 11-28-2007.

KATHERINE CONNOLLY, EXAMINING ATTOR-  
NEY

**Int. Cl.: 41**

**Prior U.S. Cls.: 100, 101 and 107**

**United States Patent and Trademark Office**

**Reg. No. 3,467,447**

**Registered July 15, 2008**

**SERVICE MARK  
PRINCIPAL REGISTER**

**FESTIVAL 56**

BRIGHAM, DEXTER JAMES (UNITED STATES  
INDIVIDUAL)  
503 S. CHURCH ST.  
PRINCETON, IL 61356

FOR: ENTERTAINMENT IN THE NATURE OF  
THEATER PRODUCTIONS, IN CLASS 41 (U.S. CLS.  
100, 101 AND 107).

FIRST USE 1-0-2004; IN COMMERCE 4-0-2004.

THE MARK CONSISTS OF STANDARD CHAR-  
ACTERS WITHOUT CLAIM TO ANY PARTICULAR  
FONT, STYLE, SIZE, OR COLOR.

NO CLAIM IS MADE TO THE EXCLUSIVE  
RIGHT TO USE "FESTIVAL", APART FROM THE  
MARK AS SHOWN.

SER. NO. 77-339,432, FILED 11-28-2007.

TEJBIR SINGH, EXAMINING ATTORNEY



**Int. Cl.: 16**

**Prior U.S. Cls.: 2, 5, 22, 23, 29, 37, 38 and 50**

**Reg. No. 3,467,448**

**United States Patent and Trademark Office**

**Registered July 15, 2008**

**TRADEMARK  
PRINCIPAL REGISTER**

**CATDADDY**

RIDEAU, RODERICK (UNITED STATES INDIVIDUAL)  
906 24TH STREET  
GRETNA, LA 70053

FOR: MAGAZINES FEATURING MUSIC, MOVIES, ENTERTAINMENT, FASHION, STYLE, CURRENT EVENTS, FEMALE MODELS, CELEBRITY INFORMATION AND INTERVIEWS, AND URBAN CULTURE TOPICS, IN CLASS 16 (U.S. CLS. 2, 5, 22, 23, 29, 37, 38 AND 50).

FIRST USE 6-15-2002; IN COMMERCE 6-15-2002.

THE MARK CONSISTS OF STANDARD CHARACTERS WITHOUT CLAIM TO ANY PARTICULAR FONT, STYLE, SIZE, OR COLOR.

SER. NO. 77-339,439, FILED 11-28-2007.

ALYSSA PALADINO, EXAMINING ATTORNEY

Int. Cl.: 35

Prior U.S. Cls.: 100, 101 and 102

United States Patent and Trademark Office

Reg. No. 3,467,449

Registered July 15, 2008

SERVICE MARK  
PRINCIPAL REGISTER



CARBERRY, SUSAN (GREAT BRITAIN INDIVIDUAL)  
25144 CORTE DE LOS PAJAROS  
MURRIETA, CA 92563

FOR: RETAIL STORES FEATURING CAKES AND CAKE DECORATING SUPPLIES, IN CLASS 35 (U.S. CLS. 100, 101 AND 102).

FIRST USE 8-20-2007; IN COMMERCE 8-20-2007.

NO CLAIM IS MADE TO THE EXCLUSIVE RIGHT TO USE "CAKE", APART FROM THE MARK AS SHOWN.

THE MARK CONSISTS OF THE STYLIZED WORDS "THE CAKE COTTAGE" LOCATED INSIDE OF A BANNER. BELOW THE WORDS AND BANNER IS A STYLIZED FRAME WITH AN IMAGE OF A CAKE.

SER. NO. 77-339,440, FILED 11-28-2007.

KATHERINE CONNOLLY, EXAMINING ATTORNEY

Int. Cl.: 36

Prior U.S. Cls.: 100, 101 and 102

United States Patent and Trademark Office

Reg. No. 3,467,450

Registered July 15, 2008

**SERVICE MARK  
PRINCIPAL REGISTER**



WILLIAMS, VELDA A. (UNITED STATES INDIVIDUAL)

P.O. BOX 2212

GLOBE, AZ 85502

FOR: FINANCIAL PLANNING, IN CLASS 36 (U.S. CLS. 100, 101 AND 102).

FIRST USE 9-4-2007; IN COMMERCE 9-4-2007.

THE COLOR(S) RUSTY PURPLE, BURNT ORANGE AND WHITE IS/ARE CLAIMED AS A FEATURE OF THE MARK.

THE MARK CONSISTS OF THREE BURNT ORANGE BAGS OF MONEY, EACH BEARING A RUSTY PURPLE DOLLAR SIGN AND TIE, BOTH WITH A WHITE SHADOW. THE BAGS INCLUDE A LEFT, LOWERMOST BAG OF MONEY, A RIGHT, UPPERMOST BAG OF MONEY, AND AN INTERMEDIATE BAG OF MONEY THEREBETWEEN. A HUMAN FIGURE IN RUSTY PURPLE APPEARS TO BE WALKING ON TOP OF EACH OF THE INTERMEDIATE AND RIGHT, UPPERMOST BAGS OF MONEY.

SER. NO. 77-339,443, FILED 11-28-2007.

KATHERINE CHANG, EXAMINING ATTORNEY

**Int. Cl.: 39**

**Prior U.S. Cls.: 100 and 105**

**United States Patent and Trademark Office**

**Reg. No. 3,467,451**

**Registered July 15, 2008**

**SERVICE MARK  
PRINCIPAL REGISTER**

**IDRIVE**

PRO SOFTNET CORPORATION (CALIFORNIA  
CORPORATION)  
SUITE 690  
2130 VICTORY BOULEVARD  
WOODLAND HILLS, CA 91367

FOR: WEB BASED ONLINE ELECTRONIC DATA  
SERVICES, NAMELY, PROVIDING THE STORAGE  
OF ELECTRONIC DATA, IN CLASS 39 (U.S. CLS. 100  
AND 105).

FIRST USE 9-28-2001; IN COMMERCE 9-28-2001.

THE MARK CONSISTS OF STANDARD CHAR-  
ACTERS WITHOUT CLAIM TO ANY PARTICULAR  
FONT, STYLE, SIZE, OR COLOR.

SER. NO. 77-339,457, FILED 11-28-2007.

SARA THOMAS, EXAMINING ATTORNEY

**Int. Cl.: 35**

**Prior U.S. Cls.: 100, 101 and 102**

**United States Patent and Trademark Office**

**Reg. No. 3,467,452**

**Registered July 15, 2008**

**SERVICE MARK  
PRINCIPAL REGISTER**



ALL STATES TAX SERVICES, LLC (MARYLAND  
LTD LIAB CO), DBA ALL STATES TAX  
7610 PENNSYLVANIA AVE.  
FORESTVILLE, MD 20747

FOR: INCOME TAX PREPARATION, IN CLASS 35  
(U.S. CLS. 100, 101 AND 102).

FIRST USE 1-1-2005; IN COMMERCE 1-1-2005.

NO CLAIM IS MADE TO THE EXCLUSIVE  
RIGHT TO USE "TAX", APART FROM THE MARK  
AS SHOWN.

THE MARK CONSISTS OF THE STYLIZED TEXT  
"ALL STATES TAX" CENTERED INSIDE AN OUT-  
LINE OF THE UNITED STATES.

SER. NO. 77-339,472, FILED 11-28-2007.

PAUL E. FAHRENKOPF, EXAMINING ATTORNEY

**Int. Cl.: 45**

**Prior U.S. Cls.: 100 and 101**

**United States Patent and Trademark Office**

**Reg. No. 3,467,453**

**Registered July 15, 2008**

---

**SERVICE MARK  
PRINCIPAL REGISTER**

**Securing Your Innovations**

BERENATO, WHITE & STAVISH (MARYLAND  
LTD LIAB CO)  
SUITE 240  
6550 ROCK SPRING DRIVE  
BETHESDA, MD 20817

THE MARK CONSISTS OF STANDARD CHAR-  
ACTERS WITHOUT CLAIM TO ANY PARTICULAR  
FONT, STYLE, SIZE, OR COLOR.

FOR: LEGAL SERVICES, IN CLASS 45 (U.S. CLS.  
100 AND 101).

SER. NO. 77-339,480, FILED 11-28-2007.

FIRST USE 12-31-2005; IN COMMERCE 12-31-2005.

ELLEN PERKINS, EXAMINING ATTORNEY

Int. Cl.: 25

Prior U.S. Cls.: 22 and 39

United States Patent and Trademark Office

Reg. No. 3,467,454

Registered July 15, 2008

TRADEMARK  
PRINCIPAL REGISTER

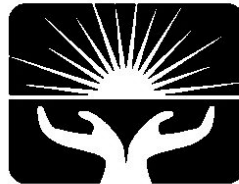

*Divine Dzion*

DIVINE DZION (MISSOURI CORPORATION)  
11612 FRANCETTA  
ST. LOUIS, MO 63138

THE MARK CONSISTS OF AN ABSTRACT DESIGN WITH THE STYLIZED TEXT "DIVINE DZION".

FOR: HOSIERY, NAMELY, PANTYHOSE, KNEE HIGHS, TIGHTS, THIGH HIGHS, SOCKS, IN CLASS 25 (U.S. CLS. 22 AND 39).

SER. NO. 77-339,484, FILED 11-28-2007.

FIRST USE 6-0-2004; IN COMMERCE 8-0-2004.

HOWARD B. LEVINE, EXAMINING ATTORNEY

**Int. Cl.: 25**

**Prior U.S. Cls.: 22 and 39**

**United States Patent and Trademark Office**

**Reg. No. 3,467,455**

**Registered July 15, 2008**

**TRADEMARK  
PRINCIPAL REGISTER**

# Rebelette

HERNANDEZ, ERICA J. (UNITED STATES IN-  
DIVIDUAL)  
3033 E. VALLEY BLVD. UNIT 15  
WEST COVINA, CA 91792

FOR: SHORTS; DRESSES; JUMPERS; SHIRTS;  
JACKETS; T-SHIRTS; SWEAT PANTS; SWEAT  
SHIRTS; SWEAT SHORTS; SWEATERS; LEGGINGS;  
PANTS; TIGHTS; TANK TOPS; TUNICS, IN CLASS  
25 (U.S. CLS. 22 AND 39).

FIRST USE 10-13-2007; IN COMMERCE 10-13-2007.

THE MARK CONSISTS OF STANDARD CHAR-  
ACTERS WITHOUT CLAIM TO ANY PARTICULAR  
FONT, STYLE, SIZE, OR COLOR.

SER. NO. 77-339,521, FILED 11-28-2007.

DAVID MILLER, EXAMINING ATTORNEY



Int. Cl.: 35

Prior U.S. Cls.: 100, 101 and 102

United States Patent and Trademark Office

Reg. No. 3,467,456

Registered July 15, 2008

**SERVICE MARK  
PRINCIPAL REGISTER**



SELECT APPOINTMENTS (HOLDINGS) LIMITED (UNITED KINGDOM CORPORATION)  
2ND FLOOR CHURCHILL HOUSE  
26-30 UPPER MARLBOROUGH ROAD  
ST. ALBANS, ENGLAND AL13UU

FOR: EMPLOYMENT AGENCY SERVICES; EMPLOYMENT CONSULTANCY SERVICES; EMPLOYMENT COUNSELING; INFORMATION SERVICES RELATING TO JOBS AND CAREER OPPORTUNITIES; PLACING JOB ADVERTISEMENTS FOR OTHERS; PROVIDING AN ON-LINE WEBSITE FEATURING JOB ADVERTISEMENTS; PERSONNEL MANAGEMENT SERVICES; PERSONNEL RECRUITMENT; PSYCHOLOGICAL TESTING FOR THE SELECTION OF PERSONNEL; INFORMATION AND ADVISORY SERVICES RELATING TO THE

AFORESAID, IN CLASS 35 (U.S. CLS. 100, 101 AND 102).

FIRST USE 10-0-2006; IN COMMERCE 10-0-2006.

THE COLOR(S) BLUE AND ORANGE IS/ARE CLAIMED AS A FEATURE OF THE MARK.

THE MARK CONSISTS OF A STYLIZED PYRAMID, HALF ORANGE, HALF BLUE. THE WORD "LOCUM" IS IN BLUE AND THE WORD "MEDICAL" IS IN ORANGE.

SER. NO. 77-339,534, FILED 11-28-2007.

MICHELE SWAIN, EXAMINING ATTORNEY

**Int. Cl.: 44**

**Prior U.S. Cls.: 100 and 101**

**United States Patent and Trademark Office**

**Reg. No. 3,467,457**

**Registered July 15, 2008**

**SERVICE MARK  
PRINCIPAL REGISTER**

**BEST FACE FORWARD**

GALDERMA, S.A. (SWITZERLAND SOCIÉTÉ  
ANONYME (SA))  
ZUGERSTRASSE 8  
CHAM, SWITZERLAND CH-6330

THE MARK CONSISTS OF STANDARD CHAR-  
ACTERS WITHOUT CLAIM TO ANY PARTICULAR  
FONT, STYLE, SIZE, OR COLOR.

FOR: PROVIDING MEDICAL AND HEALTH-  
CARE INFORMATION IN THE FIELDS OF SKIN  
CARE AND DERMATOLOGY, IN CLASS 44 (U.S.  
CLS. 100 AND 101).

SER. NO. 77-339,569, FILED 11-29-2007.

FIRST USE 5-20-2004; IN COMMERCE 5-20-2004.

ANTHONY RINKER, EXAMINING ATTORNEY

**Int. Cl.: 16**

**Prior U.S. Cls.: 2, 5, 22, 23, 29, 37, 38 and 50**

**United States Patent and Trademark Office**

**Reg. No. 3,467,458**

**Registered July 15, 2008**

**TRADEMARK  
PRINCIPAL REGISTER**

**701**

FELLOWES, INC. (ILLINOIS CORPORATION)  
1789 NORWOOD  
ITASCA, IL 60143

THE MARK CONSISTS OF STANDARD CHAR-  
ACTERS WITHOUT CLAIM TO ANY PARTICULAR  
FONT, STYLE, SIZE, OR COLOR.

FOR: CORRUGATED RECORD STORAGE  
BOXES, IN CLASS 16 (U.S. CLS. 2, 5, 22, 23, 29, 37, 38  
AND 50).

SER. NO. 77-339,654, FILED 11-29-2007.

FIRST USE 12-1-1893; IN COMMERCE 12-1-1983.

DAVID COLLIER, EXAMINING ATTORNEY

**Int. Cl.: 41**

**Prior U.S. Cls.: 100, 101 and 107**

**United States Patent and Trademark Office**

**Reg. No. 3,467,459**

**Registered July 15, 2008**

**SERVICE MARK  
PRINCIPAL REGISTER**

**FAKE DRAMA. PRETEND  
INJURIES. REAL KIDS.**

2 UNDER ENTERTAINMENT (OHIO LTD LIAB  
CO)  
SUITE 100  
1404 GOODALE BOULEVARD  
COLOMBUS, OH 43212

FOR: ENTERTAINMENT SERVICES, NAMELY, A  
CONTINUING MEDICAL DRAMA SERIES PROVID-  
ED THROUGH SATELLITE-DELIVERED TELEVI-  
SION, TELEVISION, INTERNET PROTOCOL  
TELEVISION, THE INTERNET, AND MOBILE TEL-  
ECOMMUNICATION NETWORKS, IN CLASS 41  
(U.S. CLS. 100, 101 AND 107).

FIRST USE 10-2-2007; IN COMMERCE 10-2-2007.

THE MARK CONSISTS OF STANDARD CHAR-  
ACTERS WITHOUT CLAIM TO ANY PARTICULAR  
FONT, STYLE, SIZE, OR COLOR.

SER. NO. 77-339,661, FILED 11-29-2007.

BRIAN PINO, EXAMINING ATTORNEY

**Int. Cl.: 33**

**Prior U.S. Cls.: 47 and 49**

**United States Patent and Trademark Office**

**Reg. No. 3,467,460**

**Registered July 15, 2008**

**TRADEMARK  
PRINCIPAL REGISTER**

**LUAN**

VIÑA FRANCISCO DE AGUIRRE S.A. (CHILE  
SOCIEDAD ANONIMA (SA))  
LA CHIMBA SUR S/N  
OVALLE, CHILE

OWNER OF CHILE REG. NO. 730604, DATED 8-5-  
2005, EXPIRES 8-5-2015.

FOR: WINES, IN CLASS 33 (U.S. CLS. 47 AND 49).

SER. NO. 77-339,695, FILED 11-29-2007.

THE MARK CONSISTS OF STANDARD CHAR-  
ACTERS WITHOUT CLAIM TO ANY PARTICULAR  
FONT, STYLE, SIZE, OR COLOR.

DOMINICK J. SALEMI, EXAMINING ATTORNEY

**Int. Cl.: 16**

**Prior U.S. Cls.: 2, 5, 22, 23, 29, 37, 38 and 50**

**Reg. No. 3,467,461**

**United States Patent and Trademark Office**

**Registered July 15, 2008**

**TRADEMARK  
PRINCIPAL REGISTER**

**Resorts & Great Hotels**

WORLD PUBLICATIONS, LLC (DELAWARE LTD  
LIAB CO)  
460 N. ORLANDO AVENUE, SUITE 200  
WINTER PARK, FL 32789

FOR: PRINTED PUBLICATIONS, NAMELY, MA-  
GAZINES, IN THE FIELDS OF RESORTS, HOTELS  
AND TRAVEL, IN CLASS 16 (U.S. CLS. 2, 5, 22, 23, 29,  
37, 38 AND 50).

FIRST USE 1-1-1987; IN COMMERCE 1-1-1987.

THE MARK CONSISTS OF STANDARD CHAR-  
ACTERS WITHOUT CLAIM TO ANY PARTICULAR  
FONT, STYLE, SIZE, OR COLOR.

OWNER OF U.S. REG. NO. 3,201,063.

SEC. 2(F).

SER. NO. 77-339,741, FILED 11-29-2007.

ROBIN CHOSID, EXAMINING ATTORNEY

**Int. Cl.: 41**

**Prior U.S. Cls.: 100, 101 and 107**

**United States Patent and Trademark Office**

**Reg. No. 3,467,462**

**Registered July 15, 2008**

**SERVICE MARK  
PRINCIPAL REGISTER**

**MORE THAN MONEY**

GENE DICKISON (UNITED STATES INDIVIDUAL)  
1081 RUNNING VALLEY ROAD  
STROUDSBURG, PA 18360

FOR: ENTERTAINMENT, NAMELY, A CONTINUING CALL-IN TALK SHOW BROADCAST OVER RADIO, TELEVISION, THE INTERNET, AUDIO AND VIDEO MEDIA HOSTED BY A FINANCIAL PLANNER WHO PROVIDES GENERAL INFORMATION ABOUT INVESTMENTS, INCOME TAXES, ESTATE PLANNING AND BUSINESS, IN CLASS 41 (U.S. CLS. 100, 101 AND 107).

FIRST USE 2-5-1992; IN COMMERCE 2-5-1992.

THE MARK CONSISTS OF STANDARD CHARACTERS WITHOUT CLAIM TO ANY PARTICULAR FONT, STYLE, SIZE, OR COLOR.

SER. NO. 77-339,747, FILED 11-29-2007.

IRA J. GOODSaid, EXAMINING ATTORNEY

**Int. Cl.: 16**

**Prior U.S. Cls.: 2, 5, 22, 23, 29, 37, 38 and 50**

**United States Patent and Trademark Office**

**Reg. No. 3,467,463**

**Registered July 15, 2008**

**TRADEMARK  
PRINCIPAL REGISTER**

**BRIDGE STREET**

O & S HOLDINGS, LLC (DELAWARE LTD LIAB  
CO)  
2ND FLOOR  
3130 WILSHIRE BLVD.  
SANTA MONICA, CA 90403

FOR: PRINTED MATTER IN THE NATURE OF  
GIFT CARDS, GIFT CERTIFICATES, BUSINESS  
DIRECTORIES FEATURING SHOPPER'S GUIDES,  
STORE DIRECTORIES AND MAPS, CALENDARS  
OF EVENTS, AND RESTAURANT INFORMATION  
GUIDES, IN CLASS 16 (U.S. CLS. 2, 5, 22, 23, 29, 37, 38  
AND 50).

FIRST USE 11-1-2007; IN COMMERCE 11-1-2007.

THE MARK CONSISTS OF STANDARD CHAR-  
ACTERS WITHOUT CLAIM TO ANY PARTICULAR  
FONT, STYLE, SIZE, OR COLOR.

OWNER OF U.S. REG. NO. 2,875,588.

SER. NO. 77-339,750, FILED 11-29-2007.

MIDGE BUTLER, EXAMINING ATTORNEY



**Int. Cl.: 41**

**Prior U.S. Cls.: 100, 101 and 107**

**United States Patent and Trademark Office**

**Reg. No. 3,467,464**

**Registered July 15, 2008**

**SERVICE MARK  
PRINCIPAL REGISTER**

# Total Choice

HARRAH'S LICENSE COMPANY, LLC (NEVADA  
LTD LIAB CO)  
ONE HARRAH'S COURT  
LAS VEGAS, NV 89119

FOR: CASINO AND GAMING SERVICES FEATURING A FREQUENT CUSTOMER REWARD PROGRAM SERVICE WHICH ALLOWS PARTICIPANTS TO EARN DISCOUNTS, COMPLEMENTARY SERVICES AND FREE GIFTS, CONDUCTING AND PROVIDING FACILITIES FOR SPECIAL EVENTS FEATURING CASINO AND GAMING CONTESTS, IN CLASS 41 (U.S. CLS. 100, 101 AND 107).

FIRST USE 1-1-2008; IN COMMERCE 1-1-2008.

THE MARK CONSISTS OF STANDARD CHARACTERS WITHOUT CLAIM TO ANY PARTICULAR FONT, STYLE, SIZE, OR COLOR.

OWNER OF U.S. REG. NOS. 2,209,160, 2,476,727 AND OTHERS.

SER. NO. 77-339,754, FILED 11-29-2007.

MICHAEL SOUDERS, EXAMINING ATTORNEY

**Int. Cl.: 16**

**Prior U.S. Cls.: 2, 5, 22, 23, 29, 37, 38 and 50**

**Reg. No. 3,467,465**

**United States Patent and Trademark Office**

**Registered July 15, 2008**

**TRADEMARK  
PRINCIPAL REGISTER**

# Sport Fishing

WORLD PUBLICATIONS, LLC (DELAWARE LTD  
LIAB CO)  
460 N. ORLANDO AVENUE, SUITE 200  
WINTER PARK, FL 32789

FOR: PUBLICATION, NAMELY, MAGAZINES IN  
THE FIELDS OF OFFSHORE AND NEARSHORE  
FISHING, INSTRUCTIONAL TECHNIQUE, BOAT-  
ING, SAFETY AND CONSERVATION , IN CLASS 16  
(U.S. CLS. 2, 5, 22, 23, 29, 37, 38 AND 50).

FIRST USE 11-1-1994; IN COMMERCE 11-1-1994.

THE MARK CONSISTS OF STANDARD CHAR-  
ACTERS WITHOUT CLAIM TO ANY PARTICULAR  
FONT, STYLE, SIZE, OR COLOR.

OWNER OF U.S. REG. NO. 3,027,150.

SEC. 2(F).

SER. NO. 77-339,766, FILED 11-29-2007.

ROBIN CHOSID, EXAMINING ATTORNEY

**Int. Cl.: 45**

**Prior U.S. Cls.: 100 and 101**

**United States Patent and Trademark Office**

**Reg. No. 3,467,466**

**Registered July 15, 2008**

**SERVICE MARK  
PRINCIPAL REGISTER**



**KOLEY ■ JESSEN**

KOLEY JESSEN P.C., L.L.O. (NEBRASKA CORPORATION)  
SUITE 800  
ONE PACIFIC PLACE, 1125 S 103RD STREET  
OMAHA, NE 68124

OWNER OF U.S. REG. NO. 2,711,265.

THE MARK CONSISTS OF A SQUARE BETWEEN THE NAMES "KOLEY" AND "JESSEN".

FOR: LEGAL SERVICES, IN CLASS 45 (U.S. CLS. 100 AND 101).

SER. NO. 77-339,767, FILED 11-29-2007.

FIRST USE 7-30-2007; IN COMMERCE 7-30-2007.

INGRID C. EULIN, EXAMINING ATTORNEY

**Int. Cl.: 41**

**Prior U.S. Cls.: 100, 101 and 107**

**United States Patent and Trademark Office**

**Reg. No. 3,467,467**

**Registered July 15, 2008**

**SERVICE MARK  
PRINCIPAL REGISTER**

**MORE THAN MONEY WITH GENE  
DICKISON**

GENE DICKISON (UNITED STATES INDIVIDUAL)  
1081 RUNNING VALLEY ROAD  
STROUDSBURG, PA 18360

FOR: ENTERTAINMENT, NAMELY, A CONTINUING CALL-IN TALK SHOW BROADCAST OVER RADIO, TELEVISION, THE INTERNET, AUDIO AND VIDEO MEDIA HOSTED BY A FINANCIAL PLANNER WHO PROVIDES GENERAL INFORMATION ABOUT INVESTMENTS, INCOME TAXES, ESTATE PLANNING AND BUSINESS, IN CLASS 41 (U.S. CLS. 100, 101 AND 107).

FIRST USE 2-5-1992; IN COMMERCE 2-5-1992.

THE MARK CONSISTS OF STANDARD CHARACTERS WITHOUT CLAIM TO ANY PARTICULAR FONT, STYLE, SIZE, OR COLOR.

SER. NO. 77-339,769, FILED 11-29-2007.

IRA J. GOODSaid, EXAMINING ATTORNEY

**Int. Cl.: 30**

**Prior U.S. Cl.: 46**

**United States Patent and Trademark Office**

**Reg. No. 3,467,468**

**Registered July 15, 2008**

**TRADEMARK  
PRINCIPAL REGISTER**

NERCESSIAN KETTLE CORN NYC

NERCESSIAN KETTLE CORN NYC, LLC (DELA-  
WARE LTD LIAB CO)

C/O KENNETH R. NERCESSIAN

5535 NETHERLAND AVENUE, #5E

BRONX, NY 10471

FOR: POPCORN, IN CLASS 30 (U.S. CL. 46).

FIRST USE 11-2-2007; IN COMMERCE 11-2-2007.

THE MARK CONSISTS OF STANDARD CHAR-  
ACTERS WITHOUT CLAIM TO ANY PARTICULAR  
FONT, STYLE, SIZE, OR COLOR.

NO CLAIM IS MADE TO THE EXCLUSIVE  
RIGHT TO USE "KETTLE CORN NYC", APART  
FROM THE MARK AS SHOWN.

SER. NO. 77-339,770, FILED 11-29-2007.

RICHARD WHITE, EXAMINING ATTORNEY

**Int. Cl.: 17**

**Prior U.S. Cls.: 1, 5, 12, 13, 35 and 50**

**United States Patent and Trademark Office**

**Reg. No. 3,467,469**

**Registered July 15, 2008**

**TRADEMARK  
PRINCIPAL REGISTER**

**Durowedge**

DUROWEDGE LLC. (NEW YORK LTD LIAB CO)  
#205  
200 WILLIAM ST.  
RYEBROOK, NY 10573

THE MARK CONSISTS OF STANDARD CHAR-  
ACTERS WITHOUT CLAIM TO ANY PARTICULAR  
FONT, STYLE, SIZE, OR COLOR.

FOR: DOOR STOPS OF RUBBER, IN CLASS 17  
(U.S. CLS. 1, 5, 12, 13, 35 AND 50).

SER. NO. 77-339,783, FILED 11-29-2007.

FIRST USE 6-0-2005; IN COMMERCE 9-0-2007.

INGRID C. EULIN, EXAMINING ATTORNEY

**Int. Cl.: 35**

**Prior U.S. Cls.: 100, 101 and 102**

**United States Patent and Trademark Office**

**Reg. No. 3,467,470**

**Registered July 15, 2008**

**SERVICE MARK  
PRINCIPAL REGISTER**

**TAHARI**

ELIE TAHARI (UNITED STATES INDIVIDUAL)  
16 BLEEKER STREET  
MILLBURN, NJ 07041

FOR: RETAIL APPAREL AND ACCESSORIES  
STORES, IN CLASS 35 (U.S. CLS. 100, 101 AND 102).

FIRST USE 3-31-1986; IN COMMERCE 3-31-1986.

THE MARK CONSISTS OF STANDARD CHAR-  
ACTERS WITHOUT CLAIM TO ANY PARTICULAR  
FONT, STYLE, SIZE, OR COLOR.

OWNER OF U.S. REG. NOS. 1,489,405, 2,681,767  
AND OTHERS.

SER. NO. 77-339,825, FILED 11-29-2007.

LAURIE MAYES, EXAMINING ATTORNEY

**Int. Cl.: 28**

**Prior U.S. Cls.: 22, 23, 38 and 50**

**United States Patent and Trademark Office**

**Reg. No. 3,467,471**

**Registered July 15, 2008**

**TRADEMARK  
PRINCIPAL REGISTER**

**HURLEY**

SCHOOGI, INC. (MONTANA CORPORATION)  
32050 EAST FRONTAGE RD.  
BOZEMAN, MT 59715

THE MARK CONSISTS OF STANDARD CHAR-  
ACTERS WITHOUT CLAIM TO ANY PARTICULAR  
FONT, STYLE, SIZE, OR COLOR.

FOR: PET TOYS, IN CLASS 28 (U.S. CLS. 22, 23, 38  
AND 50).

SER. NO. 77-339,834, FILED 11-29-2007.

FIRST USE 3-22-2004; IN COMMERCE 3-22-2004.

ADA HAN, EXAMINING ATTORNEY



**Int. Cl.: 41**

**Prior U.S. Cls.: 100, 101 and 107**

**United States Patent and Trademark Office**

**Reg. No. 3,467,472**

**Registered July 15, 2008**

**SERVICE MARK  
PRINCIPAL REGISTER**

**RCP**

RCP, INC. (TEXAS CORPORATION)  
601 JEFFERSON STREET, SUITE 305  
HOUSTON, TX 77002

FOR: EDUCATIONAL SERVICES, NAMELY,  
PROVIDING WORKSHOPS, SEMINARS, AND  
TRAINING COURSES IN THE FIELD OF REGULA-  
TORY COMPLIANCE, IN CLASS 41 (U.S. CLS. 100,  
101 AND 107).

FIRST USE 2-0-1995; IN COMMERCE 2-0-1995.

THE MARK CONSISTS OF STANDARD CHAR-  
ACTERS WITHOUT CLAIM TO ANY PARTICULAR  
FONT, STYLE, SIZE, OR COLOR.

SER. NO. 77-339,846, FILED 11-29-2007.

EUGENIA MARTIN, EXAMINING ATTORNEY

**Int. Cl.: 45**

**Prior U.S. Cls.: 100 and 101**

**United States Patent and Trademark Office**

**Reg. No. 3,467,473**

**Registered July 15, 2008**

**SERVICE MARK  
PRINCIPAL REGISTER**

**ASK THE GURU**

RUBEN ALCOBA, P.A. (FLORIDA CORPORATION)  
SUITE 211  
3399 NW 72 AVENUE  
MIAMI, FL 33122

FOR: LEGAL SERVICES; LEGAL SERVICES, NAMELY, PREPARATION OF APPLICATIONS FOR TRADEMARK REGISTRATION; LEGAL SERVICES, NAMELY, TRADEMARK SEARCHING AND CLEARANCE SERVICES; LICENSING OF INTELLECTUAL PROPERTY; PATENT LICENSING;

ATTORNEY SERVICES, IN CLASS 45 (U.S. CLS. 100 AND 101).

FIRST USE 11-29-2007; IN COMMERCE 11-29-2007.

THE MARK CONSISTS OF STANDARD CHARACTERS WITHOUT CLAIM TO ANY PARTICULAR FONT, STYLE, SIZE, OR COLOR.

SER. NO. 77-339,850, FILED 11-29-2007.

LAURIE KAUFMAN, EXAMINING ATTORNEY

**Int. Cl.: 3**

**Prior U.S. Cls.: 1, 4, 6, 50, 51 and 52**

**United States Patent and Trademark Office**

**Reg. No. 3,467,474**

**Registered July 15, 2008**

**TRADEMARK  
PRINCIPAL REGISTER**

**CHEMATIC**

DOBER CHEMICAL CORPORATION (ILLINOIS  
CORPORATION)  
11230 KATHERINE'S CROSSING  
WOODRIDGE, IL 60517

FOR: CLEANING COMPOSITIONS FOR USE IN  
THE PHARMACEUTICAL INDUSTRY, IN CLASS 3  
(U.S. CLS. 1, 4, 6, 50, 51 AND 52).

FIRST USE 3-24-1994; IN COMMERCE 3-24-1994.

THE MARK CONSISTS OF STANDARD CHAR-  
ACTERS WITHOUT CLAIM TO ANY PARTICULAR  
FONT, STYLE, SIZE, OR COLOR.

OWNER OF U.S. REG. NO. 1,409,210.

SER. NO. 77-339,863, FILED 11-29-2007.

REBECCA EISINGER, EXAMINING ATTORNEY

**Int. Cl.: 42**

**Prior U.S. Cls.: 100 and 101**

**United States Patent and Trademark Office**

**Reg. No. 3,467,475**

**Registered July 15, 2008**

**SERVICE MARK  
PRINCIPAL REGISTER**

**PHENOMBLUE**

PHENOMBLUE, LLC (NEBRASKA LTD LIAB CO)  
2626 HARNEY STREET  
OMAHA, NE 68131

THE MARK CONSISTS OF STANDARD CHAR-  
ACTERS WITHOUT CLAIM TO ANY PARTICULAR  
FONT, STYLE, SIZE, OR COLOR.

FOR: DESIGN AND DEVELOPMENT OF COM-  
PUTER GRAPHICS, ANIMATION AND SOFTWARE  
FOR OTHERS, IN CLASS 42 (U.S. CLS. 100 AND 101).

SER. NO. 77-339,877, FILED 11-29-2007.

FIRST USE 3-26-2004; IN COMMERCE 3-26-2004.

REBECCA EISINGER, EXAMINING ATTORNEY

**Int. Cl.: 20**

**Prior U.S. Cls.: 2, 13, 22, 25, 32 and 50**

**United States Patent and Trademark Office**

**Reg. No. 3,467,476**

**Registered July 15, 2008**

**TRADEMARK  
PRINCIPAL REGISTER**

**BARKING LICENSE**

YAPPYHAPPY.COM (CALIFORNIA PARTNER-  
SHIP)  
1301 ELK GROVE  
IRVINE, CA 92618

THE MARK CONSISTS OF STANDARD CHAR-  
ACTERS WITHOUT CLAIM TO ANY PARTICULAR  
FONT, STYLE, SIZE, OR COLOR.

FOR: PLASTIC DOG TAGS AND KEY CHAINS, IN  
CLASS 20 (U.S. CLS. 2, 13, 22, 25, 32 AND 50).

SER. NO. 77-339,879, FILED 11-29-2007.

FIRST USE 12-17-2001; IN COMMERCE 3-5-2002.

GEOFFREY FOSDICK, EXAMINING ATTORNEY

**Int. Cl.: 35**

**Prior U.S. Cls.: 100, 101 and 102**

**United States Patent and Trademark Office**

**Reg. No. 3,467,477**

**Registered July 15, 2008**

**SERVICE MARK  
PRINCIPAL REGISTER**

**IT'S NOT JUST AN  
IRONWORKER.**

COMEQ, INC. (MARYLAND CORPORATION)  
10521 INDUSTRIAL PARK EAST ROAD  
WHITE MARSH, MD 21162

THE MARK CONSISTS OF STANDARD CHAR-  
ACTERS WITHOUT CLAIM TO ANY PARTICULAR  
FONT, STYLE, SIZE, OR COLOR.

FOR: WHOLESALE DISTRIBUTORSHIPS FEA-  
TURING METAL MACHINERY, IN CLASS 35 (U.S.  
CLS. 100, 101 AND 102).

SER. NO. 77-339,881, FILED 11-29-2007.

FIRST USE 9-5-2007; IN COMMERCE 9-5-2007.

GEOFFREY FOSDICK, EXAMINING ATTORNEY

**Int. Cl.: 41**

**Prior U.S. Cls.: 100, 101 and 107**

**United States Patent and Trademark Office**

**Reg. No. 3,467,478**

**Registered July 15, 2008**

**SERVICE MARK  
PRINCIPAL REGISTER**

**DESIGN MATTERS**

WOLPIN, STEPHEN (UNITED STATES INDIVIDUAL)  
P.O. BOX 352  
SANTA PAULA, CA 93061

FOR: EDUCATIONAL SERVICES, NAMELY, DEVELOPING CURRICULUM FOR OTHERS IN THE FIELDS OF SITE AND PROJECT PLANNING AND IMPLEMENTATION, ARCHITECTURE DESIGN, TEAM MANAGEMENT AND FACILITATION, BUSINESS DEVELOPMENT, ENVIRONMENTAL CONSTRAINTS AND PLANNING, AND GOVERNMENT PERMITTING PROCESSES, IN CLASS 41 (U.S. CLS. 100, 101 AND 107).

FIRST USE 11-12-1992; IN COMMERCE 11-12-1992.

THE MARK CONSISTS OF STANDARD CHARACTERS WITHOUT CLAIM TO ANY PARTICULAR FONT, STYLE, SIZE, OR COLOR.

NO CLAIM IS MADE TO THE EXCLUSIVE RIGHT TO USE "DESIGN", APART FROM THE MARK AS SHOWN.

SER. NO. 77-339,894, FILED 11-29-2007.

JEFF DEFORD, EXAMINING ATTORNEY

**Int. Cl.: 45**

**Prior U.S. Cls.: 100 and 101**

**United States Patent and Trademark Office**

**Reg. No. 3,467,479**

**Registered July 15, 2008**

**SERVICE MARK  
PRINCIPAL REGISTER**

**DESIGN MATTERS**

WOLPIN, STEPHEN (UNITED STATES INDIVIDUAL)  
P.O. BOX 352  
SANTA PAULA, CA 93061

FOR: PERMITTING, NAMELY, OBTAINING ENVIRONMENTAL, DESIGN, ZONING, AND OTHER GOVERNMENTAL PERMITS FOR DEVELOPMENT PROJECTS; REVIEWING STANDARDS AND PRACTICES TO ASSURE COMPLIANCE WITH ENVIRONMENTAL, DESIGN, AND ZONING LAWS AND REGULATIONS, IN CLASS 45 (U.S. CLS. 100 AND 101).

FIRST USE 10-16-1983; IN COMMERCE 10-16-1983.

THE MARK CONSISTS OF STANDARD CHARACTERS WITHOUT CLAIM TO ANY PARTICULAR FONT, STYLE, SIZE, OR COLOR.

NO CLAIM IS MADE TO THE EXCLUSIVE RIGHT TO USE "DESIGN", APART FROM THE MARK AS SHOWN.

SER. NO. 77-339,902, FILED 11-29-2007.

JEFF DEFORD, EXAMINING ATTORNEY



**Int. Cl.: 16**

**Prior U.S. Cls.: 2, 5, 22, 23, 29, 37, 38 and 50**

**United States Patent and Trademark Office**

**Reg. No. 3,467,480**

**Registered July 15, 2008**

**TRADEMARK  
PRINCIPAL REGISTER**

# Darken Realm

FOSSIL RIDGE BOOKS, INC. (COLORADO CORPORATION)  
13218 KEARNEY STREET  
THORTON, CO 80602

THE MARK CONSISTS OF STANDARD CHARACTERS WITHOUT CLAIM TO ANY PARTICULAR FONT, STYLE, SIZE, OR COLOR.

FOR: SERIES OF FICTION BOOKS, IN CLASS 16  
(U.S. CLS. 2, 5, 22, 23, 29, 37, 38 AND 50).

SER. NO. 77-339,905, FILED 11-29-2007.

FIRST USE 3-5-2005; IN COMMERCE 6-1-2005.

REBECCA EISINGER, EXAMINING ATTORNEY

Int. Cl.: 41

Prior U.S. Cls.: 100, 101 and 107

United States Patent and Trademark Office

Reg. No. 3,467,481

Registered July 15, 2008

SERVICE MARK  
PRINCIPAL REGISTER



FULFILLED COUPLE LLC (WISCONSIN LTD  
LIAB CO)  
735 MARGEO DR.  
NEENAH, WI 54956

FOR: PERSONAL COACHING SERVICES IN THE  
FIELD OF MARRIAGE, IN CLASS 41 (U.S. CLS. 100,  
101 AND 107).

FIRST USE 10-15-2007; IN COMMERCE 11-1-2007.

NO CLAIM IS MADE TO THE EXCLUSIVE  
RIGHT TO USE "COUPLE CLUB", APART FROM  
THE MARK AS SHOWN.

THE COLOR(S) BLACK AND GOLD IS/ARE  
CLAIMED AS A FEATURE OF THE MARK.

THE MARK CONSISTS OF THE STYLIZED  
PHRASE "THE FULFILLED COUPLE" IN BLACK  
"CLUB" IN GOLD WITH A GOLD RIBBON UNDER-  
NEATH "COUPLE CLUB" THE PHRASE "WHY JUST  
BE A MARRIED COUPLE...WHEN YOU COULD BE  
A FULFILLED COUPLE?" IN BLACK IN THE LOW-  
ER LEFT CORNER OF THE MARK.

SEC. 2(F).

SER. NO. 77-339,914, FILED 11-29-2007.

SALLY SHIH, EXAMINING ATTORNEY

**Int. Cl.: 36**

**Prior U.S. Cls.: 100, 101 and 102**

**United States Patent and Trademark Office**

**Reg. No. 3,467,482**

**Registered July 15, 2008**

**SERVICE MARK  
PRINCIPAL REGISTER**

# Ablegrove Realty

ABLEGROVE REALTY GROUP, LLC (MISSISSIPPI LTD LIAB CO)  
45 54TH STREET  
GULFPORT, MS 39507

FOR: EVALUATION OF REAL PROPERTY; REAL ESTATE AGENCIES; REAL ESTATE BROKERAGE; REAL ESTATE CONSULTANCY; REAL ESTATE CONSULTATION; REAL ESTATE ESCROW SERVICES; REAL ESTATE INVESTMENT; REAL ESTATE INVESTMENT SERVICES IN THE NATURE OF PURCHASING AND SELLING OF REAL ESTATE FOR OTHERS; REAL ESTATE LISTING; REAL ESTATE MULTIPLE LISTING SERVICES; REAL ESTATE PROCUREMENT FOR OTHERS, IN CLASS 36 (U.S. CLS. 100, 101 AND 102).

FIRST USE 1-1-2007; IN COMMERCE 1-1-2007.

THE MARK CONSISTS OF STANDARD CHARACTERS WITHOUT CLAIM TO ANY PARTICULAR FONT, STYLE, SIZE, OR COLOR.

NO CLAIM IS MADE TO THE EXCLUSIVE RIGHT TO USE "REALTY", APART FROM THE MARK AS SHOWN.

SER. NO. 77-339,922, FILED 11-29-2007.

JEFF DEFORD, EXAMINING ATTORNEY

**Int. Cl.: 16**

**Prior U.S. Cls.: 2, 5, 22, 23, 29, 37, 38 and 50**

**United States Patent and Trademark Office**

**Reg. No. 3,467,483**

**Registered July 15, 2008**

**TRADEMARK  
PRINCIPAL REGISTER**

# Water Ski

WORLD PUBLICATIONS, LLC (DELAWARE LTD  
LIAB CO)  
460 N. ORLANDO AVENUE, SUITE 200  
WINTER PARK, FL 32789

FOR: MAGAZINES IN THE FIELD OF WATER-  
SKIING, IN CLASS 16 (U.S. CLS. 2, 5, 22, 23, 29, 37, 38  
AND 50).

FIRST USE 10-1-1978; IN COMMERCE 10-1-1978.

THE MARK CONSISTS OF STANDARD CHAR-  
ACTERS WITHOUT CLAIM TO ANY PARTICULAR  
FONT, STYLE, SIZE, OR COLOR.

OWNER OF U.S. REG. NO. 1,882,124.

SEC. 2(F).

SER. NO. 77-339,924, FILED 11-29-2007.

ROBIN CHOSID, EXAMINING ATTORNEY

**Int. Cl.: 35**

**Prior U.S. Cls.: 100, 101 and 102**

**United States Patent and Trademark Office**

**Reg. No. 3,467,484**

**Registered July 15, 2008**

**SERVICE MARK  
PRINCIPAL REGISTER**

# LiveBrochure

WORLD PUBLICATIONS, LLC (DELAWARE LTD  
LIAB CO)  
460 N. ORLANDO AVENUE, SUITE 200  
WINTER PARK, FL 32789

FOR: PROVIDING MARKETING AND ADVERTISING SERVICES, NAMELY, BRANDED PROMOTIONAL PRODUCTS OFFERED THROUGH PRINT, EMAIL AND ONLINE PROGRAMS , IN CLASS 35 (U.S. CLS. 100, 101 AND 102).

FIRST USE 8-4-2004; IN COMMERCE 8-4-2004.

THE MARK CONSISTS OF STANDARD CHARACTERS WITHOUT CLAIM TO ANY PARTICULAR FONT, STYLE, SIZE, OR COLOR.

OWNER OF U.S. REG. NO. 3,028,693.

SER. NO. 77-339,941, FILED 11-29-2007.

ROBIN CHOSID, EXAMINING ATTORNEY

**Int. Cl.: 35**

**Prior U.S. Cls.: 100, 101 and 102**

**United States Patent and Trademark Office**

**Reg. No. 3,467,485**

**Registered July 15, 2008**

**SERVICE MARK  
PRINCIPAL REGISTER**

**AZBIZ.COM**

WICK COMMUNICATIONS CO. (ARIZONA CORPORATION)  
SUITE 302  
333 WEST WILCOX BOULEVARD  
SIERRA VISTA, AZ 85635

FOR: PROVIDING A WEBSITE WHICH FEATURES ADVERTISEMENTS FOR THE GOODS AND SERVICES OF OTHERS ON A GLOBAL COMPUTER NETWORK, IN CLASS 35 (U.S. CLS. 100, 101 AND 102).

FIRST USE 3-0-2000; IN COMMERCE 3-0-2000.

THE MARK CONSISTS OF STANDARD CHARACTERS WITHOUT CLAIM TO ANY PARTICULAR FONT, STYLE, SIZE, OR COLOR.

SER. NO. 77-339,963, FILED 11-29-2007.

JOHN WILKE, EXAMINING ATTORNEY

Int. Cl.: 30

Prior U.S. Cl.: 46

United States Patent and Trademark Office

Reg. No. 3,467,486

Registered July 15, 2008

TRADEMARK  
PRINCIPAL REGISTER



MOUSSE MAGNIFIQUE (CALIFORNIA SOLE  
PROPRIETORSHIP)  
32091 VIA TONADA  
SAN JUAN CAPISTRANO, CA 92675

FOR: DESSERTS IN THE NATURE OF CAKES,  
PUDDINGS, MOUSSES, PIES, BAKERY DESSERTS  
AND BAKERY GOODS, IN CLASS 30 (U.S. CL. 46).

FIRST USE 9-24-2004; IN COMMERCE 10-29-2004.

OWNER OF U.S. REG. NO. 3,148,005.

THE MARK CONSISTS OF A MOOSE WEARING  
A BERET, A MUSTACHE AND A BLACK SHIRT  
HOLDING A TRAY IN ONE HAND CONTAINING A  
HORIZONTALLY STRIPED DESSERT SURROUND-  
ED BY CHERRIES, AND WISPS OF VAPOR  
ABOVE THE DESSERT WITH A CHERRY ON TOP.

THE ENGLISH TRANSLATION OF THE WORD  
"MAGNIFIQUE" IN THE MARK IS MAGNIFICENT.

SER. NO. 77-339,972, FILED 11-29-2007.

DANIEL CAPSHAW, EXAMINING ATTORNEY

**Int. Cl.: 39**

**Prior U.S. Cls.: 100 and 105**

**United States Patent and Trademark Office**

**Reg. No. 3,467,487**

**Registered July 15, 2008**

**SERVICE MARK  
PRINCIPAL REGISTER**

**AVANTAIR**

AVANTAIR, INC. (NEVADA CORPORATION)  
4311 GENERAL HOWARD DRIVE  
CLEARWATER, FL 33762

FOR: AIR TRANSPORTATION, IN CLASS 39 (U.S.  
CLS. 100 AND 105).

FIRST USE 10-5-2002; IN COMMERCE 10-5-2002.

THE MARK CONSISTS OF STANDARD CHAR-  
ACTERS WITHOUT CLAIM TO ANY PARTICULAR  
FONT, STYLE, SIZE, OR COLOR.

OWNER OF U.S. REG. NOS. 2,847,359 AND  
2,874,274.

SER. NO. 77-339,973, FILED 11-29-2007.

LINDA M. KING, EXAMINING ATTORNEY



**Int. Cl.: 9**

**Prior U.S. Cls.: 21, 23, 26, 36 and 38**

**Reg. No. 3,467,488**

**United States Patent and Trademark Office**

**Registered July 15, 2008**

---

**TRADEMARK  
PRINCIPAL REGISTER**

# MagneFinder

HORDIS, ROBERT V (UNITED STATES INDIVIDUAL)  
154 COUNTRY CLUB DR  
LUMBERTON, NJ 08048

THE MARK CONSISTS OF STANDARD CHARACTERS WITHOUT CLAIM TO ANY PARTICULAR FONT, STYLE, SIZE, OR COLOR.

FOR: MAGNETIC OBJECT DETECTORS, IN CLASS 9 (U.S. CLS. 21, 23, 26, 36 AND 38).

SER. NO. 77-339,988, FILED 11-29-2007.

FIRST USE 7-10-2007; IN COMMERCE 7-13-2007.

LINDA M. KING, EXAMINING ATTORNEY

**Int. Cl.: 39**

**Prior U.S. Cls.: 100 and 105**

**United States Patent and Trademark Office**

**Reg. No. 3,467,489**

**Registered July 15, 2008**

**SERVICE MARK  
PRINCIPAL REGISTER**

**AVANTAIR EDGE**

AVANTAIR, INC. (NEVADA CORPORATION)  
4311 GENERAL HOWARD DRIVE  
CLEARWATER, FL 33762

FOR: CHARTER TRAVEL SERVICE ENABLING  
TRAVELERS TO PURCHASE BLOCKS OF AIR-  
PLANE FLIGHT HOURS, IN CLASS 39 (U.S. CLS.  
100 AND 105).

FIRST USE 9-17-2007; IN COMMERCE 9-17-2007.

THE MARK CONSISTS OF STANDARD CHAR-  
ACTERS WITHOUT CLAIM TO ANY PARTICULAR  
FONT, STYLE, SIZE, OR COLOR.

OWNER OF U.S. REG. NOS. 2,847,359 AND  
2,874,274.

SER. NO. 77-340,021, FILED 11-29-2007.

LINDA M. KING, EXAMINING ATTORNEY

**Int. Cl.: 41**

**Prior U.S. Cls.: 100, 101 and 107**

**United States Patent and Trademark Office**

**Reg. No. 3,467,490**

**Registered July 15, 2008**

**SERVICE MARK  
PRINCIPAL REGISTER**



THE BATTLE FOR MANHATTAN, LLC (NEW YORK LTD LIAB CO)  
104 W. 29TH STREET  
NEW YORK, NY 10001

FOR: ORGANISATION OF SPORTS COMPETITIONS, IN CLASS 41 (U.S. CLS. 100, 101 AND 107).

FIRST USE 10-30-2007; IN COMMERCE 10-30-2007.

NO CLAIM IS MADE TO THE EXCLUSIVE RIGHT TO USE "WEST SIDE", "EAST SIDE" AND "MANHATTAN", APART FROM THE MARK AS SHOWN.

THE COLOR(S) BLUE, RED, WHITE AND GREEN IS/ARE CLAIMED AS A FEATURE OF THE MARK.

THE MARK CONSISTS OF A BLUE CIRCLE WITH THE WORDS "THE BATTLE FOR MANHATTAN" IN WHITE INSIDE THE CIRCLE WITH A RED TRAIN WITH THE WORDS "WEST SIDE" IN WHITE AND A GREEN TRAIN WITH THE WORDS "EAST SIDE" IN WHITE ENCIRCLING A LIGHT BLUE CIRCLE WITH WHITE LINES AND A SKYSCRAPER IN THE MIDDLE.

SER. NO. 77-340,036, FILED 11-29-2007.

ELISSA GARBER KON, EXAMINING ATTORNEY

**Int. Cl.: 16**

**Prior U.S. Cls.: 2, 5, 22, 23, 29, 37, 38 and 50**

**United States Patent and Trademark Office**

**Reg. No. 3,467,491**

**Registered July 15, 2008**

**TRADEMARK  
PRINCIPAL REGISTER**

**702**

FELLOWES, INC. (ILLINOIS CORPORATION)  
1789 NORWOOD  
ITASCA, IL 60143

THE MARK CONSISTS OF STANDARD CHAR-  
ACTERS WITHOUT CLAIM TO ANY PARTICULAR  
FONT, STYLE, SIZE, OR COLOR.

FOR: CORRUGATED RECORD STORAGE  
BOXES, IN CLASS 16 (U.S. CLS. 2, 5, 22, 23, 29, 37, 38  
AND 50).

SER. NO. 77-340,058, FILED 11-29-2007.

FIRST USE 12-1-1983; IN COMMERCE 12-1-1983.

DAVID COLLIER, EXAMINING ATTORNEY

**Int. Cl.: 41**

**Prior U.S. Cls.: 100, 101 and 107**

**United States Patent and Trademark Office**

**Reg. No. 3,467,492**

**Registered July 15, 2008**

**SERVICE MARK  
PRINCIPAL REGISTER**

**SHUTTERBOOTH**

SHUTTER BOOTH LLC (MICHIGAN LTD LIAB  
CO)  
P.O. BOX 1082  
ROYAL OAK, MI 48068

THE MARK CONSISTS OF STANDARD CHAR-  
ACTERS WITHOUT CLAIM TO ANY PARTICULAR  
FONT, STYLE, SIZE, OR COLOR.

FOR: RENTAL OF PHOTOGRAPHIC EQUIP-  
MENT, NAMELY, CUSTOMIZABLE PORTABLE  
PHOTO BOOTHS, IN CLASS 41 (U.S. CLS. 100, 101  
AND 107).

SER. NO. 77-340,061, FILED 11-29-2007.

FIRST USE 9-15-2007; IN COMMERCE 9-15-2007.

ANN E. SAPPENFIELD, EXAMINING ATTORNEY

Int. Cl.: 36

Prior U.S. Cls.: 100, 101 and 102

**United States Patent and Trademark Office**

**Reg. No. 3,467,493**

Registered July 15, 2008

**SERVICE MARK  
PRINCIPAL REGISTER**



**A PENNY IN EVERY PINT**

FLEISCHER ENTERPRISES, INC. (MARYLAND CORPORATION)  
2231 DISTRIBUTION CIRCLE  
SILVER SPRING, MD 20910

FOR: CHARITABLE FUND RAISING, IN CLASS 36 (U.S. CLS. 100, 101 AND 102).

FIRST USE 6-1-2005; IN COMMERCE 6-1-2005.

OWNER OF U.S. REG. NO. 3,338,697.

THE MARK CONSISTS OF LIKENESS OF ABRAHAM LINCOLN WEARING FIREFIGHTER HELMET WITH PHRASE "A PENNY IN EVERY PINT" UNDERNEATH.

SER. NO. 77-340,066, FILED 11-29-2007.

ESTHER BELENKER, EXAMINING ATTORNEY

**Int. Cls.: 9 and 42**

**Prior U.S. Cls.: 21, 23, 26, 36, 38, 100 and 101**

**United States Patent and Trademark Office**

**Reg. No. 3,467,494**

**Registered July 15, 2008**

**TRADEMARK  
SERVICE MARK  
PRINCIPAL REGISTER**



SCANCO, LLC (OHIO LTD LIAB CO)  
472 PORTAGE LAKES DRIVE  
AKRON, OH 44319

FOR: COMPUTER SOFTWARE FOR INTEGRATING BAR CODE AND RADIO FREQUENCY IDENTIFICATION (RFID) SCANNING, BARCODE PRINTING, AND RADIO FREQUENCY IDENTIFICATION (RFID) SCANNING AND RELATED DOCUMENT MANAGEMENT FOR PRODUCT INVENTORY CONTROL, SHIPPING, THE RECEIPT THEREOF, AND INVOICING INTO OFF-THE-SHELF ACCOUNTING SOFTWARE SYSTEMS, IN CLASS 9 (U.S. CLS. 21, 23, 26, 36 AND 38).

FIRST USE 3-26-1992; IN COMMERCE 3-26-1992.

FOR: SCIENTIFIC AND TECHNOLOGICAL SERVICES IN THE FIELD OF AUTHORING, DESIGN,

DEVELOPMENT, AND DEPLOYMENT OF LOGISTICS COMPUTER SOFTWARE DESIGNED TO INTEGRATE BAR CODE AND RADIO FREQUENCY IDENTIFICATION (RFID) SCANNING, BARCODE PRINTING, AND RADIO FREQUENCY IDENTIFICATION (RFID) WRITING HARDWARE INTO OFF-THE-SHELF ACCOUNTING SOFTWARE SYSTEMS, IN CLASS 42 (U.S. CLS. 100 AND 101).

FIRST USE 3-26-1992; IN COMMERCE 3-26-1992.

THE MARK CONSISTS OF A BAR CODE HAVING A CURVED LINE EXTENDING THERETHROUGH AND TO THE LEFT OF THE WORD "SCANCO".

SER. NO. 77-340,077, FILED 11-29-2007.

SANJEEV VOHRA, EXAMINING ATTORNEY

**Int. Cls.: 41 and 42**

**Prior U.S. Cls.: 100, 101 and 107**

**United States Patent and Trademark Office**

**Reg. No. 3,467,495**

**Registered July 15, 2008**

**SERVICE MARK  
PRINCIPAL REGISTER**

# STUDIO TIGA

STUDIO TIGA, INC. (CALIFORNIA CORPORATION)  
STE. C  
2630 WALNUT AVE.  
TUSTIN, CA 92780

FOR: PRODUCTION OF VIDEO AND CREATION OF VISUAL EFFECTS FOR OTHERS FOR USE IN DVD'S, TELEVISION PROGRAMS AND ON WEBSITES; PRODUCTION OF VIDEO AND COMPUTER GAME SOFTWARE, IN CLASS 41 (U.S. CLS. 100, 101 AND 107).

FIRST USE 5-1-2004; IN COMMERCE 6-11-2004.

FOR: DESIGN AND DEVELOPMENT OF MULTIMEDIA PRODUCTS; DESIGN, CREATION AND

MAINTENANCE OF WEB SITES FOR OTHERS, IN CLASS 42 (U.S. CLS. 100 AND 101).

FIRST USE 5-1-2004; IN COMMERCE 6-11-2004.

THE MARK CONSISTS OF STANDARD CHARACTERS WITHOUT CLAIM TO ANY PARTICULAR FONT, STYLE, SIZE, OR COLOR.

NO CLAIM IS MADE TO THE EXCLUSIVE RIGHT TO USE "STUDIO", APART FROM THE MARK AS SHOWN.

SER. NO. 77-340,082, FILED 11-29-2007.

MARGERY A. TIERNEY, EXAMINING ATTORNEY



**Int. Cl.: 9**

**Prior U.S. Cls.: 21, 23, 26, 36 and 38**

**United States Patent and Trademark Office**

**Reg. No. 3,467,496**

**Registered July 15, 2008**

**TRADEMARK  
PRINCIPAL REGISTER**

**CITY LITES**

CITY LITES ELECTRIC SIGN CO., INC. (NEVADA CORPORATION)  
SUITE 26A  
4625 WYNN RD.  
LAS VEGAS, NV 89103

THE MARK CONSISTS OF STANDARD CHARACTERS WITHOUT CLAIM TO ANY PARTICULAR FONT, STYLE, SIZE, OR COLOR.

FOR: ELECTRIC SIGNS, IN CLASS 9 (U.S. CLS. 21, 23, 26, 36 AND 38).

SER. NO. 77-340,086, FILED 11-29-2007.

FIRST USE 3-1-1989; IN COMMERCE 3-1-1989.

MARGERY A. TIERNEY, EXAMINING ATTORNEY

**Int. Cl.: 9**

**Prior U.S. Cls.: 21, 23, 26, 36 and 38**

**Reg. No. 3,467,497**

**United States Patent and Trademark Office**

**Registered July 15, 2008**

**TRADEMARK  
PRINCIPAL REGISTER**

**SEEING LIFE IN A NEW LIGHT**

CAMBRIDGE RESEARCH & INSTRUMENTATION, INC. (DELAWARE CORPORATION)  
35-B CABOT ROAD  
WOBURN, MA 01801

FOR: LABORATORY EQUIPMENT SOLD AS A UNIT FOR LIFE SCIENCE, MULTISPECTRAL IMAGING AND POLARIZED LIGHT IMAGING, NAMELY, AN IMAGING SYSTEM PRIMARILY COMPRISING COMPUTER SOFTWARE, COMPUTER HARDWARE, MONITORS, CAMERAS, OPTICAL COUPLERS, OPTICAL POLARIZERS, LIGHT FILTERS AND POLARIZING COMPENSATORS FOR THE MEASUREMENT AND ANALYSIS OF STRESS, POLARIZATION, OPTICAL RETARDANCE, BIREFRINGENCE, AND RELATED PROPERTIES OF BOTH MACROSCOPIC AND MICROSCOPIC SAMPLES, ALL THE FOREGOING SOLD AS A UNIT, INSTRUCTION MANUALS SOLD TOGETHER THEREWITH; SMALL ANIMAL IMAGING SYSTEMS PRIMARILY COMPRISING A DIGITAL CAMERA AND A TUNABLE FILTER, USED WITH LENSES AND FIXED FILTERS TO OBTAIN IMAGES OF ANIMAL SPECIMENS, AND COMPUTER SOFTWARE FOR USE IN OPERATING THE DIGITAL IMAGING SYSTEM, CONTROLLING THE STAGE AND LENSES, OR INTERPRETING THE IMAGES OBTAINED THEREBY, ALL OF THE FOREGOING SOLD AS A UNIT, INSTRUCTIONAL MANUALS SOLD TOGETHER THEREWITH; DIGITAL IMAGING SYSTEMS PRIMARILY COMPRISING A DIGITAL CAMERA AND A TUNABLE FILTER, USED WITH MICROSCOPES OR LENSES TO OBTAIN IMAGES OF SAMPLES OR OF NATURAL SCENES, AND COMPUTER SOFTWARE FOR USE IN OPERATING THE DIGITAL IMAGING SYSTEM, CONTROLLING THE MICROSCOPES OR LENSES, OR INTERPRETING THE IMAGES OBTAINED THEREBY AND ADAPTORS FOR MICRO-

SCOPES AND LENSES, ALL OF THE FOREGOING SOLD AS A UNIT FOR OPTICAL IMAGING, INSTRUCTIONAL MANUALS SOLD TOGETHER THEREWITH; DIGITAL IMAGING SYSTEMS PRIMARILY COMPRISING AN ILLUMINATOR, A DIGITAL CAMERA, OPTICAL INTERFERENCE FILTERS AND A TUNABLE FILTER, USED FOR FLUORESCENCE OPTICAL IMAGING OF SAMPLES, AND COMPUTER SOFTWARE FOR USE IN OPERATING THE DIGITAL IMAGING SYSTEM, OR INTERPRETING THE IMAGES OBTAINED THEREBY, COMPUTERS, AND ADAPTORS FOR LENSES AND MICROSCOPES, ALL OF THE FOREGOING SOLD AS A UNIT FOR OPTICAL IMAGING, INSTRUCTION MANUALS SOLD TOGETHER THEREWITH; DIGITAL IMAGING SYSTEM PRIMARILY COMPRISING COMPUTER SOFTWARE, COMPUTER HARDWARE, MONITORS, CAMERAS, LIQUID CRYSTAL COMPENSATORS, DIGITAL CONTROLLERS, CIRCULAR POLARIZERS AND LIGHT FILTERS USED FOR THE IMAGING, MEASUREMENT AND ANALYSIS OF SPINDLES AND BIREFRINGENT STRUCTURES, ALL OF THE FOREGOING SOLD AS A UNIT FOR OPTICAL IMAGING, INSTRUCTION MANUALS SOLD TOGETHER THEREWITH; OPTICAL COUPLERS, OPTICAL FILTERS, IN CLASS 9 (U.S. CLS. 21, 23, 26, 36 AND 38).

FIRST USE 8-4-2005; IN COMMERCE 2-17-2006.

THE MARK CONSISTS OF STANDARD CHARACTERS WITHOUT CLAIM TO ANY PARTICULAR FONT, STYLE, SIZE, OR COLOR.

SER. NO. 77-340,108, FILED 11-29-2007.

BARBARA GAYNOR, EXAMINING ATTORNEY

**Int. Cl.: 7**

**Prior U.S. Cls.: 13, 19, 21, 23, 31, 34 and 35**

**United States Patent and Trademark Office**

**Reg. No. 3,467,498**

**Registered July 15, 2008**

---

**TRADEMARK  
PRINCIPAL REGISTER**

**SKYPARK**

APEX SKYPARK (CALIFORNIA CORPORATION)  
1150 N. RED GUM ST., SUITE F  
ANAHEIM, CA 92806

THE MARK CONSISTS OF STANDARD CHARACTERS WITHOUT CLAIM TO ANY PARTICULAR FONT, STYLE, SIZE, OR COLOR.

FOR: POWER-OPERATED LIFTS FOR MOVING, PARKING AND STORING LAND VEHICLES, IN CLASS 7 (U.S. CLS. 13, 19, 21, 23, 31, 34 AND 35).

SER. NO. 77-340,110, FILED 11-29-2007.

FIRST USE 2-1-2007; IN COMMERCE 2-1-2007.

CAROLINE WOOD, EXAMINING ATTORNEY

**Int. Cl.: 30**

**Prior U.S. Cl.: 46**

**United States Patent and Trademark Office**

**Reg. No. 3,467,499**

**Registered July 15, 2008**

**TRADEMARK  
PRINCIPAL REGISTER**

**MOTHER TRUCKER**

GREEN TRUCK, LLC (CALIFORNIA LTD LIAB  
CO)  
3515 HELMS AVE.  
CULVER CITY, CA 90232

THE MARK CONSISTS OF STANDARD CHAR-  
ACTERS WITHOUT CLAIM TO ANY PARTICULAR  
FONT, STYLE, SIZE, OR COLOR.

FOR: SANDWICHES, IN CLASS 30 (U.S. CL. 46).

SER. NO. 77-340,123, FILED 11-29-2007.

FIRST USE 10-1-2007; IN COMMERCE 10-1-2007.

DORITT L. CARROLL, EXAMINING ATTORNEY

**Int. Cl.: 16**

**Prior U.S. Cls.: 2, 5, 22, 23, 29, 37, 38 and 50**

**United States Patent and Trademark Office**

**Reg. No. 3,467,500**

**Registered July 15, 2008**

**TRADEMARK  
PRINCIPAL REGISTER**

**703**

FELLOWES, INC. (ILLINOIS CORPORATION)  
1789 NORWOOD AVE.  
ITASCA, IL 60143

THE MARK CONSISTS OF STANDARD CHAR-  
ACTERS WITHOUT CLAIM TO ANY PARTICULAR  
FONT, STYLE, SIZE, OR COLOR.

FOR: CORRUGATED RECORD STORAGE  
BOXES, IN CLASS 16 (U.S. CLS. 2, 5, 22, 23, 29, 37, 38  
AND 50).

SER. NO. 77-340,138, FILED 11-29-2007.

FIRST USE 12-1-1983; IN COMMERCE 12-1-1983.

DAVID COLLIER, EXAMINING ATTORNEY

**Int. Cl.: 8**

**Prior U.S. Cls.: 23, 28 and 44**

**United States Patent and Trademark Office**

**Reg. No. 3,467,501**

**Registered July 15, 2008**

**TRADEMARK  
PRINCIPAL REGISTER**

**T-LIGHT**

ANDIS COMPANY (WISCONSIN CORPORATION)  
1800 RENAISSANCE BLVD.  
STURTEVANT, WI 53177

THE MARK CONSISTS OF STANDARD CHARACTERS WITHOUT CLAIM TO ANY PARTICULAR FONT, STYLE, SIZE, OR COLOR.

FOR: ELECTRIC HAIR CLIPPERS AND TRIMMERS, IN CLASS 8 (U.S. CLS. 23, 28 AND 44).

SER. NO. 77-340,158, FILED 11-29-2007.

FIRST USE 11-3-2006; IN COMMERCE 11-3-2006.

JENNIFER MARTIN, EXAMINING ATTORNEY

**Int. Cl.: 5**

**Prior U.S. Cls.: 6, 18, 44, 46, 51 and 52**

**Reg. No. 3,467,502**

**United States Patent and Trademark Office**

**Registered July 15, 2008**

**TRADEMARK  
PRINCIPAL REGISTER**

**DR. D**

PEDIAGREEN, LLC (NEW JERSEY LTD LIAB  
CO)  
P.O. BOX 2182  
LIVINGSTON, NJ 070397782

THE MARK CONSISTS OF STANDARD CHAR-  
ACTERS WITHOUT CLAIM TO ANY PARTICULAR  
FONT, STYLE, SIZE, OR COLOR.

FOR: NUTRITIONAL SUPPLEMENTS, IN CLASS  
5 (U.S. CLS. 6, 18, 44, 46, 51 AND 52).

SER. NO. 77-340,169, FILED 11-29-2007.

FIRST USE 10-30-2007; IN COMMERCE 10-30-2007.

JENNIFER MARTIN, EXAMINING ATTORNEY

**Int. Cl.: 45**

**Prior U.S. Cls.: 100 and 101**

**United States Patent and Trademark Office**

**Reg. No. 3,467,503**

**Registered July 15, 2008**

**SERVICE MARK  
PRINCIPAL REGISTER**

**DRESSQUEST**

CALLISON, ELEANOR MARCUS (UNITED STATES INDIVIDUAL), DBA DRESSQUEST  
6000 BROOKSIDE BOULEVARD  
KANSAS CITY, MO 64113

FOR: RENTAL OF CLOTHING; RENTAL OF DRESSES; RENTAL OF EVENING DRESSES; RENTAL OF EVENING WEAR; RENTAL OF FORMAL WEAR; RENTAL OF HANDBAGS, CLUTCHES AND PURSES, IN CLASS 45 (U.S. CLS. 100 AND 101).

FIRST USE 10-13-2006; IN COMMERCE 6-23-2007.

THE MARK CONSISTS OF STANDARD CHARACTERS WITHOUT CLAIM TO ANY PARTICULAR FONT, STYLE, SIZE, OR COLOR.

SER. NO. 77-340,173, FILED 11-29-2007.

JIM RINGLE, EXAMINING ATTORNEY



**Int. Cl.: 15**

**Prior U.S. Cls.: 2, 21 and 36**

**United States Patent and Trademark Office**

**Reg. No. 3,467,504**

**Registered July 15, 2008**

**TRADEMARK  
PRINCIPAL REGISTER**

**GRABBIT**

PURGAR, BIELINSKI & SAMSON, LLC. (OHIO  
LTD LIAB CO)  
4723 FOREST GROVE DRIVE  
BRUNSWICK, OH 44212

THE MARK CONSISTS OF STANDARD CHAR-  
ACTERS WITHOUT CLAIM TO ANY PARTICULAR  
FONT, STYLE, SIZE, OR COLOR.

FOR: STANDS FOR MUSICAL INSTRUMENTS,  
IN CLASS 15 (U.S. CLS. 2, 21 AND 36).

SER. NO. 77-340,184, FILED 11-29-2007.

FIRST USE 1-31-2005; IN COMMERCE 1-31-2005.

JAMES LOVELACE, EXAMINING ATTORNEY

Int. Cl.: 39

Prior U.S. Cls.: 100 and 105

United States Patent and Trademark Office

Reg. No. 3,467,505

Registered July 15, 2008

SERVICE MARK  
PRINCIPAL REGISTER

Produce a *Fresh*  
*Experience* Together!

IF&P FOODS, INC. (INDIANA CORPORATION)  
5941 WEST 82ND STREET  
INDIANAPOLIS, IN 46268

FIRST USE 1-1-2007; IN COMMERCE 1-1-2007.

SER. NO. 77-340,186, FILED 11-29-2007.

FOR: DISTRIBUTION SERVICES, NAMELY, DELIVERY OF FRESH FRUITS AND FRESH VEGETABLES, IN CLASS 39 (U.S. CLS. 100 AND 105).

JIM RINGLE, EXAMINING ATTORNEY

**Int. Cl.: 41**

**Prior U.S. Cls.: 100, 101 and 107**

**United States Patent and Trademark Office**

**Reg. No. 3,467,506**

**Registered July 15, 2008**

**SERVICE MARK  
PRINCIPAL REGISTER**

**YOGASNOOZE**

BONNIE SLIFKIN (UNITED STATES INDIVIDUAL)  
APARTMENT 3  
330 EAST 11TH STREET  
NEW YORK, NY 10003

FOR: EDUCATIONAL SERVICES, NAMELY, PROVIDING CLASSES, SEMINARS, AND WORKSHOPS, IN THE FIELD OF EXERCISE, IN CLASS 41 (U.S. CLS. 100, 101 AND 107).

FIRST USE 4-1-2007; IN COMMERCE 4-1-2007.

THE MARK CONSISTS OF STANDARD CHARACTERS WITHOUT CLAIM TO ANY PARTICULAR FONT, STYLE, SIZE, OR COLOR.

OWNER OF U.S. REG. NOS. 2,222,389 AND 3,264,106.

SER. NO. 77-340,199, FILED 11-29-2007.

CIMMERIAN COLEMAN, EXAMINING ATTORNEY

**Int. Cl.: 16**

**Prior U.S. Cls.: 2, 5, 22, 23, 29, 37, 38 and 50**

**United States Patent and Trademark Office**

**Reg. No. 3,467,507**

**Registered July 15, 2008**

**TRADEMARK  
PRINCIPAL REGISTER**

**704**

FELLOWES, INC. (ILLINOIS CORPORATION)  
1789 NORWOOD AVENUE  
ITASCA, IL 60143

THE MARK CONSISTS OF STANDARD CHAR-  
ACTERS WITHOUT CLAIM TO ANY PARTICULAR  
FONT, STYLE, SIZE, OR COLOR.

FOR: CORRUGATED RECORD STORAGE  
BOXES, IN CLASS 16 (U.S. CLS. 2, 5, 22, 23, 29, 37, 38  
AND 50).

SER. NO. 77-340,202, FILED 11-29-2007.

FIRST USE 12-1-1983; IN COMMERCE 12-1-1983.

DAVID COLLIER, EXAMINING ATTORNEY

**Int. Cls.: 39 and 43**

**Prior U.S. Cls.: 100, 101 and 105**

**United States Patent and Trademark Office**

**Reg. No. 3,467,508**

**Registered July 15, 2008**

**SERVICE MARK  
PRINCIPAL REGISTER**

# LatinEscapes

VICTORY TRAVEL, INC. (CALIFORNIA CORPORATION)  
2611 ZOE AVE.  
HUNTINGTON PARK, CA 90255

FOR: ARRANGING EXCURSIONS FOR TOURISTS; TOURIST AGENCY SERVICES; TRAVEL AGENCY SERVICES, NAMELY, MAKING RESERVATIONS AND BOOKINGS FOR TRANSPORTATION; TRAVEL BOOKING AGENCIES, IN CLASS 39 (U.S. CLS. 100 AND 105).

FIRST USE 3-22-2003; IN COMMERCE 3-22-2003.

FOR: PROVIDING TRAVEL LODGING INFORMATION SERVICES AND TRAVEL LODGING

BOOKING AGENCY SERVICES FOR TRAVELERS; TRAVEL AGENCY SERVICES, NAMELY, MAKING RESERVATIONS AND BOOKING FOR TEMPORARY LODGING, IN CLASS 43 (U.S. CLS. 100 AND 101).

FIRST USE 3-22-2003; IN COMMERCE 3-22-2003.

THE MARK CONSISTS OF STANDARD CHARACTERS WITHOUT CLAIM TO ANY PARTICULAR FONT, STYLE, SIZE, OR COLOR.

SER. NO. 77-340,209, FILED 11-29-2007.

HOWARD B. LEVINE, EXAMINING ATTORNEY

**Int. Cl.: 16**

**Prior U.S. Cls.: 2, 5, 22, 23, 29, 37, 38 and 50**

**United States Patent and Trademark Office**

**Reg. No. 3,467,509**

**Registered July 15, 2008**

**TRADEMARK  
PRINCIPAL REGISTER**

**705**

FELLOWES, INC. (ILLINOIS CORPORATION)  
1789 NORWOOD AVE.  
ITASCA, IL 60143

THE MARK CONSISTS OF STANDARD CHAR-  
ACTERS WITHOUT CLAIM TO ANY PARTICULAR  
FONT, STYLE, SIZE, OR COLOR.

FOR: CORRUGATED RECORD STORAGE  
BOXES, IN CLASS 16 (U.S. CLS. 2, 5, 22, 23, 29, 37, 38  
AND 50).

SER. NO. 77-340,230, FILED 11-29-2007.

FIRST USE 12-1-1983; IN COMMERCE 12-1-1983.

DAVID COLLIER, EXAMINING ATTORNEY

**Int. Cl.: 35**

**Prior U.S. Cls.: 100, 101 and 102**

**United States Patent and Trademark Office**

**Reg. No. 3,467,510**

**Registered July 15, 2008**

**SERVICE MARK  
PRINCIPAL REGISTER**

**OUCH POINT**

INFOUSA INC. (DELAWARE CORPORATION)  
5711 S 86TH CIRCLE  
OMAHA, NE 68127

FOR: OPINION POLLING, NAMELY, PUBLIC  
OPINION POLLING GATHERED FROM UNITED  
STATES CONSUMERS AND PROVIDING ANALY-  
SIS AND COMMENT VIA PRESS RELEASES, PRINT  
MEDIA AND THE INTERNET , IN CLASS 35 (U.S.  
CLS. 100, 101 AND 102).

FIRST USE 5-9-2007; IN COMMERCE 5-9-2007.

THE MARK CONSISTS OF STANDARD CHAR-  
ACTERS WITHOUT CLAIM TO ANY PARTICULAR  
FONT, STYLE, SIZE, OR COLOR.

SER. NO. 77-340,330, FILED 11-29-2007.

SEAN CROWLEY, EXAMINING ATTORNEY

**Int. Cl.: 41**

**Prior U.S. Cls.: 100, 101 and 107**

**United States Patent and Trademark Office**

**Reg. No. 3,467,511**

**Registered July 15, 2008**

**SERVICE MARK  
PRINCIPAL REGISTER**



THE UNIVERSITY OF NORTH ALABAMA (ALABAMA CORPORATION)  
UNA BOX 5003  
FLORENCE, AL 356320001

FOR: EDUCATION SERVICES IN THE NATURE OF COURSES AT THE UNIVERSITY LEVEL; PROVIDING VARIOUS FACILITIES FOR AN ARRAY OF SPORTING EVENTS, SPORTS AND ATHLETIC COMPETITIONS AND AWARDS PROGRAMMES; ENCOURAGING AMATEUR SPORTS AND PHYSICAL EDUCATION BY ORGANIZING, PROMOTING, SPONSORING, SANCTIONING, CONDUCTING, ADMINISTERING, REGULATING

AND GOVERNING AMATEUR ATHLETIC PROGRAMS AND ACTIVITIES, IN CLASS 41 (U.S. CLS. 100, 101 AND 107).

FIRST USE 6-30-1992; IN COMMERCE 7-31-1995.

THE MARK CONSISTS OF A CHARACTERIZED FLAME ABOVE THE THREE LETTERS "UNA".

SER. NO. 77-340,350, FILED 11-29-2007.

CIMMERIAN COLEMAN, EXAMINING ATTORNEY



**Int. Cl.: 16**

**Prior U.S. Cls.: 2, 5, 22, 23, 29, 37, 38 and 50**

**United States Patent and Trademark Office**

**Reg. No. 3,467,512**

**Registered July 15, 2008**

**TRADEMARK  
PRINCIPAL REGISTER**

**SEATBELT SUSPENSE**

COLLINS, BRANDILYN (UNITED STATES INDIVIDUAL)

7 BENNETT RD.

REDWOOD CITY, CA 94062

FOR: SUSPENSE NOVELS, IN CLASS 16 (U.S. CLS. 2, 5, 22, 23, 29, 37, 38 AND 50).

FIRST USE 2-0-2005; IN COMMERCE 8-0-2006.

THE MARK CONSISTS OF STANDARD CHARACTERS WITHOUT CLAIM TO ANY PARTICULAR FONT, STYLE, SIZE, OR COLOR.

NO CLAIM IS MADE TO THE EXCLUSIVE RIGHT TO USE "SUSPENSE", APART FROM THE MARK AS SHOWN.

SER. NO. 77-340,362, FILED 11-29-2007.

HOWARD B. LEVINE, EXAMINING ATTORNEY

**Int. Cl.: 9**

**Prior U.S. Cls.: 21, 23, 26, 36 and 38**

**Reg. No. 3,467,513**

**United States Patent and Trademark Office**

**Registered July 15, 2008**

---

**TRADEMARK  
PRINCIPAL REGISTER**

**PAY\$0Z**

CHERY, JEFF (UNITED STATES INDIVIDUAL)  
#5H  
1734 MADISON AVE  
NEW YORK, NY 10029

THE MARK CONSISTS OF STANDARD CHARACTERS WITHOUT CLAIM TO ANY PARTICULAR FONT, STYLE, SIZE, OR COLOR.

FOR: PRE-RECORDED CDS, VIDEO TAPES, AUDIO TAPES AND DVDS FEATURING HIP-HOP MUSIC, IN CLASS 9 (U.S. CLS. 21, 23, 26, 36 AND 38).

SER. NO. 77-340,386, FILED 11-29-2007.

FIRST USE 11-1-2005; IN COMMERCE 11-1-2005.

JANICE L. MCMORROW, EXAMINING ATTORNEY

**Int. Cl.: 35**

**Prior U.S. Cls.: 100, 101 and 102**

**United States Patent and Trademark Office**

**Reg. No. 3,467,514**

**Registered July 15, 2008**

**SERVICE MARK  
PRINCIPAL REGISTER**

# Envisionaries

GENUSSYSTEMS (WASHINGTON LTD LIAB CO)  
SUITE 202  
3888 NW RANDALL WAY  
SILVERDALE, WA 98383

FOR: ON-LINE RETAIL STORE SERVICES FEATURING PRINTED PRODUCTS; RETAIL SERVICES BY DIRECT SOLICITATION BY SALES AGENTS IN THE FIELD OF PRINTED PRODUCTS, IN CLASS 35 (U.S. CLS. 100, 101 AND 102).

FIRST USE 1-1-1999; IN COMMERCE 1-1-1999.

THE MARK CONSISTS OF STANDARD CHARACTERS WITHOUT CLAIM TO ANY PARTICULAR FONT, STYLE, SIZE, OR COLOR.

SER. NO. 77-340,399, FILED 11-29-2007.

JANICE L. MCMORROW, EXAMINING ATTORNEY

**Int. Cl.: 41**

**Prior U.S. Cls.: 100, 101 and 107**

**United States Patent and Trademark Office**

**Reg. No. 3,467,515**

**Registered July 15, 2008**

**SERVICE MARK  
PRINCIPAL REGISTER**

# The Moment

THE NEW YORK TIMES COMPANY (NEW  
YORK CORPORATION)  
620 EIGHTH AVENUE  
NEW YORK, NY 10018

FOR: ON-LINE JOURNALS, NAMELY, BLOGS  
FEATURING NEWS AND INFORMATION IN THE  
FIELDS OF FASHION, STYLE, ART, DESIGN, TRA-  
VEL, TRENDS, DINING, FOOD, CULTURAL  
EVENTS, AND NIGHTLIFE; PROVIDING NEWS-  
LETTERS IN THE FIELD OF FASHION, STYLE,  
ART, DESIGN, TRAVEL, TRENDS, DINING, FOOD,

CULTURAL EVENTS, AND NIGHTLIFE VIA E-  
MAIL, IN CLASS 41 (U.S. CLS. 100, 101 AND 107).

FIRST USE 11-29-2007; IN COMMERCE 11-29-2007.

THE MARK CONSISTS OF STANDARD CHAR-  
ACTERS WITHOUT CLAIM TO ANY PARTICULAR  
FONT, STYLE, SIZE, OR COLOR.

SER. NO. 77-340,404, FILED 11-29-2007.

BILL DAWE, EXAMINING ATTORNEY

**Int. Cl.: 41**

**Prior U.S. Cls.: 100, 101 and 107**

**United States Patent and Trademark Office**

**Reg. No. 3,467,516**

**Registered July 15, 2008**

**SERVICE MARK  
PRINCIPAL REGISTER**



THE UNIVERSITY OF NORTH ALABAMA (ALABAMA CORPORATION)  
UNA BOX 5003  
FLORENCE, AL 356320001

FOR: ENCOURAGING AMATEUR SPORTS AND PHYSICAL EDUCATION BY ORGANIZING, PROMOTING, SPONSORING, SANCTIONING, CONDUCTING, ADMINISTERING, REGULATING AND GOVERNING AMATEUR ATHLETIC PROGRAMS AND ACTIVITIES; PROVIDING VARIOUS FACILITIES FOR AN ARRAY OF SPORTING EVENTS, SPORTS AND ATHLETIC COMPETITIONS

AND AWARDS PROGRAMMES, IN CLASS 41 (U.S. CLS. 100, 101 AND 107).

FIRST USE 9-1-2003; IN COMMERCE 9-1-2004.

THE MARK CONSISTS OF A LION NECK AND HEAD FACING TO THE RIGHT WITH THE LETTERS "UNA" INSERTED IN THE NECK AREA.

SER. NO. 77-340,425, FILED 11-29-2007.

CIMMERIAN COLEMAN, EXAMINING ATTORNEY

**Int. Cl.: 30**

**Prior U.S. Cl.: 46**

**United States Patent and Trademark Office**

**Reg. No. 3,467,517**

**Registered July 15, 2008**

**TRADEMARK  
PRINCIPAL REGISTER**

**ANN LOUISE**

FIRST LADY OF NUTRITION, INC. (IDAHO  
CORPORATION)  
1928 EAST RODKEY DRIVE  
POST FALLS, ID 83854

THE MARK CONSISTS OF STANDARD CHAR-  
ACTERS WITHOUT CLAIM TO ANY PARTICULAR  
FONT, STYLE, SIZE, OR COLOR.

FOR: CRACKERS, IN CLASS 30 (U.S. CL. 46).

SER. NO. 77-340,458, FILED 11-29-2007.

FIRST USE 2-0-2007; IN COMMERCE 3-0-2007.

KHANH LE, EXAMINING ATTORNEY

**Int. Cl.: 35**

**Prior U.S. Cls.: 100, 101 and 102**

**United States Patent and Trademark Office**

**Reg. No. 3,467,518**

**Registered July 15, 2008**

**SERVICE MARK  
PRINCIPAL REGISTER**

**TALLEY**

TALLEY COMMUNICATIONS CORPORATION  
(CALIFORNIA CORPORATION)

12976 SANDOVAL STREET

SANTA FE SPRINGS, CA 90670

FOR: DISTRIBUTORSHIP SERVICES IN THE  
FIELD OF WIRELESS COMMUNICATIONS EQUIP-  
MENT, IN CLASS 35 (U.S. CLS. 100, 101 AND 102).

FIRST USE 4-8-1997; IN COMMERCE 4-8-1997.

THE MARK CONSISTS OF STANDARD CHAR-  
ACTERS WITHOUT CLAIM TO ANY PARTICULAR  
FONT, STYLE, SIZE, OR COLOR.

OWNER OF U.S. REG. NOS. 2,165,968, 2,477,148  
AND OTHERS.

SEC. 2(F).

SER. NO. 77-340,484, FILED 11-29-2007.

JUSTINE D. PARKER, EXAMINING ATTORNEY

**Int. Cl.: 3**

**Prior U.S. Cls.: 1, 4, 6, 50, 51 and 52**

**United States Patent and Trademark Office**

**Reg. No. 3,467,519**

**Registered July 15, 2008**

**TRADEMARK  
PRINCIPAL REGISTER**

**WHY BE PRETTY WHEN YOU CAN  
BE GORGEOUS?**

TOO FACED COSMETICS, INC. (CALIFORNIA  
CORPORATION)  
17361 ARMSTRONG AVENUE  
IRVINE, CA 92614

FOR: COSMETICS AND MAKE-UP; FACE  
CREAMS FOR COSMETIC USE; LOTIONS FOR  
COSMETIC PURPOSES; MAKE-UP KITS COM-  
PRISED OF LIPGLOSS, BLUSH, EYESHADOW, EYE-  
BROW PENCILS, EYEBROW STENCILS, EYEBROW  
CREAM AND PRESSED POWDER; BODY AND  
BEAUTY CARE COSMETICS, IN CLASS 3 (U.S.  
CLS. 1, 4, 6, 50, 51 AND 52).

FIRST USE 1-1-1999; IN COMMERCE 1-1-1999.

THE MARK CONSISTS OF STANDARD CHAR-  
ACTERS WITHOUT CLAIM TO ANY PARTICULAR  
FONT, STYLE, SIZE, OR COLOR.

SER. NO. 77-340,556, FILED 11-29-2007.

ERIN FALK, EXAMINING ATTORNEY



**Int. Cl.: 41**

**Prior U.S. Cls.: 100, 101 and 107**

**United States Patent and Trademark Office**

**Reg. No. 3,467,520**

**Registered July 15, 2008**

**SERVICE MARK  
PRINCIPAL REGISTER**



ALLIANCE FRANCAISE OF GREENWICH (CON-  
NECTICUT NON-PROFIT ORGANIZATION)  
299 GREENWICH AVENUE  
GREENWICH, CT 06830

FOR: EDUCATION SERVICES, NAMELY, PRO-  
VIDING CLASSES, SEMINARS, WORKSHOPS IN  
THE FIELD OF CINEMA STUDIES, FILM, HIS-  
TORY, FRENCH AND WOMEN'S STUDIES; EN-  
TERTAINMENT SERVICES, NAMELY, PLANNING  
AND CONDUCTING A SERIES OF FILM FESTI-  
VALS, IN CLASS 41 (U.S. CLS. 100, 101 AND 107).

FIRST USE 3-15-2005; IN COMMERCE 3-15-2005.

NO CLAIM IS MADE TO THE EXCLUSIVE  
RIGHT TO USE "FRENCH CINEMA", APART  
FROM THE MARK AS SHOWN.

SER. NO. 77-340,590, FILED 11-29-2007.

STEPHEN AQUILA, EXAMINING ATTORNEY

**Int. Cl.: 25**

**Prior U.S. Cls.: 22 and 39**

**United States Patent and Trademark Office**

**Reg. No. 3,467,521**

**Registered July 15, 2008**

**TRADEMARK  
PRINCIPAL REGISTER**



ZOVO LINGERIE COMPANY, LLC (WASHING-  
TON LTD LIAB CO)  
5336 SW LANDER STREET  
SEATTLE, WA 98116

FIRST USE 11-15-2004; IN COMMERCE 11-15-2004.

SER. NO. 77-340,593, FILED 11-29-2007.

FOR: LINGERIE, IN CLASS 25 (U.S. CLS. 22 AND  
39).

JANICE L. MCMORROW, EXAMINING ATTOR-  
NEY

Int. Cl.: 35

Prior U.S. Cls.: 100, 101 and 102

United States Patent and Trademark Office

Reg. No. 3,467,522

Registered July 15, 2008

**SERVICE MARK  
PRINCIPAL REGISTER**



KIMCO STAFFING SERVICES, INC. (CALIFORNIA CORPORATION)  
17872 COWAN AVENUE  
IRVINE, CA 92614

FOR: EMPLOYMENT HIRING, RECRUITING, PLACEMENT, STAFFING AND CAREER NETWORKING SERVICES, IN CLASS 35 (U.S. CLS. 100, 101 AND 102).

FIRST USE 11-17-2006; IN COMMERCE 11-17-2006.

THE MARK CONSISTS OF AN ABSTRACT DESIGN IN THE FORM OF HORIZONTAL LINES FORMING A CIRCLE WITH A STYLIZED LETTER "K", AND THE STYLIZED TEXT "KIMCO EXPECT HIRE RESULTS!".

SER. NO. 77-340,597, FILED 11-29-2007.

AMY ALFIERI, EXAMINING ATTORNEY

**Int. Cls.: 18, 25 and 41**

**Prior U.S. Cls.: 1, 2, 3, 22, 39, 41, 100, 101 and 107**

**United States Patent and Trademark Office**

**Reg. No. 3,467,523**

**Registered July 15, 2008**

**TRADEMARK  
SERVICE MARK  
PRINCIPAL REGISTER**

**CALIFORNIA AVOCADO FESTIVAL**

CALIFORNIA AVOCADO FESTIVAL, INC. (CALIFORNIA CORPORATION)  
1056-B EUGENIA PLACE  
CARPINTERIA, CA 93013

FOR: TOTE BAGS, IN CLASS 18 (U.S. CLS. 1, 2, 3, 22 AND 41).

FIRST USE 8-1-1987; IN COMMERCE 8-1-1987.

FOR: SWEAT SHIRTS, T-SHIRTS, HEADGEAR, NAMELY, CAPS, AND APRONS, IN CLASS 25 (U.S. CLS. 22 AND 39).

FIRST USE 8-1-1987; IN COMMERCE 8-1-1987.

FOR: ENTERTAINMENT IN THE NATURE OF COMMUNITY FESTIVAL FEATURING A VARIETY OF ACTIVITIES, NAMELY, EXHIBITIONS FEATURING AVOCADO PRODUCTS AND THE LIKE, IN CLASS 41 (U.S. CLS. 100, 101 AND 107).

FIRST USE 8-1-1987; IN COMMERCE 8-1-1987.

THE MARK CONSISTS OF STANDARD CHARACTERS WITHOUT CLAIM TO ANY PARTICULAR FONT, STYLE, SIZE, OR COLOR.

NO CLAIM IS MADE TO THE EXCLUSIVE RIGHT TO USE "AVOCADO FESTIVAL", APART FROM THE MARK AS SHOWN.

SEC. 2(F).

SER. NO. 77-340,598, FILED 11-29-2007.

LINDA ORNDORFF, EXAMINING ATTORNEY

**Int. Cls.: 6, 20, 25, 35, 36 and 37**

**Prior U.S. Cls.: 2, 12, 13, 14, 22, 23, 25, 32, 39, 50, 100, 101, 102, 103 and 106**

**Reg. No. 3,467,524**

**United States Patent and Trademark Office**

**Registered July 15, 2008**

**TRADEMARK  
SERVICE MARK  
PRINCIPAL REGISTER**



CARL BLACK AUTOMOTIVE GROUP, LLC  
(GEORGIA LTD LIAB CO)  
1110 ROBERTS BOULEVARD NW  
KENNESAW, GA 30144

FOR: METAL LICENSE PLATES, IN CLASS 6 (U.S. CLS. 2, 12, 13, 14, 23, 25 AND 50).

FIRST USE 7-10-1999; IN COMMERCE 7-10-1999.

FOR: PLASTIC KEY CHAIN TAGS, IN CLASS 20 (U.S. CLS. 2, 13, 22, 25, 32 AND 50).

FIRST USE 7-10-1999; IN COMMERCE 7-10-1999.

FOR: JACKETS; SHIRTS; HATS, IN CLASS 25 (U.S. CLS. 22 AND 39).

FIRST USE 7-10-1999; IN COMMERCE 7-10-1999.

FOR: AUTOMOBILE DEALERSHIPS; RETAIL AUTOMOBILE PARTS AND ACCESSORIES STORES, IN CLASS 35 (U.S. CLS. 100, 101 AND 102).

FIRST USE 7-10-1999; IN COMMERCE 7-10-1999.

FOR: FINANCING RELATING TO AUTOMOBILES, IN CLASS 36 (U.S. CLS. 100, 101 AND 102).

FIRST USE 7-10-1999; IN COMMERCE 7-10-1999.

FOR: AUTOMOBILE REPAIR AND MAINTENANCE, IN CLASS 37 (U.S. CLS. 100, 103 AND 106).

FIRST USE 7-10-1999; IN COMMERCE 7-10-1999.

THE NAME "CARL BLACK" IDENTIFIES A LIVING INDIVIDUAL WHOSE CONSENT IS OF RECORD.

SER. NO. 77-340,638, FILED 11-29-2007.

ALICE SUE CARRUTHERS, EXAMINING ATTORNEY

**Int. Cl.: 41**

**Prior U.S. Cls.: 100, 101 and 107**

**United States Patent and Trademark Office**

**Reg. No. 3,467,525**

**Registered July 15, 2008**

**SERVICE MARK  
PRINCIPAL REGISTER**

**PerCE**

PERCE LLC (DELAWARE LTD LIAB CO)  
C/O CURTIS, MALLET-PREVOST, COLT & MOSLE  
101 PARK AVENUE, 34TH FLOOR  
NEW YORK, NY 101780061

FOR: PROVIDING CONTINUING BUSINESS  
EDUCATION COURSES; PROVIDING CONTINU-  
ING MEDICAL EDUCATION COURSES; PROVID-  
ING CONTINUING NURSING EDUCATION  
COURSES, IN CLASS 41 (U.S. CLS. 100, 101 AND 107).

FIRST USE 10-31-2006; IN COMMERCE 10-31-2006.

THE MARK CONSISTS OF STANDARD CHAR-  
ACTERS WITHOUT CLAIM TO ANY PARTICULAR  
FONT, STYLE, SIZE, OR COLOR.

SER. NO. 77-340,648, FILED 11-29-2007.

NATALIE POLZER, EXAMINING ATTORNEY

**Int. Cl.: 41**

**Prior U.S. Cls.: 100, 101 and 107**

**United States Patent and Trademark Office**

**Reg. No. 3,467,526**

**Registered July 15, 2008**

**SERVICE MARK  
PRINCIPAL REGISTER**

**CAMP MILLIONAIRE**

ELISABETH A. DONATI (UNITED STATES IN-  
DIVIDUAL)  
131 CHAPALA STREET  
SANTA BARBARA, CA 93101

FOR: EDUCATIONAL SERVICES, NAMELY,  
CONDUCTING CAMPS, CLASSES, SEMINARS,  
CONFERENCES AND WORKSHOPS IN THE FIELD  
OF FINANCIAL LITERACY EDUCATION AND  
WEALTH CREATION, INCLUDING THE DISTRI-  
BUTION OF COURSE MATERIALS AND INSTRUC-  
TIONAL WORKBOOKS IN CONNECTION  
THEREWITH, FOR KIDS, TEENS AND ADULTS,  
IN CLASS 41 (U.S. CLS. 100, 101 AND 107).

FIRST USE 11-25-2007; IN COMMERCE 11-25-2007.

THE MARK CONSISTS OF STANDARD CHAR-  
ACTERS WITHOUT CLAIM TO ANY PARTICULAR  
FONT, STYLE, SIZE, OR COLOR.

NO CLAIM IS MADE TO THE EXCLUSIVE  
RIGHT TO USE "CAMP", APART FROM THE  
MARK AS SHOWN.

SER. NO. 77-340,688, FILED 11-29-2007.

LINDA ORNDORFF, EXAMINING ATTORNEY

**Int. Cl.: 20**

**Prior U.S. Cls.: 2, 13, 22, 25, 32 and 50**

**United States Patent and Trademark Office**

**Reg. No. 3,467,527**

**Registered July 15, 2008**

**TRADEMARK  
PRINCIPAL REGISTER**



MIHELIC, RICHARD LEE (UNITED STATES INDIVIDUAL)  
2680 STONEBURY  
ROCHESTER HILLS, MI 48307

FOR: PET CUSHIONS; PET RAMP; PORTABLE BEDS FOR PETS, IN CLASS 20 (U.S. CLS. 2, 13, 22, 25, 32 AND 50).

FIRST USE 10-15-2007; IN COMMERCE 10-15-2007.

THE COLOR(S) BLACK, RED AND WHITE IS/ ARE CLAIMED AS A FEATURE OF THE MARK.

THE MARK CONSISTS OF DOG PAW WITH BLACK TOE PRINTS AND RED PAW PAD, "LITTLE RUFF STUFF" IN BLACK, OUTLINED BY A POLYGON. THE COLOR BLACK APPEARS ON THE WORDING "LITTLE RUFF STUFF", THE OUTLINE OF THE POLYGON AND THE TOE PRINTS OF THE DOG PAW, RED APPEARS ON THE PAW PAD AND WHITE ON THE BACKGROUND OF THE POLYGON.

SER. NO. 77-340,693, FILED 11-29-2007.

ALICE BENMAMAN, EXAMINING ATTORNEY



**Int. Cl.: 24**

**Prior U.S. Cls.: 42 and 50**

**United States Patent and Trademark Office**

**Reg. No. 3,467,528**

**Registered July 15, 2008**

**TRADEMARK  
PRINCIPAL REGISTER**



TODDY'S COLLECTION, INC. (CALIFORNIA CORPORATION), DBA TODDY'S  
2070 RESEARCH DR.  
LIVERMORE, CA 94550

THE MARK CONSISTS OF THE NAME "TODDY'S" WITH A DESIGN IN PLACE OF THE "O". THE DESIGN IS A WOMAN SITTING IN A WHEEL WITH A CASTLE RISING BEHIND HER.

FOR: BLANKET THROWS, IN CLASS 24 (U.S. CLS. 42 AND 50).

SER. NO. 77-340,703, FILED 11-29-2007.

FIRST USE 10-14-2006; IN COMMERCE 11-12-2007.

DORITT L. CARROLL, EXAMINING ATTORNEY

Int. Cl.: 11

Prior U.S. Cls.: 13, 21, 23, 31 and 34

United States Patent and Trademark Office

Reg. No. 3,467,529

Registered July 15, 2008

TRADEMARK  
PRINCIPAL REGISTER



TOMPKINS, KURT WEST (UNITED STATES IN-  
DIVIDUAL)  
P.O. BOX 206  
SNOOK, TX 77878

FOR: ELECTRIC FANS, IN CLASS 11 (U.S. CLS. 13,  
21, 23, 31 AND 34).

FIRST USE 11-1-2005; IN COMMERCE 1-15-2006.

NO CLAIM IS MADE TO THE EXCLUSIVE  
RIGHT TO USE "BEDFAN PERSONAL COOLING  
SYSTEM", APART FROM THE MARK AS SHOWN.

THE COLOR(S) DARK BLUE LITE BLUE WHITE  
IS/ARE CLAIMED AS A FEATURE OF THE MARK.

THE MARK CONSISTS OF STYLIZED WORDS,  
"BEDFAN PERSONAL COOLING SYSTEM" IN  
DARK BLUE, AN OVAL AND 1 CURVED LINE IN  
DARK BLUE, AND THE WORD "THE" AND 4  
CURVED LINES IN LIGHT BLUE.

SER. NO. 77-340,745, FILED 11-30-2007.

ANTHONY RINKER, EXAMINING ATTORNEY

**Int. Cl.: 36**

**Prior U.S. Cls.: 100, 101 and 102**

**United States Patent and Trademark Office**

**Reg. No. 3,467,530**

**Registered July 15, 2008**

**SERVICE MARK  
PRINCIPAL REGISTER**



ANNE ARUNDEL COUNTY FEDERAL CREDIT  
UNION (MARYLAND FEDERALLY CHAR-  
TERED CREDIT UNION)  
8436 VETERANS HIGHWAY  
MILLERSVILLE, MD 21108

FOR: CREDIT UNIONS, IN CLASS 36 (U.S. CLS.  
100, 101 AND 102).

FIRST USE 1-1-2007; IN COMMERCE 1-1-2007.

NO CLAIM IS MADE TO THE EXCLUSIVE  
RIGHT TO USE "FCU", APART FROM THE MARK  
AS SHOWN.

THE MARK CONSISTS OF LIGHTHOUSE WITH  
THE LETTERS "AACE FCU".

SER. NO. 77-340,767, FILED 11-30-2007.

LAURIE KAUFMAN, EXAMINING ATTORNEY

**Int. Cl.: 41**

**Prior U.S. Cls.: 100, 101 and 107**

**United States Patent and Trademark Office**

**Reg. No. 3,467,531**

**Registered July 15, 2008**

**SERVICE MARK  
PRINCIPAL REGISTER**

**GET REAL CONFERENCES**

SHELLEY HENDRIX (UNITED STATES INDIVIDUAL)  
4802 SHALLOW CREEK DRIVE  
KENNESAW, GA 30144 AND  
ERICA BRANCH (UNITED STATES INDIVIDUAL)  
215 LEWIS CT.  
CANTON, GA 30114

FOR: TEACHING OTHERS HOW TO GROW CLOSER TO GOD THROUGH THE AUTHENTIC MESSAGE OF GOD'S WORD FROM THE BIBLE, IN CLASS 41 (U.S. CLS. 100, 101 AND 107).

FIRST USE 2-28-2006; IN COMMERCE 2-28-2006.

THE MARK CONSISTS OF STANDARD CHARACTERS WITHOUT CLAIM TO ANY PARTICULAR FONT, STYLE, SIZE, OR COLOR.

NO CLAIM IS MADE TO THE EXCLUSIVE RIGHT TO USE "CONFERENCES", APART FROM THE MARK AS SHOWN.

SER. NO. 77-340,784, FILED 11-30-2007.

LOURDES AYALA, EXAMINING ATTORNEY

**Int. Cl.: 14**

**Prior U.S. Cls.: 2, 27, 28 and 50**

**United States Patent and Trademark Office**

**Reg. No. 3,467,532**

**Registered July 15, 2008**

**TRADEMARK  
PRINCIPAL REGISTER**

**DANUTA**

DANUTA, INC. (NEW MEXICO CORPORATION)  
133 WEST SAN FRANCISCO STREET  
SANTA FE, NM 87501

THE MARK CONSISTS OF STANDARD CHAR-  
ACTERS WITHOUT CLAIM TO ANY PARTICULAR  
FONT, STYLE, SIZE, OR COLOR.

FOR: JEWELRY, IN CLASS 14 (U.S. CLS. 2, 27, 28  
AND 50).

SER. NO. 77-340,808, FILED 11-30-2007.

FIRST USE 12-1-2003; IN COMMERCE 12-1-2003.

LOURDES AYALA, EXAMINING ATTORNEY

**Int. Cl.: 41**

**Prior U.S. Cls.: 100, 101 and 107**

**United States Patent and Trademark Office**

**Reg. No. 3,467,533**

**Registered July 15, 2008**

**SERVICE MARK  
PRINCIPAL REGISTER**



THE UNIVERSITY OF NORTH ALABAMA (ALABAMA CORPORATION)  
UNA BOX 5003  
FLORENCE, AL 356320001

FOR: ORGANISATION OF SPORTS EVENTS IN THE FIELD OF FOOTBALL; ENTERTAINMENT IN THE NATURE OF FOOTBALL GAMES, IN CLASS 41 (U.S. CLS. 100, 101 AND 107).

FIRST USE 9-1-2005; IN COMMERCE 9-1-2005.

THE MARK CONSISTS OF A SIDE PROFILE OF THE HEAD OF A LION WITHIN AN OVAL OUTLINE.

SER. NO. 77-340,819, FILED 11-30-2007.

CIMMERIAN COLEMAN, EXAMINING ATTORNEY

**Int. Cl.: 29**

**Prior U.S. Cl.: 46**

**United States Patent and Trademark Office**

**Reg. No. 3,467,534**

**Registered July 15, 2008**

**TRADEMARK  
PRINCIPAL REGISTER**

**MAMBO CHICKEN WINGS**

MANGO'S TROPICAL CAFE, INC. (FLORIDA  
CORPORATION)  
900 OCEAN DRIVE  
MIAMI BEACH, FL 33139

OWNER OF U.S. REG. NO. 3,108,906.

FOR: PREPACKAGED COOKED CHICKEN  
WINGS, IN CLASS 29 (U.S. CL. 46).

NO CLAIM IS MADE TO THE EXCLUSIVE  
RIGHT TO USE "CHICKEN WINGS", APART FROM  
THE MARK AS SHOWN.

FIRST USE 4-2-2007; IN COMMERCE 4-2-2007.

SER. NO. 77-340,845, FILED 11-30-2007.

THE MARK CONSISTS OF STANDARD CHAR-  
ACTERS WITHOUT CLAIM TO ANY PARTICULAR  
FONT, STYLE, SIZE, OR COLOR.

GEOFFREY FOSDICK, EXAMINING ATTORNEY

**Int. Cl.: 30**

**Prior U.S. Cl.: 46**

**United States Patent and Trademark Office**

**Reg. No. 3,467,535**

**Registered July 15, 2008**

**TRADEMARK  
PRINCIPAL REGISTER**

**CHUCK WAGON'S OWN**

CHUCK WAGON'S OWN, INC. (OHIO CORPORATION)  
6299 DRESSLER ROAD NW  
NORTH CANTON, OH 44720

THE MARK CONSISTS OF STANDARD CHARACTERS WITHOUT CLAIM TO ANY PARTICULAR FONT, STYLE, SIZE, OR COLOR.

FOR: CONEY SAUCE, IN CLASS 30 (U.S. CL. 46).

SER. NO. 77-340,898, FILED 11-30-2007.

FIRST USE 11-1-2007; IN COMMERCE 11-1-2007.

MIDGE BUTLER, EXAMINING ATTORNEY



**Int. Cl.: 36**

**Prior U.S. Cls.: 100, 101 and 102**

**United States Patent and Trademark Office**

**Reg. No. 3,467,536**

**Registered July 15, 2008**

**SERVICE MARK  
PRINCIPAL REGISTER**

OUR PEOPLE. YOUR STRENGTH.

WILLIAM A. GRAHAM COMPANY (PENNSYLVANIA CORPORATION), DBA THE GRAHAM COMPANY  
THE GRAHAM BUILDING  
ONE PENN SQUARE WEST  
PHILADELPHIA, PA 19102

FOR: INSURANCE SERVICES, NAMELY, INSURANCE AGENCY AND BROKERAGE SERVICES, INSURANCE CONSULTATION SERVICES, INSURANCE CLAIMS MANAGEMENT SERVICES, INSURANCE LOSS CONTROL SERVICES, HEALTH AND WELLNESS RISK MANAGEMENT SERVICES AND

INSURANCE RISK MANAGEMENT SERVICES, IN CLASS 36 (U.S. CLS. 100, 101 AND 102).

FIRST USE 1-0-2007; IN COMMERCE 1-0-2007.

THE MARK CONSISTS OF STANDARD CHARACTERS WITHOUT CLAIM TO ANY PARTICULAR FONT, STYLE, SIZE, OR COLOR.

SER. NO. 77-340,922, FILED 11-30-2007.

SALLY SHIH, EXAMINING ATTORNEY

**Int. Cl.: 35**

**Prior U.S. Cls.: 100, 101 and 102**

**United States Patent and Trademark Office**

**Reg. No. 3,467,537**

**Registered July 15, 2008**

**SERVICE MARK  
PRINCIPAL REGISTER**

**fatpenguinmedia.com**

RYAN PERRY ENTERPRISES, INC. (ARIZONA  
CORPORATION)  
1234 S. POWER ROAD, SUITE 206  
MESA, AZ 85206

THE MARK CONSISTS OF STANDARD CHAR-  
ACTERS WITHOUT CLAIM TO ANY PARTICULAR  
FONT, STYLE, SIZE, OR COLOR.

FOR: PROMOTION, ADVERTISING AND MAR-  
KETING OF ON-LINE WEBSITES, IN CLASS 35 (U.S.  
CLS. 100, 101 AND 102).

SER. NO. 77-340,931, FILED 11-30-2007.

FIRST USE 6-4-2005; IN COMMERCE 7-15-2005.

KYLE PEETE, EXAMINING ATTORNEY

**Int. Cl.: 36**

**Prior U.S. Cls.: 100, 101 and 102**

**United States Patent and Trademark Office**

**Reg. No. 3,467,538**

**Registered July 15, 2008**

**SERVICE MARK  
PRINCIPAL REGISTER**

**SAVESMART DIRECT**

BANK OF AMERICAN FORK (UTAH CORPORATION)  
33 EAST MAIN STREET  
AMERICAN FORK, UT 84003

FOR: FINANCIAL SERVICES, NAMELY, ONLINE SAVINGS ACCOUNTS, IN CLASS 36 (U.S. CLS. 100, 101 AND 102).

FIRST USE 9-27-2007; IN COMMERCE 9-27-2007.

THE MARK CONSISTS OF STANDARD CHARACTERS WITHOUT CLAIM TO ANY PARTICULAR FONT, STYLE, SIZE, OR COLOR.

NO CLAIM IS MADE TO THE EXCLUSIVE RIGHT TO USE "DIRECT", APART FROM THE MARK AS SHOWN.

SER. NO. 77-340,936, FILED 11-30-2007.

JUDITH HELFMAN, EXAMINING ATTORNEY

**Int. Cl.: 5**

**Prior U.S. Cls.: 6, 18, 44, 46, 51 and 52**

**Reg. No. 3,467,539**

**United States Patent and Trademark Office**

**Registered July 15, 2008**

**TRADEMARK  
PRINCIPAL REGISTER**

**Propolaid**

ESI S.P.A. (ITALY CORPORATION)  
PIAZZA VELASCA 5  
MILAN, ITALY 20122

OWNER OF ERPN CMNTY TM OFC REG. NO.  
4890935, DATED 1-12-2007, EXPIRES 2-6-2016.

FOR: (BASED ON USE IN COMMERCE) DIET-  
ARY SUPPLEMENTS(BASED ON 44(E)) DIETARY  
SUPPLEMENTS, IN CLASS 5 (U.S. CLS. 6, 18, 44, 46, 51  
AND 52).

THE MARK CONSISTS OF THE WORD "PROPO-  
LAID" IS UNDERLINED.

SER. NO. 77-340,970, FILED 11-30-2007.

FIRST USE 3-17-2006; IN COMMERCE 9-0-2006.

JOHN DALIER, EXAMINING ATTORNEY

**Int. Cl.: 41**

**Prior U.S. Cls.: 100, 101 and 107**

**United States Patent and Trademark Office**

**Reg. No. 3,467,540**

**Registered July 15, 2008**

**SERVICE MARK  
PRINCIPAL REGISTER**

**dailyniner.com**

RYAN PERRY ENTERPRISES, INC. (ARIZONA  
CORPORATION)  
1234 S. POWER ROAD, SUITE 206  
MESA, AZ 85206

FOR: ENTERTAINMENT SERVICES, NAMELY,  
PROVIDING A WEBSITE FEATURING PHOTO-  
GRAPHIC, AUDIO, VIDEO AND PROSE PRESEN-  
TATIONS FEATURING ADULT  
ENTERTAINMENT, IN CLASS 41 (U.S. CLS. 100,  
101 AND 107).

FIRST USE 2-15-2006; IN COMMERCE 3-31-2006.

THE MARK CONSISTS OF STANDARD CHAR-  
ACTERS WITHOUT CLAIM TO ANY PARTICULAR  
FONT, STYLE, SIZE, OR COLOR.

SER. NO. 77-340,971, FILED 11-30-2007.

KYLE PEETE, EXAMINING ATTORNEY

**Int. Cl.: 25**

**Prior U.S. Cls.: 22 and 39**

**United States Patent and Trademark Office**

**Reg. No. 3,467,541**

**Registered July 15, 2008**

**TRADEMARK  
PRINCIPAL REGISTER**

**SMOOTHEZE**

TRIAD CATALOG CO., L.L.C. (MISSOURI LTD  
LIAB CO)  
1100 N. LINDBERGH  
ST. LOUIS, MO 63132

THE MARK CONSISTS OF STANDARD CHAR-  
ACTERS WITHOUT CLAIM TO ANY PARTICULAR  
FONT, STYLE, SIZE, OR COLOR.

FOR: WOMEN'S CLOTHING, NAMELY, PANTS  
AND JEANS, IN CLASS 25 (U.S. CLS. 22 AND 39).

SER. NO. 77-340,988, FILED 11-30-2007.

FIRST USE 7-19-2007; IN COMMERCE 7-19-2007.

BARBARA BROWN, EXAMINING ATTORNEY

**Int. Cl.: 41**

**Prior U.S. Cls.: 100, 101 and 107**

**United States Patent and Trademark Office**

**Reg. No. 3,467,542**

**Registered July 15, 2008**

**SERVICE MARK  
PRINCIPAL REGISTER**

**z0d.com**

RYAN PERRY ENTERPRISES, INC. (ARIZONA  
CORPORATION)  
1234 S. POWER ROAD, SUITE 206  
MESA, AZ 85206

FOR: ENTERTAINMENT SERVICES, NAMELY,  
PROVIDING A WEBSITE FEATURING PHOTO-  
GRAPHIC, AUDIO, VIDEO AND PROSE PRESEN-  
TATIONS FEATURING ADULT  
ENTERTAINMENT, IN CLASS 41 (U.S. CLS. 100,  
101 AND 107).

FIRST USE 11-24-2006; IN COMMERCE 12-15-2006.

THE MARK CONSISTS OF STANDARD CHAR-  
ACTERS WITHOUT CLAIM TO ANY PARTICULAR  
FONT, STYLE, SIZE, OR COLOR.

SER. NO. 77-340,996, FILED 11-30-2007.

KYLE PEETE, EXAMINING ATTORNEY

**Int. Cl.: 41**

**Prior U.S. Cls.: 100, 101 and 107**

**United States Patent and Trademark Office**

**Reg. No. 3,467,543**

**Registered July 15, 2008**

**SERVICE MARK  
PRINCIPAL REGISTER**

**gorillamask.net**

RYAN PERRY ENTERPRISES, INC. (ARIZONA  
CORPORATION)  
1234 S. POWER ROAD, SUITE 206  
MESA, AZ 85206

FOR: ENTERTAINMENT SERVICES, NAMELY,  
PROVIDING A WEBSITE FEATURING PHOTO-  
GRAPHIC, AUDIO, VIDEO AND PROSE PRESEN-  
TATIONS FEATURING VIRAL ENTERTAINMENT,  
IN CLASS 41 (U.S. CLS. 100, 101 AND 107).

FIRST USE 5-19-2003; IN COMMERCE 6-30-2003.

THE MARK CONSISTS OF STANDARD CHAR-  
ACTERS WITHOUT CLAIM TO ANY PARTICULAR  
FONT, STYLE, SIZE, OR COLOR.

SER. NO. 77-341,029, FILED 11-30-2007.

KYLE PEETE, EXAMINING ATTORNEY



**Int. Cl.: 36**

**Prior U.S. Cls.: 100, 101 and 102**

**United States Patent and Trademark Office**

**Reg. No. 3,467,544**

**Registered July 15, 2008**

**SERVICE MARK  
PRINCIPAL REGISTER**

**GoHealth Insurance**

NORVAX, INC. (ILLINOIS CORPORATION)  
214 W. HURON STREET  
CHICAGO, IL 60610

FOR: INFORMATION COLLECTION AND DISSEMINATION SERVICES, NAMELY, GATHERING AND DISSEMINATION OF INFORMATION REGARDING PROSPECTIVE INSURANCE BUYERS, IN CLASS 36 (U.S. CLS. 100, 101 AND 102).

FIRST USE 4-10-2007; IN COMMERCE 4-10-2007.

THE MARK CONSISTS OF STANDARD CHARACTERS WITHOUT CLAIM TO ANY PARTICULAR FONT, STYLE, SIZE, OR COLOR.

NO CLAIM IS MADE TO THE EXCLUSIVE RIGHT TO USE "INSURANCE", APART FROM THE MARK AS SHOWN.

SER. NO. 77-341,123, FILED 11-30-2007.

JOHN WILKE, EXAMINING ATTORNEY

**Int. Cl.: 8**

**Prior U.S. Cls.: 23, 28 and 44**

**United States Patent and Trademark Office**

**Reg. No. 3,467,545**

**Registered July 15, 2008**

**TRADEMARK  
PRINCIPAL REGISTER**

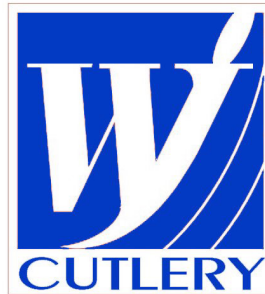

CHAO, JOY (OKLAHOMA CORPORATION), DBA  
WUU JAU CO., INC.  
2600 SOUTH KELLY AVENUE  
EDMOND, OK 73013

FOR: JAPANESE SWORDS; SABRES; SWORDS;  
HUNTING KNIVES; JAPANESE CHOPPING KITCH-  
EN KNIVES; PEN KNIVES; POCKET KNIVES;  
THROWING KNIVES; DAGGERS; MACHETES, IN  
CLASS 8 (U.S. CLS. 23, 28 AND 44).

FIRST USE 1-1-2007; IN COMMERCE 1-1-2007.

NO CLAIM IS MADE TO THE EXCLUSIVE  
RIGHT TO USE "CUTLERY", APART FROM THE  
MARK AS SHOWN.

THE COLOR(S) WHITE AND BLUE IS/ARE  
CLAIMED AS A FEATURE OF THE MARK.

THE MERGED "WJ" LETTERS AND LINES IN  
THE MARK ARE WHITE; THE BACKGROUND OF  
THE "WJ" DESIGN IS BLUE; THE WORDING  
"CUTLERY" IS BLUE.

SER. NO. 77-341,200, FILED 11-30-2007.

DANIEL CAPSHAW, EXAMINING ATTORNEY

**Int. Cl.: 40**

**Prior U.S. Cls.: 100, 103 and 106**

**United States Patent and Trademark Office**

**Reg. No. 3,467,546**

**Registered July 15, 2008**

**SERVICE MARK  
PRINCIPAL REGISTER**

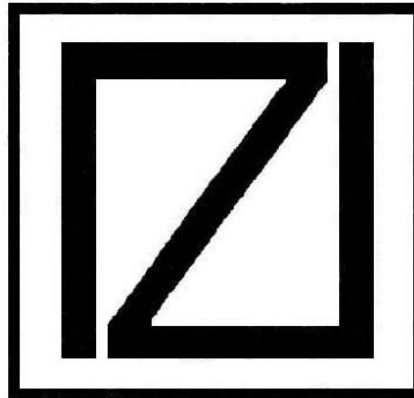

INTERAMERICAN ZINC, INC. (DELAWARE  
CORPORATION)  
245 N. FILLMORE ROAD  
COLDWATER, MI 49036

FOR: RECYCLING SERVICES, IN CLASS 40 (U.S.  
CLS. 100, 103 AND 106).

FIRST USE 3-0-1980; IN COMMERCE 3-0-1980.

OWNER OF U.S. REG. NOS. 2,043,438 AND  
2,065,076.

THE MARK CONSISTS OF THE LETTERS "IZI"  
WITHIN A RECTANGULAR BORDER.

SER. NO. 77-341,201, FILED 11-30-2007.

LYDIA BELZER, EXAMINING ATTORNEY

**Int. Cl.: 30**

**Prior U.S. Cl.: 46**

**United States Patent and Trademark Office**

**Reg. No. 3,467,547**

**Registered July 15, 2008**

**TRADEMARK  
PRINCIPAL REGISTER**



MK COOKIES (ILLINOIS PARTNERSHIP)  
NO. 1206  
1455 N. SANDBURG TERRACE  
CHICAGO, IL 60610

FOR: COOKIES, IN CLASS 30 (U.S. CL. 46).

FIRST USE 3-1-2007; IN COMMERCE 3-1-2007.

NO CLAIM IS MADE TO THE EXCLUSIVE  
RIGHT TO USE "COOKIES", APART FROM THE  
MARK AS SHOWN.

THE MARK CONSISTS OF "M K COOKIES" AND  
DESIGN.

SER. NO. 77-341,206, FILED 11-30-2007.

DEZMONA MIZELLE, EXAMINING ATTORNEY

**Int. Cl.: 9**

**Prior U.S. Cls.: 21, 23, 26, 36 and 38**

**United States Patent and Trademark Office**

**Reg. No. 3,467,548**

**Registered July 15, 2008**

**TRADEMARK  
PRINCIPAL REGISTER**

**SENSOR**  
**Instruments that make sense**

REFERENCE LLC (IOWA LTD LIAB CO)  
690 ½ E. BRIDGE ST.  
ELKADER, IA 52043

FIRST USE 1-0-2007; IN COMMERCE 1-0-2007.

FOR: ELECTRONIC MEASURING DEVICES FOR MEASUREMENT OF MOTION, POSITION, AND ORIENTATION, NAMELY, SENSORS AND TRANSDUCERS FOR DISPLACEMENT, VELOCITY, AND ACCELERATION; ACCELEROMETERS; DATA LOGGERS FOR ALL OF THE FOREGOING, IN CLASS 9 (U.S. CLS. 21, 23, 26, 36 AND 38).

NO CLAIM IS MADE TO THE EXCLUSIVE RIGHT TO USE "SENSOR", APART FROM THE MARK AS SHOWN.

SER. NO. 77-341,208, FILED 11-30-2007.

LINDA E. BLOHM, EXAMINING ATTORNEY

**Int. Cl.: 1**

**Prior U.S. Cls.: 1, 5, 6, 10, 26 and 46**

**United States Patent and Trademark Office**

**Reg. No. 3,467,549**

**Registered July 15, 2008**

**TRADEMARK  
PRINCIPAL REGISTER**

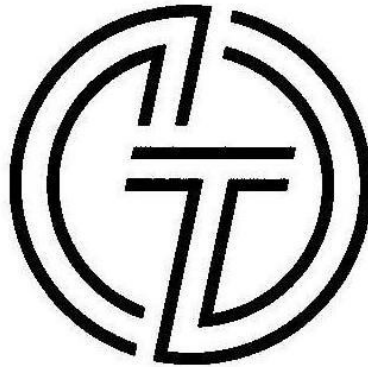

CLEAN DIESEL TECHNOLOGIES, INC. (DELA-  
WARE CORPORATION)  
SUITE 702  
300 ATLANTIC STREET  
STAMFORD, CT 069013522

FOR: CHEMICAL ADDITIVES FOR FUEL  
TREATMENT, IN CLASS 1 (U.S. CLS. 1, 5, 6, 10, 26  
AND 46).

FIRST USE 4-0-2002; IN COMMERCE 4-0-2002.

OWNER OF U.S. REG. NOS. 1,401,753, 2,896,154  
AND OTHERS.

THE MARK CONSISTS OF THE LETTERS "C",  
"D" AND "T" ARRANGED IN A CIRCULAR PAT-  
TERN.

SER. NO. 77-341,222, FILED 11-30-2007.

MELISSA VALLILLO, EXAMINING ATTORNEY

**Int. Cl.: 36**

**Prior U.S. Cls.: 100, 101 and 102**

**United States Patent and Trademark Office**

**Reg. No. 3,467,550**

**Registered July 15, 2008**

**SERVICE MARK  
PRINCIPAL REGISTER**

**The Hartford Mutual Funds**

HARTFORD FIRE INSURANCE COMPANY  
(CONNECTICUT CORPORATION)  
LAW DEPT.-TECH/IP TRADEMARK UNIT-HO1-09  
ONE HARTFORD PLAZA  
HARTFORD, CT 06155

FOR: INVESTMENT SERVICES, NAMELY, MUTUAL FUND INVESTMENT SERVICES AND MUTUAL FUND BROKERAGE SERVICES, IN CLASS 36 (U.S. CLS. 100, 101 AND 102).

FIRST USE 7-0-1996; IN COMMERCE 7-0-1996.

THE MARK CONSISTS OF STANDARD CHARACTERS WITHOUT CLAIM TO ANY PARTICULAR FONT, STYLE, SIZE, OR COLOR.

OWNER OF U.S. REG. NO. 2,408,978.

NO CLAIM IS MADE TO THE EXCLUSIVE RIGHT TO USE "MUTUAL FUNDS", APART FROM THE MARK AS SHOWN.

SEC. 2(F) AS TO "HARTFORD".

SER. NO. 77-341,236, FILED 11-30-2007.

ALYSSA PALADINO, EXAMINING ATTORNEY

**Int. Cls.: 3 and 4**

**Prior U.S. Cls.: 1, 4, 6, 15, 50, 51 and 52**

**United States Patent and Trademark Office**

**Reg. No. 3,467,551**

**Registered July 15, 2008**

**TRADEMARK  
PRINCIPAL REGISTER**

**FRESH LAUNDRY**

FUSION BRANDS INTERNATIONAL SRL (BARBADOS COMPANY)  
GROVE, 21 PINE ROAD  
BELLEVILLE ST. MICHAEL, BARBADOS BB11113

FOR: EAU DE PARFUM, BODY LOTION, SHOWER GEL AND LINEN SPRAY, IN CLASS 3 (U.S. CLS. 1, 4, 6, 50, 51 AND 52).

FIRST USE 1-0-2005; IN COMMERCE 1-0-2005.

FOR: CANDLES, IN CLASS 4 (U.S. CLS. 1, 6 AND 15).

FIRST USE 1-0-2005; IN COMMERCE 1-0-2005.

THE MARK CONSISTS OF STANDARD CHARACTERS WITHOUT CLAIM TO ANY PARTICULAR FONT, STYLE, SIZE, OR COLOR.

SER. NO. 77-341,265, FILED 11-30-2007.

GIANCARLO CASTRO, EXAMINING ATTORNEY



**Int. Cl.: 8**

**Prior U.S. Cls.: 23, 28 and 44**

**Reg. No. 3,467,552**

**United States Patent and Trademark Office**

**Registered July 15, 2008**

**TRADEMARK  
PRINCIPAL REGISTER**

The logo for WARTECH USA features the word "WARTECH" in a bold, stylized, blocky font. Below "WARTECH", the letters "USA" are written in a smaller, simpler font. Three horizontal lines are positioned between "WARTECH" and "USA".

CHAO, JOY (OKLAHOMA CORPORATION), DBA  
WUU JAU CO., INC.  
2600 SOUTH KELLY AVENUE  
EDMOND, OK 73013

FIRST USE 2-1-2007; IN COMMERCE 2-1-2007.

FOR: FOLDING KNIVES; HUNTING KNIVES;  
JAPANESE CHOPPING KITCHEN KNIVES; PEN  
KNIVES; POCKET KNIVES; THROWING KNIVES;  
MACHETES; JAPANESE SWORDS; SABRES;  
SWORDS; DAGGERS, IN CLASS 8 (U.S. CLS. 23, 28  
AND 44).

NO CLAIM IS MADE TO THE EXCLUSIVE  
RIGHT TO USE "USA", APART FROM THE MARK  
AS SHOWN.

SER. NO. 77-341,266, FILED 11-30-2007.

DANIEL CAPSHAW, EXAMINING ATTORNEY

**Int. Cl.: 7**

**Prior U.S. Cls.: 13, 19, 21, 23, 31, 34 and 35**

**United States Patent and Trademark Office**

**Reg. No. 3,467,553**

**Registered July 15, 2008**

**TRADEMARK  
PRINCIPAL REGISTER**

**TOOLS NOT TOYS!**

Q INDUSTRIES, INC. (NEVADA CORPORATION)  
SUITE 130  
401 EAST LAS OLAS BOULEVARD  
FT. LAUDERDALE, FL 33316

FOR: AIR COMPRESSORS, IN CLASS 7 (U.S. CLS.  
13, 19, 21, 23, 31, 34 AND 35).

FIRST USE 12-30-2005; IN COMMERCE 12-30-2005.

THE MARK CONSISTS OF STANDARD CHAR-  
ACTERS WITHOUT CLAIM TO ANY PARTICULAR  
FONT, STYLE, SIZE, OR COLOR.

OWNER OF U.S. REG. NO. 3,192,832.

NO CLAIM IS MADE TO THE EXCLUSIVE  
RIGHT TO USE "TOOLS", APART FROM THE  
MARK AS SHOWN.

SER. NO. 77-341,268, FILED 11-30-2007.

IRA J. GOODSaid, EXAMINING ATTORNEY

**Int. Cl.: 43**

**Prior U.S. Cls.: 100 and 101**

**United States Patent and Trademark Office**

**Reg. No. 3,467,554**

**Registered July 15, 2008**

**SERVICE MARK  
PRINCIPAL REGISTER**

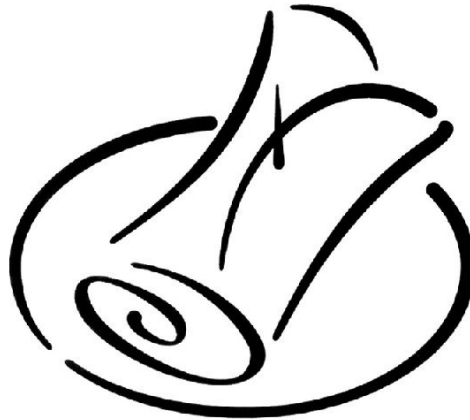

OLGA'S KITCHEN, INC. (MICHIGAN CORPORATION)  
1940 NORTHWOOD DRIVE  
TROY, MI 48084

THE MARK CONSISTS OF A WRAP WITHIN A CIRCULAR DESIGN.

FOR: CARRY-OUT RESTAURANTS; RESTAURANT SERVICES, IN CLASS 43 (U.S. CLS. 100 AND 101).

SER. NO. 77-341,284, FILED 11-30-2007.

FIRST USE 5-0-2003; IN COMMERCE 5-0-2003.

GEORGE LORENZO, EXAMINING ATTORNEY

**Int. Cl.: 39**

**Prior U.S. Cls.: 100 and 105**

**United States Patent and Trademark Office**

**Reg. No. 3,467,555**

**Registered July 15, 2008**

**SERVICE MARK  
PRINCIPAL REGISTER**



MAVERICK BUSINESS ADVENTURES, LLC  
(MARYLAND LTD LIAB CO)  
7731 TUCKERMAN LANE # 162  
PATOMAC, MD 20854

FOR: PROVIDING ADVENTURE TRAVEL AND  
EXCURSION SERVICES, IN CLASS 39 (U.S. CLS. 100  
AND 105).

FIRST USE 9-1-2007; IN COMMERCE 10-1-2007.

NO CLAIM IS MADE TO THE EXCLUSIVE  
RIGHT TO USE "BUSINESS ADVENTURES",  
APART FROM THE MARK AS SHOWN.

THE COLOR(S) BLACK, GREEN AND WHITE IS/  
ARE CLAIMED AS A FEATURE OF THE MARK.

THE MARK CONSISTS OF A BLACK BOX, THE  
COLOR GREEN FORMS THE WORD "MAVERICK",  
THE COLOR WHITE FORMS THE HAND DESIGN  
WITHIN THE WORD "MAVERICK" AND THE  
WORDS "BUSINESS ADVENTURES".

SER. NO. 77-341,302, FILED 11-30-2007.

BRIAN NEVILLE, EXAMINING ATTORNEY

**Int. Cl.: 41**

**Prior U.S. Cls.: 100, 101 and 107**

**United States Patent and Trademark Office**

**Reg. No. 3,467,556**

**Registered July 15, 2008**

**SERVICE MARK  
PRINCIPAL REGISTER**



MAVERICK BUSINESS ADVENTURES, LLC  
(MARYLAND LTD LIAB CO)  
7731 TUCKERMAN LANE # 162  
PATOMAC, MD 20854

THE COLOR(S) BLACK, GREEN AND WHITE IS/  
ARE CLAIMED AS A FEATURE OF THE MARK.

FOR: EDUCATION SERVICES, NAMELY, PRO-  
VIDING CLASSES, SEMINARS AND WORKSHOPS  
DIRECTED TO TOP ENTREPRENEURS FOR THE  
PURPOSE OF NETWORKING, BUSINESS BUILD-  
ING AND RELATIONSHIP DEVELOPMENT, IN  
CLASS 41 (U.S. CLS. 100, 101 AND 107).

THE MARK CONSISTS OF A BLACK BOX, THE  
COLOR GREEN FORMS THE WORD "MAVERICK",  
THE COLOR WHITE FORMS THE HAND DESIGN  
WITHIN THE WORD "MAVERICK" AND THE  
WORDS "BUSINESS ADVENTURES".

FIRST USE 9-1-2007; IN COMMERCE 10-1-2007.

SER. NO. 77-341,321, FILED 11-30-2007.

NO CLAIM IS MADE TO THE EXCLUSIVE  
RIGHT TO USE "BUSINESS ADVENTURES",  
APART FROM THE MARK AS SHOWN.

BRIAN NEVILLE, EXAMINING ATTORNEY

**Int. Cl.: 16**

**Prior U.S. Cls.: 2, 5, 22, 23, 29, 37, 38 and 50**

**United States Patent and Trademark Office**

**Reg. No. 3,467,557**

**Registered July 15, 2008**

**TRADEMARK  
PRINCIPAL REGISTER**

**724**

FELLOWES, INC. (ILLINOIS CORPORATION)  
1789 NORWOOD AVE.  
ITASCA, IL 60143

THE MARK CONSISTS OF STANDARD CHAR-  
ACTERS WITHOUT CLAIM TO ANY PARTICULAR  
FONT, STYLE, SIZE, OR COLOR.

FOR: CORRUGATED RECORD STORAGE  
BOXES, IN CLASS 16 (U.S. CLS. 2, 5, 22, 23, 29, 37, 38  
AND 50).

SER. NO. 77-341,344, FILED 11-30-2007.

FIRST USE 12-1-1983; IN COMMERCE 12-1-1983.

DAVID COLLIER, EXAMINING ATTORNEY

**Int. Cls.: 24 and 25**

**Prior U.S. Cls.: 22, 39, 42 and 50**

**United States Patent and Trademark Office**

**Reg. No. 3,467,558**

**Registered July 15, 2008**

**TRADEMARK  
PRINCIPAL REGISTER**

**EUROPEAN LUXURY ORGANICS**

SDH ENTERPRISES, INC. (CALIFORNIA CORPORATION)  
495C EDISON COURT  
FAIRFIELD, CA 94534

FOR: BED SHEETS, PILLOW CASES, PILLOW SHAMS, BED BLANKETS, THROWS, BED SKIRTS, BATH SHEETS, BATH TOWELS, WASHCLOTHS, HAND TOWELS, KITCHEN TOWELS, COMFORTERS, DUVET COVERS, BLANKET COVERS, AND BEDSPREADS, IN CLASS 24 (U.S. CLS. 42 AND 50).

FIRST USE 7-30-2007; IN COMMERCE 7-30-2007.

FOR: BATH ROBES, ROBES, KIMONO, NIGHTWEAR, PAJAMAS, TANK TOPS, CAMISOLES, AND SLIPPERS, IN CLASS 25 (U.S. CLS. 22 AND 39).

FIRST USE 7-30-2007; IN COMMERCE 7-30-2007.

THE MARK CONSISTS OF STANDARD CHARACTERS WITHOUT CLAIM TO ANY PARTICULAR FONT, STYLE, SIZE, OR COLOR.

NO CLAIM IS MADE TO THE EXCLUSIVE RIGHT TO USE "EUROPEAN" AND "ORGANICS", APART FROM THE MARK AS SHOWN.

SER. NO. 77-341,350, FILED 11-30-2007.

TEJBIR SINGH, EXAMINING ATTORNEY

**Int. Cl.: 42**

**Prior U.S. Cls.: 100 and 101**

**United States Patent and Trademark Office**

**Reg. No. 3,467,559**

**Registered July 15, 2008**

**SERVICE MARK  
PRINCIPAL REGISTER**



VIAMET PHARMACEUTICALS (DELAWARE CORPORATION)  
SUITE 200  
406 BLACKWELL STREET  
DURHAM, NC 27701

FOR: RESEARCH AND DEVELOPMENT SERVICES FOR PHARMACEUTICAL PREPARATIONS AND SUBSTANCES, IN CLASS 42 (U.S. CLS. 100 AND 101).

FIRST USE 8-31-2007; IN COMMERCE 8-31-2007.

THE MARK CONSISTS OF THREE TRIANGLES, TWO OF WHICH ARE CO-JOINED AND FACING STRAIGHT UP WHILE THE THIRD TRIANGLE IS UPSIDE DOWN WITH ITS PEAK POINTING TO THE MIDDLE SPACE BETWEEN THE TWO CO-JOINED TRIANGLES. THE TRIANGLES ALL OVERLAP A CIRCULAR SHAPE APPEARING IN THE BACKGROUND.

SER. NO. 77-341,367, FILED 11-30-2007.

GEORGE LORENZO, EXAMINING ATTORNEY



**Int. Cl.: 16**

**Prior U.S. Cls.: 2, 5, 22, 23, 29, 37, 38 and 50**

**United States Patent and Trademark Office**

**Reg. No. 3,467,560**

**Registered July 15, 2008**

**TRADEMARK  
PRINCIPAL REGISTER**

**789**

FELLOWES, INC. (ILLINOIS CORPORATION)  
1789 NORWOOD AVENUE  
ITASCA, IL 60143

THE MARK CONSISTS OF STANDARD CHAR-  
ACTERS WITHOUT CLAIM TO ANY PARTICULAR  
FONT, STYLE, SIZE, OR COLOR.

FOR: CORRUGATED RECORD STORAGE  
BOXES, IN CLASS 16 (U.S. CLS. 2, 5, 22, 23, 29, 37, 38  
AND 50).

SER. NO. 77-341,385, FILED 11-30-2007.

FIRST USE 12-1-1983; IN COMMERCE 12-1-1983.

DAVID COLLIER, EXAMINING ATTORNEY

**Int. Cl.: 7**

**Prior U.S. Cls.: 13, 19, 21, 23, 31, 34 and 35**

**United States Patent and Trademark Office**

**Reg. No. 3,467,561**

**Registered July 15, 2008**

**TRADEMARK  
PRINCIPAL REGISTER**

**ULTRAFLEX**

TB WOOD'S ENTERPRISES, INC. (DELAWARE  
CORPORATION)  
440 NORTH FIFTH AVENUE  
CHAMBERSBURG, PA 17201

THE MARK CONSISTS OF STANDARD CHAR-  
ACTERS WITHOUT CLAIM TO ANY PARTICULAR  
FONT, STYLE, SIZE, OR COLOR.

FOR: VARIABLE FREQUENCY DRIVES FOR AC  
MOTORS, IN CLASS 7 (U.S. CLS. 13, 19, 21, 23, 31, 34  
AND 35).

SER. NO. 77-341,430, FILED 11-30-2007.

FIRST USE 8-1-2007; IN COMMERCE 8-1-2007.

EVELYN BRADLEY, EXAMINING ATTORNEY

**Int. Cl.: 43**

**Prior U.S. Cls.: 100 and 101**

**United States Patent and Trademark Office**

**Reg. No. 3,467,562**

**Registered July 15, 2008**

**SERVICE MARK  
PRINCIPAL REGISTER**

**Our Cooking Keeps You Good  
Looking**

ENERGY KITCHEN, INC. (NEW YORK COR-  
PORATION)  
300 EAST 41ST STREET  
NEW YORK, NY 10017

THE MARK CONSISTS OF STANDARD CHAR-  
ACTERS WITHOUT CLAIM TO ANY PARTICULAR  
FONT, STYLE, SIZE, OR COLOR.

FOR: RESTAURANT SERVICES, IN CLASS 43  
(U.S. CLS. 100 AND 101).

SER. NO. 77-341,431, FILED 11-30-2007.

FIRST USE 7-0-2003; IN COMMERCE 7-0-2003.

JESSICA A. POWERS, EXAMINING ATTORNEY

**Int. Cl.: 16**

**Prior U.S. Cls.: 2, 5, 22, 23, 29, 37, 38 and 50**

**United States Patent and Trademark Office**

**Reg. No. 3,467,563**

**Registered July 15, 2008**

**TRADEMARK  
PRINCIPAL REGISTER**

**7241**

FELLOWES, INC. (ILLINOIS CORPORATION)  
1789 NORWOOD AVE.  
ITASCA, IL 60143

THE MARK CONSISTS OF STANDARD CHAR-  
ACTERS WITHOUT CLAIM TO ANY PARTICULAR  
FONT, STYLE, SIZE, OR COLOR.

FOR: CORRUGATED RECORD STORAGE  
BOXES, IN CLASS 16 (U.S. CLS. 2, 5, 22, 23, 29, 37, 38  
AND 50).

SER. NO. 77-341,433, FILED 11-30-2007.

FIRST USE 12-1-1983; IN COMMERCE 12-1-1983.

DAVID COLLIER, EXAMINING ATTORNEY

**Int. Cl.: 36**

**Prior U.S. Cls.: 100, 101 and 102**

**United States Patent and Trademark Office**

**Reg. No. 3,467,564**

**Registered July 15, 2008**

**SERVICE MARK  
PRINCIPAL REGISTER**

**SURETRADE**

HISTORYQUEST, LLC (NEW JERSEY LTD LIAB  
CO)  
1 COLLES AVENUE  
MORRISTOWN, NJ 07960

THE MARK CONSISTS OF STANDARD CHAR-  
ACTERS WITHOUT CLAIM TO ANY PARTICULAR  
FONT, STYLE, SIZE, OR COLOR.

FOR: INVESTMENT BY ELECTRONIC MEANS,  
IN CLASS 36 (U.S. CLS. 100, 101 AND 102).

SER. NO. 77-341,435, FILED 11-30-2007.

FIRST USE 11-30-2007; IN COMMERCE 11-30-2007.

JENNIFER MARTIN, EXAMINING ATTORNEY

**Int. Cls.: 29 and 30**

**Prior U.S. Cl.: 46**

**United States Patent and Trademark Office**

**Reg. No. 3,467,565**

**Registered July 15, 2008**

**TRADEMARK  
PRINCIPAL REGISTER**

**CANTARE**

CANTARE FOODS, INC. (NEVADA CORPORATION)  
7651 ST. ANDREWS AVE.  
85 DIVISION AVE  
SAN DIEGO, CA 92154

FOR: CHEESE; CREAM CHEESE; MASCARPONE; FRESH UNRIPENED CHEESES; PROCESSED VEGETABLES; VEGETABLE SALADS; VEGETABLE-BASED SPREADS; CHEESE SPREADS; SALADS EXCEPT MACARONI, RICE, AND PASTA SALAD; GARDEN SALADS, IN CLASS 29 (U.S. CL. 46).

FIRST USE 8-1-1992; IN COMMERCE 8-1-1992.

FOR: SALSA; BAKERY DESSERTS; BAKERY GOODS; BAKERY PRODUCTS; BAKERY PRODUCTS, NAMELY SWEET BAKERY GOODS; DOUGH-BASED POCKETS WITH FILLING CON-

SISTING PRIMARILY OF MEATS, POULTRY, FISH, FRUITS AND VEGETABLES AND CHEESE, IN CLASS 30 (U.S. CL. 46).

FIRST USE 8-1-1992; IN COMMERCE 8-1-1992.

THE MARK CONSISTS OF STANDARD CHARACTERS WITHOUT CLAIM TO ANY PARTICULAR FONT, STYLE, SIZE, OR COLOR.

THE FOREIGN WORDING IN THE MARK TRANSLATES INTO ENGLISH AS TO SING; TO SQUEAL.

SER. NO. 77-341,459, FILED 11-30-2007.

MARTHA SANTOMARTINO, EXAMINING ATTORNEY

Int. Cl.: 43

Prior U.S. Cls.: 100 and 101

United States Patent and Trademark Office

Reg. No. 3,467,566

Registered July 15, 2008

SERVICE MARK  
PRINCIPAL REGISTER



HEALTH MEX, INC. (ILLINOIS CORPORATION)  
7816 WEST NORTH AVENUE  
ELMWOOD PARK, IL 60707

FOR: RESTAURANT, BAR AND CATERING SERVICES; RESTAURANTS FEATURING HOME DELIVERY; TAKE-OUT RESTAURANT SERVICES, IN CLASS 43 (U.S. CLS. 100 AND 101).

FIRST USE 5-1-2007; IN COMMERCE 5-1-2007.

OWNER OF U.S. REG. NO. 2,335,044.

NO CLAIM IS MADE TO THE EXCLUSIVE RIGHT TO USE "GRILL CANTINA", APART FROM THE MARK AS SHOWN.

THE COLOR(S) RED, YELLOW, BLACK, AND GREEN IS/ARE CLAIMED AS A FEATURE OF THE MARK.

THE MARK CONSISTS OF THE LITERAL MATTER "SALSERIA GRILL CANTINA" WITH THE WORD "SALSERIA" IN STYLIZED RED LETTERING WITH A YELLOW BORDER; AND, DIRECTLY BENEATH THE WORD "SALSERIA" AND WITHIN A BLACK RECTANGLE DESIGN ELEMENT WITH A YELLOW DECORATIVE BORDER DESIGN ELEMENT, THE WORDS "GRILL" AND "CANTINA" IN STYLIZED YELLOW LETTERING PAIRED WITH A DESIGN ELEMENT CONSISTING OF TWO CROSSED RED CHILI PEPPERS WITH GREEN STEMS THAT APPEARS IN THE MIDDLE OF THE BLACK RECTANGLE AND SEPARATES THE WORDS "GRILL" AND "CANTINA".

SER. NO. 77-341,480, FILED 11-30-2007.

MORGAN WYNNE, EXAMINING ATTORNEY

**Int. Cl.: 28**

**Prior U.S. Cls.: 22, 23, 38 and 50**

**United States Patent and Trademark Office**

**Reg. No. 3,467,567**

**Registered July 15, 2008**

---

**TRADEMARK  
PRINCIPAL REGISTER**

**ZISC**

SCHOGGI, INC. (MONTANA CORPORATION)  
32050 EAST FRONTAGE ROAD  
BOZEMAN, MT 59715

THE MARK CONSISTS OF STANDARD CHAR-  
ACTERS WITHOUT CLAIM TO ANY PARTICULAR  
FONT, STYLE, SIZE, OR COLOR.

FOR: PET TOYS, IN CLASS 28 (U.S. CLS. 22, 23, 38  
AND 50).

SER. NO. 77-341,580, FILED 11-30-2007.

FIRST USE 3-7-2006; IN COMMERCE 3-7-2006.

ADA HAN, EXAMINING ATTORNEY



**Int. Cl.: 20**

**Prior U.S. Cls.: 2, 13, 22, 25, 32 and 50**

**United States Patent and Trademark Office**

**Reg. No. 3,467,568**

**Registered July 15, 2008**

---

**TRADEMARK  
PRINCIPAL REGISTER**

**BIG SKY BED**

SCHOGGI, INC. (MONTANA CORPORATION)  
32050 EAST FRONTAGE ROAD  
BOZEMAN, MT 59715

FOR: BEDS FOR HOUSEHOLD PETS, IN CLASS  
20 (U.S. CLS. 2, 13, 22, 25, 32 AND 50).

FIRST USE 3-15-2006; IN COMMERCE 3-15-2006.

THE MARK CONSISTS OF STANDARD CHAR-  
ACTERS WITHOUT CLAIM TO ANY PARTICULAR  
FONT, STYLE, SIZE, OR COLOR.

NO CLAIM IS MADE TO THE EXCLUSIVE  
RIGHT TO USE "BED", APART FROM THE MARK  
AS SHOWN.

SER. NO. 77-341,590, FILED 11-30-2007.

ADA HAN, EXAMINING ATTORNEY

**Int. Cl.: 24**

**Prior U.S. Cls.: 42 and 50**

**United States Patent and Trademark Office**

**Reg. No. 3,467,569**

**Registered July 15, 2008**

**TRADEMARK  
PRINCIPAL REGISTER**

**BIG SKY BLANKET**

SCHOGGI, INC. (MONTANA CORPORATION)  
32050 EAST FRONTAGE ROAD  
BOZEMAN, MT 59715

FOR: PET BLANKETS, IN CLASS 24 (U.S. CLS. 42  
AND 50).

FIRST USE 3-15-2006; IN COMMERCE 3-15-2006.

THE MARK CONSISTS OF STANDARD CHAR-  
ACTERS WITHOUT CLAIM TO ANY PARTICULAR  
FONT, STYLE, SIZE, OR COLOR.

NO CLAIM IS MADE TO THE EXCLUSIVE  
RIGHT TO USE "BLANKET", APART FROM THE  
MARK AS SHOWN.

SER. NO. 77-341,601, FILED 11-30-2007.

ADA HAN, EXAMINING ATTORNEY

**Int. Cl.: 10**

**Prior U.S. Cls.: 26, 39 and 44**

**United States Patent and Trademark Office**

**Reg. No. 3,467,570**

**Registered July 15, 2008**

**TRADEMARK  
PRINCIPAL REGISTER**

**MARVEL-MINI**

AGELESS BEAUTY CORP. (CALIFORNIA CORPORATION)  
SUITE 350  
28470 AVE STANFORD  
VALENCIA, CA 91355

THE MARK CONSISTS OF STANDARD CHARACTERS WITHOUT CLAIM TO ANY PARTICULAR FONT, STYLE, SIZE, OR COLOR.

FOR: ELECTRONIC LIGHT THERAPY APPARATUS FOR THE SKIN, IN CLASS 10 (U.S. CLS. 26, 39 AND 44).

SER. NO. 77-341,624, FILED 11-30-2007.

FIRST USE 3-20-2007; IN COMMERCE 3-20-2007.

LINDA ORNDORFF, EXAMINING ATTORNEY

**Int. Cl.: 9**

**Prior U.S. Cls.: 21, 23, 26, 36 and 38**

**Reg. No. 3,467,571**

**United States Patent and Trademark Office**

**Registered July 15, 2008**

---

**TRADEMARK  
PRINCIPAL REGISTER**

**LISTEN**

LISTEN TECHNOLOGIES CORPORATION  
(UTAH CORPORATION)  
14912 HERITAGECREST WAY  
BLUFFDALE, UT 84065

THE MARK CONSISTS OF STANDARD CHARACTERS WITHOUT CLAIM TO ANY PARTICULAR FONT, STYLE, SIZE, OR COLOR.

FOR: WIRELESS AUDIO DEVICES AND ACCESSORIES, NAMELY, WIRELESS RECEIVERS, WIRELESS STATIONARY AND PORTABLE TRANSMITTERS, WIRELESS SPEAKERS AND WIRELESS MICROPHONES AND EARPHONES, IN CLASS 9 (U.S. CLS. 21, 23, 26, 36 AND 38).

SEC. 2(F).

SER. NO. 77-341,663, FILED 11-30-2007.

FIRST USE 9-0-1999; IN COMMERCE 9-0-1999.

SUSAN STIGLITZ, EXAMINING ATTORNEY

**Int. Cl.: 5**

**Prior U.S. Cls.: 6, 18, 44, 46, 51 and 52**

**Reg. No. 3,467,572**

**United States Patent and Trademark Office**

**Registered July 15, 2008**

---

**TRADEMARK  
PRINCIPAL REGISTER**

**PET-EASE**

NUTRI-VET LLC (IDAHO CORPORATION)  
495 N. DUPONT AVENUE  
BOISE, ID 83713

FIRST USE 6-28-2002; IN COMMERCE 6-28-2002.

FOR: NUTRITIONAL SUPPLEMENTS FOR PETS,  
NAMELY, NUTRITIONAL SUPPLEMENTS USED  
TO CALM PETS, MODIFY BEHAVIOR, ALLEVIATE  
ANXIETY AND REDUCE STRESS, IN CLASS 5 (U.S.  
CLS. 6, 18, 44, 46, 51 AND 52).

THE MARK CONSISTS OF STANDARD CHAR-  
ACTERS WITHOUT CLAIM TO ANY PARTICULAR  
FONT, STYLE, SIZE, OR COLOR.

SER. NO. 77-341,668, FILED 11-30-2007.

JERI J. FICKES, EXAMINING ATTORNEY

**Int. Cl.: 25**

**Prior U.S. Cls.: 22 and 39**

**United States Patent and Trademark Office**

**Reg. No. 3,467,573**

**Registered July 15, 2008**

**TRADEMARK  
PRINCIPAL REGISTER**

**CATCH THE SPIRIT**

CATCH THE SPIRIT, LLC (UTAH LTD LIAB CO)  
3737 NORTH 970 EAST  
PROVO, UT 84604

THE MARK CONSISTS OF STANDARD CHAR-  
ACTERS WITHOUT CLAIM TO ANY PARTICULAR  
FONT, STYLE, SIZE, OR COLOR.

FOR: APPAREL, NAMELY, T-SHIRTS, SWEAT-  
SHIRTS, SHIRTS, SHORTS, PANTS, TRUNKS,  
SWEATERS, UNIFORMS, CAPS, HATS AND JACK-  
ETS, IN CLASS 25 (U.S. CLS. 22 AND 39).

SER. NO. 77-341,699, FILED 11-30-2007.

FIRST USE 9-30-1996; IN COMMERCE 9-30-1996.

RONALD MCMORROW, EXAMINING ATTORNEY

**Int. Cl.: 5**

**Prior U.S. Cls.: 6, 18, 44, 46, 51 and 52**

**Reg. No. 3,467,574**

**United States Patent and Trademark Office**

**Registered July 15, 2008**

---

**TRADEMARK  
PRINCIPAL REGISTER**

**XLEAN**

BUILT FOR HEALTH, INC. (NEVADA CORPORATION)  
3635 S. FORT APACHE ROAD SUITE 200-36  
LAS VEGAS, NV 89147

THE MARK CONSISTS OF STANDARD CHARACTERS WITHOUT CLAIM TO ANY PARTICULAR FONT, STYLE, SIZE, OR COLOR.

FOR: DIETARY AND NUTRITIONAL SUPPLEMENTS, IN CLASS 5 (U.S. CLS. 6, 18, 44, 46, 51 AND 52).

SER. NO. 77-341,709, FILED 11-30-2007.

FIRST USE 5-18-2003; IN COMMERCE 5-18-2003.

GIANCARLO CASTRO, EXAMINING ATTORNEY

**Int. Cl.: 31**

**Prior U.S. Cls.: 1 and 46**

**United States Patent and Trademark Office**

**Reg. No. 3,467,575**

**Registered July 15, 2008**

**TRADEMARK  
PRINCIPAL REGISTER**

**ROYAL HAWAIIAN**

PLANTHAVEN, INC (CALIFORNIA CORPORATION)

P.O. BOX 3056

SANTA BARBARA, CA 931303056

FOR: LIVE PLANTS, NAMELY, COLOCASIAS, IN CLASS 31 (U.S. CLS. 1 AND 46).

FIRST USE 9-17-2007; IN COMMERCE 9-17-2007.

THE MARK CONSISTS OF STANDARD CHARACTERS WITHOUT CLAIM TO ANY PARTICULAR FONT, STYLE, SIZE, OR COLOR.

NO CLAIM IS MADE TO THE EXCLUSIVE RIGHT TO USE "HAWAIIAN", APART FROM THE MARK AS SHOWN.

SER. NO. 77-341,716, FILED 11-30-2007.

STEPHANIE ALI, EXAMINING ATTORNEY



**Int. Cl.: 20**

**Prior U.S. Cls.: 2, 13, 22, 25, 32 and 50**

**United States Patent and Trademark Office**

**Reg. No. 3,467,576**

**Registered July 15, 2008**

**TRADEMARK  
PRINCIPAL REGISTER**



GORDON UMI KAI (UNITED STATES INDIVIDUAL)  
3372 KILAUEA AVENUE  
HONOLULU, HI 96816

THE MARK CONSISTS OF 4 ISOCELES TRIANGLES IN A DIAMOND CONFIGURATION.

FOR: WORKS OF ART OF WOOD; SCULPTURES OF BONE, IVORY, WOOD; WOOD CARVINGS, IN CLASS 20 (U.S. CLS. 2, 13, 22, 25, 32 AND 50).

SER. NO. 77-341,731, FILED 11-30-2007.

FIRST USE 3-0-1992; IN COMMERCE 3-0-1992.

ESTHER BELENKER, EXAMINING ATTORNEY

**Int. Cl.: 44**

**Prior U.S. Cls.: 100 and 101**

**United States Patent and Trademark Office**

**Reg. No. 3,467,577**

**Registered July 15, 2008**

**SERVICE MARK  
PRINCIPAL REGISTER**

**MIRACLE TERRACE**

ISAC NOVIAN (UNITED STATES INDIVIDUAL)  
7951 MELROSE AVENUE  
LOS ANGELES, VT 90046

THE MARK CONSISTS OF STANDARD CHAR-  
ACTERS WITHOUT CLAIM TO ANY PARTICULAR  
FONT, STYLE, SIZE, OR COLOR.

FOR: COUNSELING AND REHABILITATIVE  
SERVICES FOR ALCOHOL AND CHEMICAL DE-  
PENDENCY, IN CLASS 44 (U.S. CLS. 100 AND 101).

SER. NO. 77-341,732, FILED 11-30-2007.

FIRST USE 6-1-2006; IN COMMERCE 6-1-2006.

STEPHANIE ALI, EXAMINING ATTORNEY

**Int. Cls.: 36 and 38**

**Prior U.S. Cls.: 100, 101, 102 and 104**

**United States Patent and Trademark Office**

**Reg. No. 3,467,578**

**Registered July 15, 2008**

**SERVICE MARK  
PRINCIPAL REGISTER**

# Vntelco

AVT GROUP, INC. (CALIFORNIA CORPORATION)  
9039 BOLSA AVE., SUITE 211  
WESTMINSTER, CA 92683

FOR: PREPAID TELECOMMUNICATIONS CALLING CARD SERVICES; TELECOMMUNICATIONS RESELLER SERVICES, NAMELY, TELECOMMUNICATIONS AIR TIME BROKERAGE SERVICES; TELEPHONE CALLING CARD SERVICES, IN CLASS 36 (U.S. CLS. 100, 101 AND 102).

FIRST USE 1-1-2006; IN COMMERCE 1-1-2006.

FOR: BROADCASTING SERVICES AND PROVISION OF TELECOMMUNICATION ACCESS TO FILMS AND TV PROGRAMMES PROVIDED VIA A VIDEO-ON-DEMAND SERVICE; BROADCASTING SERVICES AND PROVISION OF TELECOMMUNICATION ACCESS TO VIDEO AND AUDIO CONTENT PROVIDED VIA A VIDEO-ON-DEMAND SERVICE VIA THE INTERNET; COMMUNICATIONS VIA MULTINATIONAL TELECOMMUNICATION NETWORKS; DATA TRANSMISSION AND RECEPTION SERVICES VIA TELECOMMUNICATION MEANS; ELECTRONIC EXCHANGE OF DATA STORED IN DATABASES ACCESSIBLE VIA TELECOMMUNICATION NETWORKS; HIGH BIT-RATE DATA TRANSMISSION SERVICES FOR TELECOMMUNICATION NETWORK OPERATORS; INFORMATION ABOUT TELECOMMUNICATION; LEASING OF TELECOMMUNICATION EQUIPMENT; LEASING OF TELECOMMUNICATION EQUIPMENT, NAMELY, SWITCHES, ROUTERS AND OTHER RELATED COMPONENTS; LEASING OF TELECOMMUNICATIONS LINES; PROVIDING ACCESS TO TELECOMMUNICATION NETWORKS; PROVIDING ELECTRONIC TELECOMMUNICATION CONNECTIONS; PROVIDING TELECOMMUNICATION CHANNELS FOR TEleshopping SERVICES; PROVIDING TELECOMMUNICATION CONNECTIONS TO THE INTERNET OR DATA-

SES; PROVIDING TELECOMMUNICATIONS CONNECTIONS TO A GLOBAL COMPUTER NETWORK; PROVIDING TELECOMMUNICATIONS CONNECTIONS TO THE INTERNET OR DATABASES; PROVIDING THIRD PARTY USERS WITH ACCESS TO TELECOMMUNICATION INFRASTRUCTURE; RENTAL OF EQUIPMENT FOR TELECOMMUNICATIONS; RENTAL OF TELECOMMUNICATION EQUIPMENT; RENTAL OF TELECOMMUNICATION EQUIPMENT INCLUDING TELEPHONES AND FACSIMILE APPARATUS; RENTAL OF TELECOMMUNICATION EQUIPMENT SUCH AS SWITCHES, ROUTERS AND OTHER RELATED COMPONENTS; RENTAL OF TELECOMMUNICATIONS APPARATUS; RENTAL OF TELECOMMUNICATIONS APPARATUS AND INSTALLATIONS; RENTAL OF TELECOMMUNICATIONS LINES; SIGNAL TRANSMISSION FOR ELECTRONIC COMMERCE VIA TELECOMMUNICATION SYSTEMS AND DATA COMMUNICATION SYSTEMS; TELECOMMUNICATION ACCESS SERVICES; TELECOMMUNICATION CONSULTATION IN THE NATURE OF TECHNICAL CONSULTING IN THE FIELD OF AUDIO, TEXT AND VISUAL DATA TRANSMISSION AND COMMUNICATION; TELECOMMUNICATION SERVICES IN THE FIELD OF PROVIDING LONG DISTANCE SERVICE WITH AUDIO ADVERTISING FOR OTHERS AS A COMPONENT OF THE LONG DISTANCE SERVICE; TELECOMMUNICATION SERVICES, NAMELY, CALL HUNTING; TELECOMMUNICATION SERVICES, NAMELY, LOCAL AND LONG DISTANCE TRANSMISSION OF VOICE, DATA, GRAPHICS AND VIDEO BY MEANS OF BROADBAND OPTICAL OR WIRELESS NETWORKS; TELECOMMUNICATION SERVICES, NAMELY, LOCAL AND LONG DISTANCE TRANSMISSION OF VOICE, DATA, GRAPHICS AND VIDEO BY MEANS OF BROADBAND, COPPER AND OPTICAL OR WIRELESS NETWORKS; TELECOMMUNICATION SERVICES, NAMELY, LOCAL AND LONG DISTANCE TRANSMISSION OF VOICE, DATA, GRAPHICS BY MEANS

OF TELEPHONE, TELEGRAPHIC, CABLE, AND SATELLITE TRANSMISSIONS; TELECOMMUNICATION SERVICES, NAMELY, PROVIDING ACCESS TO PICTURES, VIDEO, ALARM STATUS, BUILDING PLANS AND OTHER BUILDING AND SECURITY INFORMATION AT A REMOTE STATION; TELECOMMUNICATION SERVICES, NAMELY, PROVIDING INTERNET ACCESS VIA BROADBAND OPTICAL OR WIRELESS NETWORKS; TELECOMMUNICATION SERVICES, NAMELY, TRANSMISSION OF PODCASTS; TELECOMMUNICATION SERVICES, NAMELY, TRANSMISSION OF VOICE, DATA AND DOCUMENTS, IN THE FIELD OF AIR TRAFFIC CONTROL, AERONAUTICAL AND AIRCRAFT NAVIGATION, AERONAUTICAL TELECOMMUNICATIONS, AND AERONAUTICAL INFORMATION; TELECOMMUNICATION SERVICES, NAMELY, TRANSMISSION OF VOICE, DATA AND DOCUMENTS, IN THE FIELD OF ENVIRONMENTAL PROTECTION; TELECOMMUNICATION SERVICES, NAMELY, TRANSMISSION OF VOICE, DATA AND DOCUMENTS, IN THE FIELD OF SEARCH AND RESCUE OPERATIONS AND FIRE FIGHTING OPERATIONS; TELECOMMUNICATION SERVICES, NAMELY, TRANSMISSION OF WEBCASTS; TELECOMMUNICATIONS BY E-MAIL; TELECOMMUNICATIONS CONSULTATION; TELECOMMUNICATIONS GATEWAY SERVICES; TELECOMMUNICATIONS RESELLER SERVICES, NAMELY, PROVIDING LONG DISTANCE TELECOMMUNICATION SERVICES; TELECOMMUNICATIONS ROUTING AND JUNCTION SERVICES; TELECOMMUNICATIONS SERVICES, NAMELY INTERCEPTING AND PREVENTING UNSOLICITED CALLS FROM TELEMARKETERS; TELECOM-

MUNICATIONS SERVICES, NAMELY PROVIDING FIBER OPTIC NETWORK SERVICES; TELECOMMUNICATIONS SERVICES, NAMELY, ISDN SERVICES; TELECOMMUNICATIONS SERVICES, NAMELY, PERSONAL COMMUNICATION SERVICES; TELECOMMUNICATIONS SERVICES, NAMELY, ROUTING CALLS TO LOCAL THIRD-PARTY TAXI-CAB DISPATCHERS IN THE VICINITY OF THE CALLER; TELEPHONE TELECOMMUNICATIONS SERVICES PROVIDED VIA PREPAID TELEPHONE CALLING CARDS; TRANSFER OF DATA BY TELECOMMUNICATION; TRANSFER OF DATA BY TELECOMMUNICATIONS; TRANSMISSION AND RECEPTION OF DATABASE INFORMATION VIA THE TELECOMMUNICATION NETWORK; TRANSMISSION OF DATABASE INFORMATION VIA TELECOMMUNICATIONS NETWORKS; TRANSMISSION OF INFORMATION ON OPTICAL TELECOMMUNICATION NETWORKS; TRANSMISSION OF STOCK MARKET INFORMATION WITH THE HELP OF TELECOMMUNICATION MEDIA; WIRELESS TELEPHONE TELECOMMUNICATIONS SERVICES, NAMELY, WIRELESS MOBILE TELEPHONE CALLING PLANS, IN CLASS 38 (U.S. CLS. 100, 101 AND 104).

FIRST USE 1-1-2006; IN COMMERCE 1-1-2006.

THE MARK CONSISTS OF STANDARD CHARACTERS WITHOUT CLAIM TO ANY PARTICULAR FONT, STYLE, SIZE, OR COLOR.

SER. NO. 77-341,740, FILED 11-30-2007.

ARETHA SOMERVILLE, EXAMINING ATTORNEY

**Int. Cl.: 31**

**Prior U.S. Cls.: 1 and 46**

**United States Patent and Trademark Office**

**Reg. No. 3,467,579**

**Registered July 15, 2008**

**TRADEMARK  
PRINCIPAL REGISTER**



FLYING HORSE BAKERY (CALIFORNIA LTD  
LIAB CO), DBA FLYING HORSE BAKERY  
13212 TESLA ROAD  
LIVERMORE, CA 94550

FOR: EDIBLE HORSE TREATS, IN CLASS 31 (U.S.  
CLS. 1 AND 46).

FIRST USE 7-1-2007; IN COMMERCE 9-1-2007.

THE COLOR(S) DARK CHOCOLATE BROWN  
LIGHT CHOCOLATE BROWN IS/ARE CLAIMED  
AS A FEATURE OF THE MARK.

THE MARK CONSISTS OF A LIGHT CHOCO-  
LATE WINGED HORSE IN THE BACKGROUND.  
THE WORDS "FLYING HORSE BAKERY", UNDER-  
LINED, USING DARK CHOCOLATE BROWN, IN  
THE FOREGROUND, LOCATED IN THE MIDDLE  
OF THE WINGED HORSE.

SER. NO. 77-341,745, FILED 11-30-2007.

STEPHANIE ALI, EXAMINING ATTORNEY

**Int. Cl.: 35**

**Prior U.S. Cls.: 100, 101 and 102**

**United States Patent and Trademark Office**

**Reg. No. 3,467,580**

**Registered July 15, 2008**

**SERVICE MARK  
PRINCIPAL REGISTER**

**One Call We Staff It All!**

ACCEL EMPLOYMENT SERVICES, INC. (CALI-  
FORNIA CORPORATION)  
308 15TH ST.  
OAKLAND, CA 94612

FOR: EMPLOYMENT AGENCIES; TEMPORARY  
EMPLOYMENT AGENCIES; EMPLOYMENT  
COUNSELING AND RECRUITING; EMPLOYMENT  
HIRING, RECRUITING, PLACEMENT, STAFFING  
AND CAREER NETWORKING SERVICES; EM-  
PLOYMENT OUTPLACEMENT SERVICES, IN  
CLASS 35 (U.S. CLS. 100, 101 AND 102).

FIRST USE 11-27-2007; IN COMMERCE 11-27-2007.

THE MARK CONSISTS OF STANDARD CHAR-  
ACTERS WITHOUT CLAIM TO ANY PARTICULAR  
FONT, STYLE, SIZE, OR COLOR.

SER. NO. 77-341,755, FILED 11-30-2007.

MICHAEL WEBSTER, EXAMINING ATTORNEY

**Int. Cl.: 18**

**Prior U.S. Cls.: 1, 2, 3, 22 and 41**

**United States Patent and Trademark Office**

**Reg. No. 3,467,581**

**Registered July 15, 2008**

**TRADEMARK  
PRINCIPAL REGISTER**

**refind originals**

REFIND ORIGINALS (INDIANA LTD LIAB CO)  
920 N. GRAHAM AVE.  
INDIANAPOLIS, IN 46219

FOR: HANDBAGS, PURSES AND WALLETS;  
BACKPACKS, IN CLASS 18 (U.S. CLS. 1, 2, 3, 22  
AND 41).

FIRST USE 5-1-2007; IN COMMERCE 8-10-2007.

THE MARK CONSISTS OF STANDARD CHAR-  
ACTERS WITHOUT CLAIM TO ANY PARTICULAR  
FONT, STYLE, SIZE, OR COLOR.

NO CLAIM IS MADE TO THE EXCLUSIVE  
RIGHT TO USE "ORIGINALS", APART FROM THE  
MARK AS SHOWN.

SER. NO. 77-341,785, FILED 11-30-2007.

MARY ROSSMAN, EXAMINING ATTORNEY

**Int. Cl.: 41**

**Prior U.S. Cls.: 100, 101 and 107**

**United States Patent and Trademark Office**

**Reg. No. 3,467,582**

**Registered July 15, 2008**

**SERVICE MARK  
PRINCIPAL REGISTER**

**LEROY'S**

LEROY'S HORSE AND SPORTS PLACE (NEVA-  
DA CORPORATION)  
675 GRIER DRIVE  
LAS VEGAS, NV 89119

FOR: BETTING SERVICES, IN CLASS 41 (U.S. CLS.  
100, 101 AND 107).

FIRST USE 11-0-1977; IN COMMERCE 11-0-1977.

THE MARK CONSISTS OF STANDARD CHAR-  
ACTERS WITHOUT CLAIM TO ANY PARTICULAR  
FONT, STYLE, SIZE, OR COLOR.

OWNER OF U.S. REG. NOS. 2,143,897 AND  
2,148,537.

SER. NO. 77-341,809, FILED 12-1-2007.

MARLENE BELL, EXAMINING ATTORNEY



**Int. Cl.: 41**

**Prior U.S. Cls.: 100, 101 and 107**

**United States Patent and Trademark Office**

**Reg. No. 3,467,583**

**Registered July 15, 2008**

**SERVICE MARK  
PRINCIPAL REGISTER**

The logo for LEROY'S features the word "LEROY'S" in a bold, italicized, sans-serif font. To the left of the letter "L", there are three horizontal lines of varying lengths that trail off to the left, suggesting motion or speed.

LEROY'S HORSE AND SPORTS PLACE (NEVA-  
DA CORPORATION)  
675 GRIER DRIVE  
LAS VEGAS, NV 89119

FOR: BETTING SERVICES, IN CLASS 41 (U.S. CLS.  
100, 101 AND 107).

FIRST USE 3-0-2007; IN COMMERCE 3-0-2007.

OWNER OF U.S. REG. NOS. 2,143,897 AND  
2,148,537.

THE MARK CONSISTS OF HORIZONTAL LINES  
TRAILING THE WORD "LEROY'S" SUGGESTING  
MOVEMENT.

SER. NO. 77-341,810, FILED 12-1-2007.

MARLENE BELL, EXAMINING ATTORNEY

Int. Cl.: 12

Prior U.S. Cls.: 19, 21, 23, 31, 35 and 44

Reg. No. 3,467,584

United States Patent and Trademark Office

Registered July 15, 2008

TRADEMARK  
PRINCIPAL REGISTER



The logo consists of the words "SUPER FAT" in a bold, blocky, sans-serif font. On either side of the text is a stylized triple bar element, resembling a bicycle rack or a similar structure, with three horizontal bars and a vertical support.

DISCOUNT, ALAN C. (UNITED STATES INDIVIDUAL)  
5504 MARTINGALE WAY  
FONTANA, CA 92336

FOR: BICYCLE BELLS; BICYCLE CHAINS; BICYCLE FRAMES; BICYCLE GEARS; BICYCLE GRIP TAPE; BICYCLE HANDLEBAR GRIPS; BICYCLE HORNS; BICYCLE KICKSTANDS; BICYCLE PARTS, NAMELY, BRAKE SHOES; BICYCLE PARTS, NAMELY, CHANGE-SPEED GEARS; BICYCLE PARTS, NAMELY, DISK WHEELS; BICYCLE PARTS, NAMELY, DRIVE CHAINS; BICYCLE PARTS, NAMELY, DRIVE TRAINS; BICYCLE PARTS, NAMELY, FORK CROWN COVERS; BICYCLE PARTS, NAMELY, FORKS; BICYCLE PARTS, NAMELY, FRONT FORK JOINTS; BICYCLE PARTS, NAMELY, GEAR WHEELS; BICYCLE PARTS, NAMELY, HANDLE BAR ENDS; BICYCLE PARTS, NAMELY, HANDLE BAR STEMS; BICYCLE PARTS, NAMELY, SPROCKETS; BICYCLE PARTS, NAMELY, TUBES AND CONNECTORS FOR BICYCLE FRAMES; BICYCLE PEDALS; BICYCLE PUMPS; BICYCLE RACKS FOR VEHICLES; BICYCLE SADDLE COVERS; BICYCLE SADDLES; BICYCLE SEAT POSTS; BICYCLE STANDS; BICYCLE TAGS; BICYCLE TRAILERS (RIYAKAH); BICYCLE TRAINING WHEELS; BICYCLE WATER BOTTLE CAGES; BICYCLE WHEELS; BICYCLES; DELIVERY BICYCLES; FITTED BICYCLE COVERS; FRAMES FOR BICYCLES; FRAMES, FOR LUGGAGE CARRIERS, FOR BICYCLES; FRONT AND

REAR BICYCLE RACK PACKS; HANDLEBARS; INNER TUBES; INNER TUBES FOR BICYCLES; MOTORS FOR BICYCLES; MOUNTAIN BICYCLES; MUDGUARDS; PANNIER BAGS FOR BICYCLES; RACING BICYCLES; RIMS FOR BICYCLE WHEELS; ROAD RACING BICYCLES; SADDLE COVERS FOR BICYCLES; SADDLES FOR BICYCLES; SAFETY PADS FOR BICYCLES; SPOKES FOR BICYCLE WHEELS; TANDEM BICYCLES; TIRE INFLATORS; TIRES; TIRES FOR CHILDRENS' BICYCLES; TOURING BICYCLES; WATER BOTTLE HOLDERS FOR BICYCLES; WHEEL HUBS; WHEEL RIMS; WHEELS FOR BICYCLES, CYCLES, IN CLASS 12 (U.S. CLS. 19, 21, 23, 31, 35 AND 44).

FIRST USE 9-15-2006; IN COMMERCE 9-15-2006.

OWNER OF U.S. REG. NO. 3,353,971.

NO CLAIM IS MADE TO THE EXCLUSIVE RIGHT TO USE "SUPER FAT", APART FROM THE MARK AS SHOWN.

THE MARK CONSISTS OF A TRIPLE BAR ELEMENT FLANKING EITHER SIDE OF A STYLIZED REPRESENTATION OF THE WORDS "SUPER FAT".

SER. NO. 77-341,819, FILED 12-1-2007.

JEFFERY COWARD, EXAMINING ATTORNEY

**Int. Cl.: 41**

**Prior U.S. Cls.: 100, 101 and 107**

**United States Patent and Trademark Office**

**Reg. No. 3,467,585**

**Registered July 15, 2008**

**SERVICE MARK  
PRINCIPAL REGISTER**

# Abhorsen

MCKEEN, SCOTT A. (UNITED STATES INDIVIDUAL)  
508 CANDLEMAKERS LN.  
RUSTBURG, VA 24588

THE MARK CONSISTS OF STANDARD CHARACTERS WITHOUT CLAIM TO ANY PARTICULAR FONT, STYLE, SIZE, OR COLOR.

FOR: ENTERTAINMENT IN THE NATURE OF LIVE PERFORMANCES BY A MUSICAL GROUP, IN CLASS 41 (U.S. CLS. 100, 101 AND 107).

SER. NO. 77-341,887, FILED 12-1-2007.

FIRST USE 12-1-2006; IN COMMERCE 12-1-2006.

NANCY CLARKE, EXAMINING ATTORNEY

**Int. Cl.: 45**

**Prior U.S. Cls.: 100 and 101**

**United States Patent and Trademark Office**

**Reg. No. 3,467,586**

**Registered July 15, 2008**

**SERVICE MARK  
PRINCIPAL REGISTER**

**iRovr**

MADSEN, ERIK C. (UNITED STATES INDIVIDUAL)  
1995 EAST COALTON RD, #73-104  
SUPERIOR, CO 80027

THE MARK CONSISTS OF STANDARD CHARACTERS WITHOUT CLAIM TO ANY PARTICULAR FONT, STYLE, SIZE, OR COLOR.

FOR: ONLINE SOCIAL NETWORKING SERVICES, IN CLASS 45 (U.S. CLS. 100 AND 101).

SER. NO. 77-341,890, FILED 12-1-2007.

FIRST USE 7-6-2007; IN COMMERCE 7-6-2007.

JILL PRATER, EXAMINING ATTORNEY

**Int. Cl.: 41**

**Prior U.S. Cls.: 100, 101 and 107**

**United States Patent and Trademark Office**

**Reg. No. 3,467,587**

**Registered July 15, 2008**

**SERVICE MARK  
PRINCIPAL REGISTER**

# Lighting the Torch

GALVANIC COMMUNICATIONS, LLC (CALIFORNIA LTD LIAB CO)  
99 CLEVELAND ROAD #29  
PLEASANT HILL, CA 94523

FOR: EDUCATIONAL SERVICES, NAMELY, PROVIDING CLASSES, SEMINARS, WORKSHOPS, TRAININGS, PRACTICUMS AND MENTORSHIPS IN THE FIELDS OF HOLISTIC FINANCIAL LIFE PLANNING, IN CLASS 41 (U.S. CLS. 100, 101 AND 107).

FIRST USE 12-1-2007; IN COMMERCE 12-1-2007.

THE MARK CONSISTS OF STANDARD CHARACTERS WITHOUT CLAIM TO ANY PARTICULAR FONT, STYLE, SIZE, OR COLOR.

SER. NO. 77-341,893, FILED 12-1-2007.

JILL PRATER, EXAMINING ATTORNEY

**Int. Cl.: 11**

**Prior U.S. Cls.: 13, 21, 23, 31 and 34**

**United States Patent and Trademark Office**

**Reg. No. 3,467,588**

**Registered July 15, 2008**

**TRADEMARK  
PRINCIPAL REGISTER**

**ACAIR2000**

SALISBURY ELECTRICAL SAFETY, L.L.C. (DE-  
LAWARE LTD LIAB CO), DBA W.H. SALIS-  
BURY & CO.  
7520 NORTH LONG AVE.  
SKOKIE, IL 60077

THE MARK CONSISTS OF STANDARD CHAR-  
ACTERS WITHOUT CLAIM TO ANY PARTICULAR  
FONT, STYLE, SIZE, OR COLOR.

FOR: AIR-CONDITIONING, AIR COOLING AND  
VENTILATION APPARATUS AND INSTRUMENTS,  
IN CLASS 11 (U.S. CLS. 13, 21, 23, 31 AND 34).

SER. NO. 77-341,985, FILED 12-2-2007.

FIRST USE 12-1-2006; IN COMMERCE 1-1-2007.

ARETHA SOMERVILLE, EXAMINING ATTORNEY

**Int. Cl.: 11**

**Prior U.S. Cls.: 13, 21, 23, 31 and 34**

**United States Patent and Trademark Office**

**Reg. No. 3,467,589**

**Registered July 15, 2008**

**TRADEMARK  
PRINCIPAL REGISTER**

**ACAIR3000**

SALISBURY ELECTRICAL SAFETY, L.L.C. (DE-  
LAWARE LTD LIAB CO), DBA W.H. SALIS-  
BURY & CO.  
7520 NORTH LONG AVE.  
SKOKIE, IL 60077

THE MARK CONSISTS OF STANDARD CHAR-  
ACTERS WITHOUT CLAIM TO ANY PARTICULAR  
FONT, STYLE, SIZE, OR COLOR.

FOR: AIR-CONDITIONING, AIR COOLING AND  
VENTILATION APPARATUS AND INSTRUMENTS,  
IN CLASS 11 (U.S. CLS. 13, 21, 23, 31 AND 34).

SER. NO. 77-341,988, FILED 12-2-2007.

FIRST USE 12-1-2006; IN COMMERCE 2-11-2007.

ARETHA SOMERVILLE, EXAMINING ATTORNEY

**Int. Cl.: 38**

**Prior U.S. Cls.: 100, 101 and 104**

**United States Patent and Trademark Office**

**Reg. No. 3,467,590**

**Registered July 15, 2008**

**SERVICE MARK  
PRINCIPAL REGISTER**

**NTDTV**

UNIVERSAL COMMUNICATIONS NETWORK,  
INC. (NEW JERSEY CORPORATION), DBA  
NEW TANG DYNASTY TELEVISION  
SUITE #1200  
229 W. 28TH STREET  
NEW YORK, NY 10001

FOR: BROADCASTING OF TELEVISION PRO-  
GRAMMES; CABLE TELEVISION BROADCAST-  
ING; SATELLITE TELEVISION BROADCASTING;  
TELEVISION BROADCASTING; TELEVISION PRO-  
GRAMME BROADCASTING VIA CABLE; BROAD-  
CASTING PROGRAMS VIA A GLOBAL COMPUTER

NETWORK, IN CLASS 38 (U.S. CLS. 100, 101 AND  
104).

FIRST USE 2-1-2002; IN COMMERCE 2-1-2002.

THE MARK CONSISTS OF THE ENGLISH WORD  
"NTDTV" WITH "NTD" IN BOLD FONT.

SER. NO. 77-341,989, FILED 12-2-2007.

SHAILA SETTLES, EXAMINING ATTORNEY



**Int. Cl.: 9**

**Prior U.S. Cls.: 21, 23, 26, 36 and 38**

**Reg. No. 3,467,591**

**United States Patent and Trademark Office**

**Registered July 15, 2008**

**TRADEMARK  
PRINCIPAL REGISTER**

**SpeCLED**

SEMICONDUCTOR TECHNOLOGY RESEARCH,  
INC. (VIRGINIA CORPORATION)  
SUITE 108  
10404 PATTERSON AVE.  
RICHMOND, VA 23238

FOR: COMPUTER SOFTWARE FOR THREE-DI-  
MENSIONAL MODELING OF CURRENT SPREAD-  
ING AND TEMPERATURE DISTRIBUTION IN  
OPTOELECTRONIC DEVICES, NAMELY, LIGHT-  
EMITTING AND LASER DIODES, AND FOR OPTI-  
MIZATION OF THE CHIP LAYOUT, IN CLASS 9  
(U.S. CLS. 21, 23, 26, 36 AND 38).

FIRST USE 7-1-2005; IN COMMERCE 3-1-2006.

THE MARK CONSISTS OF STANDARD CHAR-  
ACTERS WITHOUT CLAIM TO ANY PARTICULAR  
FONT, STYLE, SIZE, OR COLOR.

SER. NO. 77-342,028, FILED 12-2-2007.

SUE LAWRENCE, EXAMINING ATTORNEY

**Int. Cl.: 9**

**Prior U.S. Cls.: 21, 23, 26, 36 and 38**

**Reg. No. 3,467,592**

**United States Patent and Trademark Office**

**Registered July 15, 2008**

---

**TRADEMARK  
PRINCIPAL REGISTER**

**RATRO**

SEMICONDUCTOR TECHNOLOGY RESEARCH,  
INC. (VIRGINIA CORPORATION)  
SUITE 108  
10404 PATTERSON AVE.  
RICHMOND, VA 23238

FOR: COMPUTER SOFTWARE FOR THREE-DI-  
MENSIONAL MODELING OF LIGHT EXTRAC-  
TION FROM LIGHT-EMITTING DIODES, IN  
CLASS 9 (U.S. CLS. 21, 23, 26, 36 AND 38).

FIRST USE 2-1-2005; IN COMMERCE 4-1-2006.

THE MARK CONSISTS OF STANDARD CHAR-  
ACTERS WITHOUT CLAIM TO ANY PARTICULAR  
FONT, STYLE, SIZE, OR COLOR.

SER. NO. 77-342,041, FILED 12-2-2007.

SUE LAWRENCE, EXAMINING ATTORNEY

**Int. Cl.: 35**

**Prior U.S. Cls.: 100, 101 and 102**

**United States Patent and Trademark Office**

**Reg. No. 3,467,593**

**Registered July 15, 2008**

**SERVICE MARK  
PRINCIPAL REGISTER**

**LONG LIVE HEALTH**

PALISADES COMPOUNDING PHARMACY, INC.  
(CALIFORNIA CORPORATION)  
540 PALISADES DRIVE  
PACIFIC PALISADES, CA 90272

THE MARK CONSISTS OF STANDARD CHAR-  
ACTERS WITHOUT CLAIM TO ANY PARTICULAR  
FONT, STYLE, SIZE, OR COLOR.

FOR: RETAIL PHARMACY SERVICES, IN CLASS  
35 (U.S. CLS. 100, 101 AND 102).

SER. NO. 77-342,052, FILED 12-2-2007.

FIRST USE 11-20-2007; IN COMMERCE 11-20-2007.

IRA J. GOODSaid, EXAMINING ATTORNEY

**Int. Cl.: 5**

**Prior U.S. Cls.: 6, 18, 44, 46, 51 and 52**

**United States Patent and Trademark Office**

**Reg. No. 3,467,594**

**Registered July 15, 2008**

**TRADEMARK  
PRINCIPAL REGISTER**

**ISOPTHOR**

ENSYSTEX, INC. (NORTH CAROLINA CORPORATION)  
2713 BREEZEWOOD AVENUE  
FAYETTEVILLE, NC 28303

FOR: PESTICIDES, INSECTICIDES, TERMITICIDES, HERBICIDES, FUNGICIDES, ALGAECIDES, AND PARASITICIDES FOR HOME, GARDEN, LAWN AND PROFESSIONAL USE IN PREPARATIONS FOR KILLING WEEDS AND DESTROYING VERMIN, IN CLASS 5 (U.S. CLS. 6, 18, 44, 46, 51 AND 52).

FIRST USE 9-15-2003; IN COMMERCE 6-1-2007.

THE MARK CONSISTS OF STANDARD CHARACTERS WITHOUT CLAIM TO ANY PARTICULAR FONT, STYLE, SIZE, OR COLOR.

SER. NO. 77-342,169, FILED 12-3-2007.

CAROLYN CATALDO, EXAMINING ATTORNEY

**Int. Cl.: 36**

**Prior U.S. Cls.: 100, 101 and 102**

**United States Patent and Trademark Office**

**Reg. No. 3,467,595**

**Registered July 15, 2008**

**SERVICE MARK  
PRINCIPAL REGISTER**

**CAN'T WE ALL JUST GET A  
LOAN?**

PALISADES CAPITAL, LLC (NEVADA LTD LIAB  
CO)

1919 S. LA CIENEGA BLVD.

LOS ANGELES, CA 90034

FOR: LOAN FINANCING, IN CLASS 36 (U.S. CLS.  
100, 101 AND 102).

FIRST USE 11-13-2007; IN COMMERCE 11-13-2007.

THE MARK CONSISTS OF STANDARD CHAR-  
ACTERS WITHOUT CLAIM TO ANY PARTICULAR  
FONT, STYLE, SIZE, OR COLOR.

NO CLAIM IS MADE TO THE EXCLUSIVE  
RIGHT TO USE "LOAN", APART FROM THE  
MARK AS SHOWN.

SER. NO. 77-342,216, FILED 12-3-2007.

JUDITH HELFMAN, EXAMINING ATTORNEY

**Int. Cl.: 6**

**Prior U.S. Cls.: 2, 12, 13, 14, 23, 25 and 50**

**Reg. No. 3,467,596**

**United States Patent and Trademark Office**

**Registered July 15, 2008**

**TRADEMARK  
PRINCIPAL REGISTER**

**NEWGARD**

SUNICO GROUP INC. (CALIFORNIA CORPORATION)  
583 W. EXPLORER ST.  
BREA, CA 92821

FOR: DOOR HARDWARE, NAMELY, KEYS AND KEY CYLINDERS; METAL DOOR BOLTS; METAL LOCKS, IN CLASS 6 (U.S. CLS. 2, 12, 13, 14, 23, 25 AND 50).

FIRST USE 5-0-2007; IN COMMERCE 5-0-2007.

THE MARK CONSISTS OF STANDARD CHARACTERS WITHOUT CLAIM TO ANY PARTICULAR FONT, STYLE, SIZE, OR COLOR.

OWNER OF U.S. REG. NO. 1,964,528.

SER. NO. 77-342,363, FILED 12-3-2007.

RONALD AIKENS, EXAMINING ATTORNEY

**Int. Cl.: 36**

**Prior U.S. Cls.: 100, 101 and 102**

**United States Patent and Trademark Office**

**Reg. No. 3,467,597**

**Registered July 15, 2008**

**SERVICE MARK  
PRINCIPAL REGISTER**

**Better people. Better  
service. Better bank.**

FIRST NEIGHBORHOOD BANK, INC. (WEST  
VIRGINIA CORPORATION)  
216 MARKET STREET  
SPENCER, WV 25276

THE MARK CONSISTS OF STANDARD CHAR-  
ACTERS WITHOUT CLAIM TO ANY PARTICULAR  
FONT, STYLE, SIZE, OR COLOR.

FOR: BANKING AND FINANCING SERVICES,  
IN CLASS 36 (U.S. CLS. 100, 101 AND 102).

SER. NO. 77-342,384, FILED 12-3-2007.

FIRST USE 10-4-2007; IN COMMERCE 10-4-2007.

RONALD AIKENS, EXAMINING ATTORNEY

**Int. Cl.: 41**

**Prior U.S. Cls.: 100, 101 and 107**

**United States Patent and Trademark Office**

**Reg. No. 3,467,598**

**Registered July 15, 2008**

**SERVICE MARK  
PRINCIPAL REGISTER**

**LIVES OF SIGNIFICANCE AND  
SERVICE**

NORTH PARK UNIVERSITY (ILLINOIS CORPORATION)  
3225 WEST FOSTER AVENUE  
CHICAGO, IL 60625

FOR: EDUCATIONAL SERVICES, NAMELY, PROVIDING COURSES OF INSTRUCTION AT THE UNDERGRADUATE, GRADUATE, DOCTORAL AND CONTINUING EDUCATION LEVELS IN A WIDE VARIETY OF FIELDS; ENTERTAINMENT SERVICES, NAMELY, ARRANGING AND CONDUCTING ATHLETIC AND SPORTS EVENTS AND COMPETITIONS, PUBLIC SPEAKING EVENTS AND VISUAL, LITERARY AND PERFORMING ARTS PRESENTATIONS INCLUDING MUSICAL, SPORTS, DANCE AND THEATRICAL PERFOR-

MANCES; AND RECREATION SERVICES IN THE NATURE OF PROVIDING SWIMMING POOLS, TENNIS COURTS, BASKETBALL COURTS, FOOTBALL STADIUMS AND EXERCISE FACILITIES, IN CLASS 41 (U.S. CLS. 100, 101 AND 107).

FIRST USE 8-0-1997; IN COMMERCE 8-0-1997.

THE MARK CONSISTS OF STANDARD CHARACTERS WITHOUT CLAIM TO ANY PARTICULAR FONT, STYLE, SIZE, OR COLOR.

SER. NO. 77-342,407, FILED 12-3-2007.

RONALD AIKENS, EXAMINING ATTORNEY



**Int. Cl.: 41**

**Prior U.S. Cls.: 100, 101 and 107**

**United States Patent and Trademark Office**

**Reg. No. 3,467,599**

**Registered July 15, 2008**

**SERVICE MARK  
PRINCIPAL REGISTER**

# Water Ski

WORLD PUBLICATIONS, LLC (DELAWARE LTD  
LIAB CO)  
460 N. ORLANDO AVENUE, SUITE 200  
WINTER PARK, FL 32789

FOR: PROVIDING ONLINE PUBLICATIONS,  
NAMELY, MAGAZINES IN THE FIELD OF WATER  
SKIING, IN CLASS 41 (U.S. CLS. 100, 101 AND 107).

FIRST USE 11-0-1998; IN COMMERCE 11-0-1998.

THE MARK CONSISTS OF STANDARD CHAR-  
ACTERS WITHOUT CLAIM TO ANY PARTICULAR  
FONT, STYLE, SIZE, OR COLOR.

OWNER OF U.S. REG. NO. 1,882,124.

SEC. 2(F).

SER. NO. 77-342,490, FILED 12-3-2007.

ROBIN CHOSID, EXAMINING ATTORNEY

**Int. Cl.: 35**

**Prior U.S. Cls.: 100, 101 and 102**

**United States Patent and Trademark Office**

**Reg. No. 3,467,600**

**Registered July 15, 2008**

**SERVICE MARK  
PRINCIPAL REGISTER**

**Creating Demand.  
Delivering Talent.  
Changing Lives.**

NAS RECRUITMENT COMMUNICATIONS, LLC  
(OHIO LTD LIAB CO)  
ONE INFINITY CORPORATE CENTRE DRIVE  
CLEVELAND, OH 44125

THE MARK CONSISTS OF STANDARD CHAR-  
ACTERS WITHOUT CLAIM TO ANY PARTICULAR  
FONT, STYLE, SIZE, OR COLOR.

FOR: RECRUITMENT ADVERTISING AGENCY  
SERVICES, IN CLASS 35 (U.S. CLS. 100, 101 AND 102).

SER. NO. 77-342,527, FILED 12-3-2007.

FIRST USE 10-23-2007; IN COMMERCE 10-23-2007.

MICHAEL KEATING, EXAMINING ATTORNEY

**Int. Cls.: 35 and 36**

**Prior U.S. Cls.: 100, 101 and 102**

**United States Patent and Trademark Office**

**Reg. No. 3,467,601**

**Registered July 15, 2008**

**SERVICE MARK  
PRINCIPAL REGISTER**

**ADC**

ASSOCIATED DISCOUNT CLUBS OF AMERICA,  
LLC (UTAH LTD LIAB CO)  
3652 SOUTH 425 WEST  
BOUNTIFUL, UT 84010

FOR: BUYING CLUBS AND PROMOTING THE  
GOODS AND SERVICES OF OTHERS THROUGH  
THE DISTRIBUTION OF DISCOUNT CARDS, IN  
CLASS 35 (U.S. CLS. 100, 101 AND 102).

FIRST USE 7-20-2006; IN COMMERCE 7-20-2006.

FOR: PROVIDING REBATES AT PARTICIPAT-  
ING ESTABLISHMENTS OF OTHERS THROUGH

USE OF A MEMBERSHIP CARD, IN CLASS 36 (U.S.  
CLS. 100, 101 AND 102).

FIRST USE 7-20-2006; IN COMMERCE 7-20-2006.

THE MARK CONSISTS OF STANDARD CHAR-  
ACTERS WITHOUT CLAIM TO ANY PARTICULAR  
FONT, STYLE, SIZE, OR COLOR.

SER. NO. 77-342,540, FILED 12-3-2007.

ANTHONY RINKER, EXAMINING ATTORNEY

**Int. Cls.: 35 and 42**

**Prior U.S. Cls.: 100, 101 and 102**

**United States Patent and Trademark Office**

**Reg. No. 3,467,602**

**Registered July 15, 2008**

**SERVICE MARK  
PRINCIPAL REGISTER**

# HostBaby

MUSICBABY LLC (WYOMING LTD LIAB CO)  
2710 THOMES AVE  
CHEYENNE, WY 820013029

FOR: PROMOTING THE GOODS AND SERVICES OF OTHERS BY PROVIDING HYPERTEXT LINKS TO THE WEB SITES OF OTHERS, IN CLASS 35 (U.S. CLS. 100, 101 AND 102).

FIRST USE 11-15-1999; IN COMMERCE 11-15-1999.

FOR: DESIGN, CREATION, HOSTING, MAINTENANCE OF WEBSITES FOR OTHERS; TECHNOL-

OGY ADVICE PROVIDED TO INTERNET USERS BY MEANS OF A SUPPORT HOTLINE, IN CLASS 42 (U.S. CLS. 100 AND 101).

FIRST USE 11-15-1999; IN COMMERCE 11-15-1999.

THE MARK CONSISTS OF STANDARD CHARACTERS WITHOUT CLAIM TO ANY PARTICULAR FONT, STYLE, SIZE, OR COLOR.

SER. NO. 77-342,570, FILED 12-3-2007.

ELIZABETH HUGHITT, EXAMINING ATTORNEY

**Int. Cl.: 19**

**Prior U.S. Cls.: 1, 12, 33 and 50**

**Reg. No. 3,467,603**

**United States Patent and Trademark Office**

**Registered July 15, 2008**

**TRADEMARK  
PRINCIPAL REGISTER**

# Songgo Ritty

SONGGO RITTY LUMBER PRODUCTS (CANADA), INC. (CANADA CORPORATION)  
1538 BOUL DES CHENAUX  
TOIS RIVIERES, CANADA G9A1A1

FOR: BAMBOO FLOORING; CHEMICALLY TREATED WOOD, NAMELY, WOOD BEAMS, WOOD BOARDS, WOOD JOISTS, WOOD RAFTERS, WOOD SIDING, WOOD TILE FLOORS AND FLOORING, WOOD TRIM, WOODEN BEAMS, WOODEN FLOORING, WOODEN AILINGS, AND WOODEN WAINSCOTING, ALL OF THE ABOVE CONTAINING A FIRE RETARDANT CHEMICAL; FLOOR BOARDS; FLOOR TILES OF WOOD; FLOORING UNDERLAYMENT MADE OF CORK; FLOORING UNDERLAYMENTS; LAMINATE FLOORING; PARQUET FLOOR BOARDS; PAR-

QUET FLOORING; PARQUET FLOORING AND PARQUET SLABS; PARQUET FLOORING MADE OF WOOD; PARQUET FLOORING OF WOOD; PARQUET WOOD FLOORING; VENEER FOR FLOORS; WOOD TILE FLOORS; WOODEN FLOORING, IN CLASS 19 (U.S. CLS. 1, 12, 33 AND 50).

FIRST USE 1-1-2000; IN COMMERCE 1-1-2000.

THE MARK CONSISTS OF STANDARD CHARACTERS WITHOUT CLAIM TO ANY PARTICULAR FONT, STYLE, SIZE, OR COLOR.

SER. NO. 77-342,602, FILED 12-3-2007.

KATINA MISTER, EXAMINING ATTORNEY

**Int. Cl.: 41**

**Prior U.S. Cls.: 100, 101 and 107**

**United States Patent and Trademark Office**

**Reg. No. 3,467,604**

**Registered July 15, 2008**

**SERVICE MARK  
PRINCIPAL REGISTER**

**Resorts & Great Hotels**

WORLD PUBLICATIONS, LLC (DELAWARE LTD  
LIAB CO)  
460 N. ORLANDO AVENUE, SUITE 200  
WINTER PARK, FL 32789

FOR: PROVIDING ONLINE PUBLICATIONS,  
NAMELY, MAGAZINES IN THE FIELDS OF GEN-  
ERAL INTEREST TOPICS IN THE FIELDS OF  
RESORTS, HOTELS AND TRAVEL , IN CLASS 41  
(U.S. CLS. 100, 101 AND 107).

FIRST USE 2-0-1998; IN COMMERCE 2-0-1998.

THE MARK CONSISTS OF STANDARD CHAR-  
ACTERS WITHOUT CLAIM TO ANY PARTICULAR  
FONT, STYLE, SIZE, OR COLOR.

OWNER OF U.S. REG. NO. 3,201,063.

SEC. 2(F).

SER. NO. 77-342,617, FILED 12-3-2007.

ROBIN CHOSID, EXAMINING ATTORNEY

**Int. Cl.: 35**

**Prior U.S. Cls.: 100, 101 and 102**

**United States Patent and Trademark Office**

**Reg. No. 3,467,605**

**Registered July 15, 2008**

**SERVICE MARK  
PRINCIPAL REGISTER**

# PromoBaby

MUSICBABY LLC (WYOMING LTD LIAB CO)  
2710 THOMES AVE  
CHEYENNE, WY 820013029

FOR: ADVERTISING SERVICES, PUBLIC RELATIONS AND MARKETING SERVICES, NAMELY, PROMOTING AND MARKETING THE GOODS AND SERVICES OF OTHERS THROUGH ALL PUBLIC COMMUNICATION MEANS; MANAGEMENT AND COMPILATION OF COMPUTERISED DATABASES; PROMOTING THE GOODS AND SERVICES OF OTHERS THROUGH SEARCH ENGINE REFERRAL TRAFFIC ANALYSIS AND REPORTING; PROMOTING, ADVERTISING AND MARKETING OF

THE ON-LINE WEBSITES OF OTHERS; PROMOTION AND MARKETING SERVICES AND RELATED CONSULTING, IN CLASS 35 (U.S. CLS. 100, 101 AND 102).

FIRST USE 9-23-2007; IN COMMERCE 9-23-2007.

THE MARK CONSISTS OF STANDARD CHARACTERS WITHOUT CLAIM TO ANY PARTICULAR FONT, STYLE, SIZE, OR COLOR.

SER. NO. 77-342,633, FILED 12-3-2007.

ELIZABETH HUGHITT, EXAMINING ATTORNEY

**Int. Cl.: 20**

**Prior U.S. Cls.: 2, 13, 22, 25, 32 and 50**

**United States Patent and Trademark Office**

**Reg. No. 3,467,606**

**Registered July 15, 2008**

**TRADEMARK  
PRINCIPAL REGISTER**

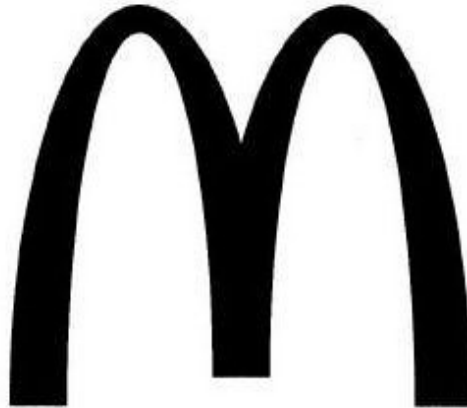

**MCDONALD'S CORPORATION (DELAWARE  
CORPORATION)  
ONE MCDONALD'S PLAZA  
OAK BROOK, IL 60523**

**THE MARK CONSISTS OF ARCHES.**

**FOR: DRINKING STRAWS, IN CLASS 20 (U.S.  
CLS. 2, 13, 22, 25, 32 AND 50).**

**SER. NO. 77-342,651, FILED 12-3-2007.**

**FIRST USE 12-30-1991; IN COMMERCE 12-30-1991.**

**HOWARD SMIGA, EXAMINING ATTORNEY**



**Int. Cl.: 36**

**Prior U.S. Cls.: 100, 101 and 102**

**United States Patent and Trademark Office**

**Reg. No. 3,467,607**

**Registered July 15, 2008**

**SERVICE MARK  
PRINCIPAL REGISTER**

**RIVER GIVER**

THOMAS, DENISE (UNITED STATES INDIVIDUAL)  
604 MATHIS ROAD  
JACKSONVILLE, FL 32211

THE MARK CONSISTS OF STANDARD CHARACTERS WITHOUT CLAIM TO ANY PARTICULAR FONT, STYLE, SIZE, OR COLOR.

FOR: CHARITABLE FUND RAISING, IN CLASS 36 (U.S. CLS. 100, 101 AND 102).

SER. NO. 77-342,653, FILED 12-3-2007.

FIRST USE 4-20-2007; IN COMMERCE 4-20-2007.

ALICIA COLLINS, EXAMINING ATTORNEY

**Int. Cl.: 28**

**Prior U.S. Cls.: 22, 23, 38 and 50**

**United States Patent and Trademark Office**

**Reg. No. 3,467,608**

**Registered July 15, 2008**

---

**TRADEMARK  
PRINCIPAL REGISTER**

**Big Hitter**

UNIQUE SPORTS PRODUCTS INC. (GEORGIA  
CORPORATION)  
840 MCFARLAND PARKWAY  
ALPHARETTA, GA 30004

THE MARK CONSISTS OF STANDARD CHAR-  
ACTERS WITHOUT CLAIM TO ANY PARTICULAR  
FONT, STYLE, SIZE, OR COLOR.

FOR: TENNIS RACKET STRINGS, IN CLASS 28  
(U.S. CLS. 22, 23, 38 AND 50).

SER. NO. 77-342,661, FILED 12-3-2007.

FIRST USE 10-1-2005; IN COMMERCE 1-1-2006.

LINDA M. KING, EXAMINING ATTORNEY

**Int. Cl.: 16**

**Prior U.S. Cls.: 2, 5, 22, 23, 29, 37, 38 and 50**

**Reg. No. 3,467,609**

**United States Patent and Trademark Office**

**Registered July 15, 2008**

---

**TRADEMARK  
PRINCIPAL REGISTER**

**STRIKEFORCE**

ISKA ENTERTAINMENT COMPANY (FLORIDA  
CORPORATION)  
SUITE D  
5000 NW 27TH COURT  
GAINSVILLE, FL 32606

FIRST USE 6-30-1995; IN COMMERCE 6-30-1995.

THE MARK CONSISTS OF STANDARD CHAR-  
ACTERS WITHOUT CLAIM TO ANY PARTICULAR  
FONT, STYLE, SIZE, OR COLOR.

FOR: PRINTED MATERIALS, NAMELY, EVENT  
AND COMPETITION PROGRAMS, POSTERS AND  
PENS, ALL RELATED TO MARTIAL ARTS EVENTS  
AND COMPETITIONS , IN CLASS 16 (U.S. CLS. 2, 5,  
22, 23, 29, 37, 38 AND 50).

SER. NO. 77-342,673, FILED 12-3-2007.

KATHRYN COWARD, EXAMINING ATTORNEY

**Int. Cls.: 30 and 43**

**Prior U.S. Cls.: 46, 100 and 101**

**United States Patent and Trademark Office**

**Reg. No. 3,467,610**

**Registered July 15, 2008**

**TRADEMARK  
SERVICE MARK  
PRINCIPAL REGISTER**

**TAPEX**

TAPIOCA EXPRESS INC. (CALIFORNIA CORPORATION)  
SUITE 105  
228 W VALLEY BLVD  
ALHAMBRA, CA 91801

FOR: COFFEE-BASED BEVERAGE CONTAINING MILK; PREPARED COFFEE AND COFFEE-BASED BEVERAGES; MIXES IN THE NATURE OF CONCENTRATES, SYRUPS OR POWDERS USED IN THE PREPARATION OF TEA BASED BEVERAGES; TEA-BASED BEVERAGES WITH FRUIT FLAVORING; FROZEN YOGURT; FROZEN YOGURT MIXES, IN CLASS 30 (U.S. CL. 46).

FIRST USE 8-13-2007; IN COMMERCE 8-13-2007.

FOR: CAFE-RESTAURANTS; PROVISION OF FOOD AND DRINK IN RESTAURANTS; RESTAURANT AND BAR SERVICES, IN CLASS 43 (U.S. CLS. 100 AND 101).

FIRST USE 8-13-2007; IN COMMERCE 8-13-2007.

THE MARK CONSISTS OF STANDARD CHARACTERS WITHOUT CLAIM TO ANY PARTICULAR FONT, STYLE, SIZE, OR COLOR.

SER. NO. 77-342,674, FILED 12-3-2007.

BILL DAWE, EXAMINING ATTORNEY

**Int. Cl.: 16**

**Prior U.S. Cls.: 2, 5, 22, 23, 29, 37, 38 and 50**

**United States Patent and Trademark Office**

**Reg. No. 3,467,611**

**Registered July 15, 2008**

**TRADEMARK  
PRINCIPAL REGISTER**

**7242**

FELLOWES, INC. (ILLINOIS CORPORATION)  
1789 NORWOOD AVENUE  
ITASCA, IL 60143

THE MARK CONSISTS OF STANDARD CHAR-  
ACTERS WITHOUT CLAIM TO ANY PARTICULAR  
FONT, STYLE, SIZE, OR COLOR.

FOR: CORRUGATED RECORD STORAGE  
BOXES, IN CLASS 16 (U.S. CLS. 2, 5, 22, 23, 29, 37, 38  
AND 50).

SER. NO. 77-342,760, FILED 12-3-2007.

FIRST USE 5-15-1999; IN COMMERCE 5-15-1999.

DAVID COLLIER, EXAMINING ATTORNEY

**Int. Cl.: 16**

**Prior U.S. Cls.: 2, 5, 22, 23, 29, 37, 38 and 50**

**United States Patent and Trademark Office**

**Reg. No. 3,467,612**

**Registered July 15, 2008**

**TRADEMARK  
PRINCIPAL REGISTER**

**7243**

FELLOWES, INC. (ILLINOIS CORPORATION)  
1789 NORWOOD AVENUE  
ITASCA, IL 60143

THE MARK CONSISTS OF STANDARD CHAR-  
ACTERS WITHOUT CLAIM TO ANY PARTICULAR  
FONT, STYLE, SIZE, OR COLOR.

FOR: CORRUGATED RECORD STORAGE  
BOXES, IN CLASS 16 (U.S. CLS. 2, 5, 22, 23, 29, 37, 38  
AND 50).

SER. NO. 77-342,794, FILED 12-3-2007.

FIRST USE 6-1-1998; IN COMMERCE 6-1-1998.

DAVID COLLIER, EXAMINING ATTORNEY

**Int. Cl.: 19**

**Prior U.S. Cls.: 1, 12, 33 and 50**

**United States Patent and Trademark Office**

**Reg. No. 3,467,613**

**Registered July 15, 2008**

**TRADEMARK  
PRINCIPAL REGISTER**

**TIARA**

DORIC PRODUCTS, INC. (INDIANA CORPORATION)  
P.O. BOX 10  
MARSHALL, IL 62441

THE MARK CONSISTS OF STANDARD CHARACTERS WITHOUT CLAIM TO ANY PARTICULAR FONT, STYLE, SIZE, OR COLOR.

FOR: BURIAL VAULTS MADE OF NON-METAL,  
IN CLASS 19 (U.S. CLS. 1, 12, 33 AND 50).

SER. NO. 77-342,797, FILED 12-3-2007.

FIRST USE 9-0-1983; IN COMMERCE 9-0-1983.

JENNIFER MARTIN, EXAMINING ATTORNEY

**Int. Cls.: 35, 39 and 42**

**Prior U.S. Cls.: 100, 101, 102 and 105**

**United States Patent and Trademark Office**

**Reg. No. 3,467,614**

**Registered July 15, 2008**

**SERVICE MARK  
PRINCIPAL REGISTER**

# MusicBaby

MUSICBABY LLC (WYOMING LTD LIAB CO)  
2710 THOMES AVE  
CHEYENNE, WY 820013029

FOR: PERSONAL MANAGEMENT SERVICES FOR MUSICAL PERFORMERS; PROVIDING A WEBSITE THAT FEATURES AN ONLINE MARKET FOR USERS TO LIST OFFERED OR WANTED PERSONAL AND BUSINESS ASSETS AND SKILLS FOR HIRE, RENT, SALE OR AUCTION TRANSACTED ON THE BASIS OF PREDEFINED PERFORMANCE AND CLOSING TERMS AND CONDITIONS; MANAGEMENT AND COMPILATION OF COMPUTERIZED DATABASES; PROMOTION AND MARKETING SERVICES AND RELATED CONSULTING; ON-LINE RETAIL STORE SERVICES FEATURING DOWNLOADABLE PRE-RECORDED MUSIC AND VIDEO, IN CLASS 35 (U.S. CLS. 100, 101 AND 102).

FIRST USE 11-21-2007; IN COMMERCE 11-21-2007.

FOR: DISTRIBUTION SERVICES, NAMELY, DELIVERY OF PRERECORDED MUSIC AND AUDIOVISUAL ITEMS; WAREHOUSING SERVICES,

NAMELY, STORAGE, DISTRIBUTION, PICK-UP, PACKING, AND SHIPPING OF PRERECORDED MUSIC AND AUDIOVISUAL ITEMS, IN CLASS 39 (U.S. CLS. 100 AND 105).

FIRST USE 11-21-2007; IN COMMERCE 11-21-2007.

FOR: DESIGN, CREATION, HOSTING, MAINTENANCE OF WEBSITES FOR OTHERS; COMPUTER SERVICES, NAMELY, DIGITAL FORMATTING AND COMPRESSION OF MUSIC AND IMAGES, NAMELY, PROCESSING OF DIGITAL MUSIC AND VIDEO IMAGES INTO DOWNLOADABLE PRODUCTS, IN CLASS 42 (U.S. CLS. 100 AND 101).

FIRST USE 11-21-2007; IN COMMERCE 11-21-2007.

THE MARK CONSISTS OF STANDARD CHARACTERS WITHOUT CLAIM TO ANY PARTICULAR FONT, STYLE, SIZE, OR COLOR.

SER. NO. 77-342,799, FILED 12-3-2007.

ELIZABETH HUGHITT, EXAMINING ATTORNEY



**Int. Cl.: 14**

**Prior U.S. Cls.: 2, 27, 28 and 50**

**United States Patent and Trademark Office**

**Reg. No. 3,467,615**

**Registered July 15, 2008**

**TRADEMARK  
PRINCIPAL REGISTER**

**ANDROID**

OKO INTERNATIONAL CO. (FLORIDA CORPORATION)  
336 POWERLINE ROAD  
DEERFIELD BEACH, FL 33442

FOR: TIMEPIECES, WATCHES AND WATCH BANDS, IN CLASS 14 (U.S. CLS. 2, 27, 28 AND 50).

FIRST USE 11-1-1994; IN COMMERCE 12-1-1994.

THE MARK CONSISTS OF STANDARD CHARACTERS WITHOUT CLAIM TO ANY PARTICULAR FONT, STYLE, SIZE, OR COLOR.

OWNER OF U.S. REG. NO. 3,079,247.

SER. NO. 77-342,820, FILED 12-3-2007.

DANIEL CAPSHAW, EXAMINING ATTORNEY

**Int. Cl.: 25**

**Prior U.S. Cls.: 22 and 39**

**United States Patent and Trademark Office**

**Reg. No. 3,467,616**

**Registered July 15, 2008**

**TRADEMARK  
PRINCIPAL REGISTER**



LAXWEAR, LLC (OHIO LTD LIAB CO)  
4219 HARRISON AVENUE  
CINCINNATI, OH 45211

THE MARK CONSISTS OF A SILHOUETTE OF A  
RUNNING LACROSSE PLAYER, WITH A BALL IN  
HIS STICK, AND READY TO PASS OR SHOOT.

FOR: POLO SHIRTS; PULLOVERS; SWEAT  
SHIRTS; T-SHIRTS, IN CLASS 25 (U.S. CLS. 22 AND  
39).

SER. NO. 77-342,842, FILED 12-3-2007.

FIRST USE 8-1-2007; IN COMMERCE 10-1-2007.

STEVEN JACKSON, EXAMINING ATTORNEY

**Int. Cl.: 35**

**Prior U.S. Cls.: 100, 101 and 102**

**United States Patent and Trademark Office**

**Reg. No. 3,467,617**

**Registered July 15, 2008**

**SERVICE MARK  
PRINCIPAL REGISTER**

**Temptation In Every Bite**

FANCY FOODS SOUTH ORANGE, LLC (NEW  
JERSEY LTD LIAB CO)  
420 A NYC TERMINAL MARKET  
BRONX, NY 10474

THE MARK CONSISTS OF STANDARD CHAR-  
ACTERS WITHOUT CLAIM TO ANY PARTICULAR  
FONT, STYLE, SIZE, OR COLOR.

FOR: RETAIL STORE SERVICES FEATURING A  
WIDE VARIETY OF CONSUMER GOODS OF OTH-  
ERS, IN CLASS 35 (U.S. CLS. 100, 101 AND 102).

SER. NO. 77-342,862, FILED 12-3-2007.

FIRST USE 11-1-2007; IN COMMERCE 11-1-2007.

REBECCA GILBERT, EXAMINING ATTORNEY

**Int. Cl.: 9**

**Prior U.S. Cls.: 21, 23, 26, 36 and 38**

**Reg. No. 3,467,618**

**United States Patent and Trademark Office**

**Registered July 15, 2008**

---

**TRADEMARK  
PRINCIPAL REGISTER**

# Laser Valet

SCARAB TECHNOLOGIES, LLC (TEXAS LTD  
LIAB CO)  
6423 TURNER WAY  
DALLAS, TX 75230

THE MARK CONSISTS OF STANDARD CHAR-  
ACTERS WITHOUT CLAIM TO ANY PARTICULAR  
FONT, STYLE, SIZE, OR COLOR.

FOR: ELECTRONIC NAVIGATIONAL AND PO-  
SITIONING APPARATUS AND INSTRUMENTS, IN  
CLASS 9 (U.S. CLS. 21, 23, 26, 36 AND 38).

SER. NO. 77-342,880, FILED 12-3-2007.

FIRST USE 6-4-1994; IN COMMERCE 1-23-1995.

SAIMA MAKHDOOM, EXAMINING ATTORNEY

**Int. Cl.: 41**

**Prior U.S. Cls.: 100, 101 and 107**

**United States Patent and Trademark Office**

**Reg. No. 3,467,619**

**Registered July 15, 2008**

**SERVICE MARK  
PRINCIPAL REGISTER**

**WE LIVE FOR MUSIC**

ZENBU MEDIA LLC (DELAWARE LTD LIAB  
CO)  
11TH FLOOR  
104 WEST 29TH STREET  
NEW YORK, NY 10022

FOR: MULTIMEDIA PUBLISHING OF MAGAZINES, ELECTRONIC MEDIA, MUSIC, VIDEO, SOFTWARE AND BOOKS; ENTERTAINMENT, NAMELY, LIVE MUSIC, ART AND CULTURAL CONCERTS AND EVENTS, IN CLASS 41 (U.S. CLS. 100, 101 AND 107).

FIRST USE 9-11-2007; IN COMMERCE 9-11-2007.

THE MARK CONSISTS OF STANDARD CHARACTERS WITHOUT CLAIM TO ANY PARTICULAR FONT, STYLE, SIZE, OR COLOR.

SER. NO. 77-342,934, FILED 12-3-2007.

CURTIS FRENCH, EXAMINING ATTORNEY

**Int. Cl.: 39**

**Prior U.S. Cls.: 100 and 105**

**United States Patent and Trademark Office**

**Reg. No. 3,467,620**

**Registered July 15, 2008**

**SERVICE MARK  
PRINCIPAL REGISTER**



MADISON GAS AND ELECTRIC COMPANY  
(WISCONSIN CORPORATION)  
P.O. BOX 1231  
MADISON, WI 537011231

THE MARK CONSISTS OF A LIGHTBULB, PART OF WHICH IS A LEAF, AND THE WORDS "GREEN POWER TOMORROW" AND "CHOOSE RENEWABLE ENERGY TODAY".

FOR: PUBLIC UTILITY SERVICES IN THE NATURE OF RENEWABLE ENERGY DISTRIBUTION, IN CLASS 39 (U.S. CLS. 100 AND 105).

SER. NO. 77-342,942, FILED 12-3-2007.

FIRST USE 11-30-2007; IN COMMERCE 11-30-2007.

OWNER OF U.S. REG. NO. 3,217,797.

JAMES LOVELACE, EXAMINING ATTORNEY

**Int. Cl.: 9**

**Prior U.S. Cls.: 21, 23, 26, 36 and 38**

**Reg. No. 3,467,621**

**United States Patent and Trademark Office**

**Registered July 15, 2008**

**TRADEMARK  
PRINCIPAL REGISTER**



TRUE VISION INC (INDIANA CORPORATION)  
1601 E 53RD STREET - STE 3  
ANDERSON, IN 46013

FOR: AUDIO SPEAKERS, IN CLASS 9 (U.S. CLS.  
21, 23, 26, 36 AND 38).

FIRST USE 10-14-2003; IN COMMERCE 10-14-2003.

THE MARK CONSISTS OF A SERIES OF THREE  
INTERCONNECTED BLOCK LETTERS "TVI" WITH  
AN AUDIO SPEAKER DESIGN TO THE LEFT OF

THE THREE LETTERS. THE LETTERS AND SPEAK-  
ER DESIGN ARE ON A RECTANGULAR BACK-  
GROUND WITH THE CORNERS CUT AT SMALL 45  
DEGREE ANGLES TO PRODUCE AN IRREGULAR  
OCTAGON. THE "TVI" LETTERS AND SPEAKER  
DESIGN ARE SURROUNDED BY A THIN LINE  
NEAR THE EDGE OF THE BACKGROUND.

SER. NO. 77-342,946, FILED 12-3-2007.

JAMES LOVELACE, EXAMINING ATTORNEY

**Int. Cl.: 43**

**Prior U.S. Cls.: 100 and 101**

**United States Patent and Trademark Office**

**Reg. No. 3,467,622**

**Registered July 15, 2008**

**SERVICE MARK  
PRINCIPAL REGISTER**

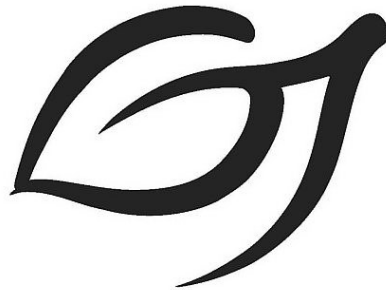

GREEN TRUCK, LLC (CALIFORNIA LTD LIAB  
CO)  
3515 HELMS AVE.  
CULVER CITY, CA 90232

THE MARK CONSISTS OF A STYLIZED DRAW-  
ING OF A LEAF FORMED BY THE LETTERS "GT".

FOR: CATERING; MOBILE CAFE SERVICES FOR  
PROVIDING FOOD AND DRINK, IN CLASS 43 (U.S.  
CLS. 100 AND 101).

SER. NO. 77-343,004, FILED 12-3-2007.

FIRST USE 9-1-2007; IN COMMERCE 9-1-2007.

DORITT L. CARROLL, EXAMINING ATTORNEY



**Int. Cl.: 39**

**Prior U.S. Cls.: 100 and 105**

**United States Patent and Trademark Office**

**Reg. No. 3,467,623**

**Registered July 15, 2008**

**SERVICE MARK  
PRINCIPAL REGISTER**

# Freedom Cartage

FREEDOM CARTAGE, LLC (MICHIGAN LTD  
LIAB CO)  
3246 E. MAPLE AVE.  
FLINT, MI 48507

FOR: COURIER SERVICES; EXPRESS DELIVERY  
OF GOODS BY TRUCK; PARCEL DELIVERY; SHIP-  
PING AND DELIVERY SERVICES, NAMELY, PICK-  
UP, TRANSPORTATION, AND DELIVERY OF  
PACKAGES AND LETTERS BY VARIOUS MODES  
OF TRANSPORTATION, IN CLASS 39 (U.S. CLS. 100  
AND 105).

FIRST USE 4-4-2007; IN COMMERCE 4-23-2007.

THE MARK CONSISTS OF STANDARD CHAR-  
ACTERS WITHOUT CLAIM TO ANY PARTICULAR  
FONT, STYLE, SIZE, OR COLOR.

NO CLAIM IS MADE TO THE EXCLUSIVE  
RIGHT TO USE "CARTAGE", APART FROM THE  
MARK AS SHOWN.

SER. NO. 77-343,008, FILED 12-3-2007.

KAREN K. BUSH, EXAMINING ATTORNEY

Int. Cl.: 43

Prior U.S. Cls.: 100 and 101

United States Patent and Trademark Office

Reg. No. 3,467,624

Registered July 15, 2008

SERVICE MARK  
PRINCIPAL REGISTER



GREEN TRUCK, LLC (CALIFORNIA LTD LIAB  
CO)  
3515 HELMS AVE.  
CULVER CITY, CA 90232

FOR: CATERING; MOBILE CAFE SERVICES FOR  
PROVIDING FOOD AND DRINK, IN CLASS 43 (U.S.  
CLS. 100 AND 101).

FIRST USE 9-1-2007; IN COMMERCE 9-1-2007.

THE MARK CONSISTS OF THE WORDS  
"GREEN" AND "TRUCK" IN STYLIZED CURSIVE  
LETTERING, WITH A LEAF GROWING FROM THE  
"G" IN "GREEN," AND FROM THE "K" IN  
"TRUCK".

SER. NO. 77-343,042, FILED 12-3-2007.

DORITT L. CARROLL, EXAMINING ATTORNEY

**Int. Cls.: 25 and 35**

**Prior U.S. Cls.: 22, 39, 100, 101 and 102**

**United States Patent and Trademark Office**

**Reg. No. 3,467,625**

**Registered July 15, 2008**

**TRADEMARK  
SERVICE MARK  
PRINCIPAL REGISTER**

**COTTON IS THE ENEMY**

UNDER ARMOUR, INC. (MARYLAND CORPORATION)  
1020 HULL STREET  
BALTIMORE, MD 21230

FOR: FULL LINE OF ATHLETIC CLOTHING, IN CLASS 25 (U.S. CLS. 22 AND 39).

FIRST USE 8-11-2006; IN COMMERCE 8-11-2006.

FOR: RETAIL STORE SERVICES FEATURING APPAREL AND SPORTING GOODS, IN CLASS 35 (U.S. CLS. 100, 101 AND 102).

FIRST USE 8-11-2006; IN COMMERCE 8-11-2006.

THE MARK CONSISTS OF STANDARD CHARACTERS WITHOUT CLAIM TO ANY PARTICULAR FONT, STYLE, SIZE, OR COLOR.

SER. NO. 77-343,053, FILED 12-3-2007.

DAVID C. REIHNER, EXAMINING ATTORNEY

Int. Cl.: 32

Prior U.S. Cls.: 45, 46 and 48

Reg. No. 3,467,626

United States Patent and Trademark Office

Registered July 15, 2008

TRADEMARK  
PRINCIPAL REGISTER

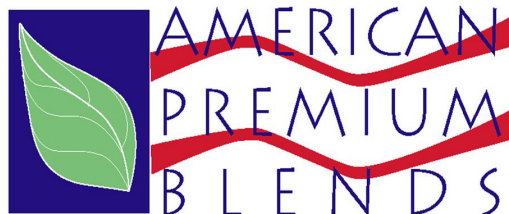

SOL RESOURCE, LLC (MICHIGAN LTD LIABILITY CO), DBA AMERICAN PREMIUM BLENDS  
22 STOCKTON DR.  
MONROE, MI 48162

FOR: CONCENTRATES, SYRUPS OR POWDERS USED IN THE PREPARATION OF SOFT DRINKS; FRUIT CONCENTRATES AND PUREES USED AS INGREDIENTS OF BEVERAGES; FRUIT DRINKS; FRUIT DRINKS AND JUICES, IN CLASS 32 (U.S. CLS. 45, 46 AND 48).

FIRST USE 2-0-2007; IN COMMERCE 2-0-2007.

OWNER OF U.S. REG. NO. 3,367,346.

NO CLAIM IS MADE TO THE EXCLUSIVE RIGHT TO USE "AMERICAN PREMIUM BLENDS", APART FROM THE MARK AS SHOWN.

THE COLOR(S) WHITE, BLUE, GREEN AND RED IS/ARE CLAIMED AS A FEATURE OF THE MARK.

THE MARK CONSISTS OF A GREEN LEAF WITH WHITE LINES SET INSIDE OF A BLUE RECTANGLE IS FLANKED TO THE RIGHT BY TWO RED RIBBON STYLE LINES. THE RIBBON STYLE LINES ARE SEPARATED FROM THE RECTANGLE BY WHITE SPACE. THE TWO RED RIBBON STYLE LINES ARE STACKED VERTICALLY AND SEPARATED FROM EACH OTHER BY WHITE SPACE. WRITTEN IN BLUE OVER THE RED RIBBON STYLE LINES AND THE WHITE SPACE ARE THE WORDS "AMERICAN PREMIUM BLENDS". THE WORDS ARE STACKED VERTICALLY SO THAT "AMERICAN" IS OVER "PREMIUM" AND "PREMIUM" IS OVER "BLENDS".

SER. NO. 77-343,115, FILED 12-4-2007.

GINA FINK, EXAMINING ATTORNEY

**Int. Cl.: 25**

**Prior U.S. Cls.: 22 and 39**

**United States Patent and Trademark Office**

**Reg. No. 3,467,627**

**Registered July 15, 2008**

**TRADEMARK  
PRINCIPAL REGISTER**

**SUPER DUTY**

FORD MOTOR COMPANY (DELAWARE CORPORATION)  
ONE AMERICAN ROAD  
DEARBORN, MI 48126

FOR: T-SHIRTS, POLO SHIRTS AND CAPS, IN CLASS 25 (U.S. CLS. 22 AND 39).

FIRST USE 4-1-2005; IN COMMERCE 4-1-2005.

THE MARK CONSISTS OF STANDARD CHARACTERS WITHOUT CLAIM TO ANY PARTICULAR FONT, STYLE, SIZE, OR COLOR.

OWNER OF U.S. REG. NOS. 2,332,851, 3,158,613 AND OTHERS.

SER. NO. 77-343,322, FILED 12-4-2007.

JESSICA A. POWERS, EXAMINING ATTORNEY

**Int. Cl.: 9**

**Prior U.S. Cls.: 21, 23, 26, 36 and 38**

**Reg. No. 3,467,628**

**United States Patent and Trademark Office**

**Registered July 15, 2008**

---

**TRADEMARK  
PRINCIPAL REGISTER**

**vTask**

VISTA SOFTWARE, INC. (ARIZONA CORPORATION)  
855 E. RIVER RD. #50  
TUCSON, AZ 85718

THE MARK CONSISTS OF STANDARD CHARACTERS WITHOUT CLAIM TO ANY PARTICULAR FONT, STYLE, SIZE, OR COLOR.

FOR: COMPUTER SOFTWARE DEVELOPMENT TOOLS, IN CLASS 9 (U.S. CLS. 21, 23, 26, 36 AND 38).

SER. NO. 77-343,614, FILED 12-4-2007.

FIRST USE 12-1-2007; IN COMMERCE 12-1-2007.

DANNEAN HETZEL, EXAMINING ATTORNEY

**Int. Cl.: 42**

**Prior U.S. Cls.: 100 and 101**

**United States Patent and Trademark Office**

**Reg. No. 3,467,629**

**Registered July 15, 2008**

**SERVICE MARK  
PRINCIPAL REGISTER**

**HWRF**

NATIONAL OCEANIC AND ATMOSPHERIC AD-  
MINISTRATION (UNITED STATES AGENCY  
OF THE UNITED STATES GOVERNMENT)  
1401 CONSTITUTION AVENUE, NW  
WASHINGTON, DC 20230

FOR: SCIENTIFIC AND TECHNOLOGICAL SER-  
VICES AND RESEARCH, NAMELY, COLLECTING  
DATA AND PROVIDING FORECASTS ON HURRI-  
CANES, TROPICAL STORMS, TROPICAL DEPRES-  
SIONS AND OTHER TROPICAL WEATHER  
SYSTEMS, PROVIDING STORM TRACKING IN-  
FORMATION, STORM PROJECTION PREDIC-  
TIONS, AND DATA ABOUT HURRICANES,  
TROPICAL STORMS, TROPICAL DEPRESSIONS

AND OTHER TROPICAL WEATHER SYSTEMS,  
INCLUDING THE PROVISION OF THESE SERVI-  
CES BY MEANS OF A GLOBAL COMPUTER NET-  
WORK, IN CLASS 42 (U.S. CLS. 100 AND 101).

FIRST USE 6-15-2007; IN COMMERCE 6-15-2007.

THE MARK CONSISTS OF STANDARD CHAR-  
ACTERS WITHOUT CLAIM TO ANY PARTICULAR  
FONT, STYLE, SIZE, OR COLOR.

SER. NO. 77-343,734, FILED 12-4-2007.

ELISSA GARBER KON, EXAMINING ATTORNEY

**Int. Cl.: 35**

**Prior U.S. Cls.: 100, 101 and 102**

**United States Patent and Trademark Office**

**Reg. No. 3,467,630**

**Registered July 15, 2008**

**SERVICE MARK  
PRINCIPAL REGISTER**

# Therasupply

THERASUPPLY (PENNSYLVANIA LTD LIAB  
CO)  
2508 APPLE ROAD  
FOGELSVILLE, PA 18051

FOR: RETAIL DISTRIBUTORSHIPS FEATURING  
MEDICAL EQUIPMENT AND SUPPLIES FOR  
CHIROPRACTIC, REHABILITATION AND MAS-  
SAGE THERAPY, ADVERTISING AND ADVER-  
TISEMENT SERVICES, IN CLASS 35 (U.S. CLS. 100,  
101 AND 102).

FIRST USE 10-22-2007; IN COMMERCE 11-25-2007.

THE MARK CONSISTS OF STANDARD CHAR-  
ACTERS WITHOUT CLAIM TO ANY PARTICULAR  
FONT, STYLE, SIZE, OR COLOR.

NO CLAIM IS MADE TO THE EXCLUSIVE  
RIGHT TO USE "SUPPLY", APART FROM THE  
MARK AS SHOWN.

SER. NO. 77-344,259, FILED 12-5-2007.

RONALD AIKENS, EXAMINING ATTORNEY



**Int. Cl.: 42**

**Prior U.S. Cls.: 100 and 101**

**United States Patent and Trademark Office**

**Reg. No. 3,467,631**

**Registered July 15, 2008**

**SERVICE MARK  
PRINCIPAL REGISTER**

The logo for micronit MICROFLUIDICS. The word "micronit" is written in a bold, lowercase, blue sans-serif font. Above the letters "i" and "t" in "micronit" are two small blue dots. Below "micronit", the word "MICROFLUIDICS" is written in a smaller, all-caps, light blue sans-serif font.

MICRONIT MICROFLUIDICS B.V. (NETHERLANDS CORPORATION)  
COLOSSEUM 15  
ENSCHEDA, NETHERLANDS 7521

FOR: DESIGN AND DEVELOPMENT FOR OTHERS OF COMPONENTS AND DEVICES WITH MICROFLUIDIC CAPABILITIES; DESIGN AND DEVELOPMENT FOR OTHERS OF TESTING AND LABORATORY APPARATUS AND INSTRUMENTS, IN CLASS 42 (U.S. CLS. 100 AND 101).

PRIORITY CLAIMED UNDER SEC. 44(D) ON BENELUX APPLICATION NO. 1139754, FILED 7-20-2007, REG. NO. 829200, DATED 12-6-2007, EXPIRES 7-20-2017.

NO CLAIM IS MADE TO THE EXCLUSIVE RIGHT TO USE "MICROFLUIDICS", APART FROM THE MARK AS SHOWN.

THE COLOR(S) NAVY BLUE AND LIGHT BLUE IS/ARE CLAIMED AS A FEATURE OF THE MARK.

THE MARK CONSISTS OF THE TERM "MICRONIT" IN NAVY BLUE ABOVE THE TERM "MICROFLUIDICS" IN A LIGHTER SHADE OF BLUE. THE DOTS ABOVE THE LETTERS "I" IN "MICRONIT" ARE THE LIGHTER SHADE OF BLUE.

SER. NO. 77-344,424, FILED 12-5-2007.

GINA FINK, EXAMINING ATTORNEY

**Int. Cls.: 9, 16 and 41**

**Prior U.S. Cls.: 2, 5, 21, 22, 23, 26, 29, 36, 37, 38, 50,  
100, 101 and 107**

**Reg. No. 3,467,632**

**United States Patent and Trademark Office**

**Registered July 15, 2008**

**TRADEMARK  
SERVICE MARK  
PRINCIPAL REGISTER**

# Michael Rood

ROOD, MICHAEL (UNITED STATES INDIVIDUAL)  
SUITE 200  
991 84TH STREET SW  
BYRON CENTER, MI 49315 AND  
ROOD, JUDITH (UNITED STATES INDIVIDUAL)  
SUITE 200  
991 84TH STREET SW  
BYRON CENTER, MI 49315

FOR: AUDIO AND VIDEO RECORDINGS FEATURING SCRIPTURAL EDUCATION; PROVIDING DOWNLOADABLE ELECTRONIC NEWSLETTERS IN THE FIELD OF SCRIPTURAL EDUCATION SERVICES, IN CLASS 9 (U.S. CLS. 21, 23, 26, 36 AND 38).

FIRST USE 9-0-1999; IN COMMERCE 9-0-1999.

FOR: BROCHURES ABOUT SCRIPTURAL EDUCATION SERVICES; NEWSLETTERS IN THE FIELD

OF SCRIPTURAL EDUCATION SERVICES; STUDY GUIDES, IN CLASS 16 (U.S. CLS. 2, 5, 22, 23, 29, 37, 38 AND 50).

FIRST USE 9-0-1999; IN COMMERCE 9-0-1999.

FOR: ENTERTAINMENT SERVICES, NAMELY, PROVIDING WEBCASTS IN THE FIELD OF SCRIPTURAL EDUCATION SERVICES, IN CLASS 41 (U.S. CLS. 100, 101 AND 107).

FIRST USE 9-0-1999; IN COMMERCE 9-0-1999.

THE MARK CONSISTS OF STANDARD CHARACTERS WITHOUT CLAIM TO ANY PARTICULAR FONT, STYLE, SIZE, OR COLOR.

SER. NO. 77-344,447, FILED 12-5-2007.

CHERYL CLAYTON, EXAMINING ATTORNEY

**Int. Cl.: 35**

**Prior U.S. Cls.: 100, 101 and 102**

**United States Patent and Trademark Office**

**Reg. No. 3,467,633**

**Registered July 15, 2008**

**SERVICE MARK  
PRINCIPAL REGISTER**

**GOtham GREEN**

GOTHAM CITY NETWORKING, INC. (NEW  
YORK CORPORATION)  
15TH FLOOR  
485 MADISON AVENUE  
NEW YORK, NY 10022

FOR: GENERAL BUSINESS NETWORKING RE-  
FERRAL SERVICES, NAMELY, PROMOTING THE  
GOODS AND SERVICES OF OTHERS BY PASSING  
BUSINESS LEADS AND REFERRALS AMONG  
GROUP MEMBERS, IN CLASS 35 (U.S. CLS. 100,  
101 AND 102).

FIRST USE 11-17-2007; IN COMMERCE 11-19-2007.

THE MARK CONSISTS OF STANDARD CHAR-  
ACTERS WITHOUT CLAIM TO ANY PARTICULAR  
FONT, STYLE, SIZE, OR COLOR.

SER. NO. 77-344,578, FILED 12-5-2007.

GIANCARLO CASTRO, EXAMINING ATTORNEY

**Int. Cl.: 33**

**Prior U.S. Cls.: 47 and 49**

**United States Patent and Trademark Office**

**Reg. No. 3,467,634**

**Registered July 15, 2008**

---

**TRADEMARK  
PRINCIPAL REGISTER**

**Crooked Row**

ROANOKE VALLEY WINE COMPANY (VIRGINIA CORPORATION)  
106 STONEY BATTERY ROAD  
TROUTVILLE, VA 24175

FOR: WINE, IN CLASS 33 (U.S. CLS. 47 AND 49).

FIRST USE 12-19-2007; IN COMMERCE 12-19-2007.

THE MARK CONSISTS OF STANDARD CHARACTERS WITHOUT CLAIM TO ANY PARTICULAR FONT, STYLE, SIZE, OR COLOR.

SER. NO. 77-344,737, FILED 12-5-2007.

JACQUELINE A. LAVINE, EXAMINING ATTORNEY

**Int. Cl.: 10**

**Prior U.S. Cls.: 26, 39 and 44**

**United States Patent and Trademark Office**

**Reg. No. 3,467,635**

**Registered July 15, 2008**

**TRADEMARK  
PRINCIPAL REGISTER**

**ENDORING**

JORDCO, INC. (OREGON CORPORATION)  
595 N.W. 167TH AVENUE  
BEAVERTON, OR 97006

FOR: FOAM INSERTS FOR USE WITH A DENTAL INSTRUMENT FOR ENDODONTIC AND DENTAL HYGIENE PROCEDURES, IN CLASS 10 (U.S. CLS. 26, 39 AND 44).

FIRST USE 3-3-1980; IN COMMERCE 3-3-1980.

THE MARK CONSISTS OF STANDARD CHARACTERS WITHOUT CLAIM TO ANY PARTICULAR FONT, STYLE, SIZE, OR COLOR.

OWNER OF U.S. REG. NO. 2,211,077.

SER. NO. 77-344,946, FILED 12-5-2007.

KEVIN DINALLO, EXAMINING ATTORNEY

**Int. Cl.: 21**

**Prior U.S. Cls.: 2, 13, 23, 29, 30, 33, 40 and 50**

**Reg. No. 3,467,636**

**United States Patent and Trademark Office**

**Registered July 15, 2008**

---

**TRADEMARK  
PRINCIPAL REGISTER**

# Diaper Champ

TSAI, DENNY T.H. (UNITED STATES INDIVIDUAL)

1607 S. CAMPUS AVE

ONTARIO, CA 91761

FOR: BATHROOM PAILS; PAILS, IN CLASS 21  
(U.S. CLS. 2, 13, 23, 29, 30, 33, 40 AND 50).

FIRST USE 6-6-1997; IN COMMERCE 3-31-1998.

THE MARK CONSISTS OF STANDARD CHARACTERS WITHOUT CLAIM TO ANY PARTICULAR FONT, STYLE, SIZE, OR COLOR.

NO CLAIM IS MADE TO THE EXCLUSIVE RIGHT TO USE "DIAPER", APART FROM THE MARK AS SHOWN.

SER. NO. 77-345,101, FILED 12-5-2007.

ELLEN PERKINS, EXAMINING ATTORNEY

**Int. Cl.: 9**

**Prior U.S. Cls.: 21, 23, 26, 36 and 38**

**United States Patent and Trademark Office**

**Reg. No. 3,467,637**

**Registered July 15, 2008**

**TRADEMARK  
PRINCIPAL REGISTER**

# Win of a Lifetime

C2 GAMING, LLC (NEVADA LTD LIAB CO),  
DBA C2 GAMING  
1945 PAMA LANE  
LAS VEGAS, NV 89119

THE MARK CONSISTS OF STANDARD CHAR-  
ACTERS WITHOUT CLAIM TO ANY PARTICULAR  
FONT, STYLE, SIZE, OR COLOR.

FOR: GAMING MACHINES, NAMELY, ELEC-  
TRONIC SLOT AND BINGO MACHINES, IN CLASS  
9 (U.S. CLS. 21, 23, 26, 36 AND 38).

SER. NO. 77-345,111, FILED 12-5-2007.

FIRST USE 10-3-2005; IN COMMERCE 10-3-2005.

JESSICA A. POWERS, EXAMINING ATTORNEY

**Int. Cls.: 35 and 44**

**Prior U.S. Cls.: 100, 101 and 102**

**United States Patent and Trademark Office**

**Reg. No. 3,467,638**

**Registered July 15, 2008**

**SERVICE MARK  
PRINCIPAL REGISTER**

**DISTINCT CHOICE**

DISTINCT CHOICE MATURE LIVING SOLUTIONS, LLC (WISCONSIN LTD LIAB CO)  
SUITE 130  
5307 S. 92ND STREET  
HALES CORNERS, WI 53130

FOR: REFERRAL SERVICES IN THE FIELD OF ELDERLY CARE, NAMELY, REFERRALS FOR THE ELDERLY REGARDING IN-HOME AND OUT-PATIENT CARE, HOUSING OPTIONS, ASSISTED LIVING PROGRAMS, COMPANION CARE, MOVING SERVICES FOR THE ELDERLY, LEGAL COUNSEL SPECIALIZING IN SENIOR LAW, DOCTOR AND MEDICAL CARE, FINANCIAL ADVISORY SERVICES, FAMILY CARE, REAL ESTATE SALES, ADULT DAY CARE, HOSPICE AND FUNERAL SERVICES, THERAPY SERVICES, AND MANAGEMENT OF HEALTH CARE FOR THE ELDERLY, IN CLASS 35 (U.S. CLS. 100, 101 AND 102).

FIRST USE 8-20-2007; IN COMMERCE 8-20-2007.

FOR: CONSULTING SERVICES IN MANAGEMENT OF HEALTH CARE FOR THE ELDERLY , IN CLASS 44 (U.S. CLS. 100 AND 101).

FIRST USE 8-20-2007; IN COMMERCE 8-20-2007.

THE MARK CONSISTS OF STANDARD CHARACTERS WITHOUT CLAIM TO ANY PARTICULAR FONT, STYLE, SIZE, OR COLOR.

SER. NO. 77-345,332, FILED 12-6-2007.

DAVID COLLIER, EXAMINING ATTORNEY



**Int. Cl.: 31**

**Prior U.S. Cls.: 1 and 46**

**United States Patent and Trademark Office**

**Reg. No. 3,467,639**

**Registered July 15, 2008**

**TRADEMARK  
PRINCIPAL REGISTER**

**Fido Eats.**

FIDOEATS, INC. (NEW YORK CORPORATION)  
79 GARD AVENUE  
BRONXVILLE, NY 10708

FOR: DOG TREATS, IN CLASS 31 (U.S. CLS. 1  
AND 46).

FIRST USE 4-30-2006; IN COMMERCE 4-30-2006.

THE MARK CONSISTS OF STANDARD CHAR-  
ACTERS WITHOUT CLAIM TO ANY PARTICULAR  
FONT, STYLE, SIZE, OR COLOR.

NO CLAIM IS MADE TO THE EXCLUSIVE  
RIGHT TO USE "EATS", APART FROM THE MARK  
AS SHOWN.

SER. NO. 77-345,335, FILED 12-6-2007.

MATTHEW EINSTEIN, EXAMINING ATTORNEY

**Int. Cls.: 9, 14, 25, 28 and 41**

**Prior U.S. Cls.: 2, 21, 22, 23, 26, 27, 28, 36, 38, 39, 50,  
100, 101 and 107**

**Reg. No. 3,467,640**

**United States Patent and Trademark Office**

**Registered July 15, 2008**

**TRADEMARK  
SERVICE MARK  
PRINCIPAL REGISTER**

**UGA**

BOARD OF REGENTS OF THE UNIVERSITY  
SYSTEM OF GEORGIA (GEORGIA STATE  
AGENCY)  
270 WASHINGTON STREET, S.W.  
ATLANTA, GA 30334

FOR: MAGNETS, IN CLASS 9 (U.S. CLS. 21, 23, 26,  
36 AND 38).

FIRST USE 4-0-1990; IN COMMERCE 4-0-1990.

FOR: JEWELRY; CHARMS; PENDANTS, IN  
CLASS 14 (U.S. CLS. 2, 27, 28 AND 50).

FIRST USE 4-0-1990; IN COMMERCE 4-0-1990.

FOR: T-SHIRTS; BASEBALL CAPS; GOLF CAPS,  
IN CLASS 25 (U.S. CLS. 22 AND 39).

FIRST USE 4-0-1990; IN COMMERCE 4-0-1990.

FOR: STUFFED AND PLUSH TOYS, IN CLASS 28  
(U.S. CLS. 22, 23, 38 AND 50).

FIRST USE 4-0-1990; IN COMMERCE 4-0-1990.

FOR: EDUCATIONAL SERVICES, NAMELY,  
PROVIDING COURSES OF INSTRUCTION AT

THE UNIVERSITY LEVEL AND DISTRIBUTION  
OF COURSE MATERIAL IN CONNECTION THERE-  
WITH; EDUCATION SERVICES, NAMELY, PRO-  
VIDING LIVE AND ON-LINE COURSES IN THE  
FIELD OF LIBERAL ARTS AND SCIENCES AND  
GRADUATE STUDIES AND MASTER'S DEGREE  
PROGRAMS; ENTERTAINMENT IN THE NATURE  
OF SPORTING EVENTS, NAMELY, BASEBALL,  
BASKETBALL, CROSS COUNTRY, EQUESTRIAN,  
FOOTBALL, GOLF, GYMNASTICS, SOCCER, SOFT-  
BALL, SWIMMING AND DIVING, TENNIS, TRACK  
AND FIELD AND VOLLEYBALL GAMES, IN CLASS  
41 (U.S. CLS. 100, 101 AND 107).

FIRST USE 0-0-1895; IN COMMERCE 0-0-1895.

THE MARK CONSISTS OF STANDARD CHAR-  
ACTERS WITHOUT CLAIM TO ANY PARTICULAR  
FONT, STYLE, SIZE, OR COLOR.

OWNER OF U.S. REG. NO. 3,031,190.

SER. NO. 77-345,454, FILED 12-6-2007.

JUSTINE D. PARKER, EXAMINING ATTORNEY

**Int. Cls.: 37 and 42**

**Prior U.S. Cls.: 100, 101, 103 and 106**

**United States Patent and Trademark Office**

**Reg. No. 3,467,641**

**Registered July 15, 2008**

**SERVICE MARK  
PRINCIPAL REGISTER**



V3 COMPANIES LTD. (DELAWARE LTD LIAB  
CO)  
7325 JANES AVENUE  
WOODRIDGE, IL 60517

FOR: CONSTRUCTION MANAGEMENT; LAND  
DEVELOPMENT SERVICES, NAMELY, PLANNING  
AND LAYING OUT OF RESIDENTIAL AND/OR  
COMMERCIAL COMMUNITIES, IN CLASS 37 (U.S.  
CLS. 100, 103 AND 106).

FIRST USE 2-0-2005; IN COMMERCE 2-0-2005.

FOR: CIVIL ENGINEERING; SURVEYING AND  
ENGINEERING, IN CLASS 42 (U.S. CLS. 100 AND  
101).

FIRST USE 2-0-2005; IN COMMERCE 2-0-2005.

OWNER OF U.S. REG. NO. 2,501,264.

THE COLOR(S) LIGHT GREY, DARK GREY AND  
RED IS/ARE CLAIMED AS A FEATURE OF THE  
MARK.

THE MARK CONSISTS OF A RED "V" INSIDE A  
PARTIAL LIGHT GREY CIRCLE WITH A DARK  
GREY "3" MAKING UP THE REST OF THE CIRCLE  
ON THE LOWER RIGHT SIDE. WHITE APPEARS IN  
THE DRAWING TO INDICATE A TRANSPARENT  
BACKGROUND.

SER. NO. 77-345,724, FILED 12-6-2007.

REBECCA EISINGER, EXAMINING ATTORNEY

**Int. Cl.: 10**

**Prior U.S. Cls.: 26, 39 and 44**

**United States Patent and Trademark Office**

**Reg. No. 3,467,642**

**Registered July 15, 2008**

**TRADEMARK  
PRINCIPAL REGISTER**

**MIRACLE MASSAGER**

CALIFORNIA EXOTIC NOVELTIES LLC (CALIFORNIA LTD LIAB CO)

14235 RAMONA AVE.

CHINO, CA 91710

FOR: ADULT SEXUAL AIDS, NAMELY, VIBRATORS, IN CLASS 10 (U.S. CLS. 26, 39 AND 44).

FIRST USE 6-1-2007; IN COMMERCE 6-1-2007.

THE MARK CONSISTS OF STANDARD CHARACTERS WITHOUT CLAIM TO ANY PARTICULAR FONT, STYLE, SIZE, OR COLOR.

NO CLAIM IS MADE TO THE EXCLUSIVE RIGHT TO USE "MASSAGER", APART FROM THE MARK AS SHOWN.

SER. NO. 77-346,378, FILED 12-7-2007.

BARBARA BROWN, EXAMINING ATTORNEY

**Int. Cl.: 16**

**Prior U.S. Cls.: 2, 5, 22, 23, 29, 37, 38 and 50**

**United States Patent and Trademark Office**

**Reg. No. 3,467,643**

**Registered July 15, 2008**

**TRADEMARK  
PRINCIPAL REGISTER**

**FOOD SAFETY SOLUTIONS**

ECOLAB INC. (DELAWARE CORPORATION)  
ESC/F7  
370 WABASHA STREET N.  
ST. PAUL, MN 55102

FOR: PERIODICAL, NAMELY, CATALOG FOR  
FOOD INDUSTRY FEATURING FOOD SAFETY  
PRODUCTS, IN CLASS 16 (U.S. CLS. 2, 5, 22, 23, 29,  
37, 38 AND 50).

FIRST USE 3-1-1999; IN COMMERCE 3-1-1999.

THE MARK CONSISTS OF STANDARD CHAR-  
ACTERS WITHOUT CLAIM TO ANY PARTICULAR  
FONT, STYLE, SIZE, OR COLOR.

NO CLAIM IS MADE TO THE EXCLUSIVE  
RIGHT TO USE "FOOD SAFETY", APART FROM  
THE MARK AS SHOWN.

SEC. 2(F).

SER. NO. 77-346,390, FILED 12-7-2007.

JEAN IM, EXAMINING ATTORNEY

**Int. Cl.: 24**

**Prior U.S. Cls.: 42 and 50**

**United States Patent and Trademark Office**

**Reg. No. 3,467,644**

**Registered July 15, 2008**

**TRADEMARK  
PRINCIPAL REGISTER**

**SOFT 'N' STABLE**

HOLLINGSWORTH & VOSE COMPANY (MAS-  
SACHUSETTS CORPORATION)  
112 WASHINGTON STREET  
EAST WALPOLE, MA 02032

FOR: WET-LAID, SOFT CUTAWAY EMBROI-  
DERY BACKING MADE OF NON-WOVEN TEX-  
TILE FABRICS USED FOR STABILIZING HOOPED  
FABRIC DURING MACHINE EMBROIDER, IN  
CLASS 24 (U.S. CLS. 42 AND 50).

FIRST USE 7-14-2000; IN COMMERCE 7-14-2000.

THE MARK CONSISTS OF STANDARD CHAR-  
ACTERS WITHOUT CLAIM TO ANY PARTICULAR  
FONT, STYLE, SIZE, OR COLOR.

OWNER OF U.S. REG. NO. 2,538,697.

SEC. 2(F).

SER. NO. 77-346,505, FILED 12-7-2007.

SIMON TENG, EXAMINING ATTORNEY

**Int. Cl.: 40**

**Prior U.S. Cls.: 100, 103 and 106**

**United States Patent and Trademark Office**

**Reg. No. 3,467,645**

**Registered July 15, 2008**

**SERVICE MARK  
PRINCIPAL REGISTER**

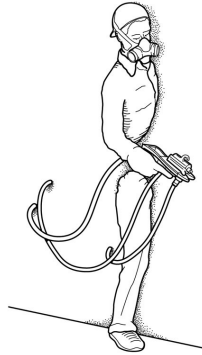

OSBORN CONTRACT SERVICES, INC. (SOUTH  
CAROLINA CORPORATION)  
125 SUNBELT COURT  
GREER, SC 29650

THE MARK CONSISTS OF AN IMAGE OF A MAN  
COMING OUT OF A WALL HOLDING A TOOL  
CONNECTED TO THREE HOSES THAT EXTEND  
INTO THE WALL.

FOR: APPLYING COATINGS TO WALLS,  
FLOORS AND CONTAINMENTS FOR WATER-  
PROOFING AND INCREASING CHEMICAL RESIS-  
TANCE, IN CLASS 40 (U.S. CLS. 100, 103 AND 106).

SER. NO. 77-346,687, FILED 12-7-2007.

FIRST USE 12-3-2007; IN COMMERCE 12-3-2007.

ANDREA SAUNDERS, EXAMINING ATTORNEY

**Int. Cl.: 3**

**Prior U.S. Cls.: 1, 4, 6, 50, 51 and 52**

**United States Patent and Trademark Office**

**Reg. No. 3,467,646**

**Registered July 15, 2008**

**TRADEMARK  
PRINCIPAL REGISTER**

**PRINCIPAL SECRET GODDESS  
GLOSS**

VICTORIA PRINCIPAL PRODUCTIONS, INC.  
(CALIFORNIA CORPORATION)  
9255 SUNSET BOULEVARD  
LOS ANGELES, CA 90069

FOR: SKIN AND BODY CARE PREPARATIONS,  
NAMELY, COSMETICS, IN CLASS 3 (U.S. CLS. 1, 4, 6,  
50, 51 AND 52).

FIRST USE 9-10-2005; IN COMMERCE 9-10-2005.

THE MARK CONSISTS OF STANDARD CHAR-  
ACTERS WITHOUT CLAIM TO ANY PARTICULAR  
FONT, STYLE, SIZE, OR COLOR.

NO CLAIM IS MADE TO THE EXCLUSIVE  
RIGHT TO USE "GLOSS", APART FROM THE  
MARK AS SHOWN.

SER. NO. 77-346,767, FILED 12-7-2007.

KATHRYN COWARD, EXAMINING ATTORNEY



**Int. Cl.: 36**

**Prior U.S. Cls.: 100, 101 and 102**

**United States Patent and Trademark Office**

**Reg. No. 3,467,647**

**Registered July 15, 2008**

**SERVICE MARK  
PRINCIPAL REGISTER**

# Think RetIRAm<sup>ent</sup>

MASSACHUSETTS FINANCIAL SERVICES COMPANY (DELAWARE CORPORATION)  
500 BOYLSTON STREET  
BOSTON, MA 02116

FOR: FINANCIAL SERVICES FOR INVESTMENT COMPANIES, NAMELY, ESTABLISHING MUTUAL FUNDS FOR OTHERS; INVESTMENT ADVISORY AND MANAGEMENT SERVICES; ADMINISTRATION OF MUTUAL FUNDS; MUTUAL FUND DISTRIBUTION SERVICES, IN CLASS 36 (U.S. CLS. 100, 101 AND 102).

FIRST USE 12-17-2007; IN COMMERCE 12-17-2007.

THE MARK CONSISTS OF STANDARD CHARACTERS WITHOUT CLAIM TO ANY PARTICULAR FONT, STYLE, SIZE, OR COLOR.

SER. NO. 77-346,863, FILED 12-7-2007.

AISHA SALEM, EXAMINING ATTORNEY

**Int. Cl.: 36**

**Prior U.S. Cls.: 100, 101 and 102**

**United States Patent and Trademark Office**

**Reg. No. 3,467,648**

**Registered July 15, 2008**

**SERVICE MARK  
PRINCIPAL REGISTER**

**ARCH PROPERTY MAXIMIZER  
POLICY**

ARCH CAPITAL GROUP (U.S.) INC. (DELA-  
WARE CORPORATION)  
53RD FLOOR  
ONE LIBERTY PLAZA  
NEW YORK, NY 10006

FOR: INSURANCE UNDERWRITING SERVICES  
IN THE FIELD OF PROPERTY, IN CLASS 36 (U.S.  
CLS. 100, 101 AND 102).

FIRST USE 11-12-2007; IN COMMERCE 11-12-2007.

THE MARK CONSISTS OF STANDARD CHAR-  
ACTERS WITHOUT CLAIM TO ANY PARTICULAR  
FONT, STYLE, SIZE, OR COLOR.

OWNER OF U.S. REG. NOS. 3,116,628, 3,353,130  
AND OTHERS.

NO CLAIM IS MADE TO THE EXCLUSIVE  
RIGHT TO USE "PROPERTY MAXIMIZER POL-  
ICY", APART FROM THE MARK AS SHOWN.

SER. NO. 77-347,010, FILED 12-7-2007.

KATHERINE STOIDES, EXAMINING ATTORNEY

**Int. Cl.: 36**

**Prior U.S. Cls.: 100, 101 and 102**

**United States Patent and Trademark Office**

**Reg. No. 3,467,649**

**Registered July 15, 2008**

**SERVICE MARK  
PRINCIPAL REGISTER**

**JERSEYS OFF THEIR BACKS**

MUSCULAR DYSTROPHY ASSOCIATION, INC.  
(NEW YORK NON-PROFIT CORPORATION)  
3300 EAST SUNRISE DRIVE  
TUCSON, AZ 85718

FOR: CHARITABLE FUNDRAISING SERVICES  
FOR BASIC AND APPLIED RESEARCH INTO NEU-  
ROMUSCULAR DISORDERS AND FOR FUNDING  
SERVICES TO PERSONS AFFLICTED BY SUCH  
DISORDERS, IN CLASS 36 (U.S. CLS. 100, 101 AND  
102).

FIRST USE 2-1-1999; IN COMMERCE 2-1-1999.

THE MARK CONSISTS OF STANDARD CHAR-  
ACTERS WITHOUT CLAIM TO ANY PARTICULAR  
FONT, STYLE, SIZE, OR COLOR.

OWNER OF U.S. REG. NO. 2,515,857.

SEC. 2(F).

SER. NO. 77-347,030, FILED 12-7-2007.

AMY ALFIERI, EXAMINING ATTORNEY

**Int. Cl.: 42**

**Prior U.S. Cls.: 100 and 101**

**United States Patent and Trademark Office**

**Reg. No. 3,467,650**

**Registered July 15, 2008**

**SERVICE MARK  
PRINCIPAL REGISTER**



EVALUATIONKIT, LLC (COLORADO LTD LIAB  
CO)  
UNIT R 104  
8300 FAIRMOUNT DRIVE  
DENVER, CO 80247

FOR: COMPUTER SERVICES, NAMELY, PROVIDING TEMPORARY USE OF NON-DOWNLOADABLE COMPUTER SOFTWARE FOR AUTHORIZING, DESIGNING AND DEPLOYMENT OF ONLINE QUESTIONNAIRES, SURVEYS, AND OTHER FEEDBACK AND DATA COLLECTION ACTIVITIES VIA COMPUTER NETWORKS; PROVIDING TEMPORARY USE OF NON-DOWNLOADABLE COMPUTER SOFTWARE FOR THE ADMINISTRATION, DISTRIBUTION, COLLECTION, REPORTING, ANALYSIS, AND PRESENTATION OF INFORMATION GATH-

ERED VIA COMPUTER NETWORKS; HOSTING WEB-BASED QUESTIONNAIRES, SURVEYS, AND OTHER FEEDBACK AND DATA COLLECTION TOOLS FOR OTHERS, IN CLASS 42 (U.S. CLS. 100 AND 101).

FIRST USE 4-1-2006; IN COMMERCE 4-1-2006.

THE MARK CONSISTS OF THE DESIGN OF A STICK FIGURE STUDENT SITTING AT A DESK WITH A LAPTOP ON THE DESK, DISPLAYED ON A SOLID CIRCLE.

SER. NO. 77-347,381, FILED 12-8-2007.

BONNIE LUKEN, EXAMINING ATTORNEY

**Int. Cl.: 41**

**Prior U.S. Cls.: 100, 101 and 107**

**United States Patent and Trademark Office**

**Reg. No. 3,467,651**

**Registered July 15, 2008**

**SERVICE MARK  
PRINCIPAL REGISTER**

**ALL OF US SINGLES**

AOUS LLC (NEVADA LTD LIAB CO)  
134 W. 1965 S.  
WASHINGTON, UT 84780

FOR: ENTERTAINMENT SERVICES, NAMELY,  
CONDUCTING PARTIES FOR THE PURPOSE OF  
DATING AND SOCIAL INTRODUCTION FOR  
ADULTS, IN CLASS 41 (U.S. CLS. 100, 101 AND 107).

FIRST USE 5-1-2007; IN COMMERCE 12-8-2007.

THE MARK CONSISTS OF STANDARD CHAR-  
ACTERS WITHOUT CLAIM TO ANY PARTICULAR  
FONT, STYLE, SIZE, OR COLOR.

SER. NO. 77-347,392, FILED 12-8-2007.

WILLIAM VERHOSEK, EXAMINING ATTORNEY

**Int. Cl.: 30**

**Prior U.S. Cl.: 46**

**United States Patent and Trademark Office**

**Reg. No. 3,467,652**

**Registered July 15, 2008**

**TRADEMARK  
PRINCIPAL REGISTER**

**BioBread**

WRIGHT, BRUCE (UNITED STATES INDIVIDUAL)  
2199A PRINCETON STREET  
SARASOTA, FL 34237

THE MARK CONSISTS OF STANDARD CHARACTERS WITHOUT CLAIM TO ANY PARTICULAR FONT, STYLE, SIZE, OR COLOR.

FOR: BREAD AND BUNS, IN CLASS 30 (U.S. CL. 46).

SER. NO. 77-347,436, FILED 12-8-2007.

FIRST USE 12-7-2007; IN COMMERCE 12-7-2007.

GEOFFREY FOSDICK, EXAMINING ATTORNEY

**Int. Cl.: 12**

**Prior U.S. Cls.: 19, 21, 23, 31, 35 and 44**

**United States Patent and Trademark Office**

**Reg. No. 3,467,653**

**Registered July 15, 2008**

**TRADEMARK  
PRINCIPAL REGISTER**

# Hollywood Hot Rods

LADD, TROY LEIGHTON (UNITED STATES IN-  
DIVIDUAL)  
16493 MANCHESTER  
APPLE VALLEY, CA 92394

FOR: LAND VEHICLES, NAMELY, CUSTOM  
AND RESTORED CARS AND TRUCKS, IN CLASS  
12 (U.S. CLS. 19, 21, 23, 31, 35 AND 44).

FIRST USE 12-31-1991; IN COMMERCE 4-30-2002.

THE MARK CONSISTS OF STANDARD CHAR-  
ACTERS WITHOUT CLAIM TO ANY PARTICULAR  
FONT, STYLE, SIZE, OR COLOR.

OWNER OF U.S. REG. NO. 3,312,394.

NO CLAIM IS MADE TO THE EXCLUSIVE  
RIGHT TO USE "HOT RODS", APART FROM THE  
MARK AS SHOWN.

SEC. 2(F).

SER. NO. 77-347,596, FILED 12-9-2007.

KRISTIN DAHLING, EXAMINING ATTORNEY

**Int. Cls.: 35, 37, 41 and 42**

**Prior U.S. Cls.: 100, 101, 102, 103, 106 and 107**

**United States Patent and Trademark Office**

**Reg. No. 3,467,654**

**Registered July 15, 2008**

**SERVICE MARK  
PRINCIPAL REGISTER**

**Advantage Business  
Solutions, Inc.**

MAY III, EDGAR FLOYD (UNITED STATES  
INDIVIDUAL)  
310 WEST WASHINGTON STREET  
FERTILE, IA 50434

FOR: BUSINESS MANAGEMENT AND CONSULTATION; ACCOUNTING SERVICES; CREATIVE MARKETING DESIGN SERVICES; HUMAN RESOURCES CONSULTATION , IN CLASS 35 (U.S. CLS. 100, 101 AND 102).

FIRST USE 8-23-2005; IN COMMERCE 8-23-2005.

FOR: INSTALLATION, MAINTENANCE AND REPAIR OF COMPUTER HARDWARE, IN CLASS 37 (U.S. CLS. 100, 103 AND 106).

FIRST USE 8-25-2005; IN COMMERCE 8-25-2005.

FOR: COMPUTER EDUCATION TRAINING, IN CLASS 41 (U.S. CLS. 100, 101 AND 107).

FIRST USE 8-25-2005; IN COMMERCE 8-25-2005.

FOR: SOFTWARE DESIGN AND DEVELOPMENT; DESIGN, CREATION, HOSTING, MAINTENANCE OF WEBSITES FOR OTHERS; COMPUTER NETWORK DESIGN FOR OTHERS, IN CLASS 42 (U.S. CLS. 100 AND 101).

FIRST USE 8-25-2005; IN COMMERCE 8-25-2005.

THE MARK CONSISTS OF STANDARD CHARACTERS WITHOUT CLAIM TO ANY PARTICULAR FONT, STYLE, SIZE, OR COLOR.

NO CLAIM IS MADE TO THE EXCLUSIVE RIGHT TO USE "BUSINESS SOLUTIONS, INC.", APART FROM THE MARK AS SHOWN.

SER. NO. 77-347,638, FILED 12-10-2007.

REBECCA GILBERT, EXAMINING ATTORNEY



**Int. Cl.: 16**

**Prior U.S. Cls.: 2, 5, 22, 23, 29, 37, 38 and 50**

**United States Patent and Trademark Office**

**Reg. No. 3,467,655**

**Registered July 15, 2008**

**TRADEMARK  
PRINCIPAL REGISTER**

**311**

FELLOWES, INC. (ILLINOIS CORPORATION)  
1789 NORWOOD AVE.  
ITASCA, IL 60143

THE MARK CONSISTS OF STANDARD CHAR-  
ACTERS WITHOUT CLAIM TO ANY PARTICULAR  
FONT, STYLE, SIZE, OR COLOR.

FOR: CORRUGATED RECORD STORAGE  
BOXES, IN CLASS 16 (U.S. CLS. 2, 5, 22, 23, 29, 37, 38  
AND 50).

SER. NO. 77-347,775, FILED 12-10-2007.

FIRST USE 6-30-1963; IN COMMERCE 6-30-1963.

DAVID COLLIER, EXAMINING ATTORNEY

**Int. Cl.: 16**

**Prior U.S. Cls.: 2, 5, 22, 23, 29, 37, 38 and 50**

**United States Patent and Trademark Office**

**Reg. No. 3,467,656**

**Registered July 15, 2008**

**TRADEMARK  
PRINCIPAL REGISTER**

**312**

FELLOWES, INC. (ILLINOIS CORPORATION)  
1789 NORWOOD AVE.  
ITASCA, IL 60143

THE MARK CONSISTS OF STANDARD CHAR-  
ACTERS WITHOUT CLAIM TO ANY PARTICULAR  
FONT, STYLE, SIZE, OR COLOR.

FOR: CORRUGATED RECORD STORAGE  
BOXES, IN CLASS 16 (U.S. CLS. 2, 5, 22, 23, 29, 37, 38  
AND 50).

SER. NO. 77-347,807, FILED 12-10-2007.

FIRST USE 6-30-1963; IN COMMERCE 6-30-1963.

DAVID COLLIER, EXAMINING ATTORNEY

**Int. Cl.: 35**

**Prior U.S. Cls.: 100, 101 and 102**

**United States Patent and Trademark Office**

**Reg. No. 3,467,657**

**Registered July 15, 2008**

**SERVICE MARK  
PRINCIPAL REGISTER**

**start my song**

BARDOM.COM, LLC (FLORIDA LTD LIAB CO)  
1309 ELIZA ST  
KEY WEST, FL 33040

FOR: ONLINE COMMERCIAL EXCHANGE SERVICE FOR SONGWRITERS AND SONG PRODUCERS, NAMELY, A WEBSITE THAT ALLOWS SONGWRITERS TO PAY TO POST NEW SONGS AND PRODUCERS AND GENERAL PUBLIC CAN LISTEN TO THE SONG, IN CLASS 35 (U.S. CLS. 100, 101 AND 102).

FIRST USE 9-15-2007; IN COMMERCE 10-12-2007.

THE MARK CONSISTS OF STANDARD CHARACTERS WITHOUT CLAIM TO ANY PARTICULAR FONT, STYLE, SIZE, OR COLOR.

NO CLAIM IS MADE TO THE EXCLUSIVE RIGHT TO USE "SONG", APART FROM THE MARK AS SHOWN.

SER. NO. 77-347,897, FILED 12-10-2007.

FLORENTINA BLANDU, EXAMINING ATTORNEY

**Int. Cl.: 5**

**Prior U.S. Cls.: 6, 18, 44, 46, 51 and 52**

**United States Patent and Trademark Office**

**Reg. No. 3,467,658**

**Registered July 15, 2008**

**TRADEMARK  
PRINCIPAL REGISTER**

**ERBAVEN**

ESI S.P.A. (ITALY CORPORATION)  
PIAZZA VELASCA, 5  
MILAN, ITALY 20122

THE MARK CONSISTS OF STANDARD CHAR-  
ACTERS WITHOUT CLAIM TO ANY PARTICULAR  
FONT, STYLE, SIZE, OR COLOR.

FOR: DIETARY SUPPLEMENTS, IN CLASS 5 (U.S.  
CLS. 6, 18, 44, 46, 51 AND 52).

SER. NO. 77-347,929, FILED 12-10-2007.

FIRST USE 10-2-1996; IN COMMERCE 10-2-1996.

JOHN DALIER, EXAMINING ATTORNEY

**Int. Cl.: 41**

**Prior U.S. Cls.: 100, 101 and 107**

**United States Patent and Trademark Office**

**Reg. No. 3,467,659**

**Registered July 15, 2008**

**SERVICE MARK  
PRINCIPAL REGISTER**

# Emotional Eloquence

CORNELIA CORPORATION (COLORADO CORPORATION)  
2504 SHALIMAR DRIVE  
COLORADO SPRINGS, CO 809151031

FOR: EDUCATIONAL SERVICES, NAMELY, PROVIDING SPEECHES AND WORKSHOPS AND DISTRIBUTING COURSE MATERIALS THEREWITH IN THE FIELDS OF PRESENTATION SKILLS AND LEADERSHIP, IN CLASS 41 (U.S. CLS. 100, 101 AND 107).

FIRST USE 7-17-2007; IN COMMERCE 7-17-2007.

THE MARK CONSISTS OF STANDARD CHARACTERS WITHOUT CLAIM TO ANY PARTICULAR FONT, STYLE, SIZE, OR COLOR.

SER. NO. 77-347,957, FILED 12-10-2007.

RAUL CORDOVA, EXAMINING ATTORNEY

**Int. Cl.: 39**

**Prior U.S. Cls.: 100 and 105**

**United States Patent and Trademark Office**

**Reg. No. 3,467,660**

**Registered July 15, 2008**

**SERVICE MARK  
PRINCIPAL REGISTER**

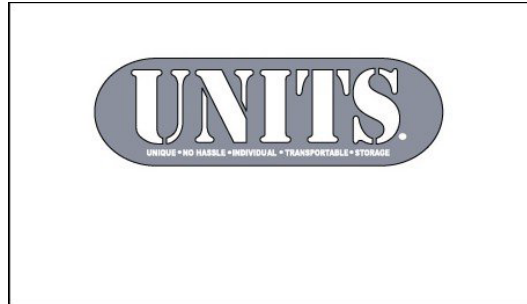

MHM GROUP, INC. (SOUTH CAROLINA CORPORATION)  
1773 LABOR CAMP ROAD  
MT. PLEASANT, SC 29464

FOR: TRANSPORTATION BY TRUCK AND RENTAL OF MOBILE STORAGE CONTAINERS FOR HOUSEHOLD GOODS, IN CLASS 39 (U.S. CLS. 100 AND 105).

FIRST USE 12-7-2007; IN COMMERCE 12-7-2007.

OWNER OF U.S. REG. NO. 3,049,132.

THE MARK CONSISTS OF THE WORD "UNITS" ABOVE THE WORDS "UNIQUE-NO HASSLE-INDIVIDUAL-TRANSPORTABLE-STORAGE" IN AN OVAL.

SER. NO. 77-348,114, FILED 12-10-2007.

KATHY DE JONGE, EXAMINING ATTORNEY

**Int. Cl.: 16**

**Prior U.S. Cls.: 2, 5, 22, 23, 29, 37, 38 and 50**

**United States Patent and Trademark Office**

**Reg. No. 3,467,661**

**Registered July 15, 2008**

**TRADEMARK  
PRINCIPAL REGISTER**

**FULL CIRCLE**

QUALITY TRANSPARENT BAG, INC. (MICHIGAN CORPORATION)  
110 MCGRAW STREET  
BAY CITY, MI 48707

THE MARK CONSISTS OF STANDARD CHARACTERS WITHOUT CLAIM TO ANY PARTICULAR FONT, STYLE, SIZE, OR COLOR.

FOR: PLASTIC REFUSE BAGS, IN CLASS 16 (U.S. CLS. 2, 5, 22, 23, 29, 37, 38 AND 50).

SER. NO. 77-348,190, FILED 12-10-2007.

FIRST USE 1-7-1992; IN COMMERCE 1-7-1992.

LESLEY LAMOTHE, EXAMINING ATTORNEY

**Int. Cl.: 41**

**Prior U.S. Cls.: 100, 101 and 107**

**United States Patent and Trademark Office**

**Reg. No. 3,467,662**

**Registered July 15, 2008**

**SERVICE MARK  
PRINCIPAL REGISTER**

**VINDULGENCE**

WENTE BROS. (CALIFORNIA CORPORATION)  
5565 TESLA ROAD  
LIVERMORE, CA 94550

THE MARK CONSISTS OF STANDARD CHAR-  
ACTERS WITHOUT CLAIM TO ANY PARTICULAR  
FONT, STYLE, SIZE, OR COLOR.

FOR: ENTERTAINMENT IN THE NATURE OF  
MEDIA AND CONSUMER EVENTS FEATURING  
WINE, MUSIC, FOOD, AND FASHION, IN CLASS 41  
(U.S. CLS. 100, 101 AND 107).

SER. NO. 77-348,198, FILED 12-10-2007.

FIRST USE 3-0-2006; IN COMMERCE 3-0-2006.

JAY FLOWERS, EXAMINING ATTORNEY



**Int. Cl.: 41**

**Prior U.S. Cls.: 100, 101 and 107**

**United States Patent and Trademark Office**

**Reg. No. 3,467,663**

**Registered July 15, 2008**

**SERVICE MARK  
PRINCIPAL REGISTER**

**SCHOLARSHIP IN ACTION**

SYRACUSE UNIVERSITY (NEW YORK NOT  
FOR PROFIT EDUCATION CORPORATION)  
303 UNIVERSITY PLACE  
SYRACUSE, NY 13202

THE MARK CONSISTS OF STANDARD CHAR-  
ACTERS WITHOUT CLAIM TO ANY PARTICULAR  
FONT, STYLE, SIZE, OR COLOR.

FOR: EDUCATION SERVICES IN THE NATURE  
OF COURSES AT THE UNIVERSITY LEVEL, IN  
CLASS 41 (U.S. CLS. 100, 101 AND 107).

SER. NO. 77-348,202, FILED 12-10-2007.

FIRST USE 1-30-2005; IN COMMERCE 1-30-2005.

ELISSA GARBER KON, EXAMINING ATTORNEY

**Int. Cl.: 10**

**Prior U.S. Cls.: 26, 39 and 44**

**United States Patent and Trademark Office**

**Reg. No. 3,467,664**

**Registered July 15, 2008**

**TRADEMARK  
PRINCIPAL REGISTER**

**DREAM MASSAGER**

CALIFORNIA EXOTIC NOVELTIES LLC (CALI-  
FORNIA LTD LIAB CO)

14235 RAMONA AVENUE

CHINO, CA 91710

FOR: ADULT SEXUAL AIDS, NAMELY, VIBRA-  
TORS, IN CLASS 10 (U.S. CLS. 26, 39 AND 44).

FIRST USE 6-1-2007; IN COMMERCE 6-1-2007.

THE MARK CONSISTS OF STANDARD CHAR-  
ACTERS WITHOUT CLAIM TO ANY PARTICULAR  
FONT, STYLE, SIZE, OR COLOR.

NO CLAIM IS MADE TO THE EXCLUSIVE  
RIGHT TO USE "MASSAGER", APART FROM THE  
MARK AS SHOWN.

SER. NO. 77-348,205, FILED 12-10-2007.

BARBARA BROWN, EXAMINING ATTORNEY

Int. Cls.: 25 and 32

Prior U.S. Cls.: 22, 39, 45, 46 and 48

United States Patent and Trademark Office

Reg. No. 3,467,665

Registered July 15, 2008

TRADEMARK  
PRINCIPAL REGISTER



COORS GLOBAL PROPERTIES, INC. (COLOR-  
ADO CORPORATION)  
CE 235  
17735 W. 32ND AVENUE  
GOLDEN, CO 80401

FOR: T-SHIRTS, SWEATSHIRTS, HATS AND  
CAPS, IN CLASS 25 (U.S. CLS. 22 AND 39).

FIRST USE 3-0-2006; IN COMMERCE 3-0-2006.

FOR: BEER , IN CLASS 32 (U.S. CLS. 45, 46 AND  
48).

FIRST USE 1-0-2006; IN COMMERCE 1-0-2006.

NO CLAIM IS MADE TO THE EXCLUSIVE  
RIGHT TO USE "BREWING CO." "SINCE 1873",  
APART FROM THE MARK AS SHOWN.

SER. NO. 77-348,303, FILED 12-10-2007.

ALLISON HOLTZ, EXAMINING ATTORNEY

**Int. Cl.: 29**

**Prior U.S. Cl.: 46**

**United States Patent and Trademark Office**

**Reg. No. 3,467,666**

**Registered July 15, 2008**

**TRADEMARK  
PRINCIPAL REGISTER**

**BOATLOAD BAG**

THE FISHIN' COMPANY (DELAWARE COR-  
PORATION)  
105 SOUTH MERIDIAN  
PUYALLUP, WA 98371

NO CLAIM IS MADE TO THE EXCLUSIVE  
RIGHT TO USE "BAG", APART FROM THE MARK  
AS SHOWN.

FOR: FROZEN FISH, IN CLASS 29 (U.S. CL. 46).

FIRST USE 1-0-2003; IN COMMERCE 3-0-2003.

SER. NO. 77-348,867, FILED 12-11-2007.

THE MARK CONSISTS OF STANDARD CHAR-  
ACTERS WITHOUT CLAIM TO ANY PARTICULAR  
FONT, STYLE, SIZE, OR COLOR.

DAVID MILLER, EXAMINING ATTORNEY

**Int. Cl.: 29**

**Prior U.S. Cl.: 46**

**United States Patent and Trademark Office**

**Reg. No. 3,467,667**

**Registered July 15, 2008**

**TRADEMARK  
PRINCIPAL REGISTER**

**BOATLOAD BOX**

THE FISHIN' COMPANY (DELAWARE COR-  
PORATION)  
105 SOUTH MERIDIAN  
PUYALLUP, WA 98371

NO CLAIM IS MADE TO THE EXCLUSIVE  
RIGHT TO USE "BOX", APART FROM THE MARK  
AS SHOWN.

FOR: FROZEN FISH, IN CLASS 29 (U.S. CL. 46).

FIRST USE 1-0-2003; IN COMMERCE 3-0-2003.

SER. NO. 77-348,871, FILED 12-11-2007.

THE MARK CONSISTS OF STANDARD CHAR-  
ACTERS WITHOUT CLAIM TO ANY PARTICULAR  
FONT, STYLE, SIZE, OR COLOR.

DAVID MILLER, EXAMINING ATTORNEY

**Int. Cl.: 16**

**Prior U.S. Cls.: 2, 5, 22, 23, 29, 37, 38 and 50**

**United States Patent and Trademark Office**

**Reg. No. 3,467,668**

**Registered July 15, 2008**

**TRADEMARK  
PRINCIPAL REGISTER**

**12770**

FELLOWES, INC. (ILLINOIS CORPORATION)  
1789 NORWOOD AVE.  
ITASCA, IL 60143

THE MARK CONSISTS OF STANDARD CHAR-  
ACTERS WITHOUT CLAIM TO ANY PARTICULAR  
FONT, STYLE, SIZE, OR COLOR.

FOR: CORRUGATED RECORD STORAGE  
BOXES, IN CLASS 16 (U.S. CLS. 2, 5, 22, 23, 29, 37, 38  
AND 50).

SER. NO. 77-348,963, FILED 12-11-2007.

FIRST USE 5-15-1999; IN COMMERCE 5-15-1999.

DAVID COLLIER, EXAMINING ATTORNEY

**Int. Cl.: 16**

**Prior U.S. Cls.: 2, 5, 22, 23, 29, 37, 38 and 50**

**United States Patent and Trademark Office**

**Reg. No. 3,467,669**

**Registered July 15, 2008**

**TRADEMARK  
PRINCIPAL REGISTER**

**12775**

FELLOWES, INC. (ILLINOIS CORPORATION)  
1789 NORWOOD AVE.  
ITASCA, IL 60143

THE MARK CONSISTS OF STANDARD CHAR-  
ACTERS WITHOUT CLAIM TO ANY PARTICULAR  
FONT, STYLE, SIZE, OR COLOR.

FOR: CORRUGATED RECORD STORAGE  
BOXES, IN CLASS 16 (U.S. CLS. 2, 5, 22, 23, 29, 37, 38  
AND 50).

SER. NO. 77-348,998, FILED 12-11-2007.

FIRST USE 5-15-1999; IN COMMERCE 5-15-1999.

DAVID COLLIER, EXAMINING ATTORNEY

**Int. Cl.: 22**

**Prior U.S. Cls.: 1, 2, 7, 19, 22, 42 and 50**

**Reg. No. 3,467,670**

**United States Patent and Trademark Office**

**Registered July 15, 2008**

---

**TRADEMARK  
PRINCIPAL REGISTER**

# Bead 'n Stretch

TONER PLASTICS INCORPORATED (MASSACHUSETTS CORPORATION)  
699 SILVER STREET  
AGAWAM, MA 01001

FOR: PLASTIC CORD USED IN JEWELRY MAKING AND BEADING SOLD TO CONSUMERS, JEWELERS, MANUFACTURERS, DISTRIBUTORS AND COMMERCIAL WHOLESALERS, IN CLASS 22 (U.S. CLS. 1, 2, 7, 19, 22, 42 AND 50).

FIRST USE 1-5-2000; IN COMMERCE 1-5-2000.

THE MARK CONSISTS OF STANDARD CHARACTERS WITHOUT CLAIM TO ANY PARTICULAR FONT, STYLE, SIZE, OR COLOR.

SER. NO. 77-349,024, FILED 12-11-2007.

PATRICIA EVANKO, EXAMINING ATTORNEY



**Int. Cl.: 41**

**Prior U.S. Cls.: 100, 101 and 107**

**United States Patent and Trademark Office**

**Reg. No. 3,467,671**

**Registered July 15, 2008**

**SERVICE MARK  
PRINCIPAL REGISTER**



CHINESE AMERICAN REAL ESTATE PROFESSIONAL ASSOCIATION, INC. (CALIFORNIA CORPORATION)  
C/O LAW OFFICES  
323 WEST VALLEY BLVD., APT. 202  
ALHAMBRA, CA 91803

FOR: SOCIAL CLUB SERVICES, NAMELY, ARRANGING, ORGANIZING, AND HOSTING SOCIAL EVENTS, GET-TOGETHERS, AND PARTIES FOR CLUB MEMBERS, IN CLASS 41 (U.S. CLS. 100, 101 AND 107).

FIRST USE 6-1-2004; IN COMMERCE 5-1-2006.

THE COLOR(S) RED, WHITE AND BLUE IS/ARE CLAIMED AS A FEATURE OF THE MARK.

THE MARK CONSISTS OF A GRAPHICAL DEPICTION OF A HOME IN THE COLOR BLUE WITH THE TERM "CAREPA" IN THE COLOR RED SUPERIMPOSED OVER THE HOME ALL ON A WHITE BACKGROUND.

SER. NO. 77-349,083, FILED 12-11-2007.

ANDREA SAUNDERS, EXAMINING ATTORNEY

**Int. Cl.: 41**

**Prior U.S. Cls.: 100, 101 and 107**

**United States Patent and Trademark Office**

**Reg. No. 3,467,672**

**Registered July 15, 2008**

**SERVICE MARK  
PRINCIPAL REGISTER**

**CLIMBS**

BOARD OF REGENTS OF THE UNIVERSITY OF  
WISCONSIN SYSTEM (WISCONSIN COR-  
PORATION)  
361 BASCOM HALL 500 LINCOLN DRIVE  
MADISON, WI 53706

FOR: EDUCATIONAL SERVICES, NAMELY,  
CONDUCTING SEMINARS, WORKSHOPS, CON-  
FERENCES, COURSES AND PROFESSIONAL DE-  
VELOPMENT TRAINING PROGRAMS FOR  
TEACHERS, ADMINISTRATORS AND EDUCA-  
TION PERSONNEL IN THE FIELDS OF CLASS-  
ROOM INSTRUCTION FOR ENGLISH LANGUAGE  
LEARNERS AND CLASSROOM ASSESSMENT OF

LIMITED ENGLISH PROFICIENT STUDENTS, IN  
CLASS 41 (U.S. CLS. 100, 101 AND 107).

FIRST USE 12-31-2006; IN COMMERCE 12-31-2006.

THE MARK CONSISTS OF STANDARD CHAR-  
ACTERS WITHOUT CLAIM TO ANY PARTICULAR  
FONT, STYLE, SIZE, OR COLOR.

SER. NO. 77-349,470, FILED 12-11-2007.

WENDY GOODMAN, EXAMINING ATTORNEY

**Int. Cl.: 28**

**Prior U.S. Cls.: 22, 23, 38 and 50**

**United States Patent and Trademark Office**

**Reg. No. 3,467,673**

**Registered July 15, 2008**

---

**TRADEMARK  
PRINCIPAL REGISTER**

**Buzz Baby**

K.S. TOYS, LTD. (HONG KONG CORPORATION)  
RM 312-315, PENINSULA CENTRE 67 MODY RD.  
HONG KONG, HONG KONG

FOR: ELECTRIC ACTION TOYS; MECHANICAL  
ACTION TOYS, IN CLASS 28 (U.S. CLS. 22, 23, 38  
AND 50).

FIRST USE 9-15-2007; IN COMMERCE 9-15-2007.

THE MARK CONSISTS OF STANDARD CHAR-  
ACTERS WITHOUT CLAIM TO ANY PARTICULAR  
FONT, STYLE, SIZE, OR COLOR.

NO CLAIM IS MADE TO THE EXCLUSIVE  
RIGHT TO USE "BABY", APART FROM THE MARK  
AS SHOWN.

SER. NO. 77-349,636, FILED 12-11-2007.

DAVID MILLER, EXAMINING ATTORNEY

**Int. Cl.: 36**

**Prior U.S. Cls.: 100, 101 and 102**

**United States Patent and Trademark Office**

**Reg. No. 3,467,674**

**Registered July 15, 2008**

**SERVICE MARK  
PRINCIPAL REGISTER**



FIRST NATIONAL OF NEBRASKA, INC. (NEBRASKA CORPORATION)  
STOP 3290  
1620 DODGE STREET  
OMAHA, NE 681973290

FOR: BANKING SERVICES, IN CLASS 36 (U.S. CLS. 100, 101 AND 102).

FIRST USE 10-16-2000; IN COMMERCE 10-16-2000.

OWNER OF U.S. REG. NOS. 1,270,238, 2,735,324 AND OTHERS.

NO CLAIM IS MADE TO THE EXCLUSIVE RIGHT TO USE "FIRST NATIONAL BANK OF COLORADO", APART FROM THE MARK AS SHOWN.

THE MARK CONSISTS OF THE NUMERAL ONE IN A CIRCLE AND THE WORDS "FIRST NATIONAL BANK OF COLORADO".

SER. NO. 77-349,829, FILED 12-12-2007.

MICHAEL ENGEL, EXAMINING ATTORNEY

**Int. Cls.: 16 and 41**

**Prior U.S. Cls.: 2, 5, 22, 23, 29, 37, 38, 50, 100, 101 and 107**

**United States Patent and Trademark Office**

**Reg. No. 3,467,675**

**Registered July 15, 2008**

**TRADEMARK  
SERVICE MARK  
PRINCIPAL REGISTER**

**FIRST LINE THERAPY**

METAGENICS, INC. (DELAWARE CORPORATION)  
100 AVENIDA LA PATA  
SAN CLEMENTE, CA 92673

FOR: PRINTED EDUCATIONAL MATERIALS AND PRINTED PRACTICE MANAGEMENT MATERIALS FOR HEALTHCARE PRACTITIONERS, NAMELY, PRINTED BOOKS FOR PATIENT EDUCATION ON THE SUBJECT OF HEALTH AND NUTRITION, PRINTED BOOKS FOR PRACTICE MANAGEMENT ON THE SUBJECTS OF HEALTH AND NUTRITION, PRINTED BOOKS FOR PROFESSIONAL EDUCATION ON THE SUBJECTS OF HEALTH AND NUTRITION, POSTERS AND BROCHURES FOR PATIENT EDUCATION AND PROFESSIONAL EDUCATION ON THE SUBJECTS OF HEALTH AND NUTRITION, IN CLASS 16 (U.S. CLS. 2, 5, 22, 23, 29, 37, 38 AND 50).

FIRST USE 9-9-2002; IN COMMERCE 9-11-2002.

FOR: EDUCATIONAL AND PRACTICE MANAGEMENT SEMINARS FOR HEALTHCARE PRACTITIONERS IN THE FIELDS OF HEALTH AND NUTRITION, IN CLASS 41 (U.S. CLS. 100, 101 AND 107).

FIRST USE 9-9-2002; IN COMMERCE 9-11-2002.

THE MARK CONSISTS OF STANDARD CHARACTERS WITHOUT CLAIM TO ANY PARTICULAR FONT, STYLE, SIZE, OR COLOR.

OWNER OF U.S. REG. NO. 2,818,514.

SEC. 2(F).

SER. NO. 77-349,868, FILED 12-12-2007.

ESTHER BELENKER, EXAMINING ATTORNEY

**Int. Cls.: 14 and 35**

**Prior U.S. Cls.: 2, 27, 28, 50, 100, 101 and 102**

**United States Patent and Trademark Office**

**Reg. No. 3,467,676**

**Registered July 15, 2008**

**TRADEMARK  
SERVICE MARK  
PRINCIPAL REGISTER**

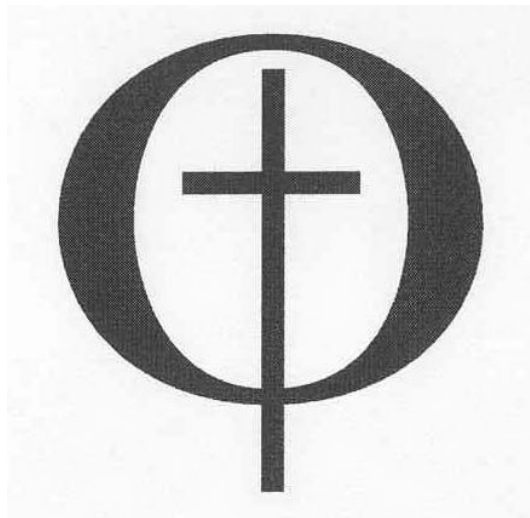

A. JOSEPH LIPTON (UNITED STATES INDIVIDUAL)  
PMB 494  
2250 RIVER ROAD  
MT. BETHEL, PA 18343

FOR: JEWELRY, INCLUDING NECKLACES, PENDANTS, EARRINGS, PINS, RINGS, CHARMS, BRACELETS; AND PRECIOUS AND SEMI-PRECIOUS GEMSTONES, IN CLASS 14 (U.S. CLS. 2, 27, 28 AND 50).

FIRST USE 4-0-2007; IN COMMERCE 4-0-2007.

FOR: CATALOG ORDERING SERVICES; MAIL ORDER SERVICES; TELEPHONE ORDERING SERVICES; AND ON-LINE RETAIL STORE SERVICES, ALL FEATURING JEWELRY AND GEMSTONES, IN CLASS 35 (U.S. CLS. 100, 101 AND 102).

FIRST USE 4-0-2007; IN COMMERCE 4-0-2007.

THE MARK CONSISTS OF A CIRCLE WITH AN IMAGE OF A CROSS INSERTED IN THE CIRCLE.

SER. NO. 77-350,005, FILED 12-12-2007.

ANNE MADDEN, EXAMINING ATTORNEY

**Int. Cls.: 35 and 44**

**Prior U.S. Cls.: 100, 101 and 102**

**United States Patent and Trademark Office**

**Reg. No. 3,467,677**

**Registered July 15, 2008**

**SERVICE MARK  
PRINCIPAL REGISTER**



DISTINCT CHOICE MATURE LIVING SOLUTIONS, LLC (WISCONSIN LTD LIAB CO)  
SUITE 130  
5307 S. 92ND STREET  
HALES CORNERS, WI 53130

FOR: REFERRAL SERVICES IN THE FIELD OF ELDERLY CARE, NAMELY, REFERRALS FOR THE ELDERLY REGARDING IN-HOME AND OUT-PATIENT CARE, HOUSING OPTIONS, ASSISTED LIVING PROGRAMS, COMPANION CARE, MOVING SERVICES FOR THE ELDERLY, LEGAL COUNSEL SPECIALIZING IN SENIOR LAW, DOCTOR AND MEDICAL CARE, FINANCIAL ADVISORY SERVICES, FAMILY CARE, REAL ESTATE SALES, ADULT DAY CARE, HOSPICE AND FUNERAL SERVICES, THERAPY SERVICES, AND MANAGEMENT OF HEALTH CARE FOR THE ELDERLY, IN CLASS 35 (U.S. CLS. 100, 101 AND 102).

FIRST USE 8-20-2007; IN COMMERCE 8-20-2007.

FOR: CONSULTING SERVICES IN MANAGEMENT OF HEALTH CARE FOR THE ELDERLY, IN CLASS 44 (U.S. CLS. 100 AND 101).

FIRST USE 8-20-2007; IN COMMERCE 8-20-2007.

NO CLAIM IS MADE TO THE EXCLUSIVE RIGHT TO USE "MATURE LIVING SOLUTIONS", APART FROM THE MARK AS SHOWN.

THE MARK CONSISTS OF THE WORDS "DISTINCT CHOICE" TO THE RIGHT OF AN IMAGE OF A HOUSE, WITH THE TAGLINE "MATURE LIVING SOLUTIONS" CENTERED UNDERNEATH WITH A LINE ON EITHER SIDE OF THE TAGLINE.

SER. NO. 77-350,371, FILED 12-12-2007.

DAVID COLLIER, EXAMINING ATTORNEY

**Int. Cls.: 16, 35 and 39**

**Prior U.S. Cls.: 2, 5, 22, 23, 29, 37, 38, 50, 100, 101, 102  
and 105**

**Reg. No. 3,467,678**

**United States Patent and Trademark Office**

**Registered July 15, 2008**

**TRADEMARK  
SERVICE MARK  
PRINCIPAL REGISTER**



UNITED STATES POSTAL SERVICE (UNITED STATES INDEPENDENT ESTABLISHMENT OF THE EXECUTIVE BRANCH OF THE UNITED STATES GOVERNMENT)  
475 L'ENFANT PLAZA SW  
WASHINGTON, DC 20260

FOR: PRINTED MATERIALS, NAMELY, ENVELOPES AND CARDBOARD AND CORRUGATED BOXES FOR SHIPPING AND PACKAGING, SHIPPING LABELS AND CARDBOARD MAILING TUBES, IN CLASS 16 (U.S. CLS. 2, 5, 22, 23, 29, 37, 38 AND 50).

FIRST USE 4-0-1995; IN COMMERCE 4-0-1995.

FOR: SORTING, HANDLING, AND RECEIVING PACKAGES, LETTERS, ADVERTISEMENTS, CATALOGS, PUBLICATIONS AND OTHER ITEMS OF MAIL, IN CLASS 35 (U.S. CLS. 100, 101 AND 102).

FIRST USE 4-0-1995; IN COMMERCE 4-0-1995.

FOR: PICKUP, TRANSPORTATION, AND DELIVERY OF PACKAGES, LETTERS, ADVERTISE-

MENTS, CATALOGS, PUBLICATIONS AND OTHER ITEMS OF MAIL BY VARIOUS MODES OF TRANSPORTATION; COURIER SERVICES; PACKAGING ARTICLES FOR TRANSPORTATION, IN CLASS 39 (U.S. CLS. 100 AND 105).

FIRST USE 4-0-1995; IN COMMERCE 4-0-1995.

OWNER OF U.S. REG. NOS. 2,247,552, 2,538,835 AND OTHERS.

NO CLAIM IS MADE TO THE EXCLUSIVE RIGHT TO USE "MAIL", APART FROM THE MARK AS SHOWN.

THE MARK CONSISTS OF IN PART, THE STYLIZED HEAD OF AN EAGLE.

SEC. 2(F) AS TO "PRIORITY MAIL" .

SER. NO. 77-351,162, FILED 12-13-2007.

JEFFERY COWARD, EXAMINING ATTORNEY



Int. Cl.: 31

Prior U.S. Cls.: 1 and 46

United States Patent and Trademark Office

Reg. No. 3,467,679

Registered July 15, 2008

TRADEMARK  
PRINCIPAL REGISTER

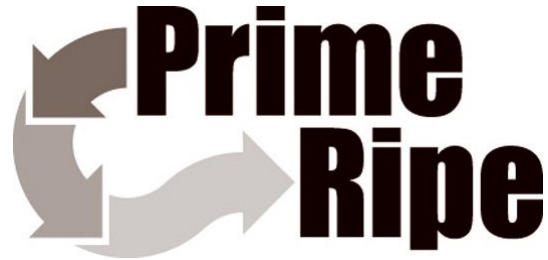

PRIME PRODUCE INTERNATIONAL, LLC (CALIFORNIA LTD LIAB CO)  
350 N. CYPRESS STREET  
ORANGE, CA 928661028

FOR: RIPENED FRESH FRUITS AND VEGETABLES, IN CLASS 31 (U.S. CLS. 1 AND 46).

FIRST USE 10-1-2006; IN COMMERCE 10-1-2006.

NO CLAIM IS MADE TO THE EXCLUSIVE RIGHT TO USE "RIPE", APART FROM THE MARK AS SHOWN.

THE MARK CONSISTS OF THREE STYLIZED ARROWS FORMING A THREE-QUARTER CIRCLE WITH EACH ARROW BEING A LIGHTER SHADE OF THE PREVIOUS ONE AND THE WORDS "PRIME RIME".

SER. NO. 77-351,200, FILED 12-13-2007.

DAWN FELDMAN, EXAMINING ATTORNEY

**Int. Cl.: 35**

**Prior U.S. Cls.: 100, 101 and 102**

**United States Patent and Trademark Office**

**Reg. No. 3,467,680**

**Registered July 15, 2008**

---

**SERVICE MARK  
PRINCIPAL REGISTER**

**richrecs**

EDVERT, INC. (DELAWARE CORPORATION),  
DBA RICHRELEVANCE  
1915 BISHOP RD.  
BELMONT, CA 94002

THE MARK CONSISTS OF STANDARD CHAR-  
ACTERS WITHOUT CLAIM TO ANY PARTICULAR  
FONT, STYLE, SIZE, OR COLOR.

FOR: INTERNET ADVERTISING SERVICES; AD-  
VERTISING SERVICES, IN CLASS 35 (U.S. CLS. 100,  
101 AND 102).

SER. NO. 77-351,202, FILED 12-13-2007.

FIRST USE 12-12-2007; IN COMMERCE 12-12-2007.

HOWARD SMIGA, EXAMINING ATTORNEY

**Int. Cl.: 28**

**Prior U.S. Cls.: 22, 23, 38 and 50**

**United States Patent and Trademark Office**

**Reg. No. 3,467,681**

**Registered July 15, 2008**

**TRADEMARK  
PRINCIPAL REGISTER**

**SOFT AND TENDER**

DAN-DEE INTERNATIONAL, LTD. (DELAWARE  
CORPORATION)  
106 HARBOR DRIVE  
JERSEY CITY, NJ 07305

THE MARK CONSISTS OF STANDARD CHAR-  
ACTERS WITHOUT CLAIM TO ANY PARTICULAR  
FONT, STYLE, SIZE, OR COLOR.

FOR: PLUSH TOYS, IN CLASS 28 (U.S. CLS. 22, 23,  
38 AND 50).

SER. NO. 77-351,287, FILED 12-13-2007.

FIRST USE 3-20-1989; IN COMMERCE 3-20-1989.

LINDA E. BLOHM, EXAMINING ATTORNEY

**Int. Cls.: 35 and 42**

**Prior U.S. Cls.: 100, 101 and 102**

**United States Patent and Trademark Office**

**Reg. No. 3,467,682**

**Registered July 15, 2008**

**SERVICE MARK  
PRINCIPAL REGISTER**

# Ideas That Stick

SPITBALL, LLC (NEW JERSEY LTD LIAB CO)  
PO BOX 8775  
RED BANK, NJ 07701

FOR: ADVERTISING AGENCIES, NAMELY, PROMOTING THE GOODS AND SERVICES OF OTHERS THROUGH ALL PUBLIC COMMUNICATION MEANS, DEVELOPMENT OF MARKETING STRATEGIES AND CONCEPTS , IN CLASS 35 (U.S. CLS. 100, 101 AND 102).

FIRST USE 6-1-2007; IN COMMERCE 6-1-2007.

FOR: DESIGN, CREATION, HOSTING, MAINTENANCE OF WEBSITES FOR OTHERS, DESIGN AND DEVELOPMENT OF MULTIMEDIA PRODUCTS, GRAPHIC DESIGN SERVICES, NAMELY, DESIGN

OF PRINT ADVERTISEMENTS, BILLBOARDS, BROCHURES, COMMERCIALS, CORPORATE LOGOS, TRADE SHOW BOOTHS, PRINTED COLLATERAL, PRESENTATIONS AND PACKAGING, COMPUTER-AIDED DESIGN OF VIDEO GRAPHICS, IN CLASS 42 (U.S. CLS. 100 AND 101).

FIRST USE 6-1-2007; IN COMMERCE 6-1-2007.

THE MARK CONSISTS OF STANDARD CHARACTERS WITHOUT CLAIM TO ANY PARTICULAR FONT, STYLE, SIZE, OR COLOR.

SER. NO. 77-351,325, FILED 12-13-2007.

SOPHIA S. KIM, EXAMINING ATTORNEY

**Int. Cl.: 9**

**Prior U.S. Cls.: 21, 23, 26, 36 and 38**

**Reg. No. 3,467,683**

**United States Patent and Trademark Office**

**Registered July 15, 2008**

---

**TRADEMARK  
PRINCIPAL REGISTER**

**POWERHOUSE**

COMMSCOPE, INC. OF NORTH CAROLINA  
(NORTH CAROLINA CORPORATION)  
1100 COMMSCOPE PLACE, S.E.  
HICKORY, NC 28602

FIRST USE 9-30-1999; IN COMMERCE 9-30-1999.

FOR: TELECOMMUNICATIONS PRODUCT,  
NAMELY, A POWER CABINET PLATFORM USED  
TO HOUSE RECTIFIERS, BATTERIES AND POWER  
DISTRIBUTION UNITS ALL USED IN THE AREA  
OF TELECOMMUNICATIONS, IN CLASS 9 (U.S.  
CLS. 21, 23, 26, 36 AND 38).

THE MARK CONSISTS OF STANDARD CHAR-  
ACTERS WITHOUT CLAIM TO ANY PARTICULAR  
FONT, STYLE, SIZE, OR COLOR.

SER. NO. 77-351,350, FILED 12-13-2007.

TRICIA SONNEBORN, EXAMINING ATTORNEY

**Int. Cl.: 9**

**Prior U.S. Cls.: 21, 23, 26, 36 and 38**

**Reg. No. 3,467,684**

**United States Patent and Trademark Office**

**Registered July 15, 2008**

---

**TRADEMARK  
PRINCIPAL REGISTER**

**SKYSCOPE**

MORRIS & LEE (NEW YORK CORPORATION),  
DBA SCIENCE FIRST  
95 BOTSFORD PLACE  
BUFFALO, NY 14216

FOR: PHOTOGRAPHIC FILM VIEWERS, IN  
CLASS 9 (U.S. CLS. 21, 23, 26, 36 AND 38).

FIRST USE 5-2-1968; IN COMMERCE 5-2-1968.

THE MARK CONSISTS OF STANDARD CHAR-  
ACTERS WITHOUT CLAIM TO ANY PARTICULAR  
FONT, STYLE, SIZE, OR COLOR.

OWNER OF U.S. REG. NO. 866,293.

SER. NO. 77-351,399, FILED 12-13-2007.

DEZMONA MIZELLE, EXAMINING ATTORNEY

**Int. Cl.: 35**

**Prior U.S. Cls.: 100, 101 and 102**

**United States Patent and Trademark Office**

**Reg. No. 3,467,685**

**Registered July 15, 2008**

**SERVICE MARK  
PRINCIPAL REGISTER**

**A LITTLE TIME, A LOT OF  
GOOD.**

AMERICAN CANCER SOCIETY, INC. (NEW  
YORK CORPORATION)  
NATIONAL HOME OFFICE  
250 WILLIAMS STREET  
ATLANTA, GA 30303

FOR: PROMOTING PUBLIC AWARENESS OF  
CANCER RESEARCH, PREVENTION, AND DETEC-  
TION; CHARITABLE SERVICES, NAMELY, ORGA-  
NIZING AND CONDUCTING VOLUNTEER  
PROGRAMS, IN CLASS 35 (U.S. CLS. 100, 101 AND  
102).

FIRST USE 8-8-2007; IN COMMERCE 8-8-2007.

THE MARK CONSISTS OF STANDARD CHAR-  
ACTERS WITHOUT CLAIM TO ANY PARTICULAR  
FONT, STYLE, SIZE, OR COLOR.

SER. NO. 77-351,520, FILED 12-13-2007.

ELLEN B. AWRICH, EXAMINING ATTORNEY

**Int. Cl.: 35**

**Prior U.S. Cls.: 100, 101 and 102**

**United States Patent and Trademark Office**

**Reg. No. 3,467,686**

**Registered July 15, 2008**

**SERVICE MARK  
PRINCIPAL REGISTER**

**richmail**

EDVERT, INC. (DELAWARE CORPORATION),  
DBA RICHRELEVANCE  
1915 BISHOP RD.  
BELMONT, CA 94002

THE MARK CONSISTS OF STANDARD CHAR-  
ACTERS WITHOUT CLAIM TO ANY PARTICULAR  
FONT, STYLE, SIZE, OR COLOR.

FOR: ADVERTISING SERVICES; INTERNET AD-  
VERTISING SERVICES, IN CLASS 35 (U.S. CLS. 100,  
101 AND 102).

SER. NO. 77-351,742, FILED 12-13-2007.

FIRST USE 12-13-2007; IN COMMERCE 12-13-2007.

HOWARD SMIGA, EXAMINING ATTORNEY



**Int. Cl.: 35**

**Prior U.S. Cls.: 100, 101 and 102**

**United States Patent and Trademark Office**

**Reg. No. 3,467,687**

**Registered July 15, 2008**

**SERVICE MARK  
PRINCIPAL REGISTER**

**SHILOH SHARPS**

POWDER RIVER RIFLE COMPANY, INC. (MONTANA CORPORATION)  
PO BOX 279  
BIG TIMBER, MT 59011

FOR: ONLINE RETAIL STORE SERVICES FEATURING RIFLES; FIREARM SIGHTS; FIREARM SIGHT CADDIES; FIREARM SCOPES; FIREARM SCOPE MOUNTS; BLOW TUBES; WIND CHARTS; SHOOTING MATS; SHOOTING STICKS; RIFLE SLINGS; GUN STANDS; CARTRIDGE BELTS; SIGHT SACKS; SCOREBOOKS FOR USE IN TARGET SHOOTING; SPOTTING BOARDS FOR USE IN TARGET SHOOTING; CLEANING SUPPLIES, NAMELY, GUN CLEANING PATCHES, GUN SOLVENTS, GUN OIL, GUN CLEANING CLOTHS, CLEANER FOR BRASS CARTRIDGES, CERAMIC MEDIA AND TUMBLER USED FOR CLEANING BRASS, GUN CLEANING ROD, GUN GLOW USED FOR CLEANING WOOD AND OUTER PARTS OF A GUN; RELOADING EQUIPMENT, NAMELY, POWDER MEASURES, LUBRICANT/SIZER, RELOADING PRESSES, SEATER PRESSES, INLINE DIES,

RELOADING DIES, DROP TUBES, PLASTIC AND FIBER WADS, BULLET LUBES, RELOADING BLOCKS, DE-PRIMING TOOLS, AND PAPER CARTRIDGE KITS FOR PERCUSSION RIFLES; CLOTHING, NAMELY, T-SHIRTS, SWEATSHIRTS, CAPS, COATS, VESTS, SHIRTS; BELT BUCKLES; BOOKS RELATING TO FIREARMS AND HUNTING; DVDS AND CDS RELATING TO HUNTING THEMES; MUGS; COASTERS; POSTERS; CALENDARS; MOUSE PADS, IN CLASS 35 (U.S. CLS. 100, 101 AND 102).

FIRST USE 7-27-2004; IN COMMERCE 7-27-2004.

THE MARK CONSISTS OF STANDARD CHARACTERS WITHOUT CLAIM TO ANY PARTICULAR FONT, STYLE, SIZE, OR COLOR.

SER. NO. 77-351,892, FILED 12-13-2007.

DOMINICK J. SALEMI, EXAMINING ATTORNEY

**Int. Cl.: 33**

**Prior U.S. Cls.: 47 and 49**

**United States Patent and Trademark Office**

**Reg. No. 3,467,688**

**Registered July 15, 2008**

**TRADEMARK  
PRINCIPAL REGISTER**

**Pappy Van Winkle's**

VAN WINKLE WHISKEY COMPANY LLC (KEN-  
TUCKY LTD LIAB CO)

2843 BROWNSBORO ROAD

LOUISVILLE, KY 40206

FOR: WHISKEY, IN CLASS 33 (U.S. CLS. 47 AND  
49).

FIRST USE 12-1-1994; IN COMMERCE 12-1-1994.

THE MARK CONSISTS OF STANDARD CHAR-  
ACTERS WITHOUT CLAIM TO ANY PARTICULAR  
FONT, STYLE, SIZE, OR COLOR.

THE NAME(S), PORTRAIT(S), AND/OR SIGNA-  
TURE(S) SHOWN IN THE MARK DOES NOT IDEN-  
TIFY A PARTICULAR LIVING INDIVIDUAL.

SER. NO. 77-351,967, FILED 12-14-2007.

NAAKWAMA ANKRAH, EXAMINING ATTORNEY

**Int. Cls.: 16 and 40**

**Prior U.S. Cls.: 2, 5, 22, 23, 29, 37, 38, 50, 100, 103 and 106**

**Reg. No. 3,467,689**

**United States Patent and Trademark Office**

**Registered July 15, 2008**

**TRADEMARK  
SERVICE MARK  
PRINCIPAL REGISTER**



ENNIS, INC. (TEXAS CORPORATION)  
2441 PRESIDENTIAL PARKWAY  
MIDLOTHIAN, TX 76065

FOR: PRINTED MATERIAL, NAMELY, INTEGRATED FORMS AND VALUE ADD PRODUCTS, NAMELY, DIRECT MAIL POSTCARDS, INTEGRATED PAPER LABELS, INTEGRATED PAPER CARDS FOR CUSTOM APPLICATIONS, NAMELY, MEMBERSHIP CARDS, IDENTIFICATION CARDS, VISITOR PASSES, PLAN BENEFIT CARDS, BUSINESS CARDS, PHONE INDEX CARDS, COUPON CARDS, DISCOUNT CARDS, AND INFORMATION CARDS FEATURING TEXT AND IMAGES, INTEGRATED PAPER INCORPORATING MAGNETIC SUBSTRATE AND DIE CUT INTO SHAPES SOLD AS A UNIT, INTEGRATED PAPER DECALS, INTEGRATED PAPER INCORPORATING POLYESTER BASED OVER LAMINATE WITH COLORED SCRATCH OFF COATING TO BLOCK OR SECURE PRINTED PROMOTIONAL WORDS OR IMAGES FROM VIEW, CHAIN OF CUSTODY FORMS, AND PACKAGE INSERTS, NAMELY PACKING INFORMATION SHEETS, IN CLASS 16 (U.S. CLS. 2, 5, 22, 23, 29, 37, 38 AND 50).

FIRST USE 9-15-2006; IN COMMERCE 9-15-2006.

FOR: PRINTING INTEGRATED FORMS AND VALUE ADD PRODUCTS, NAMELY, DIRECT MAIL POSTCARDS, INTEGRATED LABELS, INTEGRATED CARDS, INTEGRATED MAGNETS, INTEGRATED DECALS, SCRATCH OFF CARDS, CHAIN OF CUSTODY FORMS, AND PACKAGE INSERTS, IN CLASS 40 (U.S. CLS. 100, 103 AND 106).

FIRST USE 9-15-2006; IN COMMERCE 9-15-2006.

OWNER OF U.S. REG. NO. 3,393,460.

THE MARK CONSISTS OF THE WORD "ENFUSION" IN LOWER-CASE LETTERS. INSIDE THE LETTER "O" IS A CIRCLE WITH A TAIL THAT ARCS BACK OVER THE WORD. ON THE END OF THE ARC ARE TWO SMALL CIRCLES, WHICH ARE ON TOP OF PART OF THE LETTER "N".

SER. NO. 77-352,180, FILED 12-14-2007.

GENE MACIOL, EXAMINING ATTORNEY

**Int. Cl.: 33**

**Prior U.S. Cls.: 47 and 49**

**United States Patent and Trademark Office**

**Reg. No. 3,467,690**

**Registered July 15, 2008**

**TRADEMARK  
PRINCIPAL REGISTER**

**IZTIC**

TEQUILA AMBICION, S.A. DE C.V. (MEXICO  
CORPORATION)  
BOLIVAR #1 P.A., COL. CENTRO  
MEXICO, D.F., MEXICO 06080

OWNER OF MEXICO REG. NO. 1002272, DATED  
9-14-2007, EXPIRES 8-24-2017.

FOR: TEQUILA; ALCOHOLIC BEVERAGES EX-  
CEPT BEERS, IN CLASS 33 (U.S. CLS. 47 AND 49).

SER. NO. 77-352,315, FILED 12-14-2007.

THE MARK CONSISTS OF STANDARD CHAR-  
ACTERS WITHOUT CLAIM TO ANY PARTICULAR  
FONT, STYLE, SIZE, OR COLOR.

DEIRDRE ROBERTSON, EXAMINING ATTORNEY

**Int. Cl.: 35**

**Prior U.S. Cls.: 100, 101 and 102**

**United States Patent and Trademark Office**

**Reg. No. 3,467,691**

**Registered July 15, 2008**

**SERVICE MARK  
PRINCIPAL REGISTER**



EDVERT, INC. (DELAWARE CORPORATION),  
DBA RICHRELEVANCE.  
1915 BISHOP RD.  
BELMONT, CA 94002

FOR: ADVERTISING SERVICES; INTERNET AD-  
VERTISING SERVICES, IN CLASS 35 (U.S. CLS. 100,  
101 AND 102).

FIRST USE 10-15-2007; IN COMMERCE 10-15-2007.

THE MARK CONSISTS OF TWO LOWERCASE  
"R"S ENCLOSED BY STYLIZED BRACKETS, A  
CONSTRUCT WHICH IS SLIGHTLY ROTATED  
AROUND THE Y-AXIS INTO THE Z-PLANE, FOL-  
LOWED BY THE WORD "RICHRELEVANCE" IN  
LOWERCASE.

SER. NO. 77-352,340, FILED 12-14-2007.

HOWARD SMIGA, EXAMINING ATTORNEY

**Int. Cl.: 19**

**Prior U.S. Cls.: 1, 12, 33 and 50**

**United States Patent and Trademark Office**

**Reg. No. 3,467,692**

**Registered July 15, 2008**

---

**TRADEMARK  
PRINCIPAL REGISTER**

# CONCERTO

SECOA, INC. (MINNESOTA CORPORATION)  
8650 109TH AVE. NORTH  
CHAMPLIN, MN 55316

FOR: PERFORMANCE STAGE SYSTEM COM-  
POSED OF NON-METAL PORTABLE ACOUSTIC  
WALL PANELS DESIGNED TO PROVIDE AN  
ACOUSTIC ENCLOSURE FOR MUSICAL AND  
THEATRICAL PERFORMANCES, IN CLASS 19  
(U.S. CLS. 1, 12, 33 AND 50).

FIRST USE 9-0-2006; IN COMMERCE 9-0-2006.

THE MARK CONSISTS OF STANDARD CHAR-  
ACTERS WITHOUT CLAIM TO ANY PARTICULAR  
FONT, STYLE, SIZE, OR COLOR.

SER. NO. 77-352,624, FILED 12-14-2007.

DANNEAN HETZEL, EXAMINING ATTORNEY

**Int. Cl.: 19**

**Prior U.S. Cls.: 1, 12, 33 and 50**

**United States Patent and Trademark Office**

**Reg. No. 3,467,693**

**Registered July 15, 2008**

**TRADEMARK  
PRINCIPAL REGISTER**

**MAESTRO**

SECOA, INC. (MINNESOTA CORPORATION)  
8650 109TH AVE. NORTH  
CHAMPLIN, MN 55316

FOR: PERFORMANCE STAGE SYSTEM COM-  
POSED OF NON-METAL PORTABLE ACOUSTIC  
WALL PANELS DESIGNED TO PROVIDE AN  
ACOUSTIC ENCLOSURE FOR MUSICAL AND  
THEATRICAL PERFORMANCES, IN CLASS 19  
(U.S. CLS. 1, 12, 33 AND 50).

FIRST USE 7-0-2001; IN COMMERCE 7-0-2001.

THE MARK CONSISTS OF STANDARD CHAR-  
ACTERS WITHOUT CLAIM TO ANY PARTICULAR  
FONT, STYLE, SIZE, OR COLOR.

SER. NO. 77-352,826, FILED 12-14-2007.

DANNEAN HETZEL, EXAMINING ATTORNEY

**Int. Cl.: 9**

**Prior U.S. Cls.: 21, 23, 26, 36 and 38**

**United States Patent and Trademark Office**

**Reg. No. 3,467,694**

**Registered July 15, 2008**

**TRADEMARK  
PRINCIPAL REGISTER**

**SF3**

SCT PERFORMANCE, LLC (NORTH CAROLINA  
LTD LIAB CO)  
975 FLORIDA CENTRAL PARKWAY  
SUITE 1900  
LONGWOOD, FL 32750

FOR: ELECTRONIC AUTOMOTIVE TUNING DE-  
VICE, NAMELY, ELECTRONIC CONTROL HARD-  
WARE UNIT WHICH INTERFACES WITH A CAR'S  
DRIVE-TRAIN COMPUTER SYSTEM AND REPRO-  
GRAMS THE CAR'S MICROCHIP TO MAKE IT GO  
FASTER, HAVE MORE POWER AND GET BETTER

GAS MILEAGE, IN CLASS 9 (U.S. CLS. 21, 23, 26, 36  
AND 38).

FIRST USE 6-1-2007; IN COMMERCE 6-1-2007.

THE MARK CONSISTS OF STANDARD CHAR-  
ACTERS WITHOUT CLAIM TO ANY PARTICULAR  
FONT, STYLE, SIZE, OR COLOR.

SER. NO. 77-352,923, FILED 12-14-2007.

SUNG IN, EXAMINING ATTORNEY



**Int. Cl.: 9**

**Prior U.S. Cls.: 21, 23, 26, 36 and 38**

**Reg. No. 3,467,695**

**United States Patent and Trademark Office**

**Registered July 15, 2008**

---

**TRADEMARK  
PRINCIPAL REGISTER**

**POWER FLASH**

SCT PERFORMANCE, LLC (NORTH CAROLINA  
LTD LIAB CO)  
975 FLORIDA CENTRAL PARKWAY  
SUITE 1900  
LONGWOOD, FL 32750

FOR: ELECTRONIC AUTOMOTIVE TUNING DE-  
VICE, NAMELY, ELECTRONIC CONTROL HARD-  
WARE UNIT WHICH INTERFACES WITH A CAR'S  
DRIVE-TRAIN COMPUTER SYSTEM AND REPRO-  
GRAMS THE CAR'S MICROCHIP TO MAKE IT GO  
FASTER, HAVE MORE POWER AND GET BETTER

GAS MILEAGE, IN CLASS 9 (U.S. CLS. 21, 23, 26, 36  
AND 38).

FIRST USE 6-1-2007; IN COMMERCE 6-1-2007.

THE MARK CONSISTS OF STANDARD CHAR-  
ACTERS WITHOUT CLAIM TO ANY PARTICULAR  
FONT, STYLE, SIZE, OR COLOR.

SER. NO. 77-352,932, FILED 12-14-2007.

SUNG IN, EXAMINING ATTORNEY

**Int. Cl.: 43**

**Prior U.S. Cls.: 100 and 101**

**United States Patent and Trademark Office**

**Reg. No. 3,467,696**

**Registered July 15, 2008**

**SERVICE MARK  
PRINCIPAL REGISTER**



RASTAN LLC (MASSACHUSETTS LTD LIAB CO)  
C/O BLUE ANGUS CAFE, 34 BROADWAY ROAD  
DRACUT, MA 01826

THE MARK CONSISTS OF THE HEAD OF A  
BULL WITH HORNS AND A BANDANA AROUND  
THE NECK.

FOR: PROVISION OF FOOD AND DRINK IN  
RESTAURANTS; RESTAURANT, BAR AND CA-  
TERING SERVICES; TAKE-OUT RESTAURANT  
SERVICES, IN CLASS 43 (U.S. CLS. 100 AND 101).

SER. NO. 77-353,218, FILED 12-16-2007.

FIRST USE 9-15-2006; IN COMMERCE 9-15-2006.

TRACY CROSS, EXAMINING ATTORNEY

Int. Cl.: 5

Prior U.S. Cls.: 6, 18, 44, 46, 51 and 52

United States Patent and Trademark Office

Reg. No. 3,467,697

Registered July 15, 2008

TRADEMARK  
PRINCIPAL REGISTER



SWEET CAROLINE'S HORSE COOKIES INCORPORATED (NEVADA CORPORATION), DBA SWEET CAROLINE'S HORSE COOKIES INCORPORATED  
1127 MELVILLE DRIVE  
LAS VEGAS, NV 89102

FOR: ANIMAL FEED SUPPLEMENTS; MINERAL FOOD SUPPLEMENTS; MINERAL SUPPLEMENTS, IN CLASS 5 (U.S. CLS. 6, 18, 44, 46, 51 AND 52).

FIRST USE 10-11-2007; IN COMMERCE 10-11-2007.

NO CLAIM IS MADE TO THE EXCLUSIVE RIGHT TO USE "HORSE COOKIES", APART FROM THE MARK AS SHOWN.

THE COLOR(S) BLACK, TOMATO RED, WHITE IS/ARE CLAIMED AS A FEATURE OF THE MARK.

THE MARK CONSISTS OF THE WORDS "SWEET CAROLINE'S HORSE COOKIES" IN BLACK LETTERING, WITH A TOMATO RED HEART AND WHITE HORSE HEADS.

SER. NO. 77-353,285, FILED 12-16-2007.

CHRISIE B. KING, EXAMINING ATTORNEY

**Int. Cl.: 3**

**Prior U.S. Cls.: 1, 4, 6, 50, 51 and 52**

**United States Patent and Trademark Office**

**Reg. No. 3,467,698**

**Registered July 15, 2008**

**TRADEMARK  
PRINCIPAL REGISTER**

**DNA ULTRACUSTOM**

GENELINK, INC. (PENNSYLVANIA CORPORATION)  
NEWPORT FINANCIAL CENTER  
123 TOWN SQUARE PLACE #313  
JERSEY CITY, NJ 07310

THE MARK CONSISTS OF STANDARD CHARACTERS WITHOUT CLAIM TO ANY PARTICULAR FONT, STYLE, SIZE, OR COLOR.

FOR: NON-MEDICATED SKINCARE PREPARATIONS, IN CLASS 3 (U.S. CLS. 1, 4, 6, 50, 51 AND 52).

SER. NO. 77-353,827, FILED 12-17-2007.

FIRST USE 8-0-2004; IN COMMERCE 8-0-2004.

SHAUNIA CARLYLE, EXAMINING ATTORNEY

**Int. Cl.: 12**

**Prior U.S. Cls.: 19, 21, 23, 31, 35 and 44**

**United States Patent and Trademark Office**

**Reg. No. 3,467,699**

**Registered July 15, 2008**

**TRADEMARK  
PRINCIPAL REGISTER**

**EMERGER**

DRAGONFLY BOATWORKS LLC (FLORIDA  
LTD LIAB CO)  
4575 N. US 1 STE 10 VERO BEACH, FL 32960  
VERO BEACH, FL 32967

FOR: BOAT HULLS; BOATS; BOATS AND  
STRUCTURAL PARTS THEREFOR; FISHING  
BOATS; STRUCTURAL PARTS FOR BOATS; VES-  
SELS; JON BOATS; KAYAK-LIKE BOATS, IN CLASS  
12 (U.S. CLS. 19, 21, 23, 31, 35 AND 44).

FIRST USE 5-15-2007; IN COMMERCE 5-15-2007.

THE MARK CONSISTS OF STANDARD CHAR-  
ACTERS WITHOUT CLAIM TO ANY PARTICULAR  
FONT, STYLE, SIZE, OR COLOR.

SER. NO. 77-353,839, FILED 12-17-2007.

KARANENDRA S. CHHINA, EXAMINING ATTOR-  
NEY

**Int. Cl.: 33**

**Prior U.S. Cls.: 47 and 49**

**United States Patent and Trademark Office**

**Reg. No. 3,467,700**

**Registered July 15, 2008**

**TRADEMARK  
PRINCIPAL REGISTER**

**CONCEPT**

CAIN CELLARS, INC. (CALIFORNIA CORPORATION)  
3800 LANGTRY ROAD  
ST. HELENA, CA 94574

FOR: WINE, IN CLASS 33 (U.S. CLS. 47 AND 49).

FIRST USE 8-24-2006; IN COMMERCE 8-24-2006.

THE MARK CONSISTS OF STANDARD CHARACTERS WITHOUT CLAIM TO ANY PARTICULAR FONT, STYLE, SIZE, OR COLOR.

OWNER OF U.S. REG. NO. 2,893,588.

SER. NO. 77-354,174, FILED 12-17-2007.

ELLEN PERKINS, EXAMINING ATTORNEY

**Int. Cl.: 38**

**Prior U.S. Cls.: 100, 101 and 104**

**United States Patent and Trademark Office**

**Reg. No. 3,467,701**

**Registered July 15, 2008**

**SERVICE MARK  
PRINCIPAL REGISTER**

**AT&T BLUE ROOM**

AT&T INTELLECTUAL PROPERTY II, L.P. (NE-  
VADA LIMITED PARTNERSHIP)  
645 EAST PLUMB LANE  
RENO, NV 89502

FOR: TELECOMMUNICATIONS SERVICES,  
NAMELY, STREAMING OF AUDIO AND VIDEO  
MATERIAL ON THE INTERNET TARGETED TO-  
WARDS ADULTS AND YOUNG ADULTS , IN  
CLASS 38 (U.S. CLS. 100, 101 AND 104).

FIRST USE 1-1-2006, THE MARK WAS FIRST  
USED ANYWHERE IN A DIFFERENT FORM  
OTHER THAN THAT SOUGHT TO BE  
REGISTERED ON 04/15/2005.; IN COMMERCE  
1-1-2006, THE MARK WAS FIRST USED IN

COMMERCE IN A DIFFERENT FORM OTHER  
THAN THAT SOUGHT TO BE REGISTERED ON  
04/15/2005..

THE MARK CONSISTS OF STANDARD CHAR-  
ACTERS WITHOUT CLAIM TO ANY PARTICULAR  
FONT, STYLE, SIZE, OR COLOR.

OWNER OF U.S. REG. NOS. 2,076,848, 3,274,801  
AND OTHERS.

SER. NO. 77-354,352, FILED 12-18-2007.

ARETHA SOMERVILLE, EXAMINING ATTORNEY

**Int. Cl.: 36**

**Prior U.S. Cls.: 100, 101 and 102**

**United States Patent and Trademark Office**

**Reg. No. 3,467,702**

**Registered July 15, 2008**

**SERVICE MARK  
PRINCIPAL REGISTER**

**AtSite**

ATSITE REAL ESTATE, INC. (D.C. CORPORATION)  
SUITE 701  
1150 CONNECTICUT AVE., NW  
WASHINGTON, DC 20036

THE MARK CONSISTS OF STANDARD CHARACTERS WITHOUT CLAIM TO ANY PARTICULAR FONT, STYLE, SIZE, OR COLOR.

FOR: REAL ESTATE CONSULTATION, IN CLASS 36 (U.S. CLS. 100, 101 AND 102).

SER. NO. 77-354,386, FILED 12-18-2007.

FIRST USE 1-1-2001; IN COMMERCE 1-1-2001.

MELVIN AXILBUND, EXAMINING ATTORNEY



**Int. Cl.: 28**

**Prior U.S. Cls.: 22, 23, 38 and 50**

**United States Patent and Trademark Office**

**Reg. No. 3,467,703**

**Registered July 15, 2008**

**TRADEMARK  
PRINCIPAL REGISTER**

# Treehouse

LOONEY LABORATORIES, INC. (MARYLAND CORPORATION), DBA LOONEY LABS  
PO BOX 761  
COLLEGE PARK, MD 20741

FOR: BOARD GAMES, IN CLASS 28 (U.S. CLS. 22, 23, 38 AND 50).

FIRST USE 1-19-2006; IN COMMERCE 3-14-2006.

THE MARK CONSISTS OF STANDARD CHARACTERS WITHOUT CLAIM TO ANY PARTICULAR FONT, STYLE, SIZE, OR COLOR.

SER. NO. 77-354,618, FILED 12-18-2007.

REBECCA POVARCHUK, EXAMINING ATTORNEY

**Int. Cl.: 36**

**Prior U.S. Cls.: 100, 101 and 102**

**United States Patent and Trademark Office**

**Reg. No. 3,467,704**

**Registered July 15, 2008**

**SERVICE MARK  
PRINCIPAL REGISTER**

**MarQCuS**

LEHMAN BROTHERS INC. (DELAWARE COR-  
PORATION)  
745 SEVENTH AVENUE  
NEW YORK, NY 10019

THE MARK CONSISTS OF STANDARD CHAR-  
ACTERS WITHOUT CLAIM TO ANY PARTICULAR  
FONT, STYLE, SIZE, OR COLOR.

FOR: FOREIGN EXCHANGE TRADING TRANS-  
ACTIONS AND PROVIDING TRADING STRATEGY  
FINANCIAL ADVICE, IN CLASS 36 (U.S. CLS. 100,  
101 AND 102).

SER. NO. 77-354,772, FILED 12-18-2007.

FIRST USE 4-0-2007; IN COMMERCE 4-0-2007.

IRA J. GOODSaid, EXAMINING ATTORNEY

**Int. Cl.: 28**

**Prior U.S. Cls.: 22, 23, 38 and 50**

**United States Patent and Trademark Office**

**Reg. No. 3,467,705**

**Registered July 15, 2008**

**TRADEMARK  
PRINCIPAL REGISTER**

# Looney Labs

LOONEY LABORATORIES, INC. (MARYLAND CORPORATION), DBA LOONEY LABS  
PO BOX 761  
COLLEGE PARK, MD 20741

NO CLAIM IS MADE TO THE EXCLUSIVE RIGHT TO USE "LABS", APART FROM THE MARK AS SHOWN.

FOR: BOARD GAMES; CARD GAMES, IN CLASS 28 (U.S. CLS. 22, 23, 38 AND 50).

SER. NO. 77-354,782, FILED 12-18-2007.

FIRST USE 11-10-1996; IN COMMERCE 3-5-1997.

THE MARK CONSISTS OF STANDARD CHARACTERS WITHOUT CLAIM TO ANY PARTICULAR FONT, STYLE, SIZE, OR COLOR.

REBECCA POVARCHUK, EXAMINING ATTORNEY

**Int. Cls.: 41, 42 and 44**

**Prior U.S. Cls.: 100, 101 and 107**

**United States Patent and Trademark Office**

**Reg. No. 3,467,706**

**Registered July 15, 2008**

**SERVICE MARK  
PRINCIPAL REGISTER**

**Fighting to save the soul  
of sport**

ANTI-DOPING RESEARCH, INC. (CALIFORNIA CORPORATION)  
3873 GRANDVIEW BOULEVARD  
LOS ANGELES, CA 90067

FOR: EDUCATIONAL SERVICES, NAMELY, DEVELOPING CURRICULUM FOR OTHERS IN THE FIELD OF SPORTS DOPING; EDUCATIONAL SERVICES, NAMELY, DEVELOPING, ARRANGING, AND CONDUCTING EDUCATIONAL CONFERENCES AND PROGRAMS AND PROVIDING COURSES OF INSTRUCTION IN THE FIELD OF SPORTS DOPING, IN CLASS 41 (U.S. CLS. 100, 101 AND 107).

FIRST USE 11-1-2006; IN COMMERCE 11-1-2006.

FOR: LABORATORY RESEARCH IN THE FIELD OF SPORTS DOPING; CONSULTING SERVICES IN THE FIELD OF COLLECTION OF EVIDENCE FOR FORENSIC PURPOSES; PROVIDING INFORMATION IN THE FIELD OF COLLECTION OF EVIDENCE FOR FORENSIC PURPOSES; CONSULTING SERVICES IN THE FIELDS OF FORENSIC SCIENCE , IN CLASS 42 (U.S. CLS. 100 AND 101).

FIRST USE 11-1-2006; IN COMMERCE 11-1-2006.

FOR: DRUG TESTING FOR SUBSTANCE ABUSE; MEDICAL TESTING, IN CLASS 44 (U.S. CLS. 100 AND 101).

FIRST USE 11-1-2006; IN COMMERCE 11-1-2006.

THE MARK CONSISTS OF STANDARD CHARACTERS WITHOUT CLAIM TO ANY PARTICULAR FONT, STYLE, SIZE, OR COLOR.

SER. NO. 77-355,266, FILED 12-18-2007.

CIMMERIAN COLEMAN, EXAMINING ATTORNEY

**Int. Cl.: 42**

**Prior U.S. Cls.: 100 and 101**

**United States Patent and Trademark Office**

**Reg. No. 3,467,707**

**Registered July 15, 2008**

**SERVICE MARK  
PRINCIPAL REGISTER**

**EGEN**

EXPRESSION GENETICS, INC. (ALABAMA CORPORATION)  
2215 MOCK ROAD  
HUNTSVILLE, AL 35801

FOR: SCIENTIFIC RESEARCH AND DEVELOPMENT SERVICES FOR OTHERS IN THE FIELD OF THERAPEUTIC PREPARATIONS FOR THE PREVENTION OF DISEASES AND DISORDERS, IN CLASS 42 (U.S. CLS. 100 AND 101).

FIRST USE 5-1-2004; IN COMMERCE 5-1-2004.

THE MARK CONSISTS OF STANDARD CHARACTERS WITHOUT CLAIM TO ANY PARTICULAR FONT, STYLE, SIZE, OR COLOR.

OWNER OF U.S. REG. NO. 2,836,612.

SER. NO. 77-355,694, FILED 12-19-2007.

MICHAEL TANNER, EXAMINING ATTORNEY

**Int. Cl.: 27**

**Prior U.S. Cls.: 19, 20, 37, 42 and 50**

**United States Patent and Trademark Office**

**Reg. No. 3,467,708**

**Registered July 15, 2008**

**TRADEMARK  
PRINCIPAL REGISTER**



DPM ENTERPRISES, INC. (TENNESSEE CORPORATION)  
128 REGINAL PARK DRIVE  
KINGSPORT, TN 37660

THE MARK CONSISTS OF A STYLIZED "X" AND THE NUMBER "2" ON A RECTANGULAR BACKGROUND.

FOR: CARPET TILES, IN CLASS 27 (U.S. CLS. 19, 20, 37, 42 AND 50).

SER. NO. 77-355,850, FILED 12-19-2007.

FIRST USE 1-31-2004; IN COMMERCE 12-14-2005.

ANTHONY RINKER, EXAMINING ATTORNEY

**Int. Cl.: 36**

**Prior U.S. Cls.: 100, 101 and 102**

**United States Patent and Trademark Office**

**Reg. No. 3,467,709**

**Registered July 15, 2008**

**SERVICE MARK  
PRINCIPAL REGISTER**



NEW MEXICO EDUCATORS FEDERAL CREDIT  
UNION (UNITED STATES CREDIT UNION)  
P.O. BOX 8530  
ALBUQUERQUE, NM 87198

THE MARK CONSISTS OF A LAMP OF KNOWL-  
EDGE.

FOR: FINANCIAL SERVICES, NAMELY, COOP-  
ERATIVE CREDIT UNIONS AND ONLINE BANK-  
ING, IN CLASS 36 (U.S. CLS. 100, 101 AND 102).

SER. NO. 77-356,186, FILED 12-19-2007.

FIRST USE 1-1-1982; IN COMMERCE 1-1-1982.

DEZMONA MIZELLE, EXAMINING ATTORNEY

**Int. Cl.: 16**

**Prior U.S. Cls.: 2, 5, 22, 23, 29, 37, 38 and 50**

**Reg. No. 3,467,710**

**United States Patent and Trademark Office**

**Registered July 15, 2008**

**TRADEMARK  
PRINCIPAL REGISTER**

# Tahoe Perspective

HARRAH'S LICENSE COMPANY, LLC (NEVADA  
LTD LIAB CO)  
ONE HARRAH'S COURT  
LAS VEGAS, NV 89119

FOR: MAGAZINES FEATURING TRAVEL, CASINO GAMING, RECREATION, SPORTS, ENTERTAINMENT, DINING, AND LOCAL ATTRACTIONS AND EVENTS, IN CLASS 16 (U.S. CLS. 2, 5, 22, 23, 29, 37, 38 AND 50).

FIRST USE 12-17-2007; IN COMMERCE 12-17-2007.

THE MARK CONSISTS OF STANDARD CHARACTERS WITHOUT CLAIM TO ANY PARTICULAR FONT, STYLE, SIZE, OR COLOR.

NO CLAIM IS MADE TO THE EXCLUSIVE RIGHT TO USE "TAHOE", APART FROM THE MARK AS SHOWN.

SER. NO. 77-357,824, FILED 12-21-2007.

MICHAEL SOUDERS, EXAMINING ATTORNEY



**Int. Cls.: 9 and 35**

**Prior U.S. Cls.: 21, 23, 26, 36, 38, 100, 101 and 102**

**United States Patent and Trademark Office**

**Reg. No. 3,467,711**

**Registered July 15, 2008**

**TRADEMARK  
SERVICE MARK  
PRINCIPAL REGISTER**

**TRAGON**

TRAGON CORPORATION (CALIFORNIA CORPORATION)  
365 CONVENTION WAY  
REDWOOD CITY, CA 94063

FOR: COMPUTER SOFTWARE FOR ANALYSIS OF CONSUMER BUYING HABITS AND NEEDS PROVIDED WITH THE HELP OF SENSORY, QUALITY AND QUANTITY-RELATED DATA, IN CLASS 9 (U.S. CLS. 21, 23, 26, 36 AND 38).

FIRST USE 3-28-1980; IN COMMERCE 3-28-1980.

FOR: ADVICE ON THE ANALYSIS OF CONSUMER BUYING HABITS AND NEEDS PROVIDED

WITH THE HELP OF SENSORY, QUALITY AND QUANTITY-RELATED DATA, IN CLASS 35 (U.S. CLS. 100, 101 AND 102).

FIRST USE 9-16-1977; IN COMMERCE 9-16-1977.

THE MARK CONSISTS OF STANDARD CHARACTERS WITHOUT CLAIM TO ANY PARTICULAR FONT, STYLE, SIZE, OR COLOR.

SER. NO. 77-358,482, FILED 12-21-2007.

CAROLYN GRAY, EXAMINING ATTORNEY

**Int. Cl.: 37**

**Prior U.S. Cls.: 100, 103 and 106**

**United States Patent and Trademark Office**

**Reg. No. 3,467,712**

**Registered July 15, 2008**

**SERVICE MARK  
PRINCIPAL REGISTER**

**ROBERT LUCKE INTERESTS**

ROBERT LUCKE INTERESTS, INC. (OHIO CORPORATION)  
SUITE B  
8825 CHAPEL SQUARE DRIVE  
CINCINNATI, OH 45249

FOR: CONSTRUCTION SERVICES, NAMELY, PLANNING, LAYING OUT AND CUSTOM CONSTRUCTION AND REMODELING OF RESIDENTIAL AND COMMERCIAL COMMUNITIES; CUSTOM CONSTRUCTION AND REMODELING OF HOMES; RESIDENTIAL AND COMMERCIAL BUILDING CONSTRUCTION AND REMODELING; RESIDENTIAL AND BUILDING CONSTRUCTION CONSULTING, IN CLASS 37 (U.S. CLS. 100, 103 AND 106).

FIRST USE 6-23-2005; IN COMMERCE 6-23-2005.

THE MARK CONSISTS OF STANDARD CHARACTERS WITHOUT CLAIM TO ANY PARTICULAR FONT, STYLE, SIZE, OR COLOR.

THE NAME "ROBERT LUCKE" IDENTIFIES A LIVING INDIVIDUAL WHOSE CONSENT IS OF RECORD.

SER. NO. 77-358,488, FILED 12-21-2007.

JOHN WILKE, EXAMINING ATTORNEY

**Int. Cl.: 37**

**Prior U.S. Cls.: 100, 103 and 106**

**United States Patent and Trademark Office**

**Reg. No. 3,467,713**

**Registered July 15, 2008**

**SERVICE MARK  
PRINCIPAL REGISTER**

**LUCKE HOMES**

LUCKE HOMES, INC. (OHIO CORPORATION)  
SUITE B  
8825 CHAPEL SQUARE DRIVE  
CINCINNATI, OH 45249

FOR: CONSTRUCTION SERVICES, NAMELY,  
PLANNING, LAYING OUT AND CUSTOM CON-  
STRUCTION AND REMODELING OF RESIDEN-  
TIAL AND COMMERCIAL COMMUNITIES;  
CUSTOM CONSTRUCTION AND REMODELING  
OF HOMES; RESIDENTIAL AND COMMERCIAL  
BUILDING CONSTRUCTION AND REMODELING;  
RESIDENTIAL AND BUILDING CONSTRUCTION  
CONSULTING, IN CLASS 37 (U.S. CLS. 100, 103 AND  
106).

FIRST USE 11-6-1980; IN COMMERCE 11-6-1980.

THE MARK CONSISTS OF STANDARD CHAR-  
ACTERS WITHOUT CLAIM TO ANY PARTICULAR  
FONT, STYLE, SIZE, OR COLOR.

NO CLAIM IS MADE TO THE EXCLUSIVE  
RIGHT TO USE "HOMES", APART FROM THE  
MARK AS SHOWN.

SEC. 2(F).

SER. NO. 77-358,498, FILED 12-21-2007.

JOHN WILKE, EXAMINING ATTORNEY

**Int. Cl.: 13**

**Prior U.S. Cls.: 2 and 9**

**United States Patent and Trademark Office**

**Reg. No. 3,467,714**

**Registered July 15, 2008**

**TRADEMARK  
PRINCIPAL REGISTER**

**GUN BUDDY**

GAMO USA CORP. (FLORIDA CORPORATION)  
SUITE 914  
3911 SW 47TH AVENUE  
FORT LAUDERDALE, FL 33314

FOR: FIREARM SLINGS; RIFLE SLINGS; SLING  
STRAPS FOR FIREARMS, IN CLASS 13 (U.S. CLS. 2  
AND 9).

FIRST USE 11-26-2007; IN COMMERCE 11-26-2007.

THE MARK CONSISTS OF STANDARD CHAR-  
ACTERS WITHOUT CLAIM TO ANY PARTICULAR  
FONT, STYLE, SIZE, OR COLOR.

NO CLAIM IS MADE TO THE EXCLUSIVE  
RIGHT TO USE "GUN", APART FROM THE MARK  
AS SHOWN.

SER. NO. 77-359,424, FILED 12-26-2007.

KEVON CHISOLM, EXAMINING ATTORNEY

**Int. Cl.: 30**

**Prior U.S. Cl.: 46**

**United States Patent and Trademark Office**

**Reg. No. 3,467,715**

**Registered July 15, 2008**

**TRADEMARK  
PRINCIPAL REGISTER**

# Chicken Crave

PITA PIT, INC. (DELAWARE CORPORATION)  
105 NORTH 4TH STREET, SUITE 208  
COEUR D'ALENE, ID 83814

FOR: PITA BREAD SANDWICH CONTAINING  
GRILLED CHICKEN BREAST, HAM AND AMER-  
ICAN SWISS CHEESE FOR CONSUMPTION ON OR  
OFF THE PREMISES, IN CLASS 30 (U.S. CL. 46).

FIRST USE 1-2-2006; IN COMMERCE 1-2-2006.

THE MARK CONSISTS OF STANDARD CHAR-  
ACTERS WITHOUT CLAIM TO ANY PARTICULAR  
FONT, STYLE, SIZE, OR COLOR.

NO CLAIM IS MADE TO THE EXCLUSIVE  
RIGHT TO USE "CHICKEN", APART FROM THE  
MARK AS SHOWN.

SER. NO. 77-360,036, FILED 12-27-2007.

JANICE KIM, EXAMINING ATTORNEY

**Int. Cl.: 36**

**Prior U.S. Cls.: 100, 101 and 102**

**United States Patent and Trademark Office**

**Reg. No. 3,467,716**

**Registered July 15, 2008**

**SERVICE MARK  
PRINCIPAL REGISTER**

# Wealth By Mortgage

COOK, GEORGE (UNITED STATES INDIVIDUAL)  
700 S HIGHLAND STREET  
ARLINGTON, VA 22204

FOR: PROCUREMENT OF MORTGAGES FOR OTHERS; CONSULTING SERVICES IN THE FIELD OF PROCUREMENT OF MORTGAGES FOR OTHERS, IN CLASS 36 (U.S. CLS. 100, 101 AND 102).

FIRST USE 1-1-2006; IN COMMERCE 6-28-2007.

THE MARK CONSISTS OF STANDARD CHARACTERS WITHOUT CLAIM TO ANY PARTICULAR FONT, STYLE, SIZE, OR COLOR.

SER. NO. 77-360,781, FILED 12-28-2007.

JAMES MACFARLANE, EXAMINING ATTORNEY

**Int. Cl.: 28**

**Prior U.S. Cls.: 22, 23, 38 and 50**

**United States Patent and Trademark Office**

**Reg. No. 3,467,717**

**Registered July 15, 2008**

**TRADEMARK  
PRINCIPAL REGISTER**

**BARE WITH ME**

CALIFORNIA EXOTIC NOVELTIES LLC (CALI-  
FORNIA LTD LIAB CO)  
14235 RAMONA AVE.  
CHINO, CA 91710

THE MARK CONSISTS OF STANDARD CHAR-  
ACTERS WITHOUT CLAIM TO ANY PARTICULAR  
FONT, STYLE, SIZE, OR COLOR.

FOR: PARLOR GAMES, IN CLASS 28 (U.S. CLS. 22,  
23, 38 AND 50).

SER. NO. 77-361,348, FILED 12-28-2007.

FIRST USE 6-1-2007; IN COMMERCE 6-1-2007.

BARBARA BROWN, EXAMINING ATTORNEY

**Int. Cl.: 9**

**Prior U.S. Cls.: 21, 23, 26, 36 and 38**

**Reg. No. 3,467,718**

**United States Patent and Trademark Office**

**Registered July 15, 2008**

---

**TRADEMARK  
PRINCIPAL REGISTER**

**FETIS**

SEMICONDUCTOR TECHNOLOGY RESEARCH,  
INC. (VIRGINIA CORPORATION)  
SUITE 108  
10404 PATTERSON AVE.  
RICHMOND, VA 23238

FOR: COMPUTER SOFTWARE FOR MODELING  
OF FIELD-EFFECT TRANSISTORS AND HIGH  
ELECTRON MOBILITY TRANSISTORS, IN CLASS  
9 (U.S. CLS. 21, 23, 26, 36 AND 38).

FIRST USE 6-1-2005; IN COMMERCE 1-1-2006.

THE MARK CONSISTS OF STANDARD CHAR-  
ACTERS WITHOUT CLAIM TO ANY PARTICULAR  
FONT, STYLE, SIZE, OR COLOR.

SER. NO. 77-361,650, FILED 12-30-2007.

SUE LAWRENCE, EXAMINING ATTORNEY



**Int. Cl.: 10**

**Prior U.S. Cls.: 26, 39 and 44**

**Reg. No. 3,467,719**

**United States Patent and Trademark Office**

**Registered July 15, 2008**

---

**TRADEMARK  
PRINCIPAL REGISTER**

**ESC**

DEPUY, INC. (DELAWARE CORPORATION)  
700 ORTHOPAEDIC DRIVE  
WARSAW, IN 46581

THE MARK CONSISTS OF STANDARD CHAR-  
ACTERS WITHOUT CLAIM TO ANY PARTICULAR  
FONT, STYLE, SIZE, OR COLOR.

FOR: LINERS FOR ORTHOPAEDIC IMPLANTS,  
IN CLASS 10 (U.S. CLS. 26, 39 AND 44).

SER. NO. 77-362,045, FILED 12-31-2007.

FIRST USE 0-0-2006; IN COMMERCE 0-0-2006.

MELVIN AXILBUND, EXAMINING ATTORNEY

**Int. Cl.: 25**

**Prior U.S. Cls.: 22 and 39**

**United States Patent and Trademark Office**

**Reg. No. 3,467,720**

**Registered July 15, 2008**

**TRADEMARK  
PRINCIPAL REGISTER**

**WESTERN LIGHTS**

KARMAN, INC. (COLORADO CORPORATION),  
DBA ROPER APPAREL AND FOOTWEAR  
14707 E. 2ND AVENUE SUITE 300  
AURORA, CO 80011

FOR: CLOTHING, NAMELY, SHIRTS, KNIT AND  
WOVEN SHIRTS, BLOUSES, JEANS, PANTS,  
SHORTS, SKIRTS, DRESSES, SWEATERS, SWEAT-  
SHIRTS, T-SHIRTS, JACKETS, COATS, HATS,  
BELTS, CAPS, SOCKS, FOOTWEAR AND HEAD-  
WEAR, IN CLASS 25 (U.S. CLS. 22 AND 39).

FIRST USE 9-0-2006; IN COMMERCE 9-0-2006.

THE MARK CONSISTS OF STANDARD CHAR-  
ACTERS WITHOUT CLAIM TO ANY PARTICULAR  
FONT, STYLE, SIZE, OR COLOR.

SER. NO. 77-362,067, FILED 12-31-2007.

ERNEST SHOSHO, EXAMINING ATTORNEY

**Int. Cl.: 36**

**Prior U.S. Cls.: 100, 101 and 102**

**United States Patent and Trademark Office**

**Reg. No. 3,467,721**

**Registered July 15, 2008**

**SERVICE MARK  
PRINCIPAL REGISTER**

**First Payment Systems, LLC**

JORGE FERNANDEZ (UNITED STATES INDIVIDUAL)

8735 SW 116TH STREET

MIAMI, FL 33176

FOR: CREDIT CARD PAYMENT PROCESSING SERVICES, IN CLASS 36 (U.S. CLS. 100, 101 AND 102).

FIRST USE 6-1-2002; IN COMMERCE 7-1-2002.

THE MARK CONSISTS OF STANDARD CHARACTERS WITHOUT CLAIM TO ANY PARTICULAR FONT, STYLE, SIZE, OR COLOR.

NO CLAIM IS MADE TO THE EXCLUSIVE RIGHT TO USE "PAYMENT SYSTEMS, LLC", APART FROM THE MARK AS SHOWN.

SER. NO. 77-362,362, FILED 1-2-2008.

MICHAEL WEBSTER, EXAMINING ATTORNEY

**Int. Cl.: 25**

**Prior U.S. Cls.: 22 and 39**

**United States Patent and Trademark Office**

**Reg. No. 3,467,722**

**Registered July 15, 2008**

**TRADEMARK  
PRINCIPAL REGISTER**

**EXPLORER**

SAN MAR CORPORATION (WASHINGTON  
CORPORATION)  
PO BOX 529  
PRESTON, WA 98050

FOR: CLOTHING, NAMELY, SHIRTS AND  
SPORT SHIRTS, IN CLASS 25 (U.S. CLS. 22 AND 39).

FIRST USE 9-28-2006; IN COMMERCE 9-28-2006.

THE MARK CONSISTS OF STANDARD CHAR-  
ACTERS WITHOUT CLAIM TO ANY PARTICULAR  
FONT, STYLE, SIZE, OR COLOR.

OWNER OF U.S. REG. NO. 3,323,081.

SER. NO. 77-362,895, FILED 1-2-2008.

ESTHER BELENKER, EXAMINING ATTORNEY

**Int. Cl.: 35**

**Prior U.S. Cls.: 100, 101 and 102**

**United States Patent and Trademark Office**

**Reg. No. 3,467,723**

**Registered July 15, 2008**

**SERVICE MARK  
PRINCIPAL REGISTER**

**R-Fees**

RENAISSANCE SYSTEMS AND SERVICES, LLC  
(MICHIGAN LTD LIAB CO)  
4100 OKEMOS RD.  
OKEMOS, MI 48864

THE MARK CONSISTS OF STANDARD CHAR-  
ACTERS WITHOUT CLAIM TO ANY PARTICULAR  
FONT, STYLE, SIZE, OR COLOR.

FOR: PROVIDING A LIST OF FEES CHARGED  
BY MEDICAL AND DENTAL PROVIDERS BASED  
ON GEOGRAPHIC LOCATION, IN CLASS 35 (U.S.  
CLS. 100, 101 AND 102).

SER. NO. 77-363,291, FILED 1-3-2008.

FIRST USE 12-31-2005; IN COMMERCE 10-31-2006.

DEZMONA MIZELLE, EXAMINING ATTORNEY

**Int. Cl.: 27**

**Prior U.S. Cls.: 19, 20, 37, 42 and 50**

**United States Patent and Trademark Office**

**Reg. No. 3,467,724**

**Registered July 15, 2008**

**TRADEMARK  
PRINCIPAL REGISTER**

**C&D ESSENTIALS**

COLOUR & DESIGN, INC. (ARKANSAS CORPORATION)  
2210 CANTRELL ROAD  
LITTLE ROCK, AR 72202

FOR: WALLPAPER; WALLPAPER IN THE NATURE OF ROOMSIZE DECORATIVE ADHESIVE WALL COVERINGS; NON-TEXTILE WALL COVERINGS; WALLCOVERINGS, IN CLASS 27 (U.S. CLS. 19, 20, 37, 42 AND 50).

FIRST USE 5-6-2005; IN COMMERCE 5-6-2005.

THE MARK CONSISTS OF STANDARD CHARACTERS WITHOUT CLAIM TO ANY PARTICULAR FONT, STYLE, SIZE, OR COLOR.

SER. NO. 77-363,545, FILED 1-3-2008.

WENDY GOODMAN, EXAMINING ATTORNEY

**Int. Cl.: 27**

**Prior U.S. Cls.: 19, 20, 37, 42 and 50**

**Reg. No. 3,467,725**

**United States Patent and Trademark Office**

**Registered July 15, 2008**

---

**TRADEMARK  
PRINCIPAL REGISTER**

**CEYLON**

COLOUR & DESIGN, INC. (ARKANSAS CORPORATION)  
2210 CANTRELL ROAD  
LITTLE ROCK, AR 72202

FOR: WALLPAPER; WALLPAPER IN THE NATURE OF ROOMSIZE DECORATIVE ADHESIVE WALL COVERINGS; NON-TEXTILE WALL COVERINGS; WALLCOVERINGS, IN CLASS 27 (U.S. CLS. 19, 20, 37, 42 AND 50).

FIRST USE 1-10-2003; IN COMMERCE 1-10-2003.

THE MARK CONSISTS OF STANDARD CHARACTERS WITHOUT CLAIM TO ANY PARTICULAR FONT, STYLE, SIZE, OR COLOR.

SER. NO. 77-363,564, FILED 1-3-2008.

WENDY GOODMAN, EXAMINING ATTORNEY

**Int. Cl.: 27**

**Prior U.S. Cls.: 19, 20, 37, 42 and 50**

**Reg. No. 3,467,726**

**United States Patent and Trademark Office**

**Registered July 15, 2008**

**TRADEMARK  
PRINCIPAL REGISTER**

**CAMBRIA**

COLOUR & DESIGN, INC. (ARKANSAS CORPORATION)  
2210 CANTRELL ROAD  
LITTLE ROCK, AR 72202

FOR: WALLPAPER; WALLPAPER IN THE NATURE OF ROOMSIZE DECORATIVE ADHESIVE WALL COVERINGS; NON-TEXTILE WALL COVERINGS; WALLCOVERINGS, IN CLASS 27 (U.S. CLS. 19, 20, 37, 42 AND 50).

FIRST USE 9-24-1999; IN COMMERCE 9-24-1999.

THE MARK CONSISTS OF STANDARD CHARACTERS WITHOUT CLAIM TO ANY PARTICULAR FONT, STYLE, SIZE, OR COLOR.

SER. NO. 77-363,582, FILED 1-3-2008.

WENDY GOODMAN, EXAMINING ATTORNEY



**Int. Cl.: 20**

**Prior U.S. Cls.: 2, 13, 22, 25, 32 and 50**

**United States Patent and Trademark Office**

**Reg. No. 3,467,727**

**Registered July 15, 2008**

**TRADEMARK  
PRINCIPAL REGISTER**

**DenHaus**

HARDWOOD HIDEAWAY (WASHINGTON CORPORATION)  
2049 144TH AVE SE  
BELLEVUE, WA 98007

FOR: PET CRATES; PET CUSHIONS; PET FURNITURE; PLAYHOUSES FOR PETS; PORTABLE BEDS FOR PETS, IN CLASS 20 (U.S. CLS. 2, 13, 22, 25, 32 AND 50).

FIRST USE 12-23-2007; IN COMMERCE 12-23-2007.

THE COLOR(S) BROWN AND GREEN IS/ARE CLAIMED AS A FEATURE OF THE MARK.

THE MARK CONSISTS OF THE WORDING "DEN" IN BROWN, THE WORDING "HAUS" IN GREEN AND FEATURES OF A DOG'S FACE IN BROWN.

THE FOREIGN WORDING IN THE MARK "HAUS" TRANSLATES INTO ENGLISH AS HOUSE.

SER. NO. 77-363,650, FILED 1-3-2008.

MELISSA VALLILLO, EXAMINING ATTORNEY

**Int. Cl.: 35**

**Prior U.S. Cls.: 100, 101 and 102**

**United States Patent and Trademark Office**

**Reg. No. 3,467,728**

**Registered July 15, 2008**

**SERVICE MARK  
PRINCIPAL REGISTER**

VICTORIA'S SECRET LOOK BOOK

VICTORIA'S SECRET STORES BRAND MAN-  
AGEMENT, INC. (DELAWARE CORPORA-  
TION)

FOUR LIMITED PARKWAY  
REYNOLDSBURG, OH 43068

FOR: MAIL ORDER CATALOG SERVICES FEATURING PERSONAL CARE PRODUCTS, LINGERIE, CLOTHING AND SHOES, IN CLASS 35 (U.S. CLS. 100, 101 AND 102).

FIRST USE 7-27-2007; IN COMMERCE 7-27-2007.

THE MARK CONSISTS OF STANDARD CHARACTERS WITHOUT CLAIM TO ANY PARTICULAR FONT, STYLE, SIZE, OR COLOR.

OWNER OF U.S. REG. NOS. 1,146,199, 2,557,051 AND OTHERS.

NO CLAIM IS MADE TO THE EXCLUSIVE RIGHT TO USE "BOOK", APART FROM THE MARK AS SHOWN.

SER. NO. 77-364,517, FILED 1-4-2008.

THOMAS MANOR, EXAMINING ATTORNEY

**Int. Cl.: 31**

**Prior U.S. Cls.: 1 and 46**

**United States Patent and Trademark Office**

**Reg. No. 3,467,729**

**Registered July 15, 2008**

**TRADEMARK  
PRINCIPAL REGISTER**

**SPRING FEVER**

SYNGENTA PARTICIPATIONS AG (SWITZER-  
LAND CORPORATION)  
SCHWARZWALDALLEE 215  
BASEL, SWITZERLAND CH4058

FOR: FLOWER SEEDS, SEEDLINGS, LIVING  
PLANTS AND NATURAL LIVE FLOWERS, YOUNG  
LIVE PLANTS, CUTTINGS AND OTHER PARTS OF  
LIVE PLANTS OR YOUNG LIVE PLANTS SUITA-  
BLE FOR MULTIPLICATION, IN CLASS 31 (U.S.  
CLS. 1 AND 46).

FIRST USE 3-1-2005; IN COMMERCE 3-1-2005.

THE MARK CONSISTS OF STANDARD CHAR-  
ACTERS WITHOUT CLAIM TO ANY PARTICULAR  
FONT, STYLE, SIZE, OR COLOR.

SER. NO. 77-365,321, FILED 1-7-2008.

WENDY JUN, EXAMINING ATTORNEY

**Int. Cl.: 35**

**Prior U.S. Cls.: 100, 101 and 102**

**United States Patent and Trademark Office**

**Reg. No. 3,467,730**

**Registered July 15, 2008**

**SERVICE MARK  
PRINCIPAL REGISTER**

**TX**

THOMPSON HOTELS LLC (DELAWARE LTD  
LIAB CO)  
100 VANDAM STREET, 4TH FLOOR  
NEW YORK, NY 10013

FOR: RETAIL AND GIFT STORE SERVICES  
FEATURING A WIDE VARIETY OF CONSUMER  
GOODS OF OTHERS LOCATED IN HOTELS  
OWNED AND/OR MANAGED BY APPLICANT OR  
ITS AFFILIATES, IN CLASS 35 (U.S. CLS. 100, 101  
AND 102).

FIRST USE 5-15-2007; IN COMMERCE 5-15-2007.

THE MARK CONSISTS OF STANDARD CHAR-  
ACTERS WITHOUT CLAIM TO ANY PARTICULAR  
FONT, STYLE, SIZE, OR COLOR.

SER. NO. 77-365,503, FILED 1-7-2008.

ELLEN B. AWRICH, EXAMINING ATTORNEY

**Int. Cls.: 9 and 16**

**Prior U.S. Cls.: 2, 5, 21, 22, 23, 26, 29, 36, 37, 38 and 50**

**United States Patent and Trademark Office**

**Reg. No. 3,467,731**

**Registered July 15, 2008**

**TRADEMARK  
PRINCIPAL REGISTER**

**DEX**

DEX MEDIA, INC. (DELAWARE CORPORATION)  
198 INVERNESS DRIVE WEST  
ENGLEWOOD, CO 80112

FOR: DOWNLOADABLE ELECTRONIC PUBLICATIONS IN THE NATURE OF AN ELECTRONIC MAGAZINE IN THE FIELDS OF BUSINESS, ADVERTISING, AND MARKETING, IN CLASS 9 (U.S. CLS. 21, 23, 26, 36 AND 38).

FIRST USE 5-0-2007; IN COMMERCE 5-0-2007.

FOR: MAGAZINES FEATURING INFORMATION IN THE FIELDS OF BUSINESS, ADVERTIS-

ING, AND MARKETING, IN CLASS 16 (U.S. CLS. 2, 5, 22, 23, 29, 37, 38 AND 50).

FIRST USE 6-0-2007; IN COMMERCE 6-0-2007.

THE MARK CONSISTS OF STANDARD CHARACTERS WITHOUT CLAIM TO ANY PARTICULAR FONT, STYLE, SIZE, OR COLOR.

OWNER OF U.S. REG. NOS. 2,561,784, 3,268,025 AND OTHERS.

SER. NO. 77-365,588, FILED 1-7-2008.

MATTHEW PAPPAS, EXAMINING ATTORNEY

**Int. Cl.: 10**

**Prior U.S. Cls.: 26, 39 and 44**

**United States Patent and Trademark Office**

**Reg. No. 3,467,732**

**Registered July 15, 2008**

**TRADEMARK  
PRINCIPAL REGISTER**

**WaterWhirl Massager**

CALIFORNIA EXOTIC NOVELTIES LLC (CALIFORNIA LTD LIAB CO)

14235 RAMONA AVENUE

CHINO, CA 91710

FOR: ADULT SEXUAL AIDS, NAMELY, VIBRATORS, IN CLASS 10 (U.S. CLS. 26, 39 AND 44).

FIRST USE 6-1-2007; IN COMMERCE 6-1-2007.

THE MARK CONSISTS OF STANDARD CHARACTERS WITHOUT CLAIM TO ANY PARTICULAR FONT, STYLE, SIZE, OR COLOR.

NO CLAIM IS MADE TO THE EXCLUSIVE RIGHT TO USE "MASSAGER", APART FROM THE MARK AS SHOWN.

SER. NO. 77-365,746, FILED 1-7-2008.

BARBARA BROWN, EXAMINING ATTORNEY

**Int. Cl.: 41**

**Prior U.S. Cls.: 100, 101 and 107**

**United States Patent and Trademark Office**

**Reg. No. 3,467,733**

**Registered July 15, 2008**

**SERVICE MARK  
PRINCIPAL REGISTER**

**THE CURE FOR FINANCIAL  
CANCER**

MORROW FINANCIAL NETWORK (TEXAS  
SOLE PROPRIETORSHIP)  
402 N CARROLL AVE STE 100  
SOUTHLAKE, TX 76092

FOR: EDUCATIONAL SERVICES, NAMELY,  
CONDUCTING SEMINARS, WORKSHOPS, PRO-  
GRAMS AND PRESENTATIONS IN THE FIELD  
OF FINANCE AND FINANCIAL INVESTMENTS  
AND DISTRIBUTION OF COURSE MATERIAL IN  
CONNECTION THEREWITH, IN CLASS 41 (U.S.  
CLS. 100, 101 AND 107).

FIRST USE 7-0-2007; IN COMMERCE 7-0-2007.

THE MARK CONSISTS OF STANDARD CHAR-  
ACTERS WITHOUT CLAIM TO ANY PARTICULAR  
FONT, STYLE, SIZE, OR COLOR.

SER. NO. 77-366,086, FILED 1-7-2008.

CHERYL CLAYTON, EXAMINING ATTORNEY

**Int. Cl.: 41**

**Prior U.S. Cls.: 100, 101 and 107**

**United States Patent and Trademark Office**

**Reg. No. 3,467,734**

**Registered July 15, 2008**

**SERVICE MARK  
PRINCIPAL REGISTER**



BFS BRANDS, LLC (DELAWARE LTD LIAB CO)  
535 MARRIOTT DRIVE  
NASHVILLE, TN 37214

FOR: PROVIDING RECOGNITION AND INCENTIVES BY WAY OF AWARDS AND CONTESTS TO DEMONSTRATE EXCELLENCE IN THE FIELD OF DRIVER SAFETY EDUCATION VIA AN INTERNET WEBSITE, IN CLASS 41 (U.S. CLS. 100, 101 AND 107).

FIRST USE 4-23-2006; IN COMMERCE 4-23-2006.

NO CLAIM IS MADE TO THE EXCLUSIVE RIGHT TO USE "SAFETY", APART FROM THE MARK AS SHOWN.

THE COLOR(S) WHITE, YELLOW AND BLACK IS/ARE CLAIMED AS A FEATURE OF THE MARK.

THE MARK CONSISTS OF THE WORDS "SAFETY" AND ".COM" IN WHITE, "SCHOLARS" IN YELLOW, A WHITE UNDERLINE, A YELLOW STREET SIGN WITH A BLACK ARROW, AND AN OVERALL BLACK BACKGROUND.

SER. NO. 77-366,317, FILED 1-8-2008.

RICHARD WHITE, EXAMINING ATTORNEY



**Int. Cl.: 41**

**Prior U.S. Cls.: 100, 101 and 107**

**United States Patent and Trademark Office**

**Reg. No. 3,467,735**

**Registered July 15, 2008**

**SERVICE MARK  
PRINCIPAL REGISTER**

**BLOOD FEATHER PRODUCTIONS**

KEITH TYLER AND JOHN MIKRUT (UNITED STATES INDIVIDUAL), DBA BLOOD FEATHER PRODUCTIONS  
520 WEST BURNETT ST.  
LONG BEACH, UNITED STATES 90806

FOR: ENTERTAINMENT IN THE NATURE OF THEATER PRODUCTIONS; ENTERTAINMENT PRODUCTION OF FILMS, TELEVISION SHOWS, RADIO SHOWS, AUDIO AND VISUAL SHOWS FOR NEW DIGITAL MEDIA INCLUDING BROADCASTS OVER THE INTERNET, STAGE PLAYS AND MUSICAL SHOWS; MOTION PICTURE FILM PRODUCTION; MUSIC PRODUCTION SERVICES; MOBILE MEDIA AND ENTERTAINMENT SERVICES IN THE NATURE OF CONTENT PREPARATION, POST-PRODUCTION; MULTIMEDIA ENTERTAINMENT SERVICES IN THE NATURE OF RECORDING PRODUCTION AND POST-PRODUCTION SERVICES IN THE FIELDS OF MUSIC, VIDEO, AND FILMS; OPERATION OF VIDEO EQUIPMENT OR AUDIO EQUIPMENT ETC FOR PRODUCTION OF RADIO, TELEVISION, OR INTERNET PROGRAMS; POST-PRODUCTION EDITING SERVICES IN THE FIELDS OF MUSIC, VIDEOS, AND FILMS; PRODUCTION AND DISTRIBUTION OF MOTION PICTURES; PRODUCTION AND DISTRIBUTION OF TELEVISION SHOWS AND MOVIES; PRODUCTION AND DISTRIBUTION OF RADIO PROGRAMS; PRODUCTION OF CABLE TELEVISION PROGRAMS; PRODUCTION OF DVDS, VIDEOTAPES AND TELEVISION; PROGRAMS IN THE NATURE

OF DOCUMENTARIES, EDUCATIONAL, INFORMATIONAL AND FICTIONAL STORY PROGRAMS; PRODUCTION OF SOUND AND VIDEO RECORDINGS; RADIO ENTERTAINMENT PRODUCTION; TELEVISION PRODUCTION; DOWNLOADABLE MP3 RECORDINGS, ONLINE DISCUSSION BOARDS, WEBCASTS AND PODCASTS FEATURING MUSIC, AUDIO BOOKS AND NEWS BROADCASTS; PRODUCTION OF ENTERTAINMENT IN THE NATURE OF AN ON-GOING SPECIAL VARIETY SHOW, MUSIC AND COMEDY SHOW, AUDIO RECORDINGS AND VIDEO RECORDINGS, PLAYS, MUSICAL PLAYS, AND READER'S THEATRE DISTRIBUTED OR BROADCAST OVER TELEVISION, RADIO, SATELLITE, INTERNET, AUDIO AND VIDEO MEDIA, IN CLASS 41 (U.S. CLS. 100, 101 AND 107).

FIRST USE 2-10-2000; IN COMMERCE 10-13-2000.

THE MARK CONSISTS OF STANDARD CHARACTERS WITHOUT CLAIM TO ANY PARTICULAR FONT, STYLE, SIZE, OR COLOR.

NO CLAIM IS MADE TO THE EXCLUSIVE RIGHT TO USE "PRODUCTIONS", APART FROM THE MARK AS SHOWN.

SER. NO. 77-366,338, FILED 1-8-2008.

MIDGE BUTLER, EXAMINING ATTORNEY

**Int. Cl.: 3**

**Prior U.S. Cls.: 1, 4, 6, 50, 51 and 52**

**United States Patent and Trademark Office**

**Reg. No. 3,467,736**

**Registered July 15, 2008**

**TRADEMARK  
PRINCIPAL REGISTER**



ROUX LABORATORIES, INC. (NEW YORK CORPORATION), DBA D/B/A COLOMER USA  
5344 OVERMYER DRIVE  
JACKSONVILLE, FL 32254

FOR: HAIR CARE PRODUCTS, NAMELY, SHAMPOO, CONDITIONER, HAIR STYLING PREPARATIONS, NAMELY, STYLING CREAMS, POMADES, LOTIONS, GELS, LEAVE-IN CONDITIONING SPRAY, AND HAIR SPRAY, IN CLASS 3 (U.S. CLS. 1, 4, 6, 50, 51 AND 52).

FIRST USE 7-1-2007; IN COMMERCE 7-1-2007.

THE MARK CONSISTS OF CIRCLE WITH THE WORDS "COMMITMENT TO PURITY" AROUND THE CIRCLE'S CIRCUMFERENCE AND A DROP DESIGN IN THE CENTER.

SER. NO. 77-366,614, FILED 1-8-2008.

JENNY PARK, EXAMINING ATTORNEY

**Int. Cl.: 36**

**Prior U.S. Cls.: 100, 101 and 102**

**United States Patent and Trademark Office**

**Reg. No. 3,467,737**

**Registered July 15, 2008**

**SERVICE MARK  
PRINCIPAL REGISTER**

**LIFETIME RETIREMENT  
PLANNING WITH WACHOVIA  
SECURITIES**

WACHOVIA CORPORATION (NORTH CAROLINA CORPORATION)  
ONE WACHOVIA CENTER  
301 S. COLLEGE ST., 30TH FLOOR, NC0630  
CHARLOTTE, NC 282880630

FOR: INVESTMENT ADVISORY SERVICES; INVESTMENT CONSULTATION SERVICES; INVESTMENT MANAGEMENT SERVICES; PROVIDING INFORMATION AND ADVICE IN THE FIELD OF FINANCE, FINANCIAL INVESTMENTS, FINANCIAL VALUATIONS, AND THE FINANCIAL ASPECTS OF RETIREMENT, IN CLASS 36 (U.S. CLS. 100, 101 AND 102).

FIRST USE 11-30-2006; IN COMMERCE 11-30-2006.

THE MARK CONSISTS OF STANDARD CHARACTERS WITHOUT CLAIM TO ANY PARTICULAR FONT, STYLE, SIZE, OR COLOR.

NO CLAIM IS MADE TO THE EXCLUSIVE RIGHT TO USE "LIFETIME RETIREMENT PLANNING", APART FROM THE MARK AS SHOWN.

SER. NO. 77-366,823, FILED 1-8-2008.

JILL PRATER, EXAMINING ATTORNEY

**Int. Cl.: 36**

**Prior U.S. Cls.: 100, 101 and 102**

**United States Patent and Trademark Office**

**Reg. No. 3,467,738**

**Registered July 15, 2008**

**SERVICE MARK  
PRINCIPAL REGISTER**

**GET THERE. YOUR WAY.**

WACHOVIA CORPORATION (NORTH CAROLINA CORPORATION)  
ONE WACHOVIA CENTER  
301 S. COLLEGE ST., 30TH FLOOR, NC0630  
CHARLOTTE, NC 282880630

FOR: INVESTMENT ADVISORY SERVICES; INVESTMENT CONSULTATION SERVICES; INVESTMENT MANAGEMENT SERVICES; PROVIDING INFORMATION AND ADVICE IN THE FIELD OF FINANCE, FINANCIAL INVESTMENTS, FINANCIAL VALUATIONS, AND THE FINANCIAL AS-

PECTS OF RETIREMENT, IN CLASS 36 (U.S. CLS. 100, 101 AND 102).

FIRST USE 11-30-2006; IN COMMERCE 11-30-2006.

THE MARK CONSISTS OF STANDARD CHARACTERS WITHOUT CLAIM TO ANY PARTICULAR FONT, STYLE, SIZE, OR COLOR.

SER. NO. 77-366,878, FILED 1-8-2008.

JILL PRATER, EXAMINING ATTORNEY

**Int. Cl.: 9**

**Prior U.S. Cls.: 21, 23, 26, 36 and 38**

**United States Patent and Trademark Office**

**Reg. No. 3,467,739**

**Registered July 15, 2008**

**TRADEMARK  
PRINCIPAL REGISTER**

**EL VIDEO-MAESTRO DE INGLÉS  
CONVERSACIONAL**

LEXICON MARKETING OPERATING LUXEM-  
BOURG S.A.R.L. (LUXEMBOURG SOCIÉTÉ À  
RESPONSABILITÉ LIMITÉE (SARL))  
5 RUE GUILLAUME KROLL  
LUXEMBOURG, LUXEMBOURG L-1882

FOR: PRERECORDED AUDIO TAPES FEATUR-  
ING LANGUAGE COURSES; PRERECORDED DI-  
GITAL VIDEO DISKS FEATURING LANGUAGE  
COURSES, IN CLASS 9 (U.S. CLS. 21, 23, 26, 36 AND  
38).

FIRST USE 0-0-1999; IN COMMERCE 0-0-1999.

THE MARK CONSISTS OF STANDARD CHAR-  
ACTERS WITHOUT CLAIM TO ANY PARTICULAR  
FONT, STYLE, SIZE, OR COLOR.

OWNER OF U.S. REG. NOS. 1,627,082, 3,139,949,  
AND 3,252,247.

THE FOREIGN WORDING IN THE MARK  
TRANSLATES INTO ENGLISH AS THE VIDEO  
TEACHER OF CONVERSATIONAL ENGLISH.

SEC. 2(F).

SER. NO. 77-367,063, FILED 1-8-2008.

MATTHEW EINSTEIN, EXAMINING ATTORNEY

**Int. Cl.: 42**

**Prior U.S. Cls.: 100 and 101**

**United States Patent and Trademark Office**

**Reg. No. 3,467,740**

**Registered July 15, 2008**

---

**SERVICE MARK  
PRINCIPAL REGISTER**

# HAIR CAST

POST-NEWSWEEK STATIONS, INC. (DELA-  
WARE CORPORATION)  
550 WEST LAFAYETTE BOULEVARD  
DETROIT, MI 48226

THE MARK CONSISTS OF STANDARD CHAR-  
ACTERS WITHOUT CLAIM TO ANY PARTICULAR  
FONT, STYLE, SIZE, OR COLOR.

FOR: PROVIDING WEATHER INFORMATION,  
IN CLASS 42 (U.S. CLS. 100 AND 101).

SER. NO. 77-367,630, FILED 1-9-2008.

FIRST USE 6-0-2005; IN COMMERCE 6-0-2005.

MARGERY A. TIERNEY, EXAMINING ATTORNEY

**Int. Cl.: 44**

**Prior U.S. Cls.: 100 and 101**

**United States Patent and Trademark Office**

**Reg. No. 3,467,741**

**Registered July 15, 2008**

---

**SERVICE MARK  
PRINCIPAL REGISTER**

**I SAW IT FIRST!**

RODALE INC. (PENNSYLVANIA CORPORATION)  
33 EAST MINOR STREET  
EMMAUS, PA 180980099

FOR: PROVIDING ONLINE INFORMATION IN  
THE FIELD OF BEAUTY, SKIN AND HAIR CARE,  
COSMETICS AND RELATED ACCESSORIES, IN  
CLASS 44 (U.S. CLS. 100 AND 101).

FIRST USE 1-1-2008; IN COMMERCE 1-1-2008.

THE MARK CONSISTS OF STANDARD CHARACTERS WITHOUT CLAIM TO ANY PARTICULAR FONT, STYLE, SIZE, OR COLOR.

SER. NO. 77-367,647, FILED 1-9-2008.

MARLENE BELL, EXAMINING ATTORNEY

**Int. Cl.: 41**

**Prior U.S. Cls.: 100, 101 and 107**

**United States Patent and Trademark Office**

**Reg. No. 3,467,742**

**Registered July 15, 2008**

**SERVICE MARK  
PRINCIPAL REGISTER**

**EL REY DE LA RADIO**

SPANISH BROADCASTING SYSTEM, INC. (DE-  
LAWARE CORPORATION)  
PENTHOUSE 2  
2601 S. BAYSHORE DRIVE  
COCONUT GROVE, FL 33133

FOR: ENTERTAINMENT SERVICES, NAMELY,  
RADIO PROGRAMS FEATURING PERFORMAN-  
CES BY A RADIO PERSONALITY; ENTERTAIN-  
MENT SERVICES, NAMELY, PERSONAL  
APPEARANCES BY A RADIO PERSONALITY; EN-  
TERTAINMENT SERVICES, NAMELY, LIVE PER-  
FORMANCES BY A RADIO PERSONALITY, IN  
CLASS 41 (U.S. CLS. 100, 101 AND 107).

FIRST USE 9-13-1993; IN COMMERCE 9-13-1993.

THE MARK CONSISTS OF STANDARD CHAR-  
ACTERS WITHOUT CLAIM TO ANY PARTICULAR  
FONT, STYLE, SIZE, OR COLOR.

NO CLAIM IS MADE TO THE EXCLUSIVE  
RIGHT TO USE "RADIO", APART FROM THE  
MARK AS SHOWN.

THE ENGLISH TRANSLATION OF "EL REY DE  
LA RADIO" IS THE KING OF THE RADIO.

SER. NO. 77-368,584, FILED 1-10-2008.

JENNIFER HETU, EXAMINING ATTORNEY



**Int. Cl.: 21**

**Prior U.S. Cls.: 2, 13, 23, 29, 30, 33, 40 and 50**

**United States Patent and Trademark Office**

**Reg. No. 3,467,743**

**Registered July 15, 2008**

**TRADEMARK  
PRINCIPAL REGISTER**

**SportLaps**

BALDWIN, BONNY C. (UNITED STATES INDIVIDUAL)  
111 CLYDE FREELS RD  
SUNBRIGHT, TN 37872

THE MARK CONSISTS OF STANDARD CHARACTERS WITHOUT CLAIM TO ANY PARTICULAR FONT, STYLE, SIZE, OR COLOR.

FOR: MEAL AND SERVING TRAYS, IN CLASS 21 (U.S. CLS. 2, 13, 23, 29, 30, 33, 40 AND 50).

SER. NO. 77-368,899, FILED 1-10-2008.

FIRST USE 8-2-2007; IN COMMERCE 8-2-2007.

MARY BOAGNI, EXAMINING ATTORNEY

**Int. Cls.: 35 and 44**

**Prior U.S. Cls.: 100, 101 and 102**

**United States Patent and Trademark Office**

**Reg. No. 3,467,744**

**Registered July 15, 2008**

**SERVICE MARK  
PRINCIPAL REGISTER**

# BABY STEPS

FL FOOD LION, INC. (FLORIDA CORPORATION)  
2110 EXECUTIVE DRIVE  
SALISBURY, NC 28145

FOR: RETAIL GROCERY STORE SERVICES FEATURING BONUS INCENTIVE PROGRAMS FOR CUSTOMERS TO RECEIVE DISCOUNTS AND DISCOUNT COUPONS ON BABY PRODUCTS, IN CLASS 35 (U.S. CLS. 100, 101 AND 102).

FIRST USE 4-0-2006; IN COMMERCE 4-0-2006.

FOR: PROVIDING INFORMATION ON INFANT HEALTH, IN CLASS 44 (U.S. CLS. 100 AND 101).

FIRST USE 4-0-2006; IN COMMERCE 4-0-2006.

THE MARK CONSISTS OF STANDARD CHARACTERS WITHOUT CLAIM TO ANY PARTICULAR FONT, STYLE, SIZE, OR COLOR.

OWNER OF U.S. REG. NO. 3,314,480.

NO CLAIM IS MADE TO THE EXCLUSIVE RIGHT TO USE "BABY", APART FROM THE MARK AS SHOWN.

SER. NO. 77-369,637, FILED 1-11-2008.

ROBIN CHOSID, EXAMINING ATTORNEY

**Int. Cl.: 35**

**Prior U.S. Cls.: 100, 101 and 102**

**United States Patent and Trademark Office**

**Reg. No. 3,467,745**

**Registered July 15, 2008**

**SERVICE MARK  
PRINCIPAL REGISTER**

**PET PARTNERS**

FL FOOD LION, INC. (FLORIDA CORPORATION)  
2110 EXECUTIVE DRIVE  
SALISBURY, NC 28145

FOR: RETAIL GROCERY STORE SERVICES FEATURING BONUS INCENTIVE PROGRAMS FOR CUSTOMERS TO RECEIVE DISCOUNTS AND DISCOUNT COUPONS FOR PET PRODUCTS, IN CLASS 35 (U.S. CLS. 100, 101 AND 102).

FIRST USE 9-26-2007; IN COMMERCE 9-26-2007.

THE MARK CONSISTS OF STANDARD CHARACTERS WITHOUT CLAIM TO ANY PARTICULAR FONT, STYLE, SIZE, OR COLOR.

NO CLAIM IS MADE TO THE EXCLUSIVE RIGHT TO USE "PET", APART FROM THE MARK AS SHOWN.

SER. NO. 77-369,639, FILED 1-11-2008.

ROBIN CHOSID, EXAMINING ATTORNEY

**Int. Cl.: 35**

**Prior U.S. Cls.: 100, 101 and 102**

**United States Patent and Trademark Office**

**Reg. No. 3,467,746**

**Registered July 15, 2008**

**SERVICE MARK  
PRINCIPAL REGISTER**

**BOOKS IN HAND**

AMERICAN READING COMPANY (PENNSYLVANIA CORPORATION)  
201 S. GULPH ROAD  
KING OF PRUSSIA, PA 19406

FOR: ONLINE RETAIL BOOK STORE SERVICES; RETAIL BOOK STORE SERVICES; RETAIL BOOK STORE SERVICES IN THE FIELD OF A READING PROGRAM FOR PRE-KINDERGARTEN THROUGH SECONDARY SCHOOL STUDENTS FOR ASSESSING THE LEVEL OF DIFFICULTY OF BOOKS, IN CLASS 35 (U.S. CLS. 100, 101 AND 102).

FIRST USE 1-1-2008; IN COMMERCE 1-1-2008.

THE MARK CONSISTS OF STANDARD CHARACTERS WITHOUT CLAIM TO ANY PARTICULAR FONT, STYLE, SIZE, OR COLOR.

NO CLAIM IS MADE TO THE EXCLUSIVE RIGHT TO USE "BOOKS", APART FROM THE MARK AS SHOWN.

SER. NO. 77-369,827, FILED 1-11-2008.

NAPOLEON SHARMA, EXAMINING ATTORNEY

**Int. Cl.: 9**

**Prior U.S. Cls.: 21, 23, 26, 36 and 38**

**Reg. No. 3,467,747**

**United States Patent and Trademark Office**

**Registered July 15, 2008**

---

**TRADEMARK  
PRINCIPAL REGISTER**

**ODS**

FUCHS AUDIO TECHNOLOGY, LLC (NEW JERSEY LTD LIAB CO)  
73 COLLINS AVENUE  
BLOOMFIELD, NJ 07003

THE MARK CONSISTS OF STANDARD CHARACTERS WITHOUT CLAIM TO ANY PARTICULAR FONT, STYLE, SIZE, OR COLOR.

FOR: MUSICAL INSTRUMENT AMPLIFIERS, IN CLASS 9 (U.S. CLS. 21, 23, 26, 36 AND 38).

SER. NO. 77-371,032, FILED 1-14-2008.

FIRST USE 12-31-2002; IN COMMERCE 12-31-2002.

ELLEN BURNS, EXAMINING ATTORNEY

**Int. Cl.: 36**

**Prior U.S. Cls.: 100, 101 and 102**

**United States Patent and Trademark Office**

**Reg. No. 3,467,748**

**Registered July 15, 2008**

**SERVICE MARK  
PRINCIPAL REGISTER**

**WE ALL HAVE THE POWER TO  
GRANT A WISH**

MAKE-A-WISH FOUNDATION OF AMERICA  
(ARIZONA CORPORATION)  
3550 NORTH CENTRAL AVENUE, SUITE 300  
PHOENIX, AZ 85012

THE MARK CONSISTS OF STANDARD CHAR-  
ACTERS WITHOUT CLAIM TO ANY PARTICULAR  
FONT, STYLE, SIZE, OR COLOR.

FOR: CHARITABLE FUND RAISING, IN CLASS  
36 (U.S. CLS. 100, 101 AND 102).

SER. NO. 77-371,923, FILED 1-15-2008.

FIRST USE 1-5-2007; IN COMMERCE 1-5-2007.

HEATHER THOMPSON, EXAMINING ATTORNEY

**Int. Cl.: 36**

**Prior U.S. Cls.: 100, 101 and 102**

**United States Patent and Trademark Office**

**Reg. No. 3,467,749**

**Registered July 15, 2008**

**SERVICE MARK  
PRINCIPAL REGISTER**

**XactPAY Plus**

HARTFORD FIRE INSURANCE COMPANY  
(CONNECTICUT CORPORATION)  
LAW DEPT.-CORP.TECH/IP TM UNIT-HO109  
ONE HARTFORD PLAZA  
HARTFORD, CT 06155

FOR: WORKER'S COMPENSATION SERVICES,  
NAMELY, ELECTRONIC PROCESSING OF WORK-  
ER'S COMPENSATION PREMIUMS THROUGH A  
DIRECT LINK TO THE CUSTOMER'S PAYROLL, IN  
CLASS 36 (U.S. CLS. 100, 101 AND 102).

FIRST USE 8-31-2007; IN COMMERCE 8-31-2007.

THE MARK CONSISTS OF STANDARD CHAR-  
ACTERS WITHOUT CLAIM TO ANY PARTICULAR  
FONT, STYLE, SIZE, OR COLOR.

OWNER OF U.S. REG. NO. 3,133,851.

NO CLAIM IS MADE TO THE EXCLUSIVE  
RIGHT TO USE "PLUS", APART FROM THE MARK  
AS SHOWN.

SER. NO. 77-372,157, FILED 1-15-2008.

ALYSSA PALADINO, EXAMINING ATTORNEY

**Int. Cl.: 36**

**Prior U.S. Cls.: 100, 101 and 102**

**United States Patent and Trademark Office**

**Reg. No. 3,467,750**

**Registered July 15, 2008**

**SERVICE MARK  
PRINCIPAL REGISTER**

**XactPAY Web**

HARTFORD FIRE INSURANCE COMPANY  
(CONNECTICUT CORPORATION)  
LAW DEPT.-CORP.TECH/IP TM UNIT-HO109  
ONE HARTFORD PLAZA  
HARTFORD, CT 06155

FOR: WORKER'S COMPENSATION SERVICES,  
NAMELY, ELECTRONIC PROCESSING OF WORK-  
ER'S COMPENSATION PREMIUMS THROUGH A  
DIRECT LINK TO THE CUSTOMER'S PAYROLL, IN  
CLASS 36 (U.S. CLS. 100, 101 AND 102).

FIRST USE 7-31-2007; IN COMMERCE 7-31-2007.

THE MARK CONSISTS OF STANDARD CHAR-  
ACTERS WITHOUT CLAIM TO ANY PARTICULAR  
FONT, STYLE, SIZE, OR COLOR.

OWNER OF U.S. REG. NO. 3,133,851.

NO CLAIM IS MADE TO THE EXCLUSIVE  
RIGHT TO USE "WEB", APART FROM THE MARK  
AS SHOWN.

SER. NO. 77-372,161, FILED 1-15-2008.

ALYSSA PALADINO, EXAMINING ATTORNEY



**Int. Cl.: 41**

**Prior U.S. Cls.: 100, 101 and 107**

**United States Patent and Trademark Office**

**Reg. No. 3,467,751**

**Registered July 15, 2008**

**SERVICE MARK  
PRINCIPAL REGISTER**



THE UNIVERSITY OF NORTH ALABAMA (ALABAMA CORPORATION)  
UNA BOX 5003  
FLORENCE, AL 356320001

FOR: ENCOURAGING AMATEUR SPORTS AND PHYSICAL EDUCATION BY ORGANIZING, PROMOTING, SPONSORING, SANCTIONING, CONDUCTING, ADMINISTERING, REGULATING AND GOVERNING AMATEUR ATHLETIC PROGRAMS AND ACTIVITIES; PROVIDING VARIOUS FACILITIES FOR AN ARRAY OF SPORTING EVENTS, SPORTS AND ATHLETIC COMPETITIONS

AND AWARDS PROGRAMMES, IN CLASS 41 (U.S. CLS. 100, 101 AND 107).

FIRST USE 9-1-2004; IN COMMERCE 9-1-2004.

THE MARK CONSISTS OF A LION NECK AND HEAD FACING TO THE RIGHT WITHIN A CIRCLE.

SER. NO. 77-373,042, FILED 1-16-2008.

CIMMERIAN COLEMAN, EXAMINING ATTORNEY

**Int. Cl.: 7**

**Prior U.S. Cls.: 13, 19, 21, 23, 31, 34 and 35**

**Reg. No. 3,467,752**

**United States Patent and Trademark Office**

**Registered July 15, 2008**

**TRADEMARK  
PRINCIPAL REGISTER**

# Aerodyne

ABANAKI CORPORATION (OHIO CORPORATION), DBA AERODYNE DEVELOPMENT  
17387 MUNN RD.  
CHAGRIN FALLS, OH 44023

THE MARK CONSISTS OF STANDARD CHARACTERS WITHOUT CLAIM TO ANY PARTICULAR FONT, STYLE, SIZE, OR COLOR.

FOR: VALVES BEING PARTS OF MACHINES; DUST SEPARATORS; PNEUMATIC CONVEYORS; SCREW CONVEYORS, IN CLASS 7 (U.S. CLS. 13, 19, 21, 23, 31, 34 AND 35).

SER. NO. 77-374,515, FILED 1-17-2008.

FIRST USE 6-30-1949; IN COMMERCE 8-31-1949.

ANTHONY RINKER, EXAMINING ATTORNEY

**Int. Cl.: 16**

**Prior U.S. Cls.: 2, 5, 22, 23, 29, 37, 38 and 50**

**United States Patent and Trademark Office**

**Reg. No. 3,467,753**

**Registered July 15, 2008**

**TRADEMARK  
PRINCIPAL REGISTER**

# FriendSaver

HATTORI, MARSHALL K. (UNITED STATES  
INDIVIDUAL)  
19999 STEVENS CREEK BLVD. UNIT 105  
CUPERTINO, CA 95014

THE MARK CONSISTS OF STANDARD CHAR-  
ACTERS WITHOUT CLAIM TO ANY PARTICULAR  
FONT, STYLE, SIZE, OR COLOR.

FOR: SCRAPBOOK ALBUMS, IN CLASS 16 (U.S.  
CLS. 2, 5, 22, 23, 29, 37, 38 AND 50).

SER. NO. 77-374,704, FILED 1-17-2008.

FIRST USE 10-10-1996; IN COMMERCE 10-10-1996.

B. PARADEWELAI, EXAMINING ATTORNEY

**Int. Cl.: 9**

**Prior U.S. Cls.: 21, 23, 26, 36 and 38**

**Reg. No. 3,467,754**

**United States Patent and Trademark Office**

**Registered July 15, 2008**

---

**TRADEMARK  
PRINCIPAL REGISTER**

**TRULOGIC**

FINESSE SOLUTIONS, LLC. (DELAWARE LTD  
LIAB CO)  
BLDG. 1  
3350 SCOTT BLVD  
SANTA CLARA, CA 950543107

FOR: COMPUTER HARDWARE WHICH CON-  
TROLS THE COMMUNICATION BETWEEN BIO-  
PROCESS MONITORING INSTRUMENTATION  
AND DIAGNOSTIC SOFTWARE, IN CLASS 9 (U.S.  
CLS. 21, 23, 26, 36 AND 38).

FIRST USE 11-8-2007; IN COMMERCE 11-8-2007.

THE MARK CONSISTS OF STANDARD CHAR-  
ACTERS WITHOUT CLAIM TO ANY PARTICULAR  
FONT, STYLE, SIZE, OR COLOR.

SER. NO. 77-376,783, FILED 1-21-2008.

GRETTA YAO, EXAMINING ATTORNEY

**Int. Cl.: 29**

**Prior U.S. Cl.: 46**

**United States Patent and Trademark Office**

**Reg. No. 3,467,755**

**Registered July 15, 2008**

**TRADEMARK  
PRINCIPAL REGISTER**

**SUPERCARGED BY NATURE!**

WELLS' DAIRY, INC. (IOWA CORPORATION)  
P.O. BOX 1310  
ONE BLUE BUNNY DRIVE  
LE MARS, IA 51031

THE MARK CONSISTS OF STANDARD CHAR-  
ACTERS WITHOUT CLAIM TO ANY PARTICULAR  
FONT, STYLE, SIZE, OR COLOR.

FOR: YOGURT, IN CLASS 29 (U.S. CL. 46).

SER. NO. 77-377,215, FILED 1-22-2008.

FIRST USE 7-29-2007; IN COMMERCE 7-29-2007.

SONYA STEPHENS, EXAMINING ATTORNEY

**Int. Cl.: 33**

**Prior U.S. Cls.: 47 and 49**

**United States Patent and Trademark Office**

**Reg. No. 3,467,756**

**Registered July 15, 2008**

**TRADEMARK  
PRINCIPAL REGISTER**



BARONESS SMALL ESTATES, INC. (COLORADO  
CORPORATION)  
2395 WEST 2ND AVENUE  
DENVER, CO 80223

THE MARK CONSISTS OF A PARTIAL OUTLINE  
OF A HUMAN FIGURE.

FOR: RED WINE; WHITE WINE; WINES; TABLE  
WINES, IN CLASS 33 (U.S. CLS. 47 AND 49).

SER. NO. 77-377,813, FILED 1-22-2008.

FIRST USE 9-13-2006; IN COMMERCE 9-13-2006.

JENNIFER HETU, EXAMINING ATTORNEY

**Int. Cl.: 35**

**Prior U.S. Cls.: 100, 101 and 102**

**United States Patent and Trademark Office**

**Reg. No. 3,467,757**

**Registered July 15, 2008**

**SERVICE MARK  
PRINCIPAL REGISTER**



THE GREAT ATLANTIC & PACIFIC TEA COMPANY, INC. (MARYLAND CORPORATION)  
2 PARAGON DRIVE  
MONTVALE, NJ 07645

FOR: SUPERMARKETS; RETAIL STORE SERVICES FEATURING A WIDE VARIETY OF CONSUMER GOODS OF OTHERS, IN CLASS 35 (U.S. CLS. 100, 101 AND 102).

FIRST USE 6-26-2004; IN COMMERCE 6-26-2004.

OWNER OF U.S. REG. NO. 2,085,126.

THE MARK CONSISTS OF DESIGN OF THE LETTER "S" WITHIN A CIRCLE WITH DESIGN OF A LEAF OFF THE RIGHT, BOTTOM PORTION OF THE LETTER "S" ALSO WITHIN THE CIRCLE. THE WORD "SUPERFRESH" SHOWN BELOW THE DESIGN AND OUTSIDE OF THE CIRCLE.

SER. NO. 77-378,422, FILED 1-23-2008.

WENDY JUN, EXAMINING ATTORNEY

**Int. Cl.: 36**

**Prior U.S. Cls.: 100, 101 and 102**

**United States Patent and Trademark Office**

**Reg. No. 3,467,758**

**Registered July 15, 2008**

**SERVICE MARK  
PRINCIPAL REGISTER**

**WACHOVIA SECURITIES  
RESOURCE ACCOUNT**

WACHOVIA CORPORATION (NORTH CAROLINA CORPORATION)  
ONE WACHOVIA CENTER  
301 S COLLEGE ST., 30TH FLOOR, NC0630  
CHARLOTTE, NC 282880630

FOR: CHECKING ACCOUNT SERVICES, IN CLASS 36 (U.S. CLS. 100, 101 AND 102).

FIRST USE 8-6-2007; IN COMMERCE 8-6-2007.

THE MARK CONSISTS OF STANDARD CHARACTERS WITHOUT CLAIM TO ANY PARTICULAR FONT, STYLE, SIZE, OR COLOR.

NO CLAIM IS MADE TO THE EXCLUSIVE RIGHT TO USE "SECURITIES RESOURCE ACCOUNT", APART FROM THE MARK AS SHOWN.

SER. NO. 77-378,611, FILED 1-23-2008.

JILL PRATER, EXAMINING ATTORNEY



**Int. Cl.: 28**

**Prior U.S. Cls.: 22, 23, 38 and 50**

**United States Patent and Trademark Office**

**Reg. No. 3,467,759**

**Registered July 15, 2008**

**TRADEMARK  
PRINCIPAL REGISTER**

**VEGAS PRO**

FIRST PLACE PUBLICATIONS (IDAHO LTD  
LIAB CO)  
535 PARTRIDGE LANE  
REXBURG, ID 83440

THE MARK CONSISTS OF STANDARD CHAR-  
ACTERS WITHOUT CLAIM TO ANY PARTICULAR  
FONT, STYLE, SIZE, OR COLOR.

FOR: MANUALLY-OPERATED EXERCISE  
EQUIPMENT, IN CLASS 28 (U.S. CLS. 22, 23, 38  
AND 50).

SER. NO. 77-378,862, FILED 1-23-2008.

FIRST USE 12-27-2007; IN COMMERCE 12-27-2007.

FLORENTINA BLANDU, EXAMINING ATTORNEY

**Int. Cl.: 1**

**Prior U.S. Cls.: 1, 5, 6, 10, 26 and 46**

**Reg. No. 3,467,760**

**United States Patent and Trademark Office**

**Registered July 15, 2008**

---

**TRADEMARK  
PRINCIPAL REGISTER**

**BioNatra**

AGRI-GRO MARKETING, INC. (MISSOURI CORPORATION)  
HC 4 BOX 333  
DONIPHAN, MO 63935

FIRST USE 11-15-2002; IN COMMERCE 1-15-2003.

FOR: CONCENTRATED, STABILIZED, BIOLOGICAL ENZYMES AND MICROORGANISMS FOR USE AS AN ADDITIVE IN THE TREATMENT OF BIOSOLIDS AND ODORS INCLUDING BUT NOT LIMITED TO MUNICIPAL, INDUSTRIAL, RESIDENTIAL, AND AGRICULTURAL WASTEWATER, IN CLASS 1 (U.S. CLS. 1, 5, 6, 10, 26 AND 46).

THE MARK CONSISTS OF STANDARD CHARACTERS WITHOUT CLAIM TO ANY PARTICULAR FONT, STYLE, SIZE, OR COLOR.

SER. NO. 77-379,324, FILED 1-24-2008.

NAAKWAMA ANKRAH, EXAMINING ATTORNEY

**Int. Cl.: 30**

**Prior U.S. Cl.: 46**

**United States Patent and Trademark Office**

**Reg. No. 3,467,761**

**Registered July 15, 2008**

**TRADEMARK  
PRINCIPAL REGISTER**

**MEAT THE DAY**

PITA PIT, INC. (DELAWARE CORPORATION)  
105 NORTH 4TH STREET, SUITE 208  
COEUR D'ALENE, ID 83864

FOR: BREAKFAST SANDWICHES CONSISTING  
OF MEAT, POTATOES, EGGS, CHEESE AND  
SAUCE IN PITA BREAD, IN CLASS 30 (U.S. CL. 46).

FIRST USE 1-2-2006; IN COMMERCE 1-2-2006.

THE MARK CONSISTS OF STANDARD CHAR-  
ACTERS WITHOUT CLAIM TO ANY PARTICULAR  
FONT, STYLE, SIZE, OR COLOR.

NO CLAIM IS MADE TO THE EXCLUSIVE  
RIGHT TO USE "MEAT", APART FROM THE  
MARK AS SHOWN.

SER. NO. 77-379,476, FILED 1-24-2008.

JANICE KIM, EXAMINING ATTORNEY

**Int. Cl.: 35**

**Prior U.S. Cls.: 100, 101 and 102**

**United States Patent and Trademark Office**

**Reg. No. 3,467,762**

**Registered July 15, 2008**

**SERVICE MARK  
PRINCIPAL REGISTER**

**BIMBO**

GRUPO BIMBO, S.A. B. DE C.V. (MEXICO CORPORATION)  
PROLONGACION PASEO DE LA REFORMA  
NO. 1000, COL PENA BLANCA SANTA FE  
MEXICO CITY, MEXICO 01210

FOR: RETAIL BAKERY SHOPS; RETAIL GROCERY STORES, IN CLASS 35 (U.S. CLS. 100, 101 AND 102).

FIRST USE 6-30-1998; IN COMMERCE 8-31-2007.

THE MARK CONSISTS OF STANDARD CHARACTERS WITHOUT CLAIM TO ANY PARTICULAR FONT, STYLE, SIZE, OR COLOR.

OWNER OF U.S. REG. NOS. 1,413,535, 2,767,227 AND OTHERS.

SER. NO. 77-379,516, FILED 1-24-2008.

MARCIE MILONE, EXAMINING ATTORNEY

**Int. Cl.: 30**

**Prior U.S. Cl.: 46**

**United States Patent and Trademark Office**

**Reg. No. 3,467,763**

**Registered July 15, 2008**

**TRADEMARK  
PRINCIPAL REGISTER**

**TAMANACO**

SONAFI (FRANCE SOCIÉTÉ PAR ACTIONS SIM-  
PLIFIÉE (SAS))  
42 RUE RIEUSSEC  
VIROFLAY, FRANCE 78220

FOR: CHOCOLATE AND CHOCOLATE CANDY,  
IN CLASS 30 (U.S. CL. 46).

FIRST USE 11-14-2000; IN COMMERCE 11-14-2000.

THE MARK CONSISTS OF STANDARD CHAR-  
ACTERS WITHOUT CLAIM TO ANY PARTICULAR  
FONT, STYLE, SIZE, OR COLOR.

OWNER OF U.S. REG. NO. 2,532,715.

SER. NO. 77-380,255, FILED 1-25-2008.

ELI HELLMAN, EXAMINING ATTORNEY

**Int. Cl.: 43**

**Prior U.S. Cls.: 100 and 101**

**United States Patent and Trademark Office**

**Reg. No. 3,467,764**

**Registered July 15, 2008**

**SERVICE MARK  
PRINCIPAL REGISTER**

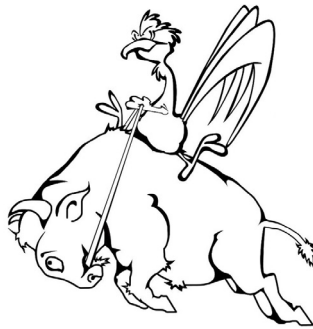

NATIVE NEW YORKER OF AMERICA, INC.  
(ARIZONA CORPORATION)  
BLDG. 6, #122  
1757 EAST BASELINE  
GILBERT, AZ 85234

THE MARK CONSISTS OF A CHICKEN RIDING  
A BUFFALO.

FOR: RESTAURANT, BAR AND CATERING SER-  
VICES, IN CLASS 43 (U.S. CLS. 100 AND 101).

SER. NO. 77-381,231, FILED 1-25-2008.

FIRST USE 9-0-2007; IN COMMERCE 9-0-2007.

LANA PHAM, EXAMINING ATTORNEY

**Int. Cl.: 42**

**Prior U.S. Cls.: 100 and 101**

**United States Patent and Trademark Office**

**Reg. No. 3,467,765**

**Registered July 15, 2008**

**SERVICE MARK  
PRINCIPAL REGISTER**

student feedback made  
simple

EVALUATIONKIT, LLC (COLORADO LTD LIAB  
CO)  
UNIT R104  
8300 FAIRMOUNT DRIVE  
DENVER, CO 80247

FOR: COMPUTER SERVICES, NAMELY, PROVIDING TEMPORARY USE OF NON-DOWNLOADABLE COMPUTER SOFTWARE FOR AUTHORIZING, DESIGNING AND DEPLOYMENT OF ONLINE QUESTIONNAIRES, SURVEYS, AND OTHER FEEDBACK AND DATA COLLECTION ACTIVITIES VIA COMPUTER NETWORKS; PROVIDING TEMPORARY USE OF NON-DOWNLOADABLE COMPUTER SOFTWARE FOR THE ADMINISTRATION, DISTRIBUTION, COLLECTION, REPORTING, ANALYSIS, AND PRESENTATION OF INFORMATION GATHERED VIA COMPUTER NETWORKS; HOSTING WEB-BASED QUESTIONNAIRES, SURVEYS, AND

OTHER FEEDBACK AND DATA COLLECITON TOOLS FOR OTHERS, IN CLASS 42 (U.S. CLS. 100 AND 101).

FIRST USE 1-1-2008; IN COMMERCE 1-1-2008.

THE MARK CONSISTS OF STANDARD CHARACTERS WITHOUT CLAIM TO ANY PARTICULAR FONT, STYLE, SIZE, OR COLOR.

NO CLAIM IS MADE TO THE EXCLUSIVE RIGHT TO USE "STUDENT FEEDBACK", APART FROM THE MARK AS SHOWN.

SER. NO. 77-381,350, FILED 1-26-2008.

BONNIE LUKEN, EXAMINING ATTORNEY

**Int. Cl.: 1**

**Prior U.S. Cls.: 1, 5, 6, 10, 26 and 46**

**United States Patent and Trademark Office**

**Reg. No. 3,467,766**

**Registered July 15, 2008**

**TRADEMARK  
PRINCIPAL REGISTER**

**VINTAGEZYM**

KERRY GROUP SERVICES INTERNATIONAL  
LIMITED (IRELAND COMPANY)  
PRINCÉS STREET  
TRALEE, COUNTY KERRY, IRELAND

FOR: ENZYMES USED IN WINEMAKING OR  
BREWING; ENZYMES FOR USE IN THE BEVER-  
AGE INDUSTRY, IN CLASS 1 (U.S. CLS. 1, 5, 6, 10, 26  
AND 46).

THE MARK CONSISTS OF STANDARD CHAR-  
ACTERS WITHOUT CLAIM TO ANY PARTICULAR  
FONT, STYLE, SIZE, OR COLOR.

OWNER OF IRELAND REG. NO. 236065, DATED  
3-16-2007, EXPIRES 3-16-2014.

THE TERM "VINTAGEZYM" HAS NO MEANING  
IN ENGLISH.

SER. NO. 77-381,535, FILED 1-27-2008.

DORITT L. CARROLL, EXAMINING ATTORNEY



**Int. Cl.: 9**

**Prior U.S. Cls.: 21, 23, 26, 36 and 38**

**Reg. No. 3,467,767**

**United States Patent and Trademark Office**

**Registered July 15, 2008**

---

**TRADEMARK  
PRINCIPAL REGISTER**

**ACCUPROX**

EATON CORPORATION (OHIO CORPORATION)  
1111 SUPERIOR AVENUE  
CLEVELAND, OH 44114

THE MARK CONSISTS OF STANDARD CHAR-  
ACTERS WITHOUT CLAIM TO ANY PARTICULAR  
FONT, STYLE, SIZE, OR COLOR.

FOR: INDUCTIVE PROXIMITY SENSOR, IN  
CLASS 9 (U.S. CLS. 21, 23, 26, 36 AND 38).

SER. NO. 77-381,671, FILED 1-28-2008.

FIRST USE 1-25-2007; IN COMMERCE 1-25-2007.

AMEETA JORDAN, EXAMINING ATTORNEY

Int. Cl.: 29

Prior U.S. Cl.: 46

United States Patent and Trademark Office

Reg. No. 3,467,768

Registered July 15, 2008

**TRADEMARK  
PRINCIPAL REGISTER**

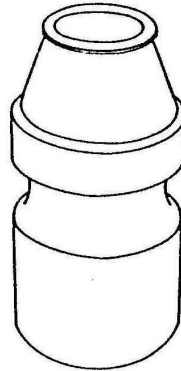

KABUSHIKI KAISHA YAKULT HONSHA (JAPAN CORPORATION)  
1-19, HIGASHI SHIMBASHI 1-CHOME  
MINATO-KU, TOKYO, JAPAN

FOR: FERMENTED MILK BEVERAGES, IN CLASS 29 (U.S. CL. 46).

FIRST USE 10-0-1968; IN COMMERCE 10-0-1999.

OWNER OF U.S. REG. NO. 1,512,202.

THE MARK CONSISTS OF THE CONFIGURATION OF A BOTTLE WHICH IS CYLINDRICAL AT THE BASE, NARROWS AT THE MIDDLE, AND IS TAPERED NEAR THE TOP, FEATURING A CONE-LIKE DESIGN AT THE TOP.

SEC. 2(F).

SER. NO. 77-382,207, FILED 1-28-2008.

COLLEEN KEARNEY, EXAMINING ATTORNEY

**Int. Cl.: 41**

**Prior U.S. Cls.: 100, 101 and 107**

**United States Patent and Trademark Office**

**Reg. No. 3,467,769**

**Registered July 15, 2008**

**SERVICE MARK  
PRINCIPAL REGISTER**

**Inside Sports and Fitness**

INSIDE SPORTS AND FITNESS (KANSAS LTD  
LIAB CO)  
6807 W. 295TH STREET  
LOUISBURG, KS 66053

FOR: INSTRUCTION IN THE AREAS OF FIT-  
NESS, EXERCISE, WEIGHT TRAINING, AND ATH-  
LETIC TRAINING, IN CLASS 41 (U.S. CLS. 100, 101  
AND 107).

FIRST USE 6-1-2007; IN COMMERCE 6-1-2007.

THE MARK CONSISTS OF STANDARD CHAR-  
ACTERS WITHOUT CLAIM TO ANY PARTICULAR  
FONT, STYLE, SIZE, OR COLOR.

NO CLAIM IS MADE TO THE EXCLUSIVE  
RIGHT TO USE "SPORTS AND FITNESS", APART  
FROM THE MARK AS SHOWN.

SER. NO. 77-386,444, FILED 2-1-2008.

ALYSSA PALADINO, EXAMINING ATTORNEY

**Int. Cl.: 35**

**Prior U.S. Cls.: 100, 101 and 102**

**United States Patent and Trademark Office**

**Reg. No. 3,467,770**

**Registered July 15, 2008**

**SERVICE MARK  
PRINCIPAL REGISTER**

**START MY IDEA**

BARDOM.COM, LLC (FLORIDA LTD LIAB CO)  
1309 ELIZA ST.  
KEY WEST, FL 33040

FOR: PROVIDING A WEBSITE AT WHICH THE PUBLIC CAN POST CREATIVE IDEATIONS IN THE FIELD OF BUSINESS AND RESPOND TO ADVERTISEMENTS FOR THEIR SERVICES, IN CLASS 35 (U.S. CLS. 100, 101 AND 102).

FIRST USE 8-21-2007; IN COMMERCE 10-1-2007.

THE MARK CONSISTS OF STANDARD CHARACTERS WITHOUT CLAIM TO ANY PARTICULAR FONT, STYLE, SIZE, OR COLOR.

NO CLAIM IS MADE TO THE EXCLUSIVE RIGHT TO USE "IDEA", APART FROM THE MARK AS SHOWN.

SER. NO. 77-386,646, FILED 2-1-2008.

FLORENTINA BLANDU, EXAMINING ATTORNEY

**Int. Cl.: 29**

**Prior U.S. Cl.: 46**

**United States Patent and Trademark Office**

**Reg. No. 3,467,771**

**Registered July 15, 2008**

**TRADEMARK  
PRINCIPAL REGISTER**



WHITEWAVE FOODS COMPANY (DELAWARE CORPORATION)  
12002 AIRPORT WAY  
BROOMFIELD, CO 80021

FOR: DAIRY PRODUCTS EXCLUDING ICE CREAM, ICE MILK AND FROZEN YOGURT, IN CLASS 29 (U.S. CL. 46).

FIRST USE 3-0-1999; IN COMMERCE 3-0-1999.

OWNER OF U.S. REG. NOS. 1,975,824, 2,633,769, AND 3,070,586.

NO CLAIM IS MADE TO THE EXCLUSIVE RIGHT TO USE "ORGANIC", APART FROM THE MARK AS SHOWN.

THE MARK CONSISTS OF A LEAPING COW HOLDING A BANNER IN FRONT OF A GLOBE, TOGETHER WITH THE WORDS "HORIZON ORGANIC".

SER. NO. 77-387,822, FILED 2-4-2008.

BRIAN NEVILLE, EXAMINING ATTORNEY

**Int. Cl.: 10**

**Prior U.S. Cls.: 26, 39 and 44**

**United States Patent and Trademark Office**

**Reg. No. 3,467,772**

**Registered July 15, 2008**

**TRADEMARK  
PRINCIPAL REGISTER**

**COMFORTFLEX**

KAZ, INCORPORATED (NEW YORK CORPORATION)  
1775 BROADWAY, SUITE 2405  
NEW YORK, NY 10019

THE MARK CONSISTS OF STANDARD CHARACTERS WITHOUT CLAIM TO ANY PARTICULAR FONT, STYLE, SIZE, OR COLOR.

FOR: THERMOMETERS FOR MEDICAL PURPOSES, IN CLASS 10 (U.S. CLS. 26, 39 AND 44).

SER. NO. 77-387,953, FILED 2-4-2008.

FIRST USE 8-0-1998; IN COMMERCE 8-0-1998.

DAVID MILLER, EXAMINING ATTORNEY

**Int. Cl.: 38**

**Prior U.S. Cls.: 100, 101 and 104**

**United States Patent and Trademark Office**

**Reg. No. 3,467,773**

**Registered July 15, 2008**

**SERVICE MARK  
PRINCIPAL REGISTER**

**THE NY ROCK EXPERIENCE**

EMMIS RADIO, LLC (INDIANA LTD LIAB CO)  
SUITE 700  
40 MONUMENT CIRCLE  
INDIANAPOLIS, IN 46204

FOR: RADIO BROADCASTING SERVICES, IN  
CLASS 38 (U.S. CLS. 100, 101 AND 104).

FIRST USE 2-5-2008; IN COMMERCE 2-5-2008.

THE MARK CONSISTS OF STANDARD CHAR-  
ACTERS WITHOUT CLAIM TO ANY PARTICULAR  
FONT, STYLE, SIZE, OR COLOR.

NO CLAIM IS MADE TO THE EXCLUSIVE  
RIGHT TO USE "NY ROCK", APART FROM THE  
MARK AS SHOWN.

SER. NO. 77-389,096, FILED 2-5-2008.

DANNEAN HETZEL, EXAMINING ATTORNEY

**Int. Cl.: 41**

**Prior U.S. Cls.: 100, 101 and 107**

**United States Patent and Trademark Office**

**Reg. No. 3,467,774**

**Registered July 15, 2008**

---

**SERVICE MARK  
PRINCIPAL REGISTER**

**Bitten**

THE NEW YORK TIMES COMPANY (NEW  
YORK CORPORATION)  
620 EIGHTH AVENUE  
NEW YORK, NY 10018

THE MARK CONSISTS OF STANDARD CHAR-  
ACTERS WITHOUT CLAIM TO ANY PARTICULAR  
FONT, STYLE, SIZE, OR COLOR.

FOR: ON-LINE JOURNALS, NAMELY, BLOGS  
FEATURING FOOD, COOKING AND RESTAU-  
RANTS, IN CLASS 41 (U.S. CLS. 100, 101 AND 107).

SER. NO. 77-389,711, FILED 2-6-2008.

FIRST USE 2-5-2008; IN COMMERCE 2-5-2008.

BILL DAWE, EXAMINING ATTORNEY



**Int. Cls.: 9 and 36**

**Prior U.S. Cls.: 21, 23, 26, 36, 38, 100, 101 and 102**

**United States Patent and Trademark Office**

**Reg. No. 3,467,775**

**Registered July 15, 2008**

**TRADEMARK  
SERVICE MARK  
PRINCIPAL REGISTER**

**THE CARD THAT CARRIES YOU ...**

ALTA INVESTMENTS, LLC (MARYLAND LTD  
LIAB CO)  
1501 SULGRAVE AVE.  
SUITE 200  
BALTIMORE, MD 21209

FOR: ENCODED SMART CARDS CONTAINING  
PROGRAMMING USED TO ALLOW PAYMENT  
FOR TRANSPORTATION SERVICES; MAGNETI-  
CALLY ENCODED DEBIT CARDS, IN CLASS 9  
(U.S. CLS. 21, 23, 26, 36 AND 38).

FIRST USE 5-1-2007; IN COMMERCE 5-1-2007.

FOR: DEBIT ACCOUNT SERVICES FEATURING  
STORED VALUE CARDS, PREPAID CARDS, AND  
ENCODED SMART CARS FOR USE WITH TRANS-

PORTATION SERVICES AND RETAIL SERVICES;  
DEBIT CARD SERVICES; ISSUING STORED VALUE  
CARDS; PRE-PAID PURCHASE CARD SERVICES,  
NAMELY, PROCESSING ELECTRONIC PAY-  
MENTS MADE THROUGH PREPAID CARDS, IN  
CLASS 36 (U.S. CLS. 100, 101 AND 102).

FIRST USE 7-10-2007; IN COMMERCE 7-10-2007.

THE MARK CONSISTS OF STANDARD CHAR-  
ACTERS WITHOUT CLAIM TO ANY PARTICULAR  
FONT, STYLE, SIZE, OR COLOR.

SER. NO. 77-390,096, FILED 2-6-2008.

ANTHONY RINKER, EXAMINING ATTORNEY

**Int. Cl.: 9**

**Prior U.S. Cls.: 21, 23, 26, 36 and 38**

**United States Patent and Trademark Office**

**Reg. No. 3,467,776**

**Registered July 15, 2008**

**TRADEMARK  
PRINCIPAL REGISTER**

**I.D.MATE OMNI**

EN-VISION AMERICA, INC. (ILLINOIS CORPORATION)  
1845 W. HOVEY AVE.  
NORMAL, IL 61761

FOR: BAR CODE READER, IN CLASS 9 (U.S. CLS. 21, 23, 26, 36 AND 38).

FIRST USE 10-17-1997; IN COMMERCE 10-17-1997.

THE MARK CONSISTS OF STANDARD CHARACTERS WITHOUT CLAIM TO ANY PARTICULAR FONT, STYLE, SIZE, OR COLOR.

OWNER OF U.S. REG. NO. 2,467,022.

NO CLAIM IS MADE TO THE EXCLUSIVE RIGHT TO USE "I.D.", APART FROM THE MARK AS SHOWN.

SER. NO. 77-391,248, FILED 2-7-2008.

DANNEAN HETZEL, EXAMINING ATTORNEY

Int. Cls.: 35 and 43

Prior U.S. Cls.: 100, 101 and 102

United States Patent and Trademark Office

Reg. No. 3,467,777

Registered July 15, 2008

SERVICE MARK  
PRINCIPAL REGISTER



LIBORIO MARKET, INC. (CALIFORNIA CORPORATION)  
171 S. HUDON AVE  
PASADENA, CA 91101

FOR: RETAIL GROCERY STORES, RETAIL SUPERMARKETS, IN-STORE RETAIL DELICATESSEN, IN STORE TAKE OUT BAKERY SERVICES, IN-STORE BUTCHER SERVICES, IN-STORE BAKERY, FEATURING TORTILLA MAKING, IN-STORE BUTCHER, FEATURING, POULTRY PROCESSING; RETAIL STORE SERVICES FEATURING CREAM FOR TAKE OUT; AND RETAIL STORE SERVICES FEATURING JUICES FOR TAKE OUT, IN CLASS 35 (U.S. CLS. 100, 101 AND 102).

FIRST USE 2-1-2006; IN COMMERCE 2-1-2006.

FOR: IN-STORE RESTAURANT; IN STORE TAKE OUT JUICE BAR SERVICES; AND IN STORE TAKE OUT CREAM BAR SERVICES IN THE NATURE OF A RESTAURANT, IN CLASS 43 (U.S. CLS. 100 AND 101).

FIRST USE 2-1-2006; IN COMMERCE 2-1-2006.

NO CLAIM IS MADE TO THE EXCLUSIVE RIGHT TO USE "MERCADO" AND "EST 1966", APART FROM THE MARK AS SHOWN.

THE COLOR(S) RED, WHITE, GREEN, BLUE IS/ ARE CLAIMED AS A FEATURE OF THE MARK.

THE MARK CONSISTS OF A THREE QUARTERS COMPLETE GREEN OVAL SHAPE. ENTERING THE THREE QUARTERS COMPLETE GREEN OVAL SHAPE FROM THE ONE QUARTER INCOMPLETE SECTION OF THE GREEN OVAL SHAPE IS THE LITERAL TERM "RANCHO" IN BLUE STANDARD BLOCK TEXT. INSIDE THE THREE QUARTERS COMPLETE GREEN OVAL SHAPE IS THE LITERAL TERM "LIBORIO" IN RED CURSIVE TEXT. INSIDE THE THREE QUARTERS COMPLETE GREEN OVAL SHAPE, BELOW THE LITERAL TERM "LIBORIO" IS THE LITERAL TERMS "SU MERCADO" IN BLUE CAPITALIZED STANDARD BLOCK TEXT. ALL OF THE AFOREMENTIONED DESCRIPTION IS PLACED ON A WHITE BACKGROUND.

THE ENGLISH TRANSLATION OF THE MARK IS A PEASANT FROM A RURAL AREA; YOUR MARKET.

SER. NO. 77-394,804, FILED 2-12-2008.

CHERYL CLAYTON, EXAMINING ATTORNEY

Int. Cl.: 35

Prior U.S. Cls.: 100, 101 and 102

United States Patent and Trademark Office

Reg. No. 3,467,778

Registered July 15, 2008

**SERVICE MARK  
PRINCIPAL REGISTER**



MORINAGA NYUGYO KABUSHIKI KAISHA  
(JAPAN CORPORATION), DBA MORINAGA  
MILK INDUSTRY CO., LTD.  
33-1, SHIBA 5-CHOME, MINATO-KU  
TOKYO, JAPAN

FOR: COMPUTERIZED ON-LINE RETAIL STORE  
SERVICES IN THE FIELD OF FOOD, BEVERAGES,  
AND FOOD SUPPLEMENTS, IN CLASS 35 (U.S. CLS.  
100, 101 AND 102).

FIRST USE 2-28-2007; IN COMMERCE 2-28-2007.

OWNER OF U.S. REG. NOS. 3,081,771 AND  
3,147,533.

THE MARK CONSISTS OF A STYLIZED LETTER  
"M" ABOVE THE WORDING "MORI-NU".

SER. NO. 77-395,553, FILED 2-13-2008.

DAVID MURRAY, EXAMINING ATTORNEY

**Int. Cl.: 1**

**Prior U.S. Cls.: 1, 5, 6, 10, 26 and 46**

**Reg. No. 3,467,779**

**United States Patent and Trademark Office**

**Registered July 15, 2008**

---

**TRADEMARK  
PRINCIPAL REGISTER**

**BIG CHICKEN**

NEW EARTH ORGANICS, LLC (GEORGIA LTD  
LIAB CO)  
SUITE 230-304  
3600 DALLAS HIGHWAY, NW  
MARIETTA, GA 30064

THE MARK CONSISTS OF STANDARD CHAR-  
ACTERS WITHOUT CLAIM TO ANY PARTICULAR  
FONT, STYLE, SIZE, OR COLOR.

FOR: FERTILIZERS; PLANT FOOD; NATURAL  
FERTILIZERS, IN CLASS 1 (U.S. CLS. 1, 5, 6, 10, 26  
AND 46).

SER. NO. 77-397,262, FILED 2-14-2008.

FIRST USE 2-8-2008; IN COMMERCE 2-8-2008.

JACLYN KIDWELL, EXAMINING ATTORNEY

**Int. Cl.: 45**

**Prior U.S. Cls.: 100 and 101**

**United States Patent and Trademark Office**

**Reg. No. 3,467,780**

**Registered July 15, 2008**

**SERVICE MARK  
PRINCIPAL REGISTER**

**DREAMHOST**

NEW DREAM NETWORK, LLC (CALIFORNIA  
LTD LIAB CO)  
PMB #257  
417 ASSOCIATED ROAD  
BREA, CA 92821

FOR: REGISTRATION OF DOMAIN NAMES FOR  
IDENTIFICATION OF USERS ON A GLOBAL COM-  
PUTER NETWORK, IN CLASS 45 (U.S. CLS. 100 AND  
101).

FIRST USE 9-27-2002; IN COMMERCE 9-27-2002.

THE MARK CONSISTS OF STANDARD CHAR-  
ACTERS WITHOUT CLAIM TO ANY PARTICULAR  
FONT, STYLE, SIZE, OR COLOR.

OWNER OF U.S. REG. NOS. 2,664,983, 2,665,588,  
AND 3,058,368.

SER. NO. 77-399,714, FILED 2-18-2008.

JACLYN KIDWELL, EXAMINING ATTORNEY

**Int. Cl.: 36**

**Prior U.S. Cls.: 100, 101 and 102**

**United States Patent and Trademark Office**

**Reg. No. 3,467,781**

**Registered July 15, 2008**

**SERVICE MARK  
PRINCIPAL REGISTER**

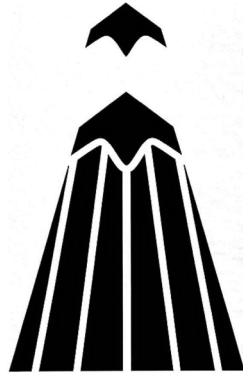

ALTIRA GROUP LLC (COLORADO LTD LIAB  
CO)  
1675 BROADWAY, SUITE 2400  
DENVER, CO 80202

FOR: FINANCIAL INVESTMENT SERVICES IN  
THE FIELD OF OIL AND GAS TECHNOLOGY;  
VENTURE CAPITAL INVESTMENT; FINANCIAL  
INVESTMENT SERVICES IN THE FIELD OF EN-  
ERGY TECHNOLOGY, RENEWABLE ENERGY,  
SUSTAINABLE ENERGY, ENERGY EFFICIENCY,

AND ELECTRIC POWER, IN CLASS 36 (U.S. CLS.  
100, 101 AND 102).

FIRST USE 2-3-1997; IN COMMERCE 2-3-1997.

OWNER OF U.S. REG. NO. 2,202,720.

SER. NO. 77-403,227, FILED 2-21-2008.

ALLISON SCHRODY, EXAMINING ATTORNEY

**Int. Cls.: 35 and 43**

**Prior U.S. Cls.: 100, 101 and 102**

**United States Patent and Trademark Office**

**Reg. No. 3,467,782**

**Registered July 15, 2008**

**SERVICE MARK  
PRINCIPAL REGISTER**

**RANCHO LIBORIO SU MERCADO**

LIBORIO MARKET, INC. (CALIFORNIA CORPORATION)  
171 S. HUDSON AVE.  
PASADENA, CA 91101

FOR: RETAIL GROCERY STORES, RETAIL SUPERMARKETS, IN-STORE RETAIL DELICATESSEN, IN STORE TAKE OUT BAKERY SERVICES, IN-STORE BUTCHER SERVICES, IN-STORE BAKERY, FEATURING TORTILLA MAKING, IN-STORE BUTCHER, FEATURING, POULTRY PROCESSING; RETAIL STORE SERVICES FEATURING CREAM FOR TAKE OUT; AND RETAIL STORE SERVICES FEATURING JUICES FOR TAKE OUT, IN CLASS 35 (U.S. CLS. 100, 101 AND 102).

FIRST USE 2-1-2006; IN COMMERCE 2-1-2006.

FOR: IN-STORE RESTAURANT; IN STORE TAKE OUT JUICE BAR SERVICES; AND IN STORE TAKE OUT CREAM BAR SERVICES IN THE NATURE OF

A RESTAURANT, IN CLASS 43 (U.S. CLS. 100 AND 101).

FIRST USE 2-1-2006; IN COMMERCE 2-1-2006.

THE MARK CONSISTS OF STANDARD CHARACTERS WITHOUT CLAIM TO ANY PARTICULAR FONT, STYLE, SIZE, OR COLOR.

NO CLAIM IS MADE TO THE EXCLUSIVE RIGHT TO USE "MERCADO", APART FROM THE MARK AS SHOWN.

THE FOREIGN WORDING IN THE MARK TRANSLATES INTO ENGLISH AS A PEASANT FROM A RURAL AREA; YOUR MARKET.

SER. NO. 77-405,187, FILED 2-25-2008.

CHERYL CLAYTON, EXAMINING ATTORNEY



**Int. Cls.: 3, 16, 21, 29, 30, 32, 35 and 43**

**Prior U.S. Cls.: 1, 2, 4, 5, 6, 13, 22, 23, 29, 30, 33, 37, 38, 40, 45, 46, 48, 50, 51, 52, 100, 101 and 102**

**Reg. No. 3,467,783**

**United States Patent and Trademark Office**

**Registered July 15, 2008**

**TRADEMARK  
SERVICE MARK  
PRINCIPAL REGISTER**

**LIBORIO MARKETS**

LIBORIO MARKET, INC. (CALIFORNIA CORPORATION)  
171 S. HUDSON AVE.  
PASADENA, CA 91101

FOR: LAUNDRY BLEACH, IN CLASS 3 (U.S. CLS. 1, 4, 6, 50, 51 AND 52).

FIRST USE 12-31-2005; IN COMMERCE 12-31-2005.

FOR: PAPER NAPKINS, PAPER TOWELS, BATHROOM TISSUE, NAMELY, TOILET PAPER, IN CLASS 16 (U.S. CLS. 2, 5, 22, 23, 29, 37, 38 AND 50).

FIRST USE 12-31-2002; IN COMMERCE 12-31-2002.

FOR: DISPOSABLE TABLE PLATES, NAMELY, FOAM PLATES, IN CLASS 21 (U.S. CLS. 2, 13, 23, 29, 30, 33, 40 AND 50).

FIRST USE 12-31-2007; IN COMMERCE 12-31-2007.

FOR: GROUND SHRIMP, OIL, NAMELY, CORN OIL FOR FOOD, TOMATO PASTE, CANNED FRUIT, CANNED VEGETABLES, CANNED BEANS, NAMELY, BLACK BEANS, RED BEANS, GARBANZO BEANS, PINTO BEANS, DAIRY PRODUCTS EXCLUDING ICE CREAM, ICE MILK AND FROZEN YOGURT, MILK, CHEESE, CREAM, EGGS, DRIED BEANS, IN CLASS 29 (U.S. CL. 46).

FIRST USE 12-31-1996; IN COMMERCE 12-31-1996.

FOR: TAMALES SPICES, SPICES, FOOD SEASONING, TAMARINDO, DRIED CORN HUSKS FOR TAMALES, EDIBLE SALT, MAYONNAISE, MUSTARD, KETCHUP, VINEGAR, FLAVORED VINEGAR, TOMATO SAUCE, HOMINY, FROZEN CONFECTIONS, NAMELY, ICE POPS, TORTILLAS, TORTILLA CHIPS, TORTILLA SHELLS, BREAD

AND BUNS, RICE AND RICE FLOUR, IN CLASS 30 (U.S. CL. 46).

FIRST USE 12-31-1984; IN COMMERCE 12-31-1984.

FOR: BOTTLED WATER, IN CLASS 32 (U.S. CLS. 45, 46 AND 48).

FIRST USE 12-31-2004; IN COMMERCE 12-31-2004.

FOR: RETAIL GROCERY STORES, RETAIL SUPERMARKETS, IN-STORE RETAIL DELICATESSEN, IN STORE TAKE OUT BAKERY SERVICES, IN-STORE BUTCHER SERVICES, IN-STORE BAKERY, FEATURING TORTILLA MAKING, IN-STORE BUTCHER, FEATURING, POULTRY PROCESSING; RETAIL STORE SERVICES FEATURING CREAM FOR TAKE OUT; AND RETAIL STORE SERVICES FEATURING JUICES FOR TAKE OUT, IN CLASS 35 (U.S. CLS. 100, 101 AND 102).

FIRST USE 12-31-1984; IN COMMERCE 12-31-1984.

FOR: IN-STORE RESTAURANT; IN STORE TAKE OUT JUICE BAR SERVICES; AND IN STORE TAKE OUT CREAM BAR SERVICES IN THE NATURE OF A RESTAURANT, IN CLASS 43 (U.S. CLS. 100 AND 101).

FIRST USE 12-31-1984; IN COMMERCE 12-31-1984.

THE MARK CONSISTS OF STANDARD CHARACTERS WITHOUT CLAIM TO ANY PARTICULAR FONT, STYLE, SIZE, OR COLOR.

NO CLAIM IS MADE TO THE EXCLUSIVE RIGHT TO USE "MARKETS", APART FROM THE MARK AS SHOWN.

THE FOREIGN WORDING IN THE MARK  
TRANSLATES INTO ENGLISH AS A PEASANT  
FROM A RURAL AREA.

SER. NO. 77-409,060, FILED 2-28-2008.

CHERYL CLAYTON, EXAMINING ATTORNEY

**Int. Cls.: 3, 16, 21, 29, 30, 32, 35 and 43**

**Prior U.S. Cls.: 1, 2, 4, 5, 6, 13, 22, 23, 29, 30, 33, 37, 38, 40, 45, 46, 48, 50, 51, 52, 100, 101 and 102**

**Reg. No. 3,467,784**

**United States Patent and Trademark Office**

**Registered July 15, 2008**

**TRADEMARK  
SERVICE MARK  
PRINCIPAL REGISTER**



LIBORIO MARKET, INC. (CALIFORNIA CORPORATION)  
171 S. HUDSON AVE.  
PASADENA, CA 91101

FOR: LAUNDRY BLEACH, IN CLASS 3 (U.S. CLS. 1, 4, 6, 50, 51 AND 52).

FIRST USE 12-31-2005; IN COMMERCE 12-31-2005.

FOR: PAPER NAPKINS, PAPER TOWELS, BATHROOM TISSUE, NAMELY, TOILET PAPER, IN CLASS 16 (U.S. CLS. 2, 5, 22, 23, 29, 37, 38 AND 50).

FIRST USE 12-31-2002; IN COMMERCE 12-31-2002.

FOR: DISPOSABLE TABLE PLATES, NAMELY, FOAM PLATES, IN CLASS 21 (U.S. CLS. 2, 13, 23, 29, 30, 33, 40 AND 50).

FIRST USE 12-31-2007; IN COMMERCE 12-31-2007.

FOR: GROUND SHRIMP, OIL, NAMELY, CORN OIL FOR FOOD, TOMATO PASTE, CANNED FRUIT, CANNED VEGETABLES, CANNED BEANS, NAMELY, BLACK BEANS, RED BEANS, GARBANZO BEANS, PINTO BEANS, DAIRY PRODUCTS EXCLUDING ICE CREAM, ICE MILK AND FROZEN YOGURT, MILK, CHEESE, CREAM, EGGS, DRIED BEANS, IN CLASS 29 (U.S. CL. 46).

FIRST USE 12-31-1996; IN COMMERCE 12-31-1996.

FOR: TAMALES SPICES, SPICES, FOOD SEASONING, TAMARINDO, DRIED CORN HUSKS FOR TAMALES, EDIBLE SALT, MAYONNAISE, MUSTARD, KETCHUP, VINEGAR, FLAVORED VINEGAR, TOMATO SAUCE, HOMINY, FROZEN

CONFECTIONS, NAMELY, ICE POPS, TORTILLAS, TORTILLA CHIPS, TORTILLA SHELLS, BREAD AND BUNS, RICE AND RICE FLOUR, IN CLASS 30 (U.S. CL. 46).

FIRST USE 12-31-1984; IN COMMERCE 12-31-1984.

FOR: BOTTLED WATER, IN CLASS 32 (U.S. CLS. 45, 46 AND 48).

FIRST USE 12-31-2004; IN COMMERCE 12-31-2004.

FOR: RETAIL GROCERY STORES, RETAIL SUPERMARKETS, IN-STORE RETAIL DELICATESSEN, IN STORE TAKE OUT BAKERY SERVICES, IN-STORE BUTCHER SERVICES, IN-STORE BAKERY, FEATURING TORTILLA MAKING, IN-STORE BUTCHER, FEATURING, POULTRY PROCESSING; RETAIL STORE SERVICES FEATURING CREAM FOR TAKE OUT; AND RETAIL STORE SERVICES FEATURING JUICES FOR TAKE OUT, IN CLASS 35 (U.S. CLS. 100, 101 AND 102).

FIRST USE 12-31-2000; IN COMMERCE 12-31-2000.

FOR: IN-STORE RESTAURANT; IN STORE TAKE OUT JUICE BAR SERVICES; AND IN STORE TAKE OUT CREAM BAR SERVICES IN THE NATURE OF A RESTAURANT, IN CLASS 43 (U.S. CLS. 100 AND 101).

FIRST USE 12-31-2000; IN COMMERCE 12-31-2000.

NO CLAIM IS MADE TO THE EXCLUSIVE RIGHT TO USE "MARKETS" AND "EST. 1966" , APART FROM THE MARK AS SHOWN.

THE COLOR(S) RED, BLUE, WHITE IS/ARE CLAIMED AS A FEATURE OF THE MARK.

THE MARK CONSISTS OF A BLUE OVAL SHAPE THAT ENTIRELY ENCIRCLES RED AND BLUE LETTERING WHICH COLLECTIVELY SPELLS OUT THE ENTIRE LITERAL ELEMENT, "LIBORIO MARKETS". THE RED LITERAL ELEMENT SPELLING "LIBORIO" APPEARS IN CURSIVE TEXT. THE BLUE LITERAL ELEMENT SPELLING "MARKETS EST. 1966" APPEARS IN STANDARD BLOCK TEXT

BELOW THE RED CURSIVE LITERAL ELEMENT. ALL OF THE AFOREMENTIONED DESCRIPTION IS PLACED ON A WHITE BACKGROUND.

THE FOREIGN WORDING IN THE MARK TRANSLATES INTO ENGLISH AS A PEASANT FROM A RURAL AREA.

SER. NO. 77-412,239, FILED 3-4-2008.

CHERYL CLAYTON, EXAMINING ATTORNEY

**Int. Cl.: 11**

**Prior U.S. Cls.: 13, 21, 23, 31 and 34**

**United States Patent and Trademark Office**

**Reg. No. 3,467,785**

**Registered July 15, 2008**

**TRADEMARK  
PRINCIPAL REGISTER**



LA FANTAISIE INTERNATIONAL CORP. (TAI-  
WAN CORPORATION)  
22 FL., NO. 106, SEC. 2, TUN HUA S. RD.  
TAIPEI, TAIWAN

FOR: FLASHLIGHT; REFRIGERATORS; ELEC-  
TRIC TOASTERS; HAIR DRYERS; ELECTRIC COF-  
FEE MAKERS; SHOWER NOZZLES; ICE CREAM  
MAKERS; WATER HEATERS FOR DOMESTIC USE;  
PORTABLE THERMAL SELF-HEATING BOX FOR  
THE PURPOSE OF HEATING FOOD; ELECTRIC  
MAGNETIC COOKING OVENS; MICROWAVE  
OVENS; ELECTRIC RADIATORS; AND ELECTRIC

DISPENSER FOR HAIR FRESHENERS, IN CLASS 11  
(U.S. CLS. 13, 21, 23, 31 AND 34).

FIRST USE 12-20-2000; IN COMMERCE 12-20-2000.

THE ENGLISH TRANSLATION OF THE WORDS  
"LA FANTAISIE" IN THE MARK IS "THE FANTA-  
SY."

SER. NO. 77-975,047, FILED 5-2-2007.

MONIQUE MILLER, EXAMINING ATTORNEY

**Int. Cl.: 3**

**Prior U.S. Cls.: 1, 4, 6, 50, 51 and 52**

**Reg. No. 3,467,786**

**United States Patent and Trademark Office**

**Registered July 15, 2008**

**TRADEMARK  
PRINCIPAL REGISTER**



SOUTH SEAS AIRBRUSH TANNING SYSTEMS,  
LLC (COLORADO LTD LIAB CO)  
5968 SNOWY PLOVER COURT  
FORT COLLINS, CO 80528

FOR: SKIN CARE PRODUCTS; NAMELY, CLEANSERS, MASKS, MOISTURIZERS, TONERS, CONDITIONERS, LOTIONS, CREAMS, SKIN AND SHOWER GELS, BRONZERS, LIQUID TANNING MISTS, ANTI-AGING SERUMS, BODY POLISH, BODY WASH, BODY SCRUBS, BODY BUTTERS, BATH SALTS, SUNSCREEN PRODUCTS, NAMELY, LOTIONS, CREAMS, SPRAYS, STICKS; TANNING PRODUCTS, NAMELY, SKIN GELS FOR ACCELERATING, ENHANCING OR EXTENDING TANS, LOTIONS, CREAMS, SPRAYS, STICKS, EXTENDERS, NAMELY, SKIN GELS, LOTIONS, CREAMS; COSMETICS; NON-MEDICATED LIP CARE PRO-

DUCTS, NAMELY, BALMS, MOISTURIZING AND PROTECTIVE STICKS AND GLOSSES, IN CLASS 3 (U.S. CLS. 1, 4, 6, 50, 51 AND 52).

FIRST USE 1-14-2004; IN COMMERCE 1-22-2004.

OWNER OF U.S. REG. NO. 2,979,040.

THE MARK CONSISTS OF A STYLIZED REPRESENTATION OF A PALM TREE IN WHICH THE TRUNK IS FORMED BY A STYLIZED DEPICTION OF A HUMAN FIGURE.

SER. NO. 77-975,069, FILED 9-28-2006.

CAROLYN GRAY, EXAMINING ATTORNEY

**Int. Cl.: 3**

**Prior U.S. Cls.: 1, 4, 6, 50, 51 and 52**

**Reg. No. 3,467,787**

**United States Patent and Trademark Office**

**Registered July 15, 2008**

**TRADEMARK  
PRINCIPAL REGISTER**

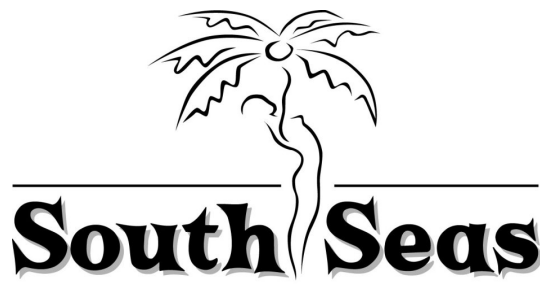

SOUTH SEAS AIRBRUSH TANNING SYSTEMS,  
LLC (COLORADO LTD LIAB CO)  
5968 SNOWY PLOVER COURT  
FORT COLLINS, CO 80528

FOR: SKIN CARE PRODUCTS; NAMELY, CLEANSERS, MASKS, MOISTURIZERS, TONERS, CONDITIONERS, LOTIONS, CREAMS, SKIN AND SHOWER GELS, BRONZERS, LIQUID TANNING MISTS, ANTI-AGING SERUMS, BODY POLISH, BODY WASH, BODY SCRUBS, BODY BUTTERS, BATH SALTS, SUNSCREEN PRODUCTS, NAMELY, LOTIONS, CREAMS, SPRAYS, STICKS; TANNING PRODUCTS, NAMELY, SKIN GELS FOR ACCELERATING, ENHANCING OR EXTENDING TANS, LOTIONS, CREAMS, SPRAYS, STICKS, EXTENDERS, NAMELY, SKIN GELS, LOTIONS, CREAMS;

COSMETICS; NON-MEDICATED LIP CARE PRODUCTS, NAMELY, BALMS, MOISTURIZING AND PROTECTIVE STICKS AND GLOSSES, IN CLASS 3 (U.S. CLS. 1, 4, 6, 50, 51 AND 52).

FIRST USE 1-14-2004; IN COMMERCE 1-22-2004.

THE MARK CONSISTS OF THE WORDS "SOUTH SEAS" WITH A STYLIZED PALM TREE POSITIONED BETWEEN THE WORDS; THE TRUNK OF THE PALM TREE BEING FORMED BY A STYLIZED HUMAN FIGURE.

SER. NO. 77-975,086, FILED 9-27-2006.

CAROLYN GRAY, EXAMINING ATTORNEY

**Int. Cls.: 36 and 37**

**Prior U.S. Cls.: 100, 101, 102, 103 and 106**

**United States Patent and Trademark Office**

**Reg. No. 3,467,788**

**Registered July 15, 2008**

**SERVICE MARK  
PRINCIPAL REGISTER**

**[PFE]**

INGRAM ENTITIES, INC. (GEORGIA CORPORATION)  
5400 BOWMAN RD.  
MACON, GA 31210

FOR: ASSESSMENT AND MANAGEMENT OF REAL ESTATE; EVALUATION OF REAL PROPERTY; FINANCIAL VALUATION OF PERSONAL PROPERTY AND REAL ESTATE; LEASING OF REAL ESTATE; REAL ESTATE ACQUISITION SERVICES; REAL ESTATE CONSULTATION; REAL ESTATE INVESTMENT; REAL ESTATE MANAGEMENT; REAL ESTATE MANAGEMENT CONSULTATION; REAL ESTATE PROCUREMENT FOR OTHERS; REAL ESTATE VALUATION SERVICES; REAL ESTATE VALUATIONS, IN CLASS 36 (U.S. CLS. 100, 101 AND 102).

FIRST USE 2-4-2007; IN COMMERCE 2-4-2007.

FOR: REAL ESTATE DEVELOPMENT; REAL ESTATE SITE SELECTION, IN CLASS 37 (U.S. CLS. 100, 103 AND 106).

FIRST USE 2-4-2007; IN COMMERCE 2-4-2007.

THE MARK CONSISTS OF STANDARD CHARACTERS WITHOUT CLAIM TO ANY PARTICULAR FONT, STYLE, SIZE, OR COLOR.

SER. NO. 77-975,222, FILED 3-13-2007.

BARBARA A. GOLD, EXAMINING ATTORNEY



**Int. Cl.: 31**

**Prior U.S. Cls.: 1 and 46**

**United States Patent and Trademark Office**

**Reg. No. 3,467,789**

**Registered July 15, 2008**

**TRADEMARK  
PRINCIPAL REGISTER**



INGRAM ENTITIES, INC. (GEORGIA CORPORATION)  
5400 BOWMAN RD.  
MACON, GA 31210

THE STIPPLING ON THE DRAWING IS FOR SHADING PURPOSES ONLY.

FOR: NON-DEBARKED TIMBER; RAW TIMBER; UNDRRESSED TIMBER; UNPROCESSED TIMBER; UNSAWN TIMBER; HAY; MULCH, IN CLASS 31 (U.S. CLS. 1 AND 46).

THE MARK CONSISTS OF A BARN, SILO AND A FENCE WITH THE WORDS "INGRAM FARMS" BELOW THE BARN.

FIRST USE 2-4-2007; IN COMMERCE 2-4-2007.

SER. NO. 77-975,246, FILED 3-13-2007.

NO CLAIM IS MADE TO THE EXCLUSIVE RIGHT TO USE "FARMS", APART FROM THE MARK AS SHOWN.

BARBARA A. GOLD, EXAMINING ATTORNEY

**Int. Cls.: 36 and 37**

**Prior U.S. Cls.: 100, 101, 102, 103 and 106**

**United States Patent and Trademark Office**

**Reg. No. 3,467,790**

**Registered July 15, 2008**

**SERVICE MARK  
PRINCIPAL REGISTER**

**Ingram Development  
Properties, LLC**

INGRAM ENTITIES, INC. (GEORGIA CORPORATION)  
5400 BOWMAN RD.  
MACON, GA 31210

FOR: ASSESSMENT AND MANAGEMENT OF REAL ESTATE; EVALUATION OF REAL PROPERTY; FINANCIAL VALUATION OF PERSONAL PROPERTY AND REAL ESTATE; LEASING OF REAL ESTATE; REAL ESTATE ACQUISITION SERVICES; REAL ESTATE CONSULTATION; REAL ESTATE INVESTMENT; REAL ESTATE MANAGEMENT; REAL ESTATE MANAGEMENT CONSULTATION; REAL ESTATE PROCUREMENT FOR OTHERS; REAL ESTATE VALUATION SERVICES; REAL ESTATE VALUATIONS, IN CLASS 36 (U.S. CLS. 100, 101 AND 102).

FIRST USE 2-4-2007; IN COMMERCE 2-4-2007.

FOR: REAL ESTATE DEVELOPMENT; REAL ESTATE SITE SELECTION, IN CLASS 37 (U.S. CLS. 100, 103 AND 106).

FIRST USE 2-4-2007; IN COMMERCE 2-4-2007.

THE MARK CONSISTS OF STANDARD CHARACTERS WITHOUT CLAIM TO ANY PARTICULAR FONT, STYLE, SIZE, OR COLOR.

NO CLAIM IS MADE TO THE EXCLUSIVE RIGHT TO USE "DEVELOPMENT PROPERTIES, LLC", APART FROM THE MARK AS SHOWN.

SER. NO. 77-975,248, FILED S.R. 3-14-2007 AM. P.R. 2-9-2008.

BARBARA A. GOLD, EXAMINING ATTORNEY

**Int. Cls.: 36 and 37**

**Prior U.S. Cls.: 100, 101, 102, 103 and 106**

**United States Patent and Trademark Office**

**Reg. No. 3,467,791**

**Registered July 15, 2008**

**SERVICE MARK  
PRINCIPAL REGISTER**

# Ingram Properties

INGRAM ENTITIES, INC. (GEORGIA CORPORATION)  
5400 BOWMAN RD.  
MACON, GA 31201

FOR: ASSESSMENT AND MANAGEMENT OF REAL ESTATE; EVALUATION OF REAL PROPERTY; FINANCIAL VALUATION OF PERSONAL PROPERTY AND REAL ESTATE; LEASING OF REAL ESTATE; REAL ESTATE ACQUISITION SERVICES; REAL ESTATE CONSULTATION; REAL ESTATE INVESTMENT; REAL ESTATE MANAGEMENT; REAL ESTATE MANAGEMENT CONSULTATION; REAL ESTATE PROCUREMENT FOR OTHERS; REAL ESTATE VALUATION SERVICES; REAL ESTATE VALUATIONS, IN CLASS 36 (U.S. CLS. 100, 101 AND 102).

FIRST USE 2-4-2007; IN COMMERCE 2-4-2007.

FOR: REAL ESTATE DEVELOPMENT; REAL ESTATE SITE SELECTION, IN CLASS 37 (U.S. CLS. 100, 103 AND 106).

FIRST USE 2-4-2007; IN COMMERCE 2-4-2007.

THE MARK CONSISTS OF STANDARD CHARACTERS WITHOUT CLAIM TO ANY PARTICULAR FONT, STYLE, SIZE, OR COLOR.

NO CLAIM IS MADE TO THE EXCLUSIVE RIGHT TO USE "PROPERTIES", APART FROM THE MARK AS SHOWN.

SER. NO. 77-975,249, FILED S.R. 3-14-2007 AM. P.R. 2-9-2008.

BARBARA A. GOLD, EXAMINING ATTORNEY

**Int. Cls.: 16 and 41**

**Prior U.S. Cls.: 2, 5, 22, 23, 29, 37, 38, 50, 100, 101 and 107**

**Reg. No. 3,467,792**

**United States Patent and Trademark Office**

**Registered July 15, 2008**

**TRADEMARK  
SERVICE MARK  
PRINCIPAL REGISTER**



INTERNATIONAL ASSOCIATION OF SOFTWARE ARCHITECTS (TEXAS NON-PROFIT CORPORATION)

7901 CAMERON RD., SUITE 259  
AUSTIN, TX 78754

FOR: EDUCATIONAL PUBLICATIONS, NAME-  
LY, TRAINING MANUALS IN THE FIELD OF IT  
ARCHITECTURE; PRINTED INSTRUCTIONAL,  
EDUCATIONAL, AND TEACHING MATERIALS  
IN THE FIELD OF IT ARCHITECTURE, IN CLASS  
16 (U.S. CLS. 2, 5, 22, 23, 29, 37, 38 AND 50).

FIRST USE 2-1-2003; IN COMMERCE 2-1-2003.

FOR: EDUCATION IN THE FIELD OF IT ARCHI-  
TECTURE RENDERED THROUGH CORRESPON-  
DENCE COURSES; EDUCATION IN THE FIELD OF  
IT ARCHITECTURE RENDERED THROUGH VI-  
DEO CONFERENCE; EDUCATION SERVICES,  
NAME- LY, PROVIDING LIVE AND ON-LINE MA-  
TERIALS IN THE FIELD OF IT ARCHITECTURE  
CORRECTED TO ARCHITECTURE; EDUCATION-  
AL SERVICES, NAME- LY, CONDUCTING INFOR-  
MAL ON-LINE PROGRAMS IN THE FIELDS OF IT  
ARCHITECTURE, AND PRINTABLE MATERIALS  
DISTRIBUTED THEREWITH; EDUCATIONAL SER-  
VICES, NAME- LY, CONDUCTING INFORMAL PRO-  
GRAMS IN THE FIELDS OF IT ARCHITECTURE,  
USING ON-LINE ACTIVITIES AND INTERACTIVE  
EXHIBITS, AND PRINTABLE MATERIALS DIS-  
TRIBUTED THEREWITH, IN CLASS 41 (U.S. CLS.  
100, 101 AND 107).

FIRST USE 2-1-2003; IN COMMERCE 2-1-2003.

THE COLOR(S) DARK BLUE, MEDIUM BLUE,  
LIGHT BLUE, DARK GRAY IS/ARE CLAIMED AS A  
FEATURE OF THE MARK.

THE MARK CONSISTS OF FOUR SQUARES/  
RECTANGLES. EACH OF THE FOUR SQUARES/  
RECTANGLES SIT SIDE-BY-SIDE. EACH OF THE  
FOUR SQUARES/RECTANGLES CONTAINS ONE  
OF FOUR BACKGROUND COLORS AND A LET-  
TER; EACH LETTER IS COMPOSED OF ONE OF  
FOUR COLORS. THE FIRST SQUARE/RECTANGLE  
CONTAINS A DARK BLUE BACKGROUND AND A  
CAPITAL "I". THE CAPITAL "I" IS MEDIUM BLUE.  
THE SECOND SQUARE/RECTANGLE CONTAINS  
A MEDIUM BLUE BACKGROUND AND CAPITAL  
"A". THE CAPITAL "A" IS LIGHT BLUE. THE  
THIRD SQUARE/RECTANGLE CONTAINS A  
LIGHT BLUE BACKGROUND AND A CAPITAL  
"S". THE CAPITAL "S" IS DARK GREY. THE  
FOURTH SQUARE/RECTANGLE CONTAINS A  
DARK GREY BACKGROUND AND A CAPITAL  
"A". THE CAPITAL "A" IS DARK BLUE.

SER. NO. 77-975,289, FILED 4-24-2007.

KAREN SEVERSON, EXAMINING ATTORNEY

**Int. Cls.: 9, 16, 18, 24, 25 and 26**

**Prior U.S. Cls.: 1, 2, 3, 5, 21, 22, 23, 26, 29, 36, 37, 38,  
39, 40, 41, 42 and 50**

**Reg. No. 3,467,793**

**United States Patent and Trademark Office**

**Registered July 15, 2008**

**TRADEMARK  
PRINCIPAL REGISTER**

# GREEN PORT

BOARD OF HARBOR COMMISSIONERS OF THE  
CITY OF LONG BEACH (CALIFORNIA MU-  
NICIPAL CORPORATION)

11TH FLOOR  
333 WEST OCEAN BLVD.  
LONG BEACH, CA 90802

FOR: SUNGLASSES, IN CLASS 9 (U.S. CLS. 21, 23,  
26, 36 AND 38).

FIRST USE 7-0-2003; IN COMMERCE 7-0-2003.

FOR: PENS, PENCILS, AND DRAWING RULERS,  
IN CLASS 16 (U.S. CLS. 2, 5, 22, 23, 29, 37, 38 AND 50).

FIRST USE 7-0-2003; IN COMMERCE 7-0-2003.

FOR: ALL-PURPOSE CARRYING BAGS, IN  
CLASS 18 (U.S. CLS. 1, 2, 3, 22 AND 41).

FIRST USE 7-0-2003; IN COMMERCE 7-0-2003.

FOR: CLOTH FLAGS, IN CLASS 24 (U.S. CLS. 42  
AND 50).

FIRST USE 7-0-2003; IN COMMERCE 7-0-2003.

FOR: CLOTHING, NAMELY, SHIRTS; HATS; SUN  
VISORS , IN CLASS 25 (U.S. CLS. 22 AND 39).

FIRST USE 7-0-2003; IN COMMERCE 7-0-2003.

FOR: SHOE LACES, IN CLASS 26 (U.S. CLS. 37, 39,  
40, 42 AND 50).

FIRST USE 7-0-2003; IN COMMERCE 7-0-2003.

THE MARK CONSISTS OF STANDARD CHAR-  
ACTERS WITHOUT CLAIM TO ANY PARTICULAR  
FONT, STYLE, SIZE, OR COLOR.

SER. NO. 77-975,307, FILED 6-14-2007.

SHANNON TWOHIG, EXAMINING ATTORNEY

**Int. Cl.: 16**

**Prior U.S. Cls.: 2, 5, 22, 23, 29, 37, 38 and 50**

**Reg. No. 3,467,794**

**United States Patent and Trademark Office**

**Registered July 15, 2008**

---

**TRADEMARK  
PRINCIPAL REGISTER**

**Extra  
New York**

9278 COMMUNICATIONS, INC. (DELAWARE  
CORPORATION)  
1942 WILLIAMSBRIDGE ROAD  
BRONX, NY 10461

NO CLAIM IS MADE TO THE EXCLUSIVE  
RIGHT TO USE "NEW YORK", APART FROM THE  
MARK AS SHOWN.

FOR: PRE-PAID PHONE CARDS, NOT MAGNE-  
TICALLY ENCODED, IN CLASS 16 (U.S. CLS. 2, 5, 22,  
23, 29, 37, 38 AND 50).

SER. NO. 78-127,102, FILED 5-8-2002.

FIRST USE 2-1-2002; IN COMMERCE 2-1-2002.

ANDREA K. NADELMAN, EXAMINING ATTOR-  
NEY

**Int. Cl.: 42**

**Prior U.S. Cls.: 100 and 101**

**United States Patent and Trademark Office**

**Reg. No. 3,467,795**

**Registered July 15, 2008**

**SERVICE MARK  
PRINCIPAL REGISTER**



LISLE, EVA, BARNARD (UNITED STATES IN-  
DIVIDUAL)  
815 EL CHORRO WAY  
SACRAMENTO, CA 95864

NO CLAIM IS MADE TO THE EXCLUSIVE  
RIGHT TO USE "SOLUTIONS" , APART FROM  
THE MARK AS SHOWN.

FOR: INTERNET WEB SITE DESIGN, IN CLASS 42  
(U.S. CLS. 100 AND 101).

SER. NO. 78-156,456, FILED 8-21-2002.

FIRST USE 1-1-2000; IN COMMERCE 1-1-2000.

RON FAIRBANKS, EXAMINING ATTORNEY

**Int. Cls.: 5 and 35**

**Prior U.S. Cls.: 6, 18, 44, 46, 51, 52, 100, 101 and 102**

**United States Patent and Trademark Office**

**Reg. No. 3,467,796**

**Registered July 15, 2008**

**TRADEMARK  
SERVICE MARK  
PRINCIPAL REGISTER**

**FARMACIAS SIMILARES**

FARMACIAS DE SIMILARES, S.A. DE C.V.  
(MEXICO CORPORATION)  
ALEMANIA NO. 10, COL. INDEPENDENCIA  
MEXICO CITY, MEXICO 03630

FOR: PHARMACEUTICAL PREPARATIONS FOR HUMAN PURPOSES, NAMELY, ANALGESICS, ANTIBIOTICS, ANTIDIABETICS, ANTIDIARRHEALS, ANTIFUNGAL PREPARATIONS, ANTIHYPERTENSIVES, ANTIHISTAMINES, ANTI-INFLAMMATORY AND ANTIARTHRITIC PREPARATIONS, ANTHELMINTICS, CARDIOVASCULAR AGENTS, ALLERGY PREPARATIONS, DERMATOLOGIC AGENTS, DIURETICS, DIETARY SUPPLEMENTS FOR MEDICAL PURPOSES, LAXATIVES, ANTEN-DOTOXIN ANTIBODIES, PEDICULICIDES, PREPARATIONS FOR TREATING NAUSEA AND VERTIGO, SLEEP AIDS, STIMULANTS, TRANQUILIZERS AND PSYCHOTHERAPEUTIC PREPARATIONS; VITAMINS; SANITIZERS FOR HOUSEHOLD, HOSPITAL, INSTITUTIONAL AND INDUSTRIAL USES; DIETARY SUPPLEMENTS; BABY FOOD; DENTAL IMPRESSION MATERIALS; DENTAL WAXES; ALL PURPOSE DISINFECTANTS; DISINFECTING HAND WASHES; DISINFECTANTS FOR MEDICAL INSTRUMENTS; PREPARATIONS FOR DESTROYING VERMIN; FUNGICIDES FOR

DOMESTIC AND AGRICULTURAL USE; AND HERBICIDES FOR DOMESTIC AND AGRICULTURAL USE, IN CLASS 5 (U.S. CLS. 6, 18, 44, 46, 51 AND 52).

FOR: RETAIL PHARMACY SERVICES, IN CLASS 35 (U.S. CLS. 100, 101 AND 102).

OWNER OF PERU REG. NO. 00033091, DATED 8-13-2003, EXPIRES 8-13-2013.

OWNER OF PERU REG. NO. 00101382, DATED 10-28-2004, EXPIRES 10-28-2014.

NO CLAIM IS MADE TO THE EXCLUSIVE RIGHT TO USE "FARMACIAS", APART FROM THE MARK AS SHOWN.

THE FOREIGN WORDING IN THE MARK TRANSLATES INTO ENGLISH AS EQUAL PHARMACIES.

SER. NO. 78-186,747, FILED 11-19-2002.

LEIGH LOWRY, EXAMINING ATTORNEY



Int. Cls.: 5 and 35

Prior U.S. Cls.: 6, 18, 44, 46, 51, 52, 100, 101 and 102

United States Patent and Trademark Office

Reg. No. 3,467,797

Registered July 15, 2008

TRADEMARK  
SERVICE MARK  
PRINCIPAL REGISTER

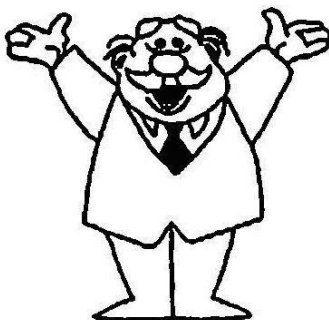

*Dr. Simi*

FARMACIAS DE SIMILARES, S.A. DE C.V.  
(MEXICO CORPORATION)  
ALEMANIA NO. 10  
COL. INDEPENDENCIA  
MEXICO CITY, MEXICO 03630

FOR: PHARMACEUTICAL PREPARATIONS FOR HUMAN PURPOSES, NAMELY, ANALGESICS, ANTIBIOTICS, ANTIDIABETICS, ANTIDIARRHEALS, ANTIFUNGAL PREPARATIONS, ANTIHYPERTENSIVES, ANTIHISTAMINES, ANTI-INFLAMMATORY AND ANTIARTHRITIC PREPARATIONS, ANTHELMINTICS, CARDIOVASCULAR AGENTS, ALLERGY PREPARATIONS, DERMATOLOGIC AGENTS, DIURETICS, DIETARY SUPPLEMENTS FOR MEDICAL PURPOSES, LAXATIVES, ANTIEN-DOTOXIN ANTIBODIES, PEDICULICIDES, PREPARATIONS FOR TREATING NAUSEA AND VERTIGO, SLEEP AIDS, STIMULANTS, TRANQUI-

LIZERS AND PSYCHOTHERAPEUTIC PREPARATIONS, IN CLASS 5 (U.S. CLS. 6, 18, 44, 46, 51 AND 52).

FOR: RETAIL PHARMACY SERVICES, IN CLASS 35 (U.S. CLS. 100, 101 AND 102).

OWNER OF MEXICO REG. NO. 630551, DATED 8-20-1999, EXPIRES 8-20-2009.

OWNER OF MEXICO REG. NO. 629808, DATED 8-20-1999, EXPIRES 8-20-2009.

THE NAME "DR. SIMI" DOES NOT IDENTIFY A PARTICULAR LIVING INDIVIDUAL.

SER. NO. 78-186,750, FILED 11-19-2002.

LEIGH LOWRY, EXAMINING ATTORNEY

**Int. Cl.: 16**

**Prior U.S. Cls.: 2, 5, 22, 23, 29, 37, 38 and 50**

**United States Patent and Trademark Office**

**Reg. No. 3,467,798**

**Registered July 15, 2008**

---

**TRADEMARK  
PRINCIPAL REGISTER**

**EXTRA**

9278 COMMUNICATIONS INC. (DELAWARE  
CORPORATION)  
1942 WILLIAMSBRIDGE ROAD  
BRONX, NY 10461

FOR: PREPAID PHONE CARDS, NOT MAGNETI-  
CALLY ENCODED, IN CLASS 16 (U.S. CLS. 2, 5, 22,  
23, 29, 37, 38 AND 50).

FIRST USE 2-1-2002; IN COMMERCE 2-2-2002.

OWNER OF U.S. REG. NO. 2,736,711.

SER. NO. 78-222,499, FILED 3-6-2003.

AISHA CLARKE, EXAMINING ATTORNEY

**Int. Cl.: 43**

**Prior U.S. Cls.: 100 and 101**

**United States Patent and Trademark Office**

**Reg. No. 3,467,799**

**Registered July 15, 2008**

**SERVICE MARK  
PRINCIPAL REGISTER**



MEDITERRANEO CHICKEN SAC (PERU CORPORATION)  
AV JOSE GALVEZ BARRENECHEA 145  
LIMA, PERU 27

FOR: RESTAURANT SERVICES, IN CLASS 43  
(U.S. CLS. 100 AND 101).

OWNER OF PERU REG. NO. 6757, DATED 6-2-1994, EXPIRES 5-2-2014.

NO CLAIM IS MADE TO THE EXCLUSIVE RIGHT TO USE "MEDITERRANEO CHICKEN", APART FROM THE MARK AS SHOWN.

THE ENGLISH TRANSLATION OF THE WORD "MEDITERRANEO" IN THE MARK IS "MEDITERRANEAN".

SER. NO. 78-242,842, FILED 4-28-2003.

DARRYL SPRUILL, EXAMINING ATTORNEY

**Int. Cls.: 29, 30, 31 and 32**

**Prior U.S. Cls.: 1, 45, 46 and 48**

**United States Patent and Trademark Office**

**Reg. No. 3,467,800**

**Registered July 15, 2008**

**TRADEMARK  
PRINCIPAL REGISTER**



OMAR KASSEM ALESAYI & CO. LTD. (SAUDI ARABIA CORPORATION)  
6TH FLOOR ALESAYI PLAZA  
BAGHDADIYA, MEDINA ROAD P.O. BOX 8680  
JEDDAH, 21492, SAUDI ARABIA

FOR: MEAT, FISH, POULTRY AND GAME; MEAT EXTRACTS; PRESERVED, DRIED AND COOKED FRUITS AND VEGETABLES; MILK AND OTHER DAIRY PRODUCTS, NAMELY, CHEESE AND PROCESSED CHEESE, SOUR CREAM, YOGURT, BUTTER, MARGARINE, EDIBLE OILS AND FATS; FRUIT PRESERVES, IN CLASS 29 (U.S. CL. 46).

FOR: TEA, FLOUR AND PREPARATIONS MADE FROM CEREALS, NAMELY, READY TO EAT CEREAL DERIVED FOOD BARS AND CEREAL-BASED SNACK FOOD, BISCUITS, CAKES, PASTRY AND CONFECTIONERY, NAMELY, CANDY AND CANDY CHIPS FOR BAKING, HONEY, SAUCES; MALT, NAMELY, MALT FOR FOOD PURPOSES AND MALT EXTRACT USED AS FLAVORING, IN CLASS 30 (U.S. CL. 46).

FOR: AGRICULTURAL SEEDS, NAMELY, CORN, ALFALFA, SOYBEAN, GRASSES AND CLO-

VER SEEDS, FOODSTUFFS FOR ANIMALS, IN CLASS 31 (U.S. CLS. 1 AND 46).

FOR: NON-ALCOHOLIC MINERAL AND AERATED WATERS; OTHER NON-ALCOHOLIC DRINKS, NAMELY, SODA WATER AND FRUIT PUNCH; SYRUPS FOR MAKING SOFT DRINKS; MALT, NAMELY, MALT WORT, MALT SYRUP FOR BEVERAGES, MALT BEER, IN CLASS 32 (U.S. CLS. 45, 46 AND 48).

OWNER OF LEBANON REG. NO. 114013, DATED 10-12-2006, EXPIRES 10-12-2021.

NO CLAIM IS MADE TO THE EXCLUSIVE RIGHT TO USE "FARMS", APART FROM THE MARK AS SHOWN.

THE MARK CONSISTS OF THE WORDS "GREEN FARMS" WITHIN A CIRCLE AND SURROUNDED BY AN ORNATE BORDER.

SER. NO. 78-251,027, FILED 5-16-2003.

GEOFFREY FOSDICK, EXAMINING ATTORNEY

**Int. Cls.: 9, 38 and 42**

**Prior U.S. Cls.: 21, 23, 26, 36, 38, 100, 101 and 104**

**Reg. No. 3,467,801**

**United States Patent and Trademark Office**

**Registered July 15, 2008**

**TRADEMARK  
SERVICE MARK  
PRINCIPAL REGISTER**

**BT FINANCE HIGHWAY**

BRITISH TELECOMMUNICATIONS PUBLIC  
LIMITED COMPANY (UNITED KINGDOM  
LTD LIAB CO)  
81 NEWGATE STREET  
LONDON EC1A 7AJ, ENGLAND

FOR: TELECOMMUNICATIONS AND DATA COMMUNICATIONS GOODS FOR USE IN DIGITAL AND ANALOG SYSTEMS AND FOR ON-SITE AND REMOTE TELECOMMUNICATIONS AND DATA COMMUNICATIONS ACCESS, NAMELY, APPARATUS FOR RECORDING, TRANSMISSION OR REPRODUCTION OF SOUND AND IMAGES, TELEPHONE APPARATUS, VIDEO TRANSMISSION APPARATUS, WIRELESS TELEPHONY APPARATUS, APPARATUS FOR TRANSMISSION OF COMMUNICATION, AND TRANSMITTING AND RECEIVING APPARATUS FOR RADIO AND TELEVISION BROADCASTING AND FOR LONG-DISTANCE TRANSMISSION; ELECTRONIC FINANCIAL TRANSACTION SOFTWARE FOR OPERATION OF COMPUTER TELEPHONY CONSOLES, SWITCHES AND COMPUTER PERIPHERALS; CD-ROMS FEATURING INFORMATION RELATING TO THE FIELD OF TELECOMMUNICATIONS AND FINANCE; BLANK MAGNETIC AND OPTICAL DATA CARRIERS; PRE-RECORDED MAGNETIC AND OPTICAL DATA CARRIERS CONTAINING INFORMATION ON THE TOPIC OF TELECOMMUNICATIONS AND FINANCE; COMPUTER HARDWARE; COMPUTER SOFTWARE FOR DATA PROCESSING, FOR TELECOMMUNICATIONS APPARATUS AND SERVICES AND FOR COMPUTER NETWORKS; COMPUTER PERIPHERALS, IN CLASS 9 (U.S. CLS. 21, 23, 26, 36 AND 38).

FOR: TELECOMMUNICATIONS SERVICES, NAMELY, AUDIO TELECONFERENCING; VIDEO TELECONFERENCING; SATELLITE TRANSMISSION SERVICES; ELECTRONIC, ELECTRIC, AND

DIGITAL TRANSMISSION OF VOICE, DATA, DOCUMENTS, COMPUTER PROGRAMS, IMAGES, SIGNALS, AND MESSAGES; ELECTRONIC MAIL SERVICES; PROVIDING TELECOMMUNICATIONS CONNECTIONS TO A GLOBAL COMPUTER NETWORK; PROVIDING MULTIPLE-USER ACCESS TO COMPUTER DATABASES AND THE INTERNET; PROVISION OF TELECOMMUNICATIONS LINKS TO COMPUTER DATABASES AND WEBSITES ON THE INTERNET; DELIVERY OF MULTIMEDIA CONTENT OVER ELECTRONIC COMMUNICATIONS NETWORKS; TRANSMISSION OF SOUND, PICTURE AND DATA SIGNALS; TRANSMISSION OF SOUND, VIDEO AND INFORMATION; LOCAL AND LONG DISTANCE TRANSMISSION OF VOICE, DATA, GRAPHICS BY MEANS OF TELEPHONE, TELEGRAPHIC, CABLE, AND SATELLITE TRANSMISSIONS; RENTAL AND LEASING OF TELECOMMUNICATION EQUIPMENT; WIRELESS DIGITAL MESSAGING SERVICES; INTERNET PORTAL SERVICES; PROVIDING INFORMATION IN THE FIELD OF TELECOMMUNICATIONS, IN CLASS 38 (U.S. CLS. 100, 101 AND 104).

FOR: CONSULTING SERVICES IN THE FIELDS OF TELECOMMUNICATIONS NETWORKS; RESEARCH AND DEVELOPMENT SERVICES FOR NEW PRODUCTS FOR OTHERS IN THE FIELD OF TELECOMMUNICATIONS NETWORKS; DEVELOPMENT OF COMPUTER SOFTWARE FOR OTHERS; COMPUTER PROGRAMMING FOR OTHERS; COMPUTER NETWORK DESIGN FOR OTHERS; TECHNICAL SUPPORT, NAMELY, MONITORING OF NETWORK SYSTEMS; INSTALLATION AND MAINTENANCE OF COMPUTER SOFTWARE FOR OTHERS; WRITING, DEVELOPMENT, UPDATING AND DESIGN OF COMPUTER SOFTWARE FOR OTHERS; PLANNING AND DESIGN SERVICES ALL RELATING TO TELECOMMUNICATIONS NETWORKS; INTEGRATION OF COMPUTER SYSTEMS

AND NETWORKS, IN CLASS 42 (U.S. CLS. 100 AND 101).

THE MARK CONSISTS OF STANDARD CHARACTERS WITHOUT CLAIM TO ANY PARTICULAR FONT, STYLE, SIZE, OR COLOR.

OWNER OF ERPN CMNTY TM OFC REG. NO. 003372901, DATED 3-3-2005, EXPIRES 9-26-2013.

OWNER OF U.S. REG. NOS. 1,847,190, 2,703,344 AND OTHERS.

NO CLAIM IS MADE TO THE EXCLUSIVE RIGHT TO USE "FINANCE", APART FROM THE MARK AS SHOWN.

SER. NO. 78-338,331, FILED 12-9-2003.

KATHERINE CONNOLLY, EXAMINING ATTORNEY

**Int. Cl.: 38**

**Prior U.S. Cls.: 100, 101 and 104**

**United States Patent and Trademark Office**

**Reg. No. 3,467,802**

**Registered July 15, 2008**

**SERVICE MARK  
PRINCIPAL REGISTER**

**VIBEMATCH**

TELIGENCE (US), INC. (NEVADA CORPORATION)  
1045 HOWE STREET STE. 700  
VANCOUVER, CANADA V6Z 2A9

FOR: ELECTRONIC VOICE MESSAGING, NAME-  
LY, THE RECORDING, STORAGE AND SUBSE-  
QUENT TRANSMISSION OF MESSAGES FOR  
SOCIAL PURPOSES, TELEPHONE COMMUNICA-  
TIONS SERVICES, IN CLASS 38 (U.S. CLS. 100, 101  
AND 104).

FIRST USE 11-23-2003; IN COMMERCE 11-23-2003.

THE MARK CONSISTS OF STANDARD CHAR-  
ACTERS WITHOUT CLAIM TO ANY PARTICULAR  
FONT, STYLE, SIZE, OR COLOR.

OWNER OF U.S. REG. NOS. 2,670,065, 2,830,404,  
AND 2,830,405.

SER. NO. 78-341,642, FILED 12-16-2003.

BRIDGETT SMITH, EXAMINING ATTORNEY

**Int. Cls.: 9 and 18**

**Prior U.S. Cls.: 1, 2, 3, 21, 22, 23, 26, 36, 38 and 41**

**United States Patent and Trademark Office**

**Reg. No. 3,467,803**

**Registered July 15, 2008**

**TRADEMARK  
PRINCIPAL REGISTER**

**LONSDALE**

LONSDALE SPORTS LIMITED (UNITED KINGDOM CORPORATION)  
GRENVILLE COURT BRITWELL ROAD  
BURNHAM, SL1 8DF, UNITED KINGDOM

FOR: POUCHES, FILES, CASES, STORAGE SYSTEMS, NAMELY, RECORDED OR UNRECORDED DATA STORING CARRIERS FOR ELECTRONIC TEXT; AND ORGANIZERS FOR RECORDED OR UNRECORDED DATA STORING CARRIERS FOR ELECTRONIC TEXT, IMAGES, SOUND, VIDEO COMPUTER SOFTWARE, ELECTRONIC GAMES AND MOBILE PHONES; MOBILE PHONE ACCESSORIES; TELECOMMUNICATIONS AND TELEPHONE APPARATUS AND INSTRUMENTS, NAMELY, TELEPHONE ANSWERING MACHINES, TELEPHONE APPARATUS, NAMELY, INTERCOMS, AUTOMATIC TELEPHONE DIALERS, TELEPHONE EQUIPMENT, NAMELY, CALLER IDENTIFICATION BOXES, CELLULAR TELEPHONES, RADIO TELEPHONES; CALCULATORS; SPECTACLES AND SUNGLASSES AND CORDS, CASES AND HOLDERS THEREFOR, MAGNETS; SWIM MASKS AND GOGGLES, IN CLASS 9 (U.S. CLS. 21, 23, 26, 36 AND 38).

FOR: TRUNKS AND TRAVELING BAGS; UMBRELLAS, PARASOLS AND WALKING STICKS; CASES, NAMELY, ATTACHÉ CASES, BRIEFCASES, BUSINESS CARD CASES, BUSINESS CASES, CALLING CARD CASES, CREDIT CARD CASES, DOCUMENT CASES, KEY CASES, OVERNIGHT CASES,

COSMETIC, TOILETRY AND VANITY CASES SOLD EMPTY, CATALOGUE CASES, SUITCASES; AND BAGS, NAMELY, ATHLETIC BAGS, ALL PURPOSE ATHLETIC BAGS, ALL PURPOSE SPORTS BAGS, BEACH BAGS, BOOK BAGS, CARRY-ON BAGS, CLUTCH BAGS, DUFFEL BAGS, GYM BAGS, LEATHER SHOPPING BAGS, OVERNIGHT BAGS, SCHOOL BAGS, SHOULDER BAGS, TEXTILE SHOPPING BAGS, TRAVEL BAGS, COSMETIC BAGS SOLD EMPTY, HANDBAGS, SHAVING BAGS SOLD EMPTY; RUCKSACKS, KNAPSACKS, BACKPACKS, SHOE BAGS, SPORTS BAGS, BEACH BAGS; AND SHOULDER BELTS, STRAPS AND BANDS OF LEATHER; BANDOLIERS, BOXES, NAMELY, HAT BOXES FOR TRAVEL; WALLETS, PURSES, SATCHELS AND LUGGAGE, IN CLASS 18 (U.S. CLS. 1, 2, 3, 22 AND 41).

THE MARK CONSISTS OF STANDARD CHARACTERS WITHOUT CLAIM TO ANY PARTICULAR FONT, STYLE, SIZE, OR COLOR.

OWNER OF UNITED KINGDOM REG. NO. 2329920, DATED 4-17-2003, EXPIRES 4-17-2013.

OWNER OF U.S. REG. NOS. 1,353,454, 2,600,526 AND OTHERS.

SER. NO. 78-353,720, FILED 1-19-2004.

PAULA MAHONEY, EXAMINING ATTORNEY



**Int. Cls.: 7, 11 and 12**

**Prior U.S. Cls.: 13, 19, 21, 23, 31, 34, 35 and 44**

**United States Patent and Trademark Office**

**Reg. No. 3,467,804**

**Registered July 15, 2008**

**TRADEMARK  
PRINCIPAL REGISTER**



MANUFACTURERA DE IMPLEMENTOS, S.A.  
DE C.V. (MEXICO CORPORATION)  
AV. 3 JOSE B. LIZARDI, S/N ZONA INDUSTRI  
AL;  
CORDOBA, VERACRUZ, MEXICO 94640

FOR: ASSEMBLY LINE TABLE SYSTEM COM-  
POSED OF CONVEYER BELTS AND TABLES FOR  
REMOVING ROCKS AND WASHING SUGAR  
CANE; AND CARGO SLINGS MADE OF STEEL  
CHAINS AND METAL HOOKS FOR HAULING  
AND LIFTING SUGAR CANE, IN CLASS 7 (U.S.  
CLS. 13, 19, 21, 23, 31, 34 AND 35).

FIRST USE 0-0-1964; IN COMMERCE 0-0-1981.

FOR: FACTORY SYSTEMS FOR PROCESSING  
SUGAR COMPRISED OF STEAM EVAPORATORS  
FOR REMOVING MOISTURE FROM SUGAR; TUB-  
ULAR GAS HEATERS FOR DRYING SUGAR; AND

INDUSTRIAL GAS BOILERS FOR BOILING CANE  
SUGAR COMPRISED OF STEEL TANKS, IN CLASS  
11 (U.S. CLS. 13, 21, 23, 31 AND 34).

FIRST USE 0-0-1964; IN COMMERCE 0-0-1981.

FOR: TRACTOR OR TRUCK TOWED OPEN  
TRAILERS FOR HAULING RUBBLE OR TRASH;  
SEMI-TRAILER DUMP TRUCKS; SEMI-TRAILER  
HOPPER TANK TRUCKS; SEMI-TRAILER ELLIP-  
TICAL TANK TRUCKS; AND SEMI-TRAILER CY-  
LINDRICAL TANK TRUCKS, IN CLASS 12 (U.S.  
CLS. 19, 21, 23, 31, 35 AND 44).

FIRST USE 0-0-1964; IN COMMERCE 0-0-1981.

SER. NO. 78-384,532, FILED 3-15-2004.

BILL DAWE, EXAMINING ATTORNEY

**Int. Cls.: 20, 21 and 22**

**Prior U.S. Cls.: 1, 2, 7, 13, 19, 22, 23, 25, 29, 30, 32, 33,  
40, 42 and 50**

**Reg. No. 3,467,805**

**United States Patent and Trademark Office**

**Registered July 15, 2008**

**TRADEMARK  
PRINCIPAL REGISTER**

**FAMILY VALUES**

FAMILY DOLLAR STORES OF MICHIGAN, INC.  
(MICHIGAN CORPORATION)  
10401 OLD MONROE ROAD  
MATTHEWS, NC 28105

FOR: COAT HANGERS, HAMPERS, AND METAL  
SHOE RACKS, METAL GARMENT RACKS, IN  
CLASS 20 (U.S. CLS. 2, 13, 22, 25, 32 AND 50).

FIRST USE 1-31-2004; IN COMMERCE 1-31-2004.

FOR: IRONING BOARDS, NON-METAL STO-  
RAGE BASKETS NOT FOR COMMERCIAL USE,  
NON-METAL LAUNDRY BASKETS, IRONING  
BOARD PADS, SHAPED IRONING BOARD COV-  
ERS, AND CLOTHESPINS, IN CLASS 21 (U.S. CLS. 2,  
13, 23, 29, 30, 33, 40 AND 50).

FIRST USE 1-31-2004; IN COMMERCE 1-31-2004.

FOR: LAUNDRY BAGS, CLOTHESPIN BAGS,  
CLOTHESLINES, IN CLASS 22 (U.S. CLS. 1, 2, 7, 19,  
22, 42 AND 50).

FIRST USE 1-31-2004; IN COMMERCE 1-31-2004.

THE MARK CONSISTS OF STANDARD CHAR-  
ACTERS WITHOUT CLAIM TO ANY PARTICULAR  
FONT, STYLE, SIZE, OR COLOR.

OWNER OF U.S. REG. NO. 2,386,264.

SER. NO. 78-394,602, FILED 4-1-2004.

AMOS T. MATTHEWS, JR., EXAMINING ATTOR-  
NEY

**Int. Cl.: 25**

**Prior U.S. Cls.: 22 and 39**

**United States Patent and Trademark Office**

**Reg. No. 3,467,806**

**Registered July 15, 2008**

**TRADEMARK  
PRINCIPAL REGISTER**



**FUN BOXERS**

FUN APPAREL INC. (TEXAS CORPORATION)  
10650 KINGHURST DRIVE  
HOUSTON, TX 77099

FOR: BOXER SHORTS, SLEEPWEAR AND LOUN-  
GEWEAR FOR MEN, WOMEN, BOYS AND GIRLS,  
IN CLASS 25 (U.S. CLS. 22 AND 39).

FIRST USE 1-1-1993; IN COMMERCE 2-25-1993.

NO CLAIM IS MADE TO THE EXCLUSIVE  
RIGHT TO USE "BOXERS", APART FROM THE  
MARK AS SHOWN.

SER. NO. 78-398,934, FILED 4-8-2004.

APRIL L. RADEMACHER, EXAMINING ATTOR-  
NEY

**Int. Cls.: 14, 18 and 25**

**Prior U.S. Cls.: 1, 2, 3, 22, 27, 28, 39, 41 and 50**

**United States Patent and Trademark Office**

**Reg. No. 3,467,807**

**Registered July 15, 2008**

**TRADEMARK  
PRINCIPAL REGISTER**

**PUNKYSISTERS**

DEVILS AND ANGELS LIMITED (UNITED KINGDOM LIMITED COMPANY)  
27-28 UPLANDS BUSINESS PARK  
BLACKHORSE LANE, WALTHAMSTOW  
LONDON, UNITED KINGDOM E17 5QJ

FOR: SEMI-PRECIOUS AND PRECIOUS STONES; HOROLOGICAL AND OTHER CHRONOMETRIC INSTRUMENTS, NAMELY, WRIST WATCHES, POCKET WATCHES AND CLOCKS; JEWELRY AND IMITATION JEWELRY; PARTS AND FITTINGS FOR ALL THE AFORESAID GOODS, IN CLASS 14 (U.S. CLS. 2, 27, 28 AND 50).

FOR: TRUNKS; TRAVEL CASES; LUGGAGE; SUITCASES; HOLDALLS; PORTMANTEAUX; VALISES; BAGS, NAMELY BUMBAGS, SPORTS BAGS, CASUAL BAGS, HANDBAGS, SHOULDER BAGS, TRAVELING BAGS, ATHLETIC BAGS, BOOK BAGS, CLUTCH BAGS, TOILET BAGS AND CARRIER BAGS; RUCKSACKS; BACKPACKS; BRIEF-CASES; ATTACHÉ CASES; MUSIC CASES; SATCHELS; BEAUTY CASES SOLD EMPTY; CARRIERS FOR SUITS, FOR SHIRTS AND FOR DRESSES; TIE CASES; NOTECASES; NOTEBOOK HOLDERS; DOCUMENT CASES AND HOLDERS; CREDIT CARD CASES AND HOLDERS; WALLETS; PURSES; UMBRELLAS; PARASOLS; WALKING

STICKS; SADDLES; PARTS AND FITTINGS FOR ALL THE AFORESAID GOODS, IN CLASS 18 (U.S. CLS. 1, 2, 3, 22 AND 41).

FOR: ARTICLES OF CLOTHING, NAMELY, SHIRTS, T-SHIRTS, SWEAT SHIRTS, SWEATERS, JUMPERS, TOPS, CARDIGANS, PANTS, TROUSERS, JEANS, SHORTS, UNDERWEAR, VESTS, UNDERPANTS, LINGERIE, NIGHT DRESSES, PAJAMAS, COATS, JACKETS, RAIN COATS, OVERCOATS, DRESSES, SKIRTS, SHAWLS AND DUNGAREES; BOOTS; SHOES; SLIPPERS; SANDALS; SNEAKERS; SOCKS; HOSIERY; HATS; CAPS; BELTS; SCARVES; GLOVES; MITTENS; BELTS, IN CLASS 25 (U.S. CLS. 22 AND 39).

THE MARK CONSISTS OF STANDARD CHARACTERS WITHOUT CLAIM TO ANY PARTICULAR FONT, STYLE, SIZE, OR COLOR.

OWNER OF ERPN CMNTY TM OFC REG. NO. 3399871, DATED 3-30-2005, EXPIRES 10-10-2013.

SER. NO. 78-429,666, FILED 6-3-2004.

GIANCARLO CASTRO, EXAMINING ATTORNEY

**Int. Cls.: 7, 9, 37, 38, 40 and 42**

**Prior U.S. Cls.: 13, 19, 21, 23, 26, 31, 34, 35, 36, 38, 100, 101, 103, 104 and 106**

**Reg. No. 3,467,808**

**United States Patent and Trademark Office**

**Registered July 15, 2008**

**TRADEMARK  
SERVICE MARK  
PRINCIPAL REGISTER**

**NBSTECH**

NBS TECHNOLOGIES INC. (CANADA CORPORATION)  
703 AVENUE  
TORONTO, CANADA M9C 5E9

FOR: MACHINERY AND HARDWARE NAMELY EMBOSsing, MILLING, EMBEDDING AND LAMINATING MACHINERY FOR CUSTOMIZING CARDS, NAMELY, FOR EMBOSsing AND ENCODING FINANCIAL CREDIT AND DEBIT CARDS, MAGNETIC CODED CARDS, PERSONAL IDENTIFICATION CARDS, PROMOTIONAL CARDS AND SMART CARDS, IN CLASS 7 (U.S. CLS. 13, 19, 21, 23, 31, 34 AND 35).

FOR: PRINTERS FOR CUSTOMIZING CARDS, NAMELY, FOR TRANSPOSING CUSTOM GRAPHICS AND PHOTOGRAPHIC IMAGES ONTO FINANCIAL CREDIT AND DEBIT CARDS, MAGNETIC CODED CARDS, PERSONAL IDENTIFICATION CARDS, PROMOTIONAL CARDS AND SMART CARDS; POINT OF SALE TERMINALS FOR PROCESSING DEBIT AND CREDIT CARD TRANSACTION AND RETAIL GIFT CARD AND REWARD PROGRAMS; SECURE IDENTIFICATION AND ACCESS CONTROL HARDWARE AND SOFTWARE; COMPUTER SOFTWARE FOR USE IN CUSTOMIZING FINANCIAL CREDIT AND DEBIT CARDS; MAGNETIC CODED CARDS, PERSONAL IDENTIFICATION CARDS, PROMOTIONAL CARDS AND

SMART CARDS; COMPUTER SOFTWARE FOR USE IN PRINTERS FOR CUSTOMIZING FINANCIAL CREDIT AND DEBIT CARDS, MAGNETIC CODED CARDS, PERSONAL IDENTIFICATION CARDS, PROMOTIONAL CARDS AND SMART CARDS; COMPUTER SOFTWARE FOR USE IN DEVELOPING CUSTOMIZED TELECOMMUNICATION GATEWAYS; COMPUTER SOFTWARE FOR USE IN DEBIT AND CREDIT TRANSACTIONS; COMPUTER SOFTWARE FOR USE IN SECURING ELECTRONIC TRANSACTIONS; COMPUTER SOFTWARE FOR USE IN INTEGRATING RETAIL GIFT CARD AND REWARD PROGRAMS AT POINT OF SALE; COMPUTER SOFTWARE FOR USE IN CUSTOMIZING POINT OF SALE TERMINALS; COMPUTER SOFTWARE FOR USE IN DEVELOPING DIAL-IN AND WIRELESS COMMUNICATION APPLICATIONS IN CONJUNCTION WITH FINANCIAL CREDIT AND DEBIT CARDS, MAGNETIC CODED CARDS, PERSONAL IDENTIFICATION CARDS, PROMOTIONAL CARDS, AND SMART CARDS; SOFTWARE FOR USE IN ELECTRONIC CASH REGISTERS, IN CLASS 9 (U.S. CLS. 21, 23, 26, 36 AND 38).

FOR: PROVIDING MAINTENANCE SERVICES, NAMELY FOR MACHINERY AND HARDWARE FOR EMBOSsing AND ENCODING FINANCIAL CREDIT AND DEBIT CARDS, MAGNETIC CODED CARDS, PERSONAL IDENTIFICATION CARDS,

PROMOTIONAL CARDS AND SMART CARDS; PROVIDING MAINTENANCE SERVICES, NAMELY FOR PRINTERS FOR TRANSPOSING CUSTOM GRAPHICS AND PHOTOGRAPHIC IMAGES ONTO FINANCIAL CREDIT AND DEBIT CARDS, MAGNETIC CODED CARDS, PERSONAL IDENTIFICATION CARDS, PROMOTIONAL CARDS AND SMART CARDS; PROVIDING REPAIR SERVICES, NAMELY FOR EQUIPMENT FOR EMBOSsing AND ENCODING FINANCIAL CREDIT AND DEBIT CARDS, MAGNETIC CODED CARDS, PERSONAL IDENTIFICATION CARDS, PROMOTIONAL CARDS AND SMART CARDS; PROVIDING REPAIR SERVICES, NAMELY FOR PRINTERS FOR TRANSPOSING CUSTOM GRAPHICS AND PHOTOGRAPHIC IMAGES ONTO FINANCIAL CREDIT AND DEBIT CARDS, MAGNETIC CODED CARDS, PERSONAL IDENTIFICATION CARDS, PROMOTIONAL CARDS AND SMART CARDS; PROVIDING REPAIR SERVICES, NAMELY FOR POINT OF SALE TERMINALS FOR PROCESSING DEBIT AND CREDIT CARD TRANSACTIONS AND RETAIL GIFT CARD AND REWARD PROGRAMS, IN CLASS 37 (U.S. CLS. 100, 103 AND 106).

FOR: TELECOMMUNICATION GATEWAY SERVICES FOR PROCESSING FINANCIAL DEBIT AND CREDIT CARD TRANSACTIONS; ELECTRONIC TRANSMISSION OF DATA AND DOCUMENTS, IN CLASS 38 (U.S. CLS. 100, 101 AND 104).

FOR: CARD PRINTING, NAMELY TRANSPOSING CUSTOM GRAPHICS AND PHOTOGRAPHIC IMAGES ONTO FINANCIAL CREDIT AND DEBIT CARDS, MAGNETIC CODED CARDS, PERSONAL IDENTIFICATION CARDS, PROMOTIONAL CARDS AND SMART CARDS; CREDIT AND DEBIT CARD TRANSACTION PROCESSING SERVICES; CARD CUSTOMIZATION, NAMELY EMBOSsing AND ENCODING FINANCIAL CREDIT AND DEBIT CARDS, MAGNETIC CODED CARDS, PERSONAL IDENTIFICATION CARDS, PROMOTIONAL CARDS AND SMART CARDS, IN CLASS 40 (U.S. CLS. 100, 103 AND 106).

FOR: COMPUTER SOFTWARE DESIGN, NAMELY, OF COMPUTER SOFTWARE FOR USE IN PRINTING CUSTOM GRAPHICS AND PHOTOGRAPHIC IMAGES ONTO FINANCIAL CREDIT AND DEBIT CARDS, MAGNETIC CODED CARDS, PERSONAL IDENTIFICATION CARDS, PROMOTIONAL CARDS AND SMART CARDS; COMPUTER SOFTWARE DESIGN, NAMELY, OF COMPUTER SOFTWARE FOR USE IN DEVELOPMENT CUSTOMIZED TELECOMMUNICATION GATEWAYS; COMPUTER SOFTWARE DESIGN, NAMELY, OF COMPUTER SOFTWARE FOR USE IN DEBIT AND CREDIT TRANSACTIONS; COMPUTER SOFTWARE DESIGN, NAMELY, OF COMPUTER SOFTWARE FOR USE IN SECURING ELECTRONIC TRANSACTIONS; COMPUTER SOFTWARE DESIGN, NAMELY, OF COMPUTER SOFTWARE FOR USE IN INTEGRATING RETAIL GIFT CARD AND REWARD PROGRAMS AT POINT OF SALE; COMPUTER SOFTWARE DESIGN, NAMELY, OF COMPUTER SOFTWARE FOR USE IN CUSTOMIZING POINT OF SALE TERMINALS; COMPUTER SOFTWARE DESIGN, NAMELY, OF COMPUTER SOFTWARE FOR USE IN CUSTOMIZING FINANCIAL CREDIT AND DEBIT CARDS, MAGNETIC CODED CARDS, PERSONAL IDENTIFICATION CARDS, PROMOTIONAL CARDS AND SMART CARDS, IN CLASS 42 (U.S. CLS. 100 AND 101).

THE MARK CONSISTS OF STANDARD CHARACTERS WITHOUT CLAIM TO ANY PARTICULAR FONT, STYLE, SIZE, OR COLOR.

PRIORITY CLAIMED UNDER SEC. 44(D) ON CANADA APPLICATION NO. 1214995, FILED 4-28-2004, REG. NO. TMA662,496, DATED 4-11-2006, EXPIRES 4-11-2021.

SER. NO. 78-439,825, FILED 6-23-2004.

DOMINICK J. SALEMI, EXAMINING ATTORNEY

**Int. Cls.: 7, 9, 36, 37, 38, 40 and 42**

**Prior U.S. Cls.: 13, 19, 21, 23, 26, 31, 34, 35, 36, 38, 100, 101, 102, 103, 104 and 106**

**Reg. No. 3,467,809**

**United States Patent and Trademark Office**

**Registered July 15, 2008**

**TRADEMARK  
SERVICE MARK  
PRINCIPAL REGISTER**



NBS TECHNOLOGIES INC. (CANADA CORPORATION)  
703 EVANS AVENUE  
TORONTO, CANADA M9C 5E9

FOR: MACHINERY AND HARDWARE NAMELY EMBOSSING, MILLING, EMBEDDING AND LAMINATING MACHINERY FOR CUSTOMIZING CARDS, NAMELY, FOR EMBOSSING AND ENCODING FINANCIAL CREDIT AND DEBIT CARDS, MAGNETIC CODED CARDS, PERSONAL IDENTIFICATION CARDS, PROMOTIONAL CARDS AND SMART CARDS, IN CLASS 7 (U.S. CLS. 13, 19, 21, 23, 31, 34 AND 35).

FOR: PRINTERS FOR CUSTOMIZING CARDS, NAMELY, FOR TRANSPOSING CUSTOM GRAPHICS AND PHOTOGRAPHIC IMAGES ONTO FINANCIAL CREDIT AND DEBIT CARDS, MAGNETIC CODED CARDS, PERSONAL IDENTIFICATION CARDS, PROMOTIONAL CARDS AND SMART CARDS; POINT OF SALE TERMINALS FOR PROCESSING DEBIT AND CREDIT CARD TRANSACTIONS AND RETAIL GIFT CARD AND REWARD PROGRAMS; SECURE IDENTIFICATION AND ACCESS CONTROL HARDWARE AND SOFTWARE; COMPUTER SOFTWARE FOR USE IN CUSTOMIZING FINANCIAL CREDIT AND DEBIT CARDS, MAGNETIC CODED CARDS, PERSONAL IDENTIFICATION CARDS, PROMOTIONAL CARDS AND SMART CARDS; COMPUTER SOFTWARE FOR USE IN PRINTERS FOR CUSTOMIZING FINANCIAL CREDIT AND DEBIT CARDS,

MAGNETIC CODED CARDS, PERSONAL IDENTIFICATION CARDS, PROMOTIONAL CARDS AND SMART CARDS; COMPUTER SOFTWARE FOR USE IN DEVELOPING CUSTOMIZED TELECOMMUNICATION GATEWAYS; COMPUTER SOFTWARE FOR USE IN DEBIT AND CREDIT TRANSACTIONS; COMPUTER SOFTWARE FOR USE IN SECURING ELECTRONIC TRANSACTIONS; COMPUTER SOFTWARE FOR USE IN INTEGRATING RETAIL GIFT CARD AND REWARD PROGRAMS AT POINT OF SALE; COMPUTER SOFTWARE FOR USE IN CUSTOMIZING POINT OF SALE TERMINALS; COMPUTER SOFTWARE FOR USE IN DEVELOPING DIAL-IN AND WIRELESS COMMUNICATION APPLICATIONS IN CONJUNCTION WITH FINANCIAL CREDIT AND DEBIT CARDS, MAGNETIC CODED CARDS, PERSONAL IDENTIFICATION CARDS, PROMOTIONAL CARDS, AND SMART CARDS; SOFTWARE FOR USE IN ELECTRONIC CASH REGISTERS, IN CLASS 9 (U.S. CLS. 21, 23, 26, 36 AND 38).

FOR: CREDIT AND DEBIT CARD TRANSACTION PROCESSING SERVICES, IN CLASS 36 (U.S. CLS. 100, 101 AND 102).

FOR: PROVIDING MAINTENANCE SERVICES, NAMELY FOR MACHINERY AND HARDWARE FOR EMBOSSING AND ENCODING FINANCIAL CREDIT AND DEBIT CARDS, MAGNETIC CODED CARDS, PERSONAL IDENTIFICATION CARDS, PROMOTIONAL CARDS AND SMART CARDS;

PROVIDING MAINTENANCE SERVICES, NAMELY FOR PRINTERS FOR TRANSPOSING CUSTOM GRAPHICS AND PHOTOGRAPHIC IMAGES ONTO FINANCIAL CREDIT AND DEBIT CARDS, MAGNETIC CODED CARDS, PERSONAL IDENTIFICATION CARDS, PROMOTIONAL CARDS AND SMART CARDS; PROVIDING REPAIR SERVICES, NAMELY FOR EQUIPMENT FOR EMBOSsing AND ENCODING FINANCIAL CREDIT AND DEBIT CARDS, MAGNETIC CODED CARDS, PERSONAL IDENTIFICATION CARDS, PROMOTIONAL CARDS AND SMART CARDS; PROVIDING REPAIR SERVICES, NAMELY FOR PRINTERS FOR TRANSPOSING CUSTOM GRAPHICS AND PHOTOGRAPHIC IMAGES ONTO FINANCIAL CREDIT AND DEBIT CARDS, MAGNETIC CODED CARDS, PERSONAL IDENTIFICATION CARDS, PROMOTIONAL CARDS AND SMART CARDS; PROVIDING REPAIR SERVICES, NAMELY FOR POINT OF SALE TERMINALS FOR PROCESSING DEBIT AND CREDIT CARD TRANSACTIONS AND RETAIL GIFT CARD AND REWARD PROGRAMS, IN CLASS 37 (U.S. CLS. 100, 103 AND 106).

FOR: TELECOMMUNICATION GATEWAY SERVICES FOR PROCESSING FINANCIAL DEBIT AND CREDIT CARD TRANSACTIONS; ELECTRONIC TRANSMISSION OF DATA AND DOCUMENTS, IN CLASS 38 (U.S. CLS. 100, 101 AND 104).

FOR: CARD PRINTING, NAMELY TRANSPOSING CUSTOM GRAPHICS AND PHOTOGRAPHIC IMAGES ONTO FINANCIAL CREDIT AND DEBIT CARDS, MAGNETIC CODED CARDS, PERSONAL IDENTIFICATION CARDS, PROMOTIONAL CARDS AND SMART CARDS; CARD CUSTOMIZATION, NAMELY EMBOSsing AND ENCODING FINANCIAL CREDIT AND DEBIT CARDS, MAGNETIC CODED CARDS, PERSONAL IDENTIFICATION CARDS, PROMOTIONAL CARDS AND SMART CARDS, IN CLASS 40 (U.S. CLS. 100, 103 AND 106).

FOR: COMPUTER SOFTWARE DESIGN, NAMELY, OF COMPUTER SOFTWARE FOR USE IN PRINTING CUSTOM GRAPHICS AND PHOTOGRAPHIC IMAGES ONTO FINANCIAL CREDIT AND DEBIT CARDS, MAGNETIC CODED CARDS, PERSONAL IDENTIFICATION CARDS, PROMOTIONAL CARDS AND SMART CARDS; COMPUTER SOFTWARE DESIGN, NAMELY, OF COMPUTER SOFTWARE FOR USE IN DEVELOPING CUSTOMIZED TELECOMMUNICATION GATEWAYS; COMPUTER SOFTWARE DESIGN, NAMELY, OF COMPUTER SOFTWARE FOR USE IN DEBIT AND CREDIT TRANSACTIONS; COMPUTER SOFTWARE DESIGN, NAMELY, OF COMPUTER SOFTWARE FOR USE IN SECURING ELECTRONIC TRANSACTIONS; COMPUTER SOFTWARE DESIGN, NAMELY, OF COMPUTER SOFTWARE FOR USE IN INTEGRATING RETAIL GIFT CARD AND REWARD PROGRAMS AT POINT OF SALE; COMPUTER SOFTWARE DESIGN, NAMELY, OF COMPUTER SOFTWARE FOR USE IN CUSTOMIZING POINT OF SALE TERMINALS; COMPUTER SOFTWARE DESIGN, NAMELY, OF COMPUTER SOFTWARE FOR USE IN CUSTOMIZING FINANCIAL CREDIT AND DEBIT CARDS, MAGNETIC CODED CARDS, PERSONAL IDENTIFICATION CARDS, PROMOTIONAL CARDS AND SMART CARDS, IN CLASS 42 (U.S. CLS. 100 AND 101).

PRIORITY CLAIMED UNDER SEC. 44(D) ON CANADA APPLICATION NO. 1215002, FILED 4-28-2004, REG. NO. TMA662,494, DATED 4-11-2006, EXPIRES 4-11-2021.

THE MARK IS NOT IN COLOR.

SER. NO. 78-439,833, FILED 6-23-2004.

DOMINICK J. SALEMI, EXAMINING ATTORNEY



Int. Cl.: 43

Prior U.S. Cls.: 100 and 101

United States Patent and Trademark Office

Reg. No. 3,467,810

Registered July 15, 2008

SERVICE MARK  
PRINCIPAL REGISTER



WILD EAGLE LODGE, INC. (WISCONSIN CORPORATION)  
4443 CHAIN O'LAKES ROAD  
EAGLE RIVER, WI 54521

FOR: HOTEL AND RESORT SERVICES AND RELATED HOSPITALITY SERVICES, NAMELY, PROVIDING FOOD AND BEVERAGES FOR GUESTS, IN CLASS 43 (U.S. CLS. 100 AND 101).

FIRST USE 3-25-2004; IN COMMERCE 3-25-2004.

OWNER OF U.S. REG. NOS. 1,437,972, 2,393,477 AND OTHERS.

NO CLAIM IS MADE TO THE EXCLUSIVE RIGHT TO USE LODGE, APART FROM THE MARK AS SHOWN.

THE COLOR(S) GREEN, WHITE, BROWN, YELLOW, AND BLUE IS/ARE CLAIMED AS A FEATURE OF THE MARK.

THE MARK CONSISTS OF THE WORDS "WILD EAGLE LODGE" IN GREEN STYLIZED LETTERING WITH THE LETTER "I" COMPOSED OF A FEATHER. THE EAGLE HAS A WHITE HEAD AND TAIL, BROWN BODY AND WINGS, AND A YELLOW BEAK AND FEET. THE WATER BELOW THE EAGLE IS BLUE.

SER. NO. 78-448,242, FILED 7-9-2004.

JEFF DEFORD, EXAMINING ATTORNEY

**Int. Cl.: 25**

**Prior U.S. Cls.: 22 and 39**

**United States Patent and Trademark Office**

**Reg. No. 3,467,811**

**Registered July 15, 2008**

**TRADEMARK  
PRINCIPAL REGISTER**

**TAGUR**

WILLIAMS WESLEY WAYNE (UNITED STATES  
INDIVIDUAL)  
12 PINNACLE DRIVE  
SOUTH BURLINGTON, VT 05403

FIRST USE 9-29-2004; IN COMMERCE 9-29-2004.

SER. NO. 78-464,597, FILED 8-9-2004.

FOR: SHOES, POLO SHIRTS, JEANS, DRESS  
SHIRTS, SWEATERS, SUITS, BELTS, UNDERWEAR,  
SOCKS AND JACKETS, IN CLASS 25 (U.S. CLS. 22  
AND 39).

RONALD MCMORROW, EXAMINING ATTORNEY

**Int. Cl.: 41**

**Prior U.S. Cls.: 100, 101 and 107**

**United States Patent and Trademark Office**

**Reg. No. 3,467,812**

**Registered July 15, 2008**

**SERVICE MARK  
PRINCIPAL REGISTER**

**TUNGSTEN LEARNING**

EDISON SCHOOLS INC. (DELAWARE CORPORATION)  
521 FIFTH AVENUE  
NEW YORK, NY 10175

FOR: DEVELOPMENT AND DISSEMINATION OF EDUCATIONAL MATERIALS FOR OTHERS IN THE FIELD OF ELEMENTARY, MIDDLE AND HIGH SCHOOL EDUCATION; EDUCATIONAL CONSULTING SERVICES PROVIDED TO OTHERS IN THE FIELDS OF ELEMENTARY, MIDDLE AND HIGH SCHOOL EDUCATION AND IMPROVING STUDENT LEARNING PERFORMANCE; DEVELOPMENT FOR OTHERS AND DISSEMINATION OF RESEARCH-BASED STUDENT ACHIEVEMENT DIAGNOSTIC TESTS IN THE FIELD OF ELEMENTARY, MIDDLE AND HIGH SCHOOL

EDUCATION, IN CLASS 41 (U.S. CLS. 100, 101 AND 107).

FIRST USE 8-31-2003; IN COMMERCE 8-31-2003.

THE MARK CONSISTS OF STANDARD CHARACTERS WITHOUT CLAIM TO ANY PARTICULAR FONT, STYLE, SIZE, OR COLOR.

NO CLAIM IS MADE TO THE EXCLUSIVE RIGHT TO USE "LEARNING", APART FROM THE MARK AS SHOWN.

SER. NO. 78-473,502, FILED 8-25-2004.

MARY I. SPARROW, EXAMINING ATTORNEY

**Int. Cl.: 9**

**Prior U.S. Cls.: 21, 23, 26, 36 and 38**

**United States Patent and Trademark Office**

**Reg. No. 3,467,813**

**Registered July 15, 2008**

**TRADEMARK  
PRINCIPAL REGISTER**

**Flex-Site**

EXAMSOFT WORLDWIDE INC (FLORIDA CORPORATION)  
350 JIM MORAN BLVD SUITE 120  
DEERFIELD BEACH, FL 33442

FOR: COMPUTER SOFTWARE FOR TESTING PURPOSES, NAMELY, FOR, PREPARING, TAKING, AND SCORING ACADEMIC, PROFESSIONAL LICENSING, DISTANCE-LEARNING, AND ONLINE EXAMINATIONS, IN CLASS 9 (U.S. CLS. 21, 23, 26, 36 AND 38).

FIRST USE 12-6-2000; IN COMMERCE 12-22-2000.

THE MARK CONSISTS OF STANDARD CHARACTERS WITHOUT CLAIM TO ANY PARTICULAR FONT, STYLE, SIZE, OR COLOR.

SER. NO. 78-476,824, FILED 8-31-2004.

MARK T. MULLEN, EXAMINING ATTORNEY

**Int. Cls.: 9, 35, 36, 38 and 42**

**Prior U.S. Cls.: 21, 23, 26, 36, 38, 100, 101, 102 and 104**

**Reg. No. 3,467,814**

**United States Patent and Trademark Office**

**Registered July 15, 2008**

**TRADEMARK  
SERVICE MARK  
PRINCIPAL REGISTER**

**MICROGEN APTITUDE**

MICROGEN PLC (UNITED KINGDOM PUBLIC LIMITED COMPANY (PLC))

FLEET HOUSE

FLEETWOOD PARK, BARLEY WAY

FLEET GU51 2 QJ, UNITED KINGDOM

FOR: COMPUTER SOFTWARE FOR USE IN FINANCIAL SERVICES FOR THE AUTOMATION OF BUSINESS AND DATA PROCESSING; COMPUTER SOFTWARE FOR USE IN FINANCIAL SERVICES FOR FRONT AND BACK OFFICE ADMINISTRATION, PERFORMANCE MANAGEMENT AND ANALYTICS, ASSET AND FUND MANAGEMENT, FINANCE INTEGRATION, PRODUCT LINE PROFIT AND LOSS ANALYSIS, FOR FINANCIAL CONTROL, DERIVATIVES, VALUATION AND INTEGRATION OF PRICING MODELS, FOR TREASURY AND DERIVATIVES TRADING, FOR BANK PAYMENT SYSTEMS, FOR RECONCILIATIONS, FOR ENTERPRISE PAYMENT CONTROL AND PAYMENTS MANAGEMENT SYSTEMS, FOR FINANCIAL INTEGRATION, PROFITABILITY ANALYSIS AND FINANCIAL REPORTING REQUIREMENTS, FOR FORECASTING, TRADING, PRICING, FOR USE IN EBILLING, AND FOR USE IN BILL DATA ANALYSIS; COMPUTER SOFTWARE FOR USE IN FINANCIAL SERVICES FOR MANAGEMENT AND AUTOMATION OF HUMAN AND DOCUMENT WORKFLOW PROCESSES; COMPUTER SOFTWARE FOR USE IN FINANCIAL SERVICES AND BILL DATA ANALYSIS IN RETAIL SERVICES, COMMERCIAL, PUBLIC AND UTILITY SECTORS, FOR OFFICE ADMINISTRATION, PERFORMANCE MANAGEMENT, PROFIT AND LOSS ANALYSIS AND MANAGEMENT, RECONCILIATIONS, FOR FINANCIAL CONTROL, FOR BANK PAYMENT SYSTEMS, FOR ENTERPRISE PAYMENT CONTROL AND PAYMENTS MANAGEMENT SYSTEMS, FOR FINANCIAL INTEGRATION, PROFITABILITY ANALYSIS AND FINANCIAL REPORTING REQUIREMENTS, FOR FORECASTING, TRADING, PRICING, FOR RE-

FINANCIAL REPORTING REQUIREMENTS, FOR FORECASTING, TRADING, AND/OR PRICING, FOR PRICE AND COST CALCULATIONS, QUOTATIONS, CONTRACT AND INVOICE MANAGEMENT, FOR COST DISBURSEMENT MANAGEMENT, FOR MARGIN MANAGEMENT, FOR CREDITS REDEMPTION, FOR MANAGEMENT OF LOYALTY PROGRAMS, FOR USE IN EBILLING, AND FOR USE IN BILL DATA ANALYSIS; COMPUTER SOFTWARE FOR USE IN FINANCIAL SERVICES FOR INTEGRATION WITH THIRD PARTY SOFTWARE AND/OR HARDWARE PRODUCTS; COMPUTER SOFTWARE WHICH ENABLES THE DELIVERY OF APPLICATIONS OVER THE INTERNET; APPLICATION DEVELOPMENT PLATFORM SOFTWARE FOR THE INTERNET, INTRANETS AND EXTRANETS FOR THE AUTOMATION OF BUSINESS AND DATA PROCESSING; APPLICATION DEVELOPMENT PLATFORM SOFTWARE FOR THE INTERNET, INTRANETS AND EXTRANETS FOR USE IN MANAGEMENT AND AUTOMATION OF HUMAN AND DEVELOPMENT WORKFLOW PROCESSES; APPLICATION DEVELOPMENT PLATFORM SOFTWARE FOR THE INTERNET, INTRANETS AND EXTRANETS SERVICES FOR USE IN FINANCIAL SERVICES IN FRONT AND BACK OFFICE ADMINISTRATION, PERFORMANCE MANAGEMENT AND ANALYTICS, ASSET AND FUND MANAGEMENT, FINANCE INTEGRATION, PRODUCT LINE PROFIT AND LOSS ANALYSIS, FOR FINANCIAL CONTROL, DERIVATIVES, VALUATION AND INTEGRATION OF PRICING MODELS, FOR TREASURY AND DERIVATIVES TRADING, FOR BANK PAYMENT SYSTEMS, FOR ENTERPRISE PAYMENT CONTROL AND PAYMENTS MANAGEMENT SYSTEMS, FOR FINANCIAL INTEGRATION, PROFITABILITY ANALYSIS AND FINANCIAL REPORTING REQUIREMENTS, FOR FORECASTING, TRADING, PRICING, FOR RE-

CONCILIATIONS, FOR USE IN EBILLING, AND FOR USE IN BILL DATA ANALYSIS; APPLICATION DEVELOPMENT PLATFORM SOFTWARE FOR THE INTERNET, INTRANETS AND EXTRANETS FOR USE IN RETAIL SERVICES, COMMERCIAL, PUBLIC AND UTILITY SECTORS, FOR OFFICE ADMINISTRATION, PERFORMANCE MANAGEMENT, PROFIT AND LOSS ANALYSIS AND MANAGEMENT, FOR FINANCIAL CONTROL, FOR BANK PAYMENT SYSTEMS, FOR ENTERPRISE PAYMENT CONTROL AND PAYMENTS MANAGEMENT SYSTEMS, FOR FINANCIAL INTEGRATION, PROFITABILITY ANALYSIS AND FINANCIAL REPORTING REQUIREMENTS, FOR FORECASTING, TRADING, AND/OR PRICING, FOR PRICE AND COST CALCULATIONS, QUOTATIONS, CONTRACT AND INVOICE MANAGEMENT, FOR COST DISBURSEMENT MANAGEMENT, FOR MARGIN MANAGEMENT, FOR CREDITS REDEMPTION, FOR MANAGEMENT OF LOYALTY PROGRAMS, FOR USE IN EBILLING, AND FOR USE IN BILL DATA ANALYSIS; COMPUTER SOFTWARE FOR MEASURING MONITORING, REGULATING AND CHECKING COMPUTER SYSTEMS, DATABASES, INTERNET, EXTRANET AND INTRANET SITES, LANS, WEB SERVERS, E-COMMERCE SERVERS, MAIL SERVERS, UNIFORM RESOURCE LOCATORS, FIRE WALLS AND INTERNET PROTOCOLS; COMPUTER SOFTWARE TO ENABLE DOWNLOADING AND UPLOADING DATA TO A DATABASE, THE INTERNET, EXTRANETS OR INTRANETS, COMPUTER INSTALLATIONS, APPARATUS AND INSTRUMENTS, COMPUTER TERMINALS, COMPUTER PRINTERS, COMPUTER KEYBOARDS, COMPUTER MONITORS, COMPUTER DISC DRIVES, COMPUTER INTERFACE APPARATUS AND INSTRUMENTS FOR RECORDING PROGRAMS, DATA AND DATABASES, IN CLASS 9 (U.S. CLS. 21, 23, 26, 36 AND 38).

FOR: PREPARATION OF BUSINESS OR FINANCIAL REPORTS RELATING TO PERFORMANCE METRICS, ANALYTICS, PROFIT AND LOSS MANAGEMENT, PRODUCT AND SERVICE TIME TO MARKET METRICS, COMMERCIAL AND CONTRACTUAL PROCESS MONITORING, HUMAN RESOURCE MANAGEMENT, HUMAN AND DEVELOPMENT WORKFLOW, MARKET POSITION, FORECASTING, TRADING, AND/OR PRICING, IN CLASS 35 (U.S. CLS. 100, 101 AND 102).

FOR: CONSULTANCY IN RELATION TO ON-LINE PAYMENT METHODS, IN CLASS 36 (U.S. CLS. 100, 101 AND 102).

FOR: ONLINE, NAMELY, VOICE OVER INTERNET PROTOCOL, MULTIPLE USER DIAL-UP ACCESS TO THE INTERNET, WIRELESS FACSIMILE, TELEPHONE AND LOCAL AREA NETWORK CONNECTIVITY, OR WIRELESS BROADBAND COMMUNICATION SERVICES; PROVISION OF TELECOMMUNICATIONS ACCESS AND/OR ON-LINE LINKS TO COMPUTER DATABASES, INTRANETS, EXTRANETS, THE INTERNET AND/OR WEB SERVICE CALLS TO SOFTWARE APPLICATIONS; ELECTRONIC MAIL SERVICES; INFORMATION

ABOUT COMMUNICATIONS AND BROADCASTING PROVIDED BY ELECTRONIC MEDIA; PROVIDING ACCESS TO ON-LINE INFORMATION AND/OR COMMUNICATIONS SERVICES; TELECOMMUNICATION, NAMELY, TRANSFER OF INFORMATION, COMPUTER PROGRAMS AND/OR ANY OTHER DATA; PROVIDING ACCESS TO REMOTE DOCUMENT HANDLING SYSTEMS; PROVIDING ACCESS TO ON-LINE DOCUMENT VAULTS; ADVISORY AND CONSULTANCY SERVICES IN RELATION TO TELECOMMUNICATIONS AND COMMUNICATIONS, INCLUDING COMPUTER, INTERNET, INTRANET AND/OR EXTRANET COMMUNICATIONS; PROVIDING MULTIPLE USER ACCESS TIME TO THE INTERNET; PROVISIONS OF ON-LINE BULLETIN BOARDS AND/OR ON-LINE INTERACTIVE BULLETIN BOARDS IN THE FIELDS OF FINANCIAL SERVICES, RETAIL SERVICES, INSURANCE SERVICES, WHOLESALE BANKING, RETAIL BANKING, OR BUSINESS, IN THE FIELDS OF COMPUTER SOFTWARE, AUTOMATION AND DATA PROCESSING, MANAGEMENT AND AUTOMATION OF HUMAN AND DOCUMENT WORKFLOW PROCESSES, IN CLASS 38 (U.S. CLS. 100, 101 AND 104).

FOR: CREATING AND MAINTAINING WEBSITES FOR OTHERS; HOSTING THE WEBSITES OF OTHERS; INSTALLATION AND MAINTENANCE OF COMPUTER SOFTWARE; TECHNICAL SUPPORT, NAMELY, REGULATING, CHECKING, MONITORING THE INTERNET, INTRANETS OR EXTRANETS INCLUDING WEB SERVERS, E-COMMERCE SERVERS, MAIL SERVERS, UNIFORM RESOURCE LOCATORS, ROUTERS AND/OR FIRE WALLS; TECHNICAL RESEARCH RELATING TO OR INVOLVING THE INTERNET, EXTRANET OR INTRANETS; TECHNICAL COMPLIANCE WITH STANDARDS, GUIDELINES AND LAWS RELATING TO THE INTERNET, EXTRANET OR INTRANETS INCLUDING WEB SERVERS, E-COMMERCE SERVERS, MAIL SERVERS, UNIFORM RESOURCE LOCATORS, ROUTERS AND/OR FIREWALLS; TECHNICAL SUPPORT, NAMELY, ON LINE AND INTERNET, INTRANET AND /OR EXTRANET BACK UP SERVICES FOR COMPUTER DATA AND STATISTICS; ADVISORY, CONSULTANCY, WARNING AND/OR PERFORMANCE REPORTING SERVICES IN RESPECT OF THE TECHNICAL FUNCTIONING AND PERFORMANCE OF THE INTERNET, EXTRANETS OR INTRANETS; CONSULTANCY IN THE FIELD OF INFORMATION TECHNOLOGY, COMPUTERS AND/OR COMMUNICATORS; TECHNICAL CONSULTANCY IN RELATION TO ON-LINE PAYMENTS METHODS; COMPUTER AIDED PHOTO DESIGN; PROFESSIONAL NON-BUSINESS CONSULTANCY NAMELY, COMPUTER CONSULTANCY; TECHNICAL COMPUTER SUPPORT SERVICES, NAMELY, TROUBLESHOOTING OF COMPUTER HARDWARE AND SOFTWARE PROBLEMS, AND MONITORING COMPUTER SYSTEMS; COMPUTER DATA RECOVERY SERVICES; COMPUTER PROGRAMMING FOR OTHERS; COMPUTER SYSTEM ANALYSIS; COMPUTER CONSULTANCY; RENTAL AND LEASING OF COMPUTER HARDWARE AND/OR OF COMPUTER SOFTWARE; PROVIDING

MAINTENANCE OF COMPUTER DATABASES; CONSULTANCY SERVICES RELATING TO INFORMATION STORAGE; TECHNICAL SUPPORT, NAMELY, TROUBLESHOOTING COMPUTER SOFTWARE PROBLEMS AND MONITORING COMPUTER SOFTWARE AND/OR MAINTENANCE OF COMPUTER SOFTWARE; DESIGN AND/OR DEVELOPMENT OF COMPUTER SOFTWARE, IN CLASS 42 (U.S. CLS. 100 AND 101).

THE MARK CONSISTS OF STANDARD CHARACTERS WITHOUT CLAIM TO ANY PARTICULAR FONT, STYLE, SIZE, OR COLOR.

PRIORITY CLAIMED UNDER SEC. 44(D) ON ERPN CMNTY TM OFC APPLICATION NO. 004048492, FILED 9-28-2004, REG. NO. 004048492, DATED 5-19-2006, EXPIRES 9-28-2014.

SER. NO. 78-518,367, FILED 11-17-2004.

KARANENDRA S. CHHINA, EXAMINING ATTORNEY

**Int. Cl.: 45**

**Prior U.S. Cls.: 100 and 101**

**United States Patent and Trademark Office**

**Reg. No. 3,467,815**

**Registered July 15, 2008**

**SERVICE MARK  
PRINCIPAL REGISTER**



BUCKNER, KRISTOPHER TODD (UNITED STATES CORPORATION)  
14979 PRAIRIE AVE.  
LAWNDALE, CA 90260

FOR: INTELLECTUAL PROPERTY DETECTIVE SERVICES AND PRIVATE INVESTIGATIVE SERVICES LIMITED TO THE AREA OF INTELLECTUAL PROPERTY, IN CLASS 45 (U.S. CLS. 100 AND 101).

FIRST USE 7-1-1994; IN COMMERCE 7-1-1994.

NO CLAIM IS MADE TO THE EXCLUSIVE RIGHT TO USE "INVESTIGATIVE CONSULTANTS", APART FROM THE MARK AS SHOWN.

THE COLOR(S) BLACK, WHITE, AND RED IS/ ARE CLAIMED AS A FEATURE OF THE MARK.

THE LARGE CIRCLE IS BLACK. THE LETTERING IN THE MARK IS RED. THE BACKGROUND IN THE MARK IS WHITE; THE SMALL CIRCLES AND THE CIRCLE INSIDE THE LARGE BLACK CIRCLE ARE ALSO WHITE.

SER. NO. 78-522,613, FILED 11-24-2004.

PAUL F. GAST, EXAMINING ATTORNEY



**Int. Cls.: 16, 35 and 36**

**Prior U.S. Cls.: 2, 5, 22, 23, 29, 37, 38, 50, 100, 101 and 102**

**Reg. No. 3,467,816**

**United States Patent and Trademark Office**

**Registered July 15, 2008**

**TRADEMARK  
SERVICE MARK  
PRINCIPAL REGISTER**



MAN GROUP PLC (UNITED KINGDOM CORPORATION)  
SUGAR QUAY  
LONDON, UNITED KINGDOM EC3R 6DU

FOR: PRINTED AND PAPER MATERIALS, NAMELY, BROCHURES, BOOKS, LEAFLETS, MAGAZINES, NEWSLETTERS, CALENDARS, AND BOOKMARKS IN THE FIELDS OF BANKING AND FINANCIAL SERVICES, IN CLASS 16 (U.S. CLS. 2, 5, 22, 23, 29, 37, 38 AND 50).

FOR: BUSINESS INFORMATION, CONSULTING AND MANAGEMENT SERVICES, EXCLUDING CONSULTING IN THE FIELD OF HUMAN RESOURCES, PERSONNEL MANAGEMENT AND EMPLOYMENT COUNSELING AND RECRUITING; ADVERTISING AND ADVERTISEMENT SERVICES, IN CLASS 35 (U.S. CLS. 100, 101 AND 102).

FOR: BANKING AND FINANCIAL SERVICES, NAMELY, BROKERAGE AND ON-LINE BROKERAGE SERVICES IN THE FIELDS OF BANKING, FINANCE, AND INVESTMENTS; COMMODITIES AND FUTURES BROKERAGE; BROKERAGE AND

MANAGEMENT OF FUTURES FUNDS, EQUITIES AND FOREIGN EXCHANGE TRANSACTIONS; TRADING AND ARBITRAGE OF DERIVATIVES; INVESTMENT FUND MANAGEMENT FOR OTHERS; MANAGEMENT OF INVESTMENT PRODUCTS, NAMELY, FUNDS; QUOTATION OF STOCK EXCHANGE PRICES; PROVIDING INFORMATION, ADVISORY, AND CONSULTANCY SERVICES RELATING TO THE AFORESAID SERVICES, IN THE FIELDS OF BANKING, FINANCE AND INVESTMENTS, IN CLASS 36 (U.S. CLS. 100, 101 AND 102).

OWNER OF UNITED KINGDOM REG. NO. 2332309, DATED 10-10-2003, EXPIRES 5-16-2013.

NO CLAIM IS MADE TO THE EXCLUSIVE RIGHT TO USE "FINANCIAL", APART FROM THE MARK AS SHOWN.

SER. NO. 78-526,986, FILED 12-3-2004.

SUSAN RICHARDS, EXAMINING ATTORNEY

**Int. Cls.: 9 and 36**

**Prior U.S. Cls.: 21, 23, 26, 36, 38, 100, 101 and 102**

**Reg. No. 3,467,817**

**United States Patent and Trademark Office**

**Registered July 15, 2008**

**TRADEMARK  
SERVICE MARK  
PRINCIPAL REGISTER**

**MODASOLUTIONS**

MODASOLUTIONS CORPORATION (CANADA CORPORATION)  
SUITE 125  
250 GREENBANK ROAD  
OTTAWA, CANADA K2H 8X4

FOR: COMPUTER SOFTWARE, NAMELY, ON-LINE PAYMENT GATEWAY SOFTWARE FOR PROCESSING AND TRANSMITTING BILL PAYMENT DATA OVER THE INTERNET FOR USE BY ONLINE RETAILERS, ONLINE AUCTION SITES AND THEIR CUSTOMERS, AND PRINTED DOCUMENTATION PROVIDED THEREWITH AS A PACKAGE, IN CLASS 9 (U.S. CLS. 21, 23, 26, 36 AND 38).

FOR: ELECTRONIC PAYMENT, NAMELY, PROCESSING AND TRANSMITTING BILL PAYMENT DATA IN THE NATURE OF HOSTING A SECURE ON-LINE BILLING GATEWAY FOR RECEIVING ORDER INFORMATION, GENERATING INVOL-

CES, PROCESSING PAYMENT INFORMATION AND CREATING AND FORWARDING RECEIPTS RELATING TO PURCHASE OF GOODS AND SERVICES ON THE INTERNET, IN CLASS 36 (U.S. CLS. 100, 101 AND 102).

THE MARK CONSISTS OF STANDARD CHARACTERS WITHOUT CLAIM TO ANY PARTICULAR FONT, STYLE, SIZE, OR COLOR.

PRIORITY CLAIMED UNDER SEC. 44(D) ON CANADA APPLICATION NO. 1239596, FILED 12-3-2004, REG. NO. TMA655724, DATED 12-22-2005, EXPIRES 12-22-2020.

SER. NO. 78-530,202, FILED 12-9-2004.

ALLISON SCHRODY, EXAMINING ATTORNEY

**Int. Cl.: 5**

**Prior U.S. Cls.: 6, 18, 44, 46, 51 and 52**

**Reg. No. 3,467,818**

**United States Patent and Trademark Office**

**Registered July 15, 2008**

**TRADEMARK  
PRINCIPAL REGISTER**

**DURVIK**

NOVARTIS AG (SWITZERLAND CORPORATION)  
4002  
BASEL, SWITZERLAND

FOR: PHARMACEUTICAL PREPARATIONS FOR THE PREVENTION AND TREATMENT OF DISORDERS OF THE NERVOUS SYSTEM, THE IMMUNE SYSTEM, THE CARDIOVASCULAR SYSTEM, THE RESPIRATORY SYSTEM, THE MUSCULOSKELETAL SYSTEM, THE GENITOURINARY SYSTEM, FOR THE TREATMENT OF INFLAMMATORY DISORDERS, FOR USE IN DERMATOLOGY, IN HEMATOLOGY, IN ONCOLOGY, IN TRANSPLANTATION, IN OPHTHALMOLOGY, FOR USE IN THE GASTROENTEROLOGICAL AREA AND THE PREVENTION AND TREATMENT OF OCULAR DISORDERS OR DISEASES; ANTI-

INFECTIVES, PHARMACEUTICAL PREPARATIONS TREATING BACTERIAL-BASED DISEASE, ANTIVIRALS, ANTIBIOTICS, AND ANTIFUNGALS; PHARMACEUTICAL PREPARATIONS, IN CLASS 5 (U.S. CLS. 6, 18, 44, 46, 51 AND 52).

THE MARK CONSISTS OF STANDARD CHARACTERS WITHOUT CLAIM TO ANY PARTICULAR FONT, STYLE, SIZE, OR COLOR.

OWNER OF SWITZERLAND REG. NO. 524070, DATED 6-30-2004, EXPIRES 6-30-2014.

SER. NO. 78-533,783, FILED 12-16-2004.

SUZANNE BLANE, EXAMINING ATTORNEY

**Int. Cl.: 3**

**Prior U.S. Cls.: 1, 4, 6, 50, 51 and 52**

**United States Patent and Trademark Office**

**Reg. No. 3,467,819**

**Registered July 15, 2008**

**TRADEMARK  
PRINCIPAL REGISTER**

**QUANTA BIO-COLOR  
DE LAFIER**

INDUSTRIA DE PRODUCTOS QUIMICOS Y  
COSMETICOS, C. POR A. (DOMINICAN REP  
CORPORATION)  
CALLE H, ZONA INDUSTRIAL DE HERRERA  
SANTO DOMINGO, DOMINICAN REP

FOR: HAIR DYES, HAIR SHAMPOOS AND HAIR  
CARE PREPARATIONS, IN CLASS 3 (U.S. CLS. 1, 4, 6,  
50, 51 AND 52).

THE MARK CONSISTS OF STANDARD CHAR-  
ACTERS WITHOUT CLAIM TO ANY PARTICULAR  
FONT, STYLE, SIZE, OR COLOR.

OWNER OF DOMINICAN REP REG. NO. 144094,  
DATED 10-15-2004, EXPIRES 10-15-2014.

OWNER OF U.S. REG. NO. 1,501,835.

THE FOREIGN WORDING IN THE MARK  
TRANSLATES INTO ENGLISH AS QUANTA BIO-  
COLOR OF LAFIER.

SER. NO. 78-534,991, FILED 12-18-2004.

DOMINICK J. SALEMI, EXAMINING ATTORNEY

**Int. Cl.: 2**

**Prior U.S. Cls.: 6, 11 and 16**

**United States Patent and Trademark Office**

**Reg. No. 3,467,820**

**Registered July 15, 2008**

**TRADEMARK  
PRINCIPAL REGISTER**



PPG KANSAI AUTOMOTIVE FINISHES TECHNOLOGY, LP (DELAWARE LIMITED PARTNERSHIP)  
1886 LYNNBURY WOODS ROAD  
DOVER, DE 19904

FOR: COATING COMPOSITIONS IN THE NATURE OF PAINT FOR APPLICATION TO VEHICLES, IN CLASS 2 (U.S. CLS. 6, 11 AND 16).

FIRST USE 11-12-2004; IN COMMERCE 11-12-2004.

NO CLAIM IS MADE TO THE EXCLUSIVE RIGHT TO USE "AUTOMOTIVE FINISHES", APART FROM THE MARK AS SHOWN.

THE MARK CONSISTS OF THE WORDS "AUTOMOTIVE FINISHES" ABOVE WHICH A VERTICAL RECTANGLE, DIAGONALLY DIVIDED BY THE LETTERS "P," "K," "A" AND "F" ADJACENT TO WHICH THE WORDS "PPG" AND "KANSAI" APPEAR.

SER. NO. 78-553,489, FILED 1-25-2005.

AMY GEARIN, EXAMINING ATTORNEY

Int. Cl.: 29

Prior U.S. Cl.: 46

United States Patent and Trademark Office

Reg. No. 3,467,821

Registered July 15, 2008

TRADEMARK  
PRINCIPAL REGISTER



MEGHANA FOODS, INC. (WASHINGTON CORPORATION)  
27410 SE 22ND WAY  
SAMMAMISH, WA 98075

FOR: FOOD AND DAIRY PRODUCTS, NAMELY, BUTTER, GHEE, CREAM, YOGURT AND CHEESE, IN CLASS 29 (U.S. CL. 46).

FIRST USE 10-10-2003; IN COMMERCE 10-10-2003.

NO CLAIM IS MADE TO THE EXCLUSIVE RIGHT TO USE "TAAZA" AND "FRESH", APART FROM THE MARK AS SHOWN.

THE COLOR(S) DARK BLUE, RED, BLACK AND YELLOW IS/ARE CLAIMED AS A FEATURE OF THE MARK.

THE COLOR DARK BLUE APPEARS IN THE TERM "TAAZA" AND IS OUTLINED IN RED SUPERIMPOSED OVER A SUN LIKE YELLOW BACKGROUND AND THE COLOR BLACK APPEARS IN THE TERMS "MEANS FRESH".

THE FOREIGN WORDING IN THE MARK TRANSLATES INTO ENGLISH AS FRESH.

SER. NO. 78-564,914, FILED 2-10-2005.

MICHELE SWAIN, EXAMINING ATTORNEY

**Int. Cl.: 30**

**Prior U.S. Cl.: 46**

**Reg. No. 3,467,822**

**United States Patent and Trademark Office**

**Registered July 15, 2008**

---

**TRADEMARK  
PRINCIPAL REGISTER**

**EVERYONE'S GOT A  
FAVORITE**

ENTENMANN'S PRODUCTS, INC. (DELAWARE  
CORPORATION)  
300 W. NORTH AVENUE  
NORTHLAKE, IL 60164

FOR: BAKERY PRODUCTS, NAMELY, CAKES,  
PASTRIES, PIES, DONUTS, COOKIES, MUFFINS,  
ROLLS, BISCUITS, CRACKERS, IN CLASS 30 (U.S.  
CL. 46).

FIRST USE 2-28-2005; IN COMMERCE 2-28-2005.

THE MARK CONSISTS OF STANDARD CHAR-  
ACTERS WITHOUT CLAIM TO ANY PARTICULAR  
FONT, STYLE, SIZE, OR COLOR.

SER. NO. 78-565,386, FILED 2-11-2005.

NORA BUCHANAN WILL, EXAMINING ATTOR-  
NEY

**Int. Cls.: 9 and 28**

**Prior U.S. Cls.: 21, 22, 23, 26, 36, 38 and 50**

**Reg. No. 3,467,823**

**United States Patent and Trademark Office**

**Registered July 15, 2008**

**TRADEMARK  
PRINCIPAL REGISTER**

**AFRICAN RICHES**

ATRONIC INTERNATIONAL GMBH (FED REP  
GERMANY CORPORATION)  
BORSIGSTRASSE 26  
32312 LÜBBECKE, FED REP GERMANY

FOR: ELECTRIC AND ELECTRONIC APPARATUS, INSTRUMENTS, DEVICES AND MACHINES NAMELY, COIN OPERATED GAMING AND GAMBLING MACHINES AND GAMING AND GAMBLING MACHINES OPERABLE WITH BILLS, MAGNETIC CARDS, COMPUTER CHIPS, MICRO-PROCESSOR DEVICES AND TOKENS; MECHANISMS FOR COIN OPERATED AND COIN CONTROLLED MACHINES, NAMELY MECHANICAL UNITS FOR DISPENSING COINS TO THE OPERATOR; APPARATUSES FOR BILLING OPERATIONS OF THE AFORE-STATED GAMING AND GAMBLING MACHINES, NAMELY COMPUTER HARDWARE AND SOFTWARE FOR GENERATING BILLS IN CONNECTION WITH COIN OPERATED GAMING MACHINES; AUTOMATED DATA STORAGE MACHINES IN THE NATURE OF COMPUTERS, COMPUTER DATA PRINTERS FOR DISPLAYING TOTAL WINNINGS IN FRONT OF GAMING MACHINES; ELECTRONIC PRINTED CIRCUIT BOARDS; COIN COUNTING AND SORTING MACHINES; VENDING MACHINES WHICH PROVIDE TOKENS, COUPONS AND GAME CARDS; ELECTRIC AND ELECTRONIC MACHINES AND APPARATUSES FOR GAMES, AMUSEMENT, ENTERTAINMENT AND GAMING, NAMELY, SLOT MACHINES, GAMING EQUIPMENT, NAMELY GAMING MACHINES, VIDEO SLOT MACHINES; CASINO GAMBLING DEVICES, NAMELY SLOT MACHINES AND STRUCTURAL PARTS THEREFOR; COIN DROP-DOWN CAROUSELS FOR SLOT MACHINES AND GAMING MACHINES; TV MONITORS, LCD-DISPLAY MONITORS FOR GAMBLING MACHINES; ELEC-

TRONIC CASINO GAME MACHINES; ELECTRIC AND ELECTRONIC GAMING AND GAMBLING MACHINES; GAMBLING MACHINES, NAMELY, BETTING MACHINES FOR BETTING ON JACKPOTS; COMPUTER GAME CASSETTES AND CARTRIDGES FOR ELECTRONIC POCKET GAMES, VIDEO GAME MACHINES FOR USE WITH TELEVISION; PRERECORDED DATA CARRIERS PROGRAMMED FOR ELECTRONIC VIDEO AND AUDIO DISPLAY FOR PLAYING ELECTRONIC GAMES, IN CLASS 9 (U.S. CLS. 21, 23, 26, 36 AND 38).

FOR: ELECTRIC AND ELECTRONIC STAND ALONE VIDEO MACHINES FEATURING GAMES-, AMUSEMENT AND SPORTS-AND ENTERTAINMENT ALL FOR USE INDIVIDUALLY OR AS A NETWORK, NAMELY, COIN-OPERATED STAND ALONE COMPACT VIDEO GAME SPORTS MACHINES FEATURING SPORTS ENTERTAINMENT; HANDHELD UNITS FOR PLAYING ELECTRONIC PARLOR GAMES; COIN OPERATED COMPACT VIDEO GAME SPORTS MACHINES FOR PLAYING IN SMALL AREAS, NAMELY, DARTS, TABLE SOCCER, POOL-BILLIARD, SNOOKER, SHOOTING GALLERIES, PINBALL GAMES; VIDEO GAMES AND INSTRUMENTS NAMELY, HAND HELD UNITS FOR PLAYING VIDEO GAMES; STAND ALONE VIDEO GAME MACHINES, IN CLASS 28 (U.S. CLS. 22, 23, 38 AND 50).

THE MARK CONSISTS OF STANDARD CHARACTERS WITHOUT CLAIM TO ANY PARTICULAR FONT, STYLE, SIZE, OR COLOR.

PRIORITY CLAIMED UNDER SEC. 44(D) ON ERPN CMNTY TM OFC APPLICATION NO. 004237061, FILED 2-17-2005, REG. NO. 004237061, DATED 4-19-2006, EXPIRES 2-17-2015.



SER. NO. 78-579,385, FILED 3-3-2005.

NELSON SNYDER, EXAMINING ATTORNEY

Int. Cls.: 18, 25, 32 and 33

Prior U.S. Cls.: 1, 2, 3, 22, 39, 41, 45, 46, 47, 48 and 49

Reg. No. 3,467,824

United States Patent and Trademark Office

Registered July 15, 2008

TRADEMARK  
PRINCIPAL REGISTER



JACKSON INTERNATIONAL TRADING COMPANY K. D. BRÜHL GESELLSCHAFT M.B.H. & CO. KG (AUSTRIA CORPORATION)  
SCHMIEDGASSE 12  
8010 GRAZ, AUSTRIA

FOR: ALPENSTOCKS, ANIMAL CARRIERS, BAGS, NAMELY, ALL PURPOSE SPORTS BAGS, ANIMAL HARNESSSES, ANIMAL LEASHES, ANIMAL SKINS AND HIDES, ALL PURPOSE ATHLETIC BAGS, INFANT CARRIERS WORN ON THE BODY, BACKPACKS, BEACH UMBRELLAS, BILLFOLDS, BITS FOR ANIMALS, HORSE BLANKETS, HORSE BLINDERS, BLINDERS FOR CHICKENS TO PREVENT FIGHTING, HAT BOXES FOR TRAVEL, HORSE BRIDLES, BRIEFCASES, ATTACHÉ CASES, CANE HANDLES, CANES, GUT FOR MAKING FOOD CASINGS, CAT O'NINE TAILS, CAT SCRATCHING POSTS, PURSES, DOG COLLARS, UMBRELLA COVERS, PET CUSHIONS, DOG CLOTHING, RAWHIDE CHEWS FOR DOGS, DRAWSTRING POUCHES, FRAMES FOR UMBRELLAS, FUR PELTS, HORSE HALTERS, CANE HANDLES, UMBRELLA HANDLES, HARNESSSES, HAVERSACKS, KNAPSACKS, LUGGAGE, MUZZLES, PARASOLS, BRIEFCASE-TYPE PORTFOLIOS, PORTMANTEAUS, FELT POUCHES, REINS, UMBRELLA RINGS, RUCKSACKS, SADDLERY, SATCHELS, ANIMAL SKINS, WALKING STICKS, HARNESS STRAPS, LUGGAGE TAGS, THONGS, VALISES, WALLETS, AND WHIPS, IN CLASS 18 (U.S. CLS. 1, 2, 3, 22 AND 41).

FOR: CLOTHING, NAMELY ANKLET SOCKS, PARKAS, ANORAKS, APRONS, ASCOTS, ATHLETIC FOOTWEAR, ATHLETIC SHOES, ATHLETIC UNIFORMS, BABUSHKAS, BABY BUNTING, SKI

BOOT BAGS, BANDANNAS, HEAD BANDS, NECK BANDS, BATHING SUITS, BATHING CAPS, BATHROBES, BEACH COVER-UPS, BEACH WEAR, BED JACKETS, CLOTHING BELTS, BERETS, CLOTH BIBS, BIKINIS, BLAZERS, BLOOMERS, BLOUSES, BLOUSONS, BOAS, BODY SHAPERS, BODY SUITS, BOLEROS, BONNETS, BOOTIES, BOOTS, BOTTOMS, BRAS, BRASSIERES, BREECHES, UNDERWEAR BRIEFS, BUSTIERS, CAFTANS, CAMISOLES, CAPES, CLOTHING CAPS, CARDIGANS, CASOCKS, CHAPS, CHEMISES, CLOGS, COATS, COLLARS, COMPETITOR'S NUMBERS OF TEXTILE, CORSELETS, CORSETS, HALLOWEEN COSTUMES, COVERALLS, COVER-UPS, CRAVATS, CREEPERS, CUFFS, CULOTTES, CUMMERBUNDS, CLOTH DIAPERS, DICKIES, DRESSES, GOWNS, DUNGAREES, DUSTERS, EAR MUFFS, ESPADRILLES, FOUL WEATHER GEAR, FOUNDATION GARMENTS, FROCKS, FUR COATS, GABARDINES, GAITERS, GALOSHES, GAUCHOS, FOUNDATION GARMENT GIRDLES, GLOVES, SHIRTS, OVERCOATS, SHORTS, GYM SUITS, MASQUERADE COSTUMES AND MASKS SOLD IN CONNECTION THEREWITH, HALTER TOPS, HATS, HEAD WEAR, HEEL INSERTS, HEELS, HOODS, HOSIERY, HOUSECOATS, INFANT WEAR, INNER SOLES, INSERTS, JACKETS, JEANS, JERSEYS, JODHPURS, JOGGING SUITS, JUMPERS, JUMPSUITS, KERCHIEFS, KILTS, KIMONOS, KNEE HIGHS, KNICKERS, LEG WARMERS, LEGGINGS, LEOTARDS, LINGERIE, LOUNGEWEAR, MAILLOTS, MANTILLAS, MANTLES, MITTENS, MOCCASINS, MUFFLERS, MUFFS, MUKLUKS, MUU MUUS, NECK BANDS, NECKERCHIEFS, NECKTIES, NECKWEAR, NEGLIGES, OVERALLS, SHOULDER PADS FOR CLOTHING, PAJAMAS, PANTALOONS, PANTIES, PANTS, PAN-

TYHOSE, PAREU, PARKAS, PEDAL PUSHERS, PEIGNOIRS, PINAFORE, POCKET SQUARES, PONCHOS, PULLOVERS, VESTS, RAIN WEAR, ROBES, ROMPERS, RUBBERS, SANDALS, SARONGS, SASHES, SCARVES, SHAWLS, SHIFTS, SHOES, SKIRTS, SKI WEAR, SLACKS, SLEEPWEAR, SLIPPERS, SLIPS, SMOCKS, SNEAKERS, SOCKS, INNER SOLES, STOCKINGS, STOLES, SUN VISORS, SUSPENDERS, SWEAT BANDS, SWEATERS, T-SHIRTS, TAILLEURS, TANGAS, TANK TOPS, TEDDIES, TENNIS WEAR, THERMAL UNDERWEAR, TIES, TIGHTS, TOE BOXES, TOGAS, TOPS, TORGUES, TRACKSUITS, TROUSERS, TUNICS, TUBANS, TUXEDOS, UNDERWEAR, UNIFORMS, UNITARDS, VEILS, VISORS, WRAPS AND ZORI, IN CLASS 25 (U.S. CLS. 22 AND 39).

FOR: BEERS; MINERAL WATER; CARBONATED AND NON-CARBONATED SOFT DRINKS; FRUIT DRINKS AND FRUIT JUICES; SYRUPS FOR MAKING SOFT DRINKS, IN CLASS 32 (U.S. CLS. 45, 46 AND 48).

FOR: ALCOHOLIC BEVERAGES; NAMELY SCOTCH, GIN, BRANDY, VODKA AND LIQUEUR, IN CLASS 33 (U.S. CLS. 47 AND 49).

OWNER OF AUSTRIA REG. NO. 239257, DATED 6-6-2007, EXPIRES 6-6-2017.

OWNER OF U.S. REG. NO. 2,818,593.

THE MARK CONSISTS OF THE WORDS "ROYAL COUNTRY LIFE" BENEATH A COAT OF ARMS WHERE TWO LIONS SURROUND A SHIELD ON WHICH THE LETTER B APPEARS, WITH A CROWN APPEARING AT THE TOP OF THE SHIELD AND EMPTY BANNER APPEARING AT THE BOTTOM OF THE SHIELD.

SER. NO. 78-581,884, FILED 3-7-2005.

JASON TURNER, EXAMINING ATTORNEY

**Int. Cl.: 25**

**Prior U.S. Cls.: 22 and 39**

**United States Patent and Trademark Office**

**Reg. No. 3,467,825**

**Registered July 15, 2008**

**TRADEMARK  
PRINCIPAL REGISTER**



B-YOUNG A/S (DENMARK CORPORATION)  
KOKBJERG 14  
KOLDING, DENMARK DK-6000

FOR: BATHING SUITS, BEACHWEAR, T-SHIRTS,  
SHIRTS, SHORTS, UNDERWEAR, SOCKS, STOCK-  
ING, DRESSING GOWNS, SKIRTS, PANTS, OVER-  
ALLS, JACKETS, VESTS, JERSEYS, JUMPERS,  
PULLOVERS; KNITWEAR, NAMELY, KNITTED  
SWEATERS, KNITTED PANTS, KNITTED SHIRTS  
AND KNITTED JACKETS; SWEATERS, SUITS,  
DRESSES, FROCKS, OVERCOATS, SCARFS, BELTS,

GLOVES; HEADWEAR; FOOTWEAR, IN CLASS 25  
(U.S. CLS. 22 AND 39).

PRIORITY CLAIMED UNDER SEC. 44(D) ON  
ERPN CMNTY TM OFC APPLICATION NO.  
004228995, FILED 1-5-2005, REG. NO. 004228995,  
DATED 2-7-2008, EXPIRES 1-5-2015.

SER. NO. 78-582,678, FILED 3-8-2005.

COLLEEN KEARNEY, EXAMINING ATTORNEY

**Int. Cl.: 35**

**Prior U.S. Cls.: 100, 101 and 102**

**United States Patent and Trademark Office**

**Reg. No. 3,467,826**

**Registered July 15, 2008**

**SERVICE MARK  
PRINCIPAL REGISTER**



EXECUTIVE TOUR AND TRAVEL SERVICES,  
INC. (FLORIDA CORPORATION)  
301 INDIGO DRIVE  
DAYTONA BEACH, FL 32114

FOR: ORGANIZING AND CONDUCTING IN-  
CENTIVE TRAVEL AWARD PROGRAMS TO PRO-  
MOTE THE SALE OF PRODUCTS AND SERVICES  
OF OTHERS, IN CLASS 35 (U.S. CLS. 100, 101 AND  
102).

FIRST USE 3-25-1996; IN COMMERCE 3-25-1996.

THE COLOR(S) BLUE, RED AND GOLDEN-YEL-  
LOW IS/ARE CLAIMED AS A FEATURE OF THE  
MARK.

THE MARK CONSISTS OF A STYLIZED GOLDEN  
YELLOW SHOOTING STAR BETWEEN THE BLUE  
WORDS "FLY FREE" AND THE RED WORD  
"AMERICA".

SEC. 2(F) AS TO "FLY FREE AMERICA".

SER. NO. 78-588,725, FILED 3-16-2005.

MICHELLE DUBOIS, EXAMINING ATTORNEY

Int. Cls.: 29 and 30

Prior U.S. Cl.: 46

United States Patent and Trademark Office

Reg. No. 3,467,827

Registered July 15, 2008

TRADEMARK  
PRINCIPAL REGISTER



PASSION FOR BETTER FOOD

VION N.V. (NETHERLANDS LTD LIAB CO)  
NCB WEG 10  
5681 RH BEST, NETHERLANDS

FOR: MEAT, SAUSAGE, FISH, POULTRY AND GAME, SEAFOOD; MEAT EXTRACTS; MEAT, SAUSAGE, FISH, POULTRY, GAME, FRUIT AND VEGETABLE PRESERVES; PRESERVED AND COOKED FRUITS AND VEGETABLES; JELLIES, PROCESSED POTATOES, NAMELY, PROCESSED POTATOES IN THE FORM OF INSTANT POTATO FLAKES, POTATOES POWDER, CROQUETS, CHIPS, FRIED POTATOES, POTATO DUMPLINGS; RÖSTI NAMELY, FRIED GRATED POTATO CAKES, POTATO PANCAKES, CRISPS, POTATO STICKS; JAMS; EGGS, MILK AND MILK PRODUCTS, NAMELY, BUTTER, MARGARINE, CHEESE, CREAM, YOGURT, QUARK, MILK POWDER FOR FOOD, MILK DRINKS WITH HIGH MILK CONTENT, KEFIR; EDIBLE OILS AND FATS, MAYONNAISE; SOUPS, MEAT STOCK, MEAT BROTH, STEWS, PROCESSED BEANS; PROCESSED SALTED AND UNSALTED NUTS, IN CLASS 29 (U.S. CL. 46).

FOR: COFFEE, ARTIFICIAL COFFEE, TEA, COCOA, COCOA SPREADS, COCOA MIXES OR COCOA BUTTER AND COCOA BASED INGREDIENTS FOR CONFECTIONARY PRODUCTS, POWDER CONTAINING COCOA FOR PREPARING DRINKS, RICE, TAPIOCA, SAGO; FLOUR AND PASTRIES MADE FROM CEREALS, DEHUSKED WHOLE GRAINS, IN PARTICULAR, WHEAT, OATS, BARLEY, RYE, MILLET, MAIZE AND BUCKWHEAT, AND WHEATBRAN, WHEATGERM, CORNMEAL, MAIZE SEMOLINA, LINSEED, MUESLI AND MUE-

SLI BARS CONSISTING OF CEREAL FLAKES, DRIED FRUITS AND NUTS, POPCORN, PASTA; NOODLES; PIZZAS; PIES OF MEAT, FISH GAME, FOIE GRAS, VEGETABLES AND FRUITS; BREAD TOAST, CRISPBREAD AND DRIED FLATBREAD, BREAD ROLLS, SMALL CAKES AND PATISSERIE, CAKES, CONFECTIONARY, TARTS AND BAKERY DESSERTS; ICE; HONEY, TREACLE; YEAST, BAKING POWDER, CUSTARD POWDER, BAKING FLAVORINGS, BAKING ESSENCES; SUGAR, CANDY SWEETS, CHEWING GUM, MARZIPAN, MARZIPAN SUBSTITUTES, NOUGAT, CHOCOLATE, MARZIPAN, NOUGAT AND CHOCOLATE PRODUCTS, SWEETS WITH A LIQUID FILLING, IN PARTICULAR OF WINES OR SPIRITS; SAVORY PASTRIES; FRUIT BASED SNACK FOOD, POTATO BASED SNACK FOOD, VEGETABLE BASED SNACK FOOD; SALT, PEPPER, MUSTARD, VINEGAR, SPICE SAUCES, SALAD DRESSINGS; SPICES; ICE, IN CLASS 30 (U.S. CL. 46).

PRIORITY CLAIMED UNDER SEC. 44(D) ON ERPN CMNTY TM OFC APPLICATION NO. 004337903, FILED 3-14-2005, REG. NO. 004337903, DATED 1-22-2007, EXPIRES 3-14-2015.

THE COLOR(S) GREEN AND BLUE IS/ARE CLAIMED AS A FEATURE OF THE MARK.

"THE MARK CONSISTS OF THE WORDING VION PASSION FOR BETTER FOOD IN BLUE FONT; SURROUNDING VION ARE TWO INCOMPLETE BUT INTERSECTING OVALS THE LEFT OF WHICH IS GREEN AND THE RIGHT OF WHICH IS

BLUE, THEY FORM A SHAPE SUGGESTING A  
"V".

SER. NO. 78-594,357, FILED 3-24-2005.

LINDA MICKLEBURGH, EXAMINING ATTORNEY

**Int. Cl.: 35**

**Prior U.S. Cls.: 100, 101 and 102**

**United States Patent and Trademark Office**

**Reg. No. 3,467,828**

**Registered July 15, 2008**

**SERVICE MARK  
PRINCIPAL REGISTER**

# Got Kosher?

GOT KOSHER, INC. (CALIFORNIA CORPORATION)  
1410 S. LIVONIA AVE.  
LOS ANGELES, CA 90035

FOR: WHOLESALE, INSTITUTIONAL AND RETAIL STORE SERVICES, ONLINE ORDERING SERVICES, MAIL ORDER SERVICES, ALL FEATURING GOURMET FOOD PRODUCTS SUCH AS SANDWICHES, MEALS, AND KOSHER FOODS, IN CLASS 35 (U.S. CLS. 100, 101 AND 102).

FIRST USE 1-1-2005; IN COMMERCE 2-1-2005.

THE MARK CONSISTS OF STANDARD CHARACTERS WITHOUT CLAIM TO ANY PARTICULAR FONT, STYLE, SIZE, OR COLOR.

NO CLAIM IS MADE TO THE EXCLUSIVE RIGHT TO USE "KOSHER", APART FROM THE MARK AS SHOWN.

SER. NO. 78-614,098, FILED 4-21-2005.

SHARON MEIER, EXAMINING ATTORNEY



**Int. Cl.: 36**

**Prior U.S. Cls.: 100, 101 and 102**

**United States Patent and Trademark Office**

**Reg. No. 3,467,829**

**Registered July 15, 2008**

**SERVICE MARK  
PRINCIPAL REGISTER**

**THE ATM/DEBIT NETWORK  
CHOICE!**

PULSE EFT ASSOCIATION LP (DELAWARE  
LIMITED PARTNERSHIP)  
1301 MCKINNEY, SUITE 2500  
HOUSTON, TX 77010

FOR: ELECTRONIC PAYMENTS, NAMELY,  
ELECTRONIC FUNDS TRANSFERS AND PAY-  
MENTS AT THE POINT-OF-SALE AND WHEN  
ORDERING GOODS AND SERVICES OVER A GLO-  
BAL COMPUTER NETWORK, ELECTRONIC  
BANKING SERVICES AND AUTOMATED TELLER  
MACHINE SERVICES, EXCLUDING CONSUMER-  
DIRECTED CREDIT CARD AND DEBIT CARD  
SERVICES, IN CLASS 36 (U.S. CLS. 100, 101 AND 102).

FIRST USE 5-11-2005; IN COMMERCE 5-11-2005.

THE MARK CONSISTS OF STANDARD CHAR-  
ACTERS WITHOUT CLAIM TO ANY PARTICULAR  
FONT, STYLE, SIZE, OR COLOR.

NO CLAIM IS MADE TO THE EXCLUSIVE  
RIGHT TO USE "ATM DEBIT NETWORK", APART  
FROM THE MARK AS SHOWN.

SER. NO. 78-631,243, FILED 5-17-2005.

KELLY BOULTON, EXAMINING ATTORNEY

Int. Cl.: 9

Prior U.S. Cls.: 21, 23, 26, 36 and 38

United States Patent and Trademark Office

Reg. No. 3,467,830

Registered July 15, 2008

TRADEMARK  
PRINCIPAL REGISTER

The logo for VisionTracker features the word "visiontracker" in a lowercase, sans-serif font. The "vision" part is in a dark purple color, and the "tracker" part is in a teal color. Above the "i" in "vision", there are five dots of varying sizes and colors (purple, teal, and light blue) arranged in a slight arc. Below the main text, the words "envision pharma" are written in a smaller, lowercase, sans-serif font in a teal color.

ENVISION PHARMA, INC. (CONNECTICUT CORPORATION)  
3530 POST ROAD  
SOUTHPORT, CT 06890

FOR: COMPUTER SOFTWARE AND DOWNLOADABLE COMPUTER SOFTWARE TO MANAGE THE SUBMISSION AND EVALUATION OF APPLICATIONS FOR INDEPENDENT MEDICAL RESEARCH GRANTS, AND MANAGE THE SCHEDULE AND BUDGET EXPECTATIONS OF GRANTS THAT HAVE BEEN APPROVED FOR FUNDING, IN CLASS 9 (U.S. CLS. 21, 23, 26, 36 AND 38).

FIRST USE 8-1-2002; IN COMMERCE 8-1-2002.

NO CLAIM IS MADE TO THE EXCLUSIVE RIGHT TO USE "PHARMA", APART FROM THE MARK AS SHOWN.

THE COLOR(S) GREEN AND PURPLE IS/ARE CLAIMED AS A FEATURE OF THE MARK.

THE TERM "VISION" IN THE MARK IS IN THE COLOR PURPLE. THE TERM "TRACKER" IN THE MARK IS IN THE COLOR GREEN. THE WORDS "ENVISION PHARMA" IN THE MARK ARE IN THE COLOR PURPLE. THE DESIGN ELEMENT CONSISTING OF FIVE DOTS SPANNING THE LETTERS "ISI" IN THE TERM "VISION" ARE IN SHADES OF GREEN AND PURPLE FROM LEFT TO RIGHT.

SER. NO. 78-638,818, FILED 5-27-2005.

SHANNON TWOHIG, EXAMINING ATTORNEY

**Int. Cl.: 9**

**Prior U.S. Cls.: 21, 23, 26, 36 and 38**

**United States Patent and Trademark Office**

**Reg. No. 3,467,831**

**Registered July 15, 2008**

**TRADEMARK  
PRINCIPAL REGISTER**

**SERENITI**

SERENITI INC. (DELAWARE CORPORATION)  
111 PAVONIA AVENUE  
SUITE 700  
JERSEY CITY, NJ 07310

FOR: COMPUTER PERIPHERALS, NAMELY, ROUTERS, AND SOFTWARE FOR USE IN MANAGING THE OPERATION, MAINTENANCE AND UPDATING OF COMPUTER SOFTWARE AND SYSTEMS, MANAGING INTERNET PROTOCOL (IP) NETWORK SERVICES, MANAGING HOSTED SERVICES, AND MANAGING THE OPERATION, MAINTENANCE AND UPDATING OF SOFTWARE APPLICATION SERVICES AND OPERATIONAL SUPPORT SYSTEMS (OSS'S), USED BY RESIDEN-

TIAL CONSUMERS, BUSINESSES AND PROVIDERS OF HIGH-SPEED ACCESS TO WIDE-AREA AND LOCAL-AREA NETWORKS AND THE INTERNET, IN CLASS 9 (U.S. CLS. 21, 23, 26, 36 AND 38).

FIRST USE 5-11-2005; IN COMMERCE 5-11-2005.

THE MARK CONSISTS OF STANDARD CHARACTERS WITHOUT CLAIM TO ANY PARTICULAR FONT, STYLE, SIZE, OR COLOR.

SER. NO. 78-640,303, FILED 5-31-2005.

DAVID ELTON, EXAMINING ATTORNEY

**Int. Cls.: 35 and 41**

**Prior U.S. Cls.: 100, 101, 102 and 107**

**United States Patent and Trademark Office**

**Reg. No. 3,467,832**

**Registered July 15, 2008**

**SERVICE MARK  
PRINCIPAL REGISTER**



INTERNATIONAL TENNIS HALL OF FAME  
(NEW YORK NON-PROFIT CORPORATION)  
OFFICE MANAGER  
NEWPORT, RI 02840

FOR: RETAIL STORE AND GIFT STORE SERVICES, FEATURING TENNIS RELATED BOOKS AND VIDEOS, TENNIS RELATED CLOTHING, PRODUCTS AND ACCESSORIES, IN CLASS 35 (U.S. CLS. 100, 101 AND 102).

FIRST USE 2-6-1977; IN COMMERCE 1-1-1988.

FOR: EDUCATIONAL AND ENTERTAINMENT SERVICES, NAMELY, OPERATION OF A TENNIS MUSEUM, ORGANIZING AND CONDUCTING PROGRAMS TO CELEBRATE AND RECORD THE ACHIEVEMENTS OF INDIVIDUAL TENNIS PLAYERS, AND ORGANIZING AND CONDUCTING TENNIS TOURNAMENTS AND CLASSES AND CLINICS FOR TENNIS, IN CLASS 41 (U.S. CLS. 100, 101 AND 107).

FIRST USE 2-6-1977; IN COMMERCE 1-1-1988.

OWNER OF U.S. REG. NO. 2,796,640.

NO CLAIM IS MADE TO THE EXCLUSIVE RIGHT TO USE "TENNIS HALL OF FAME", APART FROM THE MARK AS SHOWN.

THE COLORS RED, YELLOW, GREEN, BLACK, AND WHITE ARE CLAIMED AS A FEATURE OF THE MARK.

THE COLOR GREEN APPEARS IN THE BACKGROUND, IN THE TENNIS RACQUET ON THE LEFT SIDE, AND IN THE CHECKERBOARD PATTERN. THE COLOR YELLOW APPEARS IN THE WORDING, IN THE TROPHY ON THE LEFT SIDE, AND IN THE INNER OVAL BORDER. THE COLOR WHITE APPEARS IN THE OUTER OVAL BORDER AND IN THE TROPHY ON THE RIGHT SIDE. THE COLOR RED APPEARS IN THE CHECKERBOARD PATTERN AND IN THE TENNIS RACQUET ON THE RIGHT SIDE.

SEC. 2(F) AS TO "INTERNATIONAL".

SER. NO. 78-644,458, FILED 6-6-2005.

LEIGH CAROLINE CASE, EXAMINING ATTORNEY

**Int. Cl.: 1**

**Prior U.S. Cls.: 1, 5, 6, 10, 26 and 46**

**United States Patent and Trademark Office**

**Reg. No. 3,467,833**

**Registered July 15, 2008**

**TRADEMARK  
PRINCIPAL REGISTER**

**TRUCKER'S BEST**

BELL ADDITIVES, INC. (FLORIDA CORPORATION)  
1340 BENNETT DRIVE  
LONGWOOD, FL 32750

FOR: CHEMICAL DIESEL FUEL ADDITIVE, IN CLASS 1 (U.S. CLS. 1, 5, 6, 10, 26 AND 46).

FIRST USE 11-30-1995; IN COMMERCE 11-30-1995.

THE MARK CONSISTS OF STANDARD CHARACTERS WITHOUT CLAIM TO ANY PARTICULAR FONT, STYLE, SIZE, OR COLOR.

SEC. 2(F).

SER. NO. 78-648,262, FILED 6-10-2005.

JASON ROTH, EXAMINING ATTORNEY

**Int. Cl.: 9**

**Prior U.S. Cls.: 21, 23, 26, 36 and 38**

**Reg. No. 3,467,834**

**United States Patent and Trademark Office**

**Registered July 15, 2008**

**TRADEMARK  
PRINCIPAL REGISTER**



SAMSUNG SDI CO., LTD. (REPUBLIC OF KOREA LIMITED LIABILITY COMPANY)  
575, SHIN-DONG, YEONGTONG-GU  
SUWON-SI, GYEONGGI-DO, REPUBLIC OF KOREA

FOR: MONITORS FOR COMPUTER; CATHODE RAY TUBES; PLASMA DISPLAY PANELS; COMPUTERS; ELECTRIC DISCHARGE TUBES OTHER THAN FOR LIGHTING; TV RECEIVERS; FIELD EMISSION DISPLAYS, IN CLASS 9 (U.S. CLS. 21, 23, 26, 36 AND 38).

OWNER OF REPUBLIC OF KOREA REG. NO. 0702625, DATED 3-16-2007, EXPIRES 3-16-2017.

THE COLORS GREEN AND WHITE ARE CLAIMED AS A FEATURE OF THE MARK.

THE COLOR GREEN APPEARS IN THE TWO OVERLAPPING OVALS AND THE LEAF ON TOP OF THE LARGER OVAL. THE COLOR WHITE APPEARS IN THE WORDS "WELL GREEN".

SER. NO. 78-651,563, FILED 6-15-2005.

WENDY JUN, EXAMINING ATTORNEY

**Int. Cls.: 9, 16, 38, 40, 41 and 42**

**Prior U.S. Cls.: 2, 5, 21, 22, 23, 26, 29, 36, 37, 38, 50,  
100, 101, 103, 104, 106 and 107**

**Reg. No. 3,467,835**

**United States Patent and Trademark Office**

**Registered July 15, 2008**

**TRADEMARK  
SERVICE MARK  
PRINCIPAL REGISTER**

# lawlex

LOUIS VOGEL (FRANCE INDIVIDUAL)  
6, AVENUE PIERRE LER DE SERBIE  
PARIS, FRANCE 75116

FOR: APPARATUS FOR RECORDING, TRANSMISSION, AND REPRODUCTION OF SOUND AND PICTURES, NAMELY, DIGITAL VIDEO RECORDERS, DVD PLAYERS, CD PLAYERS, MAGNETOPHONES, DICTAPHONES, AND MP3 PLAYERS; MAGNETIC RECORDING MEDIA AND ACOUSTIC DISKS ESPECIALLY IN THE JUDICIAL, FISCAL AND FINANCIAL AREAS, NAMELY, PRE-RECORDED COMPACT OPTICAL DISKS FEATURING JUDICIAL, FISCAL AND FINANCIAL INFORMATION AND ELECTRONIC PUBLICATIONS, FEATURING JUDICIAL, FISCAL AND FINANCIAL INFORMATION, THAT ARE DOWNLOADABLE FROM ELECTRONIC DATABASES OR FROM RESOURCES SUPPLIED ON THE INTERNET, INCLUDING WEB SITES; PRE-RECORDED COMPACT DIGITAL DISKS AND FLOPPY COMPUTER DISKS FEATURING JUDICIAL, FISCAL AND FINANCIAL INFORMATION; COMPUTER SOFTWARE ALLOWING A SEARCH FOR DATA, IN PARTICULAR IN THE JUDICIAL, FISCAL AND FINANCIAL FIELDS; COMPUTER SOFTWARE DOWNLOADABLE FROM THE INTERNET IN THE FIELD OF LEGAL, FISCAL AND FINANCIAL INFORMATION INTENDED FOR LEGAL SPECIALISTS, IN CLASS 9 (U.S. CLS. 21, 23, 26, 36 AND 38).

FOR: PRINTED PRODUCTS, NAMELY, BOOKS, MAGAZINES, NEWSPAPERS, BOOKS FEATURING REVIEWS, BROCHURES, HANDBOOKS, BOOKLETS, AND BOOKS FEATURING OPUSCULES ALL IN THE FIELD OF LEGAL, FISCAL AND FINANCIAL INFORMATION; PROFESSIONAL PUBLICATIONS, NAMELY, JOURNALS IN THE

JUDICIAL, FISCAL AND FINANCIAL AREAS; PAPERS, NAMELY, COPY PAPERS, COLOR PAPERS, PRINTING PAPERS; CARDBOARD CARTONS; PHOTOGRAPHIC AND STATIONERY ITEMS, NAMELY, PHOTOGRAPHS, STATIONERY, ENVELOPES, FOLDERS; TRAINING AND TEACHING EQUIPMENT WITH THE EXCEPTION OF APPARATUS, NAMELY, PRINTED INSTRUCTIONAL AND TEACHING MATERIALS AND GUIDES IN THE JUDICIAL, FISCAL AND FINANCIAL AREAS, IN CLASS 16 (U.S. CLS. 2, 5, 22, 23, 29, 37, 38 AND 50).

FOR: TELECOMMUNICATIONS, PRESS AND INFORMATION AGENCIES, NAMELY, NEWS AGENCIES INVOLVED IN THE TRANSMISSION OF NEWS ITEMS TO NEWS REPORTING ORGANIZATIONS; COMMUNICATION BY COMPUTER TERMINALS, NAMELY, ELECTRONIC TRANSMISSION OF DATA, MESSAGES, DOCUMENTS, IMAGES, SIGNALS AND VOICE; INFORMATION TELECOMMUNICATION SERVICES INCLUDING WEB PAGES, NAMELY, PROVIDING WEB SITES FEATURING TELECOMMUNICATION INFORMATION IN THE FIELDS OF TELECOMMUNICATION NETWORKS AND ELECTRONIC TRANSMISSIONS; TELECOMMUNICATION SERVICES BY COMPUTER PROGRAMS AND OF ALL OTHER DATA, NAMELY, TELECOMMUNICATION GATEWAY SERVICES; TELECOMMUNICATION SERVICES SUPPLIED THROUGH THE INTERNET, NAMELY, TELECOMMUNICATION ACCESS SERVICES AND PROVIDING ELECTRONIC TELECOMMUNICATION CONNECTIONS; ELECTRONIC AND COMPUTER MAIL AND MESSAGING SERVICES; ORGANIZATION OF DISCUSSION FORUMS AND INFORMATION SUPPLY AND NEWS SERVICES ON THE INTERNET, NAMELY, PROVIDING ONLINE ELECTRONIC BULLETIN BOARDS AND

CHAT ROOMS FOR TRANSMISSION OF MESSAGES AMONG COMPUTER USERS IN THE FIELD OF LEGAL, FISCAL AND FINANCIAL INFORMATION; SUPPLY OF ACCESS BY TELECOMMUNICATIONS AND CONNECTION TO A COMPUTER DATABASE OR TO THE INTERNET, NAMELY, TELECOMMUNICATION ACCESS SERVICES, PROVIDING ELECTRONIC TELECOMMUNICATION CONNECTIONS, AND TRANSMISSION OF DATABASE INFORMATION VIA TELECOMMUNICATION NETWORKS, IN CLASS 38 (U.S. CLS. 100, 101 AND 104).

FOR: PRINTING SERVICES, IN CLASS 40 (U.S. CLS. 100, 103 AND 106).

FOR: EDUCATION, NAMELY, PROVIDING SEMINARS AND CONFERENCES IN THE JUDICIAL, FISCAL AND FINANCIAL AREAS; TRAINING IN THE JUDICIAL, FISCAL AND FINANCIAL AREAS; TRAINING SERVICES IN THE JUDICIAL, FISCAL AND FINANCIAL FIELDS VIA ON LINE FROM A COMPUTER DATABASE OR THE INTERNET; PUBLISHING OF BOOKS AND MAGAZINES; BOOK LOANING; ORGANIZATION OF COMPETITIONS IN THE FIELD OF EDUCATION; ORGANIZATION AND MANAGEMENT OF

COLLOQUIUMS, CONFERENCES, CONGRESSES IN THE JUDICIAL, FISCAL AND FINANCIAL FIELDS; ORGANIZATION OF EXHIBITIONS FOR CULTURAL OR EDUCATIONAL PURPOSES IN THE JUDICIAL, FISCAL AND FINANCIAL FIELDS; PROVIDING ON-LINE PUBLICATIONS IN THE NATURE OF BOOKS, MAGAZINES, NEWSLETTERS AND NEWSPAPERS IN THE FIELDS OF LEGAL, FISCAL AND FINANCIAL INFORMATION, IN CLASS 41 (U.S. CLS. 100, 101 AND 107).

FOR: JUDICIAL SERVICES, NAMELY, LEGAL SERVICES; PROGRAMMING FOR COMPUTERS; COMPUTER SERVICES, NAMELY, ACTING AS AN APPLICATION SERVICE PROVIDER IN THE FIELD OF KNOWLEDGE MANAGEMENT TO HOST COMPUTER APPLICATION SOFTWARE FOR SEARCHING AND RETRIEVING INFORMATION FROM DATABASES AND COMPUTER NETWORKS, IN CLASS 42 (U.S. CLS. 100 AND 101).

OWNER OF FRANCE REG. NO. 003021033, DATED 9-15-2000, EXPIRES 4-12-2010.

SER. NO. 78-663,579, FILED 7-5-2005.

SOPHIA S. KIM, EXAMINING ATTORNEY



**Int. Cl.: 9**

**Prior U.S. Cls.: 21, 23, 26, 36 and 38**

**United States Patent and Trademark Office**

**Reg. No. 3,467,836**

**Registered July 15, 2008**

---

**TRADEMARK  
PRINCIPAL REGISTER**

**Pinnacle**

RESTEK CORPORATION (PENNSYLVANIA  
CORPORATION)  
110 BENNER CIRCLE  
BELLEFONTE, PA 16823

THE MARK CONSISTS OF STANDARD CHAR-  
ACTERS WITHOUT CLAIM TO ANY PARTICULAR  
FONT, STYLE, SIZE, OR COLOR.

FOR: HIGH PRESSURE LIQUID CHROMATO-  
GRAPHY COLUMNS FOR CHEMICAL ANALYSIS,  
IN CLASS 9 (U.S. CLS. 21, 23, 26, 36 AND 38).

SER. NO. 78-669,095, FILED 7-13-2005.

FIRST USE 7-1-1995; IN COMMERCE 7-1-1995.

DAVID YONTEF, EXAMINING ATTORNEY

**Int. Cls.: 9 and 10**

**Prior U.S. Cls.: 21, 23, 26, 36, 38, 39 and 44**

**United States Patent and Trademark Office**

**Reg. No. 3,467,837**

**Registered July 15, 2008**

**TRADEMARK  
PRINCIPAL REGISTER**

**FORTUNA UNIVERSAL**

POULTEN & GRAF GMBH (FED REP GERMA-  
NY CORPORATION)  
AM BILDACKER 3-7  
WERTHEIM/MAIN, FED REP GERMANY 97877

FOR: LABORATORY EQUIPMENT MADE OF  
GLASS OR PLASTICS, NAMELY, SYRINGES, PIP-  
ETTES AND DISPENSERS; REUSABLE DISPENSER  
SYRINGES FOR LABORATORY USE, NAMELY,  
GRADUATED AND NON-GRADUATED SYRIN-  
GES COMPRISING GLASS CYLINDERS AND  
GLASS METAL PLUNGERS FOR LABORATORY  
REQUIREMENTS; DISPENSERS, NAMELY, DIS-  
PENSERS USED IN PROFESSIONAL LABORATOR-  
IES FOR DISPENSING AGGRESSIVE LIQUIDS FOR  
USE IN CHEMICAL OR MEDICAL ANALYSIS;  
METERING DEVICES FOR METERING LIQUIDS,  
NAMELY, METERING DEVICES FOR USE IN CHE-  
MICAL OR MEDICAL ANALYSIS; PRECISION ME-  
TERING DEVICES FOR LABORATORY  
REQUIREMENTS, NAMELY, VOLUMETRIC  
FLASKS, MEASURING CYLINDERS, PIPETTES,  
BURETTES , IN CLASS 9 (U.S. CLS. 21, 23, 26, 36  
AND 38).

FOR: MEDICAL SYRINGES, NAMELY, GRADU-  
ATED AND NON-GRADUATED SYRINGES COM-  
PRISING GLASS CYLINDERS AND GLASS OR  
METAL PLUNGERS; DISPOSABLE AND MEDICAL  
SYRINGES, NAMELY, DISPOSABLE SYRINGES  
MADE OF GLASS OR PLASTICS FOR MEDICAL  
REQUIREMENTS, IN CLASS 10 (U.S. CLS. 26, 39  
AND 44).

THE MARK CONSISTS OF STANDARD CHAR-  
ACTERS WITHOUT CLAIM TO ANY PARTICULAR  
FONT, STYLE, SIZE, OR COLOR.

PRIORITY CLAIMED UNDER SEC. 44(D) ON  
ERPNTY TM OFC APPLICATION NO.  
004386694, FILED 4-13-2005, REG. NO. 004386694,  
DATED 4-26-2006, EXPIRES 4-13-2015.

SER. NO. 78-670,160, FILED 7-14-2005.

ALYSSA PALADINO, EXAMINING ATTORNEY

**Int. Cls.: 9 and 10**

**Prior U.S. Cls.: 21, 23, 26, 36, 38, 39 and 44**

**Reg. No. 3,467,838**

**United States Patent and Trademark Office**

**Registered July 15, 2008**

**TRADEMARK  
PRINCIPAL REGISTER**

**UNIFIX**

POULTEN & GRAF GMBH (FED REP GERMA-  
NY CORPORATION)  
AM BILDACKER 3-7  
WERTHEIM/MAIN, FED REP GERMANY 97877

FOR: DISPOSABLE REUSABLE DISPENSER SYR-  
INGES FOR USE IN LABORATORIES, NAMELY,  
GRADUATED AND NON-GRADUATED SYRIN-  
GES COMPRISING GLASS CYLINDERS AND  
GLASS METAL PLUNGERS; DISPOSABLE DISPEN-  
SERS FOR USE IN LABORATORIES; METERING  
DEVICES FOR METERING LIQUIDS, NAMELY,  
FOR MEASURING THE DOSAGE OF LIQUIDS;  
PRECISION METERING DOSAGE DISPENSERS  
FOR USE IN LABORATORIES, IN CLASS 9 (U.S.  
CLS. 21, 23, 26, 36 AND 38).

FOR: SYRINGES FOR MEDICAL USE, NAMELY,  
GRADUATED AND NON-GRADUATED COMPRIS-

ING GLASS CYLINDERS AND GLASS OR METAL  
PLUNGERS; DISPOSABLE SYRINGES MADE OF  
GLASS OR PLASTICS FOR MEDICAL USE, IN  
CLASS 10 (U.S. CLS. 26, 39 AND 44).

THE MARK CONSISTS OF STANDARD CHAR-  
ACTERS WITHOUT CLAIM TO ANY PARTICULAR  
FONT, STYLE, SIZE, OR COLOR.

PRIORITY CLAIMED UNDER SEC. 44(D) ON  
ERPNTY TM OFC APPLICATION NO.  
004394227, FILED 4-19-2005, REG. NO. 004394227,  
DATED 5-2-2006, EXPIRES 4-19-2015.

SER. NO. 78-670,215, FILED 7-14-2005.

ALYSSA PALADINO, EXAMINING ATTORNEY

Int. Cl.: 43

Prior U.S. Cls.: 100 and 101

United States Patent and Trademark Office

Reg. No. 3,467,839

Registered July 15, 2008

**SERVICE MARK  
PRINCIPAL REGISTER**



L & L FRANCHISE, INC. (HAWAII CORPORATION)

931 UNIVERSITY AVE., STE. 202  
HONOLULU, HI 96813

FOR: RESTAURANTS AND RESTAURANT SERVICES, NAMELY, FAST FOOD, SELF-SERVICE AND TAKE OUT RESTAURANTS AND RESTAURANT SERVICES, IN CLASS 43 (U.S. CLS. 100 AND 101).

FIRST USE 2-4-2005, THE MARK WAS FIRST USED ANYWHERE IN A DIFFERENT FORM OTHER THAN THAT SOUGHT TO BE REGISTERED ON 06/01/1991.; IN COMMERCE 2-4-2005, THE MARK WAS FIRST USED IN COMMERCE IN A DIFFERENT FORM OTHER THAN THAT SOUGHT TO BE REGISTERED ON 03/01/1999..

OWNER OF U.S. REG. NOS. 2,371,282, 2,953,874 AND OTHERS.

NO CLAIM IS MADE TO THE EXCLUSIVE RIGHT TO USE "BARBECUE", APART FROM THE MARK AS SHOWN.

THE COLOR(S) YELLOW, RED, WHITE AND BLACK IS/ARE CLAIMED AS A FEATURE OF THE MARK.

THE MARK CONSISTS OF THE YELLOW WORDING "L & L HAWAIIAN BARBECUE" IN THE CENTER OF A RED SURFBOARD WITH WHITE STRIPES ABOVE AND BELOW THE WORDING, AND A WHITE BORDER. THE SURFBOARD, WORDING, AND STRIPES ARE OUTLINED IN BLACK.

SEC. 2(F) AS TO "HAWAIIAN BARBECUE".

SER. NO. 78-671,756, FILED 7-15-2005.

LYDIA BELZER, EXAMINING ATTORNEY

**Int. Cl.: 20**

**Prior U.S. Cls.: 2, 13, 22, 25, 32 and 50**

**Reg. No. 3,467,840**

**United States Patent and Trademark Office**

**Registered July 15, 2008**

**TRADEMARK  
PRINCIPAL REGISTER**

**DOB**

HANSSEM CO., LTD. (REPUBLIC OF KOREA CORPORATION)  
665, SUNGKOK-DONG, DANWON-GU, ANSAN  
KYUNGKI-DO, REPUBLIC OF KOREA 425-836

FOR: MEERSCHAUM; YELLOW AMBER, NAME-  
LY, PIECES OF AMBER USED AS DECORATION  
ON FURNITURE, FURNITURE HANDLES, TABLE  
TOPS AND JEWELRY CASES; INFLATABLE PUB-  
LICITY OBJECTS; UPRIGHT SIGNBOARDS OF  
WOOD AND PLASTIC; PLACARDS OF WOOD  
AND PLASTIC; IDENTIFICATION WRIST-BANDS,  
NOT OF METAL, FOR HOSPITALS; LICENSE  
PLATES, NOT OF METAL; PLASTIC LABELS FOR  
INSTITUTE NUMBERING, NOT OF METAL; RE-  
GISTRATION PLATES, NOT OF METAL; NAME-  
PLATES, NOT OF METAL; DOOR NAMEPLATES,  
NOT OF METAL; NUMBER-PLATES, NOT OF ME-  
TAL; IDENTITY PLATES, NOT OF METAL; PLAS-  
TIC LABELS FOR OPERATION METHOD DISPLAY,  
NOT OF METAL; FLAGPOLES; MEMORIAL CUPS,  
NAMELY, NON METAL CUPS USED TO HOLD  
FLAGS ON TOP OF MEMORIAL STONES, NOT OF  
METAL; MEMORIAL TABLETS, NOT OF METAL,  
NAMELY, PLACARDS TO BE USED ON MEMOR-  
IAL STONES; DOG KENNELS; KENNELS FOR  
HOUSEHOLD PETS; PET CUSHIONS; WALL LAD-  
DERS, NOT OF METAL; LADDERS, NOT OF ME-  
TAL; LADDERS FOR LIBRARY, NOT OF METAL;  
BOXES MADE OF WOOD; BOXES MADE OF PLAS-  
TIC; SEALING CAPS OF WOOD AND PLASTIC;  
BOTTLE CAPS OF WOOD AND PLASTIC; BOTTLE  
STOPPERS OF WOOD AND PLASTIC; LIDS OF  
WOOD AND PLASTIC, FOR PACKING; STOPPERS  
OF WOOD AND PLASTIC, FOR PACKING; TRES-  
TLE TABLES; LECTERNS; MIRRORS; SEATS;  
DRESSERS; DIVANS; LOCKERS; HAT STANDS;  
BENCHES; ORIENTAL FOLDING PARTITION  
SCREENS; SIDEBOARDS; JEWELRY CASES, NOT  
OF PRECIOUS METAL; WATER BEDS, NOT FOR  
MEDICAL PURPOSES; THREE-MIRROR DRES-  
SING TABLES; BOOKSHELVES; FILING CABINETS;

RACKS NAMELY, COAT RACKS, DISPLAY  
RACKS, SHOE RACKS; SETTEES; SOFAS; DINING  
TABLES; NEWSPAPER DISPLAY STANDS; SHOE  
CABINETS; EASY CHAIRS; NON-METAL KEY  
RACKS, BOARDS AND CABINETS FOR THE PLAC-  
EMENT OF KEYS; CLOTHES HANGERS; UM-  
BRELLA STANDS; MEDICINE CABINETS;  
CHAIRS; NON-METAL CLOTHES CHESTS; CABI-  
NETS FOR HAIRDRESSING AND BEAUTY SUP-  
PLIES; LOUNGE CHAIRS; WARDROBES; DISPLAY  
STANDS; SHOWCASES, NAMELY, DISPLAY  
CASES; CUPBOARDS; TEA CABINETS; PLASTIC  
BOOK BOXES; BOOKSTANDS; DESKS; BOOK  
RESTS; FULL-LENGTH MIRRORS; BEDS; TABLES;  
ARMCHAIRS; PIANO STOOL; FLOWER-POT PED-  
ESTALS; DRESSING TABLES; INTERIOR WINDOW  
BLINDS, NAMELY, WOVEN TIMBER BLINDS,  
SLATTED INDOOR BLINDS, BLINDS OF REED,  
RATTAN OR BAMBOO, AND INDOOR WINDOW  
BLINDS; PICTURE FRAMES; PICTURE FRAMES  
WIND CHIMES; FURNITURE FOR GARDENS,  
NAMELY, PINWHEELS FOR GARDEN DECORA-  
TION, NOT OF METAL; MATTRESS; BANGSUK  
KOREAN CUSHIONS; PILLOWS; CRADLES; CUSH-  
IONS; HAND-HELD FLAT FANS; SCREWS, NOT OF  
METAL; NUTS, NOT OF METAL; RIVETS, NOT OF  
METAL; NAILS, NOT OF METAL; BOLTS, NOT OF  
METAL; WASHERS, NOT OF METAL AND NOT OF  
RUBBER OR VULCANIZED FIBERS FOR CON-  
STRUCTING FURNITURE, CABINETRY, SHEL-  
VING AND RACKS; LOCKS NOT OF METAL AND  
NOT ELECTRIC; CURTAIN RAILS; NON-METAL  
CURTAIN ROLLERS; CURTAIN RINGS; CURTAIN  
RODS; CURTAIN HOOKS; ANCHOR BOLTS FOR  
BRIDGE CONNECTING, NOT OF METAL; FLOOR  
HINGES, NOT OF METAL; HINGES OF PLASTIC;  
MIRROR TILES; DRAUGHT-MAN'S TABLES;  
HAIRDRESSERS' CHAIRS; PLAYPENS FOR BA-  
BIES; INFANT WALKERS; TENT PEGS, NOT OF  
METAL; SLEEPING BAGS FOR CAMPING; NON-  
MAGNETIC KEY CARDS OF PLASTICS; STATUES  
OF THE VIRGIN MARY MADE OF WOOD; STA-

TUES OF THE VIRGIN MARY MADE OF WAX; STATUES OF THE VIRGIN MARY MADE OF PLASTER; STATUES OF THE VIRGIN MARY MADE OF PLASTICS; STATUES OF BUDDHA MADE OF WOOD; STATUES OF BUDDHA MADE OF WAX; STATUES OF BUDDHA MADE OF PLASTER; STATUES OF BUDDHA MADE OF PLASTICS; STATUES OF JESUS CHRIST MADE OF WOOD; STATUES OF JESUS CHRIST MADE OF WAX; STATUES OF JESUS CHRIST MADE OF PLASTER; STATUES OF JESUS CHRIST MADE OF PLASTICS; SCULPTURES MADE OF WOOD; SCULPTURES MADE OF WAX; SCULPTURES MADE OF PLASTER; SCULPTURES MADE OF PLASTIC; TAILORS' DUMMIES; MANNEQUINS FOR CLOTHING DIS-

PLAY; DRESSMAKERS' DUMMIES , IN CLASS 20 (U.S. CLS. 2, 13, 22, 25, 32 AND 50).

THE MARK CONSISTS OF STANDARD CHARACTERS WITHOUT CLAIM TO ANY PARTICULAR FONT, STYLE, SIZE, OR COLOR.

PRIORITY CLAIMED UNDER SEC. 44(D) ON REPUBLIC OF KOREA APPLICATION NO. 402005022238, FILED 5-18-2005, REG. NO. 40-0666298, DATED 6-14-2006, EXPIRES 6-14-2016.

SER. NO. 78-680,264, FILED 7-28-2005.

DAVID YONTEF, EXAMINING ATTORNEY

**Int. Cl.: 28**

**Prior U.S. Cls.: 22, 23, 38 and 50**

**United States Patent and Trademark Office**

**Reg. No. 3,467,841**

**Registered July 15, 2008**

**TRADEMARK  
PRINCIPAL REGISTER**

**PAWPARAZZI**

NOODLE HEAD INC. (CALIFORNIA CORPORATION)  
1616 STATE ST  
SANTA BARBARA, CA 93101

FOR: CHILDREN'S MULTIPLE ACTIVITY TOYS,  
IN CLASS 28 (U.S. CLS. 22, 23, 38 AND 50).

FIRST USE 7-15-2005; IN COMMERCE 7-15-2005.

THE MARK CONSISTS OF STANDARD CHARACTERS WITHOUT CLAIM TO ANY PARTICULAR FONT, STYLE, SIZE, OR COLOR.

SER. NO. 78-683,730, FILED 8-2-2005.

JANICE L. MCMORROW, EXAMINING ATTORNEY

**Int. Cl.: 37**

**Prior U.S. Cls.: 100, 103 and 106**

**United States Patent and Trademark Office**

**Reg. No. 3,467,842**

**Registered July 15, 2008**

**SERVICE MARK  
PRINCIPAL REGISTER**

**WE CARE MORE**

NEFF RENTAL, INC. (FLORIDA CORPORATION)  
SUITE 400  
3750 N.W. 87TH AVENUE  
MIAMI, FL 33178

THE MARK CONSISTS OF STANDARD CHARACTERS WITHOUT CLAIM TO ANY PARTICULAR FONT, STYLE, SIZE, OR COLOR.

FOR: RENTAL AND LEASING OF CONSTRUCTION AND INDUSTRIAL BUILDING EQUIPMENT, IN CLASS 37 (U.S. CLS. 100, 103 AND 106).

SER. NO. 78-697,473, FILED 8-22-2005.

FIRST USE 6-1-2005; IN COMMERCE 6-1-2005.

THEODORE MCBRIDE, EXAMINING ATTORNEY



**Int. Cls.: 36, 37 and 41**

**Prior U.S. Cls.: 100, 101, 102, 103, 106 and 107**

**United States Patent and Trademark Office**

**Reg. No. 3,467,843**

**Registered July 15, 2008**

**SERVICE MARK  
PRINCIPAL REGISTER**



AIG BAKER ORANGE BEACH WHARF, L.L.C.  
(DELAWARE LTD LIAB CO)  
1701 LEE BRANCH LANE  
BIRMINGHAM, AL 35242

FOR: REAL ESTATE MANAGEMENT SERVICES FOR MIXED-USE PROJECTS, NAMELY, MANAGING A MIXED-USE COMMERCIAL AND RESIDENTIAL RESORT COMMUNITY, IN CLASS 36 (U.S. CLS. 100, 101 AND 102).

FIRST USE 6-30-2004; IN COMMERCE 6-30-2004.

FOR: REAL ESTATE DEVELOPMENT SERVICES FOR MIXED-USE PROJECTS, NAMELY, PLANNING, LAYING OUT, CONSTRUCTION, AND DEVELOPING A MIXED-USE COMMERCIAL AND RESIDENTIAL RESORT COMMUNITY, IN CLASS 37 (U.S. CLS. 100, 103 AND 106).

FIRST USE 6-30-2004; IN COMMERCE 6-30-2004.

FOR: RECREATIONAL SERVICES, NAMELY, PROVIDING ENTERTAINMENT SERVICES AND ENTERTAINMENT AND RECREATIONAL FACILITIES ALL OF THE FOREGOING IN THE NATURE OF PROVIDING FACILITIES FOR MOVIES AND CONCERTS AND PROVIDING SWIMMING POOLS AND FITNESS AND EXERCISE FACILITIES, WITHIN A MIXED-USE COMMERCIAL AND RESIDENTIAL RESORT COMMUNITY, IN CLASS 41 (U.S. CLS. 100, 101 AND 107).

FIRST USE 6-30-2004; IN COMMERCE 6-30-2004.

OWNER OF U.S. REG. NO. 3,189,076.

SEC. 2(F) AS TO "WHARF".

SER. NO. 78-710,999, FILED 9-12-2005.

BERYL GARDNER, EXAMINING ATTORNEY

**Int. Cl.: 45**

**Prior U.S. Cls.: 100 and 101**

**United States Patent and Trademark Office**

**Reg. No. 3,467,844**

**Registered July 15, 2008**

**SERVICE MARK  
PRINCIPAL REGISTER**

**SECURITIES MOSAIC**

KNOWLEDGE MOSAIC LLC (DELAWARE LIMITED LIABILITY COMPANY)  
3450 16TH AVE. W.; SUITE 301  
SEATTLE, WA 98119

FOR: PROVIDING AN ON-LINE DATABASE IN THE FIELD OF BUSINESS LAW FOR LEGAL RESEARCH PURPOSES, IN CLASS 45 (U.S. CLS. 100 AND 101).

FIRST USE 9-0-2000; IN COMMERCE 5-0-2002.

THE MARK CONSISTS OF STANDARD CHARACTERS WITHOUT CLAIM TO ANY PARTICULAR FONT, STYLE, SIZE, OR COLOR.

NO CLAIM IS MADE TO THE EXCLUSIVE RIGHT TO USE "SECURITIES", APART FROM THE MARK AS SHOWN.

SER. NO. 78-713,299, FILED 9-15-2005.

LESLIE RICHARDS, EXAMINING ATTORNEY

**Int. Cl.: 25**

**Prior U.S. Cls.: 22 and 39**

**United States Patent and Trademark Office**

**Reg. No. 3,467,845**

**Registered July 15, 2008**

**TRADEMARK  
PRINCIPAL REGISTER**

**HOSS INTROPIA**

AT LEAST, S.A. (SPAIN CORPORATION)  
JOSÉ ABASCAL, 55  
MADRID, SPAIN 28003

OWNER OF SPAIN REG. NO. 2.673.349, DATED 10-7-2005, EXPIRES 10-7-2015.

FOR: DRESSES, TIES, BELTS, SOCKS, SCARVES,  
HATS, LINGERIE, FOOTWEAR, IN CLASS 25 (U.S.  
CLS. 22 AND 39).

THE WORDING "HOSS INTROPIA" HAS NO  
MEANING IN A FOREIGN LANGUAGE.

THE MARK CONSISTS OF STANDARD CHAR-  
ACTERS WITHOUT CLAIM TO ANY PARTICULAR  
FONT, STYLE, SIZE, OR COLOR.

SER. NO. 78-728,972, FILED 10-7-2005.

ANTHONY RINKER, EXAMINING ATTORNEY

Int. Cl.: 25

Prior U.S. Cls.: 22 and 39

United States Patent and Trademark Office

Reg. No. 3,467,846

Registered July 15, 2008

TRADEMARK  
PRINCIPAL REGISTER



THUG LIFE CLOTHING CO. (CALIFORNIA  
PARTNERSHIP)  
21329 MULHOLLAND DRIVE  
WOODLAND HILLS, CA 91364

FIRST USE 7-10-1996; IN COMMERCE 7-10-1996.

SER. NO. 78-732,936, FILED 10-13-2005.

FOR: T-SHIRTS, PANTS, SWEATSHIRTS, SWEAT-  
PANTS, ATHLETIC JERSEYS, BASEBALL CAPS  
AND JACKETS, IN CLASS 25 (U.S. CLS. 22 AND 39).

LINDA ORNDORFF, EXAMINING ATTORNEY

**Int. Cl.: 30**

**Prior U.S. Cl.: 46**

**United States Patent and Trademark Office**

**Reg. No. 3,467,847**

**Registered July 15, 2008**

**TRADEMARK  
PRINCIPAL REGISTER**



SAPPORO HOLDINGS LIMITED (NEW ZEALAND COMPANY)  
C/- GRANT THORNTON (CHCH) LIMITED  
9TH LEVEL ANTHONY HARPER BLDG., 47 CATHEDRAL SQUARE  
CHRISTCHURCH, NEW ZEALAND

FOR: PREPARATIONS MADE FROM CEREALS, NOT BEING BAKERY GOODS, NAMELY, MOLDED CEREAL BASED BARS; CONFECTIONARY, NAMELY, CANDY; ICES, NAMELY FROZEN DESSERTS,

FRUIT ICES AND FRUIT BASED ICES, ICE MILK AND ICE MILK BARS, IN CLASS 30 (U.S. CL. 46).

PRIORITY CLAIMED UNDER SEC. 44(D) ON NEW ZEALAND APPLICATION NO. 731406, FILED 6-20-2005, REG. NO. 731406, DATED 5-10-2007, EXPIRES 6-20-2015.

SER. NO. 78-737,977, FILED 10-21-2005.

BRENDAN MCCAULEY, EXAMINING ATTORNEY

**Int. Cl.: 43**

**Prior U.S. Cls.: 100 and 101**

**United States Patent and Trademark Office**

**Reg. No. 3,467,848**

**Registered July 15, 2008**

**SERVICE MARK  
PRINCIPAL REGISTER**

**PALMOLIVE KITCHEN**

COLGATE PALMOLIVE COMPANY (DELA-  
WARE CORPORATION)  
300 PARK AVENUE  
NEW YORK, NY 10022

FOR: PROVIDING INFORMATION IN THE  
FIELD OF COOKING TIPS AND RECIPES VIA  
THE INTERNET, IN CLASS 43 (U.S. CLS. 100 AND  
101).

FIRST USE 12-22-2005; IN COMMERCE 12-22-2005.

THE MARK CONSISTS OF STANDARD CHAR-  
ACTERS WITHOUT CLAIM TO ANY PARTICULAR  
FONT, STYLE, SIZE, OR COLOR.

OWNER OF U.S. REG. NOS. 861,145 AND 1,961,815.

SER. NO. 78-738,200, FILED 10-21-2005.

DAVID MURRAY, EXAMINING ATTORNEY

Int. Cl.: 25

Prior U.S. Cls.: 22 and 39

United States Patent and Trademark Office

Reg. No. 3,467,849

Registered July 15, 2008

TRADEMARK  
PRINCIPAL REGISTER



AALFS MANUFACTURING, INC. (IOWA CORPORATION)  
1005 4TH STREET, P.O. BOX 3567  
SIOUX CITY, IA 51102

FIRST USE 6-26-2006; IN COMMERCE 6-26-2006.

SER. NO. 78-740,605, FILED 10-26-2005.

FOR: CLOTHING, NAMELY, JEANS, IN CLASS 25  
(U.S. CLS. 22 AND 39).

MARY BOAGNI, EXAMINING ATTORNEY

Int. Cl.: 44

Prior U.S. Cls.: 100 and 101

United States Patent and Trademark Office

Reg. No. 3,467,850

Registered July 15, 2008

**SERVICE MARK  
PRINCIPAL REGISTER**

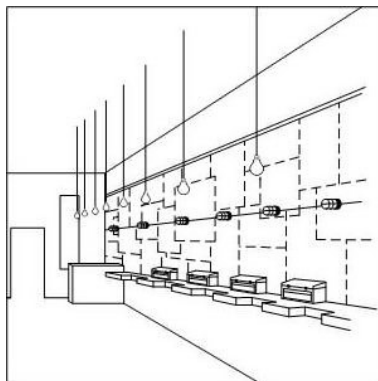

FLOYD'S 99 HOLDINGS, LLC (COLORADO LTD  
LIAB CO)  
4333 CHEROKEE STREET  
DENVER, CO 80216

FOR: BARBER SHOP AND BEAUTY AND HAIR-  
DRESSING SALON SERVICES, IN CLASS 44 (U.S.  
CLS. 100 AND 101).

FIRST USE 2-20-2001; IN COMMERCE 2-20-2001.

THE MARK CONSISTS OF THE DESIGN OF THE  
INTERIOR OF A BARBERSHOP ENCOMPASSING  
VAPOR LOCK LIGHTS IN METAL CAGES, PEN-  
DANT LIGHTING WITH EXPOSED BULBS, ME-

CHANIC'S TOOL BOXES, STAINLESS STEEL  
COUNTERTOPS WITH CUT-INS AND CUT-OUTS,  
A VERTICAL WALL SIGN, AND A DISPLAY WALL  
FOR DISPLAYING MUSIC THEMED POSTERS.  
THE FEATURES SHOWN IN DOTTED LINES ARE  
NOT CLAIMED AS PART OF THE MARK AND ARE  
INTENDED ONLY TO SHOW THE POSITION OF  
SUCH FEATURES.

SEC. 2(F).

SER. NO. 78-742,462, FILED 10-28-2005.

MARTHA FROMM, EXAMINING ATTORNEY



**Int. Cl.: 45**

**Prior U.S. Cls.: 100 and 101**

**United States Patent and Trademark Office**

**Reg. No. 3,467,851**

**Registered July 15, 2008**

**SERVICE MARK  
PRINCIPAL REGISTER**



WARNER, DEBORAH J.R.G. (UNITED STATES  
INDIVIDUAL)  
135 ROCK STRAIN DRIVE  
LITTLETON, NH 03561

THE MARK CONSISTS OF FOUR HANDS HOLD-  
ING AN UPSIDE-DOWN HAMMER.

FOR: PROVIDING INFORMATION IN THE  
FIELD OF SELF-IMPROVEMENT, IN CLASS 45  
(U.S. CLS. 100 AND 101).

SER. NO. 78-743,198, FILED 10-29-2005.

FIRST USE 2-1-2005; IN COMMERCE 2-1-2005.

ERNEST SHOSHO, EXAMINING ATTORNEY

Int. Cl.: 37

Prior U.S. Cls.: 100, 103 and 106

United States Patent and Trademark Office

Reg. No. 3,467,852

Registered July 15, 2008

SERVICE MARK  
PRINCIPAL REGISTER



STANEK CONSTRUCTORS, INC. (COLORADO CORPORATION)  
SUITE 200  
651 CORPORATE CIRCLE  
GOLDEN, CO 80401

FOR: CONSTRUCTION OF WATER AND WASTE-WATER FACILITIES, IN CLASS 37 (U.S. CLS. 100, 103 AND 106).

FIRST USE 6-1-1999; IN COMMERCE 6-1-1999.

OWNER OF U.S. REG. NO. 3,271,723.

NO CLAIM IS MADE TO THE EXCLUSIVE RIGHT TO USE "CONSTRUCTORS, INC.", APART FROM THE MARK AS SHOWN.

SEC. 2(F).

SER. NO. 78-744,878, FILED 11-1-2005.

MARIA-VICTORIA SUAREZ, EXAMINING ATTORNEY

**Int. Cl.: 9**

**Prior U.S. Cls.: 21, 23, 26, 36 and 38**

**United States Patent and Trademark Office**

**Reg. No. 3,467,853**

**Registered July 15, 2008**

**TRADEMARK  
PRINCIPAL REGISTER**

# Health Companion

STABILIX CORPORATION (CALIFORNIA CORPORATION)  
PMB 206  
20770 HWY. 281 NORTH, SUITE 108  
SAN ANTONIO, TX 78258

FOR: CONSUMER-CENTRIC SOFTWARE TOOL THAT ALLOWS INDIVIDUALS TO MANAGE THEIR OWN HEALTHCARE QUALITY AND COST, NAMELY, COMPUTER SOFTWARE TO ASSIST INDIVIDUALS IN TRACKING ADMINISTRATIVE, FINANCIAL AND CLINICAL INFORMATION REGARDING THEIR OWN FAMILY'S HEALTH, AND PERSONAL PRODUCTIVITY SOFTWARE TOOL USED BY AN INDIVIDUAL TO COLLECT, PLAN, AND ANALYZE HEALTHCARE RELATED DATA IN THE DAILY MANAGEMENT OF THE INDIVI-

DUAL'S FAMILY HEALTHCARE, IN CLASS 9 (U.S. CLS. 21, 23, 26, 36 AND 38).

FIRST USE 10-27-2005; IN COMMERCE 10-27-2005.

THE MARK CONSISTS OF STANDARD CHARACTERS WITHOUT CLAIM TO ANY PARTICULAR FONT, STYLE, SIZE, OR COLOR.

NO CLAIM IS MADE TO THE EXCLUSIVE RIGHT TO USE "HEALTH", APART FROM THE MARK AS SHOWN.

SER. NO. 78-746,388, FILED 11-3-2005.

ANDREA K. NADELMAN, EXAMINING ATTORNEY

**Int. Cls.: 35 and 41**

**Prior U.S. Cls.: 100, 101, 102 and 107**

**United States Patent and Trademark Office**

**Reg. No. 3,467,854**

**Registered July 15, 2008**

**SERVICE MARK  
PRINCIPAL REGISTER**

**THE NEW TEACHER PROJECT**

THE NEW TEACHER PROJECT (DELAWARE CORPORATION)  
11TH FLOOR  
304 PARK AVENUE SOUTH  
NEW YORK, NY 10010

FOR: EMPLOYMENT SERVICES, NAMELY, RECRUITING INDIVIDUALS TO TEACH CLASSES IN PRIMARY AND SECONDARY PUBLIC SCHOOLS IN THE FIELDS OF READING, WRITING, SPELLING, GRAMMAR, LANGUAGES, GEOGRAPHY, SOCIAL STUDIES, MATHEMATICS, SCIENCE, NUTRITION, HEALTH, PHYSICAL EDUCATION, COMPUTER AND INFORMATION TECHNOLOGY, MUSIC, ART AND LITERATURE; CONSULTING SERVICES PROVIDED TO PRIMARY AND SECONDARY PUBLIC SCHOOLS IN THE FIELD OF RECRUITING AND HIRING OF INDIVIDUALS TO TEACH CLASSES, IN CLASS 35 (U.S. CLS. 100, 101 AND 102).

FIRST USE 11-0-1998; IN COMMERCE 11-0-1998.

FOR: EDUCATIONAL SERVICES, NAMELY, TRAINING INDIVIDUALS TO TEACH CLASSES IN PRIMARY AND SECONDARY PUBLIC SCHOOLS IN THE FIELDS OF READING, WRITING, SPELLING, GRAMMAR, LANGUAGES, GEOGRAPHY, SOCIAL STUDIES, MATHEMATICS, SCIENCE, NUTRITION, HEALTH, PHYSICAL EDUCATION, COMPUTER AND INFORMATION TECHNOLOGY, MUSIC, ART AND LITERATURE, IN CLASS 41 (U.S. CLS. 100, 101 AND 107).

FIRST USE 11-0-1998; IN COMMERCE 11-0-1998.

THE MARK CONSISTS OF STANDARD CHARACTERS WITHOUT CLAIM TO ANY PARTICULAR FONT, STYLE, SIZE, OR COLOR.

SEC. 2(F).

SER. NO. 78-746,810, FILED 11-3-2005.

ANNE MADDEN, EXAMINING ATTORNEY

**Int. Cl.: 42**

**Prior U.S. Cls.: 100 and 101**

**United States Patent and Trademark Office**

**Reg. No. 3,467,855**

**Registered July 15, 2008**

**SERVICE MARK  
PRINCIPAL REGISTER**

**VISUAL REPORTS STUDIO**

VISUAL RISK SOLUTIONS, INC. (OHIO CORPORATION)  
5000 BRADENTON AVENUE  
DUBLIN, OH 43017

FOR: INSURANCE RELATED SERVICES, NAME-  
LY PROVIDING ON-LINE NON-DOWNLOADABLE  
SOFTWARE TO BUSINESSES FOR RISK MANAGE-  
MENT AND INSURANCE CLAIMS ADMINISTRA-  
TION, IN CLASS 42 (U.S. CLS. 100 AND 101).

FIRST USE 5-1-2004; IN COMMERCE 5-1-2004.

THE MARK CONSISTS OF STANDARD CHAR-  
ACTERS WITHOUT CLAIM TO ANY PARTICULAR  
FONT, STYLE, SIZE, OR COLOR.

NO CLAIM IS MADE TO THE EXCLUSIVE  
RIGHT TO USE "REPORTS STUDIO", APART  
FROM THE MARK AS SHOWN.

SER. NO. 78-751,828, FILED 11-11-2005.

DOMINIC FATHY, EXAMINING ATTORNEY

**Int. Cl.: 35**

**Prior U.S. Cls.: 100, 101 and 102**

**United States Patent and Trademark Office**

**Reg. No. 3,467,856**

**Registered July 15, 2008**

**SERVICE MARK  
PRINCIPAL REGISTER**

**kayakcity.com**

ADVENTURE MOUNTAIN SPORTS INC. (CALIFORNIA CORPORATION)  
1609 WATT AVE.  
SACRAMENTO, CA 95864

FOR: RETAIL STORE SERVICES, AVAILABLE THROUGH COMPUTER COMMUNICATIONS AND INTERACTIVE TELEVISION, FEATURING SPORTING GOODS, INFLATABLE BOATS, KAYAKS, CANOES, CAR RACKS, BOATS, CLOTHING, FOOTWEAR, PUBLICATIONS, TRAVEL EQUIPMENT, RAFTS, PADDLES, LIFE VEST, BOATING AND KAYAKING ACCESSORIES, TRAILERS, BOAT MOTORS, SKIS, SNOWBOARDS, BICYCLES, IN CLASS 35 (U.S. CLS. 100, 101 AND 102).

FIRST USE 2-1-2005; IN COMMERCE 2-1-2005.

THE MARK CONSISTS OF STANDARD CHARACTERS WITHOUT CLAIM TO ANY PARTICULAR FONT, STYLE, SIZE, OR COLOR.

OWNER OF U.S. REG. NO. 3,320,636.

SER. NO. 78-752,651, FILED 11-11-2005.

MARCIE MILONE, EXAMINING ATTORNEY

**Int. Cl.: 43**

**Prior U.S. Cls.: 100 and 101**

**United States Patent and Trademark Office**

**Reg. No. 3,467,857**

**Registered July 15, 2008**

**SERVICE MARK  
PRINCIPAL REGISTER**

# ORDERUP

JEET, LLC (TEXAS LIMITED LIABILITY COMPANY)  
331 ROBINHOOD  
SAN ANTONIO, TX 78209

THE MARK CONSISTS OF STANDARD CHARACTERS WITHOUT CLAIM TO ANY PARTICULAR FONT, STYLE, SIZE, OR COLOR.

FOR: RESTAURANT SERVICES, IN CLASS 43 (U.S. CLS. 100 AND 101).

SER. NO. 78-756,992, FILED 11-18-2005.

FIRST USE 2-15-2004; IN COMMERCE 2-15-2004.

MARY MUNSON, EXAMINING ATTORNEY

**Int. Cls.: 7 and 8**

**Prior U.S. Cls.: 13, 19, 21, 23, 28, 31, 34, 35 and 44**

**Reg. No. 3,467,858**

**United States Patent and Trademark Office**

**Registered July 15, 2008**

**TRADEMARK  
PRINCIPAL REGISTER**



CARLTON COMPANY (OREGON CORPORATION)  
PO BOX 68309  
MILWAUKIE, OR 97268

FOR: EQUIPMENT AND ACCESSORIES FOR CHAINSAWS, NAMELY, CHAINSAW CHAIN, CHAINSAW GUIDE BARS, CHAINSAW SPROCKET TIPS, CHAINSAW RIM SPROCKETS, CHAINSAW REELERS, CHAINSAW FILE GUIDES, PROTECTIVE COVERS FOR CHAINSAWS, CHAINSAW NYLON STARTER ROPE, SPARK PLUGS FOR CHAINSAWS, LAWNMOWERS, BRUSH CUTTERS, AND TRACTORS; EQUIPMENT AND ACCESSORIES FOR HARVESTER SAWS, NAMELY, HARVESTER SAW CHAIN, HARVESTER SAW GUIDE BARS, HARVESTER SAW SPROCKET TIPS, HARVESTER SAW REELERS, IN CLASS 7 (U.S. CLS. 13, 19, 21, 23, 31, 34 AND 35).

FIRST USE 7-0-1999; IN COMMERCE 7-0-1999.

FOR: HAND TOOLS, NAMELY, CHAINSAW CHAIN RIVET INSTALLERS AND BREAKERS, CHAINSAW FILES, CHAINSAW BAR GUIDE GROOVE CLEANERS, CHAINSAW GUIDE BAR GREASE GUNS, HARVESTER SAW CHAIN RIVET INSTALLERS AND BREAKERS, IN CLASS 8 (U.S. CLS. 23, 28 AND 44).

FIRST USE 7-0-1999; IN COMMERCE 7-0-1999.

OWNER OF U.S. REG. NO. 1,307,681.

NO CLAIM IS MADE TO THE EXCLUSIVE RIGHT TO USE "SAW CHAIN", APART FROM THE MARK AS SHOWN.

SER. NO. 78-759,737, FILED 11-22-2005.

MARK SPARACINO, EXAMINING ATTORNEY



**Int. Cl.: 2**

**Prior U.S. Cls.: 6, 11 and 16**

**United States Patent and Trademark Office**

**Reg. No. 3,467,859**

**Registered July 15, 2008**

**TRADEMARK  
PRINCIPAL REGISTER**

**GLASSCLAD**

GELEST, INC. (PENNSYLVANIA CORPORATION)  
11 STEEL ROAD EAST  
MORRISVILLE, PA 19067

FOR: POLYSILOXANE AND SILANE COATING COMPOSITIONS FOR PROVIDING SILICONE FILMS ON GLASS AND VITREOUS SURFACES OR IMPARTING GLASS-LIKE PROPERTIES TO OTHER SURFACES OF LABORATORY AND INDUSTRIAL EQUIPMENT, IN CLASS 2 (U.S. CLS. 6, 11 AND 16).

FIRST USE 9-12-1979; IN COMMERCE 9-12-1979.

THE MARK CONSISTS OF STANDARD CHARACTERS WITHOUT CLAIM TO ANY PARTICULAR FONT, STYLE, SIZE, OR COLOR.

SER. NO. 78-762,309, FILED 11-29-2005.

SANDRA MANIOS, EXAMINING ATTORNEY

**Int. Cl.: 16**

**Prior U.S. Cls.: 2, 5, 22, 23, 29, 37, 38 and 50**

**Reg. No. 3,467,860**

**United States Patent and Trademark Office**

**Registered July 15, 2008**

---

**TRADEMARK  
PRINCIPAL REGISTER**

**LA TARJETA GORDA**

T & T, LLC (ST.CHRIST-NEVIS CORPORATION)  
MAIN STREET, P.O. BOX 556  
CHARLESTOWN, ST.CHRIST-NEVIS

FOR: PRE-PAID TELEPHONE CALLING CARDS,  
NOT MAGNETICALLY ENCODED, IN CLASS 16  
(U.S. CLS. 2, 5, 22, 23, 29, 37, 38 AND 50).

FIRST USE 7-5-2005; IN COMMERCE 7-5-2005.

THE MARK CONSISTS OF STANDARD CHAR-  
ACTERS WITHOUT CLAIM TO ANY PARTICULAR  
FONT, STYLE, SIZE, OR COLOR.

NO CLAIM IS MADE TO THE EXCLUSIVE  
RIGHT TO USE "TARJETA", APART FROM THE  
MARK AS SHOWN.

THE FOREIGN WORDING IN THE MARK  
TRANSLATES INTO ENGLISH AS "THE FAT  
CARD".

SER. NO. 78-763,152, FILED 11-30-2005.

DARRYL SPRUILL, EXAMINING ATTORNEY

Int. Cl.: 30

Prior U.S. Cl.: 46

United States Patent and Trademark Office

Reg. No. 3,467,861

Registered July 15, 2008

TRADEMARK  
PRINCIPAL REGISTER



SANCHEZ, JOSE MARIA (ARGENTINA INDIVIDUAL)  
LISANDRO DE LA TORRE 1555  
BUENOS AIRES, ARGENTINA 1440

FOR: CROISSANTS, IN CLASS 30 (U.S. CL. 46).

OWNER OF ARGENTINA REG. NO. 2.014.674,  
DATED 3-10-2005, EXPIRES 3-10-2015.

NO CLAIM IS MADE TO THE EXCLUSIVE  
RIGHT TO USE "LAS MEDIALUNAS", APART  
FROM THE MARK AS SHOWN.

THE ENGLISH TRANSLATION OF THE WORD  
"LAS MEDIALUNAS DEL ABUELOS" IN THE  
MARK IS GRANDFATHER'S CROISSANTS.

SER. NO. 78-769,955, FILED 12-9-2005.

AMOS T. MATTHEWS, JR., EXAMINING ATTORNEY

**Int. Cl.: 9**

**Prior U.S. Cls.: 21, 23, 26, 36 and 38**

**United States Patent and Trademark Office**

**Reg. No. 3,467,862**

**Registered July 15, 2008**

**TRADEMARK  
PRINCIPAL REGISTER**

**DART 10FX**

KUSTOM MUSICAL AMPLIFICATION, INC.  
(OHIO CORPORATION)

3015 KUSTOM DRIVE

HEBRON, KY 41048

FOR: MUSICAL INSTRUMENT AMPLIFIERS, IN  
CLASS 9 (U.S. CLS. 21, 23, 26, 36 AND 38).

FIRST USE 12-14-2005; IN COMMERCE 12-14-2005.

THE MARK CONSISTS OF STANDARD CHAR-  
ACTERS WITHOUT CLAIM TO ANY PARTICULAR  
FONT, STYLE, SIZE, OR COLOR.

NO CLAIM IS MADE TO THE EXCLUSIVE  
RIGHT TO USE "10FX", APART FROM THE MARK  
AS SHOWN.

SER. NO. 78-770,449, FILED 12-9-2005.

SHARON MEIER, EXAMINING ATTORNEY

**Int. Cl.: 9**

**Prior U.S. Cls.: 21, 23, 26, 36 and 38**

**United States Patent and Trademark Office**

**Reg. No. 3,467,863**

**Registered July 15, 2008**

**TRADEMARK  
PRINCIPAL REGISTER**

**MEASUREMENT SPECIALTIES**

MEASUREMENT SPECIALTIES, INC. (NEW JERSEY CORPORATION)  
1000 LUCAS WAY  
HAMPTON, VA 23666

FOR: ELECTRIC AND ELECTRONIC SENSORS AND TRANSDUCERS FOR PRESSURE, FORCE, VIBRATION, POSITION, ROTATION, TILT, ACCELERATION, FLUID LEVEL, STRAIN, SHOCK, HUMIDITY AND PHOTO OPTICS; ELECTRONIC SWITCHES AND KEYPADS; ELECTRIC AND ELECTRONIC TRAFFIC SENSORS; CABLES MADE OF PIEZOELECTRIC FLUOROPOLYMER FILM, NAMELY, COAXIAL CABLES; CABLES MADE OF PIEZOELECTRIC FLUOROPOLYMER FILM FOR USE AS SENSORS IN SENSING PRESSURE, VIBRATION AND FORCE; ELECTRONIC COMPONENTS, NAMELY, PIEZOELECTRIC FLUOROPOLYMER FILM, IN CLASS 9 (U.S. CLS. 21, 23, 26, 36 AND 38).

FIRST USE 12-31-1991; IN COMMERCE 12-31-1991.

THE MARK CONSISTS OF STANDARD CHARACTERS WITHOUT CLAIM TO ANY PARTICULAR FONT, STYLE, SIZE, OR COLOR.

NO CLAIM IS MADE TO THE EXCLUSIVE RIGHT TO USE "MEASUREMENT", APART FROM THE MARK AS SHOWN.

SEC. 2(F).

SER. NO. 78-777,234, FILED 12-20-2005.

JOHN DWYER, EXAMINING ATTORNEY

**Int. Cl.: 41**

**Prior U.S. Cls.: 100, 101 and 107**

**United States Patent and Trademark Office**

**Reg. No. 3,467,864**

**Registered July 15, 2008**

**SERVICE MARK  
PRINCIPAL REGISTER**

**AVWORSHIPSYSTEMS**

CMP ENTERTAINMENT MEDIA, INC. (DELA-  
WARE CORPORATION)  
460 PARK AVENUE SOUTH, 9TH FLOOR  
NEW YORK, NY 10016

FOR: PROVIDING ONLINE NEWS AND INFOR-  
MATION ABOUT TECHNOLOGY IN THE FIELDS  
OF AUDIO, VIDEO, LIGHTING, PRESENTATION,  
AND DUPLICATION TECHNOLOGIES , IN CLASS  
41 (U.S. CLS. 100, 101 AND 107).

FIRST USE 7-28-2004; IN COMMERCE 7-28-2004.

THE MARK CONSISTS OF STANDARD CHAR-  
ACTERS WITHOUT CLAIM TO ANY PARTICULAR  
FONT, STYLE, SIZE, OR COLOR.

SER. NO. 78-778,205, FILED 12-21-2005.

HEATHER SAPP, EXAMINING ATTORNEY

**Int. Cl.: 5**

**Prior U.S. Cls.: 6, 18, 44, 46, 51 and 52**

**United States Patent and Trademark Office**

**Reg. No. 3,467,865**

**Registered July 15, 2008**

**TRADEMARK  
PRINCIPAL REGISTER**

**COLOSSUS**

OPTIMUM NUTRITION, INC. (FLORIDA CORPORATION)  
600 N. COMMERCE  
AURORA, IL 60504

THE MARK CONSISTS OF STANDARD CHARACTERS WITHOUT CLAIM TO ANY PARTICULAR FONT, STYLE, SIZE, OR COLOR.

FOR: NUTRITIONAL FOOD SUPPLEMENTS IN THE FORM OF OVERSIZED, HIGH-PROTEIN BASED COOKIES, IN CLASS 5 (U.S. CLS. 6, 18, 44, 46, 51 AND 52).

SER. NO. 78-778,938, FILED 12-22-2005.

FIRST USE 5-19-2005; IN COMMERCE 5-19-2005.

KIMBERLY PERRY, EXAMINING ATTORNEY

**Int. Cl.: 35**

**Prior U.S. Cls.: 100, 101 and 102**

**United States Patent and Trademark Office**

**Reg. No. 3,467,866**

**Registered July 15, 2008**

**SERVICE MARK  
PRINCIPAL REGISTER**

**WTS**

WTS AG (FED REP GERMANY AKTIENGESELL-  
SCHAFT)  
THOMAS-WIMMER-RING 3  
MUNICH, FED REP GERMANY 80539

FOR: INCOME TAX CONSULTATION; INCOME  
TAX PREPARATION; TAX ADVISORY SERVICES;  
TAX AND TAXATION PLANNING, ADVICE, IN-  
FORMATION AND CONSULTANCY SERVICES;  
TAX CONSULTATION; TAX FILING SERVICES;  
TAX PREPARATION, IN CLASS 35 (U.S. CLS. 100,  
101 AND 102).

FIRST USE 3-9-2005; IN COMMERCE 3-9-2005.

THE MARK CONSISTS OF STANDARD CHAR-  
ACTERS WITHOUT CLAIM TO ANY PARTICULAR  
FONT, STYLE, SIZE, OR COLOR.

SER. NO. 78-788,914, FILED 1-10-2006.

CAROL SPILS, EXAMINING ATTORNEY



**Int. Cls.: 7 and 17**

**Prior U.S. Cls.: 1, 5, 12, 13, 19, 21, 23, 31, 34, 35 and 50**

**United States Patent and Trademark Office**

**Reg. No. 3,467,867**

**Registered July 15, 2008**

**TRADEMARK  
PRINCIPAL REGISTER**

# Resilon-T

COMPRESSOR ENGINEERING CORPORATION  
(TEXAS CORPORATION)  
5440 ALDER  
HOUSTON, TX 77081

FOR: PISTON RINGS, RIDER RINGS, MECHANICAL PACKING RINGS, ROD PACKING RINGS, AND OIL WIPER RINGS FOR USE IN RECIPROCATING COMPRESSORS AND MADE FROM THERMOPLASTIC BLENDED MATERIALS BOTH WITH AND WITHOUT POLYETHERETHERKETONE, POLYTETRAFLUOROETHYLENE, OR POLYPHENYLENE SULFIDE, IN CLASS 7 (U.S. CLS. 13, 19, 21, 23, 31, 34 AND 35).

FIRST USE 10-1-1993; IN COMMERCE 10-1-1993.

FOR: THERMOPLASTIC BLENDED MATERIAL, NAMELY, COMPOUNDS IN SOLID ROD TUBULAR FORM OR IN SOLID PLATE STOCK, BOTH WITH

AND WITHOUT POLYETHERETHERKETONE, POLYTETRAFLUOROETHYLENE, OR POLYPHENYLENE SULFIDE, USED TO MANUFACTURE PISTON RINGS, RIDER RINGS, MECHANICAL PACKING RINGS, ROD PACKING RINGS, AND OIL WIPER RINGS FOR USE IN RECIPROCATING COMPRESSORS, IN CLASS 17 (U.S. CLS. 1, 5, 12, 13, 35 AND 50).

FIRST USE 10-1-1993; IN COMMERCE 10-1-1993.

THE MARK CONSISTS OF STANDARD CHARACTERS WITHOUT CLAIM TO ANY PARTICULAR FONT, STYLE, SIZE, OR COLOR.

SER. NO. 78-790,160, FILED 1-12-2006.

LYDIA BELZER, EXAMINING ATTORNEY

**Int. Cl.: 11**

**Prior U.S. Cls.: 13, 21, 23, 31 and 34**

**United States Patent and Trademark Office**

**Reg. No. 3,467,868**

**Registered July 15, 2008**

**TRADEMARK  
PRINCIPAL REGISTER**

**PROVIDENCE**

KOHLER CO. (WISCONSIN CORPORATION)  
444 HIGHLAND DRIVE  
KOHLER, WI 53044

THE MARK CONSISTS OF STANDARD CHAR-  
ACTERS WITHOUT CLAIM TO ANY PARTICULAR  
FONT, STYLE, SIZE, OR COLOR.

FOR: LAVATORIES AND SINKS, IN CLASS 11  
(U.S. CLS. 13, 21, 23, 31 AND 34).

SER. NO. 78-792,155, FILED 1-16-2006.

FIRST USE 6-1-1996; IN COMMERCE 6-1-1996.

BRIAN PINO, EXAMINING ATTORNEY

**Int. Cls.: 39 and 43**

**Prior U.S. Cls.: 100, 101 and 105**

**United States Patent and Trademark Office**

**Reg. No. 3,467,869**

**Registered July 15, 2008**

**SERVICE MARK  
PRINCIPAL REGISTER**

The logo for Lifestyles Resorts features the word "Lifestyles" in a large, elegant, cursive script font. Below it, the word "RESORTS" is written in a bold, uppercase, sans-serif font with a slightly distressed or textured appearance.

LSO, LTD. (CALIFORNIA CORPORATION)  
2641 W. LA PALMA AVENUE, SUITE A  
ANAHEIM, CA 92801

FOR: ARRANGING TRAVEL TOURS; COORDINATING TRAVEL ARRANGEMENTS FOR INDIVIDUALS AND FOR GROUPS; TRAVEL BOOKING AGENCIES; TRAVEL CLUBS; TRAVEL, EXCURSION AND CRUISE ARRANGEMENT, IN CLASS 39 (U.S. CLS. 100 AND 105).

FIRST USE 4-9-2002; IN COMMERCE 4-9-2002.

FOR: MAKING HOTEL RESERVATIONS FOR OTHERS; RESERVATION OF HOTEL ROOMS FOR TRAVELERS; RESORT HOTELS, IN CLASS 43 (U.S. CLS. 100 AND 101).

FIRST USE 4-9-2002; IN COMMERCE 4-9-2002.

OWNER OF U.S. REG. NOS. 2,010,283, 2,010,285 AND OTHERS.

NO CLAIM IS MADE TO THE EXCLUSIVE RIGHT TO USE "RESORTS", APART FROM THE MARK AS SHOWN.

THE MARK CONSISTS OF THE WORD "LIFESTYLES" IN STYLIZED FORM COUPLED WITH THE WORD "RESORTS".

SER. NO. 78-793,880, FILED 1-18-2006.

KIMBERLY PERRY, EXAMINING ATTORNEY

**Int. Cls.: 9, 16, 42 and 44**

**Prior U.S. Cls.: 2, 5, 21, 22, 23, 26, 29, 36, 37, 38, 50,  
100 and 101**

**Reg. No. 3,467,870**

**United States Patent and Trademark Office**

**Registered July 15, 2008**

**TRADEMARK  
SERVICE MARK  
PRINCIPAL REGISTER**

**KIGS  
KIMS  
ACROSTUDY**

PFIZER HEALTH AB (SWEDEN CORPORATION)  
LINDHAGENSGATAN 100  
STOCKHOLM, SWEDEN SE-11287

FOR: COMPUTER PROGRAMS AND SOFTWARE FOR ENTERING NEW MEDICAL PATIENT DATA INTO A DATABASE CONTAINING PRE-RECORDED MEDICAL PATIENT DATA, AND FOR MANAGING AND ANALYZING MEDICAL PATIENT DATA WITHIN THE DATABASE, IN CLASS 9 (U.S. CLS. 21, 23, 26, 36 AND 38).

FOR: PRINTED MATTER, PUBLICATIONS, AND PRINTED INSTRUCTIONAL AND TEACHING MATERIALS, NAMELY, BOOKS, JOURNALS, NEWSLETTERS, MAGAZINES, AND STATIONERY IN THE FIELD OF PHARMACEUTICALS AND MEDICAL TREATMENT, AND CONTAINING MEDICAL PATIENT DATA, IN CLASS 16 (U.S. CLS. 2, 5, 22, 23, 29, 37, 38 AND 50).

FOR: PROVIDING ON-LINE NON-DOWNLOADABLE COMPUTER SOFTWARE FOR ENTERING NEW MEDICAL PATIENT DATA INTO A DATABASE CONTAINING PRE-RECORDED MEDICAL PATIENT DATA, AND FOR MANAGING AND ANALYZING MEDICAL PATIENT DATA WITHIN THE DATABASE; COMPUTER SERVICES, NAMELY, COMPILING MEDICAL PATIENT DATA FROM

A VARIETY OF SOURCES, PROCESSING AND PERFORMING ANALYSIS ON INDIVIDUAL PATIENT DATA AND DATA FOR A GROUP OF PATIENTS; SCIENTIFIC RESEARCH SERVICES IN THE MEDICAL AND PHARMACEUTICAL FIELD; PROVIDING MEDICAL INFORMATION AND ADVISORY SERVICES IN THE FIELD OF PHARMACEUTICAL RESEARCH AND DEVELOPMENT, IN CLASS 42 (U.S. CLS. 100 AND 101).

FOR: PROVIDING MEDICAL, PATIENT AND PHARMACEUTICAL DATA VIA COMPUTER GENERATED REPORTS; PROVIDING MEDICAL INFORMATION AND ADVISORY SERVICES IN THE FIELD OF MEDICAL TREATMENT AND MEDICAL PATIENT DATA; MAINTAINING MEDICAL DATA, NAMELY, PATIENT MEDICAL DATA AND PATIENT HISTORY INFORMATION, IN CLASS 44 (U.S. CLS. 100 AND 101).

OWNER OF ERPN CMNTY TM OFC REG. NO. 004857454, DATED 6-21-2007, EXPIRES 1-18-2016.

OWNER OF U.S. REG. NOS. 2,138,534 AND 2,215,721.

SER. NO. 78-805,706, FILED 2-2-2006.

DAVID C. REIHNER, EXAMINING ATTORNEY

**Int. Cl.: 36**

**Prior U.S. Cls.: 100, 101 and 102**

**United States Patent and Trademark Office**

**Reg. No. 3,467,871**

**Registered July 15, 2008**

**SERVICE MARK  
PRINCIPAL REGISTER**

**LONG TRAIL CAPITAL**

LONG TRAIL CAPITAL, LLC (VERMONT LTD  
LIAB CO)  
328 MARSH FAMILY ROAD  
QUECHEE, VT 05059

FOR: INVESTMENT ADVISORY SERVICES, NAMELY, ADVISORY SERVICES TO ALTERNATIVE INVESTMENT FUND SPONSORS ON STRUCTURING AND MARKETING PRIVATE EQUITY FUNDS, HEDGE FUNDS AND FUND-OF-FUND VEHICLES, NOT INCLUDING THE PERFORMANCE OF MARKETING SERVICES OR PARTICIPATION IN THE OFFER OR SALE OF SECURITIES; INVESTMENT CONSULTATION SERVICES, NAMELY, ASSISTANCE TO ALTERNATIVE INVESTMENT MANAGERS IN ESTABLISHING STRATEGIC ALLIANCES, DESIGNING INVESTMENT DEVELOPMENT ACTIVITIES, BUT NOT INCLUDING THE PERFORMANCE OF MARKET-

ING SERVICES OR PARTICIPATION IN THE OFFER OR SALE OF SECURITIES, IN CLASS 36 (U.S. CLS. 100, 101 AND 102).

FIRST USE 8-9-2000; IN COMMERCE 8-9-2000.

THE MARK CONSISTS OF STANDARD CHARACTERS WITHOUT CLAIM TO ANY PARTICULAR FONT, STYLE, SIZE, OR COLOR.

NO CLAIM IS MADE TO THE EXCLUSIVE RIGHT TO USE "CAPITAL", APART FROM THE MARK AS SHOWN.

SER. NO. 78-808,279, FILED 2-6-2006.

CHRIS WELLS, EXAMINING ATTORNEY

**Int. Cl.: 3**

**Prior U.S. Cls.: 1, 4, 6, 50, 51 and 52**

**United States Patent and Trademark Office**

**Reg. No. 3,467,872**

**Registered July 15, 2008**

**TRADEMARK  
PRINCIPAL REGISTER**

**URBAN BOTANIC**

QUEST GROUP, LLC (UTAH LTD LIAB CO)  
967 WEST CENTER  
OREM, UT 84057

FOR: PERSONAL CARE ITEMS FEATURING  
CUSTOMIZED FRAGRANCES WHICH MAY BE  
USED SEPARATELY OR WITHIN PERFUME,  
BODY LOTION, SHOWER GEL AND BUBBLE BATH  
PROVIDED EXCLUSIVELY THROUGH DIRECT,  
IN-HOME SALES, IN CLASS 3 (U.S. CLS. 1, 4, 6, 50,  
51 AND 52).

FIRST USE 9-14-2005; IN COMMERCE 9-14-2005.

THE MARK CONSISTS OF STANDARD CHAR-  
ACTERS WITHOUT CLAIM TO ANY PARTICULAR  
FONT, STYLE, SIZE, OR COLOR.

NO CLAIM IS MADE TO THE EXCLUSIVE  
RIGHT TO USE "BOTANIC", APART FROM THE  
MARK AS SHOWN.

SER. NO. 78-811,618, FILED 2-9-2006.

ODESSA BIBBINS, EXAMINING ATTORNEY

Int. Cl.: 30

Prior U.S. Cl.: 46

United States Patent and Trademark Office

Reg. No. 3,467,873

Registered July 15, 2008

TRADEMARK  
PRINCIPAL REGISTER



AGAINST THE GRAIN GOURMET FOODS LLC  
(VERMONT LTD LIAB CO)  
22 BROWNE CT #119  
BRATTLEBORO, VT 05301

FOR: GLUTEN FREE BAKERY GOODS, IN  
CLASS 30 (U.S. CL. 46).

FIRST USE 12-5-2005; IN COMMERCE 12-5-2005.

NO CLAIM IS MADE TO THE EXCLUSIVE  
RIGHT TO USE "GLUTEN FREE GOURMET" ,  
APART FROM THE MARK AS SHOWN.

THE COLORS RED, BLACK, WHITE, GREY ARE  
CLAIMED AS A FEATURE OF THE MARK.

THE COLOR RED APPEARS IN THE WORD  
"AGAINST". THE COLOR GRAY APPEARS IN  
THE WORD "GRAIN". THE COLOR BLACK AP-  
PEARS IN THE WORD "THE" AND "GOURMET"  
AND IN THE BOX DESIGN. THE COLOR WHITE  
APPEARS IN THE WORDING "THE GLUTEN  
FREE" AND IN THE BACKGROUND.

SER. NO. 78-812,354, FILED 2-10-2006.

JENNIFER VASQUEZ, EXAMINING ATTORNEY

**Int. Cl.: 16**

**Prior U.S. Cls.: 2, 5, 22, 23, 29, 37, 38 and 50**

**Reg. No. 3,467,874**

**United States Patent and Trademark Office**

**Registered July 15, 2008**

---

**TRADEMARK  
PRINCIPAL REGISTER**

**ERAZORS**

THE BOARD DUDES, INC. (CALIFORNIA CORPORATION)  
215 DEININGER CIRCLE  
CORONA, CA 92880

FOR: SCHOOL SUPPLIES, NAMELY, WRITING INSTRUMENTS, PENS, MARKERS, HIGHLIGHTERS, AND DRY ERASE WRITING BOARDS AND WRITING SURFACES, IN CLASS 16 (U.S. CLS. 2, 5, 22, 23, 29, 37, 38 AND 50).

FIRST USE 8-0-2004; IN COMMERCE 3-0-2005.

THE MARK CONSISTS OF STANDARD CHARACTERS WITHOUT CLAIM TO ANY PARTICULAR FONT, STYLE, SIZE, OR COLOR.

SER. NO. 78-813,843, FILED 2-13-2006.

MARY I. SPARROW, EXAMINING ATTORNEY



**Int. Cl.: 29**

**Prior U.S. Cl.: 46**

**United States Patent and Trademark Office**

**Reg. No. 3,467,875**

**Registered July 15, 2008**

**TRADEMARK  
PRINCIPAL REGISTER**



PREMIER ORGANICS (CALIFORNIA CORPORATION)  
UNIT D  
851 81ST AVENUE  
OAKLAND, CA 94621

FOR: NUT BUTTERS MADE FROM CASHEWS, ALMONDS, WALNUTS, PECANS, SUNFLOWER SEEDS, COCONUTS, PISTACHIOS, BRAZIL NUTS AND TAHINI, NAMELY, SESAME SEEDS, IN CLASS 29 (U.S. CL. 46).

FIRST USE 11-29-2004; IN COMMERCE 11-29-2004.

THE COLOR(S) GREEN, YELLOW AND BLACK IS/ARE CLAIMED AS A FEATURE OF THE MARK.

THE COLOR GREEN APPEARS IN THE LEAF DESIGN-ELEMENT. THE COLOR YELLOW APPEARS IN THE LITERAL PORTION ARTISANA. THE COLOR BLACK APPEARS IN THE SHADOWING OF THE LITERAL PORTION ARTISANA.

THE MARK CONSISTS OF "ARTISANA" WRITTEN IN YELLOW AND BLACK ON A GREEN LEAF.

SER. NO. 78-814,409, FILED 2-14-2006.

ROBIN CHOSID, EXAMINING ATTORNEY

Int. Cl.: 3

Prior U.S. Cls.: 1, 4, 6, 50, 51 and 52

United States Patent and Trademark Office

Reg. No. 3,467,876

Registered July 15, 2008

TRADEMARK  
PRINCIPAL REGISTER



LABORATOIRES DERMO-COSMETIK, INC. (CANADA CORPORATION)  
68, STINSON STREET  
MONTREAL, CANADA H4N 2E7

FOR: COSMETOLOGICAL PRODUCTS, NAME-  
LY, MAKEUP REMOVAL CREAMS AND LOTIONS  
FOR THE FACE; DAY AND NIGHT CREAMS;  
ERASING CREAMS, NAMELY, ANTI-AGING  
CREAM, ANTI-FRECKLE CREAM AND ANTI-  
WRINKLE CREAM; FIRING AND MOISTURIZ-  
ING BODY, SKIN, FACE AND EYE CREAMS; AGE  
SPOT REDUCING CREAMS; BIO-STIMULANT  
BODY, SKIN, FACE AND EYE CREAMS; EXFO-  
LIATING CREAMS FOR THE BODY; HAND  
CREAMS; ALCOHOL-FREE TONING LOTIONS  
FOR THE FACE; BEAUTY MASKS; GEL SOAPS  
FOR THE BODY AND HAIR; REVITALIZING, AS-  
TRINGENT AND MOISTURIZING FACE, SKIN  
AND BODY CREAMS CONTAINED IN AMPULES;  
MAKEUP-REMOVAL AND EYELINER CREAMS;  
REGENERATING BODY OILS; BODY SLENDERIZ-  
ING PRODUCTS, NAMELY, REDUCING GELS;  
GEL TONERS; THERMO-ACTIVE SLIMMING CON-  
CENTRATES, NAMELY, CREAMS AND LOTIONS  
FOR CELLULITE REDUCTION; WRINKLE PRO-  
DUCTS, NAMELY, FIRING FACE, SKIN AND  
BODY CREAMS; FIRING FACE, SKIN AND

BODY CREAMS CONTAINED IN AMPULES; BODY,  
SKIN, FACE AND EYE CREAMS WITH MINK OIL;  
DEPILATORY PRODUCTS, NAMELY, HAIR-RE-  
MOVAL CREAMS; LOTIONS, GELS AND CREAMS  
FOR SKIN TANNING, IN CLASS 3 (U.S. CLS. 1, 4, 6,  
50, 51 AND 52).

FIRST USE 4-3-2006; IN COMMERCE 4-3-2006.

PRIORITY CLAIMED UNDER SEC. 44(D) ON  
CANADA APPLICATION NO. 1,287,386, FILED 1-25-  
2006.

OWNER OF U.S. REG. NOS. 1,592,687 AND  
2,907,701.

NO CLAIM IS MADE TO THE EXCLUSIVE  
RIGHT TO USE "PARIS", APART FROM THE  
MARK AS SHOWN.

THE NAME "G.M. COLLIN" DOES NOT IDENTI-  
FY A LIVING INDIVIDUAL.

SER. NO. 78-816,367, FILED 2-16-2006.

DAVID YONTEF, EXAMINING ATTORNEY

**Int. Cl.: 16**

**Prior U.S. Cls.: 2, 5, 22, 23, 29, 37, 38 and 50**

**Reg. No. 3,467,877**

**United States Patent and Trademark Office**

**Registered July 15, 2008**

**TRADEMARK  
PRINCIPAL REGISTER**

**ADRENALINE**

A WAVE BLUE WORLD, INC. (NEW YORK CORPORATION)  
1 MORTON SQUARE, APT. 5EW  
NEW YORK, NY 10014

THE MARK CONSISTS OF STANDARD CHARACTERS WITHOUT CLAIM TO ANY PARTICULAR FONT, STYLE, SIZE, OR COLOR.

FOR: COMIC BOOKS, IN CLASS 16 (U.S. CLS. 2, 5, 22, 23, 29, 37, 38 AND 50).

SER. NO. 78-816,760, FILED 2-16-2006.

FIRST USE 6-10-2005; IN COMMERCE 6-10-2005.

ELI HELLMAN, EXAMINING ATTORNEY

**Int. Cl.: 37**

**Prior U.S. Cls.: 100, 103 and 106**

**United States Patent and Trademark Office**

**Reg. No. 3,467,878**

**Registered July 15, 2008**

**SERVICE MARK  
PRINCIPAL REGISTER**

**THE SHOP @ SHOW READY**

SHOW READY, INC. (CALIFORNIA CORPORATION)  
5595 FRESCA DRIVE  
LA PALMA, CA 90623

THE MARK CONSISTS OF STANDARD CHARACTERS WITHOUT CLAIM TO ANY PARTICULAR FONT, STYLE, SIZE, OR COLOR.

FOR: CARPENTRY, IN CLASS 37 (U.S. CLS. 100, 103 AND 106).

SER. NO. 78-817,013, FILED 2-16-2006.

FIRST USE 1-5-2002; IN COMMERCE 1-5-2002.

RON FAIRBANKS, EXAMINING ATTORNEY

**Int. Cl.: 3**

**Prior U.S. Cls.: 1, 4, 6, 50, 51 and 52**

**Reg. No. 3,467,879**

**United States Patent and Trademark Office**

**Registered July 15, 2008**

**TRADEMARK  
PRINCIPAL REGISTER**

**ACTIFIRM**

ACTIVE ORGANICS LP (TEXAS LIMITED PART-  
NERSHIP)  
1097 YATES STREET  
LEWISVILLE, TX 750574829

FOR: PERSONAL CARE, COSMETICS AND SKIN  
CARE PRODUCTS, NAMELY EXFOLIANTS,  
SCRUBS, PEELS, MOISTURIZERS AND CLEANS-  
ERS, ALL FOR TOPICAL APPLICATION TO THE  
SKIN; LOTIONS, GELS, CREAMS AND SERUMS  
FOR USE ON THE SKIN; FACIAL MASKS; SUN  
SCREEN PREPARATIONS; HAIR CARE PREPARA-  
TIONS, IN CLASS 3 (U.S. CLS. 1, 4, 6, 50, 51 AND 52).

FIRST USE 1-8-1995; IN COMMERCE 1-8-1995.

THE MARK CONSISTS OF STANDARD CHAR-  
ACTERS WITHOUT CLAIM TO ANY PARTICULAR  
FONT, STYLE, SIZE, OR COLOR.

OWNER OF U.S. REG. NOS. 2,008,488 AND  
2,747,243.

SER. NO. 78-827,171, FILED 3-2-2006.

ANDREA SAUNDERS, EXAMINING ATTORNEY

**Int. Cls.: 24 and 25**

**Prior U.S. Cls.: 22, 39, 42 and 50**

**United States Patent and Trademark Office**

**Reg. No. 3,467,880**

**Registered July 15, 2008**

**TRADEMARK  
PRINCIPAL REGISTER**

**bgreen**

COTTON KNIT TRADING, INC. (CALIFORNIA CORPORATION)  
ATTN: MIKE FARID  
3097 E. ANA ST.  
RANCHO DONINGUEZ, CA 90221

FOR: BEDSHEETS; DUVET COVERS; TOWELS; WASHCLOTHS, IN CLASS 24 (U.S. CLS. 42 AND 50).

FIRST USE 3-1-2005; IN COMMERCE 3-1-2005.

FOR: BRAS; DRESSES; HATS; HEAVY JACKETS; JACKETS; JERSEYS; MUSCLE TOPS; PANTIES; PANTS; SHAWLS; SHIFTS; SHIRTS; SHORT SET;

SHORT-SLEEVED OR LONG-SLEEVED T-SHIRTS; SHORTS; SWEAT SHIRTS; TANK TOPS; TOPS; UNDERWEAR, IN CLASS 25 (U.S. CLS. 22 AND 39).

FIRST USE 3-1-2005; IN COMMERCE 3-1-2005.

THE MARK CONSISTS OF STANDARD CHARACTERS WITHOUT CLAIM TO ANY PARTICULAR FONT, STYLE, SIZE, OR COLOR.

SER. NO. 78-831,501, FILED 3-7-2006.

TEJBIR SINGH, EXAMINING ATTORNEY

**Int. Cl.: 12**

**Prior U.S. Cls.: 19, 21, 23, 31, 35 and 44**

**Reg. No. 3,467,881**

**United States Patent and Trademark Office**

**Registered July 15, 2008**

**TRADEMARK  
PRINCIPAL REGISTER**



LEE, PATRICK H. (UNITED STATES INDIVIDUAL)  
7711 INDUSTRY AVE  
PICO RIVERA, CA 90660

FIRST USE 6-1-1996; IN COMMERCE 10-15-1998.

SER. NO. 78-840,462, FILED 3-17-2006.

FOR: STROLLERS, TRICYCLES, JOGGING STROLLERS, IN CLASS 12 (U.S. CLS. 19, 21, 23, 31, 35 AND 44).

MARY MUNSON, EXAMINING ATTORNEY

**Int. Cl.: 41**

**Prior U.S. Cls.: 100, 101 and 107**

**United States Patent and Trademark Office**

**Reg. No. 3,467,882**

**Registered July 15, 2008**

**SERVICE MARK  
PRINCIPAL REGISTER**



SANOFI-AVENTIS (FRANCE CORPORATION)  
174, AVENUE DE FRANCE  
PARIS, FRANCE 75013

FOR: EDUCATIONAL SERVICES, NAMELY,  
CONDUCTING WORKSHOPS AND SEMINARS  
FOR PATIENTS AND HEALTHCARE PROVIDERS,  
ALL IN THE FIELDS OF IMPROVEMENT TO  
QUALITY HEALTHCARE SERVICES AND DISEASE  
MANAGEMENT AND DISTRIBUTING COURSE  
MATERIALS THEREWITH IN PRINT OR ELEC-  
TRONIC FORMAT, IN CLASS 41 (U.S. CLS. 100, 101  
AND 107).

FIRST USE 12-5-2005; IN COMMERCE 12-5-2005.

NO CLAIM IS MADE TO THE EXCLUSIVE  
RIGHT TO USE "HEALTH", APART FROM THE  
MARK AS SHOWN.

THE COLOR GREY IN THE MARK IS FOR  
SHADING PURPOSES. COLOR IS NOT CLAIMED  
AS A FEATURE OF THE MARK.

SER. NO. 78-842,467, FILED 3-21-2006.

BERYL GARDNER, EXAMINING ATTORNEY



**Int. Cls.: 9 and 12**

**Prior U.S. Cls.: 19, 21, 23, 26, 31, 35, 36, 38 and 44**

**Reg. No. 3,467,883**

**United States Patent and Trademark Office**

**Registered July 15, 2008**

**TRADEMARK  
PRINCIPAL REGISTER**

# AVANTGUARD

ELBIT SYSTEMS LTD. (ISRAEL CORPORATION)  
P.O. BOX 539  
ADVANCED TECHNOLOGY CENTER  
HAIFA, ISRAEL 31053

FOR: BATTLE, ARTILLERY AND URBAN WARFARE MANAGEMENT SYSTEMS PRIMARILY COMPRISED OF COMPUTER HARDWARE AND COMPUTER SOFTWARE FOR WARFARE OPERATION AND CONTROL; REMOTELY CONTROLLED WEAPONS SYSTEMS PRIMARILY COMPRISED OF COMPUTER HARDWARE AND COMPUTER SOFTWARE, COMPUTER NETWORK INFRASTRUCTURE, MEDIA ADAPTER, TACTICAL MESSAGE ORIENTED MIDDLEWARE, AUTOMATIC, GEOGRAPHICAL PUBLISH AND SUBSCRIBE MODULE, ALL FOR THE REMOTE OPERATION AND CONTROL OF WEAPONS SYSTEMS; DAY/NIGHT CONTROL SYSTEMS PRIMARILY COMPRISED OF A CONTROL STATION WITH COMPUTER MONITORS FOR DISPLAY OF AREA MAPS, STATUS INDICATOR, REMOTE PILOTING AND CONTROLLING UNIT, AND COMPUTER HARDWARE AND COMPUTER SOFTWARE ALL FOR THE OPERATION AND CONTROL OF DAY/NIGHT CONTROL SYSTEMS; LASER RANGE FINDERS FOR SURVEILLANCE CAMERAS; THERMAL IMAGING SYSTEMS PRIMARILY COMPRISED OF DAY AND NIGHT CAMERA, VIDEO DISPLAY, SENSOR AND ALERTING DEVICE FOR OBSERVATION OF IMAGES; LASER WARNING SYSTEMS PRIMARILY COMPRISED OF LASER RANGE FINDER, VIDEO DISPLAY, SENSOR AND DETECTION DEVICE FOR ALERTING PURPOSES; DIGITAL SOLDIER SYSTEMS, NAMELY, INTEGRATED INFANTRY COMBAT SYSTEMS PRIMARILY COMPRISED OF TACTICAL COMPUTER HAVING OPERATING AND MANAGING SOFTWARE, DISPLAY SCREENS FOR DAY AND NIGHT VIEWING, EYEPIECE FOR DISPLAYING DATA, IMAGES OR VIDEO, URBAN OR INDOOR NAVIGATION APPARATUS, FIRE CONTROL AND MANAGE-

MENT APPARATUS, DETECTORS AND SENSORS, TARGET ACQUISITION APPARATUS, GPS RECEIVER, WIRELESS LAN AND TACTICAL MODEMS, HELMETS AND BACK PACKS TO BE USED WITH THE AFORESAID SYSTEMS; BORDER AND RECONNAISSANCE SYSTEMS PRIMARILY COMPRISED OF SURVEYING, PHOTOGRAPHIC, IMAGING, OPTICAL, MEASURING AND CHECKING APPARATUS FOR USE IN SURVEILLANCE AND BORDER SECURITY; ULTRASONIC PROXIMITY SENSORS; COMMUNICATION SYSTEMS PRIMARILY COMPRISED OF COMPUTER HARDWARE AND COMPUTER OPERATING SYSTEM SOFTWARE, COMPUTER NETWORK INFRASTRUCTURE, MEDIA ADAPTER, TACTICAL MESSAGE ORIENTED MIDDLEWARE, AUTOMATIC, GEOGRAPHICAL PUBLISH AND SUBSCRIBE MODULE, FOR A TACTICAL INTEREST AND LOCATION BASED INFORMATION DISSEMINATION SYSTEM CONNECTING COMMAND, CONTROL, COMMUNICATIONS, COMPUTERS AND INTELLIGENCE APPLICATIONS; TELECOMMUNICATION SYSTEMS PRIMARILY COMPRISED OF SATELLITE ANTENNAE, RECEIVERS, TRANSMITTERS, VERY SMALL APERTURE TERMINALS, COMPUTER OPERATING HARDWARE AND ASSOCIATED SOFTWARE FOR USE IN THE AFOREMENTIONED GOODS, ALL FOR RECEPTION AND BROADCASTING OF SATELLITE COMMUNICATION SIGNALS, ENABLING TWO-WAY, SIMULTANEOUS VOICE, VIDEO, DATA, INTERNET, TELEPHONE, FACSIMILE AND E-MAIL COMMUNICATIONS; VIDEO CAMERAS; CAMERAS; EQUIPMENT FOR RECEIVING, PROCESSING AND TRANSMITTING VOICE, VIDEO, DATA AND INFORMATION VIA TELECOMMUNICATIONS AND WIRELESS SIGNALS, NAMELY, TELECOMMUNICATION SYSTEMS PRIMARILY COMPRISED OF RECEIVERS, MODULATORS, TRANSMITTERS, MULTIPLEXERS, DECODER BOXES, DATA PROCESSORS, INTEGRATED CIRCUITS, COMPUTER HARDWARE AND OPERAT-

ING SYSTEM SOFTWARE FOR USE IN THE AFOREMENTIONED GOODS; PHOTOGRAPHIC SYSTEMS PRIMARILY COMPRISED OF DAY AND NIGHT CAMERAS, PROXIMITY SENSORS, LASER OBJECT DETECTORS, AND COMPUTER PROCESSING SOFTWARE FOR IMAGE DISPLAY AND ANALYSIS; SYSTEMS FOR DETECTION AND PROTECTION AGAINST MISSILES PRIMARILY COMPRISED OF INFRARED, ULTRA-VIOLET AND RADAR MISSILE WARNING DETECTORS INDICATING THAT A MISSILE HAS BEEN FIRED, LASER GENERATED JAMMERS PRODUCING LASER BEAMS TO COUNTER FIRED MISSILES, FORWARD-LOOKING INFRARED/FLIR, THERMAL CAMERA FOR ACQUISITION AND TRACKING OF MISSILES, HIGH SPEED ARMORED TURRET ENABLING ACCURATE TRACKING OF MISSILES SEEKERS, AND SYSTEM PROCESSOR HARDWARE COORDINATING AFORESAID PARTS; MULTI-SENSOR THERMAL IMAGING SYSTEMS PRIMARILY COMPRISED OF INFRARED AND OPTICAL SENSORS, AND TEMPERATURE SENSORS; THERMAL IMAGING SYSTEMS FOR MARITIME, GROUND AND AIRCRAFT APPLICATIONS PRIMARILY COMPRISED OF SIGNAL TRANSMITTERS AND DETECTORS, CAMERAS, AND COMPUTER PROCESSORS FOR IMAGE DISPLAY AND ANALYSIS FOR DAY AND NIGHT SCANNING, TRACKING, OBSERVATION AND TARGETING FOR MARINE, GROUND AND AIR APPLICATIONS FOR USE IN THE FIELD OF MILITARY RECOGNIZANCE, TRACKING, SURVEILLANCE, TARGETING AND NAVIGATION; FLIGHT AND VEHICLE

DRIVE TRAINING SIMULATORS; GPS SYSTEMS PRIMARILY CONSISTING OF COMPUTER HARDWARE, COMPUTER SOFTWARE FOR OPERATION AND CONTROL OF THE GLOBAL POSITIONING SYSTEM, TRANSMITTERS, RECEIVERS, AND NETWORK INTERFACE DEVICES; ANTENNAS; AND DIRECTIONAL MICROPHONES; ALL OF THE AFORESAID GOODS USED FOR SECURITY AND MILITARY PURPOSES, IN CLASS 9 (U.S. CLS. 21, 23, 26, 36 AND 38).

FOR: UNMANNED ARMORED AND NON-ARMORED VEHICLES AND STRUCTURAL PARTS THEREOF, IN CLASS 12 (U.S. CLS. 19, 21, 23, 31, 35 AND 44).

THE MARK CONSISTS OF STANDARD CHARACTERS WITHOUT CLAIM TO ANY PARTICULAR FONT, STYLE, SIZE, OR COLOR.

PRIORITY CLAIMED UNDER SEC. 44(D) ON ISRAEL APPLICATION NO. 184190, FILED 10-2-2005, REG. NO. 184190, DATED 8-6-2007, EXPIRES 10-2-2015.

PRIORITY CLAIMED UNDER SEC. 44(D) ON ISRAEL APPLICATION NO. 184189, FILED 10-2-2005, REG. NO. 184189, DATED 8-7-2007, EXPIRES 10-2-2015.

SER. NO. 78-846,964, FILED 3-27-2006.

ANTHONY RINKER, EXAMINING ATTORNEY

**Int. Cls.: 25 and 28**

**Prior U.S. Cls.: 22, 23, 38, 39 and 50**

**United States Patent and Trademark Office**

**Reg. No. 3,467,884**

**Registered July 15, 2008**

**TRADEMARK  
PRINCIPAL REGISTER**

**SPORT-N-WOOD**

J.J. LEEVER (UNITED STATES INDIVIDUAL)

706 COLUMBIA STREET

ALEXANDRIA, IN 46001

FOR: APPAREL AND CLOTHING, NAMELY, JACKETS, COATS, T-SHIRTS, VESTS, SPORTS SHIRTS, BASEBALL CAPS AND HATS, IN CLASS 25 (U.S. CLS. 22 AND 39).

FIRST USE 2-15-2005; IN COMMERCE 2-15-2005.

FOR: HUNTING GOODS, NAMELY, HUNTING GAME CALLS, IN CLASS 28 (U.S. CLS. 22, 23, 38 AND 50).

FIRST USE 2-15-2004; IN COMMERCE 2-15-2004.

THE MARK CONSISTS OF STANDARD CHARACTERS WITHOUT CLAIM TO ANY PARTICULAR FONT, STYLE, SIZE, OR COLOR.

SER. NO. 78-847,225, FILED 3-27-2006.

ROBIN CHOSID, EXAMINING ATTORNEY

**Int. Cl.: 9**

**Prior U.S. Cls.: 21, 23, 26, 36 and 38**

**United States Patent and Trademark Office**

**Reg. No. 3,467,885**

**Registered July 15, 2008**

**TRADEMARK  
PRINCIPAL REGISTER**

**ELISAWARE**

VMRD, INC. (WASHINGTON CORPORATION)  
4641 PULLMAN-ALBION ROAD  
PULLMAN, WA 99163

THE MARK CONSISTS OF STANDARD CHAR-  
ACTERS WITHOUT CLAIM TO ANY PARTICULAR  
FONT, STYLE, SIZE, OR COLOR.

FOR: COMPUTER SOFTWARE FOR USE IN THE  
MANAGEMENT OF LAB DATA AND SPECIMENS  
FOR VETERINARY LABORATORIES, IN CLASS 9  
(U.S. CLS. 21, 23, 26, 36 AND 38).

SER. NO. 78-847,430, FILED 3-28-2006.

FIRST USE 12-31-2005; IN COMMERCE 12-31-2005.

PRISCILLA MILTON, EXAMINING ATTORNEY

**Int. Cls.: 6 and 7**

**Prior U.S. Cls.: 2, 12, 13, 14, 19, 21, 23, 25, 31, 34, 35  
and 50**

**Reg. No. 3,467,886**

**United States Patent and Trademark Office**

**Registered July 15, 2008**

**TRADEMARK  
PRINCIPAL REGISTER**

**GRKFASTENERS**

GRK CANADA LIMITED (CANADA CORPORATION)  
1499 ROSSLYN ROAD  
THUNDER BAY, CANADA ONTARIO P

FOR: METAL SCREWS AND FASTENERS, NAMELY, ADJUSTABLE DISTANCE SCREWS, RUGGED STRUCTURAL SCREWS, CABINET SCREWS, TRIM SCREWS, COMPOSITE DECKING SCREWS, COUNTERSINKING SCREWS, AND SIDING SCREWS; METAL SCREWS FOR USE WITH WOOD, METAL AND CONCRETE; ACCESSORIES FOR SCREWS AND FASTENERS, NAMELY, METAL CAPS USED TO COVER SCREWS, IN CLASS 6 (U.S. CLS. 2, 12, 13, 14, 23, 25 AND 50).

FIRST USE 4-0-2001; IN COMMERCE 4-0-2001.

FOR: TOOLS, NAMELY, BITS FOR POWER-OPERATED SCREW DRIVERS, COMPONENT PARTS

FOR POWER-OPERATED SCREW DRIVERS IN THE NATURE OF BIT HOLDERS, AND SCREW GUIDES FOR POWER-OPERATED SCREWDRIVERS, IN CLASS 7 (U.S. CLS. 13, 19, 21, 23, 31, 34 AND 35).

FIRST USE 4-0-2001; IN COMMERCE 4-0-2001.

THE MARK CONSISTS OF STANDARD CHARACTERS WITHOUT CLAIM TO ANY PARTICULAR FONT, STYLE, SIZE, OR COLOR.

PRIORITY CLAIMED UNDER SEC. 44(D) ON CANADA APPLICATION NO. 1292250, FILED 3-2-2006, REG. NO. TMA682650, DATED 2-28-2007, EXPIRES 2-28-2022.

SER. NO. 78-848,100, FILED 3-28-2006.

LAURA HAMMEL, EXAMINING ATTORNEY

**Int. Cls.: 12, 27 and 42**

**Prior U.S. Cls.: 19, 20, 21, 23, 31, 35, 37, 42, 44, 50, 100  
and 101**

**Reg. No. 3,467,887**

**United States Patent and Trademark Office**

**Registered July 15, 2008**

**TRADEMARK  
SERVICE MARK  
PRINCIPAL REGISTER**



TREVES SA (FRANCE SOCIETE ANONYME)  
109, RUE DU FAUBOURG SAINT-HONORE  
PARIS, FRANCE 75008

FOR: LAND VEHICLES; AIR VEHICLES, NAME-  
LY, AIRPLANES, AIRCRAFTS, GLIDERS, HELI-  
COPTERS; WATER VEHICLES, NAMELY,  
YACHTS, POWER BOATS, ENGINE DRIVEN  
BOATS, SAILBOATS, HYDROFOIL BOATS; APPA-  
RATUS FOR LOCOMOTION BY LAND, AIR OR  
WATER, NAMELY, AIRPLANES, LAND VEHICLES  
AND BOATS; HEAD RESTS FOR VEHICLE SEATS;  
AUTOMOBILE BODIES, AUTOMOBILE BUMPERS,  
SUN BLINDS ADAPTED FOR AUTOMOBILES; UP-  
HOLSTERY FOR VEHICLES; SEAT COVERS FOR  
VEHICLES; VEHICLE SEATS, IN CLASS 12 (U.S. CLS.  
19, 21, 23, 31, 35 AND 44).

FOR: NON-SLIP FLOOR MATS FOR LAND, AIR  
OR WATER VEHICLES; CARPETS FOR MOTOR  
VEHICLES; FLOOR COVERINGS; CARPET UNDER-  
LAY; CARPETS, RUGS, MATS AND MATTING,  
AND LINOLEUM FOR COVERING EXISTING  
FLOORS, IN CLASS 27 (U.S. CLS. 19, 20, 37, 42 AND  
50).

FOR: TECHNICAL RESEARCH FOR THE DEVEL-  
OPMENT OF NEW PRODUCTS IN THE FIELD OF

TEXTILES AND MOTOR VEHICLES; TEXTILE  
TESTING; CHEMICAL RESEARCH; GRAPHIC  
ARTS DESIGN; MATERIAL TESTING; WEB SITE  
HOSTING; INDUSTRIAL DESIGN SERVICES; AND  
MECHANICAL RESEARCH, IN CLASS 42 (U.S. CLS.  
100 AND 101).

OWNER OF ERPN CMNTY TM OFC REG. NO.  
004007721, DATED 12-12-2005, EXPIRES 9-2-2014.

THE COLOR(S) BLUE AND BLACK IS/ARE  
CLAIMED AS A FEATURE OF THE MARK.

THE COLOR BLACK APPEARS IN THE WORD-  
ING AND THE COLOR BLUE APPEARS IN THE  
TWO CURVED BANDS AND THE SQUARE DE-  
SIGN.

THE ENGLISH TRANSLATION OF THE FRENCH  
WORD "TRÈVES" IN THE MARK IS "TRIER,"  
WHICH IS A CITY IN GERMANY.

SER. NO. 78-848,686, FILED 3-29-2006.

LAURA HAMMEL, EXAMINING ATTORNEY

**Int. Cls.: 9 and 41**

**Prior U.S. Cls.: 21, 23, 26, 36, 38, 100, 101 and 107**

**Reg. No. 3,467,888**

**United States Patent and Trademark Office**

**Registered July 15, 2008**

**TRADEMARK  
SERVICE MARK  
PRINCIPAL REGISTER**

**STABLE ENTERTAINMENT**

THE DEAK GROUP, INC. (FLORIDA CORPORATION)  
3401 POWERLINE ROAD  
FORT LAUDERDALE, FL 33309

FOR: PRE-RECORDED VIDEO DISCS, FEATURING ADULT ENTERTAINMENT; PRE-RECORDED VIDEO TAPES FEATURING ADULT ENTERTAINMENT, IN CLASS 9 (U.S. CLS. 21, 23, 26, 36 AND 38).

FIRST USE 10-15-1998; IN COMMERCE 6-1-1999.

FOR: ENTERTAINMENT SERVICES, NAMELY, PRODUCTION AND DISTRIBUTION OF MOTION PICTURES, IN CLASS 41 (U.S. CLS. 100, 101 AND 107).

FIRST USE 10-15-1998; IN COMMERCE 6-1-1999.

THE MARK CONSISTS OF STANDARD CHARACTERS WITHOUT CLAIM TO ANY PARTICULAR FONT, STYLE, SIZE, OR COLOR.

OWNER OF U.S. REG. NO. 2,506,964.

NO CLAIM IS MADE TO THE EXCLUSIVE RIGHT TO USE "ENTERTAINMENT", APART FROM THE MARK AS SHOWN.

SER. NO. 78-849,158, FILED 3-29-2006.

MICHAEL WIENER, EXAMINING ATTORNEY

**Int. Cls.: 3 and 9**

**Prior U.S. Cls.: 1, 4, 6, 21, 23, 26, 36, 38, 50, 51 and 52**

**United States Patent and Trademark Office**

**Reg. No. 3,467,889**

**Registered July 15, 2008**

**TRADEMARK  
PRINCIPAL REGISTER**

**ERMANNNO  
SCERVINO**

ERMANNNO PAN-EUROPE KFT. (HUNGARY  
COMPANY)  
Ó UTCA 6.2/1  
BUDAPEST, HUNGARY H-11060

FOR: FRAGRANCE PRODUCTS FOR PERSONAL  
USE, NAMELY, PERFUMES, EAU DE PARFUM,  
EAU DE TOILETTE, EAU DE COLOGNE; ESSEN-  
TIAL OILS FOR PERSONAL USE; DEODORANTS  
FOR PERSONAL USE; PERFUMED CREAMS AND  
LOTIONS FOR FACE AND BODY CARE PURPOSES;  
MAKE-UP; SKIN SOAPS; HAIR LOTIONS; BATH  
LOTIONS, IN CLASS 3 (U.S. CLS. 1, 4, 6, 50, 51 AND  
52).

FOR: EYEGASSES; SUNGLASSES; SPORTS  
GLASSES; EYEGGLASS ACCESSORIES, NAMELY,

EYEGGLASS FRAMES, EYEGGLASS CHAINS, EYE-  
GLASS CORDS, EYEGGLASS CASES, IN CLASS 9 (U.S.  
CLS. 21, 23, 26, 36 AND 38).

OWNER OF ERPN CMNTY TM OFC REG. NO.  
004278933, DATED 3-28-2006, EXPIRES 3-28-2016.

OWNER OF U.S. REG. NOS. 2,596,720, 2,599,998,  
AND 2,899,336.

THE NAME ERMANNNO SCERVINO DOES NOT  
IDENTIFY A LIVING INDIVIDUAL.

SER. NO. 78-849,178, FILED 3-29-2006.

IRA J. GOODSaid, EXAMINING ATTORNEY



**Int. Cl.: 42**

**Prior U.S. Cls.: 100 and 101**

**United States Patent and Trademark Office**

**Reg. No. 3,467,890**

**Registered July 15, 2008**

**SERVICE MARK  
PRINCIPAL REGISTER**

**ADVANCING THE SCIENCE OF  
CELLULAR MEDICINE**

CYTONOME, INC. (DELAWARE CORPORATION)  
27 DRYDOCK AVENUE  
BOSTON, MA 02210

FOR: RESEARCH AND DEVELOPMENT OF  
CELL BASED AND TRANSFUSION MEDICINE  
USING OPTICAL SORTING FOR CELL SELECTION  
OR PRODUCTION, IN CLASS 42 (U.S. CLS. 100 AND  
101).

FIRST USE 5-2-2006; IN COMMERCE 5-2-2006.

THE MARK CONSISTS OF STANDARD CHARACTERS WITHOUT CLAIM TO ANY PARTICULAR FONT, STYLE, SIZE, OR COLOR.

SER. NO. 78-850,702, FILED 3-30-2006.

EDWARD FENNESSY, EXAMINING ATTORNEY

**Int. Cl.: 43**

**Prior U.S. Cls.: 100 and 101**

**United States Patent and Trademark Office**

**Reg. No. 3,467,891**

**Registered July 15, 2008**

**SERVICE MARK  
PRINCIPAL REGISTER**

**MANSION ON FORSYTH PARK**

THE MANSION HOTEL, L.P. (GEORGIA LIMITED PARTNERSHIP)  
4901 VINELAND ROAD  
SUITE 650  
ORLANDO, FL 32811

FOR: HOTEL, BAR AND RESTAURANT SERVICES; PROVIDING BANQUET AND SOCIAL FUNCTION FACILITIES FOR SPECIAL OCCASIONS, IN CLASS 43 (U.S. CLS. 100 AND 101).

FIRST USE 4-1-2004; IN COMMERCE 4-1-2004.

THE MARK CONSISTS OF STANDARD CHARACTERS WITHOUT CLAIM TO ANY PARTICULAR FONT, STYLE, SIZE, OR COLOR.

SEC. 2(F).

SER. NO. 78-853,176, FILED 4-4-2006.

VIVIAN MICZNIK FIRST, EXAMINING ATTORNEY

**Int. Cl.: 11**

**Prior U.S. Cls.: 13, 21, 23, 31 and 34**

**United States Patent and Trademark Office**

**Reg. No. 3,467,892**

**Registered July 15, 2008**

**TRADEMARK  
PRINCIPAL REGISTER**

**TROJANUV4000PLUS**

TROJANUV4000PLUS (CANADA CORPORATION)

3020 GORE ROAD

LONDON, ONTARIO, CANADA N5V 5T7

FOR: WATER AND FLUID TREATMENT EQUIPMENT, NAMELY MECHANICAL REACTORS WHICH UTILIZES ULTRA-VIOLET TECHNOLOGY FOR THE TREATMENT, DISINFECTANT, PURIFICATION, AND STERILIZATION OF WATER AND OTHER FLUIDS FOR INDUSTRIAL, COMMERCIAL, MUNICIPAL, AND RESIDENTIAL USE, IN CLASS 11 (U.S. CLS. 13, 21, 23, 31 AND 34).

THE MARK CONSISTS OF STANDARD CHARACTERS WITHOUT CLAIM TO ANY PARTICULAR FONT, STYLE, SIZE, OR COLOR.

PRIORITY CLAIMED UNDER SEC. 44(D) ON CANADA APPLICATION NO. 1295821, FILED 3-29-2006, REG. NO. TMA692107, DATED 7-16-2007, EXPIRES 7-16-2022.

OWNER OF U.S. REG. NOS. 1,916,334, 3,052,154 AND OTHERS.

SER. NO. 78-854,208, FILED 4-5-2006.

ANNE MADDEN, EXAMINING ATTORNEY

**Int. Cl.: 16**

**Prior U.S. Cls.: 2, 5, 22, 23, 29, 37, 38 and 50**

**Reg. No. 3,467,893**

**United States Patent and Trademark Office**

**Registered July 15, 2008**

**TRADEMARK  
PRINCIPAL REGISTER**

**CHAMEX**

INTERNATIONAL PAPER DO BRASIL LTDA.  
(BRAZIL CORPORATION)  
RODOVIA SP 340, KM 171,  
MOGI GUAÇU, SAO PAULO, BRAZIL 13840-970

FOR: PAPER, NAMELY, COPY PAPER, PRINT-  
ING PAPER, FAX PAPER, WRITING PAPER, LASER  
PRINTING PAPER, RECYCLED PAPER, COLORED  
PAPER, BOND PAPER, FIBER PAPER, IN CLASS 16  
(U.S. CLS. 2, 5, 22, 23, 29, 37, 38 AND 50).

THE MARK CONSISTS OF STANDARD CHAR-  
ACTERS WITHOUT CLAIM TO ANY PARTICULAR  
FONT, STYLE, SIZE, OR COLOR.

OWNER OF BRAZIL REG. NO. 820072338, DATED  
10-19-1999, EXPIRES 10-19-2009.

SER. NO. 78-854,806, FILED 4-5-2006.

JULIE GUTTADAURO, EXAMINING ATTORNEY

**Int. Cls.: 35 and 42**

**Prior U.S. Cls.: 100, 101 and 102**

**United States Patent and Trademark Office**

**Reg. No. 3,467,894**

**Registered July 15, 2008**

**SERVICE MARK  
PRINCIPAL REGISTER**

**DR. MIKEL J HARRY**

DR. MIKEL J. HARRY, LTD. (ARIZONA CORPORATION)  
P.O. BOX 26990  
SCOTTSDALE, AZ 85255

FOR: RETAIL STORE SERVICES FOR PRODUCTS IN THE FIELD OF QUALITY AND PROCESS IMPROVEMENT AND CONTROL, IN CLASS 35 (U.S. CLS. 100, 101 AND 102).

FIRST USE 11-15-1993; IN COMMERCE 11-15-1993.

FOR: ACCREDITATION SERVICES, NAMELY, ESTABLISHING STANDARDS FOR BUSINESS PROCESS AND QUALITY IMPROVEMENT SERVICES IN THE FIELD OF QUALITY AND PROCESS IMPROVEMENT AND CONTROL FOR THE PURPOSE

OF ACCREDITATION, IN CLASS 42 (U.S. CLS. 100 AND 101).

FIRST USE 11-15-1993; IN COMMERCE 11-15-1993.

THE MARK CONSISTS OF STANDARD CHARACTERS WITHOUT CLAIM TO ANY PARTICULAR FONT, STYLE, SIZE, OR COLOR.

THE NAME "DR. MIKEL J. HARRY" IDENTIFIES A LIVING INDIVIDUAL WHOSE CONSENT IS OF RECORD.

SER. NO. 78-858,242, FILED 4-10-2006.

COLLEEN DOMBROW, EXAMINING ATTORNEY

**Int. Cl.: 1**

**Prior U.S. Cls.: 1, 5, 6, 10, 26 and 46**

**United States Patent and Trademark Office**

**Reg. No. 3,467,895**

**Registered July 15, 2008**

---

**TRADEMARK  
PRINCIPAL REGISTER**

**WaterSavr**

WATERSAVR GLOBAL SOLUTIONS, INC (NE-  
VADA CORPORATION)  
2614 QUEENSWOOD DRIVE  
VICTORIA, CANADA V8N 1X5

FOR: WATER TREATMENT CHEMICAL FOR  
USE ON VARIOUS WATER BODIES OR AGRICUL-  
TURAL LAND TO REDUCE EVAPORATION, IN  
CLASS 1 (U.S. CLS. 1, 5, 6, 10, 26 AND 46).

FIRST USE 1-1-2004; IN COMMERCE 1-1-2004.

THE MARK CONSISTS OF STANDARD CHAR-  
ACTERS WITHOUT CLAIM TO ANY PARTICULAR  
FONT, STYLE, SIZE, OR COLOR.

SER. NO. 78-861,067, FILED 4-13-2006.

LINDA LAVACHE, EXAMINING ATTORNEY

Int. Cls.: 9, 25 and 41

Prior U.S. Cls.: 21, 22, 23, 26, 36, 38, 39, 100, 101 and 107

Reg. No. 3,467,896

United States Patent and Trademark Office

Registered July 15, 2008

TRADEMARK  
SERVICE MARK  
PRINCIPAL REGISTER



MALA CARA MUZIC, LLC (NEW YORK LTD  
LIAB CO)  
52 ADAMS PLACE  
FREEHOLD, NJ 07728

FIRST USE 1-1-2006; IN COMMERCE 1-1-2006.

FOR: MUSICAL SOUND RECORDINGS, IN  
CLASS 9 (U.S. CLS. 21, 23, 26, 36 AND 38).

NO CLAIM IS MADE TO THE EXCLUSIVE  
RIGHT TO USE "MUSIC", APART FROM THE  
MARK AS SHOWN.

FIRST USE 1-1-2006; IN COMMERCE 1-1-2006.

FOR: SHORT-SLEEVED OR LONG-SLEEVED T-  
SHIRTS, IN CLASS 25 (U.S. CLS. 22 AND 39).

THE MARK CONSISTS OF THE WORDS "MALA  
CARA" WITH AN IMAGE OF A FANCIFUL CHAR-  
ACTER HOLDING THE WORDS "MUZIC" UNDER-  
NEATH.

FIRST USE 1-1-2006; IN COMMERCE 1-1-2006.

FOR: ENTERTAINMENT SERVICES, NAMELY,  
PROVIDING A WEB SITE FEATURING MUSICAL  
PERFORMANCES, MUSICAL VIDEOS, RELATED  
FILM CLIPS, PHOTOGRAPHS, AND OTHER MUL-  
TIMEDIA MATERIALS, IN CLASS 41 (U.S. CLS. 100,  
101 AND 107).

THE FOREIGN WORDING IN THE MARK  
TRANSLATES INTO ENGLISH AS "BAD FACE".

SER. NO. 78-863,312, FILED 4-18-2006.

STEVEN PEREZ, EXAMINING ATTORNEY

**Int. Cl.: 41**

**Prior U.S. Cls.: 100, 101 and 107**

**United States Patent and Trademark Office**

**Reg. No. 3,467,897**

**Registered July 15, 2008**

**SERVICE MARK  
PRINCIPAL REGISTER**



**Fitness Doc**

FELCH, JENNIFER (UNITED STATES INDIVIDUAL)  
P.O. BOX 16995  
ENCINO, CA 91316

THE COLORS RED, BLUE AND BLACK ARE CLAIMED AS A FEATURE OF THE MARK.

FOR: PERSONAL TRAINING SERVICES, NAMELY, PHYSICAL FITNESS TRAINING AND STRENGTH AND CONDITIONING TRAINING, IN CLASS 41 (U.S. CLS. 100, 101 AND 107).

THE MARK CONSISTS OF A THREE-DIMENSIONAL DESIGN OF RED SWIRLS AROUND A BLUE PERSON AND THE WORDING "FITNESS DOC" IN BLACK.

FIRST USE 9-24-2005; IN COMMERCE 9-24-2005.

SER. NO. 78-865,270, FILED 4-19-2006.

NO CLAIM IS MADE TO THE EXCLUSIVE RIGHT TO USE "FITNESS", APART FROM THE MARK AS SHOWN.

KATHY DE JONGE, EXAMINING ATTORNEY



**Int. Cls.: 41 and 45**

**Prior U.S. Cls.: 100, 101 and 107**

**United States Patent and Trademark Office**

**Reg. No. 3,467,898**

**Registered July 15, 2008**

**SERVICE MARK  
PRINCIPAL REGISTER**

**NEW CANAAN SOCIETY**

NEW CANAAN SOCIETY, INC. (CONNECTICUT CORPORATION)  
85 ROSEBROOK RD  
NEW CANAAN, CT 06840

FOR: EDUCATIONAL SERVICES, NAMELY, PROVIDING WORKSHOPS AND SEMINARS FOR THE STUDY OF SPIRITUAL AND RELIGIOUS ISSUES, IN CLASS 41 (U.S. CLS. 100, 101 AND 107).

FIRST USE 1-1-1999; IN COMMERCE 2-1-1999.

FOR: MINISTERIAL SERVICES, NAMELY, PROVIDING CLUBS FOR CHRISTIAN MEN IN THE FIELD OF PRAYER AND SPIRITUALITY AND HOLDING SPIRITUAL MEETINGS AND RE-

TREATS FOR MEMBERS AND THEIR FAMILIES, IN CLASS 45 (U.S. CLS. 100 AND 101).

FIRST USE 1-1-1999; IN COMMERCE 2-1-1999.

THE MARK CONSISTS OF STANDARD CHARACTERS WITHOUT CLAIM TO ANY PARTICULAR FONT, STYLE, SIZE, OR COLOR.

SEC. 2(F).

SER. NO. 78-869,844, FILED 4-26-2006.

HOWARD B. LEVINE, EXAMINING ATTORNEY

**Int. Cl.: 9**

**Prior U.S. Cls.: 21, 23, 26, 36 and 38**

**United States Patent and Trademark Office**

**Reg. No. 3,467,899**

**Registered July 15, 2008**

**TRADEMARK  
PRINCIPAL REGISTER**

**EZI**

ZI CORPORATION OF CANADA, INC. (CANADA CORPORATION)  
2100, 840-7TH AVENUE SW  
CALGARY, CANADA T2P 3G2

FOR: COMPUTER PROGRAMS AND SOFTWARE TO PROVIDE ENHANCED TEXT INPUT INTO ELECTRONIC DEVICES, NAMELY, MOBILE PHONES, VOIP PHONES, TELEMATIC SYSTEMS, TELEVISION SETTOP BOXES, HAND-HELD COMPUTERS, ELECTRONIC GAMING DEVICES, PERSONAL DIGITAL ASSISTANTS, UNIVERSAL REMOTE CONTROL DEVICES AND OTHER CONSUMER ELECTRONIC DEVICES CONTAINING ANY ONE OF A 12-BUTTON KEYPAD, A VIRTUAL OR HARDWARE KEYBOARD, A TOUCH SCREEN, A DIAL, A JOYSTICK OR ANY OTHER INPUT

METHOD, IN CLASS 9 (U.S. CLS. 21, 23, 26, 36 AND 38).

THE MARK CONSISTS OF STANDARD CHARACTERS WITHOUT CLAIM TO ANY PARTICULAR FONT, STYLE, SIZE, OR COLOR.

PRIORITY CLAIMED UNDER SEC. 44(D) ON CANADA APPLICATION NO. 1279889, FILED 11-17-2005, REG. NO. TMA701661, DATED 11-26-2007, EXPIRES 11-26-2022.

SER. NO. 78-871,261, FILED 4-27-2006.

JULIE GUTTADAURO, EXAMINING ATTORNEY

**Int. Cls.: 41 and 45**

**Prior U.S. Cls.: 100, 101 and 107**

**United States Patent and Trademark Office**

**Reg. No. 3,467,900**

**Registered July 15, 2008**

**SERVICE MARK  
PRINCIPAL REGISTER**

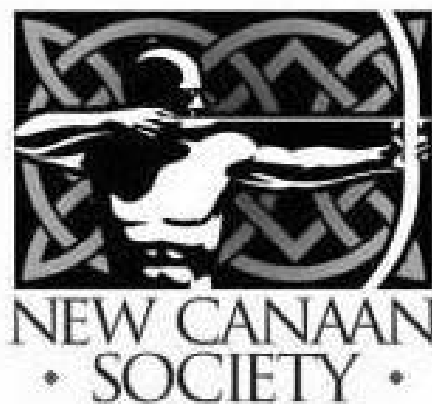

NEW CANAAN SOCIETY, INC. (CONNECTICUT CORPORATION)  
85 ROSEBROOK RD  
NEW CANAAN, CT 06840

FOR: EDUCATIONAL SERVICES, NAMELY, PROVIDING WORKSHOPS AND SEMINARS FOR THE STUDY OF SPIRITUAL AND RELIGIOUS ISSUES, IN CLASS 41 (U.S. CLS. 100, 101 AND 107).

FIRST USE 8-1-2005; IN COMMERCE 8-1-2005.

FOR: MINISTERIAL SERVICES, NAMELY, PROVIDING CLUBS FOR CHRISTIAN MEN IN THE FIELD OF PRAYER AND SPIRITUALITY AND HOLDING SPIRITUAL MEETINGS AND RE-

TREATS FOR MEMBERS AND THEIR FAMILIES, IN CLASS 45 (U.S. CLS. 100 AND 101).

FIRST USE 8-1-2005; IN COMMERCE 8-1-2005.

THE MARK CONSISTS OF A SILHOUETTE OF A MAN PERFORMING ARCHERY AGAINST A BACKGROUND CONSISTING OF A CELTIC KNOT.

SEC. 2(F).

SER. NO. 78-872,036, FILED 4-28-2006.

HOWARD B. LEVINE, EXAMINING ATTORNEY

**Int. Cl.: 35**

**Prior U.S. Cls.: 100, 101 and 102**

**United States Patent and Trademark Office**

**Reg. No. 3,467,901**

**Registered July 15, 2008**

**SERVICE MARK  
PRINCIPAL REGISTER**

**ADWISE**

TECHWISE RESEARCH, INC. (CALIFORNIA  
CORPORATION)  
3525 DEL MAR HEIGHTS ROAD #278  
SAN DIEGO, CA 921302122

THE MARK CONSISTS OF STANDARD CHAR-  
ACTERS WITHOUT CLAIM TO ANY PARTICULAR  
FONT, STYLE, SIZE, OR COLOR.

FOR: CONDUCTING BUSINESS AND MARKET  
RESEARCH SURVEYS, IN CLASS 35 (U.S. CLS. 100,  
101 AND 102).

SER. NO. 78-872,134, FILED 4-28-2006.

FIRST USE 1-9-2006; IN COMMERCE 2-6-2006.

SUSAN RICHARDS, EXAMINING ATTORNEY

**Int. Cl.: 43**

**Prior U.S. Cls.: 100 and 101**

**United States Patent and Trademark Office**

**Reg. No. 3,467,902**

**Registered July 15, 2008**

**SERVICE MARK  
PRINCIPAL REGISTER**



STATION CASINOS, INC. (NEVADA CORPORATION)  
1505 S. PAVILION CENTER DRIVE  
LAS VEGAS, NV 89135

FOR: RESTAURANT, BAR AND LOUNGE SERVICES, IN CLASS 43 (U.S. CLS. 100 AND 101).

FIRST USE 4-18-2006; IN COMMERCE 4-18-2006.

THE MARK CONSISTS OF TWO ROWS OF DOTS ABOVE A RECTANGLE, WITH THE WORDS "ROCKS LOUNGE" WRITTEN WITHIN THE RECTANGLE AND TWO LINES OF DOTS BELOW THE RECTANGLE.

SER. NO. 78-874,755, FILED 5-2-2006.

WILLIAM ROSSMAN, EXAMINING ATTORNEY

**Int. Cl.: 9**

**Prior U.S. Cls.: 21, 23, 26, 36 and 38**

**Reg. No. 3,467,903**

**United States Patent and Trademark Office**

**Registered July 15, 2008**

---

**TRADEMARK  
PRINCIPAL REGISTER**

**MUSHROOM JAZZ**

FARINA, MARK (UNITED STATES INDIVIDUAL)  
561 WINDSOR STREET, SUITE A-307  
SOMERVILLE, MA 02143

FOR: PRE-RECORDED PHONOGRAPH RECORDS, AUDIO CASSETTES, DIGITAL COMPACT DISCS, MP3 FILES, DIGITAL AUDIO FILES AND DVD AUDIO DISCS FEATURING MUSIC, IN CLASS 9 (U.S. CLS. 21, 23, 26, 36 AND 38).

FIRST USE 1-1-1995; IN COMMERCE 1-1-1995.

THE MARK CONSISTS OF STANDARD CHARACTERS WITHOUT CLAIM TO ANY PARTICULAR FONT, STYLE, SIZE, OR COLOR.

NO CLAIM IS MADE TO THE EXCLUSIVE RIGHT TO USE "JAZZ", APART FROM THE MARK AS SHOWN.

SER. NO. 78-876,054, FILED 5-3-2006.

WILLIAM ROSSMAN, EXAMINING ATTORNEY

**Int. Cl.: 42**

**Prior U.S. Cls.: 100 and 101**

**United States Patent and Trademark Office**

**Reg. No. 3,467,904**

**Registered July 15, 2008**

**SERVICE MARK  
PRINCIPAL REGISTER**

**DDEX**

DIGITAL DATA EXCHANGE, LLC (DELAWARE CORPORATION)  
ONE LINCOLN PLAZA  
NEW YORK, NY 10023

FOR: SERVICES IN THE FIELD OF DISTRIBUTION OF DIGITAL CONTENT AND RELATED INFORMATION SHARING, NAMELY, DESIGNING, DEVELOPING AND MAINTAINING STANDARDS, PROGRAMS, SOFTWARE, AND FIRMWARE DIRECTED TO THE DISTRIBUTION AND MANAGEMENT OF DIGITAL CONTENT

AND RELATED INFORMATION SHARING, IN CLASS 42 (U.S. CLS. 100 AND 101).

FIRST USE 5-4-2006; IN COMMERCE 5-4-2006.

THE MARK CONSISTS OF STANDARD CHARACTERS WITHOUT CLAIM TO ANY PARTICULAR FONT, STYLE, SIZE, OR COLOR.

SER. NO. 78-877,505, FILED 5-5-2006.

KIMBERLY FRYE, EXAMINING ATTORNEY

**Int. Cls.: 7, 9 and 11**

**Prior U.S. Cls.: 13, 19, 21, 23, 26, 31, 34, 35, 36 and 38**

**United States Patent and Trademark Office**

**Reg. No. 3,467,905**

**Registered July 15, 2008**

**TRADEMARK  
PRINCIPAL REGISTER**

# MASTER HEAT

MASTER APPLIANCE CORP. (WISCONSIN CORPORATION)  
2420 18TH STREET  
RACINE, WI 53403

FOR: POWER HEAT TOOLS, NAMELY, BUTANE POWERED SOLDERING IRONS, BUTANE POWERED CUTTING TORCHES, ELECTRIC POWERED CUTTING TORCHES, AND FLAME PRODUCING CUTTING TORCHES; ELECTRIC POWERED BLOW TORCHES; BUTANE POWERED BLOW TORCHES, AND FLAME PRODUCING BLOW TORCHES, IN CLASS 7 (U.S. CLS. 13, 19, 21, 23, 31, 34 AND 35).

FIRST USE 1-23-2003; IN COMMERCE 1-23-2003.

FOR: HEAT TOOLS, NAMELY, ELECTRIC POWERED SOLDERING IRONS AND HAND-OPERATED HEAT TORCHES, NAMELY, ELECTRIC POWERED WELDING TORCHES, BUTANE POWERED WELDING TORCHES, FLAME PRODUCING WELDING TORCHES, IN CLASS 9 (U.S. CLS. 21, 23, 26, 36 AND 38).

FIRST USE 1-23-2003; IN COMMERCE 1-23-2003.

FOR: HAND HELD HEAT TOOLS, NAMELY FLAMELESS HEAT GUNS; HEAT GUNS; HEAT TOOLS IN THE NATURE OF HOT AIR BLOWERS; ALL OF THE FOREGOING EXCLUDING SPACE HEATERS, IN CLASS 11 (U.S. CLS. 13, 21, 23, 31 AND 34).

FIRST USE 10-6-1978; IN COMMERCE 10-6-1978.

THE MARK CONSISTS OF STANDARD CHARACTERS WITHOUT CLAIM TO ANY PARTICULAR FONT, STYLE, SIZE, OR COLOR.

OWNER OF U.S. REG. NO. 1,139,876.

NO CLAIM IS MADE TO THE EXCLUSIVE RIGHT TO USE "HEAT", APART FROM THE MARK AS SHOWN.

SER. NO. 78-886,503, FILED 5-18-2006.

SARA THOMAS, EXAMINING ATTORNEY



**Int. Cl.: 43**

**Prior U.S. Cls.: 100 and 101**

**United States Patent and Trademark Office**

**Reg. No. 3,467,906**

**Registered July 15, 2008**

**SERVICE MARK  
PRINCIPAL REGISTER**

**FAIR EXPO CENTER**

MIAMI-DADE COUNTY FAIR & EXPOSITION,  
INC. (FLORIDA CORPORATION)

10901 CORAL WAY

MIAMI, FL 33165

FOR: PROVIDING FACILITIES FOR FAIRS AND  
EXHIBITIONS; PROVISION OF FAIR AND EXHIBI-  
TION FACILITIES, IN CLASS 43 (U.S. CLS. 100 AND  
101).

FIRST USE 6-30-1997; IN COMMERCE 6-30-1997.

THE MARK CONSISTS OF STANDARD CHAR-  
ACTERS WITHOUT CLAIM TO ANY PARTICULAR  
FONT, STYLE, SIZE, OR COLOR.

NO CLAIM IS MADE TO THE EXCLUSIVE  
RIGHT TO USE "EXPO CENTER", APART FROM  
THE MARK AS SHOWN.

SEC. 2(F).

SER. NO. 78-887,413, FILED 5-19-2006.

STEVEN R. FINE, EXAMINING ATTORNEY

**Int. Cl.: 35**

**Prior U.S. Cls.: 100, 101 and 102**

**United States Patent and Trademark Office**

**Reg. No. 3,467,907**

**Registered July 15, 2008**

**SERVICE MARK  
PRINCIPAL REGISTER**

**3**

GIZZIO, INC. (PENNSYLVANIA CORPORATION)  
P.O. BOX 1686  
WEST CHESTER, PA 19380

FOR: CUSTOMER SERVICE IN THE FIELD OF PET PRODUCTS, NAMELY, PRODUCTS FOR LHASA APSO, LOWCHEN, PUG, AND SHIH TZU CANINES; INVENTORYING MERCHANDISE FOR LHASA APSO, LOWCHEN, PUG, AND SHIH TZU CANINES; ON-LINE RETAIL STORE SERVICES FEATURING PET PRODUCTS, NAMELY, PRODUCTS FOR LHASA APSO, LOWCHEN, PUG, AND SHIH TZU CANINES; PRODUCT MERCHANDISING, NAMELY, PRODUCTS FOR LHASA APSO, LOWCHEN, PUG, AND SHIH TZU CANINES; PROMOTING THE GOODS AND SERVICES OF OTHERS THROUGH ON-LINE ORDERING AND CATALOGING OF THOSE GOODS AND SERVICES, NAMELY, GOOD AND SERVICES FOR LHASA APSO, LOWCHEN, PUG, AND SHIH TZU CANINES; PROMOTING THE GOODS AND SERVICES OF OTHERS VIA A GLOBAL COMPUTER NETWORK, NAMELY, GOODS AND SERVICES FOR LHASA APSO, LOWCHEN, PUG, AND SHIH TZU CANINES; PROVIDING AN ON-LINE COMPUTER DATABASE FEATURING TRADE INFORMATION IN THE FIELD OF PET PRODUCTS, NAMELY, PRODUCTS FOR LHASA APSO, LOWCHEN, PUG, AND SHIH TZU CANINES; PROVIDING CONSUMER PRO-

DUCT INFORMATION VIA THE INTERNET, NAMELY, PRODUCTS FOR LHASA APSO, LOWCHEN, PUG, AND SHIH TZU CANINES; PROVIDING INFORMATION ABOUT THE GOODS AND SERVICES OF OTHERS VIA THE GLOBAL COMPUTER NETWORK, NAMELY, GOODS AND SERVICES FOR LHASA APSO, LOWCHEN, PUG, AND SHIH TZU CANINES; PROVIDING INFORMATION ABOUT THE TRADING OF PET PRODUCTS, NAMELY, PRODUCTS FOR LHASA APSO, LOWCHEN, PUG, AND SHIH TZU CANINES; RETAIL STORE SERVICES FEATURING A WIDE VARIETY OF CONSUMER GOODS OF OTHERS, NAMELY, GOODS FOR LHASA APSO, LOWCHEN, PUG, AND SHIH TZU CANINES; SHOPPERS' GUIDE INFORMATION FOR LHASA APSO, LOWCHEN, PUG, AND SHIH TZU CANINES, IN CLASS 35 (U.S. CLS. 100, 101 AND 102).

FIRST USE 6-14-2001; IN COMMERCE 6-14-2001.

THE MARK CONSISTS OF STANDARD CHARACTERS WITHOUT CLAIM TO ANY PARTICULAR FONT, STYLE, SIZE, OR COLOR.

SER. NO. 78-887,552, FILED 5-19-2006.

HANNO RITTNER, EXAMINING ATTORNEY

Int. Cl.: 35

Prior U.S. Cls.: 100, 101 and 102

United States Patent and Trademark Office

Reg. No. 3,467,908

Registered July 15, 2008

**SERVICE MARK  
PRINCIPAL REGISTER**

4

GIZZIO, INC. (PENNSYLVANIA CORPORATION)  
P.O. BOX 1686  
WEST CHESTER, PA 19380

FOR: CUSTOMER SERVICE IN THE FIELD OF PET PRODUCTS, NAMELY, PRODUCTS FOR MINIATURE AMERICAN ESKIMO DOG, AUSTRALIAN TERRIER, BORDER TERRIER, BOSTON TERRIER, CAIRN TERRIER, CAVALIER KING CHARLES SPANIEL, DANDIE DINMONT TERRIER, FRENCH BULLDOG, NORFOLK TERRIER, NORWICH TERRIER, PARSON RUSSELL TERRIER, MINIATURE POODLE, SCHIPPERKE, MINIATURE SCHNAUZER, AND TIBETAN SPANIEL CANINES; INVENTORING MERCHANDISE FOR MINIATURE AMERICAN ESKIMO DOG, AUSTRALIAN TERRIER, BORDER TERRIER, BOSTON TERRIER, CAIRN TERRIER, CAVALIER KING CHARLES SPANIEL, DANDIE DINMONT TERRIER, FRENCH BULLDOG, NORFOLK TERRIER, NORWICH TERRIER, PARSON RUSSELL TERRIER, MINIATURE POODLE, SCHIPPERKE, MINIATURE SCHNAUZER, AND TIBETAN SPANIEL CANINES; ON-LINE RETAIL STORE SERVICES FEATURING PET PRODUCTS, NAMELY, PRODUCTS FOR MINIATURE AMERICAN ESKIMO DOG, AUSTRALIAN TERRIER, BORDER TERRIER, BOSTON TERRIER, CAIRN TERRIER, CAVALIER KING CHARLES SPANIEL, DANDIE DINMONT TERRIER, FRENCH BULLDOG, NORFOLK TERRIER, NORWICH TERRIER, PARSON RUSSELL TERRIER, MINIATURE POODLE, SCHIPPERKE, MINIATURE SCHNAUZER, AND TIBETAN SPANIEL CANINES; PRODUCT MERCHANDISING, NAMELY, PRODUCTS FOR MINIATURE AMERICAN ESKIMO DOG, AUSTRALIAN TERRIER, BORDER TERRIER, BOSTON TERRIER, CAIRN TERRIER, CAVALIER KING CHARLES SPANIEL, DANDIE DINMONT TERRIER, FRENCH BULLDOG, NORFOLK TERRIER, NORWICH TERRIER, PARSON RUSSELL TERRIER, MINIATURE POODLE, SCHIPPERKE, MINIATURE SCHNAUZER, AND TIBETAN SPANIEL

CANINES; PROMOTING THE GOODS AND SERVICES OF OTHERS THROUGH ON-LINE ORDERING AND CATALOGING OF THOSE GOODS AND SERVICES, NAMELY, GOOD AND SERVICES FOR MINIATURE AMERICAN ESKIMO DOG, AUSTRALIAN TERRIER, BORDER TERRIER, BOSTON TERRIER, CAIRN TERRIER, CAVALIER KING CHARLES SPANIEL, DANDIE DINMONT TERRIER, FRENCH BULLDOG, NORFOLK TERRIER, NORWICH TERRIER, PARSON RUSSELL TERRIER, MINIATURE POODLE, SCHIPPERKE, MINIATURE SCHNAUZER, AND TIBETAN SPANIEL CANINES; PROMOTING THE GOODS AND SERVICES OF OTHERS VIA A GLOBAL COMPUTER NETWORK, NAMELY, GOODS AND SERVICES FOR MINIATURE AMERICAN ESKIMO DOG, AUSTRALIAN TERRIER, BORDER TERRIER, BOSTON TERRIER, CAIRN TERRIER, CAVALIER KING CHARLES SPANIEL, DANDIE DINMONT TERRIER, FRENCH BULLDOG, NORFOLK TERRIER, NORWICH TERRIER, PARSON RUSSELL TERRIER, MINIATURE POODLE, SCHIPPERKE, MINIATURE SCHNAUZER, AND TIBETAN SPANIEL CANINES; PROVIDING AN ON-LINE COMPUTER DATABASE FEATURING TRADE INFORMATION IN THE FIELD OF PET PRODUCTS, NAMELY, PRODUCTS FOR MINIATURE AMERICAN ESKIMO DOG, AUSTRALIAN TERRIER, BORDER TERRIER, BOSTON TERRIER, CAIRN TERRIER, CAVALIER KING CHARLES SPANIEL, DANDIE DINMONT TERRIER, FRENCH BULLDOG, NORFOLK TERRIER, NORWICH TERRIER, PARSON RUSSELL TERRIER, MINIATURE POODLE, SCHIPPERKE, MINIATURE SCHNAUZER, AND TIBETAN SPANIEL CANINES; PROVIDING BUSINESS MARKETING INFORMATION FOR MINIATURE AMERICAN ESKIMO DOG, AUSTRALIAN TERRIER, BORDER TERRIER, BOSTON TERRIER, CAIRN TERRIER, CAVALIER KING CHARLES SPANIEL, DANDIE DINMONT TERRIER, FRENCH BULLDOG, NORFOLK TERRIER, NORWICH TERRIER, PARSON RUSSELL TERRIER, MINIATURE POODLE, SCHIPPERKE, MINIATURE SCHNAUZER, AND TIBETAN SPANIEL

DLE, SCHIPPERKE, MINIATURE SCHNAUZER, AND TIBETAN SPANIEL CANINES; PROVIDING CONSUMER PRODUCT INFORMATION VIA THE INTERNET, NAMELY, PRODUCTS FOR MINIATURE AMERICAN ESKIMO DOG, AUSTRALIAN TERRIER, BORDER TERRIER, BOSTON TERRIER, CAIRN TERRIER, CAVALIER KING CHARLES SPANIEL, DANDIE DINMONT TERRIER, FRENCH BULLDOG, NORFOLK TERRIER, NORWICH TERRIER, PARSON RUSSELL TERRIER, MINIATURE POODLE, SCHIPPERKE, MINIATURE SCHNAUZER, AND TIBETAN SPANIEL CANINES; PROVIDING INFORMATION ABOUT THE GOODS AND SERVICES OF OTHERS VIA THE GLOBAL COMPUTER NETWORK, NAMELY, GOODS AND SERVICES FOR MINIATURE AMERICAN ESKIMO DOG, AUSTRALIAN TERRIER, BORDER TERRIER, BOSTON TERRIER, CAIRN TERRIER, CAVALIER KING CHARLES SPANIEL, DANDIE DINMONT TERRIER, FRENCH BULLDOG, NORFOLK TERRIER, NORWICH TERRIER, PARSON RUSSELL TERRIER, MINIATURE POODLE, SCHIPPERKE, MINIATURE SCHNAUZER, AND TIBETAN SPANIEL CANINES; PROVIDING INFORMATION ABOUT THE TRADING OF PET PRODUCTS, NAMELY, PRODUCTS FOR MINIATURE AMERICAN ESKIMO DOG, AUSTRALIAN TERRIER, BORDER TERRIER, BOSTON TERRIER, CAIRN TERRIER, CAVALIER KING CHARLES SPANIEL, DANDIE DINMONT TERRIER, FRENCH BULLDOG, NORFOLK TERRIER, NORWICH TERRIER, PARSON RUSSELL TERRIER, MINIATURE POODLE, SCHIPPERKE, MINIATURE SCHNAUZER, AND TIBETAN SPANIEL CANINES;

AND TIBETAN SPANIEL CANINES; RETAIL STORE SERVICES FEATURING A WIDE VARIETY OF CONSUMER GOODS OF OTHERS, NAMELY, GOODS FOR MINIATURE AMERICAN ESKIMO DOG, AUSTRALIAN TERRIER, BORDER TERRIER, BOSTON TERRIER, CAIRN TERRIER, CAVALIER KING CHARLES SPANIEL, DANDIE DINMONT TERRIER, FRENCH BULLDOG, NORFOLK TERRIER, NORWICH TERRIER, PARSON RUSSELL TERRIER, MINIATURE POODLE, SCHIPPERKE, MINIATURE SCHNAUZER, AND TIBETAN SPANIEL CANINES; SHOPPERS' GUIDE INFORMATION FOR MINIATURE AMERICAN ESKIMO DOG, AUSTRALIAN TERRIER, BORDER TERRIER, BOSTON TERRIER, CAIRN TERRIER, CAVALIER KING CHARLES SPANIEL, DANDIE DINMONT TERRIER, FRENCH BULLDOG, NORFOLK TERRIER, NORWICH TERRIER, PARSON RUSSELL TERRIER, MINIATURE POODLE, SCHIPPERKE, MINIATURE SCHNAUZER, AND TIBETAN SPANIEL CANINES, IN CLASS 35 (U.S. CLS. 100, 101 AND 102).

FIRST USE 6-14-2001; IN COMMERCE 6-14-2001.

THE MARK CONSISTS OF STANDARD CHARACTERS WITHOUT CLAIM TO ANY PARTICULAR FONT, STYLE, SIZE, OR COLOR.

SER. NO. 78-887,558, FILED 5-19-2006.

HANNO RITTNER, EXAMINING ATTORNEY

**Int. Cl.: 42**

**Prior U.S. Cls.: 100 and 101**

**United States Patent and Trademark Office**

**Reg. No. 3,467,909**

**Registered July 15, 2008**

**SERVICE MARK  
PRINCIPAL REGISTER**

**GIFTNET**

MICHAEL C. FINA COMPANY (NEW YORK  
CORPORATION)  
545 FIFTH AVENUE  
NEW YORK, NY 10017

THE MARK CONSISTS OF STANDARD CHAR-  
ACTERS WITHOUT CLAIM TO ANY PARTICULAR  
FONT, STYLE, SIZE, OR COLOR.

FOR: PROVIDING COMPUTER SERVICES BY  
CREATING CUSTOMIZED WEBSITES FOR OTH-  
ERS FEATURING EMPLOYEE RECOGNITION  
PROGRAMS, IN CLASS 42 (U.S. CLS. 100 AND 101).

SER. NO. 78-890,419, FILED 5-23-2006.

FIRST USE 9-0-1998; IN COMMERCE 9-0-1998.

KAPIL BHANOT, EXAMINING ATTORNEY

**Int. Cl.: 38**

**Prior U.S. Cls.: 100, 101 and 104**

**United States Patent and Trademark Office**

**Reg. No. 3,467,910**

**Registered July 15, 2008**

**SERVICE MARK  
PRINCIPAL REGISTER**

**Application Quality Score**

IPANEMA TECHNOLOGIES (FRANCE CORPORATION)  
28, RUE DE LA REDOUTE  
FONTENAY AUX ROSES, FRANCE 92260

FOR: DATA TRANSMISSION PROCESSING, NAMELY, COMMUNICATIONS BY COMPUTER TERMINALS; COMMUNICATION BY FIBER OPTIC NETWORKS; TELECOMMUNICATIONS SERVICES, NAMELY, TRANSMISSION OF VOICE, VIDEO, DATA AND DOCUMENTS IN THE FIELD NETWORK MANAGEMENT, NETWORK TRAFFIC MANAGEMENT, NETWORK SERVICE LEVEL MANAGEMENT AND NETWORK SECURITY; COMPUTER-AIDED TRANSMISSION OF MESSA-

GES AND IMAGES, IN CLASS 38 (U.S. CLS. 100, 101 AND 104).

THE MARK CONSISTS OF STANDARD CHARACTERS WITHOUT CLAIM TO ANY PARTICULAR FONT, STYLE, SIZE, OR COLOR.

PRIORITY CLAIMED UNDER SEC. 44(D) ON ERPN CMNTY TM OFC APPLICATION NO. 005079694, FILED 5-17-2006, REG. NO. 005079694, DATED 4-16-2007, EXPIRES 5-17-2016.

SER. NO. 78-890,722, FILED 5-23-2006.

DAYNA BROWNE, EXAMINING ATTORNEY

**Int. Cl.: 35**

**Prior U.S. Cls.: 100, 101 and 102**

**United States Patent and Trademark Office**

**Reg. No. 3,467,911**

**Registered July 15, 2008**

**SERVICE MARK  
PRINCIPAL REGISTER**

**TECHLAW GROUP, INC.**

TECHLAW GROUP, INC. (PENNSYLVANIA  
NON-PROFIT CORPORATION)  
C/O ACKERMANN PR  
1111 NORTSHORE DRIVE, NW, SUITE N-400  
KNOXVILLE, TN 37919

FOR: ASSOCIATION SERVICES, NAMELY, PROMOTING THE INTERESTS OF LAW FIRMS BY FOSTERING, MAINTAINING AND EXPANDING MEMBER LAW FIRMS' EXPERTISE AND RESOURCES IN AREAS OF LAW OF CONCERN OR INTEREST TO TECHNOLOGY-BASED BUSINESSES, IN CLASS 35 (U.S. CLS. 100, 101 AND 102).

FIRST USE 5-18-1994; IN COMMERCE 5-18-1994.

THE MARK CONSISTS OF STANDARD CHARACTERS WITHOUT CLAIM TO ANY PARTICULAR FONT, STYLE, SIZE, OR COLOR.

NO CLAIM IS MADE TO THE EXCLUSIVE RIGHT TO USE "GROUP AND INC", APART FROM THE MARK AS SHOWN.

SEC. 2(F).

SER. NO. 78-894,326, FILED 5-26-2006.

MARGARET POWER, EXAMINING ATTORNEY

**Int. Cl.: 35**

**Prior U.S. Cls.: 100, 101 and 102**

**United States Patent and Trademark Office**

**Reg. No. 3,467,912**

**Registered July 15, 2008**

**SERVICE MARK  
PRINCIPAL REGISTER**

**Connect to Quality**

KBA CONSULTING GROUP (CALIFORNIA CORPORATION)  
424 G STREET, SUITE 203  
LINCOLN, CA 95648

FOR: INTERNET REFERRAL SITE LINKING HOME OWNERS TO HOME IMPROVEMENT PROFESSIONALS, IN CLASS 35 (U.S. CLS. 100, 101 AND 102).

FIRST USE 3-1-2006; IN COMMERCE 4-1-2006.

THE MARK CONSISTS OF STANDARD CHARACTERS WITHOUT CLAIM TO ANY PARTICULAR FONT, STYLE, SIZE, OR COLOR.

SER. NO. 78-894,528, FILED 5-26-2006.

DEIRDRE ROBERTSON, EXAMINING ATTORNEY



**Int. Cl.: 16**

**Prior U.S. Cls.: 2, 5, 22, 23, 29, 37, 38 and 50**

**United States Patent and Trademark Office**

**Reg. No. 3,467,913**

**Registered July 15, 2008**

**TRADEMARK  
PRINCIPAL REGISTER**



THE EXECUTOR OF THE FRANK K. LICCIARDI  
ESTATE (SOUTH CAROLINA ESTATE)  
1296 MARVIN AVENUE  
CHARLESTON, SC 29407

FOR: PAINTINGS, IN CLASS 16 (U.S. CLS. 2, 5, 22,  
23, 29, 37, 38 AND 50).

FIRST USE 1-1-1933; IN COMMERCE 1-1-1933.

THE COLOR(S) RED, BLUE, YELLOW, BLACK,  
GREEN, BROWN AND WHITE IS/ARE CLAIMED  
AS A FEATURE OF THE MARK.

THE MARK CONSISTS OF COLOR PAINTINGS  
BY FRANK LICCIARDI WITH HIS SIGNATURE ON  
EACH PAINTING. THE COLORS RED, BLUE, YEL-  
LOW, BLACK, GREEN, BROWN, AND WHITE  
APPEAR UNDER AND AROUND THE MARK  
"LICCIARDI" IN THE LOWER RIGHT CORNER  
OF EACH PAINTING.

SER. NO. 78-902,815, FILED 6-7-2006.

CAROLYN GRAY, EXAMINING ATTORNEY

**Int. Cls.: 9, 16 and 41**

**Prior U.S. Cls.: 2, 5, 21, 22, 23, 26, 29, 36, 37, 38, 50,  
100, 101 and 107**

**Reg. No. 3,467,914**

**United States Patent and Trademark Office**

**Registered July 15, 2008**

**TRADEMARK  
SERVICE MARK  
PRINCIPAL REGISTER**

# FORM

BE FREE FORM LLC (WASHINGTON LTD LIAB  
CO), DBA STUDIO IGNITE  
UNIT #155  
117 E. LOUISA ST.  
SEATTLE, WA 98102

FOR: PRE-RECORDED CD'S, VIDEO TAPES, DI-  
GITAL VIDEO DISKS, AND DVD'S FEATURING  
MULTI-SENSORY LEARNING, SPIRITUAL FOR-  
MATION, SPIRITUAL MEDITATION AND INTE-  
GRATED PHYSICAL TRAINING AND EXERCISE,  
IN CLASS 9 (U.S. CLS. 21, 23, 26, 36 AND 38).

FIRST USE 10-31-2002; IN COMMERCE 10-31-2002.

FOR: PRINTED INSTRUCTIONAL, EDUCATION-  
AL, AND TEACHING MATERIALS IN THE FIELD  
OF MULTI-SENSORY LEARNING, SPIRITUAL  
FORMATION, SPIRITUAL MEDITATION AND IN-  
TEGRATED PHYSICAL TRAINING AND EXER-  
CISE, IN CLASS 16 (U.S. CLS. 2, 5, 22, 23, 29, 37, 38  
AND 50).

FIRST USE 10-31-2002; IN COMMERCE 10-31-2002.

FOR: EDUCATIONAL SERVICES, NAMELY,  
CONDUCTING CLASSES, SEMINARS, RETREATS,  
TEACHER TRAINING WORKSHOPS AND IN-  
STRUCTIONAL GUIDANCE, NAMELY, TEACH-  
ING, IN MULTI-SENSORY LEARNING,  
SPIRITUAL FORMATION, SPIRITUAL MEDITA-  
TION, MEDITATIVE MOVEMENT, AND INTEGRA-  
TED PHYSICAL TRAINING AND EXERCISE, IN  
CLASS 41 (U.S. CLS. 100, 101 AND 107).

FIRST USE 10-31-2002; IN COMMERCE 10-31-2002.

THE MARK CONSISTS OF STANDARD CHAR-  
ACTERS WITHOUT CLAIM TO ANY PARTICULAR  
FONT, STYLE, SIZE, OR COLOR.

SER. NO. 78-905,946, FILED 6-12-2006.

LOURDES AYALA, EXAMINING ATTORNEY

Int. Cl.: 16

Prior U.S. Cls.: 2, 5, 22, 23, 29, 37, 38 and 50

United States Patent and Trademark Office

Reg. No. 3,467,915

Registered July 15, 2008

TRADEMARK  
PRINCIPAL REGISTER

*Blue  
Selections*

BENAVIDES SERRANO JUAN MANUEL (MEX-  
ICO CORPORATION)  
GEO 202 Y 204, PARQUE IND. KALOS GPE.  
GUADALUPE, MEXICO 67190

FOR: BATHROOM TISSUE, PAPER TOWELS,  
PAPER NAPKINS, CELLULOSE WIPES, IN CLASS  
16 (U.S. CLS. 2, 5, 22, 23, 29, 37, 38 AND 50).

FIRST USE 5-6-2005; IN COMMERCE 8-29-2005.

OWNER OF MEXICO REG. NO. 919808, DATED  
11-4-2005, EXPIRES 11-4-2015.

THE COLOR(S) BLUE AND WHITE IS/ARE  
CLAIMED AS A FEATURE OF THE MARK.

THE MARK CONSISTS OF THE WORDS "BLUE  
SELECTIONS" IN A STYLIZED FONT. THE COLOR  
BLUE FORMS THE EDGES OF THE MARK AND  
THE COLOR WHITE APPEARS INSIDE THE LET-  
TERING OF THE MARK.

SER. NO. 78-907,950, FILED 6-14-2006.

JACLYN KIDWELL, EXAMINING ATTORNEY

**Int. Cl.: 41**

**Prior U.S. Cls.: 100, 101 and 107**

**United States Patent and Trademark Office**

**Reg. No. 3,467,916**

**Registered July 15, 2008**

**SERVICE MARK  
PRINCIPAL REGISTER**



PRIMORDIAL SOUP LTD. (CYPRUS COMPANY)  
DIAGOROU 4  
KERMIA BUILDING 6TH FLOOR, OFFICE 601  
NICOSIA, CYPRUS 1097

FOR: ELECTRONIC PUBLISHING SERVICES,  
NAMELY, PUBLICATION OF TEXT AND GRAPHIC  
WORKS OF OTHERS ONLINE, FEATURING NEWS,  
DIARIES, DIRECTORIES OF WEB SITE LINKS IN  
THE FIELDS OF SUBMITTER'S CHOOSING, COM-  
MENTARY IN THE FIELDS OF SUBMITTER'S  
CHOOSING, PHOTOS, POETRY, MINI-ESSAYS IN  
THE FIELDS OF SUBMITTER'S CHOOSING, PRO-  
JECT UPDATES, NON-FICTION IN THE FIELD OF

SUBMITTER'S CHOOSING AND FICTION, IN  
CLASS 41 (U.S. CLS. 100, 101 AND 107).

FIRST USE 9-1-2001; IN COMMERCE 9-1-2001.

OWNER OF U.S. REG. NO. 3,075,631.

THE MARK CONSISTS OF A PENCIL DRAWING  
A CIRCLE AND THE WORD LIVEJOURNAL .

SEC. 2(F) AS TO "LIVE JOURNAL".

SER. NO. 78-910,527, FILED 6-16-2006.

CARYN GLASSER, EXAMINING ATTORNEY

**Int. Cl.: 41**

**Prior U.S. Cls.: 100, 101 and 107**

**United States Patent and Trademark Office**

**Reg. No. 3,467,917**

**Registered July 15, 2008**

**SERVICE MARK  
PRINCIPAL REGISTER**

# THE INTEGRAL

GOPAL DEVANATHAN (CANADA CORPORATION)  
3065 CARROLL STREET  
SAINT-LAURENT, CANADA H4K2G5

FOR: ENTERTAINMENT IN THE NATURE OF VISUAL AND AUDIO PERFORMANCES, AND MUSICAL, VARIETY, NEWS AND COMEDY SHOWS; ENTERTAINMENT IN THE NATURE OF VISUAL AND AUDIO PERFORMANCES, NAMELY, MUSICAL BAND, ROCK GROUP, GYMNASTIC, DANCE, AND BALLET PERFORMANCES; ENTERTAINMENT NAMELY, LIVE PERFORMANCES BY A MUSICAL BAND; ENTERTAINMENT SERVICES, NAMELY, PROVIDING A WEB SITE FEATURING MUSICAL PERFORMANCES, MUSICAL VIDEOS, RELATED FILM CLIPS, PHOTOGRAPHS, AND OTHER MULTIMEDIA MATERIALS; ENTERTAINMENT, NAMELY LIVE MUSIC CONCERTS; ENTERTAINMENT, NAMELY LIVE PERFORMANCES

BY MUSICAL BANDS; ENTERTAINMENT, NAMELY, LIVE PERFORMANCES BY ROCK GROUPS; MUSIC PRODUCTION SERVICES; MUSIC PUBLISHING SERVICES; PRESENTATION OF MUSICAL PERFORMANCE, IN CLASS 41 (U.S. CLS. 100, 101 AND 107).

THE MARK CONSISTS OF STANDARD CHARACTERS WITHOUT CLAIM TO ANY PARTICULAR FONT, STYLE, SIZE, OR COLOR.

PRIORITY CLAIMED UNDER SEC. 44(D) ON CANADA APPLICATION NO. 1302107, FILED 5-18-2006, REG. NO. 78910715, DATED 7-30-2007, EXPIRES 7-30-2022.

SER. NO. 78-910,715, FILED 6-17-2006.

FLORENTINA BLANDU, EXAMINING ATTORNEY

**Int. Cl.: 25**

**Prior U.S. Cls.: 22 and 39**

**United States Patent and Trademark Office**

**Reg. No. 3,467,918**

**Registered July 15, 2008**

**TRADEMARK  
PRINCIPAL REGISTER**

# Algierz Gear

ALGIERZ, DANIEL (UNITED STATES INDIVIDUAL)

7002 RAMSGATE PLACE #7

LOS ANGELES, CA 90045

FOR: T-SHIRTS, IN CLASS 25 (U.S. CLS. 22 AND 39).

FIRST USE 2-23-2004; IN COMMERCE 2-23-2004.

THE MARK CONSISTS OF STANDARD CHARACTERS WITHOUT CLAIM TO ANY PARTICULAR FONT, STYLE, SIZE, OR COLOR.

NO CLAIM IS MADE TO THE EXCLUSIVE RIGHT TO USE "GEAR", APART FROM THE MARK AS SHOWN.

SER. NO. 78-910,796, FILED 6-18-2006.

ANN E. SAPPENFIELD, EXAMINING ATTORNEY

Int. Cl.: 41

Prior U.S. Cls.: 100, 101 and 107

United States Patent and Trademark Office

Reg. No. 3,467,919

Registered July 15, 2008

SERVICE MARK  
PRINCIPAL REGISTER

国際大山空手道連盟

OYAMA, YASUHIKO (UNITED STATES INDIVIDUAL)  
1804 29TH AVENUE SOUTH  
BIRMINGHAM, AL 35209

FOR: KARATE INSTRUCTION, IN CLASS 41 (U.S. CLS. 100, 101 AND 107).

FIRST USE 0-0-1980; IN COMMERCE 0-0-1980.

OWNER OF U.S. REG. NOS. 1,545,741, 1,651,554, AND 3,070,782.

NO CLAIM IS MADE TO THE EXCLUSIVE RIGHT TO USE THE NON-LATIN CHARACTERS THAT MEAN "WORLD" AND "KARATE ORGANIZATION", APART FROM THE MARK AS SHOWN.

THE MARK CONSISTS OF JAPANESE KANJI CHARACTERS MEANING WORLD OYAMA KARATE ORGANIZATION.

THE ENGLISH TRANSLATION OF KOKUSAI OYAMA KARATEDO RENMEI IS WORLD OYAMA KARATE ORGANIZATION.

THE NON-LATIN CHARACTERS IN THE MARK TRANSLITERATE TO KOKUSAI OYAMA KARATEDO RENMEI.

SER. NO. 78-913,287, FILED 6-21-2006.

PAULA MAHONEY, EXAMINING ATTORNEY

**Int. Cl.: 35**

**Prior U.S. Cls.: 100, 101 and 102**

**United States Patent and Trademark Office**

**Reg. No. 3,467,920**

**Registered July 15, 2008**

**SERVICE MARK  
PRINCIPAL REGISTER**

**SIZE SEXY**

EW3 GROUP (LOUISIANA CORPORATION)  
POB 4069  
NEW ORLEANS, LA 70178

THE MARK CONSISTS OF STANDARD CHAR-  
ACTERS WITHOUT CLAIM TO ANY PARTICULAR  
FONT, STYLE, SIZE, OR COLOR.

FOR: RETAIL STORE SERVICES AND MAIL  
ORDER SERVICES FEATURING WOMENS CLOTH-  
ING, SHOES, AND APPAREL, IN CLASS 35 (U.S.  
CLS. 100, 101 AND 102).

SER. NO. 78-913,592, FILED 6-21-2006.

FIRST USE 7-1-2004; IN COMMERCE 7-1-2004.

BONNIE LUKEN, EXAMINING ATTORNEY



**Int. Cl.: 9**

**Prior U.S. Cls.: 21, 23, 26, 36 and 38**

**Reg. No. 3,467,921**

**United States Patent and Trademark Office**

**Registered July 15, 2008**

**TRADEMARK  
PRINCIPAL REGISTER**

**DOUBLE FUSION**

DOUBLE FUSION INC. (DELAWARE CORPORATION)  
300 BEALE STREET, SUITE D  
SAN FRANCISCO, CA 94105

FOR: COMPUTER SOFTWARE RELATING TO THE DELIVERY OF CUSTOMIZED ADVERTISEMENTS AND COLLECTION OF DATA FROM USERS OF INTERACTIVE ELECTRONIC GAMES; SOFTWARE AND ELECTRONIC GAMES, NAMELY, SOFTWARE GAMES RECORDED ON CD-ROM AND DIGITAL VIDEO DISCS FOR COMPUTERS; SOFTWARE GAMES RECORDED ON CD-ROMS, DIGITAL VIDEO DISCS, AND CARTRIDGES FOR CONSOLE AND INDIVIDUAL PORTABLE GAMING SYSTEMS; SOFTWARE GAMES THAT ARE

DOWNLOADABLE FROM A REMOTE COMPUTER SITE; AND SOFTWARE GAMES FOR MOBILE PHONES, PERSONAL DIGITAL ASSISTANTS, AND HANDHELD COMPUTERS, IN CLASS 9 (U.S. CLS. 21, 23, 26, 36 AND 38).

FIRST USE 5-1-2005; IN COMMERCE 5-1-2005.

THE MARK CONSISTS OF STANDARD CHARACTERS WITHOUT CLAIM TO ANY PARTICULAR FONT, STYLE, SIZE, OR COLOR.

SER. NO. 78-914,273, FILED 6-22-2006.

ELLEN PERKINS, EXAMINING ATTORNEY

**Int. Cl.: 38**

**Prior U.S. Cls.: 100, 101 and 104**

**United States Patent and Trademark Office**

**Reg. No. 3,467,922**

**Registered July 15, 2008**

**SERVICE MARK  
PRINCIPAL REGISTER**

**DOUBLE FUSION**

DOUBLE FUSION INC. (DELAWARE CORPORATION)  
300 BEALE STREET, SUITE D  
SAN FRANCISCO, CA 94105

FOR: COMMUNICATIONS SERVICES, NAMELY, ELECTRONIC TRANSMISSION OF ADVERTISEMENTS TO USERS OF COMPUTERS AND OTHER ELECTRONIC DEVICES; COMMUNICATIONS SERVICES, NAMELY, TRANSMITTING STREAMED VISUAL ADVERTISING VIA THE INTERNET; TRANSMISSION AND RECEIPT OF INFORMATION BY ELECTRONIC COMMUNICATIONS NETWORKS; AND PROVIDING MULTIPLE-USER INTERACTIVE ACCESS TO A GLOBAL COMPUTER INFORMATION NETWORK VIA COMPUTER NET-

WORKS, MOBILE TELEPHONES, PERSONAL DIGITAL ASSISTANTS, CONSOLE AND INDIVIDUAL PORTABLE GAMING SYSTEMS, HANDHELD COMPUTERS AND PERSONAL COMPUTERS, IN CLASS 38 (U.S. CLS. 100, 101 AND 104).

FIRST USE 5-1-2005; IN COMMERCE 5-1-2005.

THE MARK CONSISTS OF STANDARD CHARACTERS WITHOUT CLAIM TO ANY PARTICULAR FONT, STYLE, SIZE, OR COLOR.

SER. NO. 78-914,333, FILED 6-22-2006.

ELLEN PERKINS, EXAMINING ATTORNEY

**Int. Cls.: 35 and 42**

**Prior U.S. Cls.: 100, 101 and 102**

**United States Patent and Trademark Office**

**Reg. No. 3,467,923**

**Registered July 15, 2008**

**SERVICE MARK  
PRINCIPAL REGISTER**

**CHANGE OR DIE**

THE REPUBLIK CORPORATION (DELAWARE CORPORATION)  
313 WEST MAIN STREET  
DURHAM, NC 27701

FOR: ADVERTISING AGENCY SERVICES; CORPORATE IDENTITY DEVELOPMENT FOR OTHERS; NAMING AND BRANDING OF PRODUCTS AND SERVICES FOR OTHERS; MARKET RESEARCH SERVICES; MARKET ANALYSIS; DEVELOPMENT AND IMPLEMENTATION OF MARKETING STRATEGIES FOR OTHERS; BUSINESS CONSULTING SERVICES FOR OTHERS IN THE FIELDS OF ADVERTISING, MARKETING, CORPORATE IDENTITY DEVELOPMENT, PRODUCT BRANDING, STRATEGIC BRANDING, BRAND POSITIONING AND PRODUCT PROMOTION; PROMOTING THE GOODS AND SERVICES OF OTHERS THROUGH THE DISTRIBUTION OF PRINT, AUDIO AND VIDEO PROMOTIONAL MATERIALS AND BY RENDERING SALES PROMOTIONAL ADVICE, AND PREPARING ADVERTISING OF OTHERS; PURCHASE AND PROCUREMENT OF MEDIA TIME IN RADIO BROADCASTS, TELEVISION BROADCASTS AND

VIDEO DISTRIBUTED VIA THE WORLD WIDE WEB, IN CLASS 35 (U.S. CLS. 100, 101 AND 102).

FIRST USE 6-10-2006; IN COMMERCE 3-18-2008.

FOR: DESIGN SERVICES AND DESIGN CONSULTATION FOR OTHERS IN THE FIELDS OF BRAND NAMES AND LOGOS, CORPORATE IDENTITIES, PACKAGE DESIGN, GRAPHIC DESIGN, PROMOTIONAL MATERIALS AND RETAIL SPACE; COMPUTER CONSULTATION SERVICES, NAMELY, DESIGNING AND DEVELOPING WEBSITES FOR OTHERS ON A GLOBAL COMPUTER NETWORK , IN CLASS 42 (U.S. CLS. 100 AND 101).

FIRST USE 6-10-2006; IN COMMERCE 3-18-2008.

THE MARK CONSISTS OF STANDARD CHARACTERS WITHOUT CLAIM TO ANY PARTICULAR FONT, STYLE, SIZE, OR COLOR.

SER. NO. 78-915,669, FILED 6-23-2006.

TIMOTHY FINNEGAN, EXAMINING ATTORNEY

**Int. Cl.: 41**

**Prior U.S. Cls.: 100, 101 and 107**

**United States Patent and Trademark Office**

**Reg. No. 3,467,924**

**Registered July 15, 2008**

**SERVICE MARK  
PRINCIPAL REGISTER**

**BUD PRODUCTIONS**

ANHEUSER-BUSCH, INCORPORATED (MIS-  
SOURI CORPORATION)

202-6

ONE BUSCH PLACE

ST. LOUIS, MO 63118

FOR: TELEVISION PRODUCTION SERVICES, IN  
CLASS 41 (U.S. CLS. 100, 101 AND 107).

FIRST USE 4-21-2006; IN COMMERCE 4-21-2006.

THE MARK CONSISTS OF STANDARD CHAR-  
ACTERS WITHOUT CLAIM TO ANY PARTICULAR  
FONT, STYLE, SIZE, OR COLOR.

OWNER OF U.S. REG. NOS. 666,367, 3,128,915 AND  
OTHERS.

NO CLAIM IS MADE TO THE EXCLUSIVE  
RIGHT TO USE "PRODUCTIONS", APART FROM  
THE MARK AS SHOWN.

SER. NO. 78-917,544, FILED 6-27-2006.

JANICE L. MCMORROW, EXAMINING ATTOR-  
NEY

**Int. Cls.: 35, 39 and 41**

**Prior U.S. Cls.: 100, 101, 102, 105 and 107**

**United States Patent and Trademark Office**

**Reg. No. 3,467,925**

**Registered July 15, 2008**

**SERVICE MARK  
PRINCIPAL REGISTER**

# 55 DEGREES

55 DEGREES, LLC (CALIFORNIA LTD LIAB CO)  
1210 CHURCH STREET  
ST. HELENA, CA 94574

FOR: WINE INVENTORY MONITORING, TRACKING AND REPORTING OPTIMAL DATES FOR WINE CONSUMPTION, PROVIDING REFERRALS FOR SHIPPING WINE; RECOMMENDING RESTAURANTS, HOTELS, WINERIES AND OTHER SITES OF INTEREST, PROVIDING ONLINE INFORMATION AND NOTIFICATIONS REGARDING PROXY BIDDING OPPORTUNITIES, CHARITY AUCTIONS; INFOMEDIARY SERVICES, NAMELY, FACILITATING SALES, TRADES AND SHARE ALLOTMENTS OF WINES BETWEEN WINE CLUB MEMBERS; PROVIDING ONLINE MARKETING AND PROMOTIONAL INFORMATION AND NOTIFICATIONS REGARDING NEW WINE RELEASES AND WINERY OPENINGS; GENERAL BUSINESS NETWORKING REFERRAL SERVICES, NAMELY, PROMOTING THE GOODS AND SERVICES OF OTHERS BY PASSING BUSINESS LEADS AND REFERRALS AMONG MEMBERS; PROMOTING THE GOODS AND SERVICES OF OTHERS BY PROVIDING HYPERTEXT LINKS TO THE WEB SITES OF OTHERS AND DISTRIBUTING ADVERTISING MATERIALS THROUGH A VARIETY OF METHODS, IN CLASS 35 (U.S. CLS. 100, 101 AND 102).

FIRST USE 6-1-2000; IN COMMERCE 6-1-2000.

FOR: WINE STORAGE SERVICES, NAMELY, SECURE AND PROPER STORAGE OF WINE FOR OTHERS, WINE PICK-UP, DELIVERY AND SHIPMENT RECEIPT SERVICES; ARRANGING FOR TOURS; PROVIDING ONLINE INFORMATION AND NOTIFICATIONS REGARDING WINE STORAGE, IN CLASS 39 (U.S. CLS. 100 AND 105).

FIRST USE 11-18-1999; IN COMMERCE 11-18-1999.

FOR: WINE CLUB MEMBERSHIP SERVICES, ARRANGING FOR WINE TASTINGS, HOSTING PRIVATE WINE TASTINGS, PROVIDING ONLINE INFORMATION AND NOTIFICATIONS REGARDING WINE AND CHARITY EVENTS, PARTIES FOR NEW WINE RELEASES AND WINERY OPENINGS, IN CLASS 41 (U.S. CLS. 100, 101 AND 107).

FIRST USE 6-1-2000; IN COMMERCE 6-1-2000.

THE MARK CONSISTS OF STANDARD CHARACTERS WITHOUT CLAIM TO ANY PARTICULAR FONT, STYLE, SIZE, OR COLOR.

OWNER OF U.S. REG. NOS. 2,523,640 AND 2,992,580.

SEC. 2(F).

SER. NO. 78-918,354, FILED 6-27-2006.

JAMES A. RAUEN, EXAMINING ATTORNEY

**Int. Cl.: 39**

**Prior U.S. Cls.: 100 and 105**

**United States Patent and Trademark Office**

**Reg. No. 3,467,926**

**Registered July 15, 2008**

**SERVICE MARK  
PRINCIPAL REGISTER**

**EXCELLENCE IN FLIGHT**

KOREAN AIRLINES CO., LTD. (REPUBLIC OF  
KOREA CORPORATION)  
41-3, SEOSOMUN-DONG, CHUNG-KU  
SEOUL, REPUBLIC OF KOREA

FOR: TRANSPORTATION OF TRAVELERS BY  
AIR; INTERNATIONAL COMPLEX TRANSPORTA-  
TION, NAMELY, TRANSPORTATION OF PASSEN-  
GERS AND/OR GOODS BY AIR;  
TRANSPORTATION RESERVATION SERVICES;  
TRAVEL AND TRANSPORTATION INFORMA-  
TION SERVICES; AIR TRANSPORT AGENCY,  
NAMELY, MAKING RESERVATIONS AND BOOK-  
ING FOR TRANSPORTATION OF PASSENGERS  
AND GOODS BY AIR; AIR TRANSPORT; TRANS-  
PORTATION AND TRAVEL RESERVATION SER-

VICES; BOOKING OF SEATS FOR TRAVEL; AND  
TRAVEL AGENCY SERVICES, NAMELY, MAKING  
RESERVATIONS AND BOOKINGS FOR TRANS-  
PORTATION, IN CLASS 39 (U.S. CLS. 100 AND 105).

FIRST USE 3-0-2004; IN COMMERCE 11-0-2004.

THE MARK CONSISTS OF STANDARD CHAR-  
ACTERS WITHOUT CLAIM TO ANY PARTICULAR  
FONT, STYLE, SIZE, OR COLOR.

SER. NO. 78-918,417, FILED 6-28-2006.

LAURA HAMMEL, EXAMINING ATTORNEY

**Int. Cl.: 25**

**Prior U.S. Cls.: 22 and 39**

**United States Patent and Trademark Office**

**Reg. No. 3,467,927**

**Registered July 15, 2008**

**TRADEMARK  
PRINCIPAL REGISTER**

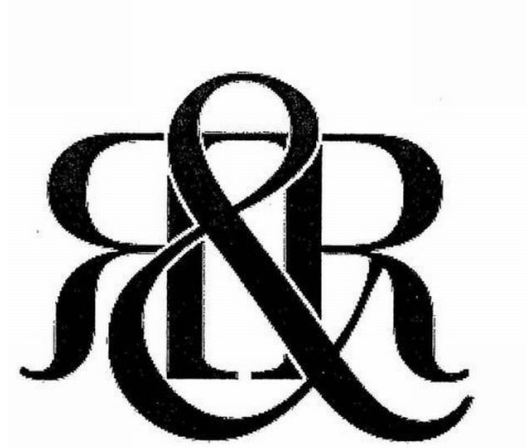

ROCK & REPUBLIC ENTERPRISES, INC. (CALIFORNIA CORPORATION)  
3525 EASTHAM DRIVE  
CULVER CITY, CA 90232

FOR: APPAREL, NAMELY, ONE PIECE GARMENTS FOR INFANTS, BELTS, BLAZERS, BLOUSES, CAPRIS, COATS, CORSETS, DRESSES, GOWNS, HALTER TOPS, HATS, JACKETS, JEANS, KNIT TOPS, LINGERIE, SCARVES, SHIRTS, SHOES, SWEATERS, SWEATSHIRTS, SWEATPANTS, SWIMWEAR, TEE SHIRTS, THERMAL SHIRTS, THER-

MAL PANTS, TROUSERS, TIES, TANK TOPS, TRENCH COATS, WINTER COATS, SKIRTS, SHORTS, VESTS, WOVEN TOPS, IN CLASS 25 (U.S. CLS. 22 AND 39).

FIRST USE 2-0-2006; IN COMMERCE 2-0-2006.

SER. NO. 78-920,391, FILED 6-29-2006.

LINDA E. BLOHM, EXAMINING ATTORNEY

Int. Cl.: 25

Prior U.S. Cls.: 22 and 39

United States Patent and Trademark Office

Reg. No. 3,467,928

Registered July 15, 2008

TRADEMARK  
PRINCIPAL REGISTER



ROCK & REPUBLIC ENTERPRISES, INC. (CALIFORNIA CORPORATION)  
3525 EASTHAM DRIVE  
CULVER CITY, CA 90232

FOR: APPAREL, NAMELY, ONE PIECE GARMENTS FOR INFANTS, BELTS, BLAZERS, BLOUSES, CAPRIS, COATS, CORSETS, DRESSES, GOWNS, HALTER TOPS, HATS, JACKETS, JEANS, KNIT TOPS, LINGERIE, SCARVES, SHIRTS, SHOES, SWEATERS, SWEATSHIRTS, SWEATPANTS, SWIMWEAR, TEE SHIRTS, THERMAL SHIRTS, THERMAL PANTS, TROUSERS, TIES, TANK TOPS,

TRENCH COATS, WINTER COATS, SKIRTS, SHORTS, VESTS, WOVEN TOPS, IN CLASS 25 (U.S. CLS. 22 AND 39).

FIRST USE 1-0-2006; IN COMMERCE 1-0-2006.

THE MARK CONSISTS OF MISCELLANEOUS DESIGN.

SER. NO. 78-920,397, FILED 6-29-2006.

LINDA E. BLOHM, EXAMINING ATTORNEY



Int. Cl.: 33

Prior U.S. Cls.: 47 and 49

United States Patent and Trademark Office

Reg. No. 3,467,929

Registered July 15, 2008

TRADEMARK  
PRINCIPAL REGISTER



MARTELL & CO (FRANCE CORPORATION)  
PLACE EDOUARD MARTELL  
COGNAC, FRANCE 16100

FOR: POTABLE DISTILLED SPIRITS AND LI-  
QUEURS, IN CLASS 33 (U.S. CLS. 47 AND 49).

FIRST USE 1-0-2006; IN COMMERCE 4-14-2006.

OWNER OF U.S. REG. NOS. 2,000,148, 3,114,395  
AND OTHERS.

NO CLAIM IS MADE TO THE EXCLUSIVE  
RIGHT TO USE NO CLAIM IS MADE TO THE  
EXCLUSIVE RIGHT TO USE "FONDEE EN 1715"  
AND THE SHAPE OF A BOTTLE APART FROM  
THE MARK AS SHOWN, APART FROM THE MARK  
AS SHOWN.

"JEAN MARTELL" DOES NOT IDENTIFY A  
PARTICULAR LIVING INDIVIDUAL.

THE MARK CONSISTS OF A THREE DIMEN-  
SIONAL BOTTLE WITH THE WORDS "NOBLIGE  
MARTELL, FONDEE EN 1715" WITH A SHIELD,  
THE SIGNATURE "J. MARTELL 1715" AND THE  
SIGNATURE "JEAN MARTELL" APPEARING AT  
THE NECK OF THE BOTTLE.

THE ENGLISH TRANSLATION OF "FONDEE EN  
1715" IS "FOUNDED IN 1715".

SER. NO. 78-923,069, FILED 7-5-2006.

EVELYN BRADLEY, EXAMINING ATTORNEY

**Int. Cl.: 35**

**Prior U.S. Cls.: 100, 101 and 102**

**United States Patent and Trademark Office**

**Reg. No. 3,467,930**

**Registered July 15, 2008**

**SERVICE MARK  
PRINCIPAL REGISTER**

**STARSIAN**

CJ MEDIA, INC. (REPUBLIC OF KOREA CORPORATION)  
KANGNAM-GU  
97-1, CHONGDAM-DONG  
SEOUL, REPUBLIC OF KOREA

FOR: DISSEMINATION OF ADVERTISING MATERIAL; ADVERTISING PLANNING; ADVERTISING AGENCIES, NAMELY, PROMOTING THE GOODS AND SERVICES OF OTHERS; PUBLICATION OF PUBLICITY TEXTS; CORPORATE ADVERTISEMENT AND PROMOTION; RADIO ADVERTISING; CINEMA ADVERTISING; ON-LINE ADVERTISING ON COMPUTER COMMUNICATION NETWORKS; TELEVISION ADVERTISING;

SALES PROMOTION SERVICES, IN CLASS 35 (U.S. CLS. 100, 101 AND 102).

THE MARK CONSISTS OF STANDARD CHARACTERS WITHOUT CLAIM TO ANY PARTICULAR FONT, STYLE, SIZE, OR COLOR.

PRIORITY CLAIMED UNDER SEC. 44(D) ON REPUBLIC OF KOREA APPLICATION NO. 2006-0016195, FILED 6-26-2006, REG. NO. 0150684, DATED 6-27-2007, EXPIRES 6-27-2017.

SER. NO. 78-923,585, FILED 7-6-2006.

GISELLE AGOSTO, EXAMINING ATTORNEY

**Int. Cls.: 20 and 21**

**Prior U.S. Cls.: 2, 13, 22, 23, 25, 29, 30, 32, 33, 40 and 50**

**United States Patent and Trademark Office**

**Reg. No. 3,467,931**

**Registered July 15, 2008**

**TRADEMARK  
PRINCIPAL REGISTER**

**SHOWTIME**

DART CONTAINER CORPORATION (NEVADA CORPORATION)  
500 HOGSBACK ROAD  
MASON, MI 48854

FOR: CLEAR PLASTIC HINGED TRAYS, NAME-  
LY, PLASTIC CONTAINERS AND COVERS SOLD  
AS A UNIT TO THE FOOD SERVICE INDUSTRY  
FOR FOOD PRODUCTS; COMMERCIAL PACKA-  
GING MATERIALS IN THE NATURE OF THERMO-  
FORMED PLASTIC TRAYS, NAMELY, CLEAR  
PLASTIC HINGED UTILITY TRAYS, IN CLASS 20  
(U.S. CLS. 2, 13, 22, 25, 32 AND 50).

FIRST USE 6-26-1989; IN COMMERCE 6-26-1989.

FOR: FOOD TRAYS, NAMELY, CLEAR PLASTIC  
HINGED TRAYS, IN CLASS 21 (U.S. CLS. 2, 13, 23, 29,  
30, 33, 40 AND 50).

FIRST USE 6-26-1989; IN COMMERCE 6-26-1989.

THE MARK CONSISTS OF STANDARD CHAR-  
ACTERS WITHOUT CLAIM TO ANY PARTICULAR  
FONT, STYLE, SIZE, OR COLOR.

SER. NO. 78-924,291, FILED 7-7-2006.

ALLISON SCHRODY, EXAMINING ATTORNEY

**Int. Cl.: 35**

**Prior U.S. Cls.: 100, 101 and 102**

**United States Patent and Trademark Office**

**Reg. No. 3,467,932**

**Registered July 15, 2008**

**SERVICE MARK  
PRINCIPAL REGISTER**

# Franchise Gator

AQUANTIVE, INC. (WASHINGTON CORPORATION)  
SUITE 1800  
821 SECOND AVENUE  
SEATTLE, WA 98104

FOR: ADVERTISING AND MARKETING SERVICES IN THE FIELD OF BUYING AND SELLING FRANCHISES, IN CLASS 35 (U.S. CLS. 100, 101 AND 102).

FIRST USE 12-26-2001; IN COMMERCE 12-26-2001.

THE MARK CONSISTS OF STANDARD CHARACTERS WITHOUT CLAIM TO ANY PARTICULAR FONT, STYLE, SIZE, OR COLOR.

NO CLAIM IS MADE TO THE EXCLUSIVE RIGHT TO USE "FRANCHISE", APART FROM THE MARK AS SHOWN.

SER. NO. 78-925,139, FILED 7-8-2006.

DAVID TAYLOR, EXAMINING ATTORNEY

**Int. Cls.: 6, 16, 35, 39 and 42**

**Prior U.S. Cls.: 2, 5, 12, 13, 14, 22, 23, 25, 29, 37, 38,  
50, 100, 101, 102 and 105**

**Reg. No. 3,467,933**

**United States Patent and Trademark Office**

**Registered July 15, 2008**

**TRADEMARK  
SERVICE MARK  
PRINCIPAL REGISTER**

# SUPPLY SIDE

SUPPLY SIDE, LLC (OHIO LTD LIAB CO)  
23750 ST. CLAIR AVENUE  
CLEVELAND, OH 44117

FOR: METAL PADLOCKS, IN CLASS 6 (U.S. CLS. 2, 12, 13, 14, 23, 25 AND 50).

FIRST USE 6-0-1993; IN COMMERCE 6-0-1993.

FOR: PACKAGING, MOVING AND STORAGE SUPPLIES, NAMELY, CORRUGATED CARDBOARD, CARDBOARD AND PAPER MAILING AND CARDBOARD GIFT BOXES; PAPER AND CARDBOARD MEDIA MAILERS; CARDBOARD MAILING TUBES; ENVELOPES; PAPER POUCHES FOR PACKAGING; SHIPPING LABELS; PAPER PACKING MATERIALS, NAMELY, CELL KITS, PACKING PAPER, AND PACKING CHIPS MADE FROM PAPER PULP; SLOTTED CARDBOARD BOX DIVIDERS; CARDBOARD DISH PACKS; PAPER MOVING PADS; PLASTIC FILM FOR HOUSEHOLD USE; AIR CELLULAR CUSHIONING MATERIALS, NAMELY, PLASTIC BUBBLE PACKS FOR WRAPPING OR PACKING, BUBBLE MAILERS; DECORATIVE PACKAGING MATERIALS, NAMELY, GIFT WRAP AND PAPER AND PLASTIC POUCHES; ADHESIVE TAPE FOR HOUSEHOLD PURPOSES; WRITING INSTRUMENTS AND CARDBOARD DISPLAYS FOR RETAIL SALE OF SUCH PRODUCTS, IN CLASS 16 (U.S. CLS. 2, 5, 22, 23, 29, 37, 38 AND 50).

FIRST USE 6-0-1993; IN COMMERCE 6-0-1993.

FOR: BUSINESS SERVICES, NAMELY, LOGISTICS, SERVICES IN THE FIELD OF INVENTORY

CONTROL, OPERATIONS MANAGEMENT, AND SUPPLY-CHAIN SOLUTIONS; MERCHANDISING, NAMELY, PRODUCT MERCHANDISING, IN CLASS 35 (U.S. CLS. 100, 101 AND 102).

FIRST USE 6-0-1993; IN COMMERCE 6-0-1993.

FOR: DISTRIBUTION SERVICES, NAMELY, DELIVERY OF PACKAGING, SHIPPING, MOVING, STORAGE AND OFFICE SUPPLIES ORDERED BY TELEPHONE, MAIL OR ELECTRONIC CATALOG FOR THE POSTAL SERVICE CENTER, SELF-STORAGE, HARDWARE AND TRUCK RENTAL INDUSTRIES, IN CLASS 39 (U.S. CLS. 100 AND 105).

FIRST USE 6-0-1993; IN COMMERCE 6-0-1993.

FOR: LAYOUT AND DESIGN SERVICES FOR RETAIL MOVING AND STORAGE STORES, IN CLASS 42 (U.S. CLS. 100 AND 101).

FIRST USE 6-0-1993; IN COMMERCE 6-0-1993.

THE MARK CONSISTS OF STANDARD CHARACTERS WITHOUT CLAIM TO ANY PARTICULAR FONT, STYLE, SIZE, OR COLOR.

NO CLAIM IS MADE TO THE EXCLUSIVE RIGHT TO USE "SUPPLY", APART FROM THE MARK AS SHOWN.

SER. NO. 78-925,457, FILED 7-10-2006.

GEORGIA CARTY, EXAMINING ATTORNEY

**Int. Cl.: 19**

**Prior U.S. Cls.: 1, 12, 33 and 50**

**Reg. No. 3,467,934**

**United States Patent and Trademark Office**

**Registered July 15, 2008**

**TRADEMARK  
PRINCIPAL REGISTER**



FLOOR TECHNOLOGIES, INC. (FLORIDA CORPORATION)

11911 WEST OKEECHOBEE ROAD

HIALEAH GARDENS, FL 33018

FOR: FLOORING UNDERLAYMENTS, IN CLASS 19 (U.S. CLS. 1, 12, 33 AND 50).

FIRST USE 10-14-1991; IN COMMERCE 0-0-1992.

NO CLAIM IS MADE TO THE EXCLUSIVE RIGHT TO USE "FLOOR" AND "INC.", APART FROM THE MARK AS SHOWN.

THE MARK CONSISTS OF STYLIZED LETTERS "F" AND "T" AND THE WORDS "FLOOR TECHNOLOGIES, INC.".

SER. NO. 78-925,920, FILED 7-10-2006.

PAUL E. FAHRENKOPF, EXAMINING ATTORNEY

**Int. Cl.: 42**

**Prior U.S. Cls.: 100 and 101**

**United States Patent and Trademark Office**

**Reg. No. 3,467,935**

**Registered July 15, 2008**

**SERVICE MARK  
PRINCIPAL REGISTER**

**SUPERCONNECTIVITY**

4DK TECHNOLOGIES, INC. (VIRGINIA CORPORATION)  
2325 DULLES CORNER BLVD. SUITE 430  
HERNDON, VA 20171

FOR: DEVELOPMENT OF NEW TECHNOLOGY FOR OTHERS IN THE FIELD OF SOFTWARE DEVELOPMENT, WIRELESS COMMUNICATIONS, AND GENERAL TELECOMMUNICATIONS SERVICE DEVELOPMENT, MULTIMEDIA ROUTING AND INTEROPERATIONS; PRODUCT DEVELOPMENT FOR OTHERS; PRODUCT DEVELOPMENT CONSULTATION; COMPUTER SOFTWARE DEVELOPMENT; TECHNOLOGY CONSULTATION IN THE FIELD OF TELECOMMUNICATIONS; SCIENTIFIC RESEARCH AND DEVELOPMENT; ADVI-

SORY SERVICES IN THE FIELD OF PRODUCT DEVELOPMENT; CONSULTING SERVICES IN THE FIELD OF COMPUTER SOFTWARE INTEROPERABILITY, IN CLASS 42 (U.S. CLS. 100 AND 101).

FIRST USE 1-1-2006; IN COMMERCE 1-1-2006.

THE MARK CONSISTS OF STANDARD CHARACTERS WITHOUT CLAIM TO ANY PARTICULAR FONT, STYLE, SIZE, OR COLOR.

SER. NO. 78-925,998, FILED 7-10-2006.

JAMES STEIN, EXAMINING ATTORNEY

**Int. Cls.: 6, 7, 11 and 42**

**Prior U.S. Cls.: 2, 12, 13, 14, 19, 21, 23, 25, 31, 34, 35,  
50, 100 and 101**

**Reg. No. 3,467,936**

**United States Patent and Trademark Office**

**Registered July 15, 2008**

**TRADEMARK  
SERVICE MARK  
PRINCIPAL REGISTER**

**SAS GLOBAL POWER**

SURE ALLOY STEEL CORPORATION (OHIO CORPORATION)  
25880 COMMERCE DR.  
MADISON HEIGHTS, MI 48071

FOR: METALS, NAMELY, STEEL; METAL ALLOYS, NAMELY, STEEL ALLOYS AND CHROMIUM CARBIDE WELD ALLOYS FOR ABRASION RESISTANT APPLICATIONS IN FURTHER MANUFACTURING; METALLIC WELD OVERLAYS, NAMELY, CHROMIUM CARBIDE WELD OVERLAY MATERIALS FOR ABRASION RESISTANT APPLICATIONS IN FURTHER MANUFACTURING, IN CLASS 6 (U.S. CLS. 2, 12, 13, 14, 23, 25 AND 50).

FIRST USE 2-1-2006; IN COMMERCE 2-1-2006.

FOR: MACHINE PARTS MADE OF METALS AND METAL ALLOYS ALL FOR USE IN COAL PULVERIZING MACHINES AND COAL CRUSHING MACHINES FOR USE IN FOSSIL FUEL POWER PLANTS, NAMELY, COAL CLASSIFIERS, CONES FOR COAL CLASSIFIERS, BLADES FOR COAL CLASSIFIERS, MILL OUTLET DIFFUSERS, MULTI-OUTLET DIFFUSERS, STATIC CLASSIFIERS, VALVES, MILL BOTTOMS, VANE WHEELS, ADJUSTABLE ORIFICES, COAL SIZING GRIDS, COAL CHUTES, RECLAIM HOPPER GRATING AND CRUSHER HAMMERS, IN CLASS 7 (U.S. CLS. 13, 19, 21, 23, 31, 34 AND 35).

FIRST USE 2-1-2006; IN COMMERCE 2-1-2006.

FOR: PARTS FOR USE IN PULVERIZED COAL BURNERS AND PULVERIZED COAL EXHAUSTER FANS MADE OF METAL AND METAL ALLOYS FOR USE IN FOSSIL FUEL POWER PLANTS,

NAMELY, NOZZLE TILTS, NOZZLES, TUBE CUFFS, ELBOW PATCHES, BURNER DIFFUSERS, MILL OUTLET DIFFUSERS, MULTI-OUTLET DIFFUSERS, PRE-RIFFLE DIFFUSERS, VALVES, ROTATING VANE WHEELS AND MILL BOTTOMS, IN CLASS 11 (U.S. CLS. 13, 21, 23, 31 AND 34).

FIRST USE 2-1-2006; IN COMMERCE 2-1-2006.

FOR: DESIGN AND TESTING OF NEW PRODUCTS FOR OTHERS IN THE FIELD OF FOSSIL FUEL POWER PLANTS; DIAGNOSTIC TESTING SERVICES IN THE FIELD OF POWER PLANTS, NAMELY, ISOKINETIC FUEL PIPE SAMPLING AND COMBUSTION MONITORING; DESIGN, TESTING, AND ENGINEERING OF NEW PRODUCTS FOR OTHERS IN THE FIELD OF METALLURGY AND WELD OVERLAYS; DIAGNOSTIC SERVICES FOR OTHERS REGARDING THE OPTIMIZATION OF BROILER COMBUSTION, IN CLASS 42 (U.S. CLS. 100 AND 101).

FIRST USE 2-1-2006; IN COMMERCE 2-1-2006.

THE MARK CONSISTS OF STANDARD CHARACTERS WITHOUT CLAIM TO ANY PARTICULAR FONT, STYLE, SIZE, OR COLOR.

NO CLAIM IS MADE TO THE EXCLUSIVE RIGHT TO USE "GLOBAL POWER", APART FROM THE MARK AS SHOWN.

SER. NO. 78-926,540, FILED 7-11-2006.

SUNG IN, EXAMINING ATTORNEY



**Int. Cls.: 5, 29 and 30**

**Prior U.S. Cls.: 6, 18, 44, 46, 51 and 52**

**United States Patent and Trademark Office**

**Reg. No. 3,467,937**

**Registered July 15, 2008**

**TRADEMARK  
PRINCIPAL REGISTER**

# GRANOVITA

GRANOVITA UK LIMITED (UNITED KINGDOM CORPORATION)  
5 STANTON CLOSE  
FINEDON ROAD INDUSTRIAL ESTATE  
WELLINGBOROUGH, UNITED KINGDOM NN8 4HN

FOR: NUTRITIONAL AND HEALTH FOOD SUPPLEMENTS COMPOSED OF ORGANICALLY GROWN PLANT SPROUTS, OILS AND POWDERS; NUTRACEUTICALS FOR USE AS A DIETARY SUPPLEMENT AND FOOD SUPPLEMENTS COMPRISED OF PROCESSED PLANT SPROUTS, OILS AND POWDERS, IN CLASS 5 (U.S. CLS. 6, 18, 44, 46, 51 AND 52).

FOR: PROCESSED VEGETABLES, NAMELY, BEAN SPROUTS, CHICK PEAS, GREEN PEAS, EDIBLE SPROUTED SEEDS, BEANS, FLAX SPROUTS, ALFALFASPROUTS, RED CLOVER SPROUTS, BROCCOLI SPROUTS, RADISH SPROUTS, MUSTARD SPROUTS, FENUGREEK

SPROUTS, GARLIC SPROUTS, SOY SPROUTS, CHICK PEA SPROUTS, GREEN PEA SPROUTS, YELLOW PEA SPROUTS, CANOLA SPROUTS, IN CLASS 29 (U.S. CL. 46).

FOR: PROCESSED GRAINS, IN CLASS 30 (U.S. CL. 46).

THE MARK CONSISTS OF STANDARD CHARACTERS WITHOUT CLAIM TO ANY PARTICULAR FONT, STYLE, SIZE, OR COLOR.

PRIORITY CLAIMED UNDER SEC. 44(D) ON UNITED KINGDOM APPLICATION NO. 2425209, FILED 6-22-2006, REG. NO. 2425209, DATED 2-8-2008, EXPIRES 6-22-2016.

SER. NO. 78-927,471, FILED 7-12-2006.

DAVID ELTON, EXAMINING ATTORNEY

**Int. Cls.: 9, 37 and 42**

**Prior U.S. Cls.: 21, 23, 26, 36, 38, 100, 101, 103 and 106**

**Reg. No. 3,467,938**

**United States Patent and Trademark Office**

**Registered July 15, 2008**

**TRADEMARK  
SERVICE MARK  
PRINCIPAL REGISTER**

**MEDIAMORFX**

ILLUMINATING CONCEPTS, LTD. (MICHIGAN CORPORATION)  
30733 W. TEN MILE ROAD  
FARMINGTON HILLS, MI 48336

FOR: COMPUTER HARDWARE AND SOFTWARE FOR MONITORING, CONTROLLING AND INTEGRATING PUBLIC SERVICE UTILITIES, PUBLIC SAFETY SYSTEMS, MULTIMEDIA DEVICES, NAMELY, AUDIO, VIDEO DIGITAL MEDIA AND GRAPHICS CONTENT DELIVERY DEVICES AND LIGHTING SYSTEMS, NAMELY, SENSORS, TWO WAY COMMUNICATION DEVICES, LIGHTING CONTROLS AND ELECTRIC LIGHTING FIXTURES AND PARTS AND ACCESSORIES THEREFOR FOR PERSONAL, BUSINESS OR GOVERNMENTAL AGENCY USE; DOWNLOADABLE SOFTWARE FOR GATHERING, RECEIVING AND DELIVERING INFORMATION ABOUT THE MONITORING, CONTROLLING AND INTEGRATING OF PUBLIC SERVICE UTILITIES, PUBLIC SAFETY SYSTEMS, MULTIMEDIA DEVICES AND LIGHT SYSTEMS VIA A WIRED OR WIRELESS COMPUTER NETWORK AND THE INTERNET FOR PERSONAL, BUSINESS OR GOVERNMENT AGENCY USE, IN CLASS 9 (U.S. CLS. 21, 23, 26, 36 AND 38).

FIRST USE 12-8-2002; IN COMMERCE 2-2-2004.

FOR: INSTALLATION, REPAIR AND MAINTENANCE OF COMPUTER HARDWARE FOR MONITORING, CONTROLLING AND INTEGRATING PUBLIC SERVICE UTILITIES, PUBLIC SAFETY SYSTEMS, MULTIMEDIA PRODUCTS AND LIGHTING SYSTEMS FOR PERSONAL, BUSINESS OR GOVERNMENTAL AGENCY USE, IN CLASS 37 (U.S. CLS. 100, 103 AND 106).

FIRST USE 12-8-2002; IN COMMERCE 2-2-2004.

FOR: DESIGN AND DEVELOPMENT OF COMPUTER HARDWARE AND SOFTWARE FOR MONITORING, CONTROLLING AND INTEGRATING PUBLIC SERVICE UTILITIES, PUBLIC SAFETY SYSTEMS, MULTIMEDIA PRODUCTS AND LIGHTING SYSTEMS FOR PERSONAL USE OR USE BY BUSINESSES OR GOVERNMENTAL AGENCIES; PROVIDING ONLINE NON-DOWNLOADABLE SOFTWARE FOR GATHERING, RECEIVING AND DELIVERING INFORMATION ABOUT THE MONITORING, CONTROLLING AND INTEGRATING OF PUBLIC SERVICE UTILITIES, PUBLIC SAFETY SYSTEMS, MULTIMEDIA DEVICES AND LIGHTING SYSTEMS VIA A WIRED OR WIRELESS COMPUTER NETWORK AND THE INTERNET FOR PERSONAL, BUSINESS OR GOVERNMENTAL AGENCY USE; ANALYSIS OF COMPUTER HARDWARE AND SOFTWARE FOR MONITORING, CONTROLLING AND INTEGRATING PUBLIC SERVICE UTILITIES, PUBLIC SAFETY SYSTEMS, MULTIMEDIA PRODUCTS AND LIGHTING SYSTEMS FOR PERSONAL, BUSINESS OR GOVERNMENTAL AGENCY USE; INSTALLATION, REPAIR AND MAINTENANCE OF COMPUTER SOFTWARE FOR MONITORING, CONTROLLING AND INTEGRATING PUBLIC SERVICE UTILITIES, PUBLIC SAFETY SYSTEMS, MULTIMEDIA PRODUCTS AND LIGHTING SYSTEMS FOR PERSONAL, BUSINESS OR GOVERNMENTAL AGENCY USE, IN CLASS 42 (U.S. CLS. 100 AND 101).

FIRST USE 12-8-2002; IN COMMERCE 2-2-2004.

THE MARK CONSISTS OF STANDARD CHARACTERS WITHOUT CLAIM TO ANY PARTICULAR FONT, STYLE, SIZE, OR COLOR.

SER. NO. 78-928,931, FILED 7-13-2006.

KATHERINE CONNOLLY, EXAMINING ATTORNEY

Int. Cls.: 35 and 41

Prior U.S. Cls.: 100, 101, 102 and 107

United States Patent and Trademark Office

Reg. No. 3,467,939

Registered July 15, 2008

SERVICE MARK  
PRINCIPAL REGISTER



SOCIETY OF COMPETITIVE INTELLIGENCE  
PROFESSIONALS (D.C. CORPORATION)  
SUITE 600  
1700 DIAGONAL ROAD  
ALEXANDRIA, VA 22314

FOR: ASSOCIATION SERVICES, NAMELY, PROMOTING THE INTEREST OF COMPETITIVE INTELLIGENCE PROFESSIONALS AND THE COMPETITIVE INTELLIGENCE INDUSTRY, IN CLASS 35 (U.S. CLS. 100, 101 AND 102).

FIRST USE 8-0-2004; IN COMMERCE 8-0-2004.

FOR: EDUCATIONAL SERVICES, NAMELY, ARRANGING AND CONDUCTING COURSES OF INSTRUCTION, CONFERENCES, WORKSHOPS, SEMINARS AND SYMPOSIA IN THE FIELD OF

COMPETITIVE INTELLIGENCE, IN CLASS 41 (U.S. CLS. 100, 101 AND 107).

FIRST USE 8-0-2004; IN COMMERCE 8-0-2004.

OWNER OF U.S. REG. NOS. 2,033,487, 2,235,548, AND 2,440,242.

NO CLAIM IS MADE TO THE EXCLUSIVE RIGHT TO USE "SOCIETY" , APART FROM THE MARK AS SHOWN.

SEC. 2(F) AS TO "OF COMPETITIVE INTELLIGENCE PROFESSIONALS".

SER. NO. 78-931,184, FILED 7-17-2006.

SCOTT BIBB, EXAMINING ATTORNEY

**Int. Cl.: 41**

**Prior U.S. Cls.: 100, 101 and 107**

**United States Patent and Trademark Office**

**Reg. No. 3,467,940**

**Registered July 15, 2008**

**SERVICE MARK  
PRINCIPAL REGISTER**



**Society of  
Competitive Intelligence  
Professionals**

**INSTITUTE**

SOCIETY OF COMPETITIVE INTELLIGENCE  
PROFESSIONALS (D.C. CORPORATION)  
SUITE 600  
1700 DIAGONAL ROAD  
ALEXANDRIA, VA 22314

FOR: EDUCATIONAL SERVICES, NAMELY, AR-  
RANGING AND CONDUCTING COURSES OF IN-  
STRUCTION, CONFERENCES, WORKSHOPS,  
SEMINARS AND SYMPOSIA IN THE FIELD OF  
COMPETITIVE INTELLIGENCE, IN CLASS 41 (U.S.  
CLS. 100, 101 AND 107).

FIRST USE 4-0-2005; IN COMMERCE 4-0-2005.

OWNER OF U.S. REG. NOS. 2,033,487, 2,235,548,  
AND 2,440,242.

NO CLAIM IS MADE TO THE EXCLUSIVE  
RIGHT TO USE "INSTITUTE" AND "SOCIETY",  
APART FROM THE MARK AS SHOWN.

SEC. 2(F) AS TO "OF COMPETITIVE INTELLI-  
GENCE PROFESSIONALS".

SER. NO. 78-931,302, FILED 7-17-2006.

SCOTT BIBB, EXAMINING ATTORNEY

Int. Cl.: 23

Prior U.S. Cl.: 43

United States Patent and Trademark Office

Reg. No. 3,467,941

Registered July 15, 2008

TRADEMARK  
PRINCIPAL REGISTER

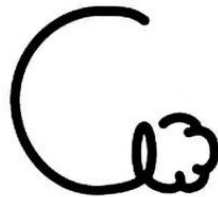

*Cashmere-like  
Cotton*

ESQUEL ENTERPRISES LIMITED (HONG KONG  
CORPORATION)  
12/F, HARBOUR CENTRE  
25 HARBOUR ROAD  
WANCHAI, HONG KONG

FOR: YAMS AND THREADS, FOR TEXTILE USE,  
MADE IN WHOLE OR IN SIGNIFICANT PART OF  
CASHMERE-LIKE COTTON, IN CLASS 23 (U.S. CL.  
43).

OWNER OF HONG KONG REG. NO. 300101339,  
DATED 10-28-2003, EXPIRES 10-27-2013.

NO CLAIM IS MADE TO THE EXCLUSIVE  
RIGHT TO USE "CASHMERE-LIKE COTTON",  
APART FROM THE MARK AS SHOWN.

THE MARK CONSISTS OF A STYLIZED LETTER  
"C".

SER. NO. 78-936,117, FILED 7-24-2006.

SAMUEL E. SHARPER JR., EXAMINING ATTOR-  
NEY

**Int. Cl.: 3**

**Prior U.S. Cls.: 1, 4, 6, 50, 51 and 52**

**Reg. No. 3,467,942**

**United States Patent and Trademark Office**

**Registered July 15, 2008**

**TRADEMARK  
PRINCIPAL REGISTER**

**SNAP!**

ROCHESTER MIDLAND CORPORATION (NEW  
YORK CORPORATION)  
P.O. BOX 31515  
333 HOLLENBECK STREET  
ROCHESTER, NY 146031515

FOR: CLEANING CHEMICALS SOLD IN CON-  
CENTRATED FORM IN CONTAINERS USED FOR  
DISPENSING PROPERLY DILUTED CLEANING  
SOLUTIONS FOR COMMERCIAL CLEANING  
AND JANITORIAL PURPOSES AND THE ACCES-  
SORIES SOLD THEREWITH FOR DILUTING AND  
DISPENSING COMPRISED OF METERING  
VALVES, TUBING, DISPENSING SPIGOTS, WATER  
SUPPLY, AND STORAGE RACK THAT STORES  
CONCENTRATED CLEANING CHEMICAL CON-  
TAINERS, DILUTES CLEANING CONCENTRATES  
WITH WATER, PROPORTIONS AND DISPENSES

PROPERLY DILUTED MIXTURES OF CLEANING  
CHEMICALS AND WATER IN QUANTITIES SUI-  
TABLE FOR CLEANING PURPOSES, IN EACH  
CASE, FOR USE IN THE JANITORIAL AND SANI-  
TATION MARKETS , IN CLASS 3 (U.S. CLS. 1, 4, 6, 50,  
51 AND 52).

FIRST USE 9-16-2002; IN COMMERCE 9-16-2002.

THE MARK CONSISTS OF STANDARD CHAR-  
ACTERS WITHOUT CLAIM TO ANY PARTICULAR  
FONT, STYLE, SIZE, OR COLOR.

SER. NO. 78-937,013, FILED 7-25-2006.

JENNY PARK, EXAMINING ATTORNEY

**Int. Cl.: 44**

**Prior U.S. Cls.: 100 and 101**

**United States Patent and Trademark Office**

**Reg. No. 3,467,943**

**Registered July 15, 2008**

**SERVICE MARK  
PRINCIPAL REGISTER**

**PACEPARTNERS**

ON LOK, INC. (CALIFORNIA NON-PROFIT  
CORPORATION)  
1333 BUSH STREET  
SAN FRANCISCO, CA 94019

THE MARK CONSISTS OF STANDARD CHAR-  
ACTERS WITHOUT CLAIM TO ANY PARTICULAR  
FONT, STYLE, SIZE, OR COLOR.

FOR: CONSULTING SERVICES IN THE FIELD  
OF HEALTH CARE FOR THE ELDERLY, IN CLASS  
44 (U.S. CLS. 100 AND 101).

SER. NO. 78-940,379, FILED 7-28-2006.

FIRST USE 10-15-2006; IN COMMERCE 10-15-2006.

SETH A. RAPPAPORT, EXAMINING ATTORNEY

Int. Cl.: 35

Prior U.S. Cls.: 100, 101 and 102

United States Patent and Trademark Office

Reg. No. 3,467,944

Registered July 15, 2008

SERVICE MARK  
PRINCIPAL REGISTER



ALARIS INCOME GROWTH FUND L.P. (CANADA LIMITED PARTNERSHIP)  
125, 101-6TH STREET S.W.  
CALGARY, CANADA T2P 5K7

OWNER OF U.S. REG. NO. 2,504,822.

FOR: RETAIL STORE SERVICES IN THE FIELD OF CARPETING AND FLOOR COVERINGS, IN CLASS 35 (U.S. CLS. 100, 101 AND 102).

NO CLAIM IS MADE TO THE EXCLUSIVE RIGHT TO USE "DISCOUNT CARPET & FLOORING", APART FROM THE MARK AS SHOWN.

PRIORITY CLAIMED UNDER SEC. 44(D) ON CANADA APPLICATION NO. 1291020, FILED 2-6-2006, REG. NO. TMA700090, DATED 11-2-2007, EXPIRES 11-2-2022.

SER. NO. 78-942,491, FILED 8-1-2006.

KIM SAITO, EXAMINING ATTORNEY



**Int. Cl.: 41**

**Prior U.S. Cls.: 100, 101 and 107**

**United States Patent and Trademark Office**

**Reg. No. 3,467,945**

**Registered July 15, 2008**

**SERVICE MARK  
PRINCIPAL REGISTER**



MEN OF ESSENCE (TEXAS CORPORATION)  
5510 GREENWICH DRIVE  
ARLINGTON, TX 76018

FOR: ENTERTAINMENT SERVICES, NAMELY,  
CONDUCTING PARTIES AND CULTURAL  
EVENTS FOR THE PURPOSE OF CULTURAL EX-  
CHANGE AND SHARED COMMUNITY SERVICE  
AMONG PROFESSIONAL GAY MEN OF COLOR ,  
IN CLASS 41 (U.S. CLS. 100, 101 AND 107).

FIRST USE 10-2-2005; IN COMMERCE 4-30-2006.

THE COLOR(S) BLUE, GREEN AND WHITE IS/  
ARE CLAIMED AS A FEATURE OF THE MARK.

THE MARK CONSISTS OF THE FOLLOWING:  
THE COLOR BLUE APPEARS IN THE STARS AND  
THE GLOBE PORTION OF THE "E"; THE COLOR  
GREEN APPEARS IN THE "E" PORTION AND THE  
ARROW SYMBOL; THE COLOR WHITE APPEARS  
IN THE MERIDIANS OF THE GLOBE DESIGN.

SER. NO. 78-943,273, FILED 8-2-2006.

HOWARD B. LEVINE, EXAMINING ATTORNEY

Int. Cls.: 35 and 41

Prior U.S. Cls.: 100, 101, 102 and 107

United States Patent and Trademark Office

Reg. No. 3,467,946

Registered July 15, 2008

SERVICE MARK  
PRINCIPAL REGISTER

**BFF**  
B R I D A L

BFF BRIDAL LLC (NEW YORK LTD LIAB CO)  
15C  
95 WORTH STREET  
NEW YORK, NY 10013

FOR: ONLINE RETAIL STORE SERVICES IN THE FIELDS OF WEDDINGS AND SPECIAL EVENTS; ADVERTISING AND PROMOTING GOODS AND SERVICES OF OTHERS RELATED TO WEDDINGS AND SPECIAL EVENTS; PROVIDING CONSUMER INFORMATION SERVICES AND REFERRALS IN THE FIELDS OF WEDDINGS, SPECIAL EVENTS AND EVENT PLANNING FOR PRODUCTS, SERVICES, EVENTS, ACTIVITIES, FACILITIES AND LOCATIONS, IN CLASS 35 (U.S. CLS. 100, 101 AND 102).

FIRST USE 4-0-2006; IN COMMERCE 4-0-2006.

FOR: SPECIAL EVENT AND WEDDING PLANNING SERVICES; SPECIAL EVENT AND WEDDING

PLANNING CONSULTATION AND COORDINATION SERVICES; PROVIDING INFORMATION, ADVICE AND REVIEWS IN THE FIELDS OF WEDDING PLANNING, SPECIAL EVENTS AND EVENT PLANNING; PROVIDING ONLINE NEWSLETTERS IN THE FIELDS OF WEDDING PLANNING, SPECIAL EVENTS AND EVENT PLANNING, IN CLASS 41 (U.S. CLS. 100, 101 AND 107).

FIRST USE 4-0-2006; IN COMMERCE 4-0-2006.

NO CLAIM IS MADE TO THE EXCLUSIVE RIGHT TO USE "BRIDAL", APART FROM THE MARK AS SHOWN.

SER. NO. 78-943,357, FILED 8-2-2006.

PAULA MAHONEY, EXAMINING ATTORNEY

**Int. Cl.: 1**

**Prior U.S. Cls.: 1, 5, 6, 10, 26 and 46**

**Reg. No. 3,467,947**

**United States Patent and Trademark Office**

**Registered July 15, 2008**

**TRADEMARK  
PRINCIPAL REGISTER**

**EM**

EM RESEARCH ORGANIZATION, INC. (JAPAN CORPORATION)  
2440 N. COYOTE DR., SUITE 126  
TUCSON, AZ 85745

FOR: CHEMICAL PRESERVATIVE COMPOSITIONS, NAMELY, ANTIOXIDANTS AND ANTIOXIDANT AGENTS FOR USE IN THE MANUFACTURE OF SOAP AND VEGETABLE OILS, AND FOR USE IN THE PRODUCTION OF A WIDE VARIETY OF CHEMICALS; AND ANTIOXIDANT FOOD PRESERVATIVE COMPOSITIONS; RUST INHIBITORS FOR INDUSTRIAL USE; PLANT GROWTH REGULATING AND PLANT GROWTH STIMULATING AND ENHANCING PREPARATIONS; SOIL CONDITIONERS; ORGANIC FERTILIZERS; FERTILIZERS AND COMPOST, IN CLASS 1 (U.S. CLS. 1, 5, 6, 10, 26 AND 46).

FIRST USE 12-0-1986; IN COMMERCE 12-0-1986.

THE MARK CONSISTS OF STANDARD CHARACTERS WITHOUT CLAIM TO ANY PARTICULAR FONT, STYLE, SIZE, OR COLOR.

OWNER OF U.S. REG. NOS. 2,276,378, 3,151,313 AND OTHERS.

SEC. 2(F).

SER. NO. 78-944,352, FILED 8-3-2006.

ANDREA BUTLER, EXAMINING ATTORNEY

**Int. Cl.: 41**

**Prior U.S. Cls.: 100, 101 and 107**

**United States Patent and Trademark Office**

**Reg. No. 3,467,948**

**Registered July 15, 2008**

**SERVICE MARK  
PRINCIPAL REGISTER**

**INVESTMENT RESEARCH  
CHALLENGE**

THE NEW YORK SOCIETY OF SECURITY ANALYSTS, INC. (NEW YORK NON-PROFIT CORPORATION)  
2ND FLOOR  
1177 AVENUE OF THE AMERICAS  
NEW YORK, NY 100362714

FOR: EDUCATIONAL SERVICES, NAMELY, DEVELOPING AND CONDUCTING PROGRAMS IN WHICH INDUSTRY LEADING PROFESSIONALS TEACH BUSINESS AND FINANCE STUDENTS HOW TO RESEARCH AND REPORT ON PUBLICLY TRADED COMPANIES, IN CLASS 41 (U.S. CLS. 100, 101 AND 107).

FIRST USE 9-0-2002; IN COMMERCE 9-0-2002.

THE MARK CONSISTS OF STANDARD CHARACTERS WITHOUT CLAIM TO ANY PARTICULAR FONT, STYLE, SIZE, OR COLOR.

NO CLAIM IS MADE TO THE EXCLUSIVE RIGHT TO USE "INVESTMENT RESEARCH", APART FROM THE MARK AS SHOWN.

SER. NO. 78-944,884, FILED 8-4-2006.

ANDREA BUTLER, EXAMINING ATTORNEY

**Int. Cl.: 44**

**Prior U.S. Cls.: 100 and 101**

**United States Patent and Trademark Office**

**Reg. No. 3,467,949**

**Registered July 15, 2008**

**SERVICE MARK  
PRINCIPAL REGISTER**



**The Institute for  
Female Pelvic Medicine  
& Reconstructive Surgery**

*Caring Specialists. Restoring Pelvic Support. Curing Incontinence.*

FPM ENTERPRISES L.L.C. (PENNSYLVANIA  
LTD LIAB CO)  
SUITE 111  
2200 W. HAMILTON STREET  
ALLENTOWN, PA 18104

FOR: HEALTHCARE SERVICES, PROVIDING  
INFORMATION IN THE FIELDS OF HEALTHCARE  
AND WOMEN'S HEALTH ISSUES VIA THE INTER-  
NET, IN CLASS 44 (U.S. CLS. 100 AND 101).

FIRST USE 7-0-2003; IN COMMERCE 7-0-2003.

OWNER OF U.S. REG. NOS. 2,749,058 AND  
2,945,341.

NO CLAIM IS MADE TO THE EXCLUSIVE  
RIGHT TO USE "CARING SPECIALISTS. RESTOR-  
ING PELVIC SUPPORT. CURING INCONTI-  
NENCE.", APART FROM THE MARK AS SHOWN.

SEC. 2(F) AS TO "THE INSTITUTE FOR FEMALE  
PELVIC MEDICINE & RECONSTRUCTIVE SUR-  
GERY".

SER. NO. 78-946,053, FILED 8-7-2006.

ANDREA BUTLER, EXAMINING ATTORNEY

**Int. Cls.: 20, 35, 40 and 42**

**Prior U.S. Cls.: 2, 13, 22, 25, 32, 50, 100, 101, 102, 103  
and 106**

**Reg. No. 3,467,950**

**United States Patent and Trademark Office**

**Registered July 15, 2008**

**TRADEMARK  
SERVICE MARK  
PRINCIPAL REGISTER**



INMARK, INC. (GEORGIA CORPORATION)  
675 HARTMAN ROAD  
AUSTELL, GA 30168

FOR: MEDICAL SHIPPING CONTAINERS FOR  
DIAGNOSTIC AND INFECTIOUS MATERIALS,  
NAMELY, NONMETAL CONTAINERS FOR THE  
TRANSPORT AND STORAGE OF ORGANS, TIS-  
SUES AND CELLS FOR MEDICAL AND SCIENTI-  
FIC PURPOSES, IN CLASS 20 (U.S. CLS. 2, 13, 22, 25,  
32 AND 50).

FIRST USE 0-0-2005; IN COMMERCE 0-0-2005.

FOR: DISTRIBUTORSHIP SERVICES IN THE  
FIELD OF PACKAGING CONTAINERS AND AC-  
CESSORIES THEREFOR TO THE ORDER AND  
SPECIFICATION OF OTHERS, IN CLASS 35 (U.S.  
CLS. 100, 101 AND 102).

FIRST USE 0-0-2005; IN COMMERCE 0-0-2005.

FOR: CUSTOM IMPRINTING OF SHIPPING  
PACKAGES WITH DECORATIVE DESIGNS, IN  
CLASS 40 (U.S. CLS. 100, 103 AND 106).

FIRST USE 0-0-2005; IN COMMERCE 0-0-2005.

FOR: DESIGN FOR OTHERS IN THE FIELD OF  
SHIPPING PACKAGES, IN CLASS 42 (U.S. CLS. 100  
AND 101).

FIRST USE 0-0-2005; IN COMMERCE 0-0-2005.

OWNER OF U.S. REG. NO. 1,303,124.

NO CLAIM IS MADE TO THE EXCLUSIVE  
RIGHT TO USE "NORTH AMERICA", APART  
FROM THE MARK AS SHOWN.

SER. NO. 78-946,404, FILED 8-7-2006.

SKYE YOUNG, EXAMINING ATTORNEY

**Int. Cls.: 16, 35, 36 and 41**

**Prior U.S. Cls.: 2, 5, 22, 23, 29, 37, 38, 50, 100, 101, 102  
and 107**

**Reg. No. 3,467,951**

**United States Patent and Trademark Office**

**Registered July 15, 2008**

**TRADEMARK  
SERVICE MARK  
PRINCIPAL REGISTER**

**HOLT**

CSFB HOLT LLC (DELAWARE LTD LIAB CO)  
11 MADISON AVENUE  
NEW YORK, NY 10010

FOR: INFORMATIONAL REPORTS AND MARKET COMMENTARIES DEALING WITH INVESTMENT STRATEGIES, FINANCIAL ANALYSIS, AND TECHNIQUES FOR EVALUATION OF SECURITIES, IN CLASS 16 (U.S. CLS. 2, 5, 22, 23, 29, 37, 38 AND 50).

FIRST USE 1-31-2002; IN COMMERCE 1-31-2002.

FOR: PROVIDING METHODOLOGY, METRICS AND DATA FOR ANALYZING PERFORMANCE AND VALUATION OF COMPANIES, IN CLASS 35 (U.S. CLS. 100, 101 AND 102).

FIRST USE 1-31-2002; IN COMMERCE 1-31-2002.

FOR: FINANCIAL PLANNING AND INVESTMENT ADVISORY SERVICES, IN CLASS 36 (U.S. CLS. 100, 101 AND 102).

FIRST USE 1-31-2002; IN COMMERCE 1-31-2002.

FOR: EDUCATIONAL SERVICES, NAMELY, CONDUCTING TRAINING SESSIONS, SEMINARS, WORKSHOPS, AND CLASSES, WHICH PROVIDE INSTRUCTION IN TECHNIQUES FOR EVALUATION OF SECURITIES AND COMPANY PERFORMANCE, IN CLASS 41 (U.S. CLS. 100, 101 AND 107).

FIRST USE 1-31-2002; IN COMMERCE 1-31-2002.

THE MARK CONSISTS OF STANDARD CHARACTERS WITHOUT CLAIM TO ANY PARTICULAR FONT, STYLE, SIZE, OR COLOR.

OWNER OF U.S. REG. NO. 1,631,869.

SEC. 2(F).

SER. NO. 78-947,419, FILED 8-8-2006.

LINDA E. BLOHM, EXAMINING ATTORNEY

**Int. Cls.: 35 and 40**

**Prior U.S. Cls.: 100, 101, 102, 103 and 106**

**United States Patent and Trademark Office**

**Reg. No. 3,467,952**

**Registered July 15, 2008**

**SERVICE MARK  
PRINCIPAL REGISTER**

**ZAR ZANA'S**

ZAR ZANA'S (CALIFORNIA SOLE PROPRIETORSHIP)  
601 KENTUCKY AVE.  
WOODLAND, CA 95695

FOR: RETAIL STORE SERVICES FEATURING PRINTS, POSTERS, PHOTOGRAPHS, AND LIMITED EDITION FINE ART PRINTS, IN CLASS 35 (U.S. CLS. 100, 101 AND 102).

FIRST USE 7-1-1982; IN COMMERCE 7-1-1982.

FOR: CUSTOM PICTURE FRAMING AND MATTING SERVICES, IN CLASS 40 (U.S. CLS. 100, 103 AND 106).

FIRST USE 7-1-1982; IN COMMERCE 7-1-1982.

THE MARK CONSISTS OF STANDARD CHARACTERS WITHOUT CLAIM TO ANY PARTICULAR FONT, STYLE, SIZE, OR COLOR.

THE NAME ZAR ZANA'S DOES NOT IDENTIFY A LIVING INDIVIDUAL.

SER. NO. 78-949,014, FILED 8-9-2006.

PATRICIA EVANKO, EXAMINING ATTORNEY



**Int. Cl.: 5**

**Prior U.S. Cls.: 6, 18, 44, 46, 51 and 52**

**Reg. No. 3,467,953**

**United States Patent and Trademark Office**

**Registered July 15, 2008**

---

**TRADEMARK  
PRINCIPAL REGISTER**

**ORGANIC LIFE VITAMINS**

CONQUEST INTERNATIONAL, INC. (NEVADA  
CORPORATION)  
2530 N. ONTARIO STREET  
BURBANK, CA 91504

FOR: NUTRITIONAL SUPPLEMENTS MADE  
WITH ORGANIC INGREDIENTS, IN CLASS 5 (U.S.  
CLS. 6, 18, 44, 46, 51 AND 52).

FIRST USE 3-0-2005; IN COMMERCE 3-0-2005.

THE MARK CONSISTS OF STANDARD CHAR-  
ACTERS WITHOUT CLAIM TO ANY PARTICULAR  
FONT, STYLE, SIZE, OR COLOR.

NO CLAIM IS MADE TO THE EXCLUSIVE  
RIGHT TO USE "ORGANIC" AND "VITAMINS",  
APART FROM THE MARK AS SHOWN.

SER. NO. 78-954,012, FILED 8-17-2006.

JENNIFER VASQUEZ, EXAMINING ATTORNEY

Prior U.S. Cl.: A

United States Patent and Trademark Office

Reg. No. 3,467,954

Registered July 15, 2008

CERTIFICATION MARK  
PRINCIPAL REGISTER

PARMIGIANO  
REGGIANO

CONSORZIO DEL FORMAGGIO PARMIGIANO-  
REGGIANO (ITALY CONSORTIUM, A LEGAL  
ENTITY CHARTERED BY THE REPUBLIC OF  
ITALY)

VIA KENNEDY, 18  
REGGIO EMILIA, ITALY 42100

FOR: CHEESE, IN CLASS A (U.S. CL. A).

FIRST USE 4-10-1954; IN COMMERCE 5-25-1965.

OWNER OF U.S. REG. NOS. 1,753,059, 1,892,496  
AND OTHERS.

THE MARK CONSISTS OF THE WORD "PARMI-  
GIANO" POSITIONED OVER THE WORD "RE-  
GGIANO".

THE FOREIGN WORDING IN THE MARK  
TRANSLATES INTO ENGLISH AS "OF OR FROM  
PARMA" AND "OF OR FROM REGGIO".

THE CERTIFICATION MARK, AS USED BY  
PERSONS AUTHORIZED BY CERTIFIER, CERTI-  
FIES THAT THE GOODS ORIGINATE IN THE  
PARMA-REGGIO REGION OF ITALY, SPECIFI-  
CALLY THE ZONE COMPRISING THE TERRI-  
TORY OF THE PROVINCES OF PARMA, REGGIO  
EMILIA, MODENA AND MANTUA ON THE RIGHT  
BANK OF THE RIVER PO AND BOLOGNA ON THE  
LEFT BANK OF THE RIVER RENO.

SER. NO. 78-955,589, FILED 8-18-2006.

KELLY MCCOY, EXAMINING ATTORNEY

**Int. Cls.: 35, 38 and 41**

**Prior U.S. Cls.: 100, 101, 102, 104 and 107**

**Reg. No. 3,467,955**

**United States Patent and Trademark Office**

**Registered July 15, 2008**

**SERVICE MARK  
PRINCIPAL REGISTER**

# BUZZ OUT LOUD

CNET NETWORKS, INC. (DELAWARE CORPORATION)  
235 SECOND STREET, FOURTH FLOOR  
SAN FRANCISCO, CA 94105

FOR: PROVIDING CONSUMER PRODUCT INFORMATION, NAMELY, NEWS, INFORMATION, REVIEWS, AND COMMENTARY ABOUT THE GOODS AND SERVICES OF OTHERS, VIA PODCASTS AND ELECTRONIC COMMUNICATION NETWORKS, IN THE FIELDS OF COMPUTERS, COMPUTING, COMPUTER SOFTWARE, ELECTRONIC GAMING, WEB SITE DESIGN AND HOSTING, SOFTWARE APPLICATION HOSTING, HIGH TECHNOLOGY, ELECTRONIC COMMUNICATIONS, ELECTRONIC COMMERCE, CONSUMER ELECTRONICS, AND DIGITAL TECHNOLOGIES, IN CLASS 35 (U.S. CLS. 100, 101 AND 102).

FIRST USE 3-30-2005; IN COMMERCE 3-30-2005.

FOR: TELECOMMUNICATIONS SERVICES, NAMELY, ELECTRONIC TRANSMISSION OF TEXT, AUDIO, VIDEO, IMAGES, COMPUTER SOFTWARE, AND MULTIMEDIA DATA VIA ELECTRONIC COMMUNICATIONS NETWORKS; PROVIDING ON-LINE BULLETIN BOARDS FOR TRANSMISSION OF MESSAGES AMONG USERS CONCERNING CURRENT EVENTS, COMPUTERS, COMPUTING, COMPUTER SOFTWARE, ELECTRONIC GAMING, WEB SITE DESIGN AND HOSTING, SOFTWARE APPLICATION HOSTING, HIGH

TECHNOLOGY, ELECTRONIC COMMUNICATIONS, ELECTRONIC COMMERCE, CONSUMER ELECTRONICS, AND DIGITAL CULTURE, IN CLASS 38 (U.S. CLS. 100, 101 AND 104).

FIRST USE 3-30-2005; IN COMMERCE 3-30-2005.

FOR: EDUCATIONAL AND ENTERTAINMENT SERVICES, NAMELY, PROVIDING PODCASTS AND RADIO PROGRAMS DELIVERED VIA ELECTRONIC COMMUNICATIONS NETWORKS, ALL IN THE FIELDS OF CURRENT EVENTS, COMPUTERS, COMPUTING, COMPUTER SOFTWARE, ELECTRONIC GAMING, WEB SITE DESIGN AND HOSTING, SOFTWARE APPLICATION HOSTING, HIGH TECHNOLOGY, ELECTRONIC COMMUNICATIONS, ELECTRONIC COMMERCE, CONSUMER ELECTRONICS, DIGITAL TECHNOLOGIES, AND DIGITAL CULTURE, IN CLASS 41 (U.S. CLS. 100, 101 AND 107).

FIRST USE 3-30-2005; IN COMMERCE 3-30-2005.

THE MARK CONSISTS OF STANDARD CHARACTERS WITHOUT CLAIM TO ANY PARTICULAR FONT, STYLE, SIZE, OR COLOR.

SER. NO. 78-957,114, FILED 8-21-2006.

MICHELLE DUBOIS, EXAMINING ATTORNEY

**Int. Cls.: 18 and 25**

**Prior U.S. Cls.: 1, 2, 3, 22, 39 and 41**

**United States Patent and Trademark Office**

**Reg. No. 3,467,956**

**Registered July 15, 2008**

**TRADEMARK  
PRINCIPAL REGISTER**



OLD HARBOR OUTFITTERS, LLC (CONNECTI-  
CUT LTD LIAB CO)  
540 BARNUM AVE. 3RD FLOOR  
BRIDGEPORT, CT 06608

FOR: SPORTS BAGS, IN CLASS 18 (U.S. CLS. 1, 2, 3,  
22 AND 41).

FIRST USE 3-16-2006; IN COMMERCE 3-16-2006.

FOR: BOARD SHORTS; FOUL WEATHER GEAR;  
GLOVES; HATS; SHORTS; SPORTS SHIRTS; SWEAT  
SHIRTS; T-SHIRTS, IN CLASS 25 (U.S. CLS. 22 AND  
39).

FIRST USE 3-16-2006; IN COMMERCE 3-16-2006.

NO CLAIM IS MADE TO THE EXCLUSIVE  
RIGHT TO USE "OUTFITTERS", APART FROM  
THE MARK AS SHOWN.

THE MARK CONSISTS OF A THRESHER SHARK  
INSIDE OF AN ELLIPSE WHICH IS ABOVE THE  
WORDS, "OLD HARBOR OUTFITTERS". THE LET-  
TER "H" IN "HARBOR" IS STYLIZED.

SER. NO. 78-957,726, FILED 8-22-2006.

JIM RINGLE, EXAMINING ATTORNEY

**Int. Cl.: 41**

**Prior U.S. Cls.: 100, 101 and 107**

**United States Patent and Trademark Office**

**Reg. No. 3,467,957**

**Registered July 15, 2008**

**SERVICE MARK  
PRINCIPAL REGISTER**

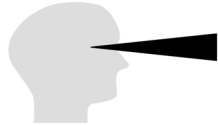

**NeuroPsychoEconomics**

SCHILKE, OLIVER (FED REP GERMANY INDIVIDUAL)  
LOESENBACHER LANDSTR. 127  
LUEDENSCHIED, FED REP GERMANY 58515

FOR: ARRANGING OF SEMINARS AND CONFERENCES; ONLINE JOURNALS, NAMELY, BLOGS FEATURING NEUROECONOMICS; PUBLICATION OF TEXTS, BOOKS, JOURNALS, IN CLASS 41 (U.S. CLS. 100, 101 AND 107).

THE MARK CONSISTS OF THE BUST OF A HEAD WITH A LONG TRIANGLE COMING OUT OF THE EYES OF THE HEAD. THE WORDING "NEUROPSYCHOECONOMICS" IS TO THE RIGHT OF THE DESIGN ELEMENT.

SER. NO. 78-958,188, FILED 8-23-2006.

FIRST USE 10-0-2005; IN COMMERCE 10-0-2005.

SETH A. RAPPAPORT, EXAMINING ATTORNEY

**Int. Cl.: 38**

**Prior U.S. Cls.: 100, 101 and 104**

**United States Patent and Trademark Office**

**Reg. No. 3,467,958**

**Registered July 15, 2008**

**SERVICE MARK  
PRINCIPAL REGISTER**

**WILV**

BONNEVILLE INTERNATIONAL CORPORA-  
TION (UTAH CORPORATION)  
BROADCAST HOUSE, 55 NORTH 300 WEST  
SALT LAKE CITY, UT 84180

THE MARK CONSISTS OF STANDARD CHAR-  
ACTERS WITHOUT CLAIM TO ANY PARTICULAR  
FONT, STYLE, SIZE, OR COLOR.

FOR: RADIO BROADCASTING SERVICES, IN  
CLASS 38 (U.S. CLS. 100, 101 AND 104).

SER. NO. 78-958,355, FILED 8-23-2006.

FIRST USE 11-5-2004; IN COMMERCE 11-5-2004.

BENJAMIN ALLEN, EXAMINING ATTORNEY

**Int. Cl.: 38**

**Prior U.S. Cls.: 100, 101 and 104**

**United States Patent and Trademark Office**

**Reg. No. 3,467,959**

**Registered July 15, 2008**

**SERVICE MARK  
PRINCIPAL REGISTER**

**WIL**

BONNEVILLE INTERNATIONAL CORPORA-  
TION (UTAH CORPORATION)  
BROADCAST HOUSE, 55 NORTH 300 WEST  
SALT LAKE CITY, UT 84180

THE MARK CONSISTS OF STANDARD CHAR-  
ACTERS WITHOUT CLAIM TO ANY PARTICULAR  
FONT, STYLE, SIZE, OR COLOR.

FOR: RADIO BROADCASTING SERVICES, IN  
CLASS 38 (U.S. CLS. 100, 101 AND 104).

SER. NO. 78-958,463, FILED 8-23-2006.

FIRST USE 6-29-2005; IN COMMERCE 6-29-2005.

BENJAMIN ALLEN, EXAMINING ATTORNEY

**Int. Cl.: 28**

**Prior U.S. Cls.: 22, 23, 38 and 50**

**United States Patent and Trademark Office**

**Reg. No. 3,467,960**

**Registered July 15, 2008**

**TRADEMARK  
PRINCIPAL REGISTER**



MATTEL, INC. (DELAWARE CORPORATION)  
333 CONTINENTAL BLVD.  
M1-1518  
EL SEGUNDO, CA 90245

NO CLAIM IS MADE TO THE EXCLUSIVE  
RIGHT TO USE "BRAIN GAMES", APART FROM  
THE MARK AS SHOWN.

FOR: HANDHELD UNITS FOR PLAYING ELEC-  
TRONIC GAMES, IN CLASS 28 (U.S. CLS. 22, 23, 38  
AND 50).

SER. NO. 78-959,911, FILED 8-24-2006.

FIRST USE 5-4-2007; IN COMMERCE 5-4-2007.

JESSICA A. POWERS, EXAMINING ATTORNEY



**Int. Cl.: 5**

**Prior U.S. Cls.: 6, 18, 44, 46, 51 and 52**

**Reg. No. 3,467,961**

**United States Patent and Trademark Office**

**Registered July 15, 2008**

---

**TRADEMARK  
PRINCIPAL REGISTER**

**MUCUS-AID**

HEALTH PRODUCTS EXPRESS, INC. (MASSACHUSETTS CORPORATION)  
P.O. BOX 8  
WINTHROP, MA 02152

THE MARK CONSISTS OF STANDARD CHARACTERS WITHOUT CLAIM TO ANY PARTICULAR FONT, STYLE, SIZE, OR COLOR.

FOR: PREPARATIONS FOR TREATING COLDS, IN CLASS 5 (U.S. CLS. 6, 18, 44, 46, 51 AND 52).

SER. NO. 78-961,874, FILED 8-28-2006.

FIRST USE 8-23-2006; IN COMMERCE 8-23-2006.

LAURA HAMMEL, EXAMINING ATTORNEY

**Int. Cl.: 11**

**Prior U.S. Cls.: 13, 21, 23, 31 and 34**

**United States Patent and Trademark Office**

**Reg. No. 3,467,962**

**Registered July 15, 2008**

**TRADEMARK  
PRINCIPAL REGISTER**

**BLADE**

BETA-CALCO INC. (CANADA CORPORATION)  
88 ST. REGIS CRESCENT SOUTH  
NORTH YORK, ONTARIO, CANADA M3J 1Y8

FOR: LIGHTING FIXTURES, IN CLASS 11 (U.S.  
CLS. 13, 21, 23, 31 AND 34).

FIRST USE 1-26-2007; IN COMMERCE 6-11-2007.

THE MARK CONSISTS OF STANDARD CHAR-  
ACTERS WITHOUT CLAIM TO ANY PARTICULAR  
FONT, STYLE, SIZE, OR COLOR.

PRIORITY CLAIMED UNDER SEC. 44(D) ON  
CANADA APPLICATION NO. 1,314,214, FILED 8-24-  
2006, REG. NO. TMA708,665, DATED 2-29-2008, EX-  
PIRES 3-1-2023.

SER. NO. 78-962,438, FILED 8-29-2006.

PATRICIA EVANKO, EXAMINING ATTORNEY

**Int. Cl.: 8**

**Prior U.S. Cls.: 23, 28 and 44**

**United States Patent and Trademark Office**

**Reg. No. 3,467,963**

**Registered July 15, 2008**

**TRADEMARK  
PRINCIPAL REGISTER**

QUALITY YOU ASK FOR BY NAME

SWANSON TOOL CO., INC. (DELAWARE CORPORATION)  
211 ONTARIO ST.  
FRANKFORT, IL 60423

THE MARK CONSISTS OF STANDARD CHARACTERS WITHOUT CLAIM TO ANY PARTICULAR FONT, STYLE, SIZE, OR COLOR.

FOR: HAND TOOLS, NAMELY, SQUARES, IN CLASS 8 (U.S. CLS. 23, 28 AND 44).

SER. NO. 78-963,131, FILED 8-29-2006.

FIRST USE 12-0-1997; IN COMMERCE 12-0-1997.

GIANCARLO CASTRO, EXAMINING ATTORNEY

**Int. Cl.: 36**

**Prior U.S. Cls.: 100, 101 and 102**

**United States Patent and Trademark Office**

**Reg. No. 3,467,964**

**Registered July 15, 2008**

**SERVICE MARK  
PRINCIPAL REGISTER**

**VINTAGE WINE TRUST**

VINTAGE WINE TRUST INC. (MARYLAND CORPORATION)  
1101 FIFTH AVENUE, SUITE 300  
SAN RAFAEL, CA 94901

FOR: FINANCIAL INVESTMENT SERVICES IN THE FIELD OF WINERIES AND VINEYARDS, IN CLASS 36 (U.S. CLS. 100, 101 AND 102).

FIRST USE 6-0-2004; IN COMMERCE 3-23-2005.

THE MARK CONSISTS OF STANDARD CHARACTERS WITHOUT CLAIM TO ANY PARTICULAR FONT, STYLE, SIZE, OR COLOR.

NO CLAIM IS MADE TO THE EXCLUSIVE RIGHT TO USE "TRUST", APART FROM THE MARK AS SHOWN.

SER. NO. 78-963,324, FILED 8-29-2006.

ELLEN PERKINS, EXAMINING ATTORNEY

**Int. Cl.: 35**

**Prior U.S. Cls.: 100, 101 and 102**

**United States Patent and Trademark Office**

**Reg. No. 3,467,965**

**Registered July 15, 2008**

**SERVICE MARK  
PRINCIPAL REGISTER**

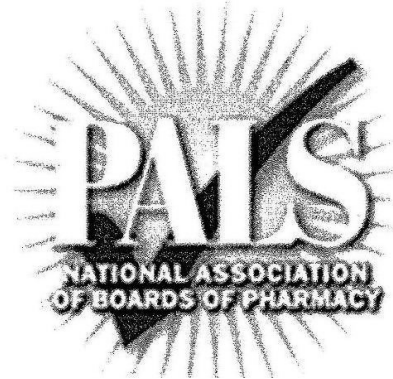

NATIONAL ASSOCIATION OF BOARDS OF  
PHARMACY (KENTUCKY CORPORATION)  
1600 FEEHANVILLE DRIVE  
MOUNT PROSPECT, IL 60056

FOR: PROVIDING AN ONLINE PHARMACY  
DIRECTORY INFORMATION SERVICE, IN CLASS  
35 (U.S. CLS. 100, 101 AND 102).

FIRST USE 6-30-2006; IN COMMERCE 6-30-2006.

OWNER OF U.S. REG. NOS. 1,162,334 AND  
1,959,575.

SEC. 2(F) AS TO "NATIONAL ASSOCIATION OF  
BOARDS OF PHARMACY".

SER. NO. 78-965,245, FILED 8-31-2006.

AISHA SALEM, EXAMINING ATTORNEY

**Int. Cl.: 7**

**Prior U.S. Cls.: 13, 19, 21, 23, 31, 34 and 35**

**United States Patent and Trademark Office**

**Reg. No. 3,467,966**

**Registered July 15, 2008**

**TRADEMARK  
PRINCIPAL REGISTER**

**H.E.A.T.**

SMITH INTERNATIONAL, INC. (DELAWARE  
CORPORATION)  
PATENT SERVICES  
16740 HARDY STREET  
HOUSTON, TX 77032

FOR: DOWNHOLE MOTORS, NAMELY, TUR-  
BINES, FOR DRILLING OIL AND GAS WELLS, IN  
CLASS 7 (U.S. CLS. 13, 19, 21, 23, 31, 34 AND 35).

FIRST USE 3-8-2007; IN COMMERCE 3-8-2007.

THE MARK CONSISTS OF STANDARD CHAR-  
ACTERS WITHOUT CLAIM TO ANY PARTICULAR  
FONT, STYLE, SIZE, OR COLOR.

SER. NO. 78-965,691, FILED 9-1-2006.

KATHERINE CONNOLLY, EXAMINING ATTOR-  
NEY

**Int. Cl.: 9**

**Prior U.S. Cls.: 21, 23, 26, 36 and 38**

**Reg. No. 3,467,967**

**United States Patent and Trademark Office**

**Registered July 15, 2008**

**TRADEMARK  
PRINCIPAL REGISTER**

THE RICHARDS CORPORATION

THE RICHARDS CORPORATION (VIRGINIA  
CORPORATION)  
44931 FALCON PLACE  
STERLING, VA 201669510

FIRST USE 9-30-1993; IN COMMERCE 9-30-1993.

THE MARK CONSISTS OF STANDARD CHAR-  
ACTERS WITHOUT CLAIM TO ANY PARTICULAR  
FONT, STYLE, SIZE, OR COLOR.

FOR: ILLUMINATING TABLES FOR VIEWING  
AERIAL AND SIMILAR WIDE STRIP FILMS,  
NAMELY, HIGH INTENSITY FIXED OPTICS AND  
SPLIT STAGE CARRIAGE TABLES, FILM FEEDING  
ATTACHMENTS AND HANDLERS FOR ASSOCIA-  
TION WITH SUCH FILM VIEWING TABLES, STE-  
REOSCOPIC VIEWERS, ALL FOR SALE TO  
GOVERNMENTAL AGENCIES AND SCIENTIFIC  
DEPARTMENTS OF INSTITUTIONS, SUCH AS UNI-  
VERSITIES, IN CLASS 9 (U.S. CLS. 21, 23, 26, 36 AND  
38).

NO CLAIM IS MADE TO THE EXCLUSIVE  
RIGHT TO USE "CORPORATION", APART FROM  
THE MARK AS SHOWN.

SEC. 2(F) AS TO "RICHARDS".

SER. NO. 78-965,879, FILED 9-1-2006.

MARTHA FROMM, EXAMINING ATTORNEY

**Int. Cls.: 1 and 5**

**Prior U.S. Cls.: 1, 5, 6, 10, 18, 26, 44, 46, 51 and 52**

**United States Patent and Trademark Office**

**Reg. No. 3,467,968**

**Registered July 15, 2008**

**TRADEMARK  
PRINCIPAL REGISTER**

# MBEC Assay

MBEC BIOPRODUCTS INC. (CANADA CORPORATION)  
SUITE 870  
10020-101A AVENUE  
EDMONTON, CANADA T5J 3G2

FOR: INVITRO DIAGNOSTIC ASSAYS FOR THE GROWTH AND TESTING OF BIOFILMS FOR SCIENTIFIC AND RESEARCH USE, IN CLASS 1 (U.S. CLS. 1, 5, 6, 10, 26 AND 46).

FOR: INVITRO DIAGNOSTIC ASSAYS FOR THE GROWTH AND TESTING OF BIOFILMS FOR MEDICAL USE, IN CLASS 5 (U.S. CLS. 6, 18, 44, 46, 51 AND 52).

THE MARK CONSISTS OF STANDARD CHARACTERS WITHOUT CLAIM TO ANY PARTICULAR FONT, STYLE, SIZE, OR COLOR.

PRIORITY CLAIMED UNDER SEC. 44(D) ON CANADA APPLICATION NO. 1,292,177, FILED 3-2-2006, REG. NO. TMA694,063, DATED 8-14-2007, EXPIRES 8-14-2022.

NO CLAIM IS MADE TO THE EXCLUSIVE RIGHT TO USE "ASSAY", APART FROM THE MARK AS SHOWN.

SER. NO. 78-965,914, FILED 9-1-2006.

PATRICIA EVANKO, EXAMINING ATTORNEY



**Int. Cls.: 1 and 5**

**Prior U.S. Cls.: 1, 5, 6, 10, 18, 26, 44, 46, 51 and 52**

**United States Patent and Trademark Office**

**Reg. No. 3,467,969**

**Registered July 15, 2008**

**TRADEMARK  
PRINCIPAL REGISTER**

# MBEC HTP Assay

MBEC BIOPRODUCTS INC. (CANADA CORPORATION)  
SUITE 870  
10020-101A AVENUE  
EDMONTON, CANADA T5J 3G2

FOR: INVITRO DIAGNOSTIC ASSAYS FOR THE GROWTH AND TESTING OF BIOFILMS FOR SCIENTIFIC AND RESEARCH USE, IN CLASS 1 (U.S. CLS. 1, 5, 6, 10, 26 AND 46).

FOR: INVITRO DIAGNOSTIC ASSAYS FOR THE GROWTH AND TESTING OF BIOFILMS FOR MEDICAL USE, IN CLASS 5 (U.S. CLS. 6, 18, 44, 46, 51 AND 52).

THE MARK CONSISTS OF STANDARD CHARACTERS WITHOUT CLAIM TO ANY PARTICULAR FONT, STYLE, SIZE, OR COLOR.

PRIORITY CLAIMED UNDER SEC. 44(D) ON CANADA APPLICATION NO. 1,292,178, FILED 3-2-2006, REG. NO. TMA693,935, DATED 8-10-2007, EXPIRES 8-10-2022.

NO CLAIM IS MADE TO THE EXCLUSIVE RIGHT TO USE "HTP ASSAY", APART FROM THE MARK AS SHOWN.

SER. NO. 78-965,928, FILED 9-1-2006.

PATRICIA EVANKO, EXAMINING ATTORNEY

**Int. Cls.: 1 and 5**

**Prior U.S. Cls.: 1, 5, 6, 10, 18, 26, 44, 46, 51 and 52**

**United States Patent and Trademark Office**

**Reg. No. 3,467,970**

**Registered July 15, 2008**

**TRADEMARK  
PRINCIPAL REGISTER**

**MBEC P&G Assay**

MBEC BIOPRODUCTS INC. (CANADA CORPORATION)  
SUITE 870  
10020-101A AVENUE  
EDMONTON, CANADA T5J 3G2

FOR: INVITRO DIAGNOSTIC ASSAYS FOR THE GROWTH AND TESTING OF BIOFILMS FOR SCIENTIFIC AND RESEARCH USE, IN CLASS 1 (U.S. CLS. 1, 5, 6, 10, 26 AND 46).

FOR: INVITRO DIAGNOSTIC ASSAYS FOR THE GROWTH AND TESTING OF BIOFILMS FOR MEDICAL USE, IN CLASS 5 (U.S. CLS. 6, 18, 44, 46, 51 AND 52).

THE MARK CONSISTS OF STANDARD CHARACTERS WITHOUT CLAIM TO ANY PARTICULAR FONT, STYLE, SIZE, OR COLOR.

PRIORITY CLAIMED UNDER SEC. 44(D) ON CANADA APPLICATION NO. 1,292,184, FILED 3-2-2006, REG. NO. TMA694,062, DATED 8-14-2007, EXPIRES 8-14-2022.

NO CLAIM IS MADE TO THE EXCLUSIVE RIGHT TO USE "ASSAY", APART FROM THE MARK AS SHOWN.

SER. NO. 78-965,941, FILED 9-1-2006.

PATRICIA EVANKO, EXAMINING ATTORNEY

**Int. Cl.: 41**

**Prior U.S. Cls.: 100, 101 and 107**

**United States Patent and Trademark Office**

**Reg. No. 3,467,971**

**Registered July 15, 2008**

**SERVICE MARK  
PRINCIPAL REGISTER**

**SUNCARE CENTRAL**

SUNCARE CENTRAL, INC. (FLORIDA CORPORATION)  
5325 ROCKBOURNE COURT  
ORLANDO, FL 32812

FOR: TEACHING, TRAINING, EDUCATING IN THE FORM OF SEMINARS, WORKSHOPS, COURSES IN THE FIELD OF SKINCARE BY PROVIDING ADVICE FOR OBTAINING SUNTANS AND AVOIDING OR TREATING SUNBURNS, EDUCATIONAL DEMONSTRATIONS TO DEMONSTRATE PROPER APPLICATION OF PROTECTIVE SUNTANNING, AFTER SUN AND SKIN CARE LOTIONS, OILS

AND CREAMS, IN CLASS 41 (U.S. CLS. 100, 101 AND 107).

FIRST USE 0-0-1990; IN COMMERCE 0-0-1990.

THE MARK CONSISTS OF STANDARD CHARACTERS WITHOUT CLAIM TO ANY PARTICULAR FONT, STYLE, SIZE, OR COLOR.

SER. NO. 78-966,082, FILED 9-1-2006.

NAKIA HENRY, EXAMINING ATTORNEY

**Int. Cl.: 41**

**Prior U.S. Cls.: 100, 101 and 107**

**United States Patent and Trademark Office**

**Reg. No. 3,467,972**

**Registered July 15, 2008**

**SERVICE MARK  
PRINCIPAL REGISTER**

**LEARN BEFORE YOU BURN**

SUNCARE CENTRAL, INC. (FLORIDA CORPORATION)  
5325 ROCKBOURNE COURT  
ORLANDO, FL 32812

FOR: TEACHING, TRAINING, EDUCATING IN THE FORM OF SEMINARS, WORKSHOPS, COURSES IN THE FIELD OF SKINCARE BY PROVIDING ADVICE FOR OBTAINING SUNTANS AND AVOIDING OR TREATING SUNBURNS, EDUCATIONAL DEMONSTRATIONS TO DEMONSTRATE PROPER APPLICATION OF PROTECTIVE SUNTANNING, AFTER SUN AND SKIN CARE LOTIONS, OILS

AND CREAMS, IN CLASS 41 (U.S. CLS. 100, 101 AND 107).

FIRST USE 0-0-1990; IN COMMERCE 0-0-1990.

THE MARK CONSISTS OF STANDARD CHARACTERS WITHOUT CLAIM TO ANY PARTICULAR FONT, STYLE, SIZE, OR COLOR.

SER. NO. 78-966,090, FILED 9-1-2006.

NAKIA HENRY, EXAMINING ATTORNEY

**Int. Cl.: 1**

**Prior U.S. Cls.: 1, 5, 6, 10, 26 and 46**

**United States Patent and Trademark Office**

**Reg. No. 3,467,973**

**Registered July 15, 2008**

**TRADEMARK  
PRINCIPAL REGISTER**

**POWER SLIDE**

INNOVATIVE FLUID SYSTEMS INC. (CANADA  
CORPORATION)  
200, 407 - 3RD STREET SW  
CALGARY, ALBERTA T2P 4Z2

FOR: CHEMICAL ADDITIVES FOR OIL WELL  
DRILLING FLUID, IN CLASS 1 (U.S. CLS. 1, 5, 6, 10,  
26 AND 46).

THE MARK CONSISTS OF STANDARD CHAR-  
ACTERS WITHOUT CLAIM TO ANY PARTICULAR  
FONT, STYLE, SIZE, OR COLOR.

PRIORITY CLAIMED UNDER SEC. 44(D) ON  
CANADA APPLICATION NO. 1315319, FILED 9-5-  
2006, REG. NO. TMA696319, DATED 9-11-2007, EX-  
PIRES 9-11-2022.

SER. NO. 78-967,738, FILED 9-6-2006.

CARYN GLASSER, EXAMINING ATTORNEY

**Int. Cls.: 9, 16 and 41**

**Prior U.S. Cls.: 2, 5, 21, 22, 23, 26, 29, 36, 37, 38, 50,  
100, 101 and 107**

**Reg. No. 3,467,974**

**United States Patent and Trademark Office**

**Registered July 15, 2008**

**TRADEMARK  
SERVICE MARK  
PRINCIPAL REGISTER**

**RAYID**

RAYID INTERNATIONAL, LLC (COLORADO  
LTD LIAB CO)  
P.O. BOX 31  
REDVALE, CO 81431

FOR: EDUCATIONAL AUDIO-VIDEO PRO-  
DUCTS, NAMELY, PRE-RECORDED CDS, VIDEO  
TAPES, LASER DISKS AND DVDS FEATURING  
INFORMATION REGARDING THE STRUCTURAL  
CONSTITUTION OF THE EYE AND FAMILY TREE  
DYNAMICS, IN CLASS 9 (U.S. CLS. 21, 23, 26, 36 AND  
38).

FIRST USE 1-1-1980; IN COMMERCE 1-1-1980.

FOR: BOOKS IN THE FIELD OF STRUCTURAL  
CONSTITUTION OF THE IRIS OF THE EYE AND  
FAMILY TREE DYNAMICS; PRINTED CHARTS, IN  
CLASS 16 (U.S. CLS. 2, 5, 22, 23, 29, 37, 38 AND 50).

FIRST USE 1-1-1980; IN COMMERCE 1-1-1980.

FOR: EDUCATIONAL SERVICES, NAMELY,  
CONDUCTING EDUCATIONAL PROGRAMS, LEC-  
TURES, AND RETREATS IN THE FIELD OF  
STRUCTURAL CONSTITUTION OF THE IRIS OF  
THE EYE AND FAMILY TREE DYNAMICS, IN  
CLASS 41 (U.S. CLS. 100, 101 AND 107).

FIRST USE 1-1-1980; IN COMMERCE 1-1-1980.

THE MARK CONSISTS OF STANDARD CHAR-  
ACTERS WITHOUT CLAIM TO ANY PARTICULAR  
FONT, STYLE, SIZE, OR COLOR.

SER. NO. 78-969,104, FILED 9-7-2006.

KAPIL BHANOT, EXAMINING ATTORNEY

**Int. Cl.: 41**

**Prior U.S. Cls.: 100, 101 and 107**

**United States Patent and Trademark Office**

**Reg. No. 3,467,975**

**Registered July 15, 2008**

**SERVICE MARK  
PRINCIPAL REGISTER**

**BabyPips.com**

BABYPIPS.COM LLC (VIRGINIA PARTNERSHIP)  
PO BOX 29591  
RICHMOND, VA 23242

FIRST USE 11-0-2005; IN COMMERCE 11-0-2005.

FOR: EDUCATION SERVICES, NAMELY, PROVIDING AN ONLINE LEARNING CURRICULUM AND PROVIDING ONLINE LEARNING COURSES ALL IN THE FIELD OF FOREIGN CURRENCY EXCHANGE OR FOREX, IN CLASS 41 (U.S. CLS. 100, 101 AND 107).

THE MARK CONSISTS OF STANDARD CHARACTERS WITHOUT CLAIM TO ANY PARTICULAR FONT, STYLE, SIZE, OR COLOR.

SER. NO. 78-973,222, FILED 9-13-2006.

MONIQUE MILLER, EXAMINING ATTORNEY

**Int. Cl.: 9**

**Prior U.S. Cls.: 21, 23, 26, 36 and 38**

**Reg. No. 3,467,976**

**United States Patent and Trademark Office**

**Registered July 15, 2008**

**TRADEMARK  
PRINCIPAL REGISTER**

**ORIGIN'L FABRIC**

TIME'S UP (NEVADA CORPORATION)  
6355 SUNSET CORPORATE DRIVE  
LAS VEGAS, NV 89120

NO CLAIM IS MADE TO THE EXCLUSIVE  
RIGHT TO USE "FABRIC", APART FROM THE  
MARK AS SHOWN.

FOR: MOUSE PADS, IN CLASS 9 (U.S. CLS. 21, 23,  
26, 36 AND 38).

SEC. 2(F).

FIRST USE 1-1-2000; IN COMMERCE 1-1-2000.

SER. NO. 78-974,718, FILED 9-14-2006.

THE MARK CONSISTS OF STANDARD CHAR-  
ACTERS WITHOUT CLAIM TO ANY PARTICULAR  
FONT, STYLE, SIZE, OR COLOR.

EMILY CHUO, EXAMINING ATTORNEY



**Int. Cl.: 24**

**Prior U.S. Cls.: 42 and 50**

**United States Patent and Trademark Office**

**Reg. No. 3,467,977**

**Registered July 15, 2008**

**TRADEMARK  
PRINCIPAL REGISTER**

**ORIGIN'L FABRIC**

TIME'S UP (NEVADA CORPORATION)  
6355 SUNSET CORPORATE DRIVE  
LAS VEGAS, NV 89120

FOR: COUNTER MATS, NAMELY, PLACE MATS  
OF TEXTILE MATERIAL AND PLACE MATS OF  
PLASTIC, IN CLASS 24 (U.S. CLS. 42 AND 50).

FIRST USE 1-1-2000; IN COMMERCE 1-1-2000.

THE MARK CONSISTS OF STANDARD CHAR-  
ACTERS WITHOUT CLAIM TO ANY PARTICULAR  
FONT, STYLE, SIZE, OR COLOR.

NO CLAIM IS MADE TO THE EXCLUSIVE  
RIGHT TO USE "FABRIC", APART FROM THE  
MARK AS SHOWN.

SEC. 2(F).

SER. NO. 78-974,733, FILED 9-14-2006.

EMILY CHUO, EXAMINING ATTORNEY

**Int. Cl.: 16**

**Prior U.S. Cls.: 2, 5, 22, 23, 29, 37, 38 and 50**

**United States Patent and Trademark Office**

**Reg. No. 3,467,978**

**Registered July 15, 2008**

**TRADEMARK  
PRINCIPAL REGISTER**

**DOG GONE SMART**

ONTHANK, CHRISTOPHER (UNITED STATES  
INDIVIDUAL)  
15 OLD BOSTON ROAD  
WILTON, CT 06897

THE MARK CONSISTS OF STANDARD CHAR-  
ACTERS WITHOUT CLAIM TO ANY PARTICULAR  
FONT, STYLE, SIZE, OR COLOR.

FOR: PAMPHLETS AND HANDOUTS ON THE  
SUBJECT OF DOG TRAINING, IN CLASS 16 (U.S.  
CLS. 2, 5, 22, 23, 29, 37, 38 AND 50).

SER. NO. 78-978,009, FILED 9-7-2005.

FIRST USE 8-28-1998; IN COMMERCE 8-28-1998.

JUDITH HELFMAN, EXAMINING ATTORNEY

**Int. Cl.: 28**

**Prior U.S. Cls.: 22, 23, 38 and 50**

**Reg. No. 3,467,979**

**United States Patent and Trademark Office**

**Registered July 15, 2008**

**TRADEMARK  
PRINCIPAL REGISTER**

**HŌKŪLI'A**

1250 OCEANSIDE PARTNERS (HAWAII LIMITED PARTNERSHIP)  
8777 N. GAINES CENTER DRIVE, SUITE 205  
SCOTTSDALE, AZ 85258

FOR: SPORTING GOODS, NAMELY, GOLF GLOVES, GOLF BALLS, GOLF CLUBS, GOLF BAGS, AND NON-MOTORIZED GOLF CLUB CARTS, IN CLASS 28 (U.S. CLS. 22, 23, 38 AND 50).

FIRST USE 2-1-1999; IN COMMERCE 2-1-1999.

THE MARK CONSISTS OF STANDARD CHARACTERS WITHOUT CLAIM TO ANY PARTICULAR FONT, STYLE, SIZE, OR COLOR.

"THE FOREIGN WORDING IN THE MARK TRANSLATES INTO ENGLISH AS STAR OF DESIRE."

SER. NO. 78-978,806, FILED 6-28-2005.

GISSELLE AGOSTO, EXAMINING ATTORNEY

**Int. Cl.: 9**

**Prior U.S. Cls.: 21, 23, 26, 36 and 38**

**Reg. No. 3,467,980**

**United States Patent and Trademark Office**

**Registered July 15, 2008**

---

**TRADEMARK  
PRINCIPAL REGISTER**

**OCEAN**

SCHLUMBERGER TECHNOLOGY CORPORATION (TEXAS CORPORATION)  
SUITE 1700  
5599 SAN FELIPE  
HOUSTON, TX 77027

FOR: COMPUTER SOFTWARE FOR USE IN COMPUTER SYSTEM AND APPLICATION DEVELOPMENT, DEPLOYMENT AND MANAGEMENT, USED IN THE OIL AND GAS EXPLORATION INDUSTRIES TO SUPPORT PETROCHEMICAL DRILLING AND PRODUCTION OPERATIONS AND INSTRUCTIONAL MANUALS DISTRIBUTED

THEREWITH AS A UNIT, IN CLASS 9 (U.S. CLS. 21, 23, 26, 36 AND 38).

FIRST USE 5-11-2005; IN COMMERCE 5-11-2005.

THE MARK CONSISTS OF STANDARD CHARACTERS WITHOUT CLAIM TO ANY PARTICULAR FONT, STYLE, SIZE, OR COLOR.

SER. NO. 78-979,384, FILED 8-28-2006.

MARILYN IZZI, EXAMINING ATTORNEY

**Int. Cl.: 12**

**Prior U.S. Cls.: 19, 21, 23, 31, 35 and 44**

**Reg. No. 3,467,981**

**United States Patent and Trademark Office**

**Registered July 15, 2008**

---

**TRADEMARK  
PRINCIPAL REGISTER**

**PERFORMANCE MOBILITY**

PRIDE MOBILITY PRODUCTS CORPORATION  
(PENNSYLVANIA CORPORATION)  
182 SUSQUEHANNA AVENUE  
EXETER, PA 18643

FOR: PERSONAL MOBILITY VEHICLES, NAME-  
LY, MOTORIZED SCOOTERS, AND MANUAL AND  
MOTORIZED WHEELCHAIRS FOR ELDERLY, DIS-  
ABLED, INFIRM AND HANDICAPPED INDIVI-  
DUALS; LIFTS ATTACHED TO VEHICLES FOR  
LIFTING SCOOTERS AND MANUAL AND MO-  
TORIZED WHEELCHAIRS INTO OR ONTO AUTO-  
MOBILES, VANS, TRUCKS, TRAILER,  
RECREATIONAL VEHICLES AND OTHER MULTI-  
PASSENGER VEHICLES, IN CLASS 12 (U.S. CLS. 19,  
21, 23, 31, 35 AND 44).

FIRST USE 4-1-2006; IN COMMERCE 4-1-2006.

THE MARK CONSISTS OF STANDARD CHAR-  
ACTERS WITHOUT CLAIM TO ANY PARTICULAR  
FONT, STYLE, SIZE, OR COLOR.

NO CLAIM IS MADE TO THE EXCLUSIVE  
RIGHT TO USE "MOBILITY", APART FROM THE  
MARK AS SHOWN.

SER. NO. 78-979,904, FILED 6-28-2006.

MICHAEL LITZAU, EXAMINING ATTORNEY

**Int. Cl.: 9**

**Prior U.S. Cls.: 21, 23, 26, 36 and 38**

**Reg. No. 3,467,982**

**United States Patent and Trademark Office**

**Registered July 15, 2008**

**TRADEMARK  
PRINCIPAL REGISTER**

**SCRAP OPTIMISER**

TUBE CITY IMS, LLC (DELAWARE LTD LIAB  
CO)  
12 MONONGAHELA AVENUE  
GLASSPORT, PA 15045

FOR: COMPUTER SOFTWARE FOR USE IN  
PURCHASING, AND CHARGING FURNACES  
WITH, RAW MATERIALS IN THE FIELDS OF  
STEELMAKING AND METALS PRODUCTION, IN  
CLASS 9 (U.S. CLS. 21, 23, 26, 36 AND 38).

FIRST USE 8-16-1995; IN COMMERCE 8-16-1995.

THE MARK CONSISTS OF STANDARD CHAR-  
ACTERS WITHOUT CLAIM TO ANY PARTICULAR  
FONT, STYLE, SIZE, OR COLOR.

OWNER OF U.S. REG. NO. 3,044,883.

SEC. 2(F).

SER. NO. 78-979,913, FILED 8-9-2006.

WON TEAK OH, EXAMINING ATTORNEY

**Int. Cls.: 36 and 42**

**Prior U.S. Cls.: 100, 101 and 102**

**United States Patent and Trademark Office**

**Reg. No. 3,467,983**

**Registered July 15, 2008**

**SERVICE MARK  
PRINCIPAL REGISTER**

**CAPTURE THE SOLUTION, NOT  
THE PROBLEM**

STRUCTURED RISK, INC. (CALIFORNIA CORPORATION)  
SUITE 120  
2000 CROW CANYON PLACE  
SAN RAMON, CA 94583

FOR: RISK MANAGEMENT CONSULTATION, IN CLASS 36 (U.S. CLS. 100, 101 AND 102).

FIRST USE 6-15-2006; IN COMMERCE 6-15-2006.

FOR: PROVIDING ONLINE NON-DOWNLOADABLE SOFTWARE FOR ORGANIZING, VIEWING AND LISTENING TO DOCUMENTS, SOUND CLIPS, PHOTOS AND VIDEOS RELATING TO CONSTRUCTION PROJECTS FOR USE IN THE FIELDS OF REAL ESTATE, CONSTRUCTION AND INSURANCE, IN CLASS 42 (U.S. CLS. 100 AND 101).

TION PROJECTS FOR USE IN THE FIELDS OF REAL ESTATE, CONSTRUCTION AND INSURANCE, IN CLASS 42 (U.S. CLS. 100 AND 101).

FIRST USE 6-15-2006; IN COMMERCE 6-15-2006.

THE MARK CONSISTS OF STANDARD CHARACTERS WITHOUT CLAIM TO ANY PARTICULAR FONT, STYLE, SIZE, OR COLOR.

SER. NO. 78-979,945, FILED 7-31-2006.

COLLEEN KEARNEY, EXAMINING ATTORNEY

**Int. Cls.: 9 and 42**

**Prior U.S. Cls.: 21, 23, 26, 36, 38, 100 and 101**

**United States Patent and Trademark Office**

**Reg. No. 3,467,984**

**Registered July 15, 2008**

**TRADEMARK  
SERVICE MARK  
PRINCIPAL REGISTER**



OPTION, NAAMLOZE VENNOOTSCHAP (BELGIUM JOINT STOCK COMPANY)  
KOLONEL BEGAULTLAAN 45  
B-3012 WILSELE  
BELGIUM

FOR: TELECOMMUNICATIONS INSTRUMENTS AND APPARATUS, NAMELY, ELECTRONIC CARDS FOR RECORDAL, PROCESSING AND TRANSMITTING DATA AND IMAGES; COMPUTERS, DATA PROCESSING EQUIPMENT; COMPUTER PROGRAMS, IN PARTICULAR AN INTERFACE WHICH ENABLES THE INTEGRATION OF MOBILE TELEPHONE SERVICES WITH OTHER SYSTEMS, SUCH AS LAPTOPS, MOBILE TELEPHONES AND THE LIKE; TELEPHONES AND FAX MACHINES, IN CLASS 9 (U.S. CLS. 21, 23, 26, 36 AND 38).

FOR: CONDUCTING FEASIBILITY STUDIES AND PRODUCT DEVELOPMENT CONCERNING TELECOMMUNICATIONS INSTRUMENTS AND APPARATUS, NAMELY, ELECTRONIC CARDS FOR RECORDAL, PROCESSING AND TRANSMITTING DATA AND IMAGES; CONDUCTING FEASIBILITY STUDIES AND PRODUCT DEVELOPMENT CONCERNING COMPUTERS, DATA PROCESSORS, AND COMPUTER PROGRAMS, IN PARTICULAR AN INTERFACE WHICH ENABLES THE INTEGRATION OF MOBILE TELEPHONE SERVICES WITH OTHER SYSTEMS, SUCH AS LAPTOPS, MOBILE

TELEPHONES AND THE LIKE; CONDUCTING FEASIBILITY STUDIES AND PRODUCT DEVELOPMENT CONCERNING TELEPHONES AND FAX MACHINES, IN CLASS 42 (U.S. CLS. 100 AND 101).

OWNER OF INTERNATIONAL REGISTRATION 0834427 DATED 8-11-2004, EXPIRES 8-11-2014.

NO CLAIM IS MADE TO THE EXCLUSIVE RIGHT TO USE "MOBILITY MANAGER", APART FROM THE MARK AS SHOWN.

THE COLOR(S) RED AND GREEN IS/ARE CLAIMED AS A FEATURE OF THE MARK.

THE MARK CONSISTS OF THE WORDING "GLOBETROTTER MOBILITY MANAGER" AND DESIGN FEATURE, WHEREIN THE DESIGN FEATURE COMPRISES A FOUR PART DIAMOND DESIGN, WHERE THE TOP THREE PARTS ARE IN GREEN, THE BOTTOM PART IN LIGHT GREEN, THE "GLOBETROTTER" PORTION OF THE MARK IS IN LIGHT GREEN AND THE "MOBILITY MANAGER" PORTION OF THE MARK IS IN RED.

SER. NO. 79-005,691, FILED 8-11-2004.

MARK SPARACINO, EXAMINING ATTORNEY



**Int. Cls.: 35 and 36**

**Prior U.S. Cls.: 100, 101 and 102**

**United States Patent and Trademark Office**

**Reg. No. 3,467,985**

**Registered July 15, 2008**

**SERVICE MARK  
PRINCIPAL REGISTER**

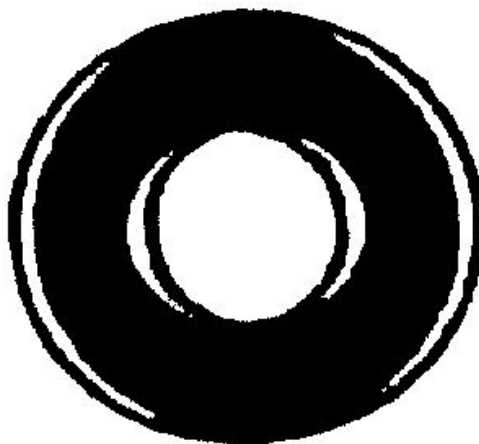

MACQUARIE BANK LIMITED (AUSTRALIA COMPANY)  
20 BOND STREET  
SYDNEY NSW 2000  
AUSTRALIA

FOR: CORPORATE ADVISORY SERVICES INCLUDING PROVIDING ADVICE ON CORPORATE STRATEGIES AND RESTRUCTURES, MERGER, ACQUISITION, JOINT VENTURES AND SALES AND PURCHASES OF BUSINESSES; MANAGING CLIENT AND CUSTOMER RELATION ISSUES; ECONOMIC FORECASTING AND MARKET RESEARCH; AUDITING AND DUE DILIGENCE SERVICES; ADVERTISING AND PROMOTION SERVICES, IN CLASS 35 (U.S. CLS. 100, 101 AND 102).

FOR: FINANCIAL SERVICES, NAMELY, CORPORATE FINANCE SERVICES CONSISTING OF CONSULTATION AND MANAGEMENT, FINANCIAL DUE DILIGENCE IN THE NATURE OF CONDUCTING SUFFICIENT ANALYSIS BEFORE MAKING LOAN OR INVESTMENT RECOMMENDATIONS, FINANCIAL DECISION MAKING FOR CORPORATIONS, PROJECT FINANCE SERVICES, NAMELY, PROJECT FINANCING, MAJOR PROJECT FINANCING SERVICES; PROVIDING FINANCIAL ADVICE IN RELATION TO MERGERS AND ACQUISITIONS; CAPITAL RAISING SERVICES NAMELY, PROVIDING WORKING CAPITAL THROUGH LISTED AND UNLISTED EQUITY, HYBRID INSTRUMENTS AND DEBT, INVESTING IN UNLISTED EQUITY, INVESTING IN LISTED EQUI-

TY, NAMELY, FLOATING PRIVATE COMPANIES, RAISING NEW EQUITY FOR LISTED COMPANIES OR SELLING EXISTING EQUITY IN LISTED COMPANIES, INVESTING IN HYBRID INSTRUMENTS, NAMELY, CONVERTIBLE BONDS AND PREFERENCE SHARES; INCOME SECURITIES, RESET PREFERENCE SHARES AND EXCHANGEABLES; DEBT AND TRANSACTION RESTRUCTURING, NAMELY, FINANCING THROUGH CAPITAL MARKETS, BRIDGING ARRANGEMENTS, LONG AND SHORT-TERM UNDER WRITINGS, BANK SYNDICATIONS, AND SUBORDINATED DEBT PLACEMENTS; INSTITUTIONAL STOCK BROKERAGE, NAMELY, ASSISTING OTHERS IN CASH EQUITY SALES, SALES TRADING; FACILITATION TRADING AND EXECUTION; ADVISORY SERVICES IN RELATION TO THE STRUCTURING OF THE RAISING OF EQUITY CAPITAL; FINANCIAL MARKET SERVICES, NAMELY, COMMODITIES TRADING FOR OTHERS, TRADING OF EQUITIES, DERIVATIVES TRADING TREASURIES TRADING, DEBT TRADING AND FUTURES TRADING; TRADING, STRUCTURING AND FINANCING ALL IN RELATION TO COMMODITIES INCLUDING FINANCING, HEDGING, TRADING AND MARKET MAKING AND TAILORED RISK MANAGEMENT SERVICES FOR COMMODITIES, THE AGRICULTURAL SECTOR AND THE ENERGY SECTOR; FOREIGN EXCHANGE SERVICES FOR COMMODITIES, NAMELY, IN RELATION TO STRUCTURED DERIVATIVE PRODUCTS, DEBT MARKETS FOR THE ARRANGING AND PLACEMENT OF DEBTS; PROVIDING SECONDARY MARKET LIQUIDITY

IN GOVERNMENT, CORPORATE, GLOBAL AND ASSET-BACKED SECURITIES, PROVIDING RISK MANAGEMENT CONSULTATION REGARDING STRUCTURED SECURITIES AND DERIVATIVE BASED PRODUCTS RELATING TO CREDIT AND INTEREST RATE RISK AND THE SECURITIZATION OF MORTGAGES, EQUIPMENT AND MOTOR VEHICLE SECURITIES; TREASURY SERVICES, NAMELY, FUNDING LIQUIDITY AND INTEREST RATE RISK MANAGEMENT, DOMESTIC AND INTERNATIONAL FUNDING MARKETS SERVICES; RESEARCH SERVICES, NAMELY, FINANCIAL RESEARCH SERVICES, ECONOMIC COMMODITY AND FINANCIAL TREND REVIEW, COMMENTARY, ANALYSIS AND FORECASTING; FINANCIAL MARKET SERVICES IN RELATION TO EQUITY DERIVATIVES, NAMELY, PROVIDING UNLISTED EQUITY-BASED PRODUCTS CONSISTING OF TECHNOLOGY VENTURE CAPITAL, PRIVATE EQUITY AND PROPERTY; PROVIDING SERVICES AS PRINCIPAL TRADER FOR CLIENT TRANSACTIONS IN LISTED SECURITIES, ISSUES OF EQUITY WARRANTS, STRUCTURED EQUITY AND INTERNATIONAL MARKET RISK MANAGEMENT SERVICES; FINANCIAL MARKET SERVICES IN RELATION TO GLOBAL EQUITY TRADING, NAMELY, BUYING AND SELLING EQUITIES FOR OTHERS ON INTERNATIONAL EXCHANGES; FINANCIAL MANAGEMENT SERVICES IN RELATION TO HEDGE FUNDS; LENDING SERVICES, NAMELY, ASSET FINANCING SERVICES, PROPERTY FINANCE SERVICES, MORTGAGES SERVICES, SECURITIZATION SERVICES, MARGIN LENDING SERVICES, BUSINESS BANKING SERVICES, SECURITIZED LENDING SERVICES; LENDING TO CORPORATIONS, INDIVIDUALS AND GOVERNMENT; FINANCING SERVICES, NAMELY, FINANCING OF LOANS, LEASE FINANCING SERVICES, NAMELY, LEASE PURCHASE FINANCING SERVICES, STRUCTURED FINANCING SERVICES, NAMELY, ADVISING ON LARGE ASSET FINANCING; CROSS BORDER FINANCING AS IT RELATES TO LEASING AND STRUCTURED FINANCING; SHARES, NAMELY, FULL SERVICE STOCK BROKERAGE SERVICES, ONLINE TRADING, INTERNATIONAL TRADING; MARKET ANALYSIS; LOANS, NAMELY, INVESTMENT LOANS, MORTGAGES AND PROPERTY LOANS, PROPERTY, NAMELY, INVESTMENT LOANS, LISTED PROPERTY TRUSTS; LISTED PROPERTY MANAGED FUNDS, UNLISTED PROPERTY TRUSTS, MORTGAGES AND PROPERTY LOANS; INTERNATIONAL TRADING, EXCHANGE TRADED OPTIONS AND FUTURES, CASH MANAGEMENT TRUST ADMINISTRATION SERVICES, RETAIL SUPERANNUATION SERVICES CONSISTING OF PENSION SCHEMES FOR NON-CORPORATE ENTITIES, PROVISION AND MANAGEMENT OF ANNUITY AND PENSION PRODUCTS, RETAIL INVESTMENT PLATFORM ADMINISTRATION SERVICES; ALTERNATIVE ASSET FUND MANAGEMENT SERVICES, NAMELY, INVESTMENT MANAGEMENT OF AND DISTRIBUTION OF VARIABLE ANNUITIES; THIRD PARTY MANAGED FUND DISTRIBUTION SERVICES, NAMELY, INVESTMENT FUND TRANSFER AND TRANSACTION SERVICES; STOCK BROKERAGE

AND INVESTMENT PLANNING SERVICES, ON-LINE STOCKBROKERAGE SERVICES, STRATEGIC FINANCIAL PLANNING SERVICES, EXECUTIVE WEALTH MANAGEMENT SERVICES, NAMELY, FINANCIAL MANAGEMENT; PRIVATE BANKING SERVICES; PRIVATE FINANCIAL PORTFOLIO MANAGEMENT SERVICES, ADVISORY SERVICES AND DEALING SERVICES CONSISTING OF TRADING SERVICES IN RELATION TO CURRENCIES, COMMODITIES, DERIVATIVES, BONDS AND CASH SECURITIES; FUNDS MANAGEMENT FOR INDIVIDUALS; TRADITIONAL FUNDS FINANCIAL MANAGEMENT, SECURITIES FUNDS FINANCIAL MANAGEMENT, NAMELY, PROVIDING MANAGED FUNDS IN EQUITIES, ALTERNATIVE INVESTMENTS, CURRENCY, CASH, BALANCED FUNDS, FIXED INTEREST AND SMALL CAP EQUITIES; SPECIALIST FUNDS FINANCIAL MANAGEMENT SERVICES, PROPERTY FUNDS FINANCIAL MANAGEMENT SERVICES AND PRIVATE EQUITY FUNDS FINANCIAL MANAGEMENT SERVICES; BROKERAGE SERVICES, NAMELY, STOCK BROKERAGE SERVICES; PRIVATE CLIENT BROKERAGE SERVICES, NAMELY, INVESTMENT BROKERAGE AND TRADING SERVICES FOR INDIVIDUALS; PROVIDING FINANCIAL INFORMATION, PROVIDING FINANCIAL INFORMATION ON-LINE; BANKING SERVICES; INVESTMENT SERVICES, NAMELY CAPITAL INVESTMENT SERVICES CONSISTING OF INVESTMENT OF FUNDS FOR OTHERS; INVESTMENT BANKING SERVICES; INVESTMENT MANAGEMENT SERVICES TO CORPORATIONS, BUSINESSES AND INDIVIDUALS; RISK MANAGEMENT SERVICES TO CORPORATIONS, BUSINESSES AND INDIVIDUALS; RISK AND CAPITAL INVESTMENT FUND MANAGEMENT SERVICES FOR FINANCING LEASED ASSETS, PROPERTY INVESTMENT BANKING; FINANCIAL ADVISORY AND FINANCIAL MANAGEMENT SERVICES; COMMODITIES TRADING; FUTURES TRADING; LIFE INSURANCE BROKERAGE, NAMELY, TERM, INCOME PROTECTION AND DISABILITY INSURANCE; INSURANCE PREMIUM FUNDING; INCOME PROTECTION AND DISABILITY INSURANCE UNDERWRITING SERVICES, NAMELY, PROCURING SUBSCRIBERS OR PURCHASERS FOR DEBT, EQUITY OR OTHER SECURITIES OFFERED FOR ISSUE OR SUBSCRIPTION; VALUATION SERVICES, NAMELY, FISCAL VALUATION OF BUSINESSES AND COMPANIES; FINANCIAL VALUATION OF LISTED AND UNLISTED SECURITIES, FINANCIAL VALUATIONS OF FINANCIAL ASSETS AND OF INFRASTRUCTURE ASSETS, VALUATION OF REAL PROPERTY, FINANCIAL VALUATION OF PERSONAL PROPERTY AND FINANCIAL VALUATION OF INTELLECTUAL PROPERTY; RISK ADVISORY SERVICES REGARDING FINANCIAL AND COMMODITY RELATED ISSUES, FINANCIAL ADVISORY SERVICES IN RELATION TO PROPERTY INVESTMENT BANKING, CORPORATE AND PROJECT FINANCING TRANSACTIONS; LEASE PURCHASE SERVICES, NAMELY, LEASE-PURCHASE FINANCING, COMMERCIAL LEASE PURCHASE, NAMELY, COMMERCIAL LEASE-PURCHASE FINANCING AND LEASEBACK TRANSACTIONS, NAMELY,

LEASE-PURCHASE FINANCING, LONG-TERM  
REAL ESTATE LEASING; FISCAL VALUATION  
SERVICES, REAL ESTATE MANAGEMENT; FI-  
NANCIAL SPONSORSHIP OF VARIOUS SPORTING,  
CULTURAL, ART AND ENTERTAINMENT  
EVENTS, IN CLASS 36 (U.S. CLS. 100, 101 AND 102).

OWNER OF INTERNATIONAL REGISTRATION  
0842105 DATED 5-21-2004, EXPIRES 5-21-2014.

OWNER OF U.S. REG. NO. 2,539,228.

SER. NO. 79-008,474, FILED 5-21-2004.

RUDY R. SINGLETON, EXAMINING ATTORNEY

**Int. Cl.: 3**

**Prior U.S. Cls.: 1, 4, 6, 50, 51 and 52**

**United States Patent and Trademark Office**

**Reg. No. 3,467,986**

**Registered July 15, 2008**

**TRADEMARK  
PRINCIPAL REGISTER**

**RICA**

R.I.C.A. S.R.L. (ITALY LTD LIAB JT ST CO)  
VIA G. CARDUCCI, 8  
I-95040 MOTTA S. ANASTASIA (CATANIA), ITALY

FOR: PERFUMERY; ETHEREAL OILS, NAMELY, ESSENTIAL OILS FOR PERSONAL USE; COSMETICS; HAIR PREPARATIONS, NAMELY, HAIR STYLING PREPARATIONS, HAIR CLEANING PREPARATIONS, HAIR DYE, HAIR SHAMPOO AND HAIR BALM; DEODORANTS FOR PERSONAL USE; SOAP; AND DEPILATORY PREPARATIONS, IN CLASS 3 (U.S. CLS. 1, 4, 6, 50, 51 AND 52).

THE MARK CONSISTS OF STANDARD CHARACTERS WITHOUT CLAIM TO ANY PARTICULAR FONT, STYLE, SIZE, OR COLOR.

OWNER OF INTERNATIONAL REGISTRATION 0842341 DATED 1-28-2005, EXPIRES 1-28-2015.

THE ENGLISH TRANSLATION OF THE WORD "RICA" IN THE MARK IS "RICH".

SER. NO. 79-008,566, FILED 1-28-2005.

MELISSA VALLILLO, EXAMINING ATTORNEY

**Int. Cls.: 9, 10, 42 and 44**

**Prior U.S. Cls.: 21, 23, 26, 36, 38, 39, 44, 100 and 101**

**Reg. No. 3,467,987**

**United States Patent and Trademark Office**

**Registered July 15, 2008**

**TRADEMARK  
SERVICE MARK  
PRINCIPAL REGISTER**

**MIRADIS**

MIRADIS HOLDING AG (SWITZERLAND COMPANY)  
SEESTRASSE 61  
CH-6052 HERGISWIL  
SWITZERLAND

FOR: X-RAY APPARATUS NOT FOR USE IN HUMAN, DENTAL AND VETERINARY MEDICINE, NAMELY, X-RAY RECEIVERS FOR RADIOGRAPHIC IMAGES; COMPUTER SOFTWARE LOADED OR LOADABLE ON DATA MEDIA, NAMELY, COMPUTER SOFTWARE FOR PROCESSING IMAGES OBTAINED BY MEANS OF X-RAYS; DATA PROCESSORS FOR CONTROLLING X-RAY DETECTORS FOR RADIOGRAPHIC IMAGES AND FOR PROCESSING DIGITAL IMAGES OBTAINED BY MEANS OF X-RAYS, IN CLASS 9 (U.S. CLS. 21, 23, 26, 36 AND 38).

FOR: MEDICAL X-RAY APPARATUS FOR USE IN HUMAN, DENTAL AND VETERINARY MEDICINE, IN CLASS 10 (U.S. CLS. 26, 39 AND 44).

FOR: RENTAL OF X-RAY APPARATUS FOR RESEARCH AND TESTING OF MATERIALS; SCI-

ENTIFIC AND TECHNOLOGICAL SERVICES, NAMELY, DESIGN AND DEVELOPMENT OF X-RAY APPARATUS; CREATING DATA PROCESSING PROGRAMS, NAMELY, COMPUTER PROGRAM DESIGN FOR PROCESSING DIGITAL IMAGES OBTAINED BY MEANS OF X-RAYS, IN CLASS 42 (U.S. CLS. 100 AND 101).

FOR: RENTAL OF X-RAY APPARATUS FOR MEDICAL PURPOSES, IN CLASS 44 (U.S. CLS. 100 AND 101).

PRIORITY DATE OF 12-22-2004 IS CLAIMED.

OWNER OF INTERNATIONAL REGISTRATION 0863853 DATED 2-28-2005, EXPIRES 2-28-2015.

SER. NO. 79-015,943, FILED 2-28-2005.

RAMONA ORTIGA, EXAMINING ATTORNEY

**Int. Cls.: 9, 10, 16 and 44**

**Prior U.S. Cls.: 2, 5, 21, 22, 23, 26, 29, 36, 37, 38, 39,  
44, 50, 100 and 101**

**Reg. No. 3,467,988**

**United States Patent and Trademark Office**

**Registered July 15, 2008**

**TRADEMARK  
SERVICE MARK  
PRINCIPAL REGISTER**

# **ASTRON CLINICA**

ASTRON CLINICA LIMITED (UNITED KINGDOM LTD LIAB CO)  
THE MOUNT, TOFT, CAMBRIDGE  
CAMBRIDGESHIRE CB3 7RL, UNITED KINGDOM

FOR: RECOGNITION APPARATUS INCORPORATING SCANNERS FOR USE IN SKIN IMAGING TECHNOLOGY TO ENABLE EXAMINATION OF THE SKIN AND NON-INVASIVE VIEWING BENEATH THE SKIN; CAMERAS; COMPUTERS FOR USE WITH OR AS SCANNER; DIGITAL GRAPHIC SCANNERS; HAND-HELD SCANNERS; OPTICAL SCANNERS; COMPUTER PROGRAMS FOR OPERATING AND READING SCANNERS; COMPUTER PROGRAMS FOR DIAGNOSING SKIN AND BENEATH THE SKIN; SCANNERS FOR ENTERING DATA AND IMAGES INTO COMPUTERS; SCANNERS; CINEMATOGRAPHIC FILMS; COMPACT DISCS AND LASER DISCS FEATURING MEDICAL MONITORING, TESTING AND EVALUATING PROGRAMS; COMPUTER SOFTWARE FOR THE DIAGNOSIS AND MANAGEMENT OF SKIN COMPLAINTS INCLUDING PSORIASIS, ECZEMA AND BASAL CELL CARCINOMA; COMPUTER SOFTWARE TO ENABLE SEARCHING FOR DATA; APPLICATORS FOR APPLYING COMPUTER GENERATED DATA TO THE BODY OTHER THAN FOR MEDICAL PURPOSES; COMPUTER SOFTWARE TO ENABLE THE NON-INVASIVE SCANNING AND PROBING, CAPTURING, VISUAL INSPECTION, ANALYZING, UNDERSTANDING AND MONITORING OF THE SKIN SURFACE AND BENEATH THE SKIN BY CONTACT OR WITHOUT SKIN CONTACT; COMPUTER SOFTWARE FOR USE IN MONITORING AND DIAGNOSING BIOCHEMICAL REACTIONS AND PHENOMENA; SPECTROPHOTOMETERS; LABORATORY EQUIPMENT, NAMELY, SPECTRAL MEASURING AND IMAGING APPARATUS AND INSTRUMENTS; CASES, BAGS, HOLD-ALLS, CARRIERS AND CONTAINERS, ALL ADAPTED FOR CARRYING OR FOR STORING ANY OF THE AFORESAID GOODS, IN CLASS 9 (U.S. CLS. 21, 23, 26, 36 AND 38).

FOR: MEDICAL DEVICES FOR THE NON-INVASIVE IMAGING OF STRUCTURES INSIDE THE SKIN AND OTHER EPITHELIAL TISSUES; NON-INVASIVE DEVICES FOR THE DIAGNOSIS AND MANAGEMENT OF HUMAN AND ANIMAL EPITHELIAL TISSUE CONDITIONS; DEVICES FOR MEDICAL PURPOSES TO ENABLE THE NON-INVASIVE SCANNING AND PROBING, CAPTURING, VISUAL INSPECTION, ANALYZING, UNDERSTANDING AND MONITORING OF THE SKIN SURFACE AND BENEATH THE SKIN BY SKIN CONTACT OR WITHOUT SKIN CONTACT; APPARATUS AND INSTRUMENTS FOR FACILITATING THE MANAGEMENT OF DIABETIC WOUNDS; DIAGNOSTIC TESTERS FOR MEDICAL PURPOSES, NAMELY, FOR PSORIASIS, ECZEMA AND BASAL CELL CARCINOMA; SCANNERS FOR MEDICAL USE, NAMELY, MOBILE SCANNERS AND HAND-HELD SCANNERS; APPARATUS AND INSTRUMENTS FOR THE DIAGNOSIS OF PIGMENTED LESIONS AND MELANOMA; MEASURING APPARATUS FOR THE HISTOLOGICAL PROPERTIES OF EPITHELIAL TISSUES; NONE OF THE FOREGOING GOODS BEING MICRODERM ABRASION SKIN TREATMENT MACHINES, IN CLASS 10 (U.S. CLS. 26, 39 AND 44).

FOR: PHOTOGRAPHS, PHOTOGRAPHS OF IMAGES, INSTRUCTIONAL AND TEACHING MATERIALS, BOOKS, CATALOGUES, BROCHURES, MANUALS, MAGAZINES, DATA BOOKS FEATURING DATA FLOW PLANS, INPUT AND OUTPUT FORMS FOR DATA PROCESSING, DATA SHEETS, DATA RECORDED IN PAPER OR CARD FORM, GRAPHS, DOCUMENT FILES, FOLDERS AND BINDERS, ALL THE FOREGOING BEING FOR USE IN THE FIELD OF SKIN TECHNOLOGY DEALING WITH UNDERSTANDING THE CONSTRUCTION OF THE SKIN, IDENTIFYING THE PRESENCE OF SKIN CONDITIONS, MAINTAINING SKIN HEALTH AND/OR MONITORING AND RECOGNIZING THE TREATMENT AND EFFECT OF SKIN CANCER, SKIN CONDITIONS, SKIN HEALTH,

SKIN COSMETICS AND SKIN PHARMACEUTICALS, IN CLASS 16 (U.S. CLS. 2, 5, 22, 23, 29, 37, 38 AND 50).

FOR: MEDICAL, OPTICAL, PHYSICAL THERAPY, PHYSIOTHERAPY, PSYCHOLOGICAL, PLASTIC SURGERY AND HEALTH CARE SERVICES; VETERINARY SERVICES; PHARMACEUTICAL ADVICE; CONSULTANCY SERVICES RELATING TO MEDICAL AND HEALTH MATTERS; HEALTH ASSESSMENT AND CONSULTANCY SERVICES; HEALTH AND SANATORIUM SERVICES; HEALTH SCREENING SERVICES; MEDICAL CLINIC SERVICES; MEDICAL MONITORING, TESTING, INSPECTION, IMAGING AND DIAGNOSTIC SERVICES; DIAGNOSTIC TESTING RELATING TO THE BODIES OF HUMANS AND ANIMALS; BEAUTY SALONS FEATURING HYGIENE AND BEAUTY CARE; MONITORING AND DIAGNOSING BIOCHEMICAL REACTIONS AND PHENOMENA; IMAGING SERVICES FOR MEDICAL PURPOSES; SERVICES COMPRISING THE NON-INVASIVE IMAGING OF STRUCTURES INSIDE THE SKIN AND OTHER EPITHELIAL TISSUES; DERMATOLOGICAL SERVICES; ORTHOPAEDIC SERVICES; SKIN AND OTHER EPITHELIAL TISSUE IMAGING AND DIAGNOSIS; INTRACUTANEOUS ANALYSIS SERVICES; SPECTROSCOPY FOR MEDICAL PURPOSES; IMAGE ANALYSES FOR EXAMINING SKIN AND OTHER EPITHELIAL TISSUE DISORDERS; MEASURING SERVICES FOR RECORDING CHANGES

IN THE BLOOD SUPPLY TO THE SKIN AND OTHER EPITHELIAL TISSUES; WOUND HEALING SERVICES; MEDICAL SCANNING SERVICES; RENTAL OF EQUIPMENT FOR PERFORMING ANY OF THE AFORESAID SERVICES, NAMELY, MEDICAL APPARATUS, APPLIANCES AND INSTRUMENTS AND MEDICAL TESTING, DIAGNOSTIC AND MONITORING EQUIPMENT; HEALTH CARE AND BEAUTY CARE INFORMATION, ADVISORY AND CONSULTANCY SERVICES ALL RELATING TO THE AFOREMENTIONED SERVICES, IN CLASS 44 (U.S. CLS. 100 AND 101).

PRIORITY DATE OF 8-16-2004 IS CLAIMED.

OWNER OF INTERNATIONAL REGISTRATION 0866941 DATED 10-1-2004, EXPIRES 10-1-2014.

NO CLAIM IS MADE TO THE EXCLUSIVE RIGHT TO USE "CLINICA", APART FROM THE MARK AS SHOWN.

THE FOREIGN WORDING IN THE MARK TRANSLATES INTO ENGLISH AS CLINIC.

SER. NO. 79-017,111, FILED 10-1-2004.

MATTHEW MCDOWELL, EXAMINING ATTORNEY

**Int. Cls.: 7 and 40**

**Prior U.S. Cls.: 13, 19, 21, 23, 31, 34, 35, 100, 103 and 106**

**Reg. No. 3,467,989**

**United States Patent and Trademark Office**

**Registered July 15, 2008**

**TRADEMARK  
SERVICE MARK  
PRINCIPAL REGISTER**

# **IXMATION**

SECKLER AG (SWITZERLAND SOCIÉTÉ PAR ACTIONS)  
MOOSSTRASSE 9, POSTFACH  
PIETERLEN, SWITZERLAND CH2542

FOR: CUSTOM, MADE TO ORDER MACHINES AND MACHINES TOOLS, NAMELY, AUTOMATIC AND SEMI-AUTOMATIC ASSEMBLY AND MANUFACTURING MACHINES AND MACHINE TOOLS, AND REPLACEMENT PARTS THEREFOR, FOR USE IN A WIDE VARIETY OF INDUSTRIAL AND COMMERCIAL ASSEMBLY APPLICATIONS IN A WIDE VARIETY OF SECTORS INCLUDING THE AUTOMOBILE, HYDRAULICS, PNEUMATICS, MEDICAL, CONSUMER GOODS, HOUSEHOLD, JEWELRY AND WATCH INDUSTRIES, IN CLASS 7 (U.S. CLS. 13, 19, 21, 23, 31, 34 AND 35).

FOR: CUSTOM TREATMENT OF MATERIALS TO THE ORDER AND SPECIFICATION OF OTHERS IN THE MANUFACTURE OF A WIDE VARIETY OF GOODS NOT LIMITED BY TYPE AND WHICH USE

AUTOMATED HANDLING TECHNOLOGY TO IN AN UNLIMITED NUMBER OF INDUSTRIES SUCH AS THE AUTOMOBILE, HYDRAULICS, PNEUMATICS, MEDICAL, CONSUMER GOODS, HOUSEHOLD, JEWELRY AND WATCH INDUSTRIES, IN CLASS 40 (U.S. CLS. 100, 103 AND 106).

THE MARK CONSISTS OF STANDARD CHARACTERS WITHOUT CLAIM TO ANY PARTICULAR FONT, STYLE, SIZE, OR COLOR.

PRIORITY DATE OF 7-4-2005 IS CLAIMED.

OWNER OF INTERNATIONAL REGISTRATION 0874639 DATED 12-20-2005, EXPIRES 12-20-2015.

SER. NO. 79-020,087, FILED 12-20-2005.

SKYE YOUNG, EXAMINING ATTORNEY



**Int. Cls.: 9, 35, 36 and 41**

**Prior U.S. Cls.: 21, 23, 26, 36, 38, 100, 101, 102 and 107**

**United States Patent and Trademark Office**

**Reg. No. 3,467,990**

**Registered July 15, 2008**

**TRADEMARK  
SERVICE MARK  
PRINCIPAL REGISTER**

# Claret Clover

DR. CLEMENS R. ODENDAHL (FED REP GER-  
MANY INDIVIDUAL)  
HÖHENWEG 211  
66133 SAARBRÜCKEN  
FED REP GERMANY

FOR: COMPUTER SOFTWARE FOR THE ANALYSIS AND THE MANAGEMENT OF INTRA- AND INTER-ORGANIZATIONAL BUSINESS COLLABORATIONS, NAMELY, TO MEASURE THE COMPATIBILITY OF BUSINESS PARTNERS, TO ANALYZE WEAKNESSES AND CONFLICT POTENTIALS OF BUSINESS PARTNERS WORKING TOGETHER, TO GENERATE SOLUTIONS SOLVING THE PROBLEMS DETERMINED BY THE ANALYSIS, TO BENCHMARK BUSINESS COLLABORATIONS WITH THE GOAL OF ANALYZING THE DEGREE OF GOAL ACCOMPLISHMENT, IN CLASS 9 (U.S. CLS. 21, 23, 26, 36 AND 38).

FOR: BUSINESS MANAGEMENT AND ORGANIZATION CONSULTANCY; BUSINESS PROCESSES CONSULTANCY; MANAGEMENT AND ORGANIZATION CONSULTANCY; BUSINESS AND ORGANIZATIONAL CONCEPTION, CONSULTANCY, PLANNING, DESIGN, ARRANGING AND CONDUCTING OF CORPORATE-OVERLAPPING BUSINESS COLLABORATIONS NAMELY, TO IMPROVE BUSINESS MANAGEMENT, BETWEEN COMPANIES, BETWEEN DEPARTMENTS WITHIN ONE COMPANY AS WELL AS BETWEEN COMPANIES AND AUTHORITIES; BUSINESS AND ORGANIZATIONAL CONCEPTION, CONSULTANCY, PLANNING, DESIGN, ARRANGING AND CONDUCTING OF MERGERS AND ACQUISITIONS; BUSINESS AND ORGANIZATIONAL ANALYSIS AND IMPROVEMENT OF IN-HOUSE AND CORPORATE-OVERLAPPING BUSINESS PROCESSES; BUSINESS AND ORGANIZATIONAL PROJECT MANAGEMENT; BUSINESS AND ORGANIZATIONAL MARKET AND BUSINESS STRATEGY CONSULTING; CONSULTANCY REGARDING ORGANIZATION AND CONTROLLING IN CORPO-

RATE-OVERLAPPING BUSINESS COLLABORATIONS NAMELY, TO IMPROVE BUSINESS MANAGEMENT, BETWEEN COMPANIES, BETWEEN DEPARTMENTS WITHIN ONE COMPANY AS WELL AS BETWEEN COMPANIES AND AUTHORITIES; INTERIM MANAGEMENT OF BUSINESSES; DEVELOPMENT OF BUSINESS AND ORGANIZATIONAL STUDIES, CONCEPTIONS AND SPECIFICATIONS; REORGANIZATION BUSINESS MANAGEMENT SERVICES; TECHNICAL MARKET AND STRATEGY BUSINESS CONSULTING; TECHNICAL MARKET BUSINESS ADVICE AND TECHNICAL STRATEGY BUSINESS CONSULTING, IN CLASS 35 (U.S. CLS. 100, 101 AND 102).

FOR: FINANCIAL AFFAIRS, NAMELY, FINANCIAL MANAGEMENT FOR BUSINESS COLLABORATIONS TO IMPROVE BUSINESS MANAGEMENT AND MERGERS AND ACQUISITIONS; MONETARY AFFAIRS, NAMELY, FINANCIAL PLANNING AND INVESTMENT FUND TRANSFER AND TRANSACTION SERVICES FOR BUSINESS COLLABORATIONS AS WELL AS IN MERGERS AND ACQUISITIONS; INSURANCE, NAMELY, FINANCIAL EVALUATION FOR INSURANCE PURPOSES IN BUSINESS COLLABORATIONS AS WELL AS IN MERGERS AND ACQUISITIONS; REAL ESTATE AFFAIRS, NAMELY, REAL ESTATE ACQUISITION SERVICES FOR BUSINESS COLLABORATIONS AS WELL AS IN MERGERS AND ACQUISITIONS; CONSULTANCY IN THE FIELD OF FINANCIAL DUE DILIGENCE, ENTERING STOCK MARKETS, FINANCIAL EVALUATION OF COMPANIES, FINANCIAL REORGANIZATION OF COMPANIES, RECAPITALIZATION AND INSOLVENCY CONSULTANCY NAMELY, THE DEVELOPMENT AND RATING OF CONCEPTIONS FOR RECAPITALIZATION, CONTROLLING OF AGREED PLANS FOR RECAPITALIZATION, DEVELOPMENT OF CONCEPTIONS FOR RECAPITALIZATION SPECIFIED FOR INSOLVENCY ADMINISTRATORS, CREDITORS AND PURCHASER;

FINANCIAL MARKET AND STRATEGY CONSULTING, IN CLASS 36 (U.S. CLS. 100, 101 AND 102).

FOR: ARRANGING AND CONDUCTING OF SEMINARS, WORKSHOPS, TRAININGS, SYMPOSIUMS, CONFERENCES AND CONGRESSES ALL IN THE FIELD OF BUSINESS COLLABORATIONS AS WELL AS IN THE FIELD OF MERGERS AND ACQUISITIONS, IN CLASS 41 (U.S. CLS. 100, 101 AND 107).

THE MARK CONSISTS OF STANDARD CHARACTERS WITHOUT CLAIM TO ANY PARTICULAR FONT, STYLE, SIZE, OR COLOR.

OWNER OF INTERNATIONAL REGISTRATION 0877131 DATED 1-28-2005, EXPIRES 1-28-2015.

SER. NO. 79-020,957, FILED 1-28-2005.

KATHERINE M. DUBRAY, EXAMINING ATTORNEY

**Int. Cl.: 9**

**Prior U.S. Cls.: 21, 23, 26, 36 and 38**

**United States Patent and Trademark Office**

**Reg. No. 3,467,991**

**Registered July 15, 2008**

**TRADEMARK  
PRINCIPAL REGISTER**

**FirePro**

CELANOVA LIMITED (CYPRUS LTD LIAB CO)  
EV. PAPACHRISTOFOROU NO. 18  
PETOUSIS BUILDING 1ST FLOOR; CY-3720 LIMAS-  
SOL  
CYPRUS

FOR: FIRE EXTINGUISHERS, IN CLASS 9 (U.S.  
CLS. 21, 23, 26, 36 AND 38).

OWNER OF INTERNATIONAL REGISTRATION  
0776689 DATED 2-8-2002, EXPIRES 2-8-2012.

THE COLOR(S) RED IS/ARE CLAIMED AS A  
FEATURE OF THE MARK.

THE COLOR RED APPEARS IN THE WORDING  
"FIREPRO".

SER. NO. 79-021,228, FILED 12-20-2005.

RON FAIRBANKS, EXAMINING ATTORNEY

Int. Cl.: 3

Prior U.S. Cls.: 1, 4, 6, 50, 51 and 52

Reg. No. 3,467,992

United States Patent and Trademark Office

Registered July 15, 2008

TRADEMARK  
PRINCIPAL REGISTER

HAIR  COMPANY

HAIR COMPANY S.R.L. (ITALY SOCIÉTÉ À  
RESPONSABILITÉ LIMITÉE)  
VIA SIRACUSA, 8  
I-21050 BOLLADELLO DI CAIRATE (VARESE)  
ITALY

FOR: HAIR PRODUCTS, NAMELY, HAIR SPRAY,  
HAIR CONDITIONERS, HAIR DYES, HAIR WAV-  
ING PREPARATIONS, DETERGENT, SOAPS,  
BLEACHING PRODUCTS, NAMELY, BLEACHING  
PREPARATIONS FOR COSMETIC PURPOSES; FAB-  
RIC SOFTENERS; SOAPS; BLEACHING PREPARA-  
TIONS AND OTHER SUBSTANCES, NAMELY,  
LAUNDRY SOAPS FOR LAUNDRY USE; CLEAN-  
ING, POLISHING, SCOURING AND ABRASIVE  
PREPARATIONS; COSMETICS IN GENERAL,  
NAMELY, PERFUMES, PERFUMES IN SOLID  
FORM, DEODORANTS, SOAPS, LIQUID SOAPS,  
CAKES OF SOAP, BATH FOAM, FOAMING BATH  
GELS, FOAMING BATH BEADS, TOOTHPASTES,  
SHAMPOOS, ESSENTIAL OILS, HAIR LOTIONS,  
PREPARATIONS FOR PERMANENT HAIR WAVES  
AND FOR SETTING HAIR, HAIR GELS, FACE  
CREAMS, MASCARA, EYE LINERS, EYE SHA-

DOWS, MAKE-UP PENCILS, FACE POWDER, LIP-  
STICKS, FOUNDATIONS, BODY CREAMS, NAIL  
POLISH, NAIL HARDENERS, SUN TANNING OILS  
AND CREAMS, IN CLASS 3 (U.S. CLS. 1, 4, 6, 50, 51  
AND 52).

OWNER OF INTERNATIONAL REGISTRATION  
0882565 DATED 12-30-2005, EXPIRES 12-30-2015.

NO CLAIM IS MADE TO THE EXCLUSIVE  
RIGHT TO USE "HAIR COMPANY", APART FROM  
THE MARK AS SHOWN.

THE MARK CONSISTS OF THE WORDING  
"HAIR COMPANY"; THE LETTER "C" AND HALF  
OF THE LETTER "O" ARE WRITTEN INSIDE A  
DOT.

SER. NO. 79-022,892, FILED 12-30-2005.

CAROLYN CATALDO, EXAMINING ATTORNEY

**Int. Cls.: 8 and 9**

**Prior U.S. Cls.: 21, 23, 26, 28, 36, 38 and 44**

**United States Patent and Trademark Office**

**Reg. No. 3,467,993**

**Registered July 15, 2008**

**TRADEMARK  
PRINCIPAL REGISTER**

***Klippon***

WEIDMÜLLER INTERFACE; GMBH & CO. KG  
(FED REP GERMANY LTD LIAB CO)  
KLINGENBERGSTRASSE 16  
32758 DETMOLD  
FED REP GERMANY

FOR: HAND TOOLS FOR ELECTRICIANS,  
NAMELY, CRIMPING TOOLS AND STRIPPERS, IN  
CLASS 8 (U.S. CLS. 23, 28 AND 44).

FOR: ELECTRICAL CONNECTORS AND ELEC-  
TRICAL TRANSFORMERS, NAMELY, TERMINALS  
FOR ELECTRONIC USE; PARTS OF TERMINALS  
FOR ELECTRIC PURPOSES, NAMELY, CONNec-  
TION STRIPS, CONNECTORS AS WELL AS ELEC-  
TRONIC PLUG-IN ELEMENTS, NAMELY,  
SUPPORTS FOR PRINTED CIRCUIT BOARDS, RE-  
LAY SOCKETS, ELECTRONIC CIRCUITS WITH  
HOUSINGS; ACCESSORIES AND PARTS OF THE  
TERMINALS MENTIONED BEFORE, NAMELY,

PROFILED SUPPORTS, SAFETY CABINETS FIT-  
TED WITH PROFILED SUPPORTS, TEST PROBES,  
PLUG SOCKETS, CROSS CONNECTIONS, PROTEC-  
TIVE SHEATHS FOR WIRES; ALL THE AFORE-  
MENTIONED EQUIPMENT CONSISTS OF  
PRESSED, STAMPED, DRAWN, TURNED AND  
MOLDED PIECES MADE OF METAL AND/OR  
INJECTED, MOLDED AND CAST PIECES OF SYN-  
THETIC MATERIALS AND THERMOSETTING  
AND THERMOPLASTIC RESINS, IN CLASS 9 (U.S.  
CLS. 21, 23, 26, 36 AND 38).

OWNER OF INTERNATIONAL REGISTRATION  
0470292 DATED 6-19-1982, EXPIRES 6-19-2012.

SER. NO. 79-022,986, FILED 2-3-2006.

THOMAS MANOR, EXAMINING ATTORNEY

**Int. Cls.: 29, 30, 32 and 44**

**Prior U.S. Cls.: 45, 46, 48, 100 and 101**

**Reg. No. 3,467,994**

**United States Patent and Trademark Office**

**Registered July 15, 2008**

**TRADEMARK  
SERVICE MARK  
PRINCIPAL REGISTER**

**KWANG DONG  
PHARMACEUTICAL CO., LTD.**

KWANG DONG PHARMACEUTICAL CO., LTD.  
(REPUBLIC OF KOREA LIMITED COMPANY)  
5F, GYEONGAM B/D 157-27 SAMSEONG-DONG,  
GANGNAM-GU; SEOUL 135-526  
REPUBLIC OF KOREA

FOR: PRESERVED BEANS; PRESERVED RED PEPPER; PROCESSED GARLIC; PRESERVED PINE MUSHROOM; PRESERVED GINSENGS FOR USE AS A VEGETABLE; PROCESSED GINSENGS FOR USE AS A VEGETABLE; DRIED VEGETABLES; LACTIC ACID BACTERIA DRINKS; SEA TANGLE, NAMELY, KELP; CHLORELLA IN THE FORM OF DRIED EDIBLE ALGAE AND ALGAE FOOD BEVERAGES, NAMELY, SEAWEED DRINKS, IN CLASS 29 (U.S. CL. 46).

FOR: PROCESSED HERBS, NAMELY, PERILLA POWDER; BROWN RICE FLOUR; CEREAL SOUP, NAMELY, BREAKFAST CEREAL, PROCESSED CEREALS; SHERBETS; ICE CREAM; ROYAL JELLY FOR HUMAN CONSUMPTION FOR FOOD PURPOSES; CHITOLIGOSACCHARIDE, NAMELY, POWDERED SUGAR; OOLONG TEA; GINSENG TEA; COFFEE-BASED BEVERAGES, IN CLASS 30 (U.S. CL. 46).

FOR: VEGETABLE JUICES; FRUIT SYRUPS, NAMELY, SYRUPS FOR MAKING BEVERAGES; NON-ALCOHOLIC FRUIT EXTRACTS USED IN THE PREPARATION OF BEVERAGES; PASTILLES FOR EFFERVESCING BEVERAGES; NON-ALCOHOLIC COCKTAILS, NAMELY, NON-ALCOHOLIC COCKTAIL MIXES; APPLE JUICES; ORANGE JUICE; SHERBETS; GINSENG POWDERS FOR EFFERVESCING BEVERAGES; GINSENG EXTRACTS FOR BEVERAGES, NOT FOR MEDICAL PURPOSES;

PINEAPPLE JUICES; WATER, NAMELY, NON-MEDICATED WATERS CONTAINING VITAMIN C; FRUIT JUICE BASED BEVERAGES CONTAINING VITAMIN C; APPLE JUICE BASED MIXED BEVERAGES, IN CLASS 32 (U.S. CLS. 45, 46 AND 48).

FOR: HEALTH CARE; HOSPITALS; PHARMACY, NAMELY, PHARMACEUTICAL CONSULTATION; DISPENSING OF PHARMACEUTICAL PREPARATIONS; PHARMACEUTICAL ADVICE; RENTAL OF MEDICAL AND HEALTH CARE EQUIPMENT; MEDICAL ASSISTANCE, NAMELY, MEDICAL ASSISTANCE CONSULTANCY PROVIDED BY DOCTORS AND OTHER SPECIALIZED MEDICAL PERSONNEL; MEDICAL PRODUCT INFORMATION; CLINICAL MEDICINE, NAMELY, MEDICAL CLINICS; ORIENTAL MEDICAL CLINICS, IN CLASS 44 (U.S. CLS. 100 AND 101).

THE MARK CONSISTS OF STANDARD CHARACTERS WITHOUT CLAIM TO ANY PARTICULAR FONT, STYLE, SIZE, OR COLOR.

OWNER OF INTERNATIONAL REGISTRATION  
0882759 DATED 3-7-2005, EXPIRES 3-7-2015.

NO CLAIM IS MADE TO THE EXCLUSIVE RIGHT TO USE "PHARMACEUTICAL CO., LTD.", APART FROM THE MARK AS SHOWN.

SER. NO. 79-023,044, FILED 3-7-2005.

KATHERINE M. DUBRAY, EXAMINING ATTORNEY

Int. Cls.: 16 and 28

Prior U.S. Cls.: 2, 5, 22, 23, 29, 37, 38 and 50

Reg. No. 3,467,995

United States Patent and Trademark Office

Registered July 15, 2008

TRADEMARK  
PRINCIPAL REGISTER

K o t e n c o t e n c o

GRAND PRIX CO., LTD. (JAPAN CORPORATION)

SHIN-OSAKA GRAND PRIX BLDG.

7-8-21, NISHINAKAJIMA YODOGAWA-KU, OSAKA-SHI

OSAKA 532-0011, JAPAN

FOR: PASTES AND OTHER ADHESIVES FOR STATIONERY OR HOUSEHOLD PURPOSES, ELECTRIC STAPLERS FOR OFFICES, DRAWING INSTRUMENTS, TYPEWRITERS, ELECTRIC PENCIL SHARPENERS, BABIES' DIAPERS OF PAPER, INDUSTRIAL PACKAGING CONTAINERS OF PAPER, PLASTIC FILM FOR WRAPPING FOOD FOR HOUSEHOLD USE, GARBAGE BAGS OF PAPER FOR HOUSEHOLD USE, GARBAGE BAGS OF PLASTICS FOR HOUSEHOLD USE, PAPER PATTERNS FOR DRESSES, KNITTING AND CLOTHES; BANNERS OF PAPER, FLAGS OF PAPER, INDOOR AQUARIA AND AQUARIUM HOODS, HYGIENIC PAPER, TOWELS OF PAPER, TABLE NAPKINS OF PAPER, HAND TOWELS OF PAPER, HANDKERCHIEFS OF PAPER, TABLE CLOTHS OF PAPER, PAPER AND CARDBOARD, STATIONERY, PRINTED MATTER, NAMELY, PICTURE POSTCARDS, SHEET MUSIC, SONGBOOKS, CALENDARS, PRINTED TIMETABLES, NEWSPAPERS, GEOGRAPHICAL MAPS, DIARIES, PICTURE BOOKS, COMIC BOOKS, BOOKS ABOUT TOYS, BOOKS ABOUT ANIMATION, BOOKS ABOUT DOLLS, COMIC MAGAZINES, MAGAZINES ABOUT ANIMATION, MAGAZINES ABOUT TOYS, MAGAZINES ABOUT DOLLS, TRAVEL MAGAZINES, TRADING CARDS; PAINTINGS AND CALLIGRAPHIC WORKS, PHOTOGRAPHS, PHOTOGRAPH STANDS, IN CLASS 16 (U.S. CLS. 2, 5, 22, 23, 29, 37, 38 AND 50).

FOR: WAX FOR SKIS; AMUSEMENT MACHINES AND APPARATUS FOR USE IN AMUSEMENT PARKS, NAMELY, SLIDES FOR AMUSEMENT PARKS, AMUSEMENT PARK RIDES, SEESAWS FOR AMUSEMENT PARKS, TARGET SHOOTING GAME MACHINES FOR AMUSEMENT PARKS, AMUSEMENT GAME MACHINES, COIN OPERATED AMUSEMENT MACHINES; TOYS FOR DOMESTIC PETS; TOYS, NAMELY, ELECTRICALLY-DRIVEN TOYS, FLYWHEEL-DRIVEN ACTION TOYS AND TOY VEHICLES, WOODEN KENDO

SWORD TOYS MADE OF BOARD OR PLANK, WOODEN ANIMAL TOYS SHAPED BY JIGSAWS, WOODEN LAND VEHICLE TOYS SHAPED BY JIGSAWS, WOODEN AQUATIC VEHICLE TOYS SHAPED BY JIGSAWS, WOODEN AIRCRAFT TOYS SHAPED BY JIGSAWS, WOODEN TOY PUZZLES SHAPED BY JIGSAWS, WOODEN PIECES FOR SHOGI GAME SHAPED BY JIGSAW, WOOD BUILDING OR CONSTRUCTION TOY BLOCKS SHAPED BY TURNING LATHES, ONE PIECE CHARACTER TOYS FORMED OF CELLULOID, CLOCKWORK TOYS OF PLASTICS, HOLLOW CELLULOID BATH TOYS, PLASTIC TOY FIGURINES FORMED BY HOLLOW MOLDING, HOLLOW RUBBER ACTION TOY FIGURES FORMED BY MOLDING PROCESS, HOLLOW RUBBER PLAY FIGURES FORMED BY BONDING, SOLID RUBBER POSITIONABLE TOY FIGURES FORMED BY MOLDING PROCESS, CORN STEM TOY DOLLS; DOLLS; BOARD GAMES, NAMELY, "GO" GAMES AND DIAMOND GAMES; JAPANESE PLAYING CARDS CALLED "UTAGARUTA;" JAPANESE CHESS CALLED "SHOGI" GAMES; DICE; JAPANESE DICE GAMES CALLED "SUGOROKU;" DICE CUPS; CHESS, NAMELY, CHESS SETS, CHESS PIECES, CHESS BOARDS, HAND HELD UNIT FOR PLAYING ELECTRONIC CHESS; CHECKERS, CHECKER SETS; CONJURING APPARATUS, NAMELY, MAGIC TRICKS; DOMINOES; PLAYING CARDS; JAPANESE PLAYING CARDS CALLED "HANAFUDA;" MAH-JONG; GAME MACHINES AND APPARATUS, NAMELY, STAND ALONE VIDEO GAMES, HORIZONTAL PINBALL MACHINES, JAPANESE HORIZONTAL PIN BALL MACHINES, LOTTERY WHEELS, JAPANESE VERTICAL PINBALL MACHINES (PACHINKO MACHINES); BILLIARD EQUIPMENT, NAMELY, BILLIARD CUES, CHALK FOR BILLIARD CUES, BILLIARD BALLS, BILLIARD MARKERS, BILLIARD TABLES; SPORTS EQUIPMENT, NAMELY, BASEBALL AND SOFTBALL IMPLEMENTS, NAMELY, BASES, BATS, BATTING TEES, MITTS, GLOVES, BASEBALLS, SOFTBALLS, PLATE BRUSHES, PITCHING SCREENS, BALL GAME IMPLEMENTS, NAMELY, BASKET BALLS, SOCCER BALLS, FOOTBALLS, BASKET BALL HOOPS, FOOTBALL CHEST PADS, SOCCER GOALS, TETHER BALLS, KNEE PADS FOR ATHLETIC USE, TRACK AND FIELD EVENT IMPLEMENTS, NAME-

LY, VAULTING POLES, RELAY BATONS, HURDLES, STARTING BLOCKS, JAVELINS, SHOT PUTS, TENNIS AND BADMINTON IMPLEMENTS, NAME-  
LY, NETS, RACKETS, TENNIS BALLS, RACKET  
COVERS, RACKET STRINGS, BADMINTON SHUT-  
TLECOCKS, BADMINTON SETS, TABLE TENNIS  
IMPLEMENTS, NAMELY, BALLS, NETS, PADDLES,  
POST SETS, TABLES, ICE HOCKEY AND FIELD  
HOCKEY IMPLEMENTS, NAMELY, GLOVES,  
PUCKS, STICKS, HOCKEY CHEST PROTECTORS,  
FIELD HOCKEY BALLS, ROLLER HOCKEY  
SKATES, ICE HOCKEY SKATES, ICE HOCKEY  
GOALIE PADS, GOLF IMPLEMENTS, NAMELY,  
GOLF CLUBS, BAGS, BALLS, TEES, BALL MAR-  
KERS, GLOVES, GOLF CLUB GRIPS, BOWLING  
IMPLEMENTS, NAMELY, BALLS, BOWLING BALL  
BAGS, BOWLING BALL COVERS, PINS, GLOVES,  
SKIING IMPLEMENTS, NAMELY, SKI BAGS, BIND-  
INGS, BRAKES, WAX, SKIS, SKATING IMPL-  
MENTS, NAMELY, ICE SKATES, IN LINE SKATES,  
BLADE GUARDS, BOXING IMPLEMENTS, NAME-  
LY, BAGS, GLOVES, SWIVELS, ARCHERY IMPL-  
MENTS, NAMELY, ARM GUARDS, ARROW  
FLETCHING DEVICES, ARROW POINTS, ARROWS,  
BOW CASES, BOWS, BOW STRING CHANGERS,  
BOW STRINGS, FINGER TABS, QUIVERS, ARCHE-  
RY SETS, TARGETS, FENCING IMPLEMENTS,  
NAMELY, FOILS, GAUNTLETS, MASKS, KENDO  
IMPLEMENTS, NAMELY, WOODEN SWORDS,

BAMBOO SWORDS, PLASTRONS, MASKS, APPLI-  
ANCES FOR GYMNASTICS, NAMELY, SPRING  
BOARDS, HORIZONTAL BARS, PARALLEL BARS,  
VAULTING HORSES, BALANCE BEAMS, APPLIAN-  
CES FOR RHYTHMIC SPORTIVE GYMNASTICS  
WITH APPARATUS, NAMELY, HOOPS, RIBBON  
STICK, BALL, ROPE, CLUBS, WEIGHTLIFTING  
IMPLEMENTS, NAMELY, BENCHES AND BENCH  
ACCESSORIES, BELTS, GLOVES, DIVING IMPL-  
MENTS, NAMELY, SCUBA FINS AND FLIPPERS,  
SCUBA SPEARFISHING HARPOON GUNS AND  
SPRING ACTIVATED SPEAR GUNS; FISHING  
TACKLE; TOY BUTTERFLY NETS, IN CLASS 28  
(U.S. CLS. 22, 23, 38 AND 50).

PRIORITY DATE OF 6-21-2005 IS CLAIMED.

OWNER OF INTERNATIONAL REGISTRATION  
0882951 DATED 8-15-2005, EXPIRES 8-15-2015.

THE FOREIGN WORDING IN THE MARK  
TRANSLATES INTO ENGLISH AS SMALL ANGEL.

SER. NO. 79-023,121, FILED 8-15-2005.

LEIGH LOWRY, EXAMINING ATTORNEY



**Int. Cls.: 9, 16, 35, 38 and 42**

**Prior U.S. Cls.: 2, 5, 21, 22, 23, 26, 29, 36, 37, 38, 50,  
100, 101, 102 and 104**

**Reg. No. 3,467,996**

**United States Patent and Trademark Office**

**Registered July 15, 2008**

**TRADEMARK  
SERVICE MARK  
PRINCIPAL REGISTER**

**blucom**

APS ASTRA PLATFORM SERVICES GMBH (FED  
REP GERMANY LTD LIAB CO)  
BETASTR. 1-5  
85774 UNTERFÖHRING  
FED REP GERMANY

FOR: DEVICES AND INSTRUMENTS FOR RECORDING, STORING, TRANSMITTING, DISPLAYING, REQUESTING AND PROCESSING OF INFORMATION AND DATA, NAMELY, CELLULAR TELEPHONES, TELEVISION SETS, HANDHELD COMPUTERS, PERSONAL DIGITAL ASSISTANTS (PDA), DIGITAL SET TOP BOXES, COMPUTERS; DEVICES AND INSTRUMENTS FOR SENDING AND RECEIVING MESSAGES, NAMELY, CELLULAR TELEPHONES, PERSONAL DIGITAL ASSISTANTS (PDA), COMPUTERS AND DATA PROCESSORS; COMPUTER AND TELEVISION SET PERIPHERAL DEVICES, NAMELY, SET-TOP-BOXES AND REMOTE CONTROLS; PARTS AND ACCESSORIES FOR DIGITAL TV SETS AND COMPUTERS, NAMELY, ELECTRICAL WIRE AND WIRELESS COMPUTER PERIPHERALS AND WIRELESS ANTENNAS; COMPUTER COMMUNICATIONS SOFTWARE FOR CONNECTING USERS OF TELECOMMUNICATIONS APPARATUSES, NAMELY, TRANSMITTING DEVICES IN THE NATURE OF WIRELESS TELEPHONY APPARATUSES, ROUTERS, MODEMS FOR CONNECTIONS TO DATABASES AND THE INTERNET; COMMUNICATIONS AND TELECOMMUNICATIONS APPARATUSES AND INSTRUMENTS, NAMELY, MOBILE TELEPHONES, HANDHELD COMPUTERS AND PERSONAL DIGITAL ASSISTANTS (PDA); PERIPHERAL DEVICES, PARTS AND ACCESSORIES IN THE NATURE OF GSM, GPRS, 3G, WLAN (WIRELESS LOCAL AREA NETWORK) AND WIRELESS INTERFACES FOR MOBILE TELEPHONES,

HANDHELD COMPUTERS AND PERSONAL DIGITAL ASSISTANTS (PDA); COMPUTER PROGRAMS FOR BROWSING THE INTERNET; COMPUTER SOFTWARE FOR ONLINE, INTERACTIVE, CD-ROM AND MULTIMEDIA PURPOSES, NAMELY, COMMUNICATIONS SOFTWARE FOR CONNECTING BROADCAST DECODERS AND/OR COMPUTERS FOR USE WITH CELLULAR TELEPHONES AND HANDHELD COMPUTERS, PERSONAL DIGITAL ASSISTANTS (PDA) AND TELEVISION BROADCASTS; DATA AND INFORMATION STORED ON ELECTRONIC MEDIA AND TRANSMITTING DEVICES SUCH AS SET-TOP-BOXES, CELLULAR TELEPHONES AND OTHER MEMORY CHIP SETS WITH STORAGE CAPABILITY; BLANK DATA RECORDING CARRIERS, NAMELY, DIGITAL SMART CARDS; PRE-RECORDED DATA RECORDING CARRIERS, NAMELY, ENCODED CHIP CARDS AND SMART CARDS CONTAINING PROGRAMMING FOR THE OPERATION OF INTERACTIVE SERVICES IN A BROADCAST ENVIRONMENT; TRANSMITTING DEVICES, APPARATUSES AND INSTRUMENTS FOR RADIO AND TELEVISION RECEPTION, TRANSMISSION, RECORDING, AND DATA COLLECTION, NAMELY, DIGITAL SET TOP BOXES; PERIPHERAL DEVICES, PARTS AND ACCESSORIES FOR TELEVISIONS AND DIGITAL SET TOP BOXES, NAMELY, TELEVISION REMOTE CONTROLS, SET TOP BOX REMOTE CONTROLS, PRERECORDED ELECTRONIC DATA CARRIERS IN THE NATURE OF DIGITAL CHIP SETS FEATURING TELEVISION AND RADIO PROGRAMS, IN CLASS 9 (U.S. CLS. 21, 23, 26, 36 AND 38).

FOR: MAGAZINES IN THE FIELD OF COMPUTERS; PUBLICATIONS IN THE NATURE OF BOOKLETS AND BROCHURES RELATED TO

INFORMATION TECHNOLOGY, IN CLASS 16 (U.S. CLS. 2, 5, 22, 23, 29, 37, 38 AND 50).

FOR: DATABASE MANAGEMENT, NAMELY, COMPILATION OF DATA IN COMPUTER DATABASES AND FILE MANAGEMENT ON COMPUTERS, IN CLASS 35 (U.S. CLS. 100, 101 AND 102).

FOR: PROVISION OF ACCESS TO DATA OR DOCUMENTS STORED ELECTRONICALLY IN CENTRAL FILES FOR REMOTE CONSULTATION, NAMELY, PROVISION OF ACCESS TO COMPUTER DATABASES IN COMPUTER NETWORKS AND PROVISION OF TELECOMMUNICATIONS ACCESS TO ELECTRONIC COMMUNICATIONS NETWORKS AND ELECTRONIC DATABASES IN SUCH NETWORKS; DIGITAL COMPUTER ASSISTED TRANSMISSION OF MESSAGES, DATA AND IMAGES; DIGITAL TRANSMISSION OF SOUND, IMAGES AND DATA BY CABLE, SATELLITE, OVER THE AIR, COMPUTER AND COMPUTER NETWORKS; TELEPHONE AND CELLULAR COMMUNICATIONS SERVICES, FACSIMILE AND TELEX TRANSMISSION SERVICES, PROVIDING E-MAIL SERVICES, COMPUTER TERMINAL COMMUNICATIONS SERVICES, TELEVISION AND RADIO BROADCASTING SERVICES, NAMELY, INTERACTIVE TELEVISION PROGRAMS; BROADCASTING OF RADIO AND TELEVISION PROGRAMS BY WIRE, CABLE, SATELLITE RADIO, VIDEOTEXT, INTERNET; BROADCASTING OF TELEVISION PROGRAMS, CABLE TELEVISION PROGRAMS

AND RADIO PROGRAMS; PROVIDING ACCESS TO TELECOMMUNICATIONS NETWORKS, NAMELY, PROVISION OF ACCESS TO COMPUTER DATABASES, PROVISION OF ACCESS TO COMPUTER DATABASES IN COMPUTER NETWORKS, PROVISION OF ACCESS TO ELECTRONIC DATABASES, PROVISION OF ACCESS TIME TO DIGITAL DATABASES ON A GLOBAL COMPUTER NETWORK, IN CLASS 38 (U.S. CLS. 100, 101 AND 104).

FOR: RESEARCH IN THE FIELD OF DIGITAL TELEVISION TECHNOLOGY; DEVELOPMENT IN THE FIELD OF COMPUTER HARDWARE AND SOFTWARE FOR OTHERS; DEVELOPMENT OF COMPUTER PROGRAMS; ELECTRONIC DATABASE DEVELOPMENT SERVICES; HOSTING OF DIGITAL CONTENT ON THE INTERNET, NAMELY, THE WEBSITES AND IMAGES OF OTHERS FOR DISPLAY ON DIGITAL TECHNOLOGY DEVICES, IN CLASS 42 (U.S. CLS. 100 AND 101).

THE MARK CONSISTS OF STANDARD CHARACTERS WITHOUT CLAIM TO ANY PARTICULAR FONT, STYLE, SIZE, OR COLOR.

OWNER OF INTERNATIONAL REGISTRATION 0883972 DATED 11-7-2005, EXPIRES 11-7-2015.

SER. NO. 79-023,453, FILED 11-7-2005.

ERNEST SHOSHO, EXAMINING ATTORNEY

Int. Cls.: 9, 28 and 41

Prior U.S. Cls.: 21, 22, 23, 26, 36, 38, 50, 100, 101 and 107

United States Patent and Trademark Office

Reg. No. 3,467,997

Registered July 15, 2008

TRADEMARK  
SERVICE MARK  
PRINCIPAL REGISTER



GAMING SUPPORT B.V. (NETHERLANDS B.V.)  
INDUSTRIEWEG 29  
NL-3044 AS ROTTERDAM  
NETHERLANDS

FOR: COMPUTER SOFTWARE AND COMPUTER HARDWARE, NAMELY, COMPUTER SOFTWARE AND COMPUTER HARDWARE FOR THE OPERATION OF ENTERTAINMENT GAMES OR TO SUPPORT THE OPERATION OF ENTERTAINMENT GAMES, AND COMPONENT PARTS FOR THE AFOREMENTIONED GOODS; AND ELECTRONIC GAME MACHINES OF CHANCE ADAPTED FOR USE WITH COMPUTERS OR MONITORS; SLOT MACHINES; MACHINES FOR PLAYING GAMES OF CHANCE, IN CLASS 9 (U.S. CLS. 21, 23, 26, 36 AND 38).

FOR: GAMES AND AMUSEMENT MACHINES, COIN-OPERATED AND OTHERWISE, NAMELY, AMUSEMENT GAME MACHINES, COIN-OPERATED VIDEO GAMES, COIN-OPERATED AMUSEMENT MACHINES; PLAYING CARDS; GAMES OF CHANCE PLAYED WITH CARDS AND GAME COMPONENTS; TOY SLOT MACHINES, IN CLASS 28 (U.S. CLS. 22, 23, 38 AND 50).

FOR: ENTERTAINMENT AND AMUSEMENT SERVICES, NAMELY, AMUSEMENT PARKS, PROVIDING ON-LINE POKER GAMES, AMUSEMENT ARCADES; CASINOS SERVICES; ORGANIZATION OF GAMES OF CHANCE; CONSULTATION IN RELATION TO THE AFOREMENTIONED SERVICES, NAMELY, CONSULTATION SERVICES IN THE FIELD OF CASINOS AND ORGANIZING GAMES OF CHANCE, IN CLASS 41 (U.S. CLS. 100, 101 AND 107).

PRIORITY DATE OF 8-10-2005 IS CLAIMED.

OWNER OF INTERNATIONAL REGISTRATION  
0887798 DATED 1-31-2006, EXPIRES 1-31-2016.

NO CLAIM IS MADE TO THE EXCLUSIVE RIGHT TO USE "DOUBLE DOWN BONUS", APART FROM THE MARK AS SHOWN.

SER. NO. 79-024,942, FILED 1-31-2006.

DAYNA BROWNE, EXAMINING ATTORNEY

Int. Cls.: 35, 38 and 41

Prior U.S. Cls.: 100, 101, 102, 104 and 107

United States Patent and Trademark Office

Reg. No. 3,467,998

Registered July 15, 2008

SERVICE MARK  
PRINCIPAL REGISTER

# Swensee

DELOUVRIER MATTHIEU (FRANCE INDIVIDUAL)  
90, BOULEVARD MAURICE BARRES  
F-92200 NEUILLY SUR SEINE, FRANCE

FOR: ADVERTISING; BUSINESS MANAGEMENT; BUSINESS ADMINISTRATION; OFFICE FUNCTIONS, IN CLASS 35 (U.S. CLS. 100, 101 AND 102).

FOR: TELECOMMUNICATIONS, NAMELY, PROVIDING PRIVATE AND SECURE REAL TIME ELECTRONIC COMMUNICATION OVER A COMPUTER NETWORK, IN CLASS 38 (U.S. CLS. 100, 101 AND 104).

FOR: EDUCATIONAL AND TRAINING SERVICES, NAMELY, DISSEMINATION OF EDUCATIONAL MATERIALS OF OTHERS, AND ARRANGING FOR TELEPHONE MENTORING SESSIONS, ALL IN

THE FIELD OF BUSINESS INVOLVED IN INTERNATIONAL TRADE, IN CLASS 41 (U.S. CLS. 100, 101 AND 107).

THE MARK CONSISTS OF STANDARD CHARACTERS WITHOUT CLAIM TO ANY PARTICULAR FONT, STYLE, SIZE, OR COLOR.

PRIORITY DATE OF 10-17-2005 IS CLAIMED.

OWNER OF INTERNATIONAL REGISTRATION  
0888024 DATED 4-4-2006, EXPIRES 4-4-2016.

SER. NO. 79-025,053, FILED 4-4-2006.

RAMONA ORTIGA, EXAMINING ATTORNEY

Int. Cl.: 33

Prior U.S. Cls.: 47 and 49

United States Patent and Trademark Office

Reg. No. 3,467,999

Registered July 15, 2008

TRADEMARK  
PRINCIPAL REGISTER



"YEREVAN BRANDY COMPANY" CJSC (ARMENIA CLOSED JOINT STOCK COMPANY)  
2, ISAKOV AVENUE  
375082 YEREVAN  
ARMENIA

FOR: ALCOHOLIC BEVERAGES, EXCLUDING BEER, NAMELY, BRANDY, IN CLASS 33 (U.S. CLS. 47 AND 49).

OWNER OF INTERNATIONAL REGISTRATION 0890063 DATED 11-18-2005, EXPIRES 11-18-2015.

OWNER OF U.S. REG. NOS. 1,983,815 AND 2,669,482.

NO CLAIM IS MADE TO THE EXCLUSIVE RIGHT TO USE "THE NON-LATIN CHARACTERS MEANING AGED 20 YEARS" 'YEREVAN BRANDY COMPANY' 'ALCOHOL 41% PRODUCE OF ARMENIA' 'VOLUME 0.5 LITERS', APART FROM THE MARK AS SHOWN.

THE COLOR(S) YELLOW, BROWN, ORANGE, BLUE, GREEN., BLACK AND BEIGE IS/ARE CLAIMED AS A FEATURE OF THE MARK.

THE COLOR YELLOW APPEARS IN THE OUTER RING OF THE OVAL, IN THE RING INSIDE THE SOLID BROWN RING, IN THE INTERIOR RING NEXT TO THE DOTTED BROWN RING, INSIDE THE WORD "ARARAT" (IN CYRILLIC CHARAC-

TER, LOOKING LIKE "APAPAT" IN LATIN CHARACTERS), AND WITHIN THE DESIGN ABOVE "ARARAT"; THE COLOR BROWN APPEARS IN THE SOLID RING CONTAINING THE YELLOW RING, IN THE WORDING APPEARING ALONG THE BOTTOM OF THE MARK, IN THE DOTTED LINE SURROUNDING THE WORDING AND THE DESIGN, AND IN THE OUTLINE OF THE WORDING "ARARAT"; THE COLOR ORANGE APPEARS IN THE DESIGN ABOVE THE WORDING "ARARAT"; THE COLOR BLUE APPEARS IN THE DESIGN ABOVE THE WORD "ARARAT"; THE COLOR GREEN APPEARS IN THE DESIGN ABOVE THE WORD "ARARAT"; THE COLOR BLACK APPEARS IN THE ARMENIAN WORDING BENEATH "ARARAT", AND IN THE TERMS ON EITHER SIDE OF 20 AND IN THE 20; AND THE COLOR BEIGE APPEARS IN THE BACKGROUND OF THE MARK.

THE NON-LATIN CHARACTERS IN THE MARK TRANSLITERATE TO "ARARAT", "NAIRI", "TARI 20 LET", "KREP. 41% RESPUBLIKA ARMENIA YEREVANSKLY KONYACHNIY ZAVOD VMEST 0.5 L" AND THIS MEANS "ARARAT" "NAIRI", "AGED 20 YEARS" AND "ALC 41% PRODUCE OF ARMENIA, YEREVAN BRANDY COMPANY, VOLUME 0.5 LITERS" IN ENGLISH.

SER. NO. 79-025,766, FILED 11-18-2005.

SUNG IN, EXAMINING ATTORNEY

Int. Cl.: 33

Prior U.S. Cls.: 47 and 49

United States Patent and Trademark Office

Reg. No. 3,468,000

Registered July 15, 2008

TRADEMARK  
PRINCIPAL REGISTER



"YEREVAN BRANDY COMPANY" CJSC (ARMENIA CLOSED JOINT STOCK COMPANY)  
2, ISAKOV AVENUE  
375082 YEREVAN  
ARMENIA

FOR: ALCOHOLIC BEVERAGES, EXCLUDING BEER, NAMELY, BRANDY, IN CLASS 33 (U.S. CLS. 47 AND 49).

OWNER OF INTERNATIONAL REGISTRATION 0890072 DATED 11-18-2005, EXPIRES 11-18-2015.

OWNER OF U.S. REG. NOS. 2,540,815 AND 2,669,482.

NO CLAIM IS MADE TO THE EXCLUSIVE RIGHT TO USE "AGED 10 YEARS 42% VOL. YEREVAN BRANDY COMPANY PRODUCE OF ARMENIA 70 CLE", APART FROM THE MARK AS SHOWN.

THE COLOR(S) YELLOW, BROWN, DARK BLUE, LIGHT BLUE, RED, WHITE, BLACK AND BEIGE IS/ ARE CLAIMED AS A FEATURE OF THE MARK.

THE COLOR YELLOW APPEARS IN THE OUTER BORDER OF THE MARK, IN THE THIN BORDER INSIDE THE OUTER BORDER, IN THE ARCHING BORDER DESIGN, IN THE WORDING "ARARAT", IN THE ARMENIAN WORD BENEATH "AKHTA-

MAR", AND IN THE SCENERY DESIGN; THE COLOR BROWN APPEARS IN THE AREA INSIDE THE OUTER BORDER AND INSIDE THE THIN INNER BORDER, IN THE ARCHING BORDER DESIGN, IN THE OUTLINE OF THE WORD "ARARAT", IN THE WORDING "AGED 10 YEARS 42% VOL. YEREVAN BRANDY COMPANY - PRODUCE OF ARMENIA 70 CLE", AND IN THE OBJECTS IN THE TWO RIGHT CIRCLES AND THE TWO LEFT CIRCLES; THE COLOR DARK BLUE APPEARS IN THE MOUNTAINS OF THE SCENERY DESIGN, AND IN THE WORD "AKHTAMAR"; THE COLOR LIGHT BLUE APPEARS IN THE WATER AND SKY OF THE SCENERY DESIGN; THE COLOR RED APPEARS IN THE MOUNTAINS OF THE SCENERY DESIGN; THE COLOR WHITE APPEARS IN THE BACKGROUND WITHIN THE TWO RIGHT CIRCLES; THE COLOR BLACK APPEARS IN THE MOUNTAINS IN THE SCENERY DESIGN; AND THE COLOR BEIGE APPEARS IN THE TRAPEZOID CONTAINING THE WORDS, AND THE BACKGROUND OF THE TWO LEFT CIRCLES.

THE NON-LATIN CHARACTERS IN THE MARK TRANSLITERATE TO "AKHTAMAR" AND THIS MEANS "AKHTAMAR" IN ENGLISH (A WORD COMPOSED OF AN INTERJECTION "AKH" WHICH IS EQUIVALENT TO "OH" IN ENGLISH AND A FEMALE NAME "TAMAR" USED TO REFER TO AN ANCIENT ARMENIAN LEGEND).

SER. NO. 79-025,775, FILED 11-18-2005.

SUNG IN, EXAMINING ATTORNEY

**Int. Cls.: 11, 20, 24, 26 and 27**

**Prior U.S. Cls.: 2, 13, 19, 20, 21, 22, 23, 25, 31, 32, 34,  
37, 39, 40, 42 and 50**

**Reg. No. 3,468,001**

**United States Patent and Trademark Office**

**Registered July 15, 2008**

**TRADEMARK  
PRINCIPAL REGISTER**

**BEAUMONT & FLETCHER**

BEAUMONT & FLETCHER LIMITED (UNITED  
KINGDOM COMPANY)

261 FULHAM ROAD

LONDON SW3 6HY

UNITED KINGDOM

FOR: LIGHTING APPARATUS AND INSTRUMENTS, NAMELY, CEILING LIGHTS, WALL LIGHTS, CHANDELIERS; PARTS AND FITTINGS FOR ALL THE AFORESAID GOODS, NAMELY, LAMPSHADES, IN CLASS 11 (U.S. CLS. 13, 21, 23, 31 AND 34).

FOR: FURNITURE, NAMELY, SOFAS, CHAIRS AND FOOTSTOOLS; MIRRORS; PICTURE FRAMES, IN CLASS 20 (U.S. CLS. 2, 13, 22, 25, 32 AND 50).

FOR: TEXTILES AND TEXTILE GOODS, NAMELY, FABRICS FOR USE IN COVERING FURNITURE AND FOR USE AS CURTAINS; BED AND TABLE COVERS, NAMELY, BEDSPREADS AND TEXTILE TABLE CLOTHS; TEXTILE FABRICS

FOR UPHOLSTERY, IN CLASS 24 (U.S. CLS. 42 AND 50).

FOR: LACE AND EMBROIDERY, RIBBONS AND BRAID; BUTTONS, HOOKS AND EYES FOR CLOTHING; ARTIFICIAL FLOWERS; PASSEMENTERIE, IN CLASS 26 (U.S. CLS. 37, 39, 40, 42 AND 50).

FOR: WALL COVERINGS; WALL PAPER, IN CLASS 27 (U.S. CLS. 19, 20, 37, 42 AND 50).

THE MARK CONSISTS OF STANDARD CHARACTERS WITHOUT CLAIM TO ANY PARTICULAR FONT, STYLE, SIZE, OR COLOR.

OWNER OF INTERNATIONAL REGISTRATION  
0890544 DATED 5-16-2006, EXPIRES 5-16-2016.

SER. NO. 79-025,939, FILED 5-16-2006.

LEIGH LOWRY, EXAMINING ATTORNEY



**Int. Cls.: 9, 41 and 42**

**Prior U.S. Cls.: 21, 23, 26, 36, 38, 100, 101 and 107**

**Reg. No. 3,468,002**

**United States Patent and Trademark Office**

**Registered July 15, 2008**

**TRADEMARK  
SERVICE MARK  
PRINCIPAL REGISTER**



DIMAGIC CO., LTD. (JAPAN CORPORATION)  
3, KANDA-NERIBEICHO  
CHIYODA-KUTOKYO 101-0022  
JAPAN

FOR: WIRE COMMUNICATION MACHINES AND APPARATUS, NAMELY, HANDS-FREE DEVICES FOR WIRED COMMUNICATIONS, AND WIRED MODEM AND WIRED LAN CARDS; BROADCASTING MACHINES AND APPARATUS, NAMELY, DECODERS FOR RECEIVING AND DECODING SATELLITE SIGNALS, HARD DISK RECORDERS FOR RECORDING TELEVISION PROGRAMS, MUSIC, VIDEOS, AND MOVIES, AND SET TOP BOXES FOR INTERNET PROTOCOL TELEVISION, CABLE, AND SATELLITE; TELEVISION RECEIVERS IN THE NATURE OF TELEVISION SETS; TELEVISION TRANSMITTERS; RADIO RECEIVERS; RADIO TRANSMITTERS; AERONAUTICAL AND MARINE RADIO COMMUNICATION MACHINES AND APPARATUS; PORTABLE RADIO COMMUNICATION MACHINES AND APPARATUS IN THE NATURE OF MOBILE COMMUNICATION DATA TERMINALS, MOBILE TELEPHONES, CELLULAR TELEPHONES, AND WALKIE TALKIES; NAVIGATION APPARATUS FOR VEHICLES IN THE NATURE OF ON-BOARD COMPUTERS; AUDIO FREQUENCY MACHINES AND APPARATUS, NAMELY, AUDIO RECORDERS WITH PLAYBACK CAPABILITY, TAPE RECORDERS, MUSIC PLAYERS IN THE NATURE OF COMPUTERS, CD PLAYERS, MP3 PLAYERS, AND RECORD PLAYERS, DOCKING STATIONS FOR MUSIC PLAYERS IN THE NATURE OF COMPUTERS, CD PLAYERS, MP3 PLAYERS, AND RECORD PLAYERS; MULTI-

MEDIA SPEAKERS, HANDHELD MEDIA PLAYERS, AND HOME ENTERTAINMENT SYSTEMS COMPRISED OF COMPUTERS, GAME CONSOLES, DVD PLAYERS, OPTICAL DISC PLAYERS, SET TOP BOXES, TELEVISIONS, AUDIO VISUAL RECEIVERS AND AMPLIFIERS, AND AUDIO SPEAKERS; PUBLIC-ADDRESS SYSTEMS AND INSTRUMENTS; VIDEO CAMERAS BEING CAMCORDERS; VIDEO DISC PLAYERS; PARTS AND ACCESSORIES FOR TELECOMMUNICATION MACHINES AND APPARATUS, NAMELY, HANDS-FREE DEVICES FOR MOBILE AND CELLULAR TELEPHONES, MEMORY CARDS, AND FLASH MEMORY CARDS; HEADPHONES; COMPUTERS; COMPUTER PROGRAMS FOR ENHANCING SOUND, SOUND SIGNALS, AND SOUND FREQUENCY; SIGNAL PROCESSING PROGRAMS FOR CREATING AND VIRTUALIZING SURROUND SOUND SIGNALS AND FOR ENHANCING LOW AND HIGH FREQUENCY; RECORDED COMPACT DISCS FEATURING MUSIC; RECORDED VIDEO DISCS AND DVDS FEATURING MUSIC, VIDEOS, AND MOVIES; DOWNLOADABLE ELECTRONIC PUBLICATIONS, NAMELY, BOOKS, MAGAZINES, AND NEWSLETTERS FEATURING INFORMATION OF GENERAL INTEREST; ELECTRONIC PUBLICATIONS AVAILABLE ON PRERECORDED CDS, DVDS, OPTICAL DISCS, AND FLOPPY DISCS, NAMELY, BOOKS, MAGAZINES, AND NEWSLETTERS FEATURING INFORMATION OF GENERAL INTEREST, IN CLASS 9 (U.S. CLS. 21, 23, 26, 36 AND 38).

FOR: PROVIDING ELECTRONIC PUBLICATIONS, NAMELY, PROVIDING A WEBSITE WITH NON-DOWNLOADABLE BOOKS, MAGAZINES

AND NEWSLETTERS, ALL FEATURING INFORMATION OF GENERAL INTEREST, IN CLASS 41 (U.S. CLS. 100, 101 AND 107).

FOR: TECHNICAL ADVICE RELATING TO PERFORMANCE AND OPERATION OF COMPUTERS, AUTOMOBILE TECHNOLOGICAL ENTERTAINMENT EQUIPMENT AND COMMUNICATIONS-RELATED TECHNOLOGICAL EQUIPMENT AND TECHNOLOGIES, AIRPLANE TECHNOLOGICAL ENTERTAINMENT EQUIPMENT AND TECHNOLOGICAL COMMUNICATIONS-RELATED EQUIPMENT AND TECHNOLOGIES, AND RELATED EQUIPMENT, TECHNOLOGIES, AND DEVICES THAT REQUIRE HIGH LEVELS OF PERSONAL KNOWLEDGE, SKILL OR EXPERIENCE OF THE OPERATORS TO MEET THE REQUIRED ACCURA-

CY IN OPERATING THEM, NAMELY, AUDIO AND ACOUSTIC TECHNOLOGY FOR USE IN COMPUTERS, ELECTRONICS HARDWARE, AMPLIFIERS, SPEAKERS, TELEVISIONS, RADIOS, CD PLAYERS, DVD PLAYERS, RECORD PLAYERS, MP3 PLAYERS, AND GAME CONSOLES; COMPUTER SOFTWARE DESIGN, COMPUTER PROGRAMMING, OR MAINTENANCE OF COMPUTER SOFTWARE, IN CLASS 42 (U.S. CLS. 100 AND 101).

OWNER OF INTERNATIONAL REGISTRATION 0890791 DATED 5-8-2006, EXPIRES 5-8-2016.

SER. NO. 79-026,037, FILED 5-8-2006.

LYDIA BELZER, EXAMINING ATTORNEY

**Int. Cls.: 3, 9, 11, 12, 20, 21, 22, 25 and 28**

**Prior U.S. Cls.: 1, 2, 4, 6, 7, 13, 19, 21, 22, 23, 25, 26, 29, 30, 31, 32, 33, 34, 35, 36, 38, 39, 40, 42, 44, 50, 51 and 52**

**Reg. No. 3,468,003**

**United States Patent and Trademark Office**

**Registered July 15, 2008**

**TRADEMARK  
PRINCIPAL REGISTER**

# **PLIM Swiss**

PLIM COOPERATION AG (SWITZERLAND LTD  
LIAB CO)

WALDEGGSTR. 38

CH-3097 BERN-LIEBEFELD

SWITZERLAND

FOR: CLEANING, POLISHING, SCOURING AND ABRASIVE LIQUIDS AND POWDERS; CARE PRODUCTS FOR MOTORBIKES, NAMELY, CHROME POLISH, PAINT POLISH, CHAIN CLEANER, AND POLYMER SEALANT FOR CLEANING, SHINING AND PROTECTING MOTORBIKE EXTERIOR SURFACES, IN CLASS 3 (U.S. CLS. 1, 4, 6, 50, 51 AND 52).

FOR: PROTECTIVE EQUIPMENT FOR MOTORCYCLING, NAMELY, PROTECTIVE EYEWEAR, PROTECTIVE HELMETS, FACE PROTECTION SHIELDS, KNEE PROTECTION SHIELDS, ELBOW PROTECTION SHIELDS, PROTECTIVE GLOVES FOR PROTECTION AGAINST ACCIDENTS, PROTECTIVE CLOTHING; ON-BOARD MOTORBIKE COMPUTERS; SKI GOGGLES, SPORTS GOGGLES, SUNGLASSES, PROTECTIVE HELMETS FOR SKIERS AND SKI-JUMPERS, SPORTS HELMETS, PROTECTIVE GLOVES FOR SKIERS FOR PROTECTION AGAINST ACCIDENTS; BICYCLE ACCESSORIES, NAMELY, BICYCLE SPEEDOMETERS, CYCLING HELMETS, ON-BOARD BICYCLE COMPUTERS; MP3 PLAYERS; CD PLAYERS, DVD PLAYERS; VIDEO TAPE RECORDERS, DIGITAL VIDEO RECORDERS; DVD RECORDERS, VIDEO TAPE PLAYERS, VIDEO DISC PLAYERS; VIDEO CAMERAS; RADIOS, TELEVISIONS; VIDEO MONITORS, BABY MONITORS, COMPUTER MONITORS; TAPE RECORDERS, NAMELY, SOUND RECORDING AND REPRODUCTION APPARATUS; TELEPHONES; COMPUTERS; PROTECTIVE HELMETS FOR MOTORCYCLE AND BICYCLE RIDERS, IN CLASS 9 (U.S. CLS. 21, 23, 26, 36 AND 38).

FOR: BICYCLE ACCESSORIES, NAMELY, BICYCLE LAMPS, BICYCLE REFLECTORS; LIGHTS FOR TWO-WHEELED VEHICLES, AND LIGHT HOLDERS FOR TWO-WHEELED VEHICLES, NAMELY BICYCLE LAMP HOLDER; GAS COOKERS, PETROL STOVES; LIGHTING, HEATING, COOKING AND REFRIGERATING APPARATUS, NAMELY, LIGHTING PANELS FOR LAND VEHICLES, LAMPS, ELECTRIC TORCHES FOR LIGHTING, SEARCH LIGHTS, FLASH LIGHTS, ELECTRIC LIGHTS FOR CHRISTMAS TREES, ELECTRIC CEILING LIGHTS, ICE BOXES IN THE NATURE OF REFRIGERATORS; ICE MACHINES, ELECTRIC AIR REHEATERS, GAS BURNERS FOR DOMESTIC USE, FURNACE GAS BOILERS, GAS LAMPS, ELECTRIC LIGHT BULBS, ELECTRIC GRILLS FOR COOKING, CHARCOAL GRILLS FOR COOKING, RADIATORS, HEATING PLATES IN THE NATURE OF ELECTRIC HOT PLATES, HEATERS FOR VEHICLES FOR CLIMATE CONTROL, FURNACES, CHANDELIERS, GAS COOKERS, ELECTRIC SLOW COOKERS, REFRIGERATORS, OIL LAMPS, SAFETY LAMPS FOR UNDERGROUND USE, DIVING LIGHTS, LIGHT BULBS FOR DIRECTIONAL SIGNALS FOR VEHICLES, MICROWAVE OVENS FOR COOKING, GAS STOVES, ELECTRIC STOVES, ALCOHOL BURNERS FOR DOMESTIC USE, POCKET SEARCH LIGHTS, NON-ELECTRIC POCKET WARMERS IN THE NATURE OF CHEMICALLY-ACTIVATED HEATING PACKETS FOR WARMING HANDS NOT FOR MEDICAL PURPOSES, HOT WATER BOTTLES, GAS PATIO HEATERS, OUTDOOR COOKERS FOR CURING FOOD, IN CLASS 11 (U.S. CLS. 13, 21, 23, 31 AND 34).

FOR: BICYCLES AND ACCESSORIES THEREFOR, NAMELY, SADDLES FOR BICYCLES, BRAKES FOR BICYCLE, BICYCLE STANDS, RIMS FOR WHEELS OF BICYCLES, BELLS FOR BICYCLES, CHAINS FOR BICYCLES, BASKET ADAP-

TED FOR CYCLES, HANDLE BARS FOR BICYCLES, MOTORS FOR CYCLES, CYCLE WHEEL HUBS, PEDALS FOR BICYCLES, PUMPS FOR BICYCLES, WHEELS FOR BICYCLES, FRAMES FOR BICYCLES, BICYCLE TIRES, TUBELESS TIRES FOR BICYCLE, INNER TUBES FOR BICYCLES, SPOKES FOR BICYCLE WHEELS; BICYCLE STABILIZERS, NAMELY, BICYCLE TRAINING WHEELS; TURN SIGNAL INDICATORS FOR BICYCLES, LUGGAGE SADDLE BAGS FOR BICYCLES, CRANKS FOR BICYCLES, MUDGUARDS FOR BICYCLES, SADDLES FOR BICYCLES, GEARS FOR BICYCLES, BICYCLE CHAINS, CHAIN GUARDS FOR BICYCLES, LUGGAGE CARRIERS FOR BICYCLES, BICYCLE BELLS, BICYCLE PUMPS; MOTORBIKES AND ACCESSORIES THEREFOR, NAMELY, MOTORCYCLE SADDLEBAGS, SADDLE COVERS FOR MOTORCYCLES, MOTORCYCLE SADDLES; MOTORBIKE HANDLEBARS, MOTORBIKE CHAINS, MOTORCYCLE CHAIN PINIONS, MOTORCYCLE LUGGAGE CARRIERS, MOTORCYCLE AND BICYCLE PORTERS, NAMELY, LUGGAGE CARRIER FOR VEHICLES; MOTORCYCLE FOOTRESTS, MOTORCYCLE STANDS, MOTORCYCLE CLUTCH LEVERS, MOTORCYCLE BRAKE LEVERS, RUBBER GRIPS FOR MOTORBIKE HANDLEBARS; FITTED MOTORCYCLE HANDLEBAR PROTECTORS, IN CLASS 12 (U.S. CLS. 19, 21, 23, 31, 35 AND 44).

FOR: FURNITURE, CAMPING FURNITURE OF WOOD, PLASTIC, METAL; CAMPING SEATS, TABLES, STOOLS, SLEEPING BAGS, MATTRESSES, SLEEPING MATS FOR CAMPING PURPOSES; BEDDING, NAMELY, PLASTIC FASTENERS FOR HOLDING BED LINENS IN PLACE, MIRRORS, IN CLASS 20 (U.S. CLS. 2, 13, 22, 25, 32 AND 50).

FOR: BOTTLES SOLD EMPTY, ALUMINUM DRINKING BOTTLES, VACUUM FLASKS, POTS, HOUSEHOLD OR KITCHEN CONTAINERS NOT OF PRECIOUS METAL OR COATED THEREWITH, IN CLASS 21 (U.S. CLS. 2, 13, 23, 29, 30, 33, 40 AND 50).

FOR: INSECT PROTECTION NETS, BUTTERFLY NETS, TENTS, TARPAULINS, SAILS, SACKS FOR THE TRANSPORTATION OR STORAGE OF MATERIALS IN BULK., IN CLASS 22 (U.S. CLS. 1, 2, 7, 19, 22, 42 AND 50).

FOR: CLOTHING, NAMELY, SHIRTS, PANTS, SHORTS, PULLOVERS, SOCKS, GLOVES, UNDERWEAR, T-SHIRTS, SUITS, BATHING SUITS, BATHING TRUNKS, BATH ROBES, BELTS FOR CLOTHING, SCARVES, TROUSERS, JACKETS, PELISSES, COATS, PAJAMAS, SKIRTS, STOCKINGS, SWEATERS, VESTS; WATER PROOF CLOTHING, NAMELY, WATER PROOF PANTS, WATER PROOF JACKETS, WATER PROOF GLOVES, WATER PROOF SHOES, WATER PROOF HATS; KNITWEAR FOR CLOTHING, NAMELY, KNIT SHIRTS, KNIT

SKIRTS, KNIT PULLOVER; FOOTWEAR, HATS, CAPS, HEADWEAR; SPORTS CLOTHING, NAMELY, SPORT SHIRTS, SPORT BRAS, SPORTS JERSEYS, SPORT TROUSERS, SPORT T-SHIRTS; SPORTS SHOES; WINTER SPORTS CLOTHING, NAMELY, SKI BIBS, SKI BOOTS; CLOTHING FOR MOTORCYCLISTS, NAMELY, LEATHER JACKETS, LEATHER PANTS, LEATHER GLOVES; AND GLOVES FOR MOTORCYCLISTS, BOOTS FOR MOTORCYCLISTS; CLOTHING FOR CYCLISTS, NAMELY, CYCLING SHORTS, CYCLING SHIRTS, CYCLING TROUSERS, CYCLING T-SHIRTS; GLOVES FOR CYCLISTS, SHOES FOR CYCLISTS, IN CLASS 25 (U.S. CLS. 22 AND 39).

FOR: GAMES AND PLAYTHINGS, NAMELY, BOARD GAMES, BENDABLE TOYS, PLAY BALLOONS, BALLS FOR GAMES, TOY BUILDING GAMES, BUILDING BLOCKS AS TOYS, RADIO-CONTROLLED TOY VEHICLES, TOY PISTOLS, DOLLS, PLAYING CARDS, GAME TABLES FOR INDOOR FOOTBALL, DICE, TOY VEHICLES, FLYING DISCS AS TOYS, PARLOR GAMES; GYMNAS-TIC AND SPORTING ARTICLES, NAMELY, BOXING GLOVES, ICE SKATING BOOTS SOLD AS A UNIT WITH SKATES ATTACHED, ROLLER SKATING BOOTS SOLD AS A UNIT WITH SKATES ATTACHED, STATIONARY EXERCISE BICYCLES, BADMINTON SHUTTLECOCKS, PARAGLIDERS, GOLF GLOVES, GOLF CLUBS, GOLF BAGS WITH OR WITHOUT WHEELS, HOCKEY STICKS FOR ICE HOCKEY, HOCKEY STICKS FOR FIELD HOCKEY, HOCKEY STICKS FOR STREET HOCKEY, IN-LINE ROLLER-SKATES, DARTS, ROLLER SKATES, SAIL BOARDS, SKATE BOARDS, SKIS, SNOWBOARDS, RACKETS FOR TENNIS, SQUASH, AND BADMINTON; TENNIS NETS, BILLIARD TABLES, TABLES FOR TABLE TENNIS, GYMNAS-TIC PARALLEL BARS, AND BODY-BUILDING APPARATUS, NAMELY, BAR-BELLS, EXERCISE WEIGHTS, WEIGHT LIFTING BELTS, WEIGHT LIFTING GLOVES; BOB-SLEIGHS, ICE SKATES, SNOWBOARDS, SKIS, IN CLASS 28 (U.S. CLS. 22, 23, 38 AND 50).

PRIORITY DATE OF 12-21-2005 IS CLAIMED.

OWNER OF INTERNATIONAL REGISTRATION 0891991 DATED 2-15-2006, EXPIRES 2-15-2016.

NO CLAIM IS MADE TO THE EXCLUSIVE RIGHT TO USE "SWISS", APART FROM THE MARK AS SHOWN.

SER. NO. 79-026,437, FILED 2-15-2006.

LEIGH LOWRY, EXAMINING ATTORNEY

**Int. Cls.: 3, 9, 14, 16, 18, 24, 25, 26 and 35**

**Prior U.S. Cls.: 1, 2, 3, 4, 5, 6, 21, 22, 23, 26, 27, 28, 29, 36, 37, 38, 39, 40, 41, 42, 50, 51, 52, 100, 101 and 102**

**Reg. No. 3,468,004**

**United States Patent and Trademark Office**

**Registered July 15, 2008**

**TRADEMARK  
SERVICE MARK  
PRINCIPAL REGISTER**



GA MODEFINE S.A. (SWITZERLAND SOCIETÀ  
PER AZIONI)  
VIA PENATE 4  
CH-6850 MENDRISIO, SWITZERLAND

FOR: BLEACHING PREPARATIONS, DETERGENTS AND FABRIC SOFTENERS FOR LAUNDRY USE; CLEANING PREPARATIONS FOR BATHROOMS, KITCHENS, CABINETS AND APPLIANCES AND FOR LAUNDRY USE; POLISHING PREPARATIONS FOR USE IN BATHROOMS, ON KITCHEN CABINETS, APPLIANCES AND ON FURNITURE; SCOURING PREPARATIONS FOR USE IN BATHROOMS AND KITCHEN APPLIANCES AND FIXTURES; ABRASIVE CLEANING PREPARATIONS FOR USE IN BATHROOMS AND KITCHEN APPLIANCES AND FIXTURES; HAND, FACIAL AND BATH SOAPS; PERFUMERY, ESSENTIAL OILS FOR PERSONAL USE, COSMETICS, HAIR LOTIONS; DENTIFRICES, IN CLASS 3 (U.S. CLS. 1, 4, 6, 50, 51 AND 52).

FOR: SCIENTIFIC, NAUTICAL, SURVEYING, PHOTOGRAPHIC, CINEMATOGRAPHIC, OPTICAL, WEIGHING, MEASURING, SIGNALLING, CHECKING, SUPERVISION, LIFE SAVING AND TEACHING APPARATUS AND INSTRUMENTS, NAMELY, SPECTACLES, EYEGLASSES, SUNGLASSES, SPORT GLASSES, PINCE-NEZ, CASES FOR EYEGLASSES AND SUNGLASSES, CHAINS FOR EYEGLASSES AND SUNGLASSES, FRAMES FOR EYEGLASSES AND SUNGLASSES, LENSES FOR EYEGLASSES AND SUNGLASSES, PHOTOGRAPHIC CAMERAS, OPTICAL FILTERS, CINEMATOGRAPHIC CAMERAS; APPARATUS AND INSTRUMENTS FOR CONDUCTING, SWITCHING, TRANSFORMING, ACCUMULATING, REGULATING OR CONTROLLING ELECTRICITY, NAMELY, ELECTRICAL SWITCHES, ELECTRICAL CONDUCTORS; APPARATUS FOR RECORDING, TRANSMITTING AND REPRODUCING SOUND OR IMAGE, NAMELY, MAGNETIC RECORDING

MEDIA AND RECORDING DISCS, NAMELY, BLANK COMPACT DISCS, BLANK CD-ROMS FOR SOUND AND VIDEO RECORDING, DVD DISCS, PRE-RECORDED COMPACT DISCS, AUDIO CASSETTES, PHONOGRAPH RECORDS, VIDEOTAPE AND DIGITAL VIDEO DISCS, ALL FEATURING MUSIC AND FASHION, COMPACT DISC PLAYERS; AUTOMATIC VENDING MACHINES, CASH REGISTERS; CALCULATORS; DATA PROCESSORS AND COMPUTERS; FIRE EXTINGUISHERS, IN CLASS 9 (U.S. CLS. 21, 23, 26, 36 AND 38).

FOR: PRECIOUS METALS AND THEIR ALLOYS AND GOODS MADE OF THESE MATERIALS OR PLATED THEREWITH INCLUDED IN THIS CLASS, NAMELY, WATCH STRAPS, JEWELRY AND WATCH CASES MADE OF PRECIOUS METALS, TRAYS AND ASHTRAYS MADE OF PRECIOUS METALS, CIGARETTE BOXES OF PRECIOUS METALS, NAPKIN RINGS OF PRECIOUS METALS; JEWELRY, NAMELY, EARRINGS, BRACELETS, NECKLACES, RINGS, PENDANTS, BROOCHES, CHAINS, PINS, MEDALLIONS, CUFFLINKS, TIE CLIPS; PRECIOUS STONES, TIMEPIECES AND CHRONOMETRIC INSTRUMENTS, NAMELY WATCHES, IN CLASS 14 (U.S. CLS. 2, 27, 28 AND 50).

FOR: PAPER, CARDBOARD AND GOODS MADE THEREOF, NAMELY, ADDRESS BOOKS, AGENDAS, PHOTOGRAPHS, PHOTOGRAPH ALBUMS, ANNIVERSARY BOOKS, ANNOUNCEMENT CARDS, APPOINTMENT BOOKS, BLANK CARDS, BLANK NOTE CARDS, BLANK OR PARTIALLY PRINTED LABELS NOT FOR TEXTILE, BLANK OR PARTIALLY PRINTED POSTCARDS, BOOK COVERS, BOOK HOLDERS, BOOKENDS, BOOKMARKS, BUSINESS CARDS, CALENDARS, POCKET MEMORANDUM BOOKS, STATIONERY, WRITING PAPER, NOTEBOOKS, MEMO PAPER, POSTERS, GREETING CARDS, NOTE CARDS, CATALOGUES IN THE FIELDS OF FASHION, HOME DESIGN,

FURNITURE, ACCESSORIES, ART, SHOPPING, GARDENING AND GARDEN FURNITURE; ENVELOPES, BOXES FOR PENS, PAPER BOXES, CARDBOARD CONTAINERS, CARDBOARD OR PAPER DISPLAYS FOR MERCHANDIZING PRODUCTS AND EXHIBITIONS, PRINTED PAPER OR CARDBOARD SIGNS, PRICE TAGS, PRODUCT COMPOSITION TAGS AND CARE INSTRUCTION TAGS, COIN AND STAMP ALBUMS; PRINTED MATTER, NAMELY, BOOKS, MAGAZINES AND BROCHURES IN THE FIELDS OF FASHION, HOME DESIGN, FURNITURE, ACCESSORIES, ART, SHOPPING, GARDENING AND GARDEN FURNITURE; BOOKBINDING MATERIAL, NAMELY, BINDING, WIRE AND TAPE; STATIONERY, ADHESIVES FOR STATIONERY OF HOUSEHOLD PURPOSES; ARTISTS' SUPPLIES, NAMELY, ARTISTS' PENS, ARTISTS' BRUSHES, ARTISTS' PASTELS, ART PAPER, ART PRINTS, ART PICTURES, SKETCH PADS; PAINTBRUSHES; TYPEWRITERS AND OFFICE ARTICLES, NAMELY, PENCILS, PEN HOLDERS, FOUNTAIN PENS, ERASERS, WRITING INKS, INKWELLS, BALL POINT PENS, PENCIL CASES, PAPER CLIPS, BULLETIN BOARDS; PRINTED INSTRUCTIONAL AND TEACHING MATERIAL IN THE FIELD OF FASHION, HOME DESIGN, FURNITURE AND ACCESSORIES; PLASTIC MATERIALS, NAMELY, PLASTIC BAGS AND PLASTIC BUBBLE PACKS FOR WRAPPING AND FOR PACKAGING; PRINTER' S TYPE, PRINTING BLOCKS, IN CLASS 16 (U.S. CLS. 2, 5, 22, 23, 29, 37, 38 AND 50).

FOR: LEATHER AND IMITATIONS OF LEATHER SOLD IN BULK; LEATHER GOODS, NAMELY, HANDBAGS, PURSES, WALLETS, BRIEFCASES, TOILETRY CASES SOLD EMPTY, COSMETIC CASES SOLD EMPTY; ANIMAL SKINS, ANIMAL HIDES; TRUNKS AND TRAVELING BAGS; UMBRELLAS, PARASOLS AND WALKING STICKS; WHIPS, HARNESSSES AND SADDLERY, IN CLASS 18 (U.S. CLS. 1, 2, 3, 22 AND 41).

FOR: TEXTILES AND TEXTILE GOODS NAMELY, FABRIC FOR UPHOLSTERY, FABRIC FOR

MAKING CLOTHES; BED AND TABLE COVERS, NAMELY, BED SPREADS, BED SHEETS, COMFORTERS, DUVETS, DUVET COVERS, BLANKETS, TABLE CLOTHS NOT OF PAPER, TEXTILE NAPKINS, IN CLASS 24 (U.S. CLS. 42 AND 50).

FOR: CLOTHING, NAMELY, PULLOVERS, CARDIGANS, SWEATERS, TROUSERS, SKIRTS, JACKETS, BLOUSES, SHIRTS, JEANS, SWEATPANTS, SHORTS, SWEATSHIRTS, SUITS, DRESSES, OVERCOATS, COATS, RAINCOATS, BELTS, JERSEYS, NECKWEAR, SCARVES, SOCKS AND STOCKINGS, TIGHTS, VESTS, WAISTCOATS, JUMPERS, TRACKSUITS, BLOUSONS, GYMSUITS, KNICKERS, T-SHIRTS, ANORAKS, SUSPENDERS, LOUNGEWEAR, UNDERWEAR, BRASSIERES, CORSETS, PETTICOATS, NIGHTGOWNS, DRESSING GOWNS, BATH ROBES, BEACHWEAR, SLEEPWEAR, OVERALLS, HEADGEAR, NAMELY, HATS AND CAPS; GLOVES, FOOTWEAR, NAMELY, SHOES, SANDALS, BOOTS AND SLIPPERS, IN CLASS 25 (U.S. CLS. 22 AND 39).

FOR: LACE AND EMBROIDERY, RIBBONS AND BRAID; BUTTONS FOR CLOTHING, HOOKS AND EYES, SAFETY PINS, SEWING PINS, NEEDLES; ARTIFICIAL FLOWERS, IN CLASS 26 (U.S. CLS. 37, 39, 40, 42 AND 50).

FOR: ADVERTISING; BUSINESS MANAGEMENT; BUSINESS ADMINISTRATION; PROVIDING OFFICE FUNCTIONS, IN CLASS 35 (U.S. CLS. 100, 101 AND 102).

PRIORITY DATE OF 2-10-2006 IS CLAIMED.

OWNER OF INTERNATIONAL REGISTRATION 0892491 DATED 7-18-2006, EXPIRES 7-18-2016.

SER. NO. 79-026,595, FILED 7-18-2006.

ELI HELLMAN, EXAMINING ATTORNEY

**Int. Cl.: 25**

**Prior U.S. Cls.: 22 and 39**

**United States Patent and Trademark Office**

**Reg. No. 3,468,005**

**Registered July 15, 2008**

**TRADEMARK  
PRINCIPAL REGISTER**

**ME TOO**

SPIRIT WHOLESALE APS (DENMARK PRIVATE  
LIMITED COMPANY)  
FREDERICIAVEJ 403  
DK-7100 VEJLE, DENMARK

FOR: INFANT AND CHILDREN CLOTHING FOR  
SIZES 0-14, NAMELY, COATS, JACKETS, COVER-  
ALLS, SWIMSUITS, SHIRTS, PANTS, FROCKS, PI-  
NAFORES, DRESSES, SKIRTS, SWEATERS,  
TIGHTS, SOCKS, STOCKINGS, LEGGINGS, T-  
SHIRTS, JUMP SUITS, HOODED SWEATSHIRTS,  
SWEATPANTS, HATS, BANDANAS, KNIT SHIRTS,  
KNIT PANTS, KNIT DRESSES, KNIT COATS, KNIT  
HOSIERY, KNIT SKIRTS, VESTS, OXFORD SHIRTS,

BABY INFANT SLEEPERS, BABY BUNTINGS, IN  
CLASS 25 (U.S. CLS. 22 AND 39).

THE MARK CONSISTS OF STANDARD CHAR-  
ACTERS WITHOUT CLAIM TO ANY PARTICULAR  
FONT, STYLE, SIZE, OR COLOR.

OWNER OF INTERNATIONAL REGISTRATION  
0759732 DATED 6-11-2001, EXPIRES 6-11-2011.

SER. NO. 79-027,534, FILED 5-15-2006.

CYNTHIA SLOAN, EXAMINING ATTORNEY

Int. Cls.: 9, 35 and 42

Prior U.S. Cls.: 21, 23, 26, 36, 38, 100, 101 and 102

United States Patent and Trademark Office

Reg. No. 3,468,006

Registered July 15, 2008

**TRADEMARK  
SERVICE MARK  
PRINCIPAL REGISTER**

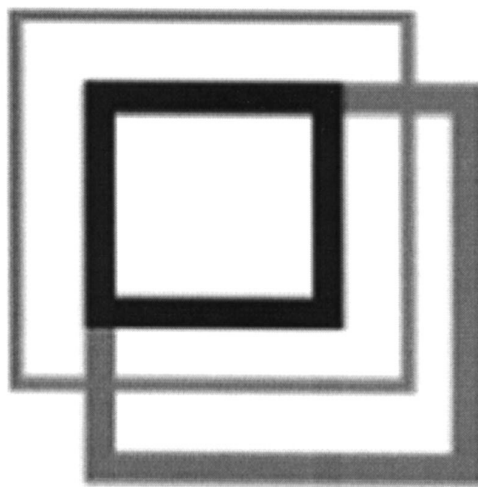

SENSIUM NV (BELGIUM NV)  
KAPELDREEF 75  
B-3001 LEUVEN  
BELGIUM

FOR: DEVICES AND APPARATUS FOR SENSING, MONITORING, RECORDING AND TRANSMITTING SIGNALS AND INFORMATION, NAMELY, BIOSENSORS THAT DETECT POISON, CONTAMINANTS, POLLUTANTS, BACTERIA; PESTICIDES, HERBICIDES AND FUNGICIDE, CHEMICAL SENSORS THAT DETECT OXIDES, PHOSPHATES, CARBONATES, SODIUM, GLUCOSE, CHLORINES AND HYDROGEN, ELECTRICAL SENSORS THAT DETECT TEMPERATURE POSITIONS, DISTANCE, HUMIDITY, SOUND, MOTION, ACCELERATION, VOLTAGE AND CURRENT, OPTICAL SENSORS THAT DETECT LIGHT, BODY WEARABLE OR IMPLANTABLE SENSORS THAT DETECT PHYSICAL AND NEUROLOGICAL ACTIVITY, SOC/SIP SENSOR DEVICES THAT DETECT CURRENT, VOLTAGE AND FREQUENCY; NETWORKS THAT ARE WIRELESS CONNECTED TO EACH OTHER AND THAT INTERACT WITH EACH OTHER IN ORDER TO TRANSMIT THE DATA GENERATED BY THE SENSORS, NAMELY, ELECTRONIC DATA RELAYS FOR SENSORS; WIRELESS SENSOR NETWORK PRODUCTS, NAMELY, WIRELESS CONTROLLER TO MONITOR AND CONTROL THE FUNCTIONING OF OTHER ELECTRONIC DEVICES; WIRELESS COM-

MUNICATION DEVICES, NAMELY, RADIO IDENTIFICATION TAGS AND TWO WAY RADIOS; RECEIVING AND PROCESSING APPARATUS FOR THE AFOREMENTIONED WIRELESS SENSOR NETWORK PRODUCTS, NAMELY, MOBILE COMPUTING AND OPERATING PLATFORMS CONSISTING OF DATA TRANSCIVERS, WIRELESS NETWORKS AND GATEWAYS FOR THE COLLECTION AND MANAGEMENT OF DATE AND VEHICLE LOCATING, TRACKING AND SECURITY SYSTEM, SENSOR NODES IN THE NATURE OF COMPUTER TERMINALS, GATEWAY NODES IN THE NATURE OF COMPUTER NETWORK ROUTERS AND DATA PROCESSORS HOSTS IN THE NATURE OF MAINFRAME COMPUTERS FOR THE AFOREMENTIONED WIRELESS SENSOR NETWORK PRODUCTS; EMBEDDED AND NON-EMBEDDED SOFTWARE FOR USE IN DATA PROCESSING FOR THE AFOREMENTIONED WIRELESS SENSOR NETWORK PRODUCTS, INCLUDING INTERFACE DRIVERS AND REAL-TIME OPERATING SYSTEMS; COMPUTER SOFTWARE FOR THE AFOREMENTIONED APPLICATIONS FOR USE IN INFORMATION TRANSMISSION, CONNECTING AND DATA PROCESSING; COMPUTER SOFTWARE FOR THE DEVELOPMENT OF COMMUNICATIONS IN WIRELESS SENSOR NETWORKS, DATABASE INTEGRATION, DATABASE MANAGEMENT AND UPDATING OF COMPUTER SOFTWARE; AND COMPUTER SOFTWARE FOR USE IN EVALUA-



TION OF COMMUNICATIONS, CONNECTING AND DATA PROCESSING IN SENSOR WIRELESS NETWORKS THAT ARE WIRELESSLY CONNECTED TO EACH OTHER AND THAT INTERACT WITH EACH OTHER IN ORDER TRANSMIT THE DATA GENERATED BY THE SENSORS, IN CLASS 9 (U.S. CLS. 21, 23, 26, 36 AND 38).

FOR: COLLECTION, MANAGEMENT OF DATA DERIVED FROM WIRELESS SENSOR NETWORK DEVICES AND APPARATUS IN THE FIELD OF BIOSENSORS THAT DETECT POISON, CONTAMINANTS, POLLUTANTS, BACTERIA, PESTICIDES, HERBICIDES AND FUNGICIDE, CHEMICAL SENSORS THAT DETECT OXIDES, PHOSPHATES, CARBONATES, SODIUM, GLUCOSE, CHLORINES AND HYDROGEN, ELECTRICAL SENSORS THAT DETECT TEMPERATURE POSITIONS, DISTANCE, HUMIDITY, SOUND, MOTION, ACCELERATION, VOLTAGE AND CURRENT, OPTICAL SENSORS THAT DETECT LIGHT, BODY WEARABLE OR IMPLANTABLE SENSORS THAT DETECT PHYSICAL AND NEUROLOGICAL ACTIVITY, SOC/SIP SENSOR DEVICES THAT DETECT CURRENT, VOLTAGE AND FREQUENCY; ANALYZING OF BUSINESS AND OPERATIONAL DATA DERIVED FROM WIRELESS NETWORKS THAT INTERACT WITH EACH OTHER IN ORDER TO TRANSMIT THE DATA GENERATED BY THE SENSORS; INFORMATION, ADVICE AND CONSULTANCY IN THE FIELD OF BUSINESS SERVICES, NAMELY, FACILITY MANAGEMENT OF TECHNICAL OPERATIONS, DATA PROCESSING AND DATABASE MANAGEMENT, IN CLASS 35 (U.S. CLS. 100, 101 AND 102).

FOR: DESIGN FOR OTHERS AND DEVELOPMENT OF THE DEVICES AND APPARATUS FOR SENSING, MONITORING, RECORDING AND TRANSMITTING SIGNALS AND INFORMATION OF, NAMELY, BIOSENSORS, CHEMICAL SENSORS, ELECTRICAL SENSORS, OPTICAL SENSORS, BODY WEARABLE OR IMPLANTABLE SENSORS, SOC/SIP SENSOR DEVICES; DEVELOPMENT AND DESIGN FOR OTHERS OF NETWORKS THAT ARE WIRELESSLY CONNECTED TO EACH OTHER AND THAT INTERACT WITH EACH OTHER IN ORDER TO TRANSMIT THE DATA GENERATED

BY THE SENSORS, OF WIRELESS SENSOR NETWORK PRODUCTS, OF WIRELESS COMMUNICATION DEVICES, OF RECEIVING AND PROCESSING APPARATUS FOR THE AFOREMENTIONED WIRELESS SENSOR NETWORK PRODUCTS, OF SENSOR NODES, AND OF GATEWAY NODES FOR THE AFOREMENTIONED WIRELESS SENSOR NETWORK PRODUCTS; DEVELOPMENT AND DESIGN FOR OTHERS OF EMBEDDED AND NON-EMBEDDED SOFTWARE FOR USE IN DATA PROCESSING FOR THE AFOREMENTIONED WIRELESS SENSOR NETWORK PRODUCTS, INCLUDING INTERFACE DRIVERS AND REAL-TIME OPERATING SYSTEMS; DEVELOPMENT AND DESIGN FOR OTHERS OF COMPUTER SOFTWARE FOR THE AFOREMENTIONED APPLICATIONS; DEVELOPMENT AND DESIGN FOR OTHERS OF SOFTWARE FOR THE DEVELOPMENT OF COMPUTER SOFTWARE FOR EVALUATION OF NETWORKS THAT ARE WIRELESSLY CONNECTED TO EACH OTHER AND THAT INTERACT WITH EACH OTHER IN ORDER TO TRANSMIT THE DATA GENERATED BY THE SENSORS; RESEARCH SERVICES, NAMELY, RESEARCH OF NEW PRODUCTS FOR OTHERS; CONSULTATION IN THE FIELD OF RESEARCH OF NEW PRODUCTS FOR OTHERS; TECHNICAL SUPPORT SERVICES, NAMELY, TROUBLESHOOTING AUTOMATION PROBLEMS FOR WIRELESS NETWORKS SYSTEMS THAT INTERACT WITH EACH OTHER IN ORDER TO TRANSMIT THE DATA GENERATED BY THE SENSORS, IN CLASS 42 (U.S. CLS. 100 AND 101).

PRIORITY DATE OF 11-7-2005 IS CLAIMED.

OWNER OF INTERNATIONAL REGISTRATION 0897290 DATED 5-3-2006, EXPIRES 5-3-2016.

THE MARK CONSISTS OF THREE INTERSECTING SQUARES FORMING A STYLIZED MICROCHIP.

SER. NO. 79-028,423, FILED 5-3-2006.

LEIGH LOWRY, EXAMINING ATTORNEY

**Int. Cls.: 16, 35, 36 and 38**

**Prior U.S. Cls.: 2, 5, 22, 23, 29, 37, 38, 50, 100, 101, 102  
and 104**

**Reg. No. 3,468,007**

**United States Patent and Trademark Office**

**Registered July 15, 2008**

**TRADEMARK  
SERVICE MARK  
PRINCIPAL REGISTER**

**WMAM**

WESTLB MELLON ASSET; MANAGEMENT HOLDINGS LIMITED (UNITED KINGDOM PRIVATE LIMITED LIABILITY COMPANY) WOOLGATE EXCHANGE, 25 BASINGHALL STREET; LONDON EC2V 5HA UNITED KINGDOM

FOR: PRINTED MATTER, NAMELY, BROCHURES, HANDOUTS, MAGAZINES, CLIENT PRESENTATIONS HANDOUTS, PRESS RELEASES, FINANCIAL ANALYSIS REPORTS, AND BOOKS, THE FOREGOING IN THE FIELD OF BANKING AND FINANCE, IN CLASS 16 (U.S. CLS. 2, 5, 22, 23, 29, 37, 38 AND 50).

FOR: ADVERTISING; BUSINESS MANAGEMENT; BUSINESS ADMINISTRATION AND BUSINESS CONSULTANCY; PROVIDING OFFICE FUNCTIONS, IN CLASS 35 (U.S. CLS. 100, 101 AND 102).

FOR: INSURANCE SERVICES, NAMELY, INSURANCE BROKERAGE; FINANCIAL AND MONETARY AFFAIRS IN THE NATURE OF BANKING SERVICES, FINANCIAL ANALYSIS AND CONSULTANCY, INVESTMENT ANALYSIS AND CONSULTANCY, CAPITAL INVESTMENT CONSULTATION, FINANCIAL MANAGEMENT, INVESTMENT FUND TRANSFER AND TRANSACTION SERVICES, SAVINGS ACCOUNT SERVICES, MONEY LENDING, BANKING SERVICES FEATURING ACCEPTING DEPOSITS, ISSUING SUBSTITUTE BONDS, BANKING SERVICES FEATURING ACCEPTED FIXED INTERVAL INSTALLMENT DEPOSITS, LOANS AND DISCOUNT OF BILLS, MONEY TRANSFER SERVICES, OFFERING FINANCIAL LIABILITY GUARANTEES, BANKING SERVICES FEATURING ACCEPTING BILLS OF EXCHANGE; WEALTH MANAGEMENT FOR INDIVIDUALS, CORPORATIONS AND OTHERS, NAMELY, RESEARCH AND ANALYSIS OF FINANCIAL

MARKETS, FINANCIAL PLANNING ADVICE AND SERVICES, STOCK EXCHANGE QUOTATIONS, OFFERING FOREIGN MONETARY EXCHANGE TRANSACTIONS, BANKING SERVICES IN THE NATURE OF OFFERING LETTERS OF CREDIT, ACTING AS A NOMINATED BANK UNDER LETTERS OF CREDIT, CONFIRMATION OF LETTERS OF CREDIT, PURCHASE OF CLAIMS UNDER LETTERS OF CREDIT, AND ADVICE RELATING TO LETTERS OF CREDIT, SECURITIES UNDERWRITING SERVICES, PROVIDING FINANCIAL INFORMATION VIA GLOBAL COMMUNICATIONS NETWORKS; SECURITY TRANSACTIONS, NAMELY, MORTGAGING OF SECURITIES, SECURITIES BROKERAGE SERVICES; FINANCIAL SERVICES IN THE NATURE OF AN INVESTMENT SECURITY; SECURITY BROKERAGE; ALL OF THE AFOREMENTIONED SERVICES ALSO PROVIDED VIA THE INTERNET; FINANCIAL VALUATION OF PERSONAL PROPERTY AND REAL ESTATE, REAL ESTATE TRUSTEE SERVICES, IN CLASS 36 (U.S. CLS. 100, 101 AND 102).

FOR: TELECOMMUNICATIONS SERVICES, NAMELY, PERSONAL COMMUNICATION SERVICES AND PERSONAL COMMUNICATION SERVICES FOR INSTITUTIONS; PROVIDING MULTI-USER ACCESS TO A GLOBAL COMPUTER INFORMATION NETWORK; E-MAIL SERVICES; INTERNET SERVICE PROVIDER; ACCESS AND RECEPTION SERVICES, NAMELY, PROVIDING ACCESS TO DATABASES, PROVISION OF ACCESS TO ELECTRONIC SITES; ELECTRONIC AND WIRELESS ELECTRONIC TRANSMISSION OF DATA AND MESSAGES; PROVIDING ACCESS TO ELECTRONIC TRADING PLATFORMS; PROVIDING ONLINE FORUMS, PLATFORMS AND CHAT ROOMS FOR TRANSMISSION OF MESSAGES AMONG COMPUTER USERS CONCERNING COMMERCIAL AND FINANCIAL INFORMATION, IN CLASS 38 (U.S. CLS. 100, 101 AND 104).

THE MARK CONSISTS OF STANDARD CHAR-  
ACTERS WITHOUT CLAIM TO ANY PARTICULAR  
FONT, STYLE, SIZE, OR COLOR.

OWNER OF INTERNATIONAL REGISTRATION  
0897601 DATED 8-10-2006, EXPIRES 8-10-2016.

SER. NO. 79-028,528, FILED 8-10-2006.

PRIORITY DATE OF 3-17-2006 IS CLAIMED.

ELI HELLMAN, EXAMINING ATTORNEY

**Int. Cl.: 28**

**Prior U.S. Cls.: 22, 23, 38 and 50**

**United States Patent and Trademark Office**

**Reg. No. 3,468,008**

**Registered July 15, 2008**

**TRADEMARK  
PRINCIPAL REGISTER**

**URBANX**

TOYMONSTER LTD (CHINA COMPANY)  
ROOM AB, F1. 31 JIA LI MANSION  
NO. 2 LANE, 1228 WEST YAN AN ROAD; CHANG-  
NING DISTRICT, SHANGHAI 200052  
CHINA

FOR: TOYS, GAMES AND PLAYTHINGS, NAME-  
LY, PLAYGROUND APPARATUS, NAMELY,  
SWINGS, SEE-SAWS, SLIDES, MONKEY BARS;  
JUNGLE GYMS; TOY VEHICLES; TOY SCOOTERS,  
IN CLASS 28 (U.S. CLS. 22, 23, 38 AND 50).

THE MARK CONSISTS OF STANDARD CHAR-  
ACTERS WITHOUT CLAIM TO ANY PARTICULAR  
FONT, STYLE, SIZE, OR COLOR.

OWNER OF INTERNATIONAL REGISTRATION  
0898072 DATED 4-26-2006, EXPIRES 4-26-2016.

SER. NO. 79-028,678, FILED 4-26-2006.

BERNICE MIDDLETON, EXAMINING ATTORNEY

**Int. Cl.: 9**

**Prior U.S. Cls.: 21, 23, 26, 36 and 38**

**United States Patent and Trademark Office**

**Reg. No. 3,468,009**

**Registered July 15, 2008**

**TRADEMARK  
PRINCIPAL REGISTER**

**MULTI 4**

TECHNOMARK, (FRANCE SOCIÉTÉ À RE-  
SPONSABILITÉ LIMITÉE)  
27 RUE FRANÇOIS GILLET  
F-42400 SAINT-CHAMOND, FRANCE

FOR: SCIENTIFIC, ELECTRICAL APPARATUS  
AND INSTRUMENTS FOR THE INDELIBLE  
MARKING OF INDUSTRIAL PARTS AND TOOLS,  
NAMELY, MARKING APPARATUS USING LASER-  
DRIVEN MICRO-IMPACT TECHNOLOGY, CALI-  
BRATING EQUIPMENT FOR TESTING; COMPU-  
TER SOFTWARE FOR PROGRAMMING,  
DIRECTING AND USING THE GRAINING AND  
MARKING MACHINES AND THE GRAINING AND  
MARKING EQUIPMENTS; COMPUTER SOFT-

WARE FOR MANAGING DATABASE RELATED  
TO MARKING OPERATIONS; COMPUTER SOFT-  
WARE FOR TRANSFERRING MARKING DATA;  
COMPUTER SOFTWARE FOR CREATING LOGOS,  
IN CLASS 9 (U.S. CLS. 21, 23, 26, 36 AND 38).

OWNER OF INTERNATIONAL REGISTRATION  
0898328 DATED 5-29-2006, EXPIRES 5-29-2016.

SER. NO. 79-028,838, FILED 5-29-2006.

LINDA ORNDORFF, EXAMINING ATTORNEY

**Int. Cls.: 1 and 5**

**Prior U.S. Cls.: 1, 5, 6, 10, 18, 26, 44, 46, 51 and 52**

**United States Patent and Trademark Office**

**Reg. No. 3,468,010**

**Registered July 15, 2008**

**TRADEMARK  
PRINCIPAL REGISTER**

**PREDEASY**

SOLVO BIOTECHNOLÓGIAI ZRT.  
KÖZÉP FASOR 52  
H-6726 SZEGED  
HUNGARY

FOR: CHEMICALS USED IN INDUSTRY, SCIENCE AND PHOTOGRAPHY; CHEMICAL PREPARATIONS FOR USE IN AGRICULTURE, HORTICULTURE AND FORESTRY, NAMELY, CHEMICAL PREPARATIONS FOR THE TREATMENT OF SEEDS; UNPROCESSED ARTIFICIAL RESINS, UNPROCESSED PLASTICS; MANURES; FIRE EXTINGUISHING COMPOSITIONS; TEMPERING AND SOLDERING PREPARATIONS; CHEMICAL PRODUCTS FOR THE FRESH-KEEPING AND PRESERVING OF FOODS; TANNING SUBSTANCES, NAMELY, TANNING AGENTS FOR USE IN THE MANUFACTURE OF LEATHER; ADHESIVES FOR GENERAL INDUSTRIAL USE, IN CLASS 1 (U.S. CLS. 1, 5, 6, 10, 26 AND 46).

FOR: PHARMACEUTICAL AND VETERINARY PREPARATIONS, NAMELY, ATPASE ASSAY KITS COMPRISING REAGENTS, A MEMBRANE, SOLUTIONS FOR PREPARING THE MEMBRANE, ASSAY MIX AND DEVELOPER FOR DETECTING THE INTERACTION OF TEST COMPOUNDS WITH SPECIFIC PROTEINS RETAINED IN THE TRANSPORT

MEMBRANE, THE INTERACTIONS BEING ANALYZED TO AID IN THE DEVELOPMENT OF PHARMACEUTICAL AND VETERINARY PREPARATIONS; SANITARY PREPARATIONS FOR MEDICAL PURPOSES, DIETETIC SUBSTANCES ADAPTED FOR MEDICAL PURPOSES, FOOD FOR BABIES; MEDICAL PLASTERS; GAUZE FOR DRESSING; MATERIAL FOR STOPPING TEETH; DENTAL WAX; DISINFECTANTS FOR SANITARY PURPOSES; PREPARATIONS FOR DESTROYING VERMIN; FUNGICIDES AND HERBICIDES, IN CLASS 5 (U.S. CLS. 6, 18, 44, 46, 51 AND 52).

THE MARK CONSISTS OF STANDARD CHARACTERS WITHOUT CLAIM TO ANY PARTICULAR FONT, STYLE, SIZE, OR COLOR.

PRIORITY DATE OF 7-12-2006 IS CLAIMED.

OWNER OF INTERNATIONAL REGISTRATION 0898867 DATED 8-23-2006, EXPIRES 8-23-2016.

SER. NO. 79-029,039, FILED 8-23-2006.

EDWARD NELSON, EXAMINING ATTORNEY

**Int. Cls.: 18 and 25**

**Prior U.S. Cls.: 1, 2, 3, 22, 39 and 41**

**United States Patent and Trademark Office**

**Reg. No. 3,468,011**

**Registered July 15, 2008**

**TRADEMARK  
PRINCIPAL REGISTER**

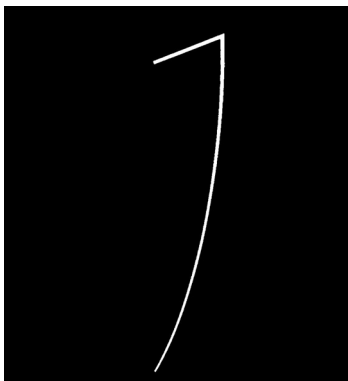

STILAB S.R.L. (ITALY LIMITED LIABILITY CORPORATION)  
VIA FREDIANI SNC  
I-59100 PRATO  
ITALY

FOR: LEATHER AND IMITATION LEATHER; LEATHER AND IMITATION LEATHER PRODUCTS, NAMELY, BELT BAGS AND HIP BAGS, WALLETS, PURSES, TRUNKS AND TRAVELING BAGS, SUITCASES, GARMENT BAGS FOR TRAVEL; VANITY CASES SOLD EMPTY; RUCKSACKS; ANIMAL SKINS, ANIMAL HIDES; UMBRELLAS, PARASOLS AND WALKING STICKS; WHIPS, HARNESSES AND SADDLERY, IN CLASS 18 (U.S. CLS. 1, 2, 3, 22 AND 41).

FOR: CLOTHING, NAMELY, COATS, MANTLES, RAINCOATS, DRESSES, SUITS, SKIRTS, JACKETS, TROUSERS, PANTS, JEANS, WAISTCOATS, SHIRTS, T-SHIRTS, BLOUSES, JERSEYS, SWEA-

TERS, BLAZERS, CARDIGANS, TOPS, STOCKINGS, SOCKS, UNDERWEAR, CORSETS, NIGHT-GOWNS, PAJAMAS, BATHROBES, BATHING SUITS, SUN SUITS, SPORT JACKETS, WIND-RESISTANT JACKETS, ANORAKS, SWEAT SUITS, TIES, NECKTIES, SCARVES, SHAWLS, FOULARDS, CAPS, HATS, GLOVES, SASHES, BELTS; FOOTWEAR., IN CLASS 25 (U.S. CLS. 22 AND 39).

PRIORITY DATE OF 6-23-2006 IS CLAIMED.

OWNER OF INTERNATIONAL REGISTRATION 0900943 DATED 10-2-2006, EXPIRES 10-2-2016.

SER. NO. 79-029,598, FILED 10-2-2006.

SUSAN RICHARDS, EXAMINING ATTORNEY

**Int. Cls.: 18 and 25**

**Prior U.S. Cls.: 1, 2, 3, 22, 39 and 41**

**United States Patent and Trademark Office**

**Reg. No. 3,468,012**

**Registered July 15, 2008**

**TRADEMARK  
PRINCIPAL REGISTER**

# ILARIA NISTRI

STILAB S.R.L. (ITALY LIMITED LIABILITY CORPORATION)  
VIA FREDIANI SNC  
I-59100 PRATO  
ITALY

FOR: LEATHER AND IMITATION LEATHER; LEATHER AND IMITATION LEATHER PRODUCTS, NAMELY, BELT BAGS AND HIP BAGS, WALLETS, PURSES, TRUNKS AND TRAVELING BAGS, SUITCASES, GARMENT BAGS FOR TRAVEL; UNFITTED VANITY CASES; RUCKSACKS; ANIMAL SKINS, ANIMAL HIDES; UMBRELLAS, PARASOLS AND WALKING STICKS; WHIPS, HARNESSES AND SADDLERY, IN CLASS 18 (U.S. CLS. 1, 2, 3, 22 AND 41).

FOR: CLOTHING, NAMELY, COATS, MANTLES, RAINCOATS, DRESSES, SUITS, SKIRTS, JACKETS, TROUSERS, PANTS, JEANS, WAISTCOATS, SHIRTS, T-SHIRTS, BLOUSES, JERSEYS, SWEATERS, BLAZERS, CARDIGANS, TOPS, STOCKINGS, SOCKS, UNDERWEAR, CORSETS, NIGHT-GOWNS,

PAJAMAS, BATHROBES, BATHING SUITS, SUN SUITS, SPORT JACKETS, WIND-RESISTANT JACKETS, ANORAKS, SWEAT SUITS, TIES, NECKTIES, SCARVES, SHAWLS, FOULARDS, CAPS, HATS, GLOVES, SASHES, BELTS; FOOTWEAR., IN CLASS 25 (U.S. CLS. 22 AND 39).

THE MARK CONSISTS OF STANDARD CHARACTERS WITHOUT CLAIM TO ANY PARTICULAR FONT, STYLE, SIZE, OR COLOR.

OWNER OF INTERNATIONAL REGISTRATION 0901175 DATED 7-31-2006, EXPIRES 7-31-2016.

THE NAME ILARIA NISTRI IDENTIFIES A LIVING INDIVIDUAL WHOSE CONSENT IS OF RECORD.

SER. NO. 79-029,969, FILED 7-31-2006.

SUSAN RICHARDS, EXAMINING ATTORNEY



**Int. Cls.: 3 and 24**

**Prior U.S. Cls.: 1, 4, 6, 42, 50, 51 and 52**

**United States Patent and Trademark Office**

**Reg. No. 3,468,013**

**Registered July 15, 2008**

**TRADEMARK  
PRINCIPAL REGISTER**

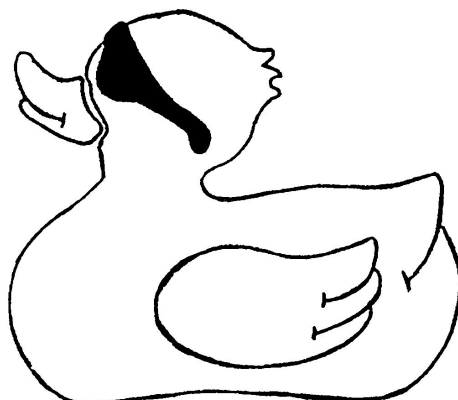

GILLI S.R.L. (ITALY LTD LIAB CO)  
VIA DELLA SPIGA, 5  
I-20121 MILANO  
ITALY

FOR: SOAPS; PERFUMERY; ESSENTIAL OILS;  
COSMETICS; HAIR LOTIONS; DENTIFRICES, IN  
CLASS 3 (U.S. CLS. 1, 4, 6, 50, 51 AND 52).

FOR: TEXTILE AND TEXTILE GOODS, NAME-  
LY, TEXTILE LABELS, TEXTILE NAPKINS, CHE-  
NILLE FABRIC, COTTON FABRIC, FLAX FABRIC;  
TOWELS, SEA AND BEACH TOWELS; TABLE  
CLOTHS NOT OF PAPER; BED SHEETS, BATH  
SHEETS, BEDCOVERS, NAMELY, DUVETS, BED-

SPREADS, BED BLANKETS, AND HOUSEHOLD  
LINEN, IN CLASS 24 (U.S. CLS. 42 AND 50).

PRIORITY DATE OF 7-14-2006 IS CLAIMED.

OWNER OF INTERNATIONAL REGISTRATION  
0903240 DATED 10-9-2006, EXPIRES 10-9-2016.

THE MARK CONSISTS OF A PICTURE OF A  
STYLIZED DUCK WITH SUNGLASSES.

SER. NO. 79-030,844, FILED 10-9-2006.

LEIGH LOWRY, EXAMINING ATTORNEY

**Int. Cl.: 6**

**Prior U.S. Cls.: 2, 12, 13, 14, 23, 25 and 50**

**Reg. No. 3,468,014**

**United States Patent and Trademark Office**

**Registered July 15, 2008**

**TRADEMARK  
PRINCIPAL REGISTER**

C.D. WÄLZHOLZ-BROCKHAUS GMBH (FED  
REP GERMANY GMBH)  
FELDMÜHLENSTR. 55  
58093 HAGEN  
FED REP GERMANY

FOR: COMMON METALS AND THEIR ALLOYS, NAMELY, STEEL, STEEL MATERIALS AND STEEL BASED ALLOYS, UNALLOYED CARBON STEEL, ALLOYED CARBON STEEL, MAGNETIC SOFT IRON, MICRO ALLOYED FINE GRAIN STEEL, COLD ROLLED STEEL, HARDENED AND TEMPERED STEEL STRIPS, TEXTURE ROLLED STEEL STRIPS, ELECTRO MAGNETIC STEEL MATERIALS, COLD ROLLED LOW CARBON STEEL STRIP, NARROW STEEL STRIP; COMMON METALS, UNWROUGHT AND SEMI WROUGHT, NAMELY, STEEL AND STEEL BASED ALLOYS, UNALLOYED CARBON STEEL, ALLOYED CARBON STEEL, MAGNETIC SOFT IRON, MICRO ALLOYED FINE GRAIN STEEL, COLD ROLLED STEEL, HARDENED AND TEMPERED STEEL STRIPS, TEXTURE ROLLED STEEL STRIPS, ELECTRO MAGNETIC STEEL MATERIALS, COLD ROLLED LOW CARBON STEEL STRIP, NARROW STEEL STRIP; WIRES OF METAL AND METAL ALLOYS NOT FOR ELECTRICAL PURPOSES; STRIPS MADE OF METAL FOR FURTHER MANUFACTURE, NAMELY, PULLING STRIPS AND PRESSURE STRIPS FOR SKIS, STRIPS FOR THE CHAIN INDUSTRY PARTICULARLY BUSHINGS, ROLLERS, LINKS, STRIPS FOR WINDSHIELD WIPERS, STRIPS FOR CONSUMER ITEMS, STRIPS FOR PACKAGING PURPOSES, STRIPS FOR CONSTRUCTION PARTS AND PARTICULARLY FOR FORM PARTS AND PRECISION PARTS, STRIPS FOR FURNITURE PARTS AND FURNITURE MOUNTINGS, STRIPS FOR OFFICE SUPPLIES, STRIPS FOR HINGES, STRIPS FOR TABLE LEGS AND CHAIR LEGS,

STRIPS FOR ELECTROTECHNICAL SWITCH-GEARS AND SAFEGUARDING ASSEMBLIES, STRIPS FOR BICYCLE BELLS, STRIPS FOR TRANSMISSION LAMELLAE, STRIPS FOR WELDING RODS, STRIPS MADE OF SPRING MATERIALS, STRIPS FOR ROCKER LEVERS, STRIPS FOR DIAPHRAGM SPRINGS, STRIPS FOR SAW BLADES, STRIPS FOR FLAT SPRINGS, STRIPS FOR SEAT SLIDES, STRIPS FOR RETRACTOR SPRINGS; PROFILES MADE FROM METAL FOR FURTHER MANUFACTURE, NAMELY, PROFILES FOR SKI EDGES AND SNOWBOARD EDGES, PROFILES FOR RETAINING RINGS, PROFILES FOR SAW BLADES, PROFILES FOR STEEL EDGES, PROFILES FOR GUIDE RINGS, PROFILES FOR CHAIN ELEMENTS AND ESPECIALLY FOR CAMSHAFT DRIVE CHAINS, PROFILES FOR SLEEVES, PROFILES FOR WIRE GOODS, PROFILES FOR WELDINGS RODS, PROFILES FOR PROFILED SPRINGS, PROFILES FOR SEAT SLIDES; IRON STRIP; BAR IRON; SHEET IRON; IRON PIPES; STEEL, UNWROUGHT AND SEMI-WROUGHT; STEEL ALLOYS; STEEL STRIP; SHEET STEEL, ESPECIALLY SHEET STEEL MADE OF STEEL AND STEEL MATERIALS, SHEET STEEL OF DIFFERENT COATINGS AND SURFACE QUALITIES ON THE TWO SIDES OF THE SHEET STEEL, SHEET STEEL FOR AUTOMOBILE PARTS, BODYWORK PANELS, NAMELY, BLANKS FOR METAL WORKING PARTS; STEEL WIRE; STEEL PIPES AND TUBES; CAST STEEL; KNIFE STEEL; MAGNET STEEL; STAINLESS STEEL; SECTIONAL STEEL; BAR STEEL; IRON GOODS AND METAL GOODS, NAMELY, SHEET METAL AND METAL STRIPS FOR USE IN THE CONSTRUCTION OF SAW BLADES, LAWNMOWERS, SECATEURS, HEDGE-CLIPPERS, SEAT BELTS, GAS-TYPE SHOCK ABSORBERS, VALVES FOR COMPRESSORS, WIND-SCREEN WIPERS, VACUUM CLEANERS, DOG LEASHES, PARTS FOR CARS, SEAT SLIDES, AND

PARTS FOR GEARS; SPRINGS OF METAL; SPRING WIRE; SHEET STEEL IN THE FORM OF ELECTRICAL STEEL; DYNAMO SHEETS IN THE NATURE OF METAL SHEETS FOR FURTHER MANUFACTURE, NAMELY, SHEETS FOR ENERGY CONVERSION IN ELECTRICAL DRIVES AND ENGINES, SHEETS FOR ENERGY CONVERSION IN ENERGY SUPPLY EQUIPMENT, POLE PLATES AND SHEETS FOR ELECTROTECHNICAL USE WITH COATINGS, SHEETS WITH HIGH PERMEABILITY; METAL FOILS, IN CLASS 6 (U.S. CLS. 2, 12, 13, 14, 23, 25 AND 50).

PRIORITY DATE OF 12-24-2005 IS CLAIMED.

OWNER OF INTERNATIONAL REGISTRATION 0903890 DATED 6-23-2006, EXPIRES 6-23-2016.

SER. NO. 79-031,050, FILED 6-23-2006.

KRISTINA MORRIS, EXAMINING ATTORNEY

**Int. Cl.: 6**

**Prior U.S. Cls.: 2, 12, 13, 14, 23, 25 and 50**

**Reg. No. 3,468,015**

**United States Patent and Trademark Office**

**Registered July 15, 2008**

**TRADEMARK  
PRINCIPAL REGISTER**

**TRIWAEEL**

C.D. WÄLZHOLZ-BROCKHAUS GMBH (FED  
REP GERMANY GESELLSCHAFT MIT BES-  
CHRÄNKTER HAFTUNG (GMBH))  
FELDMÜHLENSTR. 55  
58093 HAGEN  
FED REP GERMANY

FOR: COMMON METALS AND THEIR ALLOYS, NAMELY, STEEL, STEEL MATERIALS AND STEEL BASED ALLOYS, UNALLOYED CARBON STEEL, ALLOYED CARBON STEEL, MAGNETIC SOFT IRON, MICRO ALLOYED FINE GRAIN STEEL, COLD ROLLED STEEL, HARDENED AND TEMPERED STEEL STRIPS, TEXTURE ROLLED STEEL STRIPS, ELECTRO MAGNETIC STEEL, COLD ROLLED LOW CARBON STEEL STRIP, NARROW STEEL STRIP; COMMON METALS, UNWROUGHT AND SEMI WROUGHT, NAMELY, STEEL AND STEEL BASED ALLOYS, UNALLOYED CARBON STEEL, ALLOYED CARBON STEEL, MAGNETIC SOFT IRON, MICRO ALLOYED FINE GRAIN STEEL, COLD ROLLED STEEL, HARDENED AND TEMPERED STEEL STRIPS, TEXTURE ROLLED STEEL STRIPS, ELECTRO MAGNETIC STEEL, COLD ROLLED LOW CARBON STEEL STRIP, NARROW STEEL STRIP; WIRES OF METAL AND METAL ALLOYS; METAL STRIPS FOR FURTHER MANUFACTURE; PROFILES MADE FROM METAL, NAMELY, METAL PROFILES IN THE NATURE OF ELONGATED SECTIONAL METAL PARTS FOR FURTHER MANUFACTURE AND SECTION SHAPED METAL PARTS FOR FURTHER MANUFACTURE; IRON STRIP FOR FURTHER MANU-

FACTURE; BAR IRON FOR FURTHER MANUFACTURE; SHEET IRON; IRON PIPES; STEEL, UNWROUGHT AND SEMI-WROUGHT; STEEL ALLOYS; STEEL STRIP; SHEET STEEL, NAMELY, SHEET STEEL MADE OF STEEL AND STEEL MATERIALS, SHEET STEEL OF DIFFERENT COATINGS AND SURFACE QUALITIES ON THE TWO SIDES OF THE SHEET STEEL, AND SHEET STEEL FOR USE AS A RAW MATERIAL FOR AUTOMOBILE PARTS; BODYWORK PANELS, NAMELY, METAL PANELS FOR USE AS A RAW MATERIAL FOR METAL WORKING PARTS; STEEL WIRE; STEEL PIPES AND TUBES; CAST STEEL; BLADE STEEL; MAGNET STEEL; STAINLESS STEEL; SECTIONAL STEEL; BAR STEEL; SPRINGS OF METAL; SPRING WIRE; SHEET STEEL IN THE FORM OF ELECTRICAL STEEL; METAL SHEETS, PLATES, AND POLES FOR FURTHER MANUFACTURE; METAL FOILS, IN CLASS 6 (U.S. CLS. 2, 12, 13, 14, 23, 25 AND 50).

PRIORITY DATE OF 4-4-2006 IS CLAIMED.

OWNER OF INTERNATIONAL REGISTRATION  
0903991 DATED 9-21-2006, EXPIRES 9-21-2016.

SER. NO. 79-031,118, FILED 9-21-2006.

REBECCA POVARCHUK, EXAMINING ATTORNEY

**Int. Cls.: 9, 35, 37 and 41**

**Prior U.S. Cls.: 21, 23, 26, 36, 38, 100, 101, 102, 103,  
106 and 107**

**Reg. No. 3,468,016**

**United States Patent and Trademark Office**

**Registered July 15, 2008**

**TRADEMARK  
SERVICE MARK  
PRINCIPAL REGISTER**

# **SPONDER**

KAROLIN MACHINE TOOL AB (SWEDEN JOINT  
STOCK COMPANY)  
KUNGSGATEN 64, 4TR  
SE-101 20 STOCKHOLM  
SWEDEN

FOR: COMPUTER PROGRAMS USED TO MONI-  
TOR THE STATUS OF INDUSTRIAL ROBOTS AND  
MACHINERY; INDUSTRIAL COMPUTERS AND  
PLC (PROGRAM LOGIC COMPUTERS); CONTROL  
APPARATUS AND INSTRUMENTS FOR THE  
TRANSMISSION AND RECEPTION OF MESSAGES  
AND DATA, NAMELY, TELECOMMUNICATIONS  
TRANSMITTERS, SATELLITE TRANSMITTERS  
AND RECEIVERS, TRANSMITTERS OF ELECTRO-  
NIC SIGNALS, DIGITAL TRANSMITTERS, OPTI-  
CAL TRANSMITTERS, ELECTRONIC  
TRANSMITTERS AND RECEIVERS, AND WEB  
CAMERAS FOR SENDING AND COLLECTING IN-  
FORMATION AND DATA CONCERNING INDUS-  
TRIAL PROCESSES, IN CLASS 9 (U.S. CLS. 21, 23, 26,  
36 AND 38).

FOR: PROVIDING STATISTICAL INFORMA-  
TION IN CONNECTION WITH THE SUPPORT,  
REPAIR, MAINTENANCE AND INSTALLATION  
OF ROBOTS AND MACHINES FOR BUSINESSES

OR COMMERCIAL PURPOSES, IN CLASS 35 (U.S.  
CLS. 100, 101 AND 102).

FOR: REPAIR, MAINTENANCE AND INSTALLA-  
TION OF ROBOTS AND MACHINES; PROVISION  
OF INFORMATION IN THE FIELD OF REPAIR,  
MAINTENANCE AND INSTALLATION OF RO-  
BOTS AND MACHINES, IN CLASS 37 (U.S. CLS.  
100, 103 AND 106).

FOR: EDUCATION AND TRAINING SERVICES,  
NAMELY, CLASSES, SEMINARS, WORKSHOPS,  
TUTORIAL SESSIONS IN THE FIELDS OF REPAIR,  
MAINTENANCE AND INSTALLATION OF RO-  
BOTS AND MACHINES, IN CLASS 41 (U.S. CLS.  
100, 101 AND 107).

PRIORITY DATE OF 3-13-2006 IS CLAIMED.

OWNER OF INTERNATIONAL REGISTRATION  
0904375 DATED 9-4-2006, EXPIRES 9-4-2016.

SER. NO. 79-031,261, FILED 9-4-2006.

ALICE BENMAMAN, EXAMINING ATTORNEY

**Int. Cls.: 7, 8 and 37**

**Prior U.S. Cls.: 13, 19, 21, 23, 28, 31, 34, 35, 44, 100,  
103 and 106**

**Reg. No. 3,468,017**

**United States Patent and Trademark Office**

**Registered July 15, 2008**

**TRADEMARK  
SERVICE MARK  
PRINCIPAL REGISTER**

# QuickPlate

HAWEKA AG (FED REP GERMANY AKTIEN-  
GESELLSCHAFT)  
KOKENHORSTSTRABE 4  
30938 BURGWEDEL, FED REP GERMANY

FOR: MACHINES FOR TIRE ASSEMBLY, HY-  
DRAULIC LIFT TABLES FOR TIRE ASSEMBLY;  
MACHINES FOR DYNAMIC BALANCING AND  
ASSEMBLY OF TIRES AND STRUCTURAL PARTS  
THEREOF; MACHINE TOOLS FOR TIRE ASSEM-  
BLY, MOTORS FOR MACHINES FOR DYNAMIC  
BALANCING AND ASSEMBLY OF TIRES; SHAFT  
COUPLINGS, NOT FOR LAND VEHICLES, FOR  
TRANSMISSION OF POWER AS PARTS OF MA-  
CHINES FOR DYNAMIC BALANCING AND AS-  
SEMBLY OF TIRES, IN CLASS 7 (U.S. CLS. 13, 19, 21,  
23, 31, 34 AND 35).

FOR: HAND OPERATED TOOLS FOR DYNAMIC  
BALANCING AND FOR ASSEMBLY OF TIRES,  
NAMELY, CLAMPS, IN CLASS 8 (U.S. CLS. 23, 28  
AND 44).

FOR: DYNAMIC BALANCING AND INSTALLA-  
TION OF WHEELS; REPAIR AND RETREADING  
OF TIRES; REPAIRING OF TIRES; REMOLDING  
AND VULCANIZING OF TIRES FOR TIRE REPAIR;  
TIRE ROTATING AND BALANCING, IN CLASS 37  
(U.S. CLS. 100, 103 AND 106).

THE MARK CONSISTS OF STANDARD CHAR-  
ACTERS WITHOUT CLAIM TO ANY PARTICULAR  
FONT, STYLE, SIZE, OR COLOR.

OWNER OF INTERNATIONAL REGISTRATION  
0904497 DATED 8-3-2006, EXPIRES 8-3-2016.

SER. NO. 79-031,300, FILED 8-3-2006.

KAPIL BHANOT, EXAMINING ATTORNEY

**Int. Cls.: 9, 16 and 35**

**Prior U.S. Cls.: 2, 5, 21, 22, 23, 26, 29, 36, 37, 38, 50,  
100, 101 and 102**

**Reg. No. 3,468,018**

**United States Patent and Trademark Office**

**Registered July 15, 2008**

**TRADEMARK  
SERVICE MARK  
PRINCIPAL REGISTER**



RUDOLF BENECKE (FED REP GERMANY IN-  
DIVIDUAL)  
LUITPOLDPLATZ 10-12  
95444 BAYREUTH  
FED REP GERMANY

FOR: CHECKING APPARATUS AND INSTRU-  
MENTS, NAMELY, ACCESS CONTROL SYSTEMS  
FOR CAR PARKS OR PARKING LOTS; AUTOMAT-  
IC VENDING MACHINES; ELECTRONIC PARKING  
LOT TICKET DISPENSERS; DATA PROCESSING  
EQUIPMENT, NAMELY, DATA PROCESSORS,  
SCANNERS, OPTICAL READERS, MAGNETIC EN-  
CODERS, COMPUTER SOFTWARE AND HARD-  
WARE FOR DISSEMINATING ADVERTISING FOR  
OTHERS, NAMELY, TO CONTROL THE AUTO-  
MATIC DISTRIBUTION OF ADVERTISING FLY-  
ERS, ADVERTISING BROCHURES AND  
ADVERTISING INFORMATION LEAFLETS VIA  
AUTOMATIC VENDING MACHINES; COMPUTER  
PROGRAMS FOR THE ENABLING OF ACCESS OR  
ENTRANCE CONTROL; AND COMPUTERS , IN  
CLASS 9 (U.S. CLS. 21, 23, 26, 36 AND 38).

FOR: PAPER, CARDBOARD; GOODS MADE  
FROM PAPER AND CARDBOARD INCLUDED IN

THIS CLASS, NAMELY, BLANK OR PARTIALLY  
PRINTED PAPER LABELS; PRINTED MATTER,  
NAMELY, PRINTED PAPER LABELS, ADVERTIS-  
ING SIGNS OF PAPER OR CARDBOARD, IN CLASS  
16 (U.S. CLS. 2, 5, 22, 23, 29, 37, 38 AND 50).

FOR: ADVERTISING, IN CLASS 35 (U.S. CLS. 100,  
101 AND 102).

PRIORITY DATE OF 3-21-2006 IS CLAIMED.

OWNER OF INTERNATIONAL REGISTRATION  
0904603 DATED 9-19-2006, EXPIRES 9-19-2016.

NO CLAIM IS MADE TO THE EXCLUSIVE  
RIGHT TO USE "ADVERTISING", APART FROM  
THE MARK AS SHOWN.

SER. NO. 79-031,348, FILED 9-19-2006.

SHARON MEIER, EXAMINING ATTORNEY

**Int. Cl.: 3**

**Prior U.S. Cls.: 1, 4, 6, 50, 51 and 52**

**United States Patent and Trademark Office**

**Reg. No. 3,468,019**

**Registered July 15, 2008**

**TRADEMARK  
PRINCIPAL REGISTER**

The logo consists of the word "MIU" in a bold, stylized, black font, followed by a space and then "MIU" again in the same font. The letters are thick and blocky, with a slightly irregular, hand-drawn appearance.

PRADA S.A. (LUXEMBOURG SOCIETE ANON-  
YME)  
23, RUE ALDRINGEN  
L-1118 LUXEMBOURG, LUXEMBOURG

OWNER OF INTERNATIONAL REGISTRATION  
0686197 DATED 12-2-1997, EXPIRES 12-2-2017.

FOR: COSMETICS, NAMELY, DAY AND NIGHT  
CREAMS, SKIN CLEANSING LOTIONS AND  
CREAMS FOR THE FACE AND BODY, BUBBLE  
BATHS; SHAVING FOAM, AFTER-SHAVE, MAKE-  
UP, FOUNDATION, NAIL VARNISH, PERSONAL  
DEODORANTS FOR MEN AND WOMEN, HAND  
SOAPS AND BABY SOAPS, SHAMPOOS, HAIR  
RINSES; PERFUMES, EAU-DE-TOILETTE AND ES-  
SENTIAL OILS FOR PERSONAL USE FOR MEN  
AND WOMEN; HAIR CARE PRODUCTS, NAMELY,  
HAIR SPRAYS, IN CLASS 3 (U.S. CLS. 1, 4, 6, 50, 51  
AND 52).

OWNER OF U.S. REG. NOS. 2,378,349, 3,216,018  
AND OTHERS.

THE NAME "MIU MIU" IDENTIFIES THE LIV-  
ING INDIVIDUAL MIUCCIA PRADA WHOSE CON-  
SENT IS OF RECORD.

SER. NO. 79-031,517, FILED 4-3-2006.

LEIGH LOWRY, EXAMINING ATTORNEY



**Int. Cl.: 42**

**Prior U.S. Cls.: 100 and 101**

**United States Patent and Trademark Office**

**Reg. No. 3,468,020**

**Registered July 15, 2008**

**SERVICE MARK  
PRINCIPAL REGISTER**

# Health Prism

GENEOS OY (FINLAND JOINT STOCK COMPANY)  
TUKHOLMANKATU 2, 2. KRS  
FI-00250 HELSINKI  
FINLAND

FOR: MEDICAL RESEARCH, PHARMACEUTICAL DEVELOPMENT SERVICES IN THE FIELDS OF MOLECULAR MEDICINE, CLINICAL STUDIES AND HEALTH CARE, NAMELY, SCIENTIFIC RESEARCH CONSULTING FOR IMPROVED CLINICAL TRIAL DESIGN; PHARMACEUTICAL RESEARCH IN THE FIELD OF MOLECULAR MEDICINE FEATURING MODELING OF CLINICAL TRIALS; MEDICAL RESEARCH THAT ANALYZES DATA TO IDENTIFY PATTERNS ACROSS PATIENT GROUPS OR DISEASE PROGRESSION; MEDICAL RESEARCH, NAMELY, IDENTIFICATION AND VALIDATION OF DISEASE CHARACTERISTICS IN SPECIFIC GENE BIOMARKERS, PROTEIN BIOMARKERS AND METABOLITE BIOMARKERS FOR USE IN DRUG DEVELOPMENT, MOLECULAR DIAGNOSTICS AND IMPROVED PATIENT CARE; MEDICAL RESEARCH FEATURING THE DISCOVERY AND VALIDATION OF

BIOMARKERS FOR THE ASSOCIATION WITH DISEASE PHENOTYPE, NAMELY, VALIDATING THE CLINICAL RELEVANCE OF BIOMARKERS AND CHARACTERIZING NEW BIOMARKERS, IN CLASS 42 (U.S. CLS. 100 AND 101).

THE MARK CONSISTS OF STANDARD CHARACTERS WITHOUT CLAIM TO ANY PARTICULAR FONT, STYLE, SIZE, OR COLOR.

PRIORITY DATE OF 4-8-2005 IS CLAIMED.

OWNER OF INTERNATIONAL REGISTRATION 0905158 DATED 9-9-2005, EXPIRES 9-9-2015.

NO CLAIM IS MADE TO THE EXCLUSIVE RIGHT TO USE "HEALTH" , APART FROM THE MARK AS SHOWN.

SER. NO. 79-031,597, FILED 9-9-2005.

ROBERT STRUCK, EXAMINING ATTORNEY

**Int. Cl.: 33**

**Prior U.S. Cls.: 47 and 49**

**United States Patent and Trademark Office**

**Reg. No. 3,468,021**

**Registered July 15, 2008**

**TRADEMARK  
PRINCIPAL REGISTER**

**MORGANTE**

MORGANTE S.R.L. (ITALY SOCIETA A RE-  
SPONSABILITA LIMITATA)  
CONTRADA RACALMARE  
I-92020 GROTTA (AG)  
ITALY

FOR: ALCOHOLIC BEVERAGES EXCEPT BEER,  
NAMELY, WINES AND LIQUEURS, IN CLASS 33  
(U.S. CLS. 47 AND 49).

THE MARK CONSISTS OF STANDARD CHAR-  
ACTERS WITHOUT CLAIM TO ANY PARTICULAR  
FONT, STYLE, SIZE, OR COLOR.

OWNER OF INTERNATIONAL REGISTRATION  
0905654 DATED 10-31-2006, EXPIRES 10-31-2016.

SEC. 2(F).

SER. NO. 79-031,770, FILED 10-31-2006.

FLORENTINA BLANDU, EXAMINING ATTORNEY

Int. Cls.: 29, 30 and 32

Prior U.S. Cls.: 45, 46 and 48

United States Patent and Trademark Office

Reg. No. 3,468,022

Registered July 15, 2008

TRADEMARK  
PRINCIPAL REGISTER



COMPAGNIE GERVAIS DANONE (FRANCE SOCIÉTÉ ANONYME)

17, BOULEVARD HAUSSMANN

F-75009 PARIS

FRANCE

FOR: DRIED, PRESERVED AND/OR COOKED FRUITS AND VEGETABLES; COMPOTES, JAMS, FRUIT COULIS, JELLIES; SOUPS; FOOD PRESERVES MAINLY CONSISTING OF MEAT, ESPECIALLY HAM, POULTRY AND/OR GAME, FISH; PREPARED, DEHYDRATED, COOKED, PRESERVED AND DEEP-FROZEN DISHES, MAINLY CONSISTING OF MEAT, ESPECIALLY HAM, POULTRY AND/OR GAME, FISH; SAVORY OR SWEET, PLAIN OR FLAVORED FRUIT BASED AND VEGETABLE BASED SNACK FOODS; POTATO CRISPS, DRIED FRUIT MIXES, PREPARED WALNUTS, HAZELNUTS, PEANUTS AND CASHEWS; COCKTAIL SNACKS MADE OF CHARCUTERIE; MILK, MILK POWDER, FLAVORED JELLIFIED MILKS AND WHIPPED DAIRY TOPPING; DAIRY PRODUCTS EXCLUDING ICE CREAM, ICE MILK AND FROZEN YOGURT; FRESH CREAM, BUTTER, CHEESE SPREADS, CHEESES, RIPENED CHEESES, MOULD-RIPENED CHEESES, FRESH UNRIPENED CHEESES AND PICKLED CHEESES, SOFT WHITE CHEESE, PLAIN OR AROMATIZED FRESH CHEESE IN PASTE OR LIQUID FIRM; BEVERAGES MAINLY CONSISTING OF MILK OR MILK PRODUCTS, MILK BEVERAGES, WITH MILK PREDOMINATING, MILK BEVERAGES CONTAINING

FRUITS; FLAVORED FERMENTED MILK, IN CLASS 29 (U.S. CL. 46).

FOR: COFFEE, TEA, COCOA, CHOCOLATE, COFFEE-BASED BEVERAGES, COCOA-BASED BEVERAGES, CHOCOLATE-BASED BEVERAGES, RICE, PUFFED RICE, TAPIOCA; FLOURS, SWEET OR SAVORY TARTS, SWEET OR SAVORY PIES, PIZZAS; PLAIN, FLAVORED AND/OR FILLED PASTA, BREAKFAST CEREALS, BISCUITS MADE FROM CEREALS; PREPARED DISHES MAINLY CONTAINING PASTA; PREPARED DISHES ESSENTIALLY CONSISTING OF PASTRY; BREAD, RUSKS, SWEET BISCUITS; SAVORY BISCUITS; WAFERS; CAKES; PASTRIES; WAFFLES; SAVORY OR SWEET COCKTAIL SNACKS CONTAINING BAKING DOUGH, BISCUIT MIXTURE OR PASTRY MIXTURE; ALL THESE GOODS BEING PLAIN AND/OR TOPPED AND/OR FILLED AND/OR FLAVORED; CONFECTIONERY, NAMELY, PASTILLES; EDIBLE ICES, ICE CREAMS ESSENTIALLY MADE WITH YOGHURT, ICE-CREAMS, SORBET; FROZEN YOGURT, FLAVORED FROZEN WATER; HONEY, SALT, MUSTARD, VINEGAR, SAUCES, SWEET SAUCES, PASTA SAUCES, SPICES, IN CLASS 30 (U.S. CL. 46).

FOR: STILL WATER, SPARKLING WATER, MINERAL WATER; FRUIT OR VEGETABLE JUICES, BEVERAGES MADE WITH FRUITS OR VEGETABLES; NON-ALCOHOLIC FRUIT OR VEGETABLE EXTRACTS USED IN THE PREPARATION OF BEVERAGES; GINGER BEER; LEMONADES, SOFT

DRINKS, FROZEN FRUIT-BASED SORBET BEVERAGES; SYRUPS FOR BEVERAGES, NON-ALCOHOLIC BEVERAGES CONTAINING LACTIC FERMENTS, IN CLASS 32 (U.S. CLS. 45, 46 AND 48).

PRIORITY DATE OF 4-26-2006 IS CLAIMED.

OWNER OF INTERNATIONAL REGISTRATION 0906331 DATED 10-13-2006, EXPIRES 10-13-2016.

THE COLOR(S) BLUE, GREEN, YELLOW, ORANGE, FUCHSIA AND VIOLET IS/ARE CLAIMED AS A FEATURE OF THE MARK.

THE BACK IS BLUE, THE CENTRAL BACK IS WHITE, THE HALATION BETWEEN THE TWO BACKS IS LIGHT BLUE DEGRADED TO WHITE, THE BACK OF THE "7" IS DARK BLUE, THE PERSONAGES IN THE "7" ARE BLUE; THE ARC OF CIRCLE IS COMPOSED OF THE RAINBOW'S COLORS NAMELY FROM LEFT TO RIGHT, BLUE, GREEN, YELLOW, ORANGE, FUCHSIA, VIOLET AND DARK BLUE.

SER. NO. 79-032,036, FILED 10-13-2006.

DOMINIC J. FERRAIUOLO, EXAMINING ATTORNEY

**Int. Cl.: 42**

**Prior U.S. Cls.: 100 and 101**

**United States Patent and Trademark Office**

**Reg. No. 3,468,023**

**Registered July 15, 2008**

**SERVICE MARK  
PRINCIPAL REGISTER**

**SOYAK**

SOYAK INSAAT; VE TICARET ANONIM SIRKETI (TURKEY JOINT STOCK COMPANY)

BÜYÜKDERE CAD. NO. 38

MECIDIYEKÖY, ISTANBUL

TURKEY

THE MARK CONSISTS OF STANDARD CHARACTERS WITHOUT CLAIM TO ANY PARTICULAR FONT, STYLE, SIZE, OR COLOR.

OWNER OF INTERNATIONAL REGISTRATION 0906428 DATED 9-14-2005, EXPIRES 9-14-2015.

FOR: ENGINEERING ADVISORY SERVICES; ARCHITECTURAL SERVICES, NAMELY, CONSULTING SERVICES IN THE NATURE OF ARCHITECTURAL DESIGN; URBAN PLANNING SERVICES; AND QUALITY CONTROL SERVICES FOR OTHERS, IN CLASS 42 (U.S. CLS. 100 AND 101).

THE FOREIGN WORDING IN THE MARK TRANSLATES INTO ENGLISH AS "NOTHING".

SER. NO. 79-032,071, FILED 9-14-2005.

SHARON MEIER, EXAMINING ATTORNEY

**Int. Cls.: 9, 35 and 42**

**Prior U.S. Cls.: 21, 23, 26, 36, 38, 100, 101 and 102**

**Reg. No. 3,468,024**

**United States Patent and Trademark Office**

**Registered July 15, 2008**

**TRADEMARK  
SERVICE MARK  
PRINCIPAL REGISTER**

**TD BID**

TRADEDOUBLER AKTIEBOLAG (SWEDEN  
LIMITED COMPANY)  
BAMHUSGATAN 12  
SE-111 23 STOCKHOLM  
SWEDEN

FOR: OPERATING SYSTEM PROGRAMS AND  
COMPUTER PROGRAMS FOR TRACKING AND  
ANALYZING ONLINE SURFING AND PURCHAS-  
ING ACTIVITIES, IN CLASS 9 (U.S. CLS. 21, 23, 26, 36  
AND 38).

FOR: COMPILATION AND INPUT OF INFOR-  
MATION IN COMPUTERIZED DATABASES; PRO-  
FESSIONAL BUSINESS CONSULTANCY; ONLINE  
ADVERTISING; PURCHASING ADVERTISING  
SPACE FOR OTHERS ON MEDIA, NAMELY, ON  
DIGITAL MEDIA; BUSINESS CONSULTANCY AND  
MARKET RESEARCH WITH REGARD TO DIFFER-  
ENT MEDIA; PLANNING SERVICES, NAMELY,  
ADVISING BUSINESSES IN THE SELECTION OF  
MEDIA FOR PROMOTING THEIR BUSINESS AND  
ACQUIRING ADVERTISING SPACE IN THE RE-  
COMMENDED MEDIA; ADVERTISING PROMO-  
TION AND MARKETING; SALES PROMOTION;  
PUBLICATION OF PUBLICITY TEXTS; PRODUC-  
TION OF ADVERTISEMENTS; CUSTOMER RELA-  
TIONSHIP MANAGEMENT; CONDUCTING  
MARKET RESEARCH AND MARKET ANALYSIS;  
RESEARCH AND INFORMATION RELATING TO  
BUSINESS AFFAIRS, ADVERTISING AND MAR-  
KETING; STATISTICAL ANALYSIS AND COMPI-  
LATION OF STATISTICAL RESULTS FOR  
BUSINESS PURPOSES; BUSINESS ADMINISTRA-  
TION; PROVIDING INFORMATION RELATING  
TO THE AFORESAID SERVICES; PROVISION OF  
THE AFORESAID SERVICES ONLINE FROM A

COMPUTER DATABASE OR THE INTERNET; AD-  
VERTISING AND MARKETING IN THE NATURE  
OF COMPILING ADVERTISEMENTS FOR USE AS  
HOMEPAGES ON THE INTERNET, NAMELY, AD  
SERVING; ADVISORY AND CONSULTANCY SER-  
VICES IN THE FIELD OF DIGITAL ADVERTISING  
AND MARKETING, IN CLASS 35 (U.S. CLS. 100, 101  
AND 102).

FOR: COMPUTER PROGRAMMING IN THE  
FIELD OF DIGITAL ADVERTISING AND MAR-  
KETING; MAINTENANCE AND UPDATING OF  
COMPUTER PROGRAMS AND DESIGN OF COM-  
PUTER PROGRAMS FOR PERFORMANCE-BASED  
MARKETING AND SALES ON THE INTERNET,  
AND FOR SYSTEMS FOR ADMINISTERING IN-  
TERNET COOPERATION, INTERNET SALES, TRA-  
DEMARK AND MARKETING ACTIVITIES;  
COMPUTER SYSTEMS ANALYSIS, NAMELY,  
TRACKING AND MEASURING INTERNET ACTIV-  
ITIES, DEVELOPMENT AND PROGRAMMING  
WITH REGARD TO ONLINE MARKETING AND  
SALES SOLUTIONS WHEREBY MARKETING AC-  
TIVITIES CAN BE GEARED TO CURRENT PRO-  
DUCT SALES, IN CLASS 42 (U.S. CLS. 100 AND 101).

PRIORITY DATE OF 9-27-2006 IS CLAIMED.

OWNER OF INTERNATIONAL REGISTRATION  
0906493 DATED 10-25-2006, EXPIRES 10-25-2016.

SER. NO. 79-032,095, FILED 10-25-2006.

JAMES STEIN, EXAMINING ATTORNEY

**Int. Cls.: 9, 35 and 42**

**Prior U.S. Cls.: 21, 23, 26, 36, 38, 100, 101 and 102**

**United States Patent and Trademark Office**

**Reg. No. 3,468,025**

**Registered July 15, 2008**

**TRADEMARK  
SERVICE MARK  
PRINCIPAL REGISTER**

# TD TOOLBOX

TRADEDOUBLER AKTIEBOLAG (SWEDEN  
LIMITED COMPANY)  
BAMHUSGATAN 12  
SE-111 23 STOCKHOLM  
SWEDEN

FOR: OPERATING SYSTEM PROGRAMS AND  
COMPUTER PROGRAMS FOR TRACKING AND  
ANALYZING ONLINE SURFING AND PURCHAS-  
ING ACTIVITIES, IN CLASS 9 (U.S. CLS. 21, 23, 26, 36  
AND 38).

FOR: COMPILATION AND INPUT OF INFOR-  
MATION IN COMPUTERIZED DATABASES; PRO-  
FESSIONAL BUSINESS CONSULTANCY; ONLINE  
ADVERTISING; PURCHASING ADVERTISING  
SPACE FOR OTHERS ON MEDIA, NAMELY, ON  
DIGITAL MEDIA; BUSINESS CONSULTANCY AND  
MARKET RESEARCH WITH REGARD TO DIFFER-  
ENT MEDIA; PLANNING SERVICES, NAMELY,  
ADVISING BUSINESSES IN THE SELECTION OF  
MEDIA FOR PROMOTING THEIR BUSINESS AND  
ACQUIRING ADVERTISING SPACE IN THE RE-  
COMMENDED MEDIA; ADVERTISING PROMO-  
TION AND MARKETING; SALES PROMOTION;  
PUBLICATION OF PUBLICITY TEXTS; PRODU-  
TION OF ADVERTISEMENTS; CUSTOMER RELA-  
TIONSHIP MANAGEMENT; CONDUCTING  
MARKET RESEARCH AND MARKET ANALYSIS;  
RESEARCH AND INFORMATION RELATING TO  
BUSINESS AFFAIRS, ADVERTISING AND MAR-  
KETING; STATISTICAL ANALYSIS AND COMPI-  
LATION OF STATISTICAL RESULTS FOR  
BUSINESS PURPOSES; BUSINESS ADMINISTRA-  
TION; PROVIDING INFORMATION RELATING  
TO THE AFORESAID SERVICES; PROVISION OF  
THE AFORESAID SERVICES ONLINE FROM A

COMPUTER DATABASE OR THE INTERNET; AD-  
VERTISING AND MARKETING IN THE NATURE  
OF COMPILING ADVERTISEMENTS FOR USE AS  
HOMEPAGES ON THE INTERNET, NAMELY, AD  
SERVING; ADVISORY AND CONSULTANCY SER-  
VICES IN THE FIELD OF DIGITAL ADVERTISING  
AND MARKETING, IN CLASS 35 (U.S. CLS. 100, 101  
AND 102).

FOR: COMPUTER PROGRAMMING IN THE  
FIELD OF DIGITAL ADVERTISING AND MAR-  
KETING; MAINTENANCE AND UPDATING OF  
COMPUTER PROGRAMS AND DESIGN OF COM-  
PUTER PROGRAMS FOR PERFORMANCE-BASED  
MARKETING AND SALES ON THE INTERNET,  
AND FOR SYSTEMS FOR ADMINISTERING IN-  
TERNET COOPERATION, INTERNET SALES, TRA-  
DEMARK AND MARKETING ACTIVITIES;  
COMPUTER SYSTEMS ANALYSIS, NAMELY,  
TRACKING AND MEASURING INTERNET ACTIV-  
ITIES, DEVELOPMENT AND PROGRAMMING  
WITH REGARD TO ONLINE MARKETING AND  
SALES SOLUTIONS WHEREBY MARKETING AC-  
TIVITIES CAN BE GEARED TO CURRENT PRO-  
DUCT SALES, IN CLASS 42 (U.S. CLS. 100 AND 101).

PRIORITY DATE OF 9-27-2006 IS CLAIMED.

OWNER OF INTERNATIONAL REGISTRATION  
0906494 DATED 10-25-2006, EXPIRES 10-25-2016.

SER. NO. 79-032,096, FILED 10-25-2006.

JAMES STEIN, EXAMINING ATTORNEY

**Int. Cls.: 9, 35 and 42**

**Prior U.S. Cls.: 21, 23, 26, 36, 38, 100, 101 and 102**

**United States Patent and Trademark Office**

**Reg. No. 3,468,026**

**Registered July 15, 2008**

**TRADEMARK  
SERVICE MARK  
PRINCIPAL REGISTER**

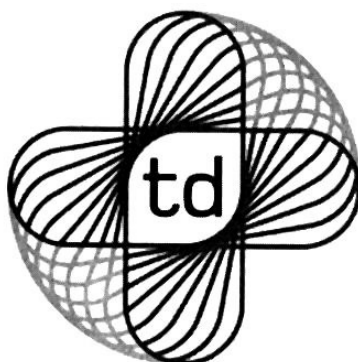

TRADEDOUBLER AKTIEBOLAG (SWEDEN  
LIMITED COMPANY)  
BAMHUSGATAN 12  
SE-111 23 STOCKHOLM  
SWEDEN

FOR: OPERATING SYSTEM PROGRAMS AND  
COMPUTER PROGRAMS FOR TRACKING AND  
ANALYZING ONLINE SURFING AND PURCHAS-  
ING ACTIVITIES, IN CLASS 9 (U.S. CLS. 21, 23, 26, 36  
AND 38).

FOR: COMPILATION AND INPUT OF INFOR-  
MATION IN COMPUTERIZED DATABASES; PRO-  
FESSIONAL BUSINESS CONSULTANCY; ONLINE  
ADVERTISING; PURCHASING ADVERTISING  
SPACE FOR OTHERS ON MEDIA, NAMELY, ON  
DIGITAL MEDIA; BUSINESS CONSULTANCY AND  
MARKET RESEARCH WITH REGARD TO DIFFER-  
ENT MEDIA; PLANNING SERVICES, NAMELY,  
ADVISING BUSINESSES IN THE SELECTION OF  
MEDIA FOR PROMOTING THEIR BUSINESS AND  
ACQUIRING ADVERTISING SPACE IN THE RE-  
COMMENDED MEDIA; ADVERTISING PROMO-  
TION AND MARKETING; SALES PROMOTION;  
PUBLICATION OF PUBLICITY TEXTS; PRODU-  
TION OF ADVERTISEMENTS; CUSTOMER RELA-  
TIONSHIP MANAGEMENT; CONDUCTING  
MARKET RESEARCH AND MARKET ANALYSIS;  
RESEARCH AND INFORMATION RELATING TO  
BUSINESS AFFAIRS, ADVERTISING AND MAR-  
KETING; STATISTICAL ANALYSIS AND COMPI-  
LATION OF STATISTICAL RESULTS FOR  
BUSINESS PURPOSES; BUSINESS ADMINISTRA-  
TION; PROVIDING INFORMATION RELATING

TO THE AFORESAID SERVICES; PROVISION OF  
THE AFORESAID SERVICES ONLINE FROM A  
COMPUTER DATABASE OR THE INTERNET; AD-  
VERTISING AND MARKETING IN THE NATURE  
OF COMPILING ADVERTISEMENTS FOR USE AS  
HOMEPAGES ON THE INTERNET, NAMELY, AD  
SERVING; ADVISORY AND CONSULTANCY SER-  
VICES IN THE FIELD OF DIGITAL ADVERTISING  
AND MARKETING, IN CLASS 35 (U.S. CLS. 100, 101  
AND 102).

FOR: COMPUTER PROGRAMMING IN THE  
FIELD OF DIGITAL ADVERTISING AND MAR-  
KETING; MAINTENANCE AND UPDATING OF  
COMPUTER PROGRAMS AND DESIGN OF COM-  
PUTER PROGRAMS FOR PERFORMANCE-BASED  
MARKETING AND SALES ON THE INTERNET,  
AND FOR SYSTEMS FOR ADMINISTERING IN-  
TERNET COOPERATION, INTERNET SALES, TRA-  
DEMARK AND MARKETING ACTIVITIES;  
COMPUTER SYSTEMS ANALYSIS, NAMELY  
TRACKING AND MEASURING INTERNET ACTIV-  
ITIES, DEVELOPMENT AND PROGRAMMING  
WITH REGARD TO ONLINE MARKETING AND  
SALES SOLUTIONS WHEREBY MARKETING AC-  
TIVITIES CAN BE GEARED TO CURRENT PRO-  
DUCT SALES, IN CLASS 42 (U.S. CLS. 100 AND 101).

PRIORITY DATE OF 9-28-2006 IS CLAIMED.

OWNER OF INTERNATIONAL REGISTRATION  
0906495 DATED 10-25-2006, EXPIRES 10-25-2016.



SER. NO. 79-032,097, FILED 10-25-2006.

JAMES STEIN, EXAMINING ATTORNEY

**Int. Cls.: 9, 35 and 42**

**Prior U.S. Cls.: 21, 23, 26, 36, 38, 100, 101 and 102**

**Reg. No. 3,468,027**

**United States Patent and Trademark Office**

**Registered July 15, 2008**

**TRADEMARK  
SERVICE MARK  
PRINCIPAL REGISTER**

# TD REACH

TRADEDOUBLER AKTIEBOLAG (SWEDEN  
LIMITED COMPANY)  
BAMHUSGATAN 12  
SE-111 23 STOCKHOLM  
SWEDEN

FOR: OPERATING SYSTEM PROGRAMS AND  
COMPUTER PROGRAMS FOR TRACKING AND  
ANALYZING ONLINE SURFING AND PURCHAS-  
ING ACTIVITIES, IN CLASS 9 (U.S. CLS. 21, 23, 26, 36  
AND 38).

FOR: COMPILATION AND INPUT OF INFOR-  
MATION IN COMPUTERIZED DATABASES; PRO-  
FESSIONAL BUSINESS CONSULTANCY; ONLINE  
ADVERTISING; PURCHASING ADVERTISING  
SPACE FOR OTHERS ON MEDIA, NAMELY, ON  
DIGITAL MEDIA; BUSINESS CONSULTANCY AND  
MARKET RESEARCH WITH REGARD TO DIFFER-  
ENT MEDIA; PLANNING SERVICES, NAMELY,  
ADVISING BUSINESSES IN THE SELECTION OF  
MEDIA FOR PROMOTING THEIR BUSINESS AND  
ACQUIRING ADVERTISING SPACE IN THE RE-  
COMMENDED MEDIA; ADVERTISING PROMO-  
TION AND MARKETING; SALES PROMOTION;  
PUBLICATION OF PUBLICITY TEXTS; PRODUC-  
TION OF ADVERTISEMENTS; CUSTOMER RELA-  
TIONSHIP MANAGEMENT; CONDUCTING  
MARKET RESEARCH AND MARKET ANALYSIS;  
RESEARCH AND INFORMATION RELATING TO  
BUSINESS AFFAIRS, ADVERTISING AND MAR-  
KETING; STATISTICAL ANALYSIS AND COMPI-  
LATION OF STATISTICAL RESULTS FOR  
BUSINESS PURPOSES; BUSINESS ADMINISTRA-  
TION; PROVIDING INFORMATION RELATING  
TO THE AFORESAID SERVICES; PROVISION OF  
THE AFORESAID SERVICES ONLINE FROM A

COMPUTER DATABASE OR THE INTERNET; AD-  
VERTISING AND MARKETING IN THE NATURE  
OF COMPILING ADVERTISEMENTS FOR USE AS  
HOMEPAGES ON THE INTERNET, NAMELY, AD  
SERVING; ADVISORY AND CONSULTANCY SER-  
VICES IN THE FIELD OF DIGITAL ADVERTISING  
AND MARKETING, IN CLASS 35 (U.S. CLS. 100, 101  
AND 102).

FOR: COMPUTER PROGRAMMING IN THE  
FIELD OF DIGITAL ADVERTISING AND MAR-  
KETING; MAINTENANCE AND UPDATING OF  
COMPUTER PROGRAMS AND DESIGN OF COM-  
PUTER PROGRAMS FOR PERFORMANCE-BASED  
MARKETING AND SALES ON THE INTERNET,  
AND FOR SYSTEMS FOR ADMINISTERING IN-  
TERNET COOPERATION, INTERNET SALES, TRA-  
DEMARK AND MARKETING ACTIVITIES;  
COMPUTER SYSTEMS ANALYSIS, NAMELY,  
TRACKING AND MEASURING INTERNET ACTIV-  
ITIES, DEVELOPMENT AND PROGRAMMING  
WITH REGARD TO ONLINE MARKETING AND  
SALES SOLUTIONS WHEREBY MARKETING AC-  
TIVITIES CAN BE GEARED TO CURRENT PRO-  
DUCT SALES, IN CLASS 42 (U.S. CLS. 100 AND 101).

PRIORITY DATE OF 9-27-2006 IS CLAIMED.

OWNER OF INTERNATIONAL REGISTRATION  
0906496 DATED 10-25-2006, EXPIRES 10-25-2016.

SER. NO. 79-032,098, FILED 10-25-2006.

JAMES STEIN, EXAMINING ATTORNEY

**Int. Cls.: 9, 35 and 42**

**Prior U.S. Cls.: 21, 23, 26, 36, 38, 100, 101 and 102**

**Reg. No. 3,468,028**

**United States Patent and Trademark Office**

**Registered July 15, 2008**

**TRADEMARK  
SERVICE MARK  
PRINCIPAL REGISTER**

**TD PULL**

TRADEDOUBLER AKTIEBOLAG (SWEDEN  
LIMITED COMPANY)  
BAMHUSGATAN 12  
SE-111 23 STOCKHOLM  
SWEDEN

FOR: OPERATING SYSTEM PROGRAMS AND  
COMPUTER PROGRAMS FOR TRACKING AND  
ANALYZING ONLINE SURFING AND PURCHAS-  
ING ACTIVITIES, IN CLASS 9 (U.S. CLS. 21, 23, 26, 36  
AND 38).

FOR: COMPILATION AND INPUT OF INFOR-  
MATION IN COMPUTERIZED DATABASES; PRO-  
FESSIONAL BUSINESS CONSULTANCY; ONLINE  
ADVERTISING; PURCHASING ADVERTISING  
SPACE FOR OTHERS ON MEDIA, NAMELY, ON  
DIGITAL MEDIA; BUSINESS CONSULTANCY AND  
MARKET RESEARCH WITH REGARD TO DIFFER-  
ENT MEDIA; PLANNING SERVICES, NAMELY,  
ADVISING BUSINESSES IN THE SELECTION OF  
MEDIA FOR PROMOTING THEIR BUSINESS AND  
ACQUIRING ADVERTISING SPACE IN THE RE-  
COMMENDED MEDIA; ADVERTISING PROMO-  
TION AND MARKETING; SALES PROMOTION;  
PUBLICATION OF PUBLICITY TEXTS; PRODUC-  
TION OF ADVERTISEMENTS; CUSTOMER RELA-  
TIONSHIP MANAGEMENT; CONDUCTING  
MARKET RESEARCH AND MARKET ANALYSIS;  
RESEARCH AND INFORMATION RELATING TO  
BUSINESS AFFAIRS, ADVERTISING AND MAR-  
KETING; STATISTICAL ANALYSIS AND COMPI-  
LATION OF STATISTICAL RESULTS FOR  
BUSINESS PURPOSES; BUSINESS ADMINISTRA-  
TION; PROVIDING INFORMATION RELATING  
TO THE AFORESAID SERVICES; PROVISION OF  
THE AFORESAID SERVICES ONLINE FROM A

COMPUTER DATABASE OR THE INTERNET; AD-  
VERTISING AND MARKETING IN THE NATURE  
OF COMPILING ADVERTISEMENTS FOR USE AS  
HOMEPAGES ON THE INTERNET, NAMELY, AD  
SERVING; ADVISORY AND CONSULTANCY SER-  
VICES IN THE FIELD OF DIGITAL ADVERTISING  
AND MARKETING, IN CLASS 35 (U.S. CLS. 100, 101  
AND 102).

FOR: COMPUTER PROGRAMMING IN THE  
FIELD OF DIGITAL ADVERTISING AND MAR-  
KETING; MAINTENANCE AND UPDATING OF  
COMPUTER PROGRAMS AND DESIGN OF COM-  
PUTER PROGRAMS FOR PERFORMANCE-BASED  
MARKETING AND SALES ON THE INTERNET,  
AND FOR SYSTEMS FOR ADMINISTERING IN-  
TERNET COOPERATION, INTERNET SALES, TRA-  
DEMARK AND MARKETING ACTIVITIES;  
COMPUTER SYSTEMS ANALYSIS, NAMELY,  
TRACKING AND MEASURING INTERNET ACTIV-  
ITIES, DEVELOPMENT AND PROGRAMMING  
WITH REGARD TO ONLINE MARKETING AND  
SALES SOLUTIONS WHEREBY MARKETING AC-  
TIVITIES CAN BE GEARED TO CURRENT PRO-  
DUCT SALES, IN CLASS 42 (U.S. CLS. 100 AND 101).

PRIORITY DATE OF 9-27-2006 IS CLAIMED.

OWNER OF INTERNATIONAL REGISTRATION  
0906498 DATED 10-25-2006, EXPIRES 10-25-2016.

SER. NO. 79-032,100, FILED 10-25-2006.

JAMES STEIN, EXAMINING ATTORNEY

**Int. Cls.: 9, 35 and 42**

**Prior U.S. Cls.: 21, 23, 26, 36, 38, 100, 101 and 102**

**Reg. No. 3,468,029**

**United States Patent and Trademark Office**

**Registered July 15, 2008**

**TRADEMARK  
SERVICE MARK  
PRINCIPAL REGISTER**

# TD PUSH

TRADEDOUBLER AKTIEBOLAG (SWEDEN  
LIMITED COMPANY)  
BAMHUSGATAN 12  
SE-111 23 STOCKHOLM  
SWEDEN

FOR: OPERATING SYSTEM PROGRAMS AND  
COMPUTER PROGRAMS FOR TRACKING AND  
ANALYZING ONLINE SURFING AND PURCHAS-  
ING ACTIVITIES, IN CLASS 9 (U.S. CLS. 21, 23, 26, 36  
AND 38).

FOR: COMPILATION AND INPUT OF INFOR-  
MATION IN COMPUTERIZED DATABASES; PRO-  
FESSIONAL BUSINESS CONSULTANCY; ONLINE  
ADVERTISING; PURCHASING ADVERTISING  
SPACE FOR OTHERS ON MEDIA, NAMELY, ON  
DIGITAL MEDIA; BUSINESS CONSULTANCY AND  
MARKET RESEARCH WITH REGARD TO DIFFER-  
ENT MEDIA; PLANNING SERVICES, NAMELY,  
ADVISING BUSINESSES IN THE SELECTION OF  
MEDIA FOR PROMOTING THEIR BUSINESS AND  
ACQUIRING ADVERTISING SPACE IN THE RE-  
COMMENDED MEDIA; ADVERTISING PROMO-  
TION AND MARKETING; SALES PROMOTION;  
PUBLICATION OF PUBLICITY TEXTS; PRODU-  
TION OF ADVERTISEMENTS; CUSTOMER RE-  
LATIONSHIP MANAGEMENT; CONDUCTING  
MARKET RESEARCH AND MARKET ANALYSIS;  
RESEARCH AND INFORMATION RELATING TO  
BUSINESS AFFAIRS, ADVERTISING AND MAR-  
KETING; STATISTICAL ANALYSIS AND COMPI-  
LATION OF STATISTICAL RESULTS FOR  
BUSINESS PURPOSES; BUSINESS ADMINISTRA-  
TION; PROVIDING INFORMATION RELATING  
TO THE AFORESAID SERVICES; PROVISION OF  
THE AFORESAID SERVICES ONLINE FROM A

COMPUTER DATABASE OR THE INTERNET; AD-  
VERTISING AND MARKETING IN THE NATURE  
OF COMPILING ADVERTISEMENTS FOR USE AS  
HOMEPAGES ON THE INTERNET, NAMELY, AD  
SERVING; ADVISORY AND CONSULTANCY SER-  
VICES IN THE FIELD OF DIGITAL ADVERTISING  
AND MARKETING, IN CLASS 35 (U.S. CLS. 100, 101  
AND 102).

FOR: COMPUTER PROGRAMMING IN THE  
FIELD OF DIGITAL ADVERTISING AND MAR-  
KETING; MAINTENANCE AND UPDATING OF  
COMPUTER PROGRAMS AND DESIGN OF COM-  
PUTER PROGRAMS FOR PERFORMANCE-BASED  
MARKETING AND SALES ON THE INTERNET,  
AND FOR SYSTEMS FOR ADMINISTERING IN-  
TERNET COOPERATION, INTERNET SALES, TR-  
DEMARK AND MARKETING ACTIVITIES;  
COMPUTER SYSTEMS ANALYSIS, NAMELY,  
TRACKING AND MEASURING INTERNET ACTIV-  
ITIES, DEVELOPMENT AND PROGRAMMING  
WITH REGARD TO ONLINE MARKETING AND  
SALES SOLUTIONS WHEREBY MARKETING AC-  
TIVITIES CAN BE GEARED TO CURRENT PRO-  
DUCT SALES, IN CLASS 42 (U.S. CLS. 100 AND 101).

PRIORITY DATE OF 9-27-2006 IS CLAIMED.

OWNER OF INTERNATIONAL REGISTRATION  
0906499 DATED 10-25-2006, EXPIRES 10-25-2016.

SER. NO. 79-032,101, FILED 10-25-2006.

JAMES STEIN, EXAMINING ATTORNEY

Int. Cl.: 30

Prior U.S. Cl.: 46

United States Patent and Trademark Office

Reg. No. 3,468,030

Registered July 15, 2008

TRADEMARK  
PRINCIPAL REGISTER



G.I.FI.ZE. -; GRUPPO INDUSTRIALE FILICORI ZECCHINI -; SOCIETA' PER AZIONI O PIU' BREVEMENTE; GIFIZE - S.P.A. (ITALY JOINT STOCK COMPANY)

VIA LOMBARDA, 55

CASTEL SAN PIETRO TERME; FRAZIONE OSTERIA GRANDE; I-40060 BOLOGNA

ITALY

FOR: COFFEE, UNROASTED AND ROASTED COFFEE, INCLUDING UNROASTED AND ROASTED COFFEE BEANS, GROUND, IN BAGS; FREEZE-DRIED COFFEE; COFFEE BASED BEVERAGES; COFFEE-BASED BEVERAGES WITH MILK; ARTIFICIAL COFFEE; VEGETAL PREPARATION FOR USE AS COFFEE SUBSTITUTES, COFFEE FLAVORINGS; BARLEY, NAMELY, HUSKED BARLEY, EGG BARLEY, BARLEY FLOUR; PROCESSED GRAINS, NAMELY, ROASTED BARLEY INCLUDING ROASTED BARLEY GRAINS, GROUND, IN BAGS AND INSTANT BARLEY; BARLEY-BASED BEVERAGES; REFINED BEET SUGAR; COCOA, COCOA-BASED BEVERAGES, COCOA-BASED BEVERAGES WITH MILK; CHOCOLATE; CHOCOLATE-BASED FOOD BEVERAGES NOT BEING DAIRY BASED OR VEGETABLE BASED; CHOCOLATE-BASED BEVERAGES WITH MILK, IN CLASS 30 (U.S. CL. 46).

OWNER OF INTERNATIONAL REGISTRATION 0906794 DATED 6-13-2006, EXPIRES 6-13-2016.

THE COLOR(S) OCHRE, BLACK AND WHITE IS/ ARE CLAIMED AS A FEATURE OF THE MARK.

OCHRE = THE SQUARE LABEL; BLACK = THE WORDING "FILICORI ZECCHINI"; THE OUTLINE OF THE CUP; THE UNDULATED BAND EVOCATIVE OF STREAM; WHITE = THE LOOP OF THE LETTER L; THE INSIDE OF THE LETTER O; THE INSIDE OF THE CUP.

THE MARK CONSISTS OF A SIGN DEPICTING A SUBSTANTIALLY SQUARE LABEL IN OCHRE INSIDE WHICH IS THE WORDING "FILICORI ZECCHINI" IN FANCY BLACK CHARACTERS, THE TWO PORTIONS PLACED ONE ABOVE THE OTHER, AND THE PORTION "FILICORI" BEING IN STYLIZED CHARACTERS OF A LARGER SIZE, THE LOOP OF THE LETTER L AND THE INSIDE OF THE LETTER O BEING COLORED IN WHITE, ABOVE THIS WORDING THERE BEING DEPICTED A STYLIZED WHITE CUP OUTLINED IN BLACK, RISING FROM WHICH IS AN UNDULATED BLACK BAND EVOCATIVE OF STREAM.

THE ENGLISH TRANSLATION OF THE WORD "ZECCHINI" IN THE MARK IS GOLD COINS.

SER. NO. 79-032,220, FILED 6-13-2006.

SAIMA MAKHDOOM, EXAMINING ATTORNEY

**Int. Cls.: 11, 16 and 35**

**Prior U.S. Cls.: 2, 5, 13, 21, 22, 23, 29, 31, 34, 37, 38,  
50, 100, 101 and 102**

**Reg. No. 3,468,031**

**United States Patent and Trademark Office**

**Registered July 15, 2008**

**TRADEMARK  
SERVICE MARK  
PRINCIPAL REGISTER**

# **axelmeiselicht**

AML LICHT + DESIGN GMBH (FED REP GER-  
MANY GMBH)  
WIENER PLATZ 7 RGB.  
81667 MÜNCHEN  
FED REP GERMANY

FOR: LAMP HANGING SUPPORTS, NAMELY, WALL AND CEILING FIXTURES AS PARTS OF LAMPS; LIGHTING APPARATUS AND INSTALLATIONS, NAMELY, LAMPS, LIGHTING FIXTURES AND SCONCE LIGHTING FIXTURES; LAMPS; CEILING LIGHTS; SOCKETS FOR ELECTRIC LIGHTS; ELECTRIC LIGHT BULBS; INCANDESCENT LAMPS; ELECTRIC LAMPS; LAMP GLASSES, NAMELY, GLASS PIECES AS COMPONENTS OF LAMPS IN THE NATURE OF GLASS PIECES USED TO FILTER AND TO PROJECT LIGHT IN A GIVEN COLOR, AND GLASS PLATES TO REFLECT LIGHT; LAMP GLOBES; LAMP CASINGS; LAMP SHADES; LAMP SHADE HOLDERS IN THE NATURE OF METAL ATTACHMENTS FOR LAMPS; LUMINOUS TUBES FOR LIGHTING; REFLECTOR LAMPS; GUARD DEVICES FOR LIGHTING IN THE NATURE OF GLASS OR METAL GLOBES, SHIELDS OR PLATES FOR USE AROUND A LIGHT SOURCE; STREET LAMPS, IN CLASS 11 (U.S. CLS. 13, 21, 23, 31 AND 34).

FOR: BROCHURES FEATURING HOME AND INDUSTRIAL LIGHTING AND INTERIOR DÉCOR; PHOTOGRAPHS; CATALOGUES IN THE FIELD OF HOME AND INDUSTRIAL LIGHTING AND INTER-

IOR DÉCOR; PLACARDS OF PAPER OR CARDBOARD, IN CLASS 16 (U.S. CLS. 2, 5, 22, 23, 29, 37, 38 AND 50).

FOR: UPDATING OF ADVERTISING MATERIAL; PRESENTATION OF GOODS ON COMMUNICATIONS MEDIA FOR RETAIL; GOOD AND SERVICE PRESENTATIONS, NAMELY, PRESENTING GOODS AND SERVICES TO THE PUBLIC FOR ADVERTISING PURPOSES, IN CLASS 35 (U.S. CLS. 100, 101 AND 102).

PRIORITY DATE OF 5-24-2006 IS CLAIMED.

OWNER OF INTERNATIONAL REGISTRATION 0907072 DATED 11-16-2006, EXPIRES 11-16-2016.

THE NAME "AXEL MEISE" IDENTIFIES A LIVING INDIVIDUAL WHOSE CONSENT IS OF RECORD.

THE ENGLISH TRANSLATION OF THE WORD "LICHT" IN THE MARK IS LIGHT.

SER. NO. 79-032,345, FILED 11-16-2006.

REBECCA POVARCHUK, EXAMINING ATTORNEY

**Int. Cls.: 16, 18, 21, 24 and 28**

**Prior U.S. Cls.: 1, 2, 3, 5, 13, 22, 23, 29, 30, 33, 37, 38, 40, 41, 42 and 50**

**Reg. No. 3,468,032**

**United States Patent and Trademark Office**

**Registered July 15, 2008**

**TRADEMARK  
PRINCIPAL REGISTER**



HARDIE GRANT EGMONT PTY LTD (AUSTRALIA PROPRIETARY LIMITED COMPANY)  
85 HIGH STREET  
PRAHRAN VIC 3181  
AUSTRALIA

FOR: CHILDREN'S FICTIONAL BOOKS, IN CLASS 16 (U.S. CLS. 2, 5, 22, 23, 29, 37, 38 AND 50).

FOR: BAGS, NAMELY, PURSES, SCHOOL BAGS, TRAVEL BAGS, SPORTS BAGS, BACKPACKS, JEWELRY BAGS, MAKE-UP BAGS SOLD EMPTY, IN CLASS 18 (U.S. CLS. 1, 2, 3, 22 AND 41).

FOR: SMALL DOMESTIC CONTAINERS FOR KITCHEN OR HOUSEHOLD USE; CUPS, MUGS AND DRINKING VESSELS, BOTTLES SOLD EMPTY; DRINK CARRIERS, NAMELY, FOAM DRINK HOLDERS; LUNCH BOXES AND HOUSEHOLD CONTAINERS FOR FOOD, IN CLASS 21 (U.S. CLS. 2, 13, 23, 29, 30, 33, 40 AND 50).

FOR: BEDROOM LINEN; QUILT COVERS; BATHROOM LINEN; TOWELS AND BEACH TOWELS, IN CLASS 24 (U.S. CLS. 42 AND 50).

FOR: GAMES AND PLAYTHINGS, NAMELY, DICE GAMES, ARCADE GAMES, ACTION SKILL GAMES, BATH TOYS, BENDABLE TOYS, MUSICAL TOYS, PUNCHING TOYS; GYMNAS TIC AND SPORTING ARTICLES, NAMELY, GYMNAS TIC

APPARATUS, SKIPPING ROPES, SPORT BALLS, IN CLASS 28 (U.S. CLS. 22, 23, 38 AND 50).

PRIORITY DATE OF 9-28-2006 IS CLAIMED.

OWNER OF INTERNATIONAL REGISTRATION 0907099 DATED 10-11-2006, EXPIRES 10-11-2016.

"THE COLOR(S) PURPLE, PINK, WHITE, AND BLACK IS/ARE CLAIMED AS A FEATURE OF THE MARK."

"THE MARK CONSISTS OF "GO GIRL! IN STYLIZED FORM. THE COLOR PURPLE APPEARS IN THE TEXT OF THE WORDING GO. THE COLOR PINK APPEARS IN THE TEXT OF THE WORDING GIRL!. THE COLOR WHITE APPEARS AS THE BACKGROUND, AS THE LIP DESIGN WITHIN THE LETTER R IN GIRL, AND IN THE FLOWER DESIGNS IN THE LETTER I AND ! IN THE WORDING GIRL. THE COLOR BLACK SERVES AS THE SHADOWING FOR THE WORDING.."

SER. NO. 79-032,358, FILED 10-11-2006.

ELI HELLMAN, EXAMINING ATTORNEY

**Int. Cl.: 5**

**Prior U.S. Cls.: 6, 18, 44, 46, 51 and 52**

**United States Patent and Trademark Office**

**Reg. No. 3,468,033**

**Registered July 15, 2008**

**TRADEMARK  
PRINCIPAL REGISTER**

**PEFLAVIT C**

AKTIONERNO DROUJESTVO "SOPHARMA"  
(BULGARIA CORPORATION)  
16 ILIENSKO CHAUSSE  
SOFIA, BULGARIA 1220

OWNER OF INTERNATIONAL REGISTRATION  
0749076 DATED 12-8-2000, EXPIRES 12-8-2010.

FOR: PHARMACEUTICAL PREPARATION FOR  
ENHANCING THE RESISTANCE OF THE CAPIL-  
LARY WALL AND REDUCE ITS INTENSIFIED  
PERMEABILITY, IN CLASS 5 (U.S. CLS. 6, 18, 44,  
46, 51 AND 52).

NO CLAIM IS MADE TO THE EXCLUSIVE  
RIGHT TO USE "C", APART FROM THE MARK  
AS SHOWN.

THE MARK CONSISTS OF STANDARD CHAR-  
ACTERS WITHOUT CLAIM TO ANY PARTICULAR  
FONT, STYLE, SIZE, OR COLOR.

SER. NO. 79-032,373, FILED 9-20-2006.

ANTHONY RINKER, EXAMINING ATTORNEY



**Int. Cls.: 14 and 34**

**Prior U.S. Cls.: 2, 8, 9, 17, 27, 28 and 50**

**United States Patent and Trademark Office**

**Reg. No. 3,468,034**

**Registered July 15, 2008**

**TRADEMARK  
PRINCIPAL REGISTER**

**El Cid**

ROCHUS SCHNEIDER (FED REP GERMANY  
INDIVIDUAL)  
AM ROSENBERG 12  
79238 EHRENKIRCHEN  
FED REP GERMANY

FOR: ASHTRAYS OF PRECIOUS METAL, FOR  
SMOKERS; SNUFFBOXES OF PRECIOUS METAL,  
TOBACCO JARS OF PRECIOUS METAL, IN CLASS  
14 (U.S. CLS. 2, 27, 28 AND 50).

FOR: ABSORBENT PAPER FOR TOBACCO PIPES;  
ASHTRAYS, NOT OF PRECIOUS METAL, FOR  
SMOKERS; MOUTHPIECES OF YELLOW AMBER  
FOR CIGAR AND CIGARETTE HOLDERS; FIRE-  
STONES, NAMELY, LIGHTER FLINTS; LIGHTERS  
FOR SMOKERS, LIQUIFIED GAS CONTAINERS  
FOR CIGAR LIGHTERS; CHEWING TOBACCO;  
MOUTHPIECES FOR CIGARETTE HOLDERS;  
SMOKING PIPE CLEANERS, SMOKING PIPE  
RACKS; SNUFF, SNUFF BOXES, NOT OF PRE-  
CIOUS METAL; SPITTOONS FOR TOBACCO  
USERS, NOT OF PRECIOUS METAL; MATCHES,  
MATCH BOXES AND MATCH HOLDERS, NOT OF  
PRECIOUS METAL; TOBACCO; TOBACCO POU-  
CHES, TOBACCO JARS, NOT OF PRECIOUS ME-  
TAL; TOBACCO PIPES; POCKET MACHINES FOR

ROLLING CIGARETTES; CIGARETTES CONTAIN-  
ING TOBACCO SUBSTITUTES, NOT FOR MEDI-  
CAL PURPOSES; CIGARETTE CASES, NOT OF  
PRECIOUS METAL; CIGARETTE AND CIGAR FIL-  
TERS; CIGARETTE TIPS; CIGARETTE PAPER,  
BOOKS OF CIGARETTE PAPERS; CIGARETTE  
HOLDERS, NOT OF PRECIOUS METAL; CIGAR  
CUTTERS; CIGAR CASES, NOT OF PRECIOUS  
METAL; HUMIDORS; CIGAR HOLDERS, NOT OF  
PRECIOUS METAL, IN CLASS 34 (U.S. CLS. 2, 8, 9  
AND 17).

THE MARK CONSISTS OF STANDARD CHAR-  
ACTERS WITHOUT CLAIM TO ANY PARTICULAR  
FONT, STYLE, SIZE, OR COLOR.

PRIORITY DATE OF 9-9-2005 IS CLAIMED.

OWNER OF INTERNATIONAL REGISTRATION  
0907468 DATED 3-8-2006, EXPIRES 3-8-2016.

SER. NO. 79-032,489, FILED 3-8-2006.

DEBRA LEE, EXAMINING ATTORNEY

**Int. Cls.: 16, 38 and 41**

**Prior U.S. Cls.: 2, 5, 22, 23, 29, 37, 38, 50, 100, 101, 104  
and 107**

**Reg. No. 3,468,035**

**United States Patent and Trademark Office**

**Registered July 15, 2008**

**TRADEMARK  
SERVICE MARK  
PRINCIPAL REGISTER**

# Geo Junior

G+J HOLDING GMBH (AUSTRIA LTD LIAB CO)  
PARKRING 12  
A-1010 WIEN, AUSTRIA

FOR: PRINTED MATTER, NAMELY, GENERAL INTEREST MAGAZINES AND BOOKS IN THE FIELDS OF NATURE, ENVIRONMENT, TECHNOLOGY, GEOLOGY, GEOGRAPHY, BIOLOGY, EVOLUTION, FLORA, FAUNA, SOCIOLOGY, CULTURES, CIVILIZATIONS, SPORTS, HANDICRAFT WORK, GAMES, BRAIN-TEASERS, QUIZZES, PUZZLES AND RIDDLES, BOTH FOR CHILDREN AND YOUNG PEOPLE, AS WELL AS, POSTERS, POSTCARDS, CALENDARS AND MAPS, IN CLASS 16 (U.S. CLS. 2, 5, 22, 23, 29, 37, 38 AND 50).

FOR: TELECOMMUNICATIONS SERVICES, NAMELY, TRANSMISSION OF INFORMATION TO THIRD PARTIES OVER THE INTERNET, IN CLASS 38 (U.S. CLS. 100, 101 AND 104).

FOR: EDUCATION AND TRAINING, NAMELY, PROVIDING KNOWLEDGE TESTS AND QUIZZES IN THE FIELDS OF NATURE, ENVIRONMENT, TECHNOLOGY, GEOLOGY, GEOGRAPHY, BIOLOGY, EVOLUTION, FLORA, FAUNA, SOCIOLOGY, CULTURES, CIVILIZATIONS AND SPORTS; ENTERTAINMENT SERVICES, NAMELY, PRODUCTION OF RADIO AND TELEVISION PROGRAMS AND PROVIDING ON-GOING RADIO AND TELEVISION PROGRAMS FOR CHILDREN AND

YOUNG PEOPLE IN THE FIELDS OF NATURE, ENVIRONMENT, TECHNOLOGY, GEOLOGY, GEOGRAPHY, BIOLOGY, EVOLUTION, FLORA, FAUNA, SOCIOLOGY, CULTURES, CIVILIZATIONS, SPORTS, HANDICRAFT WORK, GAMES, BRAIN-TEASERS, QUIZZES, PUZZLES AND RIDDLES; PUBLISHING AND EDITING OF BOOKS AND MAGAZINES; PUBLICATION AND EDITING OF MATTER IN PRINTED AND ELECTRONIC FORM WITH EDITORIAL AND ADVERTISING CONTENT BOTH OFF-LINE AND ON-LINE; PUBLISHING AND EDITING OF PRINTED AND ELECTRONIC MULTIMEDIA MATTER, NAMELY, AUDIO BOOKS, IN CLASS 41 (U.S. CLS. 100, 101 AND 107).

THE MARK CONSISTS OF STANDARD CHARACTERS WITHOUT CLAIM TO ANY PARTICULAR FONT, STYLE, SIZE, OR COLOR.

PRIORITY DATE OF 1-30-2006 IS CLAIMED.

OWNER OF INTERNATIONAL REGISTRATION 0907560 DATED 7-28-2006, EXPIRES 7-28-2016.

SER. NO. 79-032,521, FILED 7-28-2006.

MARCIE MILONE, EXAMINING ATTORNEY

**Int. Cl.: 32**

**Prior U.S. Cls.: 45, 46 and 48**

**United States Patent and Trademark Office**

**Reg. No. 3,468,036**

**Registered July 15, 2008**

**TRADEMARK  
PRINCIPAL REGISTER**

# Mitická

TRENCIANSKE MINERÁLNE VODY, A.S. (SLO-  
VAKIA CORPORATION)  
JAIKOVA 2  
SK-821 03 BRATISLAVA  
SLOVAKIA

FOR: NATURAL MINERAL WATERS; TABLE  
WATERS; NON-ALCOHOLIC BEVERAGES, NAME-  
LY, CARBONATED BEVERAGES; FLAVOURED  
NATURAL MINERAL WATERS AND TABLE WA-  
TERS, IN CLASS 32 (U.S. CLS. 45, 46 AND 48).

PRIORITY DATE OF 5-19-2006 IS CLAIMED.

OWNER OF INTERNATIONAL REGISTRATION  
0907797 DATED 11-9-2006, EXPIRES 11-9-2016.

SER. NO. 79-032,602, FILED 11-9-2006.

PAUL E. FAHRENKOPF, EXAMINING ATTORNEY

**Int. Cls.: 12 and 17**

**Prior U.S. Cls.: 1, 5, 12, 13, 19, 21, 23, 31, 35, 44 and 50**

**United States Patent and Trademark Office**

**Reg. No. 3,468,037**

**Registered July 15, 2008**

**TRADEMARK  
PRINCIPAL REGISTER**



MARANGONI TREAD S.P.A. (ITALY JOINT  
STOCK COMPANY)  
LOC. COLLE BAIOTTO  
I-03013 FERENTINO (FR)  
ITALY

FOR: TREADS FOR RETREADING ANY KIND  
OF PNEUMATIC TIRE, IN CLASS 12 (U.S. CLS. 19, 21,  
23, 31, 35 AND 44).

FOR: PARTIALLY PROCESSED GUM, NAMELY,  
PARTIALLY PROCESSED RUBBER; GUM USED TO  
CREATE RUBBER PROFILES USED FOR RE-  
BUILDING TIRES, IN CLASS 17 (U.S. CLS. 1, 5, 12,  
13, 35 AND 50).

PRIORITY DATE OF 10-17-2006 IS CLAIMED.

OWNER OF INTERNATIONAL REGISTRATION  
0908008 DATED 11-10-2006, EXPIRES 11-10-2016.

THE COLOR(S) WHITE, BLACK, RED IS/ARE  
CLAIMED AS A FEATURE OF THE MARK.

THE MARK CONSISTS OF THE TEXT "PROFIL  
LINER" IN A WHITE COLOR WITH A STYLIZED  
"L" FOR THE TERM LINER. A WHITE LINED  
CIRCLE SURROUNDS THE "L". THE TEXT AND  
DESIGN IS CENTERED ON A BLACK RECTANGLE  
WHICH IS PLACED ON A RED RECTANGLE.

SER. NO. 79-032,684, FILED 11-10-2006.

RENEE SERVANCE, EXAMINING ATTORNEY

**Int. Cls.: 9, 35 and 42**

**Prior U.S. Cls.: 21, 23, 26, 36, 38, 100, 101 and 102**

**Reg. No. 3,468,038**

**United States Patent and Trademark Office**

**Registered July 15, 2008**

**TRADEMARK  
SERVICE MARK  
PRINCIPAL REGISTER**

**TD TALK**

TRADEDOUBLER AKTIEBOLAG (SWEDEN  
LIMITED COMPANY)  
BAMHUSGATAN 12  
SE-111 23 STOCKHOLM  
SWEDEN

FOR: OPERATING SYSTEM PROGRAMS AND  
COMPUTER PROGRAMS FOR TRACKING AND  
ANALYZING ONLINE SURFING AND PURCHAS-  
ING ACTIVITIES, IN CLASS 9 (U.S. CLS. 21, 23, 26, 36  
AND 38).

FOR: COMPILATION AND INPUT OF INFOR-  
MATION IN COMPUTERIZED DATABASES; PRO-  
FESSIONAL BUSINESS CONSULTANCY; ONLINE  
ADVERTISING; PURCHASING ADVERTISING  
SPACE FOR OTHERS ON MEDIA, NAMELY, ON  
DIGITAL MEDIA; BUSINESS CONSULTANCY AND  
MARKET RESEARCH WITH REGARD TO DIFFER-  
ENT MEDIA; PLANNING SERVICES, NAMELY,  
ADVISING BUSINESSES IN THE SELECTION OF  
MEDIA FOR PROMOTING THEIR BUSINESS AND  
ACQUIRING ADVERTISING SPACE IN THE RE-  
COMMENDED MEDIA; ADVERTISING PROMOT-  
ION AND MARKETING; SALES PROMOTION;  
PUBLICATION OF PUBLICITY TEXTS; PRODUC-  
TION OF ADVERTISEMENTS; CUSTOMER RELA-  
TIONSHIP MANAGEMENT; CONDUCTING  
MARKET RESEARCH AND MARKET ANALYSIS;  
RESEARCH AND INFORMATION RELATING TO  
BUSINESS AFFAIRS, ADVERTISING AND MAR-  
KETING; STATISTICAL ANALYSIS AND COMPI-  
LATION OF STATISTICAL RESULTS FOR  
BUSINESS PURPOSES; BUSINESS ADMINISTRA-  
TION; PROVIDING INFORMATION RELATING  
TO THE AFORESAID SERVICES; PROVISION OF  
THE AFORESAID SERVICES ONLINE FROM A

COMPUTER DATABASE OR THE INTERNET; AD-  
VERTISING AND MARKETING IN THE NATURE  
OF COMPILING ADVERTISEMENTS FOR USE AS  
HOMEPAGES ON THE INTERNET, NAMELY, AD  
SERVING; ADVISORY AND CONSULTANCY SER-  
VICES IN THE FIELD OF DIGITAL ADVERTISING  
AND MARKETING, IN CLASS 35 (U.S. CLS. 100, 101  
AND 102).

FOR: COMPUTER PROGRAMMING IN THE  
FIELD OF DIGITAL ADVERTISING AND MAR-  
KETING; MAINTENANCE AND UPDATING OF  
COMPUTER PROGRAMS AND DESIGN OF COM-  
PUTER PROGRAMS FOR PERFORMANCE-BASED  
MARKETING AND SALES ON THE INTERNET,  
AND FOR SYSTEMS FOR ADMINISTERING IN-  
TERNET COOPERATION, INTERNET SALES, TRA-  
DEMARK AND MARKETING ACTIVITIES;  
COMPUTER SYSTEMS ANALYSIS, NAMELY,  
TRACKING AND MEASURING INTERNET ACTIV-  
ITIES, DEVELOPMENT AND PROGRAMMING  
WITH REGARD TO ONLINE MARKETING AND  
SALES SOLUTIONS WHEREBY MARKETING AC-  
TIVITIES CAN BE GEARED TO CURRENT PRO-  
DUCT SALES, IN CLASS 42 (U.S. CLS. 100 AND 101).

PRIORITY DATE OF 9-27-2006 IS CLAIMED.

OWNER OF INTERNATIONAL REGISTRATION  
0908247 DATED 10-25-2006, EXPIRES 10-25-2016.

SER. NO. 79-032,779, FILED 10-25-2006.

JAMES STEIN, EXAMINING ATTORNEY

**Int. Cls.: 3 and 10**

**Prior U.S. Cls.: 1, 4, 6, 26, 39, 44, 50, 51 and 52**

**United States Patent and Trademark Office**

**Reg. No. 3,468,039**

**Registered July 15, 2008**

**TRADEMARK  
PRINCIPAL REGISTER**

**LELO**

LELO GMBH (SWITZERLAND SOCIÉTÉ À RE-  
SPONSABILITÉ LIMITÉE)  
PARK ROHRBÜHL  
SIHLEGGSTRASSE 23; CH-8832 WOLLERAU  
SWITZERLAND

FOR: LUBRICANTS, NAMELY, INTIMATE SKIN  
MOISTURIZERS; MASSAGE GELS, NAMELY, MAS-  
SAGE OILS; ETHEREAL OILS, NAMELY, AROMA-  
THERAPY OILS; PERFUMES, BODY POWDERS,  
BODY LOTIONS; NON-MEDICATED BODY AND  
SKIN CARE PRODUCTS, NAMELY, CLEANSERS  
AND SKIN CREAM, IN CLASS 3 (U.S. CLS. 1, 4, 6, 50,  
51 AND 52).

FOR: MASSAGE APPARATUS, IN CLASS 10 (U.S.  
CLS. 26, 39 AND 44).

THE MARK CONSISTS OF STANDARD CHAR-  
ACTERS WITHOUT CLAIM TO ANY PARTICULAR  
FONT, STYLE, SIZE, OR COLOR.

OWNER OF INTERNATIONAL REGISTRATION  
0908643 DATED 11-21-2006, EXPIRES 11-21-2016.

SER. NO. 79-032,943, FILED 11-21-2006.

SIMON TENG, EXAMINING ATTORNEY

**Int. Cls.: 9, 38, 39, 40, 41 and 42**

**Prior U.S. Cls.: 21, 23, 26, 36, 38, 100, 101, 103, 104, 105, 106 and 107**

**Reg. No. 3,468,040**

**United States Patent and Trademark Office**

**Registered July 15, 2008**

**TRADEMARK  
SERVICE MARK  
PRINCIPAL REGISTER**



THOMSON (FRANCE SOCIETE ANONYME)  
46, QUAI ALPHONSE LE GALLO  
F-92100 BOULOGNE-BILLANCOURT  
FRANCE

FOR: APPARATUS AND INSTRUMENTS FOR READING, RECORDING, TRANSMITTING AND REPRODUCING SOUND AND MOVIE IMAGES, NAMELY, DIGITAL SATELLITE TRANSMITTERS AND RECEIVERS, DIGITAL CABLE TRANSMITTERS AND RECEIVERS, DIGITAL VERSATILE DISC AND OPTICAL DISC PLAYERS AND RECORDERS, HIGH DEFINITION DIGITAL VERSATILE DISC AND OPTICAL DISC PLAYERS AND RECORDERS, VIDEO RECEIVERS, ENCODERS, DECODERS, VIDEO CAMERAS, CINEMATOGRAPHIC CAMERAS, DIGITAL CAMERAS, VIDEO RECORDERS, VIDEO DISC PLAYERS, PERSONAL VIDEO RECORDERS, VIDEO-AUDIO ADAPTERS, VIDEO PROCESSING SOFTWARE, CHIPS, NAMELY, COMPUTER CHIPS, INTEGRATED CIRCUIT CHIPS FOR VIDEO PROCESSING A COMPONENT OF VIDEO GAMES SOFTWARE, INTEGRATED CIRCUIT CHIPS FOR USE WITH VIDEO PROCESSING SOFTWARE AND HARDWARE IN COMPUTERS AND SET TOP BOXES, GRAPHIC PROCESSORS NAMELY, COMPUTER GRAPHIC PROCESSOR BOARDS; SOFTWARE FOR REESTABLISHMENT OF IMAGES IN A FILM TO HIGH-DEFINITION QUALITY; CONTROL SOFTWARE FOR MODIFYING AND MANIPULATING VIDEO, FILMS, DIGITIZED COMPUTER VIDEO FILES AND ANALOG VIDEO SIGNALS; USER INTERFACE UNITS IN THE NATURE OF VIDEO SERVERS, PRODUCTION SWITCHERS, ROUTERS, SCANNERS, TELECINES, AND PROJECTORS FOR MODIFYING AND MANIPULATING VIDEO, FILMS AND DIGITAL PHOTOGRAPHS; APPARATUS FOR ENCODING, DECODING AND COMPRESSING FILMS, NAMELY, VIDEO ENCODERS, VIDEO DECODERS, COMPRESSORS, AND

MULTIPLEXERS, IN CLASS 9 (U.S. CLS. 21, 23, 26, 36 AND 38).

FOR: SERVICES FOR BROADCASTING TELEVISION AND CINEMATOGRAPHIC PROGRAMMES, NAMELY, CABLE TELEVISION BROADCASTING AND VIDEO BROADCASTING, SATELLITE TELEVISION BROADCASTING, SUBSCRIPTION TELEVISION BROADCASTING; SOUND AND IMAGE TRANSMISSION SERVICES, NAMELY TRANSMISSION OF SOUND AND VIDEO IMAGES BY SATELLITE OR VIA THE GLOBAL COMPUTER NETWORK, IN CLASS 38 (U.S. CLS. 100, 101 AND 104).

FOR: PACKAGING OF FILMS, VIDEO MEDIA, AND PHOTOGRAPHS FOR TRANSPORTATION; STORAGE OF FILMS, VIDEO MEDIA, AND PHOTOGRAPHS; DISTRIBUTION SERVICES, NAMELY, DELIVERY OF FILM, VIDEO MEDIA, AND PHOTOGRAPHS, IN CLASS 39 (U.S. CLS. 100 AND 105).

FOR: FILM AND VIDEO PROCESSING SERVICES; SERVICES FOR DEVELOPING PHOTOGRAPHS, NAMELY PRINTING, DUPLICATING AND ENLARGING, FROM DIGITAL PICTURE MEDIA; REPRODUCTION OF MOTION PICTURE FILMS, VIDEO MEDIA, AND PHOTOGRAPHS, IN CLASS 40 (U.S. CLS. 100, 103 AND 106).

FOR: MOTION PICTURE FILM PRODUCTION SERVICES; FILM POST PRODUCTION SERVICES, NAMELY, FILM EDITING, SOUNDTRACK EDITING, SOUNDTRACK WRITING AND SOUNDTRACK RECORDING, ADDING VISUAL SPECIAL EFFECTS, ADDING OPTICAL EFFECTS, ADDING SOUND EFFECTS, COLOR GRADING, AND FILM EDITING, IN CLASS 41 (U.S. CLS. 100, 101 AND 107).

FOR: SERVICES FOR BACKING UP FILMS, VIDEO MEDIA, AND PHOTOGRAPHS, NAMELY, DATA RECOVERY SERVICES COMPRISING COPYING OF DATA FOR RESTORATION IN CASE OF DATA LOSS EVENTS, OR FOR ARCHIVING ON DATA STORAGE MEDIA, NAMELY MAGNETIC TAPE, HARD DISKS, OPTICAL DISKS, FLOPPY DISKS, AND SOLID STATE STORAGE, IN CLASS 42 (U.S. CLS. 100 AND 101).

PRIORITY DATE OF 3-31-2006 IS CLAIMED.

OWNER OF INTERNATIONAL REGISTRATION  
0908722 DATED 9-12-2006, EXPIRES 9-12-2016.

NO CLAIM IS MADE TO THE EXCLUSIVE  
RIGHT TO USE "FILM GRAIN TECHNOLOGY",  
APART FROM THE MARK AS SHOWN.

SER. NO. 79-032,976, FILED 9-12-2006.

ANTHONY RINKER, EXAMINING ATTORNEY



**Int. Cls.: 12 and 17**

**Prior U.S. Cls.: 1, 5, 12, 13, 19, 21, 23, 31, 35, 44 and 50**

**United States Patent and Trademark Office**

**Reg. No. 3,468,041**

**Registered July 15, 2008**

**TRADEMARK  
PRINCIPAL REGISTER**



MARANGONI TREAD S.P.A. (ITALY JOINT STOCK COMPANY)  
LOC. COLLE BAIOTTO  
I-03013 FERENTINO (FR)  
ITALY

FOR: TREADS FOR RETREADING ANY KIND OF PNEUMATIC TIRE, IN CLASS 12 (U.S. CLS. 19, 21, 23, 31, 35 AND 44).

FOR: GUM/RUBBER PARTLY PROCESSED; PROFILES FOR USE IN FURTHER MANUFACTURING, MADE OF GUM/RUBBER FOR REBUILDING TIRES, IN CLASS 17 (U.S. CLS. 1, 5, 12, 13, 35 AND 50).

PRIORITY DATE OF 10-17-2006 IS CLAIMED.

OWNER OF INTERNATIONAL REGISTRATION 0908785 DATED 11-10-2006, EXPIRES 11-10-2016.

NO CLAIM IS MADE TO THE EXCLUSIVE RIGHT TO USE "CONTOUR", APART FROM THE MARK AS SHOWN.

THE COLOR(S) WHITE, BLACK, RED IS/ARE CLAIMED AS A FEATURE OF THE MARK.

THE MARK CONSISTS OF THE TEXT "KONTUR" IN WHITE COLOR ON A RED BACKGROUND; A BLACK STYLIZED RECTANGLE IN THE SHAPE OF A TIRE APPEARS TO THE LEFT OF THE TEXT WITH WHITE LINES ON THE RECTANGLE; AND THE COLOR RED IS TO THE LEFT OF THE TIRE DESIGN AND AT THE BOTTOM OF THE TIRE.

SER. NO. 79-033,002, FILED 11-10-2006.

TRACY WHITTAKER-BROWN, EXAMINING ATTORNEY

**Int. Cls.: 1, 5, 29, 30 and 32**

**Prior U.S. Cls.: 1, 5, 6, 10, 18, 26, 44, 45, 46, 48, 51 and 52**

**Reg. No. 3,468,042**

**United States Patent and Trademark Office**

**Registered July 15, 2008**

**TRADEMARK  
PRINCIPAL REGISTER**

# RESVIDA

DSM IP ASSETS B.V. (NETHERLANDS BESLO-  
TEN VENNOOTSCHAP)  
HET OVERLOON 1  
NL-6411 TE HEERLEN  
NETHERLANDS

FOR: CHEMICALS FOR USE IN THE MANUFACTURE OF FOOD, FOOD SUPPLEMENTS, BEVERAGES, COSMETICS AND OF DIETARY SUPPLEMENTS; CHEMICAL SUBSTANCES FOR PRESERVING FOODSTUFFS AND BEVERAGES; INDUSTRIAL CHEMICALS FOR USE IN THE PHARMACEUTICAL INDUSTRY, IN CLASS 1 (U.S. CLS. 1, 5, 6, 10, 26 AND 46).

FOR: PHARMACEUTICAL PREPARATIONS FOR USE IN TREATING AGING AND FOR CARDIOVASCULAR HEALTH; DIETETIC PREPARATIONS OR SUBSTANCES FOR MEDICAL USE, NAMELY, DIETETIC FOODS ADAPTED FOR MEDICAL USE, DIETARY FOOD SUPPLEMENTS; VITAMINS, VITAMIN PREPARATIONS; FOOD ADDITIVES FOR MEDICAL USE, NAMELY, VITAMINS, POLYPHENOL, RESVERATROL; DIETETIC FOODSTUFFS ADAPTED FOR MEDICAL USE; CHEMICAL PRODUCTS FOR PHARMACEUTICAL PURPOSE, NAMELY, PHARMACEUTICAL PREPARATIONS FOR ANTI-AGING AND CARDIOVASCULAR HEALTH, CARDIOVASCULAR PHARMACEUTICALS, IN CLASS 5 (U.S. CLS. 6, 18, 44, 46, 51 AND 52).

FOR: DIETARY SUPPLEMENTS AND FOOD SUPPLEMENTS, NOT FOR MEDICAL USE, NOT INCLUDED IN OTHER CLASSES, NAMELY, DAIRY-BASED FOOD BEVERAGES, PROTEIN FOR USE AS A FOOD ADDITIVE, EDIBLE OILS AND FATS, IN CLASS 29 (U.S. CL. 46).

FOR: DIETARY SUPPLEMENTS AND FOOD SUPPLEMENTS, NOT FOR MEDICAL USE, NOT INCLUDED IN OTHER CLASSES, NAMELY, FOOD FLAVORINGS, FOOD ADDITIVES FOR NON-NUTRITIONAL PURPOSES FOR USE AS A FLAVORING; POLYPHENOL AND RESVERATROL IN THE NATURE OF FOOD FLAVORINGS; FOOD ADDITIVES FOR NON-NUTRITIONAL PURPOSES FOR USE AS A FLAVORING, IN CLASS 30 (U.S. CL. 46).

FOR: SYRUPS FOR MAKING BEVERAGES; PREPARATIONS FOR MAKING BEVERAGES, NAMELY, FOR MAKING FRUIT FAVORED BEVERAGES, FLAVORED WATER, ENERGY DRINKS, SPORTS DRINKS, BOTTLED WATER, FRUIT DRINKS, FRUIT JUICES, VEGETABLE JUICES, HERBAL JUICES, ISOTONIC BEVERAGES, MINERAL AND CARBONATED WATERS, NON-ALCOHOLIC BEER, NON-ALCOHOLIC BEVERAGES WITH TEA FLAVOR, SMOOTHIES, AND SOFT DRINKS, IN CLASS 32 (U.S. CLS. 45, 46 AND 48).

THE MARK CONSISTS OF STANDARD CHARACTERS WITHOUT CLAIM TO ANY PARTICULAR FONT, STYLE, SIZE, OR COLOR.

PRIORITY DATE OF 5-8-2006 IS CLAIMED.

OWNER OF INTERNATIONAL REGISTRATION 0908936 DATED 11-6-2006, EXPIRES 11-6-2016.

SER. NO. 79-033,060, FILED 11-6-2006.

REBECCA POVARCHUK, EXAMINING ATTORNEY

**Int. Cl.: 9**

**Prior U.S. Cls.: 21, 23, 26, 36 and 38**

**Reg. No. 3,468,043**

**United States Patent and Trademark Office**

**Registered July 15, 2008**

**TRADEMARK  
PRINCIPAL REGISTER**

# DigiTrac

TEN HAAFT GMBH (FED REP GERMANY LTD  
LIAB CO)  
OBERER STRIETWEG 8  
75245 NEULINGEN  
FED REP GERMANY

TRIAL RECEPTION OF SOUND, IMAGES AND  
DATA, IN CLASS 9 (U.S. CLS. 21, 23, 26, 36 AND 38).

PRIORITY DATE OF 9-6-2006 IS CLAIMED.

FOR: RECEPTION EQUIPMENT FOR SATELLITE  
RECEPTION AND TERRESTRIAL RECEPTION OF  
SOUND, IMAGES AND DATA, ESPECIALLY FOR  
MOBILE USE IN CARAVANS, VEHICLES AND  
SHIPS; EQUIPMENT FOR MANUAL AND ELEC-  
TRONIC CONTROL OF RECEPTION EQUIPMENT  
FOR SATELLITES RECEPTION AND TERRES-

OWNER OF INTERNATIONAL REGISTRATION  
0909056 DATED 11-21-2006, EXPIRES 11-21-2016.

SER. NO. 79-033,111, FILED 11-21-2006.

SUZANNE BLANE, EXAMINING ATTORNEY

**Int. Cl.: 3**

**Prior U.S. Cls.: 1, 4, 6, 50, 51 and 52**

**United States Patent and Trademark Office**

**Reg. No. 3,468,044**

**Registered July 15, 2008**

**TRADEMARK  
PRINCIPAL REGISTER**

**PAPRIKA BRASIL**

COMPTOIR NOUVEAU DE LA PARFUMERIE  
(FRANCE SOCIÉTÉ ANONYME)  
23, RUE BOISSY D'ANGLAS  
F-75008 PARIS  
FRANCE

FOR: PERFUMES, IN CLASS 3 (U.S. CLS. 1, 4, 6, 50,  
51 AND 52).

THE MARK CONSISTS OF STANDARD CHAR-  
ACTERS WITHOUT CLAIM TO ANY PARTICULAR  
FONT, STYLE, SIZE, OR COLOR.

PRIORITY DATE OF 5-9-2006 IS CLAIMED.

OWNER OF INTERNATIONAL REGISTRATION  
0909365 DATED 10-30-2006, EXPIRES 10-30-2016.

NO CLAIM IS MADE TO THE EXCLUSIVE  
RIGHT TO USE "PAPRIKA", APART FROM THE  
MARK AS SHOWN.

"THE FOREIGN WORDING IN THE MARK  
TRANSLATES INTO ENGLISH AS BRAZIL."

SER. NO. 79-033,212, FILED 10-30-2006.

CHARLOTTE CORWIN, EXAMINING ATTORNEY

**Int. Cls.: 9 and 42**

**Prior U.S. Cls.: 21, 23, 26, 36, 38, 100 and 101**

**United States Patent and Trademark Office**

**Reg. No. 3,468,045**

**Registered July 15, 2008**

**TRADEMARK  
SERVICE MARK  
PRINCIPAL REGISTER**

# SULCOL

SULZER CHEMTECH AG (SWITZERLAND CORPORATION)  
SULZER-ALLEE 48  
CH-8404 WINTERTHUR  
SWITZERLAND

FOR: SOFTWARE FOR COMPUTER PROGRAMS PERFORMING CALCULATIONS FOR ANY INDUSTRY USING MATERIAL MASS TRANSFER COLUMNS; SOFTWARE FOR COMPUTER PROGRAMS PERFORMING CALCULATIONS IN CONNECTION WITH MATERIAL MASS TRANSFER COLUMNS; SOFTWARE FOR COMPUTER PROGRAMS PROVIDING INFORMATION ON THE NECESSARY SIZE FOR A MATERIAL MASS TRANSFER COLUMN; SOFTWARE FOR COMPUTER PROGRAMS PROPOSING DATA ENABLING THE DESIGN OF MATERIAL MASS TRANSFER EQUIPMENT PARTS THAT WILL BE INSTALLED IN A MATERIAL MASS TRANSFER COLUMN; AND SOFTWARE FOR COMPUTER PROGRAMS PROPOSING DATA ENABLING THE SELECTION OF MATERIAL MASS TRANSFER EQUIPMENT PARTS THAT WILL BE INSTALLED IN A MATERIAL MASS TRANSFER COLUMN, IN CLASS 9 (U.S. CLS. 21, 23, 26, 36 AND 38).

FOR: SCIENTIFIC AND TECHNOLOGICAL CONSULTING SERVICES PROVIDED ONLINE VIA THE INTERNET PERFORMING CALCULATIONS FOR ANY INDUSTRY USING MATERIAL MASS TRANSFER COLUMNS; SCIENTIFIC AND TECHNOLOGICAL CONSULTING SERVICES PROVIDED ONLINE VIA THE INTERNET PERFORMING CALCULATIONS IN CONNECTION WITH MATERIAL MASS

TRANSFER COLUMNS; SCIENTIFIC AND TECHNOLOGICAL CONSULTING SERVICES PROVIDED ONLINE VIA THE INTERNET PROVIDING INFORMATION ON THE NECESSARY SIZE FOR A MATERIAL MASS TRANSFER COLUMN; SCIENTIFIC AND TECHNOLOGICAL CONSULTING SERVICES PROVIDED ONLINE VIA THE INTERNET PROPOSING DATA ENABLING THE DESIGN OF MATERIAL MASS TRANSFER EQUIPMENT PARTS THAT WILL BE INSTALLED IN A MATERIAL MASS TRANSFER COLUMN; AND SCIENTIFIC AND TECHNOLOGICAL CONSULTING SERVICES PROVIDED ONLINE VIA THE INTERNET PROPOSING DATA ENABLING THE SELECTION OF MATERIAL MASS TRANSFER EQUIPMENT PARTS THAT WILL BE INSTALLED IN A MATERIAL MASS TRANSFER COLUMN, IN CLASS 42 (U.S. CLS. 100 AND 101).

THE MARK CONSISTS OF STANDARD CHARACTERS WITHOUT CLAIM TO ANY PARTICULAR FONT, STYLE, SIZE, OR COLOR.

PRIORITY DATE OF 6-14-2006 IS CLAIMED.

OWNER OF INTERNATIONAL REGISTRATION 0909755 DATED 9-14-2006, EXPIRES 9-14-2016.

SER. NO. 79-033,389, FILED 9-14-2006.

WILLIAM VERHOSEK, EXAMINING ATTORNEY

**Int. Cl.: 9**

**Prior U.S. Cls.: 21, 23, 26, 36 and 38**

**Reg. No. 3,468,046**

**United States Patent and Trademark Office**

**Registered July 15, 2008**

**TRADEMARK  
PRINCIPAL REGISTER**

# GateMan

IREVO, INC. (REPUBLIC OF KOREA CORPORATION)  
459-7, GASAN-DONG  
GEUMCHEON-GU; SEOUL  
REPUBLIC OF KOREA

FOR: ELECTRONICALLY CONTROLLED AUTOMATIC DOOR OPENING AND CLOSING APPARATUS, NAMELY, AUTOMATIC CONTROLLERS FOR REVOLVING DOORS, ELECTRIC DOOR CLOSING SYSTEMS, ELECTRIC DOOR OPENERS, ELECTRONIC DOOR OPENERS; ELECTRONICALLY CONTROLLED APPARATUS FOR INFORMATION COMMUNICATION, NAMELY, APPARATUS FOR TRANSMISSION OF COMMUNICATION, COMMUNICATION SERVERS; SEMICONDUCTOR CHIPS WITH BUILT-IN PASSWORD FACILITY; ELECTRIC DOOR CLOSING APPARATUS; ELECTRIC DOOR OPENING APPARATUS, NAMELY, ELECTRIC DOOR OPENER; ELECTROMECHANICAL AUTOMATIC DOOR OPENING AND CLOSING APPARATUS, NAMELY, ELECTRONIC DOOR CLOSING SYSTEMS; ELECTRIC LOCKS; ANTI-THEFT WARNING APPARATUS, NAMELY, THEFT ALARMS, BURGLAR ALARMS; HEAT SENSORS; FIRE ALARMS; ELECTRIC DOOR BELLS; VIDEO TELEPHONES; ELECTRONIC THEFT PREVENTION APPARATUS, NAMELY, THEFT ALARMS, BURGLAR ALARMS; MAGNETICALLY ENCODED KEY CARDS; MAGNETICALLY ENCODED CREDIT CARDS; SURVEILLANCE CAMERAS; THERMOSTATS; GAS LEAK ALARMS, NAMELY, GAS DETECTORS FOR DETECTING THE PRESENCE OF GAS; SOUND ALARMS, NAMELY, ELECTRIC ALARM WARNING BELLS; INTERNET PHONES; AUTOMATIC ANSWERING MACHINES; PORTABLE COMMUNICATIONS APPARATUS, NAMELY, PORTABLE TELEPHONES; APPARATUS FOR SENDING MESSAGES, NAMELY, PORTABLE TELECOMMUNICATION INSTANT MESSAGING DEVICES; MODEMS; HOME AUTOMATION COMMUNICATIONS SERVERS; HOME AUTOMATION COMMUNICATIONS SYSTEM SERVERS; ELECTRIC MONITORING APPARATUS, NAMELY, ALARM MONITORING SYSTEMS; UNIVERSAL

REMOTE CONTROLS FOR RADIOS, TELEVISIONS, STEREOS; PDAS (PERSONAL DIGITAL ASSISTANTS); SENSORS OTHER THAN FOR MEDICAL USE, NAMELY, WEATHER SENSORS FOR OPENING AND CLOSING WINDOWS; CLOSED-CIRCUIT TELEVISIONS, CLOSED-CIRCUIT TELEVISION SYSTEMS COMPRISED OF CLOSED-CIRCUIT TELEVISIONS AND CLOSED-CIRCUIT TELEVISION CAMERAS FOR SURVEILLANCE PURPOSES; VIDEO RECORDERS; HARD DISK VIDEO RECORDERS, NAMELY, DIGITAL VIDEO RECORDERS; DIGITAL AUDIO TAPE RECORDERS; HOME NETWORK INTERCOMMUNICATION APPARATUS, NAMELY, APPARATUS FOR REMOTE ACCESS OF HOME NETWORK SYSTEMS; ELECTRIC ANTI-THEFT APPARATUS, NAMELY, THEFT ALARMS, BURGLAR ALARMS; SMOKE DETECTORS; FINGERPRINT IDENTIFICATION SYSTEMS, NAMELY, VIDEO AND AUDIO MONITORS AND DEVICES FOR FINGERPRINT IMAGING, NAMELY, FINGERPRINT READERS AND SCANNERS; TIME-LAPSE VIDEO RECORDERS; CHARGE-COUPLED DEVICE CAMERAS; HARD DISCS FOR COMPUTERS RECORDED WITH SOUND FILES; HARD DISCS FOR COMPUTERS RECORDED WITH DATA; RECORDED COMPACT DISCS FEATURING INFORMATION ABOUT SECURITY SYSTEMS AND DOOR SYSTEMS; RECORDED VIDEO DISCS FEATURING INFORMATION ABOUT SECURITY SYSTEMS AND DOOR SYSTEMS; RECORDED VIDEO TAPES FEATURING INFORMATION ABOUT SECURITY SYSTEMS AND DOOR SYSTEMS; HARD COMPUTER DISCS FOR STORING VIDEO FILES; SOUND RECORDING DISCS FEATURING INFORMATION ABOUT SECURITY SYSTEMS AND DOOR SYSTEMS; APPARATUS FOR RECORDING AND PLAYING SOUND; AUTOMATIC CONTROL SYSTEMS FOR HOME USE, NAMELY, SURVEILLANCE AND SECURITY SYSTEM COMPRISING VIDEO AND AUDIO MONITORS; AUTOMATIC ELECTRONIC SECURITY SYSTEMS, SURVEILLANCE AND SECURITY SYSTEM COMPRISING VIDEO AND AUDIO MONITORS, FINGERPRINT IMAGING, READING, AND SCANNING DEVICES, DOOR

AND ENTRYWAY VIDEO ALL FOR PURPOSES OF ONE-WAY AND TWO-WAY SURVEILLANCE AND COMMUNICATIONS; VIDEO DOOR PHONE SYSTEMS COMPRISED OF AUDIO AND VIDEO MONITORS; REMOTE CONTROL APPARATUS FOR TELEMETERS; APPARATUS AND INSTRUMENTS FOR VOICE FREQUENCY TRANSMISSION; AUTOMATIC TURNSTILES; TELEPHONES; PHOTO TELEGRAPHY APPARATUS; SOUND RECORDERS;

SOUND REPRODUCTION APPARATUS, IN CLASS 9 (U.S. CLS. 21, 23, 26, 36 AND 38).

OWNER OF INTERNATIONAL REGISTRATION 0909828 DATED 3-27-2006, EXPIRES 3-27-2016.

SER. NO. 79-033,451, FILED 3-27-2006.

JASON BLAIR, EXAMINING ATTORNEY

**Int. Cls.: 7, 9 and 42**

**Prior U.S. Cls.: 13, 19, 21, 23, 26, 31, 34, 35, 36, 38, 100  
and 101**

**Reg. No. 3,468,047**

**United States Patent and Trademark Office**

**Registered July 15, 2008**

**TRADEMARK  
SERVICE MARK  
PRINCIPAL REGISTER**



ARO WELDING TECHNOLOGIES  
1 AVENUE DE TOURS  
F-72500 CHATEAU DU LOIR  
FRANCE

FOR: LASER WELDING MACHINES, IN CLASS 7  
(U.S. CLS. 13, 19, 21, 23, 31, 34 AND 35).

FOR: PROGRAMMABLE ELECTRIC WELDING  
CONTROLS, NAMELY, FOCUSING AND COLLI-  
MATING OPTICS UNITS, WELDING QUALITY  
CONTROL SENSORS; SEAM TRACKING SYSTEM  
COMPRISED OF A SEAM CAMERA, DATA PRO-  
CESSING UNIT AND MOTORIZED BEAM DELIV-  
ERY UNIT; LASER TOOLS MONITORING SYSTEM  
COMPRISED OF A COVER SLIDE MONITOR, FO-  
CUS POSITION CENTRAL AND A NOZZLE CEN-  
TERING UNIT; CONTROL SOFTWARE FOR LASER  
WELDING, LASER BRAZING AND LASER CUT-  
TING; LASER HEAD EQUALIZATION UNIT, IN  
CLASS 9 (U.S. CLS. 21, 23, 26, 36 AND 38).

FOR: ENGINEERING IN THE FIELD OF LASER  
WELDING APPARATUS AND MACHINES, TECH-  
NOLOGICAL SERVICES, NAMELY, CONSULTA-  
TION IN THE TECHNOLOGY FIELD OF LASER  
WELDING MACHINES AND APPARATUS, TECH-  
NICAL RESEARCH AND DESIGN SERVICES FOR

OTHERS IN THE FIELD OF WELDING APPARA-  
TUS AND MACHINES, RESEARCH SERVICES IN  
THE FIELD OF WELDING APPARATUS AND MA-  
CHINES, SOFTWARE DESIGN FOR OTHERS AND  
SOFTWARE DEVELOPMENT FOR WELDING MA-  
CHINES AND APPARATUS; QUALITY CONTROL  
FOR OTHERS OF WELDING APPARATUS AND  
MACHINES; MATERIALS TESTING; ENGINEER-  
ING PROJECT STUDIES, NAMELY, CONDUCTING  
OF FEASIBILITY STUDIES IN THE FIELD OF  
WELDING APPARATUS AND MACHINES, IN  
CLASS 42 (U.S. CLS. 100 AND 101).

PRIORITY DATE OF 3-22-2006 IS CLAIMED.

OWNER OF INTERNATIONAL REGISTRATION  
0909884 DATED 9-20-2006, EXPIRES 9-20-2016.

OWNER OF U.S. REG. NOS. 1,163,417, 2,306,897,  
AND 2,818,818.

SER. NO. 79-033,454, FILED 9-20-2006.

CHRISTOPHER BUONGIORNO, EXAMINING AT-  
TORNEY



Int. Cl.: 25

Prior U.S. Cls.: 22 and 39

United States Patent and Trademark Office

Reg. No. 3,468,048

Registered July 15, 2008

TRADEMARK  
PRINCIPAL REGISTER

**NARACAMICIE**

MONTENAP0 79 S.R.L. (ITALY LTD LIAB CO)  
VIA MONTENAPOLEONE 5  
I-20121 MILANO  
ITALY

OWNER OF INTERNATIONAL REGISTRATION  
0910024 DATED 5-31-2006, EXPIRES 5-31-2016.

FOR: SHIRTS; BLOUSES; PULLOVERS; GLOVES;  
CARDIGANS; JERSEYS; NECKWEAR; SWEATERS;  
SOCKS; STOCKINGS; TIGHTS; TROUSERS; LEG-  
GINGS; SKIRTS; JACKETS; JERKINS; VESTS;  
WAISTCOATS; JUMPERS; TRACK SUITS; BLOU-  
SONS; JEANS; SWEAT PANTS; GYM SUITS; KNICK-  
ERS; PANTS; SHORTS; T-SHIRTS; SWEAT-SHIRTS;  
SUITS AND DRESSES; OVERCOATS; COATS; AN-  
ORAKS; RAINCOATS; BELTS; SUSPENDERS;  
LOUNGEWEAR; UNDERWEAR; BEACHWEAR;  
SLEEPWEAR; FOOTWEAR; HEADWEAR, IN CLASS  
25 (U.S. CLS. 22 AND 39).

THE MARK CONSISTS OF A SIGN DEPICTING  
THE WORDING "NARACAMICIE" IN FANCY  
CHARACTERS, THE FINAL LETTER "E" BEING  
FLANKED BY A SERIES OF SEGMENTS PARAL-  
LEL TO THE THREE HORIZONTAL STROKES OF  
THE SAME LETTER THAT BECOME SMALLER  
AND SMALLER.

SER. NO. 79-033,490, FILED 5-31-2006.

PRIORITY DATE OF 2-13-2006 IS CLAIMED.

SHAILA SETTLES, EXAMINING ATTORNEY

**Int. Cls.: 3, 16, 21, 35, 39, 40 and 42**

**Prior U.S. Cls.: 1, 2, 4, 5, 6, 13, 22, 23, 29, 30, 33, 37,  
38, 40, 50, 51, 52, 100, 101, 102, 103, 105 and 106**

**Reg. No. 3,468,049**

**United States Patent and Trademark Office**

**Registered July 15, 2008**

**TRADEMARK  
SERVICE MARK  
PRINCIPAL REGISTER**

# Folco Scent

FOLLMANN & CO.; GESELLSCHAFT FÜR CHEMIE-WERKSTOFFE UND; -VERFAHREN-STECHNIK MBH & CO. KG (FED REP GERMANY CORPORATION)

KARLSTRASSE 59  
32423 MINDEN  
FED REP GERMANY

FOR: PERFUMERY; ESSENTIAL OILS, NAMELY, PERFUME OILS, FRAGRANCES FOR PERSONAL USE; ROOM FRAGRANCES IN MICRO-CAPSULES; ROOM FRAGRANCES IN MICRO-POROUS AND SPONGE-LIKE CARRIERS FOR THE DELAYED RELEASE OF SCENTS NOT FOR PERSONAL USE, IN CLASS 3 (U.S. CLS. 1, 4, 6, 50, 51 AND 52).

FOR: MICRO-CAPSULES IN PAPER AND CARDBOARD, NAMELY, CAPSULE SHELLS WITH SOLID CONSISTENCY FOR CONTENTS WITH LIQUID CONSISTENCY, SOLD EMPTY, MAINLY FOR USE WITH PERFUMES AND RELATED FRAGRANCES IN THE FORM OF OILS FOR PACKAGING SERVICES AND FOR ADVERTISING PURPOSES; MICRO-POROUS, SPONGE-LIKE CARRIERS, NAMELY, DECORATIVE PAPER AND CARDBOARD, SOLD EMPTY, MAINLY FOR USE OF PERFUMES AND RELATED FRAGRANCES IN THE FORM OF OILS FOR THE DELAYED RELEASE OF SCENTS, IN CLASS 16 (U.S. CLS. 2, 5, 22, 23, 29, 37, 38 AND 50).

FOR: MICRO-CAPSULES, NAMELY, CAPSULE SHELLS WITH SOLID CONSISTENCY FOR CONTENTS WITH LIQUID CONSISTENCY THAT ARE CONTAINED IN ARTICLES FOR CLEANING PURPOSES AND HOUSEHOLD SPONGES NOT OF PAPER AND CARDBOARD, SOLD EMPTY, MAINLY FOR USE WITH PERFUMES AND RELATED FRAGRANCES IN THE FORM OF OILS AND AROMAS; HOUSEHOLD SPONGES NOT OF PAPER AND CARDBOARD, SOLD EMPTY, MAINLY FOR USE OF PERFUMES AND RELATED FRAGRANCES IN THE FORM OF OILS FOR THE DELAYED RELEASE OF SCENTS, IN CLASS 21 (U.S. CLS. 2, 13, 23, 29, 30, 33, 40 AND 50).

FOR: ADVERTISING SERVICES, NAMELY, DIRECT MAIL ADVERTISING, DISSEMINATION OF ADVERTISING MATTER AND FRAGRANCE SAMPLE DISTRIBUTION FOR ADVERTISING PURPOSES USING MICRO-CAPSULES OR MICRO-POROUS, SPONGE-LIKE CARRIERS CONTAINING SCENTS; RETAIL STORE SERVICES, NAMELY, SERVICES OF A MEDIATOR OF CONTRACTS FOR THIRD PARTIES REGARDING THE MARKETING OF GOODS, WORDING OF ADVERTISING TEXTS AND ILLUSTRATIONS THEREOF REGARDING MICRO-POROUS AND SPONGE-LIKE CARRIERS, CONTAINING AROMAS IN POWDER FORM FOR THE DELAYED RELEASE OF AROMAS FOR USE WITH FOODSTUFFS, LACQUER COVERINGS, AND FOOD PACKAGING, IN CLASS 35 (U.S. CLS. 100, 101 AND 102).

FOR: WAREHOUSING SERVICES, NAMELY, DISTRIBUTION OF MICRO-POROUS AND SPONGE-LIKE CARRIERS CONTAINING AROMAS IN POWDER FORM FOR THE DELAYED RELEASE OF AROMAS IN FOODSTUFFS, LACQUER COVERINGS AND FOOD PACKAGING FOR OTHERS; DELIVERY, LOGISTICS AND REVERSE LOGISTICS SERVICES IN THE FIELD OF TRANSPORTATION, NAMELY, STORAGE, TRANSPORTATION AND DELIVERY OF MICRO-POROUS AND SPONGE-LIKE CARRIERS CONTAINING AROMAS IN POWDER FORM FOR THE DELAYED RELEASE OF AROMAS IN FOODSTUFFS, LACQUER COVERINGS AND FOOD PACKAGING FOR OTHERS BY AIR, RAIL, SHIP AND TRUCK, IN CLASS 39 (U.S. CLS. 100 AND 105).

FOR: MANUFACTURE FOR THIRD PARTIES OF MICRO-CAPSULES, ADAPTED TO CUSTOMERS' INTERESTS, CONTAINING SCENTS, MAINLY PERFUMES OR FRAGRANCES, MAINLY IN THE FORM OF OILS AND AROMAS, OR APPLYING OF SCENTS TO MICRO-POROUS, SPONGE-LIKE CARRIERS, IN PARTICULAR PERFUMES OR FRAGRANCES, MAINLY IN THE FORM OF OILS AND AROMAS, TO THE ORDER AND/OR ACCORDING

TO THE SPECIFICATIONS OF OTHERS, IN CLASS 40 (U.S. CLS. 100, 103 AND 106).

FOR: LICENSING OF INTELLECTUAL PROPERTY AND PATENT LICENSING IN THE FIELD OF MICRO-POROUS AND SPONGE-LIKE CARRIERS CONTAINING AROMAS IN POWDER FORM FOR THE DELAYED RELEASE OF AROMAS FOR USE WITH FOODSTUFFS, LACQUER COVERINGS, AND FOOD PACKAGING, IN CLASS 42 (U.S. CLS. 100 AND 101).

THE MARK CONSISTS OF STANDARD CHARACTERS WITHOUT CLAIM TO ANY PARTICULAR FONT, STYLE, SIZE, OR COLOR.

PRIORITY DATE OF 11-25-2004 IS CLAIMED.

OWNER OF INTERNATIONAL REGISTRATION 0910357 DATED 5-24-2005, EXPIRES 5-24-2015.

OWNER OF U.S. REG. NO. 3,078,434.

NO CLAIM IS MADE TO THE EXCLUSIVE RIGHT TO USE "SCENT", APART FROM THE MARK AS SHOWN.

SER. NO. 79-033,573, FILED 5-24-2005.

TRACY WHITTAKER-BROWN, EXAMINING ATTORNEY

**Int. Cls.: 1, 5, 29 and 30**

**Prior U.S. Cls.: 1, 5, 6, 10, 18, 26, 44, 46, 51 and 52**

**United States Patent and Trademark Office**

**Reg. No. 3,468,050**

**Registered July 15, 2008**

**TRADEMARK  
PRINCIPAL REGISTER**



DSM IP ASSETS B.V. (NETHERLANDS BESLO-  
TEN VENNOOTSCHAP)  
HET OVERLOON 1  
NL-6411 TE HEERLEN  
NETHERLANDS

FOR: CHEMICALS AND BIOCHEMICALS FOR USE IN THE MANUFACTURE OF FOOD, BEVERAGE AND DAIRY PRODUCTS; CHEMICAL AND BIOCHEMICAL PRODUCTS FOR PRESERVING FOODSTUFFS AND BEVERAGES; CHEMICAL AND BIOCHEMICAL PRODUCTS, NAMELY, VEGETABLE OILS, LIPIDS, FATS OR FATTY ACIDS FOR ADDITION AND SUPPLEMENTATION TO FOOD, BEVERAGE AND DAIRY PRODUCTS, WHICH ARE SLOWLY DIGESTIBLE, AND WHICH ARE SOLD TO THE MANUFACTURERS OF FOOD, BEVERAGE AND DAIRY PRODUCTS, IN CLASS 1 (U.S. CLS. 1, 5, 6, 10, 26 AND 46).

FOR: VITAMINS; MINERAL SUPPLEMENTS; MINERALS, NAMELY, MINERAL ADDITIONS AND MINERAL SUPPLEMENTS FOR HUMAN OR ANIMAL CONSUMPTION, WHICH ARE SLOWLY DIGESTIBLE; NUTRITIONAL ADDITIVES FOR HUMAN OR ANIMAL CONSUMPTION FOR MEDICAL PURPOSES; DIETETIC FOODS ADAPTED FOR MEDICAL USE; DIETETIC PREPARATIONS AND SUBSTANCES ADAPTED FOR MEDICAL PURPOSES, NAMELY, DIETARY SUPPLEMENTS WITH INGREDIENTS WHICH ARE SLOWLY DIGESTIBLE, IN CLASS 5 (U.S. CLS. 6, 18, 44, 46, 51 AND 52).

FOR: EDIBLE JELLIES, JAMS; MILK AND MILK PRODUCTS EXCLUDING ICE CREAM, ICE MILK,

AND FROZEN YOGURT; EDIBLE OILS AND FATS; DIETETIC FOODS, NOT FOR MEDICAL USE, NAMELY, DAIRY PRODUCTS EXCLUDING ICE CREAM, ICE, ICE MILK AND FROZEN YOGURT; DIETETIC FOODS NOT FOR MEDICAL USE, NAMELY DIETETIC FOODS WITH INGREDIENTS, NAMELY, MIXTURES OF VEGETABLE OILS, WHICH ARE SLOWLY DIGESTIBLE, IN CLASS 29 (U.S. CL. 46).

FOR: DIETETIC FOODS, NOT FOR MEDICAL USE, NAMELY, DAIRY PRODUCTS IN THE NATURE OF ICE CREAM, ICE, ICE MILK AND FROZEN YOGURT; DIETETIC FOODS, NOT FOR MEDICAL USE, NAMELY, BREAKFAST CEREALS, CEREAL-BASED SNACK FOODS, READY TO EAT, CEREAL DERIVED FOOD BARS, BREADS, BISCUITS, CAKES, PASTRY, AND PREPARED MEALS CONSISTING PRIMARILY OF PASTA OR RICE; ICE-CREAM; ICE, IN CLASS 30 (U.S. CL. 46).

PRIORITY DATE OF 5-17-2006 IS CLAIMED.

OWNER OF INTERNATIONAL REGISTRATION  
0910857 DATED 11-10-2006, EXPIRES 11-10-2016.

OWNER OF U.S. REG. NO. 3,265,279.

SER. NO. 79-033,614, FILED 11-10-2006.

REBECCA POVARCHUK, EXAMINING ATTORNEY

**Int. Cls.: 1, 5, 29 and 30**

**Prior U.S. Cls.: 1, 5, 6, 10, 18, 26, 44, 46, 51 and 52**

**United States Patent and Trademark Office**

**Reg. No. 3,468,051**

**Registered July 15, 2008**

**TRADEMARK  
PRINCIPAL REGISTER**

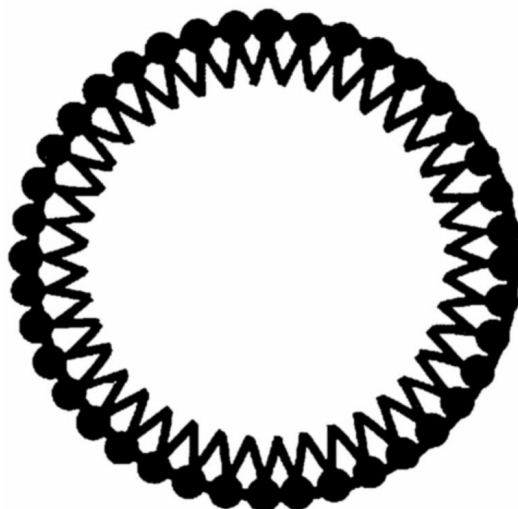

DSM IP ASSETS B.V. (NETHERLANDS BESLO-  
TEN VENNOOTSCHAP)  
HET OVERLOON 1  
NL-6411 TE HEERLEN  
NETHERLANDS

FOR: CHEMICALS AND BIOCHEMICALS FOR USE IN THE MANUFACTURE OF FOOD, BEVERAGE AND DAIRY PRODUCTS; CHEMICAL AND BIOCHEMICAL PRODUCTS FOR PRESERVING FOODSTUFFS AND BEVERAGES; CHEMICAL AND BIOCHEMICAL PRODUCTS, NAMELY, VEGETABLE OILS, LIPIDS, FATS OR FATTY ACIDS FOR ADDITION AND SUPPLEMENTATION TO FOOD, BEVERAGE AND DAIRY PRODUCTS, WHICH ARE SLOWLY DIGESTIBLE, AND WHICH ARE SOLD TO THE MANUFACTURERS OF FOOD, BEVERAGE AND DAIRY PRODUCTS, IN CLASS 1 (U.S. CLS. 1, 5, 6, 10, 26 AND 46).

FOR: VITAMINS; MINERAL SUPPLEMENTS; MINERALS, NAMELY, MINERAL ADDITIONS AND MINERAL SUPPLEMENTS FOR HUMAN OR ANIMAL CONSUMPTION, WHICH ARE SLOWLY DIGESTIBLE; NUTRITIONAL ADDITIVES FOR HUMAN OR ANIMAL CONSUMPTION FOR MEDICAL PURPOSES; DIETETIC FOODS ADAPTED FOR MEDICAL USE; DIETETIC PREPARATIONS AND SUBSTANCES ADAPTED FOR MEDICAL PURPOSES, NAMELY, DIETARY SUPPLEMENTS WITH INGREDIENTS WHICH ARE SLOWLY DIGESTIBLE, IN CLASS 5 (U.S. CLS. 6, 18, 44, 46, 51 AND 52).

FOR: EDIBLE JELLIES, JAMS; MILK AND MILK PRODUCTS EXCLUDING ICE CREAM, ICE MILK, AND FROZEN YOGURT; EDIBLE OILS AND FATS; DIETETIC FOODS, NOT FOR MEDICAL USE, NAMELY, DAIRY PRODUCTS EXCLUDING ICE CREAM, ICE, ICE MILK AND FROZEN YOGURT; DIETETIC FOODS NOT FOR MEDICAL USE, NAMELY, DIETETIC FOODS WITH INGREDIENTS, NAMELY, MIXTURES OF VEGETABLE OILS, WHICH ARE SLOWLY DIGESTIBLE, IN CLASS 29 (U.S. CL. 46).

FOR: DIETETIC FOODS, NOT FOR MEDICAL USE, NAMELY, DAIRY PRODUCTS IN THE NATURE OF ICE CREAM, ICE, ICE MILK AND FROZEN YOGURT; DIETETIC FOODS, NOT FOR MEDICAL USE, NAMELY, BREAKFAST CEREALS, CEREAL-BASED SNACK FOODS, READY TO EAT, CEREAL DERIVED FOOD BARS, BREADS, BISCUITS, CAKES, PASTRY, AND PREPARED MEALS CONSISTING PRIMARILY OF PASTA OR RICE; ICE-CREAM; ICE, IN CLASS 30 (U.S. CL. 46).

PRIORITY DATE OF 5-17-2006 IS CLAIMED.

OWNER OF INTERNATIONAL REGISTRATION  
0910856 DATED 11-10-2006, EXPIRES 11-10-2016.

SER. NO. 79-033,725, FILED 11-10-2006.

REBECCA POVARCHUK, EXAMINING ATTOR-  
NEY

**Int. Cls.: 7, 9 and 12**

**Prior U.S. Cls.: 13, 19, 21, 23, 26, 31, 34, 35, 36, 38 and 44**

**Reg. No. 3,468,052**

**United States Patent and Trademark Office**

**Registered July 15, 2008**

**TRADEMARK  
PRINCIPAL REGISTER**

# INTORQ

INTORQ BETEILIGUNGS- GMBH (FED REP  
GERMANY GMBH)  
WÜLMSE WEG 5  
31855 AERZEN  
FED REP GERMANY

FOR: SPEED REGULATORS AS PARTS FOR MACHINES AND ENGINES NOT FOR LAND VEHICLES; COUPLINGS NOT FOR LAND VEHICLES, IN PARTICULAR ELECTROMAGNETIC COUPLINGS FOR MACHINES AND ELECTROMAGNETIC BRAKES, SPRING-POWERED BRAKES AND PERMANENT MAGNET BRAKES FOR INDUSTRIAL MACHINES; CONTROL MECHANISMS FOR MACHINES, NAMELY, CONTROL MECHANISMS FOR BRAKES AND CLUTCHES, IN CLASS 7 (U.S. CLS. 13, 19, 21, 23, 31, 34 AND 35).

FOR: COMPUTER SOFTWARE FOR BRAKES AND CLUTCHES, ELECTRIC CONTROLLING

AND REGULATING APPARATUS FOR BRAKES AND COUPLINGS, NAMELY, BRAKE CONTROLLERS AND COUPLING CONTROLLERS, IN CLASS 9 (U.S. CLS. 21, 23, 26, 36 AND 38).

FOR: BRAKES FOR LAND VEHICLES, IN CLASS 12 (U.S. CLS. 19, 21, 23, 31, 35 AND 44).

THE MARK CONSISTS OF STANDARD CHARACTERS WITHOUT CLAIM TO ANY PARTICULAR FONT, STYLE, SIZE, OR COLOR.

OWNER OF INTERNATIONAL REGISTRATION 0911104 DATED 7-27-2006, EXPIRES 7-27-2016.

SER. NO. 79-033,818, FILED 7-27-2006.

LEIGH LOWRY, EXAMINING ATTORNEY

**Int. Cls.: 25, 32 and 33**

**Prior U.S. Cls.: 22, 39, 45, 46, 47, 48 and 49**

**United States Patent and Trademark Office**

**Reg. No. 3,468,053**

**Registered July 15, 2008**

**TRADEMARK  
PRINCIPAL REGISTER**

# DEVIL BAG

GLOBAL NETWORK POWER LTD. (GREAT  
BRITAIN LTD LIAB CO)  
465 BATTERSEA PARK ROAD  
LONDON SW11 4LR  
UNITED KINGDOM

FOR: BATHING SUITS; BATHING TRUNKS; BATH ROBES; IMITATION LEATHER CLOTHING, NAMELY, PANTS, TROUSERS, SUITS, CLOTHING FOR GYMNASTICS IN THE NATURE OF GYMNASIATIC SHOES, LEOTARDS, PANTS AND SHORTS; JACKETS, CORSELETS, WAISTCOATS; CLOTHING, NAMELY, SHIRTS, PANTS, TROUSERS, PULL-OVERS, SWEATERS, FROCKS, SLIPS, JACKETS, SKIRTS, COLLAR PROTECTORS, STOCKINGS; TEDDIES; MASQUERADE COSTUMES, HATS; CAPS; BASEBALL CAPS; JACKETS; SKULL CAPS, HEADGEAR, NAMELY, HEAD SCARF, BERETS; HALLOWEEN, MASQUERADE, AND CARNIVAL COSTUMES; OUTER CLOTHING, NAMELY, COATS, JACKETS, PARKAS, WATERPROOF CLOTHING IN THE NATURE OF JACKETS, PANTS, RAINWEAR AND SKIWEAR; PULLOVERS; SHOES; BOOTS FOR SPORTS; FOOTBALL SHOES; SOCKS; SPORTS SHOES; SWEATERS; TEE-SHIRTS; KNITWEAR, NAMELY, SHIRTS, TROUSERS, BATHING SUITS, BATHING TRUNKS, SLIPS, PULLOVERS, PANTS, LEGGINGS; SINGLET; OVERCOATS, IN CLASS 25 (U.S. CLS. 22 AND 39).

FOR: NON-ALCOHOLIC BEVERAGES, NAMELY, SWEET CIDER, COCKTAILS, FRUIT JUICES, VEGETABLES JUICES, LEMONADES; APERITIFS, NON-ALCOHOLIC; POWDERS FOR MAKING EFFERVESCING FRUIT BEVERAGES, NOT IN THE NATURE OF A VITAMIN SUPPLEMENT; PREPARATIONS IN THE NATURE OF PASTILLES FOR MAKING EFFERVESCING FRUIT BEVERAGES; ESSENCES FOR MAKING SOFT DRINK BEV-

ERAGES AND LIQUEURS; NON-ALCOHOLIC FRUIT EXTRACTS USED IN THE PREPARATION OF BEVERAGES; ISOTONIC BEVERAGES; ENERGY DRINKS, IN CLASS 32 (U.S. CLS. 45, 46 AND 48).

FOR: ALCOHOLIC BEVERAGES, NAMELY, DISTILLED SPIRITS OF RICE, SAKE, CURACAO, HYDROMEL; ALCOHOLIC BEVERAGES CONTAINING FRUIT; ANISETTE; APERITIFS; AR-RACK; BRANDY; PREPARED ALCOHOLIC COCKTAILS; ALCOHOLIC ESSENCES; ALCOHOLIC FRUIT EXTRACTS; ALCOHOLIC EXTRACTS; GIN; LIQUEURS; ALCOHOLIC BITTERS; RUM; DISTILLED SPIRITS; DIGESTERS, NAMELY, COGNAC, ARMAGNACS, GRAPPAS, HERB-FLAVORED LIQUEURS, WINES AS PORT WINE, SHERRY, AND WINE WITH BRANDY; LIQUEURS AND DISTILLED SPIRITS; WHISKY; VODKA, IN CLASS 33 (U.S. CLS. 47 AND 49).

THE MARK CONSISTS OF STANDARD CHARACTERS WITHOUT CLAIM TO ANY PARTICULAR FONT, STYLE, SIZE, OR COLOR.

PRIORITY DATE OF 8-19-2005 IS CLAIMED.

OWNER OF INTERNATIONAL REGISTRATION 0912552 DATED 2-17-2006, EXPIRES 2-17-2016.

NO CLAIM IS MADE TO THE EXCLUSIVE RIGHT TO USE "BAG", APART FROM THE MARK AS SHOWN.

SER. NO. 79-034,260, FILED 2-17-2006.

Laura Hammel, Examining Attorney



**Int. Cls.: 27 and 37**

**Prior U.S. Cls.: 19, 20, 37, 42, 50, 100, 103 and 106**

**United States Patent and Trademark Office**

**Reg. No. 3,468,054**

**Registered July 15, 2008**

**TRADEMARK  
SERVICE MARK  
PRINCIPAL REGISTER**

# **Polytan Mono**

GEP SPORTSTÄTTENBAU HOLDING GMBH  
(FED REP GERMANY GMBH)  
GEWERBERING 3  
86666 BURGHEIM  
FED REP GERMANY

FOR: ARTIFICIAL TURF, IN CLASS 27 (U.S. CLS.  
19, 20, 37, 42 AND 50).

FOR: INSTALLATION, MAINTENANCE, CLEAN-  
ING AND REPAIR OF SPORTS AREA COVERINGS  
AND ARTIFICIAL TURF; BUILDING CONSTRU-  
TION; IN-SITU CONSTRUCTION OF SPORTS AREA  
COVERINGS, IN CLASS 37 (U.S. CLS. 100, 103 AND  
106).

PRIORITY DATE OF 6-12-2006 IS CLAIMED.

OWNER OF INTERNATIONAL REGISTRATION  
0912568 DATED 11-14-2006, EXPIRES 11-14-2016.

"POLYTAN MONO", APPEARING IN THE MARK  
HAS NO MEANING IN A FOREIGN LANGUAGE.

SER. NO. 79-034,267, FILED 11-14-2006.

DAVID C. REIHNER, EXAMINING ATTORNEY

Int. Cl.: 30

Prior U.S. Cl.: 46

United States Patent and Trademark Office

Reg. No. 3,468,055

Registered July 15, 2008

TRADEMARK  
PRINCIPAL REGISTER



SHANGHAI FU SHENG SOYA; FOOD CO., LTD  
(CHINA CORPORATION)  
NO.20, LIUCHANG ROAD  
SHANGHAI 200443  
CHINA

FOR: SOYA PRODUCTS, NAMELY, BREAD  
WITH SOYBEAN, SOY BEAN PASTE, SOY SAUCE,  
SOYA FLOUR; GLUTEN FOR FOOD, IN CLASS 30  
(U.S. CL. 46).

OWNER OF INTERNATIONAL REGISTRATION  
0912965 DATED 1-22-2007, EXPIRES 1-22-2017.

THE ENGLISH TRANSLATION OF THE FOR-  
EIGN WORD(S) IN THE MARK IS OPEN, LITTLE  
AND BABY.

THE TRANSLITERATION OF THE NON-LATIN  
CHARACTERS IN THE MARK IS ZHANGXIAOBAO

SER. NO. 79-034,423, FILED 1-22-2007.

ANGELA GAW, EXAMINING ATTORNEY

**Int. Cls.: 9, 35, 38, 42 and 44**

**Prior U.S. Cls.: 21, 23, 26, 36, 38, 100, 101, 102 and 104**

**United States Patent and Trademark Office**

**Reg. No. 3,468,056**

**Registered July 15, 2008**

**TRADEMARK  
SERVICE MARK  
PRINCIPAL REGISTER**



MOLDA AG (FED REP GERMANY AKTIENGESELLSCHAFT)  
GARTENSTRASSE 13  
21368 DAHLENBURG  
FED REP GERMANY

FOR: ELECTRIC CONTROLLING DEVICES FOR USE IN THE TRACING OF THE GEOGRAPHICAL ORIGIN OF FOOD, FRUIT AND AGRARIAN PRODUCTS BY MEANS OF ISOTROPY ANALYSIS; CALCULATORS; DATA PROCESSORS; COMPUTER PROGRAMS AND SOFTWARE FOR USE IN THE TRACING OF THE GEOGRAPHICAL ORIGIN OF FOOD, FRUIT AND AGRARIAN PRODUCTS BY ISOTROPY ANALYSIS, IN CLASS 9 (U.S. CLS. 21, 23, 26, 36 AND 38).

FOR: CLERICAL SERVICES IN THE NATURE OF ENTERING DATA FOR THE PURPOSE OF EXPANDING, COMPLETING AND UPDATING DATABASES; BUSINESS INVESTIGATIONS IN THE NATURE OF AGRICULTURAL RESEARCH USING DATABASES AND THE INTERNET FOR THIRD PARTIES FOR THE IDENTIFICATION OF THE GEOGRAPHICAL ORIGIN OF FOOD, FRUIT AND AGRARIAN PRODUCTS, IN CLASS 35 (U.S. CLS. 100, 101 AND 102).

FOR: ELECTRONIC TRANSMISSION OF DATA VIA COMPUTER TERMINALS FOR USE IN EXPANDING, COMPLETING AND UPDATING DATABASES IN THE FIELD OF THE GEOGRAPHICAL ORIGIN OF FOOD, FRUIT AND AGRARIAN PRODUCTS, IN CLASS 38 (U.S. CLS. 100, 101 AND 104).

FOR: DEVELOPMENT OF COMPUTER HARDWARE, SOFTWARE, PROGRAMS AND DATABASES; DESIGN OF COMPUTER HARDWARE, SOFTWARE AND PROGRAMS FOR OTHERS; DESIGN OF DATABASES; MAINTENANCE OF COMPUTER SOFTWARE, COMPUTER PROGRAMS AND DATABASES PROGRAMS; UPDATING OF

COMPUTER SOFTWARE, COMPUTER PROGRAMS AND DATA BASED PROGRAMS FOR OTHERS; CREATION OF WEBSITES FOR OTHERS; SCIENTIFIC LABORATORY SERVICES IN THE NATURE OF CHEMICAL LABORATORY SERVICES FOR THE INVESTIGATION OF AND ESTABLISHMENT OF GEOGRAPHICAL ORIGIN OF FOOD, FRUIT AND AGRARIAN PRODUCTS; LABORATORY RESEARCH SERVICES IN THE AGRARIAN, FOOD AND PHARMACEUTICAL FIELDS; CHEMICAL ANALYSIS OF THE AGRARIAN, FOOD AND PHARMACEUTICAL FIELDS FOR USE IN ESTABLISHING PROOF OF ORIGIN; DESIGN AND DEVELOPMENT OF DATA PROCESSING COMPUTER SOFTWARE PROGRAMS FOR USE IN EVALUATING DATA ACHIEVED THROUGH ANALYSIS; PROVIDING QUALITY ASSURANCE SERVICES IN THE FIELD OF ESTABLISHING PROOF OF ORIGIN OF FOOD, FRUIT AND AGRARIAN PRODUCTS, IN CLASS 42 (U.S. CLS. 100 AND 101).

FOR: AGRICULTURAL ADVICE SERVICES; HORTICULTURAL SERVICES, IN CLASS 44 (U.S. CLS. 100 AND 101).

PRIORITY DATE OF 9-7-2005 IS CLAIMED.

OWNER OF INTERNATIONAL REGISTRATION 0913031 DATED 3-7-2006, EXPIRES 3-7-2016.

THE COLOR(S) BLUE AND GREY IS/ARE CLAIMED AS A FEATURE OF THE MARK.

THE COLOR BLUE APPEARS IN THE WORDING "ID" AND IN THE BACKGROUND OF THE LARGE RECTANGLE; THE COLOR GREY APPEARS IN THE WORD "FRUIT," IN THE PERIOD, IN THE

SMALL RECTANGLE, AND IN THE OUTLINE OF  
THE LARGE RECTANGLE.

SER. NO. 79-034,440, FILED 3-7-2006.

LAURA HAMMEL, EXAMINING ATTORNEY

**Int. Cls.: 1, 5, 40 and 42**

**Prior U.S. Cls.: 1, 5, 6, 10, 18, 26, 44, 46, 51, 52, 100, 101, 103 and 106**

**Reg. No. 3,468,057**

**United States Patent and Trademark Office**

**Registered July 15, 2008**

**TRADEMARK  
SERVICE MARK  
PRINCIPAL REGISTER**



PANBIO LIMITED; ACN 010 728 220 (AUSTRALIA LTD LIAB CO)  
532 SEVENTEEN MILE ROCKS ROAD  
SINNAMON PARK QLD 4073  
AUSTRALIA

FOR: CHEMICALS FOR USE IN SCIENCE; CATALYSTS, NAMELY, BIOCHEMICAL CATALYSTS, IN CLASS 1 (U.S. CLS. 1, 5, 6, 10, 26 AND 46).

FOR: DIAGNOSTIC PREPARATIONS FOR MEDICAL AND VETERINARY PURPOSES; DIAGNOSTIC REAGENTS FOR MEDICAL AND VETERINARY USE FOR SALE IN KIT FORM, KITS COMPRISED OF ENZYMES AND/OR ENZYME SUB-FRAGMENTS, ANALYTE BINDING COMPONENTS LINKED TO ENZYMES AND/OR ENZYME SUB-FRAGMENTS AND ENZYME SUBSTRATES FOR MEDICAL AND VETERINARY USE; CHEMICAL REAGENTS AND DIAGNOSTIC REAGENTS FOR MEDICAL AND VETERINARY USE; REAGENTS FOR USE IN MEDICAL AND VETERINARY ANALYTICAL AND DIAGNOSTIC TESTS; REAGENTS IN KIT FORM FOR CONDUCTING ENZYME-LINKED IMMUNOSORBENT ASSAYS (ELISA) FOR MEDICAL AND VETERINARY PURPOSES; REAGENTS FOR USE WITH ANALYZERS FOR MEDICAL AND VETERINARY PURPOSES; IMMUNOASSAY REAGENTS FOR MEDICAL AND VETERINARY USE; LABORATORY REAGENTS FOR MEDICAL AND VETERINARY USE; REAGENTS FOR USE IN MEDICAL AND VETERINARY DIAGNOSIS; IMMUNOLOGICAL PRODUCTS NAMELY ENZYME BASED ASSAY SYSTEMS FOR

DETECTION OF MARKERS OF DISEASE FOR MEDICAL AND VETERINARY USE; ENZYMES NAMELY  $\beta$ -LACTAMASE, LUCIFERASE AND OXIDOREDUCTASE FOR MEDICAL AND VETERINARY USE; ENZYMES FOR USE IN MEDICAL AND VETERINARY DIAGNOSTICS AND ANALYSIS, IN CLASS 5 (U.S. CLS. 6, 18, 44, 46, 51 AND 52).

FOR: CUSTOM MANUFACTURING SERVICES FOR OTHERS, NAMELY, MANUFACTURE OF ASSAYS, KITS OR COMPONENTS FOR USE IN VETERINARY AND MEDICAL DIAGNOSTIC ASSAYS; CUSTOM MANUFACTURING, NAMELY, THE CUSTOM MANUFACTURING OF SCIENTIFIC, MEDICAL AND VETERINARY PRODUCTS, CHEMICALS, REAGENTS, ASSAYS, ANALYTICAL AND DIAGNOSTIC TESTS, DIAGNOSTIC PRODUCTS, ENZYMES, IMMUNOLOGICAL PRODUCTS, ASSAYING AND DIAGNOSTIC APPARATUS AND INSTRUMENTS, IN CLASS 40 (U.S. CLS. 100, 103 AND 106).

FOR: RESEARCH AND DESIGN OF ANALYTICAL AND DIAGNOSTIC ASSAYS IN THE FIELD OF ANALYTE DETECTION AND DIAGNOSIS OF DISEASE; CONTRACT RESEARCH SERVICES IN THE FIELD OF DEVELOPING ANALYTICAL AND DIAGNOSTIC ASSAYS, IN CLASS 42 (U.S. CLS. 100 AND 101).

PRIORITY DATE OF 4-21-2006 IS CLAIMED.

OWNER OF INTERNATIONAL REGISTRATION  
0913109 DATED 10-19-2006, EXPIRES 10-19-2016.

SER. NO. 79-034,478, FILED 10-19-2006.

AMEETA JORDAN, EXAMINING ATTORNEY

**Int. Cls.: 35 and 42**

**Prior U.S. Cls.: 100, 101 and 102**

**United States Patent and Trademark Office**

**Reg. No. 3,468,058**

**Registered July 15, 2008**

**SERVICE MARK  
PRINCIPAL REGISTER**

# TGaffiliate

TRAFFIC GATE, LTD. (JAPAN CORPORATION)  
11-2 TORANOMON 5 CHOME  
MINATO-KU; TOKYO 105-0001  
JAPAN

FOR: ADVERTISING AND PUBLICITY SERVICES; RENTAL OF ADVERTISING SPACE ON INTERNET WEB SITES FOR PUBLICITY PURPOSES; MEDIATION OF CONTRACT FOR THE PURCHASE AND SALE OF MERCHANDISE VIA THE INTERNET; PROVIDING CONSUMER BUYING INFORMATION IN THE FIELD OF MERCHANDISE SALES ON WEB SITES; MERCHANDISING SERVICES FOR PROMOTING THE GOODS AND SERVICES OF OTHERS TO THE PURCHASING PUBLIC AND FOR INDUCING THE PURCHASING PUBLIC TO BUY THE GOODS AND SERVICES OF OTHERS THROUGH AN EXCHANGEABLE POINTS FOR GOODS AND SERVICES PROGRAM, IN CLASS 35 (U.S. CLS. 100, 101 AND 102).

FOR: COMPUTER SOFTWARE DESIGN, COMPUTER PROGRAMMING, AND MAINTENANCE

OF COMPUTER SOFTWARE; PROVIDING ON-LINE NON-DOWNLOADABLE SOFTWARE FOR MANAGING AN EXCHANGEABLE POINTS FOR GOODS AND SERVICES PROGRAM AND FOR USE IN DATABASE MANAGEMENT, IN CLASS 42 (U.S. CLS. 100 AND 101).

THE MARK CONSISTS OF STANDARD CHARACTERS WITHOUT CLAIM TO ANY PARTICULAR FONT, STYLE, SIZE, OR COLOR.

PRIORITY DATE OF 6-21-2006 IS CLAIMED.

OWNER OF INTERNATIONAL REGISTRATION 0913164 DATED 12-21-2006, EXPIRES 12-21-2016.

SER. NO. 79-034,496, FILED 12-21-2006.

PAUL MORENO, EXAMINING ATTORNEY

**Int. Cl.: 7**

**Prior U.S. Cls.: 13, 19, 21, 23, 31, 34 and 35**

**United States Patent and Trademark Office**

**Reg. No. 3,468,059**

**Registered July 15, 2008**

**TRADEMARK  
PRINCIPAL REGISTER**

# Möller Fluidflow

MÖLLER MATERIALS HANDLING GMBH (FED  
REP GERMANY LTD LIAB CO)  
HARDERSLEBENER STR. 7  
25421 PINNEBERG  
FED REP GERMANY

OWNER OF INTERNATIONAL REGISTRATION  
0913376 DATED 1-18-2007, EXPIRES 1-18-2017.

SER. NO. 79-034,541, FILED 1-18-2007.

FOR: PNEUMATIC CONVEYORS AND PARTS  
THEREFOR, FOR CONVEYING BULK GOODS, IN  
CLASS 7 (U.S. CLS. 13, 19, 21, 23, 31, 34 AND 35).

STEPHEN AQUILA, EXAMINING ATTORNEY



**Int. Cls.: 9 and 10**

**Prior U.S. Cls.: 21, 23, 26, 36, 38, 39 and 44**

**Reg. No. 3,468,060**

**United States Patent and Trademark Office**

**Registered July 15, 2008**

**TRADEMARK  
PRINCIPAL REGISTER**

# FISIOLINE

FISIOLINE; DI BATTAGLIOTTI UGO & C. S.N.C.  
(ITALY CORPORATION)  
BORGATA MOLINO, 29  
I-12060 VERDUNO (CN)  
ITALY

FOR: SCIENTIFIC, WEIGHING, MEASURING EQUIPMENT AND INSTRUMENTS, NAMELY, FREQUENCY METERS, THERMOMETERS, PRESSURE SENSORS, TEMPERATURE SENSORS AND INDICATORS, LASER GUIDE LIGHTS FOR VISUAL ALIGNMENT AND POSITIONING, NOT FOR MEDICAL PURPOSES, LIGHT PULSE RATE MONITORS, ELECTRONIC MAGNETOSTRICTIVE EQUIPMENT IN THE NATURE OF WAVE SENSORS, AND WAVE ANALYZERS, IN CLASS 9 (U.S. CLS. 21, 23, 26, 36 AND 38).

FOR: SURGICAL AND MEDICAL EQUIPMENT AND INSTRUMENTS, NAMELY, NEUROMUSCULAR STIMULATORS; LASERS FOR MEDICAL USE; ELECTRO-STIMULATORS FOR STIMULATING ALL MUSCLE FIBERS OF THE BODY FOR MEDICAL USE; MEDICAL ULTRASOUND APPARATUS FOR MEDICAL USE; EQUIPMENT AND INSTRUMENTS FOR PRESSURE THERAPY FOR MEDICAL USE, NAMELY, LINFOPRESS CONSISTING OF A MICROPROCESSOR, AN AIR COMPRESSOR, AND INFLATABLE STRAPS FOR THE BODY, ARMS, AND LEGS, ALL USED TO APPLY SEQUENTIAL PRESSURE TO THE BODY FOR THE TREATMENT OF VENOSTASIS AND LYMPHOSTASIS; EQUIPMENT AND INSTRUMENTS FOR MAGNET THERAPY FOR MEDICAL USE, NAMELY, FOR USE IN VASODILATION, ANALGESIC ACTION, ANTI-INFLAMMATORY ACTION, SPASMOLYTIC ACTIVITY, ACCELERATION OF HEALING, REDUCTION OF EDEMAS, AND MAGNETOTHERAPY; MICROWAVE EQUIPMENT AND INSTRUMENTS FOR MEDICAL USE, NAMELY, MICROWAVE STIMULATORS FOR USE IN MICROWAVE THERAPY FOR THE TREATMENT OF PAIN; ELECTRICAL INSTRUMENTS FOR THE BEAUTY SECTOR FOR STIMULATING ALL MUSCLE FIBERS, NAMELY,

ELECTROSTIMULATORS, SEQUENTIAL ELECTROSTIMULATORS, AND DRAINING ELECTROSTIMULATORS; LASERS FOR USE IN THE BEAUTY SECTOR AND NOT FOR MEDICAL USE, NAMELY, LASERS FOR REMOVING, FIXING, AND REDUCING SKIN, FACE, AND BODY IMPERFECTIONS AND LASERS FOR ANTI-AGING ACTIONS, ACNE REDUCTION, COUPEROSE REDUCTION, SKIN TONING, CELLULITE REDUCTION; ULTRASOUND EQUIPMENT AND INSTRUMENTS FOR THE BEAUTY SECTOR AND NOT FOR MEDICAL PURPOSES, NAMELY, DEVICES FOR FACE LIFTING EFFECT, REDUCTION OF ADIPOSE PANNICULUS, CELLULITE REDUCTION, AND TISSUE TONING; EQUIPMENT AND INSTRUMENTS FOR PRESSURE THERAPY IN THE BEAUTY SECTOR AND NOT FOR MEDICAL PURPOSES, NAMELY, LINFOPRESS CONSISTING OF A MICROPROCESSOR, AN AIR COMPRESSOR, AND INFLATABLE STRAPS FOR THE BODY, ARMS, AND LEGS, ALL FOR LEG SWELLING, EDEMAS BECAUSE OF POOR CIRCULATION, LYMPHATIC STASIS SKIN FIBROSIS, AND PANNICULOSIS, IN CLASS 10 (U.S. CLS. 26, 39 AND 44).

THE MARK CONSISTS OF STANDARD CHARACTERS WITHOUT CLAIM TO ANY PARTICULAR FONT, STYLE, SIZE, OR COLOR.

PRIORITY DATE OF 9-28-2006 IS CLAIMED.

OWNER OF INTERNATIONAL REGISTRATION 0913417 DATED 11-23-2006, EXPIRES 11-23-2016.

"FISIOLINE" APPEARING IN THE MARK HAS NO MEANING IN A FOREIGN LANGUAGE.

SER. NO. 79-034,554, FILED 11-23-2006.

SUNG IN, EXAMINING ATTORNEY

**Int. Cl.: 10**

**Prior U.S. Cls.: 26, 39 and 44**

**Reg. No. 3,468,061**

**United States Patent and Trademark Office**

**Registered July 15, 2008**

**TRADEMARK  
PRINCIPAL REGISTER**

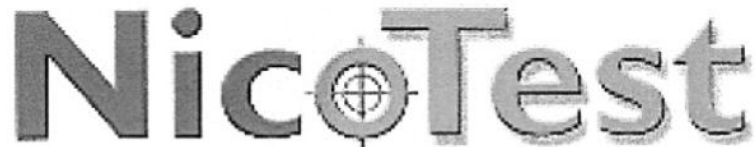

The logo for Nicotest features the word "Nicotest" in a bold, sans-serif font. The letter "O" is replaced by a target symbol, consisting of a circle with a crosshair inside. The letters are shaded to give a three-dimensional effect.

G-NOSTICS LTD (UNITED KINGDOM PRIVATE  
LIMITED COMPANY)  
68J THE BUSINESS CENTRE,  
MILTON PARK; DIDCOT, OXFORDSHIRE OX14  
4RX  
UNITED KINGDOM

FOR: DIAGNOSTIC TEST KITS FOR USE IN  
PERSONALIZING SMOKING CESSATION THER-  
APY AND NICOTINE ADDICTION TREATMENT,  
IN CLASS 10 (U.S. CLS. 26, 39 AND 44).

OWNER OF INTERNATIONAL REGISTRATION  
0913555 DATED 11-4-2005, EXPIRES 11-4-2015.

THE MARK CONSISTS OF THE WORD "NICOT-  
EST" IN STYLIZED BLOCK LETTERING WITH THE  
LETTER "O" DISPLAYED AS A TARGET. A CIRCLE  
IS DISPLAYED INSIDE THE LETTER "O" AND TWO  
STRAIGHT LINES CROSS THE LETTER "O" FORM-  
ING THE TARGET SYMBOL. ALL OF THE LET-  
TERS IN THE MARK ARE OUTLINED WITH A  
DARKENED LINE AND THE LETTERS ARE SHA-  
DED PROGRESSIVELY DARKER FROM THE LET-  
TER "N" TO THE SECOND LETTER "T".

SER. NO. 79-034,591, FILED 11-4-2005.

RENEE SERVANCE, EXAMINING ATTORNEY

Int. Cl.: 16

Prior U.S. Cls.: 2, 5, 22, 23, 29, 37, 38 and 50

Reg. No. 3,468,062

United States Patent and Trademark Office

Registered July 15, 2008

TRADEMARK  
PRINCIPAL REGISTER

E-Z DOTS

3L-LUDVIGSEN A/S (DENMARK LTD LIAB CO)  
VIBÆKVEJ 100  
DK-5690 TOMMERUP  
DENMARK

FOR: A DISPENSER FOR DISPENSING DOUBLE-SIDED, SELF-ADHESIVE TAPE FOR MOUNTING PHOTOGRAPHS, PAPER AND MATERIAL USED IN SCRAPBOOKING PROJECTS; TAPE, NAMELY, DOUBLE-SIDED ADHESIVE TAPE FOR PHOTOGRAPHS, PAPER AND MATERIAL USED IN SCRAPBOOKING PROJECTS, ADHESIVE TAPES FOR STATIONERY OR HOUSEHOLD PURPOSES, SELF-ADHESIVE TAPES FOR STATIONERY AND HOUSEHOLD PURPOSES; SELF-ADHESIVE STRIPS, STICKERS AND LABELS FOR INDEX CARDS; DEVICE FOR POSITIONING DOCUMENTS, NAMELY, DISPENSERS FOR MOUNTING STRIPS FOR STATIONERY OR HOUSEHOLD USE AND DOCUMENT HOLDERS FOR MOUNTING OF ADHESIVE STRIPS, TRANSPARENT RINGS FOR REINFORCING HOLES FOR BINDER RINGS, TRANSPARENT SELF-ADHESIVE HOLDERS FOR BUSINESS AND VISITING CARDS AND SELF-ADHESIVE LABEL HOLDERS; LABELS, NAMELY,

SELF-LAMINATING LABELS, SELF-ADHESIVE LABELS, LABEL HOLDERS, SHELVING LABEL HOLDERS, LABELS FOR 3 1/2" DISKETTES AND FLASH DRIVES, SELF-LAMINATING INDEX CARDS, SELF-LAMINATING BLANK CARDS; PHOTOGRAPH CORNERS, DOUBLE-SIDED ADHESIVE LABELS FOR PHOTOGRAPHS AND CLIPPINGS, IN CLASS 16 (U.S. CLS. 2, 5, 22, 23, 29, 37, 38 AND 50).

THE MARK CONSISTS OF STANDARD CHARACTERS WITHOUT CLAIM TO ANY PARTICULAR FONT, STYLE, SIZE, OR COLOR.

OWNER OF INTERNATIONAL REGISTRATION  
0913736 DATED 6-15-2006, EXPIRES 6-15-2016.

OWNER OF U.S. REG. NOS. 3,061,753, 3,087,829  
AND OTHERS.

SER. NO. 79-034,648, FILED 6-15-2006.

KATHERINE M. DUBRAY, EXAMINING ATTORNEY

Int. Cls.: 18 and 20

Prior U.S. Cls.: 1, 2, 3, 13, 22, 25, 32, 41 and 50

United States Patent and Trademark Office

Reg. No. 3,468,063

Registered July 15, 2008

TRADEMARK  
PRINCIPAL REGISTER



MAX MODA; DI FILANTI MASSIMILIANO (ITALLY INDIVIDUAL)  
VIA ALTOBELLI, 29  
I-47037 RIMINI, ITALY

FOR: LEATHER AND IMITATIONS THEREOF, GOODS MADE OF LEATHER AND IMITATIONS OF LEATHER, NAMELY, LEATHER CASES, LEATHER HANDBAGS, LEATHER CASES FOR CLOTHES, LEATHER HIP BAGS, SHOULDER BAGS, VALISES; ANIMAL SKINS AND HIDES; VANITY CASES SOLD EMPTY, ATTACHE CASES, LEATHER BRIEFCASES; BAGS, NAMELY, SPORT BAGS, BEACH BAGS, BOOK BAGS, SUIT BAGS, OVERNIGHT BAGS, HANDBAGS, CLUTCH BAGS, TRAVELING BAGS, SUITCASES, BACKPACKS, TRUNKS, CARRYING CASES, SATCHELS FOR MEN, WALLETS, PURSES FOR MEN AND WOMEN, DOCUMENT CASES, LEATHER NOTEPAD CASES, LEATHER CASES FOR APPOINTMENT BOOKS, LEATHER CASES FOR PLAYING CARDS, LEATHER CASES FOR MANICURE SETS; TRAVELING CASES SETS FOR TOILETRY BAGS FOR MEN AND WOMEN, THE FOREGOING SOLD EMPTY; LEATHER KEY CASES, SHOULDER STRAPS FOR BAGS, SUITCASE HANDLES AND SIMILAR ARTI-

CLES MADE OF SKIN, LEATHER AND IMITATIONS THEREOF, NAMELY, COIN PURSES, BUSINESS CARD CASES, CASES FOR CIGARETTES, CASES FOR TIES, CASES FOR SHIRTS, CASES FOR SLIPPERS, CASES FOR CLEAN SHOES, UMBRELLAS, WALKING STICKS; WHIPS AND SADDLERY GOODS, IN CLASS 18 (U.S. CLS. 1, 2, 3, 22 AND 41).

FOR: FURNITURE, NAMELY, VALETS, SLIPPER HOLDERS, TIE HOLDERS, SHOE-POLISH HOLDERS, IN CLASS 20 (U.S. CLS. 2, 13, 22, 25, 32 AND 50).

OWNER OF INTERNATIONAL REGISTRATION 0914012 DATED 8-18-2006, EXPIRES 8-18-2016.

THE ENGLISH TRANSLATION OF THE WORD "IL NUOVO BAROCCO" IN THE MARK IS THE NEW BAROQUE.

SER. NO. 79-034,724, FILED 8-18-2006.

ELI HELLMAN, EXAMINING ATTORNEY

**Int. Cls.: 9 and 42**

**Prior U.S. Cls.: 21, 23, 26, 36, 38, 100 and 101**

**Reg. No. 3,468,064**

**United States Patent and Trademark Office**

**Registered July 15, 2008**

**TRADEMARK  
SERVICE MARK  
PRINCIPAL REGISTER**

# Liteface

DAVID LUO (FRANCE INDIVIDUAL)  
1 QUAI GEORGES CLÉMENCEAU  
F-30900 NIMES  
FRANCE

FOR: OPTICAL AND OPTOELECTRONIC APPARATUS AND INSTRUMENTS, NAMELY, BACKLIT DISPLAYS, BACK LIGHTING DEVICES, LIGHT EMITTING DIODES, ORGANIC LIGHT EMITTING DIODES, POLYMER LIGHT EMITTING DIODES, LIQUID CRYSTAL DISPLAY PANELS, LIGHT GUIDES, AND PARTS AND COMPONENTS THEREFORE; ELECTRICAL APPARATUS FOR MEASURING PHYSICAL CHARACTERISTICS IN THE NATURE OF LIGHT INTENSITY AND LUMINANCE, NAMELY, SPECTROMETER, OSCILLATOR; INDICATOR LIGHTS, REFLECTIVE ELECTRIC SIGNS COMPRISING VISUAL DISPLAYS AND PARTS AND FITTINGS THEREFORE; ELECTROMECHANICAL, ELECTRONIC, OPTIC AND OPTOELECTRONIC COMPONENTS AND APPARATUS, NAMELY, SWITCHES, MULTI DISPLAY SWITCHES, LIGHT SWITCHES, ILLUMINATED SWITCHES, SAFETY SWITCHES, PUSH BUTTON SWITCHES, INSERT POWER SWITCHES, CONTROL SWITCHES, MICRO SWITCHES, INDUSTRIAL SWITCHES, POWER SWITCHES, ROTARY PUSH-BUTTON SWITCHES, KEY LOCK SWITCHES, KEY SWITCHES, CONTACT SWITCHES, MEMBRANE SWITCHES, ROTARY SWITCHES, ACTUATOR SWITCHES, PUSH WHEEL SWITCHES, SWITCHING SYSTEMS; KEYPADS, MULTI DISPLAY KEYPADS, LIGHT KEYPADS, ILLUMINATED KEYPADS, INDUSTRIAL KEYPADS, MEMBRANE KEYPADS; MULTI DISPLAY PUSH BUTTON SWITCHES, LIGHT PUSH BUTTON SWITCHES, ILLUMINATED PUSH BUTTON SWITCHES, INDUSTRIAL PUSH BUTTON SWITCHES, POWER PUSH BUTTON SWITCHES, MEMBRANE PUSH BUTTON SWITCHES, ELECTROMECHANICAL BUTTON SWITCHES; CONTACTLESS KEYPADS AND PARTS

AND FITTINGS THEREFORE, CONTACTLESS ELECTRIC SWITCHES AND ELECTRIC MICRO-SWITCHES, CONTACTLESS KEYBOARDS, ELECTRIC CONTACTLESS PRESELECTION SWITCH, ELECTRONIC CIRCUIT CARDS, INTEGRATED CIRCUITS, PRINTED CIRCUITS, ELECTRONIC CIRCUIT BOARDS FOR CONTROLLING OPTOELECTRONIC DISPLAYS, ELECTRONIC INPUT CONTROLLER, AND PARTS AND COMPONENTS FOR ALL OF THE AFORESAID; ELECTRICAL AND ELECTRONIC APPARATUS AND INSTRUMENTS, NAMELY, CIRCUIT BOARD NETWORK CONVERTERS, POWER SUPPLIES, RELAYS, ELECTRICAL SWITCHING DEVICES, NAMELY, SWITCHING BOARDS, SWITCHING DESKS, REMOTE CONTROL SWITCHES, TIMING SWITCHES; ELECTRICAL DISTRIBUTION PANELS; RECTIFIERS; TRANSFORMERS; AUTOMATIC CIRCUIT BREAKERS; COMPUTER MONITORS FOR CONTROL OF INDUSTRIAL MANUFACTURING PROCESSES; REMOTE CONTROLS FOR USE IN CONNECTION WITH INDUSTRIAL MANUFACTURING PROCESSES; ELECTRICAL CONNECTORS; REMOTE CONTROLS FOR MOTORS AND MACHINES BY CURRENT CONTROL; OPTOELECTRONIC INDICATOR APPARATUS FOR DISPLAYING INFORMATION, INDICATOR LIGHTS AND PARTS THEREFORE; RECORDING AND TRANSMISSION APPARATUS OR COMMUNICATION DEVICES WITH DATA INPUT/OUTPUT SYSTEM, NAMELY, RADIO PLAYERS, CD PLAYERS, MP3 PLAYERS, MOBILE PHONES, REMOTE CONTROLS FOR USE WITH TELEVISION APPARATUS, VIDEO GAME CONSOLES, RADIO PLAYERS, CD PLAYERS, DVD PLAYERS, MP3 PLAYERS, INDUSTRIAL MACHINERY, REMOTE CONTROLS FOR USE WITH AUTOMOBILES, NAMELY, REMOTE KEYLESS ENTRY SYSTEMS; APPARATUS AND EQUIPMENT FOR DIGITAL IMAGING IN THE NATURE OF OPTOELECTRONIC AND ELECTRONIC DEVICES, NAMELY, BACKLIT DISPLAYS, DISPLAY PANELS,

LIGHT EMITTING DIODE DISPLAYS, KEYBOARDS, MEMBRANE KEYBOARDS, KEYPADS, MEMBRANE PANELS, TOUCH PANELS, TOUCH SCREENS, CONTROL PANELS, MOTION SENSORS, INTEGRATED PANELS PROVIDING MULTIPLE SWITCHING FUNCTIONS, ELECTRICAL POWER CONTROLS AND CONTROL INSTRUMENTS, SERIES SWITCH. AND COMPONENTS AND PARTS FOR ALL OF THE AFORESAID; COMPUTER PERIPHERALS, NAMELY, ELECTRONIC MODULES AND INPUT/OUTPUT DEVICES, NAMELY, KEYBOARDS AND MODULES AND INPUT/OUTPUT DEVICES THEREFORE, KEYPADS AND KEYMATS AND MODULES AND COMPONENTS THEREFORE, SWITCH ARRAYS, INPUT CONTROLLERS, TOUCH SCREENS, TOUCH PADS, ELECTRONIC MICE, DIGITAL PENS, NUMERIC PADS, POSITION SENSORS, COORDINATE INPUT DEVICES, CURSOR CONTROL DEVICES, POINTING DEVICES, CONTROL PANELS, ADVERTISING PANELS, BOARD COMPUTERS, DATA ENTRY UNITS IN THE NATURE OF COMPUTERS AND PERSONAL DIGITAL ASSISTANTS AND KEYS AND BUTTONS THEREFORE, KEYED DATA ENTRY SYSTEMS, BUTTONS FOR USE THEREWITH, ENCODERS, ELECTRONIC BOOK READERS, JOYSTICKS, TRACKBALLS. VIDEO GAME CONTROLLERS, REMOTE CONTROLS, PORTABLE COMPUTERS, PERSONAL DIGITAL AGENDA, MOBILE PHONES, AND RELATING DATA PROCESSING SOFTWARE AND COMPONENTS AND PARTS FOR ALL OF THE AFORESAID; APPARATUS FOR RECEIVING, PROCESSING, RECORDING, TRANSMITTING AND REPRODUCING SOUND, IMAGES, DATA, ELECTRONIC MESSAGES, NAMELY, PORTABLE ELECTRONIC READERS, ELECTRONIC MESSAGE BOARDS, ELECTRONIC BILLBOARDS, ELECTRONIC SIGNS, ELECTRONIC WHITEBOARDS, INTERFACE BOARDS; ELECTRONIC VISUAL DISPLAY PANELS OR APPARATUS, WHICH CHANGE COLOR, SYMBOL OR OTHER OPTICAL CHARACTERISTICS, FOR USE ON OR IN CONNECTION WITH HAND-HELD DEVICES, INDUSTRIAL MACHINERY, INSTRUMENTATION, VEHICLES, CONSUMER ELECTRONIC DEVICES; AUTOMATIC TELLER MACHINES, SLOT MACHINES; CASH REGISTERS; COMPUTERS, CALCULATORS; DATA PROCESSING EQUIPMENT IN THE NATURE OF COMPUTERS; GAME SOFTWARE; SOFTWARE, NAMELY, SOFTWARE FOR ELECTRONIC DATA INPUT SYSTEMS, HUMAN MACHINE INTERFACES AND DISPLAYS, NAMELY, DRIVERS, SYSTEM SOFTWARE, OPERATING SOFTWARE. SOFTWARE FOR TRANSMITTING, RECEIVING, READING, PROCESSING ELECTRONIC CONTENT,

MESSAGES AND DATA; SOFTWARE FOR USE IN CONNECTION WITH IMAGE MANIPULATION AND IMAGE CONTROL, SOFTWARE TO PROVIDE AN INTERFACE BETWEEN A PERSONAL COMPUTER OR WORKSTATION AND PERIPHERALS THEREFORE, IN CLASS 9 (U.S. CLS. 21, 23, 26, 36 AND 38).

FOR: ENGINEERING EVALUATION AND RESEARCH IN THE TECHNOLOGICAL AND SCIENTIFIC FIELDS OF DISPLAY TECHNOLOGIES AND HUMAN MACHINE INTERFACES; DESIGN AND DEVELOPMENT OF COMPUTER HARDWARE AND SOFTWARE FOR USE IN THE FIELD OF HUMAN MACHINE INTERFACES AND DISPLAYS; RESEARCH AND DEVELOPMENT OF NEW PRODUCTS IN THE FIELD OF HUMAN MACHINE INTERFACES, DISPLAY TECHNOLOGIES, OPTOELECTRONICS, OPTICS AND ELECTRONICS; CONSULTATION AND RESEARCH IN THE FIELD OF OPTOELECTRONIC, DISPLAY TECHNOLOGIES AND HUMAN MACHINE INTERFACES; PREPARATION OF REPORTS AND PROVISION OF INFORMATION IN THE NATURE OF INFORMATION MATERIAL AND INSTRUCTION MANUALS RELATING TO THE AFORESAID. DESIGN OF NEW HUMAN MACHINE INTERFACES; INSTALLATION, MAINTENANCE AND UPDATE OR LEASING OF SOFTWARE IN THE FIELD OF HUMAN MACHINE INTERFACES AND DISPLAY TECHNOLOGIES; COMPUTER PROGRAMMING IN THE FIELD OF DEVICES OR MACHINES WITH HUMAN MACHINE INTERFACES AND DISPLAY TECHNOLOGIES; CONSULTING IN THE FIELD OF COMPUTERS RELATED TO DISPLAYS OR HUMAN MACHINE INTERFACES; INDUSTRIAL DESIGN IN THE FIELD OF DISPLAY TECHNOLOGIES AND HUMAN MACHINE INTERFACES, CUSTOM DESIGN AND DEVELOPMENT OF HUMAN MACHINE INTERFACES AND DISPLAY TECHNOLOGIES AND SOFTWARE RELATED HERETO TO THE SPECIFICATIONS OF OTHERS; GRAPHIC ART DESIGN, IN CLASS 42 (U.S. CLS. 100 AND 101).

THE MARK CONSISTS OF STANDARD CHARACTERS WITHOUT CLAIM TO ANY PARTICULAR FONT, STYLE, SIZE, OR COLOR.

OWNER OF INTERNATIONAL REGISTRATION 0904668 DATED 9-4-2006, EXPIRES 9-4-2016.

SER. NO. 79-034,790, FILED 9-4-2006.

JAMES A. RAUEN, EXAMINING ATTORNEY

**Int. Cls.: 7, 9 and 42**

**Prior U.S. Cls.: 13, 19, 21, 23, 26, 31, 34, 35, 36, 38, 100  
and 101**

**Reg. No. 3,468,065**

**United States Patent and Trademark Office**

**Registered July 15, 2008**

**TRADEMARK  
SERVICE MARK  
PRINCIPAL REGISTER**

**BENJAMIN**

HAVER & BOECKER OHG (FED REP GERMANY  
GENERAL PARTNERSHIP)  
CARL-HAVER-PLATZ 3  
59302 OELDE, FED REP GERMANY

FOR: PACKING MACHINES IN THE NATURE OF MACHINES FOR FILLING PAPER OR PLASTIC OPEN BAGS OR VALVE BAGS WITH BULK MATERIAL, COMESTIBLE GOODS AND ANIMAL FEED; PACKING MACHINES, NAMELY, FILLING MACHINES WITH ONE OR SEVERAL FILLING SPOUTS, AND STRUCTURAL REPLACEMENT PARTS THEREFORE; PACKING MACHINES, NAMELY, FILLING MACHINES WITH FILLING SPOUTS ARRANGED IN LINE; PACKING MACHINES, NAMELY, ROTATING FILLING MACHINES; PACKING MACHINES, NAMELY, FILLING MACHINES EQUIPPED WITH BULK MATERIAL WEIGHING EQUIPMENT IN THE NATURE OF SCALES BEING A PART OF THE MACHINE; PACKING MACHINES, NAMELY, FILLING MACHINES FOR USE IN DISPENSING LIQUID MATERIALS; PACKING MACHINES, NAMELY, MACHINES FOR FEEDING EMPTY BAGS ONTO BAG-FILLING MACHINES; PACKING MACHINES, NAMELY, EMPTY BAG MAGAZINES FOR BAG FILLING MACHINES; PACKING MACHINES, NAMELY, MACHINES FOR PLACING EMPTY VALVE BAGS ONTO VALVE BAG FILLING MACHINES; PACKING MACHINES, NAMELY, MACHINES AND MECHANICAL PARTS THEREFORE FOR CLOSING OPEN BAGS; PACKING MACHINES, NAMELY, VALVE BAG FILLING MACHINES AND PARTS THEREOF SOLD AS A UNIT THEREWITH; PACKING MACHINES, NAMELY, VALVE BAG FILLING MACHINES AND PARTS THEREFORE IN THE NATURE OF SEALING JAWS, SEALING SYSTEMS, METERING SYSTEMS, COMPRESSION SYSTEMS, FILLING SYSTEMS, AND WEIGHING SYSTEMS; METAL DETECTORS BEING PART OF PACKING MACHINES; MACHINES AND MECHANICAL PARTS THEREFORE FOR CLOSING

THE VALVES OF THE VALVE BAGS AFTER FILLING; WEIGHING SYSTEMS, NAMELY, SCALES BEING PART OF PACKING MACHINES FOR WEIGHING NET AND GROSS WEIGHTS; PACKING MACHINES AND MECHANICAL PARTS IN THE NATURE OF METAL DETECTORS SOLD AS A COMPONENT PART OF VALVE BAG FILLING MACHINES; AND CHECK WEIGHING SYSTEMS COMPRISED OF WEIGHING EQUIPMENT IN THE NATURE OF SCALES BEING A PART OF THE MACHINE, ALL SOLD AS A COMPONENT PART OF VALVE BAG FILLING MACHINES AND FOR USE IN CLOSING THE VALVES OF THE VALVE BAGS AFTER FILLING; INDUSTRIAL MACHINE PRESSES FOR PRODUCING OPEN BAGS; AUTOMATED CONVEYORS, BEING PART OF PACKING MACHINES, FOR FEEDING BULK MATERIALS FOR PROCESSING BY THE PACKING MACHINE, IN CLASS 7 (U.S. CLS. 13, 19, 21, 23, 31, 34 AND 35).

FOR: ELECTRIC CONTROLLING DEVICES FOR FILLING MACHINES AND PACKING MACHINES; ELECTRIC AND ELECTRONIC CONTROLLING DEVICES FOR FILLING SPOUTS OF PACKING MACHINES; ELECTRIC AND ELECTRONIC CONTROLLING DEVICES FOR BAG FILLING OF BULK MATERIAL; ELECTRIC LUMINESCENT DISPLAY PANELS FOR PACKING MACHINES, IN CLASS 9 (U.S. CLS. 21, 23, 26, 36 AND 38).

FOR: TECHNICAL CONSULTANCY IN THE FIELD OF DESIGN OF APPARATUS AND MACHINES FOR FILLING PURPOSES; TECHNICAL PROJECT STUDIES, NAMELY, TECHNICAL RESEARCH IN THE FIELD OF DESIGN OF APPARATUS AND MACHINES FOR FILLING PURPOSES; SCIENTIFIC RESEARCH AND DEVELOPMENT IN THE NATURE OF DESIGNING ENGINEERING STUDIES; CONDUCTING SAFETY RELATED ENGINEERING SURVEYS, IN CLASS 42 (U.S. CLS. 100 AND 101).

THE MARK CONSISTS OF STANDARD CHARACTERS WITHOUT CLAIM TO ANY PARTICULAR FONT, STYLE, SIZE, OR COLOR.

OWNER OF INTERNATIONAL REGISTRATION 0914410 DATED 9-28-2006, EXPIRES 9-28-2016.

SER. NO. 79-034,854, FILED 9-28-2006.

PRIORITY DATE OF 4-3-2006 IS CLAIMED.

KATHERINE M. DUBRAY, EXAMINING ATTORNEY



**Int. Cls.: 9, 38 and 42**

**Prior U.S. Cls.: 21, 23, 26, 36, 38, 100, 101 and 104**

**Reg. No. 3,468,066**

**United States Patent and Trademark Office**

**Registered July 15, 2008**

**TRADEMARK  
SERVICE MARK  
PRINCIPAL REGISTER**

# VALUE VERTICAL

ABB OY (FINLAND CORPORATION)  
TELLUS HOUSE  
VALIMOPOLKU 4 A; FI-00381 HELSINKI  
FINLAND

FOR: ELECTRICAL AND ELECTRONIC DEVICES, INCLUDING THEIR PARTS FOR LOCAL AND REMOTE MEASURING, MONITORING, PROTECTION, CONTROL AND AUTOMATION OF ELECTRICAL POWER GENERATION, TRANSMISSION, DISTRIBUTION AND CONSUMPTION, NAMELY, UNDER- AND OVERCURRENT PROTECTION RELAYS, UNDER- AND OVERVOLTAGE PROTECTION RELAYS, UNDERIMPEDANCE PROTECTION RELAYS, UNDERREACTANCE PROTECTION RELAYS, UNDER AND OVERFREQUENCY PROTECTION RELAYS, DIFFERENTIAL PROTECTION RELAYS, OVERLOAD PROTECTION RELAYS, UNDERPOWER PROTECTION RELAYS, CIRCUIT-BREAKER CONTROL UNITS, INTERLOCKING LOGICS FOR CIRCUIT-BREAKER AND DISCONNECTOR CONTROL AND THEIR POSITION INDICATION, ALARM ANNUNCIATORS, VOLTAGE REGULATORS, CURRENT VOLTAGE AND POWER MEASURING TRANSDUCERS, CURRENT, VOLTAGE, POWER AND ENERGY SENSORS AND METERS, DISTRIBUTION FEEDER FAULT INDICATORS; DATA PROCESSORS AND COMPUTERS; COMPUTER SOFTWARE FOR USE IN PROTECTION, DATA ACQUISITION, SUPERVISION, CONTROL, DATA TRANSFER, DATA CONVERSION AND AUTOMATION OF BAY ORIENTED AND CENTRALIZED COMPUTERS IN THE FIELD OF ELECTRICAL SUBSTATIONS AND DISTRIBUTION FEEDERS, ELECTRICAL POWER GENERATION, TRANSMISSION, DISTRIBUTION AND CONSUMPTION; INSTALLATIONS AND SYSTEMS FOR LOCAL AND REMOTE CONTROL AND AUTOMATION OF ELECTRICAL POWER DISTRIBUTION, NAMELY, METERS, REMOTE SENSORS, TRANSMITTERS AND SIGNALS COMBINED WITH COMPUTER SOFTWARE OPERATING SYSTEMS FOR USE IN PROVIDING A MEANS FOR MONITORING, MANAGING AND CONTROLLING ELECTRIC POWER GENERATION, TRANSMISSION, DISTRIBUTION, AND/OR CONSUMPTION

AND COLLECTING, STORING AND PROVIDING DATA IN THE FIELDS OF ELECTRICAL POWER GENERATION, DISTRIBUTION, TRANSMISSION AND/OR CONSUMPTION, IN CLASS 9 (U.S. CLS. 21, 23, 26, 36 AND 38).

FOR: TRANSMISSION OF DATA, NAMELY, VIA GLOBAL COMPUTER NETWORKS; PROVISION OF MULTIPLE-USER ACCESS TO COMPUTER DATA BANKS; PROVISION OF MULTIPLE-USER ACCESS TO GLOBAL COMPUTER NETWORKS; INFORMATION COLLECTION AND SUPPLY, NAMELY, TRANSMISSION OF INFORMATION BY ELECTRONIC COMMUNICATIONS NETWORKS; INFORMATION TRANSMISSION VIA TELECOMMUNICATION AND COMPUTER NETWORKS; COMMUNICATION VIA LOCAL, NATIONAL, AND MULTINATIONAL TELECOMMUNICATIONS NETWORKS; RENTAL OF ACCESS TIME TO GLOBAL COMPUTER NETWORKS; CONSULTATION IN THE FIELD OF ELECTRICAL POWER GENERATION, TRANSMISSION, DISTRIBUTION AND/OR CONSUMPTION, IN CLASS 38 (U.S. CLS. 100, 101 AND 104).

FOR: COMPUTER PROGRAMMING FOR DATA PROCESSING PURPOSES; PROVIDING TEMPORARY USE OF ON-LINE NON-DOWNLOADABLE SOFTWARE FOR USE IN ACQUIRING, STORING AND TRANSFERING DATA RELATING TO ELECTRICAL POWER GENERATION, TRANSMISSION, DISTRIBUTION AND/OR CONSUMPTION AS WELL AS FOR USE IN MONITORING, CONTROLLING, MANAGING, MANIPULATING ELECTRIC POWER GENERATION, TRANSMISSION, DISTRIBUTION AND/OR CONSUMPTION; INTELLECTUAL PROPERTY LICENSING; COMPUTER SOFTWARE DESIGN, NETWORK ENGINEER SERVICES, NAMELY, COMPUTER AND NETWORK SECURITY CONSULTING; UPDATING OF SOFTWARE; COMPUTER SUPPORT SERVICES IN THE FIELD OF PROVIDING TECHNICAL SECURITY FOR COMPUTER HARDWARE, COMPUTER NETWORKS, DATA AND COMPUTER SOFTWARE; ENGINEERING WORK, NAMELY, ENGINEERING CONSULTING, MORE PARTICULARLY CONSUL-

TATION IN THE FIELD OF TECHNICAL SECURITY; RENTAL OF COMPUTER SOFTWARE AND OF DATA PROCESSING APPARATUS; DEVELOPMENT OF COMPUTER SOFTWARE; ENGINEERING SERVICES, IN CLASS 42 (U.S. CLS. 100 AND 101).

PRIORITY DATE OF 8-9-2006 IS CLAIMED.

OWNER OF INTERNATIONAL REGISTRATION 0914486 DATED 10-10-2006, EXPIRES 10-10-2016.

SER. NO. 79-034,867, FILED 10-10-2006.

KAREN K. BUSH, EXAMINING ATTORNEY

**Int. Cl.: 5**

**Prior U.S. Cls.: 6, 18, 44, 46, 51 and 52**

**Reg. No. 3,468,067**

**United States Patent and Trademark Office**

**Registered July 15, 2008**

**TRADEMARK  
PRINCIPAL REGISTER**

# QUIT NITS

WILD CHILD WA PTY LTD (AUSTRALIA INCORPORATED COMPANY)  
LEVEL 1, 679 MURRAY STREET  
WEST PERTH, PERTH WA 6005  
AUSTRALIA

FOR: PHARMACEUTICAL PRODUCTS FOR THE TREATMENT OF HEAD, BODY AND PUBIC LICE; NATURAL THERAPEUTIC PRODUCTS AND REMEDIES, NAMELY, CREAM PRODUCTS CONTAINING ESSENTIAL OILS, NAMELY, LICE TREATMENT PREPARATIONS, HOMEOPATHIC PREPARATIONS CONTAINING ESSENTIAL OILS AND BOTANICAL EXTRACTS, NAMELY, HOMEOPATHIC PHARMACEUTICALS FOR USE IN THE TREATMENT OF HEAD, BODY AND PUBIC LICE, LOTION PRODUCTS CONTAINING ESSENTIAL OILS AND/OR BOTANICAL EXTRACTS, NAMELY, LICE TREATMENT PREPARATIONS, SOLUTIONS, NAMELY, LICE TREATMENT PREPARATIONS CONTAINING ESSENTIAL OILS AND BOTANICAL EXTRACTS FOR THE TREATMENT OF HEAD, BODY OR PUBIC LICE; MEDICINAL PREPARATIONS FOR THE TREATMENT OF HEAD, BODY OR PUBIC LICE AND INGREDIENTS FOR SUCH

PREPARATIONS, NAMELY, HEAD LICE TREATMENT PREPARATIONS, HEAD LICE PREVENTATIVE, NAMELY, PREPARATIONS FOR PREVENTING HEAD LICE INCLUDING A NIT COMB AND INSTRUCTIONAL DVD, ALL SOLD AS A UNIT, IN CLASS 5 (U.S. CLS. 6, 18, 44, 46, 51 AND 52).

THE MARK CONSISTS OF STANDARD CHARACTERS WITHOUT CLAIM TO ANY PARTICULAR FONT, STYLE, SIZE, OR COLOR.

OWNER OF INTERNATIONAL REGISTRATION 0914729 DATED 12-22-2006, EXPIRES 12-22-2016.

NO CLAIM IS MADE TO THE EXCLUSIVE RIGHT TO USE "NITS", APART FROM THE MARK AS SHOWN.

SER. NO. 79-034,955, FILED 12-22-2006.

JAMES STEIN, EXAMINING ATTORNEY

**Int. Cls.: 1, 2, 19 and 37**

**Prior U.S. Cls.: 1, 5, 6, 10, 11, 12, 16, 26, 33, 46, 50,  
100, 103 and 106**

**Reg. No. 3,468,068**

**United States Patent and Trademark Office**

**Registered July 15, 2008**

**TRADEMARK  
SERVICE MARK  
PRINCIPAL REGISTER**

**RITEC**

RITEC INTERNATIONAL LIMITED (UNITED KINGDOM LIMITED COMPANY)  
INNOVA HOUSE, INNOVA SCIENCE PARK  
4 KINETIC CRESCENT  
ENFIELD, MIDDLESEX, UNITED KINGDOM EN3 7XH

FOR: CHEMICAL PREPARATIONS FOR SCIENTIFIC PURPOSES, NAMELY, THE TREATMENT OF GLASS; CHEMICALS, NAMELY, ARTIFICIAL POLYMERIC DIRT-REPELLING RESINS FOR CHEMICALLY BONDING TO THE SURFACE OF GLASS, IN CLASS 1 (U.S. CLS. 1, 5, 6, 10, 26 AND 46).

FOR: PAINTS, VARNISHES, AND LACQUERS; RESIN-BASED COATINGS FOR USE ON GLASS; RESIN-BASED COATINGS FOR USE ON METAL, ALL EXCLUDING CORROSION PROTECTION COATING FOR PIPES, IN CLASS 2 (U.S. CLS. 6, 11 AND 16).

FOR: GLASS FOR WINDOWS; GLASS PANES FOR DOORS, WINDOWS, AND BUILDINGS; GLASS PANES FOR BUILDINGS, NAMELY, ARCHITECTURAL, SHOWER ENCLOSURE, MARINE, RAILWAY, AND RESIDENTIAL APPLICATIONS; NON-METAL ROOF COVERINGS IN THE NATURE OF GLASS ROOFS AND GLASS ROOFING TILES; GLASS ELEMENTS FOR BUILDING PANELS, NAMELY, GLASS PANELS FOR BUILDING CONSTRUCTION PURPOSES; GLASS ELEMENTS FOR WINDOWS, NAMELY, GLASS PANES; GLASS IN SHEET FORM FOR USE IN DOORS AND WINDOWS, NAMELY, COMMON SHEET GLASS FOR BUILDING, COLORED SHEET GLASS FOR BUILDING, AND DECORATIVE GLASS FOR BUILDING; GLASS LOUVERS FOR DOORS AND WINDOWS, NAMELY, NON-METAL VENTILATING DUCTS; GLASS MOULDINGS FOR BUILDINGS, NAMELY, NON-METAL DECORATIVE MOLDINGS AND DECORATIVE TRIM FOR USE IN BUILDING CON-

STRUCTION; GLASS ROOFS, NAMELY, GLASS ROOFING TILES, AND SCREENS NAMELY, NON-METAL WINDOW SCREENS; GLASS SHAPES FOR USE IN WINDOWS, NAMELY, GLASS PANES; GLASS SLABS FOR USE IN BUILDING; GLASS TILES; GLASS WALLS; GLASS BLOCKS FOR BUILDING; GLAZING ELEMENTS MADE FROM GLASS, NAMELY, GLASS POWDER MADE FROM RECYCLED WASTE FOR BUILDING PURPOSES; HEAT PROTECTIVE GLASS PANES FOR BUILDING, NAMELY, SAFETY GLASS; INSULATING GLASS PANES, IN CLASS 19 (U.S. CLS. 1, 12, 33 AND 50).

FOR: MAINTENANCE, CLEANING AND REPAIR SERVICES IN RESPECT OF GLASS AND GLASS PRODUCTS; PROVIDING INFORMATION IN THE FIELDS OF MAINTENANCE, CLEANING, AND REPAIR OF GLASS AND GLASS PRODUCTS, AND OF EXTERIOR METAL SURFACES ON BUILDINGS; MAINTENANCE, CLEANING, AND RESTORATION OF EXTERIOR METAL SURFACES ON BUILDINGS, IN CLASS 37 (U.S. CLS. 100, 103 AND 106).

THE MARK CONSISTS OF STANDARD CHARACTERS WITHOUT CLAIM TO ANY PARTICULAR FONT, STYLE, SIZE, OR COLOR.

PRIORITY DATE OF 9-18-2006 IS CLAIMED.

OWNER OF INTERNATIONAL REGISTRATION 0916881 DATED 1-4-2007, EXPIRES 1-4-2017.

SER. NO. 79-035,730, FILED 1-4-2007.

LAURA HAMMEL, EXAMINING ATTORNEY

**Int. Cls.: 9, 12 and 37**

**Prior U.S. Cls.: 19, 21, 23, 26, 31, 35, 36, 38, 44, 100,  
103 and 106**

**Reg. No. 3,468,069**

**United States Patent and Trademark Office**

**Registered July 15, 2008**

**TRADEMARK  
SERVICE MARK  
PRINCIPAL REGISTER**

**SEAFALCON**

ACHTECK GMBH (FED REP GERMANY LTD  
LIAB CO)  
RESIDENCE PARK 1-7  
19065 RABEN STEINFELD  
FED REP GERMANY

FOR: CRUISE CONTROL FOR MOTOR VEHICLES AND BOATS; ELECTRIC NAVIGATIONAL INSTRUMENTS; CHRONOGRAPHS FOR USE AS SPECIALIZED TIME RECORDING APPARATUSES; BINOCULARS, TELESCOPES; CAMERAS; ALTIMETERS; HYDROMETERS AND HYGROMETERS; COMPASSES; RADAR SYSTEMS COMPRISED OF RADAR RECEIVERS WITH AMPLIFIERS, RADAR OBJECT DETECTORS, RADAR DETECTORS; SATELLITE NAVIGATIONAL SYSTEMS, NAMELY, GPS SYSTEMS FOR NAVIGATING SHIPS AND AIRPLANES; SEXTANTS, IN CLASS 9 (U.S. CLS. 21, 23, 26, 36 AND 38).

FOR: AEROPLANES; FLYING BOATS; BOATS, IN CLASS 12 (U.S. CLS. 19, 21, 23, 31, 35 AND 44).

FOR: MAINTENANCE AND REPAIR OF AEROPLANES, BOATS AND FLYING BOATS, IN CLASS 37 (U.S. CLS. 100, 103 AND 106).

THE MARK CONSISTS OF STANDARD CHARACTERS WITHOUT CLAIM TO ANY PARTICULAR FONT, STYLE, SIZE, OR COLOR.

PRIORITY DATE OF 7-13-2006 IS CLAIMED.

OWNER OF INTERNATIONAL REGISTRATION  
0917112 DATED 1-11-2007, EXPIRES 1-11-2017.

SER. NO. 79-035,830, FILED 1-11-2007.

AMY MCMENAMIN, EXAMINING ATTORNEY

**Int. Cl.: 12**

**Prior U.S. Cls.: 19, 21, 23, 31, 35 and 44**

**Reg. No. 3,468,070**

**United States Patent and Trademark Office**

**Registered July 15, 2008**

**TRADEMARK  
PRINCIPAL REGISTER**



PICCHIO SPA (ITALY JOINT STOCK COMPANY)  
ZONA INDUSTRIALE  
I-64010 ANCARANO, TERAMO, ITALY

FOR: VEHICLES, NAMELY, AUTOMOBILES, IN  
CLASS 12 (U.S. CLS. 19, 21, 23, 31, 35 AND 44).

PRIORITY DATE OF 10-11-2006 IS CLAIMED.

OWNER OF INTERNATIONAL REGISTRATION  
0917455 DATED 1-8-2007, EXPIRES 1-8-2017.

THE COLOR(S) BLACK, GOLD YELLOW,  
GREEN, WHITE AND RED IS/ARE CLAIMED AS  
A FEATURE OF THE MARK.

"PICCHIO" INSCRIPTION, CONSTITUTED BY  
AN INITIAL BLACK "P" GRAPHICALLY DE-  
SIGNING TO REPRESENT A CURVE OF A MOTOR

RACING CIRCUIT; THE FOLLOWING LETTERS  
ARE BLACK AS WELL; THE "P" IS VISUALLY  
COMPLETED BY A RHOMBOID LOW ON THE  
LEFT HAND SIDE, WHOSE SIDE INCLINED BOR-  
DERS ARE PARALLEL TO THE ADJACENT BOR-  
DER OF THE "P"; SUCH RHOMBOID IS DIVIDED  
IN THREE PARALLEL STRIPES RESPECTIVELY OF  
GREEN, WHITE AND RED COLOUR, FROM LEFT  
TO RIGHT; THE FINAL "O" IS DESIGNED IN A  
WAY THAT SUGGESTS A SPINNING WHEEL:  
THEREFORE, IT HAS AN ATYPICAL ELLIPSE  
SHAPE WHOSE LONGER AXIS IS INCLINED FOR-  
WARD; ALL THE LETTERS AND THE RHOMBOID  
ARE BORDERED BY A THIN GOLDEN LINE.

THE ENGLISH TRANSLATION OF "PICCHIO" IS  
WOODPECKER.

SER. NO. 79-035,977, FILED 1-8-2007.

MARY ROSSMAN, EXAMINING ATTORNEY

**Int. Cl.: 12**

**Prior U.S. Cls.: 19, 21, 23, 31, 35 and 44**

**Reg. No. 3,468,071**

**United States Patent and Trademark Office**

**Registered July 15, 2008**

**TRADEMARK  
PRINCIPAL REGISTER**

**KOGA**

KOGA B.V. (NETHERLANDS LTD LIAB CO)  
9, TINWEG,  
NL-8445 PD HEERENVEEN  
NETHERLANDS

FOR: BICYCLES; BICYCLE PARTS, NAMELY BICYCLE WHEEL HUBS, BICYCLE BRAKE HUBS, BICYCLE FREE WHEELS, BICYCLE PEDALS, RUBBER PEDAL COVERS, KICKSTANDS FOR BICYCLES, FENDERS, BICYCLE HANDLE BARS, BICYCLE RIMS SPOKES, TUBULAR TIRES, INNER TUBES FOR BICYCLES, BRAKES, DUAL SEAT FRAMES, DUAL BICYCLE SEATS, BICYCLE SADDLES, BICYCLE SADDLE PINS, SPLASH GUARDS, BICYCLE HANDLE BAR GRIPS, BICYCLE CHAIN GUARDS, BICYCLE CHAINS, CHAIN WHEELS, CRANKS, GEAR WHEELS, AND BICYCLE FORKS; AND BICYCLE ACCESSORIES, NAMELY, BASKETS ADAPTED FOR BICYCLES, BAGS ADAPTED FOR

BICYCLES THAT MOUNT TO THE FRAME OF THE BICYCLE, BICYCLE BELLS, BICYCLE PUMPS, FRAMES FOR LUGGAGE CARRIERS, BRACKET FITTINGS, AND WATER BOTTLE HOLDERS ADAPTED FOR BICYCLES, IN CLASS 12 (U.S. CLS. 19, 21, 23, 31, 35 AND 44).

OWNER OF INTERNATIONAL REGISTRATION 0448816 DATED 10-26-1979, EXPIRES 10-26-2009.

THE ENGLISH TRANSLATION OF THE WORD "KOGA" IN THE MARK IS BLIGHT, FOULNESS, MILDEW, MOLD, MOLDINESS, MUSTINESS, DRY ROT, OR UNCLEANLINESS.

SER. NO. 79-035,990, FILED 2-6-2007.

SUSAN RICHARDS, EXAMINING ATTORNEY

Int. Cl.: 33

Prior U.S. Cls.: 47 and 49

United States Patent and Trademark Office

Reg. No. 3,468,072

Registered July 15, 2008

TRADEMARK  
PRINCIPAL REGISTER



PROIZVODSTVENNO-TORGOVOE RESPUBLI-  
KANSKOE; UNITARNOE PREDPRIYATIE;  
"MINSK KRISTALL"; RUP "MINSK KRIS-  
TALL" (BELARUS ENTERPRISE WHOLLY  
OWNED BY THE STATE OF BELARUS)  
UL. OKTYABRSKAYA 15  
MINSK, BELARUS 220030

THE NON-LATIN CHARACTERS IN THE MARK  
TRANSLITERATE TO BELAYA RUS. AND THIS  
MEANS THE WHITE RUS. IN ENGLISH.

FOR: ALCOHOLIC BEVERAGES, NAMELY, VOD-  
KA, IN CLASS 33 (U.S. CLS. 47 AND 49).

SER. NO. 79-036,297, FILED 1-29-2007.

OWNER OF INTERNATIONAL REGISTRATION  
0918274 DATED 1-29-2007, EXPIRES 1-29-2017.

ESTHER A. BORSUK, EXAMINING ATTORNEY



**Int. Cl.: 9**

**Prior U.S. Cls.: 21, 23, 26, 36 and 38**

**United States Patent and Trademark Office**

**Reg. No. 3,468,073**

**Registered July 15, 2008**

**TRADEMARK  
PRINCIPAL REGISTER**

**oxi::lyser**

SCAN MESSTECHNIK GMBH (AUSTRIA LTD  
LIAB CO)  
BRIGITTAGASSE 22-24  
A-1200 WIEN  
AUSTRIA

OWNER OF INTERNATIONAL REGISTRATION  
0918304 DATED 2-7-2007, EXPIRES 2-7-2017.

FOR: MEASURING APPARATUS AND INSTRUMENTS, NAMELY, SENSORS AND INSTRUMENTS FOR MEASURING PHYSICAL AND CHEMICAL PARAMETERS OF FLUIDS, IN CLASS 9 (U.S. CLS. 21, 23, 26, 36 AND 38).

SER. NO. 79-036,310, FILED 2-7-2007.

GRETTA YAO, EXAMINING ATTORNEY

**Int. Cls.: 7, 9, 37 and 42**

**Prior U.S. Cls.: 13, 19, 21, 23, 26, 31, 34, 35, 36, 38,  
100, 101, 103 and 106**

**Reg. No. 3,468,074**

**United States Patent and Trademark Office**

**Registered July 15, 2008**

**TRADEMARK  
SERVICE MARK  
PRINCIPAL REGISTER**

# **CONNECT & CAST**

SIEMENS VAI METALS TECHNOLOGIES GMBH  
& CO  
TURMSTRASSE 44  
A-4031 LINZ  
AUSTRIA

FOR: METAL CASTING MACHINES; CONTINUOUS CASTING MACHINES FOR CASTING METAL BARS, IN CLASS 7 (U.S. CLS. 13, 19, 21, 23, 31, 34 AND 35).

FOR: ELECTRICAL MEASURING SENSORS, OPEN AND CLOSED-LOOP CONTROLLERS AND MONITORING SOFTWARE TO MEASURE, CONTROL AND MONITOR MANUFACTURING PROCESSES IN METAL CASTING MACHINES AND CONTINUOUS CASTERS; PROGRAMMABLE LOGIC CONTROLLERS FOR METAL CASTING MACHINES AND CONTINUOUS CASTERS; COMPUTER PROGRAMS FOR INSTALLING AND OPERATING METAL CASTING MACHINES AND CONTINUOUS CASTERS, IN PARTICULAR FOR OPEN AND CLOSED-LOOP PROCESS CONTROL, PROCESS VISUALIZATION AND MONITORING , IN CLASS 9 (U.S. CLS. 21, 23, 26, 36 AND 38).

FOR: ERECTION AND MAINTENANCE OF METAL CASTING MACHINES AND CONTINUOUS CASTERS, IN CLASS 37 (U.S. CLS. 100, 103 AND 106).

FOR: TECHNICAL CONSULTANCY AND PLANNING IN CONNECTION WITH METAL CASTING MACHINES AND CONTINUOUS CASTERS; CONDUCTING SCIENTIFIC FEASIBILITY STUDIES IN THE FIELDS OF METAL CASTING MACHINES AND CONTINUOUS CASTERS; TECHNICAL PLANNING AND DESIGN ENGINEERING OF METAL CASTING MACHINES AND CONTINUOUS CASTERS; ENGINEERING SERVICES IN THE NATURE OF CREATION OF ENGINEERING PROCESS MODELS AND DESIGNING COMPUTER SOFTWARE FOR THE OPERATION OF METAL CASTING MACHINES AND CONTINUOUS CASTERS FOR OTHERS, IN CLASS 42 (U.S. CLS. 100 AND 101).

THE MARK CONSISTS OF STANDARD CHARACTERS WITHOUT CLAIM TO ANY PARTICULAR FONT, STYLE, SIZE, OR COLOR.

OWNER OF INTERNATIONAL REGISTRATION 0918352 DATED 11-9-2006, EXPIRES 11-9-2016.

SER. NO. 79-036,334, FILED 11-9-2006.

CHARLOTTE CORWIN, EXAMINING ATTORNEY

Int. Cls.: 3, 4, 8, 16, 21, 24, 28 and 43

Prior U.S. Cls.: 1, 2, 4, 5, 6, 13, 15, 22, 23, 28, 29, 30, 33, 37, 38, 40, 42, 44, 50, 51, 52, 100 and 101

Reg. No. 3,468,075

United States Patent and Trademark Office

Registered July 15, 2008

TRADEMARK  
SERVICE MARK  
PRINCIPAL REGISTER



METROPOLE 1850 (FRANCE GENERAL PARTNERSHIP)

LIEU-DIT "COURCHEVEL 1850"  
F-73120 SAINT BON TARENNAISE  
FRANCE

FOR: COSMETICS; SOAPS; PERFUMES, EAUX DE TOILETTE; ESSENTIAL OILS; SUNSCREEN PREPARATIONS; CLEANSING MILKS; FACE LOTIONS, DENTIFRICES; AFTER-SHAVE LOTIONS; MAKE-UP PREPARATIONS; COTTON WOOL FOR COSMETIC PURPOSES; PRE-MOISTENED COSMETIC WIPES; FOAM BATHS; SHAMPOOS; INCENSE; SCENTED WOOD FOR ADDING SCENT TO A ROOM; AIR FRESHENERS, NAMELY, SCENTED ROOM SPRAYS; AND SACHETS FOR PERFUMING LINEN, IN CLASS 3 (U.S. CLS. 1, 4, 6, 50, 51 AND 52).

FOR: SCENTED CANDLES, CANDLES FOR LIGHTING, IN CLASS 4 (U.S. CLS. 1, 6 AND 15).

FOR: SILVERWARE, NAMELY, CUTLERY, TABLE FORKS, KNIVES AND SPOONS; SHAVING SETS COMPRISED OF RAZOR BLADES AND RAZOR CASES, NAIL FILES, HAIR-REMOVING TWEEZERS, MANICURE SETS, PEDICURE SETS, ELECTRIC AND NON-ELECTRIC RAZORS, SUGAR TONGS, IN CLASS 8 (U.S. CLS. 23, 28 AND 44).

FOR: WRITING PAPER PADS; PROSPECTUSES IN THE FIELD OF DECORATION, ARTS AND CRAFTS; STATIONERY; DOCUMENT FOLDERS AND SLEEVES; PENCILS; PENS; ENVELOPES; LETTER PAPER; HOUSE HOLD LINEN OF PAPER AND PLASTIC, NAMELY, PACKAGING BAGS, PAPER PLACE MATS AND NAPKINS; HIKING MAPS, IN CLASS 16 (U.S. CLS. 2, 5, 22, 23, 29, 37, 38 AND 50).

FOR: BUTTER DISHES; GLASS STOPPERS; TEA EGGS AND TEA BALLS, TEA CADDIES; PERFUME BURNERS, GLASS HOLDERS AND RECEPTACLES FOR CANDLES; CARAFES, MENU CARD HOLDERS; KNIFE RESTS FOR THE TABLE; FLASKS, NOT OF PRECIOUS METAL; ICE BUCKETS; CHAMPAGNE BUCKETS; LIQUEUR GLASS SETS; BOTTLE OPENERS; TRAYS FOR DOMESTIC PURPOSES, NOT OF PRECIOUS METAL; DISHES, NOT OF PRECIOUS METAL; DOOR KNOBS OF PORCELAIN; PEPPER AND SALT SHAKERS, NOT OF PRECIOUS METALS; CRUMB TRAYS; NAPKIN RINGS; NOT OF PRECIOUS METAL; CANDLE STICKS, NOT OF PRECIOUS METAL; SAUCERS, NOT OF PRECIOUS METAL; STATUETTES, OF PORCELAIN, TERRA-COTTA AND GLASS; WORKS OF ART, OF PORCELAIN, TERRA-COTTA AND GLASS; DECORATIVE ITEMS MADE OF GLASS, PORCELAIN, CERAMICS OR GLAZED EARTHENWARE, NAMELY, BOWLS, DISHES, MIRROR, BALLS, SUGAR BOWLS, NOT OF PRECIOUS METAL; CUPS, NOT OF PRECIOUS METAL; TEA SERVICES; COFFEE SERVICES; TEAPOTS, NOT OF PRECIOUS METAL; CORKSCREWS; VASES, NOT OF PRECIOUS METAL; DRINKING GLASSES; STEMWARE, NAMELY, WINE GLASSES AND GLASSWARE MADE OF CRYSTAL; PLATES; DECORATIVE PLATES; COCKTAIL SHAKERS; BOWLS; BEER MUGS; EGG CUPS; BREAD BASKETS FOR DOMESTIC USE; COASTERS NOT OF PAPER AND NOT OF TABLE LINEN; SPORTS DRINKING FLASKS SOLD EMPTY; DRINKING FLASKS FOR TRAVELERS; INSULATING FLASKS; BOTTLES, SOLD EMPTY, FOR STORING AND REFRIGERATING LIQUIDS; MEAL BOXES; ISOTHERMAL BAGS FOR FOOD AND BEVERAGE STORAGE; FITTED PICNIC BASKETS; SOAP BOXES, TOOTH BRUSHES, TOILETRY BAGS CONTAINING HAIR BRUSHES AND COMBS; COMBS, HAIRBRUSHES; NAIL BRU-

SHES; CLOTHES BRUSHES; SHOE BRUSHES; SOAP HOLDERS; POWDER COMPACTS, NOT OF PRECIOUS METAL AND SOLD EMPTY; SHAVING BRUSHES; TOILET SPONGES; SMALL BOTTLES, SOLD EMPTY; AND CLOTHS FOR CLEANING, IN CLASS 21 (U.S. CLS. 2, 13, 23, 29, 30, 33, 40 AND 50).

FOR: BATH LINEN; BED LINEN; HOUSEHOLD LINEN; AND TEXTILE AND PLASTIC SHOWER CURTAINS, IN CLASS 24 (U.S. CLS. 42 AND 50).

FOR: SNOW GLOBES; PLAYING CARDS; SURFBOARDS; KNEE GUARDS AND ELBOW GUARDS FOR ATHLETIC USE; SNOW-SHOES; SOLE COVERINGS FOR SKIS; SKIS; MONOSKIS; SKI BINDINGS; BAGS FOR SKIS AND SURFBOARDS; AND SKI STICKS, IN CLASS 28 (U.S. CLS. 22, 23, 38 AND 50).

FOR: HOTEL SERVICES; HOTEL AND TEMPORARY ACCOMMODATION RESERVATION SERVI-

CES; RESTAURANT SERVICES; FAST-FOOD RESTAURANTS; SNACK BARS; CAFETERIAS, IN CLASS 43 (U.S. CLS. 100 AND 101).

PRIORITY DATE OF 7-26-2006 IS CLAIMED.

OWNER OF INTERNATIONAL REGISTRATION 0918431 DATED 12-29-2006, EXPIRES 12-29-2016.

THE ENGLISH TRANSLATION OF THE WORD "CHEVAL BLANC" IN THE MARK IS "WHITE HORSE".

SER. NO. 79-036,365, FILED 12-29-2006.

MARILYN IZZI, EXAMINING ATTORNEY

**Int. Cls.: 18 and 25**

**Prior U.S. Cls.: 1, 2, 3, 22, 39 and 41**

**Reg. No. 3,468,076**

**United States Patent and Trademark Office**

**Registered July 15, 2008**

**TRADEMARK  
PRINCIPAL REGISTER**



HI-INT S.A. (LUXEMBOURG A SOCIETE ANON-  
YME)  
19-21, BOULEVARD DU PRINCE HENRI  
L-1724 LUXEMBOURG, LUXEMBOURG

FOR: KNAPSACKS, RUCKSACKS, LEISURE  
RUCKSACKS, BRIEFCASES, SCHOOL BAGS, PUR-  
SES, WALLETS, HANDBAGS, LUGGAGE, SHOULD-  
ER BAGS, BEACH BAGS, CLUTCH BAGS, ALL  
PURPOSE SPORTS BAGS, ATTACHE CASES, TOTE  
BAGS, TRAVELLING BAGS, DOCUMENT CASES,  
COSMETIC CASES SOLD EMPTY, KEY CASES,  
TRAVELLING TRUNKS, UMBRELLAS, PARASOLS,  
WALKING STICKS, IN CLASS 18 (U.S. CLS. 1, 2, 3, 22  
AND 41).

FOR: BRASSIERES; CORSETS, BEING CLOTH-  
ING; SINGLET, PETTICOATS, NIGHTGOWNS, PY-  
JAMAS, DRESSING GOWNS, PULLOVERS, BATH  
ROBES, BATHING SUITS, BATHING CAPS;  
GLOVES AND MUFFS, BEING CLOTHING; CAR-  
DIGANS; JERSEYS, BEING CLOTHING; NECKTIES,  
NECKERCHIEFS, SCARVES, SWEATERS, SOCKS,  
STOCKINGS, TIGHTS, TROUSERS, LEGGINGS,

SKIRTS, JACKETS, JERKINS, SHIRTS, POLO  
SHIRTS, VESTS, WAISTCOATS, JUMPERS, TRACK  
SUITS, BLOUSES, JEANS, PANTIES, PANTS, BER-  
MUDA SHORTS, T-SHIRTS, SWEATSHIRTS, SUITS  
AND DRESSES, OVERCOATS, ANORAKS, COATS,  
RAINCOATS, KIMONOS, OVERALLS, SHAWLS,  
WINDCHEATERS, MITTENS; FOULARDS, BEING  
CLOTHING; CAPS, BEING CLOTHING; GARTERS;  
PANTYHOSE; BELTS, BEING CLOTHING; SUSPEN-  
DERS, SHOES, BOOTS, SLIPPERS, HATS, BERETS,  
IN CLASS 25 (U.S. CLS. 22 AND 39).

PRIORITY DATE OF 8-25-2006 IS CLAIMED.

OWNER OF INTERNATIONAL REGISTRATION  
0918526 DATED 2-19-2007, EXPIRES 2-19-2017.

SER. NO. 79-036,411, FILED 2-19-2007.

MYRIAH HABEEB, EXAMINING ATTORNEY

**Int. Cl.: 33**

**Prior U.S. Cls.: 47 and 49**

**United States Patent and Trademark Office**

**Reg. No. 3,468,077**

**Registered July 15, 2008**

**TRADEMARK  
PRINCIPAL REGISTER**



GESSLER ET FILS (FRANCE GAEC)  
DOMAINE DE JOY  
F-32110 PANJAS  
FRANCE

OWNER OF INTERNATIONAL REGISTRATION  
0918850 DATED 2-23-2007, EXPIRES 2-23-2017.

FOR: SPIRITS, NAMELY, ARMAGNAC, SPIRITS  
WITH APPELLATION OF ORIGIN, NAMELY, AR-  
MAGNAC, IN CLASS 33 (U.S. CLS. 47 AND 49).

SER. NO. 79-036,502, FILED 2-23-2007.

PRIORITY DATE OF 2-12-2007 IS CLAIMED.

RUSS HERMAN, EXAMINING ATTORNEY

**Int. Cl.: 36**

**Prior U.S. Cls.: 100, 101 and 102**

**United States Patent and Trademark Office**

**Reg. No. 3,468,078**

**Registered July 15, 2008**

**SERVICE MARK  
PRINCIPAL REGISTER**

**eNnett**

PSP CORPORATION PTY LTD (AUSTRALIA  
PROPRIETARY COMPANY)  
LEVEL 11  
MELBOURNE, VIC 3000  
AUSTRALIA

FOR: CHARGE-CARD SERVICES; CREDIT CARD  
SERVICES; DEBIT CARD SERVICES; ISSUANCE OF  
CREDIT CARD; PROVIDING ELECTRONIC PRO-  
CESSING OF CREDIT CARD TRANSACTIONS AND  
ELECTRONIC PAYMENTS VIA A GLOBAL COM-  
PUTER NETWORK, IN CLASS 36 (U.S. CLS. 100, 101  
AND 102).

THE MARK CONSISTS OF STANDARD CHAR-  
ACTERS WITHOUT CLAIM TO ANY PARTICULAR  
FONT, STYLE, SIZE, OR COLOR.

PRIORITY DATE OF 7-5-2006 IS CLAIMED.

OWNER OF INTERNATIONAL REGISTRATION  
0919380 DATED 1-5-2007, EXPIRES 1-5-2017.

SER. NO. 79-036,684, FILED 1-5-2007.

WILLIAM ROSSMAN, EXAMINING ATTORNEY

**Int. Cls.: 9, 42 and 45**

**Prior U.S. Cls.: 21, 23, 26, 36, 38, 100 and 101**

**Reg. No. 3,468,079**

**United States Patent and Trademark Office**

**Registered July 15, 2008**

**TRADEMARK  
SERVICE MARK  
PRINCIPAL REGISTER**

# EASECURE

MW SECURITY AB (SWEDEN JOINT STOCK  
COMPANY)  
STURKÖGATAN 9  
SE-211 24 MALMÖ  
SWEDEN

FOR: CHECKING AND SUPERVISION APPARATUS AND INSTRUMENTS IN THE NATURE OF PROPERTY SUPERVISION DEVICES AND OTHER APPARATUS FOR PROTECTION AGAINST SHOP LIFTING AND SIMILAR THEFT, NAMELY, THEFT ALARMS, AND ELECTRICAL, MECHANICAL AND ELECTRONIC MOTION DETECTORS AND ANTI-INTRUSION AND BURGLAR ALARMS; MINIATURIZED THEFT DETECTORS AND THEFT ALARMS; BURGLAR AND INTRUDER DETECTORS AND ALARMS FOR RESIDENTIAL AND BUSINESS PREMISES; APPARATUS FOR IDENTIFICATION CONTROL AND IDENTIFICATION PURPOSES, NAMELY, MAGNETIC IDENTIFYING CARDS, MAGNETICALLY ENCODED IDENTIFICATION BRACELETS, MOTION DETECTORS AND ALARMS; CHECKING AND SUPERVISION APPARATUS AND INSTRUMENTS IN THE NATURE OF PROPERTY SUPERVISION DEVICES AND OTHER APPARATUS FOR PROTECTION AGAINST SHOP LIFTING AND SIMILAR THEFT, NAMELY, BURGLAR AND INTRUDER DETECTORS AND ALARMS FOR RESIDENTIAL AND BUSINESS PREMISES, VIBRATION DETECTORS AND ALARMS, NOISE DETECTORS AND ALARMS, SIRENS AND LOUDSPEAKERS, SURVEILLANCE TELEVISION CAMERAS AND PHOTOGRAPHIC CAMERAS; OPEN AND CLOSED CIRCUIT VIDEO MONITORS, OPTIC SENSORS AND OPTICAL SCANNERS, ELECTRONIC LOCKS FOR RESIDENTIAL AND BUSINESS PREMISES; PHOTO ELECTRONIC BEAMS IN THE NATURE OF PROPERTY SUPERVISION DEVICES AND OTHER APPARATUS FOR PROTECTION AGAINST SHOPLIFTING AND SIMILAR THEFT, NAMELY, BURGLAR AND INTRUDER DETECTORS AND ALARMS FOR RESIDENTIAL AND BUSINESS PREMISES; PASSIVE INFRARED

OPTICAL REFLECTORS AND INFRARED BODY HEAT ELECTRONIC SENSORS; GLASS BREAKAGE DETECTORS AND ALARMS, AND ELECTRONIC CARD READERS FOR ELECTRONICALLY CONTROLLING ACCESS; PLASTIC CASES SPECIALLY ADAPTED FOR PHONOGRAPHS, VIDEOTAPES, COMPACT DISCS, TELEVISION GAME CARTRIDGES AND COMPUTER PROGRAMS DISCS; ANTI-THEFT ALARMS FOR TIES, SHOES, AND SPECTACLES AND OTHER GOODS; RECORDED COMPUTER PROGRAMS FOR ORDER PROCESSING, IN CLASS 9 (U.S. CLS. 21, 23, 26, 36 AND 38).

FOR: COMPUTER RENTAL; CONSULTANCY IN THE FIELD OF COMPUTER HARDWARE, COMPUTER SYSTEMS AND COMPUTER SECURITY; COMPUTER PROGRAMMING, UPDATING OF COMPUTER SOFTWARE FOR OTHERS, COMPUTER SOFTWARE DESIGN FOR OTHERS, DESIGN FOR OTHERS IN THE FIELD OF WRAPPING DESIGN, PACKAGING DESIGN, GRAPHIC ARTS DESIGN AND INDUSTRIAL DESIGN, RESEARCH AND DEVELOPMENT FOR NEW PRODUCTS FOR OTHERS; LICENSING OF INTELLECTUAL PROPERTY, ENGINEERING SERVICES; QUALITY CONTROL FOR OTHERS; PATENT EXPLOITATION, NAMELY, PATENT LICENSING; TECHNICAL PROJECT STUDIES, NAMELY, CONDUCTING FEASIBILITY STUDIES AND PRODUCT RESEARCH IN THE FIELD OF PERSONAL, RESIDENTIAL AND COMMERCIAL SECURITY, IN CLASS 42 (U.S. CLS. 100 AND 101).

FOR: CONSULTANCY IN SECURITY MATTERS, NAMELY, IN SECURITY AND SURVIVABILITY OF COMMERCIAL, INDUSTRIAL, AND PUBLIC FACILITIES; LOCKSMITHING, NAMELY, OPENING OF SECURITY LOCKS; NIGHT GUARDS, IN CLASS 45 (U.S. CLS. 100 AND 101).

THE MARK CONSISTS OF STANDARD CHARACTERS WITHOUT CLAIM TO ANY PARTICULAR FONT, STYLE, SIZE, OR COLOR.



PRIORITY DATE OF 10-23-2006 IS CLAIMED.

SER. NO. 79-036,746, FILED 10-25-2006.

OWNER OF INTERNATIONAL REGISTRATION  
0919645 DATED 10-25-2006, EXPIRES 10-25-2016.

KATHERINE E. HALMEN, EXAMINING ATTOR-  
NEY

**Int. Cls.: 5 and 29**

**Prior U.S. Cls.: 6, 18, 44, 46, 51 and 52**

**United States Patent and Trademark Office**

**Reg. No. 3,468,080**

**Registered July 15, 2008**

**TRADEMARK  
PRINCIPAL REGISTER**

# TATURA-BIO

TATURA MILK INDUSTRIES LIMITED (AUSTRALIA INCORPORATED COMPANY)  
236 HOGAN STREET  
TATURA VIC 3616  
AUSTRALIA

FOR: DIETETIC FOODS ADAPTED FOR MEDICAL USE; ADULT NUTRITIONAL POWDERS FOR HEALTH PURPOSES NAMELY, POWDERED NUTRITIONAL SUPPLEMENT DRINK MIX; NUTRITIONAL ADDITIVES FOR MEDICAL PURPOSES FOR USE IN FOODS AND DIETARY SUPPLEMENTS FOR HUMAN CONSUMPTION, NAMELY, MINOR MILK PROTEIN IN THE NATURE OF LACTOFERRIN, COLOSTRUM AND MILK PROTEIN CONCENTRATE; SPECIALIZED NUTRITIONAL MILKS, NAMELY, POWDERED NUTRITIONAL SUPPLEMENT DRINK MIX; NUTRITIONAL ADDITIVES FOR MEDICAL PURPOSES FOR USE IN FOODS AND DIETARY SUPPLEMENTS FOR HUMAN CONSUMPTION, NAMELY, SPECIALIZED MILK FAT INGREDIENTS; BABY FOOD, NAMELY, INFANT FORMULA AND CHILDREN'S MILK POWDER, IN CLASS 5 (U.S. CLS. 6, 18, 44, 46, 51 AND 52).

FOR: EDIBLE OILS AND FATS, EGGS, MILK AND MILK PRODUCTS, NAMELY, MILK POWDER, MILK BEVERAGES WITH HIGH MILK CONTENT, MILK INGREDIENTS, NAMELY, MILK CURD, CONDENSED MILK, MILK PROTEIN, ACIDOPHILOUS MILK; BUTTER, CHEESE, CREAM CHEESE, AND ORGANIC CHEESE, IN CLASS 29 (U.S. CL. 46).

THE MARK CONSISTS OF STANDARD CHARACTERS WITHOUT CLAIM TO ANY PARTICULAR FONT, STYLE, SIZE, OR COLOR.

OWNER OF INTERNATIONAL REGISTRATION 0919667 DATED 10-4-2006, EXPIRES 10-4-2016.

SER. NO. 79-036,752, FILED 10-4-2006.

KATHERINE E. HALMEN, EXAMINING ATTORNEY

**Int. Cls.: 6, 7, 8 and 9**

**Prior U.S. Cls.: 2, 12, 13, 14, 19, 21, 23, 25, 26, 28, 31, 34, 35, 36, 38, 44 and 50**

**Reg. No. 3,468,081**

**United States Patent and Trademark Office**

**Registered July 15, 2008**

**TRADEMARK  
PRINCIPAL REGISTER**

# WIDIA HEINLEIN

KENNAMETAL WIDIA PRODUKTIONS; GMBH  
& CO. KG (FED REP GERMANY PARTNER-  
SHIP)

MÜNCHENER STR. 125-127

45145 ESSEN

FED REP GERMANY

FOR: COMMON METALS AND ALLOYS OF COMMON METAL, UNWROUGHT AND SEMI-WORKED FOR FURTHER MANUFACTURE; HARD METALS AND ALLOYS OF HARD METAL, UNWROUGHT AND SEMI-WORKED FOR FURTHER MANUFACTURE; METAL CARBIDES AND THEIR ALLOYS, IN CLASS 6 (U.S. CLS. 2, 12, 13, 14, 23, 25 AND 50).

FOR: MANUAL TOOLS, BEING PARTS OF MACHINES, NAMELY, CUTTING TOOLS, NAMELY, CHIP REMOVING TOOLS, METAL CUTTING TOOLS AND THEIR PARTS; MANUAL TOOLS, BEING OF MACHINES, NAMELY, CUTTING TOOLS FOR DRILLING, MILLING AND TURNING AND PARTS THEREOF; MACHINES FOR SHAPE CUTTING; MACHINES FOR MACHINING TOOLS, IN PARTICULAR GRINDING MACHINES; MACHINES FOR CHANGING INDEXABLE INSERTS, AS WELL AS MANUALLY AND MECHANICALLY DRIVEN, PRE-ADJUSTING DEVICES FOR THE SAID MACHINES; MACHINES, NAMELY, METAL CUTTING MACHINE TOOLS FOR SHAPE CUTTING; TOOL CHANGE MACHINES; MACHINE PARTS, NAMELY, MILLING HEADS, CUTTING DISKS, AND MILLING CUTTERS; TOOLS FOR THE AFOREMENTIONED MACHINES, NAMELY, TURNING TOOLS, SMOOTHING TOOLS AND BROACHING TOOLS; CUTTING ELEMENTS, NAMELY, KNIVES, HARD METAL PLATES, CERAMIC PLATES AND INDEXABLE INSERTS; CORROSION-RESISTANT AND WEAR-RESISTANT MACHINE COMPONENTS, NAMELY, COATED MACHINE BEDS, JOURNALS, GUIDE AND SLIDE WAYS, SHAFTS, CHUCKS, FACE PLACES, TOOL HOLDERS, CARRIAGES, CROSS FEEDS, TURRETS, TURNTABLES; GEARS, WHEELS, PINS AND PANS; CUTTING BODIES AS MACHINE PARTS, NAMELY, CUTTING INSERTS MADE OF HARD METAL AND

HARD METAL ALLOYS, MACHINE TOOLS FOR CUTTING; CUTTING PLATES, MADE OF CERAMIC, HARD METALS AND HARD METAL ALLOYS, POLYCRYSTALLINE DIAMONDS AND CUBIC BORE NITRIDES AS MACHINE PARTS; MACHINE TOOLS FOR SHAPE CUTTING, NAMELY, MILLING HEADS, CUTTING DISKS, MILLING TOOLS, TURNING TOOLS, SMOOTHING TOOLS, BROACHING TOOLS, DRILLING TOOLS, TURN-BROACHING TOOLS, TURN-TURN-BROACHING TOOLS, TOOLS AND HIGH-SPEED TOOLS FOR SHAPE CUTTING, NAMELY, MILLING HEADS, CUTTING DISKS, MILLING TOOLS, TURNING TOOLS, SMOOTHING TOOLS, BROACHING TOOLS, DRILLING TOOLS AND TOOLS FOR FORMING DRILLING BORES, TURN-BROACHING TOOLS, TURN-TURN BROACHING TOOLS; MACHINE TOOL HOLDER MADE OF METAL AS MACHINE PARTS; TOOL HOLDERS AND TOOL SYSTEMS CONSISTING OF DIFFERENT PARTS AND TOOLS, NAMELY, CHIP REMOVING TOOLS, BROACHES, CHASERS AND COUPLINGS FOR CUTTING TOOL MACHINES; METALLIC CUTTING BODIES AS MACHINES PARTS, NAMELY, CUTTING PLATES MADE OF HARD METAL AND HARD METAL ALLOYS; MECHANICAL TOOLS, NAMELY, CUTTING TOOLS, NAMELY, NAMELY, CHIP REMOVING TOOLS, METAL CUTTING TOOLS AND THEIR PARTS; MECHANICAL TOOLS FOR DRILLING, MILLING AND TURNING AND PARTS THEREOF, IN CLASS 7 (U.S. CLS. 13, 19, 21, 23, 31, 34 AND 35).

FOR: HAND OPERATED CUTTING BODIES, NAMELY, CUTTING PLATES MADE OF HARD METAL OR HARD METAL ALLOYS; HAND OPERATED TOOLS, NAMELY, CUTTING TOOLS AND THEIR PARTS; HAND OPERATED TOOLS FOR FORMING AND DIE CUTTING; HAND OPERATED CUTTING DEVICES, NAMELY, TOOLS FOR METAL CUTTING AND CUTTING TOOLS FOR THE PAPER, TEXTILE AND PLASTICS INDUSTRY, IN CLASS 8 (U.S. CLS. 23, 28 AND 44).

FOR: ELECTRONIC COMPONENTS, NAMELY, LASER EQUIPMENT FOR IDENTIFYING AND

MARKING OF OPERATION TOOLS, MACHINE TOOLS, READERS AND CONTROL DEVICES; SURVEYING INSTRUMENTS, NAMELY, PLANE TABLES; MEASURING MACHINES, NAMELY, DERIVED-UNIT MEASURING MACHINES AND APPARATUS, IN CLASS 9 (U.S. CLS. 21, 23, 26, 36 AND 38).

THE MARK CONSISTS OF STANDARD CHARACTERS WITHOUT CLAIM TO ANY PARTICULAR FONT, STYLE, SIZE, OR COLOR.

PRIORITY DATE OF 3-15-2006 IS CLAIMED.

OWNER OF INTERNATIONAL REGISTRATION 0920166 DATED 9-2-2006, EXPIRES 9-2-2016.

THE NAME "WIDIA HEINLEIN" DOES NOT IDENTIFY A LIVING INDIVIDUAL.

SER. NO. 79-036,964, FILED 9-2-2006.

RICHARD WHITE, EXAMINING ATTORNEY

**Int. Cl.: 8**

**Prior U.S. Cls.: 23, 28 and 44**

**United States Patent and Trademark Office**

**Reg. No. 3,468,082**

**Registered July 15, 2008**

**TRADEMARK  
PRINCIPAL REGISTER**

**VENTAGLIO**

DE STEFANO, ALESSANDRO (ITALY INDIVIDUAL)  
VIA S. MARCIANO 9  
I-86079 VENAFRO  
ITALY

FOR: HAND TOOLS AND INSTRUMENTS, NAMELY, HAND HELD CUTTING TOOLS; CUTLERY, NAMELY, KNIVES, FORKS AND SPOONS; SIDE ARMS, OTHER THAN FIREARMS, NAMELY, SWORDS; RAZORS, IN CLASS 8 (U.S. CLS. 23, 28 AND 44).

PRIORITY DATE OF 9-27-2006 IS CLAIMED.

OWNER OF INTERNATIONAL REGISTRATION  
0920240 DATED 3-27-2007, EXPIRES 3-27-2017.

THE ENGLISH TRANSLATION OF THE WORD  
"VENTAGLIO" IN THE MARK IS FAN.

SER. NO. 79-036,998, FILED 3-27-2007.

SAMUEL E. SHARPER JR., EXAMINING ATTORNEY

**Int. Cls.: 1, 6, 7 and 17**

**Prior U.S. Cls.: 1, 2, 5, 6, 10, 12, 13, 14, 19, 21, 23, 25,  
26, 31, 34, 35, 46 and 50**

**Reg. No. 3,468,083**

**United States Patent and Trademark Office**

**Registered July 15, 2008**

**TRADEMARK  
PRINCIPAL REGISTER**

# ANGST+PFISTER

ANGST & PFISTER AG (SWITZERLAND SOCI-  
ÉTÉ ANONYME)

THURGAUERSTRASSE 66

CH-8050 ZÜRICH

SWITZERLAND

FOR: ADHESIVES USED IN INDUSTRY FOR COATING AND SEALING; UNPROCESSED ARTIFICIAL RESINS; UNPROCESSED PLASTICS FOR INDUSTRIAL USE; LATEX GLUE NOT FOR STATIONERY OR HOUSEHOLD PURPOSES; CHEMICAL PREPARATIONS, UNPROCESSED PLASTICS AND MINERAL SUBSTANCES IN THE NATURE OF FILTERING MATERIALS FOR DRY AND WET FILTRATION, NAMELY, DUST AND INK MIST FILTERS, FILTER MATERIALS FOR LIQUIDS AND FABRIC FILTER INSERTS, INSULATING FABRICS AND THERMAL INSULATING BOARDS, IN CLASS 1 (U.S. CLS. 1, 5, 6, 10, 26 AND 46).

FOR: METAL BUILDING MATERIALS, NAMELY, NON-ELECTRIC CABLES AND WIRES OF COMMON METAL, BINDING SCREWS FOR CABLES AND NON-ELECTRIC CABLE JOINTS, METAL SEALING CAPS, METAL IRONMONGERY, NAMELY, BOLTS, NAILS, RIVETS, SCREWS; SMALL ITEMS OF METAL HARDWARE, NAMELY, NUTS, WASHERS, SPRINGS, TUBES; GOODS OF COMMON METAL NOT INCLUDED IN OTHER CLASSES, NAMELY, RINGS, PIPES, BOLTS, DISKS, VALVES, CASINGS; FITTINGS OF METAL FOR COMPRESSED AIR DUCTS AND FOR MACHINE BELTS; FITTINGS OF METAL FOR BUILDING, NAMELY, METAL PLUGS, IN THE NATURE OF METAL PEGS, METAL TACKS, FLANGES OF METAL, METAL PIPE COLLARS; FLAT PACKINGS, NAMELY, SEALING ELEMENTS FOR HYDRAULIC AND PNEUMATIC SYSTEMS, NAMELY, METAL SEALS; METAL BOTTLE CAPS FOR USE AS SEALING ELEMENTS FOR HYDRAULIC AND PNEUMATIC SYSTEMS; BOTTLE CLOSURES AND CAPS OF METAL; PIPE MUFFS OF METAL AND COLLARS OF METAL FOR FASTENING PIPES, JUNCTIONS OF METAL FOR PIPES, IN CLASS 6 (U.S. CLS. 2, 12, 13, 14, 23, 25 AND 50).

FOR: MACHINES, AND MACHINE TOOLS FOR THE CUTTING AND FORMING OF MATERIALS; MACHINE ELEMENTS IN THE NATURE OF SPRINGS AND PARTS OF SPRINGS, AIR FILTERS FOR MACHINES FOR MECHANICAL PURPOSES; CONTROL MECHANISMS FOR MACHINES, ENGINES OR MOTORS; MOTORS AND DRIVING MOTORS OTHER THAN FOR LAND VEHICLES; POWER TRANSMISSION SHAFT COUPLINGS FOR INDUSTRIAL MACHINES AND PARTS THEREFORE; ELECTRIC CONTROLS OTHER THAN FOR LAND VEHICLES; MACHINE PARTS, NAMELY, V-BELT DRIVES, SYNCHRONOUS BELT DRIVES AND METAL BELT DRIVES; COUPLINGS AND JIGS AND FIXTURES FOR POWER TRANSMISSION OTHER THAN FOR LAND VEHICLES; MACHINE PARTS, NAMELY, IMPULSE COUPLING DEVICES AND HYDRAULIC CLUTCHES OTHER THAN FOR LAND VEHICLES, IN CLASS 7 (U.S. CLS. 13, 19, 21, 23, 31, 34 AND 35).

FOR: RUBBER, GUTTA-PERCHA, GUM AND GOODS MADE FROM THESE MATERIALS, NAMELY, STOPS OF RUBBER, RINGS OF RUBBER, V-BELTS, VIBRATING BUFFERS FOR INDUSTRIAL MACHINERY, ADHESIVE BANDS OTHER THAN STATIONERY AND NOT FOR MEDICAL OR HOUSEHOLD PURPOSES; DRAUGHT EXCLUDER STRIPS, NAMELY, NON-METAL WEATHER STRIPS FOR BUILDINGS; PLASTICS IN EXTRUDED FORM FOR USE IN MANUFACTURE; FILTER MATERIALS, NAMELY, SEMI-FINISHED PLASTICS, SYNTHETIC PLASTIC AS SEMI-FINISHED PRODUCTS IN THE FORM OF FOILS, PLATES, RODS, PROFILES, HOSES, TUBES, BLOCKS, INDUSTRIAL COATINGS, NAMELY, NATURAL AND LIQUID RUBBER; THERMOPLASTIC ELASTOMER RESINS IN PELLET FORM FOR USE IN FURTHER MANUFACTURE; PACKING, STOPPING AND INSULATING MATERIALS, NAMELY, SHEETS OF GRAPHITE-BASED MATERIAL FOR USE AS GASKETS, SEALS, PACKINGS, AND HEAT INSULATORS; GASKET MATERIAL IN SHEETS FOR USE IN BUILDING; GASKET SEALER FOR USE IN PLUMBING; WEATHERSTRIPPING SEALANTS IN THE NATURE OF CAULK; SOUNDPROOFING

MATERIALS FOR BUILDINGS AND MACHINERY; FLEXIBLE TUBES OF PLASTIC FOR INDUSTRIAL USE; FLEXIBLE COMPRESSED AIR PIPE FITTINGS, NOT OF METAL; REINFORCING MATERIALS, NOT OF METAL, FOR PIPES; PIPE MUFFS, NOT OF METAL; JUNCTIONS, NOT OF METAL, FOR PLASTIC PIPES, IN CLASS 17 (U.S. CLS. 1, 5, 12, 13, 35 AND 50).

THE MARK CONSISTS OF STANDARD CHARACTERS WITHOUT CLAIM TO ANY PARTICULAR FONT, STYLE, SIZE, OR COLOR.

PRIORITY DATE OF 11-6-2006 IS CLAIMED.

OWNER OF INTERNATIONAL REGISTRATION 0920698 DATED 1-30-2007, EXPIRES 1-30-2017.

SER. NO. 79-037,188, FILED 1-30-2007.

NAPOLEON SHARMA, EXAMINING ATTORNEY

**Int. Cls.: 3, 5 and 10**

**Prior U.S. Cls.: 1, 4, 6, 18, 26, 39, 44, 46, 50, 51 and 52**

**Reg. No. 3,468,084**

**United States Patent and Trademark Office**

**Registered July 15, 2008**

**TRADEMARK  
PRINCIPAL REGISTER**



MILLET INNOVATION (FRANCE SOCIÉTÉ ANONYME À DIRECTOIRE)  
ZA CHAMP GRAND, BP 64  
F-26270 LORLIOL-SUR-DRÔME  
FRANCE

FOR: COSMETIC PRODUCTS FOR BODY CARE AND SKIN CARE, NAMELY, CREAMS, MILKS, SERUMS, LOTIONS, MASKS, GELS FOR BODY AND FACIAL APPLICATION; COSMETIC PRODUCTS, NAMELY, CREAMS, MILKS, SERUMS, LOTIONS, MASKS, GELS FOR BODY AND FACIAL APPLICATION CONTAINING AN ACTIVE INGREDIENT WITH NATURAL SUBSTANCES AND PRODUCING MOISTURIZING, RELAXING OR EXFOLIATING EFFECT; HAIR PRODUCTS, NAMELY, SHAMPOO AND CONDITIONER; PUMICE STONE FOR PERSONAL USE; ESSENTIAL OILS; EFFERVESCENT BATH SALTS AND TABLETS FOR NON-MEDICAL PURPOSES; EXTRACTS, NAMELY, ESSENCE AND EXTRACTS OF PERFUME; LIQUID AND SOLID TOILET SOAPS, IN CLASS 3 (U.S. CLS. 1, 4, 6, 50, 51 AND 52).

FOR: PHARMACEUTICAL PREPARATIONS AND PREPARATIONS FOR MEDICAL USE, NAMELY, FOR THE TREATMENT OF DERMATOLOGICAL, BONE, CIRCULATORY, ARTICULAR, MUSCULAR, ORTHOPAEDIC DISORDERS; PHARMACEUTICAL AND MEDICAL PREPARATIONS FOR BODY CARE, NAMELY, BODY CREAM TREATMENT FOR ACNE, MYCOSIS, WARTS, IRRITATION, VARICOSE VEINS, CALLOSITY; DERMATOLOGICAL PREPARATIONS FOR SKIN CARE, NAMELY, LOTIONS, SERUMS, GELS AND CREAMS; PREPARATIONS FOR MEDICAL USE AGAINST PERSPIRATION, NAMELY, ANTI-PERSPIRANT CREAM FOR PERSONAL USE; EFFERVESCENT BATH SALTS AND TABLETS FOR MEDICAL USE; DIETETIC SUBSTANCES AND DIETETIC PREPARATIONS ADAPTED FOR MEDICAL

USE, NAMELY, NUTRITIONAL SUPPLEMENTS FOR MEDICAL USE; MATERIALS FOR DRESSINGS, NAMELY, BANDAGES; DRESSINGS FOR WOUND DRESSINGS USE, BURN DRESSINGS USE, SELF ADHESIVE DRESSINGS, TRANSDERMAL PATCHES FOR TREATMENT OF DERMATOLOGICAL, ARTICULAR, ORTHOPAEDIC DISORDERS, DRESSINGS CONTAINING AN ACTIVE INGREDIENT FOR TREATMENT OF SKIN DISORDERS, TRANSDERMAL PATCHES IMPREGNATED WITH ACTIVE SUBSTANCE FOR TREATMENT OF SKIN DISORDERS, IN CLASS 5 (U.S. CLS. 6, 18, 44, 46, 51 AND 52).

FOR: MEDICAL, ORTHOPEDIC, PODIATRIC APPARATUS AND INSTRUMENTS, NAMELY, ORTHOPEDIC BRACES, AND HEEL CUSHIONS INTENDED TO RELIEVE ARTICULAR PAINS; ORTHOPEDIC ARTICLES FOR THE CORRECTION OF DEFORMITIES OF THE FEET AND TOES, NAMELY, ORTHOPEDIC SOLES, ORTHOPEDIC ARCH SUPPORTS; TOE SEPARATORS, ORTHOPEDIC ARTICLES FOR THE PREVENTION OF ESCHARS, NAMELY, ORTHOPEDIC SUPPORT BANDAGES IN TEXTILE MATERIAL; ORTHOPEDIC ARTICLES FOR THE PREVENTION AND REDUCTION OF PRESSURE AND CHAFING ON THE FOOT, NAMELY, ORTHOPEDIC SUPPORT TUBES IN TEXTILE MATERIAL FOR THE PROTECTION OF TOES; ORTHOPEDIC ARTICLES IMPREGNATED WITH ACTIVE SUBSTANCES, NAMELY, ORTHOPEDIC SUPPORT BANDAGES IN TEXTILE MATERIAL FOR USE AS A TRANSDERMAL DRUG SOLD WITHOUT MEDICATION INTENDED TO PROTECT THE ARCH OF THE FOOT AND LIMIT THE DEFORMATION OF TOES; ORTHOPEDIC STRAPS IN TEXTILE MATERIALS INTENDED TO LIMIT THE DEFORMATION OF PULPAL AND DORSAL CORNS; ORTHOPEDIC ARTICLES MADE WITH SILICONE GELS, NAMELY, ORTHOPEDIC ARCH SUPPORTS MADE OF SILICONE GELS; ELASTIC



SHEATHS AND SUPPORT BANDAGES FOR ORTHOPEDIC PURPOSES; ORTHOPEDIC PADS; ORTHOPEDIC SOLES AND HALF-SOLES; ORTHOPEDIC STOCKINGS; ORTHOPEDIC SLIPPERS; ORTHOPEDIC SHOES, IN CLASS 10 (U.S. CLS. 26, 39 AND 44).

PRIORITY DATE OF 7-26-2006 IS CLAIMED.

OWNER OF INTERNATIONAL REGISTRATION 0920963 DATED 1-15-2007, EXPIRES 1-15-2017.

THE COLOR(S) WHITE, RED, BLUE IS/ARE CLAIMED AS A FEATURE OF THE MARK.

THE MARK COMPRISES THE TERM "DERMANTALGIC" WRITTEN IN WHITE ON A SKY-BLUE AND RED BACKGROUND.

THE MARK CONSISTS OF THE WORD "DERMANTALGIC" IN WHITE LETTERING SUPERIMPOSED ON A COLORED BACKGROUND, THE LEFT MOST PORTION OF THE MARK BEING A VERTICAL STRIPE OF THE COLOR RED, THE MIDDLE PORTION OF THE MARK PRESENTING THE LETTERS "DERM" ON A BLUE BACKGROUND, AND THE RIGHT MOST PORTION OF THE MARK PRESENTING THE LETTERS "ALGIC" ON A RED BACKGROUND.

SER. NO. 79-037,274, FILED 1-15-2007.

WILLIAM ROSSMAN, EXAMINING ATTORNEY

**Int. Cls.: 9, 41 and 42**

**Prior U.S. Cls.: 21, 23, 26, 36, 38, 100, 101 and 107**

**United States Patent and Trademark Office**

**Reg. No. 3,468,085**

**Registered July 15, 2008**

**TRADEMARK  
SERVICE MARK  
PRINCIPAL REGISTER**



NUXEO (FRENCH GUIANA SAS)  
18/20, RUE SOLEILLET  
F-75020 PARIS  
FRANCE

FOR: ENTERPRISE CONTENT MANAGEMENT SOFTWARE FOR USE IN A VARIETY OF FIELDS; DOCUMENT AND CONTENT MANAGEMENT SOFTWARE FOR MANAGING, PROCESSING, STORING, RETRIEVING, TRACKING, SECURING, CATEGORIZING, SEARCHING, PUBLISHING, ARCHIVING AND DELIVERING COMPUTER FILES, DATA AND ELECTRONIC CONTENT; COMPUTER SOFTWARE FOR DEVELOPING APPLICATIONS FOR THE MANAGEMENT, STORAGE AND PROCESSING OF ELECTRONIC CONTENT, IN CLASS 9 (U.S. CLS. 21, 23, 26, 36 AND 38).

FOR: EDUCATIONAL SERVICES, NAMELY, CONDUCTING TRAINING VIA CLASSES, CONFERENCES, WORKSHOPS, SEMINARS, LECTURES, AND ON-SITE TRAINING IN THE FIELD OF COMPUTERS AND COMPUTER SOFTWARE, IN CLASS 41 (U.S. CLS. 100, 101 AND 107).

FOR: COMPUTER SERVICES, NAMELY, CONSULTATION IN THE FIELD OF COMPUTERS AND COMPUTER SOFTWARE; PROGRAMMING, DESIGN, DEVELOPMENT, MAINTENANCE, AND UPDATING OF COMPUTER SOFTWARE FOR OTHERS, IN CLASS 42 (U.S. CLS. 100 AND 101).

OWNER OF INTERNATIONAL REGISTRATION 0921834 DATED 2-9-2007, EXPIRES 2-9-2017.

THE COLOR(S) BLUE AND YELLOW IS/ARE CLAIMED AS A FEATURE OF THE MARK.

THE WORDING "NUXEO" APPEARS IN BLUE. A YELLOW INVERTED CHECKMARK DESIGN APPEARS BEHIND.

SER. NO. 79-037,631, FILED 2-9-2007.

BERNICE MIDDLETON, EXAMINING ATTORNEY

**Int. Cls.: 25 and 35**

**Prior U.S. Cls.: 22, 39, 100, 101 and 102**

**United States Patent and Trademark Office**

**Reg. No. 3,468,086**

**Registered July 15, 2008**

**TRADEMARK  
SERVICE MARK  
PRINCIPAL REGISTER**



TREND AYAKKABI; SANAYI VE TICARET LIMITED SIRKETI (TURKEY LIMITED COMPANY)

E-5 KARAYOLU ÜZERI  
MARMARACIK KÖYÜ MEVKII; EDİRNE KISMI  
ÇORLU; TEKIRDAG  
TURKEY

FOR: FOOTWEAR, NAMELY, SHOES, EXCLUDING ORTHOPEDIC SHOES, SLIPPERS, BOOTS, SPORTS SHOES, AND LACE BOOTS; SHOE PARTS, NAMELY, HEELPIECES; HEELS, IN CLASS 25 (U.S. CLS. 22 AND 39).

FOR: RETAIL STORE SERVICES FEATURING FOOTWEAR, IN CLASS 35 (U.S. CLS. 100, 101 AND 102).

OWNER OF INTERNATIONAL REGISTRATION 0921855 DATED 1-31-2007, EXPIRES 1-31-2017.

THE COLOR(S) WHITE AND DARK GREEN IS/ ARE CLAIMED AS A FEATURE OF THE MARK.

THE MARK CONSISTS OF THE COLOR WHITE APPEARING IN THE WORDING "YESIL" AND THE COLOR DARK GREEN APPEARS IN THE REST OF THE RECTANGLE.

THE FOREIGN WORDING IN THE MARK TRANSLATES INTO ENGLISH AS "UNRIPE."

SER. NO. 79-037,637, FILED 1-31-2007.

WARREN L. OLANDRIA, EXAMINING ATTORNEY

**Int. Cl.: 41**

**Prior U.S. Cls.: 100, 101 and 107**

**United States Patent and Trademark Office**

**Reg. No. 3,468,087**

**Registered July 15, 2008**

**SERVICE MARK  
PRINCIPAL REGISTER**

# BOKATAE

SPORTSCHOOL SMIT MARTIN VOF (NETHERLANDS VENNOOTSCHAP ONDER FIRMA (VOF))  
KUIPERIJ 7 B  
NL-1185 XS AMSTERDAM  
NETHERLANDS

FOR: EDUCATION, NAMELY, PROVIDING OF TRAINING AND COURSES IN THE FIELD OF PHYSICAL FITNESS; SERVICES OF A SPORTS CENTRE, NAMELY, PROVIDING FITNESS AND EXERCISE FACILITIES, TENNIS COURTS, AND SWIMMING POOLS; PROVIDING SPORTING FACILITIES AND PERSONAL COACHING AND TRAINING IN THE FIELDS OF PHYSICAL FIT-

NESS, AEROBICS, PHYSICAL EXERCISES, WEIGHT LOSS, IN CLASS 41 (U.S. CLS. 100, 101 AND 107).

THE MARK CONSISTS OF STANDARD CHARACTERS WITHOUT CLAIM TO ANY PARTICULAR FONT, STYLE, SIZE, OR COLOR.

OWNER OF INTERNATIONAL REGISTRATION 0921871 DATED 2-16-2007, EXPIRES 2-16-2017.

SER. NO. 79-037,644, FILED 2-16-2007.

ERNEST SHOSHO, EXAMINING ATTORNEY

**Int. Cl.: 21**

**Prior U.S. Cls.: 2, 13, 23, 29, 30, 33, 40 and 50**

**United States Patent and Trademark Office**

**Reg. No. 3,468,088**

**Registered July 15, 2008**

**TRADEMARK  
PRINCIPAL REGISTER**



ZIBO EXCEL LIGHT; INDUSTRIAL PRODUCTS  
CO., LTD. (CHINA CORPORATION)  
168 MINXIANG LU  
GAOXIN JISHU CHANYE KAIFANGU.; ZIBO; 255088  
SHANDONG  
CHINA

FOR: GLASSWARE, PORCELAIN WARE, ENAMELWARE AND PLASTIC UTENSILS FOR HOUSEHOLD PURPOSES, NAMELY, BASINS, BOWLS, DISHES, KETTLES, JARS, JUGS, POTS, AND CUPS; CANDLESTICKS, NOT OF PRECIOUS METAL; GLASS, UNWORKED OR SEMI-WORKED, EXCEPT BUILDING GLASS; BEER MUGS; POTS, NOT OF PRECIOUS METAL; THERMALLY INSULATED

CONTAINERS FOR FOOD; WORKS OF ART, OF PORCELAIN, TERRA-COTTA OR GLASS AND CHINA ORNAMENTS, NAMELY, STATUES, BUSTS, FIGURINES AND STATUETTES, IN CLASS 21 (U.S. CLS. 2, 13, 23, 29, 30, 33, 40 AND 50).

OWNER OF INTERNATIONAL REGISTRATION  
0921943 DATED 4-10-2007, EXPIRES 4-10-2017.

SER. NO. 79-037,671, FILED 4-10-2007.

KIMBERLY FRYE, EXAMINING ATTORNEY

**Int. Cls.: 37, 39, 40 and 42**

**Prior U.S. Cls.: 100, 101, 103, 105 and 106**

**United States Patent and Trademark Office**

**Reg. No. 3,468,089**

**Registered July 15, 2008**

**SERVICE MARK  
PRINCIPAL REGISTER**



REMONDIS; ASSETS & SERVICES GMBH & CO.  
KG (FED REP GERMANY LIMITED PART-  
NERSHIP)  
BRUNNENSTR. 138  
44536 LÜNEN  
FED REP GERMANY

FOR: STREET CLEANING; EXTERIOR CLEANING OF BUILDINGS; INTERIOR CLEANING OF BUILDINGS; CLEANING AND REPAIR OF BOILERS; CLEANING OF ARTICLES OF CLOTHING; CLEANING OF VEHICLES; CLEANING OF WINDOWS; CLEANING OF PETROL, OIL AND GREASE DEPOSITS; CLEANING OF CESSPITS; PIPELINE AND SEWER CLEANING; GULLY CLEANING; INDUSTRIAL CLEANING; HIRING OUT OF CLEANING MACHINERY; CHEMICAL CLEANING; CONSTRUCTION OF ENVIRONMENTAL FACILITIES; REPAIR WORK, NAMELY, REPAIRS ON BUILDINGS, MACHINERY, VEHICLES, ELECTRICAL DEVICES, AIR CONDITIONING UNITS AND IT EQUIPMENT; INSTALLATION WORK OF ENVIRONMENTAL FACILITIES; CONSTRUCTION AND REPAIR OF ENVIRONMENTAL EQUIPMENT, NAMELY, REFUSE DISPOSAL SITES, PURIFICATION, INCINERATION AND DRAINAGE FACILITIES AS WELL AS GLASS REPROCESSING FACILITIES; CLEANING OF PORTABLE TOILET CABINS, PORTABLE TOILET BLOCKS AND CONTAINERS AS WELL AS THE DISPOSAL OF WASTE CONTAINERS; CONSTRUCTION CONSULTANCY, IN CLASS 37 (U.S. CLS. 100, 103 AND 106).

FOR: GARBAGE COLLECTION; TRANSPORTATION AND STORAGE OF WASTE PRODUCTS, REFUSE AND RECYCLABLE MATERIALS; REFUSE TRANSPORTATION AND STORAGE; TRANSPORTATION OF DOMESTIC, TRADE AND INDUSTRIAL WASTE AND HAZARDOUS WASTE MATERIALS; TRANSPORTATION OF INDUSTRIAL LIQUID WASTE; TRANSPORTATION OF EXCREMENT; TRANSPORTATION OF OILS AND OILY MATERIALS; TRANSPORTATION OF ENVIRONMENTALLY HAZARDOUS LIQUIDS AND

TRANSPORTATION OF ENVIRONMENTALLY HAZARDOUS SOLID MATERIALS; DELIVERY AND DISTRIBUTION OF ELECTRICAL ENERGY, GAS AND WATER; TRANSPORT OF WATER SUPPLIES; TRANSPORTATION, PACKAGING AND STORAGE OF WASTE PRODUCTS, REFUSE AND RECYCLABLE MATERIALS; RENTING STORAGE UNITS AND WASTE AND REFUSE CONTAINERS TO OTHERS; TRANSPORTATION OF PORTABLE TOILET CABINS, PORTABLE TOILET BLOCKS AND CONTAINERS AS WELL AS THE TRANSPORTATION OF WASTE CONTAINERS, IN CLASS 39 (U.S. CLS. 100 AND 105).

FOR: REPROCESSING AND CONVERSION OF WASTE MATERIALS, NAMELY, THE RECOVERY OF VALUABLE MATERIALS FROM WASTE, NAMELY, GLASS, METALS, PAPER AND CHEMICALS; DECONTAMINATION OF HAZARDOUS MATERIALS; SORTING OF REFUSE AND RECYCLABLE MATERIALS; REFUSE AND WASTE RECYCLING; DISPOSAL OF WASTE MATERIALS, NAMELY THE TREATMENT OF WASTE MATERIALS USING CHEMICAL, BIOLOGICAL, PHYSICAL AND THERMAL PROCESSES; DISPOSAL OF PORTABLE TOILET CABINS, PORTABLE TOILET BLOCKS AND CONTAINERS AS WELL AS THE DISPOSAL OF WASTE CONTAINERS BY MEANS OF DESTRUCTION AND INCINERATION; INCINERATION AND DESTRUCTION OF REFUSE AND WASTE MATERIALS; AIR PURIFICATION; MATERIAL PROCESSING, NAMELY, WASTE MATERIAL PROCESSING; WASTE WATER TREATMENT; PRODUCTION OF ENERGY, IN CLASS 40 (U.S. CLS. 100, 103 AND 106).

FOR: ENVIRONMENTAL PROTECTION COMPLIANCE CONSULTANCY; DETERMINATION OF CONCENTRATION LEVELS OF POLLUTANTS; DETERMINATION OF EMISSIONS AND IMMISSIONS LEVELS IN THE ENVIRONMENT; ENVIRONMENTAL IMPACT ASSESSMENTS; TECHNICAL CONSULTANCY, NAMELY, THE DETERMINATION OF EMISSIONS AND IMMISSIONS AND ENVIRON-

MENTAL IMPACT ASSESSMENTS; PLANNING AND RESEARCH FOR CONSTRUCTION OF ENVIRONMENTAL FACILITIES; TECHNICAL PROJECT PLANNING FOR ENVIRONMENTAL FACILITIES; ARCHITECT'S SERVICES; SERVICES OF BUILDING CONTRACTOR, NAMELY, CONSTRUCTION DRAFTING SERVICES; ENGINEERING; BIOLOGIST'S, CHEMIST'S AND PHYSICIST'S SERVICES; TECHNICAL AND CONSTRUCTION PLANNING FOR WASTE DISPOSAL AND WASTE WATER TREATMENT FACILITIES; DEVELOPMENT, PLANNING, PROJECTION, EXECUTION OF AND CONSULTANCY FOR AUTHORISATION PROCEDURES FOR FACILITIES, EQUIPMENT AND PROCESSES REGARDING CHEMICAL, PHYSICAL, THERMAL, BIOLOGICAL TREATMENT AND PROCESSING AND DUMPING OF WATER, WASTE WATER, WASTE MATERIALS AND REFUSE; CARRYING OUT OF CHEMICAL, ANALYTICAL AND TOXICOLOGICAL INVESTIGATIONS OF ALL KINDS FOR OTHERS; SCIENTIFIC AND TECHNICAL ANALYSIS AND EVALUATION OF SOILS, WATERS, GASES AND WASTE PRODUCTS; ENVIRONMENTAL PROTECTION COMPLIANCE CONSULTANCY, TECHNICAL PLANNING AND DEVELOPMENT OF ENVIRONMENTAL PROCESSES AND FACILITIES IN THE FIELD OF ENVIRONMENTAL HYGIENE AND ENERGY SUPPLIES;

TECHNICAL PROJECT PLANNING IN THE NATURE OF TECHNICAL DESIGN OF ENVIRONMENTAL FACILITIES, NAMELY, REFUSE DISPOSAL SITES, PURIFICATION, INCINERATION AND DRAINAGE FACILITIES, IN CLASS 42 (U.S. CLS. 100 AND 101).

PRIORITY DATE OF 6-12-2006 IS CLAIMED.

OWNER OF INTERNATIONAL REGISTRATION 0922016 DATED 12-9-2006, EXPIRES 12-9-2016.

OWNER OF U.S. REG. NO. 3,194,538.

THE COLOR(S) RED AND WHITE IS/ARE CLAIMED AS A FEATURE OF THE MARK.

THE COLOR WHITE APPEARS IN THE WORDING "REMONDIS" AND THE COLOR RED APPEARS IN THE RECTANGULAR BACKGROUND DESIGN.

SER. NO. 79-037,697, FILED 12-9-2006.

PETER B. BROMAGHIM, EXAMINING ATTORNEY

**Int. Cls.: 18, 25 and 35**

**Prior U.S. Cls.: 1, 2, 3, 22, 39, 41, 100, 101 and 102**

**United States Patent and Trademark Office**

**Reg. No. 3,468,090**

**Registered July 15, 2008**

**TRADEMARK  
SERVICE MARK  
PRINCIPAL REGISTER**

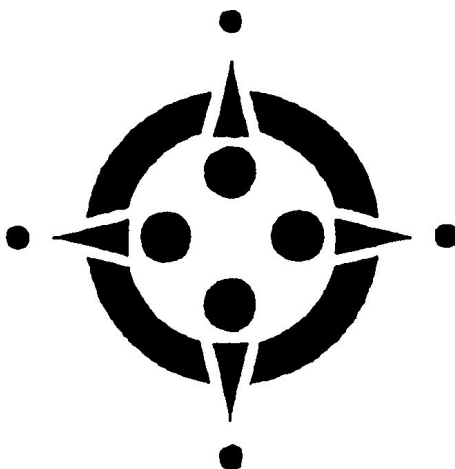

VIZYON DERI SANAYI VE; TICARET ANONIM  
SIRKETI (TURKEY CORPORATION)  
ESKI LONDRA ASFALTI NO: 79  
TR-34605 GÜNGÖREN, ISTANBUL, TURKEY

FOR: PROCESSED AND UNPROCESSED LEATHER AND FUR, IMITATION LEATHER, STOUT LEATHER, LEATHER FOR LINING; GOODS MADE OF LEATHER OR IMITATION LEATHER, NAMELY, BAGS, VALISES, WALLETS, PORTFOLIOS, CASES, KEY CASES; EMPTY TOILET BAGS, MONEY PURSES; BAGS, NAMELY, HAND BAGS, KEY BAGS, LEATHER SHOPPING BAGS, TEXTILE SHOPPING BAGS, BABY CARRYING BAGS, DOCUMENT BAGS, SCHOOL BAGS, BACKPACKS, IN CLASS 18 (U.S. CLS. 1, 2, 3, 22 AND 41).

FOR: CLOTHING MADE OF LEATHER AND THEIR ACCESSORIES, NAMELY, SHAWLS, FAST-ON CLOTH COLLARS, BANDANAS, MUFFS, BELTS, BRACES FOR CLOTHING, HEADWEAR, FOOTWEAR; ACCESSORIES, NAMELY, WRIST BANDS AND HEADBANDS, IN CLASS 25 (U.S. CLS. 22 AND 39).

FOR: THE BRINGING TOGETHER, FOR THE BENEFIT OF OTHERS, OF A VARIETY OF GOODS, ENABLING CUSTOMERS TO CONVENIENTLY VIEW AND PURCHASE THOSE GOODS, IN CLASS 35 (U.S. CLS. 100, 101 AND 102).

PRIORITY DATE OF 11-23-2006 IS CLAIMED.

OWNER OF INTERNATIONAL REGISTRATION  
0922191 DATED 3-14-2007, EXPIRES 3-14-2017.

THE MARK CONSISTS OF GEOMETRIC SHAPES  
FORMING A STYLIZED COMPASS.

SER. NO. 79-037,774, FILED 3-14-2007.

REBECCA POVARCHUK, EXAMINING ATTORNEY



**Int. Cl.: 6**

**Prior U.S. Cls.: 2, 12, 13, 14, 23, 25 and 50**

**United States Patent and Trademark Office**

**Reg. No. 3,468,091**

**Registered July 15, 2008**

**TRADEMARK  
PRINCIPAL REGISTER**

**PENTABOND**

THYSSENKRUPP STEEL AG (FED REP GERMA-  
NY AG)

KAISER-WILHELM-STR. 100

47166 DUISBURG

FED REP GERMANY

FOR: COMMON METALS, UNWROUGHT AND SEMI-WORKED, FOR FURTHER MANUFACTURE; ALUMINUM, TITANIUM MAGNESIUM, ZINC, TIN, NICKEL AND THEIR ALLOYS; STEELS; STAINLESS STEELS AND OTHER NON-RUSTING AND ACID-RESISTANT STEELS; ROLLED STEEL FINISHED PRODUCTS, MADE FROM THE AFORESAID METALS, ALLOYS, AND STEELS, NAMELY, HOT-ROLLED AND COLD-ROLLED STRIPS AND SHEETS, IN CLASS 6 (U.S. CLS. 2, 12, 13, 14, 23, 25 AND 50).

THE MARK CONSISTS OF STANDARD CHARACTERS WITHOUT CLAIM TO ANY PARTICULAR FONT, STYLE, SIZE, OR COLOR.

PRIORITY DATE OF 10-25-2006 IS CLAIMED.

OWNER OF INTERNATIONAL REGISTRATION  
0922202 DATED 3-13-2007, EXPIRES 3-13-2017.

SER. NO. 79-037,776, FILED 3-13-2007.

CAROLYN GRAY, EXAMINING ATTORNEY

**Int. Cls.: 6, 19 and 20**

**Prior U.S. Cls.: 1, 2, 12, 13, 14, 22, 23, 25, 32, 33 and 50**

**Reg. No. 3,468,092**

**United States Patent and Trademark Office**

**Registered July 15, 2008**

**TRADEMARK  
PRINCIPAL REGISTER**

**T-Pole**

SACHSEN FAHNEN GMBH & CO. KG (FED REP  
GERMANY KG)  
AM WIESENGRUND 2  
01917 KAMENZ  
FED REP GERMANY

FOR: TELESCOPIC FLAGPOLES, IN CLASS 20  
(U.S. CLS. 2, 13, 22, 25, 32 AND 50).

PRIORITY DATE OF 3-19-2007 IS CLAIMED.

FOR: METAL POLES, NAMELY, TELESCOPIC  
POLES FOR DISPLAYING ADVERTISING AND  
DECORATIVE BANNERS, FLAGS, DISPLAYS, PA-  
NELS, AND THE LIKE, IN CLASS 6 (U.S. CLS. 2, 12,  
13, 14, 23, 25 AND 50).

OWNER OF INTERNATIONAL REGISTRATION  
0922523 DATED 4-10-2007, EXPIRES 4-10-2017.

FOR: NON-METAL POLES, NAMELY, TELE-  
SCOPIC POLES MADE OF SYNTHETIC MATERIAL  
FOR DISPLAYING ADVERTISING AND DECORA-  
TIVE BANNERS, FLAGS, DISPLAYS, PANELS, AND  
THE LIKE, IN CLASS 19 (U.S. CLS. 1, 12, 33 AND 50).

SER. NO. 79-037,892, FILED 4-10-2007.

KIMBERLY FRYE, EXAMINING ATTORNEY

Int. Cls.: 3, 9, 14, 18, 24 and 25

Prior U.S. Cls.: 1, 2, 3, 4, 6, 21, 22, 23, 26, 27, 28, 36,  
38, 39, 41, 42, 50, 51 and 52

Reg. No. 3,468,093

United States Patent and Trademark Office

Registered July 15, 2008

TRADEMARK  
PRINCIPAL REGISTER



E.M.I. S.R.L. (ITALY SOCIETÀ A RESPONSABILITÀ LIMITATA)  
CORSO ITALIA, 12  
I-80024 CARDITO (NA)  
ITALY

FOR: SOAPS; PERFUMERY, ESSENTIAL OILS, COSMETICS, HAIR LOTIONS; DENTIFRICES, IN CLASS 3 (U.S. CLS. 1, 4, 6, 50, 51 AND 52).

FOR: SPECTACLE FRAMES AND SUNGLASSES, IN CLASS 9 (U.S. CLS. 21, 23, 26, 36 AND 38).

FOR: JEWELLERY, WATCHES AND CLOCKS, IN CLASS 14 (U.S. CLS. 2, 27, 28 AND 50).

FOR: LEATHER AND IMITATIONS OF LEATHER; GOODS MADE OF LEATHER AND IMITATION LEATHER, NAMELY, TRUNKS AND TRAVELLING BAGS, HANDBAGS, WALLETS, LUGGAGE, BRIEFCASES, TRAVELLING CASES, CARRY-ALL BAGS, KEY CASES, COSMETIC CASES SOLD EMPTY, PURSES, DOCUMENTS CASES; ANIMAL SKINS, ANIMAL HIDES; UMBRELLAS, PARASOLS AND WALKING STICKS, IN CLASS 18 (U.S. CLS. 1, 2, 3, 22 AND 41).

FOR: TEXTILE GOODS, NAMELY, BROCADE, COTTON FABRIC, DIAPERED LINEN, LINEN CLOTH, RAYON FABRIC, SILK FABRIC, TAFFETA, TULLE, VELVET FABRIC, WOOLEN CLOTH, CHIFFON FABRIC, ELASTIC FABRIC, TEXTILE FABRIC

OF ANIMAL SKINS IMITATIONS, BED SPREADS, BED LINEN, TABLE LINEN, HOUSEHOLD LINEN, KITCHEN LINEN, AND BATH LINEN, IN CLASS 24 (U.S. CLS. 42 AND 50).

FOR: ARTICLES OF CLOTHING FOR WOMEN, MEN AND CHILDREN, NAMELY, EVENING GOWNS, DINNER GOWNS, TEA GOWNS, WEDDING GOWNS, DRESSES, BLOUSES, SKIRTS, TROUSERS, COATS, JACKETS, SKIRTS, FUR COATS, SHIRTS, VESTS, PAJAMAS, GLOVES, SCARVES, FOULARDS, NECKTIES, BELTS, HOSIERY, LINGERIE, SWIMWEAR; HATS, CAPS; SHOES AND BOOTS, IN CLASS 25 (U.S. CLS. 22 AND 39).

OWNER OF INTERNATIONAL REGISTRATION 0922577 DATED 4-6-2007, EXPIRES 4-6-2017.

THE NAME "EMILIO SCHUBERTH" DOES NOT IDENTIFY A LIVING INDIVIDUAL.

THE MARK CONSISTS OF THE STYLIZED WORDING "EMILIO SCHUBERTH" BELOW THE DESIGN OF AN EAGLE THAT IS WEARING A CROWN ON ITS HEAD AND HAS SCROLLS AROUND ITS WINGS.

SER. NO. 79-037,899, FILED 4-6-2007.

MAUREEN DALL, EXAMINING ATTORNEY

**Int. Cls.: 3, 9, 14, 18, 25, 30, 32, 33 and 35**

**Prior U.S. Cls.: 1, 2, 3, 4, 6, 21, 22, 23, 26, 27, 28, 36, 38, 39, 41, 45, 46, 47, 48, 49, 50, 51, 52, 100, 101 and 102**

**Reg. No. 3,468,094**

**United States Patent and Trademark Office**

**Registered July 15, 2008**

**TRADEMARK  
SERVICE MARK  
PRINCIPAL REGISTER**

# Lascana

OTTO (GMBH & CO KG) (FED REP GERMANY CORPORATION)  
WANDSBEKER STR. 3-7  
22172 HAMBURG  
FED REP GERMANY

FOR: SOAPS, PERFUMERY, ESSENTIAL OILS, COSMETICS, HAIR LOTIONS, IN CLASS 3 (U.S. CLS. 1, 4, 6, 50, 51 AND 52).

FOR: GLASSES, NAMELY SPORTS GLASSES, SUNGLASSES AS WELL AS THEIR CASE, MOBILE PHONES, IN CLASS 9 (U.S. CLS. 21, 23, 26, 36 AND 38).

FOR: JEWELLERY, PRECIOUS STONES, HOROLOGICAL AND CHRONOMETRIC INSTRUMENTS, IN CLASS 14 (U.S. CLS. 2, 27, 28 AND 50).

FOR: GOODS MADE OF LEATHER, IMITATIONS OF LEATHER, VELOUR AND IMITATION SUEDE, NAMELY TRUNKS, TRAVELLING BAGS, PURSES, HANDBAGS, WALLETS, BACK PACKS, BEAUTY BAGS SOLD EMPTY, MANICURE CASES SOLD EMPTY, MOBILE PHONE BAGS, ATHLETIC BAGS; AND UMBRELLAS, PARASOLS AND WALKING STICKS, IN CLASS 18 (U.S. CLS. 1, 2, 3, 22 AND 41).

FOR: CLOTHING, NAMELY, BRAS, LINGERIE, SLIPS, G-STRINGS, PANTIES, UNDERSHIRTS, CORSAGES IN THE NATURE OF BODICES TO BE INCORPORATED INTO CLOTHING, GARTER BELTS, STRAPS FOR BRAS, BUSTIERS, BODY-SUITS, CORSETRY, PAJAMAS, NIGHTDRESSES, NEGLIGEEES, BATHROBES, T-SHIRTS, TOPS, SOCKS, STOCKINGS, TIGHTS, SKIRTS, TROUSERS, TUNICS, BEACH WEAR, BIKINIS, TANKINIS, SWIMSUITS, SHAWLS, COATS, JACKETS, BLOUSES, GLOVES, SCARVES, FOOTWEAR, HEADGEAR, NAMELY, HATS AND CAPS, IN CLASS 25 (U.S. CLS. 22 AND 39).

FOR: CANDY, IN CLASS 30 (U.S. CL. 46).

FOR: MINERAL AND AERATED WATERS AND OTHER NON-ALCOHOLIC DRINKS, NAMELY, FRUIT JUICE BEVERAGES, FRUIT JUICES, HONEY-BASED BEVERAGES, CARBONATED BEVERAGES, LEMONADES, SPORTS BEVERAGES, IN CLASS 32 (U.S. CLS. 45, 46 AND 48).

FOR: ALCOHOLIC BEVERAGES EXCEPT BEERS, NAMELY, SPARKLING WINE, IN CLASS 33 (U.S. CLS. 47 AND 49).

FOR: RETAIL STORE SERVICES, ONLINE RETAIL STORE SERVICES, MAIL ORDER SERVICES, DOOR TO DOOR RETAIL SHOPPING SERVICES FEATURING SOAPS, PERFUMERY, ESSENTIAL OILS, COSMETICS, HAIR LOTIONS, GLASSES, SUNGLASSES AS WELL AS THEIR CASES, MOBILE PHONES, JEWELLERY, PRECIOUS STONES, HOROLOGICAL AND CHRONOMETRIC INSTRUMENTS, LEATHER AND IMITATIONS OF LEATHER, AND GOODS MADE OF THESE MATERIALS, TRUNKS AND TRAVELING BAGS, BAGS, UMBRELLAS, PARASOLS AND WALKING STICKS, CLOTHING, FOOTWEAR, HEADGEAR, CANDY, MINERAL AND AERATED WATERS AND NON-ALCOHOLIC DRINKS, ALCOHOLIC BEVERAGES EXCEPT BEERS, NAMELY SPARKLING WINE, IN CLASS 35 (U.S. CLS. 100, 101 AND 102).

THE MARK CONSISTS OF STANDARD CHARACTERS WITHOUT CLAIM TO ANY PARTICULAR FONT, STYLE, SIZE, OR COLOR.

OWNER OF INTERNATIONAL REGISTRATION 0923065 DATED 2-3-2007, EXPIRES 2-3-2017.

SER. NO. 79-038,105, FILED 2-3-2007.

DARRYL SPRUILL, EXAMINING ATTORNEY

**Int. Cl.: 18**

**Prior U.S. Cls.: 1, 2, 3, 22 and 41**

**United States Patent and Trademark Office**

**Reg. No. 3,468,095**

**Registered July 15, 2008**

**TRADEMARK  
PRINCIPAL REGISTER**

**P r o t e c A**

ACE CO., LTD. (JAPAN CORPORATION)  
5-2, 4-CHOME, BAKURO-MACHI  
CHUO-KU, OSAKA-SHI; OSAKA  
JAPAN 5410059

FOR: SUITCASES; TRUNKS FOR TRAVELLING; TRAVELLING BAGS; BOSTON BAGS; HANDBAGS; ATTACHE CASES; BACKPACKS; RUCKSACKS; BAGS FOR CAMPERS, NAMELY, HUNTING BAGS AND ALL PURPOSE CARRYING BAGS FOR CAMPERS; BAGS FOR CLIMBERS, NAMELY, HIKING BAGS AND ALL PURPOSE CARRYING BAGS FOR CLIMBERS; BEACH BAGS; BRIEFCASES; WALLETS FOR BUSINESS CARDS; CARD CASES, NAMELY, BUSINESS CARD CASES, CALLING CARD CASES, AND NOTE CARD CASES; CARRY-ON BAGS; CHAIN MESH PURSES, NOT OF PRECIOUS METAL; CHARM BAGS (OMAMORI-IRE); WALLETS AND CASES FOR USE AS COMMUTATION TICKET HOLDERS; FOLDING BRIEFCASES; GARMENT BAGS FOR TRAVEL; GLADSTONE BAGS; HAVERSACKS; JAPANESE UTILITY POUCHES (SHINGEN-BUKURO); KEY CASES; KORI WICKER TRUNKS; DOCUMENT CASES FOR HOLDING SHEET MUSIC; NET BAGS FOR SHOPPING, NAMELY, LEATHER NET BAGS FOR SHOPPING AND TEXTILE NET BAGS FOR SHOPPING; POCKET WALLETS; PURSES; PURSES, NOT OF PRECIOUS METAL; SCHOOL BAGS; SCHOOL SACHELS; SCHOOL

CHILDREN'S BACKPACKS; SHOPPING BAGS, NAMELY, LEATHER SHOPPING BAGS, TEXTILE SHOPPING BAGS, MESH SHOPPING BAGS, STRING SHOPPING BAGS, AND CANVAS SHOPPING BAGS; SHOULDER BAGS; LEATHER SHOULDER STRAPS; SUITCASE HANDLES; LEATHER TRAVELLING SETS COMPRISING TRAVELLING BAG SETS, TRAVELLING CASES, TRAVELLING LUGGAGE SETS, TRAVELLING SUITCASE SETS AND TRAVELLING TRUNK SETS; VALISES; WALLETS, NOT OF PRECIOUS METAL; WHEELED SHOPPING BAGS; SUITCASE STRAPS AND STRAPS FOR LUGGAGE; DRAWSTRING ALL-PURPOSE CARRYING BAGS; POUCHES, NAMELY, DRAWSTRING POUCHES, LEATHER POUCHES, FELT POUCHES, AND TOOL POUCHES, SOLD EMPTY; VANITY CASES, SOLD EMPTY, IN CLASS 18 (U.S. CLS. 1, 2, 3, 22 AND 41).

PRIORITY DATE OF 8-9-2006 IS CLAIMED.

OWNER OF INTERNATIONAL REGISTRATION  
0923147 DATED 10-20-2006, EXPIRES 10-20-2016.

SER. NO. 79-038,138, FILED 10-20-2006.

BARBARA RUTLAND, EXAMINING ATTORNEY

**Int. Cls.: 10, 42 and 44**

**Prior U.S. Cls.: 26, 39, 44, 100 and 101**

**Reg. No. 3,468,096**

**United States Patent and Trademark Office**

**Registered July 15, 2008**

**TRADEMARK  
SERVICE MARK  
PRINCIPAL REGISTER**

**AIRLEG**

HOLZER, HEIDE-MARIE (AUSTRIA INDIVIDUAL)

HEINZELGASSE 12  
A-9020 KLAGENFURT  
AUSTRIA AND

HOLZER, GEROLD (AUSTRIA INDIVIDUAL)  
HEINZELGASSE 12

A-9020 KLAGENFURT  
AUSTRIA AND

AUSTRIA WIRTSCHAFTSSERVICE GMBH (AUSTRIA LTD LIAB CO)

UNGARGASSE 37  
A-1030 WIEN  
AUSTRIA

FOR: ARTIFICIAL LIMBS, EYES AND TEETH; ORTHOPEDIC ARTICLES, NAMELY, ORTHOPEDIC SHOES, ORTHOPEDIC INSOLES, ORTHOPEDIC SOCKS, ORTHOPEDIC STOCKINGS, ORTHOPEDIC BANDAGES, SUTURE MATERIALS, IN CLASS 10 (U.S. CLS. 26, 39 AND 44).

FOR: SCIENTIFIC AND TECHNOLOGICAL SERVICES, NAMELY, SCIENTIFIC AND TECHNOLOGICAL RESEARCH AND DESIGN RELATING TO

ORTHOPEDICS AND AMPUTATION OF EXTREMITIES AND OTHER BODY PARTS AND THEIR ORTHOPEDIC AND ORTHOTIC SUPPLY; INDUSTRIAL ANALYSIS AND RESEARCH SERVICES IN THE FIELD OF ORTHOPEDICS AND AMPUTATION OF EXTREMITIES AND OTHER BODY PARTS AS WELL AS THEIR ORTHOPEDIC AND ORTHOTIC SUPPLY, IN CLASS 42 (U.S. CLS. 100 AND 101).

FOR: MEDICAL SERVICES, IN CLASS 44 (U.S. CLS. 100 AND 101).

PRIORITY DATE OF 10-5-2006 IS CLAIMED.

OWNER OF INTERNATIONAL REGISTRATION 0923234 DATED 4-2-2007, EXPIRES 4-2-2017.

SER. NO. 79-038,170, FILED 4-2-2007.

JENNY PARK, EXAMINING ATTORNEY

**Int. Cl.: 9**

**Prior U.S. Cls.: 21, 23, 26, 36 and 38**

**United States Patent and Trademark Office**

**Reg. No. 3,468,097**

**Registered July 15, 2008**

**TRADEMARK  
PRINCIPAL REGISTER**

**XEN**

PHONIC EAR A/S (DENMARK PUBLIC LIMITED  
COMPANY)  
KONGEBAKKEN 9  
SMØRUM, DENMARK DK2765

FOR: AMPLIFIED WIRELESS TELEPHONES FOR  
PEOPLE WITH REDUCED HEARING, IN CLASS 9  
(U.S. CLS. 21, 23, 26, 36 AND 38).

THE MARK CONSISTS OF STANDARD CHAR-  
ACTERS WITHOUT CLAIM TO ANY PARTICULAR  
FONT, STYLE, SIZE, OR COLOR.

PRIORITY DATE OF 9-21-2006 IS CLAIMED.

OWNER OF INTERNATIONAL REGISTRATION  
0923268 DATED 3-21-2007, EXPIRES 3-21-2017.

SER. NO. 79-038,185, FILED 3-21-2007.

JEAN IM, EXAMINING ATTORNEY



**Int. Cls.: 9, 16, 28, 35 and 38**

**Prior U.S. Cls.: 2, 5, 21, 22, 23, 26, 29, 36, 37, 38, 50,  
100, 101, 102 and 104**

**Reg. No. 3,468,098**

**United States Patent and Trademark Office**

**Registered July 15, 2008**

**TRADEMARK  
SERVICE MARK  
PRINCIPAL REGISTER**

# Have it or hate it

JAMBA! GMBH (FED REP GERMANY LIMITED  
LIABILITY COMPANY)  
KARL-LIEBKNECHT-STR. 5  
10178 BERLIN  
FED REP GERMANY

FOR: COMPUTER HARDWARE; COMPUTER APPLICATION SOFTWARE FOR MOBILE PHONES; APPARATUS FOR RECORDING, TRANSMISSION OR REPRODUCTION OF SOUND, IMAGES AND ELECTRONIC DATA; BLANK MAGNETIC DATA-CARRIERS; PRE-RECORDED CDS AND CD-ROMS FEATURING NEWS, MUSIC, WEATHER, SPORTS AND THE ARTS; PRE-RECORDED VIDEO TAPES FEATURING NEWS, MUSIC, WETHER, SPORTS AND THE ARTS; TELECOMMUNICATION APPARATUS AND INSTRUMENTS, NAMELY, RADIO TELEPHONES AND MOBILE TELEPHONES; ENCODED SMART CARDS, NAMELY, PREPAID SMART CARDS CONTAINING PROGRAMMING WHICH ENABLES THE FUNCTIONING OF MOBILE PHONES AND PERMITS ACCESS TO THE SERVICES PROVIDED VIA THE MOBILE TELEPHONES; MOBILE PERSONAL ELECTRONIC HANDHELD UNITS FOR WIRELESS RECEIPT AND TRANSMISSION OF DATA AND VOICE COMMUNICATIONS AND FOR PERSONAL MANAGEMENT AND ORGANIZATION OF SUCH DATA; VIDEO GAME SOFTWARE AND MACHINES FOR USE WITH TELEVISION RECEIVERS ONLY; DOWNLOADABLE MUSICAL SOUND RECORDINGS; DOWNLOADABLE RING TONES, GRAPHICS AND MUSIC VIA GLOBAL COMPUTER NETWORK AND WIRELESS DEVICES; DOWNLOADABLE VIDEO RECORDINGS FEATURING NEWS, MUSIC, WEATHER, SPORTS AND THE ARTS, IN CLASS 9 (U.S. CLS. 21, 23, 26, 36 AND 38).

FOR: PRINTED MATTER, NAMELY, BOOKS AND MAGAZINES IN THE FIELD OF NEWS, MUSIC, WEATHER, SPORTS AND THE ARTS; PRINTED LEAFLETS AND BROCHURES IN THE FIELD OF NEWS, MUSIC, WEATHER, SPORTS AND THE ARTS, AND NOT FEATURING ADVERTISING; PRINTED INSTRUCTIONAL AND TEACHING

MATERIAL IN THE FIELD OF NEWS, MUSIC, WEATHER, SPORTS AND THE ARTS, IN CLASS 16 (U.S. CLS. 2, 5, 22, 23, 29, 37, 38 AND 50).

FOR: GAMES, NAMELY, BOARD GAMES, CARD GAMES, ELECTRIC AND ELECTRONIC GAMES; TOYS, NAMELY, STUFFED AND RUBBER ANIMALS; PLAYING CARDS, IN CLASS 28 (U.S. CLS. 22, 23, 38 AND 50).

FOR: ADVERTISING AND MARKETING SERVICES; PRESENTATION OF GOODS AND SERVICES FOR RETAIL PURPOSES VIA THE INTERNET; ADVERTISING AND MARKETING OF COMMERCIAL ON-LINE WEBSITES; WHOLE SALE AND RETAIL STORE SERVICES FEATURING THE FOLLOWING GOODS: MOTOR CAR ACCESSORIES; CHEMICALS USED IN INDUSTRY, SCIENCE, PHOTOGRAPHY, AGRICULTURE, HORTICULTURE AND FORESTRY; PHARMACEUTICAL AND VETERINARY PREPARATIONS; SANITARY PREPARATIONS FOR MEDICAL PURPOSES; PERFUMERY AND COSMETICS; IRONMONGERY AND SMALL ITEMS OF METAL HARDWARE; ELECTRICALLY OPERATED EQUIPMENT FOR DOMESTIC PURPOSES; ELECTRIC AND ELECTRONIC APPARATUS AND INSTRUMENTS; APPARATUS FOR RECEIVING, RECORDING, TRANSMITTING AND REPRODUCING OF SOUNDS, IMAGES AND ELECTRONICALLY PROCESSED DATA; COMPUTER HARDWARE AND SOFTWARE; DOWNLOADABLE SOUND, MUSIC, IMAGE, VIDEO AND GAME FILES; PHOTOGRAPHIC, FILM AND OPTICAL EQUIPMENT, INSTRUMENTS AND BLANK AND PRE-RECORDED ELECTRONIC DATA CARRIERS; MEDICAL APPARATUS AND INSTRUMENTS; ELECTRICAL AND NON ELECTRIC EQUIPMENT AND CONTAINERS FOR HOUSEHOLD, BATHROOM AND KITCHEN USE; COOKING AND HEATING APPARATUS; LIGHTING APPARATUS; VEHICLES; JEWELRY, HOROLOGICAL AND CHRONOMETRIC INSTRUMENTS; STATIONERIES AND PRINTED MATTER; ARTISTS' MATERIAL; FURNITURE; GOODS

MADE OF LEATHER; TRUNKS; TEXTILE GOODS; CLOTHING; FOOTWEAR; HEADGEAR; PLAY-THINGS; COMPUTER AND VIDEO GAMES; GYM-NASTIC AND SPORTING ARTICLES; DIETETIC SUBSTANCES; FOOD FOR BABIES; FOODS; BEVERAGES; TOBACCO, IN CLASS 35 (U.S. CLS. 100, 101 AND 102).

FOR: TELECOMMUNICATION SERVICES, NAMELY, RENTAL OF TELEPHONE, RADIO TELEPHONE AND RADIO FACSIMILE APPARATUS; PROVIDING ACCESS TO A GLOBAL COMPUTER NETWORK FOR DOWNLOADING COMPUTER SOFTWARE; MOBILE TELEPHONE SERVICES, INCLUDING TRANSMISSION OF TEXTS AND VOICE MESSAGES, AND PROVIDING OF ACCESS TO DOWNLOADABLE VIDEOS, GAMES, RING TONES, DATA FILES, PROGRAMS FOR LOGOS, SCREENSAVERS AND MUSIC VIA INTERNET; PROVIDING INTERNET PLATFORMS FOR REAL-TIME INTERACTION WITH OTHER COMPUTER USERS,

NAMELY, FOR PLAYING GAMES; PROVIDING ACCESS TO DATABASES SOFTWARE ON THE INTERNET FOR BUILDUP, DEVELOPMENT AND MAINTENANCE OF CONTACT NETWORK PURPOSES IN THE PRIVATE SECTOR, IN CLASS 38 (U.S. CLS. 100, 101 AND 104).

THE MARK CONSISTS OF STANDARD CHARACTERS WITHOUT CLAIM TO ANY PARTICULAR FONT, STYLE, SIZE, OR COLOR.

PRIORITY DATE OF 7-5-2006 IS CLAIMED.

OWNER OF INTERNATIONAL REGISTRATION 0924098 DATED 12-21-2006, EXPIRES 12-21-2016.

SER. NO. 79-038,450, FILED 12-21-2006.

SUZANNE BLANE, EXAMINING ATTORNEY

**Int. Cl.: 11**

**Prior U.S. Cls.: 13, 21, 23, 31 and 34**

**United States Patent and Trademark Office**

**Reg. No. 3,468,099**

**Registered July 15, 2008**

**TRADEMARK  
PRINCIPAL REGISTER**

**LIGHTSHOP**  
**ASIA-PACIFIC**

WILLIAM F BLITZER (UNITED STATES INDIVIDUAL)  
C/- SUITE 19  
336 CHURCHILL AVENUE; SUBIACO WA 6008  
AUSTRALIA

FOR: LIGHTING APPARATUS AND INSTALLATIONS, NAMELY, LIGHTING FIXTURES, LIGHTING FIXTURES FOR INCANDESCENT BULBS, LIGHTING FIXTURES FOR FLUORESCENT LIGHT TUBES, LIGHTING FIXTURES FOR HALOGEN LIGHT GLOBES, LIGHTING FIXTURES FOR LED LIGHTS; RECESSED LIGHTING FIXTURES; LAMPS; LIGHT BULBS; FLUORESCENT LIGHTING TUBES; LIGHT DIFFUSERS; STRUCTURAL PARTS AND FITTINGS FOR ALL THE AFOREMEN-

TIONED GOODS, IN CLASS 11 (U.S. CLS. 13, 21, 23, 31 AND 34).

OWNER OF INTERNATIONAL REGISTRATION  
0924114 DATED 2-5-2007, EXPIRES 2-5-2017.

NO CLAIM IS MADE TO THE EXCLUSIVE RIGHT TO USE "ASIA-PACIFIC", APART FROM THE MARK AS SHOWN.

SER. NO. 79-038,459, FILED 2-5-2007.

MICHAEL TANNER, EXAMINING ATTORNEY

**Int. Cls.: 35 and 42**

**Prior U.S. Cls.: 100, 101 and 102**

**United States Patent and Trademark Office**

**Reg. No. 3,468,100**

**Registered July 15, 2008**

**SERVICE MARK  
PRINCIPAL REGISTER**

**UNFINISHED**

UNFINISHED CO., LTD. (JAPAN CORPORATION)  
5TH FLOOR EDOBORI CENTER BUILDING,  
1-1, EDOBOR 2 CHOME.; NISHI-KU; OSAKA-SHI,  
OSAKA 550-0002  
JAPAN

FOR: ADVERTISING VIA THE INTERNET; CREATING ADVERTISEMENTS VIA THE INTERNET; ADVERTISING SERVICE VIA THE INTERNET FOR OTHERS; DISSEMINATION OF ADVERTISING FOR OTHERS VIA THE INTERNET; ADVERTISING AND PROVIDING INFORMATION ABOUT THE ADVERTISEMENT VIA THE INTERNET; ADVERTISING SERVICE AND PROVIDING ADVERTISING SPACE ON THE INTERNET; PROVIDING ADVERTISING SPACE ON INTERNET WEBSITES; REGISTRATION SERVICE TO REGISTER WEBSITE ADDRESSES TO SEARCH ENGINES ON BEHALF OF OTHERS; ADVERTISING SERVICES, NAMELY, PROVIDING INFORMATION ABOUT, AND CONDUCTING PRODUCT GIVEAWAYS, SWEEPSTAKES, QUIZZES, SURVEYS AND GAMES TO PROMOTE GOODS AND SERVICES; ADVERTISING SERVICES, NAMELY, PLANNING AND MANAGING PROMOTIONS FOR GOODS AND SERVICES; ADVERTISING SERVICES, NAMELY, REGISTRATION OF OTHERS ON SWEEPSTAKES WEBSITES; ADMINISTRATION OF DOMAIN NAME APPLICATION PROCESS FOR OTHERS; PROVIDING WEBSITE ACCESS RANKING INFORMATION, NAMELY, TRACKING WEBSITES OF OTHERS TO PROVIDE DETAILS ABOUT USER CLICK TRAFFIC OR VISITS TO THE WEBSITE; ESTABLISHING AND EDITING INFORMATION FOR COMPUTER DATABASES, NAMELY, COMPILATION AND SYSTEM-

IZATION OF INFORMATION INTO COMPUTER DATABASES, IN CLASS 35 (U.S. CLS. 100, 101 AND 102).

FOR: DEVELOPMENT, MAINTENANCE AND UPDATING WEBSITES FOR OPTIMIZING SEARCH ENGINES; DEVELOPMENT AND MAINTENANCE OF WEBSITES; COMPUTER SOFTWARE DESIGN, COMPUTER PROGRAMMING AND MAINTENANCE OF COMPUTER SOFTWARE; RENTAL OF WEB SERVERS; PROVIDING INFORMATION FOR PROVISION OF SEARCH ENGINES; PROVIDING ON-LINE NON-DOWNLOADABLE COMPUTER PROGRAMS FOR USE IN SEARCH ENGINE REGISTRATION AND OPTIMIZATION, TRACKING AND ANALYZING WEBSITE USER CLICK TRAFFIC OR VISITS TO THE WEBSITE, AND WEBPAGE OR WEBSITE CREATION; RENTING COMPUTER PROGRAMS, IN CLASS 42 (U.S. CLS. 100 AND 101).

OWNER OF INTERNATIONAL REGISTRATION  
0924115 DATED 1-26-2007, EXPIRES 1-26-2017.

THE COLOR(S) GRAY IS/ARE CLAIMED AS A FEATURE OF THE MARK.

THE COLOR GRAY APPEARS IN THE WORDING "UNFINISHED".

SER. NO. 79-038,460, FILED 1-26-2007.

SUZANNE BLANE, EXAMINING ATTORNEY

**Int. Cls.: 7, 9, 11, 12 and 25**

**Prior U.S. Cls.: 13, 19, 21, 22, 23, 26, 31, 34, 35, 36, 38,  
39 and 44**

**Reg. No. 3,468,101**

**United States Patent and Trademark Office**

**Registered July 15, 2008**

**TRADEMARK  
PRINCIPAL REGISTER**

# JARVIS MARINE

JARVIS WALKER PTY LTD; ACN 004 479 056  
(AUSTRALIA CORPORATION)  
297-305 SOUTH GIPPSLAND HIGHWAY  
DANDENONG SOUTH VIC 3175  
AUSTRALIA

FOR: MOTORS AND ENGINES FOR BOATS; INBOARD AND OUTBOARD ENGINES AND MOTORS FOR BOATS; PARTS FOR MOTORS AND ENGINES FOR BOATS, NAMELY, PISTON RINGS, ENGINE CAMSHAFTS, CONNECTING RODS FOR MACHINES, MOTORS AND ENGINES; BILGE PUMPS; WINCHES FOR BOATS, IN CLASS 7 (U.S. CLS. 13, 19, 21, 23, 31, 34 AND 35).

FOR: SUNGLASSES; ANTI-GLARE GLASSES; SPECTACLE GLASSES; SPECTACLE FRAMES; SPECTACLE CASES; SPECTACLE SUPPORT BANDS, CHAINS, CORDS AND STRAPS; GOGGLES FOR SPORTS; MARINE COMPASSES, DEPTH FINDERS, SPEEDOMETERS; MARINE NAVIGATION AND POSITIONING APPARATUS, NAMELY, COMPASSES; MARINE FISH FINDERS; SPECTACLES, SPECTACLE CASES, FRAMES, AND GLASSES, SUNGLASSES; UNDERWATER DIVING EQUIPMENT, NAMELY, AIR TANKS; RESPIRATORY APPARATUS FOR UNDERWATER DIVING, NAMELY, REGULATORS FOR USE IN SCUBA DIVING; SURVIVAL SUITS, NAMELY, INSULATED OVERALL WET SUITS AND DRY SUITS; GAUGES, NAMELY, PRESSURE GAUGES, UNDERWATER DIVING DEPTH GAUGES, TEMPERATURE GAUGES; DIVING COMPASSES; SCUBA DIVING MASKS AND GOGGLES; SNORKELS, IN CLASS 9 (U.S. CLS. 21, 23, 26, 36 AND 38).

FOR: LIGHTING APPARATUS AND INSTALLATIONS, NAMELY, LIGHTING FIXTURES, ELECTRIC TORCHES, SPOTLIGHTS, SEARCHLIGHTS; LIGHTING FOR WATER CRAFT, NAMELY, RUNNING LIGHTS FOR BOATS; LIGHTING FOR VEHICLES, NAMELY, HEADLIGHTS; ELECTRIC LAMPS; LAMP GLASSES, NAMELY, GLASS LANTERN GLOBES; LIGHT BULBS; GAS COOKING APPARATUS, NAMELY, BARBECUES, OVENS; GAS LAMPS, GLASS LAMPS, POCKET TORCHES,

WATER FILTERS; ELECTRIC, BATTERY OPERATED OR GAS POWERED ICE BOXES AND ICE CHESTS, IN CLASS 11 (U.S. CLS. 13, 21, 23, 31 AND 34).

FOR: BOATS, YACHTS, CANOES, DINGHIES; PERSONAL INFLATABLE AND COLLAPSIBLE WATER CRAFT, NAMELY, RAFTS; SCREW PROPELLERS; BOAT PARTS, NAMELY, STEERING GEARS, SPARS, FRAMES AS A STRUCTURAL PART, HULLS, FENDERS AND BUMPERS; PARTS AND ACCESSORIES FOR BOATS, YACHTS, CANOES, DINGHIES, INFLATABLE AND COLLAPSIBLE WATER CRAFT, NAMELY, CANVAS COVERS, ENCLOSURES AND WINDOWS SOLD AS A UNIT AND AFFIXED TO THE BOAT FOR RECREATIONAL MARINE USE, IN CLASS 12 (U.S. CLS. 19, 21, 23, 31, 35 AND 44).

FOR: CLOTHING, NAMELY, PANTS, TROUSERS, SWEATERS, SHIRTS; JUMPERS; JERSEYS, PARKAS, KNITWEAR, OVERCOATS, JACKETS, PULL-OVERS, SCARVES, WRISTBANDS, FISHING VESTS, HOODS; FOOTWEAR; HEADGEAR, NAMELY, HATS, CAPS, BERETS, VISORS, IN CLASS 25 (U.S. CLS. 22 AND 39).

THE MARK CONSISTS OF STANDARD CHARACTERS WITHOUT CLAIM TO ANY PARTICULAR FONT, STYLE, SIZE, OR COLOR.

PRIORITY DATE OF 12-22-2006 IS CLAIMED.

OWNER OF INTERNATIONAL REGISTRATION 0924117 DATED 2-19-2007, EXPIRES 2-19-2017.

OWNER OF U.S. REG. NO. 3,112,146.

NO CLAIM IS MADE TO THE EXCLUSIVE RIGHT TO USE "MARINE", APART FROM THE MARK AS SHOWN.

SER. NO. 79-038,461, FILED 2-19-2007.

SUZANNE BLANE, EXAMINING ATTORNEY

**Int. Cls.: 3, 18 and 25**

**Prior U.S. Cls.: 1, 2, 3, 4, 6, 22, 39, 41, 50, 51 and 52**

**United States Patent and Trademark Office**

**Reg. No. 3,468,102**

**Registered July 15, 2008**

**TRADEMARK  
PRINCIPAL REGISTER**



STÉPHANE CREMIEUX (FRANCE INDIVIDUAL)  
82 BOULEVARD FLANDRIN  
F-75116 PARIS, FRANCE

FOR: ALL PURPOSE CLEANING, POLISHING, SCOURING AND ABRASIVE PREPARATIONS; SOAPS, CAKES OF TOILET SOAP, TOILET SOAPS; PERFUMERY, PERFUMES, TOILET WATER, EAU-DE-COLOGNE; SCENTED WATER; MINT FOR PERFUMERY, BASES FOR FLOWER PERFUMES, ESSENTIAL OILS, ESSENTIAL OILS OF CEDAR WOOD, ESSENTIAL OILS OF LEMON, OIL OF ROSE, JASMINE OILS, BADIAN ESSENCE, BERGAMOT OIL, LAVENDER WATER, EXTRACTS OF FLOWERS, AMBER, MUSK OILS FOR TOILET PURPOSES, ALMOND OIL; COSMETICS, COSMETIC OILS AND LOTIONS; COSMETIC CREAMS, COSMETIC PRODUCTS FOR SKIN CARE; MILK OF ALMONDS FOR COSMETIC USE; COSMETIC PREPARATIONS AND SALTS FOR BATHING FOR NON-MEDICAL USE; CREAMS, MILKS, LOTIONS, GELS AND POWDERS FOR NON-MEDICAL USE FOR THE FACE, BODY AND HANDS; TALCUM POWDER FOR TOILETRY USE; TISSUES IMPREGNATED WITH COSMETIC LOTIONS; NON-MEDICATED MOUTH CARE PRODUCTS; MOISTURIZING EMULSIONS; BEAUTY MASKS; TANNING AND AFTER-SUN CREAMS, MILKS, GELS AND OILS FOR COSMETIC USE; SUN-TANNING PREPARATIONS; SUNSCREEN PREPARATIONS FOR COSMETIC USE; SHAMPOOS; HAIR LOTIONS; MOUSSES AND BALMS FOR HAIR CARE; SHAVING PRODUCTS, NAMELY, AFTER-SHAVE LOTIONS, SHAVING FOAM; BODY DEODORANTS; DEODORANTS FOR PERSONAL USE; NAIL POLISH AND HAIR SPRAYS; MAKE-UP AND

MAKE-UP REMOVING PRODUCTS; LIP LINER PENCILS, EYE CONTOUR PENCILS; CORRECTING PENCILS; EYELINER, LIPSTICK, MASCARA, CONCEALER; MAKE-UP; BLUSHES, EYE SHADOWS, EYE MAKE-UP; MAKE-UP POWDER; DENTIFRICES; INCENSE, POTPOURRIS, SCENTED WOOD, FRAGRANCES FOR THE HOME, AIR FRESHENERS, PERFUMES FOR INTERIORS, IN CLASS 3 (U.S. CLS. 1, 4, 6, 50, 51 AND 52).

FOR: GOODS OF LEATHER AND IMITATION LEATHER, NAMELY, HAND-BAGS, WALLETS, ATTACHE CASES, KEY CASES, SCHOOL BAGS, SUITCASES, VANITY CASES SOLD EMPTY, BRIEFCASES, PURSES, CARD CASES, NOTECASES, BEACH BAGS, BAGS FOR CLIMBERS AND CAMPERS, NAMELY, BACK-PACKS AND RUCKSACKS, TRAVELING BAGS, VALISES, GARMENT BAGS FOR TRAVEL, LEATHER TOOL BAGS SOLD EMPTY, SLING BAGS FOR CARRYING INFANTS, ANIMAL SKINS, HIDES, TRUNKS AND SUITCASES, UMBRELLAS, PARASOLS AND WALKING STICKS, WHIPS, ANIMAL HARNESSES AND SADDLERY, CLOTHING FOR PETS, NAMELY, COVERS AND COLLARS, LEATHER BAGS FOR PACKAGING, NAMELY, ENVELOPES AND POUCHES, IN CLASS 18 (U.S. CLS. 1, 2, 3, 22 AND 41).

FOR: UNDERGARMENTS; OUTER GARMENTS FOR MEN, WOMEN AND CHILDREN, NAMELY, LEATHER AND IMITATION LEATHER CLOTHING, NAMELY, LEATHER PANTS, LEATHER JACKETS; FUR CLOTHING, NAMELY, FUR VESTS, FUR COATS, FUR MUFFS; SPORTSWEAR, OTHER THAN FOR DIVING, NAMELY, SPORTS COATS, SPORTS PANTS, SPORTS SHIRTS; TRACKSUITS;

BLOUSONS; GABARDINES; RAINCOATS; COATS; MANTILLAS; MITTENS; OVERCOATS; TRENCH COATS; PARKAS; PELERINES; PELISSES; PEA JACKETS; SUITS; MASQUERADE COSTUMES; JACKETS; BLAZERS; BLOUSES; APRONS; CROSS-OVER TOPS; CARDIGANS; PULLOVERS; SWEAT-SHIRTS; JERSEYS; KNITWEAR CLOTHING, NAMELY, KNIT SWEATERS, KNIT SHIRTS; TANK TOPS; WAISTCOATS; SKIRTS; PETTICOATS; TROUSERS; JEANS; TAPERED TROUSERS; SALOPETTES, NAMELY, OVERALLS; DRESSES; LADIES' SHIRTS; SHIRTS; CHEMISETTES; TEE-SHIRTS; SHORTS; BERMUDA SHORTS; OVERCOATS; READY-MADE CLOTHING, NAMELY, READY-MADE VESTS, READY-MADE PANTS, READY-MADE SHIRTS; MUFFS; PAJAMAS; NIGHTDRESSES; NIGHT SHIRTS; DRESSING GOWNS; PEIGNOIRS; BOXER SHORTS; BATHING TRUNKS; BEACH AND SWIMWEAR; SINGLET; BATHING SUITS; UNDERCLOTHES; LEOTARDS, NAMELY, BODYSUITS; BUSTIERS; PANTIES; BRIEFS AND PANTS; BRASIERES; CORSETS; SUSPENDERS; SOCKS; STOCKINGS; TIGHTS; BANDANAS; SCARVES; SHAWLS;

SASHES FOR WEAR; STOLE; GLOVES; BELTS; BRACES AS SUSPENDERS; TIES; BOW TIES; POCKET SQUARES; MUFFLERS; BABY SLEEPING SUITS, NAMELY, BABY SLEEPERS, VESTS FOR BABIES, LAYETTES; SARIS; SHOES; FOOTWEAR, NAMELY, BEACH SHOES; SPORTS FOOTWEAR; BOOTS; ANKLE BOOTS; WOODEN SHOES, NAMELY, CLOGS; ESPADRILLES; SANDALS; SLIPPERS; BOOT LINERS; HEADGEAR, NAMELY, HATS, VEILS, CAPS, VISORS, BERETS; BONNETS; BATHING CAPS; HEADBANDS; TURBANS, IN CLASS 25 (U.S. CLS. 22 AND 39).

PRIORITY DATE OF 8-1-2006 IS CLAIMED.

OWNER OF INTERNATIONAL REGISTRATION  
0924342 DATED 1-31-2007, EXPIRES 1-31-2017.

SER. NO. 79-038,539, FILED 1-31-2007.

SUZANNE BLANE, EXAMINING ATTORNEY



**Int. Cls.: 9, 10 and 42**

**Prior U.S. Cls.: 21, 23, 26, 36, 38, 39, 44, 100 and 101**

**United States Patent and Trademark Office**

**Reg. No. 3,468,103**

**Registered July 15, 2008**

**TRADEMARK  
SERVICE MARK  
PRINCIPAL REGISTER**

# **THINK ULTRAFAST**

HIGH Q LASER PRODUCTION GMBH (AUSTRIA LTD LIAB CO)

KAISER-FRANZ-JOSEF-STR. 61

KAESTLE-AREAL, 2.OG

A-6845 HOHENEMS, AUSTRIA

FOR: LASERS, NOT FOR MEDICAL USE; SOLID STATE LASERS, NOT FOR MEDICAL USE; LASERS FOR MEASURING PURPOSES, NOT FOR MEDICAL USE; LASER BEAM SOURCES AND LASER SYSTEMS COMPRISING A LASER BEAM SOURCE, NOT FOR MEDICAL USE; COMPONENT PARTS OF LASER BEAM SOURCES AND LASER SYSTEMS, NOT FOR MEDICAL USE, IN CLASS 9 (U.S. CLS. 21, 23, 26, 36 AND 38).

FOR: LASERS FOR MEDICAL USE, IN CLASS 10 (U.S. CLS. 26, 39 AND 44).

FOR: TECHNICAL CONSULTING AND SCIENTIFIC RESEARCH IN THE FIELD OF LASER TECHNIQUE; TECHNICAL SUPPORT SERVICES, NAMELY, TROUBLESHOOTING OF EQUIPMENT AND OPERATION PROBLEMS IN THE FIELD OF LASER BASED SYSTEM SOLUTIONS, IN CLASS 42 (U.S. CLS. 100 AND 101).

PRIORITY DATE OF 7-26-2006 IS CLAIMED.

OWNER OF INTERNATIONAL REGISTRATION 0924500 DATED 1-4-2007, EXPIRES 1-4-2017.

SER. NO. 79-038,598, FILED 1-4-2007.

WANDA KAY PRICE, EXAMINING ATTORNEY

**Int. Cl.: 9**

**Prior U.S. Cls.: 21, 23, 26, 36 and 38**

**Reg. No. 3,468,104**

**United States Patent and Trademark Office**

**Registered July 15, 2008**

**TRADEMARK  
PRINCIPAL REGISTER**

CHANG ZHOU SHI WU JIN JIN XING; SHU MA  
DIAN ZI YOU XIAN GONG SI (CHINA COR-  
PORATION)  
MIAOQIAOCUN, NANXIASHUZHEN,  
WUJIN, CHANGZHOU; JIANGSU PROVINCE  
CHINA

FOR: ELECTROACOUSTIC TRANSDUCERS;  
TAPE RECORDERS; BLANK CD-ROMS FOR  
SOUND OR VIDEO RECORDING; AUDIO-VISUAL  
RECEIVERS; RECEIVERS FOR AUDIO AND VI-  
DEO; SOUND RECORDING APPARATUS; SOUND  
REPRODUCTION APPARATUS; ACOUSTIC COU-

PLERS; PERSONAL STEREOS; SOUND TRANSMIT-  
TING APPARATUS, IN CLASS 9 (U.S. CLS. 21, 23, 26,  
36 AND 38).

OWNER OF INTERNATIONAL REGISTRATION  
0924512 DATED 5-21-2007, EXPIRES 5-21-2017.

SER. NO. 79-038,603, FILED 5-21-2007.

MARCIE MILONE, EXAMINING ATTORNEY

**Int. Cls.: 9, 35 and 42**

**Prior U.S. Cls.: 21, 23, 26, 36, 38, 100, 101 and 102**

**Reg. No. 3,468,105**

**United States Patent and Trademark Office**

**Registered July 15, 2008**

**TRADEMARK  
SERVICE MARK  
PRINCIPAL REGISTER**

Tagetik CPM

GRUPPO SERVIZI HOLDING S.R.L. (ITALY LIMITED LIABILITY COMPANY)

VIA FARNESI, 141

I-55100 LUCCA FRAZIONE S. MARCO (LUCCA)

ITALY

FOR: COMPUTER SOFTWARE FOR THE MANAGEMENT OF FINANCIAL STATEMENTS OF GROUPS AND COMPANIES AND MANAGING BUSINESS BALANCE SHEETS OF COMPANIES AND GROUPS, SOFTWARE FOR MANAGING FINANCIAL AND ECONOMIC PLANNING AND FOR MANAGING THE FINAL BALANCE DRAWING AND REPORT GENERATION PROCESS; COMPUTERS; COMPUTER PROGRAMS FOR USE IN DATA BASE MANAGEMENT, FOR USE AS A SPREADSHEET, AND FOR WORD PROCESSING, FOR USE IN THE FIELDS OF BUSINESS CAPACITY PLANNING, BUSINESS EFFICIENCY PLANNING, BUSINESS RESOURCE PLANNING, BUSINESS MANPOWER PLANNING, BUSINESS ENTERPRISE RESOURCE PLANNING, BUSINESS SCHEDULING, BUSINESS PLANNING FOR BUSINESS QUALITY MANAGEMENT, BUSINESS PROJECT MANAGEMENT, BUSINESS MULTI-PROJECT MANAGEMENT, DOCUMENTATION, BUSINESS MODELLING, PLANNING AND MANAGEMENT OF BUSINESS PROCESSES, DOCUMENT MANAGEMENT, DOCUMENT ADMINISTRATION AND FINANCIAL PLANNING THAT MAY BE DOWNLOADED FROM A GLOBAL COMPUTER NETWORK; COMPUTER HARDWARE; COMPUTER SOFTWARE FOR USE IN DATA BASE MANAGEMENT, FOR USE AS A SPREADSHEET, AND FOR WORD PROCESSING, FOR USE IN THE FIELDS OF BUSINESS CAPACITY PLANNING, BUSINESS EFFICIENCY PLANNING, BUSINESS RESOURCE PLANNING, BUSINESS MANPOWER PLANNING, BUSINESS ENTERPRISE RESOURCE PLANNING, BUSINESS SCHEDULING, BUSINESS PLANNING FOR BUSINESS QUALITY MANAGEMENT, BUSINESS PROJECT MANAGEMENT, BUSINESS MULTI-PROJECT MANAGEMENT,

DOCUMENTATION, BUSINESS MODELLING, PLANNING AND MANAGEMENT OF BUSINESS PROCESSES, DOCUMENT MANAGEMENT, DOCUMENT ADMINISTRATION AND FINANCIAL PLANNING THAT MAY BE DOWNLOADED FROM A GLOBAL COMPUTER NETWORK; BLANK OPTICAL DISCS, BLANK RECORDABLE OPTICAL DISCS; BLANK MAGNETIC DISKS, COMPACT DISCS AND CD-ROMS; CALCULATING MACHINES, NAMELY CALCULATORS AND POCKET CALCULATORS; DATA PROCESSING EQUIPMENT, NAMELY DATA PROCESSORS AND COMPUTER HARDWARE; RECORDED COMPUTER PROGRAMS, FOR USE IN DATA BASE MANAGEMENT, FOR USE AS A SPREADSHEET, AND FOR WORD PROCESSING, FOR USE IN THE FIELDS OF BUSINESS CAPACITY PLANNING, BUSINESS EFFICIENCY PLANNING, BUSINESS RESOURCE PLANNING, BUSINESS MANPOWER PLANNING, BUSINESS ENTERPRISE RESOURCE PLANNING, BUSINESS SCHEDULING, BUSINESS PLANNING FOR BUSINESS QUALITY MANAGEMENT, BUSINESS PROJECT MANAGEMENT, BUSINESS MULTI-PROJECT MANAGEMENT, DOCUMENTATION, BUSINESS MODELLING, PLANNING AND MANAGEMENT OF BUSINESS PROCESSES, DOCUMENT MANAGEMENT, DOCUMENT ADMINISTRATION AND FINANCIAL PLANNING THAT MAY BE DOWNLOADED FROM A GLOBAL COMPUTER NETWORK; RECORDED COMPUTER OPERATING PROGRAMS, IN CLASS 9 (U.S. CLS. 21, 23, 26, 36 AND 38).

FOR: ASSISTANCE IN THE DRAWING UP AND MANAGEMENT OF FINANCIAL STATEMENTS OF GROUPS AND COMPANIES AND BUSINESS BALANCE SHEETS OF COMPANIES AND GROUPS; FINANCIAL RECORDS DRAFTING AND MANAGEMENT, NAMELY, ASSISTANCE IN MANAGEMENT OF FINANCIAL AND ECONOMIC PLANNING AND IN MANAGEMENT OF THE FINAL BALANCE DRAWING AND REPORT GEN-

ERATION PROCESS, IN CLASS 35 (U.S. CLS. 100, 101 AND 102).

FOR: WRITING OF COMPUTER PROGRAMS INTENDED FOR DRAWING CIVIL-LAW AND BUSINESS BALANCE SHEETS, FINANCIAL AND ECONOMIC PLANNING PROCESSES, FINAL BALANCE DRAWING AND REPORT GENERATION PROCESSES; DESIGN AND DEVELOPMENT OF COMPUTER HARDWARE AND SOFTWARE FOR OTHERS; COMPUTER SOFTWARE UPDATING FOR OTHERS; CONSULTATION IN THE FIELD OF COMPUTER HARDWARE FOR OTHERS; COMPUTER PROGRAMMING FOR OTHERS; COMPUTER RENTAL, RENTAL OF COMPUTER SOFTWARE; INSTALLATION OF COMPUTER SOFTWARE; CREATION OF SOFTWARE FOR OTHERS, IN CLASS 42 (U.S. CLS. 100 AND 101).

PRIORITY DATE OF 6-5-2006 IS CLAIMED.

OWNER OF INTERNATIONAL REGISTRATION 0924536 DATED 9-11-2006, EXPIRES 9-11-2016.

NO CLAIM IS MADE TO THE EXCLUSIVE RIGHT TO USE CPM, APART FROM THE MARK AS SHOWN.

THE MARK CONSISTS OF THE WORDING TAGETIK CPM IN FANCY CHARACTERS, THE PORTION CPM BEING UPPERCASE.

SER. NO. 79-038,610, FILED 9-11-2006.

PETER B. BROMAGHIM, EXAMINING ATTORNEY

**Int. Cl.: 14**

**Prior U.S. Cls.: 2, 27, 28 and 50**

**United States Patent and Trademark Office**

**Reg. No. 3,468,106**

**Registered July 15, 2008**

**TRADEMARK  
PRINCIPAL REGISTER**

**SEXTANT**

JUVENIA MONTRES SA (SWITZERLAND SOCI-  
ÉTÉ ANONYME)  
34, AVENUE CHARLES-NAINE  
CH-2304 LA CHAUX-DE-FONDS  
SWITZERLAND

FOR: JEWELRY; PRECIOUS STONES; TIMEPIE-  
CES AND CHRONOMETRIC INSTRUMENTS,  
NAMELY, WATCHES, WRIST WATCHES, CHRON-  
OMETERS, CLOCKS AND TABLE CLOCKS , IN  
CLASS 14 (U.S. CLS. 2, 27, 28 AND 50).

THE MARK CONSISTS OF STANDARD CHAR-  
ACTERS WITHOUT CLAIM TO ANY PARTICULAR  
FONT, STYLE, SIZE, OR COLOR.

PRIORITY DATE OF 11-27-2006 IS CLAIMED.

OWNER OF INTERNATIONAL REGISTRATION  
0924608 DATED 3-14-2007, EXPIRES 3-14-2017.

SER. NO. 79-038,630, FILED 3-14-2007.

DARRYL SPRUILL, EXAMINING ATTORNEY

Int. Cl.: 21

Prior U.S. Cls.: 2, 13, 23, 29, 30, 33, 40 and 50

United States Patent and Trademark Office

Reg. No. 3,468,107

Registered July 15, 2008

TRADEMARK  
PRINCIPAL REGISTER



BORMIOLI LUIGI S.P.A. (ITALY CORPORATION)  
VIA MOLETOLO, 6  
I-43100 PARMA (PR)  
ITALY

FOR: SMALL DOMESTIC UTENSILS AND CONTAINERS, NAMELY, ICE BUCKETS, CHAMPAGNE BUCKETS, WINE BUCKETS, COOLING BUCKETS FOR WINE, SALT, PEPPER AND MUSTARD CRUET SETS NOT OF PRECIOUS METAL, SALT CELLARS, PEPPER GRINDERS, SAUCE BOATS, EGG HOLDERS, BUTTER COOLERS, BUTTER DISHES, CANDLE HOLDERS NOT OF PRECIOUS METAL, CASSEROLE DISHES, CAVIAR COOLERS, APPLE GRATERS, SERVING TRAYS NOT OF PRECIOUS METAL, ICE PAILS, CRUETS, FLOWER VASES, DECORATIVE GLASS BOXES, CANISTERS, GLASS BOTTLES FOR PERFUME SOLD EMPTY, GLASS CONTAINERS FOR COSMETICS SOLD EMPTY; SCULPTURES, STATUES, AND FIGURINES MADE OF CHINA, CRYSTAL, EARTHENWARE, GLASS, PORCELAIN AND TERRA COTTA; DINNERWARE OF GLASS, PORCELAIN AND EARTHENWARE NAMELY, PLATES, DISHES, DISH COVERS, DISH STANDS, CUPS, SAUCERS, TEA AND COFFEE POTS, GLASSES, DRINKING GLASSES, BEER

MUGS, PORTABLE BEVERAGE DISPENSERS, BEVERAGE GLASSWARE, BEVERAGE WARE, BOWLS, RINSING BOWLS, SALAD BOWLS, TUMBLERS, PITCHERS, BOTTLES, BOTTLE WINE RACKS, CARAFES, DRINKING FLASKS, DECANTERS, JARS, JUGS, POTS, IN CLASS 21 (U.S. CLS. 2, 13, 23, 29, 30, 33, 40 AND 50).

PRIORITY DATE OF 1-10-2007 IS CLAIMED.

OWNER OF INTERNATIONAL REGISTRATION 0924745 DATED 4-5-2007, EXPIRES 4-5-2017.

NO CLAIM IS MADE TO THE EXCLUSIVE RIGHT TO USE "HIGH-TECH CRYSTAL GLASS", APART FROM THE MARK AS SHOWN.

THE MARK CONSISTS OF THE WORDS "SON-HYX HIGH-TECH CRYSTAL GLASS" POSITIONED INTO A QUADRANGULAR FIGURE WITH SOME GRAPHIC ELEMENTS.

SER. NO. 79-038,687, FILED 4-5-2007.

COLLEEN KEARNEY, EXAMINING ATTORNEY

**Int. Cl.: 38**

**Prior U.S. Cls.: 100, 101 and 104**

**United States Patent and Trademark Office**

**Reg. No. 3,468,108**

**Registered July 15, 2008**

**SERVICE MARK  
PRINCIPAL REGISTER**



FUNDACION SANTA MARIA LA REAL-; CEN-  
TRO DE ESTUDIOS DEL ROMANICO (SPAIN  
NON-PROFIT ASSOCIATION)

MONASTERIO SANTA MARÍA LA REAL  
E-34800 AGUILAR DE CAMPOO (PALENCIA)  
SPAIN

FOR: TELECOMMUNICATIONS, NAMELY,  
AUDIO AND VIDEO BROADCASTING SERVICES  
OVER THE INTERNET, BROADCASTING SERVI-  
CES AND PROVISION OF TELECOMMUNICATION  
ACCESS TO VIDEO AND AUDIO CONTENT PRO-  
VIDED VIA A VIDEO-ON-DEMAND SERVICE VIA  
THE INTERNET, STREAMING OF VIDEO MATE-  
RIAL ON THE INTERNET, IN CLASS 38 (U.S. CLS.  
100, 101 AND 104).

PRIORITY DATE OF 10-10-2006 IS CLAIMED.

OWNER OF INTERNATIONAL REGISTRATION  
0924758 DATED 12-26-2006, EXPIRES 12-26-2016.

NO CLAIM IS MADE TO THE EXCLUSIVE  
RIGHT TO USE CANAL, APART FROM THE MARK  
AS SHOWN.

THE COLOR(S) WHITE, BLACK AND PANTONE  
BLUE 072 IS/ARE CLAIMED AS A FEATURE OF  
THE MARK.

THE MARK CONSISTS OF A STYLIZED P AND C  
COMBINED IN A WAY THAT THE COMBINATION  
APPEARS LIKE A MAZE, ALL IN THE COLOR  
PANTONE BLUE 072, AND THE WORDING CANAL  
INSIDE THE MAZE APPEARS IN THE COLOR  
WHITE, AND THE WORDING PATRIMONIO BE-  
LOW THE MAZE APPEARS IN THE COLOR BLACK.

"THE FOREIGN WORDING IN THE MARK  
TRANSLATES INTO ENGLISH AS CHANNEL PA-  
TRIMONY."

SER. NO. 79-038,694, FILED 12-26-2006.

DARRYL SPRUILL, EXAMINING ATTORNEY

**Int. Cl.: 10**

**Prior U.S. Cls.: 26, 39 and 44**

**United States Patent and Trademark Office**

**Reg. No. 3,468,109**

**Registered July 15, 2008**

**TRADEMARK  
PRINCIPAL REGISTER**

**Revera**

SIEMENS AUDIOLOGISCHE TECHNIK GMBH  
(FED REP GERMANY LIMITED LIABILITY  
COMPANY)

GEBBERTSTRASSE 125

91058 ERLANGEN

FED REP GERMANY

FOR: MEDICAL HEARING AIDS FOR THE  
DEAF, IN CLASS 10 (U.S. CLS. 26, 39 AND 44).

THE MARK CONSISTS OF STANDARD CHAR-  
ACTERS WITHOUT CLAIM TO ANY PARTICULAR  
FONT, STYLE, SIZE, OR COLOR.

OWNER OF INTERNATIONAL REGISTRATION  
0924801 DATED 4-17-2007, EXPIRES 4-17-2017.

SER. NO. 79-038,714, FILED 4-17-2007.

VERNA BETH RIRIE, EXAMINING ATTORNEY



**Int. Cl.: 12**

**Prior U.S. Cls.: 19, 21, 23, 31, 35 and 44**

**Reg. No. 3,468,110**

**United States Patent and Trademark Office**

**Registered July 15, 2008**

**TRADEMARK  
PRINCIPAL REGISTER**



ZHONGSHANSHI XIAOFEIJIANG FANGDAO;  
SHEBEI YOUXIAN GONGSI (CHINA COR-  
PORATION)  
DUJIACUNCE, LIANFENG CUN,  
XIAOLANZHEN;; ZHONGSHAN; GUANGDONG  
CHINA

FOR: ANTI-THEFT DEVICES FOR VEHICLES;  
DIRECTION SIGNALS FOR VEHICLES; UPHOLS-  
TERY FOR VEHICLES; ANTI-THEFT ALARMS FOR  
VEHICLES; REVERSING ALARMS FOR VEHICLES,  
NAMESLY, BACK-UP WARNING ALARMS FOR  
VEHICLES; REMOTELY CONTROLLED LAND VE-  
HICLES FOR TRANSPORT; AUDIBLE WARNING

SYSTEMS FOR CYCLES, NAMELY, ANTI-THEFT  
ALARMS FOR MOTORCYCLES, ANTI-THEFT  
ALARMS FOR BICYCLES, IN CLASS 12 (U.S. CLS.  
19, 21, 23, 31, 35 AND 44).

OWNER OF INTERNATIONAL REGISTRATION  
0924857 DATED 5-21-2007, EXPIRES 5-21-2017.

SER. NO. 79-038,738, FILED 5-21-2007.

MARCIE MILONE, EXAMINING ATTORNEY

**Int. Cl.: 25**

**Prior U.S. Cls.: 22 and 39**

**United States Patent and Trademark Office**

**Reg. No. 3,468,111**

**Registered July 15, 2008**

**TRADEMARK  
PRINCIPAL REGISTER**

**S H U T T L E P L E A T S**

SPECCHIO CO., LTD. (JAPAN CORPORATION)  
3-3-22, KOMABA MEGURO-KU  
TOKYO 153-0041  
JAPAN

FOR: CLOTHING, NAMELY, T-SHIRTS, SHIRTS, BLOUSES, TANK TOPS, VESTS, SWEAT SHIRTS, JERSEYS, PULLOVERS, PANTS, SHORTS, SWEAT PANTS, SKIRTS, DRESSES, SUITS, JACKETS, COATS, SWEATERS, RAINWEAR, SWEAT SUITS, WARM UP SUITS, SKI SUITS, JUMP SUITS, SUSPENDERS AND BELTS, CAPS AND HATS, GLOVES, UNDERWEAR, BOXER SHORTS, BRASSIERES, UNDERSHIRTS, PANTY HOSE, PANTIES, HOSIERY, STOCKINGS, SOCKS, TIGHTS, LEOTARDS, LEG WARMERS, PAJAMAS, ROBES, NIGHTSHIRTS, NIGHTGOWNS, SWIMSUITS, NECKTIES, SCARVES, WRIST BANDS, GARTERS, NAMELY, ANKLE GARTERS AND GARTER BELT, ATHLET-

IC SHOES, FOOTWEAR, IN CLASS 25 (U.S. CLS. 22 AND 39).

THE MARK CONSISTS OF STANDARD CHARACTERS WITHOUT CLAIM TO ANY PARTICULAR FONT, STYLE, SIZE, OR COLOR.

OWNER OF INTERNATIONAL REGISTRATION 0924969 DATED 5-14-2007, EXPIRES 5-14-2017.

NO CLAIM IS MADE TO THE EXCLUSIVE RIGHT TO USE "PLEATS", APART FROM THE MARK AS SHOWN.

SER. NO. 79-038,782, FILED 5-14-2007.

ANDREA K. NADELMAN, EXAMINING ATTORNEY

**Int. Cls.: 25, 35, 36 and 37**

**Prior U.S. Cls.: 22, 39, 100, 101, 102, 103 and 106**

**United States Patent and Trademark Office**

**Reg. No. 3,468,112**

**Registered July 15, 2008**

**TRADEMARK  
SERVICE MARK  
PRINCIPAL REGISTER**

**BRENNINKMEIJER**

MADOR AG (SWITZERLAND SOCIÉTÉ ANON-  
YME (SA))  
GRAFENAUWEG 10  
CH-6300 ZUG  
SWITZERLAND

FOR: FOOTWEAR, UNDERWEAR, SLEEPWEAR,  
INFANTWEAR, SHIRTS, T-SHIRTS, SWEATERS,  
TOPS, JACKETS, PANTS, BELTS, AND SHORTS, IN  
CLASS 25 (U.S. CLS. 22 AND 39).

FOR: ADVERTISING SERVICES; BUSINESS  
MANAGEMENT; BUSINESS ADMINISTRATION  
AND OFFICE FUNCTIONS, IN CLASS 35 (U.S. CLS.  
100, 101 AND 102).

FOR: INSURANCE UNDERWRITING, INSUR-  
ANCE UNDERWRITING FOR ALL TYPES OF IN-  
SURANCE; FINANCIAL AFFAIRS, NAMELY,  
BANKING, FINANCING, FINANCIAL CONSULTA-  
TION, FINANCIAL EVALUATION FOR INSUR-  
ANCE PURPOSES, FINANCIAL EXCHANGE,  
FINANCIAL VALUATION OF PERSONAL PROP-  
ERTY AND REAL ESTATE, FINANCIAL MANAGE-  
MENT, FINANCIAL PLANNING, FINANCIAL  
RESEARCH, FINANCIAL RISK MANAGEMENT  
AND MONEY LENDING; MONETARY AFFAIRS,  
NAMELY, MONETARY EXCHANGE, ACCEPTING

AND ADMINISTERING MONETARY CHARITA-  
BLE CONTRIBUTIONS; REAL ESTATE AFFAIRS,  
NAMELY, REAL ESTATE CONSULTATION, REAL  
ESTATE INVESTMENT, REAL ESTATE MANAGE-  
MENT AND REAL ESTATE LENDING SERVICES,  
IN CLASS 36 (U.S. CLS. 100, 101 AND 102).

FOR: BUILDING CONSTRUCTION SERVICES,  
CONSTRUCTION CONSULTATION AND CON-  
STRUCTION MANAGEMENT SERVICES, IN CLASS  
37 (U.S. CLS. 100, 103 AND 106).

THE MARK CONSISTS OF STANDARD CHAR-  
ACTERS WITHOUT CLAIM TO ANY PARTICULAR  
FONT, STYLE, SIZE, OR COLOR.

OWNER OF INTERNATIONAL REGISTRATION  
0924992 DATED 3-6-2007, EXPIRES 3-6-2017.

THE WORDING "BRENNINKMEIJER" HAS NO  
MEANING IN A FOREIGN LANGUAGE.

SER. NO. 79-038,793, FILED 3-6-2007.

SANJEEV VOHRA, EXAMINING ATTORNEY

**Int. Cl.: 17**

**Prior U.S. Cls.: 1, 5, 12, 13, 35 and 50**

**United States Patent and Trademark Office**

**Reg. No. 3,468,113**

**Registered July 15, 2008**

**TRADEMARK  
PRINCIPAL REGISTER**

**COMMANDER**

DUNLOP HIFLEX UK LIMITED (UNITED KING-  
DOM PRIVATE LIMITED COMPANY)  
LEYLAND BUSINESS PARK  
CENTURION WAY; LEYLAND, LANCASHIRE  
PR253WL  
UNITED KINGDOM

FOR: HOSEPIPES NOT WHOLLY OR PRINCIPAL-  
LY OF METAL FOR HYDRAULIC AND INDUS-  
TRIAL USE, EXCLUDING NON-METAL  
HOSEPIPES FOR USE IN PAPER-MILLS AND PA-  
PER-MILL VATS, IN CLASS 17 (U.S. CLS. 1, 5, 12, 13,  
35 AND 50).

THE MARK CONSISTS OF STANDARD CHAR-  
ACTERS WITHOUT CLAIM TO ANY PARTICULAR  
FONT, STYLE, SIZE, OR COLOR.

OWNER OF INTERNATIONAL REGISTRATION  
0925026 DATED 5-3-2007, EXPIRES 5-3-2017.

SER. NO. 79-038,806, FILED 5-3-2007.

STEVEN PEREZ, EXAMINING ATTORNEY

**Int. Cls.: 1, 16 and 20**

**Prior U.S. Cls.: 1, 2, 5, 6, 10, 13, 22, 23, 25, 26, 29, 32,  
37, 38, 46 and 50**

**Reg. No. 3,468,114**

**United States Patent and Trademark Office**

**Registered July 15, 2008**

**TRADEMARK  
PRINCIPAL REGISTER**

# TP-SEAL

TOTAL PETROCHEMICALS RESEARCH FELUY,  
SOCIÉTÉ ANONYME (BELGIUM SOCIÉTÉ ANONYME)  
ZONE INDUSTRIELLE C  
B-7181 FELUY  
BELGIUM

FOR: UNPROCESSED PLASTICS; UNTREATED  
ARTIFICIAL RESINS FOR USE IN THE MANUFACTURE  
OF PACKAGING, IN CLASS 1 (U.S. CLS. 1, 5, 6,  
10, 26 AND 46).

FOR: PLASTIC WRAPS AND PLASTIC BAGS FOR  
PACKAGING, IN CLASS 16 (U.S. CLS. 2, 5, 22, 23, 29,  
37, 38 AND 50).

FOR: PACKAGING CONTAINERS OF PLASTIC  
MATERIAL; NON-METALLIC CONTAINERS FOR  
NON-EDIBLE SUBSTANCES SUCH AS FUEL, PET-

ROL, SOAP AND LIQUID OR SOLID DETERGENTS;  
NON-METALLIC CLOSURES FOR CONTAINERS,  
IN CLASS 20 (U.S. CLS. 2, 13, 22, 25, 32 AND 50).

THE MARK CONSISTS OF STANDARD CHARACTERS  
WITHOUT CLAIM TO ANY PARTICULAR FONT,  
STYLE, SIZE, OR COLOR.

PRIORITY DATE OF 9-5-2006 IS CLAIMED.

OWNER OF INTERNATIONAL REGISTRATION  
0925164 DATED 3-2-2007, EXPIRES 3-2-2017.

SER. NO. 79-038,871, FILED 3-2-2007.

SANJEEV VOHRA, EXAMINING ATTORNEY

Int. Cls.: 25, 35 and 42

Prior U.S. Cls.: 22, 39, 100, 101 and 102

United States Patent and Trademark Office

Reg. No. 3,468,115

Registered July 15, 2008

TRADEMARK  
SERVICE MARK  
PRINCIPAL REGISTER

**V I E N E T T A**  
**S E C R E T**

SÜLEYMAN GIYIM; SANAYI VE TİCARET LİMİTED SİRKETİ (TURKEY CORPORATION)  
MIMAR KEMALETTİN MAHALLESİ SAİR  
FITNAT SOKAK NO. 14/1; LALELİ, İSTANBUL  
TURKEY

FOR: CLOTHING, NAMELY, PULLOVERS, SKIRTS, DRESSES, BLOUSES, JEANS, TROUSERS, JACKETS, COATS, RAINCOATS, ANORAKS, SPORTSWEAR, NAMELY, SPORTS JERSEY, SPORTS OVER UNIFORM, SPORTS SHIRTS, SHIRTS, T-SHIRTS, SWEATSHIRTS, BEACH CLOTHES, NAMELY, BEACH COVERUPS, SHORTS, KNITWEAR, NAMELY, KNIT SHIRTS, OVERALLS, UNDERCLOTHING, BODICES, BRASSIERES, CAMISOLES, UNDERPANTS, DRESSING GOWNS, BATH ROBES, BATHING SUITS, PYJAMAS, GLOVES, SKI SUITS, HEADGEAR, NAMELY, HATS, CAPS, KNITTED CAPS, BERETS, FOOTWEAR, NAMELY, SHOES EXCLUDING ORTHOPEDIC SHOES, SLIPPERS, BOOTS, SANDALS, BEACH SHOES, SPORTS SHOES, LACE BOOTS, SHOE PARTS, NAMELY, HEELPIECES, HEELS, FOOTWEAR UPPERS, STOCKINGS, BELTS, TIES, NECKTIES, SHAWLS, SCARVES, MUFFLERS, NECK SCARVES, SARONGS, COLLARS FOR DRESSES, MANIPLES, MUFFS, WRISTBANDS, SUSPENDERS, BRACES FOR CLOTHING, GARTERS, BANDANAS, HEADBANDS, CLOTHING FOR BABIES, NAMELY, BABIES' DIAPERS OF TEXTILE, IN CLASS 25 (U.S. CLS. 22 AND 39).

FOR: ADVERTISING, ADVERTISING AGENCIES, TELEVISION ADVERTISING, RADIO ADVERTISING, ORGANIZATION OF TRADE FAIRS FOR COMMERCIAL OR ADVERTISING PURPOSES, MARKETING STUDIES, SALES PROMOTION FOR OTHERS, PUBLIC RELATIONS, SECRETARIAL SERVICES, PHOTOCOPYING, TYPING, WORD PROCESSING, TELEPHONE ANSWERING FOR UN-

AVAILABLE SUBSCRIBERS, ARRANGING NEWSPAPER SUBSCRIPTIONS FOR OTHERS, OFFICE MACHINES AND EQUIPMENT RENTAL, RENTAL OF VENDING MACHINES, ADVISORY SERVICES FOR BUSINESS MANAGEMENT, COMMERCIAL OR INDUSTRIAL MANAGEMENT ASSISTANCE, BUSINESS MANAGEMENT OF HOTELS FOR OTHERS, BUSINESS APPRAISALS, BUSINESS INQUIRIES, BUSINESS INVESTIGATIONS, STATISTICAL INFORMATION, EMPLOYMENT AGENCIES, PERSONNEL RECRUITMENT, PSYCHOLOGICAL TESTING FOR THE SELECTION OF PERSONNEL, ECONOMIC FORECASTING, IMPORT-EXPORT AGENCIES, BUSINESS MANAGEMENT OF PERFORMING ARTISTS, BUSINESS MANAGEMENT, BUSINESS ADMINISTRATION, OFFICE FUNCTIONS, THE BRINGING TOGETHER, FOR BENEFIT OF OTHERS, OF A VARIETY OF GOODS EXCLUDING THE TRANSPORT THEREOF, ENABLING CUSTOMERS TO CONVENIENTLY VIEW AND PURCHASE THOSE GOODS IN THE FIELD OF CLOTHING, IN CLASS 35 (U.S. CLS. 100, 101 AND 102).

FOR: SCIENTIFIC RESEARCH; TECHNOLOGICAL SERVICES, NAMELY, TECHNOLOGICAL RESEARCH AND DESIGN SERVICES FOR OTHERS IN THE FIELD OF CLOTHING; INDUSTRIAL ANALYSIS AND RESEARCH IN THE FIELD OF CLOTHING; DESIGN AND DEVELOPMENT OF COMPUTER HARDWARE AND SOFTWARE; LEGAL SERVICES, IN CLASS 42 (U.S. CLS. 100 AND 101).

OWNER OF INTERNATIONAL REGISTRATION  
0883942 DATED 10-11-2005, EXPIRES 10-11-2015.

"VIENETTA" APPEARING IN THE MARK HAS NO SIGNIFICANCE IN THE RELEVANT TRADE

OR INDUSTRY OR AS APPLIED TO THE GOODS/  
SERVICES LISTED IN THE APPLICATION, NO  
GEOGRAPHICAL SIGNIFICANCE, NOR ANY  
MEANING IN A FOREIGN LANGUAGE.

SER. NO. 79-038,891, FILED 4-26-2007.

SIMON TENG, EXAMINING ATTORNEY

**Int. Cls.: 35 and 41**

**Prior U.S. Cls.: 100, 101, 102 and 107**

**United States Patent and Trademark Office**

**Reg. No. 3,468,116**

**Registered July 15, 2008**

**SERVICE MARK  
PRINCIPAL REGISTER**

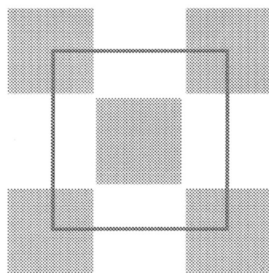

**SCQuARE**

SCQUARE INTERNATIONAL LIMITED (UNITED KINGDOM INCORPORATED COMPANY)  
3 THE SQUARE  
LIPHOOK, HAMPSHIRE GU30 7AB  
UNITED KINGDOM

FOR: BUSINESS CONSULTANCY SERVICES; BUSINESS MANAGEMENT SERVICES; MANAGEMENT CONSULTANCY, NAMELY, BUSINESS MANAGEMENT CONSULTANCY; HUMAN RESOURCES CONSULTANCY, IN CLASS 35 (U.S. CLS. 100, 101 AND 102).

FOR: EDUCATIONAL AND TRAINING SERVICES, NAMELY, ARRANGING AND CONDUCTING CONFERENCES AND SEMINARS FOR TRAINING

AND EDUCATIONAL PURPOSES IN THE FIELDS OF BUSINESS MANAGEMENT AND ADMINISTRATION; EDUCATIONAL SERVICES, NAMELY, PROVIDING COURSES OF INSTRUCTION AND TRAINING RELATING TO BUSINESS MANAGEMENT AND ADMINISTRATION, IN CLASS 41 (U.S. CLS. 100, 101 AND 107).

OWNER OF INTERNATIONAL REGISTRATION  
0925379 DATED 4-26-2007, EXPIRES 4-26-2017.

SER. NO. 79-038,963, FILED 4-26-2007.

SIMON TENG, EXAMINING ATTORNEY



**Int. Cls.: 7, 9 and 11**

**Prior U.S. Cls.: 13, 19, 21, 23, 26, 31, 34, 35, 36 and 38**

**Reg. No. 3,468,117**

**United States Patent and Trademark Office**

**Registered July 15, 2008**

**TRADEMARK  
PRINCIPAL REGISTER**

# AquaCoat

J. WAGNER GMBH (FED REP GERMANY CORPORATION)  
OTTO-LILIENTHAL-STRASSE 18  
88677 MARKDORF  
FED REP GERMANY

FOR: HYDRAULICALLY, PNEUMATICALLY AND ELECTRICALLY OPERATED MACHINES FOR SPRAYING PAINTS AND LACQUERS FOR COATING MACHINE SURFACES; AUTOMATIC LACQUERING MACHINES FOR HOT-LACQUERING MACHINE SURFACES; ELECTRICALLY, PNEUMATICALLY AND HYDRAULICALLY OPERATED SPRAY GUNS, HAND SPRAY GUNS, PUMPS, COMPRESSORS, NOZZLES AND NOZZLE EXTENSIONS OF PLASTIC AND METAL AS PARTS OF MACHINES; ELECTRICALLY, PNEUMATICALLY AND HYDRAULICALLY OPERATED CONTACT-VOLTAGE PROOF MACHINES BEING PARTS OF MACHINES AND NOZZLE EXCHANGE AND REVERSAL DEVICES, NAMELY, NOZZLE RECEIVING MACHINES AND NOZZLE HOLDERS BEING PARTS OF MACHINES WHICH CAN BE REVERSED OR EXCHANGED MANUALLY, NOZZLE SETS AS PARTS OF MACHINES, SUPPORTS FOR PAINT SPRAYING APPARATUS INSTALLATIONS FOR THE PURPOSE OF COATING MACHINE SURFACES; PAINT FILTERS; PAINT PRESSURE REGULATORS AND PAINT REDUCING VALVES BEING PARTS OF AFORESAID MACHINES FOR USE IN THE COATING OF MACHINE SURFACES; ELECTRICALLY OPERATED HAND TOOLS, NAMELY, PAINT SPRAYERS, IN CLASS 7 (U.S. CLS. 13, 19, 21, 23, 31, 34 AND 35).

FOR: HIGH-VOLTAGE ELECTRIC GENERATORS BEING PARTS OF LACQUERING MACHINES FOR COATING AND LACQUERING MACHINE SURFACES; ELECTRICAL AND ELECTRONIC INSTALLATIONS AND INSTRUMENTS FOR CONTROLLING AND REGULATING COATING AND LACQUERING MACHINE SURFACES; PAINT FILTERS FOR COATING AND LACQUERING MACHINE SURFACES, IN CLASS 9 (U.S. CLS. 21, 23, 26, 36 AND 38).

FOR: PAINT HEATERS BEING PARTS OF COATING AND LACQUERING MACHINES FOR USE IN COATING MACHINE SURFACES, IN CLASS 11 (U.S. CLS. 13, 21, 23, 31 AND 34).

THE MARK CONSISTS OF STANDARD CHARACTERS WITHOUT CLAIM TO ANY PARTICULAR FONT, STYLE, SIZE, OR COLOR.

PRIORITY DATE OF 6-23-2006 IS CLAIMED.

OWNER OF INTERNATIONAL REGISTRATION 0925409 DATED 12-21-2006, EXPIRES 12-21-2016.

SER. NO. 79-038,980, FILED 12-21-2006.

WENDY JUN, EXAMINING ATTORNEY

**Int. Cl.: 3**

**Prior U.S. Cls.: 1, 4, 6, 50, 51 and 52**

**Reg. No. 3,468,118**

**United States Patent and Trademark Office**

**Registered July 15, 2008**

---

**TRADEMARK  
PRINCIPAL REGISTER**

# LIQUID POWDER

HENKEL KOMMANDITGESELLSCHAFT AUF  
AKTIEN (SOCIÉTÉ DE DROIT ALLEMAND)  
(FED REP GERMANY SOCIÉTÉ EN COM-  
MANDITE PAR ACTIONS)

HENKELSTRASSE 67

40589 DÜSSELDORF-HOLTHAUSEN, FED REP  
GERMANY

FOR: SUBSTANCES FOR LAUNDRY USE,  
NAMELY, LAUNDRY DETERGENT, LAUNDRY  
BLEACH, FABRIC SOFTENERS, STAIN-REMOV-  
ING AGENTS, LAUNDRY STARCH, IN CLASS 3  
(U.S. CLS. 1, 4, 6, 50, 51 AND 52).

THE MARK CONSISTS OF STANDARD CHAR-  
ACTERS WITHOUT CLAIM TO ANY PARTICULAR  
FONT, STYLE, SIZE, OR COLOR.

PRIORITY DATE OF 10-30-2006 IS CLAIMED.

OWNER OF INTERNATIONAL REGISTRATION  
0925523 DATED 4-19-2007, EXPIRES 4-19-2017.

SER. NO. 79-039,027, FILED 4-19-2007.

CHERYL CLAYTON, EXAMINING ATTORNEY

**Int. Cl.: 30**

**Prior U.S. Cl.: 46**

**United States Patent and Trademark Office**

**Reg. No. 3,468,119**

**Registered July 15, 2008**

**TRADEMARK  
PRINCIPAL REGISTER**



**il tinello del  
BALSAMICO**

l'arte  
del  
balsamico

IL BORGO DEL BALSAMICO DI; R. CROTTI E C.  
-; SOCIETÀ IN ACCOMANDITA SEMPLICE  
(ITALY LIMITED PARTNERSHIP)  
VIA DELLA CHIESA, 27  
I-42020 ALBINEA (REGGIO EMILIA)  
ITALY

OWNER OF U.S. REG. NO. 3,218,207.

NO CLAIM IS MADE TO THE EXCLUSIVE  
RIGHT TO USE BALSAMICO., APART FROM THE  
MARK AS SHOWN.

FOR: VINEGAR; CONDIMENTS, NAMELY, SAL-  
AD DRESSINGS AND RELISH, AND SAUCES, IN  
CLASS 30 (U.S. CL. 46).

THE ENGLISH TRANSLATION OF THE FOR-  
EIGN WORD(S) IN THE MARK IS: THE SMALL VAT  
OF BALSAMIC; THE ART OF BALSAMIC.

PRIORITY DATE OF 3-26-2007 IS CLAIMED.

SER. NO. 79-039,056, FILED 5-15-2007.

OWNER OF INTERNATIONAL REGISTRATION  
0925601 DATED 5-15-2007, EXPIRES 5-15-2017.

MICHAEL TANNER, EXAMINING ATTORNEY

**Int. Cl.: 44**

**Prior U.S. Cls.: 100 and 101**

**United States Patent and Trademark Office**

**Reg. No. 3,468,120**

**Registered July 15, 2008**

**SERVICE MARK  
PRINCIPAL REGISTER**

**CARING FOR YOU IN ALL WAYS ALWAYS**

EVERCARE CO., LTD. (REPUBLIC OF KOREA  
LIMITED COMPANY)  
4TH, APGUJEONG BLDG,  
599 SHINSA-DONG, KANGNAM-GU.; SEOUL, 135-  
893  
REPUBLIC OF KOREA

MEDICINES; MEDICAL CLINICS, IN CLASS 44 (U.S.  
CLS. 100 AND 101).

OWNER OF INTERNATIONAL REGISTRATION  
0925765 DATED 2-6-2007, EXPIRES 2-6-2017.

FOR: HEALTH CARE; HEALTH EXAMINATION  
SERVICES; PHYSIOTHERAPY; HOSPITALS; PLAS-  
TIC SURGERY; PREPARATION OF MEDICINES BY  
PHARMACISTS; MEDICAL ASSISTANCE; MEDI-  
CAL SERVICES; PROVIDING INFORMATION ON

SER. NO. 79-039,138, FILED 2-6-2007.

Laurie Kaufman, Examining Attorney

**Int. Cls.: 5 and 30**

**Prior U.S. Cls.: 6, 18, 44, 46, 51 and 52**

**United States Patent and Trademark Office**

**Reg. No. 3,468,121**

**Registered July 15, 2008**

**TRADEMARK  
PRINCIPAL REGISTER**

# CocoaSan

DR. DÜNNER AG (SWITZERLAND SOCIÉTÉ  
ANONYME (STOCK CORPORATION))  
ARTHERSTRASSE 60  
CH-6405 IMMENSEE  
SWITZERLAND

FOR: DIETETIC FOODS ADAPTED FOR MEDICAL USE; DIETARY SUPPLEMENTS ADAPTED FOR MEDICAL USE ON THE BASIS OF PLANT EXTRACTS, NAMELY, COCOA BUTTER, IN CLASS 5 (U.S. CLS. 6, 18, 44, 46, 51 AND 52).

FOR: CHOCOLATE; CHOCOLATE CONTAINING VITAMINS AND MINERAL SUPPLEMENTS; CHOCOLATE CONTAINING TRACE ELEMENTS ON THE BASIS OF PLANT EXTRACTS, IN CLASS 30 (U.S. CL. 46).

THE MARK CONSISTS OF STANDARD CHARACTERS WITHOUT CLAIM TO ANY PARTICULAR FONT, STYLE, SIZE, OR COLOR.

PRIORITY DATE OF 9-5-2006 IS CLAIMED.

OWNER OF INTERNATIONAL REGISTRATION 0925873 DATED 2-16-2007, EXPIRES 2-16-2017.

SER. NO. 79-039,169, FILED 2-16-2007.

ASMAT KHAN, EXAMINING ATTORNEY

**Int. Cls.: 5, 29, 30, 31 and 32**

**Prior U.S. Cls.: 1, 6, 18, 44, 45, 46, 48, 51 and 52**

**Reg. No. 3,468,122**

**United States Patent and Trademark Office**

**Registered July 15, 2008**

**TRADEMARK  
PRINCIPAL REGISTER**

**i-flex**

DSM IP ASSETS B.V. (NETHERLANDS BESLO-  
TEN VENNOOTSCHAP)  
HET OVERLOON 1  
NL-6411 TE HEERLEN, NETHERLANDS

FOR: DIETETIC PREPARATIONS AND SUB-  
STANCES ADAPTED FOR MEDICAL USE, NAME-  
LY, DIETETIC FOODS ADAPTED FOR MEDICAL  
USE, DIETARY AND NUTRITIONAL SUPPLE-  
MENTS; FOOD SUPPLEMENTS FOR MEDICAL  
USE; DIETETIC BEVERAGES ADAPTED FOR MED-  
ICAL PURPOSES; VITAMINS; VITAMIN PREPARA-  
TIONS; NATURAL MEDICINES, NAMELY,  
NATURAL PHARMACEUTICAL PREPARATIONS  
FOR THE TREATMENT AND PREVENTION OF  
OSTEOARTHRITIS AND SIMILAR CONDITIONS,  
NAMELY, TREATING AND PREVENTING FLEX-  
IBILITY OR MOBILITY CONDITIONS, IN CLASS 5  
(U.S. CLS. 6, 18, 44, 46, 51 AND 52).

FOR: PRESERVED, FROZEN, DRIED AND  
COOKED FRUITS AND VEGETABLES; JELLIES,  
JAMS, COMPOTES; EDIBLE OILS, IN CLASS 29  
(U.S. CL. 46).

FOR: FLOUR; PREPARATIONS MADE FROM  
CEREALS, NAMELY, BREAKFAST CEREALS,  
READY TO EAT CEREAL DERIVED FOOD BARS;  
BREAD, PASTRY; BISCUITS; COOKIES; TEA; TEA-  
BASED BEVERAGES, IN CLASS 30 (U.S. CL. 46).

FOR: FLOWER, FRUIT, WHEAT SEEDS; NATUR-  
AL PLANTS AND FLOWERS; FRESH FRUITS AND  
VEGETABLES, IN CLASS 31 (U.S. CLS. 1 AND 46).

FOR: MINERAL AND AERATED WATERS; SYR-  
UPS FOR MAKING BEVERAGES; PREPARATIONS  
FOR MAKING FRUIT DRINKS, FRUIT JUICES,  
MINERAL AND AERATED WATERS, SYRUPS FOR  
MAKING BEVERAGES, NON-ALCOHOLIC SPORT  
DRINKS IN THE NATURE OF SOFT DRINKS; NON-  
ALCOHOLIC ENERGY DRINKS; FRUIT DRINKS  
AND FRUIT JUICES; NON-ALCOHOLIC SPORT  
DRINKS IN THE NATURE OF SOFT DRINKS, IN  
CLASS 32 (U.S. CLS. 45, 46 AND 48).

THE MARK CONSISTS OF STANDARD CHAR-  
ACTERS WITHOUT CLAIM TO ANY PARTICULAR  
FONT, STYLE, SIZE, OR COLOR.

PRIORITY DATE OF 1-19-2007 IS CLAIMED.

OWNER OF INTERNATIONAL REGISTRATION  
0926000 DATED 3-12-2007, EXPIRES 3-12-2017.

SER. NO. 79-039,242, FILED 3-12-2007.

REBECCA POVARCHUK, EXAMINING ATTOR-  
NEY

**Int. Cls.: 6, 7 and 11**

**Prior U.S. Cls.: 2, 12, 13, 14, 19, 21, 23, 25, 31, 34, 35  
and 50**

**Reg. No. 3,468,123**

**United States Patent and Trademark Office**

**Registered July 15, 2008**

**TRADEMARK  
PRINCIPAL REGISTER**

# BASICFLOW

HOVAP INTERNATIONAL (HOLLAND) B.V.  
(NETHERLANDS BESLOTEN VENNOOTSCHAP)  
TINGIETERSTRAAT 7  
WJ SNEEK, NETHERLANDS NL8601

FOR: FITTINGS OF METAL FOR PIPES, NAME-  
LY, T-PIECES, ELBOWS, JUNCTIONS, FITTINGS  
AND MANUALLY OPERATED PROCESS VALVES,  
IN CLASS 6 (U.S. CLS. 2, 12, 13, 14, 23, 25 AND 50).

FOR: PARTS OF PIPES USED IN MANUFACTUR-  
ING MACHINES USED IN THE FOOD, STIMU-  
LANT, PHARMACEUTICAL AND CHEMICAL  
INDUSTRIES, NAMELY, STAINLESS STEEL  
VALVES, TAPS AND PROCESS VALVES, SOLD  
SEPARATELY, IN CLASS 7 (U.S. CLS. 13, 19, 21, 23,  
31, 34 AND 35).

FOR: PLUMBING FITTINGS FOR PIPES, NAME-  
LY, VALVE TAPS FOR PIPES, IN CLASS 11 (U.S. CLS.  
13, 21, 23, 31 AND 34).

THE MARK CONSISTS OF STANDARD CHAR-  
ACTERS WITHOUT CLAIM TO ANY PARTICULAR  
FONT, STYLE, SIZE, OR COLOR.

OWNER OF INTERNATIONAL REGISTRATION  
0926257 DATED 1-22-2007, EXPIRES 1-22-2017.

OWNER OF U.S. REG. NO. 2,463,110.

SER. NO. 79-039,340, FILED 1-22-2007.

MARILYN IZZI, EXAMINING ATTORNEY

**Int. Cl.: 16**

**Prior U.S. Cls.: 2, 5, 22, 23, 29, 37, 38 and 50**

**United States Patent and Trademark Office**

**Reg. No. 3,468,124**

**Registered July 15, 2008**

**TRADEMARK  
PRINCIPAL REGISTER**

# Gatsby

STEFAN BEHMER (FED REP GERMANY INDIVIDUAL)  
FOLLERSTR. 46  
50676 KÖLN  
FED REP GERMANY

OWNER OF INTERNATIONAL REGISTRATION  
0926339 DATED 6-6-2007, EXPIRES 6-6-2017.

FOR: PAPER MAGAZINES, NAMELY, LIFESTYLE MAGAZINES FEATURING DESIGN, ART, FASHION AND TRAVELLING, IN CLASS 16 (U.S. CLS. 2, 5, 22, 23, 29, 37, 38 AND 50).

SER. NO. 79-039,363, FILED 6-6-2007.

PRIORITY DATE OF 12-19-2006 IS CLAIMED.

JULIE WATSON, EXAMINING ATTORNEY



**Int. Cls.: 18 and 25**

**Prior U.S. Cls.: 1, 2, 3, 22, 39 and 41**

**United States Patent and Trademark Office**

**Reg. No. 3,468,125**

**Registered July 15, 2008**

**TRADEMARK  
PRINCIPAL REGISTER**

# HIGH USE

HI-INT S.A. (LUXEMBOURG SOCIETE ANONYME)  
19-21, BOULEVARD DU PRINCE HENRI  
L-1724 LUXEMBOURG, LUXEMBOURG

FOR: KNAPSACKS, RUCKSACKS, RUCKSACKS FOR LEISURE, BRIEFCASES, SCHOOL BAGS, PURSES, WALLETS, HANDBAGS, LUGGAGE, SHOULDER BAGS, BEACH BAGS, CLUTCH BAGS, ALL PURPOSE SPORTS BAGS, ATTACHE CASES, TOTE BAGS, TRAVELLING BAGS, DOCUMENT CASES, COSMETIC CASES SOLD EMPTY, KEY CASES, TRAVELLING TRUNKS, UMBRELLAS, PARASOLS, WALKING STICKS, IN CLASS 18 (U.S. CLS. 1, 2, 3, 22 AND 41).

FOR: BRASSIERES; CORSETS, BEING CLOTHING; SINGLETS, PETTICOATS, NIGHTGOWNS, PAJAMAS, DRESSING GOWNS, PULLOVERS, BATH ROBES, BATHING SUITS, BATHING CAPS; GLOVES AND MUFFS, BEING CLOTHING; CARDIGANS; JERSEYS, BEING CLOTHING; NECKTIES, NECKERCHIEFS, SCARVES, SWEATERS, SOCKS, STOCKINGS, TIGHTS, TROUSERS, LEGGINGS, SKIRTS, JACKETS, JERKINS, SHIRTS, POLO SHIRTS, VESTS, WAISTCOATS, JUMPERS, TRACK

SUITS, BLOUSES, JEANS, PANTIES, PANTS, BERMUDA SHORTS, T-SHIRTS, SWEATSHIRTS, SUITS AND DRESSES, OVERCOATS, ANORAKS, COATS, RAINCOATS, KIMONOS, OVERALLS, SHAWLS, WINDCHEATERS, MITTENS; FOULARDS, BEING CLOTHING; CAPS, BEING CLOTHING; GARTERS; PANTYHOSES; BELTS, BEING CLOTHING; SUSPENDERS, SHOES, BOOTS, SLIPPERS, HATS, BERETS, IN CLASS 25 (U.S. CLS. 22 AND 39).

THE MARK CONSISTS OF STANDARD CHARACTERS WITHOUT CLAIM TO ANY PARTICULAR FONT, STYLE, SIZE, OR COLOR.

PRIORITY DATE OF 8-25-2006 IS CLAIMED.

OWNER OF INTERNATIONAL REGISTRATION  
0926373 DATED 2-19-2007, EXPIRES 2-19-2017.

SER. NO. 79-039,378, FILED 2-19-2007.

BERNICE MIDDLETON, EXAMINING ATTORNEY

**Int. Cls.: 3, 18 and 25**

**Prior U.S. Cls.: 1, 2, 3, 4, 6, 22, 39, 41, 50, 51 and 52**

**United States Patent and Trademark Office**

**Reg. No. 3,468,126**

**Registered July 15, 2008**

**TRADEMARK  
PRINCIPAL REGISTER**

**Gruppo La Perla  
La Perla Fashion Group**

GRUPPO LA PERLA S.P.A. (ITALY CORPORATION)  
12, VIA DEL FONDITORE  
I-40138  
BOLOGNA, ITALY I40138

FOR: PERFUMERY, COLOGNE, EAU DE TOILETTE, ESSENTIAL OILS AND HAIR LOTIONS, IN CLASS 3 (U.S. CLS. 1, 4, 6, 50, 51 AND 52).

FOR: GOODS OF LEATHER AND SKINS AND IMITATIONS THEREOF, NAMELY, TRUNKS, SUITCASES, UMBRELLAS, TRAVELING BAGS, HANDBAGS, AND WALLETS, IN CLASS 18 (U.S. CLS. 1, 2, 3, 22 AND 41).

FOR: CLOTHING, NAMELY, PANTS, SKIRTS, SHIRTS, BLOUSES, DRESSES, SHORTS, JACKETS, COATS, TIES, T-SHIRTS, AND SWEATERS, FOOTWEAR AND HEADWEAR, IN CLASS 25 (U.S. CLS. 22 AND 39).

OWNER OF INTERNATIONAL REGISTRATION  
0926389 DATED 5-4-2007, EXPIRES 5-4-2017.

OWNER OF U.S. REG. NOS. 1,451,645, 3,201,870  
AND OTHERS.

NO CLAIM IS MADE TO THE EXCLUSIVE RIGHT TO USE "GRUPPO" AND "FASHION GROUP", APART FROM THE MARK AS SHOWN.

THE ENGLISH TRANSLATION OF "GRUPPO" IS "GROUP". THE ENGLISH TRANSLATION OF "LA PERLA" IS "THE PEARL".

SER. NO. 79-039,380, FILED 5-4-2007.

JAMES STEIN, EXAMINING ATTORNEY

**Int. Cl.: 1**

**Prior U.S. Cls.: 1, 5, 6, 10, 26 and 46**

**United States Patent and Trademark Office**

**Reg. No. 3,468,127**

**Registered July 15, 2008**

**TRADEMARK  
PRINCIPAL REGISTER**



HUNTSMAN ADVANCED MATERIALS (SWITZERLAND) GMBH (SWITZERLAND GESELLSCHAFT MIT BESCHRÄNKTER HAFTUNG (GMBH))  
KLYBECKSTRASSE 200  
CH-4057 BASEL  
SWITZERLAND

FOR: CHEMICALS USED IN INDUSTRY FOR THE MANUFACTURE OF ADHESIVES; UNPROCESSED ARTIFICIAL RESINS USED AS ADHESIVES INCLUDING SYNTHETIC EPOXY RESINS FOR USE AS ADHESIVES; UNPROCESSED PLASTICS USED AS ADHESIVES; ADHESIVES USED IN INDUSTRY FOR BONDING METALS, GLASS,

CERAMICS AND/OR PLASTICS, IN CLASS 1 (U.S. CLS. 1, 5, 6, 10, 26 AND 46).

PRIORITY DATE OF 12-12-2006 IS CLAIMED.

OWNER OF INTERNATIONAL REGISTRATION 0926488 DATED 6-8-2007, EXPIRES 6-8-2017.

SER. NO. 79-039,414, FILED 6-8-2007.

JOHN SCHUYLER YARD, EXAMINING ATTORNEY

**Int. Cl.: 11**

**Prior U.S. Cls.: 13, 21, 23, 31 and 34**

**Reg. No. 3,468,128**

**United States Patent and Trademark Office**

**Registered July 15, 2008**

---

**TRADEMARK  
PRINCIPAL REGISTER**

**Neo-Neon**

NEO - NEON LIGHTING; (HE SHAN) CO., LTD  
(CHINA CORPORATION)  
GONGHE TOWN INDUSTRIAL  
DEVELOPMENT PARK, HESHAN CITY  
GUANGDONGPROVINCE, CHINA

OWNER OF INTERNATIONAL REGISTRATION  
0926519 DATED 5-30-2007, EXPIRES 5-30-2017.

FOR: ELECTRIC CHINESE LANTERNS; ELEC-  
TRIC LIGHTS FOR CHRISTMAS TREES; CURLY  
ELECTRIC LIGHT BULBS; STAGE LAMPS AND  
ELECTRIC LANTERNS, IN CLASS 11 (U.S. CLS. 13,  
21, 23, 31 AND 34).

SER. NO. 79-039,428, FILED 5-30-2007.

RENEE MCCRAY, EXAMINING ATTORNEY

**Int. Cls.: 38, 39 and 42**

**Prior U.S. Cls.: 100, 101, 104 and 105**

**United States Patent and Trademark Office**

**Reg. No. 3,468,129**

**Registered July 15, 2008**

**SERVICE MARK  
PRINCIPAL REGISTER**

# **GREENCARRIER**

GREENCARRIER SCANDINAVIA AB (SWEDEN CORPORATION)

BOX 1037  
SE-405 22 GÖTEBORG  
SWEDEN

FOR: TELECOMMUNICATIONS SERVICES RELATED TO THE TRANSPORT AND STORAGE OF GOODS, NAMELY, COMPUTER-AIDED TRANSMISSION OF MESSAGES, IMAGES, INFORMATION AND E-MAIL VIA COMPUTER, MOBILE AND TELECOMMUNICATIONS NETS; RENTAL OF COMMUNICATIONS EQUIPMENT; PROVIDING ACCESS TO DATABASES, IN CLASS 38 (U.S. CLS. 100, 101 AND 104).

FOR: TRANSPORT AND SHIPPING SERVICES, NAMELY, PICKUP, TRANSPORTATION, AND DELIVERY OF GOODS BY FLIGHT, VESSEL, TRAIN AND CAR TRANSPORT; STORAGE BUSINESS, NAMELY, WAREHOUSE STORAGE AND REFRIGERATED STORAGE; PACKAGING OF GOODS FOR TRANSPORT AND STORAGE; STORING OF GOODS; TRANSPORT AND STORAGE OF GOODS; INFORMATION AND RESERVATION SERVICES FOR TRANSPORT AND STORING, NAMELY, PRO-

VIDING INFORMATION IN THE FIELD OF TRANSPORTATION AND PHYSICAL STORAGE, TRANSPORTATION AND STORAGE RESERVATIONS SERVICES, IN CLASS 39 (U.S. CLS. 100 AND 105).

FOR: UPDATING AND RENTAL OF OPERATIVE AND APPLICATION COMPUTER SOFTWARE, RENTAL OF COMPUTERS; COMPUTER CONSULTANCY SERVICES FOR USERS OF COMPUTERS AND COMPUTER PROGRAMS, IN CLASS 42 (U.S. CLS. 100 AND 101).

PRIORITY DATE OF 11-17-2006 IS CLAIMED.

OWNER OF INTERNATIONAL REGISTRATION 0926687 DATED 1-24-2007, EXPIRES 1-24-2017.

SER. NO. 79-039,500, FILED 1-24-2007.

REBECCA POVARCHUK, EXAMINING ATTORNEY

**Int. Cl.: 10**

**Prior U.S. Cls.: 26, 39 and 44**

**United States Patent and Trademark Office**

**Reg. No. 3,468,130**

**Registered July 15, 2008**

**TRADEMARK  
PRINCIPAL REGISTER**

**SYNCHRO-BREATHE**

NEO-INHALATION TECHNOLOGIES LIMITED  
(UNITED KINGDOM LTD LIAB CO)  
57 HIGH STREET ODIHAM  
HANTS RG29 1LF, UNITED KINGDOM

FOR: INHALERS FOR MEDICAL PURPOSES  
SOLD EMPTY; ACTUATORS FOR INHALERS USED  
FOR MEDICAL PURPOSES; MEDICAL APPARA-  
TUS FOR USE IN INHALATION OF PHARMACEU-  
TICAL PRODUCTS; PARTS AND FITTINGS FOR  
THE AFORESAID GOODS, NAMELY, MOUTH PIE-  
CES FOR MEDICAL INHALERS, IN CLASS 10 (U.S.  
CLS. 26, 39 AND 44).

PRIORITY DATE OF 2-2-2007 IS CLAIMED.

OWNER OF INTERNATIONAL REGISTRATION  
0926690 DATED 3-28-2007, EXPIRES 3-28-2017.

SER. NO. 79-039,502, FILED 3-28-2007.

MARILYN IZZI, EXAMINING ATTORNEY

**Int. Cls.: 7 and 9**

**Prior U.S. Cls.: 13, 19, 21, 23, 26, 31, 34, 35, 36 and 38**

**United States Patent and Trademark Office**

**Reg. No. 3,468,131**

**Registered July 15, 2008**

**TRADEMARK  
PRINCIPAL REGISTER**



MINIMOTOR SA (SWITZERLAND SOCIETÀ ANONIMA)

CH-6980 CROGLIO, SWITZERLAND

FOR: MOTORS OTHER THAN FOR LAND VEHICLES, IN CLASS 7 (U.S. CLS. 13, 19, 21, 23, 31, 34 AND 35).

FOR: ELECTRONIC CONTROLS FOR MOTORS, IN CLASS 9 (U.S. CLS. 21, 23, 26, 36 AND 38).

OWNER OF INTERNATIONAL REGISTRATION 0926799 DATED 2-1-2007, EXPIRES 2-1-2017.

THE COLOR(S) ORANGE AND BLACK IS/ARE CLAIMED AS A FEATURE OF THE MARK.

THE MARK CONSISTS OF THE WORDING "SMART" IN BLACK, "SHELL" IN ORANGE, AND THE DESIGN OF AN ELLIPSE FORMED BY BROKEN LINES, THE BOTTOM LEFT IN BLACK, AND THE UPPER RIGHT IN ORANGE.

SER. NO. 79-039,549, FILED 2-1-2007.

REBECCA POVARCHUK, EXAMINING ATTORNEY

**Int. Cls.: 1, 3, 5, 41, 42 and 44**

**Prior U.S. Cls.: 1, 4, 5, 6, 10, 18, 26, 44, 46, 50, 51, 52,  
100, 101 and 107**

**Reg. No. 3,468,132**

**United States Patent and Trademark Office**

**Registered July 15, 2008**

**TRADEMARK  
SERVICE MARK  
PRINCIPAL REGISTER**

# RETHINK TOMORROW

NOVOZYMES A/S, (DENMARK CORPORATION)  
KROGSHOEJVEJ 36  
BAGSVAERD, DENMARK DK2880

FOR: CHEMICALS FOR USE IN INDUSTRY AND SCIENCE; CHEMICALS FOR USE IN AGRICULTURE, HORTICULTURE AND FORESTRY, NAMELY, CHEMICAL PREPARATIONS FOR THE TREATMENT OF SEEDS; CHEMICAL SUBSTANCES FOR PRESERVING FOODSTUFFS; TANNING SUBSTANCES, NAMELY, TANNING AGENTS FOR USE IN THE MANUFACTURE OF LEATHER; AND ADHESIVES FOR GENERAL INDUSTRIAL USE, IN CLASS 1 (U.S. CLS. 1, 5, 6, 10, 26 AND 46).

FOR: BLEACHING PREPARATIONS AND OTHER SUBSTANCES, NAMELY, WASHING POWDER FOR LAUNDRY USE; GENERAL PURPOSE CLEANING, POLISHING, SCOURING AND ABRASIVE LIQUIDS AND POWDERS; SOAPS; PERFUMERY; ESSENTIAL OILS; COSMETICS; AND HAIR LOTIONS, IN CLASS 3 (U.S. CLS. 1, 4, 6, 50, 51 AND 52).

FOR: PHARMACEUTICAL AND VETERINARY PREPARATIONS FOR ENZYME REPLACEMENT AND THERAPY; SANITARY PREPARATIONS FOR MEDICAL USE; DIETETIC FOODS ADAPTED FOR MEDICAL USE, FOOD FOR BABIES; DISINFECTANTS FOR SANITARY PURPOSES; PREPARATIONS FOR DESTROYING VERMIN; FUNGICIDES; AND HERBICIDES, IN CLASS 5 (U.S. CLS. 6, 18, 44, 46, 51 AND 52).

FOR: EDUCATIONAL SERVICES, NAMELY, PROVIDING CLASSES, SEMINARS AND WORKSHOPS IN THE FIELD OF USE OF CHEMICALS FOR INDUSTRIAL PURPOSES, IN CLASS 41 (U.S. CLS. 100, 101 AND 107).

FOR: CHEMICAL ANALYSIS AND RESEARCH SERVICES; AND COMPUTER PROGRAMMING, IN CLASS 42 (U.S. CLS. 100 AND 101).

FOR: MEDICAL SERVICES; VETERINARY SERVICES; HYGIENIC AND BEAUTY CARE FOR HUMAN BEINGS OR ANIMALS, NAMELY, BEAUTY SALONS AND ANIMAL GROOMING; AND AGRICULTURE SERVICES, NAMELY, AGRICULTURAL RESEARCH AND ADVICE, IN CLASS 44 (U.S. CLS. 100 AND 101).

THE MARK CONSISTS OF STANDARD CHARACTERS WITHOUT CLAIM TO ANY PARTICULAR FONT, STYLE, SIZE, OR COLOR.

PRIORITY DATE OF 12-22-2006 IS CLAIMED.

OWNER OF INTERNATIONAL REGISTRATION  
0926805 DATED 4-2-2007, EXPIRES 4-2-2017.

SER. NO. 79-039,553, FILED 4-2-2007.

ROBERT STRUCK, EXAMINING ATTORNEY



**Int. Cls.: 18 and 25**

**Prior U.S. Cls.: 1, 2, 3, 22, 39 and 41**

**United States Patent and Trademark Office**

**Reg. No. 3,468,133**

**Registered July 15, 2008**

**TRADEMARK  
PRINCIPAL REGISTER**



**CGV COMPAGNIA GONDOLIERI VENEZIANI**

DIGIORGIO, MARIANGELA (ITALY INDIVIDUAL)

VIA DEI PINI, 94

I-70051 BARLETTA (BARI)

ITALY

FOR: LEATHER AND IMITATIONS OF LEATHER, AND GOODS MADE OF THESE MATERIALS, NAMELY, BAGS, TRAVELLING BAGS, PURSES, WALLETS, KEY CASES, IN CLASS 18 (U.S. CLS. 1, 2, 3, 22 AND 41).

FOR: CLOTHING, NAMELY, SKIRTS, JACKETS, TROUSERS, T-SHIRTS, OVERCOATS, SWEATERS, JUMPERS, SHORTS, IN CLASS 25 (U.S. CLS. 22 AND 39).

OWNER OF INTERNATIONAL REGISTRATION 0926983 DATED 12-28-2006, EXPIRES 12-28-2016.

NO CLAIM IS MADE TO THE EXCLUSIVE RIGHT TO USE COMPANY, APART FROM THE MARK AS SHOWN.

THE COLOR(S) BLACK, BLUE, LIGHT BLUE, ORANGE, RED, WHITE IS/ARE CLAIMED AS A FEATURE OF THE MARK.

THE WORDING "CGV COMPAGNIA GONDOLIERI VENEZIANI" IS IN BLACK, THE SAILOR CHILD'S CAP IS BLUE AND LIGHT BLUE, THE STRIPED T-SHIRT IS RED AND WHITE, THE LETTERS "CGV", WRITTEN ON THE SAME STRIPED T-SHIRT, ARE IN LIGHT BLUE, THE TROUSERS ARE ORANGE WITH BORDER AND BUTTONS IN LIGHT BLUE COLOUR, AND THE SHOES ARE BLACK.

THE WORDING "CGV COMPAGNIA GONDOLIERI VENEZIANI" IS WRITTEN IN BLACK CAPITAL LETTERS; ABOVE, THERE IS A PICTURE OF A SAILOR CHILD WEARING A LIGHT BLUE AND BLUE CAP AND A STRIPED RED AND WHITE T-SHIRT, UPON WHICH THE LETTERS "CGV" ARE WRITTEN ON THE LEFT IN LOWER CASE LIGHT BLUE CHARACTERS; BESIDES, THE SAME SAILOR CHILD WEARS A PAIR OF ORANGE TROUSERS WITH BORDER AND BUTTONS IN LIGHT BLUE, AND BLACK SHOES; SAID SAILOR CHILD STANDS WITH HIS LEFT HAND NEAR HIS HEAD.

THE ENGLISH TRANSLATION OF THE FOREIGN WORD(S) IN THE MARK IS: VENETIAN GONDOLIERS COMPANY.

SER. NO. 79-039,625, FILED 12-28-2006.

CAROL SPILS, EXAMINING ATTORNEY

**Int. Cls.: 9, 16, 25, 28 and 42**

**Prior U.S. Cls.: 2, 5, 21, 22, 23, 26, 29, 36, 37, 38, 39,  
50, 100 and 101**

**Reg. No. 3,468,134**

**United States Patent and Trademark Office**

**Registered July 15, 2008**

**TRADEMARK  
SERVICE MARK  
PRINCIPAL REGISTER**

# **PLUMEBOOM**

FIREGLOW LIMITED (CYPRUS LIMITED COMPANY)  
MARIA HOUSE, 8 SAMOU STREET  
ST. OMOLOGITES; CY-1086 NICOSIA  
CYPRUS

FOR: ELECTRICAL AND ELECTRONIC DATA PROCESSING EQUIPMENT; APPARATUS FOR DIGITAL AND ANALOG SIGNAL PROCESSING, NAMELY, MODEMS; ELECTRICAL SWITCHING DEVICES WITH DIGITAL AND ANALOG SIGNAL PROCESSING; APPARATUS FOR THE INPUT, OUTPUT OR REPRODUCTION OF DATA, NAMELY, PRINTERS, PLOTTERS, MODEMS, LIGHT PENS, JOYSTICKS, SCANNERS; MULTI-FUNCTION KEYBOARD AND PLUG-IN CARDS THEREFORE, NAMELY SOUND CARDS; ROLLER BALL INPUT APPARATUS, NAMELY, MICE AND TRACK BALLS; INPUT DEVICES FOR COMPUTERS, NAMELY, SPEECH INPUT APPARATUS; ACOUSTIC AND OPTICAL REPRODUCTION APPARATUS FOR DATA PROCESSING APPARATUS, INCLUDING IN THE FORM OF AUXILIARY APPARATUS OR PLUG-IN APPARATUS, NAMELY, MONITORS AND LOUD SPEAKERS, INCLUDING INTEGRATED INTO GOGGLES OR HELMETS; CONSOLES AND MODULES FOR VIDEO GAMES FOR USE WITH AN EXTERNAL DISPLAY SCREEN OR MONITOR; COMPUTER GAMES PROGRAMS, COMPUTER GAMES SOFTWARE, VIDEO GAMES FOR USE IN CONNECTION WITH COMPUTERS OR TELEVISION SETS; PRERECORDED FLOPPY DISKS, MAGNETIC TAPES, CASSETTES INCLUDING VIDEOCASSETTES AND TAPE STREAMERS, HARD DISK MEMORIES AND READ-ONLY MEMORIES, RAM AND PLUG-IN MODULES, AND OPTICAL DISKS, ALL CONTAINING VIDEO GAMES OR COMPUTER GAMES; INTEGRATED CIRCUITS SUPPLIED WITH PRINTED CIRCUIT BOARDS, IN PARTICULAR PLUG-IN CARDS; ACCESSORIES FOR ELECTRONIC DATA PROCESSING APPARATUS, NAMELY, CABLES, PLUGS, DAISY WHEELS, AUTOMATIC VOLTAGE AND CURRENT REGULATORS,

EMERGENCY POWER SUPPLY APPARATUS, APPARATUS TO PROTECT AGAINST POWER SURGES, NAMELY, SURGE PLUGS; DUST FILTERS FOR USE WITH ELECTRICAL AND ELECTRONIC DATA PROCESSING EQUIPMENT AND COMPUTERS, FANS BEING PARTS OF ELECTRICAL AND ELECTRONIC DATA PROCESSING EQUIPMENT AND COMPUTERS; MOUSE PADS, IN CLASS 9 (U.S. CLS. 21, 23, 26, 36 AND 38).

FOR: PRINTING PRODUCTS IN THE FIELDS OF COMPUTER TECHNOLOGY AND COMPUTER PROGRAMS, NAMELY INSTRUCTIONS, USER MANUALS, FORMS, WORKING PROCEDURES, BOOKS INCLUDING HANDBOOKS, PROGRAM DOCUMENTATION IN THE NATURE OF PAMPHLETS, AND WRITTEN BACKGROUND MATERIAL IN THE NATURE OF PAMPHLETS, ALL IN THE FIELD OF COMPUTER PROGRAMS; MAGAZINES, PAMPHLETS, AND CATALOGUES, ALL RELATING TO COMPUTER GAMES, VIDEO GAMES, ELECTRONIC GAMES AND GAMES PLAYED VIA COMPUTER NETWORKS OR THE INTERNET; STATIONERY, CALENDARS, POSTERS, STICKERS, GREETING CARDS, GIFT WRAPPING PAPER; PAPER, CARDBOARD AND PLASTIC WRAPPING FOR GIFT WRAPPING; SINGLE OR MULTILAYERED PRINTING PAPER, INCLUDING STICKERS AND FORMS; TEACHING AND TRAINING MATERIALS IN THE FORM OF WORK BOOKS AND TRAINING HANDBOOKS, ALL IN THE FIELD OF COMPUTER TECHNOLOGY AND COMPUTER PROGRAMS; PAPER, CARDBOARD AND GOODS MADE FROM THESE MATERIALS, NAMELY, INSTRUCTIONS FOR BOARD GAMES, IN CLASS 16 (U.S. CLS. 2, 5, 22, 23, 29, 37, 38 AND 50).

FOR: CLOTHING, NAMELY, SHIRTS, T-SHIRTS, VESTS, SPORTS SHIRTS, PANTS, BRIEFS, SWEATERS, JUMPERS, CAMISOLES, JACKETS, UNDERCOATS, WINDPROOF COATS, PARKAS; FOOTWEAR; HEADGEAR, NAMELY, HATS, PA-

NAMA HATS, BEANIE HATS, CAPS AND BASE-BALL CAPS, IN CLASS 25 (U.S. CLS. 22 AND 39).

FOR: STAND ALONE VIDEO GAMES AND ARCADE GAMES; COIN, CARD OR TOKEN OPERATED ARCADE GAMES; HAND-HELD COMPUTER GAMES; PLAYING CARDS; TOYS, NAMELY, STUFFED TOYS; GYMNASTIC AND SPORTING ARTICLES, NAMELY, SPORTS BALLS AND RIBBON-MADE BALLS, IN CLASS 28 (U.S. CLS. 22, 23, 38 AND 50).

FOR: DEVELOPING FOR OTHERS AND ENHANCING AND ADJUSTING DATA PROCESSING PROGRAMS, IN CLASS 42 (U.S. CLS. 100 AND 101).

OWNER OF INTERNATIONAL REGISTRATION 0927160 DATED 1-31-2007, EXPIRES 1-31-2017.

SER. NO. 79-039,693, FILED 1-31-2007.

REBECCA POVARCHUK, EXAMINING ATTORNEY

**Int. Cls.: 3, 14, 18 and 25**

**Prior U.S. Cls.: 1, 2, 3, 4, 6, 22, 27, 28, 39, 41, 50, 51  
and 52**

**Reg. No. 3,468,135**

**United States Patent and Trademark Office**

**Registered July 15, 2008**

**TRADEMARK  
PRINCIPAL REGISTER**

**DAREL**

BENAZERAH DANIELLE; (ÉPOUSE GERBI)  
(FRANCE INDIVIDUAL)  
250BIS BOULEVARD SAINT GERMAIN  
F-75007 PARIS  
FRANCE

FOR: SOAPS, PERFUMERY, ESSENTIAL OILS,  
COSMETICS, IN CLASS 3 (U.S. CLS. 1, 4, 6, 50, 51 AND  
52).

FOR: PRECIOUS METALS AND THEIR ALLOYS  
AND GOODS IN PRECIOUS METALS OR COATED  
THEREWITH, NAMELY, RINGS, BRACELETS AND  
NECKLACES; JEWELRY, PRECIOUS STONES,  
CLOCKS, WATCHES AND CHRONOMETERS, IN  
CLASS 14 (U.S. CLS. 2, 27, 28 AND 50).

FOR: LEATHER AND IMITATION LEATHER,  
GOODS MADE OF LEATHER AND IMITATION  
LEATHER, NAMELY, HANDBAGS, TOILET BAGS  
SOLD EMPTY, BEACH BAGS, LUGGAGE BAGS,  
PURSES, WALLETS, BUSINESS CARD HOLDERS,  
CREDIT CARD HOLDERS, BILLFOLDS, BRIEFCASES,  
ATTACHE CASES; ANIMAL SKINS AND  
HIDES, TRUNKS AND SUITCASES, UMBRELLAS,  
PARASOLS AND WALKING STICKS, WHIPS, HAR-  
NESSES, AND SADDLERY, IN CLASS 18 (U.S. CLS. 1,  
2, 3, 22 AND 41).

FOR: CLOTHING FOR MEN, WOMEN, AND  
CHILDREN, NAMELY, PANTS, SLACKS, SHORTS,  
SUITS, SKIRTS, DRESSES, BLAZERS, VESTS, JACK-

ETS, TOPS, SHIRTS, BLOUSES, SWEATERS, TEE-  
SHIRTS, TANK TOPS, SWEATSHIRTS, JOGGING  
SUITS, WARMUP SUITS, OVERCOATS, COATS,  
CAPES, PONCHOS, BATHING SUITS, BEACH AND  
SWIMMING COVERUPS, LOUNGEWEAR, UNDER-  
SHIRTS, UNDERWEAR, BOXER BRIEFS AND BOX-  
ER SHORTS, BRAS, PAJAMAS, ROBES,  
HOUSECOATS, TIGHTS, LEGGINGS, STOCKINGS,  
BELTS, TIES, SUSPENDERS, SOCKS, SCARVES,  
SHAWLS, SASHES, GLOVES; HEADGEAR, NAME-  
LY HATS AND CAPS; FOOTWEAR, NAMELY,  
SHOES, BOOTS, AND SLIPPERS, IN CLASS 25 (U.S.  
CLS. 22 AND 39).

THE MARK CONSISTS OF STANDARD CHAR-  
ACTERS WITHOUT CLAIM TO ANY PARTICULAR  
FONT, STYLE, SIZE, OR COLOR.

OWNER OF INTERNATIONAL REGISTRATION  
0927274 DATED 5-11-2007, EXPIRES 5-11-2017.

OWNER OF U.S. REG. NOS. 1,336,785 AND  
2,803,886.

THE NAME "DAREL" DOES NOT IDENTIFY A  
LIVING INDIVIDUAL.

SER. NO. 79-039,728, FILED 5-11-2007.

GILBERT SWIFT, EXAMINING ATTORNEY

**Int. Cls.: 11 and 21**

**Prior U.S. Cls.: 2, 13, 21, 23, 29, 30, 31, 33, 34, 40 and 50**

**United States Patent and Trademark Office**

**Reg. No. 3,468,136**

**Registered July 15, 2008**

**TRADEMARK  
PRINCIPAL REGISTER**



HANDPRESSO (FRANCE LTD LIAB CO)  
27 QUAI FRANKLIN ROOSEVELT  
F-77920 SAMOIS SUR SEINE  
FRANCE

FOR: ELECTRIC MACHINES FOR PREPARING  
INFUSIONS, NAMELY, ELECTRIC ESPRESSO MA-  
CHINES, COFFEE MAKERS, TEA MAKERS; ELEC-  
TRIC WATER KETTLES , IN CLASS 11 (U.S. CLS. 13,  
21, 23, 31 AND 34).

FOR: NON-ELECTRIC COFFEE MAKERS, NOT  
OF PRECIOUS METAL; NON-ELECTRIC TEA MA-

KERS, NOT OF PRECIOUS METAL, IN CLASS 21  
(U.S. CLS. 2, 13, 23, 29, 30, 33, 40 AND 50).

PRIORITY DATE OF 11-10-2006 IS CLAIMED.

OWNER OF INTERNATIONAL REGISTRATION  
0927275 DATED 5-4-2007, EXPIRES 5-4-2017.

SER. NO. 79-039,729, FILED 5-4-2007.

JAMES STEIN, EXAMINING ATTORNEY

**Int. Cls.: 9 and 42**

**Prior U.S. Cls.: 21, 23, 26, 36, 38, 100 and 101**

**United States Patent and Trademark Office**

**Reg. No. 3,468,137**

**Registered July 15, 2008**

**TRADEMARK  
SERVICE MARK  
PRINCIPAL REGISTER**

**AZURSPACE**

AZUR SPACE; SOLAR POWER GMBH (FED REP  
GERMANY LTD LIAB CO)  
THERESIENSTRASSE 2  
74072 HEILBRONN, FED REP GERMANY

FOR: ELECTRIC, ELECTRONIC AND ELECTRO-  
TECHNICAL APPARATUS, DEVICES AND IN-  
STRUMENTS, NAMELY, ELECTRONIC  
DETECTORS, SEMICONDUCTOR CHIPS, INTER-  
FACES FOR DETECTORS; APPARATUS AND IN-  
STRUMENTS FOR CONDUCTING, SWITCHING,  
SWITCHING, STORING, REGULATING AND CON-  
TROLLING ELECTRICITY, NAMELY, POWER  
CONDUCTORS, POWER DISTRIBUTION PANELS,  
ELECTRONIC CONTROLLERS FOR USE WITH  
POWER CONVERTERS, POWER AMPLIFIERS,  
POWER CONTROLLERS, POWER SWITCHES, POW-  
ER TRANSFORMERS; VOLTAGE REGULATORS  
FOR ELECTRIC POWER, ELECTRIC STORAGE  
BATTERIES; VOLTAGE POWER AMPLIFIERS;  
VOLTAGE MULTIPLIERS AND INVERTERS; ELEC-  
TRIC SOLAR CELLS; SOLAR CELL MODULES  
CONSISTING OF SOLAR CELLS, ELECTRICAL  
CONNECTORS, PROTECTIVE DIODES, CON-  
TACTS, AND CARRIERS; PHOTOVOLTAIC DEVI-  
CES FOR POWER GENERATION, NAMELY,  
SOLAR CELLS, SOLAR CELL ASSEMBLIES, SOLAR  
MODULES, AND SOLAR PANELS; SEMICONDUCTOR  
DETECTORS; CHARGE REGULATORS,  
NAMELY, SOLAR CHARGE REGULATORS; CUR-  
RENT INVERTERS; LIGHT EMITTING DIODES;  
AND DIODES, IN CLASS 9 (U.S. CLS. 21, 23, 26, 36  
AND 38).

FOR: TECHNICAL PLANNING OF PHOTOVOL-  
TAIC SOLAR PLANTS; DEVELOPMENT AND RE-  
SEARCH OF SOLAR CELLS FOR THIRD PARTIES;  
TECHNICAL RESEARCH AND DEVELOPMENT OF  
SEMICONDUCTOR DETECTORS FOR THIRD PAR-  
TIES; AND TECHNICAL RESEARCH AND DEVEL-  
OPMENT FOR OTHERS OF LIGHT EMITTING  
DIODES AND DIODES, IN CLASS 42 (U.S. CLS. 100  
AND 101).

PRIORITY DATE OF 10-24-2006 IS CLAIMED.

OWNER OF INTERNATIONAL REGISTRATION  
0927367 DATED 4-23-2007, EXPIRES 4-23-2017.

THE COLOR(S) BLUE AND ORANGE IS/ARE  
CLAIMED AS A FEATURE OF THE MARK.

THE WORD "AZUR" IS SHOWN IN BLUE AND  
THE WORD "SPACE" APPEARS IN "ORANGE".

THE ENGLISH TRANSLATION OF THE WORD  
AZUR IN THE MARK IS BLUE.

SER. NO. 79-039,756, FILED 4-23-2007.

NAAKWAMA ANKRAH, EXAMINING ATTORNEY

**Int. Cls.: 9 and 42**

**Prior U.S. Cls.: 21, 23, 26, 36, 38, 100 and 101**

**Reg. No. 3,468,138**

**United States Patent and Trademark Office**

**Registered July 15, 2008**

**TRADEMARK  
SERVICE MARK  
PRINCIPAL REGISTER**



AZUR SPACE; SOLAR POWER GMBH (FED REP GERMANY LTD LIAB CO)  
THERESIENSTRASSE 2  
74072 HEILBRONN  
FED REP GERMANY

FOR: ELECTRIC, ELECTRONIC AND ELECTROMECHANICAL APPARATUS, DEVICES AND INSTRUMENTS, NAMELY, ELECTRONIC DETECTORS, SEMICONDUCTOR CHIPS, INTERFACES FOR DETECTORS; APPARATUS AND INSTRUMENTS FOR CONDUCTING, SWITCHING, STORING, REGULATING AND CONTROLLING ELECTRICITY, NAMELY, POWER CONDUCTORS, POWER DISTRIBUTION PANELS, ELECTRONIC CONTROLLERS FOR USE WITH POWER CONVERTERS, POWER AMPLIFIERS, POWER CONTROLLERS, POWER SWITCHES, POWER TRANSFORMERS; VOLTAGE REGULATORS FOR ELECTRIC POWER, ELECTRIC STORAGE BATTERIES; VOLTAGE POWER AMPLIFIERS; VOLTAGE MULTIPLIERS AND INVERTERS; ELECTRIC SOLAR CELLS; SOLAR CELL MODULES CONSISTING OF SOLAR CELLS, ELECTRICAL CONNECTORS, PROTECTIVE DIODES, CONTACTS, AND CARRIERS; PHOTOVOLTAIC DEVICES FOR POWER GENERATION, NAMELY, SOLAR CELLS, SOLAR CELL ASSEMBLIES, SOLAR MODULES, AND SOLAR PANELS; SEMICONDUCTOR DETECTORS; CHARGE REGULATORS, NAMELY, SOLAR CHARGE REGULATORS; CURRENT INVERTERS; LIGHT EMITTING DIODES; AND DIODES, IN CLASS 9 (U.S. CLS. 21, 23, 26, 36 AND 38).

FOR: TECHNICAL PLANNING FOR PHOTOVOLTAIC SOLAR PLANTS; DEVELOPMENT AND RE-

SEARCH OF SOLAR CELLS FOR THIRD PARTIES; TECHNICAL RESEARCH AND DEVELOPMENT OF SEMICONDUCTOR DETECTORS FOR THIRD PARTIES; AND TECHNICAL RESEARCH AND DEVELOPMENT FOR OTHERS OF LIGHT EMITTING DIODES AND DIODES, IN CLASS 42 (U.S. CLS. 100 AND 101).

PRIORITY DATE OF 10-24-2006 IS CLAIMED.

OWNER OF INTERNATIONAL REGISTRATION 0927370 DATED 4-23-2007, EXPIRES 4-23-2017.

THE COLOR(S) BLUE, ORANGE, RED, GREY AND WHITE IS/ARE CLAIMED AS A FEATURE OF THE MARK.

THE MARK CONSISTS OF THE WORD "AZUR" IS SHOWN IN BLUE AND THE WORD "SPACE" APPEARS IN ORANGE. A SERIES OF BLUE RECTANGLES FORMING AN ARRAY OF SOLAR PANELS IS SHOWN ABOVE THE WORDS WITH THE LOWERMOST RECTANGLE SHOWN IN RED. A WHITE LIGHT RAY APPEARS NEAR THE CENTER OF THE ARRAY AND A GREY SHADOW APPEARS BELOW THE ARRAY.

THE ENGLISH TRANSLATION OF THE WORD "AZUR" IN THE MARK IS BLUE.

SER. NO. 79-039,757, FILED 4-23-2007.

NAAKWAMA ANKRAH, EXAMINING ATTORNEY

**Int. Cls.: 9 and 42**

**Prior U.S. Cls.: 21, 23, 26, 36, 38, 100 and 101**

**United States Patent and Trademark Office**

**Reg. No. 3,468,139**

**Registered July 15, 2008**

**TRADEMARK  
SERVICE MARK  
PRINCIPAL REGISTER**

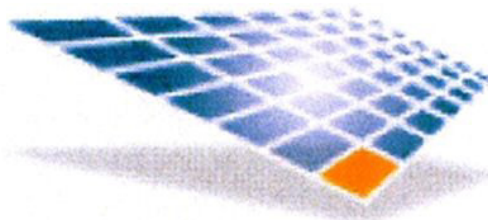

AZUR SPACE; SOLAR POWER GMBH (FED REP  
GERMANY LTD LIAB CO)  
THERESIENSTRASSE 2  
74072 HEILBRONN  
FED REP GERMANY

FOR: ELECTRIC, ELECTRONIC AND ELECTRO-  
MECHANICAL APPARATUS, DEVICES AND IN-  
STRUMENTS, NAMELY, ELECTRONIC  
DETECTORS, SEMICONDUCTOR CHIPS, INTER-  
FACES FOR DETECTORS; APPARATUS AND IN-  
STRUMENTS FOR CONDUCTING, SWITCHING,  
STORING, REGULATING AND CONTROLLING  
ELECTRICITY, NAMELY, POWER CONDUCTORS,  
POWER DISTRIBUTION PANELS, ELECTRONIC  
CONTROLLERS FOR USE WITH POWER CONVER-  
TERS, POWER AMPLIFIERS, POWER CONTROL-  
LERS, POWER SWITCHES, POWER  
TRANSFORMERS; VOLTAGE REGULATORS FOR  
ELECTRIC POWER, ELECTRIC STORAGE BAT-  
TERIES; VOLTAGE POWER AMPLIFIERS; VOL-  
TAGE MULTIPLIERS AND INVERTERS;  
ELECTRIC SOLAR CELLS; SOLAR CELL MODULES  
CONSISTING OF SOLAR CELLS, ELECTRICAL  
CONNECTORS, PROTECTIVE DIODES, CON-  
TACTS, AND CARRIERS; PHOTOVOLTAIC DEVI-  
CES FOR POWER GENERATION, NAMELY,  
SOLAR CELLS, SOLAR CELL ASSEMBLIES, SOLAR  
MODULES, AND SOLAR PANELS; SEMICONDU-  
CTOR DETECTORS; CHARGE REGULATORS,  
NAMELY, SOLAR CHARGE REGULATORS; CUR-  
RENT INVERTERS; LIGHT EMITTING DIODES;  
AND DIODES, IN CLASS 9 (U.S. CLS. 21, 23, 26, 36  
AND 38).

FOR: TECHNICAL PLANNING OF PHOTOVOL-  
TAIC SOLAR PLANTS; DEVELOPMENT AND RE-  
SEARCH OF SOLAR CELLS FOR THIRD PARTIES;  
TECHNICAL RESEARCH AND DEVELOPMENT OF  
SEMICONDUCTOR DETECTORS FOR THIRD PAR-  
TIES; AND TECHNICAL RESEARCH AND DEVEL-  
OPMENT FOR OTHERS OF LIGHT EMITTING  
DIODES AND DIODES, IN CLASS 42 (U.S. CLS. 100  
AND 101).

PRIORITY DATE OF 10-24-2006 IS CLAIMED.

OWNER OF INTERNATIONAL REGISTRATION  
0927371 DATED 4-23-2007, EXPIRES 4-23-2017.

THE COLOR(S) BLUE, ORANGE GREY AND  
WHITE IS/ARE CLAIMED AS A FEATURE OF  
THE MARK.

THE MARK CONSISTS OF A SERIES OF BLUE  
RECTANGLES FORMING AN ARRAY OF SOLAR  
PANELS IS SHOWN ABOVE THE WORDS WITH  
THE LOWERMOST RECTANGLE SHOWN IN OR-  
ANGE. A WHITE LIGHT RAY APPEARS NEAR THE  
CENTER OF THE ARRAY AND GREY SHADOW  
APPEARS BELOW THE ARRAY.

SER. NO. 79-039,758, FILED 4-23-2007.

NAAKWAMA ANKRAH, EXAMINING ATTORNEY



**Int. Cls.: 41 and 43**

**Prior U.S. Cls.: 100, 101 and 107**

**United States Patent and Trademark Office**

**Reg. No. 3,468,140**

**Registered July 15, 2008**

**SERVICE MARK  
PRINCIPAL REGISTER**

**SARRASANI**

ANDRÉ DE STOSCH SARRASANI (FED REP  
GERMANY INDIVIDUAL)  
BAHNSTRASSE 15  
65205 WIESBADEN  
FED REP GERMANY

FOR: ENTERTAINMENT SERVICES, NAMELY,  
LIVE PERFORMANCES IN THE NATURE OF VARIETY  
SHOWS, CIRCUS PERFORMANCES, MAGIC  
SHOWS AND CONJURING MAGIC SHOWS; ENTERTAINMENT  
SERVICES IN THE NATURE OF LIVE PERFORMANCE  
BY ARTISTS AND PERFORMERS, NAMELY, VARIETY  
SHOWS, CIRCUS PERFORMANCES, MAGIC SHOWS  
AND CONJURING MAGIC SHOWS; PLANNING,  
ORGANIZATION, PRODUCTION AND REALIZATION,  
NAMELY, ARRANGING AND CONDUCTING, OF ENTERTAINMENT  
IN THE NATURE OF LIVE PERFORMANCES AND  
SPECIAL EVENTS IN THE FIELDS OF VARIETY  
SHOWS, CIRCUS PERFORMANCES, MAGIC SHOWS  
AND CONJURING MAGIC SHOWS; PRODUCTION OF  
LIVE EVENTS IN

THE NATURE OF VARIETY SHOWS, CIRCUS PERFORMANCES,  
MAGIC SHOWS AND CONJURING MAGIC SHOWS;  
PROVISION OF INFORMATION ABOUT THE ABOVE-  
MENTIONED EVENTS, NAMELY, PROVIDING  
INFORMATION IN THE FIELD OF ENTERTAINMENT,  
IN CLASS 41 (U.S. CLS. 100, 101 AND 107).

FOR: CATERING SERVICES, IN CLASS 43 (U.S.  
CLS. 100 AND 101).

PRIORITY DATE OF 6-28-2006 IS CLAIMED.

OWNER OF INTERNATIONAL REGISTRATION  
0927467 DATED 12-6-2006, EXPIRES 12-6-2016.

SER. NO. 79-039,788, FILED 12-6-2006.

JAMES MACFARLANE, EXAMINING ATTORNEY

**Int. Cls.: 3 and 25**

**Prior U.S. Cls.: 1, 4, 6, 22, 39, 50, 51 and 52**

**United States Patent and Trademark Office**

**Reg. No. 3,468,141**

**Registered July 15, 2008**

**TRADEMARK  
PRINCIPAL REGISTER**

**C d e C**

C D E C (FRANCE SOCIÉTÉ À RESPONSABILITÉ  
LIMITÉE)  
44, RUE DE LA TOUR  
F-75116 PARIS  
FRANCE

FOR: BLEACHING PREPARATIONS FOR LAUNDRY USE; SUBSTANCES FOR LAUNDRY USE, NAMELY, LAUNDRY SOAP, LAUNDRY DETERGENT, LAUNDRY STARCH, LAUNDRY PRE-SOAK, LAUNDRY SIZING, BLUEING FOR LAUNDRY, ESSENTIAL OILS AS PERFUME FOR LAUNDRY PURPOSES, FABRIC SOFTENERS; POLISHING PREPARATIONS AND POWDERS; GENERAL PURPOSE CLEANING, POLISHING, AND ABRASIVE LIQUIDS AND POWDERS; SCOURING LIQUIDS AND POWDERS; ABRASIVE PREPARATIONS, NAMELY, SKIN ABRASIVE PREPARATIONS AND ABRASIVE PASTE; SOAPS, NAMELY, MEDICATED SOAPS, HAND SOAPS, LIQUID SOAPS, BATH SOAPS, AND BAR SOAPS; PERFUMES, ESSENTIAL OILS, COSMETICS, HAIR LOTIONS, SHAMPOOS, DENTIFRICES, MAKE-UP REMOVING PREPARATIONS, LIPSTICK, MAKE-UP, MASCARA, NAIL CARE PREPARATIONS; COSMETIC PRODUCTS FOR SKIN CARE, NAMELY, NON-MEDICATED SKIN CARE PREPARATIONS, MOISTURIZING CREAMS FOR SKIN CARE, COSMETIC CREAMS, CHEMICAL AND FRUIT ACID PEELS FOR SKIN, BODY POLISH, NON-MEDICATED SKIN SERUM, AND WRINKLE REMOVING SKIN CARE PREPARATIONS; BEAUTY MASKS, DEODORANTS FOR PERSONAL USE IN THE NATURE OF PERFUMERY, IN CLASS 3 (U.S. CLS. 1, 4, 6, 50, 51 AND 52).

FOR: CLOTHING, NAMELY, TEE-SHIRTS, BREECHES FOR WEAR, PANTS, TIGHTS, SOCKS, SHOES, BELTS, NECKTIES, SWIMSUITS, PAREOS, TUNICS, COATS, JACKETS, POLO SHIRTS, BATH ROBES, SUSPENDERS, DRESSES, SKIRTS, PULLOVERS, TROUSERS, SHORTS, SHIRTS, STOLES; CHILDREN'S CLOTHING, NAMELY, TEE-SHIRTS, BREECHES FOR WEAR, PANTS, TIGHTS, SOCKS, SHOES, BELTS, NECKTIES, SWIMSUITS, PAREOS, TUNICS, COATS, JACKETS, POLO SHIRTS, BATH ROBES, SUSPENDERS, DRESSES, SKIRTS, PULLOVERS, TROUSERS, SHORTS, SHIRTS, STOLES; BABY SLEEPING SUITS IN THE NATURE OF INFANT SLEEPERS; FOOTWEAR, SLIPPERS; HEADWEAR; VESTS; GLOVES; BELTS; BABY BIBS, NOT OF PAPER; MASQUERADE COSTUMES; LAYETTES; BABY BUNTINGS, IN CLASS 25 (U.S. CLS. 22 AND 39).

THE MARK CONSISTS OF STANDARD CHARACTERS WITHOUT CLAIM TO ANY PARTICULAR FONT, STYLE, SIZE, OR COLOR.

PRIORITY DATE OF 5-29-2006 IS CLAIMED.

OWNER OF INTERNATIONAL REGISTRATION  
0927485 DATED 11-28-2006, EXPIRES 11-28-2016.

SER. NO. 79-039,797, FILED 11-28-2006.

JAMES MACFARLANE, EXAMINING ATTORNEY

**Int. Cls.: 9, 35, 38 and 42**

**Prior U.S. Cls.: 21, 23, 26, 36, 38, 100, 101, 102 and 104**

**United States Patent and Trademark Office**

**Reg. No. 3,468,142**

**Registered July 15, 2008**

**TRADEMARK  
SERVICE MARK  
PRINCIPAL REGISTER**



ELERTZ LIMITED (UNITED KINGDOM UNITED KINGDOM LIMITED COMPANY)  
4 BLAIRADAM GROVE  
KELTYBRIDGE; KELTY, FIFE KY4 0JU  
UNITED KINGDOM

FOR: COMPUTER SOFTWARE AND COMPUTER PROGRAMS FOR FACILITATING THE TRANSMISSION OF BROADCAST E-MAILS; COMPUTER PROGRAMS AND COMPUTER SOFTWARE FOR MONITORING THE WEBSITES OF OTHERS, IN CLASS 9 (U.S. CLS. 21, 23, 26, 36 AND 38).

FOR: SERVICES FOR INDEXING INFORMATION AND DATA FROM WEBSITES; PROVIDING INFORMATION RELATING TO CHANGES IN THE WEBSITES OF OTHERS FOR THIRD PARTIES; PROVIDING INFORMATION RELATING CONTENT CHANGES IN THE WEBSITES OF OTHERS; PROVIDING INFORMATION RELATING TO THE GOODS AND SERVICES OF OTHERS PROVIDED BY THE WEBSITES OF THIRD PARTIES; BUSINESS MONITORING SERVICES, NAMELY, MONITORING THE WEBSITES OF OTHERS FOR PURPOSES OF DETERMINING WHEN CONTENT HAS CHANGED, IN CLASS 35 (U.S. CLS. 100, 101 AND 102).

FOR: COMMUNICATION SERVICES, NAMELY, ELECTRONIC TRANSMISSION OF DATA, IMAGES AND DOCUMENTS VIA COMPUTER TERMINALS, NETWORKS, THE INTERNET AND OTHER ELEC-

TRONIC COMMUNICATIONS NETWORKS TO CONTENT PROVIDERS AND NOT END USERS, IN CLASS 38 (U.S. CLS. 100, 101 AND 104).

FOR: COMPUTER PROGRAMMING SERVICES; PROVISION OF COMPUTER SERVICES, NAMELY, PROVISION OF COMPUTER PROGRAMMING SERVICES FEATURING DEVELOPMENT OF COMPUTER PROGRAMS TO FACILITATE SEARCHING AND RETRIEVING INFORMATION AND DATA FROM WEB SITES OF OTHERS FOR THIRD PARTIES TO FACILITATE THE MONITORING THE WEB SITES OF OTHERS, AND TO FACILITATE THE CREATION, INDEXING, SEARCHING AND RETRIEVING OF INFORMATION FROM THE WEB SITES OF OTHERS, IN CLASS 42 (U.S. CLS. 100 AND 101).

PRIORITY DATE OF 10-4-2006 IS CLAIMED.

OWNER OF INTERNATIONAL REGISTRATION 0927528 DATED 4-4-2007, EXPIRES 4-4-2017.

THE COLOR(S) ORANGE, WHITE AND GREY IS/ ARE CLAIMED AS A FEATURE OF THE MARK.

THE COLOR GRAY APPEARS INSIDE THE ARC WITH A WHITE BORDER, TO THE LEFT OF THE

ORANGE CIRCLE CONTAINING THE WHITE OUT-  
LINE OF A MEERKAT INSIDE THE ORANGE  
CIRCLE.

SER. NO. 79-039,809, FILED 4-4-2007.

ODESSA BIBBINS, EXAMINING ATTORNEY

**Int. Cls.: 1, 3 and 5**

**Prior U.S. Cls.: 1, 4, 5, 6, 10, 18, 26, 44, 46, 50, 51 and 52**

**United States Patent and Trademark Office**

**Reg. No. 3,468,143**

**Registered July 15, 2008**

**TRADEMARK  
PRINCIPAL REGISTER**

# KIOSMETINE

KITOZYME S.A. (BELGIUM CORPORATION)  
PARC INDUSTRIEL DES HAUTS SARTS  
ZONE 2, RUE HAUTE CLAIRE 4; B-4040 HERSTAL  
BELGIUM

FOR: CHEMICALS USED IN INDUSTRY AND SCIENCE; PLANT BIOPOLYMERS, NAMELY, CHITIN, CHITOSANS, CHITIN-GLUCAN AND DERIVATIVES OF THESE PRODUCTS USED IN SCIENCE AND IN THE COSMETICS INDUSTRY, IN CLASS 1 (U.S. CLS. 1, 5, 6, 10, 26 AND 46).

FOR: COSMETICS; COSMETICS BASED ON PLANT BIOPOLYMERS, IN CLASS 3 (U.S. CLS. 1, 4, 6, 50, 51 AND 52).

FOR: PHARMACEUTICAL PREPARATIONS BASED ON PLANT BIOPOLYMERS USED IN MEDICINE FOR ITS HIGH MOISTURIZING, REGENERATING, WOUND-HEALING, ANTI-AGING AND

ANTIMICROBIAL PROPERTIES, IN CLASS 5 (U.S. CLS. 6, 18, 44, 46, 51 AND 52).

THE MARK CONSISTS OF STANDARD CHARACTERS WITHOUT CLAIM TO ANY PARTICULAR FONT, STYLE, SIZE, OR COLOR.

PRIORITY DATE OF 10-30-2006 IS CLAIMED.

OWNER OF INTERNATIONAL REGISTRATION 0927614 DATED 4-26-2007, EXPIRES 4-26-2017.

THE TERM "KIOSMETINE" HAS NO MEANING IN A FOREIGN LANGUAGE.

SER. NO. 79-039,844, FILED 4-26-2007.

SIMON TENG, EXAMINING ATTORNEY

**Int. Cls.: 12, 21 and 25**

**Prior U.S. Cls.: 2, 13, 19, 21, 22, 23, 29, 30, 31, 33, 35,  
39, 40, 44 and 50**

**Reg. No. 3,468,144**

**United States Patent and Trademark Office**

**Registered July 15, 2008**

**TRADEMARK  
PRINCIPAL REGISTER**

**fi'zi:k**

SELLE ROYAL S.P.A. (ITALY CORPORATION)  
VIA VITTORIO EMANUELE, 119  
I-36050 POZZOLEONE (VI), ITALY

FOR: SADDLES AND BICYCLE ACCESSORIES,  
NAMELY, WATER BOTTLE HOLDERS FOR BI-  
CYCLES, BICYCLE HANDLES, BICYCLE PEDALS,  
KICKSTANDS, KITS FOR BICYCLES COMPOSED  
OF TOOLS AND TIRE REPAIR KITS FOR BI-  
CYCLES, IN CLASS 12 (U.S. CLS. 19, 21, 23, 31, 35  
AND 44).

FOR: BOTTLE GOURDS, IN CLASS 21 (U.S. CLS. 2,  
13, 23, 29, 30, 33, 40 AND 50).

FOR: FOOTWEAR AND CLOTHING, NAMELY,  
TRACKSUITS, SALOPETTES, SHIRTS, TROUSERS,  
SHORTS, JACKETS, SOCKS, HATS, CAPS AND  
SHOES, ALL THESE GOODS FOR CYCLING PUR-  
POSES, IN CLASS 25 (U.S. CLS. 22 AND 39).

OWNER OF INTERNATIONAL REGISTRATION  
0647720 DATED 8-2-1995, EXPIRES 8-2-2015.

OWNER OF U.S. REG. NOS. 2,045,461 AND  
3,218,231.

SER. NO. 79-039,869, FILED 4-11-2007.

CARYN GLASSER, EXAMINING ATTORNEY

**Int. Cls.: 17 and 19**

**Prior U.S. Cls.: 1, 5, 12, 13, 33, 35 and 50**

**United States Patent and Trademark Office**

**Reg. No. 3,468,145**

**Registered July 15, 2008**

**TRADEMARK  
PRINCIPAL REGISTER**

**GREYPEX**

GAPI S.R.L. (ITALY LTD LIAB CO)  
VIA MARCONI, 108  
I-24060 CASTELLI CALEPIO  
ITALY

FOR: PIPE GASKETS; NON-METAL GASKETS FOR MANUFACTURING; SEMI-FINISHED PLASTIC PRODUCTS IN THE FORM OF SHEETS, BOARDS, BANDS OR RODS; FLEXIBLE TUBES, NOT OF METAL, FOR CONSTRUCTION AND GENERAL USE, IN CLASS 17 (U.S. CLS. 1, 5, 12, 13, 35 AND 50).

FOR: NON-METALLIC RIGID PIPES; PLASTIC OR COMPOSITE MATERIALS IN THE FORM OF EXTRUDED PROFILES FOR USE IN MANUFACTURING, IN CLASS 19 (U.S. CLS. 1, 12, 33 AND 50).

THE MARK CONSISTS OF STANDARD CHARACTERS WITHOUT CLAIM TO ANY PARTICULAR FONT, STYLE, SIZE, OR COLOR.

PRIORITY DATE OF 3-13-2007 IS CLAIMED.

OWNER OF INTERNATIONAL REGISTRATION 0927966 DATED 5-22-2007, EXPIRES 5-22-2017.

SER. NO. 79-039,952, FILED 5-22-2007.

FLORENTINA BLANDU, EXAMINING ATTORNEY

**Int. Cl.: 5**

**Prior U.S. Cls.: 6, 18, 44, 46, 51 and 52**

**Reg. No. 3,468,146**

**United States Patent and Trademark Office**

**Registered July 15, 2008**

**TRADEMARK  
PRINCIPAL REGISTER**

# **NANOPEUTICS**

ELMARCO S.R.O. (CZECH REPUBLIC CORPORATION)  
V HORKÁCH 76  
CZ-460 07 LIBEREC 9  
CZECH REPUBLIC

FOR: MEDICAL PLASTERS, GAUZES, SURGICAL BANDAGES, BANDAGES FOR THE PROTECTION OF WOUNDS, BANDAGES FOR INTERNAL USE AND MEDICAL DRESSINGS, ALL INCORPORATING NANOFIBERS OR INCORPORATING MEDICALLY COATED OR IMPREGNATED NANOFIBER LAYERS FEATURING ACTIVE INGREDIENTS AND HACOMOSTATIC PREPARATIONS

FOR USE ON BOTH HUMANS AND ANIMALS, IN CLASS 5 (U.S. CLS. 6, 18, 44, 46, 51 AND 52).

THE MARK CONSISTS OF STANDARD CHARACTERS WITHOUT CLAIM TO ANY PARTICULAR FONT, STYLE, SIZE, OR COLOR.

OWNER OF INTERNATIONAL REGISTRATION 0927979 DATED 4-12-2007, EXPIRES 4-12-2017.

SER. NO. 79-039,956, FILED 4-12-2007.

JAMES GRIFFIN, EXAMINING ATTORNEY



**Int. Cl.: 10**

**Prior U.S. Cls.: 26, 39 and 44**

**United States Patent and Trademark Office**

**Reg. No. 3,468,147**

**Registered July 15, 2008**

**TRADEMARK  
PRINCIPAL REGISTER**

**MAGICUT**

KOHDENT ROLAND KOHLER; MEDIZINTECH-  
NIK GMBH & CO. KG (FED REP GERMANY  
GMBH & CO. KG)  
DANNINGEN 9  
78579 NEUHAUSEN OB ECK  
FED REP GERMANY

FOR: DENTAL AND SURGICAL INSTRUMENTS,  
NAMELY, SCISSORS WITH CERAMIC COATING  
SURFACES, IN CLASS 10 (U.S. CLS. 26, 39 AND 44).

PRIORITY DATE OF 2-14-2007 IS CLAIMED.

OWNER OF INTERNATIONAL REGISTRATION  
0928131 DATED 5-24-2007, EXPIRES 5-24-2017.

SER. NO. 79-039,991, FILED 5-24-2007.

REBECCA POVARCHUK, EXAMINING ATTOR-  
NEY

**Int. Cl.: 25**

**Prior U.S. Cls.: 22 and 39**

**United States Patent and Trademark Office**

**Reg. No. 3,468,148**

**Registered July 15, 2008**

**TRADEMARK  
PRINCIPAL REGISTER**

**FRIGO**

FRIGO PRODUCTION LTD (BR.VIRGIN IS-  
LANDS LTD LIAB CO)  
P.O. BOX 12263  
SE-102 26 STOCKHOLM  
SWEDEN

OWNER OF INTERNATIONAL REGISTRATION  
0928252 DATED 6-29-2007, EXPIRES 6-29-2017.

FOR: CLOTHES, NAMELY, MENS UNDER-  
WEAR, ATHLETIC UNDERWEAR AND SWIM-  
WEAR, IN CLASS 25 (U.S. CLS. 22 AND 39).

SER. NO. 79-040,023, FILED 6-29-2007.

PRIORITY DATE OF 12-29-2006 IS CLAIMED.

CHRIS DONINGER, EXAMINING ATTORNEY

Int. Cls.: 5, 24 and 25

Prior U.S. Cls.: 6, 18, 22, 39, 42, 44, 46, 50, 51 and 52

United States Patent and Trademark Office

Reg. No. 3,468,149

Registered July 15, 2008

TRADEMARK  
PRINCIPAL REGISTER



SENEVENS INTERNATIONAL LTD (AUSTRALIA AUSTRALIAN COMPANY)  
P.O. BOX 474  
COMO WA 6952  
AUSTRALIA

FOR: SANITARY PERSONAL PRODUCTS, NAMELY, SANITARY PADS, SANITARY NAPKINS, SANITARY PANTIES, SANITARY TOWELS, AND SANITARY KNICKERS; INCONTINENCE PRODUCTS, NAMELY, PADS, NAPKINS AND PANTS; NAPPIES FOR INCONTINENCE; DIAPERS FOR INCONTINENCE; ABSORBENT COTTON AND ABSORBENT WADDING FOR MEDICAL PURPOSES; ABSORBENT SANITARY PRODUCTS FOR THE ABSORPTION OF WASTE BODY FLUIDS AND WASTE BODY MATTER, NAMELY, SANITARY NAPKINS, AND SANITARY PADS; SANITARY PREPARATIONS FOR MEDICAL PURPOSES FOR ADULTS; ADULT DIAPERS AND NAPPIES FOR INCONTINENCE, IN CLASS 5 (U.S. CLS. 6, 18, 44, 46, 51 AND 52).

FOR: UNFITTED FURNITURE COVERING PROTECTORS OF TEXTILE AND PLASTIC; UNFITTED BED, COT, MATTRESS AND CHAIR COVERING PROTECTORS OF TEXTILE OR PLASTIC; DIAPERED LINEN, IN CLASS 24 (U.S. CLS. 42 AND 50).

FOR: BABIES' AND CHILDREN'S NAPPIES OF TEXTILE; DIAPERS OF TEXTILE AND CLOTH; CLOTHING FOR BABIES AND CHILDREN, NAMELY, UNDERGARMENTS, SHIRTS, SHORTS AND JUMPERS; BABIES' BIBS NOT OF PAPER, PANTIES;

PROTECTOR CLOTHING, NAMELY, CHILDREN'S CLOTH EATING BIBS, INFANT DIAPER COVER OF TEXTILE; TEXTILE NAPPIES AND TEXTILE DIAPERS; TEXTILE AND CLOTH DIAPERS AND NAPPY LINERS; ADULT UNDERWEAR INCLUDING UNDERPANTS AND PANTIES; CLOTHING, NAMELY, PANTS, SHIRTS, SHORTS, UNDERPANTS, PANTIES; FOOTWEAR AND HEADGEAR, NAMELY, HATS AND CAPS, IN CLASS 25 (U.S. CLS. 22 AND 39).

PRIORITY DATE OF 7-12-2006 IS CLAIMED.

OWNER OF INTERNATIONAL REGISTRATION 0928269 DATED 1-12-2007, EXPIRES 1-12-2017.

OWNER OF U.S. REG. NO. 3,187,639.

NO CLAIM IS MADE TO THE EXCLUSIVE RIGHT TO USE "NAPPY", APART FROM THE MARK AS SHOWN.

THE MARK CONSISTS OF THE TERM "SAFETIES" WITH THE DOT OVER THE LETTER "I" REPRESENTED BY A STYLIZED DEPICTION OF A GLOBE, ABOVE THE PHRASE "NATURE NAPPY".

SER. NO. 79-040,030, FILED 1-12-2007.

MYRIAH HABEEB, EXAMINING ATTORNEY

**Int. Cls.: 3, 8, 14, 18, 20 and 25**

**Prior U.S. Cls.: 1, 2, 3, 4, 6, 13, 22, 23, 25, 27, 28, 32, 39, 41, 44, 50, 51 and 52**

**Reg. No. 3,468,150**

**United States Patent and Trademark Office**

**Registered July 15, 2008**

**TRADEMARK  
PRINCIPAL REGISTER**

**TAHĪZEA**

PEARL DESIGN (SOCIÉTÉ PAR ACTIONS SIMPLIFIÉE) (FRANCE SOCIÉTÉ PAR ACTIONS SIMPLIFIÉES)  
IMMEUBLE MOUX  
PAPEETE, TAHITI; FRENCH POLYNESIA  
FRANCE

FOR: COSMETICS; PERFUMERY; SOAPS; ESSENTIAL OILS; HAIR LOTIONS; DENTIFRICES, IN CLASS 3 (U.S. CLS. 1, 4, 6, 50, 51 AND 52).

FOR: CUTLERY; FORKS; SPOONS, IN CLASS 8 (U.S. CLS. 23, 28 AND 44).

FOR: PRECIOUS METALS AND THEIR ALLOYS; JEWELRY; PRECIOUS STONES; HOROLOGICAL AND CHRONOMETRIC INSTRUMENTS; RINGS; EARRINGS; CUFF LINKS; BRACELETS; WATCH BANDS; BROOCHES; NECK CHAINS; NECKLACES; PEARLS; SEMI-PRECIOUS STONES; PENDANTS; ANKLETS; FASHION JEWELRY; JEWELRY CASES MADE OF LEATHER AND IMITATION LEATHER; JEWELRY BOXES NOT OF PRECIOUS METAL; HOROLOGICAL AND CHRONOMETRIC INSTRUMENTS, RINGS, EARRINGS, CUFF LINKS, BRACELETS, WATCH BANDS, BROOCHES, NECK CHAINS, NECKLACES, PEARLS, SEMI-PRECIOUS STONES, PENDANTS, ANKLETS AND FASHION JEWELRY MADE IN PART OF UNWORKED OR SEMI-WORKED MOTHER-OF-PEARL, IN CLASS 14 (U.S. CLS. 2, 27, 28 AND 50).

FOR: LEATHER AND IMITATION LEATHER; UMBRELLAS; SUITCASES; BEACH BAGS; RUCKSACKS; HANDBAGS; TRAVELING BAGS; VALISES;

TRAVELING SETS COMPRISED OF LUGGAGE; LEATHER LACES NAMELY FOR UMBRELLAS, SUITCASES, BEACH BAGS, RUCKSACKS, HANDBAGS, TRAVELING BAGS, VALISES AND LEATHER TRAVELING SETS COMPRISED OF LUGGAGE; LEATHER THONGS, IN CLASS 18 (U.S. CLS. 1, 2, 3, 22 AND 41).

FOR: MIRRORS; PICTURE FRAMES; RAW MOTHER-OF-PEARL, NAMELY, UNWORKED OR SEMI-WORKED MOTHER-OF-PEARL; MIRRORS AND PICTURES FRAMES MADE IN PART OF MOTHER-OF-PEARL, UNWORKED OR SEMI-WORKED MOTHER-OF-PEARL; GOODS OF MOTHER-OF-PEARL, NAMELY, UNWORKED OR SEMI-WORKED MOTHER-OF-PEARL FOR USE IN THE MANUFACTURE OF MIRRORS AND PICTURES FRAMES, IN CLASS 20 (U.S. CLS. 2, 13, 22, 25, 32 AND 50).

FOR: HEADGEAR, NAMELY, SCARVES; LEATHER OR IMITATION LEATHER BELTS, IN CLASS 25 (U.S. CLS. 22 AND 39).

OWNER OF INTERNATIONAL REGISTRATION 0928452 DATED 3-29-2007, EXPIRES 3-29-2017.

THE WORDING "TAHĪZEA" HAS NO MEANING IN A FOREIGN LANGUAGE

SER. NO. 79-040,112, FILED 3-29-2007.

WILLIAM ROSSMAN, EXAMINING ATTORNEY

Int. Cl.: 7

Prior U.S. Cls.: 13, 19, 21, 23, 31, 34 and 35

United States Patent and Trademark Office

Reg. No. 3,468,151

Registered July 15, 2008

TRADEMARK  
PRINCIPAL REGISTER

**TWIN.GO**

LEADER PUMPS GROUP S.P.A. (ITALY JOINT STOCK COMPANY)  
VIA BONANNO PISANO, 1  
I-56031 BIENTINA (PI), ITALY

FOR: SUBMERSIBLE PUMPS; SURFACE PUMPS; AQUARIUM PUMPS; SWIMMING POOL PUMPS; FOUNTAIN PUMPS; WATER PUMPS FOR GARDENING AND DOMESTIC PURPOSES; WATER PUMP ACCESSORIES, NAMELY, CHECK VALVES, SUCTION HOSES, FOOT VALVES, CONNECTING SWIVELS, DISCHARGE FITTINGS AND PUMP CONTROLS, SOLD AS UNITS WITH WATER PUMPS; COMPRESSED AIR PUMPS; PUMPS FOR HOT WATER; CENTRIFUGAL PUMPS; VACUUM PUMPS, BEING MACHINES; SUCTION PUMPS; SUMP PUMPS; POSITIVE DISPLACEMENT PUMPS; ROTARY PUMPS, NAMELY, WET ROTOR PUMPS; DIAPHRAGM PUMPS; BOOSTER SETS, NAMELY, COMPLETE PUMPS SYSTEMS, COMPRISING PUMPS, CONTROL PANELS, SUCTION AND DELIVERY MANIFOLDS, ASSEMBLED ON BASEMENTS; ELECTRIC PUMPS IN THE NATURE OF ELECTRO PUMP MACHINES; ELECTRIC PUMPS

AS PARTS OF MACHINES; PUMP CONTROL VALVES; PUMP IMPELLERS; SLUDGE PUMPS; POWER TRANSMISSIONS AND GEARING FOR MACHINES, NOT FOR LAND VEHICLES; WATER PUMPS FOR USE IN MOTORS AND ENGINES; PUMPS FOR COOLING ENGINES; ENGINES NOT FOR LAND VEHICLES, IN CLASS 7 (U.S. CLS. 13, 19, 21, 23, 31, 34 AND 35).

PRIORITY DATE OF 12-19-2006 IS CLAIMED.

OWNER OF INTERNATIONAL REGISTRATION  
0928480 DATED 4-5-2007, EXPIRES 4-5-2017.

THE MARK CONSISTS OF A SIGN DEPICTING THE WORDING "TWIN.GO" IN FANCY CHARACTERS.

SER. NO. 79-040,119, FILED 4-5-2007.

ANNE E. GUSTASON, EXAMINING ATTORNEY

Int. Cl.: 7

Prior U.S. Cls.: 13, 19, 21, 23, 31, 34 and 35

United States Patent and Trademark Office

Reg. No. 3,468,152

Registered July 15, 2008

TRADEMARK  
PRINCIPAL REGISTER

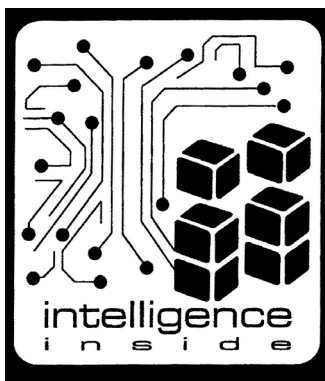

LEADER PUMPS GROUP S.P.A. (ITALY JOINT STOCK COMPANY)  
VIA BONANNO PISANO, 1  
I-56031 BIENTINA (PI), ITALY

FOR: SUBMERSIBLE PUMPS; SURFACE PUMPS; AQUARIUM PUMPS; SWIMMING POOL PUMPS; FOUNTAIN PUMPS; WATER PUMPS FOR GARDENING AND DOMESTIC PURPOSES; WATER PUMP ACCESSORIES, NAMELY, CHECK VALVES, SUCTION HOSES, FOOT VALVES, CONNECTING SWIVELS, DISCHARGE FITTINGS AND PUMP CONTROLS, SOLD AS UNITS WITH WATER PUMPS; COMPRESSED AIR PUMPS; PUMPS FOR HOT WATER; CENTRIFUGAL PUMPS; VACUUM PUMPS, BEING MACHINES; SUCTION PUMPS; SUMP PUMPS; POSITIVE DISPLACEMENT PUMPS; ROTARY PUMPS, NAMELY, WET ROTOR PUMPS; DIAPHRAGM PUMPS; BOOSTER SETS, NAMELY, COMPLETE PUMPS SYSTEMS, COMPRISING PUMPS, CONTROL PANELS, SUCTION AND DELIVERY MANIFOLDS, ASSEMBLED ON BASEMENTS; ELECTRIC PUMPS IN THE NATURE OF ELECTRO PUMP MACHINES; ELECTRIC PUMPS AS PARTS OF MACHINES; PUMP CONTROL VALVES; PUMP IMPELLERS; SLUDGE PUMPS; POWER TRANSMISSIONS AND GEARING FOR MACHINES, NOT FOR LAND VEHICLES; WATER

PUMPS FOR USE IN MOTORS AND ENGINES; PUMPS FOR COOLING ENGINES; ENGINES NOT FOR LAND VEHICLES, IN CLASS 7 (U.S. CLS. 13, 19, 21, 23, 31, 34 AND 35).

PRIORITY DATE OF 12-19-2006 IS CLAIMED.

OWNER OF INTERNATIONAL REGISTRATION 0928481 DATED 4-5-2007, EXPIRES 4-5-2017.

THE MARK CONSISTS OF A SIGN COMPOSED OF A RECTANGLE CONTAINING A SMALLER RECTANGLE WITH ROUND CORNERS, INSERTED INSIDE WHICH THERE IS THE ILLUSTRATION OF A SERIES OF BROKEN LINES HAVING A SMALL CIRCLE AT THE BEGINNING AND END, SIX CUBES PLACED ONE ABOVE THE OTHER AND POSITIONED IN GROUPS OF THREE AND THE WORDING "INTELLIGENCE INSIDE" IN FANCY CHARACTERS.

SER. NO. 79-040,120, FILED 4-5-2007.

ANNE E. GUSTASON, EXAMINING ATTORNEY

**Int. Cl.: 7**

**Prior U.S. Cls.: 13, 19, 21, 23, 31, 34 and 35**

**United States Patent and Trademark Office**

**Reg. No. 3,468,153**

**Registered July 15, 2008**

**TRADEMARK  
PRINCIPAL REGISTER**

# I-CHARGER

RICHWOOD CREEK PTY LTD (AUSTRALIA  
COMPANY)  
8 FOREST RIDGE CRESCENT  
GRANDCHESTER QLD 4340  
AUSTRALIA

FOR: SUPERCHARGERS FOR INTERNAL COM-  
BUSTION ENGINES; COMPRESSORS FOR INTER-  
NAL COMBUSTION ENGINES, NAMELY, SCREW  
COMPRESSORS, LOBE COMPRESSORS, VANE  
COMPRESSORS, BLADE COMPRESSORS, GAS  
COMPRESSORS, AIR COMPRESSORS, ELECTRIC  
COMPRESSORS, HYDRAULIC COMPRESSORS;  
AIR INTAKE DEVICES, NAMELY, AIR-INTAKE  
TUBES, FILTERS, WATER-COOLED CONDEN-  
SERS, AIR-COOLED CONDENSERS, WATER-AIR  
COOLED CONDENSERS AND COMPRESSED AIR

PUMPS FOR USE IN CARS AND TRUCKS, IN  
CLASS 7 (U.S. CLS. 13, 19, 21, 23, 31, 34 AND 35).

THE MARK CONSISTS OF STANDARD CHAR-  
ACTERS WITHOUT CLAIM TO ANY PARTICULAR  
FONT, STYLE, SIZE, OR COLOR.

PRIORITY DATE OF 10-19-2006 IS CLAIMED.

OWNER OF INTERNATIONAL REGISTRATION  
0928485 DATED 4-11-2007, EXPIRES 4-11-2017.

SER. NO. 79-040,122, FILED 4-11-2007.

CHARISMA HAMPTON, EXAMINING ATTORNEY

**Int. Cls.: 18 and 25**

**Prior U.S. Cls.: 1, 2, 3, 22, 39 and 41**

**United States Patent and Trademark Office**

**Reg. No. 3,468,154**

**Registered July 15, 2008**

**TRADEMARK  
PRINCIPAL REGISTER**

**VANTO**

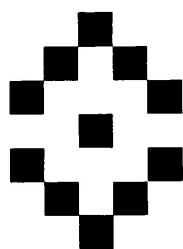

VIRGI S.R.L. (ITALY SOCIÉTÉ À RESPONSABILITÉ LIMITÉE (S.A.R.L.))  
CORSO MATTEOTTI 38  
I-10121 TORINO, ITALY

FOR: ARTICLES OF LEATHER OR OF IMITATION LEATHER, NAMELY, BAGS, PURSES, BACKPACKS, TRAVELLING BAGS, VANITY CASES SOLD EMPTY, BOXES, CARD HOLDERS, PAPER HOLDERS, KEY HOLDERS, DOCUMENT HOLDERS AND ADDRESS BOOK HOLDERS, CASES, BRACELETS; LUGGAGE TRUNKS AND SUITCASES; UMBRELLAS, PARASOLS, WALKING STICKS; WHIPS, HARNESSES AND SADDLERY, IN CLASS 18 (U.S. CLS. 1, 2, 3, 22 AND 41).

FOR: CLOTHING, NAMELY, COATS, JACKETS, RAINCOATS, BLAZER, TROUSERS, JEANS, SKIRTS, DRESS, TAILLEURS, SUITS, PULLOVERS, T-SHIRTS, SHIRTS, TOPS, UNDERWEAR, NIGHT-SHIRT, NIGHTGOWN, PAJAMAS, BATHROBES,

SWIMMING SUITS, SHAWLS, SCARVES, TIES, NECKTIES, STOCKINGS, SOCKS, GLOVES, BELTS; ARTICLES OF CLOTHING MADE FROM LEATHER OR OF IMITATION OF LEATHER, NAMELY, COATS, JACKETS, TROUSERS, SKIRTS, TOPS, DRESS, GLOVES, BELTS; FOOTWEAR AND BOOTS; HEADWEAR, IN CLASS 25 (U.S. CLS. 22 AND 39).

OWNER OF INTERNATIONAL REGISTRATION  
0928656 DATED 5-22-2007, EXPIRES 5-22-2017.

THE FOREIGN WORDING IN THE MARK  
TRANSLATES INTO ENGLISH AS PRIDE, MERIT  
OR CREDIT.

SER. NO. 79-040,193, FILED 5-22-2007.

SUSAN LESLIE DUBOIS, EXAMINING ATTORNEY



Int. Cl.: 37

Prior U.S. Cls.: 100, 103 and 106

Reg. No. 3,468,155

United States Patent and Trademark Office

Registered July 15, 2008

**SERVICE MARK  
PRINCIPAL REGISTER**

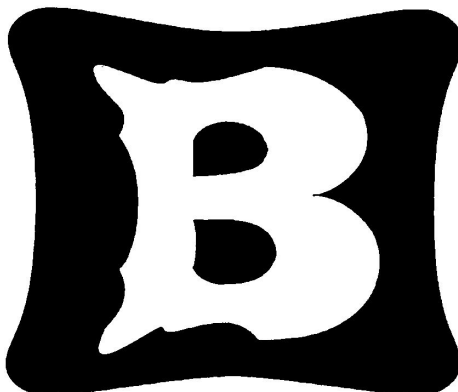

KABUSHIKI KAISHA R.C. CORE; (R.C. CORE  
CO., LTD.) (JAPAN CORPORATION LIMITED)  
4-5, AOBADAI 1-CHOME,  
MEGURO-KU; TOKYO 153-0042  
JAPAN

FOR: GENERAL BUILDING CONSTRUCTION WORKS; NON-UNDERWATER DREDGING; GENERAL CIVIL ENGINEERING WORKS IN THE NATURE OF CONSTRUCTION SERVICES; ROAD PAVING; MASONRY; GLAZING; STEEL STRUCTURE CONSTRUCTION WORKS; PLASTERING; CARPENTRY; TILE LAYING, BRICKLAYING OR BLOCK LAYING; JOINERY; BUILDING REINFORCING; PAINTING; SCAFFOLDING, EARTHWORKS OR CONCRETE CONSTRUCTION; UPHOLSTERING; BUILDING DAMP-PROOFING; ROOFING SERVICES; PLUMBING; INSTALLATION OF MACHINERY, NAMELY, FIRE ALARMS, AIR-CONDITIONING APPARATUS FOR INDUSTRIAL PURPOSES, BOILERS, PUMPS, VIDEO FREQUENCY MACHINES AND APPARATUS, FACSIMILE MACHINES, TELEPHONES, RADIOS, TELEVISION SETS, CONSTRUCTION MACHINES AND APPARATUS, ELECTRIC LIGHTING APPARATUS, POWER GENERATORS, ELECTRIC MOTORS, MEASURING AND TESTING MACHINES AND INSTRUMENTS METALWORKING MACHINES AND TOOLS MACHINES AND APPARATUS FOR LUMBERING, WOODWORKING, OR VENEER OR PLYWOOD MAKING, PAINTING MACHINES AND APPARATUS, STORAGE TANKS, MECHANICAL PARKING SYSTEMS BICYCLE PARKING APPARATUS WATER POLLUTION CONTROL EQUIPMENT, WATER PURIFYING APPARATUS, LOCKS, GAS WATER

HEATERS, NON-ELECTRIC COOKING HEATERS, GAME MACHINES AND APPARATUS, BATHTUBS AND THE LIKE, TOILET STOOL UNITS WITH A WASHING WATER SQUIRTS, CHIMNEY SWEEPING MACHINERY AND APPARATUS, ELECTRIC WASHING MACHINES; DRILLING OF WELLS; INSTALLATION OF ELECTRICAL SYSTEMS; TELECOMMUNICATION WIRING; INSTALLATION OF THERMAL INSULATING FOR BUILDINGS; CONSTRUCTION CONSULTANCY; OPERATION IN THE NATURE OF WORKING, RUNNING AND CHECKING BUILDINGS AND BUILDING EQUIPMENT, NAMELY, INSPECTING AND MAINTENANCE OF BUILDINGS AND MAINTENANCE OF BUILDING EQUIPMENT; CUSTOM SHIPBUILDING; REPAIR OR MAINTENANCE OF VESSELS; AIRCRAFT MAINTENANCE OR REPAIR; REPAIR OF BICYCLES; REPAIR OR MAINTENANCE OF AUTOMOBILES; REPAIR OR MAINTENANCE OF RAILWAY ROLLING STOCK; REPAIR OR MAINTENANCE OF TWO-WHEELED MOTOR VEHICLES; REPAIR OR MAINTENANCE OF MOVIE PROJECTORS; REPAIR OR MAINTENANCE OF OVERHEAD PROJECTORS; REPAIR OF BINOCULARS; REPAIR OF CAMERAS; REPAIR OF LENSES; REPAIR OR MAINTENANCE OF ELEVATORS; REPAIR OR MAINTENANCE OF CONVEYORS; REPAIR OR MAINTENANCE OF FIRE ALARMS; REPAIR OR MAINTENANCE OF OFFICE MACHINES AND APPARATUS; REPAIR OR MAINTENANCE OF AIR-CONDITIONING APPARATUS FOR INDUSTRIAL PURPOSES; BURNER MAINTENANCE OR REPAIR; REPAIR OR MAINTENANCE OF BOILERS; PUMP REPAIR OR MAINTENANCE; REPAIR OR MAINTENANCE OF FREEZING MA-

CHINES AND APPARATUS; REPAIR OR MAINTENANCE OF COMPUTERS; REPAIR OR MAINTENANCE OF VIDEO FREQUENCY MACHINES AND APPARATUS; REPAIR OF FACSIMILE MACHINES; REPAIR OR MAINTENANCE OF CONSTRUCTION MACHINES AND APPARATUS; REPAIR OR MAINTENANCE OF CONSUMER ELECTRIC APPLIANCES; REPAIR OR MAINTENANCE OF ELECTRIC LIGHTING APPARATUS; REPAIR OR MAINTENANCE OF POWER DISTRIBUTION OR CONTROL MACHINES AND APPARATUS; REPAIR OR MAINTENANCE OF POWER GENERATORS; REPAIR OR MAINTENANCE OF ELECTRIC MOTORS; REPAIR OR MAINTENANCE OF LABORATORY APPARATUS AND INSTRUMENTS; REPAIR OR MAINTENANCE OF MEASURING AND TESTING MACHINES AND INSTRUMENTS; REPAIR OR MAINTENANCE OF MEDICAL MACHINES AND APPARATUS; REPAIR OR MAINTENANCE OF FIREARMS; REPAIR OR MAINTENANCE OF PRINTING OR BOOKBINDING MACHINES AND APPARATUS; REPAIR OR MAINTENANCE OF CHEMICAL PROCESSING MACHINES AND APPARATUS; REPAIR OR MAINTENANCE OF GLASSWARE MANUFACTURING MACHINES AND APPARATUS; REPAIR OR MAINTENANCE OF FISHING MACHINES AND INSTRUMENTS; REPAIR OR MAINTENANCE OF METALWORKING MACHINES AND TOOLS; REPAIR OR MAINTENANCE OF SHOE MAKING MACHINES AND INSTRUMENTS; REPAIR OR MAINTENANCE OF INDUSTRIAL FURNACES; REPAIR OR MAINTENANCE OF MINING MACHINES AND APPARATUS; REPAIR OR MAINTENANCE OF RUBBER-GOODS MANUFACTURING MACHINES AND APPARATUS; REPAIR OR MAINTENANCE OF INTEGRATED CIRCUITS MANUFACTURING MACHINES AND SYSTEMS; REPAIR OR MAINTENANCE OF SEMICONDUCTOR MANUFACTURING MACHINES AND SYSTEMS; REPAIR OR MAINTENANCE OF MACHINES AND APPARATUS FOR PROCESSING FOODS OR BEVERAGES; REPAIR OR MAINTENANCE OF MACHINES AND APPARATUS FOR LUMBERING, WOODWORKING, OR VENEER OR PLYWOOD MAKING; REPAIR OR MAINTENANCE OF TEXTILE MACHINES AND APPARATUS; REPAIR OR MAINTENANCE OF TOBACCO PROCESSING MACHINES; REPAIR OR MAINTENANCE OF PAINTING MACHINES AND APPARATUS; REPAIR OR MAINTENANCE OF PLOWING MACHINES AND IMPLEMENTS OTHER THAN HAND-HELD TOOLS; REPAIR OR MAINTENANCE OF CULTIVATING MACHINES AND IMPLEMENTS; REPAIR OR MAINTENANCE OF HARVESTING MACHINES AND IMPLEMENTS; REPAIR OR MAINTENANCE OF PLANT FIBER PROCESSING MACHINES AND IMPLEMENTS; REPAIR OR MAINTENANCE OF FODDER PRESSES; REPAIR OR MAINTENANCE OF FODDER CUTTERS; REPAIR OR MAINTENANCE OF FODDER MIXERS; REPAIR OR MAINTENANCE OF FODDER MILLS; REPAIR OR MAINTENANCE OF MACHINES AND APPARATUS FOR PULP-MAKING, PAPER MAKING OR PAPER-WORKING; REPAIR OR MAINTENANCE OF PLASTIC PROCESSING MACHINES AND APPARATUS; REPAIR OR MAINTENANCE OF PACKING OR WRAP-

PING MACHINES AND APPARATUS; REPAIR OR MAINTENANCE OF SEWING MACHINES; REPAIR OR MAINTENANCE OF STORAGE TANKS; REPAIR OR MAINTENANCE OF GASOLINE STATION EQUIPMENT; REPAIR OR MAINTENANCE OF MECHANICAL PARKING SYSTEMS; REPAIR OR MAINTENANCE OF BICYCLE PARKING APPARATUS; REPAIR OR MAINTENANCE OF INDUSTRIAL DISH WASHING MACHINES; REPAIR OR MAINTENANCE OF COOKING APPARATUS FOR INDUSTRIAL PURPOSES; REPAIR OR MAINTENANCE OF INDUSTRIAL WASHING MACHINES; REPAIR OR MAINTENANCE OF VEHICLE WASHING INSTALLATIONS; REPAIR OR MAINTENANCE OF VENDING MACHINES; REPAIR OR MAINTENANCE OF POWER-DRIVEN FLOOR CLEANING MACHINES; REPAIR OR MAINTENANCE OF AMUSEMENT MACHINES AND APPARATUS; REPAIR OR MAINTENANCE OF MACHINES AND APPARATUS FOR USE IN BEAUTY SALONS OR BARBERS' SHOPS; REPAIR OR MAINTENANCE OF WATER POLLUTION CONTROL EQUIPMENT; REPAIR OR MAINTENANCE OF WATER PURIFYING APPARATUS; REPAIR OR MAINTENANCE OF WASTE COMPACTING MACHINES AND APPARATUS; REPAIR OR MAINTENANCE OF WASTE CRUSHING MACHINES AND APPARATUS; REPAIR OR MAINTENANCE OF DIVING MACHINES AND APPARATUS; REPAIR OR MAINTENANCE OF NUCLEAR POWER PLANTS; REPAIR OR MAINTENANCE OF CHEMICAL PLANTS; FURNITURE RESTORATION; UMBRELLA REPAIR; REPAIR OR MAINTENANCE OF MUSICAL INSTRUMENTS; SAFE MAINTENANCE OR REPAIR; CLOCK AND WATCH REPAIR OR MAINTENANCE; SHARPENING OF SCISSORS AND KITCHEN KNIVES; SETUP OR REPAIR OF LOCKS; REPAIR OR MAINTENANCE OF GAS WATER HEATERS; REPAIR OR MAINTENANCE OF NON-ELECTRIC COOKING HEATERS; REPAIR OR MAINTENANCE OF COOKING POTS AND PANS; REPAIR OR MAINTENANCE OF SIGNBOARDS; REPAIR OF TOYS OR DOLLS; REPAIR OF SPORTS EQUIPMENT; REPAIR OF BILLIARD EQUIPMENT; REPAIR OF GAME MACHINES AND APPARATUS; REPAIR OR MAINTENANCE OF BATHTUBS AND THE LIKE; REPAIR OF TOILET STOOL UNITS WITH A WASHING WATER SQUIRTS; REPAIR OF FISHING TACKLE; REPAIR OF SPECTACLES; CHIMNEY SWEEPING; CLEANING OF BUILDING EXTERIOR SURFACES; WINDOW CLEANING; CARPET AND RUG CLEANING; FLOOR POLISHING; SEPTIC TANK CLEANING; BATHTUB AND BATH BOILER CLEANING; STREET CLEANING; STORAGE TANK CLEANING; DISINFECTING OF TELEPHONE HAND SETS; VERMIN EXTERMINATING OTHER THAN FOR AGRICULTURE, FORESTRY OR HORTICULTURE; STERILIZATION OF MEDICAL MACHINES AND APPARATUS; RENTAL OF CONSTRUCTION MACHINES AND APPARATUS; RENTAL OF FLOOR CLEANING MACHINES; RENTAL OF MOPS; RENTAL OF CAR-WASHING APPARATUS; RENTAL OF ELECTRIC WASHING MACHINES; RENTAL OF LAUNDRY DRYERS; RENTAL OF SPIN DRYERS FOR CLOTHES; RENTAL OF MINING MACHINES

AND APPARATUS, IN CLASS 37 (U.S. CLS. 100, 103  
AND 106).

SER. NO. 79-040,224, FILED 3-12-2007.

OWNER OF INTERNATIONAL REGISTRATION  
0928761 DATED 3-12-2007, EXPIRES 3-12-2017.

WILLIAM ROSSMAN, EXAMINING ATTORNEY

**Int. Cls.: 9, 16, 37, 38, 41, 42 and 45**

**Prior U.S. Cls.: 2, 5, 21, 22, 23, 26, 29, 36, 37, 38, 50,  
100, 101, 103, 104, 106 and 107**

**Reg. No. 3,468,156**

**United States Patent and Trademark Office**

**Registered July 15, 2008**

**TRADEMARK  
SERVICE MARK  
PRINCIPAL REGISTER**



SES DIGITAL DISTRIBUTION SERVICES AG; C/  
O SCHELLENBERG WITTMER (SWITZER-  
LAND AG)

LÖWENSTRASSE 19  
CH-8023 ZÜRICH  
SWITZERLAND

FOR: SCIENTIFIC, NAUTICAL, SURVEYING, PHOTOGRAPHIC, CINEMATOGRAPHIC, OPTICAL, WEIGHING, MEASURING, SIGNALING, CHECKING AND SUPERVISION, LIFE SAVING AND TEACHING APPARATUS AND INSTRUMENTS, NAMELY, SENSING AND SIGNALING DEVICES FOR MEASUREMENT AND QUALITY CONTROL OF MATERIALS PROCESSING BY LASER, PHOTOGRAPHIC FILTERS, CINEMATOGRAPHIC CAMERAS; APPARATUS AND INSTRUMENTS FOR CONDUCTING, SWITCHING, TRANSFORMING, ACCUMULATING, REGULATING OR CONTROLLING ELECTRICITY, NAMELY, ELECTRICAL CONDUCTORS, ELECTRIC SWITCHES, ELECTRICAL TRANSFORMERS, ELECTRIC ACCUMULATORS, VOLTAGE REGULATORS FOR ELECTRIC POWER, ELECTRICAL CONTROLLERS; APPARATUS FOR RECORDING, TRANSMITTING AND REPRODUCING SOUND OR IMAGES; BLANK MAGNETIC DATA CARRIERS; BLANK RECORDABLE OPTICAL DISCS; AUTOMATIC AND MECHANICAL VENDING MACHINES FOR COIN-OPERATED APPARATUS, NAMELY, AUTOMATIC AND MECHANICAL

VENDING MACHINES, COIN-OPERATED VIDEO GAMES, COIN-OPERATED AMUSEMENT MACHINES, COIN-OPERATED GATES FOR CAR PARKING FACILITIES; CASH REGISTERS; CALCULATORS; DATA PROCESSING AND COMPUTER EQUIPMENT, NAMELY, DATA PROCESSORS, CENTRAL PROCESSING UNITS FOR PROCESSING INFORMATION, DATA, SOUND OR IMAGES, BACK UP DRIVES FOR COMPUTERS; FIRE EXTINGUISHERS; APPARATUS FOR BROADCASTING, TRANSMITTING, RECORDING AND RECEIVING RADIO OR TELEVISION SIGNALS VIA SATELLITE OR CABLE, NAMELY, RADIO AND TELEVISION SIGNAL TRANSMITTERS, RADIO AND TELEVISION SIGNAL RECEIVERS, DVD RECEIVERS; SATELLITES; TRANSPONDERS; APPARATUS FOR RECEIVING, RECORDING AND DECODING DATA WITH MODEM FUNCTION, NAMELY, SET-TOP BOXES; DVD MACHINES, NAMELY, DVD RECEIVERS AND HARD DISK DVD RECEIVERS; SATELLITE DISHES, SATELLITE AERIALS, AERIALS; TELEVISIONS; REMOTE CONTROL UNITS FOR TELEVISIONS; EQUIPMENT FOR TELEVISION VIA CABLE OR SATELLITE, NAMELY, CABLE TELEVISION CONVERTERS, RECEIVERS FOR SATELLITES; APPARATUS FOR VIDEO RECORDING AND REPRODUCTION, NAMELY, DIGITAL VIDEO RECORDERS; AMPLIFIERS; AERIALS FOR THE RECEPTION OF SIGNALS VIA SATELLITE; VIDEO RECORDINGS FEATURING MUSIC, SELF-IMPROVEMENT HELP, MATHEMATICS INSTRU-

TION; SPECTACLES; SUNGLASSES, IN CLASS 9 (U.S. CLS. 21, 23, 26, 36 AND 38).

FOR: PRINTED PERIODICALS IN THE FIELD OF TELEVISION PROGRAMMING; MANUALS IN THE FIELD OF TECHNICAL EQUIPMENT; PAPER, CARDBOARD AND GOODS MADE FROM THESE MATERIALS, NAMELY, BOXES OF PAPER OR CARDBOARD, CARDBOARD PACKAGING, PACKING PAPER; PHOTOGRAPHS; STATIONERY; OFFICE REQUISITES, NAMELY, ADHESIVE TAPE DISPENSERS, CORRECTING FLUID FOR TYPE, FINGER-STALLS, FRANKING MACHINES, ENVELOPE SEALING MACHINES, PUNCHES, RUBBER BANDS, STAPLERS; INSTRUCTIONAL AND TEACHING MATERIAL, NAMELY, INSTRUCTION SHEETS, MANUALS IN THE FIELD OF INSTRUCTIONAL MATH, TEACHING TILES; PLASTIC MATERIALS FOR PACKAGING, NAMELY, ENVELOPES, BAGS AND PLASTIC FILM NOT FOR COMMERCIAL OR INDUSTRIAL PURPOSES; PRINTING TYPE; PRINTING BLOCKS, IN CLASS 16 (U.S. CLS. 2, 5, 22, 23, 29, 37, 38 AND 50).

FOR: REPAIR, INSTALLATION AND MAINTENANCE OF TELECOMMUNICATION EQUIPMENT, EQUIPMENT FOR COMMUNICATION VIA SATELLITE, EQUIPMENT FOR BROADCASTING TELEVISION AND RADIO PROGRAMS, SET-TOP BOXES, AERIALS FOR THE RECEPTION OF SIGNALS VIA SATELLITE, MEMORY OR MICROPROCESSOR CARDS, IN CLASS 37 (U.S. CLS. 100, 103 AND 106).

FOR: TELECOMMUNICATIONS SERVICES, NAMELY, PERSONAL COMMUNICATION SERVICES, ISDN SERVICES, TELECOMMUNICATIONS ACCESS SERVICES, DATA TRANSMISSION AND RECEPTION SERVICES VIA TELECOMMUNICATION MEANS, TELECOMMUNICATIONS GATEWAY SERVICES; TELEPHONE COMMUNICATION SERVICES; SATELLITE COMMUNICATION SERVICES; TRANSMISSION OF SOUND, PICTURE AND DATA SIGNALS, NAMELY, TRANSMISSION OF RADIO PROGRAMS, DATA, AND TELEVISION PROGRAMS VIA SATELLITE; RADIO PROGRAM BROADCASTING VIA SATELLITE; SATELLITE TELEVISION BROADCASTING; TELETXT SERVICES; TRANSMISSION OF SOUND, PICTURE AND DATA SIGNALS, NAMELY, TRANSMISSION AND DISSEMINATION OF DATA, PICTURES AND NEWS VIA COMPUTER ASSISTED WITH MODEM, NARROWBAND, BROADBAND, AND TELEVISION CONNECTIONS; ONLINE SERVICES, NAMELY, PROVIDING ON-LINE COMMUNICATIONS LINKS WHICH TRANSFER THE WEBSITE USER TO OTHER LOCAL AND GLOBAL WEB PAGES; COMMUNICATIONS BY COMPUTER TERMINALS; TRANSMISSION OF DATA, TEXTS AND PICTURES; PROVIDING EQUIPMENT FOR COMMUNICATION VIA SATELLITE; TRANSMISSION OF SOUND, PICTURE AND DATA SIGNALS, NAMELY, TRANSMISSION OF DATA, PICTURES, MUSIC, FILMS AND MULTIMEDIA PROGRAMS VIA COMPUTER AND THE INTERNET; PROVIDING TELECOMMUNICATION CONNECTIONS TO GLOBAL COMPUTER NETWORKS; PROVISION OF ACCESS TO A GLOBAL COMPUTER NETWORK; ELECTRO-

NIC MESSAGE TRANSMISSION VIA TELEVISION SIGNAL DECODER; TRANSMISSION OF SOUND, PICTURE AND DATA SIGNALS, NAMELY, SIGNAL MODULATION AND COMPRESSION FOR SIGNAL TRANSMISSION AND FOR TRANSMISSION VIA SATELLITE; ENCRYPTION OF RADIO AND TELEVISION PROGRAMS; RENTAL OF ACCESS TIME TO SATELLITES FOR TRANSMITTING TELEVISION PROGRAMS OR TRANSMITTING ENCRYPTED DATA; CONSULTING IN THE FIELD OF TRANSMITTING AND DISSEMINATING RADIO AND TELEVISION PROGRAMS AND DATA VIA SATELLITE; ELECTRONIC MAIL SERVICES VIA CABLED NETWORKS, SATELLITE NETWORKS, WIRELESS NETWORKS AND GLOBAL COMMUNICATION NETWORKS; PRESS AND INFORMATION AGENCIES FEATURING THE TRANSMISSION OF NEWS ITEMS TO NEWS REPORTING ORGANIZATIONS; PROVIDING PORTALS ON THE INTERNET, NAMELY, PROVIDING MULTIPLE-USER ACCESS TO A GLOBAL COMPUTER INFORMATION NETWORK; PROVIDING TELECOMMUNICATION CHANNELS FOR TELESHOPPING; PROVIDING THE ELECTRONIC TELECOMMUNICATION CONNECTION AND THE EQUIPMENT FOR VIDEO-CONFERENCES; TRANSMISSION OF ELECTRONIC MESSAGES; RENTAL OF EQUIPMENT AND INSTRUMENTS FOR TELECOMMUNICATIONS; RENTAL OF ACCESS TIME TO GLOBAL COMPUTER NETWORKS; CONSULTING IN THE FIELD OF TELECOMMUNICATIONS, IN CLASS 38 (U.S. CLS. 100, 101 AND 104).

FOR: PUBLICATION OF ELECTRONIC NEWSPAPERS ACCESSIBLE VIA A GLOBAL COMPUTER NETWORK, IN CLASS 41 (U.S. CLS. 100, 101 AND 107).

FOR: SCIENTIFIC AND TECHNOLOGICAL SERVICES AND RELATED RESEARCH AND DESIGN SERVICES, NAMELY, SCIENTIFIC RESEARCH, SCIENTIFIC INVESTIGATIONS FOR MEDICAL PURPOSES; DESIGN AND DEVELOPMENT OF COMPUTERS AND SOFTWARE; DEVELOPMENT, INSTALLATION, MAINTENANCE AND UPDATING OF COMPUTER PROGRAMS AND SOFTWARE FOR THE TRANSFORMATION AND RECORDING OF RADIO AND TELEVISION PROGRAMS AND DATA; COMPUTER PROGRAMMING FOR DATA-PROCESSING PURPOSES; DESIGN AND DEVELOPMENT OF COMPUTERS AND THEIR PERIPHERAL EQUIPMENT; DESIGN OF WEBSITES; COMPUTER SECURITY SERVICE, NAMELY, RESTRICTING ACCESS TO AND BY COMPUTER NETWORKS TO AND OF UNDESIRED WEB SITES, MEDIA AND INDIVIDUALS AND FACILITIES VIA DIGITAL KEYS AND ELECTRONIC SIGNATURES; GRAPHIC ARTS DESIGN SERVICES; IMAGE PROCESSING SOFTWARE DESIGN; SECURING AND RECORDING OF ELECTRONIC DATA, NAMELY, RECORDING DATA FOR OTHERS ON OPTICAL, DIGITAL AND MAGNETIC MEDIA FOR ELECTRONIC STORAGE; COMPUTER RENTAL; RENTAL OF A DATABASE SERVER; RECORDING DATA FOR OTHERS ON OPTICAL, DIGITAL AND MAGNETIC MEDIA FOR ELECTRONIC STORAGE, IN CLASS 42 (U.S. CLS. 100 AND 101).

FOR: LEGAL SERVICES; LEGAL SERVICES,  
NAMELY, MANAGEMENT AND EXPLOITATION  
OF COPYRIGHTS AND INDUSTRIAL PROPERTY  
TITLES FOR THIRD PARTIES; LICENSING OF  
FILMS, TELEVISION AND VIDEO, IN CLASS 45  
(U.S. CLS. 100 AND 101).

PRIORITY DATE OF 8-9-2006 IS CLAIMED.

OWNER OF INTERNATIONAL REGISTRATION  
0928817 DATED 1-29-2007, EXPIRES 1-29-2017.

SER. NO. 79-040,239, FILED 1-29-2007.

KATHERINE E. HALMEN, EXAMINING ATTOR-  
NEY

**Int. Cls.: 7, 11 and 37**

**Prior U.S. Cls.: 13, 19, 21, 23, 31, 34, 35, 100, 103 and 106**

**Reg. No. 3,468,157**

**United States Patent and Trademark Office**

**Registered July 15, 2008**

**TRADEMARK  
SERVICE MARK  
PRINCIPAL REGISTER**

**TOC**

F.W. OVENTROP GMBH & CO. KG (FED REP  
GERMANY LIMITED PARTNERSHIP)  
PAUL-OVENTROP-STRASSE 1  
59939 OLSBERG  
FED REP GERMANY

FOR: MACHINES FOR FILTERING OIL, IN  
CLASS 7 (U.S. CLS. 13, 19, 21, 23, 31, 34 AND 35).

FOR: DEAERATORS WHICH CONTAIN HEAT-  
ING OIL FILTERS FOR USE IN BUILDING TECH-  
NOLOGY AND THE AUTOMOTIVE INDUSTRY;  
ELECTRIC SPACE HEATERS; HEATING PLANTS,  
NAMELY, HOT WATER HEATERS, SOLAR HEAT-  
ERS FOR PROVIDING HEAT TO BUILDINGS  
AND WATER, RADIANT HEATERS, RADIANT  
FLOOR HEATERS, HYDRONIC SNOW MELTING  
HEATERS FOR DRIVEWAYS, SIDEWALKS, ROOFS  
AND GUTTERS, SOLAR COLLECTORS, IN CLASS  
11 (U.S. CLS. 13, 21, 23, 31 AND 34).

FOR: BUILDING CONSTRUCTION AND UN-  
DERGROUND BUILDING CONSTRUCTION; IN-

STALLATION OF HEATING FURNACES,  
ELECTRIC SPACE HEATERS, DEAERATORS  
WHICH CONTAIN HEATING OIL FILTERS FOR  
USE IN BUILDING TECHNOLOGY AND THE AU-  
TOMOTIVE INDUSTRY AND MACHINES FOR  
FILTERING OIL, IN CLASS 37 (U.S. CLS. 100, 103  
AND 106).

THE MARK CONSISTS OF STANDARD CHAR-  
ACTERS WITHOUT CLAIM TO ANY PARTICULAR  
FONT, STYLE, SIZE, OR COLOR.

OWNER OF INTERNATIONAL REGISTRATION  
0928841 DATED 11-24-2006, EXPIRES 11-24-2016.

THE WORDING "TOC" HAS NO MEANING IN  
FOREIGN LANGUAGE.

SER. NO. 79-040,251, FILED 11-24-2006.

DANIEL CAPSHAW, EXAMINING ATTORNEY

**Int. Cls.: 9, 10 and 11**

**Prior U.S. Cls.: 13, 21, 23, 26, 31, 34, 36, 38, 39 and 44**

**Reg. No. 3,468,158**

**United States Patent and Trademark Office**

**Registered July 15, 2008**

**TRADEMARK  
PRINCIPAL REGISTER**

**NOVAESTETYC**  
digital & biotechnology instruments

NOVAVISION GROUP S.R.L. (ITALY SOCIÉTÉ  
RESPONSABILITÉ LIMITÉE)

F.LLI RUFFINI, 10

I-20123 MILANO

ITALY

FOR: ELECTRONIC AND SCIENTIFIC APPARATUS, NAMELY, BLANK ELECTRONIC CHIP CARDS, ELECTRONIC CIRCUITS; NAUTICAL, SURVEYING AND ELECTRICAL APPARATUS AND INSTRUMENTS, NAMELY, SURVEYING MACHINES AND INSTRUMENTS; COMPACT DISC PLAYERS; MP3 PLAYERS; CELLULAR TELEPHONES; ELECTRIC CABLES; ELECTRIC SWITCHES; ELECTRONIC APPARATUS AND INSTRUMENTS, NAMELY, ELECTRONIC AGENDAS, ELECTRONIC CIRCUIT BOARDS, ELECTRONIC CODING UNITS; TELEVISION APPARATUS, NAMELY, TELEVISION SETS, TELEVISION TRANSMITTERS; SET-TOP BOXES FOR TELEVISION SETS; RADIOS, RADIO RECEIVERS, RADIO TRANSMITTERS, RADIO TELEPHONES, RECORD PLAYERS; PHONOGRAPH RECORDS FEATURING MUSIC; BLANK AUDIO TAPES; BLANK VIDEO TAPES AND DIGITAL VIDEO RECORDERS; OPTICAL DISC PLAYERS; PHOTOGRAPHIC, CINEMATOGRAFIC, OPTICAL, WEIGHING, MEASURING AND SIGNALING APPARATUS, NAMELY, PHOTOGRAPHIC CAMERAS, PHOTOGRAPHIC PROJECTORS, CINEMATOGRAFIC FILM, OPTICAL CABLES; VIDEO CAMERAS; APPARATUS FOR LIVE RECORDING AND BROADCASTING OF TELEVISION SHOWS, NAMELY, PROGRAMMABLE DIGITAL TELEVISION RECORDERS; TRANSPONDERS FOR RADIO AND TELEVISION STATIONS; RADIO AND TELEVISION AERIALS; APPARATUS FOR THE REMOTE AMPLIFICATION, RECEPTION AND TRANSMISSION OF RADIO SIGNALS, NAMELY, AMPLIFIERS, RADIO RECEIVERS, RADIO TRANSMITTERS; SPECTACLES; SUNGLASSES; SPECTACLE GLASSES; MONITORING, INSPECTION, EMERGENCY, LIFE-SAVING AND TEACHING APPARATUS, NAMELY, BABY MONITORS, OPTICAL INSPECTION APPARATUS FOR INDUS-

TRIAL USE, LIFE-SAVING RAFTS; AUTOMATIC COIN OR TOKEN-OPERATED APPARATUS, NAMELY, COIN-OPERATED GATES FOR CAR PARKING FACILITIES; SOUND AMPLIFIERS AND CINEMATOGRAFIC PROJECTORS; CASH REGISTERS; CALCULATORS; FIRE EXTINGUISHERS; ELECTRIC FLAT IRONS; COMPUTER PROGRAMS FOR COMPUTERS FOR USE IN DATABASE MANAGEMENT, USE AS A SPREAD SHEET, WORD PROCESSING; COMPUTERS; CARDS FOR COMPUTERS, NAMELY, COMPUTER FAX MODERN CARDS, MEMORY CARDS; MICROPROCESSORS FOR COMPUTERS; COMPUTER PRINTERS; MODEM; FACSIMILE MACHINES; TELEPHONE APPARATUS; MICROPROCESSORS; SOFTWARE FOR USE IN DATABASE MANAGEMENT, FOR USE AS A SPREADSHEET, AND FOR WORD PROCESSING, FOR THE AESTHETICS FIELD; EAR-PLUGS FOR SLEEPING, SOUND-PROOFING, AND SWIMMING, NOT FOR MEDICAL PURPOSES; EPILUMINESCENCE VIDEO CAMERAS FOR DERMATOLOGICAL MEDICAL AND AESTHETIC USE, IN CLASS 9 (U.S. CLS. 21, 23, 26, 36 AND 38).

FOR: SURGICAL, MEDICAL AND VETERINARY APPARATUS AND INSTRUMENTS FOR USE IN GENERAL SURGERY; DENTAL INSTRUMENTS, NAMELY, PICKS, BURRS, MIRRORS, ORAL IRRIGATORS; DENTAL APPARATUS, NAMELY, INTRA-ORAL LIGHT SYSTEMS; ELECTROMEDICAL DEVICES, NAMELY, CARDIAC ELECTRODES, MEDICAL ELECTRODES, ELECTROCARDIOGRAPHS; BIOMEDICAL APPARATUS FOR BEAUTY AND HEALTH CARE, NAMELY, FACIAL TONING MACHINES FOR COSMETIC USE, LASERS FOR THE COSMETIC TREATMENT OF THE FACE AND SKIN; DIAGNOSTIC APPARATUS FOR MEDICAL PURPOSES, NAMELY, APPARATUS FOR CLINICAL DIAGNOSIS, ULTRASOUND DIAGNOSTIC APPARATUS; MASKS AND DEVICES FOR COSMETIC AND MEDICAL USE, NAMELY, ANESTHETIC MASKS, SURGICAL MASKS, OXYGEN MASKS FOR MEDICAL USE; APPARATUS



FOR SKIN EXAMINATION FOR MEDICAL AND COSMETIC PURPOSES, NAMELY, SKIN CARE ANALYZERS AND LIGHT THERAPY EQUIPMENT, NAMELY, A BLACK-LIGHT BLUE LAMP UNIT FOR USE IN IDENTIFICATION OF A VARIETY OF SKIN CONDITIONS; SYRINGES FOR MEDICAL PURPOSES AND FOR INJECTION; ARTIFICIAL LIMBS, EYES AND TEETH; SURGICAL PROSTHESES FOR BREAST, HAND; ORTHOPEDIC SUPPORT BANDAGES; SPECIAL FURNITURE FOR SURGICAL USE, FOR DENTISTS AND VETERINARIANS, NAMELY, DENTAL CHAIRS, MEDICAL PATIENT TREATMENT CHAIRS, OPERATING TABLES, PATIENT EXAMINATION TABLES; SURGICAL INSTRUMENTS FOR PLASTIC AND COSMETIC SURGERY, IN CLASS 10 (U.S. CLS. 26, 39 AND 44).

FOR: APPARATUS FOR LIGHTING, NAMELY, LIGHTING FIXTURES, LIGHTING TUBES; CHANDELIERS; LAMPS; LAMPS FOR BEAUTY SERVICES; SUN LAMPS; XENON LAMPS; ELECTRIC LIGHT BULBS AND SPOTLIGHTS; HEATING APPARATUS, NAMELY, HOT-AIR SPACE HEATERS, HOT-WATER SPACE HEATERS, PAVEMENT HEATERS, AND STEAM HEATING APPARATUS; FURNACE BOILERS FOR HEATING INSTALLATIONS; GAS BURNERS FOR HEATING INSTALLATIONS FOR INDUSTRIAL, COMMERCIAL, AND DOMESTIC USE; APPARATUS FOR PRODUCING STEAM, NAMELY, STEAM GENERATORS, STEAM VALVES, STEAM RADIATORS FOR HEATING BUILDINGS; APPARATUS FOR COOKING PURPOSES, NAMELY, COOKTOPS, COOKING RANGERS, DOMESTIC AND COMMERCIAL COOKING OVENS, MICROWAVE COOKING OVENS; APPARATUS FOR REFRIGERATING PURPOSES, NAMELY, REFRIGERATING MACHINES, REFRIGERATORS; AIR CONDITIONING APPARATUS; APPARATUS FOR DRYING PURPOSES,

NAMELY, CLOTHES DRYERS, HAIR DRYERS, ELECTRIC HOT AIR HAND DRYERS; APPARATUS FOR VENTILATING PURPOSES, NAMELY, VENTILATING EXHAUST FANS, VENTILATING FANS FOR COMMERCIAL AND INDUSTRIAL USE, VENTILATING LOUVERS, AND VENTILATION HOODS; APPARATUS FOR WATER SUPPLY, NAMELY, SINKS, BATHTUBS, AND PIPES BEING PARTS OF SANITARY FACILITIES; SANITARY INSTALLATIONS, NAMELY, PIPES BEING PARTS OF SANITARY FACILITIES, OZONE SANITIZERS FOR AIR AND WATER, URINALS, TOILETS, TOILET BOWLS, SINKS; AND LAMPS FOR BEAUTY PURPOSES, IN CLASS 11 (U.S. CLS. 13, 21, 23, 31 AND 34).

PRIORITY DATE OF 11-16-2006 IS CLAIMED.

OWNER OF INTERNATIONAL REGISTRATION 0928853 DATED 2-7-2007, EXPIRES 2-7-2017.

NO CLAIM IS MADE TO THE EXCLUSIVE RIGHT TO USE "DIGITAL & BIOTECHNOLOGY INSTRUMENTS", APART FROM THE MARK AS SHOWN.

THE MARK CONSISTS OF THE TEXT "NOVAESTETYC" WRITTEN IN FANCY LETTERS AND UNDERNEATH BETWEEN TWO PARALLEL LINES THE TEXT "DIGITAL & BIOTECHNOLOGY INSTRUMENTS".

SER. NO. 79-040,258, FILED 2-7-2007.

KATHERINE E. HALMEN, EXAMINING ATTORNEY

**Int. Cl.: 25**

**Prior U.S. Cls.: 22 and 39**

**United States Patent and Trademark Office**

**Reg. No. 3,468,159**

**Registered July 15, 2008**

**TRADEMARK  
PRINCIPAL REGISTER**

# **STABILUS**

STABILUS SAFETY GMBH (FED REP GERMA-  
NY SOCIÉTÉ A RESPONSABILITÉ LIMITÉE)  
NÜRMBERGER STRAÙE 16  
86720 NÖRDLINGEN  
FED REP GERMANY

OWNER OF INTERNATIONAL REGISTRATION  
0567782 DATED 3-1-1991, EXPIRES 3-1-2011.

SER. NO. 79-040,299, FILED 5-23-2007.

FOR: FOOTWEAR, IN CLASS 25 (U.S. CLS. 22 AND  
39).

AMY HELLA, EXAMINING ATTORNEY

**Int. Cl.: 7**

**Prior U.S. Cls.: 13, 19, 21, 23, 31, 34 and 35**

**Reg. No. 3,468,160**

**United States Patent and Trademark Office**

**Registered July 15, 2008**

**TRADEMARK  
PRINCIPAL REGISTER**

**JOYEE**

JIANGSU JOYEE; SEWING MACHINE CO., LTD.  
(CHINA CORPORATION)  
WANPING EAST ROAD  
HENGSHAN TOWN; WUJIANG, JIANGSU  
CHINA

FOR: WHIPSTITCH SEWING MACHINES; MACHINES FOR USE IN SHOE REPAIR; CLOTH CUTTING MACHINES; SEWING MACHINES; INDUSTRIAL SEWING MACHINE PLATES; LOCKSTITCH SEWING MACHINES; DRIVING MOTORS OTHER THAN FOR LAND VEHICLES; RADIATORS

(COOLING) FOR MOTORS AND ENGINES; STARTERS FOR MOTORS AND ENGINES, IN CLASS 7 (U.S. CLS. 13, 19, 21, 23, 31, 34 AND 35).

OWNER OF INTERNATIONAL REGISTRATION  
0928958 DATED 11-14-2006, EXPIRES 11-14-2016.

SER. NO. 79-040,323, FILED 11-14-2006.

MARGARET POWER, EXAMINING ATTORNEY

**Int. Cl.: 11**

**Prior U.S. Cls.: 13, 21, 23, 31 and 34**

**United States Patent and Trademark Office**

**Reg. No. 3,468,161**

**Registered July 15, 2008**

**TRADEMARK  
PRINCIPAL REGISTER**

# Grohe SilkMove

GROHE AG (FED REP GERMANY CORPORATION)  
HAUPTSTRAÙE 137  
58675 HEMER  
FED REP GERMANY

FOR: WATER CONDUITS BEING PARTS OF SANITARY FACILITIES FOR KITCHEN AND SANITARY USE; MIXER FAUCETS MIXING COLD AND WARM WATER, IN PARTICULAR THOSE OPERATED BY ONE HAND FOR WASHBASINS AND UTILITY SINKS, BIDETS, TUBS AND SHOWERS; SHOWERS; SHOWER FITTINGS, NAMELY, SHOWER FAUCET EXTENSIONS, SHOWER COMBINATION SYSTEMS FOR BATHROOMS, SHOWER BARS, SHOWER HOLDERS, INDIVIDUAL PARTS AND REPLACEMENTS PARTS FOR ALL THE AFORESAID GOODS, IN CLASS 11 (U.S. CLS. 13, 21, 23, 31 AND 34).

THE MARK CONSISTS OF STANDARD CHARACTERS WITHOUT CLAIM TO ANY PARTICULAR FONT, STYLE, SIZE, OR COLOR.

OWNER OF INTERNATIONAL REGISTRATION 0929032 DATED 4-12-2007, EXPIRES 4-12-2017.

OWNER OF U.S. REG. NOS. 1,151,616, 2,781,356 AND OTHERS.

SER. NO. 79-040,351, FILED 4-12-2007.

REBECCA POVARCHUK, EXAMINING ATTORNEY

**Int. Cl.: 39**

**Prior U.S. Cls.: 100 and 105**

**United States Patent and Trademark Office**

**Reg. No. 3,468,162**

**Registered July 15, 2008**

**SERVICE MARK  
PRINCIPAL REGISTER**



INTERGLOBO S.R.L. (ITALY S.R.L.)  
PIAZZA DANTE, 7 - 4<sup>a</sup> PIANO  
I-16121 GENOVA  
ITALY

FOR: TRANSPORT, NAMELY, MARINE TRANSPORT, RAILWAY AND TRUCK TRANSPORT, AIR TRANSPORT, TRANSPORT OF OILS AND GASES BY PIPELINE; PACKAGING OF GOODS FOR TRANSPORTATION IN CONTAINERS; STORAGE OF CONTAINERS NAMELY, WAREHOUSE STORAGE; DELIVERY OF GOODS BY AIR, RAIL, SHIP OR TRUCK; CARGO HANDLING, NAMELY, LOADING AND UNLOADING, FREIGHT FORWARDING; DELIVERY CONTAINER RENTAL; PROVIDING INFORMATION REGARDING TRANSPORTATION AND STORAGE OF CARGO; LOGISTICS SERVICES, NAMELY STORAGE, TRANSPORTATION AND DELIVERY OF DOCUMENTS, PACKAGES, RAW MATERIALS, AND OTHER FREIGHT FOR OTHERS BY AIR, RAIL, SHIP OR TRUCK; VEHICLE TOWING; SALVA-

GING, NAMELY, BOAT SALVAGE AT SEA; TRAFFIC MANAGEMENT SERVICES FOR OTHERS, NAMELY, CREATING TRAFFIC PLANS OF CONTAINER TERMINALS AND OF AIR CARGO TERMINALS, SHIP BROKERAGE SERVICES; LEASING OF AIR CRAFTS, TRAVEL ARRANGEMENT NAMELY, ARRANGING TRAVEL TOURS; RENTAL OF VESSELS AND TRUCKS FOR TRANSPORT BY SEA AND LAND, IN CLASS 39 (U.S. CLS. 100 AND 105).

PRIORITY DATE OF 10-18-2006 IS CLAIMED.

OWNER OF INTERNATIONAL REGISTRATION  
0929061 DATED 2-19-2007, EXPIRES 2-19-2017.

SER. NO. 79-040,363, FILED 2-19-2007.

ATTIYA MALIK, EXAMINING ATTORNEY

**Int. Cl.: 21**

**Prior U.S. Cls.: 2, 13, 23, 29, 30, 33, 40 and 50**

**United States Patent and Trademark Office**

**Reg. No. 3,468,163**

**Registered July 15, 2008**

**TRADEMARK  
PRINCIPAL REGISTER**

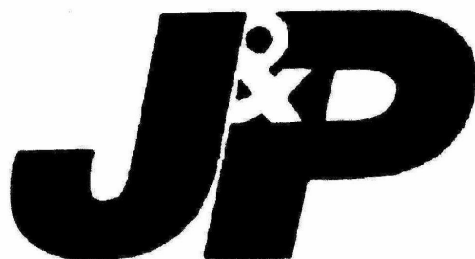

SHANXI J&P TRADING CO., LTD. (CHINA CORPORATION)  
#3, RONGXIN ROAD  
GAOXIN DEVELOPMENT ZONE, XI'AN; SHANXI CHINA

FOR: GLASSWARE FOR HOUSEHOLD PURPOSES, NAMELY, CUPS, DISHES, KETTLES, URNS; PAINTED BEVERAGE GLASSWARE; GLASS FLASKS; GLASS JARS; BOWLS; WORKS OF ART OF GLASS; GLASS CAPS, NAMELY, GLASS STOPPERS; BOXES OF GLASS; GLASS RECEPTACLES, NAMELY, GLASS BASINS, IN CLASS 21 (U.S. CLS. 2, 13, 23, 29, 30, 33, 40 AND 50).

OWNER OF INTERNATIONAL REGISTRATION  
0929246 DATED 4-13-2007, EXPIRES 4-13-2017.

THE MARK CONSISTS OF THE VERBAL ELEMENT "J&P".

SER. NO. 79-040,433, FILED 4-13-2007.

BERNICE MIDDLETON, EXAMINING ATTORNEY

**Int. Cls.: 1 and 2**

**Prior U.S. Cls.: 1, 5, 6, 10, 11, 16, 26 and 46**

**United States Patent and Trademark Office**

**Reg. No. 3,468,164**

**Registered July 15, 2008**

**TRADEMARK  
PRINCIPAL REGISTER**



DYSTAR TEXTILFARBEN GMBH & CO.;  
DEUTSCHLAND KG (FED REP GERMANY  
LIMITED PARTNERSHIP)  
65926 FRANKFURT AM MAIN  
FED REP GERMANY

FOR: TEXTILE AUXILIARIES, NAMELY, CHEMICALS USED IN THE MANUFACTURE AND FINISH OF TEXTILES; OPTICAL BRIGHTENERS, NAMELY, CHEMICAL PRODUCTS FOR BRIGHTENING DYESTUFFS, IN CLASS 1 (U.S. CLS. 1, 5, 6, 10, 26 AND 46).

FOR: DYES AND COLORANTS FOR DYEING TEXTILES AND OTHER SUBSTRATES, IN CLASS 2 (U.S. CLS. 6, 11 AND 16).

PRIORITY DATE OF 2-1-2007 IS CLAIMED.

OWNER OF INTERNATIONAL REGISTRATION  
0929257 DATED 3-28-2007, EXPIRES 3-28-2017.

THE COLOR(S) WHITE, RED (HKS 13), VIOLET (HKS 34), BLUE (HKS 44), GREEN (HKS 54), YELLOW (HKS 4), ORANGE (HKS 7) IS/ARE CLAIMED AS A FEATURE OF THE MARK.

THE MARK CONSISTS OF A SIX-POINTED STAR, WHEREIN THE STAR IS WHITE AND THE SIX FIELDS FORMED BY THE OUTER BOUNDARY LINES OF THE STAR AND THE INNER BOUNDARY LINES OF THE CIRCLE ARE COLORED AS FOLLOWS, STARTING AT THE TOP-CENTER AREA AND WORKING AROUND CLOCKWISE: RED, VIOLET, BLUE, GREEN, YELLOW AND ORANGE.

SER. NO. 79-040,437, FILED 3-28-2007.

MARILYN IZZI, EXAMINING ATTORNEY

**Int. Cl.: 10**

**Prior U.S. Cls.: 26, 39 and 44**

**United States Patent and Trademark Office**

**Reg. No. 3,468,165**

**Registered July 15, 2008**

**TRADEMARK  
PRINCIPAL REGISTER**

**SilvR dose**

ERNST MÜHLBAUER GMBH & CO. KG (FED  
REP GERMANY GMBH & CO. KG)  
KOOGSTRAAT 4  
25870 NORDERFRIEDRICHSKOOG  
FED REP GERMANY

OWNER OF INTERNATIONAL REGISTRATION  
0929332 DATED 5-14-2007, EXPIRES 5-14-2017.

FOR: CONTAINERS FOR MIXING DENTAL MA-  
TERIALS SUCH AS FILLING AND BONDING, IN  
CLASS 10 (U.S. CLS. 26, 39 AND 44).

NO CLAIM IS MADE TO THE EXCLUSIVE  
RIGHT TO USE "DOSE", APART FROM THE MARK  
AS SHOWN.

THE MARK CONSISTS OF STANDARD CHAR-  
ACTERS WITHOUT CLAIM TO ANY PARTICULAR  
FONT, STYLE, SIZE, OR COLOR.

SER. NO. 79-040,473, FILED 5-14-2007.

PRIORITY DATE OF 11-14-2006 IS CLAIMED.

EVELYN BRADLEY, EXAMINING ATTORNEY



**Int. Cl.: 5**

**Prior U.S. Cls.: 6, 18, 44, 46, 51 and 52**

**United States Patent and Trademark Office**

**Reg. No. 3,468,166**

**Registered July 15, 2008**

**TRADEMARK  
PRINCIPAL REGISTER**

**VENZIOV**

GENMAB A/S (DENMARK AKTIESELSKAP (A/S))  
TOLDBODGADE 33  
DK-1253 COPENHAGEN K, DENMARK

FOR: PHARMACEUTICAL PREPARATIONS AND SUBSTANCES FOR THE TREATMENT OF CANCER, AIDS (ACQUIRED IMMUNE DEFICIENCY SYNDROME) AND OTHER INFECTIOUS DISEASES, IMMUNE AND AUTOIMMUNE DISEASES, INFLAMMATORY DISEASES, NEURODEGENERATIVE DISEASES AND CARDIOVASCULAR DISEASES, IN CLASS 5 (U.S. CLS. 6, 18, 44, 46, 51 AND 52).

THE MARK CONSISTS OF STANDARD CHARACTERS WITHOUT CLAIM TO ANY PARTICULAR FONT, STYLE, SIZE, OR COLOR.

PRIORITY DATE OF 12-22-2006 IS CLAIMED.

OWNER OF INTERNATIONAL REGISTRATION 0929435 DATED 6-21-2007, EXPIRES 6-21-2017.

THE TERM "VENZIOV" IN THE MARK HAS NO MEANING IN A FOREIGN LANGUAGE.

SER. NO. 79-040,512, FILED 6-21-2007.

KRISTINA MORRIS, EXAMINING ATTORNEY

**Int. Cls.: 18, 25 and 35**

**Prior U.S. Cls.: 1, 2, 3, 22, 39, 41, 100, 101 and 102**

**United States Patent and Trademark Office**

**Reg. No. 3,468,167**

**Registered July 15, 2008**

**TRADEMARK  
SERVICE MARK  
PRINCIPAL REGISTER**



GOLFINO AG (FED REP GERMANY AKTIEN-  
GESELLSCHAFT)  
HUMBOLDTSTR. 19  
21509 GLINDE  
FED REP GERMANY

FOR: IMITATIONS OF LEATHER; LEATHER GOODS, NAMELY, BAGS, GARMENT BAGS, ANIMAL SKINS, HIDES; TRUNKS AND TRAVELING BAGS, HOLDALLS, HANDBAGS; CONTAINERS NOT SPECIFICALLY DESIGNED FOR THE OBJECTS TO BE CARRIED THEREIN, NAMELY, ALL-PURPOSE CARRYING BAGS, SHOE BAGS FOR TRAVEL, SPONGE BAGS IN THE NATURE OF TOILETRY BAGS SOLD EMPTY; SMALL LEATHER GOODS, NAMELY, PURSES, POCKET WALLETS, KEY WALLETS, UMBRELLAS, PARASOLS AND WALKING STICKS; WHIPS, HARNESS AND SADDLERY, IN CLASS 18 (U.S. CLS. 1, 2, 3, 22 AND 41).

FOR: CLOTHING, NAMELY, BERMUDA SHORTS, BLOUSES, CARDIGANS, COATS, DRESSES, FLEECE JACKETS, GLOVES, JACKETS, POLO SHIRTS, PULLOVERS, PULLUNDERS IN THE NATURE OF SLEEVELESS TOPS, RAIN JACKETS, RAIN TROUSERS, RAINCOATS, SCARFS, SHIRTS, SKIRTS, SOCKS, SWEATSHIRTS, TROUSERS, PANTS, T-SHIRTS, AND WAISTCOATS; FOOTWEAR; HEADGEAR, NAMELY, CAPS, HATS, HEADBANDS, RAIN HATS, VISORS; BELTS, IN CLASS 25 (U.S. CLS. 22 AND 39).

FOR: ADVERTISING; BUSINESS MANAGEMENT SERVICES; BUSINESS ADMINISTRATION; OFFICE FUNCTIONS; PRESENTATION OF GOODS AND SERVICES IN SUPERMARKETS, RETAIL OUTLETS, DEPARTMENT STORES AND ONLINE SHOPS; OPERATING SUPERMARKETS, RETAIL OUTLETS, DEPARTMENT STORES AND ONLINE SHOPS FOR OTHERS, NAMELY, THE ARRANGING AND CONCLUDING OF CONTRACTS FOR THE PURCHASE AND SALE OF GOODS AND THE USE OF SERVICES; OPERATING ONLINE RETAIL SHOPS FOR SELLERS OF GOODS AND/OR SERVICES; ORDER PLACEMENT, ARRANGING FOR DELIVERY OF PARCELS VIA GROUND AND AIR CARRIERS, AND INVOICE MANAGEMENT; BUSINESS MERCHANDISING DISPLAY SERVICES; DEMONSTRATION OF GOODS; RETAIL STORE SERVICES FEATURING LEATHER AND IMITATIONS OF LEATHER AND GOODS MADE OF THESE MATERIALS, ANIMAL SKINS, HIDES, TRUNKS AND TRAVELLING BAGS, HOLDALLS, HANDBAGS AND OTHER CONTAINERS NOT SPECIFICALLY DESIGNED FOR THE OBJECTS TO BE CARRIED THEREIN, SMALL LEATHER GOODS, IN PARTICULAR PURSES, POCKET WALLETS, KEY WALLETS, KEY FOBS, UMBRELLAS, PARASOLS AND WALKING STICKS, WHIPS, HARNESS AND SADDLERY; CLOTHING, FOOTWEAR, HEADWEAR, BELTS, IN CLASS 35 (U.S. CLS. 100, 101 AND 102).

OWNER OF INTERNATIONAL REGISTRATION  
0929457 DATED 2-14-2007, EXPIRES 2-14-2017.

SER. NO. 79-040,521, FILED 2-14-2007.

ATTIYA MALIK, EXAMINING ATTORNEY

Int. Cl.: 18

Prior U.S. Cls.: 1, 2, 3, 22 and 41

United States Patent and Trademark Office

Reg. No. 3,468,168

Registered July 15, 2008

TRADEMARK  
PRINCIPAL REGISTER



ROSSI VINCENZO (ITALY INDIVIDUAL)  
VIA PRIVATA BERGAMO, 33  
I-20030 SEREGNO (MILANO)  
ITALY

FOR: BRIEFCASE-STYLE PORTFOLIOS, CASES  
OF LEATHER OR LEATHERBOARD, SCHOOL  
SATCHELS, SCHOOL BAGS, SMALL SUITCASES,  
BRIEFCASES, IN CLASS 18 (U.S. CLS. 1, 2, 3, 22 AND  
41).

OWNER OF INTERNATIONAL REGISTRATION  
0929509 DATED 4-16-2007, EXPIRES 4-16-2017.

THE NAME "ENZO ROSSI" IDENTIFIES A LIV-  
ING INDIVIDUAL WHOSE CONSENT IS OF RE-  
CORD.

SER. NO. 79-040,538, FILED 4-16-2007.

REBECCA POVARCHUK, EXAMINING ATTOR-  
NEY

**Int. Cls.: 5 and 42**

**Prior U.S. Cls.: 6, 18, 44, 46, 51, 52, 100 and 101**

**United States Patent and Trademark Office**

**Reg. No. 3,468,169**

**Registered July 15, 2008**

**TRADEMARK  
SERVICE MARK  
PRINCIPAL REGISTER**

The logo for Loramyc features the word "Loramyc" in a blue, sans-serif font. The letter "O" is stylized with a glowing, circular effect around it, suggesting a lens or a light source.

BIOALLIANCE, PHARMA (FRANCE SOCIÉTÉ  
ANONYME A DIRECTOIRE)  
59 RUE DU GÉNÉRAL MARTIAL VALIN  
F-75015 PARIS  
FRANCE

FOR: PRODUCTS FOR MEDICAL USE, NAMELY,  
BIO-ADHESIVE COMPRESSED TABLETS FOR  
ORAL USE, IN THE TREATMENT OF FUNGAL  
INFECTIONS, OROPHARYNGEAL CANDIASIS,  
AND OTHER ORAL INFECTIONS, IN CLASS 5  
(U.S. CLS. 6, 18, 44, 46, 51 AND 52).

FOR: LABORATORY RESEARCH AND ANALY-  
SIS IN THE FIELD OF PHARMACEUTICAL PRO-  
DUCTS IN THE FORM OF BIO-ADHESIVE  
COMPRESSED TABLETS FOR THE TREATMENT  
OF FUNGAL INFECTIONS, OROPHARYNGEAL  
CANDIASIS AND OTHER ORAL INFECTIONS, IN  
CLASS 42 (U.S. CLS. 100 AND 101).

PRIORITY DATE OF 11-24-2006 IS CLAIMED.

OWNER OF INTERNATIONAL REGISTRATION  
0929625 DATED 5-14-2007, EXPIRES 5-14-2017.

THE COLOR(S) BLUE AND DARK BLUE IS/ARE  
CLAIMED AS A FEATURE OF THE MARK.

"THE MARK CONSISTS OF THE COLOR DARK  
BLUE APPEARS IN THE LOWER PORTION OF THE  
LETTERS "L, R, A, M, Y" AND "C", AND IN THE  
MIDDLE OF THE LETTER "O". THE COLOR BLUE  
APPEARS IN THE UPPER PORTION OF THE LET-  
TERS "L, R, A, M, Y" AND "C", AND IN DESIGN  
ELEMENT SURROUNDING THE LETTER "O".

SER. NO. 79-040,566, FILED 5-14-2007.

ANNE FARRELL, EXAMINING ATTORNEY

**Int. Cl.: 5**

**Prior U.S. Cls.: 6, 18, 44, 46, 51 and 52**

**United States Patent and Trademark Office**

**Reg. No. 3,468,170**

**Registered July 15, 2008**

**TRADEMARK  
PRINCIPAL REGISTER**

**GENBRIA**

GENMAB A/S (DENMARK AKTIESELSKAP (A/  
S))  
TOLDBODGADE 33  
DK-1253 COPENHAGEN K  
DENMARK

FOR: PHARMACEUTICAL PREPARATIONS  
AND SUBSTANCES FOR THE TREATMENT OF  
CANCER, AIDS (ACQUIRED IMMUNE DEFICIEN-  
CY SYNDROME) AND OTHER INFECTIOUS DIS-  
EASES, IMMUNE AND AUTOIMMUNE DISEASES,  
INFLAMMATORY DISEASES, NEURODEGENERA-  
TIVE DISEASES AND CARDIOVASCULAR DISEA-  
SES, IN CLASS 5 (U.S. CLS. 6, 18, 44, 46, 51 AND 52).

THE MARK CONSISTS OF STANDARD CHAR-  
ACTERS WITHOUT CLAIM TO ANY PARTICULAR  
FONT, STYLE, SIZE, OR COLOR.

PRIORITY DATE OF 12-22-2006 IS CLAIMED.

OWNER OF INTERNATIONAL REGISTRATION  
0929643 DATED 6-21-2007, EXPIRES 6-21-2017.

THE TERM GENBRIA IN THE MARK HAS NO  
MEANING IN A FOREIGN LANGUAGE.

SER. NO. 79-040,578, FILED 6-21-2007.

KRISTINA MORRIS, EXAMINING ATTORNEY

**Int. Cl.: 5**

**Prior U.S. Cls.: 6, 18, 44, 46, 51 and 52**

**United States Patent and Trademark Office**

**Reg. No. 3,468,171**

**Registered July 15, 2008**

**TRADEMARK  
PRINCIPAL REGISTER**

**EPTRIOR**

GENMAB A/S (DENMARK AKTIESELSKAP (A/  
S))  
TOLDBODGADE 33  
DK-1253 COPENHAGEN K, DENMARK

FOR: PHARMACEUTICAL PREPARATIONS  
AND SUBSTANCES FOR THE TREATMENT OF  
CANCER, AIDS (ACQUIRED IMMUNE DEFICIEN-  
CY SYNDROME) AND OTHER INFECTIOUS DIS-  
EASES, IMMUNE AND AUTOIMMUNE DISEASES,  
INFLAMMATORY DISEASES, NEURODEGENERA-  
TIVE DISEASES AND CARDIOVASCULAR DISEA-  
SES, IN CLASS 5 (U.S. CLS. 6, 18, 44, 46, 51 AND 52).

THE MARK CONSISTS OF STANDARD CHAR-  
ACTERS WITHOUT CLAIM TO ANY PARTICULAR  
FONT, STYLE, SIZE, OR COLOR.

PRIORITY DATE OF 12-22-2006 IS CLAIMED.

OWNER OF INTERNATIONAL REGISTRATION  
0929644 DATED 6-21-2007, EXPIRES 6-21-2017.

THE TERM "EPTRIOR" IN THE MARK HAS NO  
MEANING IN A FOREIGN LANGUAGE.

SER. NO. 79-040,579, FILED 6-21-2007.

KRISTINA MORRIS, EXAMINING ATTORNEY

**Int. Cl.: 5**

**Prior U.S. Cls.: 6, 18, 44, 46, 51 and 52**

**United States Patent and Trademark Office**

**Reg. No. 3,468,172**

**Registered July 15, 2008**

**TRADEMARK  
PRINCIPAL REGISTER**

**ABVENTEC**

GENMAB A/S (DENMARK AKTIESELSKAP (A/  
S))  
TOLDBODGADE 33  
DK-1253 COPENHAGEN K  
DENMARK

FOR: PHARMACEUTICAL PREPARATIONS  
AND SUBSTANCES FOR THE TREATMENT OF  
CANCER, AIDS (ACQUIRED IMMUNE DEFICIEN-  
CY SYNDROME) AND OTHER INFECTIOUS DIS-  
EASES, IMMUNE AND AUTOIMMUNE DISEASES,  
INFLAMMATORY DISEASES, NEURODEGENERA-  
TIVE DISEASES AND CARDIOVASCULAR DISEA-  
SES, IN CLASS 5 (U.S. CLS. 6, 18, 44, 46, 51 AND 52).

THE MARK CONSISTS OF STANDARD CHAR-  
ACTERS WITHOUT CLAIM TO ANY PARTICULAR  
FONT, STYLE, SIZE, OR COLOR.

PRIORITY DATE OF 12-22-2006 IS CLAIMED.

OWNER OF INTERNATIONAL REGISTRATION  
0929645 DATED 6-21-2007, EXPIRES 6-21-2017.

SER. NO. 79-040,580, FILED 6-21-2007.

KRISTINA MORRIS, EXAMINING ATTORNEY



**Int. Cl.: 7**

**Prior U.S. Cls.: 13, 19, 21, 23, 31, 34 and 35**

**Reg. No. 3,468,173**

**United States Patent and Trademark Office**

**Registered July 15, 2008**

**TRADEMARK  
PRINCIPAL REGISTER**

# **MOVICHROM**

KSB AKTIENGESELLSCHAFT (FED REP GER-  
MANY JOINT STOCK COMPANY)  
JOHANN-KLEIN-STRASSE 9  
67227 FRANKENTHAL  
FED REP GERMANY

FOR: PUMPS, NAMELY, ELECTRIC PUMPS,  
PUMPS FOR WATER SUPPLY, WASTE WATER  
DISPOSAL, PRESSURE BOOSTING, DRAINAGE,  
SEWAGE LIFTING PURPOSES, SLURRY, COOLING  
OR HEAT TRANSFER FLUID CIRCULATING  
PUMPS, SEWAGE PUMPS, SUBMERSIBLE PUMPS,  
CENTRIFUGAL PUMPS, FLUE GAS SCRUBBER  
PUMPS, BOILER FEED PUMPS, CONDENSATE  
PUMPS, REVERSE OSMOSIS PUMPS, WELL PUMPS,  
CORROSION-RESISTANT PUMPS, HERMETICAL-  
LY-SEALED PUMPS, DESALINATION PLANT  
PUMPS, IRRIGATION PUMPS, MAGNETIC DRIVE  
PUMPS, EXPLOSION-PROOF PUMPS; OIL AND

CHEMICAL PUMPS FOR HANDLING AGGRES-  
SIVE, TOXIC, EXPLOSIVE, VALUABLE, INFLAM-  
MABLE, MALODOROUS OR HARMFUL LIQUIDS;  
FOR CRUDE OIL TRANSPORT AND OTHER PET-  
ROCHEMICAL APPLICATIONS; MULTI-STAGE  
WATER PUMPS FOR GARDEN SPRINKLING, IR-  
RIGATION SYSTEMS, RAIN WATER UTILISA-  
TION, DOMESTIC AND MUNICIPAL WATER  
SUPPLY AND AGRICULTURAL FACILITIES, IN  
CLASS 7 (U.S. CLS. 13, 19, 21, 23, 31, 34 AND 35).

OWNER OF INTERNATIONAL REGISTRATION  
0556295 DATED 6-9-1990, EXPIRES 6-9-2010.

SER. NO. 79-040,595, FILED 3-20-2007.

BERNICE MIDDLETON, EXAMINING ATTORNEY

**Int. Cls.: 9 and 16**

**Prior U.S. Cls.: 2, 5, 21, 22, 23, 26, 29, 36, 37, 38 and 50**

**Reg. No. 3,468,174**

**United States Patent and Trademark Office**

**Registered July 15, 2008**

**TRADEMARK  
PRINCIPAL REGISTER**

**CIVIQ**

BIOFARMA (FRANCE SOCIÉTÉ PAR ACTIONS  
SIMPLIFIÉE (SAS))  
22, RUE GARNIER  
F-92200 NEUILLY-SUR-SEINE  
FRANCE

FOR: DOWNLOADABLE ELECTRONIC PUBLICATIONS AND ELECTRONIC PUBLICATIONS RECORDED ON CD-ROMS AND DIGITAL VERSATILE DISKS, ALL IN THE HEALTHCARE FIELD, NAMELY, QUESTIONNAIRES FOR USE IN EVALUATING PATIENT QUALITY OF LIFE FOR MEDICAL AND SCIENTIFIC PURPOSES, IN CLASS 9 (U.S. CLS. 21, 23, 26, 36 AND 38).

FOR: PRINTED PUBLICATIONS IN THE HEALTHCARE FIELD, NAMELY, QUESTIONNAIRES FOR USE IN EVALUATING PATIENT QUALITY OF LIFE FOR MEDICAL AND SCIENTIFIC PURPOSES, IN CLASS 16 (U.S. CLS. 2, 5, 22, 23, 29, 37, 38 AND 50).

OWNER OF INTERNATIONAL REGISTRATION  
0787832 DATED 5-14-2002, EXPIRES 5-14-2012.

SER. NO. 79-040,609, FILED 12-11-2006.

KAELIE KUNG, EXAMINING ATTORNEY

Int. Cl.: 17

Prior U.S. Cls.: 1, 5, 12, 13, 35 and 50

United States Patent and Trademark Office

Reg. No. 3,468,175

Registered July 15, 2008

TRADEMARK  
PRINCIPAL REGISTER



RECIPNEU - EMPRESA NACIONAL; DE RECI-  
CLAGEM DE PNEUS, LDA. (PORTUGAL LTD  
LIAB CO)

EDIFICIO RECIPNEU,

PARQUE INDUSTRIAL DE SINES; P-7520-997 MON-  
TEFEIO, SINES

PORTUGAL

FOR: GRANULES OF CRYOGENIC COLOURED  
RUBBER FOR ARTIFICIAL TURF INFILL, IN  
CLASS 17 (U.S. CLS. 1, 5, 12, 13, 35 AND 50).

PRIORITY DATE OF 2-22-2007 IS CLAIMED.

OWNER OF INTERNATIONAL REGISTRATION  
0929693 DATED 5-29-2007, EXPIRES 5-29-2017.

NO CLAIM IS MADE TO THE EXCLUSIVE  
RIGHT TO USE "CRYOGENIC RUBBER GRANU-  
LATES", APART FROM THE MARK AS SHOWN.

THE COLOR(S) GREEN, PALE GREEN, ORANGE,  
YELLOW, RED, BLUE, LILAC AND VIOLET IS/ARE  
CLAIMED AS A FEATURE OF THE MARK.

THE COLOR GREEN APPEARS IN THE WORD-  
ING "GRAINBOW," THE COLOR BLUE APPEARS  
IN THE WORDING "CRYOGENIC RUBBER GRAN-  
ULATES BY RECIPNEU", AND THE COLORS  
GREEN, PALE GREEN, ORANGE, YELLOW, RED,  
BLUE, LILAC AND VIOLET APPEAR AS DOTS IN  
THE DESIGN.

SER. NO. 79-040,637, FILED 5-29-2007.

ROBERT STRUCK, EXAMINING ATTORNEY

**Int. Cls.: 12 and 21**

**Prior U.S. Cls.: 2, 13, 19, 21, 23, 29, 30, 31, 33, 35, 40,  
44 and 50**

**United States Patent and Trademark Office**

**Reg. No. 3,468,176**

**Registered July 15, 2008**

**TRADEMARK  
PRINCIPAL REGISTER**

**EXCELION**

SAINT-GOBAIN SULLY (FRANCE SOCIÉTÉ PAR  
ACTIONS SIMPLIFIÉE)  
16 ROUTE D'ISDES  
BP 32; F-45600  
SULLY-SUR-LOIRE, FRANCE

FOR: WINDOW PANES FOR ALL LAND, AIR OR  
SEA CRAFT, IN CLASS 12 (U.S. CLS. 19, 21, 23, 31, 35  
AND 44).

FOR: UNWORKED OR SEMI-WORKED GLASS,  
GLASS FOR WINDOW PANES FOR LAND, AIR OR  
SEA CRAFT, IN CLASS 21 (U.S. CLS. 2, 13, 23, 29, 30,  
33, 40 AND 50).

PRIORITY DATE OF 11-24-2006 IS CLAIMED.

OWNER OF INTERNATIONAL REGISTRATION  
0929705 DATED 5-18-2007, EXPIRES 5-18-2017.

SER. NO. 79-040,643, FILED 5-18-2007.

JAMES STEIN, EXAMINING ATTORNEY

**Int. Cls.: 22 and 28**

**Prior U.S. Cls.: 1, 2, 7, 19, 22, 23, 38, 42 and 50**

**Reg. No. 3,468,177**

**United States Patent and Trademark Office**

**Registered July 15, 2008**

**TRADEMARK  
PRINCIPAL REGISTER**



SEAWORKS SARL (FRANCE SOCIÉTÉ À RE-  
SPONSABILITÉ LIMITÉE (SARL))  
25-27 RUE AMIRAL TROUDE  
F-29200 BREST  
FRANCE

OWNER OF INTERNATIONAL REGISTRATION  
0929713 DATED 5-25-2007, EXPIRES 5-25-2017.

FOR: SAILS, IN CLASS 22 (U.S. CLS. 1, 2, 7, 19, 22, 42  
AND 50).

THE TRANSLITERATION OF THE NON-LATIN  
CHARACTERS IN THE MARK IS KONA.

FOR: WINDSURFING BOARDS, IN CLASS 28  
(U.S. CLS. 22, 23, 38 AND 50).

SER. NO. 79-040,651, FILED 5-25-2007.

PRIORITY DATE OF 12-15-2006 IS CLAIMED.

WARREN L. OLANDRIA, EXAMINING ATTOR-  
NEY

Int. Cl.: 7

Prior U.S. Cls.: 13, 19, 21, 23, 31, 34 and 35

Reg. No. 3,468,178

United States Patent and Trademark Office

Registered July 15, 2008

TRADEMARK  
PRINCIPAL REGISTER

**DRAIN IT**

LEADER PUMPS GROUP S.P.A. (ITALY JOINT STOCK COMPANY)  
VIA BONANNO PISANO, 1  
I-56031 BIENTINA (PI), ITALY

FOR: SUBMERSIBLE PUMPS; SURFACE PUMPS; AQUARIUM PUMPS; SWIMMING POOL PUMPS; FOUNTAIN PUMPS; WATER PUMPS FOR GARDENING AND DOMESTIC PURPOSES; WATER PUMP ACCESSORIES, NAMELY, CHECK VALVES, SUCTION HOSES, FOOT VALVES, CONNECTING SWIVELS, DISCHARGE FITTINGS AND PUMP CONTROLS, SOLD AS UNITS WITH WATER PUMPS; COMPRESSED AIR PUMPS; PUMPS FOR HOT WATER; CENTRIFUGAL PUMPS; VACUUM PUMPS, BEING MACHINES; SUCTION PUMPS; SUMP PUMPS; POSITIVE DISPLACEMENT PUMPS; ROTARY PUMPS, NAMELY, WET ROTOR PUMPS; DIAPHRAGM PUMPS; BOOSTER SETS, NAMELY, COMPLETE PUMPS SYSTEMS, COMPRISING PUMPS, CONTROL PANELS, SUCTION AND DELIVERY MANIFOLDS, ASSEMBLED ON BASEMENTS; ELECTRIC PUMPS IN THE NATURE OF ELECTRO PUMP MACHINES; ELECTRIC PUMPS

AS PARTS OF MACHINES; PUMP CONTROL VALVES; PUMP IMPELLERS; SLUDGE PUMPS; POWER TRANSMISSIONS AND GEARING FOR MACHINES, NOT FOR LAND VEHICLES; WATER PUMPS FOR USE IN MOTORS AND ENGINES; PUMPS FOR COOLING ENGINES; ENGINES NOT FOR LAND VEHICLES, IN CLASS 7 (U.S. CLS. 13, 19, 21, 23, 31, 34 AND 35).

PRIORITY DATE OF 2-22-2007 IS CLAIMED.

OWNER OF INTERNATIONAL REGISTRATION 0929806 DATED 5-15-2007, EXPIRES 5-15-2017.

THE MARK CONSISTS OF A SIGN DEPICTING THE WORDING "DRAIN IT" IN FANCY CHARACTERS.

SER. NO. 79-040,680, FILED 5-15-2007.

ANNE E. GUSTASON, EXAMINING ATTORNEY

Int. Cl.: 25

Prior U.S. Cls.: 22 and 39

United States Patent and Trademark Office

Reg. No. 3,468,179

Registered July 15, 2008

TRADEMARK  
PRINCIPAL REGISTER



— 1892 · 1990 —

LUIS TRENKER

LUIS T. - S.R.L. (ITALY LIMITED LIABILITY  
COMPANY)  
VIA CASTEL FIRMIANO, 35  
I-39100 BOLZANO  
ITALY

SNEAKERS, SWEATBANDS AND TRACK SUITS;  
FOOTWEAR, IN CLASS 25 (U.S. CLS. 22 AND 39).

PRIORITY DATE OF 3-19-2007 IS CLAIMED.

OWNER OF INTERNATIONAL REGISTRATION  
0929821 DATED 5-25-2007, EXPIRES 5-25-2017.

NO CLAIM IS MADE TO THE EXCLUSIVE  
RIGHT TO USE 1892 1990, APART FROM THE  
MARK AS SHOWN.

"THE NAME(S), PORTRAIT(S), AND/OR SIGNA-  
TURE(S) SHOWN IN THE MARK DOES NOT IDENT-  
TIFY A PARTICULAR LIVING INDIVIDUAL."

SER. NO. 79-040,687, FILED 5-25-2007.

FOR: CLOTHING FOR MEN, WOMEN AND  
CHILDREN, NAMELY, UNDERCLOTHING,  
SHIRTS, JERKINS, SKIRTS, TROUSERS, JEANS,  
JACKETS, WAISTCOATS, APRONS, RAINCOATS,  
COATS, TIES, GLOVES, SCARVES, HATS, CAPS,  
SOCKS, STOCKINGS, SWEATSHIRTS, OVERALLS,  
PAJAMAS, BOXER PANTS, BATHING SUITS,  
OVERCOATS, CLOAKS, SWEATERS, CARDIGANS,  
BELTS, SHAWLS, SINGLETs, VESTS, BLOUSES,  
SHORTS; CLOTHING FOR MEN AND WOMEN,  
NAMELY, SUITS; CLOTHING FOR WOMEN,  
NAMELY, EVENING DRESSES; SPORTS CLOTH-  
ING, NAMELY, SKI WEAR, WIND JACKETS, SWIM-  
MING CAPS, BASEBALL UNIFORMS, TENNIS  
WEAR, GOLF PANTS, SHIRTS AND SKIRTS, SPORT  
SHOES, SPORT SHIRTS, SPORT CAPS, SPORT  
SOCKS, SPORT STOCKINGS, SPORT UNIFORMS,

JORDAN BAKER, EXAMINING ATTORNEY

**Int. Cl.: 1**

**Prior U.S. Cls.: 1, 5, 6, 10, 26 and 46**

**United States Patent and Trademark Office**

**Reg. No. 3,468,180**

**Registered July 15, 2008**

**TRADEMARK  
PRINCIPAL REGISTER**

**SOLUPLUS**

BASF SE  
CARL-BOSCH-STRASSE 38  
67056 LUDWIGSHAFEN  
FED REP GERMANY

FOR: CHEMICALS USED IN INDUSTRY, NAME-  
LY, RAW MATERIALS AND AUXILIARY AGENTS  
FOR THE COSMETIC AND PHARMACEUTICAL  
INDUSTRY, IN CLASS 1 (U.S. CLS. 1, 5, 6, 10, 26 AND  
46).

THE MARK CONSISTS OF STANDARD CHAR-  
ACTERS WITHOUT CLAIM TO ANY PARTICULAR  
FONT, STYLE, SIZE, OR COLOR.

OWNER OF INTERNATIONAL REGISTRATION  
0929827 DATED 5-25-2007, EXPIRES 5-25-2017.

SER. NO. 79-040,691, FILED 5-25-2007.

PAUL E. FAHRENKOPF, EXAMINING ATTORNEY



**Int. Cls.: 7, 9 and 42**

**Prior U.S. Cls.: 13, 19, 21, 23, 26, 31, 34, 35, 36, 38, 100  
and 101**

**Reg. No. 3,468,181**

**United States Patent and Trademark Office**

**Registered July 15, 2008**

**TRADEMARK  
SERVICE MARK  
PRINCIPAL REGISTER**

HAVER & BOECKER OHG (FED REP GERMANY  
GENERAL PARTNERSHIP)  
CARL-HAVER-PLATZ 3  
59302 OELDE  
FED REP GERMANY

FOR: FILLING MACHINES FOR FILLING BAGS WITH BULK MATERIAL FOR OPEN BAGS AND VALVE BAGS MADE OF PAPER OR PLASTIC; FILLING MACHINES WITH ONE OR SEVERAL FILLING SPOUTS AND THEIR PARTS AND ACCESSORIES, NAMELY, BEARINGS FOR TRANSMISSION SHAFTS, CYLINDERS, REGULATORS; FILLING MACHINES WITH FILLING SPOUTS ARRANGED IN LINE; ROTATING FILLING MACHINES; FILLING MACHINES EQUIPPED WITH BULK MATERIAL WEIGHERS; FILLING MACHINES FOR LIQUID MATERIALS; MACHINES FOR FEEDING BAG FILLING MACHINES WITH EMPTY BAGS; MAGAZINES FOR EMPTY BAGS AS PARTS OR ACCESSORIES OF BAG FILLING MACHINES; MACHINES FOR PLACING EMPTY VALVE BAGS ONTO VALVE BAG FILLING MACHINES; MACHINES AND MECHANICAL PARTS FOR CLOSING OPEN BAGS, NAMELY, SEALING DEVICES FOR VALVE BAGS AND SEALING DEVICES FOR OPEN BAGS; MACHINES AND MECHANICAL PARTS, NAMELY, MECHANICAL SEALS FOR CLOSING THE VALVES OF VALVE BAGS AFTER FILLING; MACHINES FOR PRODUCING OPEN PAPER AND PLASTIC BAGS; CONVEYERS AND FEEDERS FOR SUPPLYING FILLING MACHINES WITH BULK MATERIAL, IN CLASS 7 (U.S. CLS. 13, 19, 21, 23, 31, 34 AND 35).

FOR: ELECTRIC CONTROLLING UNITS FOR FILLING MACHINES AND PACKING MACHINES; ELECTRIC AND ELECTRONIC CONTROLLING

DEVICES FOR FILLING SPOUTS OF PACKING MACHINES; ELECTRIC AND ELECTRONIC CONTROLLING DEVICES FOR MACHINES THAT FILL BAGS WITH BULK MATERIAL; ELECTRIC LUMINESCENT DISPLAY PANELS FOR PACKING MACHINES; ELECTRIC AND ELECTRONIC CONTROLLING DEVICES FOR CONTROLLING WEIGHERS THAT ARE USED TO MEASURE BULK MATERIALS AS THEY GO INTO FILLING AND PACKING MACHINES; METERING DEVICES FOR FEEDING BULK MATERIAL INTO FILLING MACHINES, IN CLASS 9 (U.S. CLS. 21, 23, 26, 36 AND 38).

FOR: TECHNICAL CONSULTANCY IN RELATION TO THE DESIGN OF APPARATUS AND MACHINES IN THE FIELD OF FILLING; TECHNICAL PROJECT STUDIES IN RELATION TO THE DESIGN OF APPARATUS AND MACHINES FOR FILLING PURPOSES; ENGINEERING STUDIES, NAMELY, THE CONDUCTING OF SAFETY RELEVANT ENGINEERING SURVEYS, IN CLASS 42 (U.S. CLS. 100 AND 101).

THE MARK CONSISTS OF STANDARD CHARACTERS WITHOUT CLAIM TO ANY PARTICULAR FONT, STYLE, SIZE, OR COLOR.

PRIORITY DATE OF 9-8-2006 IS CLAIMED.

OWNER OF INTERNATIONAL REGISTRATION  
0929896 DATED 3-6-2007, EXPIRES 3-6-2017.

SER. NO. 79-040,717, FILED 3-6-2007.

MARILYN IZZI, EXAMINING ATTORNEY

Int. Cl.: 33

Prior U.S. Cls.: 47 and 49

United States Patent and Trademark Office

Reg. No. 3,468,182

Registered July 15, 2008

TRADEMARK  
PRINCIPAL REGISTER

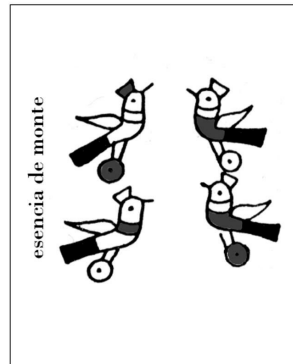

INVERSIONES COLAS, S.L. (SPAIN SOCIEDAD  
LIMITADA)  
PINTOR SOROLLA, 22, 1° A  
E-46002 VALENCIA  
SPAIN

THE FOREIGN WORDING IN THE MARK  
TRANSLATES INTO ENGLISH AS "MOUNTAIN  
ESSENCE."

FOR: WINES, IN CLASS 33 (U.S. CLS. 47 AND 49).

SER. NO. 79-040,732, FILED 3-14-2007.

PRIORITY DATE OF 3-13-2007 IS CLAIMED.

OWNER OF INTERNATIONAL REGISTRATION  
0929945 DATED 3-14-2007, EXPIRES 3-14-2017.

REBECCA POVARCHUK, EXAMINING ATTOR-  
NEY

Int. Cls.: 9 and 35

Prior U.S. Cls.: 21, 23, 26, 36, 38, 100, 101 and 102

Reg. No. 3,468,183

United States Patent and Trademark Office

Registered July 15, 2008

TRADEMARK  
SERVICE MARK  
PRINCIPAL REGISTER



ANDREA SELINA NEVILL (AUSTRALIA INDIVIDUAL)

C/- TRADEMARK WORKS

LEVEL 50; 101 COLLINS STREET; MELBOURNEVIC  
3000

AUSTRALIA AND

JOHN WARRIEDAR NEVILL (AUSTRALIA INDIVIDUAL)

C/- TRADEMARK WORKS

LEVEL 50; 101 COLLINS STREET; MELBOURNEVIC  
3000

AUSTRALIA

FOR: CHRONOGRAPHS FOR USE AS SPECIALIZED TIME RECORDING APPARATUS AND TIME RECORDING MACHINES, TIME CLOCKS USED AS TIME RECORDING DEVICES; TIME RECORDING APPARATUS, NAMELY, TIME RECORDING MACHINES AND ELECTRONIC CLOCKS; ELECTRONIC TIME RECORDING APPARATUS; TIME RECORDING INSTRUMENTS, NAMELY, ELECTRONIC CLOCKS AND CLOCK MACHINES; COMPUTER HARDWARE FOR OPERATING TIME RECORDING APPARATUSES AND PAYROLL EMPLOYEE TIMEKEEPING; COMPUTER MEMORIES, IN CLASS 9 (U.S. CLS. 21, 23, 26, 36 AND 38).

FOR: RETAIL STORE SERVICES, INCLUDING ONLINE RETAIL SERVICES, FEATURING TIME RECORDING DEVICES, TIME RECORDING MACHINES, ELECTRONIC CLOCKS AND ELECTRONIC CLOCK CARD MACHINES; BUSINESS ADVICE TO OTHERS RELATING TO SALES OF TIME RECORDING DEVICES, TIME RECORDING MACHINES, ELECTRONIC CLOCKS AND ELECTRONIC CLOCK CARD MACHINES; DISTRIBUTORSHIP SERVICES IN THE FIELD OF TIME RECORDING DEVICES, TIME RECORDING MACHINES, ELECTRONIC CLOCKS AND ELECTRONIC CLOCK CARD MACHINES, IN CLASS 35 (U.S. CLS. 100, 101 AND 102).

OWNER OF INTERNATIONAL REGISTRATION  
0929952 DATED 3-26-2007, EXPIRES 3-26-2017.

NO CLAIM IS MADE TO THE EXCLUSIVE RIGHT TO USE "TIME" OR "AUSTRALIA WIDE", APART FROM THE MARK AS SHOWN.

SER. NO. 79-040,735, FILED 3-26-2007.

REBECCA POVARCHUK, EXAMINING ATTORNEY

**Int. Cls.: 17, 19 and 22**

**Prior U.S. Cls.: 1, 2, 5, 7, 12, 13, 19, 22, 33, 35, 42 and 50**

**Reg. No. 3,468,184**

**United States Patent and Trademark Office**

**Registered July 15, 2008**

**TRADEMARK  
PRINCIPAL REGISTER**

**DELTA-TRELA**

EWALD DÖRKEN AG (FED REP GERMANY  
JOINT STOCK COMPANY)

WETTERSTRASSE 58

58313 HERDECKE

FED REP GERMANY

FOR: SEMI-FINISHED GOODS MADE FROM PLASTICS, NAMELY, PLASTIC SHEETING FOR USE AS DROP CLOTHS; SEALING MATERIAL, NAMELY, POLYURETHANE FILM FOR USE IN SEALING AND INSULATING; SEALING AND INSULATING SHEETS, NAMELY, SHEETS OF PLASTIC FABRIC USED AS AN INSULATING INFILTRATION BARRIER FOR BUILDING CONSTRUCTION; ROOF UNDERLAY, NAMELY, PLASTIC SHEETING USED IN THE CONSTRUCTION INDUSTRY AS A VAPOR BARRIER; PLASTIC SHEETING USED IN THE CONSTRUCTION INDUSTRY, NAMELY, CARRIER SHEETS, DIMPLED SHEETS, SHEETS FOR HIGH-PITCHED ROOFS, SCAFFOLDING SHEETS MADE FROM PLASTIC; PLASTIC SHEETING USED IN THE CONSTRUCTION INDUSTRY, NAMELY, SEALING AND INSULATING PLASTIC SHEETS IN THE NATURE OF WRAPPINGS FOR FOUNDATIONS AND BASEMENT; PLASTIC SHEETING FOR USE AS DROP CLOTHS, NAMELY, SHEETS FOR HIGH PITCHED ROOFS, SCAFFOLDING SHEETS MADE FROM PLASTIC FOR CONSTRUCTION PURPOSES; INSULATING PLASTIC FILMS, NAMELY, SHEETS OF PLASTIC FABRIC USED AS AN INSULATING INFILTRATION BARRIER IN BUILDING OR BUILDING INSULATION, INSULATING WATERPROOFING MEMBRANES; PLASTIC FILMS, NAMELY, COVERINGS FOR STORE ROOMS; PLASTIC SHEETING FOR AGRICULTURAL PURPOSES; PROTECTION AND DRAINING SHEETS MADE FROM PLASTIC, NAMELY, PLASTIC SHEETING FOR UNDERGROUND CONSTRUCTION PURPOSES, NAMELY, COVERING AND PROTECTING THE EXTERIOR SURFACES OF BASEMENT AND FOUNDATION WALLS; BUILDING INSULATION, NAMELY, INSULATING FILMS, INSULATING FABRICS; INSULATING MATERIALS FOR BUILDINGS; INSULATING BOARDS; SCAFFOLDING

SHEETS FOR CONSTRUCTION PURPOSES, IN CLASS 17 (U.S. CLS. 1, 5, 12, 13, 35 AND 50).

FOR: REINFORCED AND NON-REINFORCED SEPARATING, PROTECTING AND DRAINING SHEETS FOR CONSTRUCTION PURPOSES, NAMELY, PLASTIC WEBBING MATERIAL USED TO REINFORCE BITUMINOUS WATERPROOFING SHEETS; REINFORCED AND NON-REINFORCED DIMPLED SHEETS FOR CONSTRUCTION PURPOSES, NAMELY, PLASTIC WEBBING MATERIAL USED TO REINFORCE BITUMINOUS WATERPROOFING SHEETS; REINFORCED AND NON-REINFORCED CARRIER SHEETS FOR CONSTRUCTION PURPOSES, NAMELY, PLASTIC COMPOSITE SHEETS FOR BUILDING PURPOSES; INDUSTRIAL TEXTILES AND WOVEN FABRICS FOR CONSTRUCTION PURPOSES, NAMELY, GEOTEXTILES FOR USE IN CONNECTION WITH ROAD CONSTRUCTION, RAILROAD CONSTRUCTION, TUNNEL CONSTRUCTION, WATERWAY CONSTRUCTION AND PUBLIC WORKS CONSTRUCTION; GEOTEXTILES FOR THE PURPOSES OF DRAINAGE, STABILIZING INCLINES, RECULTIVATION, PLANT SUPPORT, ABSORPTION, FILTRATION, SEPARATION, STABILIZATION AND REINFORCEMENT OF THE SOIL; SMALL PREFABRICATED GREEN HOUSES, IN CLASS 19 (U.S. CLS. 1, 12, 33 AND 50).

FOR: TARPAULINS FOR CONSTRUCTION PURPOSES, INCLUDED IN THIS CLASS; STEEP ROOF TARPAULINS, COVERING AND SCAFFOLDING TARPAULINS MADE FROM PLASTICS; COVERING AND SCAFFOLDING TARPAULINS FOR CONSTRUCTION PURPOSES, IN CLASS 22 (U.S. CLS. 1, 2, 7, 19, 22, 42 AND 50).

THE MARK CONSISTS OF STANDARD CHARACTERS WITHOUT CLAIM TO ANY PARTICULAR FONT, STYLE, SIZE, OR COLOR.

PRIORITY DATE OF 12-22-2006 IS CLAIMED.

OWNER OF INTERNATIONAL REGISTRATION  
0930085 DATED 5-23-2007, EXPIRES 5-23-2017.

SER. NO. 79-040,782, FILED 5-23-2007.

OWNER OF U.S. REG. NOS. 3,154,276 AND  
3,185,428.

SUSAN LESLIE DUBOIS, EXAMINING ATTORNEY

**Int. Cls.: 6 and 9**

**Prior U.S. Cls.: 2, 12, 13, 14, 21, 23, 25, 26, 36, 38 and 50**

**Reg. No. 3,468,185**

**United States Patent and Trademark Office**

**Registered July 15, 2008**

**TRADEMARK  
PRINCIPAL REGISTER**

**BeCode**

MATTHIAS BLUNCK (FED REP GERMANY INDIVIDUAL)  
HEGESTRAßE 6-16  
58300 WETTER  
FED REP GERMANY AND  
PETER BOCK (FED REP GERMANY INDIVIDUAL)  
HEGESTRAßE 6-16  
58300 WETTER  
FED REP GERMANY

FOR: METAL HANDLES FOR FURNITURE DOORS AND CASEMENTS, IN PARTICULAR KNOBS AND GRIPS, INCLUDED IN THIS CLASS, IN CLASS 6 (U.S. CLS. 2, 12, 13, 14, 23, 25 AND 50).

FOR: ELECTRONIC LOCKS FOR FURNITURE DOORS AND CASEMENTS, IN CLASS 9 (U.S. CLS. 21, 23, 26, 36 AND 38).

THE MARK CONSISTS OF STANDARD CHARACTERS WITHOUT CLAIM TO ANY PARTICULAR FONT, STYLE, SIZE, OR COLOR.

OWNER OF INTERNATIONAL REGISTRATION 0930102 DATED 5-30-2007, EXPIRES 5-30-2017.

THE WORD "BECODE" APPEARING IN THE MARK HAS NO MEANING IN A FOREIGN LANGUAGE.

SER. NO. 79-040,787, FILED 5-30-2007.

STEVEN PEREZ, EXAMINING ATTORNEY

**Int. Cl.: 3**

**Prior U.S. Cls.: 1, 4, 6, 50, 51 and 52**

**United States Patent and Trademark Office**

**Reg. No. 3,468,186**

**Registered July 15, 2008**

**TRADEMARK  
PRINCIPAL REGISTER**

**JEANNE**

ARTHES S.A. (FRANCE SOCIETE ANONYME)  
PARC INDUSTRIEL DES BOIS DE GRASSE  
BP 91006; F-06131 GRASSE  
FRANCE

OWNER OF INTERNATIONAL REGISTRATION  
0930122 DATED 6-26-2007, EXPIRES 6-26-2017.

FOR: SOAPS, PERFUMERY PRODUCTS, ESSEN-  
TIAL OILS, COSMETIC PRODUCTS, HAIR LO-  
TIONS, IN CLASS 3 (U.S. CLS. 1, 4, 6, 50, 51 AND 52).

OWNER OF U.S. REG. NO. 3,023,851.

SER. NO. 79-040,798, FILED 6-26-2007.

THE MARK CONSISTS OF STANDARD CHAR-  
ACTERS WITHOUT CLAIM TO ANY PARTICULAR  
FONT, STYLE, SIZE, OR COLOR.

MATTHEW MCDOWELL, EXAMINING ATTOR-  
NEY

**Int. Cl.: 3**

**Prior U.S. Cls.: 1, 4, 6, 50, 51 and 52**

**United States Patent and Trademark Office**

**Reg. No. 3,468,187**

**Registered July 15, 2008**

**TRADEMARK  
PRINCIPAL REGISTER**

**AROME by ARTHES**

ARTHES S.A. (FRANCE SOCIETE ANONYME)  
PARC INDUSTRIEL DES BOIS DE GRASSE  
BP 91006; F-06131 GRASSE  
FRANCE

OWNER OF U.S. REG. NO. 3,023,851.

FOR: SOAPS, PERFUMERY PRODUCTS, ESSEN-  
TIAL OILS, COSMETIC PRODUCTS, HAIR LO-  
TIONS, IN CLASS 3 (U.S. CLS. 1, 4, 6, 50, 51 AND 52).

NO CLAIM IS MADE TO THE EXCLUSIVE  
RIGHT TO USE "AROME", APART FROM THE  
MARK AS SHOWN.

THE MARK CONSISTS OF STANDARD CHAR-  
ACTERS WITHOUT CLAIM TO ANY PARTICULAR  
FONT, STYLE, SIZE, OR COLOR.

THE ENGLISH TRANSLATION OF "AROME" IN  
THE MARK IS FLAVOR.

OWNER OF INTERNATIONAL REGISTRATION  
0930125 DATED 6-26-2007, EXPIRES 6-26-2017.

SER. NO. 79-040,800, FILED 6-26-2007.

MATTHEW MCDOWELL, EXAMINING ATTOR-  
NEY



**Int. Cls.: 17, 19 and 22**

**Prior U.S. Cls.: 1, 2, 5, 7, 12, 13, 19, 22, 33, 35, 42 and 50**

**Reg. No. 3,468,188**

**United States Patent and Trademark Office**

**Registered July 15, 2008**

**TRADEMARK  
PRINCIPAL REGISTER**

**DELTA-TEKK**

EWALD DÖRKEN AG (FED REP GERMANY  
JOINT STOCK COMPANY)

WETTERSTRASSE 58

58313 HERDECKE

FED REP GERMANY

FOR: SEMI-FINISHED GOODS MADE FROM PLASTICS, NAMELY, PLASTIC SHEETING FOR USE AS DROP CLOTHS; SEALING MATERIAL, NAMELY, POLYURETHANE FILM FOR USE IN SEALING AND INSULATING; SEALING AND INSULATING SHEETS, NAMELY, SHEETS OF PLASTIC FABRIC USED AS AN INSULATING INFILTRATION BARRIER FOR BUILDING CONSTRUCTION; ROOF UNDERLAY, NAMELY, PLASTIC SHEETING USED IN THE CONSTRUCTION INDUSTRY AS A VAPOR BARRIER; PLASTIC SHEETING USED IN THE CONSTRUCTION INDUSTRY, NAMELY, CARRIER SHEETS, DIMPLED SHEETS, SHEETS FOR HIGH-PITCHED ROOFS, SCAFFOLDING SHEETS MADE FROM PLASTIC; PLASTIC SHEETING USED IN THE CONSTRUCTION INDUSTRY, NAMELY, SEALING AND INSULATING PLASTIC SHEETS IN THE NATURE OF WRAPPINGS FOR FOUNDATIONS AND BASEMENT; PLASTIC SHEETING FOR USE AS DROP CLOTHS, NAMELY, SHEETS FOR HIGH PITCHED ROOFS, SCAFFOLDING SHEETS MADE FROM PLASTIC FOR CONSTRUCTION PURPOSES; INSULATING PLASTIC FILMS, NAMELY, SHEETS OF PLASTIC FABRIC USED AS AN INSULATING INFILTRATION BARRIER IN BUILDING OR BUILDING INSULATION, INSULATING WATERPROOFING MEMBRANES; PLASTIC FILMS, NAMELY, COVERINGS FOR STORE ROOMS; PLASTIC SHEETING FOR AGRICULTURAL PURPOSES; PROTECTION AND DRAINING SHEETS MADE FROM PLASTIC, NAMELY, PLASTIC SHEETING FOR UNDERGROUND CONSTRUCTION PURPOSES, NAMELY, COVERING AND PROTECTING THE EXTERIOR SURFACES OF BASEMENT AND FOUNDATION WALLS; BUILDING INSULATION, NAMELY, INSULATING FILMS, INSULATING FABRICS; INSULATING MATERIALS FOR BUILDINGS; INSULATING BOARDS; SCAFFOLDING

SHEETS FOR CONSTRUCTION PURPOSES, IN CLASS 17 (U.S. CLS. 1, 5, 12, 13, 35 AND 50).

FOR: REINFORCED AND NON-REINFORCED SEPARATING, PROTECTING AND DRAINING SHEETS FOR CONSTRUCTION PURPOSES, NAMELY, PLASTIC WEBBING MATERIAL USED TO REINFORCE BITUMINOUS WATERPROOFING SHEETS; REINFORCED AND NON-REINFORCED DIMPLED SHEETS FOR CONSTRUCTION PURPOSES, NAMELY, PLASTIC WEBBING MATERIAL USED TO REINFORCE BITUMINOUS WATERPROOFING SHEETS; REINFORCED AND NON-REINFORCED CARRIER SHEETS FOR CONSTRUCTION PURPOSES, NAMELY, PLASTIC COMPOSITE SHEETS FOR BUILDING PURPOSES; INDUSTRIAL TEXTILES AND WOVEN FABRICS FOR CONSTRUCTION PURPOSES, NAMELY, GEOTEXTILES FOR USE IN CONNECTION WITH ROAD CONSTRUCTION, RAILROAD CONSTRUCTION, TUNNEL CONSTRUCTION, WATERWAY CONSTRUCTION AND PUBLIC WORKS CONSTRUCTION; GEOTEXTILES FOR THE PURPOSES OF DRAINAGE, STABILIZING INCLINES, RECULTIVATION, PLANT SUPPORT, ABSORPTION, FILTRATION, SEPARATION, STABILIZATION AND REINFORCEMENT OF THE SOIL; SMALL PREFABRICATED GREEN HOUSES, IN CLASS 19 (U.S. CLS. 1, 12, 33 AND 50).

FOR: TARPAULINS FOR CONSTRUCTION PURPOSES, INCLUDED IN THIS CLASS; STEEP ROOF TARPAULINS, COVERING AND SCAFFOLDING TARPAULINS MADE FROM PLASTICS; COVERING AND SCAFFOLDING TARPAULINS FOR CONSTRUCTION PURPOSES, IN CLASS 22 (U.S. CLS. 1, 2, 7, 19, 22, 42 AND 50).

THE MARK CONSISTS OF STANDARD CHARACTERS WITHOUT CLAIM TO ANY PARTICULAR FONT, STYLE, SIZE, OR COLOR.

PRIORITY DATE OF 12-22-2006 IS CLAIMED.

OWNER OF INTERNATIONAL REGISTRATION  
0930191 DATED 5-23-2007, EXPIRES 5-23-2017.

SER. NO. 79-040,813, FILED 5-23-2007.

OWNER OF U.S. REG. NOS. 3,154,276 AND  
3,185,428.

SUSAN LESLIE DUBOIS, EXAMINING ATTORNEY

Int. Cls.: 5 and 16

Prior U.S. Cls.: 2, 5, 6, 18, 22, 23, 29, 37, 38, 44, 46, 50,  
51 and 52

United States Patent and Trademark Office

Reg. No. 3,468,189

Registered July 15, 2008

TRADEMARK  
PRINCIPAL REGISTER

*Saniline*

SANICARE AB (SWEDEN CORPORATION)  
MEJERIVÄGEN 4, 2TR  
SE-117 43 STOCKHOLM  
SWEDEN

FOR: MEDICAL PLASTERS; MATERIALS FOR  
DRESSINGS, NAMELY, GAUZE, BANDAGES; IN-  
CONTINENCE DIAPERS, IN CLASS 5 (U.S. CLS. 6,  
18, 44, 46, 51 AND 52).

FOR: SOFT-PAPER PRODUCTS, NAMELY, SOFT  
PAPER ABSORBING MATS FOR USE IN BED BY

PERSONS WITH INCONTINENCE PROBLEMS, IN-  
TER ALIA, IN HOSPITALS, IN CLASS 16 (U.S. CLS. 2,  
5, 22, 23, 29, 37, 38 AND 50).

OWNER OF INTERNATIONAL REGISTRATION  
0930343 DATED 2-23-2007, EXPIRES 2-23-2017.

SER. NO. 79-040,867, FILED 2-23-2007.

MARILYN IZZI, EXAMINING ATTORNEY

**Int. Cls.: 6, 7, 11, 17, 19, 20 and 35**

**Prior U.S. Cls.: 1, 2, 5, 12, 13, 14, 19, 21, 22, 23, 25, 31, 32, 33, 34, 35, 50, 100, 101 and 102**

**Reg. No. 3,468,190**

**United States Patent and Trademark Office**

**Registered July 15, 2008**

**TRADEMARK  
SERVICE MARK  
PRINCIPAL REGISTER**

**compler**

"DOSPEL" SPÓLKA Z O.O. (POLAND LTD LIAB  
CO)  
UL. LESNA 156  
PL-42-200 CZESTOCHOWA  
POLAND

FOR: METAL BUILDING MATERIALS, NAME-  
LY, SOFFITS AND FASCIA; METAL HARDWARE,  
NAMELY, NUTS, SPRINGS AND WASHERS; METAL  
PIPES; SHEET METAL LININGS; REINFOR-  
CING MATERIALS OF METAL FOR BUILDING  
PURPOSES; METAL MARQUEES, NAMELY,  
TRANSPORTABLE BUILDINGS OF METAL; NON-  
LUMINOUS AND NON-MECHANICAL METAL  
SIGNS; CHIMNEY COWLS OF METAL; METAL  
HOOKS; METAL FASTENERS, NAMELY, LUGS  
FOR CABLES OR TUBES; METAL CABLE CLIPS;  
METALLIC ELBOWS FOR PIPES; BRANCHING  
PIPES OF METAL; METAL FITTINGS FOR BUILD-  
ING, NAMELY, HOSE AND JOINERY; METAL  
CLAMPS AND METAL HOOKS FOR PIPES; METAL  
SCREWS; CRAMPONS OF METAL; METAL BOLTS;  
METAL PIPES AND CONDUITS FOR CENTRAL  
HEATING; DUCTS OF METAL FOR VENTILATING  
AND AIR CONDITIONING INSTALLATIONS; ME-  
TAL PIPE COUPLINGS AND JOINTS; METAL EL-  
BOWS FOR PIPES; METAL PIPE JUNCTIONS;  
METAL FLANGES CHIMNEYS OF METAL, METAL  
GRATINGS; METAL CHIMNEY POTS; METAL PIPE  
MUFFS; METAL REINFORCING MATERIALS FOR  
PIPES, NAMELY, METAL PIPE CLIPS AND METAL  
PIPE COLLARS; METAL CONDUITS AND PIPING;  
METAL VALVES, NAMELY, MANUALLY-OPER-  
ATED METAL VALVES, IN CLASS 6 (U.S. CLS. 2,  
12, 13, 14, 23, 25 AND 50).

FOR: ELECTRIC KITCHEN MACHINES, NAME-  
LY, MIXERS AND ELECTRIC FOOD CHOPPERS,  
ELECTRIC COFFEE GRINDERS, ELECTRIC PEP-  
PER MILLS, ELECTRIC KNIVES, ELECTRIC FOOD

PROCESSORS AND ELECTRIC DISH WASHERS;  
AIR SUCTION MACHINES; POWER-OPERATED  
BLOWERS; AIR FILTERS FOR MECHANICAL PUR-  
POSES; AIR FILTERS FOR MOTORS AND EN-  
GINES; MACHINE PANS. NAMELY, MOLDS FOR  
USE IN THE MANUFACTURE OF ELECTRIC  
KITCHEN MACHINES; REGULATORS BEING  
PARTS OF MACHINES; ENGINES NOT FOR LAND  
VEHICLES; ELECTRIC MOTORS FOR MACHINES;  
COMPRESSORS FOR REFRIGERATORS AND AIR  
CONDITIONERS; FANS FOR MACHINE ENGINES;  
INJECTION MOLDING MACHINES; HEAT EX-  
CHANGERS BEING PARTS OF MACHINES, IN  
CLASS 7 (U.S. CLS. 13, 19, 21, 23, 31, 34 AND 35).

FOR: LIGHTING FIXTURES; FREEZERS; AIR  
CONDITIONERS; REFRIGERATORS; HEAT FUR-  
NACES; HEAT PUMPS AND HEAT REGISTERS; ICE  
CHESTS; GAS WATER HEATERS, HOT WATER  
HEATERS, SOLAR WATER HEATERS; RADIA-  
TORS; ELECTRIC RE HEATERS, NAMELY AIR RE  
HEATERS, NAMELY, ELECTRIC RADIANT AIR  
HEATERS, ELECTRIC SPACE AIR HEATERS;ELEC-  
TRIC RADIATORS FOR HEATING BUILDINGS;  
FURNACES; THERMAL VENTILATORS FOR DO-  
MESTIC AND INDUSTRIAL USE;VENTILATORS  
FOR DOMESTIC AND INDUSTRIAL USE; VENTI-  
LATORS FOR AERATING CONDUITS; HEAT EX-  
CHANGERS; VENTILATION HOODS; HOT AIR  
CHIMNEY BLOWERS; CEILING FANS; INDUS-  
TRIAL AIR FILTER MACHINES; AIR CONDITION-  
ING APPARATUS; CENTRAL AIR CONDITIONING  
INSTALLATIONS; ELECTRIC FANS FOR USE IN  
AIR CONDITIONERS; AIR FILTERS FOR INDUS-  
TRIAL INSTALLATIONS; AIR FILTERS FOR DO-  
MESTIC USE; AIR FILTERS FOR AIR  
CONDITIONING UNITS; PIPES BEING PARTS OF  
SANITARY FACILITIES; STEAM GENERATORS;  
HAIR DRYERS; DESICCATING UNITS FOR DO-  
MESTIC AND INDUSTRIAL USE, NAMELY PRO-

DUCING DRIED FRUITS AND DRIED FOOD; LAMPS; SOCKETS FOR ELECTRICAL LIGHTS, IN CLASS 11 (U.S. CLS. 13, 21, 23, 31 AND 34).

FOR: INSULATORS FOR NON-METALLIC AND METALLIC PIPES AND CONDUITS, NAMELY, UNDERGROUND OR INDUSTRIAL PIPES AND CONDUITS, PIPES AND CONDUITS FOR VENTILATIONS AND AIR CONDITIONING INSTALLATIONS; INSULATORS FOR ELECTRICAL CABLES; SEMI-FINISHED PLASTIC FOAM OR FILM FOR USE IN THE MANUFACTURE OF FILTERS; JUNCTIONS NOT OF METAL FOR NON-METALLIC AND METALLIC PIPES; FLEXIBLE NON-METALLIC PIPES; PIPE JACKETS, NOT OF METAL FOR USE WITH NON-METALLIC AND METALLIC PIPES; JUNCTIONS NOT OF METAL FOR USE WITH NON-METALLIC AND METALLIC PIPES, STUFFING OF PLASTIC OR RUBBER, SEALS FOR NON-METALLIC AND METALLIC PIPE CONNECTIONS; CAULKING, IN CLASS 17 (U.S. CLS. 1, 5, 12, 13, 35 AND 50).

FOR: NON-METALLIC BUILDING MATERIALS, NAMELY, WALLS BOARDS OF WOOD OR PLASTIC, DECKING BOARDS OF WOOD OR PLASTIC, AND PARTICLE BOARDS; NON-METALLIC RIGID PIPES; NON-METAL CHIMNEY POTS; NON-METAL CHIMNEY COWLS; CHIMNEY SHAFTS, NOT OF METAL; NON-METAL CHIMNEYS; NON-METAL LATTICES; NON-METAL GRATINGS, SANDSTONE TUBES; NON-METAL AIR CONDITIONING DUCTS, NON-METAL VENTILATING DUCTS; GUTTER PIPES NOT OF METAL; NON-METAL WATER PIPES; NON-METAL GUTTERS, IN CLASS 19 (U.S. CLS. 1, 12, 33 AND 50).

FOR: VALVES OF PLASTIC BEING OTHER THAN MACHINE PARTS; NON-METAL CABLE CLIPS; NON-METAL PIPE CLIPS; PLASTIC FASTENERS, NAMELY, LUGS FOR CABLES OR TUBES; FIRE-PLACE SCREENS, IN CLASS 20 (U.S. CLS. 2, 13, 22, 25, 32 AND 50).

FOR: MANAGEMENT OF COMPUTERIZED FILES; ORGANIZATION OF EXHIBITIONS FOR COMMERCIAL OR ADVERTISING PURPOSES IN THE VENTILATION AND HEATING INDUSTRY; DEMONSTRATION OF GOODS BY ELECTRONIC MEANS, ALSO FOR THE BENEFIT OF THE SO-CALLED TEleshopping AND HOME SHOPPING SERVICES; SALES PROMOTION FOR OTHERS; ONLINE ADVERTISING ON A COMPUTER COMMUNICATION NETWORK; ADVERTISING; BUSINESS MANAGEMENT SERVICES, NAMELY, MANAGING LOGISTICS, REVERSE LOGISTICS, SUPPLY CHAIN SERVICES SUPPLY CHAIN VISIBILITY AND SYNCHRONIZATION. SUPPLY AND DEMAND FORECASTING AND PRODUCT DISTRIBUTION PROCESSES FOR OTHERS; BUSINESS MANAGEMENT OF PERFORMING ARTISTS; ONLINE RETAIL STORE SERVICES FEATURING VENTILATION AND AIR CONDITIONING PRODUCTS, CONSTRUCTION MATERIALS AND HOUSEHOLD GOODS, NAMELY, ELECTRIC AND ELECTRONICS APPLIANCES; RETAIL AND WHOLESALE OUTLETS FEATURING INDUSTRIAL, VENTILATION AND AIR CONDITIONING PRODUCTS, CONSTRUCTION MATERIALS AND HOUSEHOLD GOODS, NAMELY, ELECTRIC AND ELECTRONICS APPLIANCES, IN CLASS 35 (U.S. CLS. 100, 101 AND 102).

THE MARK CONSISTS OF STANDARD CHARACTERS WITHOUT CLAIM TO ANY PARTICULAR FONT, STYLE, SIZE, OR COLOR.

OWNER OF INTERNATIONAL REGISTRATION 0930347 DATED 3-26-2007, EXPIRES 3-26-2017.

SER. NO. 79-040,869, FILED 3-26-2007.

BERNICE MIDDLETON, EXAMINING ATTORNEY

**Int. Cls.: 19, 21, 37, 40 and 42**

**Prior U.S. Cls.: 1, 2, 12, 13, 23, 29, 30, 33, 40, 50, 100,  
101, 103 and 106**

**Reg. No. 3,468,191**

**United States Patent and Trademark Office**

**Registered July 15, 2008**

**TRADEMARK  
SERVICE MARK  
PRINCIPAL REGISTER**

**Derix**

WILHELM DERIX GLASGESTALTUNG GMBH &  
CO. KG (FED REP GERMANY LIMITED  
PARTNERSHIP)  
PLATTER STRAÙE 94  
65232 TAUNUSSTEIN  
FED REP GERMANY

FOR: BUILDING GLASS; ROOFING, NOT OF METAL; WINDOWS, NOT OF METAL; WINDOW GLASS EXCEPT FOR VEHICLE WINDOWS; WINDOW GLASS, FOR BUILDING; PLATE GLASS WINDOWS, FOR BUILDING; STAINED-GLASS WINDOWS; CASEMENT WINDOWS, NOT OF METAL; GLASS LININGS, NOT OF METAL, FOR BUILDING; GLASS COVERINGS, NOT OF METAL, FOR BUILDING; CLADDING, NOT OF METAL, FOR BUILDING; GLASS FACINGS, NOT OF METAL, FOR BUILDING; GLASS SURFACINGS, NOT OF METAL, FOR BUILDING; GLASS WALL LININGS, NOT OF METAL, FOR BUILDING; ALABASTER GLASS, IN CLASS 19 (U.S. CLS. 1, 12, 33 AND 50).

FOR: DECORATIVE GLASS NOT FOR BUILDING; ENAMELED GLASS; GLASS, UNWORKED OR SEMI-WORKED EXCEPT BUILDING GLASS; WORKS OF ART, OF GLASS; OPAL GLASS; OPALINE GLASS, IN CLASS 21 (U.S. CLS. 2, 13, 23, 29, 30, 33, 40 AND 50).

FOR: CONSTRUCTION SERVICES, NAMELY, CONSTRUCTION, INSTALLATION, MAINTENANCE AND REPAIR OF ROOFING AND CLADDING; INSTALLATION, MAINTENANCE AND REPAIR OF ROOFING, CLADDING, WINDOWS, WINDOW GLASS, PLATE GLASS WINDOWS, STAINED-GLASS WINDOWS, CASEMENT WINDOWS, GLASS LININGS, GLASS COVERINGS,

GLASS FACINGS, GLASS SURFACINGS, GLASS WALL LININGS, ENAMELED GLASS, WORKS OF ART OF GLASS, OPAL GLASS, AND OPALINE GLASS IN BUILDINGS AND MEMORIALS; VARNISHING OF GLASS; SANDING OF GLASS, IN CLASS 37 (U.S. CLS. 100, 103 AND 106).

FOR: WINDOW TINTING TREATMENT, BEING SURFACE COATING; LAMINATING OF GLASS; LASER SCRIBING; BURNISHING BY ABRASION; GLASS STAINING; CUSTOM ASSEMBLING OF MATERIALS FOR OTHERS, IN CLASS 40 (U.S. CLS. 100, 103 AND 106).

FOR: ARCHITECTURAL CONSULTATION; INDUSTRIAL DESIGN; ENGINEERING; CONSTRUCTION DRAFTING; TECHNICAL PROJECT STUDIES, NAMELY, RESEARCH AND SURVEYS RELATED TO GLASS AND OBJECTS MADE OF GLASS, IN CLASS 42 (U.S. CLS. 100 AND 101).

THE MARK CONSISTS OF STANDARD CHARACTERS WITHOUT CLAIM TO ANY PARTICULAR FONT, STYLE, SIZE, OR COLOR.

PRIORITY DATE OF 11-14-2006 IS CLAIMED.

OWNER OF INTERNATIONAL REGISTRATION 0930358 DATED 5-8-2007, EXPIRES 5-8-2017.

SEC. 2(F).

SER. NO. 79-040,871, FILED 5-8-2007.

ROBIN CHOSID, EXAMINING ATTORNEY

**Int. Cl.: 21**

**Prior U.S. Cls.: 2, 13, 23, 29, 30, 33, 40 and 50**

**United States Patent and Trademark Office**

**Reg. No. 3,468,192**

**Registered July 15, 2008**

**TRADEMARK  
PRINCIPAL REGISTER**

**Volcano**

DEROMA S.P.A. (ITALY JOINT STOCK COMPAN-  
NY)  
VIA PASUBIO, 17  
I-36034 MALO (VI)  
ITALY

OWNER OF INTERNATIONAL REGISTRATION  
0930366 DATED 5-15-2007, EXPIRES 5-15-2017.

FOR: POTS AND CONTAINERS FOR GARDEN  
USE MADE OF BAKED CLAY, ALL COLORED  
BLACK, IN CLASS 21 (U.S. CLS. 2, 13, 23, 29, 30, 33, 40  
AND 50).

SER. NO. 79-040,876, FILED 5-15-2007.

PRIORITY DATE OF 12-14-2006 IS CLAIMED.

GISELLE AGOSTO, EXAMINING ATTORNEY

**Int. Cl.: 9**

**Prior U.S. Cls.: 21, 23, 26, 36 and 38**

**Reg. No. 3,468,193**

**United States Patent and Trademark Office**

**Registered July 15, 2008**

**TRADEMARK  
PRINCIPAL REGISTER**



MARCOLIN S.P.A. (ITALY JOINT STOCK COMPANY)  
31, VIA NOAI  
I-32040 VALLESSELLA DI CADORE  
ITALY

FOR: SPECTACLES, SPECTACLE LENSES, SPECTACLE FRAMES, SPECTACLE CASES, IN CLASS 9 (U.S. CLS. 21, 23, 26, 36 AND 38).

OWNER OF INTERNATIONAL REGISTRATION 0428901 DATED 2-4-1977, EXPIRES 2-4-2017.

OWNER OF U.S. REG. NOS. 1,270,622 AND 2,248,081.

THE MARK CONSISTS OF THE WORDING "MARCOLIN" IN STYLIZED FORMAT, WITH A SHADED CIRCLE ATTACHED TO THE LEFT OF THE STYLIZED LETTER "M".

SER. NO. 79-040,892, FILED 3-20-2007.

REBECCA POVARCHUK, EXAMINING ATTORNEY



**Int. Cl.: 10**

**Prior U.S. Cls.: 26, 39 and 44**

**United States Patent and Trademark Office**

**Reg. No. 3,468,194**

**Registered July 15, 2008**

**TRADEMARK  
PRINCIPAL REGISTER**

The logo for WINTRAY features the word "WINTRAY" in a stylized, bold, sans-serif font. The letter "W" is solid black. The letter "I" is a vertical line with a series of horizontal bars, resembling a screw thread. The letter "N" is solid black. The letter "T" is a solid black horizontal bar with a small circle at its top center. The letter "R" is a solid black vertical bar with a small circle at its top center. The letter "A" is a solid black vertical bar with a small circle at its top center. The letter "Y" is a solid black vertical bar with a small circle at its top center. The letters "T", "R", "A", and "Y" are outlined in white.

KOHDENT ROLAND KOHLER; MEDIZINTECH-  
NIK GMBH & CO. KG (FED REP GERMANY  
GMBH & CO. KG)

DANNINGEN 9  
78579 NEUHAUSEN  
FED REP GERMANY

OWNER OF INTERNATIONAL REGISTRATION  
0798855 DATED 2-24-2003, EXPIRES 2-24-2013.

SER. NO. 79-040,936, FILED 3-19-2007.

FOR: IMPRESSION TRAYS OF METAL FOR  
DENTAL IMPLANTS, IN CLASS 10 (U.S. CLS. 26, 39  
AND 44).

REBECCA POVARCHUK, EXAMINING ATTOR-  
NEY

**Int. Cls.: 14, 16 and 41**

**Prior U.S. Cls.: 2, 5, 22, 23, 27, 28, 29, 37, 38, 50, 100,  
101 and 107**

**Reg. No. 3,468,195**

**United States Patent and Trademark Office**

**Registered July 15, 2008**

**TRADEMARK  
SERVICE MARK  
PRINCIPAL REGISTER**



**KRONOMETRY**

RONCHETTI WALTER (FRANCE INDIVIDUAL)  
56 BOULEVARD CHANOINE CARTELLIER  
F-69230 SAINT-GENIS-LAVAL  
FRANCE

FOR: HOROLOGICAL AND CHRONOMETRIC  
INSTRUMENTS AND CASES THEREFOR, JEWEL-  
RY, WATCHES, PRECIOUS STONES, IN CLASS 14  
(U.S. CLS. 2, 27, 28 AND 50).

FOR: PENS; CATALOGUES IN THE FIELD OF  
TIMEPIECES, JEWELRY AND PENS, IN CLASS 16  
(U.S. CLS. 2, 5, 22, 23, 29, 37, 38 AND 50).

FOR: PUBLISHING OF CATALOGUES AND MA-  
GAZINES FEATURING TIMEPIECES, JEWELRY  
AND PENS, IN CLASS 41 (U.S. CLS. 100, 101 AND  
107).

OWNER OF INTERNATIONAL REGISTRATION  
0930450 DATED 2-7-2007, EXPIRES 2-7-2017.

NO CLAIM IS MADE TO THE EXCLUSIVE  
RIGHT TO USE "CHRONOMETRY", "1999", AND  
"CHRONOMETRY" LIMITED TO THE FOLLOW-  
ING GOODS - HOROLOGICAL AND CHRONOMET-  
RIC INSTRUMENTS AND CASES THEREFOR, AND  
WATCHES IN IC 014; CATALOGUES IN THE FIELD  
OF TIMEPIECES, JEWELRY AND PENS IN IC 016;  
AND PUBLISHING OF CATALOGUES AND MA-  
GAZINES FEATURING TIMEPIECES, JEWELRY  
AND PENS IN IC 041., APART FROM THE MARK  
AS SHOWN.

SER. NO. 79-040,985, FILED 2-7-2007.

ODESSA BIBBINS, EXAMINING ATTORNEY

**Int. Cls.: 37, 41, 42, 43 and 44**

**Prior U.S. Cls.: 100, 101, 103, 106 and 107**

**Reg. No. 3,468,196**

**United States Patent and Trademark Office**

**Registered July 15, 2008**

**SERVICE MARK  
PRINCIPAL REGISTER**

# TIGER WOODS

TIGER WOODS ENTERPRISES S.A. (SWITZERLAND CORPORATION)  
C/O MEISSER & PARTNER, BAHNHOFSTRASSE 8  
CH-7250 KLOSTERS, SWITZERLAND

FOR: BUILDING CONSTRUCTION; REPAIR, INSTALLATION SERVICES OF TURF WATERING PIPES AND CONTROLS; BUILDING CONSTRUCTION SERVICES OF GOLF FACILITIES; MAINTENANCE OF GOLF COURSES AND GOLF DRIVING RANGES, IN CLASS 37 (U.S. CLS. 100, 103 AND 106).

FOR: EDUCATIONAL SERVICES, NAMELY, CONDUCTING PERSONAL LESSONS IN THE FIELD OF GOLFING; TRAINING IN THE USE OF GOLF CLUBS; SERVICES OF A GOLF CLUB; SPORTS INSTRUCTION, NAMELY, GOLF INSTRUCTION; ENTERTAINMENT AND RECREATIONAL SERVICES IN THE NATURE OF SPORT EVENTS, NAMELY, GOLF TOURNAMENTS; TEACHING IN THE FIELD OF GOLF; ARRANGING OF SPORTS LESSONS, NAMELY, GOLF LESSONS; ORGANIZING SPORTING AND CULTURAL ACTIVITIES; PROVIDING GOLF FACILITIES, ORGANISATION OF CONVENTIONS IN THE FIELD OF GOLFING; ORGANIZATION OF ATHLETIC COMPETITIONS; ENTERTAINMENT IN THE NATURE OF GOLFING COMPETITIONS, IN CLASS 41 (U.S. CLS. 100, 101 AND 107).

FOR: CONSULTING SERVICES IN THE FIELD OF ARCHITECTURAL DESIGN OF CONSTRUCTION AND BUILDING OF GOLF COURSES AND GOLF DRIVING RANGES; ARCHITECTURAL DESIGN SERVICES, NAMELY, DRAWING UP OF BLUEPRINTS FOR THE CONSTRUCTION AND BUILDING OF GOLF COURSES AND GOLF DRIV-

ING RANGES; PROVIDING DESIGN SERVICES FOR OTHERS IN THE FIELD OF GOLF COURSES; ARCHITECTURAL DESIGN SERVICES IN THE FIELD OF GOLF COURSES; LANDSCAPING DESIGN SERVICES, IN CLASS 42 (U.S. CLS. 100 AND 101).

FOR: PROVIDING FOOD AND DRINK; PROVIDING TEMPORARY ACCOMMODATION; HOTELS; FAST-FOOD RESTAURANTS; CAFÉS, IN CLASS 43 (U.S. CLS. 100 AND 101).

FOR: HEALTH AND BEAUTY CARE SERVICES, NAMELY, HEALTH AND WELLNESS PROGRAMS, COSMETIC BODY CARE SERVICES, AND HEALTH SPA SERVICES, IN CLASS 44 (U.S. CLS. 100 AND 101).

THE MARK CONSISTS OF STANDARD CHARACTERS WITHOUT CLAIM TO ANY PARTICULAR FONT, STYLE, SIZE, OR COLOR.

PRIORITY DATE OF 12-14-2006 IS CLAIMED.

OWNER OF INTERNATIONAL REGISTRATION 0930572 DATED 4-24-2007, EXPIRES 4-24-2017.

THE NAME "TIGER WOODS" IDENTIFIES A LIVING INDIVIDUAL WHOSE CONSENT IS OF RECORD.

SER. NO. 79-041,026, FILED 4-24-2007.

WENDY JUN, EXAMINING ATTORNEY

Int. Cl.: 30

Prior U.S. Cl.: 46

United States Patent and Trademark Office

Reg. No. 3,468,197

Registered July 15, 2008

TRADEMARK  
PRINCIPAL REGISTER



CHOCOLAFABRIKEN LINDT & SPRÜNGLI  
AG (SWITZERLAND SOCIÉTÉ ANONYME)  
SEESTRASSE 204  
CH-8802 KILCHBERG, SWITZERLAND

FOR: CHOCOLATE, IN CLASS 30 (U.S. CL. 46).

PRIORITY DATE OF 11-28-2006 IS CLAIMED.

OWNER OF INTERNATIONAL REGISTRATION  
0930595 DATED 5-25-2007, EXPIRES 5-25-2017.

NO CLAIM IS MADE TO THE EXCLUSIVE  
RIGHT TO USE "MAITRE CHOCOLATIER DEPUIS  
1845", APART FROM THE MARK AS SHOWN.

THE COLOR(S) DARK BROWN, LIGHT BROWN,  
DARK ORANGE, LIGHT ORANGE, WHITE, GRAY  
AND GOLD IS/ARE CLAIMED AS A FEATURE OF  
THE MARK.

THE MARK CONSISTS OF A PICTURE OF CHO-  
COLATES AND AN ORANGE SLICE ON A DARK  
BROWN BACKGROUND. THE COLOR DARK

BROWN IS FOUND IN ALL THE CHOCOLATE.  
THE COLOR LIGHT BROWN APPEARS AS THE  
FILLING OF ONE OF THE CHOCOLATES AND  
UNDER THE PICTURE OF THE CHOCOLATES AS  
HIGHLIGHTING. THE COLOR DARK ORANGE  
APPEARS IN THE ORANGE SLICE AND THE  
COLOR LIGHT ORANGE APPEARS IN THE OR-  
ANGE SLICE AND AS THE FILLING OF ONE OF  
THE CHOCOLATES. THE COLOR WHITE AND  
GRAY APPEARS IN SWIRL HIGHLIGHTING  
AROUND THE CHOCOLATE AND ORANGE SLICE.  
THE COLOR GOLD APPEARS AS THE SEAL AT  
THE BOTTOM OF THE MARK AND AS A BORDER  
ON THE TOP AND BOTTOM OF THE MARK.

THE NON-LATIN CHARACTERS IN THE MARK  
TRANSLITERATE TO "LINDT & SPRÜNGLI MAI-  
TRE CHOCOLATIER DEPUIS 1845" AND THIS  
MEANS "LINDT & SPRÜNGLI MASTER CHOCO-  
LATIERS SINCE 1845" IN ENGLISH.

SER. NO. 79-041,032, FILED 5-25-2007.

DAWN FELDMAN, EXAMINING ATTORNEY

Int. Cl.: 30

Prior U.S. Cl.: 46

United States Patent and Trademark Office

Reg. No. 3,468,198

Registered July 15, 2008

TRADEMARK  
PRINCIPAL REGISTER



CHOCOLADEFABRIKEN LINDT & SPRÜNGLI  
AG (SWITZERLAND SOCIÉTÉ ANONYME)  
SEESTRASSE 204  
CH-8802 KILCHBERG, SWITZERLAND

FOR: CHOCOLATE, IN CLASS 30 (U.S. CL. 46).

PRIORITY DATE OF 11-28-2006 IS CLAIMED.

OWNER OF INTERNATIONAL REGISTRATION  
0930596 DATED 5-25-2007, EXPIRES 5-25-2017.

NO CLAIM IS MADE TO THE EXCLUSIVE  
RIGHT TO USE "MAITRE CHOCOLATIER DEPUIS  
1845", APART FROM THE MARK AS SHOWN.

THE COLOR(S) DARK BROWN, LIGHT BROWN,  
GREEN, LIGHT GREEN, WHITE, GRAY AND  
GOLD IS/ARE CLAIMED AS A FEATURE OF THE  
MARK.

THE MARK CONSISTS OF A PICTURE OF CHO-  
COLATES AND A LIME SLICE ON A DARK  
BROWN BACKGROUND WITH 11 INDIVIDUAL  
LIMES BACKSET UNDERNEATH THE CHOCO-

LATE. THE COLOR DARK BROWN IS FOUND IN  
ALL THE CHOCOLATE. THE COLOR LIGHT  
BROWN IS FOUND IN THE FILLING PART OF  
ONE OF THE CHOCOLATES AND UNDER THE  
PICTURE OF THE CHOCOLATES AS HIGHLIGHT-  
ING. THE COLOR LIGHT GREEN IS FOUND AS  
THE FILLING PART OF ONE OF THE CHOCO-  
LATES. THE COLOR GREEN AND LIGHT GREEN  
IS FOUND ON THE LIME SLICE AND THE BACK-  
SET LIMES UNDER THE CHOCOLATE. THE COL-  
OR WHITE AND GRAY APPEARS IN SWIRL  
HIGHLIGHTING AROUND THE CHOCOLATE  
AND LIME SLICE. THE COLOR GOLD APPEARS  
AS THE SEAL AT THE BOTTOM OF THE MARK  
AND AS A BORDER ON THE TOP AND BOTTOM  
OF THE MARK.

THE NON-LATIN CHARACTERS IN THE MARK  
TRANSLITERATE TO "LINDT & SPRÜNGLI MAI-  
TRE CHOCOLATIER DEPUIS 1845" AND THIS  
MEANS "LINDT & SPRÜNGLI MASTER CHOCO-  
LATIERS SINCE 1845" IN ENGLISH.

SER. NO. 79-041,033, FILED 5-25-2007.

DAWN FELDMAN, EXAMINING ATTORNEY

Int. Cl.: 30

Prior U.S. Cl.: 46

United States Patent and Trademark Office

Reg. No. 3,468,199

Registered July 15, 2008

TRADEMARK  
PRINCIPAL REGISTER



CHOCOLADEFABRIKEN LINDT & SPRÜNGLI  
AG (SWITZERLAND SOCIÉTÉ ANONYME)  
SEESTRASSE 204  
CH-8802 KILCHBERG, SWITZERLAND

FOR: CHOCOLATE, IN CLASS 30 (U.S. CL. 46).

PRIORITY DATE OF 11-28-2006 IS CLAIMED.

OWNER OF INTERNATIONAL REGISTRATION  
0930597 DATED 5-25-2007, EXPIRES 5-25-2017.

NO CLAIM IS MADE TO THE EXCLUSIVE  
RIGHT TO USE "MAITRE CHOCOLATIER DEPUIS  
1845", APART FROM THE MARK AS SHOWN.

THE COLOR(S) DARK BROWN, LIGHT BROWN,  
RED, GREEN, WHITE, GRAY AND GOLD IS/ARE  
CLAIMED AS A FEATURE OF THE MARK.

THE MARK CONSISTS OF A PICTURE OF CHO-  
COLATES, CHERRIES AND A RED PEPPER ON A  
DARK BROWN BACKGROUND. THE COLOR

DARK BROWN IS FOUND IN ALL THE CHOCO-  
LATE. THE COLOR LIGHT BROWN IS FOUND  
UNDER THE PICTURE OF THE CHOCOLATES AS  
HIGHLIGHTING. THE COLOR RED APPEARS AS  
THE CHERRIES, THE PEPPER AND AS THE FILL-  
ING OF ONE OF THE CHOCOLATES. THE COLOR  
GREEN APPEARS AS THE STEMS TO THE CHER-  
RIES AND THE PEPPER. THE COLOR WHITE AND  
GRAY APPEARS IN SWIRL HIGHLIGHTING  
AROUND THE CHOCOLATE, CHERRIES AND  
PEPPER. THE COLOR GOLD APPEARS AS THE  
SEAL AT THE BOTTOM OF THE MARK AND AS A  
BORDER ON THE TOP AND BOTTOM OF THE  
MARK.

THE NON-LATIN CHARACTERS IN THE MARK  
TRANSLITERATE TO "LINDT & SPRÜNGLI MAI-  
TRE CHOCOLATIER DEPUIS 1845" AND THIS  
MEANS "LINDT & SPRÜNGLI MASTER CHOCO-  
LATIERS SINCE 1845" IN ENGLISH.

SER. NO. 79-041,034, FILED 5-25-2007.

DAWN FELDMAN, EXAMINING ATTORNEY

Int. Cl.: 30

Prior U.S. Cl.: 46

United States Patent and Trademark Office

Reg. No. 3,468,200

Registered July 15, 2008

TRADEMARK  
PRINCIPAL REGISTER



CHOCOLADEFABRIKEN LINDT & SPRÜNGLI  
AG (SWITZERLAND SOCIÉTÉ ANONYME)  
SEESTRASSE 204  
CH-8802 KILCHBERG, SWITZERLAND

FOR: CHOCOLATE, IN CLASS 30 (U.S. CL. 46).

PRIORITY DATE OF 11-28-2006 IS CLAIMED.

OWNER OF INTERNATIONAL REGISTRATION  
0930599 DATED 5-25-2007, EXPIRES 5-25-2017.

NO CLAIM IS MADE TO THE EXCLUSIVE  
RIGHT TO USE "MAITRE CHOCOLATIER DEPUIS  
1845", APART FROM THE MARK AS SHOWN.

THE COLOR(S) DARK BROWN, LIGHT BROWN,  
PINK, RED, OCHER, LILAC, ORANGE, WHITE,  
GRAY AND GOLD IS/ARE CLAIMED AS A FEAT-  
URE OF THE MARK.

THE MARK CONSISTS OF A PICTURE OF CHO-  
COLATES, A FIG AND A PIECE OF CARAMEL ON  
A DARK BROWN BACKGROUND. THE COLOR  
LIGHT BROWN IS FOUND UNDER THE PICTURE

OF THE CHOCOLATES AS HIGHLIGHTING. THE  
COLOR DARK BROWN IS FOUND ON ALL THE  
CHOCOLATE. THE COLOR PINK IS FOUND AS  
THE FILLING IN THE CHOCOLATE. THE COLOR  
RED APPEARS AS THE CENTER OF THE FIG. THE  
COLOR OCHER APPEARS AS THE STEM OF THE  
FIG. THE COLOR LILAC APPEARS AS THE OUT-  
SIDE OF THE FIG. THE COLOR ORANGE APPEARS  
AS THE CARAMEL AND THE MELTED CARAMEL  
BELOW. THE COLOR WHITE AND GRAY AP-  
PEARS IN SWIRL HIGHLIGHTING AROUND THE  
CHOCOLATE, FIG AND CARAMEL. THE COLOR  
GOLD APPEARS AS THE SEAL AT THE BOTTOM  
OF THE MARK AND AS A BORDER ON THE TOP  
AND BOTTOM OF THE MARK.

THE NON-LATIN CHARACTERS IN THE MARK  
TRANSLITERATE TO "LINDT & SPRÜNGLI MAI-  
TRE CHOCOLATIER DEPUIS 1845" AND THIS  
MEANS "LINDT & SPRÜNGLI MASTER CHOCO-  
LATIERS SINCE 1845" IN ENGLISH.

SER. NO. 79-041,035, FILED 5-25-2007.

DAWN FELDMAN, EXAMINING ATTORNEY

Int. Cl.: 30

Prior U.S. Cl.: 46

United States Patent and Trademark Office

Reg. No. 3,468,201

Registered July 15, 2008

TRADEMARK  
PRINCIPAL REGISTER



CHOCOLAFABRIKEN LINDT & SPRÜNGLI  
AG (SWITZERLAND SOCIÉTÉ ANONYME)  
SEESTRASSE 204  
CH-8802 KILCHBERG  
SWITZERLAND

FOR: CHOCOLATE, IN CLASS 30 (U.S. CL. 46).

PRIORITY DATE OF 11-28-2006 IS CLAIMED.

OWNER OF INTERNATIONAL REGISTRATION  
0930600 DATED 5-25-2007, EXPIRES 5-25-2017.

NO CLAIM IS MADE TO THE EXCLUSIVE  
RIGHT TO USE "MAITRE CHOCOLATIER DEPUIS  
1845", APART FROM THE MARK AS SHOWN.

THE COLOR(S) DARK BROWN, LIGHT BROWN,  
WHITE, GRAY AND GOLD IS/ARE CLAIMED AS A  
FEATURE OF THE MARK.

THE MARK CONSISTS OF A PICTURE OF CHO-  
COLATES ON A DARK BROWN BACKGROUND.  
THE COLOR DARK BROWN IS FOUND IN ALL  
THE CHOCOLATE. THE COLOR LIGHT BROWN IS  
FOUND UNDER THE PICTURE OF THE CHO-  
COLATES AS HIGHLIGHTING. THE COLOR WHITE  
AND GRAY APPEARS IN SWIRL HIGHLIGHTING  
AROUND THE CHOCOLATES. THE COLOR GOLD  
APPEARS AS THE SEAL AT THE BOTTOM OF THE  
MARK AND AS A BORDER ON THE TOP AND  
BOTTOM OF THE MARK.

THE NON-LATIN CHARACTERS IN THE MARK  
TRANSLITERATE TO "LINDT & SPRÜNGLI MAI-  
TRE CHOCOLATIER DEPUIS 1845" AND THIS  
MEANS "LINDT & SPRÜNGLI MASTER CHO-  
COLATIERS SINCE 1845" IN ENGLISH.

SER. NO. 79-041,036, FILED 5-25-2007.

DAWN FELDMAN, EXAMINING ATTORNEY



**Int. Cl.: 25**

**Prior U.S. Cls.: 22 and 39**

**United States Patent and Trademark Office**

**Reg. No. 3,468,202**

**Registered July 15, 2008**

**TRADEMARK  
PRINCIPAL REGISTER**

**ADNYHVVH**

EUSEPI DANIËLE (BELGIUM INDIVIDUAL)  
AVENUE DES ARMURES 51  
B-1190 BRUXELLES  
BRUSSELS, BELGIUM

THE MARK CONSISTS OF STANDARD CHARACTERS WITHOUT CLAIM TO ANY PARTICULAR FONT, STYLE, SIZE, OR COLOR.

FOR: CLOTHING, NAMELY, PANTS, SHIRTS, COATS, SWEATERS, SWIM SUITS, SHIRTS, POLO-SHIRTS, T-SHIRTS, SUITS, SKIRTS, COATS, PULL-OVERS, TROUSERS, DRESSES, JACKETS, SHAWLS, SCARVES, CLOTHING BELTS, BATHING SUITS, UNDERPANTS, SOCKS AND STOCKINGS; FOOTWEAR, BOOTS AND SANDALS; HEADWEAR, NAMELY, HATS AND CAPS; GLOVES; WATER-PROOF CLOTHING, NAMELY, RAIN COATS; BEACH CLOTHES, NAMELY, BEACH COVER-UPS, BEACH FOOTWEAR, SWIMWEAR, SWIMMING CAPS, IN CLASS 25 (U.S. CLS. 22 AND 39).

OWNER OF INTERNATIONAL REGISTRATION  
0930736 DATED 4-24-2007, EXPIRES 4-24-2017.

"ADNYHVVH" MEANS IN ENGLISH, I AM WHAT I AM.

SER. NO. 79-041,094, FILED 4-24-2007.

DAVID HOFFMAN, EXAMINING ATTORNEY

**Int. Cl.: 5**

**Prior U.S. Cls.: 6, 18, 44, 46, 51 and 52**

**United States Patent and Trademark Office**

**Reg. No. 3,468,203**

**Registered July 15, 2008**

**TRADEMARK  
PRINCIPAL REGISTER**

**ABVANTEC**

GENMAB A/S (DENMARK AKTIESELSKAP (A/  
S))  
TOLDBODGADE 33  
DK-1253 COPENHAGEN K  
DENMARK

FOR: PHARMACEUTICAL PREPARATIONS  
AND SUBSTANCES FOR THE TREATMENT OF  
CANCER, AIDS (ACQUIRED IMMUNE DEFICIEN-  
CY SYNDROME) AND OTHER INFECTIOUS DIS-  
EASES, IMMUNE AND AUTOIMMUNE DISEASES,  
INFLAMMATORY DISEASES, NEURODEGENERA-  
TIVE DISEASES AND CARDIOVASCULAR DISEA-  
SES, IN CLASS 5 (U.S. CLS. 6, 18, 44, 46, 51 AND 52).

THE MARK CONSISTS OF STANDARD CHAR-  
ACTERS WITHOUT CLAIM TO ANY PARTICULAR  
FONT, STYLE, SIZE, OR COLOR.

PRIORITY DATE OF 12-22-2006 IS CLAIMED.

OWNER OF INTERNATIONAL REGISTRATION  
0930846 DATED 6-21-2007, EXPIRES 6-21-2017.

SER. NO. 79-041,127, FILED 6-21-2007.

KRISTINA MORRIS, EXAMINING ATTORNEY

**Int. Cls.: 9, 42 and 44**

**Prior U.S. Cls.: 21, 23, 26, 36, 38, 100 and 101**

**United States Patent and Trademark Office**

**Reg. No. 3,468,204**

**Registered July 15, 2008**

**TRADEMARK  
SERVICE MARK  
PRINCIPAL REGISTER**

# HERD NAVIGATOR

LATTEC I/S (DENMARK INTERESSENTSKAB (I/S))  
SLANGERUPGADE 69  
DK-3400 HILLERØD  
DENMARK

FOR: ELECTRIC ANALYSIS APPARATUS NOT FOR HUMAN MEDICAL USE, NAMELY, MEASURING AND TESTING APPARATUS FOR ANALYZING MILK SAMPLES FROM COWS FOR BIOLOGICAL PARAMETERS, AND COMPUTER SOFTWARE FOR OPERATION OF THE FOREGOING, IN CLASS 9 (U.S. CLS. 21, 23, 26, 36 AND 38).

FOR: BIOLOGICAL AND CHEMICAL RESEARCH AND ANALYSIS; QUALITY CONTROL FOR OTHERS, IN CLASS 42 (U.S. CLS. 100 AND 101).

FOR: VETERINARY SERVICES, NAMELY, TENDING TO ANIMALS, IN CLASS 44 (U.S. CLS. 100 AND 101).

THE MARK CONSISTS OF STANDARD CHARACTERS WITHOUT CLAIM TO ANY PARTICULAR FONT, STYLE, SIZE, OR COLOR.

PRIORITY DATE OF 12-22-2006 IS CLAIMED.

OWNER OF INTERNATIONAL REGISTRATION 0930847 DATED 5-24-2007, EXPIRES 5-24-2017.

NO CLAIM IS MADE TO THE EXCLUSIVE RIGHT TO USE "HERD", APART FROM THE MARK AS SHOWN.

SER. NO. 79-041,128, FILED 5-24-2007.

KELLY MCCOY, EXAMINING ATTORNEY

**Int. Cl.: 9**

**Prior U.S. Cls.: 21, 23, 26, 36 and 38**

**United States Patent and Trademark Office**

**Reg. No. 3,468,205**

**Registered July 15, 2008**

**TRADEMARK  
PRINCIPAL REGISTER**

# Nitro PDF

BINARYTHING.COM PTY LTD (AUSTRALIA  
COMPANY)

LEVEL 3

370 LITTLE BOURKE STREET; MELBOURNE  
VIC3000

AUSTRALIA

FOR: COMPUTER SOFTWARE, NAMELY, SOFTWARE FOR CREATING, READING, EDITING, MANAGING, PRINTING, INDEXING AND RETRIEVING ELECTRONIC DOCUMENTS AND FILES, AND PRINTED INSTRUCTIONAL MANUALS, SOLD TOGETHER AS A UNIT; SOFTWARE FOR USE WITH OPTICAL SCANNERS; SOFTWARE FOR PAGE RECOGNITION AND RENDERING, IN CLASS 9 (U.S. CLS. 21, 23, 26, 36 AND 38).

THE MARK CONSISTS OF STANDARD CHARACTERS WITHOUT CLAIM TO ANY PARTICULAR FONT, STYLE, SIZE, OR COLOR.

PRIORITY DATE OF 12-5-2006 IS CLAIMED.

OWNER OF INTERNATIONAL REGISTRATION 0931059 DATED 5-25-2007, EXPIRES 5-25-2017.

NO CLAIM IS MADE TO THE EXCLUSIVE RIGHT TO USE "PDF", APART FROM THE MARK AS SHOWN.

SER. NO. 79-041,170, FILED 5-25-2007.

DAWN FELDMAN, EXAMINING ATTORNEY

**Int. Cls.: 1 and 5**

**Prior U.S. Cls.: 1, 5, 6, 10, 18, 26, 44, 46, 51 and 52**

**United States Patent and Trademark Office**

**Reg. No. 3,468,206**

**Registered July 15, 2008**

**TRADEMARK  
PRINCIPAL REGISTER**

Litesse

The logo for Litesse features the word "Litesse" in a clean, sans-serif font. Below the text is a stylized, thick black wave that starts under the 'L', rises to a peak under the 'e', and then falls back down, resembling a smile or a wave.

DANISCO A/S (DENMARK COMPANY)  
LANGEBROGADE 1  
P.O. BOX 17; DK-1001 COPENHAGEN K  
DENMARK

FOR: REDUCED CALORIE BULKING AGENTS,  
NAMELY, FAT-REPLACERS AND CHEMICAL AR-  
TIFICIAL SWEETENERS, ALL FOR USE IN THE  
MANUFACTURE OF FOOD, BEVERAGES AND  
ANIMAL FEED, IN CLASS 1 (U.S. CLS. 1, 5, 6, 10, 26  
AND 46).

FOR: CHEMICAL SWEETENERS FOR MEDICAL  
USE, NAMELY, DIETETIC SUGAR, IN CLASS 5 (U.S.  
CLS. 6, 18, 44, 46, 51 AND 52).

PRIORITY DATE OF 10-27-2006 IS CLAIMED.

OWNER OF INTERNATIONAL REGISTRATION  
0931200 DATED 4-20-2007, EXPIRES 4-20-2017.

SER. NO. 79-041,212, FILED 4-20-2007.

DAVID HOFFMAN, EXAMINING ATTORNEY

**Int. Cl.: 10**

**Prior U.S. Cls.: 26, 39 and 44**

**United States Patent and Trademark Office**

**Reg. No. 3,468,207**

**Registered July 15, 2008**

**TRADEMARK  
PRINCIPAL REGISTER**

**SECTRA MICRODOSE  
MAMMOGRAPHY**

SECTRA IMTEC AB (SWEDEN LIMITED COMPANY)  
TEKNIKRINGEN 2  
SE-583 30 LINKÖPING  
SWEDEN

FOR: MEDICAL RADIOLOGIC APPARATUS AND INSTRUMENTS, NAMELY, MAMMOGRAPHY UNITS AND RADIOLOGIC SCREENS; X-RAY APPARATUS AND X-RAY PICTURES FOR MEDICAL PURPOSES; APPARATUS AND INSTRUMENTS FOR RECORDING, TRANSMISSION AND REPRODUCTION OF X-RAY PICTURES FOR MEDICAL PURPOSES, NAMELY, MEDICAL RADIOLOGIC APPARATUS; AND PICTURE-HANDLING SYSTEMS COMPRISED PRIMARILY OF MEDICAL RADIOLOGIC APPARATUS AND INSTRUMENTS, COMPUTER HARDWARE AND COMPUTER SOFTWARE FOR FILING AND COMMUNICATION OF

MEDICAL PICTURES, IN CLASS 10 (U.S. CLS. 26, 39 AND 44).

THE MARK CONSISTS OF STANDARD CHARACTERS WITHOUT CLAIM TO ANY PARTICULAR FONT, STYLE, SIZE, OR COLOR.

OWNER OF INTERNATIONAL REGISTRATION 0783878 DATED 3-13-2002, EXPIRES 3-13-2012.

NO CLAIM IS MADE TO THE EXCLUSIVE RIGHT TO USE "MICRODOSE MAMMOGRAPHY", APART FROM THE MARK AS SHOWN.

SER. NO. 79-041,268, FILED 12-20-2006.

BENJAMIN ALLEN, EXAMINING ATTORNEY

**Int. Cls.: 6, 11 and 17**

**Prior U.S. Cls.: 1, 2, 5, 12, 13, 14, 21, 23, 25, 31, 34, 35  
and 50**

**Reg. No. 3,468,208**

**United States Patent and Trademark Office**

**Registered July 15, 2008**

**TRADEMARK  
PRINCIPAL REGISTER**



BLÜCHER METAL A/S (DENMARK CORPORATION)  
PUGDALVEJ 1  
DK-7480 VILDBJERG  
DENMARK

FOR: BUILDING PARTS OF METAL, NAMELY, ROOFING, GRATINGS WITH OR WITHOUT INFILLINGS, DRAIN PIPES MADE OF METAL, METAL GUTTER PIPES, ELBOWS OF METAL FOR PIPES, CABLE FITTINGS OF METAL, IN CLASS 6 (U.S. CLS. 2, 12, 13, 14, 23, 25 AND 50).

FOR: REGULATING ACCESSORIES FOR WATER SUPPLY, NAMELY, METERED VALVES, PIPES BEING PARTS OF SANITARY FACILITIES, PLUMB-

ING FITTINGS, NAMELY, DRAINS, IN CLASS 11 (U.S. CLS. 13, 21, 23, 31 AND 34).

FOR: PACKING, STOPPING AND INSULATING MATERIALS, NAMELY, PACKING AND PROOFING OF RUBBER AND GUM FOR USE IN MANUFACTURE; FLEXIBLE PIPES NOT OF METAL, IN CLASS 17 (U.S. CLS. 1, 5, 12, 13, 35 AND 50).

OWNER OF INTERNATIONAL REGISTRATION 0789859 DATED 9-27-2002, EXPIRES 9-27-2012.

SER. NO. 79-041,269, FILED 2-1-2007.

ELLEN B. AWRICH, EXAMINING ATTORNEY

**Int. Cls.: 9, 18 and 25**

**Prior U.S. Cls.: 1, 2, 3, 21, 22, 23, 26, 36, 38, 39 and 41**

**Reg. No. 3,468,209**

**United States Patent and Trademark Office**

**Registered July 15, 2008**

**TRADEMARK  
PRINCIPAL REGISTER**

# DRYKORN

MARCO GÖTZ (FED REP GERMANY INDIVIDUAL)  
SCHELLINGSTRASSE 4  
97074 WÜRZBURG  
FED REP GERMANY

FOR: SPECTACLES, SPECTACLE FRAMES; SUNGLASSES; SPECTACLE CASES, IN CLASS 9 (U.S. CLS. 21, 23, 26, 36 AND 38).

FOR: LEATHER AND IMITATION LEATHER; GOODS MADE OF THESE MATERIALS, NAMELY, HANDBAGS, TRAVELING TRUNKS, SUITCASES, PURSES, POCKET WALLETS, KEY CASES NOT OF PRECIOUS METAL, IN CLASS 18 (U.S. CLS. 1, 2, 3, 22 AND 41).

FOR: CLOTHING, NAMELY, BATHROBES, DRESSING GOWNS, KITCHEN APRONS, BLOUSES, T-SHIRTS, SWEATSHIRTS, SKIRTS, DRESSES,

SUITS, PAJAMAS, TIGHTS, JEANS, SHORT PANTS, EVENING DRESSES, TIES, SCARVES, COATS, JACKETS, CARDIGANS, PANTS, SHIRTS, COATS, BLAZERS, SOCKS, SWEATERS, CULOTTES, AND UNDERWEAR; HEADGEAR, NAMELY, HATS AND CAPS; FOOTWEAR, NAMELY, BOOTS, SHOES AND SLIPPERS, IN CLASS 25 (U.S. CLS. 22 AND 39).

THE MARK CONSISTS OF STANDARD CHARACTERS WITHOUT CLAIM TO ANY PARTICULAR FONT, STYLE, SIZE, OR COLOR.

OWNER OF INTERNATIONAL REGISTRATION 0834497 DATED 3-15-2004, EXPIRES 3-15-2014.

SER. NO. 79-041,277, FILED 12-7-2006.

EUGENIA MARTIN, EXAMINING ATTORNEY



**Int. Cls.: 8, 9, 11, 20, 21 and 22**

**Prior U.S. Cls.: 1, 2, 7, 13, 19, 21, 22, 23, 25, 26, 28, 29, 30, 31, 32, 33, 34, 36, 38, 40, 42, 44 and 50**

**Reg. No. 3,468,210**

**United States Patent and Trademark Office**

**Registered July 15, 2008**

**TRADEMARK  
PRINCIPAL REGISTER**

**PEREL**

VELLEMAN COMPONENTS,; NAAMLOZE VEN-  
NOOTSCHAP (BELGIUM NAAMLOZE VEN-  
NOOTSCHAP)  
INDUSTRIETERREIN 33  
B-9890 GAVERE, BELGIUM

FOR: HAND-OPERATED HAND TOOLS AND IMPLEMENTS, NAMELY, CLAMPS, CARPENTER'S CLAMPS, RATCHET HANDLES, CHISELS, AXES, HATCHETS, TIMBER WEDGES, NAMELY, HACK SAWS; SCRAPERS, SNOW SHOVELS, GRASS SHEARS AND PRUNERS, CULTIVATORS; HAND-PUMPED SPRAYERS FOR HOUSEHOLD AND GARDEN APPLICATIONS; HAND SAWS, NAMELY, HACK SAWS, MITER SAWS, WOOD SAWS, AND PRUNING SAWS; BLADES FOR HAND SAWS; AUTO REPAIR TOOL KIT COMPRISED OF PLIERS, FORKS, KNIVES, WRENCHES, OIL FILTER WRENCH, WHEEL WRENCH, HAND JACKS, HAND OPERATED LIFTING JACKS, MANUALLY-OPERATED JACKS, STANDS FOR HAND JACKS, HAND-OPERATED PUMPS, TOOL HOLDERS, WIRE AND CABLE STRIPPERS, WELDING CORNER VICES, PLUG SPANNERS, HAND TOOLS, NAMELY, SOCKET SETS, HAND TOOLS, NAMELY, BOLT CUTTERS, HAND TOOLS, NAMELY, TUBE BENDERS, TUBE CUTTERS, AND COMPUTER REPAIR TOOL KIT COMPRISED OF PIPE CUTTERS, KNIVES, WIRE CUTTERS; CHALK LINE REELS, HAMMERS, MALLETS, TILE SPACERS, CROWBARS, PUNCHES, EXPLOSIVE ACTUATED TOOLS FOR DRIVING RIVETS, CRIMPING IRONS, CAULKING GUNS, PINCERS, SCREWDRIVERS, TROWELS, GROUT FLOATS, ADJUSTABLE SPANNERS, MULTIPURPOSE SCISSORS, SANDERS, DRILLS AND DRILL BITS FOR HAND DRILLS, PLANERS, HAND-POWERED STAPLE GUNS, IN CLASS 8 (U.S. CLS. 23, 28 AND 44).

FOR: SCIENTIFIC, NAUTICAL, SURVEYING, PHOTOGRAPHIC, CINEMATOGRAPHIC, OPTICAL, WEIGHING, MEASURING, SIGNALING,

CHECKING, SUPERVISION, LIFE SAVING AND TEACHING APPARATUS AND INSTRUMENTS, NAMELY, SURVEYING MACHINES AND INSTRUMENTS, CAMERAS, CINEMATOGRAPHIC CAMERAS, SCALES, MEASURING TAPES, SIGNALING BUOYS, DIRECTIONAL COMPASSES, LIFE-SAVING AND PROTECTION EQUIPMENT, NAMELY, LIFE BELTS, LIFE JACKETS, LIFE NETS, LIFE PRESERVERS, LIFE SAVING RAFTS, LIFE-BUOYS, PROTECTIVE EYEWEAR, NETWORK ROUTERS, TIMERS, ELECTRICAL LIGHTS FOR USE IN CRAFTSMANSHIP WORK, NAMELY, WARNING LIGHTS; THERMOMETERS, THERMOSTATS, ELECTRICAL SWITCHES, ADAPTER PLUGS, BATTERY ADAPTERS, CABLE JUMP LEADS, PRESSURE GAUGES, DESK OR CAR MOUNTED UNITS INCORPORATING A LOUDSPEAKER TO ALLOW A TELEPHONE HANDSET TO BE USED HANDS-FREE, CELL PHONE BATTERY CHARGERS, ELECTRIC NIGHT LIGHTS, SELF-ADHESIVE LIGHT EMITTING DIODES (LEDS), BUILD-IN RADIO WITH REMOTE CONTROL, BATTERY CHARGERS, METAL DETECTORS, RADIO TRANSMITTERS AND RECEIVERS, REMOTE CONTROLS FOR TELEVISIONS, CDS, AND DVDS, TIME CLOCKS, ELECTRIC DOOR CHIMES, COUNTERFEIT MONEY DETECTION LIGHT TO BE USED IN RETAIL STORES AND BANKS, ELECTRIC DEVICES FOR ATTRACTING AND KILLING INSECTS, ELECTRIC AND POWER CABLES, PLUG CONNECTORS, ELECTRONIC RECEIVERS FOR REMOTE CONTROLS, ELECTRIC LIGHT DIMMERS, REELS FOR ELECTRIC WIRE AND CABLE, ENERGY METERS, ELECTRIC METERS, VOLTAGE TESTERS, ELECTRICAL OUTLET TESTER, ULTRASONIC DETECTORS FOR LIVE WIRING AND METAL OR WOODEN STUDS; ELECTRICAL POWER DISTRIBUTION BLOCKS, EXTENSION CABLES, ELECTRICAL POWER EXTENSION CORDS, ADAPTERS, POWER CABLES, ELECTRICAL SOCKETS; APPARATUS AND INSTRUMENTS FOR CONDUCTING, SWITCHING, TRANSFORMING, ACCUMULAT-

ING, REGULATING OR CONTROLLING ELECTRICITY, NAMELY, ELECTRICAL SWITCHES, TRANSFORMERS, ACCUMULATOR BOXES; APPARATUS FOR RECORDING, TRANSMITTING AND REPRODUCING SOUND OR IMAGES; MAGNETIC AND OPTICAL RECORDING MEDIA, NAMELY, BLANK MAGNETIC DISCS, RECORDING DISCS, NAMELY, BLANK MAGNETIC DATA CARRIERS, BLANK OPTICAL DISCS; DATA PROCESSING EQUIPMENT AND COMPUTERS, NAMELY, CENTRAL PROCESSING UNITS FOR PROCESSING DATA; ELECTRIC SOLDERING APPARATUS; POCKET CALIPERS FOR MEASURING; MEASURING RULES; CARPENTER'S LEVELS; BATTERIES; HIGHWAY SAFETY CONES; DISPOSABLE PROTECTIVE GLOVES FOR INDUSTRIAL USE; KNEE PADS FOR WORKERS; PROTECTIVE EAR COVERINGS; SPY CAMERAS; BUILDING SECURITY SYSTEMS COMPRISING SOFTWARE AND HARDWARE FOR PROVIDING PICTURE, VIDEO, ALARM STATUS, BUILDING PLANS, AND OTHER INFORMATION TO A REMOTE STATION; ACCESS CONTROL AND ALARM MONITORING SYSTEMS; CAR REVERSING SYSTEMS COMPRISED OF VIDEO CAMERA AND MONITORING; WIRELESS CAMERAS; SAFETY PRODUCTS, NAMELY, REFLECTIVE SAFETY BANDS TO BE WORN ON THE BODY; REFLECTIVE AND ILLUMINATED CLOTHING FOR SAFETY PURPOSES; SAFETY MARKERS, NAMELY, PLASTIC SAFETY FENCING; MEGAPHONES; VIDEO MONITORS; SAFETY GOGGLES, WELDING GOGGLES, SAFETY HELMETS, WELDING HELMETS; PARTICULATE RESPIRATORS OTHER THAN FOR ARTIFICIAL RESPIRATION; ELECTRIC CONNECTORS FOR ROPE LIGHTS, MOUNTING DEVICES FOR CAMERAS, MONITORS, AND LIGHTS; ELECTRONIC SAFES, IN CLASS 9 (U.S. CLS. 21, 23, 26, 36 AND 38).

FOR: LIGHTING FIXTURES, SOLAR LIGHT FIXTURES, NAMELY, INDOOR AND OUTDOOR SOLAR POWERED LIGHTING UNITS AND FIXTURES, APPARATUS FOR THE EXCHANGE OF SUBSTANCES AND HEAT FOR USE IN THE PRODUCTION OF STEAM, FOR USE IN COOKING AND FOR USE IN REFRIGERATION; INDUSTRIAL DRYERS FOR HEATING AND DEHUMIDIFYING, WATER FILTERS, ELECTRIC PATIO HEATERS, HEATING ELEMENTS, ELECTRIC SPACE HEATERS, IRRIGATION SPRAY NOZZLES, PLUMBING FITTINGS, NAMELY, COUPLERS, FLASHLIGHTS; LIGHTING APPLIANCES FOR THE GARDEN, NAMELY, PAVER LIGHTS, BARBECUES, LED (LIGHT EMITTING DIODES) LIGHTING FIXTURES FOR USE IN DISPLAY, COMMERCIAL, INDUSTRIAL, RESIDENTIAL, AND ARCHITECTURAL ACCENT LIGHTING APPLICATIONS, BICYCLE LIGHTS, LAMP BULBS, HALOGEN LIGHT BULBS, PORTABLE LAMPS, PORTABLE BATTERY-OPERATED LIGHTS THAT CAN BE PLACED ON SURFACES WHERE OTHER LIGHT SOURCES ARE UNAVAILABLE, ELECTRIC FANS, LANTERNS, AUTOMOTIVE HEADLAMPS, FLUORESCENT ELECTRIC LIGHT BULBS, ELECTRIC TORCHES

FOR LIGHTING, SPOTLIGHTS, ELECTRONIC RECEIVERS FOR REMOTE CONTROL, PROPANE TORCHES FOR LIGHTING, GAS TORCHES FOR LIGHTING, HEAT GUNS, GAS BURNERS, SOLDERING LAMPS, CAMPING GAS STOVES, ELECTRICAL HEATING TAPES, DJ LASER LIGHT PROJECTORS; DJ DANCING, FLASHING, SYNCHRONIZED TO MUSIC AND DJ LIGHT BALLS, NAMELY, FLASHING STROBE LIGHT APPARATUS, FLUORESCENT ELECTRIC LIGHT BULBS, ROPE LIGHTS, NAMELY, LIGHTS IN THE SHAPE OF ROPES; HOT AIR BLOWERS; DJ LIGHT AND SMOKE MACHINE FOR CREATING THEATRICAL EFFECTS, IN CLASS 11 (U.S. CLS. 13, 21, 23, 31 AND 34).

FOR: NON-METALLIC FURNITURE CASTORS, IN CLASS 20 (U.S. CLS. 2, 13, 22, 25, 32 AND 50).

FOR: HOUSEHOLD UTENSILS NOT OF PRECIOUS METAL OR COATED THEREWITH OR SILVERED, NAMELY, SIEVES, GARDEN HOSE SPRAYERS, MOUSE TRAPS, RAT TRAPS; CONTAINERS FOR HOUSEHOLD OR KITCHEN USE NOT OF PRECIOUS METAL; INSECT TRAPS; COMBS AND SPONGES FOR HOUSEHOLD PURPOSES, ABRASIVE SPONGES, PLUNGERS FOR CLEARING BLOCKED DRAINS, HAND-OPERATED GRINDERS, CLOTHES DRYING HANGERS; AIR DUSTING GUN, NAMELY, DUSTERS, SCRUBBING AND SCRAPING BRUSHES; BRUSH-MAKING MATERIALS; ARTICLES FOR CLEANING PURPOSES, NAMELY, CLEANING CLOTHS AND COMBS; STEEL WOOL FOR CLEANING; UNWORKED OR SEMI-WORKED GLASS EXCEPT GLASS USED IN BUILDING; BEVERAGE GLASSWARE, PORCELAIN AND EARTHENWARE MUGS NOT INCLUDED IN OTHER CLASSES; SPATULAS FOR BUTTER; SPATULAS AND BRUSHES FOR BASTING MEAT TO BE USED IN COOKING, IN CLASS 21 (U.S. CLS. 2, 13, 23, 29, 30, 33, 40 AND 50).

FOR: ROPES, STRINGS; BIRD NETS, NAMELY, COMMERCIAL NETS; TENTS, AWNINGS, TARPULINS, SAILS, SACKS AND BAGS FOR THE TRANSPORTATION OR STORAGE OF MATERIALS IN BULK, CARGO SLINGS OF ROPE, IN CLASS 22 (U.S. CLS. 1, 2, 7, 19, 22, 42 AND 50).

THE MARK CONSISTS OF STANDARD CHARACTERS WITHOUT CLAIM TO ANY PARTICULAR FONT, STYLE, SIZE, OR COLOR.

OWNER OF INTERNATIONAL REGISTRATION 0931394 DATED 5-29-2007, EXPIRES 5-29-2017.

THE WORDING "PEREL" HAS NO MEANING IN A FOREIGN LANGUAGE.

SER. NO. 79-041,297, FILED 5-29-2007.

ELIZABETH KAJUBI, EXAMINING ATTORNEY

Int. Cl.: 33

Prior U.S. Cls.: 47 and 49

**United States Patent and Trademark Office**

**Reg. No. 3,468,211**

Registered July 15, 2008

**TRADEMARK  
PRINCIPAL REGISTER**



**Riunite**



CANTINE COOPERATIVE RIUNITE -; SOCIETA'  
COOPERATIVA AGRICOLA (ITALY COOP-  
ERATIVE)  
VIA G. BRODOLINI, 24  
I-42040 CAMPEGINE (REGGIO EMILIA)  
ITALY

OWNER OF U.S. REG. NOS. 1,006,101, 2,108,246  
AND OTHERS.

THE ENGLISH TRANSLATION OF THE FOR-  
EIGN WORD(S) IN THE MARK IS: REUNITED.

FOR: WINES, IN CLASS 33 (U.S. CLS. 47 AND 49).

SER. NO. 79-041,327, FILED 5-15-2007.

OWNER OF INTERNATIONAL REGISTRATION  
0931490 DATED 5-15-2007, EXPIRES 5-15-2017.

KATHERINE E. HALMEN, EXAMINING ATTOR-  
NEY

**Int. Cls.: 9 and 35**

**Prior U.S. Cls.: 21, 23, 26, 36, 38, 100, 101 and 102**

**Reg. No. 3,468,212**

**United States Patent and Trademark Office**

**Registered July 15, 2008**

**TRADEMARK  
SERVICE MARK  
PRINCIPAL REGISTER**

**NARCYSO**

GIOMO STEFANO (ITALY INDIVIDUAL)  
VIA TRAVERI, 17  
I-31030 BIANCADE DI RONCADE (TV), ITALY

FOR: SCIENTIFIC, NAUTICAL, SURVEYING, ELECTRIC, PHOTOGRAPHIC, CINEMATOGRAPHIC, OPTICAL, WEIGHING, MEASURING, SIGNALING, CHECKING AND SUPERVISING INSTRUMENTS, NAMELY, CAMERAS, VIDEO CAMERAS, OPTICAL LENSES; APPARATUS FOR RECORDING, TRANSMISSION OR REPRODUCTION OF SOUND OR IMAGES; AUTOMATIC VENDING MACHINES AND MECHANISMS FOR COIN-OPERATED APPARATUS, NAMELY, COIN COUNTING MACHINES; CASH REGISTERS, CALCULATING MACHINES, DATA PROCESSING EQUIPMENT, NAMELY, DATA PROCESSORS AND COMPUTERS, IN CLASS 9 (U.S. CLS. 21, 23, 26, 36 AND 38).

FOR: ADVERTISING; BUSINESS MANAGEMENT; BUSINESS ADMINISTRATION; OFFICE

FUNCTIONS, IN CLASS 35 (U.S. CLS. 100, 101 AND 102).

THE MARK CONSISTS OF STANDARD CHARACTERS WITHOUT CLAIM TO ANY PARTICULAR FONT, STYLE, SIZE, OR COLOR.

PRIORITY DATE OF 10-24-2006 IS CLAIMED.

OWNER OF INTERNATIONAL REGISTRATION 0931496 DATED 4-10-2007, EXPIRES 4-10-2017.

THE WORDING "NARCYSO" IN THE MARK HAS NO MEANING IN ENGLISH.

SER. NO. 79-041,331, FILED 4-10-2007.

MARK PILARO, EXAMINING ATTORNEY

Int. Cl.: 7

Prior U.S. Cls.: 13, 19, 21, 23, 31, 34 and 35

United States Patent and Trademark Office

Reg. No. 3,468,213

Registered July 15, 2008

TRADEMARK  
PRINCIPAL REGISTER

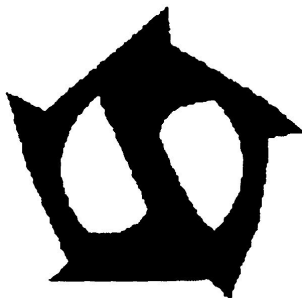

**WISECRAFT**

CIXI GUANGHUA SHIYE YOUXIAN GONGSI  
(CHINA CORPORATION)  
QIAODONGCUN  
XIAOLINZHEN, CIXI; 315000 ZHEJIANG  
CHINA

FOR: CUTTING TOOL, NAMELY, DIAMOND-  
POINTED METAL-CUTTING TOOL, CEMENTED  
CARBIDE CUTTING TOOL; GAS OPERATED SOL-  
DERING BLOW PIPES; SPOT FACING WORK CUT-  
TER, NAMELY, MILLING CUTTER, TRENCH  
CUTTER; ELECTRIC SCREWDRIVER, NAMELY,  
A POWER-OPERATED SCREWDRIVER; MACHINE  
PARTS, NAMELY, DRILLING HEADS, CIRCULAR  
SAW BLADE; PNEUMATIC SPRAY GUNS FOR

PAINT; RECIPROCATING SAW BLADES FOR POW-  
ER TOOLS; TOOLS THAT ARE PARTS OF MA-  
CHINES, NAMELY, DRILLING BITS; POWER  
OPERATED TOOLS, NAMELY, BELT SAW, IN  
CLASS 7 (U.S. CLS. 13, 19, 21, 23, 31, 34 AND 35).

OWNER OF INTERNATIONAL REGISTRATION  
0931519 DATED 12-6-2006, EXPIRES 12-6-2016.

SER. NO. 79-041,340, FILED 12-6-2006.

DAVID I, EXAMINING ATTORNEY

**Int. Cl.: 8**

**Prior U.S. Cls.: 23, 28 and 44**

**United States Patent and Trademark Office**

**Reg. No. 3,468,214**

**Registered July 15, 2008**

**TRADEMARK  
PRINCIPAL REGISTER**

**WINBAG**

DISSING TRADING A/S (DENMARK CORPORATION)  
STABELVEJ 5, HÅRBY  
DK-8660 SKANDERBORG  
DENMARK

FOR: HAND TOOLS AND IMPLEMENTS, NAME-  
LY, AN INFLATABLE CUSHION APPARATUS FOR  
SECURING AND HOLDING WORK PIECES, APPLI-  
ANCES AND STRUCTURAL COMPONENTS IN  
POSITION TO ALLOW ADJUSTMENT, INSTALLA-  
TION, FASTENING AND SECUREMENT, IN CLASS  
8 (U.S. CLS. 23, 28 AND 44).

THE MARK CONSISTS OF STANDARD CHAR-  
ACTERS WITHOUT CLAIM TO ANY PARTICULAR  
FONT, STYLE, SIZE, OR COLOR.

PRIORITY DATE OF 1-2-2007 IS CLAIMED.

OWNER OF INTERNATIONAL REGISTRATION  
0931595 DATED 6-7-2007, EXPIRES 6-7-2017.

THE WORDING "WINBAG" HAS NO MEANING  
IN A FOREIGN LANGUAGE.

SER. NO. 79-041,380, FILED 6-7-2007.

RAMONA ORTIGA, EXAMINING ATTORNEY

**Int. Cl.: 12**

**Prior U.S. Cls.: 19, 21, 23, 31, 35 and 44**

**United States Patent and Trademark Office**

**Reg. No. 3,468,215**

**Registered July 15, 2008**

**TRADEMARK  
PRINCIPAL REGISTER**

**bibi**

LAMPRECHT AG (SWITZERLAND CORPORATION)  
ALTHARDSTRASSE 246  
CH-8105 REGENSDORF  
SWITZERLAND

FOR: TRAILER WITH SADDLE SEAT FOR PRAMS, IN CLASS 12 (U.S. CLS. 19, 21, 23, 31, 35 AND 44).

THE MARK CONSISTS OF STANDARD CHARACTERS WITHOUT CLAIM TO ANY PARTICULAR FONT, STYLE, SIZE, OR COLOR.

PRIORITY DATE OF 11-28-2006 IS CLAIMED.

OWNER OF INTERNATIONAL REGISTRATION 0931651 DATED 5-25-2007, EXPIRES 5-25-2017.

OWNER OF U.S. REG. NOS. 2,479,026 AND 3,047,196.

THE FOREIGN WORDING IN THE MARK TRANSLATES INTO ENGLISH AS CHICKEN.

SER. NO. 79-041,397, FILED 5-25-2007.

DAWN FELDMAN, EXAMINING ATTORNEY

Int. Cl.: 33

Prior U.S. Cls.: 47 and 49

United States Patent and Trademark Office

Reg. No. 3,468,216

Registered July 15, 2008

TRADEMARK  
PRINCIPAL REGISTER

CERETTO



CERETTO AZIENDE VITIVINICOLE S.R.L. (ITALY ITALIAN COMPANY LIMITED)  
LOC. SAN CASSIANO, 34  
I-12051 ALBA, CUNEO  
ITALY

THE WORDING "BLANGE' CERETTO" HAS NO MEANING IN ENGLISH.

FOR: ALCOHOLIC BEVERAGES EXCEPT BEERS,  
IN CLASS 33 (U.S. CLS. 47 AND 49).

SER. NO. 79-041,410, FILED 5-23-2007.

OWNER OF INTERNATIONAL REGISTRATION  
0931676 DATED 5-23-2007, EXPIRES 5-23-2017.

NATALIE POLZER, EXAMINING ATTORNEY



**Int. Cl.: 10**

**Prior U.S. Cls.: 26, 39 and 44**

**United States Patent and Trademark Office**

**Reg. No. 3,468,217**

**Registered July 15, 2008**

**TRADEMARK  
PRINCIPAL REGISTER**

# THOMMEN

THOMMEN MEDICAL AG (SWITZERLAND SOCIÉTÉ ANONYME)  
HAUPTSTRASSE 87  
CH-4437 WALDENBURG, SWITZERLAND

FOR: SURGICAL, MEDICAL AND DENTAL APPARATUS AND INSTRUMENTS, NAMELY, DENTAL IMPLANTS AND DENTAL IMPLANT SUPERSTRUCTURES; PROSTHETIC INSTRUMENTS FOR DENTAL PURPOSES, DENTAL DRILLS AND TORQUE RATCHETS; DENTAL FIXTURES, NAMELY, PREFABRICATED PARTS FOR CROWNS, BRIDGES AND PONTICS; PROSTHETIC DENTAL ABUTMENTS; AND ATTACHMENTS, CONNECTORS, FRAMES, AND CASTINGS FOR DENTAL IMPLANT SUPERSTRUCTURES, IN CLASS 10 (U.S. CLS. 26, 39 AND 44).

THE MARK CONSISTS OF STANDARD CHARACTERS WITHOUT CLAIM TO ANY PARTICULAR FONT, STYLE, SIZE, OR COLOR.

PRIORITY DATE OF 2-13-2007 IS CLAIMED.

OWNER OF INTERNATIONAL REGISTRATION 0931730 DATED 7-27-2007, EXPIRES 7-27-2017.

SEC. 2(F).

SER. NO. 79-041,434, FILED 7-27-2007.

COLLEEN DOMBROW, EXAMINING ATTORNEY

**Int. Cl.: 42**

**Prior U.S. Cls.: 100 and 101**

**United States Patent and Trademark Office**

**Reg. No. 3,468,218**

**Registered July 15, 2008**

**SERVICE MARK  
PRINCIPAL REGISTER**



DIPL.-ING. GEORG HOF (AUSTRIA INDIVIDUAL)  
UFERSTRASSE 25/3  
A-3011 PURKERSDORF, AUSTRIA

OWNER OF INTERNATIONAL REGISTRATION  
0931954 DATED 4-6-2007, EXPIRES 4-6-2017.

FOR: SCIENTIFIC AND TECHNOLOGICAL SERVICES AND RESEARCH AND DESIGN RELATING THERETO, NAMELY, PRODUCT DESIGN AND DEVELOPMENT OF MACHINES USED FOR REHABILITATIVE AND THERAPEUTIC PURPOSES; INDUSTRIAL ANALYSIS AND RESEARCH SERVICES, NAMELY, PRODUCT DEVELOPMENT, MATERIAL TESTING, TECHNICAL INSPECTION OF DEVICES AND MACHINES; DEVELOPMENT SERVICES REGARDING NEW PRODUCTS FOR THIRD PARTIES, NAMELY, DEVELOPMENT OF MATERIAL, EQUIPMENT AND DEVICES; TECHNICAL ANALYSIS IN THE FIELD OF SPORT EQUIPMENT AND SPORT PRODUCTS; CHEMICAL ANALYSIS; DESIGN AND TECHNICAL DRAFTING OF PRODUCTS, IN CLASS 42 (U.S. CLS. 100 AND 101).

THE MARK CONSISTS OF THE SILHOUETTE OF A MAN RUNNING WITH HIS ARMS ALMOST PARALLEL TO THE GROUND. THE FIGURE IS POSITIONED SIMILARLY TO THE SHAPE OF A BICYCLE, WHERE THE FIGURE'S ARMS APPEAR TO BE HANDLEBARS AND TORSO APPEARS AS THE BICYCLE FRAME. AN INCOMPLETE CIRCLE ENCLOSES THE MAN'S FRONT FOOT AND CALF, APPEARING AS THE FRONT WHEEL OF A BICYCLE. A SECOND INCOMPLETE CIRCLE SURROUNDS THE FIGURE AND WHEEL, AS IN AN ARENA OR RINK.

SER. NO. 79-041,538, FILED 4-6-2007.

PRIORITY DATE OF 12-6-2006 IS CLAIMED.

LAURIE KAUFMAN, EXAMINING ATTORNEY

Int. Cls.: 9, 14, 18 and 25

Prior U.S. Cls.: 1, 2, 3, 21, 22, 23, 26, 27, 28, 36, 38, 39,  
41 and 50

Reg. No. 3,468,219

United States Patent and Trademark Office

Registered July 15, 2008

TRADEMARK  
PRINCIPAL REGISTER



BIJOU BRIGITTE; MODISCHE ACCESSOIRES  
AG (FED REP GERMANY CORPORATION)  
POPPENBÜTTELER BOGEN 1  
22399 HAMBURG  
FED REP GERMANY

FOR: SPECTACLE FRAMES, SUNGLASSES, IN  
CLASS 9 (U.S. CLS. 21, 23, 26, 36 AND 38).

FOR: JEWELLERY; FASHION JEWELLERY;  
TIMEPIECES; JEWELLERY, NAMELY, WATCH-  
STRAPS OF LEATHER, IN CLASS 14 (U.S. CLS. 2,  
27, 28 AND 50).

FOR: LEATHER AND IMITATION LEATHER;  
UNWORKED OR SEMIWORKED LEATHER; LEA-  
THER AND IMITATION LEATHER BAGS; LEA-  
THER BAGS, SUITCASES AND WALLETS;

LEATHER HANDBAGS, IN CLASS 18 (U.S. CLS. 1,  
2, 3, 22 AND 41).

FOR: LEATHER BELTS, HEADGEAR, NAMELY,  
HATS AND CAPS, IN CLASS 25 (U.S. CLS. 22 AND  
39).

PRIORITY DATE OF 1-17-2007 IS CLAIMED.

OWNER OF INTERNATIONAL REGISTRATION  
0932133 DATED 7-3-2007, EXPIRES 7-3-2017.

SER. NO. 79-041,621, FILED 7-3-2007.

ALLISON HOLTZ, EXAMINING ATTORNEY

**Int. Cls.: 1 and 5**

**Prior U.S. Cls.: 1, 5, 6, 10, 18, 26, 44, 46, 51 and 52**

**United States Patent and Trademark Office**

**Reg. No. 3,468,220**

**Registered July 15, 2008**

**TRADEMARK  
PRINCIPAL REGISTER**

**INITIUM**

BASF SE  
CARL-BOSCH-STRASSE 38  
67056 LUDWIGSHAFEN  
FED REP GERMANY

FOR: CHEMICALS USED IN AGRICULTURE, HORTICULTURE, FORESTRY, NAMELY, PLANT FORTIFYING PREPARATIONS, SEED PRESERVING SUBSTANCES, SURFACTANTS, PLANT GROWTH REGULATING PREPARATIONS, IN CLASS 1 (U.S. CLS. 1, 5, 6, 10, 26 AND 46).

FOR: PESTICIDES, NAMELY, PREPARATIONS FOR DESTROYING VERMIN, FUNGICIDES, HERBICIDES, INSECTICIDES, IN CLASS 5 (U.S. CLS. 6, 18, 44, 46, 51 AND 52).

THE MARK CONSISTS OF STANDARD CHARACTERS WITHOUT CLAIM TO ANY PARTICULAR FONT, STYLE, SIZE, OR COLOR.

PRIORITY DATE OF 3-27-2007 IS CLAIMED.

OWNER OF INTERNATIONAL REGISTRATION 0932155 DATED 6-26-2007, EXPIRES 6-26-2017.

THE FOREIGN WORDING IN THE MARK TRANSLATES INTO ENGLISH AS "BEGINNING".

SER. NO. 79-041,630, FILED 6-26-2007.

KATINA MISTER, EXAMINING ATTORNEY

**Int. Cl.: 1**

**Prior U.S. Cls.: 1, 5, 6, 10, 26 and 46**

**United States Patent and Trademark Office**

**Reg. No. 3,468,221**

**Registered July 15, 2008**

**TRADEMARK  
PRINCIPAL REGISTER**

**ICETRIPLE**

PALSGAARD A/S (DENMARK AKTIESELSKAP  
(A/S))  
PALSGAARDVEJ 10  
DK-7130 JUELMINDE  
DENMARK

FOR: CHEMICAL PRODUCTS FOR USE IN THE  
MANUFACTURE OF FOODS, NAMELY, FOOD  
ADDITIVES IN THE FORM OF EMULSIFIERS  
AND STABILIZERS FOR MODIFYING THE TEX-  
TURE, STRUCTURE AND SENSORY CHARACTER-  
TISTICIS AND FOR IMPROVING STORAGE  
STABILITY, IN CLASS 1 (U.S. CLS. 1, 5, 6, 10, 26  
AND 46).

THE MARK CONSISTS OF STANDARD CHAR-  
ACTERS WITHOUT CLAIM TO ANY PARTICULAR  
FONT, STYLE, SIZE, OR COLOR.

PRIORITY DATE OF 5-31-2007 IS CLAIMED.

OWNER OF INTERNATIONAL REGISTRATION  
0932175 DATED 6-22-2007, EXPIRES 6-22-2017.

SER. NO. 79-041,643, FILED 6-22-2007.

PAM WILLIS, EXAMINING ATTORNEY

**Int. Cls.: 29 and 30**

**Prior U.S. Cl.: 46**

**United States Patent and Trademark Office**

**Reg. No. 3,468,222**

**Registered July 15, 2008**

**TRADEMARK  
PRINCIPAL REGISTER**

**GAZI**

GARMO AG (FED REP GERMANY CORPORATION)  
ULMER STRABE 191  
70188 STUTTGART, FED REP GERMANY

FOR: SAUSAGE AND MEAT; CANNED SAUSAGE AND MEATS; DAIRY PRODUCTS, NAMELY, CHEESE, YOGURT, SOFT WHITE CHEESE, BUTTER AND CREAM, IN CLASS 29 (U.S. CL. 46).

FOR: PUDDINGS, IN CLASS 30 (U.S. CL. 46).

OWNER OF INTERNATIONAL REGISTRATION  
0587386 DATED 5-20-1992, EXPIRES 5-20-2012.

THE WORDING "GAZI" HAS NO MEANING IN A FOREIGN LANGUAGE.

SER. NO. 79-041,672, FILED 2-23-2007.

ELI HELLMAN, EXAMINING ATTORNEY

**Int. Cls.: 3 and 5**

**Prior U.S. Cls.: 1, 4, 6, 18, 44, 46, 50, 51 and 52**

**United States Patent and Trademark Office**

**Reg. No. 3,468,223**

**Registered July 15, 2008**

**TRADEMARK  
PRINCIPAL REGISTER**

**IACVITA**

MEDESTEA; RESEARCH & PRODUCTION S.P.A.  
(ITALY SOCIETE PAR ACTIONS)  
VIA RIBES, 5  
I-10010 COLLERETTO GIACOSA (TO)  
ITALY

FOR: COSMETICS, HAIR LOTIONS, IN CLASS 3  
(U.S. CLS. 1, 4, 6, 50, 51 AND 52).

FOR: PHARMACEUTICAL PREPARATIONS FOR  
HUMAN AND VETERINARY TREATMENT OF  
ALL THE DISEASES OR CONDITIONS WHERE AN  
IMPORTANT PRODUCTION OF ROS OCCURS  
DURING THE ETIOPATHOLOGICAL COURSE,  
NAMELY, NEURODEGENERATIVE DISORDERS,  
ISCHEMIA AND REPERFUSION IN BODY'S OR-  
GANS, HYPERTENSION, DIABETES, CANCER,  
SEPTIC SHOCK, TOXICITY FROM DRUGS, PRO-

TECTION FROM RADIATION, INFLAMMATION,  
PAIN, ORGAN DEGENERATIVE DISEASES,  
ATHEROSCLEROSIS, AGING, HYPERLIPIDEMIA,  
EPILEPSY, RHEUMATOID ARTHRITIS, IN CLASS 5  
(U.S. CLS. 6, 18, 44, 46, 51 AND 52).

THE MARK CONSISTS OF STANDARD CHAR-  
ACTERS WITHOUT CLAIM TO ANY PARTICULAR  
FONT, STYLE, SIZE, OR COLOR.

OWNER OF INTERNATIONAL REGISTRATION  
0932362 DATED 6-20-2007, EXPIRES 6-20-2017.

SER. NO. 79-041,750, FILED 6-20-2007.

DAVID TAYLOR, EXAMINING ATTORNEY

**Int. Cls.: 35, 36, 37, 42 and 45**

**Prior U.S. Cls.: 100, 101, 102, 103 and 106**

**United States Patent and Trademark Office**

**Reg. No. 3,468,224**

**Registered July 15, 2008**

**SERVICE MARK  
PRINCIPAL REGISTER**

**Hypo  Public Finance**

HYPO REAL ESTATE HOLDING AG (FED REP  
GERMANY JOINT STOCK COMPANY)  
UNSÖLDSTR. 2  
80538 MÜNCHEN  
FED REP GERMANY

FOR: ADVERTISING; BUSINESS MANAGE-  
MENT; BUSINESS ADMINISTRATION; OFFICE  
FUNCTIONS, IN CLASS 35 (U.S. CLS. 100, 101 AND  
102).

FOR: FINANCIAL AFFAIRS, NAMELY, PUBLIC  
SECTOR FINANCE, INFRASTRUCTURE AND AS-  
SET BASED FINANCE; MONETARY AFFAIRS,  
NAMELY, MONEY LENDING, ASSET BASED FI-  
NANCE, CAPITAL MARKETS AND ASSET MAN-  
AGEMENT; REAL ESTATE AFFAIRS, NAMELY,  
APPRAISAL OF REAL ESTATE, LEASING OF REAL  
ESTATE, REAL ESTATE BROKERAGE, IN CLASS 36  
(U.S. CLS. 100, 101 AND 102).

FOR: FACILITY MANAGEMENT, NAMELY,  
TECHNICAL ADVICE CONCERNING MAINTEN-  
ANCE OF REAL ESTATE PROPERTY, IN CLASS  
37 (U.S. CLS. 100, 103 AND 106).

FOR: ARCHITECTURAL CONSULTATION; AR-  
CHITECTURE DESIGN; PROPERTY DEVELOP-  
MENT SERVICES, NAMELY, TECHNICAL  
DRAFTING OF BUILDING PROJECTS; INDUS-  
TRIAL DESIGN; DESIGN OF INTERIOR DECOR;  
RESEARCH IN THE FIELD OF PHYSICS, IN CLASS  
42 (U.S. CLS. 100 AND 101).

FOR: LITIGATION SERVICES; MEDIATION; LI-  
CENSING OF INTELLECTUAL PROPERTY; LEGAL  
ADVICE RELATED TO FRANCHISING; TECHNICAL

CAL ADVICE RELATED TO LICENSING OF IN-  
TELLECTUAL PROPERTY, IN CLASS 45 (U.S. CLS.  
100 AND 101).

PRIORITY DATE OF 9-18-2006 IS CLAIMED.

OWNER OF INTERNATIONAL REGISTRATION  
0932435 DATED 3-16-2007, EXPIRES 3-16-2017.

OWNER OF U.S. REG. NOS. 2,871,809 AND  
2,871,811.

NO CLAIM IS MADE TO THE EXCLUSIVE  
RIGHT TO USE "PUBLIC FINANCE", APART FROM  
THE MARK AS SHOWN.

THE COLOR(S) GREEN AND BLACK IS/ARE  
CLAIMED AS A FEATURE OF THE MARK.

THE MARK CONSISTS OF VERBAL ELEMENT  
"HYPO" IN BLACK, LOGO AND VERBAL ELE-  
MENT "PUBLIC FINANCE" IN GREEN.

THE TERM "HYPO" DOES NOT HAVE ANY  
SIGNIFICANCE IN THE RELEVANT TRADE, ANY  
GEOGRAPHICAL SIGNIFICANCE OR ANY MEAN-  
ING IN A FOREIGN LANGUAGE.

SER. NO. 79-041,779, FILED 3-16-2007.

NAPOLEON SHARMA, EXAMINING ATTORNEY



**Int. Cls.: 14 and 18**

**Prior U.S. Cls.: 1, 2, 3, 22, 27, 28, 41 and 50**

**United States Patent and Trademark Office**

**Reg. No. 3,468,225**

**Registered July 15, 2008**

**TRADEMARK  
PRINCIPAL REGISTER**

**CARESSE D'ORCHIDEES**

CARTIER INTERNATIONAL N.V.; A HOLDING AND TRADING COMPANY; ORGANIZED AND EXISTING UNDER THE LAWS OF THE NETHERLANDS ANTILLES (NETHERLD ANTILLES LTD LIAB CO)

SCHARLOOWEG 33

CURAÇAO

NETHERLD ANTILLES

FOR: GOODS IN PRECIOUS METALS AND COATED THEREWITH, NAMELY, CUFF-LINKS, TIE CLIPS, RINGS, BRACELETS, EARRINGS, NECKLACES, AND BROOCHES; WATCHES; CHRONOMETERS; CLOCKS; WATCH STRAPS; WATCH BRACELETS; BOXES OF PRECIOUS METALS FOR WATCHES AND JEWELRY; MONEY CLIPS, IN CLASS 14 (U.S. CLS. 2, 27, 28 AND 50).

FOR: LEATHERWARE, NAMELY, BRIEFCASES, TRAVELLING SETS CONSISTING OF SUITCASES AND TRAVEL BAGS, VANITY CASES SOLD EMPTY, AND KEY CASES; GOODS MADE OF LEATHER AND IMITATIONS OF LEATHER NOT INCLUDED IN OTHER CLASSES, NAMELY, ATTACHÉ-CASES, WALLETS, HANDBAGS, BACKPACKS, TRAVELLING BAGS, WHEELED BAGS, TRUNKS, SUITCA-

SES, PURSES NOT OF PRECIOUS METAL, CARD CASES, POUCHES; BANDS OF LEATHER, UMBRELLAS, PARASOLS, WALKING STICKS, AND WHIPS AND SADDLERY, IN CLASS 18 (U.S. CLS. 1, 2, 3, 22 AND 41).

THE MARK CONSISTS OF STANDARD CHARACTERS WITHOUT CLAIM TO ANY PARTICULAR FONT, STYLE, SIZE, OR COLOR.

PRIORITY DATE OF 4-18-2006 IS CLAIMED.

OWNER OF INTERNATIONAL REGISTRATION 0932495 DATED 10-17-2006, EXPIRES 10-17-2016.

THE FOREIGN WORDING IN THE MARK TRANSLATES INTO ENGLISH AS "CARESS OF ORCHIDS".

SER. NO. 79-041,804, FILED 10-17-2006.

MELVIN AXILBUND, EXAMINING ATTORNEY

**Int. Cl.: 14**

**Prior U.S. Cls.: 2, 27, 28 and 50**

**United States Patent and Trademark Office**

**Reg. No. 3,468,226**

**Registered July 15, 2008**

**TRADEMARK  
PRINCIPAL REGISTER**

**NESSA**

NESSA SÀRL; C/O NAT SERVICES SA (SWITZERLAND LTD LIAB CO)  
2, RUE DE JARGONNANT  
CH-1207 GENÈVE  
SWITZERLAND

FOR: PRECIOUS METALS AND THEIR ALLOYS; GOODS MADE OF PRECIOUS METALS AND THEIR ALLOYS OR PLATED THEREWITH, NAMELY, BADGES, BUSTS, FIGURES, SCULPTURES, STATUES, STATUETTES, ORNAMENTS, WORKS OF ART; JEWELRY, PRECIOUS STONES; HOROLOGICAL AND CHRONOMETRIC INSTRUMENTS, IN CLASS 14 (U.S. CLS. 2, 27, 28 AND 50).

THE MARK CONSISTS OF STANDARD CHARACTERS WITHOUT CLAIM TO ANY PARTICULAR FONT, STYLE, SIZE, OR COLOR.

PRIORITY DATE OF 10-27-2006 IS CLAIMED.

OWNER OF INTERNATIONAL REGISTRATION 0932502 DATED 3-15-2007, EXPIRES 3-15-2017.

THE WORDING "NESSA" HAS NO MEANING IN A FOREIGN LANGUAGE.

SER. NO. 79-041,808, FILED 3-15-2007.

NATALIE POLZER, EXAMINING ATTORNEY

**Int. Cls.: 3 and 44**

**Prior U.S. Cls.: 1, 4, 6, 50, 51, 52, 100 and 101**

**United States Patent and Trademark Office**

**Reg. No. 3,468,227**

**Registered July 15, 2008**

**TRADEMARK  
SERVICE MARK  
PRINCIPAL REGISTER**

# MICROSKIN

BLONDE HOLDINGS PTY LTD (AUSTRALIA  
CORPORATION)  
271B RODE ROAD  
WAVELL HEIGHTS QLD 4012  
AUSTRALIA

FOR: SOAPS, NAMELY, LIQUID SOAPS AND SKIN SOAPS; PERFUMERY; ESSENTIAL OILS; COSMETICS; HAIR LOTIONS; MAKE-UP; MAKE-UP REMOVING PREPARATIONS; NAIL CARE PREPARATIONS; NON-MEDICATED SKIN CARE PREPARATIONS; SUNSCREEN PREPARATIONS, NAMELY, SUN BLOCK, SUNSCREEN AND SUN-TANNING PREPARATIONS; COSMETIC KITS COMPRISED OF SKIN CONDITION CONCEALING PREPARATIONS AND MAKE-UP REMOVING PREPARATIONS; PREPARATIONS FOR CONCEALING SKIN CONDITIONS AND DISORDERS INCLUDING BLEMISHES, BIRTHMARKS, SCARRING, BURNS, GRAFTS, PIGMENTATION MARKS, VARICOSE VEINS, ACNE AND TATTOOS, NAMELY, CONCEALERS FOR SKIN, FACE AND BODY, IN CLASS 3 (U.S. CLS. 1, 4, 6, 50, 51 AND 52).

FOR: MEDICAL SERVICES; BEAUTY SERVICES, NAMELY, SERVICES OF A MAKE-UP ARTIST; HYGIENIC AND BEAUTY CARE FOR HUMAN BEINGS, NAMELY, SKIN CARE SALONS AND SKIN COLOR CORRECTING SALONS; MEDICAL CLINICS; BEAUTY SALONS; CONSULTANCY AND ADVISORY SERVICES IN RELATION TO MEDICAL AND BEAUTY CARE SERVICES, NAMELY, PROVIDING MEDICAL INFORMATION, PROVIDING INFORMATION ON SKIN CARE AND SKIN COLOR

CORRECTION, AND CONSULTATIONS WITH A MAKE-UP ARTIST; PROVIDING INFORMATION, INCLUDING ON-LINE, ABOUT HYGIENIC AND BEAUTY CARE FOR HUMAN BEINGS, NAMELY, PROVIDING INFORMATION ON SKIN CARE AND SKIN COLOR CORRECTION; RENTAL OF MEDICAL AND BEAUTY CARE EQUIPMENT AND INSTRUMENTS; DIAGNOSTIC SERVICES IN RELATION TO SKIN, NAMELY, COSMETIC ANALYSIS; SERVICES IN RELATION TO CONCEALING SKIN CONDITIONS AND DISORDERS INCLUDING BLEMISHES, BIRTHMARKS, SCARRING, BURNS, GRAFTS, PIGMENTATION MARKS, VARICOSE VEINS, ACNE AND TATTOOS, NAMELY, MEDICAL TESTING AND COSMETIC ANALYSIS; WHEREIN NONE OF THE AFOREMENTIONED SERVICES INCLUDE SERVICES RELATING TO SKIN GRAFTING AND TRANSPLANTATION, IN CLASS 44 (U.S. CLS. 100 AND 101).

THE MARK CONSISTS OF STANDARD CHARACTERS WITHOUT CLAIM TO ANY PARTICULAR FONT, STYLE, SIZE, OR COLOR.

OWNER OF INTERNATIONAL REGISTRATION  
0932574 DATED 6-15-2007, EXPIRES 6-15-2017.

SER. NO. 79-041,844, FILED 6-15-2007.

KATHERINE M. DUBRAY, EXAMINING ATTORNEY

Int. Cls.: 29, 30 and 32

Prior U.S. Cls.: 45, 46 and 48

Reg. No. 3,468,228

United States Patent and Trademark Office

Registered July 15, 2008

TRADEMARK  
PRINCIPAL REGISTER



MAGLIO ARTE DOLCIARIA S.R.L. (ITALY LTD  
LIAB CO)

VIA P. REFOLO, 6

MAGLIE (LE), ITALY I73024

FOR: PRESERVED, DRIED AND COOKED FRUITS; JELLIES, JAMS; FRUIT SAUCES, NAME-  
LY, APPLESAUCE; FRUIT PRESERVES; EGGS,  
MILK AND MILK PRODUCTS EXCLUDING ICE  
CREAM, ICE MILK AND FROZEN YOGURT; YO-  
GHURT; EDIBLE OILS AND FATS, IN CLASS 29  
(U.S. CL. 46).

FOR: COCOA; COCOA EXTRACTS AND COCOA  
POWDER FOR THE FOOD AND DRINKS INDUS-  
TRY; OAT COCOA, NAMELY, ROLLED OATS;  
CHOCOLATE COMPOUNDS, NAMELY CHOCO-  
LATE FOR MAKING CHOCOLATES, DIPS, TOP-  
PINGS AND CHOCOLATE DECORATIONS;  
HOLLOW CHOCOLATE SHELLS, NAMELY, FOR  
CONFECTIONERY AND FOR CANDY; CHOCO-  
LATE-COVERED DRIED FRUIT; EASTER EGGS,  
NAMELY, EGG SHAPED CHOCOLATE CANDIES;  
CHOCOLATE CANDIES; DRAGEES, NAMELY, SU-  
GAR-COATED NUTS AND SMALL SILVER-CO-  
LORED SUGAR BALLS FOR DECORATING  
BAKED GOODS; CHOCOLATE FOR BAKING,  
NAMELY, CHOCOLATE FLAKES FOR BAKING;  
BAKERY MIXES, NAMELY, CAKE, MUFFIN AND  
COOKIE MIXES; CHOCOLATE; CHOCOLATE  
BARS, FILLED AND NON-FILLED; CHOCOLATE  
BARS; CHOCOLATE CONFECTIONERY; CHOCO-  
LATE ICING; SWEETS, NAMELY, CANDIES; MAR-  
ZIPAN; MARZIPAN SUBSTITUTES; HONEY;  
PREPARATIONS ENTIRELY OR PARTIALLY  
MADE FROM SUGAR, TO BE USED AS SUBSTI-

TUTES FOR HONEY; CHOCOLATE AND CANDIES  
FOR DECORATING CHRISTMAS TREES; CHOCO-  
LATES, NAMELY, CHOCOLATES FILLED WITH  
LIQUIDS, NAMELY, FILLED WITH WINE AND  
SPIRITS; CHOCOLATES; CHOCOLATE-BASED  
FOOD BEVERAGES; CHOCOLATE SAUCES AND  
CHOCOLATE SYRUPS; SPREADS CONTAINING  
CHOCOLATE; COOKIES; BISCUITS; FRESH AND  
PRESERVED PASTRY; CONFECTIONERY, NAME-  
LY, PASTILLES; YEAST POWDER; PUDDINGS IN  
POWDERED FORM, NAMELY, INSTANT PUD-  
DING MIXES; CANDIES WITH LIQUID CENTERS,  
FRUIT JELLIES; YEAST EXTRACTS FOR FOOD;  
COFFEE; COFFEE-BASED BEVERAGES; COFFEE  
BEANS; GROUND COFFEE BEANS, IN CLASS 30  
(U.S. CL. 46).

FOR: NON-ALCOHOLIC DRINKS, NAMELY,  
MOCKTAILS, CARBONATED BEVERAGES, NON-  
ALCOHOLIC FRUIT JUICE BEVERAGES; FRUIT  
DRINKS AND FRUIT JUICES; SYRUPS FOR MAK-  
ING BEVERAGES; OTHER NON-ALCOHOLIC PRE-  
PARATIONS, NAMELY, CONCENTRATES AND  
POWDERS FOR MAKING BEVERAGES; ALMOND  
MILK NOT BEING MILK SUBSTITUTES, IN CLASS  
32 (U.S. CLS. 45, 46 AND 48).

OWNER OF INTERNATIONAL REGISTRATION  
0932575 DATED 5-25-2007, EXPIRES 5-25-2017.

THE MARK CONSISTS OF THE STYLIZED RE-  
PRESENTATION OF A CARRIAGE WITH HORSE  
AND COACHMAN ON THE UPPER PART AND  
BELOW IN THE WORD "MAGLIO" INSERTED IN A

RECTANGULAR SHAPE, ALL INSERTED IN A  
SQUARE FRAME.

SER. NO. 79-041,845, FILED 5-25-2007.

BERNICE MIDDLETON, EXAMINING ATTORNEY

**Int. Cl.: 9**

**Prior U.S. Cls.: 21, 23, 26, 36 and 38**

**United States Patent and Trademark Office**

**Reg. No. 3,468,229**

**Registered July 15, 2008**

**TRADEMARK  
PRINCIPAL REGISTER**



LINYI HUATAI BATTERY; MANUFACTURE CO.  
(CHINA CORPORATION)  
TANGTOU TOWN  
LINYI CITY; SHANDONG  
CHINA

FOR: BATTERIES FOR FLASHLIGHTS; BATTERIES; GALVANIC CELLS; ELECTRIC ACCUMULATORS; SOLAR BATTERIES; BATTERIES FOR LIGHTING; HIGH TENSION BATTERIES; BATTERIES FOR POCKETLAMPS; ACCUMULATOR JARS; BATTERY CASES; ELECTRIC ACCUMULATORS FOR VEHICLES, IN CLASS 9 (U.S. CLS. 21, 23, 26, 36 AND 38).

OWNER OF INTERNATIONAL REGISTRATION  
0932876 DATED 6-27-2007, EXPIRES 6-27-2017.

NO CLAIM IS MADE TO THE EXCLUSIVE  
RIGHT TO USE "POWER", APART FROM THE  
MARK AS SHOWN.

SER. NO. 79-041,938, FILED 6-27-2007.

JOHN SCHUYLER YARD, EXAMINING ATTORNEY

**Int. Cl.: 16**

**Prior U.S. Cls.: 2, 5, 22, 23, 29, 37, 38 and 50**

**Reg. No. 3,468,230**

**United States Patent and Trademark Office**

**Registered July 15, 2008**

**TRADEMARK  
PRINCIPAL REGISTER**



WENZHOU WENTAI PEN INDUSTRY CO., LTD  
(CHINA CORPORATION)  
NO. 27 SUB-ZONE, ECONOMIC & TECHNICAL  
DEVELOPMENT ZONE, WENZHOU  
325000 ZHEJIANG, CHINA

FOR: COLOR PENCILS; COLORED PENS; WRIT-  
ING INSTRUMENTS; STATIONERY; PEN AND  
PENCIL CASES AND BOXES; STATIONERY CASES;  
PENCIL SHARPENERS; RUBBER ERASERS; WRIT-  
ING INK; INDIA INK; INK FOR WRITING INSTRU-  
MENTS; DRAWING INSTRUMENTS; PASTEL  
CRAYONS; PASTES AND DHEIVES FOR STA-  
TIONERY OR HOUSEHOLD PURPOSES; ADHE-  
SIVES FOR STATIONERY OR HOUSEHOLD

PURPOSES, IN CLASS 16 (U.S. CLS. 2, 5, 22, 23, 29,  
37, 38 AND 50).

OWNER OF INTERNATIONAL REGISTRATION  
0932878 DATED 6-21-2007, EXPIRES 6-21-2017.

THE WORDING "XUEZI" HAS NO MEANING IN  
ENGLISH.

SER. NO. 79-041,939, FILED 6-21-2007.

MAUREEN DALL, EXAMINING ATTORNEY

**Int. Cl.: 9**

**Prior U.S. Cls.: 21, 23, 26, 36 and 38**

**United States Patent and Trademark Office**

**Reg. No. 3,468,231**

**Registered July 15, 2008**

**TRADEMARK  
PRINCIPAL REGISTER**

**MAGNESHIELD**

ESSEX NEXANS EUROPE (FRANCE SOCIETE  
PAR ACTIONS SIMPLIFIEE)

L'EUROPÉEN -

PARC TERTIAIRE DE LA CROIX -; RUE JEAN  
MONNET; F-60200 COMPIÈGNE

FRANCE

FOR: ELECTRICAL WINDING WIRES, IN CLASS  
9 (U.S. CLS. 21, 23, 26, 36 AND 38).

THE MARK CONSISTS OF STANDARD CHAR-  
ACTERS WITHOUT CLAIM TO ANY PARTICULAR  
FONT, STYLE, SIZE, OR COLOR.

OWNER OF INTERNATIONAL REGISTRATION  
0728601 DATED 2-24-2000, EXPIRES 2-24-2010.

SER. NO. 79-041,943, FILED 6-13-2007.

ESTHER BELENKER, EXAMINING ATTORNEY



**Int. Cl.: 25**

**Prior U.S. Cls.: 22 and 39**

**United States Patent and Trademark Office**

**Reg. No. 3,468,232**

**Registered July 15, 2008**

**TRADEMARK  
PRINCIPAL REGISTER**



SCARPE ITALIANE S.R.L. (ITALY LTD LIAB CO)  
3 VIA PICCINNI  
I-20131 MILANO, ITALY

FOR: SHOES, IN CLASS 25 (U.S. CLS. 22 AND 39).

OWNER OF INTERNATIONAL REGISTRATION  
0803232 DATED 4-1-2003, EXPIRES 4-1-2013.

NO CLAIM IS MADE TO THE EXCLUSIVE  
RIGHT TO USE "SCARPE ITALIANE", APART  
FROM THE MARK AS SHOWN.

THE MARK CONSISTS OF THE WORDS  
"SCARPE ITALIANE" IN SPECIAL FONT; BOTH  
WORDS ARE SEPARATED BY A STYLIZED FIG-  
URE OF A MAN, COMPRISING TWO CURVED  
LINES AND A SMALL CIRCLE.

THE ENGLISH TRANSLATION OF THE WORDS  
"SCARPE ITALIANE" IS ITALIAN FOOTWEAR.

SER. NO. 79-041,944, FILED 4-2-2007.

REBECCA POVARCHUK, EXAMINING ATTOR-  
NEY

**Int. Cls.: 9, 16 and 42**

**Prior U.S. Cls.: 2, 5, 21, 22, 23, 26, 29, 36, 37, 38, 50,  
100 and 101**

**Reg. No. 3,468,233**

**United States Patent and Trademark Office**

**Registered July 15, 2008**

**TRADEMARK  
SERVICE MARK  
PRINCIPAL REGISTER**

# INNOCIELO

BLUECIELO ECM SOLUTIONS HOLDING B.V.  
(NETHERLANDS BESLOTEN VENNOOTSCHAP)  
HANDELSKADE 49  
NL-2288 BA RIJSWIJK  
NETHERLANDS

FOR: PRERECORDED MAGNETIC DATA CARRIERS AND COMPUTER PROGRAMS FOR CREATION, MANAGEMENT, COLLABORATION AND DISTRIBUTION OF TECHNICAL ASSET INFORMATION IN THE FIELD OF DESIGN AND ENGINEERING; VIDEO RECORDINGS CONTAINING PRINTED DATABASES ABOUT ENGINEERING AND DESIGN; PRERECORDED VIDEOTAPES AND PRERECORDED MAGNETIC DATA CARRIERS CONTAINING PRINTED DATABASES IN THE FIELD OF ENGINEERING AND DESIGN; COMPUTER SOFTWARE IN THE FORM OF PUNCHED CARDS FOR CREATION, MANAGEMENT, COLLABORATION AND DISTRIBUTION OF TECHNICAL ASSET INFORMATION; MAGNETIC TAPES DRIVES AND REELS FOR ELECTRIC WIRE AND MICROFICHES FOR ENGINEERING AND DESIGN; MAGNETIC TAPE DRIVES, MAGNETIC TAPE DRIVE COMPONENT PARTS, NAMELY, REELS FOR MAGNET TAPE DRIVES, IN CLASS 9 (U.S. CLS. 21, 23, 26, 36 AND 38).

FOR: PRINTED MATTER, NAMELY, MANUALS, LEAFLETS AND BROCHURES IN THE FIELD OF ENGINEERING AND DESIGN; CONTINUOUS FORMS IN THE NATURE OF BUSINESS FORMS, BLANK FORMS AND DESIGN FORMS; EDUCATIONAL PUBLICATIONS, NAMELY, TEXT BOOKS AND MANUALS IN THE FIELD OF ENGINEERING AND DESIGN; DATABASE OUTPUTS, NAMELY, DATA PROCESSING PROGRAMMES IN PRINTED FORM, DATABASE MANUALS IN THE NATURE OF COMPUTER MANUALS FOR ENGINEERING AND DESIGN, BOOKS IN THE FIELD OF ENGI-

NEERING AND DESIGN; PRINTED CORRESPONDENCE COURSE MATERIALS IN THE FIELD OF ENGINEERING AND DESIGN; HANDBOOKS IN THE FIELD OF ENGINEERING AND DESIGN; COMPUTER RIBBONS, IN CLASS 16 (U.S. CLS. 2, 5, 22, 23, 29, 37, 38 AND 50).

FOR: COMPUTER PROGRAMMING, COMPUTER HARDWARE AND SOFTWARE DEVELOPMENT AND COMPUTER-AIDED ENGINEERING SERVICES FOR OTHERS; MANAGEMENT OF COMPUTER PROJECTS; DESIGNING AND DEVELOPING ON-LINE COMPUTER SOFTWARE SYSTEMS AND SOFTWARE; COMPUTER SYSTEM METHODOLOGY SERVICES, NAMELY, COMPUTER NETWORK DESIGN FOR OTHERS; AND DEVELOPMENT SERVICES, NAMELY, DEVELOPING OF DRIVER AND OPERATING SYSTEM SOFTWARE; COMPUTER CONSULTANCY IN THE NATURE OF PROVIDING ADVICE IN THE FIELD OF COMPUTER SOFTWARE AND ENGINEERING SOFTWARE MANAGEMENT, AUTOMATION RECOMMENDATIONS AND COMPUTER INFORMATION, IN CLASS 42 (U.S. CLS. 100 AND 101).

THE MARK CONSISTS OF STANDARD CHARACTERS WITHOUT CLAIM TO ANY PARTICULAR FONT, STYLE, SIZE, OR COLOR.

PRIORITY DATE OF 2-27-2007 IS CLAIMED.

OWNER OF INTERNATIONAL REGISTRATION 0933012 DATED 6-19-2007, EXPIRES 6-19-2017.

SER. NO. 79-041,992, FILED 6-19-2007.

RON FAIRBANKS, EXAMINING ATTORNEY

**Int. Cls.: 8 and 10**

**Prior U.S. Cls.: 23, 26, 28, 39 and 44**

**United States Patent and Trademark Office**

**Reg. No. 3,468,234**

**Registered July 15, 2008**

**TRADEMARK  
PRINCIPAL REGISTER**

# EQUAPOD

VALOIS SAS (FRANCE CORPORATION)  
LE PRIEURÉ, BPG  
F-27110 LE NEUBOURG, FRANCE

FOR: HAND-OPERATED HAND TOOLS AND IMPLEMENTS, NAMELY, HAND-OPERATED PUMPS FOR EJECTING PRODUCTS FROM CONTAINERS AND SPRAYING THEM; MANUALLY OPERATED PUMPS, IN CLASS 8 (U.S. CLS. 23, 28 AND 44).

FOR: MEDICAL APPARATUS AND INSTRUMENTS FOR DISTRIBUTION, ADMINISTRATION AND DOSING OF MEDICINES AND PHARMACEUTICAL PRODUCTS; DEVICES FOR DISTRIBUTION AND DOSING OF PHARMACEUTICAL PRODUCTS, NAMELY, PUMP DEVICES; DEVICES FOR DISTRIBUTION AND DOSING OF PHARMACEUTICAL PRODUCTS, NAMELY, PUMP DEVICES SUITABLE FOR NASAL OR ORAL ADMINISTRATION OF SOLUTIONS WITHOUT PRESERVATIVES;

DEVICES FOR DISTRIBUTION AND DOSING OF PHARMACEUTICAL PRODUCTS, NAMELY, PUMP DEVICES, IN PARTICULAR SEALED PUMP DEVICES FOR NASAL OR ORAL ADMINISTRATION OF MEDICINES; DEVICES FOR DISTRIBUTION AND DOSING OF PHARMACEUTICAL PRODUCTS, IN PARTICULAR PUMP DEVICES FOR NASAL OR ORAL ADMINISTRATION OF MEDICINES; PUMPS AS PARTS OF THE AFORESAID DEVICES, IN CLASS 10 (U.S. CLS. 26, 39 AND 44).

PRIORITY DATE OF 11-16-2006 IS CLAIMED.

OWNER OF INTERNATIONAL REGISTRATION  
0933114 DATED 5-11-2007, EXPIRES 5-11-2017.

SER. NO. 79-042,022, FILED 5-11-2007.

KRISTINA MORRIS, EXAMINING ATTORNEY

**Int. Cls.: 9, 16 and 41**

**Prior U.S. Cls.: 2, 5, 21, 22, 23, 26, 29, 36, 37, 38, 50,  
100, 101 and 107**

**Reg. No. 3,468,235**

**United States Patent and Trademark Office**

**Registered July 15, 2008**

**TRADEMARK  
SERVICE MARK  
PRINCIPAL REGISTER**

# CERAN

CERAN LINGUA INTERNATIONAL,; EN  
ABRÈGÉ C.L.I., SOCIÉTÉ ANONYME (BEL-  
GIUM JOINT STOCK COMPANY)  
AVENUE DES PETITS SAPINS 27  
B-4900 SPA, BELGIUM

FOR: MAGNETIC DATA CARRIERS, NAMELY,  
PRERECORDED AUDIO TAPES, VIDEO TAPES,  
COMPACT DISCS, CD ROMS AND DVDS FEATUR-  
ING LANGUAGE TEACHING LESSONS; AND  
MULTIMEDIA SOFTWARE RECORDED ON DATA  
MEDIA FOR USE IN TEACHING LANGUAGES, IN  
CLASS 9 (U.S. CLS. 21, 23, 26, 36 AND 38).

FOR: PRINTED MATTER, NAMELY, BOOKS,  
MANUALS AND BOOKLETS FOR USE IN TEACH-  
ING LANGUAGES, IN CLASS 16 (U.S. CLS. 2, 5, 22,  
23, 29, 37, 38 AND 50).

FOR: LANGUAGE TEACHING INSTRUCTION;  
LANGUAGE INSTRUCTION RENDERED VIA COR-  
RESPONDENCE COURSES, TELEPHONE COUR-  
SES, RESIDENTIAL COURSES AND SEMINARS;  
EDUCATIONAL SERVICES, NAMELY, ORGANIZA-

TION OF COURSES AND SEMINARS IN THE FIELD  
OF TEACHING LANGUAGES, IN CLASS 41 (U.S.  
CLS. 100, 101 AND 107).

THE MARK CONSISTS OF STANDARD CHAR-  
ACTERS WITHOUT CLAIM TO ANY PARTICULAR  
FONT, STYLE, SIZE, OR COLOR.

PRIORITY DATE OF 2-15-2007 IS CLAIMED.

OWNER OF INTERNATIONAL REGISTRATION  
0933195 DATED 7-16-2007, EXPIRES 7-16-2017.

OWNER OF U.S. REG. NO. 2,233,310.

THE MARK "CERAN" HAS NO MEANING IN A  
FOREIGN LANGUAGE

SER. NO. 79-042,061, FILED 7-16-2007.

WILLIAM ROSSMAN, EXAMINING ATTORNEY

**Int. Cls.: 7 and 9**

**Prior U.S. Cls.: 13, 19, 21, 23, 26, 31, 34, 35, 36 and 38**

**United States Patent and Trademark Office**

**Reg. No. 3,468,236**

**Registered July 15, 2008**

**TRADEMARK  
PRINCIPAL REGISTER**

**QUICK**          **SHAFT**

MINIMOTOR SA (SWITZERLAND SOCIÉTÉ  
ANONYME (SA))  
CH-6980 CROGLIO  
SWITZERLAND

FOR: MOTORS OTHER THAN FOR LAND VEHICLES, IN CLASS 7 (U.S. CLS. 13, 19, 21, 23, 31, 34 AND 35).

FOR: ELECTRONIC CONTROLS FOR MOTORS, IN CLASS 9 (U.S. CLS. 21, 23, 26, 36 AND 38).

PRIORITY DATE OF 2-1-2007 IS CLAIMED.

OWNER OF INTERNATIONAL REGISTRATION 0933450 DATED 7-18-2007, EXPIRES 7-18-2017.

THE COLOR(S) ORANGE, BLACK IS/ARE CLAIMED AS A FEATURE OF THE MARK.

THE MARK CONSISTS OF THE WORDING "QUICK" IN BLACK, "SHAFT" IN ORANGE, WITH A LINE UNDER THE ELEMENT "QUICK" IN BLACK; AND A LINE ABOVE THE ELEMENT "SHAFT" IN ORANGE.

SER. NO. 79-042,171, FILED 7-18-2007.

BERNICE MIDDLETON, EXAMINING ATTORNEY

**Int. Cls.: 9, 38 and 42**

**Prior U.S. Cls.: 21, 23, 26, 36, 38, 100, 101 and 104**

**United States Patent and Trademark Office**

**Reg. No. 3,468,237**

**Registered July 15, 2008**

**TRADEMARK  
SERVICE MARK  
PRINCIPAL REGISTER**

# PATCHWORK 3D

LUMISCAPHE SARL (FRANCE CORPORATION)  
SITE TECHNOLOGIQUE DE MARTICOT -  
3 CHEMIN DE MARTICOT  
F-33610 CESTAS, FRANCE

FOR: SOFTWARE DEVELOPMENT TOOLS FOR  
USE IN GRAPHIC COMPUTING, IN CLASS 9 (U.S.  
CLS. 21, 23, 26, 36 AND 38).

FOR: COMPUTER AIDED TRANSMISSION OF  
MESSAGES AND IMAGES VIA INTERNET OR  
PRIVATE NETWORKS; PROVIDING ACCESS TO  
DATABASES; AND TELECONFERENCING SERVI-  
CES, IN CLASS 38 (U.S. CLS. 100, 101 AND 104).

FOR: WRITING OF TECHNICAL EXPERT RE-  
PORTS OF ENGINEERS; RESEARCH AND DEVEL-  
OPMENT OF NEW PRODUCTS; COMPUTER

PROGRAMMING, IN CLASS 42 (U.S. CLS. 100 AND  
101).

THE MARK CONSISTS OF STANDARD CHAR-  
ACTERS WITHOUT CLAIM TO ANY PARTICULAR  
FONT, STYLE, SIZE, OR COLOR.

OWNER OF INTERNATIONAL REGISTRATION  
0933497 DATED 6-19-2007, EXPIRES 6-19-2017.

NO CLAIM IS MADE TO THE EXCLUSIVE  
RIGHT TO USE "3D", APART FROM THE MARK  
AS SHOWN.

SER. NO. 79-042,194, FILED 6-19-2007.

RON FAIRBANKS, EXAMINING ATTORNEY

**Int. Cls.: 9, 38 and 42**

**Prior U.S. Cls.: 21, 23, 26, 36, 38, 100, 101 and 104**

**Reg. No. 3,468,238**

**United States Patent and Trademark Office**

**Registered July 15, 2008**

**TRADEMARK  
SERVICE MARK  
PRINCIPAL REGISTER**

**LUMISCAPHE**

LUMISCAPHE SARL (FRANCE CORPORATION)  
SITE TECHNOLOGIQUE DE MARTICOT -  
3 CHEMIN DE MARTICOT; F-33610 CESTAS  
FRANCE

FOR: SOFTWARE DEVELOPMENT TOOLS FOR  
USE IN GRAPHIC COMPUTING, IN CLASS 9 (U.S.  
CLS. 21, 23, 26, 36 AND 38).

FOR: COMPUTER AIDED TRANSMISSION OF  
MESSAGES AND IMAGES VIA INTERNET OR  
PRIVATE NETWORKS; PROVIDING ACCESS TO  
DATABASES; TELECONFERENCING SERVICES,  
IN CLASS 38 (U.S. CLS. 100, 101 AND 104).

FOR: WRITING OF TECHNICAL EXPERT RE-  
PORTS OF ENGINEERS; RESEARCH AND DEVEL-

OPMENT OF NEW PRODUCTS; COMPUTER  
PROGRAMMING, IN CLASS 42 (U.S. CLS. 100 AND  
101).

THE MARK CONSISTS OF STANDARD CHAR-  
ACTERS WITHOUT CLAIM TO ANY PARTICULAR  
FONT, STYLE, SIZE, OR COLOR.

OWNER OF INTERNATIONAL REGISTRATION  
0933501 DATED 6-19-2007, EXPIRES 6-19-2017.

SER. NO. 79-042,198, FILED 6-19-2007.

RON FAIRBANKS, EXAMINING ATTORNEY

**Int. Cl.: 9**

**Prior U.S. Cls.: 21, 23, 26, 36 and 38**

**Reg. No. 3,468,239**

**United States Patent and Trademark Office**

**Registered July 15, 2008**

**TRADEMARK  
PRINCIPAL REGISTER**



INTERFACE CORPORATION (JAPAN CORPORATION)

10-21, KYOBASHI-CHO

MINAMI-KU.; HIROSHIMA-SHI; HIROSHIMA 732-0828

JAPAN

FOR: CARDBUS-COMPLIANT ELECTRONIC MACHINES, APPARATUS AND THEIR PARTS, NAMELY, COMPUTERS AND COMPUTER HARDWARE; AND CARDBUS-COMPLIANT COMPUTER SOFTWARE FOR USE AS A SPREADSHEET, IN CLASS 9 (U.S. CLS. 21, 23, 26, 36 AND 38).

OWNER OF INTERNATIONAL REGISTRATION 0933511 DATED 6-25-2007, EXPIRES 6-25-2017.

OWNER OF U.S. REG. NOS. 2,507,463 AND 3,021,720.

NO CLAIM IS MADE TO THE EXCLUSIVE RIGHT TO USE "CARD BUS", APART FROM THE MARK AS SHOWN.

SER. NO. 79-042,205, FILED 6-25-2007.

AMY HELLA, EXAMINING ATTORNEY



**Int. Cl.: 10**

**Prior U.S. Cls.: 26, 39 and 44**

**United States Patent and Trademark Office**

**Reg. No. 3,468,240**

**Registered July 15, 2008**

**TRADEMARK  
PRINCIPAL REGISTER**

**ROMAX**

MEDACTA INTERNATIONAL S.A. (SWITZERLAND CORPORATION)  
STRADA REGINA  
CH-6874 CASTEL SAN PIETRO, SWITZERLAND

FOR: PROSTHESES FOR BREASTS, HANDS AND LEGS; ORTHOPAEDIC ARTICLES, INSTRUMENTS AND ACCESSORIES, NAMELY, FOOTWEAR, BELTS, BRACES, JOINT IMPLANTS, SOLES, SUPPORTS, AND SUPPORT BANDAGES, IN CLASS 10 (U.S. CLS. 26, 39 AND 44).

PRIORITY DATE OF 2-28-2007 IS CLAIMED.

OWNER OF INTERNATIONAL REGISTRATION  
0933801 DATED 7-30-2007, EXPIRES 7-30-2017.

THIS MARK CONSISTS OF THE EXPRESSION "ROMAX" IN WHICH THE CENTRAL LETTER "M" IS FORMED BY TWO SAIL-LIKE SOLID RIGHT ANGLE TRIANGLES, SLIGHTLY INCLINED TOWARDS THE RIGHT.

SER. NO. 79-042,336, FILED 7-30-2007.

ERNEST SHOSHO, EXAMINING ATTORNEY

**Int. Cls.: 9 and 42**

**Prior U.S. Cls.: 21, 23, 26, 36, 38, 100 and 101**

**Reg. No. 3,468,241**

**United States Patent and Trademark Office**

**Registered July 15, 2008**

**TRADEMARK  
SERVICE MARK  
PRINCIPAL REGISTER**

**PROCASH-PURITY-SEAL**

WINCOR NIXDORF INTERNATIONAL GMBH  
(FED REP GERMANY CORPORATION)  
HEINZ-NIXDORF-RING 1  
33106 PADERBORN  
FED REP GERMANY

FOR: CASH RECEIVING AND CASH DISPENSING MACHINES, NAMELY, AUTOMATIC TELLER MACHINES; CASH DISPENSERS, NAMELY, AUTOMATIC TELLER MACHINES; CASH RECEIVERS, NAMELY, AUTOMATIC TELLER MACHINES; SELF-SERVICED CONTAINER TAKE-BACK SYSTEMS, COMPRISED OF AN EMPTY BOTTLE RETURN MACHINE; ELECTRONIC CASH REGISTERS; SELF-SERVICE POINT-OF-SALE SYSTEMS, COMPRISED OF DISPLAY AND KEYBOARD; MULTI-FUNCTIONAL TERMINALS, NAMELY, ELECTRONIC PAYMENT TERMINALS; POSTAL TERMINALS, NAMELY, STAMP DISPENSING MACHINES; TICKET TERMINALS, NAMELY, TICKET DISPENSING MACHINES; AUTOMATIC GOODS DISPENSERS, NAMELY, CASH DISPENSERS; COMPUTER TERMINALS PROVIDED WITH CARD READER, KEYBOARD, PRINTER, TOUCH SCREEN, LOUDSPEAKER, DISPLAY, INTERNET CONNECTION SOLD TOGETHER AS A UNIT; COMPUTER SOFTWARE FOR CASH DISPENSING AND RECEIVING MACHINES, SELF-SERVICED CASH DISPENSERS, CASH RECEIVERS, SELF-SERVICED CONTAINER TAKE-BACK SYSTEMS, BOTTLE TAKE-BACK SYSTEMS, POSTAL TERMINALS, STAMP DISPENSING MACHINES, POSTAL GOODS DISPATCHER MACHINES, TICKET TERMINALS, AUTOMATIC GOODS DISPENSERS, SELF-SERVICE DEVICES, ELECTRONIC CASH REGISTERS, SELF-SERVICE POINT-OF-SALE SYSTEMS, MULTI-FUNCTIONAL TERMINALS WITH PAYMENT FUNCTION FOR USE IN DATABASE MANAGEMENT; DATA PROCESSING PROGRAMS FOR USE IN DATABASE MANAGEMENT; COMPUTER SOFTWARE, NAMELY, OPEN OBJECT-ORIENTATED SOFTWARE TECHNOLOGIES FOR USE IN DATABASE MANAGEMENT; COMPUTER SOFTWARE FOR CONTROLLING AND OPERATING ELECTRO-TECHNICAL AND ELECTRONIC APPARATUS, DEVICES AND INSTRUMENTS, COMPU-

TER TERMINALS, SELF-SERVICED CONTAINER TAKE-BACK SYSTEMS, BOTTLE TAKE-BACK SYSTEMS, CASH DISPENSERS, CASH RECEIVERS, POSTAL TERMINALS, STAMP DISPENSING MACHINES, POSTAL GOODS DISPATCHER MACHINES, SELF-SERVICE DEVICES, ELECTRONIC CASH REGISTERS, SELF-SERVICE POINT-OF-SALE SYSTEMS, PRINTERS, MULTI-FUNCTIONAL TERMINALS WITH PAYMENT FUNCTION, IN CLASS 9 (U.S. CLS. 21, 23, 26, 36 AND 38).

FOR: DEVELOPING, DESIGNING AND RENTAL OF DATA PROCESSING PROGRAMS FOR OTHERS; DESIGNING COMPUTER SOFTWARE FOR SELF-SERVICE SYSTEMS AND TERMINAL DEVICES SUCH AS VENDING MACHINES, ELECTRONIC CASH REGISTERS, SELF-SERVICE POINT-OF-SALE SYSTEMS, CASH DISPENSERS, CASH RECEIVERS, SELF-SERVICED CONTAINER TAKE-BACK SYSTEMS, BOTTLE TAKE-BACK SYSTEMS, POSTAL TERMINALS, STAMP DISPENSING MACHINES, POSTAL GOODS DISPATCHER MACHINES, TICKET TERMINALS, AUTOMATIC GOODS DISPENSERS, TERMINALS WITH PAYMENT FUNCTION FOR OTHERS; DESIGNING COMPUTER SOFTWARE USED FOR BANKING TRANSACTIONS FOR OTHERS; TECHNICAL CONSULTANCY SERVICES WITH REGARD TO THE USE OF THE AFOREMENTIONED COMPUTER SOFTWARE, IN CLASS 42 (U.S. CLS. 100 AND 101).

THE MARK CONSISTS OF STANDARD CHARACTERS WITHOUT CLAIM TO ANY PARTICULAR FONT, STYLE, SIZE, OR COLOR.

PRIORITY DATE OF 1-24-2007 IS CLAIMED.

OWNER OF INTERNATIONAL REGISTRATION 0934320 DATED 7-9-2007, EXPIRES 7-9-2017.

SER. NO. 79-042,553, FILED 7-9-2007.

JANICE KIM, EXAMINING ATTORNEY

**Int. Cls.: 9 and 42**

**Prior U.S. Cls.: 21, 23, 26, 36, 38, 100 and 101**

**Reg. No. 3,468,242**

**United States Patent and Trademark Office**

**Registered July 15, 2008**

**TRADEMARK  
SERVICE MARK  
PRINCIPAL REGISTER**

**PROCASH-ULTRA-CLEAN**

WINCOR NIXDORF INTERNATIONAL GMBH  
(FED REP GERMANY CORPORATION)  
HEINZ-NIXDORF-RING 1  
33106 PADERBORN  
FED REP GERMANY

FOR: CASH RECEIVING AND CASH DISPENSING MACHINES, NAMELY, AUTOMATIC TELLER MACHINES; CASH DISPENSERS, NAMELY, AUTOMATIC TELLER MACHINES; CASH RECEIVERS, NAMELY, AUTOMATIC TELLER MACHINES; SELF-SERVICED CONTAINER TAKE-BACK SYSTEMS, COMPRISED OF AN EMPTY BOTTLE RETURN MACHINE; ELECTRONIC CASH REGISTERS; SELF-SERVICE POINT-OF-SALE SYSTEMS, COMPRISED OF DISPLAY AND KEYBOARD; MULTI-FUNCTIONAL TERMINALS, NAMELY, ELECTRONIC PAYMENT TERMINALS; POSTAL TERMINALS, NAMELY, STAMP DISPENSING MACHINES; TICKET TERMINALS, NAMELY, TICKET DISPENSING MACHINES; AUTOMATIC GOODS DISPENSERS, NAMELY, CASH DISPENSERS; COMPUTER TERMINALS PROVIDED WITH CARD READER, KEYBOARD, PRINTER, TOUCH SCREEN, LOUDSPEAKER, DISPLAY, INTERNET CONNECTION SOLD TOGETHER AS A UNIT; COMPUTER SOFTWARE FOR CASH DISPENSING AND RECEIVING MACHINES, SELF-SERVICED CASH DISPENSERS, CASH RECEIVERS, SELF-SERVICED CONTAINER TAKE-BACK SYSTEMS, BOTTLE TAKE-BACK SYSTEMS, POSTAL TERMINALS, STAMP DISPENSING MACHINES, POSTAL GOODS DISPATCHER MACHINES, TICKET TERMINALS, AUTOMATIC GOODS DISPENSERS, SELF-SERVICE DEVICES, ELECTRONIC CASH REGISTERS, SELF-SERVICE POINT-OF-SALE SYSTEMS, MULTI-FUNCTIONAL TERMINALS WITH PAYMENT FUNCTION FOR USE IN DATABASE MANAGEMENT; DATA PROCESSING PROGRAMS FOR USE IN DATABASE MANAGEMENT; COMPUTER SOFTWARE, NAMELY, OPEN OBJECT-ORIENTATED SOFTWARE TECHNOLOGIES FOR USE IN DATABASE MANAGEMENT; COMPUTER SOFTWARE FOR CONTROLLING AND OPERATING ELECTRO-TECHNICAL AND ELECTRONIC APPARATUS, DEVICES AND INSTRUMENTS, COMPU-

TER TERMINALS, SELF-SERVICED CONTAINER TAKE-BACK SYSTEMS, BOTTLE TAKE-BACK SYSTEMS, CASH DISPENSERS, CASH RECEIVERS, POSTAL TERMINALS, STAMP DISPENSING MACHINES, POSTAL GOODS DISPATCHER MACHINES, SELF-SERVICE DEVICES, ELECTRONIC CASH REGISTERS, SELF-SERVICE POINT-OF-SALE SYSTEMS, PRINTERS, MULTI-FUNCTIONAL TERMINALS WITH PAYMENT FUNCTION, IN CLASS 9 (U.S. CLS. 21, 23, 26, 36 AND 38).

FOR: DEVELOPING, DESIGNING AND RENTAL OF DATA PROCESSING PROGRAMS FOR OTHERS; DESIGNING COMPUTER SOFTWARE FOR SELF-SERVICE SYSTEMS AND TERMINAL DEVICES SUCH AS VENDING MACHINES, ELECTRONIC CASH REGISTERS, SELF-SERVICE POINT-OF-SALE SYSTEMS, CASH DISPENSERS, CASH RECEIVERS, SELF-SERVICED CONTAINER TAKE-BACK SYSTEMS, BOTTLE TAKE-BACK SYSTEMS, POSTAL TERMINALS, STAMP DISPENSING MACHINES, POSTAL GOODS DISPATCHER MACHINES, TICKET TERMINALS, AUTOMATIC GOODS DISPENSERS, TERMINALS WITH PAYMENT FUNCTION FOR OTHERS; DESIGNING COMPUTER SOFTWARE USED FOR BANKING TRANSACTIONS FOR OTHERS; TECHNICAL CONSULTANCY SERVICES WITH REGARD TO THE USE OF THE AFOREMENTIONED COMPUTER SOFTWARE, IN CLASS 42 (U.S. CLS. 100 AND 101).

THE MARK CONSISTS OF STANDARD CHARACTERS WITHOUT CLAIM TO ANY PARTICULAR FONT, STYLE, SIZE, OR COLOR.

PRIORITY DATE OF 1-24-2007 IS CLAIMED.

OWNER OF INTERNATIONAL REGISTRATION 0934321 DATED 7-9-2007, EXPIRES 7-9-2017.

SER. NO. 79-042,554, FILED 7-9-2007.

JANICE KIM, EXAMINING ATTORNEY

**Int. Cl.: 1**

**Prior U.S. Cls.: 1, 5, 6, 10, 26 and 46**

**Reg. No. 3,468,243**

**United States Patent and Trademark Office**

**Registered July 15, 2008**

**TRADEMARK  
PRINCIPAL REGISTER**

**VELOTHENE**

PLAASTEKA LIMITED (UNITED KINGDOM  
LTD LIAB CO)  
54 HILLBURY AVENUE  
HARROW, MIDDLESEX, HA3 8EW  
UNITED KINGDOM

FOR: CHEMICALS FOR USE IN INDUSTRY,  
INCLUDING USE IN PLASTICS PROCESSING; IN-  
DUSTRIAL CHEMICAL ADDITIVES FOR GENER-  
AL INDUSTRIAL USE; CHEMICAL ADDITIVES,  
INCLUDING PLASTICS ADDITIVES, FOR USE IN  
THE PRODUCTION OF PLASTICS MATERIALS OR  
FOR USE IN THE MANUFACTURE OF PLASTICS  
PRODUCTS BY INJECTION MOULDING OR EX-  
TRUSION; UNPROCESSED SYNTHETIC RESINS AS  
RAW MATERIALS IN THE FORM OF POWDER,  
PELLETS OR GRANULES FOR USE IN THE PRO-  
DUCTION OF PLASTICS; INJECTION MOULDING  
COMPOUNDS CONTAINING PLASTICS IN FORM  
OF PELLETS, POWDER OR GRANULES FOR GEN-  
ERAL INDUSTRIAL USE; REINFORCED SYN-

THETIC INJECTION MOULDING COMPOUNDS  
IN PELLET, POWDER OR GRANULE FORM; UN-  
PROCESSED PLASTICS FOR USE IN THE EXTRU-  
SION AND INJECTION MOULDING INDUSTRIES,  
IN CLASS 1 (U.S. CLS. 1, 5, 6, 10, 26 AND 46).

THE MARK CONSISTS OF STANDARD CHAR-  
ACTERS WITHOUT CLAIM TO ANY PARTICULAR  
FONT, STYLE, SIZE, OR COLOR.

PRIORITY DATE OF 6-18-2007 IS CLAIMED.

OWNER OF INTERNATIONAL REGISTRATION  
0934378 DATED 7-4-2007, EXPIRES 7-4-2017.

SER. NO. 79-042,578, FILED 7-4-2007.

CARYN GLASSER, EXAMINING ATTORNEY

**Int. Cl.: 9**

**Prior U.S. Cls.: 21, 23, 26, 36 and 38**

**Reg. No. 3,468,244**

**United States Patent and Trademark Office**

**Registered July 15, 2008**

**TRADEMARK  
PRINCIPAL REGISTER**



KONINKLIJKE PHILIPS ELECTRONICS N.V.  
(NETHERLANDS LIMITED LIABILITY COM-  
PANY)

GROENEWOUDSEWEG 1  
NL-5621 BA EINDHOVEN  
NETHERLANDS

FOR: BLANK RECORDABLE AND REWRITABLE OPTICAL AND MAGNETO-OPTICAL DISCS, NAMELY, COMPACT DISCS AND DVD DISCS; COMPUTER SOFTWARE PROGRAMS FOR RECORDING WRITING AND COPYING SOUND, IMAGES AND DATA ON COMPACT DISCS, CD-ROM DISCS AND DVD DISCS; COMPUTERS; OPTICAL DISC DRIVES; AND REPLACEMENT PARTS FOR

THE AFORESAID GOODS, IN CLASS 9 (U.S. CLS. 21, 23, 26, 36 AND 38).

PRIORITY DATE OF 2-5-2007 IS CLAIMED.

OWNER OF INTERNATIONAL REGISTRATION  
0934760 DATED 7-26-2007, EXPIRES 7-26-2017.

OWNER OF U.S. REG. NO. 3,233,643.

SER. NO. 79-042,689, FILED 7-26-2007.

MICHELE SWAIN, EXAMINING ATTORNEY

**Int. Cls.: 7, 9 and 42**

**Prior U.S. Cls.: 13, 19, 21, 23, 26, 31, 34, 35, 36, 38, 100  
and 101**

**Reg. No. 3,468,245**

**United States Patent and Trademark Office**

**Registered July 15, 2008**

**TRADEMARK  
SERVICE MARK  
PRINCIPAL REGISTER**

**VIEC**

AIBEL AS (NORWAY LTD LIAB CO)  
BERGERVEIEN 12  
N-1375 BILLINGSTAD  
NORWAY

FOR: PROCESSING SYSTEMS CONSISTING OF OIL AND WATER SEPARATORS; COALESCERS NAMELY, MECHANICAL COALESCERS FOR SEPARATION OF OIL AND WATER; DEVICES FOR SEPARATING WATER FROM OIL WELL FLUIDS NAMELY, COALESCERS, IN CLASS 7 (U.S. CLS. 13, 19, 21, 23, 31, 34 AND 35).

FOR: PROCESSING SYSTEMS NAMELY, ELECTROSTATIC COALESCERS; ELECTRONIC DEVICES FOR SEPARATING WATER FROM OIL WELL FLUIDS, NAMELY, COALESCERS, IN CLASS 9 (U.S. CLS. 21, 23, 26, 36 AND 38).

FOR: SCIENTIFIC AND TECHNOLOGICAL SERVICES AS WELL AS RESEARCH AND DEVELOPMENT, INDUSTRIAL ANALYSIS AND RESEARCH ALL IN THE FIELD OF OIL AND WATER SEPARA-

TION PROCESSING AND COALESCERS; TECHNICAL AND PROFESSIONAL CONSULTANCY IN THE FIELD OF OIL AND WATER SEPARATION PROCESSING AND COALESCERS; ENGINEERING, CHEMICAL ANALYSIS, ANALYSIS FOR OIL FIELD EXPLOITATION, OIL FIELD SURVEYS AND CONSULTANCY IN CONNECTION HEREWITH, IN CLASS 42 (U.S. CLS. 100 AND 101).

THE MARK CONSISTS OF STANDARD CHARACTERS WITHOUT CLAIM TO ANY PARTICULAR FONT, STYLE, SIZE, OR COLOR.

PRIORITY DATE OF 10-4-2006 IS CLAIMED.

OWNER OF INTERNATIONAL REGISTRATION 0934947 DATED 4-3-2007, EXPIRES 4-3-2017.

SER. NO. 79-042,734, FILED 4-3-2007.

PETER B. BROMAGHIM, EXAMINING ATTORNEY

**Int. Cls.: 9 and 42**

**Prior U.S. Cls.: 21, 23, 26, 36, 38, 100 and 101**

**Reg. No. 3,468,246**

**United States Patent and Trademark Office**

**Registered July 15, 2008**

**TRADEMARK  
SERVICE MARK  
PRINCIPAL REGISTER**

# **PROCASH-BAK-EX**

WINCOR NIXDORF INTERNATIONAL GMBH  
(FED REP GERMANY CORPORATION)  
HEINZ-NIXDORF-RING 1  
33106 PADERBORN  
FED REP GERMANY

FOR: CASH RECEIVING AND CASH DISPENSING MACHINES, NAMELY, AUTOMATIC TELLER MACHINES; CASH DISPENSERS, NAMELY, AUTOMATIC TELLER MACHINES; CASH RECEIVERS, NAMELY, AUTOMATIC TELLER MACHINES; SELF-SERVICED CONTAINER TAKE-BACK SYSTEMS, COMPRISED OF AN EMPTY BOTTLE RETURN MACHINE; ELECTRONIC CASH REGISTERS; SELF-SERVICE POINT-OF-SALE SYSTEMS, COMPRISED OF DISPLAY AND KEYBOARD; MULTI-FUNCTIONAL TERMINALS, NAMELY, ELECTRONIC PAYMENT TERMINALS; POSTAL TERMINALS, NAMELY, STAMP DISPENSING MACHINES; TICKET TERMINALS, NAMELY, TICKET DISPENSING MACHINES; AUTOMATIC GOODS DISPENSERS, NAMELY, CASH DISPENSERS; COMPUTER TERMINALS PROVIDED WITH CARD READER, KEYBOARD, PRINTER, TOUCH SCREEN, LOUDSPEAKER, DISPLAY, INTERNET CONNECTION SOLD TOGETHER AS A UNIT; COMPUTER SOFTWARE FOR CASH DISPENSING AND RECEIVING MACHINES, SELF-SERVICED CASH DISPENSERS, CASH RECEIVERS, SELF-SERVICED CONTAINER TAKE-BACK SYSTEMS, BOTTLE TAKE-BACK SYSTEMS, POSTAL TERMINALS, STAMP DISPENSING MACHINES, POSTAL GOODS DISPATCHER MACHINES, TICKET TERMINALS, AUTOMATIC GOODS DISPENSERS, SELF-SERVICE DEVICES, ELECTRONIC CASH REGISTERS, SELF-SERVICE POINT-OF-SALE SYSTEMS, MULTI-FUNCTIONAL TERMINALS WITH PAYMENT FUNCTION FOR USE IN DATABASE MANAGEMENT; DATA PROCESSING PROGRAMS FOR USE IN DATABASE MANAGEMENT; COMPUTER SOFTWARE, NAMELY, OPEN OBJECT-ORIENTATED SOFTWARE TECHNOLOGIES FOR USE IN DATABASE MANAGEMENT; COMPUTER SOFTWARE FOR CONTROLLING AND OPERATING ELECTRO-TECHNICAL AND ELECTRONIC APPARATUS, DEVICES AND INSTRUMENTS, COMPU-

TER TERMINALS, SELF-SERVICED CONTAINER TAKE-BACK SYSTEMS, BOTTLE TAKE-BACK SYSTEMS, CASH DISPENSERS, CASH RECEIVERS, POSTAL TERMINALS, STAMP DISPENSING MACHINES, POSTAL GOODS DISPATCHER MACHINES, SELF-SERVICE DEVICES, ELECTRONIC CASH REGISTERS, SELF-SERVICE POINT-OF-SALE SYSTEMS, PRINTERS, MULTI-FUNCTIONAL TERMINALS WITH PAYMENT FUNCTION, IN CLASS 9 (U.S. CLS. 21, 23, 26, 36 AND 38).

FOR: DEVELOPING, DESIGNING AND RENTAL OF DATA PROCESSING PROGRAMS FOR OTHERS; DESIGNING COMPUTER SOFTWARE FOR SELF-SERVICE SYSTEMS AND TERMINAL DEVICES SUCH AS VENDING MACHINES, ELECTRONIC CASH REGISTERS, SELF-SERVICE POINT-OF-SALE SYSTEMS, CASH DISPENSERS, CASH RECEIVERS, SELF-SERVICED CONTAINER TAKE-BACK SYSTEMS, BOTTLE TAKE-BACK SYSTEMS, POSTAL TERMINALS, STAMP DISPENSING MACHINES, POSTAL GOODS DISPATCHER MACHINES, TICKET TERMINALS, AUTOMATIC GOODS DISPENSERS, TERMINALS WITH PAYMENT FUNCTION FOR OTHERS; DESIGNING COMPUTER SOFTWARE USED FOR BANKING TRANSACTIONS FOR OTHERS; TECHNICAL CONSULTANCY SERVICES WITH REGARD TO THE USE OF THE AFOREMENTIONED COMPUTER SOFTWARE, IN CLASS 42 (U.S. CLS. 100 AND 101).

THE MARK CONSISTS OF STANDARD CHARACTERS WITHOUT CLAIM TO ANY PARTICULAR FONT, STYLE, SIZE, OR COLOR.

PRIORITY DATE OF 1-24-2007 IS CLAIMED.

OWNER OF INTERNATIONAL REGISTRATION 0934971 DATED 7-9-2007, EXPIRES 7-9-2017.

SER. NO. 79-042,745, FILED 7-9-2007.

JANICE KIM, EXAMINING ATTORNEY

**Int. Cls.: 9 and 10**

**Prior U.S. Cls.: 21, 23, 26, 36, 38, 39 and 44**

**United States Patent and Trademark Office**

**Reg. No. 3,468,247**

**Registered July 15, 2008**

**TRADEMARK  
PRINCIPAL REGISTER**

**典雅**

**TENGA**

KABUSHIKI KAISHA TENGA (JAPAN CORPORATION), TA TENGA CO., LTD.  
58-10, CHUO 2-CHOME, NAKANO-KU  
3F LUCK STAR BLDG.  
TOKYO, JAPAN 1640011

FOR: EXPOSED CINEMATOGRAPHIC FILMS; EXPOSED SLIDE FILMS; SLIDE FILM MOUNTS; RECORDED VIDEO DISCS AND VIDEO TAPES FEATURING HUMAN SEXUALITY, IN CLASS 9 (U.S. CLS. 21, 23, 26, 36 AND 38).

FOR: MEDICAL MACHINES AND APPARATUS, NAMELY, SEMEN COLLECTION MACHINES AND BODY FLUID COLLECTION MACHINES; ELECTRIC VIBRATOR MASSAGE APPARATUS FOR MEDICAL PURPOSES, NAMELY, ELECTRIC VIBRATING MASSAGERS; SEXUAL INTERCOURSE AUXILIARY DEVICES, NAMELY, INFLATABLE LIFE-SIZED DOLLS USED IN SEXUAL ACTIVITY; MASTURBATION AUXILIARY DEVICES IN THE

NATURE OF ADULT SEXUAL AIDES, NAMELY, ARTIFICIAL PENISES, VIBRATORS, AND ARTIFICIAL VAGINAS, IN CLASS 10 (U.S. CLS. 26, 39 AND 44).

OWNER OF INTERNATIONAL REGISTRATION 0934985 DATED 5-17-2007, EXPIRES 5-17-2017.

THE ENGLISH TRANSLATION OF "TENGA" IS REFINEMENT OR ELEGANCE.

THE TRANSLITERATION OF THE NON-LATIN CHARACTERS IN THE MARK IS "TENGA".

SER. NO. 79-042,754, FILED 5-17-2007.

ROBERT STRUCK, EXAMINING ATTORNEY



**Int. Cl.: 3**

**Prior U.S. Cls.: 1, 4, 6, 50, 51 and 52**

**United States Patent and Trademark Office**

**Reg. No. 3,468,248**

**Registered July 15, 2008**

**TRADEMARK  
PRINCIPAL REGISTER**

**CO2, Jeanne ARTHES**

ARTHES (FRANCE SOCIETE ANONYME)  
PARC INDUSTRIEL DES BOIS DE GRASSE  
BP 91006; F-06131 GRASSE  
FRANCE

FOR: SOAPS, PERFUMERY GOODS, ESSENTIAL  
OILS, COSMETIC PRODUCTS, HAIR LOTIONS, IN  
CLASS 3 (U.S. CLS. 1, 4, 6, 50, 51 AND 52).

THE MARK CONSISTS OF STANDARD CHAR-  
ACTERS WITHOUT CLAIM TO ANY PARTICULAR  
FONT, STYLE, SIZE, OR COLOR.

OWNER OF INTERNATIONAL REGISTRATION  
0859369 DATED 6-20-2005, EXPIRES 6-20-2015.

OWNER OF U.S. REG. NO. 3,023,851.

THE NAME JEANNE ARTHES DOES NOT IDENTIFY  
A LIVING INDIVIDUAL.

SER. NO. 79-042,855, FILED 6-26-2007.

MATTHEW MCDOWELL, EXAMINING ATTOR-  
NEY

**Int. Cls.: 35 and 41**

**Prior U.S. Cls.: 100, 101, 102 and 107**

**United States Patent and Trademark Office**

**Reg. No. 3,468,249**

**Registered July 15, 2008**

**SERVICE MARK  
PRINCIPAL REGISTER**

# **COPERA**

JNB DEVELOPPEMENT (FRANCE SOCIÉTÉ PAR  
ACTION SIMPLIFIÉE)  
6, RUE DU GÉNÉRAL DE LARMINAT  
F-75015 PARIS  
FRANCE

FOR: BUSINESS ORGANIZATION AND MANAGEMENT CONSULTING; RESEARCH FOR BUSINESS PURPOSES; BUSINESS INQUIRIES; PROFESSIONAL BUSINESS CONSULTING, IN PARTICULAR BUSINESS ORGANIZATION CONSULTING IN CARE ESTABLISHMENTS FOR ALL QUESTIONS OF AN ORGANIZATIONAL NATURE; BUSINESS MANAGEMENT IN THE NATURE OF DECISION AND FUNCTIONAL ANALYSIS; BUSINESS MANAGEMENT IN THE NATURE OF WORK FLOW OPTIMIZATION SERVICES FOR GOOD PHARMACEUTICAL PRACTICES; BUSINESS AUDITING; EFFICIENCY EXPERTS IN THE SCIENTIFIC ENVIRONMENTAL FIELD, NAMELY, EXPERT COMMERCIAL BUSINESS REPORTING; BUSINESS AUDITING FOR PHARMACEUTICAL ORGANIZATIONS AND STRATEGIES; BUSINESS MANAGEMENT IN THE NATURE OF ASSISTANCE IN CARRYING OUT BUSINESS PROJECTS IN THE FIELD OF PHARMACOLOGY AND IN THE HEALTH CARE SECTOR; COMMERCIAL INFORMATION AGENCY; RESEARCH FOR BUSINESS PURPOSES; PROFESSIONAL BUSINESS CONSULTING; DISSEMINATION OF ADVERTISING MATERIAL IN THE NATURE OF LEAFLETS, PROSPECTUSES, PRINTED MATTER, SAMPLES; MARKET RESEARCH STUDIES; EFFICIENCY EXPERTS; SERVICES CONSISTING OF THE COMPILATION AND SYSTEMIZATION OF WRITTEN DATA IN A DATABASE; CONDUCTING BUSINESS RESEARCH IN COMPUTER DATABASES FOR THIRD PARTIES; MARKETING RESEARCH; COST PRICE ANALYSIS; COST ANALYSIS FOR OPTIMI-

ZATION AND MINIMIZATION; PROVIDING STATISTICAL INFORMATION; COMPUTER FILE MANAGEMENT, PUBLIC RELATIONS; ARRANGING AND CONDUCTING MARKETING PROMOTIONAL EVENTS FOR OTHERS IN COMPLIANCE WITH RECOMMENDATIONS AND WITH THE ADMINISTRATIVE DOCTRINE IN FORCE; COMPUTERIZED DATABASE COMPILATION, IN CLASS 35 (U.S. CLS. 100, 101 AND 102).

FOR: ARRANGING AND CONDUCTING OF COLLOQUIA, CONVENTIONS, SEMINARS AND EXHIBITIONS IN THE FIELD OF PHARMACEUTICAL RESEARCH; ARRANGING OF CONFERENCES AND CONVENTIONS IN THE FIELD OF PHARMACEUTICAL RESEARCH; ARRANGING AND CONDUCTING TRAINING WORKSHOPS AND SEMINARS IN THE FIELD OF PHARMACEUTICAL RESEARCH; PUBLICATION OF BOOKS; EDUCATIONAL SERVICES, NAMELY, PROVIDING TRAINING FOR STAFF ON REGULATORY REQUIREMENTS OF THE HEALTH CARE INDUSTRIES, IN CLASS 41 (U.S. CLS. 100, 101 AND 107).

PRIORITY DATE OF 6-21-2006 IS CLAIMED.

OWNER OF INTERNATIONAL REGISTRATION  
0935228 DATED 12-19-2006, EXPIRES 12-19-2016.

THE MARK HAS NO MEANING IN ANY FOREIGN LANGUAGE.

SER. NO. 79-042,903, FILED 12-19-2006.

TARAH HARDY, EXAMINING ATTORNEY

**Int. Cl.: 5**

**Prior U.S. Cls.: 6, 18, 44, 46, 51 and 52**

**Reg. No. 3,468,250**

**United States Patent and Trademark Office**

**Registered July 15, 2008**

**TRADEMARK  
PRINCIPAL REGISTER**

**TWYNSTA**

BOEHRINGER INGELHEIM INTERNATIONAL  
GMBH (FED REP GERMANY CORPORATION)

55218 INGELHEIM  
FED REP GERMANY

FOR: PHARMACEUTICAL PREPARATIONS FOR THE TREATMENT OF DISEASES AND DISORDERS OF THE ALIMENTARY TRACT AND METABOLISM, AND BLOOD AND BLOOD FORMING ORGANS; PHARMACEUTICAL PREPARATIONS FOR THE TREATMENT OF DISEASES AND DISORDERS OF THE CARDIOVASCULAR SYSTEM, MUSCULOSKELETAL SYSTEM, CENTRAL NERVOUS SYSTEM, PERIPHERAL NERVOUS SYSTEM, GENITOURINARY SYSTEM AND RESPIRATORY SYSTEM; AND PHARMACEUTICAL PREPARATIONS FOR THE TREATMENT OF DERMATOLOGICAL, HORMONAL, INFECTIOUS, VIRAL AND

ONCOLOGICAL DISEASES AND DISORDERS, IN CLASS 5 (U.S. CLS. 6, 18, 44, 46, 51 AND 52).

THE MARK CONSISTS OF STANDARD CHARACTERS WITHOUT CLAIM TO ANY PARTICULAR FONT, STYLE, SIZE, OR COLOR.

PRIORITY DATE OF 2-28-2007 IS CLAIMED.

OWNER OF INTERNATIONAL REGISTRATION 0935516 DATED 8-3-2007, EXPIRES 8-3-2017.

SER. NO. 79-043,030, FILED 8-3-2007.

KATHERINE E. HALMEN, EXAMINING ATTORNEY

**Int. Cl.: 5**

**Prior U.S. Cls.: 6, 18, 44, 46, 51 and 52**

**United States Patent and Trademark Office**

**Reg. No. 3,468,251**

**Registered July 15, 2008**

**TRADEMARK  
PRINCIPAL REGISTER**

**TRAJENTA**

BOEHRINGER INGELHEIM INTERNATIONAL  
GMBH (FED REP GERMANY CORPORATION)

55218 INGELHEIM  
FED REP GERMANY

FOR: PHARMACEUTICAL PREPARATIONS FOR THE TREATMENT OF DISEASES AND DISORDERS OF THE ALIMENTARY TRACT AND METABOLISM, AND BLOOD AND BLOOD FORMING ORGANS; PHARMACEUTICAL PREPARATIONS FOR THE TREATMENT OF DISEASES AND DISORDERS OF THE CARDIOVASCULAR SYSTEM, MUSCULOSKELETAL SYSTEM, CENTRAL NERVOUS SYSTEM, PERIPHERAL NERVOUS SYSTEM, GENITOURINARY SYSTEM AND RESPIRATORY SYSTEM; AND PHARMACEUTICAL PREPARATIONS FOR THE TREATMENT OF DERMATOLOGICAL, HORMONAL, INFECTIOUS, VIRAL AND

ONCOLOGICAL DISEASES AND DISORDERS, IN CLASS 5 (U.S. CLS. 6, 18, 44, 46, 51 AND 52).

THE MARK CONSISTS OF STANDARD CHARACTERS WITHOUT CLAIM TO ANY PARTICULAR FONT, STYLE, SIZE, OR COLOR.

PRIORITY DATE OF 2-28-2007 IS CLAIMED.

OWNER OF INTERNATIONAL REGISTRATION 0935517 DATED 8-3-2007, EXPIRES 8-3-2017.

SER. NO. 79-043,031, FILED 8-3-2007.

KATHERINE E. HALMEN, EXAMINING ATTORNEY

**Int. Cl.: 5**

**Prior U.S. Cls.: 6, 18, 44, 46, 51 and 52**

**United States Patent and Trademark Office**

**Reg. No. 3,468,252**

**Registered July 15, 2008**

**TRADEMARK  
PRINCIPAL REGISTER**

# ROMULET

BOEHRINGER INGELHEIM INTERNATIONAL  
GMBH (FED REP GERMANY CORPORATION)

55218 INGELHEIM  
FED REP GERMANY

FOR: PHARMACEUTICAL PREPARATIONS FOR THE TREATMENT OF DISEASES AND DISORDERS OF THE ALIMENTARY TRACT AND METABOLISM, AND BLOOD AND BLOOD FORMING ORGANS; PHARMACEUTICAL PREPARATIONS FOR THE TREATMENT OF DISEASES AND DISORDERS OF THE CARDIOVASCULAR SYSTEM, MUSCULOSKELETAL SYSTEM, CENTRAL NERVOUS SYSTEM, PERIPHERAL NERVOUS SYSTEM, GENITOURINARY SYSTEM AND RESPIRATORY SYSTEM; AND PHARMACEUTICAL PREPARATIONS FOR THE TREATMENT OF DERMATOLOGICAL, HORMONAL, INFECTIOUS, VIRAL AND

ONCOLOGICAL DISEASES AND DISORDERS, IN CLASS 5 (U.S. CLS. 6, 18, 44, 46, 51 AND 52).

THE MARK CONSISTS OF STANDARD CHARACTERS WITHOUT CLAIM TO ANY PARTICULAR FONT, STYLE, SIZE, OR COLOR.

PRIORITY DATE OF 2-28-2007 IS CLAIMED.

OWNER OF INTERNATIONAL REGISTRATION 0935518 DATED 8-3-2007, EXPIRES 8-3-2017.

SER. NO. 79-043,032, FILED 8-3-2007.

KATHERINE E. HALMEN, EXAMINING ATTORNEY

**Int. Cls.: 1 and 3**

**Prior U.S. Cls.: 1, 4, 5, 6, 10, 26, 46, 50, 51 and 52**

**United States Patent and Trademark Office**

**Reg. No. 3,468,253**

**Registered July 15, 2008**

**TRADEMARK  
PRINCIPAL REGISTER**

**PURGATOR**

LICCIARDI, NATALE, DIPL.-ING. (ITALY INDIVIDUAL)  
GROßBERGHAUSEN 6B  
42859 REMSCHEID  
FED REP GERMANY

FOR: ANTI-FREEZE PREPARATIONS FOR VEHICLES, IN CLASS 1 (U.S. CLS. 1, 5, 6, 10, 26 AND 46).

FOR: CARE PREPARATIONS FOR CARS, BOATS, AND AIRPLANES, NAMELY, DETERGENTS INCLUDING SOAPS, WASHING ADDITIVES, CLEANING, SCOURING, ABRASIVE, AND POLISHING PREPARATIONS, NAMELY, POWDERS AND LIQUIDS, INCLUDING POLISHING PREPARATIONS FOR METAL, STAINLESS STEEL AND ALUMINUM; PLASTIC CLEANER; PANE CLEANING PREPARATIONS, NAMELY, GLASS CLEANER, PANE CLEANING ADDITIVES, NAMELY, TAR REMOVER; CARE PREPARATIONS FOR RUBBER, NAMELY, RUBBER DRESSINGS; CARE PREPARATIONS FOR PLASTIC, NAMELY, CLEANER FOR PLASTIC

PRODUCTS; CLEANING PREPARATIONS AND CARE PREPARATIONS FOR INSIDE OF VEHICLES POLISHING WAXES FOR VEHICLES AND AIRPLANES, NAMELY, NANO WAXES AND LACQUER CARE WAXES AS INCLUDED IN THIS CLASS, IN CLASS 3 (U.S. CLS. 1, 4, 6, 50, 51 AND 52).

THE MARK CONSISTS OF STANDARD CHARACTERS WITHOUT CLAIM TO ANY PARTICULAR FONT, STYLE, SIZE, OR COLOR.

PRIORITY DATE OF 11-14-2006 IS CLAIMED.

OWNER OF INTERNATIONAL REGISTRATION 0935639 DATED 5-8-2007, EXPIRES 5-8-2017.

SER. NO. 79-043,074, FILED 5-8-2007.

WILLIAM ROSSMAN, EXAMINING ATTORNEY

**Int. Cl.: 29**

**Prior U.S. Cl.: 46**

**United States Patent and Trademark Office**

**Reg. No. 3,468,254**

**Registered July 15, 2008**

**TRADEMARK  
PRINCIPAL REGISTER**

# Exquisagurt

HUBER EINKAUF GMBH & CO. KG (AUSTRIA  
GMBH & CO. KG)  
AM KOHLPLATZ 7  
A-6600 PFLACH  
AUSTRIA

FOR: CHEESE, YOGURT, MILK BEVERAGES,  
NAMELY, MILK; MIXED BEVERAGES, NAMELY,  
YOGURT AND WHEY BEVERAGES; PROBIOTIC  
BEVERAGES, NAMELY, PROBIOTIC YOGURT  
DRINKS, PROBIOTIC MILK, AND PROBIOTIC  
WHEY DRINKS, IN CLASS 29 (U.S. CL. 46).

PRIORITY DATE OF 3-28-2007 IS CLAIMED.

OWNER OF INTERNATIONAL REGISTRATION  
0935725 DATED 8-14-2007, EXPIRES 8-14-2017.

SER. NO. 79-043,106, FILED 8-14-2007.

SHANNON TWOHIG, EXAMINING ATTORNEY

Int. Cl.: 33

Prior U.S. Cls.: 47 and 49

United States Patent and Trademark Office

Reg. No. 3,468,255

Registered July 15, 2008

TRADEMARK  
PRINCIPAL REGISTER

LA CHASSE DE FRANCE

GABRIEL MEFFRE (FRANCE SOCIÉTÉ PAR  
ACTIONS SIMPLIFIÉE)  
LE VILLAGE  
F-84190 GIGONDAS  
FRANCE

FOR: WINES, IN CLASS 33 (U.S. CLS. 47 AND 49).

THE MARK CONSISTS OF STANDARD CHAR-  
ACTERS WITHOUT CLAIM TO ANY PARTICULAR  
FONT, STYLE, SIZE, OR COLOR.

PRIORITY DATE OF 2-5-2007 IS CLAIMED.

OWNER OF INTERNATIONAL REGISTRATION  
0935871 DATED 8-3-2007, EXPIRES 8-3-2017.

OWNER OF U.S. REG. NOS. 1,892,304, 2,620,855,  
AND 2,788,437.

NO CLAIM IS MADE TO THE EXCLUSIVE  
RIGHT TO USE "FRANCE", APART FROM THE  
MARK AS SHOWN.

THE ENGLISH TRANSLATION OF "LA CHASSE  
DE FRANCE" IN THE MARK IS THE RELIQUARY  
OF FRANCE.

SER. NO. 79-043,140, FILED 8-3-2007.

MARILYN IZZI, EXAMINING ATTORNEY



**Int. Cl.: 33**

**Prior U.S. Cls.: 47 and 49**

**United States Patent and Trademark Office**

**Reg. No. 3,468,256**

**Registered July 15, 2008**

**TRADEMARK  
PRINCIPAL REGISTER**

**FETE DE FAMILLE**

SOCIETE CIVILE AGRICOLE; "DOMAINE DE LA  
VOUGERAIE" (FRANCE SOCIÉTÉ EN COM-  
MANDITE PAR ACTIONS)  
PREMEAUX-PRISSEY  
F-21700 NUITS SAINT GEORGES, FRANCE

FOR: SPARKLING WINES AND WINES, IN  
CLASS 33 (U.S. CLS. 47 AND 49).

THE MARK CONSISTS OF STANDARD CHAR-  
ACTERS WITHOUT CLAIM TO ANY PARTICULAR  
FONT, STYLE, SIZE, OR COLOR.

PRIORITY DATE OF 3-16-2007 IS CLAIMED.

OWNER OF INTERNATIONAL REGISTRATION  
0936011 DATED 8-17-2007, EXPIRES 8-17-2017.

THE ENGLISH TRANSLATION OF "FETE DE  
FAMILLE" IS FAMILY GATHERING.

SER. NO. 79-043,248, FILED 8-17-2007.

ANDREA K. NADELMAN, EXAMINING ATTOR-  
NEY

**Int. Cls.: 7 and 9**

**Prior U.S. Cls.: 13, 19, 21, 23, 26, 31, 34, 35, 36 and 38**

**Reg. No. 3,468,257**

**United States Patent and Trademark Office**

**Registered July 15, 2008**

**TRADEMARK  
PRINCIPAL REGISTER**

**RH-SC**

SMS MEVAC GMBH (FED REP GERMANY LIMITED COMPANY)  
3A, BAMLERSTRASSE  
45141 ESSEN  
FED REP GERMANY

FOR: MACHINES FOR SECONDARY AND VACUUM METALLURGICAL PROCESSES, NAMELY, MACHINES FOR DEGASSING TREATMENT OF LIQUID STEEL; INSTALLATIONS CONSISTING OF MACHINES FOR SECONDARY AND VACUUM METALLURGICAL PROCESSES, NAMELY, RECIRCULATION VACUUM DEGASSERS; STRUCTURAL PARTS OF THE AFORESAID MACHINES AND INSTALLATIONS, IN CLASS 7 (U.S. CLS. 13, 19, 21, 23, 31, 34 AND 35).

FOR: CONTROL AND REGULATING APPARATUS FOR MACHINES FOR SECONDARY AND VACUUM METALLURGICAL PROCESSES AND FOR INSTALLATIONS CONSISTING OF MACHINES FOR SECONDARY AND VACUUM METALLURGICAL PROCESSES, NAMELY, ELECTRONIC CONTROL SYSTEMS FOR MACHINES; DATA PROCESSORS AND COMPUTERS; COMPUTER PROGRAMS FOR CONTROLLING

AND REGULATING MACHINES FOR SECONDARY AND VACUUM METALLURGICAL PROCESSES AND FOR CONTROLLING AND REGULATING INSTALLATIONS CONSISTING OF MACHINES FOR SECONDARY AND VACUUM METALLURGICAL PROCESSES, IN CLASS 9 (U.S. CLS. 21, 23, 26, 36 AND 38).

THE MARK CONSISTS OF STANDARD CHARACTERS WITHOUT CLAIM TO ANY PARTICULAR FONT, STYLE, SIZE, OR COLOR.

PRIORITY DATE OF 11-15-2006 IS CLAIMED.

OWNER OF INTERNATIONAL REGISTRATION 0936174 DATED 5-8-2007, EXPIRES 5-8-2017.

THE WORDINGS "RH-SC", "RH" AND "SC" HAS NO MEANING IN A FOREIGN LANGUAGE.

SER. NO. 79-043,306, FILED 5-8-2007.

ROBERT STRUCK, EXAMINING ATTORNEY

**Int. Cl.: 42**

**Prior U.S. Cls.: 100 and 101**

**United States Patent and Trademark Office**

**Reg. No. 3,468,258**

**Registered July 15, 2008**

**SERVICE MARK  
PRINCIPAL REGISTER**

**BELMEDIM**

BELMEDIM,; NAAMLOZE VENNOOTSCHAP  
(BELGIUM JOINT STOCK COMPANY)  
BERGEKOUTER 99A  
B-9300 AALST  
BELGIUM

FOR: SCIENTIFIC AND TECHNOLOGICAL SERVICES, NAMELY, SCIENTIFIC RESEARCH AND DEVELOPMENT, TECHNOLOGY CONSULTATION AND RESEARCH IN THE FIELD OF MEDICINE; INDUSTRIAL ANALYSIS AND RESEARCH SERVICES IN THE FIELD OF MEDICINE AND MEDICAL DIAGNOSTICS; DESIGN AND DEVELOPMENT OF COMPUTER HARDWARE AND SOFTWARE; DESIGN AND DEVELOPMENT OF SOFTWARE PROGRAMS WITH REGARD TO MEDICAL IMAGING OR RADIOLOGY, IN CLASS 42 (U.S. CLS. 100 AND 101).

THE MARK CONSISTS OF STANDARD CHARACTERS WITHOUT CLAIM TO ANY PARTICULAR FONT, STYLE, SIZE, OR COLOR.

PRIORITY DATE OF 2-27-2007 IS CLAIMED.

OWNER OF INTERNATIONAL REGISTRATION  
0936276 DATED 8-16-2007, EXPIRES 8-16-2017.

SER. NO. 79-043,346, FILED 8-16-2007.

ELI HELLMAN, EXAMINING ATTORNEY

**Int. Cl.: 3**

**Prior U.S. Cls.: 1, 4, 6, 50, 51 and 52**

**United States Patent and Trademark Office**

**Reg. No. 3,468,259**

**Registered July 15, 2008**

**TRADEMARK  
PRINCIPAL REGISTER**



FARECLA PRODUCTS LIMITED (UNITED  
KINGDOM PRIVATE LIMITED COMPANY)  
BROADMEADS  
WARE, UNITED KINGDOM SG12 9HS

FOR: CLEANING AND SCOURING PREPARA-  
TIONS; ABRASIVE AND POLISHING PREPARA-  
TIONS AND COMPOUNDS; AUTOMOBILE WAX  
GLAZES FOR CLEANING AND POLISHING; AU-  
TOMOBILE WAXES, IN CLASS 3 (U.S. CLS. 1, 4, 6, 50,  
51 AND 52).

PRIORITY DATE OF 6-22-2007 IS CLAIMED.

OWNER OF INTERNATIONAL REGISTRATION  
0936538 DATED 7-10-2007, EXPIRES 7-10-2017.

OWNER OF U.S. REG. NO. 2,702,974.

THE WORDING "G3" HAS NO MEANING  
OTHER THAN TRADEMARK SIGNIFICANCE.

SER. NO. 79-043,455, FILED 7-10-2007.

MATTHEW MCDOWELL, EXAMINING ATTOR-  
NEY

**Int. Cl.: 1**

**Prior U.S. Cls.: 1, 5, 6, 10, 26 and 46**

**Reg. No. 3,468,260**

**United States Patent and Trademark Office**

**Registered July 15, 2008**

**TRADEMARK  
PRINCIPAL REGISTER**

# REVOLYMER

REVOLYMER LIMITED REVOLYMER TECHNOLOGY CENTRE (UNITED KINGDOM LIMITED COMPANY)  
REVOLYMER TECHNOLOGY CENTRE  
DOCK ROAD, MOSTYN HOLYWELL  
FLINTSHIRE, UNITED KINGDOM CH8 9HE

FOR: UNPROCESSED ARTIFICIAL RESINS, UNPROCESSED PLASTICS; CHEMICALS FOR USE IN THE MANUFACTURE OF PHARMACEUTICAL AND VETERINARY PREPARATIONS, DRUG DELIVERY SYSTEMS, MEDICAL DEVICES AND PERSONAL HEALTHCARE PRODUCTS, DETERGENTS AND SURFACTANTS, FOOD AND DRINK, CHEWING GUM AND CONFECTIONERY, PAINTS AND COATINGS, TEXTILES, PACKAGING, BLEACHING PREPARATIONS, SOAPS AND COSMETICS, OILS, GREASES AND FUELS, AND RUBBER AND PLASTICS IN EXTRUDED FORM; POLYMERS USED IN SCIENCE AND PHOTOGRAPHY, AND IN AGRICULTURE, HORTICULTURE AND FORESTRY; POLYMERS USED IN INDUSTRY IN THE MANUFACTURE OF PHARMACEUTICAL AND VETERINARY PREPARATIONS, DRUG DELIVERY SYSTEMS, MEDICAL DEVICES AND PERSONAL HEALTHCARE PRODUCTS, DETERGENTS AND SURFACTANTS, FOOD AND DRINK, CHEWING GUM AND CONFECTIONERY, PAINTS AND

COATINGS, TEXTILES, PACKAGING, BLEACHING PREPARATIONS, SOAPS AND COSMETICS, OILS, GREASES AND FUELS, AND RUBBER AND PLASTICS IN EXTRUDED FORM; CHEMICALS USED IN CHEWING GUM BASES AND CHEWING GUM; CHEMICAL SUBSTANCES FOR USE IN THE MANUFACTURE OF FOOD, IN CLASS 1 (U.S. CLS. 1, 5, 6, 10, 26 AND 46).

THE MARK CONSISTS OF STANDARD CHARACTERS WITHOUT CLAIM TO ANY PARTICULAR FONT, STYLE, SIZE, OR COLOR.

PRIORITY DATE OF 1-8-2007 IS CLAIMED.

OWNER OF INTERNATIONAL REGISTRATION 0936689 DATED 6-28-2007, EXPIRES 6-28-2017.

"REVOLYMER" HAS NO MEANING IN A FOREIGN LANGUAGE.

SER. NO. 79-043,533, FILED 6-28-2007.

NAPOLEON SHARMA, EXAMINING ATTORNEY

**Int. Cl.: 10**

**Prior U.S. Cls.: 26, 39 and 44**

**United States Patent and Trademark Office**

**Reg. No. 3,468,261**

**Registered July 15, 2008**

**TRADEMARK  
PRINCIPAL REGISTER**

**AMETHRINE**

AMETHRINE (FRANCE SOCIÉTÉ PAR ACTIONS  
SIMPLIFIÉE)  
60 AVENUE ROCKFELLER  
F-69008 LYON  
FRANCE

FOR: SURGICAL APPARATUS AND INSTRUMENTS; MEDICAL APPARATUS AND INSTRUMENTS FOR DETECTING EPILEPSY; SURGICAL AND MEDICAL APPARATUS AND INSTRUMENTS, NAMELY, MEDICAL DEVICES FOR MONITORING AND DETECTING EPILEPSY VIA A SYSTEM FOR AUTOMATIC RECORDING OF EPILEPTIC SEIZURES ON A HARD DISK, IN CLASS 10 (U.S. CLS. 26, 39 AND 44).

THE MARK CONSISTS OF STANDARD CHARACTERS WITHOUT CLAIM TO ANY PARTICULAR FONT, STYLE, SIZE, OR COLOR.

PRIORITY DATE OF 12-7-2006 IS CLAIMED.

OWNER OF INTERNATIONAL REGISTRATION  
0936879 DATED 6-5-2007, EXPIRES 6-5-2017.

SER. NO. 79-043,616, FILED 6-5-2007.

AMY GEARIN, EXAMINING ATTORNEY

Int. Cls.: 3, 14, 18, 24, 25 and 28

Prior U.S. Cls.: 1, 2, 3, 4, 6, 22, 23, 27, 28, 38, 39, 41, 42, 50, 51 and 52

Reg. No. 3,468,262

United States Patent and Trademark Office

Registered July 15, 2008

TRADEMARK  
PRINCIPAL REGISTER



P I N C E L O U P

COLETTE JOBERT (FRANCE INDIVIDUAL)  
18 RUE DU REGARD  
F-75006 PARIS  
FRANCE

FOR: NON-MEDICATED CARE AND CLEANING PRODUCTS FOR DOGS AND CATS, NAMELY, PERFUMES, SOAPS, ESSENTIAL OILS, COSMETICS, DENTIFRICES, IN CLASS 3 (U.S. CLS. 1, 4, 6, 50, 51 AND 52).

FOR: JEWELRY, TIMEPIECES, JEWELRY CHAINS, KEY RINGS OF PRECIOUS METAL, MEDALS, BRACELETS, IN CLASS 14 (U.S. CLS. 2, 27, 28 AND 50).

FOR: LEATHER AND IMITATION LEATHER; ANIMAL SKINS, HIDES; WHIPS AND SADDLERY; WALLETS, CHANGE PURSES, HANDBAGS, BACKPACKS, WHEELED DUFFLE BAGS; BEACH, TRAVEL AND SCHOOL BAGS; UNFITTED VANITY CASES; COLLARS AND CLOTHING AND LEASHES FOR ANIMALS; NETS USED AS BAGS FOR CARRYING, MESH SHOPPING BAGS; BAGS OR SMALL BAGS, NAMELY, ENVELOPES AND POUCHES FOR PACKAGING MADE OF LEATHER, IN CLASS 18 (U.S. CLS. 1, 2, 3, 22 AND 41).

FOR: TEXTILES, NAMELY, BED LINEN, BED COMFORTERS, BED BLANKETS, PLAID BED BLANKETS, BED LINEN, HOUSEHOLD LINEN, TABLE LINEN NOT OF PAPER, TABLE CLOTHS NOT OF PAPER, TABLE MATS NOT OF PAPER, AND BATH LINEN NOT INCLUDING CLOTHING, IN CLASS 24 (U.S. CLS. 42 AND 50).

FOR: CLOTHING, NAMELY, TOPS, BOTTOMS, JACKETS, FROCKS, SKIRTS, TROUSERS, WATER-

PROOF JACKETS AND PANTS, PARKAS, SHIRTS, T-SHIRTS, SWEATERS, PULLOVERS, FOOTWEAR, HEADWEAR; FURS CAPS; FUR HATS, IN CLASS 25 (U.S. CLS. 22 AND 39).

FOR: GAMES, NAMELY, CARDS GAME, BOARD GAMES; TOYS, NAMELY, BALLS FOR GAMES, PLAY BALLOONS, PET TOYS; BATTERY OPERATED ACTION TOYS, ELECTRONIC ACTION TOYS; ELECTRONIC TOY VEHICLES; ELECTRONICALLY OPERATED TOY MOTOR VEHICLES; MECHANICAL ACTION TOYS; MUSICAL TOYS; RADIO CONTROLLED TOY VEHICLES; TALKING TOYS; TOY ACTION FIGURES AND ACCESSORIES THEREFOR; TOY ROBOTS; TRANSFORMING ROBOTIC TOYS, IN CLASS 28 (U.S. CLS. 22, 23, 38 AND 50).

OWNER OF INTERNATIONAL REGISTRATION  
0937007 DATED 3-26-2007, EXPIRES 3-26-2017.

THE COLOR(S) VERMILION RED AND DARK GREY IS/ARE CLAIMED AS A FEATURE OF THE MARK.

THE STYLIZED WORDING "PINCE LOUP" APPEARS IN VERMILION RED. A STYLIZED ANIMAL APPEARS IN DARK GREY ABOVE THE WORDING.

THE TERM "PINCELOUP" HAS NO MEANING IN A FOREIGN LANGUAGE.

SER. NO. 79-043,669, FILED 3-26-2007.

MARILYN IZZI, EXAMINING ATTORNEY

Int. Cl.: 28

Prior U.S. Cls.: 22, 23, 38 and 50

United States Patent and Trademark Office

Reg. No. 3,468,263

Registered July 15, 2008

TRADEMARK  
PRINCIPAL REGISTER

The logo features the words "The Bidoz Body" in a highly stylized, cursive script. The letters are interconnected, with the "B" in "Bidoz" being particularly large and prominent, and the "B" in "Body" being smaller and positioned below it. The overall appearance is that of a handwritten signature or a calligraphic brand mark.

FOURNIER-BIDOZ ANDRÉ (FRANCE INDIVIDUAL)  
855 ROUTE DES GORGES DU BORNE  
F-74800 SAINT PIERRE EN FAUCIGNY, FRANCE

OWNER OF INTERNATIONAL REGISTRATION  
0937119 DATED 8-6-2007, EXPIRES 8-6-2017.

FOR: FISHING ARTICLES, NAMELY, FISHING TACKLE, FISH HOOKS, LURES FOR FISHING, COMPONENT PARTS OF FISHING LURES, FISHING RODS, ARTIFICIAL FISHING BAIT, ARTIFICIAL FISHING BAITS, FLOATS FOR FISHING, BITE SENSORS, FLOATS FOR ANGLING, ODOROUS FISHING LURES, FISHING LINES, REELS FOR FISHING RODS, FISHING REELS, FISHING CREELS, IN CLASS 28 (U.S. CLS. 22, 23, 38 AND 50).

THE MARK CONSISTS OF THE STYLIZED WORDING "THE BIDOZ BODY", WITH THE TWO LETTERS "B" JOINED TOGETHER AND FORMING THE DESIGN OF A FRESH WATER SHRIMP.

SER. NO. 79-043,714, FILED 8-6-2007.

PRIORITY DATE OF 2-22-2007 IS CLAIMED.

REBECCA POVARCHUK, EXAMINING ATTORNEY



**Int. Cls.: 9, 35, 38, 39 and 42**

**Prior U.S. Cls.: 21, 23, 26, 36, 38, 100, 101, 102, 104  
and 105**

**Reg. No. 3,468,264**

**United States Patent and Trademark Office**

**Registered July 15, 2008**

**TRADEMARK  
SERVICE MARK  
PRINCIPAL REGISTER**



JFG NETWORKS (FRANCE SOCIÉTÉ PAR ACTIONS DE DROIT FRANÇAIS)  
5 AVENUE DAUMESNIL  
F-94160 ST MANDE  
FRANCE

FOR: SOFTWARE FOR THE DEVELOPMENT AND THE MANAGEMENT OF A WEB SITE AND AN INTERACTIVE WEB BLOG , IN CLASS 9 (U.S. CLS. 21, 23, 26, 36 AND 38).

FOR: ADVERTISING SERVICES, SALES PROMOTION FOR OTHERS ON COMPUTER NETWORKS; DISSEMINATION OF ADVERTISEMENTS ON COMPUTER NETWORKS; ONLINE ADVERTISING SERVICES ON COMPUTER AND ELECTRONIC NETWORKS; PROVIDING COMMERCIAL, ADVERTISING, ADMINISTRATIVE AND ACCOUNTING INFORMATION ON COMPUTER NETWORKS; COMPUTER FILE MANAGEMENT; COMPILATION OF INFORMATION INTO COMPUTER DATABASES; ORGANIZATION OF EXHIBITIONS FOR COMMERCIAL AND ADVERTISING PURPOSES; RENTAL OF ADVERTISING SPACE; RENTAL OF ADVERTISING TIME ON ALL MEANS OF COMMUNICATION; PROVIDING INFORMATION ON COMMERCIAL, ADVERTISING, ADMINISTRATIVE AND ACCOUNTING AFFAIRS; BUSINESS INFORMATION RESEARCH IN COMPUTER FILES FOR THIRD PARTIES; TRANSCRIPTION OF COMMUNICATIONS; COMPUTER FILE OR DATA STORAGE SERVICES, IN CLASS 35 (U.S. CLS. 100, 101 AND 102).

FOR: COMMUNICATION VIA COMPUTER TERMINALS; ELECTRONIC MESSAGING; PROVIDING CONNECTION VIA TELECOMMUNICA-

TION TO A COMPUTER, ELECTRONIC AND TELEMATIC NETWORK; COMPUTER-ASSISTED TRANSMISSION OF MESSAGES AND IMAGES; TRANSMISSION OF INFORMATION HELD IN DATABASES BY TELECOMMUNICATION; PROVISION OF ACCESS TO COMPUTER, ELECTRONIC AND TELEMATIC NETWORK; GATEWAY SERVICES FOR TELECOMMUNICATIONS; TELECOMMUNICATION SERVICES, NAMELY, PROVIDING MULTIPLE USER ACCESS TO GLOBAL COMPUTER INFORMATION NETWORKS VIA COMPUTER AND MOBILE PHONE; AUDIO AND VIDEO TELECONFERENCING SERVICES, IN CLASS 38 (U.S. CLS. 100, 101 AND 104).

FOR: ELECTRONIC STORAGE OF MEDIA FOR DATA AND DOCUMENTS; PROVIDING ONLINE INFORMATION IN THE FIELD OF ELECTRONIC DATA STORAGE, IN CLASS 39 (U.S. CLS. 100 AND 105).

FOR: DEVELOPMENT OF SOFTWARE; COMPUTER SOFTWARE INSTALLATION, UPDATING AND MAINTENANCE; COMPUTER PROGRAMMING; COMPUTER CONSULTING; ENGINEERING; SURVEYING; COMPUTER ENGINEER SERVICES, NAMELY, PROVIDING STUDY, ANALYSIS, RESEARCH AND REPORTS IN CONNECTION WITH COMPUTERS; DESIGN OF COMPUTER SYSTEMS; PROVIDING SCIENTIFIC AND TECHNICAL INFORMATION ON COMPUTER NETWORKS; HOSTING OF WEB SITES, DEVELOPMENT AND MAINTENANCE OF WEB SITES FOR THIRD PARTIES, IN CLASS 42 (U.S. CLS. 100 AND 101).

PRIORITY DATE OF 10-19-2006 IS CLAIMED.

OWNER OF INTERNATIONAL REGISTRATION  
0937126 DATED 4-12-2007, EXPIRES 4-12-2017.

THE MARK CONSISTS OF THE WORDING  
"OVER" IN ORANGE, THE WORDING "BLOG" IN  
BLACK, AND A SPEECH BUBBLE DESIGN IN  
ORANGE.

SER. NO. 79-043,716, FILED 4-12-2007.

THE COLOR(S) ORANGE AND BLACK IS/ARE  
CLAIMED AS A FEATURE OF THE MARK.

REBECCA POVARCHUK, EXAMINING ATTOR-  
NEY

**Int. Cl.: 5**

**Prior U.S. Cls.: 6, 18, 44, 46, 51 and 52**

**United States Patent and Trademark Office**

**Reg. No. 3,468,265**

**Registered July 15, 2008**

**TRADEMARK  
PRINCIPAL REGISTER**

# **Metobject**

MEDAC GESELLSCHAFT FÜR KLINISCHE; SPE-  
ZIALPRÄPARATE MBH (FED REP GERMANY  
LTD LIAB CO)

THEATERSTRASSE 6  
22880 WEDEL  
FED REP GERMANY

FOR: PHARMACEUTICAL PREPARATIONS FOR  
TREATING CANCER AND AUTOIMMUNE DISEA-  
SES, IN CLASS 5 (U.S. CLS. 6, 18, 44, 46, 51 AND 52).

THE MARK CONSISTS OF STANDARD CHAR-  
ACTERS WITHOUT CLAIM TO ANY PARTICULAR  
FONT, STYLE, SIZE, OR COLOR.

OWNER OF INTERNATIONAL REGISTRATION  
0789755 DATED 9-26-2002, EXPIRES 9-26-2012.

SER. NO. 79-043,799, FILED 8-2-2007.

LAURA HAMMEL, EXAMINING ATTORNEY

**Int. Cls.: 2, 9, 16 and 41**

**Prior U.S. Cls.: 2, 5, 6, 11, 16, 21, 22, 23, 26, 29, 36, 37,  
38, 50, 100, 101 and 107**

**Reg. No. 3,468,266**

**United States Patent and Trademark Office**

**Registered July 15, 2008**

**TRADEMARK  
SERVICE MARK  
PRINCIPAL REGISTER**

**Mindkiss**

DAGMAR WOYDE-KÖHLER (FED REP GERMA-  
NY INDIVIDUAL)  
ROONSTRASSE 23  
76137 KARLSRUHE  
FED REP GERMANY

FOR: PAINTS, VARNISHES, LACQUERS; COLOR-  
ANTS; MORDANTS FOR USE IN THE FIELD OF  
ARTWORK; RAW NATURAL RESINS; METALS IN  
FOIL AND POWDER FORM FOR PAINTERS, DEC-  
ORATORS, PRINTERS AND ARTISTS, IN CLASS 2  
(U.S. CLS. 6, 11 AND 16).

FOR: COMPUTER SOFTWARE FOR CREATING,  
VIEWING, MANIPULATING, EDITING, MANA-  
GING, INDEXING, CATALOGUING, SORTING,  
ORGANIZING, STORING, TRANSFERRING, SYN-  
CHRONIZING, PRINTING, AND EXCHANGING  
DIGITAL PHOTOGRAPHS, DIGITAL AND GRA-  
PHIC IMAGES, DATA, TEXT, AUDIO, VIDEO,  
MULTIMEDIA AND INTERACTIVE DOCUMENTS  
AND WORKS, TEXT DOCUMENTS, AND RECOR-  
DED INFORMATION, IN CLASS 9 (U.S. CLS. 21, 23,  
26, 36 AND 38).

FOR: PAPER AND CARDBOARD; PAPER AND  
CARDBOARD GOODS, NAMELY, CANVAS PA-

NELS FOR ARTISTIC PURPOSES; PRINTED MAT-  
TER, NAMELY, EXHIBITION CATALOGS IN THE  
FIELD OF ARTWORK EXHIBITIONS; PHOTO-  
GRAPHS; STATIONERY; ARTISTS' MATERIALS,  
NAMELY, ARTIST'S PENS; PAINT BRUSHES, IN  
CLASS 16 (U.S. CLS. 2, 5, 22, 23, 29, 37, 38 AND 50).

FOR: ORGANIZING EXHIBITIONS FOR CUL-  
TURAL AND EDUCATIONAL PURPOSES, NAME-  
LY, PUBLIC PRESENTATIONS OF ARTWORK AND  
LITERATURE FOR CULTURAL AND EDUCA-  
TIONAL PURPOSES, IN CLASS 41 (U.S. CLS. 100,  
101 AND 107).

THE MARK CONSISTS OF STANDARD CHAR-  
ACTERS WITHOUT CLAIM TO ANY PARTICULAR  
FONT, STYLE, SIZE, OR COLOR.

OWNER OF INTERNATIONAL REGISTRATION  
0937601 DATED 8-15-2007, EXPIRES 8-15-2017.

SER. NO. 79-043,884, FILED 8-15-2007.

SANJEEV VOHRA, EXAMINING ATTORNEY

Int. Cl.: 42

Prior U.S. Cls.: 100 and 101

United States Patent and Trademark Office

Reg. No. 3,468,267

Registered July 15, 2008

**SERVICE MARK  
PRINCIPAL REGISTER**



PARION ULUSLARARASI GÖZETİM; HİZMETLERİ LİMİTED SİRKETİ (TURKEY LİMİTED COMPANY)

HÜRRİYET MAHALLESİ CUMHURİYET

CADDESİ NO: 41 D:5; GÜNESLİ BAGCILAR

İSTANBUL, TURKEY

FOR: SCIENTIFIC RESEARCH SERVICES, NAMELY, SCIENTIFIC RESEARCH, CONDUCTING CLINICAL TRIALS; SURVEYING SERVICES, NAMELY, SURVEYING, SURVEY DESIGN AND RESEARCH; ENGINEERING SERVICES, NAMELY, ENGINEERING, CONDUCTING ENGINEERING SURVEYS; CHEMICAL RESEARCH; GEOLOGICAL RESEARCH; OIL-FIELD SURVEYING; MATERIAL TESTING; METEOROLOGICAL INFORMATION SERVICES, NAMELY, METEOROLOGICAL FORECASTING; ENGINEERING CONSULTANCY SERVICES; ARCHITECTURAL CONSULTANCY SERVICES; TECHNICAL PROJECT STUDIES SERVICES, NAMELY, TECHNICAL SURVEYING; LAND SURVEYING; CALIBRATION; URBAN PLANNING; RESEARCH IN THE FIELD OF ENVIRONMENTAL PROTECTION SERVICES; UNDERWATER EXPLORATION; QUALITY CONTROL FOR OTHERS; VEHICLE ROADWORTHINESS TESTING SERVICES, NAMELY, DEVELOPMENT AND TESTING OF OCCUPANT PROTECTION SYSTEMS FOR MOTOR VEHICLE; NATIONAL AND INTERNATIONAL SURVEYING SERVICES, NAMELY, LAND SURVEYING, GEOLOGICAL SURVEYING, IN CLASS 42 (U.S. CLS. 100 AND 101).

OWNER OF INTERNATIONAL REGISTRATION 0937726 DATED 5-14-2007, EXPIRES 5-14-2017.

NO CLAIM IS MADE TO THE EXCLUSIVE RIGHT TO USE "ULUSLARARASI GÖZETİM HİZMETLERİ LİMİTED SİRKETİ", APART FROM THE MARK AS SHOWN.

THE COLOR(S) RED, GRAY, AND BLUE IS/ARE CLAIMED AS A FEATURE OF THE MARK.

THE MARK COMPRISES THE LITERAL ELEMENT "PARION ULUSLARARASI GÖZETİM HİZMETLERİ LİMİTED SİRKETİ" AND A DESIGN ELEMENT OF A PINE TREE NEXT TO A WINDING ROAD. THE LITERAL ELEMENT APPEARS TO THE RIGHT OF THE DESIGN ELEMENT. THE COLOR RED APPEARS IN THE LITERAL ELEMENT OF THE MARK AND OUTLINES THE PINE TREE AND WINDING ROAD. THE COLOR GRAY APPEARS IN THE PINE TREE AND AREA SURROUNDING THE WINDING ROAD. THE COLOR BLUE APPEARS IN THE BACKGROUND OF THE MARK AND THE WINDING ROAD.

THE FOREIGN WORDING IN THE MARK TRANSLATES INTO ENGLISH AS "INTERNATIONAL SURVEILLANCE SERVICES LİMİTED COMPANY".

SER. NO. 79-043,905, FILED 5-14-2007.

LAURIE KAUFMAN, EXAMINING ATTORNEY

**Int. Cl.: 9**

**Prior U.S. Cls.: 21, 23, 26, 36 and 38**

**Reg. No. 3,468,268**

**United States Patent and Trademark Office**

**Registered July 15, 2008**

**TRADEMARK  
PRINCIPAL REGISTER**



NBB CONTROLS + COMPONENTS AG (FED  
REP GERMANY AG)  
OTTO-HAHN-STR. 1-3  
75248 ÖLBRONN-DÜRRN  
FED REP GERMANY

FOR: ELECTRIC AND ELECTRONIC DEVICES FOR COMMUNICATIONS TRANSMISSION, NAMELY, RADIO REMOTE CONTROL SYSTEMS AND APPARATUS CONSISTING PRIMARILY OF TRANSMITTERS, RECEIVERS AND ACTUATING ELEMENTS FOR USE IN CONTROLLING ALL KINDS OF MACHINES IN THE FIELD OF INDUSTRY AND COMMERCE; COMPONENTS OF RADIO REMOTE CONTROL SYSTEMS, NAMELY, TRANSMITTERS AND RECEIVERS AND ACTUATING ELEMENTS FOR OPERATING RADIO REMOTE CONTROL SYSTEMS, NAMELY, JOYSTICKS AND SWITCHES; PERIPHERALS AND DEVICES FOR RADIO REMOTE CONTROL APPARATUS, NAMELY, MOUNTINGS, HOUSINGS, COVERS MADE OF PLASTICS OR METAL, ALL OF WHICH ARE SPECIALLY ADAPTED TO THE SHAPE OF THE RADIO REMOTE CONTROL APPARATUS; ELECTRIC CABLES; ELECTRIC AND ELECTRONIC COMPONENTS AND CIRCUITS IN DISCRETE AND INTEGRAL DESIGN FOR USE IN RADIO REMOTE CONTROL SYSTEMS, NAMELY, AMPLIFIERS,

CONVERTERS, SIGNAL PROCESSORS, OSCILLATORS, MODULATORS, DEMODULATORS, CODERS, DECODERS, RELAYS, RECTIFIERS, MICROPROCESSORS, IN CLASS 9 (U.S. CLS. 21, 23, 26, 36 AND 38).

PRIORITY DATE OF 2-5-2007 IS CLAIMED.

OWNER OF INTERNATIONAL REGISTRATION  
0937754 DATED 6-6-2007, EXPIRES 6-6-2017.

NO CLAIM IS MADE TO THE EXCLUSIVE RIGHT TO USE "TECHNOLOGY", APART FROM THE MARK AS SHOWN.

THE MARK CONSISTS OF THE LETTERS "SMJ" IN STYLIZED LETTERING WITH A VERTICAL AND A HORIZONTAL LINE EXTENDING FROM THE LETTER "S". THE WORD "TECHNOLOGY" IS DISPLAYED BELOW THE LETTERS "SMJ".

SER. NO. 79-043,922, FILED 6-6-2007.

RENEE SERVANCE, EXAMINING ATTORNEY

**Int. Cl.: 32**

**Prior U.S. Cls.: 45, 46 and 48**

**United States Patent and Trademark Office**

**Reg. No. 3,468,269**

**Registered July 15, 2008**

**TRADEMARK  
PRINCIPAL REGISTER**



MAXIMILIEN DE HOOP CARTIER (ARGENTINA INDIVIDUAL)  
RUE DU PETIT BEAULIEU 5  
CH-1004 LAUSANNE  
SWITZERLAND

FOR: BEERS; MINERAL AND AERATED WATERS, IN CLASS 32 (U.S. CLS. 45, 46 AND 48).

OWNER OF INTERNATIONAL REGISTRATION 0937906 DATED 8-28-2007, EXPIRES 8-28-2017.

THE MARK CONSISTS OF AN ABSTRACT DESIGN WITH THE LITERAL ELEMENT "PRIMITIVA" FOUND TO THE RIGHT.

THE ENGLISH TRANSLATION OF THE WORD "PRIMITIVA" IN THE MARK IS "PRIMITIVE".

SER. NO. 79-043,963, FILED 8-28-2007.

DAVID HOFFMAN, EXAMINING ATTORNEY



**Int. Cl.: 10**

**Prior U.S. Cls.: 26, 39 and 44**

**United States Patent and Trademark Office**

**Reg. No. 3,468,270**

**Registered July 15, 2008**

**TRADEMARK  
PRINCIPAL REGISTER**



THOMMEN MEDICAL AG (SWITZERLAND SO-  
CIÉTÉ ANONYME)  
HAUPTSTRASSE 87  
CH-4437 WALDENBURG, SWITZERLAND

FOR: SURGICAL APPARATUS AND INSTRU-  
MENTS; MEDICAL AND DENTAL APPARATUS  
AND INSTRUMENTS, NAMELY, DENTAL IM-  
PLANTS AND DENTAL IMPLANT SUPERSTRUC-  
TURES, PROSTHETIC INSTRUMENTS FOR  
DENTAL PURPOSES, DENTAL DRILLS AND TOR-  
QUE RATCHETS; DENTAL FIXTURES, NAMELY,  
PREFABRICATED PARTS FOR CROWNS,  
BRIDGES AND PONTICS; PROSTHETIC DENTAL  
ABUTMENTS; AND ATTACHMENTS, CONNEC-  
TORS, FRAMES, AND CASTINGS FOR DENTAL  
IMPLANT SUPERSTRUCTURES, IN CLASS 10 (U.S.  
CLS. 26, 39 AND 44).

PRIORITY DATE OF 6-8-2007 IS CLAIMED.

OWNER OF INTERNATIONAL REGISTRATION  
0937942 DATED 9-7-2007, EXPIRES 9-7-2017.

NO CLAIM IS MADE TO THE EXCLUSIVE  
RIGHT TO USE "MEDICAL" , APART FROM THE  
MARK AS SHOWN.

SER. NO. 79-043,978, FILED 9-7-2007.

COLLEEN DOMBROW, EXAMINING ATTORNEY

**Int. Cl.: 5**

**Prior U.S. Cls.: 6, 18, 44, 46, 51 and 52**

**Reg. No. 3,468,271**

**United States Patent and Trademark Office**

**Registered July 15, 2008**

**TRADEMARK  
PRINCIPAL REGISTER**

**TQORDY**

BOEHRINGER INGELHEIM INTERNATIONAL  
GMBH (FED REP GERMANY CORPORATION)  
55218 INGELHEIM  
FED REP GERMANY

FOR: PHARMACEUTICAL PREPARATIONS FOR THE TREATMENT OF DISEASES AND DISORDERS OF THE ALIMENTARY TRACT AND METABOLISM, AND BLOOD AND BLOOD FORMING ORGANS; PHARMACEUTICAL PREPARATIONS FOR THE TREATMENT OF DISEASES AND DISORDERS OF THE CARDIOVASCULAR SYSTEM, MUSCULOSKELETAL SYSTEM, CENTRAL NERVOUS SYSTEM, PERIPHERAL NERVOUS SYSTEM, GENITOURINARY SYSTEM AND RESPIRATORY SYSTEM; AND PHARMACEUTICAL PREPARATIONS FOR THE TREATMENT OF DERMATOLOGICAL, HORMONAL, INFECTIOUS, VIRAL AND

ONCOLOGICAL DISEASES AND DISORDERS, IN CLASS 5 (U.S. CLS. 6, 18, 44, 46, 51 AND 52).

THE MARK CONSISTS OF STANDARD CHARACTERS WITHOUT CLAIM TO ANY PARTICULAR FONT, STYLE, SIZE, OR COLOR.

PRIORITY DATE OF 2-28-2007 IS CLAIMED.

OWNER OF INTERNATIONAL REGISTRATION  
0937961 DATED 8-28-2007, EXPIRES 8-28-2017.

SER. NO. 79-043,986, FILED 8-28-2007.

KATHERINE E. HALMEN, EXAMINING ATTORNEY

Int. Cls.: 25 and 35

Prior U.S. Cls.: 22, 39, 100, 101 and 102

United States Patent and Trademark Office

Reg. No. 3,468,272

Registered July 15, 2008

TRADEMARK  
SERVICE MARK  
PRINCIPAL REGISTER



PANCO KOLLEKTIF SIRKETI; SADI LEVI VE  
ORTAKLARI (TURKEY COLLECTIVE PART-  
NERSHIP)

ULUBAS CADDESİ NO: 29  
SEYRANTEPE İSTANBUL  
TURKEY

FOR: BABY AND CHILDREN CLOTHING,  
NAMELY, CLOTH BIBS, HATS, TOPS, T-SHIRTS,  
PANTS, SHOES, UNDERWEAR, DRESSES, SHIRTS,  
BLOUSES, SOCKS, BATHING SUITS, SLEEPWEAR,  
JUMPERS, SWIMWEAR AND JACKETS, COATS,  
AND SWEATERS, AND SHOES AND FOOTWEAR,  
IN CLASS 25 (U.S. CLS. 22 AND 39).

FOR: ONLINE RETAIL STORE SERVICES, MAIL  
ORDER CATALOGS, AND RETAIL STORES FEAT-  
URING BABY AND CHILDREN CLOTHING,  
SHOES, TOYS, DOLLS, GAMES, BEDDING AND  
ROOM DECOR, FURNITURE, DIAPER AND HAND  
BAGS, STROLLERS AND BABY ACCESSORIES,  
BOOKS, PRE-RECORDED MUSIC AND VIDEO  
MEDIA, HEALTH AND BEAUTY PRODUCTS,  
BABY ANNOUNCEMENTS, IN CLASS 35 (U.S. CLS.  
100, 101 AND 102).

PRIORITY DATE OF 2-23-2007 IS CLAIMED.

OWNER OF INTERNATIONAL REGISTRATION  
0938137 DATED 3-28-2007, EXPIRES 3-28-2017.

THE COLOR(S) GREEN, RED, YELLOW, BLUE,  
ORANGE, AND BLACK IS/ARE CLAIMED AS A  
FEATURE OF THE MARK.

THE COLOR GREEN APPEARS IN THE STY-  
LIZED LETTER "P", THE COLOR RED APPEARS IN  
THE STYLIZED LETTER "A", THE COLOR YEL-  
LOW APPEARS IN THE STYLIZED LETTER "N",  
THE COLOR BLUE APPEARS IN THE STYLIZED  
LETTER "Ç", THE COLOR ORANGE APPEARS IN  
THE STYLIZED LETTER "O", AND THE COLOR  
BLACK OUTLINES THE LETTERING AND DESIGN  
PORTION OF THE MARK. THE COLOR WHITE IS  
INTENDED TO INDICATE BACKGROUND AND IS  
NOT PART OF THE MARK.

SER. NO. 79-044,045, FILED 3-28-2007.

Laurie Kaufman, Examining Attorney

**Int. Cl.: 5**

**Prior U.S. Cls.: 6, 18, 44, 46, 51 and 52**

**Reg. No. 3,468,273**

**United States Patent and Trademark Office**

**Registered July 15, 2008**

**TRADEMARK  
PRINCIPAL REGISTER**

**REVUBB**

SANOFI-AVENTIS (FRANCE SOCIÉTÉ ANON-  
YME)  
174 AVENUE DE FRANCE  
F-75013 PARIS, FRANCE

PRIORITY DATE OF 3-29-2007 IS CLAIMED.

FOR: PHARMACEUTICAL PRODUCTS FOR THE  
PREVENTION AND TREATMENT OF DISEASES  
AND DISORDERS OF THE CENTRAL NERVOUS  
SYSTEM, IN CLASS 5 (U.S. CLS. 6, 18, 44, 46, 51 AND  
52).

OWNER OF INTERNATIONAL REGISTRATION  
0938299 DATED 9-6-2007, EXPIRES 9-6-2017.

THE MARK CONSISTS OF STANDARD CHAR-  
ACTERS WITHOUT CLAIM TO ANY PARTICULAR  
FONT, STYLE, SIZE, OR COLOR.

SER. NO. 79-044,130, FILED 9-6-2007.

FRANK LATTUCA, EXAMINING ATTORNEY

Int. Cl.: 36

Prior U.S. Cls.: 100, 101 and 102

United States Patent and Trademark Office

Reg. No. 3,468,274

Registered July 15, 2008

SERVICE MARK  
PRINCIPAL REGISTER

**DEXION**

DEXION CAPITAL PLC (UNITED KINGDOM  
PUBLIC LIMITED COMPANY)  
9 BRIDEWELL PLACE  
LONDON EC4V 6AW  
UNITED KINGDOM

FOR: FINANCIAL AFFAIRS, NAMELY, FINANCIAL EXCHANGE; MONETARY AFFAIRS, NAMELY, MONETARY EXCHANGE; FINANCIAL SERVICES, NAMELY, FINANCIAL ANALYSIS AND FINANCIAL CONSULTANCY; PROVISION OF FINANCIAL RESEARCH AND FINANCIAL INFORMATION, NAMELY, IN THE NATURE OF RATES OF EXCHANGE; INVESTMENT MANAGEMENT; FUND MANAGEMENT, NAMELY, MANAGEMENT OF A CAPITAL INVESTMENT FUND; FUND MANAGEMENT SERVICES, NAMELY, MANAGEMENT OF A PRIVATE EQUITY FUND; HEDGE FUND SERVICES; HEDGE FUND MANAGEMENT SERVICES; FINANCIAL ADVISORY AND RESEARCH SERVICES IN THE FIELD OF FINANCIAL SERVICES AND FUND MANAGEMENT, INCLUDING STRUCTURED INVESTMENT PRODUCTS; FINANCIAL CONSULTANCY SERVICES IN THE FIELD OF FINANCIAL SERVICES AND FUND MANAGEMENT, INCLUDING STRUCTURED INVESTMENT PRODUCTS; FINANCIAL SERVICES PROVIDED VIA THE INTERNET,

NAMELY, ELECTRONIC FUND TRANSFER; FINANCIAL RESEARCH AND FINANCIAL INFORMATION SERVICES PROVIDED VIA THE INTERNET; FINANCIAL RESEARCH AND FINANCIAL INFORMATION SERVICES PROVIDED BY ACCESS TO A COMPUTER DATABASE; PROVISION OF FINANCIAL RESEARCH AND FINANCIAL INFORMATION IN THE FIELD OF PORTFOLIO MANAGEMENT, INCLUDING STRUCTURED INVESTMENT PRODUCTS , IN CLASS 36 (U.S. CLS. 100, 101 AND 102).

PRIORITY DATE OF 9-20-2006 IS CLAIMED.

OWNER OF INTERNATIONAL REGISTRATION  
0938492 DATED 3-7-2007, EXPIRES 3-7-2017.

THE FOREIGN WORDING IN THE MARK  
TRANSLATES INTO ENGLISH AS RIGHT AS OP-  
POSED TO LEFT, RIGHT HAND OR SIDE.

SER. NO. 79-044,225, FILED 3-7-2007.

WILLIAM ROSSMAN, EXAMINING ATTORNEY

**Int. Cl.: 9**

**Prior U.S. Cls.: 21, 23, 26, 36 and 38**

**United States Patent and Trademark Office**

**Reg. No. 3,468,275**

**Registered July 15, 2008**

**TRADEMARK  
PRINCIPAL REGISTER**

**VIRTUALLY ME**

NUUME DIGITAL, S.L. (SPAIN CORPORATION)  
C/ TALLERS, 77, 2<sup>o</sup>-1<sup>a</sup>  
BARCELONA  
SPAIN

PRIORITY DATE OF 3-14-2007 IS CLAIMED.

FOR: COMPUTER PROGRAMS TO CREATE,  
DEPLOY AND DISTRIBUTE REALISTIC LOOKING  
VIRTUAL CHARACTERS VIA AN INTERNET  
PLATFORM, IN CLASS 9 (U.S. CLS. 21, 23, 26, 36  
AND 38).

OWNER OF INTERNATIONAL REGISTRATION  
0938578 DATED 8-1-2007, EXPIRES 8-1-2017.

SER. NO. 79-044,251, FILED 8-1-2007.

THE MARK CONSISTS OF STANDARD CHAR-  
ACTERS WITHOUT CLAIM TO ANY PARTICULAR  
FONT, STYLE, SIZE, OR COLOR.

DAVID HOFFMAN, EXAMINING ATTORNEY

**Int. Cl.: 25**

**Prior U.S. Cls.: 22 and 39**

**United States Patent and Trademark Office**

**Reg. No. 3,468,276**

**Registered July 15, 2008**

**TRADEMARK  
PRINCIPAL REGISTER**



K.K. ENDO SEISAKUSHO (JAPAN CORPORATION)  
987 HIGASHIOHTA  
TSUBAME-SHI; NIIGATA-KEN 959-1244  
JAPAN

FOR: NON-JAPANESE STYLE OUTERCLOTHING, NAMELY, POLO SHIRTS, GOLF SHIRTS, JUMPERS, VESTS, PANTS, TROUSERS, SLACKS, SWEATERS, JACKETS, SWEAT SHIRTS, WIND COATS AND WIND-JACKETS; CLOTHES FOR SPORTS, NAMELY, GOLFING CAP, GOLFING HAT, GOLFING RAINWEAR AND SUN VISOR;

GARTERS; SOCKS SUSPENDERS; SUSPENDERS; WAISTBANDS; BELTS FOR CLOTHING; MASQUERADE COSTUMES; BOOTS FOR SPORTS, IN CLASS 25 (U.S. CLS. 22 AND 39).

OWNER OF INTERNATIONAL REGISTRATION  
0938647 DATED 9-10-2007, EXPIRES 9-10-2017.

SER. NO. 79-044,275, FILED 9-10-2007.

SHANNON TWOHIG, EXAMINING ATTORNEY

Int. Cl.: 34

Prior U.S. Cls.: 2, 8, 9 and 17

United States Patent and Trademark Office

Reg. No. 3,468,277

Registered July 15, 2008

TRADEMARK  
PRINCIPAL REGISTER

# SILVER LAKE

ALOIS PÖSCHL GMBH & CO. KG (FED REP  
GERMANY LTD. CORPORATION)  
DIESELSTRASSE 1  
84144 GEISENHAUSEN  
FED REP GERMANY

FOR: TOBACCO, RAW AND PROCESSED; TOBACCO PRODUCTS, NAMELY, CIGARETTES, CIGARS, CIGARILLOS; SMOKING TOBACCO; TOBACCO PIPES; PIPE FILTERS, PIPE CLEANERS, PIPE STANDS, PIPE STEMS AND PIPE TOOLS, ALL NOT MADE OF PRECIOUS METAL OR PLATED; MOISTURE-RETAINING CONTAINERS FOR TOBACCO PRODUCTS; CIGARETTE PAPERS; CIGARETTE ROLLING APPARATUS; CIGARETTE SLEEVES; CIGARETTE SLEEVE FILLERS; MATCHES; CIGARETTE HOLDERS NOT MADE OF PRECIOUS METAL OR PLATED; TOBACCO POUCHES; LIGHTER FLINTS AND FIRESTONES; CARTONS AND POUCHES FOR CIGARS, CIGARETTES, PIPES, SNUFF AND TOBACCO; ASHTRAYS NOT MADE OF PRECIOUS METAL OR PLATED; HERBS FOR SMOKING; TOBACCO TINS NOT MADE OF PRECIOUS METAL OR PLATED; CONTAINERS

FOR CIGAR AND CIGARETTE LIGHTERS; GAS POCKET CIGARETTE LIGHTERS NOT MADE OF PRECIOUS METAL OR PLATED; SNUFF; SNUFF TAKERS' ARTICLES, NAMELY, SNUFF BOXES AND SNUFF DISPENSERS NOT MADE OF PRECIOUS METAL OR PLATED; CHEWING TOBACCO; PARTS AND FITTINGS FOR ALL THE AFORESAID GOODS, IN CLASS 34 (U.S. CLS. 2, 8, 9 AND 17).

THE MARK CONSISTS OF STANDARD CHARACTERS WITHOUT CLAIM TO ANY PARTICULAR FONT, STYLE, SIZE, OR COLOR.

PRIORITY DATE OF 4-18-2007 IS CLAIMED.

OWNER OF INTERNATIONAL REGISTRATION  
0938703 DATED 7-16-2007, EXPIRES 7-16-2017.

SER. NO. 79-044,291, FILED 7-16-2007.

WENDY JUN, EXAMINING ATTORNEY



**Int. Cls.: 9, 35, 37, 38, 42 and 45**

**Prior U.S. Cls.: 21, 23, 26, 36, 38, 100, 101, 102, 103,  
104 and 106**

**Reg. No. 3,468,278**

**United States Patent and Trademark Office**

**Registered July 15, 2008**

**TRADEMARK  
SERVICE MARK  
PRINCIPAL REGISTER**



O&O SOFTWARE GMBH (FED REP GERMANY  
GESELLSCHAFT MIT BESCHRÄNKTER HAF-  
TUNG (GMBH))  
AM BORSIGTURM 48  
13507 BERLIN  
FED REP GERMANY

FOR: COMPUTERS; COMPUTER PERIPHERAL DEVICES, NAMELY, PRINTERS, COMPUTER MICE, MONITORS, SCANNING DEVICES, AND SPEAKERS; CD AND DVD PLAYERS; TELEPHONES; CAMERAS; COMPUTER SOFTWARE FOR NETWORK SECURITY, ENHANCEMENT OF PERFORMANCE COMPUTER HARDWARE, DATA RECOVERY, AND COMPUTER HARD DRIVE AND NETWORK ADMINISTRATION THAT MAY BE DOWNLOADABLE FROM A GLOBAL COMPUTER NETWORK; BLANK SMART CARDS; BLANK MAGNETIC DATA CARRIERS; MAGNETIC STRIP CARDS, IN CLASS 9 (U.S. CLS. 21, 23, 26, 36 AND 38).

FOR: MANAGEMENT AND ORGANIZATION CONSULTING IN BUSINESS MATTERS AND BUSINESS CONSULTING; ORGANIZATIONAL PROJECT PLANNING AND ORGANIZATIONAL PROJECT MANAGEMENT FOR COMPUTER HARDWARE AND SOFTWARE AS WELL AS COMMUNICATIONS TECHNOLOGY; FILE MANAGEMENT BY COMPUTERS; SYSTEMIZING AND ARRANGEMENT OF DATA IN COMPUTER DATABASES; BUSINESS MARKETING SERVICES; BOOKKEEPING AND OFFICE WORK FOR THIRD PARTIES; BUSINESS INQUIRIES, ALSO BY TELE-

PHONE AND VIA DATA NETWORKS; ANSWERING SERVICE VIA TELEPHONE, FAX, AND E-MAIL FOR UNAVAILABLE SUBSCRIBERS, IN CLASS 35 (U.S. CLS. 100, 101 AND 102).

FOR: INSTALLATION, MAINTENANCE, AND REPAIR OF COMPUTER HARDWARE; INSTALLATION AND MAINTENANCE OF NETWORK SYSTEMS AND DATA TECHNICAL FACILITIES AND HARDWARE; ONLINE MAINTENANCE AND ONLINE UPDATING OF COMPUTER HARDWARE, IN CLASS 37 (U.S. CLS. 100, 103 AND 106).

FOR: TELECOMMUNICATIONS, NAMELY, COMPUTER AIDED TRANSMISSION OF MESSAGES, IMAGES AND DATA; WEB-MESSAGING IN THE NATURE OF TRANSFERRING NEWS TO INTERNET ADDRESSES; DELIVERY OF NEWS AND INFORMATION IN THE FORM OF MESSAGES BY ELECTRONIC TRANSMISSION; PROVIDING ACCESS TO TELECOMMUNICATION NETWORKS; INTERNET SERVICE PROVIDER (ISP), IN CLASS 38 (U.S. CLS. 100, 101 AND 104).

FOR: DRAWING UP, DEVELOPMENT, FURTHER DEVELOPMENT, MAINTENANCE, UPDATE, DESIGN AND INSTALLATION OF SOFTWARE; TECHNICAL PROJECT PLANNING AND DEVELOPMENT OF COMPUTERS, COMPUTER HARDWARE AND COMPUTER NETWORKS; RESEARCH IN THE FIELD OF COMPUTER INDUSTRY, SOFTWARE AND COMMUNICATION TECHNOLOGY; RENTING OF SOFTWARE FOR USE OVER THE

INTERNET AND OTHER COMMUNICATION NETWORKS; RENTING OF ELECTRONIC MEMORY SPACE IN DATA PROCESSING CENTERS, NAME-  
LY, RENTAL OF ELECTRONIC BANDWIDTH FOR OTHERS; REPARATION AND MAINTENANCE OF SOFTWARE IN DATA PROCESSING CENTERS; DISPOSITION OF MEMORY SPACE ON SERVERS, NAME-  
LY, PROVIDING RANDOM ACCESS MEM-  
ORY FOR OTHERS; ELECTRONIC DATA STO-  
RAGE AND DATA BACKUP; TECHNICAL CONSULTATION REGARDING THE EMPLOY-  
MENT OF COMPUTER HARDWARE AND COM-  
PUTER SOFTWARE AS WELL AS COMMUNICATION TECHNOLOGY OF ALL SORTS IN MANAGEMENT AND IN INTERNAL AND EX-  
TERNAL, ALSO GLOBAL NETWORKS; PROVISION OF AN INTERNET SEARCH ENGINE; INSTALLA-  
TION AND MAINTENANCE OF NETWORK SYS-  
TEMS AND DATA TECHNICAL FACILITIES SOFTWARE; ONLINE MAINTENANCE AND ON-

LINE UPDATE OF COMPUTER SOFTWARE, IN CLASS 42 (U.S. CLS. 100 AND 101).

FOR: LICENSING OF SOFTWARE, IN CLASS 45 (U.S. CLS. 100 AND 101).

PRIORITY DATE OF 2-1-2007 IS CLAIMED.

OWNER OF INTERNATIONAL REGISTRATION 0938771 DATED 8-1-2007, EXPIRES 8-1-2017.

THE MARK CONSISTS OF TWO INTERTWINED STYLIZED LETTER "O'S".

SER. NO. 79-044,322, FILED 8-1-2007.

DAVID HOFFMAN, EXAMINING ATTORNEY

**Int. Cl.: 5**

**Prior U.S. Cls.: 6, 18, 44, 46, 51 and 52**

**Reg. No. 3,468,279**

**United States Patent and Trademark Office**

**Registered July 15, 2008**

**TRADEMARK  
PRINCIPAL REGISTER**

**detan**

ECZACIBASI HOLDING ANONIM SIRKETI  
(TURKEY JOINT STOCK COMPANY)  
KANYON OFIS BÜYÜKDERE CAD. NO: 185  
TR-34394 LEVENT/ISTANBUL  
TURKEY

OWNER OF INTERNATIONAL REGISTRATION  
0938841 DATED 7-24-2007, EXPIRES 7-24-2017.

SER. NO. 79-044,343, FILED 7-24-2007.

FOR: INSECT REPELLENT INCENSE, INSECT  
REPELLENTS, INSECTICIDES, IN CLASS 5 (U.S.  
CLS. 6, 18, 44, 46, 51 AND 52).

JEFF DEFORD, EXAMINING ATTORNEY

**Int. Cls.: 1, 29 and 40**

**Prior U.S. Cls.: 1, 5, 6, 10, 26, 46, 100, 103 and 106**

**United States Patent and Trademark Office**

**Reg. No. 3,468,280**

**Registered July 15, 2008**

**TRADEMARK  
SERVICE MARK  
PRINCIPAL REGISTER**

# **MOFINATION**

MOFIN S.R.L. (ITALY LTD LIAB CO)  
VIA PIETRO CUSTODI, 12  
I-28100 NOVARA  
ITALY

FOR: MICROORGANISMS, IN PARTICULAR LACTIC BACTERIA, YEASTS AND FERMENTS INTENDED FOR THE FOOD INDUSTRY; MICROORGANISM COMPONENTS, IN PARTICULAR PROTEINS AND PROTEIN COMPONENTS FOR INDUSTRIAL AND SCIENTIFIC PURPOSES; MICROORGANISM CULTURES, IN PARTICULAR LIQUID CULTURES, CONCENTRATED CULTURES OF LACTIC BACTERIA AND/OR YEASTS HAVING A PROBIOTIC ACTION ON THE HUMAN ORGANISM AND ON REARED ANIMAL SPECIES THAT ARE NOT FOR MEDICAL OR VETERINARY USE, IN CLASS 1 (U.S. CLS. 1, 5, 6, 10, 26 AND 46).

FOR: FERMENTED PRODUCTS AND FERMENTED MILK, IN PARTICULAR YOGURT; FERMENTED CHEESE PRODUCTS, NAMELY, FERMENTED CHEESE; MILK, MILK CURD, MILK POWDER, MILK PROTEINS, FERMENTED MILK; FOODS, NAMELY MILK, CHEESE, YOGURT, CREAM AND SOUR CREAM AND FOOD SUPPLEMENTS, NAMELY MILK PROTEIN AND PROTEINS FOR HUMAN CONSUMPTION, NOT FOR MEDICAL USE, CONTAINING MICROORGANISM CULTURES, IN PARTICULAR LIQUID CULTURES, CONCENTRATED CULTURES OF LACTIC BACTERIA AND/OR YEASTS HAVING A PROBIOTIC ACTION ON THE HUMAN ORGANISM AND ON REARED ANIMAL SPECIES THAT ARE NOT FOR

MEDICAL OR VETERINARY USE, IN CLASS 29 (U.S. CL. 46).

FOR: SERVICES, NAMELY, MIXING, HEATING, COOLING, PASTEURIZING AND PROCESSING RELATING TO THE TRANSFORMATION AND/OR TREATMENT OF SUBSTANCES INTENDED FOR THE FOOD INDUSTRY, IN PARTICULAR SUBSTANCES INTENDED FOR THE FOOD INDUSTRY CONTAINING MICROORGANISMS, IN PARTICULAR LACTIC BACTERIA, YEASTS AND FERMENTS, MICROORGANISM CULTURES, IN PARTICULAR LIQUID CULTURES, CONCENTRATED CULTURES OF LACTIC BACTERIA AND/OR YEASTS HAVING A PROBIOTIC ACTION ON THE HUMAN ORGANISM AND ON REARED ANIMAL SPECIES; TRANSFORMATION AND/OR HEAT TREATMENT OF MILK INTENDED IN PARTICULAR FOR THE CHEESE INDUSTRY, IN CLASS 40 (U.S. CLS. 100, 103 AND 106).

THE MARK CONSISTS OF STANDARD CHARACTERS WITHOUT CLAIM TO ANY PARTICULAR FONT, STYLE, SIZE, OR COLOR.

PRIORITY DATE OF 2-2-2007 IS CLAIMED.

OWNER OF INTERNATIONAL REGISTRATION 0938960 DATED 7-31-2007, EXPIRES 7-31-2017.

SER. NO. 79-044,390, FILED 7-31-2007.

JEFF DEFORD, EXAMINING ATTORNEY

**Int. Cls.: 5 and 42**

**Prior U.S. Cls.: 6, 18, 44, 46, 51, 52, 100 and 101**

**Reg. No. 3,468,281**

**United States Patent and Trademark Office**

**Registered July 15, 2008**

**TRADEMARK  
SERVICE MARK  
PRINCIPAL REGISTER**

**M & P**

CUM PHARMA CONSULTING ANSTALT  
(LIECHTENSTEIN CORPORATION)  
AEULESTRASSE 38  
FL-9490 VADUZ  
LIECHTENSTEIN

FOR: MEDICINES FOR THE TREATMENT OF  
DEPRESSION, PARKINSON'S DISEASE, STROKE  
AND ALZHEIMER'S DISEASE AS WELL AS FOR  
HORMONE REPLACEMENT THERAPY, IN CLASS  
5 (U.S. CLS. 6, 18, 44, 46, 51 AND 52).

FOR: MEDICAL LABORATORIES; DNA ANALY-  
SIS SERVICES, IN CLASS 42 (U.S. CLS. 100 AND 101).

OWNER OF INTERNATIONAL REGISTRATION  
0682768 DATED 10-1-1997, EXPIRES 10-1-2017.

SER. NO. 79-044,413, FILED 10-2-2007.

GINA HAYES, EXAMINING ATTORNEY

**Int. Cl.: 9**

**Prior U.S. Cls.: 21, 23, 26, 36 and 38**

**Reg. No. 3,468,282**

**United States Patent and Trademark Office**

**Registered July 15, 2008**

**TRADEMARK  
PRINCIPAL REGISTER**

# SONOPROSTATE

BRACCO INTERNATIONAL B.V. (NETHERLANDS PRIVATE LIMITED COMPANY)

3051, STRAWINSKYLAAN,

NL-1077 ZX AMSTERDAM

NETHERLANDS

FOR: SOFTWARE FOR PROCESSING IMAGES FOR THE ANALYSIS OF MEDICAL CONTRAST IMAGING DURING ECOGRAPHIC EXAMINATIONS, NAMELY, FOR THE ENHANCED VISUALIZATION OF POSSIBLE PROSTATE LESIONS, IN CLASS 9 (U.S. CLS. 21, 23, 26, 36 AND 38).

THE MARK CONSISTS OF STANDARD CHARACTERS WITHOUT CLAIM TO ANY PARTICULAR FONT, STYLE, SIZE, OR COLOR.

PRIORITY DATE OF 7-31-2007 IS CLAIMED.

OWNER OF INTERNATIONAL REGISTRATION 0939012 DATED 9-25-2007, EXPIRES 9-25-2017.

SER. NO. 79-044,446, FILED 9-25-2007.

MARILYN IZZI, EXAMINING ATTORNEY

**Int. Cl.: 9**

**Prior U.S. Cls.: 21, 23, 26, 36 and 38**

**United States Patent and Trademark Office**

**Reg. No. 3,468,283**

**Registered July 15, 2008**

**TRADEMARK  
PRINCIPAL REGISTER**

**SONOTUMOR**

BRACCO INTERNATIONAL B.V. (NETHERLANDS PRIVATE LIMITED COMPANY)

3051, STRAWINSKYLAAN,

NL-1077 ZX AMSTERDAM

NETHERLANDS

FOR: SOFTWARE FOR PROCESSING IMAGES FOR THE ANALYSIS OF MEDICAL CONTRAST IMAGING DURING ECOGRAPHIC EXAMINATIONS, NAMELY, FOR THE ENHANCED VISUALIZATION OF POSSIBLE TUMOROUS LESIONS, IN CLASS 9 (U.S. CLS. 21, 23, 26, 36 AND 38).

THE MARK CONSISTS OF STANDARD CHARACTERS WITHOUT CLAIM TO ANY PARTICULAR FONT, STYLE, SIZE, OR COLOR.

PRIORITY DATE OF 7-31-2007 IS CLAIMED.

OWNER OF INTERNATIONAL REGISTRATION 0939020 DATED 9-25-2007, EXPIRES 9-25-2017.

SER. NO. 79-044,452, FILED 9-25-2007.

MARILYN IZZI, EXAMINING ATTORNEY

**Int. Cl.: 9**

**Prior U.S. Cls.: 21, 23, 26, 36 and 38**

**United States Patent and Trademark Office**

**Reg. No. 3,468,284**

**Registered July 15, 2008**

**TRADEMARK  
PRINCIPAL REGISTER**

**SONOTUMOUR**

BRACCO INTERNATIONAL B.V. (NETHERLANDS PRIVATE LIMITED COMPANY)

3051, STRAWINSKYLAAN,

NL-1077 ZX AMSTERDAM

NETHERLANDS

FOR: SOFTWARE FOR PROCESSING IMAGES FOR THE ANALYSIS OF MEDICAL CONTRAST IMAGING DURING ECOGRAPHIC EXAMINATIONS, NAMELY, FOR THE ENHANCED VISUALIZATION OF POSSIBLE TUMOROUS LESIONS, IN CLASS 9 (U.S. CLS. 21, 23, 26, 36 AND 38).

THE MARK CONSISTS OF STANDARD CHARACTERS WITHOUT CLAIM TO ANY PARTICULAR FONT, STYLE, SIZE, OR COLOR.

PRIORITY DATE OF 7-31-2007 IS CLAIMED.

OWNER OF INTERNATIONAL REGISTRATION 0939021 DATED 9-25-2007, EXPIRES 9-25-2017.

SER. NO. 79-044,453, FILED 9-25-2007.

MARILYN IZZI, EXAMINING ATTORNEY



**Int. Cls.: 18, 20 and 25**

**Prior U.S. Cls.: 1, 2, 3, 13, 22, 25, 32, 39, 41 and 50**

**United States Patent and Trademark Office**

**Reg. No. 3,468,285**

**Registered July 15, 2008**

**TRADEMARK  
PRINCIPAL REGISTER**

**LOMOGRAPHY**

LOMOGRAPHISCHE AG (AUSTRIA PUBLIC  
LIMITED COMPANY)  
HOLLERGASSE 41  
A-1150 WIEN  
AUSTRIA

FOR: TRAVELING TRUNKS AND VALISES,  
BRIEFCASES, BEACH BAGS, WALLETS, CAMPING  
BAGS, DOCUMENTS CASES, CANVAS SHOPPING  
BAGS, KEY CASES, HANDBAGS, TRAVELING  
BAGS, RUCKSACKS, UMBRELLAS, PARASOLS,  
ROLL BAGS, BABY CARRYING BAGS, IN CLASS  
18 (U.S. CLS. 1, 2, 3, 22 AND 41).

FOR: FURNITURE, MIRRORS, PICTURE  
FRAMES, BEDS, PLANT RACKS, CARD INDEX  
CABINETS, CUPBOARDS AND PLASTIC BOXES,  
CUSHIONS, PILLOWS, COMPUTER KEYBOARD  
TRAYS NOT OF METAL, SALES COUNTERS,  
CHAIRS, DECK CHAIRS, TABLES, IN CLASS 20  
(U.S. CLS. 2, 13, 22, 25, 32 AND 50).

FOR: CLOTHING, NAMELY, SHIRTS, T-SHIRTS,  
PANTS, JACKETS, COATS, UNDERWEAR; FOOT-  
WEAR; HEADWEAR , IN CLASS 25 (U.S. CLS. 22  
AND 39).

THE MARK CONSISTS OF STANDARD CHAR-  
ACTERS WITHOUT CLAIM TO ANY PARTICULAR  
FONT, STYLE, SIZE, OR COLOR.

PRIORITY DATE OF 2-14-2007 IS CLAIMED.

OWNER OF INTERNATIONAL REGISTRATION  
0939100 DATED 7-30-2007, EXPIRES 7-30-2017.

OWNER OF U.S. REG. NOS. 299,576 AND 2,593,671.

SER. NO. 79-044,479, FILED 7-30-2007.

GENE MACIOL, EXAMINING ATTORNEY

**Int. Cl.: 10**

**Prior U.S. Cls.: 26, 39 and 44**

**United States Patent and Trademark Office**

**Reg. No. 3,468,286**

**Registered July 15, 2008**

**TRADEMARK  
PRINCIPAL REGISTER**

**ELPENHALER**

ELPEN PHARMACEUTICAL CO. INC. (GREECE  
CORPORATION)  
95, MARATHONOS AVE.  
PIKERMI; GR-190 09 ATTICA  
GREECE

FOR: INHALERS FOR MEDICAL USE, IN CLASS  
10 (U.S. CLS. 26, 39 AND 44).

PRIORITY DATE OF 5-2-2007 IS CLAIMED.

OWNER OF INTERNATIONAL REGISTRATION  
0939139 DATED 9-21-2007, EXPIRES 9-21-2017.

THE WORDING "ELPENHALER" HAS NO  
MEANING IN A FOREIGN LANGUAGE.

SER. NO. 79-044,492, FILED 9-21-2007.

ANTHONY RINKER, EXAMINING ATTORNEY

**Int. Cls.: 1, 6, 36, 37 and 40**

**Prior U.S. Cls.: 1, 2, 5, 6, 10, 12, 13, 14, 23, 25, 26, 46, 50, 100, 101, 102, 103 and 106**

**Reg. No. 3,468,287**

**United States Patent and Trademark Office**

**Registered July 15, 2008**

**TRADEMARK  
SERVICE MARK  
PRINCIPAL REGISTER**



COALCO AG (SWITZERLAND SOCIÉTÉ ANONYME (SA))  
GRABENSTRASSE 42  
CH-6301 ZUG, SWITZERLAND

FOR: CHEMICALS USED IN INDUSTRY AND SCIENCE; CHEMICAL PREPARATIONS FOR USE IN AGRICULTURE, HORTICULTURE AND FORESTRY, NAMELY, SPECIALTY CHEMICALS, NAMELY, CHEMICAL ADDITIVES FOR GENERAL INDUSTRIAL USE IN THE MANUFACTURE OF A WIDE VARIETY OF GOODS, IN CLASS 1 (U.S. CLS. 1, 5, 6, 10, 26 AND 46).

FOR: COMMON METALS AND THEIR ALLOYS FOR FURTHER MANUFACTURE, METAL BUILDING MATERIAL, NAMELY, ALUMINIUM AND TITANIUM ALLOY, STEEL IN THE FORM OF SHEETS, PLATES, FOILS AND REELS ORES, NAMELY, COPPER ORES, NICKEL ORES, ZINC ORES AND TIN ORES, IN CLASS 6 (U.S. CLS. 2, 12, 13, 14, 23, 25 AND 50).

FOR: REAL ESTATE AFFAIRS, NAMELY, AGENCIES OR BROKERAGE FOR RENTING OF BUILDINGS, LAND ACQUISITION, REAL ESTATE BROKERAGE, LEASING OF OFFICE SPACE, LEAS-

ING OF REAL ESTATE, LEASING OF REAL PROPERTY, MANAGEMENT OF BUILDINGS, REAL ESTATE ACQUISITION SERVICES, REAL ESTATE AGENCIES, REAL ESTATE MANAGEMENT, RENTAL OF APARTMENTS, IN CLASS 36 (U.S. CLS. 100, 101 AND 102).

FOR: CONSTRUCTION AND RENOVATION OF BUILDINGS, CONSTRUCTION MANAGEMENT AND CONSTRUCTION PLANNING, IN CLASS 37 (U.S. CLS. 100, 103 AND 106).

FOR: TREATMENT OF MATERIALS, NAMELY, TREATMENT OF METAL AND GALVANIZATION, IN CLASS 40 (U.S. CLS. 100, 103 AND 106).

PRIORITY DATE OF 3-30-2007 IS CLAIMED.

OWNER OF INTERNATIONAL REGISTRATION 0939155 DATED 9-10-2007, EXPIRES 9-10-2017.

SER. NO. 79-044,500, FILED 9-10-2007.

SHANNON TWOHIG, EXAMINING ATTORNEY

**Int. Cl.: 9**

**Prior U.S. Cls.: 21, 23, 26, 36 and 38**

**Reg. No. 3,468,288**

**United States Patent and Trademark Office**

**Registered July 15, 2008**

---

**TRADEMARK  
PRINCIPAL REGISTER**

**WeldEye**

WELDINDUSTRY AS (NORWAY CORPORATION)  
POSTBOKS 670  
N-5403 STORD  
NORWAY

OWNER OF INTERNATIONAL REGISTRATION  
0939293 DATED 9-4-2007, EXPIRES 9-4-2017.

FOR: COMPUTER SOFTWARE PROGRAMS FOR  
DOCUMENT MANAGEMENT, DATABASE MAN-  
AGEMENT, USE AS A SPREAD SHEET, WORD  
PROCESSING FOR USE IN THE WELDING INDUS-  
TRY, IN CLASS 9 (U.S. CLS. 21, 23, 26, 36 AND 38).

SER. NO. 79-044,536, FILED 9-4-2007.

CARYN GLASSER, EXAMINING ATTORNEY

**Int. Cls.: 12, 35 and 37**

**Prior U.S. Cls.: 19, 21, 23, 31, 35, 44, 100, 101, 102,  
103 and 106**

**Reg. No. 3,468,289**

**United States Patent and Trademark Office**

**Registered July 15, 2008**

**TRADEMARK  
SERVICE MARK  
PRINCIPAL REGISTER**

**CONTIRE**

CONTINENTAL AKTIENGESELLSCHAFT (FED  
REP GERMANY JOINT STOCK COMPANY)  
VAHRENWALDER STRASSE 9  
30165 HANNOVER, FED REP GERMANY

FOR: TIRES; PNEUMATIC TIRES FOR VEHICLES, IN PARTICULAR RETREADED AND RENEWED PNEUMATIC TIRES FOR VEHICLES; SOLID RUBBER TIRES; COMPLETE WHEELS; INNER TUBES FOR TIRES; TREADS FOR RETREADING TIRES; SELF-ADHESIVE PATCHES FOR TIRES; WHEEL RIMS, IN CLASS 12 (U.S. CLS. 19, 21, 23, 31, 35 AND 44).

FOR: BUSINESS MANAGEMENT, MARKETING, ADVERTISING; ORGANIZATION AND ARRANGING OF ADVERTISING EVENTS; ORGANIZATION OF FAIRS AND EXHIBITIONS FOR COMMERCIAL OR ADVERTISING PURPOSES; SALES PROMOTION SERVICES; PROVIDING OFFICE FUNCTIONS, BUSINESS INFORMATION, BUSINESS CONSULTANCY, SERVICES WITH REGARD TO PRODUCT PRESENTATION TO THE PUBLIC, ONLINE ADVERTISING SERVICES FOR THIRD PARTIES, RETAIL AND WHOLESALE STORE SERVICES FEATURING TIRES; ONLINE

RETAIL AND WHOLESALE STORE SERVICES FEATURING TIRES, IN CLASS 35 (U.S. CLS. 100, 101 AND 102).

FOR: VEHICLE SERVICE, NAMELY, MAINTENANCE AND REPAIR OF VEHICLES AND TIRES; RETREADING OF TIRES; VULCANIZATION OF AUTOMOBILE TIRES; MOBILE VEHICLE REPAIR SERVICES, IN CLASS 37 (U.S. CLS. 100, 103 AND 106).

THE MARK CONSISTS OF STANDARD CHARACTERS WITHOUT CLAIM TO ANY PARTICULAR FONT, STYLE, SIZE, OR COLOR.

PRIORITY DATE OF 5-16-2007 IS CLAIMED.

OWNER OF INTERNATIONAL REGISTRATION  
0939366 DATED 8-16-2007, EXPIRES 8-16-2017.

SER. NO. 79-044,562, FILED 8-16-2007.

ELI HELLMAN, EXAMINING ATTORNEY

**Int. Cls.: 9 and 42**

**Prior U.S. Cls.: 21, 23, 26, 36, 38, 100 and 101**

**United States Patent and Trademark Office**

**Reg. No. 3,468,290**

**Registered July 15, 2008**

**TRADEMARK  
SERVICE MARK  
PRINCIPAL REGISTER**



ZCOST MANAGEMENT (FRANCE SOCIÉTÉ À  
RESPONSABILITÉ LIMITÉE)  
15 RUE DE TREVALY  
F-44420 LA TURBALLE  
FRANCE

FOR: COST CONTROL AND VALUE-FOR-MON-  
EY FINANCIAL MANAGEMENT COMPUTER  
SOFTWARE, IN CLASS 9 (U.S. CLS. 21, 23, 26, 36  
AND 38).

FOR: SOFTWARE DESIGN, DEVELOPMENT, IN-  
STALLATION, UPDATING, AND MAINTENANCE;  
COMPUTER PROGRAMMING; COMPUTER CON-  
SULTING, IN CLASS 42 (U.S. CLS. 100 AND 101).

PRIORITY DATE OF 3-9-2007 IS CLAIMED.

OWNER OF INTERNATIONAL REGISTRATION  
0939375 DATED 9-7-2007, EXPIRES 9-7-2017.

NO CLAIM IS MADE TO THE EXCLUSIVE  
RIGHT TO USE "COST MANAGEMENT", APART  
FROM THE MARK AS SHOWN.

THE COLOR(S) GRAY AND BLUE IS/ARE  
CLAIMED AS A FEATURE OF THE MARK.

THE COLOR BLUE APPEARS IN THE LETTER  
"Z" AND IN THE DESIGN OF THE LETTER "O" IN  
THE WORD "COST", AND THE COLOR GRAY  
APPEARS IN THE WORD "MANAGEMENT" AND  
THE LETTERS "C", "S" AND "T" OF THE WORD  
"COST".

SER. NO. 79-044,565, FILED 9-7-2007.

DAVID HOFFMAN, EXAMINING ATTORNEY

**Int. Cls.: 6, 40 and 42**

**Prior U.S. Cls.: 2, 12, 13, 14, 23, 25, 50, 100, 101, 103  
and 106**

**Reg. No. 3,468,291**

**United States Patent and Trademark Office**

**Registered July 15, 2008**

**TRADEMARK  
SERVICE MARK  
PRINCIPAL REGISTER**

# TEXSTEEL

CORUS TECHNOLOGY BV (NETHERLANDS  
LIMITED COMPANY)  
WENCKEBACHSTRAAT 1  
NL-1951 JZ VELSEN-NOORD  
NETHERLANDS

FOR: COMMON METALS AND THEIR ALLOYS  
IN THE FORM OF SHEETS, STRIPS OR BANDS,  
ALSO IN ROLLED FORM; COMMON METALS AND  
THEIR ALLOYS IN THE FORM OF SHEETS, STRIPS  
OR BANDS, ALSO IN ROLLED FORM, WHICH  
MAY BE PROVIDED WITH A METAL OR ORGANIC  
COATING; STEEL IN THE FORM OF SHEETS,  
STRIPS OR BANDS, ALSO IN ROLLED FORM;  
STEEL IN THE FORM OF SHEETS, STRIPS OR  
BANDS, WHICH MAY BE PROVIDED WITH A  
METAL OR ORGANIC COATING, IN CLASS 6  
(U.S. CLS. 2, 12, 13, 14, 23, 25 AND 50).

FOR: TREATMENT OF METALS, APPLYING  
COATINGS TO METALS AND PROVIDING INFOR-  
MATION RELATING THERETO; ADVICE RELAT-  
ING TO THE TREATMENT AND COATING OF  
MATERIAL IN THE FORM OF SHEETS, PROVIDED  
TO ARCHITECTS, BUILDERS AND CONSTRUC-  
TORS, DESIGNERS AND SUPPLIERS OF DOMES-  
TIC SUPPLIES, ELECTRONIC SUPPLIERS, OFFICE  
SUPPLIES AND TO FIRMS WHICH TREAT SHEETS,  
IN CLASS 40 (U.S. CLS. 100, 103 AND 106).

FOR: SCIENTIFIC AND TECHNOLOGICAL SER-  
VICES, NAMELY RESEARCH ON BONDING  
METHODS AND ADHESIVES, RESEARCH ON  
THE PROCESSING METHODS USED BY THE CUS-  
TOMERS, AND RESEARCH ON THE PERFOR-  
MANCE OF COMMON METALS AND THEIR  
ALLOYS IN THE FORM OF SHEETS, STRIPS OR  
BANDS, ALSO IN ROLLED FORM, RESEARCH ON  
THE PERFORMANCE OF COMMON METALS AND  
THEIR ALLOYS IN THE FORM OF SHEETS, STRIPS  
OR BANDS, ALSO IN ROLLED FORM, WHICH  
MAY BE PROVIDED WITH A METAL OR ORGANIC

COATING, RESEARCH ON THE PERFORMANCE  
OF STEEL IN THE FORM OF SHEETS, STRIPS OR  
BANDS, ALSO IN ROLLED FORM, RESEARCH ON  
THE PERFORMANCE OF STEEL IN THE FORM OF  
SHEETS, STRIPS OR BANDS, WHICH MAY BE  
PROVIDED WITH A METAL OR ORGANIC COAT-  
ING; SERVICES IN THE FIELD OF INDUSTRIAL  
ANALYSIS AND INDUSTRIAL RESEARCH, NAME-  
LY RESEARCH ON BONDING METHODS AND  
ADHESIVES, RESEARCH ON THE PROCESSING  
METHODS USED BY THE CUSTOMERS, AND  
RESEARCH ON THE PERFORMANCE OF COM-  
MON METALS AND THEIR ALLOYS IN THE FORM  
OF SHEETS, STRIPS OR BANDS, ALSO IN ROLLED  
FORM, RESEARCH ON THE PERFORMANCE OF  
COMMON METALS AND THEIR ALLOYS IN THE  
FORM OF SHEETS, STRIPS OR BANDS, ALSO IN  
ROLLED FORM, WHICH MAY BE PROVIDED  
WITH A METAL OR ORGANIC COATING, RE-  
SEARCH ON THE PERFORMANCE OF STEEL IN  
THE FORM OF SHEETS, STRIPS OR BANDS, ALSO  
IN ROLLED FORM, RESEARCH ON THE PERFOR-  
MANCE OF STEEL IN THE FORM OF SHEETS,  
STRIPS OR BANDS, WHICH MAY BE PROVIDED  
WITH A METAL OR ORGANIC COATING, IN  
CLASS 42 (U.S. CLS. 100 AND 101).

THE MARK CONSISTS OF STANDARD CHAR-  
ACTERS WITHOUT CLAIM TO ANY PARTICULAR  
FONT, STYLE, SIZE, OR COLOR.

PRIORITY DATE OF 12-20-2006 IS CLAIMED.

OWNER OF INTERNATIONAL REGISTRATION  
0939703 DATED 6-11-2007, EXPIRES 6-11-2017.

SER. NO. 79-044,638, FILED 6-11-2007.

SHAILA SETTLES, EXAMINING ATTORNEY

**Int. Cls.: 2, 7 and 8**

**Prior U.S. Cls.: 6, 11, 13, 16, 19, 21, 23, 28, 31, 34, 35  
and 44**

**Reg. No. 3,468,292**

**United States Patent and Trademark Office**

**Registered July 15, 2008**

**TRADEMARK  
PRINCIPAL REGISTER**

**FillClean**

PETER KWASNY GMBH (FED REP GERMANY  
LTD LIAB CO)  
HEILBRONNER STRASSE 96  
74831 GUNDELSHEIM  
FED REP GERMANY

FOR: PAINTS, VARNISHES, LACQUERS; PAINTS,  
VARNISHES, LACQUERS SOLD IN AEROSOL  
CANS; RUST PRESERVATIVES IN THE NATURE  
OF COATINGS; WOOD PRESERVATIVES; ANTI-  
CORROSION PREPARATIONS IN THE FORM OF  
COATINGS, IN CLASS 2 (U.S. CLS. 6, 11 AND 16).

FOR: POWER-OPERATED SPRAY EQUIPMENT  
FOR PAINTS, VARNISHES, LACQUERS AND PRE-  
PARATION MATERIALS FOR VARNISHING, IN  
CLASS 7 (U.S. CLS. 13, 19, 21, 23, 31, 34 AND 35).

FOR: HAND-OPERATED VAPORIZERS AND  
FILLING DEVICES, IN PARTICULAR FOR PAINTS,

VARNISHES, LACQUERS AND PREPARATION  
MATERIALS FOR VARNISHING, IN CLASS 8 (U.S.  
CLS. 23, 28 AND 44).

THE MARK CONSISTS OF STANDARD CHAR-  
ACTERS WITHOUT CLAIM TO ANY PARTICULAR  
FONT, STYLE, SIZE, OR COLOR.

PRIORITY DATE OF 3-5-2007 IS CLAIMED.

OWNER OF INTERNATIONAL REGISTRATION  
0939726 DATED 8-29-2007, EXPIRES 8-29-2017.

SER. NO. 79-044,644, FILED 8-29-2007.

DAVID MURRAY, EXAMINING ATTORNEY



**Int. Cls.: 7 and 40**

**Prior U.S. Cls.: 13, 19, 21, 23, 31, 34, 35, 100, 103 and 106**

**United States Patent and Trademark Office**

**Reg. No. 3,468,293**

**Registered July 15, 2008**

**TRADEMARK  
SERVICE MARK  
PRINCIPAL REGISTER**

# **TOPOCROM**

TOPOCROM SYSTEMS AG (SWITZERLAND  
CORPORATION)  
FOHLENWEIDE  
CH-8570 WEINFELDEN  
SWITZERLAND

FOR: MACHINES FOR COATING SURFACES OF  
METAL, SINTERING MATERIALS AND PLASTIC  
WITH CHROMIUM , IN CLASS 7 (U.S. CLS. 13, 19, 21,  
23, 31, 34 AND 35).

FOR: MATERIAL PROCESSING, NAMELY,  
COATING SURFACES OF METAL, SINTERING  
MATERIALS AND PLASTIC WITH CHROMIUM,

GALVANIZATION, IN CLASS 40 (U.S. CLS. 100, 103  
AND 106).

OWNER OF INTERNATIONAL REGISTRATION  
0632958 DATED 3-20-1995, EXPIRES 3-20-2015.

OWNER OF U.S. REG. NO. 2,261,955.

SER. NO. 79-044,662, FILED 8-9-2007.

AMY HELLA, EXAMINING ATTORNEY

**Int. Cls.: 3, 4, 9, 14 and 16**

**Prior U.S. Cls.: 1, 2, 4, 5, 6, 15, 21, 22, 23, 26, 27, 28,  
29, 36, 37, 38, 50, 51 and 52**

**Reg. No. 3,468,294**

**United States Patent and Trademark Office**

**Registered July 15, 2008**

**TRADEMARK  
PRINCIPAL REGISTER**

**BO TREE**

OLIVER ROSE (FED REP GERMANY INDIVIDUAL)  
FLAT 1202 AVENUE HEIGHTS,  
5 AVENUE ROAD; LONDON N6 5DS  
UNITED KINGDOM

FOR: PERSONAL SKINCARE PREPARATIONS, SOAPS, SHAMPOOS, PERFUMES, ESSENTIAL OILS, COSMETICS AND HAIR LOTIONS, PERSONAL DEODORANTS, SCENTED ROOM SPRAYS, IN CLASS 3 (U.S. CLS. 1, 4, 6, 50, 51 AND 52).

FOR: SCENTED CANDLES, IN CLASS 4 (U.S. CLS. 1, 6 AND 15).

FOR: DOWNLOADABLE MUSICAL SOUND RECORDINGS, COMPACT DISCS FEATURING MUSIC, IN CLASS 9 (U.S. CLS. 21, 23, 26, 36 AND 38).

FOR: JEWELLERY, IN CLASS 14 (U.S. CLS. 2, 27, 28 AND 50).

FOR: PRINTED MATERIAL, NAMELY, STATIONERY, PERIODICALS AND BOOKS ON THE SUBJECTS OF WELLNESS, SPIRITUALITY, HISTORY, CULTURE, ART, TRAVEL, MEDICINE, SKINCARE, PSYCHOLOGY, IN CLASS 16 (U.S. CLS. 2, 5, 22, 23, 29, 37, 38 AND 50).

OWNER OF INTERNATIONAL REGISTRATION 0939800 DATED 8-23-2007, EXPIRES 8-23-2017.

SER. NO. 79-044,717, FILED 8-23-2007.

ANGELA M. MICHELI, EXAMINING ATTORNEY

**Int. Cls.: 9, 14, 18 and 25**

**Prior U.S. Cls.: 1, 2, 3, 21, 22, 23, 26, 27, 28, 36, 38, 39,  
41 and 50**

**Reg. No. 3,468,295**

**United States Patent and Trademark Office**

**Registered July 15, 2008**

**TRADEMARK  
PRINCIPAL REGISTER**



ÇAK TEXTILE B.V. (NETHERLANDS LIMITED  
LIABILITY COMPANY)  
KIOTOWEG 162  
NL-3047 BG ROTTERDAM  
NETHERLANDS

FOR: GLASSES, NAMELY, OPTICAL GLASSES  
AND SUNGLASSES; APPARATUS FOR RECORD-  
ING, TRANSMISSION OR REPRODUCTION OF  
SOUND OR IMAGES; BLANK MAGNETIC DATA  
CARRIERS, BLANK RECORDABLE OPTICAL  
DISCS; PROTECTIVE HEADGEAR FOR FOOT-  
BALL, BOXING AND HORSE BACK RIDING, IN  
CLASS 9 (U.S. CLS. 21, 23, 26, 36 AND 38).

FOR: JEWELRY; IMITATION JEWELRY; GOLD,  
BRACELETS, RINGS, NECKLACES, EARRINGS,  
DIAMONDS, PRECIOUS STONES, PENDANTS JEW-  
ELRY, CUFF LINKS, TIE-PINS, PINS, BROOCHES;  
WATCHES AND TIME MEASURE DEVICES,  
NAMELY, CHRONOMETERS AND PARTS THERE-  
OF; WATCHBANDS; ORNAMENTS AND STATUES  
OF PRECIOUS METALS; KEY RINGS OF PRECIOUS  
METAL, IN CLASS 14 (U.S. CLS. 2, 27, 28 AND 50).

FOR: TREATED OR NON-TREATED LEATHER  
AND ANIMAL SKIN, IMITATION LEATHER,  
STOUT LEATHER; LEATHER BAGS, TRAVEL  
CASES, WALLETS, BILLFOLDS, CARRY-ALL  
BAGS, HAT BOXES AND CASES OF LEATHER OR  
STOUT LEATHER; EMPTY MAKE-UP CASES, EMP-  
TY TOOL BAGS, BACKPACKS, BRIEFCASES, TEX-  
TILE AND LEATHER SHOPPING AND SCHOOL  
BAGS; UMBRELLAS, WALKING STICKS; WHIPS,

HARNESSES AND HARNESS FITTINGS, SADDLES,  
STIRRUPS, HORSE BRIDLES, IN CLASS 18 (U.S.  
CLS. 1, 2, 3, 22 AND 41).

FOR: CLOTHING OF COMBED COTTON, TRI-  
COT, DENIM, LEATHER AND PAPER, NAMELY,  
JEANS, SWEATERS, T-SHIRTS; SPORTS CLOTH-  
ING, NAMELY, T-SHIRTS AND SPORTS BRAS;  
UNDERWEAR, GLOVES, SOCKS; FOOTWEAR,  
NAMELY RUBBER BOOTS, BOOTS, SLIPPERS, IN-  
FANT'S SHOES AND PARTS THEREOF; SHOES  
FOR SPORT AND THEIR SPIKES; SHOE PARTS,  
NAMELY, SOLES, HEELS, AND UPPERS; HEAD-  
GEAR, NAMELY, HATS, BERETS, CAPS, CAPS  
WITH A PEAK; SPECIAL TEXTILE CLOTHES FOR  
BABIES, NAMELY, BABY JACKETS, TEXTILE  
BABY DIAPERS; TIES, BOW TIES, FOULARDS,  
SHAWLS, SCARVES, PAREOS; SARONGS, COL-  
LARS, BANDANAS, MUFFS, ARMBANDS, HEAD-  
BANDS; BELTS, SUSPENDERS, GARTER BELTS, IN  
CLASS 25 (U.S. CLS. 22 AND 39).

PRIORITY DATE OF 11-7-2006 IS CLAIMED.

OWNER OF INTERNATIONAL REGISTRATION  
0940001 DATED 5-1-2007, EXPIRES 5-1-2017.

SER. NO. 79-044,784, FILED 5-1-2007.

KELLY MCCOY, EXAMINING ATTORNEY

Int. Cl.: 33

Prior U.S. Cls.: 47 and 49

United States Patent and Trademark Office

Reg. No. 3,468,296

Registered July 15, 2008

TRADEMARK  
PRINCIPAL REGISTER

**FORMOSO**  
(Portugal)

SOGEVINUS FINE WINES, S.A. (PORTUGAL  
SOCIÉTÉ ANONYME)  
AV. DIOGO LEITE, 344  
P-4400-111 VILA NOVA DE GAIA  
PORTUGAL

FOR: TABLE WINES, VERY SWEET WINES OR  
WINES WITH BODY, SPARKLING WINES, CIDER,  
SPIRITS AND EAUX-DE-VIE (BRANDY), LI-  
QUEURS, IN CLASS 33 (U.S. CLS. 47 AND 49).

OWNER OF INTERNATIONAL REGISTRATION  
0142882 DATED 8-9-1949, EXPIRES 8-9-2009.

NO CLAIM IS MADE TO THE EXCLUSIVE  
RIGHT TO USE "PORTUGAL", APART FROM THE  
MARK AS SHOWN.

THE ENGLISH TRANSLATION OF THE FOR-  
EIGN WORD(S) IN THE MARK IS: "HANDSOME".

SER. NO. 79-044,865, FILED 9-21-2007.

LAURIE KAUFMAN, EXAMINING ATTORNEY

**Int. Cl.: 10**

**Prior U.S. Cls.: 26, 39 and 44**

**United States Patent and Trademark Office**

**Reg. No. 3,468,297**

**Registered July 15, 2008**

**TRADEMARK  
PRINCIPAL REGISTER**

**SEGURLOCK**

LABORATORIOS INIBSA, S.A. (SPAIN SOCIEDAD ANONIMA (LIMITED LIABILITY COMPANY))

CARRETERA DE SABADELL A GRANOLLERS  
KM. 14,5  
E-08185 LLIÇA DE VALL, BARCELONA, SPAIN

FOR: SURGICAL AND MEDICAL APPARATUS AND INSTRUMENTS, NAMELY, CATHETERS FOR CLINICAL AND MEDICAL USE NOT INCLUDING SECUREMENT SYSTEMS FOR ATTACHING CATHETERS, SURGICAL TUBES AND DRAINS, AND MEDICAL LEADS TO PATIENTS, IN THIS CLASS, IN CLASS 10 (U.S. CLS. 26, 39 AND 44).

OWNER OF INTERNATIONAL REGISTRATION 0642866 DATED 9-5-1995, EXPIRES 9-5-2015.

OWNER OF U.S. REG. NO. 2,470,830.

THE WORDING "SEGURLOCK" HAS NO MEANING IN A FOREIGN LANGUAGE.

SER. NO. 79-044,880, FILED 7-24-2007.

MICHAEL TANNER, EXAMINING ATTORNEY

**Int. Cl.: 16**

**Prior U.S. Cls.: 2, 5, 22, 23, 29, 37, 38 and 50**

**Reg. No. 3,468,298**

**United States Patent and Trademark Office**

**Registered July 15, 2008**

**TRADEMARK  
PRINCIPAL REGISTER**

**KIARA**

CARTIERE DEL GARDA S.P.A. (ITALY CORPORATION)

VIALE ROVERETO, 15

I-38066 RIVA DEL GARDA (TN)

ITALY

THE MARK CONSISTS OF STANDARD CHARACTERS WITHOUT CLAIM TO ANY PARTICULAR FONT, STYLE, SIZE, OR COLOR.

OWNER OF INTERNATIONAL REGISTRATION  
0860508 DATED 4-15-2005, EXPIRES 4-15-2015.

FOR: CARDBOARD AND COATED PRINTING PAPERS IN SHEETS AND REELS, IN CLASS 16 (U.S. CLS. 2, 5, 22, 23, 29, 37, 38 AND 50).

SER. NO. 79-044,914, FILED 6-7-2007.

MICHAEL TANNER, EXAMINING ATTORNEY

**Int. Cl.: 26**

**Prior U.S. Cls.: 37, 39, 40, 42 and 50**

**Reg. No. 3,468,299**

**United States Patent and Trademark Office**

**Registered July 15, 2008**

**TRADEMARK  
PRINCIPAL REGISTER**

**HESTIA**

ADERANS HOLDINGS CO., LTD.  
6-3, SHINJUKU 1-CHOME,  
SHINJUKU-KUTOKYO 160-8429  
JAPAN

FOR: HAIR ORNAMENTS, NAMELY, WIGS, HAIRPIECES, HAIRPIECES FOR JAPANESE HAIR STYLING (KAMISHIN), BARRETTES (HAIR-SLIDES), FALSE HAIR FOR JAPANESE HAIR STYLING (KAMOJI), ORIENTAL HAIR PINS, ORNAMENTAL HAIR PINS FOR JAPANESE HAIR STYLING (KOGAI), BACK-HAIRPIECES FIXING PINS FOR JAPANESE HAIR STYLING (TABODOME), BACK-HAIRPIECES FOR JAPANESE HAIR STYLING (TABOMINO), TOUPEES (FALSE HAIR), HAIR RIBBONS FOR JAPANESE HAIR STYLING (TEGARA), HAIR TASSEL ORNAMENTS FOR JAPANESE HAIR STYLING (NAGAKE), HAIR NETS, HAIR BANDS, HAIR PINS AND GRIPS, PLASTIC, METAL AND RUBBER STOPS IN THE NATURE OF HAIR CLIPS, FLEXIBLE SHEETS HAVING ON

BOTH SIDES ADHESIVE SURFACES, AND HARD SHEETS HAVING ON ONE SIDE ROWS ORDER TO PREVENT THE FALSE HAIR FROM FALLING OFF THE HEAD, CHIGNONS FOR JAPANESE HAIR STYLING (MAGE), ORNAMENTAL COMBS FOR JAPANESE HAIR STYLING (MARUGUSHI), HAIR RIBBONS, HAIR TASSEL STRINGS FOR JAPANESE HAIR STYLING (MOTOYUI), IN CLASS 26 (U.S. CLS. 37, 39, 40, 42 AND 50).

THE MARK CONSISTS OF STANDARD CHARACTERS WITHOUT CLAIM TO ANY PARTICULAR FONT, STYLE, SIZE, OR COLOR.

OWNER OF INTERNATIONAL REGISTRATION  
0940253 DATED 5-18-2007, EXPIRES 5-18-2017.

SER. NO. 79-044,960, FILED 5-18-2007.

KELLEY WELLS, EXAMINING ATTORNEY

**Int. Cl.: 33**

**Prior U.S. Cls.: 47 and 49**

**United States Patent and Trademark Office**

**Reg. No. 3,468,300**

**Registered July 15, 2008**

**TRADEMARK  
PRINCIPAL REGISTER**

**CASA BURMESTER**

SOGEVINUS FINE WINES, S.A. (PORTUGAL  
SOCIÉTÉ ANONYME)  
AV. DIOGO LEITE, 344  
P-4400-111 VILA NOVA DE GAIA  
PORTUGAL

OWNER OF U.S. REG. NOS. 1,601,689 AND  
2,233,661.

FOR: TABLE WINES, IN CLASS 33 (U.S. CLS. 47  
AND 49).

THE ENGLISH TRANSLATION OF THE FOR-  
EIGN WORD(S) IN THE MARK IS: "BURMESTER  
HOUSE".

THE MARK CONSISTS OF STANDARD CHAR-  
ACTERS WITHOUT CLAIM TO ANY PARTICULAR  
FONT, STYLE, SIZE, OR COLOR.

SER. NO. 79-045,017, FILED 9-14-2007.

OWNER OF INTERNATIONAL REGISTRATION  
0940462 DATED 9-14-2007, EXPIRES 9-14-2017.

LAURIE KAUFMAN, EXAMINING ATTORNEY



**Int. Cl.: 33**

**Prior U.S. Cls.: 47 and 49**

**United States Patent and Trademark Office**

**Reg. No. 3,468,301**

**Registered July 15, 2008**

**TRADEMARK  
PRINCIPAL REGISTER**

**DIALOGO**

GANCIA S.P.A. (ITALY CORPORATION)  
CORSO LIBERTA', 70  
I-14053 CANELLI (AT), ITALY

OWNER OF INTERNATIONAL REGISTRATION  
0940525 DATED 9-11-2007, EXPIRES 9-11-2017.

FOR: ALCOHOLIC BEVERAGES, NAMELY,  
WINES, SPARKLING WINES, FRUIT WINES,  
GRAPE WINES, APERITIFS, APERITIFS WITH A  
WINE BASE, IN CLASS 33 (U.S. CLS. 47 AND 49).

THE ENGLISH TRANSLATION OF THE WORD  
"DIALOGO" IS DIALOGUE.

THE MARK CONSISTS OF STANDARD CHAR-  
ACTERS WITHOUT CLAIM TO ANY PARTICULAR  
FONT, STYLE, SIZE, OR COLOR.

SER. NO. 79-045,047, FILED 9-11-2007.

JAMES STEIN, EXAMINING ATTORNEY

**Int. Cls.: 9 and 42**

**Prior U.S. Cls.: 21, 23, 26, 36, 38, 100 and 101**

**United States Patent and Trademark Office**

**Reg. No. 3,468,302**

**Registered July 15, 2008**

**TRADEMARK  
SERVICE MARK  
PRINCIPAL REGISTER**

**altair**

ERSOL THIN FILM GMBH (FED REP GERMA-  
NY GMBH)  
SONNENTOR 2  
99098 ERFURT  
FED REP GERMANY

FOR: SOLAR CELLS FOR ELECTRICITY GEN-  
ERATION, SOLAR MODULES FOR ELECTRICITY  
GENERATION, SOLAR ELECTRICITY INSTALLA-  
TIONS, PHOTOVOLTAIC INSTALLATIONS FOR  
ELECTRICITY GENERATION; COMPONENTS  
AND SPARE PARTS FOR SOLAR POWER AND  
PHOTOVOLTAIC INSTALLATIONS, IN CLASS 9  
(U.S. CLS. 21, 23, 26, 36 AND 38).

FOR: TECHNICAL CONSULTANCY WITH RE-  
GARD TO THE CONSTRUCTION OF PHOTOVOL-  
TAIC INSTALLATIONS, TECHNICAL PLANNING  
OF PHOTOVOLTAIC INSTALLATIONS; RESEARCH

IN THE FIELD OF PHOTOVOLTAICS AND SOLAR  
TECHNOLOGY, IN PARTICULAR TECHNICAL DE-  
VELOPMENT OF COMPONENTS, EQUIPMENT  
AND SYSTEMS FOR PHOTOVOLTAICS AND FOR  
SOLAR POWER INSTALLATIONS, IN CLASS 42  
(U.S. CLS. 100 AND 101).

PRIORITY DATE OF 3-22-2007 IS CLAIMED.

OWNER OF INTERNATIONAL REGISTRATION  
0940535 DATED 9-14-2007, EXPIRES 9-14-2017.

SER. NO. 79-045,053, FILED 9-14-2007.

SHARON MEIER, EXAMINING ATTORNEY

**Int. Cls.: 18, 25 and 35**

**Prior U.S. Cls.: 1, 2, 3, 22, 39, 41, 100, 101 and 102**

**United States Patent and Trademark Office**

**Reg. No. 3,468,303**

**Registered July 15, 2008**

**TRADEMARK  
SERVICE MARK  
PRINCIPAL REGISTER**

**sixtyseven**

ROS AGUILAR, PASCUAL (SPAIN INDIVIDUAL)  
PARTIDA DE ALGODA, P2 Nº 37  
E-03296 ELCHE (ALICANTE)  
SPAIN

FOR: LEATHER AND IMITATION LEATHER;  
GOODS MADE OF LEATHER AND IMITATION  
LEATHER, NAMELY, HANDBAGS, WALLETS,  
AND BAGS IN THE NATURE OF ALL-PURPOSE  
CARRYING BAGS, ALL-PURPOSE SPORT BAGS,  
BELT BAGS, BAGS FOR UMBRELLAS, CLUTCH  
BAGS, DUFFEL BAGS, AND OVERNIGHT BAGS;  
ANIMALS SKINS AND HIDES; TRUNKS AND  
SUITCASES; UMBRELLAS, SUNSHADES IN THE  
NATURE OF PARASOLS AND SUN UMBRELLAS;  
WALKING STICKS, WHIPS, AND SADDLERY, IN  
CLASS 18 (U.S. CLS. 1, 2, 3, 22 AND 41).

FOR: CLOTHING, NAMELY, SHIRTS, SHORTS,  
PANTS, AND DRESSES; FOOTWEAR, AND HEAD-  
GEAR, NAMELY, HATS, CAPS, AND VISORS, IN  
CLASS 25 (U.S. CLS. 22 AND 39).

FOR: ADVERTISING AND BUSINESS MANAGE-  
MENT; BUSINESS ADMINISTRATION; PROVID-  
ING OFFICE FUNCTIONS, IN CLASS 35 (U.S. CLS.  
100, 101 AND 102).

OWNER OF INTERNATIONAL REGISTRATION  
0940654 DATED 5-2-2007, EXPIRES 5-2-2017.

OWNER OF U.S. REG. NO. 3,059,166.

SER. NO. 79-045,111, FILED 5-2-2007.

SHAILA SETTLES, EXAMINING ATTORNEY

**Int. Cl.: 7**

**Prior U.S. Cls.: 13, 19, 21, 23, 31, 34 and 35**

**Reg. No. 3,468,304**

**United States Patent and Trademark Office**

**Registered July 15, 2008**

**TRADEMARK  
PRINCIPAL REGISTER**



**LUNG CHEUNG M&E**

FUJIAN JIANYANG LUNGCHEUNG; MACHIN-  
ERY ELECTRON CO., LTD. (CHINA COR-  
PORATION)  
NO.16, BAOSHAN ROAD, JIANYANG  
354200 FUJIAN  
CHINA

FOR: CUTTING MACHINES; WINE PRESSES;  
FOUNDRY MACHINES; AIR COMPRESSORS FOR  
MACHINES; COMBINES; PAPERMAKING MA-  
CHINES; VAPORIZE MACHINES FOR CALICO;  
DIE-STAMPING MACHINES; BATTERY-POWERED  
ENGINES FOR MACHINES, IN CLASS 7 (U.S. CLS.  
13, 19, 21, 23, 31, 34 AND 35).

OWNER OF INTERNATIONAL REGISTRATION  
0940664 DATED 7-6-2007, EXPIRES 7-6-2017.

THE FIRST CHINESE CHARACTER WHOSE  
TRANSLITERATION IS "LONG" MEANS "DRA-  
GON"; THE SECOND CHINESE CHARACTER  
WHOSE TRANSLITERATION IS "XIANG" MEANS  
"FLYING". THE WORDING "LUNG CHEUNG" HAS  
NO MEANING IN A FOREIGN LANGUAGE.

THE TRANSLITERATION OF THE NON-LATIN  
CHARACTERS IN THE MARK IS: "LONG XIANG".

SER. NO. 79-045,114, FILED 7-6-2007.

DEBRA LEE, EXAMINING ATTORNEY

**Int. Cl.: 19**

**Prior U.S. Cls.: 1, 12, 33 and 50**

**United States Patent and Trademark Office**

**Reg. No. 3,468,305**

**Registered July 15, 2008**

**TRADEMARK  
PRINCIPAL REGISTER**

**PARKETOFF**

PARKETOFF; (SOCIETY WITH LIMITED LIABILITY) (RUSSIAN FED. SOCIETY WITH LIMITED LIABILITY)

STR. 1 D. 121, IZMAILOVSKIY PROSP.  
RU-105203 MOSKVA  
RUSSIAN FED.

PARQUET SLABS, PARQUET FLOOR BOARDS, IN CLASS 19 (U.S. CLS. 1, 12, 33 AND 50).

OWNER OF INTERNATIONAL REGISTRATION  
0940703 DATED 8-29-2007, EXPIRES 8-29-2017.

FOR: MATERIALS FOR FLOORING, NOT OF METAL, NAMELY, SOLID WOOD FLOORING, PARQUET FLOORING, LAMINATE FLOORING,

SER. NO. 79-045,131, FILED 8-29-2007.

JACLYN KIDWELL, EXAMINING ATTORNEY

Int. Cl.: 9

Prior U.S. Cls.: 21, 23, 26, 36 and 38

United States Patent and Trademark Office

Reg. No. 3,468,306

Registered July 15, 2008

TRADEMARK  
PRINCIPAL REGISTER



WALDHAUSEN GMBH & CO. KG (FED REP  
GERMANY GMBH & CO. KG)  
VON-HÜNEFELD-STRABE 53  
50829 KÖLN, FED REP GERMANY

OWNER OF INTERNATIONAL REGISTRATION  
0940930 DATED 9-24-2007, EXPIRES 9-24-2017.

FOR: RIDING HELMETS, SAFETY VESTS FOR  
EQUITATION, IN CLASS 9 (U.S. CLS. 21, 23, 26, 36  
AND 38).

SER. NO. 79-045,232, FILED 9-24-2007.

PRIORITY DATE OF 4-4-2007 IS CLAIMED.

ELI HELLMAN, EXAMINING ATTORNEY

**Int. Cls.: 9, 36 and 42**

**Prior U.S. Cls.: 21, 23, 26, 36, 38, 100, 101 and 102**

**United States Patent and Trademark Office**

**Reg. No. 3,468,307**

**Registered July 15, 2008**

**TRADEMARK  
SERVICE MARK  
PRINCIPAL REGISTER**

**nemesis**

ERSOL THIN FILM GMBH (FED REP GERMA-  
NY GMBH)  
SONNENTOR 2  
99098 ERFURT  
FED REP GERMANY

FOR: SOLAR CELLS FOR ELECTRICITY GEN-  
ERATION, SOLAR MODULES FOR ELECTRICITY  
GENERATION, SOLAR ELECTRICITY INSTALLA-  
TIONS, PHOTOVOLTAIC INSTALLATIONS FOR  
ELECTRICITY GENERATION; COMPONENTS  
AND SPARE PARTS FOR SOLAR POWER AND  
PHOTOVOLTAIC INSTALLATIONS, IN CLASS 9  
(U.S. CLS. 21, 23, 26, 36 AND 38).

FOR: FINANCIAL CONSULTANCY, FINANCIAL  
CONSULTANCY IN MATTERS RELATING TO SAV-  
INGS AND INVESTMENT, INVESTMENT CONSUL-  
TANCY; FINANCING SERVICES, FINANCIAL  
ANALYSIS, FINANCIAL INVESTMENT BROKER-  
AGE FEATURING MUTUAL FUNDS FOR THE  
FINANCING OF SOLAR ELECTRICITY INSTALLA-  
TIONS AND SOLAR POWER PLANTS, IN CLASS 36  
(U.S. CLS. 100, 101 AND 102).

FOR: TECHNICAL CONSULTANCY WITH RE-  
GARD TO THE CONSTRUCTION OF PHOTOVOL-  
TAIC INSTALLATIONS, TECHNICAL PLANNING  
OF PHOTOVOLTAIC INSTALLATIONS; RESEARCH  
IN THE FIELD OF PHOTOVOLTAICS AND SOLAR  
ENGINEERING, IN PARTICULAR TECHNICAL  
DEVELOPMENT OF COMPONENTS, EQUIPMENT  
AND SYSTEMS FOR PHOTOVOLTAICS AND FOR  
SOLAR POWER INSTALLATIONS, IN CLASS 42  
(U.S. CLS. 100 AND 101).

PRIORITY DATE OF 3-22-2007 IS CLAIMED.

OWNER OF INTERNATIONAL REGISTRATION  
0941151 DATED 9-14-2007, EXPIRES 9-14-2017.

SER. NO. 79-045,286, FILED 9-14-2007.

SHARON MEIER, EXAMINING ATTORNEY

Int. Cl.: 25

Prior U.S. Cls.: 22 and 39

United States Patent and Trademark Office

Reg. No. 3,468,308

Registered July 15, 2008

**TRADEMARK  
PRINCIPAL REGISTER**



MATARRESE BARBARA (ITALY INDIVIDUAL)  
VIA A. SANDULLI, 75  
I-00135 ROME  
ITALY

FOR: BATHING COSTUMES, IN CLASS 25 (U.S.  
CLS. 22 AND 39).

OWNER OF INTERNATIONAL REGISTRATION  
0941326 DATED 9-3-2007, EXPIRES 9-3-2017.

NO CLAIM IS MADE TO THE EXCLUSIVE  
RIGHT TO USE "BEACHWEAR", APART FROM  
THE MARK AS SHOWN.

THE TRADEMARK CONSISTS OF A RECTAN-  
GULAR LABEL, INSIDE OF WHICH THERE ARE  
SOME DROPS OF WATER; IN THE MIDDLE OF  
THE LABEL THERE ARE THE WORDS "EAU VIVE"  
AND "BEACHWEAR".

THE ENGLISH TRANSLATION OF THE FOR-  
EIGN WORD(S) IN THE MARK IS: "SPRING WATER  
BEACHWEAR".

SER. NO. 79-045,314, FILED 9-3-2007.

WILLIAM VERHOSEK, EXAMINING ATTORNEY



Int. Cls.: 29, 30 and 31

Prior U.S. Cls.: 1 and 46

United States Patent and Trademark Office

Reg. No. 3,468,309

Registered July 15, 2008

TRADEMARK  
PRINCIPAL REGISTER

**GREENARTICA**

DALLAS INTEL LTD (RUSSIAN FED. LTD LIAB  
CO)

PROFSOYUZNAYA STR., 93A

RU-117997 MOSCOW

RUSSIAN FED.

FOR: MEAT, FISH, POULTRY AND GAME; MEAT EXTRACTS; PRESERVED, DRIED AND COOKED FRUIT AND VEGETABLES; EDIBLE OILS AND FATS, NAMELY, PROCESSED EDIBLE ANCHOVY OILS AND FATS; BOUILLON, INCLUDING INSTANT BOUILLON; COCONUT FAT; EDIBLE FATS, NAMELY, SUET FOR FOOD; FROZEN PRECOOKED MEALS CONSISTING PRIMARILY OF MEAT, FISH, POULTRY OR VEGETABLES WITH PASTRY; FROZEN PRECOOKED MEALS CONSISTING PRIMARILY OF MEAT, FISH, POULTRY OR VEGETABLES WITH SAUCES, HERBS AND SPICES; RAISINS; TINNED MEAT; TINNED VEGETABLES; TINNED FISH; TINNED FRUITS; BOUILLON CONCENTRATES IN POWDER AND BLOCK FORM; SPINY LOBSTERS, NOT LIVE; COLZA OIL FOR FOOD, NAMELY, MAIZE OIL FOR FOOD, COCOA OIL FOR FOOD, COCONUT OIL FOR FOOD, CORN OIL FOR FOOD, SESAME OIL FOR FOOD, LINSEED OIL FOR FOOD, OLIVE OIL FOR FOOD, PALM OIL FOR FOOD, SUNFLOWER OIL FOR FOOD, RAPE OIL FOR FOOD, SOYA OIL FOR FOOD; MUSSELS, NOT LIVE; SHELLFISH, NOT LIVE; PROCESSED MEAT, NAMELY, PROCESSED LAMB MEAT, PROCESSED BEEF MEAT, PROCESSED PORK MEAT, PROCESSED RABBIT MEAT; PRESERVED MEAT; FROZEN PRECOOKED MEAT; POTATO FRITTERS; LOBSTERS, NOT LIVE; TOMATO PUREE; FROZEN FISH PRODUCTS, NAMELY, FROZEN FISH SAUSAGES AND FROZEN FISH CAKES; CRUSTACEANS, NOT LIVE; POULTRY, NOT LIVE, NAMELY, GOOSE, CHICKEN, TURKEY, DUCK, PHEASANT; VEGETABLE SALADS; FRUIT SALADS; TOMATO JUICE FOR COOKING; VEGETABLE JUICE FOR COOKING; PREPARATIONS FOR MAKING BOUILLON, INCLUDING INSTANT BOUILLON; PREPARATIONS FOR MAKING SOUP, INCLUDING INSTANT SOUP; PREPARATIONS FOR MAKING POTATO PUREE; SOUP, INCLUDING INSTANT SOUP; VEGETABLE SOUP, INCLUDING INSTANT VEGETABLE SOUP; OYSTERS, NOT

LIVE; FISH FILLETS; FROZEN FRUITS AND VEGETABLES; FROZEN VEGETABLE AND FRUIT MIX; FRUIT, STEWED, INCLUDING DRIED STEWED FRUIT; POTATO FLAKES; POTATO PUREE; POTATO CHIPS; FRUIT CHIPS; MEAT EXTRACTS, IN CLASS 29 (U.S. CL. 46).

FOR: COFFEE; TEA; COCOA; RICE; ARTIFICIAL COFFEE; PREPARATIONS MADE FROM CEREALS, NAMELY, BREAKFAST CEREALS AND CEREAL-BASED SNACK FOODS; PASTRY; CONDIMENT SAUCES; SPICES; VERMICELLI, INCLUDING INSTANT VERMICELLI; CLOVES; THICKENING AGENTS FOR COOKING FOODSTUFFS; COFFEE SUBSTITUTES; VEGETAL PREPARATIONS FOR USE AS COFFEE SUBSTITUTES; FARINACEOUS FOOD PASTES FOR HUMAN CONSUMPTION INCLUDING INSTANT PASTES; GINGER POWDER; CAPERS FOR USE AS CONDIMENTS; CURRY; GRUEL, WITH A MILK BASE, FOR FOOD, INCLUDING INSTANT GRUEL; BOILED RICE; KETCHUP; GROUND CINNAMON SPICES; GROATS IN THE NATURE OF PROCESSED GRAINS FOR HUMAN FOOD; MILLED CORN; ROASTED CORN; TURMERIC SPICES FOR FOOD; NOODLES INCLUDING INSTANT NOODLES; FROZEN FOOD PASTES WITH VEGETABLES FOR FLAVORING FOODS; MUESLI; COFFEE-BASED BEVERAGES; TEA-BASED BEVERAGES; CRUSHED PROCESSED OATS; HUSKED OATS; OAT FLAKES; PEPPER SPICES, INCLUDING WHITE, RED AND BLACK PEPPER SPICES; POPCORN; OAT-BASED FOOD, NAMELY, PROCESSED OATS, OATMEAL AND ROLLED OATS; RICE, INCLUDING INSTANT PREPARATION RICE; MEAT SAUCE; SOYA SAUCE; TOMATO SAUCE; SPAGHETTI; SEASONINGS; RUSKS; PROCESSED HERBS; FLAKES, NAMELY, OAT FLAKES AND CORN FLAKES; TEA, NAMELY, GREEN TEA, FRUIT TEA, BLACK TEA, FRUIT ICED TEA AND BLACK ICED TEA; CHIPS, NAMELY, CHOCOLATE CHIPS, CORN CHIPS, WHEAT CHIPS AND GRAIN CHIPS; PRESERVED GARDEN HERBS, NAMELY, PRESERVED BASIL, LEMON BALM, PEPPERMINT, OREGANO, PARSLEY, DILL AND SAGE SEASONING, IN CLASS 30 (U.S. CL. 46).

FOR: AGRICULTURAL, HORTICULTURAL AND FORESTRY PRODUCTS AND GRAINS NOT INCLUDED IN OTHER CLASSES, NAMELY, AGRICULTURAL SEEDS AND UNPROCESSED EDIBLE SEEDS; FRESH FRUITS AND VEGETABLES; FRESH BEANS; NATURAL WEED PLANTS FOR HUMAN CONSUMPTION; FRESH PEAS; FRESH MUSHROOMS; UNPROCESSED CEREAL GRAINS; RAW COCOA BEANS; FRESH POTATOES; LIVE SPINY LOBSTERS; LEAVES OF THE PALM TREE; FRESH ONIONS; LIVE MUSSELS; UNPROCESSED ALMONDS; LIVE SHELLFISH; UNPROCESSED OATS; LIVE LOBSTERS; UNPROCESSED PEPPERS; LIVE POULTRY; LIVE CRUSTACEANS; UNPROCESSED WHEAT; UNPROCESSED RICE; RYE SEED; LIVE FISH; UNPROCESSED LETTUCE; UNPROCESSED

BEETS; LIVE OYSTERS, IN CLASS 31 (U.S. CLS. 1 AND 46).

THE MARK CONSISTS OF STANDARD CHARACTERS WITHOUT CLAIM TO ANY PARTICULAR FONT, STYLE, SIZE, OR COLOR.

PRIORITY DATE OF 12-12-2006 IS CLAIMED.

OWNER OF INTERNATIONAL REGISTRATION 0941380 DATED 5-17-2007, EXPIRES 5-17-2017.

SER. NO. 79-045,363, FILED 5-17-2007.

DAVID YONTEF, EXAMINING ATTORNEY

**Int. Cl.: 25**

**Prior U.S. Cls.: 22 and 39**

**United States Patent and Trademark Office**

**Reg. No. 3,468,310**

**Registered July 15, 2008**

**TRADEMARK  
PRINCIPAL REGISTER**

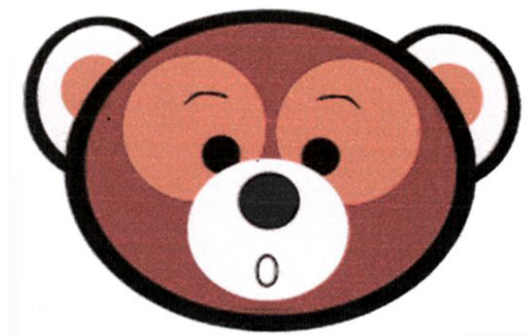

HENRY HALLILA (FINLAND INDIVIDUAL)  
HAPPOTIE 10 B 17  
FI-53920 LAPPEENRANTA, FINLAND

FOR: CLOTHING, NAMELY, SHIRTS, T-SHIRTS,  
TANK TOPS AND HATS, IN CLASS 25 (U.S. CLS. 22  
AND 39).

OWNER OF INTERNATIONAL REGISTRATION  
0941498 DATED 9-7-2007, EXPIRES 9-7-2017.

THE COLOR(S) BROWN, LIGHT BROWN, BLACK  
AND WHITE IS/ARE CLAIMED AS A FEATURE OF  
THE MARK.

THE MARK CONSISTS OF THE COLOR BROWN  
APPEARS IN THE FACE OF THE BEAR DESIGN;  
THE COLOR LIGHT BROWN APPEARS IN THE  
EYES AREAS AND EARS OF THE BEAR DESIGN;  
THE COLOR WHITE APPEARS IN THE MOUTH  
AND EAR AREAS OF THE BEAR DESIGN; THE  
COLOR BLACK APPEARS IN THE NOSE, MOUTH,  
EYES, BROWS AND THE OUTLINE OF THE MARK.

SER. NO. 79-045,400, FILED 9-7-2007.

HOWARD B. LEVINE, EXAMINING ATTORNEY

Int. Cl.: 7

Prior U.S. Cls.: 13, 19, 21, 23, 31, 34 and 35

United States Patent and Trademark Office

Reg. No. 3,468,311

Registered July 15, 2008

TRADEMARK  
PRINCIPAL REGISTER

ナノ・ゲッター

NANO GETTER

ASHIZAWA FINETECH LTD. (JAPAN CORPORATION)  
4-2, AKANEHAMA 1-CHOME,  
NARASHINO-SHI; CHIBA-KEN 275-8572  
JAPAN

FOR: GRINDING MACHINES FOR CHEMICAL PROCESSING; AGITATING MACHINES FOR CHEMICAL PROCESSING, NAMELY, AGITATORS FOR CIRCULATING LIQUID MEDIA; MIXING AND BLENDING MACHINES FOR CHEMICAL PROCESSING, IN CLASS 7 (U.S. CLS. 13, 19, 21, 23, 31, 34 AND 35).

OWNER OF INTERNATIONAL REGISTRATION  
0941519 DATED 9-13-2007, EXPIRES 9-13-2017.

THE TRANSLITERATION "NANO GETTA" HAS NO MEANING IN THE ENGLISH LANGUAGE BUT MAY BE PRONOUNCED AS "NANO GETTER".

THE TRANSLITERATION OF THE NON-LATIN CHARACTERS IN THE MARK IS "NANO GETTA".

SER. NO. 79-045,406, FILED 9-13-2007.

DEIRDRE ROBERTSON, EXAMINING ATTORNEY

**Int. Cl.: 14**

**Prior U.S. Cls.: 2, 27, 28 and 50**

**United States Patent and Trademark Office**

**Reg. No. 3,468,312**

**Registered July 15, 2008**

**TRADEMARK  
PRINCIPAL REGISTER**

**LIMES**

ICKLER GMBH (FED REP GERMANY GMBH)  
HIRSAUERSTR. 214  
75180 PFORZHEIM, FED REP GERMANY

OWNER OF INTERNATIONAL REGISTRATION  
0941556 DATED 9-24-2007, EXPIRES 9-24-2017.

FOR: WATCHES, IN CLASS 14 (U.S. CLS. 2, 27, 28  
AND 50).

SER. NO. 79-045,417, FILED 9-24-2007.

THE MARK CONSISTS OF STANDARD CHAR-  
ACTERS WITHOUT CLAIM TO ANY PARTICULAR  
FONT, STYLE, SIZE, OR COLOR.

MARK PILARO, EXAMINING ATTORNEY

**Int. Cl.: 14**

**Prior U.S. Cls.: 2, 27, 28 and 50**

**United States Patent and Trademark Office**

**Reg. No. 3,468,313**

**Registered July 15, 2008**

**TRADEMARK  
PRINCIPAL REGISTER**

**ARCHIMEDE**

ICKLER GMBH (FED REP GERMANY GMBH)  
HIRSAUERSTR. 214  
75180 PFORZHEIM, FED REP GERMANY

FOR: WATCHES, IN CLASS 14 (U.S. CLS. 2, 27, 28  
AND 50).

THE MARK CONSISTS OF STANDARD CHAR-  
ACTERS WITHOUT CLAIM TO ANY PARTICULAR  
FONT, STYLE, SIZE, OR COLOR.

OWNER OF INTERNATIONAL REGISTRATION  
0941708 DATED 9-24-2007, EXPIRES 9-24-2017.

THE NAME "ARCHIMEDE" DOES NOT IDENTI-  
FY A LIVING INDIVIDUAL.

THE WORD "ARCHIMEDE" HAS NO MEANING  
IN ENGLISH.

SER. NO. 79-045,462, FILED 9-24-2007.

MARK PILARO, EXAMINING ATTORNEY

**Int. Cl.: 5**

**Prior U.S. Cls.: 6, 18, 44, 46, 51 and 52**

**United States Patent and Trademark Office**

**Reg. No. 3,468,314**

**Registered July 15, 2008**

**TRADEMARK  
PRINCIPAL REGISTER**

**AFFLUNO**

NOVARTIS AG (SWITZERLAND CORPORATION)  
CH-4002 BASEL  
SWITZERLAND

FOR: VACCINES FOR HUMAN USE, IN CLASS 5  
(U.S. CLS. 6, 18, 44, 46, 51 AND 52).

THE MARK CONSISTS OF STANDARD CHARACTERS WITHOUT CLAIM TO ANY PARTICULAR FONT, STYLE, SIZE, OR COLOR.

PRIORITY DATE OF 7-3-2007 IS CLAIMED.

OWNER OF INTERNATIONAL REGISTRATION  
0941725 DATED 10-10-2007, EXPIRES 10-10-2017.

SER. NO. 79-045,470, FILED 10-10-2007.

SHAILA SETTLES, EXAMINING ATTORNEY

**Int. Cl.: 5**

**Prior U.S. Cls.: 6, 18, 44, 46, 51 and 52**

**United States Patent and Trademark Office**

**Reg. No. 3,468,315**

**Registered July 15, 2008**

**TRADEMARK  
PRINCIPAL REGISTER**

**AVFLUNOV**

NOVARTIS AG (SWITZERLAND CORPORATION)  
CH-4002 BASEL  
SWITZERLAND

FOR: VACCINES FOR HUMAN USE, IN CLASS 5  
(U.S. CLS. 6, 18, 44, 46, 51 AND 52).

THE MARK CONSISTS OF STANDARD CHARACTERS WITHOUT CLAIM TO ANY PARTICULAR FONT, STYLE, SIZE, OR COLOR.

PRIORITY DATE OF 7-3-2007 IS CLAIMED.

OWNER OF INTERNATIONAL REGISTRATION  
0941726 DATED 10-10-2007, EXPIRES 10-10-2017.

SER. NO. 79-045,471, FILED 10-10-2007.

SHAILA SETTLES, EXAMINING ATTORNEY



**Int. Cl.: 5**

**Prior U.S. Cls.: 6, 18, 44, 46, 51 and 52**

**United States Patent and Trademark Office**

**Reg. No. 3,468,316**

**Registered July 15, 2008**

**TRADEMARK  
PRINCIPAL REGISTER**

**ATFLUNOV**

NOVARTIS AG (SWITZERLAND CORPORATION)  
CH-4002 BASEL, SWITZERLAND

OWNER OF INTERNATIONAL REGISTRATION  
0941727 DATED 10-10-2007, EXPIRES 10-10-2017.

FOR: VACCINES FOR HUMAN USE, IN CLASS 5  
(U.S. CLS. 6, 18, 44, 46, 51 AND 52).

THE MARK CONSISTS OF STANDARD CHARACTERS WITHOUT CLAIM TO ANY PARTICULAR FONT, STYLE, SIZE, OR COLOR.

SER. NO. 79-045,472, FILED 10-10-2007.

PRIORITY DATE OF 7-3-2007 IS CLAIMED.

SHAILA SETTLES, EXAMINING ATTORNEY

**Int. Cl.: 5**

**Prior U.S. Cls.: 6, 18, 44, 46, 51 and 52**

**United States Patent and Trademark Office**

**Reg. No. 3,468,317**

**Registered July 15, 2008**

**TRADEMARK  
PRINCIPAL REGISTER**

**AFFLUNOV**

NOVARTIS AG (SWITZERLAND CORPORATION)  
CH-4002 BASEL  
SWITZERLAND

FOR: VACCINES FOR HUMAN USE, IN CLASS 5  
(U.S. CLS. 6, 18, 44, 46, 51 AND 52).

THE MARK CONSISTS OF STANDARD CHARACTERS WITHOUT CLAIM TO ANY PARTICULAR FONT, STYLE, SIZE, OR COLOR.

PRIORITY DATE OF 7-3-2007 IS CLAIMED.

OWNER OF INTERNATIONAL REGISTRATION  
0941728 DATED 10-10-2007, EXPIRES 10-10-2017.

SER. NO. 79-045,473, FILED 10-10-2007.

SHAILA SETTLES, EXAMINING ATTORNEY

Int. Cls.: 35, 36, 42 and 45

Prior U.S. Cls.: 100, 101 and 102

United States Patent and Trademark Office

Reg. No. 3,468,318

Registered July 15, 2008

**SERVICE MARK  
PRINCIPAL REGISTER**

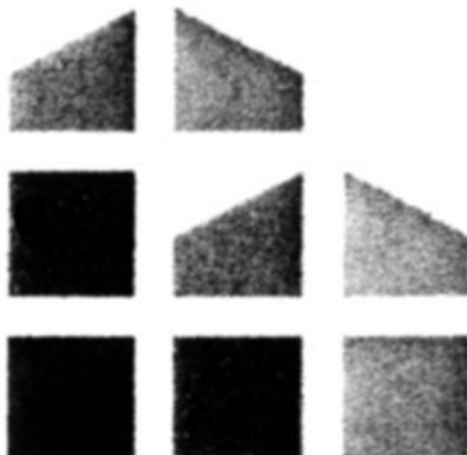

FONCIA (FRANCE SOCIÉTÉ ANONYME (SA))  
13 AVENUE LEBRUN  
F-92160 ANTONY  
FRANCE

FOR: ADVERTISING; COMPUTER FILE MANAGEMENT IN CONNECTION WITH REAL ESTATE AND THE RENTAL OF REAL ESTATE PROPERTY; ASSISTANCE AND ADVICE REGARDING BUSINESS ORGANIZATION AND MANAGEMENT; BUSINESS MANAGEMENT; BUSINESS ADMINISTRATION; BUSINESS RESEARCH AND INVESTIGATIONS; ASSISTANCE IN INDUSTRIAL AND COMMERCIAL ENTERPRISE MANAGEMENT AND ESPECIALLY CARRYING OUT STRATEGIC BUSINESS AUDITS FOR COMPANIES; MARKET STUDIES; PROFESSIONAL BUSINESS CONSULTING; BUSINESS VALUATIONS AND APPRAISALS; ACCOUNTING; CONSULTING AND INFORMATION CONCERNING ACCOUNTING; TAX DECLARATION PREPARATION; ACCOUNT AUDITING; BOOKKEEPING; DRAWING UP OF STATEMENTS OF ACCOUNTS, IN CLASS 35 (U.S. CLS. 100, 101 AND 102).

FOR: REAL ESTATE AGENCIES; REAL ESTATE AFFAIRS, NAMELY, REAL ESTATE ADVERTISING SERVICES; PROVIDING HOME WARRANTY ADMINISTRATION; VALUATIONS, BUILDING AND PROPERTY MANAGEMENT; FLAT AND OFFICE RENTAL; RENTAL MANAGEMENT FOR REAL ESTATE PROPERTIES; ADVICE ON REAL ESTATE RENTAL; REAL ESTATE BROKERAGE; SERVICES

OF REAL ESTATE MANAGEMENT PROVIDED BY MANAGEMENT AGENTS; REAL ESTATE TRANSACTIONS, NAMELY LENDING SERVICES; EVALUATIONS AND APPRAISALS OF APARTMENTS, APARTMENT BUILDINGS, INDUSTRIAL AND COMMERCIAL BUILDINGS, COMMERCIAL LAND, INDUSTRIAL LAND AND RURAL AREAS; INSURANCE AGENCIES; LIFE INSURANCE BROKERAGE; INSURANCE BROKERAGE; FINANCIAL AND MONETARY AFFAIRS, NAMELY, FINANCIAL AND INSURANCE INFORMATION AND CONSULTING; INSURANCE; FOREIGN EXCHANGE TRANSACTIONS; FINANCIAL MANAGEMENT; FISCAL VALUATIONS AND ASSESSMENTS; FINANCIAL LOANS AND ESPECIALLY FINANCIAL LOANS FOR THE PURCHASE AND THE CONSTRUCTION OF REAL ESTATE PROPERTY; FINANCIAL INVESTMENT IN THE FIELD OF REAL ESTATE; BUSINESS CONSULTING IN THE CONTEXT OF REAL ESTATE ACQUISITIONS, STOCK EXCHANGE LISTINGS FOR COMPANIES; CAPITAL CONSTITUTION AND INVESTMENT IN THE FORM OF REAL ESTATE WEALTH INVESTMENT TO BENEFIT FROM TAX REDUCTIONS OR FROM AMORTISATION MEASURES ON INVESTED CAPITAL; CONSULTING AND INFORMATION ON FISCAL EVALUATIONS AND ASSESSMENTS; FINANCIAL ANALYSIS, ESPECIALLY ACCOUNTS ANALYSIS; PROFESSIONAL CONSULTING RELATING TO FINANCE, IN CLASS 36 (U.S. CLS. 100, 101 AND 102).

FOR: EVALUATION AND TESTING OF REAL ESTATE FOR THE PRESENCE OF HAZARDOUS MATERIALS; CARRYING OUT TECHNICAL SURVEYS WITH REGARD TO THE PRESENCE OF ASBESTOS, LEAD, TERMITES OR ANY TYPE OF PARASITE IN THE CONTEXT OF A REAL ESTATE EXPERT; COMPUTER SOFTWARE DESIGN AND COMPUTER PROGRAMMING IN THE FIELD OF REAL ESTATE MATTERS; UPDATING AND MAINTENANCE OF COMPUTER SOFTWARE ESPECIALLY IN THE INSURANCE AND REAL ESTATE SPHERE; ENGINEERING SERVICES FOR BUILDING AND PROPERTY CONDITION ASSESSMENT; FACILITY MANAGEMENT, REPAIR AND RESTORATION, BUILDING INSTRUMENTATION AND MONITORING, AND ENVIRONMENTAL CONSULTING; CONDUCTING ENGINEERING SURVEYS, IN CLASS 42 (U.S. CLS. 100 AND 101).

FOR: LEGAL SERVICES IN INSURANCE AND REAL ESTATE, NAMELY, PROVIDING LEGAL CONSULTATION IN THE FIELD OF INSURANCE AND REAL ESTATE, IN CLASS 45 (U.S. CLS. 100 AND 101).

PRIORITY DATE OF 11-27-2006 IS CLAIMED.

OWNER OF INTERNATIONAL REGISTRATION 0941800 DATED 5-4-2007, EXPIRES 5-4-2017.

SER. NO. 79-045,500, FILED 5-4-2007.

ANTHONY RINKER, EXAMINING ATTORNEY

**Int. Cl.: 33**

**Prior U.S. Cls.: 47 and 49**

**United States Patent and Trademark Office**

**Reg. No. 3,468,319**

**Registered July 15, 2008**

**TRADEMARK  
PRINCIPAL REGISTER**

**PORTO CRYSTAL**

SOGEVINUS FINE WINES, S.A. (PORTUGAL  
SOCIÉTÉ ANONYME)  
AV. DIOGO LEITE, 344  
P-4400-111 VILA NOVA DE GAIA  
PORTUGAL

NO CLAIM IS MADE TO THE EXCLUSIVE  
RIGHT TO USE "PORTO", APART FROM THE  
MARK AS SHOWN.

FOR: PORT WINES, FOR EXPORT, IN CLASS 33  
(U.S. CLS. 47 AND 49).

THE FOREIGN WORDING IN THE MARK  
TRANSLATES INTO ENGLISH AS "PORT".

THE MARK CONSISTS OF STANDARD CHAR-  
ACTERS WITHOUT CLAIM TO ANY PARTICULAR  
FONT, STYLE, SIZE, OR COLOR.

SER. NO. 79-045,508, FILED 9-24-2007.

OWNER OF INTERNATIONAL REGISTRATION  
0941820 DATED 9-24-2007, EXPIRES 9-24-2017.

LAURIE KAUFMAN, EXAMINING ATTORNEY

**Int. Cl.: 33**

**Prior U.S. Cls.: 47 and 49**

**United States Patent and Trademark Office**

**Reg. No. 3,468,320**

**Registered July 15, 2008**

**TRADEMARK  
PRINCIPAL REGISTER**

**ROCHA**

SOGEVINUS FINE WINES, S.A. (PORTUGAL  
SOCIÉTÉ ANONYME)  
AV. DIOGO LEITE, 344  
P-4400-111 VILA NOVA DE GAIA  
PORTUGAL

FOR: WINE, PORT WINES AND EAUX-DE-VIE,  
IN CLASS 33 (U.S. CLS. 47 AND 49).

THE MARK CONSISTS OF STANDARD CHAR-  
ACTERS WITHOUT CLAIM TO ANY PARTICULAR  
FONT, STYLE, SIZE, OR COLOR.

OWNER OF INTERNATIONAL REGISTRATION  
0942410 DATED 9-14-2007, EXPIRES 9-14-2017.

THE ENGLISH TRANSLATION OF THE FOR-  
EIGN WORD(S) IN THE MARK IS ROCK.

SER. NO. 79-045,759, FILED 9-14-2007.

Laurie Kaufman, Examining Attorney

**Int. Cl.: 33**

**Prior U.S. Cls.: 47 and 49**

**United States Patent and Trademark Office**

**Reg. No. 3,468,321**

**Registered July 15, 2008**

**TRADEMARK  
PRINCIPAL REGISTER**

**BROTHERS IN ARMS NO. 6**

BALRATH PTY LTD (AUSTRALIA CORPORATION)  
LAKE PLAINS ROAD  
LANGHORNE CREEK SA 5255  
AUSTRALIA

OWNER OF INTERNATIONAL REGISTRATION  
0942767 DATED 10-15-2007, EXPIRES 10-15-2017.

FOR: WINE, IN CLASS 33 (U.S. CLS. 47 AND 49).

OWNER OF U.S. REG. NO. 2,808,266.

THE MARK CONSISTS OF STANDARD CHARACTERS WITHOUT CLAIM TO ANY PARTICULAR FONT, STYLE, SIZE, OR COLOR.

SER. NO. 79-045,894, FILED 10-15-2007.

PRIORITY DATE OF 9-7-2007 IS CLAIMED.

DOMINIC FATHY, EXAMINING ATTORNEY

Int. Cl.: 20

Prior U.S. Cls.: 2, 13, 22, 25, 32 and 50

United States Patent and Trademark Office

Reg. No. 3,468,322

Registered July 15, 2008

TRADEMARK  
PRINCIPAL REGISTER

# LA CIVIDINA

LA CIVIDINA SRL (ITALY JOINT-STOCK COMPANY WITH LIMITED LIABILITY)  
VIA CIVIDINA, 176  
I-33030 MARTIGNACCO (UD)  
ITALY

FOR: ARMCHAIRS; DECORATIVE BEAD CURTAINS; BED FRAMES; BEDROOM FURNITURE; BEDS; BENCHES; WORK BENCHES; VENETIAN BLINDS; WINDOW BLINDS; WOOD CHOPPING BLOCK TABLES; BOOK CASES; BOOSTER SEATS; NON-METAL TOOL BOXES; PLASTIC BOXES; WOOD BOXES; FURNITURE TOY BOXES; JEWELRY BOXES NOT OF METAL; LETTER BOXES NOT OF METAL; FILING CABINETS; KITCHEN CABINETS; FURNITURE CABINETS; NON-METAL CABLE CLIPS; CARPET COASTERS FOR PROTECTING FURNITURE LEGS; NON-METAL CASTERS; PLASTIC CASTERS; CHAIR PADS; CHAIRS; DECK CHAIRS; FURNITURE CHESTS; FURNITURE TOOL CHESTS NOT OF METAL; NON-METAL MONEY CLIPS; NON-METAL PIPE CLIPS; FITTED FABRIC FURNITURE COVERS; CREDENZAS; CURTAIN RAILS; NON-METAL CURTAIN RINGS; CURTAIN RODS; CUSHIONS; SEAT CUSHIONS; PLASTIC CAKE DECORATIONS; GIFT PACKAGE DECORATIONS MADE OF PLASTICS; DESKS; FURNITURE, NAMELY, SALES AND DISPLAY COUNTERS; DIVANS; ROOM DIVIDERS; DIVIDERS FOR DRAWERS; DOORS FOR FURNITURE; FURNITURE DRAFTING TABLES; FOOTSTOOLS; PICTURE FRAME MOLDINGS; EMBROIDERY FRAMES; FURNITURE FRAMES; PICTURE FRAMES; FURNITURE; BUMPER GUARDS FOR

FURNITURE; LAWN FURNITURE; LIVING ROOM FURNITURE; OFFICE FURNITURE; OUTDOOR FURNITURE; FURNITURE MOLDINGS; FURNITURE PARTITIONS; FURNITURE PARTS, NAMELY, CHAIR LEGS, TABLE LEGS, TABLE LEAVES, ARM RESTS; HIGHCHAIRS; LOVE SEATS; MATTRESSES; FURNITURE MIRRORS; DECORATIVE MOBILES; OTTOMANS; MOVABLE OFFICE PARTITIONS; PILLOWS; FURNITURE RECLINERS; FURNITURE SCREENS; FIRE SCREENS FOR DOMESTIC USE; FURNITURE SEATS; SOFAS; STOOLS; INDUSTRIAL WORK TABLES; FURNITURE TABLES, IN CLASS 20 (U.S. CLS. 2, 13, 22, 25, 32 AND 50).

THE MARK CONSISTS OF STANDARD CHARACTERS WITHOUT CLAIM TO ANY PARTICULAR FONT, STYLE, SIZE, OR COLOR.

PRIORITY DATE OF 7-10-2006 IS CLAIMED.

OWNER OF INTERNATIONAL REGISTRATION 0904247 DATED 9-18-2006, EXPIRES 9-18-2016.

THE WORDING "LA CIVINIDA" HAS NO MEANING IN A FOREIGN LANGUAGE.

SER. NO. 79-045,943, FILED 12-13-2006.

LINDA E. BLOHM, EXAMINING ATTORNEY



**Int. Cls.: 1 and 17**

**Prior U.S. Cls.: 1, 5, 6, 10, 12, 13, 26, 35, 46 and 50**

**United States Patent and Trademark Office**

**Reg. No. 3,468,323**

**Registered July 15, 2008**

**TRADEMARK  
PRINCIPAL REGISTER**



SIKA AG (SWITZERLAND CORPORATION)  
ZUGERSTRASSE 50  
CH-6341 BAAR  
SWITZERLAND

FOR: CHEMICALS USED IN INDUSTRY; UN-PROCESSED ARTIFICIAL AND SYNTHETIC RESINS AND UNPROCESSED PLASTICS ALL IN POWDER, LIQUID, OR PASTE FORM; ADHESIVES FOR INDUSTRIAL PURPOSES, IN CLASS 1 (U.S. CLS. 1, 5, 6, 10, 26 AND 46).

FOR: SEALING MATERIALS FOR INDUSTRIAL PURPOSES, NAMELY, ADHESIVE SEALANT AND CAULKING COMPOUND, SEALANT COMPOUNDS FOR JOINTS, AND WATERPROOF SEALANTS; WATERPROOF PACKING MATERIALS IN THE NATURE OF TAPES FOR FORMING SEALS ON JOINTS, IN CLASS 17 (U.S. CLS. 1, 5, 12, 13, 35 AND 50).

PRIORITY DATE OF 6-13-2007 IS CLAIMED.

OWNER OF INTERNATIONAL REGISTRATION  
0942819 DATED 10-2-2007, EXPIRES 10-2-2017.

NO CLAIM IS MADE TO THE EXCLUSIVE RIGHT TO USE "ADVANCED TECHNOLOGY", APART FROM THE MARK AS SHOWN.

THE COLOR(S) YELLOW, RED, LIGHT GREY, DARK GREY, WHITE, AND BLACK IS/ARE CLAIMED AS A FEATURE OF THE MARK.

THE COLOR RED APPEARS IN THE NUMBER "4", WHICH ALSO FORMS THE "A" IN "AT"; THE COLOR YELLOW APPEARS IN THE BACKGROUND CIRCLE; THE COLOR LIGHT GRAY APPEARS IN THE BOTTOM LEFT HAND PART OF THE "A" IN "AT" AND IN THE "T" IN "AT"; THE COLOR LIGHT GRAY ALSO APPEARS IN THE WORDING "ADVANCED TECHNOLOGY"; THE COLOR DARK GRAY APPEARS IN THE WORD "ALL"; THE COLOR BLACK APPEARS AS SHADOWING BEHIND THE AT; THE COLOR WHITE APPEARS AS OUTLINING AROUND THE WORDS "ADVANCED TECHNOLOGY".

SER. NO. 79-045,966, FILED 10-2-2007.

COLLEEN KEARNEY, EXAMINING ATTORNEY

**Int. Cl.: 28**

**Prior U.S. Cls.: 22, 23, 38 and 50**

**United States Patent and Trademark Office**

**Reg. No. 3,468,324**

**Registered July 15, 2008**

**TRADEMARK  
PRINCIPAL REGISTER**



SUNLINE CO., LTD. (JAPAN CORPORATION)  
1600-21, KUGAMACHI,  
IWAKUNI-SHI; YAMAGUCHI 742-0315  
JAPAN

FOR: FISHING TACKLES, NAMELY, FISHING  
LINES, FISHING SPOOLS, FISHING BOXES AND  
BAGS, FISHING HOOKS, FISHING FLOATS, LAND-  
ING NETS FOR ANGLERS AND LURES FOR FISH-  
ING, IN CLASS 28 (U.S. CLS. 22, 23, 38 AND 50).

PRIORITY DATE OF 5-15-2007 IS CLAIMED.

OWNER OF INTERNATIONAL REGISTRATION  
0942925 DATED 9-26-2007, EXPIRES 9-26-2017.

SER. NO. 79-046,000, FILED 9-26-2007.

MICHAEL WEBSTER, EXAMINING ATTORNEY

**Int. Cl.: 41**

**Prior U.S. Cls.: 100, 101 and 107**

**United States Patent and Trademark Office**

**Reg. No. 3,468,325**

**Registered July 15, 2008**

**SERVICE MARK  
PRINCIPAL REGISTER**

# LEADING TEAMS

LEADING TEAMS AUSTRALIA PTY LIMITED  
(AUSTRALIA AUSTRALIAN PROPRIETARY  
COMPANY)  
122 CHETWYND STREET  
NORTH MELBOURNE, AUSTRALIA VIC 3051

FOR: EDUCATION AND TRAINING SERVICES,  
NAMELY, PROVIDING SEMINARS, CLASSES AND  
WORKSHOPS IN THE FIELD OF LEADERSHIP  
AND PERSONAL DEVELOPMENT; EDUCATION  
AND TRAINING SERVICES, NAMELY, ARRAN-  
GING AND CONDUCTING SEMINARS, CLASSES  
AND WORKSHOPS FOR SPORTING CLUBS, COR-  
PORATE ORGANIZATIONS AND SCHOOLS IN  
RELATION TO LEADERSHIP, TEAMWORK,  
COACHING MENTORING AND PERSONAL DE-  
VELOPMENT, IN CLASS 41 (U.S. CLS. 100, 101 AND  
107).

THE MARK CONSISTS OF STANDARD CHAR-  
ACTERS WITHOUT CLAIM TO ANY PARTICULAR  
FONT, STYLE, SIZE, OR COLOR.

PRIORITY DATE OF 8-31-2007 IS CLAIMED.

OWNER OF INTERNATIONAL REGISTRATION  
0943211 DATED 9-26-2007, EXPIRES 9-26-2017.

SER. NO. 79-046,105, FILED 9-26-2007.

MICHAEL WEBSTER, EXAMINING ATTORNEY

**Int. Cl.: 25**

**Prior U.S. Cls.: 22 and 39**

**United States Patent and Trademark Office**

**Reg. No. 3,468,326**

**Registered July 15, 2008**

**TRADEMARK  
PRINCIPAL REGISTER**



CAZZOLA GAETANO (ITALY CAZZOLA GAETANO, A SOLE PROPRIETORSHIP OF ITALY, COMPOSED OF CAZZOLA GAETANO, A CITIZEN OF ITALY.)

VIALE MILANO,  
FRAZ. ALTE CECCATO; I-36041 MONTECCHIO  
MAGGIORE (VI)  
ITALY

FOR: SOCKS, STOCKINGS, TIGHTS; UNDERWEAR, NAMELY, BRAS, CAMISOLES, PETTICOATS, CORSETS, UNDERSHIRTS, UNDERPANTS, SLIPS, IN CLASS 25 (U.S. CLS. 22 AND 39).

PRIORITY DATE OF 6-8-2007 IS CLAIMED.

OWNER OF INTERNATIONAL REGISTRATION  
0943317 DATED 9-5-2007, EXPIRES 9-5-2017.

THE COLOR(S) YELLOW, OCHRE, ORANGE, BLACK AND WHITE IS/ARE CLAIMED AS A FEATURE OF THE MARK.

THE MARK CONSISTS OF A BLACK SQUARE WITH A DOUBLE BORDER; INSIDE, STARTING FROM ABOVE, THERE IS A YELLOW, OCHRE AND ORANGE GRAPHIC SIGN, BELOW THERE IS THE WORDING "GAETANO" AND "CAZZOLA" IN WHITE BLOCK LETTERS PUT ON TWO LINES.

SER. NO. 79-046,144, FILED 9-5-2007.

BRIAN NEVILLE, EXAMINING ATTORNEY

**Int. Cl.: 25**

**Prior U.S. Cls.: 22 and 39**

**United States Patent and Trademark Office**

**Reg. No. 3,468,327**

**Registered July 15, 2008**

**TRADEMARK  
PRINCIPAL REGISTER**

**GOONDY WINDY**

ARTEXTYL (FRANCE SOCIÉTÉ À RESPONSABILITÉ LIMITÉE)  
4, RUE CHARLES PERRAULT  
F-69100 VILLEURBANNE, FRANCE

FOR: CLOTHING, NAMELY, BONNETS, GLOVES, SOCKS, BELTS, SUSPENDERS, TEE-SHIRTS, PULLOVERS, POLO SHIRTS, SWEAT-SHIRTS, SHIRTS, TROUSERS, WINDCHEATER, PARKAS, JACKETS, SKI OVERALLS, SHORTS, BERMUDA SHORTS, BATHING SUITS, SKIRTS, DRESSES; FOOTWEAR, HEADWEAR, IN CLASS 25 (U.S. CLS. 22 AND 39).

THE MARK CONSISTS OF STANDARD CHARACTERS WITHOUT CLAIM TO ANY PARTICULAR FONT, STYLE, SIZE, OR COLOR.

OWNER OF INTERNATIONAL REGISTRATION  
0724091 DATED 11-16-1999, EXPIRES 11-16-2009.

SER. NO. 79-046,193, FILED 5-10-2007.

DAVID TAYLOR, EXAMINING ATTORNEY

**Int. Cls.: 9 and 11**

**Prior U.S. Cls.: 13, 21, 23, 26, 31, 34, 36 and 38**

**United States Patent and Trademark Office**

**Reg. No. 3,468,328**

**Registered July 15, 2008**

**TRADEMARK  
PRINCIPAL REGISTER**



PC ELECTRIC GESELLSCHAFT M.B.H. (AUSTRIA LTD LIAB CO)  
DIESSEITS 145  
A-4973 ST. MARTIN IM INNKREIS, AUSTRIA

FOR: ELECTRIC AND ELECTRONIC APPARATUS, NAMELY, ADAPTER PLUGS, ADAPTERS, CONNECTORS FOR ELECTRONIC CIRCUITS, DISTRIBUTION TRANSFORMERS AND DISTRIBUTION BOXES, PLUG ADAPTORS, PLUG CONNECTORS, PLUG-IN CONNECTORS, ELECTRIC CABLES AND CABLE REELS, PLASTIC CONDUIT FOR ELECTRICAL USE, PLASTIC CONDUIT FOR USE IN ELECTRICAL INSTALLATIONS, ELECTRONIC AND LIGHT SWITCHES, IN CLASS 9 (U.S. CLS. 21, 23, 26, 36 AND 38).

FOR: LIGHTING FIXTURES, SOCKETS FOR ELECTRIC LIGHTS, IN CLASS 11 (U.S. CLS. 13, 21, 23, 31 AND 34).

PRIORITY DATE OF 4-25-2007 IS CLAIMED.

OWNER OF INTERNATIONAL REGISTRATION 0943478 DATED 9-3-2007, EXPIRES 9-3-2017.

THE COLOR(S) RED AND WHITE IS/ARE CLAIMED AS A FEATURE OF THE MARK.

THE MARK CONSISTS OF THE LETTERS "PCE" IN WHITE WITHIN A RED RECTANGLE.

SER. NO. 79-046,241, FILED 9-3-2007.

REBECCA POVARCHUK, EXAMINING ATTORNEY

**Int. Cls.: 37 and 40**

**Prior U.S. Cls.: 100, 103 and 106**

**United States Patent and Trademark Office**

**Reg. No. 3,468,329**

**Registered July 15, 2008**

**SERVICE MARK  
PRINCIPAL REGISTER**



KABUSHIKI KAISHA KYOTOSANGYO (JAPAN CORPORATION)  
70-1, MEGAWA, MAKISHIMA-CHO  
UJI-SHI  
KYOTO 611-0041, JAPAN

OWNER OF INTERNATIONAL REGISTRATION  
0943778 DATED 10-4-2007, EXPIRES 10-4-2017.

FOR: CLEANING, CARING AND REPAIR OF FUR AND LEATHER GOODS; WASHING AND LAUNDRY OF CLOTHING; PRESSING OF CLOTHING; MENDING OF CLOTHING; RENOVATION OF CLOTHING IN THE NATURE OF CLOTHING REPAIR, IN CLASS 37 (U.S. CLS. 100, 103 AND 106).

THE NON-LATIN CHARACTER(S) IN THE MARK TRANSLITERATES INTO "KEAMENTE", AND THIS MEANS [NO SPECIFIC MEANING] IN ENGLISH.

FOR: PROCESSING AND WORKING TREATMENT INCLUDING DRYING TREATMENT OF FABRIC, CLOTHING, AND FUR, NAMELY, CONDITIONING, DYEING, DEODORIZING AND COLOR FIXING OF CLOTHING, FABRIC, AND FUR, IN CLASS 40 (U.S. CLS. 100, 103 AND 106).

THE NON-LATIN CHARACTERS IN THE MARK TRANSLITERATE INTO KEAMENTE, AND THIS HAS NO SPECIFIC MEANING IN ENGLISH.

SER. NO. 79-046,357, FILED 10-4-2007.

JAMES MACFARLANE, EXAMINING ATTORNEY

**Int. Cl.: 5**

**Prior U.S. Cls.: 6, 18, 44, 46, 51 and 52**

**United States Patent and Trademark Office**

**Reg. No. 3,468,330**

**Registered July 15, 2008**

**TRADEMARK  
PRINCIPAL REGISTER**

**PATUPIGIN**

NOVARTIS AG (SWITZERLAND CORPORATION)  
CH-4002 BASEL  
SWITZERLAND

FOR: PHARMACEUTICAL PREPARATIONS FOR  
USE IN ONCOLOGY, IN CLASS 5 (U.S. CLS. 6, 18, 44,  
46, 51 AND 52).

THE MARK CONSISTS OF STANDARD CHAR-  
ACTERS WITHOUT CLAIM TO ANY PARTICULAR  
FONT, STYLE, SIZE, OR COLOR.

PRIORITY DATE OF 9-28-2007 IS CLAIMED.

OWNER OF INTERNATIONAL REGISTRATION  
0943896 DATED 11-13-2007, EXPIRES 11-13-2017.

SER. NO. 79-046,400, FILED 11-13-2007.

LAURIE KAUFMAN, EXAMINING ATTORNEY



**Int. Cl.: 5**

**Prior U.S. Cls.: 6, 18, 44, 46, 51 and 52**

**United States Patent and Trademark Office**

**Reg. No. 3,468,331**

**Registered July 15, 2008**

**TRADEMARK  
PRINCIPAL REGISTER**

**PATUVIGIN**

NOVARTIS AG (SWITZERLAND CORPORATION)  
CH-4002 BASEL  
SWITZERLAND

FOR: PHARMACEUTICAL PREPARATIONS FOR  
USE IN ONCOLOGY, IN CLASS 5 (U.S. CLS. 6, 18, 44,  
46, 51 AND 52).

THE MARK CONSISTS OF STANDARD CHAR-  
ACTERS WITHOUT CLAIM TO ANY PARTICULAR  
FONT, STYLE, SIZE, OR COLOR.

PRIORITY DATE OF 9-28-2007 IS CLAIMED.

OWNER OF INTERNATIONAL REGISTRATION  
0943898 DATED 11-13-2007, EXPIRES 11-13-2017.

SER. NO. 79-046,402, FILED 11-13-2007.

LAURIE KAUFMAN, EXAMINING ATTORNEY

**Int. Cl.: 5**

**Prior U.S. Cls.: 6, 18, 44, 46, 51 and 52**

**United States Patent and Trademark Office**

**Reg. No. 3,468,332**

**Registered July 15, 2008**

**TRADEMARK  
PRINCIPAL REGISTER**

**TUVYGIN**

NOVARTIS AG (SWITZERLAND CORPORATION)  
CH-4002 BASEL  
SWITZERLAND

OWNER OF INTERNATIONAL REGISTRATION  
0943899 DATED 11-13-2007, EXPIRES 11-13-2017.

FOR: PHARMACEUTICAL PREPARATIONS FOR  
USE IN ONCOLOGY, IN CLASS 5 (U.S. CLS. 6, 18, 44,  
46, 51 AND 52).

OWNER OF U.S. REG. NO. 2,788,703.

THE MARK CONSISTS OF STANDARD CHAR-  
ACTERS WITHOUT CLAIM TO ANY PARTICULAR  
FONT, STYLE, SIZE, OR COLOR.

SER. NO. 79-046,403, FILED 11-13-2007.

PRIORITY DATE OF 9-28-2007 IS CLAIMED.

Laurie Kaufman, Examining Attorney

**Int. Cl.: 5**

**Prior U.S. Cls.: 6, 18, 44, 46, 51 and 52**

**United States Patent and Trademark Office**

**Reg. No. 3,468,333**

**Registered July 15, 2008**

**TRADEMARK  
PRINCIPAL REGISTER**

# TUBLIGIN

NOVARTIS AG (SWITZERLAND CORPORATION)  
CH-4002 BASEL  
SWITZERLAND

FOR: PHARMACEUTICAL PREPARATIONS FOR  
USE IN ONCOLOGY, IN CLASS 5 (U.S. CLS. 6, 18, 44,  
46, 51 AND 52).

THE MARK CONSISTS OF STANDARD CHAR-  
ACTERS WITHOUT CLAIM TO ANY PARTICULAR  
FONT, STYLE, SIZE, OR COLOR.

PRIORITY DATE OF 9-28-2007 IS CLAIMED.

OWNER OF INTERNATIONAL REGISTRATION  
0943900 DATED 11-13-2007, EXPIRES 11-13-2017.

SER. NO. 79-046,404, FILED 11-13-2007.

LAURIE KAUFMAN, EXAMINING ATTORNEY

**Int. Cl.: 5**

**Prior U.S. Cls.: 6, 18, 44, 46, 51 and 52**

**United States Patent and Trademark Office**

**Reg. No. 3,468,334**

**Registered July 15, 2008**

**TRADEMARK  
PRINCIPAL REGISTER**

**GEPAXYM**

NOVARTIS AG (SWITZERLAND CORPORATION)  
CH-4002 BASEL  
SWITZERLAND

OWNER OF INTERNATIONAL REGISTRATION  
0943903 DATED 11-13-2007, EXPIRES 11-13-2017.

FOR: PHARMACEUTICAL PREPARATIONS FOR  
USE IN ONCOLOGY, IN CLASS 5 (U.S. CLS. 6, 18, 44,  
46, 51 AND 52).

OWNER OF U.S. REG. NO. 3,023,277.

THE MARK CONSISTS OF STANDARD CHAR-  
ACTERS WITHOUT CLAIM TO ANY PARTICULAR  
FONT, STYLE, SIZE, OR COLOR.

SER. NO. 79-046,407, FILED 11-13-2007.

PRIORITY DATE OF 9-28-2007 IS CLAIMED.

LAURIE KAUFMAN, EXAMINING ATTORNEY

**Int. Cls.: 11, 29, 30 and 43**

**Prior U.S. Cls.: 13, 21, 23, 31, 34, 46, 100 and 101**

**United States Patent and Trademark Office**

**Reg. No. 3,468,335**

**Registered July 15, 2008**

**TRADEMARK  
SERVICE MARK  
PRINCIPAL REGISTER**



LUIGI LAVAZZA SPA (ITALY CORPORATION)  
CORSO NOVARA, 59  
I-10154 TORINO, ITALY

FOR: ELECTRIC COFFEE MACHINES, ELECTRIC COFFEE PERCOLATORS, IN CLASS 11 (U.S. CLS. 13, 21, 23, 31 AND 34).

FOR: MILK, MILK BASED AND DERIVED PRODUCT EXCLUDING ICE CREAM, ICE MILK AND FROZEN YOGURT, IN CLASS 29 (U.S. CL. 46).

FOR: COFFEE, COFFEE BLENDS, DECAFFEINATED COFFEE AND COFFEE EXTRACTS, IN CLASS 30 (U.S. CL. 46).

FOR: RESTAURANTS, COFFEE HOUSES, CATERING OF FOOD AND DRINK, IN CLASS 43 (U.S. CLS. 100 AND 101).

PRIORITY DATE OF 3-23-2007 IS CLAIMED.

OWNER OF INTERNATIONAL REGISTRATION  
0943981 DATED 8-27-2007, EXPIRES 8-27-2017.

OWNER OF U.S. REG. NOS. 1,201,336, 2,236,996  
AND OTHERS.

THE MARK CONSISTS OF THE WORDING "LAVAZZA A MODO MIO"; "LAVAZZA", BEING PART OF THE APPLICANT'S NAME, IS PLACED IN A CIRCULAR PRINT; BELOW THIS THERE IS THE WORDING "A MODO MIO", ON TWO LINES, WITH "MIO", OF LARGER DIMENSIONS, HAVING THE LETTER "O" COMPOSED OF TWO CIRCULAR PRINTS ONE PLACED INSIDE THE OTHER; ALL BEING INSIDE A RECTANGULAR PRINT.

THE ENGLISH TRANSLATION OF THE FOREIGN WORD(S) IN THE MARK IS "A MODO MIO" MAY BE TRANSLATED AS "MY WAY".

SER. NO. 79-046,439, FILED 8-27-2007.

GISELLE AGOSTO, EXAMINING ATTORNEY

Int. Cl.: 33

Prior U.S. Cls.: 47 and 49

United States Patent and Trademark Office

Reg. No. 3,468,336

Registered July 15, 2008

TRADEMARK  
PRINCIPAL REGISTER

GUARDA RIOS

QUATRO ÂNCORAS -; INVESTIMENTOS IMOBILIÁRIOS.; TURÍSTICOS E AGRÍCOLAS, LDA  
(PORTUGAL SOCIEDADE POR QUOTAS LIMITADA (LDA))

RUA PASSEIO DAS ÂNCORAS  
LOTE 4.22.01 - MORADIA R  
P-1990-083 LISBOA, PORTUGAL

FOR: WINE, IN CLASS 33 (U.S. CLS. 47 AND 49).

THE MARK CONSISTS OF STANDARD CHARACTERS WITHOUT CLAIM TO ANY PARTICULAR FONT, STYLE, SIZE, OR COLOR.

PRIORITY DATE OF 4-23-2007 IS CLAIMED.

OWNER OF INTERNATIONAL REGISTRATION  
0944020 DATED 10-23-2007, EXPIRES 10-23-2017.

THE ENGLISH TRANSLATION OF "GUARDA RIOS IS KINGFISHER".

SER. NO. 79-046,454, FILED 10-23-2007.

MICHAEL TANNER, EXAMINING ATTORNEY

**Int. Cl.: 10**

**Prior U.S. Cls.: 26, 39 and 44**

**United States Patent and Trademark Office**

**Reg. No. 3,468,337**

**Registered July 15, 2008**

**TRADEMARK  
PRINCIPAL REGISTER**

**veinwave**

SOVEREIGN MEDICAL HEALTH LIMITED  
(UNITED KINGDOM LIMITED COMPANY)  
1ST FLOOR, 9 CHURCH ROAD  
STANMORE, MIDDLESEX HA7 4AR  
UNITED KINGDOM

FOR: MEDICAL DEVICES THAT USE AN EPILATOR TYPE NEEDLE FOR THE TREATMENT OF VASCULAR BLEMISHES, SPIDER VEINS, SKIN TAGS AND OTHER COSMETIC SKIN CONDITIONS, IN CLASS 10 (U.S. CLS. 26, 39 AND 44).

THE MARK CONSISTS OF STANDARD CHARACTERS WITHOUT CLAIM TO ANY PARTICULAR FONT, STYLE, SIZE, OR COLOR.

OWNER OF INTERNATIONAL REGISTRATION  
0944307 DATED 10-18-2007, EXPIRES 10-18-2017.

SER. NO. 79-046,553, FILED 10-18-2007.

EDWARD FENNESSY, EXAMINING ATTORNEY

**Int. Cls.: 35, 42 and 45**

**Prior U.S. Cls.: 100, 101 and 102**

**United States Patent and Trademark Office**

**Reg. No. 3,468,338**

**Registered July 15, 2008**

**SERVICE MARK  
PRINCIPAL REGISTER**



UNIPAT BEHEER B.V. (NETHERLANDS BESLO-  
TEN VENNOOTSCHAP)  
JOHAN DE WITTLAAN 7  
NL-2517 JR DEN HAAG  
NETHERLANDS

FOR: BUSINESS INFORMATION AND ASSIS-  
TANCE SERVICES, NAMELY SYSTEMATIZATION  
OF DATA IN A CENTRAL DATABASE, COLLEC-  
TION OF DATA IN A CENTRAL DATABASE,  
ELECTRONIC SYSTEMATIZATION OF PATENT,  
DESIGN AND TRADEMARK DATA IN A CEN-  
TRAL DATABASE AND INFORMATION REND-  
ERED BY DATABASES CONCERNING AFORE-  
MENTIONED SERVICES, IN CLASS 35 (U.S. CLS.  
100, 101 AND 102).

FOR: SCIENTIFIC CONSULTANCY RELATED  
TO PATENTS; TECHNOLOGICAL CONSULTANCY  
RELATED TO PATENTS; SCIENTIFIC RESEARCH  
RELATED TO PATENTS; WEBHOSTING FOR MAK-  
ING AVAILABLE AND EXCHANGING INFORMA-  
TION RELATED TO PATENTS, TRADEMARKS,  
DESIGNS AND RELATED KNOW-HOW, IN CLASS  
42 (U.S. CLS. 100 AND 101).

FOR: LEGAL SERVICES, NAMELY LEGAL AD-  
VICE RELATED TO PATENT RIGHTS, DESIGN  
RIGHTS, TRADEMARK RIGHTS AND COPY-  
RIGHTS; WATCHING SERVICES RELATED TO  
PATENT RIGHTS, DESIGN RIGHTS, TRADEMARK  
RIGHTS AND RELATED KNOW-HOW, IN CLASS 45  
(U.S. CLS. 100 AND 101).

PRIORITY DATE OF 1-12-2007 IS CLAIMED.

OWNER OF INTERNATIONAL REGISTRATION  
0944423 DATED 7-12-2007, EXPIRES 7-12-2017.

NO CLAIM IS MADE TO THE EXCLUSIVE  
RIGHT TO USE "VIRTUAL" AND "NETWORK",  
APART FROM THE MARK AS SHOWN.

SER. NO. 79-046,596, FILED 7-12-2007.

BRIAN NEVILLE, EXAMINING ATTORNEY



**Int. Cl.: 44**

**Prior U.S. Cls.: 100 and 101**

**United States Patent and Trademark Office**

**Reg. No. 3,468,339**

**Registered July 15, 2008**

**SERVICE MARK  
PRINCIPAL REGISTER**

# **GOLD REGISTRY**

NOVARTIS AG (SWITZERLAND CORPORATION)  
CH-4002 BASEL  
SWITZERLAND

FOR: PROVIDING A DATABASE FOR TREATMENT, RESEARCH AND DIAGNOSTIC PURPOSES IN THE FIELD OF ONCOLOGY, WHICH ALLOWS INPUTTING AND COLLECTION OF DATA AND INFORMATION; PROVIDING ON-LINE MEDICAL INFORMATION RELATING TO ONCOLOGY, IN CLASS 44 (U.S. CLS. 100 AND 101).

THE MARK CONSISTS OF STANDARD CHARACTERS WITHOUT CLAIM TO ANY PARTICULAR FONT, STYLE, SIZE, OR COLOR.

PRIORITY DATE OF 7-3-2007 IS CLAIMED.

OWNER OF INTERNATIONAL REGISTRATION  
0944562 DATED 10-22-2007, EXPIRES 10-22-2017.

NO CLAIM IS MADE TO THE EXCLUSIVE RIGHT TO USE "REGISTRY", APART FROM THE MARK AS SHOWN.

SER. NO. 79-046,632, FILED 10-22-2007.

DOMINIC FATHY, EXAMINING ATTORNEY

**Int. Cl.: 6**

**Prior U.S. Cls.: 2, 12, 13, 14, 23, 25 and 50**

**Reg. No. 3,468,340**

**United States Patent and Trademark Office**

**Registered July 15, 2008**

**TRADEMARK  
PRINCIPAL REGISTER**



HU LU DAO SHI GANG GUAN GONG; YE YOU  
XIAN GONG SI (CHINA CORPORATION)  
CISHAN VILLAGE, LIANWAN TOWN  
LONGGANG DISTRICT,; HULUDAO CITY;  
125003LIAO NING PROVINCE  
CHINA

PIPES; PIPEWORK OF METAL, IN CLASS 6 (U.S.  
CLS. 2, 12, 13, 14, 23, 25 AND 50).

OWNER OF INTERNATIONAL REGISTRATION  
0944638 DATED 11-19-2007, EXPIRES 11-19-2017.

FOR: STEEL PIPES; WATER-PIPES OF METAL;  
PENSTOCK PIPES (OF METAL); ELBOWS OF ME-  
TAL FOR PIPES; JUNCTIONS OF METAL FOR

SER. NO. 79-046,654, FILED 11-19-2007.

ALLISON HOLTZ, EXAMINING ATTORNEY

Int. Cl.: 33

Prior U.S. Cls.: 47 and 49

United States Patent and Trademark Office

Reg. No. 3,468,341

Registered July 15, 2008

TRADEMARK  
PRINCIPAL REGISTER

**FEIST**

**OPORTO  
PORTUGAL**

SOGEVINUS FINE WINES, S.A. (PORTUGAL  
SOCIÉTÉ ANONYME)  
AV. DIOGO LEITE, 344  
P-4400-111 VILA NOVA DE GAIA  
PORTUGAL

NO CLAIM IS MADE TO THE EXCLUSIVE  
RIGHT TO USE "OPORTO OR PORTUGAL", APART  
FROM THE MARK AS SHOWN.

FOR: PORT WINES, EAUX-DE-VIE, VER-  
MOUTHS, WINES AND LIQUEURS, IN CLASS 33  
(U.S. CLS. 47 AND 49).

SER. NO. 79-046,671, FILED 10-25-2007.

OWNER OF INTERNATIONAL REGISTRATION  
0245910 DATED 7-24-1961, EXPIRES 7-24-2011.

LAURIE KAUFMAN, EXAMINING ATTORNEY

**Int. Cl.: 5**

**Prior U.S. Cls.: 6, 18, 44, 46, 51 and 52**

**Reg. No. 3,468,342**

**United States Patent and Trademark Office**

**Registered July 15, 2008**

**TRADEMARK  
PRINCIPAL REGISTER**

**MICAJUMO**

BOEHRINGER INGELHEIM INTERNATIONAL  
GMBH (FED REP GERMANY CORPORATION)  
55218 INGELHEIM  
FED REP GERMANY

FOR: PHARMACEUTICAL PREPARATIONS AND SUBSTANCES FOR THE TREATMENT OF DISEASES AND DISORDERS OF THE ALIMENTARY TRACT AND METABOLISM, AND BLOOD AND BLOOD FORMING ORGANS; PHARMACEUTICAL PREPARATIONS AND SUBSTANCES FOR THE TREATMENT OF DISEASES AND DISORDERS OF THE CARDIOVASCULAR SYSTEM, MUSCULOSKELETAL SYSTEM, CENTRAL NERVOUS SYSTEM, PERIPHERAL NERVOUS SYSTEM, GENITOURINARY SYSTEM AND RESPIRATORY SYSTEM; AND PHARMACEUTICAL PREPARATIONS AND SUBSTANCES FOR THE TREATMENT OF DERMATOLOGICAL, HORMONAL, INFEC-

TIOUS, VIRAL AND ONCOLOGICAL DISEASES AND DISORDERS, IN CLASS 5 (U.S. CLS. 6, 18, 44, 46, 51 AND 52).

THE MARK CONSISTS OF STANDARD CHARACTERS WITHOUT CLAIM TO ANY PARTICULAR FONT, STYLE, SIZE, OR COLOR.

PRIORITY DATE OF 4-28-2007 IS CLAIMED.

OWNER OF INTERNATIONAL REGISTRATION 0945180 DATED 10-25-2007, EXPIRES 10-25-2017.

SER. NO. 79-046,884, FILED 10-25-2007.

CHRISTOPHER BUONGIORNO, EXAMINING ATTORNEY

**Int. Cl.: 14**

**Prior U.S. Cls.: 2, 27, 28 and 50**

**United States Patent and Trademark Office**

**Reg. No. 3,468,343**

**Registered July 15, 2008**

**TRADEMARK  
PRINCIPAL REGISTER**

**NAUTIC*F*ISH**

FRANK DILBAKOWSKI (FED REP GERMANY  
INDIVIDUAL)  
KÖNIGSBERGERSTR. 15  
31737 RINTELN  
FED REP GERMANY

OWNER OF INTERNATIONAL REGISTRATION  
0945369 DATED 8-13-2007, EXPIRES 8-13-2017.

FOR: WATCH BOXES; CLOCKS; WATCHES;  
CHRONOGRAPHS FOR USE AS WATCHES, IN  
CLASS 14 (U.S. CLS. 2, 27, 28 AND 50).

SER. NO. 79-046,942, FILED 8-13-2007.

LAURIE KAUFMAN, EXAMINING ATTORNEY

Int. Cl.: 25

Prior U.S. Cls.: 22 and 39

United States Patent and Trademark Office

Reg. No. 3,468,344

Registered July 15, 2008

TRADEMARK  
PRINCIPAL REGISTER

*Santia*

GUANGDONG SANTIA FASHION CO., LTD  
(CHINA CORPORATION)  
1-4F, INDUSTRY MANSION  
H-15, NO. 20, LIANJIANG ROAD; 515041 SHANTOU  
CITY, GUANGDONG  
CHINA

FOR: CLOTHING, NAMELY, COATS, PANTS,  
CHEMISES, SKIRTS, LAYETTES, APRONS, BATH  
ROBES, TEE-SHIRTS, JACKETS, JEANS, PULL-  
OVERS, UNIFORMS, SHIRTS, SWEATERS, IN  
CLASS 25 (U.S. CLS. 22 AND 39).

OWNER OF INTERNATIONAL REGISTRATION  
0945410 DATED 11-21-2007, EXPIRES 11-21-2017.

THE ENGLISH WORD "SANTIA" HAS NO MEAN-  
ING IN A FOREIGN LANGUAGE.

SER. NO. 79-046,952, FILED 11-21-2007.

CAROLYN CATALDO, EXAMINING ATTORNEY

**Int. Cl.: 35**

**Prior U.S. Cls.: 100, 101 and 102**

**United States Patent and Trademark Office**

**Reg. No. 3,468,345**

**Registered July 15, 2008**

**SERVICE MARK  
PRINCIPAL REGISTER**

**BPerformanceSmart**

**BSMART INNOVATIONS PTY LTD (AUSTRALIA  
PRIVATE COMPANY)**

**LEVEL 7**

**288 EDWARD STREET**

**BRISBANE QLD 4000, AUSTRALIA**

**FOR: BUSINESS CONSULTANCY RELATING TO  
THE ADMINISTRATION OF INFORMATION  
TECHNOLOGY, IN CLASS 35 (U.S. CLS. 100, 101  
AND 102).**

**THE MARK CONSISTS OF STANDARD CHAR-  
ACTERS WITHOUT CLAIM TO ANY PARTICULAR  
FONT, STYLE, SIZE, OR COLOR.**

**OWNER OF INTERNATIONAL REGISTRATION  
0945464 DATED 11-21-2007, EXPIRES 11-21-2017.**

**SER. NO. 79-046,996, FILED 11-21-2007.**

**ANDREA BUTLER, EXAMINING ATTORNEY**

**Int. Cls.: 10 and 12**

**Prior U.S. Cls.: 19, 21, 23, 26, 31, 35, 39 and 44**

**United States Patent and Trademark Office**

**Reg. No. 3,468,346**

**Registered July 15, 2008**

**TRADEMARK  
PRINCIPAL REGISTER**

**X:PANDA**

R82 A/S (DENMARK LTD LIAB CO)  
PARALLELVEJ 6  
DK-8751 GEDVED  
DENMARK

FOR: MEDICAL APPARATUS AND INSTRUMENTS FOR DISABLED PERSONS, NAMELY, ADAPTED CHAIR SEATS, IN CLASS 10 (U.S. CLS. 26, 39 AND 44).

FOR: PUSHCHAIRS IN THE NATURE OF STROLLERS FOR CHILDREN, WHEELCHAIRS FOR DISABLED PERSONS, AND PARTS AND ACCESSORIES THEREFORE, NAMELY, FRAMES, BACKRESTS, FOOTRESTS, PUSH HANDLES, WHEELS, HUBS, TIRES, HAND RIMS, WHEEL LOCKS, FITTED BACK UPHOLSTERY, FITTED SEAT UPHOLSTERY, FITTED SEAT CUSHIONS, SIDE GUARDS, ANTI-TIP MECHANISMS FOR PREVENTING THE WHEELCHAIR FROM TIPPING OVER, CAMBERS MECHANISMS FOR ADJUSTING ACCESS TO THE WHEELCHAIR, AXELS, STEMS, ARMRESTS, SEAT BELTS, FRAME PROTECTORS, CALF STRAPS, FITTED BACK PACKS, FITTED

SEAT POUCHES, SPOKE GUARDS, CASTER PIN LOCKS, STROLLER HANDLES, LUGGAGE CARRIERS, ROLLERS USED FOR SPORTING ACTIVITIES, HEADRESTS, AND FITTED TRAYS, IN CLASS 12 (U.S. CLS. 19, 21, 23, 31, 35 AND 44).

THE MARK CONSISTS OF STANDARD CHARACTERS WITHOUT CLAIM TO ANY PARTICULAR FONT, STYLE, SIZE, OR COLOR.

PRIORITY DATE OF 4-23-2007 IS CLAIMED.

OWNER OF INTERNATIONAL REGISTRATION 0945486 DATED 10-18-2007, EXPIRES 10-18-2017.

OWNER OF U.S. REG. NOS. 1,914,163 AND 3,117,895.

SER. NO. 79-047,003, FILED 10-18-2007.

ANDREA HACK, EXAMINING ATTORNEY



Int. Cl.: 28

Prior U.S. Cls.: 22, 23, 38 and 50

United States Patent and Trademark Office

Reg. No. 3,468,347

Registered July 15, 2008

TRADEMARK  
PRINCIPAL REGISTER

The logo for 'Tycoon' is written in a bold, black, cursive script. The letters are thick and connected, with a prominent underline that extends across the width of the word. The 'T' is particularly large and stylized, with a long horizontal stroke that curves upwards at the end.

CRANE CO., LTD. (JAPAN CORPORATION)  
1308-9, ODANAKA  
TSUYAMA-SHI; OKAYAMA 708-0006  
JAPAN

OWNER OF INTERNATIONAL REGISTRATION  
0945712 DATED 11-8-2007, EXPIRES 11-8-2017.

FOR: GOLF EQUIPMENT, NAMELY, GOLF  
CLUBS, GOLF PUTTERS, GOLF BAGS, IN CLASS  
28 (U.S. CLS. 22, 23, 38 AND 50).

SER. NO. 79-047,081, FILED 11-8-2007.

JOHN KELLY, EXAMINING ATTORNEY

**Int. Cl.: 5**

**Prior U.S. Cls.: 6, 18, 44, 46, 51 and 52**

**Reg. No. 3,468,348**

**United States Patent and Trademark Office**

**Registered July 15, 2008**

**TRADEMARK  
PRINCIPAL REGISTER**

**RELBISCA**

BOEHRINGER INGELHEIM PHARMA GMBH &  
CO. KG (FED REP GERMANY CORPORATION  
ORGANIZED UNDER THE LAWS OF  
GERMANY)  
55218 INGELHEIM  
FED REP GERMANY

FOR: PHARMACEUTICAL PREPARATIONS  
AND SUBSTANCES FOR THE TREATMENT OF  
DISEASES AND DISORDERS OF THE ALIMEN-  
TARY TRACT AND METABOLISM, AND BLOOD  
AND BLOOD FORMING ORGANS; PHARMACEU-  
TICAL PREPARATIONS AND SUBSTANCES FOR  
THE TREATMENT OF DISEASES AND DISORDERS  
OF THE CARDIOVASCULAR SYSTEM, MUSCU-  
LOSKELETAL SYSTEM, CENTRAL NERVOUS SYS-  
TEM, PERIPHERAL NERVOUS SYSTEM,  
GENITOURINARY SYSTEM AND RESPIRATORY  
SYSTEM; AND PHARMACEUTICAL PREPARA-

TIONS AND SUBSTANCES FOR THE TREATMENT  
OF DERMATOLOGICAL, HORMONAL, INFEC-  
TIOUS, VIRAL AND ONCOLOGICAL DISEASES  
AND DISORDERS, IN CLASS 5 (U.S. CLS. 6, 18, 44,  
46, 51 AND 52).

THE MARK CONSISTS OF STANDARD CHAR-  
ACTERS WITHOUT CLAIM TO ANY PARTICULAR  
FONT, STYLE, SIZE, OR COLOR.

OWNER OF INTERNATIONAL REGISTRATION  
0945719 DATED 10-31-2007, EXPIRES 10-31-2017.

SER. NO. 79-047,084, FILED 10-31-2007.

KATHY DE JONGE, EXAMINING ATTORNEY

**Int. Cl.: 5**

**Prior U.S. Cls.: 6, 18, 44, 46, 51 and 52**

**Reg. No. 3,468,349**

**United States Patent and Trademark Office**

**Registered July 15, 2008**

**TRADEMARK  
PRINCIPAL REGISTER**

**REXAMBRO**

BOEHRINGER INGELHEIM PHARMA GMBH &  
CO. KG (FED REP GERMANY CORPORA-  
TION ORGANIZED UNDER THE LAWS OF  
GERMANY)  
55218 INGELHEIM  
FED REP GERMANY

FOR: PHARMACEUTICAL PREPARATIONS  
AND SUBSTANCES FOR THE TREATMENT OF  
DISEASES AND DISORDERS OF THE ALIMEN-  
TARY TRACT AND METABOLISM, AND BLOOD  
AND BLOOD FORMING ORGANS; PHARMACEU-  
TICAL PREPARATIONS AND SUBSTANCES FOR  
THE TREATMENT OF DISEASES AND DISORDERS  
OF THE CARDIOVASCULAR SYSTEM, MUSCU-  
LOSKELETAL SYSTEM, CENTRAL NERVOUS SYS-  
TEM, PERIPHERAL NERVOUS SYSTEM,  
GENITOURINARY SYSTEM AND RESPIRATORY  
SYSTEM; AND PHARMACEUTICAL PREPARA-  
TIONS AND SUBSTANCES FOR THE TREATMENT

OF DERMATOLOGICAL, HORMONAL, INFEC-  
TIOUS, VIRAL AND ONCOLOGICAL DISEASES  
AND DISORDERS, IN CLASS 5 (U.S. CLS. 6, 18, 44,  
46, 51 AND 52).

THE MARK CONSISTS OF STANDARD CHAR-  
ACTERS WITHOUT CLAIM TO ANY PARTICULAR  
FONT, STYLE, SIZE, OR COLOR.

PRIORITY DATE OF 5-14-2007 IS CLAIMED.

OWNER OF INTERNATIONAL REGISTRATION  
0945720 DATED 10-31-2007, EXPIRES 10-31-2017.

SER. NO. 79-047,085, FILED 10-31-2007.

KATHY DE JONGE, EXAMINING ATTORNEY

**Int. Cl.: 5**

**Prior U.S. Cls.: 6, 18, 44, 46, 51 and 52**

**Reg. No. 3,468,350**

**United States Patent and Trademark Office**

**Registered July 15, 2008**

**TRADEMARK  
PRINCIPAL REGISTER**

**RELKIRBO**

BOEHRINGER INGELHEIM PHARMA GMBH &  
CO. KG (FED REP GERMANY CORPORA-  
TION ORGANIZED UNDER THE LAWS OF  
GERMANY)  
55218 INGELHEIM  
FED REP GERMANY

FOR: PHARMACEUTICAL PREPARATIONS  
AND SUBSTANCES FOR THE TREATMENT OF  
DISEASES AND DISORDERS OF THE ALIMEN-  
TARY TRACT AND METABOLISM, AND BLOOD  
AND BLOOD FORMING ORGANS; PHARMACEU-  
TICAL PREPARATIONS AND SUBSTANCES FOR  
THE TREATMENT OF DISEASES AND DISORDERS  
OF THE CARDIOVASCULAR SYSTEM, MUSCU-  
LOSKELETAL SYSTEM, CENTRAL NERVOUS SYS-  
TEM, PERIPHERAL NERVOUS SYSTEM,  
GENITOURINARY SYSTEM AND RESPIRATORY  
SYSTEM; AND PHARMACEUTICAL PREPARA-  
TIONS AND SUBSTANCES FOR THE TREATMENT

OF DERMATOLOGICAL, HORMONAL, INFEC-  
TIOUS, VIRAL AND ONCOLOGICAL DISEASES  
AND DISORDERS, IN CLASS 5 (U.S. CLS. 6, 18, 44,  
46, 51 AND 52).

THE MARK CONSISTS OF STANDARD CHAR-  
ACTERS WITHOUT CLAIM TO ANY PARTICULAR  
FONT, STYLE, SIZE, OR COLOR.

PRIORITY DATE OF 5-14-2007 IS CLAIMED.

OWNER OF INTERNATIONAL REGISTRATION  
0945721 DATED 10-31-2007, EXPIRES 10-31-2017.

SER. NO. 79-047,086, FILED 10-31-2007.

KATHY DE JONGE, EXAMINING ATTORNEY

**Int. Cl.: 5**

**Prior U.S. Cls.: 6, 18, 44, 46, 51 and 52**

**Reg. No. 3,468,351**

**United States Patent and Trademark Office**

**Registered July 15, 2008**

**TRADEMARK  
PRINCIPAL REGISTER**

**REBRANQ**

BOEHRINGER INGELHEIM PHARMA GMBH &  
CO. KG (FED REP GERMANY CORPORA-  
TION ORGANIZED UNDER THE LAWS OF  
GERMANY)  
55218 INGELHEIM  
FED REP GERMANY

FOR: PHARMACEUTICAL PREPARATIONS  
AND SUBSTANCES FOR THE TREATMENT OF  
DISEASES AND DISORDERS OF THE ALIMEN-  
TARY TRACT AND METABOLISM, AND BLOOD  
AND BLOOD FORMING ORGANS; PHARMACEU-  
TICAL PREPARATIONS AND SUBSTANCES FOR  
THE TREATMENT OF DISEASES AND DISORDERS  
OF THE CARDIOVASCULAR SYSTEM, MUSCU-  
LOSKELETAL SYSTEM, CENTRAL NERVOUS SYS-  
TEM, PERIPHERAL NERVOUS SYSTEM,  
GENITOURINARY SYSTEM AND RESPIRATORY  
SYSTEM; AND PHARMACEUTICAL PREPARA-  
TIONS AND SUBSTANCES FOR THE TREATMENT

OF DERMATOLOGICAL, HORMONAL, INFEC-  
TIOUS, VIRAL AND ONCOLOGICAL DISEASES  
AND DISORDERS, IN CLASS 5 (U.S. CLS. 6, 18, 44,  
46, 51 AND 52).

THE MARK CONSISTS OF STANDARD CHAR-  
ACTERS WITHOUT CLAIM TO ANY PARTICULAR  
FONT, STYLE, SIZE, OR COLOR.

PRIORITY DATE OF 5-14-2007 IS CLAIMED.

OWNER OF INTERNATIONAL REGISTRATION  
0945722 DATED 10-31-2007, EXPIRES 10-31-2017.

SER. NO. 79-047,087, FILED 10-31-2007.

KATHY DE JONGE, EXAMINING ATTORNEY

**Int. Cls.: 7, 12 and 20**

**Prior U.S. Cls.: 2, 13, 19, 21, 22, 23, 25, 31, 32, 34, 35,  
44 and 50**

**Reg. No. 3,468,352**

**United States Patent and Trademark Office**

**Registered July 15, 2008**

**TRADEMARK  
PRINCIPAL REGISTER**

**SOFTBLOCK**  
**SYSTEM**

CLABER S.P.A. (ITALY S.P.A. DI DIRITTO ITALIANO)  
VIA PONTEBBANA, 22  
I-33080 FIUME VENETO (PN)  
ITALY

FOR: POWER-OPERATED HOSE REELS, NOT OF METAL, FOR FLEXIBLE HOSES FOR THE WATERING OF GARDENS, VEGETABLE GARDENS, GREENHOUSES, CULTIVATED FIELDS AND GOLF COURSES, IN CLASS 7 (U.S. CLS. 13, 19, 21, 23, 31, 34 AND 35).

FOR: HOSE REEL TROLLEYS FOR FLEXIBLE HOSES FOR THE WATERING OF GARDENS, VEGETABLE GARDENS, GREENHOUSES, CULTIVATED FIELDS AND GOLF COURSES, TROLLEYS FOR THE COLLECTION AND TRANSPORT OF LEAVES, CUT GRASS, PAPER, WASTE FROM GARDENS, VEGETABLE GARDENS, GREENHOUSES AND FIELDS, INDUSTRIAL WASTE, IN CLASS 12 (U.S. CLS. 19, 21, 23, 31, 35 AND 44).

FOR: HAND-OPERATED HOSE REELS, NOT OF METAL, FOR FLEXIBLE HOSES FOR THE WATERING OF GARDENS, VEGETABLE GARDENS, GREENHOUSES, CULTIVATED FIELDS AND GOLF COURSES, IN CLASS 20 (U.S. CLS. 2, 13, 22, 25, 32 AND 50).

OWNER OF INTERNATIONAL REGISTRATION  
0945841 DATED 10-17-2007, EXPIRES 10-17-2017.

NO CLAIM IS MADE TO THE EXCLUSIVE RIGHT TO USE "SYSTEM", APART FROM THE MARK AS SHOWN.

THE TRADEMARK CONSISTS OF THE WORDS "SOFTBLOCK SYSTEM" IN SPECIAL CHARACTERS.

SER. NO. 79-047,121, FILED 10-17-2007.

GEOFFREY FOSDICK, EXAMINING ATTORNEY

**Int. Cl.: 6**

**Prior U.S. Cls.: 2, 12, 13, 14, 23, 25 and 50**

**United States Patent and Trademark Office**

**Reg. No. 3,468,353**

**Registered July 15, 2008**

**TRADEMARK  
PRINCIPAL REGISTER**

UVÅN HAGFORS TEKNOLOGI AKTIEBOLAG  
(SWEDEN LIMITED COMPANY)  
UVÅVÄGEN 2  
SE-683 40 UDDEHOLM  
SWEDEN

OWNER OF INTERNATIONAL REGISTRATION  
0945846 DATED 11-26-2007, EXPIRES 11-26-2017.

FOR: COMMON METALS AND THEIR ALLOYS,  
NAMELY, PIG IRON IN FORM OF PELLETS, IN  
CLASS 6 (U.S. CLS. 2, 12, 13, 14, 23, 25 AND 50).

SER. NO. 79-047,126, FILED 11-26-2007.

PRIORITY DATE OF 7-3-2007 IS CLAIMED.

MARIA-VICTORIA SUAREZ, EXAMINING ATTOR-  
NEY

**Int. Cl.: 33**

**Prior U.S. Cls.: 47 and 49**

**United States Patent and Trademark Office**

**Reg. No. 3,468,354**

**Registered July 15, 2008**

**TRADEMARK  
PRINCIPAL REGISTER**

**THE ROSE COLOURED GLASSES**

D'ARENBERG PTY LTD (AUSTRALIA PROPRIETARY LIMITED COMPANY (PTY LTD))  
OSBORN ROAD  
MCLAREN VALE SA 5171  
AUSTRALIA

PRIORITY DATE OF 8-24-2007 IS CLAIMED.

OWNER OF INTERNATIONAL REGISTRATION  
0945867 DATED 11-8-2007, EXPIRES 11-8-2017.

FOR: WINE, IN CLASS 33 (U.S. CLS. 47 AND 49).

SER. NO. 79-047,128, FILED 11-8-2007.

THE MARK CONSISTS OF STANDARD CHARACTERS WITHOUT CLAIM TO ANY PARTICULAR FONT, STYLE, SIZE, OR COLOR.

JOHN KELLY, EXAMINING ATTORNEY



**Int. Cl.: 1**

**Prior U.S. Cls.: 1, 5, 6, 10, 26 and 46**

**United States Patent and Trademark Office**

**Reg. No. 3,468,355**

**Registered July 15, 2008**

**TRADEMARK  
PRINCIPAL REGISTER**

**AMITROPAINT**

AGRANA STÄRKE GMBH (AUSTRIA LTD LIAB  
CO)  
DONAU-CITY-STR. 9  
A-1220 WIEN  
AUSTRIA

OWNER OF INTERNATIONAL REGISTRATION  
0946059 DATED 11-23-2007, EXPIRES 11-23-2017.

FOR: STARCH FOR INDUSTRIAL PURPOSES, IN  
CLASS 1 (U.S. CLS. 1, 5, 6, 10, 26 AND 46).

SER. NO. 79-047,208, FILED 11-23-2007.

PRIORITY DATE OF 6-18-2007 IS CLAIMED.

ALLISON HOLTZ, EXAMINING ATTORNEY

**Int. Cls.: 1, 3 and 16**

**Prior U.S. Cls.: 1, 2, 4, 5, 6, 10, 22, 23, 26, 29, 37, 38,  
46, 50, 51 and 52**

**Reg. No. 3,468,356**

**United States Patent and Trademark Office**

**Registered July 15, 2008**

**TRADEMARK  
PRINCIPAL REGISTER**

**KAREBAC**

SALAMA (FRANCE INDIVIDUAL)  
500 EAST 77 STREET APPT 1719  
NEW YORK, NY 10162  
UNITED STATES

FOR: ADHESIVE TAPES FOR INDUSTRIAL USE, NAMELY, ADHESIVE TAPE FOR THE MOTOR CAR INDUSTRY, ADHESIVE TAPE FOR THE AUTOMOTIVE INDUSTRY, ADHESIVE TAPE FOR THE HARDWARE INDUSTRY, AND ADHESIVE TAPE FOR THE AVIATION INDUSTRY, IN CLASS 1 (U.S. CLS. 1, 5, 6, 10, 26 AND 46).

FOR: ABRASIVE CLOTH; ABRASIVE CLOTH AND PAPER; ABRASIVE SANDPAPER; ABRASIVE PASTE; ABRASIVE ROLLS; ABRASIVE SAND; ABRASIVE SHEETS; ABRASIVE STRIPS, IN CLASS 3 (U.S. CLS. 1, 4, 6, 50, 51 AND 52).

FOR: ADHESIVE TAPES FOR STATIONERY OR HOUSEHOLD USE, IN CLASS 16 (U.S. CLS. 2, 5, 22, 23, 29, 37, 38 AND 50).

THE MARK CONSISTS OF STANDARD CHARACTERS WITHOUT CLAIM TO ANY PARTICULAR FONT, STYLE, SIZE, OR COLOR.

PRIORITY DATE OF 5-3-2007 IS CLAIMED.

OWNER OF INTERNATIONAL REGISTRATION 0946588 DATED 10-31-2007, EXPIRES 10-31-2017.

SER. NO. 79-047,403, FILED 10-31-2007.

CARRIE GENOVESE, EXAMINING ATTORNEY

**Int. Cl.: 5**

**Prior U.S. Cls.: 6, 18, 44, 46, 51 and 52**

**United States Patent and Trademark Office**

**Reg. No. 3,468,357**

**Registered July 15, 2008**

**TRADEMARK  
PRINCIPAL REGISTER**

**ACLORIA**

BIOALLIANCE, PHARMA (FRANCE SOCIÉTÉ  
ANONYME À DIRECTOIRE)  
59 RUE DU GÉNÉRAL MARTIAL VALIN  
F-75015 PARIS  
FRANCE

FOR: PHARMACEUTICAL COMPOSITIONS FOR  
THE TREATMENT OF HERPES, IN CLASS 5 (U.S.  
CLS. 6, 18, 44, 46, 51 AND 52).

THE MARK CONSISTS OF STANDARD CHAR-  
ACTERS WITHOUT CLAIM TO ANY PARTICULAR  
FONT, STYLE, SIZE, OR COLOR.

PRIORITY DATE OF 4-30-2007 IS CLAIMED.

OWNER OF INTERNATIONAL REGISTRATION  
0946589 DATED 10-30-2007, EXPIRES 10-30-2017.

SER. NO. 79-047,404, FILED 10-30-2007.

NAPOLEON SHARMA, EXAMINING ATTORNEY

**Int. Cl.: 5**

**Prior U.S. Cls.: 6, 18, 44, 46, 51 and 52**

**United States Patent and Trademark Office**

**Reg. No. 3,468,358**

**Registered July 15, 2008**

**TRADEMARK  
PRINCIPAL REGISTER**

**LABIRIA**

BIOALLIANCE PHARMA (FRANCE SOCIÉTÉ  
ANONYME À DIRECTOIRE)  
59 RUE DU GÉNÉRAL MARTIAL VALIN  
F-75015 PARIS  
FRANCE

FOR: PHARMACEUTICAL COMPOSITIONS FOR  
THE TREATMENT OF HERPES, IN CLASS 5 (U.S.  
CLS. 6, 18, 44, 46, 51 AND 52).

THE MARK CONSISTS OF STANDARD CHAR-  
ACTERS WITHOUT CLAIM TO ANY PARTICULAR  
FONT, STYLE, SIZE, OR COLOR.

PRIORITY DATE OF 4-30-2007 IS CLAIMED.

OWNER OF INTERNATIONAL REGISTRATION  
0946590 DATED 10-30-2007, EXPIRES 10-30-2017.

SER. NO. 79-047,405, FILED 10-30-2007.

NAPOLEON SHARMA, EXAMINING ATTORNEY

**Int. Cl.: 20**

**Prior U.S. Cls.: 2, 13, 22, 25, 32 and 50**

**United States Patent and Trademark Office**

**Reg. No. 3,468,359**

**Registered July 15, 2008**

**TRADEMARK  
PRINCIPAL REGISTER**

**BARRIVIERA**

BARRIVIERA CAPPE S.R.L. (ITALY SOCIETA A  
RESPONSABILITA LIMITATA)  
VIA GERE, 42  
I-33080 PRATA DI PORDENONE (PN)  
ITALY

OWNER OF INTERNATIONAL REGISTRATION  
0946606 DATED 11-13-2007, EXPIRES 11-13-2017.

SER. NO. 79-047,412, FILED 11-13-2007.

FOR: KITCHEN FURNITURE, IN CLASS 20 (U.S.  
CLS. 2, 13, 22, 25, 32 AND 50).

AMY MCMENAMIN, EXAMINING ATTORNEY

**Int. Cl.: 1**

**Prior U.S. Cls.: 1, 5, 6, 10, 26 and 46**

**United States Patent and Trademark Office**

**Reg. No. 3,468,360**

**Registered July 15, 2008**

**TRADEMARK  
PRINCIPAL REGISTER**

# Lignofast

COLLANO AG (SWITZERLAND SOCIÉTÉ  
ANONYME)  
CH-6203 SEMPACH STATION  
SWITZERLAND

FOR: ADHESIVES FOR USE IN INDUSTRY, IN  
CLASS 1 (U.S. CLS. 1, 5, 6, 10, 26 AND 46).

THE MARK CONSISTS OF STANDARD CHAR-  
ACTERS WITHOUT CLAIM TO ANY PARTICULAR  
FONT, STYLE, SIZE, OR COLOR.

PRIORITY DATE OF 5-30-2007 IS CLAIMED.

OWNER OF INTERNATIONAL REGISTRATION  
0946761 DATED 11-21-2007, EXPIRES 11-21-2017.

SER. NO. 79-047,472, FILED 11-21-2007.

DANIEL CAPSHAW, EXAMINING ATTORNEY

**Int. Cl.: 10**

**Prior U.S. Cls.: 26, 39 and 44**

**United States Patent and Trademark Office**

**Reg. No. 3,468,361**

**Registered July 15, 2008**

---

**TRADEMARK  
PRINCIPAL REGISTER**

**NUTRIFLOWER**

VYGON (FRANCE SOCIÉTÉ ANONYME)  
5 RUE ADELINÉ  
F-95440 ECOUEN  
FRANCE

OWNER OF INTERNATIONAL REGISTRATION  
0946818 DATED 11-15-2007, EXPIRES 11-15-2017.

FOR: SURGICAL INSTRUMENTS DESIGNED  
FOR GASTROTOMY, IN CLASS 10 (U.S. CLS. 26, 39  
AND 44).

SER. NO. 79-047,494, FILED 11-15-2007.

PRIORITY DATE OF 6-7-2007 IS CLAIMED.

AMEETA JORDAN, EXAMINING ATTORNEY

**Int. Cl.: 5**

**Prior U.S. Cls.: 6, 18, 44, 46, 51 and 52**

**United States Patent and Trademark Office**

**Reg. No. 3,468,362**

**Registered July 15, 2008**

**TRADEMARK  
PRINCIPAL REGISTER**

The logo consists of the word "EXJUM" in a bold, stylized, sans-serif font. The letter 'j' is lowercase and has a solid black dot above it. The letters are thick and blocky, with some internal cutouts, particularly in the 'E' and 'J'.

U.S. LABORATORI PHARMANDRE' S.R.L. (ITALY LTD LIAB CO)  
VIA G. C. BECCARIA, 27  
I-05100 TERNI  
ITALY

THE TRADEMARK IS MADE UP OF THE WORD  
"EXJUM" WRITTEN IN PARTICULAR WRITING.

FOR: DISINFECTANTS FOR MEDICAL PURPOSES, IN CLASS 5 (U.S. CLS. 6, 18, 44, 46, 51 AND 52).

SER. NO. 79-047,495, FILED 11-19-2007.

OWNER OF INTERNATIONAL REGISTRATION  
0946819 DATED 11-19-2007, EXPIRES 11-19-2017.

SHANNON TWOHIG, EXAMINING ATTORNEY



**Int. Cl.: 10**

**Prior U.S. Cls.: 26, 39 and 44**

**United States Patent and Trademark Office**

**Reg. No. 3,468,363**

**Registered July 15, 2008**

**TRADEMARK  
PRINCIPAL REGISTER**

**JOLIFE**

JOLIFE AB (SWEDEN JOINT STOCK COMPANY)  
IDEON  
SE-223 70 LUND, SWEDEN

PRIORITY DATE OF 11-6-2007 IS CLAIMED.

FOR: MEDICAL APPARATUS AND INSTRUMENTS FOR USE IN RESUSCITATION; MEDICAL APPARATUS AND INSTRUMENTS FOR USE IN CARDIOPULMONARY RESUSCITATION, IN CLASS 10 (U.S. CLS. 26, 39 AND 44).

OWNER OF INTERNATIONAL REGISTRATION  
0947123 DATED 11-16-2007, EXPIRES 11-16-2017.

THE MARK CONSISTS OF STANDARD CHARACTERS WITHOUT CLAIM TO ANY PARTICULAR FONT, STYLE, SIZE, OR COLOR.

SER. NO. 79-047,610, FILED 11-16-2007.

ELI HELLMAN, EXAMINING ATTORNEY

**Int. Cl.: 7**

**Prior U.S. Cls.: 13, 19, 21, 23, 31, 34 and 35**

**Reg. No. 3,468,364**

**United States Patent and Trademark Office**

**Registered July 15, 2008**

**TRADEMARK  
PRINCIPAL REGISTER**



GEBR. SCHUMACHER; GERÄTEBAUGESELL-  
SCHAFT MBH (FED REP GERMANY LTD  
LIAB CO)  
AM SPORTPLATZ  
57612 EICHELHARDT, FED REP GERMANY

FOR: MACHINE PARTS, NAMELY, PARTS OF  
AGRICULTURAL MACHINES, PARTS OF REAP-  
ING, MOWING AND HARVESTING MACHINES,  
NAMELY, BAR MOVERS, MOWING CUTTERS,  
GUIDES FOR MOWING CUTTERS, BLADES, CUT-  
TER BARS, RECIPROCATING FINGERS, CROP  
LIFTERS, DRIVE GEARBOXES FOR MOWING  
CUTTERS, CLEANING SIEVES FOR COMBINE  
HARVESTERS, REELS OF REAPERS, HYDRAULIC

COUPLINGS, CUTTING ASSEMBLIES, INDIVI-  
DUAL PARTS OF CUTTING ASSEMBLIES, IN  
CLASS 7 (U.S. CLS. 13, 19, 21, 23, 31, 34 AND 35).

PRIORITY DATE OF 8-16-2007 IS CLAIMED.

OWNER OF INTERNATIONAL REGISTRATION  
0947339 DATED 11-13-2007, EXPIRES 11-13-2017.

SER. NO. 79-047,660, FILED 11-13-2007.

DAVID HOFFMAN, EXAMINING ATTORNEY

**Int. Cl.: 33**

**Prior U.S. Cls.: 47 and 49**

**United States Patent and Trademark Office**

**Reg. No. 3,468,365**

**Registered July 15, 2008**

**TRADEMARK  
PRINCIPAL REGISTER**

**Ambrello**

GEVEMA GMBH (FED REP GERMANY LTD  
LIAB CO)  
KADEKERWEG 2  
24340 ECKERNFÖRDE, FED REP GERMANY

FOR: ALCOHOLIC BEVERAGES, NAMELY, DIS-  
TILLED SPIRITS AND LIQUEURS, IN CLASS 33  
(U.S. CLS. 47 AND 49).

THE MARK CONSISTS OF STANDARD CHAR-  
ACTERS WITHOUT CLAIM TO ANY PARTICULAR  
FONT, STYLE, SIZE, OR COLOR.

PRIORITY DATE OF 7-19-2007 IS CLAIMED.

OWNER OF INTERNATIONAL REGISTRATION  
0947615 DATED 11-23-2007, EXPIRES 11-23-2017.

SER. NO. 79-047,780, FILED 11-23-2007.

MICHAEL GAAFAR, EXAMINING ATTORNEY

**Int. Cl.: 27**

**Prior U.S. Cls.: 19, 20, 37, 42 and 50**

**United States Patent and Trademark Office**

**Reg. No. 3,468,366**

**Registered July 15, 2008**

**TRADEMARK  
PRINCIPAL REGISTER**

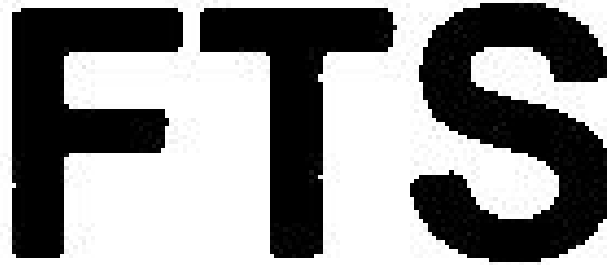

MONDO SPA (ITALY CORPORATION)  
PIAZZALE EDMONDO STROPPIANA 1  
FRAZIONE GALLO; I-12051  
ALBA (CN), ITALY

FOR: ARTIFICIAL TURF, IN CLASS 27 (U.S. CLS.  
19, 20, 37, 42 AND 50).

THE MARK CONSISTS OF STANDARD CHAR-  
ACTERS WITHOUT CLAIM TO ANY PARTICULAR  
FONT, STYLE, SIZE, OR COLOR.

PRIORITY DATE OF 10-19-2007 IS CLAIMED.

OWNER OF INTERNATIONAL REGISTRATION  
0947765 DATED 11-27-2007, EXPIRES 11-27-2017.

SER. NO. 79-047,851, FILED 11-27-2007.

JAMES STEIN, EXAMINING ATTORNEY

**Int. Cl.: 18**

**Prior U.S. Cls.: 1, 2, 3, 22 and 41**

**United States Patent and Trademark Office**

**Reg. No. 3,468,367**

**Registered July 15, 2008**

**TRADEMARK  
PRINCIPAL REGISTER**

**COTTING**

MECASEAT, S.A. (BELGIUM SOCIEDAD ANÓNIMA)  
VLAMINGSTRAAT 7  
INDUSTRIEZONE ZUID; B-8560 WEVELGEM  
BELGIUM

FOR: LEATHER AND IMITATIONS OF LEATHER; ANIMAL SKINS, HIDES; TRUNKS AND TRAVELLING BAGS; UMBRELLAS, PARASOLS AND WALKING STICKS; WHIPS, HARNESS AND SADDLERY, IN CLASS 18 (U.S. CLS. 1, 2, 3, 22 AND 41).

THE MARK CONSISTS OF STANDARD CHARACTERS WITHOUT CLAIM TO ANY PARTICULAR FONT, STYLE, SIZE, OR COLOR.

OWNER OF INTERNATIONAL REGISTRATION  
0948054 DATED 10-23-2007, EXPIRES 10-23-2017.

SER. NO. 79-047,963, FILED 10-23-2007.

SHANNON TWOHIG, EXAMINING ATTORNEY

**Int. Cls.: 9, 41 and 42**

**Prior U.S. Cls.: 21, 23, 26, 36, 38, 100, 101 and 107**

**Reg. No. 3,468,368**

**United States Patent and Trademark Office**

**Registered July 15, 2008**

**TRADEMARK  
SERVICE MARK  
PRINCIPAL REGISTER**

# LINGUATEC

LINGUATEC GMBH (FED REP GERMANY  
GMBH)  
GOTTFRIED-KELLER-STRASSE 12  
81245 MÜNCHEN  
FED REP GERMANY

FOR: DATA PROCESSING APPARATUS AND COMPUTERS; COMPUTER SOFTWARE FOR TRANSLATING TEXT OR SPEECH BETWEEN AT LEAST TWO LANGUAGES; COMPUTER SOFTWARE FOR TRANSFORMING SPEECH TO TEXT OR TEXT TO SPEECH; APPARATUS FOR RECORDING, TRANSMISSION, STORAGE OR REPRODUCTION OF SOUND OR IMAGES; DOWNLOADABLE ELECTRONIC PUBLICATIONS IN THE NATURE OF MANUALS, BROCHURES AND NEWSLETTERS AND RELATING TO TRANSLATION OR TO TRANSFORMING SPEECH TO TEXT OR TEXT TO SPEECH; ELECTRONIC APPARATUS, NAMELY, HAND-HELD COMPUTERS, FOR TRANSFORMING SPEECH TO TEXT OR TEXT TO SPEECH; ELECTRONIC APPARATUS, NAMELY, HAND-HELD COMPUTERS, FOR LANGUAGE TRANSLATION, IN CLASS 9 (U.S. CLS. 21, 23, 26, 36 AND 38).

FOR: PUBLICATION AND ISSUANCE OF IMAGE, AUDIO AND VIDEO DATA VIA THE INTERNET; MULTIMEDIA PUBLISHING OF BOOKS, MAGAZINES, JOURNALS, SOFTWARE, GAMES, MUSIC AND ELECTRONIC PUBLICATIONS; TRANSLATION SERVICES; TRANSLATION SERVICES USING ELECTRONIC MEDIA; ONLINE PUB-

LISHING OF ELECTRONIC DICTIONARIES, IN CLASS 41 (U.S. CLS. 100, 101 AND 107).

FOR: PROGRAMMING, UPDATING, DESIGN AND INSTALLING OF COMPUTER SOFTWARE; PROVIDING TEMPORARY USE OF NON-DOWNLOADABLE COMPUTER SOFTWARE FOR LANGUAGE TRANSLATION; PROVIDING TEMPORARY USE OF NON-DOWNLOADABLE COMPUTER SOFTWARE FOR TRANSFORMING SPEECH TO TEXT OR TEXT TO SPEECH; TRANSFORMATION OF SPEECH TO TEXT OR TEXT TO SPEECH USING ELECTRONIC MEDIA, IN CLASS 42 (U.S. CLS. 100 AND 101).

THE MARK CONSISTS OF STANDARD CHARACTERS WITHOUT CLAIM TO ANY PARTICULAR FONT, STYLE, SIZE, OR COLOR.

PRIORITY DATE OF 1-8-2007 IS CLAIMED.

OWNER OF INTERNATIONAL REGISTRATION 0948151 DATED 7-3-2007, EXPIRES 7-3-2017.

OWNER OF U.S. REG. NO. 2,840,765.

SER. NO. 79-047,993, FILED 7-3-2007.

SHANNON TWOHIG, EXAMINING ATTORNEY

**Int. Cl.: 33**

**Prior U.S. Cls.: 47 and 49**

**United States Patent and Trademark Office**

**Reg. No. 3,468,369**

**Registered July 15, 2008**

**TRADEMARK  
PRINCIPAL REGISTER**

**FISHCAGE**

HUNGERFORD HILL WINES PTY. LIMITED  
(AUSTRALIA PRIVATE PROPRIETARY LIMITED COMPANY)

SUITE 115

JONES BAY WHARF; 19-21 PIRRAMA ROAD; PYRMONT NSW 2009

AUSTRALIA

FOR: WINE; PORT WINE, IN CLASS 33 (U.S. CLS. 47 AND 49).

THE MARK CONSISTS OF STANDARD CHARACTERS WITHOUT CLAIM TO ANY PARTICULAR FONT, STYLE, SIZE, OR COLOR.

OWNER OF INTERNATIONAL REGISTRATION 0948302 DATED 11-28-2007, EXPIRES 11-28-2017.

SER. NO. 79-048,082, FILED 11-28-2007.

TINA BROWN, EXAMINING ATTORNEY

**Int. Cls.: 20, 22 and 24**

**Prior U.S. Cls.: 1, 2, 7, 13, 19, 22, 25, 32, 42 and 50**

**United States Patent and Trademark Office**

**Reg. No. 3,468,370**

**Registered July 15, 2008**

**TRADEMARK  
PRINCIPAL REGISTER**

**MOODUL**

ADVANSA B.V. (NETHERLANDS JOINT STOCK  
COMPANY)  
HOLLAND OFFICE CENTRE KRUISWEG 829  
2ND FLOOR  
HOOFDDORP, NETHERLANDS NL2132

FOR: PILLOWS, IN CLASS 20 (U.S. CLS. 2, 13, 22,  
25, 32 AND 50).

FOR: TEXTILE FIBERS , IN CLASS 22 (U.S. CLS. 1,  
2, 7, 19, 22, 42 AND 50).

FOR: FABRICS FOR TEXTILE USE, IN CLASS 24  
(U.S. CLS. 42 AND 50).

PRIORITY DATE OF 11-1-2007 IS CLAIMED.

OWNER OF INTERNATIONAL REGISTRATION  
0948317 DATED 11-27-2007, EXPIRES 11-27-2017.

SER. NO. 79-048,087, FILED 11-27-2007.

JAMES STEIN, EXAMINING ATTORNEY



**Int. Cls.: 12 and 28**

**Prior U.S. Cls.: 19, 21, 22, 23, 31, 35, 38, 44 and 50**

**United States Patent and Trademark Office**

**Reg. No. 3,468,371**

**Registered July 15, 2008**

**TRADEMARK  
PRINCIPAL REGISTER**

**GHOST**

BAYERISCHE MOTOREN WERKE AKTIENGE-  
SELLSCHAFT (FED REP GERMANY AKTIEN-  
GESELLSCHAFT (JOINT STOCK COMPANY))  
PETUELRING 130  
80809 MÜNCHEN  
FED REP GERMANY

FOR: AUTOMOBILES AND STRUCTURAL  
PARTS THEREFOR, IN CLASS 12 (U.S. CLS. 19, 21,  
23, 31, 35 AND 44).

FOR: MINIATURES OF AUTOMOBILES, IN  
CLASS 28 (U.S. CLS. 22, 23, 38 AND 50).

THE MARK CONSISTS OF STANDARD CHAR-  
ACTERS WITHOUT CLAIM TO ANY PARTICULAR  
FONT, STYLE, SIZE, OR COLOR.

PRIORITY DATE OF 5-23-2007 IS CLAIMED.

OWNER OF INTERNATIONAL REGISTRATION  
0949033 DATED 11-21-2007, EXPIRES 11-21-2017.

SER. NO. 79-048,302, FILED 11-21-2007.

EUGENIA MARTIN, EXAMINING ATTORNEY

Int. Cl.: 29

Prior U.S. Cl.: 46

United States Patent and Trademark Office

Reg. No. 3,468,372

Registered July 15, 2008

TRADEMARK  
PRINCIPAL REGISTER



FRANTOI OLERARI UMBRI CO. SRL (ITALY  
LTD LIAB CO)  
STRADA STATALE FLAMINIA KM. 135,00  
FRAZIONE LOCALITÀ SAN GIACOMO; I-06049  
SPOLETO (PG)  
ITALY

FOR: VEGETABLE OIL, IN CLASS 29 (U.S. CL. 46).

PRIORITY DATE OF 10-30-2007 IS CLAIMED.

OWNER OF INTERNATIONAL REGISTRATION  
0949074 DATED 11-22-2007, EXPIRES 11-22-2017.

TRADEMARK CONSISTING OF THE WORDING  
"GIVE ME 5" WRITTEN IN ITALICS AND SPECIAL  
CHARACTERS.

SER. NO. 79-048,320, FILED 11-22-2007.

KHANH LE, EXAMINING ATTORNEY

**Int. Cl.: 11**

**Prior U.S. Cls.: 13, 21, 23, 31 and 34**

**United States Patent and Trademark Office**

**Reg. No. 3,468,373**

**Registered July 15, 2008**

**TRADEMARK  
PRINCIPAL REGISTER**

**GROK**

LEDS C4, S.A. (SPAIN SOCIEDAD ANONIMA)  
AFORES S/N  
E-25750 TORA (LLEIDA)  
SPAIN

OWNER OF INTERNATIONAL REGISTRATION  
0819065 DATED 1-22-2004, EXPIRES 1-22-2014.

FOR: ALL KINDS OF ELECTRIC LAMPS, IN  
CLASS 11 (U.S. CLS. 13, 21, 23, 31 AND 34).

SER. NO. 79-048,343, FILED 11-26-2007.

THE MARK CONSISTS OF STANDARD CHAR-  
ACTERS WITHOUT CLAIM TO ANY PARTICULAR  
FONT, STYLE, SIZE, OR COLOR.

CHRISTINA SOBRAL, EXAMINING ATTORNEY

**Int. Cl.: 28**

**Prior U.S. Cls.: 22, 23, 38 and 50**

**United States Patent and Trademark Office**

**Reg. No. 3,468,374**

**Registered July 15, 2008**

**TRADEMARK  
PRINCIPAL REGISTER**

**J A V L N F X**

MITSUBISHI RAYON CO., LTD. (JAPAN CORPORATION)  
6-41, KONAN 1-CHOME  
MINATO-KU; TOKYO 108-8506  
JAPAN

FOR: SHAFTS FOR GOLF CLUBS, IN CLASS 28  
(U.S. CLS. 22, 23, 38 AND 50).

THE MARK CONSISTS OF STANDARD CHARACTERS WITHOUT CLAIM TO ANY PARTICULAR FONT, STYLE, SIZE, OR COLOR.

PRIORITY DATE OF 11-29-2007 IS CLAIMED.

OWNER OF INTERNATIONAL REGISTRATION  
0949817 DATED 12-18-2007, EXPIRES 12-18-2017.

SER. NO. 79-048,612, FILED 12-18-2007.

JOHN KELLY, EXAMINING ATTORNEY

**Int. Cls.: 9, 12, 16 and 25**

**Prior U.S. Cls.: 2, 5, 19, 21, 22, 23, 26, 29, 31, 35, 36, 37, 38, 39, 44 and 50**

**Reg. No. 3,468,375**

**United States Patent and Trademark Office**

**Registered July 15, 2008**

**TRADEMARK  
PRINCIPAL REGISTER**



SPORT & LEISURE DIRECT.COM LTD (SLD)  
(UNITED KINGDOM LIMITED COMPANY)  
STATION ROAD  
NORTH HYKEHAM, LINCOLN LN6 9AL  
UNITED KINGDOM

FOR: MOTORCYCLE CRASH HELMETS; MOTORCYCLE GOGGLES; SUNGLASSES; MOUSE PADS; SPECTACLES; PROTECTIVE CLOTHING FOR MOTORCYCLE RIDERS, NAMELY, REINFORCED MOTORCYCLE LEATHER CLOTHING, IN CLASS 9 (U.S. CLS. 21, 23, 26, 36 AND 38).

FOR: TWO WHEELED MOTOR VEHICLES; ON-ROAD MOTORCYCLES; OFF-ROAD MOTORCYCLES; LAND VEHICLES; LAND VEHICLES, NAMELY, FOUR WHEELED QUAD BIKES; LAND VEHICLES, NAMELY, THREE WHEELED TRIKES; PERSONAL WATERCRAFT, NAMELY, WATER SCOOTERS; SNOW MOBILES; STRUCTURAL PARTS FOR ALL AFORESAID, NAMELY GENUINE AFTER MARKET STRUCTURAL PARTS, IN CLASS 12 (U.S. CLS. 19, 21, 23, 31, 35 AND 44).

FOR: STATIONERY ITEMS, NAMELY, PENS, RUBBER ERASERS, DRAWING RULERS, PENCILS, MARKERS, ADHESIVE TAPES FOR STATIONERY PURPOSES, STICKERS AND DECALS; PAPER FLAGS; PAPER BANNERS; POSTERS; LEAFLETS ABOUT MOTORCYCLES; INFORMATIONAL FLYERS FEATURING MOTORCYCLES; BROCHURES

ABOUT MOTORCYCLES; TECHNICAL PRODUCT INFORMATIONAL SHEETS ABOUT MOTORCYCLES; OWNERS MANUALS IN THE FIELD OF MOTORCYCLES; WORKSHOP MANUALS IN THE FIELD OF MOTORCYCLES, IN CLASS 16 (U.S. CLS. 2, 5, 22, 23, 29, 37, 38 AND 50).

FOR: SHIRTS; T-SHIRTS; SWEATERS; JACKETS; WIND RESISTANT JACKETS; RAINCOATS; SPORTS WEAR, NAMELY, TRACK PANTS, TRACK SUITS, JERSEYS, UNIFORMS; NECKTIES; GLOVES; SOCKS; HATS; CAPS; SHOES; BOOTS; MOTORCYCLE RIDERS BOOTS; MOTORCYCLE RIDERS ARTICLES OF OUTER CLOTHING, NAMELY, JACKETS, PANTS, MOTORCYCLE GLOVES; UNDERWEAR; MOTORCYCLE BOOTS; TROUSERS, IN CLASS 25 (U.S. CLS. 22 AND 39).

PRIORITY DATE OF 5-9-2007 IS CLAIMED.

OWNER OF INTERNATIONAL REGISTRATION 0950023 DATED 6-13-2007, EXPIRES 6-13-2017.

SER. NO. 79-048,701, FILED 6-13-2007.

KATHERINE E. HALMEN, EXAMINING ATTORNEY

Int. Cl.: 43

Prior U.S. Cls.: 100 and 101

United States Patent and Trademark Office

Reg. No. 3,468,376

Registered July 15, 2008

SERVICE MARK  
PRINCIPAL REGISTER



KUNMING FOOD; SERVICE CO., LTD JIANXI-  
NYUAN (CHINA CORPORATION)  
NO. 195, BAOSHAN STREET  
KUNMING CITY  
YUNNAN PROVINCE, CHINA

FOR: RESTAURANTS, IN CLASS 43 (U.S. CLS. 100  
AND 101).

OWNER OF INTERNATIONAL REGISTRATION  
0950376 DATED 11-13-2007, EXPIRES 11-13-2017.

THE ENGLISH TRANSLATION OF THE FOR-  
EIGN WORD(S) IN THE MARK ARE: THE FIRST

CHARACTER MEANS "CONSTRUCTION"; THE  
SECOND CHARACTER MEANS "NEW"; THE LAST  
CHARACTER MEANS "GARDEN".

THE TRANSLITERATION OF THE NON-LATIN  
CHARACTERS IN THE MARK IS: "JIAN XIN  
YUAN".

SER. NO. 79-048,840, FILED 11-13-2007.

DAVID HOFFMAN, EXAMINING ATTORNEY

**Int. Cls.: 7 and 12**

**Prior U.S. Cls.: 13, 19, 21, 23, 31, 34, 35 and 44**

**United States Patent and Trademark Office**

**Reg. No. 3,468,377**

**Registered July 15, 2008**

**TRADEMARK  
PRINCIPAL REGISTER**

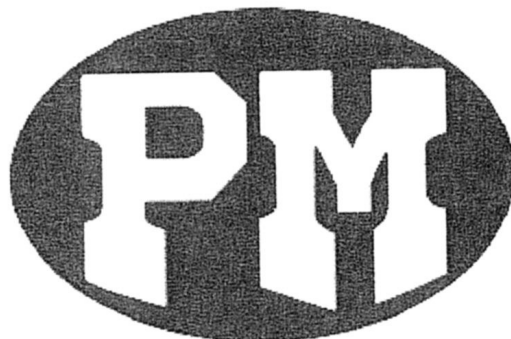

PM GROUP S.P.A. (ITALY JOINT STOCK COMPANY)  
VIA VERDI, 22  
I-41018 SAN CESARIO SUL PANARO (MODENA)  
ITALY

FOR: LIFTING AND HOISTING APPARATUS, NAMELY, CRANES; WINCHES; HOISTS; ELEVATORS, BEING LIFTS; LIFTING INSTALLATIONS FOR THE TRANSPORT OF PERSONS AND GOODS; POWER-OPERATED LIFTING AND MOVING EQUIPMENT, NAMELY, PIPE LAYERS, FORK LIFTS, AND LIFTS; CONVEYORS, BEING MACHINES; POWER-OPERATED LIFT USED TO TRANSPORT AND PLACE PORTABLE STORAGE CONTAINERS; CAPSTANS; DERRICKS; LIFT BELTS; ELEVATOR BELTS; ELEVATORS AND PARTS THEREOF; MECHANICAL AND HYDRAULIC HOISTS, PULLEYS AND LIFTING JACKS; LIFTING AND HOISTING APPARATUS FOR LAND VEHICLES, NAMELY, CRANES; LIFTING AND HOISTING APPARATUS FOR AIR VEHICLES,

NAMELY, CRANES , IN CLASS 7 (U.S. CLS. 13, 19, 21, 23, 31, 34 AND 35).

FOR: BOAT DAVITS; LIFT TRUCKS; FORK LIFT TRUCKS, IN CLASS 12 (U.S. CLS. 19, 21, 23, 31, 35 AND 44).

OWNER OF INTERNATIONAL REGISTRATION  
0950448 DATED 4-16-2007, EXPIRES 4-16-2017.

THE MARK IS COMPOSED OF THE FANCY INSCRIPTION "PM" WRITTEN IN STYLIZED CAPITAL LETTERS, SQUARED AND WITH THE ENDS ENLARGED AND INCLUDED IN NEGATIVE IN AN OVAL.

SER. NO. 79-048,849, FILED 4-16-2007.

SCOTT BIBB, EXAMINING ATTORNEY

**Int. Cl.: 35**

**Prior U.S. Cls.: 100, 101 and 102**

**United States Patent and Trademark Office**

**Reg. No. 3,468,378**

**Registered July 15, 2008**

**SERVICE MARK  
PRINCIPAL REGISTER**



CARTIER INTERNATIONAL N.V.; A HOLDING  
AND TRADING COMPANY; ORGANIZED  
AND EXISTING UNDER THE; LAWS OF  
THE NETHERLANDS ANTILLES (NETHERLD  
ANTILLES LTD LIAB CO)  
SCHARLOOWEG 33  
CURAÇAO  
NETHERLD ANTILLES

FOR: ORGANIZATION OF BUSINESS PLAN  
COMPETITIONS , IN CLASS 35 (U.S. CLS. 100, 101  
AND 102).

PRIORITY DATE OF 11-16-2006 IS CLAIMED.

OWNER OF INTERNATIONAL REGISTRATION  
0950694 DATED 5-11-2007, EXPIRES 5-11-2017.

SER. NO. 79-048,945, FILED 5-11-2007.

ROBERT STRUCK, EXAMINING ATTORNEY



**Int. Cl.: 3**

**Prior U.S. Cls.: 1, 4, 6, 50, 51 and 52**

**United States Patent and Trademark Office**

**Reg. No. 3,468,379**

**Registered July 15, 2008**

**TRADEMARK  
PRINCIPAL REGISTER**

***K\_Clean***

DANDONG KANGCHILING; TOOTHPASTE CO.,  
LTD. (CHINA CORPORATION)  
NO. 148, ZHONGHE VILLAGE  
LANGTOU TOWN.; ZHENXING DISTRICT.; DAN-  
DONG CITY; LIAONING  
CHINA

OWNER OF INTERNATIONAL REGISTRATION  
0950794 DATED 1-10-2008, EXPIRES 1-10-2018.

SER. NO. 79-048,982, FILED 1-10-2008.

FOR: DENTIFRICES, IN CLASS 3 (U.S. CLS. 1, 4, 6,  
50, 51 AND 52).

DANIEL CAPSHAW, EXAMINING ATTORNEY

**Int. Cl.: 19**

**Prior U.S. Cls.: 1, 12, 33 and 50**

**Reg. No. 3,468,380**

**United States Patent and Trademark Office**

**Registered July 15, 2008**

**TRADEMARK  
PRINCIPAL REGISTER**

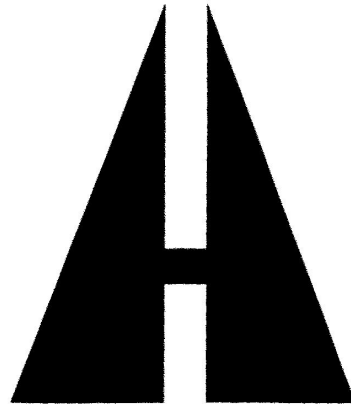

**HUAZHJIE**

ZHEJIANG HUAZHJIE PLASTIC; BUILDING MATERIAL CO., LTD (CHINA CORPORATION)

NO. 898, ZHONGXING NORTH RD.

WUKANG TOWN.; DEQING COUNTY; ZHEJIANG PROVINCE

CHINA

FOR: BUILDING MATERIALS, NAMELY, WALL, HARDWOOD, DECKING, WOOD, PARTICLE BOARDS; BUILDING MATERIALS, NAMELY, CELLULAR PVC TRIM; NON-METAL CEILING PANELS; NON-METAL GATES AND FENCING; NON-

METAL DECORATIVE MOLDINGS AND DECORATIVE TRIM FOR USE IN BUILDING CONSTRUCTION; BUILDING MATERIALS, NAMELY, DECKING BOARDS, IN CLASS 19 (U.S. CLS. 1, 12, 33 AND 50).

OWNER OF INTERNATIONAL REGISTRATION 0951541 DATED 11-15-2007, EXPIRES 11-15-2017.

SER. NO. 79-049,206, FILED 11-15-2007.

EUGENIA MARTIN, EXAMINING ATTORNEY

**Int. Cl.: 33**

**Prior U.S. Cls.: 47 and 49**

**United States Patent and Trademark Office**

**Reg. No. 3,468,381**

**Registered July 15, 2008**

**TRADEMARK  
PRINCIPAL REGISTER**

**GORRONDONA**

BENTALDE, S.L. (SPAIN SOCIEDAD LIMITADA)  
GIBELORRATZAGAKO SAN PELAIO, 1  
(GORRONDONA BASERRIA); E-48130  
BAKIO (BIZKAIA), SPAIN

OWNER OF INTERNATIONAL REGISTRATION  
0951740 DATED 9-24-2007, EXPIRES 9-24-2017.

FOR: ALCOHOLIC BEVERAGES EXCEPT BEERS,  
IN CLASS 33 (U.S. CLS. 47 AND 49).

SER. NO. 79-049,294, FILED 9-24-2007.

THE MARK CONSISTS OF STANDARD CHAR-  
ACTERS WITHOUT CLAIM TO ANY PARTICULAR  
FONT, STYLE, SIZE, OR COLOR.

WENDY JUN, EXAMINING ATTORNEY

**Int. Cls.: 10 and 21**

**Prior U.S. Cls.: 2, 13, 23, 26, 29, 30, 33, 39, 40, 44 and 50**

**United States Patent and Trademark Office**

**Reg. No. 3,468,382**

**Registered July 15, 2008**

**TRADEMARK  
PRINCIPAL REGISTER**

# FIXAFLOSS

KERRHAWE S.A. (SWITZERLAND SOCIÉTÉ ANONYME)  
VIA STRECCE  
CH-6934 BIOGGIO  
SWITZERLAND

FOR: DENTAL APPARATUS AND INSTRUMENTS DESIGNED FOR FASTENING COFFERDAMS OF RUBBER, IN CLASS 10 (U.S. CLS. 26, 39 AND 44).

FOR: DENTAL FLOSS, IN CLASS 21 (U.S. CLS. 2, 13, 23, 29, 30, 33, 40 AND 50).

THE MARK CONSISTS OF STANDARD CHARACTERS WITHOUT CLAIM TO ANY PARTICULAR FONT, STYLE, SIZE, OR COLOR.

PRIORITY DATE OF 5-25-2007 IS CLAIMED.

OWNER OF INTERNATIONAL REGISTRATION 0951750 DATED 11-23-2007, EXPIRES 11-23-2017.

SER. NO. 79-049,298, FILED 11-23-2007.

KELLY BOULTON, EXAMINING ATTORNEY

**Int. Cl.: 33**

**Prior U.S. Cls.: 47 and 49**

**United States Patent and Trademark Office**

**Reg. No. 3,468,383**

**Registered July 15, 2008**

**TRADEMARK  
PRINCIPAL REGISTER**

**TAMIZ**

BODEGAS REYES, S.L. (SPAIN S.L.)  
PZA. DE LOS VOLUNTARIOS, 4  
E-47300 PEÑAFIEL (VALLADOLID), SPAIN

FOR: WINE, IN CLASS 33 (U.S. CLS. 47 AND 49).

THE MARK CONSISTS OF STANDARD CHARACTERS WITHOUT CLAIM TO ANY PARTICULAR FONT, STYLE, SIZE, OR COLOR.

OWNER OF INTERNATIONAL REGISTRATION  
0952699 DATED 7-26-2007, EXPIRES 7-26-2017.

THE ENGLISH TRANSLATION OF THE FOREIGN WORD(S) IN THE MARK IS "SIEVE".

SER. NO. 79-049,633, FILED 7-26-2007.

ANDREA K. NADELMAN, EXAMINING ATTORNEY

**Int. Cl.: 1**

**Prior U.S. Cls.: 1, 5, 6, 10, 26 and 46**

**Reg. No. 3,468,384**

**United States Patent and Trademark Office**

**Registered July 15, 2008**

**TRADEMARK  
PRINCIPAL REGISTER**

The logo for SINOSWEET features the word "SINOSWEET" in a bold, sans-serif font. The letter "I" is stylized with a vertical line that has a small circle at the top. Above the "I" and "N" are several small, grey, circular dots of varying sizes, arranged in a slightly curved path.

JIANGSU HANGUANG SINOSWEET CO., LTD.  
(CHINA CORPORATION)  
YANGZHUCUN, DAPUZHEN  
YIXING; JIANGSU 214226  
CHINA

OWNER OF INTERNATIONAL REGISTRATION  
0860892 DATED 6-21-2005, EXPIRES 6-21-2015.

SER. NO. 79-049,763, FILED 11-27-2007.

FOR: ARTIFICIAL SWEETENERS, NAMELY, AS-  
PARTAME, IN CLASS 1 (U.S. CLS. 1, 5, 6, 10, 26 AND  
46).

SEAN CROWLEY, EXAMINING ATTORNEY

**Int. Cl.: 9**

**Prior U.S. Cls.: 21, 23, 26, 36, and 38**

**Reg. No. 3,468,385**

**United States Patent and Trademark Office**

**Registered July 15, 2008**

---

**TRADEMARK  
PRINCIPAL REGISTER**

**AMP CONTROLS**

HETRONIC USA INC. (OKLAHOMA CORPORATION)  
4300 HIGHLINE BOULEVARD  
BUILDING A  
OKLAHOMA CITY, OK 73108

FOR: CONTROL DEVICES FOR MINING PRODUCTS, NAMELY, MICROPROCESSOR-BASED CONTROLLERS FOR LOADERS, CRANES, TUNNEL DRILLING RIGS, CONVEYORS, AND MATERIAL HANDLERS, IN CLASS 9 (U.S. CLS. 21, 23, 26, 36 AND 38).

FIRST USE 10-5-2007; IN COMMERCE 10-5-2007.

THE MARK CONSISTS OF STANDARD CHARACTERS WITHOUT CLAIM TO ANY PARTICULAR FONT, STYLE, SIZE, OR COLOR.

NO CLAIM IS MADE TO THE EXCLUSIVE RIGHT TO USE "CONTROLS", APART FROM THE MARK AS SHOWN.

SN 75-631,451, FILED 2-1-1999.

MICHAEL WEBSTER, EXAMINING ATTORNEY

**Int. Cls.: 38, 41, and 42**

**Prior U.S. Cls.: 100, 101, 104, and 107**

**United States Patent and Trademark Office**

**Reg. No. 3,468,386**

**Registered July 15, 2008**

**SERVICE MARK  
PRINCIPAL REGISTER**

**E4E**

E4E, INC. (CALIFORNIA CORPORATION)  
3979 FREEDOM CIRCLE, SIXTH FLOOR  
SANTA CLARA, CA 95054

FOR: PROVIDING MULTIPLE-USER ACCESS TO  
A GLOBAL COMPUTER NETWORK, IN CLASS 38  
(U.S. CLS. 100, 101 AND 104).

FIRST USE 11-0-2000; IN COMMERCE 11-0-2000.

FOR: ON-LINE RESEARCH REPORTS ON THE  
SUBJECTS OF INFORMATION TECHNOLOGY  
AND DATABASE MANAGEMENT, IN CLASS 41  
(U.S. CLS. 100, 101 AND 107).

FIRST USE 11-0-2000; IN COMMERCE 11-0-2000.

FOR: COMPUTER SERVICES, NAMELY, PRO-  
VIDING A SEARCH ENGINE FOR OBTAINING  
DATA ON A GLOBAL COMPUTER NETWORK, IN  
CLASS 42 (U.S. CLS. 100 AND 101).

FIRST USE 11-0-2000; IN COMMERCE 11-0-2000.

SN 75-735,367, FILED 7-19-1999.

ALICE BENMAMAN, EXAMINING ATTORNEY



**Int. Cl.: 9**

**Prior U.S. Cls.: 21, 23, 26, 36, and 38**

**United States Patent and Trademark Office**

**Reg. No. 3,468,387**

**Registered July 15, 2008**

**TRADEMARK  
PRINCIPAL REGISTER**

**SPOT**

SALSPOT LTD. (UNITED KINGDOM CORPORATION)  
27 WRIGHTS LANE  
LONDON W85TZ, UNITED KINGDOM

FOR: DOWNLOADABLE ELECTRONIC PUBLICATIONS IN THE NATURE OF MATERIALS PUBLISHED ON WEBSITES ACCESSIBLE THROUGH THE GLOBAL COMPUTER NETWORK, FEATURING A FICTIONAL DOG, IN CLASS 9 (U.S. CLS. 21, 23, 26, 36 AND 38).

FIRST USE 1-0-2008; IN COMMERCE 1-0-2008.

OWNER OF U.S. REG. NO. 2,282,459.

SN 76-104,780, FILED 8-7-2000.

WON TEAK OH, EXAMINING ATTORNEY

**Int. Cl.: 33**

**Prior U.S. Cls.: 47 and 49**

**United States Patent and Trademark Office**

**Reg. No. 3,468,388**

**Registered July 15, 2008**

**TRADEMARK  
PRINCIPAL REGISTER**

**PLATINO**

RON MATUSALEM & MATUSA OF FLORIDA,  
INC. (FLORIDA CORPORATION)  
1205 S. W. 37TH AVENUE  
MIAMI, FL 33135

THE ENGLISH TRANSLATION OF "PLATINO" IS  
"PLATINUM".

FOR: RUM, IN CLASS 33 (U.S. CLS. 47 AND 49).

SN 76-256,473, FILED 5-14-2001.

FIRST USE 9-18-2006; IN COMMERCE 9-18-2006.

GEORGIA CARTY, EXAMINING ATTORNEY

**Int. Cls.: 35, 38, and 41**

**Prior U.S. Cls.: 100, 101, 102, 104, and 107**

**United States Patent and Trademark Office**

**Reg. No. 3,468,389**

**Registered July 15, 2008**

**SERVICE MARK  
PRINCIPAL REGISTER**

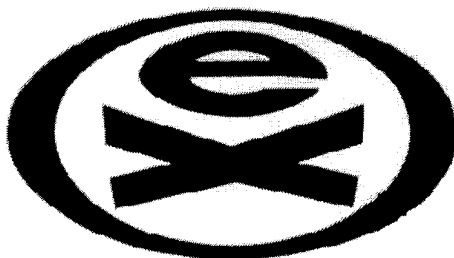

UPC PROGRAMMING B.V.  
KONINGIN WILHELMINAPLEIN 2-4  
1062 HK AMSTERDAM, NETHERLANDS AND  
EXTREME NETWORKS (EUROPE) LIMITED  
THE COACH HOUSE  
ASHFORD LODGE  
HALSTEAD ESSEX C09 2RR, UNITED KINGDOM

FOR: PROMOTING THE GOODS AND SERVICES OF OTHERS BY PREPARING AND DISSEMINATING ADVERTISEMENTS THROUGH A GLOBAL COMPUTER NETWORK; PROMOTING THE GOODS AND SERVICES OF OTHERS BY PROVIDING HYPERTEXT LINKS TO THE WEB SITES OF OTHERS; PROMOTING THE GOODS AND SERVICES OF OTHERS BY PROVIDING A WEB SITE AT WHICH USERS CAN LINK WEB SITES OF OTHERS FEATURING MERCHANDISE, NEWS, SPONSORS AND PERSONALITIES IN THE FIELD OF SPORTS, NEWS, RECREATION, ENTERTAINMENT AND CULTURE; DISTRIBUTION OF ADVERTISING MATERIALS, IN CLASS 35 (U.S. CLS. 100, 101 AND 102).

FIRST USE 5-0-2000; IN COMMERCE 5-0-2000.

FOR: TELECOMMUNICATION SERVICES, NAMELY, DIGITAL TRANSMISSION OF SOUND, VIDEO AND IMAGES BY MEANS OF A GLOBAL COMPUTER NETWORK; ELECTRIC, ELECTRONIC AND DIGITAL TRANSMISSION OF VOICE, DATA, IMAGE, SIGNALS AND MESSAGES, IN CLASS 38 (U.S. CLS. 100, 101 AND 104).

FIRST USE 5-0-2000; IN COMMERCE 5-0-2000.

FOR: ENTERTAINMENT IN THE NATURE OF ONGOING VIDEO PROGRAMS DISTRIBUTED VIA A GLOBAL COMPUTER NETWORK IN THE FIELD OF SPORTS, ENTERTAINMENT, NEWS, RECREATION AND CULTURE, IN CLASS 41 (U.S. CLS. 100, 101 AND 107).

FIRST USE 5-0-2000; IN COMMERCE 5-0-2000.

SN 76-260,319, FILED 5-22-2001.

ANGELA M. MICHELI, EXAMINING ATTORNEY

**Int. Cl.: 35**

**Prior U.S. Cls.: 100, 101, and 102**

**United States Patent and Trademark Office**

**Reg. No. 3,468,390**

**Registered July 15, 2008**

**SERVICE MARK  
PRINCIPAL REGISTER**

**CLICK LOGIC**

XSSOCIATE, LLC (CALIFORNIA LTD LIAB CO)  
4630 GEARY BOULEVARD, SUITE 101  
SAN FRANCISCO, CA 94118

FOR: PROMOTING THE GOODS AND SERVICES  
OF OTHERS BY PREPARING AND PLACING AD-  
VERTISEMENTS VIA THE GLOBAL COMPUTER  
NETWORK, IN CLASS 35 (U.S. CLS. 100, 101 AND  
102).

FIRST USE 12-1-2006; IN COMMERCE 12-1-2006.

THE MARK CONSISTS OF STANDARD CHAR-  
ACTERS WITHOUT CLAIM TO ANY PARTICULAR  
FONT, STYLE, SIZE, OR COLOR.

SN 76-308,283, FILED 9-4-2001.

WILLIAM ROSSMAN, EXAMINING ATTORNEY

**Int. Cl.: 9**

**Prior U.S. Cls.: 21, 23, 26, 36, and 38**

**United States Patent and Trademark Office**

**Reg. No. 3,468,391**

**Registered July 15, 2008**

**TRADEMARK  
PRINCIPAL REGISTER**

**SYMPHONIC**

FUNAI ELECTRIC COMPANY LIMITED (JAPAN CORPORATION)  
7-1, NAKAQAITO 7-CHOME  
DAITO-SHI  
OSAKA, JAPAN

FOR: COMPACT DISC CASES; COMPACT DISC PLAYERS; DIGITAL VERSATILE DISC PLAYERS; COMPUTER DISC DRIVES; COMPUTER MEMORIES; COMPUTER MONITORS; COMPUTER PERIPHERALS; COMPUTERS; BLANK COMPUTER DISCS ON WHICH INFORMATION AND/OR SOUND AND IMAGE DATA IS TO BE DIGITALLY RECORDED; INTEGRATED CIRCUITS; COMPUTER KEYBOARDS; LASER PRINTERS; INK JET PRINTERS; SCANNERS; DISC STORAGE RACKS; DISC STORAGE WALLETS; CARRYING BAGS FOR VIDEO CASSETTE PLAYERS; CARRYING BAGS FOR VIDEO TAPE RECORDERS; CARRYING BAGS FOR DIGITAL VERSATILE DISC PLAYERS; CARRYING

BAGS FOR LIQUID CRYSTAL DISPLAY MONITORS; CARRYING BAGS FOR AUDIO-VISUAL APPARATUS AND ACCESSORIES THEREOF INCLUDING SOFTWARE, CASSETTES AND ATTACHMENTS; CARRYING BAG USED AS A HOLDER OF A PORTABLE TELEVISION SET AND A PORTABLE COMBINED TELEVISION SET AND VIDEO TAPE PLAYER, IN CLASS 9 (U.S. CLS. 21, 23, 26, 36 AND 38).

FIRST USE 12-0-1989; IN COMMERCE 8-0-2001.

OWNER OF U.S. REG. NOS. 706,244, 1,133,541, AND 1,713,126.

SN 76-320,749, FILED 10-2-2001.

HEATHER THOMPSON, EXAMINING ATTORNEY

**Int. Cls.: 9 and 38**

**Prior U.S. Cls.: 21, 23, 26, 36, 38, 100, 101, and 104**

**United States Patent and Trademark Office**

**Reg. No. 3,468,392**

**Registered July 15, 2008**

**TRADEMARK  
SERVICE MARK  
PRINCIPAL REGISTER**

**ESP**

TPUSA, INC. (DELAWARE CORPORATION)  
1991 SOUTH 4650 WEST  
SALT LAKE CITY, UT 84104

FOR: VOICE RESPONSE PROCESSING EQUIPMENT AND COMPUTER SOFTWARE PROGRAMS FOR INTEGRATING INTERACTIVE VOICE RESPONSE OR KEYPAD ENTRIES WITH A DESKTOP COMPUTER THROUGH TELEPHONY INTEGRATION TECHNOLOGY VIA THE INTERNET, IN CLASS 9 (U.S. CLS. 21, 23, 26, 36 AND 38).

FIRST USE 1-0-1999; IN COMMERCE 1-0-1999.

FOR: PROVIDING TELECOMMUNICATION CONNECTIONS BETWEEN INTERACTIVE VOICE

RESPONSE PROCESSING SOFTWARE AND A DESKTOP COMPUTER THROUGH TELEPHONY INTEGRATION TECHNOLOGY VIA THE INTERNET, IN CLASS 38 (U.S. CLS. 100, 101 AND 104).

FIRST USE 1-0-1999; IN COMMERCE 1-0-1999.

THE MARK CONSISTS OF STANDARD CHARACTERS WITHOUT CLAIM TO ANY PARTICULAR FONT, STYLE, SIZE, OR COLOR.

SN 76-349,791, FILED 12-17-2001.

RUSS HERMAN, EXAMINING ATTORNEY

**Int. Cls.: 29 and 30**

**Prior U.S. Cl.: 46**

**United States Patent and Trademark Office**

**Reg. No. 3,468,393**

**Registered July 15, 2008**

**TRADEMARK  
PRINCIPAL REGISTER**



DULCES Y CONSERVAS HELIOS S.A. (SPAIN  
CORPORATION)  
CTRA. BURGOS A PORTUGAL KM  
129 APARTADO 371  
47080 VALLADOLID, SPAIN

FOR: JAMS AND MARMALADES AND POR-  
TIONS OF JAMS AND MARMALADES; VEGETA-  
BLE PRESERVES; FRUITS IN SYRUP; PICKLES IN  
VINEGARS; PICOS, NAMELY FRUIT PASTE WED-  
GES, AND CANDIED FRUIT, ALL EXCLUDING  
DRIED FRUITS AND PLUMS, IN CLASS 29 (U.S. CL.  
46).

FIRST USE 6-1-1936; IN COMMERCE 6-1-2003.

FOR: FONDANT, TOMATO SAUCE, HONEY  
AND PORTIONS FOR HONEY, AND SWEETENED  
GELATIN, IN CLASS 30 (U.S. CL. 46).

FIRST USE 6-1-1936; IN COMMERCE 6-1-2003.

THE TRANSLATION OF THE WORD "HELIOS" IS  
"SUN".

SN 76-362,789, FILED 1-28-2002.

BRENDAN MCCAULEY, EXAMINING ATTORNEY

Int. Cl.: 28

Prior U.S. Cls.: 22, 23, 38, and 50

United States Patent and Trademark Office

Reg. No. 3,468,394

Registered July 15, 2008

TRADEMARK  
PRINCIPAL REGISTER



GRAVITY CORPORATION (REPUBLIC OF KOREA CORPORATION)  
6TH FLOOR, SHINKOO BLDG.  
620-2 SHINSA-DONG, KANGNAM-GU  
SEOUL, REPUBLIC OF KOREA

FOR: DOMESTIC PET TOYS; TOY COSTUME MASKS; RUBBER CHARACTER TOYS; REMOTE CONTROL TOYS, NAMELY, CARS AND TRUCKS; MASCOT DOLLS; TOY BUILDING BLOCKS; PLUSH TEXTILE TOYS; PLASTIC TOYS, NAMELY, BABY MULTIPLE-ACTIVITY; REMOTE-CONTROL OPERATED GAMES, NAMELY, HANDHELD GAME APPLIANCE; AMUSEMENT MACHINES, NAMELY, STAND-ALONE VIDEO GAME MACHINES, BOTH AUTOMATIC AND COIN-OPERATED; BACKGAMMON GAME SETS; CHESS GAME SETS; GOLF

GLOVES; ROLLER SKATES; ROCKING HORSES, IN CLASS 28 (U.S. CLS. 22, 23, 38 AND 50).

FIRST USE 6-1-2003; IN COMMERCE 6-1-2003.

THE MARK CONSISTS OF THE TERM OF "RAGNAROK" IN NORSE MYTHOLOGY .

THE FOREIGN WORDING IN THE MARK TRANSLATES INTO ENGLISH AS THE DESTRUCTION OF THE WORLD IN THE LAST GREAT CONFLICT BETWEEN THE GODS AND THE FORCES OF EVIL.

SN 76-432,004, FILED 7-15-2002.

WON TEAK OH, EXAMINING ATTORNEY



**Int. Cl.: 29**

**Prior U.S. Cl.: 46**

**United States Patent and Trademark Office**

**Reg. No. 3,468,395**

**Registered July 15, 2008**

**TRADEMARK  
PRINCIPAL REGISTER**

**PEACOCK**

TERFLOTH TRADE MARKS LIMITED (BERMUDA LIMITED CORPORATION)  
P.O. BOX HM 2826  
HAMILTON HM LX, BERMUDA

FOR: CANNED MEAT, NAMELY, LUNCHEON MEAT, CORNED BEEF, VIENNA SAUSAGES; POULTRY; FROZEN MEATS; MEAT EXTRACTS; PRESERVED, DRIED, COOKED CANNED FRUITS AND CANNED VEGETABLES; CANNED, PREPARED FROZEN FISH, NAMELY, TUNA, MACKEREL, SARDINES, HERRING, SALMON; CANNED SEAFOOD, NAMELY, SHRIMP, OYSTERS, CRAB, LOBSTER; SOUPS, NAMELY, CHICKEN NOODLE SOUP, CANNED SOUPS, DRIED SOUPS, SOUP MIXES; JAMS; JELLIES; MARMALADES; DAIRY DERIVED PRODUCTS, NAMELY, PROCESSED CHEESE, BUTTER; SOUR CREAM; WHIPPING

CREAM; YOGURT; MILK PRODUCTS, NAMELY, MILK, CONDENSED MILK; MILK BASED DRINKS, NAMELY, FLAVORED MILK; PEANUT BUTTER; COCONUT MILK; COCONUT CREAM; EDIBLE OILS AND FATS, NAMELY, OLIVE OIL, CANOLA OIL; PASTES, NAMELY, FRUIT PASTES, VEGETABLE PASTES, MEAT PASTES, TOMATO PASTE; PROCESSED PULSES, NAMELY, LENTILS, PEAS, BEANS; PICKLES; HOT PEPPER PASTE; CRANBERRY SAUCE AND/OR APPLE SAUCE, IN CLASS 29 (U.S. CL. 46).

FIRST USE 11-0-2003; IN COMMERCE 5-15-2008.

SN 76-443,018, FILED 8-22-2002.

ESTHER BELENKER, EXAMINING ATTORNEY

**Int. Cls.: 8, 9, 14, 16, 18, 20, 21, 22, 25, and 28**

**Prior U.S. Cls.: 1, 2, 3, 5, 7, 13, 19, 21, 22, 23, 25, 26, 27, 28, 29, 30, 32, 33, 36, 37, 38, 39, 40, 41, 42, 44, and 50**

**Reg. No. 3,468,396**

**United States Patent and Trademark Office**

**Registered July 15, 2008**

**TRADEMARK  
PRINCIPAL REGISTER**

**MAKER OF THE GENUINE SWISS ARMY KNIFE**

WENGER S.A. (SWITZERLAND CORPORATION)  
CH-2800 DELEMONT, SWITZERLAND

FOR: COOKING UTENSILS FOR CAMPING, NAMELY, FORKS, KNIVES, IN CLASS 8 (U.S. CLS. 23, 28 AND 44).

FIRST USE 0-0-2000; IN COMMERCE 0-0-2000.

FOR: COMPUTER CARRYING CASES, MOBILE PHONE AND CELL PHONE CASES AND SPECIALTY HOLSTERS FOR CARRYING PERSONAL DIGITAL ASSISTANTS, IN CLASS 9 (U.S. CLS. 21, 23, 26, 36 AND 38).

FIRST USE 6-0-2003; IN COMMERCE 6-0-2003.

FOR: ALARM CLOCKS, IN CLASS 14 (U.S. CLS. 2, 27, 28 AND 50).

FIRST USE 8-0-1997; IN COMMERCE 8-0-1997.

FOR: LEATHER PASSPORT HOLDERS, IN CLASS 16 (U.S. CLS. 2, 5, 22, 23, 29, 37, 38 AND 50).

FIRST USE 6-0-2003; IN COMMERCE 6-0-2003.

FOR: ALL-PURPOSE DRY BAGS, LUGGAGE, BACKPACKS, DAYPACKS, DUFFEL BAGS, UTILITY BAGS, SHOULDER BAGS, CASUAL BAGS, BRIEFCASES, NON-MOTORIZED WHEELED PACKS; TOILETRY CASES SOLD EMPTY, TRAVEL BAGS, SMALL PERSONAL LEATHER GOODS, NAMELY, MONEY POUCHES, WALLETS, SHAVING BAGS SOLD EMPTY, UMBRELLAS AND BRIEFCASE-TYPE PORTFOLIOS, IN CLASS 18 (U.S. CLS. 1, 2, 3, 22 AND 41).

FIRST USE 7-3-2003; IN COMMERCE 7-3-2003.

FOR: SLEEPING AND NAP MATS, NON-METAL MONEY CLIPS, LEATHER PICTURE FRAMES, SLEEPING BAGS, AIR MATTRESSES FOR USE WHEN CAMPING, INFLATABLE MATTRESSES FOR USE WHEN CAMPING; LEATHER KEY FOBS, LEATHER AIRLINE TICKET HOLDERS, IN CLASS 20 (U.S. CLS. 2, 13, 22, 25, 32 AND 50).

FIRST USE 1-7-2003; IN COMMERCE 1-7-2003.

FOR: PORTABLE COOLERS AND PORTABLE INSULATED COOLER BAGS, IN CLASS 21 (U.S. CLS. 2, 13, 23, 29, 30, 33, 40 AND 50).

FIRST USE 5-1-2007; IN COMMERCE 5-1-2007.

FOR: TENTS, SCREEN HOUSES IN THE NATURE OF A TENT, GAZEBO-LIKE SHELTERS IN THE NATURE OF A TENT, IN CLASS 22 (U.S. CLS. 1, 2, 7, 19, 22, 42 AND 50).

FIRST USE 1-7-2003; IN COMMERCE 1-7-2003.

FOR: CLOTHING, NAMELY, FOOTWEAR, IN CLASS 25 (U.S. CLS. 22 AND 39).

FIRST USE 3-1-2007; IN COMMERCE 3-1-2007.

FOR: AIR MATTRESSES FOR RECREATIONAL AND HOME USE, INFLATABLE MATTRESSES FOR RECREATIONAL AND HOME USE, IN CLASS 28 (U.S. CLS. 22, 23, 38 AND 50).

FIRST USE 1-6-2004; IN COMMERCE 1-6-2004.

SN 76- 448,331, FILED 9-10-2002.

BRENDAN REGAN, EXAMINING ATTORNEY

**Int. Cls.: 6, 9, 16, 18, and 20**

**Prior U.S. Cls.: 1, 2, 3, 5, 12, 13, 14, 21, 22, 23, 25, 26,  
29, 32, 36, 37, 38, 41, and 50**

**Reg. No. 3,468,397**

**United States Patent and Trademark Office**

**Registered July 15, 2008**

**TRADEMARK  
PRINCIPAL REGISTER**

**MAKER OF THE GENUINE SWISS ARMY KNIFE**

WENGER S.A. (SWITZERLAND CORPORATION)  
CH-2800 DELEMONT, SWITZERLAND

FOR: METAL SECURITY CABLES FOR ELECTRONIC DEVICES, IN CLASS 6 (U.S. CLS. 2, 12, 13, 14, 23, 25 AND 50).

FIRST USE 7-0-2006; IN COMMERCE 7-0-2006.

FOR: CAMERA CASES, AND BATTERY CHARGERS FOR ELECTRONIC DEVICES; HOLDERS AND CARRYING CASES FOR ELECTRONIC DEVICES, NAMELY, FOR PERSONAL DIGITAL ASSISTANTS, MOBILE PHONES SUNGLASS CASES SOLD EMPTY, IN CLASS 9 (U.S. CLS. 21, 23, 26, 36 AND 38).

FIRST USE 7-3-2003; IN COMMERCE 7-3-2003.

FOR: BINDERS, CARD FILES, FOLDERS, BINDERS FOLIOS; MEMO PADS, NOTE PADS, AND WRITING PADS ADDRESS BOOKS, IN CLASS 16 (U.S. CLS. 2, 5, 22, 23, 29, 37, 38 AND 50).

FIRST USE 6-0-2003; IN COMMERCE 6-0-2003.

FOR: CATALOG CASES, NAME AND CALLING CARD CASES, TOILETRY CASES SOLD EMPTY, LUGGAGE STRAPS, LUGGAGE TAGS, NON-MOTORIZED COLLAPSIBLE LUGGAGE CARTS, WAISTPACKS, SHOPPING BAGS, BAGS WORN ON THE BODY, BUSINESS CASES, SHOE BAGS FOR TRAVEL, TRAVEL PACKING CUBES, TRAVEL BAGS, TRAVEL POUCHES, ALL-PURPOSE PERSONAL CARE BAGS, SMALL PERSONAL LEATHER GOODS, NAMELY, BILLFOLDS, COIN PURSES, CREDIT CARD CASES, NECK AND NECKLACE WALLETS, OPERA WALLETS; UNFITTED BAGS FOR HANDHELD ELECTRONIC DEVICES, IN CLASS 18 (U.S. CLS. 1, 2, 3, 22 AND 41).

FIRST USE 7-3-2003; IN COMMERCE 7-3-2003.

FOR: PICTURE FRAMES, IN CLASS 20 (U.S. CLS. 2, 13, 22, 25, 32 AND 50).

FIRST USE 10-0-2003; IN COMMERCE 10-0-2003.

SN 76-470,859, FILED 11-29-2002.

BRENDAN REGAN, EXAMINING ATTORNEY

**Int. Cls.: 6, 8, 9, 14, 16, 18, 20, 21, 22, 25, and 28**

**Prior U.S. Cls.: 1, 2, 3, 5, 7, 12, 13, 14, 19, 21, 22, 23, 25, 26, 27, 28, 29, 30, 32, 33, 36, 37, 38, 39, 40, 41, 42, 44, and 50**

**Reg. No. 3,468,398**

**United States Patent and Trademark Office**

**Registered July 15, 2008**

**TRADEMARK  
PRINCIPAL REGISTER**

**WENGER. MAKER OF THE GENUINE SWISS ARMY KNIFE**

WENGER S.A. (SWITZERLAND CORPORATION)  
CH-2800 DELEMONT, SWITZERLAND

FOR: METAL SECURITY CABLES FOR ELECTRONIC DEVICES, IN CLASS 6 (U.S. CLS. 2, 12, 13, 14, 23, 25 AND 50).

FIRST USE 7-0-2006; IN COMMERCE 7-0-2006.

FOR: COOKING UTENSILS FOR CAMPING, NAMELY, FORKS, KNIVES, IN CLASS 8 (U.S. CLS. 23, 28 AND 44).

FIRST USE 0-0-2000; IN COMMERCE 0-0-2000.

FOR: COMPUTER CARRYING CASES, MOBILE PHONE AND CELL PHONE CASES AND SPECIALTY HOLSTERS FOR CARRYING PERSONAL DIGITAL ASSISTANTS; HOLDERS AND CARRYING CASES FOR ELECTRONIC DEVICES, NAMELY, FOR PERSONAL DIGITAL ASSISTANTS, MOBILE PHONES; CAMERA CASES, SUNGLASS CASES SOLD EMPTY, IN CLASS 9 (U.S. CLS. 21, 23, 26, 36 AND 38).

FIRST USE 7-3-2003; IN COMMERCE 7-3-2003.

FOR: ALARM CLOCKS, IN CLASS 14 (U.S. CLS. 2, 27, 28 AND 50).

FIRST USE 8-0-1997; IN COMMERCE 8-0-1997.

FOR: BINDERS, FOLIOS; MEMO PADS, NOTE PADS, AND WRITING PADS; ADDRESS BOOKS, LEATHER PASSPORT HOLDERS, IN CLASS 16 (U.S. CLS. 2, 5, 22, 23, 29, 37, 38 AND 50).

FIRST USE 6-0-2003; IN COMMERCE 6-0-2003.

FOR: ALL-PURPOSE DRY BAGS, LUGGAGE, BACKPACKS, DAYPACKS, DUFFEL BAGS, UTILI-

TY BAGS, SHOULDER BAGS, CASUAL BAGS, BRIEFCASES, NON-MOTORIZED WHEELED PACKS, COSMETIC CASES SOLD EMPTY AND TOILETRY CASES SOLD EMPTY, TRAVEL BAGS, SMALL PERSONAL LEATHER GOODS, NAMELY, MONEY POUCHES, WALLETS, AND SHAVING BAGS SOLD EMPTY, UMBRELLAS AND BRIEFCASE-TYPE PORTFOLIOS; CATALOG CASES, NAME AND CALLING CARD CASES, TOILETRY CASES SOLD EMPTY, LUGGAGE STRAPS, LUGGAGE TAGS, NON-MOTORIZED COLLAPSIBLE LUGGAGE CARTS, WAISTPACKS, SHOPPING BAGS, BAGS WORN ON THE BODY, BUSINESS CASES, SHOE BAGS FOR TRAVEL, TRAVEL PACKING CUBES, TRAVEL BAGS, TRAVEL POUCHES, ALL-PURPOSE PERSONAL CARE BAGS, SMALL PERSONAL LEATHER GOODS, NAMELY, BILLFOLDS, COIN PURSES, CREDIT CARD CASES, NECK AND NECKLACE WALLETS, OPERA WALLETS; UNFITTED BAGS FOR HANDHELD ELECTRONIC DEVICES, IN CLASS 18 (U.S. CLS. 1, 2, 3, 22 AND 41).

FIRST USE 7-3-2003; IN COMMERCE 7-3-2003.

FOR: PICTURE FRAMES, SLEEPING AND NAP MATS, NON-METAL MONEY CLIPS, LEATHER PICTURE FRAMES, SLEEPING BAGS, AIR MATTRESSES FOR USE WHEN CAMPING, INFLATABLE MATTRESSES FOR USE WHEN CAMPING, LEATHER KEY FOBS; LEATHER AIRLINE TICKET HOLDERS, IN CLASS 20 (U.S. CLS. 2, 13, 22, 25, 32 AND 50).

FIRST USE 1-7-2003; IN COMMERCE 1-7-2003.

FOR: PORTABLE COOLERS AND PORTABLE INSULATED COOLER BAGS, IN CLASS 21 (U.S. CLS. 2, 13, 23, 29, 30, 33, 40 AND 50).

FIRST USE 5-1-2007; IN COMMERCE 5-1-2007.

FOR: TENTS, SCREEN HOUSES IN THE NATURE OF A TENT, GAZEBO-LIKE SHELTERS IN THE NATURE OF A TENT, IN CLASS 22 (U.S. CLS. 1, 2, 7, 19, 22, 42 AND 50).

FIRST USE 1-7-2003; IN COMMERCE 1-7-2003.

FOR: CLOTHING, NAMELY, FOOTWEAR, IN CLASS 25 (U.S. CLS. 22 AND 39).

FIRST USE 3-1-2007; IN COMMERCE 3-1-2007.

FOR: AIR MATTRESSES FOR RECREATIONAL AND HOME USE, INFLATABLE MATTRESSES FOR RECREATIONAL AND HOME USE, IN CLASS 28 (U.S. CLS. 22, 23, 38 AND 50).

FIRST USE 1-6-2004; IN COMMERCE 1-6-2004.

OWNER OF U.S. REG. NOS. 1,719,835 AND 2,094,131.

SN 76-470,867, FILED 11-29-2002.

BRENDAN REGAN, EXAMINING ATTORNEY

Int. Cls.: 35 and 38

Prior U.S. Cls.: 100, 101, 102, and 104

United States Patent and Trademark Office

Reg. No. 3,468,399

Registered July 15, 2008

SERVICE MARK  
PRINCIPAL REGISTER



AEGIS TRADEMARK BV (NETHERLANDS  
COMPANY)

MUSEUM PLAZA, WETERINGSCHANS 87B

AMSTERDAM 1017 RZ, NETHERLANDS

FOR: (BASED ON USE IN COMMERCE) (BASED ON 44(E)) ADVERTISING, NAMELY, CREATING CORPORATE AND BRAND IDENTITY FOR OTHERS; MARKET RESEARCH; DATA PROCESSING; BUSINESS MANAGEMENT; DISSEMINATION OF ADVERTISING MATERIAL, BROCHURES, AND PRODUCT SAMPLES FOR OTHERS; RENTAL OF ADVERTISING SPACE; PREPARING OF ADVERTISING MATERIAL FOR OTHERS; DIRECT MAIL ADVERTISING; BUSINESS MARKETING CONSULTANCY; PROVIDING BUSINESS MARKETING INFORMATION; CONDUCTING MARKETING STUDIES; CONDUCTING MARKET AND BUSINESS RESEARCH AND SURVEYS; PREPARING MAILING LISTS; DIRECT OR INDIRECT PRODUCT MERCHANDISING SERVICES; BUSINESS MANAGEMENT AND CONSULTATION SERVICES; BUSINESS MANAGEMENT AND SUPERVISION; EFFICIENCY EXPERTS; BUSINESS INVESTIGATIONS; BUSINESS AND BUSINESS MANAGEMENT AND BUSINESS ORGANIZATION CONSULTANCY; ARRANGING AND CONDUCTING TRADE SHOWS IN THE FIELDS OF ADVERTISING AND MARKETING; ECONOMIC FORECASTING; ADVERTISING AGENCY SERVICES INCLUDING RADIO AND TELEVISION ADVERTISING, PROVIDING STATISTICAL INFORMATION FOR BUSINESS AND COMMERCIAL PURPOSES, IN CLASS 35 (U.S. CLS. 100, 101 AND 102).

FIRST USE 1-6-2003; IN COMMERCE 1-6-2003.

FOR: (BASED ON 44(E)) CABLE TELEVISION BROADCASTING; ELECTRONIC TRANSMISSION OF DATA AND DOCUMENTS BY COMPUTER TERMINALS AND FIBER OPTIC NETWORKS; ELECTRONIC BULLETIN BOARDS FOR TRANSMISSION OF MESSAGES AMONG COMPUTER USERS CONCERNING MARKETING ACTIVITIES AND BUSINESS INFORMATION; ELECTRONIC MAIL SERVICES; ELECTRONIC TRANSMISSION OF MESSAGES; PROVIDING TELECOMMUNICATIONS CONNECTIONS TO A GLOBAL COMPUTER NETWORK; RADIO BROADCASTING; SATELLITE TRANSMISSION; TELEVISION BROADCASTING; TECHNICAL CONSULTATIONS IN THE FIELDS OF TELECOMMUNICATIONS AND OF COMPUTERS, IN CLASS 38 (U.S. CLS. 100, 101 AND 104).

FIRST USE 1-6-2003; IN COMMERCE 1-6-2003.

PRIORITY CLAIMED UNDER SEC. 44(D) ON BENELUX APPLICATION NO. 1015147, FILED 7-24-2002, REG. NO. 0718353, DATED 7-24-2002, EXPIRES 7-24-2012.

THE COLOR(S) TURQUOISE, ORANGE AND YELLOW IS/ARE CLAIMED AS A FEATURE OF THE MARK.

THE MARK CONSISTS OF THE LETTERS "SYNOVATE" ARE DARK TURQUOISE AND THE DESIGN ABOVE FEATURES A DARK ORANGE HALF CIRCLE ON THE LEFT FADING TO MID ORANGE SEGMENTS AT THE TOP AND BOTTOM WITH A RIGHT INNER MID ORANGE HALF CIRCLE AND YELLOW INNER LEFT AND OUTER RIGHT HALF CIRCLES.

SN 76-481,087, FILED 1-8-2003.

BARNEY CHARLON, EXAMINING ATTORNEY

**Int. Cl.: 10**

**Prior U.S. Cls.: 26, 39, and 44**

**Reg. No. 3,468,400**

**United States Patent and Trademark Office**

**Registered July 15, 2008**

---

**TRADEMARK  
PRINCIPAL REGISTER**

**EQUIVAS**

BUCHNER, KELLY W. (UNITED STATES INDIVIDUAL)  
8710 E. 101ST PL.  
TULSA, OK 741336969

"EQUI" IS A SHORTENED VERSION OF EQUINE MEANING RELATED TO HORSES AND "VAS" IS A SHORTENED VERSION OF VASCULAR MEANING PERTAINING TO FLUID OR BLOOD DUCTS.

FOR: NON-INVASIVE MEDICAL APPARATUS FOR VASCULAR ENHANCEMENT, NAMELY, A MACHINE FOR ELECTRO-STIMULATION OF DEEP-LAYERED MUSCLE CONTRACTIONS, IN CLASS 10 (U.S. CLS. 26, 39 AND 44).

SN 76-492,348, FILED 2-26-2003.

FIRST USE 8-12-2006; IN COMMERCE 8-12-2006.

DAVID TAYLOR, EXAMINING ATTORNEY



**Int. Cl.: 10**

**Prior U.S. Cls.: 26, 39, and 44**

**United States Patent and Trademark Office**

**Reg. No. 3,468,401**

**Registered July 15, 2008**

---

**TRADEMARK  
PRINCIPAL REGISTER**

**ULTRAVAS**

BUCHNER, KELLY W. (UNITED STATES INDIVIDUAL)  
8710 E. 101ST PL.  
TULSA, OK 741336969

FOR: NON-INVASIVE MEDICAL APPARATUS FOR VASCULAR ENHANCEMENT, NAMELY, A MACHINE FOR ELECTRO-STIMULATION OF DEEP-LAYERED MUSCLE CONTRACTIONS, IN CLASS 10 (U.S. CLS. 26, 39 AND 44).

FIRST USE 7-7-2006; IN COMMERCE 7-7-2006.

"VAS" IS A SHORTENED VERSION OF VASCULAR MEANING PERTAINING TO FLUID OR BLOOD DUCTS.

SN 76-492,349, FILED 2-26-2003.

DAVID TAYLOR, EXAMINING ATTORNEY

**Int. Cls.: 16 and 45**

**Prior U.S. Cls.: 2, 5, 22, 23, 29, 37, 38, 50, 100, and 101**

**United States Patent and Trademark Office**

**Reg. No. 3,468,402**

**Registered July 15, 2008**

**TRADEMARK  
SERVICE MARK  
PRINCIPAL REGISTER**

**WORLD PRAYER CENTER**

NEW LIFE CHURCH (COLORADO CORPORATION)  
11025 STATE HIGHWAY 83 NORTH  
COLORADO SPRINGS, CO 80921

FOR: PRINTED MATERIALS, NAMELY, PAMPHLETS, MAGAZINES, NEWSLETTERS AND CATALOGUES, ALL IN THE FIELDS OF RELIGION AND EDUCATION, IN CLASS 16 (U.S. CLS. 2, 5, 22, 23, 29, 37, 38 AND 50).

FIRST USE 4-1-2003; IN COMMERCE 4-1-2003.

FOR: MINISTERIAL AND RELIGIOUS SERVICES, NAMELY, OPERATING PLACES OF ASSEMBLY AND CONGREGATION FOR PRAYER,

PRAYER INFORMATION, AND WORSHIP; CONDUCTING RELIGIOUS PROGRAMS, NAMELY, PROVIDING RELIGIOUS WORSHIP SERVICES, IN CLASS 45 (U.S. CLS. 100 AND 101).

FIRST USE 4-1-2003; IN COMMERCE 4-1-2003.

NO CLAIM IS MADE TO THE EXCLUSIVE RIGHT TO USE "PRAYER CENTER" , APART FROM THE MARK AS SHOWN.

SN 76-494,094, FILED 3-3-2003.

BRENDAN MCCAULEY, EXAMINING ATTORNEY

**Int. Cls.: 9, 35, and 41**

**Prior U.S. Cls.: 21, 23, 26, 36, 38, 100, 101, 102, and 107**

**Reg. No. 3,468,403**

**United States Patent and Trademark Office**

**Registered July 15, 2008**

**TRADEMARK  
SERVICE MARK  
PRINCIPAL REGISTER**

**CITYREALM**

XDYNE, INC. (ILLINOIS CORPORATION)  
1785 SOUTH PAW PAW ROAD  
EARLVILLE, IL 60518

FOR: COMPUTER SOFTWARE, NAMELY, THREE-DIMENSIONAL VIRTUAL MODELS OF CITIES, INCLUDING BUILDINGS AND RELATED STRUCTURES, TRANSPORTATION SYSTEMS, STREETS, AND THE SURROUNDING ENVIRONMENT THEREOF USED FOR BUSINESS PROMOTIONS AND RELOCATION, IN CLASS 9 (U.S. CLS. 21, 23, 26, 36 AND 38).

FIRST USE 6-0-2003; IN COMMERCE 6-0-2003.

FOR: ADVERTISING SERVICES, NAMELY, PROVIDING BUSINESS DIRECTORY SERVICES

THROUGH THE SOFTWARE AND DVD INDUSTRIES, IN CLASS 35 (U.S. CLS. 100, 101 AND 102).

FIRST USE 6-0-2003; IN COMMERCE 6-0-2003.

FOR: PROVIDING INFORMATION CONCERNING ENTERTAINMENT, CULTURAL AND SPORTING EVENTS AND ACTIVITIES AT PARTICULAR SITES IN A SPECIFIED GEOGRAPHIC AREA AS DETERMINED BY A COMPUTER SOFTWARE SUBSCRIBER, IN CLASS 41 (U.S. CLS. 100, 101 AND 107).

FIRST USE 6-0-2003; IN COMMERCE 6-0-2003.

SN 76-497,143, FILED 3-13-2003.

LINDA ESTRADA, EXAMINING ATTORNEY

**Int. Cl.: 18**

**Prior U.S. Cls.: 1, 2, 3, 22, and 41**

**Reg. No. 3,468,404**

**United States Patent and Trademark Office**

**Registered July 15, 2008**

---

**TRADEMARK  
PRINCIPAL REGISTER**

**L'AUBERGE DU LAC**

PINNACLE ENTERTAINMENT, INC. (DELA-  
WARE CORPORATION)  
3800 HOWARD HUGHES PARKWAY, SUITE 1800  
LAS VEGAS, NV 89109

THE ENGLISH TRANSLATION OF THE MARK IS  
"THE INN AT THE LAKE".

FOR: LEATHER BAGS, IN CLASS 18 (U.S. CLS. 1,  
2, 3, 22 AND 41).

SN 76-533,124, FILED 7-28-2003.

FIRST USE 6-1-2005; IN COMMERCE 6-1-2005.

B. PARADEWELAI, EXAMINING ATTORNEY

**Int. Cl.: 16**

**Prior U.S. Cls.: 2, 5, 22, 23, 29, 37, 38, and 50**

**United States Patent and Trademark Office**

**Reg. No. 3,468,405**

**Registered July 15, 2008**

**TRADEMARK  
PRINCIPAL REGISTER**

**L'AUBERGE DU LAC**

PINNACLE ENTERTAINMENT, INC. (DELA-  
WARE CORPORATION)  
3800 HOWARD HUGHES PARKWAY, SUITE 1800  
LAS VEGAS, NV 89109

FOR: PERIODIC PUBLICATIONS, NAMELY,  
PAMPHLETS, BROCHURES, MAGAZINES CON-  
CERNING EVENTS AT AND FACILITIES OF A  
HOTEL, RESORT AND CASINO; WRITING IN-  
STRUMENTS; STATIONERY; POSTCARDS; CA-  
LENDARS, IN CLASS 16 (U.S. CLS. 2, 5, 22, 23, 29,  
37, 38 AND 50).

FIRST USE 6-1-2007; IN COMMERCE 6-1-2007.

THE ENGLISH TRANSLATION OF THE MARK IS  
"THE INN AT THE LAKE".

SN 76-533,198, FILED 7-28-2003.

ALICIA COLLINS, EXAMINING ATTORNEY

**Int. Cls.: 9 and 42**

**Prior U.S. Cls.: 21, 23, 26, 36, 38, 100, and 101**

**United States Patent and Trademark Office**

**Reg. No. 3,468,406**

**Registered July 15, 2008**

**TRADEMARK  
SERVICE MARK  
PRINCIPAL REGISTER**

**TRUST EVALUATION SYSTEM**

CLOUDMARK, INC. (DELAWARE CORPORATION)  
128 KING STREET, SECOND FLOOR  
SAN FRANCISCO, CA 94107

FOR: COMPUTER SOFTWARE FOR DETECTING, FILTERING, MONITORING, REPORTING, BLOCKING, REMOVING, AND PREVENTING UNSOLICITED, BULK, UNWANTED OR CONTENT-INAPPROPRIATE ELECTRONIC MAIL, DATA, SOUNDS AND IMAGES; CONTENT FILTERING SOFTWARE; SOFTWARE FOR USE IN TRACKING SENDERS OF UNSOLICITED, BULK, UNWANTED OR CONTENT-INAPPROPRIATE ELECTRONIC MAIL, DATA, SOUNDS AND IMAGES; A FEATURE OF COMPUTER SOFTWARE FOR USE IN DETECTING, FILTERING, MONITORING, REPORTING, BLOCKING, REMOVING, AND PREVENTING UNSOLICITED, BULK, UNWANTED OR CONTENT-INAPPROPRIATE ELECTRONIC MAIL, DATA, SOUNDS AND IMAGES; A FEATURE OF COMPUTER SOFTWARE FOR USE IN FILTERING CONTENT, IN CLASS 9 (U.S. CLS. 21, 23, 26, 36 AND 38).

FIRST USE 6-19-2002; IN COMMERCE 4-25-2003.

FOR: COMPUTER SERVICES, NAMELY, DETECTING, FILTERING, MONITORING, REPORTING, BLOCKING, REMOVING, TRACKING AND PREVENTING UNWANTED AND UNSOLICITED ELECTRONIC MESSAGES SENT VIA ELECTRONIC MEANS, IN CLASS 42 (U.S. CLS. 100 AND 101).

FIRST USE 6-19-2002; IN COMMERCE 4-25-2003.

NO CLAIM IS MADE TO THE EXCLUSIVE RIGHT TO USE "EVALUATION SYSTEM", APART FROM THE MARK AS SHOWN.

SN 76-562,612, FILED 11-26-2003.

ALEXANDER L. POWERS, EXAMINING ATTORNEY

**Int. Cl.: 41**

**Prior U.S. Cls.: 100, 101, and 107**

**United States Patent and Trademark Office**

**Reg. No. 3,468,407**

**Registered July 15, 2008**

**SERVICE MARK  
PRINCIPAL REGISTER**

**JONATHON BRANDMEIER**

BRANDMEIER, JONATHON (UNITED STATES  
INDIVIDUAL)  
BOX #133  
40 E. CHICAGO AVE  
CHICAGO, IL 60611

FOR: ENTERTAINMENT, NAMELY, A CONTINUING MUSIC, VARIETY AND COMEDY SHOW BROADCAST OVER RADIO, IN CLASS 41 (U.S. CLS. 100, 101 AND 107).

FIRST USE 4-19-2004; IN COMMERCE 4-19-2004.

THE MARK CONSISTS OF STANDARD CHARACTERS WITHOUT CLAIM TO ANY PARTICULAR FONT, STYLE, SIZE, OR COLOR.

THE MARK CONSISTS OF THE NAME OF A LIVING INDIVIDUAL WHOSE CONSENT IS HEREBY MADE OF RECORD.

SN 76-563,518, FILED 11-20-2003.

HELEN BRYAN, EXAMINING ATTORNEY

**Int. Cl.: 10**

**Prior U.S. Cls.: 26, 39, and 44**

**United States Patent and Trademark Office**

**Reg. No. 3,468,408**

**Registered July 15, 2008**

**TRADEMARK  
PRINCIPAL REGISTER**

**BOOB TUBE**

RUSSELL, MIDGE (UNITED STATES INDIVIDUAL)  
P.O. BOX 503  
9113 BAY AVENUE  
NORTH BEACH, MD 20714

FOR: MEDICAL DEVICES, NAMELY, HARD PLASTIC TUBES TO LIFT AND SEPARATE WOMEN'S BREASTS WHILE SLEEPING OR LYING HORIZONTALLY, IN CLASS 10 (U.S. CLS. 26, 39 AND 44).

FIRST USE 4-20-2008; IN COMMERCE 4-20-2008.

THE MARK CONSISTS OF STANDARD CHARACTERS WITHOUT CLAIM TO ANY PARTICULAR FONT, STYLE, SIZE, OR COLOR.

SN 76-564,706, FILED 12-11-2003.

CAROLINE WOOD, EXAMINING ATTORNEY



Int. Cls.: 25, 28, 35, and 41

Prior U.S. Cls.: 22, 23, 38, 39, 50, 100, 101, 102, and 107

United States Patent and Trademark Office

Reg. No. 3,468,409

Registered July 15, 2008

TRADEMARK  
SERVICE MARK  
PRINCIPAL REGISTER



WILLIS, DONTRELLE (UNITED STATES INDIVIDUAL)  
C/O CAPITAL ADVISORS CONSULTING, LLC  
508 STONEBRIDGE COURT  
PLEASANT HILL, CA 94523

FOR: APPAREL, NAMELY, T-SHIRTS, HATS, CAPS, SWEATSHIRTS, JACKETS, JERSEYS, SHOES, AND PANTS, IN CLASS 25 (U.S. CLS. 22 AND 39).

FIRST USE 4-15-2007; IN COMMERCE 4-15-2007.

FOR: BASEBALL EQUIPMENT, NAMELY, BASEBALL BATS, MITTS, HELMETS, BALLS, GLOVES, MASKS, AND PROTECTIVE PADDING, IN CLASS 28 (U.S. CLS. 22, 23, 38 AND 50).

FIRST USE 12-15-2007; IN COMMERCE 12-15-2007.

FOR: PROMOTING THE GOODS AND/OR SERVICES OF OTHERS THROUGH THE ISSUANCE OF

PRODUCT ENDORSEMENTS, IN CLASS 35 (U.S. CLS. 100, 101 AND 102).

FIRST USE 10-13-2006; IN COMMERCE 10-13-2006.

FOR: SPORTS CAMPS FOR YOUTH AND AMATEURS FOR IMPROVING BASEBALL SKILLS AND TECHNIQUES; INSTRUCTION IN THE FIELD OF BASEBALL, IN CLASS 41 (U.S. CLS. 100, 101 AND 107).

FIRST USE 7-15-2007; IN COMMERCE 7-15-2007.

THE DEPICTION SHOWN IN THE MARK IS OF A PARTICULAR LIVING INDIVIDUAL.

THE MARK CONSISTS OF A SILHOUETTE..

SN 76-566,234, FILED 11-19-2003.

ROBERT C. CLARK JR., EXAMINING ATTORNEY

**Int. Cl.: 8**

**Prior U.S. Cls.: 23, 28, and 44**

**Reg. No. 3,468,410**

**United States Patent and Trademark Office**

**Registered July 15, 2008**

---

**TRADEMARK  
PRINCIPAL REGISTER**

**CHÉCI**

AMERICAN INTERNATIONAL INDUSTRIES  
(CALIFORNIA PARTNERSHIP)  
2220 GASPAR AVENUE  
LOS ANGELES, CA 90046

FIRST USE 12-12-2007; IN COMMERCE 12-12-2007.

FOR: PEDICURE IMPLEMENTS, NAMELY, NAIL FILES; MANICURE IMPLEMENTS, NAMELY, NAIL FILES; HAND-HELD FILES; FOOT FILES; HAND TOOLS, NAMELY, FILES; MULTI-FUNCTION HAND TOOLS COMPRISED OF FILES; NAIL FILES; HAND OPERATED ABRADING TOOLS, IN CLASS 8 (U.S. CLS. 23, 28 AND 44).

THE MARK CONSISTS OF STANDARD CHARACTERS WITHOUT CLAIM TO ANY PARTICULAR FONT, STYLE, SIZE, OR COLOR.

SN 76-567,844, FILED 12-31-2003.

TERESA M. RUPP, EXAMINING ATTORNEY

**Int. Cls.: 9, 16, 25, 35, and 41**

**Prior U.S. Cls.: 2, 5, 21, 22, 23, 26, 29, 36, 37, 38, 39, 50, 100, 101, 102, and 107**

**Reg. No. 3,468,411**

**United States Patent and Trademark Office**

**Registered July 15, 2008**

**TRADEMARK  
SERVICE MARK  
PRINCIPAL REGISTER**



MODELGOLF LLC (DELAWARE CORPORATION)  
75 FEDERAL STREET  
BOSTON, MA 02110

FOR: COMPUTER SOFTWARE FOR DETERMINING PERFORMANCE MODELS OF HUMAN MOTION, NAMELY, PHYSICAL ACTIVITIES, SKILLS AND TASKS; COMPUTER SOFTWARE FOR DETERMINING EQUIPMENT FITTING USING PERFORMANCE MODELS OF INDIVIDUALS PERFORMING PHYSICAL ACTIVITIES, SKILLS AND TASKS RELATED TO ONE OR MORE HUMAN MOTIONS; COMPUTER SOFTWARE FOR DETERMINING PERFORMANCE MODELS OF INDIVIDUALS PERFORMING PHYSICAL ACTIVITIES, SKILLS AND TASKS RELATED TO GOLF FOR EVALUATION, DEVELOPMENT AND TEACHING OF GOLF FUNDAMENTALS AND SKILLS; COMPUTER SOFTWARE FOR DETERMINING EQUIPMENT FITTING USING PERFORMANCE MODELS OF INDIVIDUALS PERFORMING PHYSICAL ACTIVITIES, SKILLS AND TASKS RELATED TO GOLF AND USER MANUALS SOLD AS A UNIT THEREWITH AND DOWNLOADABLE PRINTED MATERIALS ACCESSED VIA A MULTI-USER INFORMATION NETWORK, SUCH AS THE INTERNET, NAMELY, PRINTED MATERIALS, NAMELY, BOOKS, MANUALS, INSTRUCTIONAL MATERIALS, PRESS RELEASES, NEWSLETTERS, MAGAZINES, AND PRINTED PROMOTIONAL MATERIALS, NAMELY, INFORMATIONAL FLYERS, BROCHURES, CATALOGS AND ADVERTISEMENTS, FEATURING INFORMATION IN THE FIELD OF GOLF, IN CLASS 9 (U.S. CLS. 21, 23, 26, 36 AND 38).

FIRST USE 1-15-2004; IN COMMERCE 1-15-2004.

FOR: PRINTED MATERIALS, NAMELY, MANUALS, INSTRUCTIONAL MATERIALS, AND PRINTED PROMOTIONAL MATERIALS, NAMELY, INFORMATIONAL FLYERS, BROCHURES, CATALOGS AND ADVERTISEMENTS FEATURING INFORMATION IN THE FIELD OF GOLF, IN CLASS 16 (U.S. CLS. 2, 5, 22, 23, 29, 37, 38 AND 50).

FIRST USE 1-15-2004; IN COMMERCE 1-15-2004.

FOR: CLOTHING, NAMELY, SHIRTS, SWEATERS, T-SHIRTS, SWEATSHIRTS, HATS AND VISORS, IN CLASS 25 (U.S. CLS. 22 AND 39).

FIRST USE 1-15-2004; IN COMMERCE 1-15-2004.

FOR: RETAIL STORE SERVICES FEATURING GOLF-RELATED ITEMS, IN CLASS 35 (U.S. CLS. 100, 101 AND 102).

FIRST USE 1-15-2004; IN COMMERCE 1-15-2004.

FOR: EDUCATIONAL SERVICES, NAMELY, CONDUCTING CLASSES, SESSIONS, TUTORIALS, WORKSHOPS, SEMINARS, LECTURES AND CONFERENCES IN THE FIELD OF GOLF; AND TRAINING SERVICES, NAMELY, PROVIDING INSTRUCTIONS IN THE FIELD OF GOLF, IN CLASS 41 (U.S. CLS. 100, 101 AND 107).

FIRST USE 1-15-2004; IN COMMERCE 1-15-2004.

OWNER OF U.S. REG. NO. 2,863,008.

NO CLAIM IS MADE TO THE EXCLUSIVE RIGHT TO USE "GOLF", APART FROM THE MARK AS SHOWN.

SN 76-571,728, FILED 1-23-2004.

GIANCARLO CASTRO, EXAMINING ATTORNEY

**Int. Cls.: 9, 16, 25, and 28**

**Prior U.S. Cls.: 2, 5, 21, 22, 23, 26, 29, 36, 37, 38, 39,  
and 50**

**Reg. No. 3,468,412**

**United States Patent and Trademark Office**

**Registered July 15, 2008**

**TRADEMARK  
PRINCIPAL REGISTER**

**KUNG FU PANDA**

DREAMWORKS ANIMATION L.L.C. (DELA-  
WARE LTD LIAB JT ST CO)  
1000 FLOWER STREET  
GLENDALE, CA 91201

FOR: HOLDERS FOR COMPACT DISCS, COM-  
PUTER GAME SOFTWARE RELATING TO OR  
CONNECTED WITH AN ANIMATED MOTION PIC-  
TURE; COMPUTER SOFTWARE CARTRIDGES,  
MAGNETS, SUNGLASSES, IN CLASS 9 (U.S. CLS.  
21, 23, 26, 36 AND 38).

FIRST USE 5-1-2008; IN COMMERCE 5-1-2008.

FOR: PAPER PARTY DECORATIONS; PAPER  
PARTY SUPPLIES, NAMELY, PAPER PARTY HATS,  
PAPER NAPKINS, PAPER PLACE MATS, GIFT-  
WRAPPING PAPER AND PAPER RIBBONS FOR  
GIFT WRAPPING, PAPER TABLE CLOTHS AND  
PAPER PARTY BAGS; CHILDREN'S ACTIVITY  
BOOKS, CHILDREN'S STORYBOOKS, COLORING  
BOOKS, DAILY PLANNERS, CALENDARS, STICK-  
ER ALBUMS, STICKERS; RUBBER STAMPS, TEM-  
PORARY TATTOOS, PENCILS, PENS, PENCIL  
ERASERS, PEN CASES AND PENCIL CASES, PEN  
BOXES AND PENCIL BOXES, PENCIL SHARPEN-  
ERS, MARKERS, POSTERS, TRADING CARDS,  
GREETING CARDS, PENNANTS MADE OF PAPER,  
AND ACTIVITY KITS CONSISTING OF STICKERS  
AND STAMPS WITH ALL OF THE GOODS IDENTI-  
FIED ABOVE IN THIS CLASS RELATING TO OR  
CONNECTED WITH AN ANIMATED MOTION PIC-  
TURE, IN CLASS 16 (U.S. CLS. 2, 5, 22, 23, 29, 37, 38  
AND 50).

FIRST USE 5-1-2008; IN COMMERCE 5-1-2008.

FOR: SHIRTS AND TOPS, DRESSES, SKIRTS,  
SWEATSHIRTS AND SWEAT PANTS, SWEATSUITS,

CAPS AND HATS, COATS AND JACKETS, HOSI-  
ERY, SHOES, BOOTS, SLIPPERS, PAJAMAS, ROBES,  
SLEEPSHIRTS, SLEEPWEAR, UNDERWEAR, HAL-  
LOWEEN COSTUMES, IN CLASS 25 (U.S. CLS. 22  
AND 39).

FIRST USE 5-1-2008; IN COMMERCE 5-1-2008.

FOR: ACTION FIGURES AND ACCESSORIES  
THEREFOR, BATHTUB TOYS, KITES, BOARD  
GAMES, COSTUME MASKS, DIE CAST MINIA-  
TURE TOY VEHICLES, DOLLS, DOLL ACCESSOR-  
IES, DOLL CLOTHING, BENDABLE PLAY  
FIGURES, INFLATABLE VINYL PLAY FIGURES,  
JIGSAW PUZZLES, PLUSH TOYS, RIDE-ON TOYS,  
BALLOONS, TOY BANKS, WATER SQUIRTING  
TOYS, STUFFED TOYS, TOY VEHICLES, CHRIST-  
MAS TREE ORNAMENTS; TOY 3D REELS WITH  
VIEWERS; PLAYING CARDS, IN CLASS 28 (U.S.  
CLS. 22, 23, 38 AND 50).

FIRST USE 5-1-2008; IN COMMERCE 5-1-2008.

THE MARK CONSISTS OF STANDARD CHAR-  
ACTERS WITHOUT CLAIM TO ANY PARTICULAR  
FONT, STYLE, SIZE, OR COLOR.

OWNER OF U.S. REG. NOS. 2,457,467, 2,665,088,  
AND OTHERS.

NO CLAIM IS MADE TO THE EXCLUSIVE  
RIGHT TO USE "PANDA" , APART FROM THE  
MARK AS SHOWN.

SN 76-573,662, FILED 2-3-2004.

MATTHEW KLINE, EXAMINING ATTORNEY

**Int. Cl.: 9**

**Prior U.S. Cls.: 21, 23, 26, 36, and 38**

**Reg. No. 3,468,413**

**United States Patent and Trademark Office**

**Registered July 15, 2008**

---

**TRADEMARK  
PRINCIPAL REGISTER**

**ULTRASUN**

AQUATHERM INDUSTRIES, INC. (DELAWARE  
CORPORATION)  
1940 RUTGERS UNIVERSITY BLVD.  
LAKEWOOD, NJ 08701

THE MARK CONSISTS OF STANDARD CHAR-  
ACTERS WITHOUT CLAIM TO ANY PARTICULAR  
FONT, STYLE, SIZE, OR COLOR.

FOR: SOLAR ENERGY COLLECTORS, IN CLASS  
9 (U.S. CLS. 21, 23, 26, 36 AND 38).

SN 76-576,894, FILED 2-23-2004.

FIRST USE 1-31-2008; IN COMMERCE 1-31-2008.

MONIQUE MILLER, EXAMINING ATTORNEY

**Int. Cl.: 19**

**Prior U.S. Cls.: 1, 12, 33, and 50**

**United States Patent and Trademark Office**

**Reg. No. 3,468,414**

**Registered July 15, 2008**

**TRADEMARK  
PRINCIPAL REGISTER**

**RHINO**

IBB, INC. (FLORIDA CORPORATION)  
2804 LUTZ LAKE FERN ROAD  
LUTZ, FL 33558

FOR: NON-METALLIC BUILDING MATERIALS,  
NAMELY, SOUND WALLS, RETAINING WALLS,  
BUFFER WALLS, SECURITY WALLS AND PRIV-  
ACY WALLS COMPRISING FOAM CORE PANELS  
ENCASED WITHIN PROTECTIVE SURFACE PA-  
NELS; COLUMNS; AND ENCLOSURES FOR DUMP-  
STERS AND OTHER EXTERIOR STORAGE

CONTAINERS, IN CLASS 19 (U.S. CLS. 1, 12, 33  
AND 50).

FIRST USE 5-4-2005; IN COMMERCE 5-4-2005.

THE MARK CONSISTS OF STANDARD CHAR-  
ACTERS WITHOUT CLAIM TO ANY PARTICULAR  
FONT, STYLE, SIZE, OR COLOR.

SN 76-577,604, FILED 2-25-2004.

SUSAN STIGLITZ, EXAMINING ATTORNEY

**Int. Cl.: 12**

**Prior U.S. Cls.: 19, 21, 23, 31, 35, and 44**

**Reg. No. 3,468,415**

**United States Patent and Trademark Office**

**Registered July 15, 2008**

**TRADEMARK  
PRINCIPAL REGISTER**

**REDI-TRAY**

LARGE, RICHARD L. (UNITED STATES INDIVIDUAL)  
9505 S. 27TH ST  
LINCOLN, NE 68512

FIRST USE 1-1-2004; IN COMMERCE 1-1-2004.

FOR: WHEELCHAIR TRAYS AND ITS HARDWARE COMPONENTS CONSISTING OF TRAYS, METAL CLAMPS, SWIVEL, TUBING, RUBBER CLASP, LEATHER EXTENSION, AND POLYETHYLENE TRIGGER STRAP ALL ATTACHED TO THE WHEELCHAIR AND SOLD AS A UNIT, IN CLASS 12 (U.S. CLS. 19, 21, 23, 31, 35 AND 44).

THE MARK CONSISTS OF STANDARD CHARACTERS WITHOUT CLAIM TO ANY PARTICULAR FONT, STYLE, SIZE, OR COLOR.

SN 76-578,326, FILED 3-1-2004.

ZACHARY BELLO, EXAMINING ATTORNEY



**Int. Cl.: 42**

**Prior U.S. Cls.: 100 and 101**

**United States Patent and Trademark Office**

**Reg. No. 3,468,416**

**Registered July 15, 2008**

**SERVICE MARK  
PRINCIPAL REGISTER**

**eProduction Services**

EPRODUCTION SERVICES CORPORATION (CALIFORNIA CORPORATION)  
748 VISTA ENSUENO  
ALPINE, CA 91901

FOR: COMPUTER SERVICE, NAMELY, ACTING AS A DATABASE HOST AND WEB-BASED FULFILLMENT PROVIDER FOR THE MANAGEMENT OF CONTENT AND DISTRIBUTION OF TARGETED PUBLISHED MATERIALS , IN CLASS 42 (U.S. CLS. 100 AND 101).

FIRST USE 4-15-2004; IN COMMERCE 10-1-2007.

THE MARK CONSISTS OF STANDARD CHARACTERS WITHOUT CLAIM TO ANY PARTICULAR FONT, STYLE, SIZE, OR COLOR.

NO CLAIM IS MADE TO THE EXCLUSIVE RIGHT TO USE "SERVICES", APART FROM THE MARK AS SHOWN.

SN 76-582,927, FILED 3-18-2004.

IRA J. GOODSaid, EXAMINING ATTORNEY

**Int. Cl.: 35**

**Prior U.S. Cls.: 100, 101, and 102**

**United States Patent and Trademark Office**

**Reg. No. 3,468,417**

**Registered July 15, 2008**

**SERVICE MARK  
PRINCIPAL REGISTER**

**RAPATRIONS NEFERTITI**

RAGAB, MARIE-JOSÉ (UNITED STATES INDIVIDUAL)  
505 GLYNDON STREET, N.E.  
VIENNA, VA 22180

FOR: PROMOTING PUBLIC AWARENESS OF THE IMPORTANCE OF PROTECTING ANTIQUITIES FROM THEFT AND LOOTING, OF PREVENTING AND SUPPRESSING THE TRAFFIC IN STOLEN AND LOOTED ANTIQUITIES, AND OF REPATRIATING ANTIQUITIES REMOVED FROM CULTURAL AND GEOGRAPHIC SITES OF ORIGINAL DISCOVERY, IN CLASS 35 (U.S. CLS. 100, 101 AND 102).

FIRST USE 4-9-2008; IN COMMERCE 4-9-2008.

THE MARK CONSISTS OF STANDARD CHARACTERS WITHOUT CLAIM TO ANY PARTICULAR FONT, STYLE, SIZE, OR COLOR.

"RAPATRIONS NEFERTITI" IS NOT THE NAME OF A PARTICULAR LIVING INDIVIDUAL.

THE FRENCH PHASE "RAPATRIONS NEFERTITI" TRANSLATES INTO ENGLISH AS BRING NEFERTITI HOME.

SN 76-589,058, FILED 4-28-2004.

ROBERT C. CLARK JR., EXAMINING ATTORNEY

**Int. Cl.: 28**

**Prior U.S. Cls.: 22, 23, 38, and 50**

**United States Patent and Trademark Office**

**Reg. No. 3,468,418**

**Registered July 15, 2008**

**TRADEMARK  
PRINCIPAL REGISTER**

**GOOROO**

STELOR PRODUCTIONS, LLC (UNITED STATES  
LTD LIAB CO)  
14701 MOCKINGBIRD DRIVE  
DARNESTOWN, MD 20874

THE MARK CONSISTS OF STANDARD CHAR-  
ACTERS WITHOUT CLAIM TO ANY PARTICULAR  
FONT, STYLE, SIZE, OR COLOR.

FOR: TOYS, NAMELY, STUFFED AND PLUSH  
TOYS, IN CLASS 28 (U.S. CLS. 22, 23, 38 AND 50).

SN 76-591,381, FILED 5-7-2004.

FIRST USE 5-22-2008; IN COMMERCE 5-22-2008.

KELLEY WELLS, EXAMINING ATTORNEY

**Int. Cl.: 29**

**Prior U.S. Cl.: 46**

**United States Patent and Trademark Office**

**Reg. No. 3,468,419**

**Registered July 15, 2008**

**TRADEMARK  
PRINCIPAL REGISTER**

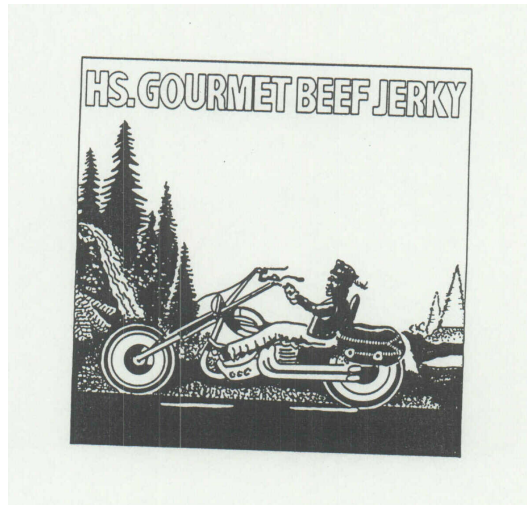

HS FREE RIDE INC. (ILLINOIS CORPORATION)  
2217 HAWTHORNE AVENUE  
MELROSE PARK, IL 60164

FOR: GOURMET BEEF JERKY, IN CLASS 29 (U.S.  
CL. 46).

FIRST USE 6-8-2004; IN COMMERCE 7-31-2007.

NO CLAIM IS MADE TO THE EXCLUSIVE  
RIGHT TO USE "GOURMET BEEF JERKY", APART  
FROM THE MARK AS SHOWN.

THE LIKENESS (OR, "PORTRAIT") IN THE  
MARK IDENTIFIES A LIVING INDIVIDUAL  
WHOSE CONSENT IS OF RECORD.

SN 76-596,130, FILED 6-8-2004.

KRISTIN DAHLING, EXAMINING ATTORNEY

**Int. Cl.: 44**

**Prior U.S. Cls.: 100 and 101**

**United States Patent and Trademark Office**

**Reg. No. 3,468,420**

**Registered July 15, 2008**

**SERVICE MARK  
PRINCIPAL REGISTER**

**LUMENOSCOPY**

ZILA PHARMACEUTICALS, INC. (NEVADA CORPORATION)  
ATTN: BRENDA PARSON  
5227 NORTH 7TH ST  
PHOENIX, AZ 850142800

FOR: MEDICAL SERVICES, NAMELY, CONDUCTING EXAMINATIONS OF THE ORAL CAVITY USING PARTICULAR SCREENING DEVICES FOR DETECTING ABNORMAL TISSUE, IN CLASS 44 (U.S. CLS. 100 AND 101).

FIRST USE 7-1-2006; IN COMMERCE 11-1-2006.

THE MARK CONSISTS OF STANDARD CHARACTERS WITHOUT CLAIM TO ANY PARTICULAR FONT, STYLE, SIZE, OR COLOR.

OWNER OF U.S. REG. NO. 2,670,202.

SN 76-606,050, FILED 8-9-2004.

ELISSA GARBER KON, EXAMINING ATTORNEY

**Int. Cl.: 28**

**Prior U.S. Cls.: 22, 23, 38, and 50**

**United States Patent and Trademark Office**

**Reg. No. 3,468,421**

**Registered July 15, 2008**

**TRADEMARK  
PRINCIPAL REGISTER**

**TODDWORLD**

TAFFY PRODUCTIONS, LLC (CALIFORNIA LTD  
LIAB CO)  
21300 OXNARD STREET, SUITE 100  
WOODLAND HILLS, CA 91367

THE MARK CONSISTS OF STANDARD CHAR-  
ACTERS WITHOUT CLAIM TO ANY PARTICULAR  
FONT, STYLE, SIZE, OR COLOR.

FOR: TOYS, GAMES AND PLAYTHINGS, NAME-  
LY, CARD GAMES; DOLLS; PLUSH AND STUFFED  
DOLLS AND TOYS; CLOTH DOLLS; JIGSAW PUZ-  
ZLES, IN CLASS 28 (U.S. CLS. 22, 23, 38 AND 50).

SN 76-609,357, FILED 8-30-2004.

FIRST USE 5-31-2006; IN COMMERCE 5-31-2006.

HELENE LIWINSKI, EXAMINING ATTORNEY

**Int. Cl.: 28**

**Prior U.S. Cls.: 22, 23, 38, and 50**

**United States Patent and Trademark Office**

**Reg. No. 3,468,422**

**Registered July 15, 2008**

**TRADEMARK  
PRINCIPAL REGISTER**

**PET ALIEN**

TAFFY PRODUCTIONS, LLC (CALIFORNIA LTD  
LIAB CO)  
SUITE 100  
21300 OXNARD STREET  
WOODLAND HILLS, CA 91367

FOR: TOYS, GAMES AND PLAYTHINGS, NAME-  
LY, CARD GAMES; DOLLS; PLUSH AND STUFFED  
DOLLS AND TOYS; CLOTH DOLLS; CHRISTMAS  
STOCKINGS; TOY WATCHES; BATH TOYS; TOY  
MODELING DOUGH; BUBBLE MAKING WAND  
AND SOLUTION SETS; HAND PUPPETS; MOLDED  
PLASTIC TOY FIGURINES; ACTION FIGURES  
AND ACCESSORIES THEREOF; BATTERY-OPER-  
ATED ACTION TOYS; RIDE-ON TOYS; TOY VEH-  
ICLES; BOARD GAMES; ROLE PLAYING GAMES;  
JIGSAW PUZZLES; MUSICAL TOYS; BUILDING  
BLOCKS; FLYING DISCS; YO-YOS; BALLOONS;  
DECORATIONS FOR CHRISTMAS TREES; TOY  
FILM CARTRIDGE AND VIEWER; SPORTING AR-  
TICLES, NAMELY, BALLS, BASEBALLS, FOOT-

BALLS, BASEBALL BATS, PLAYGROUND BALLS,  
GOLF BALLS, SOCCER BALLS, ACTION BALLS,  
PADDLE BALL GAMES, ALL BASED ON A TELE-  
VISION SERIES; HAND HELD UNIT FOR PLAYING  
VIDEO GAMES; STAND ALONE VIDEO GAME  
MACHINES; COIN-OPERATED VIDEO GAMES, IN  
CLASS 28 (U.S. CLS. 22, 23, 38 AND 50).

FIRST USE 1-19-1998; IN COMMERCE 1-19-1998.

THE MARK CONSISTS OF STANDARD CHAR-  
ACTERS WITHOUT CLAIM TO ANY PARTICULAR  
FONT, STYLE, SIZE, OR COLOR.

OWNER OF U.S. REG. NO. 2,226,748.

SN 76-609,363, FILED 8-30-2004.

HELENE LIWINSKI, EXAMINING ATTORNEY

**Int. Cl.: 25**

**Prior U.S. Cls.: 22 and 39**

**United States Patent and Trademark Office**

**Reg. No. 3,468,423**

**Registered July 15, 2008**

**TRADEMARK  
PRINCIPAL REGISTER**

**LEAVE NO VOTER BEHIND**

FRIEL, JAMES P. (UNITED STATES INDIVIDUAL)  
20 VAIL STREET  
NORTHPORT, NY 11768

THE MARK CONSISTS OF STANDARD CHARACTERS WITHOUT CLAIM TO ANY PARTICULAR FONT, STYLE, SIZE, OR COLOR.

FOR: CLOTHING IN THE NATURE OF SHIRTS AND HATS, IN CLASS 25 (U.S. CLS. 22 AND 39).

SN 76-611,482, FILED 9-10-2004.

FIRST USE 2-10-2005; IN COMMERCE 2-10-2005.

EVELYN BRADLEY, EXAMINING ATTORNEY



**Int. Cl.: 25**

**Prior U.S. Cls.: 22 and 39**

**United States Patent and Trademark Office**

**Reg. No. 3,468,424**

**Registered July 15, 2008**

**TRADEMARK  
PRINCIPAL REGISTER**



AZZARO PARALLEL, PROIZVODNJA TEKSTILA  
I EXPORT-IMPORT D.O.O. (SERBIA/MONTE-  
NEGRO LTD LIAB CO)  
PRVE PRUGE BR. 31-A  
11000 BEOGRAD, SERBIA/MONTENEGRO

FOR: CLOTHING, NAMELY, SHIRTS, PANTS,  
WRAPS, SCARVES, TROUSERS, SHIRTS, T-SHIRTS,  
SKIRTS, BLOUSES, BLAZERS, JEANS, DRESSES,  
CORSETS, TOPS, JACKETS, COATS, SWEATERS,  
TURTLENECKS, JERSEYS, VESTS, SOCKS, SWEAT-  
SHIRTS, GLOVES, SLACKS, SUITS, PAJAMAS, LIN-  
GERIE, SUSPENDERS, SWIMSUITS, BELTS;  
NECKWEAR, NAMELY, TIES, BOLO TIES AND  
BOW TIES, UNDERWEAR, NAMELY, CHILDREN'S,  
WOMEN'S AND MEN'S UNDERWEAR, UNDER-  
PANTS, BOXER SHORTS, PANTYHOSE, BRAS,  
BRIEFS, CAMISOLES, THONGS UNDERWEAR,  
THERMAL UNDERWEAR, KNITTED UNDER-  
WEAR, DISPOSABLE UNDERWEAR; FOOTWEAR;

HEADWEAR, NAMELY, HATS, CAPS, BERETS,  
VISORS, AND HOODS, IN CLASS 25 (U.S. CLS. 22  
AND 39).

FIRST USE 9-0-2004; IN COMMERCE 9-0-2004.

THE COLOR(S) RED (CRIMSON) IS/ARE  
CLAIMED AS A FEATURE OF THE MARK.

AN OUTLINE OF THE LETTERS IS IN COLOUR  
DEEP-RED (CRIMSON) WHICH IS A FEATURE OF  
THE MARK TO BE PROTECTED.

SN 76-612,004, FILED 9-14-2004.

KIMBERLY PERRY, EXAMINING ATTORNEY

**Int. Cl.: 25**

**Prior U.S. Cls.: 22 and 39**

**United States Patent and Trademark Office**

**Reg. No. 3,468,425**

**Registered July 15, 2008**

**TRADEMARK  
PRINCIPAL REGISTER**

**V-CELL**

MERRELL, JOSH (UNITED STATES INDIVIDUAL)  
17822-C GILLETTE AVENUE  
IRVINE, CA 92614

FOR: CLOTHING, NAMELY, MEN'S, WOMEN'S AND CHILDREN'S CASUAL AND DRESS CLOTHING, NAMELY, SHIRTS, PANTS, SHORTS, JACKETS, TOPS, HOODED SWEATSHIRTS, LONG SLEEVED SHIRTS, AND HEADWEAR , IN CLASS 25 (U.S. CLS. 22 AND 39).

FIRST USE 11-15-2005; IN COMMERCE 11-15-2005.

THE MARK CONSISTS OF STANDARD CHARACTERS WITHOUT CLAIM TO ANY PARTICULAR FONT, STYLE, SIZE, OR COLOR.

SN 76-616,475, FILED 10-15-2004.

TARAH HARDY, EXAMINING ATTORNEY

**Int. Cl.: 35**

**Prior U.S. Cls.: 100, 101, and 102**

**United States Patent and Trademark Office**

**Reg. No. 3,468,426**

**Registered July 15, 2008**

**SERVICE MARK  
PRINCIPAL REGISTER**

**IGNITING BUSINESS**

EXECUTIVE DEVELOPMENT ARCHITECTS LLC  
(COLORADO LIMITED LIABILITY CORPORATION)

1317 SO. VINE STREET  
DENVER, CO 80210

FOR: BUSINESS CONSULTING SERVICES, IN  
CLASS 35 (U.S. CLS. 100, 101 AND 102).

FIRST USE 2-6-2004; IN COMMERCE 2-6-2004.

THE MARK CONSISTS OF STANDARD CHARACTERS WITHOUT CLAIM TO ANY PARTICULAR FONT, STYLE, SIZE, OR COLOR.

NO CLAIM IS MADE TO THE EXCLUSIVE RIGHT TO USE "BUSINESS", APART FROM THE MARK AS SHOWN.

SN 76-617,706, FILED 10-25-2004.

KAREN K. BUSH, EXAMINING ATTORNEY

**Int. Cl.: 41**

**Prior U.S. Cls.: 100, 101, and 107**

**United States Patent and Trademark Office**

**Reg. No. 3,468,427**

**Registered July 15, 2008**

---

**SERVICE MARK  
PRINCIPAL REGISTER**

**FAST TRACK TO YOUR DREAMS**

GRANTHAM EDUCATION CORPORATION  
(LOUISIANA CORPORATION)  
3461 GRANTHAM COLLEGE ROAD  
SLIDELL, LA 70460

FOR: EDUCATIONAL SERVICES, NAMELY,  
PROVIDING ACCREDITED AND CERTIFIED  
COURSES OF INSTRUCTION AT THE POST-SEC-  
ONDARY AND COLLEGE LEVEL , IN CLASS 41  
(U.S. CLS. 100, 101 AND 107).

FIRST USE 1-1-2008; IN COMMERCE 1-1-2008.

THE MARK CONSISTS OF STANDARD CHAR-  
ACTERS WITHOUT CLAIM TO ANY PARTICULAR  
FONT, STYLE, SIZE, OR COLOR.

SN 76-622,269, FILED 11-26-2004.

JILL C. ALT, EXAMINING ATTORNEY

**Int. Cl.: 41**

**Prior U.S. Cls.: 100, 101, and 107**

**United States Patent and Trademark Office**

**Reg. No. 3,468,428**

**Registered July 15, 2008**

**SERVICE MARK  
PRINCIPAL REGISTER**

**FAST TRACK TO A BETTER LIFE**

GRANTHAM EDUCATION CORPORATION  
(LOUISIANA CORPORATION)  
3461 GRANTHAM COLLEGE ROAD  
SLIDELL, LA 70460

FOR: EDUCATIONAL SERVICES, NAMELY,  
PROVIDING ACCREDITED AND CERTIFIED  
COURSES OF INSTRUCTION AT THE POST-SEC-  
ONDARY AND COLLEGE LEVEL , IN CLASS 41  
(U.S. CLS. 100, 101 AND 107).

FIRST USE 1-1-2008; IN COMMERCE 1-1-2008.

THE MARK CONSISTS OF STANDARD CHAR-  
ACTERS WITHOUT CLAIM TO ANY PARTICULAR  
FONT, STYLE, SIZE, OR COLOR.

SN 76-622,274, FILED 11-26-2004.

JILL C. ALT, EXAMINING ATTORNEY

**Int. Cl.: 25**

**Prior U.S. Cls.: 22 and 39**

**United States Patent and Trademark Office**

**Reg. No. 3,468,429**

**Registered July 15, 2008**

**TRADEMARK  
PRINCIPAL REGISTER**

**GRAN TURISMO**

KABUSHIKI KAISHA SONY COMPUTER ENTERTAINMENT (JAPAN CORPORATION), TA SONY COMPUTER ENTERTAINMENT INC., 2-6-21, MINAMI-AOYMA MINATO-KU TOKYO, 107-0062, JAPAN

FOR: CLOTHING, NAMELY, T-SHIRTS AND SHOES, IN CLASS 25 (U.S. CLS. 22 AND 39).

FIRST USE 2-22-2005; IN COMMERCE 2-22-2005.

THE MARK CONSISTS OF STANDARD CHARACTERS WITHOUT CLAIM TO ANY PARTICULAR FONT, STYLE, SIZE, OR COLOR.

OWNER OF U.S. REG. NOS. 2,434,947 AND 2,608,621.

THE ENGLISH TRANSLATION OF "GRAN TURISMO" IS "GRAND TOURISM".

SN 76-623,626, FILED 12-7-2004.

TRACY WHITTAKER-BROWN, EXAMINING ATTORNEY

**Int. Cl.: 9**

**Prior U.S. Cls.: 21, 23, 26, 36, and 38**

**Reg. No. 3,468,430**

**United States Patent and Trademark Office**

**Registered July 15, 2008**

---

**TRADEMARK  
PRINCIPAL REGISTER**

**FlexiNet**

BOARD & BATTEN INTERNATIONAL INC.  
(CAYMAN ISLANDS COMPANY)  
INTERNATIONAL MANAGEMENT SERVICES  
LTD.  
HARBOUR CENTRE, 4TH FLOOR, NORTH  
CHURCHSTREETSTREET  
GEORGETOWN, CAYMAN ISLANDS

FOR: SAFETY NETS AND NETTED ENCLOSURES FOR USE WITH INDOOR AND OUTDOOR EXERCISE, GYMNAS TIC AND PLAY EQUIPMENT, AND TRAMPOLINES, IN CLASS 9 (U.S. CLS. 21, 23, 26, 36 AND 38).

FIRST USE 7-0-2005; IN COMMERCE 7-0-2005.

THE MARK CONSISTS OF STANDARD CHARACTERS WITHOUT CLAIM TO ANY PARTICULAR FONT, STYLE, SIZE, OR COLOR.

SN 76-624,184, FILED 12-10-2004.

ALICIA COLLINS, EXAMINING ATTORNEY

**Int. Cl.: 10**

**Prior U.S. Cls.: 26, 39, and 44**

**United States Patent and Trademark Office**

**Reg. No. 3,468,431**

**Registered July 15, 2008**

**TRADEMARK  
PRINCIPAL REGISTER**



ORTHOVITA, INC. (PENNSYLVANIA CORPORATION)  
77 GREAT VALLEY PARKWAY  
MALVERN, PA 19355

FIRST USE 2-11-2008; IN COMMERCE 2-11-2008.

OWNER OF U.S. REG. NO. 2,127,529.

FOR: ORTHOPEDIC SURGICAL MATERIALS AND SUPPLIES, NAMELY, SYNTHETIC BONE GRAFT COMPOSED OF BIOACTIVE GLASS GRANULES AND CALCIUM PHOSPHATE GRANULES AND SUBSTRATES, IN CLASS 10 (U.S. CLS. 26, 39 AND 44).

SN 76-628,433, FILED 1-20-2005.

KRISTINA MORRIS, EXAMINING ATTORNEY



**Int. Cl.: 9**

**Prior U.S. Cls.: 21, 23, 26, 36, and 38**

**United States Patent and Trademark Office**

**Reg. No. 3,468,432**

**Registered July 15, 2008**

---

**TRADEMARK  
PRINCIPAL REGISTER**

**DRAGONS 8'S**

AGS LLC (DELAWARE LTD LIAB CO)  
TWO EMBARCADERO CENTER, SUITE 2320  
SAN FRANCISCO, CA 94111

FOR: ELECTRONIC GAMING MACHINES AND  
SOFTWARE, NAMELY, SLOT MACHINES, VIDEO  
GAMING MACHINES FOR USE IN GAMING FA-  
CILITIES, AND VIDEO GAME SOFTWARE, IN  
CLASS 9 (U.S. CLS. 21, 23, 26, 36 AND 38).

FIRST USE 4-23-2008; IN COMMERCE 4-23-2008.

THE MARK CONSISTS OF STANDARD CHAR-  
ACTERS WITHOUT CLAIM TO ANY PARTICULAR  
FONT, STYLE, SIZE, OR COLOR.

SN 76-629,643, FILED 1-27-2005.

MARLENE BELL, EXAMINING ATTORNEY

**Int. Cl.: 35**

**Prior U.S. Cls.: 100, 101, and 102**

**United States Patent and Trademark Office**

**Reg. No. 3,468,433**

**Registered July 15, 2008**

**SERVICE MARK  
PRINCIPAL REGISTER**

**NANTUCKET SEAFOOD**

FOX RUN HOLDINGS, LLC (DELAWARE LTD  
LIAB CO)  
1907 STOUT DRIVE  
IVYLAND, PA 18947

FOR: CATALOG ORDERING SERVICES, RETAIL  
STORE AND ONLINE RETAIL STORE SERVICES  
FEATURING GADGETS, UTENSILS AND KITCHEN  
ACCESSORIES FOR THE COOKING AND EATING  
OF SEAFOOD, INCLUDING BUT NOT  
LIMITED TO LOBSTER BIBS, STEAM POTS, LOB-  
STER CRACKERS, CRAB MALLETS AND SHRIMP

DEVEINERS, IN CLASS 35 (U.S. CLS. 100, 101 AND  
102).

FIRST USE 3-1-2005; IN COMMERCE 3-1-2005.

THE MARK CONSISTS OF STANDARD CHAR-  
ACTERS WITHOUT CLAIM TO ANY PARTICULAR  
FONT, STYLE, SIZE, OR COLOR.

SN 76-630,128, FILED 2-1-2005.

KHANH LE, EXAMINING ATTORNEY

**Int. Cl.: 44**

**Prior U.S. Cls.: 100 and 101**

**United States Patent and Trademark Office**

**Reg. No. 3,468,434**

**Registered July 15, 2008**

**SERVICE MARK  
PRINCIPAL REGISTER**



**BOLIO  
SYSTEM**

BOLIO, RAFAEL (MEXICO INDIVIDUAL)  
11335 N.W. 66TH STREET  
MIAMI, FL 33178

FIRST USE 11-15-2005; IN COMMERCE 11-15-2005.

FOR: WEIGHT REDUCTION DIET PLANNING AND SUPERVISION SERVICES, NAMELY, MEAL PLANNING AND NUTRITIONAL COUNSELING SERVICES; NUTRITIONAL CONSULTATION, NAMELY, WEIGHT CONTROL EVALUATION; WEIGHT CONTROL DIET PLANNING; PERSONAL DIET PLANNING SERVICES FOR WEIGHT LOSS, WEIGHT CONTROL AND WEIGHT MAINTENANCE, IN CLASS 44 (U.S. CLS. 100 AND 101).

NO CLAIM IS MADE TO THE EXCLUSIVE RIGHT TO USE "SYSTEM", APART FROM THE MARK AS SHOWN.

SN 76-635,126, FILED 4-4-2005.

ALEXANDER L. POWERS, EXAMINING ATTORNEY

**Int. Cl.: 41**

**Prior U.S. Cls.: 100, 101, and 107**

**United States Patent and Trademark Office**

**Reg. No. 3,468,435**

**Registered July 15, 2008**

**SERVICE MARK  
PRINCIPAL REGISTER**

ARUP INSTITUTE FOR CLINICAL AND EXPERIMENTAL PATHOLOGY

ASSOCIATED REGIONAL AND UNIVERSITY  
PATHOLOGISTS, INC. (UTAH CORPORATION)  
500 CHIPETA WAY  
SALT LAKE CITY, UT 84108

FOR: EDUCATIONAL SERVICES, NAMELY, ARRANGING AND CONDUCTING CLASSES, SEMINARS, CONFERENCES, COLLOQUIUMS, WORKSHOPS AND DISCUSSIONS, AND DISTRIBUTING EDUCATIONAL MATERIALS, BROCHURES AND REPORTS IN CONNECTION THEREWITH, IN THE FIELDS OF PATHOLOGY, CLINICAL PATHOLOGY, ANATOMIC PATHOLOGY, HISTOPATHOLOGY, HISTOLOGY, INFECTIOUS DISEASES, DISEASE PATHOLOGY, INFECTIOUS DISEASE PATHOLOGY, STAINING ANALYSIS, VIROLOGY, HEMATOPATHOLOGY, HEMATOLOGY, PROTEOMICS, HEMOSTASIS, THROMBOSIS, FLOW ANALYSIS, FLOW CYTOMETRY, CAPILLARY ELECTROPHORESIS, GENETICS, MOLECULAR GENETICS, BIOCHEMICAL GENETICS, GENETIC DISEASES, GENE IDENTIFICATION, GENE SEQUENCING, NUCLEOTIDE SEQUENCING, GENOTYPIC IDENTIFICATION, PHENOTYPIC IDENTIFICATION, PROBE SYNTHESIS, MASS SPECTROMETRY, TANDEM MASS SPECTROMETRY, MOLECULAR TESTING, MOLECULAR DIAGNOSTICS, MOLECULAR EVALUATION, CYTOPATHOLOGY, CYTOLOGY, CYTOGENETICS, ONCOLOGY, TUMOR DETECTION, TUMOR MARKERS, TUMOR DIAGNOSTICS, MUTATION DETECTION, MUTATION ANALYSIS, MORPHOLOGIC CHANGE, IMMUNO-

PATHOLOGY, IMMUNOLOGY, IMMUNOHEMATOLOGY, IMMUNOHISTOCHEMICAL STAINING, IMMUNOFLUORESCENCE, AUTOIMMUNE DISORDERS, MICROBIOLOGY, SEROLOGY, MICROBIAL SEROLOGY, ENDOCRINOLOGY, CLINICAL CHEMISTRY, TOXICOLOGY, CLINICAL TOXICOLOGY, TOXINS, PHARMACOGENOMICS, THERAPEUTIC DRUGS, TRANSPLANTATION PATHOLOGY, SURGICAL PATHOLOGY, AUTOPSY PATHOLOGY, METABOLICS, METABOLIC STATUS, NUTRITIONAL STATUS, MICROSCOPY, CORE LAB TESTING, ENGINEERING ANALYSIS, LABORATORY AUTOMATION, MEDICAL INFORMATICS, AND HEALTH CARE, IN CLASS 41 (U.S. CLS. 100, 101 AND 107).

FIRST USE 6-9-2006; IN COMMERCE 6-9-2006.

THE MARK CONSISTS OF STANDARD CHARACTERS WITHOUT CLAIM TO ANY PARTICULAR FONT, STYLE, SIZE, OR COLOR.

OWNER OF U.S. REG. NOS. 1,411,801 AND 1,890,442.

NO CLAIM IS MADE TO THE EXCLUSIVE RIGHT TO USE "INSTITUTE FOR CLINICAL AND EXPERIMENTAL PATHOLOGY", APART FROM THE MARK AS SHOWN.

SN 76-635,439, FILED 4-8-2005.

ARETHA SOMERVILLE, EXAMINING ATTORNEY

**Int. Cl.: 35**

**Prior U.S. Cls.: 100, 101, and 102**

**United States Patent and Trademark Office**

**Reg. No. 3,468,436**

**Registered July 15, 2008**

**SERVICE MARK  
PRINCIPAL REGISTER**



INTERNATIONAL CROSSBALL ASSOCIATION,  
INC. (CALIFORNIA CORPORATION)  
17111 BEACH BLVD., SUITE212  
HUNTINGTON BEACH, CA 92647

FOR: COORDINATION OF RECREATIONAL SPORTING OPPORTUNITIES FOR INDIVIDUALS WHO WISH TO PARTICIPATE IN TEAM CROSSBALL LEAGUE SPORTS; ADMINISTRATION OF COMMUNITY RECREATIONAL SPORTS LEAGUES FEATURING THE GAME OF CROSSBALL; ASSOCIATION SERVICES, NAMELY, PROMOTING THE INTERESTS OF THE TEAM SPORT OF CROSSBALL, IN CLASS 35 (U.S. CLS. 100, 101 AND 102).

FIRST USE 11-10-2007; IN COMMERCE 11-10-2007.

NO CLAIM IS MADE TO THE EXCLUSIVE RIGHT TO USE "INTERNATIONAL CROSSBALL ASSOCIATION", APART FROM THE MARK AS SHOWN.

SN 76-640,158, FILED 6-3-2005.

ALEXANDER L. POWERS, EXAMINING ATTORNEY

**Int. Cl.: 36**

**Prior U.S. Cls.: 100, 101, and 102**

**United States Patent and Trademark Office**

**Reg. No. 3,468,437**

**Registered July 15, 2008**

**SERVICE MARK  
PRINCIPAL REGISTER**

**ELM INCOME GROUP**

ELM INCOME GROUP, INC. (DELAWARE CORPORATION)  
1666 K STREET NW, SUITE 700  
WASHINGTON, DC 20006

FOR: DESIGNING ANNUITIES; DESIGNING INSURANCE CONTRACTS, NAMELY, LIFE, ACCIDENTAL DEATH AND DISMEMBERMENT, DISABILITY INCOME, DENTAL AND MEDICAL; INSURANCE BROKERAGE SERVICES, NAMELY, ANNUITY CONTRACTS AND INSURANCE CONTRACTS; INSURANCE CONSULTATION; AND INVESTMENT BROKERAGE SERVICES, IN CLASS 36 (U.S. CLS. 100, 101 AND 102).

FIRST USE 8-0-2005; IN COMMERCE 8-0-2005.

THE MARK CONSISTS OF STANDARD CHARACTERS WITHOUT CLAIM TO ANY PARTICULAR FONT, STYLE, SIZE, OR COLOR.

NO CLAIM IS MADE TO THE EXCLUSIVE RIGHT TO USE "INCOME GROUP", APART FROM THE MARK AS SHOWN.

SN 76-646,490, FILED 9-8-2005.

KELLY BOULTON, EXAMINING ATTORNEY

**Int. Cls.: 35 and 42**

**Prior U.S. Cls.: 100, 101, and 102**

**United States Patent and Trademark Office**

**Reg. No. 3,468,438**

**Registered July 15, 2008**

**SERVICE MARK  
PRINCIPAL REGISTER**

# McBee Consulting

MCBEE ASSOCIATES, INC. (MARYLAND CORPORATION)  
997 OLD EAGLE SCHOOL ROAD  
SUITE 205  
WAYNE, PA 19087

FOR: BUSINESS ADMINISTRATION CONSULTANCY SERVICES IN THE FIELD OF BUSINESS OPERATIONS, METHODOLOGY DEVELOPMENT, AND BUSINESS MANAGEMENT TO OPTIMIZE REVENUE POTENTIAL FOR HEALTHCARE INSTITUTIONS AND ORGANIZATIONS, NAMELY, ACCOUNTS RECEIVABLE, REVENUE ENHANCEMENT, CENTRAL BUSINESS OFFICE, CONTRACT PAYMENT RECOVERY, REIMBURSEMENT, OPERATIONS IMPROVEMENT, ACCOUNTING SERVICES, INTERNAL ACCOUNT AUDITING, INTERIM MANAGEMENT, STRATEGIC ANALYSIS AND PLANNING, TURN AROUND SERVICES, DATABASE MANAGEMENT, TRANSACTION STANDARDS, POLICIES AND PROCEDURES, OPERATIONAL IMPROVEMENTS, STRATEGIC BENCHMARKING AND OUTSOURCING, IN CLASS 35 (U.S. CLS. 100, 101 AND 102).

FIRST USE 4-1-2008; IN COMMERCE 4-1-2008.

FOR: REVIEW OF STANDARDS AND PRACTICES ENSURING COMPLIANCE WITH MEDICARE, MEDICAID, AND HIPPA LAWS AND REGULATIONS, IN CLASS 42 (U.S. CLS. 100 AND 101).

FIRST USE 4-1-2008; IN COMMERCE 4-1-2008.

THE MARK CONSISTS OF STANDARD CHARACTERS WITHOUT CLAIM TO ANY PARTICULAR FONT, STYLE, SIZE, OR COLOR.

OWNER OF U.S. REG. NO. 3,322,099.

NO CLAIM IS MADE TO THE EXCLUSIVE RIGHT TO USE "CONSULTING", APART FROM THE MARK AS SHOWN.

SEC. 2(F).

SN 76-647,549, FILED 9-27-2005.

DAVID HOFFMAN, EXAMINING ATTORNEY

**Int. Cl.: 41**

**Prior U.S. Cls.: 100, 101, and 107**

**United States Patent and Trademark Office**

**Reg. No. 3,468,439**

**Registered July 15, 2008**

**SERVICE MARK  
PRINCIPAL REGISTER**

**FX 360°**

GLOBAL FUTURES & FOREX, LTD. (MICHIGAN CORPORATION)  
4760 E. FULTON ROAD, SUITE 201  
ADA, MI 49301

FOR: EDUCATIONAL SERVICES, NAMELY, PROVIDING INSTRUCTIONAL CLASSES, SEMINARS AND WORKSHOPS, IN-PERSON, OVER THE TELEPHONE AND VIA THE INTERNET IN THE FIELD OF SECURITIES AND FOREIGN CURRENCY, IN CLASS 41 (U.S. CLS. 100, 101 AND 107).

FIRST USE 9-0-2006; IN COMMERCE 9-0-2006.

THE MARK CONSISTS OF STANDARD CHARACTERS WITHOUT CLAIM TO ANY PARTICULAR FONT, STYLE, SIZE, OR COLOR.

NO CLAIM IS MADE TO THE EXCLUSIVE RIGHT TO USE "FX", APART FROM THE MARK AS SHOWN.

SN 76-648,515, FILED 10-14-2005.

STEVEN R. FINE, EXAMINING ATTORNEY



**Int. Cl.: 11**

**Prior U.S. Cls.: 13, 21, 23, 31, and 34**

**United States Patent and Trademark Office**

**Reg. No. 3,468,440**

**Registered July 15, 2008**

**TRADEMARK  
PRINCIPAL REGISTER**

**Muskòka**

GREENWAY HOME PRODUCTS LIMITED (CANADA CORPORATION)  
400 SOUTHGATE DRIVE  
GUELPH, ONTARIO N1G, 4P5, CANADA

FOR: WOOD, GAS, ELECTRIC AND GEL FIRE PLACES, WATER FILTRATION AND PURIFICATION UNITS FOR DOMESTIC AND COMMERCIAL USE; BARBECUES, RESIDENTIAL AND COMMERCIAL ELECTRIC RADIANT HEATERS AND GAS HEATERS, NAMELY, BASE BOARD HEATERS, UNIT HEATERS, WALL INSERT HEATERS, PORTABLE HEATERS, CONSTRUCTION HEATERS, CABINET HEATERS, FLOOR INSERT HEATERS, INFRA-RED HEATERS, RADIANT HEATERS, GAS ZONE HEATERS, SPACE HEATERS, AIR HEATERS, CEILING HEATERS, AND UNDER-CONCRETE HEATERS; FURNACES AND GAS RADIANT TUBE HEATERS FOR RESIDENTIAL AND COMMERCIAL USE, IN CLASS 11 (U.S. CLS. 13, 21, 23, 31 AND 34).

FIRST USE 10-1-2006; IN COMMERCE 10-1-2006.

PRIORITY CLAIMED UNDER SEC. 44(D) ON CANADA APPLICATION NO. 1273613, FILED 9-27-2005, REG. NO. 690509, DATED 6-21-2007, EXPIRES 6-21-2022.

NO CLAIM IS MADE TO THE EXCLUSIVE RIGHT TO USE "MUSKOKA", APART FROM THE MARK AS SHOWN.

THE MARK CONSISTS OF A STYLIZED REPRESENTATION OF THE TERM "MUSKOKA" WHICH A FLAME DESIGN THAT REPRESENTS THE SMALL LETTER O.

SN 76-648,738, FILED 10-18-2005.

WARREN L. OLANDRIA, EXAMINING ATTORNEY

**Int. Cl.: 9**

**Prior U.S. Cls.: 21, 23, 26, 36, and 38**

**Reg. No. 3,468,441**

**United States Patent and Trademark Office**

**Registered July 15, 2008**

**TRADEMARK  
PRINCIPAL REGISTER**

**ZERO-IN**

THE TRUSTEES OF THE MARILYN A. GASQUE  
REVOCABLE TRUST, A NORTH CAROLINA  
TRUST, THE TRUSTEES COMPRISING SA-  
MUEL N. GASQUE, A U.S. CITIZEN (NORTH  
CAROLINA TRUST)  
394 OLD TANGLEWOOD TRAIL  
HENDERSONVILLE, NC 28739

FOR: DRILL-HOLE LOCATION SYSTEM COM-  
PRISED OF ELECTROMAGNETIC TRANSMIT-  
TERS AND ELECTROMAGNETIC SENSORS,  
SUCH AS RADIO, SONIC AND MAGNETIC TRANS-  
MITTERS AND SENSORS, USED TO LOCATE A  
PROPER POSITION FROM A BLIND SIDE OF A

WALL AND DRILL A HOLE THERETHROUGH, IN  
CLASS 9 (U.S. CLS. 21, 23, 26, 36 AND 38).

FIRST USE 4-29-2006; IN COMMERCE 4-29-2006.

THE MARK CONSISTS OF STANDARD CHAR-  
ACTERS WITHOUT CLAIM TO ANY PARTICULAR  
FONT, STYLE, SIZE, OR COLOR.

SN 76-649,587, FILED 11-1-2005.

SUNG IN, EXAMINING ATTORNEY

**Int. Cl.: 35**

**Prior U.S. Cls.: 100, 101, and 102**

**United States Patent and Trademark Office**

**Reg. No. 3,468,442**

**Registered July 15, 2008**

**SERVICE MARK  
PRINCIPAL REGISTER**

**AURORA NOVA**

CULLEM, JAMES G. (UNITED STATES INDIVIDUAL)  
98 LESLIE ROAD  
ROWLEY, MA 01969

THE MARK CONSISTS OF STANDARD CHARACTERS WITHOUT CLAIM TO ANY PARTICULAR FONT, STYLE, SIZE, OR COLOR.

FOR: BUSINESS CONSULTING SERVICES IN THE FIELD OF INTELLECTUAL PROPERTY, EXCLUDING THE ENERGY INDUSTRY, IN CLASS 35 (U.S. CLS. 100, 101 AND 102).

SN 76-649,977, FILED 11-8-2005.

FIRST USE 5-5-2007; IN COMMERCE 5-5-2007.

ANGELA M. MICHELI, EXAMINING ATTORNEY

**Int. Cl.: 41**

**Prior U.S. Cls.: 100, 101, and 107**

**United States Patent and Trademark Office**

**Reg. No. 3,468,443**

**Registered July 15, 2008**

---

**SERVICE MARK  
PRINCIPAL REGISTER**

**HEARTSTREAMING**

THE HEARTS CENTER, INC. (ILLINOIS CORPORATION)  
P.O. BOX 277  
LIVINGSTON, MT 59047

THE MARK CONSISTS OF STANDARD CHARACTERS WITHOUT CLAIM TO ANY PARTICULAR FONT, STYLE, SIZE, OR COLOR.

FOR: EDUCATIONAL SERVICES, NAMELY, COURSES, SEMINARS AND WORKSHOPS FOR FOSTERING SPIRITUAL GROWTH AND DEVELOPMENT, IN CLASS 41 (U.S. CLS. 100, 101 AND 107).

SN 76-650,870, FILED 11-25-2005.

FIRST USE 12-29-2007; IN COMMERCE 12-29-2007.

KELLY CHOE, EXAMINING ATTORNEY

**Int. Cls.: 25 and 41**

**Prior U.S. Cls.: 22, 39, 100, 101, and 107**

**United States Patent and Trademark Office**

**Reg. No. 3,468,444**

**Registered July 15, 2008**

**TRADEMARK  
SERVICE MARK  
PRINCIPAL REGISTER**

**LOST IN THE 70'S**

HRP CREATIVE SERVICES CO., LLC (FLORIDA  
LTD LIAB CO)

SUITE 500

622 EAST WASHINGTON STREET

ORLANDO, FL 32801

FOR: CLOTHING, NAMELY, T-SHIRTS, POLO  
SHIRTS, SWEATSHIRTS, CAPS, HATS, FOOTWEAR  
AND JACKETS , IN CLASS 25 (U.S. CLS. 22 AND 39).

FIRST USE 4-15-2008; IN COMMERCE 4-15-2008.

FOR: ENTERTAINMENT SERVICES, NAMELY,  
AMUSEMENT PARK AND THEME PARK SERVI-  
CES, IN CLASS 41 (U.S. CLS. 100, 101 AND 107).

FIRST USE 10-15-2007; IN COMMERCE 10-15-2007.

THE MARK CONSISTS OF STANDARD CHAR-  
ACTERS WITHOUT CLAIM TO ANY PARTICULAR  
FONT, STYLE, SIZE, OR COLOR.

SN 76-651,645, FILED 12-8-2005.

AMEETA JORDAN, EXAMINING ATTORNEY

**Int. Cl.: 41**

**Prior U.S. Cls.: 100, 101, and 107**

**United States Patent and Trademark Office**

**Reg. No. 3,468,445**

**Registered July 15, 2008**

**SERVICE MARK  
PRINCIPAL REGISTER**

**BORN IN THE USA**

HRP CREATIVE SERVICES CO., LLC (FLORIDA  
LTD LIAB CO)  
121 SOUTH ORANGE AVENUE, SUITE 1250  
ORLANDO, FL 32801

THE MARK CONSISTS OF STANDARD CHAR-  
ACTERS WITHOUT CLAIM TO ANY PARTICULAR  
FONT, STYLE, SIZE, OR COLOR.

FOR: ENTERTAINMENT SERVICES, NAMELY,  
AMUSEMENT PARK AND THEME PARK SERVI-  
CES, IN CLASS 41 (U.S. CLS. 100, 101 AND 107).

SN 76-651,647, FILED 12-8-2005.

FIRST USE 10-15-2007; IN COMMERCE 10-15-2007.

AMEETA JORDAN, EXAMINING ATTORNEY

**Int. Cl.: 41**

**Prior U.S. Cls.: 100, 101, and 107**

**Reg. No. 3,468,446**

**United States Patent and Trademark Office**

**Registered July 15, 2008**

---

**SERVICE MARK  
PRINCIPAL REGISTER**

**ALL ACCESS ENTRY PLAZA**

HRP CREATIVE SERVICES CO., LLC (FLORIDA  
LTD LIAB CO)  
SUITE 1250  
121 SOUTH ORANGE AVENUE  
ORLANDO, FL 32801

FOR: ENTERTAINMENT SERVICES, NAMELY,  
AMUSEMENT PARK AND THEME PARK SERVI-  
CES, IN CLASS 41 (U.S. CLS. 100, 101 AND 107).

FIRST USE 10-15-2007; IN COMMERCE 10-15-2007.

THE MARK CONSISTS OF STANDARD CHAR-  
ACTERS WITHOUT CLAIM TO ANY PARTICULAR  
FONT, STYLE, SIZE, OR COLOR.

NO CLAIM IS MADE TO THE EXCLUSIVE  
RIGHT TO USE "ENTRY PLAZA", APART FROM  
THE MARK AS SHOWN.

SN 76-651,649, FILED 12-8-2005.

AMEETA JORDAN, EXAMINING ATTORNEY

**Int. Cl.: 9**

**Prior U.S. Cls.: 21, 23, 26, 36, and 38**

**United States Patent and Trademark Office**

**Reg. No. 3,468,447**

**Registered July 15, 2008**

**TRADEMARK  
PRINCIPAL REGISTER**

**CAPTURING THE REAL YOU**

GOCHA, ALAN (UNITED STATES INDIVIDUAL)  
P.O. BOX 250666  
FRANKLIN, MI 48025

FOR: COMPACT DISKS, DVD'S, VIDEOTAPES,  
AUDIO RECORDINGS, SOUND RECORDINGS, LA-  
SER DISKS, DOWNLOADABLE VIDEO RECORD-  
INGS, FEATURING INTERVIEWS OF OTHERS, IN  
CLASS 9 (U.S. CLS. 21, 23, 26, 36 AND 38).

FIRST USE 2-27-2007; IN COMMERCE 8-17-2007.

THE MARK CONSISTS OF STANDARD CHAR-  
ACTERS WITHOUT CLAIM TO ANY PARTICULAR  
FONT, STYLE, SIZE, OR COLOR.

SN 76-652,648, FILED 12-29-2005.

REBECCA POVARCHUK, EXAMINING ATTOR-  
NEY



**Int. Cl.: 44**

**Prior U.S. Cls.: 100 and 101**

**United States Patent and Trademark Office**

**Reg. No. 3,468,448**

**Registered July 15, 2008**

**SERVICE MARK  
PRINCIPAL REGISTER**

**LIFEAGENT**

PROSOCIAL APPLICATIONS INC. (COLORADO CORPORATION)  
1630 A 30TH STREET SUITE 288  
BOULDER, CO 80301

FOR: PROVIDING ON-LINE NON-DOWNLOADABLE COMPUTERIZED DATABASE DEFINING A HEALTH CARE INFORMATION SYSTEM ACCESSIBLE VIA THE INTERNET FOR AUTHORIZED USERS INCLUSIVE OF CONSUMERS, AUTHORIZED FAMILY CAREGIVERS, HEALTHCARE PROVIDERS AND ENTERPRISES IN THE HEALTH CARE FIELD TO ADD AND SHARE MEDICAL INFORMATION, HEALTH AND HUMAN SERVICE RECORDS, MEDICAL CHARTS AND MEDICAL DOCUMENTS BETWEEN SUCH USERS IN ACCORDANCE WITH AUTHORIZED DATA CATEGORIES

AND FUNCTIONS STORED WITHIN HOLISTIC CLIENT ACCOUNTS IDENTIFIED IN THE DATABASE UNDER THE CONTROL OF SUCH CLIENT ACCOUNT HOLDERS OR THEIR LEGAL REPRESENTATIVES THROUGH A SOFTWARE PROGRAM, IN CLASS 44 (U.S. CLS. 100 AND 101).

FIRST USE 1-15-2005; IN COMMERCE 1-15-2005.

THE MARK CONSISTS OF STANDARD CHARACTERS WITHOUT CLAIM TO ANY PARTICULAR FONT, STYLE, SIZE, OR COLOR.

SN 76-652,831, FILED 1-4-2006.

MICHAEL GAAFAR, EXAMINING ATTORNEY

**Int. Cl.: 5**

**Prior U.S. Cls.: 6, 18, 44, 46, 51, and 52**

**Reg. No. 3,468,449**

**United States Patent and Trademark Office**

**Registered July 15, 2008**

**TRADEMARK  
PRINCIPAL REGISTER**

**SHUFFLE**

MARS, INCORPORATED (DELAWARE CORPORATION)  
6885 ELM STREET  
MCLEAN, VA 221013883

THE MARK CONSISTS OF STANDARD CHARACTERS WITHOUT CLAIM TO ANY PARTICULAR FONT, STYLE, SIZE, OR COLOR.

FOR: NUTRITIONALLY FORTIFIED ENERGY FOOD MIXES FOR USE AS NUTRITIONAL SUPPLEMENTS OR MEAL REPLACEMENT, IN CLASS 5 (U.S. CLS. 6, 18, 44, 46, 51 AND 52).

SN 76-654,558, FILED 2-3-2006.

FIRST USE 12-0-2006; IN COMMERCE 12-0-2006.

EVELYN BRADLEY, EXAMINING ATTORNEY

**Int. Cl.: 42**

**Prior U.S. Cls.: 100 and 101**

**United States Patent and Trademark Office**

**Reg. No. 3,468,450**

**Registered July 15, 2008**

---

**SERVICE MARK  
PRINCIPAL REGISTER**

**PEOPLERANK**

WINK TECHNOLOGIES, INC. (DELAWARE  
CORPORATION)  
5150 EL CAMINO REAL #C20  
LOS ALTOS, CA 94022

FIRST USE 3-14-2006; IN COMMERCE 3-14-2006.

SN 76-654,885, FILED 2-10-2006.

FOR: COMPUTER SERVICES, NAMELY, PRO-  
VIDING SEARCH ENGINES FOR OBTAINING  
DATA ON A GLOBAL COMPUTER NETWORK, IN  
CLASS 42 (U.S. CLS. 100 AND 101).

RONALD AIKENS, EXAMINING ATTORNEY

**Int. Cls.: 9 and 15**

**Prior U.S. Cls.: 2, 21, 23, 26, 36, and 38**

**United States Patent and Trademark Office**

**Reg. No. 3,468,451**

**Registered July 15, 2008**

**TRADEMARK  
PRINCIPAL REGISTER**

**TENORI-ON**

YAMAHA CORPORATION (JAPAN CORPORATION)  
10-1, NAKAZAWA-CHO, HAMAMATSU-SHI  
SHIZUOKA, JAPAN

FOR: SAMPLING UNITS, NAMELY, DIGITAL PHRASE SAMPLERS USED TO RECORD, REPLAY, AND EDIT DIGITALLY STORED MUSIC SAMPLES; MUSIC SYNTHESIZERS, NAMELY, DESK TOP CONTROL UNITS USED TO SYNTHESIZE MUSIC THAT DO NOT FUNCTION INDEPENDENTLY AS MUSICAL INSTRUMENTS; ELECTRONIC TONE GENERATORS; ELECTRONIC MUSIC SEQUENCERS; ELECTRONIC CIRCUITS FOR GENERATING, EFFECTING, RECORDING AND/OR REPRODUCING SOUND; ELECTRONIC SOUND GENERATORS AND MUSIC CREATORS THAT ALLOW THE USER TO COMPOSE, PRODUCE, OR PLAY MUSIC WITH VISUAL INTERFACE; ELECTRONIC APPARATUS COMPRISED OF GENERATORS, SPEAKERS, AND LIGHT-EMITTING INPUTS AND DISPLAYS FOR USE IN COMPOSING, PRO-

DUCING AND PLAYING MUSIC, IN CLASS 9 (U.S. CLS. 21, 23, 26, 36 AND 38).

FIRST USE 4-3-2008; IN COMMERCE 4-3-2008.

FOR: MUSICAL INSTRUMENTS, NAMELY, ELECTRONIC MUSICAL INSTRUMENTS THAT ALLOW THE USER TO COMPOSE, PRODUCE, OR PLAY MUSIC WITH VISUAL INTERFACE; ELECTRONIC MUSICAL INSTRUMENTS CONTAINING LIGHT-EMITTING INPUTS AND DISPLAYS, IN CLASS 15 (U.S. CLS. 2, 21 AND 36).

FIRST USE 4-3-2008; IN COMMERCE 4-3-2008.

THE MARK CONSISTS OF STANDARD CHARACTERS WITHOUT CLAIM TO ANY PARTICULAR FONT, STYLE, SIZE, OR COLOR.

SN 76-655,660, FILED 2-24-2006.

ANTHONY RINKER, EXAMINING ATTORNEY

**Int. Cl.: 30**

**Prior U.S. Cl.: 46**

**United States Patent and Trademark Office**

**Reg. No. 3,468,452**

**Registered July 15, 2008**

**TRADEMARK  
PRINCIPAL REGISTER**

**CHOCO  
NILLA**

MARILAN ALIMENTOS S.A. (BRAZIL COR-  
PORATION)

AV. JOSÉ DE GRANDE 518/642 MARILIA  
STATE OF SÃO PAULO, BRAZIL

FIRST USE 0-0-2006; IN COMMERCE 0-0-2006.

SN 76-655,877, FILED 3-1-2006.

FOR: BAKERY GOODS, NAMELY, BISCUITS IN  
THE NATURE OF COOKIES, IN CLASS 30 (U.S. CL.  
46).

TRACY WHITTAKER-BROWN, EXAMINING AT-  
TORNEY

**Int. Cl.: 21**

**Prior U.S. Cls.: 2, 13, 23, 29, 30, 33, 40, and 50**

**Reg. No. 3,468,453**

**United States Patent and Trademark Office**

**Registered July 15, 2008**

**TRADEMARK  
PRINCIPAL REGISTER**

**ONDA**

CASABELLA HOLDINGS, L.L.C. (DELAWARE  
LTD LIAB CO)  
400 CORPORATE DRIVE  
BLAUVELT, NY 10913

FOR: HOUSEHOLD CLEANING DEVICES,  
NAMELY, BROOMS AND DUSTPAN SETS, IN  
CLASS 21 (U.S. CLS. 2, 13, 23, 29, 30, 33, 40 AND 50).

FIRST USE 3-31-2006; IN COMMERCE 3-31-2006.

THE MARK CONSISTS OF STANDARD CHAR-  
ACTERS WITHOUT CLAIM TO ANY PARTICULAR  
FONT, STYLE, SIZE, OR COLOR.

THE FOREIGN WORDING IN THE MARK  
TRANSLATES INTO ENGLISH AS WAVE.

SN 76-656,307, FILED 3-9-2006.

JANICE KIM, EXAMINING ATTORNEY

Int. Cl.: 8

Prior U.S. Cls.: 23, 28, and 44

Reg. No. 3,468,454

United States Patent and Trademark Office

Registered July 15, 2008

TRADEMARK  
PRINCIPAL REGISTER

# RAY DENG

JUI-DENG INDUSTRIAL CORP. (TAIWAN CORPORATION)  
NO. 3-19, LANE 365  
CHUNG SHAN S. ROADYUNG KANG CITYYUNG  
KANG CITY  
TAINAN HSIEN, TAIWAN 00000

FOR: MANUALLY OPERATED HAND TOOLS FOR USE IN REPAIRING VEHICLES, NAMELY, SOCKET SETS, WRENCHES, SOCKET SPANNERS, PLIERS, NIPPERS, TONGS, PINCERS, CLAMPS, SCREWDRIVERS, NUT DRIVERS, RATCHET WRENCHES, SCRAPERS, HAMMERS, FILES AND DRILLS; VEHICLE TIRE REMOVAL TOOLS, NAMELY, MANUAL HEX KEY WRENCHES, MANUAL TIRE VALVE CORE REMOVERS, MANUAL TIRE VALVE STEM REMOVERS, MANUAL TIRE LEVERS, MANUAL TIRE IRONS; VEHICLE WINDSHIELD REMOVAL TOOLS, NAMELY, HAND OPERATED REAMERS, HAND OPERATED WINDSHIELD SCRAPERS, HAND OPERATED WINDSHIELD MOLDING REMOVERS, HAND OPERATED WINDSHIELD WEATHER STRIP CUTTING KNIVES, HAND OPERATED WINDSHIELD SEALANT REMOVERS, HAND OPERATED WINDSHIELD SUCTION LIFTERS; HAND OPERATED TOOLS, NAMELY, AUTOMOBILE SHEET METAL DENT REPAIR AND REMOVAL TOOLS; MULTI-FUNCTION HAND TOOLS, NAMELY, PLIERS FOR USE IN VEHICLE DOOR SKIN REMOVAL AND

INSTALLATION; TOOL KITS PRIMARILY COMPRISED OF HAND OPERATED TOOLS, NAMELY, SCREWDRIVERS, WRENCHES, SOCKET SETS; AUTOMOBILE SERVICE KIT PRIMARILY COMPRISING HAND TOOLS, NAMELY, PLIERS, WRENCHES AND SOCKET SETS SOLD AS A UNIT WITH REPLACEMENT HEADLAMPS, IN CLASS 8 (U.S. CLS. 23, 28 AND 44).

FIRST USE 11-0-2007; IN COMMERCE 11-0-2007.

THE MARK CONSISTS OF STANDARD CHARACTERS WITHOUT CLAIM TO ANY PARTICULAR FONT, STYLE, SIZE, OR COLOR.

THE NAME(S), PORTRAIT(S), AND/OR SIGNATURE(S) SHOWN IN THE MARK DOES NOT IDENTIFY A PARTICULAR LIVING INDIVIDUAL.

"RAY DENG" IS A TRANSLITERATION OF "JUI-DENG" WHICH TRANSLATES INTO ENGLISH AS "VIGOROUS STIRRUP". "RAY DENG" APPEARING IN THE MARK HAS NO MEANING IN A FOREIGN LANGUAGE.

SN 76-656,513, FILED 3-10-2006.

BERYL GARDNER, EXAMINING ATTORNEY

**Int. Cl.: 37**

**Prior U.S. Cls.: 100, 103, and 106**

**United States Patent and Trademark Office**

**Reg. No. 3,468,455**

**Registered July 15, 2008**

**SERVICE MARK  
PRINCIPAL REGISTER**

**SHOW READY**

SHOW READY, LLC (CALIFORNIA LTD LIAB  
CO)  
2720 POMONA BLVD.  
POMONA, CA 91768

FOR: INSTALLATION AND DISMANTLING OF  
TRADE SHOWS EXHIBITIONS IN ALL FIELDS OF  
INTEREST, IN CLASS 37 (U.S. CLS. 100, 103 AND 106).

FIRST USE 1-1-1998; IN COMMERCE 1-1-1998.

THE MARK CONSISTS OF STANDARD CHAR-  
ACTERS WITHOUT CLAIM TO ANY PARTICULAR  
FONT, STYLE, SIZE, OR COLOR.

NO CLAIM IS MADE TO THE EXCLUSIVE  
RIGHT TO USE "SHOW", APART FROM THE  
MARK AS SHOWN.

SN 76-656,850, FILED 3-20-2006.

ANNE MADDEN, EXAMINING ATTORNEY



**Int. Cls.: 3 and 5**

**Prior U.S. Cls.: 1, 4, 6, 18, 44, 46, 50, 51, and 52**

**United States Patent and Trademark Office**

**Reg. No. 3,468,456**

**Registered July 15, 2008**

**TRADEMARK  
PRINCIPAL REGISTER**



CALEEL + HAYDEN, L.L.C. (DELAWARE LTD  
LIAB CO)  
1810 BLAKE STREET  
DENVER, CO 80202

FOR: SKIN CARE PRODUCTS, NAMELY,  
CLEANSING CREAMS, CLEANSING BARS, FA-  
CIAL SOAPS, FACIAL MOISTURIZER, FACIAL  
SCRUBS, REVITALIZING FACIAL MASKS, TO-  
NERS, LIGHTENERS, MOISTURIZERS, AND SKIN  
CREAMS, IN CLASS 3 (U.S. CLS. 1, 4, 6, 50, 51 AND  
52).

FIRST USE 4-30-2006; IN COMMERCE 4-30-2006.

FOR: CHEMICAL PEEL PREPARATIONS FOR  
THE SKIN, IN CLASS 5 (U.S. CLS. 6, 18, 44, 46, 51 AND  
52).

FIRST USE 4-30-2006; IN COMMERCE 4-30-2006.

SN 76-658,809, FILED 4-21-2006.

BERNICE MIDDLETON, EXAMINING ATTORNEY

**Int. Cls.: 9 and 41**

**Prior U.S. Cls.: 21, 23, 26, 36, 38, 100, 101, and 107**

**United States Patent and Trademark Office**

**Reg. No. 3,468,457**

**Registered July 15, 2008**

**TRADEMARK  
SERVICE MARK  
PRINCIPAL REGISTER**

# Over G Fighters

KABUSHIKI KAISHA TAITO (JAPAN CORPORATION)  
NO.5-3, HIRAKAWACHO 2-CHOME  
CHIYODAKU, TOKYO, JAPAN

FOR: COMPUTER PROGRAMS FOR PRE-RECORDED GAMES; DOWNLOADABLE COMPUTER SOFTWARE AND PROGRAMS FOR HOME USE GAME MACHINES, FOR ON-LINE GAMES, FOR PERSONAL COMPUTERS, FOR CELLULAR TELEPHONES; ELECTRONIC GAME PROGRAMS FOR GAME WEBSITES FOR ONLINE GAMES; DOWNLOADABLE MUSIC AND VOCAL INFORMATION VIA THE INTERNET AND WIRELESS DEVICES, IN CLASS 9 (U.S. CLS. 21, 23, 26, 36 AND 38).

FIRST USE 6-27-2006; IN COMMERCE 6-27-2006.

FOR: PROVIDING AMUSEMENT ARCADE SERVICES, NAMELY, PROVIDING AMUSEMENT FACILITIES AND ENTERTAINMENT IN THE

NATURE OF ELECTRONIC GAMING AND PROVIDING INFORMATION IN THE FIELD OF ENTERTAINMENT; ENTERTAINMENT SERVICES, NAMELY, PROVIDING AN ON-LINE COMPUTER GAME; ENTERTAINMENT SERVICES IN THE NATURE OF COMPETITIONS IN THE FIELD OF COMPUTER GAMES AND PROVIDING GAME SCORE RANKING INFORMATION, IN CLASS 41 (U.S. CLS. 100, 101 AND 107).

FIRST USE 6-27-2006; IN COMMERCE 6-27-2006.

THE MARK CONSISTS OF STANDARD CHARACTERS WITHOUT CLAIM TO ANY PARTICULAR FONT, STYLE, SIZE, OR COLOR.

SN 76-659,786, FILED 5-5-2006.

ANNE E. GUSTASON, EXAMINING ATTORNEY

**Int. Cl.: 44**

**Prior U.S. Cls.: 100 and 101**

**United States Patent and Trademark Office**

**Reg. No. 3,468,458**

**Registered July 15, 2008**

**SERVICE MARK  
PRINCIPAL REGISTER**

**MAIN STREET**

MAIN STREET CHILDREN'S DENTISTRY AND  
ORTHODONTICS (FLORIDA LTD LIAB CO)  
13195 SW 134TH STREET  
2ND FLOOR  
MIAMI, FL 33186

FOR: DENTISTRY AND ORTHODONTIC SERVI-  
CES, IN CLASS 44 (U.S. CLS. 100 AND 101).

FIRST USE 11-1-2005; IN COMMERCE 11-1-2005.

THE MARK CONSISTS OF STANDARD CHAR-  
ACTERS WITHOUT CLAIM TO ANY PARTICULAR  
FONT, STYLE, SIZE, OR COLOR.

SN 76-660,869, FILED 5-31-2006.

ANDREA K. NADELMAN, EXAMINING ATTOR-  
NEY

Int. Cl.: 30

Prior U.S. Cl.: 46

United States Patent and Trademark Office

Reg. No. 3,468,459

Registered July 15, 2008

TRADEMARK  
PRINCIPAL REGISTER



SILVER JOE'S CORPORATION (ARKANSAS CORPORATION), DBA SILVER JOE'S COFFEE COMPANY,  
5000 ROGERS AVENUE, SUITE 800  
8TH FLOOR  
FORT SMITH, AR 72903

THE NAME "SILVER JOE" DOES NOT IDENTIFY A LIVING INDIVIDUAL.

THE MARK CONSISTS OF THE STYLIZED WORDING "SILVER JOE'S".

FOR: COFFEE, IN CLASS 30 (U.S. CL. 46).

SN 76-661,059, FILED 6-5-2006.

FIRST USE 9-22-2006; IN COMMERCE 9-22-2006.

JAMES MACFARLANE, EXAMINING ATTORNEY

**Int. Cl.: 11**

**Prior U.S. Cls.: 13, 21, 23, 31, and 34**

**United States Patent and Trademark Office**

**Reg. No. 3,468,460**

**Registered July 15, 2008**

**TRADEMARK  
PRINCIPAL REGISTER**

**CLEAR ADVANTAGE**

ARROW PNEUMATICS, INC. (ILLINOIS CORPORATION)  
2111 W. 21ST STREET  
BROADVIEW, IL 601554627

THE MARK CONSISTS OF STANDARD CHARACTERS WITHOUT CLAIM TO ANY PARTICULAR FONT, STYLE, SIZE, OR COLOR.

FOR: DESICCANT DRYERS FOR COMPRESSED AIR, IN CLASS 11 (U.S. CLS. 13, 21, 23, 31 AND 34).

SN 76-661,156, FILED 6-2-2006.

FIRST USE 4-25-2008; IN COMMERCE 4-25-2008.

DANNEAN HETZEL, EXAMINING ATTORNEY

**Int. Cl.: 9**

**Prior U.S. Cls.: 21, 23, 26, 36, and 38**

**Reg. No. 3,468,461**

**United States Patent and Trademark Office**

**Registered July 15, 2008**

**TRADEMARK  
PRINCIPAL REGISTER**

# STATURE

DYADEM INTERNATIONAL LTD. (CANADA CORPORATION)  
SUITE 401, 9050 YONGE STREET  
RICHMOND HILL, ONTARIO, CANADA L4C 9S6

FOR: COMPUTER SOFTWARE THAT UNIFIES THE QUALITY ANALYSIS, DESIGN, AND CONTROL PROCESSES THAT SPAN A PRODUCT OR PROCESS'S LIFECYCLE, THAT FEATURES SYSTEM DECOMPOSITION BY FUNCTION, ITEM AND PROCESS, ANALYSIS AND AUTHORING, PUBLISHING OF CONTROL PLANS AND INSPECTION PLANS, AND OTHER QUALITY-CENTRIC DATA AND PROCESSES, AND THAT INCLUDES CORE FUNCTIONS SUPPORTING THESE FEATURES IN THE NATURE OF STUDY AUTHORING, WORKFLOW, DOCUMENT MANAGEMENT, DOCUMENT PUBLISHING, VERSION CONTROL, CONFIGURA-

TION MANAGEMENT, CHANGE MANAGEMENT, AND ENTERPRISE INTEGRATION TO OTHER SYSTEMS, FOR USE BY MANUFACTURERS IN DISCRETE AND PROCESS MANUFACTURING AND OTHER INDUSTRIES OR FUNCTIONS WITH COMPLEX QUALITY PROCESSES, IN CLASS 9 (U.S. CLS. 21, 23, 26, 36 AND 38).

FIRST USE 12-11-2007; IN COMMERCE 12-11-2007.

THE MARK CONSISTS OF STANDARD CHARACTERS WITHOUT CLAIM TO ANY PARTICULAR FONT, STYLE, SIZE, OR COLOR.

SN 76-661,445, FILED 6-9-2006.

PAUL E. FAHRENKOPF, EXAMINING ATTORNEY

**Int. Cl.: 9**

**Prior U.S. Cls.: 21, 23, 26, 36, and 38**

**Reg. No. 3,468,462**

**United States Patent and Trademark Office**

**Registered July 15, 2008**

**TRADEMARK  
PRINCIPAL REGISTER**

**STATURE  
QUALITY LIFECYCLE MANAGEMENT**

DYADEM INTERNATIONAL LTD. (CANADA CORPORATION)  
SUITE 401, 9050 YONGE STREET  
RICHMOND HILL, ONTARIO, CANADA L4C 9S6

FOR: COMPUTER SOFTWARE THAT UNIFIES THE QUALITY ANALYSIS, DESIGN, AND CONTROL PROCESSES THAT SPAN A PRODUCT OR PROCESS'S LIFECYCLE, THAT FEATURES SYSTEM DECOMPOSITION BY FUNCTION, ITEM AND PROCESS, ANALYSIS AND AUTHORING, PUBLISHING OF CONTROL PLANS AND INSPECTION PLANS, AND OTHER QUALITY-CENTRIC DATA AND PROCESSES, AND THAT INCLUDES CORE FUNCTIONS SUPPORTING THESE FEATURES IN THE NATURE OF STUDY AUTHORING, WORKFLOW, DOCUMENT MANAGEMENT, DOCUMENT PUBLISHING, VERSION CONTROL, CONFIGURATION MANAGEMENT, CHANGE MANAGEMENT, AND ENTERPRISE INTEGRATION TO OTHER

SYSTEMS, FOR USE BY MANUFACTURERS IN DISCRETE AND PROCESS MANUFACTURING AND OTHER INDUSTRIES OR FUNCTIONS WITH COMPLEX QUALITY PROCESSES, IN CLASS 9 (U.S. CLS. 21, 23, 26, 36 AND 38).

FIRST USE 12-11-2007; IN COMMERCE 12-11-2007.

THE MARK CONSISTS OF STANDARD CHARACTERS WITHOUT CLAIM TO ANY PARTICULAR FONT, STYLE, SIZE, OR COLOR.

NO CLAIM IS MADE TO THE EXCLUSIVE RIGHT TO USE "QUALITY LIFECYCLE MANAGEMENT", APART FROM THE MARK AS SHOWN.

SN 76-661,447, FILED 6-9-2006.

PAUL E. FAHRENKOPF, EXAMINING ATTORNEY

**Int. Cl.: 35**

**Prior U.S. Cls.: 100, 101, and 102**

**United States Patent and Trademark Office**

**Reg. No. 3,468,463**

**Registered July 15, 2008**

**SERVICE MARK  
PRINCIPAL REGISTER**



BLUEFLY, INC. (NEW YORK CORPORATION)  
42 WEST 38TH STREET  
9TH FLOOR  
NEW YORK, NY 10018

FOR: COMPUTERIZED ON-LINE RETAIL SERVICES, FEATURING APPAREL, ACCESSORIES, AND HOME FURNISHINGS, IN CLASS 35 (U.S. CLS. 100, 101 AND 102).

FIRST USE 4-2-2008; IN COMMERCE 4-2-2008.

THE COLOR(S) BLUE AND GRAY IS/ARE CLAIMED AS A FEATURE OF THE MARK.

THE IMAGE OF THE FLY IN THE MARK IS DEPICTED IN THE COLOR GRAY, THE WORD "BLUE" IN THE MARK IS DEPICTED IN THE COLOR BLUE, AND THE WORD "FLY" IN THE MARK IS DEPICTED IN THE COLOR GRAY

THE MARK CONSISTS OF THE IMAGE OF A FLY AND THE WORD "BLUEFLY"

SN 76-663,629, FILED 7-25-2006.

GIANCARLO CASTRO, EXAMINING ATTORNEY



**Int. Cl.: 9**

**Prior U.S. Cls.: 21, 23, 26, 36, and 38**

**Reg. No. 3,468,464**

**United States Patent and Trademark Office**

**Registered July 15, 2008**

**TRADEMARK  
PRINCIPAL REGISTER**

**CONSOLE**

CLEARONE COMMUNICATIONS, INC. (UTAH  
CORPORATION)  
1825 RESEARCH WAY  
SALT LAKE CITY, UT 84119

THE MARK CONSISTS OF STANDARD CHAR-  
ACTERS WITHOUT CLAIM TO ANY PARTICULAR  
FONT, STYLE, SIZE, OR COLOR.

FOR: COMPUTER SOFTWARE FOR USE IN  
AUDIO CONFERENCING SYSTEMS, IN CLASS 9  
(U.S. CLS. 21, 23, 26, 36 AND 38).

SN 76-663,868, FILED 7-31-2006.

FIRST USE 9-13-2007; IN COMMERCE 9-13-2007.

ALEXANDER L. POWERS, EXAMINING ATTOR-  
NEY

**Int. Cl.: 10**

**Prior U.S. Cls.: 26, 39, and 44**

**United States Patent and Trademark Office**

**Reg. No. 3,468,465**

**Registered July 15, 2008**

**TRADEMARK  
PRINCIPAL REGISTER**



MINRAD, INC. (DELAWARE CORPORATION)  
50 COBHAM DRIVE  
ORCHARD PARK, NY 14127

FOR: SURGICAL INSTRUMENTS, NAMELY, SYRINGES, TROCARS, ASPIRATORS, BIOPSY DEVICES, INTRODUCER AND SPINAL NEEDLES, CORE TISSUE CUTTERS, DRILLS, AND CANNULAS, ALL ADAPTED TO BE GUIDED BY AN ENERGY BEAM TARGETING AND DIRECTING SYSTEM, IN CLASS 10 (U.S. CLS. 26, 39 AND 44).

FIRST USE 6-6-2006; IN COMMERCE 6-6-2006.

THE MARK CONSISTS OF A VERTICAL LINE WITH LINES EMANATING OUT TO THE RIGHT, AROUND A DISC, WITH THE WORD "MINRAD" BETWEEN THE VERTICAL LINE AND THE LARGER DISC, WHICH IS PARTIALLY DISSECTED BY A VERTICAL LINE, A SMALLER DISC TO THE RIGHT OF THE LARGER DISC, CONNECTED TO THE LARGER DISC BY A HORIZONTAL LINE.

SN 76-664,567, FILED 8-14-2006.

MICHAEL LITZAU, EXAMINING ATTORNEY

**Int. Cl.: 5**

**Prior U.S. Cls.: 6, 18, 44, 46, 51, and 52**

**United States Patent and Trademark Office**

**Reg. No. 3,468,466**

**Registered July 15, 2008**

**TRADEMARK  
PRINCIPAL REGISTER**



SCHIFF NUTRITION INTERNATIONAL, INC.  
(DELAWARE CORPORATION)  
2002 SOUTH 5070 WEST  
SALT LAKE CITY, UT 84104

OWNER OF U.S. REG. NOS. 2,225,004, 2,668,777,  
AND OTHERS.

FOR: DIETARY SUPPLEMENTS; DIETARY SUPPLEMENTS, NAMELY, DIETARY SUPPLEMENTS IN THE FORM OF LIQUID DRINKS AND POWDERED DRINK MIXES, TABLETS, AND READY TO EAT FOOD BARS, SPECIFICALLY, READY TO EAT NUTRITIONAL FOOD BARS USED AS A MEAL REPLACEMENT; HERBAL SUPPLEMENTS, IN CLASS 5 (U.S. CLS. 6, 18, 44, 46, 51 AND 52).

NO CLAIM IS MADE TO THE EXCLUSIVE RIGHT TO USE "OVER 70 YEARS OF GUARANTEED QUALITY", APART FROM THE MARK AS SHOWN.

SN 76-665,877, FILED 9-11-2006.

FIRST USE 7-1-2007; IN COMMERCE 7-1-2007.

RONALD AIKENS, EXAMINING ATTORNEY

**Int. Cl.: 38**

**Prior U.S. Cls.: 100, 101, and 104**

**United States Patent and Trademark Office**

**Reg. No. 3,468,467**

**Registered July 15, 2008**

---

**SERVICE MARK  
PRINCIPAL REGISTER**

**VS MEDIA**

VS MEDIA, INC. (CALIFORNIA CORPORATION)  
26672 AGOURA ROAD  
CALABASAS, CA 91302

FOR: COMMUNICATION SERVICES, NAMELY,  
PERSONAL COMMUNICATION SERVICES PROVIDED  
OVER THE INTERNET; STREAMING OF  
VIDEO MATERIALS ON THE INTERNET; AND  
AUDIO AND VIDEO BROADCASTING , IN CLASS  
38 (U.S. CLS. 100, 101 AND 104).

FIRST USE 12-0-1998; IN COMMERCE 12-0-1998.

THE MARK CONSISTS OF STANDARD CHAR-  
ACTERS WITHOUT CLAIM TO ANY PARTICULAR  
FONT, STYLE, SIZE, OR COLOR.

NO CLAIM IS MADE TO THE EXCLUSIVE  
RIGHT TO USE "MEDIA", APART FROM THE  
MARK AS SHOWN.

SN 76-666,510, FILED 9-25-2006.

LINDA E. BLOHM, EXAMINING ATTORNEY

**Int. Cl.: 1**

**Prior U.S. Cls.: 1, 5, 6, 10, 26, and 46**

**United States Patent and Trademark Office**

**Reg. No. 3,468,468**

**Registered July 15, 2008**

**TRADEMARK  
PRINCIPAL REGISTER**

**TRICHROME**

ATOTECH DEUTSCHLAND GMBH (FED REP  
GERMANY CORPORATION)  
POSTFACH 21 07 80  
BERLIN, FED REP GERMANY 10507

FOR: CHEMICALS USED FOR ELECTROPLATING TRIVALENT CHROMIUM, NAMELY, STABILIZERS, CHROME ADJUSTORS, REGULATORS, CORRECTORS, ADDITIVES, COMPOUNDS, PURIFIERS, POST-DIPS, ELECTROCHROMATES AND RESINS, IN CLASS 1 (U.S. CLS. 1, 5, 6, 10, 26 AND 46).

FIRST USE 2-1-1994; IN COMMERCE 2-1-1994.

THE MARK CONSISTS OF STANDARD CHARACTERS WITHOUT CLAIM TO ANY PARTICULAR FONT, STYLE, SIZE, OR COLOR.

OWNER OF FED REP GERMANY REG. NO. 30624557, DATED 6-23-2006, EXPIRES 4-30-2016.

OWNER OF U.S. REG. NO. 1,088,444.

SN 76-666,543, FILED 9-25-2006.

DOMINIC FATHY, EXAMINING ATTORNEY

**Int. Cl.: 15**

**Prior U.S. Cls.: 2, 21, and 36**

**United States Patent and Trademark Office**

**Reg. No. 3,468,469**

**Registered July 15, 2008**

**TRADEMARK  
PRINCIPAL REGISTER**

**CLARFLUPET**

CLARFLUPET, LLC (NEW HAMPSHIRE LTD  
LIAB CO)  
79 LIME KILN ROAD  
PIKE, NH 03780

FOR: MUSICAL INSTRUMENT, NAMELY, A  
SINGLE INSTRUMENT MUSICAL TEACHING AID  
THAT ALLOWS A PERSON TO LEARN HOW TO  
PLAY SINGLE-REED INSTRUMENTS, TRANS-  
VERSE FLUTES AND BRASS INSTRUMENTS , IN  
CLASS 15 (U.S. CLS. 2, 21 AND 36).

FIRST USE 11-30-2006; IN COMMERCE 11-30-2006.

THE MARK CONSISTS OF STANDARD CHAR-  
ACTERS WITHOUT CLAIM TO ANY PARTICULAR  
FONT, STYLE, SIZE, OR COLOR.

SN 76-667,853, FILED 10-23-2006.

LINDA E. BLOHM, EXAMINING ATTORNEY

**Int. Cls.: 9 and 11**

**Prior U.S. Cls.: 13, 21, 23, 26, 31, 34, 36, and 38**

**United States Patent and Trademark Office**

**Reg. No. 3,468,470**

**Registered July 15, 2008**

**TRADEMARK  
PRINCIPAL REGISTER**

**SMARTWALL**

INSIGHT LIGHTING, INC. (NEW MEXICO CORPORATION)  
4341 FULCRUM WAY  
RIO RANCHO, NM 87124

FOR: LED (LIGHT EMITTING DIODE) DISPLAY PANELS FEATURING LED'S, COMPUTER SOFTWARE FOR OPERATING THE PANEL DISPLAY, AND ELECTRONIC CONTROLLERS AND SWITCHES, IN CLASS 9 (U.S. CLS. 21, 23, 26, 36 AND 38).

FIRST USE 11-1-2007; IN COMMERCE 11-1-2007.

FOR: LED (LIGHT-EMITTING DIODE) LIGHTING FIXTURE PANEL SYSTEMS COMPRISED OF

LIGHTING FIXTURES, LED'S, COMPUTER SOFTWARE FOR DETECTING AND CONTROLLING LIGHT, AND ELECTRONIC CONTROLLERS AND SENSORS, IN CLASS 11 (U.S. CLS. 13, 21, 23, 31 AND 34).

FIRST USE 11-1-2007; IN COMMERCE 11-1-2007.

THE MARK CONSISTS OF STANDARD CHARACTERS WITHOUT CLAIM TO ANY PARTICULAR FONT, STYLE, SIZE, OR COLOR.

SN 76-668,025, FILED 10-25-2006.

CHARLOTTE CORWIN, EXAMINING ATTORNEY

**Int. Cl.: 42**

**Prior U.S. Cls.: 100 and 101**

**United States Patent and Trademark Office**

**Reg. No. 3,468,471**

**Registered July 15, 2008**

**SERVICE MARK  
PRINCIPAL REGISTER**

**FM SERVER**

SEPIALINE (CALIFORNIA CORPORATION)  
114 SANSOME STREET, SUITE 920  
SAN FRANCISCO, CA 94104

FOR: PROVIDING ON-LINE NON-DOWNLOAD-  
ABLE COMPUTER SOFTWARE FOR USE IN COL-  
LECTING AND ANALYZING DATA RELATED TO  
OFFICE EXPENSES SUCH AS PRINTING, COPY-  
ING, SCANNING OR FAXING , IN CLASS 42 (U.S.  
CLS. 100 AND 101).

FIRST USE 2-20-2007; IN COMMERCE 4-12-2007.

THE MARK CONSISTS OF STANDARD CHAR-  
ACTERS WITHOUT CLAIM TO ANY PARTICULAR  
FONT, STYLE, SIZE, OR COLOR.

NO CLAIM IS MADE TO THE EXCLUSIVE  
RIGHT TO USE "SERVER", APART FROM THE  
MARK AS SHOWN.

SN 76-668,299, FILED 10-30-2006.

PAULA MAHONEY, EXAMINING ATTORNEY



**Int. Cl.: 30**

**Prior U.S. Cl.: 46**

**United States Patent and Trademark Office**

**Reg. No. 3,468,472**

**Registered July 15, 2008**

**TRADEMARK  
PRINCIPAL REGISTER**



DOUGLAS, REGINALD (UNITED STATES INDIVIDUAL)  
23464 WAGON TRAIL ROAD  
DIAMOND BAR, CA 91765

NO CLAIM IS MADE TO THE EXCLUSIVE RIGHT TO USE THE OUTLINE OF THE ISLAND OF JAMAICA, APART FROM THE MARK AS SHOWN.

FOR: BREAD, IN CLASS 30 (U.S. CL. 46).

SN 76-668,309, FILED 10-30-2006.

FIRST USE 10-10-2006; IN COMMERCE 10-10-2006.

BRIAN PINO, EXAMINING ATTORNEY

**Int. Cl.: 5**

**Prior U.S. Cls.: 6, 18, 44, 46, 51, and 52**

**Reg. No. 3,468,473**

**United States Patent and Trademark Office**

**Registered July 15, 2008**

**TRADEMARK  
PRINCIPAL REGISTER**



JOHNSON & JOHNSON (NEW JERSEY CORPORATION)  
ONE JOHNSON & JOHNSON PLAZA  
NEW BRUNSWICK, NJ 089337001

FOR: PHARMACEUTICALS FOR TREATING  
CENTRAL NERVOUS SYSTEM DISORDERS, MENTAL  
HEALTH DISEASES, AND SCHIZOPHRENIA,  
IN CLASS 5 (U.S. CLS. 6, 18, 44, 46, 51 AND 52).

FIRST USE 1-3-2007; IN COMMERCE 1-3-2007.

OWNER OF U.S. REG. NOS. 1,097,170, 2,389,068,  
AND 2,465,129.

NO CLAIM IS MADE TO THE EXCLUSIVE  
RIGHT TO USE "L.P.", APART FROM THE MARK  
AS SHOWN.

SN 76-669,502, FILED 11-24-2006.

CAROLINE WOOD, EXAMINING ATTORNEY

Int. Cl.: 18

Prior U.S. Cls.: 1, 2, 3, 22, and 41

Reg. No. 3,468,474

United States Patent and Trademark Office

Registered July 15, 2008

TRADEMARK  
PRINCIPAL REGISTER

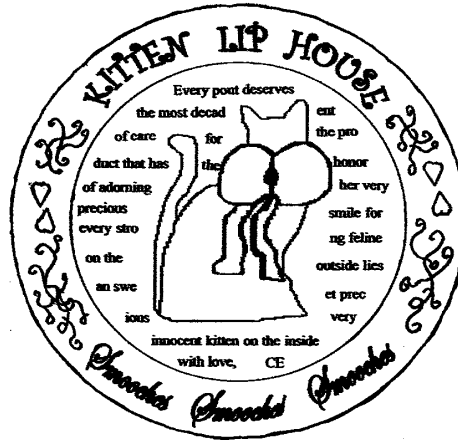

D'ORO DOLCETTO GROUP (MARYLAND SOLE PROPRIETORSHIP)  
4267 58TH AVE #12  
BLADENSBURG, MD 20710

FIRST USE 5-20-2005; IN COMMERCE 7-14-2007.

SN 76-669,904, FILED 12-1-2006.

FOR: COSMETIC CASES SOLD EMPTY AND LUGGAGE TRUNKS, IN CLASS 18 (U.S. CLS. 1, 2, 3, 22 AND 41).

BRIAN PINO, EXAMINING ATTORNEY

Int. Cl.: 43

Prior U.S. Cls.: 100 and 101

United States Patent and Trademark Office

Reg. No. 3,468,475

Registered July 15, 2008

**SERVICE MARK  
PRINCIPAL REGISTER**



CALZ PIZZA INC. (VIRGINIA CORPORATION)  
3324 HOLLAND ROAD  
VIRGINIA BEACH, VA 23452

FOR: FOOD SERVICE, NAMELY, FAST FOOD  
AND NON-STOP RESTAURANT SERVICES, IN  
CLASS 43 (U.S. CLS. 100 AND 101).

FIRST USE 12-31-1982; IN COMMERCE 12-31-1982.

THE COLOR(S) YELLOW, RED, BLUE, BLACK  
AND WHITE IS/ARE CLAIMED AS A FEATURE OF  
THE MARK.

BUCKET IS RED, WITH FOOD STICKING OUT  
THE TOP. CHICKEN IS RED AND YELLOW WITH A  
BLUE SHIRT. WORDS ARE BLACK (PIZZA.SUB-  
S.WINGS). CAL'Z IS IN BLOCK LETTERS WITH  
DEPTH, THE DEPTH IS BLUE AND BLACK, THE  
FRONT OF THE LETTERS IS WHITE WITH SOME  
AGE SHOWING(CRACKS AND DOTS) (CHISELED  
STONE) THE CHICKEN IS HOLDING A SLICE OF  
PIZZA. THE DOTS BETWEEN PIZZA, SUBS, AND  
WINGS IS RED.

THE COLOR RED APPEARS IN THE BUCKET,  
THE FEET, BEAK AND HEAD OF THE CHICKEN  
AND THE PEPPERONI ON TOP OF THE SLICE OF  
PIZZA, THE COLOR YELLOW APPEARS IN THE  
HUMANIZED CHICKEN AND THE PREPARED  
CHICKEN AND SUBMARINE SANDWICH IN THE  
BUCKET; THE COLOR BLUE APPEARS ON THE  
SHIRT OF THE CHICKEN AND THE SHADING IN  
THE LETTERS FOR "CAL'Z", THE COLOR BLACK  
APPEARS IN THE DETAIL ON THE CHICKEN AND  
BUCKET, THE EYES OF THE CHICKEN, THE  
BORDERS OF THE WORDING "CAL'Z", THE  
WORDING "PIZZA SUBS WINGS" AND THE DOTS  
APPEARING BETWEEN THESE WORDS, AND IN  
THE DETAIL REPRESENTING THE CRACKED  
STONE OF THE LETTERS IN "CAL'Z", AND THE  
COLOR WHITE APPEARS IN THE LETTERS FOR  
THE WORD "CAL'Z", THE LETTERS OF THE  
WORD "CAL'Z" PRESENTED ON THE BUCKET,  
AND IN THE CHEESE ON THE SLICE OF PIZZA.

SN 76-669,913, FILED 12-4-2006.

SUSAN RICHARDS, EXAMINING ATTORNEY

**Int. Cls.: 37 and 42**

**Prior U.S. Cls.: 100, 101, 103, and 106**

**United States Patent and Trademark Office**

**Reg. No. 3,468,476**

**Registered July 15, 2008**

**SERVICE MARK  
PRINCIPAL REGISTER**



RYLAND ORGANIZATION COMPANY (CALIFORNIA CORPORATION)  
24025 PARK SORRENTO  
CALABASAS, CA 91302

FOR: CONSTRUCTION SERVICES, NAMELY, PLANNING, LAYING OUT AND CONSTRUCTION OF NEW RESIDENTIAL HOMES BASED ON DESIGN AND CONSTRUCTION CRITERIA THAT PROVIDES HIGHER ENERGY EFFICIENCIES AND IMPROVED ENVIRONMENTAL QUALITY CONTROL FEATURES TO SUCH HOMES, IN CLASS 37 (U.S. CLS. 100, 103 AND 106).

FIRST USE 10-1-2007; IN COMMERCE 10-1-2007.

FOR: PROVIDING INFORMATION VIA THE INTERNET AND WORLD WIDE WEB REGARDING THE DESIGN OF NEW RESIDENTIAL HOMES, INCLUDING INFORMATION RELATING TO DE-

SIGN AND CONSTRUCTION OPTIONS THAT PROVIDE HIGHER ENERGY EFFICIENCIES AND IMPROVED ENVIRONMENTAL QUALITY CONTROL FEATURES TO SUCH HOMES; AND PROVIDING ARCHITECTURAL CONSULTATION SERVICES TO NEW HOME BUYERS FEATURING INFORMATION REGARDING DESIGN AND CONSTRUCTION OPTIONS THAT PROVIDE HIGHER ENERGY EFFICIENCIES AND IMPROVED ENVIRONMENTAL QUALITY CONTROL FEATURES TO SUCH HOMES, IN CLASS 42 (U.S. CLS. 100 AND 101).

FIRST USE 10-1-2007; IN COMMERCE 10-1-2007.

SN 76-669,932, FILED 12-4-2006.

ALEXANDER L. POWERS, EXAMINING ATTORNEY

Int. Cl.: 25

Prior U.S. Cls.: 22 and 39

United States Patent and Trademark Office

Reg. No. 3,468,477

Registered July 15, 2008

TRADEMARK  
PRINCIPAL REGISTER



RAY, DIANNE LOUISE (UNITED STATES INDIVIDUAL)

3713 WISCONSIN AVENUE

ST. LOUIS, MO 631184139 AND

RAY, ALLEN DAVID (UNITED STATES INDIVIDUAL)

3713 WISCONSIN AVENUE

ST. LOUIS, MO 631184139

FOR: T-SHIRTS, JERSEYS, JACKETS, APRONS, TROUSERS, FOOTWEAR, AND HEADWEAR, IN CLASS 25 (U.S. CLS. 22 AND 39).

FIRST USE 2-7-2008; IN COMMERCE 2-7-2008.

THE COLOR(S) RED, YELLOW, BLACK, WHITE AND ORANGE IS/ARE CLAIMED AS A FEATURE OF THE MARK.

THE COLOR WHITE APPEARS IN THE CIRCULAR LETTER "A" IN THE CENTER OF THE MARK, TRIMMED IN ORANGE AND WITH A BLACK AND WHITE COMPASS NEEDLE POINTING TO "N" AND "S". THE COLOR BLACK APPEARS IN THE CIRCULAR LETTER "P" OF THE MARK, AND TRIMMED IN RED. THE COLOR YELLOW APPEARS IN THE CIRCLE LETTER "O" OF THE MARK, TRIMMED IN RED AND WHITE, AND ALSO BLACK LETTERS N,S,E, W. THE COLOR RED APPEARS IN THE CIRCULAR LETTER "C" OF THE MARK, TRIMMED IN YELLOW AND WITH THE WORDING "ALL PEOPLE OF COLOR" IN BLACK LETTERS IN THE LETTER "C" OF THE MARK.

SN 76-670,203, FILED 12-11-2006.

SHAUNIA CARLYLE, EXAMINING ATTORNEY

Int. Cl.: 28

Prior U.S. Cls.: 22, 23, 38, and 50

United States Patent and Trademark Office

Reg. No. 3,468,478

Registered July 15, 2008

TRADEMARK  
PRINCIPAL REGISTER



BOARD & BATTEN INTERNATIONAL INC.  
(CAYMAN ISLANDS COMPANY)  
C/OINTERNATIONAL MANAGEMENT SERVICES  
LTD. HARBOUR CENTRE, 4TH FLOOR  
GEORGETOWN, CAYMAN ISLANDS

FOR: GAMES AND PLAYTHINGS, NAMELY,  
TRAMPOLINES FOR PLAY AND EXERCISE PUR-  
POSES AND PARTS AND FITTINGS THEREFOR, IN  
CLASS 28 (U.S. CLS. 22, 23, 38 AND 50).

FIRST USE 2-0-2005; IN COMMERCE 2-0-2005.

OWNER OF U.S. REG. NO. 3,197,867.

NO CLAIM IS MADE TO THE EXCLUSIVE  
RIGHT TO USE "SPRING FREE", APART FROM  
THE MARK AS SHOWN.

THE MARK CONSISTS OF AN OVAL WITHIN  
WHICH IS A GRADUATED SHADED STYLISTIC  
"S". THE WORD "SPRINGFREE" APPEARS TO THE  
RIGHT OF THE OVAL.

SN 76-670,512, FILED 12-18-2006.

CHARLES L. JENKINS, EXAMINING ATTORNEY

**Int. Cl.: 45**

**Prior U.S. Cls.: 100 and 101**

**United States Patent and Trademark Office**

**Reg. No. 3,468,479**

**Registered July 15, 2008**

**SERVICE MARK  
PRINCIPAL REGISTER**

**LET'S GRAB A DRINK!**

IT'S JUST A DRINK!, LLC (MINNESOTA LTD  
LIAB CO), DBA LET'S GRAB A DRINK!,  
7850 W. 96TH STREET  
BLOOMINGTON, MN 55438

THE MARK CONSISTS OF STANDARD CHAR-  
ACTERS WITHOUT CLAIM TO ANY PARTICULAR  
FONT, STYLE, SIZE, OR COLOR.

FOR: ON-LINE SOCIAL NETWORKING SERVI-  
CES; AND INTERNET-BASED SOCIAL NETWORK-  
ING, INTRODUCTION AND DATING SERVICES,  
IN CLASS 45 (U.S. CLS. 100 AND 101).

SN 76-670,635, FILED 12-21-2006.

FIRST USE 2-1-2007; IN COMMERCE 2-1-2007.

ELIZABETH BEYER, EXAMINING ATTORNEY



**Int. Cl.: 4**

**Prior U.S. Cls.: 1, 6, and 15**

**United States Patent and Trademark Office**

**Reg. No. 3,468,480**

**Registered July 15, 2008**

**TRADEMARK  
PRINCIPAL REGISTER**

**BESSENCE**

MORSELS, L.P. (TEXAS LIMITED PARTNER-  
SHIP)  
500 WEST 6TH ST.  
SUITE 101 (2ND FLOOR)  
AUSTIN, TX 78701

THE MARK CONSISTS OF STANDARD CHAR-  
ACTERS WITHOUT CLAIM TO ANY PARTICULAR  
FONT, STYLE, SIZE, OR COLOR.

FOR: SCENTED CANDLES, IN CLASS 4 (U.S. CLS.  
1, 6 AND 15).

SN 76-671,575, FILED 1-19-2007.

FIRST USE 9-1-2007; IN COMMERCE 9-1-2007.

MAUREEN DALL, EXAMINING ATTORNEY

**Int. Cl.: 1**

**Prior U.S. Cls.: 1, 5, 6, 10, 26, and 46**

**Reg. No. 3,468,481**

**United States Patent and Trademark Office**

**Registered July 15, 2008**

**TRADEMARK  
PRINCIPAL REGISTER**

**HOH SHIELD**

MILLER CHEMICAL & FERTILIZER CORPORATION  
(PENNSYLVANIA CORPORATION)  
120 RADIO ROAD  
BOX 333  
HANOVER, PA 17331

FOR: AGRICULTURAL CHEMICALS FOR APPLICATION ONTO CROPS TO MINIMIZE MOISTURE ABSORPTION, IN CLASS 1 (U.S. CLS. 1, 5, 6, 10, 26 AND 46).

FIRST USE 7-31-2007; IN COMMERCE 7-31-2007.

THE MARK CONSISTS OF STANDARD CHARACTERS WITHOUT CLAIM TO ANY PARTICULAR FONT, STYLE, SIZE, OR COLOR.

NO CLAIM IS MADE TO THE EXCLUSIVE RIGHT TO USE "HOH", APART FROM THE MARK AS SHOWN.

SN 76-671,693, FILED 1-23-2007.

JOHN DWYER, EXAMINING ATTORNEY

**Int. Cls.: 9 and 35**

**Prior U.S. Cls.: 21, 23, 26, 36, 38, 100, 101, and 102**

**United States Patent and Trademark Office**

**Reg. No. 3,468,482**

**Registered July 15, 2008**

**TRADEMARK  
SERVICE MARK  
PRINCIPAL REGISTER**

**DISKLAVIERMUSICSTORE**

YAMAHA CORPORATION (JAPAN CORPORATION)  
10-1, NAKAZAWA-CHO  
HAMAMATSU-SHI  
SHIZUOKA, JAPAN

FOR: DOWNLOADABLE MUSIC FILES; COMPUTER SOFTWARE FOR PLAYING MUSIC; DOWNLOADABLE ELECTRONIC MUSIC PROVIDED FROM A COMPUTER NETWORK; DOWNLOADABLE MUSIC DATA FOR USE IN THE OPERATION OF ELECTRONIC MUSICAL INSTRUMENTS, IN CLASS 9 (U.S. CLS. 21, 23, 26, 36 AND 38).

FIRST USE 4-1-2007; IN COMMERCE 4-1-2007.

FOR: RETAIL ONLINE MUSIC STORES, IN CLASS 35 (U.S. CLS. 100, 101 AND 102).

FIRST USE 4-1-2007; IN COMMERCE 4-1-2007.

THE MARK CONSISTS OF STANDARD CHARACTERS WITHOUT CLAIM TO ANY PARTICULAR FONT, STYLE, SIZE, OR COLOR.

OWNER OF U.S. REG. NO. 2,586,495.

SN 76-671,828, FILED 1-25-2007.

CHARLES L. JENKINS, EXAMINING ATTORNEY

**Int. Cl.: 25**

**Prior U.S. Cls.: 22 and 39**

**United States Patent and Trademark Office**

**Reg. No. 3,468,483**

**Registered July 15, 2008**

**TRADEMARK  
PRINCIPAL REGISTER**

**FREE WHO YOU ARE**

FISHER, PHIL (UNITED STATES INDIVIDUAL)  
824 5TH AVENUE SOUTH  
NAPLES, FL 34102 AND  
HILLIER, WES (UNITED STATES INDIVIDUAL)  
824 5TH AVENUE SOUTH  
NAPLES, FL 34102

FOR: CLOTHING, NAMELY, T-SHIRTS, SWEAT  
SHIRTS AND HATS, IN CLASS 25 (U.S. CLS. 22 AND  
39).

FIRST USE 12-1-2006; IN COMMERCE 2-5-2007.

THE MARK CONSISTS OF STANDARD CHAR-  
ACTERS WITHOUT CLAIM TO ANY PARTICULAR  
FONT, STYLE, SIZE, OR COLOR.

SN 76-671,963, FILED 1-29-2007.

JORDAN BAKER, EXAMINING ATTORNEY

**Int. Cl.: 42**

**Prior U.S. Cls.: 100 and 101**

**United States Patent and Trademark Office**

**Reg. No. 3,468,484**

**Registered July 15, 2008**

**SERVICE MARK  
PRINCIPAL REGISTER**

**VOLUNTEER BUILDER**

SCHOOL FAMILY MEDIA, INC. (MASSACHUSETTS CORPORATION)  
100 STONEWALL BOULEVARD, SUITE 3  
WRENTHAM, MA 02093

FOR: PROVIDING ON-LINE NON-DOWNLOADABLE SOFTWARE FOR ORGANIZING, MANAGING, TRACKING AND REPORTING VOLUNTEER CONTACT AND INTEREST DATA AND GROUP EVENT DATA FOR SCHOOL AND PARENT GROUPS, IN CLASS 42 (U.S. CLS. 100 AND 101).

FIRST USE 1-0-2005; IN COMMERCE 5-28-2008.

THE MARK CONSISTS OF STANDARD CHARACTERS WITHOUT CLAIM TO ANY PARTICULAR FONT, STYLE, SIZE, OR COLOR.

NO CLAIM IS MADE TO THE EXCLUSIVE RIGHT TO USE "VOLUNTEER", APART FROM THE MARK AS SHOWN.

SN 76-672,052, FILED 1-31-2007.

MICHAEL LITZAU, EXAMINING ATTORNEY

**Int. Cl.: 25**

**Prior U.S. Cls.: 22 and 39**

**United States Patent and Trademark Office**

**Reg. No. 3,468,485**

**Registered July 15, 2008**

**TRADEMARK  
PRINCIPAL REGISTER**

**WHERE ROCK COMES TO PLAY**

HRP CREATIVE SERVICES CO., LLC (FLORIDA  
LTD LIAB CO)  
211 GEORGE BISHOP PARKWAY  
MYRTLE BEACH, SC 29579

THE MARK CONSISTS OF STANDARD CHAR-  
ACTERS WITHOUT CLAIM TO ANY PARTICULAR  
FONT, STYLE, SIZE, OR COLOR.

FOR: CLOTHING, NAMELY, T-SHIRTS, POLO  
SHIRTS, SWEATSHIRTS, CAPS, HATS, FOOTWEAR  
AND JACKETS, IN CLASS 25 (U.S. CLS. 22 AND 39).

SN 76-673,251, FILED 2-27-2007.

FIRST USE 10-15-2007; IN COMMERCE 10-15-2007.

RAUL CORDOVA, EXAMINING ATTORNEY

**Int. Cl.: 41**

**Prior U.S. Cls.: 100, 101, and 107**

**Reg. No. 3,468,486**

**United States Patent and Trademark Office**

**Registered July 15, 2008**

---

**SERVICE MARK  
PRINCIPAL REGISTER**

**WHERE ROCK COMES TO PLAY**

HRP CREATIVE SERVICES CO., LLC (FLORIDA  
LTD LIAB CO)  
211 GEORGE BISHOP PARKWAY  
MYRTLE BEACH, SC 29579

THE MARK CONSISTS OF STANDARD CHAR-  
ACTERS WITHOUT CLAIM TO ANY PARTICULAR  
FONT, STYLE, SIZE, OR COLOR.

FOR: ENTERTAINMENT SERVICES, NAMELY,  
AMUSEMENT PARK AND THEME PARK SERVI-  
CES, IN CLASS 41 (U.S. CLS. 100, 101 AND 107).

SN 76-673,252, FILED 2-27-2007.

FIRST USE 10-15-2007; IN COMMERCE 10-15-2007.

RAUL CORDOVA, EXAMINING ATTORNEY

**Int. Cl.: 28**

**Prior U.S. Cls.: 22, 23, 38, and 50**

**United States Patent and Trademark Office**

**Reg. No. 3,468,487**

**Registered July 15, 2008**

**TRADEMARK  
PRINCIPAL REGISTER**

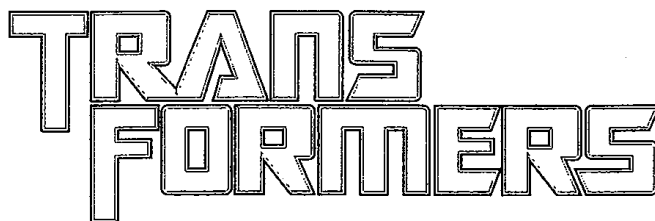

HASBRO, INC. (RHODE ISLAND CORPORATION)  
1027 NEWPORT AVENUE  
PAWTUCKET, RI 02862

FOR: TOY ACTION FIGURES, TOY VEHICLES  
AND TOY ROBOTS CONVERTIBLE INTO OTHER  
VISUAL TOY FORMS AND ACCESSORIES FOR  
USE THEREWITH, IN CLASS 28 (U.S. CLS. 22, 23, 38  
AND 50).

FIRST USE 5-23-2007; IN COMMERCE 5-23-2007.

OWNER OF U.S. REG. NO. 2,455,261.

SN 76-673,701, FILED 3-7-2007.

DORITT L. CARROLL, EXAMINING ATTORNEY



**Int. Cl.: 41**

**Prior U.S. Cls.: 100, 101, and 107**

**United States Patent and Trademark Office**

**Reg. No. 3,468,488**

**Registered July 15, 2008**

**SERVICE MARK  
PRINCIPAL REGISTER**

**MISSION CONTROL BP**

ALPHAMEDICA, INC. (DELAWARE CORPORATION)  
220 WHITE PLAINS ROAD  
TARRYTOWN, NY 10591

FOR: EDUCATIONAL SERVICES, NAMELY, PROVIDING CONTINUING MEDICAL EDUCATION COURSES TO ELIGIBLE PARTICIPANTS ABOUT HYPERTENSION AND RELATED CONDITIONS AND DISTRIBUTING A PACKAGE OF RELATED COURSE MATERIALS IN CONNECTION THEREWITH, IN CLASS 41 (U.S. CLS. 100, 101 AND 107).

FIRST USE 11-27-2006; IN COMMERCE 2-17-2007.

THE MARK CONSISTS OF STANDARD CHARACTERS WITHOUT CLAIM TO ANY PARTICULAR FONT, STYLE, SIZE, OR COLOR.

NO CLAIM IS MADE TO THE EXCLUSIVE RIGHT TO USE "BP", APART FROM THE MARK AS SHOWN.

SN 76-673,778, FILED 3-5-2007.

ALEXANDER L. POWERS, EXAMINING ATTORNEY

**Int. Cl.: 14**

**Prior U.S. Cls.: 2, 27, 28, and 50**

**United States Patent and Trademark Office**

**Reg. No. 3,468,489**

**Registered July 15, 2008**

---

**TRADEMARK  
PRINCIPAL REGISTER**

**Lisa Confetti**

BAKER, ELISS (UNITED STATES INDIVIDUAL)  
PO BOX 3568  
SAN DIEGO, CA 92163

THE MARK CONSISTS OF STANDARD CHARACTERS WITHOUT CLAIM TO ANY PARTICULAR FONT, STYLE, SIZE, OR COLOR.

FOR: JEWELRY; HAND MADE AND MANUFACTURED JEWELRY, NAMELY, NECKLACES, EARRINGS AND BRACELETS, IN CLASS 14 (U.S. CLS. 2, 27, 28 AND 50).

SN 76-673,970, FILED 3-12-2007.

FIRST USE 3-1-2007; IN COMMERCE 9-8-2007.

REGINA DRUMMOND, EXAMINING ATTORNEY

Int. Cl.: 21

Prior U.S. Cls.: 2, 13, 23, 29, 30, 33, 40, and 50

United States Patent and Trademark Office

Reg. No. 3,468,490

Registered July 15, 2008

TRADEMARK  
PRINCIPAL REGISTER

*The Bird Silo*

MARTIN, JOHN R. JR (UNITED STATES INDIVIDUAL)  
28 ROCK POINT ROAD  
WHEELING, WV 260033731

NO CLAIM IS MADE TO THE EXCLUSIVE RIGHT TO USE "BIRD", APART FROM THE MARK AS SHOWN.

FOR: BIRD FEEDER, IN CLASS 21 (U.S. CLS. 2, 13, 23, 29, 30, 33, 40 AND 50).

SN 76-673,994, FILED 3-12-2007.

FIRST USE 3-1-2008; IN COMMERCE 4-1-2008.

RONALD AIKENS, EXAMINING ATTORNEY

**Int. Cl.: 43**

**Prior U.S. Cls.: 100 and 101**

**United States Patent and Trademark Office**

**Reg. No. 3,468,491**

**Registered July 15, 2008**

**SERVICE MARK  
PRINCIPAL REGISTER**

**TASTE OF PARADISE GRILL**

HRP CREATIVE SERVICES CO., LLC (FLORIDA  
LTD LIAB CO)

211 GEORGE BISHOP PARKWAY

MYRTLE BEACH, SC 29579

FOR: RESTAURANT SERVICES, IN CLASS 43  
(U.S. CLS. 100 AND 101).

FIRST USE 10-15-2007; IN COMMERCE 10-15-2007.

THE MARK CONSISTS OF STANDARD CHAR-  
ACTERS WITHOUT CLAIM TO ANY PARTICULAR  
FONT, STYLE, SIZE, OR COLOR.

NO CLAIM IS MADE TO THE EXCLUSIVE  
RIGHT TO USE "GRILL", APART FROM THE  
MARK AS SHOWN.

SN 76-674,096, FILED 3-15-2007.

RAUL CORDOVA, EXAMINING ATTORNEY

**Int. Cl.: 41**

**Prior U.S. Cls.: 100, 101, and 107**

**United States Patent and Trademark Office**

**Reg. No. 3,468,492**

**Registered July 15, 2008**

**SERVICE MARK  
PRINCIPAL REGISTER**

**LONDON CAB RIDE**

HRP CREATIVE SERVICES CO., LLC (FLORIDA  
LTD LIAB CO)  
211 GEORGE BISHOP PARKWAY  
MYRTLE BEACH, SC 29579

FOR: ENTERTAINMENT IN THE NATURE OF  
AN AMUSEMENT PARK RIDE, IN CLASS 41 (U.S.  
CLS. 100, 101 AND 107).

FIRST USE 10-15-2007; IN COMMERCE 10-15-2007.

THE MARK CONSISTS OF STANDARD CHAR-  
ACTERS WITHOUT CLAIM TO ANY PARTICULAR  
FONT, STYLE, SIZE, OR COLOR.

NO CLAIM IS MADE TO THE EXCLUSIVE  
RIGHT TO USE "RIDE", APART FROM THE MARK  
AS SHOWN.

SN 76-674,098, FILED 3-15-2007.

RAUL CORDOVA, EXAMINING ATTORNEY

**Int. Cl.: 41**

**Prior U.S. Cls.: 100, 101, and 107**

**United States Patent and Trademark Office**

**Reg. No. 3,468,493**

**Registered July 15, 2008**

**SERVICE MARK  
PRINCIPAL REGISTER**

**IRIE CRAFTS BAZAAR**

HRP CREATIVE SERVICES CO., LLC (FLORIDA  
LTD LIAB CO)  
211 GEORGE BISHOP PARKWAY  
MYRTLE BEACH, SC 29579

FOR: ENTERTAINMENT SERVICES, NAMELY,  
AMUSEMENT PARK AND THEME PARK SERVI-  
CES, IN CLASS 41 (U.S. CLS. 100, 101 AND 107).

FIRST USE 10-15-2007; IN COMMERCE 10-15-2007.

THE MARK CONSISTS OF STANDARD CHAR-  
ACTERS WITHOUT CLAIM TO ANY PARTICULAR  
FONT, STYLE, SIZE, OR COLOR.

NO CLAIM IS MADE TO THE EXCLUSIVE  
RIGHT TO USE "BAZAAR", APART FROM THE  
MARK AS SHOWN.

SN 76-675,198, FILED 4-9-2007.

RAUL CORDOVA, EXAMINING ATTORNEY

**Int. Cl.: 41**

**Prior U.S. Cls.: 100, 101, and 107**

**United States Patent and Trademark Office**

**Reg. No. 3,468,494**

**Registered July 15, 2008**

**SERVICE MARK  
PRINCIPAL REGISTER**

**JUST A SWINGIN'**

HRP CREATIVE SERVICES CO., LLC (FLORIDA  
LTD LIAB CO)

211 GEORGE BISHOP PARKWAY

MYRTLE BEACH, SC 29579

FOR: ENTERTAINMENT IN THE NATURE OF  
AN AMUSEMENT PARK RIDE, IN CLASS 41 (U.S.  
CLS. 100, 101 AND 107).

FIRST USE 10-15-2007; IN COMMERCE 10-15-2007.

THE MARK CONSISTS OF STANDARD CHAR-  
ACTERS WITHOUT CLAIM TO ANY PARTICULAR  
FONT, STYLE, SIZE, OR COLOR.

NO CLAIM IS MADE TO THE EXCLUSIVE  
RIGHT TO USE "SWINGIN'", APART FROM THE  
MARK AS SHOWN.

SN 76-675,199, FILED 4-9-2007.

RAUL CORDOVA, EXAMINING ATTORNEY

**Int. Cl.: 41**

**Prior U.S. Cls.: 100, 101, and 107**

**United States Patent and Trademark Office**

**Reg. No. 3,468,495**

**Registered July 15, 2008**

**SERVICE MARK  
PRINCIPAL REGISTER**

**ALL THE KING'S HORSES**

HRP CREATIVE SERVICES CO., LLC (FLORIDA  
LTD LIAB CO)  
211 GEORGE BISHOP PARKWAY  
MYRTLE BEACH, SC 29579

THE MARK CONSISTS OF STANDARD CHAR-  
ACTERS WITHOUT CLAIM TO ANY PARTICULAR  
FONT, STYLE, SIZE, OR COLOR.

FOR: ENTERTAINMENT IN THE NATURE OF  
AN AMUSEMENT PARK RIDE, IN CLASS 41 (U.S.  
CLS. 100, 101 AND 107).

SN 76-675,206, FILED 4-9-2007.

FIRST USE 10-15-2007; IN COMMERCE 10-15-2007.

RAUL CORDOVA, EXAMINING ATTORNEY



**Int. Cl.: 36**

**Prior U.S. Cls.: 100, 101, and 102**

**United States Patent and Trademark Office**

**Reg. No. 3,468,496**

**Registered July 15, 2008**

**SERVICE MARK  
PRINCIPAL REGISTER**

**AMERICA'S DIVIDEND SOURCE**

BOUCHARD INC (DELAWARE CORPORATION)  
59 RIDGE RD  
YORK, ME 03909

FOR: FINANCIAL SERVICES, NAMELY, PROVIDING DIVIDEND STOCK INFORMATION, IN CLASS 36 (U.S. CLS. 100, 101 AND 102).

FIRST USE 4-4-2007; IN COMMERCE 4-4-2007.

THE MARK CONSISTS OF STANDARD CHARACTERS WITHOUT CLAIM TO ANY PARTICULAR FONT, STYLE, SIZE, OR COLOR.

SN 76-675,222, FILED 4-9-2007.

ALICE SUE CARRUTHERS, EXAMINING ATTORNEY

**Int. Cl.: 36**

**Prior U.S. Cls.: 100, 101, and 102**

**United States Patent and Trademark Office**

**Reg. No. 3,468,497**

**Registered July 15, 2008**

**SERVICE MARK  
PRINCIPAL REGISTER**

**THE BELTWAY BANK**

NEWFIRST NATIONAL BANK (UNITED STATES  
NATIONAL BANKING ASSOCIATION)

202 EAST JACKSON STREET

EL CAMPO, TX 77437

FOR: BANKING SERVICES, IN CLASS 36 (U.S.  
CLS. 100, 101 AND 102).

FIRST USE 6-5-2007; IN COMMERCE 6-5-2007.

THE MARK CONSISTS OF STANDARD CHAR-  
ACTERS WITHOUT CLAIM TO ANY PARTICULAR  
FONT, STYLE, SIZE, OR COLOR.

NO CLAIM IS MADE TO THE EXCLUSIVE  
RIGHT TO USE "BANK", APART FROM THE  
MARK AS SHOWN.

SN 76-675,650, FILED 4-18-2007.

MARTHA FROMM, EXAMINING ATTORNEY

**Int. Cl.: 10**

**Prior U.S. Cls.: 26, 39, and 44**

**Reg. No. 3,468,498**

**United States Patent and Trademark Office**

**Registered July 15, 2008**

**TRADEMARK  
PRINCIPAL REGISTER**

**REFRESH**

SUPERMAX, INC. (ILLINOIS CORPORATION)  
WHITE OAK BUSINESS PARK  
2225 WHITE OAK CIRCLE  
AURORA, IL 60502

THE MARK CONSISTS OF STANDARD CHAR-  
ACTERS WITHOUT CLAIM TO ANY PARTICULAR  
FONT, STYLE, SIZE, OR COLOR.

FOR: MEDICAL GLOVES, NAMELY, SURGICAL  
GLOVES, EXAMINATION GLOVES, DENTAL  
GLOVES, IN CLASS 10 (U.S. CLS. 26, 39 AND 44).

SN 76-676,643, FILED 5-10-2007.

FIRST USE 6-30-2007; IN COMMERCE 6-30-2007.

AHSEN KHAN, EXAMINING ATTORNEY

**Int. Cl.: 28**

**Prior U.S. Cls.: 22, 23, 38, and 50**

**United States Patent and Trademark Office**

**Reg. No. 3,468,499**

**Registered July 15, 2008**

**TRADEMARK  
PRINCIPAL REGISTER**

**BUSY LIL' PURSE**

HASBRO, INC. (RHODE ISLAND CORPORATION)  
1027 NEWPORT AVENUE  
PAWTUCKET, RI 02862

OWNER OF U.S. REG. NO. 2,935,968 AND OTHERS.

FOR: TOY PURSE AND ACCESSORIES FOR USE THEREWITH, IN CLASS 28 (U.S. CLS. 22, 23, 38 AND 50).

NO CLAIM IS MADE TO THE EXCLUSIVE RIGHT TO USE "PURSE", APART FROM THE MARK AS SHOWN.

FIRST USE 10-29-2007; IN COMMERCE 10-29-2007.

SN 76-677,021, FILED 5-17-2007.

THE MARK CONSISTS OF STANDARD CHARACTERS WITHOUT CLAIM TO ANY PARTICULAR FONT, STYLE, SIZE, OR COLOR.

CORY BOONE, EXAMINING ATTORNEY

**Int. Cl.: 10**

**Prior U.S. Cls.: 26, 39, and 44**

**Reg. No. 3,468,500**

**United States Patent and Trademark Office**

**Registered July 15, 2008**

**TRADEMARK  
PRINCIPAL REGISTER**

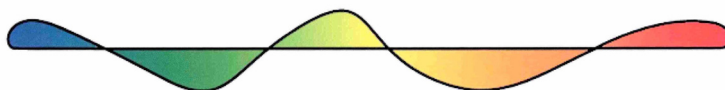

PHOTOMED TECHNOLOGIES, INC. (CALIFORNIA CORPORATION)  
65 FRANCISCAN WAY  
KENSINGTON, CA 94707

FOR: APPARATUS AND EQUIPMENT FOR USING ELECTROMAGNETIC RADIATION FOR TREATING DISORDERS OF THE NERVES, MUSCLES AND/OR BLOOD VESSELS; APPARATUS AND EQUIPMENT FOR USING ELECTROMAGNETIC RADIATION FOR TREATING DISORDERS OF THE NERVES, MUSCLES AND/OR BLOOD VESSELS CONTAINING COMPUTER HARDWARE AND COMPONENT OPERATING SOFTWARE THEREFOR SOLD AS A UNIT, IN CLASS 10 (U.S. CLS. 26, 39 AND 44).

FIRST USE 7-1-2003; IN COMMERCE 4-17-2007.

THE COLOR(S) BLACK, BLUE, GREEN, YELLOW, RED, AND ORANGE IS/ARE CLAIMED AS A FEATURE OF THE MARK.

THE COLOR BLACK APPEARS IN THE WAVY LINE AND THE STRAIGHT LINE. THE COLOR BLUE APPEARS IN THE LOOP ABOVE THE LINE ON THE LEFT OF THE DESIGN, THE COLOR GREEN APPEARS IN THE LOOP NEXT TO THE BLUE, THE COLOR YELLOW APPEARS IN THE LOOP NEXT TO THE COLOR GREEN, THE COLOR ORANGE APPEARS IN THE LOOP NEXT TO THE COLOR YELLOW, AND THE COLOR RED APPEARS IN THE LAST LOOP TO THE RIGHT.

SN 76-677,095, FILED 5-18-2007.

CAROLINE WOOD, EXAMINING ATTORNEY

**Int. Cl.: 9**

**Prior U.S. Cls.: 21, 23, 26, 36, and 38**

**Reg. No. 3,468,501**

**United States Patent and Trademark Office**

**Registered July 15, 2008**

**TRADEMARK  
PRINCIPAL REGISTER**



THE OUTDOOR RECREATION GROUP (CALIFORNIA CORPORATION)  
1919 VINEBURN AVENUE  
LOS ANGELES, CA 90032

DUCT TAPE, PONCHOS, PLAYING CARDS, MATCHES, BROCHURE ABOUT EMERGENCY INFORMATION, ALL SOLD AS A UNIT, IN CLASS 9 (U.S. CLS. 21, 23, 26, 36 AND 38).

FOR: EMERGENCY PREPAREDNESS KITS CONSISTING OF RADIOS, SAFETY WHISTLES, COMPASSES, DUST MASKS, MULTI-FUNCTION HAND TOOLS COMPRISED OF SCREWDRIVERS, KNIVES, CAN OPENERS, FILE, AND PLIERS, BLANKETS FOR OUTDOOR USE, FLASHLIGHTS, FIRST-AID KITS, EMERGENCY FOOD AND WATER, ROPE,

FIRST USE 9-20-2007; IN COMMERCE 3-7-2008.

SN 76-678,873, FILED 6-28-2007.

ANGELA GAW, EXAMINING ATTORNEY

**Int. Cl.: 19**

**Prior U.S. Cls.: 1, 12, 33, and 50**

**United States Patent and Trademark Office**

**Reg. No. 3,468,502**

**Registered July 15, 2008**

**TRADEMARK  
PRINCIPAL REGISTER**

**SPEC ONE BY CAPELLA**

ARMSTRONG HARDWOOD FLOORING COM-  
PANY (TENNESSEE CORPORATION)  
2500 COLUMBIA AVENUE  
LANCASTER, PA 17603

FOR: WOOD FLOORING, IN CLASS 19 (U.S. CLS.  
1, 12, 33 AND 50).

FIRST USE 12-0-2007; IN COMMERCE 12-0-2007.

THE MARK CONSISTS OF STANDARD CHAR-  
ACTERS WITHOUT CLAIM TO ANY PARTICULAR  
FONT, STYLE, SIZE, OR COLOR.

OWNER OF U.S. REG. NOS. 2,613,437, 3,128,857,  
AND 3,308,735.

SN 76-680,158, FILED 8-1-2007.

KELLY BOULTON, EXAMINING ATTORNEY

**Int. Cl.: 12**

**Prior U.S. Cls.: 19, 21, 23, 31, 35, and 44**

**Reg. No. 3,468,503**

**United States Patent and Trademark Office**

**Registered July 15, 2008**

---

**TRADEMARK  
PRINCIPAL REGISTER**

**ERA**

WINNEBAGO INDUSTRIES, INC. (IOWA CORPORATION)  
605 WEST CRYSTAL LAKE ROAD  
FOREST CITY, IA 50436

FOR: MOTOR HOMES, IN CLASS 12 (U.S. CLS. 19, 21, 23, 31, 35 AND 44).

FIRST USE 2-27-2008; IN COMMERCE 2-27-2008.

THE MARK CONSISTS OF STANDARD CHARACTERS WITHOUT CLAIM TO ANY PARTICULAR FONT, STYLE, SIZE, OR COLOR.

SN 76-680,519, FILED 8-9-2007.

KATHLEEN M. VANSTON, EXAMINING ATTORNEY



**Int. Cl.: 35**

**Prior U.S. Cls.: 100, 101, and 102**

**United States Patent and Trademark Office**

**Reg. No. 3,468,504**

**Registered July 15, 2008**

**SERVICE MARK  
PRINCIPAL REGISTER**

**INNOVATION LINE**

INNOVATION SPECIALTIES, INC. (CALIFORNIA CORPORATION)  
11869 TEALE STREET  
CULVER CITY, CA 90230

FOR: DISTRIBUTORSHIPS IN THE FIELD OF SPECIALITY AND CORPORATE PROMOTIONAL ITEMS PRODUCED BY OTHERS, NAMELY, LUGGAGE TAGS, LANYARDS, KEYCHAINS, WRITING INSTRUMENTS, DESK ACCESSORIES, CLOCKS, GOLF BALL HOLDERS, PEDOMETERS, CLIP BOARDS, TROPHY AWARDS, COMPUTER ACCESSORIES, CALCULATORS, TAPE MEASURES,

BADGE HOLDERS AND THERMOMETERS, IN CLASS 35 (U.S. CLS. 100, 101 AND 102).

FIRST USE 1-1-2008; IN COMMERCE 1-1-2008.

THE MARK CONSISTS OF STANDARD CHARACTERS WITHOUT CLAIM TO ANY PARTICULAR FONT, STYLE, SIZE, OR COLOR.

SN 76-680,604, FILED 8-10-2007.

TARAH HARDY, EXAMINING ATTORNEY

**Int. Cl.: 19**

**Prior U.S. Cls.: 1, 12, 33, and 50**

**United States Patent and Trademark Office**

**Reg. No. 3,468,505**

**Registered July 15, 2008**

**TRADEMARK  
PRINCIPAL REGISTER**

**TESTED TO WITHSTAND THE UNEXPECTED**

AWI LICENSING COMPANY (DELAWARE COR-  
PORATION)  
802 WEST STREET  
WILMINGTON, DE 19801

THE MARK CONSISTS OF STANDARD CHAR-  
ACTERS WITHOUT CLAIM TO ANY PARTICULAR  
FONT, STYLE, SIZE, OR COLOR.

FOR: NON-METAL FLOORS, NAMELY, WOOD  
BOARDS, LAMINATE PLANKS AND STRIPS, VI-  
NYL, CERAMIC AND PORCELAIN TILES, IN  
CLASS 19 (U.S. CLS. 1, 12, 33 AND 50).

SN 76-680,987, FILED 8-22-2007.

FIRST USE 4-2-2007; IN COMMERCE 10-5-2007.

IRA J. GOODSID, EXAMINING ATTORNEY

**Int. Cls.: 10, 31, and 32**

**Prior U.S. Cls.: 1, 26, 39, 44, 45, 46, and 48**

**United States Patent and Trademark Office**

**Reg. No. 3,468,506**

**Registered July 15, 2008**

**TRADEMARK  
PRINCIPAL REGISTER**

**STERILOX**

PURICORE, INC. (DELAWARE CORPORATION)  
508 LAPP ROAD  
MALVERN, PA 19355

FOR: FLUID CHEMICAL BIOCIDES DISPENSING MACHINES FOR CLEANSING, DISINFECTING, STERILIZING OR WASHING WOUNDS, BURNS, INVASIVE SURGICAL OPENINGS, HANDS AND OTHER SKIN AREAS; AND SURGICAL GLOVES, SURGICAL GOWNS, AND SURGICAL MASKS, IN CLASS 10 (U.S. CLS. 26, 39 AND 44).

FIRST USE 1-31-2005; IN COMMERCE 1-31-2005.

FOR: FOOD ADDITIVE FOR NON-NUTRITIONAL PURPOSES FOR USE AS A BIOCIDES, IN CLASS 31 (U.S. CLS. 1 AND 46).

FIRST USE 1-31-2005; IN COMMERCE 1-31-2005.

FOR: STERILE DRINKING WATER, IN CLASS 32 (U.S. CLS. 45, 46 AND 48).

FIRST USE 1-31-2005; IN COMMERCE 1-31-2005.

SN 76-977,484, FILED 11-9-2001.

ALEXANDER L. POWERS, EXAMINING ATTORNEY

**Int. Cl.: 1**

**Prior U.S. Cls.: 1, 5, 6, 10, 26, and 46**

**United States Patent and Trademark Office**

**Reg. No. 3,468,507**

**Registered July 15, 2008**

**TRADEMARK  
PRINCIPAL REGISTER**

**ENDOLINE**

L'OREAL (FRANCE SOCIETE ANONYME)  
14, RUE ROYALE  
PARIS, FRANCE 75008

FOR: CHEMICAL INGREDIENT FOR COSMETIC  
PRODUCTS, IN CLASS 1 (U.S. CLS. 1, 5, 6, 10, 26 AND  
46).

FIRST USE 7-1-2007; IN COMMERCE 7-1-2007.

THE MARK CONSISTS OF STANDARD CHAR-  
ACTERS WITHOUT CLAIM TO ANY PARTICULAR  
FONT, STYLE, SIZE, OR COLOR.

OWNER OF FRANCE REG. NO. 063412123, DA-  
TED 2-23-2006, EXPIRES 2-23-2016.

SN 77-000,217, FILED 9-15-2006.

MELVIN AXILBUND, EXAMINING ATTORNEY

**Int. Cl.: 10**

**Prior U.S. Cls.: 26, 39, and 44**

**Reg. No. 3,468,508**

**United States Patent and Trademark Office**

**Registered July 15, 2008**

---

**TRADEMARK  
PRINCIPAL REGISTER**

**ENTELLUS MEDICAL**

ENTELLUS MEDICAL, INC. (DELAWARE CORPORATION)  
6705 WEDGWOOD COURT N.  
MAPLE GROVE, MN 55311

FOR: MEDICAL DEVICES, NAMELY, KITS FOR USE IN SINUS SURGERY CONSISTING OF TROCARS, SHEATHS, CANNULAS, BALLOON DILATION CATHETERS, AND IRRIGATION CATHETERS, IN CLASS 10 (U.S. CLS. 26, 39 AND 44).

FIRST USE 10-31-2007; IN COMMERCE 10-31-2007.

THE MARK CONSISTS OF STANDARD CHARACTERS WITHOUT CLAIM TO ANY PARTICULAR FONT, STYLE, SIZE, OR COLOR.

NO CLAIM IS MADE TO THE EXCLUSIVE RIGHT TO USE "MEDICAL", APART FROM THE MARK AS SHOWN.

SN 77-000,506, FILED 9-15-2006.

ZHALEH DELANEY, EXAMINING ATTORNEY

**Int. Cl.: 35**

**Prior U.S. Cls.: 100, 101, and 102**

**United States Patent and Trademark Office**

**Reg. No. 3,468,509**

**Registered July 15, 2008**

**SERVICE MARK  
PRINCIPAL REGISTER**



ACCOUNTANTS TO YOU, LLC (KENTUCKY  
LTD LIAB CO)  
SUITE 790  
655 EDEN PARK DRIVE  
CINCINNATI, OH 45202

FOR: PROVIDING TEMPORARY AND PERMA-  
NENT PLACEMENT OF SALES PROFESSIONALS,  
IN CLASS 35 (U.S. CLS. 100, 101 AND 102).

FIRST USE 1-31-2006; IN COMMERCE 1-31-2006.

THE MARK CONSISTS OF THE STYLIZED  
WORDING "SALES PROS 2 YOU" WITH AN AS-  
CENDING CROOKED ARROWING STARTING AT  
THE BOTTOM OF THE LETTER "S" IN "SALES"  
AND ENDING AT THE TOP OF THE WORD "PROS"  
BETWEEN THE LETTERS "P" AND "R".

SN 77-001,595, FILED 9-18-2006.

TASHIA BUNCH, EXAMINING ATTORNEY

**Int. Cl.: 30**

**Prior U.S. Cl.: 46**

**United States Patent and Trademark Office**

**Reg. No. 3,468,510**

**Registered July 15, 2008**

**TRADEMARK  
PRINCIPAL REGISTER**

**OHIYES**

HAITAI CONFECTIONERY AND FOODS CO.,  
LTD. (REPUBLIC OF KOREA CORPORATION)  
321-4 CHONHEUNG-RI  
SUNGGUH-EUP, CHEONAN CITY  
CHOONGCHUNGNAM-DO, REPUBLIC OF KOREA

THE MARK CONSISTS OF STANDARD CHAR-  
ACTERS WITHOUT CLAIM TO ANY PARTICULAR  
FONT, STYLE, SIZE, OR COLOR.

FOR: CHOCOLATE CAKES, IN CLASS 30 (U.S. CL.  
46).

SN 77-002,939, FILED 9-20-2006.

FIRST USE 12-29-1984; IN COMMERCE 11-6-2006.

ALLISON SCHRODY, EXAMINING ATTORNEY

**Int. Cl.: 41**

**Prior U.S. Cls.: 100, 101, and 107**

**United States Patent and Trademark Office**

**Reg. No. 3,468,511**

**Registered July 15, 2008**

**SERVICE MARK  
PRINCIPAL REGISTER**



SHAFFER, SETH A (UNITED STATES INDIVIDUAL)  
3406 SHEPHERD STREET  
CHEVY CHASE, MD 20815

FOR: EDUCATIONAL SERVICES, NAMELY, DEVELOPING CURRICULUM AND EDUCATIONAL MATERIALS FOR OTHERS AND TRAINING, MONITORING, AND MENTORING TEACHERS, ALL IN THE FIELD OF PRIMARY AND SECONDARY EDUCATION FOR PHYSICALLY CHALLENGED AND MENTALLY CHALLENGED CHILDREN AND YOUNG ADULTS, IN CLASS 41 (U.S. CLS. 100, 101 AND 107).

FIRST USE 10-1-2006; IN COMMERCE 10-1-2006.

NO CLAIM IS MADE TO THE EXCLUSIVE RIGHT TO USE "EDUCATION", APART FROM THE MARK AS SHOWN.

THE COLOR(S) WHITE, YELLOW, ORANGE, RED, LIGHT GREEN, DARK GREEN, LIGHT BLUE, DARK BLUE, AND PURPLE IS/ARE CLAIMED AS A FEATURE OF THE MARK.

THE MARK CONSISTS OF A DESIGN ELEMENT OF EIGHT BENDING STICK FIGURES THAT FAN OUT, ABOVE THE WORDING "HARMONY THROUGH EDUCATION". THE COLOR WHITE APPEARS AS THE BACKGROUND COLOR. THE COLOR YELLOW APPEARS IN THE FIRST STICK FIGURE FROM THE LEFT. THE COLOR ORANGE APPEARS IN THE SECOND STICK FIGURE FROM THE LEFT. THE COLOR RED APPEARS IN THE THIRD STICK FIGURE FROM THE LEFT. THE COLOR LIGHT GREEN APPEARS IN THE FOURTH STICK FIGURE FROM THE LEFT. THE COLOR DARK GREEN APPEARS IN THE FIFTH STICK FIGURE FROM THE LEFT. THE COLOR LIGHT BLUE APPEARS IN THE SIXTH STICK FIGURE FROM THE LEFT. THE COLOR DARK BLUE APPEARS IN THE SEVENTH STICK FIGURE FROM THE LEFT. THE COLOR PURPLE APPEARS IN THE EIGHTH STICK FIGURE FROM THE LEFT AND THE WORDING "HARMONY THROUGH EDUCATION".

SN 77-003,169, FILED 9-20-2006.

TINA KUAN, EXAMINING ATTORNEY



**Int. Cl.: 41**

**Prior U.S. Cls.: 100, 101, and 107**

**United States Patent and Trademark Office**

**Reg. No. 3,468,512**

**Registered July 15, 2008**

---

**SERVICE MARK  
PRINCIPAL REGISTER**

**IT AIN'T GONNA RIDE ITSELF**

GISLI M. JOHANNSSON (ICELAND INDIVIDUAL)  
1708 RIVERSIDE DRIVE  
OLD HICKORY, TN 37138

THE MARK CONSISTS OF STANDARD CHARACTERS WITHOUT CLAIM TO ANY PARTICULAR FONT, STYLE, SIZE, OR COLOR.

FOR: ENTERTAINMENT, NAMELY, LIVE PERFORMANCES BY A MUSICAL BAND, IN CLASS 41 (U.S. CLS. 100, 101 AND 107).

SN 77-003,419, FILED 9-20-2006.

FIRST USE 7-30-2007; IN COMMERCE 7-30-2007.

JESSICA FATHY, EXAMINING ATTORNEY

Int. Cl.: 25

Prior U.S. Cls.: 22 and 39

United States Patent and Trademark Office

Reg. No. 3,468,513

Registered July 15, 2008

TRADEMARK  
PRINCIPAL REGISTER



RAFIYQ AMIYR ABDELLAH (UNITED STATES  
INDIVIDUAL)  
380 LEWIS AVENUE 1 - A  
BROOKLYN, NY 11233

FOR: BELTS; BIBS NOT OF CLOTH OR PAPER;  
CAPS; CHILDREN'S AND INFANTS' CLOTH BIBS;  
CHILDREN'S CLOTH EATING BIBS; CLOTH BIBS;  
CLOTH BIBS FOR ADULT DINERS; CLOTH BIBS  
FOR USE BY SENIOR CITIZENS OR PHYSICALLY  
OR MENTALLY-CHALLENGED PERSONS; CLOTH  
DIAPERS; CLOTHING FOR WEAR IN JUDO PRACTICES;  
CLOTHING FOR WEAR IN WRESTLING  
GAMES; CLOTHING, NAMELY, ARM WARMERS;  
CLOTHING, NAMELY, FOLK COSTUMES; CLOTH-  
ING, NAMELY, KNEE WARMERS; CLOTHING,  
NAMELY, NECK TUBES; CLOTHING, NAMELY,  
WRAP-AROUNDS; CORSETS; DUSTERS; FOU-  
LARDS; HOODS; INFANT AND TODDLER ONE  
PIECE CLOTHING; INFANT CLOTH DIAPERS;  
JERSEYS; LEATHER BELTS; MANTLES; MUF-  
FLERS; NON-DISPOSABLE CLOTH TRAINING  
PANTS; PARTS OF CLOTHING, NAMELY, GUS-  
SETS FOR TIGHTS, GUSSETS FOR STOCKINGS,  
GUSSETS FOR BATHING SUITS, GUSSETS FOR

UNDERWEAR, GUSSETS FOR LEOTARDS AND  
GUSSETS FOR FOOTLETS; PERSPIRATION AB-  
SORBENT UNDERWEAR CLOTHING; SHIFTS;  
SHORT SETS; SHOULDER PADS FOR CLOTHING;  
SHOULDER WRAPS; SWADDLING CLOTHES;  
TIES; TOPS; UNDERARM CLOTHING SHIELDS;  
WRAPS, IN CLASS 25 (U.S. CLS. 22 AND 39).

FIRST USE 2-1-2006; IN COMMERCE 2-13-2006.

NO CLAIM IS MADE TO THE EXCLUSIVE  
RIGHT TO USE "BLACK COTTON PREMIUM  
THREADS" AND THE "DO NOT BLEACH" SYM-  
BOL, APART FROM THE MARK AS SHOWN.

THE MARK CONSISTS OF A BABY LAMB WITH  
A CROWN AND A "DO NOT BLEACH" SYMBOL ON  
THE BACK SIDE. ALSO THE WORDING "BLACK  
COTTON PREMIUM THREADS" IS SPELLED OUT  
BENEATH THE LAMB.

SN 77-003,815, FILED 9-20-2006.

JENNIFER VASQUEZ, EXAMINING ATTORNEY

**Int. Cl.: 9**

**Prior U.S. Cls.: 21, 23, 26, 36, and 38**

**United States Patent and Trademark Office**

**Reg. No. 3,468,514**

**Registered July 15, 2008**

**TRADEMARK  
PRINCIPAL REGISTER**

**TWILIGHT**

ATOM LIGHTING, INC. (ARIZONA CORPORATION)  
950 EAST TODD DRIVE  
TEMPE, AZ 85283

FOR: POWER COMPONENTS, NAMELY, LOW VOLTAGE ELECTRICAL TRANSFORMERS, TIMING AND SENSOR CONTROLS COMPRISED OF TIME CLOCKS, RELAYS, CONTACTORS, PHOTOCELLS, FUSES, AND CIRCUIT BREAKERS; FOR USE IN LANDSCAPE APPLICATIONS, IN CLASS 9 (U.S. CLS. 21, 23, 26, 36 AND 38).

FIRST USE 10-25-2006; IN COMMERCE 10-25-2006.

THE MARK CONSISTS OF STANDARD CHARACTERS WITHOUT CLAIM TO ANY PARTICULAR FONT, STYLE, SIZE, OR COLOR.

SN 77-003,817, FILED 9-20-2006.

CURTIS FRENCH, EXAMINING ATTORNEY

**Int. Cl.: 35**

**Prior U.S. Cls.: 100, 101, and 102**

**United States Patent and Trademark Office**

**Reg. No. 3,468,515**

**Registered July 15, 2008**

**SERVICE MARK  
PRINCIPAL REGISTER**



HDS IP HOLDING, LLC (NEVADA LTD LIAB  
CO)  
SUITE 850  
101 CONVENTION CENTER DRIVE  
LAS VEGAS, NV 89109

FOR: RETAIL STORE AND DISTRIBUTORSHIP  
SERVICES PROVIDED TO OTHER BUSINESSES  
FEATURING HOME IMPROVEMENT SERVICES  
PERFORMED BY OTHERS, MUNICIPAL WATER  
SUPPLY EQUIPMENT, WATER TREATMENT  
EQUIPMENT, AND SEWAGE AND PLUMBING  
EQUIPMENT, IN CLASS 35 (U.S. CLS. 100, 101 AND  
102).

FIRST USE 10-27-2006; IN COMMERCE 10-27-2006.

NO CLAIM IS MADE TO THE EXCLUSIVE  
RIGHT TO USE "SUPPLY WATERWORKS", APART  
FROM THE MARK AS SHOWN.

THE COLOR(S) MUSTARD YELLOW, BLACK  
AND WHITE IS/ARE CLAIMED AS A FEATURE  
OF THE MARK.

THE MARK CONSISTS OF THE SHAPE OF TWO  
RECTANGLES WITHIN A DOUBLE LINED BOR-  
DER, SEPARATED BY A SINGLE WHITE LINE. THE  
LETTERS "HD", WITH A CIRCLE IN THE CENTER  
OF THE LETTERS "HD", AND THE WORD "SUP-  
PLY" APPEAR IN THE SMALLER RECTANGLE ON  
THE LEFT. THE WORD "WATERWORKS" AP-  
PEARS IN THE LARGER SHAPED RECTANGLE  
ON THE RIGHT HAND SIDE. A DROP OF WATER  
APPEARS IN PLACE OF THE LETTER "O" IN  
"WATERWORKS". THE COLOR MUSTARD YEL-  
LOW APPEARS IN THE LETTERS "HD"; THE  
COLOR WHITE APPEARS IN THE CIRCLE AT  
THE CENTER OF THE LETTERS "HD", IN THE  
WORD "SUPPLY", IN THE WORD "WATER-  
WORKS", IN THE WATERDROP AND IN THE  
BORDER SURROUNDING THE RECTANGLE OF  
THE MARK; AND THE COLOR BLACK APPEARS  
AS A BACKGROUND FOR THE ENTIRE MARK.

SN 77-004,589, FILED 9-21-2006.

MARK T. MULLEN, EXAMINING ATTORNEY

**Int. Cl.: 30**

**Prior U.S. Cl.: 46**

**United States Patent and Trademark Office**

**Reg. No. 3,468,516**

**Registered July 15, 2008**

**TRADEMARK  
PRINCIPAL REGISTER**

**PistachiOats**

SANO VILLA (CALIFORNIA CORPORATION)  
150 E 44TH ST 16A  
NEW YORK, NY 10017

THE MARK CONSISTS OF STANDARD CHAR-  
ACTERS WITHOUT CLAIM TO ANY PARTICULAR  
FONT, STYLE, SIZE, OR COLOR.

FOR: FOOD PACKAGE COMBINATIONS CON-  
SISTING PRIMARILY OF BREAD, CRACKERS  
AND/OR COOKIES, IN CLASS 30 (U.S. CL. 46).

SN 77-004,814, FILED 9-21-2006.

FIRST USE 10-8-2007; IN COMMERCE 10-8-2007.

CHERYL CLAYTON, EXAMINING ATTORNEY

**Int. Cl.: 25**

**Prior U.S. Cls.: 22 and 39**

**United States Patent and Trademark Office**

**Reg. No. 3,468,517**

**Registered July 15, 2008**

**TRADEMARK  
PRINCIPAL REGISTER**

**VIVAHORA**

VIVAHORA, LLC (FLORIDA LTD LIAB CO)

1521 ALTON ROAD, #78

MIAMI BEACH, FL 33139

FOR: SPORTSWEAR, NAMELY, T-SHIRTS, IN  
CLASS 25 (U.S. CLS. 22 AND 39).

FIRST USE 12-31-2006; IN COMMERCE 12-31-2006.

THE MARK CONSISTS OF STANDARD CHAR-  
ACTERS WITHOUT CLAIM TO ANY PARTICULAR  
FONT, STYLE, SIZE, OR COLOR.

THE FOREIGN WORDING IN THE MARK  
TRANSLATES INTO ENGLISH AS "HOORAY  
NOW".

SN 77-005,530, FILED 9-22-2006.

NATALIE POLZER, EXAMINING ATTORNEY

**Int. Cl.: 14**

**Prior U.S. Cls.: 2, 27, 28, and 50**

**United States Patent and Trademark Office**

**Reg. No. 3,468,518**

**Registered July 15, 2008**

---

**TRADEMARK  
PRINCIPAL REGISTER**

**STUDIO 8**

MIMI SO INTERNATIONAL LLC (DELAWARE  
LTD LIAB CO)  
5TH FLOOR  
645 FIFTH AVENUE  
NEW YORK, NY 10022

THE MARK CONSISTS OF STANDARD CHAR-  
ACTERS WITHOUT CLAIM TO ANY PARTICULAR  
FONT, STYLE, SIZE, OR COLOR.

FOR: JEWELRY, IN CLASS 14 (U.S. CLS. 2, 27, 28  
AND 50).

SN 77-005,569, FILED 9-22-2006.

FIRST USE 6-3-2006; IN COMMERCE 6-3-2006.

RAMONA ORTIGA, EXAMINING ATTORNEY

**Int. Cls.: 9, 35, 38, 41, and 42**

**Prior U.S. Cls.: 21, 23, 26, 36, 38, 100, 101, 102, 104,  
and 107**

**Reg. No. 3,468,519**

**United States Patent and Trademark Office**

**Registered July 15, 2008**

**TRADEMARK  
SERVICE MARK  
PRINCIPAL REGISTER**

**MYDJ**

MUSICIP CORPORATION (DELAWARE COR-  
PORATION)  
SUITE 201  
605 E. HUNTINGTON DRIVE  
MONROVIA, CA 91016

FOR: CONTROL SOFTWARE FOR MANAGING,  
IDENTIFYING AND SELECTING MUSIC AND FOR  
CREATING MUSIC PLAYLISTS; SOFTWARE DE-  
VELOPMENT KITS (SDK) FOR ADAPTING SUCH  
CONTROL SOFTWARE FOR USE WITH MP3 PLAY-  
ERS AND CD PLAYERS, AND FIRMWARE EM-  
BEDDED IN THIRD PARTY CONSUMER  
PRODUCTS AND ENTERPRISE NETWORK SER-  
VERS TO ENABLE SUCH CONTROL SOFTWARE,  
IN CLASS 9 (U.S. CLS. 21, 23, 26, 36 AND 38).

FIRST USE 10-31-2006; IN COMMERCE 11-30-2006.

FOR: PROVIDING MUSIC PURCHASING INFOR-  
MATION, IN CLASS 35 (U.S. CLS. 100, 101 AND 102).

FIRST USE 10-31-2006; IN COMMERCE 11-30-2006.

FOR: ELECTRONIC DELIVERY OF METADATA  
RELATING TO SONGS AND ALBUMS, IN CLASS 38  
(U.S. CLS. 100, 101 AND 104).

FIRST USE 10-31-2006; IN COMMERCE 11-30-2006.

FOR: MUSIC INFORMATION SERVICES, NAME-  
LY, IDENTIFICATION OF SONGS, ALBUMS, COM-  
PACT DISKS, AND COMPACT DISK TRACKS, IN  
CLASS 41 (U.S. CLS. 100, 101 AND 107).

FIRST USE 10-31-2006; IN COMMERCE 11-30-2006.

FOR: CONSULTING SERVICES FOR INTEGRAT-  
ING MUSIC RELATED FIRMWARE INTO CONSU-  
MER PRODUCTS AND ENTERPRISE SERVERS, IN  
CLASS 42 (U.S. CLS. 100 AND 101).

FIRST USE 10-31-2006; IN COMMERCE 11-30-2006.

THE MARK CONSISTS OF STANDARD CHAR-  
ACTERS WITHOUT CLAIM TO ANY PARTICULAR  
FONT, STYLE, SIZE, OR COLOR.

SN 77-005,757, FILED 9-22-2006.

MICHAEL LITZAU, EXAMINING ATTORNEY



**Int. Cl.: 33**

**Prior U.S. Cls.: 47 and 49**

**United States Patent and Trademark Office**

**Reg. No. 3,468,520**

**Registered July 15, 2008**

**TRADEMARK  
PRINCIPAL REGISTER**

**SOLSBURY HILL**

POWER, JOHN C. (UNITED STATES INDIVIDUAL)  
P.O. BOX 114  
THE SEA RANCH, CA 95497

THE MARK CONSISTS OF STANDARD CHARACTERS WITHOUT CLAIM TO ANY PARTICULAR FONT, STYLE, SIZE, OR COLOR.

FOR: WINE, IN CLASS 33 (U.S. CLS. 47 AND 49).

SN 77-006,041, FILED 9-23-2006.

FIRST USE 9-28-2007; IN COMMERCE 9-28-2007.

REBECCA EISINGER, EXAMINING ATTORNEY

**Int. Cl.: 21**

**Prior U.S. Cls.: 2, 13, 23, 29, 30, 33, 40, and 50**

**United States Patent and Trademark Office**

**Reg. No. 3,468,521**

**Registered July 15, 2008**

**TRADEMARK  
PRINCIPAL REGISTER**

**SMART BROOM 1600**

POLYCLEAN INNOVATIONS, LLC (MISSOURI  
LTD LIAB CO)  
7380 MARIETTA AVENUE  
ST. LOUIS, MO 63143

FOR: BROOMS, IN CLASS 21 (U.S. CLS. 2, 13, 23, 29,  
30, 33, 40 AND 50).

FIRST USE 2-15-2008; IN COMMERCE 2-15-2008.

THE MARK CONSISTS OF STANDARD CHAR-  
ACTERS WITHOUT CLAIM TO ANY PARTICULAR  
FONT, STYLE, SIZE, OR COLOR.

OWNER OF U.S. REG. NO. 2,513,616.

NO CLAIM IS MADE TO THE EXCLUSIVE  
RIGHT TO USE "BROOM", APART FROM THE  
MARK AS SHOWN.

SN 77-006,659, FILED 9-25-2006.

KHANH LE, EXAMINING ATTORNEY

**Int. Cl.: 6**

**Prior U.S. Cls.: 2, 12, 13, 14, 23, 25, and 50**

**Reg. No. 3,468,522**

**United States Patent and Trademark Office**

**Registered July 15, 2008**

---

**TRADEMARK  
PRINCIPAL REGISTER**

**eyewall armor**

AMERICAN BUILDERS & CONTRACTORS SUPPLY CO., INC. (DELAWARE CORPORATION)  
1 ABC PARKWAY  
BELOIT, WI 53511

FOR: METALLIC SHUTTERS, METALLIC SLATED SHUTTERS, METAL ROLL SHUTTERS, METAL WINDOW SHUTTERS, METAL ROLLING WINDOW SHUTTERS, IN CLASS 6 (U.S. CLS. 2, 12, 13, 14, 23, 25 AND 50).

FIRST USE 9-25-2006; IN COMMERCE 11-30-2006.

THE MARK CONSISTS OF STANDARD CHARACTERS WITHOUT CLAIM TO ANY PARTICULAR FONT, STYLE, SIZE, OR COLOR.

SN 77-006,695, FILED 9-25-2006.

LINDA ORNDORFF, EXAMINING ATTORNEY

**Int. Cl.: 9**

**Prior U.S. Cls.: 21, 23, 26, 36, and 38**

**Reg. No. 3,468,523**

**United States Patent and Trademark Office**

**Registered July 15, 2008**

---

**TRADEMARK  
PRINCIPAL REGISTER**

**HI-TECH**

THOMAS & BETTS INTERNATIONAL, INC. (DE-  
LAWARE CORPORATION)  
501 SILVERSIDE ROAD, SUITE 67  
WILMINGTON, DE 19809

THE MARK CONSISTS OF STANDARD CHAR-  
ACTERS WITHOUT CLAIM TO ANY PARTICULAR  
FONT, STYLE, SIZE, OR COLOR.

FOR: HI-VOLTAGE ELECTRICAL FUSES FOR  
DISTRIBUTION AND TRANSMISSION OF ELEC-  
TRICAL POWER, IN CLASS 9 (U.S. CLS. 21, 23, 26, 36  
AND 38).

SN 77-007,794, FILED 9-26-2006.

FIRST USE 12-31-1984; IN COMMERCE 12-31-1984.

GINA HAYES, EXAMINING ATTORNEY

**Int. Cl.: 9**

**Prior U.S. Cls.: 21, 23, 26, 36, and 38**

**United States Patent and Trademark Office**

**Reg. No. 3,468,524**

**Registered July 15, 2008**

**TRADEMARK  
PRINCIPAL REGISTER**

**DELIVERYTRAK**

WR HESS COMPANY (OKLAHOMA CORPORATION)  
3030 N.W. EXPRESSWAY, SUITE 1500  
OKLAHOMA CITY, OK 73112

FOR: COMPUTER SOFTWARE FOR AUTOMATING THE FUEL MANAGEMENT PROCESS AND ALL WHOLESALE FUEL TRANSPORT OPERATIONS WHEREIN LOADING AND DISPATCH INFORMATION IS TRANSMITTED DIRECTLY TO AN ON-BOARD TRUCK COMPUTER THAT PROVIDES PAPERLESS DELIVERY TICKETS; INVOICES VIA FAX OR EMAIL AND ELECTRONICALLY CAPTURES CUSTOMER SIGNATURES TO BE PRINTED ON THE DELIVERY TICKET AND SENT WITH THE

INVOICE, IN CLASS 9 (U.S. CLS. 21, 23, 26, 36 AND 38).

FIRST USE 5-7-2008; IN COMMERCE 5-7-2008.

THE MARK CONSISTS OF STANDARD CHARACTERS WITHOUT CLAIM TO ANY PARTICULAR FONT, STYLE, SIZE, OR COLOR.

OWNER OF U.S. REG. NOS. 2,059,779, 2,074,237, AND 2,840,490.

SN 77-008,753, FILED 9-27-2006.

KATHLEEN LORENZO, EXAMINING ATTORNEY

**Int. Cl.: 35**

**Prior U.S. Cls.: 100, 101, and 102**

**United States Patent and Trademark Office**

**Reg. No. 3,468,525**

**Registered July 15, 2008**

**SERVICE MARK  
PRINCIPAL REGISTER**

# Breakaway Ventures

BALDWIN, DENNIS M (UNITED STATES INDIVIDUAL)  
125 BEARD WAY  
NEEDHAM, MA 02492

FOR: BUSINESS CONSULTING IN THE AREA OF BUSINESS STRATEGY FOR GROWTH STAGE COMPANIES, IN CLASS 35 (U.S. CLS. 100, 101 AND 102).

FIRST USE 5-11-2007; IN COMMERCE 6-5-2007.

THE MARK CONSISTS OF STANDARD CHARACTERS WITHOUT CLAIM TO ANY PARTICULAR FONT, STYLE, SIZE, OR COLOR.

NO CLAIM IS MADE TO THE EXCLUSIVE RIGHT TO USE "VENTURES", APART FROM THE MARK AS SHOWN.

SN 77-009,146, FILED 9-27-2006.

AMY ALFIERI, EXAMINING ATTORNEY

**Int. Cl.: 19**

**Prior U.S. Cls.: 1, 12, 33, and 50**

**United States Patent and Trademark Office**

**Reg. No. 3,468,526**

**Registered July 15, 2008**

**TRADEMARK  
PRINCIPAL REGISTER**

**THE LOOK AND FEEL OF REAL  
SPLIT CEDAR**

ATLANTIS PLASTICS, INC. (FLORIDA COR-  
PORATION)  
P.O. BOX 2118  
ELKHART, IN 46515

THE MARK CONSISTS OF STANDARD CHAR-  
ACTERS WITHOUT CLAIM TO ANY PARTICULAR  
FONT, STYLE, SIZE, OR COLOR.

FOR: NON-METAL SIDING MADE OF POLY-  
PROPYLENE, IN CLASS 19 (U.S. CLS. 1, 12, 33 AND  
50).

SN 77-009,255, FILED 9-28-2006.

FIRST USE 4-1-2002; IN COMMERCE 4-1-2002.

HENRY S. ZAK, EXAMINING ATTORNEY

**Int. Cl.: 19**

**Prior U.S. Cls.: 1, 12, 33, and 50**

**United States Patent and Trademark Office**

**Reg. No. 3,468,527**

**Registered July 15, 2008**

**TRADEMARK  
PRINCIPAL REGISTER**



ATLANTIS PLASTICS, INC. (FLORIDA COR-  
PORATION)  
P.O. BOX 2118  
ELKHART, IN 46515

OWNER OF U.S. REG. NO. 2,595,463.

FOR: POLYPROPYLENE SIDING, IN CLASS 19  
(U.S. CLS. 1, 12, 33 AND 50).

SN 77-009,266, FILED 9-28-2006.

FIRST USE 4-1-2002; IN COMMERCE 4-1-2002.

HENRY S. ZAK, EXAMINING ATTORNEY



**Int. Cl.: 19**

**Prior U.S. Cls.: 1, 12, 33, and 50**

**United States Patent and Trademark Office**

**Reg. No. 3,468,528**

**Registered July 15, 2008**

**TRADEMARK  
PRINCIPAL REGISTER**

**ULTRA ARCH**

STRUCTUS BUILDING TECHNOLOGIES INC  
(OREGON CORPORATION)

20870 REDSIDE COURT

BEND, OR 97701

FOR: DRYWALL CONSTRUCTION PRODUCTS,  
NAMELY, NON-METAL PREFINISHED TRIM PIE-  
CES, FLEXTRIM PIECES AND NON-METAL DRY-  
WALL ARCH FINISHING PIECES, IN CLASS 19 (U.S.  
CLS. 1, 12, 33 AND 50).

FIRST USE 10-25-2006; IN COMMERCE 10-25-2006.

THE MARK CONSISTS OF STANDARD CHAR-  
ACTERS WITHOUT CLAIM TO ANY PARTICULAR  
FONT, STYLE, SIZE, OR COLOR.

OWNER OF U.S. REG. NOS. 2,222,318, 2,292,468,  
AND 2,295,590.

NO CLAIM IS MADE TO THE EXCLUSIVE  
RIGHT TO USE "ARCH", APART FROM THE  
MARK AS SHOWN.

SN 77-010,231, FILED 9-29-2006.

LINDA ORNDORFF, EXAMINING ATTORNEY

**Int. Cl.: 36**

**Prior U.S. Cls.: 100, 101, 102, and 200**

**United States Patent and Trademark Office**

**Reg. No. 3,468,529**

**Registered July 15, 2008**

**SERVICE MARK  
COLLECTIVE MEMBERSHIP  
PRINCIPAL REGISTER**



METRO BROKERS, INC. (COLORADO CORPORATION)  
SUITE 200  
4 INVERNESS COURT EAST  
ENGLEWOOD, CO 80112

FOR: COMMERCIAL AND RESIDENTIAL REAL ESTATE BROKERAGE, IN CLASS 36 (U.S. CLS. 100, 101 AND 102).

FIRST USE 1-0-2007; IN COMMERCE 1-0-2007.

FOR: INDICATING MEMBERSHIP IN AN ASSOCIATION OF INDEPENDENT REAL ESTATE BROKERS, IN CLASS 200 (U.S. CL. 200).

FIRST USE 1-0-2007; IN COMMERCE 1-0-2007.

OWNER OF U.S. REG. NOS. 1,423,233 AND 2,956,945.

NO CLAIM IS MADE TO THE EXCLUSIVE RIGHT TO USE "BROKERS" AND "REAL ESTATE" AND "INDEPENDENT COMPANIES EST. 1976", APART FROM THE MARK AS SHOWN.

THE MARK CONSISTS OF DESIGN OF AN OCTAGON.

SEC. 2(F) AS TO "METRO BROKERS".

SN 77-010,534, FILED 9-29-2006.

NICHOLAS ALTREE, EXAMINING ATTORNEY

**Int. Cl.: 36**

**Prior U.S. Cls.: 100, 101, and 102**

**United States Patent and Trademark Office**

**Reg. No. 3,468,530**

**Registered July 15, 2008**

**SERVICE MARK  
PRINCIPAL REGISTER**

**COPPICE ASSET MANAGEMENT**

COPPICE ASSET MANAGEMENT LLC (DELA-  
WARE LTD LIAB CO)  
C/O LARKSPUR SERVICES, P.O. BOX 500  
6384 STUART STREET  
THE PLAINS, VA 20198

FOR: FINANCIAL SERVICES, NAMELY, THE  
PROVISION OF FINANCIAL AND INVESTMENT  
ADVICE, COUNSELING AND INVESTING SERVI-  
CES IN THE FIELD OF SECURITIES; ASSISTING  
OTHERS WITH THE COMPLETION OF FINANCIAL  
TRANSACTIONS FOR STOCKS, BONDS, SECURI-  
TIES AND EQUITIES, IN CLASS 36 (U.S. CLS. 100, 101  
AND 102).

FIRST USE 10-1-2006; IN COMMERCE 10-1-2006.

THE MARK CONSISTS OF STANDARD CHAR-  
ACTERS WITHOUT CLAIM TO ANY PARTICULAR  
FONT, STYLE, SIZE, OR COLOR.

NO CLAIM IS MADE TO THE EXCLUSIVE  
RIGHT TO USE "ASSET MANAGEMENT", APART  
FROM THE MARK AS SHOWN.

SN 77-010,639, FILED 9-29-2006.

JOSETTE BEVERLY, EXAMINING ATTORNEY

**Int. Cl.: 25**

**Prior U.S. Cls.: 22 and 39**

**United States Patent and Trademark Office**

**Reg. No. 3,468,531**

**Registered July 15, 2008**

**TRADEMARK  
PRINCIPAL REGISTER**

**S. C. P.**

SCOOP MANAGEMENT LLC (NEW YORK LTD  
LIAB CO)  
4TH FLOOR  
532 BROADWAY  
NEW YORK, NY 10012

FOR: HIGH END CLOTHING, NAMELY, SHIRTS,  
T-SHIRTS, TANK TOPS, SWEAT SHIRTS, SWEA-  
TERS, JACKETS, PANTS, JEANS, SUITS, BATHING

SUITS, SCARVES, UNDERWEAR AND FOOT-  
WEAR, IN CLASS 25 (U.S. CLS. 22 AND 39).

FIRST USE 2-15-2007; IN COMMERCE 2-15-2007.

SN 77-011,023, FILED 9-29-2006.

JILL C. ALT, EXAMINING ATTORNEY

Int. Cls.: 9, 10, 25, 35, 38, 39, and 42

Prior U.S. Cls.: 21, 22, 23, 26, 36, 38, 39, 44, 100, 101, 102, 104, and 105

Reg. No. 3,468,532

United States Patent and Trademark Office

Registered July 15, 2008

TRADEMARK  
SERVICE MARK  
PRINCIPAL REGISTER

GARMIN

GARMIN LTD. (CAYMAN ISLANDS CORPORATION)  
P.O. BOX 10670  
45 MARKET ST., SUITE 3206B, GARDENIA CT.  
CAMANA BAY, CAYMAN ISLANDS KY1 1006

FOR: SATELLITE NAVIGATION SYSTEMS, NAMELY, A GLOBAL POSITIONING SYSTEM (GPS); ELECTRONIC NAVIGATIONAL DEVICES, NAMELY, GLOBAL POSITIONING SATELLITE (GPS) BASED NAVIGATION RECEIVERS; ELECTRONIC DEPTH SOUNDERS; PORTABLE COMMUNICATION DEVICES, NAMELY, RADIO TRANSCEIVERS AND WIRELESS TELEPHONES; PRE-RECORDED CD-ROMS AND CARTRIDGES FEATURING DIGITAL MAP DATA AND SOFTWARE FOR FACILITATING USE OF GPS BASED NAVIGATION RECEIVERS, RADIO TRANSCEIVERS AND WIRELESS TELEPHONE; GLOBAL POSITIONING SYSTEMS COMPRISED OF COMPUTERS, TRANSMITTERS, NETWORK INTERFACE DEVICES, GPS RECEIVERS, ANTENNAS, AND A LCD DISPLAY; AUTOMOBILE NAVIGATION APPARATUS FEATURING GPS RECEIVERS, DIGITAL MAP DISPLAYS AND TURN-BY-TURN INSTRUCTIONS; ELECTRONIC MARINE NAVIGATION PRODUCTS, NAMELY, CHART PLOTTERS AND SONAR DEPTH SOUNDERS; AVIONICS, NAMELY, PORTABLE AND PANEL MOUNTED ELECTRONIC NAVIGATION INSTRUMENTS FOR ASSISTING A PILOT IN NAVIGATING AN AIRCRAFT, PRIMARY FLIGHT DISPLAYS AND MULTI-FUNCTION FLIGHT DISPLAYS; GPS RECEIVERS; PORTABLE GPS DEVICES, NAMELY, ELECTRONIC INSTRUMENTS FOR DETERMINING AND OUTPUTTING POSITION AND SPEED; MARINE ELECTRONIC APPARATUS, NAMELY, MARINE SONAR FISH FINDERS; ELECTRONIC CHART PLOTTERS; WIRELESS COMMUNICATIONS RADIOS; WIRELESS COMMUNICATIONS

RADIOS FEATURING A GPS RECEIVER; PERSONAL DIGITAL ASSISTANTS FEATURING A GPS RECEIVER AND ELECTRONIC MAPS; SATELLITE RADIO RECEIVERS; ELECTRONIC NAVIGATION DEVICES, NAMELY, GPS RECEIVERS HAVING AN ELECTRONIC COMPASS; ELECTRONIC NAVIGATION DEVICES NAMELY, GPS RECEIVERS HAVING AN ALTIMETER; ELECTRONIC STORAGE MEDIA, NAMELY, CD-ROMS, DVDS, DISCS AND CARDS CONTAINING MAP DATA; AND NAVIGATION SOFTWARE FOR CALCULATING AND DISPLAYING ROUTE; AVIONICS, COMMUNICATIONS, NAVIGATIONAL AND VEHICLE MONITORING EQUIPMENT, NAMELY, RADIO, NAVIGATIONAL AND GLOBAL POSITIONING SYSTEM RECEIVERS; DATA RADIO COMMUNICATIONS TRANSCEIVERS, DATA PROCESSORS AND DATA PROCESSING CONSOLES; THEFT DETERRENT SOFTWARE SOLD AS A COMPONENT OF GLOBAL POSITIONING SYSTEM (GPS) UNIT; COMPUTER SOFTWARE TO ENABLE THE TRANSMISSION OF MAPPING, NAVIGATION, TRAFFIC, WEATHER AND POINT-OF-INTEREST INFORMATION TO TELECOMMUNICATIONS NETWORKS, CELLULAR TELEPHONES AND NAVIGATION DEVICES; COMPUTER SOFTWARE FOR THE MARKING AND UPLOADING OF INFORMATION ABOUT PLACES OF INTEREST TO A GLOBAL POSITIONING SYSTEM, AND RETRIEVAL OF THIS INFORMATION VIA AUDIO TRANSMISSION AND VISUAL DISPLAY, SOLD AS A COMPONENT OF A GLOBAL POSITIONING SYSTEM UNIT; COMPUTER SOFTWARE FOR INPUTTING, STORING, PROCESSING OR OUTPUTTING PERSONAL EXERCISE OR FITNESS INFORMATION; PORTABLE PERSONAL NAVIGATION DEVICES; PORTABLE PERSONAL NAVIGATION DEVICES FEATURING TRAVEL GUIDE FEATURES, LANGUAGE TRANS-

LATION FEATURES, DICTIONARY FEATURES AND AUDIBLE BOOK-PLAYER FEATURES; WIRELESS TWO-WAY RADIOS; AND ELECTRONIC HANDHELD DEVICES, NAMELY, A COMBINATION TWO-WAY RADIO AND GPS RECEIVER; COMPUTER SOFTWARE, NAMELY, AN APPLICATION ALLOWING ENHANCED SATELLITE ACQUISITION, SOLD AS A COMPONENT PART OF A GLOBAL POSITIONING SYSTEM (GPS); MOTORCYCLE NAVIGATION SYSTEM FEATURING GPS RECEIVER, DIGITAL MAP DISPLAYS AND TURN-BY-TURN INSTRUCTIONS; HANDHELD GLOBAL POSITIONING SYSTEM (GPS) CONSISTING OF COMPUTERS, COMPUTER SOFTWARE, TRANSMITTERS, RECEIVERS AND NETWORK INTERFACE DEVICES; FM BAND RADIO RECEIVERS; ELECTRIC CABLES; BATTERY PACKS; ANTENNAS; PROTECTIVE CARRYING CASES FOR GPS UNITS; AND ELECTRONIC PET PRODUCTS, NAMELY, A GLOBAL POSITIONING SYSTEM USED TO LOCATE PETS, CONSISTING OF A GPS RECEIVER AND A TRANSMITTER WORN BY THE PET THAT TRANSMITS TO A RECEIVER HELD BY THE PET OWNER; ELECTRONIC EXERCISE MONITOR, NAMELY, AN ELECTRONIC TRACKING DEVICE; ELECTRONIC EXERCISE MONITOR FEATURING A GPS RECEIVER, NAMELY, AN ELECTRONIC TRACKING DEVICE, IN CLASS 9 (U.S. CLS. 21, 23, 26, 36 AND 38).

FIRST USE 4-25-1991; IN COMMERCE 4-25-1991.

FOR: ELECTRONIC EXERCISE MONITORS, NAMELY, A HEART RATE MONITOR; ELECTRONIC EXERCISE MONITOR FEATURING A GPS RECEIVER, NAMELY, A HEART RATE MONITOR, IN CLASS 10 (U.S. CLS. 26, 39 AND 44).

FIRST USE 11-10-2003; IN COMMERCE 11-10-2003.

FOR: CLOTHING, NAMELY, SHIRTS, HATS AND CAPS, IN CLASS 25 (U.S. CLS. 22 AND 39).

FIRST USE 9-27-2006; IN COMMERCE 9-27-2006.

FOR: DEALERSHIP SERVICES IN THE FIELDS OF COMMUNICATIONS, NAVIGATION AND AVIONICS EQUIPMENT; VALUE-ADDED RESELLER DISTRIBUTORSHIP AND WHOLESALE DISTRIBUTORSHIP SERVICES IN THE FIELDS OF AVIONICS, COMMUNICATIONS AND NAVIGATION, IN CLASS 35 (U.S. CLS. 100, 101 AND 102).

FIRST USE 4-10-2003; IN COMMERCE 4-10-2003.

FOR: TRANSMISSION OF A GLOBAL POSITIONING SYSTEM USER'S LOCATION TO OTHERS VIA TELECOMMUNICATION AND GLOBAL COMMUNICATION NETWORKS, IN CLASS 38 (U.S. CLS. 100, 101 AND 104).

FIRST USE 3-0-1999; IN COMMERCE 3-0-1999.

FOR: PROVIDING MAPPING, NAVIGATION, TRAFFIC AND POINT-OF-INTEREST INFORMATION VIA TELECOMMUNICATION NETWORKS, CELLULAR TELEPHONES AND WIRELESS NAVIGATION DEVICES, IN CLASS 39 (U.S. CLS. 100 AND 105).

FIRST USE 9-0-2005; IN COMMERCE 9-0-2005.

FOR: PROVIDING WEATHER INFORMATION VIA TELECOMMUNICATION NETWORKS, CELLULAR TELEPHONES AND WIRELESS NAVIGATION DEVICES, IN CLASS 42 (U.S. CLS. 100 AND 101).

FIRST USE 9-0-2005; IN COMMERCE 9-0-2005.

THE MARK CONSISTS OF STANDARD CHARACTERS WITHOUT CLAIM TO ANY PARTICULAR FONT, STYLE, SIZE, OR COLOR.

OWNER OF U.S. REG. NOS. 2,288,989, 2,949,731, AND 3,107,462.

SN 77-011,743, FILED 10-2-2006.

AMOS T. MATTHEWS, JR., EXAMINING ATTORNEY

**Int. Cl.: 5**

**Prior U.S. Cls.: 6, 18, 44, 46, 51, and 52**

**Reg. No. 3,468,533**

**United States Patent and Trademark Office**

**Registered July 15, 2008**

**TRADEMARK  
PRINCIPAL REGISTER**

**PREVELLE**

MENTOR CORPORATION (MINNESOTA CORPORATION)  
201 MENTOR DRIVE  
SANTA BARBARA, CA 93111

FOR: MEDICAL DEVICES, NAMELY, SELF CONTAINED SYRINGES AND AMPULES PRE-FILLED WITH HYALURONIC ACID AND DERIVATIVES THEREOF ALONE, OR IN COMBINATION WITH OTHER POLYSACCHARIDES, AND WITH OR WITHOUT LIDOCAINE; INJECTABLE DERMAL FILLER, TO BE INJECTED UNDER THE SKIN, USED TO REDUCE OR ELIMINATE FINE LINES AND WRINKLES, FILL SCARS AND CONTOUR THE LIPS AND FACE; MEDICAL DEVICES, NAMELY, DERMAL FILLER KITS COMPRISING A SYR-

INGE PRE-FILLED WITH INJECTABLE DERMAL FILLER; ALL THE AFORESAID FOR USE IN DOCTORS' OFFICES, HOSPITALS AND MEDISPAS, IN CLASS 5 (U.S. CLS. 6, 18, 44, 46, 51 AND 52).

FIRST USE 5-12-2008; IN COMMERCE 5-12-2008.

THE MARK CONSISTS OF STANDARD CHARACTERS WITHOUT CLAIM TO ANY PARTICULAR FONT, STYLE, SIZE, OR COLOR.

SN 77-012,961, FILED 10-3-2006.

TOBY BULLOFF, EXAMINING ATTORNEY

Int. Cl.: 25

Prior U.S. Cls.: 22 and 39

United States Patent and Trademark Office

Reg. No. 3,468,534

Registered July 15, 2008

TRADEMARK  
PRINCIPAL REGISTER



CARROLL COMPANIES, INC. (NORTH CAROLINA CORPORATION)  
1640 OLD HWY 421 SOUTH  
BOONE, NC 28607

FOR: LEATHER JACKETS, IN CLASS 25 (U.S. CLS. 22 AND 39).

FIRST USE 9-1-2005; IN COMMERCE 9-1-2005.

NO CLAIM IS MADE TO THE EXCLUSIVE RIGHT TO USE "ORIGINAL WEAR" , APART FROM THE MARK AS SHOWN.

THE COLOR(S) RED, WHITE AND BLUE IS/ARE CLAIMED AS A FEATURE OF THE MARK.

THE MARK CONSISTS OF THE ENTIRE DESIGN IS OVAL WITH THE WIDTH BEING LONGER THEN THE HEIGHT. A BLUE BACKGROUND WITH A WHITE SQUIGGLY LINE IS THE BORDER. THE WORDS "CARROLL ORIGINAL WEAR" IS IN RED. THE "C" IN "CARROLL" IS LARGE AND THE "A" IS SWALLOWED BY THE LARGE "C". THE "R" AT THE END OF "WEAR" IS AS LARGE AS THE "C" IN "CARROLL". HALFWAY UNDER THE WORD "ORIGINAL" AND ABOVE THE SQUIGGLY WHITE LINE AT THE BOTTOM THERE IS A FIVE POINTED STAR WHICH IS WHITE.

SN 77-014,643, FILED 10-5-2006.

SARA THOMAS, EXAMINING ATTORNEY



Int. Cl.: 31

Prior U.S. Cls.: 1 and 46

United States Patent and Trademark Office

Reg. No. 3,468,535

Registered July 15, 2008

TRADEMARK  
PRINCIPAL REGISTER

# Tiffany Teff

J.C. WATSON COMPANY (IDAHO CORPORATION)  
201 EAST MAIN STREET  
PO BOX 300  
PARMA, ID 83660

NO CLAIM IS MADE TO THE EXCLUSIVE RIGHT TO USE "TEFF", APART FROM THE MARK AS SHOWN.

FOR: AGRICULTURAL SEEDS FOR GROWING LIVESTOCK FEED IN THE NATURE OF TEFF, IN CLASS 31 (U.S. CLS. 1 AND 46).

THE NAME "TIFFANY TEFF" DOES NOT IDENTIFY ANY LIVING INDIVIDUAL.

FIRST USE 3-31-2007; IN COMMERCE 3-31-2007.

SN 77-014,903, FILED 10-5-2006.

THE MARK CONSISTS OF STANDARD CHARACTERS WITHOUT CLAIM TO ANY PARTICULAR FONT, STYLE, SIZE, OR COLOR.

BRIAN PINO, EXAMINING ATTORNEY

**Int. Cl.: 36**

**Prior U.S. Cls.: 100, 101, and 102**

**United States Patent and Trademark Office**

**Reg. No. 3,468,536**

**Registered July 15, 2008**

**SERVICE MARK  
PRINCIPAL REGISTER**

**COMPASS BUSINESSCLASS  
ONLINE**

COMPASS BANCSHARES, INC. (DELAWARE  
CORPORATION)  
15 SOUTH 20TH STREET, 12TH FLOOR  
BIRMINGHAM, AL 35233

FOR: BANKING SERVICES, IN CLASS 36 (U.S.  
CLS. 100, 101 AND 102).

FIRST USE 10-8-2007; IN COMMERCE 10-8-2007.

THE MARK CONSISTS OF STANDARD CHAR-  
ACTERS WITHOUT CLAIM TO ANY PARTICULAR  
FONT, STYLE, SIZE, OR COLOR.

OWNER OF U.S. REG. NOS. 1,604,027, 1,894,328,  
AND OTHERS.

NO CLAIM IS MADE TO THE EXCLUSIVE  
RIGHT TO USE "BUSINESS CLASS ONLINE",  
APART FROM THE MARK AS SHOWN.

SN 77-014,914, FILED 10-5-2006.

MARGERY A. TIERNEY, EXAMINING ATTORNEY

**Int. Cl.: 14**

**Prior U.S. Cls.: 2, 27, 28, and 50**

**United States Patent and Trademark Office**

**Reg. No. 3,468,537**

**Registered July 15, 2008**

**TRADEMARK  
PRINCIPAL REGISTER**

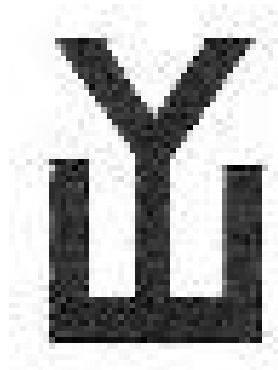

THOMPSON, JOAN A. (UNITED STATES INDIVIDUAL)  
802 CYPRESS GROVE LANE, APT. 104  
POMPANO BEACH, FL 33069

FOR: JEWELRY, IN CLASS 14 (U.S. CLS. 2, 27, 28 AND 50).

FIRST USE 7-25-2007; IN COMMERCE 7-25-2007.

THE MARK CONSISTS OF A RANDOM DESIGN.

SN 77-015,472, FILED 10-6-2006.

ARETHA SOMERVILLE, EXAMINING ATTORNEY

**Int. Cl.: 23**

**Prior U.S. Cl.: 43**

**United States Patent and Trademark Office**

**Reg. No. 3,468,538**

**Registered July 15, 2008**

**TRADEMARK  
PRINCIPAL REGISTER**



AMERICAN & EFIRD ENTERPRISES, INC.  
(NORTH CAROLINA CORPORATION)  
22 AMERICAN STREET  
MOUNT HOLLY, NC 28120

OWNER OF U.S. REG. NOS. 695,405 AND 1,723,867.

SN 77-015,497, FILED 10-6-2006.

FOR: THREAD; YARN, IN CLASS 23 (U.S. CL. 43).

FIRST USE 11-0-2007; IN COMMERCE 11-0-2007.

ALEXANDER L. POWERS, EXAMINING ATTOR-  
NEY

Int. Cl.: 9

Prior U.S. Cls.: 21, 23, 26, 36, and 38

Reg. No. 3,468,539

United States Patent and Trademark Office

Registered July 15, 2008

TRADEMARK  
PRINCIPAL REGISTER



PNY TECHNOLOGIES, INC. (DELAWARE CORPORATION)  
299 WEBRO ROAD  
PARSIPPANY, NJ 07054

FOR: COMPUTER PERIPHERAL DEVICES, NAMELY, FLASH MEMORY CARDS, FLASH CARD READERS, MEMORY UPGRADES, COMPU-

TER MEMORY CHIPS, AND GRAPHIC CARDS, IN CLASS 9 (U.S. CLS. 21, 23, 26, 36 AND 38).

FIRST USE 11-1-2006; IN COMMERCE 11-1-2006.

SN 77-016,337, FILED 10-7-2006.

ALICIA COLLINS, EXAMINING ATTORNEY

**Int. Cls.: 9, 16, 19, and 20**

**Prior U.S. Cls.: 1, 2, 5, 12, 13, 21, 22, 23, 25, 26, 29, 32, 33, 36, 37, 38, and 50**

**Reg. No. 3,468,540**

**United States Patent and Trademark Office**

**Registered July 15, 2008**

**TRADEMARK  
PRINCIPAL REGISTER**

**SIMPLE AND SMART**

SMART FURNITURE, INC. (DELAWARE CORPORATION)  
430 MARKET STREET  
CHATTANOOGA, TN 37402

FOR: MODULAR FURNITURE ACCESSORIES, NAMELY, STORAGE RACKS FOR COMPUTER OR AUDIO-VISUAL MEDIA IN THE FORM OF COMPACT DISCS, AUDIO OR VIDEO CASSETTES, AND DVDS, IN CLASS 9 (U.S. CLS. 21, 23, 26, 36 AND 38).

FIRST USE 12-31-2000; IN COMMERCE 12-31-2000.

FOR: MODULAR FURNITURE ACCESSORIES, NAMELY, ORGANIZERS FOR STATIONERY USE, DESK TOP ORGANIZERS, BOOKENDS AND ORGANIZER TRAYS, IN CLASS 16 (U.S. CLS. 2, 5, 22, 23, 29, 37, 38 AND 50).

FIRST USE 12-31-2000; IN COMMERCE 12-31-2000.

FOR: PORTABLE TRADE SHOW DISPLAY BOOTHS NOT MADE PRIMARILY OF METAL, IN CLASS 19 (U.S. CLS. 1, 12, 33 AND 50).

FIRST USE 12-31-2000; IN COMMERCE 12-31-2000.

FOR: MODULAR FURNITURE AND FURNITURE PARTS, NAMELY, DISPLAY RACKS, SALES AND DISPLAY COUNTERS, RETAIL POINT OF PURCHASE DISPLAYS, AND STORAGE RACKS, IN CLASS 20 (U.S. CLS. 2, 13, 22, 25, 32 AND 50).

FIRST USE 12-31-2000; IN COMMERCE 12-31-2000.

THE MARK CONSISTS OF STANDARD CHARACTERS WITHOUT CLAIM TO ANY PARTICULAR FONT, STYLE, SIZE, OR COLOR.

OWNER OF U.S. REG. NO. 2,379,151.

SN 77-016,648, FILED 10-9-2006.

SUNG IN, EXAMINING ATTORNEY

**Int. Cl.: 41**

**Prior U.S. Cls.: 100, 101, and 107**

**United States Patent and Trademark Office**

**Reg. No. 3,468,541**

**Registered July 15, 2008**

**SERVICE MARK  
PRINCIPAL REGISTER**

**UNDERGROUND FITNESS**

PAST, MARLA (UNITED STATES INDIVIDUAL)  
140 GARTH ROAD  
SCARSDALE, NY 10583

FOR: HEALTH CLUB SERVICES, NAMELY, PROVIDING INSTRUCTION AND EQUIPMENT IN THE FIELD OF PHYSICAL EXERCISE, IN CLASS 41 (U.S. CLS. 100, 101 AND 107).

FIRST USE 9-30-2006; IN COMMERCE 9-30-2006.

THE MARK CONSISTS OF STANDARD CHARACTERS WITHOUT CLAIM TO ANY PARTICULAR FONT, STYLE, SIZE, OR COLOR.

NO CLAIM IS MADE TO THE EXCLUSIVE RIGHT TO USE "FITNESS", APART FROM THE MARK AS SHOWN.

SN 77-017,295, FILED 10-9-2006.

RONALD AIKENS, EXAMINING ATTORNEY

**Int. Cls.: 9 and 35**

**Prior U.S. Cls.: 21, 23, 26, 36, 38, 100, 101, and 102**

**United States Patent and Trademark Office**

**Reg. No. 3,468,542**

**Registered July 15, 2008**

**TRADEMARK  
SERVICE MARK  
PRINCIPAL REGISTER**

**LINKSPAN**

HANGER ORTHOPEDIC GROUP, INC. (DELA-  
WARE CORPORATION)  
SUITE 1200  
TWO BETHESDA METRO CENTER  
BETHESDA, MD 20814

FOR: COMPUTER OPERATING SYSTEM FOR  
PATIENT INFORMATION AND CLAIMS, IN CLASS  
9 (U.S. CLS. 21, 23, 26, 36 AND 38).

FIRST USE 11-1-2006; IN COMMERCE 11-1-2006.

FOR: MANAGEMENT OF PROVIDER NET-  
WORK FOR GENERAL ADMINISTRATION OF  
ORTHOTIC AND PROSTHETIC FOCUSED HEALTH

CARE SERVICES, IN CLASS 35 (U.S. CLS. 100, 101  
AND 102).

FIRST USE 11-1-2006; IN COMMERCE 11-1-2006.

THE MARK CONSISTS OF STANDARD CHAR-  
ACTERS WITHOUT CLAIM TO ANY PARTICULAR  
FONT, STYLE, SIZE, OR COLOR.

SN 77-017,804, FILED 10-10-2006.

ALICE SUE CARRUTHERS, EXAMINING ATTOR-  
NEY



**Int. Cl.: 9**

**Prior U.S. Cls.: 21, 23, 26, 36, and 38**

**Reg. No. 3,468,543**

**United States Patent and Trademark Office**

**Registered July 15, 2008**

**TRADEMARK  
PRINCIPAL REGISTER**

**DEEP END**

KUSTOM MUSICAL AMPLIFICATION INC.  
(OHIO CORPORATION)  
3015 KUSTOM DRIVE  
HEBRON, KY 41048

FOR: MUSICAL INSTRUMENT AMPLIFIERS  
AND SOUND AMPLIFICATION SYSTEMS CON-  
SISTING OF SPEAKERS, SPEAKER CABINETS,  
AMPLIFIER CONTROL PANELS, CONNECTING  
CABLES, WIRES, PLUGS, AND PARTS AND FIT-  
TINGS FOR ALL OF THE FOREGOING, IN CLASS 9  
(U.S. CLS. 21, 23, 26, 36 AND 38).

FIRST USE 1-18-2007; IN COMMERCE 1-18-2007.

THE MARK CONSISTS OF STANDARD CHAR-  
ACTERS WITHOUT CLAIM TO ANY PARTICULAR  
FONT, STYLE, SIZE, OR COLOR.

SN 77-019,328, FILED 10-12-2006.

ALICIA COLLINS, EXAMINING ATTORNEY

**Int. Cl.: 41**

**Prior U.S. Cls.: 100, 101, and 107**

**United States Patent and Trademark Office**

**Reg. No. 3,468,544**

**Registered July 15, 2008**

**SERVICE MARK  
PRINCIPAL REGISTER**

# LEADERSHIP

LEADERSHIP DIRECTORIES, INC. (D.C. CORPORATION)  
104 FIFTH AVENUE  
NEW YORK, NY 10011

FOR: PROVIDING AN ONLINE COMPUTER DATABASE AND DIRECTORIES FEATURING INFORMATION IN THE NATURE OF PROFILES OF PROMINENT INDIVIDUALS AND ORGANIZATIONS IN GOVERNMENT, BUSINESS, AND PROFESSIONAL ARENAS, IN CLASS 41 (U.S. CLS. 100, 101 AND 107).

FIRST USE 11-30-2006; IN COMMERCE 11-30-2006.

THE MARK CONSISTS OF STANDARD CHARACTERS WITHOUT CLAIM TO ANY PARTICULAR FONT, STYLE, SIZE, OR COLOR.

SN 77-019,760, FILED 10-12-2006.

SHAUNIA CARLYLE, EXAMINING ATTORNEY

**Int. Cl.: 35**

**Prior U.S. Cls.: 100, 101, and 102**

**United States Patent and Trademark Office**

**Reg. No. 3,468,545**

**Registered July 15, 2008**

**SERVICE MARK  
PRINCIPAL REGISTER**

**LEADERSHIP DATAFEEDS**

LEADERSHIP DIRECTORIES, INC. (D.C. CORPORATION)  
104 FIFTH AVENUE  
NEW YORK, NY 10011

FOR: COLLECTION, PREPARATION, COMPOSITION, STORAGE, PROCESSING, ACQUISITION, UPDATES, AND PROVISION OF USER-DEFINED INFORMATION IN THE NATURE OF PROFILES OF PROMINENT INDIVIDUALS AND ORGANIZATIONS IN GOVERNMENT, BUSINESS, AND PROFESSIONAL ARENAS, IN CLASS 35 (U.S. CLS. 100, 101 AND 102).

FIRST USE 11-30-2006; IN COMMERCE 11-30-2006.

THE MARK CONSISTS OF STANDARD CHARACTERS WITHOUT CLAIM TO ANY PARTICULAR FONT, STYLE, SIZE, OR COLOR.

NO CLAIM IS MADE TO THE EXCLUSIVE RIGHT TO USE "DATAFEEDS", APART FROM THE MARK AS SHOWN.

SN 77-019,815, FILED 10-12-2006.

SHAUNIA CARLYLE, EXAMINING ATTORNEY

**Int. Cl.: 7**

**Prior U.S. Cls.: 13, 19, 21, 23, 31, 34, and 35**

**Reg. No. 3,468,546**

**United States Patent and Trademark Office**

**Registered July 15, 2008**

**TRADEMARK  
PRINCIPAL REGISTER**

**SPS SYNTEX**

SPS SYNTEX KABUSHIKI KAISHA (JAPAN CORPORATION), DBA SPS SYNTEX INC.,

3-2-1 SAKADO, TAKATSU-KU

KAWASAKI-SHI, KANAGAWA, JAPAN

FOR: SINTERING MACHINES, IN CLASS 7 (U.S. CLS. 13, 19, 21, 23, 31, 34 AND 35).

FIRST USE 8-19-2005; IN COMMERCE 7-21-2006.

THE MARK CONSISTS OF STANDARD CHARACTERS WITHOUT CLAIM TO ANY PARTICULAR FONT, STYLE, SIZE, OR COLOR.

NO CLAIM IS MADE TO THE EXCLUSIVE RIGHT TO USE "SPS", APART FROM THE MARK AS SHOWN.

SN 77-019,834, FILED 10-12-2006.

RUDY R. SINGLETON, EXAMINING ATTORNEY

**Int. Cl.: 35**

**Prior U.S. Cls.: 100, 101, and 102**

**United States Patent and Trademark Office**

**Reg. No. 3,468,547**

**Registered July 15, 2008**

**SERVICE MARK  
PRINCIPAL REGISTER**

**SPHERES**

FULL LIFE CENTERS LLC (ILLINOIS LTD LIAB  
CO)  
2750 N. RACINE  
CHICAGO, IL 60614

FOR: RETAIL STORE SERVICES, ONLINE RE-  
TAIL STORE SERVICES, AND MAIL ORDER SER-  
VICES FEATURING PRODUCTS IN THE FIELDS  
OF SELF-IMPROVEMENT, PERSONAL EMPOWER-  
MENT, MOTIVATION, LIFESTYLE, CAREER, PER-  
SONAL RELATIONSHIPS, HEALTH AND  
NUTRITION, FINANCE, PERSONAL RELAXATION  
AND ENTERTAINMENT, CHARITABLE AND  
COMMUNITY SERVICE, SPIRITUALITY, AND  
HOME DECORATING, NAMELY, CANDLES,  
ROOM SPRAYS, ROOM DIFFUSERS, HARD SOAPS,  
LIQUID SOAPS, BODY LOTIONS, AROMATHER-  
APY AND INCENSES, CANDY, MINTS, CHOCO-

LATE, MUGS, JOURNALS, ART, HOUSEWARES,  
PENS, PENCILS, BOOKS, SPORTS EQUIPMENT,  
ZEN TOOLS, POSTCARDS, GREETING CARDS,  
TRAVEL-RELATED GIFTS, COFFEE AND TEA  
RELATED GOODS, AND HOME DECORATION  
OBJECTS, IN CLASS 35 (U.S. CLS. 100, 101 AND 102).

FIRST USE 11-1-2007; IN COMMERCE 11-1-2007.

THE MARK CONSISTS OF STANDARD CHAR-  
ACTERS WITHOUT CLAIM TO ANY PARTICULAR  
FONT, STYLE, SIZE, OR COLOR.

SN 77-020,334, FILED 10-13-2006.

AISHA CLARKE, EXAMINING ATTORNEY

**Int. Cl.: 5**

**Prior U.S. Cls.: 6, 18, 44, 46, 51, and 52**

**Reg. No. 3,468,548**

**United States Patent and Trademark Office**

**Registered July 15, 2008**

---

**TRADEMARK  
PRINCIPAL REGISTER**

**CARDIOLACTIS**

TECHNOLOGIE BIOLACTIS INC. (CANADA  
CORPORATION)  
2152, CHEMIN ST-JOSEPH, C.P. 1091  
LA BAIE, CANADA G7B3P3

THE MARK CONSISTS OF STANDARD CHAR-  
ACTERS WITHOUT CLAIM TO ANY PARTICULAR  
FONT, STYLE, SIZE, OR COLOR.

FOR: FUNCTIONAL FOOD SUPPLEMENT THAT  
HELPS MANAGE CARDIOVASCULAR RISKS BY  
REGULATING CIRCULATING BLOOD LIPIDS, IN  
CLASS 5 (U.S. CLS. 6, 18, 44, 46, 51 AND 52).

SN 77-020,465, FILED 10-13-2006.

FIRST USE 11-23-2006; IN COMMERCE 11-23-2006.

DOMINIC FATHY, EXAMINING ATTORNEY

**Int. Cl.: 35**

**Prior U.S. Cls.: 100, 101, and 102**

**United States Patent and Trademark Office**

**Reg. No. 3,468,549**

**Registered July 15, 2008**

**SERVICE MARK  
PRINCIPAL REGISTER**

**SCRAP-A-FAIRE**

MEREDITH CORPORATION (IOWA CORPORATION)  
1716 LOCUST STREET  
DES MOINES, IA 503093023

THE MARK CONSISTS OF STANDARD CHARACTERS WITHOUT CLAIM TO ANY PARTICULAR FONT, STYLE, SIZE, OR COLOR.

FOR: CONDUCTING AN ON-LINE TRADE SHOW EXHIBITION IN THE FIELD OF SCRAP-BOOKING, IN CLASS 35 (U.S. CLS. 100, 101 AND 102).

SN 77-020,627, FILED 10-13-2006.

FIRST USE 12-5-2006; IN COMMERCE 12-5-2006.

LAURIE KAUFMAN, EXAMINING ATTORNEY

**Int. Cl.: 25**

**Prior U.S. Cls.: 22 and 39**

**United States Patent and Trademark Office**

**Reg. No. 3,468,550**

**Registered July 15, 2008**

**TRADEMARK  
PRINCIPAL REGISTER**

**breadandbutter**

BREADANDBUTTER DESIGNS INC (CALIFORNIA CORPORATION)  
12611 WEST WASHINGTON BLVD.  
LOS ANGELES, CA 90006

THE MARK CONSISTS OF STANDARD CHARACTERS WITHOUT CLAIM TO ANY PARTICULAR FONT, STYLE, SIZE, OR COLOR.

FOR: BLOUSES; DRESSES; T-SHIRTS; TANK TOPS, IN CLASS 25 (U.S. CLS. 22 AND 39).

SN 77-021,103, FILED 10-13-2006.

FIRST USE 6-20-2006; IN COMMERCE 6-20-2006.

TOBY BULLOFF, EXAMINING ATTORNEY



**Int. Cls.: 9, 10, 38, 39, and 42**

**Prior U.S. Cls.: 21, 23, 26, 36, 38, 39, 44, 100, 101, 104, and 105**

**Reg. No. 3,468,551**

**United States Patent and Trademark Office**

**Registered July 15, 2008**

**TRADEMARK  
SERVICE MARK  
PRINCIPAL REGISTER**



**GARMIN**

GARMIN LTD. (CAYMAN ISLANDS CORPORATION)

P.O. BOX 10670

45 MARKET ST., SUITE 3206B, GARDENIA CT.  
CAMANA BAY, CAYMAN ISLANDS

FOR: SATELLITE NAVIGATION SYSTEMS, NAMELY, A GLOBAL POSITIONING SYSTEM (GPS); ELECTRONIC NAVIGATIONAL DEVICES, NAMELY, GLOBAL POSITIONING SATELLITE (GPS) BASED NAVIGATION RECEIVERS; ELECTRONIC DEPTH SOUNDERS; PORTABLE COMMUNICATION DEVICES, NAMELY, RADIO TRANSCEIVERS AND WIRELESS TELEPHONES; PRE-RECORDED CD-ROMS AND CARTRIDGES FEATURING DIGITAL MAP DATA AND SOFTWARE FOR FACILITATING USE OF GPS BASED NAVIGATION RECEIVERS, RADIO TRANSCEIVERS AND WIRELESS TELEPHONE; GLOBAL POSITIONING SYSTEMS COMPRISED OF COMPUTERS, TRANSMITTERS, NETWORK INTERFACE DEVICES, GPS RECEIVERS, ANTENNAS, AND A LCD DISPLAY; AUTOMOBILE NAVIGATION APPARATUS FEATURING GPS RECEIVERS, DIGITAL MAP DISPLAYS AND TURN-BY-TURN INSTRUCTIONS; ELECTRONIC MARINE NAVIGATION PRODUCTS, NAMELY, CHART PLOTTERS AND SONAR DEPTH SOUNDERS; AVIONICS, NAMELY, PORTABLE AND PANEL MOUNTED ELECTRONIC NAVIGATION INSTRUMENTS FOR ASSISTING A PILOT IN NAVIGATING AN AIRCRAFT, PRIMARY FLIGHT DISPLAYS AND MULTI-FUNCTION FLIGHT DISPLAYS; GPS RECEIVERS; PORTABLE GPS DEVICES, NAMELY, ELECTRONIC INSTRUMENTS FOR DETERMINING AND OUTPUTTING POSITION AND SPEED; MARINE ELECTRONIC APPARATUS, NAMELY, MARINE SONAR FISH FINDERS; ELECTRONIC CHART PLOTTERS; WIRELESS COMMUNICA-

TIONS RADIOS; WIRELESS COMMUNICATIONS RADIOS FEATURING A GPS RECEIVER; PERSONAL DIGITAL ASSISTANTS FEATURING A GPS RECEIVER AND ELECTRONIC MAPS; SATELLITE RADIO RECEIVERS; ELECTRONIC NAVIGATION DEVICES, NAMELY, GPS RECEIVERS HAVING AN ELECTRONIC COMPASS; ELECTRONIC NAVIGATION DEVICES, NAMELY, GPS RECEIVERS HAVING AN ALTIMETER; ELECTRONIC STORAGE MEDIA, NAMELY, CD-ROMS, DVDS, DISCS AND CARDS CONTAINING MAP DATA; AND NAVIGATION SOFTWARE FOR CALCULATING AND DISPLAYING ROUTE; AVIONICS, COMMUNICATIONS, NAVIGATIONAL AND VEHICLE MONITORING EQUIPMENT, NAMELY, RADIO, NAVIGATIONAL AND GLOBAL POSITIONING SYSTEM RECEIVERS; DATA RADIO COMMUNICATIONS TRANSCEIVERS, DATA PROCESSORS AND DATA PROCESSING CONSOLES; THEFT DETERRENT SOFTWARE SOLD AS A COMPONENT OF GLOBAL POSITIONING SYSTEM (GPS) UNIT; COMPUTER SOFTWARE TO ENABLE THE TRANSMISSION OF MAPPING, NAVIGATION, TRAFFIC, WEATHER AND POINT-OF-INTEREST INFORMATION TO TELECOMMUNICATIONS NETWORKS, CELLULAR TELEPHONES AND NAVIGATION DEVICES; COMPUTER SOFTWARE FOR THE MARKING AND UPLOADING OF INFORMATION ABOUT PLACES OF INTEREST TO A GLOBAL POSITIONING SYSTEM, AND RETRIEVAL OF THIS INFORMATION VIA AUDIO TRANSMISSION AND VISUAL DISPLAY, SOLD AS A COMPONENT OF A GLOBAL POSITIONING SYSTEM UNIT; COMPUTER SOFTWARE FOR INPUTTING, STORING, PROCESSING OR OUTPUTTING PERSONAL EXERCISE OR FITNESS INFORMATION; PORTABLE PERSONAL NAVIGATION DEVICES; PORTABLE PERSONAL NAVIGATION DEVICES FEATURING

TRAVEL GUIDE FEATURES, LANGUAGE TRANSLATION FEATURES, DICTIONARY FEATURES AND AUDIBLE BOOK-PLAYER FEATURES; WIRELESS TWO-WAY RADIOS; AND ELECTRONIC HANDHELD DEVICES, NAMELY, A COMBINATION TWO-WAY RADIO AND GPS RECEIVER; COMPUTER SOFTWARE, NAMELY, AN APPLICATION ALLOWING ENHANCED SATELLITE ACQUISITION, SOLD AS A COMPONENT PART OF A GLOBAL POSITIONING SYSTEM (GPS); MOTOR-CYCLE NAVIGATION SYSTEM FEATURING GPS RECEIVER, DIGITAL MAP DISPLAYS AND TURN-BY-TURN INSTRUCTIONS; HANDHELD GLOBAL POSITIONING SYSTEM (GPS) CONSISTING OF COMPUTERS, COMPUTER SOFTWARE, TRANSMITTERS, RECEIVERS AND NETWORK INTERFACE DEVICES; FM BAND RADIO RECEIVERS; ELECTRIC CABLES; BATTERY PACKS; ANTENNAS; PROTECTIVE CARRYING CASES FOR GPS UNITS; AND ELECTRONIC PET PRODUCTS, NAMELY, A GLOBAL POSITIONING SYSTEM USED TO LOCATE PETS, CONSISTING OF A GPS RECEIVER AND A TRANSMITTER WORN BY THE PET THAT TRANSMITS TO A RECEIVER HELD BY THE PET OWNER; ELECTRONIC EXERCISE MONITOR, NAMELY, AN ELECTRONIC TRACKING DEVICE; ELECTRONIC EXERCISE MONITOR FEATURING A GPS RECEIVER, NAMELY, AN ELECTRONIC TRACKING DEVICE, IN CLASS 9 (U.S. CLS. 21, 23, 26, 36 AND 38).

FIRST USE 10-29-2006; IN COMMERCE 10-29-2006.

FOR: ELECTRONIC EXERCISE MONITORS, NAMELY, A HEART RATE MONITOR; ELECTRONIC EXERCISE MONITOR FEATURING A GPS RECEIVER, NAMELY, A HEART RATE MONITOR, IN CLASS 10 (U.S. CLS. 26, 39 AND 44).

FIRST USE 10-0-2007; IN COMMERCE 10-0-2007.

FOR: TRANSMISSION OF A GLOBAL POSITIONING SYSTEM USER'S LOCATION TO OTHERS VIA TELECOMMUNICATION AND GLOBAL COMMUNICATION NETWORKS, IN CLASS 38 (U.S. CLS. 100, 101 AND 104).

FIRST USE 1-0-2007; IN COMMERCE 1-0-2007.

FOR: PROVIDING MAPPING, NAVIGATION, TRAFFIC AND POINT-OF-INTEREST INFORMATION VIA TELECOMMUNICATION NETWORKS, CELLULAR TELEPHONES AND WIRELESS NAVIGATION DEVICES, IN CLASS 39 (U.S. CLS. 100 AND 105).

FIRST USE 1-0-2007; IN COMMERCE 1-0-2007.

FOR: PROVIDING WEATHER INFORMATION VIA TELECOMMUNICATION NETWORKS, CELLULAR TELEPHONES AND WIRELESS NAVIGATION DEVICES, IN CLASS 42 (U.S. CLS. 100 AND 101).

FIRST USE 1-0-2007; IN COMMERCE 1-0-2007.

OWNER OF U.S. REG. NOS. 2,288,989, 2,949,731, AND 3,107,462.

THE MARK CONSISTS OF A STYLIZED ISO-SCALES TRIANGLE DESIGN AND THE STYLIZED WORD "GARMIN".

SN 77-021,124, FILED 10-13-2006.

AMOS T. MATTHEWS, JR., EXAMINING ATTORNEY

**Int. Cl.: 44**

**Prior U.S. Cls.: 100 and 101**

**United States Patent and Trademark Office**

**Reg. No. 3,468,552**

**Registered July 15, 2008**

**SERVICE MARK  
PRINCIPAL REGISTER**



**GARZA, MARIA GUADALUPE (MEXICO INDIVIDUAL)**

**VILLA DE ARAGON CP 66273**

**AV GOMEZ MORIN 404 LOCALES D0-D1-DW COL  
SAN PEDRO GARZA GARCIA, MEXICO**

**FIRST USE 12-15-2005; IN COMMERCE 12-15-2005.**

**SN 77-021,136, FILED 10-13-2006.**

**FOR: LASER HAIR REMOVAL, IN CLASS 44 (U.S. CLS. 100 AND 101).**

**AMEETA JORDAN, EXAMINING ATTORNEY**

Int. Cl.: 9

Prior U.S. Cls.: 21, 23, 26, 36, and 38

United States Patent and Trademark Office

Reg. No. 3,468,553

Registered July 15, 2008

TRADEMARK  
PRINCIPAL REGISTER



GARMIN LTD. (CAYMAN ISLANDS CORPORATION)  
PO BOX 30464 SMB, 5TH FLOOR, HARBOUR PL.  
103 SOUTH CHURCH STREET  
GEORGE TOWN, CAYMAN ISLANDS

FOR: SATELLITE NAVIGATION SYSTEMS, NAMELY, A GLOBAL POSITIONING SYSTEM (GPS); ELECTRONIC NAVIGATIONAL DEVICES, NAMELY, GLOBAL POSITIONING SATELLITE (GPS) BASED NAVIGATION RECEIVERS; ELECTRONIC DEPTH SOUNDERS; PORTABLE COMMUNICATION DEVICES, NAMELY, RADIO TRANSCEIVERS AND WIRELESS TELEPHONES; PRE-RECORDED CD-ROMS AND CARTRIDGES FEATURING DIGITAL MAP DATA AND SOFTWARE FOR FACILITATING USE OF GPS BASED NAVIGATION RECEIVERS, RADIO TRANSCEIVERS AND WIRELESS TELEPHONE; GLOBAL POSITIONING SYSTEMS COMPRISED OF COMPUTERS, TRANSMITTERS, NETWORK INTERFACE DEVICES, GPS RECEIVERS, ANTENNAS, AND A LCD DISPLAY; AUTOMOBILE NAVIGATION APPARATUS FEATURING GPS RECEIVERS, DIGITAL MAP DISPLAYS AND TURN-BY-TURN INSTRUCTIONS; ELECTRONIC MARINE NAVIGATION PRODUCTS, NAMELY, CHART PLOTTERS AND SONAR DEPTH SOUNDERS; AVIONICS, NAMELY, PORTABLE AND PANEL MOUNTED ELECTRONIC NAVIGATION INSTRUMENTS FOR ASSISTING A PILOT IN NAVIGATING AN AIRCRAFT, PRIMARY FLIGHT DISPLAYS AND MULTI-FUNCTION FLIGHT DISPLAYS; GPS RECEIVERS; PORTABLE GPS DEVICES, NAMELY, ELECTRONIC INSTRUMENTS FOR DETERMINING AND OUTPUTTING POSITION AND SPEED; MARINE ELECTRONIC APPARATUS, NAMELY, MARINE SONAR FISH FINDERS; ELECTRONIC CHART PLOTTERS; WIRELESS COMMUNICATIONS RADIOS; WIRELESS COMMUNICATIONS RADIOS FEATURING A GPS RECEIVER; PERSONAL DIGITAL ASSISTANTS FEATURING A GPS

RECEIVER AND ELECTRONIC MAPS; SATELLITE RADIO RECEIVERS; ELECTRONIC NAVIGATION DEVICES, NAMELY, GPS RECEIVERS HAVING AN ELECTRONIC COMPASS; ELECTRONIC NAVIGATION DEVICES NAMELY, GPS RECEIVERS HAVING AN ALTIMETER; ELECTRONIC STORAGE MEDIA, NAMELY, CD-ROMS, DVDS, DISCS AND CARDS CONTAINING MAP DATA; AND NAVIGATION SOFTWARE FOR CALCULATING AND DISPLAYING ROUTE; AVIONICS, COMMUNICATIONS, NAVIGATIONAL AND VEHICLE MONITORING EQUIPMENT, NAMELY, RADIO, NAVIGATIONAL AND GLOBAL POSITIONING SYSTEM RECEIVERS; DATA RADIO COMMUNICATIONS TRANSCEIVERS, DATA PROCESSORS AND DATA PROCESSING CONSOLES; THEFT DETERRENT SOFTWARE SOLD AS A COMPONENT OF GLOBAL POSITIONING SYSTEM (GPS) UNIT; COMPUTER SOFTWARE TO ENABLE THE TRANSMISSION OF MAPPING, NAVIGATION, TRAFFIC, WEATHER AND POINT-OF-INTEREST INFORMATION TO TELECOMMUNICATIONS NETWORKS, CELLULAR TELEPHONES AND NAVIGATION DEVICES; COMPUTER SOFTWARE FOR THE MARKING AND UPLOADING OF INFORMATION ABOUT PLACES OF INTEREST TO A GLOBAL POSITIONING SYSTEM, AND RETRIEVAL OF THIS INFORMATION VIA AUDIO TRANSMISSION AND VISUAL DISPLAY, SOLD AS A COMPONENT OF A GLOBAL POSITIONING SYSTEM UNIT; COMPUTER SOFTWARE FOR INPUTTING, STORING, PROCESSING OR OUTPUTTING PERSONAL EXERCISE OR FITNESS INFORMATION; PORTABLE PERSONAL NAVIGATION DEVICES; PORTABLE PERSONAL NAVIGATION DEVICES FEATURING TRAVEL GUIDE FEATURES, LANGUAGE TRANSLATION FEATURES, DICTIONARY FEATURES AND AUDIBLE BOOK-PLAYER FEATURES; WIRELESS TWO-WAY RADIOS; AND ELECTRONIC HANDHELD DEVICES, NAMELY, A COMBINATION TWO-WAY RADIO AND GPS RECEIVER;

COMPUTER SOFTWARE, NAMELY AN APPLICATION ALLOWING ENHANCED SATELLITE ACQUISITION, SOLD AS A COMPONENT PART OF A GLOBAL POSITIONING SYSTEM (GPS); MOTOR-CYCLE NAVIGATION SYSTEM FEATURING GPS RECEIVER, DIGITAL MAP DISPLAYS AND TURN-BY-TURN INSTRUCTIONS; HANDHELD GLOBAL POSITIONING SYSTEM (GPS) CONSISTING OF COMPUTERS, COMPUTER SOFTWARE, TRANSMITTERS, RECEIVERS AND NETWORK INTERFACE DEVICES; FM BAND RADIO RECEIVERS; ELECTRIC CABLES; BATTERY PACKS; ANTENNAS; PROTECTIVE CARRYING CASES FOR GPS UNITS; AND ELECTRONIC PET PRODUCTS, NAMELY, A GLOBAL POSITIONING SYSTEM USED TO LOCATE PETS, CONSISTING OF A GPS RECEIVER AND A TRANSMITTER WORN BY THE PET THAT TRANSMITS TO A RECEIVER HELD BY THE PET OWNER, IN CLASS 9 (U.S. CLS. 21, 23, 26, 36 AND 38).

FIRST USE 10-29-2006; IN COMMERCE 10-29-2006.

OWNER OF U.S. REG. NOS. 2,288,989, 2,949,731, AND 3,107,462.

THE COLOR(S) BLUE AND BLACK IS/ARE CLAIMED AS A FEATURE OF THE MARK.

THE MARK CONSISTS OF A BLUE STYLIZED ISOSCELES TRIANGLE DESIGN AND THE STYLIZED WORD "GARMIN" IN BLACK.

SN 77-021,159, FILED 10-13-2006.

AMOS T. MATTHEWS, JR., EXAMINING ATTORNEY

**Int. Cl.: 10**

**Prior U.S. Cls.: 26, 39, and 44**

**United States Patent and Trademark Office**

**Reg. No. 3,468,554**

**Registered July 15, 2008**

**TRADEMARK  
PRINCIPAL REGISTER**

**AGENTO**

C. R. BARD, INC. (NEW JERSEY CORPORATION)  
730 CENTRAL AVENUE  
MURRAY HILL, NJ 07974

FOR: ENDOTRACHEAL TUBES AND PARTS AND FITTINGS THEREFOR; AND COATING FOR ENDOTRACHEAL TUBES SOLD AS A COMPONENT OF THE FINISHED TUBES, IN CLASS 10 (U.S. CLS. 26, 39 AND 44).

FIRST USE 12-31-2007; IN COMMERCE 12-31-2007.

THE MARK CONSISTS OF STANDARD CHARACTERS WITHOUT CLAIM TO ANY PARTICULAR FONT, STYLE, SIZE, OR COLOR.

SN 77-022,090, FILED 10-16-2006.

DOMINIC FATHY, EXAMINING ATTORNEY

**Int. Cl.: 19**

**Prior U.S. Cls.: 1, 12, 33, and 50**

**United States Patent and Trademark Office**

**Reg. No. 3,468,555**

**Registered July 15, 2008**

**TRADEMARK  
PRINCIPAL REGISTER**

**THREE RIVERS STONE**

L&W STONE CORPORATION (CALIFORNIA  
CORPORATION)  
P.O. BOX 1224  
ORLAND, CA 95963

FOR: BUILDING STONES; PAVING STONES;  
WALL STONES, IN CLASS 19 (U.S. CLS. 1, 12, 33  
AND 50).

FIRST USE 1-1-2002; IN COMMERCE 1-1-2002.

THE MARK CONSISTS OF STANDARD CHAR-  
ACTERS WITHOUT CLAIM TO ANY PARTICULAR  
FONT, STYLE, SIZE, OR COLOR.

NO CLAIM IS MADE TO THE EXCLUSIVE  
RIGHT TO USE "STONE", APART FROM THE  
MARK AS SHOWN.

SN 77-023,267, FILED 10-17-2006.

JAMES LOVELACE, EXAMINING ATTORNEY

**Int. Cl.: 25**

**Prior U.S. Cls.: 22 and 39**

**United States Patent and Trademark Office**

**Reg. No. 3,468,556**

**Registered July 15, 2008**

---

**TRADEMARK  
PRINCIPAL REGISTER**

**BORAT**

TWENTIETH CENTURY FOX FILM CORPORATION (DELAWARE CORPORATION)  
10201 WEST PICO BOULEVARD  
LOS ANGELES, CA 90035

THE MARK CONSISTS OF STANDARD CHARACTERS WITHOUT CLAIM TO ANY PARTICULAR FONT, STYLE, SIZE, OR COLOR.

FOR: HATS; CAPS; T-SHIRTS; SHIRTS, IN CLASS 25 (U.S. CLS. 22 AND 39).

SN 77-023,582, FILED 10-18-2006.

FIRST USE 9-30-2006; IN COMMERCE 9-30-2006.

NICHOLAS ALTREE, EXAMINING ATTORNEY



**Int. Cl.: 32**

**Prior U.S. Cls.: 45, 46, and 48**

**United States Patent and Trademark Office**

**Reg. No. 3,468,557**

**Registered July 15, 2008**

---

**TRADEMARK  
PRINCIPAL REGISTER**

# Love Tale

SIERRA NEVADA BREWING CO. (CALIFORNIA  
CORPORATION)  
1075 E. 20TH ST.  
CHICO, CA 95928

THE MARK CONSISTS OF STANDARD CHAR-  
ACTERS WITHOUT CLAIM TO ANY PARTICULAR  
FONT, STYLE, SIZE, OR COLOR.

FOR: ALE, IN CLASS 32 (U.S. CLS. 45, 46 AND 48).

SN 77-024,485, FILED 10-18-2006.

FIRST USE 6-3-2008; IN COMMERCE 6-3-2008.

DOMINICK J. SALEMI, EXAMINING ATTORNEY

**Int. Cls.: 5 and 10**

**Prior U.S. Cls.: 6, 18, 26, 39, 44, 46, 51, and 52**

**United States Patent and Trademark Office**

**Reg. No. 3,468,558**

**Registered July 15, 2008**

**TRADEMARK  
PRINCIPAL REGISTER**

**ENGENEX**

BOEHRINGER TECHNOLOGIES LP (PENNSYLVANIA LIMITED PARTNERSHIP)  
500 E. WASHINGTON STREET  
NORRISTOWN, PA 19401

FOR: WOUND DRESSINGS, IN CLASS 5 (U.S. CLS. 6, 18, 44, 46, 51 AND 52).

FIRST USE 1-30-2007; IN COMMERCE 1-30-2007.

FOR: WOUND DRAINAGE APPARATUS; WOUND SUCTION APPARATUS, IN CLASS 10 (U.S. CLS. 26, 39 AND 44).

FIRST USE 1-30-2007; IN COMMERCE 1-30-2007.

THE MARK CONSISTS OF STANDARD CHARACTERS WITHOUT CLAIM TO ANY PARTICULAR FONT, STYLE, SIZE, OR COLOR.

THE WORDING "ENGENEX" HAS NO MEANING IN A FOREIGN LANGUAGE.

SN 77-025,656, FILED 10-20-2006.

SUSAN RICHARDS, EXAMINING ATTORNEY

Int. Cl.: 25

Prior U.S. Cls.: 22 and 39

United States Patent and Trademark Office

Reg. No. 3,468,559

Registered July 15, 2008

TRADEMARK  
PRINCIPAL REGISTER



MCCOMAS, ANNE MARIE (UNITED STATES  
INDIVIDUAL)  
3697 CAMINITO CIELO DEL MAR  
SAN DIEGO, CA 92130

FOR: BANDANAS; BATHING COSTUMES FOR  
WOMEN; COATS FOR MEN AND WOMEN; DRES-  
SES; FOOTWEAR FOR MEN AND WOMEN; FOOT-  
WEAR FOR WOMEN; GYM SHORTS; GYM SUITS;  
HATS; HEADBANDS; LEOTARDS AND TIGHTS  
FOR WOMEN, MEN AND CHILDREN OF NYLON,  
COTTON OR OTHER TEXTILE FIBERS; MEN AND  
WOMEN JACKETS, COATS, TROUSERS, VESTS;  
MEN'S SUITS, WOMEN'S SUITS; MONEY BELTS;  
PANTS; SHOES; SHORT-SLEEVED OR LONG-

SLEEVED T-SHIRTS; SHORTS; SKI BOOT BAGS;  
SKIRTS; SOCKS; SUN VISORS; SUSPENDER BELTS  
FOR MEN; SUSPENDER BELTS FOR WOMEN;  
SWEAT PANTS; SWEAT SHIRTS; SWIMSUITS; UN-  
DER GARMENTS; UNIFORMS; WAIST BELTS; WO-  
MEN'S SHOES; WOMEN'S UNDERWEAR, IN CLASS  
25 (U.S. CLS. 22 AND 39).

FIRST USE 11-15-2006; IN COMMERCE 4-4-2007.

SN 77-025,775, FILED 10-20-2006.

KAPIL BHANOT, EXAMINING ATTORNEY

**Int. Cl.: 20**

**Prior U.S. Cls.: 2, 13, 22, 25, 32, and 50**

**Reg. No. 3,468,560**

**United States Patent and Trademark Office**

**Registered July 15, 2008**

---

**TRADEMARK  
PRINCIPAL REGISTER**

**DISPLAYTIME**

HANGERLOGIC INC (CANADA CORPORATION)  
ALLARD  
LASALLE, CANADA H8N1Y8.

THE MARK CONSISTS OF STANDARD CHARACTERS WITHOUT CLAIM TO ANY PARTICULAR FONT, STYLE, SIZE, OR COLOR.

FOR: DISPLAY TYPE APPAREL HANGERS, IN CLASS 20 (U.S. CLS. 2, 13, 22, 25, 32 AND 50).

SN 77-027,399, FILED 10-23-2006.

FIRST USE 1-31-2007; IN COMMERCE 1-31-2007.

MICHAEL SOUDERS, EXAMINING ATTORNEY

**Int. Cls.: 38 and 42**

**Prior U.S. Cls.: 100, 101, and 104**

**United States Patent and Trademark Office**

**Reg. No. 3,468,561**

**Registered July 15, 2008**

**SERVICE MARK  
PRINCIPAL REGISTER**



BROCADE COMMUNICATIONS SYSTEMS, INC.  
(CALIFORNIA CORPORATION)  
1745 TECHNOLOGY DRIVE  
SAN JOSE, CA 95110

FOR: PROVIDING ACCESS TO DATABASES  
THAT COMPRISE A PRODUCT KNOWLEDGE  
BASE, IN CLASS 38 (U.S. CLS. 100, 101 AND 104).

FIRST USE 2-0-2007; IN COMMERCE 2-0-2007.

FOR: TECHNICAL SUPPORT SERVICES, NAME-  
LY, TROUBLESHOOTING OF COMPUTER HARD-  
WARE AND SOFTWARE PROBLEMS; PROVIDING  
ONLINE DATABASES WHICH PROVIDE A CATA-  
LOG OF COMPUTER SOFTWARE IN THE FIELD  
OF STORAGE AREA NETWORKS THAT MAY BE

DOWNLOADED FROM THE DATABASE, IN CLASS  
42 (U.S. CLS. 100 AND 101).

FIRST USE 2-0-2007; IN COMMERCE 2-0-2007.

THE COLOR(S) RED IS/ARE CLAIMED AS A  
FEATURE OF THE MARK.

THE MARK CONSISTS OF A STYLIZED LETTER  
"B".

SN 77-027,601, FILED 10-23-2006.

CHERYL CLAYTON, EXAMINING ATTORNEY

**Int. Cl.: 3**

**Prior U.S. Cls.: 1, 4, 6, 50, 51, and 52**

**Reg. No. 3,468,562**

**United States Patent and Trademark Office**

**Registered July 15, 2008**

---

**TRADEMARK  
PRINCIPAL REGISTER**

**SALON EXPERT**

L'OREAL USA CREATIVE, INC. (DELAWARE  
CORPORATION)

575 FIFTH AVENUE

NEW YORK, NY 10017

FOR: NAIL POLISH, IN CLASS 3 (U.S. CLS. 1, 4, 6,  
50, 51 AND 52).

FIRST USE 4-1-2007; IN COMMERCE 4-1-2007.

THE MARK CONSISTS OF STANDARD CHAR-  
ACTERS WITHOUT CLAIM TO ANY PARTICULAR  
FONT, STYLE, SIZE, OR COLOR.

NO CLAIM IS MADE TO THE EXCLUSIVE  
RIGHT TO USE "SALON", APART FROM THE  
MARK AS SHOWN.

SN 77-027,723, FILED 10-24-2006.

PATRICIA EVANKO, EXAMINING ATTORNEY

**Int. Cl.: 3**

**Prior U.S. Cls.: 1, 4, 6, 50, 51, and 52**

**Reg. No. 3,468,563**

**United States Patent and Trademark Office**

**Registered July 15, 2008**

---

**TRADEMARK  
PRINCIPAL REGISTER**

**AROMA SENSATIONS**

COLGATE-PALMOLIVE COMPANY (DELA-  
WARE CORPORATION)  
300 PARK AVENUE  
NEW YORK, NY 10022

FOR: FABRIC SOFTENERS AND FABRIC CON-  
DITIONERS, IN CLASS 3 (U.S. CLS. 1, 4, 6, 50, 51 AND  
52).

FIRST USE 8-9-2007; IN COMMERCE 8-9-2007.

THE MARK CONSISTS OF STANDARD CHAR-  
ACTERS WITHOUT CLAIM TO ANY PARTICULAR  
FONT, STYLE, SIZE, OR COLOR.

NO CLAIM IS MADE TO THE EXCLUSIVE  
RIGHT TO USE "AROMA", APART FROM THE  
MARK AS SHOWN.

SN 77-029,103, FILED 10-25-2006.

WILLIAM VERHOSEK, EXAMINING ATTORNEY

**Int. Cl.: 5**

**Prior U.S. Cls.: 6, 18, 44, 46, 51, and 52**

**United States Patent and Trademark Office**

**Reg. No. 3,468,564**

**Registered July 15, 2008**

**TRADEMARK  
PRINCIPAL REGISTER**

**AVED-DIGEST MULTI**

ANABOLIC LABORATORIES, LLC (CALIFORNIA LTD LIAB CO)  
46 CORPORATE PARK, SUITE 100  
IRVINE, CA 92606

FOR: VITAMINS AND NUTRITIONAL SUPPLEMENTS, IN CLASS 5 (U.S. CLS. 6, 18, 44, 46, 51 AND 52).

FIRST USE 5-31-2001; IN COMMERCE 5-31-2001.

THE MARK CONSISTS OF STANDARD CHARACTERS WITHOUT CLAIM TO ANY PARTICULAR FONT, STYLE, SIZE, OR COLOR.

NO CLAIM IS MADE TO THE EXCLUSIVE RIGHT TO USE "MULTI", APART FROM THE MARK AS SHOWN.

SN 77-029,399, FILED 10-25-2006.

ESTHER A. BORSUK, EXAMINING ATTORNEY



**Int. Cl.: 42**

**Prior U.S. Cls.: 100 and 101**

**United States Patent and Trademark Office**

**Reg. No. 3,468,565**

**Registered July 15, 2008**

---

**SERVICE MARK  
PRINCIPAL REGISTER**



UNISTRUX CORPORATION (CALIFORNIA CORPORATION)  
1888 CENTURY PARK EAST, #1015  
LOS ANGELES, CA 90067

NO CLAIM IS MADE TO THE EXCLUSIVE RIGHT TO USE "CORPORATION", APART FROM THE MARK AS SHOWN.

FOR: RESEARCH AND DEVELOPMENT AND CONSULTATION RELATED THERETO IN THE FIELD OF MODULAR HOUSING, IN CLASS 42 (U.S. CLS. 100 AND 101).

SN 77-029,491, FILED 10-25-2006.

FIRST USE 1-1-2007; IN COMMERCE 1-1-2007.

LINDSEY RUBIN, EXAMINING ATTORNEY

**Int. Cl.: 36**

**Prior U.S. Cls.: 100, 101, and 102**

**United States Patent and Trademark Office**

**Reg. No. 3,468,566**

**Registered July 15, 2008**

**SERVICE MARK  
PRINCIPAL REGISTER**

**SAVE YOURSELF**

THE TRUSTEES OF THE SUZE ORMAN REVOC-  
ABLE TRUST, A CALIFORNIA TRUST, THE  
TRUSTEES COMPRISING SUZE ORMAN, A  
U.S. CITIZEN (CALIFORNIA TRUST)  
SUITE 270  
64 EAST UWCHLAN AVENUE  
EXTON, PA 19341

FOR: FINANCIAL SERVICES, NAMELY, SAV-  
INGS PROGRAMS FOR INDIVIDUALS AND AD-  
MINISTRATION OF SAVINGS PROGRAMS, IN  
CLASS 36 (U.S. CLS. 100, 101 AND 102).

FIRST USE 2-27-2007; IN COMMERCE 2-27-2007.

THE MARK CONSISTS OF STANDARD CHAR-  
ACTERS WITHOUT CLAIM TO ANY PARTICULAR  
FONT, STYLE, SIZE, OR COLOR.

SN 77-031,286, FILED 10-27-2006.

WILLIAM ROSSMAN, EXAMINING ATTORNEY

**Int. Cl.: 10**

**Prior U.S. Cls.: 26, 39, and 44**

**United States Patent and Trademark Office**

**Reg. No. 3,468,567**

**Registered July 15, 2008**

**TRADEMARK  
PRINCIPAL REGISTER**

**INTELLIPAP**

SUNRISE MEDICAL HHG INC. (CALIFORNIA  
CORPORATION)  
7477 EAST DRY CREEK PARKWAY  
LONGMONT, CO 80503

FOR: BREATHING APPARATUS FOR MEDICAL  
PURPOSES, NAMELY, POSITIVE AIRWAY PRES-  
SURE BREATHING APPARATUS FOR USE IN  
SLEEP THERAPY, IN CLASS 10 (U.S. CLS. 26, 39  
AND 44).

FIRST USE 12-30-2007; IN COMMERCE 12-30-2007.

THE MARK CONSISTS OF STANDARD CHAR-  
ACTERS WITHOUT CLAIM TO ANY PARTICULAR  
FONT, STYLE, SIZE, OR COLOR.

SN 77-031,647, FILED 10-28-2006.

RONALD MCMORROW, EXAMINING ATTORNEY

**Int. Cl.: 25**

**Prior U.S. Cls.: 22 and 39**

**United States Patent and Trademark Office**

**Reg. No. 3,468,568**

**Registered July 15, 2008**

**TRADEMARK  
PRINCIPAL REGISTER**

**KOALA BABY NATURAL**

GEOFFREY, LLC (DELAWARE LTD LIAB CO)  
ONE GEOFFREY WAY  
WAYNE, NJ 07470

FOR: BABY AND CHILDREN'S CLOTHING,  
NAMELY, COVERALLS, OVERALLS, SHIRTS, TEE  
SHIRTS, BODYSUITS, JEANS, PANTS, KNIT PANTS,  
Twill PANTS, KNIT AND WOVEN SHORTS,  
DRESSES, ROMPERS, JUMPERS, UNDERWEAR,  
SWEATSHIRTS, SOFT SOLE SHOES, HATS, CAPS,  
BUNTINGS, JACKETS, SHORTALLS, CLOTH BIBS,  
LAYETTE AND SOCKS, IN CLASS 25 (U.S. CLS. 22  
AND 39).

FIRST USE 7-31-2007; IN COMMERCE 7-31-2007.

THE MARK CONSISTS OF STANDARD CHAR-  
ACTERS WITHOUT CLAIM TO ANY PARTICULAR  
FONT, STYLE, SIZE, OR COLOR.

OWNER OF U.S. REG. NOS. 2,180,961, 2,244,703,  
AND OTHERS.

NO CLAIM IS MADE TO THE EXCLUSIVE  
RIGHT TO USE "BABY NATURAL", APART FROM  
THE MARK AS SHOWN.

SN 77-031,956, FILED 10-30-2006.

BERYL GARDNER, EXAMINING ATTORNEY

**Int. Cl.: 41**

**Prior U.S. Cls.: 100, 101, and 107**

**United States Patent and Trademark Office**

**Reg. No. 3,468,569**

**Registered July 15, 2008**

**SERVICE MARK  
PRINCIPAL REGISTER**

# Impacto Latino

CRUZ, MARIO (EL SALVADOR INDIVIDUAL)  
18 SWAN ST., APT. 1  
EVERETT, MA 02149

FOR: COMPOSITION OF MUSIC FOR OTHERS;  
ENTERTAINMENT, NAMELY, LIVE PERFORMAN-  
CES BY A MUSICAL BAND; ENTERTAINMENT,  
NAMELY, LIVE MUSIC CONCERTS; MUSIC PRO-  
DUCTION SERVICES; MUSIC PUBLISHING SERVI-  
CES, IN CLASS 41 (U.S. CLS. 100, 101 AND 107).

FIRST USE 4-30-2006; IN COMMERCE 9-10-2006.

THE MARK CONSISTS OF STANDARD CHAR-  
ACTERS WITHOUT CLAIM TO ANY PARTICULAR  
FONT, STYLE, SIZE, OR COLOR.

NO CLAIM IS MADE TO THE EXCLUSIVE  
RIGHT TO USE "LATINO", APART FROM THE  
MARK AS SHOWN.

THE FOREIGN WORDING IN THE MARK  
TRANSLATES INTO ENGLISH AS "LATIN IM-  
PACT".

SN 77-032,439, FILED 10-30-2006.

JOHN KELLY, EXAMINING ATTORNEY

**Int. Cl.: 25**

**Prior U.S. Cls.: 22 and 39**

**United States Patent and Trademark Office**

**Reg. No. 3,468,570**

**Registered July 15, 2008**

**TRADEMARK  
PRINCIPAL REGISTER**

RUBIN, MARC (UNITED STATES INDIVIDUAL)  
6519 EAST SPRING ROAD  
SCOTTSDALE, AZ 85254

FOR: ATHLETIC UNIFORMS; BANDANAS;  
BASEBALL CAPS; BERMUDA SHORTS; BICYCLE  
GLOVES; BICYCLING GLOVES; CAPS; CAPS WITH  
VISORS; CYCLISTS' JERSEYS; GYM SHORTS;  
HATS; JACKETS; JERSEYS; JOGGING OUTFITS;  
JOGGING PANTS; JOGGING SUITS; MUSCLE  
TOPS; POLO SHIRTS; SHIRTS; SPORT SHIRTS;  
SPORTS JERSEYS; SWEAT PANTS; SWEAT SHIRTS;  
SWEAT SHORTS; SWEAT SUITS; SWIM WEAR;  
SWIM WEAR FOR GENTLEMEN AND LADIES;  
SWIMSUITS; T-SHIRTS; TANK TOPS; TOPS; TRACK  
PANTS; TRACK SUITS; TRACKSUITS; WALKING

SHORTS; WARM UP SUITS; WIND-JACKETS, IN  
CLASS 25 (U.S. CLS. 22 AND 39).

FIRST USE 2-28-2007; IN COMMERCE 2-28-2007.

THE COLOR(S) BLUE IS/ARE CLAIMED AS A  
FEATURE OF THE MARK.

THE MARK CONSISTS OF THE NUMBER "10"  
AND THE LETTERS "HR" IN BLUE.

SN 77-033,348, FILED 10-31-2006.

BRENDAN REGAN, EXAMINING ATTORNEY

**Int. Cl.: 9**

**Prior U.S. Cls.: 21, 23, 26, 36, and 38**

**Reg. No. 3,468,571**

**United States Patent and Trademark Office**

**Registered July 15, 2008**

**TRADEMARK  
PRINCIPAL REGISTER**

**EMBOT**

EMBOTICS CORPORATION (CANADA CORPORATION)  
EMBOTICS CORPORATION  
320 MARCH ROAD, SUITE 100  
KANATA, ONTARIO, CANADA K2K 2E3

FOR: COMPUTER SOFTWARE, NAMELY, APPLICATION SOFTWARE FOR ADMINISTRATION, MANAGEMENT AND SECURITY OF COMPUTER SYSTEMS, IN CLASS 9 (U.S. CLS. 21, 23, 26, 36 AND 38).

FIRST USE 5-20-2008; IN COMMERCE 5-20-2008.

THE MARK CONSISTS OF STANDARD CHARACTERS WITHOUT CLAIM TO ANY PARTICULAR FONT, STYLE, SIZE, OR COLOR.

PRIORITY CLAIMED UNDER SEC. 44(D) ON CANADA APPLICATION NO. 1300218, FILED 5-3-2006.

SN 77-033,915, FILED 11-1-2006.

VERNA BETH RIRIE, EXAMINING ATTORNEY

**Int. Cl.: 36**

**Prior U.S. Cls.: 100, 101, and 102**

**United States Patent and Trademark Office**

**Reg. No. 3,468,572**

**Registered July 15, 2008**

**SERVICE MARK  
PRINCIPAL REGISTER**

# Repair Advantage

GMAC LLC (DELAWARE LTD LIAB CO)  
200 RENAISSANCE CENTER  
DETROIT, MI 48265

FOR: INSURANCE SERVICES, NAMELY, INSURANCE UNDERWRITING AND CLAIMS ADMINISTRATION OF EXTENDED MOTOR VEHICLE SERVICE CONTRACTS FOR THE REPAIR AND MAINTENANCE OF MOTOR VEHICLES, GUARANTEED ASSET PROTECTION CONTRACTS AND EXTENDED MOTOR VEHICLE MAINTENANCE CONTRACTS, IN CLASS 36 (U.S. CLS. 100, 101 AND 102).

FIRST USE 4-0-2007; IN COMMERCE 4-0-2007.

THE MARK CONSISTS OF STANDARD CHARACTERS WITHOUT CLAIM TO ANY PARTICULAR FONT, STYLE, SIZE, OR COLOR.

NO CLAIM IS MADE TO THE EXCLUSIVE RIGHT TO USE "REPAIR", APART FROM THE MARK AS SHOWN.

SN 77-034,218, FILED 11-1-2006.

ROBIN MITTLER, EXAMINING ATTORNEY



**Int. Cls.: 9, 16, 35, 36, and 41**

**Prior U.S. Cls.: 2, 5, 21, 22, 23, 26, 29, 36, 37, 38, 50,  
100, 101, 102, and 107**

**Reg. No. 3,468,573**

**United States Patent and Trademark Office**

**Registered July 15, 2008**

**TRADEMARK  
SERVICE MARK  
PRINCIPAL REGISTER**

**VETERANS AND THEIR  
FINANCIAL FUTURE**

ASSET MARKETING SYSTEMS INSURANCE  
SERVICES, LLC (DELAWARE LTD LIAB CO)  
9715 BUSINESSPARK AVENUE  
SAN DIEGO, CA 92131

FOR: PRE-RECORDED AUDIO AND VIDEO  
TAPES, CDS AND DVDS FEATURING TRAINING  
AND EDUCATIONAL MATERIALS IN THE FIELDS  
OF FINANCIAL PLANNING AND FINANCIAL  
PRODUCTS, IN CLASS 9 (U.S. CLS. 21, 23, 26, 36  
AND 38).

FIRST USE 9-1-2006; IN COMMERCE 9-1-2006.

FOR: PRINTED TRAINING AND EDUCATION-  
AL MATERIALS IN THE FIELDS OF FINANCIAL  
PLANNING AND FINANCIAL PRODUCTS, IN  
CLASS 16 (U.S. CLS. 2, 5, 22, 23, 29, 37, 38 AND 50).

FIRST USE 9-1-2006; IN COMMERCE 9-1-2006.

FOR: DIRECT MAIL ADVERTISING SERVICES;  
PROVIDING DIRECT E-MAIL ADVERTISING SER-  
VICES, PRODUCTION AND PLACEMENT OF  
PRINT, RADIO AND TELEVISION ADVERTISING  
FOR OTHERS, AND BUSINESS MANAGEMENT  
SERVICES IN THE FIELDS OF FINANCIAL PLAN-

NING AND FINANCIAL PRODUCTS, IN CLASS 35  
(U.S. CLS. 100, 101 AND 102).

FIRST USE 9-1-2006; IN COMMERCE 9-1-2006.

FOR: PROVIDING FINANCIAL INFORMATION,  
ANALYSIS AND CONSULTATION, IN CLASS 36  
(U.S. CLS. 100, 101 AND 102).

FIRST USE 9-1-2006; IN COMMERCE 9-1-2006.

FOR: EDUCATIONAL SERVICES, NAMELY,  
PROVIDING CLASSES AND SEMINARS IN THE  
FIELDS OF FINANCIAL PLANNING AND FINAN-  
CIAL PRODUCTS, IN CLASS 41 (U.S. CLS. 100, 101  
AND 107).

FIRST USE 9-1-2006; IN COMMERCE 9-1-2006.

THE MARK CONSISTS OF STANDARD CHAR-  
ACTERS WITHOUT CLAIM TO ANY PARTICULAR  
FONT, STYLE, SIZE, OR COLOR.

SN 77-034,417, FILED 11-1-2006.

RAUL CORDOVA, EXAMINING ATTORNEY

**Int. Cls.: 9 and 16**

**Prior U.S. Cls.: 2, 5, 21, 22, 23, 26, 29, 36, 37, 38, and 50**

**United States Patent and Trademark Office**

**Reg. No. 3,468,574**

**Registered July 15, 2008**

**TRADEMARK  
PRINCIPAL REGISTER**

**SAFCON**

U.S. TSUBAKI, INC. (ILLINOIS CORPORATION)  
301 E. MARQUARDT DRIVE  
WHEELING, IL 60090

FOR: OVERLOAD PROTECTION DEVICES, NAMELY, ELECTRONIC POWER INTERRUPTERS AND SYSTEM SHUT DOWNS FOR SYSTEM SHOCK LOADS, OVERLOADS AND UNDERLOADS , IN CLASS 9 (U.S. CLS. 21, 23, 26, 36 AND 38).

FIRST USE 5-14-2008; IN COMMERCE 5-14-2008.

FOR: PRINTED BROCHURES AND BOOKLETS IN THE FIELD OF OVERLOAD PROTECTION DEVICES, NAMELY, ELECTRONIC POWER INTER-

RUPTERS AND SYSTEM SHUT DOWNS FOR SYSTEM SHOCK LOADS, OVERLOADS AND UNDERLOADS, IN CLASS 16 (U.S. CLS. 2, 5, 22, 23, 29, 37, 38 AND 50).

FIRST USE 5-14-2008; IN COMMERCE 5-14-2008.

THE MARK CONSISTS OF STANDARD CHARACTERS WITHOUT CLAIM TO ANY PARTICULAR FONT, STYLE, SIZE, OR COLOR.

SN 77-035,188, FILED 11-2-2006.

FRED MANDIR, EXAMINING ATTORNEY

**Int. Cl.: 35**

**Prior U.S. Cls.: 100, 101, and 102**

**United States Patent and Trademark Office**

**Reg. No. 3,468,575**

**Registered July 15, 2008**

**SERVICE MARK  
PRINCIPAL REGISTER**

# LeadBackOffice

PEAK IMPACT INC. (CANADA CORPORATION)  
2 BEAVERBROOK ROAD, SUITE 204  
OTTAWA ONTARIO, CANADA K2K 1L1

FOR: ELECTRONIC COMMERCE SERVICES,  
NAMELY, THE OPERATION OF AN ON-LINE  
MARKETING AGENCY TO ASSIST POTENTIAL  
BUYERS OF COMMODITIES OR SERVICES OF  
ANY KIND IN FINDING SELLERS THEREOF IN  
THE NATURE OF PROVIDING BUSINESS LEADS  
AND TO PROVIDE BUSINESS INFORMATION RE-

LATED TO LEAD GENERATION, IN CLASS 35 (U.S.  
CLS. 100, 101 AND 102).

FIRST USE 5-26-2008; IN COMMERCE 5-26-2008.

THE MARK CONSISTS OF STANDARD CHAR-  
ACTERS WITHOUT CLAIM TO ANY PARTICULAR  
FONT, STYLE, SIZE, OR COLOR.

SN 77-035,310, FILED 11-2-2006.

DOMINIC FATHY, EXAMINING ATTORNEY

**Int. Cl.: 9**

**Prior U.S. Cls.: 21, 23, 26, 36, and 38**

**Reg. No. 3,468,576**

**United States Patent and Trademark Office**

**Registered July 15, 2008**

---

**TRADEMARK  
PRINCIPAL REGISTER**

***QuantuMike***

MITUTOYO CORPORATION (JAPAN CORPORATION)  
20-1, SAKADO 1-CHOME, TAKATSU-KU  
KAWASAKI, KANAGAWA, JAPAN

OWNER OF JAPAN REG. NO. 5073613, DATED 8-31-2007, EXPIRES 8-31-2017.

FOR: DIGITAL MICROMETERS, IN CLASS 9 (U.S. CLS. 21, 23, 26, 36 AND 38).

SN 77-035,570, FILED 11-2-2006.

FIRST USE 11-1-2007; IN COMMERCE 4-1-2008.

JAY BESCH, EXAMINING ATTORNEY

**Int. Cls.: 16 and 35**

**Prior U.S. Cls.: 2, 5, 22, 23, 29, 37, 38, 50, 100, 101, and 102**

**United States Patent and Trademark Office**

**Reg. No. 3,468,577**

**Registered July 15, 2008**

**TRADEMARK  
SERVICE MARK  
PRINCIPAL REGISTER**

**INVITATIONS FOR BETTER  
LIVING**

IDEARC MEDIA CORP. (DELAWARE CORPORATION)  
2200 W. AIRFIELD DRIVE  
DALLAS/FORT WORTH AIRPORT, TX 752619810

FOR: POSTCARDS THAT PROMOTE THE GOODS AND SERVICES OF OTHERS, IN CLASS 16 (U.S. CLS. 2, 5, 22, 23, 29, 37, 38 AND 50).

FIRST USE 5-15-2007; IN COMMERCE 5-15-2007.

FOR: ADVERTISING AND PROMOTION SERVICES AND CONSULTING SERVICES RELATED THERETO; PROMOTING THE GOODS AND SERVICES OF OTHERS THROUGH THE DISTRIBUTION OF ADVERTISING MATERIALS, NAMELY, POSTCARDS, IN CLASS 35 (U.S. CLS. 100, 101 AND 102).

FIRST USE 7-25-2007; IN COMMERCE 7-25-2007.

THE MARK CONSISTS OF STANDARD CHARACTERS WITHOUT CLAIM TO ANY PARTICULAR FONT, STYLE, SIZE, OR COLOR.

SN 77-036,300, FILED 11-3-2006.

RUDY R. SINGLETON, EXAMINING ATTORNEY

**Int. Cl.: 41**

**Prior U.S. Cls.: 100, 101, and 107**

**United States Patent and Trademark Office**

**Reg. No. 3,468,578**

**Registered July 15, 2008**

**SERVICE MARK  
PRINCIPAL REGISTER**

**SPLINTER CELL CONVICTION**

UBISOFT INC. (CALIFORNIA CORPORATION)  
625 THIRD STREET, THIRD FLOOR  
SAN FRANCISCO, CA 94107

FOR: ENTERTAINMENT SERVICES NAMELY,  
PROVIDING AN ON-LINE COMPUTER GAME FOR  
OTHERS OVER LOCAL AREA COMPUTER NET-  
WORKS AND PROVIDING INFORMATION ON-  
LINE RELATING TO COMPUTER GAMES, VIDEO  
GAMES AND COMPUTER AND VIDEO GAMES  
RELATED PRODUCTS, NAMELY, COMPUTER  
MONITORS, COMPUTER PROCESSORS, COMPU-  
TER CONTROLLERS FOR ELECTRONIC VIDEO  
GAMES, GRAPHIC CARDS, SPEAKERS, CONSOLE  
VIDEO GAME MACHINES, CONSOLE VIDEO

GAME CONTROLLERS, AND MOBILE PHONES,  
IN CLASS 41 (U.S. CLS. 100, 101 AND 107).

FIRST USE 5-31-2007; IN COMMERCE 5-31-2007.

THE MARK CONSISTS OF STANDARD CHAR-  
ACTERS WITHOUT CLAIM TO ANY PARTICULAR  
FONT, STYLE, SIZE, OR COLOR.

OWNER OF U.S. REG. NOS. 2,748,543, 3,158,809,  
AND OTHERS.

SN 77-036,486, FILED 11-3-2006.

CHRISTINA SOBRAL, EXAMINING ATTORNEY

**Int. Cl.: 10**

**Prior U.S. Cls.: 26, 39, and 44**

**United States Patent and Trademark Office**

**Reg. No. 3,468,579**

**Registered July 15, 2008**

**TRADEMARK  
PRINCIPAL REGISTER**

**PATRIOT**

GLOBUS MEDICAL, INC. (DELAWARE CORPORATION)  
2560 GENERAL ARMISTEAD AVENUE  
AUDUBON, PA 19403

THE MARK CONSISTS OF STANDARD CHARACTERS WITHOUT CLAIM TO ANY PARTICULAR FONT, STYLE, SIZE, OR COLOR.

FOR: SPINAL IMPLANTS, MADE FROM ARTIFICIAL MATERIALS, FOR USE IN SPINE SURGERY, IN CLASS 10 (U.S. CLS. 26, 39 AND 44).

SN 77-036,693, FILED 11-3-2006.

FIRST USE 2-5-2008; IN COMMERCE 2-5-2008.

ALYSSA PALADINO, EXAMINING ATTORNEY

**Int. Cls.: 5 and 44**

**Prior U.S. Cls.: 6, 18, 44, 46, 51, 52, 100, and 101**

**United States Patent and Trademark Office**

**Reg. No. 3,468,580**

**Registered July 15, 2008**

**TRADEMARK  
SERVICE MARK  
PRINCIPAL REGISTER**

**VYVANSE**

SHIRE LLC (KENTUCKY LTD LIAB CO)  
9200 BROOKFIELD COURT  
FLORENCE, KY 41042

FOR: PHARMACEUTICAL PREPARATIONS  
ACTING ON THE CENTRAL NERVOUS SYSTEM,  
IN CLASS 5 (U.S. CLS. 6, 18, 44, 46, 51 AND 52).

FIRST USE 6-4-2007; IN COMMERCE 6-4-2007.

FOR: PROVIDING MEDICAL INFORMATION IN  
THE FIELD OF PHARMACEUTICAL PRODUCTS  
AND SERVICES, IN CLASS 44 (U.S. CLS. 100 AND  
101).

FIRST USE 6-4-2007; IN COMMERCE 6-4-2007.

THE MARK CONSISTS OF STANDARD CHAR-  
ACTERS WITHOUT CLAIM TO ANY PARTICULAR  
FONT, STYLE, SIZE, OR COLOR.

"VYVANSE" APPEARING IN THE MARK HAS  
NO SIGNIFICANCE IN THE RELEVANT TRADE  
OR INDUSTRY OR, NO GEOGRAPHICAL SIGNIFI-  
CANCE, NOR ANY MEANING IN A FOREIGN  
LANGUAGE.

SN 77-037,206, FILED 11-6-2006.

KEVIN DINALLO, EXAMINING ATTORNEY



**Int. Cl.: 9**

**Prior U.S. Cls.: 21, 23, 26, 36, and 38**

**United States Patent and Trademark Office**

**Reg. No. 3,468,581**

**Registered July 15, 2008**

**TRADEMARK  
PRINCIPAL REGISTER**

**MASQUE  ENTERTAINMENT**

THE MASQUE SOUND AND RECORDING CORPORATION (NEW YORK CORPORATION)  
21 EAST UNION AVENUE  
EAST RUTHERFORD, NJ 07073

FOR: PRE-RECORDED DVD'S FEATURING DRAMATIC, DANCE, AND/OR MUSICAL PERFORMANCES, IN CLASS 9 (U.S. CLS. 21, 23, 26, 36 AND 38).

FIRST USE 11-1-2005; IN COMMERCE 11-1-2005.

OWNER OF U.S. REG. NOS. 2,023,126, 2,026,468, AND OTHERS.

NO CLAIM IS MADE TO THE EXCLUSIVE RIGHT TO USE "ENTERTAINMENT", APART FROM THE MARK AS SHOWN.

SN 77-038,474, FILED 11-7-2006.

CAROLYN GRAY, EXAMINING ATTORNEY

**Int. Cl.: 5**

**Prior U.S. Cls.: 6, 18, 44, 46, 51, and 52**

**Reg. No. 3,468,582**

**United States Patent and Trademark Office**

**Registered July 15, 2008**

---

**TRADEMARK  
PRINCIPAL REGISTER**

# Calorie Cutter

CURB YOUR CRAVINGS, LLC (NEW YORK LTD  
LIAB CO)

2784 ARDIS PLACE

BELLMORE, NY 17710

FOR: DIETARY SUPPLEMENT FOR WEIGHT  
LOSS, IN CLASS 5 (U.S. CLS. 6, 18, 44, 46, 51 AND 52).

FIRST USE 10-5-2006; IN COMMERCE 10-5-2006.

THE MARK CONSISTS OF STANDARD CHAR-  
ACTERS WITHOUT CLAIM TO ANY PARTICULAR  
FONT, STYLE, SIZE, OR COLOR.

NO CLAIM IS MADE TO THE EXCLUSIVE  
RIGHT TO USE "CALORIE", APART FROM THE  
MARK AS SHOWN.

SN 77-039,199, FILED 11-8-2006.

GIANCARLO CASTRO, EXAMINING ATTORNEY

Int. Cl.: 30

Prior U.S. Cl.: 46

United States Patent and Trademark Office

Reg. No. 3,468,583

Registered July 15, 2008

TRADEMARK  
PRINCIPAL REGISTER



FLOWERS BAKERIES BRANDS, INC. (DELAWARE CORPORATION)  
1105 NORTH MARKET STREET  
WILMINGTON, DE 19899

FOR: TORTILLAS, IN CLASS 30 (U.S. CL. 46).

FIRST USE 12-30-2006; IN COMMERCE 12-30-2006.

OWNER OF U.S. REG. NO. 1,827,611.

NO CLAIM IS MADE TO THE EXCLUSIVE RIGHT TO USE "FLOUR TORTILLAS" AND "BURRITO STYLE", APART FROM THE MARK AS SHOWN.

THE MARK CONSISTS OF THE WORDS "MI CASA" IN A SCRIPT FORM WITH A STYLIZED CROWN ABOVE; UNDERNEATH ARE THE WORDS "FLOUR TORTILLAS" IN A STYLIZED GEOMETRIC FORM AND UNDER THAT ARE STYLIZED STALKS OF GRAIN AND UNDER THAT IS AN OVAL SHAPE WITH THE WORDS "BURRITO STYLE".

THE FOREIGN WORDING IN THE MARK TRANSLATES INTO ENGLISH AS "MY HOUSE".

SN 77-039,289, FILED 11-8-2006.

GISELLE AGOSTO, EXAMINING ATTORNEY

**Int. Cls.: 3 and 5**

**Prior U.S. Cls.: 1, 4, 6, 18, 44, 46, 50, 51, and 52**

**United States Patent and Trademark Office**

**Reg. No. 3,468,584**

**Registered July 15, 2008**

**TRADEMARK  
PRINCIPAL REGISTER**



MERIAL LIMITED (UNITED KINGDOM CORPORATION)  
SANDRINGHAM HOUSE  
SANDRINGHAM AVENUE, HARLOW BUSINESS PARK  
HARLOW, CM19 5QA, UNITED KINGDOM

FOR: COSMETICS, IN CLASS 3 (U.S. CLS. 1, 4, 6, 50, 51 AND 52).

FIRST USE 1-12-2007; IN COMMERCE 1-12-2007.

FOR: VETERINARY PREPARATIONS, NAMELY, DENTAL CLEANING PREPARATIONS TO PRE-

VENT THE BUILD-UP OF PLAQUE AND BACTERIA, IN CLASS 5 (U.S. CLS. 6, 18, 44, 46, 51 AND 52).

FIRST USE 1-12-2007; IN COMMERCE 1-12-2007.

THE MARK CONSISTS OF THE HEAD OF A DOG WITH THE MOUTH OPEN AND THE WORDING "FLIP THE LIP" IN THE OPEN MOUTH.

SN 77-039,541, FILED 11-8-2006.

ROBERT STRUCK, EXAMINING ATTORNEY

**Int. Cls.: 1, 5, and 29**

**Prior U.S. Cls.: 1, 5, 6, 10, 18, 26, 44, 46, 51, and 52**

**United States Patent and Trademark Office**

**Reg. No. 3,468,585**

**Registered July 15, 2008**

**TRADEMARK  
PRINCIPAL REGISTER**

**NOT FOR THE FAINT OF HEART**

POMWONDERFUL LLC (DELAWARE LTD LIAB  
CO)  
11444 W. OLYMPIC BLVD., 10TH FLOOR  
LOS ANGELES, CA 90064

FOR: POMEGRANATE EXTRACTS, FOR USE IN  
THE PREPARATION OF PHARMACEUTICAL PRO-  
DUCTS AND PREPARATIONS, IN CLASS 1 (U.S.  
CLS. 1, 5, 6, 10, 26 AND 46).

FIRST USE 5-7-2007; IN COMMERCE 5-7-2007.

FOR: DIETARY AND NUTRITIONAL SUPPLE-  
MENTS DERIVED FROM AND CONTAINING PO-  
MEGRANATE EXTRACTS AND PLANT  
EXTRACTS; NUTRACEUTICALS FOR USE AS A  
DIETARY SUPPLEMENT DERIVED FROM AND  
CONTAINING POMEGRANATE EXTRACTS AND  
PLANT EXTRACTS; ANTI-CANCER PREPARA-  
TIONS; PHARMACEUTICAL PRODUCTS AND  
PREPARATIONS DERIVED FROM AND CONTAIN-

ING POMEGRANATE EXTRACTS AND PLANT  
EXTRACTS, FOR THE TREATMENT OF VIRAL  
AND INFECTIOUS DISEASES , IN CLASS 5 (U.S.  
CLS. 6, 18, 44, 46, 51 AND 52).

FIRST USE 5-7-2007; IN COMMERCE 5-7-2007.

FOR: POMEGRANATE EXTRACTS, FOR USE AS  
AN INGREDIENT IN FOOD PRODUCTS, IN CLASS  
29 (U.S. CL. 46).

FIRST USE 5-7-2007; IN COMMERCE 5-7-2007.

THE MARK CONSISTS OF STANDARD CHAR-  
ACTERS WITHOUT CLAIM TO ANY PARTICULAR  
FONT, STYLE, SIZE, OR COLOR.

SN 77-040,048, FILED 11-8-2006.

CHERYL CLAYTON, EXAMINING ATTORNEY

**Int. Cl.: 9**

**Prior U.S. Cls.: 21, 23, 26, 36, and 38**

**Reg. No. 3,468,586**

**United States Patent and Trademark Office**

**Registered July 15, 2008**

---

**TRADEMARK  
PRINCIPAL REGISTER**

**SYMBOLSTIX**

SYMBOLSTIX LLC (OHIO LTD LIAB CO)  
366 NORTH MAIN STREET  
HURON, OH 44839

FIRST USE 3-10-2008; IN COMMERCE 3-10-2008.

FOR: DOWNLOADABLE PICTURES AND  
DRAWINGS FEATURING SYMBOLS USED FOR  
COMMUNICATION AVAILABLE VIA THE INTER-  
NET AND WIRELESS DEVICES, IN CLASS 9 (U.S.  
CLS. 21, 23, 26, 36 AND 38).

THE MARK CONSISTS OF STANDARD CHAR-  
ACTERS WITHOUT CLAIM TO ANY PARTICULAR  
FONT, STYLE, SIZE, OR COLOR.

SN 77-040,275, FILED 11-9-2006.

ROBIN MITTLER, EXAMINING ATTORNEY

**Int. Cl.: 25**

**Prior U.S. Cls.: 22 and 39**

**United States Patent and Trademark Office**

**Reg. No. 3,468,587**

**Registered July 15, 2008**

**TRADEMARK  
PRINCIPAL REGISTER**

**AXIS MODERN COAST**

PEI LICENSING, INC. (DELAWARE CORPORATION)  
3000 NW 107TH AVENUE  
MIAMI, FL 33172

FOR: CLOTHING, NAMELY, KNIT AND WOVEN SHIRTS, SWEATERS, PANTS, SHORTS, JACKETS, SPORT COATS, BLAZERS AND COATS, IN CLASS 25 (U.S. CLS. 22 AND 39).

FIRST USE 3-0-2008; IN COMMERCE 3-0-2008.

THE MARK CONSISTS OF STANDARD CHARACTERS WITHOUT CLAIM TO ANY PARTICULAR FONT, STYLE, SIZE, OR COLOR.

OWNER OF U.S. REG. NOS. 1,348,121 AND 2,276,574.

SN 77-041,827, FILED 11-10-2006.

ZACHARY BELLO, EXAMINING ATTORNEY

**Int. Cl.: 3**

**Prior U.S. Cls.: 1, 4, 6, 50, 51, and 52**

**Reg. No. 3,468,588**

**United States Patent and Trademark Office**

**Registered July 15, 2008**

---

**TRADEMARK  
PRINCIPAL REGISTER**

**INVISI-LIFTS**

IN CLOVER MARKETING, LLC (NEVADA LTD  
LIAB CO)  
11601 WILSHIRE BLVD., SUITE 210  
LOS ANGELES, CA 90025

THE MARK CONSISTS OF STANDARD CHAR-  
ACTERS WITHOUT CLAIM TO ANY PARTICULAR  
FONT, STYLE, SIZE, OR COLOR.

FOR: ADHESIVES FOR COSMETIC USE, IN  
CLASS 3 (U.S. CLS. 1, 4, 6, 50, 51 AND 52).

SN 77-043,106, FILED 11-13-2006.

FIRST USE 8-27-2007; IN COMMERCE 8-27-2007.

MARGARET POWER, EXAMINING ATTORNEY



**Int. Cl.: 28**

**Prior U.S. Cls.: 22, 23, 38, and 50**

**United States Patent and Trademark Office**

**Reg. No. 3,468,589**

**Registered July 15, 2008**

**TRADEMARK  
PRINCIPAL REGISTER**

**BATTLESTACK**

SPEED STACKS, INC. (COLORADO CORPORATION)  
14 INVERNESS DRIVE EAST, #D100  
ENGLEWOOD, CO 80112

THE MARK CONSISTS OF STANDARD CHARACTERS WITHOUT CLAIM TO ANY PARTICULAR FONT, STYLE, SIZE, OR COLOR.

FOR: ACTION SKILL GAMES AND BOARD GAMES, IN CLASS 28 (U.S. CLS. 22, 23, 38 AND 50).

SN 77-045,144, FILED 11-15-2006.

FIRST USE 5-0-2008; IN COMMERCE 5-0-2008.

AMY GEARIN, EXAMINING ATTORNEY

**Int. Cl.: 35**

**Prior U.S. Cls.: 100, 101, and 102**

**United States Patent and Trademark Office**

**Reg. No. 3,468,590**

**Registered July 15, 2008**

**SERVICE MARK  
PRINCIPAL REGISTER**

** LaborTrader.com**

LABORTRADER.COM (MICHIGAN LTD LIAB  
CO)  
304 MAPLE STREET  
HOWELL, MI 48843

THE MARK CONSISTS OF A RIGHT TRIANGLE  
AND THE STYLIZED TEXT OF THE WORDING  
"LABORTRADER.COM"..

FOR: PROVIDING AN ON-LINE COMMERCIAL  
INFORMATION DIRECTORY ON THE INTERNET,  
IN CLASS 35 (U.S. CLS. 100, 101 AND 102).

SN 77-046,540, FILED 11-17-2006.

FIRST USE 8-20-2007; IN COMMERCE 8-20-2007.

DAVID TAYLOR, EXAMINING ATTORNEY

**Int. Cl.: 42**

**Prior U.S. Cls.: 100 and 101**

**United States Patent and Trademark Office**

**Reg. No. 3,468,591**

**Registered July 15, 2008**

**SERVICE MARK  
PRINCIPAL REGISTER**

**e-pubXpress**

PUBLISHERS PRINTING COMPANY, INC. (KEN-  
TUCKY CORPORATION)  
100 FRANK E. SIMON AVENUE  
SHEPHERDSVILLE, KY 40165

FOR: PROVIDING TEMPORARY USE OF ON-  
LINE, NON-DOWNLOADABLE SOFTWARE FOR  
ENABLING USERS TO LAY OUT AND PRODUCE  
DIGITAL AND ON-LINE MAGAZINES , IN CLASS  
42 (U.S. CLS. 100 AND 101).

FIRST USE 4-15-2008; IN COMMERCE 4-15-2008.

THE MARK CONSISTS OF STANDARD CHAR-  
ACTERS WITHOUT CLAIM TO ANY PARTICULAR  
FONT, STYLE, SIZE, OR COLOR.

SN 77-049,489, FILED 11-22-2006.

JILL C. ALT, EXAMINING ATTORNEY

**Int. Cl.: 33**

**Prior U.S. Cls.: 47 and 49**

**United States Patent and Trademark Office**

**Reg. No. 3,468,592**

**Registered July 15, 2008**

**TRADEMARK  
PRINCIPAL REGISTER**

**CONTRASTE**

WENTE BROS. (CALIFORNIA CORPORATION)  
5565 TESLA ROAD  
LIVERMORE, CA 94550

FOR: WINES, IN CLASS 33 (U.S. CLS. 47 AND 49).

FIRST USE 4-2-2008; IN COMMERCE 4-2-2008.

THE MARK CONSISTS OF STANDARD CHARACTERS WITHOUT CLAIM TO ANY PARTICULAR FONT, STYLE, SIZE, OR COLOR.

THE ENGLISH TRANSLATION OF THE WORDING "CONTRASTE" IS "CONTRAST".

SN 77-049,855, FILED 11-22-2006.

INGRID C. EULIN, EXAMINING ATTORNEY

Int. Cl.: 36

Prior U.S. Cls.: 100, 101, and 102

United States Patent and Trademark Office

Reg. No. 3,468,593

Registered July 15, 2008

SERVICE MARK  
PRINCIPAL REGISTER



BOSERA ASSET MANAGEMENT CO., LTD. (CHINA CORPORATION)  
29/F, CHINA MERCHANTS BANK TOWER  
7088 SHENNAN ROAD, FUTIAN DISTRICT  
SHENZHEN, 518040, CHINA

FOR: ACCIDENT INSURANCE UNDERWRITING; ACTUARIAL SERVICES; INSURANCE BROKERAGE; INSURANCE UNDERWRITING; FIRE INSURANCE UNDERWRITING; HEALTH INSURANCE UNDERWRITING; MARINE INSURANCE UNDERWRITING; LIFE INSURANCE UNDERWRITING; INSURANCE CONSULTANCY; PROVIDING INSURANCE INFORMATION; BANKING; MUTUAL FUND ESTABLISHMENT, SPONSORSHIP, INVESTMENT, DISTRIBUTION AND BROKERAGE; CAPITAL INVESTMENT CONSULTATION; EQUITY CAPITAL INVESTMENTS; MANAGEMENT OF CAPITAL INVESTMENT FUNDS; FUNDS INVESTMENTS; MONETARY EXCHANGE; ISSUING OF TRAVELERS' CHECKS; FINANCIAL CLEARING SERVICES; LOAN FINANCING; FINANCIAL EVALUATION IN THE FIELDS OF INSURANCE, BANKING, REAL ESTATE; FINANCING SERVICES; FINANCIAL MANAGEMENT; MORTGAGE BANKING; SAVINGS BANKS; BROKERAGE FOR HIRE-PURCHASE; FINANCIAL ANALYSIS; CHECK VERIFICATION; FINANCIAL CONSULTANCY; CREDIT CARD SERVICES; DEBIT CARD SERVICES; ELECTRONIC FUNDS TRANS-

FER; PROVIDING FINANCIAL INFORMATION; ISSUANCE OF TOKENS OF VALUE; ISSUANCE OF CREDIT CARDS; RETIREMENT PAYMENT SERVICES; HOME BANKING; SECURITIES BROKERAGE; STOCK EXCHANGE QUOTATIONS; LEASING OF REAL ESTATE; REAL ESTATE MANAGEMENT; RENTAL OF OFFICE SPACE; BROKERAGE IN THE FIELD OF SECURITIES; GUARANTEES, NAMELY, GUARANTEE ASSURANCE UNDERWRITING; FINANCIAL GUARANTEE AND SURETY; MONEY ORDER PAYMENT GUARANTEE SERVICES; PAWN-BROKERAGE; CHARITABLE FUND RAISING; FACTORING AGENCIES; FIDUCIARY REPRESENTATIVE SERVICES; FIDUCIARY TAX PAYMENT PROCESSING SERVICES; TRUSTEESHIP REPRESENTATIVE SERVICES, IN CLASS 36 (U.S. CLS. 100, 101 AND 102).

FIRST USE 7-13-2006; IN COMMERCE 4-1-2008.

THE NON-LATIN CHARACTERS IN THE MARK TRANSLITERATE TO BO; SHI AND THESE MEAN EXTENSIVE; TIME IN ENGLISH.

SN 77-050,768, FILED 11-27-2006.

ARETHA SOMERVILLE, EXAMINING ATTORNEY

**Int. Cl.: 33**

**Prior U.S. Cls.: 47 and 49**

**United States Patent and Trademark Office**

**Reg. No. 3,468,594**

**Registered July 15, 2008**

**TRADEMARK  
PRINCIPAL REGISTER**

**MURARI**

BANFI PRODUCTS CORPORATION (NEW YORK  
CORPORATION)  
1111 CEDAR SWAMP ROAD  
OLD BROOKVILLE, NY 11545

THE MARK CONSISTS OF STANDARD CHAR-  
ACTERS WITHOUT CLAIM TO ANY PARTICULAR  
FONT, STYLE, SIZE, OR COLOR.

FOR: WINES, IN CLASS 33 (U.S. CLS. 47 AND 49).

SN 77-051,177, FILED 11-27-2006.

FIRST USE 9-26-2007; IN COMMERCE 11-1-2007.

GEORGE LORENZO, EXAMINING ATTORNEY

**Int. Cl.: 14**

**Prior U.S. Cls.: 2, 27, 28, and 50**

**United States Patent and Trademark Office**

**Reg. No. 3,468,595**

**Registered July 15, 2008**

**TRADEMARK  
PRINCIPAL REGISTER**

**DIAMOND MINE ALLIANCE**

JEWELRY MARKETING COMPANY, LLC (NEW  
YORK LTD LIAB CO)

1200 SIXTH AVENUE, 3RD FLOOR

NEW YORK, NY 10036

FOR: DIAMONDS, IN CLASS 14 (U.S. CLS. 2, 27, 28  
AND 50).

FIRST USE 8-1-2006; IN COMMERCE 12-1-2006.

THE MARK CONSISTS OF STANDARD CHAR-  
ACTERS WITHOUT CLAIM TO ANY PARTICULAR  
FONT, STYLE, SIZE, OR COLOR.

NO CLAIM IS MADE TO THE EXCLUSIVE  
RIGHT TO USE "DIAMOND MINE", APART FROM  
THE MARK AS SHOWN.

SN 77-053,322, FILED 11-29-2006.

BERNICE MIDDLETON, EXAMINING ATTORNEY

**Int. Cl.: 25**

**Prior U.S. Cls.: 22 and 39**

**United States Patent and Trademark Office**

**Reg. No. 3,468,596**

**Registered July 15, 2008**

**TRADEMARK  
PRINCIPAL REGISTER**

**BRISAS**

BDSRCO, INC. (DELAWARE CORPORATION)  
SUITE 202  
103 FOULK ROAD  
WILMINGTON, DE 19803

FOR: FOOTWEAR, IN CLASS 25 (U.S. CLS. 22 AND 39).

FIRST USE 6-1-2007; IN COMMERCE 6-1-2007.

THE MARK CONSISTS OF STANDARD CHARACTERS WITHOUT CLAIM TO ANY PARTICULAR FONT, STYLE, SIZE, OR COLOR.

THE FOREIGN WORDING IN THE MARK TRANSLATES INTO ENGLISH AS BREEZES.

SN 77-053,763, FILED 11-30-2006.

BRENDAN MCCAULEY, EXAMINING ATTORNEY



**Int. Cl.: 16**

**Prior U.S. Cls.: 2, 5, 22, 23, 29, 37, 38, and 50**

**United States Patent and Trademark Office**

**Reg. No. 3,468,597**

**Registered July 15, 2008**

**TRADEMARK  
PRINCIPAL REGISTER**

**ANTENNA**

HARRIS PUBLICATIONS, INC. (NEW YORK CORPORATION)  
1115 BROADWAY  
NEW YORK, NY 10010

FOR: MAGAZINE FEATURING PRODUCT INFORMATION FOR CONSUMERS IN THE AREAS OF CASUAL CLOTHING, FOOTWEAR AND CLOTHING ACCESSORIES, ELECTRONIC GADGETS NOT INCLUDING ANTENNAS, PERSONAL HEALTH, BOOKS, MUSIC, WATCHES, AND SPORTING EQUIPMENT; MAGAZINE FEATURING ARTICLES OF GENERAL INTEREST TO CONSUMERS ABOUT INNOVATIVE RETAILERS AND RETAIL ESTABLISHMENTS THAT FEATURE CASUAL CLOTHING, FOOTWEAR AND CLOTHING ACCESSORIES, ELECTRONIC GADGETS NOT INCLUDING ANTENNAS, PERSONAL HEALTH, BOOKS,

MUSIC, WATCHES, AND SPORTING EQUIPMENT; MAGAZINE FEATURING ARTICLES OF GENERAL INTEREST TO CONSUMERS ABOUT PRODUCT INNOVATORS; MAGAZINE FEATURING ARTICLES OF GENERAL INTEREST TO CONSUMERS IN THE AREA OF LIFESTYLE, IN CLASS 16 (U.S. CLS. 2, 5, 22, 23, 29, 37, 38 AND 50).

FIRST USE 7-31-2007; IN COMMERCE 7-31-2007.

THE MARK CONSISTS OF STANDARD CHARACTERS WITHOUT CLAIM TO ANY PARTICULAR FONT, STYLE, SIZE, OR COLOR.

SN 77-053,769, FILED 11-30-2006.

MAUREEN DALL, EXAMINING ATTORNEY

**Int. Cl.: 11**

**Prior U.S. Cls.: 13, 21, 23, 31, and 34**

**United States Patent and Trademark Office**

**Reg. No. 3,468,598**

**Registered July 15, 2008**

---

**TRADEMARK  
PRINCIPAL REGISTER**

**PERILITE**

STRYKER CORPORATION (MICHIGAN CORPORATION)  
2825 AIRVIEW BOULEVARD  
KALAMAZOO, MI 49002

THE MARK CONSISTS OF STANDARD CHARACTERS WITHOUT CLAIM TO ANY PARTICULAR FONT, STYLE, SIZE, OR COLOR.

FOR: SURGICAL LIGHTING, NAMELY, LIGHTING FIXTURES USED IN AN OPERATING ROOM NOT FOR MEDICAL TREATMENT PURPOSES, IN CLASS 11 (U.S. CLS. 13, 21, 23, 31 AND 34).

SN 77-055,029, FILED 12-1-2006.

FIRST USE 12-28-2007; IN COMMERCE 12-28-2007.

ALEX KEAM, EXAMINING ATTORNEY

**Int. Cl.: 43**

**Prior U.S. Cls.: 100 and 101**

**United States Patent and Trademark Office**

**Reg. No. 3,468,599**

**Registered July 15, 2008**

---

**SERVICE MARK  
PRINCIPAL REGISTER**

**UNCLE BUD'S**

UNCLE BUD'S, LLC (TENNESSEE LTD LIAB CO)  
210 FIFTH AVENUE SOUTH, APT. NO. 1  
FRANKLIN, TN 37064

THE MARK CONSISTS OF STANDARD CHAR-  
ACTERS WITHOUT CLAIM TO ANY PARTICULAR  
FONT, STYLE, SIZE, OR COLOR.

FOR: RESTAURANT SERVICES; RESTAURANTS,  
IN CLASS 43 (U.S. CLS. 100 AND 101).

SN 77-057,020, FILED 12-5-2006.

FIRST USE 12-27-2006; IN COMMERCE 12-27-2006.

GISELLE AGOSTO, EXAMINING ATTORNEY

**Int. Cl.: 9**

**Prior U.S. Cls.: 21, 23, 26, 36, and 38**

**United States Patent and Trademark Office**

**Reg. No. 3,468,600**

**Registered July 15, 2008**

**TRADEMARK  
PRINCIPAL REGISTER**



MARKET-MATCH B.V. (NETHERLANDS CORPORATION)  
ZEESLUIWEG 63  
DEN HAAG, NETHERLANDS 2583DP

FOR: ELECTRIC AND ELECTRONIC OFFICE APPARATUS, NAMELY, AN ELECTRONIC DEVICE THAT DETECTS COUNTERFEIT MONEY AND DOCUMENTS, AN ELECTRONIC DEVICE THAT COUNTS AND CHECKS FOR COUNTERFEIT BANK NOTES, AN ELECTRONIC DEVICE THAT COUNTS AND SORTS COINS, AND ELECTRONIC MONEY COUNTING SCALES; SECURITY PRODUCTS, NAMELY, CAMERAS, ELECTRONIC SAFES, MICROPHONES, DIGITAL VIDEO RECOR-

DERS, MOTION DETECTION SENSORS AND PERIMETER DETECTION SENSORS; TIME REGISTRATION SYSTEMS, NAMELY, ELECTRONIC DEVICES FOR CONTROLLING AND TRACKING ENTRY AND PROVIDING ACCESS CONTROL BY MEANS OF FINGERPRINTS OR ELECTRONIC ID CARDS, IN CLASS 9 (U.S. CLS. 21, 23, 26, 36 AND 38).

FIRST USE 4-0-2004; IN COMMERCE 4-0-2004.

SN 77-059,443, FILED 12-7-2006.

SANJEEV VOHRA, EXAMINING ATTORNEY

**Int. Cls.: 41 and 44**

**Prior U.S. Cls.: 100, 101, and 107**

**United States Patent and Trademark Office**

**Reg. No. 3,468,601**

**Registered July 15, 2008**

**SERVICE MARK  
PRINCIPAL REGISTER**

**WELLNESS INFORMATION ZONE**

HUMANA INC. (DELAWARE CORPORATION)  
500 WEST MAIN STREET  
LOUISVILLE, KY 40202

FOR: EDUCATIONAL SERVICES, NAMELY, COURSES OF INSTRUCTION, CLASSES, SEMINARS, WORKSHOPS, CONFERENCES, AND LECTURES FOR PUBLIC LIBRARIES IN THE FIELDS OF HEALTH, MEDICINE, MEDICAL PRACTICES, MEDICAL ETHICS, MEDICAL EDUCATION AND HEALTH CARE, AND THE DISTRIBUTION OF WRITTEN AND MULTI-MEDIA LEARNING MATERIALS, LEARNING TOOLS, AND ELECTRONIC MATERIALS VIA A WEBSITE TO ENHANCE THE HEALTH INFORMATION COLLECTION AT PUBLIC LIBRARIES IN CONNECTION THEREWITH; EDUCATIONAL SERVICES, NAMELY, A PROGRAM TO PROMOTE THE INTERESTS OF A HEALTHY COMMUNITY BY PROVIDING LECTURES, SEMINARS AND WORKSHOPS IN THE FIELDS OF HEALTH, MEDICINE, MEDICAL PRACTICES, MEDICAL ETHICS, MEDICAL EDUCATION AND HEALTH CARE AND THE DISTRIBUTION OF EDUCATION MATERIALS OF OTHERS; EDUCATIONAL SERVICES, NAMELY, PROVIDING TRAINING ON ACCESSING THE INTERNET IN ORDER TO OBTAIN INFORMATION RELATED TO HEALTH, MEDICINE, MEDICAL PRACTICES,

MEDICAL ETHICS, MEDICAL EDUCATION AND HEALTH CARE; PROVIDING A WEBSITE FEATURING EDUCATIONAL INFORMATION IN THE FIELDS OF MEDICAL EDUCATION, IN CLASS 41 (U.S. CLS. 100, 101 AND 107).

FIRST USE 2-28-2007; IN COMMERCE 2-28-2007.

FOR: PROVIDING A WEBSITE FEATURING EDUCATIONAL INFORMATION IN THE FIELDS OF HEALTH, MEDICINE, MEDICAL PRACTICES, MEDICAL ETHICS, AND HEALTH CARE, IN CLASS 44 (U.S. CLS. 100 AND 101).

FIRST USE 2-28-2007; IN COMMERCE 2-28-2007.

THE MARK CONSISTS OF STANDARD CHARACTERS WITHOUT CLAIM TO ANY PARTICULAR FONT, STYLE, SIZE, OR COLOR.

NO CLAIM IS MADE TO THE EXCLUSIVE RIGHT TO USE "WELLNESS INFORMATION", APART FROM THE MARK AS SHOWN.

SN 77-059,876, FILED 12-8-2006.

CHRISTINA SOBRAL, EXAMINING ATTORNEY

**Int. Cl.: 10**

**Prior U.S. Cls.: 26, 39, and 44**

**United States Patent and Trademark Office**

**Reg. No. 3,468,602**

**Registered July 15, 2008**

**TRADEMARK  
PRINCIPAL REGISTER**

**SOUL MATE**

LIFESCIENCE SOLUTIONS, LLC (DELAWARE  
LTD LIAB CO)  
THE RICHARDSON BUILDING  
13950 BALLANTYNE CORPORATE PLACE  
CHARLOTTE, NC 28277

FOR: MEDICAL DEVICES, NAMELY, IMPLANTABLE PULSE GENERATORS CAPABLE OF REMOTE INTERROGATION FOR REAL TIME WIRELESS REMOTE MONITORING OF ORGANS AND TISSUE, IN CLASS 10 (U.S. CLS. 26, 39 AND 44).

FIRST USE 8-27-2007; IN COMMERCE 8-27-2007.

THE MARK CONSISTS OF STANDARD CHARACTERS WITHOUT CLAIM TO ANY PARTICULAR FONT, STYLE, SIZE, OR COLOR.

SN 77-060,250, FILED 12-8-2006.

JOHN KELLY, EXAMINING ATTORNEY

Int. Cl.: 25

Prior U.S. Cls.: 22 and 39

United States Patent and Trademark Office

Reg. No. 3,468,603

Registered July 15, 2008

TRADEMARK  
PRINCIPAL REGISTER

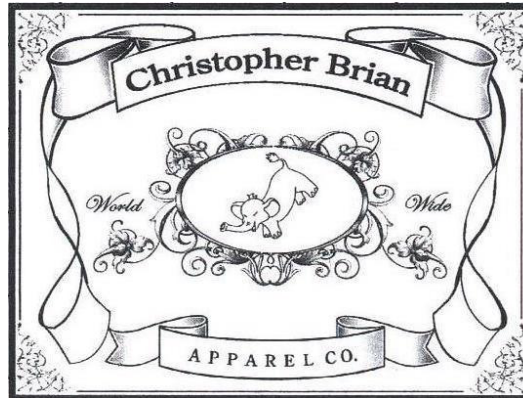

CHRISTOPHER BRIAN APPAREL, INC. (CALIFORNIA CORPORATION)  
SUITE 240  
6320 CANOGA AVENUE  
WOODLAND HILLS, CA 91367

FOR: ANKLE BOOTS; ANKLE SOCKS; ANKLETS; ASCOTS; ATHLETIC SHOES; BALLOON PANTS; BANDANAS; BELTS; BELTS MADE OF LEATHER; BIB OVERALLS; BLOUSES; BOOTS; BOW TIES; BOXER BRIEFS; BOXER SHORTS; BRIEFS; CAMP SHIRTS; CAPRI PANTS; CARGO PANTS; CHILDREN'S AND INFANTS' CLOTH BIBS; COATS; COATS FOR MEN AND WOMEN; COATS MADE OF COTTON; COATS OF DENIM; CROP TOPS; DENIM JACKETS; DENIMS; DRESS SHIRTS; DRESS SUITS; DRESSES; DRESSES MADE FROM SKINS; FLEECE SHORTS; FOOTWEAR FOR MEN; FOOTWEAR FOR MEN AND WOMEN; FOOTWEAR FOR WOMEN; FUR COATS AND JACKETS; FUR JACKETS; GLOVES; HALTER TOPS; HATS; HEAD SCARVES; HEAVY JACKETS; INFANT AND TODDLER ONE PIECE CLOTHING; INFANTS' SHOES AND BOOTS; JACKET LINERS; JACKETS; JEANS; JOGGING OUTFITS; JOGGING PANTS; JOGGING SUITS; KNIT SHIRTS; KNITTED UNDERWEAR; LADIES' BOOTS; LADIES' UNDERWEAR; LEATHER BELTS; LEATHER COATS; LEATHER JACKETS; LEATHER PANTS; LEATHER SHOES; LONG JACKETS; LONG SLEEVED VESTS; MEN AND WOMEN JACKETS, COATS, TROUSERS, VESTS; MEN'S SOCKS; MEN'S SUITS; MEN'S SUITS, WOMEN'S SUITS; MOCK TURTLE-NECK SWEATERS; MONEY BELTS; ONE PIECE GARMENT FOR INFANTS AND TODDLERS; OPEN-NECKED SHIRTS; OVER COATS; OVERALLS; PANTIES, SHORTS AND

BRIEFS; PANTS; PANTYHOSE; PIQUE SHIRTS; POLO SHIRTS; QUILTED VESTS; RAIN COATS; RAIN JACKETS; RAINPROOF JACKETS; RIDING COATS; SCARVES; SHAWLS AND HEADSCARVES; SHAWLS AND STOLE; SHIRT FRONTS; SHIRTS; SHIRTS FOR SUITS; SHOES; SHORT SETS; SHORT-SLEEVED OR LONG-SLEEVED T-SHIRTS; SHORT-SLEEVED SHIRTS; SHORTS; SHOULDER SCARVES; SILK SCARVES; SKIRT SUITS; SKIRTS; SKIRTS AND DRESSES; SKORTS; SLEEP SHIRTS; SLEEVED OR SLEEVELESS JACKETS; SMOKING JACKETS; SNEAKERS; SOCKS; SOCKS AND STOCKINGS; SPORT COATS; SPORT SHIRTS; SPORTS JACKETS; SPORTS SHIRTS; SPORTS SHIRTS WITH SHORT SLEEVES; STOCKINGS; SUEDE JACKETS; SUIT COATS; SUITS; SUSPENDER BELTS FOR MEN; SUSPENDER BELTS FOR WOMEN; SWEAT PANTS; SWEAT SHIRTS; SWEAT SUITS; SWEATERS; T-SHIRTS; TANK TOPS; THONGS; TIES; TOP COATS; TOPS; TRACK SUITS; TRENCH COATS; TURTLE-NECK SWEATERS; UNDERWEAR; V-NECK SWEATERS; VESTED SUITS; VESTS; WAIST BELTS; WALKING SHORTS; WATERPROOF JACKETS AND PANTS; WIND VESTS; WOMEN'S SHOES; WOMEN'S UNDERWEAR, IN CLASS 25 (U.S. CLS. 22 AND 39).

FIRST USE 2-13-2007; IN COMMERCE 2-13-2007.

NO CLAIM IS MADE TO THE EXCLUSIVE RIGHT TO USE "WORLD WIDE" AND "APPAREL CO.", APART FROM THE MARK AS SHOWN.

THE NAME(S), PORTRAIT(S), AND/OR SIGNATURE(S) SHOWN IN THE MARK IDENTIFIES

"CHRISTOPHER BRIAN STOKES", WHOSE CONSENT(S) TO REGISTER IS SUBMITTED.

THE MARK CONSISTS OF THE TERMS "CHRISTOPHER BRIAN" IN RIBBONS ABOVE AN ELEPHANT INSIDE AN OVAL OUTLINED WITH CURVED DESIGNS AND THE TERMS "WORLD"

AND "WIDE" ON THE SIDES OF THE OVAL. THE TERMS "APPAREL CO." APPEAR BELOW THE OVAL IN A RIBBON DESIGN.

SN 77-060,938, FILED 12-11-2006.

CAROLINE WOOD, EXAMINING ATTORNEY



**Int. Cls.: 9 and 28**

**Prior U.S. Cls.: 21, 22, 23, 26, 36, 38, and 50**

**Reg. No. 3,468,604**

**United States Patent and Trademark Office**

**Registered July 15, 2008**

**TRADEMARK  
PRINCIPAL REGISTER**

**DYNAMIS**

BACHMAN EUROPE PLC (UNITED KINGDOM  
PUBLIC LIMITED COMPANY (PLC))  
MOAT WAY, BARWELL  
LEICESTER, UNITED KINGDOM LE98EY

FOR: ELECTRIC AND ELECTRONIC CONTROL-  
LERS FOR TOY AND MODEL TRAIN SETS, IN  
CLASS 9 (U.S. CLS. 21, 23, 26, 36 AND 38).

FIRST USE 8-1-2007; IN COMMERCE 8-1-2007.

FOR: TOY AND MODEL TRAIN SETS COM-  
PRISED OF TOY AND MODEL TRAINS, TOY AND  
MODEL TRAIN TRACKS AND ELECTRIC AND  
ELECTRONIC CONTROLLERS THEREFOR, ALL  
SOLD AS A UNIT; TOY AND MODEL TRAINS,

TOY AND MODEL TRAIN TRACKS, MODEL KITS  
FOR TOY AND MODEL TRAIN SETS, TOY MODEL  
HOBBY CRAFT KITS, AND PARTS AND FITTINGS  
FOR THE AFORESAID GOODS, IN CLASS 28 (U.S.  
CLS. 22, 23, 38 AND 50).

FIRST USE 8-1-2007; IN COMMERCE 8-1-2007.

THE MARK CONSISTS OF STANDARD CHAR-  
ACTERS WITHOUT CLAIM TO ANY PARTICULAR  
FONT, STYLE, SIZE, OR COLOR.

SN 77-061,862, FILED 12-11-2006.

RONALD MCMORROW, EXAMINING ATTORNEY

Int. Cl.: 25

Prior U.S. Cls.: 22 and 39

United States Patent and Trademark Office

Reg. No. 3,468,605

Registered July 15, 2008

TRADEMARK  
PRINCIPAL REGISTER

CHRISTOPHER BRIAN

CHRISTOPHER BRIAN APPAREL, INC. (NEVADA CORPORATION)  
SUITE 240  
6320 CANOGA AVENUE  
WOODLAND HILLS, CA 91367

FOR: ANKLE BOOTS; ANKLE SOCKS; ANKLETS; ASCOTS; ATHLETIC SHOES; BALLOON PANTS; BANDANAS; BELTS; BELTS MADE OF LEATHER; BIB OVERALLS; BLOUSES; BOOTS; BOW TIES; BOXER BRIEFS; BOXER SHORTS; BRIEFS; CAMP SHIRTS; CAPRI PANTS; CARGO PANTS; CHILDREN'S AND INFANTS' CLOTH BIBS; COATS; COATS FOR MEN AND WOMEN; COATS MADE OF COTTON; COATS OF DENIM; CROP TOPS; DENIM JACKETS; DENIMS; DRESS SHIRTS; DRESS SUITS; DRESSES; DRESSES MADE FROM SKINS; FLEECE SHORTS; FOOTWEAR FOR MEN; FOOTWEAR FOR MEN AND WOMEN; FOOTWEAR FOR WOMEN; FUR COATS AND JACKETS; FUR JACKETS; GLOVES; HALTER TOPS; HATS; HEAD SCARVES; HEAVY JACKETS; INFANT AND TODDLER ONE PIECE CLOTHING; INFANTS' SHOES AND BOOTS; JACKET LINERS; JACKETS; JEANS; JOGGING OUTFITS; JOGGING PANTS; JOGGING SUITS; KNIT SHIRTS; KNITTED UNDERWEAR; LADIES' BOOTS; LADIES' UNDERWEAR; LEATHER BELTS; LEATHER COATS; LEATHER JACKETS; LEATHER PANTS; LEATHER SHOES; LONG JACKETS; LONG SLEEVED VESTS; MEN AND WOMEN JACKETS, COATS, TROUSERS, VESTS; MEN'S SOCKS; MEN'S SUITS; MEN'S SUITS, WOMEN'S SUITS; MOCK TURTLE-NECK SWEATERS; MONEY BELTS; ONE PIECE GARMENT FOR INFANTS AND TODDLERS; OPEN-NECKED SHIRTS; OVER COATS; OVERALLS; PANTIES, SHORTS AND BRIEFS; PANTS; PANTYHOSE; PIQUE SHIRTS; POLO SHIRTS; QUILTED VESTS; RAIN COATS; RAIN JACKETS; RAINPROOF JACKETS; RIDING

COATS; SCARVES; SHAWLS AND HEADSCARVES; SHAWLS AND STOLE; SHIRT FRONTS; SHIRTS; SHIRTS FOR SUITS; SHOES; SHORT SETS; SHORT-SLEEVED OR LONG-SLEEVED T-SHIRTS; SHORT-SLEEVED SHIRTS; SHORTS; SHOULDER SCARVES; SILK SCARVES; SKIRT SUITS; SKIRTS; SKIRTS AND DRESSES; SKORTS; SLEEP SHIRTS; SLEEVED OR SLEEVELESS JACKETS; SMOKING JACKETS; SNEAKERS; SOCKS; SOCKS AND STOCKINGS; SPORT COATS; SPORT SHIRTS; SPORTS JACKETS; SPORTS SHIRTS; SPORTS SHIRTS WITH SHORT SLEEVES; STOCKINGS; SUEDE JACKETS; SUIT COATS; SUITS; SUSPENDER BELTS FOR MEN; SUSPENDER BELTS FOR WOMEN; SWEAT PANTS; SWEAT SHIRTS; SWEAT SUITS; SWEATERS; T-SHIRTS; TANK TOPS; THONGS; TIES; TOP COATS; TOPS; TRACK SUITS; TRENCH COATS; TURTLE-NECK SWEATERS; UNDERWEAR; V-NECK SWEATERS; VESTED SUITS; VESTS; WAIST BELTS; WALKING SHORTS; WATERPROOF JACKETS AND PANTS; WIND VESTS; WOMEN'S SHOES; WOMEN'S UNDERWEAR, IN CLASS 25 (U.S. CLS. 22 AND 39).

FIRST USE 2-13-2007; IN COMMERCE 2-13-2007.

THE MARK CONSISTS OF STANDARD CHARACTERS WITHOUT CLAIM TO ANY PARTICULAR FONT, STYLE, SIZE, OR COLOR.

THE NAME(S), PORTRAIT(S), AND/OR SIGNATURE(S) SHOWN IN THE MARK IDENTIFIES "CHRISTOPHER BRIAN STOKES", WHOSE CONSENT(S) TO REGISTER IS SUBMITTED.

SN 77-061,948, FILED 12-12-2006.

CAROLINE WOOD, EXAMINING ATTORNEY

**Int. Cl.: 5**

**Prior U.S. Cls.: 6, 18, 44, 46, 51, and 52**

**United States Patent and Trademark Office**

**Reg. No. 3,468,606**

**Registered July 15, 2008**

**TRADEMARK  
PRINCIPAL REGISTER**



JOHNSON & JOHNSON (NEW JERSEY CORPORATION)  
ONE JOHNSON & JOHNSON PLAZA  
NEW BRUNSWICK, NJ 089337001

THE MARK CONSISTS OF A HAND HOLDING A TEARDROP WITH A STARBURST AT THE BASE OF THE TEARDROP.

FOR: SANITIZING PREPARATIONS, NAMELY, HAND SANITIZERS HAVING ANTI-MICROBIAL AND ANTI-BACTERIAL PROPERTIES; GERMICIDES, IN CLASS 5 (U.S. CLS. 6, 18, 44, 46, 51 AND 52).

SN 77-062,334, FILED 12-12-2006.

FIRST USE 0-0-2007; IN COMMERCE 0-0-2007.

KEVIN DINALLO, EXAMINING ATTORNEY

**Int. Cl.: 42**

**Prior U.S. Cls.: 100 and 101**

**United States Patent and Trademark Office**

**Reg. No. 3,468,607**

**Registered July 15, 2008**

**SERVICE MARK  
PRINCIPAL REGISTER**



THE GROUNDWATER FOUNDATION (NEBRASKA NON-PROFIT CORPORATION)  
5561 S. 48TH STREET, STE. 215  
LINCOLN, NE 68516

FOR: ENVIRONMENTAL SERVICES IN THE FIELD OF ANALYSIS AND TESTING OF GROUNDWATER PRACTICES, AND REPORTS ASSOCIATED THEREWITH, OF LOCATIONS SUCH AS GOLF COURSES AND CITY PARKS, IN CLASS 42 (U.S. CLS. 100 AND 101).

FIRST USE 2-28-2007; IN COMMERCE 2-28-2007.

OWNER OF U.S. REG. NO. 2,569,704.

NO CLAIM IS MADE TO THE EXCLUSIVE RIGHT TO USE "GROUNDWATER", APART FROM THE MARK AS SHOWN.

THE COLOR(S) WHITE, BLACK, AND GREEN IS/ARE CLAIMED AS A FEATURE OF THE MARK.

THE MARK CONSISTS OF A U-SHAPE WITH A STRAIGHT EDGE ACROSS THE TOP OF THE U-SHAPE. WHITE BACKGROUND WITH BLACK LETTERING AROUND THE INSIDE OF THE PERIMETER OF THE U-SHAPE. GREEN AND WHITE HORIZONTAL LINES IN THE MIDDLE OF THE U-SHAPE WHICH FORM THE OUTLINE OF A WATER DROP.

SN 77-064,135, FILED 12-14-2006.

EMILY CARLSEN, EXAMINING ATTORNEY

**Int. Cl.: 35**

**Prior U.S. Cls.: 100, 101, and 102**

**United States Patent and Trademark Office**

**Reg. No. 3,468,608**

**Registered July 15, 2008**

**SERVICE MARK  
PRINCIPAL REGISTER**

**FIND YOURS QVC**

ER MARKS, INC. (DELAWARE CORPORATION)  
SUITE 205B SECOND FLOOR BANCROFT BUILDING  
3411 SILVERSIDE ROAD; CONCORD PLAZA  
WILMINGTON, DE 19810

FOR: PROVIDING HOME SHOPPING SERVICES  
IN THE FIELD OF GENERAL MERCHANDISE BY  
MEANS OF TELEVISION; RETAIL STORE SERVI-  
CES AVAILABLE THROUGH INTERACTIVE TELE-  
VISION FEATURING GENERAL MERCHANDISE;  
AND RETAIL SHOPPING SERVICES IN THE FIELD  
OF GENERAL MERCHANDISE BY MEANS OF  
INTERNET, MOBILE PHONE AND PORTABLE  
AND HAND-HELD DIGITAL AND ELECTRONIC  
DEVICES, IN CLASS 35 (U.S. CLS. 100, 101 AND 102).

FIRST USE 4-30-2007; IN COMMERCE 4-30-2007.

THE MARK CONSISTS OF STANDARD CHAR-  
ACTERS WITHOUT CLAIM TO ANY PARTICULAR  
FONT, STYLE, SIZE, OR COLOR.

OWNER OF U.S. REG. NOS. 1,930,782, 2,098,066,  
AND OTHERS.

SN 77-064,276, FILED 12-14-2006.

K. MARGARET LE, EXAMINING ATTORNEY

**Int. Cls.: 35 and 45**

**Prior U.S. Cls.: 100, 101, and 102**

**United States Patent and Trademark Office**

**Reg. No. 3,468,609**

**Registered July 15, 2008**

**SERVICE MARK  
PRINCIPAL REGISTER**

**SMARTTALENT**

SMARTTALENT LLC (WASHINGTON LTD LIAB  
CO)  
1321 FOURTH AVENUE  
SEATTLE, WA 98101

FOR: HUMAN RESOURCES CONSULTING, BUSINESS CONSULTING IN THE FIELD OF SCREENING, EVALUATING AND TRAINING JOB RECRUITS; JOB, PROFESSIONAL EMPLOYMENT, EXECUTIVE, CAREER AND PERSONNEL PLACEMENT SERVICES; EMPLOYMENT HIRING, RECRUITING AND STAFFING SERVICES; EXECUTIVE SEARCH SERVICES; ONLINE BUSINESS DIRECTORIES FEATURING JOB LISTINGS AND EMPLOYMENT CANDIDATE BIOS; EMPLOYMENT COUNSELING; TEMPORARY EMPLOYMENT AGENCIES; PROVIDING OFFICE SUPPORT STAFF SERVICES; EMPLOYMENT OUTPLACEMENT SERVICES; ON-SITE BUSINESS MANAGEMENT; OVERSIGHT IN THE NATURE OF BUSINESS MANAGEMENT AND BUSINESS SUPERVISION SERVICES; ADMINISTRATION OF ACCOUNTING AND BUSINESS PAYROLL SERVICES FOR OTHERS; FULL-TIME JOB PLACEMENT; TEMPORARY JOB PLACEMENT; TEMP-TO-HIRE JOB PLACEMENT; ACCOUNTING SERVICES; OPERATION OF TELEPHONE CALL CENTERS FOR

OTHERS; CUSTOMER SERVICE IN THE FIELD OF HUMAN RESOURCES; WAREHOUSE STAFFING SERVICES; DISTRIBUTION CENTER STAFFING SERVICES; TRANSPORTATION STAFFING SERVICES; MEDICAL OFFICE STAFFING SERVICES; LEGAL OFFICE STAFFING SERVICES; ADMINISTRATIVE STAFFING SERVICES; FINANCIAL STAFFING SERVICES; PROFESSIONAL STAFFING SERVICES; PRE-EMPLOYMENT SKILLS EVALUATION TO DETERMINE EMPLOYMENT SKILLS, IN CLASS 35 (U.S. CLS. 100, 101 AND 102).

FIRST USE 7-0-2001; IN COMMERCE 7-0-2007.

FOR: PRE-EMPLOYMENT BACKGROUND SCREENING, IN CLASS 45 (U.S. CLS. 100 AND 101).

FIRST USE 7-0-2001; IN COMMERCE 7-0-2007.

THE MARK CONSISTS OF STANDARD CHARACTERS WITHOUT CLAIM TO ANY PARTICULAR FONT, STYLE, SIZE, OR COLOR.

SN 77-065,699, FILED 12-15-2006.

ALEX KEAM, EXAMINING ATTORNEY

**Int. Cls.: 9, 19, and 21**

**Prior U.S. Cls.: 1, 2, 12, 13, 21, 23, 26, 29, 30, 33, 36,  
38, 40, and 50**

**Reg. No. 3,468,610**

**United States Patent and Trademark Office**

**Registered July 15, 2008**

**TRADEMARK  
PRINCIPAL REGISTER**



FLOOR AND DECOR OUTLETS OF AMERICA,  
INC. (GEORGIA CORPORATION)  
SUITE 400  
245 TOWNPARK DRIVE  
KENNESAW, GA 30144

OWNER OF U.S. REG. NOS. 3,102,586, 3,110,827,  
AND OTHERS.

FOR: INSTRUCTIONAL DVDS IN THE FIELD OF  
STONE, TILE, AND MARBLE INSTALLATION, IN  
CLASS 9 (U.S. CLS. 21, 23, 26, 36 AND 38).

THE COLOR(S) RED, WHITE, AND BLACK IS/  
ARE CLAIMED AS A FEATURE OF THE MARK.

FIRST USE 0-0-2006; IN COMMERCE 0-0-2006.

FOR: NON-METAL BUILDING MATERIALS,  
NAMELY, WOOD FLOORING AND TRAVERTINE  
TILES, IN CLASS 19 (U.S. CLS. 1, 12, 33 AND 50).

THE MARK CONSISTS OF THE WORDS  
"FLOOR" AND "DECOR" IN BLACK LETTERS  
STACKED ON TOP OF EACH OTHER WITH AN  
AMPERSAND THE FULL HEIGHT OF THE  
STACKED WORDS IN WHITE ON A RED BACK-  
GROUND TO THE RIGHT OF THE WORDS.

FIRST USE 4-0-2003; IN COMMERCE 12-0-2003.

SEC. 2(F) AS TO "FLOOR & DECOR".

FOR: PLASTIC BUCKETS, IN CLASS 21 (U.S. CLS.  
2, 13, 23, 29, 30, 33, 40 AND 50).

SN 77-067,782, FILED 12-19-2006.

FIRST USE 8-0-2004; IN COMMERCE 8-0-2004.

TAMARA FRAZIER, EXAMINING ATTORNEY

**Int. Cls.: 14, 16, 25, and 41**

**Prior U.S. Cls.: 2, 5, 22, 23, 27, 28, 29, 37, 38, 39, 50,  
100, 101, and 107**

**Reg. No. 3,468,611**

**United States Patent and Trademark Office**

**Registered July 15, 2008**

**TRADEMARK  
SERVICE MARK  
PRINCIPAL REGISTER**



KW INTELLECTUAL PROPERTIES, INC. (FLORIDA CORPORATION)  
1400 BROADWAY BLVD., SE  
POLK CITY, FL 33868

FOR: JEWELRY, NECKLACES, LAPEL PINS, PENDANTS, RINGS, BRACELETS, CLOCKS, CUFFLINKS, EARRINGS, IN CLASS 14 (U.S. CLS. 2, 27, 28 AND 50).

FIRST USE 6-29-2007; IN COMMERCE 6-29-2007.

FOR: POSTERS, POSTCARDS, GREETING CARDS, ART PICTURES, ART PRINTS, IN CLASS 16 (U.S. CLS. 2, 5, 22, 23, 29, 37, 38 AND 50).

FIRST USE 6-29-2007; IN COMMERCE 6-29-2007.

FOR: CLOTHING, NAMELY, COATS, JACKETS, SHIRTS, T-SHIRTS, SWEATSHIRTS, SHORTS, PANTS, SWEATPANTS, CAPS, HATS, IN CLASS 25 (U.S. CLS. 22 AND 39).

FIRST USE 6-29-2007; IN COMMERCE 6-29-2007.

FOR: ENTERTAINMENT SERVICES, NAMELY, MOTION PICTURE FILM PRODUCTION, ANIMATION PRODUCTION SERVICES, PRODUCTION OF STATE PRESENTATIONS IN THE NATURE OF PLAYS AND HISTORICAL PRESENTATIONS; AMUSEMENT AND EDUCATIONAL SERVICES IN THE NATURE OF AMUSEMENT PARK AND THEME PARK SERVICES, MUSEUMS; ENTERTAINMENT SERVICES IN THE NATURE OF PROVIDING RIDES IN A HOT AIR BALLOON, HELICOPTER AND AIRPLANES, IN CLASS 41 (U.S. CLS. 100, 101 AND 107).

FIRST USE 7-27-2006; IN COMMERCE 11-3-2006.

THE MARK CONSISTS OF A STYLIZED BIRD, WITH A SEMI-CIRCLE ABOVE IT, ALONG WITH A STAR DESIGN.

SN 77-068,043, FILED 12-20-2006.

COLLEEN KEARNEY, EXAMINING ATTORNEY



**Int. Cl.: 9**

**Prior U.S. Cls.: 21, 23, 26, 36, and 38**

**Reg. No. 3,468,612**

**United States Patent and Trademark Office**

**Registered July 15, 2008**

---

**TRADEMARK  
PRINCIPAL REGISTER**



NIKON CORPORATION (JAPAN CORPORATION)  
2-3, MARUNOUCHI 3-CHOME, CHIYODA-KU  
TOKYO, JAPAN 100

FIRST USE 7-1-2007; IN COMMERCE 7-1-2007.

SN 77-068,553, FILED 12-20-2006.

FOR: RIFLESCOPES, IN CLASS 9 (U.S. CLS. 21, 23,  
26, 36 AND 38).

JESSICA FATHY, EXAMINING ATTORNEY

**Int. Cl.: 9**

**Prior U.S. Cls.: 21, 23, 26, 36, and 38**

**Reg. No. 3,468,613**

**United States Patent and Trademark Office**

**Registered July 15, 2008**

---

**TRADEMARK  
PRINCIPAL REGISTER**

**Lucky Dragon**

GLOBAL GAMING GROUP (NEVADA CORPORATION)  
3035 E PATRICK LN #14  
LAS VEGAS, NV 89120

THE MARK CONSISTS OF STANDARD CHARACTERS WITHOUT CLAIM TO ANY PARTICULAR FONT, STYLE, SIZE, OR COLOR.

FOR: GAMING EQUIPMENT, NAMELY, SLOT MACHINES WITH OR WITHOUT VIDEO OUTPUT, IN CLASS 9 (U.S. CLS. 21, 23, 26, 36 AND 38).

SN 77-068,626, FILED 12-20-2006.

FIRST USE 3-12-2007; IN COMMERCE 3-12-2007.

DAVID MURRAY, EXAMINING ATTORNEY

**Int. Cl.: 9**

**Prior U.S. Cls.: 21, 23, 26, 36, and 38**

**Reg. No. 3,468,614**

**United States Patent and Trademark Office**

**Registered July 15, 2008**

**TRADEMARK  
PRINCIPAL REGISTER**

**HELIOS**

QUANTUM OPTICS, INC. (DELAWARE COR-  
PORATION)  
500 GEORGE WASHINGTON HIGHWAY  
SMITHFIELD, RI 02917

THE MARK CONSISTS OF STANDARD CHAR-  
ACTERS WITHOUT CLAIM TO ANY PARTICULAR  
FONT, STYLE, SIZE, OR COLOR.

FOR: SUNGLASSES, IN CLASS 9 (U.S. CLS. 21, 23,  
26, 36 AND 38).

SN 77-068,731, FILED 12-20-2006.

FIRST USE 12-0-2006; IN COMMERCE 3-0-2007.

MARGARET POWER, EXAMINING ATTORNEY

**Int. Cl.: 44**

**Prior U.S. Cls.: 100 and 101**

**United States Patent and Trademark Office**

**Reg. No. 3,468,615**

**Registered July 15, 2008**

**SERVICE MARK  
PRINCIPAL REGISTER**



**THE HEART INSTITUTE**  
**AT SUMMERLIN HOSPITAL**

UHS OF DELAWARE, INC. (DELAWARE CORPORATION)

367 SOUTH GULPH ROAD  
KING OF PRUSSIA, PA 19406

FOR: MEDICAL AND HEALTHCARE SERVICES,  
IN CLASS 44 (U.S. CLS. 100 AND 101).

FIRST USE 1-0-2007; IN COMMERCE 1-0-2007.

OWNER OF U.S. REG. NOS. 1,987,751, 2,804,443,  
AND 3,059,851.

NO CLAIM IS MADE TO THE EXCLUSIVE  
RIGHT TO USE "HEART INSTITUTE" AND "HOSPITAL",  
APART FROM THE MARK AS SHOWN.

SN 77-069,195, FILED 12-21-2006.

PAULA MAHONEY, EXAMINING ATTORNEY

Int. Cl.: 30

Prior U.S. Cl.: 46

United States Patent and Trademark Office

Reg. No. 3,468,616

Registered July 15, 2008

TRADEMARK  
PRINCIPAL REGISTER



H&C

H&C FOOD INDUSTRIAL CO., LTD. (TAIWAN  
CORPORATION)  
TAINAN TECHNOLOGY INDUSTRIAL PARK  
NO. 8, GUNG YE 6TH RD.  
TAINAN CITY, TAIWAN

FOR: CHOCOLATE, CHOCOLATE BARS, CHOCOLATE CANDIES, CHOCOLATE CHIPS, CHOCOLATE COVERED NUTS, CHOCOLATE COVERED RAISINS, CHOCOLATE PASTES, CHOCOLATE POWDER, CHOCOLATE SYRUP, AND COCOA, IN CLASS 30 (U.S. CL. 46).

FIRST USE 10-16-2007; IN COMMERCE 10-16-2007.

THE MARK CONSISTS OF A RIGHT-HAND HOLDING A BAR OF CHOCOLATE.

SN 77-069,333, FILED 12-21-2006.

CHRISTINA SOBRAL, EXAMINING ATTORNEY

**Int. Cl.: 41**

**Prior U.S. Cls.: 100, 101, and 107**

**United States Patent and Trademark Office**

**Reg. No. 3,468,617**

**Registered July 15, 2008**

---

**SERVICE MARK  
PRINCIPAL REGISTER**

**Napafit**

NAPAFIT LLC (DELAWARE LTD LIAB CO)  
33 COVE COURT  
NAPA, CA 94559

THE MARK CONSISTS OF STANDARD CHAR-  
ACTERS WITHOUT CLAIM TO ANY PARTICULAR  
FONT, STYLE, SIZE, OR COLOR.

FOR: PERSONAL TRAINER SERVICES, IN CLASS  
41 (U.S. CLS. 100, 101 AND 107).

SN 77-069,495, FILED 12-21-2006.

FIRST USE 4-24-2006; IN COMMERCE 4-24-2006.

PAUL MORENO, EXAMINING ATTORNEY

**Int. Cl.: 28**

**Prior U.S. Cls.: 22, 23, 38, and 50**

**United States Patent and Trademark Office**

**Reg. No. 3,468,618**

**Registered July 15, 2008**

**TRADEMARK  
PRINCIPAL REGISTER**

**TIVIT**

SAS GAMES, INC. (DELAWARE CORPORATION)  
SUITE 1  
403 BREVARD AVENUE  
COCOA, FL 32922

FOR: POSITIONABLE THREE DIMENSIONAL  
TOY FOR USE IN GAMES, IN CLASS 28 (U.S. CLS.  
22, 23, 38 AND 50).

FIRST USE 5-13-2008; IN COMMERCE 5-13-2008.

THE MARK CONSISTS OF STANDARD CHAR-  
ACTERS WITHOUT CLAIM TO ANY PARTICULAR  
FONT, STYLE, SIZE, OR COLOR.

OWNER OF U.S. REG. NO. 2,937,515.

SN 77-069,571, FILED 12-21-2006.

DAVID H. STINE, EXAMINING ATTORNEY

**Int. Cl.: 25**

**Prior U.S. Cls.: 22 and 39**

**United States Patent and Trademark Office**

**Reg. No. 3,468,619**

**Registered July 15, 2008**

**TRADEMARK  
PRINCIPAL REGISTER**

**RAIN CHEK**

HUNCHAN LTD. (HONG KONG PRIVATE LIMITED LIABILITY COMPANY)  
2103-6 BILLION PLAZA, 8 CHEUNG YUE ST.  
KOWLOON, HONG KONG

THE MARK CONSISTS OF STANDARD CHARACTERS WITHOUT CLAIM TO ANY PARTICULAR FONT, STYLE, SIZE, OR COLOR.

FOR: COATS; JACKETS; OVERALLS; PANTS; SUITS; VESTS, IN CLASS 25 (U.S. CLS. 22 AND 39).

SN 77-070,090, FILED 12-22-2006.

FIRST USE 9-8-2007; IN COMMERCE 9-8-2007.

PAUL MORENO, EXAMINING ATTORNEY



**Int. Cl.: 10**

**Prior U.S. Cls.: 26, 39, and 44**

**United States Patent and Trademark Office**

**Reg. No. 3,468,620**

**Registered July 15, 2008**

**TRADEMARK  
PRINCIPAL REGISTER**

**THIRD EYE**

AVANTIS MEDICAL SYSTEMS, INC. (CALIFORNIA CORPORATION)  
263 SANTA ANA CT.  
SUNNYVALE, CA 94085

THE MARK CONSISTS OF STANDARD CHARACTERS WITHOUT CLAIM TO ANY PARTICULAR FONT, STYLE, SIZE, OR COLOR.

FOR: MEDICAL DEVICES, NAMELY, ENDOSCOPES, IN CLASS 10 (U.S. CLS. 26, 39 AND 44).

SN 77-070,516, FILED 12-22-2006.

FIRST USE 10-3-2006; IN COMMERCE 6-27-2007.

AISHA CLARKE, EXAMINING ATTORNEY

**Int. Cl.: 10**

**Prior U.S. Cls.: 26, 39, and 44**

**United States Patent and Trademark Office**

**Reg. No. 3,468,621**

**Registered July 15, 2008**

**TRADEMARK  
PRINCIPAL REGISTER**

**RETROSCOPE**

AVANTIS MEDICAL SYSTEMS, INC. (CALIFORNIA CORPORATION)  
263 SANTA ANA CT.  
SUNNYVALE, CA 94085

THE MARK CONSISTS OF STANDARD CHARACTERS WITHOUT CLAIM TO ANY PARTICULAR FONT, STYLE, SIZE, OR COLOR.

FOR: MEDICAL DEVICES, NAMELY, ENDOSCOPES, IN CLASS 10 (U.S. CLS. 26, 39 AND 44).

SN 77-070,530, FILED 12-22-2006.

FIRST USE 10-3-2006; IN COMMERCE 6-27-2007.

AISHA CLARKE, EXAMINING ATTORNEY

**Int. Cl.: 10**

**Prior U.S. Cls.: 26, 39, and 44**

**United States Patent and Trademark Office**

**Reg. No. 3,468,622**

**Registered July 15, 2008**

**TRADEMARK  
PRINCIPAL REGISTER**

**AVANTIS MEDICAL SYSTEMS**

AVANTIS MEDICAL SYSTEMS, INC. (CALIFORNIA CORPORATION)

263 SANTA ANA CT.

SUNNYVALE, CA 94085

FOR: MEDICAL DEVICES, NAMELY, ENDOSCOPES, IN CLASS 10 (U.S. CLS. 26, 39 AND 44).

FIRST USE 10-3-2006; IN COMMERCE 6-27-2007.

THE MARK CONSISTS OF STANDARD CHARACTERS WITHOUT CLAIM TO ANY PARTICULAR FONT, STYLE, SIZE, OR COLOR.

NO CLAIM IS MADE TO THE EXCLUSIVE RIGHT TO USE "MEDICAL SYSTEMS", APART FROM THE MARK AS SHOWN.

SN 77-070,536, FILED 12-22-2006.

AISHA CLARKE, EXAMINING ATTORNEY

**Int. Cl.: 9**

**Prior U.S. Cls.: 21, 23, 26, 36, and 38**

**Reg. No. 3,468,623**

**United States Patent and Trademark Office**

**Registered July 15, 2008**

---

**TRADEMARK  
PRINCIPAL REGISTER**

**ESSENTIAL NAS PLATFORM**

HITACHI DATA SYSTEMS CORPORATION (DE-  
LAWARE CORPORATION)  
750 CENTRAL EXPRESSWAY  
SANTA CLARA, CA 95050

FOR: COMPUTER HARDWARE AND SOFTWARE, NAMELY, FOR USE IN DATA STORAGE, OPERATION OF COMPUTER APPLICATION AND NETWORKS, NETWORK-ATTACHED STORAGE (NAS) GATEWAY SYSTEMS AND INSTRUCTION MANUALS SOLD AS A UNIT THEREWITH, IN CLASS 9 (U.S. CLS. 21, 23, 26, 36 AND 38).

FIRST USE 3-4-2008; IN COMMERCE 3-4-2008.

THE MARK CONSISTS OF STANDARD CHARACTERS WITHOUT CLAIM TO ANY PARTICULAR FONT, STYLE, SIZE, OR COLOR.

NO CLAIM IS MADE TO THE EXCLUSIVE RIGHT TO USE "NAS PLATFORM", APART FROM THE MARK AS SHOWN.

SN 77-070,669, FILED 12-22-2006.

KAREN K. BUSH, EXAMINING ATTORNEY

**Int. Cl.: 1**

**Prior U.S. Cls.: 1, 5, 6, 10, 26, and 46**

**Reg. No. 3,468,624**

**United States Patent and Trademark Office**

**Registered July 15, 2008**

**TRADEMARK  
PRINCIPAL REGISTER**

**BERGSTROM NUTRITION**

CARDINAL ASSOCIATES (WASHINGTON CORPORATION), DBA BERGSTROM NUTRITION, 1000 W. 8TH STREET VANCOUVER, WA 98660

FOR: CHEMICALS FOR USE IN THE MANUFACTURE OF COSMETICS AND DIETARY SUPPLEMENTS, N A M E L Y , METHYLSULFONYLMETHANE, IN CLASS 1 (U.S. CLS. 1, 5, 6, 10, 26 AND 46).

FIRST USE 10-1-2007; IN COMMERCE 10-1-2007.

THE MARK CONSISTS OF STANDARD CHARACTERS WITHOUT CLAIM TO ANY PARTICULAR FONT, STYLE, SIZE, OR COLOR.

NO CLAIM IS MADE TO THE EXCLUSIVE RIGHT TO USE "NUTRITION", APART FROM THE MARK AS SHOWN.

SN 77-070,722, FILED 12-22-2006.

ELIZABETH BEYER, EXAMINING ATTORNEY

**Int. Cls.: 9, 25, and 41**

**Prior U.S. Cls.: 21, 22, 23, 26, 36, 38, 39, 100, 101, and 107**

**United States Patent and Trademark Office**

**Reg. No. 3,468,625**

**Registered July 15, 2008**

**TRADEMARK  
SERVICE MARK  
PRINCIPAL REGISTER**

# Souldidium

MCKNIGHT, MICHAEL (UNITED STATES INDIVIDUAL)  
11417 BELLE HAVEN DR  
NEW PORT RICHEY, FL 34654

FOR: PRE-RECORDED CDS, VIDEO TAPES, LASER DISKS AND DVDS FEATURING ENTERTAINMENT, NAMELY, LIVE MUSICAL, DRAMATIC AND ARTISTIC PERFORMANCES BY ARTISTS, IN CLASS 9 (U.S. CLS. 21, 23, 26, 36 AND 38).

FIRST USE 4-3-2007; IN COMMERCE 4-3-2007.

FOR: CAPS; HATS; JACKETS; PANTS; SHORT-SLEEVED OR LONG-SLEEVED T-SHIRTS; SWEAT BANDS; SWEAT PANTS; SWEAT SHIRTS; SWEAT SHORTS; T-SHIRTS, IN CLASS 25 (U.S. CLS. 22 AND 39).

FIRST USE 4-7-2007; IN COMMERCE 4-7-2007.

FOR: ENTERTAINMENT, NAMELY, LIVE PERFORMANCES BY A MUSICAL BAND, IN CLASS 41 (U.S. CLS. 100, 101 AND 107).

FIRST USE 4-7-2007; IN COMMERCE 4-7-2007.

THE MARK CONSISTS OF STANDARD CHARACTERS WITHOUT CLAIM TO ANY PARTICULAR FONT, STYLE, SIZE, OR COLOR.

SN 77-070,961, FILED 12-23-2006.

DAVID I, EXAMINING ATTORNEY

**Int. Cls.: 9, 25, and 41**

**Prior U.S. Cls.: 21, 22, 23, 26, 36, 38, 39, 100, 101, and 107**

**Reg. No. 3,468,626**

**United States Patent and Trademark Office**

**Registered July 15, 2008**

**TRADEMARK  
SERVICE MARK  
PRINCIPAL REGISTER**



MCKNIGHT, MICHAEL (UNITED STATES INDIVIDUAL)  
11417 BELLE HAVEN DR  
NEW PORT RICHEY, FL 34654

FOR: PRE-RECORDED CDS, VIDEO TAPES, LASER DISKS AND DVDS FEATURING ENTERTAINMENT, NAMELY, LIVE MUSICAL, DRAMATIC AND ARTISTIC PERFORMANCES BY ARTISTS, IN CLASS 9 (U.S. CLS. 21, 23, 26, 36 AND 38).

FIRST USE 4-3-2007; IN COMMERCE 4-3-2007.

FOR: CAPS; HATS; PANTS; SHORT-SLEEVED OR LONG-SLEEVED T-SHIRTS; SWEAT BANDS; SWEAT PANTS; SWEAT SHIRTS; SWEAT SHORTS; T-SHIRTS, IN CLASS 25 (U.S. CLS. 22 AND 39).

FIRST USE 4-7-2007; IN COMMERCE 4-7-2007.

FOR: ENTERTAINMENT, NAMELY, LIVE PERFORMANCES BY A MUSICAL BAND, IN CLASS 41 (U.S. CLS. 100, 101 AND 107).

FIRST USE 4-7-2007; IN COMMERCE 4-7-2007.

THE COLOR(S) RED, YELLOW AND BLACK IS/ARE CLAIMED AS A FEATURE OF THE MARK.

THE MARK CONSISTS OF A DOUBLE OR SCISSOR "S" SYMBOL IN RED, YELLOW AND BLACK.

SN 77-070,964, FILED 12-23-2006.

DAVID I, EXAMINING ATTORNEY

**Int. Cls.: 42 and 45**

**Prior U.S. Cls.: 100 and 101**

**United States Patent and Trademark Office**

**Reg. No. 3,468,627**

**Registered July 15, 2008**

**SERVICE MARK  
PRINCIPAL REGISTER**

**BIBADEE**

MADHOGARHIA, SUSHIL (UNITED STATES INDIVIDUAL)  
6520 PLATT AVE #220  
WEST HILLS, CA 91307

FOR: COMPUTER SERVICES, NAMELY, HOSTING ONLINE WEB FACILITIES FOR OTHERS FOR ORGANIZING AND CONDUCTING PLAYDATES, ONLINE MEETINGS, GATHERINGS, AND INTERACTIVE DISCUSSIONS; COMPUTER SERVICES IN THE NATURE OF CUSTOMIZED WEB PAGES FEATURING USER-DEFINED INFORMATION, PERSONAL PROFILES AND INFORMATION, IN CLASS 42 (U.S. CLS. 100 AND 101).

FIRST USE 3-3-2008; IN COMMERCE 3-3-2008.

FOR: COUNSELING, NAMELY, OFFERING ADVICE REGARDING PLAYDATES, FRIENDSHIP AND PERSONAL WELL BEING VIA A GLOBAL COMPUTER NETWORK, IN CLASS 45 (U.S. CLS. 100 AND 101).

FIRST USE 3-3-2008; IN COMMERCE 3-3-2008.

THE MARK CONSISTS OF STANDARD CHARACTERS WITHOUT CLAIM TO ANY PARTICULAR FONT, STYLE, SIZE, OR COLOR.

SN 77-071,444, FILED 12-26-2006.

ANDREA BUTLER, EXAMINING ATTORNEY



**Int. Cl.: 12**

**Prior U.S. Cls.: 19, 21, 23, 31, 35, and 44**

**Reg. No. 3,468,628**

**United States Patent and Trademark Office**

**Registered July 15, 2008**

**TRADEMARK  
PRINCIPAL REGISTER**



SCARAB MOTORSPORTS LLC (KANSAS LTD  
LIAB CO)  
3509 W 71ST STREET  
PRAIRIE VILLAGE, KS 66208

THE MARK CONSISTS OF TWO INTERLOCK-  
ING SNAKES SURROUNDING THE STYLIZED DE-  
SIGN OF A SCARAB BEETLE.

FOR: AUTOMOBILE BODIES; AUTOMOBILE  
BUMPERS; AUTOMOBILE CHASSIS, IN CLASS 12  
(U.S. CLS. 19, 21, 23, 31, 35 AND 44).

SN 77-071,790, FILED 12-27-2006.

FIRST USE 10-1-2007; IN COMMERCE 2-28-2008.

REBECCA POVARCHUK, EXAMINING ATTOR-  
NEY

**Int. Cl.: 24**

**Prior U.S. Cls.: 42 and 50**

**United States Patent and Trademark Office**

**Reg. No. 3,468,629**

**Registered July 15, 2008**

**TRADEMARK  
PRINCIPAL REGISTER**



LUNA LULLABY (TEXAS CORPORATION)  
10060 PHANTOM LANE  
MCKINNEY, TX 75070

THE MARK CONSISTS OF A STYLIZED FORM  
FOR THE WORDS "LUNA LULLABY" INSIDE A  
CLOUD-LIKE DESIGN.

FOR: BED BLANKETS; CHILDREN'S BLANKETS;  
RECEIVING BLANKETS, IN CLASS 24 (U.S. CLS. 42  
AND 50).

SN 77-071,866, FILED 12-27-2006.

FIRST USE 3-2-2007; IN COMMERCE 4-12-2007.

ANGELA GAW, EXAMINING ATTORNEY

**Int. Cl.: 5**

**Prior U.S. Cls.: 6, 18, 44, 46, 51, and 52**

**United States Patent and Trademark Office**

**Reg. No. 3,468,630**

**Registered July 15, 2008**

**TRADEMARK  
PRINCIPAL REGISTER**

**TRU EBV-G**

MERIDIAN BIOSCIENCE, INC. (OHIO CORPORATION)  
3471 RIVER HILLS DRIVE  
CINCINNATI, OH 45244

FOR: DIAGNOSTIC TEST KITS CONTAINING TRANSFER PIPETTES, POUCHED DEVICE COMPRISING A PLASTIC HOLDER AND TEST STRIP, A POUCHED CONJUGATE TUBE COMPRISING LYOPHILIZED CONJUGATE BEAD, SAMPLE DILUENT, POSITIVE CONTROL, NEGATIVE CONTROL, AND RUNNING BUFFER, FOR QUALITATIVE DIAGNOSIS FOR EPSTEIN-BARR VIRUS FOR USE IN MED-

ICAL OR CLINICAL LABORATORIES, IN CLASS 5 (U.S. CLS. 6, 18, 44, 46, 51 AND 52).

FIRST USE 8-21-2007; IN COMMERCE 8-21-2007.

THE MARK CONSISTS OF STANDARD CHARACTERS WITHOUT CLAIM TO ANY PARTICULAR FONT, STYLE, SIZE, OR COLOR.

SN 77-071,919, FILED 12-27-2006.

EDWARD NELSON, EXAMINING ATTORNEY

**Int. Cl.: 5**

**Prior U.S. Cls.: 6, 18, 44, 46, 51, and 52**

**Reg. No. 3,468,631**

**United States Patent and Trademark Office**

**Registered July 15, 2008**

**TRADEMARK  
PRINCIPAL REGISTER**

**TRU EBV-M**

MERIDIAN BIOSCIENCE, INC. (OHIO CORPORATION)  
3471 RIVER HILLS DRIVE  
CINCINNATI, OH 45244

FOR: DIAGNOSTIC TEST KITS CONTAINING TRANSFER PIPETTES, POUCHED DEVICE COMPRISING A PLASTIC HOLDER AND TEST STRIP, A POUCHED CONJUGATE TUBE COMPRISING LYOPHILIZED CONJUGATE BEAD, SAMPLE DILUENT, POSITIVE CONTROL, NEGATIVE CONTROL, AND RUNNING BUFFER, FOR THE DETECTION OF THE EPSTEIN-BARR VIRUS FOR USE IN MEDICAL

AND CLINICAL LABORATORIES, IN CLASS 5 (U.S. CLS. 6, 18, 44, 46, 51 AND 52).

FIRST USE 8-21-2007; IN COMMERCE 8-21-2007.

THE MARK CONSISTS OF STANDARD CHARACTERS WITHOUT CLAIM TO ANY PARTICULAR FONT, STYLE, SIZE, OR COLOR.

SN 77-071,929, FILED 12-27-2006.

EDWARD NELSON, EXAMINING ATTORNEY

**Int. Cl.: 36**

**Prior U.S. Cls.: 100, 101, and 102**

**United States Patent and Trademark Office**

**Reg. No. 3,468,632**

**Registered July 15, 2008**

---

**SERVICE MARK  
PRINCIPAL REGISTER**

**Creating Confident  
Investors**

PAUL WINKLER, INC. (TENNESSEE CORPORATION)  
3050 BUSINESS PARK CR., SUITE 503  
GOODLETTSVILLE, TN 37072

THE MARK CONSISTS OF STANDARD CHARACTERS WITHOUT CLAIM TO ANY PARTICULAR FONT, STYLE, SIZE, OR COLOR.

FOR: ADVICE RELATING TO INVESTMENTS, IN CLASS 36 (U.S. CLS. 100, 101 AND 102).

SN 77-072,162, FILED 12-27-2006.

FIRST USE 10-1-2007; IN COMMERCE 10-1-2007.

JENNIFER MARTIN, EXAMINING ATTORNEY

**Int. Cl.: 9**

**Prior U.S. Cls.: 21, 23, 26, 36, and 38**

**Reg. No. 3,468,633**

**United States Patent and Trademark Office**

**Registered July 15, 2008**

---

**TRADEMARK  
PRINCIPAL REGISTER**

**SDM**

HOYA CORPORATION (JAPAN CORPORATION)  
7-5, NAKAOCHIAI 2-CHOME, SHINJUKU-KU  
TOKYO, JAPAN

FOR: SINGLE LENS REFLEX INTERCHANGE-  
ABLE CAMERA LENS DRIVEN BY SUPERSONIC  
MOTOR, IN CLASS 9 (U.S. CLS. 21, 23, 26, 36 AND 38).

FIRST USE 8-1-2007; IN COMMERCE 8-1-2007.

THE MARK CONSISTS OF STANDARD CHAR-  
ACTERS WITHOUT CLAIM TO ANY PARTICULAR  
FONT, STYLE, SIZE, OR COLOR.

SN 77-073,518, FILED 12-29-2006.

TRACY WHITTAKER-BROWN, EXAMINING AT-  
TORNEY

Int. Cl.: 32

Prior U.S. Cls.: 45, 46, and 48

United States Patent and Trademark Office

Reg. No. 3,468,634

Registered July 15, 2008

TRADEMARK  
PRINCIPAL REGISTER

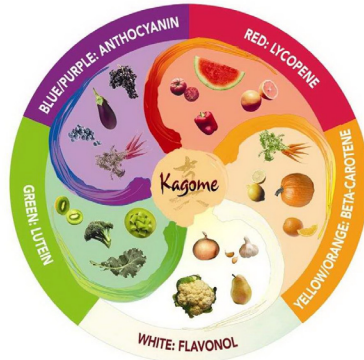

KAGOME CO., LTD. (JAPAN CORPORATION)  
14-15, 3-CHOME NISHIKI, NAKA-KU  
NAGOYA, JAPAN

FOR: BLENDED JUICES OF VEGETABLES AND  
FRUITS, IN CLASS 32 (U.S. CLS. 45, 46 AND 48).

FIRST USE 3-19-2007; IN COMMERCE 4-4-2007.

OWNER OF U.S. REG. NOS. 1,589,138, 2,315,177,  
AND 3,152,823.

NO CLAIM IS MADE TO THE EXCLUSIVE  
RIGHT TO USE "BLUE/PURPLE ANTHOCYANIN,  
RED: LYCOPENE, YELLOW/ORANGE BETA-CAROTENE,  
WHITE: FLAVONOL, GREEN LUTEIN," AS  
WELL AS THE REPRESENTATIONS OF THE  
FRUITS AND VEGETABLES DEPICTED IN THE  
MARK, NAMELY, GRAPES, EGGPLANT, BEETS,  
PEPPERS, TOMATOES, WATERMELON, GRAPE-  
FRUIT, CARROTS, ORANGES, PUMPKIN, LEM-  
ONS, ORANGES, ONIONS, PEARS,  
CAULIFLOWER, GARLIC, KIWI, BROCCOLI,  
GREEN LEAF AND BERRIES, APART FROM THE  
MARK AS SHOWN.

THE APPLICANT CLAIMS COLOR AS A FEAT-  
URE OF THE MARK, NAMELY, WHITE, BLUE,  
PURPLE, RED, ORANGE, YELLOW, GREEN,  
PEACH, AND BROWN.

THE MARK CONSISTS OF THE DESIGN OF A  
WHEEL OR DISC DIVIDED INTO SECTIONS  
SHOWING A BLUE AND PURPLE SECTION AT  
TOP LEFT; A RED AND ORANGE SECTION AT  
TOP RIGHT; AN ORANGE AND YELLOW SECTION AT  
RIGHT; A WHITE SECTION AT THE BOTTOM; A  
GREEN SECTION AT LEFT; AND A PEACH-CO-  
LORED SECTION IN THE CENTER WITH THE  
WORD "KAGOME" IN PURPLE AND THE KANJI  
CHARACTER MAKOTO IN BROWN. THE MARK  
CONSISTS OF THE FOLLOWING WORDINGS:  
"BLUE/PURPLE: ANTHOCYANIN" IN THE COLOR  
WHITE ON A PURPLE BACKGROUND, "RED:  
LYCOPENE" IN THE COLOR WHITE ON A RED-  
DISH ORANGE BACKGROUND, "YELLOW/OR-  
ANGE: BETA-CAROTENE" IN THE COLOR  
WHITE ON AN ORANGE BACKGROUND, "WHITE:  
FLAVONOL" IN THE COLOR DARK BROWN ON  
AN IVORY BACKGROUND, "GREEN: LUTEIN" IN  
THE COLOR WHITE ON A GREEN BACKGROUND.

THE ENGLISH TRANSLATION OF THE WORD  
"KAGOME" IN THE MARK IS "WOVEN BAMBOO  
PATTERNS".

THE KANJI CHARACTER IN THE MARK  
TRANSLITERATES TO "MAKOTO" AND THIS  
TRANSLATES TO "TRUE" IN ENGLISH.

SN 77-073,655, FILED 12-29-2006.

MATTHEW EINSTEIN, EXAMINING ATTORNEY

**Int. Cl.: 36**

**Prior U.S. Cls.: 100, 101, and 102**

**United States Patent and Trademark Office**

**Reg. No. 3,468,635**

**Registered July 15, 2008**

**SERVICE MARK  
PRINCIPAL REGISTER**

**Home Loan Investment Bank**

HOME LOAN INVESTMENT BANK, F.S.B.  
(RHODE ISLAND CHARTERED BANK)  
1 HOME LOAN PLAZA, SUITE 3  
WARWICK, RI 02886

FOR: BANKING; MORTGAGE BANKING;  
MORTGAGE BANKING SERVICES, NAMELY, ORI-  
GINATION, ACQUISITION, SERVICING, SECURI-  
TIZATION AND BROKERAGE OF MORTGAGE  
LOANS; MORTGAGE SERVICES, NAMELY, BUY-  
ER PRE-QUALIFICATION OF MORTGAGES FOR  
MORTGAGE BROKERS AND BANKS; ON-LINE  
BANKING SERVICES; SAVINGS BANK SERVICES,  
IN CLASS 36 (U.S. CLS. 100, 101 AND 102).

FIRST USE 1-25-2007; IN COMMERCE 1-25-2007.

THE MARK CONSISTS OF STANDARD CHAR-  
ACTERS WITHOUT CLAIM TO ANY PARTICULAR  
FONT, STYLE, SIZE, OR COLOR.

OWNER OF U.S. REG. NOS. 2,937,895 AND  
3,210,777.

NO CLAIM IS MADE TO THE EXCLUSIVE  
RIGHT TO USE "BANK", APART FROM THE  
MARK AS SHOWN.

SEC. 2(F).

SN 77-074,051, FILED 1-1-2007.

LINDA POWELL, EXAMINING ATTORNEY



**Int. Cl.: 41**

**Prior U.S. Cls.: 100, 101, and 107**

**United States Patent and Trademark Office**

**Reg. No. 3,468,636**

**Registered July 15, 2008**

---

**SERVICE MARK  
PRINCIPAL REGISTER**

**OFFICIAL NETWORK OF  
WHITETAIL**

VERSUS, L.P. (DELAWARE LIMITED PARTNER-  
SHIP)  
TWO STAMFORD PLAZA  
281 TRESSER BOULEVARD  
STAMFORD, CT 06901

FOR: ENTERTAINMENT SERVICES IN THE  
NATURE OF TELEVISION PROGRAMMING; PRO-  
DUCTION OF TELEVISION PROGRAMS AND DIS-  
TRIBUTION OF TELEVISION PROGRAMMING TO  
CABLE TELEVISION SYSTEMS; PROVIDING IN-  
FORMATION RELATING TO TELEVISION PRO-  
GRAMMING VIA GLOBAL COMPUTER

NETWORK, IN CLASS 41 (U.S. CLS. 100, 101 AND  
107).

FIRST USE 12-22-2006; IN COMMERCE 12-22-2006.

THE MARK CONSISTS OF STANDARD CHAR-  
ACTERS WITHOUT CLAIM TO ANY PARTICULAR  
FONT, STYLE, SIZE, OR COLOR.

SN 77-074,565, FILED 1-2-2007.

BRENDAN REGAN, EXAMINING ATTORNEY

**Int. Cl.: 42**

**Prior U.S. Cls.: 100 and 101**

**United States Patent and Trademark Office**

**Reg. No. 3,468,637**

**Registered July 15, 2008**

**SERVICE MARK  
PRINCIPAL REGISTER**

**YOUR PHONE YOUR LIFE**

MYRAPIDMD CORP. (NEVADA CORPORATION)  
13428 MAXELLA AVENUE, #635  
MARINA DEL REY, CA 90292

FIRST USE 9-1-2007; IN COMMERCE 9-1-2007.

FOR: MEDICAL DATA SERVICES, NAMELY,  
CREATING DATABASES OF PERSONAL MEDICAL  
DATA AND CONVERSION OF SAID DATA SO  
THAT IT CAN BE STORED AND RETRIEVED VIA  
HANDHELD PERSONAL ELECTRONIC DEVICES,  
IN CLASS 42 (U.S. CLS. 100 AND 101).

THE MARK CONSISTS OF STANDARD CHAR-  
ACTERS WITHOUT CLAIM TO ANY PARTICULAR  
FONT, STYLE, SIZE, OR COLOR.

SN 77-074,702, FILED 1-2-2007.

MARTHA FROMM, EXAMINING ATTORNEY

**Int. Cl.: 6**

**Prior U.S. Cls.: 2, 12, 13, 14, 23, 25, and 50**

**Reg. No. 3,468,638**

**United States Patent and Trademark Office**

**Registered July 15, 2008**

---

**TRADEMARK  
PRINCIPAL REGISTER**

**STREAMLINE**

HALE PRODUCTS, INC. (DELAWARE CORPORATION)  
700 SPRING MILL AVE  
CONSHOHOCKEN, PA 19428

THE MARK CONSISTS OF STANDARD CHARACTERS WITHOUT CLAIM TO ANY PARTICULAR FONT, STYLE, SIZE, OR COLOR.

FOR: METAL COUPLINGS FOR HYDRAULIC RESCUE TOOLS AND HOSES, IN CLASS 6 (U.S. CLS. 2, 12, 13, 14, 23, 25 AND 50).

SN 77-075,307, FILED 1-3-2007.

FIRST USE 5-1-2007; IN COMMERCE 5-1-2007.

ANGELA GAW, EXAMINING ATTORNEY

**Int. Cl.: 30**

**Prior U.S. Cl.: 46**

**United States Patent and Trademark Office**

**Reg. No. 3,468,639**

**Registered July 15, 2008**

**TRADEMARK  
PRINCIPAL REGISTER**

**THE ENLIGHTENED PATH TO  
SNACKING**

FRITO-LAY TRADING COMPANY GMBH  
(SWITZERLAND LTD LIAB CO)  
SPITALGASSE 2  
BERN, SWITZERLAND CH-3011

THE MARK CONSISTS OF STANDARD CHAR-  
ACTERS WITHOUT CLAIM TO ANY PARTICULAR  
FONT, STYLE, SIZE, OR COLOR.

FOR: CRACKERS; RICE CRACKERS; RICE  
FLOUR; RICE-BASED SNACK FOODS, IN CLASS  
30 (U.S. CL. 46).

SN 77-075,414, FILED 1-3-2007.

FIRST USE 3-0-2007; IN COMMERCE 3-0-2007.

MARGARET POWER, EXAMINING ATTORNEY

**Int. Cls.: 40 and 42**

**Prior U.S. Cls.: 100, 101, 103, and 106**

**United States Patent and Trademark Office**

**Reg. No. 3,468,640**

**Registered July 15, 2008**

**SERVICE MARK  
PRINCIPAL REGISTER**

**JJ LABS**

JUNE JACOBS LABS, LLC (DELAWARE LTD  
LIAB CO)  
46 GRAPHIC PLACE  
MOONACHIE, NJ 07074

FOR: MANUFACTURING SERVICES FOR OTHERS IN THE FIELD OF HAIR, SKIN AND ORAL CARE PRODUCTS, IN CLASS 40 (U.S. CLS. 100, 103 AND 106).

FIRST USE 5-0-2001; IN COMMERCE 5-0-2001.

FOR: RESEARCH AND DEVELOPMENT OF HAIR, SKIN AND ORAL CARE PRODUCTS FOR OTHERS, IN CLASS 42 (U.S. CLS. 100 AND 101).

FIRST USE 1-0-2002; IN COMMERCE 1-0-2002.

THE MARK CONSISTS OF STANDARD CHARACTERS WITHOUT CLAIM TO ANY PARTICULAR FONT, STYLE, SIZE, OR COLOR.

NO CLAIM IS MADE TO THE EXCLUSIVE RIGHT TO USE "LABS", APART FROM THE MARK AS SHOWN.

SN 77-075,518, FILED 1-3-2007.

BARBARA RUTLAND, EXAMINING ATTORNEY

**Int. Cl.: 41**

**Prior U.S. Cls.: 100, 101, and 107**

**United States Patent and Trademark Office**

**Reg. No. 3,468,641**

**Registered July 15, 2008**

**SERVICE MARK  
PRINCIPAL REGISTER**



MASSACHUSETTS MEDICAL DEVICE INDUSTRY COUNCIL, INC. (MASSACHUSETTS NON-PROFIT CORPORATION)  
715 ALBANY STREET, TW1  
BOSTON, MA 02118

FOR: BUSINESS COACHING SERVICES FOR ENTREPRENEURS IN THE MEDICAL DEVICE AND BIOMEDICAL INDUSTRIES, IN CLASS 41 (U.S. CLS. 100, 101 AND 107).

FIRST USE 12-13-2007; IN COMMERCE 12-13-2007.

THE COLOR(S) RED, ORANGE, YELLOW, AND GRAY IS/ARE CLAIMED AS A FEATURE OF THE MARK.

THE MARK CONSISTS OF THE WORD "MEDTECH" IN GRAY FOLLOWED BY THE WORD IN "IGNITE" IN CAPITAL LETTERS WITH A STYLIZED FLAME ABOVE "IGNITE". THE COLOR OF "IGNITE" AND THE FLAME IS RED AT THE BOTTOM, THEN ORANGE IN THE MIDDLE AND FINALLY YELLOW AT THE TOP, EXCEPT FOR THE TWO BOTTOM FLAMES, WHICH ARE YELLOW. "INSPIRING GROWTH IN NEW INNOVATIVE TECHNOLOGY ENTERPRISES" APPEARS UNDER "MEDTECH IGNITE" IN GRAY.

SN 77-075,761, FILED 1-4-2007.

KAPIL BHANOT, EXAMINING ATTORNEY

**Int. Cl.: 42**

**Prior U.S. Cls.: 100 and 101**

**United States Patent and Trademark Office**

**Reg. No. 3,468,642**

**Registered July 15, 2008**

**SERVICE MARK  
PRINCIPAL REGISTER**

**e-nForce**

COLLECTRONICS, INC. (TEXAS CORPORATION)  
3710 RAWLINS STREET, SUITE 1400  
DALLAS, TX 752194217

FOR: COMPUTER SERVICES, NAMELY, AN APPLICATION SERVICE PROVIDER FEATURING SOFTWARE FOR COVENANT ENFORCEMENT IN THE FIELDS OF LAW, REAL ESTATE AND COMMUNITY ASSOCIATION, IN CLASS 42 (U.S. CLS. 100 AND 101).

FIRST USE 12-31-2007; IN COMMERCE 12-31-2007.

THE MARK CONSISTS OF STANDARD CHARACTERS WITHOUT CLAIM TO ANY PARTICULAR FONT, STYLE, SIZE, OR COLOR.

SN 77-076,315, FILED 1-4-2007.

BRIAN CALLAGHAN, EXAMINING ATTORNEY

**Int. Cl.: 36**

**Prior U.S. Cls.: 100, 101, and 102**

**United States Patent and Trademark Office**

**Reg. No. 3,468,643**

**Registered July 15, 2008**

---

**SERVICE MARK  
PRINCIPAL REGISTER**

**DECISION FINDER**

AURORA LOAN SERVICES LLC (DELAWARE  
LTD LIAB CO)  
10350 PARK MEADOWS DRIVE  
LITTLETON, CO 80124

FOR: MORTGAGE SERVICES, NAMELY, AUTO-  
MATED MORTGAGE APPROVAL SERVICES, IN  
CLASS 36 (U.S. CLS. 100, 101 AND 102).

FIRST USE 1-14-2008; IN COMMERCE 1-14-2008.

THE MARK CONSISTS OF STANDARD CHAR-  
ACTERS WITHOUT CLAIM TO ANY PARTICULAR  
FONT, STYLE, SIZE, OR COLOR.

SN 77-076,672, FILED 1-5-2007.

CHRISTOPHER BUONGIORNO, EXAMINING AT-  
TORNEY



**Int. Cl.: 35**

**Prior U.S. Cls.: 100, 101, and 102**

**United States Patent and Trademark Office**

**Reg. No. 3,468,644**

**Registered July 15, 2008**

**SERVICE MARK  
PRINCIPAL REGISTER**

**EPC**

ENTRYPOINT COMMUNICATIONS LLC (DELA-  
WARE LTD LIAB CO)  
200 AMERICAN METRO BLVD., SUITE 120  
HAMILTON, NJ 08619

FOR: ADVERTISING SERVICES, NAMELY, IN-  
STORE ADVERTISING AND PROMOTIONAL PRO-  
GRAMS FOR OTHERS IN WHICH DISPENSERS  
DISPENSE SHEETS DISPLAYING PROMOTIONAL  
OFFERS TO SHOPPERS; ADVERTISING AGENCY  
SERVICES, NAMELY, PROMOTING THE SALE OF  
GOODS OF OTHERS BY PROVIDING POINT OF  
SALE DISPLAY ADVERTISEMENTS AND SALE

PROMOTIONAL MATERIAL FOR USE IN RETAIL  
STORES, IN CLASS 35 (U.S. CLS. 100, 101 AND 102).

FIRST USE 3-19-2007; IN COMMERCE 3-19-2007.

THE MARK CONSISTS OF STANDARD CHAR-  
ACTERS WITHOUT CLAIM TO ANY PARTICULAR  
FONT, STYLE, SIZE, OR COLOR.

SN 77-077,481, FILED 1-6-2007.

TOBY BULLOFF, EXAMINING ATTORNEY

**Int. Cl.: 10**

**Prior U.S. Cls.: 26, 39, and 44**

**United States Patent and Trademark Office**

**Reg. No. 3,468,645**

**Registered July 15, 2008**

**TRADEMARK  
PRINCIPAL REGISTER**

**CLEAR IMAGE**

SPECIALITY APPLIANCES WORKS, INC.  
(GEORGIA CORPORATION)  
4905 HAMMOND INDUSTRIAL DRIVE  
CUMMING, GA 30041

THE MARK CONSISTS OF STANDARD CHAR-  
ACTERS WITHOUT CLAIM TO ANY PARTICULAR  
FONT, STYLE, SIZE, OR COLOR.

FOR: ORTHODONTIC APPLIANCES, IN CLASS  
10 (U.S. CLS. 26, 39 AND 44).

SN 77-077,714, FILED 1-8-2007.

FIRST USE 10-15-2007; IN COMMERCE 10-15-2007.

SHANNON TWOHIG, EXAMINING ATTORNEY

**Int. Cl.: 44**

**Prior U.S. Cls.: 100 and 101**

**United States Patent and Trademark Office**

**Reg. No. 3,468,646**

**Registered July 15, 2008**

**SERVICE MARK  
PRINCIPAL REGISTER**

**CALORIES ON DEMAND**

PLATKIN, CHARLES S. (UNITED STATES INDIVIDUAL)  
P.O. BOX 398616  
MIAMI BEACH, FL 33239

THE MARK CONSISTS OF STANDARD CHARACTERS WITHOUT CLAIM TO ANY PARTICULAR FONT, STYLE, SIZE, OR COLOR.

FOR: PROVIDING HEALTH INFORMATION VIA THE INTERNET AND WIRELESS DEVICES, IN CLASS 44 (U.S. CLS. 100 AND 101).

SN 77-078,131, FILED 1-8-2007.

FIRST USE 6-1-2007; IN COMMERCE 6-1-2007.

AMEETA JORDAN, EXAMINING ATTORNEY

**Int. Cls.: 16, 35, 41, and 44**

**Prior U.S. Cls.: 2, 5, 22, 23, 29, 37, 38, 50, 100, 101, 102, and 107**

**Reg. No. 3,468,647**

**United States Patent and Trademark Office**

**Registered July 15, 2008**

**TRADEMARK  
SERVICE MARK  
PRINCIPAL REGISTER**



CHILDBIRTH EDUCATION CLASSES AND PRODUCTS, INC. (CALIFORNIA CORPORATION)  
P.O. BOX 7755  
RIVERSIDE, CA 92513

FOR: PAMPHLETS IN THE FIELD OF PREPARED CHILD BIRTH EDUCATION; PUBLICATIONS, NAMELY, BROCHURES, BOOKLETS, AND TEACHING MATERIALS IN THE FIELD OF PREPARED CHILD BIRTH EDUCATION; PRINTED INSTRUCTIONAL, EDUCATIONAL, AND TEACHING MATERIALS IN THE FIELD OF PREPARED CHILD BIRTH EDUCATION, IN CLASS 16 (U.S. CLS. 2, 5, 22, 23, 29, 37, 38 AND 50).

FIRST USE 12-17-2007; IN COMMERCE 12-17-2007.

FOR: ONLINE RETAIL STORE SERVICES FEATURING EDUCATIONAL PRODUCTS IN THE FIELD OF CHILD BIRTH EDUCATION, CLOTHING, MASSAGE IMPLEMENTS, TOILETRIES, CDS, BOOKS, TOYS, BABY CARRIERS WORN ON THE BODY, STROLLERS, BREAST FEEDING PUMPS, NURSING PADS, NURSING BRAS, DIAPERS, AND JEWELRY, IN CLASS 35 (U.S. CLS. 100, 101 AND 102).

FIRST USE 12-16-2006; IN COMMERCE 12-16-2006.

FOR: PROVIDING A WEB SITE FEATURING INFORMATION ABOUT PREPARED CHILDBIRTH EDUCATION; EDUCATION SERVICES, NAMELY, PROVIDING CLASSES, SEMINARS, WORKSHOPS IN THE FIELD OF HEATH EDUCATION AND

PREPARED CHILDBIRTH EDUCATION; TEACHING IN FIELD OF HEALTH EDUCATION AND PREPARED CHILDBIRTH EDUCATION; TRAINING IN THE FIELD OF HEALTH EDUCATION AND PREPARED CHILDBIRTH EDUCATION, IN CLASS 41 (U.S. CLS. 100, 101 AND 107).

FIRST USE 12-16-2006; IN COMMERCE 12-16-2006.

FOR: PROVIDING MEDICAL INFORMATION, CONSULTANCY AND ADVISORY SERVICES; RELAXATION THERAPY IN THE NATURE OF AUTOGENOUS TRAINING, IN CLASS 44 (U.S. CLS. 100 AND 101).

FIRST USE 12-16-2006; IN COMMERCE 12-16-2006.

NO CLAIM IS MADE TO THE EXCLUSIVE RIGHT TO USE "CHILDBIRTH EDUCATION CLASSES & PRODUCTS, INC.", APART FROM THE MARK AS SHOWN.

THE MARK CONSISTS OF A STYLIZED MARK WITH A NEWBORN BABY LYING ON A FLOWER WITH LEAVES SHOWING. THE LETTERS AND WORDS IN THE TRADEMARK ARE BENEATH THE FLOWER.

SN 77-078,402, FILED 1-8-2007.

MICHELLE DUBOIS, EXAMINING ATTORNEY

**Int. Cl.: 1**

**Prior U.S. Cls.: 1, 5, 6, 10, 26, and 46**

**Reg. No. 3,468,648**

**United States Patent and Trademark Office**

**Registered July 15, 2008**

**TRADEMARK  
PRINCIPAL REGISTER**

**DOUBLEMER**

DOUBLE BOND CHEMICAL IND. CO., LTD.  
(TAIWAN CORPORATION)  
4F, NO. 959, ZHONGZHENG ROAD  
ZHONGHE CITY  
TAIPEI COUNTY 235, TAIWAN

FOR: CHEMICALS, NAMELY, ULTRAVIOLET  
CURABLE OLIGOMERS AND MONOMERS FOR  
USE IN THE MANUFACTURE OF INKS AND  
COATINGS, IN CLASS 1 (U.S. CLS. 1, 5, 6, 10, 26  
AND 46).

FIRST USE 7-10-2007; IN COMMERCE 7-10-2007.

THE MARK CONSISTS OF STANDARD CHAR-  
ACTERS WITHOUT CLAIM TO ANY PARTICULAR  
FONT, STYLE, SIZE, OR COLOR.

SN 77-078,833, FILED 1-9-2007.

MAUREEN DALL, EXAMINING ATTORNEY

Int. Cl.: 25

Prior U.S. Cls.: 22 and 39

United States Patent and Trademark Office

Reg. No. 3,468,649

Registered July 15, 2008

TRADEMARK  
PRINCIPAL REGISTER

CHRISTOPHER BRIAN  
COLLECTION

CHRISTOPHER BRIAN APPAREL, INC. (NEVADA CORPORATION)  
SUITE 240  
6320 CANOGA AVENUE  
WOODLAND HILLS, CA 91367

FOR: ANKLE BOOTS; ANKLE SOCKS; ANKLETS; ASCOTS; ATHLETIC SHOES; BALLOON PANTS; BANDANAS; BELTS; BELTS MADE OF LEATHER; BIB OVERALLS; BLOUSES; BOOTS; BOW TIES; BOXER BRIEFS; BOXER SHORTS; BRIEFS; BRIEFS; CAPRI PANTS; CAPS; CARGO PANTS; CHILDREN'S AND INFANTS' CLOTH BIBS; COATS; COATS FOR MEN AND WOMEN; COATS MADE OF COTTON; COATS OF DENIM; CROP TOPS; DENIM JACKETS; DENIMS; DRESS SHIRTS; DRESS SUITS; DRESSES; DRESSES MADE FROM SKINS; EVENING DRESSES; FLEECE SHORTS; FOOTWEAR; FOOTWEAR FOR MEN; FOOTWEAR FOR MEN AND WOMEN; FOOTWEAR FOR WOMEN; FOOTWEAR NOT FOR SPORTS; FOOTWEAR, NAMELY, PUMPS; FUR COATS; FUR COATS AND JACKETS; FUR JACKETS; GLOVES; HALTER TOPS; HATS; HEAD SCARVES; HEAVY JACKETS; INFANT AND TODDLER ONE PIECE CLOTHING; INFANTS' SHOES AND BOOTS; JACKET LINERS; JACKETS; JEANS; JOGGING OUTFITS; JOGGING PANTS; JOGGING SUITS; KNIT SHIRTS; KNITTED CAPS; KNITTED UNDERWEAR; LADIES' BOOTS; LADIES' UNDERWEAR; LEATHER BELTS; LEATHER COATS; LEATHER JACKETS; LEATHER PANTS; LEATHER SHOES; LONG JACKETS; LONG SLEEVED VESTS; MEN AND WOMEN JACKETS, COATS, TROUSERS, VESTS; MEN'S SOCKS; MEN'S SUITS; MEN'S SUITS, WOMEN'S SUITS; MOCK TURTLE-NECK SWEATERS; MONEY BELTS; ONE PIECE GARMENT FOR INFANTS AND TODDLERS; OPEN-NECKED SHIRTS; OVER COATS; OVERALLS; OVERCOATS; PANTIES; PANTIES, SHORTS AND BRIEFS; PANTS; PANTYHOSE; PIQUE SHIRTS; POLO SHIRTS; QUILTED VESTS; RAIN COATS; RAIN JACKETS; RAIN-PROOF JACKETS; RIDING BOOTS; RIDING

COATS; RIDING GLOVES; SCARVES; SHAWLS; SHAWLS AND HEADSCARVES; SHAWLS AND STOLE; SHIRT FRONTS; SHIRTS; SHIRTS FOR SUITS; SHOES; SHORT SETS; SHORT-SLEEVED OR LONG-SLEEVED T-SHIRTS; SHORT-SLEEVED SHIRTS; SHORTS; SHOULDER SCARVES; SILK SCARVES; SKIRT SUITS; SKIRTS; SKIRTS AND DRESSES; SKORTS; SLEEP SHIRTS; SLEEPING GARMENTS; SLEEVED OR SLEEVELESS JACKETS; SMOKING JACKETS; SNEAKERS; SOCKS; SOCKS AND STOCKINGS; SPORT COATS; SPORTS JACKETS; SPORTS SHIRTS; SPORTS SHIRTS WITH SHORT SLEEVES; STOCKINGS; SUEDE JACKETS; SUIT COATS; SUITS; SUITS OF LEATHER; SUSPENDER BELTS FOR MEN; SUSPENDER BELTS FOR WOMEN; SUSPENDERS; SWEAT PANTS; SWEAT SHIRTS; SWEAT SUITS; SWEATERS; T-SHIRTS; TANK TOPS; TANK-TOPS; THONGS; TIES; TOP COATS; TOPS; TRACK SUITS; TRENCH COATS; TURTLENECK SWEATERS; UNDER GARMENTS; UNDERWEAR; V-NECK SWEATERS; VESTED SUITS; VESTS; WAIST BELTS; WALKING SHORTS; WATERPROOF JACKETS AND PANTS; WIND COATS; WIND SHIRTS; WIND VESTS; WOMEN'S SHOES; WOMEN'S UNDERWEAR; WOVEN OR KNITTED UNDERWEAR; WRAPS, IN CLASS 25 (U.S. CLS. 22 AND 39).

FIRST USE 2-13-2007; IN COMMERCE 2-13-2007.

THE MARK CONSISTS OF STANDARD CHARACTERS WITHOUT CLAIM TO ANY PARTICULAR FONT, STYLE, SIZE, OR COLOR.

NO CLAIM IS MADE TO THE EXCLUSIVE RIGHT TO USE "COLLECTION", APART FROM THE MARK AS SHOWN.

THE NAME(S), PORTRAIT(S), AND/OR SIGNATURE(S) SHOWN IN THE MARK IDENTIFIES "CHRISTOPHER BRIAN STOKES", WHOSE CONSENT(S) TO REGISTER IS SUBMITTED.

SN 77-079,201, FILED 1-9-2007.

CAROLINE WOOD, EXAMINING ATTORNEY

**Int. Cl.: 22**

**Prior U.S. Cls.: 1, 2, 7, 19, 22, 42, and 50**

**United States Patent and Trademark Office**

**Reg. No. 3,468,650**

**Registered July 15, 2008**

**TRADEMARK  
PRINCIPAL REGISTER**

**ELASTY**

TEIJIN FIBERS LIMITED (JAPAN CORPORATION)  
6-7, MINAMIHOMMACHI 1-CHOME  
CHUO-KU, OSAKA, JAPAN

THE MARK CONSISTS OF STANDARD CHARACTERS WITHOUT CLAIM TO ANY PARTICULAR FONT, STYLE, SIZE, OR COLOR.

FOR: POLYESTER FIBERS FOR NON-TEXTILE PURPOSES, IN CLASS 22 (U.S. CLS. 1, 2, 7, 19, 22, 42 AND 50).

SN 77-079,537, FILED 1-10-2007.

FIRST USE 7-1-2007; IN COMMERCE 7-1-2007.

KEVIN DINALLO, EXAMINING ATTORNEY



**Int. Cl.: 35**

**Prior U.S. Cls.: 100, 101, and 102**

**United States Patent and Trademark Office**

**Reg. No. 3,468,651**

**Registered July 15, 2008**

---

**SERVICE MARK  
PRINCIPAL REGISTER**

**NECOS**

NORTHEAST BUILDING PRODUCTS COR-  
PORATION (PENNSYLVANIA CORPORA-  
TION)  
4280 ARAMINGO AVENUE  
PHILADELPHIA, PA 191245007

FOR: ONLINE COMPUTERIZED SERVICE FOR  
ORDERING BUILDING MATERIALS, NAMELY,  
DOORS, WINDOWS AND GLASS BLOCKS, IN  
CLASS 35 (U.S. CLS. 100, 101 AND 102).

FIRST USE 8-15-2007; IN COMMERCE 8-15-2007.

THE MARK CONSISTS OF STANDARD CHAR-  
ACTERS WITHOUT CLAIM TO ANY PARTICULAR  
FONT, STYLE, SIZE, OR COLOR.

SN 77-079,982, FILED 1-10-2007.

ERIN FALK, EXAMINING ATTORNEY

**Int. Cl.: 9**

**Prior U.S. Cls.: 21, 23, 26, 36, and 38**

**Reg. No. 3,468,652**

**United States Patent and Trademark Office**

**Registered July 15, 2008**

**TRADEMARK  
PRINCIPAL REGISTER**

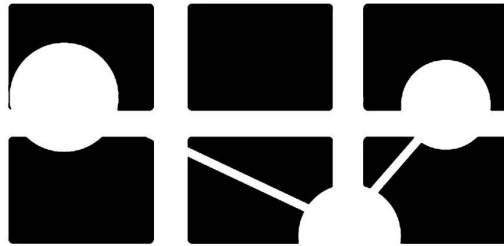

BEHAVIORAL RECOGNITION SYSTEMS, INC.  
(TEXAS CORPORATION)  
2100 WEST LOOP SOUTH 9TH FLOOR  
HOUSTON, TX 77027

FOR: COMPUTER HARDWARE AND BEHAVIOR RECOGNITION SOFTWARE WHICH ENABLES VIDEO SURVEILLANCE CAMERAS TO MONITOR ABNORMAL BEHAVIOR, IN CLASS 9 (U.S. CLS. 21, 23, 26, 36 AND 38).

FIRST USE 12-3-2007; IN COMMERCE 12-3-2007.

THE MARK CONSISTS OF TWO ROWS OF THREE RECTANGLES EACH. A FIRST CIRCLE

BRIDGES THE SPACE BETWEEN THE FIRST RECTANGLE OF EACH ROW, A SECOND CIRCLE BRIDGES THE SPACE BETWEEN THE LAST TWO RECTANGLES OF THE SECOND ROW, AND A THIRD CIRCLE BRIDGES THE SPACE BETWEEN THE LAST RECTANGLES OF EACH ROW. LINES CONNECT THE FIRST AND SECOND CIRCLES AND THE SECOND AND THIRD CIRCLES.

SN 77-080,177, FILED 1-10-2007.

LESLEY LAMOTHE, EXAMINING ATTORNEY

**Int. Cl.: 36**

**Prior U.S. Cls.: 100, 101, and 102**

**United States Patent and Trademark Office**

**Reg. No. 3,468,653**

**Registered July 15, 2008**

**SERVICE MARK  
PRINCIPAL REGISTER**

**QUARTERBACK FUNDING**

QUARTERBACK FUNDING, INC. (DELAWARE  
CORPORATION)  
SUITE 206  
600 EAST JEFFERSON STREET  
ROCKVILLE, MD 20852

FOR: FINANCIAL SERVICES, NAMELY, CASH  
ADVANCES FOR BUSINESSES, IN CLASS 36 (U.S.  
CLS. 100, 101 AND 102).

FIRST USE 12-0-2007; IN COMMERCE 12-0-2007.

THE MARK CONSISTS OF STANDARD CHAR-  
ACTERS WITHOUT CLAIM TO ANY PARTICULAR  
FONT, STYLE, SIZE, OR COLOR.

NO CLAIM IS MADE TO THE EXCLUSIVE  
RIGHT TO USE "FUNDING", APART FROM THE  
MARK AS SHOWN.

SN 77-080,184, FILED 1-10-2007.

CHRISTINA SOBRAL, EXAMINING ATTORNEY

**Int. Cl.: 14**

**Prior U.S. Cls.: 2, 27, 28, and 50**

**United States Patent and Trademark Office**

**Reg. No. 3,468,654**

**Registered July 15, 2008**

**TRADEMARK  
PRINCIPAL REGISTER**

**GORILLA GUARDS**

AMERICAN TIME & SIGNAL, CO. (MINNESOTA  
CORPORATION)

140 THIRD STREET SOUTH

DASSEL, MN 55325

FOR: CLOCKS AND WIRE GUARDS FOR TIME  
CLOCKS, IN CLASS 14 (U.S. CLS. 2, 27, 28 AND 50).

FIRST USE 7-31-2007; IN COMMERCE 7-31-2007.

THE MARK CONSISTS OF STANDARD CHAR-  
ACTERS WITHOUT CLAIM TO ANY PARTICULAR  
FONT, STYLE, SIZE, OR COLOR.

NO CLAIM IS MADE TO THE EXCLUSIVE  
RIGHT TO USE "GUARDS", APART FROM THE  
MARK AS SHOWN.

SN 77-080,286, FILED 1-10-2007.

NAAKWAMA ANKRAH, EXAMINING ATTORNEY

**Int. Cl.: 9**

**Prior U.S. Cls.: 21, 23, 26, 36, and 38**

**Reg. No. 3,468,655**

**United States Patent and Trademark Office**

**Registered July 15, 2008**

**TRADEMARK  
PRINCIPAL REGISTER**



PHARMACEUTICAL SERVICES CORPORATION  
(DELAWARE CORPORATION)

700 CORPORATE CENTER DR, SUITE 201

POMONA, CA 91768

FOR: COMPUTER SOFTWARE THAT ENABLES THE USER TO SEARCH RELEVANT LAWS AND REGULATIONS, AND TO PREPARE OBSERVATIONS AND REPORTS WITH USER-INPUT TEXT THAT UTILIZES TEXT FROM THE SELECTED LAWS AND REGULATIONS, IN CLASS 9 (U.S. CLS. 21, 23, 26, 36 AND 38).

FIRST USE 12-15-2006; IN COMMERCE 12-15-2006.

THE COLOR(S) RED, YELLOW, ORANGE, BLUE AND BLACK IS/ARE CLAIMED AS A FEATURE OF THE MARK.

THE MARK CONSISTS OF A RED CHECK MARK INSIDE A YELLOW SQUARE OUTLINED IN ORANGE, AND THE LETTERS "AUDITCA" TO THE RIGHT OF THE DESIGN IN BLUE LETTERS AND THE WORDING "YOUR COMPLIANCE MONITOR" IN BLACK LETTERS UNDER THE LETTERS "AUDITCA".

SN 77-080,337, FILED 1-10-2007.

RENEE SERVANCE, EXAMINING ATTORNEY

**Int. Cl.: 9**

**Prior U.S. Cls.: 21, 23, 26, 36, and 38**

**Reg. No. 3,468,656**

**United States Patent and Trademark Office**

**Registered July 15, 2008**

---

**TRADEMARK  
PRINCIPAL REGISTER**

**XENITH**

XENITH, INC. (DELAWARE CORPORATION)  
29 COMMONWEALTH AVENUE  
BOSTON, MA 02116

THE MARK CONSISTS OF STANDARD CHAR-  
ACTERS WITHOUT CLAIM TO ANY PARTICULAR  
FONT, STYLE, SIZE, OR COLOR.

FOR: PROTECTIVE HEADGEAR FOR USE IN  
SPORTS AND HAZARDOUS ACTIVITIES, IN CLASS  
9 (U.S. CLS. 21, 23, 26, 36 AND 38).

SN 77-080,584, FILED 1-11-2007.

FIRST USE 2-4-2008; IN COMMERCE 2-4-2008.

HELENE LIWINSKI, EXAMINING ATTORNEY

**Int. Cl.: 39**

**Prior U.S. Cls.: 100 and 105**

**United States Patent and Trademark Office**

**Reg. No. 3,468,657**

**Registered July 15, 2008**

**SERVICE MARK  
PRINCIPAL REGISTER**



MEDJET ASSISTANCE, L.L.C. (ALABAMA LTD  
LIAB CO)  
4900 69TH STREET NORTH  
BIRMINGHAM, AL 35206

FOR: AIR TRANSPORTATION; AMBULANCE  
TRANSPORT, IN CLASS 39 (U.S. CLS. 100 AND 105).

FIRST USE 2-1-2007; IN COMMERCE 2-1-2007.

OWNER OF U.S. REG. NOS. 2,558,160, 2,616,782,  
AND 3,084,105.

THE MARK CONSISTS OF CROSS WITH SUPER-  
IMPOSED SPHERE.

SN 77-080,689, FILED 1-11-2007.

EMILY CARLSEN, EXAMINING ATTORNEY

**Int. Cl.: 39**

**Prior U.S. Cls.: 100 and 105**

**United States Patent and Trademark Office**

**Reg. No. 3,468,658**

**Registered July 15, 2008**

**SERVICE MARK  
PRINCIPAL REGISTER**

**POLAR ONLINE**

PRINCESS CRUISE LINES, LTD. (BERMUDA CORPORATION)  
LEGAL DEPARTMENT  
24305 TOWN CENTER DRIVE  
SANTA CLARITA, CA 91355

FOR: TRAVEL AGENCY SERVICES, NAMELY, MAKING RESERVATIONS AND BOOKINGS FOR TRANSPORTATION; PROVIDING AN INTERACTIVE ONLINE COMPUTER DATABASE IN THE FIELD OF TRAVEL INFORMATION WHICH PERMITS THE USER TO SEARCH, PRICE, RESERVE AND UPGRADE CRUISES, TOURS AND VACATIONS, CREATE AND MANAGE GROUP TRAVEL, SELECT AND MODIFY PASSENGER AMENITIES AND ITINERARIES AND EXTEND BOOKING OPTIONS, IN CLASS 39 (U.S. CLS. 100 AND 105).

FIRST USE 1-1-2005; IN COMMERCE 1-1-2005.

THE MARK CONSISTS OF STANDARD CHARACTERS WITHOUT CLAIM TO ANY PARTICULAR FONT, STYLE, SIZE, OR COLOR.

NO CLAIM IS MADE TO THE EXCLUSIVE RIGHT TO USE "ONLINE" , APART FROM THE MARK AS SHOWN.

SN 77-080,763, FILED 1-11-2007.

THOMAS MANOR, EXAMINING ATTORNEY



**Int. Cl.: 9**

**Prior U.S. Cls.: 21, 23, 26, 36, and 38**

**United States Patent and Trademark Office**

**Reg. No. 3,468,659**

**Registered July 15, 2008**

**TRADEMARK  
PRINCIPAL REGISTER**

**ONESOURCE eTOOLS**

PRINCESS CRUISE LINES, LTD. (BERMUDA CORPORATION)  
LEGAL DEPARTMENT  
24305 TOWN CENTER DRIVE  
SANTA CLARITA, CA 91355

FOR: PROVIDING DOWNLOADABLE LOGOS, RADIO SCRIPTS, DESKTOP PICTURES, VIDEO FOOTAGE AND ELECTRONIC TRAVEL PERIODICALS, BROCHURES, ADVERTISING TEXT AND AUDIO, VIA A WEB SITE, FOR USE TO CREATE CUSTOM OR NON-CUSTOM SALES, ADVERTISING AND MARKETING MATERIALS FOR USE IN THE TRAVEL INDUSTRY, IN CLASS 9 (U.S. CLS. 21, 23, 26, 36 AND 38).

FIRST USE 6-1-2007; IN COMMERCE 6-1-2007.

THE MARK CONSISTS OF STANDARD CHARACTERS WITHOUT CLAIM TO ANY PARTICULAR FONT, STYLE, SIZE, OR COLOR.

NO CLAIM IS MADE TO THE EXCLUSIVE RIGHT TO USE "ETOOLS", APART FROM THE MARK AS SHOWN.

SN 77-080,793, FILED 1-11-2007.

THOMAS MANOR, EXAMINING ATTORNEY

**Int. Cl.: 39**

**Prior U.S. Cls.: 100 and 105**

**United States Patent and Trademark Office**

**Reg. No. 3,468,660**

**Registered July 15, 2008**

**SERVICE MARK  
PRINCIPAL REGISTER**

**VALUELOGIC**

CB TRAVEL CORP. (UTAH CORPORATION)  
SUITE 300  
5588 SOUTH GREEN STREET  
SALT LAKE CITY, UT 84123

THE MARK CONSISTS OF STANDARD CHAR-  
ACTERS WITHOUT CLAIM TO ANY PARTICULAR  
FONT, STYLE, SIZE, OR COLOR.

FOR: TRAVEL INFORMATION SERVICES, IN  
CLASS 39 (U.S. CLS. 100 AND 105).

SN 77-080,975, FILED 1-11-2007.

FIRST USE 4-20-2007; IN COMMERCE 4-20-2007.

ELIZABETH BEYER, EXAMINING ATTORNEY

**Int. Cls.: 7 and 20**

**Prior U.S. Cls.: 2, 13, 19, 21, 22, 23, 25, 31, 32, 34, 35,  
and 50**

**Reg. No. 3,468,661**

**United States Patent and Trademark Office**

**Registered July 15, 2008**

---

**TRADEMARK  
PRINCIPAL REGISTER**

**RAPIDAIR SYSTEMS**

RAPID AIR LLC (WISCONSIN LTD LIAB CO)  
250 NORTH SUNNYSLOPE ROAD, SUITE 205  
BROOKFIELD, WI 53005

FOR: PNEUMATIC PUMPS FOR INFLATABLE  
BEDS, IN CLASS 7 (U.S. CLS. 13, 19, 21, 23, 31, 34 AND  
35).

FIRST USE 0-0-2007; IN COMMERCE 0-0-2007.

FOR: INFLATABLE BED KITS FOR PERSONAL  
USE CONSISTING PRIMARILY OF AN INFLATA-  
BLE BED AIR CHAMBER, NAMELY, AN AIR  
MATTRESS FOR PERSONAL USE AND ALSO CON-  
SISTING OF A PNEUMATIC PUMP, AND ELECTRI-  
CAL PUMP CONTROLS, NAMELY, HAND-HELD  
WIRED PENDANTS USED FOR CONTROLLING

THE OPERATION OF PUMPS, IN CLASS 20 (U.S.  
CLS. 2, 13, 22, 25, 32 AND 50).

FIRST USE 0-0-2007; IN COMMERCE 0-0-2007.

THE MARK CONSISTS OF STANDARD CHAR-  
ACTERS WITHOUT CLAIM TO ANY PARTICULAR  
FONT, STYLE, SIZE, OR COLOR.

NO CLAIM IS MADE TO THE EXCLUSIVE  
RIGHT TO USE "SYSTEMS", APART FROM THE  
MARK AS SHOWN.

SN 77-081,191, FILED 1-11-2007.

MATTHEW EINSTEIN, EXAMINING ATTORNEY

**Int. Cls.: 7 and 20**

**Prior U.S. Cls.: 2, 13, 19, 21, 22, 23, 25, 31, 32, 34, 35,  
and 50**

**Reg. No. 3,468,662**

**United States Patent and Trademark Office**

**Registered July 15, 2008**

**TRADEMARK  
PRINCIPAL REGISTER**

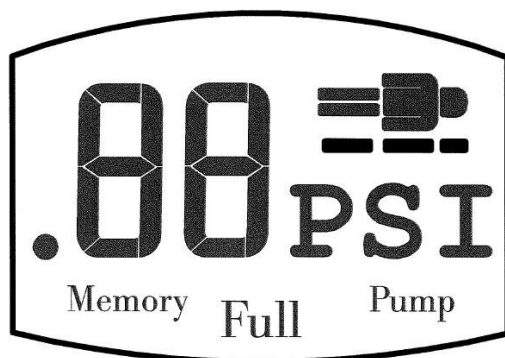

RAPID AIR LLC (WISCONSIN LTD LIAB CO)  
250 NORTH SUNNYSLOPE ROAD, SUITE 205  
BROOKFIELD, WI 53005

FOR: PNEUMATIC PUMPS FOR INFLATABLE  
BEDS, IN CLASS 7 (U.S. CLS. 13, 19, 21, 23, 31, 34 AND  
35).

FIRST USE 0-0-2007; IN COMMERCE 0-0-2007.

FOR: INFLATABLE BED KITS FOR PERSONAL  
USE CONSISTING PRIMARILY OF AN INFLATA-  
BLE BED AIR CHAMBER, NAMELY, AN AIR  
MATTRESS FOR PERSONAL USE AND ALSO CON-  
SISTING OF A PNEUMATIC PUMP, AND ELECTRI-

CAL PUMP CONTROLS, NAMELY, HAND-HELD  
WIRED PENDANTS USED FOR CONTROLLING  
THE OPERATION OF PUMPS, IN CLASS 20 (U.S.  
CLS. 2, 13, 22, 25, 32 AND 50).

FIRST USE 0-0-2007; IN COMMERCE 0-0-2007.

NO CLAIM IS MADE TO THE EXCLUSIVE  
RIGHT TO USE ".88 PSI", "PUMP" AND "FULL",  
APART FROM THE MARK AS SHOWN.

SN 77-081,192, FILED 1-11-2007.

MATTHEW EINSTEIN, EXAMINING ATTORNEY

**Int. Cl.: 20**

**Prior U.S. Cls.: 2, 13, 22, 25, 32, and 50**

**Reg. No. 3,468,663**

**United States Patent and Trademark Office**

**Registered July 15, 2008**

**TRADEMARK  
PRINCIPAL REGISTER**



RAPID AIR LLC (WISCONSIN LTD LIAB CO)  
P.O. BOX 20810  
MILWAUKEE, WI 53220

FOR: INFLATABLE BED KITS FOR PERSONAL USE CONSISTING PRIMARILY OF AN INFLATABLE BED AIR CHAMBER, NAMELY, AN AIR MATTRESS FOR PERSONAL USE AND ALSO CONSISTING OF A PNEUMATIC PUMP, AND ELECTRICAL PUMP CONTROLS, NAMELY, HAND-HELD WIRED PENDANTS USED FOR CONTROLLING

THE OPERATION OF PUMPS, IN CLASS 20 (U.S. CLS. 2, 13, 22, 25, 32 AND 50).

FIRST USE 5-27-2008; IN COMMERCE 5-27-2008.

THE MARK CONSISTS OF MAN FIGURE.

SN 77-081,195, FILED 1-11-2007.

MATTHEW EINSTEIN, EXAMINING ATTORNEY

Int. Cl.: 32

Prior U.S. Cls.: 45, 46, and 48

Reg. No. 3,468,664

United States Patent and Trademark Office

Registered July 15, 2008

TRADEMARK  
PRINCIPAL REGISTER



PRIMO WATER CORPORATION (DELAWARE CORPORATION)  
104 CAMBRIDGE PLAZA DRIVE  
WINSTON-SALEM, NC 27104

FOR: BOTTLED DRINKING WATER, IN CLASS 32 (U.S. CLS. 45, 46 AND 48).

FIRST USE 2-0-2007; IN COMMERCE 2-0-2007.

OWNER OF U.S. REG. NOS. 3,137,295, 3,160,767, AND 3,166,619.

THE COLOR(S) BLUE AND AQUA IS/ARE CLAIMED AS A FEATURE OF THE MARK.

THE WORDING "TASTE PERFECTION" IS IN THE COLOR AQUA, AND THE WORDING "PRIMO" AND STYLIZED BUBBLE DESIGN ARE IN THE COLOR BLUE.

SN 77-081,242, FILED 1-11-2007.

JEAN IM, EXAMINING ATTORNEY

**Int. Cl.: 12**

**Prior U.S. Cls.: 19, 21, 23, 31, 35, and 44**

**United States Patent and Trademark Office**

**Reg. No. 3,468,665**

**Registered July 15, 2008**

**TRADEMARK  
PRINCIPAL REGISTER**

**SCOOTLINE**

SRI USA, INC. (DELAWARE CORPORATION)  
200 JOHN JAMES AUDUBON PKWY.  
AMHERST, NY 14228

THE MARK CONSISTS OF STANDARD CHAR-  
ACTERS WITHOUT CLAIM TO ANY PARTICULAR  
FONT, STYLE, SIZE, OR COLOR.

FOR: TIRES, IN CLASS 12 (U.S. CLS. 19, 21, 23, 31,  
35 AND 44).

SN 77-081,250, FILED 1-11-2007.

FIRST USE 3-10-2008; IN COMMERCE 3-10-2008.

KRISTIN DAHLING, EXAMINING ATTORNEY

**Int. Cls.: 3 and 21**

**Prior U.S. Cls.: 1, 2, 4, 6, 13, 23, 29, 30, 33, 40, 50, 51,  
and 52**

**Reg. No. 3,468,666**

**United States Patent and Trademark Office**

**Registered July 15, 2008**

**TRADEMARK  
PRINCIPAL REGISTER**

**MINERAL EFFECTS**

BEAUTY HOLDING LLC (DELAWARE LTD  
LIAB CO)  
3001 COLORADO BLVD.  
DENTON, TX 76210

FOR: MAKE-UP, IN CLASS 3 (U.S. CLS. 1, 4, 6, 50,  
51 AND 52).

FIRST USE 4-2-2008; IN COMMERCE 4-2-2008.

FOR: MAKE-UP BRUSHES , IN CLASS 21 (U.S.  
CLS. 2, 13, 23, 29, 30, 33, 40 AND 50).

FIRST USE 4-2-2008; IN COMMERCE 4-2-2008.

THE MARK CONSISTS OF STANDARD CHAR-  
ACTERS WITHOUT CLAIM TO ANY PARTICULAR  
FONT, STYLE, SIZE, OR COLOR.

NO CLAIM IS MADE TO THE EXCLUSIVE  
RIGHT TO USE "MINERAL", APART FROM THE  
MARK AS SHOWN.

SN 77-081,616, FILED 1-12-2007.

TRACY WHITTAKER-BROWN, EXAMINING AT-  
TORNEY



**Int. Cl.: 28**

**Prior U.S. Cls.: 22, 23, 38, and 50**

**Reg. No. 3,468,667**

**United States Patent and Trademark Office**

**Registered July 15, 2008**

---

**TRADEMARK  
PRINCIPAL REGISTER**

**JET BLASTER**

SHOOT THE MOON PRODUCTS II, LLC (CALI-  
FORNIA LTD LIAB CO)  
7011 KOLL CENTER PARKWAY, SUITE 110  
PLEASANTON, CA 94566

THE MARK CONSISTS OF STANDARD CHAR-  
ACTERS WITHOUT CLAIM TO ANY PARTICULAR  
FONT, STYLE, SIZE, OR COLOR.

FOR: TOYS FOR CHILDREN, NAMELY, FOOT-  
BALLS MADE OUT OF FOAM, AND TOY FOAM  
BALLS HAVING FANCIFUL SHAPES, IN CLASS 28  
(U.S. CLS. 22, 23, 38 AND 50).

SN 77-081,985, FILED 1-12-2007.

FIRST USE 5-0-2007; IN COMMERCE 3-0-2008.

LINDA E. BLOHM, EXAMINING ATTORNEY

**Int. Cl.: 5**

**Prior U.S. Cls.: 6, 18, 44, 46, 51, and 52**

**Reg. No. 3,468,668**

**United States Patent and Trademark Office**

**Registered July 15, 2008**

---

**TRADEMARK  
PRINCIPAL REGISTER**

**TOURNEY**

VALENT U.S.A. CORPORATION (CALIFORNIA  
CORPORATION)  
SUITE 200  
1600 N. RIVIERA AVENUE  
WALNUT CREEK, CA 94596

THE MARK CONSISTS OF STANDARD CHAR-  
ACTERS WITHOUT CLAIM TO ANY PARTICULAR  
FONT, STYLE, SIZE, OR COLOR.

FOR: FUNGICIDES, IN CLASS 5 (U.S. CLS. 6, 18,  
44, 46, 51 AND 52).

SN 77-082,175, FILED 1-12-2007.

FIRST USE 2-15-2008; IN COMMERCE 2-15-2008.

JENNIFER VASQUEZ, EXAMINING ATTORNEY

**Int. Cl.: 35**

**Prior U.S. Cls.: 100, 101, and 102**

**United States Patent and Trademark Office**

**Reg. No. 3,468,669**

**Registered July 15, 2008**

**SERVICE MARK  
PRINCIPAL REGISTER**

**TASTE PERFECTION**

PRIMO WATER CORPORATION (DELAWARE  
CORPORATION)  
104 CAMBRIDGE PLAZA DRIVE  
WINSTON-SALEM, NC 27104

FOR: DISTRIBUTORSHIP SERVICES IN THE  
FIELD OF BOTTLED DRINKING WATER, IN  
CLASS 35 (U.S. CLS. 100, 101 AND 102).

FIRST USE 3-0-2008; IN COMMERCE 3-0-2008.

THE MARK CONSISTS OF STANDARD CHAR-  
ACTERS WITHOUT CLAIM TO ANY PARTICULAR  
FONT, STYLE, SIZE, OR COLOR.

SN 77-082,459, FILED 1-12-2007.

JEAN IM, EXAMINING ATTORNEY

Int. Cl.: 35

Prior U.S. Cls.: 100, 101, and 102

United States Patent and Trademark Office

Reg. No. 3,468,670

Registered July 15, 2008

SERVICE MARK  
PRINCIPAL REGISTER



PRIMO WATER CORPORATION (DELAWARE CORPORATION)  
104 CAMBRIDGE PLAZA DRIVE  
WINSTON-SALEM, NC 27104

FOR: DISTRIBUTORSHIP SERVICES IN THE FIELD OF BOTTLED DRINKING WATER, IN CLASS 35 (U.S. CLS. 100, 101 AND 102).

FIRST USE 3-0-2008; IN COMMERCE 3-0-2008.

OWNER OF U.S. REG. NOS. 3,137,295, 3,160,767, AND 3,166,619.

THE COLOR(S) BLUE AND AQUA IS/ARE CLAIMED AS A FEATURE OF THE MARK.

THE WORDING "TASTE PERFECTION" IS IN THE COLOR AQUA, AND THE WORDING "PRIMO" AND STYLIZED BUBBLE DESIGN ARE IN THE COLOR BLUE.

SN 77-082,463, FILED 1-12-2007.

JEAN IM, EXAMINING ATTORNEY

**Int. Cl.: 16**

**Prior U.S. Cls.: 2, 5, 22, 23, 29, 37, 38, and 50**

**United States Patent and Trademark Office**

**Reg. No. 3,468,671**

**Registered July 15, 2008**

**TRADEMARK  
PRINCIPAL REGISTER**

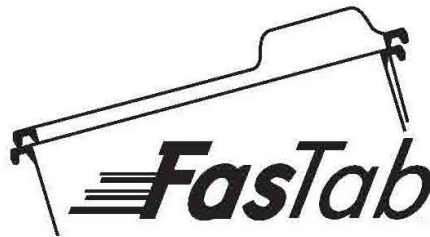

THE SMEAD MANUFACTURING COMPANY  
(MINNESOTA CORPORATION)  
600 SMEAD BOULEVARD  
HASTING, MN 55033

FOR: OFFICE AND FILING SUPPLIES, NAMELY,  
BINDERS, FILE FOLDERS, ADHESIVE FILE LA-  
BELS, CLASSIFICATION FOLDERS, FILE JACKETS,  
FILE POCKETS, DOCUMENT FOLDERS IN THE  
FORM OF WALLETS, EXPANDING FILES, HANG-  
ING FOLDERS, BRIEF AND REPORT COVERS,  
BINDER COVERS, DOCUMENT PORTFOLIOS,

AND PORTFOLIOS FOR HOLDING PADS OF PA-  
PER, IN CLASS 16 (U.S. CLS. 2, 5, 22, 23, 29, 37, 38 AND  
50).

FIRST USE 5-1-2008; IN COMMERCE 5-1-2008.

SN 77-083,098, FILED 1-15-2007.

ALEXANDER L. POWERS, EXAMINING ATTOR-  
NEY

**Int. Cl.: 30**

**Prior U.S. Cl.: 46**

**United States Patent and Trademark Office**

**Reg. No. 3,468,672**

**Registered July 15, 2008**

**TRADEMARK  
PRINCIPAL REGISTER**

**AURA**

NEW ERA BRANDS, LLC (ILLINOIS LTD LIAB  
CO)  
910 SKOKIE BLVD., SUITE 107  
NORTHBROOK, IL 60062

THE MARK CONSISTS OF STANDARD CHAR-  
ACTERS WITHOUT CLAIM TO ANY PARTICULAR  
FONT, STYLE, SIZE, OR COLOR.

FOR: CANDY; CANDY MINTS; CHEWING GUM,  
IN CLASS 30 (U.S. CL. 46).

SN 77-083,159, FILED 1-15-2007.

FIRST USE 5-0-2007; IN COMMERCE 5-0-2007.

EMILY CARLSEN, EXAMINING ATTORNEY

**Int. Cl.: 30**

**Prior U.S. Cl.: 46**

**United States Patent and Trademark Office**

**Reg. No. 3,468,673**

**Registered July 15, 2008**

**TRADEMARK  
PRINCIPAL REGISTER**

**CLIP 'N' GO**

NEW ERA BRANDS, LLC (ILLINOIS LTD LIAB  
CO)  
910 SKOKIE BLVD., SUITE 107  
NORTHBROOK, IL 60062

THE MARK CONSISTS OF STANDARD CHAR-  
ACTERS WITHOUT CLAIM TO ANY PARTICULAR  
FONT, STYLE, SIZE, OR COLOR.

FOR: CANDY; CANDY MINTS; CHEWING GUM,  
IN CLASS 30 (U.S. CL. 46).

SN 77-083,192, FILED 1-15-2007.

FIRST USE 5-0-2007; IN COMMERCE 5-0-2007.

EMILY CARLSEN, EXAMINING ATTORNEY

**Int. Cl.: 16**

**Prior U.S. Cls.: 2, 5, 22, 23, 29, 37, 38, and 50**

**Reg. No. 3,468,674**

**United States Patent and Trademark Office**

**Registered July 15, 2008**

**TRADEMARK  
PRINCIPAL REGISTER**

**MG**

THE VERMONT CENTER FOR THE BOOK, INCORPORATING THE VERMONT READING PROJECT (VERMONT NON-PROFIT CORPORATION)

256 HAYWOOD ROAD  
CHESTER, VT 05143

FOR: SERIES OF PRINTED EDUCATIONAL ACTIVITY GUIDES, NAMELY, PRINTED BOOKS FOR USE BY PARENTS AND OTHER ADULTS TO HELP CHILDREN DEVELOP SKILLS AND KNOWLEDGE IN THE FIELDS OF READING, MATHEMATICS, SCIENCE, SOCIAL STUDIES AND ENVIRONMENTAL SCIENCE AND; EDUCATIONAL KITS COMPRISED OF A CHILDREN'S BOOK, EDUCATIONAL

ACTIVITY MATERIALS, AND AN INSTRUCTIONAL MANUAL, IN CLASS 16 (U.S. CLS. 2, 5, 22, 23, 29, 37, 38 AND 50).

FIRST USE 8-28-2006; IN COMMERCE 8-28-2006.

THE MARK CONSISTS OF STANDARD CHARACTERS WITHOUT CLAIM TO ANY PARTICULAR FONT, STYLE, SIZE, OR COLOR.

SN 77-083,767, FILED 1-16-2007.

EDWARD NELSON, EXAMINING ATTORNEY



**Int. Cl.: 9**

**Prior U.S. Cls.: 21, 23, 26, 36, and 38**

**United States Patent and Trademark Office**

**Reg. No. 3,468,675**

**Registered July 15, 2008**

**TRADEMARK  
PRINCIPAL REGISTER**

**CINEMA RIBBON TRIO**

ELAN HOME SYSTEMS, L.L.C. (KENTUCKY  
LLC)  
1300 NEW CIRCLE ROAD; SUITE 150  
LEXINGTON, KY 405054259

THE MARK CONSISTS OF STANDARD CHAR-  
ACTERS WITHOUT CLAIM TO ANY PARTICULAR  
FONT, STYLE, SIZE, OR COLOR.

FOR: LOUDSPEAKERS, IN CLASS 9 (U.S. CLS. 21,  
23, 26, 36 AND 38).

SN 77-083,903, FILED 1-16-2007.

FIRST USE 3-31-2007; IN COMMERCE 3-31-2007.

ANTHONY RINKER, EXAMINING ATTORNEY

**Int. Cls.: 1 and 17**

**Prior U.S. Cls.: 1, 5, 6, 10, 12, 13, 26, 35, 46, and 50**

**United States Patent and Trademark Office**

**Reg. No. 3,468,676**

**Registered July 15, 2008**

**TRADEMARK  
PRINCIPAL REGISTER**

**GREENSERIES**

HENKEL CORPORATION (DELAWARE CORPORATION)  
THE TRIAD, SUITE 200  
2200 RENAISSANCE BOULEVARD  
GULPH MILLS, PA 19406

FOR: ADHESIVES FOR USE IN HOME AND BUILDING CONSTRUCTION, RENOVATION, MAINTENANCE AND REPAIR , IN CLASS 1 (U.S. CLS. 1, 5, 6, 10, 26 AND 46).

FIRST USE 3-21-2007; IN COMMERCE 3-21-2007.

FOR: ADHESIVE SEALANT FOR GENERAL USE; SEALANT FOR BUILDING; AND CAULKING COM-

POUND, IN CLASS 17 (U.S. CLS. 1, 5, 12, 13, 35 AND 50).

FIRST USE 3-21-2007; IN COMMERCE 3-21-2007.

THE MARK CONSISTS OF STANDARD CHARACTERS WITHOUT CLAIM TO ANY PARTICULAR FONT, STYLE, SIZE, OR COLOR.

SN 77-083,939, FILED 1-16-2007.

EMILY CARLSEN, EXAMINING ATTORNEY

**Int. Cls.: 1 and 17**

**Prior U.S. Cls.: 1, 5, 6, 10, 12, 13, 26, 35, 46, and 50**

**United States Patent and Trademark Office**

**Reg. No. 3,468,677**

**Registered July 15, 2008**

**TRADEMARK  
PRINCIPAL REGISTER**



HENKEL CORPORATION (DELAWARE CORPORATION)  
THE TRIAD, SUITE 200  
2200 RENAISSANCE BOULEVARD  
GULPH MILLS, PA 19406

FOR: ADHESIVES FOR USE IN HOME AND BUILDING CONSTRUCTION, RENOVATION, MAINTENANCE AND REPAIR, IN CLASS 1 (U.S. CLS. 1, 5, 6, 10, 26 AND 46).

FIRST USE 3-21-2007; IN COMMERCE 3-21-2007.

FOR: ADHESIVE SEALANT FOR GENERAL USE; SEALANT FOR BUILDING; AND CAULKING COMPOUND, IN CLASS 17 (U.S. CLS. 1, 5, 12, 13, 35 AND 50).

FIRST USE 3-21-2007; IN COMMERCE 3-21-2007.

NO CLAIM IS MADE TO THE EXCLUSIVE RIGHT TO USE "GREEN BUILDING", APART FROM THE MARK AS SHOWN.

THE MARK CONSISTS OF THE STYLIZED WORD "GREENSERIES" WITH A DESIGN OF THREE LEAVES ABOVE IT, AND THE STYLIZED WORDS FOR GREEN BUILDING UNDERNEATH.

SN 77-083,950, FILED 1-16-2007.

EMILY CARLSEN, EXAMINING ATTORNEY

**Int. Cl.: 25**

**Prior U.S. Cls.: 22 and 39**

**United States Patent and Trademark Office**

**Reg. No. 3,468,678**

**Registered July 15, 2008**

**TRADEMARK  
PRINCIPAL REGISTER**

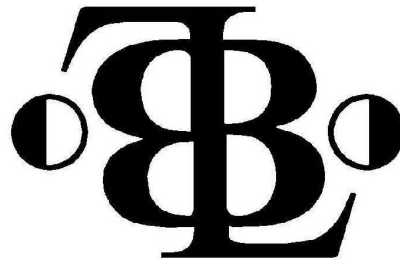

HORTON, ANTHONY J. (UNITED STATES IN-  
DIVIDUAL)  
215 LONG TRAIL LANE  
ROCKVILLE, MD 20850

FIRST USE 3-1-2008; IN COMMERCE 3-1-2008.

SN 77-084,346, FILED 1-17-2007.

FOR: CLOTHING, NAMELY, CAPS, SHIRTS,  
SWEAT SHIRTS, AND T-SHIRTS, IN CLASS 25 (U.S.  
CLS. 22 AND 39).

KAREN BRACEY, EXAMINING ATTORNEY

**Int. Cl.: 35**

**Prior U.S. Cls.: 100, 101, and 102**

**United States Patent and Trademark Office**

**Reg. No. 3,468,679**

**Registered July 15, 2008**

**SERVICE MARK  
PRINCIPAL REGISTER**

**PHILLY. FROM THE INSIDE  
OUT.**

GREATER PHILADELPHIA TOURISM MARKET-  
ING CORPORATION (PENNSYLVANIA COR-  
PORATION)

30 S. 17TH STREET, SUITE 1710  
PHILADELPHIA, PA 19103

FOR: PROMOTING TOURISM IN THE PHILA-  
DELPHIA REGION, IN CLASS 35 (U.S. CLS. 100, 101  
AND 102).

FIRST USE 4-17-2007; IN COMMERCE 4-17-2007.

THE MARK CONSISTS OF STANDARD CHAR-  
ACTERS WITHOUT CLAIM TO ANY PARTICULAR  
FONT, STYLE, SIZE, OR COLOR.

NO CLAIM IS MADE TO THE EXCLUSIVE  
RIGHT TO USE "PHILLY", APART FROM THE  
MARK AS SHOWN.

SN 77-084,452, FILED 1-17-2007.

KAREN K. BUSH, EXAMINING ATTORNEY

**Int. Cl.: 45**

**Prior U.S. Cls.: 100 and 101**

**United States Patent and Trademark Office**

**Reg. No. 3,468,680**

**Registered July 15, 2008**

---

**SERVICE MARK  
PRINCIPAL REGISTER**

**VOICEPRISM**

VOICEPRISM, LLC (DELAWARE LTD LIAB CO)  
SUITE 2100  
203 N. LASALLE ST  
CHICAGO, IL 60601

FOR: LICENSING OF SOFTWARE AND HARD-  
WARE FOR THE DETECTION OF HUMAN EMOTI-  
ON THROUGH VOICE ANALYSIS, IN CLASS 45  
(U.S. CLS. 100 AND 101).

FIRST USE 8-21-2007; IN COMMERCE 8-21-2007.

THE MARK CONSISTS OF STANDARD CHAR-  
ACTERS WITHOUT CLAIM TO ANY PARTICULAR  
FONT, STYLE, SIZE, OR COLOR.

SN 77-084,742, FILED 1-17-2007.

ZACHARY BELLO, EXAMINING ATTORNEY

**Int. Cl.: 5**

**Prior U.S. Cls.: 6, 18, 44, 46, 51, and 52**

**United States Patent and Trademark Office**

**Reg. No. 3,468,681**

**Registered July 15, 2008**

**TRADEMARK  
PRINCIPAL REGISTER**

**OCU-BETIC**

FLOURISH WELLNESS, INC. (FLORIDA CORPORATION)  
2620 HICKORY RIDGE ROAD  
TALLAHASSEE, FL 32308

THE MARK CONSISTS OF STANDARD CHARACTERS WITHOUT CLAIM TO ANY PARTICULAR FONT, STYLE, SIZE, OR COLOR.

FOR: DIETARY AND NUTRITIONAL SUPPLEMENTS, IN CLASS 5 (U.S. CLS. 6, 18, 44, 46, 51 AND 52).

SN 77-084,745, FILED 1-17-2007.

FIRST USE 4-7-2008; IN COMMERCE 4-7-2008.

LINDA E. BLOHM, EXAMINING ATTORNEY

**Int. Cl.: 20**

**Prior U.S. Cls.: 2, 13, 22, 25, 32, and 50**

**Reg. No. 3,468,682**

**United States Patent and Trademark Office**

**Registered July 15, 2008**

---

**TRADEMARK  
PRINCIPAL REGISTER**

**SUDDEN SHADOWS**

BORDERS UNLIMITED, INC. (KENTUCKY CORPORATION)  
365 PEARCE INDUSTRIAL BLVD.  
SHELBYVILLE, KY 40065

THE MARK CONSISTS OF STANDARD CHARACTERS WITHOUT CLAIM TO ANY PARTICULAR FONT, STYLE, SIZE, OR COLOR.

FOR: VINYL DECORATIVE APPLIQUÉS, NAME-  
LY, DESIGNS FOR USE AS DECORATION TO BE  
APPLIED ON WALLS AND OTHER SOLID SURFACES,  
IN CLASS 20 (U.S. CLS. 2, 13, 22, 25, 32 AND 50).

SN 77-084,780, FILED 1-17-2007.

FIRST USE 5-14-2007; IN COMMERCE 5-14-2007.

JANET LEE, EXAMINING ATTORNEY



**Int. Cl.: 30**

**Prior U.S. Cl.: 46**

**United States Patent and Trademark Office**

**Reg. No. 3,468,683**

**Registered July 15, 2008**

**TRADEMARK  
PRINCIPAL REGISTER**

# Indian Tonight

NIRMALA'S KITCHEN INC. (NEW YORK COR-  
PORATION)

690 NEW PALTZ ROAD

HIGHLAND, NY 12528

FOR: READY-MADE SAUCES; SAUCES, IN  
CLASS 30 (U.S. CL. 46).

FIRST USE 3-1-2007; IN COMMERCE 3-1-2007.

THE MARK CONSISTS OF STANDARD CHAR-  
ACTERS WITHOUT CLAIM TO ANY PARTICULAR  
FONT, STYLE, SIZE, OR COLOR.

NO CLAIM IS MADE TO THE EXCLUSIVE  
RIGHT TO USE "INDIAN", APART FROM THE  
MARK AS SHOWN.

SN 77-085,325, FILED 1-18-2007.

VERNA BETH RIRIE, EXAMINING ATTORNEY

**Int. Cl.: 30**

**Prior U.S. Cl.: 46**

**United States Patent and Trademark Office**

**Reg. No. 3,468,684**

**Registered July 15, 2008**

**TRADEMARK  
PRINCIPAL REGISTER**

# Thai Tonight

NIRMALA'S KITCHEN INC. (NEW YORK COR-  
PORATION)

690 NEW PALTZ ROAD

HIGHLAND, NY 12528

FOR: READY-MADE SAUCES; SAUCES, IN  
CLASS 30 (U.S. CL. 46).

FIRST USE 3-1-2007; IN COMMERCE 3-1-2007.

THE MARK CONSISTS OF STANDARD CHAR-  
ACTERS WITHOUT CLAIM TO ANY PARTICULAR  
FONT, STYLE, SIZE, OR COLOR.

NO CLAIM IS MADE TO THE EXCLUSIVE  
RIGHT TO USE "THAI", APART FROM THE MARK  
AS SHOWN.

SN 77-085,331, FILED 1-18-2007.

VERNA BETH RIRIE, EXAMINING ATTORNEY

**Int. Cls.: 1, 40, and 42**

**Prior U.S. Cls.: 1, 5, 6, 10, 26, 46, 100, 101, 103, and 106**

**Reg. No. 3,468,685**

**United States Patent and Trademark Office**

**Registered July 15, 2008**

**TRADEMARK  
SERVICE MARK  
PRINCIPAL REGISTER**



PRIMORIGEN BIOSCIENCES LLC (WISCONSIN  
LTD LIAB CO)  
SUITE 257  
510 CHARMANY DRIVE  
MADISON, WI 53719

FOR: CHEMICAL AND BIOCHEMICAL REAGENTS AND BIOLOGICAL PRODUCTS FOR COMMERCIAL, INDUSTRIAL, SCIENTIFIC, CLINICAL LABORATORY OR RESEARCH USE, NAMELY CELLS, STEM CELLS, CELL LINE ARRAYS, CELL LINE SLIDES, CELL CULTURE MEDIA, CELL GROWTH SUPPLEMENTS, NAMELY, HYPOTHALAMIC EXTRACTS, TISSUE ARRAYS, TISSUE SLIDES, ANTIBODIES, NAMELY, MONOCLONAL AND POLYCLONAL ANTIBODIES, ANTIBODY ARRAYS, LIGANDS, ENZYMES, ENZYME INHIBITORS FOR IN VITRO RESEARCH USE, VECTORS, LIPIDS, ASSAY KITS COMPRISED OF SLIDES ARRAYED WITH CAPTURE ANTIBODIES AND FRAMED WITH WELL FORMERS, PROTEIN STANDARDS AND CONTROLS, BIOTYNLATED DETECTION ANTIBODIES, STREPTAVIDIN FLUOR, WASH REAGENTS AND ASSOCIATED REAGENTS, LOADING CONTROLS IN THE NATURE OF LOADING CONTROL ANTIBODIES AND PROTEINS, TAGS AND MARKERS, NAMELY, TAG AND MARKER ANTIBODIES AND PROTEINS, PEPTIDES, MODIFIED AND PURIFIED RECOMBINANT PROTEINS, PURIFIED NATURAL PROTEINS; PROTEINS CONTAINING NON NATURAL AMINO ACIDS, PROTEIN ARRAYS, AND KITS FOR THE EXPRESSION, AMPLIFICATION, PURIFICATION AND ANALYSIS OF BIOLOGICAL SAMPLES, SAID KITS CONSISTING PRIMARILY OF ONE OR MORE OF THE FOLLOWING PROTEINS, NUCLEIC ACIDS, ANTIBODIES, CELLS, GELS, PROBES, BUFFERS, STAINS AND ASSOCIATED REAGENTS AND DEVICES, NAMELY, SLIDES FOR QUANTIFICATION OF PROTEINS AND PEPTIDES FOR CARRYING OUT SAID PURPOSES, ALL FOR

COMMERCIAL, INDUSTRIAL, SCIENTIFIC, CLINICAL LABORATORY OR RESEARCH USE, IN CLASS 1 (U.S. CLS. 1, 5, 6, 10, 26 AND 46).

FIRST USE 10-1-2007; IN COMMERCE 10-1-2007.

FOR: ANTIBODY GENERATION AND ANTIBODY PRODUCTION FOR OTHERS, ANTIBODY PURIFICATION, ANTIBODY FRAGMENTATION, MANUFACTURE OF ANTIBODIES FOR OTHERS, IN CLASS 40 (U.S. CLS. 100, 103 AND 106).

FIRST USE 9-30-2006; IN COMMERCE 12-27-2006.

FOR: PHARMACEUTICAL RESEARCH SERVICES, NAMELY, ANTIBODY AND ANTISERA SERVICES, NAMELY, ANTIBODY SCREENING, ANTIBODY LABELING, ANTIBODY PACKAGING, ANTIBODY TESTING, ANTIBODY CHARACTERIZATION, HYBRIDOMA CELL LINE DEVELOPMENT, IMMUNOGEN PREPARATION, IMMUNIZATION AND PRODUCTION, CUSTOM TISSUE CULTURE SERVICES, IMMUNOASSAY DEVELOPMENT AND TESTING, IN CLASS 42 (U.S. CLS. 100 AND 101).

FIRST USE 9-30-2006; IN COMMERCE 12-27-2006.

NO CLAIM IS MADE TO THE EXCLUSIVE RIGHT TO USE "BIOSCIENCES LLC", APART FROM THE MARK AS SHOWN.

THE COLOR(S) BLACK, DARK GREY AND LIGHT GREY IS/ARE CLAIMED AS A FEATURE OF THE MARK.

THE MARK CONSISTS OF A STYLIZED REPRESENTATION OF THREE ANIMAL CELLS SURROUNDED BY AN ARC, NEXT TO THE WORDS "PRIMORIGEN BIOSCIENCES LLC". THE WORD "PRIMORIGEN"

AND THE ARC SURROUNDING THE THREE OVALS ARE BLACK. THE WORDS "BIOSCIENCES LLC" AND THE SMALLER OVALS WITHIN THE LARGE OVALS ARE DARK GREY. THE REMAINDER OF THE LARGE OVALS ARE A LIGHTER SHADE OF GREY.

SN 77-085,981, FILED 1-18-2007.

REBECCA GILBERT, EXAMINING ATTORNEY

Int. Cl.: 30

Prior U.S. Cl.: 46

United States Patent and Trademark Office

Reg. No. 3,468,686

Registered July 15, 2008

TRADEMARK  
PRINCIPAL REGISTER



MARTIN, PHILIP R. III (COLORADO SOLE PROPRIETORSHIP)  
795 FOX HILL COURT  
BOULDER, CO 80303

FOR: HONEY, IN CLASS 30 (U.S. CL. 46).

FIRST USE 9-1-2006; IN COMMERCE 9-1-2006.

NO CLAIM IS MADE TO THE EXCLUSIVE RIGHT TO USE "HONEY", APART FROM THE MARK AS SHOWN.

THE COLOR(S) YELLOW, ORANGE, AND BLACK IS/ARE CLAIMED AS A FEATURE OF THE MARK.

THE MARK CONSISTS OF THE COLOR YELLOW APPEARS IN THE WINGS OF THE BEE, THE COLOR ORANGE APPEARS IN THE BODY AND THE EYE OF THE BEE, AND THE COLOR BLACK APPEARS IN THE DETAIL ON THE BODY OF THE BEE, THE DOTS REPRESENTING THE FLIGHT PATH OF THE BEE, AND IN THE QUOTATION MARKS AND THE WORDING "MY OTHER HONEY".

SN 77-086,180, FILED 1-18-2007.

SUSAN RICHARDS, EXAMINING ATTORNEY

**Int. Cl.: 7**

**Prior U.S. Cls.: 13, 19, 21, 23, 31, 34, and 35**

**Reg. No. 3,468,687**

**United States Patent and Trademark Office**

**Registered July 15, 2008**

---

**TRADEMARK  
PRINCIPAL REGISTER**

**Vicwon**

VICWON CORPORATION (CANADA CORPORATION)  
1697 WESTBRIDGE WAY  
MISSISSAUGA, CANADA L5N7S7

THE MARK CONSISTS OF STANDARD CHARACTERS WITHOUT CLAIM TO ANY PARTICULAR FONT, STYLE, SIZE, OR COLOR.

FOR: HANDHELD ELECTRIC HEATED KNIFE FOR CUTTING FOAM, PLASTIC AND RUBBER, IN CLASS 7 (U.S. CLS. 13, 19, 21, 23, 31, 34 AND 35).

SN 77-086,557, FILED 1-19-2007.

FIRST USE 3-18-2008; IN COMMERCE 3-18-2008.

TRACY WHITTAKER-BROWN, EXAMINING ATTORNEY

**Int. Cl.: 30**

**Prior U.S. Cl.: 46**

**United States Patent and Trademark Office**

**Reg. No. 3,468,688**

**Registered July 15, 2008**

**TRADEMARK  
PRINCIPAL REGISTER**

**PIZZA-TIZERS**

WEGMANS FOOD MARKETS, INC. (NEW YORK  
CORPORATION)  
1500 BROOKS AVENUE, P.O. BOX 30844  
ROCHESTER, NY 14603

FOR: PACKAGED HORS D'OEUVRES, NAMELY,  
PREPARED MIXTURES OF TOMATO SAUCE,  
CHEESE, AND SPICES INSIDE OF A FLOUR  
CRUST; PACKAGED HORS D'OEUVRES, NAMELY,  
PREPARED MIXTURES OF TOMATO SAUCE,  
CHEESE, MEAT, AND SPICES INSIDE OF A FLOUR  
CRUST, IN CLASS 30 (U.S. CL. 46).

FIRST USE 5-31-2007; IN COMMERCE 5-31-2007.

THE MARK CONSISTS OF STANDARD CHAR-  
ACTERS WITHOUT CLAIM TO ANY PARTICULAR  
FONT, STYLE, SIZE, OR COLOR.

SN 77-086,602, FILED 1-19-2007.

MARK T. MULLEN, EXAMINING ATTORNEY

**Int. Cls.: 25 and 28**

**Prior U.S. Cls.: 22, 23, 38, 39, and 50**

**United States Patent and Trademark Office**

**Reg. No. 3,468,689**

**Registered July 15, 2008**

**TRADEMARK  
PRINCIPAL REGISTER**



PAMIAS, FRANCISCO (UNITED STATES INDIVIDUAL)  
472 MARLBORO RD.  
OLD BRIDGE, NJ 08857

FOR: CAPS; JOGGING SUITS; PANTS; SHIRTS;  
SHOES; SHORTS; SWEATERS; T-SHIRTS, IN CLASS  
25 (U.S. CLS. 22 AND 39).

FIRST USE 8-1-2007; IN COMMERCE 8-1-2007.

FOR: GOLF PUTTER COVERS; GOLF PUTTERS,  
IN CLASS 28 (U.S. CLS. 22, 23, 38 AND 50).

FIRST USE 8-1-2007; IN COMMERCE 8-1-2007.

SN 77-086,614, FILED 1-19-2007.

ALEXANDER L. POWERS, EXAMINING ATTORNEY



**Int. Cl.: 28**

**Prior U.S. Cls.: 22, 23, 38, and 50**

**United States Patent and Trademark Office**

**Reg. No. 3,468,690**

**Registered July 15, 2008**

**TRADEMARK  
PRINCIPAL REGISTER**



PAMIAS, FRANCISCO (UNITED STATES INDIVIDUAL)  
472 MARLBORO RD.  
OLD BRIDGE, NJ 08857

FOR: GOLF PUTTER COVERS; GOLF PUTTERS,  
IN CLASS 28 (U.S. CLS. 22, 23, 38 AND 50).

FIRST USE 8-1-2007; IN COMMERCE 8-1-2007.

NO CLAIM IS MADE TO THE EXCLUSIVE  
RIGHT TO USE "GOLF", APART FROM THE MARK  
AS SHOWN.

SN 77-086,700, FILED 1-19-2007.

ALEXANDER L. POWERS, EXAMINING ATTORNEY

**Int. Cl.: 10**

**Prior U.S. Cls.: 26, 39, and 44**

**United States Patent and Trademark Office**

**Reg. No. 3,468,691**

**Registered July 15, 2008**

**TRADEMARK  
PRINCIPAL REGISTER**

**RECOVERAIR**

RECOVERCARE (PENNSYLVANIA LTD LIAB  
CO)  
5185 CAMPUS DRIVE, SUITE 300  
PLYMOUTH MEETING, PA 19462

FOR: MEDICAL PRODUCTS, NAMELY, AIR  
MATTRESSES AND POWER UNITS SOLD OR REN-  
TED AS A UNIT FOR USE BY HOSPITALS, NUR-  
SING HOMES, AND HOME CARE PATIENTS FOR  
THE PREVENTION AND TREATMENT OF DECU-  
BITUS ULCERS, NAMELY, BEDSORES, IN CLASS  
10 (U.S. CLS. 26, 39 AND 44).

FIRST USE 2-1-2008; IN COMMERCE 2-1-2008.

THE MARK CONSISTS OF STANDARD CHAR-  
ACTERS WITHOUT CLAIM TO ANY PARTICULAR  
FONT, STYLE, SIZE, OR COLOR.

SN 77-086,724, FILED 1-19-2007.

JULIE WATSON, EXAMINING ATTORNEY

**Int. Cl.: 29**

**Prior U.S. Cl.: 46**

**United States Patent and Trademark Office**

**Reg. No. 3,468,692**

**Registered July 15, 2008**

**TRADEMARK  
PRINCIPAL REGISTER**

**NATURE'S SNACK**

PRIME SNAX CORP. (NEVADA CORPORATION)  
SUITE 700  
1750 SOUTH 500 WEST  
SALT LAKE CITY, UT 84115

THE MARK CONSISTS OF STANDARD CHARACTERS WITHOUT CLAIM TO ANY PARTICULAR FONT, STYLE, SIZE, OR COLOR.

NO CLAIM IS MADE TO THE EXCLUSIVE RIGHT TO USE "SNACK", APART FROM THE MARK AS SHOWN.

FOR: JERKY, IN CLASS 29 (U.S. CL. 46).

SN 77-086,927, FILED 1-19-2007.

FIRST USE 4-30-2007; IN COMMERCE 4-30-2007.

LINDA E. BLOHM, EXAMINING ATTORNEY

**Int. Cl.: 8**

**Prior U.S. Cls.: 23, 28, and 44**

**United States Patent and Trademark Office**

**Reg. No. 3,468,693**

**Registered July 15, 2008**

**TRADEMARK  
PRINCIPAL REGISTER**

**SCOMB**

RANDALL B. LOWE (PENNSYLVANIA SOLE  
PROPRIETORSHIP)  
120 FOURTH STREET  
MT. WOLF, PA 17347

FOR: HAND TOOLS, NAMELY, TOOLS CONSIST-  
ING OF ANY COMBINATION OF SCISSORS AND  
COMB JOINED TOGETHER AS ONE INSTRUMENT  
TO INCLUDE A COMB OR COMB ASSEMBLY  
ATTACHED TO OR PART OF THE BLADES OF  
SCISSORS; SCISSORS, SCISSOR BLADES AND  
HAND OPERATED HAIR CLIPPERS FOR USE ON

HUMAN HAIR OR PETS, IN CLASS 8 (U.S. CLS. 23,  
28 AND 44).

FIRST USE 6-6-2008; IN COMMERCE 6-6-2008.

THE MARK CONSISTS OF STANDARD CHAR-  
ACTERS WITHOUT CLAIM TO ANY PARTICULAR  
FONT, STYLE, SIZE, OR COLOR.

SN 77-087,269, FILED 1-20-2007.

HENRY S. ZAK, EXAMINING ATTORNEY

**Int. Cl.: 6**

**Prior U.S. Cls.: 2, 12, 13, 14, 23, 25, and 50**

**United States Patent and Trademark Office**

**Reg. No. 3,468,694**

**Registered July 15, 2008**

**TRADEMARK  
PRINCIPAL REGISTER**

# Saf-T-Fold

DUNBARTON CORPORATION (ALABAMA CORPORATION)  
PO BOX 6416  
DOTHAN, AL 36302

THE MARK CONSISTS OF STANDARD CHARACTERS WITHOUT CLAIM TO ANY PARTICULAR FONT, STYLE, SIZE, OR COLOR.

FOR: DOOR PANELS OF METAL, IN CLASS 6 (U.S. CLS. 2, 12, 13, 14, 23, 25 AND 50).

SN 77-087,436, FILED 1-21-2007.

FIRST USE 2-1-2007; IN COMMERCE 10-1-2007.

MICHELE SWAIN, EXAMINING ATTORNEY

**Int. Cls.: 6 and 19**

**Prior U.S. Cls.: 1, 2, 12, 13, 14, 23, 25, 33, and 50**

**United States Patent and Trademark Office**

**Reg. No. 3,468,695**

**Registered July 15, 2008**

**TRADEMARK  
PRINCIPAL REGISTER**

**ATHOME**

DUNBARTON CORPORATION (ALABAMA COR-  
PORATION)  
PO BOX 6416  
DOTHAN, AL 36302

FOR: DOOR PANELS OF METAL, IN CLASS 6  
(U.S. CLS. 2, 12, 13, 14, 23, 25 AND 50).

FIRST USE 2-1-2007; IN COMMERCE 10-1-2007.

FOR: DOOR PANELS, NOT OF METAL , IN  
CLASS 19 (U.S. CLS. 1, 12, 33 AND 50).

FIRST USE 2-1-2007; IN COMMERCE 10-1-2007.

THE MARK CONSISTS OF STANDARD CHAR-  
ACTERS WITHOUT CLAIM TO ANY PARTICULAR  
FONT, STYLE, SIZE, OR COLOR.

SN 77-087,438, FILED 1-21-2007.

MICHELE SWAIN, EXAMINING ATTORNEY

**Int. Cl.: 6**

**Prior U.S. Cls.: 2, 12, 13, 14, 23, 25, and 50**

**United States Patent and Trademark Office**

**Reg. No. 3,468,696**

**Registered July 15, 2008**

**TRADEMARK  
PRINCIPAL REGISTER**

# Marker Door

DUNBARTON CORPORATION (ALABAMA COR-  
PORATION)

PO BOX 6416

DOTHAN, AL 36302

FOR: DOOR PANELS OF METAL, IN CLASS 6  
(U.S. CLS. 2, 12, 13, 14, 23, 25 AND 50).

FIRST USE 2-1-2007; IN COMMERCE 10-1-2007.

THE MARK CONSISTS OF STANDARD CHAR-  
ACTERS WITHOUT CLAIM TO ANY PARTICULAR  
FONT, STYLE, SIZE, OR COLOR.

NO CLAIM IS MADE TO THE EXCLUSIVE  
RIGHT TO USE "DOOR", APART FROM THE  
MARK AS SHOWN.

SN 77-087,439, FILED 1-21-2007.

MICHELE SWAIN, EXAMINING ATTORNEY

Int. Cl.: 30

Prior U.S. Cl.: 46

United States Patent and Trademark Office

Reg. No. 3,468,697

Registered July 15, 2008

**TRADEMARK  
PRINCIPAL REGISTER**

**Patti Rogers Baking Company**

MARSHALL, PETER R. (UNITED STATES INDIVIDUAL)

2910 E 57ST AVE., STE. 5

#260

SPOKANE, WA 99223 AND

FAVREAU, MICHELE (UNITED STATES INDIVIDUAL)

2910 E 57ST AVE., STE. 5

#260

SPOKANE, WA 992237844

FOR: BAKERY PRODUCTS, IN CLASS 30 (U.S. CL. 46).

FIRST USE 1-1-2007; IN COMMERCE 1-1-2007.

THE MARK CONSISTS OF STANDARD CHARACTERS WITHOUT CLAIM TO ANY PARTICULAR FONT, STYLE, SIZE, OR COLOR.

NO CLAIM IS MADE TO THE EXCLUSIVE RIGHT TO USE "BAKING COMPANY", APART FROM THE MARK AS SHOWN.

THE NAME "PATTI ROGERS" DOES NOT IDENTIFY A LIVING INDIVIDUAL.

SN 77-087,506, FILED 1-21-2007.

ELIZABETH BEYER, EXAMINING ATTORNEY



**Int. Cl.: 11**

**Prior U.S. Cls.: 13, 21, 23, 31, and 34**

**United States Patent and Trademark Office**

**Reg. No. 3,468,698**

**Registered July 15, 2008**

**TRADEMARK  
PRINCIPAL REGISTER**

**ADCA**

VALSTEAM ADCA ENGINEERING, SA (PORTUGAL CORPORATION)  
TRAV. DA DOUROANA  
PONTE DA PEDRA  
LEIRIA, PORTUGAL 2400

FOR: AIR PURGERS, WATER SAMPLE COOLERS, STEAM TO WATER MIXERS, TEMPERATURE CONTROL VALVES, DIRECT STEAM INJECTION HUMIDIFIERS, HEAT EXCHANGERS NOT BEING PART OF MACHINES, EXHAUST HEADS, SIGHT GLASSES, IN CLASS 11 (U.S. CLS. 13, 21, 23, 31 AND 34).

FIRST USE 5-16-2008; IN COMMERCE 5-16-2008.

THE MARK CONSISTS OF STANDARD CHARACTERS WITHOUT CLAIM TO ANY PARTICULAR FONT, STYLE, SIZE, OR COLOR.

SN 77-087,702, FILED 1-22-2007.

SHANNON TWOHIG, EXAMINING ATTORNEY

**Int. Cl.: 9**

**Prior U.S. Cls.: 21, 23, 26, 36, and 38**

**Reg. No. 3,468,699**

**United States Patent and Trademark Office**

**Registered July 15, 2008**

**TRADEMARK  
PRINCIPAL REGISTER**

**REBEL MONKEY**

REBEL MONKEY, INC. (DELAWARE CORPORATION)  
135 W. 20TH STREET, 5TH FLOOR  
NEW YORK, NY 10011

FOR: COMPUTER GAME SOFTWARE; COMPUTER GAME SOFTWARE AND MANUALS SOLD AS A UNIT; COMPUTER VIDEO GAME SOFTWARE; COMPUTER VIDEO GAME SOFTWARE AND MANUALS SOLD AS A UNIT, IN CLASS 9 (U.S. CLS. 21, 23, 26, 36 AND 38).

FIRST USE 1-16-2007; IN COMMERCE 1-16-2007.

THE MARK CONSISTS OF STANDARD CHARACTERS WITHOUT CLAIM TO ANY PARTICULAR FONT, STYLE, SIZE, OR COLOR.

SN 77-087,925, FILED 1-22-2007.

JIM RINGLE, EXAMINING ATTORNEY

**Int. Cl.: 9**

**Prior U.S. Cls.: 21, 23, 26, 36, and 38**

**Reg. No. 3,468,700**

**United States Patent and Trademark Office**

**Registered July 15, 2008**

---

**TRADEMARK  
PRINCIPAL REGISTER**

**Steinfest**

GLOBAL GAMING GROUP (NEVADA CORPORATION)  
3035 E PATRICK LN #14  
LAS VEGAS, NV 89120

THE MARK CONSISTS OF STANDARD CHARACTERS WITHOUT CLAIM TO ANY PARTICULAR FONT, STYLE, SIZE, OR COLOR.

FOR: GAMING EQUIPMENT, NAMELY, SLOT MACHINES WITH OR WITHOUT VIDEO OUTPUT, IN CLASS 9 (U.S. CLS. 21, 23, 26, 36 AND 38).

SN 77-089,088, FILED 1-23-2007.

FIRST USE 7-25-2007; IN COMMERCE 7-25-2007.

GISELLE AGOSTO, EXAMINING ATTORNEY

**Int. Cl.: 28**

**Prior U.S. Cls.: 22, 23, 38, and 50**

**United States Patent and Trademark Office**

**Reg. No. 3,468,701**

**Registered July 15, 2008**

**TRADEMARK  
PRINCIPAL REGISTER**



RIDEMAKERZ, LLC (DELAWARE LTD LIAB  
CO)  
8191 STRAWBERRY LANE  
FALLS CHURCH, VA 22042

FOR: TOY VEHICLES, PARTS AND ACCESSOR-  
IES THEREFOR, IN CLASS 28 (U.S. CLS. 22, 23, 38  
AND 50).

FIRST USE 6-1-2007; IN COMMERCE 6-1-2007.

THE COLOR(S) BLACK, GRAY, RED AND  
WHITE IS/ARE CLAIMED AS A FEATURE OF  
THE MARK.

THE MARK CONSISTS OF A RECTANGULAR  
BLACK FIELD BORDERED ON TOP AND BOTTOM  
BY A GRAY STRIPE. ON THE LEFT SIDE OF THE  
BLACK FIELD IS A CIRCULAR SYMBOL INCOR-  
PORATING A STYLIZED LETTER "R" IN WHITE  
AND "Z" IN RED. THE WORD "RIDEMAKERZ" IN  
BLOCK LETTERS APPEARS AT AN UPWARD  
ANGLE ON THE REMAINDER OF THE BLACK  
FIELD WITH THE LETTERS "R", "I", "D", "E" AND  
"Z" IN RED AND THE LETTERS "M", "A", "K", "E"  
AND "R" IN WHITE.

SN 77-089,620, FILED 1-24-2007.

MICHELE SWAIN, EXAMINING ATTORNEY

Int. Cl.: 25

Prior U.S. Cls.: 22 and 39

United States Patent and Trademark Office

Reg. No. 3,468,702

Registered July 15, 2008

TRADEMARK  
PRINCIPAL REGISTER

RACELAB FERRAMENTA

RUSSO, MICHAEL J. (CANADA INDIVIDUAL)  
17A MAPLE GROVE AVE.  
RICHMOND HILL, ONTARIO, CANADA L4E-2T9

FOR: CARGO PANTS; DENIM JACKETS; DEN-  
IMS; DOWN JACKETS; DRESS SHIRTS; GOLF  
SHIRTS; HEADGEAR, NAMELY, CAPS, HATS; HEA-  
VY JACKETS; JACKETS; KNIT SHIRTS; LEATHER  
JACKETS; MEN AND WOMEN JACKETS, COATS,  
TROUSERS, VESTS; NECKTIES; OPEN-NECKED  
SHIRTS; PIQUE SHIRTS; POLO SHIRTS; RAIN  
JACKETS; RAINPROOF JACKETS; SHORT TROU-  
SERS; SHORT-SLEEVED OR LONG-SLEEVED T-  
SHIRTS; SKI JACKETS; SLEEVED OR SLEEVELESS  
JACKETS; SPORT SHIRTS; SPORTS JACKETS;  
SPORTS SHIRTS WITH SHORT SLEEVES; SUEDE  
JACKETS; SWEAT PANTS; SWEAT SHIRTS; SWEAT

SHORTS; T-SHIRTS; WALKING SHORTS; WATER-  
PROOF JACKETS AND PANTS; WIND RESISTANT  
JACKETS, IN CLASS 25 (U.S. CLS. 22 AND 39).

FIRST USE 6-8-2007; IN COMMERCE 1-2-2008.

THE MARK CONSISTS OF STANDARD CHAR-  
ACTERS WITHOUT CLAIM TO ANY PARTICULAR  
FONT, STYLE, SIZE, OR COLOR.

THE ENGLISH TRANSLATION OF THE WORD  
"FERRAMENTA" IN THE MARK IS "HARDWARE"  
OR "IRON TOOLS."

SN 77-089,912, FILED 1-24-2007.

ZHALEH DELANEY, EXAMINING ATTORNEY

**Int. Cl.: 41**

**Prior U.S. Cls.: 100, 101, and 107**

**United States Patent and Trademark Office**

**Reg. No. 3,468,703**

**Registered July 15, 2008**

**SERVICE MARK  
PRINCIPAL REGISTER**

# Open Heart Marketing

BONNICI, ERIC W. (UNITED STATES INDIVIDUAL)  
P.O. BOX 6772  
KAMUELA, HI 96743

FOR: EDUCATION SERVICES, NAMELY, PROVIDING CLASSES, WORKSHOPS, MENTORING, AND SEMINARS IN THE FIELD OF A MARKETING DISCIPLINE THAT PERPETUATES EVOLUTIONARY PROGRESSION, EASE AND JOY OF LIFE, PLAYFUL INTERPRETATION, ACKNOWLEDGING COMMONALITY AND CONNECTION, MUTUAL RESPECT, APPRECIATION OF DIFFERENCES, AND PEACEFUL COEXISTENCE OF ALL HUMANKIND, AND DISTRIBUTING COURSE MATERIALS IN CONNECTION THEREWITH, IN CLASS 41 (U.S. CLS. 100, 101 AND 107).

FIRST USE 4-0-2008; IN COMMERCE 4-0-2008.

THE MARK CONSISTS OF STANDARD CHARACTERS WITHOUT CLAIM TO ANY PARTICULAR FONT, STYLE, SIZE, OR COLOR.

NO CLAIM IS MADE TO THE EXCLUSIVE RIGHT TO USE "MARKETING" , APART FROM THE MARK AS SHOWN.

SN 77-091,521, FILED 1-25-2007.

RAMONA ORTIGA, EXAMINING ATTORNEY

**Int. Cl.: 31**

**Prior U.S. Cls.: 1 and 46**

**United States Patent and Trademark Office**

**Reg. No. 3,468,704**

**Registered July 15, 2008**

**TRADEMARK  
PRINCIPAL REGISTER**

**Yodog**

TRENT R. MOBRAATEN (WISCONSIN CORPORATION)  
800 WISCONSIN ST, BLDG 13  
P.O. BOX 1316  
EAU CLAIRE, WI 54702

THE MARK CONSISTS OF STANDARD CHARACTERS WITHOUT CLAIM TO ANY PARTICULAR FONT, STYLE, SIZE, OR COLOR.

FOR: DOG TREATS, IN CLASS 31 (U.S. CLS. 1 AND 46).

SN 77-091,729, FILED 1-26-2007.

FIRST USE 3-31-2008; IN COMMERCE 3-31-2008.

GEORGIA CARTY, EXAMINING ATTORNEY

**Int. Cls.: 9 and 18**

**Prior U.S. Cls.: 1, 2, 3, 21, 22, 23, 26, 36, 38, and 41**

**United States Patent and Trademark Office**

**Reg. No. 3,468,705**

**Registered July 15, 2008**

**TRADEMARK  
PRINCIPAL REGISTER**

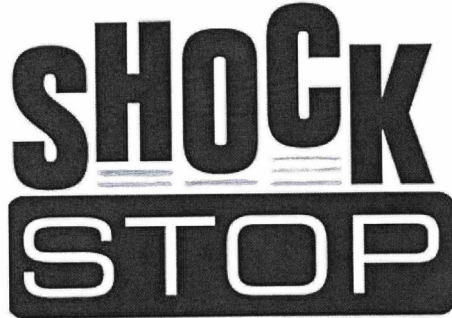

BRIGGS & RILEY TRAVELWARE, LLC (DELA-  
WARE LTD LIAB CO)  
400 WIRELESS BOULEVARD  
HAUPPAUGE, NY 11788

FOR: WHEELS AND SHOULDER STRAPS FOR  
LUGGAGE, NAMELY, LAPTOP CASES, IN CLASS 9  
(U.S. CLS. 21, 23, 26, 36 AND 38).

FIRST USE 10-0-2007; IN COMMERCE 10-0-2007.

FOR: WHEELS AND SHOULDER STRAPS FOR  
LUGGAGE, NAMELY, SUITCASES, IN CLASS 18  
(U.S. CLS. 1, 2, 3, 22 AND 41).

FIRST USE 10-0-2007; IN COMMERCE 10-0-2007.

THE MARK CONSISTS OF THE WORDS "SHOCK  
STOP" IN SPECIAL FORM WITH LINES APPEAR-  
ING UNDER THE LETTERS HOC IN THE WORD  
"SHOCK" AND THE WORD "STOP" APPEARING  
ON A RECTANGLE.

SN 77-091,910, FILED 1-26-2007.

ALEXANDER L. POWERS, EXAMINING ATTOR-  
NEY



**Int. Cl.: 15**

**Prior U.S. Cls.: 2, 21, and 36**

**United States Patent and Trademark Office**

**Reg. No. 3,468,706**

**Registered July 15, 2008**

**TRADEMARK  
PRINCIPAL REGISTER**

**Professor String**

CIMSTRAT, INC. (ILLINOIS CORPORATION)  
3907 TERRY AVE.  
CRYSTAL LAKE, IL 60014

THE COLOR ORANGE IS LOCATED IN THE WORD "PROFESSOR" AND THE COLOR PURPLE IS LOCATED IN THE WORD "STRING".

FOR: GUITAR STRINGS, IN CLASS 15 (U.S. CLS. 2, 21 AND 36).

FIRST USE 3-1-2007; IN COMMERCE 1-1-2008.

THE MARK CONSISTS OF THE WORD "PROFESSOR" PRECEDING THE WORD "STRING".

NO CLAIM IS MADE TO THE EXCLUSIVE RIGHT TO USE "STRING" , APART FROM THE MARK AS SHOWN.

SN 77-092,889, FILED 1-27-2007.

THE APPLICANT CLAIMS COLOR AS A FEATURE OF THE MARK, NAMELY, ORANGE AND PURPLE.

NATALIE POLZER, EXAMINING ATTORNEY

**Int. Cl.: 30**

**Prior U.S. Cl.: 46**

**United States Patent and Trademark Office**

**Reg. No. 3,468,707**

**Registered July 15, 2008**

**TRADEMARK  
PRINCIPAL REGISTER**

**ROCKET TRIPLE**

JOHNNY ROCKETS LICENSING CORPORATION  
(CALIFORNIA CORPORATION)  
25550 COMMERCENTRE DRIVE, SUITE 200  
LAKE FOREST, CA 92630

OWNER OF U.S. REG. NOS. 2,726,750, 3,063,291,  
AND OTHERS.

FOR: HAMBURGER SANDWICHES FOR CON-  
SUMPTION ON OR OFF THE PREMISES, IN CLASS  
30 (U.S. CL. 46).

NO CLAIM IS MADE TO THE EXCLUSIVE  
RIGHT TO USE "TRIPLE", APART FROM THE  
MARK AS SHOWN.

FIRST USE 6-0-2007; IN COMMERCE 6-0-2007.

SN 77-093,884, FILED 1-29-2007.

THE MARK CONSISTS OF STANDARD CHAR-  
ACTERS WITHOUT CLAIM TO ANY PARTICULAR  
FONT, STYLE, SIZE, OR COLOR.

ALYSSA PALADINO, EXAMINING ATTORNEY

**Int. Cl.: 25**

**Prior U.S. Cls.: 22 and 39**

**United States Patent and Trademark Office**

**Reg. No. 3,468,708**

**Registered July 15, 2008**

**TRADEMARK  
PRINCIPAL REGISTER**

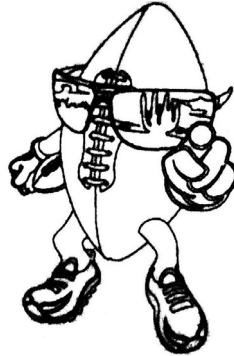

ARIZONA SUPER BOWL HOST COMMITTEE  
(ARIZONA NON-PROFIT CORPORATION)  
ONE ARIZONA CENTER, 400 E VAN BUREN  
SUITE 600  
PHOENIX, AZ 85004

THE MARK CONSISTS OF A DESIGN OF A  
PERSONIFIED FOOTBALL WEARING SUNGLAS-  
SES AND SNEAKERS; AND HOLDING A SMALLER  
FOOTBALL.

FOR: MEN'S, WOMEN'S AND CHILDREN'S  
CLOTHING, NAMELY, CAPS, HATS, T-SHIRTS,  
GOLF SHIRTS, IN CLASS 25 (U.S. CLS. 22 AND 39).

SN 77-094,384, FILED 1-30-2007.

FIRST USE 2-28-2007; IN COMMERCE 2-28-2007.

BERNICE MIDDLETON, EXAMINING ATTORNEY

**Int. Cl.: 21**

**Prior U.S. Cls.: 2, 13, 23, 29, 30, 33, 40, and 50**

**Reg. No. 3,468,709**

**United States Patent and Trademark Office**

**Registered July 15, 2008**

---

**TRADEMARK  
PRINCIPAL REGISTER**

**JACK DANIEL'S**

JACK DANIEL'S PROPERTIES, INC. (DELA-  
WARE CORPORATION)  
4040 CIVIC CENTER DRIVE, SUITE 528  
SAN RAFAEL, CA 94903

FOR: COOLERS FOR FOOD AND BEVERAGES;  
PORTABLE COOLERS, IN CLASS 21 (U.S. CLS. 2, 13,  
23, 29, 30, 33, 40 AND 50).

FIRST USE 3-31-2005; IN COMMERCE 3-31-2005.

THE MARK CONSISTS OF STANDARD CHAR-  
ACTERS WITHOUT CLAIM TO ANY PARTICULAR  
FONT, STYLE, SIZE, OR COLOR.

THE NAME "JACK DANIEL'S" DOES NOT IDEN-  
TIFY A LIVING INDIVIDUAL.

SN 77-095,721, FILED 1-31-2007.

KATHERINE M. DUBRAY, EXAMINING ATTOR-  
NEY

**Int. Cl.: 20**

**Prior U.S. Cls.: 2, 13, 22, 25, 32, and 50**

**Reg. No. 3,468,710**

**United States Patent and Trademark Office**

**Registered July 15, 2008**

---

**TRADEMARK  
PRINCIPAL REGISTER**

**JACK DANIEL'S**

JACK DANIEL'S PROPERTIES, INC. (DELA-  
WARE CORPORATION)  
4040 CIVIC CENTER DRIVE, SUITE 528  
SAN RAFAEL, CA 94903

FOR: OUTDOOR FURNITURE, NAMELY, FOLD-  
ING CHAIRS, IN CLASS 20 (U.S. CLS. 2, 13, 22, 25, 32  
AND 50).

FIRST USE 3-31-2005; IN COMMERCE 3-31-2005.

THE MARK CONSISTS OF STANDARD CHAR-  
ACTERS WITHOUT CLAIM TO ANY PARTICULAR  
FONT, STYLE, SIZE, OR COLOR.

THE NAME "JACK DANIEL'S" DOES NOT IDEN-  
TIFY A LIVING INDIVIDUAL.

SN 77-095,758, FILED 1-31-2007.

KATHERINE M. DUBRAY, EXAMINING ATTOR-  
NEY

**Int. Cl.: 40**

**Prior U.S. Cls.: 100, 103, and 106**

**United States Patent and Trademark Office**

**Reg. No. 3,468,711**

**Registered July 15, 2008**

**SERVICE MARK  
PRINCIPAL REGISTER**

**SYAGRUS SYSTEMS**

SYAGRUS SYSTEMS, LLC (MINNESOTA LTD  
LIAB CO)  
4370 WEST ROUND LAKE ROAD  
ARDEN HILLS, MN 55112

FOR: CONTRACT MANUFACTURING IN THE  
FIELD OF SEMICONDUCTORS, IN CLASS 40 (U.S.  
CLS. 100, 103 AND 106).

FIRST USE 9-1-2007; IN COMMERCE 9-1-2007.

THE MARK CONSISTS OF STANDARD CHAR-  
ACTERS WITHOUT CLAIM TO ANY PARTICULAR  
FONT, STYLE, SIZE, OR COLOR.

NO CLAIM IS MADE TO THE EXCLUSIVE  
RIGHT TO USE "SYSTEMS", APART FROM THE  
MARK AS SHOWN.

SN 77-096,513, FILED 2-1-2007.

RONALD AIKENS, EXAMINING ATTORNEY

**Int. Cl.: 27**

**Prior U.S. Cls.: 19, 20, 37, 42, and 50**

**United States Patent and Trademark Office**

**Reg. No. 3,468,712**

**Registered July 15, 2008**

**TRADEMARK  
PRINCIPAL REGISTER**



HAMPTON DIRECT, INC. (VERMONT CORPORATION)  
350 PIONEER DRIVE  
WILLISTON, VT 05495

FOR: ADJUSTABLE LENGTH DOUBLE-SIDED DEVICE COMPRISED OF A MATERIAL WITH INSULATING PROPERTIES COVERED BY FABRIC LOCATED AT THE BASE PORTION OF THE WALL OPENING THAT PROVIDES PROTECTION FROM THE ELEMENTS, IN CLASS 27 (U.S. CLS. 19, 20, 37, 42 AND 50).

FIRST USE 9-21-2007; IN COMMERCE 9-21-2007.

OWNER OF U.S. REG. NO. 3,185,885.

NO CLAIM IS MADE TO THE EXCLUSIVE RIGHT TO USE "TWIN DRAFT GUARD", APART FROM THE MARK AS SHOWN.

SN 77-096,889, FILED 2-1-2007.

BRIAN PINO, EXAMINING ATTORNEY

**Int. Cl.: 29**

**Prior U.S. Cl.: 46**

**United States Patent and Trademark Office**

**Reg. No. 3,468,713**

**Registered July 15, 2008**

**TRADEMARK  
PRINCIPAL REGISTER**



L.S.I., INC. - NEW GLARUS (WISCONSIN CORPORATION)  
ONE SNACKFOOD LANE, P.O. BOX 397  
MINONG, WI 54859

OWNER OF U.S. REG. NOS. 1,253,877 AND 2,911,218.

FOR: MEAT-BASED SNACKS, IN CLASS 29 (U.S. CL. 46).

SN 77-097,955, FILED 2-2-2007.

FIRST USE 2-0-2007; IN COMMERCE 2-0-2007.

JAMES LOVELACE, EXAMINING ATTORNEY



**Int. Cls.: 28, 35, and 41**

**Prior U.S. Cls.: 22, 23, 38, 50, 100, 101, 102, and 107**

**United States Patent and Trademark Office**

**Reg. No. 3,468,714**

**Registered July 15, 2008**

**TRADEMARK  
SERVICE MARK  
PRINCIPAL REGISTER**

**RENT A GYM**

BERRY, EDWARD F. (UNITED STATES INDIVIDUAL)

233 12 STREET, SUITE 100A  
COLUMBUS, GA 31901

FOR: EXERCISE MACHINES, IN CLASS 28 (U.S. CLS. 22, 23, 38 AND 50).

FIRST USE 7-1-2007; IN COMMERCE 7-1-2007.

FOR: RETAIL STORES FEATURING EXERCISE MACHINES, IN CLASS 35 (U.S. CLS. 100, 101 AND 102).

FIRST USE 7-1-2007; IN COMMERCE 7-1-2007.

FOR: RENTAL OF EXERCISE MACHINES, IN CLASS 41 (U.S. CLS. 100, 101 AND 107).

FIRST USE 7-1-2007; IN COMMERCE 7-1-2007.

THE MARK CONSISTS OF STANDARD CHARACTERS WITHOUT CLAIM TO ANY PARTICULAR FONT, STYLE, SIZE, OR COLOR.

NO CLAIM IS MADE TO THE EXCLUSIVE RIGHT TO USE "GYM", APART FROM THE MARK AS SHOWN.

SN 77-098,232, FILED 2-2-2007.

KAREN K. BUSH, EXAMINING ATTORNEY

**Int. Cl.: 16**

**Prior U.S. Cls.: 2, 5, 22, 23, 29, 37, 38, and 50**

**Reg. No. 3,468,715**

**United States Patent and Trademark Office**

**Registered July 15, 2008**

---

**TRADEMARK  
PRINCIPAL REGISTER**

# Beachhearts

WILLIAMS, CHERI (UNITED STATES INDIVIDUAL)  
1784 W. NORTHFIELD BLVD. #227  
MURFREESBORO, TN 37129

THE MARK CONSISTS OF STANDARD CHARACTERS WITHOUT CLAIM TO ANY PARTICULAR FONT, STYLE, SIZE, OR COLOR.

FOR: PAPER, CARDBOARD; PHOTOGRAPHS; STATIONERY; ADHESIVES FOR STATIONERY OR HOUSEHOLD PURPOSES, IN CLASS 16 (U.S. CLS. 2, 5, 22, 23, 29, 37, 38 AND 50).

SN 77-098,754, FILED 2-4-2007.

FIRST USE 11-15-2007; IN COMMERCE 11-15-2007.

DEIRDRE ROBERTSON, EXAMINING ATTORNEY

Int. Cl.: 44

Prior U.S. Cls.: 100 and 101

United States Patent and Trademark Office

Reg. No. 3,468,716

Registered July 15, 2008

**SERVICE MARK  
PRINCIPAL REGISTER**



JUST THE NURSE, LLC (MINNESOTA LTD LIAB  
CO)  
7723 COUNTY ROAD 45 SOUTH  
OWATONNA, MN 55060

FOR: HOME NURSING AID SERVICES; NUR-  
SING CARE, IN CLASS 44 (U.S. CLS. 100 AND 101).

FIRST USE 4-3-2006; IN COMMERCE 1-1-2008.

NO CLAIM IS MADE TO THE EXCLUSIVE  
RIGHT TO USE "NURSE", APART FROM THE  
MARK AS SHOWN.

THE COLOR(S) BLUE, WHITE, YELLOW,  
BROWN, BLACK, RED AND PEACH IS/ARE  
CLAIMED AS A FEATURE OF THE MARK.

THE MARK CONSISTS OF FEMALE NURSE  
WITH BROWN HAIR AND PEACH SKIN WEARING  
A TRADITIONAL WHITE NURSE UNIFORM,  
WHITE HAT WITH RED FIRST AID CROSS, AND  
YELLOW SWEATER AND CARRYING A BROWN  
MEDICAL BAG, WITH THE BLACK SCRIPTED  
WORDS, "JUST THE NURSE," LOCATED INSIDE  
A LIGHT-BLUE CIRCLE.

SN 77-099,209, FILED 2-5-2007.

MARGARET POWER, EXAMINING ATTORNEY

**Int. Cl.: 21**

**Prior U.S. Cls.: 2, 13, 23, 29, 30, 33, 40, and 50**

**United States Patent and Trademark Office**

**Reg. No. 3,468,717**

**Registered July 15, 2008**

**TRADEMARK  
PRINCIPAL REGISTER**

# GetBlasted

THE AMERICAN BELT COMPANY (PENNSYLVANIA CORPORATION)  
1355 ADAMS ROAD  
BENSALEM, PA 19020

FOR: ALL PURPOSE PORTABLE HOUSEHOLD CONTAINERS; BEVERAGE GLASSWARE; BOTTLES, SOLD EMPTY; CUPS; DECORATIVE GLASS; DRINKING CUPS; DRINKING GLASSES; GLASS BEVERAGWARE; GLASS MUGS; GLASS STORAGE JARS; HOUSEHOLD CONTAINERS FOR FOODS; PLASTIC CUPS; PLASTIC STORAGE CONTAINERS FOR DOMESTIC USE; PORTABLE BEVERAGE COOLERS; PORTABLE BEVERAGE

DISPENSERS; SHOT GLASSES; THERMAL INSULATED CONTAINERS FOR FOOD OR BEVERAGE, IN CLASS 21 (U.S. CLS. 2, 13, 23, 29, 30, 33, 40 AND 50).

FIRST USE 1-15-2008; IN COMMERCE 1-15-2008.

THE MARK CONSISTS OF STANDARD CHARACTERS WITHOUT CLAIM TO ANY PARTICULAR FONT, STYLE, SIZE, OR COLOR.

SN 77-099,596, FILED 2-5-2007.

SANJEEV VOHRA, EXAMINING ATTORNEY

**Int. Cl.: 21**

**Prior U.S. Cls.: 2, 13, 23, 29, 30, 33, 40, and 50**

**Reg. No. 3,468,718**

**United States Patent and Trademark Office**

**Registered July 15, 2008**

**TRADEMARK  
PRINCIPAL REGISTER**

# LavaLush

THE AMERICAN BELT COMPANY (PENNSYLVANIA CORPORATION)  
1355 ADAMS ROAD  
BENSALEM, PA 19020

FOR: ALL PURPOSE PORTABLE HOUSEHOLD CONTAINERS; BEVERAGE GLASSWARE; BOTTLES, SOLD EMPTY; CONTAINERS FOR HOUSEHOLD OR KITCHEN USE; CUPS; DECORATIVE GLASS; DRINKING CUPS; DRINKING GLASSES; GLASS BEVERAGWARE; GLASS MUGS; GLASS STORAGE JARS; HOUSEHOLD CONTAINERS FOR FOODS; PLASTIC CUPS; PORTABLE BEVERAGE COOLERS; PORTABLE BEVERAGE DISPENSERS;

SHOT GLASSES; THERMAL INSULATED CONTAINERS FOR FOOD OR BEVERAGE, IN CLASS 21 (U.S. CLS. 2, 13, 23, 29, 30, 33, 40 AND 50).

FIRST USE 1-15-2008; IN COMMERCE 1-15-2008.

THE MARK CONSISTS OF STANDARD CHARACTERS WITHOUT CLAIM TO ANY PARTICULAR FONT, STYLE, SIZE, OR COLOR.

SN 77-099,620, FILED 2-5-2007.

SANJEEV VOHRA, EXAMINING ATTORNEY

**Int. Cl.: 9**

**Prior U.S. Cls.: 21, 23, 26, 36, and 38**

**Reg. No. 3,468,719**

**United States Patent and Trademark Office**

**Registered July 15, 2008**

---

**TRADEMARK  
PRINCIPAL REGISTER**

**VizSeek**

IMAGINESTICS, LLC (INDIANA LTD LIAB CO)  
PURDUE RESEARCH PARK  
1801 KALBERER RD., SUITE A100  
WEST LAFAYETTE, IN 47906

THE MARK CONSISTS OF STANDARD CHARACTERS WITHOUT CLAIM TO ANY PARTICULAR FONT, STYLE, SIZE, OR COLOR.

FOR: COMPUTER SEARCH ENGINE SOFTWARE, IN CLASS 9 (U.S. CLS. 21, 23, 26, 36 AND 38).

SN 77-099,913, FILED 2-6-2007.

FIRST USE 11-15-2007; IN COMMERCE 11-15-2007.

EVELYN BRADLEY, EXAMINING ATTORNEY

**Int. Cl.: 9**

**Prior U.S. Cls.: 21, 23, 26, 36, and 38**

**Reg. No. 3,468,720**

**United States Patent and Trademark Office**

**Registered July 15, 2008**

---

**TRADEMARK  
PRINCIPAL REGISTER**

**IMS**

SWANSON TOOL COMPANY, INC. (ILLINOIS  
CORPORATION)  
211 ONTARIO STREET  
FRANKFORT, IL 60423

THE MARK CONSISTS OF STANDARD CHAR-  
ACTERS WITHOUT CLAIM TO ANY PARTICULAR  
FONT, STYLE, SIZE, OR COLOR.

FOR: LEVELS, NAMELY, PLUMB LEVELS, SPIR-  
IT LEVELS AND TORPEDO LEVELS, IN CLASS 9  
(U.S. CLS. 21, 23, 26, 36 AND 38).

SN 77-100,534, FILED 2-6-2007.

FIRST USE 5-31-2007; IN COMMERCE 5-31-2007.

PAUL MORENO, EXAMINING ATTORNEY

**Int. Cl.: 3**

**Prior U.S. Cls.: 1, 4, 6, 50, 51, and 52**

**Reg. No. 3,468,721**

**United States Patent and Trademark Office**

**Registered July 15, 2008**

**TRADEMARK  
PRINCIPAL REGISTER**

**IOPE  
WHITEGEN RXC  
INTENSIVE PROGRAM**

AMOREPACIFIC CORPORATION (REPUBLIC OF  
KOREA CORPORATION)  
181, 2-KA HANGANG-RO, YONGSAN-KU  
SEOUL, REPUBLIC OF KOREA 140-777

FOR: NON-MEDICATED NOURISHING  
CREAMS FOR THE SKIN; BEAUTY MILK; SKIN  
MOISTURIZER; NON-MEDICATED SKIN CARE  
PREPARATIONS, NAMELY, SKIN TONERS; SKIN  
LOTIONS; SKIN EMOLLIENTS AND SKIN CLARI-  
FIERS; SKIN WHITENING CREAMS; BEAUTY SER-  
UMS; SKIN CARE PRODUCTS, NAMELY, NON-  
MEDICATED SKIN SERUM, IN CLASS 3 (U.S. CLS.  
1, 4, 6, 50, 51 AND 52).

FIRST USE 8-0-2007; IN COMMERCE 11-0-2007.

THE MARK CONSISTS OF STANDARD CHAR-  
ACTERS WITHOUT CLAIM TO ANY PARTICULAR  
FONT, STYLE, SIZE, OR COLOR.

OWNER OF U.S. REG. NOS. 2,297,281, 2,743,515,  
AND 3,154,551.

SN 77-100,739, FILED 2-6-2007.

CHRISTINA SOBRAL, EXAMINING ATTORNEY



**Int. Cl.: 35**

**Prior U.S. Cls.: 100, 101, and 102**

**United States Patent and Trademark Office**

**Reg. No. 3,468,722**

**Registered July 15, 2008**

**SERVICE MARK  
PRINCIPAL REGISTER**

**ALWAYS IN BLOOM**

CCC ASSOCIATES COMPANY, INC. (ALABAMA  
CORPORATION)  
P.O. BOX 3508  
MONTGOMERY, AL 36109

FOR: WHOLESALE NURSERY AND GREEN-  
HOUSE STORES FEATURING LANDSCAPE  
PLANTS, TREES, SHRUBS, ORNAMENTAL  
GRASSES, GROUND COVERS, DECIDUOUS OR-  
NAMENTALS AND PERENNIAL PLANTS, HORTI-  
CULTURE AND LANDSCAPE SUPPLIES AND  
ACCESSORIES, IN CLASS 35 (U.S. CLS. 100, 101  
AND 102).

FIRST USE 2-0-2008; IN COMMERCE 2-0-2008.

THE MARK CONSISTS OF STANDARD CHAR-  
ACTERS WITHOUT CLAIM TO ANY PARTICULAR  
FONT, STYLE, SIZE, OR COLOR.

SN 77-100,872, FILED 2-6-2007.

ANDREA SAUNDERS, EXAMINING ATTORNEY

**Int. Cl.: 35**

**Prior U.S. Cls.: 100, 101, and 102**

**United States Patent and Trademark Office**

**Reg. No. 3,468,723**

**Registered July 15, 2008**

**SERVICE MARK  
PRINCIPAL REGISTER**

**LA VIDA TOMA VISA**

VISA INTERNATIONAL SERVICE ASSOCIATION  
(DELAWARE CORPORATION)  
M1-11A  
900 METRO CENTER BOULEVARD  
FOSTER CITY, CA 94404

FOR: PROMOTING THE SALE OF GOODS AND SERVICES OF OTHERS BY MEANS OF ADVERTISEMENTS, COUPONS, DISCOUNTS AND INCENTIVES IN THE NATURE OF REWARD POINTS AND VALUE ADDED OFFERS GENERATED IN CONNECTION WITH THE USE OF PAYMENT CARDS; PROMOTING SPORTS COMPETITIONS AND EVENTS OF OTHERS; PROMOTING CONCERTS AND CULTURAL EVENTS OF OTHERS, IN CLASS 35 (U.S. CLS. 100, 101 AND 102).

FIRST USE 3-1-2006; IN COMMERCE 3-1-2006.

THE MARK CONSISTS OF STANDARD CHARACTERS WITHOUT CLAIM TO ANY PARTICULAR FONT, STYLE, SIZE, OR COLOR.

THE FOREIGN WORDING IN THE MARK TRANSLATES INTO ENGLISH AS LIFE TAKES.

SN 77-100,876, FILED 2-6-2007.

EMILY CARLSEN, EXAMINING ATTORNEY

**Int. Cl.: 38**

**Prior U.S. Cls.: 100, 101, and 104**

**United States Patent and Trademark Office**

**Reg. No. 3,468,724**

**Registered July 15, 2008**

**SERVICE MARK  
PRINCIPAL REGISTER**

**MINO**

MINO WIRELESS USA, INC. (CALIFORNIA COR-  
PORATION)  
2901 TASMAN DR. STE#210  
SANTA CLARA, CA 95054

THE MARK CONSISTS OF STANDARD CHAR-  
ACTERS WITHOUT CLAIM TO ANY PARTICULAR  
FONT, STYLE, SIZE, OR COLOR.

FOR: MOBILE TELEPHONE COMMUNICATION,  
IN CLASS 38 (U.S. CLS. 100, 101 AND 104).

SN 77-100,932, FILED 2-6-2007.

FIRST USE 1-1-2005; IN COMMERCE 6-30-2005.

KAREN BRACEY, EXAMINING ATTORNEY

Int. Cls.: 5 and 44

Prior U.S. Cls.: 6, 18, 44, 46, 51, 52, 100, and 101

United States Patent and Trademark Office

Reg. No. 3,468,725

Registered July 15, 2008

TRADEMARK  
SERVICE MARK  
PRINCIPAL REGISTER

The word "Kalia" is written in a large, elegant, black cursive script. The letters are fluid and interconnected, with a prominent flourish on the final 'a' that extends downwards and to the left.

IRIS GIN, M.D. AND RODNEY GIN, M.D. MEDICAL CORPORATION (CALIFORNIA CORPORATION)  
15055 LOS GATOS BLVD., SUITE 100  
LOS GATOS, CA 95032

FOR: MEDICATED SKIN CARE PREPARATIONS, IN CLASS 5 (U.S. CLS. 6, 18, 44, 46, 51 AND 52).

FIRST USE 2-1-2006; IN COMMERCE 2-1-2006.

FOR: MEDICAL SERVICES, NAMELY, DERMATOLOGY, IN CLASS 44 (U.S. CLS. 100 AND 101).

FIRST USE 2-1-2006; IN COMMERCE 2-1-2006.

THE MARK CONSISTS OF THE WORD "KALIA" IN STYLIZED LETTERS.

THE FOREIGN WORDING IN THE MARK TRANSLATES INTO ENGLISH AS "BEAUTY".

SN 77-101,004, FILED 2-6-2007.

HENRY S. ZAK, EXAMINING ATTORNEY

**Int. Cl.: 42**

**Prior U.S. Cls.: 100 and 101**

**United States Patent and Trademark Office**

**Reg. No. 3,468,726**

**Registered July 15, 2008**

**SERVICE MARK  
PRINCIPAL REGISTER**

**IMAGINE INSPIRED DESIGN**

ARCHITECTURAL RESOURCE, LLC (MICHIGAN LTD LIAB CO)

SUITE C

1220 JEWETT

ANN ARBOR, MI 48104

FOR: ARCHITECTURAL DESIGN, IN CLASS 42  
(U.S. CLS. 100 AND 101).

FIRST USE 9-1-2007; IN COMMERCE 9-1-2007.

THE MARK CONSISTS OF STANDARD CHARACTERS WITHOUT CLAIM TO ANY PARTICULAR FONT, STYLE, SIZE, OR COLOR.

NO CLAIM IS MADE TO THE EXCLUSIVE RIGHT TO USE "DESIGN", APART FROM THE MARK AS SHOWN.

SN 77-101,014, FILED 2-6-2007.

ALEXANDER L. POWERS, EXAMINING ATTORNEY

**Int. Cl.: 41**

**Prior U.S. Cls.: 100, 101, and 107**

**United States Patent and Trademark Office**

**Reg. No. 3,468,727**

**Registered July 15, 2008**

**SERVICE MARK  
PRINCIPAL REGISTER**

**RUN TO LIVE...LIVE TO RUN**

**BOLDER BOULDER, INC. (COLORADO CORPORATION)  
5500 CENTRAL AVE  
BOULDER, CO 80301**

**FOR: ARRANGING AND CONDUCTING ATHLETIC COMPETITIONS IN THE NATURE OF RUNNING RACES; EDUCATIONAL SERVICES, NAMELY, WORKSHOPS, SEMINARS AND CLASSES IN THE FIELD OF NUTRITION, FITNESS, AND CONDITIONING, IN CLASS 41 (U.S. CLS. 100, 101 AND 107).**

**FIRST USE 5-0-2007; IN COMMERCE 5-0-2007.**

**THE MARK CONSISTS OF STANDARD CHARACTERS WITHOUT CLAIM TO ANY PARTICULAR FONT, STYLE, SIZE, OR COLOR.**

**SN 77-101,293, FILED 2-7-2007.**

**ALICE SUE CARRUTHERS, EXAMINING ATTORNEY**

**Int. Cls.: 35 and 41**

**Prior U.S. Cls.: 100, 101, 102, and 107**

**United States Patent and Trademark Office**

**Reg. No. 3,468,728**

**Registered July 15, 2008**

**SERVICE MARK  
PRINCIPAL REGISTER**

# Local Knowledge

MAINE BOATS, HOMES & HARBORS, INC.  
(MAINE CORPORATION)  
P.O. BOX 758  
43 MECHANIC STREET, SUITE 300  
CAMDEN, ME 04843

FOR: ARRANGING AND CONDUCTING TRADE SHOWS IN THE FIELD OF BOATMAKING, BOAT SALES, COASTAL-THEMED FURNITURE AND ARTWORK, MARINE GEAR, AND MUSIC; PROVIDING A SEARCHABLE ONLINE ADVERTISING GUIDE FEATURING THE GOODS AND SERVICES OF OTHER ON-LINE VENDORS ON THE INTERNET; PROVIDING AN ON-LINE COMMERCIAL INFORMATION DIRECTORY ON THE INTERNET, IN CLASS 35 (U.S. CLS. 100, 101 AND 102).

FIRST USE 4-1-2008; IN COMMERCE 4-1-2008.

FOR: ON-LINE PUBLICATION OF ELECTRONIC MAGAZINES; ON-LINE PUBLICATION OF ELECTRONIC MAGAZINES FEATURING STORIES ON BOATS, TRAVEL, COASTAL LIVING, AND COASTAL-THEMED ART AND FURNITURE; PUBLICATION OF ELECTRONIC MAGAZINES; PUBLISHING OF WEB MAGAZINES, IN CLASS 41 (U.S. CLS. 100, 101 AND 107).

FIRST USE 4-1-2008; IN COMMERCE 4-1-2008.

THE MARK CONSISTS OF STANDARD CHARACTERS WITHOUT CLAIM TO ANY PARTICULAR FONT, STYLE, SIZE, OR COLOR.

SN 77-101,589, FILED 2-7-2007.

MATTHEW MCDOWELL, EXAMINING ATTORNEY

**Int. Cl.: 9**

**Prior U.S. Cls.: 21, 23, 26, 36, and 38**

**Reg. No. 3,468,729**

**United States Patent and Trademark Office**

**Registered July 15, 2008**

**TRADEMARK  
PRINCIPAL REGISTER**



MICROSOFT CORPORATION (WASHINGTON CORPORATION)  
ONE MICROSOFT WAY  
REDMOND, WA 980526399

THE MARK CONSISTS OF THE WORD "CRACK-DOWN" WITH A FANCIFUL GEOMETRIC SHAPE AND SKYLINE IN THE BACKGROUND.

FOR: COMPUTER PROGRAMS, NAMELY, GAME SOFTWARE FOR USE ON COMPUTERS AND VIDEO GAME PLAYERS, IN CLASS 9 (U.S. CLS. 21, 23, 26, 36 AND 38).

SN 77-102,014, FILED 2-7-2007.

FIRST USE 2-20-2007; IN COMMERCE 2-20-2007.

AHSEN KHAN, EXAMINING ATTORNEY



**Int. Cl.: 33**

**Prior U.S. Cls.: 47 and 49**

**United States Patent and Trademark Office**

**Reg. No. 3,468,730**

**Registered July 15, 2008**

**TRADEMARK  
PRINCIPAL REGISTER**

**FIELDS OF GOLD**

POWER, JOHN C. (UNITED STATES INDIVIDUAL)  
P.O. BOX 114  
THE SEA RANCH, CA 95497

THE MARK CONSISTS OF STANDARD CHARACTERS WITHOUT CLAIM TO ANY PARTICULAR FONT, STYLE, SIZE, OR COLOR.

FOR: WHITE WINE; WINE, IN CLASS 33 (U.S. CLS. 47 AND 49).

SN 77-102,141, FILED 2-7-2007.

FIRST USE 9-28-2007; IN COMMERCE 9-28-2007.

GEORGE LORENZO, EXAMINING ATTORNEY

**Int. Cl.: 28**

**Prior U.S. Cls.: 22, 23, 38, and 50**

**United States Patent and Trademark Office**

**Reg. No. 3,468,731**

**Registered July 15, 2008**

---

**TRADEMARK  
PRINCIPAL REGISTER**

**PUZZYBOOK**

SHURE PRODUCTS, INC. (ILLINOIS CORPORATION)  
2129 WEST NORTH AVENUE  
CHICAGO, IL 60647

THE MARK CONSISTS OF STANDARD CHARACTERS WITHOUT CLAIM TO ANY PARTICULAR FONT, STYLE, SIZE, OR COLOR.

FOR: PUZZLES, IN CLASS 28 (U.S. CLS. 22, 23, 38 AND 50).

SN 77-102,710, FILED 2-8-2007.

FIRST USE 11-9-2007; IN COMMERCE 11-9-2007.

TIMOTHY FINNEGAN, EXAMINING ATTORNEY

**Int. Cl.: 9**

**Prior U.S. Cls.: 21, 23, 26, 36, and 38**

**Reg. No. 3,468,732**

**United States Patent and Trademark Office**

**Registered July 15, 2008**

---

**TRADEMARK  
PRINCIPAL REGISTER**

**LOGIQ**

HALLIBURTON ENERGY SERVICES, INC. (DE-  
LAWARE CORPORATION)  
1-B-121  
2601 BELTLINE ROAD  
CARROLLTON, TX 75006

FOR: DOWNHOLE SURVEY AND MEASURE-  
MENT EQUIPMENT, NAMELY, WIRELINE MEA-  
SUREMENT GAUGES, RECORDERS, TOOL  
STRING, TELEMETRY SENSORS, AND COMPU-  
TER HARDWARE AND SOFTWARE, ALL USED IN  
OIL AND GAS WELL LOGGING TO MEASURE THE  
PHYSICAL AND CHEMICAL PROPERTIES PRE-  
SENT IN AN OIL OR GAS WELL TO DETERMINE

IF THE WELL IS LIKELY TO YIELD OIL OR GAS, IN  
CLASS 9 (U.S. CLS. 21, 23, 26, 36 AND 38).

FIRST USE 4-30-2006; IN COMMERCE 4-30-2006.

THE MARK CONSISTS OF STANDARD CHAR-  
ACTERS WITHOUT CLAIM TO ANY PARTICULAR  
FONT, STYLE, SIZE, OR COLOR.

SN 77-103,527, FILED 2-9-2007.

ROBIN MITTLER, EXAMINING ATTORNEY

**Int. Cl.: 16**

**Prior U.S. Cls.: 2, 5, 22, 23, 29, 37, 38, and 50**

**Reg. No. 3,468,733**

**United States Patent and Trademark Office**

**Registered July 15, 2008**

**TRADEMARK  
PRINCIPAL REGISTER**

**ENKEBOLL GALLERY  
RESIDENTIAL INTERIORS OF  
DISTINCTION**

THE ENKEBOLL CO. (CALIFORNIA CORPORATION), DBA ENKEBOLL DESIGNS,  
16506 AVALON BLVD.  
CARSON, CA 90746

FOR: PERIODICAL PUBLICATIONS, NAMELY, BROCHURES, CATALOGS AND MAGAZINES IN THE FIELD OF ARCHITECTURAL MOLDINGS AND WOODCARVINGS AND INTERIOR DESIGN, IN CLASS 16 (U.S. CLS. 2, 5, 22, 23, 29, 37, 38 AND 50).

FIRST USE 11-1-2007; IN COMMERCE 11-1-2007.

THE MARK CONSISTS OF STANDARD CHARACTERS WITHOUT CLAIM TO ANY PARTICULAR FONT, STYLE, SIZE, OR COLOR.

NO CLAIM IS MADE TO THE EXCLUSIVE RIGHT TO USE "INTERIORS", APART FROM THE MARK AS SHOWN.

SN 77-103,579, FILED 2-9-2007.

KIMBERLY PERRY, EXAMINING ATTORNEY

**Int. Cl.: 28**

**Prior U.S. Cls.: 22, 23, 38, and 50**

**United States Patent and Trademark Office**

**Reg. No. 3,468,734**

**Registered July 15, 2008**

---

**TRADEMARK  
PRINCIPAL REGISTER**

**REFRAZE**

SOUTHERN FOX, LLC (FLORIDA LTD LIAB CO)  
3077 DESOTO ROAD  
SARASOTA, FL 34234

THE MARK CONSISTS OF STANDARD CHAR-  
ACTERS WITHOUT CLAIM TO ANY PARTICULAR  
FONT, STYLE, SIZE, OR COLOR.

FOR: BOARD GAMES; PARLOR GAMES; PARTY  
GAMES, IN CLASS 28 (U.S. CLS. 22, 23, 38 AND 50).

SN 77-103,607, FILED 2-9-2007.

FIRST USE 2-15-2008; IN COMMERCE 2-15-2008.

TASHIA BUNCH, EXAMINING ATTORNEY

**Int. Cls.: 12 and 28**

**Prior U.S. Cls.: 19, 21, 22, 23, 31, 35, 38, 44, and 50**

**United States Patent and Trademark Office**

**Reg. No. 3,468,735**

**Registered July 15, 2008**

**TRADEMARK  
PRINCIPAL REGISTER**



WOOSUNG I.B. CO., LTD. (REPUBLIC OF KOREA CORPORATION)  
331-10, HYOSUNG-DONG, GYERYANG-GU  
INCHEON, REPUBLIC OF KOREA

FOR: MOTORBOATS; RAFTING BOATS; FISHING BOATS; BOATS; CANOES; YACHTS; PADDLES FOR CANOES; HYDROPLANES; SLEIGHS , IN CLASS 12 (U.S. CLS. 19, 21, 23, 31, 35 AND 44).

FIRST USE 10-25-2007; IN COMMERCE 10-25-2007.

FOR: SURFBOARDS; SURF SKIS; WATERSKIS; BAGS ESPECIALLY DESIGNED FOR SURFBOARDS; SURFBOARD LEASHES; SAILBOARDS; SAILBOARD MASTS; HARNESS FOR SAILBOARDS; SWIMMING BOARDS; SAILS AND SAILBOARDS FOR BOARDSAILING; INFLATABLE INNER TUBES FOR AQUATIC RECREATIONAL USE, IN CLASS 28 (U.S. CLS. 22, 23, 38 AND 50).

FIRST USE 10-25-2007; IN COMMERCE 10-25-2007.

THE COLOR(S) RED, DARK BLUE, LIGHT BLUE, AQUA, AND WHITE IS/ARE CLAIMED AS A FEATURE OF THE MARK.

THE MARK CONSISTS OF THE COLOR RED APPEARS IN THE LARGE LETTER "Z" OUTLINED IN DARK BLUE; THE COLOR DARK BLUE APPEARS IN A WAVE OR FIN SHAPE BISECTING THE LETTER "Z" AT THE CENTER, AND AT THE BOTTOM OF THE LETTERS "PRO"; LIGHT BLUE APPEARS AT THE TOP OF THE "PRO" LETTERS, IN THE CURVED STROKE THAT CROSSES THE CURVED BAND THAT APPEARS IN AQUA; THE COLOR WHITE APPEARS BISECTING THE BLUE LETTERS OF "PRO," AS OUTLINING AS A BACKGROUND TO THE ENTIRE MARK.

SN 77-103,784, FILED 2-9-2007.

JILL C. ALT, EXAMINING ATTORNEY

**Int. Cl.: 9**

**Prior U.S. Cls.: 21, 23, 26, 36, and 38**

**United States Patent and Trademark Office**

**Reg. No. 3,468,736**

**Registered July 15, 2008**

**TRADEMARK  
PRINCIPAL REGISTER**

**PLAYREADY**

MICROSOFT CORPORATION (WASHINGTON  
CORPORATION)  
ONE MICROSOFT WAY  
REDMOND, WA 980526399

THE MARK CONSISTS OF STANDARD CHAR-  
ACTERS WITHOUT CLAIM TO ANY PARTICULAR  
FONT, STYLE, SIZE, OR COLOR.

FOR: DIGITAL RIGHTS MANAGEMENT SOFT-  
WARE; AND DATA ENCRYPTION SOFTWARE, IN  
CLASS 9 (U.S. CLS. 21, 23, 26, 36 AND 38).

SN 77-103,883, FILED 2-9-2007.

FIRST USE 8-0-2007; IN COMMERCE 8-0-2007.

AHSEN KHAN, EXAMINING ATTORNEY

**Int. Cl.: 9**

**Prior U.S. Cls.: 21, 23, 26, 36, and 38**

**Reg. No. 3,468,737**

**United States Patent and Trademark Office**

**Registered July 15, 2008**

**TRADEMARK  
PRINCIPAL REGISTER**

**SAVE YOUR LIFE**

SEAGATE TECHNOLOGY LLC (DELAWARE  
LTD LIAB CO)  
920 DISC DRIVE  
SCOTTS VALLEY, CA 95067

THE MARK CONSISTS OF STANDARD CHAR-  
ACTERS WITHOUT CLAIM TO ANY PARTICULAR  
FONT, STYLE, SIZE, OR COLOR.

FOR: COMPUTER PERIPHERALS, NAMELY,  
DISC DRIVES FOR DATA STORAGE, IN CLASS 9  
(U.S. CLS. 21, 23, 26, 36 AND 38).

SN 77-104,170, FILED 2-9-2007.

FIRST USE 8-0-2007; IN COMMERCE 8-0-2007.

JAY BESCH, EXAMINING ATTORNEY



**Int. Cl.: 25**

**Prior U.S. Cls.: 22 and 39**

**United States Patent and Trademark Office**

**Reg. No. 3,468,738**

**Registered July 15, 2008**

**TRADEMARK  
PRINCIPAL REGISTER**

**HANES BY ME**

HBI BRANDED APPAREL LIMITED, INC. (DE-  
LAWARE CORPORATION)  
1000 EAST HANES MILL ROAD  
WINSTON-SALEM, NC 27105

FOR: SHIRTS; T-SHIRTS, IN CLASS 25 (U.S. CLS.  
22 AND 39).

FIRST USE 3-31-2007; IN COMMERCE 3-31-2007.

THE MARK CONSISTS OF STANDARD CHAR-  
ACTERS WITHOUT CLAIM TO ANY PARTICULAR  
FONT, STYLE, SIZE, OR COLOR.

OWNER OF U.S. REG. NOS. 847,649, 2,121,985,  
AND OTHERS.

SN 77-105,086, FILED 2-12-2007.

LINDA ESTRADA, EXAMINING ATTORNEY

**Int. Cls.: 14, 18, and 25**

**Prior U.S. Cls.: 1, 2, 3, 22, 27, 28, 39, 41, and 50**

**United States Patent and Trademark Office**

**Reg. No. 3,468,739**

**Registered July 15, 2008**

**TRADEMARK  
PRINCIPAL REGISTER**



TRANSFORMATION TEES, LLC (NEW JERSEY  
LTD LIAB CO)  
33 MT. RASCAL ROAD  
HACKETTSTOWN, NJ 07840

FOR: JEWELRY, IN CLASS 14 (U.S. CLS. 2, 27, 28  
AND 50).

FIRST USE 6-0-2007; IN COMMERCE 6-0-2007.

FOR: TOTE BAGS, CARRY-ALL BAGS, IN CLASS  
18 (U.S. CLS. 1, 2, 3, 22 AND 41).

FIRST USE 6-0-2007; IN COMMERCE 6-0-2007.

FOR: CLOTHING, NAMELY T-SHIRTS AND  
SHIRTS, IN CLASS 25 (U.S. CLS. 22 AND 39).

FIRST USE 6-0-2007; IN COMMERCE 6-0-2007.

SN 77-105,307, FILED 2-12-2007.

YAT SYE, LEE, EXAMINING ATTORNEY

**Int. Cl.: 37**

**Prior U.S. Cls.: 100, 103, and 106**

**United States Patent and Trademark Office**

**Reg. No. 3,468,740**

**Registered July 15, 2008**

**SERVICE MARK  
PRINCIPAL REGISTER**

**ENVISIONING STRUCTURE**

SHOLAR ARCHITECTURE, P.C. (COLORADO  
PROFESSIONAL CORPORATION)  
143 UNION BLVD., SUITE 200  
LAKEWOOD, CO 80228 AND  
SHOLAR CONSTRUCTION, LLC (COLORADO LTD  
LIAB CO)  
143 UNION BLVD., SUITE 200  
LAKEWOOD, CO 80228

FOR: CUSTOM CONSTRUCTION PLANNING,  
CONSTRUCTION AND CONSTRUCTION MAN-  
AGEMENT OF RESIDENTIAL AND COMMERCIAL  
COMMUNITIES; LAND DEVELOPMENT SERVI-  
CES, NAMELY, DEVELOPMENT IN THE NATURE

OF PLANNING AND LAYING OUT RESIDENTIAL  
AND COMMERCIAL COMMUNITIES, IN CLASS 37  
(U.S. CLS. 100, 103 AND 106).

FIRST USE 1-2-2007; IN COMMERCE 1-2-2007.

THE MARK CONSISTS OF STANDARD CHAR-  
ACTERS WITHOUT CLAIM TO ANY PARTICULAR  
FONT, STYLE, SIZE, OR COLOR.

SN 77-105,394, FILED 2-12-2007.

AMEETA JORDAN, EXAMINING ATTORNEY

**Int. Cl.: 16**

**Prior U.S. Cls.: 2, 5, 22, 23, 29, 37, 38, and 50**

**United States Patent and Trademark Office**

**Reg. No. 3,468,741**

**Registered July 15, 2008**

**TRADEMARK  
PRINCIPAL REGISTER**

# Jack Cards

JACK CARDS LLC (MASSACHUSETTS LTD LIAB  
CO)

P.O. BOX 55071 #42297

BOSTON, MA 022055071

FOR: GREETING CARDS, IN CLASS 16 (U.S. CLS.  
2, 5, 22, 23, 29, 37, 38 AND 50).

FIRST USE 1-1-2005; IN COMMERCE 8-15-2007.

THE MARK CONSISTS OF STANDARD CHAR-  
ACTERS WITHOUT CLAIM TO ANY PARTICULAR  
FONT, STYLE, SIZE, OR COLOR.

NO CLAIM IS MADE TO THE EXCLUSIVE  
RIGHT TO USE "CARDS", APART FROM THE  
MARK AS SHOWN.

SN 77-105,668, FILED 2-12-2007.

DEZMONA MIZELLE, EXAMINING ATTORNEY

**Int. Cl.: 36**

**Prior U.S. Cls.: 100, 101, and 102**

**United States Patent and Trademark Office**

**Reg. No. 3,468,742**

**Registered July 15, 2008**

---

**SERVICE MARK  
PRINCIPAL REGISTER**

**STANDARD GENERAL**

STANDARD GENERAL L.P. (DELAWARE LIMITED PARTNERSHIP)  
650 MADISON AVENUE, 26TH FLOOR  
NEW YORK, NY 10022

THE MARK CONSISTS OF STANDARD CHARACTERS WITHOUT CLAIM TO ANY PARTICULAR FONT, STYLE, SIZE, OR COLOR.

FOR: INVESTMENT MANAGEMENT SERVICES; INVESTMENT FUND SERVICES; AND HEDGE FUNDS, IN CLASS 36 (U.S. CLS. 100, 101 AND 102).

SN 77-105,861, FILED 2-13-2007.

FIRST USE 8-0-2007; IN COMMERCE 8-0-2007.

KIMBERLY FRYE, EXAMINING ATTORNEY

**Int. Cl.: 25**

**Prior U.S. Cls.: 22 and 39**

**United States Patent and Trademark Office**

**Reg. No. 3,468,743**

**Registered July 15, 2008**

**TRADEMARK  
PRINCIPAL REGISTER**

**ALVEE**

GARZA, RAYNALDO (UNITED STATES INDIVIDUAL)  
14 MONARCH BAY PLAZA, SUITE 475  
MONARCH BEACH, CA 92629

FOR: CLOTHING, NAMELY, SHIRTS, BLOUSES, T-SHIRTS, SWEATERS, SCARVES, PAJAMAS, LINGERIE, JACKETS, UNDERGARMENTS, BOXERS, SOCKS, PANTIES, PANTS, SWEATPANTS, JOGGING SUITS, POLO SHIRTS, TANK TOPS, TIES; HEADGEAR, NAMELY, CAPS, BEANIES, COWBOY HATS, TUXEDO HATS, DINNER WEAR HATS;

SHOES, NAMELY, ATHLETIC SHOES, IN CLASS 25 (U.S. CLS. 22 AND 39).

FIRST USE 2-13-2007; IN COMMERCE 8-17-2007.

THE MARK CONSISTS OF STANDARD CHARACTERS WITHOUT CLAIM TO ANY PARTICULAR FONT, STYLE, SIZE, OR COLOR.

SN 77-106,192, FILED 2-13-2007.

JENNIFER VASQUEZ, EXAMINING ATTORNEY

**Int. Cl.: 28**

**Prior U.S. Cls.: 22, 23, 38, and 50**

**Reg. No. 3,468,744**

**United States Patent and Trademark Office**

**Registered July 15, 2008**

---

**TRADEMARK  
PRINCIPAL REGISTER**

**AWX**

JT SPORTS LLC (DELAWARE LTD LIAB CO)  
5818 EL CAMINO REAL  
CARLSBAD, CA 92008

THE MARK CONSISTS OF STANDARD CHAR-  
ACTERS WITHOUT CLAIM TO ANY PARTICULAR  
FONT, STYLE, SIZE, OR COLOR.

FOR: PAINT BALLS AND PELLETS, NAMELY,  
PAINT BALL TAGGING PELLETS, IN CLASS 28  
(U.S. CLS. 22, 23, 38 AND 50).

SN 77-106,620, FILED 2-13-2007.

FIRST USE 6-0-2006; IN COMMERCE 6-0-2006.

PAUL MORENO, EXAMINING ATTORNEY

**Int. Cls.: 35 and 37**

**Prior U.S. Cls.: 100, 101, 102, 103, and 106**

**United States Patent and Trademark Office**

**Reg. No. 3,468,745**

**Registered July 15, 2008**

**SERVICE MARK  
PRINCIPAL REGISTER**

# HowToSurveillance

ARPINO, ROBERT (UNITED STATES INDIVIDUAL)  
2165 EAST CORTEZ DRIVE  
GILBERT, AZ 85234

FOR: ONLINE RETAIL STORE SERVICES FEATURING SURVEILLANCE CAMERAS, NAMELY, BULLET CAMERAS, DOME CAMERAS, BOX CAMERAS, BOARD CAMERAS, MINIATURE CAMERAS, WIRED AND WIRELESS CAMERAS AND RELATED TRANSMITTERS AND RECEIVERS, COVERT CAMERAS, NANNY CAMS, AND CAMERAS WITH BUILT-IN INFRARED EMITTERS; ONLINE RETAIL STORE SERVICES FEATURING DIGITAL VIDEO RECORDERS, DIGITAL VIDEO RECORDING CARDS FOR PERSONAL COMPUTERS, AND COMPLETE SURVEILLANCE DIGITAL RECORDING SYSTEMS FOR HOME USE, COMMERCIAL USE AND LAW ENFORCEMENT PURPOSES; ONLINE RETAIL STORE SERVICES FEATURING DIGITAL VOICE RECORDERS; ONLINE RETAIL STORE SERVICES FEATURING ACCESSORIES FOR THAT EQUIPMENT, NAMELY,

POWER AND VIDEO CABLES, COAXIAL CABLES, CONNECTORS, POWER SUPPLIES, BATTERY PACKS, AND POWER ADAPTERS, IN CLASS 35 (U.S. CLS. 100, 101 AND 102).

FIRST USE 12-24-2006; IN COMMERCE 12-24-2006.

FOR: PROVIDING ONLINE INFORMATION REGARDING INSTALLING AND MAINTAINING HOME SURVEILLANCE SYSTEMS AND ITS COMPONENTS, IN CLASS 37 (U.S. CLS. 100, 103 AND 106).

FIRST USE 12-24-2006; IN COMMERCE 12-24-2006.

THE MARK CONSISTS OF STANDARD CHARACTERS WITHOUT CLAIM TO ANY PARTICULAR FONT, STYLE, SIZE, OR COLOR.

SN 77-106,854, FILED 2-13-2007.

MICHAEL LITZAU, EXAMINING ATTORNEY



**Int. Cl.: 9**

**Prior U.S. Cls.: 21, 23, 26, 36, and 38**

**United States Patent and Trademark Office**

**Reg. No. 3,468,746**

**Registered July 15, 2008**

**TRADEMARK  
PRINCIPAL REGISTER**

**ONE**

HAIRART INTERNATIONAL, INC. (CALIFORNIA CORPORATION)  
400 WEST 157TH ST.  
GARDENA, CA 90248

THE MARK CONSISTS OF STANDARD CHARACTERS WITHOUT CLAIM TO ANY PARTICULAR FONT, STYLE, SIZE, OR COLOR.

FOR: HAIR APPLIANCES, NAMELY, ELECTRIC HAIR CURLERS, ELECTRIC FLAT IRONS, IN CLASS 9 (U.S. CLS. 21, 23, 26, 36 AND 38).

SN 77-107,692, FILED 2-14-2007.

FIRST USE 7-13-2007; IN COMMERCE 7-13-2007.

ALICIA COLLINS, EXAMINING ATTORNEY

**Int. Cls.: 9 and 11**

**Prior U.S. Cls.: 13, 21, 23, 26, 31, 34, 36, and 38**

**United States Patent and Trademark Office**

**Reg. No. 3,468,747**

**Registered July 15, 2008**

**TRADEMARK  
PRINCIPAL REGISTER**

**iTech**

HAIRART INTERNATIONAL, INC. (CALIFORNIA CORPORATION)  
400 WEST 157TH ST.  
GARDENA, CA 90248

FOR: HAIR APPLIANCES, NAMELY, ELECTRIC HAIR CURLERS AND ELECTRIC FLAT IRONS, IN CLASS 9 (U.S. CLS. 21, 23, 26, 36 AND 38).

FIRST USE 4-23-2006; IN COMMERCE 4-23-2006.

FOR: WATER IONIZERS FOR IONIZING WATER FOR USE WITH SKIN AND HAIR, IN CLASS 11 (U.S. CLS. 13, 21, 23, 31 AND 34).

FIRST USE 4-23-2006; IN COMMERCE 4-23-2006.

THE MARK CONSISTS OF STANDARD CHARACTERS WITHOUT CLAIM TO ANY PARTICULAR FONT, STYLE, SIZE, OR COLOR.

SN 77-107,796, FILED 2-14-2007.

ALICIA COLLINS, EXAMINING ATTORNEY

Int. Cl.: 16

Prior U.S. Cls.: 2, 5, 22, 23, 29, 37, 38, and 50

United States Patent and Trademark Office

Reg. No. 3,468,748

Registered July 15, 2008

TRADEMARK  
PRINCIPAL REGISTER



BASHO PRESS, LLC (WASHINGTON LTD LIAB  
CO)  
10924 MUKILTEO SPEEDWAY #222  
MUKILTEO, WA 98275

FOR: PRINTED MATERIALS, NAMELY SERIES  
OF NON-FICTION POETRY BOOKS, STATIONERY,  
GREETING CARDS, ALL CONTAINING ORIGINAL  
POETRY, IN CLASS 16 (U.S. CLS. 2, 5, 22, 23, 29, 37, 38  
AND 50).

FIRST USE 6-1-2007; IN COMMERCE 6-1-2007.

THE NAME(S), PORTRAIT(S), AND/OR SIGNA-  
TURE(S) SHOWN IN THE MARK IDENTIFIES  
"DAVID ASH", WHOSE CONSENT(S) TO REGISTER  
IS SUBMITTED.

THE MARK CONSISTS OF A FIGURE OF A  
SEATED, BEARDED MAN WEARING GLASSES  
AND A ROBE HOLDING A LARGE PAINTBRUSH.

SN 77-107,797, FILED 2-14-2007.

ALEXANDER L. POWERS, EXAMINING ATTOR-  
NEY

**Int. Cl.: 5**

**Prior U.S. Cls.: 6, 18, 44, 46, 51, and 52**

**United States Patent and Trademark Office**

**Reg. No. 3,468,749**

**Registered July 15, 2008**

**TRADEMARK  
PRINCIPAL REGISTER**

**COQSOURCE**

SOURCE ONE GLOBAL PARTNERS (ILLINOIS  
LTD LIAB CO)  
SUITE 427  
401 EAST ILLINOIS  
CHICAGO, IL 60611

THE MARK CONSISTS OF STANDARD CHAR-  
ACTERS WITHOUT CLAIM TO ANY PARTICULAR  
FONT, STYLE, SIZE, OR COLOR.

FOR: DIETARY SUPPLEMENTS, IN CLASS 5 (U.S.  
CLS. 6, 18, 44, 46, 51 AND 52).

SN 77-107,996, FILED 2-15-2007.

FIRST USE 1-1-2007; IN COMMERCE 1-1-2007.

BARBARA BROWN, EXAMINING ATTORNEY

**Int. Cl.: 3**

**Prior U.S. Cls.: 1, 4, 6, 50, 51, and 52**

**United States Patent and Trademark Office**

**Reg. No. 3,468,750**

**Registered July 15, 2008**

**TRADEMARK  
PRINCIPAL REGISTER**

**true haircare**

EMPIRE BEAUTY SUPPLY CORP (CALIFORNIA CORPORATION)  
7800 BROADWAY  
LEMON GROVE, CA 91945 AND  
BRYCE GOLDMAN (UNITED STATES INDIVIDUAL)  
7800 BROADWAY  
LEMON GROVE, CA 91945

FOR: HAIR CARE PRODUCTS, NAMELY, SHAMPOO, CONDITIONER, FINISHING RINSE, HAIR SPRAY, SCULPTING GEL, HAIR MOUSSE, HAIR SETTING LOTION, HAIR FIXATIVES, NAMELY, HAIR WAX, PERMANENT WAVE SOLUTION, STYLING SPRAY GEL AND HAIR POMADES, IN CLASS 3 (U.S. CLS. 1, 4, 6, 50, 51 AND 52).

FIRST USE 4-15-2007; IN COMMERCE 5-4-2008.

THE MARK CONSISTS OF STANDARD CHARACTERS WITHOUT CLAIM TO ANY PARTICULAR FONT, STYLE, SIZE, OR COLOR.

NO CLAIM IS MADE TO THE EXCLUSIVE RIGHT TO USE "HAIRCARE", APART FROM THE MARK AS SHOWN.

SN 77-108,403, FILED 2-15-2007.

MARLENE BELL, EXAMINING ATTORNEY

**Int. Cl.: 42**

**Prior U.S. Cls.: 100 and 101**

**United States Patent and Trademark Office**

**Reg. No. 3,468,751**

**Registered July 15, 2008**

---

**SERVICE MARK  
PRINCIPAL REGISTER**

**RIGHT CONTENT + RIGHT  
DELIVERY = RIGHT RESULTS**

SMART MULTIMEDIA, INC. (TEXAS CORPORATION)  
SUITE 105  
2440 SOUTH BLVD.  
HOUSTON, TX 77098

THE MARK CONSISTS OF STANDARD CHARACTERS WITHOUT CLAIM TO ANY PARTICULAR FONT, STYLE, SIZE, OR COLOR.

FOR: DESIGN AND DEVELOPMENT OF MULTIMEDIA PRODUCTS, IN CLASS 42 (U.S. CLS. 100 AND 101).

SN 77-109,171, FILED 2-16-2007.

FIRST USE 11-1-2006; IN COMMERCE 11-1-2006.

MAUREEN DALL, EXAMINING ATTORNEY

**Int. Cl.: 30**

**Prior U.S. Cl.: 46**

**United States Patent and Trademark Office**

**Reg. No. 3,468,752**

**Registered July 15, 2008**

**TRADEMARK  
PRINCIPAL REGISTER**

**SWEET GREATINGS**

CERRETA CANDY COMPANY, INC. (ARIZONA  
CORPORATION)  
5345 W. GLENDALE AVENUE  
GLENDALE, AZ 85301

NO CLAIM IS MADE TO THE EXCLUSIVE  
RIGHT TO USE "SWEET", APART FROM THE  
MARK AS SHOWN.

FOR: CANDY, IN CLASS 30 (U.S. CL. 46).

FIRST USE 11-0-2007; IN COMMERCE 11-0-2007.

SN 77-109,213, FILED 2-16-2007.

THE MARK CONSISTS OF STANDARD CHAR-  
ACTERS WITHOUT CLAIM TO ANY PARTICULAR  
FONT, STYLE, SIZE, OR COLOR.

JENNIFER VASQUEZ, EXAMINING ATTORNEY

**Int. Cl.: 36**

**Prior U.S. Cls.: 100, 101, and 102**

**United States Patent and Trademark Office**

**Reg. No. 3,468,753**

**Registered July 15, 2008**

**SERVICE MARK  
PRINCIPAL REGISTER**

HELPING OTHERS MOVE FORWARD

TRAVIS ROY FOUNDATION (MASSACHUSETTS  
CHARITABLE TRUST)  
C/O EDWARDS ANGELL PALMER & DODGE LLP  
111 HUNTINGTON AVENUE  
BOSTON, MA 02199

FOR: CHARITABLE FUND RAISING; PROVID-  
ING GRANTS TO RESEARCH ORGANIZATIONS  
AND REHABILITATION INSTITUTIONS IN THE  
FIELD OF SPINAL CORD INJURIES AND TO  
INDIVIDUALS COPING WITH SPINAL CORD IN-  
JURIES, IN CLASS 36 (U.S. CLS. 100, 101 AND 102).

FIRST USE 4-18-2007; IN COMMERCE 4-18-2007.

THE MARK CONSISTS OF STANDARD CHAR-  
ACTERS WITHOUT CLAIM TO ANY PARTICULAR  
FONT, STYLE, SIZE, OR COLOR.

SN 77-109,272, FILED 2-16-2007.

MICHELE SWAIN, EXAMINING ATTORNEY



**Int. Cl.: 9**

**Prior U.S. Cls.: 21, 23, 26, 36, and 38**

**Reg. No. 3,468,754**

**United States Patent and Trademark Office**

**Registered July 15, 2008**

**TRADEMARK  
PRINCIPAL REGISTER**

IMOTIONS EMOTION TECHNOLOGY

IMOTIONS - EMOTION TECHNOLOGY A/S  
(DENMARK PRIVATE LIMITED COMPANY)  
VESTERGADE 18 E  
COPENHAGEN, DENMARK DK-1456

THE MARK CONSISTS OF STANDARD CHARACTERS WITHOUT CLAIM TO ANY PARTICULAR FONT, STYLE, SIZE, OR COLOR.

FOR: COMPUTER SOFTWARE FOR USE IN TRACKING AND COLLECTING INFORMATION ABOUT THE EYE PROPERTIES AND PSYCHO-PHYSIOLOGICAL CHANGES OF HUMANS AND MEASURING, ANALYZING, MODELING AND REPRODUCING THE COGNITIVE, AND EMOTIONAL PROCESSES IN HUMAN BEINGS, IN CLASS 9 (U.S. CLS. 21, 23, 26, 36 AND 38).

OWNER OF U.S. REG. NO. 3,245,073.

NO CLAIM IS MADE TO THE EXCLUSIVE RIGHT TO USE "EMOTION TECHNOLOGY", APART FROM THE MARK AS SHOWN.

SN 77-109,672, FILED 2-16-2007.

FIRST USE 4-16-2007; IN COMMERCE 4-16-2007.

CHARLES L. JENKINS, EXAMINING ATTORNEY

**Int. Cl.: 10**

**Prior U.S. Cls.: 26, 39, and 44**

**United States Patent and Trademark Office**

**Reg. No. 3,468,755**

**Registered July 15, 2008**

**TRADEMARK  
PRINCIPAL REGISTER**

**AVAILTA SOLO**

C. R. BARD, INC. (NEW JERSEY CORPORATION)  
730 CENTRAL AVENUE  
MURRAY HILL, NJ 07974

FOR: MEDICAL NEEDLES AND INTRODUCERS, SURGICAL IMPLANTS PRIMARILY COMPRISED OF ARTIFICIAL MATERIAL AND PARTS AND FITTINGS THEREFOR, IN CLASS 10 (U.S. CLS. 26, 39 AND 44).

FIRST USE 6-25-2007; IN COMMERCE 6-25-2007.

THE MARK CONSISTS OF STANDARD CHARACTERS WITHOUT CLAIM TO ANY PARTICULAR FONT, STYLE, SIZE, OR COLOR.

SN 77-109,715, FILED 2-16-2007.

GINA HAYES, EXAMINING ATTORNEY

**Int. Cl.: 35**

**Prior U.S. Cls.: 100, 101, and 102**

**United States Patent and Trademark Office**

**Reg. No. 3,468,756**

**Registered July 15, 2008**

**SERVICE MARK  
PRINCIPAL REGISTER**

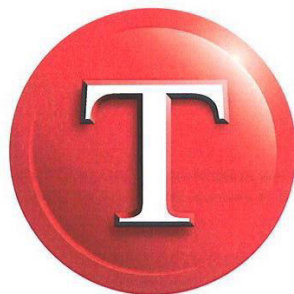

**TAYLOR**

TAYLOR GLOBAL, INC. (NEW YORK CORPORATION)  
350 FIFTH AVENUE  
SUITE 3800  
NEW YORK, NY 10118

FOR: PUBLIC AND MEDIA RELATIONS SERVICES; BUSINESS MARKETING CONSULTING IN THE FIELD OF BRAND DEVELOPMENT AND BRAND IDENTITY; PROMOTING SPORTS COMPETITIONS AND/OR EVENTS OF OTHERS; PROVIDING MARKETING AND PROMOTION OF SPECIAL EVENTS BUT NOT BUSINESS CONVENTIONS OR BUSINESS CONFERENCES, IN CLASS 35 (U.S. CLS. 100, 101 AND 102).

FIRST USE 3-26-2007; IN COMMERCE 3-26-2007.

THE COLOR(S) RED, WHITE AND BLACK IS/ARE CLAIMED AS A FEATURE OF THE MARK.

THE MARK CONSISTS OF AN EMBOLDENED LETTER "T" IN WHITE FONT SURROUNDED BY A RED CIRCLE. THE WORD "TAYLOR" APPEARS BENEATH THE ENCIRCLED "T" IN REGULAR BLACK LETTERS.

SN 77-109,874, FILED 2-16-2007.

G. MAYERSCHOFF, EXAMINING ATTORNEY

**Int. Cls.: 9, 37, and 42**

**Prior U.S. Cls.: 21, 23, 26, 36, 38, 100, 101, 103, and 106**

**Reg. No. 3,468,757**

**United States Patent and Trademark Office**

**Registered July 15, 2008**

**TRADEMARK  
SERVICE MARK  
PRINCIPAL REGISTER**



HARRIS STRATEX NETWORKS OPERATING CORPORATION (DELAWARE CORPORATION)  
637 DAVIS DRIVE  
MORRISVILLE, NC 27560

FOR: WIRELESS COMMUNICATIONS SYSTEMS, NAMELY, DIGITAL MODEMS, MULTIPLEXERS, MICROWAVE RADIO TRANSMITTERS, MICROWAVE RADIO RECEIVERS, MICROWAVE RADIO TRANSCEIVERS, AND ANTENNAS, ALL SOLD SEPARATELY AND AS A UNIT; COMPUTER SOFTWARE FOR INTERCONNECTING STATIONS IN MOBILE NETWORKS AND MANUALS DISTRIBUTED AS A UNIT THEREWITH; COMPUTER SOFTWARE FOR PROVIDING LOCAL ACCESS TO TELECOMMUNICATIONS SYSTEMS AND MANUALS DISTRIBUTED AS A UNIT THEREWITH; NETWORK COMPUTER SYSTEMS CONSISTING OF COMPUTER TERMINALS AND COMPUTER SOFTWARE FOR USE IN DIAGNOSTIC MONITORING, MAINTENANCE AND CONTROL OF WIRELESS COMMUNICATIONS SYSTEMS, AND MANUALS DISTRIBUTED AS A UNIT THEREWITH; COMPUTER SOFTWARE FOR TELECOMMUNICATIONS NETWORK MANAGEMENT AND

OPERATIONAL SYSTEMS SUPPORT AND MANUALS DISTRIBUTED AS A UNIT THEREWITH, IN CLASS 9 (U.S. CLS. 21, 23, 26, 36 AND 38).

FIRST USE 1-26-2007; IN COMMERCE 1-26-2007.

FOR: INSTALLATION, MAINTENANCE AND REPAIR SERVICES OF WIRELESS COMMUNICATIONS SYSTEMS FOR OTHERS, IN CLASS 37 (U.S. CLS. 100, 103 AND 106).

FIRST USE 1-26-2007; IN COMMERCE 1-26-2007.

FOR: DESIGN SERVICES FOR OTHERS IN THE FIELD OF WIRELESS COMMUNICATIONS SYSTEMS, IN CLASS 42 (U.S. CLS. 100 AND 101).

FIRST USE 1-26-2007; IN COMMERCE 1-26-2007.

THE MARK CONSISTS OF THE WORDS "HARRIS STRATEX" AND THE DESIGN OF A FAN.

SN 77-110,134, FILED 2-17-2007.

AMEETA JORDAN, EXAMINING ATTORNEY

**Int. Cl.: 24**

**Prior U.S. Cls.: 42 and 50**

**United States Patent and Trademark Office**

**Reg. No. 3,468,758**

**Registered July 15, 2008**

**TRADEMARK  
PRINCIPAL REGISTER**

# Belly Button Bunch

GOOLEY, JESSICA, JENKINS (UNITED STATES  
INDIVIDUAL)  
2 HAYDEN LANE  
SHREWSBURY, MA 01545

THE MARK CONSISTS OF STANDARD CHAR-  
ACTERS WITHOUT CLAIM TO ANY PARTICULAR  
FONT, STYLE, SIZE, OR COLOR.

FOR: TEXTILE WALL HANGINGS, IN CLASS 24  
(U.S. CLS. 42 AND 50).

SN 77-110,183, FILED 2-17-2007.

FIRST USE 1-22-2008; IN COMMERCE 4-10-2008.

KATHRYN COWARD, EXAMINING ATTORNEY

**Int. Cls.: 35 and 40**

**Prior U.S. Cls.: 100, 101, 102, 103, and 106**

**United States Patent and Trademark Office**

**Reg. No. 3,468,759**

**Registered July 15, 2008**

**SERVICE MARK  
PRINCIPAL REGISTER**

**THE RIVER GROUP**

THE RIVER GROUP (NEW JERSEY LTD LIAB  
CO)  
12 SLEEPY HOLLOW ROAD  
UPPER SADDLE RIVER, NJ 07458

FOR: BUSINESS CONSULTING SERVICES IN  
THE FIELD OF HEALTHCARE TECHNOLOGY,  
NAMELY, TECHNOLOGY NEEDS ASSESSMENT,  
PROCUREMENT, IMPLEMENTATION, INSTALLA-  
TION AND SUPPORT; PROJECT MANAGEMENT  
SERVICES IN THE HEALTHCARE INDUSTRY, IN  
CLASS 35 (U.S. CLS. 100, 101 AND 102).

FIRST USE 5-31-2007; IN COMMERCE 5-31-2007.

FOR: CUSTOM MANUFACTURING OF WOOD  
FURNITURE AND CABINetry, IN CLASS 40 (U.S.  
CLS. 100, 103 AND 106).

FIRST USE 5-31-2007; IN COMMERCE 5-31-2007.

THE MARK CONSISTS OF STANDARD CHAR-  
ACTERS WITHOUT CLAIM TO ANY PARTICULAR  
FONT, STYLE, SIZE, OR COLOR.

NO CLAIM IS MADE TO THE EXCLUSIVE  
RIGHT TO USE "GROUP" , APART FROM THE  
MARK AS SHOWN.

SN 77-110,199, FILED 2-17-2007.

RICHARD A. STRASER, EXAMINING ATTORNEY

**Int. Cl.: 9**

**Prior U.S. Cls.: 21, 23, 26, 36, and 38**

**United States Patent and Trademark Office**

**Reg. No. 3,468,760**

**Registered July 15, 2008**

**TRADEMARK  
PRINCIPAL REGISTER**

# BioLumix

BIOLUMIX, INC. (MICHIGAN CORPORATION)  
2765 EMBER WAY  
ANN ARBOR, MI 48104

TRIAL SAMPLES, IN CLASS 9 (U.S. CLS. 21, 23, 26, 36  
AND 38).

FIRST USE 4-8-2008; IN COMMERCE 4-8-2008.

FOR: MICROBIOLOGY INSTRUMENTATION,  
NAMELY, OPTICAL READERS FOR THE DETEC-  
TION OF MICROBIAL GROWTH; SCIENTIFIC AP-  
PARATUS, NAMELY, MICROBIOLOGICAL TEST  
KITS CONSISTING PRIMARILY OF GROWTH  
MEDIA AND DYE INDICATORS FOR THE DETEC-  
TION OF BACTERIA IN MEDICAL AND INDUS-

THE MARK CONSISTS OF STANDARD CHAR-  
ACTERS WITHOUT CLAIM TO ANY PARTICULAR  
FONT, STYLE, SIZE, OR COLOR.

SN 77-110,738, FILED 2-19-2007.

ANDREW RHIM, EXAMINING ATTORNEY

**Int. Cl.: 28**

**Prior U.S. Cls.: 22, 23, 38, and 50**

**United States Patent and Trademark Office**

**Reg. No. 3,468,761**

**Registered July 15, 2008**

**TRADEMARK  
PRINCIPAL REGISTER**



SAYERS, JOSEPH P. (UNITED STATES INDIVIDUAL)  
277 BROADWAY BLVD.  
BATTLE CREEK, MI 49037

THE MARK CONSISTS OF THE LETTERS "JPS",  
IN WHICH THE LETTER "J" IS REPRESENTED AS  
A FISHING HOOK.

FOR: FISHING LURES, IN CLASS 28 (U.S. CLS. 22,  
23, 38 AND 50).

SN 77-110,927, FILED 2-19-2007.

FIRST USE 5-9-2008; IN COMMERCE 5-9-2008.

WENDY JUN, EXAMINING ATTORNEY



**Int. Cl.: 29**

**Prior U.S. Cl.: 46**

**United States Patent and Trademark Office**

**Reg. No. 3,468,762**

**Registered July 15, 2008**

**TRADEMARK  
PRINCIPAL REGISTER**

# Doctor Hummus

ROUIN, SABEUR (UNITED STATES INDIVIDUAL)  
7024 S. CLAIBORNE AVE.  
GILBERT, AZ 85297

NO CLAIM IS MADE TO THE EXCLUSIVE RIGHT TO USE "HUMMUS", APART FROM THE MARK AS SHOWN.

FOR: BEAN DIP, IN CLASS 29 (U.S. CL. 46).

FIRST USE 1-1-2004; IN COMMERCE 1-1-2006.

SN 77-111,289, FILED 2-20-2007.

THE MARK CONSISTS OF STANDARD CHARACTERS WITHOUT CLAIM TO ANY PARTICULAR FONT, STYLE, SIZE, OR COLOR.

CHERYL CLAYTON, EXAMINING ATTORNEY

**Int. Cl.: 9**

**Prior U.S. Cls.: 21, 23, 26, 36, and 38**

**United States Patent and Trademark Office**

**Reg. No. 3,468,763**

**Registered July 15, 2008**

**TRADEMARK  
PRINCIPAL REGISTER**



JAYBIRD GEAR LLC (UTAH LTD LIAB CO)  
#500  
2825 EAST COTTONWOOD PARKWAY  
SALT LAKE CITY, UT 84121

FOR: PORTABLE STEREO SYSTEMS COMPOSED OF STEREO TUNERS, STEREO AMPLIFIERS, STEREO RECEIVERS, AND SPEAKERS; PERSONAL STEREO SYSTEMS COMPOSED OF STEREO TUNERS, STEREO AMPLIFIERS, STEREO RECEIVERS, AND SPEAKERS; EARPHONES; RADIO

FREQUENCY RECEIVERS; AND MP3 PLAYERS, IN CLASS 9 (U.S. CLS. 21, 23, 26, 36 AND 38).

FIRST USE 11-15-2007; IN COMMERCE 11-15-2007.

THE MARK CONSISTS OF STYLIZED "JB".

SN 77-111,293, FILED 2-20-2007.

KAREN K. BUSH, EXAMINING ATTORNEY

**Int. Cl.: 10**

**Prior U.S. Cls.: 26, 39, and 44**

**Reg. No. 3,468,764**

**United States Patent and Trademark Office**

**Registered July 15, 2008**

**TRADEMARK  
PRINCIPAL REGISTER**

**STERI COVER**

R4 VASCULAR, INC. (DELAWARE CORPORATION)  
4 WILLOW TERRACE  
HOBOKEN, NJ 07030

FOR: CATHETERS AND PARTS AND FITTINGS THEREFOR; COMPRESSION BANDAGES; ELASTIC BANDAGES; PROSTHETIC TISSUES FOR PARIETAL, VISCERAL AND VASCULAR USE; VASCULAR ACCESS PORTS FOR MEDICAL USE , IN CLASS 10 (U.S. CLS. 26, 39 AND 44).

FIRST USE 12-31-2007; IN COMMERCE 12-31-2007.

THE MARK CONSISTS OF STANDARD CHARACTERS WITHOUT CLAIM TO ANY PARTICULAR FONT, STYLE, SIZE, OR COLOR.

NO CLAIM IS MADE TO THE EXCLUSIVE RIGHT TO USE "COVER", APART FROM THE MARK AS SHOWN.

SN 77-111,598, FILED 2-20-2007.

JUSTINE D. PARKER, EXAMINING ATTORNEY

**Int. Cl.: 5**

**Prior U.S. Cls.: 6, 18, 44, 46, 51, and 52**

**Reg. No. 3,468,765**

**United States Patent and Trademark Office**

**Registered July 15, 2008**

**TRADEMARK  
PRINCIPAL REGISTER**

**ASSAYASSURE**

SIERRA MOLECULAR CORPORATION (DELA-  
WARE CORPORATION)  
21109-C LONGEWAY ROAD  
SONORA, CA 95370

FOR: CHEMICAL REAGENTS FOR MEDICAL  
PURPOSES, NAMELY, FOR USE IN PRESERVING  
EX VIVO BIOLOGICAL SAMPLES FOR MOLECU-  
LAR ANALYSIS, IN CLASS 5 (U.S. CLS. 6, 18, 44, 46, 51  
AND 52).

FIRST USE 1-5-2008; IN COMMERCE 1-5-2008.

THE MARK CONSISTS OF STANDARD CHAR-  
ACTERS WITHOUT CLAIM TO ANY PARTICULAR  
FONT, STYLE, SIZE, OR COLOR.

SN 77-111,756, FILED 2-20-2007.

ANTHONY RINKER, EXAMINING ATTORNEY

**Int. Cl.: 16**

**Prior U.S. Cls.: 2, 5, 22, 23, 29, 37, 38, and 50**

**United States Patent and Trademark Office**

**Reg. No. 3,468,766**

**Registered July 15, 2008**

**TRADEMARK  
PRINCIPAL REGISTER**

**Jetstream Sport**

MITSUBISHI PENCIL CO., LTD. (JAPAN CORPORATION)  
5-23-37, HIGASHI-OHI, SHINAGAWA-KU  
TOKYO, JAPAN

FOR: WRITING INSTRUMENTS, IN CLASS 16  
(U.S. CLS. 2, 5, 22, 23, 29, 37, 38 AND 50).

FIRST USE 3-1-2007; IN COMMERCE 3-1-2007.

OWNER OF U.S. REG. NO. 2,902,446.

THE MARK CONSISTS OF THE WORDS "JET-  
STREAM SPORT" IN STYLIZED LETTERING.

SN 77-112,132, FILED 2-21-2007.

JOHN WILKE, EXAMINING ATTORNEY

**Int. Cl.: 25**

**Prior U.S. Cls.: 22 and 39**

**United States Patent and Trademark Office**

**Reg. No. 3,468,767**

**Registered July 15, 2008**

**TRADEMARK  
PRINCIPAL REGISTER**

**COMFORT CRAZE**

HBI BRANDED APPAREL ENTERPRISES, LLC  
(DELAWARE LTD LIAB CO)

1000 EAST HANES MILL ROAD

WINSTON-SALEM, NC 27105

FOR: BRAS, IN CLASS 25 (U.S. CLS. 22 AND 39).

FIRST USE 6-15-2007; IN COMMERCE 6-15-2007.

THE MARK CONSISTS OF STANDARD CHARACTERS WITHOUT CLAIM TO ANY PARTICULAR FONT, STYLE, SIZE, OR COLOR.

OWNER OF U.S. REG. NOS. 2,626,619 AND 3,026,615.

SN 77-112,262, FILED 2-21-2007.

CURTIS FRENCH, EXAMINING ATTORNEY

**Int. Cls.: 35, 36, and 42**

**Prior U.S. Cls.: 100, 101, and 102**

**United States Patent and Trademark Office**

**Reg. No. 3,468,768**

**Registered July 15, 2008**

**SERVICE MARK  
PRINCIPAL REGISTER**

# Value Planning

BLAINE, JAMES DAVID (UNITED STATES INDIVIDUAL)

7887 EMBRY POINT

SAN DIEGO, CA 92126

FOR: ASSISTANCE WITH BUSINESS MANAGEMENT AND PLANNING; ASSISTANCE, ADVISORY SERVICES AND CONSULTANCY WITH REGARD TO BUSINESS PLANNING, BUSINESS ANALYSIS, BUSINESS MANAGEMENT, AND BUSINESS ORGANIZATION; BUSINESS ADVISORY SERVICES, CONSULTANCY AND INFORMATION; BUSINESS CONSULTATION SERVICES; BUSINESS CONSULTING AND INFORMATION SERVICES; BUSINESS CONSULTING, MANAGEMENT, PLANNING AND SUPERVISION; BUSINESS MANAGEMENT AND ADVICE; BUSINESS MANAGEMENT AND CONSULTATION; BUSINESS MANAGEMENT PLANNING; BUSINESS MEETING PLANNING; BUSINESS PLANNING; CONSULTING SERVICES IN BUSINESS ORGANIZATION AND MANAGEMENT; PROFESSIONAL BUSINESS CONSULTATION; PROJECT MANAGEMENT SERVICES FOR OTHERS IN THE FIELDS OF LANGUAGE TRANSLATION, CUSTOM WRITING, TEXT ADAPTATION, INTERPRETING AND PROOFREADING; PROVIDING BUSINESS MANAGEMENT INFORMATION IN CONNECTION WITH CONSULTING AND ADVISORY SERVICES IN THE FIELD OF STRATEGIC PLANNING; PROVIDING INFORMATION IN THE FIELD OF TIME MANAGEMENT FOR BUSINESS PURPOSES, IN CLASS 35 (U.S. CLS. 100, 101 AND 102).

FIRST USE 5-29-2007; IN COMMERCE 6-8-2007.

FOR: PROJECT FINANCING; RISK MANAGEMENT CONSULTATION, IN CLASS 36 (U.S. CLS. 100, 101 AND 102).

FIRST USE 5-29-2007; IN COMMERCE 6-8-2007.

FOR: COMPUTER CONSULTATION; COMPUTER PROJECT MANAGEMENT SERVICES; COMPUTER SOFTWARE CONSULTANCY; COMPUTER SOFTWARE CONSULTATION; CONSULTANCY IN THE FIELD OF SOFTWARE DESIGN; CONSULTATION SERVICES IN THE FIELDS OF SELECTION, IMPLEMENTATION AND USE OF COMPUTER HARDWARE AND SOFTWARE SYSTEMS FOR OTHERS; CONSULTING SERVICES IN THE FIELD OF DESIGN, SELECTION, IMPLEMENTATION AND USE OF COMPUTER HARDWARE AND SOFTWARE SYSTEMS FOR OTHERS; INFORMATION TECHNOLOGY CONSULTATION; PROVIDING QUALITY ASSURANCE SERVICES IN THE FIELD OF PROJECT MANAGEMENT; QUALITY CONTROL FOR OTHERS, IN CLASS 42 (U.S. CLS. 100 AND 101).

FIRST USE 5-29-2007; IN COMMERCE 6-8-2007.

THE MARK CONSISTS OF STANDARD CHARACTERS WITHOUT CLAIM TO ANY PARTICULAR FONT, STYLE, SIZE, OR COLOR.

NO CLAIM IS MADE TO THE EXCLUSIVE RIGHT TO USE "PLANNING", APART FROM THE MARK AS SHOWN.

SN 77-112,405, FILED 2-21-2007.

H. M. FISHER, EXAMINING ATTORNEY

**Int. Cl.: 25**

**Prior U.S. Cls.: 22 and 39**

**United States Patent and Trademark Office**

**Reg. No. 3,468,769**

**Registered July 15, 2008**

**TRADEMARK  
PRINCIPAL REGISTER**

**BEAUTIFUL CURVES**

HBI BRANDED APPAREL ENTERPRISES, LLC  
(DELAWARE LTD LIAB CO)  
1000 EAST HANES MILL ROAD  
WINSTON-SALEM, NC 27105

FOR: BRAS, IN CLASS 25 (U.S. CLS. 22 AND 39).

FIRST USE 6-15-2007; IN COMMERCE 6-15-2007.

THE MARK CONSISTS OF STANDARD CHARACTERS WITHOUT CLAIM TO ANY PARTICULAR FONT, STYLE, SIZE, OR COLOR.

OWNER OF U.S. REG. NO. 2,695,945.

SN 77-112,461, FILED 2-21-2007.

CURTIS FRENCH, EXAMINING ATTORNEY



**Int. Cl.: 3**

**Prior U.S. Cls.: 1, 4, 6, 50, 51, and 52**

**United States Patent and Trademark Office**

**Reg. No. 3,468,770**

**Registered July 15, 2008**

**TRADEMARK  
PRINCIPAL REGISTER**

**SOFT SCRUB**

HENKEL CONSUMER GOODS INC. (DELA-  
WARE CORPORATION)  
M.S. 2214  
15501 NORTH DIAL BOULEVARD  
SCOTTSDALE, AZ 852601619

FOR: DISHWASHING DETERGENTS, IN CLASS 3  
(U.S. CLS. 1, 4, 6, 50, 51 AND 52).

FIRST USE 5-1-2007; IN COMMERCE 5-1-2007.

THE MARK CONSISTS OF STANDARD CHAR-  
ACTERS WITHOUT CLAIM TO ANY PARTICULAR  
FONT, STYLE, SIZE, OR COLOR.

OWNER OF U.S. REG. NO. 3,328,732.

NO CLAIM IS MADE TO THE EXCLUSIVE  
RIGHT TO USE "SCRUB", APART FROM THE  
MARK AS SHOWN.

SN 77-112,786, FILED 2-21-2007.

GISELLE AGOSTO, EXAMINING ATTORNEY

**Int. Cl.: 36**

**Prior U.S. Cls.: 100, 101, and 102**

**United States Patent and Trademark Office**

**Reg. No. 3,468,771**

**Registered July 15, 2008**

---

**SERVICE MARK  
PRINCIPAL REGISTER**

**SIX DEGREES CAPITAL  
MANAGEMENT**

SIX DEGREES CAPITAL MANAGEMENT L.L.C.  
(DELAWARE LTD LIAB CO)  
190 S. LASALLE ST., #3800  
CHICAGO, IL 60603

FOR: FINANCIAL INVESTMENT IN THE FIELD  
OF STRUCTURED CREDIT AND ASSET MANAGE-  
MENT; INVESTMENT MANAGEMENT; INVEST-  
MENT OF FUNDS FOR OTHERS; MANAGEMENT  
OF A CAPITAL INVESTMENT FUND, IN CLASS 36  
(U.S. CLS. 100, 101 AND 102).

FIRST USE 2-28-2007; IN COMMERCE 2-28-2007.

THE MARK CONSISTS OF STANDARD CHAR-  
ACTERS WITHOUT CLAIM TO ANY PARTICULAR  
FONT, STYLE, SIZE, OR COLOR.

NO CLAIM IS MADE TO THE EXCLUSIVE  
RIGHT TO USE "CAPITAL MANAGEMENT",  
APART FROM THE MARK AS SHOWN.

SN 77-112,858, FILED 2-21-2007.

MELVIN AXILBUND, EXAMINING ATTORNEY

**Int. Cl.: 21**

**Prior U.S. Cls.: 2, 13, 23, 29, 30, 33, 40, and 50**

**United States Patent and Trademark Office**

**Reg. No. 3,468,772**

**Registered July 15, 2008**

**TRADEMARK  
PRINCIPAL REGISTER**

**EASEBETWEEN**

RANIR, LLC (DELAWARE LTD LIAB CO)  
4701 EAST PARIS SE  
GRAND RAPIDS, MI 49512

FOR: ORAL CARE PRODUCTS, NAMELY, INTERDENTAL BRUSHES AND FLOSSERS, IN CLASS 21 (U.S. CLS. 2, 13, 23, 29, 30, 33, 40 AND 50).

FIRST USE 4-14-2008; IN COMMERCE 4-14-2008.

THE MARK CONSISTS OF STANDARD CHARACTERS WITHOUT CLAIM TO ANY PARTICULAR FONT, STYLE, SIZE, OR COLOR.

OWNER OF U.S. REG. NO. 2,815,657.

SN 77-113,086, FILED 2-22-2007.

TASHIA BUNCH, EXAMINING ATTORNEY

**Int. Cl.: 36**

**Prior U.S. Cls.: 100, 101, and 102**

**United States Patent and Trademark Office**

**Reg. No. 3,468,773**

**Registered July 15, 2008**

**SERVICE MARK  
PRINCIPAL REGISTER**

**PURPLE COW CREDIT**

CITY AUTO CREDIT, LLC (FLORIDA LTD LIAB  
CO)  
SUITE 510  
200 MANSELL COURT EAST  
ROSWELL, GA 30076

FOR: CONSUMER CREDIT LOAN FINANCING  
SERVICES, IN CLASS 36 (U.S. CLS. 100, 101 AND 102).

FIRST USE 1-1-2007; IN COMMERCE 1-1-2007.

THE MARK CONSISTS OF STANDARD CHAR-  
ACTERS WITHOUT CLAIM TO ANY PARTICULAR  
FONT, STYLE, SIZE, OR COLOR.

NO CLAIM IS MADE TO THE EXCLUSIVE  
RIGHT TO USE "CREDIT", APART FROM THE  
MARK AS SHOWN.

SN 77-113,698, FILED 2-22-2007.

CHARLES L. JENKINS, EXAMINING ATTORNEY

**Int. Cl.: 16**

**Prior U.S. Cls.: 2, 5, 22, 23, 29, 37, 38, and 50**

**Reg. No. 3,468,774**

**United States Patent and Trademark Office**

**Registered July 15, 2008**

**TRADEMARK  
PRINCIPAL REGISTER**

**BREAKTHROUGHS IN HEALTH**

VIDEO PLUS, LP (TEXAS LIMITED PARTNER-  
SHIP)  
200 SWISHER ROAD  
LAKE DALLAS, TX 75065

FOR: MAGAZINES DISTRIBUTED ON NEWS-  
TANDS IN THE FIELD OF MEDICAL AND HERBAL  
TREATMENTS FOR ILLNESS AND PREVENTA-  
TIVE MEDICATION, IN CLASS 16 (U.S. CLS. 2, 5,  
22, 23, 29, 37, 38 AND 50).

FIRST USE 8-1-2006; IN COMMERCE 8-1-2006.

THE MARK CONSISTS OF STANDARD CHAR-  
ACTERS WITHOUT CLAIM TO ANY PARTICULAR  
FONT, STYLE, SIZE, OR COLOR.

SN 77-114,490, FILED 2-23-2007.

HANNO RITTNER, EXAMINING ATTORNEY

Int. Cl.: 9

Prior U.S. Cls.: 21, 23, 26, 36, and 38

Reg. No. 3,468,775

United States Patent and Trademark Office

Registered July 15, 2008

TRADEMARK  
PRINCIPAL REGISTER

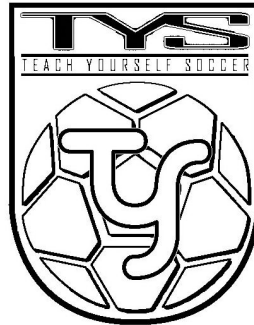

TEACH YOURSELF SOCCER (CALIFORNIA  
CORPORATION)  
SUITE 800  
7700 IRVINE CENTER DRIVE  
IRVINE, CA 92618

FOR: DVDS FEATURING SOCCER TRAINING,  
IN CLASS 9 (U.S. CLS. 21, 23, 26, 36 AND 38).

FIRST USE 4-1-2007; IN COMMERCE 11-20-2007.

NO CLAIM IS MADE TO THE EXCLUSIVE  
RIGHT TO USE "TEACH YOURSELF SOCCER",  
APART FROM THE MARK AS SHOWN.

THE MARK CONSISTS OF SOCCER BALL WITH  
INSIGNIA.

SN 77-114,584, FILED 2-23-2007.

KEVIN DINALLO, EXAMINING ATTORNEY

**Int. Cl.: 39**

**Prior U.S. Cls.: 100 and 105**

**United States Patent and Trademark Office**

**Reg. No. 3,468,776**

**Registered July 15, 2008**

**SERVICE MARK  
PRINCIPAL REGISTER**

**WE CAN HANDLE IT**

AMWARE EXPRESS, LLC (OHIO LTD LIAB CO)  
19801 HOLLAND ROAD  
CLEVELAND, OH 44142

FOR: CARGO HANDLING; DELIVERY OF  
GOODS BY TRUCK, RAIL, AIR AND SHIP; RENTAL  
OF WAREHOUSE SPACE; WAREHOUSE STORAGE;  
WAREHOUSING SERVICES, IN CLASS 39 (U.S. CLS.  
100 AND 105).

FIRST USE 5-6-2007; IN COMMERCE 5-6-2007.

THE MARK CONSISTS OF STANDARD CHAR-  
ACTERS WITHOUT CLAIM TO ANY PARTICULAR  
FONT, STYLE, SIZE, OR COLOR.

SN 77-114,881, FILED 2-23-2007.

DEIRDRE ROBERTSON, EXAMINING ATTORNEY

**Int. Cl.: 9**

**Prior U.S. Cls.: 21, 23, 26, 36, and 38**

**Reg. No. 3,468,777**

**United States Patent and Trademark Office**

**Registered July 15, 2008**

---

**TRADEMARK  
PRINCIPAL REGISTER**

**PULSEO**

NEWPORT CORPORATION (NEVADA COR-  
PORATION)  
1791 DEERE AVENUE  
IRVINE, CA 92606

THE MARK CONSISTS OF STANDARD CHAR-  
ACTERS WITHOUT CLAIM TO ANY PARTICULAR  
FONT, STYLE, SIZE, OR COLOR.

FOR: LASERS FOR NON-MEDICAL USE, IN  
CLASS 9 (U.S. CLS. 21, 23, 26, 36 AND 38).

SN 77-115,173, FILED 2-23-2007.

FIRST USE 4-7-2008; IN COMMERCE 4-7-2008.

PAUL MORENO, EXAMINING ATTORNEY



**Int. Cl.: 9**

**Prior U.S. Cls.: 21, 23, 26, 36, and 38**

**United States Patent and Trademark Office**

**Reg. No. 3,468,778**

**Registered July 15, 2008**

---

**TRADEMARK  
PRINCIPAL REGISTER**

**AbelCam**

SEIZ, STEFAN (SWITZERLAND INDIVIDUAL)  
STAHLRAIN 10  
BRUGG, SWITZERLAND 5200

FOR: COMPUTER SOFTWARE FOR MONITORING, CONTROLLING AND AUTOMATING THE OPERATION OF MULTIPLE VIDEO CAMERAS AND VIDEO CAPTURE DEVICES CONNECTED TO COMPUTERS, IN CLASS 9 (U.S. CLS. 21, 23, 26, 36 AND 38).

FIRST USE 3-1-2007; IN COMMERCE 3-1-2007.

THE MARK CONSISTS OF STANDARD CHARACTERS WITHOUT CLAIM TO ANY PARTICULAR FONT, STYLE, SIZE, OR COLOR.

SN 77-115,176, FILED 2-23-2007.

DAVID TAYLOR, EXAMINING ATTORNEY

**Int. Cl.: 25**

**Prior U.S. Cls.: 22 and 39**

**United States Patent and Trademark Office**

**Reg. No. 3,468,779**

**Registered July 15, 2008**

**TRADEMARK  
PRINCIPAL REGISTER**

**PLUOT**

S.I.T., INC. (CALIFORNIA CORPORATION)  
3018-A ALVARDO STREET  
SAN LEANDRO, CA 94577

FOR: CHILDREN'S CLOTHING, NAMELY, JACKETS, COATS, PLAYSUITS, PANTS, OVERALLS, VESTS, HATS, MITTENS, PONCHOS, SWEATSHIRTS, AND SHORTS, IN CLASS 25 (U.S. CLS. 22 AND 39).

FIRST USE 7-5-2007; IN COMMERCE 7-5-2007.

THE MARK CONSISTS OF STANDARD CHARACTERS WITHOUT CLAIM TO ANY PARTICULAR FONT, STYLE, SIZE, OR COLOR.

SN 77-115,209, FILED 2-23-2007.

LAURA HAMMEL, EXAMINING ATTORNEY

**Int. Cl.: 32**

**Prior U.S. Cls.: 45, 46, and 48**

**Reg. No. 3,468,780**

**United States Patent and Trademark Office**

**Registered July 15, 2008**

---

**TRADEMARK  
PRINCIPAL REGISTER**

**SPAZMATIC!**

3 RING REFRESHMENTS LLC (MICHIGAN LTD  
LIAB CO)  
32575 FOLSOM ROAD  
FARMINGTON HILLS, MI 48336

THE MARK CONSISTS OF STANDARD CHAR-  
ACTERS WITHOUT CLAIM TO ANY PARTICULAR  
FONT, STYLE, SIZE, OR COLOR.

FOR: BEVERAGES, NAMELY, ENERGY  
DRINKS, IN CLASS 32 (U.S. CLS. 45, 46 AND 48).

SN 77-115,602, FILED 2-25-2007.

FIRST USE 5-25-2007; IN COMMERCE 5-25-2007.

DANIEL BRODY, EXAMINING ATTORNEY

**Int. Cl.: 9**

**Prior U.S. Cls.: 21, 23, 26, 36, and 38**

**Reg. No. 3,468,781**

**United States Patent and Trademark Office**

**Registered July 15, 2008**

---

**TRADEMARK  
PRINCIPAL REGISTER**

**GS-OXYPLOT**

AGILENT TECHNOLOGIES, INC. (DELAWARE  
CORPORATION)  
MS 1A-LC  
5301 STEVENS CREEK BLVD.  
SANTA CLARA, CA 95051

THE MARK CONSISTS OF STANDARD CHAR-  
ACTERS WITHOUT CLAIM TO ANY PARTICULAR  
FONT, STYLE, SIZE, OR COLOR.

FOR: CHROMATOGRAPHY COLUMNS, IN  
CLASS 9 (U.S. CLS. 21, 23, 26, 36 AND 38).

SN 77-116,561, FILED 2-26-2007.

FIRST USE 4-1-2007; IN COMMERCE 4-1-2007.

AMY ALFIERI, EXAMINING ATTORNEY

Int. Cls.: 3, 4, 11, and 21

Prior U.S. Cls.: 1, 2, 4, 6, 13, 15, 21, 23, 29, 30, 31, 33,  
34, 40, 50, 51, and 52

Reg. No. 3,468,782

United States Patent and Trademark Office

Registered July 15, 2008

TRADEMARK  
PRINCIPAL REGISTER

# Natural Spirits

GAINES GROUP LLC (TEXAS LTD LIAB CO)  
SUITE A-100  
2901 W. SAM HOUSTON PKWY  
HOUSTON, TX 77043

FOR: DEODORANT SOAP; DETERGENT SOAP;  
DISINFECTANT SOAPS; DISINFECTING PER-  
FUMED SOAPS; GRANULATED SOAPS; HAND  
SOAPS; INDUSTRIAL SOAP; LAUNDRY SOAP; LI-  
QUID SOAPS; LIQUID SOAPS FOR HANDS AND  
FACE; PERFUMED SOAP; PERFUMED SOAPS;  
SKIN SOAP; SOAPS; SOAPS AND DETERGENTS;  
SOAPS FOR HOUSEHOLD USE; SOAPS FOR PER-  
SONAL USE; WATERLESS SOAP, IN CLASS 3 (U.S.  
CLS. 1, 4, 6, 50, 51 AND 52).

FIRST USE 5-5-2008; IN COMMERCE 5-5-2008.

FOR: CANDLES; CANDLES FOR LIGHTING;  
PERFUMED CANDLES; SCENTED CANDLES, IN  
CLASS 4 (U.S. CLS. 1, 6 AND 15).

FIRST USE 5-5-2008; IN COMMERCE 5-5-2008.

FOR: DIFFUSERS FOR HOME FRAGRANCING;  
ELECTRIC CANDLES; NON-ELECTRIC AIR DIF-  
FUSERS COMPRISED OF A WICK AND OIL IN A  
CONTAINER USED TO EMIT SCENT WHEN LIT, IN  
CLASS 11 (U.S. CLS. 13, 21, 23, 31 AND 34).

FIRST USE 5-5-2008; IN COMMERCE 5-5-2008.

FOR: CANDLE HOLDERS; CANDLE HOLDERS  
NOT OF PRECIOUS METAL; CANDLE HOLDERS  
OF PRECIOUS METAL; CANDLE RINGS; CANDLE  
RINGS NOT OF PRECIOUS METAL; CANDLE  
RINGS OF PRECIOUS METAL; CANDLE SNUFFER  
AND TRAY COMBINATION; CANDLE SNUFFER  
AND TRAY COMBINATION MADE IN WHOLE OR  
IN PART OF PRECIOUS METAL; CANDLE SNUF-  
FERS; CANDLE SNUFFERS NOT OF PRECIOUS  
METAL; CANDLE SNUFFERS OF PRECIOUS ME-  
TAL; DISPENSERS FOR LIQUID SOAP; PILLAR  
CANDLE PLATE MADE IN WHOLE OR IN PART  
OF PRECIOUS METAL; PILLAR CANDLE PLATES;  
PLASTIC MOLDS FOR HOUSEHOLD USE IN MAK-  
ING SOAP; POTPOURRI DISHES; SOAP BOXES;  
SOAP BRACKETS; SOAP CONTAINERS; SOAP  
DISHES; SOAP DISPENSERS; SOAP HOLDERS;  
SOAP HOLDERS AND BOXES; WALL SOAP  
DISHES, IN CLASS 21 (U.S. CLS. 2, 13, 23, 29, 30, 33,  
40 AND 50).

FIRST USE 5-5-2008; IN COMMERCE 5-5-2008.

THE MARK CONSISTS OF STANDARD CHAR-  
ACTERS WITHOUT CLAIM TO ANY PARTICULAR  
FONT, STYLE, SIZE, OR COLOR.

SN 77-116,600, FILED 2-26-2007.

ANDREW RHIM, EXAMINING ATTORNEY

**Int. Cl.: 41**

**Prior U.S. Cls.: 100, 101, and 107**

**United States Patent and Trademark Office**

**Reg. No. 3,468,783**

**Registered July 15, 2008**

**SERVICE MARK  
PRINCIPAL REGISTER**

**KEEP FLIPPIN**

KEEP FLIPPIN GYMNASTICS FRANCHISE, INC.  
(FLORIDA CORPORATION)  
6761 INDIANTOWN ROAD  
JUPITER, FL 33458

FOR: GYMNASTICS INSTRUCTION; PHYSICAL FITNESS INSTRUCTION; ENTERTAINMENT SERVICES, NAMELY, CONDUCTING PARTIES; PERSONAL COACHING SERVICES IN THE FIELD OF GYMNASTICS; EDUCATIONAL SERVICES, NAMELY, CONDUCTING CLASSES IN THE FIELD OF GYMNASTICS, IN CLASS 41 (U.S. CLS. 100, 101 AND 107).

FIRST USE 9-1-1996; IN COMMERCE 8-11-2003.

THE MARK CONSISTS OF STANDARD CHARACTERS WITHOUT CLAIM TO ANY PARTICULAR FONT, STYLE, SIZE, OR COLOR.

SN 77-116,795, FILED 2-27-2007.

PAUL MORENO, EXAMINING ATTORNEY

**Int. Cl.: 1**

**Prior U.S. Cls.: 1, 5, 6, 10, 26, and 46**

**Reg. No. 3,468,784**

**United States Patent and Trademark Office**

**Registered July 15, 2008**

---

**TRADEMARK  
PRINCIPAL REGISTER**

**MAGNA FLORA**

SUPER ABSORBENT COMPANY (NEVADA CORPORATION)  
3610 E. SOUTHERN AVENUE, SUITE 5  
PHOENIX, CA 85040

FOR: MOISTURE ABSORBENT POLYMER WITH FERTILIZERS FOR USE IN THE FIELD OF AGRICULTURE, IN CLASS 1 (U.S. CLS. 1, 5, 6, 10, 26 AND 46).

FIRST USE 11-30-2007; IN COMMERCE 11-30-2007.

THE MARK CONSISTS OF STANDARD CHARACTERS WITHOUT CLAIM TO ANY PARTICULAR FONT, STYLE, SIZE, OR COLOR.

THE FOREIGN WORDING IN THE MARK TRANSLATES INTO ENGLISH AS GREAT VEGETATION.

SN 77-116,950, FILED 2-27-2007.

BRENDAN REGAN, EXAMINING ATTORNEY

**Int. Cl.: 25**

**Prior U.S. Cls.: 22 and 39**

**United States Patent and Trademark Office**

**Reg. No. 3,468,785**

**Registered July 15, 2008**

**TRADEMARK  
PRINCIPAL REGISTER**



SHOEPURCHASE/HERITAGE FOOTWEAR, LLC  
(WISCONSIN LTD LIAB CO)  
110 EVERGLADE DR  
MADISON, WI 53717

THE MARK CONSISTS OF A LARGE CAP OF "H"  
AND "F" TOGETHER WITH DOTS AS SIMULATED  
FOOT PRINTS.

FOR: SHOES, IN CLASS 25 (U.S. CLS. 22 AND 39).

SN 77-117,022, FILED 2-27-2007.

FIRST USE 4-15-2008; IN COMMERCE 4-15-2008.

KIMBERLY PERRY, EXAMINING ATTORNEY



**Int. Cl.: 9**

**Prior U.S. Cls.: 21, 23, 26, 36, and 38**

**United States Patent and Trademark Office**

**Reg. No. 3,468,786**

**Registered July 15, 2008**

**TRADEMARK  
PRINCIPAL REGISTER**

**MYSTICAL LOTUS**

WMS GAMING INC. (DELAWARE CORPORATION)  
800 SOUTH NORTHPOINT BOULEVARD  
WAUKEGAN, IL 60085

FOR: GAMING MACHINES THAT GENERATE OR DISPLAY WAGER OUTCOMES; GAMING SOFTWARE THAT GENERATES OR DISPLAYS WAGER OUTCOMES OF GAMING MACHINES, IN CLASS 9 (U.S. CLS. 21, 23, 26, 36 AND 38).

FIRST USE 11-13-2007; IN COMMERCE 11-13-2007.

THE MARK CONSISTS OF STANDARD CHARACTERS WITHOUT CLAIM TO ANY PARTICULAR FONT, STYLE, SIZE, OR COLOR.

SN 77-117,030, FILED 2-27-2007.

LESLEY LAMOTHE, EXAMINING ATTORNEY

**Int. Cl.: 9**

**Prior U.S. Cls.: 21, 23, 26, 36, and 38**

**United States Patent and Trademark Office**

**Reg. No. 3,468,787**

**Registered July 15, 2008**

**TRADEMARK  
PRINCIPAL REGISTER**

**CAJUN FIRE**

WMS GAMING INC. (DELAWARE CORPORATION)  
800 SOUTH NORTHPOINT BOULEVARD  
WAUKEGAN, IL 60085

FOR: GAMING MACHINES THAT GENERATE OR DISPLAY WAGER OUTCOMES; GAMING SOFTWARE THAT GENERATES OR DISPLAYS WAGER OUTCOMES OF GAMING MACHINES, IN CLASS 9 (U.S. CLS. 21, 23, 26, 36 AND 38).

FIRST USE 2-20-2008; IN COMMERCE 2-20-2008.

THE MARK CONSISTS OF STANDARD CHARACTERS WITHOUT CLAIM TO ANY PARTICULAR FONT, STYLE, SIZE, OR COLOR.

SN 77-117,033, FILED 2-27-2007.

LESLEY LAMOTHE, EXAMINING ATTORNEY

**Int. Cl.: 20**

**Prior U.S. Cls.: 2, 13, 22, 25, 32, and 50**

**United States Patent and Trademark Office**

**Reg. No. 3,468,788**

**Registered July 15, 2008**

**TRADEMARK  
PRINCIPAL REGISTER**



RSM FURNITURE RESOURCES (CALIFORNIA CORPORATION)  
2807 BARRANCA PARKWAY  
IRVINE, CA 92606

FOR: BEDS; BENCHES; CHAIRS; CHAISE LOUNGES; COUCHES; DESKS; DINING CHAIRS; DINING ROOM TABLES; DINING TABLES; DRESSERS; FURNITURE; FURNITURE, NAMELY, WALL UNITS; INDOOR WINDOW BLINDS; LOUNGE CHAIRS; LOVE SEATS; OFFICE CHAIRS; OFFICE DESKS; OFFICE FURNITURE; OFFICE SEATS; OFFICE TABLES; RECLINERS; SEATING FURNI-

TURE; SEATS; SOFAS; TABLES; WRITING DESKS, IN CLASS 20 (U.S. CLS. 2, 13, 22, 25, 32 AND 50).

FIRST USE 9-12-2001; IN COMMERCE 10-16-2001.

THE MARK CONSISTS OF SQUARE DESIGN WITH ANGLED LINES INSIDE THE SQUARE.

SN 77-117,340, FILED 2-27-2007.

AMY HELLA, EXAMINING ATTORNEY

**Int. Cl.: 16**

**Prior U.S. Cls.: 2, 5, 22, 23, 29, 37, 38, and 50**

**United States Patent and Trademark Office**

**Reg. No. 3,468,789**

**Registered July 15, 2008**

---

**TRADEMARK  
PRINCIPAL REGISTER**

**TRUFLEX**

DOMTAR INC. (CANADA CORPORATION)  
395 DE MAISONNEUVE BLVD. WEST  
MONTRAL, CANADA H3A1L6

THE MARK CONSISTS OF STANDARD CHAR-  
ACTERS WITHOUT CLAIM TO ANY PARTICULAR  
FONT, STYLE, SIZE, OR COLOR.

FOR: PRINTING PAPER, IN CLASS 16 (U.S. CLS. 2,  
5, 22, 23, 29, 37, 38 AND 50).

SN 77-117,612, FILED 2-27-2007.

FIRST USE 3-5-2007; IN COMMERCE 3-5-2007.

HELENE LIWINSKI, EXAMINING ATTORNEY

**Int. Cls.: 3, 9, and 14**

**Prior U.S. Cls.: 1, 2, 4, 6, 21, 23, 26, 27, 28, 36, 38, 50, 51, and 52**

**Reg. No. 3,468,790**

**United States Patent and Trademark Office**

**Registered July 15, 2008**

**TRADEMARK  
PRINCIPAL REGISTER**

**RADIOSHACK TECHNOLOGY PLUS**

TRS QUALITY, INC. (DELAWARE CORPORATION)  
MAIL STOP # CF4-101  
300 RADIOSHACK CIRCLE  
FORT WORTH, TX 76102

FOR: SPRAY CLEANING PREPARATION FOR TELEVISION TUNERS, IN CLASS 3 (U.S. CLS. 1, 4, 6, 50, 51 AND 52).

FIRST USE 8-1-2007; IN COMMERCE 8-1-2007.

FOR: DISK JOCKEY EQUIPMENT, NAMELY, AUDIO MIXERS, AMPLIFIERS, EQUALIZERS, SOUND RECEIVERS AND TURNTABLES; TIRE GAUGES; GOLF SCOPES; COMPASSES; KARAOKE MACHINES; DIGITAL VIDEO RECORDERS; HOME AUDIO AND VIDEO COMPONENTS, NAMELY, RECEIVERS, CD PLAYERS, DVD PLAYERS, HOME THEATER SYSTEM COMPRISING RECEIVERS, LCD DISPLAY SCREENS, LOUDSPEAKERS AND REMOTE CONTROLS FOR SUCH ITEMS; RADIOS, RADIOS INCORPORATING CLOCKS, AND HD RECEIVERS AND TUNERS; AND PORTABLE AUDIO AND VIDEO COMPONENTS, NAMELY, CD PLAYERS, BOOM BOXES, DVD PLAYERS, MP3 PLAYERS, AND HEADPHONES; PROTECTIVE CARRYING CASES FOR PORTABLE MUSIC PLAYERS, NAMELY, MP3 PLAYERS; ARM BANDS FOR CARRYING PORTABLE MUSIC PLAYERS, NAMELY, MP3 PLAYERS; COMPUTER DOCKING STATIONS; PORTABLE SPEAKERS; VIDEO SCREENS; VIDEO ADAPTORS AND CORDS; WIRELESS ADAPTORS; POWER ADAPTORS AND CHARGERS; FM TRANSMITTERS; CASSETTE ADAPTERS; CAMERA MODULES, AND CABLE MANAGING DEVICES, NAMELY, JUMP LEADS AND CONNECTORS; SPEAKER DOCK; INLINE REMOTES FOR PORTABLE MUSIC PLAYERS, NAMELY, CD PLAYERS AND MP3 PLAYERS; STEREO TUNERS; AUDIO SPEAKERS AND AUDIO SPEAKER ENCLOSURES;

RADIO RECEIVING APPARATUS, NAMELY, MICROPHONES AND SWITCHES; INTERCOMS, WIRELESS REMOTE CONTROL UNITS, AND WIRELESS ROOM MONITORS; ELECTRONIC COMMUNICATIONS EQUIPMENT, NAMELY, PAGERS, TELEPHONES AND FACSIMILE MACHINES AND PARTS THEREFOR; PHONOGRAPH STYLUS, NEEDLES AND CARTRIDGES, BLANK AUDIO AND VIDEO RECORDING TAPES; ELECTRONIC CALCULATORS; DRY CELL BATTERIES; ELECTRICAL TELEPHONE ANSWERING APPARATUS AND TELEPHONE AMPLIFIERS; MICROCOMPUTER SYSTEMS COMPRISING MICROPROCESSORS, KEYBOARDS, VIDEO DISPLAYS, IN THE NATURE OF CRT'S (CATHODE RAY TUBES) FOR USE IN CONNECTION WITH COMPUTER DISPLAYS, COMPUTER MEMORIES, AND DATA CASSETTE RECORDERS AND PRE-RECORDED CASSETTES COMPRISED OF COMPUTER OPERATING SOFTWARE, DATABASE MANAGEMENT SOFTWARE, WORD PROCESSING SOFTWARE AND SPREADSHEET SOFTWARE RECORDED THEREON; VIDEO EQUIPMENT, NAMELY, TELEVISIONS AND SATELLITE TV ANTENNAS; MULTITESTERS FOR MEASURING VOLTAGE CURRENTS AND RESISTANCE, VOLTMETERS, OHMMETERS, SOUND LEVEL METERS, THICKNESS GAUGES, COMPASSES, MICROSCOPES, BINOCULARS, COMBINATION TELESCOPES AND MICROSCOPES, MAGNIFYING LENSES, BUILT-IN TEST LAMPS FOR PHOTOGRAPHIC FLASH GUNS, AND PHOTOGRAPHIC TIMERS; RADAR DETECTORS FOR AUTOMOTIVE USE, BATTERY TESTERS, DC POWER SUPPLIES, NONMEDICAL ELECTRONIC THERMOMETERS; ELECTRICAL COMPONENTS, NAMELY, RADIO AND TELEVISION INTERFERENCE FILTERS, PLUG CONNECTORS, ELECTRICAL RESISTANCE WIRE, GROUND RODS, CABLE CLIPS, ELECTRICAL SWITCHES, TRANSISTORS, IC GATES, POTENTIOMETERS, RESISTORS, AMPLIFIERS,

VOLTAGE REGULATORS, FLIP-FLOP TRIGGER CIRCUITS, COUNTERS/DIVIDERS FOR USE AS IC TUNERS, IC DRIVERS, VOLTAGE COMPARATORS, RECTIFIERS, DIODES, CAPACITORS, TUBULAR ELECTROLYTES, PRINTED CIRCUIT BOARDS AND TERMINALS THEREFOR, CB AND SCANNER ANTENNAS, UHF/VHF TELEVISION ANTENNAS, FM ANTENNAS, COAXIAL CABLES, TWIN LEAD CABLES, ELECTRIC SOLDERING IRONS, ELECTRIC SOLDERING GUNS, ELECTRICAL ENGRAVING PENCILS, REMOTE CONTROL TELEVISION TIMER, BICYCLE RADIOS, PHOTO-ELECTRIC-EYE RELAY UNITS, ANTENNA ROTORS, AC LINE INTERFERENCE FILTERS AND BATTERY CHARGERS; VIDEO PROCESSOR, CAMCORDER/VCR DUBBING PROCESSOR, VIDEO SELECTOR SWITCH, MULTIPLE VIDEO DISTRIBUTION SWITCH, NAMELY, A SYSTEM THAT WILL SEND SIGNALS FROM A CABLE BOX, VCR SATELLITE SYSTEM OR ANTENNA TO SEVERAL TELEVISIONS IN THE SAME HOUSE, WITH ONE COAXIAL CABLE, ELECTRICAL CABLE CONNECTOR, REMOTE CONTROL EXTENDER IN THE NATURE OF A SIGNAL AMPLIFIER, VIDEO AMPLIFIER/ENHANCER, NON-ELECTRIC WALL STUD FINDER, ELECTRONIC AUTOMOBILE NOISE FILTERS USED TO REDUCE IGNITION/ALTERNATOR, ENGINE AND SPARK PLUG NOISE INTERFERENCE, AUTOMOBILE CIGARETTE LIGHTER POWER ADAPTER, FUSES FOR ELECTRONIC EQUIPMENT AND VEHICLES, WIRING HARNESS ADAPTERS TO ATTACH NEW CAR STEREO WIRING TO MANUFACTURER'S WIRING HARNESS, VOLTAGE SPIKE PROTECTORS, AC POWERSTRIPS AND OUTLET PLUGS, AC EXTENSION CORDS, INFRARED FLOODLIGHT SECURITY SYSTEMS COMPRISED OF INFRARED MOTION DETECTORS, DOOR AND WINDOW SENSORS, LAMP DIMMER MODULE AND REMOTE CONTROLS, MAGNETS, TELEPHONE PLUGS, TELEPHONE JACKS, TELEPHONE WIRE, TELEPHONE CABLE, TELEPHONE CONNECTION ADAPTERS, SATELLITE TV NOISE BLOCK CONVERTERS, FEED HORN ANTENNAS, WIRELESS TV TRANSMITTERS/RECEIVERS, CAMCORDER CARRYING CASES, CAMCORDER TRIPODS, CABLE TV CONVERTER, ELECTRIC DOOR CHIMES, AC POWER CORDS AND EXTENSION CORDS, AUDIO CONNECTORS, AUDIO CONNECTION ADAPTERS, POWER TRANSFORMERS, AC-TO-DC VOLTAGE ADAPTERS, DC-TO-AC VOLTAGE ADAPTERS, DC POWER CORDS AND EXTENSION CORDS, SHORTWAVE ANTENNAS, AUDIO TRANSFORMERS, ELECTRONIC TEST EQUIPMENT CONNECTION ADAPTERS, MULTI-CONDUCTOR CABLE, AMATEUR RADIO ANTENNAS, AMATEUR RADIO ANTENNA COMPONENTS, NAMELY, STEEL SPRINGS, CLAMPS, CLIPS, AMATEUR RADIO CONNECTORS, MIRROR/LUGGAGE RACK BRACKETS, AND REPLACEMENT WHIPS; ELECTRIC BUZZERS, ELECTRIC RELAYS FOR AC AND DC POW-

ER, MERCURY SWITCHES, RELAY SOCKETS, SOLDER TYPE PRINTER CONNECTORS, IDC TYPE PRINTER CONNECTORS, INFRARED DIODES, INFRARED PHOTO TRANSISTORS, INFRARED SENSOR, TEMPERATURE MODULE, NAMELY, A THERMOMETER WITH CAPABILITIES TO CONTROL A BUZZER, LED, FAN OR HEATER AT PRESENT TEMPERATURES; ELECTRONIC COUNTER MODULE, SOLAR KITS COMPRISED OF SOLAR CELL PREWIRED TO SMALL DC MOTOR, COLOR WHEELS, PROPELLER AND DATA BOOKLET, MINIATURE AMPLIFIERS AND MAGNIFYING GLASSES; CAMCORDERS, DIGITAL CAMERAS, PHOTO PRINTERS, FLASH MEMORY CARDS, FLASH CARD READERS, POWER INVERTERS, SURGE PROTECTORS AND POWER STRIPS, TELEVISIONS, DVD RECORDERS, DIGITAL VIDEO RECORDERS, SATELLITE TELEVISION SYSTEMS COMPRISED OF RECEIVERS AND TRANSMITTERS, PROJECTORS, STEREO SHELF SYSTEMS, NAMELY, STEREOS, SPEAKERS AND ELECTRICAL CONNECTIONS, CASSETTE DECKS, ELECTRICAL CONNECTORS, ELECTRICAL WIRE, AUDIO/VISUAL CABLES, RADAR DETECTORS, ELECTRONIC DRIVER NAVIGATION UNITS, HOME SECURITY SYSTEMS, VOICE RECORDERS, ELECTRONIC DATA ORGANIZERS, DIGITAL COPIERS, INTERCOMS, DESKTOP COMPUTERS, NOTEBOOK COMPUTERS, PERSONAL DIGITAL ASSISTANTS, COMPUTER MONITORS, PRINTERS, DIGITAL DISK DRIVES, CENTRAL PROCESSING UNITS, MEMORY CARDS, MOTHERBOARDS, COMPUTER CARRYING CASES, SOUND CARDS, VIDEO DISPLAY CARDS, INTERNET PHONES, WALKIE-TALKIE RADIOS, PAGERS, SCANNER, WEATHER RADIOS, CORDLESS PHONES, WIRELESS PHONE ACCESSORIES, NAMELY, CHARGERS AND HANDS FREE DEVICES, IN CLASS 9 (U.S. CLS. 21, 23, 26, 36 AND 38).

FIRST USE 8-1-2007; IN COMMERCE 8-1-2007.

FOR: CLOCKS AND WATCHES , IN CLASS 14 (U.S. CLS. 2, 27, 28 AND 50).

FIRST USE 8-1-2007; IN COMMERCE 8-1-2007.

THE MARK CONSISTS OF STANDARD CHARACTERS WITHOUT CLAIM TO ANY PARTICULAR FONT, STYLE, SIZE, OR COLOR.

OWNER OF U.S. REG. NOS. 2,019,438, 2,164,296, AND OTHERS.

NO CLAIM IS MADE TO THE EXCLUSIVE RIGHT TO USE "TECHNOLOGY PLUS", APART FROM THE MARK AS SHOWN.

SN 77-117,625, FILED 2-27-2007.

JAY FLOWERS, EXAMINING ATTORNEY

**Int. Cl.: 9**

**Prior U.S. Cls.: 21, 23, 26, 36, and 38**

**United States Patent and Trademark Office**

**Reg. No. 3,468,791**

**Registered July 15, 2008**

---

**TRADEMARK  
PRINCIPAL REGISTER**

**ENTRUST**

PARA SYSTEMS, INC. (TEXAS CORPORATION)  
1455 LEMAY DRIVE  
CARROLLTON, TX 75007

THE MARK CONSISTS OF STANDARD CHAR-  
ACTERS WITHOUT CLAIM TO ANY PARTICULAR  
FONT, STYLE, SIZE, OR COLOR.

FOR: ELECTRICAL POWER SUPPLIES, IN CLASS  
9 (U.S. CLS. 21, 23, 26, 36 AND 38).

SN 77-117,718, FILED 2-27-2007.

FIRST USE 5-0-2007; IN COMMERCE 5-0-2007.

H. M. FISHER, EXAMINING ATTORNEY

**Int. Cl.: 32**

**Prior U.S. Cls.: 45, 46, and 48**

**United States Patent and Trademark Office**

**Reg. No. 3,468,792**

**Registered July 15, 2008**

**TRADEMARK  
PRINCIPAL REGISTER**



IZZE BEVERAGE CO. (DELAWARE CORPORATION)  
2990 CENTER GREEN COURT SOUTH  
BOULDER, CO 10577

FOR: LIGHT BEVERAGES, NAMELY, SOFT DRINKS, FRUIT JUICE DRINKS, IN CLASS 32 (U.S. CLS. 45, 46 AND 48).

FIRST USE 5-1-2007; IN COMMERCE 5-1-2007.

OWNER OF U.S. REG. NO. 2,697,979.

THE MARK CONSISTS OF A CROSS SECTION FRUIT SLICE DESIGN AND THE WORDS "IZZE ESQUE" IN STYLIZED FORM.

SN 77-118,524, FILED 2-28-2007.

ANNE MADDEN, EXAMINING ATTORNEY



**Int. Cl.: 32**

**Prior U.S. Cls.: 45, 46, and 48**

**United States Patent and Trademark Office**

**Reg. No. 3,468,793**

**Registered July 15, 2008**

**TRADEMARK  
PRINCIPAL REGISTER**

**IZZE  
ESQUE**

IZZE BEVERAGE CO. (DELAWARE CORPORATION)  
2990 CENTER GREEN COURT SOUTH  
BOULDER, CO 10577

FOR: LIGHT BEVERAGES, NAMELY, SOFT DRINKS, FRUIT JUICE DRINKS, IN CLASS 32 (U.S. CLS. 45, 46 AND 48).

FIRST USE 5-1-2007; IN COMMERCE 5-1-2007.

OWNER OF U.S. REG. NO. 2,697,979.

THE MARK CONSISTS OF THE WORDS "IZZE ESQUE" IN STYLIZED FORM.

SN 77-118,531, FILED 2-28-2007.

ANNE MADDEN, EXAMINING ATTORNEY

Int. Cl.: 3

Prior U.S. Cls.: 1, 4, 6, 50, 51, and 52

United States Patent and Trademark Office

Reg. No. 3,468,794

Registered July 15, 2008

TRADEMARK  
PRINCIPAL REGISTER

The logo features a stylized lowercase letter 'i' in red with a solid red dot above it. To the right of the 'i' is the word 'STRAIGHT' in a bold, black, sans-serif font. Below the 'i' and 'STRAIGHT' is the word 'SYSTEM' in a smaller, black, sans-serif font, with each letter centered under the corresponding letter of 'STRAIGHT'.

I.B.S. BEAUTY, INC. (CALIFORNIA CORPORATION)  
10015 PIONEER BLVD.  
SANTA FE SPRINGS, CA 90670

FOR: HAIR STRAIGHTENING PREPARATIONS,  
IN CLASS 3 (U.S. CLS. 1, 4, 6, 50, 51 AND 52).

FIRST USE 7-15-2007; IN COMMERCE 7-15-2007.

NO CLAIM IS MADE TO THE EXCLUSIVE  
RIGHT TO USE "STRAIGHT SYSTEM", APART  
FROM THE MARK AS SHOWN.

THE COLOR(S) RED AND BLACK IS/ARE  
CLAIMED AS A FEATURE OF THE MARK.

THE MARK CONSISTS OF STYLIZED WORDS  
OF "ISTRAIGHT SYSTEM". THE COLOR RED AP-  
PEARS IN THE LETTER "I" AND THE COLOR  
BLACK APPEARS IN THE WORDS "STRAIGHT  
SYSTEM".

SN 77-118,657, FILED 2-28-2007.

JORDAN BAKER, EXAMINING ATTORNEY

**Int. Cl.: 30**

**Prior U.S. Cl.: 46**

**United States Patent and Trademark Office**

**Reg. No. 3,468,795**

**Registered July 15, 2008**

**TRADEMARK  
PRINCIPAL REGISTER**

**BEDAZZLE MY BONBONS**

BLING MY BONBONS, INC. (FLORIDA CORPORATION)  
601 NE 36TH STREET SUITE 1404  
MIAMI, FL 33137

FOR: CANDIES, NAMELY, CHOCOLATES AND  
BONBONS, IN CLASS 30 (U.S. CL. 46).

FIRST USE 3-9-2007; IN COMMERCE 5-22-2007.

THE MARK CONSISTS OF STANDARD CHARACTERS WITHOUT CLAIM TO ANY PARTICULAR FONT, STYLE, SIZE, OR COLOR.

NO CLAIM IS MADE TO THE EXCLUSIVE RIGHT TO USE "BONBONS", APART FROM THE MARK AS SHOWN.

SN 77-118,698, FILED 2-28-2007.

KATHERINE M. DUBRAY, EXAMINING ATTORNEY

**Int. Cl.: 9**

**Prior U.S. Cls.: 21, 23, 26, 36, and 38**

**United States Patent and Trademark Office**

**Reg. No. 3,468,796**

**Registered July 15, 2008**

**TRADEMARK  
PRINCIPAL REGISTER**

**FIREPEX**

REHAU INCORPORATED (DELAWARE CORPORATION)  
1501 EDWARDS FERRY ROAD  
LEESBURG, VA 20176

THE MARK CONSISTS OF STANDARD CHARACTERS WITHOUT CLAIM TO ANY PARTICULAR FONT, STYLE, SIZE, OR COLOR.

FOR: SPRINKLER SYSTEMS FOR FIRE PROTECTION, IN CLASS 9 (U.S. CLS. 21, 23, 26, 36 AND 38).

SN 77-118,742, FILED 2-28-2007.

FIRST USE 4-2-2007; IN COMMERCE 4-2-2007.

JENNY PARK, EXAMINING ATTORNEY

**Int. Cl.: 36**

**Prior U.S. Cls.: 100, 101, and 102**

**United States Patent and Trademark Office**

**Reg. No. 3,468,797**

**Registered July 15, 2008**

**SERVICE MARK  
PRINCIPAL REGISTER**

# ASSURELEASE

ASSURELEASE LLC (DELAWARE CORPORATION)  
448 62ND STREET  
NEWPORT BEACH, CA 92663

FOR: INSURANCE SERVICES, NAMELY, STRUCTURING, UNDERWRITING AND PRICING INSURANCE FOR PROPERTY OWNERS OR MANAGERS RELATIVE TO POTENTIAL TENANT DAMAGES FOR PROPERTY DAMAGE AND LOSS OF RENTAL INCOME DUE TO TENANT NON-COMPLIANCE WITH LEASE AND RENTAL AGREEMENTS, AND LOSSES INCURRED IN EVICTION PROCEEDINGS; INSURANCE ADMINISTRATION, NAMELY, MONITORING OF CLAIMS BY PROPERTY OWNERS OR

MANAGERS FOR TENANT DAMAGES TO PROPERTY OR LOSSES DUE TO NON-COMPLIANCE BY TENANTS WITH LEASE OR RENTAL AGREEMENTS, IN CLASS 36 (U.S. CLS. 100, 101 AND 102).

FIRST USE 12-13-2006; IN COMMERCE 12-13-2006.

THE MARK CONSISTS OF STANDARD CHARACTERS WITHOUT CLAIM TO ANY PARTICULAR FONT, STYLE, SIZE, OR COLOR.

SN 77-118,940, FILED 2-28-2007.

NAAKWAMA ANKRAH, EXAMINING ATTORNEY

**Int. Cl.: 33**

**Prior U.S. Cls.: 47 and 49**

**United States Patent and Trademark Office**

**Reg. No. 3,468,798**

**Registered July 15, 2008**

**TRADEMARK  
PRINCIPAL REGISTER**

**JEAN SAINT HONORÉ**

MARGATE WINE AND SPIRIT COMPANY, LLC  
(NEW JERSEY LTD LIAB CO)  
3303 ATLANTIC AVENUE  
ATLANTIC CITY, NJ 08401

THE NAME(S), PORTRAIT(S), AND/OR SIGNATURE(S) SHOWN IN THE MARK DOES NOT IDENTIFY A PARTICULAR LIVING INDIVIDUAL.

FOR: WINES, IN CLASS 33 (U.S. CLS. 47 AND 49).

FIRST USE 11-6-2007; IN COMMERCE 11-6-2007.

SN 77-119,092, FILED 2-28-2007.

THE MARK CONSISTS OF STANDARD CHARACTERS WITHOUT CLAIM TO ANY PARTICULAR FONT, STYLE, SIZE, OR COLOR.

LINDA POWELL, EXAMINING ATTORNEY

Int. Cl.: 16

Prior U.S. Cls.: 2, 5, 22, 23, 29, 37, 38, and 50

United States Patent and Trademark Office

Reg. No. 3,468,799

Registered July 15, 2008

TRADEMARK  
PRINCIPAL REGISTER

ABREATH  
OF FRESH  
STATIONAIRY

MORTEN, ALISHA CONNIE (UNITED STATES  
INDIVIDUAL)  
1831 DANVILLE  
MEMPHIS, TN 38117

FOR: STATIONERY, IN CLASS 16 (U.S. CLS. 2, 5,  
22, 23, 29, 37, 38 AND 50).

FIRST USE 5-30-2008; IN COMMERCE 5-30-2008.

NO CLAIM IS MADE TO THE EXCLUSIVE  
RIGHT TO USE "STATIONERY", APART FROM  
THE MARK AS SHOWN.

THE MARK CONSISTS OF WORD "STATION-  
ERY" IS MISSPELLED TO INCORPORATE "AIR"  
INTO "STATION(AIR)Y" AND A FORM OF PAR-  
ENTHESIS IS AROUND "AIR" TO BRING MEAN-  
ING TO TITLE.

SN 77-119,174, FILED 2-28-2007.

DANIEL BRODY, EXAMINING ATTORNEY

**Int. Cl.: 35**

**Prior U.S. Cls.: 100, 101, and 102**

**United States Patent and Trademark Office**

**Reg. No. 3,468,800**

**Registered July 15, 2008**

**SERVICE MARK  
PRINCIPAL REGISTER**



ASSOCIATION HEALTHCARE MANAGEMENT,  
INC. (TEXAS CORPORATION)  
9791 WESTHEIMER ROAD, NO. 530  
HOUSTON, TX 77042

FOR: COST MANAGEMENT FOR THE HEALTH  
CARE BENEFIT PLANS OF OTHERS; HEALTH  
CARE COST CONTAINMENT; HEALTH CARE  
COST REVIEW; HEALTH CARE UTILIZATION  
AND REVIEW SERVICES, IN CLASS 35 (U.S. CLS.  
100, 101 AND 102).

FIRST USE 3-15-2004; IN COMMERCE 3-15-2004.

OWNER OF U.S. REG. NO. 3,182,535.

NO CLAIM IS MADE TO THE EXCLUSIVE  
RIGHT TO USE "PROVIDER NETWORK, INC",  
APART FROM THE MARK AS SHOWN.

THE COLOR(S) MAROON, GRAY, AND WHITE  
IS/ARE CLAIMED AS A FEATURE OF THE MARK.

THE COLOR MAROON APPEARS IN THE LET-  
TERS "PPNI", THE WORDS "PREMIER PROVIDER  
NETWORK, INC", IN THE LINES AND THE DE-  
SIGN OF AMERICA IN THE GLOBE. THE COLOR  
GRAY APPEARS IN THE GLOBE AND THE LINE  
UNDERNEATH THE LETTERS "PPNI". THE COL-  
OR WHITE APPEARS IN THE OTHER LAND POR-  
TIONS OF THE GLOBE.

SN 77-119,374, FILED 3-1-2007.

ANNE FARRELL, EXAMINING ATTORNEY



**Int. Cl.: 44**

**Prior U.S. Cls.: 100 and 101**

**United States Patent and Trademark Office**

**Reg. No. 3,468,801**

**Registered July 15, 2008**

**SERVICE MARK  
PRINCIPAL REGISTER**

**CONSIGN ADVANTAGE**

BLOOD DIAGNOSTICS, INC. (SOUTH CAROLINA CORPORATION)  
110 CENTRUM DRIVE  
IRMO, SC 29063

FOR: BLOOD BANKS; COLLECTION AND PRESERVATION OF HUMAN BLOOD, IN CLASS 44 (U.S. CLS. 100 AND 101).

FIRST USE 1-15-2007; IN COMMERCE 1-15-2007.

THE MARK CONSISTS OF STANDARD CHARACTERS WITHOUT CLAIM TO ANY PARTICULAR FONT, STYLE, SIZE, OR COLOR.

SN 77-119,585, FILED 3-1-2007.

GINA HAYES, EXAMINING ATTORNEY

**Int. Cl.: 3**

**Prior U.S. Cls.: 1, 4, 6, 50, 51, and 52**

**Reg. No. 3,468,802**

**United States Patent and Trademark Office**

**Registered July 15, 2008**

---

**TRADEMARK  
PRINCIPAL REGISTER**

**THE BEAUTY OF INVENTION**

KAO KABUSHIKI KAISHA A/T/A KAO COR-  
PORATION (JAPAN CORPORATION)  
14-10, NIHONBASHI KAYABACHO 1-CHOME  
CHUO-KU, TOKYO, JAPAN 103-8210

THE MARK CONSISTS OF STANDARD CHAR-  
ACTERS WITHOUT CLAIM TO ANY PARTICULAR  
FONT, STYLE, SIZE, OR COLOR.

FOR: HAIR CARE PREPARATIONS, IN CLASS 3  
(U.S. CLS. 1, 4, 6, 50, 51 AND 52).

SN 77-119,601, FILED 3-1-2007.

FIRST USE 12-1-2007; IN COMMERCE 12-1-2007.

GIANCARLO CASTRO, EXAMINING ATTORNEY

**Int. Cl.: 3**

**Prior U.S. Cls.: 1, 4, 6, 50, 51, and 52**

**United States Patent and Trademark Office**

**Reg. No. 3,468,803**

**Registered July 15, 2008**

**TRADEMARK  
PRINCIPAL REGISTER**



I.B.S. BEAUTY, INC. (CALIFORNIA CORPORATION)  
10015 PIONEER BLVD.  
SANTA FE SPRINGS, CA 90670

FOR: HAIR CARE PREPARATIONS; HAIR CONDITIONER; HAIR GEL; HAIR LOTIONS; HAIR MOUSSE; HAIR NOURISHERS; HAIR OILS; HAIR RELAXERS; HAIR RELAXING PREPARATIONS; HAIR SHAMPOO; HAIR SPRAY; HAIR STYLING GEL; HAIR STYLING PREPARATIONS; HAIR STYLING SPRAY; OILS FOR HAIR CONDITIONING, IN CLASS 3 (U.S. CLS. 1, 4, 6, 50, 51 AND 52).

FIRST USE 7-15-2007; IN COMMERCE 7-15-2007.

THE COLOR(S) GREEN AND YELLOW-GREEN IS/ARE CLAIMED AS A FEATURE OF THE MARK.

THE MARK CONSISTS OF SYLIZED WORDS OF "PROSYS" AND A STYLIZED DRAWING OF SEAWEED. THE COLOR GREEN APPEARS IN THE WORDS "PROSYS" AND THE COLOR YELLOW-GREEN APPEARS IN THE DRAWING OF SEAWEED.

SN 77-119,644, FILED 3-1-2007.

JORDAN BAKER, EXAMINING ATTORNEY

**Int. Cl.: 18**

**Prior U.S. Cls.: 1, 2, 3, 22, and 41**

**Reg. No. 3,468,804**

**United States Patent and Trademark Office**

**Registered July 15, 2008**

---

**TRADEMARK  
PRINCIPAL REGISTER**

**PAKUMI**

CHRISTMAS, KATHARINE R. (UNITED STATES  
INDIVIDUAL)  
601 BONNIE BRAE PLACE  
RIVER FOREST, IL 60305

FOR: TRAVEL ACCESSORIES, NAMELY, CARRYING CASES, OVERNIGHT CASES, TOILETRY CASES, TRAVELING CASES, AND VANITY CASES, ALL SOLD EMPTY, IN CLASS 18 (U.S. CLS. 1, 2, 3, 22 AND 41).

FIRST USE 5-12-2008; IN COMMERCE 5-12-2008.

THE MARK CONSISTS OF STANDARD CHARACTERS WITHOUT CLAIM TO ANY PARTICULAR FONT, STYLE, SIZE, OR COLOR.

SN 77-119,725, FILED 3-1-2007.

TOBY BULLOFF, EXAMINING ATTORNEY

**Int. Cl.: 35**

**Prior U.S. Cls.: 100, 101, and 102**

**United States Patent and Trademark Office**

**Reg. No. 3,468,805**

**Registered July 15, 2008**

**SERVICE MARK  
PRINCIPAL REGISTER**

**USBBC**

THE CHAMBER OF COMMERCE OF THE UNITED STATES OF AMERICA (D.C. CORPORATION)  
1615 H STREET, NW  
WASHINGTON, DC 20062

FOR: ASSOCIATION SERVICES, NAMELY, PROMOTING THE INTERESTS OF AND UNDERSTANDING BETWEEN BUSINESS SECTORS OF BAHRAIN AND THE UNITED STATES, IN CLASS 35 (U.S. CLS. 100, 101 AND 102).

FIRST USE 10-0-2006; IN COMMERCE 10-0-2006.

THE MARK CONSISTS OF STANDARD CHARACTERS WITHOUT CLAIM TO ANY PARTICULAR FONT, STYLE, SIZE, OR COLOR.

SN 77-120,079, FILED 3-1-2007.

CHRISTOPHER BUONGIORNO, EXAMINING ATTORNEY

**Int. Cls.: 9, 41, and 42**

**Prior U.S. Cls.: 21, 23, 26, 36, 38, 100, 101, and 107**

**United States Patent and Trademark Office**

**Reg. No. 3,468,806**

**Registered July 15, 2008**

**TRADEMARK  
SERVICE MARK  
PRINCIPAL REGISTER**



NUCREDO LLC (DELAWARE LTD LIAB CO)  
101 MONTANA DEL LAGO DR.  
RANCHO SANTA MARGARITA, CA 92688

FOR: DOWNLOADABLE COMPUTER SOFTWARE FOR CORPORATE AND BUSINESS SOLUTIONS FOR USE IN BUSINESS MANAGEMENT, FINANCE, PURCHASING, MARKETING, SALES, HUMAN RESOURCES, AND INFORMATION TECHNOLOGY INFRASTRUCTURE FOR USE IN BUSINESS PROCESS AUTOMATION, SALES FORCE AUTOMATION, CUSTOMER RELATIONSHIP MANAGEMENT, ACCOUNTING, PAYROLL, BILL PAYING, EMPLOYEE TIME MANAGEMENT, BILLING AND EXPENSE REPORTING, FINANCIAL MANAGEMENT, COLLABORATION PLATFORMS, BUSINESS MANAGEMENT, BUSINESS TO BUSINESS TRANSACTIONS, WORKFLOW MANAGEMENT, BUSINESS DOCUMENT MANAGEMENT, ENTERPRISE RESOURCE PLANNING, CUSTOMER SUPPORT, OFFICE AND BUSINESS PRODUCTIVITY, ELECTRONIC COMMERCE TRANSACTIONS, AND ELECTRONIC BUSINESS TRANSACTIONS, IN CLASS 9 (U.S. CLS. 21, 23, 26, 36 AND 38).

FIRST USE 12-15-2004; IN COMMERCE 12-15-2004.

FOR: TRAINING IN THE FIELD OF COMPUTER SOFTWARE; ARRANGING AND CONDUCTING TRAINING WORKSHOPS IN THE FIELD OF COMPUTER SOFTWARE, IN CLASS 41 (U.S. CLS. 100, 101 AND 107).

FIRST USE 12-15-2004; IN COMMERCE 12-15-2004.

FOR: APPLICATION SERVICE PROVIDER (ASP) FEATURING SOFTWARE IN THE FIELD OF COR-

PORATE AND BUSINESS SOLUTIONS FOR USE IN BUSINESS MANAGEMENT, FINANCE, PURCHASING, MARKETING, SALES, HUMAN RESOURCES, AND INFORMATION TECHNOLOGY INFRASTRUCTURE FOR USE IN BUSINESS PROCESS AUTOMATION, SALES FORCE AUTOMATION, CUSTOMER RELATIONSHIP MANAGEMENT, ACCOUNTING, PAYROLL, BILL PAYING, EMPLOYEE TIME MANAGEMENT, BILLING AND EXPENSE REPORTING, FINANCIAL MANAGEMENT, COLLABORATION PLATFORMS, BUSINESS MANAGEMENT, BUSINESS TO BUSINESS TRANSACTIONS, WORKFLOW MANAGEMENT, BUSINESS DOCUMENT MANAGEMENT, ENTERPRISE RESOURCE PLANNING, CUSTOMER SUPPORT, OFFICE AND BUSINESS PRODUCTIVITY, ELECTRONIC COMMERCE TRANSACTIONS, AND ELECTRONIC BUSINESS TRANSACTIONS; APPLICATION SERVICE PROVIDER (ASP), NAMELY, HOSTING COMPUTER SOFTWARE APPLICATIONS FOR USE BY OTHERS; COMPUTER NETWORK DESIGN AND COMPUTER SOFTWARE DESIGN FOR THE CORPORATE AND BUSINESS ENVIRONMENT; COMPUTER NETWORK DESIGN FOR OTHERS; RENTAL OF APPLICATION SOFTWARE; REPAIR OF COMPUTER SOFTWARE; RESEARCH, DEVELOPMENT AND CONSULTATION RELATED THERETO IN THE FIELD OF COMPUTER SOFTWARE DEVELOPMENT AND SOLUTIONS; TECHNICAL SUPPORT SERVICES, NAMELY, TROUBLESHOOTING OF COMPUTER SOFTWARE PROBLEMS; CONSULTING SERVICES IN THE FIELD OF DESIGN, SELECTION, IMPLEMENTATION AND USE OF COMPUTER SOFTWARE FOR OTHERS; DEVELOPMENT, DESIGN, INSTALLATION, MAINTENANCE AND UPDATING OF COMPUTER SOFTWARE; WEBSITE HOSTING

SERVICES FOR OTHERS, IN CLASS 42 (U.S. CLS. 100 AND 101).

THE MARK CONSISTS OF TWO ARCHES EN-CASING A SEMI-CIRCLE.

SN 77-120,124, FILED 3-1-2007.

FIRST USE 12-15-2004; IN COMMERCE 12-15-2004.

AISHA SALEM, EXAMINING ATTORNEY

**Int. Cl.: 10**

**Prior U.S. Cls.: 26, 39, and 44**

**Reg. No. 3,468,807**

**United States Patent and Trademark Office**

**Registered July 15, 2008**

**TRADEMARK  
PRINCIPAL REGISTER**

**PROXCELAN**

ISORAY MEDICAL, INC. (DELAWARE CORPORATION)  
SUITE 106  
350 HILLS STREET  
RICHLAND, WA 99354

FOR: IMPLANTABLE RADIATION THERAPY DEVICES CONSISTING PRIMARILY OF RADIOACTIVE SEEDS AND A CARRIER ASSEMBLY FOR USE IN BRACHYTHERAPY OF CANCER, IN CLASS 10 (U.S. CLS. 26, 39 AND 44).

FIRST USE 10-0-2004; IN COMMERCE 11-0-2004.

THE MARK CONSISTS OF STANDARD CHARACTERS WITHOUT CLAIM TO ANY PARTICULAR FONT, STYLE, SIZE, OR COLOR.

SN 77-120,303, FILED 3-1-2007.

BERNICE MIDDLETON, EXAMINING ATTORNEY



**Int. Cl.: 25**

**Prior U.S. Cls.: 22 and 39**

**United States Patent and Trademark Office**

**Reg. No. 3,468,808**

**Registered July 15, 2008**

**TRADEMARK  
PRINCIPAL REGISTER**

**NY FOCUS 70**

M.RAFI SONS GARMENTS INDUSTRIES (USA)  
INC. (NEW JERSEY CORPORATION)  
1463 PINWOOD ST.  
RAHWAY, NJ 07065

FOR: CAPS; HATS; JACKETS; JEANS; PANTS;  
SHIRTS; SHORTS; SKULLIES; SWEAT PANTS;  
SWEAT SHIRTS; SWEAT SHORTS; SWEAT SUITS;  
SWEATERS; T-SHIRTS; VESTS, IN CLASS 25 (U.S.  
CLS. 22 AND 39).

FIRST USE 4-16-2008; IN COMMERCE 4-16-2008.

THE MARK CONSISTS OF STANDARD CHAR-  
ACTERS WITHOUT CLAIM TO ANY PARTICULAR  
FONT, STYLE, SIZE, OR COLOR.

NO CLAIM IS MADE TO THE EXCLUSIVE  
RIGHT TO USE "NY", APART FROM THE MARK  
AS SHOWN.

SN 77-120,538, FILED 3-2-2007.

NAAKWAMA ANKRAH, EXAMINING ATTORNEY

**Int. Cl.: 5**

**Prior U.S. Cls.: 6, 18, 44, 46, 51, and 52**

**Reg. No. 3,468,809**

**United States Patent and Trademark Office**

**Registered July 15, 2008**

**TRADEMARK  
PRINCIPAL REGISTER**

**Dr. Ivy**

20-20 CONSULTING, LLC (NEVADA LTD LIAB  
CO)  
25027 NORTHAMPTON FOREST DR.  
SPRING, TX 77389

THE MARK CONSISTS OF STANDARD CHAR-  
ACTERS WITHOUT CLAIM TO ANY PARTICULAR  
FONT, STYLE, SIZE, OR COLOR.

FOR: ANTI-ITCH OINTMENT; ANTIALLERGIC  
MEDICINES; MEDICATED PRE-MOISTENED TO-  
WELETTES; MEDICATED PRE-MOISTENED  
WIPES; PRE-MOISTENED MEDICATED TISSUES;  
PRE-MOISTENED MEDICATED TOWELETTES;  
PRE-MOISTENED MEDICATED WIPES, IN CLASS  
5 (U.S. CLS. 6, 18, 44, 46, 51 AND 52).

THE NAME "DR. IVY" DOES NOT IDENTIFY A  
LIVING INDIVIDUAL.

SN 77-120,689, FILED 3-2-2007.

FIRST USE 7-2-2007; IN COMMERCE 7-2-2007.

ELLEN PERKINS, EXAMINING ATTORNEY

**Int. Cls.: 9, 37, 41, and 42**

**Prior U.S. Cls.: 21, 23, 26, 36, 38, 100, 101, 103, 106,  
and 107**

**Reg. No. 3,468,810**

**United States Patent and Trademark Office**

**Registered July 15, 2008**

**TRADEMARK  
SERVICE MARK  
PRINCIPAL REGISTER**

**VENTYX**

VENTYX INC. (DELAWARE CORPORATION)  
3301 WINDY RIDGE PARKWAY  
ATLANTA, GA 30339

FOR: COMPUTER APPLICATION SOFTWARE FOR BUSINESS MANAGEMENT IN THE FIELDS OF PUBLIC AND PRIVATE UTILITIES AND ENERGY COMPANIES, MANUFACTURING, CONSUMER PRODUCTS, HEALTH CARE, EDUCATION, CABLE AND TELECOMMUNICATIONS, GOVERNMENT, TRANSPORTATION AND THIRD PARTY SERVICE PROVIDERS, IN CLASS 9 (U.S. CLS. 21, 23, 26, 36 AND 38).

FIRST USE 4-2-2007; IN COMMERCE 4-2-2007.

FOR: INSTALLATION OF COMPUTER SYSTEMS FOR USE IN CONNECTION WITH BUSINESS MANAGEMENT IN THE FIELDS OF PUBLIC AND PRIVATE UTILITIES AND ENERGY COMPANIES, MANUFACTURING, CONSUMER PRODUCTS, HEALTH CARE, EDUCATION, CABLE AND TELECOMMUNICATIONS, GOVERNMENT, TRANSPORTATION AND THIRD PARTY SERVICE PROVIDERS, IN CLASS 37 (U.S. CLS. 100, 103 AND 106).

FIRST USE 4-2-2007; IN COMMERCE 4-2-2007.

FOR: COMPUTER TRAINING SERVICES IN THE FIELD OF APPLICATION SOFTWARE FOR BUSINESS MANAGEMENT IN THE FIELDS OF PUBLIC AND PRIVATE UTILITIES AND ENERGY COMPANIES, MANUFACTURING, CONSUMER PRODUCTS, HEALTH CARE, EDUCATION, CABLE AND TELECOMMUNICATIONS, GOVERNMENT,

TRANSPORTATION AND THIRD PARTY SERVICE PROVIDERS, IN CLASS 41 (U.S. CLS. 100, 101 AND 107).

FIRST USE 4-2-2007; IN COMMERCE 4-2-2007.

FOR: COMPUTER SERVICES, NAMELY, THE DESIGN, DEVELOPMENT, PROGRAMMING, SUPPORT AND UPDATING OF COMPUTER SOFTWARE FOR BUSINESS MANAGEMENT IN THE FIELDS OF PUBLIC AND PRIVATE UTILITIES AND ENERGY COMPANIES, MANUFACTURING, CONSUMER PRODUCTS, HEALTH CARE, EDUCATION, CABLE AND TELECOMMUNICATIONS, GOVERNMENT, TRANSPORTATION AND THIRD PARTY SERVICE PROVIDERS; APPLICATION SERVICE PROVIDER FEATURING COMPUTER APPLICATION SOFTWARE FOR BUSINESS MANAGEMENT IN THE FIELDS OF PUBLIC AND PRIVATE UTILITIES AND ENERGY COMPANIES, MANUFACTURING, CONSUMER PRODUCTS, HEALTH CARE, EDUCATION, CABLE AND TELECOMMUNICATIONS, GOVERNMENT, TRANSPORTATION AND THIRD PARTY SERVICE PROVIDERS, IN CLASS 42 (U.S. CLS. 100 AND 101).

FIRST USE 4-2-2007; IN COMMERCE 4-2-2007.

THE MARK CONSISTS OF STANDARD CHARACTERS WITHOUT CLAIM TO ANY PARTICULAR FONT, STYLE, SIZE, OR COLOR.

SN 77-120,904, FILED 3-2-2007.

NAKWAMA ANKRAH, EXAMINING ATTORNEY

**Int. Cl.: 43**

**Prior U.S. Cls.: 100 and 101**

**United States Patent and Trademark Office**

**Reg. No. 3,468,811**

**Registered July 15, 2008**

**SERVICE MARK  
PRINCIPAL REGISTER**

**JOIA FABULOUS PIZZA &  
MARTINI BAR**

SRA GROUP, LLC (FLORIDA LTD LIAB CO)  
P.O. BOX 5363  
SARASOTA, FL 34277

FOR: RESTAURANT AND BAR SERVICES, IN  
CLASS 43 (U.S. CLS. 100 AND 101).

FIRST USE 1-23-2008; IN COMMERCE 1-23-2008.

THE MARK CONSISTS OF STANDARD CHAR-  
ACTERS WITHOUT CLAIM TO ANY PARTICULAR  
FONT, STYLE, SIZE, OR COLOR.

NO CLAIM IS MADE TO THE EXCLUSIVE  
RIGHT TO USE "PIZZA & MARTINI BAR", APART  
FROM THE MARK AS SHOWN.

SN 77-120,998, FILED 3-2-2007.

KELLY BOULTON, EXAMINING ATTORNEY

**Int. Cl.: 5**

**Prior U.S. Cls.: 6, 18, 44, 46, 51, and 52**

**Reg. No. 3,468,812**

**United States Patent and Trademark Office**

**Registered July 15, 2008**

---

**TRADEMARK  
PRINCIPAL REGISTER**

**CHOCOMIND**

JARROW FORMULAS, INC. (CALIFORNIA CORPORATION)  
1824 SOUTH ROBERTSON BLVD.  
LOS ANGELES, CA 900354317

THE MARK CONSISTS OF STANDARD CHARACTERS WITHOUT CLAIM TO ANY PARTICULAR FONT, STYLE, SIZE, OR COLOR.

FOR: DIETARY AND NUTRITIONAL SUPPLEMENTS IN THE FORM OF CAPSULES AND TABLETS, IN CLASS 5 (U.S. CLS. 6, 18, 44, 46, 51 AND 52).

SN 77-121,012, FILED 3-2-2007.

FIRST USE 7-31-2007; IN COMMERCE 7-31-2007.

PAUL MORENO, EXAMINING ATTORNEY

**Int. Cl.: 28**

**Prior U.S. Cls.: 22, 23, 38, and 50**

**Reg. No. 3,468,813**

**United States Patent and Trademark Office**

**Registered July 15, 2008**

---

**TRADEMARK  
PRINCIPAL REGISTER**

**POWIE WOWIE**

WOO HOO, INC. (FLORIDA CORPORATION)  
118 HAVEN BEACH DRIVE  
INDIAN ROCKS BEACH, FL 33785

THE MARK CONSISTS OF STANDARD CHAR-  
ACTERS WITHOUT CLAIM TO ANY PARTICULAR  
FONT, STYLE, SIZE, OR COLOR.

FOR: SNOWBOARDS, IN CLASS 28 (U.S. CLS. 22,  
23, 38 AND 50).

SN 77-121,114, FILED 3-2-2007.

FIRST USE 12-1-2007; IN COMMERCE 1-1-2008.

DAVID TAYLOR, EXAMINING ATTORNEY

**Int. Cl.: 21**

**Prior U.S. Cls.: 2, 13, 23, 29, 30, 33, 40, and 50**

**United States Patent and Trademark Office**

**Reg. No. 3,468,814**

**Registered July 15, 2008**

---

**TRADEMARK  
PRINCIPAL REGISTER**

**PUSH N' PRINT**

WILTON INDUSTRIES, INC. (DELAWARE CORPORATION)  
2240 WEST 75TH STREET  
WOODRIDGE, IL 60517

THE MARK CONSISTS OF STANDARD CHARACTERS WITHOUT CLAIM TO ANY PARTICULAR FONT, STYLE, SIZE, OR COLOR.

FOR: BAKEWARE, IN CLASS 21 (U.S. CLS. 2, 13, 23, 29, 30, 33, 40 AND 50).

SN 77-121,139, FILED 3-2-2007.

FIRST USE 8-1-2007; IN COMMERCE 8-1-2007.

CURTIS FRENCH, EXAMINING ATTORNEY

**Int. Cls.: 18 and 25**

**Prior U.S. Cls.: 1, 2, 3, 22, 39, and 41**

**United States Patent and Trademark Office**

**Reg. No. 3,468,815**

**Registered July 15, 2008**

**TRADEMARK  
PRINCIPAL REGISTER**

**So-Fine**

SO-FINE DESIGNS INC. (CANADA CORPORATION)  
165 BARR STREET  
ST. LAURENT, QUEBEC, CANADA H4T1W6

FOR: BAGS, NAMELY, PURSES, TEXTILE SHOPPING BAGS, TOTE BAGS AND BEACH BAGS; PET CLOTHING, IN CLASS 18 (U.S. CLS. 1, 2, 3, 22 AND 41).

FIRST USE 12-31-2003; IN COMMERCE 12-31-2003.

FOR: WEARING APPAREL AND ACCESSORIES, NAMELY, HALTER TOPS, TUBE TOPS, TANK TOPS, SKIRTS, DRESSES, FLEECE BOTTOMS, NAMELY, PANTS, DRESS SHIRTS, HOODED TOPS, CAPRI PANTS AND SCARVES; ATHLETIC WEAR,

NAMELY, TRACK SUITS; SWIMWEAR, NAMELY, SWIM SUITS AND BEACH WRAP SKIRTS; OUTERWEAR, NAMELY, OVERCOATS AND PONCHOS; INTIMATE WEAR, NAMELY, LEG WARMERS; HEADWEAR, NAMELY, TOQUES, IN CLASS 25 (U.S. CLS. 22 AND 39).

FIRST USE 12-31-2005; IN COMMERCE 12-31-2005.

THE MARK CONSISTS OF STANDARD CHARACTERS WITHOUT CLAIM TO ANY PARTICULAR FONT, STYLE, SIZE, OR COLOR.

SN 77-121,324, FILED 3-2-2007.

MARLENE BELL, EXAMINING ATTORNEY



**Int. Cls.: 9 and 11**

**Prior U.S. Cls.: 13, 21, 23, 26, 31, 34, 36, and 38**

**United States Patent and Trademark Office**

**Reg. No. 3,468,816**

**Registered July 15, 2008**

**TRADEMARK  
PRINCIPAL REGISTER**

**POWER IQ**

BEAUTY HOLDING LLC (DELAWARE LTD  
LIAB CO)  
LEGAL DEPARTMENT  
3001 COLORADO BLVD.  
DENTON, TX 76210

FOR: ELECTRIC HAIR CURLING IRONS; ELECTRIC FLAT IRONS, IN CLASS 9 (U.S. CLS. 21, 23, 26, 36 AND 38).

FIRST USE 11-20-2007; IN COMMERCE 11-20-2007.

FOR: HAND-HELD ELECTRIC HAIR DRYERS, IN CLASS 11 (U.S. CLS. 13, 21, 23, 31 AND 34).

FIRST USE 10-31-2007; IN COMMERCE 10-31-2007.

THE MARK CONSISTS OF STANDARD CHARACTERS WITHOUT CLAIM TO ANY PARTICULAR FONT, STYLE, SIZE, OR COLOR.

SN 77-121,943, FILED 3-5-2007.

TRACY WHITTAKER-BROWN, EXAMINING ATTORNEY

**Int. Cl.: 9**

**Prior U.S. Cls.: 21, 23, 26, 36, and 38**

**Reg. No. 3,468,817**

**United States Patent and Trademark Office**

**Registered July 15, 2008**

---

**TRADEMARK  
PRINCIPAL REGISTER**

# TeamRelay

SALAR, INC. (MARYLAND CORPORATION)  
#110  
1820 LANCASTER STREET  
BALTIMORE, MD 21231

FOR: COMPUTER SOFTWARE FOR USE IN THE HEALTHCARE FIELD, NAMELY, SOFTWARE FOR MANAGING, STORING, ANALYZING, MAINTAINING, PROCESSING, STRUCTURING, REVIEWING, BUILDING, EDITING, DISTRIBUTING, COMMUNICATING, ORGANIZING, SHARING, REFERENCING, MONITORING AND INTEGRATING HEALTHCARE INFORMATION; COMPUTER

SOFTWARE FOR AUTOMATING CLINICAL AND ADMINISTRATIVE HEALTHCARE PROCESSES, IN CLASS 9 (U.S. CLS. 21, 23, 26, 36 AND 38).

FIRST USE 2-1-2007; IN COMMERCE 2-1-2007.

THE MARK CONSISTS OF STANDARD CHARACTERS WITHOUT CLAIM TO ANY PARTICULAR FONT, STYLE, SIZE, OR COLOR.

SN 77-121,956, FILED 3-5-2007.

DAVID I, EXAMINING ATTORNEY

**Int. Cl.: 9**

**Prior U.S. Cls.: 21, 23, 26, 36, and 38**

**Reg. No. 3,468,818**

**United States Patent and Trademark Office**

**Registered July 15, 2008**

---

**TRADEMARK  
PRINCIPAL REGISTER**

# TeamQuery

SALAR, INC. (MARYLAND CORPORATION)  
#110  
1820 LANCASTER STREET  
BALTIMORE, MD 21231

FOR: COMPUTER SOFTWARE FOR USE IN THE HEALTHCARE FIELD, NAMELY, SOFTWARE FOR MANAGING, STORING, ANALYZING, MAINTAINING, PROCESSING, STRUCTURING, REVIEWING, BUILDING, EDITING, DISTRIBUTING, COMMUNICATING, ORGANIZING, SHARING, REFERENCING, MONITORING AND INTEGRATING HEALTHCARE INFORMATION; COMPUTER

SOFTWARE FOR AUTOMATING CLINICAL AND ADMINISTRATIVE HEALTHCARE PROCESSES, IN CLASS 9 (U.S. CLS. 21, 23, 26, 36 AND 38).

FIRST USE 2-1-2007; IN COMMERCE 2-1-2007.

THE MARK CONSISTS OF STANDARD CHARACTERS WITHOUT CLAIM TO ANY PARTICULAR FONT, STYLE, SIZE, OR COLOR.

SN 77-121,964, FILED 3-5-2007.

DAVID I, EXAMINING ATTORNEY

**Int. Cl.: 41**

**Prior U.S. Cls.: 100, 101, and 107**

**United States Patent and Trademark Office**

**Reg. No. 3,468,819**

**Registered July 15, 2008**

**SERVICE MARK  
PRINCIPAL REGISTER**

**INSIGHTS INCITE CHANGE**

SYRACUSE UNIVERSITY (NEW YORK EDUCATIONAL INSTITUTION)  
303 UNIVERSITY PLACE  
SYRACUSE, NY 132442020

FOR: EDUCATING AT UNIVERSITY OR COLLEGES; EDUCATION SERVICES IN THE NATURE OF COURSES AT THE UNIVERSITY LEVEL; PROVIDING COURSES OF INSTRUCTION AT THE COLLEGE LEVEL, IN CLASS 41 (U.S. CLS. 100, 101 AND 107).

FIRST USE 9-28-2007; IN COMMERCE 9-28-2007.

THE MARK CONSISTS OF STANDARD CHARACTERS WITHOUT CLAIM TO ANY PARTICULAR FONT, STYLE, SIZE, OR COLOR.

SN 77-122,122, FILED 3-5-2007.

NICHOLAS ALTREE, EXAMINING ATTORNEY

**Int. Cl.: 41**

**Prior U.S. Cls.: 100, 101, and 107**

**United States Patent and Trademark Office**

**Reg. No. 3,468,820**

**Registered July 15, 2008**

---

**SERVICE MARK  
PRINCIPAL REGISTER**

**MIND NINJA**

NICHOLAS M. BENTLEY (UNITED STATES IN-  
DIVIDUAL)  
2676 WINDY XING DRIVE  
WINSTON SALEM, NC 27127

THE MARK CONSISTS OF STANDARD CHAR-  
ACTERS WITHOUT CLAIM TO ANY PARTICULAR  
FONT, STYLE, SIZE, OR COLOR.

FOR: PROVIDING ON-LINE COMPUTER  
GAMES, IN CLASS 41 (U.S. CLS. 100, 101 AND 107).

SN 77-122,145, FILED 3-5-2007.

FIRST USE 12-0-2007; IN COMMERCE 12-0-2007.

ANDREA HACK, EXAMINING ATTORNEY

**Int. Cls.: 29, 35, and 43**

**Prior U.S. Cls.: 46, 100, 101, and 102**

**United States Patent and Trademark Office**

**Reg. No. 3,468,821**

**Registered July 15, 2008**

**TRADEMARK  
SERVICE MARK  
PRINCIPAL REGISTER**

**교촌치킨**

KYOCHON F&B CO., LTD. (REPUBLIC OF KOREA CORPORATION)  
CHILGOK-GUN  
15-8 CHEONPYEONG-RI GASAN-MYEON  
GYEONGSANGBUK-DO, REPUBLIC OF KOREA

FOR: POTATO CHIPS, PHEASANT MEAT, CHICKEN, PORK, HORSE MEAT, BEEF, MUTTON, DUCK MEAT, ARTIFICIAL MEAT, NAMELY, SAUSAGE, TURKEY, HARE MEAT, DESICCATED EGGS, EGGS, FROZEN EGGS, QUAIL EGGS, POWDERED EGGS, DUCK EGGS, LIVER, LIVER PATE, PASTES LIVER, MEAT EXTRACTS, MEAT JELLIES, PORK CUTLETS, RENNET, BACON, BOUILLON, PREPARATIONS FOR MAKING BOUILLON, BROTH, BLACK PUDDING BLOOD SAUSAGE, BEEFSTEAK, CHARCUTERIE, SAUSAGES, TRIPE, ANIMAL MARROW FOR FOOD, UNFLAVORED AND UNSWEETENED GELATINS FOR FOOD, BEEF JERKY, SAUSAGES IN BATTER, CANNED MEAT, HAM, HAMBURGER MEAT, IN CLASS 29 (U.S. CL. 46).

FIRST USE 3-13-1991; IN COMMERCE 4-30-2007.

FOR: THEATER-TYPE BAR MANAGEMENT FOR OTHERS; DANCE HALL-TYPE BAR MANAGEMENT FOR OTHERS; RESTAURANT CHAIN SERVICES, NAMELY, RESTAURANT FRANCHISING; GENERAL BAR MANAGEMENT FOR OTHERS; JAPANESE RESTAURANT MANAGEMENT FOR OTHERS; OPERATING RETAIL BAKERY

SHOPS; CHINESE RESTAURANT MANAGEMENT FOR OTHERS; KOREAN BAR MANAGEMENT FOR OTHERS; KOREAN RESTAURANT MANAGEMENT FOR OTHERS, IN CLASS 35 (U.S. CLS. 100, 101 AND 102).

FIRST USE 3-13-1991; IN COMMERCE 4-30-2007.

FOR: OPERATING TOURIST RESTAURANTS, TEA ROOMS, RESTAURANTS, BUFFET RESTAURANTS, WESTERN STYLE RESTAURANTS, SELF-SERVICE RESTAURANTS, CAFES, CAFETERIAS, CANTEENS, SNACK-BARS, IN CLASS 43 (U.S. CLS. 100 AND 101).

FIRST USE 3-13-1991; IN COMMERCE 4-30-2007.

THE MARK CONSISTS OF KOREAN CHARACTERS.

THE ENGLISH TRANSLATION OF THE WORD "KYOCHON" IN THE MARK IS "A VILLAGE WITH A KOREAN TRADITIONAL LOCAL SCHOOL".

THE KOREAN CHARACTERS IN THE MARK TRANSLITERATE TO "KYOCHON CHICKEN".

SN 77-122,176, FILED 3-5-2007.

ROBIN CHOSID, EXAMINING ATTORNEY

**Int. Cl.: 21**

**Prior U.S. Cls.: 2, 13, 23, 29, 30, 33, 40, and 50**

**Reg. No. 3,468,822**

**United States Patent and Trademark Office**

**Registered July 15, 2008**

---

**TRADEMARK  
PRINCIPAL REGISTER**

**HOT OR COLD, MEGA HAS IT  
ALL!**

MEGATRADE INTERNATIONAL, INC. (TEN-  
NESSEE CORPORATION)  
2727 WESTWOOD DRIVE  
NASHVILLE, TN 37204

FOR: VACUUM FLASKS, JUGS, PORTABLE  
COOLERS AND LUNCH BOXES, IN CLASS 21 (U.S.  
CLS. 2, 13, 23, 29, 30, 33, 40 AND 50).

FIRST USE 10-31-2006; IN COMMERCE 10-31-2006.

THE MARK CONSISTS OF STANDARD CHAR-  
ACTERS WITHOUT CLAIM TO ANY PARTICULAR  
FONT, STYLE, SIZE, OR COLOR.

OWNER OF U.S. REG. NOS. 2,414,284, 2,414,639,  
AND OTHERS.

SN 77-122,282, FILED 3-5-2007.

KATHLEEN M. VANSTON, EXAMINING ATTOR-  
NEY

**Int. Cl.: 32**

**Prior U.S. Cls.: 45, 46, and 48**

**Reg. No. 3,468,823**

**United States Patent and Trademark Office**

**Registered July 15, 2008**

---

**TRADEMARK  
PRINCIPAL REGISTER**

**CABOTELLA**

BAJA BREWING COMPANY S.A. DE C.V. (MEX-  
ICO CORPORATION)  
COL. CENTRO  
MORELOS E/COMONFORT Y OBREGON 1277  
SAN JOSE DEL CABO, BCS, MEXICO 23400

THE MARK CONSISTS OF STANDARD CHAR-  
ACTERS WITHOUT CLAIM TO ANY PARTICULAR  
FONT, STYLE, SIZE, OR COLOR.

FOR: BEER, IN CLASS 32 (U.S. CLS. 45, 46 AND 48).

SN 77-122,583, FILED 3-5-2007.

FIRST USE 1-1-2008; IN COMMERCE 2-15-2008.

HEATHER THOMPSON, EXAMINING ATTORNEY



**Int. Cl.: 9**

**Prior U.S. Cls.: 21, 23, 26, 36, and 38**

**Reg. No. 3,468,824**

**United States Patent and Trademark Office**

**Registered July 15, 2008**

---

**TRADEMARK  
PRINCIPAL REGISTER**

**HIJINX**

OAKLEY, INC. (WASHINGTON CORPORATION)  
ONE ICON  
FOOTHILL RANCH, CA 92610

FOR: PROTECTIVE EYEWEAR, NAMELY, SPECTACLES, PRESCRIPTION EYEWEAR, ANTI GLARE GLASSES AND SUNGLASSES AND THEIR PARTS AND ACCESSORIES, NAMELY, REPLACEMENT LENSES, FRAMES, EARSTEMS, AND NOSE PIECES; CASES SPECIALLY ADAPTED FOR SPECTACLES AND SUNGLASSES AND THEIR PARTS AND AC-

CESSORIES, IN CLASS 9 (U.S. CLS. 21, 23, 26, 36 AND 38).

FIRST USE 5-1-2007; IN COMMERCE 5-1-2007.

THE MARK CONSISTS OF STANDARD CHARACTERS WITHOUT CLAIM TO ANY PARTICULAR FONT, STYLE, SIZE, OR COLOR.

SN 77-122,667, FILED 3-5-2007.

LINDA ESTRADA, EXAMINING ATTORNEY

**Int. Cl.: 41**

**Prior U.S. Cls.: 100, 101, and 107**

**United States Patent and Trademark Office**

**Reg. No. 3,468,825**

**Registered July 15, 2008**

**SERVICE MARK  
PRINCIPAL REGISTER**

**TEEN TRAVEL NOTES**

ELIZABETH ANN SNODERLY (UNITED STATES  
INDIVIDUAL)  
POST OFFICE BOX 1018  
PAWLEYS ISLAND, SC 29585

FOR: ENTERTAINMENT IN THE NATURE OF  
ON-GOING TELEVISION PROGRAMS IN THE  
FIELD OF A REALITY-BASED TELEVISION SERIES  
FEATURING LIVE ACTION, COMEDY AND DRA-  
MA , IN CLASS 41 (U.S. CLS. 100, 101 AND 107).

FIRST USE 10-31-2006; IN COMMERCE 10-31-2006.

THE MARK CONSISTS OF STANDARD CHAR-  
ACTERS WITHOUT CLAIM TO ANY PARTICULAR  
FONT, STYLE, SIZE, OR COLOR.

NO CLAIM IS MADE TO THE EXCLUSIVE  
RIGHT TO USE "TEEN TRAVEL", APART FROM  
THE MARK AS SHOWN.

SN 77-122,787, FILED 3-5-2007.

ELIZABETH BEYER, EXAMINING ATTORNEY

**Int. Cl.: 41**

**Prior U.S. Cls.: 100, 101, and 107**

**United States Patent and Trademark Office**

**Reg. No. 3,468,826**

**Registered July 15, 2008**

**SERVICE MARK  
PRINCIPAL REGISTER**

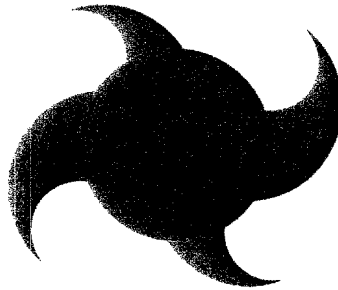

BENTLEY, NICHOLAS M. (UNITED STATES IN-  
DIVIDUAL)  
2676 WINDY XING DRIVE  
WINSTON SALEM, NC 27127

FIRST USE 12-0-2007; IN COMMERCE 12-0-2007.

SN 77-122,975, FILED 3-6-2007.

FOR: PROVIDING ON-LINE COMPUTER  
GAMES, IN CLASS 41 (U.S. CLS. 100, 101 AND 107).

ANDREA HACK, EXAMINING ATTORNEY

**Int. Cl.: 35**

**Prior U.S. Cls.: 100, 101, and 102**

**United States Patent and Trademark Office**

**Reg. No. 3,468,827**

**Registered July 15, 2008**

**SERVICE MARK  
PRINCIPAL REGISTER**

**IT'S ABOUT TIME...**

TIME PIECES UNLIMITED (GEORGIA COR-  
PORATION)

#67

3700 ATLANTA HWY

ATHENS, GA 30606

FIRST USE 9-30-2003; IN COMMERCE 9-30-2003.

SN 77-123,085, FILED 3-6-2007.

FOR: RETAIL STORE SERVICES FEATURING  
WATCHES, CLOCKS, JEWELRY, IN CLASS 35 (U.S.  
CLS. 100, 101 AND 102).

LINDSEY RUBIN, EXAMINING ATTORNEY

**Int. Cl.: 44**

**Prior U.S. Cls.: 100 and 101**

**United States Patent and Trademark Office**

**Reg. No. 3,468,828**

**Registered July 15, 2008**

**SERVICE MARK  
PRINCIPAL REGISTER**

**LIFE NEEDS COLOR**

PALM BEACH TAN, INC. (TEXAS CORPORATION)  
13800 SENLAC DRIVE, SUITE 200  
FARMERS BRANCH, TX 75234

THE MARK CONSISTS OF STANDARD CHARACTERS WITHOUT CLAIM TO ANY PARTICULAR FONT, STYLE, SIZE, OR COLOR.

FOR: TANNING SALON SERVICES, IN CLASS 44  
(U.S. CLS. 100 AND 101).

SN 77-123,503, FILED 3-6-2007.

FIRST USE 1-1-2007; IN COMMERCE 1-1-2007.

LESLEY LAMOTHE, EXAMINING ATTORNEY

**Int. Cl.: 44**

**Prior U.S. Cls.: 100 and 101**

**United States Patent and Trademark Office**

**Reg. No. 3,468,829**

**Registered July 15, 2008**

**SERVICE MARK  
PRINCIPAL REGISTER**

LIFE NEEDS COLOR ALL YEAR  
LONG

PALM BEACH TAN, INC. (TEXAS CORPORATION)  
13800 SENLAC DRIVE, SUITE 200  
FARMERS BRANCH, TX 75234

THE MARK CONSISTS OF STANDARD CHARACTERS WITHOUT CLAIM TO ANY PARTICULAR FONT, STYLE, SIZE, OR COLOR.

FOR: TANNING SALON SERVICES, IN CLASS 44  
(U.S. CLS. 100 AND 101).

SN 77-123,507, FILED 3-6-2007.

FIRST USE 1-1-2007; IN COMMERCE 1-1-2007.

LESLEY LAMOTHE, EXAMINING ATTORNEY

**Int. Cl.: 20**

**Prior U.S. Cls.: 2, 13, 22, 25, 32, and 50**

**United States Patent and Trademark Office**

**Reg. No. 3,468,830**

**Registered July 15, 2008**

**TRADEMARK  
PRINCIPAL REGISTER**

**BAYSIDE FURNISHINGS**

WHALEN FURNITURE MANUFACTURING,  
INC. (CALIFORNIA CORPORATION)  
1578 AIR WING ROAD  
SAN DIEGO, CA 92154

FOR: OFFICE FURNITURE, IN CLASS 20 (U.S.  
CLS. 2, 13, 22, 25, 32 AND 50).

FIRST USE 10-30-2006; IN COMMERCE 10-30-2006.

THE MARK CONSISTS OF STANDARD CHAR-  
ACTERS WITHOUT CLAIM TO ANY PARTICULAR  
FONT, STYLE, SIZE, OR COLOR.

OWNER OF U.S. REG. NO. 3,038,081.

NO CLAIM IS MADE TO THE EXCLUSIVE  
RIGHT TO USE "FURNISHINGS", APART FROM  
THE MARK AS SHOWN.

SN 77-123,686, FILED 3-6-2007.

ZHALEH DELANEY, EXAMINING ATTORNEY

**Int. Cl.: 18**

**Prior U.S. Cls.: 1, 2, 3, 22, and 41**

**United States Patent and Trademark Office**

**Reg. No. 3,468,831**

**Registered July 15, 2008**

**TRADEMARK  
PRINCIPAL REGISTER**

**VIZIATI**

HYPERDRIVE INTERNATIONAL (CALIFORNIA  
SOLE PROPRIETORSHIP)  
3501 TRES RIOS  
SAN CLEMENTE, CA 92673

FOR: ALL-PURPOSE CARRYING BAGS; CARRY-  
ALL BAGS; CARRY-ON BAGS; DIAPER BAGS;  
LEATHER AND IMITATION LEATHER BAGS;  
MAKE-UP BAGS SOLD EMPTY; MESSENGER  
BAGS; OVERNIGHT BAGS; SCHOOL BAGS;  
SHOULDER BAGS; SLING BAGS; TOTE BAGS; TRA-  
VEL BAGS; WRIST MOUNTED CARRYALL BAGS;  
WRISTLET BAGS, IN CLASS 18 (U.S. CLS. 1, 2, 3, 22  
AND 41).

FIRST USE 4-22-2007; IN COMMERCE 2-11-2008.

THE MARK CONSISTS OF STANDARD CHAR-  
ACTERS WITHOUT CLAIM TO ANY PARTICULAR  
FONT, STYLE, SIZE, OR COLOR.

THE FOREIGN WORDING IN THE MARK  
TRANSLATES INTO ENGLISH AS SPOILED.

SN 77-123,914, FILED 3-6-2007.

JANICE KIM, EXAMINING ATTORNEY



**Int. Cls.: 41 and 42**

**Prior U.S. Cls.: 100, 101, and 107**

**United States Patent and Trademark Office**

**Reg. No. 3,468,832**

**Registered July 15, 2008**

**SERVICE MARK  
PRINCIPAL REGISTER**



EARNED VALUE MANAGEMENT INSTITUTE,  
LLC (VIRGINIA LTD LIAB CO)  
P.O. BOX 1965  
LEESBURG, VA 20177

FOR: EDUCATION SERVICES, NAMELY, PROVIDING TUTORING IN THE FIELDS OF EARNED VALUE MANAGEMENT; EDUCATION SERVICES, NAMELY, PROVIDING EARNED VALUE MANAGEMENT TRAINING IN THE FIELD OF PROJECT MANAGEMENT, AND DISTRIBUTING COURSE MATERIALS IN CONNECTION THEREWITH; PREPARING, ADMINISTERING, AND SCORING STANDARDIZED TESTS, IN CLASS 41 (U.S. CLS. 100, 101 AND 107).

FIRST USE 11-12-2001; IN COMMERCE 11-12-2001.

FOR: TESTING, ANALYSIS AND EVALUATION OF EARNED VALUE MANAGEMENT SERVICES OF OTHERS FOR THE PURPOSE OF CERTIFICATION, IN CLASS 42 (U.S. CLS. 100 AND 101).

FIRST USE 11-12-2001; IN COMMERCE 11-12-2001.

NO CLAIM IS MADE TO THE EXCLUSIVE RIGHT TO USE "EARNED VALUE MANAGEMENT PROFESSIONAL", APART FROM THE MARK AS SHOWN.

THE COLOR(S) WHITE AND BLUE IS/ARE CLAIMED AS A FEATURE OF THE MARK.

THE COLOR BLUE APPEARS IN THE WORDING "EVMP EARNED VALUE MANAGEMENT PROFESSIONAL" APPEARING ON A WHITE FIELD.

SN 77-123,938, FILED 3-6-2007.

HANNO RITTNER, EXAMINING ATTORNEY

**Int. Cl.: 11**

**Prior U.S. Cls.: 13, 21, 23, 31, and 34**

**Reg. No. 3,468,833**

**United States Patent and Trademark Office**

**Registered July 15, 2008**

**TRADEMARK  
PRINCIPAL REGISTER**

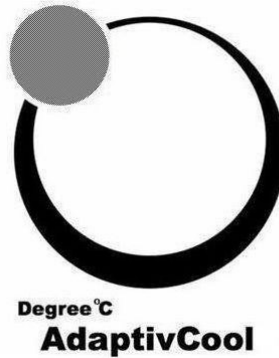

DEGREE CONTROLS, INC. (NEW HAMPSHIRE CORPORATION)  
18 MEADOWBROOK DRIVE  
MILFORD, NH 030554612

FOR: DYNAMIC AIRFLOW MANAGEMENT SYSTEM USED TO MANAGE TEMPERATURE, HUMIDITY, AIRFLOW OR PARTICULATES IN PRECISION ENVIRONMENTS SUCH AS DATA CENTERS, CLEAN ROOMS, LABORATORIES AND CRITICAL MANUFACTURING, COMPRISED OF INTELLIGENT ELECTRIC FAN OR NETWORK OF ELECTRIC FANS FEATURING AN ARRAY OF

ENVIRONMENTAL SENSORS WHICH CAN SENSE TEMPERATURE, HUMIDITY, AIRFLOW AND PARTICULATES, IN CLASS 11 (U.S. CLS. 13, 21, 23, 31 AND 34).

FIRST USE 6-0-2007; IN COMMERCE 6-0-2007.

OWNER OF U.S. REG. NO. 2,514,412.

SN 77-124,018, FILED 3-7-2007.

CHARLOTTE CORWIN, EXAMINING ATTORNEY

**Int. Cls.: 9, 35, and 42**

**Prior U.S. Cls.: 21, 23, 26, 36, 38, 100, 101, and 102**

**United States Patent and Trademark Office**

**Reg. No. 3,468,834**

**Registered July 15, 2008**

**TRADEMARK  
SERVICE MARK  
PRINCIPAL REGISTER**

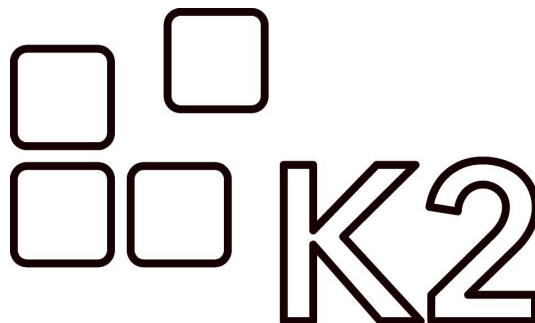

SOURCECODE TECHNOLOGY HOLDINGS, INC.  
(DELAWARE CORPORATION)  
4042 148TH AVENUE NE  
REDMOND, WA 98052

FOR: COMPUTER SOFTWARE, NAMELY, APPLICATION SOFTWARE FOR WORKFLOW AND PROCESS AUTOMATION, IN CLASS 9 (U.S. CLS. 21, 23, 26, 36 AND 38).

FIRST USE 5-20-2008; IN COMMERCE 5-20-2008.

FOR: BUSINESS CONSULTATION AND BUSINESS WORKFLOW ANALYSIS RELATING TO COMPUTER SYSTEM IMPLEMENTATION AND SYSTEM INTEGRATION FOR WORKFLOW AND PROCESS AUTOMATION, IN CLASS 35 (U.S. CLS. 100, 101 AND 102).

FIRST USE 5-20-2008; IN COMMERCE 5-20-2008.

FOR: COMPUTER SERVICES, NAMELY, COMPUTER CONSULTATION SERVICES IN THE FIELD

OF DESIGN, SELECTION, IMPLEMENTATION AND USE OF COMPUTER SOFTWARE SYSTEMS FOR OTHERS, CONSULTING SERVICES IN THE FIELD OF OFFICE AND WORKPLACE AUTOMATION; TECHNICAL SUPPORT SERVICES, NAMELY, TROUBLESHOOTING OF COMPUTER SOFTWARE PROBLEMS; MAINTENANCE OF COMPUTER SOFTWARE, IN CLASS 42 (U.S. CLS. 100 AND 101).

FIRST USE 5-20-2008; IN COMMERCE 5-20-2008.

OWNER OF U.S. REG. NOS. 2,913,030, 3,165,101, AND 3,224,625.

THE MARK CONSISTS OF A RANDOM BLOCK DESIGN INCORPORATING 4 BLOCKS ALONGSIDE THE TEXT K2.

SN 77-124,444, FILED 3-7-2007.

RICHARD A. STRASER, EXAMINING ATTORNEY

**Int. Cl.: 10**

**Prior U.S. Cls.: 26, 39, and 44**

**United States Patent and Trademark Office**

**Reg. No. 3,468,835**

**Registered July 15, 2008**

**TRADEMARK  
PRINCIPAL REGISTER**

**SIGNATURE**

LORD'S DENTAL STUDIO, INC. (WISCONSIN  
CORPORATION)  
1500 W. MAIN AVENUE  
DE PERE, WI 54115

FOR: FIXED DENTAL PROSTHETICS, NAMELY,  
CROWNS, AND BRIDGES; REMOVABLE DENTAL  
PROSTHETICS, NAMELY, DENTURES, PARTIAL  
DENTURES AND ORTHODONTIC APPLIANCES,  
IN CLASS 10 (U.S. CLS. 26, 39 AND 44).

FIRST USE 2-0-2007; IN COMMERCE 2-0-2007.

THE MARK CONSISTS OF STANDARD CHAR-  
ACTERS WITHOUT CLAIM TO ANY PARTICULAR  
FONT, STYLE, SIZE, OR COLOR.

SN 77-124,679, FILED 3-7-2007.

MARGERY A. TIERNEY, EXAMINING ATTORNEY

**Int. Cl.: 14**

**Prior U.S. Cls.: 2, 27, 28, and 50**

**United States Patent and Trademark Office**

**Reg. No. 3,468,836**

**Registered July 15, 2008**

**TRADEMARK  
PRINCIPAL REGISTER**

# Little Riddel

RIDDEL, HOLLY (UNITED STATES INDIVIDUAL)  
17121 VOSE STREET  
P.O. BOX 3093  
PALM SPRINGS, CA 92262

THE MARK CONSISTS OF STANDARD CHARACTERS WITHOUT CLAIM TO ANY PARTICULAR FONT, STYLE, SIZE, OR COLOR.

FOR: JEWELRY; RINGS; BRACELETS; NECKLACES AND EARRINGS, IN CLASS 14 (U.S. CLS. 2, 27, 28 AND 50).

SN 77-124,899, FILED 3-7-2007.

FIRST USE 10-1-2007; IN COMMERCE 10-1-2007.

ELIZABETH KAJUBI, EXAMINING ATTORNEY

**Int. Cls.: 41 and 44**

**Prior U.S. Cls.: 100, 101, and 107**

**United States Patent and Trademark Office**

**Reg. No. 3,468,837**

**Registered July 15, 2008**

**SERVICE MARK  
PRINCIPAL REGISTER**

**THE RECONNECTION**

ERIC PEARL (UNITED STATES INDIVIDUAL)  
P.O. BOX 3600  
HOLLYWOOD, CA 90078

FOR: ENTERTAINMENT SERVICES, NAMELY, IN THE NATURE OF LIVE ENTERTAINMENT PERFORMANCES AND/OR PERSONAL APPEARANCES BY A HEALER IN THE FIELDS OF PHYSICAL, EMOTIONAL, SPIRITUAL AND/OR ENERGETIC HEALING; TELEVISION PROGRAMS IN THE FIELDS OF PHYSICAL, EMOTIONAL, SPIRITUAL AND/OR ENERGETIC HEALING RENDERED THROUGH THE MEDIA OF TELEVISION, CABLE, SATELLITE, RADIO, TELEPHONE AND BROADBAND SYSTEMS, AND VIA THE INTERNET; MOTION PICTURE FILM PRODUCTIONS IN THE FIELDS OF PHYSICAL, EMOTIONAL, SPIRITUAL AND/OR ENERGETIC HEALING; RADIO PROGRAMS IN THE FIELDS OF PHYSICAL, EMOTIONAL, SPIRITUAL AND/OR ENERGETIC HEALING, IN CLASS 41 (U.S. CLS. 100, 101 AND 107).

FIRST USE 4-1-2007; IN COMMERCE 4-1-2007.

FOR: PROVIDING ON-LINE INFORMATION AND NEWS IN THE FIELDS OF PHYSICAL, EMOTIONAL, SPIRITUAL AND/OR ENERGETIC HEALING, IN CLASS 44 (U.S. CLS. 100 AND 101).

FIRST USE 4-1-2007; IN COMMERCE 4-1-2007.

THE MARK CONSISTS OF STANDARD CHARACTERS WITHOUT CLAIM TO ANY PARTICULAR FONT, STYLE, SIZE, OR COLOR.

OWNER OF U.S. REG. NOS. 2,757,926 AND 2,967,837.

SN 77-125,102, FILED 3-7-2007.

KATHY DE JONGE, EXAMINING ATTORNEY

**Int. Cl.: 25**

**Prior U.S. Cls.: 22 and 39**

**United States Patent and Trademark Office**

**Reg. No. 3,468,838**

**Registered July 15, 2008**

**TRADEMARK  
PRINCIPAL REGISTER**

**EMMA & POSH**

KNITWORK PRODUCTIONS LLC (NEW YORK  
LTD LIAB CO)  
1639 CENTRE STREET  
RIDGEWOOD, NY 11385

FOR: CLOTHING, NAMELY, TEE SHIRTS,  
SHIRTS, SWEATERS, TANK TOPS, JEANS, PANTS,  
DRESSES, SKIRTS, JACKETS, COATS, HATS, UN-  
DERWEAR, BATHING SUITS, SOCKS AND FOOT-  
WEAR, IN CLASS 25 (U.S. CLS. 22 AND 39).

FIRST USE 9-30-2007; IN COMMERCE 9-30-2007.

THE MARK CONSISTS OF STANDARD CHAR-  
ACTERS WITHOUT CLAIM TO ANY PARTICULAR  
FONT, STYLE, SIZE, OR COLOR.

"EMMA & POSH" DO NOT IDENTIFY LIVING  
INDIVIDUALS.

SN 77-125,526, FILED 3-8-2007.

ALICIA COLLINS, EXAMINING ATTORNEY

**Int. Cl.: 9**

**Prior U.S. Cls.: 21, 23, 26, 36, and 38**

**Reg. No. 3,468,839**

**United States Patent and Trademark Office**

**Registered July 15, 2008**

---

**TRADEMARK  
PRINCIPAL REGISTER**

**Aztec Queen**

GLOBAL GAMING GROUP (NEVADA CORPORATION)  
3035 E PATRICK LN #14  
LAS VEGAS, NV 89120

THE MARK CONSISTS OF STANDARD CHARACTERS WITHOUT CLAIM TO ANY PARTICULAR FONT, STYLE, SIZE, OR COLOR.

FOR: GAMING EQUIPMENT, NAMELY, SLOT MACHINES WITH OR WITHOUT VIDEO OUTPUT, IN CLASS 9 (U.S. CLS. 21, 23, 26, 36 AND 38).

SN 77-125,737, FILED 3-8-2007.

FIRST USE 3-26-2007; IN COMMERCE 3-26-2007.

EMILY CARLSEN, EXAMINING ATTORNEY



**Int. Cl.: 11**

**Prior U.S. Cls.: 13, 21, 23, 31, and 34**

**United States Patent and Trademark Office**

**Reg. No. 3,468,840**

**Registered July 15, 2008**

---

**TRADEMARK  
PRINCIPAL REGISTER**

**G-COOL**

GRINDMASTER CORPORATION (DELAWARE  
CORPORATION)  
4003 COLLINS LANE  
LOUISVILLE, KY 40245

THE MARK CONSISTS OF STANDARD CHAR-  
ACTERS WITHOUT CLAIM TO ANY PARTICULAR  
FONT, STYLE, SIZE, OR COLOR.

FOR: REFRIGERATED BEVERAGE DISPENSING  
UNITS, IN CLASS 11 (U.S. CLS. 13, 21, 23, 31 AND 34).

SN 77-125,944, FILED 3-8-2007.

FIRST USE 6-30-2007; IN COMMERCE 6-30-2007.

ZACHARY BELLO, EXAMINING ATTORNEY

**Int. Cl.: 5**

**Prior U.S. Cls.: 6, 18, 44, 46, 51, and 52**

**Reg. No. 3,468,841**

**United States Patent and Trademark Office**

**Registered July 15, 2008**

---

**TRADEMARK  
PRINCIPAL REGISTER**

**VK100**

THE WRX, LLC (ARIZONA LTD LIAB CO)  
1507 PARKSIDE LANE  
PHOENIX, AZ 85027

THE MARK CONSISTS OF STANDARD CHAR-  
ACTERS WITHOUT CLAIM TO ANY PARTICULAR  
FONT, STYLE, SIZE, OR COLOR.

FOR: BONE CEMENT FOR MEDICAL PURPOSES,  
IN CLASS 5 (U.S. CLS. 6, 18, 44, 46, 51 AND 52).

SN 77-125,991, FILED 3-8-2007.

FIRST USE 5-1-2008; IN COMMERCE 5-1-2008.

MARK T. MULLEN, EXAMINING ATTORNEY

**Int. Cl.: 25**

**Prior U.S. Cls.: 22 and 39**

**United States Patent and Trademark Office**

**Reg. No. 3,468,842**

**Registered July 15, 2008**

**TRADEMARK  
PRINCIPAL REGISTER**

**DIRT N' DUNE**

PELTS, SHAWNA (UNITED STATES INDIVIDUAL)  
18 WINDY RIDGE LANE  
KETTLE FALLS, WA 99141 AND  
PELTS, GAYLEN (UNITED STATES INDIVIDUAL)  
18 WINDY RIDGE LANE  
KETTLE FALLS, WA 99141

FOR: T-SHIRTS, IN CLASS 25 (U.S. CLS. 22 AND 39).

FIRST USE 4-3-2008; IN COMMERCE 4-3-2008.

THE MARK CONSISTS OF STANDARD CHARACTERS WITHOUT CLAIM TO ANY PARTICULAR FONT, STYLE, SIZE, OR COLOR.

SN 77-126,220, FILED 3-8-2007.

GISELLE AGOSTO, EXAMINING ATTORNEY

**Int. Cl.: 36**

**Prior U.S. Cls.: 100, 101, and 102**

**United States Patent and Trademark Office**

**Reg. No. 3,468,843**

**Registered July 15, 2008**

**SERVICE MARK  
PRINCIPAL REGISTER**

**AINA NALU**

IRONWOOD ASSOCIATES, LLC (VIRGINIA LTD  
LIAB CO)  
SUITE 201  
900 FIFTH AVENUE  
SAN RAFAEL, CA 94901

FOR: REAL ESTATE SERVICES, NAMELY, VA-  
CATION CONDONIMIUM RENTAL SERVICES,  
AND REAL ESTATE MANAGEMENT OF RESIDEN-  
TIAL PROPERTY IN THE NATURE OF CONDOMI-  
NIUM UNITS , IN CLASS 36 (U.S. CLS. 100, 101 AND  
102).

FIRST USE 2-0-2005; IN COMMERCE 2-0-2005.

THE MARK CONSISTS OF STANDARD CHAR-  
ACTERS WITHOUT CLAIM TO ANY PARTICULAR  
FONT, STYLE, SIZE, OR COLOR.

NO CLAIM IS MADE TO THE EXCLUSIVE  
RIGHT TO USE "AINA", APART FROM THE MARK  
AS SHOWN.

THE FOREIGN WORDING IN THE MARK  
TRANSLATES INTO ENGLISH AS LAND WAVE.

SN 77-126,269, FILED 3-8-2007.

JUDITH HELFMAN, EXAMINING ATTORNEY

**Int. Cl.: 35**

**Prior U.S. Cls.: 100, 101, and 102**

**United States Patent and Trademark Office**

**Reg. No. 3,468,844**

**Registered July 15, 2008**

**SERVICE MARK  
PRINCIPAL REGISTER**

**AINA NALU**

IRONWOOD ASSOCIATES, LLC (VIRGINIA LTD  
LIAB CO)  
SUITE 201  
900 FIFTH AVENUE  
SAN RAFAEL, CA 94901

FOR: REAL ESTATE SALES MANAGEMENT OF  
CONDOMINIUM UNITS, IN CLASS 35 (U.S. CLS. 100,  
101 AND 102).

FIRST USE 2-0-2005; IN COMMERCE 2-0-2005.

THE MARK CONSISTS OF STANDARD CHAR-  
ACTERS WITHOUT CLAIM TO ANY PARTICULAR  
FONT, STYLE, SIZE, OR COLOR.

NO CLAIM IS MADE TO THE EXCLUSIVE  
RIGHT TO USE "AINA", APART FROM THE MARK  
AS SHOWN.

THE FOREIGN WORDING IN THE MARK  
TRANSLATES INTO ENGLISH AS LAND WAVE.

SN 77-126,287, FILED 3-8-2007.

JUDITH HELFMAN, EXAMINING ATTORNEY

Int. Cl.: 41

Prior U.S. Cls.: 100, 101, and 107

United States Patent and Trademark Office

Reg. No. 3,468,845

Registered July 15, 2008

SERVICE MARK  
PRINCIPAL REGISTER



ANDERSON COUNTY, SOUTH CAROLINA  
(SOUTH CAROLINA BODY POLITIC AND  
CORPORATE)

ROOM 217  
101 S. MAIN ST  
ANDERSON, SC 29621

FOR: ENTERTAINMENT SERVICES, NAME-  
LY, CONDUCTING FAIRS; ENTERTAINMENT, NAME-  
LY, LIVE PERFORMANCES BY MUSICAL BANDS;  
ORGANIZING EXHIBITIONS FOR ENTERTAIN-  
MENT PURPOSES, NAMELY, COMMUNITY FESTI-  
VALS AND ART EXHIBITIONS; ORGANIZING  
COMMUNITY FESTIVALS FEATURING A VARI-  
ETY OF ACTIVITIES, NAMELY, SPORTING  
EVENTS, ART EXHIBITIONS, FLEA MARKETS,  
ETHNIC DANCES AND THE LIKE, IN CLASS 41  
(U.S. CLS. 100, 101 AND 107).

FIRST USE 4-1-2007; IN COMMERCE 4-1-2007.

NO CLAIM IS MADE TO THE EXCLUSIVE  
RIGHT TO USE "SOUTHEAST BALLOON FEST",  
APART FROM THE MARK AS SHOWN.

THE COLOR(S) RED, GREEN AND ORANGE IS/  
ARE CLAIMED AS A FEATURE OF THE MARK.

THE MARK CONSISTS OF THE PHRASE "THE  
GREAT SOUTHEAST BALLOON FEST" APPEAR-  
ING IN GREEN. IN BETWEEN THE WORDS "BAL-  
LOON" AND "FEST" IS THE DESIGN OF A  
BALLOON, DEPICTED IN RED AND ORANGE.

SN 77-126,450, FILED 3-9-2007.

EMILY CARLSEN, EXAMINING ATTORNEY

**Int. Cl.: 42**

**Prior U.S. Cls.: 100 and 101**

**United States Patent and Trademark Office**

**Reg. No. 3,468,846**

**Registered July 15, 2008**

**SERVICE MARK  
PRINCIPAL REGISTER**

**TERUTEN**

TERUTEN, INC. (REPUBLIC OF KOREA CORPORATION)  
GANGNAM-GU  
4F, ROCKET BUILDING 747-29, YEOKSAM-DONG  
SEOUL, REPUBLIC OF KOREA

FOR: COMPUTER CONSULTATION IN THE FIELD OF COMPUTER SECURITY; COMPUTER SECURITY SERVICE, NAMELY, HARD DRIVE ERASURE; COMPUTER SECURITY SERVICE, NAMELY, RESTRICTING ACCESS TO AND BY COMPUTER NETWORKS TO AND OF UNDESIRE WEB SITES, MEDIA AND INDIVIDUALS AND FACILITIES; ON-LINE SECURITY SERVICES, NAMELY, PROVIDING SECURITY AND ANONYMITY FOR ELECTRONICALLY TRANSMITTED CREDIT CARD TRANSACTIONS; CROSS-PLATFORM CONVERSION OF DIGITAL CONTENT INTO OTHER FORMS OF DIGITAL CONTENT; PROVIDING ELECTRONIC VERIFICATION OF ON-LINE ORDERS OF DIGITAL CONTENT AND GENERATING ELECTRONIC PERMISSION CODES WHICH THEN ALLOW USERS TO ACCESS SAID DIGITAL CONTENT; DATA ENCRYPTION SERVICES; APPLICATION SERVICE PROVIDER, NAMELY, PROVIDING, HOSTING, MANAGING, DEVELOPING, AND MAINTAINING APPLICA-

TIONS, SOFTWARE, WEBSITES, AND DATABASES IN THE FIELDS OF PERSONAL PRODUCTIVITY, WIRELESS COMMUNICATION, MOBILE INFORMATION ACCESS, AND REMOTE DATA MANAGEMENT FOR WIRELESS DELIVERY OF CONTENT TO HANDHELD COMPUTERS, LAPTOPS AND MOBILE ELECTRONIC DEVICES; COMPUTER SERVICE, NAMELY, ACTING AS AN APPLICATION SERVICE PROVIDER IN THE FIELD OF KNOWLEDGE MANAGEMENT TO HOST COMPUTER APPLICATION SOFTWARE FOR THE COLLECTION, EDITING, ORGANIZING, MODIFYING, BOOK MARKING, TRANSMISSION, STORAGE AND SHARING OF DATA AND INFORMATION; HOSTING OF DIGITAL CONTENT ON THE INTERNET, IN CLASS 42 (U.S. CLS. 100 AND 101).

FIRST USE 11-0-2002; IN COMMERCE 11-0-2002.

THE MARK CONSISTS OF STANDARD CHARACTERS WITHOUT CLAIM TO ANY PARTICULAR FONT, STYLE, SIZE, OR COLOR.

SN 77-126,458, FILED 3-9-2007.

MELVIN AXILBUND, EXAMINING ATTORNEY

Int. Cl.: 41

Prior U.S. Cls.: 100, 101, and 107

United States Patent and Trademark Office

Reg. No. 3,468,847

Registered July 15, 2008

SERVICE MARK  
PRINCIPAL REGISTER



ANDERSON COUNTY, SOUTH CAROLINA  
(SOUTH CAROLINA BODY POLITIC AND  
CORPORATE)  
ROOM 217  
101 S. MAIN ST.  
ANDERSON, SC 29621

FOR: ENTERTAINMENT SERVICES, NAME-  
LY, CONDUCTING FAIRS; ENTERTAINMENT, NAME-  
LY, LIVE PERFORMANCES BY MUSICAL BANDS;  
ORGANIZING EXHIBITIONS FOR ENTERTAIN-  
MENT PURPOSES, NAMELY, COMMUNITY FESTI-  
VALS AND ART EXHIBITIONS; ORGANIZING  
COMMUNITY FESTIVALS FEATURING A VARI-  
ETY OF ACTIVITIES, NAMELY, SPORTING  
EVENTS, ART EXHIBITIONS, FLEA MARKETS,  
ETHNIC DANCES AND THE LIKE, IN CLASS 41  
(U.S. CLS. 100, 101 AND 107).

FIRST USE 4-1-2007; IN COMMERCE 4-1-2007.

NO CLAIM IS MADE TO THE EXCLUSIVE  
RIGHT TO USE "SOUTHEAST BALLOON FEST",  
APART FROM THE MARK AS SHOWN.

THE COLOR(S) RED, GREEN AND ORANGE IS/  
ARE CLAIMED AS A FEATURE OF THE MARK.

THE MARK CONSISTS OF THE PHRASE "THE  
GREAT SOUTHEAST BALLOON FEST" APPEAR-  
ING IN GREEN. TO THE LEFT OF THE LITERAL  
ELEMENT, IS THE DESIGN OF A BALLOON,  
DEPICTED IN RED AND ORANGE.

SN 77-126,568, FILED 3-9-2007.

EMILY CARLSEN, EXAMINING ATTORNEY



**Int. Cl.: 16**

**Prior U.S. Cls.: 2, 5, 22, 23, 29, 37, 38, and 50**

**Reg. No. 3,468,848**

**United States Patent and Trademark Office**

**Registered July 15, 2008**

---

**TRADEMARK  
PRINCIPAL REGISTER**

**ENTRO**

BUMBLE BEE PRODUCTIONS, INC. (VIRGINIA  
CORPORATION)  
725 WATCH ISLAND REACH  
CHESAPEAKE, VA 23320

THE MARK CONSISTS OF STANDARD CHAR-  
ACTERS WITHOUT CLAIM TO ANY PARTICULAR  
FONT, STYLE, SIZE, OR COLOR.

FOR: MAGAZINES FEATURING BOOKS AND  
AUTHORS, IN CLASS 16 (U.S. CLS. 2, 5, 22, 23, 29, 37,  
38 AND 50).

SN 77-126,600, FILED 3-9-2007.

FIRST USE 10-31-2007; IN COMMERCE 10-31-2007.

JOHN HWANG, EXAMINING ATTORNEY

**Int. Cls.: 7 and 9**

**Prior U.S. Cls.: 13, 19, 21, 23, 26, 31, 34, 35, 36, and 38**

**United States Patent and Trademark Office**

**Reg. No. 3,468,849**

**Registered July 15, 2008**

---

**TRADEMARK  
PRINCIPAL REGISTER**

**FiveStarEnergy**

GECKOLOGIC GMBH (FED REP GERMANY  
LTD LIAB CO)  
INDUSTRIESTRASSE 8  
ASSLAR, HESSEN, FED REP GERMANY 35614

FOR: SOLAR-POWERED ELECTRICITY GEN-  
ERATORS, IN CLASS 7 (U.S. CLS. 13, 19, 21, 23, 31,  
34 AND 35).

FIRST USE 2-1-2008; IN COMMERCE 3-15-2008.

FOR: APPARATUS FOR CONVERTING ELEC-  
TRONIC RADIATION TO ELECTRICAL ENERGY,

NAMELY, PHOTOVOLTAIC SOLAR MODULES, IN  
CLASS 9 (U.S. CLS. 21, 23, 26, 36 AND 38).

FIRST USE 2-1-2008; IN COMMERCE 3-15-2008.

THE MARK CONSISTS OF STANDARD CHAR-  
ACTERS WITHOUT CLAIM TO ANY PARTICULAR  
FONT, STYLE, SIZE, OR COLOR.

SN 77-126,603, FILED 3-9-2007.

EMILY CARLSEN, EXAMINING ATTORNEY

**Int. Cl.: 43**

**Prior U.S. Cls.: 100 and 101**

**United States Patent and Trademark Office**

**Reg. No. 3,468,850**

**Registered July 15, 2008**

**SERVICE MARK  
PRINCIPAL REGISTER**

**APPOLONIA'S**

FIREHOUSE PIZZERIA, LTD. (IOWA CORPORATION)  
2545 JACKSON STREET  
DUBUQUE, IA 52001

THE MARK CONSISTS OF STANDARD CHARACTERS WITHOUT CLAIM TO ANY PARTICULAR FONT, STYLE, SIZE, OR COLOR.

FOR: RESTAURANT SERVICES, IN CLASS 43 (U.S. CLS. 100 AND 101).

SN 77-126,743, FILED 3-9-2007.

FIRST USE 4-0-2008; IN COMMERCE 4-0-2008.

DAVID H. STINE, EXAMINING ATTORNEY

**Int. Cl.: 21**

**Prior U.S. Cls.: 2, 13, 23, 29, 30, 33, 40, and 50**

**United States Patent and Trademark Office**

**Reg. No. 3,468,851**

**Registered July 15, 2008**

**TRADEMARK  
PRINCIPAL REGISTER**

**SOFT N TOUGH**

TOWA (USA), INC. (WASHINGTON CORPORATION)  
SUITE 4200  
601 UNION STREET  
SEATTLE, WA 98101

THE MARK CONSISTS OF STANDARD CHARACTERS WITHOUT CLAIM TO ANY PARTICULAR FONT, STYLE, SIZE, OR COLOR.

FOR: HOUSEHOLD GLOVES FOR GENERAL USE, IN CLASS 21 (U.S. CLS. 2, 13, 23, 29, 30, 33, 40 AND 50).

SN 77-126,858, FILED 3-9-2007.

FIRST USE 4-16-2007; IN COMMERCE 8-9-2007.

ALICIA COLLINS, EXAMINING ATTORNEY

**Int. Cl.: 21**

**Prior U.S. Cls.: 2, 13, 23, 29, 30, 33, 40, and 50**

**Reg. No. 3,468,852**

**United States Patent and Trademark Office**

**Registered July 15, 2008**

---

**TRADEMARK  
PRINCIPAL REGISTER**

**WITH GARDEN**

TOWA (USA), INC. (WASHINGTON CORPORATION)  
SUITE 4200  
601 UNION STREET  
SEATTLE, WA 98101

THE MARK CONSISTS OF STANDARD CHARACTERS WITHOUT CLAIM TO ANY PARTICULAR FONT, STYLE, SIZE, OR COLOR.

FOR: HOUSEHOLD GLOVES FOR GENERAL USE, IN CLASS 21 (U.S. CLS. 2, 13, 23, 29, 30, 33, 40 AND 50).

SN 77-126,879, FILED 3-9-2007.

FIRST USE 4-16-2007; IN COMMERCE 8-9-2007.

ALICIA COLLINS, EXAMINING ATTORNEY

**Int. Cl.: 20**

**Prior U.S. Cls.: 2, 13, 22, 25, 32, and 50**

**Reg. No. 3,468,853**

**United States Patent and Trademark Office**

**Registered July 15, 2008**

---

**TRADEMARK  
PRINCIPAL REGISTER**

**FAMILY & FRIENDS**

PINNACLE FRAMES AND ACCENTS, INC.  
(TEXAS CORPORATION)  
12201 TECHNOLOGY BOULEVARD #100  
AUSTIN, TX 78727

THE MARK CONSISTS OF STANDARD CHAR-  
ACTERS WITHOUT CLAIM TO ANY PARTICULAR  
FONT, STYLE, SIZE, OR COLOR.

FOR: PICTURE FRAMES, IN CLASS 20 (U.S. CLS.  
2, 13, 22, 25, 32 AND 50).

SN 77-126,881, FILED 3-9-2007.

FIRST USE 1-0-2007; IN COMMERCE 1-0-2007.

JUDITH HELFMAN, EXAMINING ATTORNEY

**Int. Cl.: 35**

**Prior U.S. Cls.: 100, 101, and 102**

**United States Patent and Trademark Office**

**Reg. No. 3,468,854**

**Registered July 15, 2008**

**SERVICE MARK  
PRINCIPAL REGISTER**

# LoanCall

SALTER, GREG (UNITED STATES INDIVIDUAL)  
SUITE C-107  
12631 E. IMPERIAL HWY.  
SANTA FE SPRINGS, CA 90670

FOR: ADVERTISING SERVICES, NAMELY, PROMOTING CREDIT, FINANCE AND MORTGAGE SERVICES OF OTHERS BY MEANS OF OPERATING AN ONLINE DIRECTORY OF SERVICE PROVIDERS, PROVIDING ONLINE DIRECTORY INFORMATION SERVICES FEATURING HYPERTEXT LINKS TO THE WEBSITES OF SERVICE PROVIDERS, AND PROVIDING SPACE AT WEBSITE FOR THE ADVERTISEMENTS OF SERVICE

PROVIDERS AND DISPLAYING ADVERTISEMENTS FOR SERVICE PROVIDERS VIA A GLOBAL COMPUTER NETWORK, IN CLASS 35 (U.S. CLS. 100, 101 AND 102).

FIRST USE 2-19-2008; IN COMMERCE 2-19-2008.

THE MARK CONSISTS OF STANDARD CHARACTERS WITHOUT CLAIM TO ANY PARTICULAR FONT, STYLE, SIZE, OR COLOR.

SN 77-127,008, FILED 3-9-2007.

DEZMONA MIZELLE, EXAMINING ATTORNEY

**Int. Cl.: 36**

**Prior U.S. Cls.: 100, 101, and 102**

**United States Patent and Trademark Office**

**Reg. No. 3,468,855**

**Registered July 15, 2008**

---

**SERVICE MARK  
PRINCIPAL REGISTER**

**MPM**

MISSOURI PROFESSIONALS MUTUAL (MISSOURI CORPORATION)  
287 NORTH LINDBERGH BLVD  
ST. LOUIS, MO 63141

THE MARK CONSISTS OF STANDARD CHARACTERS WITHOUT CLAIM TO ANY PARTICULAR FONT, STYLE, SIZE, OR COLOR.

FOR: INSURANCE UNDERWRITING SERVICES IN THE FIELD OF MEDICAL MALPRACTICE, IN CLASS 36 (U.S. CLS. 100, 101 AND 102).

SN 77-127,140, FILED 3-9-2007.

FIRST USE 3-31-2003; IN COMMERCE 3-31-2003.

REBECCA GILBERT, EXAMINING ATTORNEY



**Int. Cl.: 16**

**Prior U.S. Cls.: 2, 5, 22, 23, 29, 37, 38, and 50**

**United States Patent and Trademark Office**

**Reg. No. 3,468,856**

**Registered July 15, 2008**

**TRADEMARK  
PRINCIPAL REGISTER**

**ARTIST SECRET SOCIETY**

DAVID GAMBLE (UNITED KINGDOM INDIVIDUAL)  
DUNNINGTON BARTHOLOW & MILLER LLP  
1359 BROADWAY, SUITE 600  
NEW YORK, NY 10018

FOR: ART, NAMELY, PAINTINGS, PHOTOGRAPHS AND ART PICTURES, IN CLASS 16 (U.S. CLS. 2, 5, 22, 23, 29, 37, 38 AND 50).

FIRST USE 7-1-2007; IN COMMERCE 2-1-2008.

THE MARK CONSISTS OF STANDARD CHARACTERS WITHOUT CLAIM TO ANY PARTICULAR FONT, STYLE, SIZE, OR COLOR.

SN 77-127,185, FILED 3-9-2007.

CHRISTINA SOBRAL, EXAMINING ATTORNEY

**Int. Cl.: 41**

**Prior U.S. Cls.: 100, 101, and 107**

**Reg. No. 3,468,857**

**United States Patent and Trademark Office**

**Registered July 15, 2008**

---

**SERVICE MARK  
PRINCIPAL REGISTER**

**Summit Consulting:  
Executive and Business  
Coaching**

LARRABURE, RICARDO (UNITED STATES IN-  
DIVIDUAL)

1405 TULIP TREE LANE

WEST DES MOINES, IA 50266

FOR: PERSONAL COACHING SERVICES IN THE  
FIELD OF BUSINESS, IN CLASS 41 (U.S. CLS. 100, 101  
AND 107).

FIRST USE 4-21-2008; IN COMMERCE 4-21-2008.

THE MARK CONSISTS OF STANDARD CHAR-  
ACTERS WITHOUT CLAIM TO ANY PARTICULAR  
FONT, STYLE, SIZE, OR COLOR.

NO CLAIM IS MADE TO THE EXCLUSIVE  
RIGHT TO USE "CONSULTING" AND "EXECUTIVE  
AND BUSINESS COACHING", APART FROM THE  
MARK AS SHOWN.

SN 77-127,656, FILED 3-10-2007.

ARETHA SOMERVILLE, EXAMINING ATTORNEY

**Int. Cl.: 25**

**Prior U.S. Cls.: 22 and 39**

**United States Patent and Trademark Office**

**Reg. No. 3,468,858**

**Registered July 15, 2008**

**TRADEMARK  
PRINCIPAL REGISTER**

**SWEJJ'N**

SWEJJ, LLC (FLORIDA LTD LIAB CO)  
4400 GULF SHORE BLVD NORTH, NO. 603  
NAPLES, FL 34103

THE MARK CONSISTS OF STANDARD CHAR-  
ACTERS WITHOUT CLAIM TO ANY PARTICULAR  
FONT, STYLE, SIZE, OR COLOR.

FOR: CLOTHING, NAMELY, CAPS, T-SHIRTS, IN  
CLASS 25 (U.S. CLS. 22 AND 39).

SN 77-127,761, FILED 3-10-2007.

FIRST USE 2-25-2008; IN COMMERCE 2-25-2008.

ARETHA SOMERVILLE, EXAMINING ATTORNEY

**Int. Cl.: 36**

**Prior U.S. Cls.: 100, 101, and 102**

**United States Patent and Trademark Office**

**Reg. No. 3,468,859**

**Registered July 15, 2008**

**SERVICE MARK  
PRINCIPAL REGISTER**

**MARCAP**

MARCAP INVESTORS, LP (DELAWARE LIMITED PARTNERSHIP)  
89 SUMMIT AVENUE  
SUMMIT, NY 07901

FOR: FINANCIAL SERVICES, NAMELY, INVESTMENT ADVISORY SERVICES, INVESTMENT MANAGEMENT SERVICES, AND ASSET MANAGEMENT SERVICES, IN CLASS 36 (U.S. CLS. 100, 101 AND 102).

FIRST USE 3-2-2007; IN COMMERCE 3-2-2007.

THE MARK CONSISTS OF STANDARD CHARACTERS WITHOUT CLAIM TO ANY PARTICULAR FONT, STYLE, SIZE, OR COLOR.

SN 77-127,878, FILED 3-11-2007.

MARCIE MILONE, EXAMINING ATTORNEY

**Int. Cls.: 16 and 27**

**Prior U.S. Cls.: 2, 5, 19, 20, 22, 23, 29, 37, 38, 42, and 50**

**United States Patent and Trademark Office**

**Reg. No. 3,468,860**

**Registered July 15, 2008**

**TRADEMARK  
PRINCIPAL REGISTER**

**Tommy Bahama**

TOMMY BAHAMA GROUP, INC. (DELAWARE CORPORATION)  
222 PIEDMONT AVE., NE  
ATLANTA, GA 30308

FOR: WALLPAPER SAMPLE BOOK, IN CLASS 16 (U.S. CLS. 2, 5, 22, 23, 29, 37, 38 AND 50).

FIRST USE 1-1-2008; IN COMMERCE 1-1-2008.

FOR: WALLPAPER, IN CLASS 27 (U.S. CLS. 19, 20, 37, 42 AND 50).

FIRST USE 1-1-2008; IN COMMERCE 1-1-2008.

THE MARK CONSISTS OF STANDARD CHARACTERS WITHOUT CLAIM TO ANY PARTICULAR FONT, STYLE, SIZE, OR COLOR.

OWNER OF U.S. REG. NOS. 1,802,812, 7,597,608, AND OTHERS.

THE NAME TOMMY BAHAMA DOES NOT IDENTIFY A LIVING INDIVIDUAL.

SN 77-128,084, FILED 3-12-2007.

CAROLYN GRAY, EXAMINING ATTORNEY

**Int. Cl.: 3**

**Prior U.S. Cls.: 1, 4, 6, 50, 51, and 52**

**United States Patent and Trademark Office**

**Reg. No. 3,468,861**

**Registered July 15, 2008**

**TRADEMARK  
PRINCIPAL REGISTER**

**Tease Me Tini**

PERFORMANCE BRANDS, INC. (FLORIDA  
CORPORATION)  
963 SHOTGUN ROAD  
SUNRISE, FL 33326

FOR: SUNTANNING PREPARATIONS, IN CLASS  
3 (U.S. CLS. 1, 4, 6, 50, 51 AND 52).

FIRST USE 10-1-2007; IN COMMERCE 10-1-2007.

THE MARK CONSISTS OF STANDARD CHAR-  
ACTERS WITHOUT CLAIM TO ANY PARTICULAR  
FONT, STYLE, SIZE, OR COLOR.

OWNER OF U.S. REG. NOS. 2,936,905, 2,944,981,  
AND OTHERS.

SN 77-128,197, FILED 3-12-2007.

KRISTINA MORRIS, EXAMINING ATTORNEY

**Int. Cl.: 3**

**Prior U.S. Cls.: 1, 4, 6, 50, 51, and 52**

**United States Patent and Trademark Office**

**Reg. No. 3,468,862**

**Registered July 15, 2008**

**TRADEMARK  
PRINCIPAL REGISTER**

**need 4 speed**

PERFORMANCE BRANDS, INC. (FLORIDA  
CORPORATION)  
963 SHOTGUN ROAD  
SUNRISE, FL 33326

THE MARK CONSISTS OF STANDARD CHAR-  
ACTERS WITHOUT CLAIM TO ANY PARTICULAR  
FONT, STYLE, SIZE, OR COLOR.

FOR: SUNTANNING PREPARATIONS, IN CLASS  
3 (U.S. CLS. 1, 4, 6, 50, 51 AND 52).

SN 77-128,211, FILED 3-12-2007.

FIRST USE 10-1-2007; IN COMMERCE 10-1-2007.

KRISTINA MORRIS, EXAMINING ATTORNEY

**Int. Cl.: 3**

**Prior U.S. Cls.: 1, 4, 6, 50, 51, and 52**

**United States Patent and Trademark Office**

**Reg. No. 3,468,863**

**Registered July 15, 2008**

**TRADEMARK  
PRINCIPAL REGISTER**

**Evil**

PERFORMANCE BRANDS, INC. (FLORIDA  
CORPORATION)  
963 SHOTGUN ROAD  
SUNRISE, FL 33326

THE MARK CONSISTS OF STANDARD CHAR-  
ACTERS WITHOUT CLAIM TO ANY PARTICULAR  
FONT, STYLE, SIZE, OR COLOR.

FOR: SUNTANNING PREPARATIONS, IN CLASS  
3 (U.S. CLS. 1, 4, 6, 50, 51 AND 52).

SN 77-128,228, FILED 3-12-2007.

FIRST USE 10-1-2007; IN COMMERCE 10-1-2007.

BARBARA GAYNOR, EXAMINING ATTORNEY



**Int. Cl.: 5**

**Prior U.S. Cls.: 6, 18, 44, 46, 51, and 52**

**Reg. No. 3,468,864**

**United States Patent and Trademark Office**

**Registered July 15, 2008**

---

**TRADEMARK  
PRINCIPAL REGISTER**

**ARNIHOT**

DISTRIBUIDORA DE ALIMENTOS NATURALES  
Y NUTRICIONALES, S.A. DE C.V. (MEXICO  
SOCIEDAD ANONIMA)  
MANUEL AVILA CAMACHO # 44-A  
MEXICO, MEXICO 09570

THE MARK CONSISTS OF STANDARD CHAR-  
ACTERS WITHOUT CLAIM TO ANY PARTICULAR  
FONT, STYLE, SIZE, OR COLOR.

FOR: OINTMENTS FOR MUSCULAR ILLNESS  
FOR HUMAN, IN CLASS 5 (U.S. CLS. 6, 18, 44, 46, 51  
AND 52).

SN 77-128,429, FILED 3-12-2007.

FIRST USE 3-4-2008; IN COMMERCE 3-4-2008.

CHRISTINA SOBRAL, EXAMINING ATTORNEY

**Int. Cl.: 1**

**Prior U.S. Cls.: 1, 5, 6, 10, 26, and 46**

**United States Patent and Trademark Office**

**Reg. No. 3,468,865**

**Registered July 15, 2008**

**TRADEMARK  
PRINCIPAL REGISTER**



JETZEN INVESTMENT LIMITED (BR.VIRGIN ISLANDS CORPORATION)  
200 GLOUCESTER ROAD  
ROOM 502, 5TH FLOOR, SILVER BASE CENTRE,  
WANCHAI, HONG KONG

FOR: CHEMICALS USED IN INDUSTRY; UNPROCESSED ARTIFICIAL RESINS, UNPROCESSED PLASTICS, IN CLASS 1 (U.S. CLS. 1, 5, 6, 10, 26 AND 46).

FIRST USE 8-13-2007; IN COMMERCE 5-10-2008.

THE COLOR(S) BLUE AND RED IS/ARE CLAIMED AS A FEATURE OF THE MARK.

THE MARK CONSISTS OF A POLYGON, MORE SPECIFICALLY, AN INCOMPLETE HEXAGON DESIGN PRESENTED IN THE COLOR BLUE AND PARTIALLY DIVIDED BY THE LETTERS "JSP" IN THE COLOR RED. SIX BLUE LINES AT THE LEFT OF THE LETTERING FORM THE LEFT PORTION OF THE INCOMPLETE HEXAGON DESIGN.

THE WORDING "JSP" HAS NO MEANING IN A FOREIGN LANGUAGE.

SN 77-128,496, FILED 3-12-2007.

KEVIN CORWIN, EXAMINING ATTORNEY

**Int. Cl.: 30**

**Prior U.S. Cl.: 46**

**United States Patent and Trademark Office**

**Reg. No. 3,468,866**

**Registered July 15, 2008**

**TRADEMARK  
PRINCIPAL REGISTER**

**SAND MOUNTAIN'S FAMOUS  
SYRUP**

THOMAS, BURMA F. (UNITED STATES INDIVIDUAL)  
P.O. BOX 824  
SCOTTSBORO, AL 357680824

OWNER OF U.S. REG. NOS. 707,644, 3,135,584,  
AND 3,221,649.

FOR: TABLE SYRUP, IN CLASS 30 (U.S. CL. 46).

NO CLAIM IS MADE TO THE EXCLUSIVE  
RIGHT TO USE "FAMOUS SYRUP", APART FROM  
THE MARK AS SHOWN.

FIRST USE 4-3-2007; IN COMMERCE 4-3-2007.

SN 77-128,700, FILED 3-12-2007.

THE MARK CONSISTS OF STANDARD CHARACTERS WITHOUT CLAIM TO ANY PARTICULAR FONT, STYLE, SIZE, OR COLOR.

BRIAN PINO, EXAMINING ATTORNEY

**Int. Cl.: 28**

**Prior U.S. Cls.: 22, 23, 38, and 50**

**United States Patent and Trademark Office**

**Reg. No. 3,468,867**

**Registered July 15, 2008**

---

**TRADEMARK  
PRINCIPAL REGISTER**

**FIGHT CLUB**

HOMIESHOP, LLC (DELAWARE LTD LIAB CO)  
1511-M SYCAMORE AVE #331  
HERCULES, CA 94547

THE MARK CONSISTS OF STANDARD CHAR-  
ACTERS WITHOUT CLAIM TO ANY PARTICULAR  
FONT, STYLE, SIZE, OR COLOR.

FOR: POSITIONABLE TOY FIGURES; TOY AC-  
TION FIGURES; TOY FIGURES, IN CLASS 28 (U.S.  
CLS. 22, 23, 38 AND 50).

SN 77-128,833, FILED 3-12-2007.

FIRST USE 9-1-2006; IN COMMERCE 11-1-2007.

SARA THOMAS, EXAMINING ATTORNEY

**Int. Cl.: 10**

**Prior U.S. Cls.: 26, 39, and 44**

**Reg. No. 3,468,868**

**United States Patent and Trademark Office**

**Registered July 15, 2008**

---

**TRADEMARK  
PRINCIPAL REGISTER**

**STERILANCE**

PING, SHI GUO (CHINA INDIVIDUAL)  
108# ZINHAN STREET, SUZHOU INDUSTRY PARK  
2401 RM. #1 UNIT #19 BUILDING HUZUOAN  
SUZHOU, CHINA 215000

FIRST USE 3-1-2008; IN COMMERCE 3-1-2008.

FOR: BLOOD LANCET, LANCET, SAFETY  
BLOOD LANCET, LANCING DEVICE, LANCET  
DEVICE, SAFETY LANCING DEVICE, SURGICAL  
BLADE, STEEL HANDLE SCALPEL, SURGICAL  
SCALPEL, SAFETY SCALPEL, SAFETY STEEL  
HANDLE SCALPEL, SAFETY SURGICAL BLADE  
CARTRIDGE, IN CLASS 10 (U.S. CLS. 26, 39 AND 44).

THE MARK CONSISTS OF STANDARD CHAR-  
ACTERS WITHOUT CLAIM TO ANY PARTICULAR  
FONT, STYLE, SIZE, OR COLOR.

SN 77-129,680, FILED 3-13-2007.

KELLY BOULTON, EXAMINING ATTORNEY

**Int. Cl.: 6**

**Prior U.S. Cls.: 2, 12, 13, 14, 23, 25, and 50**

**Reg. No. 3,468,869**

**United States Patent and Trademark Office**

**Registered July 15, 2008**

---

**TRADEMARK  
PRINCIPAL REGISTER**

**EVSTAR**

EVENING STAR INTERNATIONAL, INC.  
(TEXAS CORPORATION)  
3405 172ND ST. NE  
ARLINGTON, WA 98223

THE MARK CONSISTS OF STANDARD CHAR-  
ACTERS WITHOUT CLAIM TO ANY PARTICULAR  
FONT, STYLE, SIZE, OR COLOR.

FOR: FASTENERS, NAMELY, METAL PIERCING  
BODY FOR SECURING WORK PIECES TOGE-  
THER, IN CLASS 6 (U.S. CLS. 2, 12, 13, 14, 23, 25  
AND 50).

SN 77-129,713, FILED 3-13-2007.

FIRST USE 3-1-2008; IN COMMERCE 3-1-2008.

PAULA MAHONEY, EXAMINING ATTORNEY

**Int. Cl.: 22**

**Prior U.S. Cls.: 1, 2, 7, 19, 22, 42, and 50**

**Reg. No. 3,468,870**

**United States Patent and Trademark Office**

**Registered July 15, 2008**

---

**TRADEMARK  
PRINCIPAL REGISTER**

**SMARTFILL**

MINIMUM, INC. (WASHINGTON CORPORATION)  
9227 MARY AVENUE NW  
SEATTLE, WA 98117

THE MARK CONSISTS OF STANDARD CHARACTERS WITHOUT CLAIM TO ANY PARTICULAR FONT, STYLE, SIZE, OR COLOR.

FOR: PADDING AND STUFFING MATERIALS NOT OF RUBBER, PAPER OR PLASTIC, IN CLASS 22 (U.S. CLS. 1, 2, 7, 19, 22, 42 AND 50).

SN 77-129,903, FILED 3-13-2007.

FIRST USE 8-1-2007; IN COMMERCE 8-1-2007.

MARGARET POWER, EXAMINING ATTORNEY

**Int. Cl.: 10**

**Prior U.S. Cls.: 26, 39, and 44**

**Reg. No. 3,468,871**

**United States Patent and Trademark Office**

**Registered July 15, 2008**

**TRADEMARK  
PRINCIPAL REGISTER**

**STER/LANCE**

PING, SHI GUO (CHINA INDIVIDUAL)  
108# XINHAN STREET SUZHOU INDUSTRY PARK  
2401 ROOM #1 UNIT #19 BUILDING HUZUOAN  
SUZHOU, CHINA 215000

FOR: BLOOD LANCET, LANCET, SAFETY  
BLOOD LANCET, LANCING DEVICE, LANCET  
DEVICE, SAFETY LANCING DEVICE, SURGICAL  
BLADE, STEEL HANDLE SCALPEL, SURGICAL  
SCALPEL, SAFETY SCALPEL, SAFETY STEEL  
HANDLE SCALPEL, SAFETY SURGICAL BLADE  
CARTRIDGE, IN CLASS 10 (U.S. CLS. 26, 39 AND 44).

FIRST USE 3-1-2008; IN COMMERCE 3-1-2008.

THE MARK CONSISTS OF THE BLOCK LETTERS  
"STER" AND THE BLOCK LETTERS "LANCE"  
SEPARATED WITH A SLIGHTLY ANGLED LET-  
TER "I". THE BLOCK LETTERS "E" IN THE MARK  
HAVE A MISSING SECTION IN THE VERTICAL  
LINE OF THE "E" SO THAT THE TOP HORIZON-  
TAL LINE IN "E" IS SEPARATED FROM THE REST  
OF THE "E".

SN 77-130,113, FILED 3-13-2007.

KELLY BOULTON, EXAMINING ATTORNEY



**Int. Cl.: 5**

**Prior U.S. Cls.: 6, 18, 44, 46, 51, and 52**

**Reg. No. 3,468,872**

**United States Patent and Trademark Office**

**Registered July 15, 2008**

---

**TRADEMARK  
PRINCIPAL REGISTER**

**REPAIRACELL**

WORLD HEALTH PRODUCTS, LLC (UTAH LTD  
LIAB CO)  
12685 SOUTH 125 EAST STREET  
DRAPER, UT 84020

THE MARK CONSISTS OF STANDARD CHAR-  
ACTERS WITHOUT CLAIM TO ANY PARTICULAR  
FONT, STYLE, SIZE, OR COLOR.

FOR: DIETARY SUPPLEMENT, IN CLASS 5 (U.S.  
CLS. 6, 18, 44, 46, 51 AND 52).

SN 77-130,254, FILED 3-13-2007.

FIRST USE 3-23-2007; IN COMMERCE 3-23-2007.

MATTHEW EINSTEIN, EXAMINING ATTORNEY

**Int. Cl.: 9**

**Prior U.S. Cls.: 21, 23, 26, 36, and 38**

**United States Patent and Trademark Office**

**Reg. No. 3,468,873**

**Registered July 15, 2008**

**TRADEMARK  
PRINCIPAL REGISTER**



JOHNSON, QUANTAE A (INDIANA SOLE PROPRIETORSHIP)  
P.O. BOX 441804  
INDIANAPOLIS, IN 46244

FOR: CD CASES; CD SLEEVES; DIGITAL MATERIALS, NAMELY, CD'S, DVD'S, DOWNLOADABLE AUDIO, AND DOWNLOADABLE VIDEO, ALL FEATURING MUSIC, AND INFORMATION ABOUT ARTISTS, MUSICIANS, AND PEOPLE IN THE ENTERTAINMENT BUSINESS, IN CLASS 9 (U.S. CLS. 21, 23, 26, 36 AND 38).

FIRST USE 4-18-2008; IN COMMERCE 4-18-2008.

NO CLAIM IS MADE TO THE EXCLUSIVE RIGHT TO USE "RECORDS", APART FROM THE MARK AS SHOWN.

THE COLOR(S) ORANGE, PURPLE, WHITE, BLACK, BLUE AND GRAY IS/ARE CLAIMED AS A FEATURE OF THE MARK.

THE MARK CONSISTS OF LETTERS "NAPPYCITY RECORDS" IN BLACK. "Q" IN WHITE. ORANGE SUN, PURPLE SKY, ORANGE SKY, BLACK, WHITE, BLUE, AND GRAY BUILDINGS.

SN 77-130,303, FILED 3-13-2007.

JOHN DWYER, EXAMINING ATTORNEY

**Int. Cl.: 14**

**Prior U.S. Cls.: 2, 27, 28, and 50**

**United States Patent and Trademark Office**

**Reg. No. 3,468,874**

**Registered July 15, 2008**

**TRADEMARK  
PRINCIPAL REGISTER**

**ALLSYNCPLUS**

AMERICAN TIME & SIGNAL, CO. (MINNESOTA CORPORATION)  
140 THIRD STREET  
SOUTH DASSEL, MN 55325

FOR: WIRELESS AND SYNCHRONIZED CLOCK SYSTEMS AND CLOCKS AND COMPONENTS OF WIRELESS AND SYNCHRONIZED CLOCK SYSTEMS, COMPRISING CLOCKS, CLOCK CONTROLLERS, BELLS, HORNS, TRANSMITTER ANTENNAS, AND RECEIVER ANTENNAS; WALL CLOCKS, COMPONENT PARTS FOR WIRELESS CLOCKS AND SYNCHRONIZED CLOCK SYSTEMS, NAMELY, MOTORS, MOVEMENTS, HANDS, FACES, CRYSTALS, TRANSMITTER ANTENNAS, RECEIVER ANTENNAS, RECEIVER CIRCUITRY,

TRANSMITTER CIRCUITRY, HORNS, AND BELLS, IN CLASS 14 (U.S. CLS. 2, 27, 28 AND 50).

FIRST USE 1-31-2007; IN COMMERCE 1-31-2007.

THE MARK CONSISTS OF STANDARD CHARACTERS WITHOUT CLAIM TO ANY PARTICULAR FONT, STYLE, SIZE, OR COLOR.

OWNER OF U.S. REG. NOS. 3,056,578 AND 3,170,739.

SN 77-130,655, FILED 3-14-2007.

NAAKWAMA ANKRAH, EXAMINING ATTORNEY

Int. Cl.: 31

Prior U.S. Cls.: 1 and 46

United States Patent and Trademark Office

Reg. No. 3,468,875

Registered July 15, 2008

TRADEMARK  
PRINCIPAL REGISTER



MONEER, BRENDA M. (UNITED STATES INDIVIDUAL)

STE. 2 #301

205 ST. JAMES AVE.

GOOSE CREEK, SC 29445

FOR: DOG TREATS, IN CLASS 31 (U.S. CLS. 1 AND 46).

FIRST USE 2-1-2008; IN COMMERCE 2-1-2008.

NO CLAIM IS MADE TO THE EXCLUSIVE RIGHT TO USE "FRESH BAKED DOGGIE TREATS", APART FROM THE MARK AS SHOWN.

THE MARK CONSISTS OF DOG HEAD CREATED WITH WORDS "WOOFIE JAR" WITH HAT ON BACKWARDS WITH BONE DESCRIBING "FRESH BAKED DOGGIE TREATS".

SN 77-131,411, FILED 3-14-2007.

SHANNON TWOHIG, EXAMINING ATTORNEY

Int. Cl.: 35

Prior U.S. Cls.: 100, 101, and 102

United States Patent and Trademark Office

Reg. No. 3,468,876

Registered July 15, 2008

**SERVICE MARK  
PRINCIPAL REGISTER**



TELUS CORPORATION (CANADA CORPORATION)  
TELUS LEGAL SERVICES 32S  
10020 - 100 STREET  
EDMONTON, CANADA T5J0N5

FOR: HUMAN CAPITAL MANAGEMENT OUTSOURCING SERVICES; OUTSOURCING SERVICES; BUSINESS OUTSOURCING SERVICES IN THE FIELD OF OPERATING, MAINTAINING, AND PROVIDING TELECOMMUNICATIONS INFRASTRUCTURE AND TELECOMMUNICATIONS APPLICATIONS FOR TELECOMMUNICATIONS COMPANIES; PROVIDING OUTSOURCED BUSINESS SERVICES TO OTHER COMPANIES, NAMELY, PROVIDING OUTSOURCING IN THE FIELD OF CONTACT CENTER OPERATIONS, CUSTOMER CARE SOLUTIONS, CUSTOMER MEDIATION SER-

VICES, BILLING SERVICES, HUMAN RESOURCES OPERATIONS, GEOMATICS SERVICES, WIRELESS FIELD DEPLOYMENT SERVICES, INFORMATION TECHNOLOGY SERVICES, DATA AND APPLICATION BACKUP AND DISASTER RECOVERY SERVICES, AND COMPUTER APPLICATION SERVICES, IN CLASS 35 (U.S. CLS. 100, 101 AND 102).

FIRST USE 10-0-2005; IN COMMERCE 10-0-2005.

THE MARK CONSISTS OF THE LETTER "T" WRITTEN IN A DISTINCTIVE SCRIPT.

SN 77-131,565, FILED 3-15-2007.

KAPIL BHANOT, EXAMINING ATTORNEY

**Int. Cl.: 28**

**Prior U.S. Cls.: 22, 23, 38, and 50**

**United States Patent and Trademark Office**

**Reg. No. 3,468,877**

**Registered July 15, 2008**

**TRADEMARK  
PRINCIPAL REGISTER**

**HAUNTED**

TY INC. (DELAWARE CORPORATION)  
280 CHESTNUT  
WESTMONT, IL 60559

THE MARK CONSISTS OF STANDARD CHAR-  
ACTERS WITHOUT CLAIM TO ANY PARTICULAR  
FONT, STYLE, SIZE, OR COLOR.

FOR: PLUSH TOYS; SOFT SCULPTURE PLUSH  
TOYS; STUFFED TOY ANIMALS; STUFFED TOY  
BEARS, IN CLASS 28 (U.S. CLS. 22, 23, 38 AND 50).

SN 77-131,749, FILED 3-15-2007.

FIRST USE 8-3-2007; IN COMMERCE 8-3-2007.

DEZMONA MIZELLE, EXAMINING ATTORNEY

**Int. Cl.: 29**

**Prior U.S. Cl.: 46**

**United States Patent and Trademark Office**

**Reg. No. 3,468,878**

**Registered July 15, 2008**

**TRADEMARK  
PRINCIPAL REGISTER**

**OCEANCHILL**

REGAL SPRINGS TRADING COMPANY (FLOR-  
IDA CORPORATION)  
4920 LORRAINE ROAD  
BRADENTON, FL 34211

THE MARK CONSISTS OF STANDARD CHAR-  
ACTERS WITHOUT CLAIM TO ANY PARTICULAR  
FONT, STYLE, SIZE, OR COLOR.

FOR: FRESH FISH, NAMELY, TILAPIA, IN  
CLASS 29 (U.S. CL. 46).

SN 77-132,339, FILED 3-15-2007.

FIRST USE 12-16-2006; IN COMMERCE 12-16-2006.

DAVID MURRAY, EXAMINING ATTORNEY

**Int. Cl.: 28**

**Prior U.S. Cls.: 22, 23, 38, and 50**

**United States Patent and Trademark Office**

**Reg. No. 3,468,879**

**Registered July 15, 2008**

**TRADEMARK  
PRINCIPAL REGISTER**

**ZERO GRAVITY**

AKADEMA INC. (NEW JERSEY CORPORATION)  
140 FIFTH AVE.  
HAWTHORNE, NJ 07506

FOR: BASEBALL BATTING GLOVES; BATTING  
GLOVES, IN CLASS 28 (U.S. CLS. 22, 23, 38 AND 50).

FIRST USE 8-14-2007; IN COMMERCE 8-14-2007.

THE MARK CONSISTS OF STANDARD CHAR-  
ACTERS WITHOUT CLAIM TO ANY PARTICULAR  
FONT, STYLE, SIZE, OR COLOR.

SN 77-132,399, FILED 3-15-2007.

GISELLE AGOSTO, EXAMINING ATTORNEY



**Int. Cl.: 9**

**Prior U.S. Cls.: 21, 23, 26, 36, and 38**

**Reg. No. 3,468,880**

**United States Patent and Trademark Office**

**Registered July 15, 2008**

---

**TRADEMARK  
PRINCIPAL REGISTER**

**OUTSTART TRAININGEDGE**

OUTSTART, INC. (DELAWARE CORPORATION)  
745 ATLANTIC AVENUE  
BOSTON, MA 02111

FIRST USE 8-13-2007; IN COMMERCE 8-13-2007.

FOR: COMPUTER SOFTWARE FOR USE IN CREATING, DELIVERING AND MANAGING FORMAL AND INFORMAL TRAINING PROGRAMS AND EDUCATIONAL MATERIALS FOR USE IN THE FIELDS OF TECHNOLOGY PRODUCTS TRAINING, BUSINESS SKILLS EDUCATION, AND PROFESSIONAL DEVELOPMENT, IN CLASS 9 (U.S. CLS. 21, 23, 26, 36 AND 38).

THE MARK CONSISTS OF STANDARD CHARACTERS WITHOUT CLAIM TO ANY PARTICULAR FONT, STYLE, SIZE, OR COLOR.

OWNER OF U.S. REG. NO. 2,590,823.

SN 77-132,826, FILED 3-16-2007.

TINA L. SNAPP, EXAMINING ATTORNEY

**Int. Cls.: 35, 36, and 41**

**Prior U.S. Cls.: 100, 101, 102, and 107**

**United States Patent and Trademark Office**

**Reg. No. 3,468,881**

**Registered July 15, 2008**

**SERVICE MARK  
PRINCIPAL REGISTER**

**GENERATION SCHOOLS**

GENERATION SCHOOLS NETWORK INC. (NEW YORK NON-PROFIT CORPORATION)  
150 COURT STREET, 2ND FLOOR  
BROOKLYN, NY 11201

FOR: CONSULTING FOR OTHERS IN THE OPERATION AND MANAGEMENT OF PUBLIC SCHOOLS, CHARTER SCHOOLS AND SCHOOL DISTRICTS IN THE FIELD OF ELEMENTARY, MIDDLE AND HIGH SCHOOL EDUCATION, IN CLASS 35 (U.S. CLS. 100, 101 AND 102).

FIRST USE 9-30-2006; IN COMMERCE 9-30-2006.

FOR: CHARITABLE FUND RAISING, IN CLASS 36 (U.S. CLS. 100, 101 AND 102).

FIRST USE 1-31-2005; IN COMMERCE 1-31-2005.

FOR: EDUCATIONAL SERVICES IN THE NATURE OF COURSES AND INSTRUCTION AT THE ELEMENTARY, JUNIOR HIGH AND HIGH SCHOOL LEVEL; EDUCATION SERVICES, NAMELY, MENTORING IN THE FIELD OF GENERAL AND SPECIAL EDUCATION; DEVELOPMENT AND

DISSEMINATION OF EDUCATIONAL MATERIALS IN THE FIELD OF GENERAL AND SPECIAL EDUCATION; GENERAL AND SPECIAL EDUCATION CONSULTATION; TRAINING SERVICES IN THE FIELD OF GENERAL AND SPECIAL EDUCATION; PROVIDING CLASSES, SEMINARS AND MENTORING IN THE FIELD OF PROFESSIONAL TEACHING; CONSULTING SERVICES IN THE FIELD OF EDUCATION, IN CLASS 41 (U.S. CLS. 100, 101 AND 107).

FIRST USE 8-15-2007; IN COMMERCE 8-15-2007.

THE MARK CONSISTS OF STANDARD CHARACTERS WITHOUT CLAIM TO ANY PARTICULAR FONT, STYLE, SIZE, OR COLOR.

NO CLAIM IS MADE TO THE EXCLUSIVE RIGHT TO USE "SCHOOLS", APART FROM THE MARK AS SHOWN.

SN 77-132,892, FILED 3-16-2007.

JILL C. ALT, EXAMINING ATTORNEY

**Int. Cl.: 33**

**Prior U.S. Cls.: 47 and 49**

**United States Patent and Trademark Office**

**Reg. No. 3,468,882**

**Registered July 15, 2008**

**TRADEMARK  
PRINCIPAL REGISTER**

**HOUSE JAM**

WINEWAVE, LTD (NEW YORK CORPORATION)  
420 JERICHO TURNPIKE  
JERICHO, NY 11753

THE MARK CONSISTS OF STANDARD CHAR-  
ACTERS WITHOUT CLAIM TO ANY PARTICULAR  
FONT, STYLE, SIZE, OR COLOR.

FOR: WINE, IN CLASS 33 (U.S. CLS. 47 AND 49).

SN 77-133,010, FILED 3-16-2007.

FIRST USE 7-31-2007; IN COMMERCE 8-31-2007.

LESLEY LAMOTHE, EXAMINING ATTORNEY

**Int. Cls.: 35 and 42**

**Prior U.S. Cls.: 100, 101, and 102**

**United States Patent and Trademark Office**

**Reg. No. 3,468,883**

**Registered July 15, 2008**

**SERVICE MARK  
PRINCIPAL REGISTER**

**HIGH NOON**

R. WOOLSEY AND ASSOCIATES, INC. (WASHINGTON CORPORATION)  
839 S. BRIDGE WAY PLACE  
BOISE, ID 83616

FOR: SERVICES RELATING TO THE ANALYSIS, EVALUATION, CREATION AND BRAND ESTABLISHMENT OF TRADEMARKS, TRADE NAMES AND DOMAIN NAMES; CREATIVE MARKETING DESIGN SERVICES; ADVERTISING SERVICES, NAMELY, CREATING CORPORATE AND BRAND IDENTITY FOR OTHERS, IN CLASS 35 (U.S. CLS. 100, 101 AND 102).

FIRST USE 2-16-2007; IN COMMERCE 2-16-2007.

FOR: GRAPHIC DESIGN SERVICES; DESIGN OF HOMEPAGES AND WEB-SITES, IN CLASS 42 (U.S. CLS. 100 AND 101).

FIRST USE 2-16-2007; IN COMMERCE 2-16-2007.

THE MARK CONSISTS OF STANDARD CHARACTERS WITHOUT CLAIM TO ANY PARTICULAR FONT, STYLE, SIZE, OR COLOR.

SN 77-133,247, FILED 3-16-2007.

SANJEEV VOHRA, EXAMINING ATTORNEY

**Int. Cl.: 28**

**Prior U.S. Cls.: 22, 23, 38, and 50**

**Reg. No. 3,468,884**

**United States Patent and Trademark Office**

**Registered July 15, 2008**

---

**TRADEMARK  
PRINCIPAL REGISTER**

**V-MAX**

SAYERS, JOSEPH P. (UNITED STATES INDIVIDUAL)  
277 BROADWAY BLVD.  
BATTLE CREEK, MI 49037

THE MARK CONSISTS OF STANDARD CHARACTERS WITHOUT CLAIM TO ANY PARTICULAR FONT, STYLE, SIZE, OR COLOR.

FOR: FISHING LURES, IN CLASS 28 (U.S. CLS. 22, 23, 38 AND 50).

SN 77-133,308, FILED 3-16-2007.

FIRST USE 5-9-2008; IN COMMERCE 5-9-2008.

WENDY JUN, EXAMINING ATTORNEY

**Int. Cl.: 28**

**Prior U.S. Cls.: 22, 23, 38, and 50**

**United States Patent and Trademark Office**

**Reg. No. 3,468,885**

**Registered July 15, 2008**

**TRADEMARK  
PRINCIPAL REGISTER**

**SPLASHBOB**

SAYERS, JOSEPH P. (UNITED STATES INDIVIDUAL)  
277 BROADWAY BLVD.  
BATTLE CREEK, MI 49037

THE MARK CONSISTS OF STANDARD CHARACTERS WITHOUT CLAIM TO ANY PARTICULAR FONT, STYLE, SIZE, OR COLOR.

FOR: FISHING LURES, IN CLASS 28 (U.S. CLS. 22, 23, 38 AND 50).

SN 77-133,340, FILED 3-16-2007.

FIRST USE 5-9-2008; IN COMMERCE 5-9-2008.

WENDY JUN, EXAMINING ATTORNEY

**Int. Cl.: 9**

**Prior U.S. Cls.: 21, 23, 26, 36, and 38**

**Reg. No. 3,468,886**

**United States Patent and Trademark Office**

**Registered July 15, 2008**

---

**TRADEMARK  
PRINCIPAL REGISTER**

**Yealink**

XIAMEN YEALINK NETWORK TECHNOLOGY  
CO., LTD. (CHINA LTD LIAB CO)  
7/F HUALIAN ELECTRONIC BUILDING  
TORCH HI-TECH INDUSTRIAL DEVELOPMNT  
ZONE  
XIAMEN, FUJIAN, CHINA

FOR: TELEPHONES, IN CLASS 9 (U.S. CLS. 21, 23,  
26, 36 AND 38).

FIRST USE 12-12-2005; IN COMMERCE 5-5-2008.

THE MARK CONSISTS OF STANDARD CHAR-  
ACTERS WITHOUT CLAIM TO ANY PARTICULAR  
FONT, STYLE, SIZE, OR COLOR.

SN 77-133,399, FILED 3-16-2007.

TRACY WHITTAKER-BROWN, EXAMINING AT-  
TORNEY

**Int. Cl.: 31**

**Prior U.S. Cls.: 1 and 46**

**United States Patent and Trademark Office**

**Reg. No. 3,468,887**

**Registered July 15, 2008**

**TRADEMARK  
PRINCIPAL REGISTER**

**ECOMASTER**

DLF INTERNATIONAL SEEDS, INC. (OREGON  
CORPORATION)  
PO BOX 229  
HALSEY, OR 97348

THE MARK CONSISTS OF STANDARD CHAR-  
ACTERS WITHOUT CLAIM TO ANY PARTICULAR  
FONT, STYLE, SIZE, OR COLOR.

FOR: GRASS SEED, IN CLASS 31 (U.S. CLS. 1 AND  
46).

SN 77-133,566, FILED 3-16-2007.

FIRST USE 3-21-2008; IN COMMERCE 3-21-2008.

JOHN WILKE, EXAMINING ATTORNEY



**Int. Cl.: 29**

**Prior U.S. Cl.: 46**

**Reg. No. 3,468,888**

**United States Patent and Trademark Office**

**Registered July 15, 2008**

**TRADEMARK  
PRINCIPAL REGISTER**



ORIENTAL QINGS PRODUCTS, LLC (TEXAS  
LTD LIAB CO)  
5800 RANCHESTER DRIVE  
STE 200  
HOUSTON, TX 77036

THE MARK CONSISTS OF THE MARK IS A  
DRAWING OF TWO PERSONIFIED LOBSTERS  
DANCING TOGETHER. THE LOBSTER ON THE  
LEFT APPEARS TO HAVE A CROWN AND THE  
LOBSTER ON THE RIGHT IS FEMALE.

FOR: FISH; SEAFOOD, IN CLASS 29 (U.S. CL. 46).

SN 77-133,575, FILED 3-16-2007.

FIRST USE 6-24-2007; IN COMMERCE 6-24-2007.

SUSAN RICHARDS, EXAMINING ATTORNEY

**Int. Cls.: 35 and 42**

**Prior U.S. Cls.: 100, 101, and 102**

**United States Patent and Trademark Office**

**Reg. No. 3,468,889**

**Registered July 15, 2008**

**SERVICE MARK  
PRINCIPAL REGISTER**

# 3 DOG MEDIA

3 DOG MEDIA, LLC (CALIFORNIA LTD LIAB  
CO)  
SUITE 310  
23822 VALENCIA BLVD.  
VALENCIA, CA 91355

FOR: BUSINESS MARKETING SERVICES; MAR-  
KETING CONSULTING; MARKETING PLAN DE-  
VELOPMENT; ADVERTISING AND MARKETING;  
ADVERTISING SERVICES, NAMELY, PROMOTING  
AND MARKETING THE GOODS AND SERVICES  
OF OTHERS THROUGH ALL PUBLIC COMMUNI-  
CATION MEANS, IN CLASS 35 (U.S. CLS. 100, 101  
AND 102).

FIRST USE 1-1-2008; IN COMMERCE 2-1-2008.

FOR: WEBSITE DEVELOPMENT FOR OTHERS,  
IN CLASS 42 (U.S. CLS. 100 AND 101).

FIRST USE 1-1-2008; IN COMMERCE 2-1-2008.

THE MARK CONSISTS OF STANDARD CHAR-  
ACTERS WITHOUT CLAIM TO ANY PARTICULAR  
FONT, STYLE, SIZE, OR COLOR.

NO CLAIM IS MADE TO THE EXCLUSIVE  
RIGHT TO USE "MEDIA", APART FROM THE  
MARK AS SHOWN.

SN 77-133,580, FILED 3-16-2007.

REBECCA GILBERT, EXAMINING ATTORNEY

**Int. Cl.: 5**

**Prior U.S. Cls.: 6, 18, 44, 46, 51, and 52**

**Reg. No. 3,468,890**

**United States Patent and Trademark Office**

**Registered July 15, 2008**

**TRADEMARK  
PRINCIPAL REGISTER**

**max out your water**

SURVIVAL TECH USA, INC (CALIFORNIA CORPORATION)  
4872 TOPANGA CANYON BLVD., STE 277  
WOODLAND HILLS, CA 91364

FOR: VITAMIN SUPPLEMENT IN TABLET FORM FOR USE IN MAKING AN EFFERVESCENT BEVERAGE WHEN ADDED TO WATER, IN CLASS 5 (U.S. CLS. 6, 18, 44, 46, 51 AND 52).

FIRST USE 1-1-2008; IN COMMERCE 1-15-2008.

THE MARK CONSISTS OF STANDARD CHARACTERS WITHOUT CLAIM TO ANY PARTICULAR FONT, STYLE, SIZE, OR COLOR.

NO CLAIM IS MADE TO THE EXCLUSIVE RIGHT TO USE "WATER", APART FROM THE MARK AS SHOWN.

SN 77-133,875, FILED 3-18-2007.

NELSON SNYDER, EXAMINING ATTORNEY

**Int. Cl.: 29**

**Prior U.S. Cl.: 46**

**United States Patent and Trademark Office**

**Reg. No. 3,468,891**

**Registered July 15, 2008**

**TRADEMARK  
PRINCIPAL REGISTER**

**PURELY NUTS**

KRAFT FOODS HOLDINGS, INC. (DELAWARE  
CORPORATION)

THREE LAKES DRIVE

NORTHFIELD, IL 60093

FOR: PROCESSED NUTS, IN CLASS 29 (U.S. CL.  
46).

FIRST USE 9-10-2007; IN COMMERCE 9-10-2007.

THE MARK CONSISTS OF STANDARD CHAR-  
ACTERS WITHOUT CLAIM TO ANY PARTICULAR  
FONT, STYLE, SIZE, OR COLOR.

NO CLAIM IS MADE TO THE EXCLUSIVE  
RIGHT TO USE "NUTS", APART FROM THE MARK  
AS SHOWN.

SN 77-133,955, FILED 3-19-2007.

AHSEN KHAN, EXAMINING ATTORNEY

**Int. Cl.: 35**

**Prior U.S. Cls.: 100, 101, and 102**

**United States Patent and Trademark Office**

**Reg. No. 3,468,892**

**Registered July 15, 2008**

---

**SERVICE MARK  
PRINCIPAL REGISTER**

**ASK FOR SOUTH CAROLINA.  
NOTHING'S FRESHER.  
NOTHING'S FINER.**

SOUTH CAROLINA DEPARTMENT OF AGRICULTURE (SOUTH CAROLINA STATE AGENCY)  
1200 SENATE STREET  
COLUMBIA, SC 29201

THE MARK CONSISTS OF STANDARD CHARACTERS WITHOUT CLAIM TO ANY PARTICULAR FONT, STYLE, SIZE, OR COLOR.

FOR: PROMOTING PUBLIC AWARENESS OF SOUTH CAROLINA AGRICULTURAL PRODUCTS, IN CLASS 35 (U.S. CLS. 100, 101 AND 102).

SN 77-134,088, FILED 3-19-2007.

FIRST USE 5-1-2007; IN COMMERCE 5-1-2007.

KEVIN CORWIN, EXAMINING ATTORNEY

**Int. Cl.: 35**

**Prior U.S. Cls.: 100, 101, and 102**

**United States Patent and Trademark Office**

**Reg. No. 3,468,893**

**Registered July 15, 2008**

---

**SERVICE MARK  
PRINCIPAL REGISTER**

**BUY SOUTH CAROLINA.  
NOTHING'S FRESHER.  
NOTHING'S FINER**

SOUTH CAROLINA DEPARTMENT OF AGRICULTURE (SOUTH CAROLINA STATE AGENCY)  
1200 SENATE STREET  
COLUMBIA, SC 29201

THE MARK CONSISTS OF STANDARD CHARACTERS WITHOUT CLAIM TO ANY PARTICULAR FONT, STYLE, SIZE, OR COLOR.

FOR: PROMOTING PUBLIC AWARENESS OF SOUTH CAROLINA AGRICULTURAL PRODUCTS, IN CLASS 35 (U.S. CLS. 100, 101 AND 102).

SN 77-134,099, FILED 3-19-2007.

FIRST USE 7-1-2007; IN COMMERCE 7-1-2007.

KEVIN CORWIN, EXAMINING ATTORNEY

**Int. Cl.: 9**

**Prior U.S. Cls.: 21, 23, 26, 36, and 38**

**United States Patent and Trademark Office**

**Reg. No. 3,468,894**

**Registered July 15, 2008**

**TRADEMARK  
PRINCIPAL REGISTER**

A NEW SPIN ON DISC PRINTING

SANFORD, L.P. (ILLINOIS LIMITED PARTNER-  
SHIP)  
2707 BUTTERFIELD ROAD  
OAK BROOK, IL 60523

FOR: LABEL PRINTERS THAT PRINT ON COM-  
PACT DISCS AND DVDS, IN CLASS 9 (U.S. CLS. 21,  
23, 26, 36 AND 38).

FIRST USE 10-26-2007; IN COMMERCE 10-26-2007.

THE MARK CONSISTS OF STANDARD CHAR-  
ACTERS WITHOUT CLAIM TO ANY PARTICULAR  
FONT, STYLE, SIZE, OR COLOR.

NO CLAIM IS MADE TO THE EXCLUSIVE  
RIGHT TO USE "DISC PRINTING", APART FROM  
THE MARK AS SHOWN.

SN 77-134,132, FILED 3-19-2007.

IRA J. GOODSaid, EXAMINING ATTORNEY

Prior U.S. Cl.: A

United States Patent and Trademark Office

Reg. No. 3,468,895

Registered July 15, 2008

CERTIFICATION MARK  
GOODS  
PRINCIPAL REGISTER



SOUTH CAROLINA DEPARTMENT OF AGRICULTURE (SOUTH CAROLINA STATE AGENCY)  
1200 SENATE STREET  
COLUMBIA, SC 29201

FOR: AGRICULTURAL PRODUCTS, IN CLASS A (U.S. CL. A).

FIRST USE 5-1-2007; IN COMMERCE 5-1-2007.

NO CLAIM IS MADE TO THE EXCLUSIVE RIGHT TO USE "CERTIFIED AND PRODUCT", APART FROM THE MARK AS SHOWN.

THE MARK CONSISTS OF AN OVAL WITH A MAP OF THE STATE OF SOUTH CAROLINA SU-

PERIMPOSED ON A SUNBURST INSIDE THE OVAL, WITH THE WORD CERTIFIED ABOVE AND THE PHRASE SC PRODUCT BELOW THE SUNBURST AND WITHIN THE OVAL.

THE CERTIFICATION MARK, AS INTENDED TO BE USED BY AUTHORIZED PERSONS, IS INTENDED TO CERTIFY THAT AGRICULTURAL PRODUCTS HAVE BEEN GROWN, RAISED, PROCESSED OR OTHERWISE MANUFACTURED IN THE STATE OF SOUTH CAROLINA.

SN 77-134,190, FILED 3-19-2007.

KEVIN CORWIN, EXAMINING ATTORNEY



**Int. Cls.: 9 and 28**

**Prior U.S. Cls.: 21, 22, 23, 26, 36, 38, and 50**

**United States Patent and Trademark Office**

**Reg. No. 3,468,896**

**Registered July 15, 2008**

**TRADEMARK  
PRINCIPAL REGISTER**

**FLIBBIX**

IVAN, JASON (UNITED STATES INDIVIDUAL)  
31727 NE 110TH ST.  
CARNATION, WA 98014

FOR: COMPUTER GAME SOFTWARE; VIDEO  
GAME SOFTWARE, IN CLASS 9 (U.S. CLS. 21, 23, 26,  
36 AND 38).

FIRST USE 2-6-2008; IN COMMERCE 2-6-2008.

FOR: BOARD GAMES; EQUIPMENT SOLD AS A  
UNIT FOR PLAYING BOARD GAMES; CONSTRUCTION  
TOYS; CARD GAMES; MANIPULATIVE  
GAMES; MANIPULATIVE PUZZLES; PUZZLES;

STACKING TOYS; TOY BUILDING BLOCKS; TOY  
CONSTRUCTION BLOCKS; TOY CONSTRUCTION  
SETS, IN CLASS 28 (U.S. CLS. 22, 23, 38 AND 50).

FIRST USE 3-1-2007; IN COMMERCE 2-17-2008.

THE MARK CONSISTS OF STANDARD CHAR-  
ACTERS WITHOUT CLAIM TO ANY PARTICULAR  
FONT, STYLE, SIZE, OR COLOR.

SN 77-134,429, FILED 3-19-2007.

GEORGIA CARTY, EXAMINING ATTORNEY

**Int. Cl.: 41**

**Prior U.S. Cls.: 100, 101, and 107**

**United States Patent and Trademark Office**

**Reg. No. 3,468,897**

**Registered July 15, 2008**

**SERVICE MARK  
PRINCIPAL REGISTER**

PEACE, LOVE AND LEMONADE

NANCY STAMPAHAR (UNITED STATES INDIVIDUAL)  
SUITE 920  
200 WHITE HAMPTON LANE  
PITTSBURGH, PA 152361867

THE MARK CONSISTS OF STANDARD CHARACTERS WITHOUT CLAIM TO ANY PARTICULAR FONT, STYLE, SIZE, OR COLOR.

FOR: ARRANGING PROFESSIONAL WORKSHOP AND TRAINING COURSES, IN CLASS 41 (U.S. CLS. 100, 101 AND 107).

SN 77-134,461, FILED 3-19-2007.

FIRST USE 4-2-2008; IN COMMERCE 4-2-2008.

WILLIAM VERHOSEK, EXAMINING ATTORNEY

**Int. Cl.: 30**

**Prior U.S. Cl.: 46**

**United States Patent and Trademark Office**

**Reg. No. 3,468,898**

**Registered July 15, 2008**

**TRADEMARK  
PRINCIPAL REGISTER**

**GRAPZE**

ANDREW J. BENTLEY (UNITED STATES INDIVIDUAL)  
P.O. BOX 176  
EAST KILLINGLY, CT 06243

THE MARK CONSISTS OF STANDARD CHARACTERS WITHOUT CLAIM TO ANY PARTICULAR FONT, STYLE, SIZE, OR COLOR.

FOR: TEA-BASED BEVERAGES WITH FRUIT FLAVORING, IN CLASS 30 (U.S. CL. 46).

SN 77-134,471, FILED 3-19-2007.

FIRST USE 6-1-2008; IN COMMERCE 6-1-2008.

CYNTHIA SLOAN, EXAMINING ATTORNEY

**Int. Cl.: 14**

**Prior U.S. Cls.: 2, 27, 28, and 50**

**United States Patent and Trademark Office**

**Reg. No. 3,468,899**

**Registered July 15, 2008**

---

**TRADEMARK  
PRINCIPAL REGISTER**

**E INK**

E INK CORPORATION (DELAWARE CORPORATION)  
733 CONCORD AVENUE  
CAMBRIDGE, MA 021381002

FOR: WATCHES, IN CLASS 14 (U.S. CLS. 2, 27, 28 AND 50).

FIRST USE 5-1-2008; IN COMMERCE 5-1-2008.

THE MARK CONSISTS OF STANDARD CHARACTERS WITHOUT CLAIM TO ANY PARTICULAR FONT, STYLE, SIZE, OR COLOR.

OWNER OF U.S. REG. NO. 2,578,896.

SN 77-134,532, FILED 3-19-2007.

JUDITH HELFMAN, EXAMINING ATTORNEY

Int. Cl.: 5

Prior U.S. Cls.: 6, 18, 44, 46, 51, and 52

Reg. No. 3,468,900

United States Patent and Trademark Office

Registered July 15, 2008

TRADEMARK  
PRINCIPAL REGISTER

NEWFOUND CARE

CERTIFIED WORLDWIDE LLC (CALIFORNIA  
LTD LIAB CO)  
PO BOX 310  
MOORPARK, CA 93020

FOR: VITAMINS; MINERAL SUPPLEMENTS; DIETARY SUPPLEMENTS; NUTRITIONAL SUPPLEMENTS; HERBAL SUPPLEMENTS; PROTEIN SUPPLEMENTS; NUTRACEUTICALS FOR USE AS A DIETARY SUPPLEMENT; ANTI-PYRETIC AND ANTI-INFLAMMATORY PREPARATIONS; HOMEOPATHIC PHARMACEUTICAL PREPARATIONS AND OVER-THE-COUNTER PHARMACEUTICAL PREPARATIONS, NAMELY ANALGESICS, APPETITE SUPPRESSANTS AND FAT REDUCERS, DIET PILLS AND CAPSULES, DIURETICS, SLEEPING PILLS AND TABLETS, ANTI-DROWSINESS TREATMENT PREPARATIONS, ANTIEMETICS, ANTIHISTAMINES, COUGH SUPPRESSANTS AND EXPECTORANTS, DECONGESTANTS, LAXATIVES, ANTACIDS, ANTI-FLATULANTS, DIARRHEA MEDICATION, HEMORRHOID TREATMENT PREPARATIONS, FUNGICIDES, MENSTRUAL SYMPTOM TREATMENT PREPARATIONS, TOPICAL ANESTHETICS, NOSE DROPS AND NASAL SPRAY PREPARATIONS, EYE DROPS, EAR DROPS, ENEMA PREPARATIONS, AND TRANSDERMAL PATCHES FOR USE IN THE TREATMENT OF ACHES AND PAINS OF MUSCLES AND JOINTS; HAIR GROWTH STIMULANTS; MEDICATED HAIR CARE PREPARATIONS; SMOKING CESSATION PREPARA-

TIONS; HERBAL TEAS FOR MEDICINAL PURPOSES; MEAL REPLACEMENT BARS, POWDERS, DRINK MIXES, DRINKS, AND SHAKES; FOOD FOR MEDICALLY RESTRICTED DIETS; PHARMACEUTICAL PREPARATIONS FOR TREATING DIABETES; FOOD FOR DIABETICS; ANTIBIOTIC AND ANTISEPTIC PREPARATIONS; ANTIBACTERIAL SUBSTANCES FOR MEDICAL PURPOSES; MEDICATED MOUTH CARE AND TREATMENT PREPARATIONS; MEDICATED SKIN AND SUN CARE PREPARATIONS; MEDICATED DIAPER RASH OINTMENTS AND LOTIONS; VAGINAL MOISTURIZERS, MEDICATED CLEANSERS, AND WASHES; HAND-SANITIZING PREPARATIONS; PRE-MOISTENED MEDICATED WIPES, TISSUES, AND TOWELETTS; CONTACT LENS SOLUTIONS; BABY FOOD; INFANT FORMULA; FOOD FOR INFANTS; POWDERED MILK FOR BABIES; DIETARY SUPPLEMENTS FOR ANIMALS, IN CLASS 5 (U.S. CLS. 6, 18, 44, 46, 51 AND 52).

FIRST USE 12-5-2007; IN COMMERCE 12-5-2007.

THE MARK CONSISTS OF STANDARD CHARACTERS WITHOUT CLAIM TO ANY PARTICULAR FONT, STYLE, SIZE, OR COLOR.

SN 77-134,619, FILED 3-19-2007.

ROBIN MITTLER, EXAMINING ATTORNEY

**Int. Cl.: 5**

**Prior U.S. Cls.: 6, 18, 44, 46, 51, and 52**

**Reg. No. 3,468,901**

**United States Patent and Trademark Office**

**Registered July 15, 2008**

---

**TRADEMARK  
PRINCIPAL REGISTER**

**HYDROWHEY**

OPTIMUM NUTRITION, INC. (FLORIDA CORPORATION)  
ATTN: JEN LARIMER  
700 N. COMMERCE STREET  
AURORA, IL 60504

FOR: DIETARY AND NUTRITIONAL SUPPLEMENTS, IN CLASS 5 (U.S. CLS. 6, 18, 44, 46, 51 AND 52).

FIRST USE 4-1-2008; IN COMMERCE 4-1-2008.

THE MARK CONSISTS OF STANDARD CHARACTERS WITHOUT CLAIM TO ANY PARTICULAR FONT, STYLE, SIZE, OR COLOR.

OWNER OF U.S. REG. NO. 2,941,256.

SN 77-134,768, FILED 3-19-2007.

ELLEN BURNS, EXAMINING ATTORNEY

**Int. Cl.: 33**

**Prior U.S. Cls.: 47 and 49**

**United States Patent and Trademark Office**

**Reg. No. 3,468,902**

**Registered July 15, 2008**

**TRADEMARK  
PRINCIPAL REGISTER**

**XTRAORDINARIO**

MONTGOMERY B. SMITH (UNITED STATES  
INDIVIDUAL)  
3212 SUNNYBROOK DRIVE  
CHARLOTTE, NC 28210

FOR: TEQUILA, IN CLASS 33 (U.S. CLS. 47 AND  
49).

FIRST USE 1-0-2005; IN COMMERCE 3-7-2008.

THE MARK CONSISTS OF STANDARD CHAR-  
ACTERS WITHOUT CLAIM TO ANY PARTICULAR  
FONT, STYLE, SIZE, OR COLOR.

THE ENGLISH TRANSLATION OF "EXTRAOR-  
DINARIO" IS "EXTRAORDINARY".

SN 77-135,120, FILED 3-20-2007.

MAUREEN DALL, EXAMINING ATTORNEY

**Int. Cl.: 9**

**Prior U.S. Cls.: 21, 23, 26, 36, and 38**

**Reg. No. 3,468,903**

**United States Patent and Trademark Office**

**Registered July 15, 2008**

---

**TRADEMARK  
PRINCIPAL REGISTER**

**LITESPEED**

QUEST SOFTWARE, INC. (CALIFORNIA CORPORATION)  
5 POLARIS WAY  
ALISO VIEJO, CA 92656

THE MARK CONSISTS OF STANDARD CHARACTERS WITHOUT CLAIM TO ANY PARTICULAR FONT, STYLE, SIZE, OR COLOR.

FOR: COMPUTER SOFTWARE FOR BACKUP AND ARCHIVAL OF ELECTRONIC DATABASES AND MONITORING OF THOSE BACKUPS, IN CLASS 9 (U.S. CLS. 21, 23, 26, 36 AND 38).

SN 77-135,952, FILED 3-20-2007.

FIRST USE 12-31-2001; IN COMMERCE 12-31-2001.

JENNY PARK, EXAMINING ATTORNEY



**Int. Cl.: 28**

**Prior U.S. Cls.: 22, 23, 38, and 50**

**Reg. No. 3,468,904**

**United States Patent and Trademark Office**

**Registered July 15, 2008**

---

**TRADEMARK  
PRINCIPAL REGISTER**

**BLUESPEAR**

PEDRO LASALDE (UNITED STATES INDIVIDUAL)  
URB. EL CONVENTO B39 CALLE 2  
SAN GERMAN, PUERTO RICO 00683

THE MARK CONSISTS OF STANDARD CHARACTERS WITHOUT CLAIM TO ANY PARTICULAR FONT, STYLE, SIZE, OR COLOR.

FOR: FISHING REELS; FISHING RODS; FISHING TACKLE; FISHING LURES, IN CLASS 28 (U.S. CLS. 22, 23, 38 AND 50).

SN 77-136,096, FILED 3-20-2007.

FIRST USE 4-1-2007; IN COMMERCE 10-1-2007.

ELIZABETH KAJUBI, EXAMINING ATTORNEY

**Int. Cl.: 43**

**Prior U.S. Cls.: 100 and 101**

**United States Patent and Trademark Office**

**Reg. No. 3,468,905**

**Registered July 15, 2008**

**SERVICE MARK  
PRINCIPAL REGISTER**

**GETOGETHER**

ARAMARK CORPORATION (DELAWARE COR-  
PORATION)  
29TH FLOOR  
1101 MARKET STREET  
PHILADELPHIA, PA 19107

THE MARK CONSISTS OF STANDARD CHAR-  
ACTERS WITHOUT CLAIM TO ANY PARTICULAR  
FONT, STYLE, SIZE, OR COLOR.

FOR: CATERING SERVICES, IN CLASS 43 (U.S.  
CLS. 100 AND 101).

SN 77-136,190, FILED 3-21-2007.

FIRST USE 6-1-2007; IN COMMERCE 6-1-2007.

REBECCA EISINGER, EXAMINING ATTORNEY

**Int. Cl.: 42**

**Prior U.S. Cls.: 100 and 101**

**United States Patent and Trademark Office**

**Reg. No. 3,468,906**

**Registered July 15, 2008**

**SERVICE MARK  
PRINCIPAL REGISTER**



S1 IT SOLUTIONS, INC. (IDAHO CORPORATION)  
SUITE 300  
420 WEST MAIN STREET  
BOISE, ID 83702

FOR: CONSULTATION SERVICES IN THE  
FIELDS OF SELECTION, IMPLEMENTATION  
AND USE OF COMPUTER HARDWARE AND  
SOFTWARE SYSTEMS FOR OTHERS, IN CLASS 42  
(U.S. CLS. 100 AND 101).

FIRST USE 3-1-2007; IN COMMERCE 3-1-2007.

THE COLOR(S) BLACK AND YELLOW IS/ARE  
CLAIMED AS A FEATURE OF THE MARK.

THE MARK CONSISTS OF TWO HALF CIRCLES,  
THE UPPER HALF IN BLACK, THE LOWER HALF  
IN YELLOW, WITH A CUT CIRCLE TO THE RIGHT  
IN YELLOW WITH "S1" WRITTEN IN BLACK ON  
THE INSIDE.

SN 77-136,202, FILED 3-21-2007.

EMILY CARLSEN, EXAMINING ATTORNEY

**Int. Cls.: 9 and 16**

**Prior U.S. Cls.: 2, 5, 21, 22, 23, 26, 29, 36, 37, 38, and 50**

**United States Patent and Trademark Office**

**Reg. No. 3,468,907**

**Registered July 15, 2008**

**TRADEMARK  
PRINCIPAL REGISTER**

**THE MOOD BANK**

SIEVERT, MARY (UNITED STATES INDIVIDUAL)  
6462 WEST PARK AVE.  
CHANDLER, AZ 85226

FOR: SOUND RECORDINGS FEATURING MUSIC INTENDED TO AID OR PROMOTE SELF IMPROVEMENT AND/OR MOOD CHANGE, IN CLASS 9 (U.S. CLS. 21, 23, 26, 36 AND 38).

FIRST USE 6-3-2008; IN COMMERCE 6-3-2008.

FOR: PRINTED INSTRUCTIONAL, EDUCATIONAL, AND TEACHING MATERIALS IN THE FIELD

OF SELF IMPROVEMENT AND/OR MOOD CHANGE, IN CLASS 16 (U.S. CLS. 2, 5, 22, 23, 29, 37, 38 AND 50).

FIRST USE 6-3-2008; IN COMMERCE 6-3-2008.

THE MARK CONSISTS OF STANDARD CHARACTERS WITHOUT CLAIM TO ANY PARTICULAR FONT, STYLE, SIZE, OR COLOR.

SN 77-136,210, FILED 3-21-2007.

MICHAEL SOUDERS, EXAMINING ATTORNEY

**Int. Cl.: 9**

**Prior U.S. Cls.: 21, 23, 26, 36, and 38**

**Reg. No. 3,468,908**

**United States Patent and Trademark Office**

**Registered July 15, 2008**

---

**TRADEMARK  
PRINCIPAL REGISTER**

**100 WOLVES**

IGT (NEVADA CORPORATION)  
9295 PROTOTYPE DRIVE  
RENO, NV 895218986

THE MARK CONSISTS OF STANDARD CHAR-  
ACTERS WITHOUT CLAIM TO ANY PARTICULAR  
FONT, STYLE, SIZE, OR COLOR.

FOR: GAMING MACHINES, NAMELY, DEVICES  
WHICH ACCEPT A WAGER, IN CLASS 9 (U.S. CLS.  
21, 23, 26, 36 AND 38).

SN 77-136,359, FILED 3-21-2007.

FIRST USE 3-10-2008; IN COMMERCE 3-12-2008.

ROBERT STRUCK, EXAMINING ATTORNEY

**Int. Cl.: 24**

**Prior U.S. Cls.: 42 and 50**

**United States Patent and Trademark Office**

**Reg. No. 3,468,909**

**Registered July 15, 2008**

**TRADEMARK  
PRINCIPAL REGISTER**

**MOPPINE**

WP IP, LLC (NEVADA LTD LIAB CO)  
8TH FLOOR  
28 E. 28TH STREET  
NEW YORK, NY 10016

THE MARK CONSISTS OF STANDARD CHAR-  
ACTERS WITHOUT CLAIM TO ANY PARTICULAR  
FONT, STYLE, SIZE, OR COLOR.

FOR: OVEN MITTS; KITCHEN TOWELS, IN  
CLASS 24 (U.S. CLS. 42 AND 50).

SN 77-136,396, FILED 3-21-2007.

FIRST USE 2-0-2008; IN COMMERCE 2-0-2008.

SIMON TENG, EXAMINING ATTORNEY

**Int. Cl.: 14**

**Prior U.S. Cls.: 2, 27, 28, and 50**

**United States Patent and Trademark Office**

**Reg. No. 3,468,910**

**Registered July 15, 2008**

**TRADEMARK  
PRINCIPAL REGISTER**

**OAKLEY MINUTE MACHINE**

OAKLEY, INC. (WASHINGTON CORPORATION)  
ONE ICON  
FOOTHILL RANCH, CA 92610

FOR: TIME PIECES, NAMELY, CLOCKS,  
WATCHES AND COMPONENTS THEREOF, IN  
CLASS 14 (U.S. CLS. 2, 27, 28 AND 50).

FIRST USE 3-17-2007; IN COMMERCE 3-17-2007.

THE MARK CONSISTS OF STANDARD CHAR-  
ACTERS WITHOUT CLAIM TO ANY PARTICULAR  
FONT, STYLE, SIZE, OR COLOR.

OWNER OF U.S. REG. NO. 2,409,789.

SN 77-136,989, FILED 3-21-2007.

LINDA ESTRADA, EXAMINING ATTORNEY

**Int. Cl.: 45**

**Prior U.S. Cls.: 100 and 101**

**United States Patent and Trademark Office**

**Reg. No. 3,468,911**

**Registered July 15, 2008**

**SERVICE MARK  
PRINCIPAL REGISTER**

**Daddy's Little Girl's Time  
For Redemption**

BELCHER, LAMAR (UNITED STATES INDIVIDUAL)  
62 GOODWIN STREET  
EAST HARTFORD, CT 06108 AND  
BELCHER, SHARON (UNITED STATES INDIVIDUAL)  
62 GOODWIN STREET  
EAST HARTFORD, CT 06108

FOR: PERSONAL GROWTH AND MOTIVATION  
CONSULTING SERVICES , IN CLASS 45 (U.S. CLS.  
100 AND 101).

FIRST USE 5-15-2008; IN COMMERCE 5-15-2008.

THE MARK CONSISTS OF STANDARD CHARACTERS WITHOUT CLAIM TO ANY PARTICULAR FONT, STYLE, SIZE, OR COLOR.

SN 77-137,335, FILED 3-22-2007.

RENEE MCCRAY, EXAMINING ATTORNEY



**Int. Cls.: 9 and 21**

**Prior U.S. Cls.: 2, 13, 21, 23, 26, 29, 30, 33, 36, 38, 40,  
and 50**

**Reg. No. 3,468,912**

**United States Patent and Trademark Office**

**Registered July 15, 2008**

**TRADEMARK  
PRINCIPAL REGISTER**

**WORKING HANDS**

BIG TIME HOLDINGS, INC. (GEORGIA COR-  
PORATION)  
2 WILBANKS ROAD  
ROME, GA 30161

FOR: PROTECTIVE GLOVES FOR INDUSTRIAL  
USE; PROTECTIVE WORK GLOVES, IN CLASS 9  
(U.S. CLS. 21, 23, 26, 36 AND 38).

FIRST USE 2-1-2008; IN COMMERCE 2-1-2008.

FOR: CLEANING SPONGES; HOUSEHOLD  
GLOVES FOR GENERAL USE; NON-DISPOSABLE  
LATEX GLOVES FOR GENERAL USE, IN CLASS 21  
(U.S. CLS. 2, 13, 23, 29, 30, 33, 40 AND 50).

FIRST USE 2-1-2008; IN COMMERCE 2-1-2008.

THE MARK CONSISTS OF STANDARD CHAR-  
ACTERS WITHOUT CLAIM TO ANY PARTICULAR  
FONT, STYLE, SIZE, OR COLOR.

NO CLAIM IS MADE TO THE EXCLUSIVE  
RIGHT TO USE "HANDS", APART FROM THE  
MARK AS SHOWN.

SN 77-137,425, FILED 3-22-2007.

BERNICE MIDDLETON, EXAMINING ATTORNEY

**Int. Cl.: 16**

**Prior U.S. Cls.: 2, 5, 22, 23, 29, 37, 38, and 50**

**Reg. No. 3,468,913**

**United States Patent and Trademark Office**

**Registered July 15, 2008**

**TRADEMARK  
PRINCIPAL REGISTER**

**LORNOGRAPHY**

BAKER, LORNA (UNITED STATES INDIVIDUAL)  
24 E. BARKLEY STREET  
TOPTON, PA 19562

THE MARK CONSISTS OF STANDARD CHARACTERS WITHOUT CLAIM TO ANY PARTICULAR FONT, STYLE, SIZE, OR COLOR.

FOR: PHOTOGRAPHS; ART PRINTS, IN CLASS 16 (U.S. CLS. 2, 5, 22, 23, 29, 37, 38 AND 50).

SN 77-137,613, FILED 3-22-2007.

FIRST USE 3-7-2007; IN COMMERCE 8-31-2007.

DOMINICK J. SALEMI, EXAMINING ATTORNEY

**Int. Cl.: 36**

**Prior U.S. Cls.: 100, 101, and 102**

**United States Patent and Trademark Office**

**Reg. No. 3,468,914**

**Registered July 15, 2008**

**SERVICE MARK  
PRINCIPAL REGISTER**

**PREFERENCE FLEX SELECT**

METROPOLITAN LIFE INSURANCE COMPANY  
(NEW YORK CORPORATION)  
1 METLIFE PLAZA, 27-01 QUEENS PLAZA NO.  
LONG ISLAND CITY, NY 11101

FOR: INSURANCE AND FINANCIAL SERVICES,  
NAMELY, THE UNDERWRITING AND ADMINIS-  
TRATION OF ANNUITIES, IN CLASS 36 (U.S. CLS.  
100, 101 AND 102).

FIRST USE 6-1-2007; IN COMMERCE 6-1-2007.

THE MARK CONSISTS OF STANDARD CHAR-  
ACTERS WITHOUT CLAIM TO ANY PARTICULAR  
FONT, STYLE, SIZE, OR COLOR.

OWNER OF U.S. REG. NOS. 2,684,762 AND  
2,754,518.

SN 77-137,910, FILED 3-22-2007.

PAUL MORENO, EXAMINING ATTORNEY

**Int. Cl.: 1**

**Prior U.S. Cls.: 1, 5, 6, 10, 26, and 46**

**United States Patent and Trademark Office**

**Reg. No. 3,468,915**

**Registered July 15, 2008**

**TRADEMARK  
PRINCIPAL REGISTER**



CAREMOLI USA, INC. (IOWA CORPORATION)  
23959 - 580TH STREET  
AMES, IA 50010

FOR: CITRIC ACID; CITRIC ACID FOR USE AS  
INGREDIENTS IN THE FOOD AND PHARMACEU-  
TICAL INDUSTRY, IN CLASS 1 (U.S. CLS. 1, 5, 6, 10,  
26 AND 46).

FIRST USE 6-29-2007; IN COMMERCE 6-29-2007.

NO CLAIM IS MADE TO THE EXCLUSIVE  
RIGHT TO USE "DOMESTICATED", APART FROM  
THE MARK AS SHOWN.

THE MARK CONSISTS OF A MAN STANDING IN  
THE FOREFRONT OF A FIELD HOLDING CORN  
STALKS IN ONE HAND AND A BURLAP BAG ON  
HIS SHOULDER WITH A BARN AND CULTIVATED  
FARMLAND IN THE BACKGROUND, ALL ABOVE  
THE WORDS "CARECITRIC DOMESTICATED  
CCD".

SN 77-137,995, FILED 3-22-2007.

ALICIA COLLINS, EXAMINING ATTORNEY

**Int. Cl.: 29**

**Prior U.S. Cl.: 46**

**United States Patent and Trademark Office**

**Reg. No. 3,468,916**

**Registered July 15, 2008**

**TRADEMARK  
PRINCIPAL REGISTER**

**HOME CHURNED**

SAVE-A-LOT FOOD STORES, LTD. (BERMUDA  
CORPORATION)  
100 CORPORATE OFFICE DRIVE  
EARTH CITY, MO 63045

FOR: BUTTER, MARGARINE AND VEGETABLE  
OIL SPREAD, IN CLASS 29 (U.S. CL. 46).

FIRST USE 3-24-2008; IN COMMERCE 3-24-2008.

THE MARK CONSISTS OF STANDARD CHAR-  
ACTERS WITHOUT CLAIM TO ANY PARTICULAR  
FONT, STYLE, SIZE, OR COLOR.

OWNER OF U.S. REG. NO. 2,333,847.

SN 77-138,741, FILED 3-23-2007.

NAAKWAMA ANKRAH, EXAMINING ATTORNEY

**Int. Cl.: 9**

**Prior U.S. Cls.: 21, 23, 26, 36, and 38**

**Reg. No. 3,468,917**

**United States Patent and Trademark Office**

**Registered July 15, 2008**

**TRADEMARK  
PRINCIPAL REGISTER**

**Wi PATH**

TELULAR CORPORATION (DELAWARE CORPORATION)  
SUITE 4300  
311 SOUTH WACKER DRIVE  
CHICAGO, IL 60606

FOR: CELLULAR DEVICES, NAMELY, TELECOMMUNICATION TERMINALS AND MODEMS CAPABLE OF TRANSMITTING AND RECEIVING VOICE, HIGH-SPEED DATA, AND FAX OVER CELLULAR COMMUNICATION SYSTEMS, IN CLASS 9 (U.S. CLS. 21, 23, 26, 36 AND 38).

FIRST USE 12-19-2007; IN COMMERCE 12-19-2007.

THE MARK CONSISTS OF STANDARD CHARACTERS WITHOUT CLAIM TO ANY PARTICULAR FONT, STYLE, SIZE, OR COLOR.

NO CLAIM IS MADE TO THE EXCLUSIVE RIGHT TO USE "WI", APART FROM THE MARK AS SHOWN.

SN 77-139,042, FILED 3-23-2007.

DAVID C. REIHNER, EXAMINING ATTORNEY

**Int. Cl.: 33**

**Prior U.S. Cls.: 47 and 49**

**United States Patent and Trademark Office**

**Reg. No. 3,468,918**

**Registered July 15, 2008**

**TRADEMARK  
PRINCIPAL REGISTER**

**COUNTRY ROADS**

WOMEN OF THE VINE CELLARS, LLC (NEW  
YORK LTD LIAB CO)  
417 WASHINGTON STREET  
TAPPAN, NY 10901

THE MARK CONSISTS OF STANDARD CHAR-  
ACTERS WITHOUT CLAIM TO ANY PARTICULAR  
FONT, STYLE, SIZE, OR COLOR.

FOR: WINES, IN CLASS 33 (U.S. CLS. 47 AND 49).

SN 77-139,519, FILED 3-24-2007.

FIRST USE 9-30-2007; IN COMMERCE 9-30-2007.

KIMBERLY FRYE, EXAMINING ATTORNEY

**Int. Cl.: 25**

**Prior U.S. Cls.: 22 and 39**

**United States Patent and Trademark Office**

**Reg. No. 3,468,919**

**Registered July 15, 2008**

**TRADEMARK  
PRINCIPAL REGISTER**

**NO BAGGAGE**

BARE BONZ DESIGNS (CALIFORNIA SOLE  
PROPRIETORSHIP)  
4086 LAKEVIEW DRIVE  
MARIPOSA, CA 95338

FOR: APRONS; BASEBALL CAPS; BOXER  
BRIEFS; BOXER SHORTS; CAMISOLES; CROP  
TOPS; HALTER TOPS; MUSCLE TOPS; NIGHT  
SHIRTS; PANTIES, SHORTS AND BRIEFS; POLO  
SHIRTS; SHIRTS; SWEAT SHIRTS; T-SHIRTS; TANK  
TOPS; TANKINIS; WOMEN'S UNDERWEAR, IN  
CLASS 25 (U.S. CLS. 22 AND 39).

FIRST USE 4-28-2007; IN COMMERCE 4-28-2007.

THE MARK CONSISTS OF STANDARD CHAR-  
ACTERS WITHOUT CLAIM TO ANY PARTICULAR  
FONT, STYLE, SIZE, OR COLOR.

SN 77-139,716, FILED 3-25-2007.

PAUL E. FAHRENKOPF, EXAMINING ATTORNEY



**Int. Cl.: 21**

**Prior U.S. Cls.: 2, 13, 23, 29, 30, 33, 40, and 50**

**Reg. No. 3,468,920**

**United States Patent and Trademark Office**

**Registered July 15, 2008**

---

**TRADEMARK  
PRINCIPAL REGISTER**

WITH A SPLASH OF FRESHNESS

THE PROCTER & GAMBLE COMPANY (OHIO  
CORPORATION)  
ONE PROCTER & GAMBLE PLAZA  
CINCINNATI, OH 45202

THE MARK CONSISTS OF STANDARD CHAR-  
ACTERS WITHOUT CLAIM TO ANY PARTICULAR  
FONT, STYLE, SIZE, OR COLOR.

FOR: DENTAL FLOSS, IN CLASS 21 (U.S. CLS. 2,  
13, 23, 29, 30, 33, 40 AND 50).

SN 77-139,823, FILED 3-26-2007.

FIRST USE 9-24-2007; IN COMMERCE 9-24-2007.

DAVID TAYLOR, EXAMINING ATTORNEY

**Int. Cl.: 16**

**Prior U.S. Cls.: 2, 5, 22, 23, 29, 37, 38, and 50**

**Reg. No. 3,468,921**

**United States Patent and Trademark Office**

**Registered July 15, 2008**

**TRADEMARK  
PRINCIPAL REGISTER**

**ECOJOT**

MIRAGE CREATIVE LTD. (CANADA CORPORATION)  
746 WARDEN AVENUE #3  
SCARBOROUGH, CANADA M1L4A2

FOR: BLANK JOURNAL BOOKS, BLANK WRITING JOURNALS NOTEBOOKS, SKETCHBOOKS, SKETCHPADS, PAPER AND PAPER REFILLS FOR REFILLING RING BINDERS , IN CLASS 16 (U.S. CLS. 2, 5, 22, 23, 29, 37, 38 AND 50).

FIRST USE 6-0-2007; IN COMMERCE 6-0-2007.

THE MARK CONSISTS OF STANDARD CHARACTERS WITHOUT CLAIM TO ANY PARTICULAR FONT, STYLE, SIZE, OR COLOR.

SN 77-139,990, FILED 3-26-2007.

TINA BROWN, EXAMINING ATTORNEY

**Int. Cl.: 45**

**Prior U.S. Cls.: 100 and 101**

**United States Patent and Trademark Office**

**Reg. No. 3,468,922**

**Registered July 15, 2008**

**SERVICE MARK  
PRINCIPAL REGISTER**

**BANDA BIG BOOM**

HALLMARK LICENSING, INC. (DELAWARE  
CORPORATION)  
MD 339  
2440 PERSHING RD.  
KANSAS CITY, MO 64108

FOR: PROVIDING A SELECTION OF ON-LINE  
ELECTRONIC GREETING CARDS, IN CLASS 45  
(U.S. CLS. 100 AND 101).

FIRST USE 5-19-2007; IN COMMERCE 5-19-2007.

THE MARK CONSISTS OF STANDARD CHAR-  
ACTERS WITHOUT CLAIM TO ANY PARTICULAR  
FONT, STYLE, SIZE, OR COLOR.

THE ENGLISH TRANSLATION OF THE WORD  
"BANDA" IN THE MARK IS "BAND."

SN 77-140,382, FILED 3-26-2007.

TANYA AMOS, EXAMINING ATTORNEY

**Int. Cl.: 9**

**Prior U.S. Cls.: 21, 23, 26, 36, and 38**

**United States Patent and Trademark Office**

**Reg. No. 3,468,923**

**Registered July 15, 2008**

**TRADEMARK  
PRINCIPAL REGISTER**

**VMWARE FUSION**

VMWARE, INC. (DELAWARE CORPORATION)  
3401 HILLVIEW AVE.  
PALO ALTO, CA 94304

FOR: COMPUTER SOFTWARE FOR MANA-  
GING, TESTING, AND USING MULTIPLE OPER-  
ATING SYSTEMS, AND INSTRUCTIONAL  
MANUALS THEREFOR SOLD AS A UNIT, IN  
CLASS 9 (U.S. CLS. 21, 23, 26, 36 AND 38).

FIRST USE 12-0-2006; IN COMMERCE 12-0-2006.

THE MARK CONSISTS OF STANDARD CHAR-  
ACTERS WITHOUT CLAIM TO ANY PARTICULAR  
FONT, STYLE, SIZE, OR COLOR.

OWNER OF U.S. REG. NOS. 2,491,236, 2,491,237,  
AND 2,764,540.

SN 77-140,506, FILED 3-26-2007.

MARGARET POWER, EXAMINING ATTORNEY

**Int. Cl.: 43**

**Prior U.S. Cls.: 100 and 101**

**United States Patent and Trademark Office**

**Reg. No. 3,468,924**

**Registered July 15, 2008**

**SERVICE MARK  
PRINCIPAL REGISTER**

**Mi Chula's Good Mexican**

MI CHULA'S CORPORATION (TEXAS CORPORATION)  
1432 E. SOUTHLAKE BLVD  
SUITE 551  
SOUTHLAKE, TX 76092

FOR: RESTAURANTS, IN CLASS 43 (U.S. CLS. 100 AND 101).

FIRST USE 6-1-2007; IN COMMERCE 11-26-2007.

THE MARK CONSISTS OF STANDARD CHARACTERS WITHOUT CLAIM TO ANY PARTICULAR FONT, STYLE, SIZE, OR COLOR.

NO CLAIM IS MADE TO THE EXCLUSIVE RIGHT TO USE "MEXICAN", APART FROM THE MARK AS SHOWN.

THE ENGLISH TRANSLATION OF THE WORD "MI CHULA'S GOOD MEXICAN" IN THE MARK IS MY CUTIE, MY SWEETIE, MY HONEY, MY LOVED ONE, MY SPECIAL ONE, MY PRETTY ONE, MY BABY, AND/OR MY INSOLENT ONE.

SN 77-140,759, FILED 3-26-2007.

KATHERINE M. DUBRAY, EXAMINING ATTORNEY

**Int. Cls.: 6, 19, and 37**

**Prior U.S. Cls.: 1, 2, 12, 13, 14, 23, 25, 33, 50, 100, 103,  
and 106**

**Reg. No. 3,468,925**

**United States Patent and Trademark Office**

**Registered July 15, 2008**

**TRADEMARK  
SERVICE MARK  
PRINCIPAL REGISTER**

**SMARTCARE WINDOW**

AMERICAN BUILDING SUPPLY, INC. (CALI-  
FORNIA CORPORATION)  
601 UNIVERSITY AVE STE. 278  
SACRAMENTO, CA 95825

FOR: METAL WINDOWS, IN CLASS 6 (U.S. CLS. 2,  
12, 13, 14, 23, 25 AND 50).

FIRST USE 7-1-2007; IN COMMERCE 8-1-2007.

FOR: NON-METAL WINDOWS, IN CLASS 19 (U.S.  
CLS. 1, 12, 33 AND 50).

FIRST USE 7-1-2007; IN COMMERCE 8-1-2007.

FOR: INSTALLATION OF WINDOWS, IN CLASS  
37 (U.S. CLS. 100, 103 AND 106).

FIRST USE 7-1-2007; IN COMMERCE 8-1-2007.

THE MARK CONSISTS OF STANDARD CHAR-  
ACTERS WITHOUT CLAIM TO ANY PARTICULAR  
FONT, STYLE, SIZE, OR COLOR.

NO CLAIM IS MADE TO THE EXCLUSIVE  
RIGHT TO USE "WINDOW", APART FROM THE  
MARK AS SHOWN.

SN 77-141,679, FILED 3-27-2007.

ANDREA BUTLER, EXAMINING ATTORNEY

**Int. Cl.: 16**

**Prior U.S. Cls.: 2, 5, 22, 23, 29, 37, 38, and 50**

**United States Patent and Trademark Office**

**Reg. No. 3,468,926**

**Registered July 15, 2008**

**TRADEMARK  
PRINCIPAL REGISTER**

# Surgical Ink

ALLEN, MICHAEL W. (UNITED STATES INDIVIDUAL)  
25420 LODI ROAD  
JERSEYVILLE, IL 62052

THE MARK CONSISTS OF STANDARD CHARACTERS WITHOUT CLAIM TO ANY PARTICULAR FONT, STYLE, SIZE, OR COLOR.

FOR: TEMPORARY TATTOOS, IN CLASS 16 (U.S. CLS. 2, 5, 22, 23, 29, 37, 38 AND 50).

SN 77-141,885, FILED 3-27-2007.

FIRST USE 7-1-2007; IN COMMERCE 7-1-2007.

MARGERY A. TIERNEY, EXAMINING ATTORNEY

**Int. Cl.: 25**

**Prior U.S. Cls.: 22 and 39**

**United States Patent and Trademark Office**

**Reg. No. 3,468,927**

**Registered July 15, 2008**

**TRADEMARK  
PRINCIPAL REGISTER**

# CyclingDiva

CLANCY-GARVEY, KELLY (UNITED STATES  
INDIVIDUAL)  
1938 OLD MILL RD  
SOLVANG, CA 93463

THE MARK CONSISTS OF STANDARD CHAR-  
ACTERS WITHOUT CLAIM TO ANY PARTICULAR  
FONT, STYLE, SIZE, OR COLOR.

FOR: SHORT-SLEEVED OR LONG-SLEEVED T-  
SHIRTS; SPORTS SHIRTS; HEADGEAR, NAMELY,  
RUNNING CAPS AND VISORS; CAMISOLES;  
SHORTS, IN CLASS 25 (U.S. CLS. 22 AND 39).

SN 77-142,044, FILED 3-27-2007.

FIRST USE 3-22-2008; IN COMMERCE 3-22-2008.

RONALD MCMORROW, EXAMINING ATTORNEY



**Int. Cl.: 25**

**Prior U.S. Cls.: 22 and 39**

**United States Patent and Trademark Office**

**Reg. No. 3,468,928**

**Registered July 15, 2008**

**TRADEMARK  
PRINCIPAL REGISTER**

**MELEE**

STEVEN MORENO (UNITED STATES INDIVIDUAL)  
641 NORTH POINSETTIA PLACE  
LOS ANGELES, CA 90036

FOR: CLOTHING, NAMELY, SHIRTS, T-SHIRTS, TANK TOPS, JERSEYS, RASH GUARDS, HATS, BEANIES, SWEAT-SHIRTS, HOODED SWEAT-SHIRTS, SWEAT-PANTS, JACKETS, PANTS, JEANS, UNDERWEAR, SOCKS, WRISTBANDS, TRUNKS, SHORTS, AND FOOTWEAR, IN CLASS 25 (U.S. CLS. 22 AND 39).

FIRST USE 8-1-2007; IN COMMERCE 8-1-2007.

THE MARK CONSISTS OF STANDARD CHARACTERS WITHOUT CLAIM TO ANY PARTICULAR FONT, STYLE, SIZE, OR COLOR.

SN 77-142,047, FILED 3-27-2007.

RONALD MCMORROW, EXAMINING ATTORNEY

**Int. Cl.: 25**

**Prior U.S. Cls.: 22 and 39**

**United States Patent and Trademark Office**

**Reg. No. 3,468,929**

**Registered July 15, 2008**

**TRADEMARK  
PRINCIPAL REGISTER**

**SwimDiva**

CLANCY-GARVEY, KELLY (UNITED STATES  
INDIVIDUAL)  
1938 OLD MILL RD  
SOLVANG, CA 93463

FOR: SHORT-SLEEVED OR LONG-SLEEVED T-  
SHIRTS; SPORTS SHIRTS; HEADGEAR, NAMELY,  
RUNNING CAPS AND VISORS; CAMISOLES;  
SHORTS; BATHING SUITS, IN CLASS 25 (U.S. CLS.  
22 AND 39).

FIRST USE 3-22-2008; IN COMMERCE 3-22-2008.

THE MARK CONSISTS OF STANDARD CHAR-  
ACTERS WITHOUT CLAIM TO ANY PARTICULAR  
FONT, STYLE, SIZE, OR COLOR.

SN 77-142,048, FILED 3-27-2007.

RONALD MCMORROW, EXAMINING ATTORNEY

**Int. Cl.: 9**

**Prior U.S. Cls.: 21, 23, 26, 36, and 38**

**Reg. No. 3,468,930**

**United States Patent and Trademark Office**

**Registered July 15, 2008**

**TRADEMARK  
PRINCIPAL REGISTER**

# InAuTech

INTEGRATED AUDIO TECHNOLOGIES, LLC  
(DELAWARE LTD LIAB CO)  
1351 WEST PLATA AVENUE  
MESA, AZ 85202

FOR: MULTIMEDIA AUDIO SPEAKERS, MULTIMEDIA AUDIO AMPLIFIERS, MULTIMEDIA AUDIO SIGNAL PROCESSORS, AUDIO SPEAKERS FOR AUTOMOBILES, AUDIO AMPLIFIERS FOR AUTOMOBILES, AUDIO SIGNAL PROCESSORS FOR AUTOMOBILES, AUDIO SPEAKERS FOR HOME USE, DVD PLAYERS, DVD RECORDERS, CELL PHONE AUDIO DOCKING STATION, EXTERNAL AMPLIFIED SPEAKERS FOR CELL PHONES, INTERNAL CELL PHONE AUDIO AMPLIFIERS, INTERNAL CELL PHONE SPEAKERS, EXTERNAL CELL PHONE SPEAKERS, MP3 PLAYER, DIGITAL MEDIA PLAYER, AUDIO PREAMPLIFIERS FOR HOME USE, AUDIO AMPLIFIERS FOR HOME USE, AUDIO / VIDEO SIGNAL PROCESSING PRODUCTS FOR HOME USE, AM/FM/HD-RADIO/

CD RADIO, CLOCK RADIO WITH AUDIO SPEAKERS, SOUND REINFORCEMENT AUDIO SPEAKERS, SOUND REINFORCEMENT AUDIO AMPLIFIERS, SOUND REINFORCEMENT AUDIO SIGNAL PROCESSORS, AND INTEGRATED AUDIO SYSTEMS, NAMELY, SPEAKERS AND/OR AMPLIFIERS AND/OR PROCESSORS FOR VIDEO MONITORS SUCH AS TELEVISIONS, IN CLASS 9 (U.S. CLS. 21, 23, 26, 36 AND 38).

FIRST USE 2-20-2007; IN COMMERCE 3-29-2007.

THE MARK CONSISTS OF STANDARD CHARACTERS WITHOUT CLAIM TO ANY PARTICULAR FONT, STYLE, SIZE, OR COLOR.

SN 77-142,475, FILED 3-28-2007.

DOMINICK J. SALEMI, EXAMINING ATTORNEY

**Int. Cl.: 29**

**Prior U.S. Cl.: 46**

**United States Patent and Trademark Office**

**Reg. No. 3,468,931**

**Registered July 15, 2008**

**TRADEMARK  
PRINCIPAL REGISTER**

**CELEBRITY CHEF KITCHENS**

CCK HOLDINGS, INC. (MISSOURI CORPORATION)  
7711 BONHOMME AVENUE  
SAINT LOUIS, MO 63105

OWNER OF U.S. REG. NOS. 2,882,497 AND  
3,203,233.

FOR: PRECOOKED MEALS THAT INCLUDE  
MEAT, SEAFOOD, VEGETABLES, CHEESE AND  
YOGURT AND DAIRY BEVERAGES, IN CLASS 29  
(U.S. CL. 46).

NO CLAIM IS MADE TO THE EXCLUSIVE  
RIGHT TO USE "KITCHENS", APART FROM THE  
MARK AS SHOWN.

FIRST USE 8-10-2007; IN COMMERCE 8-10-2007.

SN 77-143,900, FILED 3-29-2007.

THE MARK CONSISTS OF STANDARD CHAR-  
ACTERS WITHOUT CLAIM TO ANY PARTICULAR  
FONT, STYLE, SIZE, OR COLOR.

MELVIN AXILBUND, EXAMINING ATTORNEY

**Int. Cl.: 36**

**Prior U.S. Cls.: 100, 101, and 102**

**United States Patent and Trademark Office**

**Reg. No. 3,468,932**

**Registered July 15, 2008**

**SERVICE MARK  
PRINCIPAL REGISTER**

**Shop Online. It's  
Addictive.**

GARDNER, COLIN J (UNITED STATES INDIVIDUAL)  
923 S. MAPLE AVE  
TEMPE, AZ 85281

FOR: PROVIDING REBATES AT PARTICIPATING ESTABLISHMENTS OF OTHERS THROUGH USE OF A MEMBERSHIP CARD, IN CLASS 36 (U.S. CLS. 100, 101 AND 102).

FIRST USE 6-1-2007; IN COMMERCE 6-30-2007.

THE MARK CONSISTS OF STANDARD CHARACTERS WITHOUT CLAIM TO ANY PARTICULAR FONT, STYLE, SIZE, OR COLOR.

NO CLAIM IS MADE TO THE EXCLUSIVE RIGHT TO USE "SHOP ONLINE", APART FROM THE MARK AS SHOWN.

SN 77-143,957, FILED 3-29-2007.

JENNY PARK, EXAMINING ATTORNEY

**Int. Cl.: 25**

**Prior U.S. Cls.: 22 and 39**

**United States Patent and Trademark Office**

**Reg. No. 3,468,933**

**Registered July 15, 2008**

**TRADEMARK  
PRINCIPAL REGISTER**

**WHITE SANDS**

WHITE SANDS HAIR CARE INC. (CALIFORNIA  
CORPORATION)  
19800 MAC ARTHUR BLVD. STE C-80  
IRVINE, CA 28024

FOR: CLOTHING FOR MEN WOMEN AND  
CHILDREN, NAMELY, SHORTS, SHIRTS, T-  
SHIRTS, SKIRTS, BLOUSES, JACKETS, PANTS,  
COATS, HEADWEAR AND FOOTWEAR, IN CLASS  
25 (U.S. CLS. 22 AND 39).

FIRST USE 5-1-2008; IN COMMERCE 5-1-2008.

THE MARK CONSISTS OF STANDARD CHAR-  
ACTERS WITHOUT CLAIM TO ANY PARTICULAR  
FONT, STYLE, SIZE, OR COLOR.

OWNER OF U.S. REG. NO. 3,020,403.

SN 77-144,692, FILED 3-30-2007.

DAWN FELDMAN, EXAMINING ATTORNEY

**Int. Cl.: 27**

**Prior U.S. Cls.: 19, 20, 37, 42, and 50**

**United States Patent and Trademark Office**

**Reg. No. 3,468,934**

**Registered July 15, 2008**

**TRADEMARK  
PRINCIPAL REGISTER**

**DURASQUARES**

LJ'S PRODUCTS, LLC (ILLINOIS LTD LIAB CO)  
504 SUMMERFIELD WAY  
VENICE, FL 34292

THE MARK CONSISTS OF STANDARD CHAR-  
ACTERS WITHOUT CLAIM TO ANY PARTICULAR  
FONT, STYLE, SIZE, OR COLOR.

FOR: CARPET TILES, IN CLASS 27 (U.S. CLS. 19,  
20, 37, 42 AND 50).

SN 77-145,033, FILED 3-30-2007.

FIRST USE 11-1-2007; IN COMMERCE 11-1-2007.

ESTHER A. BORSUK, EXAMINING ATTORNEY

Int. Cl.: 7

Prior U.S. Cls.: 13, 19, 21, 23, 31, 34, and 35

United States Patent and Trademark Office

Reg. No. 3,468,935

Registered July 15, 2008

TRADEMARK  
PRINCIPAL REGISTER

***TenonCam***

HILKER, DAVID (UNITED STATES INDIVIDUAL)  
220 BISSELL PLACE  
SAN JACINTO, CA 92582

FOR: POWER TOOLS, NAMELY, ROUTERS, IN CLASS 7 (U.S. CLS. 13, 19, 21, 23, 31, 34 AND 35).

FIRST USE 5-23-2007; IN COMMERCE 5-23-2007.

THE MARK CONSISTS OF THE WORDS "TENON" AND "CAM" WRITTEN IN STYLIZED LETTERS AS A SINGLE WORD, WITH THE LETTERS "T" AND "C" IN UPPER CASE CHARACTERS.

SN 77-145,261, FILED 3-30-2007.

AMEETA JORDAN, EXAMINING ATTORNEY



**Int. Cls.: 18 and 25**

**Prior U.S. Cls.: 1, 2, 3, 22, 39, and 41**

**United States Patent and Trademark Office**

**Reg. No. 3,468,936**

**Registered July 15, 2008**

**TRADEMARK  
PRINCIPAL REGISTER**

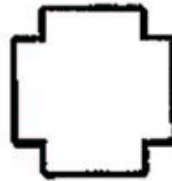

SPY OPTIC, INC. (CALIFORNIA CORPORATION)  
2070 LAS PALMAS DRIVE  
CARLSBAD, CA 92009

FOR: BAGS, NAMELY, BACKPACKS AND  
SPORTS BAGS, IN CLASS 18 (U.S. CLS. 1, 2, 3, 22  
AND 41).

FIRST USE 1-0-2002; IN COMMERCE 1-0-2002.

FOR: WEARING APPAREL, NAMELY, T-SHIRTS,  
SHIRTS, SWEATSHIRTS, PANTS, SHORTS, JACK-  
ETS, HATS, VISORS, CAPS, BELTS AND SHOES, IN  
CLASS 25 (U.S. CLS. 22 AND 39).

FIRST USE 1-0-1996; IN COMMERCE 1-0-1996.

SN 77-146,273, FILED 4-2-2007.

REBECCA POVARCHUK, EXAMINING ATTOR-  
NEY

**Int. Cl.: 42**

**Prior U.S. Cls.: 100 and 101**

**United States Patent and Trademark Office**

**Reg. No. 3,468,937**

**Registered July 15, 2008**

**SERVICE MARK  
PRINCIPAL REGISTER**



SEM INC. (CALIFORNIA CORPORATION)  
4035 LEAVERTON COURT  
ANAHEIM, CA 92807

FOR: WEBSITE DEVELOPMENT, DESIGN AND  
SEARCH ENGINE OPTIMIZATION SERVICES, IN  
CLASS 42 (U.S. CLS. 100 AND 101).

FIRST USE 6-1-2007; IN COMMERCE 6-1-2007.

NO CLAIM IS MADE TO THE EXCLUSIVE  
RIGHT TO USE "SEM" AND "SEARCH ENGINE  
MARKETING", APART FROM THE MARK AS  
SHOWN.

THE COLOR(S) BLUE, DARK BLUE, YELLOW,  
RED, GREEN, GRAY, AND WHITE IS/ARE  
CLAIMED AS A FEATURE OF THE MARK.

THE MARK CONSISTS OF A PINWHEEL "S"  
LOGO IN BLUE, GREEN, YELLOW AND RED,  
AND THE LETTERS "SEM" IN DARK BLUE WITH  
BLUE HIGHLIGHTING, AND WORDS "SEARCH  
ENGINE MARKETING" UNDERNEATH IN GRAY.  
THE BACKGROUND OF THE MARK IS WHITE.

SN 77-147,718, FILED 4-3-2007.

JIM RINGLE, EXAMINING ATTORNEY

**Int. Cl.: 41**

**Prior U.S. Cls.: 100, 101, and 107**

**United States Patent and Trademark Office**

**Reg. No. 3,468,938**

**Registered July 15, 2008**

**SERVICE MARK  
PRINCIPAL REGISTER**

**THE ELDERING INSTITUTE**

PARACOMM PARTNERS INTERNATIONAL,  
INC. (TEXAS CORPORATION)  
2034 GREEN STREET  
SAN FRANCISCO, CA 94123

FOR: TRAINING SERVICES IN THE FIELD OF  
LEADERSHIP FOR INDIVIDUALS AS THEY GROW  
OLDER AND RETIRE, IN CLASS 41 (U.S. CLS. 100,  
101 AND 107).

FIRST USE 9-30-2006; IN COMMERCE 9-30-2006.

THE MARK CONSISTS OF STANDARD CHAR-  
ACTERS WITHOUT CLAIM TO ANY PARTICULAR  
FONT, STYLE, SIZE, OR COLOR.

NO CLAIM IS MADE TO THE EXCLUSIVE  
RIGHT TO USE "INSTITUTE", APART FROM THE  
MARK AS SHOWN.

SN 77-148,240, FILED 4-4-2007.

BRENDAN MCCAULEY, EXAMINING ATTORNEY

**Int. Cl.: 42**

**Prior U.S. Cls.: 100 and 101**

**United States Patent and Trademark Office**

**Reg. No. 3,468,939**

**Registered July 15, 2008**

**SERVICE MARK  
PRINCIPAL REGISTER**

# Oratu

ALITORA SYSTEMS, INC. (DELAWARE CORPORATION)  
135 RIVINGTON, 3R  
NEW YORK, NY 10002

FOR: COMPUTER SERVICES, NAMELY, PROVIDING SEARCH ENGINES FOR OBTAINING DATA ON A GLOBAL COMPUTER NETWORK; PROVIDING CUSTOMIZED ON-LINE WEB PAGES FEATURING USER-DEFINED INFORMATION, WHICH INCLUDES SEARCH ENGINES AND ON-LINE WEB LINKS TO OTHER WEB SITES, IN CLASS 42 (U.S. CLS. 100 AND 101).

FIRST USE 11-1-2007; IN COMMERCE 12-15-2007.

THE MARK CONSISTS OF STANDARD CHARACTERS WITHOUT CLAIM TO ANY PARTICULAR FONT, STYLE, SIZE, OR COLOR.

SN 77-148,537, FILED 4-4-2007.

DAVID I, EXAMINING ATTORNEY

**Int. Cl.: 9**

**Prior U.S. Cls.: 21, 23, 26, 36, and 38**

**Reg. No. 3,468,940**

**United States Patent and Trademark Office**

**Registered July 15, 2008**

---

**TRADEMARK  
PRINCIPAL REGISTER**

**POCKET EDGE**

TRACK SCAN, INC. (NORTH CAROLINA CORPORATION)  
192 RACEWAY DRIVE  
MOORESVILLE, NC 28117

THE MARK CONSISTS OF STANDARD CHARACTERS WITHOUT CLAIM TO ANY PARTICULAR FONT, STYLE, SIZE, OR COLOR.

FOR: PROGRAMMABLE RADIO FREQUENCY RECEIVER AND SCANNER, IN CLASS 9 (U.S. CLS. 21, 23, 26, 36 AND 38).

SN 77-148,637, FILED 4-4-2007.

FIRST USE 2-28-2007; IN COMMERCE 2-28-2007.

IRA J. GOODSaid, EXAMINING ATTORNEY

**Int. Cl.: 41**

**Prior U.S. Cls.: 100, 101, and 107**

**United States Patent and Trademark Office**

**Reg. No. 3,468,941**

**Registered July 15, 2008**

**SERVICE MARK  
PRINCIPAL REGISTER**

**THE LOVE SCHOOL**

BRUCE A. ROBERTS (UNITED STATES INDIVIDUAL)  
1701 EAST LIND ROAD  
TUCSON, AZ 85719 AND  
MOLLY M. ROBERTS (UNITED STATES INDIVIDUAL)  
1701 EAST LIND ROAD  
TUCSON, AZ 85719

FOR: EDUCATION SERVICES, NAMELY, PROVIDING CLASSES, SEMINARS, AND WORKSHOPS IN THE FIELDS OF HOLISTIC MEDICINE AND NATURAL HEALING, IN CLASS 41 (U.S. CLS. 100, 101 AND 107).

FIRST USE 6-1-2008; IN COMMERCE 6-1-2008.

THE MARK CONSISTS OF STANDARD CHARACTERS WITHOUT CLAIM TO ANY PARTICULAR FONT, STYLE, SIZE, OR COLOR.

NO CLAIM IS MADE TO THE EXCLUSIVE RIGHT TO USE "SCHOOL", APART FROM THE MARK AS SHOWN.

SN 77-149,925, FILED 4-5-2007.

REBECCA GILBERT, EXAMINING ATTORNEY

**Int. Cl.: 44**

**Prior U.S. Cls.: 100 and 101**

**United States Patent and Trademark Office**

**Reg. No. 3,468,942**

**Registered July 15, 2008**

**SERVICE MARK  
PRINCIPAL REGISTER**

**THE MEDICINE BAG**

BRUCE A. ROBERTS (UNITED STATES INDIVIDUAL)  
1701 EAST LIND ROAD  
TUCSON, AZ 85719 AND  
MOLLY M. ROBERTS (UNITED STATES INDIVIDUAL)  
1701 EAST LIND ROAD  
TUCSON, AZ 85719

FOR: HEALTH CARE, IN CLASS 44 (U.S. CLS. 100 AND 101).

FIRST USE 6-1-2008; IN COMMERCE 6-1-2008.

THE MARK CONSISTS OF STANDARD CHARACTERS WITHOUT CLAIM TO ANY PARTICULAR FONT, STYLE, SIZE, OR COLOR.

SN 77-149,934, FILED 4-5-2007.

REBECCA GILBERT, EXAMINING ATTORNEY

**Int. Cl.: 16**

**Prior U.S. Cls.: 2, 5, 22, 23, 29, 37, 38, and 50**

**Reg. No. 3,468,943**

**United States Patent and Trademark Office**

**Registered July 15, 2008**

---

**TRADEMARK  
PRINCIPAL REGISTER**

# Take-Away Teabag

CHADO-EN LLC (CALIFORNIA LTD LIAB CO)  
P. O. BOX 5  
21108 PELICAN LOOP  
BODEGA BAY, CA 94923

FOR: BIODEGRADABLE SEALABLE CELLOPHANE BAG FOR STORAGE OF WET TEA LEAVES, IN CLASS 16 (U.S. CLS. 2, 5, 22, 23, 29, 37, 38 AND 50).

FIRST USE 9-14-2007; IN COMMERCE 9-14-2007.

THE MARK CONSISTS OF STANDARD CHARACTERS WITHOUT CLAIM TO ANY PARTICULAR FONT, STYLE, SIZE, OR COLOR.

NO CLAIM IS MADE TO THE EXCLUSIVE RIGHT TO USE "TEABAG", APART FROM THE MARK AS SHOWN.

SN 77-150,167, FILED 4-5-2007.

ARETHA SOMERVILLE, EXAMINING ATTORNEY



**Int. Cl.: 9**

**Prior U.S. Cls.: 21, 23, 26, 36, and 38**

**Reg. No. 3,468,944**

**United States Patent and Trademark Office**

**Registered July 15, 2008**

---

**TRADEMARK  
PRINCIPAL REGISTER**

**BLACK MAGIC**

IGT (NEVADA CORPORATION)  
9295 PROTOTYPE DRIVE  
RENO, NV 895218986

THE MARK CONSISTS OF STANDARD CHAR-  
ACTERS WITHOUT CLAIM TO ANY PARTICULAR  
FONT, STYLE, SIZE, OR COLOR.

FOR: GAMING MACHINES, NAMELY, DEVICES  
WHICH ACCEPT A WAGER, IN CLASS 9 (U.S. CLS.  
21, 23, 26, 36 AND 38).

SN 77-150,792, FILED 4-6-2007.

FIRST USE 11-5-2007; IN COMMERCE 11-5-2007.

ANTHONY RINKER, EXAMINING ATTORNEY

**Int. Cl.: 36**

**Prior U.S. Cls.: 100, 101, and 102**

**United States Patent and Trademark Office**

**Reg. No. 3,468,945**

**Registered July 15, 2008**

**SERVICE MARK  
PRINCIPAL REGISTER**

# PCT Capital

PCT CAPITAL, LLC (DELAWARE LTD LIAB CO)  
SUITE 800  
8300 GREENSBORO DRIVE  
MCLEAN, VA 22102

FOR: PRIVATE EQUITY SERVICES, NAMELY, PROVIDING COMPANIES WITH FINANCING OPTIONS SPECIFICALLY FOR THE DEVELOPMENT, PROCUREMENT, ACQUISITION AND/OR SALE OF INTELLECTUAL PROPERTY; FINANCIAL INVESTMENT IN THE FIELD OF SECURITIES; FINANCIAL SERVICES IN THE NATURE OF AN INVESTMENT SECURITY; FINANCIAL SERVICES, NAMELY, INVESTMENT FUND TRANSFER AND TRANSACTION SERVICES; FUND INVESTMENT CONSULTATION; FUNDS INVESTMENT; INVESTMENT ADVICE; INVESTMENT BROKERAGE; IN-

VESTMENT CONSULTATION; INVESTMENT MANAGEMENT; INVESTMENT FUNDS FOR OTHERS, IN CLASS 36 (U.S. CLS. 100, 101 AND 102).

FIRST USE 9-19-2007; IN COMMERCE 9-19-2007.

THE MARK CONSISTS OF STANDARD CHARACTERS WITHOUT CLAIM TO ANY PARTICULAR FONT, STYLE, SIZE, OR COLOR.

NO CLAIM IS MADE TO THE EXCLUSIVE RIGHT TO USE "CAPITAL", APART FROM THE MARK AS SHOWN.

SN 77-151,178, FILED 4-6-2007.

RICHARD A. STRASER, EXAMINING ATTORNEY

**Int. Cls.: 16 and 41**

**Prior U.S. Cls.: 2, 5, 22, 23, 29, 37, 38, 50, 100, 101, and 107**

**United States Patent and Trademark Office**

**Reg. No. 3,468,946**

**Registered July 15, 2008**

**TRADEMARK  
SERVICE MARK  
PRINCIPAL REGISTER**

**WAYFARER'S MOON**

SINGLE EDGE STUDIOS INC. (WASHINGTON CORPORATION)  
18666 REDMOND WAY  
REDMOND, WA 98052

FOR: GRAPHIC NOVELS; COMIC BOOKS, IN CLASS 16 (U.S. CLS. 2, 5, 22, 23, 29, 37, 38 AND 50).

FIRST USE 4-22-2008; IN COMMERCE 4-22-2008.

FOR: ENTERTAINMENT SERVICES, NAMELY, PROVIDING AN ONLINE COMIC STRIP, IN CLASS 41 (U.S. CLS. 100, 101 AND 107).

FIRST USE 4-7-2007; IN COMMERCE 4-7-2007.

THE MARK CONSISTS OF STANDARD CHARACTERS WITHOUT CLAIM TO ANY PARTICULAR FONT, STYLE, SIZE, OR COLOR.

SN 77-151,312, FILED 4-7-2007.

KATHRYN COWARD, EXAMINING ATTORNEY

**Int. Cls.: 16 and 41**

**Prior U.S. Cls.: 2, 5, 22, 23, 29, 37, 38, 50, 100, 101, and 107**

**Reg. No. 3,468,947**

**United States Patent and Trademark Office**

**Registered July 15, 2008**

**TRADEMARK  
SERVICE MARK  
PRINCIPAL REGISTER**

**SINGLE EDGE STUDIOS**

SINGLE EDGE STUDIOS INC. (WASHINGTON CORPORATION)  
18666 REDMOND WAY  
REDMOND, WA 98052

FOR: COMIC BOOKS; GRAPHIC NOVELS, IN CLASS 16 (U.S. CLS. 2, 5, 22, 23, 29, 37, 38 AND 50).

FIRST USE 4-22-2008; IN COMMERCE 4-22-2008.

FOR: ENTERTAINMENT SERVICES, NAMELY, PROVIDING AN ONLINE COMIC STRIP, IN CLASS 41 (U.S. CLS. 100, 101 AND 107).

FIRST USE 4-7-2007; IN COMMERCE 4-7-2007.

THE MARK CONSISTS OF STANDARD CHARACTERS WITHOUT CLAIM TO ANY PARTICULAR FONT, STYLE, SIZE, OR COLOR.

NO CLAIM IS MADE TO THE EXCLUSIVE RIGHT TO USE "STUDIOS", APART FROM THE MARK AS SHOWN.

SN 77-151,317, FILED 4-7-2007.

KATHRYN COWARD, EXAMINING ATTORNEY

**Int. Cl.: 30**

**Prior U.S. Cl.: 46**

**United States Patent and Trademark Office**

**Reg. No. 3,468,948**

**Registered July 15, 2008**

**TRADEMARK  
PRINCIPAL REGISTER**

**TWO GREAT FLAVORS, ONE  
GREAT TASTE**

PROMARK BRANDS INC. (IDAHO CORPORATION)  
2541 NORTH STOKESBERRY PLACE, SUITE 100  
MERIDIAN, ID 83646

FOR: SAUCES, IN CLASS 30 (U.S. CL. 46).

FIRST USE 5-6-2007; IN COMMERCE 5-6-2007.

THE MARK CONSISTS OF STANDARD CHARACTERS WITHOUT CLAIM TO ANY PARTICULAR FONT, STYLE, SIZE, OR COLOR.

SN 77-151,574, FILED 4-9-2007.

GINA HAYES, EXAMINING ATTORNEY

**Int. Cl.: 1**

**Prior U.S. Cls.: 1, 5, 6, 10, 26, and 46**

**Reg. No. 3,468,949**

**United States Patent and Trademark Office**

**Registered July 15, 2008**

---

**TRADEMARK  
PRINCIPAL REGISTER**

**Agronorm**

SELLIKEN, GARY (UNITED STATES INDIVIDUAL)  
3175 E. WARM SPRINGS RD. #111  
LAS VEGAS, NV 89120

THE MARK CONSISTS OF STANDARD CHARACTERS WITHOUT CLAIM TO ANY PARTICULAR FONT, STYLE, SIZE, OR COLOR.

FOR: SOIL RECONDITIONERS FOR AGRICULTURAL USE, IN CLASS 1 (U.S. CLS. 1, 5, 6, 10, 26 AND 46).

SN 77-153,303, FILED 4-10-2007.

FIRST USE 1-1-2007; IN COMMERCE 1-1-2007.

HANNO RITTNER, EXAMINING ATTORNEY

**Int. Cl.: 41**

**Prior U.S. Cls.: 100, 101, and 107**

**United States Patent and Trademark Office**

**Reg. No. 3,468,950**

**Registered July 15, 2008**

**SERVICE MARK  
PRINCIPAL REGISTER**

# Whiskey Galore

JEFFERSON DAVIS (UNITED STATES INDIVIDUAL)  
1501 LEAF CREST LANE  
BAKERSFIELD, CA 93314

FOR: ENTERTAINMENT, NAMELY, LIVE PERFORMANCES BY A MUSICAL BAND; ENTERTAINMENT, NAMELY, LIVE MUSIC CONCERTS; PRESENTATION OF MUSICAL PERFORMANCE, IN CLASS 41 (U.S. CLS. 100, 101 AND 107).

FIRST USE 4-7-1998; IN COMMERCE 4-7-1998.

THE MARK CONSISTS OF STANDARD CHARACTERS WITHOUT CLAIM TO ANY PARTICULAR FONT, STYLE, SIZE, OR COLOR.

SN 77-153,448, FILED 4-10-2007.

JOHN DWYER, EXAMINING ATTORNEY

**Int. Cl.: 43**

**Prior U.S. Cls.: 100 and 101**

**United States Patent and Trademark Office**

**Reg. No. 3,468,951**

**Registered July 15, 2008**

**SERVICE MARK  
PRINCIPAL REGISTER**

# Paperfish

PATINA RESTAURANT GROUP, LLC (DELA-  
WARE LTD LIAB CO)  
120 W. 45TH STREET 16TH FLOOR  
NEW YORK, NY 10036

THE MARK CONSISTS OF STANDARD CHAR-  
ACTERS WITHOUT CLAIM TO ANY PARTICULAR  
FONT, STYLE, SIZE, OR COLOR.

FOR: RESTAURANT AND BAR SERVICES, IN  
CLASS 43 (U.S. CLS. 100 AND 101).

SN 77-154,007, FILED 4-11-2007.

FIRST USE 11-27-2007; IN COMMERCE 11-27-2007.

IRA J. GOODSaid, EXAMINING ATTORNEY



**Int. Cls.: 9 and 16**

**Prior U.S. Cls.: 2, 5, 21, 22, 23, 26, 29, 36, 37, 38, and 50**

**Reg. No. 3,468,952**

**United States Patent and Trademark Office**

**Registered July 15, 2008**

**TRADEMARK  
PRINCIPAL REGISTER**

**KEEPING LEARNING ON TRACK**

EDUCATIONAL TESTING SERVICE (NEW YORK NON-PROFIT CORPORATION)  
ROSEDALE ROAD  
PRINCETON, NJ 08541

FOR: AUDIO RECORDINGS AND VIDEO RECORDINGS IN THE FIELD OF PROFESSIONAL DEVELOPMENT, TEACHING PRACTICES AND CLASSROOM TECHNIQUES FOR K-12 TEACHERS AND SCHOOL ADMINISTRATORS, IN CLASS 9 (U.S. CLS. 21, 23, 26, 36 AND 38).

FIRST USE 4-30-2007; IN COMMERCE 4-30-2007.

FOR: PRINTED INSTRUCTIONAL MATERIALS IN THE FIELD OF PROFESSIONAL DEVELOP-

MENT FOR K-12 TEACHERS AND SCHOOL ADMINISTRATORS, IN CLASS 16 (U.S. CLS. 2, 5, 22, 23, 29, 37, 38 AND 50).

FIRST USE 4-30-2007; IN COMMERCE 4-30-2007.

THE MARK CONSISTS OF STANDARD CHARACTERS WITHOUT CLAIM TO ANY PARTICULAR FONT, STYLE, SIZE, OR COLOR.

SN 77-155,002, FILED 4-12-2007.

REBECCA EISINGER, EXAMINING ATTORNEY

**Int. Cl.: 9**

**Prior U.S. Cls.: 21, 23, 26, 36, and 38**

**Reg. No. 3,468,953**

**United States Patent and Trademark Office**

**Registered July 15, 2008**

---

**TRADEMARK  
PRINCIPAL REGISTER**

**Mint**

INFINET WIRELESS LIMITED (BR.VIRGIN ISLANDS COMPANY)  
PALM GROVE HOUSE, P.O. BOX 438  
ROAD TOWN, TORTOLA, BR.VIRGIN ISLANDS

THE MARK CONSISTS OF STANDARD CHARACTERS WITHOUT CLAIM TO ANY PARTICULAR FONT, STYLE, SIZE, OR COLOR.

FOR: OPERATING SOFTWARE FOR TELECOMMUNICATIONS EQUIPMENT, NAMELY, WIRELESS MESH NETWORKS, IN CLASS 9 (U.S. CLS. 21, 23, 26, 36 AND 38).

SN 77-155,209, FILED 4-12-2007.

FIRST USE 11-0-2006; IN COMMERCE 11-0-2006.

CURTIS FRENCH, EXAMINING ATTORNEY

**Int. Cl.: 9**

**Prior U.S. Cls.: 21, 23, 26, 36, and 38**

**Reg. No. 3,468,954**

**United States Patent and Trademark Office**

**Registered July 15, 2008**

---

**TRADEMARK  
PRINCIPAL REGISTER**

**Wanflex**

INFINET WIRELESS LIMITED (BR.VIRGIN ISLANDS COMPANY)  
PALM GROVE HOUSE  
P.O. BOX 438  
ROAD TOWN, TORTOLA, BR.VIRGIN ISLANDS

FOR: OPERATING SOFTWARE FOR TELECOMMUNICATIONS EQUIPMENT, NAMELY, WIRELESS BRIDGES, ROUTERS AND MESH NODES, IN CLASS 9 (U.S. CLS. 21, 23, 26, 36 AND 38).

FIRST USE 11-0-2006; IN COMMERCE 11-0-2006.

THE MARK CONSISTS OF STANDARD CHARACTERS WITHOUT CLAIM TO ANY PARTICULAR FONT, STYLE, SIZE, OR COLOR.

SN 77-155,234, FILED 4-12-2007.

CURTIS FRENCH, EXAMINING ATTORNEY

**Int. Cl.: 25**

**Prior U.S. Cls.: 22 and 39**

**United States Patent and Trademark Office**

**Reg. No. 3,468,955**

**Registered July 15, 2008**

**TRADEMARK  
PRINCIPAL REGISTER**

# Femmeology

DAVIDSON, EILEEN (UNITED STATES INDIVIDUAL)  
P.O. BOX 6668  
MALIBU, CA 90264 AND  
MARTT, DEVON (UNITED STATES INDIVIDUAL)  
P.O. BOX 6668  
MALIBU, CA 90264

FOR: BELTS; BLOUSES; DRESSES; HATS; JACKETS; LEGGINGS; PANTS; SHORT-SLEEVED OR LONG-SLEEVED T-SHIRTS; SWEATERS; T-SHIRTS; SKIRTS; JUMPSUITS; EVENING DRESSES; EVE-

NING GOWNS; SWEAT SUITS, IN CLASS 25 (U.S. CLS. 22 AND 39).

FIRST USE 2-15-2008; IN COMMERCE 2-15-2008.

THE MARK CONSISTS OF STANDARD CHARACTERS WITHOUT CLAIM TO ANY PARTICULAR FONT, STYLE, SIZE, OR COLOR.

SN 77-155,380, FILED 4-12-2007.

JULIE WATSON, EXAMINING ATTORNEY

**Int. Cls.: 35, 36, 43, and 44**

**Prior U.S. Cls.: 100, 101, and 102**

**United States Patent and Trademark Office**

**Reg. No. 3,468,956**

**Registered July 15, 2008**

**SERVICE MARK  
PRINCIPAL REGISTER**



EBY GROUP, INC. (MISSOURI CORPORATION)  
706 N. LINDENWOOD  
OLATHE, KS 66062

FOR: BUSINESS MANAGEMENT OF SENIOR  
CARE CENTERS FOR OTHERS, IN CLASS 35 (U.S.  
CLS. 100, 101 AND 102).

FIRST USE 1-31-1999; IN COMMERCE 1-31-1999.

FOR: FINANCIAL SERVICES, NAMELY, ANALY-  
SIS, EVALUATION AND CONSULTATION OF CON-  
STRUCTION PROJECT FINANCING;  
COMMERCIAL REAL ESTATE BROKERAGE SER-  
VICES, IN CLASS 36 (U.S. CLS. 100, 101 AND 102).

FIRST USE 1-31-1999; IN COMMERCE 1-31-1999.

FOR: PROVIDING ASSISTED LIVING FACIL-  
ITIES, IN CLASS 43 (U.S. CLS. 100 AND 101).

FIRST USE 1-31-1999; IN COMMERCE 1-31-1999.

FOR: MEDICAL SERVICES, NAMELY, PROVID-  
ING A CARE CENTER FOR SENIOR CITIZENS, IN  
CLASS 44 (U.S. CLS. 100 AND 101).

FIRST USE 1-31-1999; IN COMMERCE 1-31-1999.

THE MARK CONSISTS OF IMAGE IS DESIGN OF  
A TREE.

SN 77-155,414, FILED 4-12-2007.

WARREN L. OLANDRIA, EXAMINING ATTOR-  
NEY

**Int. Cl.: 39**

**Prior U.S. Cls.: 100 and 105**

**United States Patent and Trademark Office**

**Reg. No. 3,468,957**

**Registered July 15, 2008**

**SERVICE MARK  
PRINCIPAL REGISTER**



NORTHWEST NATURAL GAS COMPANY, DBA  
NW NATURAL (OREGON CORPORATION)  
ONE PACIFIC SQUARE  
220 N.W. SECOND AVENUE  
PORTLAND, OR 97209

FOR: GAS UTILITIES SERVICES, NAMELY, SUPPLYING GAS FROM ALTERNATIVE BIOLOGICAL SOURCES TO GAS UTILITIES CUSTOMERS AS A HEAT SOURCE, WITH THE OBJECTIVE OF REDUCING THE RELIANCE ON NATURAL GAS AS A HEAT SOURCE, THUS REDUCING GREENHOUSE GAS EMISSIONS, IN CLASS 39 (U.S. CLS. 100 AND 105).

FIRST USE 10-0-2007; IN COMMERCE 10-0-2007.

OWNER OF U.S. REG. NO. 2,490,810.

NO CLAIM IS MADE TO THE EXCLUSIVE RIGHT TO USE "ENERGY", APART FROM THE MARK AS SHOWN.

THE MARK CONSISTS OF THE WORDS "SMART ENERGY" SEPARATED BY A FLAME WITH THE WORDS "THINKING BEYOND TOMORROW" BENEATH THE WORD "ENERGY".

SN 77-155,602, FILED 4-12-2007.

HEATHER THOMPSON, EXAMINING ATTORNEY

**Int. Cl.: 35**

**Prior U.S. Cls.: 100, 101, and 102**

**United States Patent and Trademark Office**

**Reg. No. 3,468,958**

**Registered July 15, 2008**

**SERVICE MARK  
PRINCIPAL REGISTER**



THE KROGER CO. OF MICHIGAN (MICHIGAN CORPORATION)

18334 LAUREL PARK DRIVE NORTH

LIVONIA, MI 481522686

FOR: RETAIL GROCERY STORE SERVICES FEATURING A CUSTOMER LOYALTY REWARDS PROGRAM FOR SHOPPERS, IN CLASS 35 (U.S. CLS. 100, 101 AND 102).

FIRST USE 4-30-2007; IN COMMERCE 4-30-2007.

NO CLAIM IS MADE TO THE EXCLUSIVE RIGHT TO USE "REWARDS", APART FROM THE MARK AS SHOWN.

THE MARK CONSISTS OF CART TILTING ON ITS BACK WHEELS WITH ONE AND A HALF ARCS FACING DOWNWARD BEHIND IT, GIVING THE APPEARANCE OF A BOUNCING CART, ALL ABOVE THE WORD "REWARDS".

SN 77-155,717, FILED 4-12-2007.

YAT SYE, LEE, EXAMINING ATTORNEY

**Int. Cl.: 16**

**Prior U.S. Cls.: 2, 5, 22, 23, 29, 37, 38, and 50**

**United States Patent and Trademark Office**

**Reg. No. 3,468,959**

**Registered July 15, 2008**

**TRADEMARK  
PRINCIPAL REGISTER**

**hookabooke**

DILYNN DESIGNS (NEW JERSEY LTD LIAB CO)  
14 MUSKET WAY  
PISCATAWAY, NJ 08854

THE MARK CONSISTS OF STANDARD CHAR-  
ACTERS WITHOUT CLAIM TO ANY PARTICULAR  
FONT, STYLE, SIZE, OR COLOR.

FOR: BOOKMARKS, IN CLASS 16 (U.S. CLS. 2, 5,  
22, 23, 29, 37, 38 AND 50).

SN 77-155,935, FILED 4-13-2007.

FIRST USE 6-1-2008; IN COMMERCE 6-1-2008.

SANDRA MANIOS, EXAMINING ATTORNEY



**Int. Cl.: 12**

**Prior U.S. Cls.: 19, 21, 23, 31, 35, and 44**

**Reg. No. 3,468,960**

**United States Patent and Trademark Office**

**Registered July 15, 2008**

---

**TRADEMARK  
PRINCIPAL REGISTER**

**CIVIA**

QUALITY BICYCLE PRODUCTS, INC. (MINNE-  
SOTA CORPORATION)  
6400 WEST 105TH STREET  
BLOOMINGTON, MN 55438

THE MARK CONSISTS OF STANDARD CHAR-  
ACTERS WITHOUT CLAIM TO ANY PARTICULAR  
FONT, STYLE, SIZE, OR COLOR.

FOR: BICYCLE FRAMES; BICYCLES, IN CLASS  
12 (U.S. CLS. 19, 21, 23, 31, 35 AND 44).

SN 77-156,252, FILED 4-13-2007.

FIRST USE 4-15-2008; IN COMMERCE 4-15-2008.

KIMBERLY FRYE, EXAMINING ATTORNEY

**Int. Cl.: 16**

**Prior U.S. Cls.: 2, 5, 22, 23, 29, 37, 38, and 50**

**Reg. No. 3,468,961**

**United States Patent and Trademark Office**

**Registered July 15, 2008**

**TRADEMARK  
PRINCIPAL REGISTER**



PAINTING AND DECORATING CONTRACTORS  
OF AMERICA, INCORPORATED (ILLINOIS  
CORPORATION)  
1801 PARK 270 DRIVE SUITE 220  
ST. LOUIS, MO 63146

FOR: MAGAZINES FEATURING INFORMATION AND ARTICLES ABOUT INTERIOR AND EXTERIOR PAINTING AND DECORATIVE FINISHING IN THE RESIDENTIAL, COMMERCIAL AND INDUSTRIAL ENVIRONMENTS DIRECTED TO PAINTING AND DECORATING CONTRACTORS, IN CLASS 16 (U.S. CLS. 2, 5, 22, 23, 29, 37, 38 AND 50).

FIRST USE 6-1-2007; IN COMMERCE 6-1-2007.

NO CLAIM IS MADE TO THE EXCLUSIVE RIGHT TO USE "PAINTING AND DECORATING CONTRACTORS OF AMERICA" AND "OFFICIAL

MAGAZINE", APART FROM THE MARK AS SHOWN.

THE MARK CONSISTS OF A RECTANGLE WITH THE WORDING "PDCA" ON THE LEFT AND THE WORDING "PAINTING AND DECORATING CONTRACTORS OF AMERICA" IN A CONCENTRIC CIRCLE ABOVE A PAINT BRUSH AND PAINT PALETTE DESIGN WITH THE LETTERS "18" ON THE LEFT SIDE AND "84" ON THE RIGHT. THE TERMS "DECO OFFICIAL MAGAZINE OF THE PDCA" APPEAR NEXT TO AND UNDER THE DESIGN.

SN 77-157,574, FILED 4-16-2007.

CAROLINE WOOD, EXAMINING ATTORNEY

**Int. Cl.: 9**

**Prior U.S. Cls.: 21, 23, 26, 36, and 38**

**United States Patent and Trademark Office**

**Reg. No. 3,468,962**

**Registered July 15, 2008**

**TRADEMARK  
PRINCIPAL REGISTER**

**BETRAY**

OAKLEY, INC. (WASHINGTON CORPORATION)  
ONE ICON  
FOOTHILL RANCH, CA 92610

FOR: PROTECTIVE EYEWEAR, NAMELY, SPECTACLES, PRESCRIPTION EYEWEAR, ANTI GLARE GLASSES AND SUNGLASSES AND THEIR PARTS AND ACCESSORIES, NAMELY, REPLACEMENT LENSES, FRAMES, EARSTEMS, AND NOSE PIECES; CASES SPECIALLY ADAPTED FOR SPECTACLES AND SUNGLASSES AND THEIR PARTS AND AC-

CESSORIES, IN CLASS 9 (U.S. CLS. 21, 23, 26, 36 AND 38).

FIRST USE 12-1-2007; IN COMMERCE 12-1-2007.

THE MARK CONSISTS OF STANDARD CHARACTERS WITHOUT CLAIM TO ANY PARTICULAR FONT, STYLE, SIZE, OR COLOR.

SN 77-157,944, FILED 4-16-2007.

LINDA ESTRADA, EXAMINING ATTORNEY

**Int. Cl.: 9**

**Prior U.S. Cls.: 21, 23, 26, 36, and 38**

**United States Patent and Trademark Office**

**Reg. No. 3,468,963**

**Registered July 15, 2008**

**TRADEMARK  
PRINCIPAL REGISTER**

**BELONG**

OAKLEY, INC. (WASHINGTON CORPORATION)  
ONE ICON  
FOOTHILL RANCH, CA 92610

FOR: PROTECTIVE EYEWEAR, NAMELY, SPECTACLES, PRESCRIPTION EYEWEAR, ANTI GLARE GLASSES AND SUNGLASSES AND THEIR PARTS AND ACCESSORIES, NAMELY, REPLACEMENT LENSES, FRAMES, EARSTEMS, AND NOSE PIECES; CASES SPECIALLY ADAPTED FOR SPECTACLES AND SUNGLASSES AND THEIR PARTS AND AC-

CESSORIES, IN CLASS 9 (U.S. CLS. 21, 23, 26, 36 AND 38).

FIRST USE 12-1-2007; IN COMMERCE 12-1-2007.

THE MARK CONSISTS OF STANDARD CHARACTERS WITHOUT CLAIM TO ANY PARTICULAR FONT, STYLE, SIZE, OR COLOR.

SN 77-157,947, FILED 4-16-2007.

LINDA ESTRADA, EXAMINING ATTORNEY

**Int. Cl.: 35**

**Prior U.S. Cls.: 100, 101, and 102**

**United States Patent and Trademark Office**

**Reg. No. 3,468,964**

**Registered July 15, 2008**

**SERVICE MARK  
PRINCIPAL REGISTER**

**SERVSTAR**

SANITATION STRATEGIES, LLC (MICHIGAN  
LTD LIAB CO)  
2104 JOLLY ROAD  
OKEMOS, MI 488645930

FOR: CUSTOMER SERVICE IN THE FIELD OF  
LIFE SCIENCES AND FOOD PROCESSING SANI-  
TATION UTILIZING HAND-HELD COMPUTERS  
AND SOFTWARE TO ALLOW SERVICE TECHNI-  
CIANS TO SCAN BAR CODED EQUIPMENT WHEN  
PROVIDING ROUTINE OR EMERGENCY SERVICE  
TO CUSTOMERS ALLOWING THE COLLECTED  
DATA TO BE UPLOADED TO A SERVER TO  
DOCUMENT SERVICE PERFORMED AND ALLOW

VIEWING BY CUSTOMER, IN CLASS 35 (U.S. CLS.  
100, 101 AND 102).

FIRST USE 10-0-2007; IN COMMERCE 10-0-2007.

THE MARK CONSISTS OF STANDARD CHAR-  
ACTERS WITHOUT CLAIM TO ANY PARTICULAR  
FONT, STYLE, SIZE, OR COLOR.

SN 77-158,287, FILED 4-17-2007.

PAM WILLIS, EXAMINING ATTORNEY

**Int. Cl.: 42**

**Prior U.S. Cls.: 100 and 101**

**United States Patent and Trademark Office**

**Reg. No. 3,468,965**

**Registered July 15, 2008**

**SERVICE MARK  
PRINCIPAL REGISTER**

**WISEware**

WILSON INTERESTS, LLC (LOUISIANA LTD  
LIAB CO)  
SUITE A  
1056 N. CARROLLTON AVE.  
NEW ORLEANS, LA 70119

FOR: COMPUTER SOFTWARE CONSULTATION;  
CONSULTING SERVICES IN THE FIELD OF DE-  
SIGN, SELECTION, IMPLEMENTATION AND USE  
OF COMPUTER HARDWARE AND SOFTWARE  
SYSTEMS FOR OTHERS; MAINTENANCE OF COM-  
PUTER SOFTWARE, IN CLASS 42 (U.S. CLS. 100  
AND 101).

FIRST USE 6-1-2007; IN COMMERCE 6-1-2007.

THE MARK CONSISTS OF STANDARD CHAR-  
ACTERS WITHOUT CLAIM TO ANY PARTICULAR  
FONT, STYLE, SIZE, OR COLOR.

SN 77-158,707, FILED 4-17-2007.

GEOFFREY FOSDICK, EXAMINING ATTORNEY

**Int. Cl.: 45**

**Prior U.S. Cls.: 100 and 101**

**United States Patent and Trademark Office**

**Reg. No. 3,468,966**

**Registered July 15, 2008**

**SERVICE MARK  
PRINCIPAL REGISTER**

**DRIVE TO WORK**

DRIVE-TO-WORK (VIRGINIA CORPORATION)  
3445 WEST CARY STREET  
RICHMOND, VA 23221

FOR: LEGAL SERVICES PROVIDED PRO BONO TO LOW INCOME AND PREVIOUSLY INCARCERATED INDIVIDUALS, NAMELY, ASSISTANCE IN OBTAINING DRIVER'S LICENSES, PERSONAL IDENTIFICATION CARDS, BIRTH CERTIFICATES, AND OTHER FORMS OF PERSONAL IDENTIFICATION; LEGAL SERVICES PROVIDED PRO BONO TO LOW INCOME AND PREVIOUSLY INCARCERATED INDIVIDUALS, NAMELY, LEGAL DEFENSE

OF SAID INDIVIDUALS WHEN CHARGED WITH CERTAIN TRAFFIC VIOLATIONS, IN CLASS 45 (U.S. CLS. 100 AND 101).

FIRST USE 5-1-2007; IN COMMERCE 5-1-2007.

THE MARK CONSISTS OF STANDARD CHARACTERS WITHOUT CLAIM TO ANY PARTICULAR FONT, STYLE, SIZE, OR COLOR.

SN 77-158,844, FILED 4-17-2007.

JAMES LOVELACE, EXAMINING ATTORNEY

**Int. Cl.: 8**

**Prior U.S. Cls.: 23, 28, and 44**

**United States Patent and Trademark Office**

**Reg. No. 3,468,967**

**Registered July 15, 2008**

**TRADEMARK  
PRINCIPAL REGISTER**

**HOUDINI**

MENTOR GROUP, LLC (OREGON LTD LIAB CO)  
P.O. BOX 835  
OREGON CITY, OR 97045

THE MARK CONSISTS OF STANDARD CHAR-  
ACTERS WITHOUT CLAIM TO ANY PARTICULAR  
FONT, STYLE, SIZE, OR COLOR.

FOR: MULTI-FUNCTION HAND TOOLS COM-  
PRISED OF A SEAT BELT CUTTING TOOL AND A  
SPRING-LOADED GLASS BREAKING TOOL, IN  
CLASS 8 (U.S. CLS. 23, 28 AND 44).

SN 77-158,942, FILED 4-17-2007.

FIRST USE 5-28-2008; IN COMMERCE 5-28-2008.

SARA THOMAS, EXAMINING ATTORNEY



**Int. Cls.: 1 and 19**

**Prior U.S. Cls.: 1, 5, 6, 10, 12, 26, 33, 46, and 50**

**United States Patent and Trademark Office**

**Reg. No. 3,468,968**

**Registered July 15, 2008**

**TRADEMARK  
PRINCIPAL REGISTER**

**EcoTherm**

SEPARATION TECHNOLOGIES LLC (DELA-  
WARE LTD LIAB CO)  
6071 CATAWBA ROAD  
TROUTVILLE, VA 24175

FOR: TREATED FLY ASH FOR GENERAL MAN-  
UFACTURING USE, IN CLASS 1 (U.S. CLS. 1, 5, 6, 10,  
26 AND 46).

FIRST USE 4-30-2007; IN COMMERCE 4-30-2007.

FOR: TREATED FLY ASH FOR GENERAL CON-  
STRUCTION USE, IN CLASS 19 (U.S. CLS. 1, 12, 33  
AND 50).

FIRST USE 4-30-2007; IN COMMERCE 4-30-2007.

THE MARK CONSISTS OF STYLIZED "ECO-  
THERM" MARK WITH MODIFIED RECYCLING  
SYMBOL IN "O".

SN 77-159,280, FILED 4-18-2007.

JENNIFER VASQUEZ, EXAMINING ATTORNEY

**Int. Cl.: 43**

**Prior U.S. Cls.: 100 and 101**

**United States Patent and Trademark Office**

**Reg. No. 3,468,969**

**Registered July 15, 2008**

**SERVICE MARK  
PRINCIPAL REGISTER**

**A SIGN OF THE TIMES**

TIMES GRILL RESTAURANT GROUP, LLC  
(FLORIDA LTD LIAB CO)  
12148 MANDARIN ROAD  
JACKSONVILLE, FL 32223

THE MARK CONSISTS OF STANDARD CHAR-  
ACTERS WITHOUT CLAIM TO ANY PARTICULAR  
FONT, STYLE, SIZE, OR COLOR.

FOR: RESTAURANT SERVICES, IN CLASS 43  
(U.S. CLS. 100 AND 101).

SN 77-159,498, FILED 4-18-2007.

FIRST USE 2-1-2007; IN COMMERCE 2-1-2007.

EDWARD NELSON, EXAMINING ATTORNEY

**Int. Cl.: 9**

**Prior U.S. Cls.: 21, 23, 26, 36, and 38**

**Reg. No. 3,468,970**

**United States Patent and Trademark Office**

**Registered July 15, 2008**

**TRADEMARK  
PRINCIPAL REGISTER**

**TERUTEN**

TERUTEN, INC. (REPUBLIC OF KOREA CORPORATION)  
GANGNAM-GU  
4F, ROCKET BUILDING 747-29, YEOKSAM-DONG  
SEOUL, REPUBLIC OF KOREA

FOR: COMPUTER HARDWARE; COMPUTER APPLICATION SOFTWARE FOR MOBILE PHONES; COMPUTER HARDWARE AND COMPUTER SOFTWARE PROGRAMS FOR THE INTEGRATION OF TEXT, AUDIO, GRAPHICS, STILL IMAGES AND MOVING PICTURES INTO AN INTERACTIVE DELIVERY FOR MULTIMEDIA APPLICATIONS; COMPUTER SOFTWARE FOR PROCESSING DIGITAL MUSIC FILES; COMPUTER SOFTWARE FOR ENCRYPTION; COMPUTER SOFTWARE FOR ORGANIZING AND VIEWING DIGITAL IMAGES AND PHOTOGRAPHS; COMPUTER SOFTWARE FOR USE IN RELATION TO DIGITAL ANIMATION AND SPECIAL EFFECTS OF IMAGES; COMPUTER SOFTWARE FOR WIRELESS CONTENT DELIVERY; COMPUTER SOFTWARE FOR MANIPULATING DIGITAL AUDIO INFORMATION FOR USE IN AUDIO MEDIA APPLICATIONS; COMPUTER SOFTWARE FOR USE IN THE SAFEGUARDING OF DIGITAL FILES, INCLUDING AUDIO, VIDEO, TEXT, BINARY, STILL IMAGES, GRAPHICS AND

MULTIMEDIA FILES; COMPUTER SOFTWARE FOR USE IN THE ENCRYPTION AND DECRYPTION OF DIGITAL FILES, INCLUDING AUDIO, VIDEO, TEXT, BINARY, STILL IMAGES, GRAPHICS AND MULTIMEDIA FILES; COMPUTER SOFTWARE TO ENHANCE THE AUDIO-VISUAL CAPABILITIES OF MULTIMEDIA APPLICATIONS, NAMELY, FOR THE INTEGRATION OF TEXT, AUDIO, GRAPHICS, STILL IMAGES AND MOVING PICTURES; COMPUTER SOFTWARE TO ENABLE THE TRANSMISSION OF PHOTOGRAPHS TO MOBILE TELEPHONES; COMPUTER SOFTWARE, NAMELY, SOFTWARE DEVELOPMENT TOOLS FOR THE CREATION OF MOBILE INTERNET APPLICATIONS AND CLIENT INTERFACES, IN CLASS 9 (U.S. CLS. 21, 23, 26, 36 AND 38).

FIRST USE 11-0-2002; IN COMMERCE 11-0-2002.

THE MARK CONSISTS OF STANDARD CHARACTERS WITHOUT CLAIM TO ANY PARTICULAR FONT, STYLE, SIZE, OR COLOR.

SN 77-159,685, FILED 4-18-2007.

MELVIN AXILBUND, EXAMINING ATTORNEY

**Int. Cl.: 43**

**Prior U.S. Cls.: 100 and 101**

**United States Patent and Trademark Office**

**Reg. No. 3,468,971**

**Registered July 15, 2008**

**SERVICE MARK  
PRINCIPAL REGISTER**

**GRADY DAVID'S**

DAVID MAGROGAN GROUP, LLC (PENNSYLVANIA LTD LIAB CO)  
18 WEST GAY STREET  
WEST CHESTER, PA 19380

FOR: RESTAURANT, PUB, BAR AND GRILL SERVICES; TAKE OUT FOOD SERVICES, CATERING SERVICES, IN CLASS 43 (U.S. CLS. 100 AND 101).

FIRST USE 9-30-2007; IN COMMERCE 12-31-2007.

THE MARK CONSISTS OF STANDARD CHARACTERS WITHOUT CLAIM TO ANY PARTICULAR FONT, STYLE, SIZE, OR COLOR.

THE NAME(S), PORTRAIT(S), AND/OR SIGNATURE(S) SHOWN IN THE MARK DOES NOT IDENTIFY A PARTICULAR LIVING INDIVIDUAL.

SN 77-159,956, FILED 4-18-2007.

MICHAEL ENGEL, EXAMINING ATTORNEY

**Int. Cl.: 9**

**Prior U.S. Cls.: 21, 23, 26, 36, and 38**

**United States Patent and Trademark Office**

**Reg. No. 3,468,972**

**Registered July 15, 2008**

**TRADEMARK  
PRINCIPAL REGISTER**

**TRANSLATOR STUDIO**

TRANSLATIONS.COM, INC. (DELAWARE COR-  
PORATION)  
37TH FLOOR  
3 PARK AVENUE  
NEW YORK, NY 10016

FOR: COMPUTER PROGRAMS IN THE FIELD  
OF LANGUAGE TRANSLATION, IN CLASS 9 (U.S.  
CLS. 21, 23, 26, 36 AND 38).

FIRST USE 5-0-2007; IN COMMERCE 5-0-2007.

THE MARK CONSISTS OF STANDARD CHAR-  
ACTERS WITHOUT CLAIM TO ANY PARTICULAR  
FONT, STYLE, SIZE, OR COLOR.

NO CLAIM IS MADE TO THE EXCLUSIVE  
RIGHT TO USE "TRANSLATOR", APART FROM  
THE MARK AS SHOWN.

SN 77-160,838, FILED 4-19-2007.

JULIE WATSON, EXAMINING ATTORNEY

**Int. Cl.: 30**

**Prior U.S. Cl.: 46**

**United States Patent and Trademark Office**

**Reg. No. 3,468,973**

**Registered July 15, 2008**

---

**TRADEMARK  
PRINCIPAL REGISTER**

**MOUNTAIN ECHOES**

SUN-RICH INTERNATIONAL, INC. (UNITED STATES INDIVIDUAL)  
10204 WERCH DRIVE  
WOODRIDGE, IL 60517

THE MARK CONSISTS OF STANDARD CHARACTERS WITHOUT CLAIM TO ANY PARTICULAR FONT, STYLE, SIZE, OR COLOR.

FOR: TEA, IN CLASS 30 (U.S. CL. 46).

SN 77-161,279, FILED 4-19-2007.

FIRST USE 10-4-2007; IN COMMERCE 10-31-2007.

BRENDAN REGAN, EXAMINING ATTORNEY

Int. Cl.: 16

Prior U.S. Cls.: 2, 5, 22, 23, 29, 37, 38, and 50

United States Patent and Trademark Office

Reg. No. 3,468,974

Registered July 15, 2008

TRADEMARK  
PRINCIPAL REGISTER



SCHOLASTIC INC. (NEW YORK CORPORATION)  
557 BROADWAY  
NEW YORK, NY 10012

OWNER OF U.S. REG. NOS. 1,871,292, 2,019,991,  
AND OTHERS.

FOR: A SERIES OF FICTION BOOKS FOR CHILDREN, IN CLASS 16 (U.S. CLS. 2, 5, 22, 23, 29, 37, 38 AND 50).

SN 77-161,813, FILED 4-20-2007.

FIRST USE 4-1-2008; IN COMMERCE 4-1-2008.

KATHLEEN M. VANSTON, EXAMINING ATTORNEY

**Int. Cl.: 29**

**Prior U.S. Cl.: 46**

**United States Patent and Trademark Office**

**Reg. No. 3,468,975**

**Registered July 15, 2008**

**TRADEMARK  
PRINCIPAL REGISTER**

**TEXAS KISSES**

TEXAS PIES, INC (TEXAS CORPORATION)  
4593 JUNCTION HWY #204  
INGRAM, TX 78025

NO CLAIM IS MADE TO THE EXCLUSIVE  
RIGHT TO USE "TEXAS", APART FROM THE  
MARK AS SHOWN.

FOR: JAMS; JELLIES, IN CLASS 29 (U.S. CL. 46).

FIRST USE 10-1-2006; IN COMMERCE 10-1-2006.

SN 77-162,978, FILED 4-23-2007.

THE MARK CONSISTS OF STANDARD CHAR-  
ACTERS WITHOUT CLAIM TO ANY PARTICULAR  
FONT, STYLE, SIZE, OR COLOR.

B. PARADEWELAI, EXAMINING ATTORNEY



**Int. Cl.: 16**

**Prior U.S. Cls.: 2, 5, 22, 23, 29, 37, 38, and 50**

**Reg. No. 3,468,976**

**United States Patent and Trademark Office**

**Registered July 15, 2008**

**TRADEMARK  
PRINCIPAL REGISTER**

**CUPID'S CASH**

LTD. FIRST EDITIONS, INC. (FLORIDA CORPORATION)  
2194 NEWBURY COURT  
PALM HARBOR, FL 34683

THE MARK CONSISTS OF STANDARD CHARACTERS WITHOUT CLAIM TO ANY PARTICULAR FONT, STYLE, SIZE, OR COLOR.

FOR: PRINTED VISUALS IN THE NATURE OF GREETING CARDS, COUNTER CARDS, POSTERS, PROMOTIONAL FLYERS AND PRESSURE SENSITIVE SEALS DEPICTING CUPID FOR FUNDRAISING PURPOSES, IN CLASS 16 (U.S. CLS. 2, 5, 22, 23, 29, 37, 38 AND 50).

OWNER OF U.S. REG. NOS. 1,674,185 AND 2,070,279.

SN 77-163,096, FILED 4-23-2007.

FIRST USE 1-15-2008; IN COMMERCE 1-15-2008.

BARBARA BROWN, EXAMINING ATTORNEY

**Int. Cl.: 9**

**Prior U.S. Cls.: 21, 23, 26, 36, and 38**

**Reg. No. 3,468,977**

**United States Patent and Trademark Office**

**Registered July 15, 2008**

**TRADEMARK  
PRINCIPAL REGISTER**

**WRECK THE HALLS**

CMH RECORDS INC. (CALIFORNIA CORPORATION)  
P.O. BOX 39439  
LOS ANGELES, CA 90039

THE MARK CONSISTS OF STANDARD CHARACTERS WITHOUT CLAIM TO ANY PARTICULAR FONT, STYLE, SIZE, OR COLOR.

FOR: MUSICAL SOUND RECORDINGS, IN CLASS 9 (U.S. CLS. 21, 23, 26, 36 AND 38).

SN 77-163,180, FILED 4-23-2007.

FIRST USE 10-23-2007; IN COMMERCE 10-23-2007.

MARGARET POWER, EXAMINING ATTORNEY

**Int. Cl.: 3**

**Prior U.S. Cls.: 1, 4, 6, 50, 51, and 52**

**Reg. No. 3,468,978**

**United States Patent and Trademark Office**

**Registered July 15, 2008**

---

**TRADEMARK  
PRINCIPAL REGISTER**

REVLON CUSTOM CREATIONS

REVLON CONSUMER PRODUCTS CORPORATION (DELAWARE CORPORATION)  
237 PARK AVENUE  
NEW YORK, NY 10017

FOR: COSMETICS; MAKE-UP, IN CLASS 3 (U.S. CLS. 1, 4, 6, 50, 51 AND 52).

FIRST USE 11-13-2007; IN COMMERCE 11-13-2007.

THE MARK CONSISTS OF STANDARD CHARACTERS WITHOUT CLAIM TO ANY PARTICULAR FONT, STYLE, SIZE, OR COLOR.

OWNER OF U.S. REG. NOS. 647,222, 2,974,693, AND OTHERS.

SN 77-163,262, FILED 4-23-2007.

KATHLEEN LORENZO, EXAMINING ATTORNEY

**Int. Cl.: 9**

**Prior U.S. Cls.: 21, 23, 26, 36, and 38**

**United States Patent and Trademark Office**

**Reg. No. 3,468,979**

**Registered July 15, 2008**

**TRADEMARK  
PRINCIPAL REGISTER**

**ENERGI TO GO**

EVEREADY BATTERY COMPANY, INC. (DELA-  
WARE CORPORATION)  
533 MARYVILLE UNIVERSITY DRIVE  
ST. LOUIS, MO 63141

FOR: DC/AC POWER CONVERTERS, ADAPTORS  
AND INVERTERS, IN CLASS 9 (U.S. CLS. 21, 23, 26, 36  
AND 38).

FIRST USE 6-21-2007; IN COMMERCE 6-21-2007.

THE MARK CONSISTS OF STANDARD CHAR-  
ACTERS WITHOUT CLAIM TO ANY PARTICULAR  
FONT, STYLE, SIZE, OR COLOR.

OWNER OF U.S. REG. NO. 3,137,268.

NO CLAIM IS MADE TO THE EXCLUSIVE  
RIGHT TO USE "ENERGY", APART FROM THE  
MARK AS SHOWN.

SN 77-163,923, FILED 4-24-2007.

SETH A. RAPPAPORT, EXAMINING ATTORNEY

**Int. Cl.: 25**

**Prior U.S. Cls.: 22 and 39**

**United States Patent and Trademark Office**

**Reg. No. 3,468,980**

**Registered July 15, 2008**

**TRADEMARK  
PRINCIPAL REGISTER**

**S2V**

ROCKY BRANDS, INC. (OHIO CORPORATION)  
39 EAST CANAL STREET  
NELSONVILLE, OH 45764

THE MARK CONSISTS OF STANDARD CHAR-  
ACTERS WITHOUT CLAIM TO ANY PARTICULAR  
FONT, STYLE, SIZE, OR COLOR.

FOR: FOOTWEAR, IN CLASS 25 (U.S. CLS. 22 AND  
39).

SN 77-165,283, FILED 4-25-2007.

FIRST USE 2-29-2008; IN COMMERCE 2-29-2008.

PAUL MORENO, EXAMINING ATTORNEY

**Int. Cl.: 5**

**Prior U.S. Cls.: 6, 18, 44, 46, 51, and 52**

**Reg. No. 3,468,981**

**United States Patent and Trademark Office**

**Registered July 15, 2008**

**TRADEMARK  
PRINCIPAL REGISTER**



TRAM, MARGARET (CALIFORNIA SOLE PROPRIETORSHIP)  
2560 CORPORATE PL. #D107  
MONTEREY PARK, CA 91754

FOR: DIETARY AND NUTRITIONAL SUPPLEMENTS, IN CLASS 5 (U.S. CLS. 6, 18, 44, 46, 51 AND 52).

FIRST USE 8-12-2007; IN COMMERCE 11-5-2007.

THE COLOR(S) LIGHT GREEN, DARK GREEN, DARK RED IS/ARE CLAIMED AS A FEATURE OF THE MARK.

THE MARK CONSISTS OF DARK RED BOLD ITALICIZED "NATURE'S" TO THE LEFT OF TWO LIGHT GREEN CIRCLES WITH DARK GREEN OUTLINES, WITH A DARK RED BOLD ITALICIZED "BLOOM" TO THE RIGHT OF THE TWO GREEN CIRCLES.

SN 77-167,801, FILED 4-27-2007.

BERNICE MIDDLETON, EXAMINING ATTORNEY

**Int. Cl.: 16**

**Prior U.S. Cls.: 2, 5, 22, 23, 29, 37, 38, and 50**

**Reg. No. 3,468,982**

**United States Patent and Trademark Office**

**Registered July 15, 2008**

---

**TRADEMARK  
PRINCIPAL REGISTER**

**KisLaw**

KISLAW PUBLISHING (DELAWARE CORPORATION)  
P.O. BOX 36  
ETIWANDA, CA 91739

THE MARK CONSISTS OF STANDARD CHARACTERS WITHOUT CLAIM TO ANY PARTICULAR FONT, STYLE, SIZE, OR COLOR.

FOR: STUDY GUIDES, IN CLASS 16 (U.S. CLS. 2, 5, 22, 23, 29, 37, 38 AND 50).

SN 77-168,261, FILED 4-27-2007.

FIRST USE 2-1-2007; IN COMMERCE 5-1-2007.

EMILY CHUO, EXAMINING ATTORNEY

**Int. Cl.: 31**

**Prior U.S. Cls.: 1 and 46**

**United States Patent and Trademark Office**

**Reg. No. 3,468,983**

**Registered July 15, 2008**

**TRADEMARK  
PRINCIPAL REGISTER**

**DIAMUNE**

DIAMOND V MILLS, INCORPORATED (IOWA  
CORPORATION)  
838 1ST STREET NW  
CEDAR RAPIDS, IA 52405

THE MARK CONSISTS OF STANDARD CHAR-  
ACTERS WITHOUT CLAIM TO ANY PARTICULAR  
FONT, STYLE, SIZE, OR COLOR.

FOR: NUTRITIONAL ADDITIVES FOR INCOR-  
PORATING INTO ANIMAL FOODSTUFFS, NOT  
FOR MEDICAL PURPOSES, IN CLASS 31 (U.S. CLS.  
1 AND 46).

SN 77-170,005, FILED 5-1-2007.

FIRST USE 5-30-2007; IN COMMERCE 5-30-2007.

BERNICE MIDDLETON, EXAMINING ATTORNEY



**Int. Cl.: 9**

**Prior U.S. Cls.: 21, 23, 26, 36, and 38**

**United States Patent and Trademark Office**

**Reg. No. 3,468,984**

**Registered July 15, 2008**

**TRADEMARK  
PRINCIPAL REGISTER**

**TICKETSOFT**

TICKETSOFT, L.L.C. (TEXAS LTD LIAB CO)  
ONE LINCOLN CENTER  
5400 LBJ FREEWAY, SUITE 1275  
DALLAS, TX 75240

THE MARK CONSISTS OF STANDARD CHAR-  
ACTERS WITHOUT CLAIM TO ANY PARTICULAR  
FONT, STYLE, SIZE, OR COLOR.

FOR: SOFTWARE FOR ELECTRONIC COMPU-  
TERS, NAMELY, ACCOUNTING SOFTWARE, IN  
CLASS 9 (U.S. CLS. 21, 23, 26, 36 AND 38).

SN 77-170,948, FILED 5-2-2007.

FIRST USE 4-1-2004; IN COMMERCE 4-1-2004.

BARBARA GAYNOR, EXAMINING ATTORNEY

Int. Cl.: 16

Prior U.S. Cls.: 2, 5, 22, 23, 29, 37, 38, and 50

United States Patent and Trademark Office

Reg. No. 3,468,985

Registered July 15, 2008

TRADEMARK  
PRINCIPAL REGISTER



8 NET, INC. (CALIFORNIA CORPORATION)  
13140 ALONDRA BOULEVARD  
CERRITOS, CA 90703

FOR: PRINTING PAPER; PRINTING PAPERS, IN  
CLASS 16 (U.S. CLS. 2, 5, 22, 23, 29, 37, 38 AND 50).

FIRST USE 5-2-2007; IN COMMERCE 5-2-2007.

NO CLAIM IS MADE TO THE EXCLUSIVE  
RIGHT TO USE "PAPER", APART FROM THE  
MARK AS SHOWN.

THE COLOR(S) GREEN,WHITE,BLACK IS/ARE  
CLAIMED AS A FEATURE OF THE MARK.

THE MARK CONSISTS OF THE LETTER "A" IN  
GREEN, EIGHT STARS IN WHITE LOCATED  
WITHIN THE LETTER "A" IN GREEN, THE LET-  
TERS "S" IN WHITE, "T" IN WHITE, "A" IN WHITE,  
"R" IN WHITE LOCATED WITHIN A BLACK REC-  
TANGLE LOCATED BELOW THE LETTER "A" IN  
GREEN, THE LETTERS "P" IN BLACK, "A" IN  
BLACK, "P" IN BLACK, "E" IN BLACK, "R" IN  
BLACK LOCATED BELOW THE BLACK RECTAN-  
GLE ENCOMPASSING THE WORD "STAR".

SN 77-171,116, FILED 5-2-2007.

JENNIFER VASQUEZ, EXAMINING ATTORNEY

**Int. Cl.: 16**

**Prior U.S. Cls.: 2, 5, 22, 23, 29, 37, 38, and 50**

**Reg. No. 3,468,986**

**United States Patent and Trademark Office**

**Registered July 15, 2008**

**TRADEMARK  
PRINCIPAL REGISTER**

**TU CIUDAD**

CIUDAD, LLC (INDIANA LTD LIAB CO)  
SUITE 700  
40 MONUMENT CIRCLE  
INDIANAPOLIS, IN 46204

FOR: PRINTED PUBLICATIONS, NAMELY, MAGAZINES PERTAINING TO LIFESTYLE, CULTURE, FASHION, SHOPPING, ENTERTAINMENT, DINING, LEISURE ACTIVITIES, CELEBRITIES, PERSONALITIES, CURRENT EVENTS, POLITICS AND BUSINESS, IN CLASS 16 (U.S. CLS. 2, 5, 22, 23, 29, 37, 38 AND 50).

FIRST USE 3-31-2006; IN COMMERCE 3-31-2006.

THE MARK CONSISTS OF STANDARD CHARACTERS WITHOUT CLAIM TO ANY PARTICULAR FONT, STYLE, SIZE, OR COLOR.

THE FOREIGN WORDING IN THE MARK TRANSLATES INTO ENGLISH AS "YOUR CITY".

SN 77-171,467, FILED 5-2-2007.

JAY BESCH, EXAMINING ATTORNEY

**Int. Cl.: 30**

**Prior U.S. Cl.: 46**

**United States Patent and Trademark Office**

**Reg. No. 3,468,987**

**Registered July 15, 2008**

**TRADEMARK  
PRINCIPAL REGISTER**

**ALESSI'S SCACHATTA**

PHIL'S CAKE BOX BAKERIES, INC. (FLORIDA  
CORPORATION)  
2909 WEST CYPRESS STREET  
TAMPA, FL 33609

THE ENGLISH TRANSLATION OF THE WORD  
"SCACHATTA" IN THE MARK IS SMASH THE  
BREAD.

FOR: BREAD, IN CLASS 30 (U.S. CL. 46).

FIRST USE 9-30-1912; IN COMMERCE 9-30-1912.

SN 77-171,669, FILED 5-3-2007.

THE MARK CONSISTS OF STANDARD CHAR-  
ACTERS WITHOUT CLAIM TO ANY PARTICULAR  
FONT, STYLE, SIZE, OR COLOR.

SUSAN RICHARDS, EXAMINING ATTORNEY

**Int. Cl.: 9**

**Prior U.S. Cls.: 21, 23, 26, 36, and 38**

**United States Patent and Trademark Office**

**Reg. No. 3,468,988**

**Registered July 15, 2008**

**TRADEMARK  
PRINCIPAL REGISTER**

**THE MIRIAM COLLECTION**

THE WEINSTEIN COMPANY LLC (DELAWARE  
LTD LIAB CO)  
375 GREENWICH STREET  
NEW YORK, NY 10013

FOR: PRE-RECORDED DVD'S FEATURING FIC-  
TION AND NON-FICTION COMEDY, DRAMA, AC-  
TION, ADVENTURE, HORROR, THRILLER,  
SUSPENSE, FAMILY ENTERTAINMENT AND/OR  
ANIMATION MOTION PICTURE FILMS, IN CLASS  
9 (U.S. CLS. 21, 23, 26, 36 AND 38).

FIRST USE 1-29-2008; IN COMMERCE 1-29-2008.

THE MARK CONSISTS OF STANDARD CHAR-  
ACTERS WITHOUT CLAIM TO ANY PARTICULAR  
FONT, STYLE, SIZE, OR COLOR.

NO CLAIM IS MADE TO THE EXCLUSIVE  
RIGHT TO USE "COLLECTION", APART FROM  
THE MARK AS SHOWN.

SN 77-172,054, FILED 5-3-2007.

TIMOTHY FINNEGAN, EXAMINING ATTORNEY

**Int. Cl.: 14**

**Prior U.S. Cls.: 2, 27, 28, and 50**

**United States Patent and Trademark Office**

**Reg. No. 3,468,989**

**Registered July 15, 2008**

**TRADEMARK  
PRINCIPAL REGISTER**



U NORTH AMERICA INC. (ILLINOIS CORPORATION)  
2159 WEST MADISON STREET  
CHICAGO, IL 60612

THE MARK CONSISTS OF A STAR ABOVE AN UNDERLINED LETTER "U".

FOR: JEWELRY, IN CLASS 14 (U.S. CLS. 2, 27, 28 AND 50).

SN 77-172,296, FILED 5-3-2007.

FIRST USE 4-10-2007; IN COMMERCE 4-10-2007.

AMEETA JORDAN, EXAMINING ATTORNEY

**Int. Cl.: 41**

**Prior U.S. Cls.: 100, 101, and 107**

**United States Patent and Trademark Office**

**Reg. No. 3,468,990**

**Registered July 15, 2008**

**SERVICE MARK  
PRINCIPAL REGISTER**

# CKO Kickboxing

CLUB KO FRANCHISE LLC (NEW JERSEY LTD  
LIAB CO)  
SUITE 2  
900 MADISON STREET  
HOBOKEN, NJ 07030

FOR: PHYSICAL FITNESS CONDITIONING  
CLASSES; PHYSICAL FITNESS CONSULTATION;  
PHYSICAL FITNESS INSTRUCTION, IN CLASS 41  
(U.S. CLS. 100, 101 AND 107).

FIRST USE 9-1-2007; IN COMMERCE 9-1-2007.

THE MARK CONSISTS OF STANDARD CHAR-  
ACTERS WITHOUT CLAIM TO ANY PARTICULAR  
FONT, STYLE, SIZE, OR COLOR.

NO CLAIM IS MADE TO THE EXCLUSIVE  
RIGHT TO USE "KICKBOXING", APART FROM  
THE MARK AS SHOWN.

SN 77-172,505, FILED 5-3-2007.

WILLIAM ROSSMAN, EXAMINING ATTORNEY

**Int. Cl.: 20**

**Prior U.S. Cls.: 2, 13, 22, 25, 32, and 50**

**Reg. No. 3,468,991**

**United States Patent and Trademark Office**

**Registered July 15, 2008**

---

**TRADEMARK  
PRINCIPAL REGISTER**

**REALIGN**

SITONIT, INC. (CALIFORNIA CORPORATION)  
6415 KATELLA AVENUE  
CYPRESS, CA 90630

THE MARK CONSISTS OF STANDARD CHAR-  
ACTERS WITHOUT CLAIM TO ANY PARTICULAR  
FONT, STYLE, SIZE, OR COLOR.

FOR: OFFICE CHAIRS FOR PERFORMING COM-  
PUTER KEYBOARDING TASKS, IN CLASS 20 (U.S.  
CLS. 2, 13, 22, 25, 32 AND 50).

SN 77-173,036, FILED 5-4-2007.

FIRST USE 6-30-2007; IN COMMERCE 6-30-2007.

KRISTINA MORRIS, EXAMINING ATTORNEY



**Int. Cls.: 5 and 45**

**Prior U.S. Cls.: 6, 18, 44, 46, 51, 52, 100, and 101**

**United States Patent and Trademark Office**

**Reg. No. 3,468,992**

**Registered July 15, 2008**

**TRADEMARK  
SERVICE MARK  
PRINCIPAL REGISTER**



"Your place for tarot and spells"

SPELL SPACE INCORPORATED (CALIFORNIA CORPORATION)  
PO BOX 1106  
LAKE ARROWHEAD, CA 923521106

FOR: THERAPEUTIC SPELL KITS COMPRISING POTIONS AND HERBS USED FOR ENHANCING YOUR LIFE, IN CLASS 5 (U.S. CLS. 6, 18, 44, 46, 51 AND 52).

FIRST USE 8-14-2007; IN COMMERCE 8-14-2007.

FOR: FORECASTING SERVICES IN THE NATURE OF FORTUNE TELLING; FORTUNE-TELLING, IN CLASS 45 (U.S. CLS. 100 AND 101).

FIRST USE 8-1-2007; IN COMMERCE 8-1-2007.

NO CLAIM IS MADE TO THE EXCLUSIVE RIGHT TO USE "TAROT AND SPELLS", APART FROM THE MARK AS SHOWN.

THE COLOR(S) SILVER, DARK GRAY AND DARK BROWN IS/ARE CLAIMED AS A FEATURE OF THE MARK.

THE MARK CONSISTS OF SPLASH DESIGN IS IN GRADIENT SILVER WITH DARK GRAY SHADED EDGES, LETTERING IS IN DARK BROWN BOTH INSIDE THE SPLASH DESIGN AND UNDERNEATH.

SN 77-173,763, FILED 5-5-2007.

ANNE MADDEN, EXAMINING ATTORNEY

**Int. Cls.: 9 and 12**

**Prior U.S. Cls.: 19, 21, 23, 26, 31, 35, 36, 38, and 44**

**United States Patent and Trademark Office**

**Reg. No. 3,468,993**

**Registered July 15, 2008**

**TRADEMARK  
PRINCIPAL REGISTER**

**AMWELL**

4G TECHNOLOGIES LLC (NEW JERSEY LTD LIAB  
CO)  
SUITE 2F  
154 ROUTE 206  
CHESTER, NJ 07930

FOR: ANTI-INTRUSION ALARMS; BURGLAR  
ALARMS; ELECTRICAL AND ELECTRONIC BUR-  
GLAR ALARMS; PERSONAL SECURITY ALARMS,  
IN CLASS 9 (U.S. CLS. 21, 23, 26, 36 AND 38).

FIRST USE 4-1-2008; IN COMMERCE 4-1-2008.

FOR: ANTI-THEFT ALARMS FOR VEHICLES;  
BURGLAR ALARMS FOR VEHICLES; MOTOR VE-

HICLE ALARM SYSTEMS, IN CLASS 12 (U.S. CLS.  
19, 21, 23, 31, 35 AND 44).

FIRST USE 4-1-2008; IN COMMERCE 4-1-2008.

THE MARK CONSISTS OF STANDARD CHAR-  
ACTERS WITHOUT CLAIM TO ANY PARTICULAR  
FONT, STYLE, SIZE, OR COLOR.

SN 77-173,860, FILED 5-6-2007.

RENEE MCCRAY, EXAMINING ATTORNEY

Int. Cls.: 16 and 35

Prior U.S. Cls.: 2, 5, 22, 23, 29, 37, 38, 50, 100, 101, and 102

Reg. No. 3,468,994

United States Patent and Trademark Office

Registered July 15, 2008

TRADEMARK  
SERVICE MARK  
PRINCIPAL REGISTER



HERO TO HERO, INC. (PENNSYLVANIA CORPORATION)  
SUITE 144 PMB #401  
130 WEST MAIN STREET  
COLLEGEVILLE, PA 19426

FIRST USE 8-29-2007; IN COMMERCE 8-29-2007.

FOR: GREETING CARDS, IN CLASS 16 (U.S. CLS. 2, 5, 22, 23, 29, 37, 38 AND 50).

THE MARK CONSISTS OF DESIGN OF EAGLE AND FLAG IN BLACK AND WHITE.

FIRST USE 8-29-2007; IN COMMERCE 8-29-2007.

SN 77-174,034, FILED 5-7-2007.

FOR: ON-LINE ORDERING SERVICES FEATURING CUSTOMIZED GREETING CARDS, IN CLASS 35 (U.S. CLS. 100, 101 AND 102).

JACQUELINE A. LAVINE, EXAMINING ATTORNEY

**Int. Cl.: 36**

**Prior U.S. Cls.: 100, 101, and 102**

**United States Patent and Trademark Office**

**Reg. No. 3,468,995**

**Registered July 15, 2008**

**SERVICE MARK  
PRINCIPAL REGISTER**

**BANK LESS. LIVE MORE.**

AMPLIFY FEDERAL CREDIT UNION (TEXAS  
FEDERALLY CHARTERED CREDIT UNION)  
P. O. BOX 85300  
AUSTIN, TX 78708

THE MARK CONSISTS OF STANDARD CHAR-  
ACTERS WITHOUT CLAIM TO ANY PARTICULAR  
FONT, STYLE, SIZE, OR COLOR.

FOR: CREDIT UNION SERVICES, IN CLASS 36  
(U.S. CLS. 100, 101 AND 102).

SN 77-174,655, FILED 5-7-2007.

FIRST USE 4-20-2007; IN COMMERCE 5-1-2007.

LINDA POWELL, EXAMINING ATTORNEY

**Int. Cl.: 25**

**Prior U.S. Cls.: 22 and 39**

**United States Patent and Trademark Office**

**Reg. No. 3,468,996**

**Registered July 15, 2008**

**TRADEMARK  
PRINCIPAL REGISTER**

**ALLREADY**

ALREADY LLC (TEXAS LTD LIAB CO)  
2000 STAFFORD DRIVE  
ARLINGTON, TX 76012

THE MARK CONSISTS OF STANDARD CHAR-  
ACTERS WITHOUT CLAIM TO ANY PARTICULAR  
FONT, STYLE, SIZE, OR COLOR.

FOR: FOOTWEAR; T-SHIRTS; TENNIS SHOES;  
SHOES, IN CLASS 25 (U.S. CLS. 22 AND 39).

SN 77-174,982, FILED 5-7-2007.

FIRST USE 11-7-2007; IN COMMERCE 11-7-2007.

DANNEAN HETZEL, EXAMINING ATTORNEY

**Int. Cl.: 44**

**Prior U.S. Cls.: 100 and 101**

**United States Patent and Trademark Office**

**Reg. No. 3,468,997**

**Registered July 15, 2008**

**SERVICE MARK  
PRINCIPAL REGISTER**

**PASSPORT TO THIN**

EDER-SANGIOVANNI, DORIS (UNITED STATES  
INDIVIDUAL)  
23 PLAIN ROAD  
WESTFORD, MA 01886

FOR: CONSULTING TO INDIVIDUALS AND  
COMMUNITIES ENGAGED IN GROUP WEIGHT  
LOSS PROGRAMS; WEIGHT REDUCTION DIET  
PLANNING AND SUPERVISION, IN CLASS 44  
(U.S. CLS. 100 AND 101).

FIRST USE 10-1-2007; IN COMMERCE 10-1-2007.

THE MARK CONSISTS OF STANDARD CHAR-  
ACTERS WITHOUT CLAIM TO ANY PARTICULAR  
FONT, STYLE, SIZE, OR COLOR.

SN 77-175,603, FILED 5-8-2007.

KAREN K. BUSH, EXAMINING ATTORNEY

**Int. Cl.: 36**

**Prior U.S. Cls.: 100, 101, and 102**

**United States Patent and Trademark Office**

**Reg. No. 3,468,998**

**Registered July 15, 2008**

**SERVICE MARK  
PRINCIPAL REGISTER**

# Integrity Health

FORRESTER, DOUGLAS (UNITED STATES IN-  
DIVIDUAL)  
35 BERKSHIRE DRIVE  
PRINCETON JUNCTION, NJ 08550

FOR: ADMINISTRATION OF EMPLOYER-SPON-  
SORED MEDICAL BENEFIT PLANS, IN CLASS 36  
(U.S. CLS. 100, 101 AND 102).

FIRST USE 11-9-2007; IN COMMERCE 11-9-2007.

THE MARK CONSISTS OF STANDARD CHAR-  
ACTERS WITHOUT CLAIM TO ANY PARTICULAR  
FONT, STYLE, SIZE, OR COLOR.

NO CLAIM IS MADE TO THE EXCLUSIVE  
RIGHT TO USE "HEALTH", APART FROM THE  
MARK AS SHOWN.

SN 77-175,924, FILED 5-8-2007.

KIMBERLY PERRY, EXAMINING ATTORNEY

**Int. Cl.: 9**

**Prior U.S. Cls.: 21, 23, 26, 36, and 38**

**Reg. No. 3,468,999**

**United States Patent and Trademark Office**

**Registered July 15, 2008**

**TRADEMARK  
PRINCIPAL REGISTER**



SANFORD, L.P. (ILLINOIS LIMITED PARTNER-  
SHIP)  
2707 BUTTERFIELD ROAD  
OAK BROOK, IL 60523

THE MARK CONSISTS OF BLACK AND WHITE  
DOTS ARRANGED INTO THE SHAPE OF A ELLIP-  
TICAL DISC.

FOR: PRINTER THAT LABELS BY PRINTING  
DIRECTLY ON COMPACT DISCS AND DVDS, IN  
CLASS 9 (U.S. CLS. 21, 23, 26, 36 AND 38).

SN 77-176,654, FILED 5-9-2007.

FIRST USE 10-26-2007; IN COMMERCE 10-26-2007.

RICHARD A. STRASER, EXAMINING ATTORNEY



**Int. Cl.: 20**

**Prior U.S. Cls.: 2, 13, 22, 25, 32, and 50**

**Reg. No. 3,469,000**

**United States Patent and Trademark Office**

**Registered July 15, 2008**

**TRADEMARK  
PRINCIPAL REGISTER**

**RULO**

DITTO SALES, INC. (INDIANA CORPORATION),  
DBA VERSTEEL CORPORATION,  
2332 CATHY LANE  
JASPER, IN 47547

FOR: FURNITURE, NAMELY, DESKS AND  
CHAIRS FOR OFFICES, SCHOOLS, TRAINING FA-  
CILITIES AND CONFERENCE FACILITIES, IN  
CLASS 20 (U.S. CLS. 2, 13, 22, 25, 32 AND 50).

FIRST USE 4-13-2007; IN COMMERCE 6-26-2007.

THE MARK CONSISTS OF STANDARD CHAR-  
ACTERS WITHOUT CLAIM TO ANY PARTICULAR  
FONT, STYLE, SIZE, OR COLOR.

THE ENGLISH TRANSLATION OF "RULO" IN  
THE MARK IS CURLER OR CURLING.

SN 77-177,260, FILED 5-10-2007.

SIMON TENG, EXAMINING ATTORNEY

**Int. Cl.: 20**

**Prior U.S. Cls.: 2, 13, 22, 25, 32, and 50**

**Reg. No. 3,469,001**

**United States Patent and Trademark Office**

**Registered July 15, 2008**

---

**TRADEMARK  
PRINCIPAL REGISTER**

Imperial Cat

CAT CLAWS INC./SELISKAR, CAROLYN J (AR-  
KANSAS CORPORATION)  
1004 W. BROADWAY ST  
MORRILTON, AR 72110

NO CLAIM IS MADE TO THE EXCLUSIVE  
RIGHT TO USE "CAT", APART FROM THE MARK  
AS SHOWN.

FOR: CAT SCRATCHING PADS, IN CLASS 20  
(U.S. CLS. 2, 13, 22, 25, 32 AND 50).

SN 77-177,706, FILED 5-10-2007.

FIRST USE 5-1-2007; IN COMMERCE 5-1-2007.

KAPIL BHANOT, EXAMINING ATTORNEY

**Int. Cl.: 39**

**Prior U.S. Cls.: 100 and 105**

**United States Patent and Trademark Office**

**Reg. No. 3,469,002**

**Registered July 15, 2008**

**SERVICE MARK  
PRINCIPAL REGISTER**

**VOYAGETREK**

VOYAGETREK TRAVEL, INC. (WASHINGTON CORPORATION)  
252 NE 43RD STREET  
SEATTLE, WA 98105

FOR: TRAVEL AND TOUR INFORMATION SERVICES; TRAVEL AND TOUR INFORMATION PROVIDED VIA THE GLOBAL COMPUTER NETWORK; TRAVEL AND TOUR INFORMATION SERVICES, NAMELY, PROVIDING INFORMATION ABOUT OUTDOOR EXCURSIONS, EXPEDITIONS, ADVENTURES, RECREATION TRIPS, SIGHTSEEING TOURS, AND TRAVEL VIA THE GLOBAL COMPUTER NETWORK; TRAVEL INFORMATION SERVICES, NAMELY, PROVIDING TRAVEL NEWS, MAPS, AND LISTINGS FOR USE BY TRAVELERS VIA THE GLOBAL COMPUTER NETWORK; PRO-

VIDING LINKS TO WEB SITES OF OTHERS FEATURING TRAVEL; PROVIDING LINKS TO WEB SITES OF OTHERS FEATURING INFORMATION, BOOKING AND RESERVATION FOR THE FOREGOING, IN CLASS 39 (U.S. CLS. 100 AND 105).

FIRST USE 7-6-2007; IN COMMERCE 7-6-2007.

THE MARK CONSISTS OF STANDARD CHARACTERS WITHOUT CLAIM TO ANY PARTICULAR FONT, STYLE, SIZE, OR COLOR.

SN 77-177,914, FILED 5-10-2007.

INGRID C. EULIN, EXAMINING ATTORNEY

**Int. Cl.: 28**

**Prior U.S. Cls.: 22, 23, 38, and 50**

**United States Patent and Trademark Office**

**Reg. No. 3,469,003**

**Registered July 15, 2008**

**TRADEMARK  
PRINCIPAL REGISTER**

# Puzzle Planet

INNOVATIVE ART (CALIFORNIA CORPORATION)

100 SMITH RANCH ROAD, STE 210

SAN RAFAEL, CA 94903

FOR: PUZZLES, IN CLASS 28 (U.S. CLS. 22, 23, 38 AND 50).

FIRST USE 10-1-2007; IN COMMERCE 10-1-2007.

THE MARK CONSISTS OF STANDARD CHARACTERS WITHOUT CLAIM TO ANY PARTICULAR FONT, STYLE, SIZE, OR COLOR.

NO CLAIM IS MADE TO THE EXCLUSIVE RIGHT TO USE "PUZZLE", APART FROM THE MARK AS SHOWN.

SN 77-178,189, FILED 5-10-2007.

CYNTHIA SLOAN, EXAMINING ATTORNEY

**Int. Cl.: 29**

**Prior U.S. Cl.: 46**

**United States Patent and Trademark Office**

**Reg. No. 3,469,004**

**Registered July 15, 2008**

**TRADEMARK  
PRINCIPAL REGISTER**

**CHEF'S NET**

DIRECT SOURCE SALES LIMITED LIABILITY  
COMPANY (NEW JERSEY LTD LIAB CO)  
161 ASTER CT  
WHITEHOUSE STATION, NJ 08889

THE MARK CONSISTS OF STANDARD CHAR-  
ACTERS WITHOUT CLAIM TO ANY PARTICULAR  
FONT, STYLE, SIZE, OR COLOR.

FOR: SEAFOOD, IN CLASS 29 (U.S. CL. 46).

SN 77-178,354, FILED 5-10-2007.

FIRST USE 10-0-2007; IN COMMERCE 10-0-2007.

RONALD AIKENS, EXAMINING ATTORNEY

**Int. Cl.: 9**

**Prior U.S. Cls.: 21, 23, 26, 36, and 38**

**Reg. No. 3,469,005**

**United States Patent and Trademark Office**

**Registered July 15, 2008**

---

**TRADEMARK  
PRINCIPAL REGISTER**

**SHANGRI-LA**

SPIELO MANUFACTURING ULC (CANADA CORPORATION)  
328 URQUHART AVENUE  
MONCTON, NEW BRUNSWICK, CANADA E1H2R6

FOR: RECONFIGURABLE CASINO AND LOTTERY GAMING EQUIPMENT, NAMELY, SLOT MACHINES AND VIDEO LOTTERY TERMINALS AND OPERATIONAL COMPUTER GAME SOFTWARE THEREFOR, IN CLASS 9 (U.S. CLS. 21, 23, 26, 36 AND 38).

FIRST USE 1-31-2008; IN COMMERCE 1-31-2008.

THE MARK CONSISTS OF STANDARD CHARACTERS WITHOUT CLAIM TO ANY PARTICULAR FONT, STYLE, SIZE, OR COLOR.

SN 77-178,648, FILED 5-11-2007.

REBECCA POVARCHUK, EXAMINING ATTORNEY

**Int. Cls.: 35, 40, and 42**

**Prior U.S. Cls.: 100, 101, 102, 103, and 106**

**United States Patent and Trademark Office**

**Reg. No. 3,469,006**

**Registered July 15, 2008**

**SERVICE MARK  
PRINCIPAL REGISTER**

SWITCH LIBERATE YOUR BRAND

THE SPARK AGENCY, INC. (DELAWARE CORPORATION)  
SUITE 500  
1120 S. SIXTH ST.  
ST. LOUIS, MO 63104

FOR: MARKETING AND PROMOTIONAL SERVICES, NAMELY, PLANNING, CONDUCTING, AND ORGANIZING MOBILE MARKETING EXHIBITS, TRADE SHOW EXHIBITS, POINT OF SALE EXHIBITS, AND MARKETING DISPLAYS FOR BUSINESS MEETINGS AND BUSINESS EVENTS FOR ADVERTISING PURPOSES; DESIGN OF ADVERTISING MULTIMEDIA PRESENTATIONS AND THEMED GRAPHICS FOR USE IN MARKETING CAMPAIGNS FOR OTHERS FOR TRADE SHOWS, BUSINESS MEETINGS, AND BUSINESS TO BUSINESS EVENTS, IN CLASS 35 (U.S. CLS. 100, 101 AND 102).

FIRST USE 2-0-2008; IN COMMERCE 2-0-2008.

FOR: CUSTOM MANUFACTURE OF MOBILE MARKETING EXHIBITS AND TRADE SHOW EXHIBITS, IN CLASS 40 (U.S. CLS. 100, 103 AND 106).

FIRST USE 2-0-2008; IN COMMERCE 2-0-2008.

FOR: DESIGN AND DEVELOPMENT OF WEBSITES FOR OTHERS, IN CLASS 42 (U.S. CLS. 100 AND 101).

FIRST USE 2-0-2008; IN COMMERCE 2-0-2008.

THE MARK CONSISTS OF STANDARD CHARACTERS WITHOUT CLAIM TO ANY PARTICULAR FONT, STYLE, SIZE, OR COLOR.

SN 77-179,003, FILED 5-11-2007.

DANNEAN HETZEL, EXAMINING ATTORNEY

**Int. Cl.: 38**

**Prior U.S. Cls.: 100, 101, and 104**

**United States Patent and Trademark Office**

**Reg. No. 3,469,007**

**Registered July 15, 2008**

---

**SERVICE MARK  
PRINCIPAL REGISTER**

**WIKITALK**

XERITON CORPORATION (WASHINGTON CORPORATION)  
SUITE 301  
336 - 228TH AVE. NE  
SAMMAMISH, WA 98074

FOR: PROVIDING ON-LINE DISCUSSION FORUM AND ELECTRONIC BULLETIN BOARDS FOR TRANSMISSION OF MESSAGES AMONG USERS IN THE FIELD OF GENERAL INTEREST , IN CLASS 38 (U.S. CLS. 100, 101 AND 104).

FIRST USE 9-20-2007; IN COMMERCE 9-20-2007.

THE MARK CONSISTS OF STANDARD CHARACTERS WITHOUT CLAIM TO ANY PARTICULAR FONT, STYLE, SIZE, OR COLOR.

SN 77-179,389, FILED 5-11-2007.

AISHA SALEM, EXAMINING ATTORNEY



**Int. Cl.: 16**

**Prior U.S. Cls.: 2, 5, 22, 23, 29, 37, 38, and 50**

**Reg. No. 3,469,008**

**United States Patent and Trademark Office**

**Registered July 15, 2008**

**TRADEMARK  
PRINCIPAL REGISTER**



COUNTY OF NEVADA, CALIFORNIA (CALIFORNIA COUNTY GOVERNMENT)  
950 MAIDU AVENUE  
NEVADA CITY, CA 95959

FOR: DIRECTORIES OF HEALTH, HUMAN AND SOCIAL SERVICES, IN CLASS 16 (U.S. CLS. 2, 5, 22, 23, 29, 37, 38 AND 50).

FIRST USE 3-16-2007; IN COMMERCE 3-16-2007.

NO CLAIM IS MADE TO THE EXCLUSIVE RIGHT TO USE "WWW." AND "DIAL 211" AND ".COM", APART FROM THE MARK AS SHOWN.

THE COLOR(S) MAUVE, BLACK AND WHITE IS/ARE CLAIMED AS A FEATURE OF THE MARK.

THE MAUVE COLOR APPEARS IN THE OVAL DESIGN AND IN THE HIGHLIGHTS ON THE LETTERS AND THE NUMERALS IN THE MARK; THE COLOR BLACK APPEARS IN THE LETTERS AND NUMERALS; AND THE COLOR WHITE APPEARS ON EDGES OF THE LETTERS AND NUMERALS IN THE MARK.

SN 77-180,046, FILED 5-14-2007.

CHRISTOPHER BUONGIORNO, EXAMINING ATTORNEY

**Int. Cl.: 25**

**Prior U.S. Cls.: 22 and 39**

**United States Patent and Trademark Office**

**Reg. No. 3,469,009**

**Registered July 15, 2008**

**TRADEMARK  
PRINCIPAL REGISTER**

**A.S.S. AVAILABLE SINGLE  
STRAIGHT**

CORWIN, JEFF (UNITED STATES INDIVIDUAL)  
8473 QUARTZ AVENUE  
WINNETKA, CA 91306

FOR: DRESS SHIRTS; GOLF SHIRTS; KNIT SHIRTS; OPEN-NECKED SHIRTS; POLO SHIRTS; SHIRTS; SHORT-SLEEVED OR LONG-SLEEVED T-SHIRTS; SHORT-SLEEVED SHIRTS; SPORT SHIRTS; SPORTS SHIRTS; SPORTS SHIRTS WITH SHORT SLEEVES; SWEAT SHIRTS; T-SHIRTS; DENIM JACKETS; DOWN JACKETS; HEAVY JACKETS; JACKETS; LEATHER JACKETS; LONG JACKETS; MEN AND WOMEN JACKETS, COATS, TROUSERS, VESTS; RAIN JACKETS; RAINPROOF JACKETS; SKI JACKETS; SLEEVED OR SLEEVELESS JACK-

ETS; WATERPROOF JACKETS AND PANTS; WIND-JACKETS; HATS; CAPS; CAPS WITH VISORS; GOLF CAPS; KNITTED CAPS; SKULL CAPS, IN CLASS 25 (U.S. CLS. 22 AND 39).

FIRST USE 3-1-2008; IN COMMERCE 3-1-2008.

THE MARK CONSISTS OF STANDARD CHARACTERS WITHOUT CLAIM TO ANY PARTICULAR FONT, STYLE, SIZE, OR COLOR.

SN 77-180,976, FILED 5-15-2007.

EDWARD NELSON, EXAMINING ATTORNEY

**Int. Cl.: 28**

**Prior U.S. Cls.: 22, 23, 38, and 50**

**Reg. No. 3,469,010**

**United States Patent and Trademark Office**

**Registered July 15, 2008**

---

**TRADEMARK  
PRINCIPAL REGISTER**

**SQUEAKY THING**

ASIAN WORLD OF MARTIAL ARTS, INC.  
(PENNSYLVANIA CORPORATION)  
9400 ASHTON ROAD  
PHILADELPHIA, PA 19114

THE MARK CONSISTS OF STANDARD CHARACTERS WITHOUT CLAIM TO ANY PARTICULAR FONT, STYLE, SIZE, OR COLOR.

FOR: MARTIAL ARTS EQUIPMENT, NAMELY, HAND-HELD TARGETS AND TARGETS TO BE SECURED ON PUNCHING BAGS, IN CLASS 28 (U.S. CLS. 22, 23, 38 AND 50).

SN 77-181,004, FILED 5-15-2007.

FIRST USE 8-23-2007; IN COMMERCE 8-23-2007.

LINDA ESTRADA, EXAMINING ATTORNEY

**Int. Cl.: 28**

**Prior U.S. Cls.: 22, 23, 38, and 50**

**United States Patent and Trademark Office**

**Reg. No. 3,469,011**

**Registered July 15, 2008**

**TRADEMARK  
PRINCIPAL REGISTER**

**WHO-VILLE**

DR. SEUSS ENTERPRISES, L.P. (CALIFORNIA  
LIMITED PARTNERSHIP)  
1200 PROSPECT STREET, SUITE 575  
C/O KARL ZOBELL, ESQ., DLA PIPER US LLP  
LA JOLLA, CA 920373610

FOR: CHRISTMAS TREE ORNAMENTS, IN  
CLASS 28 (U.S. CLS. 22, 23, 38 AND 50).

FIRST USE 11-0-2007; IN COMMERCE 11-0-2007.

THE MARK CONSISTS OF STANDARD CHAR-  
ACTERS WITHOUT CLAIM TO ANY PARTICULAR  
FONT, STYLE, SIZE, OR COLOR.

OWNER OF U.S. REG. NO. 2,629,038.

SN 77-181,921, FILED 5-15-2007.

GIANCARLO CASTRO, EXAMINING ATTORNEY

**Int. Cl.: 33**

**Prior U.S. Cls.: 47 and 49**

**United States Patent and Trademark Office**

**Reg. No. 3,469,012**

**Registered July 15, 2008**

**TRADEMARK  
PRINCIPAL REGISTER**

**Clareté**

KONCEPTAE, INC. (NEW YORK CORPORATION)  
270 BRONXVILLE RD, #A35  
BRONXVILLE, NY 10708

THE MARK CONSISTS OF STANDARD CHARACTERS WITHOUT CLAIM TO ANY PARTICULAR FONT, STYLE, SIZE, OR COLOR.

FOR: PREPARED ALCOHOLIC COCKTAIL, IN CLASS 33 (U.S. CLS. 47 AND 49).

SN 77-182,312, FILED 5-16-2007.

FIRST USE 7-1-2007; IN COMMERCE 11-1-2007.

ALYSSA PALADINO, EXAMINING ATTORNEY

**Int. Cl.: 42**

**Prior U.S. Cls.: 100 and 101**

**United States Patent and Trademark Office**

**Reg. No. 3,469,013**

**Registered July 15, 2008**

**SERVICE MARK  
PRINCIPAL REGISTER**

# The Dollar Channel

DELAPA, FRANK (UNITED STATES INDIVIDUAL)  
680 MARA ROSE LANE  
HARPERS FERRY, WV 25425

FOR: APPLICATION SERVICE PROVIDER (ASP) FEATURING SOFTWARE FOR USE TO ENABLE UPLOADING, POSTING, SHOWING, DISPLAYING, TAGGING, BLOGGING, SHARING OR OTHERWISE PROVIDING ELECTRONIC MEDIA OR INFORMATION OVER THE INTERNET OR OTHER COMMUNICATIONS NETWORK, IN CLASS 42 (U.S. CLS. 100 AND 101).

FIRST USE 1-1-2008; IN COMMERCE 1-1-2008.

THE MARK CONSISTS OF STANDARD CHARACTERS WITHOUT CLAIM TO ANY PARTICULAR FONT, STYLE, SIZE, OR COLOR.

SN 77-182,468, FILED 5-16-2007.

PATRICIA EVANKO, EXAMINING ATTORNEY

**Int. Cl.: 9**

**Prior U.S. Cls.: 21, 23, 26, 36, and 38**

**United States Patent and Trademark Office**

**Reg. No. 3,469,014**

**Registered July 15, 2008**

**TRADEMARK  
PRINCIPAL REGISTER**

PEARSON'S CRYSTAL DATA  
CRYSTAL STRUCTURE DATABASE  
FOR INORGANIC COMPOUNDS

ASM INTERNATIONAL (OHIO CORPORATION)  
9639 KINSMAN ROAD  
MATERIALS PARK, OH 440730002

FOR: CD-ROM OF CRYSTALLOGRAPHIC DA-  
TABASE, IN CLASS 9 (U.S. CLS. 21, 23, 26, 36 AND 38).

FIRST USE 4-25-2007; IN COMMERCE 4-25-2007.

THE MARK CONSISTS OF STANDARD CHAR-  
ACTERS WITHOUT CLAIM TO ANY PARTICULAR  
FONT, STYLE, SIZE, OR COLOR.

NO CLAIM IS MADE TO THE EXCLUSIVE  
RIGHT TO USE "CRYSTAL DATA CRYSTAL  
STRUCTURE DATABASE FOR INORGANIC COM-  
POUNDS", APART FROM THE MARK AS SHOWN.

THE NAME(S), PORTRAIT(S), AND/OR SIGNA-  
TURE(S) SHOWN IN THE MARK DOES NOT IDEN-  
TIFY A PARTICULAR LIVING INDIVIDUAL.

SN 77-182,486, FILED 5-16-2007.

INGRID C. EULIN, EXAMINING ATTORNEY

**Int. Cl.: 42**

**Prior U.S. Cls.: 100 and 101**

**United States Patent and Trademark Office**

**Reg. No. 3,469,015**

**Registered July 15, 2008**

**SERVICE MARK  
PRINCIPAL REGISTER**



AVAILITY, L.L.C. (DELAWARE LTD LIAB CO)  
SUITE 300  
7406 FULLERTON STREET  
JACKSONVILLE, FL 32256

FOR: APPLICATION SERVICE PROVIDER (ASP)  
FEATURING A SOFTWARE PLATFORM IN THE  
FIELD OF INSURANCE FOR USE BY INSURERS  
AND MEDICAL PROVIDERS FOR SUBMISSION OF  
HEALTH INSURANCE CLAIMS, VERIFICATION  
OF PATIENT HEALTH PLAN ENROLLMENT AND  
DISENROLLMENT STATUS, VERIFICATION OF  
MEDICAL PROVIDER HEALTH PLAN PARTICIPA-  
TION STATUS, VERIFICATION OF BENEFITS,  
VERIFICATION OF PATIENT ELIGIBILITY AND

TRACKING PATIENT UTILIZATION OF BENE-  
FITS, VERIFICATION OF INSURANCE PRE-AU-  
THORIZATION FOR TREATMENT, TRACKING  
THE STATUS OF THE SUBMISSION AND ADJUDI-  
CATION OF INSURANCE CLAIMS BY MEDICAL  
PROVIDERS AND INSURED, ELECTRONIC PRO-  
CESSING OF INSURANCE CLAIMS AND PAY-  
MENT , IN CLASS 42 (U.S. CLS. 100 AND 101).

FIRST USE 9-21-2004; IN COMMERCE 2-18-2002.

SN 77-182,651, FILED 5-16-2007.

BRIAN PINO, EXAMINING ATTORNEY



**Int. Cl.: 35**

**Prior U.S. Cls.: 100, 101, and 102**

**United States Patent and Trademark Office**

**Reg. No. 3,469,016**

**Registered July 15, 2008**

**SERVICE MARK  
PRINCIPAL REGISTER**

**EXERCISE 2B FIT**

EXERCISE 2B FIT, LLC (NORTH CAROLINA  
LTD LIAB CO)  
6050 FORDING CREEK LANE  
KERNERSVILLE, NC 27284

THE MARK CONSISTS OF STANDARD CHAR-  
ACTERS WITHOUT CLAIM TO ANY PARTICULAR  
FONT, STYLE, SIZE, OR COLOR.

FOR: ON-LINE RETAIL STORE SERVICES FEA-  
TURING CLOTHING AND RELATED ACCESSOR-  
IES, IN CLASS 35 (U.S. CLS. 100, 101 AND 102).

SN 77-184,214, FILED 5-17-2007.

FIRST USE 10-8-2007; IN COMMERCE 10-8-2007.

ALYSSA PALADINO, EXAMINING ATTORNEY

**Int. Cl.: 30**

**Prior U.S. Cl.: 46**

**United States Patent and Trademark Office**

**Reg. No. 3,469,017**

**Registered July 15, 2008**

**TRADEMARK  
PRINCIPAL REGISTER**

# Cake and A Prayer

CRAYTON, KIMBERLY (UNITED STATES INDIVIDUAL)  
817 E 38TH STREET  
CHICAGO, IL 60653

FOR: BAKERY DESSERTS; BAKERY GOODS; BAKERY PRODUCTS; BAKERY PRODUCTS, NAMELY, SWEET BAKERY GOODS, IN CLASS 30 (U.S. CL. 46).

FIRST USE 12-15-2007; IN COMMERCE 2-12-2008.

THE MARK CONSISTS OF STANDARD CHARACTERS WITHOUT CLAIM TO ANY PARTICULAR FONT, STYLE, SIZE, OR COLOR.

NO CLAIM IS MADE TO THE EXCLUSIVE RIGHT TO USE "CAKE", APART FROM THE MARK AS SHOWN.

SN 77-184,289, FILED 5-18-2007.

INGRID C. EULIN, EXAMINING ATTORNEY

**Int. Cl.: 33**

**Prior U.S. Cls.: 47 and 49**

**United States Patent and Trademark Office**

**Reg. No. 3,469,018**

**Registered July 15, 2008**

**TRADEMARK  
PRINCIPAL REGISTER**

**DRINK WINE AND SMILE**

VOLCANO VINEYARDS, LLC (OREGON LTD  
LIAB CO)  
1615 NW ELGIN  
BEND, OR 97701

THE MARK CONSISTS OF STANDARD CHAR-  
ACTERS WITHOUT CLAIM TO ANY PARTICULAR  
FONT, STYLE, SIZE, OR COLOR.

FOR: TABLE WINES; WINES, IN CLASS 33 (U.S.  
CLS. 47 AND 49).

SN 77-185,187, FILED 5-18-2007.

FIRST USE 4-1-2005; IN COMMERCE 4-1-2005.

KATHLEEN LORENZO, EXAMINING ATTORNEY

Int. Cl.: 42

Prior U.S. Cls.: 100 and 101

United States Patent and Trademark Office

Reg. No. 3,469,019

Registered July 15, 2008

SERVICE MARK  
PRINCIPAL REGISTER

eGenuity

EGENUITY, LLC (INDIANA LTD LIAB CO)  
134 EAST JACKSON  
PO BOX 157  
MONROE, IN 46772

FOR: APPLICATION SERVICE PROVIDER, NAMELY, PROVIDING, HOSTING, MANAGING, DEVELOPING, AND MAINTAINING APPLICATIONS, SOFTWARE, WEBSITES, AND DATABASES IN THE FIELDS OF PERSONAL PRODUCTIVITY, WIRELESS COMMUNICATION, MOBILE INFORMATION ACCESS, AND REMOTE DATA MANAGEMENT FOR WIRELESS DELIVERY OF CONTENT TO HANDHELD COMPUTERS, LAPTOPS AND MOBILE ELECTRONIC DEVICES; AUTOMOTIVE DIAGNOSTIC SERVICES FEATURING COMPUTER SOFTWARE FOR USE BY INDEPENDENT AUTOMOTIVE REPAIR PERSONNEL; COMPUTER NETWORK DESIGN AND COMPUTER SOFTWARE DESIGN FOR THE AUTOMOTIVE INDUSTRY; COMPUTER PROGRAMMING; COMPUTER SOFTWARE CONSULTATION; COMPUTER SOFTWARE DESIGN, COMPUTER PROGRAMMING, OR MAINTENANCE OF COMPUTER SOFTWARE; COMPUTER SOFTWARE DEVELOPMENT; COMPUTER SYSTEMS ANALYSIS; CONSULTANCY IN THE FIELD OF SOFTWARE DESIGN; CONSULTATION SERVICES IN THE FIELDS OF SELECTION, IMPLEMENTATION AND USE OF COMPUTER HARDWARE AND SOFTWARE SYSTEMS FOR OTHERS; CUSTOMIZATION OF COMPUTER HARDWARE AND SOFTWARE; DESIGN FOR OTHERS IN THE FIELD OF COMPUTER NETWORKS, SOFTWARE, AND COMPUTER ENGINEERING FOR POS (POINT OF SALE) APPLICATIONS; DESIGN FOR OTHERS

IN THE FIELD OF COMPUTER SOFTWARE; DESIGN OF COMPUTER NETWORKS AND SOFTWARE FOR OTHERS FOR THE AUTOMOTIVE POS (POINT OF SALE) INDUSTRY; DESIGN, DEVELOPMENT AND IMPLEMENTATION OF SOFTWARE; DEVELOPING COMPUTER PROGRAMS FOR ELECTRONIC CASH REGISTER SYSTEMS; DEVELOPMENT, UPDATING AND MAINTENANCE OF SOFTWARE AND DATA BASES; INSTALLATION OF COMPUTER SOFTWARE; INTEGRATION OF COMPUTER SYSTEMS AND NETWORKS; MAINTENANCE OF COMPUTER SOFTWARE; PERIODIC UPGRADING OF COMPUTER SOFTWARE FOR OTHERS; REPAIR OF COMPUTER SOFTWARE; SOFTWARE AUTHORING; TECHNICAL SUPPORT SERVICES, NAMELY, TROUBLESHOOTING OF COMPUTER HARDWARE AND SOFTWARE PROBLEMS; TECHNICAL SUPPORT SERVICES, NAMELY, TROUBLESHOOTING OF INDUSTRIAL PROCESS CONTROL COMPUTER SOFTWARE PROBLEMS; TECHNOLOGICAL CONSULTATION IN THE TECHNOLOGY FIELD OF SOFTWARE PROGRAMMING, IN CLASS 42 (U.S. CLS. 100 AND 101).

FIRST USE 8-0-2007; IN COMMERCE 8-0-2007.

THE MARK CONSISTS OF STANDARD CHARACTERS WITHOUT CLAIM TO ANY PARTICULAR FONT, STYLE, SIZE, OR COLOR.

SN 77-185,247, FILED 5-18-2007.

JIM RINGLE, EXAMINING ATTORNEY

**Int. Cl.: 35**

**Prior U.S. Cls.: 100, 101, and 102**

**United States Patent and Trademark Office**

**Reg. No. 3,469,020**

**Registered July 15, 2008**

**SERVICE MARK  
PRINCIPAL REGISTER**

**SIFEON**

SIFEON KNOWLEDGE-TECHNOLOGY (TAI-  
WAN CORPORATION)

NO.268-3

SEC. 2, FUSING S. RD., DA-AN DISTRICT

TAIPEI CITY 106, TAIWAN

FOR: BUSINESS CONSULTING, MARKETING  
STUDIES; PROVIDING BUSINESS STATISTICAL  
INFORMATION STUDIES FOR BUSINESS AND  
CONSULTING PURPOSES , IN CLASS 35 (U.S. CLS.  
100, 101 AND 102).

FIRST USE 12-6-2007; IN COMMERCE 12-6-2007.

THE MARK CONSISTS OF STANDARD CHAR-  
ACTERS WITHOUT CLAIM TO ANY PARTICULAR  
FONT, STYLE, SIZE, OR COLOR.

SN 77-185,485, FILED 5-20-2007.

ROBERT STRUCK, EXAMINING ATTORNEY

**Int. Cl.: 11**

**Prior U.S. Cls.: 13, 21, 23, 31, and 34**

**United States Patent and Trademark Office**

**Reg. No. 3,469,021**

**Registered July 15, 2008**

**TRADEMARK  
PRINCIPAL REGISTER**

**VILLA BELLA**

HUNTER FAN COMPANY (DELAWARE COR-  
PORATION)

2500 FRISCO AVENUE

MEMPHIS, TN 38114

FOR: CEILING FANS, IN CLASS 11 (U.S. CLS. 13,  
21, 23, 31 AND 34).

FIRST USE 9-6-2007; IN COMMERCE 9-6-2007.

THE MARK CONSISTS OF STANDARD CHAR-  
ACTERS WITHOUT CLAIM TO ANY PARTICULAR  
FONT, STYLE, SIZE, OR COLOR.

THE ENGLISH TRANSLATION OF THE ITALIAN  
WORD "VILLA BELLA" IN THE MARK IS BEAUTI-  
FUL VILLA.

SN 77-185,904, FILED 5-21-2007.

ADA HAN, EXAMINING ATTORNEY

**Int. Cl.: 44**

**Prior U.S. Cls.: 100 and 101**

**United States Patent and Trademark Office**

**Reg. No. 3,469,022**

**Registered July 15, 2008**

**SERVICE MARK  
PRINCIPAL REGISTER**

**SPA LUCE**

CIM/H&H RETAIL, LP (CALIFORNIA LIMITED  
PARTNERSHIP)  
SUITE 900  
6922 HOLLYWOOD BLVD.  
LOS ANGELES, CA 90028

FOR: HEALTH SPA SERVICES, NAMELY, PRO-  
VIDING SERVICES FOR THE HEALTH AND WELL-  
NESS OF THE BODY AND SPIRIT, AND COSMETIC  
BODY CARE SERVICES, IN CLASS 44 (U.S. CLS. 100  
AND 101).

FIRST USE 4-14-2008; IN COMMERCE 4-14-2008.

THE MARK CONSISTS OF STANDARD CHAR-  
ACTERS WITHOUT CLAIM TO ANY PARTICULAR  
FONT, STYLE, SIZE, OR COLOR.

NO CLAIM IS MADE TO THE EXCLUSIVE  
RIGHT TO USE "SPA", APART FROM THE MARK  
AS SHOWN.

THE FOREIGN WORDING IN THE MARK  
TRANSLATES INTO ENGLISH AS LIGHT.

SN 77-186,715, FILED 5-22-2007.

JANET LEE, EXAMINING ATTORNEY

**Int. Cl.: 20**

**Prior U.S. Cls.: 2, 13, 22, 25, 32, and 50**

**United States Patent and Trademark Office**

**Reg. No. 3,469,023**

**Registered July 15, 2008**

**TRADEMARK  
PRINCIPAL REGISTER**

# Lumbarmate

RISING STAR TOP CO., LTD. (TAIWAN CORPORATION)  
NO. 10, SHIAH TSUOH KENG, JHUCI TOWNSHIP  
CHIAYI COUNTY, TAIWAN

FOR: MATTRESS CUSHIONS; MATTRESSES; CUSHIONS; PILLOWS; CHAIR MATS IN THE NATURE OF A PILLOW OR SEAT LINER; CHAIR CUSHIONS; SEAT CUSHIONS; AIR MATTRESSES NOT FOR MEDICAL PURPOSES; AIR CUSHIONS NOT FOR MEDICAL PURPOSES; BACK SUPPORT CUSHIONS NOT FOR MEDICAL PURPOSES; PORTABLE BACK SUPPORT FOR USE WITH CHAIRS; FURNITURE, NAMELY, CHAIRS, SEATS, BEDS,

TABLES, DESKS, AND CHAIR SEATS; AND BACK PADS BEING PARTS OF FURNITURE, IN CLASS 20 (U.S. CLS. 2, 13, 22, 25, 32 AND 50).

FIRST USE 5-22-2007; IN COMMERCE 5-22-2007.

THE MARK CONSISTS OF STANDARD CHARACTERS WITHOUT CLAIM TO ANY PARTICULAR FONT, STYLE, SIZE, OR COLOR.

SN 77-186,793, FILED 5-22-2007.

COLLEEN DOMBROW, EXAMINING ATTORNEY



**Int. Cl.: 16**

**Prior U.S. Cls.: 2, 5, 22, 23, 29, 37, 38, and 50**

**United States Patent and Trademark Office**

**Reg. No. 3,469,024**

**Registered July 15, 2008**

**TRADEMARK  
PRINCIPAL REGISTER**

**MASTERS OF TIME**

BRENDA JOYCE DREAMS UNLIMITED, INC.  
(NEW YORK CORPORATION)  
51 SOUTH MUSTANG RANCH PLACE  
TUCSON, AZ 85748

THE MARK CONSISTS OF STANDARD CHAR-  
ACTERS WITHOUT CLAIM TO ANY PARTICULAR  
FONT, STYLE, SIZE, OR COLOR.

FOR: PRINTED MATTER, NAMELY, A SERIES  
OF FICTION BOOKS, IN CLASS 16 (U.S. CLS. 2, 5, 22,  
23, 29, 37, 38 AND 50).

SN 77-187,151, FILED 5-22-2007.

FIRST USE 10-31-2007; IN COMMERCE 10-31-2007.

INGRID C. EULIN, EXAMINING ATTORNEY

**Int. Cl.: 16**

**Prior U.S. Cls.: 2, 5, 22, 23, 29, 37, 38, and 50**

**United States Patent and Trademark Office**

**Reg. No. 3,469,025**

**Registered July 15, 2008**

**TRADEMARK  
PRINCIPAL REGISTER**



RANDOM HOUSE, INC. (NEW YORK CORPORATION)  
LEGAL DEPARTMENT  
1745 BROADWAY, 192  
NEW YORK, NY 10019

FOR: HOUSEMARK FOR FICTION AND NON-FICTION BOOKS ON A VARIETY OF TOPICS, IN CLASS 16 (U.S. CLS. 2, 5, 22, 23, 29, 37, 38 AND 50).

FIRST USE 5-28-2008; IN COMMERCE 5-28-2008.

THE MARK CONSISTS OF TWO BACK-TO-BACK "D"S.

SN 77-187,329, FILED 5-22-2007.

ANGELA M. MICHELI, EXAMINING ATTORNEY

**Int. Cl.: 42**

**Prior U.S. Cls.: 100 and 101**

**United States Patent and Trademark Office**

**Reg. No. 3,469,026**

**Registered July 15, 2008**

**SERVICE MARK  
PRINCIPAL REGISTER**

**PRESTO**

JACKBE CORPORATION (DELAWARE CORPORATION)  
4600 NORTH PARK AVENUE, SUITE 200  
CHEVY CHASE, MD 20815

FOR: PROVIDING TEMPORARY USE OF ONLINE NON-DOWNLOADABLE COMPUTER SOFTWARE USED TO ALLOW ENTERPRISE USERS TO EASILY ACCESS, INTEGRATE, AND FORMAT DISPARATE ONLINE SERVICES AND DATA BY AUTOMATICALLY COMBINING COMPLEMENTARY ELEMENTS FROM TWO OR MORE SOURCES, IN CLASS 42 (U.S. CLS. 100 AND 101).

FIRST USE 2-1-2004; IN COMMERCE 2-1-2004.

THE MARK CONSISTS OF STANDARD CHARACTERS WITHOUT CLAIM TO ANY PARTICULAR FONT, STYLE, SIZE, OR COLOR.

SN 77-187,889, FILED 5-23-2007.

JENNIFER VASQUEZ, EXAMINING ATTORNEY

**Int. Cl.: 41**

**Prior U.S. Cls.: 100, 101, and 107**

**United States Patent and Trademark Office**

**Reg. No. 3,469,027**

**Registered July 15, 2008**

**SERVICE MARK  
PRINCIPAL REGISTER**

**CAFÉ RECONCILE**

RECONCILE NEW ORLEANS, INC. (LOUISIANA  
NON-PROFIT CORPORATION)  
1631 ORETHA CASTLE HALEY BOULEVARD  
NEW ORLEANS, LA 70113

FOR: CHARITABLE SERVICES, NAMELY, PROVIDING TRAINING AND COUNSELING IN LIFE SKILLS AND INTERPERSONAL SKILLS AND PROVIDING TRAINING IN THE CONSTRUCTION, ENTERTAINMENT, HOSPITALITY, AND RESTAURANT INDUSTRIES, IN CLASS 41 (U.S. CLS. 100, 101 AND 107).

FIRST USE 5-1-2000; IN COMMERCE 5-1-2000.

THE MARK CONSISTS OF STANDARD CHARACTERS WITHOUT CLAIM TO ANY PARTICULAR FONT, STYLE, SIZE, OR COLOR.

NO CLAIM IS MADE TO THE EXCLUSIVE RIGHT TO USE "CAFE", APART FROM THE MARK AS SHOWN.

SN 77-188,508, FILED 5-23-2007.

AMOS T. MATTHEWS, JR., EXAMINING ATTORNEY

**Int. Cl.: 43**

**Prior U.S. Cls.: 100 and 101**

**United States Patent and Trademark Office**

**Reg. No. 3,469,028**

**Registered July 15, 2008**

**SERVICE MARK  
PRINCIPAL REGISTER**

**CAFÉ RECONCILE**

RECONCILE NEW ORLEANS, INC. (LOUISIANA  
NON-PROFIT CORPORATION)  
1631 ORETHA CASTLE HALEY BOULEVARD  
NEW ORLEANS, LA 70113

FOR: RESTAURANT SERVICES, IN CLASS 43  
(U.S. CLS. 100 AND 101).

FIRST USE 9-5-2000; IN COMMERCE 9-5-2000.

THE MARK CONSISTS OF STANDARD CHAR-  
ACTERS WITHOUT CLAIM TO ANY PARTICULAR  
FONT, STYLE, SIZE, OR COLOR.

NO CLAIM IS MADE TO THE EXCLUSIVE  
RIGHT TO USE "CAFE", APART FROM THE MARK  
AS SHOWN.

SN 77-188,541, FILED 5-23-2007.

AMOS T. MATTHEWS, JR., EXAMINING ATTOR-  
NEY

**Int. Cl.: 5**

**Prior U.S. Cls.: 6, 18, 44, 46, 51, and 52**

**Reg. No. 3,469,029**

**United States Patent and Trademark Office**

**Registered July 15, 2008**

---

**TRADEMARK  
PRINCIPAL REGISTER**

**VITA 26**

METABO-UP, LLC (CALIFORNIA LTD LIAB CO)  
5901 PRIESTLY DRIVE, SUITE 130  
CARLSBAD, CA 92008

THE MARK CONSISTS OF STANDARD CHAR-  
ACTERS WITHOUT CLAIM TO ANY PARTICULAR  
FONT, STYLE, SIZE, OR COLOR.

FOR: MULTI-VITAMINS AND VITAMIN SUP-  
PLEMENTS, IN CLASS 5 (U.S. CLS. 6, 18, 44, 46, 51  
AND 52).

SN 77-188,589, FILED 5-23-2007.

FIRST USE 6-11-2007; IN COMMERCE 6-11-2007.

ELISSA GARBER KON, EXAMINING ATTORNEY

**Int. Cl.: 41**

**Prior U.S. Cls.: 100, 101, and 107**

**United States Patent and Trademark Office**

**Reg. No. 3,469,030**

**Registered July 15, 2008**

**SERVICE MARK  
PRINCIPAL REGISTER**

# RECONCILE

RECONCILE NEW ORLEANS, INC. (LOUISIANA  
NON-PROFIT CORPORATION)  
1631 ORETHA CASTLE HALEY BOULEVARD  
NEW ORLEANS, LA 70113

FOR: CHARITABLE SERVICES, NAMELY, PRO-  
VIDING TRAINING AND COUNSELING IN LIFE  
SKILLS AND INTERPERSONAL SKILLS AND PRO-  
VIDING TRAINING IN THE CONSTRUCTION, EN-  
TERTAINMENT, HOSPITALITY, AND  
RESTAURANT INDUSTRIES, IN CLASS 41 (U.S.  
CLS. 100, 101 AND 107).

FIRST USE 5-1-2000; IN COMMERCE 5-1-2000.

THE MARK CONSISTS OF STANDARD CHAR-  
ACTERS WITHOUT CLAIM TO ANY PARTICULAR  
FONT, STYLE, SIZE, OR COLOR.

SN 77-188,642, FILED 5-23-2007.

AMOS T. MATTHEWS, JR., EXAMINING ATTOR-  
NEY

**Int. Cl.: 43**

**Prior U.S. Cls.: 100 and 101**

**United States Patent and Trademark Office**

**Reg. No. 3,469,031**

**Registered July 15, 2008**

**SERVICE MARK  
PRINCIPAL REGISTER**

# RECONCILE

RECONCILE NEW ORLEANS, INC. (LOUISIANA  
NON-PROFIT CORPORATION)  
1631 ORETHA CASTLE HALEY BOULEVARD  
NEW ORLEANS, LA 70113

FOR: RESTAURANT SERVICES, IN CLASS 43  
(U.S. CLS. 100 AND 101).

FIRST USE 9-5-2000; IN COMMERCE 9-5-2000.

THE MARK CONSISTS OF STANDARD CHAR-  
ACTERS WITHOUT CLAIM TO ANY PARTICULAR  
FONT, STYLE, SIZE, OR COLOR.

SN 77-188,685, FILED 5-23-2007.

AMOS T. MATTHEWS, JR., EXAMINING ATTOR-  
NEY



**Int. Cls.: 11 and 37**

**Prior U.S. Cls.: 13, 21, 23, 31, 34, 100, 103, and 106**

**United States Patent and Trademark Office**

**Reg. No. 3,469,032**

**Registered July 15, 2008**

**TRADEMARK  
SERVICE MARK  
PRINCIPAL REGISTER**

START YOUR DAY BEAUTIFUL

RHT INC. (ILLINOIS CORPORATION)  
1035 N. HILLTOP  
ITASCA, IL 60143

FOR: REPLACEMENT BATHTUBS, REPLACEMENT SHOWERS BASES, SHOWER ENCLOSURES, FITTED BATHTUB LINERS, FITTED SHOWER LINERS, BATHTUB SKIRTS, SHOWER PANS, SHOWER FLOORS, SHOWER FRAMES, SHOWER WALL SURROUNDS, IN CLASS 11 (U.S. CLS. 13, 21, 23, 31 AND 34).

FIRST USE 9-1-2007; IN COMMERCE 9-1-2007.

FOR: RENOVATION IN THE FIELD OF BATHROOMS, IN CLASS 37 (U.S. CLS. 100, 103 AND 106).

FIRST USE 9-1-2007; IN COMMERCE 9-1-2007.

THE MARK CONSISTS OF STANDARD CHARACTERS WITHOUT CLAIM TO ANY PARTICULAR FONT, STYLE, SIZE, OR COLOR.

SN 77-189,146, FILED 5-24-2007.

MONIQUE MILLER, EXAMINING ATTORNEY

**Int. Cl.: 45**

**Prior U.S. Cls.: 100 and 101**

**United States Patent and Trademark Office**

**Reg. No. 3,469,033**

**Registered July 15, 2008**

**SERVICE MARK  
PRINCIPAL REGISTER**

**ULUST**

PLYMOUTH ASSOCIATES AVV (ARUBA COR-  
PORATION)  
WEST PUNT 7  
NOORD, ARUBA

THE MARK CONSISTS OF STANDARD CHAR-  
ACTERS WITHOUT CLAIM TO ANY PARTICULAR  
FONT, STYLE, SIZE, OR COLOR.

FOR: WEB SITE SERVICES FEATURING ON-  
LINE DATING CLUB, IN CLASS 45 (U.S. CLS. 100  
AND 101).

SN 77-189,232, FILED 5-24-2007.

FIRST USE 12-30-2007; IN COMMERCE 12-30-2007.

BARBARA RUTLAND, EXAMINING ATTORNEY

**Int. Cl.: 33**

**Prior U.S. Cls.: 47 and 49**

**United States Patent and Trademark Office**

**Reg. No. 3,469,034**

**Registered July 15, 2008**

**TRADEMARK  
PRINCIPAL REGISTER**

# Spinnaker Cellars

SMALL WORLD WINE COMPANY (OREGON  
LTD LIAB CO)  
WWW.SPINDRIFTCELLARS.COM  
3700 NW MARSHALL DRIVE  
CORVALLIS, OR 973309780

FOR: GRAPE WINE, IN CLASS 33 (U.S. CLS. 47  
AND 49).

FIRST USE 3-2-2007; IN COMMERCE 5-13-2007.

THE MARK CONSISTS OF STANDARD CHAR-  
ACTERS WITHOUT CLAIM TO ANY PARTICULAR  
FONT, STYLE, SIZE, OR COLOR.

NO CLAIM IS MADE TO THE EXCLUSIVE  
RIGHT TO USE "CELLARS", APART FROM THE  
MARK AS SHOWN.

SN 77-189,360, FILED 5-24-2007.

FRANK LATTUCA, EXAMINING ATTORNEY

**Int. Cl.: 28**

**Prior U.S. Cls.: 22, 23, 38, and 50**

**Reg. No. 3,469,035**

**United States Patent and Trademark Office**

**Registered July 15, 2008**

---

**TRADEMARK  
PRINCIPAL REGISTER**

**CROSSBLADE**

TYR SPORT, INC. (CALIFORNIA CORPORATION)  
15391 SPRINGDALE STREET  
HUNTINGTON BEACH, CA 92649

THE MARK CONSISTS OF STANDARD CHARACTERS WITHOUT CLAIM TO ANY PARTICULAR FONT, STYLE, SIZE, OR COLOR.

FOR: SWIM FINS, IN CLASS 28 (U.S. CLS. 22, 23, 38 AND 50).

SN 77-190,801, FILED 5-25-2007.

FIRST USE 10-10-2007; IN COMMERCE 10-10-2007.

RUDY R. SINGLETON, EXAMINING ATTORNEY

**Int. Cl.: 35**

**Prior U.S. Cls.: 100, 101, and 102**

**United States Patent and Trademark Office**

**Reg. No. 3,469,036**

**Registered July 15, 2008**

**SERVICE MARK  
PRINCIPAL REGISTER**

**JHADIRECT**

JACK HENRY SOFTWARE/COMMLINK, L.P.  
(TEXAS LIMITED PARTNERSHIP)  
663 W. HIGHWAY 60  
P.O. BOX 807  
MONETT, MO 65708

FOR: ONLINE, TELEPHONE AND MAIL ORDER  
RETAIL STORE SERVICES FEATURING COMPU-  
TER AND OFFICE FORMS AND SUPPLIES MAR-  
KETED TO BANKS AND OTHER FINANCIAL  
INSTITUTIONS, IN CLASS 35 (U.S. CLS. 100, 101  
AND 102).

FIRST USE 10-25-2007; IN COMMERCE 10-25-2007.

THE MARK CONSISTS OF STANDARD CHAR-  
ACTERS WITHOUT CLAIM TO ANY PARTICULAR  
FONT, STYLE, SIZE, OR COLOR.

SN 77-190,860, FILED 5-25-2007.

INGRID C. EULIN, EXAMINING ATTORNEY

**Int. Cl.: 9**

**Prior U.S. Cls.: 21, 23, 26, 36, and 38**

**United States Patent and Trademark Office**

**Reg. No. 3,469,037**

**Registered July 15, 2008**

**TRADEMARK  
PRINCIPAL REGISTER**

**AGILIS VISUAL MAINTENANCE**

DIEBOLD, INCORPORATED (OHIO CORPORATION)  
5995 MAYFAIR ROAD  
NORTH CANTON, OH 44720

FOR: SOFTWARE FOR OPERATING AUTOMATED TRANSACTION MACHINES, NAMELY, SOFTWARE FOR OPERATING AUTOMATED BANKING MACHINES OR AUTOMATED TELLER MACHINES THAT RESIDES ON THE AUTOMATED BANKING MACHINE OR AUTOMATED TELLER MACHINE THAT CAUSES THE AUTOMATED BANKING MACHINE OR AUTOMATED TELLER MACHINE TO PERFORM FINANCIAL TRANSACTIONS, IN CLASS 9 (U.S. CLS. 21, 23, 26, 36 AND 38).

FIRST USE 4-30-2008; IN COMMERCE 4-30-2008.

THE MARK CONSISTS OF STANDARD CHARACTERS WITHOUT CLAIM TO ANY PARTICULAR FONT, STYLE, SIZE, OR COLOR.

OWNER OF U.S. REG. NOS. 2,770,359, 3,175,959, AND OTHERS.

NO CLAIM IS MADE TO THE EXCLUSIVE RIGHT TO USE "VISUAL MAINTENANCE" , APART FROM THE MARK AS SHOWN.

SN 77-191,351, FILED 5-27-2007.

NAAKWAMA ANKRAH, EXAMINING ATTORNEY

**Int. Cl.: 5**

**Prior U.S. Cls.: 6, 18, 44, 46, 51, and 52**

**Reg. No. 3,469,038**

**United States Patent and Trademark Office**

**Registered July 15, 2008**

---

**TRADEMARK  
PRINCIPAL REGISTER**

# The Seal That Heals

ASO CORPORATION (FLORIDA CORPORATION)  
300 SARASOTA CENTER BOULEVARD  
SARASOTA, FL 34240

THE MARK CONSISTS OF STANDARD CHARACTERS WITHOUT CLAIM TO ANY PARTICULAR FONT, STYLE, SIZE, OR COLOR.

FOR: ADHESIVE BANDAGE STRIPS FOR SKIN WOUNDS, IN CLASS 5 (U.S. CLS. 6, 18, 44, 46, 51 AND 52).

SN 77-191,472, FILED 5-28-2007.

FIRST USE 10-5-2005; IN COMMERCE 11-16-2005.

ADA HAN, EXAMINING ATTORNEY

**Int. Cl.: 9**

**Prior U.S. Cls.: 21, 23, 26, 36, and 38**

**Reg. No. 3,469,039**

**United States Patent and Trademark Office**

**Registered July 15, 2008**

---

**TRADEMARK  
PRINCIPAL REGISTER**

**AVTRAC**

RGB SYSTEMS, INCORPORATED (CALIFORNIA CORPORATION)  
1230 S. LEWIS ST.  
ANAHEIM, CA 92805

POWER, AND AUDIOVISUAL SIGNALS, IN CLASS 9 (U.S. CLS. 21, 23, 26, 36 AND 38).

FIRST USE 6-19-2007; IN COMMERCE 6-19-2007.

FOR: ELECTRIC RACEWAYS, NAMELY, FLOOR-MOUNTED, LOW-PROFILE RACEWAY SYSTEM COMPRISING ELECTRIC RACEWAYS, INLAY CAPS, TRANSITION RAMP, ELECTRIC OUTLETS, AND MODULAR CONNECTIVITY PLATES FOR DATA, POWER, AND AUDIOVISUAL SIGNALS; ELECTRICAL CONNECTORS, NAMELY, MODULAR CONNECTIVITY PLATES FOR DATA,

THE MARK CONSISTS OF STANDARD CHARACTERS WITHOUT CLAIM TO ANY PARTICULAR FONT, STYLE, SIZE, OR COLOR.

SN 77-191,650, FILED 5-29-2007.

CHRISTINA SOBRAL, EXAMINING ATTORNEY



**Int. Cl.: 39**

**Prior U.S. Cls.: 100 and 105**

**United States Patent and Trademark Office**

**Reg. No. 3,469,040**

**Registered July 15, 2008**

**SERVICE MARK  
PRINCIPAL REGISTER**

**Sky Mountain Wild Horse  
Sanctuary**

HERMAN, KAREN (UNITED STATES INDIVIDUAL)

125 KEARNEY AVE

SANTA FE, NM 87501

FOR: ANIMAL RESCUE SERVICES, IN CLASS 39  
(U.S. CLS. 100 AND 105).

FIRST USE 5-16-2007; IN COMMERCE 2-27-2008.

THE MARK CONSISTS OF STANDARD CHARACTERS WITHOUT CLAIM TO ANY PARTICULAR FONT, STYLE, SIZE, OR COLOR.

NO CLAIM IS MADE TO THE EXCLUSIVE RIGHT TO USE "WILD HORSE SANCTUARY", APART FROM THE MARK AS SHOWN.

SN 77-192,017, FILED 5-29-2007.

RUSS HERMAN, EXAMINING ATTORNEY

**Int. Cl.: 30**

**Prior U.S. Cl.: 46**

**United States Patent and Trademark Office**

**Reg. No. 3,469,041**

**Registered July 15, 2008**

**TRADEMARK  
PRINCIPAL REGISTER**

**Choco's**

LA PETITE FOODS, INC. (CALIFORNIA CORPORATION)  
POST OFFICE BOX 28404  
SAN DIEGO, CA 92198

THE MARK CONSISTS OF STANDARD CHARACTERS WITHOUT CLAIM TO ANY PARTICULAR FONT, STYLE, SIZE, OR COLOR.

FOR: ICE CREAM, ICE CREAM TRUFFLES AND FROZEN CONFECTIONS, IN CLASS 30 (U.S. CL. 46).

SN 77-192,712, FILED 5-30-2007.

FIRST USE 12-0-2007; IN COMMERCE 12-0-2007.

MARLENE BELL, EXAMINING ATTORNEY

Int. Cl.: 33

Prior U.S. Cls.: 47 and 49

United States Patent and Trademark Office

Reg. No. 3,469,042

Registered July 15, 2008

TRADEMARK  
PRINCIPAL REGISTER

*Andrew's Vat*

FQZ LLC D/B/A SHERBROOKE CELLARS (NEW  
YORK LTD LIAB CO)  
75 SOUTH BROADWAY  
WHITE PLAINS, NY 10601

FOR: WINE, IN CLASS 33 (U.S. CLS. 47 AND 49).

FIRST USE 11-27-2007; IN COMMERCE 11-27-2007.

"THE NAME(S), PORTRAIT(S), AND/OR SIGNA-  
TURE(S) SHOWN IN THE MARK IDENTIFIES

ANDREW MCMURRAY, WHOSE CONSENT(S) TO  
REGISTER IS SUBMITTED."

THE MARK CONSISTS OF THE STYLIZED  
WORDS "ANDREW'S VAT".

SN 77-193,395, FILED 5-30-2007.

TIMOTHY FINNEGAN, EXAMINING ATTORNEY

**Int. Cl.: 45**

**Prior U.S. Cls.: 100 and 101**

**United States Patent and Trademark Office**

**Reg. No. 3,469,043**

**Registered July 15, 2008**

**SERVICE MARK  
PRINCIPAL REGISTER**

OUR THINKING EXPANDS YOURS

LAHIVE & COCKFIELD, LLP (MASSACHUSETTS  
LIMITED LIABILITY PARTNERSHIP)  
ONE POST OFFICE SQUARE  
BOSTON, MA 02109

THE MARK CONSISTS OF STANDARD CHAR-  
ACTERS WITHOUT CLAIM TO ANY PARTICULAR  
FONT, STYLE, SIZE, OR COLOR.

FOR: LEGAL SERVICES, IN CLASS 45 (U.S. CLS.  
100 AND 101).

SN 77-194,469, FILED 5-31-2007.

FIRST USE 9-0-2006; IN COMMERCE 9-0-2006.

ROBIN CHOSID, EXAMINING ATTORNEY

**Int. Cl.: 33**

**Prior U.S. Cls.: 47 and 49**

**United States Patent and Trademark Office**

**Reg. No. 3,469,044**

**Registered July 15, 2008**

**TRADEMARK  
PRINCIPAL REGISTER**

**HORSE PLAY**

JACKSON FAMILY FARMS, LLC (CALIFORNIA  
LTD LIAB CO)  
421 AVIATION BLVD  
SANTA ROSA, CA 85403

THE MARK CONSISTS OF STANDARD CHAR-  
ACTERS WITHOUT CLAIM TO ANY PARTICULAR  
FONT, STYLE, SIZE, OR COLOR.

FOR: WINE, IN CLASS 33 (U.S. CLS. 47 AND 49).

SN 77-194,759, FILED 5-31-2007.

FIRST USE 2-1-2008; IN COMMERCE 2-1-2008.

DAVID I, EXAMINING ATTORNEY

**Int. Cls.: 5 and 29**

**Prior U.S. Cls.: 6, 18, 44, 46, 51, and 52**

**United States Patent and Trademark Office**

**Reg. No. 3,469,045**

**Registered July 15, 2008**

**TRADEMARK  
PRINCIPAL REGISTER**

**DOUBLE DASH WITH FLAX**

MILLER, RANDY (UNITED STATES INDIVIDUAL)  
1321 12TH AVENUE NORTHEAST  
DENHOFF, ND 58430 AND  
MILLER, DEBORAH (UNITED STATES INDIVIDUAL)  
1321 12TH AVENUE NORTHEAST  
DENHOFF, ND 58430

FOR: FLAXSEED AND FLAX LIGNANS, NAMELY, EDIBLE FLAXSEED OIL, EDIBLE MILLED FLAXSEED, EDIBLE COLD MILLED FLAXSEED, EDIBLE WHOLE SEED FLAXSEED, EDIBLE PREGROUND FLAXSEED AND EDIBLE LIGNANS FOOD INGREDIENTS AND FOOD SUPPLEMENTS CONTAINING OMEGA AND ARTIFICIALLY MANUFACTURED OMEGA, IN CLASS 5 (U.S. CLS. 6, 18, 44, 46, 51 AND 52).

FIRST USE 2-28-2008; IN COMMERCE 2-8-2008.

FOR: PROCESSED EDIBLE FLAX, NAMELY, EDIBLE MILLED FLAXSEED, EDIBLE COLD MILLED FLAXSEED, EDIBLE WHOLE SEED FLAXSEED, EDIBLE PREGROUND FLAXSEED, AND EDIBLE FLAX LIGNANS; EDIBLE FLAXSEED OIL, IN CLASS 29 (U.S. CL. 46).

FIRST USE 2-8-2008; IN COMMERCE 2-8-2008.

THE MARK CONSISTS OF STANDARD CHARACTERS WITHOUT CLAIM TO ANY PARTICULAR FONT, STYLE, SIZE, OR COLOR.

NO CLAIM IS MADE TO THE EXCLUSIVE RIGHT TO USE "FLAX", APART FROM THE MARK AS SHOWN.

SN 77-194,818, FILED 5-31-2007.

RAUL CORDOVA, EXAMINING ATTORNEY

**Int. Cl.: 29**

**Prior U.S. Cl.: 46**

**United States Patent and Trademark Office**

**Reg. No. 3,469,046**

**Registered July 15, 2008**

**TRADEMARK  
PRINCIPAL REGISTER**

UDDERLY DELICIOUS ORGANICS

AMERICAN FOOD RESOURCES, LLC (NORTH  
CAROLINA CORPORATION)

110 INDUSTRY COURT

P.O. BOX 985

NASHVILLE, NC 27856

FOR: CHEESE, IN CLASS 29 (U.S. CL. 46).

FIRST USE 5-0-2008; IN COMMERCE 5-0-2008.

THE MARK CONSISTS OF STANDARD CHAR-  
ACTERS WITHOUT CLAIM TO ANY PARTICULAR  
FONT, STYLE, SIZE, OR COLOR.

NO CLAIM IS MADE TO THE EXCLUSIVE  
RIGHT TO USE "ORGANICS", APART FROM THE  
MARK AS SHOWN.

SN 77-195,032, FILED 5-31-2007.

ANGELA M. MICHELI, EXAMINING ATTORNEY

**Int. Cl.: 35**

**Prior U.S. Cls.: 100, 101, and 102**

**United States Patent and Trademark Office**

**Reg. No. 3,469,047**

**Registered July 15, 2008**

**SERVICE MARK  
PRINCIPAL REGISTER**

**ENABLING TRANSFORMATION**

KEANE, INC. (MASSACHUSETTS CORPORATION)  
100 CITY SQUARE  
BOSTON, MA 02129

FOR: BUSINESS PROGRAM MANAGEMENT SERVICES, BUSINESS PROJECT MANAGEMENT SERVICES, HUMAN RESOURCE CONSULTING SERVICES, BUSINESS MANAGEMENT SERVICES, BUSINESS CONSULTATION SERVICES, BUSINESS PROCESS OUTSOURCING SERVICES IN A WIDE VARIETY OF FIELDS, IN CLASS 35 (U.S. CLS. 100, 101 AND 102).

FIRST USE 7-31-2007; IN COMMERCE 7-31-2007.

THE MARK CONSISTS OF STANDARD CHARACTERS WITHOUT CLAIM TO ANY PARTICULAR FONT, STYLE, SIZE, OR COLOR.

SN 77-195,283, FILED 6-1-2007.

KATHERINE M. DUBRAY, EXAMINING ATTORNEY



**Int. Cl.: 15**

**Prior U.S. Cls.: 2, 21, and 36**

**United States Patent and Trademark Office**

**Reg. No. 3,469,048**

**Registered July 15, 2008**

**TRADEMARK  
PRINCIPAL REGISTER**

**PETAL POWER**

DAISY ROCK GUITARS, LLC (CALIFORNIA  
LTD LIAB CO)  
16320 ROSCOE BOULEVARD, SUITE 100  
VAN NUYS, CA 91406

FOR: STRINGED MUSICAL INSTRUMENTS,  
NAMELY, ACOUSTIC, ACOUSTIC/ELECTRIC  
AND ELECTRIC GUITARS AND ACOUSTIC,  
ACOUSTIC/ELECTRIC AND ELECTRIC BASSES  
AND REPLACEMENT PARTS THEREFOR, AND  
STRINGED MUSICAL INSTRUMENT ACCESSOR-  
IES, NAMELY, GIG BAGS, INSTRUMENT CASES,

STANDS, PICKS AND STRINGS, IN CLASS 15 (U.S.  
CLS. 2, 21 AND 36).

FIRST USE 8-1-2007; IN COMMERCE 8-1-2007.

THE MARK CONSISTS OF STANDARD CHAR-  
ACTERS WITHOUT CLAIM TO ANY PARTICULAR  
FONT, STYLE, SIZE, OR COLOR.

SN 77-195,936, FILED 6-1-2007.

PAM WILLIS, EXAMINING ATTORNEY

**Int. Cl.: 7**

**Prior U.S. Cls.: 13, 19, 21, 23, 31, 34, and 35**

**Reg. No. 3,469,049**

**United States Patent and Trademark Office**

**Registered July 15, 2008**

---

**TRADEMARK  
PRINCIPAL REGISTER**

**BOWTIE**

NORDSON CORPORATION (OHIO CORPORATION)  
28601 CLEMENS ROAD  
WESTLAKE, OH 44145

THE MARK CONSISTS OF STANDARD CHARACTERS WITHOUT CLAIM TO ANY PARTICULAR FONT, STYLE, SIZE, OR COLOR.

FOR: HOT MELT ADHESIVE DISPENSING MACHINERY, NAMELY, GUNS, MANIFOLDS, AND MODULES, IN CLASS 7 (U.S. CLS. 13, 19, 21, 23, 31, 34 AND 35).

SN 77-196,538, FILED 6-4-2007.

FIRST USE 4-10-2008; IN COMMERCE 4-10-2008.

TAMARA FRAZIER, EXAMINING ATTORNEY

Int. Cl.: 44

Prior U.S. Cls.: 100 and 101

United States Patent and Trademark Office

Reg. No. 3,469,050

Registered July 15, 2008

SERVICE MARK  
PRINCIPAL REGISTER



JJJ ORGANIC LAWN CARE, LLC (NEW HAMPSHIRE LTD LIAB CO), DBA PURELY ORGANIC LAWN CARE,  
P.O. BOX 211  
YORK, ME 03911

FOR: LAWN CARE, IN CLASS 44 (U.S. CLS. 100 AND 101).

FIRST USE 6-30-2007; IN COMMERCE 6-30-2007.

NO CLAIM IS MADE TO THE EXCLUSIVE RIGHT TO USE "PURELY ORGANIC LAWN CARE", APART FROM THE MARK AS SHOWN.

THE COLOR(S) GREEN, BLACK, GOLD AND WHITE IS/ARE CLAIMED AS A FEATURE OF THE MARK.

THE MARK CONSISTS OF THE COLOR GREEN APPEARS IN "PURELY ORGANIC", AND IN THE BACKGROUND OF THE RECTANGULAR BOX CONTAINING THE WHITE BLADES OF GRASS, THE COLOR BLACK APPEARS IN "LAWNCARE", AND THE COLOR GOLD APPEARS IN THE OUTLINE OF THE LONG RECTANGULAR BOX CONTAINING THE IMAGE OF THE BLADES OF GRASS AND "LAWNCARE".

SN 77-196,888, FILED 6-4-2007.

TRICIA SONNEBORN, EXAMINING ATTORNEY

**Int. Cl.: 9**

**Prior U.S. Cls.: 21, 23, 26, 36, and 38**

**Reg. No. 3,469,051**

**United States Patent and Trademark Office**

**Registered July 15, 2008**

---

**TRADEMARK  
PRINCIPAL REGISTER**

**GOLDMAIL**

GOLDMAIL INC. (DELAWARE CORPORATION)  
3RD FLOOR  
2030 HARRISON STREET  
SAN FRANCISCO, CA 94110

FOR: COMPUTER SOFTWARE FOR ELECTRO-  
NIC TRANSMISSION OF MESSAGES, DATA, TEXT,  
IMAGES, DOCUMENTS, INFORMATION AND  
AUDIO AMONG COMPUTER USERS , IN CLASS 9  
(U.S. CLS. 21, 23, 26, 36 AND 38).

FIRST USE 8-4-2006; IN COMMERCE 8-4-2006.

THE MARK CONSISTS OF STANDARD CHAR-  
ACTERS WITHOUT CLAIM TO ANY PARTICULAR  
FONT, STYLE, SIZE, OR COLOR.

SN 77-196,993, FILED 6-4-2007.

LESLEY LAMOTHE, EXAMINING ATTORNEY

Int. Cl.: 32

Prior U.S. Cls.: 45, 46, and 48

Reg. No. 3,469,052

United States Patent and Trademark Office

Registered July 15, 2008

TRADEMARK  
PRINCIPAL REGISTER



MILLER PRODUCTS COMPANY (WISCONSIN  
CORPORATION)

3939 WEST HIGHLAND BOULEVARD  
MILWAUKEE, WI 53208

FOR: BEER, IN CLASS 32 (U.S. CLS. 45, 46 AND 48).

FIRST USE 9-1-2007; IN COMMERCE 9-1-2007.

THE MARK CONSISTS OF THE WORD "MI" IN  
STYLIZED FORM.

THE FOREIGN WORDING IN THE MARK  
TRANSLATES INTO ENGLISH AS "MY"

SN 77-197,166, FILED 6-4-2007.

CHRISTINA SOBRAL, EXAMINING ATTORNEY

**Int. Cl.: 32**

**Prior U.S. Cls.: 45, 46, and 48**

**United States Patent and Trademark Office**

**Reg. No. 3,469,053**

**Registered July 15, 2008**

**TRADEMARK  
PRINCIPAL REGISTER**

**MI TRADICION ORGULLO  
CERVEZA MILLER**

MILLER PRODUCTS COMPANY (WISCONSIN  
CORPORATION)  
3939 WEST HIGHLAND BOULEVARD  
MILWAUKEE, WI 53208

FOR: BEER, IN CLASS 32 (U.S. CLS. 45, 46 AND 48).

FIRST USE 9-1-2007; IN COMMERCE 9-1-2007.

THE MARK CONSISTS OF STANDARD CHAR-  
ACTERS WITHOUT CLAIM TO ANY PARTICULAR  
FONT, STYLE, SIZE, OR COLOR.

OWNER OF U.S. REG. NOS. 506,937, 2,867,701,  
AND OTHERS.

NO CLAIM IS MADE TO THE EXCLUSIVE  
RIGHT TO USE "CERVEZA", APART FROM THE  
MARK AS SHOWN.

THE FOREIGN WORDING IN THE MARK  
TRANSLATES INTO ENGLISH AS MY TRADITION  
PRIDE BEER.

SN 77-197,176, FILED 6-4-2007.

CHRISTINA SOBRAL, EXAMINING ATTORNEY

**Int. Cl.: 35**

**Prior U.S. Cls.: 100, 101, and 102**

**United States Patent and Trademark Office**

**Reg. No. 3,469,054**

**Registered July 15, 2008**

**SERVICE MARK  
PRINCIPAL REGISTER**

## Makeover For Success

FORGIONE, BARBARA (UNITED STATES INDIVIDUAL)  
109 W. FERN ST  
TAMPA, FL 33604

FOR: CHARITABLE SERVICES, NAMELY, ORGANIZING WOMEN'S GROUPS TO UNDERTAKE PROJECTS WHICH BENEFIT THE HOMELESS, ABUSED, AT RISK WOMEN AND WOMEN IN TRANSITION AND IN PAIN, WHILE ENCOURAGING EMPOWERMENT AMONG WOMEN OF ALL AGES AND ETHNICITIES; CHARITABLE SERVICES, NAMELY, ORGANIZING AND CONDUCTING VOLUNTEER PROGRAMS AND COMMUNITY SERVICE PROJECTS, IN CLASS 35 (U.S. CLS. 100, 101 AND 102).

FIRST USE 4-2-2007; IN COMMERCE 4-2-2007.

THE MARK CONSISTS OF STANDARD CHARACTERS WITHOUT CLAIM TO ANY PARTICULAR FONT, STYLE, SIZE, OR COLOR.

NO CLAIM IS MADE TO THE EXCLUSIVE RIGHT TO USE "MAKEOVER", APART FROM THE MARK AS SHOWN.

SN 77-197,423, FILED 6-5-2007.

KATHERINE CONNOLLY, EXAMINING ATTORNEY

**Int. Cl.: 3**

**Prior U.S. Cls.: 1, 4, 6, 50, 51, and 52**

**Reg. No. 3,469,055**

**United States Patent and Trademark Office**

**Registered July 15, 2008**

---

**TRADEMARK  
PRINCIPAL REGISTER**

**Bronze Candy**

SUPRE, INC. (TEXAS CORPORATION)  
SUITE 700 LB 40  
15770 N. DALLAS PARKWAY  
DALLAS, TX 75248

FOR: INDOOR AND OUTDOOR TANNING PRODUCTS, NAMELY, NON-MEDICATED TAN DARKENING LOTIONS AND SKIN MOISTURIZERS, IN CLASS 3 (U.S. CLS. 1, 4, 6, 50, 51 AND 52).

FIRST USE 10-1-2007; IN COMMERCE 11-15-2007.

THE MARK CONSISTS OF STANDARD CHARACTERS WITHOUT CLAIM TO ANY PARTICULAR FONT, STYLE, SIZE, OR COLOR.

NO CLAIM IS MADE TO THE EXCLUSIVE RIGHT TO USE "BRONZE", APART FROM THE MARK AS SHOWN.

SN 77-197,491, FILED 6-5-2007.

RONALD AIKENS, EXAMINING ATTORNEY



**Int. Cls.: 20, 25, and 28**

**Prior U.S. Cls.: 2, 13, 22, 23, 25, 32, 38, 39, and 50**

**United States Patent and Trademark Office**

**Reg. No. 3,469,056**

**Registered July 15, 2008**

**TRADEMARK  
PRINCIPAL REGISTER**



BEE POSH, LLC (NEW YORK LTD LIAB CO)  
48 WEST 37TH STREET, 2ND FLOOR  
NEW YORK, NY 10018

FOR: HOME FURNISHINGS, NAMELY, BEAN BAG CHAIRS, PILLOW CHAIRS, PILLOWS AND PICTURE FRAMES, IN CLASS 20 (U.S. CLS. 2, 13, 22, 25, 32 AND 50).

FIRST USE 10-0-2005; IN COMMERCE 10-0-2005.

FOR: MEN, WOMEN AND CHILDREN'S CLOTHING, NAMELY, SHIRTS, SKIRTS, DRESSES, PANTS, SWEATERS AND JACKETS, IN CLASS 25 (U.S. CLS. 22 AND 39).

FIRST USE 10-0-2005; IN COMMERCE 10-0-2005.

FOR: TOYS, NAMELY, PLUSH AND STUFFED ANIMALS, IN CLASS 28 (U.S. CLS. 22, 23, 38 AND 50).

FIRST USE 10-0-2005; IN COMMERCE 10-0-2005.

THE MARK CONSISTS OF THE LETTER "B" IN A CIRCLE, THE LETTERS "EE" IN A CIRCLE, THE LETTER "P" IN A CIRCLE, THE LETTER "O" IN A CIRCLE, THE LETTER "S" IN A CIRCLE, THE LETTER "H" IN A CIRCLE. THE PRECEDING IS INSIDE A RECTANGLE.

SN 77-197,881, FILED 6-5-2007.

SUSAN RICHARDS, EXAMINING ATTORNEY

**Int. Cl.: 30**

**Prior U.S. Cl.: 46**

**United States Patent and Trademark Office**

**Reg. No. 3,469,057**

**Registered July 15, 2008**

**TRADEMARK  
PRINCIPAL REGISTER**

**PATTI LABELLE GOOD LIFE**

PATTI'S GOOD LIFE, INC. (PENNSYLVANIA  
CORPORATION)  
1212 GRENOX ROAD  
WYNNEWOOD, PA 19096

FOR: SAUCES AND PACKAGED MEALS CON-  
SISTING PRIMARILY OF PASTA OR RICE, IN  
CLASS 30 (U.S. CL. 46).

FIRST USE 9-24-2007; IN COMMERCE 9-24-2007.

THE MARK CONSISTS OF STANDARD CHAR-  
ACTERS WITHOUT CLAIM TO ANY PARTICULAR  
FONT, STYLE, SIZE, OR COLOR.

THE NAME "PATTI LABELLE" IDENTIFIES A  
LIVING INDIVIDUAL WHOSE CONSENT IS OF  
RECORD.

SN 77-198,193, FILED 6-5-2007.

GEORGIA CARTY, EXAMINING ATTORNEY

**Int. Cl.: 41**

**Prior U.S. Cls.: 100, 101, and 107**

**United States Patent and Trademark Office**

**Reg. No. 3,469,058**

**Registered July 15, 2008**

---

**SERVICE MARK  
PRINCIPAL REGISTER**

**Adelie**

ADELIE PRODUCTIONS (MASSACHUSETTS  
SOLE PROPRIETORSHIP)  
33 NEWBURY NECK RD.  
NEWBURY, MA 01951

FOR: CHILDREN AND FAMILY ENTERTAIN-  
MENT CENTERS, NAMELY, INTERACTIVE PLAY  
AREAS CONTAINING ELECTRONIC GAMES  
THAT ENCOURAGE INDIVIDUAL AND GROUP  
PLAY, IN CLASS 41 (U.S. CLS. 100, 101 AND 107).

FIRST USE 3-1-2007; IN COMMERCE 3-1-2007.

THE MARK CONSISTS OF STANDARD CHAR-  
ACTERS WITHOUT CLAIM TO ANY PARTICULAR  
FONT, STYLE, SIZE, OR COLOR.

SN 77-198,799, FILED 6-6-2007.

DAWN FELDMAN, EXAMINING ATTORNEY

**Int. Cl.: 25**

**Prior U.S. Cls.: 22 and 39**

**United States Patent and Trademark Office**

**Reg. No. 3,469,059**

**Registered July 15, 2008**

**TRADEMARK  
PRINCIPAL REGISTER**

**JARMAX**

ROYAL MAX ENTERPRISES, INC. (NEW YORK  
CORPORATION)  
42 BAYBERRY ROAD  
LAWRENCE, NY 11559

FOR: BOXER SHORTS; DENIM JACKETS; JEANS;  
PANTS; SHIRTS; SHORTS; SWEAT PANTS; SWEAT  
SHIRTS; T-SHIRTS; CAPS; COATS; FOOTWEAR;  
JACKETS; SPORTS JACKETS; SLEEPWEAR, IN  
CLASS 25 (U.S. CLS. 22 AND 39).

FIRST USE 9-1-2007; IN COMMERCE 9-1-2007.

THE MARK CONSISTS OF STANDARD CHAR-  
ACTERS WITHOUT CLAIM TO ANY PARTICULAR  
FONT, STYLE, SIZE, OR COLOR.

SN 77-198,942, FILED 6-6-2007.

JENNY PARK, EXAMINING ATTORNEY

Int. Cl.: 34

Prior U.S. Cls.: 2, 8, 9, and 17

United States Patent and Trademark Office

Reg. No. 3,469,060

Registered July 15, 2008

TRADEMARK  
PRINCIPAL REGISTER



TRADEMARKS LLC (DELAWARE LTD LIAB  
CO)  
6601 WEST BROAD STREET  
RICHMOND, VA 23230

FOR: CIGARETTES, IN CLASS 34 (U.S. CLS. 2, 8, 9  
AND 17).

FIRST USE 9-11-2007; IN COMMERCE 9-11-2007.

OWNER OF U.S. REG. NOS. 594,798, 1,062,895,  
AND OTHERS.

NO CLAIM IS MADE TO THE EXCLUSIVE  
RIGHT TO USE "FILTER", "FULL FLAVOR" AND  
"20 CLASS A CIGARETTES", APART FROM THE  
MARK AS SHOWN.

THE COLOR(S) RED, BLUE, SILVER AND WHITE  
IS/ARE CLAIMED AS A FEATURE OF THE MARK.

THE MARK CONSISTS OF A RECTANGLE DE-  
SIGN WITH A DARK RED AND LIGHT RED  
HORIZONTAL STRIPE PATTERN COVERING THE  
TOP THREE-QUARTERS OF THE RECTANGLE  
AND WHITE COVERING THE BOTTOM QUARTER,  
THE LETTERS "L&M" IN WHITE, THE WORDING  
"FILTER" IN SILVER, THE WORDING "FULL FLA-  
VOR" IN RED, THE WORDING "20 CLASS A  
CIGARETTES" IN BLUE, AND A SILVER CREST  
DESIGN WITH THE LETTERS "L&M" IN WHITE IN  
THE CENTER OF A BLUE BACKGROUND.

SN 77-199,729, FILED 6-6-2007.

DAVID HOFFMAN, EXAMINING ATTORNEY

Int. Cl.: 34

Prior U.S. Cls.: 2, 8, 9, and 17

United States Patent and Trademark Office

Reg. No. 3,469,061

Registered July 15, 2008

**TRADEMARK  
PRINCIPAL REGISTER**



TRADEMARKS LLC (DELAWARE LTD LIAB  
CO)  
6601 WEST BROAD STREET  
RICHMOND, VA 23230

FOR: CIGARETTES, IN CLASS 34 (U.S. CLS. 2, 8, 9  
AND 17).

FIRST USE 9-11-2007; IN COMMERCE 9-11-2007.

OWNER OF U.S. REG. NOS. 594,798, 1,062,895,  
AND OTHERS.

THE COLOR(S) RED, BLUE, SILVER AND WHITE  
IS/ARE CLAIMED AS A FEATURE OF THE MARK.

THE MARK CONSISTS OF A RECTANGLE DE-  
SIGN WITH A DARK RED AND LIGHT RED  
HORIZONTAL STRIPE PATTERN COVERING THE  
TOP THREE-QUARTERS OF THE RECTANGLE,  
WHITE COVERING THE BOTTOM QUARTER,  
AND A SILVER CREST DESIGN WITH THE LET-  
TERS "L&M" IN WHITE IN THE CENTER OF A  
BLUE BACKGROUND.

SN 77-199,732, FILED 6-6-2007.

DAVID HOFFMAN, EXAMINING ATTORNEY

**Int. Cl.: 25**

**Prior U.S. Cls.: 22 and 39**

**United States Patent and Trademark Office**

**Reg. No. 3,469,062**

**Registered July 15, 2008**

**TRADEMARK  
PRINCIPAL REGISTER**

**JARMAX JEANS**

ROYAL MAX ENTERPRISES, INC. (NEW YORK  
CORPORATION)  
42 BAYBERRY ROAD  
LAWRENCE, NY 11559

FOR: BOXER SHORTS; DENIM JACKETS; JACK-  
ETS; JEANS; PANTS; SHIRTS; SHORTS; SWEAT  
PANTS; SWEAT SHIRTS; T-SHIRTS; SPORTS JACK-  
ETS; CAPS; COATS; FOOTWEAR; SLEEPWEAR, IN  
CLASS 25 (U.S. CLS. 22 AND 39).

FIRST USE 9-1-2007; IN COMMERCE 9-1-2007.

THE MARK CONSISTS OF STANDARD CHAR-  
ACTERS WITHOUT CLAIM TO ANY PARTICULAR  
FONT, STYLE, SIZE, OR COLOR.

NO CLAIM IS MADE TO THE EXCLUSIVE  
RIGHT TO USE "JEANS", APART FROM THE  
MARK AS SHOWN.

SN 77-199,936, FILED 6-7-2007.

JENNY PARK, EXAMINING ATTORNEY

**Int. Cl.: 43**

**Prior U.S. Cls.: 100 and 101**

**United States Patent and Trademark Office**

**Reg. No. 3,469,063**

**Registered July 15, 2008**

**SERVICE MARK  
PRINCIPAL REGISTER**



HOT STUFF FOODS, LLC (SOUTH DAKOTA  
LTD LIAB CO)  
P.O. BOX 85210  
SIOUX FALLS, SD 57118

NO CLAIM IS MADE TO THE EXCLUSIVE  
RIGHT TO USE "SPORTS GRILL" AND "EST.  
2006", APART FROM THE MARK AS SHOWN.

FOR: RESTAURANTS AND CARRY-OUT FOOD  
SHOPS, IN CLASS 43 (U.S. CLS. 100 AND 101).

SN 77-200,040, FILED 6-7-2007.

FIRST USE 12-0-2007; IN COMMERCE 12-0-2007.

GINA HAYES, EXAMINING ATTORNEY



**Int. Cl.: 43**

**Prior U.S. Cls.: 100 and 101**

**United States Patent and Trademark Office**

**Reg. No. 3,469,064**

**Registered July 15, 2008**

**SERVICE MARK  
PRINCIPAL REGISTER**



HOT STUFF FOODS, LLC (SOUTH DAKOTA  
LTD LIAB CO)  
P.O. BOX 85210  
SIOUX FALLS, SD 57118

NO CLAIM IS MADE TO THE EXCLUSIVE  
RIGHT TO USE "SPORTS GRILL" AND "EST.  
2006", APART FROM THE MARK AS SHOWN.

FOR: RESTAURANTS AND CARRY-OUT FOOD  
SHOPS, IN CLASS 43 (U.S. CLS. 100 AND 101).

SN 77-200,051, FILED 6-7-2007.

FIRST USE 12-0-2007; IN COMMERCE 12-0-2007.

SUSAN RICHARDS, EXAMINING ATTORNEY

**Int. Cls.: 9, 16, 20, and 21**

**Prior U.S. Cls.: 2, 5, 13, 21, 22, 23, 25, 26, 29, 30, 32, 33, 36, 37, 38, 40, and 50**

**Reg. No. 3,469,065**

**United States Patent and Trademark Office**

**Registered July 15, 2008**

**TRADEMARK  
PRINCIPAL REGISTER**

**HEIDI DAUS**

HEIDI DAUS (NEW JERSEY CORPORATION)  
509 RIDGEWOOD AVENUE  
GLEN RIDGE, NJ 07028

FOR: MAGNIFYING GLASSES, IN CLASS 9 (U.S. CLS. 21, 23, 26, 36 AND 38).

FIRST USE 11-0-2007; IN COMMERCE 11-0-2007.

FOR: PAPERWEIGHTS; DESK SETS; DESKTOP BUSINESS CARD HOLDERS, IN CLASS 16 (U.S. CLS. 2, 5, 22, 23, 29, 37, 38 AND 50).

FIRST USE 11-0-2007; IN COMMERCE 11-0-2007.

FOR: PICTURE FRAMES, IN CLASS 20 (U.S. CLS. 2, 13, 22, 25, 32 AND 50).

FIRST USE 11-0-2007; IN COMMERCE 11-0-2007.

FOR: CANDLESTICKS, IN CLASS 21 (U.S. CLS. 2, 13, 23, 29, 30, 33, 40 AND 50).

FIRST USE 11-0-2007; IN COMMERCE 11-0-2007.

THE MARK CONSISTS OF STANDARD CHARACTERS WITHOUT CLAIM TO ANY PARTICULAR FONT, STYLE, SIZE, OR COLOR.

OWNER OF U.S. REG. NO. 2,927,983.

THE NAME(S), PORTRAIT(S), AND/OR SIGNATURE(S) SHOWN IN THE MARK IDENTIFIES "HEIDI DAUS", WHOSE CONSENT(S) TO REGISTER IS SUBMITTED.

SN 77-200,547, FILED 6-7-2007.

RUDY R. SINGLETON, EXAMINING ATTORNEY

Int. Cl.: 35

Prior U.S. Cls.: 100, 101, and 102

United States Patent and Trademark Office

Reg. No. 3,469,066

Registered July 15, 2008

SERVICE MARK  
PRINCIPAL REGISTER



UNIFIED GROCERS, INC. (CALIFORNIA CORPORATION)  
5200 SHEILA STREET  
COMMERCE, CA 90040

FOR: DISTRIBUTORSHIP AND ONLINE DISTRIBUTORSHIP SERVICES IN THE FIELD OF GROCERY AND HOUSEHOLD PRODUCTS, IN CLASS 35 (U.S. CLS. 100, 101 AND 102).

FIRST USE 6-0-2007; IN COMMERCE 10-0-2007.

OWNER OF U.S. REG. NO. 2,659,980.

NO CLAIM IS MADE TO THE EXCLUSIVE RIGHT TO USE "GROCERS", APART FROM THE MARK AS SHOWN.

SN 77-201,603, FILED 6-8-2007.

MICHAEL ENGEL, EXAMINING ATTORNEY

**Int. Cl.: 41**

**Prior U.S. Cls.: 100, 101, and 107**

**United States Patent and Trademark Office**

**Reg. No. 3,469,067**

**Registered July 15, 2008**

**SERVICE MARK  
PRINCIPAL REGISTER**

# Dead Soldiers

BURGESS, JOEL G. (UNITED STATES INDIVIDUAL)  
STUDIO #3  
1923 WEST ALLEN STREET  
YUMA, AZ 85364

FOR: ENTERTAINMENT IN THE NATURE OF VISUAL AND AUDIO PERFORMANCES, NAMELY, MUSICAL BAND, ROCK GROUP, GYMNASTIC, DANCE, AND BALLET PERFORMANCES; ENTERTAINMENT IN THE NATURE OF A MUSICAL GROUP; ENTERTAINMENT, NAMELY, LIVE PERFORMANCES BY A MUSICAL BAND; ENTERTAINMENT, NAMELY, LIVE MUSIC CONCERTS; ENTERTAINMENT, NAMELY, LIVE PERFORMAN-

CES BY MUSICAL BANDS, IN CLASS 41 (U.S. CLS. 100, 101 AND 107).

FIRST USE 3-25-2008; IN COMMERCE 4-22-2008.

THE MARK CONSISTS OF STANDARD CHARACTERS WITHOUT CLAIM TO ANY PARTICULAR FONT, STYLE, SIZE, OR COLOR.

SN 77-202,115, FILED 6-9-2007.

ALEXANDER L. POWERS, EXAMINING ATTORNEY

Int. Cl.: 41

Prior U.S. Cls.: 100, 101, and 107

United States Patent and Trademark Office

Reg. No. 3,469,068

Registered July 15, 2008

SERVICE MARK  
PRINCIPAL REGISTER



The logo features the word "inspired." written in a fluid, handwritten cursive script. Below the word, the words "ARTIST WORKSHOP" are written in a clean, sans-serif, all-caps font.

DONNA DOWNEY, LLC (NORTH CAROLINA  
LTD LIAB CO)  
13646 TOKA COURT  
HUNTERSVILLE, NC 28078

FOR: ARRANGING, ORGANIZING, AND CON-  
DUCTING SEMINARS AND WORKSHOPS FOR  
SCRAPBOOKERS, CRAFTERS, AND ARTISTS IN  
THE FIELD OF SCRAPBOOKING, ART, COLLAGE,  
TEXTILES, AND PHOTOGRAPHY, IN CLASS 41  
(U.S. CLS. 100, 101 AND 107).

FIRST USE 12-15-2007; IN COMMERCE 12-15-2007.

NO CLAIM IS MADE TO THE EXCLUSIVE  
RIGHT TO USE "ARTIST WORKSHOP", APART  
FROM THE MARK AS SHOWN.

THE MARK CONSISTS OF THE WORD "IN-  
SPIRED" IN A HANDWRITTEN SCRIPT, ARCHING  
OVER THE WORDS "ARTIST WORKSHOP" IN  
BLOCK, CAPITALIZED LETTERS.

SN 77-202,388, FILED 6-11-2007.

KATHY DE JONGE, EXAMINING ATTORNEY

**Int. Cls.: 35, 42, and 45**

**Prior U.S. Cls.: 100, 101, and 102**

**United States Patent and Trademark Office**

**Reg. No. 3,469,069**

**Registered July 15, 2008**

**SERVICE MARK  
PRINCIPAL REGISTER**

**SHIPX**

SHIPXPRESS, INC. (DELAWARE CORPORATION)  
SUITE 104  
2315 BEACH BOULEVARD  
JACKSONVILLE BEACH, FL 32250

FOR: CONSULTING SERVICES, NAMELY, FREIGHT SHIPMENT LOGISTICS MANAGEMENT CONSULTING SERVICES FEATURING SHIPMENTS BY RAIL, TRUCK, BARGE AND OCEAN CARRIER; AND BUSINESS MANAGEMENT SERVICES, NAMELY, RAIL EQUIPMENT MANAGEMENT FOR OTHERS, IN CLASS 35 (U.S. CLS. 100, 101 AND 102).

FIRST USE 9-12-2007; IN COMMERCE 9-12-2007.

FOR: INTEGRATION OF COMPUTER SOFTWARE WITH EXISTING TRANSPORTATION ASSETS AND LOGISTICS MANAGEMENT COMPUTER SYSTEMS AND NETWORKS; INFORMATION TECHNOLOGY SERVICES, NAMELY, DEVELOPMENT OF CUSTOMIZED SOFTWARE FOR FREIGHT SHIPMENT ACROSS ALL TRANSPORTATION MODES AND EQUIPMENT MANAGEMENT AND TRACKING; HOSTING OF DIGITAL CONTENT ON THE INTERNET IN THE NATURE OF CLIENT AND FREIGHT CARRIER DATA; TECHNICAL SOFTWARE MAINTENANCE SERVICES FEATURING SUPPLY CHAIN MANAGEMENT, FREIGHT SHIPMENT MANAGEMENT AND FREIGHT TRACKING SOFTWARE; TECHNICAL MAINTENANCE OF WEB SITES FOR THIRD PARTIES; CUSTOMIZATION OF COMPUTER SOFTWARE FOR SUPPLY CHAIN MANAGEMENT,

FREIGHT SHIPMENT MANAGEMENT AND FREIGHT TRACKING; AND TECHNICAL SUPPORT SERVICES, NAMELY, TROUBLESHOOTING OF COMPUTER SOFTWARE PROBLEMS, IN CLASS 42 (U.S. CLS. 100 AND 101).

FIRST USE 9-12-2007; IN COMMERCE 9-12-2007.

FOR: LICENSING OF COMPUTER SOFTWARE FOR SUPPLY CHAIN FREIGHT SHIPMENT AND LOGISTICS MANAGEMENT AND FOR TRANSPORTATION EQUIPMENT MANAGEMENT; REVIEWING STANDARDS AND PRACTICES TO ASSURE COMPLIANCE WITH RAIL TRANSPORT REGULATIONS; AND COMPUTER SOFTWARE DESIGN FOR OTHERS FOR OPTIMIZATION OF TRANSPORTATION EQUIPMENT UTILIZATION, FREIGHT PAYMENTS AND ANALYSIS, AUDITS AND EQUIPMENT LEASING; SUPPLY CHAIN INVENTORY MANAGEMENT, IN CLASS 45 (U.S. CLS. 100 AND 101).

FIRST USE 9-12-2007; IN COMMERCE 9-12-2007.

THE MARK CONSISTS OF STANDARD CHARACTERS WITHOUT CLAIM TO ANY PARTICULAR FONT, STYLE, SIZE, OR COLOR.

OWNER OF U.S. REG. NOS. 3,182,488 AND 3,189,542.

SN 77-202,949, FILED 6-11-2007.

PATRICIA EVANKO, EXAMINING ATTORNEY

**Int. Cl.: 35**

**Prior U.S. Cls.: 100, 101, and 102**

**United States Patent and Trademark Office**

**Reg. No. 3,469,070**

**Registered July 15, 2008**

**SERVICE MARK  
PRINCIPAL REGISTER**

**CAREREAD**

AVAILITY, L.L.C. (DELAWARE LTD LIAB CO)  
SUITE 300  
7406 FULLERTON STREET  
JACKSONVILLE, FL 32256

THE MARK CONSISTS OF STANDARD CHAR-  
ACTERS WITHOUT CLAIM TO ANY PARTICULAR  
FONT, STYLE, SIZE, OR COLOR.

FOR: ELECTRONIC PROCESSING OF HEALTH  
CARE INFORMATION, IN CLASS 35 (U.S. CLS. 100,  
101 AND 102).

SN 77-203,701, FILED 6-12-2007.

FIRST USE 2-1-2007; IN COMMERCE 3-1-2007.

BRIAN PINO, EXAMINING ATTORNEY

**Int. Cl.: 43**

**Prior U.S. Cls.: 100 and 101**

**United States Patent and Trademark Office**

**Reg. No. 3,469,071**

**Registered July 15, 2008**

---

**SERVICE MARK  
PRINCIPAL REGISTER**

**BARLEY & HOPS**

THE BARLEY HOUSE WEST, INC. (CALIFORNIA CORPORATION), DBA BARLEY & HOPS, SUITE 101  
31045 HIGHWAY 79 SOUTH  
TEMECULA, CA 92592

THE MARK CONSISTS OF STANDARD CHARACTERS WITHOUT CLAIM TO ANY PARTICULAR FONT, STYLE, SIZE, OR COLOR.

FOR: TAVERN SERVICES; RESTAURANT SERVICES; BAR SERVICES, IN CLASS 43 (U.S. CLS. 100 AND 101).

SN 77-203,715, FILED 6-12-2007.

FIRST USE 9-4-2007; IN COMMERCE 9-4-2007.

KAELIE KUNG, EXAMINING ATTORNEY



**Int. Cl.: 35**

**Prior U.S. Cls.: 100, 101, and 102**

**United States Patent and Trademark Office**

**Reg. No. 3,469,072**

**Registered July 15, 2008**

**SERVICE MARK  
PRINCIPAL REGISTER**

IT'S YOUR LEASE ON THE LINE

LEVEL ONE, INC. (SOUTH CAROLINA CORPORATION)  
81 ROCKY SLOPE ROAD  
GREENVILLE, SC 29607

FOR: REAL ESTATE RENTAL CALL CENTER SERVICES, NAMELY, OPERATION OF TELEPHONE CALL CENTER SERVICES FOR OTHERS FOR RENTING APARTMENTS OF OTHERS, IN CLASS 35 (U.S. CLS. 100, 101 AND 102).

FIRST USE 9-0-2007; IN COMMERCE 9-0-2007.

THE MARK CONSISTS OF STANDARD CHARACTERS WITHOUT CLAIM TO ANY PARTICULAR FONT, STYLE, SIZE, OR COLOR.

SN 77-205,085, FILED 6-13-2007.

ANDREA K. NADELMAN, EXAMINING ATTORNEY

**Int. Cl.: 41**

**Prior U.S. Cls.: 100, 101, and 107**

**United States Patent and Trademark Office**

**Reg. No. 3,469,073**

**Registered July 15, 2008**

**SERVICE MARK  
PRINCIPAL REGISTER**

# Pathway to Purpose

FELLOWSHIP OF COMPANIES FOR CHRIST  
INTERNATIONAL, INC. (GEORGIA COR-  
PORATION)  
P.O. BOX 270784  
OKLAHOMA CITY, OK 73137

FOR: CHARITABLE SERVICES, NAMELY, PRO-  
VIDING TRAINING IN THE FIELDS OF BUSINESS  
AND RELIGION; RELIGIOUS INSTRUCTION SER-  
VICES; EDUCATIONAL SERVICES, NAMELY, CON-  
DUCTING CLASSES, SEMINARS, CONFERENCES,  
AND WORKSHOPS IN THE FIELD OF RELIGION,  
IN CLASS 41 (U.S. CLS. 100, 101 AND 107).

FIRST USE 2-16-2008; IN COMMERCE 2-16-2008.

THE MARK CONSISTS OF STANDARD CHAR-  
ACTERS WITHOUT CLAIM TO ANY PARTICULAR  
FONT, STYLE, SIZE, OR COLOR.

SN 77-206,106, FILED 6-14-2007.

SIMON TENG, EXAMINING ATTORNEY

**Int. Cl.: 29**

**Prior U.S. Cl.: 46**

**Reg. No. 3,469,074**

**United States Patent and Trademark Office**

**Registered July 15, 2008**

**TRADEMARK  
PRINCIPAL REGISTER**



MICRO ANALYTICAL SYSTEMS, INC. (CALI-  
FORNIA CORPORATION)  
160 MITCHELL ROAD  
SAN RAFAEL, CA 94903

NO CLAIM IS MADE TO THE EXCLUSIVE  
RIGHT TO USE "CERTIFIED SEAFOOD", APART  
FROM THE MARK AS SHOWN.

FOR: SEAFOOD, IN CLASS 29 (U.S. CL. 46).

SN 77-207,189, FILED 6-15-2007.

FIRST USE 12-31-2004; IN COMMERCE 12-31-2004.

ROBERT C. CLARK JR., EXAMINING ATTORNEY

**Int. Cl.: 10**

**Prior U.S. Cls.: 26, 39, and 44**

**United States Patent and Trademark Office**

**Reg. No. 3,469,075**

**Registered July 15, 2008**

**TRADEMARK  
PRINCIPAL REGISTER**

**COMFORT FIT**

JANUS DEVELOPMENT GROUP, INC. (NORTH  
CAROLINA CORPORATION)  
112 STATON ROAD  
GREENVILLE, NC 27834

FOR: SPEECH THERAPY DEVICE, NAMELY,  
APPARATUS TO AMELIORATE STUTTERING  
USING RECEIVER, AUDITORY DELAY OR FRE-  
QUENCY SHIFT CIRCUIT OR COMBINATION OF  
AUDITORY DELAY AND FREQUENCY SHIFT  
CIRCUIT, AND TRANSMITTER; SPEECH THER-  
APY DEVICE, NAMELY, APPARATUS TO AMELIO-  
RATE STUTTERING CONFIGURED FOR

POSITIONING IN OR ADJACENT TO THE EAR, IN  
CLASS 10 (U.S. CLS. 26, 39 AND 44).

FIRST USE 8-1-2007; IN COMMERCE 8-1-2007.

THE MARK CONSISTS OF STANDARD CHAR-  
ACTERS WITHOUT CLAIM TO ANY PARTICULAR  
FONT, STYLE, SIZE, OR COLOR.

SN 77-208,767, FILED 6-18-2007.

KRISTINA MORRIS, EXAMINING ATTORNEY

**Int. Cl.: 9**

**Prior U.S. Cls.: 21, 23, 26, 36, and 38**

**Reg. No. 3,469,076**

**United States Patent and Trademark Office**

**Registered July 15, 2008**

**TRADEMARK  
PRINCIPAL REGISTER**

**EAT SLEEP PLAY**

EAT SLEEP PLAY, INC. (DELAWARE CORPORATION)  
155 NORTH 400 WEST, SUITE 510  
SALT LAKE CITY, UT 84103

FIRST USE 2-5-2008; IN COMMERCE 2-5-2008.

FOR: COMPUTER GAME TAPES, DISCS, CDS, DVDS; COMPUTER GAME PROGRAMS; COMPUTER GAME SOFTWARE; DOWNLOADABLE ELECTRONIC GAMES VIA THE INTERNET AND WIRELESS DEVICES; ELECTRONIC GAME PROGRAMS; INTERACTIVE VIDEO GAME PROGRAMS, IN CLASS 9 (U.S. CLS. 21, 23, 26, 36 AND 38).

THE MARK CONSISTS OF STANDARD CHARACTERS WITHOUT CLAIM TO ANY PARTICULAR FONT, STYLE, SIZE, OR COLOR.

SN 77-208,979, FILED 6-18-2007.

GISELLE AGOSTO, EXAMINING ATTORNEY

**Int. Cl.: 11**

**Prior U.S. Cls.: 13, 21, 23, 31, and 34**

**Reg. No. 3,469,077**

**United States Patent and Trademark Office**

**Registered July 15, 2008**

---

**TRADEMARK  
PRINCIPAL REGISTER**

**ZENITH**

ZENITH ELECTRONICS LLC (DELAWARE LTD  
LIAB CO)  
2000 MILLBROOK DRIVE  
LINCOLNSHIRE, IL 60069

THE MARK CONSISTS OF STANDARD CHAR-  
ACTERS WITHOUT CLAIM TO ANY PARTICULAR  
FONT, STYLE, SIZE, OR COLOR.

FOR: AIR CONDITIONERS, IN CLASS 11 (U.S.  
CLS. 13, 21, 23, 31 AND 34).

SN 77-209,341, FILED 6-19-2007.

FIRST USE 4-1-2008; IN COMMERCE 4-1-2008.

ARETHA SOMERVILLE, EXAMINING ATTORNEY

**Int. Cl.: 3**

**Prior U.S. Cls.: 1, 4, 6, 50, 51, and 52**

**Reg. No. 3,469,078**

**United States Patent and Trademark Office**

**Registered July 15, 2008**

---

**TRADEMARK  
PRINCIPAL REGISTER**

**SCULPT AND SHAPE**

MAKE-UP ART COSMETICS INC. (DELAWARE  
CORPORATION)  
767 FIFTH AVENUE  
NEW YORK, NY 10153

THE MARK CONSISTS OF STANDARD CHAR-  
ACTERS WITHOUT CLAIM TO ANY PARTICULAR  
FONT, STYLE, SIZE, OR COLOR.

FOR: COSMETICS, IN CLASS 3 (U.S. CLS. 1, 4, 6, 50,  
51 AND 52).

SN 77-210,121, FILED 6-19-2007.

FIRST USE 11-19-2007; IN COMMERCE 11-19-2007.

PATRICIA EVANKO, EXAMINING ATTORNEY

Int. Cl.: 30

Prior U.S. Cl.: 46

United States Patent and Trademark Office

Reg. No. 3,469,079

Registered July 15, 2008

TRADEMARK  
PRINCIPAL REGISTER



LOW-COW S.A. DE C.V. (MEXICO CORPORATION)  
COLONIA DEL VALLE  
CALZADA DEL VALLE #401 LOCAL D-1  
SAN PEDRO GARZA GARCIA, MEXICO

FOR: ICE CREAM, IN CLASS 30 (U.S. CL. 46).

FIRST USE 2-0-2004; IN COMMERCE 2-0-2004.

NO CLAIM IS MADE TO THE EXCLUSIVE RIGHT TO USE "ICE CREAM" , APART FROM THE MARK AS SHOWN.

THE COLOR(S) PINK, GREEN, RED, BLUE, YELLOW, BLACK AND WHITE IS/ARE CLAIMED AS A FEATURE OF THE MARK.

THE MARK CONSISTS OF THE LETTER "L" IN THE WORD "LOW" IS IN THE COLOR PINK. THE LETTER "O" IN THE WORD "LOW" IS IN THE COLOR GREEN. THE LETTER "W" IN THE WORD "LOW" IS IN THE COLOR RED. THE LETTER "C" IN THE WORD "COW" IS IN THE COLOR BLUE. THE SECOND LETTER "O" IN THE WORD "COW" IS IN THE COLOR YELLOW AND THE LETTER "W" IN THE WORD "COW" IS IN THE COLOR RED. BETWEEN THE WORDS "LOW" AND "COW" IS A HEAD OF A BLACK AND WHITE COW. THE WORDS "THE NO GUILT ICE CREAM" IS IN THE COLOR BLACK AND APPEAR UNDER THE WORDS "LOW COW".

SN 77-210,609, FILED 6-20-2007.

DAVID TAYLOR, EXAMINING ATTORNEY



**Int. Cl.: 41**

**Prior U.S. Cls.: 100, 101, and 107**

**United States Patent and Trademark Office**

**Reg. No. 3,469,080**

**Registered July 15, 2008**

**SERVICE MARK  
PRINCIPAL REGISTER**

**POWER OF 10**

SONY PICTURES TELEVISION INC. (DELA-  
WARE CORPORATION)  
10202 W. WASHINGTON BLVD.  
CULVER CITY, CA 90232

THE MARK CONSISTS OF STANDARD CHAR-  
ACTERS WITHOUT CLAIM TO ANY PARTICULAR  
FONT, STYLE, SIZE, OR COLOR.

FOR: ENTERTAINMENT SERVICES IN THE  
NATURE OF A TELEVISION GAME SHOW, IN  
CLASS 41 (U.S. CLS. 100, 101 AND 107).

SN 77-210,798, FILED 6-20-2007.

FIRST USE 8-7-2007; IN COMMERCE 8-7-2007.

ARETHA SOMERVILLE, EXAMINING ATTORNEY

**Int. Cl.: 6**

**Prior U.S. Cls.: 2, 12, 13, 14, 23, 25, and 50**

**Reg. No. 3,469,081**

**United States Patent and Trademark Office**

**Registered July 15, 2008**

**TRADEMARK  
PRINCIPAL REGISTER**

**PLATANIUM**

WORLDWIDE JR WOOD DBA THE JOHN  
CHRISTIAN COMPANY (TEXAS LTD LIAB  
CO)

900

14101 W. HWY 290  
AUSTIN, TX 78737

FOR: NON-PRECIOUS METAL ALLOYS FOR  
FURTHER MANUFACTURING OF JEWELRY, IN  
CLASS 6 (U.S. CLS. 2, 12, 13, 14, 23, 25 AND 50).

FIRST USE 8-15-2007; IN COMMERCE 8-15-2007.

THE MARK CONSISTS OF STANDARD CHAR-  
ACTERS WITHOUT CLAIM TO ANY PARTICULAR  
FONT, STYLE, SIZE, OR COLOR.

SN 77-211,187, FILED 6-20-2007.

WILLIAM P. SHANAHAN, EXAMINING ATTOR-  
NEY

**Int. Cl.: 5**

**Prior U.S. Cls.: 6, 18, 44, 46, 51, and 52**

**Reg. No. 3,469,082**

**United States Patent and Trademark Office**

**Registered July 15, 2008**

---

**TRADEMARK  
PRINCIPAL REGISTER**

**NeuroWellness**

NEFF, ROBERT S (UNITED STATES INDIVIDUAL)  
2111 RHEIMS DR.  
CARROLLTON, TX 75006

THE MARK CONSISTS OF STANDARD CHARACTERS WITHOUT CLAIM TO ANY PARTICULAR FONT, STYLE, SIZE, OR COLOR.

FOR: AMINO ACIDS FOR NUTRITIONAL PURPOSES, IN CLASS 5 (U.S. CLS. 6, 18, 44, 46, 51 AND 52).

SN 77-212,688, FILED 6-21-2007.

FIRST USE 1-20-2006; IN COMMERCE 1-20-2006.

KELLY BOULTON, EXAMINING ATTORNEY

**Int. Cl.: 5**

**Prior U.S. Cls.: 6, 18, 44, 46, 51, and 52**

**Reg. No. 3,469,083**

**United States Patent and Trademark Office**

**Registered July 15, 2008**

---

**TRADEMARK  
PRINCIPAL REGISTER**

**AminoFoods**

NEFF, ROBERT S (UNITED STATES INDIVIDUAL)  
2111 RHEIMS DR.  
CARROLLTON, TX 75006

THE MARK CONSISTS OF STANDARD CHARACTERS WITHOUT CLAIM TO ANY PARTICULAR FONT, STYLE, SIZE, OR COLOR.

FOR: AMINO ACIDS FOR NUTRITIONAL PURPOSES, IN CLASS 5 (U.S. CLS. 6, 18, 44, 46, 51 AND 52).

SN 77-212,694, FILED 6-21-2007.

FIRST USE 8-12-2007; IN COMMERCE 1-15-2007.

KELLY BOULTON, EXAMINING ATTORNEY

**Int. Cl.: 9**

**Prior U.S. Cls.: 21, 23, 26, 36, and 38**

**Reg. No. 3,469,084**

**United States Patent and Trademark Office**

**Registered July 15, 2008**

---

**TRADEMARK  
PRINCIPAL REGISTER**

**INFOEXCHANGE**

BIO-KEY INTERNATIONAL, INC. (DELAWARE CORPORATION)  
300 NICKERSON ROAD  
MARLBOROUGH, MA 01752

FOR: COMPUTER SOFTWARE FOR RETRIEVING INFORMATION FROM A DATABASE FOR THE WIRELESS TRANSMISSION OF THAT DATA TO MOBILE COMPUTING DEVICES AND FOR THE SHARING OF THAT DATA BETWEEN MULTIPLE INSTANCES OF THE SOFTWARE PRODUCT, IN CLASS 9 (U.S. CLS. 21, 23, 26, 36 AND 38).

FIRST USE 7-13-2007; IN COMMERCE 7-13-2007.

THE MARK CONSISTS OF STANDARD CHARACTERS WITHOUT CLAIM TO ANY PARTICULAR FONT, STYLE, SIZE, OR COLOR.

SN 77-212,866, FILED 6-22-2007.

ALEXANDER L. POWERS, EXAMINING ATTORNEY

**Int. Cl.: 18**

**Prior U.S. Cls.: 1, 2, 3, 22, and 41**

**United States Patent and Trademark Office**

**Reg. No. 3,469,085**

**Registered July 15, 2008**

**TRADEMARK  
PRINCIPAL REGISTER**

**GROCERY POD**

CORPORATE GREETING CARDS, INC. (FLOR-  
IDA CORPORATION)  
6672 HUNTLEY LN N  
NAPLES, FL 34104

FOR: MESH SHOPPING BAGS; CARRY-ALL  
BAGS; TEXTILE SHOPPING BAGS; ALL-PURPOSE  
CARRYING BAGS, ALL ARE BEING USED FOR  
GROCERIES AND GOODS, NOT IN CONNECTION  
WITH PORTABLE AND HANDHELD ELECTRONIC  
DIGITAL SERVICES, IN CLASS 18 (U.S. CLS. 1, 2, 3,  
22 AND 41).

FIRST USE 5-1-2007; IN COMMERCE 5-1-2007.

THE MARK CONSISTS OF STANDARD CHAR-  
ACTERS WITHOUT CLAIM TO ANY PARTICULAR  
FONT, STYLE, SIZE, OR COLOR.

NO CLAIM IS MADE TO THE EXCLUSIVE  
RIGHT TO USE "GROCERY", APART FROM THE  
MARK AS SHOWN.

SN 77-212,971, FILED 6-22-2007.

RAUL CORDOVA, EXAMINING ATTORNEY

**Int. Cl.: 20**

**Prior U.S. Cls.: 2, 13, 22, 25, 32, and 50**

**Reg. No. 3,469,086**

**United States Patent and Trademark Office**

**Registered July 15, 2008**

**TRADEMARK  
PRINCIPAL REGISTER**

**EPIX**

CR CHROMCRAFT, INC. (DELAWARE COR-  
PORATION)  
NO. 1 QUALITY LANE  
SENATOBIA, MS 38668

THE MARK CONSISTS OF STANDARD CHAR-  
ACTERS WITHOUT CLAIM TO ANY PARTICULAR  
FONT, STYLE, SIZE, OR COLOR.

FOR: CHAIRS, IN CLASS 20 (U.S. CLS. 2, 13, 22, 25,  
32 AND 50).

SN 77-214,146, FILED 6-25-2007.

FIRST USE 3-1-2008; IN COMMERCE 3-1-2008.

MONIQUE MILLER, EXAMINING ATTORNEY

**Int. Cl.: 25**

**Prior U.S. Cls.: 22 and 39**

**United States Patent and Trademark Office**

**Reg. No. 3,469,087**

**Registered July 15, 2008**

**TRADEMARK  
PRINCIPAL REGISTER**

**YOU CAN'T FAKE THIS!**

MMA AUTHENTICS LLC (OHIO LTD LIAB CO)  
576 GEORGESVILLE ROAD  
COLUMBUS, OH 43228

THE MARK CONSISTS OF STANDARD CHAR-  
ACTERS WITHOUT CLAIM TO ANY PARTICULAR  
FONT, STYLE, SIZE, OR COLOR.

FOR: HEADWEAR; SHIRTS; SHORTS; JERSEYS;  
SWEAT SHIRTS; SWEAT SUITS; WARM UP SUITS;  
GLOVES, IN CLASS 25 (U.S. CLS. 22 AND 39).

SN 77-214,174, FILED 6-25-2007.

FIRST USE 10-1-2007; IN COMMERCE 10-1-2007.

BARBARA BROWN, EXAMINING ATTORNEY



**Int. Cl.: 20**

**Prior U.S. Cls.: 2, 13, 22, 25, 32, and 50**

**Reg. No. 3,469,088**

**United States Patent and Trademark Office**

**Registered July 15, 2008**

---

**TRADEMARK  
PRINCIPAL REGISTER**

**ZYN**

CR CHROMCRAFT, INC. (DELAWARE CORPORATION)  
NO. 1 QUALITY LANE  
SENATOBIA, MS 38668

THE MARK CONSISTS OF STANDARD CHARACTERS WITHOUT CLAIM TO ANY PARTICULAR FONT, STYLE, SIZE, OR COLOR.

FOR: CHAIRS, IN CLASS 20 (U.S. CLS. 2, 13, 22, 25, 32 AND 50).

SN 77-214,215, FILED 6-25-2007.

FIRST USE 3-1-2008; IN COMMERCE 3-1-2008.

MONIQUE MILLER, EXAMINING ATTORNEY

**Int. Cl.: 20**

**Prior U.S. Cls.: 2, 13, 22, 25, 32, and 50**

**Reg. No. 3,469,089**

**United States Patent and Trademark Office**

**Registered July 15, 2008**

---

**TRADEMARK  
PRINCIPAL REGISTER**

**MIE**

CR CHROMCRAFT, INC. (DELAWARE CORPORATION)  
NO. 1 QUALITY LANE  
SENATOBIA, MS 38668

THE MARK CONSISTS OF STANDARD CHARACTERS WITHOUT CLAIM TO ANY PARTICULAR FONT, STYLE, SIZE, OR COLOR.

FOR: CHAIRS, IN CLASS 20 (U.S. CLS. 2, 13, 22, 25, 32 AND 50).

SN 77-214,262, FILED 6-25-2007.

FIRST USE 3-1-2008; IN COMMERCE 3-1-2008.

MONIQUE MILLER, EXAMINING ATTORNEY

**Int. Cl.: 9**

**Prior U.S. Cls.: 21, 23, 26, 36, and 38**

**Reg. No. 3,469,090**

**United States Patent and Trademark Office**

**Registered July 15, 2008**

---

**TRADEMARK  
PRINCIPAL REGISTER**

**Bluewater Ampworks**

HARWATH, FRANK A. (UNITED STATES INDIVIDUAL)  
2420 CLOVERDALE RD.  
NAPERVILLE, IL 60564

THE MARK CONSISTS OF STANDARD CHARACTERS WITHOUT CLAIM TO ANY PARTICULAR FONT, STYLE, SIZE, OR COLOR.

FOR: SOUND AMPLIFIERS, IN CLASS 9 (U.S. CLS. 21, 23, 26, 36 AND 38).

SN 77-214,430, FILED 6-25-2007.

FIRST USE 3-9-2008; IN COMMERCE 3-9-2008.

HEATHER THOMPSON, EXAMINING ATTORNEY

**Int. Cl.: 28**

**Prior U.S. Cls.: 22, 23, 38, and 50**

**Reg. No. 3,469,091**

**United States Patent and Trademark Office**

**Registered July 15, 2008**

---

**TRADEMARK  
PRINCIPAL REGISTER**

**THE BOSS STOP**

TRIPLE R ARCHERY PRODUCTS (WISCONSIN  
LTD LIAB CO)  
413 WEST ALLERTON AVENUE  
MILWAUKEE, WI 53005

THE MARK CONSISTS OF STANDARD CHAR-  
ACTERS WITHOUT CLAIM TO ANY PARTICULAR  
FONT, STYLE, SIZE, OR COLOR.

FOR: ARCHERY TARGETS, IN CLASS 28 (U.S.  
CLS. 22, 23, 38 AND 50).

SN 77-215,278, FILED 6-26-2007.

FIRST USE 5-7-2008; IN COMMERCE 5-7-2008.

ARETHA SOMERVILLE, EXAMINING ATTORNEY

**Int. Cls.: 16, 25, and 41**

**Prior U.S. Cls.: 2, 5, 22, 23, 29, 37, 38, 39, 50, 100, 101,  
and 107**

**Reg. No. 3,469,092**

**United States Patent and Trademark Office**

**Registered July 15, 2008**

**TRADEMARK  
SERVICE MARK  
PRINCIPAL REGISTER**



SOLDIER'S MODELS LLC (NORTH CAROLINA  
LTD LIAB CO)  
204 HYDE PARK CT. #D  
CARY, NC 27513

THE COLOR(S) BLACK, WHITE, RED, BLUE  
AND OLIVE GREEN IS/ARE CLAIMED AS A FEAT-  
TURE OF THE MARK.

FOR: CALENDARS; GENERAL FEATURE MA-  
GAZINES; WALL CALENDARS; PRINTED CALEN-  
DARS, IN CLASS 16 (U.S. CLS. 2, 5, 22, 23, 29, 37, 38  
AND 50).

FIRST USE 12-15-2007; IN COMMERCE 12-15-2007.

FOR: SHORT-SLEEVED OR LONG-SLEEVED T-  
SHIRTS; T-SHIRTS, IN CLASS 25 (U.S. CLS. 22 AND  
39).

FIRST USE 12-15-2007; IN COMMERCE 12-15-2007.

FOR: MAGAZINE PUBLISHING; PUBLICATION  
OF MAGAZINES; PUBLICATION OF TEXTS,  
BOOKS, MAGAZINES AND OTHER PRINTED  
MATTER, IN CLASS 41 (U.S. CLS. 100, 101 AND 107).

FIRST USE 1-4-2008; IN COMMERCE 1-4-2008.

NO CLAIM IS MADE TO THE EXCLUSIVE  
RIGHT TO USE "SOLDIERS MODELS" , APART  
FROM THE MARK AS SHOWN.

THE MARK CONSISTS OF OUTSTRETCHED  
WINGS IN THE COLOR OLIVE GREEN WITH  
WHITE STRIPES AND OUTLINED IN THE COLOR  
BLACK. THE WINGS HAVE A SHIELD SUPER-  
IMPOSED THEREON IN THE CENTER. THE  
SHIELD RESEMBLES THE AMERICAN FLAG HAV-  
ING WHITE STARS ON A BLUE BACKGROUND AT  
THE TOP, AND WHITE AND RED STRIPES AT THE  
BOTTOM, ALL OUTLINED IN THE COLOR BLACK.  
A SILHOUETTE OF A MODEL IN THE COLOR  
BLACK IS SUPERIMPOSED UPON THE SHIELD.  
THE WORDS "SOLDIERS MODELS" APPEAR IN  
THE COLOR BLACK ON EITHER SIDE OF THE TOP  
OF THE OUTSTRETCHED WINGS.

SN 77-215,342, FILED 6-26-2007.

ZHALEH DELANEY, EXAMINING ATTORNEY

**Int. Cl.: 11**

**Prior U.S. Cls.: 13, 21, 23, 31, and 34**

**United States Patent and Trademark Office**

**Reg. No. 3,469,093**

**Registered July 15, 2008**

---

**TRADEMARK  
PRINCIPAL REGISTER**

**Just Press It!**

WINLITE, INC. (CALIFORNIA CORPORATION)  
19805 E. HARRISON AVE.  
CITY OF INDUSTRY, CA 91789

THE MARK CONSISTS OF STANDARD CHAR-  
ACTERS WITHOUT CLAIM TO ANY PARTICULAR  
FONT, STYLE, SIZE, OR COLOR.

FOR: LIGHTERS PRIMARILY FOR LIGHTING  
GRILLS, FIREPLACES AND CANDLES, IN CLASS  
11 (U.S. CLS. 13, 21, 23, 31 AND 34).

SN 77-216,132, FILED 6-26-2007.

FIRST USE 12-1-2007; IN COMMERCE 12-1-2007.

DANNAN HETZEL, EXAMINING ATTORNEY

**Int. Cl.: 9**

**Prior U.S. Cls.: 21, 23, 26, 36, and 38**

**United States Patent and Trademark Office**

**Reg. No. 3,469,094**

**Registered July 15, 2008**

**TRADEMARK  
PRINCIPAL REGISTER**

**CROSBY QC-PRO**

THE CROSBY GROUP, INC. (DELAWARE CORPORATION)  
POST OFFICE BOX 3128  
2801 DAWSON ROAD  
TULSA, OK 741013128

FOR: AN INTERNET-BASED RADIO FREQUENCY ID INSPECTION SYSTEM, NAMELY, SOFTWARE FOR IDENTIFYING, INSPECTING AND PROVIDING TRAINING INFORMATION REGARDING MATERIAL LIFTING PRODUCTS, IN CLASS 9 (U.S. CLS. 21, 23, 26, 36 AND 38).

FIRST USE 6-17-2007; IN COMMERCE 6-17-2007.

THE MARK CONSISTS OF STANDARD CHARACTERS WITHOUT CLAIM TO ANY PARTICULAR FONT, STYLE, SIZE, OR COLOR.

OWNER OF U.S. REG. NOS. 1,100,565, 1,709,700, AND OTHERS.

SN 77-216,907, FILED 6-27-2007.

DEZMONA MIZELLE, EXAMINING ATTORNEY

**Int. Cl.: 16**

**Prior U.S. Cls.: 2, 5, 22, 23, 29, 37, 38, and 50**

**Reg. No. 3,469,095**

**United States Patent and Trademark Office**

**Registered July 15, 2008**

---

**TRADEMARK  
PRINCIPAL REGISTER**

**VENTURE**

MEDIA SOLUTIONS, INC. (ALABAMA CORPORATION)  
126 WINSOR LANE  
PELHAM, AL 35124

THE MARK CONSISTS OF STANDARD CHARACTERS WITHOUT CLAIM TO ANY PARTICULAR FONT, STYLE, SIZE, OR COLOR.

FOR: MAGAZINES FEATURING ACCESSIBLE TRAVEL FOR ELDERLY AND IMPAIRED, IN CLASS 16 (U.S. CLS. 2, 5, 22, 23, 29, 37, 38 AND 50).

SN 77-217,082, FILED 6-27-2007.

FIRST USE 10-31-2007; IN COMMERCE 3-21-2008.

JESSICA A. POWERS, EXAMINING ATTORNEY



**Int. Cl.: 6**

**Prior U.S. Cls.: 2, 12, 13, 14, 23, 25, and 50**

**Reg. No. 3,469,096**

**United States Patent and Trademark Office**

**Registered July 15, 2008**

---

**TRADEMARK  
PRINCIPAL REGISTER**

**PEONY PAL**

ROSAEN PRODUCTS, LLC (MICHIGAN LTD  
LIAB CO)  
P. O. BOX 249  
1755 E. NINE MILE ROAD  
HAZEL PARK, MI 48030

FOR: METAL SUPPORT FRAMES FOR PLANTS,  
IN CLASS 6 (U.S. CLS. 2, 12, 13, 14, 23, 25 AND 50).

FIRST USE 2-28-2008; IN COMMERCE 2-28-2008.

THE MARK CONSISTS OF STANDARD CHAR-  
ACTERS WITHOUT CLAIM TO ANY PARTICULAR  
FONT, STYLE, SIZE, OR COLOR.

NO CLAIM IS MADE TO THE EXCLUSIVE  
RIGHT TO USE "PEONY", APART FROM THE  
MARK AS SHOWN.

SN 77-218,064, FILED 6-28-2007.

SIMON TENG, EXAMINING ATTORNEY

**Int. Cl.: 28**

**Prior U.S. Cls.: 22, 23, 38, and 50**

**Reg. No. 3,469,097**

**United States Patent and Trademark Office**

**Registered July 15, 2008**

---

**TRADEMARK  
PRINCIPAL REGISTER**

**PASSION FOR PAINTBALL**

KINGMAN INTERNATIONAL CORPORATION  
(CALIFORNIA CORPORATION)  
14010 LIVE OAK AVENUE  
BALDWIN PARK, CA 91706

FOR: PAINTBALL GUNS AND ACCESSORIES  
THEREFOR IN THE NATURE OF BARRELS, GRIP  
FRAMES, FRAME COVERS, GRIPS, EXPANSION  
CHAMBERS, SIGHT RAILS, TRIGGER ASSEM-  
BLIES AND BARREL PLUGS, IN CLASS 28 (U.S.  
CLS. 22, 23, 38 AND 50).

FIRST USE 5-15-2008; IN COMMERCE 5-15-2008.

THE MARK CONSISTS OF STANDARD CHAR-  
ACTERS WITHOUT CLAIM TO ANY PARTICULAR  
FONT, STYLE, SIZE, OR COLOR.

NO CLAIM IS MADE TO THE EXCLUSIVE  
RIGHT TO USE "PAINTBALL", APART FROM  
THE MARK AS SHOWN.

SN 77-218,640, FILED 6-29-2007.

TANYA AMOS, EXAMINING ATTORNEY

**Int. Cls.: 6, 17, and 20**

**Prior U.S. Cls.: 1, 2, 5, 12, 13, 14, 22, 23, 25, 32, 35, and 50**

**Reg. No. 3,469,098**

**United States Patent and Trademark Office**

**Registered July 15, 2008**

**TRADEMARK  
PRINCIPAL REGISTER**

# Magic Sliders

MAGIC SLIDERS JOINT VENTURE (CANADA PARTNERSHIP)  
1156 ROUTE 133  
IBERVILLE, CANADA J2X4J5

FOR: DOOR STOPS OF METAL; FELT PADS, COASTERS, GRIPPERS, BUMPERS, AND LEG TIPS, MADE PREDOMINATELY OF METAL, FOR PLACEMENT BETWEEN FURNITURE AND FLOORS, AND FOR PLACEMENT BETWEEN HARD SURFACES AND DELICATE SURFACES WITH WHICH THEY WOULD OTHERWISE COME INTO DIRECT CONTACT, IN ORDER TO REDUCE OR PREVENT SCRATCHING AND SCUFFING, AND IN ORDER TO REDUCE OR PREVENT SKIDDING AND NOISE; AND COASTERS AND CASTER CUPS, MADE PREDOMINATELY OF METAL, FOR PLACEMENT BETWEEN FURNITURE AND HARD AND CARPETED FLOORS WITH WHICH THEY WOULD OTHERWISE COME INTO DIRECT CONTACT, IN ORDER TO PREVENT DAMAGE TO FURNITURE, FLOORS, AND CARPET, AND IN ORDER TO REDUCE OR PREVENT SKIDDING AND NOISE, IN CLASS 6 (U.S. CLS. 2, 12, 13, 14, 23, 25 AND 50).

FIRST USE 12-31-2007; IN COMMERCE 12-31-2007.

FOR: DOOR STOPS OF RUBBER, IN CLASS 17 (U.S. CLS. 1, 5, 12, 13, 35 AND 50).

FIRST USE 2-28-2006; IN COMMERCE 2-28-2006.

FOR: DOOR STOPS OF PLASTIC; DOOR STOPS OF WOOD; FURNITURE CASTERS, MADE PREDOMINATELY OF MATERIALS OTHER THAN METAL, FOR HOUSEHOLD, COMMERCIAL AND INDUSTRIAL USE; FELT PADS, COASTERS, GRIP-

PERS, BUMPERS, AND LEG TIPS, MADE PREDOMINATELY OF MATERIALS OTHER THAN METAL, FOR PLACEMENT BETWEEN FURNITURE AND FLOORS, AND FOR PLACEMENT BETWEEN HARD SURFACES AND DELICATE SURFACES WITH WHICH THEY WOULD OTHERWISE COME INTO DIRECT CONTACT, IN ORDER TO REDUCE OR PREVENT SCRATCHING AND SCUFFING, AND IN ORDER TO REDUCE OR PREVENT SKIDDING AND NOISE; AND COASTERS AND CASTER CUPS, MADE PREDOMINATELY OF MATERIALS OTHER THAN METAL, FOR PLACEMENT BETWEEN FURNITURE AND HARD AND CARPETED FLOORS WITH WHICH THEY WOULD OTHERWISE COME INTO DIRECT CONTACT, IN ORDER TO PREVENT DAMAGE TO FURNITURE, FLOORS, AND CARPET, AND IN ORDER TO REDUCE OR PREVENT SKIDDING AND NOISE, IN CLASS 20 (U.S. CLS. 2, 13, 22, 25, 32 AND 50).

FIRST USE 12-31-2005; IN COMMERCE 12-31-2005.

THE MARK CONSISTS OF STANDARD CHARACTERS WITHOUT CLAIM TO ANY PARTICULAR FONT, STYLE, SIZE, OR COLOR.

OWNER OF U.S. REG. NO. 1,899,871.

NO CLAIM IS MADE TO THE EXCLUSIVE RIGHT TO USE "SLIDERS", APART FROM THE MARK AS SHOWN.

SN 77-218,766, FILED 6-29-2007 .

RONALD AIKENS, EXAMINING ATTORNEY

**Int. Cl.: 41**

**Prior U.S. Cls.: 100, 101, and 107**

**United States Patent and Trademark Office**

**Reg. No. 3,469,099**

**Registered July 15, 2008**

**SERVICE MARK  
PRINCIPAL REGISTER**

**WINESPEAK**

WINESPEAK, LLC (WISCONSIN LTD LIAB CO)  
2237 N. LEFEEBER AVE.  
MILWAUKEE, WI 53213

FOR: EDUCATION SERVICES, NAMELY, PROVIDING LIVE AND ON-LINE SEMINARS IN THE FIELD OF WINE AND WINE RELATED GOODS, INCLUDING SERVING PRODUCTS AND GLASSWARE, IN CLASS 41 (U.S. CLS. 100, 101 AND 107).

FIRST USE 11-17-2007; IN COMMERCE 11-17-2007.

THE MARK CONSISTS OF STANDARD CHARACTERS WITHOUT CLAIM TO ANY PARTICULAR FONT, STYLE, SIZE, OR COLOR.

SN 77-219,269, FILED 6-29-2007.

ANGELA M. MICHELI, EXAMINING ATTORNEY

**Int. Cl.: 44**

**Prior U.S. Cls.: 100 and 101**

**United States Patent and Trademark Office**

**Reg. No. 3,469,100**

**Registered July 15, 2008**

**SERVICE MARK  
PRINCIPAL REGISTER**

# Grave Concerns

BALLINGER, K.C. (UNITED STATES INDIVIDUAL)  
7001 S CUNNINGHAM  
GYPSUM, KS 67448

FOR: CEMETERY PLOT BEAUTIFICATION AND MAINTENANCE AND CONTINUAL UPKEEP OF FAMILY CEMETERY PLOTS, IN CLASS 44 (U.S. CLS. 100 AND 101).

FIRST USE 7-5-2007; IN COMMERCE 5-13-2008.

THE MARK CONSISTS OF STANDARD CHARACTERS WITHOUT CLAIM TO ANY PARTICULAR FONT, STYLE, SIZE, OR COLOR.

NO CLAIM IS MADE TO THE EXCLUSIVE RIGHT TO USE "GRAVE", APART FROM THE MARK AS SHOWN.

SN 77-219,765, FILED 6-30-2007.

NAAKWAMA ANKRAH, EXAMINING ATTORNEY

**Int. Cl.: 11**

**Prior U.S. Cls.: 13, 21, 23, 31, and 34**

**Reg. No. 3,469,101**

**United States Patent and Trademark Office**

**Registered July 15, 2008**

---

**TRADEMARK  
PRINCIPAL REGISTER**

**LEONA**

CRAFTMADE INTERNATIONAL (DELAWARE  
CORPORATION)  
650 S. ROYAL LANE  
COPPELL, TX 75039

THE MARK CONSISTS OF STANDARD CHAR-  
ACTERS WITHOUT CLAIM TO ANY PARTICULAR  
FONT, STYLE, SIZE, OR COLOR.

FOR: CEILING FANS, IN CLASS 11 (U.S. CLS. 13,  
21, 23, 31 AND 34).

SN 77-220,306, FILED 7-2-2007.

FIRST USE 6-1-2007; IN COMMERCE 10-1-2007.

FRANK LATTUCA, EXAMINING ATTORNEY

**Int. Cl.: 9**

**Prior U.S. Cls.: 21, 23, 26, 36, and 38**

**United States Patent and Trademark Office**

**Reg. No. 3,469,102**

**Registered July 15, 2008**

**TRADEMARK  
PRINCIPAL REGISTER**

# The 80's Game

INTELLINITIATIVE, INC. (DELAWARE CORPORATION)  
100 I STREET  
BOSTON, MA 02127

OWNER OF U.S. REG. NOS. 2,699,386 AND 2,867,416.

FOR: COMPUTER GAME SOFTWARE IN THE NATURE OF A PARLOR GAME, IN WHICH THE PLAYER ANSWERS TRIVIA QUESTIONS; DOWNLOADABLE COMPUTER GAME SOFTWARE IN THE NATURE OF A PARLOR GAME, IN WHICH THE PLAYER ANSWERS TRIVIA QUESTIONS, IN CLASS 9 (U.S. CLS. 21, 23, 26, 36 AND 38).

NO CLAIM IS MADE TO THE EXCLUSIVE RIGHT TO USE "GAME", APART FROM THE MARK AS SHOWN.

SEC. 2(F).

FIRST USE 1-1-2007; IN COMMERCE 9-1-2007.

SN 77-220,340, FILED 7-2-2007.

THE MARK CONSISTS OF STANDARD CHARACTERS WITHOUT CLAIM TO ANY PARTICULAR FONT, STYLE, SIZE, OR COLOR.

KAELIE KUNG, EXAMINING ATTORNEY

**Int. Cl.: 16**

**Prior U.S. Cls.: 2, 5, 22, 23, 29, 37, 38, and 50**

**Reg. No. 3,469,103**

**United States Patent and Trademark Office**

**Registered July 15, 2008**

---

**TRADEMARK  
PRINCIPAL REGISTER**

# Thin Threads

KIWI PUBLISHING, INC. (CONNECTICUT CORPORATION)  
20 MANVILLE ROAD  
WOODBIDGE, CT 06525

THE MARK CONSISTS OF STANDARD CHARACTERS WITHOUT CLAIM TO ANY PARTICULAR FONT, STYLE, SIZE, OR COLOR.

FOR: SERIES OF NON-FICTION BOOKS IN THE FIELD OF SHORT STORIES OF PERSONAL EXPERIENCES, IN CLASS 16 (U.S. CLS. 2, 5, 22, 23, 29, 37, 38 AND 50).

SN 77-221,993, FILED 7-3-2007.

FIRST USE 3-14-2008; IN COMMERCE 3-14-2008.

RENEE MCCRAY, EXAMINING ATTORNEY



**Int. Cl.: 5**

**Prior U.S. Cls.: 6, 18, 44, 46, 51, and 52**

**United States Patent and Trademark Office**

**Reg. No. 3,469,104**

**Registered July 15, 2008**

**TRADEMARK  
PRINCIPAL REGISTER**

**KYTOSTAT**

HEMCON MEDICAL TECHNOLOGIES, INC.  
(OREGON CORPORATION)  
SUITE 130  
10575 S.W. CASCADE AVENUE  
TIGARD, OR 97223

THE MARK CONSISTS OF STANDARD CHAR-  
ACTERS WITHOUT CLAIM TO ANY PARTICULAR  
FONT, STYLE, SIZE, OR COLOR.

FOR: BANDAGES FOR SKIN WOUNDS, IN  
CLASS 5 (U.S. CLS. 6, 18, 44, 46, 51 AND 52).

SN 77-222,856, FILED 7-5-2007.

FIRST USE 2-5-2008; IN COMMERCE 3-1-2008.

TASHIA BUNCH, EXAMINING ATTORNEY

**Int. Cl.: 38**

**Prior U.S. Cls.: 100, 101, and 104**

**United States Patent and Trademark Office**

**Reg. No. 3,469,105**

**Registered July 15, 2008**

**SERVICE MARK  
PRINCIPAL REGISTER**

**ABE'S DISCOUNT PHONE  
SERVICE**

BRYDELS JR., JOHN (UNITED STATES INDIVIDUAL)  
549 KENILWORTH PARKWAY  
BATON ROUGE, LA 70808

FOR: LOCAL AND LONG DISTANCE TELEPHONE SERVICES, PREPAID LOCAL AND LONG DISTANCE TELEPHONE SERVICES, IN CLASS 38 (U.S. CLS. 100, 101 AND 104).

FIRST USE 1-1-2008; IN COMMERCE 1-1-2008.

THE MARK CONSISTS OF STANDARD CHARACTERS WITHOUT CLAIM TO ANY PARTICULAR FONT, STYLE, SIZE, OR COLOR.

NO CLAIM IS MADE TO THE EXCLUSIVE RIGHT TO USE "DISCOUNT PHONE SERVICE", APART FROM THE MARK AS SHOWN.

THE NAME "ABE" IN THE MARK DOES NOT IDENTIFY A LIVING INDIVIDUAL.

SN 77-223,410, FILED 7-6-2007.

EMILY CHUO, EXAMINING ATTORNEY

Int. Cl.: 35

Prior U.S. Cls.: 100, 101, and 102

United States Patent and Trademark Office

Reg. No. 3,469,106

Registered July 15, 2008

**SERVICE MARK  
PRINCIPAL REGISTER**

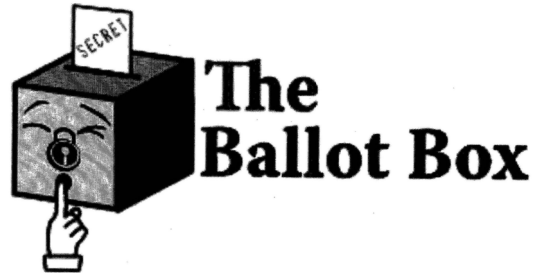

MBS REAL ESTATE SERVICES, LLC (NEVADA  
LTD LIAB CO)  
5007 SOUTH TAMARUS STREET, SUITE C  
LAS VEGAS, NV 89119

FOR: ELECTION AND VOTING SERVICES,  
NAMELY, PROVIDING ELECTION ADMINISTRA-  
TION FOR HOMEOWNER ASSOCIATION BOARD  
OF DIRECTORS ELECTIONS, BALLOT PREPARA-  
TION AND TABULATION SERVICES, PROVIDING  
INFORMATION IN THE FIELD OF ELECTIONS  
AND ELECTION RESULTS, AND PROVIDING A  
WEBSITE FEATURING INFORMATION ABOUT  
COMMUNITY-SPECIFIC ELECTIONS, IN CLASS 35  
(U.S. CLS. 100, 101 AND 102).

FIRST USE 8-8-2007; IN COMMERCE 8-8-2007.

NO CLAIM IS MADE TO THE EXCLUSIVE  
RIGHT TO USE "SECRET" AND "THE BALLOT  
BOX", APART FROM THE MARK AS SHOWN.

THE MARK CONSISTS OF A HUMAN HAND  
TOUCHING A BOX, WHICH FEATURES A STY-  
LIZED FACE, PADLOCK, AND SLOT WITH BAL-  
LOT.

SN 77-225,130, FILED 7-9-2007.

AISHA SALEM, EXAMINING ATTORNEY

Int. Cl.: 18

Prior U.S. Cls.: 1, 2, 3, 22, and 41

Reg. No. 3,469,107

United States Patent and Trademark Office

Registered July 15, 2008

TRADEMARK  
PRINCIPAL REGISTER



PROFFIT, JAE LIN (UNITED STATES INDIVIDUAL)  
7718 PAGERWOOD LANE  
HOUSTON, TX 77063

FOR: CARRYING CASES, NAMELY, HANDBAGS, PURSES, CLUTCHES, SHOULDER BAGS, TOTE BAGS, DIAPER BAGS, BACKPACKS, BRIEFCASE TYPE PORTFOLIOS, ATTACHÉ CASES, CARRY-ON BAGS, TEXTILE, LEATHER AND MESH SHOPPING BAGS, AND BRIEFCASES; ORGANIZERS FOR CARRYING CASES, NAMELY, HANDBAGS, PURSES, CLUTCHES, SHOULDER BAGS, TOTE BAGS, DIAPER BAGS, BACKPACKS, BRIEFCASE TYPE PORTFOLIOS, ATTACHÉ CASES, CARRY-ON BAGS, TEXTILE, LEATHER AND MESH SHOPPING BAGS, AND BRIEFCASES; MODULAR ORGANIZERS FOR STORAGE AND REPOSITIONABLE PLACEMENT OF A PLURALITY OF PERSONAL OR BUSINESS ITEMS WITHIN CARRYING CASES, NAMELY, HANDBAGS, PURSES, CLUTCHES, SHOULDER BAGS, TOTE BAGS, DIAPER BAGS, BACKPACKS, BRIEFCASE TYPE PORTFOLIOS, ATTACHÉ CASES, CARRY-ON BAGS, TEXTILE, LEATHER AND MESH SHOPPING BAGS, AND BRIEF CASES; ORGANIZERS COMPRISING FABRIC OR PLASTIC POCKETS AND SUPPORTING PANELS FOR CARRYING CASES, NAMELY,

HANDBAGS, PURSES, CLUTCHES, SHOULDER BAGS, TOTE BAGS, DIAPER BAGS, BACKPACKS, BRIEFCASE TYPE PORTFOLIOS, ATTACHÉ CASES, CARRY-ON BAGS, TEXTILE, LEATHER AND MESH SHOPPING BAGS, AND BRIEFCASES; MODULAR ORGANIZER THAT IS CAPABLE OF BEING USED AS A SEPARATE BRIEFCASE TYPE PORTFOLIO, PURSE OR CLUTCH FOR STORAGE AND REPOSITIONABLE PLACEMENT OF A PLURALITY OF PERSONAL OR BUSINESS ITEMS WITHIN CARRYING CASES, NAMELY, HANDBAGS, PURSES, CLUTCHES, SHOULDER BAGS, TOTE BAGS, DIAPER BAGS, BACKPACKS, BRIEFCASE TYPE PORTFOLIOS, ATTACHÉ CASES, CARRY-ON BAGS, TEXTILE, LEATHER OR MESH SHOPPING BAGS AND BRIEFCASES, IN CLASS 18 (U.S. CLS. 1, 2, 3, 22 AND 41).

FIRST USE 11-26-2007; IN COMMERCE 11-27-2007.

THE MARK CONSISTS OF THE LINE-DRAWN FIRST NAME SIGNATURE OF THE OWNER: "JAE LIN."

SN 77-226,168, FILED 7-10-2007.

MYRIAH HABEEB, EXAMINING ATTORNEY

**Int. Cl.: 3**

**Prior U.S. Cls.: 1, 4, 6, 50, 51, and 52**

**United States Patent and Trademark Office**

**Reg. No. 3,469,108**

**Registered July 15, 2008**

**TRADEMARK  
PRINCIPAL REGISTER**

**CULITO DE RANA**

BONILLA, MARK R. (UNITED STATES INDIVIDUAL)  
122 MACDOUGAL STREET #20  
NEW YORK, NY 10012

FOR: PETROLEUM JELLY FOR COSMETIC PURPOSES; BODY CREAM; SKIN CREAMS, IN CLASS 3 (U.S. CLS. 1, 4, 6, 50, 51 AND 52).

FIRST USE 4-8-2008; IN COMMERCE 4-8-2008.

THE MARK CONSISTS OF STANDARD CHARACTERS WITHOUT CLAIM TO ANY PARTICULAR FONT, STYLE, SIZE, OR COLOR.

THE FOREIGN WORDING IN THE MARK TRANSLATES INTO ENGLISH AS BUTT OF THE FROG.

SN 77-226,746, FILED 7-11-2007.

KIMBERLY PERRY, EXAMINING ATTORNEY

**Int. Cl.: 35**

**Prior U.S. Cls.: 100, 101, and 102**

**United States Patent and Trademark Office**

**Reg. No. 3,469,109**

**Registered July 15, 2008**

**SERVICE MARK  
PRINCIPAL REGISTER**

# Totally Halloween

DOLLAR TREE STORES, INC. (VIRGINIA CORPORATION)  
500 VOLVO PARKWAY  
CHESAPEAKE, VA 23320

FOR: RETAIL STORE SERVICES FEATURING HALLOWEEN RELATED GOODS, IN CLASS 35 (U.S. CLS. 100, 101 AND 102).

FIRST USE 5-7-2007; IN COMMERCE 8-25-2007.

THE MARK CONSISTS OF STANDARD CHARACTERS WITHOUT CLAIM TO ANY PARTICULAR FONT, STYLE, SIZE, OR COLOR.

NO CLAIM IS MADE TO THE EXCLUSIVE RIGHT TO USE "HALLOWEEN", APART FROM THE MARK AS SHOWN.

SN 77-227,051, FILED 7-11-2007.

DOMINIC FATHY, EXAMINING ATTORNEY

Int. Cl.: 40

Prior U.S. Cls.: 100, 103, and 106

United States Patent and Trademark Office

Reg. No. 3,469,110

Registered July 15, 2008

SERVICE MARK  
PRINCIPAL REGISTER



EAGLESOME GRAPHICS, INC. (NEW YORK CORPORATION)  
20 WEST THIRD STREET  
JAMESTOWN, NY 14701

FOR: BINDERY SERVICES FOR OTHERS, NAME-  
LY, COLLATING, FOLDING, STAPLING, PERFOR-  
ATING, CUTTING AND BINDING OF PRINTED,  
PHOTOCOPIED AND TYPEWRITTEN MATERIALS;  
CUSTOMIZED PRINTING OF COMPANY NAMES  
AND LOGOS FOR PROMOTIONAL AND ADVER-  
TISING PURPOSES ON THE GOODS OF OTHERS;  
DESIGN PRINTING FOR OTHERS; DIGITAL ON-  
DEMAND PRINTING SERVICES OF BOOKS AND  
OTHER DOCUMENTS; LITHOGRAPHIC PRINT-  
ING; OFFSET PRINTING; PHOTOGRAPHIC PRINT-  
ING; PHOTOGRAPHIC SLIDE AND/OR PRINT  
PROCESSING; PHOTOGRAVURE PRINTING; POR-  
TRAIT PRINTING; PRINTING; PRINTING OF AD-  
VERTISING MATTER; PRINTING OF BOOKS;  
PRINTING OF PATTERNS ON TEXTILES; PRINT-  
ING OF STAMPS; STATIONERY PRINTING SERVI-  
CES; THERMOGRAPHIC PRINTING SERVICES, IN  
CLASS 40 (U.S. CLS. 100, 103 AND 106).

FIRST USE 10-15-2007; IN COMMERCE 10-15-2007.

NO CLAIM IS MADE TO THE EXCLUSIVE  
RIGHT TO USE "SOLUTIONS", APART FROM  
THE MARK AS SHOWN.

THE COLOR(S) RED AND BLUE IS/ARE  
CLAIMED AS A FEATURE OF THE MARK.

THE COLOR BLUE APPEARS IN THE 3-DIMEN-  
SIONAL "K" DESIGN AND THE LITERAL POR-  
TION "KWIK" AND "EVERYTHING IN PRINT!";  
AND THE COLOR RED APPEARS IN THE STY-  
LIZED "S" SHAPE WRAPPED AROUND THE "K"  
DESIGN, THE DOT OVER THE "K", THE RECTAN-  
GLE SHAPE AT THE TOP ARC OF THE "K" AND IN  
THE LITERAL PORTION "SOLUTIONS".

SN 77-227,213, FILED 7-11-2007.

BENJAMIN OKEKE, EXAMINING ATTORNEY

**Int. Cl.: 10**

**Prior U.S. Cls.: 26, 39, and 44**

**United States Patent and Trademark Office**

**Reg. No. 3,469,111**

**Registered July 15, 2008**

**TRADEMARK  
PRINCIPAL REGISTER**

**William House Cochlear  
Implant**

ENVOY MEDICAL CORPORATION (MINNESOTA CORPORATION)  
5000 TOWNSHIP PARKWAY  
SAINT PAUL, MN 55110

FOR: MEDICAL DEVICES, NAMELY, COCHLEAR IMPLANTS COMPOSED OF ARTIFICIAL MATERIALS, IN CLASS 10 (U.S. CLS. 26, 39 AND 44).

FIRST USE 11-0-2006; IN COMMERCE 11-0-2006.

THE MARK CONSISTS OF STANDARD CHARACTERS WITHOUT CLAIM TO ANY PARTICULAR FONT, STYLE, SIZE, OR COLOR.

NO CLAIM IS MADE TO THE EXCLUSIVE RIGHT TO USE "COCHLEAR IMPLANT", APART FROM THE MARK AS SHOWN.

"THE NAME(S), PORTRAIT(S), AND/OR SIGNATURE(S) SHOWN IN THE MARK IDENTIFIES WILLIAM HOUSE, WHOSE CONSENT(S) TO REGISTER IS SUBMITTED."

SN 77-227,781, FILED 7-12-2007.

CAROLINE WOOD, EXAMINING ATTORNEY



**Int. Cl.: 45**

**Prior U.S. Cls.: 100 and 101**

**United States Patent and Trademark Office**

**Reg. No. 3,469,112**

**Registered July 15, 2008**

**SERVICE MARK  
PRINCIPAL REGISTER**

**Ace ImageWear**

HEILMAN HOLDING COMPANY (MISSOURI  
CORPORATION)

4120 TRUMAN ROAD

KANSAS CITY, MO 64127

FOR: RENTAL OF UNIFORMS, IN CLASS 45 (U.S.  
CLS. 100 AND 101).

FIRST USE 11-1-2007; IN COMMERCE 11-1-2007.

THE MARK CONSISTS OF STANDARD CHAR-  
ACTERS WITHOUT CLAIM TO ANY PARTICULAR  
FONT, STYLE, SIZE, OR COLOR.

NO CLAIM IS MADE TO THE EXCLUSIVE  
RIGHT TO USE "IMAGEWEAR", APART FROM  
THE MARK AS SHOWN.

SN 77-229,364, FILED 7-13-2007.

FRANK LATTUCA, EXAMINING ATTORNEY

**Int. Cl.: 37**

**Prior U.S. Cls.: 100, 103, and 106**

**United States Patent and Trademark Office**

**Reg. No. 3,469,113**

**Registered July 15, 2008**

**SERVICE MARK  
PRINCIPAL REGISTER**

# Team Blue

FASTSHOEZ FRANCHISE SYSTEMS, LLC  
(PENNSYLVANIA LTD LIAB CO)  
159 WEAVER ROAD  
SPRING MILLS, PA 16875

FOR: AUTOMOBILE CLEANING AND CAR  
WASHING; CAR WASHING, IN CLASS 37 (U.S.  
CLS. 100, 103 AND 106).

FIRST USE 5-16-2008; IN COMMERCE 5-16-2008.

THE MARK CONSISTS OF STANDARD CHAR-  
ACTERS WITHOUT CLAIM TO ANY PARTICULAR  
FONT, STYLE, SIZE, OR COLOR.

NO CLAIM IS MADE TO THE EXCLUSIVE  
RIGHT TO USE "TEAM", APART FROM THE  
MARK AS SHOWN.

SN 77-231,063, FILED 7-17-2007.

REBECCA EISINGER, EXAMINING ATTORNEY

**Int. Cl.: 16**

**Prior U.S. Cls.: 2, 5, 22, 23, 29, 37, 38, and 50**

**Reg. No. 3,469,114**

**United States Patent and Trademark Office**

**Registered July 15, 2008**

**TRADEMARK  
PRINCIPAL REGISTER**

**OPEN AIR MAGAZINE**

MEDIA WEST - GSI, INC. (DELAWARE CORPORATION)  
SUITE 802  
50 W. LIBERTY STREET  
RENO, NV 20036

FOR: GENERAL INTEREST MAGAZINE FEATURING ARTICLES AND INFORMATION ON OUTDOOR SPORTS, TRAVEL AND RECREATION, IN CLASS 16 (U.S. CLS. 2, 5, 22, 23, 29, 37, 38 AND 50).

FIRST USE 3-7-2008; IN COMMERCE 3-7-2008.

THE MARK CONSISTS OF STANDARD CHARACTERS WITHOUT CLAIM TO ANY PARTICULAR FONT, STYLE, SIZE, OR COLOR.

NO CLAIM IS MADE TO THE EXCLUSIVE RIGHT TO USE "MAGAZINE", APART FROM THE MARK AS SHOWN.

SN 77-231,163, FILED 7-17-2007.

MATTHEW EINSTEIN, EXAMINING ATTORNEY

**Int. Cl.: 9**

**Prior U.S. Cls.: 21, 23, 26, 36, and 38**

**Reg. No. 3,469,115**

**United States Patent and Trademark Office**

**Registered July 15, 2008**

**TRADEMARK  
PRINCIPAL REGISTER**

**BIBID AHL**

ELECTRIC VISUAL EVOLUTION, LLC (CALI-  
FORNIA LTD LIAB CO)  
1062 CALLE NEGOCIO, UNIT H  
SAN CLEMENTE, CA 92673

THE MARK CONSISTS OF STANDARD CHAR-  
ACTERS WITHOUT CLAIM TO ANY PARTICULAR  
FONT, STYLE, SIZE, OR COLOR.

FOR: SUNGLASSES AND CASES FOR SUNGLAS-  
SES, IN CLASS 9 (U.S. CLS. 21, 23, 26, 36 AND 38).

SN 77-232,692, FILED 7-18-2007.

FIRST USE 2-25-2008; IN COMMERCE 2-25-2008.

KELLY MCCOY, EXAMINING ATTORNEY

**Int. Cls.: 12 and 25**

**Prior U.S. Cls.: 19, 21, 22, 23, 31, 35, 39, and 44**

**United States Patent and Trademark Office**

**Reg. No. 3,469,116**

**Registered July 15, 2008**

**TRADEMARK  
PRINCIPAL REGISTER**

# TROPHYLITE

SCARONI, MATTHEW STEPHEN (UNITED STATES INDIVIDUAL)  
101 E. MAIN STREET  
HEBER, CA 92249 AND  
SCARONI, DAVID WATSON (UNITED STATES INDIVIDUAL)  
101 E. MAIN STREET  
HEBER, CA 92249

FOR: OFF-ROAD RACING LAND VEHICLE, IN CLASS 12 (U.S. CLS. 19, 21, 23, 31, 35 AND 44).

FIRST USE 8-0-2007; IN COMMERCE 8-0-2007.

FOR: CLOTHING, NAMELY, T-SHIRTS, POLO SHIRTS, DRESS SHIRTS, SWEATERS, BANDANAS,

JACKETS, WIND RESISTANT JACKETS, GLOVES, BEANIES, BASEBALL CAPS, VISORS, ATHLETIC SHOES, ATHLETIC SOCKS, SWEAT BANDS, IN CLASS 25 (U.S. CLS. 22 AND 39).

FIRST USE 11-0-2007; IN COMMERCE 11-0-2007.

THE MARK CONSISTS OF STANDARD CHARACTERS WITHOUT CLAIM TO ANY PARTICULAR FONT, STYLE, SIZE, OR COLOR.

SN 77-233,052, FILED 7-18-2007.

JOHN GARTNER, EXAMINING ATTORNEY

**Int. Cl.: 16**

**Prior U.S. Cls.: 2, 5, 22, 23, 29, 37, 38, and 50**

**Reg. No. 3,469,117**

**United States Patent and Trademark Office**

**Registered July 15, 2008**

---

**TRADEMARK  
PRINCIPAL REGISTER**

**SHADOW HUNTER**

VIRGIN COMICS, LLC (DELAWARE LTD LIAB  
CO)  
SUITE 407  
594 BROADWAY  
NEW YORK, NY 10012

THE MARK CONSISTS OF STANDARD CHAR-  
ACTERS WITHOUT CLAIM TO ANY PARTICULAR  
FONT, STYLE, SIZE, OR COLOR.

FOR: PRINTED MATTER, NAMELY, BOOKS,  
COMIC BOOKS AND GRAPHIC NOVELS; POSTERS,  
IN CLASS 16 (U.S. CLS. 2, 5, 22, 23, 29, 37, 38 AND 50).

SN 77-233,058, FILED 7-18-2007.

FIRST USE 12-0-2007; IN COMMERCE 12-0-2007.

DANIEL BRODY, EXAMINING ATTORNEY

**Int. Cl.: 5**

**Prior U.S. Cls.: 6, 18, 44, 46, 51, and 52**

**Reg. No. 3,469,118**

**United States Patent and Trademark Office**

**Registered July 15, 2008**

---

**TRADEMARK  
PRINCIPAL REGISTER**

**LIFESMIRACLE**

SMITH, STEVEN E. (UNITED STATES INDIVIDUAL), DBA LIFESMIRACLE,  
101 CHURCH ST., SUITE 8  
LOS GATOS, CA 95030

THE MARK CONSISTS OF STANDARD CHARACTERS WITHOUT CLAIM TO ANY PARTICULAR FONT, STYLE, SIZE, OR COLOR.

FOR: VITAMIN AND MINERAL SUPPLEMENTS,  
IN CLASS 5 (U.S. CLS. 6, 18, 44, 46, 51 AND 52).

SN 77-233,151, FILED 7-18-2007.

FIRST USE 11-12-2007; IN COMMERCE 10-26-2007.

GINA HAYES, EXAMINING ATTORNEY

**Int. Cl.: 36**

**Prior U.S. Cls.: 100, 101, and 102**

**United States Patent and Trademark Office**

**Reg. No. 3,469,119**

**Registered July 15, 2008**

**SERVICE MARK  
PRINCIPAL REGISTER**



DALE, BILL (CANADA INDIVIDUAL)  
1518-36 BLUE JAYS WAY  
TORONTO, CANADA

FOR: FUNDS INVESTMENT; HEDGE FUND INVESTMENT SERVICES; AND PROVIDING CURRENCY INDICES IN THE NATURE OF INFORMATION IN THE FIELDS OF FOREIGN CURRENCY, COMMODITIES, FINANCIAL DERIVATIVES, INTEREST RATE PRODUCTS, AND EQUITIES, IN CLASS 36 (U.S. CLS. 100, 101 AND 102).

FIRST USE 12-0-2007; IN COMMERCE 12-0-2007.

THE MARK CONSISTS OF TWO CURVED LINES THAT CROSS WITH RECTANGLES AT THE TOP OF EACH CROSSED LINE.

SN 77-234,432, FILED 7-20-2007.

CAROLINE WOOD, EXAMINING ATTORNEY



**Int. Cl.: 30**

**Prior U.S. Cl.: 46**

**United States Patent and Trademark Office**

**Reg. No. 3,469,120**

**Registered July 15, 2008**

**TRADEMARK  
PRINCIPAL REGISTER**

**BRITE ROCKS**

FARLEY'S & SATHERS CANDY COMPANY,  
INC. (DELAWARE CORPORATION)

ONE SATHER PLAZA, P.O. BOX 28

ROUND LAKE, MN 56167

FOR: CANDY, IN CLASS 30 (U.S. CL. 46).

FIRST USE 5-30-2008; IN COMMERCE 5-30-2008.

THE MARK CONSISTS OF STANDARD CHAR-  
ACTERS WITHOUT CLAIM TO ANY PARTICULAR  
FONT, STYLE, SIZE, OR COLOR.

OWNER OF U.S. REG. NOS. 1,788,939, 2,308,556,  
AND 2,480,967.

SN 77-234,513, FILED 7-20-2007.

MICHAEL ENGEL, EXAMINING ATTORNEY

**Int. Cl.: 6**

**Prior U.S. Cls.: 2, 12, 13, 14, 23, 25, and 50**

**Reg. No. 3,469,121**

**United States Patent and Trademark Office**

**Registered July 15, 2008**

---

**TRADEMARK  
PRINCIPAL REGISTER**

**ADVAN-COR**

ADVANCED TUBULAR DESIGN, LLC (OKLA-  
HOMA LTD LIAB CO)  
5785 BIRD CREEK AVENUE  
CATOOSA, OK 74015

THE MARK CONSISTS OF STANDARD CHAR-  
ACTERS WITHOUT CLAIM TO ANY PARTICULAR  
FONT, STYLE, SIZE, OR COLOR.

FOR: METAL TUBING FOR HEAT TRANSFER  
EQUIPMENT, IN CLASS 6 (U.S. CLS. 2, 12, 13, 14, 23,  
25 AND 50).

SN 77-234,566, FILED 7-20-2007.

FIRST USE 10-1-2007; IN COMMERCE 10-1-2007.

MAUREEN DALL, EXAMINING ATTORNEY

**Int. Cls.: 7 and 8**

**Prior U.S. Cls.: 13, 19, 21, 23, 28, 31, 34, 35, and 44**

**United States Patent and Trademark Office**

**Reg. No. 3,469,122**

**Registered July 15, 2008**

**TRADEMARK  
PRINCIPAL REGISTER**

**THE RIGHT TOOL AT THE  
RIGHT TIME**

PRECISION TWIST DRILL CO. (DELAWARE  
CORPORATION)  
301 INDUSTRIAL AVENUE  
CRYSTAL LAKE, IL 60012

FOR: FULL LINE OF STANDARD AND SPECIAL  
CUTTING TOOLS AND COMPONENT PARTS  
THEREOF FOR USE WITH POWER TOOLS OR  
MACHINES, IN CLASS 7 (U.S. CLS. 13, 19, 21, 23, 31,  
34 AND 35).

FIRST USE 10-12-2007; IN COMMERCE 10-12-2007.

FOR: FULL LINE OF STANDARD AND SPECIAL  
CUTTING TOOLS AND COMPONENT PARTS

THEREOF FOR USE WITH HAND TOOLS, IN  
CLASS 8 (U.S. CLS. 23, 28 AND 44).

FIRST USE 10-12-2007; IN COMMERCE 10-12-2007.

THE MARK CONSISTS OF STANDARD CHAR-  
ACTERS WITHOUT CLAIM TO ANY PARTICULAR  
FONT, STYLE, SIZE, OR COLOR.

SN 77-235,015, FILED 7-20-2007.

MATTHEW EINSTEIN, EXAMINING ATTORNEY

**Int. Cl.: 43**

**Prior U.S. Cls.: 100 and 101**

**United States Patent and Trademark Office**

**Reg. No. 3,469,123**

**Registered July 15, 2008**

**SERVICE MARK  
PRINCIPAL REGISTER**

**CROWN TOWERS**

CROWN MELBOURNE LIMITED (AUSTRALIA  
CORPORATION)  
8 WHITEMAN STREET  
SOUTHBANK, MELBOURNE, AUSTRALIA 3006

FOR: HOTEL SERVICES; HOTEL, BAR AND  
RESTAURANT SERVICES; HOTELS; RESORT HO-  
TELS, IN CLASS 43 (U.S. CLS. 100 AND 101).

FIRST USE 2-19-2008; IN COMMERCE 2-19-2008.

THE MARK CONSISTS OF STANDARD CHAR-  
ACTERS WITHOUT CLAIM TO ANY PARTICULAR  
FONT, STYLE, SIZE, OR COLOR.

SN 77-235,264, FILED 7-20-2007.

CYNTHIA SLOAN, EXAMINING ATTORNEY

**Int. Cl.: 43**

**Prior U.S. Cls.: 100 and 101**

**United States Patent and Trademark Office**

**Reg. No. 3,469,124**

**Registered July 15, 2008**

**SERVICE MARK  
PRINCIPAL REGISTER**

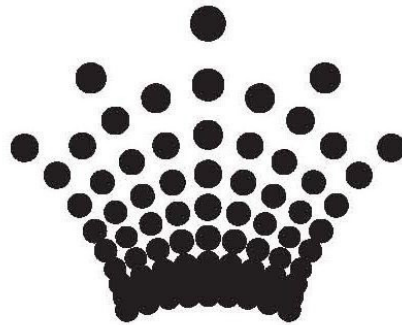

CROWN MELBOURNE LIMITED (AUSTRALIA  
CORPORATION)  
8 WHITEMAN STREET  
SOUTHBANK, MELBOURNE, AUSTRALIA 3006

FOR: HOTEL SERVICES; HOTEL, BAR AND  
RESTAURANT SERVICES; HOTELS; RESORT HO-  
TELS, IN CLASS 43 (U.S. CLS. 100 AND 101).

FIRST USE 2-19-2008; IN COMMERCE 2-19-2008.

THE MARK CONSISTS OF THE IMAGE OF A  
CROWN, COMPRISED OF A CROWN BASE AND  
NINE VERTICAL, BROKEN LINES AT VARIOUS  
ANGLES REPRESENTING THE POINTS OF THE  
CROWN.

SN 77-235,266, FILED 7-20-2007.

CYNTHIA SLOAN, EXAMINING ATTORNEY

**Int. Cl.: 10**

**Prior U.S. Cls.: 26, 39, and 44**

**Reg. No. 3,469,125**

**United States Patent and Trademark Office**

**Registered July 15, 2008**

**TRADEMARK  
PRINCIPAL REGISTER**

**Advanced Prostate System  
(APS)**

MEDICAL DIAGNOSTIC TECHNOLOGIES, INC.  
(NEVADA CORPORATION)  
5175 S DURANGO DR.  
LAS VEGAS, NV 89113

THE MARK CONSISTS OF STANDARD CHARACTERS WITHOUT CLAIM TO ANY PARTICULAR FONT, STYLE, SIZE, OR COLOR.

FOR: PROSTATE IMAGING SYSTEM COMPRISING ULTRASOUND AND MEDICAL RESONANCE IMAGING USED FOR THE SCREENING, DIAGNOSIS, AND TREATMENT OF PROSTATE CANCER THROUGH THE DETECTION OF CHANGES IN TISSUE THAT PROVIDE A STRONG LIKELIHOOD THAT CANCER IS PRESENT IN THE IDENTIFIED AREA, IN CLASS 10 (U.S. CLS. 26, 39 AND 44).

NO CLAIM IS MADE TO THE EXCLUSIVE RIGHT TO USE "ADVANCED PROSTATE SYSTEM", APART FROM THE MARK AS SHOWN.

SN 77-236,252, FILED 7-23-2007.

FIRST USE 4-1-2008; IN COMMERCE 4-1-2008.

MICHAEL KAZAZIAN, EXAMINING ATTORNEY

**Int. Cl.: 9**

**Prior U.S. Cls.: 21, 23, 26, 36, and 38**

**United States Patent and Trademark Office**

**Reg. No. 3,469,126**

**Registered July 15, 2008**

**TRADEMARK  
PRINCIPAL REGISTER**

**CIRCLE PLEX**

LEUPOLD & STEVENS, INC. (OREGON CORPORATION)  
PO BOX 688  
BEAVERTON, OR 97075

FOR: TELESCOPIC SIGHTS, OPTICAL LENS SCOPES; OPTICAL LENS SIGHTS FOR FIREARMS; OPTICAL LENS SCOPE COMPONENT, NAMELY, A RETICLE, IN CLASS 9 (U.S. CLS. 21, 23, 26, 36 AND 38).

FIRST USE 2-29-2008; IN COMMERCE 2-29-2008.

THE MARK CONSISTS OF STANDARD CHARACTERS WITHOUT CLAIM TO ANY PARTICULAR FONT, STYLE, SIZE, OR COLOR.

SN 77-236,320, FILED 7-23-2007.

CHRISTINA SOBRAL, EXAMINING ATTORNEY

Int. Cl.: 44

Prior U.S. Cls.: 100 and 101

United States Patent and Trademark Office

Reg. No. 3,469,127

Registered July 15, 2008

**SERVICE MARK  
PRINCIPAL REGISTER**

"Great Habits, Great  
Vision"

BURLINGAME, JAY J (UNITED STATES INDIVIDUAL), DBA BURLINGAME VISION ASSOCIATES,  
11806 QUIVIRA RD.  
OVERLAND PARK, KS 66210

FOR: DIETARY AND NUTRITIONAL GUIDANCE; FOOD NUTRITION CONSULTATION; NUTRITION COUNSELING; PROVIDING A WEBSITE FEATURING EDUCATIONAL INFORMATION REGARDING NUTRITION AND GENETICS; PROVIDING A WEBSITE THAT FEATURES INFORMATION ON CHILDREN'S NUTRITION; PROVIDING ASSISTANCE, FITNESS EVALUATION AND CONSULTATION TO CORPORATE CLIENTS TO HELP THEIR EMPLOYEES MAKE HEALTH, WELLNESS AND NUTRITIONAL CHANGES IN THEIR DAILY LIVING TO IMPROVE HEALTH; PROVIDING INFORMATION ABOUT DIETARY SUPPLEMENTS AND NUTRITION; OPTOMETRY SERVICES; OPHTHALMOLOGY SERVICES; TREATMENT OF EYE DISEASES AND CONDITIONS; HEALTH CARE; HEALTH CARE SERVICES, NAMELY, DISEASE MANAGEMENT PROGRAMS; HEALTH CARE SERVICES, NAMELY, WELLNESS PROGRAMS; HEALTH CARE, NAMELY, ASSISTING INDIVIDUALS TO STOP SMOKING; PROVIDING HEALTH

CARE INFORMATION BY TELEPHONE AND THE INTERNET; PROVIDING HEALTH INFORMATION; MEDICAL AND PHARMACEUTICAL CONSULTATION; MEDICAL ASSISTANCE CONSULTANCY PROVIDED BY DOCTORS AND OTHER SPECIALIZED MEDICAL PERSONNEL; MEDICAL CONSULTATIONS; MEDICAL IMAGING SERVICES, NAMELY, CONSULTING SERVICES IN THE FIELD OF USING AND OPERATING MEDICAL IMAGING APPARATUS INCLUDING X-RAY, COMPUTED TOMOGRAPHY, MAGNETIC RESONANCE IMAGING, ULTRASOUND, AND POSITRON EMISSION TOMOGRAPHY APPARATUS; PROVIDING MEDICAL INFORMATION, CONSULTANCY AND ADVISORY SERVICES, IN CLASS 44 (U.S. CLS. 100 AND 101).

FIRST USE 7-1-2007; IN COMMERCE 7-1-2007.

THE MARK CONSISTS OF STANDARD CHARACTERS WITHOUT CLAIM TO ANY PARTICULAR FONT, STYLE, SIZE, OR COLOR.

SN 77-236,599, FILED 7-23-2007.

CAROLINE WOOD, EXAMINING ATTORNEY



**Int. Cl.: 11**

**Prior U.S. Cls.: 13, 21, 23, 31, and 34**

**Reg. No. 3,469,128**

**United States Patent and Trademark Office**

**Registered July 15, 2008**

---

**TRADEMARK  
PRINCIPAL REGISTER**

**JETSTREAM**

E S ROBBINS CORPORATION (ALABAMA COR-  
PORATION)  
2802 E. AVALON AVENUE  
MUSCLE SHOALS, AL 356613748

THE MARK CONSISTS OF STANDARD CHAR-  
ACTERS WITHOUT CLAIM TO ANY PARTICULAR  
FONT, STYLE, SIZE, OR COLOR.

FOR: ELECTRIC FANS FOR AIR SCREENS AND  
AIR CURTAINS, IN CLASS 11 (U.S. CLS. 13, 21, 23, 31  
AND 34).

SN 77-238,132, FILED 7-25-2007.

FIRST USE 6-2-2008; IN COMMERCE 6-2-2008.

ZACHARY BELLO, EXAMINING ATTORNEY

**Int. Cl.: 30**

**Prior U.S. Cl.: 46**

**United States Patent and Trademark Office**

**Reg. No. 3,469,129**

**Registered July 15, 2008**

**TRADEMARK  
PRINCIPAL REGISTER**



PARTHASARATHY, MADHU (UNITED STATES INDIVIDUAL), DBA PARTHASARATHY, MADHU. B,

16308 SUNSET POINTE CT  
WILDWOOD, MO 63040 AND

PARTHASARATHY, MUKUNDAN (UNITED STATES INDIVIDUAL), DBA PARTHASARATHY, MUKUND,

16308 SUNSET POINTE CT  
WILDWOOD, MO 63040

FOR: SALSA , IN CLASS 30 (U.S. CL. 46).

FIRST USE 7-22-2007; IN COMMERCE 5-5-2008.

NO CLAIM IS MADE TO THE EXCLUSIVE RIGHT TO USE "SALSA", APART FROM THE MARK AS SHOWN.

THE COLOR(S) YELLOW, RED, BURGUNDY, BROWN OR BRICK RED IS/ARE CLAIMED AS A FEATURE OF THE MARK.

THE MARK CONSISTS OF STYLIZED LETTER "Z" IN YELLOW COLOR, STYLIZED "A" IN BURGUNDY / BRICK RED, LETTER "L". DEPICTED BY RED PEPPER, RED PEPPER CAN ALSO BE SUBSTITUTED WITH GREEN PEPPER, STYLIZED LETTER S AS DEPICTED IN LOGO, AND LETTER "A" IN YELLOW COLOR.

SN 77-238,937, FILED 7-25-2007.

KAREN BRACEY, EXAMINING ATTORNEY

Int. Cl.: 9

Prior U.S. Cls.: 21, 23, 26, 36, and 38

United States Patent and Trademark Office

Reg. No. 3,469,130

Registered July 15, 2008

**TRADEMARK  
PRINCIPAL REGISTER**

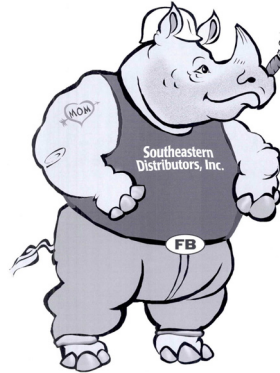

SOUTHEASTERN DISTRIBUTORS, INC. (TENNESSEE CORPORATION)

PO BOX 312

SWEETWATER, TN 37874

FOR: MOLDED PART, NAMELY, POLYETHYLENE WATER METER HOUSINGS, IN CLASS 9 (U.S. CLS. 21, 23, 26, 36 AND 38).

FIRST USE 5-1-2008; IN COMMERCE 5-1-2008.

OWNER OF U.S. REG. NO. 2,482,119.

NO CLAIM IS MADE TO THE EXCLUSIVE RIGHT TO USE "SOUTHEASTERN DISTRIBUTORS, INC.", APART FROM THE MARK AS SHOWN.

THE MARK CONSISTS OF A RHINO IN CONSTRUCTION CLOTHING, I.E.: A HARD HAT, JEANS, A T-SHIRT. THE RHINO ALSO IS SMOKING A CIGAR, NEEDS A SHAVE, AND HAS A TATOO OF THE WORD "MOM" IN A HEART WITH A ARROW THROUGH THE HEART.

SN 77-239,007, FILED 7-26-2007.

LINDA E. BLOHM, EXAMINING ATTORNEY

Int. Cl.: 42

Prior U.S. Cls.: 100 and 101

United States Patent and Trademark Office

Reg. No. 3,469,131

Registered July 15, 2008

SERVICE MARK  
PRINCIPAL REGISTER



GF HEALTH PRODUCTS, INC (GEORGIA CORPORATION)

2935 NORTHEAST PARKWAY

ATLANTA, GA 30360

FOR: PROVIDING QUALITY ASSURANCE SERVICES IN THE FIELD OF MEDICAL PRODUCTS, IN CLASS 42 (U.S. CLS. 100 AND 101).

FIRST USE 7-20-2007; IN COMMERCE 7-20-2007.

OWNER OF U.S. REG. NO. 2,009,659.

THE COLOR(S) GREEN, LIGHT GREEN, WHITE, GRAY AND BLACK IS/ARE CLAIMED AS A FEATURE OF THE MARK.

THE MARK CONSISTS OF A GREEN AND BLACK ROUND ARROW CIRCLING THE TERM "360" SHADOWED WITH OUR COMPANY NAME "GRAHAM-FIELD". THE COLOR GREEN APPEARS ON THE OUTER SIDE OF THE ARROWS ABOVE THE TERM "360". THE COLOR BLACK APPEARS ON THE UNDERSIDE OF THE ARROWS ABOVE THE TERM "360". THE COLOR GREEN APPEARS IN THE INTERIOR LOWER PART OF THE ARROW CIRCLE. THE COLOR BLACK APPEARS ON THE OUTER PART OF THE ARROW CIRCLE BELOW THE TERM "360". THE TERM "GRAHAM-FIELD" APPEARS IN WHITE WITH GRAY SHADOWING. THE TERM "360" WITH A DEGREE MARK APPEARS IN LIGHT GREEN.

SN 77-239,024, FILED 7-26-2007.

CAROLINE WOOD, EXAMINING ATTORNEY

**Int. Cl.: 9**

**Prior U.S. Cls.: 21, 23, 26, 36, and 38**

**Reg. No. 3,469,132**

**United States Patent and Trademark Office**

**Registered July 15, 2008**

---

**TRADEMARK  
PRINCIPAL REGISTER**

**SHATTERED BLADE**

KABUSHIKI KAISHA SHUEISHA (JAPAN CORPORATION), DBA A/T/A SHUEISHA INC.,  
5-10 HITOTSUBASHI 2-CHOME  
CHIYODA-KU, TOKYO, JAPAN

THE MARK CONSISTS OF STANDARD CHARACTERS WITHOUT CLAIM TO ANY PARTICULAR FONT, STYLE, SIZE, OR COLOR.

FOR: VIDEO GAME SOFTWARE, IN CLASS 9  
(U.S. CLS. 21, 23, 26, 36 AND 38).

SN 77-239,461, FILED 7-26-2007.

FIRST USE 10-9-2007; IN COMMERCE 10-9-2007.

CHRISTINE COOPER, EXAMINING ATTORNEY

**Int. Cl.: 10**

**Prior U.S. Cls.: 26, 39, and 44**

**United States Patent and Trademark Office**

**Reg. No. 3,469,133**

**Registered July 15, 2008**

**TRADEMARK  
PRINCIPAL REGISTER**

**NO-BOIL**

POWER PRODUCTS, INC. (MISSOURI CORPORATION)  
3325 WYOMING ST.  
KANSAS CITY, MO 64111

THE MARK CONSISTS OF STANDARD CHARACTERS WITHOUT CLAIM TO ANY PARTICULAR FONT, STYLE, SIZE, OR COLOR.

FOR: KINESIOLOGIC MOUTH PIECES FOR MEDICAL PURPOSES, IN CLASS 10 (U.S. CLS. 26, 39 AND 44).

SN 77-240,493, FILED 7-27-2007.

FIRST USE 6-1-2007; IN COMMERCE 6-1-2007.

MICHAEL KEATING, EXAMINING ATTORNEY

Int. Cl.: 41

Prior U.S. Cls.: 100, 101, and 107

United States Patent and Trademark Office

Reg. No. 3,469,134

Registered July 15, 2008

**SERVICE MARK  
PRINCIPAL REGISTER**



MARTINEZ, EDDIE N. (UNITED STATES INDIVIDUAL), DBA MARIANO, EDDIE,  
311 N. ROBERTSON BLVD., SUITE 810  
BEVERLY HILLS, CA 90211

FOR: MOTION PICTURE FILM PRODUCTION;  
MULTIMEDIA ENTERTAINMENT SERVICES IN  
THE NATURE OF RECORDING, PRODUCTION  
AND POST-PRODUCTION SERVICES IN THE  
FIELD OF FILMS, IN CLASS 41 (U.S. CLS. 100, 101  
AND 107).

FIRST USE 7-27-2007; IN COMMERCE 7-27-2007.

THE COLOR(S) BLUE, ORANGE, GRAY, BLACK,  
WHITE, YELLOW IS/ARE CLAIMED AS A FEAT-  
TURE OF THE MARK.

THE MARK CONSISTS OF A BLUE AND WHITE  
HALF MOON CONNECTING TO A WHITE AND  
BLUE RAY THAT CONNECTS TO A ORANGE AND  
YELLOW COMET, TO FORM THE LETTERING  
"MP". THE WORD "MIDNYTTE" APPEARS IN A  
BLUE, GREY AND BLACK COLOR SCHEME; THE  
WORD "PROJEKT" APPEARS IN A ORANGE AND  
YELLOW COLOR SCHEME; THE WORD "ENTER-  
TAINMENT" APPEARS IN A GREY AND BLUE  
COLOR SCHEME. THE BACKGROUND OF THE  
LOGO IS A BLUE AND BLACK BACKGROUND  
SYMBOLIZING A NIGHT SKY.

SN 77-241,203, FILED 7-27-2007.

HANNO RITTNER, EXAMINING ATTORNEY

**Int. Cl.: 35**

**Prior U.S. Cls.: 100, 101, and 102**

**United States Patent and Trademark Office**

**Reg. No. 3,469,135**

**Registered July 15, 2008**

**SERVICE MARK  
PRINCIPAL REGISTER**



SIFEON KNOWLEDGE-TECHNOLOGY (TAI-  
WAN CORPORATION)

19F-9, NO.241

SEC.3, WUNSIN RD., SITUN DISTRICT  
TAICHUNG CITY 407, TAIWAN

FOR: BUSINESS CONSULTING; MARKETING  
STUDIES; PROVIDING BUSINESS STATISTICAL  
INFORMATION STUDIES FOR BUSINESS AND  
CONSULTING PURPOSES , IN CLASS 35 (U.S. CLS.  
100, 101 AND 102).

FIRST USE 1-22-2008; IN COMMERCE 1-22-2008.

THE MARK CONSISTS OF A BACKWARD FA-  
CING "E" NEXT TO THE LETTER "X" WHICH IS  
FOLLOWED BY THE LETTER "E".

SN 77-241,450, FILED 7-29-2007.

ROBERT STRUCK, EXAMINING ATTORNEY



Int. Cl.: 12

Prior U.S. Cls.: 19, 21, 23, 31, 35, and 44

United States Patent and Trademark Office

Reg. No. 3,469,136

Registered July 15, 2008

TRADEMARK  
PRINCIPAL REGISTER



RHE HATCO, INC. (DELAWARE CORPORATION)  
601 MARION DRIVE  
GARLAND, TX 75042

FOR: AUTOMOBILES; LIGHT TRUCKS; PICK-UP TRUCKS; VEHICLE SEATS, IN CLASS 12 (U.S. CLS. 19, 21, 23, 31, 35 AND 44).

FIRST USE 9-28-2007; IN COMMERCE 9-28-2007.

OWNER OF U.S. REG. NOS. 330,447, 2,490,537, AND OTHERS.

THE MARK CONSISTS OF THE WORD, RESISTOL, IN STYLIZED FORM, BENEATH A REPRESENTATION OF A HAT.

SN 77-242,250, FILED 7-30-2007.

CHARISMA HAMPTON, EXAMINING ATTORNEY

**Int. Cl.: 3**

**Prior U.S. Cls.: 1, 4, 6, 50, 51, and 52**

**Reg. No. 3,469,137**

**United States Patent and Trademark Office**

**Registered July 15, 2008**

---

**TRADEMARK  
PRINCIPAL REGISTER**

# SandFoam

SIERRA MADRE MARKETING GROUP, LLC  
(CALIFORNIA LTD LIAB CO)  
55 E. HUNTINGTON DRIVE, SUITE 120  
ARCADIA, CA 91006

THE MARK CONSISTS OF STANDARD CHAR-  
ACTERS WITHOUT CLAIM TO ANY PARTICULAR  
FONT, STYLE, SIZE, OR COLOR.

FOR: ABRASIVE SHEETS, IN CLASS 3 (U.S. CLS. 1,  
4, 6, 50, 51 AND 52).

SN 77-242,345, FILED 7-30-2007.

FIRST USE 10-24-2007; IN COMMERCE 10-24-2007.

RUSS HERMAN, EXAMINING ATTORNEY

**Int. Cl.: 6**

**Prior U.S. Cls.: 2, 12, 13, 14, 23, 25, and 50**

**Reg. No. 3,469,138**

**United States Patent and Trademark Office**

**Registered July 15, 2008**

**TRADEMARK  
PRINCIPAL REGISTER**

**EPAL**

EPAL N.A., L.L.C. (IOWA LTD LIAB CO)  
306 6TH AVE SE  
CEDAR RAPIDS, IA 52401

THE MARK CONSISTS OF STANDARD CHAR-  
ACTERS WITHOUT CLAIM TO ANY PARTICULAR  
FONT, STYLE, SIZE, OR COLOR.

FOR: METAL WINDOWS; METAL DOORS, IN  
CLASS 6 (U.S. CLS. 2, 12, 13, 14, 23, 25 AND 50).

SN 77-242,828, FILED 7-31-2007.

FIRST USE 9-4-2007; IN COMMERCE 11-19-2007.

NATALIE POLZER, EXAMINING ATTORNEY

**Int. Cl.: 28**

**Prior U.S. Cls.: 22, 23, 38, and 50**

**United States Patent and Trademark Office**

**Reg. No. 3,469,139**

**Registered July 15, 2008**

**TRADEMARK  
PRINCIPAL REGISTER**

**WORKOUT 180**

CORE EXERCISE TECHNOLOGIES, LLC  
(NORTH CAROLINA LTD LIAB CO)  
520 ELLIOT STREET, SUITE 200  
CHARLOTTE, NC 28202

FOR: EXERCISE MACHINES; MANUALLY-OPERATED EXERCISE EQUIPMENT, IN CLASS 28 (U.S. CLS. 22, 23, 38 AND 50).

FIRST USE 6-2-2008; IN COMMERCE 6-2-2008.

THE MARK CONSISTS OF STANDARD CHARACTERS WITHOUT CLAIM TO ANY PARTICULAR FONT, STYLE, SIZE, OR COLOR.

NO CLAIM IS MADE TO THE EXCLUSIVE RIGHT TO USE "WORKOUT", APART FROM THE MARK AS SHOWN.

SN 77-243,543, FILED 7-31-2007.

MIDGE BUTLER, EXAMINING ATTORNEY

**Int. Cl.: 28**

**Prior U.S. Cls.: 22, 23, 38, and 50**

**United States Patent and Trademark Office**

**Reg. No. 3,469,140**

**Registered July 15, 2008**

**TRADEMARK  
PRINCIPAL REGISTER**



CORE EXERCISE TECHNOLOGIES, LLC  
(NORTH CAROLINA LTD LIAB CO)

520 ELLIOT STREET, SUITE 200

CHARLOTTE, NC 28202

FOR: EXERCISE MACHINES; MANUALLY-OPERATED EXERCISE EQUIPMENT, IN CLASS 28 (U.S. CLS. 22, 23, 38 AND 50).

FIRST USE 6-2-2008; IN COMMERCE 6-2-2008.

NO CLAIM IS MADE TO THE EXCLUSIVE RIGHT TO USE "WORKOUT", APART FROM THE MARK AS SHOWN.

THE MARK CONSISTS OF THE NUMBER 180 DEPICTED AS BEING FORMED BY A CONTINUOUS ARROW WITH THE WORD "WORKOUT" POSITIONED ABOVE.

SN 77-243,579, FILED 7-31-2007.

MIDGE BUTLER, EXAMINING ATTORNEY

**Int. Cl.: 43**

**Prior U.S. Cls.: 100 and 101**

**United States Patent and Trademark Office**

**Reg. No. 3,469,141**

**Registered July 15, 2008**

**SERVICE MARK  
PRINCIPAL REGISTER**

**GARBANZO MEDITERRANEAN  
GRILL**

GARBANZO MEDITERRANEAN GRILL, LLC  
(COLORADO LTD LIAB CO)

9385 RIVIERA HILLS DRIVE

GREENWOOD VILLAGE, CO 80111

FOR: RESTAURANT AND BAR SERVICES, IN  
CLASS 43 (U.S. CLS. 100 AND 101).

FIRST USE 1-1-2008; IN COMMERCE 1-1-2008.

THE MARK CONSISTS OF STANDARD CHAR-  
ACTERS WITHOUT CLAIM TO ANY PARTICULAR  
FONT, STYLE, SIZE, OR COLOR.

NO CLAIM IS MADE TO THE EXCLUSIVE  
RIGHT TO USE "MEDITERRANEAN GRILL",  
APART FROM THE MARK AS SHOWN.

SN 77-243,856, FILED 8-1-2007.

FRANK LATTUCA, EXAMINING ATTORNEY

Int. Cl.: 6

Prior U.S. Cls.: 2, 12, 13, 14, 23, 25, and 50

Reg. No. 3,469,142

United States Patent and Trademark Office

Registered July 15, 2008

TRADEMARK  
PRINCIPAL REGISTER

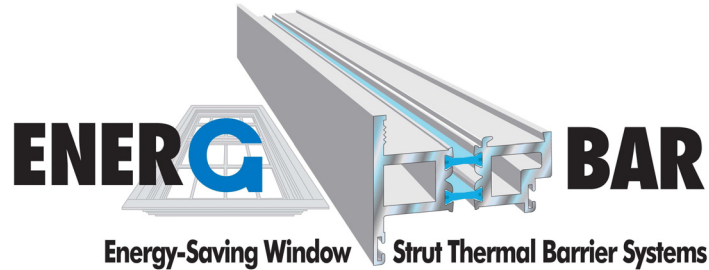

GRAHAM ARCHITECTURAL PRODUCTS CORPORATION (PENNSYLVANIA CORPORATION)  
1551 MT. ROSE AVE.  
YORK, PA 17403

FOR: ALUMINUM WINDOWS AND WINDOW FRAMES, IN CLASS 6 (U.S. CLS. 2, 12, 13, 14, 23, 25 AND 50).

FIRST USE 6-0-2007; IN COMMERCE 6-0-2007.

NO CLAIM IS MADE TO THE EXCLUSIVE RIGHT TO USE "ENERGY BAR" AND "ENERGY-SAVING WINDOW STRUT THERMAL BARRIER SYSTEMS", APART FROM THE MARK AS SHOWN.

THE COLOR(S) BLACK, GREY AND BLUE IS/ ARE CLAIMED AS A FEATURE OF THE MARK.

THE MARK CONSISTS OF THE CAPITAL LETTERS "ENER" IN BLACK, FOLLOWED BY THE

CAPITAL LETTER "G" IN BLUE AND IN FRONT OF A PERSPECTIVE VIEW OF A WINDOW FRAME RISING AT A SLIGHT ANGLE FROM FRONT TO BACK; BETWEEN "G" AND THE CAPITAL LETTERS "BAR" IN BLACK IS A CROSS SECTION AND PERSPECTIVE VIEW OF A GREY WINDOW FRAME MEMBER RISING SLIGHTLY FROM FRONT TO BACK AND CONSISTING OF TWO OUTER GREY PORTIONS BETWEEN WHICH IS A BLUE PORTION, THE OUTER CROSS SECTIONS BEING BLUE AND GREY, THE INTERMEDIATE CROSS SECTION BEING BLUE. THE WORDS "ENERGY-SAVING WINDOW STRUT THERMAL BARRIER SYSTEMS" IN BLACK ARE BELOW "ENERGBAR" AND THE DESIGN, WITH THE FIRST LETTERS CAPITALIZED.

SN 77-244,410, FILED 8-1-2007.

LINDA ESTRADA, EXAMINING ATTORNEY

**Int. Cl.: 29**

**Prior U.S. Cl.: 46**

**United States Patent and Trademark Office**

**Reg. No. 3,469,143**

**Registered July 15, 2008**

**TRADEMARK  
PRINCIPAL REGISTER**

**MINNESOTA PRAIRIES**

CAPTAIN KEN'S FOODS, INC. (MINNESOTA CORPORATION)  
344 S. ROBERT STREET  
ST. PAUL, MN 55107

FOR: CHILI; PROCESSED BEANS; FROZEN ENTREES CONSISTING PRIMARILY OF MEAT, POULTRY, FISH OR VEGETABLES, IN CLASS 29 (U.S. CL. 46).

FIRST USE 10-1-2007; IN COMMERCE 10-1-2007.

THE MARK CONSISTS OF STANDARD CHARACTERS WITHOUT CLAIM TO ANY PARTICULAR FONT, STYLE, SIZE, OR COLOR.

NO CLAIM IS MADE TO THE EXCLUSIVE RIGHT TO USE "MINNESOTA", APART FROM THE MARK AS SHOWN.

SN 77-245,163, FILED 8-2-2007.

JORDAN BAKER, EXAMINING ATTORNEY



**Int. Cl.: 28**

**Prior U.S. Cls.: 22, 23, 38, and 50**

**Reg. No. 3,469,144**

**United States Patent and Trademark Office**

**Registered July 15, 2008**

---

**TRADEMARK  
PRINCIPAL REGISTER**

**HUNT WICKED CLOSE**

DAVIDSON, BRENT W. (GEORGIA CORPORATION), DBA AVID HT, INC.,  
1991 MOUNTAIN WOODS ROAD  
BLAIRSVILLE, GA 30512

THE MARK CONSISTS OF STANDARD CHARACTERS WITHOUT CLAIM TO ANY PARTICULAR FONT, STYLE, SIZE, OR COLOR.

FOR: HUNTERS' SCENT CAMOUFLAGE, IN CLASS 28 (U.S. CLS. 22, 23, 38 AND 50).

SN 77-246,137, FILED 8-3-2007.

FIRST USE 11-1-2007; IN COMMERCE 11-1-2007.

SANJEEV VOHRA, EXAMINING ATTORNEY

**Int. Cl.: 25**

**Prior U.S. Cls.: 22 and 39**

**United States Patent and Trademark Office**

**Reg. No. 3,469,145**

**Registered July 15, 2008**

**TRADEMARK  
PRINCIPAL REGISTER**

**LADONA**

CHONG, MYUNG-SHIN (REPUBLIC OF KOREA  
INDIVIDUAL)  
150-54 9TH AVENUE  
WHITESTONE, NY 11357

THE MARK CONSISTS OF STANDARD CHAR-  
ACTERS WITHOUT CLAIM TO ANY PARTICULAR  
FONT, STYLE, SIZE, OR COLOR.

FOR: HOSIERY, IN CLASS 25 (U.S. CLS. 22 AND  
39).

SN 77-246,430, FILED 8-3-2007.

FIRST USE 10-1-2007; IN COMMERCE 10-1-2007.

BRENDAN MCCAULEY, EXAMINING ATTORNEY

**Int. Cls.: 9 and 16**

**Prior U.S. Cls.: 2, 5, 21, 22, 23, 26, 29, 36, 37, 38, and 50**

**United States Patent and Trademark Office**

**Reg. No. 3,469,146**

**Registered July 15, 2008**

**TRADEMARK  
PRINCIPAL REGISTER**

**SILICONE SPECTATOR**

SURFATECH CORPORATION (UNITED STATES CORPORATION)  
2170 LUKE EDWARDS RD.  
DACULA, GA 30019

FOR: PROVIDING DOWNLOADABLE ELECTRONIC NEWSLETTERS IN THE FIELD OF SILICONE CHEMISTRY, IN CLASS 9 (U.S. CLS. 21, 23, 26, 36 AND 38).

FIRST USE 12-1-2007; IN COMMERCE 12-1-2007.

FOR: NEWSLETTERS IN THE FIELD OF SILICONE CHEMISTRY, IN CLASS 16 (U.S. CLS. 2, 5, 22, 23, 29, 37, 38 AND 50).

FIRST USE 12-1-2007; IN COMMERCE 12-1-2007.

THE MARK CONSISTS OF STANDARD CHARACTERS WITHOUT CLAIM TO ANY PARTICULAR FONT, STYLE, SIZE, OR COLOR.

NO CLAIM IS MADE TO THE EXCLUSIVE RIGHT TO USE "SILICONE", APART FROM THE MARK AS SHOWN.

SN 77-247,318, FILED 8-4-2007.

JENNIFER VASQUEZ, EXAMINING ATTORNEY

**Int. Cl.: 43**

**Prior U.S. Cls.: 100 and 101**

**United States Patent and Trademark Office**

**Reg. No. 3,469,147**

**Registered July 15, 2008**

**SERVICE MARK  
PRINCIPAL REGISTER**



INTERVAL HOLDINGS, INC. (DELAWARE CORPORATION)  
6262 SUNSET DRIVE  
MIAMI, FL 33143

FOR: TRAVEL AGENCY SERVICES, NAMELY, MAKING RESERVATIONS AND BOOKING FOR TEMPORARY LODGING, IN CLASS 43 (U.S. CLS. 100 AND 101).

FIRST USE 10-9-2007; IN COMMERCE 10-9-2007.

THE COLOR(S) ORANGE, RED AND BLUE/GREY IS/ARE CLAIMED AS A FEATURE OF THE MARK.

THE MARK CONSISTS OF "VACATION" IN ORANGE, THE DOT ON THE LETTER "I" IN RED, AND "SOURCE.COM" IN BLUE/GREY.

SN 77-247,605, FILED 8-6-2007.

ROBIN CHOSID, EXAMINING ATTORNEY

**Int. Cls.: 9 and 41**

**Prior U.S. Cls.: 21, 23, 26, 36, 38, 100, 101, and 107**

**United States Patent and Trademark Office**

**Reg. No. 3,469,148**

**Registered July 15, 2008**

**TRADEMARK  
SERVICE MARK  
PRINCIPAL REGISTER**

# Smarty Pants

ELECTRONIC ARTS INC. (DELAWARE CORPORATION)  
209 REDWOOD SHORES PARKWAY  
REDWOOD CITY, CA 94065

FOR: COMPUTER GAME CARTRIDGES; COMPUTER GAME DISCS; INTERACTIVE MULTIMEDIA COMPUTER GAME PROGRAMS; COMPUTER GAME SOFTWARE; ENTERTAINMENT SOFTWARE IN THE NATURE OF COMPUTER GAMES FOR USE ON HANDHELD COMPUTERS, COMPUTERS, HANDHELD AND FREE STANDING VIDEO GAME CONSOLES, IN CLASS 9 (U.S. CLS. 21, 23, 26, 36 AND 38).

FIRST USE 11-13-2007; IN COMMERCE 11-13-2007.

FOR: PROVIDING A COMPUTER GAME THAT MAY BE ACCESSED NETWORK-WIDE BY NETWORK USERS; ENTERTAINMENT SERVICES, NAMELY, PROVIDING INTERACTIVE COMPUTER GAMES OVER AN ELECTRONIC NETWORK, IN CLASS 41 (U.S. CLS. 100, 101 AND 107).

FIRST USE 11-6-2007; IN COMMERCE 11-6-2007.

THE MARK CONSISTS OF STANDARD CHARACTERS WITHOUT CLAIM TO ANY PARTICULAR FONT, STYLE, SIZE, OR COLOR.

SN 77-247,709, FILED 8-6-2007.

KAPIL BHANOT, EXAMINING ATTORNEY

**Int. Cl.: 24**

**Prior U.S. Cls.: 42 and 50**

**United States Patent and Trademark Office**

**Reg. No. 3,469,149**

**Registered July 15, 2008**

**TRADEMARK  
PRINCIPAL REGISTER**

**MICROLUX**

INVISTA NORTH AMERICA S.A.R.L. (LUXEM-  
BOURG CORPORATION)  
THREE LITTLE FALLS CENTRE  
2801 CENTERVILLE ROAD  
WILMINGTON, DE 19808

FOR: COMFORTERS, MATTRESS PADS, IN  
CLASS 24 (U.S. CLS. 42 AND 50).

FIRST USE 2-28-2008; IN COMMERCE 2-28-2008.

THE MARK CONSISTS OF STANDARD CHAR-  
ACTERS WITHOUT CLAIM TO ANY PARTICULAR  
FONT, STYLE, SIZE, OR COLOR.

OWNER OF U.S. REG. NO. 2,507,227.

SN 77-247,979, FILED 8-6-2007.

KATHERINE M. DUBRAY, EXAMINING ATTOR-  
NEY

**Int. Cl.: 33**

**Prior U.S. Cls.: 47 and 49**

**United States Patent and Trademark Office**

**Reg. No. 3,469,150**

**Registered July 15, 2008**

**TRADEMARK  
PRINCIPAL REGISTER**

**RUBYSTONE**

VENTANA VINTNERS, LLC (CALIFORNIA LTD  
LIAB CO)  
2999 MONTEREY-SALINAS HWY, #10  
MONTEREY, CA 93940

THE MARK CONSISTS OF STANDARD CHAR-  
ACTERS WITHOUT CLAIM TO ANY PARTICULAR  
FONT, STYLE, SIZE, OR COLOR.

FOR: WINES, IN CLASS 33 (U.S. CLS. 47 AND 49).

SN 77-248,025, FILED 8-6-2007.

FIRST USE 6-20-2007; IN COMMERCE 6-20-2007.

ATTIYA MALIK, EXAMINING ATTORNEY

**Int. Cl.: 41**

**Prior U.S. Cls.: 100, 101, and 107**

**United States Patent and Trademark Office**

**Reg. No. 3,469,151**

**Registered July 15, 2008**

**SERVICE MARK  
PRINCIPAL REGISTER**



THE DETROIT SCHOOL OF ROCK LLC (MICHIGAN LTD LIAB CO)  
11953 FARNUM AVE  
WARREN, MI 48093

FOR: EDUCATIONAL SERVICES, NAMELY, CONDUCTING PROGRAMS IN THE FIELD OF MUSIC, IN CLASS 41 (U.S. CLS. 100, 101 AND 107).

FIRST USE 5-1-2007; IN COMMERCE 9-1-2007.

NO CLAIM IS MADE TO THE EXCLUSIVE RIGHT TO USE "DETROIT SCHOOL OF ROCK

AND POP MUSIC", APART FROM THE MARK AS SHOWN.

THE MARK CONSISTS OF THE PROFILE OF A GUITAR WITH TONGUES OF FLAME OBSCURING A PORTION OF THE GUITAR'S BASE, WITH THE WORDS "THE DETROIT SCHOOL OF ROCK AND POP MUSIC" SUPERIMPOSED ABOVE THE GUITAR.

SN 77-249,068, FILED 8-7-2007.

CAROLINE WOOD, EXAMINING ATTORNEY



**Int. Cl.: 9**

**Prior U.S. Cls.: 21, 23, 26, 36, and 38**

**Reg. No. 3,469,152**

**United States Patent and Trademark Office**

**Registered July 15, 2008**

---

**TRADEMARK  
PRINCIPAL REGISTER**

**THE SOULKEEPER**

HELM SYSTEMS, LLC (FLORIDA LTD LIAB CO)  
9TH FLOOR  
5201 BLUE LAGOON DRIVE  
MIAMI, FL 33126

FOR: COMPUTER SOFTWARE AND PROGRAMS ALL BEING COMPUTER GAMES; VIDEO GAME SOFTWARE; LASER DISKS CARTRIDGES, AUDIO AND VIDEO TAPES, AUDIO AND VIDEO CASSETTES AND CD-ROMS ALL BEARING VIDEO GAMES; VIDEO GAME COMPUTER SOFTWARE ADAPTED FOR USE WITH TELEVISION RECEIVERS AND COMPUTERS; MOTION PICTURE

FILMS FEATURING CARTOONS AND INSTRUCTION MANUALS SOLD AS A UNIT THEREWITH, IN CLASS 9 (U.S. CLS. 21, 23, 26, 36 AND 38).

FIRST USE 8-23-2003; IN COMMERCE 10-25-2007.

THE MARK CONSISTS OF STANDARD CHARACTERS WITHOUT CLAIM TO ANY PARTICULAR FONT, STYLE, SIZE, OR COLOR.

SN 77-249,105, FILED 8-7-2007.

YAT SYE, LEE, EXAMINING ATTORNEY

**Int. Cl.: 9**

**Prior U.S. Cls.: 21, 23, 26, 36, and 38**

**United States Patent and Trademark Office**

**Reg. No. 3,469,153**

**Registered July 15, 2008**

**TRADEMARK  
PRINCIPAL REGISTER**

**SHUFFLE BACCARAT**

KARAWAY GAMING, INC. (ARIZONA CORPORATION)  
8797 EAST BROADWAY  
TUCSON, AZ 85710

OWNER OF U.S. REG. NOS. 2,879,961, 2,882,250,  
AND 2,919,332.

FOR: ELECTRONIC GAME SOFTWARE, IN  
CLASS 9 (U.S. CLS. 21, 23, 26, 36 AND 38).

NO CLAIM IS MADE TO THE EXCLUSIVE  
RIGHT TO USE "BACCARAT", APART FROM THE  
MARK AS SHOWN.

FIRST USE 5-25-2008; IN COMMERCE 5-25-2008.

SN 77-249,547, FILED 8-7-2007.

THE MARK CONSISTS OF STANDARD CHARACTERS WITHOUT CLAIM TO ANY PARTICULAR FONT, STYLE, SIZE, OR COLOR.

LINDA ORNDORFF, EXAMINING ATTORNEY

**Int. Cl.: 25**

**Prior U.S. Cls.: 22 and 39**

**United States Patent and Trademark Office**

**Reg. No. 3,469,154**

**Registered July 15, 2008**

**TRADEMARK  
PRINCIPAL REGISTER**

**Angela Nuran**

A DANCE TO REMEMBER, INC. (FLORIDA CORPORATION)  
9893 CORONADO LAKE DRIVE  
BOYNTON BEACH, FL 33437

FOR: LADIES FOOTWEAR, SPECIFICALLY BRIDAL DANCE SHOES, IN CLASS 25 (U.S. CLS. 22 AND 39).

FIRST USE 8-9-2007; IN COMMERCE 8-9-2007.

THE MARK CONSISTS OF STANDARD CHARACTERS WITHOUT CLAIM TO ANY PARTICULAR FONT, STYLE, SIZE, OR COLOR.

THE NAME "ANGELA NURAN" IDENTIFIES A LIVING INDIVIDUAL WHOSE CONSENT IS OF RECORD.

SN 77-249,847, FILED 8-8-2007.

INGRID C. EULIN, EXAMINING ATTORNEY

**Int. Cl.: 21**

**Prior U.S. Cls.: 2, 13, 23, 29, 30, 33, 40, and 50**

**United States Patent and Trademark Office**

**Reg. No. 3,469,155**

**Registered July 15, 2008**

**TRADEMARK  
PRINCIPAL REGISTER**

# CleanNCare

QUADION CORPORATION (MINNESOTA CORPORATION)  
1100 XENIUM LANE NORTH  
MINNEAPOLIS, MN 55441

FOR: CONTAINERS FOR HOLDING SMALL DENTAL APPLIANCES SUCH AS RETAINERS, MOUTHGUARDS, NIPPLES, PACIFIERS AND OTHER DENTAL OR HOUSEHOLD ITEMS IN A DISHWASHER RACK FOR CLEANING, AND FOR STORAGE OF SUCH ITEMS, IN CLASS 21 (U.S. CLS. 2, 13, 23, 29, 30, 33, 40 AND 50).

FIRST USE 4-23-2008; IN COMMERCE 4-23-2008.

THE MARK CONSISTS OF STANDARD CHARACTERS WITHOUT CLAIM TO ANY PARTICULAR FONT, STYLE, SIZE, OR COLOR.

SN 77-249,854, FILED 8-8-2007.

RUSS HERMAN, EXAMINING ATTORNEY

**Int. Cl.: 35**

**Prior U.S. Cls.: 100, 101, and 102**

**United States Patent and Trademark Office**

**Reg. No. 3,469,156**

**Registered July 15, 2008**

**SERVICE MARK  
PRINCIPAL REGISTER**



THE RAIN KIDS (CALIFORNIA CORPORATION), DBA BECOMING MRS,  
1615 S LOS ANGELES ST.  
LOS ANGELES, CA 90015

FIRST USE 9-1-2007; IN COMMERCE 9-30-2007.

FOR: RETAIL STORE SERVICES FEATURING WEDDING GOWNS; WHOLESALE DISTRIBUTORSHIPS FEATURING WEDDING GOWNS, IN CLASS 35 (U.S. CLS. 100, 101 AND 102).

SN 77-251,777, FILED 8-9-2007.

MARY MUNSON, EXAMINING ATTORNEY

**Int. Cl.: 9**

**Prior U.S. Cls.: 21, 23, 26, 36, and 38**

**United States Patent and Trademark Office**

**Reg. No. 3,469,157**

**Registered July 15, 2008**

**TRADEMARK  
PRINCIPAL REGISTER**

**THERMATECT**

INFRARED, INC. (NEVADA CORPORATION)  
5301 LONGLEY LANE D-154  
RENO, NV 89511

THE MARK CONSISTS OF STANDARD CHAR-  
ACTERS WITHOUT CLAIM TO ANY PARTICULAR  
FONT, STYLE, SIZE, OR COLOR.

FOR: COMPUTER SOFTWARE FOR INFRARED  
MOTION DETECTION AND TRACKING, IN CLASS  
9 (U.S. CLS. 21, 23, 26, 36 AND 38).

SN 77-252,681, FILED 8-10-2007.

FIRST USE 3-0-2005; IN COMMERCE 3-0-2005.

BENJAMIN OKEKE, EXAMINING ATTORNEY

**Int. Cl.: 42**

**Prior U.S. Cls.: 100 and 101**

**United States Patent and Trademark Office**

**Reg. No. 3,469,158**

**Registered July 15, 2008**

**SERVICE MARK  
PRINCIPAL REGISTER**

# Let Trade Flow Electronically

TAICHI MICHAEL YEN (WASHINGTON SOLE PROPRIETORSHIP), DBA MARGINUP, SUITE B1  
15600 NE 8TH ST  
BELLEVUE, WA 98008

FOR: PROVIDING TEMPORARY USE OF NON-DOWNLOADABLE COMPUTER SOFTWARE, FOR USE IN ONLINE GLOBAL TRADE SERVICES THAT ENABLE IMPORTERS, EXPORTERS, WHOLESALERS, SUPPLIERS, MANUFACTURERS, SERVICE PROVIDERS, SELLERS, BUYERS, TRADERS, FREIGHT FORWARDERS, CARGO CARRIERS, AND THEIR PROGRAMMERS TO CONDUCT AUTOMATIC PAPERLESS TRADING BY TAKING ADVANTAGE OF THE BUILT-IN COMPUTER APPLICATION(S) TO EXCHANGE TRADING DOCUMENTS ELECTRONICALLY; PROVIDING ONLINE NON-DOWLOADABLE SOFTWARE, FOR USE IN ONLINE GLOBAL TRADE SERVICES THAT EN-

ABLE IMPORTERS, EXPORTERS, WHOLESALERS, SUPPLIERS, MANUFACTURERS, SERVICE PROVIDERS, SELLERS, BUYERS, TRADERS, FREIGHT FORWARDERS, CARGO CARRIERS, AND THEIR PROGRAMMERS TO CONDUCT AUTOMATIC PAPERLESS TRADING BY TAKING ADVANTAGE OF THE BUILT-IN COMPUTER APPLICATION(S) TO EXCHANGE TRADING DOCUMENTS ELECTRONICALLY, IN CLASS 42 (U.S. CLS. 100 AND 101).

FIRST USE 3-15-2008; IN COMMERCE 3-30-2008.

THE MARK CONSISTS OF STANDARD CHARACTERS WITHOUT CLAIM TO ANY PARTICULAR FONT, STYLE, SIZE, OR COLOR.

SN 77-252,933, FILED 8-10-2007.

CHRISTINA SOBRAL, EXAMINING ATTORNEY

**Int. Cl.: 35**

**Prior U.S. Cls.: 100, 101, and 102**

**United States Patent and Trademark Office**

**Reg. No. 3,469,159**

**Registered July 15, 2008**

**SERVICE MARK  
PRINCIPAL REGISTER**

**MeAndMyCaregiver(s)**

MEANDMYCAREGIVERS, INC. (MICHIGAN  
CORPORATION)  
6401 CONWAY RD.  
CHELSEA, MI 48118

THE MARK CONSISTS OF STANDARD CHAR-  
ACTERS WITHOUT CLAIM TO ANY PARTICULAR  
FONT, STYLE, SIZE, OR COLOR.

FOR: SUBSCRIPTION TO AN INFORMATION  
MEDIA PACKAGE, IN CLASS 35 (U.S. CLS. 100, 101  
AND 102).

SN 77-252,961, FILED 8-10-2007.

FIRST USE 1-7-2008; IN COMMERCE 1-7-2008.

DAVID H. STINE, EXAMINING ATTORNEY



**Int. Cl.: 9**

**Prior U.S. Cls.: 21, 23, 26, 36, and 38**

**Reg. No. 3,469,160**

**United States Patent and Trademark Office**

**Registered July 15, 2008**

---

**TRADEMARK  
PRINCIPAL REGISTER**

**Utah**

WEBER, TED ARNOLD (UNITED STATES INDIVIDUAL)  
301 EDGEWATER LANE  
KOKOMO, IN 46902

THE MARK CONSISTS OF STANDARD CHARACTERS WITHOUT CLAIM TO ANY PARTICULAR FONT, STYLE, SIZE, OR COLOR.

FOR: LOUDSPEAKERS, IN CLASS 9 (U.S. CLS. 21, 23, 26, 36 AND 38).

SN 77-253,040, FILED 8-11-2007.

FIRST USE 5-1-2008; IN COMMERCE 5-1-2008.

KATHERINE CHANG, EXAMINING ATTORNEY

**Int. Cl.: 35**

**Prior U.S. Cls.: 100, 101, and 102**

**United States Patent and Trademark Office**

**Reg. No. 3,469,161**

**Registered July 15, 2008**

**SERVICE MARK  
PRINCIPAL REGISTER**

**CARROTMOB**

SCHULKIN, BRENT A (UNITED STATES INDIVIDUAL)  
4840 KIERAN CT  
SANTA ROSA, CA 95405

FOR: MATCHING CONSUMERS INTERESTED IN CORPORATE SOCIAL RESPONSIBILITY WITH COMPANIES WHO ARE INTERESTED IN MAKING SOCIALLY RESPONSIBLE BUSINESS DECISIONS IN ORDER TO SELL PRODUCTS TO THAT MARKET, IN CLASS 35 (U.S. CLS. 100, 101 AND 102).

FIRST USE 11-16-2007; IN COMMERCE 2-7-2008.

THE MARK CONSISTS OF STANDARD CHARACTERS WITHOUT CLAIM TO ANY PARTICULAR FONT, STYLE, SIZE, OR COLOR.

SN 77-253,062, FILED 8-11-2007.

ANDREA BUTLER, EXAMINING ATTORNEY

**Int. Cl.: 45**

**Prior U.S. Cls.: 100 and 101**

**United States Patent and Trademark Office**

**Reg. No. 3,469,162**

**Registered July 15, 2008**

**SERVICE MARK  
PRINCIPAL REGISTER**

The logo for RHIZOME IMAGES. The word "RHIZOME" is written in a large, serif font. The letter "O" is green, and a tilde-like mark is positioned below it. The word "IMAGES" is written in a smaller, black, serif font directly below "RHIZOME".

PENNINGTON, JEN (UNITED STATES INDIVIDUAL), DBA RHIZOME DESIGN, INC.,  
24 ROY STREET, #471  
SEATTLE, WA 98109

FOR: STOCK PHOTOGRAPHY SERVICES, NAMELY, LEASING REPRODUCTION RIGHTS OF PHOTOGRAPHS AND TRANSPARENCIES TO OTHERS, IN CLASS 45 (U.S. CLS. 100 AND 101).

FIRST USE 9-1-2007; IN COMMERCE 9-12-2007.

NO CLAIM IS MADE TO THE EXCLUSIVE RIGHT TO USE "IMAGES", APART FROM THE MARK AS SHOWN.

THE COLOR(S) BLACK, BROWN AND GREEN IS/ ARE CLAIMED AS A FEATURE OF THE MARK.

THE MARK CONSISTS OF BROWN LETTERS IN THE WORD "RHIZOME" WITH THE EXCEPTION OF THE "O" AND TILDA- LIKE MARK BENEATH IT WHICH ARE IN GREEN. THE WORD, IMAGES, APPEARS IN BLACK.

SN 77-253,173, FILED 8-12-2007.

DAWN FELDMAN, EXAMINING ATTORNEY

**Int. Cl.: 24**

**Prior U.S. Cls.: 42 and 50**

**United States Patent and Trademark Office**

**Reg. No. 3,469,163**

**Registered July 15, 2008**

**TRADEMARK  
PRINCIPAL REGISTER**

**butt-ums up baby**

BUTT-UMS UP BABY (GEORGIA LTD LIAB CO)  
1392 BRIDGE MILL AVENUE  
CANTON, GA 30114

THE MARK CONSISTS OF STANDARD CHAR-  
ACTERS WITHOUT CLAIM TO ANY PARTICULAR  
FONT, STYLE, SIZE, OR COLOR.

FOR: DIAPER CHANGING PADS NOT OF PA-  
PER, IN CLASS 24 (U.S. CLS. 42 AND 50).

SN 77-253,297, FILED 8-13-2007.

FIRST USE 3-4-2008; IN COMMERCE 3-4-2008.

CURTIS FRENCH, EXAMINING ATTORNEY

**Int. Cl.: 28**

**Prior U.S. Cls.: 22, 23, 38, and 50**

**United States Patent and Trademark Office**

**Reg. No. 3,469,164**

**Registered July 15, 2008**

---

**TRADEMARK  
PRINCIPAL REGISTER**

**POWER-BLAST**

FRANKLIN SPORTS, INC. (DELAWARE COR-  
PORATION)  
17 CAMPANELLI PARKWAY  
STOUGHTON, MA 02072

THE MARK CONSISTS OF STANDARD CHAR-  
ACTERS WITHOUT CLAIM TO ANY PARTICULAR  
FONT, STYLE, SIZE, OR COLOR.

FOR: BASEBALL BATS, IN CLASS 28 (U.S. CLS. 22,  
23, 38 AND 50).

SN 77-253,651, FILED 8-13-2007.

FIRST USE 4-9-2008; IN COMMERCE 4-9-2008.

ANTHONY RINKER, EXAMINING ATTORNEY

**Int. Cl.: 10**

**Prior U.S. Cls.: 26, 39, and 44**

**Reg. No. 3,469,165**

**United States Patent and Trademark Office**

**Registered July 15, 2008**

---

**TRADEMARK  
PRINCIPAL REGISTER**

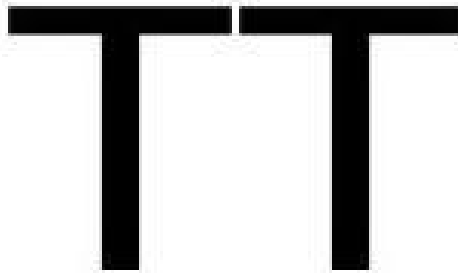

LEMAITRE VASCULAR, INC. (DELAWARE  
CORPORATION)  
63 SECOND AVENUE  
BURLINGTON, MA 01803

THE MARK CONSISTS OF STANDARD CHAR-  
ACTERS WITHOUT CLAIM TO ANY PARTICULAR  
FONT, STYLE, SIZE, OR COLOR.

FOR: STENT DELIVERY SYSTEMS, IN CLASS 10  
(U.S. CLS. 26, 39 AND 44).

SN 77-254,412, FILED 8-14-2007.

FIRST USE 1-15-2008; IN COMMERCE 1-15-2008.

ALICIA COLLINS, EXAMINING ATTORNEY

**Int. Cl.: 20**

**Prior U.S. Cls.: 2, 13, 22, 25, 32, and 50**

**United States Patent and Trademark Office**

**Reg. No. 3,469,166**

**Registered July 15, 2008**

**TRADEMARK  
PRINCIPAL REGISTER**

**CHAIRS FOR FRUITFUL  
LEARNING**

JONTI-CRAFT, INC. (MINNESOTA CORPORATION)

HIGHWAY 68

WABASSO, MN 56293

FOR: MOLDED PLASTIC CHAIRS, IN CLASS 20  
(U.S. CLS. 2, 13, 22, 25, 32 AND 50).

FIRST USE 8-17-2007; IN COMMERCE 8-17-2007.

THE MARK CONSISTS OF STANDARD CHARACTERS WITHOUT CLAIM TO ANY PARTICULAR FONT, STYLE, SIZE, OR COLOR.

NO CLAIM IS MADE TO THE EXCLUSIVE RIGHT TO USE "CHAIRS", APART FROM THE MARK AS SHOWN.

SN 77-254,764, FILED 8-14-2007.

JUSTINE D. PARKER, EXAMINING ATTORNEY

**Int. Cl.: 9**

**Prior U.S. Cls.: 21, 23, 26, 36, and 38**

**Reg. No. 3,469,167**

**United States Patent and Trademark Office**

**Registered July 15, 2008**

---

**TRADEMARK  
PRINCIPAL REGISTER**

**SWITCHBALL**

SIERRA ENTERTAINMENT, INC. (DELAWARE  
CORPORATION)  
6060 CENTER DRIVE, 5TH FLOOR  
LOS ANGELES, CA 90045

FOR: COMPUTER GAME SOFTWARE AND RE-  
LATED INSTRUCTION MANUALS AND GUIDES  
SOLD TOGETHER AS A UNIT; DOWNLOADABLE  
COMPUTER GAME SOFTWARE; INTERACTIVE  
MULTIMEDIA COMPUTER GAME PROGRAM, IN  
CLASS 9 (U.S. CLS. 21, 23, 26, 36 AND 38).

FIRST USE 10-9-2007; IN COMMERCE 10-9-2007.

THE MARK CONSISTS OF STANDARD CHAR-  
ACTERS WITHOUT CLAIM TO ANY PARTICULAR  
FONT, STYLE, SIZE, OR COLOR.

SN 77-255,900, FILED 8-15-2007.

PAUL MORENO, EXAMINING ATTORNEY



**Int. Cl.: 24**

**Prior U.S. Cls.: 42 and 50**

**United States Patent and Trademark Office**

**Reg. No. 3,469,168**

**Registered July 15, 2008**

**TRADEMARK  
PRINCIPAL REGISTER**

**SNOWSTORM**

STANDARD TEXTILE CO., INC. (ALABAMA  
CORPORATION)  
ONE KNOLLCREST DRIVE  
CINCINNATI, OH 45237

THE MARK CONSISTS OF STANDARD CHAR-  
ACTERS WITHOUT CLAIM TO ANY PARTICULAR  
FONT, STYLE, SIZE, OR COLOR.

FOR: BED BLANKETS, IN CLASS 24 (U.S. CLS. 42  
AND 50).

SN 77-255,911, FILED 8-15-2007.

FIRST USE 12-21-2007; IN COMMERCE 12-21-2007.

TARAH HARDY, EXAMINING ATTORNEY

**Int. Cls.: 16, 35, 36, and 39**

**Prior U.S. Cls.: 2, 5, 22, 23, 29, 37, 38, 50, 100, 101, 102, and 105**

**Reg. No. 3,469,169**

**United States Patent and Trademark Office**

**Registered July 15, 2008**

**TRADEMARK  
SERVICE MARK  
PRINCIPAL REGISTER**

**M1 GLOBAL SERVICES**

MACH 1 AIR SERVICES, INC. (ARIZONA CORPORATION)  
1530 WEST BROADWAY ROAD  
TEMPE, AZ 85282

FOR: E-CONTAINERS FOR SHIPPING AND TRANSPORTATION, WAREHOUSING AND STORAGE, AND PACKAGING FOR GOODS, PARCELS, CARGO, AND FREIGHT, NAMELY, CORRUGATED CARDBOARD BOXES, IN CLASS 16 (U.S. CLS. 2, 5, 22, 23, 29, 37, 38 AND 50).

FIRST USE 11-30-2007; IN COMMERCE 11-30-2007.

FOR: AIR AND OCEAN EXPORT AND IMPORT AGENCY SERVICES; INVENTORY MANAGEMENT, NAMELY, PICK-AND-PULL COMPUTERIZED INVENTORY REPORTING AND MARKET LOGISTICS MANAGEMENT IN THE FIELD OF SHIPPING AND TRANSPORTATION OF GOODS BY AIR, BOAT, RAIL, AND TRUCK, IN CLASS 35 (U.S. CLS. 100, 101 AND 102).

FIRST USE 11-30-2007; IN COMMERCE 11-30-2007.

FOR: INSURANCE SERVICES, NAMELY, WRITING PROPERTY AND CASUALTY INSURANCE FOR GOODS, PARCELS, CARGO, AND FREIGHT LOST OR DAMAGED DURING SHIPPING, TRANSPORTATION, WAREHOUSING, STORAGE AND PACKAGING, IN CLASS 36 (U.S. CLS. 100, 101 AND 102).

FIRST USE 11-30-2007; IN COMMERCE 11-30-2007.

FOR: SHIPPING AND TRANSPORTATION OF GOODS BY AIR, BOAT, RAIL, AND TRUCK SAME DAY, COUNTER-TO-COUNTER, NEXT FLIGHT OUT (NFO), OVERNIGHT, SECOND DAY, 3-5 DAY DEFERRED, TRUCKLOAD, LOCAL CARTAGE AND GROUND EXPEDITE; WAREHOUSING SERVICES, NAMELY, STORAGE, DISTRIBUTION, PICK-UP, PACKING, AND SHIPPING OF GOODS OF OTHERS; PACKAGING OF GOODS AND FREIGHT FOR TRANSPORTATION, NAMELY, PACKAGING, CRATING, BULK, RE-PACKAGING, RE-CRATING, AND BREAK-IN-BULK, IN CLASS 39 (U.S. CLS. 100 AND 105).

FIRST USE 11-30-2007; IN COMMERCE 11-30-2007.

THE MARK CONSISTS OF STANDARD CHARACTERS WITHOUT CLAIM TO ANY PARTICULAR FONT, STYLE, SIZE, OR COLOR.

NO CLAIM IS MADE TO THE EXCLUSIVE RIGHT TO USE "GLOBAL SERVICES", APART FROM THE MARK AS SHOWN.

SN 77-257,435, FILED 8-16-2007.

NAAKWAMA ANKRAH, EXAMINING ATTORNEY

**Int. Cl.: 7**

**Prior U.S. Cls.: 13, 19, 21, 23, 31, 34, and 35**

**Reg. No. 3,469,170**

**United States Patent and Trademark Office**

**Registered July 15, 2008**

---

**TRADEMARK  
PRINCIPAL REGISTER**

**SERVICEMASTER CLEAN**

SERVICEMASTER BRANDS L.L.C. (VERMONT  
LTD LIAB CO)  
100 BANK STREET  
BURLINGTON, VT 05401

FOR: CLEANING AND SPRAYING MACHINES  
AND EQUIPMENT AND THEIR COMPONENTS,  
NAMELY, WALL AND CARPET CLEANING MA-  
CHINES AND PARTS AND FITTINGS THEREFOR;  
ROTARY DISC FLOOR CLEANING MACHINES;  
VACUUM CLEANERS, IN CLASS 7 (U.S. CLS. 13, 19,  
21, 23, 31, 34 AND 35).

FIRST USE 1-1-2003; IN COMMERCE 1-1-2003.

THE MARK CONSISTS OF STANDARD CHAR-  
ACTERS WITHOUT CLAIM TO ANY PARTICULAR  
FONT, STYLE, SIZE, OR COLOR.

OWNER OF U.S. REG. NOS. 2,254,065, 2,503,864,  
AND OTHERS.

NO CLAIM IS MADE TO THE EXCLUSIVE  
RIGHT TO USE "CLEAN", APART FROM THE  
MARK AS SHOWN.

SN 77-258,245, FILED 8-17-2007.

JOHN HWANG, EXAMINING ATTORNEY

**Int. Cl.: 18**

**Prior U.S. Cls.: 1, 2, 3, 22, and 41**

**United States Patent and Trademark Office**

**Reg. No. 3,469,171**

**Registered July 15, 2008**

**TRADEMARK  
PRINCIPAL REGISTER**

# Market Sak

ZABO STUDIO (FLORIDA LTD LIAB CO)  
3 LIVE OAK CIRCLE  
TEQUESTA, FL 33469

FOR: REUSABLE TEXTILE SHOPPING BAGS  
MADE FROM NON-WOVEN POLYPROPYLENE,  
NYLON, CANVAS, POLYETHYLENE TEREPHTHA-  
LATE, HEMP AND COTTON, IN CLASS 18 (U.S. CLS.  
1, 2, 3, 22 AND 41).

FIRST USE 7-1-2007; IN COMMERCE 7-1-2007.

THE MARK CONSISTS OF STANDARD CHAR-  
ACTERS WITHOUT CLAIM TO ANY PARTICULAR  
FONT, STYLE, SIZE, OR COLOR.

NO CLAIM IS MADE TO THE EXCLUSIVE  
RIGHT TO USE "SACK", APART FROM THE MARK  
AS SHOWN.

SN 77-258,794, FILED 8-19-2007.

ALEXANDER L. POWERS, EXAMINING ATTOR-  
NEY

**Int. Cl.: 19**

**Prior U.S. Cls.: 1, 12, 33, and 50**

**United States Patent and Trademark Office**

**Reg. No. 3,469,172**

**Registered July 15, 2008**

**TRADEMARK  
PRINCIPAL REGISTER**

**KENWOOD**

CRANE FENCING SOLUTIONS, LTD. (OHIO  
LTD LIAB CO)  
4074 BETHANY ROAD  
MASON, OH 45040

THE MARK CONSISTS OF STANDARD CHAR-  
ACTERS WITHOUT CLAIM TO ANY PARTICULAR  
FONT, STYLE, SIZE, OR COLOR.

FOR: NON-METAL GATES AND FENCING, IN  
CLASS 19 (U.S. CLS. 1, 12, 33 AND 50).

SN 77-259,257, FILED 8-20-2007.

FIRST USE 9-30-2007; IN COMMERCE 10-20-2007.

SIMON TENG, EXAMINING ATTORNEY

**Int. Cl.: 9**

**Prior U.S. Cls.: 21, 23, 26, 36, and 38**

**United States Patent and Trademark Office**

**Reg. No. 3,469,173**

**Registered July 15, 2008**

**TRADEMARK  
PRINCIPAL REGISTER**

**ZOOM KIDZ SHADES**

ZOOM EYEWORKS, INC. (CALIFORNIA CORPORATION)  
2501 9TH STREET, SUITE 100  
BERKELEY, CA 94710

OWNER OF U.S. REG. NOS. 3,072,132, 3,269,129,  
AND 3,305,598.

FOR: CHILDREN'S SUNGLASSES, EYEGLASSES,  
AND EYEGLASS ACCESSORIES, NAMELY, CASES,  
CHAINS, AND LEASHES, IN CLASS 9 (U.S. CLS. 21,  
23, 26, 36 AND 38).

NO CLAIM IS MADE TO THE EXCLUSIVE  
RIGHT TO USE "KIDS SHADES", APART FROM  
THE MARK AS SHOWN.

FIRST USE 3-1-2008; IN COMMERCE 3-1-2008.

SN 77-259,453, FILED 8-20-2007.

THE MARK CONSISTS OF STANDARD CHAR-  
ACTERS WITHOUT CLAIM TO ANY PARTICULAR  
FONT, STYLE, SIZE, OR COLOR.

LINDA ORNDORFF, EXAMINING ATTORNEY

**Int. Cl.: 19**

**Prior U.S. Cls.: 1, 12, 33, and 50**

**United States Patent and Trademark Office**

**Reg. No. 3,469,174**

**Registered July 15, 2008**

**TRADEMARK  
PRINCIPAL REGISTER**

**BEECHMONT**

CRANE FENCING SOLUTIONS, LTD. (OHIO  
LTD LIAB CO)  
4074 BETHANY ROAD  
MASON, OH 45040

THE MARK CONSISTS OF STANDARD CHAR-  
ACTERS WITHOUT CLAIM TO ANY PARTICULAR  
FONT, STYLE, SIZE, OR COLOR.

FOR: NON-METAL GATES AND FENCING, IN  
CLASS 19 (U.S. CLS. 1, 12, 33 AND 50).

SN 77-259,632, FILED 8-20-2007.

FIRST USE 9-30-2007; IN COMMERCE 10-20-2007.

SIMON TENG, EXAMINING ATTORNEY

**Int. Cl.: 41**

**Prior U.S. Cls.: 100, 101, and 107**

**United States Patent and Trademark Office**

**Reg. No. 3,469,175**

**Registered July 15, 2008**

---

**SERVICE MARK  
PRINCIPAL REGISTER**

**Instruments of Change**

COVENANT CHILDREN, INC. (NEW JERSEY CORPORATION)  
250 WEST 57TH STREET, SUITE 332  
NEW YORK, NY 10107

FOR: CHARITABLE SERVICES, NAMELY, PROVIDING MUSICAL INSTRUMENTS AND MUSICAL INSTRUCTION TO NEEDY PERSONS, IN CLASS 41 (U.S. CLS. 100, 101 AND 107).

FIRST USE 1-1-2008; IN COMMERCE 2-1-2008.

THE MARK CONSISTS OF STANDARD CHARACTERS WITHOUT CLAIM TO ANY PARTICULAR FONT, STYLE, SIZE, OR COLOR.

SN 77-259,778, FILED 8-20-2007.

CORY BOONE, EXAMINING ATTORNEY



**Int. Cl.: 28**

**Prior U.S. Cls.: 22, 23, 38, and 50**

**United States Patent and Trademark Office**

**Reg. No. 3,469,176**

**Registered July 15, 2008**

**TRADEMARK  
PRINCIPAL REGISTER**

# Ring It Golf

RING IT GOLF INC. (CALIFORNIA CORPORATION)

7085 KISKA COURT

PILOT HILL, CA 95664

FOR: ACTION TARGET GAMES, IN CLASS 28  
(U.S. CLS. 22, 23, 38 AND 50).

FIRST USE 11-15-2007; IN COMMERCE 11-15-2007.

THE MARK CONSISTS OF STANDARD CHARACTERS WITHOUT CLAIM TO ANY PARTICULAR FONT, STYLE, SIZE, OR COLOR.

NO CLAIM IS MADE TO THE EXCLUSIVE RIGHT TO USE "GOLF", APART FROM THE MARK AS SHOWN.

SN 77-260,400, FILED 8-21-2007.

DAVID C. REIHNER, EXAMINING ATTORNEY

**Int. Cl.: 5**

**Prior U.S. Cls.: 6, 18, 44, 46, 51, and 52**

**Reg. No. 3,469,177**

**United States Patent and Trademark Office**

**Registered July 15, 2008**

---

**TRADEMARK  
PRINCIPAL REGISTER**

# Mom's Defense

MOM'S DEFENSE, LLC. (NEW MEXICO LTD  
LIAB CO)  
37 IRONWOOD ROAD  
NEW HARTFORD, NY 13413

THE MARK CONSISTS OF STANDARD CHAR-  
ACTERS WITHOUT CLAIM TO ANY PARTICULAR  
FONT, STYLE, SIZE, OR COLOR.

FOR: DIETARY SUPPLEMENTS, IN CLASS 5 (U.S.  
CLS. 6, 18, 44, 46, 51 AND 52).

SN 77-261,203, FILED 8-21-2007.

FIRST USE 1-10-2008; IN COMMERCE 4-26-2008.

GEOFFREY FOSDICK, EXAMINING ATTORNEY

**Int. Cl.: 16**

**Prior U.S. Cls.: 2, 5, 22, 23, 29, 37, 38, and 50**

**Reg. No. 3,469,178**

**United States Patent and Trademark Office**

**Registered July 15, 2008**

---

**TRADEMARK  
PRINCIPAL REGISTER**

**FACE VALUE**

DRYVIT SYSTEMS, INC. (RHODE ISLAND CORPORATION)  
ONE ENERGY WAY  
WEST WARWICK, RI 02893

FOR: MAGAZINES FEATURING ARTICLES RELATING TO THE CONSTRUCTION INDUSTRY, DISTRIBUTED AS A SUPPLEMENT TO OTHER CONSTRUCTION-RELATED MAGAZINES, IN CLASS 16 (U.S. CLS. 2, 5, 22, 23, 29, 37, 38 AND 50).

FIRST USE 11-1-2007; IN COMMERCE 11-1-2007.

THE MARK CONSISTS OF STANDARD CHARACTERS WITHOUT CLAIM TO ANY PARTICULAR FONT, STYLE, SIZE, OR COLOR.

SN 77-262,498, FILED 8-23-2007.

CAROLINE WOOD, EXAMINING ATTORNEY

**Int. Cl.: 35**

**Prior U.S. Cls.: 100, 101, and 102**

**United States Patent and Trademark Office**

**Reg. No. 3,469,179**

**Registered July 15, 2008**

**SERVICE MARK  
PRINCIPAL REGISTER**

**SUN LIFE SAUNAS**

J & L MONTANA ENTERPRISES, INC. (CALI-  
FORNIA CORPORATION)  
2242 CRESCENT MOON DR.  
REDDING, CA 96001

FOR: ON-LINE RETAIL STORE SERVICES FEATURING INFRARED SAUNAS FOR HOME OR BUSINESS USE, IN CLASS 35 (U.S. CLS. 100, 101 AND 102).

FIRST USE 6-12-2007; IN COMMERCE 7-1-2007.

THE MARK CONSISTS OF STANDARD CHARACTERS WITHOUT CLAIM TO ANY PARTICULAR FONT, STYLE, SIZE, OR COLOR.

NO CLAIM IS MADE TO THE EXCLUSIVE RIGHT TO USE "SAUNAS", APART FROM THE MARK AS SHOWN.

SN 77-262,570, FILED 8-23-2007.

RENEE MCCRAY, EXAMINING ATTORNEY

**Int. Cl.: 41**

**Prior U.S. Cls.: 100, 101, and 107**

**United States Patent and Trademark Office**

**Reg. No. 3,469,180**

**Registered July 15, 2008**

**SERVICE MARK  
PRINCIPAL REGISTER**

**HOW YOU DO WHAT YOU DO**

R.E.L. COMMUNICATIONS, INC. (NEW JERSEY  
CORPORATION)  
2674 LARMAR ROAD  
LOS ANGELES, CA 90068

THE MARK CONSISTS OF STANDARD CHAR-  
ACTERS WITHOUT CLAIM TO ANY PARTICULAR  
FONT, STYLE, SIZE, OR COLOR.

FOR: EDUCATIONAL SERVICES, NAMELY,  
BUSINESS SEMINARS PROVIDING INSTRUCTION  
AND INSPIRATION REGARDING CUSTOMER  
SERVICE, IN CLASS 41 (U.S. CLS. 100, 101 AND 107).

SN 77-262,833, FILED 8-23-2007.

FIRST USE 2-1-2008; IN COMMERCE 2-1-2008.

KEVIN DINALLO, EXAMINING ATTORNEY

**Int. Cl.: 9**

**Prior U.S. Cls.: 21, 23, 26, 36, and 38**

**Reg. No. 3,469,181**

**United States Patent and Trademark Office**

**Registered July 15, 2008**

---

**TRADEMARK  
PRINCIPAL REGISTER**

**BRIGHT SOLUTIONS BRILLIANT  
RESULTS**

IPLACEMENT, INC. (FLORIDA CORPORATION)  
1516 E. COLONIAL DRIVE  
ORLANDO, FL 32803

FOR: DATABASE MANAGEMENT SOFTWARE FOR USE IN THE HUMAN RESOURCES, EMPLOYMENT, RECRUITING, AND STAFFING FIELDS; COMPUTER SOFTWARE FOR APPLICATION AND DATABASE INTEGRATION IN THE HUMAN RESOURCES, EMPLOYMENT, RECRUITING, AND STAFFING FIELDS; ENTERPRISE SOFTWARE IN THE NATURE OF A DATABASE FOR NON-TRANSACTIONAL DATA AND A SEARCH ENGINE FOR DATABASE CONTENT FOR USE IN THE HUMAN

RESOURCES, EMPLOYMENT, RECRUITING AND STAFFING FIELDS, IN CLASS 9 (U.S. CLS. 21, 23, 26, 36 AND 38).

FIRST USE 7-31-2006; IN COMMERCE 7-31-2006.

THE MARK CONSISTS OF STANDARD CHARACTERS WITHOUT CLAIM TO ANY PARTICULAR FONT, STYLE, SIZE, OR COLOR.

SN 77-262,948, FILED 8-23-2007.

KATHLEEN M. VANSTON, EXAMINING ATTORNEY

**Int. Cl.: 10**

**Prior U.S. Cls.: 26, 39, and 44**

**Reg. No. 3,469,182**

**United States Patent and Trademark Office**

**Registered July 15, 2008**

---

**TRADEMARK  
PRINCIPAL REGISTER**

# Safety Color

BYNUM, W. RICHARD (UNITED STATES INDIVIDUAL)

13659 TREASURE TRAIL

SAN ANTONIO, TX 78232

FOR: MEDICAL SYRINGES, IN CLASS 10 (U.S. CLS. 26, 39 AND 44).

FIRST USE 12-1-2007; IN COMMERCE 12-1-2007.

THE MARK CONSISTS OF STANDARD CHARACTERS WITHOUT CLAIM TO ANY PARTICULAR FONT, STYLE, SIZE, OR COLOR.

NO CLAIM IS MADE TO THE EXCLUSIVE RIGHT TO USE "SAFETY", APART FROM THE MARK AS SHOWN.

SN 77-263,406, FILED 8-24-2007.

RICHARD A. STRASER, EXAMINING ATTORNEY

**Int. Cl.: 5**

**Prior U.S. Cls.: 6, 18, 44, 46, 51, and 52**

**Reg. No. 3,469,183**

**United States Patent and Trademark Office**

**Registered July 15, 2008**

**TRADEMARK  
PRINCIPAL REGISTER**



GOLDBLATT, CHRISTOPHER FISHER (UNITED STATES INDIVIDUAL), DBA GOLD LEAF SUSTAINABLE,

#320

484 B WASHINGTON ST.  
MONTEREY, CA 93940

FOR: DIETARY AND NUTRITIONAL SUPPLEMENTS, IN CLASS 5 (U.S. CLS. 6, 18, 44, 46, 51 AND 52).

FIRST USE 6-12-2003; IN COMMERCE 2-1-2007.

THE COLOR(S) BLUE, WHITE AND YELLOW IS/ ARE CLAIMED AS A FEATURE OF THE MARK.

THE MARK CONSISTS OF A BLUE RECTANGLE IN THE CENTER OF WHICH LIES THE WORD "POTENTSEA" IN WHITE LETTERS, AND TO THE RIGHT OF THE WORD, A WHITE CIRCLE IN THE CENTER OF WHICH IS A YELLOW TRIDENT.

SN 77-263,675, FILED 8-24-2007.

JILL C. ALT, EXAMINING ATTORNEY



**Int. Cl.: 16**

**Prior U.S. Cls.: 2, 5, 22, 23, 29, 37, 38, and 50**

**Reg. No. 3,469,184**

**United States Patent and Trademark Office**

**Registered July 15, 2008**

**TRADEMARK  
PRINCIPAL REGISTER**

**be clear**

DAVIS, MICHELE D (UNITED STATES INDIVIDUAL)  
957 E. CEDAR DRIVE  
CHANDLER, AZ 85249

THE MARK CONSISTS OF STANDARD CHARACTERS WITHOUT CLAIM TO ANY PARTICULAR FONT, STYLE, SIZE, OR COLOR.

FOR: DRY ERASE WRITING BOARDS AND WRITING SURFACES, IN CLASS 16 (U.S. CLS. 2, 5, 22, 23, 29, 37, 38 AND 50).

SN 77-264,523, FILED 8-26-2007.

FIRST USE 4-15-2008; IN COMMERCE 4-15-2008.

REBECCA EISINGER, EXAMINING ATTORNEY

**Int. Cl.: 13**

**Prior U.S. Cls.: 2 and 9**

**United States Patent and Trademark Office**

**Reg. No. 3,469,185**

**Registered July 15, 2008**

**TRADEMARK  
PRINCIPAL REGISTER**

**BARRACUDA**

OVER THE COUNTER INTELLIGENCE, INC  
(NEVADA CORPORATION)  
310 MCGOLDRICK WAY  
SPARKS, NV 89431

THE MARK CONSISTS OF STANDARD CHAR-  
ACTERS WITHOUT CLAIM TO ANY PARTICULAR  
FONT, STYLE, SIZE, OR COLOR.

FOR: STUN GUNS, IN CLASS 13 (U.S. CLS. 2 AND  
9).

SN 77-264,880, FILED 8-27-2007.

FIRST USE 12-24-2007; IN COMMERCE 12-24-2007.

NICHOLAS ALTREE, EXAMINING ATTORNEY

**Int. Cl.: 9**

**Prior U.S. Cls.: 21, 23, 26, 36, and 38**

**Reg. No. 3,469,186**

**United States Patent and Trademark Office**

**Registered July 15, 2008**

**TRADEMARK  
PRINCIPAL REGISTER**

**BeStar**

DE YOUNG, DIRK WILLSON (UNITED STATES  
INDIVIDUAL)  
6334 S. VOLCANO LANE  
HEREFORD, AZ 85615

FOR: AUDIO SPEAKERS; ELECTRIC BUZZERS;  
ELECTROACOUSTIC TRANSDUCERS; ANTI-IN-  
TRUSION ALARMS; ELECTRICAL AND ELECTRO-  
NIC BURGLAR ALARMS; FIRE ALARMS;  
PERSONAL SECURITY ALARMS; THEFT ALARMS;  
ULTRASONIC OBJECT DETECTORS FOR USE ON  
VEHICLES; ULTRASONIC SENSORS; ELECTRONIC  
TRANSMITTERS AND RECEIVERS FOR TELE-  
PHONE AND MOBILE PHONES; ELECTRONIC  
WARNING HORN; AUDIO CIRCUIT BOARDS; CIR-

CUIT BOARDS PROVIDED WITH INTEGRATED  
CIRCUITS; ELECTRICAL CIRCUIT BOARDS, IN  
CLASS 9 (U.S. CLS. 21, 23, 26, 36 AND 38).

FIRST USE 6-27-2007; IN COMMERCE 11-28-2007.

THE MARK CONSISTS OF STANDARD CHAR-  
ACTERS WITHOUT CLAIM TO ANY PARTICULAR  
FONT, STYLE, SIZE, OR COLOR.

SN 77-265,902, FILED 8-28-2007.

PAULA MAHONEY, EXAMINING ATTORNEY

**Int. Cl.: 43**

**Prior U.S. Cls.: 100 and 101**

**United States Patent and Trademark Office**

**Reg. No. 3,469,187**

**Registered July 15, 2008**

**SERVICE MARK  
PRINCIPAL REGISTER**

**CHILLY BLISS**

PINKBERRY, INC. (CALIFORNIA CORPORATION)  
6310 SAN VICENTE BOULEVARD  
SUITE 100  
LOS ANGELES, CA 90048

FOR: RESTAURANT SERVICES; RESTAURANTS;  
TAKE-OUT RESTAURANT SERVICES; CAFE-RESTAURANTS;  
FAST-FOOD RESTAURANTS; RESTAURANTS FEATURING FROZEN DAIRY  
DESERTS, IN CLASS 43 (U.S. CLS. 100 AND 101).

FIRST USE 11-30-2006; IN COMMERCE 11-30-2006.

THE MARK CONSISTS OF STANDARD CHARACTERS WITHOUT CLAIM TO ANY PARTICULAR FONT, STYLE, SIZE, OR COLOR.

SN 77-266,607, FILED 8-28-2007.

ESTHER A. BORSUK, EXAMINING ATTORNEY

Int. Cl.: 30

Prior U.S. Cl.: 46

United States Patent and Trademark Office

Reg. No. 3,469,188

Registered July 15, 2008

TRADEMARK  
PRINCIPAL REGISTER



ANTHONY, DARWIN (UNITED STATES INDIVIDUAL)  
151 E WILSON AVE.  
RIDGECREST, CA 93555 AND  
ANTHONY, FRANCES (UNITED STATES INDIVIDUAL)  
151 E WILSON AVE.  
RIDGECREST, CA 93555

FOR: HOT SAUCE; SALSAS, IN CLASS 30 (U.S. CL. 46).

FIRST USE 7-1-2007; IN COMMERCE 11-28-2007.

NO CLAIM IS MADE TO THE EXCLUSIVE RIGHT TO USE "SALSAS", APART FROM THE MARK AS SHOWN.

THE MARK CONSISTS OF AN ATOMIC SYMBOL WITH TOMATOES, ONIONS AND PEPPERS SHOWN ROTATING AROUND A HABANERO PEPPER.

SN 77-267,061, FILED 8-29-2007.

KIMBERLY FRYE, EXAMINING ATTORNEY

Int. Cl.: 44

Prior U.S. Cls.: 100 and 101

United States Patent and Trademark Office

Reg. No. 3,469,189

Registered July 15, 2008

**SERVICE MARK  
PRINCIPAL REGISTER**



JAMES CHAE (UNITED STATES INDIVIDUAL)  
1698 VISTA DEL NORTE  
CHINO HILLS, CA 91709

FOR: DENTAL SERVICES, IN CLASS 44 (U.S. CLS.  
100 AND 101).

FIRST USE 12-21-2007; IN COMMERCE 12-21-2007.

NO CLAIM IS MADE TO THE EXCLUSIVE  
RIGHT TO USE "DIAMOND BAR" AND "DENTAL  
GROUP", APART FROM THE MARK AS SHOWN.

THE COLOR(S) GREEN AND GREY IS/ARE  
CLAIMED AS A FEATURE OF THE MARK.

THE COLOR(S) GREEN AND LIGHT GREEN  
FOR THE DIAMOND PORTION; GREY FOR THE  
ARROW PORTION; GREY FOR THE WORD, "DIA-  
MOND"; GREEN FOR "BAR" AND LIGHT GREEN  
FOR "DENTAL GROUP" IS/ARE CLAIMED AS A  
FEATURE OF THE MARK. THE BACKGROUND  
COLOR WHITE IN THE DESIGN IS NOT CLAIMED  
AS A FEATURE OF THE MARK.

SN 77-267,244, FILED 8-29-2007.

JOHN HWANG, EXAMINING ATTORNEY

**Int. Cl.: 16**

**Prior U.S. Cls.: 2, 5, 22, 23, 29, 37, 38, and 50**

**Reg. No. 3,469,190**

**United States Patent and Trademark Office**

**Registered July 15, 2008**

**TRADEMARK  
PRINCIPAL REGISTER**

**WYPIWYG**

MAKO SURGICAL CORP. (FLORIDA CORPORATION)  
2555 DAVIE ROAD  
FORT LAUDERDALE, FL 33317

FOR: PAMPHLETS IN THE FIELD OF MINIMALLY INVASIVE SURGICAL TECHNIQUES; PRINTED INSTRUCTIONAL, EDUCATIONAL, AND TEACHING MATERIALS IN THE FIELD OF MEDICAL PROCEDURES AND MINIMALLY INVASIVE SURGICAL TECHNIQUES; BOOKLETS IN THE FIELD OF MINIMALLY INVASIVE SURGICAL TECHNIQUES; BROCHURES ABOUT MINIMALLY INVA-

SIVE SURGICAL TECHNIQUES, IN CLASS 16 (U.S. CLS. 2, 5, 22, 23, 29, 37, 38 AND 50).

FIRST USE 9-30-2007; IN COMMERCE 9-30-2007.

THE MARK CONSISTS OF STANDARD CHARACTERS WITHOUT CLAIM TO ANY PARTICULAR FONT, STYLE, SIZE, OR COLOR.

SN 77-268,186, FILED 8-30-2007.

BRENDAN REGAN, EXAMINING ATTORNEY

**Int. Cl.: 16**

**Prior U.S. Cls.: 2, 5, 22, 23, 29, 37, 38, and 50**

**Reg. No. 3,469,191**

**United States Patent and Trademark Office**

**Registered July 15, 2008**

**TRADEMARK  
PRINCIPAL REGISTER**

**RESTORING QUALITY OF LIFE  
THROUGH INNOVATION**

MAKO SURGICAL CORP. (FLORIDA CORPORATION)  
2555 DAVIE ROAD  
FORT LAUDERDALE, FL 33317

FOR: PAMPHLETS IN THE FIELD OF MINIMALLY INVASIVE SURGICAL TECHNIQUES; PRINTED INSTRUCTIONAL, EDUCATIONAL, AND TEACHING MATERIALS IN THE FIELD OF MEDICAL PROCEDURES AND MINIMALLY INVASIVE SURGICAL TECHNIQUES; BOOKLETS IN THE FIELD OF MINIMALLY INVASIVE SURGICAL TECHNIQUES; BROCHURES ABOUT MINIMALLY INVA-

SIVE SURGICAL TECHNIQUES, IN CLASS 16 (U.S. CLS. 2, 5, 22, 23, 29, 37, 38 AND 50).

FIRST USE 10-31-2007; IN COMMERCE 10-31-2007.

THE MARK CONSISTS OF STANDARD CHARACTERS WITHOUT CLAIM TO ANY PARTICULAR FONT, STYLE, SIZE, OR COLOR.

SN 77-268,204, FILED 8-30-2007.

BRENDAN REGAN, EXAMINING ATTORNEY



**Int. Cl.: 41**

**Prior U.S. Cls.: 100, 101, and 107**

**United States Patent and Trademark Office**

**Reg. No. 3,469,192**

**Registered July 15, 2008**

**SERVICE MARK  
PRINCIPAL REGISTER**

RESTORING QUALITY OF LIFE  
THROUGH INNOVATION

MAKO SURGICAL CORP. (FLORIDA CORPORATION)  
2555 DAVIE ROAD  
FORT LAUDERDALE, FL 33317

FOR: EDUCATION SERVICES, NAMELY, PROVIDING AND CONDUCTING CONFERENCES, SEMINARS, WORKSHOPS, AND CLASSES IN THE FIELDS OF MINIMALLY INVASIVE SURGICAL TECHNIQUES, IN CLASS 41 (U.S. CLS. 100, 101 AND 107).

FIRST USE 2-29-2008; IN COMMERCE 2-29-2008.

THE MARK CONSISTS OF STANDARD CHARACTERS WITHOUT CLAIM TO ANY PARTICULAR FONT, STYLE, SIZE, OR COLOR.

SN 77-268,210, FILED 8-30-2007.

BRENDAN REGAN, EXAMINING ATTORNEY

**Int. Cl.: 44**

**Prior U.S. Cls.: 100 and 101**

**United States Patent and Trademark Office**

**Reg. No. 3,469,193**

**Registered July 15, 2008**

**SERVICE MARK  
PRINCIPAL REGISTER**

RESTORING QUALITY OF LIFE  
THROUGH INNOVATION

MAKO SURGICAL CORP. (FLORIDA CORPORATION)  
2555 DAVID ROAD  
FORT LAUDERDALE, FL 33317

FOR: MEDICAL SERVICES, NAMELY, MEDICAL SERVICES IN FIELD OF ORTHOPEDIC SURGERY; MEDICAL SERVICES UTILIZING SURGICAL ROBOTIC SYSTEMS; AND MEDICAL SERVICES UTILIZING HAPTIC DEVICES, IN CLASS 44 (U.S. CLS. 100 AND 101).

FIRST USE 9-30-2007; IN COMMERCE 9-30-2007.

THE MARK CONSISTS OF STANDARD CHARACTERS WITHOUT CLAIM TO ANY PARTICULAR FONT, STYLE, SIZE, OR COLOR.

SN 77-268,215, FILED 8-30-2007.

BRENDAN REGAN, EXAMINING ATTORNEY

**Int. Cls.: 7 and 8**

**Prior U.S. Cls.: 13, 19, 21, 23, 28, 31, 34, 35, and 44**

**United States Patent and Trademark Office**

**Reg. No. 3,469,194**

**Registered July 15, 2008**

**TRADEMARK  
PRINCIPAL REGISTER**

The **Right** Tool at the **Right** Time

PRECISION TWIST DRILL CO. (DELAWARE CORPORATION)  
301 INDUSTRIAL AVENUE  
CRYSTAL LAKE, IL 60012

FOR: FULL LINE OF STANDARD AND SPECIAL CUTTING TOOLS AND COMPONENT PARTS THEREOF FOR USE WITH POWER TOOLS OR MACHINES, IN CLASS 7 (U.S. CLS. 13, 19, 21, 23, 31, 34 AND 35).

FIRST USE 10-12-2007; IN COMMERCE 10-12-2007.

FOR: FULL LINE OF STANDARD AND SPECIAL CUTTING TOOLS AND COMPONENT PARTS THEREOF FOR USE WITH HAND TOOLS, IN CLASS 8 (U.S. CLS. 23, 28 AND 44).

FIRST USE 10-12-2007; IN COMMERCE 10-12-2007.

THE COLOR(S) RED AND BLACK IS/ARE CLAIMED AS A FEATURE OF THE MARK.

THE MARK CONSISTS OF THE WORDS "THE RIGHT TOOL AT THE RIGHT TIME", WHERE THE WORD "RIGHT" IS IN RED AND THE REMAINING WORDS ARE IN BLACK.

SN 77-268,389, FILED 8-30-2007.

MATTHEW EINSTEIN, EXAMINING ATTORNEY

**Int. Cl.: 37**

**Prior U.S. Cls.: 100, 103, and 106**

**United States Patent and Trademark Office**

**Reg. No. 3,469,195**

**Registered July 15, 2008**

---

**SERVICE MARK  
PRINCIPAL REGISTER**

**TOTAL GUEST CARE**

COPELAN SERVICES, INC. (WISCONSIN COR-  
PORATION)  
W175 N5711 TECHNOLOGY DRIVE  
MEMONOME FALLS, WI 53051

FOR: PEST CONTROL SERVICES, IN CLASS 37  
(U.S. CLS. 100, 103 AND 106).

FIRST USE 9-18-2007; IN COMMERCE 9-18-2007.

THE MARK CONSISTS OF STANDARD CHAR-  
ACTERS WITHOUT CLAIM TO ANY PARTICULAR  
FONT, STYLE, SIZE, OR COLOR.

OWNER OF U.S. REG. NOS. 2,425,088 AND  
2,556,150.

SN 77-268,618, FILED 8-30-2007.

CHERYL CLAYTON, EXAMINING ATTORNEY

**Int. Cl.: 28**

**Prior U.S. Cls.: 22, 23, 38, and 50**

**United States Patent and Trademark Office**

**Reg. No. 3,469,196**

**Registered July 15, 2008**

**TRADEMARK  
PRINCIPAL REGISTER**



VENSON JR., RICHARD E. (UNITED STATES  
INDIVIDUAL), DBA VENSON PRODUCTS  
AND SERVICES,  
1754 SUGARMAPLE DR.  
COLUMBUS, OH 43229

FOR: ACTION SKILL GAMES, BOARD GAMES,  
CARD GAMES, DICE GAMES, POSITIONABLE  
PRINTED TOY FIGURES FOR USE IN GAMES,  
POSITIONABLE THREE DIMENSIONAL TOYS FOR  
USE IN GAMES, ROLE PLAYING GAMES, TRAD-  
ING CARD GAMES, IN CLASS 28 (U.S. CLS. 22, 23, 38  
AND 50).

FIRST USE 11-25-2007; IN COMMERCE 5-20-2008.

THE MARK CONSISTS OF THE WORDING  
"MARTIAL WORLD" ON TOP OF A YIN YANG  
SYMBOL.

SN 77-268,755, FILED 8-30-2007.

COLLEEN DOMBROW, EXAMINING ATTORNEY

**Int. Cl.: 14**

**Prior U.S. Cls.: 2, 27, 28, and 50**

**United States Patent and Trademark Office**

**Reg. No. 3,469,197**

**Registered July 15, 2008**

**TRADEMARK  
PRINCIPAL REGISTER**

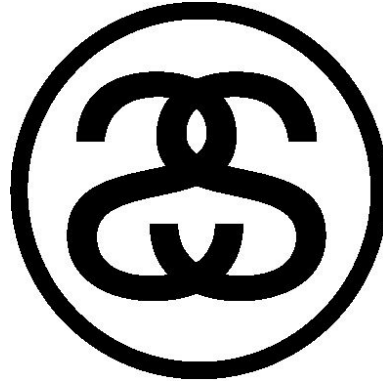

STUSSY, INC. (CALIFORNIA CORPORATION)  
17426 DAIMLER STREET  
IRVINE, CA 92614

OWNER OF U.S. REG. NOS. 2,225,736, 2,515,116,  
AND OTHERS.

FOR: JEWELRY, WATCHES, IN CLASS 14 (U.S.  
CLS. 2, 27, 28 AND 50).

SN 77-268,798, FILED 8-30-2007.

FIRST USE 12-31-1994; IN COMMERCE 12-31-1994.

MARK T. MULLEN, EXAMINING ATTORNEY

Int. Cl.: 33

Prior U.S. Cls.: 47 and 49

United States Patent and Trademark Office

Reg. No. 3,469,198

Registered July 15, 2008

TRADEMARK  
PRINCIPAL REGISTER



AVERBUCH, LISA (UNITED STATES INDIVIDUAL)  
1500 PARK AVENUE, SUITE 229  
EMERYVILLE, CA 94608

FOR: ORGANIC DISTILLED SPIRITS, IN CLASS 33 (U.S. CLS. 47 AND 49).

FIRST USE 12-21-2007; IN COMMERCE 12-21-2007.

NO CLAIM IS MADE TO THE EXCLUSIVE RIGHT TO USE "ORGANIC LIQUEURS", APART FROM THE MARK AS SHOWN.

THE MARK CONSISTS OF ONE HORIZONTAL AND ONE VERTICAL LINE WHICH BISECT EACH OTHER TO FORM 4 EQUAL SIZED SQUARES. IN EACH SQUARE IS ONE LETTER: THE LETTERS "L" AND "O" ARE POSITIONED DIRECTLY ABOVE THE LETTERS "F" AND "T", SPELLING THE WORD "LOFT." BENEATH THESE LETTERS IN SMALLER TYPEFACE APPEAR THE WORDS "ORGANIC LIQUEURS."

SN 77-272,383, FILED 9-5-2007.

REBECCA EISINGER, EXAMINING ATTORNEY

**Int. Cl.: 9**

**Prior U.S. Cls.: 21, 23, 26, 36, and 38**

**Reg. No. 3,469,199**

**United States Patent and Trademark Office**

**Registered July 15, 2008**

---

**TRADEMARK  
PRINCIPAL REGISTER**

**XCAP**

NEXUS BIOSYSTEMS, INC. (CALIFORNIA CORPORATION)  
12140 COMMUNITY ROAD  
POWAY, CA 92064

FOR: LABORATORY INSTRUMENTATION FOR USE IN THE APPLICATION OF CAPS TO AND REMOVAL OF CAPS FROM AN ARRAY OF SAMPLE TUBES, IN CLASS 9 (U.S. CLS. 21, 23, 26, 36 AND 38).

FIRST USE 10-0-2007; IN COMMERCE 10-0-2007.

THE MARK CONSISTS OF STANDARD CHARACTERS WITHOUT CLAIM TO ANY PARTICULAR FONT, STYLE, SIZE, OR COLOR.

SN 77-272,649, FILED 9-6-2007.

TOBY BULLOFF, EXAMINING ATTORNEY



**Int. Cl.: 9**

**Prior U.S. Cls.: 21, 23, 26, 36, and 38**

**United States Patent and Trademark Office**

**Reg. No. 3,469,200**

**Registered July 15, 2008**

**TRADEMARK  
PRINCIPAL REGISTER**

**NERVOUS BRICKDOWN**

ARKEDO S.A.R.L. (FRANCE CORPORATION)  
1 RUE BOULARD  
PARIS, FRANCE 75014

FOR: COMPUTER GAME SOFTWARE; VIDEO  
GAME SOFTWARE; COMPUTER GAMES AND  
VIDEO GAMES DOWNLOADABLE FROM A RE-  
MOTE COMPUTER LOCATION AND RECORDED  
ON CD-ROMS, COMPACT DISCS, AND GAME  
CARTRIDGES; DOWNLOADABLE ELECTRONIC  
PUBLICATIONS IN THE NATURE OF NEWSLET-  
TERS AND MAGAZINES FEATURING GAMES,

NAMELY, COMPUTER GAMES, VIDEO GAMES,  
IN CLASS 9 (U.S. CLS. 21, 23, 26, 36 AND 38).

FIRST USE 6-26-2007; IN COMMERCE 6-26-2007.

THE MARK CONSISTS OF STANDARD CHAR-  
ACTERS WITHOUT CLAIM TO ANY PARTICULAR  
FONT, STYLE, SIZE, OR COLOR.

SN 77-273,115, FILED 9-6-2007.

CHARLOTTE CORWIN, EXAMINING ATTORNEY

**Int. Cl.: 9**

**Prior U.S. Cls.: 21, 23, 26, 36, and 38**

**Reg. No. 3,469,201**

**United States Patent and Trademark Office**

**Registered July 15, 2008**

---

**TRADEMARK  
PRINCIPAL REGISTER**

**SmartMarine**

INTERGRAPH CORPORATION (DELAWARE  
CORPORATION)  
MAILSTOP IW2008  
HUNTSVILLE, AL 358940001

FOR: COMPUTER SOFTWARE FOR THE DESIGN, PRODUCTION AND LIFECYCLE MANAGEMENT OF SHIPS, OFFSHORE PLATFORMS, AND OTHER MARINE STRUCTURES, IN CLASS 9 (U.S. CLS. 21, 23, 26, 36 AND 38).

FIRST USE 3-31-2008; IN COMMERCE 3-31-2008.

THE MARK CONSISTS OF STANDARD CHARACTERS WITHOUT CLAIM TO ANY PARTICULAR FONT, STYLE, SIZE, OR COLOR.

SN 77-273,149, FILED 9-6-2007.

LINDA ORNDORFF, EXAMINING ATTORNEY

**Int. Cl.: 10**

**Prior U.S. Cls.: 26, 39, and 44**

**United States Patent and Trademark Office**

**Reg. No. 3,469,202**

**Registered July 15, 2008**

**TRADEMARK  
PRINCIPAL REGISTER**



GREEN TO GROW (CALIFORNIA CORPORATION)  
5021 MT. ROYAL DRIVE  
LOS ANGELES, CA 90041

FOR: BABY BOTTLE NIPPLES; BABY BOTTLES,  
IN CLASS 10 (U.S. CLS. 26, 39 AND 44).

FIRST USE 10-25-2007; IN COMMERCE 10-31-2007.

THE COLOR(S) YELLOW, GREEN, AND BLACK  
IS/ARE CLAIMED AS A FEATURE OF THE MARK.

THE MARK CONSISTS OF A YELLOW CIRCLE  
IN WHICH APPEAR TWO BLACK DOTS AND A  
BLACK ARC ARRANGED TO RESEMBLE A FACE,  
WITH TWO GREEN OVALS ON TOP OF THE  
YELLOW CIRCLE.

SN 77-273,207, FILED 9-6-2007.

SHANNON TWOHIG, EXAMINING ATTORNEY

**Int. Cl.: 10**

**Prior U.S. Cls.: 26, 39, and 44**

**United States Patent and Trademark Office**

**Reg. No. 3,469,203**

**Registered July 15, 2008**

**TRADEMARK  
PRINCIPAL REGISTER**



GREEN TO GROW (CALIFORNIA CORPORATION)  
5021 MT. ROYAL DRIVE  
LOS ANGELES, CA 90041

FOR: BABY BOTTLE NIPPLES; BABY BOTTLES,  
IN CLASS 10 (U.S. CLS. 26, 39 AND 44).

FIRST USE 10-25-2007; IN COMMERCE 10-31-2007.

THE COLOR(S) PURPLE, GREEN, AND BLACK  
IS/ARE CLAIMED AS A FEATURE OF THE MARK.

THE MARK CONSISTS OF A PURPLE CIRCLE IN WHICH APPEAR TWO BLACK DOTS AND A BLACK ARC ARRANGED TO RESEMBLE A FACE, WITH TWO GREEN OVALS ON TOP OF THE PURPLE CIRCLE.

SN 77-273,223, FILED 9-6-2007.

SHANNON TWOHIG, EXAMINING ATTORNEY

**Int. Cl.: 10**

**Prior U.S. Cls.: 26, 39, and 44**

**United States Patent and Trademark Office**

**Reg. No. 3,469,204**

**Registered July 15, 2008**

**TRADEMARK  
PRINCIPAL REGISTER**



GREEN TO GROW (CALIFORNIA CORPORATION)  
5021 MT. ROYAL DRIVE  
LOS ANGELES, CA 90041

FOR: BABY BOTTLE NIPPLES; BABY BOTTLES,  
IN CLASS 10 (U.S. CLS. 26, 39 AND 44).

FIRST USE 10-25-2007; IN COMMERCE 10-31-2007.

THE COLOR(S) ORANGE, GREEN, AND BLACK  
IS/ARE CLAIMED AS A FEATURE OF THE MARK.

THE MARK CONSISTS OF AN ORANGE CIRCLE  
IN WHICH APPEAR TWO BLACK DOTS AND A  
BLACK ARC ARRANGED TO RESEMBLE A FACE,  
WITH TWO GREEN OVALS ON TOP OF THE  
ORANGE CIRCLE.

SN 77-273,243, FILED 9-6-2007.

SHANNON TWOHIG, EXAMINING ATTORNEY

**Int. Cl.: 10**

**Prior U.S. Cls.: 26, 39, and 44**

**United States Patent and Trademark Office**

**Reg. No. 3,469,205**

**Registered July 15, 2008**

**TRADEMARK  
PRINCIPAL REGISTER**



GREEN TO GROW (CALIFORNIA CORPORATION)  
5021 MT. ROYAL DRIVE  
LOS ANGELES, CA 90041

FOR: BABY BOTTLE NIPPLES; BABY BOTTLES,  
IN CLASS 10 (U.S. CLS. 26, 39 AND 44).

FIRST USE 10-25-2007; IN COMMERCE 10-31-2007.

THE COLOR(S) RED, GREEN, AND BLACK IS/  
ARE CLAIMED AS A FEATURE OF THE MARK.

THE MARK CONSISTS OF A RED CIRCLE IN WHICH APPEAR TWO BLACK DOTS AND A BLACK ARC ARRANGED TO RESEMBLE A FACE, WITH TWO GREEN OVALS ON TOP OF THE RED CIRCLE.

SN 77-273,254, FILED 9-6-2007.

SHANNON TWOHIG, EXAMINING ATTORNEY

**Int. Cl.: 28**

**Prior U.S. Cls.: 22, 23, 38, and 50**

**United States Patent and Trademark Office**

**Reg. No. 3,469,206**

**Registered July 15, 2008**

**TRADEMARK  
PRINCIPAL REGISTER**

**BLASTING CHAMBER**

EBSCO INDUSTRIES, INC. (DELAWARE COR-  
PORATION)  
LEGAL DEPT  
5724 HWY 280 EAST  
BIRMINGHAM, AL 35242

FOR: HUNTING GAME CALLS, IN CLASS 28 (U.S.  
CLS. 22, 23, 38 AND 50).

FIRST USE 10-1-2007; IN COMMERCE 1-2-2008.

THE MARK CONSISTS OF STANDARD CHAR-  
ACTERS WITHOUT CLAIM TO ANY PARTICULAR  
FONT, STYLE, SIZE, OR COLOR.

SN 77-273,774, FILED 9-7-2007.

BARNEY CHARLON, EXAMINING ATTORNEY

**Int. Cl.: 25**

**Prior U.S. Cls.: 22 and 39**

**United States Patent and Trademark Office**

**Reg. No. 3,469,207**

**Registered July 15, 2008**

**TRADEMARK  
PRINCIPAL REGISTER**

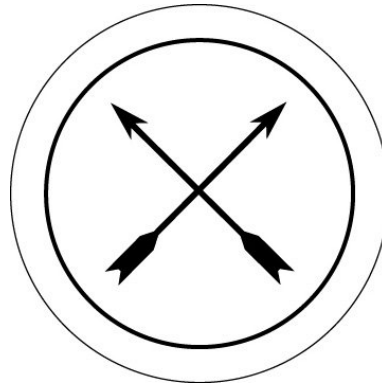

STUSSY, INC. (CALIFORNIA CORPORATION)  
17426 DAIMLER STREET  
IRVINE, CA 92861

THE MARK CONSISTS OF CROSSED ARROWS  
IN A CIRCLE.

FOR: CLOTHING, NAMELY, SHIRTS, SWEATERS,  
T-SHIRTS, IN CLASS 25 (U.S. CLS. 22 AND 39).

SN 77-274,442, FILED 9-7-2007.

FIRST USE 9-30-2007; IN COMMERCE 9-30-2007.

MARK T. MULLEN, EXAMINING ATTORNEY



**Int. Cl.: 42**

**Prior U.S. Cls.: 100 and 101**

**United States Patent and Trademark Office**

**Reg. No. 3,469,208**

**Registered July 15, 2008**

**SERVICE MARK  
PRINCIPAL REGISTER**

# CampZoom

G & B GROUP, LLC (TEXAS LTD LIAB CO)  
1717 W. 6TH STREET #460  
AUSTIN, TX 78703

FIRST USE 11-30-2007; IN COMMERCE 11-30-2007.

FOR: COMPUTER SERVICES, NAMELY, HOSTING AND MAINTAINING AN ONLINE WEBSITE FOR OTHERS TO OBTAIN INFORMATION ON YOUTH CAMPS AND ENABLING THE USER TO SUBMIT AN APPLICATION TO ALL CAMPS IN WHICH THE USER IS INTERESTED, IN CLASS 42 (U.S. CLS. 100 AND 101).

THE MARK CONSISTS OF STANDARD CHARACTERS WITHOUT CLAIM TO ANY PARTICULAR FONT, STYLE, SIZE, OR COLOR.

SN 77-275,815, FILED 9-10-2007.

ZACHARY BELLO, EXAMINING ATTORNEY

**Int. Cl.: 9**

**Prior U.S. Cls.: 21, 23, 26, 36, and 38**

**Reg. No. 3,469,209**

**United States Patent and Trademark Office**

**Registered July 15, 2008**

---

**TRADEMARK  
PRINCIPAL REGISTER**

**XPEEL**

NEXUS BIOSYSTEMS, INC. (CALIFORNIA CORPORATION)  
12140 COMMUNITY ROAD  
POWAY, CA 92064

FIRST USE 2-0-2008; IN COMMERCE 2-0-2008.

FOR: LABORATORY INSTRUMENTATION FOR USE IN THE REMOVAL OF SEALS FROM MULTI-WELL PLATES AND ARRAYS OF CONTAINERS, VIALS OR TUBES; LABORATORY INSTRUMENTATION FOR USE IN THE APPLICATION OF SEALS TO MULTI-WELL PLATES AND ARRAYS OF CONTAINERS, VIALS OR TUBES, IN CLASS 9 (U.S. CLS. 21, 23, 26, 36 AND 38).

THE MARK CONSISTS OF STANDARD CHARACTERS WITHOUT CLAIM TO ANY PARTICULAR FONT, STYLE, SIZE, OR COLOR.

SN 77-276,940, FILED 9-11-2007.

TOBY BULLOFF, EXAMINING ATTORNEY

**Int. Cl.: 9**

**Prior U.S. Cls.: 21, 23, 26, 36, and 38**

**United States Patent and Trademark Office**

**Reg. No. 3,469,210**

**Registered July 15, 2008**

**TRADEMARK  
PRINCIPAL REGISTER**

The logo for ESTELLE is rendered in a bold, stylized, outlined font. The letters are thick and have a decorative, slightly irregular appearance. The 'E' is particularly large and stylized, with a circular element at its base. The 'S' is also large and has a similar circular base. The 'T' is tall and narrow. The 'L' is tall and has a curved top. The 'L' and 'E' at the end of the word are also large and stylized, with the final 'E' having a circular base. The entire logo is black with a white outline.

ESTELLE SWARAY (UNITED STATES INDIVIDUAL)  
C/O DEWEY & LEBOEUF LLP 125 WEST 55TH ST  
NEW YORK, NY 10019

FOR: SERIES OF AUDIO RECORDINGS FEATURING MUSIC; DOWNLOADABLE MUSICAL SOUND RECORDINGS; MUSICAL SOUND RECORDINGS; MUSICAL VIDEO RECORDINGS; PRE-RECORDED CD'S, VIDEO TAPES, LASER DISKS AND DVD'S FEATURING MUSIC, IN CLASS 9 (U.S. CLS. 21, 23, 26, 36 AND 38).

FIRST USE 4-29-2008; IN COMMERCE 4-29-2008.

THE MARK CONSISTS OF "ESTELLE" IN STYLIZED FORM.

SN 77-278,030, FILED 9-12-2007.

KELLEY WELLS, EXAMINING ATTORNEY

**Int. Cl.: 41**

**Prior U.S. Cls.: 100, 101, and 107**

**United States Patent and Trademark Office**

**Reg. No. 3,469,211**

**Registered July 15, 2008**

**SERVICE MARK  
PRINCIPAL REGISTER**

# Omniallinfinitude

HELLAND, MARGARET (UNITED STATES IN-  
DIVIDUAL)  
3790 HATCHERS CIRCLE  
STOCKTON, CA 95219

FOR: EDUCATION SERVICES, NAMELY, PRO-  
VIDING LIVE AND ON-LINE CLASSES, SEMINARS,  
WORKSHOPS AND WEBCASTS IN THE FIELD OF  
BIBLE STUDY AND DISTRIBUTION OF COURSE  
MATERIAL IN CONNECTION THEREWITH, IN  
CLASS 41 (U.S. CLS. 100, 101 AND 107).

FIRST USE 9-13-2007; IN COMMERCE 9-13-2007.

THE MARK CONSISTS OF STANDARD CHAR-  
ACTERS WITHOUT CLAIM TO ANY PARTICULAR  
FONT, STYLE, SIZE, OR COLOR.

SN 77-279,265, FILED 9-13-2007.

MICHAEL KEATING, EXAMINING ATTORNEY

**Int. Cl.: 35**

**Prior U.S. Cls.: 100, 101, and 102**

**United States Patent and Trademark Office**

**Reg. No. 3,469,212**

**Registered July 15, 2008**

**SERVICE MARK  
PRINCIPAL REGISTER**

**SMILE MAKER**

WASHINGTON MUTUAL, INC. (WASHINGTON CORPORATION)  
WMC 3501  
1301 SECOND AVENUE  
SEATTLE, WA 98101

FOR: CONDUCTING EMPLOYEE INCENTIVE AWARD PROGRAMS TO PROMOTE CUSTOMER SERVICE, PRODUCTIVITY, INCREASED SALES, PERSONNEL LOYALTY, JOB PERFORMANCE, AND ON THE JOB PROFESSIONAL GROWTH AND DEVELOPMENT; CONDUCTING EMPLOYEE INCENTIVE AWARD PROGRAMS TO PROMOTE

COMPANY AND CLIENT PRODUCTS AND SERVICES, IN CLASS 35 (U.S. CLS. 100, 101 AND 102).

FIRST USE 3-12-2008; IN COMMERCE 3-12-2008.

THE MARK CONSISTS OF STANDARD CHARACTERS WITHOUT CLAIM TO ANY PARTICULAR FONT, STYLE, SIZE, OR COLOR.

SN 77-280,365, FILED 9-14-2007.

KAPIL BHANOT, EXAMINING ATTORNEY

**Int. Cl.: 28**

**Prior U.S. Cls.: 22, 23, 38, and 50**

**United States Patent and Trademark Office**

**Reg. No. 3,469,213**

**Registered July 15, 2008**

**TRADEMARK  
PRINCIPAL REGISTER**

**Ton o' Fun Bun Run**

MCSHERRY, LISA A. (UNITED STATES INDIVIDUAL)  
416 CHERRY AVENUE  
SAN BRUNO, CA 940664120

THE MARK CONSISTS OF STANDARD CHARACTERS WITHOUT CLAIM TO ANY PARTICULAR FONT, STYLE, SIZE, OR COLOR.

FOR: PET TOYS, IN CLASS 28 (U.S. CLS. 22, 23, 38 AND 50).

SN 77-280,602, FILED 9-16-2007.

FIRST USE 9-28-2007; IN COMMERCE 9-28-2007.

DAVID C. REIHNER, EXAMINING ATTORNEY

**Int. Cl.: 11**

**Prior U.S. Cls.: 13, 21, 23, 31, and 34**

**United States Patent and Trademark Office**

**Reg. No. 3,469,214**

**Registered July 15, 2008**

**TRADEMARK  
PRINCIPAL REGISTER**

**REEL HELPER**

HO-HO PRODUCTS OF GEORGIA, LLC (GEOR-  
GIA LTD LIAB CO)  
345 MCCOWAN ROAD  
FORSYTH, GA 31209

FOR: REEL DEVICE FOR REELING AND STOR-  
ING WIRES OF LIGHTS, PRIMARILY ICICLE  
STYLE DECORATION LIGHTS, IN CLASS 11 (U.S.  
CLS. 13, 21, 23, 31 AND 34).

FIRST USE 11-14-2007; IN COMMERCE 11-14-2007.

THE MARK CONSISTS OF STANDARD CHAR-  
ACTERS WITHOUT CLAIM TO ANY PARTICULAR  
FONT, STYLE, SIZE, OR COLOR.

NO CLAIM IS MADE TO THE EXCLUSIVE  
RIGHT TO USE "REEL", APART FROM THE MARK  
AS SHOWN.

SN 77-280,845, FILED 9-17-2007.

DAVID TOOLEY, EXAMINING ATTORNEY

**Int. Cl.: 32**

**Prior U.S. Cls.: 45, 46, and 48**

**United States Patent and Trademark Office**

**Reg. No. 3,469,215**

**Registered July 15, 2008**

---

**TRADEMARK  
PRINCIPAL REGISTER**

**CRAFT BEER. DONE LITE**

MILLER PRODUCTS COMPANY (WISCONSIN  
CORPORATION)  
3939 WEST HIGHLAND BOULEVARD  
MILWAUKEE, WI 53208

NO CLAIM IS MADE TO THE EXCLUSIVE  
RIGHT TO USE "CRAFT BEER AND LITE", APART  
FROM THE MARK AS SHOWN.

FOR: BEER, IN CLASS 32 (U.S. CLS. 45, 46 AND 48).

FIRST USE 2-0-2008; IN COMMERCE 2-0-2008.

SN 77-283,441, FILED 9-19-2007.

THE MARK CONSISTS OF STANDARD CHAR-  
ACTERS WITHOUT CLAIM TO ANY PARTICULAR  
FONT, STYLE, SIZE, OR COLOR.

BARBARA RUTLAND, EXAMINING ATTORNEY



**Int. Cl.: 35**

**Prior U.S. Cls.: 100, 101, and 102**

**United States Patent and Trademark Office**

**Reg. No. 3,469,216**

**Registered July 15, 2008**

**SERVICE MARK  
PRINCIPAL REGISTER**

# Vendorin

VENDORIN, INC. (NEBRASKA CORPORATION)  
10250 REGENCY CIRCLE  
SUITE 550  
OMAHA, NE 68114

FOR: PROVIDING A SEARCHABLE COMPUTER DATABASE FOR COMPANIES FEATURING BUSINESS INFORMATION FOR USE IN ESTABLISHING A PROFILE FOR SHARING INFORMATION WITH OTHER COMPANIES REGARDING ELECTRONIC COMMERCE, ONGOING VALIDATION OF THE INFORMATION CONTAINED IN THE PROFILE, AND ELECTRONIC INTEGRATION OF THE PROFILE INFORMATION INTO VENDOR MASTER

FILES OF BUYING ORGANIZATIONS, IN CLASS 35 (U.S. CLS. 100, 101 AND 102).

FIRST USE 5-1-2008; IN COMMERCE 5-1-2008.

THE MARK CONSISTS OF STANDARD CHARACTERS WITHOUT CLAIM TO ANY PARTICULAR FONT, STYLE, SIZE, OR COLOR.

SN 77-284,660, FILED 9-20-2007.

ALEXANDER L. POWERS, EXAMINING ATTORNEY

**Int. Cl.: 6**

**Prior U.S. Cls.: 2, 12, 13, 14, 23, 25, and 50**

**Reg. No. 3,469,217**

**United States Patent and Trademark Office**

**Registered July 15, 2008**

**TRADEMARK  
PRINCIPAL REGISTER**

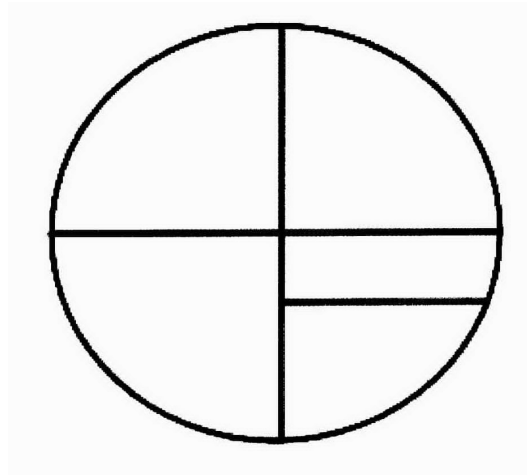

LEO INTERNATIONAL, INC. (NEW YORK CORPORATION)  
471 SUTTER AVENUE  
BROOKLYN, NY 11207

THE MARK CONSISTS OF A CIRCLE DIVIDED INTO FOUR QUADRANTS WITH AN ADDITIONAL HORIZONTAL LINE WITHIN THE BOTTOM RIGHT QUADRANT.

FOR: METAL PIPE FITTINGS, IN CLASS 6 (U.S. CLS. 2, 12, 13, 14, 23, 25 AND 50).

SN 77-285,661, FILED 9-21-2007.

FIRST USE 3-13-2008; IN COMMERCE 3-13-2008.

ROBERT LAVACHE, EXAMINING ATTORNEY

**Int. Cl.: 16**

**Prior U.S. Cls.: 2, 5, 22, 23, 29, 37, 38, and 50**

**Reg. No. 3,469,218**

**United States Patent and Trademark Office**

**Registered July 15, 2008**

---

**TRADEMARK  
PRINCIPAL REGISTER**

**SOLUTIONS GOLD**

IDEARC MEDIA CORP. (DELAWARE CORPORATION)  
2200 W. AIRFIELD DRIVE  
DFW AIRPORT, TX 752619810

THE MARK CONSISTS OF STANDARD CHARACTERS WITHOUT CLAIM TO ANY PARTICULAR FONT, STYLE, SIZE, OR COLOR.

FOR: COUPON BOOKS, IN CLASS 16 (U.S. CLS. 2, 5, 22, 23, 29, 37, 38 AND 50).

SN 77-290,506, FILED 9-27-2007.

FIRST USE 2-0-2008; IN COMMERCE 2-0-2008.

REBECCA EISINGER, EXAMINING ATTORNEY

**Int. Cl.: 25**

**Prior U.S. Cls.: 22 and 39**

**United States Patent and Trademark Office**

**Reg. No. 3,469,219**

**Registered July 15, 2008**

**TRADEMARK  
PRINCIPAL REGISTER**

**SOPHIE MAX**

LEON MAX, INC. (CALIFORNIA CORPORATION)  
3100 NEW YORK DRIVE  
PASADENA, CA 91107

FOR: FOOTWEAR FOR WOMEN; JERSEYS; LEATHER BELTS; WOMEN'S UNDERWEAR; CAPS; COATS; DRESSES; HATS; JACKETS; SHORTS; SKIRTS; SWEATERS; TANK-TOPS; TOPS; PANTS, IN CLASS 25 (U.S. CLS. 22 AND 39).

FIRST USE 2-28-2008; IN COMMERCE 2-28-2008.

THE MARK CONSISTS OF STANDARD CHARACTERS WITHOUT CLAIM TO ANY PARTICULAR FONT, STYLE, SIZE, OR COLOR.

THE NAME(S), PORTRAIT(S), AND/OR SIGNATURE(S) SHOWN IN THE MARK DOES NOT IDENTIFY A PARTICULAR LIVING INDIVIDUAL.

SN 77-304,757, FILED 10-15-2007.

BRENDAN REGAN, EXAMINING ATTORNEY

**Int. Cl.: 30**

**Prior U.S. Cl.: 46**

**United States Patent and Trademark Office**

**Reg. No. 3,469,220**

**Registered July 15, 2008**

**TRADEMARK  
PRINCIPAL REGISTER**

**CRABKER**

RICHARD OGG (UNITED STATES INDIVIDUAL)  
464 LOCUST LANE  
LITTLESTOWN, PA 17340

THE MARK CONSISTS OF STANDARD CHAR-  
ACTERS WITHOUT CLAIM TO ANY PARTICULAR  
FONT, STYLE, SIZE, OR COLOR.

FOR: CRACKERS, IN CLASS 30 (U.S. CL. 46).

SN 77-305,736, FILED 10-17-2007.

FIRST USE 3-15-2008; IN COMMERCE 3-15-2008.

RAUL CORDOVA, EXAMINING ATTORNEY

**Int. Cl.: 35**

**Prior U.S. Cls.: 100, 101, and 102**

**United States Patent and Trademark Office**

**Reg. No. 3,469,221**

**Registered July 15, 2008**

**SERVICE MARK  
PRINCIPAL REGISTER**

**MIGLOBALTRACK**

MACH 1 AIR SERVICES, INC. (ARIZONA CORPORATION)  
1530 WEST BROADWAY ROAD  
TEMPE, AZ 85282

FOR: COMPUTERIZED TRACKING AND TRACING OF GOODS, PARCELS, CARGO, AND FREIGHT DURING SHIPPING, TRANSPORTATION, WAREHOUSING, STORAGE, AND PACKAGING, IN CLASS 35 (U.S. CLS. 100, 101 AND 102).

FIRST USE 3-1-2008; IN COMMERCE 3-1-2008.

THE MARK CONSISTS OF STANDARD CHARACTERS WITHOUT CLAIM TO ANY PARTICULAR FONT, STYLE, SIZE, OR COLOR.

SN 77-306,200, FILED 10-17-2007.

NAAKWAMA ANKRAH, EXAMINING ATTORNEY

**Int. Cl.: 7**

**Prior U.S. Cls.: 13, 19, 21, 23, 31, 34, and 35**

**Reg. No. 3,469,222**

**United States Patent and Trademark Office**

**Registered July 15, 2008**

---

**TRADEMARK  
PRINCIPAL REGISTER**

**PAK'NTAINER**

MARATHON EQUIPMENT COMPANY (DELA-  
WARE) (DELAWARE CORPORATION)  
P.O. BOX 1798  
VERNON, AL 35592

THE MARK CONSISTS OF STANDARD CHAR-  
ACTERS WITHOUT CLAIM TO ANY PARTICULAR  
FONT, STYLE, SIZE, OR COLOR.

FOR: WASTE COMPACTORS AND CONTAINERS  
THEREFOR, IN CLASS 7 (U.S. CLS. 13, 19, 21, 23, 31,  
34 AND 35).

SN 77-308,894, FILED 10-19-2007.

FIRST USE 11-1-1991; IN COMMERCE 2-19-2008.

MELVIN AXILBUND, EXAMINING ATTORNEY

**Int. Cl.: 7**

**Prior U.S. Cls.: 13, 19, 21, 23, 31, 34, and 35**

**United States Patent and Trademark Office**

**Reg. No. 3,469,223**

**Registered July 15, 2008**

**TRADEMARK  
PRINCIPAL REGISTER**

**UNDENIABLY THE WORLD'S  
FINEST AIR COMPRESSOR**

COLTEC INDUSTRIES INC. (PENNSYLVANIA  
CORPORATION)  
5605 CARNEGIE BLVD.  
CHARLOTTE, NC 28209

THE MARK CONSISTS OF STANDARD CHAR-  
ACTERS WITHOUT CLAIM TO ANY PARTICULAR  
FONT, STYLE, SIZE, OR COLOR.

FOR: AIR COMPRESSORS AND PARTS THERE-  
FOR, IN CLASS 7 (U.S. CLS. 13, 19, 21, 23, 31, 34 AND  
35).

SN 77-311,191, FILED 10-23-2007.

FIRST USE 4-1-2008; IN COMMERCE 4-1-2008.

DOMINICK J. SALEMI, EXAMINING ATTORNEY



Int. Cl.: 25

Prior U.S. Cls.: 22 and 39

United States Patent and Trademark Office

Reg. No. 3,469,224

Registered July 15, 2008

TRADEMARK  
PRINCIPAL REGISTER



COBB, EVIE D. (UNITED STATES INDIVIDUAL)  
2150 S. CLAYTON ST.  
DENVER, CO 80210

FOR: MEN AND WOMEN JACKETS, COATS,  
TROUSERS, VESTS; UNDERSHIRTS; SHORT-  
SLEEVED OR LONG-SLEEVED T-SHIRTS; PAN-  
TIES, SHORTS AND BRIEFS; BOXER BRIEFS;  
PANTS; SOCKS, IN CLASS 25 (U.S. CLS. 22 AND 39).

FIRST USE 2-5-2006; IN COMMERCE 1-25-2008.

THE COLOR(S) GREEN, GRAY AND WHITE IS/  
ARE CLAIMED AS A FEATURE OF THE MARK.

THE MARK CONSISTS OF THE WORDING "IT'S  
A SNAP" IN GREEN, THE DESIGN ELEMENT OF A  
GREY AND WHITE SNAP FASTENER FORMING A  
PORTION OF THE LETTER "P", AND WHITE  
STARS APPEARING OVER THE GREY SNAP FAS-  
TENER.

SN 77-316,448, FILED 10-29-2007.

KATHY DE JONGE, EXAMINING ATTORNEY

**Int. Cl.: 13**

**Prior U.S. Cls.: 2 and 9**

**United States Patent and Trademark Office**

**Reg. No. 3,469,225**

**Registered July 15, 2008**

**TRADEMARK  
PRINCIPAL REGISTER**

**WAR DRUM**

B.J. ALAN COMPANY (OHIO CORPORATION)  
555 MARTIN LUTHER KING, JR. BLVD.  
YOUNGSTOWN, OH 445021102

THE MARK CONSISTS OF STANDARD CHAR-  
ACTERS WITHOUT CLAIM TO ANY PARTICULAR  
FONT, STYLE, SIZE, OR COLOR.

FOR: FIREWORKS, IN CLASS 13 (U.S. CLS. 2 AND  
9).

SN 77-330,132, FILED 11-15-2007.

FIRST USE 5-30-2008; IN COMMERCE 5-30-2008.

BRENDAN MCCAULEY, EXAMINING ATTORNEY

**Int. Cl.: 36**

**Prior U.S. Cls.: 100, 101, and 102**

**United States Patent and Trademark Office**

**Reg. No. 3,469,226**

**Registered July 15, 2008**

**SERVICE MARK  
PRINCIPAL REGISTER**

# Breakaway Ventures

DENNIS M BALDWIN (UNITED STATES INDIVIDUAL)  
125 BEARD WAY  
NEEDHAM, MA 02492

FOR: VENTURE CAPITAL FUNDING SERVICES TO EMERGING AND START-UP COMPANIES, IN CLASS 36 (U.S. CLS. 100, 101 AND 102).

FIRST USE 5-11-2007; IN COMMERCE 10-15-2007.

THE MARK CONSISTS OF STANDARD CHARACTERS WITHOUT CLAIM TO ANY PARTICULAR FONT, STYLE, SIZE, OR COLOR.

NO CLAIM IS MADE TO THE EXCLUSIVE RIGHT TO USE "VENTURES", APART FROM THE MARK AS SHOWN.

SN 77-975,042, FILED 9-27-2006.

AMY ALFIERI, EXAMINING ATTORNEY

**Int. Cl.: 25**

**Prior U.S. Cls.: 22 and 39**

**United States Patent and Trademark Office**

**Reg. No. 3,469,227**

**Registered July 15, 2008**

**TRADEMARK  
PRINCIPAL REGISTER**

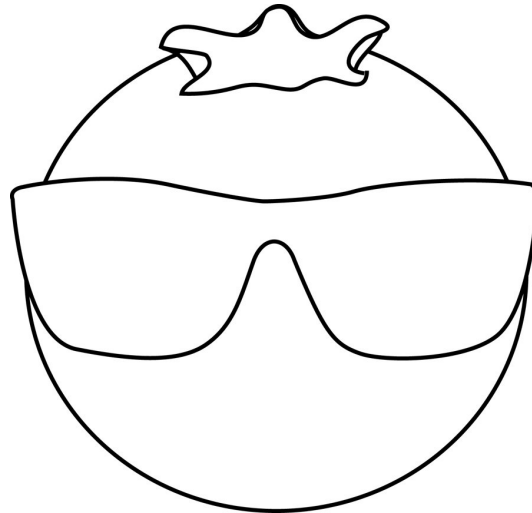

SAMBRAILO PACKAGING (CALIFORNIA CORPORATION)  
800 WALKER STREET  
WATSONVILLE, CA 95076

FOR: T-SHIRTS AND CAPS FOR USE IN CONNECTION WITH APPLICANT'S PACKAGING PRODUCTS AND PACKAGING MATERIALS, IN CLASS 25 (U.S. CLS. 22 AND 39).

FIRST USE 10-0-2006; IN COMMERCE 10-0-2006.

OWNER OF U.S. REG. NOS. 2,821,024 AND 3,018,262.

THE MARK CONSISTS OF A BLUEBERRY WEARING SPECTACLES.

SN 77-975,244, FILED 10-6-2006.

AISHA SALEM, EXAMINING ATTORNEY

**Int. Cl.: 25**

**Prior U.S. Cls.: 22 and 39**

**United States Patent and Trademark Office**

**Reg. No. 3,469,228**

**Registered July 15, 2008**

**TRADEMARK  
PRINCIPAL REGISTER**

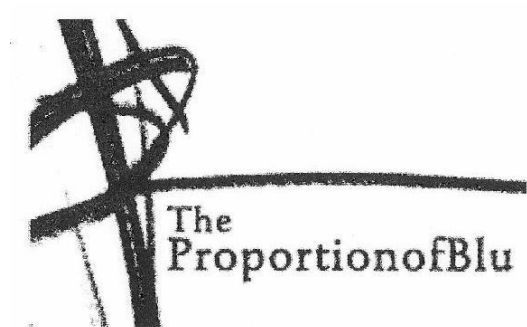

TKUU LLC (CALIFORNIA LTD LIAB CO)  
1305 MAIN STREET #B  
VENICE, CA 90291

FOR: COATS; DRESSES; JACKETS; JEANS;  
PANTS; SHORTS; SKIRTS; TOPS, IN CLASS 25 (U.S.  
CLS. 22 AND 39).

FIRST USE 6-1-2006; IN COMMERCE 6-1-2006.

THE MARK CONSISTS OF THE WORDS "THE  
PROPORTION OF BLU" WITH A DESIGN CONSIST-  
ING OF LINES AND HALF-OVAL SHAPES.

SN 77-975,281, FILED 9-20-2006.

CARYN GLASSER, EXAMINING ATTORNEY

Int. Cl.: 16

Prior U.S. Cls.: 2, 5, 22, 23, 29, 37, 38, and 50

United States Patent and Trademark Office

Reg. No. 3,469,229

Registered July 15, 2008

TRADEMARK  
PRINCIPAL REGISTER

The image shows a handwritten signature in cursive that reads "Kathy Davis". Below the signature, the words "scatter joy" are written in a smaller, lowercase font. To the right of the words "scatter joy" is a small drawing of a butterfly.

KATHY DAVIS DESIGNS, INC. (DELAWARE CORPORATION)  
1126 HORSHAM ROAD, SUITE B-1  
AMBLER, PA 19002

FOR: GREETING CARDS, IN CLASS 16 (U.S. CLS. 2, 5, 22, 23, 29, 37, 38 AND 50).

FIRST USE 6-29-2007; IN COMMERCE 6-29-2007.

THE NAME(S), PORTRAIT(S), AND/OR SIGNATURE(S) SHOWN IN THE MARK IDENTIFIES

"KATHY DAVIS", WHOSE CONSENT(S) TO REGISTER IS SUBMITTED.

THE MARK CONSISTS OF THE WORDS "KATHY DAVIS" IN SCRIPT, WITH THE WORDS "SCATTER JOY" APPEARING BELOW IN LOWER CASE PRINT, FOLLOWED BY A DRAWING OF A BUTTERFLY.

SN 77-975,549, FILED 1-2-2007.

LESLEY LAMOTHE, EXAMINING ATTORNEY

**Int. Cl.: 12**

**Prior U.S. Cls.: 19, 21, 23, 31, 35, and 44**

**Reg. No. 3,469,230**

**United States Patent and Trademark Office**

**Registered July 15, 2008**

---

**TRADEMARK  
PRINCIPAL REGISTER**

**RotoLoPerm**

CENTRO, INC. (IOWA CORPORATION)  
950 NORTH BEND DRIVE  
NORTH LIBERTY, IA 52317

THE MARK CONSISTS OF STANDARD CHAR-  
ACTERS WITHOUT CLAIM TO ANY PARTICULAR  
FONT, STYLE, SIZE, OR COLOR.

FOR: NON-METAL FUEL TANKS FOR VEHI-  
CLES, IN CLASS 12 (U.S. CLS. 19, 21, 23, 31, 35 AND  
44).

SN 77-975,566, FILED 2-23-2007.

FIRST USE 8-1-2007; IN COMMERCE 8-1-2007.

RONALD AIKENS, EXAMINING ATTORNEY

**Int. Cl.: 9**

**Prior U.S. Cls.: 21, 23, 26, 36, and 38**

**United States Patent and Trademark Office**

**Reg. No. 3,469,231**

**Registered July 15, 2008**

**TRADEMARK  
PRINCIPAL REGISTER**

**MASTERS OF TIME**

BRENDA JOYCE DREAMS UNLIMITED, INC.  
(NEW YORK CORPORATION)  
51 SOUTH MUSTANG RANCH PLACE  
TUCSON, AZ 85748

THE MARK CONSISTS OF STANDARD CHARACTERS WITHOUT CLAIM TO ANY PARTICULAR FONT, STYLE, SIZE, OR COLOR.

FOR: A SERIES OF PRE-RECORDED DVDS AND VIDEO DISCS FEATURING DRAMA AND FICTION, IN CLASS 9 (U.S. CLS. 21, 23, 26, 36 AND 38).

SN 77-975,575, FILED 5-22-2007.

FIRST USE 9-30-2007; IN COMMERCE 9-30-2007.

INGRID C. EULIN, EXAMINING ATTORNEY



Int. Cl.: 33

Prior U.S. Cls.: 47 and 49

United States Patent and Trademark Office

Reg. No. 3,469,232

Registered July 15, 2008

TRADEMARK  
PRINCIPAL REGISTER



JNJ ENTERPRISES, LLC (DELAWARE LTD LIAB  
CO)  
69 DEFCO PARK ROAD  
NORTH HAVEN, CT 06473

FIRST USE 5-8-2008; IN COMMERCE 5-8-2008.

SN 77-975,589, FILED 5-1-2007.

FOR: ALCOHOLIC BEVERAGES, NAMELY, DIS-  
TILLED SPIRITS, IN CLASS 33 (U.S. CLS. 47 AND 49).

JASON TURNER, EXAMINING ATTORNEY

**Int. Cls.: 16, 20, and 26**

**Prior U.S. Cls.: 2, 5, 13, 22, 23, 25, 29, 32, 37, 38, 39,  
40, 42, and 50**

**Reg. No. 3,469,233**

**United States Patent and Trademark Office**

**Registered July 15, 2008**

**TRADEMARK  
PRINCIPAL REGISTER**



BOBRICK WASHROOM EQUIPMENT, INC. (CALIFORNIA CORPORATION)  
11611 HART STREET  
NORTH HOLLYWOOD, CA 916055882

FOR: PAPER DISPOSABLE DIAPER CHANGING LINERS, IN CLASS 16 (U.S. CLS. 2, 5, 22, 23, 29, 37, 38 AND 50).

FIRST USE 11-30-2006; IN COMMERCE 11-30-2006.

FOR: INFANT CARE ACCESSORIES, NAMELY, DIAPER CHANGING STATIONS, CHILD BOOSTER SEATS, WALL-MOUNTED CHILD SEATS, INFANT BOOSTER SEATS, INFANT CRADLES, HIGH-CHAIRS, CHILDREN'S THEATER SEATS, BOOSTER CHAIRS; COMBINATION INFANT SEAT/

CRADLE, IN CLASS 20 (U.S. CLS. 2, 13, 22, 25, 32 AND 50).

FIRST USE 5-31-2006; IN COMMERCE 5-31-2006.

FOR: CHILD SAFETY RESTRAINT BELTS AND CHILD SAFETY RESTRAINT HARNESES, IN CLASS 26 (U.S. CLS. 37, 39, 40, 42 AND 50).

FIRST USE 5-31-2006; IN COMMERCE 5-31-2006.

OWNER OF U.S. REG. NOS. 1,845,630, 1,845,631, AND 2,433,269.

SN 77-975,595, FILED 2-9-2007.

CHARLES L. JENKINS, EXAMINING ATTORNEY

**Int. Cl.: 3**

**Prior U.S. Cls.: 1, 4, 6, 50, 51, and 52**

**Reg. No. 3,469,234**

**United States Patent and Trademark Office**

**Registered July 15, 2008**

**TRADEMARK  
PRINCIPAL REGISTER**

**PANAMA JACK NATURALS**

PANAMA JACK INTERNATIONAL, INC. (FLOR-  
IDA CORPORATION)  
230 ERNESTINE STREET  
ORLANDO, FL 32801

FOR: SUN TAN LOTIONS, SUN TAN OILS, SUN  
BLOCK PREPARATIONS, SUN SCREENS, NON-  
MEDICATED SKIN CARE CREAMS AND LOTIONS,  
FACE CREAMS; NON-MEDICATED BODY LO-  
TIONS; AND BODY GELS, IN CLASS 3 (U.S. CLS. 1,  
4, 6, 50, 51 AND 52).

FIRST USE 4-0-2008; IN COMMERCE 4-0-2008.

THE MARK CONSISTS OF STANDARD CHAR-  
ACTERS WITHOUT CLAIM TO ANY PARTICULAR  
FONT, STYLE, SIZE, OR COLOR.

OWNER OF U.S. REG. NOS. 1,673,956, 2,009,466,  
AND OTHERS.

NO CLAIM IS MADE TO THE EXCLUSIVE  
RIGHT TO USE "NATURALS", APART FROM THE  
MARK AS SHOWN.

SN 77-975,632, FILED 3-2-2007.

BARNEY CHARLON, EXAMINING ATTORNEY

**Int. Cls.: 20 and 24**

**Prior U.S. Cls.: 2, 13, 22, 25, 32, 42, and 50**

**United States Patent and Trademark Office**

**Reg. No. 3,469,235**

**Registered July 15, 2008**

**TRADEMARK  
PRINCIPAL REGISTER**

**MICRONONE**

CLEANBRANDS, LLC (DELAWARE LTD LIAB  
CO)  
400 MASSASOIT AVENUE, SUITE 300  
EAST PROVIDENCE, RI 029142012

FOR: PILLOWS, IN CLASS 20 (U.S. CLS. 2, 13, 22,  
25, 32 AND 50).

FIRST USE 2-0-2008; IN COMMERCE 2-0-2008.

FOR: MATTRESS COVERS, BOX SPRING COV-  
ERS, PILLOW CASES, DUVET COVERS, COMFOR-

TERS, BED BLANKETS, IN CLASS 24 (U.S. CLS. 42  
AND 50).

FIRST USE 2-0-2008; IN COMMERCE 2-0-2008.

THE MARK CONSISTS OF STANDARD CHAR-  
ACTERS WITHOUT CLAIM TO ANY PARTICULAR  
FONT, STYLE, SIZE, OR COLOR.

SN 77-975,633, FILED 12-15-2006.

MARGARET POWER, EXAMINING ATTORNEY

**Int. Cl.: 25**

**Prior U.S. Cls.: 22 and 39**

**United States Patent and Trademark Office**

**Reg. No. 3,469,236**

**Registered July 15, 2008**

**TRADEMARK  
PRINCIPAL REGISTER**

**MALIBU BEACH SURF CLASSICS**

TRYBULEC ENTERPRISES (ARKANSAS COR-  
PORATION)  
1 OAK VALLEY LANE  
BENTONVILLE, AR 72712

NO CLAIM IS MADE TO THE EXCLUSIVE  
RIGHT TO USE "SURF CLASSICS", APART FROM  
THE MARK AS SHOWN.

FOR: FOOTWEAR, CLOTHING AND APPAREL,  
NAMELY, HATS, SHIRTS, SHORTS, PANTS AND  
SOCKS, IN CLASS 25 (U.S. CLS. 22 AND 39).

SN 78-113,845, FILED 3-10-2002.

FIRST USE 4-1-2008; IN COMMERCE 4-1-2008.

NANCY CLARKE, EXAMINING ATTORNEY

**Int. Cls.: 6, 20, and 21**

**Prior U.S. Cls.: 2, 12, 13, 14, 22, 23, 25, 29, 30, 32, 33,  
40, and 50**

**Reg. No. 3,469,237**

**United States Patent and Trademark Office**

**Registered July 15, 2008**

**TRADEMARK  
PRINCIPAL REGISTER**

**BATHROOM JEWELRY**

CUSTOM HARDWARE MFG., INC. (IOWA CORPORATION)  
2600 KINDUSTRY  
KEOKUK, IA 52632

FOR: METAL BATHROOM AND SHOWER HARDWARE AND ACCESSORIES, NAMELY, METAL HINGES, BATHTUB AND SHOWER GRAB BARS, DOOR HARDWARE, NAMELY, HANDLES FOR DOORS, IN CLASS 6 (U.S. CLS. 2, 12, 13, 14, 23, 25 AND 50).

FIRST USE 5-2-2008; IN COMMERCE 5-2-2008.

FOR: BATHROOM AND SHOWER HARDWARE AND ACCESSORIES, NAMELY, NON-METAL DOOR HANDLES, IN CLASS 20 (U.S. CLS. 2, 13, 22, 25, 32 AND 50).

FIRST USE 5-2-2008; IN COMMERCE 5-2-2008.

FOR: TOWEL HOLDERS, BATHROOM AND SHOWER HARDWARE AND ACCESSORIES, NAMELY, SHOWER GRAB BARS NOT OF METAL, IN CLASS 21 (U.S. CLS. 2, 13, 23, 29, 30, 33, 40 AND 50).

FIRST USE 5-2-2008; IN COMMERCE 5-2-2008.

NO CLAIM IS MADE TO THE EXCLUSIVE RIGHT TO USE "BATHROOM", APART FROM THE MARK AS SHOWN.

SN 78-128,587, FILED 5-14-2002.

MARY CRAWFORD, EXAMINING ATTORNEY

**Int. Cl.: 3**

**Prior U.S. Cls.: 1, 4, 6, 50, 51, and 52**

**United States Patent and Trademark Office**

**Reg. No. 3,469,238**

**Registered July 15, 2008**

**TRADEMARK  
PRINCIPAL REGISTER**

**THE HAMPTONS COLLECTION**

MOURGES, DENISE (UNITED STATES INDIVIDUAL)  
40 FIFTH STREET  
EAST HAMPTON, NY 11937

FOR: PERFUME; ESSENTIAL OILS FOR PERSONAL USE; COSMETICS, HAIR LOTIONS, HAIR SHAMPOOS, HARI DYES AND HAIR CONDITIONERS; TOOTH PASTE AND TOOTH WHITENERS; SOAPS; SUNTAN AND SUN BLOCK LOTIONS; FACIAL CLEANSERS, BODY CLEANSERS AND SKIN CLEANSERS, SCOURING POWDERS; FLOOR POLISHES AND FURNITURE POLISHES; GENERAL PURPOSE CLEANING, POLISHING, AND ABRASIVE LIQUIDS AND POWDERS; LAUNDRY SOAP, NAMELY LAUNDRY DETERGENT, LAUNDRY BLEACH AND FABRIC SOFTENERS, IN CLASS 3 (U.S. CLS. 1, 4, 6, 50, 51 AND 52).

FIRST USE 1-30-2007; IN COMMERCE 6-17-2007.

THE MARK CONSISTS OF STANDARD CHARACTERS WITHOUT CLAIM TO ANY PARTICULAR FONT, STYLE, SIZE, OR COLOR.

OWNER OF U.S. REG. NO. 2,580,002.

NO CLAIM IS MADE TO THE EXCLUSIVE RIGHT TO USE "COLLECTION", APART FROM THE MARK AS SHOWN.

SEC. 2(F).

SN 78-136,331, FILED 6-17-2002.

MICHAEL ENGEL, EXAMINING ATTORNEY

**Int. Cl.: 9**

**Prior U.S. Cls.: 21, 23, 26, 36, and 38**

**Reg. No. 3,469,239**

**United States Patent and Trademark Office**

**Registered July 15, 2008**

---

**TRADEMARK  
PRINCIPAL REGISTER**

**IMPACT**

PLANALYTICS, INC. (PENNSYLVANIA CORPORATION)  
1325 MORRIS DRIVE, SUITE 201  
WAYNE, PA 19087

PRODUCT DISTRIBUTION AND ALLOCATION,  
AND ADVERTISING AND PROMOTION TIMING,  
IN CLASS 9 (U.S. CLS. 21, 23, 26, 36 AND 38).

FOR: SOFTWARE USED TO CORRELATE THE  
EFFECT OF WEATHER AND OTHER EXTERNAL  
CAUSAL FACTORS SUCH AS COMPETITION, DE-  
MOGRAPHICS AND ECONOMY ON CONSUMER  
DEMAND BY PRODUCT, LOCATION AND TIME  
TO SUPPORT PLANNING AND FORECASTING,

FIRST USE 5-14-2003; IN COMMERCE 5-14-2003.

SN 78-147,743, FILED 7-26-2002.

JOHN KELLY, EXAMINING ATTORNEY



**Int. Cls.: 42 and 44**

**Prior U.S. Cls.: 100 and 101**

**United States Patent and Trademark Office**

**Reg. No. 3,469,240**

**Registered July 15, 2008**

**SERVICE MARK  
PRINCIPAL REGISTER**

**TRENT JONES GOLF**

ROBERT TRENT JONES II, INC. (CALIFORNIA  
CORPORATION)  
705 FOREST AVENUE  
PALO ALTO, CA 94301

FOR: LICENSING OF INTELLECTUAL PROPER-  
TY, IN CLASS 42 (U.S. CLS. 100 AND 101).

FIRST USE 1-18-2007; IN COMMERCE 1-18-2007.

FOR: GOLF COURSE DESIGN SERVICES, IN  
CLASS 44 (U.S. CLS. 100 AND 101).

FIRST USE 7-30-2006; IN COMMERCE 7-30-2006.

OWNER OF U.S. REG. NOS. 1,662,770 AND  
1,899,912.

NO CLAIM IS MADE TO THE EXCLUSIVE  
RIGHT TO USE "GOLF", APART FROM THE MARK  
AS SHOWN.

THE NAME "ROBERT TRENT JONES III" COM-  
MONLY KNOWN AS "TRENT JONES" IDENTIFIES  
A LIVING INDIVIDUAL WHOSE CONSENT IS OF  
RECORD.

SN 78-157,922, FILED 8-26-2002.

KEVIN CORWIN, EXAMINING ATTORNEY

**Int. Cl.: 44**

**Prior U.S. Cls.: 100 and 101**

**United States Patent and Trademark Office**

**Reg. No. 3,469,241**

**Registered July 15, 2008**

---

**SERVICE MARK  
PRINCIPAL REGISTER**

**BODYVISION**

KAGAN, ROBERT L. (UNITED STATES INDIVIDUAL)  
3122 EAST COMMERCIAL BOULEVARD  
FT. LAUDERDALE, FL 33308

FIRST USE 6-26-2007; IN COMMERCE 6-26-2007.

SN 78-181,456, FILED 11-4-2002.

FOR: MEDICAL SERVICES, NAMELY, PROVIDING DIAGNOSTIC SCANNING AND IMAGING SERVICES, IN CLASS 44 (U.S. CLS. 100 AND 101).

JAMES STEIN, EXAMINING ATTORNEY

**Int. Cl.: 25**

**Prior U.S. Cls.: 22 and 39**

**United States Patent and Trademark Office**

**Reg. No. 3,469,242**

**Registered July 15, 2008**

**TRADEMARK  
PRINCIPAL REGISTER**

**LOS ANGELES RED DEVILS**

BLACK FIVES, INC. (CONNECTICUT CORPORATION)  
16 NORTH WATER STREET ,SUITE 115  
GREENWICH, CT 06830

FOR: CLOTHING, NAMELY, SHIRTS, SHORTS, JERSEYS, UNIFORMS, HATS, CAPS, SCARVES, HEADBANDS, JACKETS, COATS, TOPS, PANTS, SOCKS, SHOES, FOOTWEAR, BOOTS, SLIPPERS, SNEAKERS, ATHLETIC FOOTWEAR, UNDERWEAR, SLEEPWEAR, TIES, BOTTOMS, WRISTBANDS, SWEATBANDS, HOSIERY, SWEAT SHIRTS, SWEAT PANTS, T-SHIRTS, SWIMWEAR, BEACHWEAR, DRESSES, JUMPERS, PLAY SUITS, THERMAL UNDERWEAR, BOXER SHORTS, JEANS, JUMPSUITS, SKIRTS, OVERALLS, LEG-

GINGS, WARM-UP SUITS, AND COMPRESSION SHORTS, WHERE ALL OF THE FOREGOING ARE IN THE FIELD OF SPORTS, IN CLASS 25 (U.S. CLS. 22 AND 39).

FIRST USE 7-2-2007; IN COMMERCE 7-2-2007.

NO CLAIM IS MADE TO THE EXCLUSIVE RIGHT TO USE "LOS ANGELES", APART FROM THE MARK AS SHOWN.

SN 78-184,324, FILED 11-12-2002.

ESTHER A. BORSUK, EXAMINING ATTORNEY

**Int. Cl.: 25**

**Prior U.S. Cls.: 22 and 39**

**United States Patent and Trademark Office**

**Reg. No. 3,469,243**

**Registered July 15, 2008**

**TRADEMARK  
PRINCIPAL REGISTER**

**SIMON CARTER**

SIMON CARTER ACCESSORIES LTD. (UNITED  
KINGDOM CORPORATION)  
146 NEW LONDON ROAD  
CHELMSFORD, ESSEX, GREAT BRITAIN CM2  
OAW

FOR: FORMAL SUITS, JACKETS, WAISTCOATS  
AND TROUSERS; COATS; SOFT FORMAL SUITS;  
MOLESKIN RAINCOATS; TAILORED COTTON  
TROUSERS; SHIRTS; DENIM JEANS AND JACK-  
ETS; CORDUROY JEANS, CHINOS AND COTTON  
TROUSERS; MOLESKIN JEANS; COTTON JACK-  
ETS; LINEN TROUSERS AND JACKETS; CASUAL  
SHIRTS AND BLOUSES; KNITTED PULLOVERS,

CARDIGANS, SHIRTS; TEE-SHIRTS; POLO SHIRTS  
AND SWEATSHIRTS, IN CLASS 25 (U.S. CLS. 22  
AND 39).

FIRST USE 1-31-2003; IN COMMERCE 1-31-2003.

THE NAME "SIMON CARTER" IDENTIFIES A  
LIVING INDIVIDUAL WHOSE CONSENT IS OF  
RECORD.

SN 78-195,179, FILED 12-17-2002.

MICHAEL ENGEL, EXAMINING ATTORNEY

**Int. Cl.: 9**

**Prior U.S. Cls.: 21, 23, 26, 36, and 38**

**United States Patent and Trademark Office**

**Reg. No. 3,469,244**

**Registered July 15, 2008**

**TRADEMARK  
PRINCIPAL REGISTER**

**SPECTRAMET**

WTE CORPORATION (MASSACHUSETTS CORPORATION)  
7 ALFRED CIRCLE  
BEDFORD, MA 017302349

FOR: OPTOELECTRONIC APPARATUS FOR MEASURING AND ANALYZING THE COMPOSITION OF METAL, IN CLASS 9 (U.S. CLS. 21, 23, 26, 36 AND 38).

FIRST USE 1-20-2006; IN COMMERCE 1-20-2006.

OWNER OF U.S. REG. NO. 2,747,693.

SN 78-227,272, FILED 3-19-2003.

MONIQUE MILLER, EXAMINING ATTORNEY

**Int. Cl.: 9**

**Prior U.S. Cls.: 21, 23, 26, 36, and 38**

**United States Patent and Trademark Office**

**Reg. No. 3,469,245**

**Registered July 15, 2008**

**TRADEMARK  
PRINCIPAL REGISTER**

**VCX**

3COM CORPORATION (DELAWARE CORPORATION)  
5500 GREAT AMERICA BOULEVARD  
SANTA CLARA, CA 95052

FIRST USE 8-27-2004; IN COMMERCE 8-27-2004.

SN 78-241,293, FILED 4-23-2003.

FOR: COMPUTER TELEPHONY SOFTWARE  
THAT ENABLES TELEPHONE ACTIVITIES TO BE  
PERFORMED THROUGH A COMPUTER, IN CLASS  
9 (U.S. CLS. 21, 23, 26, 36 AND 38).

ALEXANDER L. POWERS, EXAMINING ATTORNEY

**Int. Cl.: 9**

**Prior U.S. Cls.: 21, 23, 26, 36, and 38**

**Reg. No. 3,469,246**

**United States Patent and Trademark Office**

**Registered July 15, 2008**

**TRADEMARK  
PRINCIPAL REGISTER**



ZIGBEE ALLIANCE (CALIFORNIA CORPORATION)  
BISHOP RANCH 2  
2694 BISHOP DRIVE SUITE 274  
SAN RAMON, CA 94583

FOR: ELECTRONIC AND COMPUTER DEVICES CONFORMING TO INTEROPERABILITY STANDARDS FOR WIRELESS COMMUNICATION, NAMELY, COMPUTERS; COMPUTER MICE; MICROPHONES, REMOTE CONTROLS FOR LIGHTS, AND ELECTRONIC DOOR OPENERS; SECURITY SYSTEMS COMPRISED OF SECURITY ALARMS, ANTI-INTRUSION ALARMS, INTRUSION DETECTORS, PERSONAL SECURITY ALARMS, AND ELECTRONIC MOTION SENSITIVE SWITCHES; ELECTRICAL AND HEATING SYSTEMS COM-

PRISED OF CONTROLLERS, THERMOSTATS, AND ELECTRICAL RESISTANCE HEATING WIRES; GLASS BREAKAGE MONITORING SENSORS; WIRELESS KEYPADS; SMOKE AND FIRE DETECTORS; FIRE ALARMS; ALARM STATIONS; PERSONAL TRANSPONDERS; GARAGE DOOR OPENERS; VOICE CONTROL SYSTEMS COMPRISED OF VOICE SENSORS AND VOICE RECOGNITION SOFTWARE, IN CLASS 9 (U.S. CLS. 21, 23, 26, 36 AND 38).

FIRST USE 3-22-2008; IN COMMERCE 3-22-2008.

SN 78-273,365, FILED 7-11-2003.

MICHAEL ENGEL, EXAMINING ATTORNEY

**Int. Cl.: 42**

**Prior U.S. Cls.: 100 and 101**

**United States Patent and Trademark Office**

**Reg. No. 3,469,247**

**Registered July 15, 2008**

**SERVICE MARK  
PRINCIPAL REGISTER**



CANADIAN PLASTICS INDUSTRY ASSOCIATION (CANADA CORPORATION)  
SUITE 500  
5925 AIRPORT ROAD  
MISSISSAUGA OH, CANADA L4V 1W1

FOR: REVIEWING STANDARDS AND PRACTICES TO ASSURE COMPLIANCE WITH LAWS AND REGULATIONS OF THE CANADIAN PLASTICS INDUSTRY PERTAINING TO THE ENVIRONMENT, HEALTH AND SAFETY AND COMBUSTIBILITY, IN CLASS 42 (U.S. CLS. 100 AND 101).

FIRST USE 0-0-2004; IN COMMERCE 0-0-2004.

PRIORITY CLAIMED UNDER SEC. 44(D) ON CANADA APPLICATION NO. 1165428, FILED 1-21-2003, REG. NO. TMA658443, DATED 2-9-2006, EXPIRES 2-9-2021.

SN 78-277,010, FILED 7-21-2003.

ANNE FARRELL, EXAMINING ATTORNEY



**Int. Cl.: 42**

**Prior U.S. Cls.: 100 and 101**

**United States Patent and Trademark Office**

**Reg. No. 3,469,248**

**Registered July 15, 2008**

**SERVICE MARK  
PRINCIPAL REGISTER**

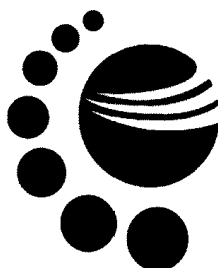

CANADIAN PLASTICS INDUSTRY ASSOCIATION (CANADA CORPORATION)  
SUITE 500  
5925 AIRPORT ROAD  
MISSISSAUGA, ONTARIO, CANADA L4V 1W1

FOR: REVIEWING STANDARDS AND PRACTICES TO ASSURE COMPLIANCE WITH LAWS AND REGULATIONS OF THE CANADIAN PLASTICS INDUSTRY PERTAINING TO THE ENVIRONMENT, HEALTH AND SAFETY AND COMBUSTIBILITY, IN CLASS 42 (U.S. CLS. 100 AND 101).

FIRST USE 0-0-2004; IN COMMERCE 0-0-2004.

PRIORITY CLAIMED UNDER SEC. 44(D) ON CANADA APPLICATION NO. 1165430, FILED 1-21-2003, REG. NO. TMA658607, DATED 2-9-2006, EXPIRES 2-9-2021.

SN 78-277,011, FILED 7-21-2003.

ANNE FARRELL, EXAMINING ATTORNEY

**Int. Cl.: 35**

**Prior U.S. Cls.: 100, 101, and 102**

**United States Patent and Trademark Office**

**Reg. No. 3,469,249**

**Registered July 15, 2008**

**SERVICE MARK  
PRINCIPAL REGISTER**

**MERCURY DISTRIBUTING**

LAWLOR & ASSOCIATES, INC. (OHIO CORPORATION)  
7001 WOOSTER PIKE  
MEDINA, OH 44256

FOR: DISTRIBUTORSHIP SERVICES FEATURING CRIBS, HIGH CHAIRS, CAR SEATS, TRICYCLES, BICYCLES, EDUCATIONAL TOYS, AND PLAY EQUIPMENT FOR THE CHILDCARE, EDUCATION, HOSPITALITY AND HEALTHCARE INDUSTRIES, IN CLASS 35 (U.S. CLS. 100, 101 AND 102).

FIRST USE 8-8-2003; IN COMMERCE 8-8-2003.

NO CLAIM IS MADE TO THE EXCLUSIVE RIGHT TO USE "DISTRIBUTING", APART FROM THE MARK AS SHOWN.

SN 78-284,743, FILED 8-7-2003.

DAWN FELDMAN, EXAMINING ATTORNEY

**Int. Cl.: 37**

**Prior U.S. Cls.: 100, 103, and 106**

**United States Patent and Trademark Office**

**Reg. No. 3,469,250**

**Registered July 15, 2008**

**SERVICE MARK  
PRINCIPAL REGISTER**

The logo features the word "Play" in a bold, black, sans-serif font. The number "4" is positioned below the "y" and is rendered in a 3D, blocky style with a dark shadow. To the right of the "4" is the word "Today" in the same bold, black, sans-serif font as "Play".

EDGETT, RICK (UNITED STATES INDIVIDUAL)  
1244 LOGAN DRIVE  
LEWISVILLE, TX 75077

PLASTIC COMPONENTS, AND SURFACING, IN  
CLASS 37 (U.S. CLS. 100, 103 AND 106).

FOR: CONSTRUCTION, MAINTENANCE, RE-  
PAIR AND INSTALLATION OF COMMERCIAL  
PLAYGROUND EQUIPMENT AND UPGRADED  
COMMERCIAL PLAYGROUND EQUIPMENT IN-  
CLUDING SLIDES, NETTING, PADS, PIPEFRAMES,

FIRST USE 5-2-2002; IN COMMERCE 5-2-2002.

SN 78-293,072, FILED 8-27-2003.

ALICIA COLLINS, EXAMINING ATTORNEY

**Int. Cls.: 9 and 25**

**Prior U.S. Cls.: 21, 22, 23, 26, 36, 38, and 39**

**United States Patent and Trademark Office**

**Reg. No. 3,469,251**

**Registered July 15, 2008**

**TRADEMARK  
PRINCIPAL REGISTER**

**ONE PIECE**

KABUSHIKI KAISHA SHUEISHA (JAPAN CORPORATION), TA SHUEISHA INC.,  
5-10 HITOTSUBASHI 2-CHOME CHIYODA-KU  
TOKYO, JAPAN

FOR: DIGITAL VIDEO DISCS AND VIDEO DISCS  
CONTAINING ANIMATED CARTOON PROGRAMS,  
IN CLASS 9 (U.S. CLS. 21, 23, 26, 36 AND 38).

FIRST USE 7-19-2000; IN COMMERCE 9-1-2005.

FOR: T-SHIRTS, IN CLASS 25 (U.S. CLS. 22 AND 39).

FIRST USE 4-1-2000; IN COMMERCE 3-1-2006.

SN 78-303,727, FILED 9-22-2003.

KATHLEEN M. VANSTON, EXAMINING ATTORNEY

**Int. Cl.: 9**

**Prior U.S. Cls.: 21, 23, 26, 36, and 38**

**United States Patent and Trademark Office**

**Reg. No. 3,469,252**

**Registered July 15, 2008**

---

**TRADEMARK  
PRINCIPAL REGISTER**

**PERFORMANCE CHAIN**

TIMOTHY P THOMAS (UNITED STATES INDIVIDUAL)  
6815 BUCKINGHAM BLVD  
BERKELEY, CA 94705

FIRST USE 9-28-2004; IN COMMERCE 9-18-2007.

SN 78-305,366, FILED 9-25-2003.

FOR: COMPUTER SOFTWARE FOR BUSINESS PERFORMANCE ANALYSIS AND PLANNING, IN CLASS 9 (U.S. CLS. 21, 23, 26, 36 AND 38).

LEIGH LOWRY, EXAMINING ATTORNEY

**Int. Cl.: 16**

**Prior U.S. Cls.: 2, 5, 22, 23, 29, 37, 38, and 50**

**United States Patent and Trademark Office**

**Reg. No. 3,469,253**

**Registered July 15, 2008**

**TRADEMARK  
PRINCIPAL REGISTER**

**THE CELLULITE CURE**

MESO MANAGEMENT LLC (NEVADA LTD  
LIAB CO)  
10 WEST 74TH STREET SUITE 1F  
NEW YORK, NY 10023

FIRST USE 10-15-2006; IN COMMERCE 10-15-2006.

FOR: SERIES OF WRITTEN MATERIALS, NAME-  
LY, BOOKS, BOOKLETS, AND PRINTED TRAIN-  
ING MATERIALS ON THE SUBJECTS OF  
CELLULITE EVALUATION AND HOW TO USE  
MESOTHERAPY TO TREAT CELLULITE, IN CLASS  
16 (U.S. CLS. 2, 5, 22, 23, 29, 37, 38 AND 50).

NO CLAIM IS MADE TO THE EXCLUSIVE  
RIGHT TO USE "CELLULITE", APART FROM THE  
MARK AS SHOWN.

SN 78-319,206, FILED 10-27-2003.

JOSETTE BEVERLY, EXAMINING ATTORNEY

**Int. Cl.: 1**

**Prior U.S. Cls.: 1, 5, 6, 10, 26, and 46**

**Reg. No. 3,469,254**

**United States Patent and Trademark Office**

**Registered July 15, 2008**

**TRADEMARK  
PRINCIPAL REGISTER**

**LURAVIDA**

AHD INTERNATIONAL, LLC (GEORGIA CORPORATION)  
SUITE 850  
3340 PEACHTREE ROAD  
ATLANTA, GA 30326

FOR: CHEMICAL ADDITIVES FOR USE IN THE MANUFACTURE OF FOODS, NAMELY, CHEMICAL ADDITIVES FOR USE IN THE MANUFACTURE OF DIETARY SUPPLEMENTS, IN CLASS 1 (U.S. CLS. 1, 5, 6, 10, 26 AND 46).

FIRST USE 1-31-2008; IN COMMERCE 1-31-2008.

THE MARK CONSISTS OF STANDARD CHARACTERS WITHOUT CLAIM TO ANY PARTICULAR FONT, STYLE, SIZE, OR COLOR.

THE FOREIGN WORDING IN THE MARK, "VIDA", TRANSLATES TO ENGLISH AS "LIFE." THE REMAINING WORDING IN THE MARK HAS NO MEANING OTHER THAN TRADEMARK SIGNIFICANCE.

SN 78-327,416, FILED 11-13-2003.

SAMUEL E. SHARPER JR., EXAMINING ATTORNEY

**Int. Cl.: 16**

**Prior U.S. Cls.: 2, 5, 22, 23, 29, 37, 38, and 50**

**Reg. No. 3,469,255**

**United States Patent and Trademark Office**

**Registered July 15, 2008**

---

**TRADEMARK  
PRINCIPAL REGISTER**

**FUNETIX**

WOODWARD, ROBERT (UNITED STATES INDIVIDUAL)  
492 REGINALD LANE  
COLLEGEVILLE, PA 19438

THE MARK CONSISTS OF STANDARD CHARACTERS WITHOUT CLAIM TO ANY PARTICULAR FONT, STYLE, SIZE, OR COLOR.

FOR: PRINTED EDUCATIONAL INSTRUCTIONAL MATERIALS IN THE FIELD OF READING, IN INTERNATIONAL CLASS 16, IN CLASS 16 (U.S. CLS. 2, 5, 22, 23, 29, 37, 38 AND 50).

SN 78-328,202, FILED 11-14-2003.

FIRST USE 11-30-2006; IN COMMERCE 11-30-2006.

MONIQUE MILLER, EXAMINING ATTORNEY



**Int. Cl.: 42**

**Prior U.S. Cls.: 100 and 101**

**United States Patent and Trademark Office**

**Reg. No. 3,469,256**

**Registered July 15, 2008**

**SERVICE MARK  
PRINCIPAL REGISTER**

**VCHAMPIONS**

CULLER, GEORGE F. (UNITED STATES INDIVIDUAL)  
2065 CHEROKEE RIDGE TRAIL  
KENNESAW, GA 30144

FOR: PROVIDING TEMPORARY USE OF ON-LINE NON-DOWNLOADABLE COMPUTER SOFTWARE FOR BUSINESS MANAGEMENT, IN CLASS 42 (U.S. CLS. 100 AND 101).

FIRST USE 5-9-2008; IN COMMERCE 5-9-2008.

THE MARK CONSISTS OF STANDARD CHARACTERS WITHOUT CLAIM TO ANY PARTICULAR FONT, STYLE, SIZE, OR COLOR.

SN 78-328,796, FILED 11-17-2003.

JEAN IM, EXAMINING ATTORNEY

**Int. Cl.: 16**

**Prior U.S. Cls.: 2, 5, 22, 23, 29, 37, 38, and 50**

**United States Patent and Trademark Office**

**Reg. No. 3,469,257**

**Registered July 15, 2008**

**TRADEMARK  
PRINCIPAL REGISTER**

**AUTORING**

JOU1 INTERNATIONAL, LLC (CALIFORNIA  
LTD LIAB CO)  
5 HUTTON CENTER DRIVE, SUITE 830  
SANTA ANA, CA 92707

FOR: OFFICE MACHINES FOR FORMING AND  
REINFORCING HOLES IN DOCUMENTS BY  
MEANS OF HOLE PUNCHING, ADHESIVE APPLI-  
CATION, AND APPLICATION OF REINFORCING  
RINGS, AND OFFICE SUPPLIES, NAMELY, REIN-  
FORCING RINGS THEREFOR, IN CLASS 16 (U.S.  
CLS. 2, 5, 22, 23, 29, 37, 38 AND 50).

FIRST USE 6-24-2004; IN COMMERCE 6-24-2004.

THE MARK CONSISTS OF STANDARD CHAR-  
ACTERS WITHOUT CLAIM TO ANY PARTICULAR  
FONT, STYLE, SIZE, OR COLOR.

SN 78-335,440, FILED 12-2-2003.

AMY GEARIN, EXAMINING ATTORNEY

**Int. Cl.: 16**

**Prior U.S. Cls.: 2, 5, 22, 23, 29, 37, 38, and 50**

**United States Patent and Trademark Office**

**Reg. No. 3,469,258**

**Registered July 15, 2008**

**TRADEMARK  
PRINCIPAL REGISTER**

**AUTO-RING**

JOUI INTERNATIONAL, LLC (CALIFORNIA  
LTD LIAB CO)  
5 HUTTON CENTER DRIVE, SUITE 830  
SANTA ANA, CA 92707

FOR: OFFICE MACHINES FOR FORMING AND  
REINFORCING HOLES IN DOCUMENTS BY  
MEANS OF HOLE PUNCHING, ADHESIVE APPLI-  
CATION, AND APPLICATION OF REINFORCING  
RINGS, AND OFFICE SUPPLIES, NAMELY, REIN-  
FORCING RINGS THEREFOR, IN CLASS 16 (U.S.  
CLS. 2, 5, 22, 23, 29, 37, 38 AND 50).

FIRST USE 5-12-2005; IN COMMERCE 5-12-2005.

THE MARK CONSISTS OF STANDARD CHAR-  
ACTERS WITHOUT CLAIM TO ANY PARTICULAR  
FONT, STYLE, SIZE, OR COLOR.

SN 78-335,442, FILED 12-2-2003.

AMY GEARIN, EXAMINING ATTORNEY

**Int. Cls.: 40 and 42**

**Prior U.S. Cls.: 100, 101, 103, and 106**

**United States Patent and Trademark Office**

**Reg. No. 3,469,259**

**Registered July 15, 2008**

**SERVICE MARK  
PRINCIPAL REGISTER**

**UNITEDPRINT**

LERCHL, WOLFGANG (FED REP GERMANY  
INDIVIDUAL)  
DARWINSTR. 6  
DRESDEN, FED REP GERMANY 01109

FOR: PRINTING SERVICES; CUSTOMIZED  
PRINTING OF COMPANY NAMES AND LOGOS  
FOR PROMOTIONAL AND ADVERTISING PURPO-  
SES ON THE GOODS OF OTHERS; PROVIDING A  
WEB SITE THROUGH WHICH CUSTOMERS CAN  
ORDER PRINTING SERVICES, IN CLASS 40 (U.S.  
CLS. 100, 103 AND 106).

FIRST USE 5-30-2008; IN COMMERCE 5-30-2008.

FOR: PROVIDING TEMPORARY USE OF NON-  
DOWNLOADABLE SOFTWARE TO OBTAIN QUO-  
TATIONS FOR PRINTING SERVICES VIA THE  
INTERNET, IN CLASS 42 (U.S. CLS. 100 AND 101).

FIRST USE 5-30-2008; IN COMMERCE 5-30-2008.

THE MARK CONSISTS OF STANDARD CHAR-  
ACTERS WITHOUT CLAIM TO ANY PARTICULAR  
FONT, STYLE, SIZE, OR COLOR.

SN 78-340,909, FILED 12-15-2003.

JIM RINGLE, EXAMINING ATTORNEY

**Int. Cl.: 14**

**Prior U.S. Cls.: 2, 27, 28, and 50**

**Reg. No. 3,469,260**

**United States Patent and Trademark Office**

**Registered July 15, 2008**

---

**TRADEMARK  
PRINCIPAL REGISTER**

**CHANGING THE FACE  
OF TIME**

BELLE DESIGNS INC. (MASSACHUSETTS COR-  
PORATION)  
590 CHARLES RIVER STREET  
NEEDHAM, MA 02492

THE MARK CONSISTS OF STANDARD CHAR-  
ACTERS WITHOUT CLAIM TO ANY PARTICULAR  
FONT, STYLE, SIZE, OR COLOR.

FOR: WATCHES AND JEWELRY, IN CLASS 14  
(U.S. CLS. 2, 27, 28 AND 50).

SN 78-344,271, FILED 12-22-2003.

FIRST USE 3-28-2008; IN COMMERCE 3-28-2008.

BARBARA GAYNOR, EXAMINING ATTORNEY

**Int. Cl.: 9**

**Prior U.S. Cls.: 21, 23, 26, 36, and 38**

**Reg. No. 3,469,261**

**United States Patent and Trademark Office**

**Registered July 15, 2008**

**TRADEMARK  
PRINCIPAL REGISTER**



MOBILE ARMOR, LLC (MISSOURI LTD LIAB  
CO)  
SUITE 110  
400 SOUTH WOODSMILL ROAD  
CHESTERFIELD, MO 63017

FOR: COMPUTER SOFTWARE, NAMELY, SE-  
CURITY PRODUCTS FOR THE PROTECTION  
AND SECURITY OF ELECTRONIC DATA AND  
INFORMATION, AND MONITORING THE SECUR-  
ITY OF COMPUTER DEVICES, IN CLASS 9 (U.S.  
CLS. 21, 23, 26, 36 AND 38).

FIRST USE 10-0-2004; IN COMMERCE 10-0-2004.

NO CLAIM IS MADE TO THE EXCLUSIVE  
RIGHT TO USE "MOBILE", APART FROM THE  
MARK AS SHOWN.

THE MARK CONSISTS OF THE PHRASE "MO-  
BILE ARMOR" AND A SHIELD DESIGN.

SN 78-347,402, FILED 1-2-2004.

DAVID TAYLOR, EXAMINING ATTORNEY

**Int. Cl.: 9**

**Prior U.S. Cls.: 21, 23, 26, 36, and 38**

**Reg. No. 3,469,262**

**United States Patent and Trademark Office**

**Registered July 15, 2008**

**TRADEMARK  
PRINCIPAL REGISTER**

**MOBILE**  **ARMOR**

MOBILE ARMOR, LLC (MISSOURI LTD LIAB  
CO)  
SUITE 110  
400 SOUTH WOODSMILL ROAD  
CHESTERFIELD, MO 63017

NO CLAIM IS MADE TO THE EXCLUSIVE  
RIGHT TO USE "MOBILE", APART FROM THE  
MARK AS SHOWN.

FOR: COMPUTER SOFTWARE, NAMELY, SE-  
CURITY PRODUCTS FOR THE PROTECTION  
AND SECURITY OF ELECTRONIC DATA AND  
INFORMATION, AND MONITORING THE SECUR-  
ITY OF COMPUTER DEVICES, IN CLASS 9 (U.S.  
CLS. 21, 23, 26, 36 AND 38).

THE MARK CONSISTS OF THE PHRASE "MO-  
BILE ARMOR" AND A SHIELD DESIGN.

SN 78-347,407, FILED 1-2-2004.

FIRST USE 10-0-2004; IN COMMERCE 10-0-2004.

DAVID TAYLOR, EXAMINING ATTORNEY

Int. Cl.: 41

Prior U.S. Cls.: 100, 101, and 107

United States Patent and Trademark Office

Reg. No. 3,469,263

Registered July 15, 2008

SERVICE MARK  
PRINCIPAL REGISTER



COMMISSION FOR THE LAS VEGAS CENTENNIAL (NEVADA NON-PROFIT CORPORATION)

9TH FLOOR  
400 STEWART AVENUE  
LAS VEGAS, NV 89101

FOR: ENTERTAINMENT SERVICES, NAMELY, PROVIDING COMMUNITY EVENTS, ART FESTIVALS, PARADES, MUSIC CONCERTS AND FESTIVALS, PRODUCTION OF TELEVISION SPECIALS IN THE NATURE OF VARIETY SHOWS, AWARDS SHOWS AND CELEBRATION SPECIALS; TRAVEL AGENCY SERVICES, NAMELY, MAKING RESERVATIONS AND BOOKINGS FOR ENTERTAINMENT, IN CLASS 41 (U.S. CLS. 100, 101 AND 107).

FIRST USE 12-31-2004; IN COMMERCE 12-31-2004.

NO CLAIM IS MADE TO THE EXCLUSIVE RIGHT TO USE "LAS VEGAS", APART FROM THE MARK AS SHOWN.

THE COLOR(S) RED, WHITE AND BLUE IS/ARE CLAIMED AS A FEATURE OF THE MARK.

THE MARK CONSISTS OF A RED SIGN WITH THE WHITE STYLIZED WORDS AND NUMBERS "LAS VEGAS CENTENNIAL 1905-2005", WITH BLUE AND WHITE CIRCLES AROUND THE SIGN, AND A BLUE STAR.

SN 78-355,693, FILED 1-22-2004.

KIMBERLY PERRY, EXAMINING ATTORNEY



**Int. Cl.: 16**

**Prior U.S. Cls.: 2, 5, 22, 23, 29, 37, 38, and 50**

**Reg. No. 3,469,264**

**United States Patent and Trademark Office**

**Registered July 15, 2008**

**TRADEMARK  
PRINCIPAL REGISTER**

**VIA ENTERTAINMENT**

DWIGHT YOAKAM PRODUCTIONS, INC. (CALIFORNIA CORPORATION)  
7920 SUNSET BLVD., SUITE 460  
LOS ANGELES, CA 90046

FOR: PUBLICATIONS, NAMELY, SHEET MUSIC, AND BOOKS IN THE FIELD OF MUSIC, IN CLASS 16 (U.S. CLS. 2, 5, 22, 23, 29, 37, 38 AND 50).

FIRST USE 12-1-2007; IN COMMERCE 12-1-2007.

THE MARK CONSISTS OF STANDARD CHARACTERS WITHOUT CLAIM TO ANY PARTICULAR FONT, STYLE, SIZE, OR COLOR.

NO CLAIM IS MADE TO THE EXCLUSIVE RIGHT TO USE "ENTERTAINMENT", APART FROM THE MARK AS SHOWN.

SN 78-359,764, FILED 1-29-2004.

INGRID C. EULIN, EXAMINING ATTORNEY

Int. Cl.: 25

Prior U.S. Cls.: 22 and 39

United States Patent and Trademark Office

Reg. No. 3,469,265

Registered July 15, 2008

TRADEMARK  
PRINCIPAL REGISTER

**EXTREME  
BOOT CAMP**

TAIX, LINDA M. (UNITED STATES INDIVIDUAL)  
1424 FOOTHILL BLVD.  
LA CANADA, CA 91011

FOR: SPORTSWEAR AND LOUNGEWEAR CLOTHING, NAMELY, T-SHIRTS, PANTS, SHORTS, SWEATSHIRTS, HEAD BANDS, PULLOVERS, BASEBALL AND KNIT CAPS, LADIES TOPS, JEANS, BELTS, UNDERGARMENTS, AND JACKETS , IN CLASS 25 (U.S. CLS. 22 AND 39).

FIRST USE 2-1-2006; IN COMMERCE 2-1-2006.

THE MARK CONSISTS OF THREE WORDS IN STENCIL FONT IN ALL CAPITAL LETTERS WITH THE "X" IN "EXTREME" ENLARGED.

SN 78-364,320, FILED 2-7-2004.

INGRID C. EULIN, EXAMINING ATTORNEY

**Int. Cls.: 35, 37, 38, 42, and 45**

**Prior U.S. Cls.: 100, 101, 102, 103, 104, and 106**

**United States Patent and Trademark Office**

**Reg. No. 3,469,266**

**Registered July 15, 2008**

**SERVICE MARK  
PRINCIPAL REGISTER**



SYNIVERSE TECHNOLOGIES, INC. (DELAWARE CORPORATION)  
201 N. FRANKLIN STREET  
8TH FLOOR  
TAMPA, FL 33602

FOR: ELECTRONIC MANAGEMENT SERVICES, NAMELY, ELECTRONIC BILLING CONSOLIDATION MANAGEMENT SERVICES AND ONLINE INFORMATION MANAGEMENT; DATA CLEARING HOUSE SERVICES FOR THE COLLECTION, TRANSLATION AND EXCHANGE OF DATA; CALL PROCESSING SERVICES, NAMELY, OPERATION OF TELEPHONE CALL CENTERS FOR OTHERS; NETWORK SERVICES, NAMELY, MANAGING TELECOMMUNICATIONS NETWORKS FOR OTHERS; MANAGEMENT OF TELECOMMUNICATIONS NETWORKS FOR OTHERS, NAMELY, MANAGING TELEPHONE SERVICES FOR OTHER CARRIERS, IN CLASS 35 (U.S. CLS. 100, 101 AND 102).

FIRST USE 3-0-2004; IN COMMERCE 3-0-2004.

FOR: MAINTENANCE OF TELECOMMUNICATIONS SYSTEMS AND TELECOMMUNICATIONS NETWORKS; NETWORK SERVICES, NAMELY, INSTALLATION OF TELECOMMUNICATIONS NETWORKS FOR OTHERS, IN CLASS 37 (U.S. CLS. 100, 103 AND 106).

FIRST USE 3-0-2004; IN COMMERCE 3-0-2004.

FOR: COMMUNICATIONS SERVICES, NAMELY, COMMUNICATIONS VIA MULTINATIONAL TELECOMMUNICATIONS NETWORKS AND TELECOMMUNICATIONS ACCESS SERVICES; HOSTED MULTIMEDIA MESSAGING SERVICES, NAMELY, PROVIDING TWO-WAY MESSAGE BROADCASTING VIA VOICE OR TEXT THROUGH WIRELESS AND WIRE LINE CONNECTIONS; MESSAGING MANAGEMENT, NAMELY, PROVIDING MESSAGE ROUTING SERVICES AND COMMUNICATION PROTOCOL TRANSLATION AND INTEROPERABILITY SERVICES TO WIRELESS OPERATORS; DATABASE SERVICES, NAMELY, PROVIDING AN ONLINE COMPUTER DATABASE IN THE FIELD OF TELECOMMUNICATIONS TO ALLOW CARRIERS TO SCREEN OR ROUTE CALLS AND PERFORM OTHER ACTIONS BASED ON INFORMATION OBTAINED FROM A QUERY TO THE DATABASE; FACILITATION OF WIRELESS AND WIRE LINE TELECOMMUNICATION SERVICES, NAMELY, PROVIDING ACCESS TO WIRELESS AND WIRE LINE TELECOMMUNICATION SERVICES, PROVIDING CONNECTIVITY AMONG WIRELESS OPERATORS, PROVIDING CALL ROUTING AND SCREENING SERVICES TO WIRELESS AND WIRE LINE OPERATORS, AND PROVIDING COMMUNICATION PROTOCOL TRANSLATION AND INTEROPERABILITY SERVICES TO WIRELESS AND WIRE LINE OPERATORS; TRANSMISSION OF VOICE, DATA IMAGES, AUDIO, VIDEO, MESSAGES AND INFORMATION VIA WIRELESS AND WIRE LINE COMMUNICATION NETWORKS; COMMUNICATIONS CONSULTING SERVICES; TELECOMMUNICATIONS

CONSULTING SERVICES IN THE FIELD OF INTER-CARRIER COMMUNICATIONS, IN CLASS 38 (U.S. CLS. 100, 101 AND 104).

FIRST USE 3-0-2004; IN COMMERCE 3-0-2004.

FOR: COMMUNICATIONS NETWORK ENGINEERING SERVICES; NETWORK SERVICES, NAMELY, DESIGNING TELECOMMUNICATIONS NETWORKS FOR OTHERS, MONITORING AND REPORTING ON THE TECHNICAL PROBLEMS OF THE TELECOMMUNICATIONS NETWORKS OF OTHERS, REPORTING PROBLEMS IN TELECOMMUNICATION NETWORKS, AND TECHNICAL TROUBLESHOOTING OF TELECOMMUNICATIONS NETWORK PROBLEMS, IN CLASS 42 (U.S. CLS. 100 AND 101).

FIRST USE 3-0-2004; IN COMMERCE 3-0-2004.

FOR: TELECOMMUNICATION FRAUD PREVENTION AND AUTHENTICATION MANAGEMENT SERVICES, NAMELY, PROVIDING AUTHENTICATION OF PERSONAL IDENTIFICATION INFORMATION VIA SECURITY MANAGEMENT SOFTWARE AND TRANSMITTING SUCH INFORMATION VIA THE INTERNET, IN CLASS 45 (U.S. CLS. 100 AND 101).

FIRST USE 3-0-2004; IN COMMERCE 3-0-2004.

SN 78-367,563, FILED 2-13-2004.

YONG KIM, EXAMINING ATTORNEY

**Int. Cl.: 5**

**Prior U.S. Cls.: 6, 18, 44, 46, 51, and 52**

**United States Patent and Trademark Office**

**Reg. No. 3,469,267**

**Registered July 15, 2008**

**TRADEMARK  
PRINCIPAL REGISTER**



EQUI LIFE LIMITED (UNITED KINGDOM CORPORATION)  
MEAD HOUSE FARM DAUNTSEY  
CHIPPENHAM, WILTSHIRE, UNITED KINGDOM  
SN15 4JA

FOR: MEDICINES FOR VETERINARY PURPOSES, NAMELY, FOR THE TREATMENT OF AND HORN INFECTIONS; PHARMACEUTICAL PREPARATIONS FOR THE TREATMENT AND PREVENTION OF HORN INFECTIONS; VETERINARY PREPARATIONS FOR THE TREATMENT AND PREVENTION OF HORN INFECTIONS; PHARMACEUTICAL AND VETERINARY PREPARATIONS USED TO MAINTAIN THE GENERAL HEALTH OF HOOVES; TOPICAL TREATMENTS FOR MAINTAINING THE GENERAL HEALTH OF HOOVES; VETERINARY LIQUID HOOF DRESSINGS FOR THE TREATMENT OF LAMINITIS AND HORN INFECTIONS AND FOR MAINTAINING THE GENERAL HEALTH OF HOOVES, IN CLASS 5 (U.S. CLS. 6, 18, 44, 46, 51 AND 52).

FIRST USE 12-12-2006; IN COMMERCE 12-28-2006.

OWNER OF ERPN CMNTY TM OFC REG. NO. 003564275, DATED 3-1-2005, EXPIRES 1-7-2014.

NO CLAIM IS MADE TO THE EXCLUSIVE RIGHT TO USE "FEET", APART FROM THE MARK AS SHOWN.

THE COLOR(S) GREEN, GOLD AND WHITE IS/ ARE CLAIMED AS A FEATURE OF THE MARK.

THE MARK CONSISTS OF THE COLORS GREEN, GOLD AND WHITE, WITH THE COLOR WHITE APPEARING IN THE WORDS "SOLUTION 4 FEET", THE COLOR GREEN APPEARING IN THE RECTANGULAR BACKGROUND AND INSIDE THE OVAL SHAPE ABOVE THE WORDS "SOLUTION 4 FEET", AND THE COLOR GOLD APPEARING IN THE TWO HORIZONTAL LINES WITHIN THE OVAL SHAPE, AROUND THE PERIMETER OF THE OVAL AND ON THE TOP AND BOTTOM EDGES OF THE GREEN RECTANGLE.

SN 78-367,724, FILED 2-13-2004.

AMY GEARIN, EXAMINING ATTORNEY

**Int. Cl.: 41**

**Prior U.S. Cls.: 100, 101, and 107**

**United States Patent and Trademark Office**

**Reg. No. 3,469,268**

**Registered July 15, 2008**

---

**SERVICE MARK  
PRINCIPAL REGISTER**

**YOU'RE FIRED**

JMBP, INC. (CALIFORNIA CORPORATION)  
1661 NORTH LINCOLN BOULEVARD SUITE 220  
LOS ANGELES, CA 90404

FOR: ENTERTAINMENT SERVICES IN THE  
NATURE OF A REALITY TELEVISION SERIES, IN  
CLASS 41 (U.S. CLS. 100, 101 AND 107).

FIRST USE 4-15-2004; IN COMMERCE 4-15-2004.

THE MARK CONSISTS OF STANDARD CHAR-  
ACTERS WITHOUT CLAIM TO ANY PARTICULAR  
FONT, STYLE, SIZE, OR COLOR.

SN 78-371,659, FILED 2-20-2004.

NICHOLAS ALTREE, EXAMINING ATTORNEY

**Int. Cls.: 41 and 42**

**Prior U.S. Cls.: 100, 101, and 107**

**United States Patent and Trademark Office**

**Reg. No. 3,469,269**

**Registered July 15, 2008**

**SERVICE MARK  
PRINCIPAL REGISTER**

**BLURB**

GITTINS, EILEEN (UNITED STATES INDIVIDUAL)  
580 CALIFORNIA STREET, SUITE 300  
SAN FRANCISCO, CA 94104

FOR: CONSULTING SERVICES IN THE PUBLISHING INDUSTRY, IN CLASS 41 (U.S. CLS. 100, 101 AND 107).

FIRST USE 5-0-2006; IN COMMERCE 5-0-2006.

FOR: COMPUTER SOFTWARE DESIGN AND CONSULTING SERVICES; FORMATTING, GRAPHICS AND TEXTUAL DESIGN SERVICES IN THE

PUBLISHING AND PRINTING INDUSTRIES, IN CLASS 42 (U.S. CLS. 100 AND 101).

FIRST USE 5-0-2006; IN COMMERCE 5-0-2006.

THE MARK CONSISTS OF STANDARD CHARACTERS WITHOUT CLAIM TO ANY PARTICULAR FONT, STYLE, SIZE, OR COLOR.

SN 78-375,744, FILED 2-27-2004.

MICHAEL ENGEL, EXAMINING ATTORNEY

**Int. Cl.: 9**

**Prior U.S. Cls.: 21, 23, 26, 36, and 38**

**United States Patent and Trademark Office**

**Reg. No. 3,469,270**

**Registered July 15, 2008**

**TRADEMARK  
PRINCIPAL REGISTER**

**X Frame Fit**

LEFORT, ALFREDO (MEXICO INDIVIDUAL)  
7809 TALBERT #5  
PLAYA DEL REY, CA 90293

THE MARK CONSISTS OF STANDARD CHARACTERS WITHOUT CLAIM TO ANY PARTICULAR FONT, STYLE, SIZE, OR COLOR.

FOR: PRE-RECORDED DVD'S FEATURING HEALTH AND FITNESS INSTRUCTION, IN CLASS 9 (U.S. CLS. 21, 23, 26, 36 AND 38).

SN 78-375,975, FILED 2-29-2004.

FIRST USE 2-0-2004; IN COMMERCE 2-0-2004.

SOPHIA S. KIM, EXAMINING ATTORNEY



**Int. Cl.: 16**

**Prior U.S. Cls.: 2, 5, 22, 23, 29, 37, 38, and 50**

**Reg. No. 3,469,271**

**United States Patent and Trademark Office**

**Registered July 15, 2008**

**TRADEMARK  
PRINCIPAL REGISTER**



DWIGHT YOAKAM PRODUCTIONS, INC. (CALIFORNIA CORPORATION)  
7920 SUNSET BLVD  
SUITE 460  
LOS ANGELES, CA 90046

NO CLAIM IS MADE TO THE EXCLUSIVE RIGHT TO USE "ENTERTAINMENT AND LLC", APART FROM THE MARK AS SHOWN.

FOR: PUBLICATIONS, NAMELY, SHEET MUSIC, BOOKS, IN THE FIELD OF MUSIC, IN CLASS 16 (U.S. CLS. 2, 5, 22, 23, 29, 37, 38 AND 50).

SN 78-378,147, FILED 3-3-2004.

FIRST USE 12-1-2007; IN COMMERCE 12-1-2007.

ALICIA COLLINS, EXAMINING ATTORNEY

**Int. Cl.: 16**

**Prior U.S. Cls.: 2, 5, 22, 23, 29, 37, 38, and 50**

**Reg. No. 3,469,272**

**United States Patent and Trademark Office**

**Registered July 15, 2008**

**TRADEMARK  
PRINCIPAL REGISTER**

**LEADERSHIP BALANCE  
SHEET**

LORE INTERNATIONAL INSTITUTE, INC. (COL-  
ORADO CORPORATION)  
P.O. BOX 1287  
DURANGO, CO 81302

FOR: MANUALS AND WORKBOOKS FOR PRO-  
FESSIONAL DEVELOPMENT OF LEADERSHIP  
SKILLS, IN CLASS 16 (U.S. CLS. 2, 5, 22, 23, 29, 37,  
38 AND 50).

FIRST USE 3-5-2004; IN COMMERCE 10-9-2006.

THE MARK CONSISTS OF STANDARD CHAR-  
ACTERS WITHOUT CLAIM TO ANY PARTICULAR  
FONT, STYLE, SIZE, OR COLOR.

NO CLAIM IS MADE TO THE EXCLUSIVE  
RIGHT TO USE "LEADERSHIP", APART FROM  
THE MARK AS SHOWN.

SN 78-379,539, FILED 3-5-2004.

AMY ALFIERI, EXAMINING ATTORNEY

**Int. Cl.: 28**

**Prior U.S. Cls.: 22, 23, 38, and 50**

**United States Patent and Trademark Office**

**Reg. No. 3,469,273**

**Registered July 15, 2008**

**TRADEMARK  
PRINCIPAL REGISTER**

**LIE DETECTOR**

MATTEL, INC. (DELAWARE CORPORATION)  
333 CONTINENTAL BLVD.  
EL SEGUNDO, CA 902455012

THE MARK CONSISTS OF STANDARD CHAR-  
ACTERS WITHOUT CLAIM TO ANY PARTICULAR  
FONT, STYLE, SIZE, OR COLOR.

FOR: TOYS, GAMES AND PLAYTHINGS, NAME-  
LY, BOARD GAMES, IN CLASS 28 (U.S. CLS. 22, 23,  
38 AND 50).

SN 78-383,448, FILED 3-12-2004.

FIRST USE 4-11-2008; IN COMMERCE 4-11-2008.

RONALD AIKENS, EXAMINING ATTORNEY

**Int. Cl.: 31**

**Prior U.S. Cls.: 1 and 46**

**United States Patent and Trademark Office**

**Reg. No. 3,469,274**

**Registered July 15, 2008**

---

**TRADEMARK  
PRINCIPAL REGISTER**

**AUNTIE OXIDANT**

PEAR BUREAU NORTHWEST (OREGON NON-  
PROFIT CORPORATION)  
4382 SE INTERNATIONAL WAY  
MILWAUKIE, OR 97222

THE MARK CONSISTS OF STANDARD CHAR-  
ACTERS WITHOUT CLAIM TO ANY PARTICULAR  
FONT, STYLE, SIZE, OR COLOR.

FOR: FRESH PEARS, IN CLASS 31 (U.S. CLS. 1  
AND 46).

SN 78-384,736, FILED 3-15-2004.

FIRST USE 4-9-2008; IN COMMERCE 4-9-2008.

DORITT L. CARROLL, EXAMINING ATTORNEY

**Int. Cl.: 39**

**Prior U.S. Cls.: 100 and 105**

**United States Patent and Trademark Office**

**Reg. No. 3,469,275**

**Registered July 15, 2008**

**SERVICE MARK  
PRINCIPAL REGISTER**

**DS WATERS**

DS WATERS, LP (DELAWARE LIMITED PART-  
NERSHIP)  
5660 NEW NORTHSIDE DRIVE  
ATLANTA, GA 30328

FOR: DELIVERY SERVICES FOR BOTTLED  
DRINKING WATER, IN CLASS 39 (U.S. CLS. 100  
AND 105).

FIRST USE 3-31-2004; IN COMMERCE 3-31-2004.

THE MARK CONSISTS OF STANDARD CHAR-  
ACTERS WITHOUT CLAIM TO ANY PARTICULAR  
FONT, STYLE, SIZE, OR COLOR.

NO CLAIM IS MADE TO THE EXCLUSIVE  
RIGHT TO USE "WATERS", APART FROM THE  
MARK AS SHOWN.

SN 78-386,000, FILED 3-17-2004.

JEFF DEFORD, EXAMINING ATTORNEY

**Int. Cl.: 9**

**Prior U.S. Cls.: 21, 23, 26, 36, and 38**

**Reg. No. 3,469,276**

**United States Patent and Trademark Office**

**Registered July 15, 2008**

---

**TRADEMARK  
PRINCIPAL REGISTER**

**BISX**

ASPECT MEDICAL SYSTEMS, INC. (DELAWARE CORPORATION)  
ONE UPLAND ROAD  
NORWOOD, MA 02062

FOR: COMPUTER PROGRAMS FOR USE IN MONITORING AND PROCESSING ELECTROENCEPHALOGRAPH SIGNALS, IN CLASS 9 (U.S. CLS. 21, 23, 26, 36 AND 38).

FIRST USE 8-0-2007; IN COMMERCE 8-0-2007.

THE MARK CONSISTS OF STANDARD CHARACTERS WITHOUT CLAIM TO ANY PARTICULAR FONT, STYLE, SIZE, OR COLOR.

OWNER OF U.S. REG. NOS. 2,226,557, 2,229,392, AND OTHERS.

SN 78-387,078, FILED 3-18-2004.

KATHY DE JONGE, EXAMINING ATTORNEY

**Int. Cl.: 9**

**Prior U.S. Cls.: 21, 23, 26, 36, and 38**

**United States Patent and Trademark Office**

**Reg. No. 3,469,277**

**Registered July 15, 2008**

**TRADEMARK  
PRINCIPAL REGISTER**

**We just record it.**

FIL, DUSAN (CANADA INDIVIDUAL)  
50 WICKSTEAD CRT.  
BRAMPTON, CANADA L6R 1N8

FOR: SET OF DIGITAL ELECTRONIC VIDEO/  
AUDIO RECORDING PRODUCTS/SYSTEMS USED  
IN MOBILE AND PORTABLE APPLICATIONS,  
NAMELY, SMALL COMPUTER-CONTROLLED  
PORTABLE DIGITAL VIDEO CAMERAS , IN CLASS  
9 (U.S. CLS. 21, 23, 26, 36 AND 38).

FIRST USE 3-17-2008; IN COMMERCE 5-4-2008.

THE MARK CONSISTS OF STANDARD CHAR-  
ACTERS WITHOUT CLAIM TO ANY PARTICULAR  
FONT, STYLE, SIZE, OR COLOR.

SN 78-388,085, FILED 3-21-2004.

INGRID C. EULIN, EXAMINING ATTORNEY

**Int. Cl.: 6**

**Prior U.S. Cls.: 2, 12, 13, 14, 23, 25, and 50**

**Reg. No. 3,469,278**

**United States Patent and Trademark Office**

**Registered July 15, 2008**

---

**TRADEMARK  
PRINCIPAL REGISTER**

**EZEE TIE**

OATWAY, GERRY (CANADA INDIVIDUAL)  
300, 1324 17 AVE SW  
CALGARY ALBERTA, CANADA T2T 5S8

THE MARK CONSISTS OF STANDARD CHAR-  
ACTERS WITHOUT CLAIM TO ANY PARTICULAR  
FONT, STYLE, SIZE, OR COLOR.

FOR: METAL ROPE CLAMPS, IN CLASS 6 (U.S.  
CLS. 2, 12, 13, 14, 23, 25 AND 50).

SN 78-389,369, FILED 3-23-2004.

FIRST USE 2-1-2008; IN COMMERCE 2-1-2008.

REBECCA EISINGER, EXAMINING ATTORNEY



Int. Cl.: 12

Prior U.S. Cls.: 19, 21, 23, 31, 35, and 44

Reg. No. 3,469,279

United States Patent and Trademark Office

Registered July 15, 2008

TRADEMARK  
PRINCIPAL REGISTER

PROGRESSIVE  
TRAINERS

EISENMANN II, AL (UNITED STATES INDIVIDUAL)  
24155 JACARANDA DRIVE  
TEHACHAPI, CA 93561 AND  
YATRON, PETER J. (UNITED STATES INDIVIDUAL)  
31521 HIPSHOT DRIVE  
CASTAIC, CA 91384

THE MARK CONSISTS OF STANDARD CHARACTERS WITHOUT CLAIM TO ANY PARTICULAR FONT, STYLE, SIZE, OR COLOR.

NO CLAIM IS MADE TO THE EXCLUSIVE RIGHT TO USE "TRAINERS", APART FROM THE MARK AS SHOWN.

FOR: TRAINING WHEELS FOR USE ON CHILDREN'S BICYCLES , IN CLASS 12 (U.S. CLS. 19, 21, 23, 31, 35 AND 44).

SN 78-393,877, FILED 3-31-2004.

FIRST USE 6-18-2006; IN COMMERCE 6-18-2006.

LINDA E. BLOHM, EXAMINING ATTORNEY

**Int. Cl.: 33**

**Prior U.S. Cls.: 47 and 49**

**United States Patent and Trademark Office**

**Reg. No. 3,469,280**

**Registered July 15, 2008**

**TRADEMARK  
PRINCIPAL REGISTER**

**DANCING HARES  
VINEYARD**

DANCING HARES VINEYARD, L.L.C. (UTAH  
LTD LIAB CO)  
P.O. BOX 853  
ST. HELENA, CA 94574

NO CLAIM IS MADE TO THE EXCLUSIVE  
RIGHT TO USE "VINEYARD", APART FROM THE  
MARK AS SHOWN.

FOR: WINES, IN CLASS 33 (U.S. CLS. 47 AND 49).

SN 78-396,409, FILED 4-5-2004.

FIRST USE 3-0-2008; IN COMMERCE 3-0-2008.

THE MARK CONSISTS OF STANDARD CHAR-  
ACTERS WITHOUT CLAIM TO ANY PARTICULAR  
FONT, STYLE, SIZE, OR COLOR.

ALEXANDER L. POWERS, EXAMINING ATTOR-  
NEY

**Int. Cl.: 5**

**Prior U.S. Cls.: 6, 18, 44, 46, 51, and 52**

**Reg. No. 3,469,281**

**United States Patent and Trademark Office**

**Registered July 15, 2008**

---

**TRADEMARK  
PRINCIPAL REGISTER**

**Biological  
Software**

LAVALLEY, J. WILLIAM (UNITED STATES IN-  
DIVIDUAL)  
6301 PATHFINDER DR  
AUSTIN, TX 78759

THE MARK CONSISTS OF STANDARD CHAR-  
ACTERS WITHOUT CLAIM TO ANY PARTICULAR  
FONT, STYLE, SIZE, OR COLOR.

FOR: HOMEOPATHIC SUPPLEMENTS, IN CLASS  
5 (U.S. CLS. 6, 18, 44, 46, 51 AND 52).

SN 78-397,578, FILED 4-7-2004.

FIRST USE 3-21-2004; IN COMMERCE 4-18-2008.

LINDA ORNDORFF, EXAMINING ATTORNEY

**Int. Cls.: 9, 13, and 25**

**Prior U.S. Cls.: 2, 9, 21, 22, 23, 26, 36, 38, and 39**

**United States Patent and Trademark Office**

**Reg. No. 3,469,282**

**Registered July 15, 2008**

**TRADEMARK  
PRINCIPAL REGISTER**

**PRAETORIAN**

DIAMONDBACK TACTICAL, LLLP (COLORADO  
LIMITED LIABILITY LIMITED PARTNER-  
SHIP)

BUILDING 1  
23040 N. 11TH AVENUE  
PHOENIX, AZ 85027

FOR: PROTECTIVE BODY ARMOR, PROTEC-  
TIVE VESTS, AND PROTECTIVE SHIELDS, ALL  
FOR THE PROTECTION AGAINST BALLISTIC PE-  
NETRATION, ALL FOR USE IN THE FIELDS OF  
MILITARY AND LAW ENFORCEMENT ACTIV-  
ITIES, IN CLASS 9 (U.S. CLS. 21, 23, 26, 36 AND 38).

FIRST USE 3-3-2008; IN COMMERCE 3-3-2008.

FOR: NYLON HOLSTER COVERS FOR PISTOLS  
AND OTHER FIREARMS; WEAPONS MAGAZINE  
POUCHES; GUN BELTS, ALL FOR USE IN THE

FIELDS OF MILITARY AND LAW ENFORCEMENT  
ACTIVITIES, IN CLASS 13 (U.S. CLS. 2 AND 9).

FIRST USE 3-3-2008; IN COMMERCE 3-3-2008.

FOR: CLOTHING, NAMELY, VESTS AND BELTS,  
FOR USE IN THE FIELDS OF MILITARY AND LAW  
ENFORCEMENT ACTIVITIES, IN CLASS 25 (U.S.  
CLS. 22 AND 39).

FIRST USE 3-3-2008; IN COMMERCE 3-3-2008.

THE MARK CONSISTS OF STANDARD CHAR-  
ACTERS WITHOUT CLAIM TO ANY PARTICULAR  
FONT, STYLE, SIZE, OR COLOR.

SN 78-399,173, FILED 4-9-2004.

ALICE BENMAMAN, EXAMINING ATTORNEY

Int. Cls.: 8 and 11

Prior U.S. Cls.: 13, 21, 23, 28, 31, 34, and 44

United States Patent and Trademark Office

Reg. No. 3,469,283

Registered July 15, 2008

TRADEMARK  
PRINCIPAL REGISTER

*freestyle systems*

FREESTYLE SYSTEMS, LLC (MASSACHUSETTS CORPORATION)  
238 CHERRY STREET  
SHREWSBURY, MA 01545

FOR: SALON TOOLS, NAMELY, HAIR CUTTING SCISSORS, IN CLASS 8 (U.S. CLS. 23, 28 AND 44).

FIRST USE 10-31-2002; IN COMMERCE 2-15-2004.

FOR: SALON TOOLS, NAMELY, CEILING MOUNTABLE HAIR DRYERS AND HOISTS FOR SUPPORTING HAIR DRYERS, IN CLASS 11 (U.S. CLS. 13, 21, 23, 31 AND 34).

FIRST USE 10-31-2002; IN COMMERCE 2-15-2004.

NO CLAIM IS MADE TO THE EXCLUSIVE RIGHT TO USE "SYSTEMS", APART FROM THE MARK AS SHOWN.

THE MARK CONSISTS OF THE WORDS ARE WRITTEN ACROSS ONE LINE. THE CHARACTERS "FREE" ARE BLACK AGAINST A CLEAR BACKGROUND. THE CHARACTERS "STYLE SYSTEMS" ARE IN BOLD TEXT, CLEAR AGAINST A BLACK BACKGROUND. THE BACKGROUND IS SHAPED LIKE A LONG RECTANGLE, WITH VERY ROUNDED EDGES ON THE RIGHT SIDE, AND A POINT ON THE LOWER LEFT CORNER. "CLEAR" IN THIS CONTEXT REFERS TO WHATEVER COLOR THE LOGO IS DISPLAYED ON.

SN 78-401,987, FILED 4-14-2004.

INGRID C. EULIN, EXAMINING ATTORNEY

**Int. Cls.: 6, 12, and 20**

**Prior U.S. Cls.: 2, 12, 13, 14, 19, 21, 22, 23, 25, 31, 32, 35, 44, and 50**

**Reg. No. 3,469,284**

**United States Patent and Trademark Office**

**Registered July 15, 2008**

**TRADEMARK  
PRINCIPAL REGISTER**



MACLEAN-FOGG COMPANY (DELAWARE CORPORATION)  
1000 ALLANSON ROAD  
MUNDELEIN, IL 60098

FOR: METAL FASTENERS, NAMELY, THREADED FASTENERS, METAL WHEEL FASTENERS, NUTS, NUTS FOR SPECIAL APPLICATIONS, NUTS FOR MOUNTING AXLE BEARINGS, NUTS THAT INCLUDE NYLON AND NYLON RINGS, NUTS HAVING RED NYLON PERMANENTLY BONDED TO THE THREADS, TWO-PIECE NUTS, NUT-WASHER ASSEMBLIES, FLANGE NUTS, LOCKING NUTS, CLINCH NUTS, WELD NUTS, SEMI-FINISHED NUTS, FLANGE SCREWS, LOCK SCREWS, SELF-LOCKING AND SELF-SEALING SCREW THREADED DEVICES, BOLTS, LOCKING BOLTS, BOLTS WITH SPECIAL THREAD CONFIGURATIONS, NUT AND BOLT ASSEMBLIES, AND WASHERS; METAL NUTS AND NUT WASHER ASSEMBLIES FOR VEHICLE SUSPENSION SYSTEMS, IN CLASS 6 (U.S. CLS. 2, 12, 13, 14, 23, 25 AND 50).

FIRST USE 12-31-1999; IN COMMERCE 12-31-1999.

FOR: VEHICLE SUSPENSION SYSTEM COMPONENTS, NAMELY, SUSPENSION LINKAGES, STABILIZER BARS, STABILIZER BAR LINKS, TORSION BARS, SUSPENSION ARMS, BALL JOINTS, AND STRUCTURAL REPLACEMENT PARTS THEREFORE, NAMELY, BUSHINGS, GROMMETS, BALL STUDS, BALL JOINT SOCKETS, BOOTS, SUSPEN-

SION SHAFTS, DRIVE SHAFTS, AND SPACERS, IN CLASS 12 (U.S. CLS. 19, 21, 23, 31, 35 AND 44).

FIRST USE 12-31-1999; IN COMMERCE 12-31-1999.

FOR: NON-METAL FASTENERS, NAMELY, NUTS, U-NUTS, NYLON NUTS, AND NYLON U-NUTS, IN CLASS 20 (U.S. CLS. 2, 13, 22, 25, 32 AND 50).

FIRST USE 12-31-1999; IN COMMERCE 12-31-1999.

NO CLAIM IS MADE TO THE EXCLUSIVE RIGHT TO USE "VEHICLE SYSTEMS", APART FROM THE MARK AS SHOWN.

THE COLOR(S) BLACK, WHITE AND TURQUOISE IS/ARE CLAIMED AS A FEATURE OF THE MARK.

THE MARK CONSISTS OF THE ENLARGED LETTERS "MVS" COLORED TURQUOISE WITH THREE PARALLEL WHITE LINES EXTENDING THROUGH THE LETTERS AND THE ATTENUATED WORDS "MACLEAN VEHICLE SYSTEMS" COLORED BLACK.

SN 78-404,651, FILED 4-20-2004.

KAPIL BHANOT, EXAMINING ATTORNEY

**Int. Cl.: 9**

**Prior U.S. Cls.: 21, 23, 26, 36, and 38**

**Reg. No. 3,469,285**

**United States Patent and Trademark Office**

**Registered July 15, 2008**

**TRADEMARK  
PRINCIPAL REGISTER**

**SKYFET**

SILICONIX INCORPORATED (DELAWARE CORPORATION)  
2201 LAURELWOOD ROAD  
SANTA CLARA, CA 950541595

THE MARK CONSISTS OF STANDARD CHARACTERS WITHOUT CLAIM TO ANY PARTICULAR FONT, STYLE, SIZE, OR COLOR.

FOR: SEMICONDUCTOR DEVICES FOR USE IN POWER SUPPLIES TO CONVERT A DC VOLTAGE TO ANOTHER DC VOLTAGE, IN CLASS 9 (U.S. CLS. 21, 23, 26, 36 AND 38).

SN 78-405,951, FILED 4-21-2004.

FIRST USE 12-28-2007; IN COMMERCE 12-28-2007.

HEATHER THOMPSON, EXAMINING ATTORNEY

**Int. Cl.: 7**

**Prior U.S. Cls.: 13, 19, 21, 23, 31, 34, and 35**

**Reg. No. 3,469,286**

**United States Patent and Trademark Office**

**Registered July 15, 2008**

---

**TRADEMARK  
PRINCIPAL REGISTER**

**RAP**

RAPT INDUSTRIES, INC. (CALIFORNIA CORPORATION)  
46535 FREMONT BOULEVARD  
FREMONT, CA 94538

THE MARK CONSISTS OF STANDARD CHARACTERS WITHOUT CLAIM TO ANY PARTICULAR FONT, STYLE, SIZE, OR COLOR.

FOR: PLASMA EQUIPMENT FOR SHAPING AND CLEANING WORK PIECES, NAMELY, A PLASMA ETCHING AND DEPOSITING MACHINE, IN CLASS 7 (U.S. CLS. 13, 19, 21, 23, 31, 34 AND 35).

SN 78-414,875, FILED 5-7-2004.

FIRST USE 3-0-2005; IN COMMERCE 3-0-2005.

ANDREW RHIM, EXAMINING ATTORNEY



**Int. Cl.: 12**

**Prior U.S. Cls.: 19, 21, 23, 31, 35, and 44**

**Reg. No. 3,469,287**

**United States Patent and Trademark Office**

**Registered July 15, 2008**

**TRADEMARK  
PRINCIPAL REGISTER**

**MACLOCK**

MAC TRAILER MANUFACTURING, INC. (OHIO  
CORPORATION)  
14955 COMMERCE AVENUE  
ALLIANCE, OH 44601

FOR: TRUCK BODIES AND TRAILERS; NAME-  
LY, DUMP BODIES, FLAT-BED BODIES AND BOX  
BODIES; AND DUMP TRAILERS, FLAT-BED TRAI-  
LERS AND BOX TRAILERS , IN CLASS 12 (U.S. CLS.  
19, 21, 23, 31, 35 AND 44).

FIRST USE 3-27-2008; IN COMMERCE 3-27-2008.

THE MARK CONSISTS OF STANDARD CHAR-  
ACTERS WITHOUT CLAIM TO ANY PARTICULAR  
FONT, STYLE, SIZE, OR COLOR.

SN 78-417,526, FILED 5-12-2004.

BRETT J. GOLDEN, EXAMINING ATTORNEY

**Int. Cl.: 25**

**Prior U.S. Cls.: 22 and 39**

**United States Patent and Trademark Office**

**Reg. No. 3,469,288**

**Registered July 15, 2008**

**TRADEMARK  
PRINCIPAL REGISTER**

# Toxic Hazard

PAULITH USA, INC. (CALIFORNIA CORPORATION)  
6460 CORVETTE STREET  
COMMERCE, CA 90040

FOR: CLOTHING AND APPAREL, NAMELY, SHIRTS, POLO SHIRTS, JERSEYS, KNIT SHIRTS, SPORT SHIRTS, T-SHIRTS AND TOPS; CAPS, HATS, SWEATERS, JACKETS, PANTS, SWEAT PANTS, SKIRTS, UNDERWEAR, BOXERS, SOCKS, FOOTWEAR AND BELTS, IN CLASS 25 (U.S. CLS. 22 AND 39).

FIRST USE 5-25-2004; IN COMMERCE 5-25-2004.

THE MARK CONSISTS OF STANDARD CHARACTERS WITHOUT CLAIM TO ANY PARTICULAR FONT, STYLE, SIZE, OR COLOR.

SN 78-424,376, FILED 5-25-2004.

DORITT L. CARROLL, EXAMINING ATTORNEY

**Int. Cl.: 19**

**Prior U.S. Cls.: 1, 12, 33, and 50**

**United States Patent and Trademark Office**

**Reg. No. 3,469,289**

**Registered July 15, 2008**

**TRADEMARK  
PRINCIPAL REGISTER**



SADDLEBACK MATERIALS COMPANY, INC.  
(CALIFORNIA CORPORATION)  
20712 INDIAN OCEAN  
LAKE FOREST, CA 92630

FOR: AGGREGATE MATERIALS, NAMELY,  
SAND AND GRAVEL, IN CLASS 19 (U.S. CLS. 1, 12,  
33 AND 50).

FIRST USE 7-1-2007; IN COMMERCE 7-1-2007.

OWNER OF U.S. REG. NO. 2,359,655.

NO CLAIM IS MADE TO THE EXCLUSIVE  
RIGHT TO USE "SAND & GRAVEL", APART FROM  
THE MARK AS SHOWN.

THE MARK LETTERING IS ITALIC AND THE  
LETTERING IS SURROUNDED BY A BOX WITH  
ROUNDED CORNERS, THE BOX IS OPEN WHERE  
IT SAYS "SAND & GRAVEL".

SN 78-425,477, FILED 5-26-2004.

LA TONIA FISHER, EXAMINING ATTORNEY

**Int. Cl.: 7**

**Prior U.S. Cls.: 13, 19, 21, 23, 31, 34, and 35**

**Reg. No. 3,469,290**

**United States Patent and Trademark Office**

**Registered July 15, 2008**

---

**TRADEMARK  
PRINCIPAL REGISTER**

**PondPerfect**

CAL PUMP (CALIFORNIA CORPORATION)  
28606 LIVINGSTON AVE  
VALENCIA, CA 91355

THE MARK CONSISTS OF STANDARD CHAR-  
ACTERS WITHOUT CLAIM TO ANY PARTICULAR  
FONT, STYLE, SIZE, OR COLOR.

FOR: WATER TRANSFER PUMPS FOR PONDS,  
WATER GARDENS, SPAS, PARTS WASHERS, MAR-  
INE AIR CONDITIONERS, AND STATUARY, IN  
CLASS 7 (U.S. CLS. 13, 19, 21, 23, 31, 34 AND 35).

SN 78-426,909, FILED 5-28-2004.

FIRST USE 8-15-2007; IN COMMERCE 8-15-2007.

RUSS HERMAN, EXAMINING ATTORNEY

**Int. Cl.: 35**

**Prior U.S. Cls.: 100, 101, and 102**

**United States Patent and Trademark Office**

**Reg. No. 3,469,291**

**Registered July 15, 2008**

---

**SERVICE MARK  
PRINCIPAL REGISTER**

**EntelliChoice**

NORESCO, LLC (DELAWARE LTD LIAB CO)  
1 RESEARCH DRIVE, SUITE 400C  
WESTBOROUGH, MA 01581

FOR: ENERGY PRICE COMPARISON SERVICES,  
NAMELY, COMPARISON OF ENERGY OPTION  
PACKAGE PRICES TO ENABLE CUSTOMERS TO  
EVALUATE THE FINANCIAL IMPACT OF VAR-  
IOUS COMBINATIONS OF SPECIFIC ENERGY  
CONSERVATION MEASURES, IN CLASS 35 (U.S.  
CLS. 100, 101 AND 102).

FIRST USE 11-8-2001; IN COMMERCE 11-8-2001.

THE MARK CONSISTS OF STANDARD CHAR-  
ACTERS WITHOUT CLAIM TO ANY PARTICULAR  
FONT, STYLE, SIZE, OR COLOR.

SN 78-427,875, FILED 6-1-2004.

RAMONA ORTIGA, EXAMINING ATTORNEY

**Int. Cls.: 14 and 25**

**Prior U.S. Cls.: 2, 22, 27, 28, 39, and 50**

**Reg. No. 3,469,292**

**United States Patent and Trademark Office**

**Registered July 15, 2008**

**TRADEMARK  
PRINCIPAL REGISTER**

**LOVESAVERS**

SHEUHMELIAN, HAGOP ARI GARABED (UNITED STATES INDIVIDUAL)  
283 S. VINEDO AVE.  
PASADENA, CA 91107

FOR: JEWELRY OF PRECIOUS METAL AND STONES, IMITATION JEWELRY AND WATCHES INCLUDING BUT NOT LIMITED TO NECKLACES, PENDANTS, EARRINGS, BRACELETS, RINGS, PINS, TIE PINS, CUFF LINKS, IN CLASS 14 (U.S. CLS. 2, 27, 28 AND 50).

FIRST USE 5-1-2004; IN COMMERCE 5-28-2008.

FOR: CLOTHING, NAMELY, PULLOVERS, CARDIGANS, SWEATERS, TROUSERS, SKIRTS, JACKETS, BLOUSES, SHIRTS, JEANS, SWEATPANTS, SHORTS, SWEATSHIRTS, SUITS, DRESSES, OVERCOATS, COATS, RAINCOATS, BELTS, JERSEYS,

NECKWEAR, SOCKS AND STOCKINGS, TIGHTS, VESTS, WAISTCOATS, JUMPERS, TRACKSUITS, OVERALLS, BLOUSONS, GYMSUITS, KNICKERS, T-SHIRTS, ANORAKS, SUSPENDERS, LOUNGEWEAR, UNDERWEAR, BENCHWEAR, SLEEPWEAR, HEADWEAR, HATS AND CAPS, SCARVES, GLOVES, SHOES, SANDALS, BOOTS AND SLIPPERS, IN CLASS 25 (U.S. CLS. 22 AND 39).

FIRST USE 5-1-2004; IN COMMERCE 5-28-2008.

THE MARK CONSISTS OF STANDARD CHARACTERS WITHOUT CLAIM TO ANY PARTICULAR FONT, STYLE, SIZE, OR COLOR.

SN 78-427,878, FILED 6-1-2004.

JOHN HWANG, EXAMINING ATTORNEY

**Int. Cl.: 5**

**Prior U.S. Cls.: 6, 18, 44, 46, 51, and 52**

**United States Patent and Trademark Office**

**Reg. No. 3,469,293**

**Registered July 15, 2008**

**TRADEMARK  
PRINCIPAL REGISTER**

**RESOLUTE**

SYGENTA PARTICIPATIONS AG (SWITZER-  
LAND CORPORATION)  
SCHWARZWALDALLEE 215  
BASEL, SWITZERLAND CH4058

FOR: PREPARATIONS FOR DESTROYING VER-  
MIN; FUNGICIDES, HERBICIDES, INSECTICIDES,  
AND PESTICIDES FOR AGRICULTURAL AND  
HORTICULTURAL USE , IN CLASS 5 (U.S. CLS. 6,  
18, 44, 46, 51 AND 52).

FIRST USE 1-1-2007; IN COMMERCE 1-1-2007.

THE MARK CONSISTS OF STANDARD CHAR-  
ACTERS WITHOUT CLAIM TO ANY PARTICULAR  
FONT, STYLE, SIZE, OR COLOR.

SN 78-439,040, FILED 6-22-2004.

KATHLEEN M. VANSTON, EXAMINING ATTOR-  
NEY

**Int. Cl.: 42**

**Prior U.S. Cls.: 100 and 101**

**United States Patent and Trademark Office**

**Reg. No. 3,469,294**

**Registered July 15, 2008**

**SERVICE MARK  
PRINCIPAL REGISTER**

**HYDRO-MEDIATION**

WATERMARK INITIATIVE (MINNESOTA SOLE  
PROPRIETORSHIP)  
SUITE # 3  
219 NORTH MAIN STREET  
STILLWATER, MN 55082

FOR: MEDIATION AND DISPUTE RESOLUTION  
SERVICES, NAMELY, ALTERNATIVE DISPUTE  
RESOLUTION SERVICES WITH RESPECT TO WA-  
TER-RELATED DISPUTES, SUCH AS HYBRID-PRO-  
CESSES, IN CLASS 42 (U.S. CLS. 100 AND 101).

FIRST USE 12-1-2005; IN COMMERCE 12-1-2005.

THE MARK CONSISTS OF STANDARD CHAR-  
ACTERS WITHOUT CLAIM TO ANY PARTICULAR  
FONT, STYLE, SIZE, OR COLOR.

SN 78-444,840, FILED 7-1-2004.

RONALD AIKENS, EXAMINING ATTORNEY



**Int. Cl.: 7**

**Prior U.S. Cls.: 13, 19, 21, 23, 31, 34, and 35**

**Reg. No. 3,469,295**

**United States Patent and Trademark Office**

**Registered July 15, 2008**

---

**TRADEMARK  
PRINCIPAL REGISTER**

**AERO LAP**

OKAMOTO CORPORATION (JAPAN CORPORATION)  
1342 BARCLAY BOULEVARD  
BUFFALO GROVE, IL 60089

FOR: MACHINE TOOLS FOR LAPPING AND POLISHING, IN CLASS 7 (U.S. CLS. 13, 19, 21, 23, 31, 34 AND 35).

FIRST USE 1-31-2005; IN COMMERCE 3-29-2005.

THE MARK CONSISTS OF STANDARD CHARACTERS WITHOUT CLAIM TO ANY PARTICULAR FONT, STYLE, SIZE, OR COLOR.

NO CLAIM IS MADE TO THE EXCLUSIVE RIGHT TO USE "LAP", APART FROM THE MARK AS SHOWN.

SN 78-456,831, FILED 7-26-2004.

ANNE FARRELL, EXAMINING ATTORNEY

**Int. Cls.: 35, 36, and 42**

**Prior U.S. Cls.: 100, 101, and 102**

**United States Patent and Trademark Office**

**Reg. No. 3,469,296**

**Registered July 15, 2008**

**SERVICE MARK  
PRINCIPAL REGISTER**

**SFR**

SECURITY BENEFIT LIFE INSURANCE COM-  
PANY (KANSAS CORPORATION)  
ONE SECURITY BENEFIT PLACE  
TOPEKA, KS 666360001

FOR: PROVIDING OFFICE FUNCTIONS IN THE  
FIELD OF EMPLOYEE RETIREMENT PLAN AD-  
MINISTRATION, IN CLASS 35 (U.S. CLS. 100, 101  
AND 102).

FIRST USE 8-0-2005; IN COMMERCE 8-0-2005.

FOR: RETIREMENT PLAN SUPPORT SERVICES,  
NAMELY, ADMINISTRATION OF EMPLOYEE RE-  
TIREMENT PLANS FOR TRUSTEES OF SUCH  
PLANS, IN CLASS 36 (U.S. CLS. 100, 101 AND 102).

FIRST USE 8-0-2005; IN COMMERCE 8-0-2005.

FOR: RETIREMENT PLAN SUPPORT SERVICES,  
NAMELY, TESTING PLANS AND PLAN CONTRI-  
BUTIONS FOR COMPLIANCE WITH FEDERAL  
RETIREMENT PLAN REGULATIONS, IN CLASS  
42 (U.S. CLS. 100 AND 101).

FIRST USE 8-0-2005; IN COMMERCE 8-0-2005.

THE MARK CONSISTS OF STANDARD CHAR-  
ACTERS WITHOUT CLAIM TO ANY PARTICULAR  
FONT, STYLE, SIZE, OR COLOR.

SN 78-459,408, FILED 7-30-2004.

ZHALEH DELANEY, EXAMINING ATTORNEY

**Int. Cls.: 16 and 20**

**Prior U.S. Cls.: 2, 5, 13, 22, 23, 25, 29, 32, 37, 38, and 50**

**United States Patent and Trademark Office**

**Reg. No. 3,469,297**

**Registered July 15, 2008**

**TRADEMARK  
PRINCIPAL REGISTER**

**CATCHPOINT**

CATCHPOINT LIMITED (UNITED KINGDOM CORPORATION)  
MANOR COTTAGE NORTHGATE LANE  
LINTON, UNITED KINGDOM LS22 4HN

FOR: PAPER LABELS, CARDBOARD LABELS AND ADHESIVE LABELS, IN CLASS 16 (U.S. CLS. 2, 5, 22, 23, 29, 37, 38 AND 50).

FIRST USE 6-26-2006; IN COMMERCE 6-26-2006.

FOR: PLASTIC LABELS AND PLASTIC ADHESIVE LABELS, IN CLASS 20 (U.S. CLS. 2, 13, 22, 25, 32 AND 50).

FIRST USE 6-28-2006; IN COMMERCE 6-28-2006.

THE MARK CONSISTS OF STANDARD CHARACTERS WITHOUT CLAIM TO ANY PARTICULAR FONT, STYLE, SIZE, OR COLOR.

OWNER OF UNITED KINGDOM REG. NO. 2313571, DATED 10-19-2002, EXPIRES 10-19-2012.

SN 78-463,114, FILED 8-6-2004.

BRETT J. GOLDEN, EXAMINING ATTORNEY

**Int. Cl.: 45**

**Prior U.S. Cls.: 100 and 101**

**United States Patent and Trademark Office**

**Reg. No. 3,469,298**

**Registered July 15, 2008**

---

**SERVICE MARK  
PRINCIPAL REGISTER**

**ASK JOAN**

LACEY, JOAN (UNITED STATES INDIVIDUAL)  
APT. 1202  
680 MADISON AVE.  
NEW YORK, NY 10021

THE MARK CONSISTS OF STANDARD CHARACTERS WITHOUT CLAIM TO ANY PARTICULAR FONT, STYLE, SIZE, OR COLOR.

FOR: PERSONAL SHOPPING SERVICES FOR OTHERS; PERSONAL GIFT SELECTION SERVICES FOR OTHERS, IN CLASS 45 (U.S. CLS. 100 AND 101).

SN 78-464,295, FILED 8-9-2004.

FIRST USE 11-16-2004; IN COMMERCE 11-16-2004.

WILLIAM VERHOSEK, EXAMINING ATTORNEY

**Int. Cl.: 14**

**Prior U.S. Cls.: 2, 27, 28, and 50**

**Reg. No. 3,469,299**

**United States Patent and Trademark Office**

**Registered July 15, 2008**

**TRADEMARK  
PRINCIPAL REGISTER**

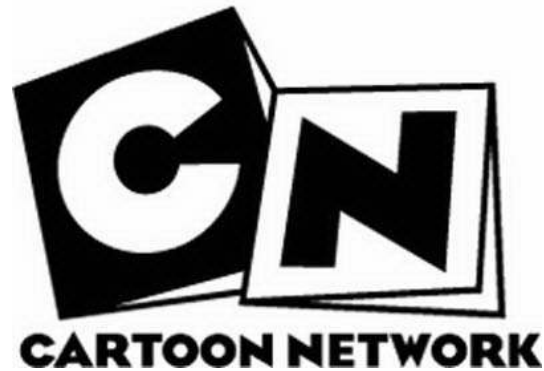

THE CARTOON NETWORK, INC. (DELAWARE CORPORATION)  
13 NORTH C/O TURNER BROADCASTING SYSTEM  
ONE CNN CENTER  
ATLANTA, GA 303032762

FIRST USE 8-31-2007; IN COMMERCE 8-31-2007.

SN 78-464,469, FILED 8-9-2004.

FOR: WRISTWATCHES, WATCH STRAPS, CHARMS, LAPEL PINS AND COSTUME JEWELRY, IN CLASS 14 (U.S. CLS. 2, 27, 28 AND 50).

ROBIN CHOSID, EXAMINING ATTORNEY

**Int. Cl.: 41**

**Prior U.S. Cls.: 100, 101, and 107**

**United States Patent and Trademark Office**

**Reg. No. 3,469,300**

**Registered July 15, 2008**

**SERVICE MARK  
PRINCIPAL REGISTER**

**SEIZE THE MINUTE**

DIGITAL CHOCOLATE, INC. (DELAWARE CORPORATION)  
1855 S. GRANT STREET  
SAN MATEO, CA 94402

FOR: PROVIDING ON-LINE GAMES; PROVIDING ON-LINE ENTERTAINMENT SERVICES AND EDUCATIONAL SERVICES IN THE NATURE OF COMPUTER GAMES; PROVIDING ON-LINE INFORMATION RELATING TO COMPUTER GAMES, ENTERTAINMENT, AND MULTIMEDIA ENTERTAINMENT APPLICATIONS, IN CLASS 41 (U.S. CLS. 100, 101 AND 107).

FIRST USE 4-18-2006; IN COMMERCE 4-18-2006.

THE MARK CONSISTS OF STANDARD CHARACTERS WITHOUT CLAIM TO ANY PARTICULAR FONT, STYLE, SIZE, OR COLOR.

SN 78-468,154, FILED 8-16-2004.

GEORGIA CARTY, EXAMINING ATTORNEY

**Int. Cl.: 31**

**Prior U.S. Cls.: 1 and 46**

**United States Patent and Trademark Office**

**Reg. No. 3,469,301**

**Registered July 15, 2008**

**TRADEMARK  
PRINCIPAL REGISTER**

**GIDDYUPPUCCINO**

PETPUCCINO, LLC (WASHINGTON LTD LIAB  
CO)  
SUITE 107  
3402 MARS COURT  
TRACY, CA 95376

THE MARK CONSISTS OF STANDARD CHAR-  
ACTERS WITHOUT CLAIM TO ANY PARTICULAR  
FONT, STYLE, SIZE, OR COLOR.

FOR: PET FOODS; EDIBLE PET TREATS; HORSE  
FEED; HORSE TREATS, IN CLASS 31 (U.S. CLS. 1  
AND 46).

SN 78-468,612, FILED 8-17-2004.

FIRST USE 10-31-2003; IN COMMERCE 3-31-2004.

CAROLYN GRAY, EXAMINING ATTORNEY

**Int. Cls.: 3, 25, 41, and 43**

**Prior U.S. Cls.: 1, 4, 6, 22, 39, 50, 51, 52, 100, 101, and 107**

**Reg. No. 3,469,302**

**United States Patent and Trademark Office**

**Registered July 15, 2008**

**TRADEMARK  
SERVICE MARK  
PRINCIPAL REGISTER**

**SANDPEARL**

CBR DEVELOPMENT I, LLC (FLORIDA LTD  
LIAB CO)  
SUITE 200  
2201 4TH STREET NORTH  
ST. PETERSBURG, FL 337044300

FOR: SPA PRODUCTS, NAMELY, PRODUCTS FOR SKIN CARE AND HAIR CARE, NAMELY, HAIR SHAMPOOS, HAIR CONDITIONERS, EXFOLIATES FOR THE HAIR AND SKIN, NON-MEDICATED STIMULATING LOTIONS FOR THE SKIN, SKIN ABRASIVE PREPARATIONS, SKIN CLARIFIERS, SKIN CLEANSERS, SKIN CLEANSING CREAM, SKIN CLEANSING LOTION, SKIN CONDITIONERS, SKIN CREAM, SKIN EMOLLIENTS, BODY WASHES, SHOWER GEL, SOAP, BODY LOTIONS, BODY CREAMS, BODY OILS, MASSAGE LOTIONS, AROMATHERAPY CREAMS AND LOTIONS, SKIN OILS, SUN PROTECTIVE SPRAYS AND LOTIONS, SKIN GELS FOR ACCELERATING, ENHANCING OR EXTENDING TANS, IN CLASS 3 (U.S. CLS. 1, 4, 6, 50, 51 AND 52).

FIRST USE 8-27-2007; IN COMMERCE 8-27-2007.

FOR: CLOTHING, NAMELY, T-SHIRTS, SWEAT SHIRTS, GOLF SHIRTS, COLLARED SHIRTS, DRESS SHIRTS, TOPS, HATS, CAPS, VISORS, PANTS, STRETCH PANTS, SHORTS, JACKETS, SKIRTS, SCARVES, SLACKS, UNDERWEAR, SOCKS, SCARVES, CLOTH BIBS, JUMPERS, JERSEYS, NIGHTWEAR, GYM SHORTS, BRAS, ROBES,

SWEATERS, DRESSES, SHOES, BELTS, WIND RESISTANT JACKETS, IN CLASS 25 (U.S. CLS. 22 AND 39).

FIRST USE 8-27-2007; IN COMMERCE 8-27-2007.

FOR: PROVIDING FITNESS AND EXERCISE FACILITIES, IN CLASS 41 (U.S. CLS. 100, 101 AND 107).

FIRST USE 8-27-2007; IN COMMERCE 8-27-2007.

FOR: RESORT HOTEL AND TEMPORARY ACCOMMODATION SERVICES; HEALTH RESORT SERVICES, NAMELY, PROVIDING FOOD AND LODGING THAT SPECIALIZE IN PROMOTING PATRONS' GENERAL HEALTH AND WELL BEING, PROVIDING GENERAL PURPOSE FACILITIES FOR MEETINGS, CONFERENCES AND EXHIBITIONS, PROVIDING BANQUET AND SOCIAL FUNCTION FACILITIES FOR SPECIAL OCCASIONS; AND RESTAURANT SERVICES, IN CLASS 43 (U.S. CLS. 100 AND 101).

FIRST USE 8-27-2007; IN COMMERCE 8-27-2007.

THE MARK CONSISTS OF STANDARD CHARACTERS WITHOUT CLAIM TO ANY PARTICULAR FONT, STYLE, SIZE, OR COLOR.



SN 78-474,387, FILED 8-26-2004.

PAM WILLIS, EXAMINING ATTORNEY

**Int. Cl.: 16**

**Prior U.S. Cls.: 2, 5, 22, 23, 29, 37, 38, and 50**

**Reg. No. 3,469,303**

**United States Patent and Trademark Office**

**Registered July 15, 2008**

**TRADEMARK  
PRINCIPAL REGISTER**

**WHO WOULD JESUS  
SUE?**

O'NEILL, MEGAN (UNITED STATES INDIVIDUAL)  
29 W. LAWRENCE ST. SUITE 210  
PONTIAC, MI 48342

THE MARK CONSISTS OF STANDARD CHARACTERS WITHOUT CLAIM TO ANY PARTICULAR FONT, STYLE, SIZE, OR COLOR.

FOR: PRINTED MATTER AND PUBLICATIONS, NAMELY, BOOKS AND BUMPER STICKERS IN THE FIELD OF FAITH BASED ADVOCACY, IN CLASS 16 (U.S. CLS. 2, 5, 22, 23, 29, 37, 38 AND 50).

SN 78-478,050, FILED 9-2-2004.

FIRST USE 4-2-2008; IN COMMERCE 4-2-2008.

KAREN BRACEY, EXAMINING ATTORNEY

**Int. Cl.: 9**

**Prior U.S. Cls.: 21, 23, 26, 36, and 38**

**Reg. No. 3,469,304**

**United States Patent and Trademark Office**

**Registered July 15, 2008**

---

**TRADEMARK  
PRINCIPAL REGISTER**

**WattWorks**

WATT SYSTEMS TECHNOLOGIES, INC. (INDIANA CORPORATION)  
3444 BRIAR PLACE  
CARMEL, IN 46033

FOR: COMPUTER SOFTWARE FOR IDENTIFYING, MANIPULATING, CREATING AND ANALYZING THE STRUCTURE AND BEHAVIOR OF SOFTWARE AND PHYSICAL MODELS FOR USE IN THE FIELDS OF SOFTWARE DEVELOPMENT AND SYSTEMS ENGINEERING; SOFTWARE DEVELOPMENT AND SYSTEM ENGINEERING MAN-

AGEMENT TOOLS, IN CLASS 9 (U.S. CLS. 21, 23, 26, 36 AND 38).

FIRST USE 2-26-2008; IN COMMERCE 2-26-2008.

THE MARK CONSISTS OF STANDARD CHARACTERS WITHOUT CLAIM TO ANY PARTICULAR FONT, STYLE, SIZE, OR COLOR.

SN 78-481,422, FILED 9-10-2004.

KELLY BOULTON, EXAMINING ATTORNEY

Int. Cl.: 25

Prior U.S. Cls.: 22 and 39

**United States Patent and Trademark Office**

**Reg. No. 3,469,305**

Registered July 15, 2008

---

**TRADEMARK  
PRINCIPAL REGISTER**

**CHO-PO**

CHO-PU SURF INTERNATIONAL LLC (CALI-  
FORNIA LTD LIAB CO)  
409 AVENIDA CRESPI  
SAN CLEMENTE, CA 92672

FOR: SURF WEAR, NAMELY, APPAREL FOR  
THE ACTION SPORTS MARKET, NAMELY, SHIRTS  
AND SHORTS, IN CLASS 25 (U.S. CLS. 22 AND 39).

FIRST USE 3-24-2004; IN COMMERCE 2-16-2007.

THE MARK CONSISTS OF STANDARD CHAR-  
ACTERS WITHOUT CLAIM TO ANY PARTICULAR  
FONT, STYLE, SIZE, OR COLOR.

SEC. 2(F).

SN 78-485,951, FILED 9-20-2004.

KIMBERLY PERRY, EXAMINING ATTORNEY

**Int. Cl.: 30**

**Prior U.S. Cl.: 46**

**United States Patent and Trademark Office**

**Reg. No. 3,469,306**

**Registered July 15, 2008**

**TRADEMARK  
PRINCIPAL REGISTER**

**HEALTHY LIFESTYLE**

LEWIS BROTHERS BAKERIES, INCORPORATED  
(MISSOURI CORPORATION), DBA LEWIS  
BAKERIES, INC.,

500 N. FULTON AVENUE  
EVANSVILLE, IN 47710

FOR: BREAD, IN CLASS 30 (U.S. CL. 46).

FIRST USE 4-18-2008; IN COMMERCE 4-18-2008.

THE MARK CONSISTS OF STANDARD CHAR-  
ACTERS WITHOUT CLAIM TO ANY PARTICULAR  
FONT, STYLE, SIZE, OR COLOR.

OWNER OF U.S. REG. NOS. 1,815,479, 2,043,907,  
AND 2,402,271.

SN 78-490,783, FILED 9-28-2004.

HELENE LIWINSKI, EXAMINING ATTORNEY

**Int. Cl.: 25**

**Prior U.S. Cls.: 22 and 39**

**United States Patent and Trademark Office**

**Reg. No. 3,469,307**

**Registered July 15, 2008**

**TRADEMARK  
PRINCIPAL REGISTER**

**RUN FREE**

RIAZI, SHIRIN (UNITED STATES INDIVIDUAL)

P.O. BOX 4777

WEST HILLS, CA 91308

FOR: FOOT COVERING PLACED ON THE FOOT  
PRIOR TO PUTTING ON SOCKS OR HOSIERY, IN  
CLASS 25 (U.S. CLS. 22 AND 39).

FIRST USE 10-15-2007; IN COMMERCE 4-5-2008.

THE MARK CONSISTS OF STANDARD CHAR-  
ACTERS WITHOUT CLAIM TO ANY PARTICULAR  
FONT, STYLE, SIZE, OR COLOR.

NO CLAIM IS MADE TO THE EXCLUSIVE  
RIGHT TO USE "RUN", APART FROM THE MARK  
AS SHOWN.

SN 78-496,956, FILED 10-8-2004.

KATHLEEN M. VANSTON, EXAMINING ATTOR-  
NEY

**Int. Cl.: 20**

**Prior U.S. Cls.: 2, 13, 22, 25, 32, and 50**

**Reg. No. 3,469,308**

**United States Patent and Trademark Office**

**Registered July 15, 2008**

---

**TRADEMARK  
PRINCIPAL REGISTER**

**The Wonder Bucket**

OLSON, LAWRENCE G (UNITED STATES INDIVIDUAL)

911 W WOODLAND AVE

PHOENIX, AZ 85007

FOR: BUCKET, IN CLASS 20 (U.S. CLS. 2, 13, 22, 25, 32 AND 50).

FIRST USE 3-22-2007; IN COMMERCE 3-22-2007.

THE MARK CONSISTS OF STANDARD CHARACTERS WITHOUT CLAIM TO ANY PARTICULAR FONT, STYLE, SIZE, OR COLOR.

NO CLAIM IS MADE TO THE EXCLUSIVE RIGHT TO USE "BUCKET", APART FROM THE MARK AS SHOWN.

SN 78-497,005, FILED 10-8-2004.

MARK RADEMACHER, EXAMINING ATTORNEY

**Int. Cls.: 9 and 41**

**Prior U.S. Cls.: 21, 23, 26, 36, 38, 100, 101, and 107**

**United States Patent and Trademark Office**

**Reg. No. 3,469,309**

**Registered July 15, 2008**

**TRADEMARK  
SERVICE MARK  
PRINCIPAL REGISTER**

**ALIGHT**

ALIGHT, LP (CALIFORNIA LIMITED PARTNER-  
SHIP)  
3424 LODGE ROAD  
PLACERVILLE, CA 95667

FOR: COMPUTER PROGRAM, NAMELY, FOR  
BUSINESS PLANNING AND FINANCIAL REPORT-  
ING, IN CLASS 9 (U.S. CLS. 21, 23, 26, 36 AND 38).

FIRST USE 3-1-2005; IN COMMERCE 3-8-2005.

FOR: ONLINE OR COMPUTER BASED EDUCA-  
TIONAL SERVICES, NAMELY, PROVIDING COUR-

SES AND TUTORIALS IN THE FIELD OF  
BUSINESS, IN CLASS 41 (U.S. CLS. 100, 101 AND 107).

FIRST USE 6-24-2005; IN COMMERCE 6-25-2005.

THE MARK CONSISTS OF STANDARD CHAR-  
ACTERS WITHOUT CLAIM TO ANY PARTICULAR  
FONT, STYLE, SIZE, OR COLOR.

SN 78-506,816, FILED 10-27-2004.

WILLIAM VERHOSEK, EXAMINING ATTORNEY



Int. Cl.: 9

Prior U.S. Cls.: 21, 23, 26, 36, and 38

United States Patent and Trademark Office

Reg. No. 3,469,310

Registered July 15, 2008

TRADEMARK  
PRINCIPAL REGISTER



LABRADOR PICTURES, LLC (CALIFORNIA LTD  
LIAB CO)  
4630 VIA VISTOSA  
SANTA BARBARA, CA 93110

FOR: ENTERTAINMENT MOTION PICTURE  
FILMS FEATURING COMEDY, DRAMA, ACTION,  
ADVENTURE, SPORTS, AND ROMANCE, PRE-RE-  
CORDED DVD'S FEATURING COMEDY, DRAMA,  
ACTION, ADVENTURE, SPORTS, AND ROMANCE,  
IN CLASS 9 (U.S. CLS. 21, 23, 26, 36 AND 38).

FIRST USE 2-2-2005; IN COMMERCE 8-25-2005.

NO CLAIM IS MADE TO THE EXCLUSIVE  
RIGHT TO USE "PICTURES" "SANTA BARBARA"  
OR "CALIFORNIA", APART FROM THE MARK AS  
SHOWN.

SN 78-508,048, FILED 10-29-2004.

DAVID H. STINE, EXAMINING ATTORNEY

**Int. Cl.: 9**

**Prior U.S. Cls.: 21, 23, 26, 36, and 38**

**Reg. No. 3,469,311**

**United States Patent and Trademark Office**

**Registered July 15, 2008**

**TRADEMARK  
PRINCIPAL REGISTER**

**KLEENGUARD**

KIMBERLY-CLARK WORLDWIDE, INC. (DELA-  
WARE CORPORATION)  
401 NORTH LAKE STREET  
NEENAH, WI 54956

FOR: RESPIRATORY MASKS FOR FILTERING  
OUT AIRBORNE PARTICLES; PROTECTIVE  
GLOVES FOR INDUSTRIAL USE, IN CLASS 9 (U.S.  
CLS. 21, 23, 26, 36 AND 38).

FIRST USE 11-27-2006; IN COMMERCE 11-27-2006.

THE MARK CONSISTS OF STANDARD CHAR-  
ACTERS WITHOUT CLAIM TO ANY PARTICULAR  
FONT, STYLE, SIZE, OR COLOR.

OWNER OF U.S. REG. NOS. 1,291,179, 1,701,747,  
AND 1,815,936.

SN 78-508,493, FILED 10-29-2004.

ALEXANDER L. POWERS, EXAMINING ATTOR-  
NEY

**Int. Cl.: 32**

**Prior U.S. Cls.: 45, 46, and 48**

**United States Patent and Trademark Office**

**Reg. No. 3,469,312**

**Registered July 15, 2008**

**TRADEMARK  
PRINCIPAL REGISTER**

**HITA TENRYOSUI**

KABUSHIKI KAISHA HITA TENRYOSUI (JAPAN  
CORPORATION)  
647, OAZA-SHODE, HITA-SHI  
OITA-KEN, JAPAN

FOR: MINERAL WATER, DRINKING WATER, IN  
CLASS 32 (U.S. CLS. 45, 46 AND 48).

FIRST USE 6-0-1998; IN COMMERCE 1-0-2007.

THE MARK CONSISTS OF STANDARD CHAR-  
ACTERS WITHOUT CLAIM TO ANY PARTICULAR  
FONT, STYLE, SIZE, OR COLOR.

NO CLAIM IS MADE TO THE EXCLUSIVE  
RIGHT TO USE "HITA", APART FROM THE MARK  
AS SHOWN.

THE NAME(S), PORTRAIT(S), AND/OR SIGNA-  
TURE(S) SHOWN IN THE MARK DOES NOT IDEN-  
TIFY A PARTICULAR LIVING INDIVIDUAL.

SN 78-508,646, FILED 10-29-2004.

GIANCARLO CASTRO, EXAMINING ATTORNEY

**Int. Cls.: 6 and 19**

**Prior U.S. Cls.: 1, 2, 12, 13, 14, 23, 25, 33, and 50**

**United States Patent and Trademark Office**

**Reg. No. 3,469,313**

**Registered July 15, 2008**

**TRADEMARK  
PRINCIPAL REGISTER**

**DPS**

WITRON LOGISTIK + INFORMATIK GMBH  
(FED REP GERMANY CORPORATION)  
NEUSTADTER STR. 21  
PARKSTEIN, FED REP GERMANY 92711

FOR: PREFABRICATED METAL WAREHOUSES,  
NAMELY, METAL RACK STORAGE UNITS, ME-  
TAL PALLET STORAGE UNITS, AND METAL  
CONTAINER STORAGE UNITS, IN CLASS 6 (U.S.  
CLS. 2, 12, 13, 14, 23, 25 AND 50).

FIRST USE 12-0-1996; IN COMMERCE 9-0-2002.

FOR: PREFABRICATED NON-METAL WARE-  
HOUSES, NAMELY, NON-METAL RACK STORAGE  
UNITS, NON-METAL PALLET STORAGE UNITS,  
AND NON-METAL CONTAINER STORAGE UNITS,  
IN CLASS 19 (U.S. CLS. 1, 12, 33 AND 50).

FIRST USE 12-0-1996; IN COMMERCE 9-0-2002.

THE MARK CONSISTS OF STANDARD CHAR-  
ACTERS WITHOUT CLAIM TO ANY PARTICULAR  
FONT, STYLE, SIZE, OR COLOR.

PRIORITY CLAIMED UNDER SEC. 44(D) ON  
ERPNTY TM OFC APPLICATION NO.  
004015368, FILED 9-8-2004, REG. NO. 004015368,  
DATED 12-15-2005, EXPIRES 9-8-2014.

SN 78-510,893, FILED 11-3-2004.

DORITT L. CARROLL, EXAMINING ATTORNEY

**Int. Cl.: 5**

**Prior U.S. Cls.: 6, 18, 44, 46, 51, and 52**

**Reg. No. 3,469,314**

**United States Patent and Trademark Office**

**Registered July 15, 2008**

---

**TRADEMARK  
PRINCIPAL REGISTER**

**NOVARX**

NOVARX CORPORATION (DELAWARE CORPORATION)  
6828 NANCY RIDGE DRIVE, SUITE 100  
SAN DIEGO, CA 92121

THE MARK CONSISTS OF STANDARD CHARACTERS WITHOUT CLAIM TO ANY PARTICULAR FONT, STYLE, SIZE, OR COLOR.

FOR: PHARMACEUTICAL PREPARATIONS FOR THE TREATMENT OF CANCER, IN CLASS 5 (U.S. CLS. 6, 18, 44, 46, 51 AND 52).

SN 78-511,553, FILED 11-4-2004.

FIRST USE 4-1-2008; IN COMMERCE 4-1-2008.

CHERYL CLAYTON, EXAMINING ATTORNEY

**Int. Cl.: 12**

**Prior U.S. Cls.: 19, 21, 23, 31, 35, and 44**

**United States Patent and Trademark Office**

**Reg. No. 3,469,315**

**Registered July 15, 2008**

**TRADEMARK  
PRINCIPAL REGISTER**

**RALLYTIME**

RALLYTIME TRAILERS, INC. (DELAWARE CORPORATION)  
2840 SFERRA AVE NW  
WARREN, OH 44483

THE MARK CONSISTS OF STANDARD CHARACTERS WITHOUT CLAIM TO ANY PARTICULAR FONT, STYLE, SIZE, OR COLOR.

FOR: TRAILERS NOT RELATING TO BASEBALL OR SOFTBALL OR TO A BASEBALL OR SOFTBALL TEAM, IN CLASS 12 (U.S. CLS. 19, 21, 23, 31, 35 AND 44).

SN 78-515,353, FILED 11-11-2004.

FIRST USE 1-3-2006; IN COMMERCE 1-3-2006.

ADA HAN, EXAMINING ATTORNEY

**Int. Cls.: 9, 16, 18, 21, 25, 35, 38, and 41**

**Prior U.S. Cls.: 1, 2, 3, 5, 13, 21, 22, 23, 26, 29, 30, 33, 36, 37, 38, 39, 40, 41, 50, 100, 101, 102, 104, and 107**

**Reg. No. 3,469,316**

**United States Patent and Trademark Office**

**Registered July 15, 2008**

**TRADEMARK  
SERVICE MARK  
PRINCIPAL REGISTER**

**ORGANIZATIONS  
ALIVE!**

YUILL, JANET ELIZABETH (CANADA INDIVIDUAL)  
SUITE #306  
1081 AMBLESIDE DRIVE  
OTTAWA, CANADA K2H 8C8

FOR: ELECTRONIC MEDIA, NAMELY, PRE-RECORDED AUDIO, DATA, AND VIDEO DISCS AND TAPES FEATURING INFORMATION ON BUSINESS, COMMUNICATIONS, CREATIVITY AND INSPIRATION, GOVERNMENT, GROUP DYNAMICS, INTERPERSONAL RELATIONS, MANAGEMENT, NOT-FOR-PROFIT ORGANIZATIONS, PERSONAL DEVELOPMENT AND WORKPLACE STRATEGIES; DIGITAL RECORDING DISCS AND TAPES FEATURING INFORMATION ON BUSINESS, COMMUNICATIONS, CREATIVITY AND INSPIRATION, GOVERNMENT, GROUP DYNAMICS, INTERPERSONAL RELATIONS, MANAGEMENT, NOT-FOR-PROFIT ORGANIZATIONS, PERSONAL DEVELOPMENT AND WORKPLACE STRATEGIES; DECORATIVE AND REFRIGERATOR MAGNETS, IN CLASS 9 (U.S. CLS. 21, 23, 26, 36 AND 38).

FIRST USE 12-1-2004; IN COMMERCE 12-1-2004.

FOR: PAPER AND PRINTED MATTER, NAMELY, SYNDICATED COLUMNS FOR PUBLICATION IN MAGAZINES AND PERIODICALS FEATURING INFORMATION ON BUSINESS, COMMUNICATIONS, CREATIVITY AND INSPIRATION, GOVERNMENT, GROUP DYNAMICS, INTERPERSONAL RELATIONS, MANAGEMENT, NOT-FOR-PROFIT ORGANIZATIONS, PERSONAL DEVELOPMENT AND WORKPLACE STRATEGIES; BOOKLETS, BOOKMARKS, BROCHURES, GREET-

ING CARDS, NEWSLETTERS AND PAMPHLETS FEATURING INFORMATION ON BUSINESS, COMMUNICATIONS, CREATIVITY AND INSPIRATION, GOVERNMENT, GROUP DYNAMICS, INTERPERSONAL RELATIONS, MANAGEMENT, NOT-FOR-PROFIT ORGANIZATIONS, PERSONAL DEVELOPMENT AND WORKPLACE STRATEGIES; PRINTED EDUCATIONAL, INSTRUCTIONAL AND TEACHING MATERIALS FEATURING INFORMATION ON BUSINESS, COMMUNICATIONS, CREATIVITY AND INSPIRATION, GOVERNMENT, GROUP DYNAMICS, INTERPERSONAL RELATIONS, MANAGEMENT, NOT-FOR-PROFIT ORGANIZATIONS, PERSONAL DEVELOPMENT AND WORKPLACE STRATEGIES; PRINTED PUBLICATIONS, NAMELY, MAGAZINES, TRADE JOURNALS AND PERIODICALS ON BUSINESS, COMMUNICATIONS, CREATIVITY AND INSPIRATION, GOVERNMENT, GROUP DYNAMICS, INTERPERSONAL RELATIONS, MANAGEMENT, NOT-FOR-PROFIT ORGANIZATIONS, PERSONAL DEVELOPMENT AND WORKPLACE STRATEGIES; PRINTS; PHOTOGRAPHS; PICTURES; PLACE CARDS AND PAPER PLACE MATS; PROMOTIONAL POSTCARDS AND POSTERS; SERIES OF FICTION AND NON-FICTION BOOKS, BINDERS, HANDBOOKS, MANUALS AND WORKBOOKS FEATURING BUSINESS, COMMUNICATIONS, CREATIVITY AND INSPIRATION, GOVERNMENT, GROUP DYNAMICS, INTERPERSONAL RELATIONS, MANAGEMENT, NOT-FOR-PROFIT ORGANIZATIONS, PERSONAL DEVELOPMENT AND WORKPLACE STRATEGIES; CALENDARS; PAPERWEIGHTS; PEN AND WRITING CASES; SIGNBOARDS MADE OF PAPER AND CARDBOARD; STANDS AND HOLDERS FOR PENS AND PENCILS; STATIONERY AND OTHER WRIT-

ING MATERIALS, NAMELY, FOLDERS, PAPER LABELS, LETTERHEAD AND ENVELOPES OF PAPER PROVIDED FOR OTHERS, NOTEBOOKS, WRITING PAPER PADS, PAPER CLASPS, PENCILS, PENS, PEN CLIPS, STENCILS, STICKERS, WRITING TABLETS, IRON-ON AND PLASTIC TRANSFERS AND PAPER AND PLASTIC TRANSPARENCIES; PAPER MAIL POUCHES; PAPER AND PLASTIC SHOPPING BAGS, IN CLASS 16 (U.S. CLS. 2, 5, 22, 23, 29, 37, 38 AND 50).

FIRST USE 12-1-2004; IN COMMERCE 12-1-2004.

FOR: ATTACHE CASES, BACKPACKS, BEACH BAGS, BRIEFCASES, BUSINESS AND CALLING CARD CASES, GARMENT BAGS FOR TRAVEL, HANDBAGS, KEY CASES, LUGGAGE, OVER-NIGHT CASES, DRAWSTRING, FELT AND LEATHER POUCHES, POCKETBOOKS, LEATHER, MESH, TEXTILE AND STRING SHOPPING BAGS, SHOULDER BAGS, SUITCASES, TOTE BAGS, UMBRELLAS AND WALLETS, IN CLASS 18 (U.S. CLS. 1, 2, 3, 22 AND 41).

FIRST USE 12-1-2004; IN COMMERCE 12-1-2004.

FOR: COASTERS NOT OF PAPER AND OTHER THAN TABLE LINEN; DISHWARE NOT OF PRECIOUS METAL, NAMELY, PLATES, BOWLS, CUPS, MUGS, SAUCERS, PLATTERS; FLASKS FOR TRAVELERS, LUNCH BOXES, PAINTED BEVERAGE GLASSWARE, IN CLASS 21 (U.S. CLS. 2, 13, 23, 29, 30, 33, 40 AND 50).

FIRST USE 12-1-2004; IN COMMERCE 12-1-2004.

FOR: CLOTHING ACCESSORIES, NAMELY, BANDANAS, BELTS, GLOVES, SCARVES, SWEAT BANDS, SUSPENDERS AND VISORS; CLOTHING, NAMELY, APRONS, BLOUSES, BOTTOMS, GOLF SHIRTS, GYM SHORTS, GYM SUITS, JERSEYS, JUMPERS, JUMP SUITS, KNIT SHIRTS, PANTS, POLO SHIRTS, PULLOVERS, SHIRTS, SHORT SETS COMPRISED OF A TOP AND A BOTTOM, SMOCKS, SUITS, SWEATERS, SWEAT PANTS, SWEAT SHIRTS, SWEAT SUITS, T-SHIRTS AND VESTS; HEAD WEAR, NAMELY, CAPS, EAR MUFFS AND HATS; OUTERWEAR, NAMELY, COATS, JACKETS, RAIN WEAR AND WRAPS, IN CLASS 25 (U.S. CLS. 22 AND 39).

FIRST USE 12-1-2004; IN COMMERCE 12-1-2004.

FOR: BUSINESS CONSULTING SERVICES, NAMELY, IN THE FIELD OF INTERPERSONAL AND BUSINESS COMMUNICATIONS AND RELATIONS, PROFESSIONAL CREATIVITY, INSPIRATION, GOVERNMENTAL CLIENTS, GROUP DYNAMICS, MANAGEMENT, NOT-FOR-PROFIT ORGANIZATIONS, PERSONAL DEVELOPMENT AND WORKPLACE STRATEGIES FOR SAFETY, HEALTH, POLICIES AND PROCEDURES; PROVIDING ONLINE DATA BASES IN THE FIELD OF BUSINESS AND BUSINESS RELATIONS, GOVERNMENTAL AFFAIRS, BUSINESS-GROUP DYNAMICS, BUSINESS MANAGEMENT, NOT-FOR-PROFIT BUSINESS ORGANIZATIONS, BUSINESS-RELATED

CAREER DEVELOPMENT AND WORKPLACE STRATEGIES FOR SAFETY, HEALTH, POLICIES AND PROCEDURES ALL DOWNLOADABLE VIA THE INTERNET; ELECTRONIC, PRINT, RADIO AND TELEVISION ADVERTISING AND COMMERCIAL PRODUCTION, IN CLASS 35 (U.S. CLS. 100, 101 AND 102).

FIRST USE 12-1-2004; IN COMMERCE 12-1-2004.

FOR: TELECOMMUNICATIONS SERVICES, NAMELY, BROADCASTING RADIO AND TELEVISION PROGRAMS AND FILMS VIA A GLOBAL COMPUTER NETWORK; COMMUNICATIONS BY TELEPHONE AND FACSIMILE TRANSMISSION; ELECTRONIC, ELECTRIC, AND DIGITAL TRANSMISSION OF VOICE, DATA, IMAGES, SOUND, SIGNAL AND MESSAGES; ELECTRONIC TRANSMISSION OF BOOKS, E-ZINES AND NEWSLETTERS VIA A GLOBAL COMPUTER NETWORK; ELECTRONIC TRANSMISSION OF GREETING CARDS AND MAILERS VIA A GLOBAL COMPUTER NETWORK; TRANSMISSION OF INFORMATION BY ELECTRONIC MEDIA, NAMELY, VIA DIGITAL NETWORKS; DELIVERY OF PERSONALIZED ELECTRONIC GREETING CARDS FEATURING INSTRUCTION, MUSIC, SOUND EFFECTS AND SPEECHES TO OTHERS VIA ELECTRONIC MAIL, IN CLASS 38 (U.S. CLS. 100, 101 AND 104).

FIRST USE 12-1-2004; IN COMMERCE 12-1-2004.

FOR: PRODUCTION AND DISTRIBUTION OF TELEVISION AND RADIO PROGRAMS; ACADEMIC, EDUCATIONAL, INFORMATIONAL AND INSTRUCTIONAL SERVICES, NAMELY, ARRANGING AND CONDUCTING SEMINARS, CONFERENCES, WORKSHOPS, AND LECTURES IN THE FIELDS OF BUSINESS, COMMUNICATIONS, CREATIVITY AND INSPIRATION, GOVERNMENT, GROUP DYNAMICS, INTERPERSONAL RELATIONS, MANAGEMENT, NOT-FOR-PROFIT ORGANIZATIONS, PERSONAL DEVELOPMENT AND WORKPLACE STRATEGIES; ENTERTAINMENT SERVICES, NAMELY, LIVE SPEAKING PERFORMANCES AND SPEAKING ENGAGEMENTS ON A VARIETY OF EDUCATIONAL, ENTERTAINING AND MOTIVATIONAL SUBJECTS; PRODUCTION OF RADIO AND TELEVISION AND FILM PROGRAMS FOR TRANSMISSION VIA BROADCAST, CABLE, DIGITAL AND GLOBAL COMPUTER NETWORK, AND PUBLICATION OF ACCOMPANYING MATERIALS IN THE FORM OF BOOKS, MAGAZINES AND NEWSLETTERS; COACHING SERVICES, NAMELY, IN THE FIELD OF BUSINESS, COMMUNICATIONS, CREATIVITY AND INSPIRATION, GOVERNMENT, GROUP DYNAMICS, INTERPERSONAL RELATIONS, MANAGEMENT, NOT-FOR-PROFIT ORGANIZATIONS, PERSONAL DEVELOPMENT AND WORKPLACE STRATEGIES; PROVIDING TELECOMMUNICATIONS SEMINARS AND WORKSHOPS TO A GLOBAL COMPUTER NETWORK, IN CLASS 41 (U.S. CLS. 100, 101 AND 107).

FIRST USE 12-1-2004; IN COMMERCE 12-1-2004.



THE MARK CONSISTS OF STANDARD CHAR-  
ACTERS WITHOUT CLAIM TO ANY PARTICULAR  
FONT, STYLE, SIZE, OR COLOR.

SN 78-516,517, FILED 11-13-2004.

BRENDAN REGAN, EXAMINING ATTORNEY

**Int. Cl.: 31**

**Prior U.S. Cls.: 1 and 46**

**United States Patent and Trademark Office**

**Reg. No. 3,469,317**

**Registered July 15, 2008**

**TRADEMARK  
PRINCIPAL REGISTER**

**CHINQUANUT**

JACKSON, AUZVILLE JR. (UNITED STATES IN-  
DIVIDUAL)  
8652 RIO GRANDE ROAD  
RICHMOND, VA 23229

FOR: SEEDLINGS; LIVING PLANTS; PLANT  
SEEDS; FRESH FRUITS, IN CLASS 31 (U.S. CLS. 1  
AND 46).

FIRST USE 5-5-2008; IN COMMERCE 5-5-2008.

THE MARK CONSISTS OF STANDARD CHAR-  
ACTERS WITHOUT CLAIM TO ANY PARTICULAR  
FONT, STYLE, SIZE, OR COLOR.

SN 78-523,093, FILED 11-26-2004.

KRISTINA MORRIS, EXAMINING ATTORNEY

**Int. Cl.: 35**

**Prior U.S. Cls.: 100, 101, and 102**

**United States Patent and Trademark Office**

**Reg. No. 3,469,318**

**Registered July 15, 2008**

**SERVICE MARK  
PRINCIPAL REGISTER**

**GATEWAY CANYONS**

HENDRICKS, JOHN S. (UNITED STATES INDIVIDUAL)  
8723 PERSIMMON TREE ROAD  
POTOMAC, MD 20854

THE MARK CONSISTS OF STANDARD CHARACTERS WITHOUT CLAIM TO ANY PARTICULAR FONT, STYLE, SIZE, OR COLOR.

FOR: RETAIL GIFT STORES, FOR CLOTHING AND SOUVENIR ITEMS; GROCERY STORES, IN CLASS 35 (U.S. CLS. 100, 101 AND 102).

SN 78-526,389, FILED 12-2-2004.

FIRST USE 7-1-2005; IN COMMERCE 7-1-2005.

BENJAMIN OKEKE, EXAMINING ATTORNEY

**Int. Cl.: 9**

**Prior U.S. Cls.: 21, 23, 26, 36, and 38**

**Reg. No. 3,469,319**

**United States Patent and Trademark Office**

**Registered July 15, 2008**

---

**TRADEMARK  
PRINCIPAL REGISTER**

**BIG RED**

WHIRLWIND CONCEPTS, INC. (WASHINGTON CORPORATION)  
1118 N. HOWE ROAD  
SPOKANE, WA 992120917

THE MARK CONSISTS OF STANDARD CHARACTERS WITHOUT CLAIM TO ANY PARTICULAR FONT, STYLE, SIZE, OR COLOR.

FOR: VENDING MACHINES; AUTOMATED WINDSHIELD WASHING FLUID DISPENSERS, IN CLASS 9 (U.S. CLS. 21, 23, 26, 36 AND 38).

SN 78-530,795, FILED 12-10-2004.

FIRST USE 1-15-2004; IN COMMERCE 1-15-2004.

WON TEAK OH, EXAMINING ATTORNEY

**Int. Cls.: 9, 15, 16, and 28**

**Prior U.S. Cls.: 2, 5, 21, 22, 23, 26, 29, 36, 37, 38, and 50**

**Reg. No. 3,469,320**

**United States Patent and Trademark Office**

**Registered July 15, 2008**

**TRADEMARK  
PRINCIPAL REGISTER**



NAME RITE, L.L.C. (DELAWARE LTD LIAB CO)  
27710 JEFFERSON AVENUE, SUITE 105  
TEMECULA, CA 92590

FOR: SPORT GOGGLES AND MASKS FOR SWIMMING; MICROPHONES, IN CLASS 9 (U.S. CLS. 21, 23, 26, 36 AND 38).

FIRST USE 7-0-2005; IN COMMERCE 7-0-2005.

FOR: MUSICAL INSTRUMENTS AND ELECTRONIC MUSICAL INSTRUMENTS, NAMELY, DRUMS, ELECTRONIC KEYBOARDS, ELECTRONIC GUITARS, SYNTHESIZERS, FLUTES, AND MARACAS, IN CLASS 15 (U.S. CLS. 2, 21 AND 36).

FIRST USE 7-0-2005; IN COMMERCE 7-0-2005.

FOR: COLORING BOOKS, ARTS AND CRAFT KITS, CHILDREN'S ACTIVITY BOOKS, IN CLASS 16 (U.S. CLS. 2, 5, 22, 23, 29, 37, 38 AND 50).

FIRST USE 7-0-2005; IN COMMERCE 7-0-2005.

FOR: CHILDREN'S MULTIPLE ACTIVITY TOYS; CONSTRUCTION TOYS; TOY BLOCKS AND SETS THEREFOR; TOY VEHICLES; PULL TOYS; TOY MUSICAL INSTRUMENTS; TOY ANIMALS AND ACCESSORIES THEREFOR; TOY FIGURES AND ACCESSORIES THEREFOR; GAMES, NAMELY, BOARD GAMES, TRIVIA GAMES, DOMINOS, CARD GAMES, HANDHELD SPORTS GAMES, NAMELY YO-YOS, SKIPPING ROPES, KITES, TE-

HER-BALL GAMES, PADDLE BALL GAMES, AND OUTDOOR ACTIVITY GAMES; NAMELY BADMINTON; ELECTRONIC GAMES, NAMELY, HANDHELD UNIT FOR PLAYING ELECTRONIC GAMES, HAND HELD UNIT FOR PLAYING VIDEO GAMES, PINBALL GAMES, HAND-HELD GAMES WITH LIQUID-CRYSTAL DISPLAYS, AND ARCADE GAMES; ELECTRONIC LEARNING TOYS, NAMELY, TOY COMPUTERS AND KEYBOARDS; TOY APPLIANCES; TOY JEWELRY; STUFFED DOGS AND ANIMALS; DOLLS AND ACCESSORIES THEREFOR; ELECTRONIC DOLLS; PUZZLES; INFLATABLE TOYS; INFLATABLE SWIMMING POOLS; ELECTRONIC DANCE MATS FOR PLAY, IN CLASS 28 (U.S. CLS. 22, 23, 38 AND 50).

FIRST USE 7-0-2005; IN COMMERCE 7-0-2005.

NO CLAIM IS MADE TO THE EXCLUSIVE RIGHT TO USE "KIDS STUFF", APART FROM THE MARK AS SHOWN.

THE COLOR(S) BLUE, YELLOW, ORANGE, RED AND PURPLE IS/ARE CLAIMED AS A FEATURE OF THE MARK.

THE MARK CONSISTS OF THE WORDS "KIDS STUFF" IN THE COLOR BLUE, SHADING OF THE WORDS "KIDS" "STUFF" IN THE COLOR RED, A BALL THAT SITS ABOVE THE "I" IN "KIDS STUFF" IN THE COLOR RED SURROUNDED BY TWO RINGS IN THE COLORS ORANGE AND PURPLE,

A BACKGROUND CIRCLE IN THE COLOR ORANGE BEHIND THE WORDS "KIDS STUFF", A MIDDLE RING SURROUNDING THE WORDS "KIDS STUFF" IN THE COLOR PURPLE, AND AN OUTERMOST RING SURROUNDING THE WORDS "KIDS STUFF" IN THE COLOR YELLOW.

SN 78-539,177, FILED 12-28-2004.

NAAKWAMA ANKRAH, EXAMINING ATTORNEY

**Int. Cl.: 3**

**Prior U.S. Cls.: 1, 4, 6, 50, 51, and 52**

**United States Patent and Trademark Office**

**Reg. No. 3,469,321**

**Registered July 15, 2008**

**TRADEMARK  
PRINCIPAL REGISTER**

**POWERPOINT**

MAKE-UP ART COSMETICS INC. (DELAWARE  
CORPORATION)  
767 FIFTH AVENUE  
NEW YORK, NY 10153

THE MARK CONSISTS OF STANDARD CHAR-  
ACTERS WITHOUT CLAIM TO ANY PARTICULAR  
FONT, STYLE, SIZE, OR COLOR.

FOR: COSMETICS, IN CLASS 3 (U.S. CLS. 1, 4, 6, 50,  
51 AND 52).

SN 78-539,708, FILED 12-29-2004.

FIRST USE 4-7-2003; IN COMMERCE 4-7-2003.

AMY GEARIN, EXAMINING ATTORNEY

**Int. Cl.: 35**

**Prior U.S. Cls.: 100, 101, and 102**

**United States Patent and Trademark Office**

**Reg. No. 3,469,322**

**Registered July 15, 2008**

**SERVICE MARK  
PRINCIPAL REGISTER**

**SUTTON PLACE**

SUTTON PLACE LIMITED (NEVADA LTD LIAB  
CO)  
SUITE 202  
5390 KIETZKE LANE  
RENO, NV 89511

FOR: BOOKKEEPING AND ACCOUNTANCY  
SERVICES, TAX PLANNING AND CONSULTA-  
TION; TAX RETURN PREPARATION, IN CLASS 35  
(U.S. CLS. 100, 101 AND 102).

FIRST USE 0-0-2004; IN COMMERCE 0-0-2004.

THE MARK CONSISTS OF STANDARD CHAR-  
ACTERS WITHOUT CLAIM TO ANY PARTICULAR  
FONT, STYLE, SIZE, OR COLOR.

SN 78-542,814, FILED 1-5-2005.

SARA THOMAS, EXAMINING ATTORNEY



**Int. Cl.: 5**

**Prior U.S. Cls.: 6, 18, 44, 46, 51, and 52**

**United States Patent and Trademark Office**

**Reg. No. 3,469,323**

**Registered July 15, 2008**

**TRADEMARK  
PRINCIPAL REGISTER**

**OMNIPRED**

ALCON, INC. (SWITZERLAND CORPORATION)  
BÖSCH 69  
CH-6331 HÜNENBERG, SWITZERLAND

THE MARK CONSISTS OF STANDARD CHARACTERS WITHOUT CLAIM TO ANY PARTICULAR FONT, STYLE, SIZE, OR COLOR.

FOR: OPHTHALMIC PHARMACEUTICAL PREPARATIONS FOR THE TREATMENT OF INFLAMMATION, IN CLASS 5 (U.S. CLS. 6, 18, 44, 46, 51 AND 52).

SN 78-544,584, FILED 1-10-2005.

FIRST USE 2-28-2008; IN COMMERCE 2-28-2008.

G. MAYERSCHOFF, EXAMINING ATTORNEY

**Int. Cl.: 9**

**Prior U.S. Cls.: 21, 23, 26, 36, and 38**

**Reg. No. 3,469,324**

**United States Patent and Trademark Office**

**Registered July 15, 2008**

**TRADEMARK  
PRINCIPAL REGISTER**

**FUSION DIGITAL  
POWER**

TEXAS INSTRUMENTS INCORPORATED (DE-  
LAWARE CORPORATION)  
MS 3999  
12500 TI BOULEVARD  
DALLAS, TX 752434136

FOR: SEMICONDUCTOR INTEGRATED CIR-  
CUITS, NAMELY, ANALOG INTEGRATED CIR-  
CUITS, DIGITAL INTEGRATED CIRCUITS, AND  
MIXED SIGNAL INTEGRATED CIRCUITS , IN  
CLASS 9 (U.S. CLS. 21, 23, 26, 36 AND 38).

FIRST USE 3-7-2005; IN COMMERCE 7-27-2005.

THE MARK CONSISTS OF STANDARD CHAR-  
ACTERS WITHOUT CLAIM TO ANY PARTICULAR  
FONT, STYLE, SIZE, OR COLOR.

NO CLAIM IS MADE TO THE EXCLUSIVE  
RIGHT TO USE "DIGITAL POWER", APART FROM  
THE MARK AS SHOWN.

SN 78-561,354, FILED 2-5-2005.

MONIQUE MILLER, EXAMINING ATTORNEY

**Int. Cl.: 9**

**Prior U.S. Cls.: 21, 23, 26, 36, and 38**

**Reg. No. 3,469,325**

**United States Patent and Trademark Office**

**Registered July 15, 2008**

**TRADEMARK  
PRINCIPAL REGISTER**

**NOVINT FALCON**

NOVINT TECHNOLOGIES, INC. (DELAWARE CORPORATION)  
4109 BRYAN AVE NW  
ALBUQUERQUE, NM 87114

FOR: COMPUTER SYSTEMS AND PERIPHERALS, NAMELY, HAPTIC INTERFACE DEVICES THAT ENABLE A USER TO INTERACT WITH A COMPUTER BY RECEIVING TACTILE FEEDBACK, MULTIDIMENSIONAL INTERFACE DEVICES THAT ENABLE A USER TO INTERACT WITH A COMPUTER IN MULTIPLE DIMENSIONS, FORCE-INPUT AND FORCE-FEEDBACK INTERFACE DEVICES THAT ENABLE A USER TO INTERACT WITH A COMPUTER BY APPLYING FORCE TO A DEVICE OR SENSING FORCE APPLIED BY THE DEVICE, COMPUTER GAME CONTROLLERS, AND

COMPUTER SOFTWARE FOR OPERATING ANY OF THE FOREGOING, IN CLASS 9 (U.S. CLS. 21, 23, 26, 36 AND 38).

FIRST USE 6-18-2007; IN COMMERCE 6-18-2007.

THE MARK CONSISTS OF STANDARD CHARACTERS WITHOUT CLAIM TO ANY PARTICULAR FONT, STYLE, SIZE, OR COLOR.

OWNER OF U.S. REG. NO. 2,512,087.

SN 78-561,994, FILED 2-7-2005.

DAVID ELTON, EXAMINING ATTORNEY

**Int. Cl.: 3**

**Prior U.S. Cls.: 1, 4, 6, 50, 51, and 52**

**Reg. No. 3,469,326**

**United States Patent and Trademark Office**

**Registered July 15, 2008**

**TRADEMARK  
PRINCIPAL REGISTER**

**CRAFTY**

SEBASTIAN INTERNATIONAL, INC. (CALIFORNIA CORPORATION)  
6109 DESOTO AVENUE  
WOODLAND HILLS, CA 91367

THE MARK CONSISTS OF STANDARD CHARACTERS WITHOUT CLAIM TO ANY PARTICULAR FONT, STYLE, SIZE, OR COLOR.

FOR: HAIR CARE PRODUCTS, NAMELY, HAIR STYLING WAX, POMADE, IN CLASS 3 (U.S. CLS. 1, 4, 6, 50, 51 AND 52).

SN 78-564,109, FILED 2-9-2005.

FIRST USE 2-0-2006; IN COMMERCE 2-0-2006.

STEVEN PEREZ, EXAMINING ATTORNEY

**Int. Cl.: 35**

**Prior U.S. Cls.: 100, 101, and 102**

**United States Patent and Trademark Office**

**Reg. No. 3,469,327**

**Registered July 15, 2008**

**SERVICE MARK  
PRINCIPAL REGISTER**



HEIFER QUEST, LLC (WISCONSIN LIMITED LIABILITY CORPORATION)  
6667 COUNTY ROAD A  
LUXEMBURG, WI 54217

FOR: DISTRIBUTORSHIP SERVICES OF BULL SEMEN FOR ARTIFICIAL INSEMINATION OF CATTLE, IN CLASS 35 (U.S. CLS. 100, 101 AND 102).

FIRST USE 7-15-2004; IN COMMERCE 12-15-2004.

NO CLAIM IS MADE TO THE EXCLUSIVE RIGHT TO USE "HEIFER", APART FROM THE MARK AS SHOWN.

THE COLOR(S) BLUE, PINK, AND BLACK IS/ARE CLAIMED AS A FEATURE OF THE MARK.

THE COLOR BLUE APPEARS IN A CURVED LINE, THE WORDING "HEIFER" AND THE "UEST" IN THE WORDING "QUEST" IS BLUE. THE COLOR PINK IS USED IN THE FEMALE SYMBOL WHICH ALSO SERVES AS THE "Q" OF THE WORD "QUEST" IN THE MARK. THE COLOR BLACK IS USED IN THE OUTLINE OF THE WORD "HEIFER", THE OUTLINE OF THE WORD "QUEST", THE OUTLINE OF THE PINK FEMALE SYMBOL AND THE OUTLINE OF THE CURVED LINE

SN 78-565,045, FILED 2-10-2005.

RAMONA ORTIGA, EXAMINING ATTORNEY

**Int. Cl.: 25**

**Prior U.S. Cls.: 22 and 39**

**United States Patent and Trademark Office**

**Reg. No. 3,469,328**

**Registered July 15, 2008**

**TRADEMARK  
PRINCIPAL REGISTER**

**UNCLE HENRY**

TAYLOR BRANDS, LLC (TENNESSEE LTD LIAB  
CO)  
1043 FORDTOWN RD.  
KINGSPORT, TN 37663

THE MARK CONSISTS OF STANDARD CHAR-  
ACTERS WITHOUT CLAIM TO ANY PARTICULAR  
FONT, STYLE, SIZE, OR COLOR.

FOR: OUTDOOR APPAREL, NAMELY, SHIRTS,  
IN CLASS 25 (U.S. CLS. 22 AND 39).

SN 78-565,920, FILED 2-11-2005.

FIRST USE 1-1-2008; IN COMMERCE 1-1-2008.

BARBARA BROWN, EXAMINING ATTORNEY

**Int. Cls.: 35 and 41**

**Prior U.S. Cls.: 100, 101, 102, and 107**

**United States Patent and Trademark Office**

**Reg. No. 3,469,329**

**Registered July 15, 2008**

**SERVICE MARK  
PRINCIPAL REGISTER**

**S4S**

STARS 4 STUDENTS, INC. (DELAWARE CORPORATION)

1 WASHINGTON SQ VLG SUITE 14-S  
NEW YORK, NY 10012

FOR: MARKETING AND ADVERTISING SERVICES RELATED TO PROMOTING THE GOODS OR SERVICES OF OTHERS BY MEANS OF CHARITABLE, EDUCATIONAL, AND ENTERTAINMENT RELATED PROGRAMS, CAMPAIGNS, AND WEBSITES; DEVELOPING AND MANAGING PROMOTIONAL CAMPAIGNS FOR BUSINESSES, GOVERNMENTAL ENTITIES, PUBLIC FIGURES, NOT-FOR-PROFIT ORGANIZATIONS, AND INDIVIDUALS AND ORGANIZATIONS IN EDUCATION, NAMELY, CHARITABLE, EDUCATIONAL, AND ENTERTAINMENT RELATED PROGRAMS, CAMPAIGNS, AND WEBSITES BY PREPARING AND PLACING ADVERTISEMENTS THROUGH VARIOUS MEDIA, NAMELY, TELEVISION, CABLE STATIONS, RADIO, CLOSED-CIRCUIT MEDIA, PRINT MATERIALS, AND WEBSITES ACCESSED THROUGH THE INTERNET AND INTRANETS; CONDUCTING COMPUTERIZED ON-LINE RETAIL STORE SERVICES FEATURING APPAREL WEAR, CLOTHING ACCESSORIES, BOOKS, MUSIC, ELECTRONICS, CELLULAR TELEPHONES, FOOD AND BEVERAGE PRODUCTS, AND NATURAL RESOURCE PRODUCTS; CONDUCTING COMPUTERIZED ON-LINE CHARITABLE SERVICES, NAMELY, CHARITABLE CAUSE PROMOTIONS, NAMELY, DEVELOPING, ORGANIZING, AND MANAGING VOLUNTEER RELATED ACTIVITIES AND VOLUNTEER PROGRAMS, AND COMMUNITY SERVICES PROJECTS, IN CLASS 35 (U.S. CLS. 100, 101 AND 102).

FIRST USE 8-1-2007; IN COMMERCE 8-1-2007.

FOR: EDUCATIONAL SERVICES, NAMELY, PROVIDING TRAINING IN THE CIVIC, SOCIAL, AND HUMANITARIAN FIELDS, THAT INVOLVES PROVIDING INFORMATION AND ACTIVITIES FURTHERING CIVIC, SOCIAL, AND HUMANITARIAN GOALS DESIGNED TO FACILITATE CHARITABLE, EDUCATIONAL, OUTREACH, AND ENTERTAINMENT RELATED PROGRAMS, CAMPAIGNS, AND WEBSITES IN THE AREA OF CHARITABLE AND EDUCATIONAL FUNDRAISING, COMMUNITY AND ECONOMIC DEVELOPMENT, THIRD WORLD AND DISASTER RELIEF EFFORTS, PUBLIC HEALTH AWARENESS, AND POLITICAL INVOLVEMENT; ENTERTAINMENT SERVICES, NAMELY, ORGANIZING EXHIBITIONS THAT PROVIDE INFORMATION AND ACTIVITIES FOR ENTERTAINMENT PURPOSES DESIGNED TO FACILITATE CHARITABLE, EDUCATIONAL, OUTREACH, AND ENTERTAINMENT RELATED PROGRAMS, CAMPAIGNS, AND WEBSITES IN THE AREA OF CHARITABLE AND EDUCATIONAL FUNDRAISING, COMMUNITY AND ECONOMIC DEVELOPMENT, THIRD WORLD AND DISASTER RELIEF EFFORTS, PUBLIC HEALTH AWARENESS, AND POLITICAL INVOLVEMENT; CONDUCTING COMPUTERIZED ON-LINE EDUCATIONAL SERVICES, NAMELY, PROVIDING TRAINING IN THE CIVIC, SOCIAL, AND HUMANITARIAN FIELDS, THAT INVOLVES PROVIDING INFORMATION AND ACTIVITIES FURTHERING CIVIC, SOCIAL, AND HUMANITARIAN GOALS DESIGNED TO FACILITATE CHARITABLE, EDUCATIONAL, OUTREACH, AND ENTERTAINMENT RELATED PROGRAMS, CAMPAIGNS, AND WEBSITES IN THE

AREA OF CHARITABLE AND EDUCATIONAL FUNDRAISING, COMMUNITY AND ECONOMIC DEVELOPMENT, THIRD WORLD AND DISASTER RELIEF EFFORTS, PUBLIC HEALTH AWARENESS, AND POLITICAL INVOLVEMENT; CONDUCTING COMPUTERIZED ON-LINE ENTERTAINMENT SERVICES, NAMELY, ORGANIZING EXHIBITION ACTIVITIES AND CAMPAIGNS, NAMELY, ORGANIZING EXHIBITION ACTIVITIES FOR ENTERTAINMENT PURPOSES DESIGNED TO FACILITATE CHARITABLE, EDUCATIONAL, OUTREACH, AND ENTERTAINMENT RELATED PROGRAMS, CAMPAIGNS, AND WEBSITES IN THE AREA OF CHARITABLE AND EDUCATIONAL FUNDRAISING, COMMUNITY AND ECONOMIC

DEVELOPMENT, THIRD WORLD AND DISASTER RELIEF EFFORTS, PUBLIC HEALTH AWARENESS, AND POLITICAL INVOLVEMENT , IN CLASS 41 (U.S. CLS. 100, 101 AND 107).

FIRST USE 8-1-2007; IN COMMERCE 8-1-2007.

THE MARK CONSISTS OF STANDARD CHARACTERS WITHOUT CLAIM TO ANY PARTICULAR FONT, STYLE, SIZE, OR COLOR.

SN 78-570,548, FILED 2-18-2005.

MARLENE BELL, EXAMINING ATTORNEY



**Int. Cls.: 35, 38, 39, 40, 42, and 44**

**Prior U.S. Cls.: 100, 101, 102, 103, 104, 105, and 106**

**United States Patent and Trademark Office**

**Reg. No. 3,469,330**

**Registered July 15, 2008**

**SERVICE MARK  
PRINCIPAL REGISTER**

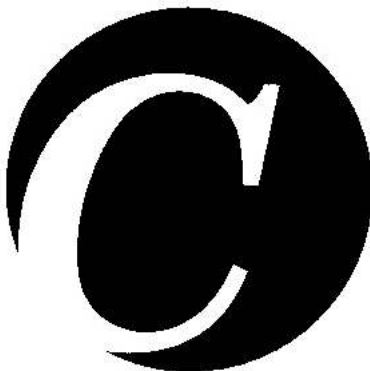

CELTIC LEASING CORP. (CALIFORNIA CORPORATION)  
4 PARK PLAZA, SUITE 300  
IRVINE, CA 92614

FOR: LEASING OF PERSONAL PROPERTY, NAMELY, OFFICE EQUIPMENT, IN CLASS 35 (U.S. CLS. 100, 101 AND 102).

FIRST USE 2-0-2005; IN COMMERCE 2-0-2005.

FOR: VOICE OVER IP SERVICES; LEASING OF PERSONAL PROPERTY, NAMELY, TELECOMMUNICATION PHONE SYSTEMS, IN CLASS 38 (U.S. CLS. 100, 101 AND 104).

FIRST USE 2-0-2005; IN COMMERCE 2-0-2005.

FOR: LEASING OF PERSONAL PROPERTY, NAMELY, MOTOR VEHICLES AND HEAVY EQUIPMENT, SPECIFICALLY TRUCKS AND INDUSTRIAL MACHINE TOOLS, IN CLASS 39 (U.S. CLS. 100 AND 105).

FIRST USE 2-0-2005; IN COMMERCE 2-0-2005.

FOR: LEASING OF PERSONAL PROPERTY, NAMELY, PRINTING EQUIPMENT, IN CLASS 40 (U.S. CLS. 100, 103 AND 106).

FIRST USE 2-0-2005; IN COMMERCE 2-0-2005.

FOR: LEASING OF PERSONAL PROPERTY, NAMELY, COMPUTER HARDWARE AND SOFTWARE, NAMELY, REFRESH PROGRAMS, SERVERS, AND CABLING, IN CLASS 42 (U.S. CLS. 100 AND 101).

FIRST USE 2-0-2005; IN COMMERCE 2-0-2005.

FOR: LEASING OF MEDICAL EQUIPMENT, IN CLASS 44 (U.S. CLS. 100 AND 101).

FIRST USE 2-0-2005; IN COMMERCE 2-0-2005.

THE MARK CONSISTS OF THE LETTER "C" IN A CIRCLE OF DIFFERENT COLOR OR DENSITY.

SN 78-570,885, FILED 2-18-2005.

RONALD AIKENS, EXAMINING ATTORNEY

**Int. Cls.: 3 and 18**

**Prior U.S. Cls.: 1, 2, 3, 4, 6, 22, 41, 50, 51, and 52**

**United States Patent and Trademark Office**

**Reg. No. 3,469,331**

**Registered July 15, 2008**

**TRADEMARK  
PRINCIPAL REGISTER**

**TRISHETTE**

TRISH MCEVOY LTD. (NEW YORK CORPORATION)  
800A FIFTH AVENUE  
NEW YORK, NY 10021

FOR: COSMETIC CASES CONTAINING A VARIETY OF COSMETIC PRODUCTS SUCH AS LIPSTICK, LIP LINER, LIP PENCILS, LIP GLOSS, FOUNDATION, BLUSH, PRESSED POWDER, MASCARA, EYE LINER, EYE PENCILS, MAKEUP BRUSHES, EYE SHADOW, UNDER EYE COVER, TOILET SOAP, CLEANSING CREAMS AND LOTIONS, TONER, ASTRINGENT, SOLD TOGETHER AS A UNIT, IN CLASS 3 (U.S. CLS. 1, 4, 6, 50, 51 AND 52).

FIRST USE 11-1-2005; IN COMMERCE 11-1-2005.

FOR: COSMETIC CASES SOLD EMPTY, IN CLASS 18 (U.S. CLS. 1, 2, 3, 22 AND 41).

FIRST USE 11-1-2005; IN COMMERCE 11-1-2005.

THE MARK CONSISTS OF STANDARD CHARACTERS WITHOUT CLAIM TO ANY PARTICULAR FONT, STYLE, SIZE, OR COLOR.

OWNER OF U.S. REG. NOS. 1,541,143, 2,815,397, AND OTHERS.

THE NAME "TRISHETTE" IDENTIFIES A LIVING INDIVIDUAL WHOSE CONSENT IS OF RECORD.

SN 78-572,465, FILED 2-22-2005.

DARRYL SPRUILL, EXAMINING ATTORNEY

**Int. Cl.: 37**

**Prior U.S. Cls.: 100, 103, and 106**

**United States Patent and Trademark Office**

**Reg. No. 3,469,332**

**Registered July 15, 2008**

**SERVICE MARK  
PRINCIPAL REGISTER**

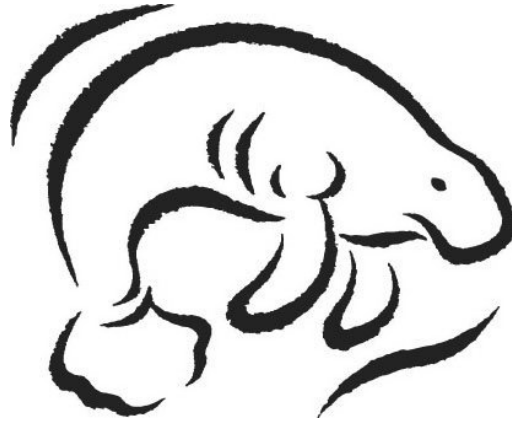

THE ST. JOE COMPANY (FLORIDA CORPORATION)  
245 RIVERSIDE AVENUE, SUITE 500  
JACKSONVILLE, FL 32202

THE MARK CONSISTS OF A DESIGN OF A  
MANATEE.

FOR: REAL ESTATE DEVELOPMENT; REAL  
ESTATE SITE SELECTION, IN CLASS 37 (U.S. CLS.  
100, 103 AND 106).

SN 78-573,056, FILED 2-23-2005.

FIRST USE 11-1-2007; IN COMMERCE 11-1-2007.

B. PARADEWELAI, EXAMINING ATTORNEY

**Int. Cls.: 9 and 41**

**Prior U.S. Cls.: 21, 23, 26, 36, 38, 100, 101, and 107**

**United States Patent and Trademark Office**

**Reg. No. 3,469,333**

**Registered July 15, 2008**

**TRADEMARK  
SERVICE MARK  
PRINCIPAL REGISTER**

**FANCY**

VEER CORPORATION (CANADA CORPORATION)  
SUITE 100  
119-14TH STREET NW  
CALGARY, CANADA T2N 1Z6

FOR: PRE-RECORDED CD-ROMS AND DVDS  
FEATURING GRAPHIC DESIGNS, IN CLASS 9 (U.S.  
CLS. 21, 23, 26, 36 AND 38).

FIRST USE 6-15-2005; IN COMMERCE 6-15-2005.

FOR: PUBLICATION OF BOOKS IN THE FIELD  
OF PHOTOGRAPHY, ART, GRAPHIC DESIGN; ON-  
LINE PUBLICATION OF BOOKS IN THE FIELD OF  
PHOTOGRAPHY, ART, AND GRAPHIC DESIGN;  
PROVIDING AN INTERACTIVE COMPUTER DA-  
TABASE FEATURING STOCK PHOTOGRAPHS,  
ARCHIVAL PHOTOGRAPHS, ART IMAGES, ILLUS-  
TRATIONS AND GRAPHIC ART DESIGNS, IN  
CLASS 41 (U.S. CLS. 100, 101 AND 107).

FIRST USE 6-15-2005; IN COMMERCE 6-15-2005.

THE MARK CONSISTS OF STANDARD CHAR-  
ACTERS WITHOUT CLAIM TO ANY PARTICULAR  
FONT, STYLE, SIZE, OR COLOR.

PRIORITY CLAIMED UNDER SEC. 44(D) ON  
CANADA APPLICATION NO. 1246319, FILED 2-7-  
2005, REG. NO. TMA676141, DATED 11-2-2006, EX-  
PIRES 11-2-2016.

PRIORITY CLAIMED UNDER SEC. 44(D) ON  
CANADA APPLICATION NO. 1246319, FILED 2-7-  
2005, REG. NO. TMA676141, DATED 11-2-2006, EX-  
PIRES 11-2-2016.

SN 78-573,761, FILED 2-23-2005.

GINA HAYES, EXAMINING ATTORNEY

Int. Cls.: 25 and 33

Prior U.S. Cls.: 22, 39, 47, and 49

United States Patent and Trademark Office

Reg. No. 3,469,334

Registered July 15, 2008

TRADEMARK  
PRINCIPAL REGISTER

UNCLE STINKY'S  
CUCKOO PARLOR

TARNELL, STEPHEN E. (UNITED STATES IN-  
DIVIDUAL)  
163 WOODVILLE-ALTON ROAD  
HOPE VALLEY, RI 02832

FOR: CLOTHING, NAMELY, T-SHIRTS, SHIRTS,  
SOCKS, APRONS, BATHROBES, BATHING SUITS,  
BEACH COVERUPS AND CAMISOLES, COATS,  
JACKETS, SUITS, SWEATERS AND HEAD BANDS  
, IN CLASS 25 (U.S. CLS. 22 AND 39).

FIRST USE 1-1-2008; IN COMMERCE 1-1-2008.

FOR: ALCOHOLIC BEVERAGES, NAMELY, VOD-  
KA, IN CLASS 33 (U.S. CLS. 47 AND 49).

FIRST USE 1-1-2008; IN COMMERCE 1-1-2008.

THE MARK CONSISTS OF STANDARD CHAR-  
ACTERS WITHOUT CLAIM TO ANY PARTICULAR  
FONT, STYLE, SIZE, OR COLOR.

"UNCLE STINKY" DOES NOT IDENTIFY A LIV-  
ING INDIVIDUAL.

SN 78-576,070, FILED 2-28-2005.

ESTHER BELENKER, EXAMINING ATTORNEY

**Int. Cls.: 35 and 41**

**Prior U.S. Cls.: 100, 101, 102, and 107**

**United States Patent and Trademark Office**

**Reg. No. 3,469,335**

**Registered July 15, 2008**

**SERVICE MARK  
PRINCIPAL REGISTER**

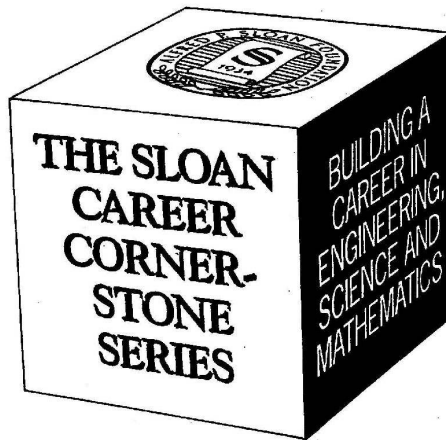

ALFRED P. SLOAN FOUNDATION (DELAWARE CORPORATION)  
630 FIFTH AVENUE  
NEW YORK, NY 10111

FOR: PROVIDING CAREER INFORMATION VIA THE INTERNET ON NETWORKING, JOB HUNTING, CAREERS AND CAREER PLANNING IN THE FIELDS OF ENGINEERING, MATHEMATICS, INFORMATION TECHNOLOGY, AND THE PHYSICAL SCIENCES; AND PROVIDING INFORMATION VIA THE INTERNET RELATING TO THE TYPICAL WORK DAY OF PROFESSIONALS IN THE AFOREMENTIONED FIELDS, IN CLASS 35 (U.S. CLS. 100, 101 AND 102).

FIRST USE 4-15-2003; IN COMMERCE 4-15-2003.

FOR: PROVIDING INFORMATION VIA THE INTERNET ON EDUCATION IN THE FIELDS OF ENGINEERING, MATHEMATICS, INFORMATION TECHNOLOGY, AND THE PHYSICAL SCIENCES, IN CLASS 41 (U.S. CLS. 100, 101 AND 107).

FIRST USE 4-15-2003; IN COMMERCE 4-15-2003.

OWNER OF U.S. REG. NOS. 2,396,401, 2,627,856, AND OTHERS.

NO CLAIM IS MADE TO THE EXCLUSIVE RIGHT TO USE "CAREER" AND "SERIES" AND "FOUNDATION" AND "1934", APART FROM THE MARK AS SHOWN.

THE NAME "ALFRED P. SLOAN" DOES NOT IDENTIFY A LIVING INDIVIDUAL.

THE MARK CONSISTS OF A CUBE DESIGN DISPLAYING THREE SIDES OF THE CUBE. ON ONE SIDE APPEARS THE WORDS "THE SLOAN CAREER CORNER-STONE SERIES"; ON THE SECOND SIDE APPEARS THE WORDS "BUILDING A CAREER IN ENGINEERING, SCIENCE AND MATHEMATICS"; ON THE TOP APPEARS A SHIELD DEVICE CONTAINING THE WORDS "ALFRED P. SLOAN FOUNDATION", THE LETTER "S" AND "1934".

SN 78-579,025, FILED 3-3-2005.

CHARLOTTE CORWIN, EXAMINING ATTORNEY

**Int. Cl.: 9**

**Prior U.S. Cls.: 21, 23, 26, 36, and 38**

**United States Patent and Trademark Office**

**Reg. No. 3,469,336**

**Registered July 15, 2008**

**TRADEMARK  
PRINCIPAL REGISTER**

# Element

TLS CORP. (OHIO CORPORATION)  
2101 SUPERIOR AVENUE  
CLEVELAND, OH 44114

ING AND/OR PLAYBACK SYSTEMS, IN CLASS 9  
(U.S. CLS. 21, 23, 26, 36 AND 38).

FIRST USE 8-0-2005; IN COMMERCE 8-0-2005.

FOR: SURFACE CONTROL CENTERS FOR  
BROADCAST STUDIOS, NAMELY, A CONTROL  
PANEL DESIGNED TO PROVIDE INPUT AND DIS-  
PLAY FUNCTIONS FOR VARIOUS AUDIO PER-  
IPHERALS, NAMELY, ROUTING SWITCHERS,  
MIXING ENGINES, SIGNAL PROCESSORS, AND  
COMPUTER-BASED AUDIO RECORDING, EDIT-

THE MARK CONSISTS OF STANDARD CHAR-  
ACTERS WITHOUT CLAIM TO ANY PARTICULAR  
FONT, STYLE, SIZE, OR COLOR.

SN 78-581,433, FILED 3-7-2005.

BRIAN PINO, EXAMINING ATTORNEY

**Int. Cl.: 25**

**Prior U.S. Cls.: 22 and 39**

**United States Patent and Trademark Office**

**Reg. No. 3,469,337**

**Registered July 15, 2008**

**TRADEMARK  
PRINCIPAL REGISTER**



LEGACY HOCKEY, LLC (DELAWARE LTD LIAB  
CO)  
201 E. JEFFERSON STREET  
PHOENIX, AZ 85004

FOR: CLOTHING, NAMELY, BEACH COVER-  
UPS, BELTS, BODY SUITS, BOXER SHORTS, CAPS,  
CLOTH BIBS, COATS, DRESSES, FOOTWEAR, EAR  
MUFFS, GLOVES, HATS, HEADBANDS, HOSIERY,  
HOUSECOATS, JACKETS, JERSEYS, MITTENS,  
NIGHTSHIRTS, PAJAMAS, PANTS, RAIN COATS,  
RAIN WEAR, ROBES, SCARVES, SHORTS, SKIRTS,  
SOCKS, SUITS, SUN VISORS, SUSPENDERS, SWEA-  
TERS, SWEATPANTS, SWEATSHIRTS, SWIMSUITS,  
SWIM TRUNKS, T-SHIRTS, POLO SHIRTS, TIES,  
UNDERWEAR, VESTS, WARM-UP SUITS AND  
WRISTBANDS, IN CLASS 25 (U.S. CLS. 22 AND 39).

FIRST USE 2-1-2005; IN COMMERCE 2-1-2005.

THE COLOR(S) YELLOW, BLUE, BLACK AND  
WHITE IS/ARE CLAIMED AS A FEATURE OF THE  
MARK.

THE COLOR YELLOW APPEARS IN THE LET-  
TERS PHX. THE LETTERS ARE OUTLINED IN  
BLACK. THE COLORS BLUE, BLACK AND WHITE  
APPEAR AT THE ENDS OF THE HOCKEY STICKS.

THE MARK CONSISTS OF THE LETTERS "PHX".  
THE LETTER "X" IS COMPRISED OF TWO UPSIDE  
DOWN HOCKEY STICKS.

SN 78-581,823, FILED 3-7-2005.

CHERYL CLAYTON, EXAMINING ATTORNEY



**Int. Cl.: 25**

**Prior U.S. Cls.: 22 and 39**

**United States Patent and Trademark Office**

**Reg. No. 3,469,338**

**Registered July 15, 2008**

**TRADEMARK  
PRINCIPAL REGISTER**



LEGACY HOCKEY, LLC (DELAWARE LTD LIAB  
CO)  
201 E. JEFFERSON STREET  
PHOENIX, AZ 85004

FOR: CLOTHING, NAMELY, BEACH COVER-  
UPS, BELTS, BODY SUITS, BOXER SHORTS, CAPS,  
CLOTH BIBS, COATS, DRESSES, FOOTWEAR, EAR  
MUFFS, GLOVES, HATS, HEADBANDS, HOSIERY,  
HOUSECOATS, JACKETS, JERSEYS, MITTENS,  
NIGHTSHIRTS, PAJAMAS, PANTS, RAIN COATS,  
RAIN WEAR, ROBES, SCARVES, SHORTS, SKIRTS,

SOCKS, SUITS, SUN VISORS, SUSPENDERS, SWEA-  
TERS, SWEATPANTS, SWEATSHIRTS, SWIMSUITS,  
SWIM TRUNKS, T-SHIRTS, POLO SHIRTS, TIES,  
UNDERWEAR, VESTS, WARM-UP SUITS AND  
WRISTBANDS, IN CLASS 25 (U.S. CLS. 22 AND 39).

FIRST USE 2-1-2005; IN COMMERCE 2-1-2005.

SN 78-581,829, FILED 3-7-2005.

CHERYL CLAYTON, EXAMINING ATTORNEY

**Int. Cl.: 44**

**Prior U.S. Cls.: 100 and 101**

**United States Patent and Trademark Office**

**Reg. No. 3,469,339**

**Registered July 15, 2008**

**SERVICE MARK  
PRINCIPAL REGISTER**

# HealthyGrowth

PFIZER HEALTH AB (SWEDEN CORPORATION)  
LINDHAGENSGATAN 100 SE-11287  
STOCKHOLM, SWEDEN

THE MARK CONSISTS OF STANDARD CHAR-  
ACTERS WITHOUT CLAIM TO ANY PARTICULAR  
FONT, STYLE, SIZE, OR COLOR.

FOR: MEDICAL INFORMATION SERVICES,  
NAMELY, PROVIDING INFORMATION ON THE  
TOPIC OF GROWTH IN CHILDREN AND GROWTH  
HORMONES, IN CLASS 44 (U.S. CLS. 100 AND 101).

SN 78-584,438, FILED 3-10-2005.

FIRST USE 12-31-2007; IN COMMERCE 12-31-2007.

JASON ROTH, EXAMINING ATTORNEY

**Int. Cl.: 5**

**Prior U.S. Cls.: 6, 18, 44, 46, 51, and 52**

**Reg. No. 3,469,340**

**United States Patent and Trademark Office**

**Registered July 15, 2008**

**TRADEMARK  
PRINCIPAL REGISTER**

**Sinuforte**

HARTINGTON PHARMACEUTICAL, S.L. (SPAIN  
LIMITED COMPANY)  
CALLE MARINA, 16-18 PLANTA 30C  
BARCELONA, SPAIN 08005

FOR: PHARMACEUTICAL PREPARATIONS,  
NAMELY, RHINOLARINGOLOGICAL AGENT  
FOR TREATMENT OF DISEASES AND DISORDERS  
IN THE EARS, NOSE AND THROAT , IN CLASS 5  
(U.S. CLS. 6, 18, 44, 46, 51 AND 52).

FIRST USE 5-1-2001; IN COMMERCE 5-1-2001.

THE MARK CONSISTS OF STANDARD CHAR-  
ACTERS WITHOUT CLAIM TO ANY PARTICULAR  
FONT, STYLE, SIZE, OR COLOR.

SN 78-584,458, FILED 3-10-2005.

HEATHER THOMPSON, EXAMINING ATTORNEY

**Int. Cl.: 10**

**Prior U.S. Cls.: 26, 39, and 44**

**Reg. No. 3,469,341**

**United States Patent and Trademark Office**

**Registered July 15, 2008**

**TRADEMARK  
PRINCIPAL REGISTER**

**SBI UNIVERSALHAND SYSTEM**

SMALL BONE INNOVATIONS, INC. (DELA-  
WARE CORPORATION)  
505 PARK AVENUE, 14TH FLOOR  
NEW YORK, NY 10022

FOR: SURGICAL KIT COMPRISED OF MEDICAL  
AND SURGICAL APPARATUS AND INSTRU-  
MENTS AND SURGICAL IMPLANTS COMPRISED  
OF ARTIFICIAL MATERIAL; SURGICAL AND  
MEDICAL APPARATUS FOR USE IN ORTHOPEDIC  
SURGERY, UPPER AND LOWER EXTREMITY  
TRAUMA, INTERNAL FIXATION, EXTERNAL  
FIXATION, ORTHOBIOLOGY, AND ARTHRO-  
PLASTY, IN CLASS 10 (U.S. CLS. 26, 39 AND 44).

FIRST USE 11-30-2005; IN COMMERCE 11-30-2005.

THE MARK CONSISTS OF STANDARD CHAR-  
ACTERS WITHOUT CLAIM TO ANY PARTICULAR  
FONT, STYLE, SIZE, OR COLOR.

NO CLAIM IS MADE TO THE EXCLUSIVE  
RIGHT TO USE "HAND SYSTEM", APART FROM  
THE MARK AS SHOWN.

SN 78-587,628, FILED 3-15-2005.

ANDREW RHIM, EXAMINING ATTORNEY

**Int. Cl.: 41**

**Prior U.S. Cls.: 100, 101, and 107**

**United States Patent and Trademark Office**

**Reg. No. 3,469,342**

**Registered July 15, 2008**

**SERVICE MARK  
PRINCIPAL REGISTER**

**jack-of-all-sports**

RIVAS, DENNY DELMARCOTTE (UNITED STATES INDIVIDUAL)  
5431 WEST 120TH STREET  
INGLEWOOD, CA 90304

FOR: ENTERTAINMENT SERVICES IN THE NATURE OF ON-GOING TELEVISION PROGRAMS FEATURING ATHLETIC COMPETITIONS AND SPORTS TOURNAMENTS , IN CLASS 41 (U.S. CLS. 100, 101 AND 107).

FIRST USE 10-16-2005; IN COMMERCE 2-22-2006.

THE MARK CONSISTS OF STANDARD CHARACTERS WITHOUT CLAIM TO ANY PARTICULAR FONT, STYLE, SIZE, OR COLOR.

SN 78-589,249, FILED 3-17-2005.

KIMBERLY PERRY, EXAMINING ATTORNEY

**Int. Cl.: 41**

**Prior U.S. Cls.: 100, 101, and 107**

**United States Patent and Trademark Office**

**Reg. No. 3,469,343**

**Registered July 15, 2008**

**SERVICE MARK  
PRINCIPAL REGISTER**

**SUCCESSFULOSOPHY**

MOIST, SHARON (UNITED STATES INDIVIDUAL)  
P.O. BOX 111401  
BOSEMAN, MT 59719

FOR: EDUCATIONAL SERVICES, NAMELY, CONDUCTING CLASSES, TELECLASSES, WORKSHOPS, SEMINARS, TELESEMINARS AND CONFERENCES IN THE FIELDS OF ACTING, ENTERTAINMENT, BUSINESS, EDUCATION AND CAREER DEVELOPMENT AND DISTRIBUTING COURSE MATERIAL, WORKBOOKS, HANDOUTS, PAMPHLETS, AND BOOKS IN CONNECTION THEREWITH; PROVIDING INFORMATION IN THE FIELDS OF ACTING, ENTERTAINMENT AND EDUCATION VIA A GLOBAL COMPUTER

NETWORK; PERSONAL COACHING, PUBLIC AND PRIVATE SPEAKING IN THE FIELDS OF ACTING, ENTERTAINMENT, EDUCATION AND PERSONAL DEVELOPMENT, IN CLASS 41 (U.S. CLS. 100, 101 AND 107).

FIRST USE 4-25-2005; IN COMMERCE 4-25-2005.

THE MARK CONSISTS OF STANDARD CHARACTERS WITHOUT CLAIM TO ANY PARTICULAR FONT, STYLE, SIZE, OR COLOR.

SN 78-597,553, FILED 3-29-2005.

JASON LOTT, EXAMINING ATTORNEY

Int. Cl.: 42

Prior U.S. Cls.: 100 and 101

United States Patent and Trademark Office

Reg. No. 3,469,344

Registered July 15, 2008

SERVICE MARK  
PRINCIPAL REGISTER



STEEL PROJECTS (FRANCE CORPORATION)  
1, RUE PORT AU PRINCE  
VIENNE, FRANCE 38200

FOR: DESIGN OF COMPUTER SOFTWARE FOR  
OTHERS, IN CLASS 42 (U.S. CLS. 100 AND 101).

FIRST USE 2-0-1994; IN COMMERCE 2-0-2000.

PRIORITY CLAIMED UNDER SEC. 44(D) ON  
UNITED KINGDOM APPLICATION NO. 2386638,  
FILED 3-9-2005.

NO CLAIM IS MADE TO THE EXCLUSIVE  
RIGHT TO USE "CAD" AND "CAM" AND "STEEL  
PROJECTS", APART FROM THE MARK AS  
SHOWN.

SN 78-600,251, FILED 4-1-2005.

COLLEEN DOMBROW, EXAMINING ATTORNEY

**Int. Cl.: 16**

**Prior U.S. Cls.: 2, 5, 22, 23, 29, 37, 38, and 50**

**Reg. No. 3,469,345**

**United States Patent and Trademark Office**

**Registered July 15, 2008**

**TRADEMARK  
PRINCIPAL REGISTER**

# The Design Instinct

LAMOUR, KRISTINA B. (UNITED STATES IN-  
DIVIDUAL)  
P.O. BOX 183  
145 MAIN STREET  
FISKEVILLE, RI 02823

FOR: EDUCATIONAL BOOKS FEATURING THE  
APPLICATION OF GRAPHIC DESIGN PRINCIPLES  
TO ALL SUBJECTS FOR PRE-KINDERGARTEN  
THROUGH HIGH SCHOOL LEVELS , IN CLASS 16  
(U.S. CLS. 2, 5, 22, 23, 29, 37, 38 AND 50).

FIRST USE 2-1-2007; IN COMMERCE 4-14-2007.

THE MARK CONSISTS OF STANDARD CHAR-  
ACTERS WITHOUT CLAIM TO ANY PARTICULAR  
FONT, STYLE, SIZE, OR COLOR.

NO CLAIM IS MADE TO THE EXCLUSIVE  
RIGHT TO USE "DESIGN", APART FROM THE  
MARK AS SHOWN.

SN 78-601,512, FILED 4-4-2005.

IRA J. GOODSaid, EXAMINING ATTORNEY



**Int. Cl.: 25**

**Prior U.S. Cls.: 22 and 39**

**United States Patent and Trademark Office**

**Reg. No. 3,469,346**

**Registered July 15, 2008**

**TRADEMARK  
PRINCIPAL REGISTER**

**FUNKY SOUL**

KOMODIDAD DISTRIBUTORS, INC. (PUERTO  
RICO CORPORATION)  
P. O. BOX 6359  
CAGUAS, PUERTO RICO 00726

FIRST USE 5-31-2007; IN COMMERCE 5-31-2007.

FOR: A LINE OF YOUNG WOMEN'S CLOTHING,  
NAMELY, SHIRTS, TOPS, TANK TOPS, HALTER  
TOPS, HOODED PULLOVERS, HOODED SWEAT-  
SHIRTS, PANTS, JEANS, SHORTS, BERMUDA  
SHORTS, CAPRIS, DRESSES, SKIRTS, JACKETS,  
CAMISOLES, UNDERWEAR, LINGERIE, UNDER-  
GARMENTS, SWIMWEAR, FOOTWEAR, SHOES,  
SANDALS, IN CLASS 25 (U.S. CLS. 22 AND 39).

THE MARK CONSISTS OF STANDARD CHAR-  
ACTERS WITHOUT CLAIM TO ANY PARTICULAR  
FONT, STYLE, SIZE, OR COLOR.

SN 78-606,911, FILED 4-12-2005.

DANIEL CAPSHAW, EXAMINING ATTORNEY

**Int. Cls.: 21 and 25**

**Prior U.S. Cls.: 2, 13, 22, 23, 29, 30, 33, 39, 40, and 50**

**United States Patent and Trademark Office**

**Reg. No. 3,469,347**

**Registered July 15, 2008**

**TRADEMARK  
PRINCIPAL REGISTER**

**GOD IS MY DAILY PLANNER**

GOWAN, SUZANNE DEWAMES (UNITED STATES INDIVIDUAL)  
2508 PLUMBROOK DR.  
SAN ANTONIO, TX 782584421

FOR: MUGS, CUPS, DRINKING GLASSES, PLASTIC WATER BOTTLES SOLD EMPTY, AND INSULATED SLEEVE HOLDERS FOR BEVERAGE CANS, IN CLASS 21 (U.S. CLS. 2, 13, 23, 29, 30, 33, 40 AND 50).

FIRST USE 10-16-2006; IN COMMERCE 10-16-2006.

FOR: WOMEN'S SHIRTS, T-SHIRTS, CAPS, VISORS, JACKETS, SWEAT SHIRTS, SWEAT PANTS,

SHORTS, JOGGING SUITS, SWEATERS, SCARVES, APRONS, IN CLASS 25 (U.S. CLS. 22 AND 39).

FIRST USE 10-16-2006; IN COMMERCE 10-16-2006.

THE MARK CONSISTS OF STANDARD CHARACTERS WITHOUT CLAIM TO ANY PARTICULAR FONT, STYLE, SIZE, OR COLOR.

SN 78-607,291, FILED 4-12-2005.

DORITT L. CARROLL, EXAMINING ATTORNEY

**Int. Cls.: 6 and 19**

**Prior U.S. Cls.: 1, 2, 12, 13, 14, 23, 25, 33, and 50**

**United States Patent and Trademark Office**

**Reg. No. 3,469,348**

**Registered July 15, 2008**

**TRADEMARK  
PRINCIPAL REGISTER**

# ProSolutions

KOHL ROOFING AND SIDING CO. (PENNSYLVANIA CORPORATION)  
1047 OLD BERNVILLE ROAD  
READING, PA 19605

FOR: ALUMINUM COIL STOCK AND TRIM FOR USE IN HOME CONSTRUCTION, IN CLASS 6 (U.S. CLS. 2, 12, 13, 14, 23, 25 AND 50).

FIRST USE 4-0-2005; IN COMMERCE 4-0-2005.

FOR: VINYL WINDOWS; VINYL DECKING AND SIDING AND VINYL RAILINGS FOR DECKS, IN CLASS 19 (U.S. CLS. 1, 12, 33 AND 50).

FIRST USE 7-0-2005; IN COMMERCE 7-0-2005.

THE MARK CONSISTS OF STANDARD CHARACTERS WITHOUT CLAIM TO ANY PARTICULAR FONT, STYLE, SIZE, OR COLOR.

SN 78-607,923, FILED 4-13-2005.

KIMBERLY FRYE, EXAMINING ATTORNEY

**Int. Cl.: 37**

**Prior U.S. Cls.: 100, 103, and 106**

**United States Patent and Trademark Office**

**Reg. No. 3,469,349**

**Registered July 15, 2008**

---

**SERVICE MARK  
PRINCIPAL REGISTER**

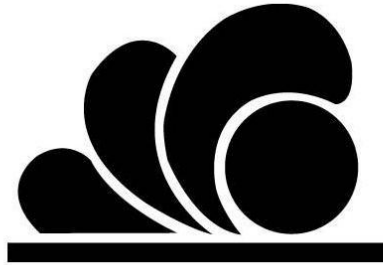

WATERWORKS INDUSTRIES. INC. (CALIFORNIA CORPORATION)  
7633 LAKEWOOD DRIVE, SUITE 205  
WINDSOR, CA 95492

FIRST USE 8-1-1992; IN COMMERCE 8-1-1992.

FOR: CONSTRUCTION, MAINTENANCE AND PEST CONTROL OF LAKES, PONDS AND SWIMMING POOLS, IN CLASS 37 (U.S. CLS. 100, 103 AND 106).

SN 78-609,020, FILED 4-14-2005.

MAUREEN DALL, EXAMINING ATTORNEY

**Int. Cl.: 9**

**Prior U.S. Cls.: 21, 23, 26, 36, and 38**

**Reg. No. 3,469,350**

**United States Patent and Trademark Office**

**Registered July 15, 2008**

**TRADEMARK  
PRINCIPAL REGISTER**



NEW BOUNDARY TECHNOLOGIES, INC (MINNESOTA CORPORATION)  
1300 GODWARD ST. NE  
SUITE 3100  
MINNEAPOLIS, MN 55413

FOR: COMPUTER SOFTWARE FOR TRACKING AND REPORTING ON COMPUTER HARDWARE AND SOFTWARE ASSETS ACROSS ORGANIZATIONS, IN CLASS 9 (U.S. CLS. 21, 23, 26, 36 AND 38).

FIRST USE 1-5-2005; IN COMMERCE 3-5-2005.

OWNER OF U.S. REG. NOS. 2,570,275 AND 3,117,905.

NO CLAIM IS MADE TO THE EXCLUSIVE RIGHT TO USE "ASSET MANAGER", APART FROM THE MARK AS SHOWN.

THE COLOR(S) GOLD AND BLUE IS/ARE CLAIMED AS A FEATURE OF THE MARK.

THE COLORS GOLD AND BLUE APPEAR IN THE TRIANGULAR DESIGN ELEMENT, THE COLOR BLUE APPEARS IN THE WORDING "PRISM", AND THE COLOR GOLD APPEARS IN THE CIRCLE DESIGN ELEMENTS AND THE WORDING "ASSET MANAGER".

SN 78-611,950, FILED 4-19-2005.

TEJBIR SINGH, EXAMINING ATTORNEY

**Int. Cl.: 35**

**Prior U.S. Cls.: 100, 101, and 102**

**United States Patent and Trademark Office**

**Reg. No. 3,469,351**

**Registered July 15, 2008**

**SERVICE MARK  
PRINCIPAL REGISTER**

# Office a'La Carte

DIMARIA, ROSE (UNITED STATES INDIVIDUAL)  
39 WEBBER ROAD  
EAST HAMPSTEAD, NH 03826

FOR: RETAIL STORE SERVICES FEATURING INFORMATION TECHNOLOGY PRODUCTS IN THE NATURE OF SOFTWARE, COMPUTERS, NETWORKING EQUIPMENT, AND OFFICE EQUIPMENT, IN CLASS 35 (U.S. CLS. 100, 101 AND 102).

FIRST USE 5-6-2008; IN COMMERCE 5-6-2008.

THE MARK CONSISTS OF STANDARD CHARACTERS WITHOUT CLAIM TO ANY PARTICULAR FONT, STYLE, SIZE, OR COLOR.

NO CLAIM IS MADE TO THE EXCLUSIVE RIGHT TO USE "OFFICE", APART FROM THE MARK AS SHOWN.

SN 78-612,984, FILED 4-20-2005.

KAREN BRACEY, EXAMINING ATTORNEY

**Int. Cl.: 25**

**Prior U.S. Cls.: 22 and 39**

**United States Patent and Trademark Office**

**Reg. No. 3,469,352**

**Registered July 15, 2008**

**TRADEMARK  
PRINCIPAL REGISTER**

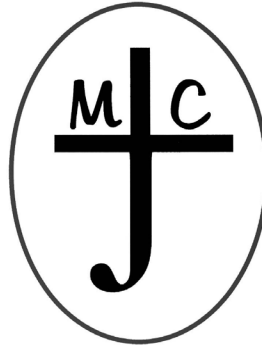

MY CHRIST JESUS OUTFITTERS, INC (NORTH  
CAROLINA CORPORATION)  
7131 CHARTWELL LN.  
CHARLOTTE, NC 28212

FIRST USE 8-30-2005; IN COMMERCE 8-30-2005.

FOR: CASUAL CLOTHING FOR MEN, WOMEN,  
AND CHILDREN, NAMELY, SHIRTS, PANTS,  
SKIRTS, SWEATERS, AND COATS, IN CLASS 25  
(U.S. CLS. 22 AND 39).

SN 78-615,569, FILED 4-24-2005.

BENJAMIN OKEKE, EXAMINING ATTORNEY

**Int. Cl.: 3**

**Prior U.S. Cls.: 1, 4, 6, 50, 51, and 52**

**United States Patent and Trademark Office**

**Reg. No. 3,469,353**

**Registered July 15, 2008**

**TRADEMARK  
PRINCIPAL REGISTER**

**TRISH MCEVOY LESS TIRED**

TRISH MCEVOY LTD. (NEW YORK CORPORATION)  
800A FIFTH AVENUE  
NEW YORK, NY 10021

OWNER OF U.S. REG. NOS. 1,541,143, 2,815,397,  
AND OTHERS.

FOR: COSMETIC PRODUCTS, NAMELY, SKIN  
CREAMS AND LOTIONS, IN CLASS 3 (U.S. CLS. 1, 4,  
6, 50, 51 AND 52).

THE NAME "TRISH MCEVOY" IDENTIFIES A  
LIVING INDIVIDUAL WHOSE CONSENT IS OF  
RECORD.

FIRST USE 11-1-2006; IN COMMERCE 11-1-2006.

SN 78-616,768, FILED 4-26-2005.

THE MARK CONSISTS OF STANDARD CHAR-  
ACTERS WITHOUT CLAIM TO ANY PARTICULAR  
FONT, STYLE, SIZE, OR COLOR.

DARRYL SPRUILL, EXAMINING ATTORNEY



**Int. Cls.: 3 and 18**

**Prior U.S. Cls.: 1, 2, 3, 4, 6, 22, 41, 50, 51, and 52**

**United States Patent and Trademark Office**

**Reg. No. 3,469,354**

**Registered July 15, 2008**

**TRADEMARK  
PRINCIPAL REGISTER**

**TRISH MCEVOY CARRY-ON  
BEAUTY**

TRISH MCEVOY LTD. (NEW YORK CORPORATION)  
800A FIFTH AVENUE  
NEW YORK, NY 10021

FOR: COSMETIC BAGS CONTAINING A VARIETY OF COSMETIC PRODUCTS SUCH AS LIPSTICK, LIP LINER, LIP PENCILS, LIP GLOSS, FOUNDATION, BLUSH, PRESSED POWDER, MASCARA, EYE LINER, EYE PENCILS, MAKEUP BRUSHES, EYE SHADOW, UNDER EYE COVER, TOILET SOAP, CLEANSING CREAMS AND LOTIONS, TONER, ASTRINGENT, SOLD TOGETHER AS A UNIT, IN CLASS 3 (U.S. CLS. 1, 4, 6, 50, 51 AND 52).

FIRST USE 11-1-2005; IN COMMERCE 11-1-2005.

FOR: COSMETIC BAGS SOLD EMPTY; HANDBAGS, WALLETS, PURSES, KEY CASES, MAKEUP CASES SOLD EMPTY, SACHELS AND KNAPSACKS, IN CLASS 18 (U.S. CLS. 1, 2, 3, 22 AND 41).

FIRST USE 11-1-2005; IN COMMERCE 11-1-2005.

THE MARK CONSISTS OF STANDARD CHARACTERS WITHOUT CLAIM TO ANY PARTICULAR FONT, STYLE, SIZE, OR COLOR.

OWNER OF U.S. REG. NOS. 1,541,143, 2,815,397, AND OTHERS.

NO CLAIM IS MADE TO THE EXCLUSIVE RIGHT TO USE "CARRY-ON BEAUTY", APART FROM THE MARK AS SHOWN.

THE NAME "TRISH MCEVOY" IDENTIFIES A LIVING INDIVIDUAL WHOSE CONSENT IS OF RECORD.

SN 78-616,784, FILED 4-26-2005.

DARRYL SPRUILL, EXAMINING ATTORNEY

**Int. Cl.: 11**

**Prior U.S. Cls.: 13, 21, 23, 31, and 34**

**Reg. No. 3,469,355**

**United States Patent and Trademark Office**

**Registered July 15, 2008**

---

**TRADEMARK  
PRINCIPAL REGISTER**

**FLECTRA**

KUTLER, MURRAY (UNITED STATES INDIVIDUAL)  
2119 SOUTH 135TH STREET  
OMAHA, NE 68144

THE MARK CONSISTS OF STANDARD CHARACTERS WITHOUT CLAIM TO ANY PARTICULAR FONT, STYLE, SIZE, OR COLOR.

FOR: FLUORESCENT LIGHT BULBS FOR USE IN COMMERCIAL AND INDUSTRIAL FACILITIES, IN CLASS 11 (U.S. CLS. 13, 21, 23, 31 AND 34).

SN 78-619,134, FILED 4-28-2005.

FIRST USE 9-1-2006; IN COMMERCE 9-1-2006.

JOHN DWYER, EXAMINING ATTORNEY

**Int. Cls.: 9, 35, 36, 38, and 42**

**Prior U.S. Cls.: 21, 23, 26, 36, 38, 100, 101, 102, and 104**

**Reg. No. 3,469,356**

**United States Patent and Trademark Office**

**Registered July 15, 2008**

**TRADEMARK  
SERVICE MARK  
PRINCIPAL REGISTER**

# 99BILL

99BILL CORPORATION (CAYMAN ISLANDS CORPORATION)  
SUITE E304  
11002 S.E. 176TH STREET  
RENTON, WA 98055

FOR: COMPUTER PROGRAMS FOR TRANSMITTING AND RECEIVING ELECTRONIC MAIL, TEXT, GRAPHICS, AUDIO, VIDEO, ELECTRONIC PAYMENT DATA, AND OTHER DATA FROM A REMOTE COMPUTER NETWORK AND FOR ACCESSING GLOBAL COMMUNICATIONS NETWORKS; COMPUTER PROGRAMS FOR ACCESSING INTERACTIVE CONTENTS AND ON-LINE SHOPPING SERVICES, AND ONLINE MARKETPLACE SERVICES; COMPUTER PROGRAMS FOR ACCESSING INFORMATION IN A WIDE VARIETY OF FIELDS INCLUDING NEWS, ENTERTAINMENT, MUSIC, TRAVEL, INVESTMENTS, ON-LINE PAYMENT, SPORTS, COMPUTERS, PARENTING, AND GENERAL REFERENCE INFORMATION; COMPUTER SOFTWARE PROGRAMS FOR ELECTRONIC PAYMENT PROCESSING AND BILL PRESENTATION, IN CLASS 9 (U.S. CLS. 21, 23, 26, 36 AND 38).

FIRST USE 9-30-2004; IN COMMERCE 9-30-2004.

FOR: PROVIDING A WEBSITE AT WHICH BUSINESSES CAN PERFORM ELECTRONIC BUSINESS TRANSACTIONS; PROVIDING AN ONLINE BUSINESS-TO-BUSINESS MARKETPLACE WHERE BUSINESSES AND USERS CAN BUY AND SELL TO EACH OTHER; ONLINE AUCTION SERVICES; BUSINESS MANAGEMENT SERVICES IN THE FIELD OF ONLINE RETAIL, MAIL ORDER, ADVERTISING, AND AUCTION SERVICES; PROVIDING COMPARISON SHOPPING INFORMATION; PROVIDING MARKET RESEARCH SERVICES, IN CLASS 35 (U.S. CLS. 100, 101 AND 102).

FIRST USE 9-30-2004; IN COMMERCE 9-30-2004.

FOR: PROVIDING ELECTRONIC BILL PAYMENT DATA FROM SEARCHABLE INDEXES AND DATABASES BY MEANS OF GLOBAL COMPUTER NETWORKS, IN CLASS 36 (U.S. CLS. 100, 101 AND 102).

FIRST USE 9-30-2004; IN COMMERCE 9-30-2004.

FOR: BROADCASTING PROGRAMS VIA A GLOBAL COMPUTER NETWORK; COMMUNICATION SERVICES, NAMELY, DELIVERY OF AUDIO, VIDEO, AND MULTIMEDIA CONTENT BY MEANS OF CELLULAR AND WIRELESS COMMUNICATION, ELECTRONIC COMMUNICATIONS NETWORKS, AND GLOBAL COMPUTER NETWORKS; PROVIDING ELECTRONIC MAIL SERVICES; WEB MESSAGING; PROVIDING CHAT ROOMS AND BULLETIN BOARD FOR THE TRANSMISSION AND POSTING OF MESSAGES AMONG INTERNET USERS CONCERNING TOPICS OF GENERAL INTEREST; ELECTRONIC ON-LINE SERVICES, NAMELY, PROVIDING A COMMUNICATIONS LINK TO GLOBAL INTERACTIVE NETWORKS FOR THE TRANSFER AND TRANSMISSION OF MESSAGES, DOCUMENTS, IMAGES, MUSIC, GAMES AND DATA; ELECTRONIC EXCHANGE OF DATA STORED IN DATABASES ACCESSIBLE VIA TELECOMMUNICATION NETWORKS, IN CLASS 38 (U.S. CLS. 100, 101 AND 104).

FIRST USE 9-30-2004; IN COMMERCE 9-30-2004.

FOR: COMPUTER SERVICES, NAMELY, PROVIDING SOFTWARE INTERFACES AVAILABLE OVER GLOBAL COMPUTER NETWORK IN ORDER TO CREATE ONLINE INFORMATION SERVICES; EXTRACTION AND RETRIEVAL OF INFORMA-

TION AND DATA MINING BY MEANS OF GLOBAL  
COMPUTER NETWORKS; DESIGN AND DEVELOPMENT OF COMPUTER SOFTWARE AND HARDWARE FOR OTHERS , IN CLASS 42 (U.S. CLS. 100 AND 101).

FIRST USE 9-30-2004; IN COMMERCE 9-30-2004.

THE MARK CONSISTS OF STANDARD CHARACTERS WITHOUT CLAIM TO ANY PARTICULAR FONT, STYLE, SIZE, OR COLOR.

SN 78-619,216, FILED 4-28-2005.

EVELYN BRADLEY, EXAMINING ATTORNEY

**Int. Cl.: 20**

**Prior U.S. Cls.: 2, 13, 22, 25, 32, and 50**

**United States Patent and Trademark Office**

**Reg. No. 3,469,357**

**Registered July 15, 2008**

**TRADEMARK  
PRINCIPAL REGISTER**

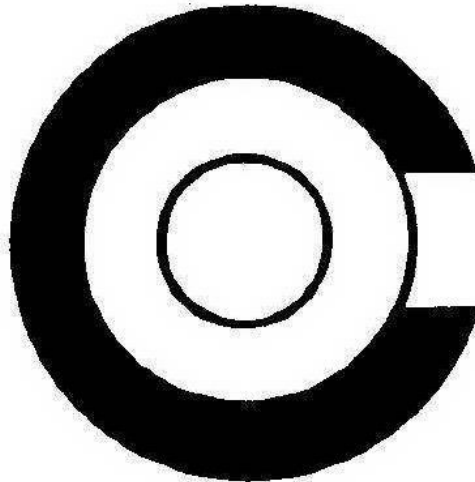

FOAMCRAFT, INC. (INDIANA CORPORATION)  
9230 HARRISON PARK COURT  
INDIANAPOLIS, IN 46216

FIRST USE 11-30-2005; IN COMMERCE 11-30-2005.

SN 78-621,266, FILED 5-2-2005.

FOR: CUSHIONS HAVING SYNTHETIC FILL-  
ING, IN CLASS 20 (U.S. CLS. 2, 13, 22, 25, 32 AND 50).

KIMBERLY PERRY, EXAMINING ATTORNEY

**Int. Cl.: 21**

**Prior U.S. Cls.: 2, 13, 23, 29, 30, 33, 40, and 50**

**Reg. No. 3,469,358**

**United States Patent and Trademark Office**

**Registered July 15, 2008**

---

**TRADEMARK  
PRINCIPAL REGISTER**

**DIMENSION**

DIMENSION MARKETING & SALES, INC.  
(UTAH CORPORATION)  
1471 EAST SHOSHONE AVENUE  
SANDY, UT 84092

THE MARK CONSISTS OF STANDARD CHAR-  
ACTERS WITHOUT CLAIM TO ANY PARTICULAR  
FONT, STYLE, SIZE, OR COLOR.

FOR: TOOTHBRUSHES, IN CLASS 21 (U.S. CLS. 2,  
13, 23, 29, 30, 33, 40 AND 50).

SN 78-625,886, FILED 5-9-2005.

FIRST USE 5-11-2006; IN COMMERCE 10-12-2006.

DAVID YONTEF, EXAMINING ATTORNEY

**Int. Cl.: 5**

**Prior U.S. Cls.: 6, 18, 44, 46, 51, and 52**

**United States Patent and Trademark Office**

**Reg. No. 3,469,359**

**Registered July 15, 2008**

**TRADEMARK  
PRINCIPAL REGISTER**



WYETH (DELAWARE CORPORATION)  
FIVE GIRALDA FARMS  
MADISON, NJ 07940

FOR: PHARMACEUTICAL PREPARATIONS,  
NAMELY, COUGH, COLD, FLU AND ALLERGY  
PREPARATIONS, IN CLASS 5 (U.S. CLS. 6, 18, 44, 46,  
51 AND 52).

FIRST USE 3-18-2005; IN COMMERCE 3-18-2005.

OWNER OF U.S. REG. NOS. 515,197, 1,985,731,  
AND OTHERS.

NO CLAIM IS MADE TO THE EXCLUSIVE  
RIGHT TO USE "PHYSICIAN" AND "RECOMMEN-  
DED" AND THE REPRESENTATION OF CADU-  
CEUS, APART FROM THE MARK AS SHOWN.

THE COLOR(S) BLACK, WHITE, GREEN IS/ARE  
CLAIMED AS A FEATURE OF THE MARK.

THE MARK CONSISTS OF A WHITE FIELD  
THAT IS SUPERIMPOSED BY A BLACK RECTAN-  
GLE AT THE TOP CONTAINING THE TRADE-  
MARK "ROBITUSSIN" IN WHITE LETTERS,  
BELOW WHICH IS AN ELONGATED OVAL, FUR-  
THER BELOW WHICH ARE ALTERNATING  
GREEN AND LIGHT GREEN HORIZONTAL LINES  
CONTAINING ON ITS LOWER PORTION A GREEN  
RECTANGLE EDGED BY A THIN BLACK LINE  
THAT IS SUPERIMPOSED ON ITS RIGHT SIDE  
BY A GREEN CIRCLE CONTAINING AT ITS CENTER  
A CADUCEUS SUPERIMPOSED CENTRALLY BY A  
BLACK RECTANGLE CONTAINING THE TRADE-  
MARK "ROBITUSSIN" IN WHITE LETTERS,  
ABOVE WHICH IS THE WORD "PHYSICIAN" IN  
BLACK AND BELOW WHICH IS THE WORD "RE-  
COMMENDED" IN BLACK.

SN 78-628,632, FILED 5-12-2005.

ASMAT KHAN, EXAMINING ATTORNEY

**Int. Cl.: 5**

**Prior U.S. Cls.: 6, 18, 44, 46, 51, and 52**

**United States Patent and Trademark Office**

**Reg. No. 3,469,360**

**Registered July 15, 2008**

**TRADEMARK  
PRINCIPAL REGISTER**

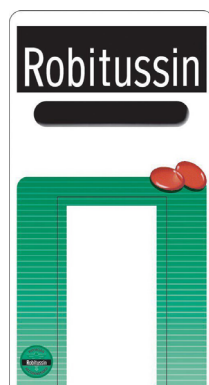

WYETH (DELAWARE CORPORATION)  
FIVE GIRALDA FARMS  
MADISON, NJ 07940

FOR: PHARMACEUTICAL PREPARATIONS,  
NAMELY, COUGH, COLD, FLU PREPARATIONS,  
IN CLASS 5 (U.S. CLS. 6, 18, 44, 46, 51 AND 52).

FIRST USE 11-30-2003; IN COMMERCE 11-30-2003.

OWNER OF U.S. REG. NOS. 515,197, 2,911,062,  
AND OTHERS.

NO CLAIM IS MADE TO THE EXCLUSIVE  
RIGHT TO USE "PHYSICIAN", "RECOMMENDED",  
THE CADUCEUS AND THE CAPSULE DESIGNS,  
APART FROM THE MARK AS SHOWN.

THE COLOR(S) BLACK, WHITE, GREEN, RED IS/  
ARE CLAIMED AS A FEATURE OF THE MARK.

THE MARK CONSISTS OF A WHITE FIELD  
THAT IS SUPERIMPOSED BY A BLACK RECTAN-  
GLE AT THE TOP CONTAINING THE TRADE-  
MARK "ROBITUSSIN" IN WHITE LETTERS,  
BELOW WHICH IS AN ELONGATED BLACK OVAL,  
FURTHER BELOW WHICH ARE ALTERNATING  
GREEN AND LIGHT GREEN HORIZONTAL LINES  
WITH A WHITE VERTICAL RECTANGLE CEN-  
TRALLY PLACED, TWO RED CAPSULES IN ITS  
UPPER RIGHT CORNER AND A GREEN CIRCLE  
IN ITS LOWER LEFT CORNER THAT ITSELF  
CONTAINS A CADUCEUS THAT IS SUPERIM-  
POSED CENTRALLY BY A BLACK RECTANGLE  
CONTAINING THE TRADEMARK "ROBITUSSIN"  
IN WHITE LETTERS, ABOVE WHICH IS THE WORD  
"PHYSICIAN" IN BLACK AND BELOW WHICH IS  
THE WORD "RECOMMENDED" IN BLACK.

SN 78-628,686, FILED 5-12-2005.

JOSETTE BEVERLY, EXAMINING ATTORNEY



**Int. Cl.: 42**

**Prior U.S. Cls.: 100 and 101**

**United States Patent and Trademark Office**

**Reg. No. 3,469,361**

**Registered July 15, 2008**

**SERVICE MARK  
PRINCIPAL REGISTER**

**NING**

NING, INC. (DELAWARE CORPORATION)  
735 EMERSON STREET  
PALO ALTO, CA 94301

FIRST USE 10-0-2005; IN COMMERCE 10-0-2005.

FOR: COMPUTER SERVICES, NAMELY, COMPUTER SOFTWARE DEVELOPMENT OF WEB APPLICATIONS FOR INTERNET USERS; PROVIDING TEMPORARY USE OF ON-LINE NON-DOWNLOADABLE SOFTWARE FOR ASSISTING IN WEBSITE DEVELOPMENT, IN CLASS 42 (U.S. CLS. 100 AND 101).

THE MARK CONSISTS OF STANDARD CHARACTERS WITHOUT CLAIM TO ANY PARTICULAR FONT, STYLE, SIZE, OR COLOR.

SN 78-629,201, FILED 5-12-2005.

RAMONA ORTIGA, EXAMINING ATTORNEY

**Int. Cl.: 5**

**Prior U.S. Cls.: 6, 18, 44, 46, 51, and 52**

**Reg. No. 3,469,362**

**United States Patent and Trademark Office**

**Registered July 15, 2008**

**TRADEMARK  
PRINCIPAL REGISTER**

**RESPREVE**

ZOOROB, GEORGE K (UNITED STATES INDIVIDUAL)  
1111 E FILLMORE ST  
COLORADO SPRINGS, CO 80907

THE MARK CONSISTS OF STANDARD CHARACTERS WITHOUT CLAIM TO ANY PARTICULAR FONT, STYLE, SIZE, OR COLOR.

FOR: DIETARY SUPPLEMENTS, NAMELY, VITAMINS, MINERALS, HERBAL AND NUTRITIONAL SUPPLEMENTS IN SOLID, LIQUID, AND POWDER FORMS, AND ANALGESIC PREPARATION, IN CLASS 5 (U.S. CLS. 6, 18, 44, 46, 51 AND 52).

SN 78-629,703, FILED 5-13-2005.

FIRST USE 5-1-2005; IN COMMERCE 6-1-2005.

WARREN L. OLANDRIA, EXAMINING ATTORNEY

**Int. Cl.: 9**

**Prior U.S. Cls.: 21, 23, 26, 36, and 38**

**United States Patent and Trademark Office**

**Reg. No. 3,469,363**

**Registered July 15, 2008**

**TRADEMARK  
PRINCIPAL REGISTER**



DANA INNOVATIONS (CALIFORNIA CORPORATION)  
212 AVENIDA FABRICANTE  
SAN CLEMENTE, CA 92672

FIRST USE 2-1-2005; IN COMMERCE 2-1-2005.

SN 78-629,886, FILED 5-13-2005.

FOR: MODULES AND CONNECTORS FOR INTERFACING HOME AUDIO SYSTEMS TO PORTABLE AUDIO PLAYERS AND RECORDERS, IN CLASS 9 (U.S. CLS. 21, 23, 26, 36 AND 38).

CORY BOONE, EXAMINING ATTORNEY

**Int. Cl.: 37**

**Prior U.S. Cls.: 100, 103, and 106**

**United States Patent and Trademark Office**

**Reg. No. 3,469,364**

**Registered July 15, 2008**

**SERVICE MARK  
PRINCIPAL REGISTER**

# Mercury Car Wash

ROBERTS, DANIEL (UNITED STATES INDIVIDUAL)  
1149 ADAMS ST  
DENVER, CO 80206

NO CLAIM IS MADE TO THE EXCLUSIVE RIGHT TO USE "CAR WASH", APART FROM THE MARK AS SHOWN.

FOR: CAR WASH SERVICES, IN CLASS 37 (U.S. CLS. 100, 103 AND 106).

SN 78-633,915, FILED 5-20-2005.

FIRST USE 11-1-2006; IN COMMERCE 11-1-2006.

THE MARK CONSISTS OF STANDARD CHARACTERS WITHOUT CLAIM TO ANY PARTICULAR FONT, STYLE, SIZE, OR COLOR.

TRACY WHITTAKER-BROWN, EXAMINING ATTORNEY

**Int. Cl.: 30**

**Prior U.S. Cl.: 46**

**United States Patent and Trademark Office**

**Reg. No. 3,469,365**

**Registered July 15, 2008**

**TRADEMARK  
PRINCIPAL REGISTER**

**SOUTHERN SWEETENER**

REMAC CORPORATION (SOUTH CAROLINA  
CORPORATION)  
ONE SPICE ROAD  
FORT MILL, SC 29715

FOR: NATURAL SWEETENERS, PANCAKE SYR-  
UP, FLAVORING SYRUPS, TOPPING SYRUPS, FLA-  
VORINGS FOR BEVERAGES, IN CLASS 30 (U.S. CL.  
46).

FIRST USE 4-14-2008; IN COMMERCE 4-14-2008.

THE MARK CONSISTS OF STANDARD CHAR-  
ACTERS WITHOUT CLAIM TO ANY PARTICULAR  
FONT, STYLE, SIZE, OR COLOR.

NO CLAIM IS MADE TO THE EXCLUSIVE  
RIGHT TO USE "SWEETENER", APART FROM  
THE MARK AS SHOWN.

SN 78-634,561, FILED 5-23-2005.

ALEXANDER L. POWERS, EXAMINING ATTOR-  
NEY

**Int. Cl.: 9**

**Prior U.S. Cls.: 21, 23, 26, 36, and 38**

**Reg. No. 3,469,366**

**United States Patent and Trademark Office**

**Registered July 15, 2008**

**TRADEMARK  
PRINCIPAL REGISTER**

# PATHWORKS

PATHWORKS SOFTWARE CORPORATION (DE-  
LAWARE CORPORATION)  
2001 LANDINGS DRIVE  
MOUNTAIN VIEW, CA 94043

FOR: COMPUTER SOFTWARE FOR USE IN  
CREATING, VIEWING, PRINTING, NAVIGATING,  
EDITING, ANNOTATING, TRACKING, INDEXING,  
ENCRYPTING, AND CONTROLLING ACCESS TO  
ELECTRONIC DOCUMENTS, IN CLASS 9 (U.S. CLS.  
21, 23, 26, 36 AND 38).

FIRST USE 11-0-2005; IN COMMERCE 11-0-2005.

THE MARK CONSISTS OF STANDARD CHAR-  
ACTERS WITHOUT CLAIM TO ANY PARTICULAR  
FONT, STYLE, SIZE, OR COLOR.

SN 78-635,314, FILED 5-23-2005.

TRACY WHITTAKER-BROWN, EXAMINING AT-  
TORNEY

**Int. Cl.: 9**

**Prior U.S. Cls.: 21, 23, 26, 36, and 38**

**Reg. No. 3,469,367**

**United States Patent and Trademark Office**

**Registered July 15, 2008**

---

**TRADEMARK  
PRINCIPAL REGISTER**

**PHOSTREX**

ECLIPSE AVIATION CORPORATION (DELA-  
WARE CORPORATION)  
2503 CLARK CARR LOOP SE  
ALBUQUERQUE, NM 87106

FOR: FIRE SUPPRESSION SYSTEMS COMPRIS-  
ING SENSORS, ELECTRONIC CONTROLS, CIR-  
CUIT BREAKERS, ELECTRICAL CONTROL  
HARNESSES, DISTRIBUTION TUBES AND NOZ-  
ZLES, PYROTECHNICS, FIRE EXTINGUISHING  
CANISTERS, CHEMICALS AND GASES, IN CLASS  
9 (U.S. CLS. 21, 23, 26, 36 AND 38).

FIRST USE 4-9-2008; IN COMMERCE 4-9-2008.

THE MARK CONSISTS OF STANDARD CHAR-  
ACTERS WITHOUT CLAIM TO ANY PARTICULAR  
FONT, STYLE, SIZE, OR COLOR.

SN 78-635,580, FILED 5-23-2005.

EDWARD NELSON, EXAMINING ATTORNEY

**Int. Cl.: 42**

**Prior U.S. Cls.: 100 and 101**

**United States Patent and Trademark Office**

**Reg. No. 3,469,368**

**Registered July 15, 2008**

**SERVICE MARK  
PRINCIPAL REGISTER**



IKON OFFICE SOLUTIONS, INC. (OHIO CORPORATION)  
70 VALLEY STREAM PARKWAY  
MALVERN, PA 19355

FOR: PROVIDING TEMPORARY USE OF SERVER-BASED NON-DOWNLOADABLE SOFTWARE THAT CAPTURES FROM OTHERS PAPER AND ELECTRONIC DOCUMENT IMAGES FROM MULTIFUNCTIONAL PERIPHERALS, DEDICATED SCANNERS, COMPUTER DESKTOPS, FACSIMILE MACHINES AND PHOTOCOPIERS, PROCESSES THE RESULTING IMAGES, DOCUMENTS, AND DATA, AND DISTRIBUTES AND ROUTES THE RESULTING DOCUMENTS, IMAGES, AND DATA INTO CONTENT REPOSITORIES, BUSINESS APPLICATIONS, WORKFLOW DATABASES, AND ELECTRONIC MAIL, USING AUTOMATED RULES, IN CLASS 42 (U.S. CLS. 100 AND 101).

FIRST USE 6-0-2005; IN COMMERCE 6-0-2005.

OWNER OF U.S. REG. NOS. 2,288,938, 2,357,850, AND OTHERS.

NO CLAIM IS MADE TO THE EXCLUSIVE RIGHT TO USE "LEGAL", APART FROM THE MARK AS SHOWN.

THE COLOR(S) RED AND BLACK IS/ARE CLAIMED AS A FEATURE OF THE MARK.

THE MARK CONSISTS OF THE TERM IKON IN RED, THE TERMS DOCACCEL LEGAL IN BLACK, AND A RED RING BEHIND THE FIRST C AND THE LETTER A IN THE TERM DOCACCEL. THE MARK APPEARS ON A TRANSPARENT BACKGROUND, AND NO OTHER COLOR IS CLAIMED AS PART OF THE MARK.

SN 78-636,378, FILED 5-24-2005.

TANYA AMOS, EXAMINING ATTORNEY



**Int. Cl.: 5**

**Prior U.S. Cls.: 6, 18, 44, 46, 51, and 52**

**Reg. No. 3,469,369**

**United States Patent and Trademark Office**

**Registered July 15, 2008**

---

**TRADEMARK  
PRINCIPAL REGISTER**

**UPDRIVE**

JARROW FORMULAS, INC. (CALIFORNIA CORPORATION)  
1824 SOUTH ROBERTSON BLVD.  
LOS ANGELES, CA 900354317

THE MARK CONSISTS OF STANDARD CHARACTERS WITHOUT CLAIM TO ANY PARTICULAR FONT, STYLE, SIZE, OR COLOR.

FOR: DIETARY AND NUTRITIONAL SUPPLEMENTS, IN CLASS 5 (U.S. CLS. 6, 18, 44, 46, 51 AND 52).

SN 78-636,438, FILED 5-24-2005.

FIRST USE 10-31-2007; IN COMMERCE 10-31-2007.

BARNEY CHARLON, EXAMINING ATTORNEY

**Int. Cl.: 42**

**Prior U.S. Cls.: 100 and 101**

**United States Patent and Trademark Office**

**Reg. No. 3,469,370**

**Registered July 15, 2008**

**SERVICE MARK  
PRINCIPAL REGISTER**



IKON OFFICE SOLUTIONS, INC. (OHIO CORPORATION)  
70 VALLEY STREAM PARKWAY  
MALVERN, PA 19355

FOR: PROVIDING TEMPORARY USE OF SERVER-BASED NON-DOWNLOADABLE SOFTWARE THAT CAPTURES FROM OTHERS PAPER AND ELECTRONIC DOCUMENT IMAGES FROM MULTIFUNCTIONAL PERIPHERALS, DEDICATED SCANNERS, COMPUTER DESKTOPS, FACSIMILE MACHINES AND PHOTOCOPIERS, PROCESSES THE RESULTING IMAGES, DOCUMENTS, AND DATA, AND DISTRIBUTES AND ROUTES THE RESULTING DOCUMENTS, IMAGES, AND DATA INTO CONTENT REPOSITORIES, BUSINESS APPLICATIONS, WORKFLOW DATABASES, AND ELECTRONIC MAIL, USING AUTOMATED RULES, IN CLASS 42 (U.S. CLS. 100 AND 101).

FIRST USE 6-0-2005; IN COMMERCE 6-0-2005.

OWNER OF U.S. REG. NOS. 2,288,938, 2,357,850, AND OTHERS.

THE COLOR(S) RED AND BLACK IS/ARE CLAIMED AS A FEATURE OF THE MARK.

THE MARK CONSISTS OF THE TERM "IKON" IN RED, THE TERM "DOCACCEL" IN BLACK, AND A RED RING BEHIND THE FIRST "C" AND THE LETTER "A" IN THE TERM "DOCACCEL". THE MARK APPEARS ON A TRANSPARENT BACKGROUND, AND NO OTHER COLOR IS CLAIMED AS PART OF THE MARK.

SN 78-636,662, FILED 5-25-2005.

TANYA AMOS, EXAMINING ATTORNEY

**Int. Cl.: 44**

**Prior U.S. Cls.: 100 and 101**

**United States Patent and Trademark Office**

**Reg. No. 3,469,371**

**Registered July 15, 2008**

**SERVICE MARK  
PRINCIPAL REGISTER**

**CELESTHEALTH SOLUTIONS**

KOPTA, STEPHEN M. (UNITED STATES INDIVIDUAL)  
6033 WOODBRIDGE TRAIL  
NEWBURGH, IN 47630 AND  
LOWRY, JENNY L. (UNITED STATES INDIVIDUAL)  
109 LONGRIDGE COURT  
LUTHERVILLE, MD 21093

FOR: PSYCHOLOGICAL ASSESSMENT, NAME-  
LY, FUNCTIONAL ASSESSMENT PROGRAM FOR  
PATIENTS FOR PURPOSES OF GUIDING TREAT-  
MENT, TRACKING OUTCOMES OF PATIENT  
TREATMENT, AND ASSESSING PROGRAM EF-  
FECTIVENESS; PSYCHOLOGICAL CONSULTING,  
IN CLASS 44 (U.S. CLS. 100 AND 101).

FIRST USE 8-31-2007; IN COMMERCE 8-31-2007.

THE MARK CONSISTS OF STANDARD CHAR-  
ACTERS WITHOUT CLAIM TO ANY PARTICULAR  
FONT, STYLE, SIZE, OR COLOR.

NO CLAIM IS MADE TO THE EXCLUSIVE  
RIGHT TO USE "SOLUTIONS", APART FROM  
THE MARK AS SHOWN.

SN 78-636,717, FILED 5-25-2005.

H. M. FISHER, EXAMINING ATTORNEY

**Int. Cl.: 28**

**Prior U.S. Cls.: 22, 23, 38, and 50**

**Reg. No. 3,469,372**

**United States Patent and Trademark Office**

**Registered July 15, 2008**

---

**TRADEMARK  
PRINCIPAL REGISTER**

**ROBOTRAINER**

BLAIR, WARNER (UNITED STATES INDIVIDUAL)  
1100 HICKORY BEND LN.  
FORT WORTH, TX 76108

FOR: SPORTS TRAINING EQUIPMENT IN THE NATURE OF A RAMP FOR RETURNING A BASKETBALL TO THE SHOOTER AND INCORPORATING ELECTRONIC EQUIPMENT THAT MOVES THE RAMP, IN CLASS 28 (U.S. CLS. 22, 23, 38 AND 50).

FIRST USE 2-20-2007; IN COMMERCE 4-15-2008.

THE MARK CONSISTS OF STANDARD CHARACTERS WITHOUT CLAIM TO ANY PARTICULAR FONT, STYLE, SIZE, OR COLOR.

SN 78-639,017, FILED 5-27-2005.

LYDIA BELZER, EXAMINING ATTORNEY

**Int. Cl.: 25**

**Prior U.S. Cls.: 22 and 39**

**United States Patent and Trademark Office**

**Reg. No. 3,469,373**

**Registered July 15, 2008**

**TRADEMARK  
PRINCIPAL REGISTER**

**Sweet Baby Valentine**

PARIS ACCESSORIES, INC. (NEW YORK CORPORATION)  
350 FIFTH AVENUE, 70TH FLOOR  
NEW YORK, NY 10118

FOR: CHILDREN'S CLOTHING, NAMELY, SLIPPERS, SHOES, SANDALS, SOCKS, TIGHTS, CLOTH BIBS, BURP CLOTHS, T-SHIRTS, PANTS, UNDERWEAR, SWEATERS, INFANT DIAPER COVERS, HATS, CAPS, GLOVES, MITTENS, SCARVES, BOOTIES, INFANT ONE PIECE TOP AND BOTTOM CLOTHING WITH SNAPS, COVERALLS, IN CLASS 25 (U.S. CLS. 22 AND 39).

FIRST USE 5-16-2008; IN COMMERCE 5-16-2008.

THE MARK CONSISTS OF STANDARD CHARACTERS WITHOUT CLAIM TO ANY PARTICULAR FONT, STYLE, SIZE, OR COLOR.

SN 78-644,002, FILED 6-6-2005.

PAULA MAHONEY, EXAMINING ATTORNEY

**Int. Cl.: 16**

**Prior U.S. Cls.: 2, 5, 22, 23, 29, 37, 38, and 50**

**Reg. No. 3,469,374**

**United States Patent and Trademark Office**

**Registered July 15, 2008**

---

**TRADEMARK  
PRINCIPAL REGISTER**

**JURDY**

JURDEN, JENIFER (UNITED STATES INDIVIDUAL)  
P.O. BOX 200  
BISHOPVILLE, MD 21813

THE MARK CONSISTS OF STANDARD CHARACTERS WITHOUT CLAIM TO ANY PARTICULAR FONT, STYLE, SIZE, OR COLOR.

FOR: PRINTED MATERIALS, NAMELY, GREETING CARDS, IN CLASS 16 (U.S. CLS. 2, 5, 22, 23, 29, 37, 38 AND 50).

SN 78-644,422, FILED 6-6-2005.

FIRST USE 2-0-2007; IN COMMERCE 4-0-2008.

CAROLINE WOOD, EXAMINING ATTORNEY

Int. Cl.: 33

Prior U.S. Cls.: 47 and 49

United States Patent and Trademark Office

Reg. No. 3,469,375

Registered July 15, 2008

TRADEMARK  
PRINCIPAL REGISTER



BRUCE H. T. LIU (CALIFORNIA CORPORATION), DBA SANTINI FINE WINES,  
16505 WORTHLEY DRIVE  
SAN LORENZO, CA 94580

FOR: WINE, IN CLASS 33 (U.S. CLS. 47 AND 49).

FIRST USE 4-1-2007; IN COMMERCE 4-1-2007.

THE COLOR(S) BLUE, YELLOW AND GREY IS/  
ARE CLAIMED AS A FEATURE OF THE MARK.

THE MARK CONSISTS OF THE BLUE WORDS  
"DI LORENZO" LOCATED IN THE MIDDLE

FRONT. ON THE BACK, THERE ARE 2 LIONS  
STANDING BOTH IN RIGHT AND LEFT SIDES  
FACING EACH OTHER, HOLDING THE SHIELD-  
LIKE SIGN WITH THE "DI LORENZO" TITLE ON  
THE TOP OF THE SIGN. ON TOP OF THE SIGN,  
THERE'S A CROWN. ALL THE GRAPHICS ARE  
GREY IN COLOR. THE BACKGROUND IS LIGHT  
YELLOW.

SN 78-644,740, FILED 6-6-2005.

DAVID TAYLOR, EXAMINING ATTORNEY

**Int. Cl.: 7**

**Prior U.S. Cls.: 13, 19, 21, 23, 31, 34, and 35**

**Reg. No. 3,469,376**

**United States Patent and Trademark Office**

**Registered July 15, 2008**

---

**TRADEMARK  
PRINCIPAL REGISTER**

**DURASCOPE**

GRUPE ENVIRONNEMENTAL LABRIE INC.  
(CANADA CORPORATION)  
175 ROUTE DU PONT  
SAINT-NICOLAS, QUEBEC, CANADA G7A 2T3

THE MARK CONSISTS OF STANDARD CHAR-  
ACTERS WITHOUT CLAIM TO ANY PARTICULAR  
FONT, STYLE, SIZE, OR COLOR.

FOR: TELESCOPIC HYDRAULIC COMPACTING  
MECHANISM USED ON REFUSE COLLECTION  
VEHICLES, IN CLASS 7 (U.S. CLS. 13, 19, 21, 23, 31,  
34 AND 35).

SN 78-645,131, FILED 6-7-2005.

FIRST USE 11-8-2007; IN COMMERCE 11-8-2007.

DAVID H. STINE, EXAMINING ATTORNEY



**Int. Cl.: 16**

**Prior U.S. Cls.: 2, 5, 22, 23, 29, 37, 38, and 50**

**United States Patent and Trademark Office**

**Reg. No. 3,469,377**

**Registered July 15, 2008**

**TRADEMARK  
PRINCIPAL REGISTER**

**FAMILIA ALWAYS**

EDITORIAL ARMONÍA, S.A. (MEXICO CORPORATION)  
RÍO BALSAS # 101  
MEXICO CITY, MEXICO 06500

FOR: MAGAZINE FEATURING FAMILY PRIDE,  
IN CLASS 16 (U.S. CLS. 2, 5, 22, 23, 29, 37, 38 AND 50).

FIRST USE 4-7-2008; IN COMMERCE 4-7-2008.

THE MARK CONSISTS OF STANDARD CHARACTERS WITHOUT CLAIM TO ANY PARTICULAR FONT, STYLE, SIZE, OR COLOR.

NO CLAIM IS MADE TO THE EXCLUSIVE RIGHT TO USE "FAMILIA", APART FROM THE MARK AS SHOWN.

THE FOREIGN WORDING IN THE MARK TRANSLATES INTO ENGLISH AS FAMILY.

SN 78-645,183, FILED 6-7-2005.

JAMES A. RAUEN, EXAMINING ATTORNEY

**Int. Cl.: 16**

**Prior U.S. Cls.: 2, 5, 22, 23, 29, 37, 38, and 50**

**Reg. No. 3,469,378**

**United States Patent and Trademark Office**

**Registered July 15, 2008**

---

**TRADEMARK  
PRINCIPAL REGISTER**

# Mann On The Street

MANN PUBLICATIONS, INC. (NEW YORK CORPORATION)  
SUITE 2254  
1440 BROADWAY  
NEW YORK, NY 10018

FOR: PERIODICAL DEVOTED TO COVERAGE SPOTLIGHTING NEWSMAKERS AND PROMINENT PERSONALITIES, ESPECIALLY THOSE IN WALL STREET AND OTHER FINANCIAL CENTERS, IN CLASS 16 (U.S. CLS. 2, 5, 22, 23, 29, 37, 38 AND 50).

FIRST USE 4-1-2002; IN COMMERCE 4-1-2006.

THE MARK CONSISTS OF STANDARD CHARACTERS WITHOUT CLAIM TO ANY PARTICULAR FONT, STYLE, SIZE, OR COLOR.

SN 78-646,980, FILED 6-9-2005.

REBECCA EISINGER, EXAMINING ATTORNEY

Int. Cl.: 33

Prior U.S. Cls.: 47 and 49

**United States Patent and Trademark Office**

**Reg. No. 3,469,379**

Registered July 15, 2008

---

**TRADEMARK  
PRINCIPAL REGISTER**

**TEKIAH**

BERCUN, HORACIO DANIEL (ARGENTINA IN-  
DIVIDUAL)

PISO 2

MAIPU 836

BUENOS AIRES, ARGENTINA 1006

FOR: WINES, IN CLASS 33 (U.S. CLS. 47 AND 49).

FIRST USE 8-31-2004; IN COMMERCE 11-12-2007.

THE MARK CONSISTS OF STANDARD CHAR-  
ACTERS WITHOUT CLAIM TO ANY PARTICULAR  
FONT, STYLE, SIZE, OR COLOR.

THE FOREIGN WORDING IN THE MARK  
TRANSLATES INTO ENGLISH AS BLAST.

SN 78-648,015, FILED 6-10-2005.

INGRID C. EULIN, EXAMINING ATTORNEY

**Int. Cl.: 20**

**Prior U.S. Cls.: 2, 13, 22, 25, 32, and 50**

**Reg. No. 3,469,380**

**United States Patent and Trademark Office**

**Registered July 15, 2008**

---

**TRADEMARK  
PRINCIPAL REGISTER**

**VERSASHADE**

LEWIS HYMAN, INC. (CALIFORNIA CORPORATION)  
860 EAST SANDHILL AVENUE  
CARSON, CA 90746

THE MARK CONSISTS OF STANDARD CHARACTERS WITHOUT CLAIM TO ANY PARTICULAR FONT, STYLE, SIZE, OR COLOR.

FOR: WINDOW SHADES, IN CLASS 20 (U.S. CLS. 2, 13, 22, 25, 32 AND 50).

SN 78-649,443, FILED 6-13-2005.

FIRST USE 11-10-2005; IN COMMERCE 11-10-2005.

PAUL CROWLEY, EXAMINING ATTORNEY

Int. Cls.: 14 and 25

Prior U.S. Cls.: 2, 22, 27, 28, 39, and 50

United States Patent and Trademark Office

Reg. No. 3,469,381

Registered July 15, 2008

TRADEMARK  
PRINCIPAL REGISTER

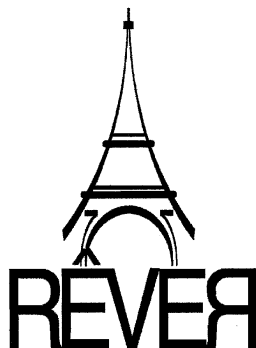

CORPORACIÓN BELLEZA JUVENIL, S.A.  
(COSTA RICA SOCIEDAD ANONIMA)  
BARRIO LA GRANJA EDIFICIO LA GRANJA  
DESPACHO NÚMERO UNOSAN PEDRO DE MON-  
TES D E ÓCASAN PEDRO DE MONTES D E ÓCA  
SAN JOSÉ, COSTA RICA

FOR: JEWELRY, NAMELY, NECKLACES, PEN-  
DANTS, BRACELETS, RINGS, EARRINGS, CHAINS,  
LAPEL PINS, BROACHES AND OTHER JEWELLED  
PINS, JEWELLED ACCESSORIES, NAMELY,  
WATCHES, WATCH STRAPS, CLOCKS, CLOCK  
PARTS, GIFT PENDANTS, IN CLASS 14 (U.S. CLS.  
2, 27, 28 AND 50).

FIRST USE 3-19-2008; IN COMMERCE 3-19-2008.

FOR: MEN'S, WOMEN'S AND CHILDREN'S AP-  
PAREL, NAMELY, KNIT SHIRTS, T-SHIRTS,  
SPORTS SHIRTS, POLO SHIRTS, DRESS SHIRTS,  
SWEATSHIRTS, SHAWLS, SHOULDER WRAPS,  
STOLES, JACKETS, VESTS, PANTS, SWEATPANTS,

SHORTS, SWIMWEAR, SCARVES, NECKTIES,  
NECKERCHIEFS, BOWTIES, SASHES, BANDANAS,  
UNDERWEAR, BRAS, PANTIES, CAMISOLES,  
SLIPS, NIGHTGOWNS, PAJAMAS, ROBES, OTHER  
SLEEPWEAR, BELTS, GLOVES, MITTENS, SOCKS,  
STOCKINGS, WRISTBANDS, CUMMERBUNDS,  
SUSPENDERS; FOOTWEAR, NAMELY, SHOES,  
BOOTS, SLIPPERS; HEADWEAR, NAMELY, HATS,  
CAPS, VISORS, BANDANAS, IN CLASS 25 (U.S. CLS.  
22 AND 39).

FIRST USE 3-19-2008; IN COMMERCE 3-19-2008.

THE MARK CONSISTS OF THE STYLIZED  
WORDING "REVER" AND DESIGN OF THE EIF-  
FEL TOWER.

SN 78-649,762, FILED 6-13-2005.

JOSETTE BEVERLY, EXAMINING ATTORNEY

**Int. Cls.: 35 and 40**

**Prior U.S. Cls.: 100, 101, 102, 103, and 106**

**United States Patent and Trademark Office**

**Reg. No. 3,469,382**

**Registered July 15, 2008**

**SERVICE MARK  
PRINCIPAL REGISTER**

**!MPRESSLINE**

IMPRESSLINE, INC. (TEXAS CORPORATION)  
3102 MAPLE AVE. SUITE 450  
DALLAS, TX 75201

FOR: PROMOTING THE GOODS AND SERVICES OF OTHERS THROUGH THE MARKETING AND DISTRIBUTION OF PROMOTIONAL ITEMS; ON-LINE WHOLESALE STORE SERVICES FEATURING PROMOTIONAL ITEMS, NAMELY, CALCULATORS, CAPS, CARDHOLDERS, CIGARETTE LIGHTERS, CLOCKS, COIN BANKS, COMPACT DISC CASES, FOAM SPORTS BALLS, INSULATED BEVERAGE MUGS AND CONTAINERS, INSULATED CASES FOR BEVERAGES, KEY CHAINS, LETTER OPENERS, NOTEBOOKS, PENS, PEN AND PENCIL HOLDERS, PORTABLE RADIOS, SEWING KITS, AND UMBRELLAS, IN CLASS 35 (U.S. CLS. 100, 101 AND 102).

FIRST USE 7-0-2002; IN COMMERCE 2-0-2005.

FOR: CUSTOM MANUFACTURE OF PROMOTIONAL ITEMS, NAMELY, CALCULATORS, CAPS, CARDHOLDERS, CIGARETTE LIGHTERS, CLOCKS, COIN BANKS, COMPACT DISC CASES, FOAM SPORTS BALLS, INSULATED BEVERAGE MUGS AND CONTAINERS, INSULATED CASES FOR BEVERAGES, KEY CHAINS, LETTER OPENERS, NOTEBOOKS, PENS, PEN AND PENCIL HOLDERS, PORTABLE RADIOS, SEWING KITS, AND UMBRELLAS, IN CLASS 40 (U.S. CLS. 100, 103 AND 106).

FIRST USE 7-0-2002; IN COMMERCE 2-0-2005.

THE MARK CONSISTS OF STANDARD CHARACTERS WITHOUT CLAIM TO ANY PARTICULAR FONT, STYLE, SIZE, OR COLOR.

SN 78-650,643, FILED 6-14-2005.

SARA THOMAS, EXAMINING ATTORNEY

**Int. Cl.: 32**

**Prior U.S. Cls.: 45, 46, and 48**

**Reg. No. 3,469,383**

**United States Patent and Trademark Office**

**Registered July 15, 2008**

**TRADEMARK  
PRINCIPAL REGISTER**

Lelü

TROPICAL WATERS KOSRAE, INC. (MICRONE-  
SIA CORPORATION)  
P.O. BOX 68  
KOSRAE, MICRONESIA 96944

THE MARK CONSISTS OF STANDARD CHAR-  
ACTERS WITHOUT CLAIM TO ANY PARTICULAR  
FONT, STYLE, SIZE, OR COLOR.

FOR: NATURAL, SPRING, AND ARTESIAN WA-  
TER FOR DRINKING, IN CLASS 32 (U.S. CLS. 45, 46  
AND 48).

SN 78-651,293, FILED 6-15-2005.

FIRST USE 4-14-2008; IN COMMERCE 4-14-2008.

JULIE WATSON, EXAMINING ATTORNEY

**Int. Cl.: 9**

**Prior U.S. Cls.: 21, 23, 26, 36, and 38**

**United States Patent and Trademark Office**

**Reg. No. 3,469,384**

**Registered July 15, 2008**

**TRADEMARK  
PRINCIPAL REGISTER**

**HOLLOW OAK RECORDS**

HOLLOW OAK RECORDS, LLC (TENNESSEE  
LTD LIAB CO)  
NO. 384  
9 MUSIC SQUARE SOUTH  
NASHVILLE, TN 372033283

FOR: SOUND RECORDINGS FEATURING MU-  
SIC; AUDIO DISCS, COMPACT DISCS, FEATURING  
MUSIC, IN CLASS 9 (U.S. CLS. 21, 23, 26, 36 AND 38).

FIRST USE 10-0-2007; IN COMMERCE 10-0-2007.

THE MARK CONSISTS OF STANDARD CHAR-  
ACTERS WITHOUT CLAIM TO ANY PARTICULAR  
FONT, STYLE, SIZE, OR COLOR.

NO CLAIM IS MADE TO THE EXCLUSIVE  
RIGHT TO USE "RECORDS", APART FROM THE  
MARK AS SHOWN.

SN 78-653,828, FILED 6-20-2005.

LINDA ORNDORFF, EXAMINING ATTORNEY



**Int. Cl.: 33**

**Prior U.S. Cls.: 47 and 49**

**United States Patent and Trademark Office**

**Reg. No. 3,469,385**

**Registered July 15, 2008**

**TRADEMARK  
PRINCIPAL REGISTER**

**DEFINING TASTE**

DIAGEO SCOTLAND LIMITED (GREAT BRIT-  
AIN CORPORATION)  
EDINBURGH PARK 5 LOCHSIDE WAY  
EDINBURGH, SCOTLAND EH12 9DT

THE MARK CONSISTS OF STANDARD CHAR-  
ACTERS WITHOUT CLAIM TO ANY PARTICULAR  
FONT, STYLE, SIZE, OR COLOR.

FOR: ALCOHOLIC BEVERAGES, NAMELY,  
WHISKY, IN CLASS 33 (U.S. CLS. 47 AND 49).

SN 78-657,073, FILED 6-23-2005.

FIRST USE 9-30-2003; IN COMMERCE 9-30-2003.

BENJAMIN OKEKE, EXAMINING ATTORNEY

**Int. Cl.: 38**

**Prior U.S. Cls.: 100, 101, and 104**

**United States Patent and Trademark Office**

**Reg. No. 3,469,386**

**Registered July 15, 2008**

**SERVICE MARK  
PRINCIPAL REGISTER**

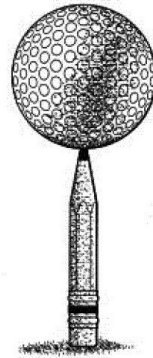

GUADALUPE VALLEY TELEPHONE COOPERATIVE, INC. (TEXAS CORPORATION)  
36101 FM 3159  
NEW BRAUNFELS, TX 78132

FOR: TELECOMMUNICATIONS SERVICES, NAMELY, PROVIDING PACKAGES OF TELEPHONE CALLING FEATURES TO LOCAL AND LONG DISTANCE TELEPHONE SERVICES IN THE NATURE OF DIFFERENT COMBINATIONS OF CALLER ID, CALL WAITING, CALL RETURN, VOICE MAIL, AUTO REDIAL, PRIORITY CALL, CALL REJECTIONS, CALL FORWARDING, INTER-

NET ACCESS, CALL BLOCKING AND THREE-WAY CALLING, IN CLASS 38 (U.S. CLS. 100, 101 AND 104).

FIRST USE 5-8-2008; IN COMMERCE 5-8-2008.

THE MARK CONSISTS OF A DRAWING OF A GOLF BALL ATOP A PENCIL.

SN 78-657,912, FILED 6-24-2005.

MICHELLE DUBOIS, EXAMINING ATTORNEY

**Int. Cl.: 9**

**Prior U.S. Cls.: 21, 23, 26, 36, and 38**

**Reg. No. 3,469,387**

**United States Patent and Trademark Office**

**Registered July 15, 2008**

**TRADEMARK  
PRINCIPAL REGISTER**

**MOTORAZR**

MOTOROLA, INC. (DELAWARE CORPORATION)  
1303 E. ALGONQUIN ROAD  
SCHAUMBURG, IL 60196

FOR: TELEPHONES, CELLULAR TELEPHONES, RADIO TRANSCEIVERS; COMPUTER SOFTWARE AND PROGRAMS USED FOR TRANSMISSION OR REPRODUCING OR RECEIVING OF SOUND, IMAGES, VIDEO OR DATA OVER A TELECOMMUNICATIONS NETWORK OR SYSTEM BETWEEN COMPUTER TERMINALS AND FOR ENHANCING AND FACILITATING USE AND ACCESS TO COMPUTER NETWORKS AND TELEPHONE NETWORKS; COMPUTER SOFTWARE FOR EXECUTING TUTORIALS AND ELECTRONIC PRODUCT MANUALS ON MOBILE PHONES OR COMPUTERS FOR PROVIDING TRAINING AND PRODUCT SUPPORT TO MOBILE PHONE CUSTOMERS; COMPUTER GAME SOFTWARE FOR MOBILE HANDSETS; COMPUTER SOFTWARE AND COMPUTER PROGRAMS FOR USE WITH MOBILE PHONES FOR ASSISTING THE USER IN DOWNLOADING MUSIC, MOVIES, ANIMATION, OR ELECTRONIC BOOKS; COMPUTER SOFTWARE FOR DISTRIBUTING INFORMATION AND INTERACTIVE MULTIMEDIA CONTENT CONTAINING TEXT, IMAGES, VIDEO AND SOUND BETWEEN WIRELESS COMMUNICATION DEVICES AND COMPUTER TERMINALS VIA A WIRELESS NETWORK; COMPUTER SOFTWARE AND PROGRAMS FOR MANAGEMENT AND OPERATION OF WIRELESS TELECOMMUNICATIONS DEVICES; COMPUTER SOFTWARE FOR ACCESSING,

SEARCHING, INDEXING AND RETRIEVING INFORMATION AND DATA FROM GLOBAL COMPUTER NETWORKS AND GLOBAL COMMUNICATION NETWORKS, AND FOR BROWSING AND NAVIGATING THROUGH WEB SITES ON SAID NETWORKS; COMPUTER SOFTWARE FOR SENDING AND RECEIVING SHORT MESSAGES AND ELECTRONIC MAIL AND FOR FILTERING NON-TEXT INFORMATION FROM THE DATA TRANSMITTED BETWEEN COMPUTER TERMINALS AND WIRELESS COMMUNICATION DEVICES; ANALOG AND DIGITAL RADIO TRANSCEIVERS OR RECEIVERS FOR DATA, VOICE, IMAGE AND VIDEO COMMUNICATION; ELECTRONIC GAME SOFTWARE FOR MOBILE HANDSETS; CAMERAS, NAMELY, PHOTOGRAPHIC CAMERAS, DIGITAL CAMERAS, MOTION PICTURE CAMERAS, VIDEO CAMERAS; CALCULATORS; GLOBAL POSITIONING UNITS, BATTERIES, BATTERY CHARGERS, POWER ADAPTERS, IN CLASS 9 (U.S. CLS. 21, 23, 26, 36 AND 38).

FIRST USE 10-30-2006; IN COMMERCE 10-30-2006.

THE MARK CONSISTS OF STANDARD CHARACTERS WITHOUT CLAIM TO ANY PARTICULAR FONT, STYLE, SIZE, OR COLOR.

SN 78-660,117, FILED 6-28-2005.

ALEXANDER L. POWERS, EXAMINING ATTORNEY

**Int. Cl.: 42**

**Prior U.S. Cls.: 100 and 101**

**United States Patent and Trademark Office**

**Reg. No. 3,469,388**

**Registered July 15, 2008**

**SERVICE MARK  
PRINCIPAL REGISTER**

**ORCHESTRATA**

INTEGRATED PERFORMANCE SYSTEMS, INC.  
(ILLINOIS CORPORATION)  
1 INDEPENDENT DR.  
JACKSONVILLE, FL 32202

FOR: CONSULTING SERVICES IN THE FIELD OF DESIGN, IMPLEMENTATION AND USE OF COMPUTER SOFTWARE SYSTEMS FOR OTHERS FOR EMPLOYEE BENEFIT MANAGEMENT IN HUMAN RESOURCES; AND PROVIDING TEMPORARY USE OF ON-LINE NON-DOWNLOADABLE SOFTWARE FOR EMPLOYEE BENEFIT

MANAGEMENT IN HUMAN RESOURCES, IN CLASS 42 (U.S. CLS. 100 AND 101).

FIRST USE 9-0-2006; IN COMMERCE 9-0-2006.

THE MARK CONSISTS OF STANDARD CHARACTERS WITHOUT CLAIM TO ANY PARTICULAR FONT, STYLE, SIZE, OR COLOR.

SN 78-660,151, FILED 6-28-2005.

INGRID C. EULIN, EXAMINING ATTORNEY

**Int. Cls.: 9 and 35**

**Prior U.S. Cls.: 21, 23, 26, 36, 38, 100, 101, and 102**

**United States Patent and Trademark Office**

**Reg. No. 3,469,389**

**Registered July 15, 2008**

**TRADEMARK  
SERVICE MARK  
PRINCIPAL REGISTER**

**KAREN MILLEN**

KAREN MILLEN LTD. (UNITED KINGDOM CORPORATION)  
13-16 LAKESIDE STANTON HARCOURT WITNEY  
OXFORDSHIRE, UNITED KINGDOM OX29 5TR

FOR: SUNGLASSES AND SUNGLASS FRAMES;  
CASES, NAMELY, CASES FOR SUNGLASSES, IN  
CLASS 9 (U.S. CLS. 21, 23, 26, 36 AND 38).

FIRST USE 4-0-2005; IN COMMERCE 4-0-2005.

FOR: RETAIL STORE SERVICES FEATURING  
EYEWEAR AND APPAREL, IN CLASS 35 (U.S. CLS.  
100, 101 AND 102).

FIRST USE 8-0-2002; IN COMMERCE 8-0-2002.

THE MARK CONSISTS OF STANDARD CHARACTERS WITHOUT CLAIM TO ANY PARTICULAR FONT, STYLE, SIZE, OR COLOR.

OWNER OF U.S. REG. NO. 2,806,908.

THE NAME(S), PORTRAIT(S), AND/OR SIGNATURE(S) SHOWN IN THE MARK IDENTIFIES "KAREN MILLEN", A LIVING INDIVIDUAL, WHOSE CONSENT(S) TO REGISTER IS SUBMITTED.

SN 78-660,246, FILED 6-28-2005.

DOMINIC FATHY, EXAMINING ATTORNEY

**Int. Cl.: 14**

**Prior U.S. Cls.: 2, 27, 28, and 50**

**United States Patent and Trademark Office**

**Reg. No. 3,469,390**

**Registered July 15, 2008**

**TRADEMARK  
PRINCIPAL REGISTER**



ZIPPMARK, INC. (DELAWARE CORPORATION)  
SUITE 1300  
1105 NORTH MARKET STREET  
WILMINGTON, DE 19801

FIRST USE 4-24-2007; IN COMMERCE 4-24-2007.

SN 78-662,100, FILED 6-30-2005.

FOR: HAND-HELD CIGARETTE AND UTILITY  
LIGHTERS OF PRECIOUS METAL, IN CLASS 14  
(U.S. CLS. 2, 27, 28 AND 50).

ATTIYA MALIK, EXAMINING ATTORNEY

**Int. Cls.: 37 and 42**

**Prior U.S. Cls.: 100, 101, 103, and 106**

**United States Patent and Trademark Office**

**Reg. No. 3,469,391**

**Registered July 15, 2008**

**SERVICE MARK  
PRINCIPAL REGISTER**

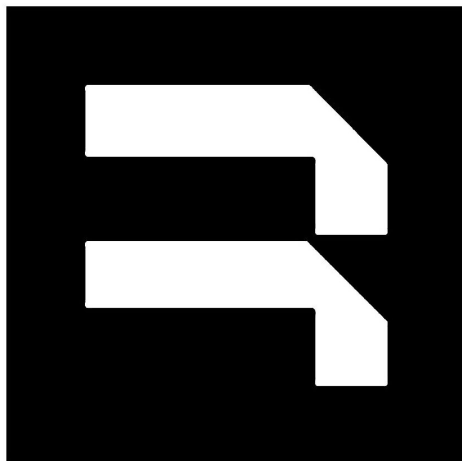

RUSSULA S.A. (SPAIN CORPORATION)  
C/PASTEUR NO. 30 10  
LA CORUÑA, SPAIN 15008

FOR: INSTALLATION OF ELECTRONIC AND MECHANICAL COMPONENTS AND SYSTEMS IN THE FIELD OF METALS MANUFACTURING AND RELATED INDUSTRIES; INSTALLATION OF COMPUTER SYSTEMS, IN CLASS 37 (U.S. CLS. 100, 103 AND 106).

FIRST USE 0-0-1997; IN COMMERCE 11-0-2000.

FOR: SCIENTIFIC, ENGINEERING, AND TECHNOLOGICAL SERVICES, NAMELY, PROVIDING DESIGN SERVICES FOR OTHERS IN THE FIELD OF ENGINEERING AND METALS MANUFACTURING; DESIGN OF ELECTRICAL, ELECTRONIC, AND MECHANICAL COMPONENTS, SYSTEMS, AND PROCESSES IN THE FIELD OF METALS MANUFACTURING AND RELATED INDUSTRIES, AND SCIENTIFIC RESEARCH RELATED THERE-

TO; INDUSTRIAL RESEARCH AND ANALYSIS, NAMELY, ENGINEERING ANALYSIS OF ELECTRONIC AND MECHANICAL CONTROL SYSTEMS FOR THE METALS MANUFACTURING INDUSTRY TO IMPROVE PRODUCTIVITY AND EFFICIENCY; DESIGN AND DEVELOPMENT OF COMPUTERS AND SOFTWARE FOR OTHERS; AND ENGINEERING CONSULTATION SERVICES; INSTALLATION OF COMPUTER SOFTWARE; SCIENTIFIC RESEARCH, IN CLASS 42 (U.S. CLS. 100 AND 101).

FIRST USE 0-0-1997; IN COMMERCE 11-0-2000.

THE MARK CONSISTS OF A SQUARE DESIGN WITH TWO GEOMETRIC FIGURES THAT FORM A STYLIZED LETTER "R".

SN 78-665,735, FILED 7-7-2005.

MAUREEN DALL, EXAMINING ATTORNEY

**Int. Cls.: 35, 39, 40, and 42**

**Prior U.S. Cls.: 100, 101, 102, 103, 105, and 106**

**United States Patent and Trademark Office**

**Reg. No. 3,469,392**

**Registered July 15, 2008**

---

**SERVICE MARK  
PRINCIPAL REGISTER**

# RecordFusion

REALTY DATA CORP. (NEW YORK CORPORATION)  
SUITE 160  
1325 FRANKLIN AVENUE  
GARDEN CITY, NY 11530

FOR: RECORDS MANAGEMENT SERVICES, NAMELY, DOCUMENT INDEXING OF PUBLIC RECORDS FOR OTHERS; COMPUTERIZED DATABASE MANAGEMENT, IN CLASS 35 (U.S. CLS. 100, 101 AND 102).

FIRST USE 9-30-2005; IN COMMERCE 9-30-2005.

FOR: ELECTRONIC STORAGE OF PUBLIC RECORD FILES AND DOCUMENTS, IN CLASS 39 (U.S. CLS. 100 AND 105).

FIRST USE 9-30-2005; IN COMMERCE 9-30-2005.

FOR: DIGITIZING OF PUBLIC RECORDS, IN CLASS 40 (U.S. CLS. 100, 103 AND 106).

FIRST USE 9-30-2005; IN COMMERCE 9-30-2005.

FOR: PROVIDING AN ON-LINE COMPUTER DATABASE FOR ACCESSING A CENTRALIZED SOURCE OF PUBLIC RECORDS, IN CLASS 42 (U.S. CLS. 100 AND 101).

FIRST USE 9-30-2005; IN COMMERCE 9-30-2005.

THE MARK CONSISTS OF STANDARD CHARACTERS WITHOUT CLAIM TO ANY PARTICULAR FONT, STYLE, SIZE, OR COLOR.

SN 78-666,466, FILED 7-8-2005.

TRICIA SONNEBORN, EXAMINING ATTORNEY



**Int. Cls.: 35 and 42**

**Prior U.S. Cls.: 100, 101, and 102**

**United States Patent and Trademark Office**

**Reg. No. 3,469,393**

**Registered July 15, 2008**

---

**SERVICE MARK  
PRINCIPAL REGISTER**

# CountyFusion

REALTY DATA CORP. (NEW YORK CORPORATION)  
SUITE 160  
1325 FRANKLIN AVENUE  
GARDEN CITY, NY 11530

FOR: RECORDS MANAGEMENT SERVICES, NAMELY, DOCUMENT INDEXING OF PUBLIC RECORDS FOR OTHERS; COMPUTERIZED DATABASE MANAGEMENT, IN CLASS 35 (U.S. CLS. 100, 101 AND 102).

FIRST USE 9-30-2005; IN COMMERCE 9-30-2005.

FOR: PROVIDING AN ON-LINE COMPUTER DATABASE FOR ACCESSING A CENTRALIZED SOURCE OF PUBLIC RECORDS, IN CLASS 42 (U.S. CLS. 100 AND 101).

FIRST USE 9-30-2005; IN COMMERCE 9-30-2005.

THE MARK CONSISTS OF STANDARD CHARACTERS WITHOUT CLAIM TO ANY PARTICULAR FONT, STYLE, SIZE, OR COLOR.

SN 78-666,490, FILED 7-8-2005.

TRICIA SONNEBORN, EXAMINING ATTORNEY

**Int. Cls.: 16 and 41**

**Prior U.S. Cls.: 2, 5, 22, 23, 29, 37, 38, 50, 100, 101, and 107**

**Reg. No. 3,469,394**

**United States Patent and Trademark Office**

**Registered July 15, 2008**

**TRADEMARK  
SERVICE MARK  
PRINCIPAL REGISTER**

**LUXETRENDS**

RELIANCE RELOCATION SERVICES, INC. (DE-  
LAWARE CORPORATION)

161 N. CLARK STREET

CHICAGO, IL 60601

FOR: PERIODIC PRINTED PUBLICATIONS,  
NAMELY, NEWSLETTERS ON THE SUBJECT OF  
REAL ESTATE, IN CLASS 16 (U.S. CLS. 2, 5, 22, 23, 29,  
37, 38 AND 50).

FIRST USE 8-29-2005; IN COMMERCE 8-29-2005.

FOR: ONLINE ELECTRONIC NEWSLETTERS IN  
THE FIELD OF REAL ESTATE, IN CLASS 41 (U.S.  
CLS. 100, 101 AND 107).

FIRST USE 11-23-2005; IN COMMERCE 11-23-2005.

THE MARK CONSISTS OF STANDARD CHAR-  
ACTERS WITHOUT CLAIM TO ANY PARTICULAR  
FONT, STYLE, SIZE, OR COLOR.

SN 78-668,800, FILED 7-12-2005.

MICHAEL WEBSTER, EXAMINING ATTORNEY

**Int. Cls.: 9, 37, and 42**

**Prior U.S. Cls.: 21, 23, 26, 36, 38, 100, 101, 103, and 106**

**Reg. No. 3,469,395**

**United States Patent and Trademark Office**

**Registered July 15, 2008**

**TRADEMARK  
SERVICE MARK  
PRINCIPAL REGISTER**

**HYBRIDYNE**

HYBRIDYNE POWER SYSTEMS CANADA INC.  
(CANADA CORPORATION)  
16715 YONGE STREET UNIT 12, SUITE 231  
NEWMARKET, ONTARIO, CANADA L3X 1X4

FOR: POWER CONVERSION ELECTRONICS AND RELATED EQUIPMENT FOR ALTERNATE AND RENEWABLE ENERGY APPLICATIONS, NAMELY, WIND TURBINES, HYDRO TURBINES, STEAM TURBINES, SILICON AND NON-SILICON SOLAR CELLS, SOLAR COLLECTORS, ALTERNATORS, GENERATORS, AND RECTIFIERS; UNINTERRUPTED POWER SUPPLY AND ENERGY STORAGE SYSTEMS FOR INDUSTRIAL, COMMERCIAL, MUNICIPAL, MILITARY AND RESIDENTIAL ELECTRICAL POWER SUPPLY USE, NAMELY, VOLTAGE CONVERTERS, VOLTAGE REGULATORS, BATTERIES, CAPACITORS, INVERTERS AND ACTIVE FILTERS, IN CLASS 9 (U.S. CLS. 21, 23, 26, 36 AND 38).

FIRST USE 7-14-2005; IN COMMERCE 7-14-2005.

FOR: INSTALLATION OF POWER SYSTEMS, INCLUDING ALTERNATE AND RENEWABLE ENERGY POWER CONVERSION SYSTEMS, FOR OTHERS, IN CLASS 37 (U.S. CLS. 100, 103 AND 106).

FIRST USE 7-14-2005; IN COMMERCE 7-14-2005.

FOR: DESIGN AND DEVELOPMENT OF POWER SYSTEMS, INCLUDING ALTERNATE AND RENEWABLE ENERGY POWER CONVERSION SYSTEMS, FOR OTHERS, IN CLASS 42 (U.S. CLS. 100 AND 101).

FIRST USE 7-14-2005; IN COMMERCE 7-14-2005.

THE MARK CONSISTS OF STANDARD CHARACTERS WITHOUT CLAIM TO ANY PARTICULAR FONT, STYLE, SIZE, OR COLOR.

PRIORITY CLAIMED UNDER SEC. 44(D) ON CANADA APPLICATION NO. 1257100, FILED 5-5-2005, REG. NO. TMA665,891, DATED 6-9-2006, EXPIRES 6-9-2021.

THE WORDING "HYBRIDYNE" HAS NO MEANING IN A FOREIGN LANGUAGE.

SN 78-668,900, FILED 7-12-2005.

NAPOLEON SHARMA, EXAMINING ATTORNEY

Int. Cl.: 30

Prior U.S. Cl.: 46

United States Patent and Trademark Office

Reg. No. 3,469,396

Registered July 15, 2008

TRADEMARK  
PRINCIPAL REGISTER



CADBURY ADAMS USA LLC (DELAWARE LTD  
LIAB CO)  
389 INTERPACE PARKWAY  
PARSIPPANY, NJ 07054

FOR: CHEWING GUM, IN CLASS 30 (U.S. CL. 46).

FIRST USE 5-31-2003; IN COMMERCE 5-31-2003.

OWNER OF U.S. REG. NO. 2,791,915.

THE COLOR(S) RED IS/ARE CLAIMED AS A  
FEATURE OF THE MARK.

THE COLOR(S) RED APPEAR IN DIFFERENT  
SHADES RANGING FROM DEEP RED TO BRIGHT  
RED.

SN 78-670,264, FILED 7-14-2005.

MARK RADEMACHER, EXAMINING ATTORNEY

**Int. Cl.: 34**

**Prior U.S. Cls.: 2, 8, 9, and 17**

**United States Patent and Trademark Office**

**Reg. No. 3,469,397**

**Registered July 15, 2008**

**TRADEMARK  
PRINCIPAL REGISTER**

**WESTFIELD**

J. M. RIDGEWORTH INC. (FLORIDA CORPORATION)  
4000 ISLAND BLVD. SUITE 206  
AVENTURA, FL 33160

THE MARK CONSISTS OF STANDARD CHARACTERS WITHOUT CLAIM TO ANY PARTICULAR FONT, STYLE, SIZE, OR COLOR.

FOR: CIGARETTES, CIGARS, IN CLASS 34 (U.S. CLS. 2, 8, 9 AND 17).

SN 78-671,989, FILED 7-17-2005.

FIRST USE 6-5-2008; IN COMMERCE 6-5-2008.

AMY GEARIN, EXAMINING ATTORNEY

**Int. Cl.: 41**

**Prior U.S. Cls.: 100, 101, and 107**

**Reg. No. 3,469,398**

**United States Patent and Trademark Office**

**Registered July 15, 2008**

---

**SERVICE MARK  
PRINCIPAL REGISTER**

**TEAM GALAXY**

MARATHON MEDIA (FRANCE SOCIETE PAR  
ACTIONS SIMPLIFIEE)  
8 BOULEVARD DES CAPUCINES  
PARIS, FRANCE 75009

FOR: RADIO AND TELEVISION ENTERTAIN-  
MENT IN THE NATURE OF ONGOING YOUTH  
AND CHILDREN'S SHOWS; SERIES OF ANIMATED  
CARTOONS BROADCAST ON TELEVISION AND  
VIA THE INTERNET; PRODUCTION OF RADIO  
AND TELEVISION PROGRAMS AND FILMS; PRO-  
VIDING EDUCATIONAL AND ENTERTAINMENT  
SERVICES BY MEANS OF AN ONLINE WEBSITE  
AND ONLINE COMPUTER DATABASE FEATUR-

ING GAMES, INFORMATION AND ACTIVITIES, IN  
CLASS 41 (U.S. CLS. 100, 101 AND 107).

FIRST USE 9-9-2006; IN COMMERCE 9-9-2006.

THE MARK CONSISTS OF STANDARD CHAR-  
ACTERS WITHOUT CLAIM TO ANY PARTICULAR  
FONT, STYLE, SIZE, OR COLOR.

SN 78-672,450, FILED 7-18-2005.

KAREN K. BUSH, EXAMINING ATTORNEY

**Int. Cl.: 9**

**Prior U.S. Cls.: 21, 23, 26, 36, and 38**

**Reg. No. 3,469,399**

**United States Patent and Trademark Office**

**Registered July 15, 2008**

**TRADEMARK  
PRINCIPAL REGISTER**

**Feature+Flex**

TOSHIBA AMERICA INFORMATION SYSTEMS,  
INC. (CALIFORNIA CORPORATION)  
9740 IRVINE BOULEVARD  
IRVINE, CA 92618

CONFIGURATIONS, IN CLASS 9 (U.S. CLS. 21, 23,  
26, 36 AND 38).

FIRST USE 8-31-2006; IN COMMERCE 8-31-2006.

FOR: TELEPHONE AND TELECOMMUNICA-  
TIONS SOFTWARE WHICH ENABLES CUSTO-  
M I Z E D P R O G R A M M I N G A N D

SN 78-674,689, FILED 7-20-2005.

GEORGIA CARTY, EXAMINING ATTORNEY

**Int. Cl.: 36**

**Prior U.S. Cls.: 100, 101, and 102**

**United States Patent and Trademark Office**

**Reg. No. 3,469,400**

**Registered July 15, 2008**

**SERVICE MARK  
PRINCIPAL REGISTER**

**WE BUY RAGGEDY HOUSES**

GOLDEN EYE INVESTMENTS, LLC (NEW JERSEY LTD LIAB CO)  
108-110 GRAND AVENUE  
NEWARK, NJ 07106

THE MARK CONSISTS OF STANDARD CHARACTERS WITHOUT CLAIM TO ANY PARTICULAR FONT, STYLE, SIZE, OR COLOR.

FOR: REAL ESTATE INVESTMENT FOR COMMERCIAL AND RESIDENTIAL PROPERTIES, IN CLASS 36 (U.S. CLS. 100, 101 AND 102).

SN 78-675,895, FILED 7-22-2005.

FIRST USE 7-22-2005; IN COMMERCE 7-25-2005.

NELSON SNYDER, EXAMINING ATTORNEY



Int. Cl.: 44

Prior U.S. Cls.: 100 and 101

United States Patent and Trademark Office

Reg. No. 3,469,401

Registered July 15, 2008

SERVICE MARK  
PRINCIPAL REGISTER

**True.Care.**

GOSHEN HEALTH SYSTEM (INDIANA CORPORATION)  
1808 CHARLTON CT.  
GOSHEN, IN 46526

NO CLAIM IS MADE TO THE EXCLUSIVE RIGHT TO USE "CARE", APART FROM THE MARK AS SHOWN.

FOR: MEDICAL SERVICES, NAMELY, INPATIENT AND OUTPATIENT MEDICAL SERVICES, IN CLASS 44 (U.S. CLS. 100 AND 101).

SN 78-675,946, FILED 7-22-2005.

FIRST USE 2-22-2005; IN COMMERCE 2-22-2005.

SUSAN STIGLITZ, EXAMINING ATTORNEY

**Int. Cl.: 28**

**Prior U.S. Cls.: 22, 23, 38, and 50**

**United States Patent and Trademark Office**

**Reg. No. 3,469,402**

**Registered July 15, 2008**

**TRADEMARK  
PRINCIPAL REGISTER**

**RUBBERBONE PRESS**

BARK OUTSIDE THE BOX, INC. (ILLINOIS CORPORATION)

821 CHICAGO AVENUE

DOWNERS GROVE, IL 60515

FOR: PET TOYS, IN CLASS 28 (U.S. CLS. 22, 23, 38 AND 50).

FIRST USE 12-28-2007; IN COMMERCE 12-28-2007.

THE MARK CONSISTS OF STANDARD CHARACTERS WITHOUT CLAIM TO ANY PARTICULAR FONT, STYLE, SIZE, OR COLOR.

NO CLAIM IS MADE TO THE EXCLUSIVE RIGHT TO USE "RUBBERBONE", APART FROM THE MARK AS SHOWN.

SN 78-676,555, FILED 7-22-2005.

INGRID C. EULIN, EXAMINING ATTORNEY

**Int. Cl.: 9**

**Prior U.S. Cls.: 21, 23, 26, 36, and 38**

**Reg. No. 3,469,403**

**United States Patent and Trademark Office**

**Registered July 15, 2008**

---

**TRADEMARK  
PRINCIPAL REGISTER**

**STEALTH MXP**

MEMORY EXPERTS INTERNATIONAL (MXI),  
INC. (CANADA FEDERAL CHARTER)  
2321 COHEN STREET  
ST-LAURENT, QUEBEC H4R 2N7

FOR: FLASH MEMORY CARDS, NAMELY, SE-  
CURE PORTABLE MEMORY STORAGE CARDS  
AND DRIVES, IN CLASS 9 (U.S. CLS. 21, 23, 26, 36  
AND 38).

FIRST USE 10-0-2005; IN COMMERCE 4-10-2006.

THE MARK CONSISTS OF STANDARD CHAR-  
ACTERS WITHOUT CLAIM TO ANY PARTICULAR  
FONT, STYLE, SIZE, OR COLOR.

NO CLAIM IS MADE TO THE EXCLUSIVE  
RIGHT TO USE "MXP", APART FROM THE MARK  
AS SHOWN.

SN 78-679,813, FILED 7-27-2005.

SARA THOMAS, EXAMINING ATTORNEY

**Int. Cl.: 3**

**Prior U.S. Cls.: 1, 4, 6, 50, 51, and 52**

**Reg. No. 3,469,404**

**United States Patent and Trademark Office**

**Registered July 15, 2008**

**TRADEMARK  
PRINCIPAL REGISTER**

**SKIN SELECTS**

PRODUCT QUEST MANUFACTURING, LLC  
(FLORIDA LTD LIAB CO)

330 CARSWELL AVENUE

HOLLY HILL, FL 32117

FOR: FACE AND BODY LOTIONS, IN CLASS 3  
(U.S. CLS. 1, 4, 6, 50, 51 AND 52).

FIRST USE 1-2-2008; IN COMMERCE 1-2-2008.

THE MARK CONSISTS OF STANDARD CHARACTERS WITHOUT CLAIM TO ANY PARTICULAR FONT, STYLE, SIZE, OR COLOR.

NO CLAIM IS MADE TO THE EXCLUSIVE RIGHT TO USE "SKIN", APART FROM THE MARK AS SHOWN.

SN 78-681,395, FILED 7-29-2005.

JORDAN BAKER, EXAMINING ATTORNEY

**Int. Cl.: 20**

**Prior U.S. Cls.: 2, 13, 22, 25, 32, and 50**

**United States Patent and Trademark Office**

**Reg. No. 3,469,405**

**Registered July 15, 2008**

**TRADEMARK  
PRINCIPAL REGISTER**



CREACIONES INDUSTRIALES SA DE CV (MEX-ICO CORPORATION)  
JOSE MARIA CHAVEZ #643  
AGUASCALIENTES, MEXICO 20000

FOR: FURNITURE, NAMELY, OFFICE DESK, CHAIRS AND TABLES, IN CLASS 20 (U.S. CLS. 2, 13, 22, 25, 32 AND 50).

FIRST USE 7-20-2006; IN COMMERCE 7-20-2006.

NO CLAIM IS MADE TO THE EXCLUSIVE RIGHT TO USE "LINEA ITALIA", APART FROM THE MARK AS SHOWN.

THE COLOR(S) GREEN, ORANGE AND WHITE IS/ARE CLAIMED AS A FEATURE OF THE MARK.

THE MARK CONSISTS OF THE WORD "LINEA" IN COLOR WHITE IN A GREEN SQUARE WITH AN

ORANGE LINE CROSSING IN THE MIDDLE OF THE SQUARE, INSIDE THE LETTER "A" IS FILLED WITH ORANGE COLOR, THE WORD "ITALIA" APPEARS IN WHITE INSIDE AN ORANGE SQUARE WITH A GREEN LINE CROSSING IN THE MIDDLE OF THE SQUARE, IN THE MIDDLE OF THE LETTERS "A" ARE FILLED WITH GREEN COLOR, BELOW THE WORDS "LINEA ITALIA" APPEARS THE WORD "CRISA" IN ORANGE COLOR WITH A GREEN LINE BEFORE AND AFTER THE WORD.

THE FOREIGN WORDING IN THE MARK TRANSLATES INTO ENGLISH AS "ITALY LINE CRISA".

SN 78-682,401, FILED 8-1-2005.

WILLIAM P. SHANAHAN, EXAMINING ATTORNEY

**Int. Cl.: 42**

**Prior U.S. Cls.: 100 and 101**

**United States Patent and Trademark Office**

**Reg. No. 3,469,406**

**Registered July 15, 2008**

**SERVICE MARK  
PRINCIPAL REGISTER**

PIONEERS OF THE INEVITABLE

POTI INC. (DELAWARE CORPORATION)  
585 HOWARD STREET, SECOND FLOOR  
SAN FRANCISCO, CA 94105

FOR: DESIGN, DEVELOPMENT, AND IMPLEMENTATION OF COMPUTER SOFTWARE FOR COMPUTER SYSTEMS AND APPLICATIONS; COMPUTER PROGRAMMING AND MAINTENANCE OF COMPUTER SOFTWARE; COMPUTER SOFTWARE CONSULTATION, IN CLASS 42 (U.S. CLS. 100 AND 101).

FIRST USE 8-0-2005; IN COMMERCE 8-0-2005.

THE MARK CONSISTS OF STANDARD CHARACTERS WITHOUT CLAIM TO ANY PARTICULAR FONT, STYLE, SIZE, OR COLOR.

SN 78-682,960, FILED 8-1-2005.

WARREN L. OLANDRIA, EXAMINING ATTORNEY

**Int. Cl.: 9**

**Prior U.S. Cls.: 21, 23, 26, 36, and 38**

**United States Patent and Trademark Office**

**Reg. No. 3,469,407**

**Registered July 15, 2008**

**TRADEMARK  
PRINCIPAL REGISTER**

PIONEERS OF THE INEVITABLE

POTI INC. (DELAWARE CORPORATION)  
585 HOWARD STREET, SECOND FLOOR  
SAN FRANCISCO, CA 94105

FOR: COMPUTER SOFTWARE FOR COMPUTER  
SYSTEM AND APPLICATION DEVELOPMENT, DE-  
PLOYMENT AND MANAGEMENT; COMPUTER  
SOFTWARE DEVELOPMENT TOOLS, IN CLASS 9  
(U.S. CLS. 21, 23, 26, 36 AND 38).

FIRST USE 8-0-2005; IN COMMERCE 8-0-2005.

THE MARK CONSISTS OF STANDARD CHAR-  
ACTERS WITHOUT CLAIM TO ANY PARTICULAR  
FONT, STYLE, SIZE, OR COLOR.

SN 78-683,021, FILED 8-1-2005.

WARREN L. OLANDRIA, EXAMINING ATTOR-  
NEY

**Int. Cls.: 35, 41, and 42**

**Prior U.S. Cls.: 100, 101, 102, and 107**

**United States Patent and Trademark Office**

**Reg. No. 3,469,408**

**Registered July 15, 2008**

**SERVICE MARK  
PRINCIPAL REGISTER**

**AVENEWS**

COPPERFIELD PUBLISHING, INC. (UTAH CORPORATION), DBA SALT LAKE CITY WEEKLY,  
248 SOUTH MAIN STREET  
SALT LAKE CITY, UT 84101

FOR: ADVERTISING, MARKETING AND PROMOTION SERVICES FOR OTHERS VIA NEWSPAPER, TELEVISION AND RADIO; ACCOUNTING SERVICES FOR OTHERS IN CONNECTION WITH NEWSPAPER RELATED SERVICES; BUSINESS MANAGEMENT OF NEWSPAPER, TELEVISION, AND RADIO SERVICES FOR OTHERS, IN CLASS 35 (U.S. CLS. 100, 101 AND 102).

FIRST USE 6-0-2005; IN COMMERCE 6-0-2005.

FOR: PUBLICATION OF NEWSPAPERS; PUBLICATION OF ELECTRONIC NEWSPAPERS ACCESSIBLE VIA A GLOBAL COMPUTER NETWORK, IN CLASS 41 (U.S. CLS. 100, 101 AND 107).

FIRST USE 3-0-2007; IN COMMERCE 3-0-2007.

FOR: HOSTING THE WEB SITES OF OTHERS, NAMELY, NEWSPAPERS, ON A COMPUTER SERVER; COMPUTER SERVICES, NAMELY, MANAGING WEB SITES FOR OTHERS IN CONNECTION WITH NEWSPAPER RELATED SERVICES, IN CLASS 42 (U.S. CLS. 100 AND 101).

FIRST USE 6-0-2005; IN COMMERCE 6-0-2005.

THE MARK CONSISTS OF STANDARD CHARACTERS WITHOUT CLAIM TO ANY PARTICULAR FONT, STYLE, SIZE, OR COLOR.

SN 78-685,145, FILED 8-3-2005.

KAPIL BHANOT, EXAMINING ATTORNEY



**Int. Cl.: 14**

**Prior U.S. Cls.: 2, 27, 28, and 50**

**United States Patent and Trademark Office**

**Reg. No. 3,469,409**

**Registered July 15, 2008**

**TRADEMARK  
PRINCIPAL REGISTER**

**FINDINGD'SIGN**

GOLDART INTERNATIONAL, INC. (NEW JERSEY CORPORATION)  
1305 FRANKLIN AVENUE SUITE 245  
GARDEN CITY, NY 11530

FOR: JEWELRY MADE IN WHOLE OR SIGNIFICANT PART OF GOLD AND SILVER, NAMELY, RINGS, BRACELETS, CHARMS, PENDANTS, NECKLACES, EARRINGS, WATCHES, CHAIN, PINS, IN CLASS 14 (U.S. CLS. 2, 27, 28 AND 50).

FIRST USE 1-3-2007; IN COMMERCE 1-3-2007.

THE MARK CONSISTS OF STANDARD CHARACTERS WITHOUT CLAIM TO ANY PARTICULAR FONT, STYLE, SIZE, OR COLOR.

SN 78-685,328, FILED 8-4-2005.

ALLISON SCHRODY, EXAMINING ATTORNEY

**Int. Cl.: 9**

**Prior U.S. Cls.: 21, 23, 26, 36, and 38**

**Reg. No. 3,469,410**

**United States Patent and Trademark Office**

**Registered July 15, 2008**

---

**TRADEMARK  
PRINCIPAL REGISTER**

**EWORKS**

EFILM, LLC (DELAWARE LTD LIAB CO)  
1146 NORTH LAS PALMAS AVENUE  
HOLLYWOOD, CA 90038

FIRST USE 11-0-2005; IN COMMERCE 11-0-2005.

FOR: COMPUTER PROGRAMS FOR EDITING THE COLOR OF MOTION PICTURE IMAGES, SOUND AND VIDEO; COMPUTER SOFTWARE FOR ORGANIZING AND VIEWING DIGITAL IMAGES; COMPUTER SOFTWARE FOR USE IN RELATION TO DIGITAL ANIMATION AND SPECIAL EFFECTS OF IMAGES, IN CLASS 9 (U.S. CLS. 21, 23, 26, 36 AND 38).

THE MARK CONSISTS OF STANDARD CHARACTERS WITHOUT CLAIM TO ANY PARTICULAR FONT, STYLE, SIZE, OR COLOR.

SN 78-687,791, FILED 8-8-2005.

DAVID YONTEF, EXAMINING ATTORNEY

**Int. Cl.: 9**

**Prior U.S. Cls.: 21, 23, 26, 36, and 38**

**United States Patent and Trademark Office**

**Reg. No. 3,469,411**

**Registered July 15, 2008**

**TRADEMARK  
PRINCIPAL REGISTER**

**PASSPORT**

PATENTS+TMS, P.C. (ILLINOIS CORPORATION)  
2849 W. ARMITAGE AVE.  
CHICAGO, IL 60647

THE MARK CONSISTS OF STANDARD CHARACTERS WITHOUT CLAIM TO ANY PARTICULAR FONT, STYLE, SIZE, OR COLOR.

FOR: COMPUTER PERIPHERALS, NAMELY, MOUSE PADS, IN CLASS 9 (U.S. CLS. 21, 23, 26, 36 AND 38).

SN 78-690,724, FILED 8-11-2005.

FIRST USE 11-30-2006; IN COMMERCE 11-30-2006.

JIM RINGLE, EXAMINING ATTORNEY

**Int. Cl.: 9**

**Prior U.S. Cls.: 21, 23, 26, 36, and 38**

**United States Patent and Trademark Office**

**Reg. No. 3,469,412**

**Registered July 15, 2008**

**TRADEMARK  
PRINCIPAL REGISTER**

**DATA-FLEKT**

SMS GROUP, L.L.C. (TEXAS LTD LIAB CO)  
28141 WALLER GLADISH ROAD  
WALLER, TX 77484

FIRST USE 8-5-2005; IN COMMERCE 11-4-2005.

FOR: SENSORS IN THE FORM OF ELECTRONIC PAVEMENT MARKERS WHICH STORE AND COMMUNICATE ELECTRONIC DATA REGARDING ADJACENT UTILITIES, UNDERGROUND UTILITIES, AND WATER AND SEWER INFRASTRUCTURES, IN CLASS 9 (U.S. CLS. 21, 23, 26, 36 AND 38).

THE MARK CONSISTS OF STANDARD CHARACTERS WITHOUT CLAIM TO ANY PARTICULAR FONT, STYLE, SIZE, OR COLOR.

SN 78-693,117, FILED 8-15-2005.

STEVEN PEREZ, EXAMINING ATTORNEY

**Int. Cl.: 41**

**Prior U.S. Cls.: 100, 101, and 107**

**United States Patent and Trademark Office**

**Reg. No. 3,469,413**

**Registered July 15, 2008**

**SERVICE MARK  
PRINCIPAL REGISTER**

**Way Safe**

FREEMAN, ANJA (UNITED STATES INDIVIDUAL)  
1522 MEADE AVE.  
SAN DIEGO, CA 92116

THE MARK CONSISTS OF STANDARD CHARACTERS WITHOUT CLAIM TO ANY PARTICULAR FONT, STYLE, SIZE, OR COLOR.

FOR: PROVIDING EDUCATIONAL INFORMATION IN THE FIELD OF PARENT/CHILD SAFETY, IN CLASS 41 (U.S. CLS. 100, 101 AND 107).

SN 78-697,733, FILED 8-22-2005.

FIRST USE 0-0-1992; IN COMMERCE 0-0-2005.

RONALD AIKENS, EXAMINING ATTORNEY

**Int. Cls.: 16, 41, and 45**

**Prior U.S. Cls.: 2, 5, 22, 23, 29, 37, 38, 50, 100, 101, and 107**

**Reg. No. 3,469,414**

**United States Patent and Trademark Office**

**Registered July 15, 2008**

**TRADEMARK  
SERVICE MARK  
PRINCIPAL REGISTER**



NATIONAL CENTER FOR MISSING AND EXPLOITED CHILDREN (D.C. CORPORATION)

CHARLES B. WANG BUILDING  
699 PRINCE STREET  
ALEXANDRIA, VA 22314

FOR: PRINTED FORMS, REPORTS, BROCHURES AND MANUALS ALL REGARDING THE IDENTIFICATION OF CHILD VICTIMS OF SEXUAL EXPLOITATION, IN CLASS 16 (U.S. CLS. 2, 5, 22, 23, 29, 37, 38 AND 50).

FIRST USE 3-15-2006; IN COMMERCE 3-15-2006.

FOR: EDUCATIONAL SERVICES, NAMELY, EDUCATING LAW ENFORCEMENT AND PROSECUTION PERSONNEL BY CONDUCTING PROGRAMS AND INSTRUCTION ABOUT IDENTIFYING CHILD VICTIMS OF SEXUAL EXPLOITATION, IN CLASS 41 (U.S. CLS. 100, 101 AND 107).

FIRST USE 3-15-2006; IN COMMERCE 3-15-2006.

FOR: IDENTIFICATION VERIFICATION SERVICES IN THE NATURE OF REVIEWING SEIZED MATERIAL FOR PREVIOUSLY IDENTIFIED CHILD VICTIMS TO ASSIST LAW ENFORCEMENT AND PROSECUTION WITH CHILD PORNOGRAPHY CONVICTIONS AND STRONGER SENTENCES AND PERFORMING IMAGE ANALYSIS ON PORNOGRAPHIC IMAGES CONTAINING UNIDENTIFIED CHILDREN TO DETERMINE THE LOCATION OF THE ABUSE AND TO ENGAGE LAW ENFORCEMENT TO IDENTIFY AND REMOVE CHILD

FROM SITE OF ABUSE, NAMELY, IDENTIFYING CHILD VICTIMS OF SEXUAL EXPLOITATION; PROVIDING INFORMATION ABOUT IDENTIFYING CHILD VICTIMS OF SEXUAL EXPLOITATION, IN CLASS 45 (U.S. CLS. 100 AND 101).

FIRST USE 3-15-2006; IN COMMERCE 3-15-2006.

OWNER OF U.S. REG. NOS. 1,494,608, 2,552,396, AND OTHERS.

NO CLAIM IS MADE TO THE EXCLUSIVE RIGHT TO USE "CHILD VICTIM IDENTIFICATION PROGRAM", APART FROM THE MARK AS SHOWN.

THE MARK CONSISTS OF THE LETTER "C" FORMING IN PART A PORTION OF A HAND CUFF ENCIRCLING A GLOBE ON WHICH THE IMAGE OF THREE CHILDREN HOLDING HANDS APPEARS, AND, THE WORDS "NATIONAL CENTER FOR MISSING & EXPLOITED CHILDREN", AND FORMING IN FURTHER PART THE LETTER "C" IN "CVIP", WHICH APPEARS ABOVE THE WORDS "CHILD VICTIM IDENTIFICATION PROGRAM", ALL WITHIN A RECTANGULAR BORDER.

SEC. 2(F) AS TO "NATIONAL CENTER FOR MISSING & EXPLOITED CHILDREN".

SN 78-698,146, FILED 8-23-2005.

HANNO RITTNER, EXAMINING ATTORNEY

**Int. Cl.: 25**

**Prior U.S. Cls.: 22 and 39**

**United States Patent and Trademark Office**

**Reg. No. 3,469,415**

**Registered July 15, 2008**

**TRADEMARK  
PRINCIPAL REGISTER**

# Killer California

LEIVA, MANUEL (UNITED STATES INDIVIDUAL)

8638 TILDEN AVE

PANORAMA CITY, CA 91402

FOR: SWEATERS, IN CLASS 25 (U.S. CLS. 22 AND 39).

FIRST USE 1-1-1996; IN COMMERCE 9-15-2007.

THE MARK CONSISTS OF STANDARD CHARACTERS WITHOUT CLAIM TO ANY PARTICULAR FONT, STYLE, SIZE, OR COLOR.

NO CLAIM IS MADE TO THE EXCLUSIVE RIGHT TO USE "CALIFORNIA", APART FROM THE MARK AS SHOWN.

SN 78-702,008, FILED 8-28-2005.

TRACY CROSS, EXAMINING ATTORNEY

**Int. Cl.: 24**

**Prior U.S. Cls.: 42 and 50**

**United States Patent and Trademark Office**

**Reg. No. 3,469,416**

**Registered July 15, 2008**

**TRADEMARK  
PRINCIPAL REGISTER**

# Embracing Hue

EMBRACING HUE LTD. (ARIZONA CORPORATION)  
4331 E. BASELINE RD., STE B-105-610  
GILBERT, AZ 85234

FOR: BED BLANKETS; BLANKET THROWS;  
BLANKETS FOR OUTDOOR USE; CHILDREN'S  
BLANKETS; PET BLANKETS; RECEIVING BLANKETS;  
SILK BED BLANKETS; SILK BLANKETS;  
WOOLLEN BLANKETS , IN CLASS 24 (U.S. CLS. 42  
AND 50).

FIRST USE 10-1-2006; IN COMMERCE 10-1-2006.

THE MARK CONSISTS OF STANDARD CHARACTERS WITHOUT CLAIM TO ANY PARTICULAR FONT, STYLE, SIZE, OR COLOR.

SN 78-706,151, FILED 9-2-2005.

YONG KIM, EXAMINING ATTORNEY



**Int. Cl.: 11**

**Prior U.S. Cls.: 13, 21, 23, 31, and 34**

**United States Patent and Trademark Office**

**Reg. No. 3,469,417**

**Registered July 15, 2008**

**TRADEMARK  
PRINCIPAL REGISTER**

**Hi-Tech Comfort**

KWAK, TAE Y. (UNITED STATES INDIVIDUAL)  
17855 FITCH AVE.  
IRVINE, CA 92614

FOR: WATER HEATERS FOR DOMESTIC USE;  
WATER HEATERS FOR DOMESTIC, COMMERCIAL  
AND INDUSTRIAL SPACE HEATING USE,  
IN CLASS 11 (U.S. CLS. 13, 21, 23, 31 AND 34).

FIRST USE 3-16-2007; IN COMMERCE 3-16-2007.

THE MARK CONSISTS OF STANDARD CHARACTERS  
WITHOUT CLAIM TO ANY PARTICULAR  
FONT, STYLE, SIZE, OR COLOR.

NO CLAIM IS MADE TO THE EXCLUSIVE  
RIGHT TO USE "HI-TECH", APART FROM THE  
MARK AS SHOWN.

SN 78-711,472, FILED 9-12-2005.

KAELIE KUNG, EXAMINING ATTORNEY

**Int. Cl.: 35**

**Prior U.S. Cls.: 100, 101, and 102**

**United States Patent and Trademark Office**

**Reg. No. 3,469,418**

**Registered July 15, 2008**

**SERVICE MARK  
PRINCIPAL REGISTER**

**Womens Dream Team**

TEAM BEACON CORPORATION (CALIFORNIA CORPORATION)  
44489 TOWN CENTER WAY, SUITE #D503  
PALM DESERT, CA 92260

FOR: ADVERTISING AND COMMERCIAL INFORMATION SERVICES, VIA THE INTERNET, IN CLASS 35 (U.S. CLS. 100, 101 AND 102).

FIRST USE 9-1-2005; IN COMMERCE 9-1-2005.

THE MARK CONSISTS OF STANDARD CHARACTERS WITHOUT CLAIM TO ANY PARTICULAR FONT, STYLE, SIZE, OR COLOR.

NO CLAIM IS MADE TO THE EXCLUSIVE RIGHT TO USE "WOMENS", APART FROM THE MARK AS SHOWN.

SN 78-715,176, FILED 9-17-2005.

EDWARD NELSON, EXAMINING ATTORNEY

**Int. Cl.: 1**

**Prior U.S. Cls.: 1, 5, 6, 10, 26, and 46**

**Reg. No. 3,469,419**

**United States Patent and Trademark Office**

**Registered July 15, 2008**

**TRADEMARK  
PRINCIPAL REGISTER**

**MOGUL**

MOGUL INTEGRATED SOLUTIONS, LLC (OHIO  
LTD LIAB CO)  
P.O. BOX 360581  
STRONGSVILLE, OH 44136

TANKS, PRE-HEATER COILS, BURNER HEADS,  
IN CLASS 1 (U.S. CLS. 1, 5, 6, 10, 26 AND 46).

FIRST USE 11-1-2003; IN COMMERCE 11-1-2003.

FOR: CHEMICAL COMPOUNDS FOR THE INHI-  
BITING AND REMOVING OF CARBON DEPOSIT,  
SOOT FORMATION, DISCOLORATION AND CON-  
GESTION IN BOILERS, FURNACES, PASTEURI-  
ZERS, STERILIZERS, BOTTLE WASHERS, ICE  
MACHINES, AFTER-COOLERS, INTER-COOLERS,  
BRINE TANKS, DIESEL ENGINES, FUEL OIL

THE MARK CONSISTS OF STANDARD CHAR-  
ACTERS WITHOUT CLAIM TO ANY PARTICULAR  
FONT, STYLE, SIZE, OR COLOR.

SN 78-717,212, FILED 9-21-2005.

PAUL E. FAHRENKOPF, EXAMINING ATTORNEY

**Int. Cl.: 41**

**Prior U.S. Cls.: 100, 101, and 107**

**United States Patent and Trademark Office**

**Reg. No. 3,469,420**

**Registered July 15, 2008**

**SERVICE MARK  
PRINCIPAL REGISTER**

**PENN FOSTER COLLEGE**

PENN FOSTER, INC. (PENNSYLVANIA CORPORATION)  
925 OAK STREET  
SCRANTON, PA 18615

FOR: PROVIDING PROGRAMS AND COURSES OF INSTRUCTION ON A VARIETY OF SUBJECTS AT THE VOCATIONAL AND COLLEGE LEVEL VIA DISTANCE LEARNING, IN CLASS 41 (U.S. CLS. 100, 101 AND 107).

FIRST USE 4-3-2006; IN COMMERCE 4-3-2006.

THE MARK CONSISTS OF STANDARD CHARACTERS WITHOUT CLAIM TO ANY PARTICULAR FONT, STYLE, SIZE, OR COLOR.

NO CLAIM IS MADE TO THE EXCLUSIVE RIGHT TO USE "PENN" AND "COLLEGE", APART FROM THE MARK AS SHOWN.

SN 78-717,454, FILED 9-21-2005.

PAUL CROWLEY, EXAMINING ATTORNEY

**Int. Cl.: 16**

**Prior U.S. Cls.: 2, 5, 22, 23, 29, 37, 38, and 50**

**Reg. No. 3,469,421**

**United States Patent and Trademark Office**

**Registered July 15, 2008**

**TRADEMARK  
PRINCIPAL REGISTER**

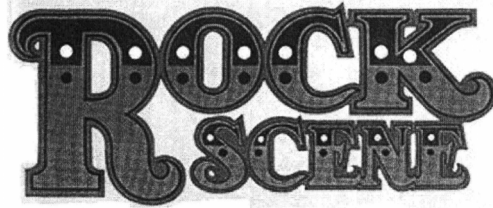

BARRETT, TARA (UNITED STATES INDIVIDUAL)  
C/O STEINBERG & RASKIN, P.C.  
1140 AVENUE OF THE AMERICAS, 15TH FLOOR  
NEW YORK, NY 100365803 AND  
WEISS, MARK (UNITED STATES INDIVIDUAL)  
185 THOUSAND OAKS DRIVE  
ATLANTIC HIGHLANDS, NJ 07716

FOR: PRINTED PUBLICATIONS, NAMELY, MAGAZINES, MAGAZINE SUPPLEMENTS, PAMPHLETS, AND BOOKS FEATURING MUSIC AND MUSICIANS, IN CLASS 16 (U.S. CLS. 2, 5, 22, 23, 29, 37, 38 AND 50).

FIRST USE 5-21-2008; IN COMMERCE 5-21-2008.

NO CLAIM IS MADE TO THE EXCLUSIVE RIGHT TO USE "ROCK", APART FROM THE MARK AS SHOWN.

THE MARK CONSISTS OF THE WORDING "ROCK SCENE" IN HIGHLY STYLIZED LETTERS. THE "R" IN "ROCK" APPEARS LARGER IN SIZE AND PROMINENCE THAN THE REMAINING LETTERS IN THE MARK. THE TERM "SCENE" APPEARS IN SMALLER LETTERS BENEATH "OCK" IN "ROCK".

SN 78-717,737, FILED 9-21-2005.

PETER B. BROMAGHIM, EXAMINING ATTORNEY

**Int. Cl.: 35**

**Prior U.S. Cls.: 100, 101, and 102**

**United States Patent and Trademark Office**

**Reg. No. 3,469,422**

**Registered July 15, 2008**

**SERVICE MARK  
PRINCIPAL REGISTER**

**BRIDGE TO EAST**

IWATANI, HIDEAKI (UNITED STATES INDIVIDUAL)  
2500 HUDSON TERRACE, 5N  
FORT LEE, NJ 070243529

FOR: ADVICE RELATING TO THE ORGANIZATION AND MANAGEMENT OF BUSINESS; ADVISORY SERVICE FOR ORGANIZATIONAL ISSUES AND BUSINESS ADMINISTRATION, WITH AND WITHOUT THE HELP OF ELECTRIC DATA BASE; ADVISORY SERVICE RELATING TO BUSINESS MANAGEMENT AND BUSINESS OPERATION; ADVISORY SERVICE RELATING TO SALE, PURCHASE AND COMMERCIALIZATION OF PRODUCTS; SURVEY, ANALYSIS, AND APPRAISALS OF ENTERPRISES; ARRANGING OF CONTRACTUAL SERVICE WITH THIRD PARTIES; ASSISTANCE IN BUSINESS MANAGEMENT AND PRODUCT COMMERCIALIZATION; ASSISTANCE TO INDUSTRIAL OR COMMERCIAL ENTERPRISES IN THE RUNNING OF THEIR BUSINESS; ASSISTANCE, ADVISORY SERVICES AND CONSULTANCY WITH REGARD TO BUSINESS PLANNING, BUSINESS ANALYSIS, BUSINESS MANAGEMENT, SURVEY, AND BUSINESS ORGANIZATION; BUSINESS ACQUISITION AND MER-

GER CONSULTATION; BUSINESS ADMINISTRATION CONSULTANCY; BUSINESS ADVICE AND ANALYSIS OF MARKET; BUSINESS ADVICE AND INFORMATION; BUSINESS CONSULTATION AND MANAGEMENT REGARDING MARKETING ACTIVITIES AND LAUNCHING OF NEW PRODUCTS; BUSINESS CONSULTATION SERVICE TO ASSIST NON-PROFIT ORGANIZATIONS IN PLANNING, MANAGING, AND CONDUCTING FUNDRAISING ACTIVITIES VIA A GLOBAL COMPUTER NETWORK; PROVIDING INFORMATION ABOUT COMMERCIAL BUSINESS AND COMMERCIAL INFORMATION VIA THE GLOBAL COMPUTER NETWORK, IN CLASS 35 (U.S. CLS. 100, 101 AND 102).

FIRST USE 7-7-2007; IN COMMERCE 7-7-2007.

THE MARK CONSISTS OF STANDARD CHARACTERS WITHOUT CLAIM TO ANY PARTICULAR FONT, STYLE, SIZE, OR COLOR.

SN 78-718,531, FILED 9-22-2005.

ARETHA SOMERVILLE, EXAMINING ATTORNEY

**Int. Cl.: 16**

**Prior U.S. Cls.: 2, 5, 22, 23, 29, 37, 38, and 50**

**Reg. No. 3,469,423**

**United States Patent and Trademark Office**

**Registered July 15, 2008**

---

**TRADEMARK  
PRINCIPAL REGISTER**

**FAMILY HOUR**

WORLD PEACE PARENTS FOUNDATION  
(UTAH CORPORATION)  
6300 SOUTH OLES LANE  
SALT LAKE CITY, UT 84171

FOR: PRINTED INSTRUCTIONAL, EDUCATIONAL, AND TEACHING MATERIALS IN THE FIELD OF PARENTING, IN CLASS 16 (U.S. CLS. 2, 5, 22, 23, 29, 37, 38 AND 50).

FIRST USE 12-20-2005; IN COMMERCE 12-20-2005.

THE MARK CONSISTS OF STANDARD CHARACTERS WITHOUT CLAIM TO ANY PARTICULAR FONT, STYLE, SIZE, OR COLOR.

NO CLAIM IS MADE TO THE EXCLUSIVE RIGHT TO USE "FAMILY", APART FROM THE MARK AS SHOWN.

SN 78-719,836, FILED 9-23-2005.

MONIQUE MILLER, EXAMINING ATTORNEY

**Int. Cl.: 30**

**Prior U.S. Cl.: 46**

**United States Patent and Trademark Office**

**Reg. No. 3,469,424**

**Registered July 15, 2008**

**TRADEMARK  
PRINCIPAL REGISTER**

**GLUTEN EVOLUTION**

SOBASKI, ANNA (UNITED STATES INDIVIDUAL)  
358 WESTDALE DRIVE  
IOWA CITY, IA 52246

FOR: BREAD MIXES, MIXES FOR BAKERY PRODUCTS, MUFFIN MIXES, IN CLASS 30 (U.S. CL. 46).

FIRST USE 3-15-2008; IN COMMERCE 3-15-2008.

THE MARK CONSISTS OF STANDARD CHARACTERS WITHOUT CLAIM TO ANY PARTICULAR FONT, STYLE, SIZE, OR COLOR.

NO CLAIM IS MADE TO THE EXCLUSIVE RIGHT TO USE "GLUTEN", APART FROM THE MARK AS SHOWN.

SN 78-724,218, FILED 9-30-2005.

MARGERY A. TIERNEY, EXAMINING ATTORNEY



**Int. Cls.: 9 and 41**

**Prior U.S. Cls.: 21, 23, 26, 36, 38, 100, 101, and 107**

**United States Patent and Trademark Office**

**Reg. No. 3,469,425**

**Registered July 15, 2008**

**TRADEMARK  
SERVICE MARK  
PRINCIPAL REGISTER**

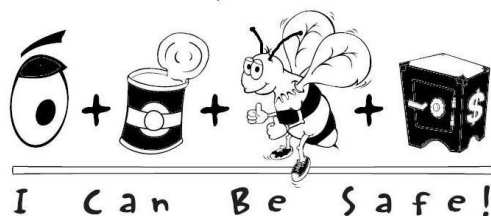

ANGELO, STEPHANIE (UNITED STATES INDIVIDUAL)

SUTIE A-105 #182  
1840 E. WARNER ROAD  
TEMPE, AZ 85284

FOR: AUDIO RECORDINGS FEATURING EDUCATIONAL INFORMATION RELATED TO SAFETY, IN CLASS 9 (U.S. CLS. 21, 23, 26, 36 AND 38).

FIRST USE 3-4-2007; IN COMMERCE 3-4-2007.

FOR: EDUCATION SERVICES, NAMELY, PROVIDING SEMINARS, WORKSHOPS AND CLASSES IN THE FIELD OF SAFETY AND THE DISTRIBUTION OF COURSE MATERIALS IN CONNECTION THEREWITH, IN CLASS 41 (U.S. CLS. 100, 101 AND 107).

FIRST USE 2-24-2004; IN COMMERCE 2-24-2004.

THE MARK CONSISTS OF A SINGLE EYEBALL WITH AN EYELID AND EYEBROW, FOLLOWED BY A PLUS SIGN, FOLLOWED BY AN OPEN CAN, FOLLOWED BY A PLUS SIGN, FOLLOWED BY A BUMBLE BEE, FOLLOWED BY A PLUS SIGN, FOLLOWED BY A SAFE. A STRAIGHT, HORIZONTAL LINE DESIGN-ELEMENT IS BENEATH THE ABOVE-MENTIONED DESIGN-ELEMENTS. THE WORDING I CAN BE SAFE! IS BENEATH THE ABOVE-MENTIONED STRAIGHT, HORIZONTAL LINE DESIGN-ELEMENT.

SN 78-724,232, FILED 9-30-2005.

ANTHONY RINKER, EXAMINING ATTORNEY

**Int. Cls.: 16, 20, 21, 22, 24, and 25**

**Prior U.S. Cls.: 1, 2, 5, 7, 13, 19, 22, 23, 25, 29, 30, 32, 33, 37, 38, 39, 40, 42, and 50**

**Reg. No. 3,469,426**

**United States Patent and Trademark Office**

**Registered July 15, 2008**

**TRADEMARK  
PRINCIPAL REGISTER**

**CRAZY ABOUT JEWELRY**

SUSAN EISEN, INC. (TEXAS CORPORATION)  
5857 N. MESA, SUITE 19  
EL PASO, TX 79912

FOR: PRINTED MATTER, NAMELY, NEWSLETTERS, BOOKS, NEWSPAPER COLUMNS, AND MAGAZINE COLUMNS RELATING TO JEWELRY; STATIONERY; NOTE PADS; POSTCARDS; CHRISTMAS CARDS; DECALS; STICKERS; BUMPER STICKERS; PAPER COASTERS, IN CLASS 16 (U.S. CLS. 2, 5, 22, 23, 29, 37, 38 AND 50).

FIRST USE 11-1-2006; IN COMMERCE 11-1-2006.

FOR: JEWELRY CONTAINERS, NAMELY, JEWELRY BOXES MADE OF WOOD AND PLASTIC WHICH ARE COVERED IN FABRIC, IN CLASS 20 (U.S. CLS. 2, 13, 22, 25, 32 AND 50).

FIRST USE 11-1-2006; IN COMMERCE 11-1-2006.

FOR: STACKABLE ORGANIZERS FOR STORING JEWELRY; JEWELRY POLISHING CLOTHS , IN CLASS 21 (U.S. CLS. 2, 13, 23, 29, 30, 33, 40 AND 50).

FIRST USE 11-1-2006; IN COMMERCE 11-1-2006.

FOR: JEWELRY STORAGE BAGS MADE OF FABRIC FOR STORING JEWELRY, IN CLASS 22 (U.S. CLS. 1, 2, 7, 19, 22, 42 AND 50).

FIRST USE 11-1-2006; IN COMMERCE 11-1-2006.

FOR: GOLF TOWELS; KITCHEN TOWELS; BAR TOWELS; DINING LINENS, IN CLASS 24 (U.S. CLS. 42 AND 50).

FIRST USE 11-1-2006; IN COMMERCE 11-1-2006.

FOR: CLOTHING, NAMELY, HEADWEAR, SHIRTS, PANTS, AND JACKETS , IN CLASS 25 (U.S. CLS. 22 AND 39).

FIRST USE 11-1-2006; IN COMMERCE 11-1-2006.

THE MARK CONSISTS OF STANDARD CHARACTERS WITHOUT CLAIM TO ANY PARTICULAR FONT, STYLE, SIZE, OR COLOR.

NO CLAIM IS MADE TO THE EXCLUSIVE RIGHT TO USE "JEWELRY", APART FROM THE MARK AS SHOWN.

SN 78-728,683, FILED 10-7-2005.

JAMES A. RAUEN, EXAMINING ATTORNEY

**Int. Cl.: 35**

**Prior U.S. Cls.: 100, 101, and 102**

**United States Patent and Trademark Office**

**Reg. No. 3,469,427**

**Registered July 15, 2008**

**SERVICE MARK  
PRINCIPAL REGISTER**

**PETSENSE**

PETSENSE, INC. (DELAWARE CORPORATION)  
14301 N. 87TH STREET, STE. 203  
SCOTTSDALE, AZ 852603686

FOR: RETAIL PET SUPPLY STORE SERVICES, IN  
CLASS 35 (U.S. CLS. 100, 101 AND 102).

FIRST USE 10-17-2005; IN COMMERCE 10-17-2005.

THE MARK CONSISTS OF STANDARD CHAR-  
ACTERS WITHOUT CLAIM TO ANY PARTICULAR  
FONT, STYLE, SIZE, OR COLOR.

OWNER OF U.S. REG. NO. 2,046,698.

SN 78-729,344, FILED 10-7-2005.

CURTIS FRENCH, EXAMINING ATTORNEY

Prior U.S. Cl.: A

United States Patent and Trademark Office

Reg. No. 3,469,428

Registered July 15, 2008

CERTIFICATION MARK  
GOODS  
PRINCIPAL REGISTER



**COMPOSTABLE**

INTERNATIONAL BIODEGRADABLE PRODUCTS INSTITUTE, INC. (DELAWARE CORPORATION)  
331 WEST 57TH STREET SUITE 415  
NEW YORK, NY 10019

FOR: POLYMERIC PRODUCTS, IN CLASS A (U.S. CL. A).

FIRST USE 7-30-2007; IN COMMERCE 7-30-2007.

OWNER OF U.S. REG. NO. 2,783,960.

NO CLAIM IS MADE TO THE EXCLUSIVE RIGHT TO USE "COMPOSTABLE", APART FROM THE MARK AS SHOWN.

THE MARK CONSISTS OF A STYLIZED LEAF AND TREE WITHIN A CIRCLE HAVING THE WORDING "COMPOSTABLE" BELOW THE DESIGN.

THE CERTIFICATION MARK, AS USED BY PERSONS AUTHORIZED BY THE CERTIFIER, CERTIFIES THAT THE POLYMERIC/PLASTIC PRODUCT WILL COMPOST QUICKLY, COMPLETELY AND SAFELY.

SN 78-729,427, FILED 10-8-2005.

DOMINIC FATHY, EXAMINING ATTORNEY

**Int. Cl.: 41**

**Prior U.S. Cls.: 100, 101, and 107**

**United States Patent and Trademark Office**

**Reg. No. 3,469,429**

**Registered July 15, 2008**

**SERVICE MARK  
PRINCIPAL REGISTER**

PENN FOSTER CAREER SCHOOL

PENN FOSTER, INC. (PENNSYLVANIA CORPORATION)  
925 OAK STREET  
SCRANTON, PA 18615

FOR: PROVIDING PROGRAMS AND COURSES OF INSTRUCTION ON A VARIETY OF SUBJECTS AT THE HIGH SCHOOL, VOCATIONAL AND COLLEGE LEVEL VIA DISTANCE LEARNING, IN CLASS 41 (U.S. CLS. 100, 101 AND 107).

FIRST USE 12-19-2005; IN COMMERCE 12-19-2005.

THE MARK CONSISTS OF STANDARD CHARACTERS WITHOUT CLAIM TO ANY PARTICULAR FONT, STYLE, SIZE, OR COLOR.

NO CLAIM IS MADE TO THE EXCLUSIVE RIGHT TO USE "PENN" AND "CAREER SCHOOL", APART FROM THE MARK AS SHOWN.

SN 78-729,961, FILED 10-10-2005.

PAUL CROWLEY, EXAMINING ATTORNEY

**Int. Cls.: 35 and 43**

**Prior U.S. Cls.: 100, 101, and 102**

**United States Patent and Trademark Office**

**Reg. No. 3,469,430**

**Registered July 15, 2008**

**SERVICE MARK  
PRINCIPAL REGISTER**

**NEED SOME R&R? GO B&B!**

GOLDREYER INCORPORATED (TEXAS CORPORATION)  
700 BRAZOS STREET SUITE B-700  
AUSTIN, TX 787013213

FOR: PROVIDING ONLINE BUSINESS DIRECTORIES FEATURING BED AND BREAKFASTS, INNS, AND OTHER TEMPORARY LODGING FACILITIES, IN CLASS 35 (U.S. CLS. 100, 101 AND 102).

FIRST USE 4-15-2008; IN COMMERCE 4-15-2008.

FOR: PROVIDING ONLINE RESERVATIONS SERVICES FOR BED AND BREAKFASTS, INNS,

AND OTHER TEMPORARY LODGING FACILITIES, IN CLASS 43 (U.S. CLS. 100 AND 101).

FIRST USE 4-15-2008; IN COMMERCE 4-15-2008.

THE MARK CONSISTS OF STANDARD CHARACTERS WITHOUT CLAIM TO ANY PARTICULAR FONT, STYLE, SIZE, OR COLOR.

SN 78-730,130, FILED 10-10-2005.

INGRID C. EULIN, EXAMINING ATTORNEY

**Int. Cl.: 44**

**Prior U.S. Cls.: 100 and 101**

**United States Patent and Trademark Office**

**Reg. No. 3,469,431**

**Registered July 15, 2008**

**SERVICE MARK  
PRINCIPAL REGISTER**

**GETBCFACTS**

ASTRAZENECA UK LIMITED (UNITED KING-  
DOM LTD LIAB CO)  
15 STANHOPE GATE  
LONDON, ENGLAND W1Y 6LN

THE MARK CONSISTS OF STANDARD CHAR-  
ACTERS WITHOUT CLAIM TO ANY PARTICULAR  
FONT, STYLE, SIZE, OR COLOR.

FOR: PROVISION OF INFORMATION AND AD-  
VICE RELATING TO THE DIAGNOSIS AND  
TREATMENT OF CANCER, IN CLASS 44 (U.S.  
CLS. 100 AND 101).

SN 78-730,580, FILED 10-11-2005.

FIRST USE 9-30-2005; IN COMMERCE 9-30-2005.

ANGELA M. MICHELI, EXAMINING ATTORNEY

**Int. Cl.: 25**

**Prior U.S. Cls.: 22 and 39**

**United States Patent and Trademark Office**

**Reg. No. 3,469,432**

**Registered July 15, 2008**

**TRADEMARK  
PRINCIPAL REGISTER**

**Bold Force**

PARIS ACCESSORIES, INC. (NEW YORK CORPORATION)  
350 FIFTH AVENUE 70TH FLOOR  
NEW YORK, NY 10118

THE MARK CONSISTS OF STANDARD CHARACTERS WITHOUT CLAIM TO ANY PARTICULAR FONT, STYLE, SIZE, OR COLOR.

FOR: CLOTHING AND FOOTWEAR, NAMELY, SCARVES, GLOVES, SOCKS, BANDANAS, HATS, IN CLASS 25 (U.S. CLS. 22 AND 39).

SN 78-730,593, FILED 10-11-2005.

FIRST USE 2-29-2008; IN COMMERCE 2-29-2008.

AMY ALFIERI, EXAMINING ATTORNEY



Int. Cls.: 36 and 42

Prior U.S. Cls.: 100, 101, and 102

United States Patent and Trademark Office

Reg. No. 3,469,433

Registered July 15, 2008

**SERVICE MARK  
PRINCIPAL REGISTER**



FNF INTELLECTUAL PROPERTY HOLDINGS,  
INC. (DELAWARE CORPORATION)

601 RIVERSIDE AVENUE  
JACKSONVILLE, FL 32204

FOR: TITLE INSURANCE SERVICES, NAMELY, AGENCY, BROKERAGE, UNDERWRITING, CONSULTANCY AND INFORMATION SERVICES FOR REAL PROPERTY LOCATED WITHIN AND OUTSIDE OF THE UNITED STATES; SERVICES FOR ORIGINATION OF MORTGAGE LOANS, REAL ESTATE TRANSACTIONS FOR OTHERS, NAMELY, REAL ESTATE EVALUATION, FINANCIAL DISBURSEMENT PROCESSING SERVICES, NAMELY, FINANCIAL CLEARING HOUSE, REAL ESTATE ESCROW AND IMPOUNDING SERVICES, CREDIT REPORTING SERVICES, REAL ESTATE LOAN DEFAULT MANAGEMENT SERVICES; FINANCIAL TRUST MANAGEMENT SERVICES, TRUSTEE'S SALE GUARANTEE SERVICES, NAMELY, GUARANTEE ASSURANCE UNDERWRITING, MORTGAGE LENDING SERVICES, FORECLOSURE AND BANKRUPTCY MANAGEMENT SERVICES, AND FINANCIAL DISCLOSURE REPORTING SERVICES; REAL ESTATE AND PERSONAL PROPERTY TRUSTEE SERVICES IN THE NATURE OF ACTING AS A QUALIFIED INTERMEDIARY FOR TAX-DEFERRED EXCHANGES FOR REAL PROPERTY AND PERSONAL PROPERTY ON OR USED IN CONNECTION WITH SUCH REAL PROPERTY AND PERSONAL PROPERTY; REAL ESTATE SERVICES FOR TIMESHARE AND RESORT PROPERTIES, NAMELY, UNDERWRITING TITLE INSURANCE, UNDERWRITING TITLE INSURANCE POLICIES, ESCROW SERVICES AND REAL ESTATE LISTINGS FOR RESALE, AND FORECLOSURE SERVICES, AND COMMERCIAL FINANCE SERVICES, NAMELY, SERVICES FOR ORIGINATING, FUNDING, ACQUIRING, SELLING, SECURITIZING AND SERVICING NON-CANCELABLE EQUIPMENT LEASES FOR OTHERS, IN CLASS 36 (U.S. CLS. 100, 101 AND 102).

FIRST USE 5-15-2008; IN COMMERCE 5-15-2008.

FOR: REAL ESTATE INSPECTION SERVICES TO DETERMINE A PROPERTY'S CONDITION, VERIFICATION OF OCCUPANCY AND INTERVIEW OF BORROWER; SERVICES FOR CLOSING AND SERVICING REAL ESTATE TRANSACTIONS FOR OTHERS, NAMELY, TITLE SEARCH SERVICES IN THE NATURE OF DUE DILIGENCE AND RESEARCH SERVICES DESIGNED TO RESOLVE AND RETRIEVE MISSING OR DEFECTIVE DOCUMENTS AND TO OBTAIN CERTIFIED COPIES OF DOCUMENTS AND CHAIN-OF-TITLE VERIFICATION; AND LEGAL SERVICES IN THE FIELD OF REAL ESTATE; CLOSING AND SERVICING REAL ESTATE TRANSACTIONS FOR OTHERS, NAMELY, REAL ESTATE CLOSING AND SETTLEMENT SERVICES; REAL ESTATE TRANSACTIONS FOR OTHERS, NAMELY, DEFAULT TITLE, NAMELY, TITLE SEARCHING; REAL ESTATE FLOOD DETERMINATION SERVICES, NAMELY, EVALUATION OF REAL ESTATE TO DETERMINE IF IT LIES WITHIN A FLOOD HAZARD AREA AND REQUIRES FLOOD INSURANCE; REAL ESTATE FLOOD HAZARD COMPLIANCE SERVICES, NAMELY, SERVICES IN THE NATURE OF TRACKING CHANGES IN FEDERAL FLOOD PLAIN DESIGNATIONS; MORTGAGE ASSIGNMENT AND RELEASE PREPARATION SERVICES, IN CLASS 42 (U.S. CLS. 100 AND 101).

FIRST USE 5-15-2008; IN COMMERCE 5-15-2008.

OWNER OF U.S. REG. NOS. 1,305,281 AND 2,941,140.

NO CLAIM IS MADE TO THE EXCLUSIVE RIGHT TO USE "TITLE GROUP", APART FROM THE MARK AS SHOWN.

SEC. 2(F) AS TO "NATIONAL".

SN 78-731,311, FILED 10-12-2005.

MARLENE BELL, EXAMINING ATTORNEY

**Int. Cl.: 25**

**Prior U.S. Cls.: 22 and 39**

**United States Patent and Trademark Office**

**Reg. No. 3,469,434**

**Registered July 15, 2008**

**TRADEMARK  
PRINCIPAL REGISTER**



RED WING SHOE COMPANY, INC. (MINNESOTA CORPORATION)  
314 MAIN STREET RIVERFRONT CENTRE  
RED WING, MN 55066

OWNER OF U.S. REG. NOS. 1,033,109 AND 2,024,160.

FOR: CLOTHING, BOOTS, PROTECTIVE FOOTWEAR, IN CLASS 25 (U.S. CLS. 22 AND 39).

SN 78-731,774, FILED 10-12-2005.

FIRST USE 10-0-2005; IN COMMERCE 10-0-2005.

GIANCARLO CASTRO, EXAMINING ATTORNEY

**Int. Cls.: 9, 16, and 45**

**Prior U.S. Cls.: 2, 5, 21, 22, 23, 26, 29, 36, 37, 38, 50,  
100, and 101**

**Reg. No. 3,469,435**

**United States Patent and Trademark Office**

**Registered July 15, 2008**

**TRADEMARK  
SERVICE MARK  
PRINCIPAL REGISTER**

**PARTNERSHIP FOR MISSIONAL  
CHURCH**

CHURCH INNOVATIONS INSTITUTE (MINNE-  
SOTA NON-PROFIT CORPORATION)  
SUITE 103  
1563 COMO AVENUE  
SAINT PAUL, MN 55108

FOR: PRERECORDED VIDEOTAPES, PRERE-  
CORDED CDS AND PRERECORDED DVDS, ALL  
IN THE FIELD OF RELIGION, IN CLASS 9 (U.S. CLS.  
21, 23, 26, 36 AND 38).

FIRST USE 12-31-2005; IN COMMERCE 12-31-2005.

FOR: TRAINING MANUALS, NEWSLETTERS,  
BROCHURES, HANDOUTS AND JOURNALS, ALL  
IN THE FIELD OF RELIGION, IN CLASS 16 (U.S.  
CLS. 2, 5, 22, 23, 29, 37, 38 AND 50).

FIRST USE 12-31-2005; IN COMMERCE 12-31-2005.

FOR: PROVIDING CONSULTING SERVICES  
AND ONLINE INFORMATION SERVICES, ALL IN  
THE FIELD OF RELIGION, IN CLASS 45 (U.S. CLS.  
100 AND 101).

FIRST USE 12-31-2005; IN COMMERCE 12-31-2005.

THE MARK CONSISTS OF STANDARD CHAR-  
ACTERS WITHOUT CLAIM TO ANY PARTICULAR  
FONT, STYLE, SIZE, OR COLOR.

NO CLAIM IS MADE TO THE EXCLUSIVE  
RIGHT TO USE "MISSIONAL CHURCH", APART  
FROM THE MARK AS SHOWN.

SN 78-732,003, FILED 10-12-2005.

RUSS HERMAN, EXAMINING ATTORNEY

**Int. Cl.: 44**

**Prior U.S. Cls.: 100 and 101**

**United States Patent and Trademark Office**

**Reg. No. 3,469,436**

**Registered July 15, 2008**

**SERVICE MARK  
PRINCIPAL REGISTER**

SOTTOPELLE VITALITY CENTER

SOTTOPELLE, INC. (ARIZONA CORPORATION)  
SUITE 101  
8412 EAST SHEA  
SCOTTSDALE, AZ 85620

FOR: MEDICAL CLINICS; MEDICAL CONSULTATIONS; MEDICAL SERVICES; PROVIDING MEDICAL INFORMATION; PROVIDING HEALTH INFORMATION; DIETARY AND NUTRITIONAL GUIDANCE; MEDICAL SERVICES, NAMELY, OBSTETRIC AND GYNECOLOGY SERVICES; AND HORMONE REPLACEMENT THERAPY, IN CLASS 44 (U.S. CLS. 100 AND 101).

FIRST USE 4-0-2006; IN COMMERCE 4-0-2006.

THE MARK CONSISTS OF STANDARD CHARACTERS WITHOUT CLAIM TO ANY PARTICULAR FONT, STYLE, SIZE, OR COLOR.

OWNER OF U.S. REG. NO. 2,916,806.

NO CLAIM IS MADE TO THE EXCLUSIVE RIGHT TO USE "SOTTO PELLE" OR "CENTER", APART FROM THE MARK AS SHOWN.

THE FOREIGN WORDING "SOTTO PELLE" IN THE MARK TRANSLATES INTO ENGLISH AS UNDER SKIN.

SN 78-732,077, FILED 10-12-2005.

STEVEN PEREZ, EXAMINING ATTORNEY

**Int. Cl.: 41**

**Prior U.S. Cls.: 100, 101, and 107**

**United States Patent and Trademark Office**

**Reg. No. 3,469,437**

**Registered July 15, 2008**

**SERVICE MARK  
PRINCIPAL REGISTER**

**GET ED**

DISNEY ENTERPRISES, INC. (DELAWARE CORPORATION)  
500 SOUTH BUENA VISTA STREET  
BURBANK, CA 91521

FOR: PRODUCTION OF ENTERTAINMENT SHOWS AND INTERACTIVE PROGRAMS FOR DISTRIBUTION VIA TELEVISION, CABLE, SATELLITE, AUDIO AND ELECTRONIC MEANS; PROVISION OF TELEVISION SHOWS VIA COMMUNICATION AND COMPUTER NETWORKS, IN CLASS 41 (U.S. CLS. 100, 101 AND 107).

FIRST USE 9-19-2005; IN COMMERCE 9-19-2005.

THE MARK CONSISTS OF STANDARD CHARACTERS WITHOUT CLAIM TO ANY PARTICULAR FONT, STYLE, SIZE, OR COLOR.

SN 78-732,894, FILED 10-13-2005.

ANNE E. GUSTASON, EXAMINING ATTORNEY

**Int. Cl.: 25**

**Prior U.S. Cls.: 22 and 39**

**United States Patent and Trademark Office**

**Reg. No. 3,469,438**

**Registered July 15, 2008**

---

**TRADEMARK  
PRINCIPAL REGISTER**

**Triple X Racing**

CAMPBELL, JONATHAN M (UNITED STATES  
INDIVIDUAL)

128 HERITAGE LANE

EASLEY, SC 29642

FOR: CLOTHING, NAMELY, SHIRTS, JACKETS  
AND HATS, IN CLASS 25 (U.S. CLS. 22 AND 39).

FIRST USE 4-28-2008; IN COMMERCE 4-29-2008.

THE MARK CONSISTS OF STANDARD CHAR-  
ACTERS WITHOUT CLAIM TO ANY PARTICULAR  
FONT, STYLE, SIZE, OR COLOR.

NO CLAIM IS MADE TO THE EXCLUSIVE  
RIGHT TO USE "RACING", APART FROM THE  
MARK AS SHOWN.

SN 78-733,049, FILED 10-13-2005.

EDWARD FENNESSY, EXAMINING ATTORNEY

**Int. Cl.: 28**

**Prior U.S. Cls.: 22, 23, 38, and 50**

**United States Patent and Trademark Office**

**Reg. No. 3,469,439**

**Registered July 15, 2008**

**TRADEMARK  
PRINCIPAL REGISTER**

**REVOLVER JOINT**

KAIYODO CO., LTD. (JAPAN CORPORATION)  
19-3, YANAGI-MACHI, KADOMA-SHI  
OSAKA, JAPAN

FOR: TOY FIGURES, TOY ACTION FIGURES,  
DOLLS, COLLECTIBLE TOY MINIATURE FIG-  
URES, TOY FIGURINES OF MODELED PLASTIC,  
TOY FIGURINES OF MODELED RESIN, TOY FIG-  
URINES OF MODELED RUBBER, TOY FIGURINES  
OF COMMON METAL, TOY FIGURE PLAYSETS,  
AND ACCESSORIES THEREFOR, IN CLASS 28 (U.S.  
CLS. 22, 23, 38 AND 50).

FIRST USE 5-0-2006; IN COMMERCE 5-0-2006.

THE MARK CONSISTS OF STANDARD CHAR-  
ACTERS WITHOUT CLAIM TO ANY PARTICULAR  
FONT, STYLE, SIZE, OR COLOR.

NO CLAIM IS MADE TO THE EXCLUSIVE  
RIGHT TO USE "REVOLVER", APART FROM THE  
MARK AS SHOWN.

SN 78-735,343, FILED 10-18-2005.

GEORGIA CARTY, EXAMINING ATTORNEY



**Int. Cl.: 24**

**Prior U.S. Cls.: 42 and 50**

**United States Patent and Trademark Office**

**Reg. No. 3,469,440**

**Registered July 15, 2008**

**TRADEMARK  
PRINCIPAL REGISTER**

**CRAFTER'S FABRIC**

CRANSTON PRINT WORKS COMPANY (RHODE  
ISLAND CORPORATION)  
1381 CRANSTON STREET  
CRANSTON, RI 02920

FOR: PRE-PRINTED FABRICS CONSISTING OF  
COTTON AND COTTON POLYESTER FOR SEWING  
AND HOME DECORATING, BUT NOT FOR USE  
ON OR WITH FABRIC SHEETS FOR PRINTING  
ELECTRONIC IMAGES , IN CLASS 24 (U.S. CLS. 42  
AND 50).

FIRST USE 0-0-2004; IN COMMERCE 0-0-2004.

THE MARK CONSISTS OF STANDARD CHAR-  
ACTERS WITHOUT CLAIM TO ANY PARTICULAR  
FONT, STYLE, SIZE, OR COLOR.

NO CLAIM IS MADE TO THE EXCLUSIVE  
RIGHT TO USE "FABRIC", APART FROM THE  
MARK AS SHOWN.

SN 78-736,082, FILED 10-19-2005.

CHRISTOPHER BUONGIORNO, EXAMINING AT-  
TORNEY

**Int. Cls.: 9, 16, 35, 36, 37, 38, 40, 41, 42, 43, 44, and 45**

**Prior U.S. Cls.: 2, 5, 21, 22, 23, 26, 29, 36, 37, 38, 50,  
100, 101, 102, 103, 104, 106, and 107**

**Reg. No. 3,469,441**

**United States Patent and Trademark Office**

**Registered July 15, 2008**

**TRADEMARK  
SERVICE MARK  
PRINCIPAL REGISTER**

**QUAMUT**

BARNES & NOBLE, INC. (DELAWARE CORPORATION)  
122 FIFTH AVENUE  
NEW YORK, NY 10011

FOR: DOWNLOADABLE ELECTRONIC PUBLICATIONS IN THE NATURE OF CHARTS, BOOKS, GUIDES AND CALENDARS ON VARIOUS HOW TO TOPICS, NAMELY, 401(K)S, 403(B)S, AND IRAS, 529S AND COLLEGE SAVINGS PLANS, ASTROLOGY, BASEBALL RULES, BEADING, BICYCLE MAINTENANCE, BLACKJACK, BLOGGING, BRIDGE, BUILDING A WEBSITE, BUSINESS ETIQUETTE, BUSINESS WRITING, BUYING A CAR, CALLIGRAPHY, CHESS, COOKING BASICS, CREDIT REPAIR, CROCHETING, DEBT CONSOLIDATION, DIGITAL CAMERAS, DIGITAL PHOTOS, DOG BREEDS, EMBROIDERY, ETF INVESTING, FENG SHUI, FOOTBALL RULES, FRESHWATER AQUARIUMS, GOLF, GRILLING AND BARBECUE, GUITAR CHORDS, HAM RADIO, HARMONICA, HOME BREWING, HOME IMPROVEMENT, ELECTRICAL, HOME IMPROVEMENT, PLUMBING, HOUSE PLANTS, HOUSEHOLD CLEANING AND ORGANIZATION, HYBRID CARS, IDENTITY THEFT, INSURANCE, INTERNET SEARCH ENGINES, INVESTING BASICS, PORTABLE DIGITAL MUSIC PLAYERS, JEWELRY MAKING, KNOTS, MARATHON TRAINING, MORTGAGES, MUSICAL INSTRUMENTS, MUTUAL FUND INVESTING, ORGANIC COOKING, PC BASICS, PERFORMANCE APPRAISALS, PERSONAL BANKRUPTCY, PERSONAL FINANCE, PHOTO EDITING COMPUTER PROGRAMS, PIANO, PILATES, PLANNING A WEDDING, PLANNING MEALS, PODCASTING, PREGNANCY, QUILTING, QUITTING SMOKING, READING FINANCIAL REPORTS, READING MUSIC, REAL ESTATE INVESTING, RETIREMENT, SALTWATER AQUARIUMS, SELLING A HOME, SEWING, SOCCER RULES, SONGWRITING, SPAM, VIRUSES AND SPYWARE,

STARTING AN ONLINE AUCTION BUSINESS, STARTING OWN BUSINESS, STOCK INVESTING, STOCK TRADING, STRETCHING, SUSHI, TAI CHI, POKER AND CARD GAMES, VITAMINS AND NUTRITIONAL SUPPLEMENTS, VOIP, WEIGHT LOSS BASICS, WEIGHT TRAINING BASICS, WEIGHT TRAINING FOR ABS, LEGS AND BUTT; WEIGHT TRAINING FOR CHEST, BACK AND ARMS, AND YOGA, IN CLASS 9 (U.S. CLS. 21, 23, 26, 36 AND 38).

FIRST USE 10-15-2007; IN COMMERCE 10-15-2007.

FOR: SERIES OF PRINTED CHARTS, BOOKS, PRINTED GUIDES AND CALENDARS ON VARIOUS HOW TO TOPICS, NAMELY, 401(K)S, 403(B)S, AND IRAS, 529S AND COLLEGE SAVINGS PLANS, ASTROLOGY, BASEBALL RULES, BEADING, BICYCLE MAINTENANCE, BLACKJACK, BLOGGING, BRIDGE, BUILDING A WEBSITE, BUSINESS ETIQUETTE, BUSINESS WRITING, BUYING A CAR, CALLIGRAPHY, CHESS, COOKING BASICS, CREDIT REPAIR, CROCHETING, DEBT CONSOLIDATION, DIGITAL CAMERAS, DIGITAL PHOTOS, DOG BREEDS, EMBROIDERY, ETF INVESTING, FENG SHUI, FOOTBALL RULES, FRESHWATER AQUARIUMS, GOLF, GRILLING AND BARBECUE, GUITAR CHORDS, HAM RADIO, HARMONICA, HOME BREWING, HOME IMPROVEMENT, ELECTRICAL HOME IMPROVEMENT, PLUMBING, HOUSE PLANTS, HOUSEHOLD CLEANING AND ORGANIZATION, HYBRID CARS, IDENTITY THEFT, INSURANCE, INTERNET SEARCH ENGINES, INVESTING BASICS, PORTABLE DIGITAL MUSIC PLAYERS, JEWELRY MAKING, KNOTS, MARATHON TRAINING, MORTGAGES, MUSICAL INSTRUMENTS, MUTUAL FUND INVESTING, ORGANIC COOKING, PC BASICS, PERFORMANCE APPRAISALS, PERSONAL BANKRUPTCY, PERSONAL FINANCE, PHOTO EDITING COMPUTER PROGRAMS, PIANO, PILATES, PLANNING A WEDDING, PLANNING MEALS, PODCASTING, PREGNANCY, QUILTING, QUITTING SMOKING, READING FINANCIAL REPORTS, READING MUSIC, REAL ESTATE INVESTING, RETIREMENT, SALTWATER AQUARIUMS, SELLING A HOME, SEWING, SOCCER RULES, SONGWRITING, SPAM, VIRUSES AND SPYWARE,

NAL BANKRUPTCY, PERSONAL FINANCE, PHOTO EDITING COMPUTER PROGRAMS, PIANO, PILATES, PLANNING A WEDDING, PLANNING MEALS, PODCASTING, PREGNANCY, QUILTING, QUITTING SMOKING, READING FINANCIAL REPORTS, READING MUSIC, REAL ESTATE INVESTING, RETIREMENT, SALTWATER AQUARIUMS, SELLING A HOME, SEWING, SOCCER RULES, SONGWRITING, SPAM, VIRUSES AND SPYWARE, STARTING AN ONLINE AUCTION BUSINESS, STARTING OWN BUSINESS, STOCK INVESTING, STOCK TRADING, STRETCHING, SUSHI, TAI CHI, POKER AND CARD GAMES, VITAMINS AND NUTRITIONAL SUPPLEMENTS, VOIP, WEIGHT LOSS BASICS, WEIGHT TRAINING BASICS, WEIGHT TRAINING FOR ABS, LEGS AND BUTT, WEIGHT TRAINING FOR CHEST, BACK AND ARMS, AND YOGA, IN CLASS 16 (U.S. CLS. 2, 5, 22, 23, 29, 37, 38 AND 50).

FIRST USE 10-15-2007; IN COMMERCE 10-15-2007.

FOR: PROVIDING NON-DOWNLOADABLE CONTENT INFORMATION ON A WEB SITE ON A GLOBAL COMPUTER NETWORK, FEATURING VARIOUS "HOW TO" TOPICS, IN THE FIELDS OF BUSINESS ADVICE AND INFORMATION, FEATURING STARTING AN ONLINE AUCTION BUSINESS, STARTING YOUR OWN BUSINESS, OBTAINING INSURANCE; BUYING A CAR, PURCHASING A MORTGAGE; READING FINANCIAL REPORTS, SELLING A HOME; PERFORMANCE APPRAISALS, IN CLASS 35 (U.S. CLS. 100, 101 AND 102).

FIRST USE 10-15-2007; IN COMMERCE 10-15-2007.

FOR: PROVIDING NON-DOWNLOADABLE CONTENT INFORMATION ON A WEB SITE ON A GLOBAL COMPUTER NETWORK, FEATURING VARIOUS "HOW TO" TOPICS, IN THE FIELDS OF PERSONAL FINANCES AND INVESTMENTS, ON INVESTING IN 401(K)'S, 403(B)'S, IRA'S, 529'S AND COLLEGE SAVINGS PLANS; REAL ESTATE AND RETIREMENT FUNDS INVESTING, ETF INVESTING; MANAGING PERSONAL FINANCE AND INVESTMENTS, STOCK INVESTING AND TRADING, MANAGING PERSONAL FINANCES, INVESTING BASICS, OBTAINING A MORTGAGE, READING FINANCIAL REPORTS, MUTUAL FUND INVESTING, DEBT CONSOLIDATION, INSURANCE BROKERAGE; FILING PERSONAL BANKRUPTCY, IN CLASS 36 (U.S. CLS. 100, 101 AND 102).

FIRST USE 10-15-2007; IN COMMERCE 10-15-2007.

FOR: PROVIDING NON-DOWNLOADABLE CONTENT INFORMATION ON A WEB SITE, ON A GLOBAL COMPUTER NETWORK, FEATURING VARIOUS "HOW TO" TOPICS, IN THE FIELDS OF HOME IMPROVEMENTS, FEATURING ELECTRICAL AND PLUMBING HOME IMPROVEMENTS; BICYCLE MAINTENANCE; HOUSEHOLD CLEANING AND ORGANIZATION, IN CLASS 37 (U.S. CLS. 100, 103 AND 106).

FIRST USE 10-15-2007; IN COMMERCE 10-15-2007.

FOR: PROVIDING NON-DOWNLOADABLE CONTENT INFORMATION ON A WEB SITE, ON A GLOBAL COMPUTER NETWORK, IN THE FIELDS OF PODCASTING AND VOIP, IN CLASS 38 (U.S. CLS. 100, 101 AND 104).

FIRST USE 10-15-2007; IN COMMERCE 10-15-2007.

FOR: PROVIDING NON-DOWNLOADABLE CONTENT INFORMATION ON A WEB SITE, ON A GLOBAL COMPUTER NETWORK, FEATURING INFORMATION ON "HOW TO" SET UP A HOME BREWERY, IN CLASS 40 (U.S. CLS. 100, 103 AND 106).

FIRST USE 10-15-2007; IN COMMERCE 10-15-2007.

FOR: PROVIDING NON-DOWNLOADABLE CONTENT INFORMATION ON A WEB SITE, ON A GLOBAL COMPUTER NETWORK, FEATURING VARIOUS "HOW TO" TOPICS, IN THE FIELDS OF ENTERTAINMENT ON UNDERSTANDING SOCCER, FOOTBALL AND BASEBALL RULES; SONGWRITING, READING MUSIC, QUILTING, PLAYING THE PIANO, HARMONICA, AND MUSICAL INSTRUMENTS, GUITAR AND CHORD PLAYING; SEWING AND EMBROIDERY; PLAYING POKER, BLACKJACK, CARD GAMES, BRIDGE, AND CHESS; BEADING, BLOGGING, USING DIGITAL CAMERAS AND TAKING DIGITAL PHOTOS; PLAYING GOLF, MAKING JEWELRY, CROCHETING IN THE FIELD OF TRAINING FEATURING TRAINING FOR WEIGHT LOSS BASICS, WEIGHT TRAINING BASICS, WEIGHT TRAINING FOR ABS, LEGS AND BUTT, AND WEIGHT TRAINING FOR CHEST, BACK AND ARMS, AND YOGA, TAI CHI AND PILATES EXERCISES, MARATHON TRAINING; PLANNING A WEDDING, PLANNING MEALS, PHOTO EDITING, OPERATING A HAM RADIO; TRAINING IN BUSINESS ETIQUETTE AND WRITING, AND PC BASICS; INSTRUCTIONS ON KNOTTING ROPE, PURCHASING AND OPERATING PORTABLE DIGITAL MUSIC PLAYERS, PURCHASING AND OPERATING HYBRID CARS, SETTING UP AND MAINTAINING SALTWATER AND FRESH WATER AQUARIUMS AND HOUSE PLANTS, IN CLASS 41 (U.S. CLS. 100, 101 AND 107).

FIRST USE 10-15-2007; IN COMMERCE 10-15-2007.

FOR: PROVIDING NON-DOWNLOADABLE CONTENT INFORMATION ON A WEB SITE ON A GLOBAL COMPUTER NETWORK FEATURING VARIOUS "HOW TO" TOPICS, NAMELY, DESIGNING A WEBSITE, COMPUTER PROGRAMS, AND INTERNET SEARCH ENGINES; SELECTING SPAM, VIRUS AND SPYWARE SOFTWARE; BUILDING DESIGN AND FENG SHUI, IN CLASS 42 (U.S. CLS. 100 AND 101).

FIRST USE 10-15-2007; IN COMMERCE 10-15-2007.

FOR: PROVIDING NON-DOWNLOADABLE CONTENT INFORMATION ON A WEB SITE ON A GLOBAL COMPUTER NETWORK FEATURING VARIOUS "HOW TO" TOPICS, IN THE FIELDS OF FOOD PREPARATION, SUSHI PREPARATION, OR-

GANIC COOKING, COOKING BASICS, GRILLING AND BARBECUING, IN CLASS 43 (U.S. CLS. 100 AND 101).

FIRST USE 10-15-2007; IN COMMERCE 10-15-2007.

FOR: PROVIDING NON-DOWNLOADABLE CONTENT INFORMATION ON A WEB SITE ON A GLOBAL COMPUTER NETWORK FEATURING VARIOUS "HOW TO" TOPICS, IN THE FIELDS OF FOOD NUTRITION, NAMELY, SELECTING THE NUTRITIONAL AND HEALTH VALUE OF FOOD AND SELECTING VITAMINS AND NUTRITIONAL SUPPLEMENTS, AND HEALTH ISSUES, NAMELY, PREGNANCY AND QUITTING SMOKING, AND IN THE FIELD OF DOG BREEDING, IN CLASS 44 (U.S. CLS. 100 AND 101).

FIRST USE 10-15-2007; IN COMMERCE 10-15-2007.

FOR: PROVIDING NON-DOWNLOADABLE CONTENT INFORMATION ON A WEB SITE ON A GLOBAL COMPUTER NETWORK, FEATURING VARIOUS "HOW TO" TOPICS IN THE FIELDS OF ASTR OLOGY CONSULTATION AND IDENTITY THEFT, IN CLASS 45 (U.S. CLS. 100 AND 101).

FIRST USE 10-15-2007; IN COMMERCE 10-15-2007.

THE MARK CONSISTS OF STANDARD CHARACTERS WITHOUT CLAIM TO ANY PARTICULAR FONT, STYLE, SIZE, OR COLOR.

THE WORDING "QUAMUT" HAS NO MEANING IN A FOREIGN LANGUAGE.

SN 78-736,254, FILED 10-19-2005.

ODESSA BIBBINS, EXAMINING ATTORNEY

**Int. Cl.: 5**

**Prior U.S. Cls.: 6, 18, 44, 46, 51, and 52**

**United States Patent and Trademark Office**

**Reg. No. 3,469,442**

**Registered July 15, 2008**

**TRADEMARK  
PRINCIPAL REGISTER**

**CARDIO 360°**

TREVOR, DANIEL (UNITED STATES INDIVIDUAL)  
940 W. KENNETH ROAD  
GLENDALE, CA 91202

FOR: VITAMIN, MINERAL AND HERBAL SUPPLEMENTS, IN CLASS 5 (U.S. CLS. 6, 18, 44, 46, 51 AND 52).

FIRST USE 1-10-2007; IN COMMERCE 1-10-2007.

THE MARK CONSISTS OF STANDARD CHARACTERS WITHOUT CLAIM TO ANY PARTICULAR FONT, STYLE, SIZE, OR COLOR.

NO CLAIM IS MADE TO THE EXCLUSIVE RIGHT TO USE "CARDIO", APART FROM THE MARK AS SHOWN.

SN 78-737,066, FILED 10-20-2005.

JASON BLAIR, EXAMINING ATTORNEY

**Int. Cl.: 9**

**Prior U.S. Cls.: 21, 23, 26, 36, and 38**

**United States Patent and Trademark Office**

**Reg. No. 3,469,443**

**Registered July 15, 2008**

**TRADEMARK  
PRINCIPAL REGISTER**



SHARP KABUSHIKI KAISHA (JAPAN CORPORATION), TA SHARP CORPORATION,  
22-22 NAGAIKE-CHO, ABENO-KU  
OSAKA, JAPAN 545-8522

FOR: COPYING MACHINES, PRINTERS, FACSIMILE MACHINES, SCANNERS AND COMBINATION OF SUCH PRODUCTS, IN CLASS 9 (U.S. CLS. 21, 23, 26, 36 AND 38).

FIRST USE 12-31-2005; IN COMMERCE 12-31-2005.

THE COLOR(S) RED, BLUE, YELLOW, GREEN AND GRAY IS/ARE CLAIMED AS A FEATURE OF THE MARK.

THE COLORS RED, BLUE, YELLOW, GREEN AND GRAY APPEAR IN VARIOUS PLACES ON THE LEAF.

SN 78-737,701, FILED 10-21-2005.

MICHAEL KAZAZIAN, EXAMINING ATTORNEY

**Int. Cl.: 43**

**Prior U.S. Cls.: 100 and 101**

**United States Patent and Trademark Office**

**Reg. No. 3,469,444**

**Registered July 15, 2008**

**SERVICE MARK  
PRINCIPAL REGISTER**

' beca

5444 ASSOCIATES (PENNSYLVANIA LIMITED  
PARTNERSHIP)  
148 SHERATON DRIVE  
NEW CUMBERLAND, PA 17070

FOR: HOTEL, BAR AND RESTAURANT SERVI-  
CES; RESTAURANT AND BAR SERVICES; RES-  
TAURANTS, IN CLASS 43 (U.S. CLS. 100 AND 101).

FIRST USE 1-1-2006; IN COMMERCE 1-1-2006.

THE MARK CONSISTS OF STANDARD CHAR-  
ACTERS WITHOUT CLAIM TO ANY PARTICULAR  
FONT, STYLE, SIZE, OR COLOR.

THE NAME "BECA" DOES NOT IDENTIFY A  
LIVING INDIVIDUAL.

SN 78-738,640, FILED 10-22-2005.

ALYSSA PALADINO, EXAMINING ATTORNEY

**Int. Cl.: 14**

**Prior U.S. Cls.: 2, 27, 28, and 50**

**United States Patent and Trademark Office**

**Reg. No. 3,469,445**

**Registered July 15, 2008**

**TRADEMARK  
PRINCIPAL REGISTER**



JOHN C NORDT CO., INC. (VIRGINIA CORPORATION)  
1420 COULTER DR. NW  
ROANOKE, VA 240121132

FOR: JEWELRY, IN CLASS 14 (U.S. CLS. 2, 27, 28 AND 50).

FIRST USE 1-2-2005; IN COMMERCE 1-2-2005.

OWNER OF U.S. REG. NO. 1,236,195.

NO CLAIM IS MADE TO THE EXCLUSIVE RIGHT TO USE "BROTHERS" AND "SINCE 1958", APART FROM THE MARK AS SHOWN.

THE NAME(S), PORTRAIT(S), AND/OR SIGNATURE(S) SHOWN IN THE MARK DOES NOT IDENTIFY A PARTICULAR LIVING INDIVIDUAL.

THE MARK CONSISTS OF THE STYLIZED WORD "GUERTIN" OVER THE STYLIZED WORD "BROTHERS" NEXT TO A FANCIFUL DESIGN OF A RING/WEDDING BAND.

SN 78-738,873, FILED 10-24-2005.

LINDA ESTRADA, EXAMINING ATTORNEY



**Int. Cl.: 11**

**Prior U.S. Cls.: 13, 21, 23, 31, and 34**

**United States Patent and Trademark Office**

**Reg. No. 3,469,446**

**Registered July 15, 2008**

**TRADEMARK  
PRINCIPAL REGISTER**

**IBAC**

TECKNOWLEDGE CAPITAL HOLDINGS LIMITED (BR.VIRGIN ISLANDS LIMITED COMPANY)  
CITCO BUILDING, WICKHAMS CAY  
P.O. BOX 662  
ROAD TOWN, TORTOLA, BR.VIRGIN ISLANDS

FOR: WASTEWATER TREATMENT AND WATER RECLAMATION UNITS, IN CLASS 11 (U.S. CLS. 13, 21, 23, 31 AND 34).

FIRST USE 8-20-2007; IN COMMERCE 8-20-2007.

THE MARK CONSISTS OF STANDARD CHARACTERS WITHOUT CLAIM TO ANY PARTICULAR FONT, STYLE, SIZE, OR COLOR.

PRIORITY CLAIMED UNDER SEC. 44(D) ON CANADA APPLICATION NO. 1274740, FILED 10-6-2005.

SN 78-739,978, FILED 10-25-2005.

COLLEEN DOMBROW, EXAMINING ATTORNEY

Int. Cl.: 33

Prior U.S. Cls.: 47 and 49

United States Patent and Trademark Office

Reg. No. 3,469,447

Registered July 15, 2008

TRADEMARK  
PRINCIPAL REGISTER



WINE BY THE SCHOTT, LLC (CALIFORNIA LTD  
LIAB CO)  
136 WESTGATE DR  
NAPA, CA 94558

FOR: GRAPE WINE; PORT WINES; RED WINE;  
SPARKLING GRAPE WINE; SWEET WINES; TABLE  
WINES; WHITE WINE; WINE, IN CLASS 33 (U.S.  
CLS. 47 AND 49).

FIRST USE 10-1-2005; IN COMMERCE 12-1-2005.

THE COLOR(S) RED, WHITE AND BLACK IS/  
ARE CLAIMED AS A FEATURE OF THE MARK.

THE MARK CONSISTS OF A BLACK SQUARE  
WITH WHITE BORDER AND WORDS "WINE BY  
THE" IN BLACK AND A SET OF RED GRAPES  
AGAINST A LEANING WHITE BOTTLE OVER THE  
RED LETTERS "SCHOTT".

SN 78-740,436, FILED 10-25-2005.

TANYA AMOS, EXAMINING ATTORNEY

Int. Cl.: 8

Prior U.S. Cls.: 23, 28, and 44

United States Patent and Trademark Office

Reg. No. 3,469,448

Registered July 15, 2008

TRADEMARK  
PRINCIPAL REGISTER

# Chestnut Tools

CANICA DESIGN INC. (CANADA CORPORATION)  
36 MILL STREET  
P.O. BOX 1238  
ALMONTE, CANADA K0A1A0

FOR: ABRADING TOOLS; BITS FOR HAND DRILLS; BLADES FOR HAND SAWS; CENTER PUNCHES; CHISELS; DRILL BITS FOR HAND DRILLS; EXTENSIONS FOR HAND TOOLS; FILES; HAMMERS; HAND HELD CUTTING TOOLS; HAND SAWS, NAMELY, HACK SAWS; HAND SAWS, NAMELY, MITER SAWS; HAND SAWS, NAMELY, WOOD SAWS; HAND TOOLS, NAMELY, ADZES; HAND TOOLS, NAMELY, AUGERS; HAND TOOLS, NAMELY, AWLS; HAND TOOLS, NAMELY, CLAMPS; HAND TOOLS, NAMELY, DRILLS; HAND TOOLS, NAMELY, FILES; HAND TOOLS, NAMELY, HAMMERS; HAND TOOLS, NAMELY, MANUALLY-OPERATED GRINDSTONES; HAND TOOLS, NAMELY, MITRE BOXES; HAND TOOLS, NAMELY, PLANERS; HAND TOOLS, NAMELY, PLANES; HAND TOOLS, NAMELY, PUNCHES; HAND TOOLS, NAMELY, RASPS; HAND TOOLS, NAMELY, REAMERS; HAND TOOLS, NAMELY, SAWS; HAND TOOLS, NAMELY, SCRAPERS; HAND TOOLS, NAMELY, SQUARES; HAND TOOLS, NAMELY, ENGRAVERS; HAND TOOLS, NAMELY, KNIFE SHARPENERS; HAND TOOLS, NAMELY, LAWN AERATORS; HAND TOOLS, NAMELY, LOPPERS; HAND TOOLS, NAMELY, MITER BOXES;

HAND TOOLS, NAMELY, NAIL SETS; HAND TOOLS, NAMELY, PAINT SCRAPERS; HAND TOOLS, NAMELY, PRUNERS; HAND TOOLS, NAMELY, PUNCHES; HAND TOOLS, NAMELY, SANDERS; HAND TOOLS, NAMELY, VICES; HAND-HELD TOOLS, NAMELY, CHISELS; HAND-OPERATED SHARPENING TOOLS AND INSTRUMENTS; HAND-OPERATED SHEARS; HOES; KNIVES; LAWN RAKES; MANUALLY OPERATED CONTAINER OPENER FOR HOUSEHOLD OR DOMESTIC USE; MANUALLY OPERATED SHARPENERS; SAWS; TOOL APRONS; TOOL BELTS; TOOL HOLDERS; TOOL POUCHES FOR ATTACHMENT TO TOOL BELTS, IN CLASS 8 (U.S. CLS. 23, 28 AND 44).

FIRST USE 11-1-2006; IN COMMERCE 11-1-2006.

THE MARK CONSISTS OF STANDARD CHARACTERS WITHOUT CLAIM TO ANY PARTICULAR FONT, STYLE, SIZE, OR COLOR.

NO CLAIM IS MADE TO THE EXCLUSIVE RIGHT TO USE "TOOLS", APART FROM THE MARK AS SHOWN.

SN 78-741,692, FILED 10-27-2005.

ELIZABETH BEYER, EXAMINING ATTORNEY

**Int. Cl.: 7**

**Prior U.S. Cls.: 13, 19, 21, 23, 31, 34, and 35**

**Reg. No. 3,469,449**

**United States Patent and Trademark Office**

**Registered July 15, 2008**

**TRADEMARK  
PRINCIPAL REGISTER**



PSC INDUSTRIAL OUTSOURCING, LP (DELA-  
WARE LIMITED PARTNERSHIP)  
2711 CENTERVILLE ROAD  
SUITE 400  
WILMINGTON, DE 19808

FOR: CLEANING SYSTEMS COMPRISING  
SLUDGE PUMPS, POWER-OPERATED SPRAYERS  
AND NOZZLES WHICH ARE PARTS OF POWER-  
OPERATED SPRAYERS FOR CLEANING, TREAT-  
ING, COATING AND DECONTAMINATING

TANKS AND OTHER VESSELS, IN CLASS 7 (U.S.  
CLS. 13, 19, 21, 23, 31, 34 AND 35).

FIRST USE 10-28-2005; IN COMMERCE 10-28-2005.

THE MARK CONSISTS, IN PART, OF A SPRAYER  
NOZZLE.

SN 78-741,833, FILED 10-27-2005.

JOHN GARTNER, EXAMINING ATTORNEY

**Int. Cl.: 41**

**Prior U.S. Cls.: 100, 101, and 107**

**United States Patent and Trademark Office**

**Reg. No. 3,469,450**

**Registered July 15, 2008**

**SERVICE MARK  
PRINCIPAL REGISTER**

**PARK AT THE PARK**

PADRES L.P. (DELAWARE LIMITED PARTNER-  
SHIP)  
100 PARK BOULEVARD  
SAN DIEGO, CA 92101

FOR: ENTERTAINMENT SERVICES, NAMELY, BASEBALL GAMES, COMPETITIONS AND EXHIBITIONS RENDERED LIVE AND THROUGH BROADCAST MEDIA INCLUDING TELEVISION AND RADIO, AND VIA A GLOBAL COMPUTER NETWORK OR A COMMERCIAL ON-LINE SERVICE; INFORMATION SERVICES, NAMELY, PROVIDING INFORMATION IN THE FIELD OF SPORTS, ENTERTAINMENT AND RELATED TOPICS, AND PROVIDING FOR INFORMATIONAL MESSAGES RELATING THERETO; ENTERTAINMENT SERVICES, NAMELY, EDUCATIONAL SERVICES IN THE NATURE OF BASEBALL SKILLS PROGRAMS, ENTERTAINMENT SERVICES, NAMELY, PRODUCTION OF PROGRAMMING BROADCAST VIA

TELEVISION, RADIO AND A GLOBAL COMPUTER NETWORK OR A COMMERCIAL ON-LINE SERVICE; ORGANIZING COMMUNITY SPORTING EVENTS; PROVIDING FACILITIES FOR SPORTS TOURNAMENTS AND COMPETITIONS RELATING TO BASEBALL; ORGANIZING AND CONDUCTING SPORTS CONTESTS, IN CLASS 41 (U.S. CLS. 100, 101 AND 107).

FIRST USE 3-0-2004; IN COMMERCE 3-0-2004.

THE MARK CONSISTS OF STANDARD CHARACTERS WITHOUT CLAIM TO ANY PARTICULAR FONT, STYLE, SIZE, OR COLOR.

SN 78-743,070, FILED 10-28-2005.

LAURIE KAUFMAN, EXAMINING ATTORNEY

**Int. Cl.: 18**

**Prior U.S. Cls.: 1, 2, 3, 22, and 41**

**Reg. No. 3,469,451**

**United States Patent and Trademark Office**

**Registered July 15, 2008**

**TRADEMARK  
PRINCIPAL REGISTER**

# ELEVATOR

HORSESENSE SADDLERS LIMITED (UNITED  
KINGDOM CORPORATION)  
COBWEBS, TED PITTS LANE, HAWKES END  
COVENTRY, UNITED KINGDOM CV5 9FL

FOR: EQUIPMENT FOR HORSES, NAMELY,  
BRIDLES, SADDLES, SADDLERY STRAPS OF LEA-  
THER, PADS FOR HORSE SADDLES, REINS,  
GIRTHS, HEADCOLLARS, NUMNAHS, PARTS  
AND FITTINGS FOR ALL THE AFORESAID  
GOODS, IN CLASS 18 (U.S. CLS. 1, 2, 3, 22 AND 41).

FIRST USE 5-1-2005; IN COMMERCE 5-1-2005.

THE MARK CONSISTS OF STANDARD CHAR-  
ACTERS WITHOUT CLAIM TO ANY PARTICULAR  
FONT, STYLE, SIZE, OR COLOR.

SN 78-744,987, FILED 11-1-2005.

PAUL E. FAHRENKOPF, EXAMINING ATTORNEY

**Int. Cl.: 1**

**Prior U.S. Cls.: 1, 5, 6, 10, 26, and 46**

**Reg. No. 3,469,452**

**United States Patent and Trademark Office**

**Registered July 15, 2008**

---

**TRADEMARK  
PRINCIPAL REGISTER**

**AQUA-NANO-LOCK**

AMSENG (ILLINOIS CORPORATION)  
676G BONDED PARKWAY  
STREAMWOOD, IL 60107

FIRST USE 10-0-2006; IN COMMERCE 10-0-2006.

FOR: INDUSTRIAL ADHESIVES, NAMELY, INDUSTRIAL ADHESIVES FOR USE IN THE PACKAGING AND CORE WINDING INDUSTRIES, THE FLOORING INDUSTRIES, THE TEXTILE AND INSULATION INDUSTRIES, AND THE WOOD AND CONSTRUCTION INDUSTRIES, IN CLASS 1 (U.S. CLS. 1, 5, 6, 10, 26 AND 46).

THE MARK CONSISTS OF STANDARD CHARACTERS WITHOUT CLAIM TO ANY PARTICULAR FONT, STYLE, SIZE, OR COLOR.

SN 78-746,076, FILED 11-3-2005.

DAVID ELTON, EXAMINING ATTORNEY

**Int. Cl.: 1**

**Prior U.S. Cls.: 1, 5, 6, 10, 26, and 46**

**Reg. No. 3,469,453**

**United States Patent and Trademark Office**

**Registered July 15, 2008**

---

**TRADEMARK  
PRINCIPAL REGISTER**

**AQUA-SANC-LOCK**

AMSENG (ILLINOIS CORPORATION)  
676G BONDED PARKWAY  
STREAMWOOD, IL 60107

FIRST USE 10-0-2006; IN COMMERCE 10-0-2006.

FOR: INDUSTRIAL ADHESIVES, NAMELY, INDUSTRIAL ADHESIVES FOR USE IN THE PACKAGING AND CORE WINDING INDUSTRIES, THE FLOORING INDUSTRIES, THE TEXTILE AND INSULATION INDUSTRIES, AND THE WOOD AND CONSTRUCTION INDUSTRIES, IN CLASS 1 (U.S. CLS. 1, 5, 6, 10, 26 AND 46).

THE MARK CONSISTS OF STANDARD CHARACTERS WITHOUT CLAIM TO ANY PARTICULAR FONT, STYLE, SIZE, OR COLOR.

SN 78-746,096, FILED 11-3-2005.

DAVID ELTON, EXAMINING ATTORNEY



**Int. Cl.: 1**

**Prior U.S. Cls.: 1, 5, 6, 10, 26, and 46**

**United States Patent and Trademark Office**

**Reg. No. 3,469,454**

**Registered July 15, 2008**

**TRADEMARK  
PRINCIPAL REGISTER**

**AQUA-SANC-SEAL**

AMSENG (ILLINOIS CORPORATION)  
676G BONDED PARKWAY  
STREAMWOOD, IL 60107

FOR: ADHESIVES FOR INDUSTRIAL APPLICATIONS, IN CLASS 1 (U.S. CLS. 1, 5, 6, 10, 26 AND 46).

FIRST USE 10-0-2006; IN COMMERCE 10-0-2006.

THE MARK CONSISTS OF STANDARD CHARACTERS WITHOUT CLAIM TO ANY PARTICULAR FONT, STYLE, SIZE, OR COLOR.

SN 78-746,108, FILED 11-3-2005.

DAVID ELTON, EXAMINING ATTORNEY

**Int. Cl.: 14**

**Prior U.S. Cls.: 2, 27, 28, and 50**

**United States Patent and Trademark Office**

**Reg. No. 3,469,455**

**Registered July 15, 2008**

**TRADEMARK  
PRINCIPAL REGISTER**

**SKY MASTER**

CASEIKO TRADING INC (CALIFORNIA COR-  
PORATION)  
SUITE 308  
629 SOUTH HILL ST  
LOS ANGELES, CA 90014

THE MARK CONSISTS OF STANDARD CHAR-  
ACTERS WITHOUT CLAIM TO ANY PARTICULAR  
FONT, STYLE, SIZE, OR COLOR.

FOR: WATCHES AND WATCH STRAPS, IN  
CLASS 14 (U.S. CLS. 2, 27, 28 AND 50).

SN 78-749,663, FILED 11-8-2005.

FIRST USE 6-1-2006; IN COMMERCE 6-1-2006.

SARA THOMAS, EXAMINING ATTORNEY

**Int. Cl.: 9**

**Prior U.S. Cls.: 21, 23, 26, 36, and 38**

**Reg. No. 3,469,456**

**United States Patent and Trademark Office**

**Registered July 15, 2008**

---

**TRADEMARK  
PRINCIPAL REGISTER**

# Knight in Shining Armor

GLOBAL GAMING GROUP, INC. (NEVADA CORPORATION)

SUITE 14  
3035 E. PATRICK LANE  
LAS VEGAS, NV 89120

FOR: GAMBLING MACHINES; GAMING EQUIPMENT, NAMELY, SLOT MACHINES WITH OR WITHOUT VIDEO OUTPUT; GAMING MACHINES; MACHINES FOR PLAYING GAMES OF CHANCE; SLOT MACHINES, IN CLASS 9 (U.S. CLS. 21, 23, 26, 36 AND 38).

FIRST USE 5-20-2006; IN COMMERCE 5-20-2006.

THE MARK CONSISTS OF STANDARD CHARACTERS WITHOUT CLAIM TO ANY PARTICULAR FONT, STYLE, SIZE, OR COLOR.

SN 78-749,757, FILED 11-8-2005.

RICHARD WHITE, EXAMINING ATTORNEY

**Int. Cl.: 9**

**Prior U.S. Cls.: 21, 23, 26, 36, and 38**

**United States Patent and Trademark Office**

**Reg. No. 3,469,457**

**Registered July 15, 2008**

**TRADEMARK  
PRINCIPAL REGISTER**

# Viking's Gold

GLOBAL GAMING GROUP, INC. (NEVADA  
CORPORATION)  
SUITE 14  
3035 E. PATRICK LANE  
LAS VEGAS, NV 89120

FOR: GAMBLING MACHINES; GAMING EQUIP-  
MENT, NAMELY, SLOT MACHINES WITH OR  
WITHOUT VIDEO OUTPUT; GAMING MACHINES;  
MACHINES FOR PLAYING GAMES OF CHANCE;  
SLOT MACHINES, IN CLASS 9 (U.S. CLS. 21, 23, 26, 36  
AND 38).

FIRST USE 2-15-2007; IN COMMERCE 2-15-2007.

THE MARK CONSISTS OF STANDARD CHAR-  
ACTERS WITHOUT CLAIM TO ANY PARTICULAR  
FONT, STYLE, SIZE, OR COLOR.

SN 78-749,764, FILED 11-8-2005.

RICHARD WHITE, EXAMINING ATTORNEY

Int. Cls.: 37 and 42

Prior U.S. Cls.: 100, 101, 103, and 106

United States Patent and Trademark Office

Reg. No. 3,469,458

Registered July 15, 2008

SERVICE MARK  
PRINCIPAL REGISTER

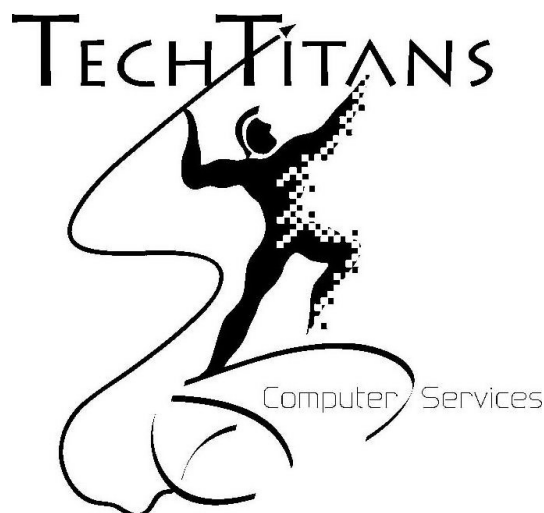

LABRIS, INC. (MARYLAND CORPORATION)  
13602 MACKERNUT COURT  
UPPER MARLBORO, MD 20774

FOR: COMPUTER INSTALLATION AND REPAIR; INSTALLATION OF COMPUTER NETWORKS; INSTALLATION OF COMPUTER SYSTEMS; MAINTENANCE AND REPAIR OF COMPUTER HARDWARE; MAINTENANCE AND REPAIR OF COMPUTER NETWORKS; REPAIR OR MAINTENANCE OF COMPUTERS; UPGRADING OF COMPUTER HARDWARE, IN CLASS 37 (U.S. CLS. 100, 103 AND 106).

FIRST USE 1-1-2006; IN COMMERCE 1-1-2006.

FOR: COMPUTER CONSULTATION; COMPUTER DIAGNOSTIC SERVICES; COMPUTER NETWORK DESIGN FOR OTHERS; CUSTOMIZATION OF COMPUTER HARDWARE AND SOFTWARE;

DESIGN AND DEVELOPMENT OF NETWORKS; DESIGN OF COMPUTERS FOR OTHERS; INSTALLATION OF COMPUTER SOFTWARE; INTEGRATION OF COMPUTER SYSTEMS AND NETWORKS; RENTING OUT HARDWARE AND SOFTWARE; REPAIR OF DAMAGED COMPUTER PROGRAMS; TECHNICAL SUPPORT SERVICES, NAMELY, TROUBLESHOOTING OF COMPUTER HARDWARE AND SOFTWARE PROBLEMS, IN CLASS 42 (U.S. CLS. 100 AND 101).

FIRST USE 1-1-2006; IN COMMERCE 1-1-2007.

NO CLAIM IS MADE TO THE EXCLUSIVE RIGHT TO USE "TECH" AND "COMPUTER SERVICES", APART FROM THE MARK AS SHOWN.

SN 78-750,058, FILED 11-9-2005.

PAUL E. FAHRENKOPF, EXAMINING ATTORNEY

**Int. Cl.: 36**

**Prior U.S. Cls.: 100, 101, and 102**

**United States Patent and Trademark Office**

**Reg. No. 3,469,459**

**Registered July 15, 2008**

**SERVICE MARK  
PRINCIPAL REGISTER**

**LOWERCASE PEOPLE JUSTICE  
FUND**

LOWERCASE PEOPLE JUSTICE FUND, INC.  
(CALIFORNIA CORPORATION)  
1025 16TH AVENUE SOUTH, SUITE 202  
NASHVILLE, TN 37212

FOR: CHARITABLE FUNDRAISING SERVICES,  
CHARITABLE FUNDRAISING SERVICES IN THE  
NATURE OF ORGANIZING COMMUNITY SPORT-  
ING, ENTERTAINMENT AND CULTURAL  
EVENTS, NAMELY, SURFING EVENTS, AUC-  
TIONS, CONCERTS, ARTISTS SHOWS AND OTHER  
EVENTS AND SHOWS FOR FUNDRAISING PUR-  
POSES, IN CLASS 36 (U.S. CLS. 100, 101 AND 102).

FIRST USE 9-13-2005; IN COMMERCE 9-13-2005.

THE MARK CONSISTS OF STANDARD CHAR-  
ACTERS WITHOUT CLAIM TO ANY PARTICULAR  
FONT, STYLE, SIZE, OR COLOR.

NO CLAIM IS MADE TO THE EXCLUSIVE  
RIGHT TO USE "FUND", APART FROM THE  
MARK AS SHOWN.

SN 78-752,568, FILED 11-11-2005.

KRISTINA MORRIS, EXAMINING ATTORNEY

**Int. Cl.: 36**

**Prior U.S. Cls.: 100, 101, and 102**

**United States Patent and Trademark Office**

**Reg. No. 3,469,460**

**Registered July 15, 2008**

**SERVICE MARK  
PRINCIPAL REGISTER**

**GREAT AMERICAN PLAN  
ADMINISTRATORS**

GREAT AMERICAN INSURANCE CO. (OHIO  
CORPORATION)  
580 WALNUT STREET  
CINCINNATI, OH 45202

OWNER OF U.S. REG. NOS. 643,400, 1,579,416,  
AND OTHERS.

FOR: THIRD PARTY EMPLOYEE BENEFIT  
PLAN AND INSURANCE ADMINISTRATION, IN  
CLASS 36 (U.S. CLS. 100, 101 AND 102).

NO CLAIM IS MADE TO THE EXCLUSIVE  
RIGHT TO USE "PLAN ADMINISTRATOR", APART  
FROM THE MARK AS SHOWN.

FIRST USE 11-1-2005; IN COMMERCE 11-1-2005.

SN 78-755,905, FILED 11-17-2005.

THE MARK CONSISTS OF STANDARD CHAR-  
ACTERS WITHOUT CLAIM TO ANY PARTICULAR  
FONT, STYLE, SIZE, OR COLOR.

BARBARA BROWN, EXAMINING ATTORNEY

**Int. Cls.: 36, 40, and 42**

**Prior U.S. Cls.: 100, 101, 102, 103, and 106**

**United States Patent and Trademark Office**

**Reg. No. 3,469,461**

**Registered July 15, 2008**

**SERVICE MARK  
PRINCIPAL REGISTER**



DELTA ENVIRONMENTAL CONSULTANTS,  
INC. (MINNESOTA CORPORATION)  
5910 RICE CREEK PARKWAY  
SHOREVIEW, MN 55126

FOR: ENVIRONMENTAL RISK MANAGEMENT CONSULTING, NAMELY, AUDITING OF OCCUPATIONAL HEALTH AND SAFETY PROGRAMS AND OVERSIGHT MANAGEMENT OF HAZARDOUS AND NON-HAZARDOUS WASTES, IN CLASS 36 (U.S. CLS. 100, 101 AND 102).

FIRST USE 9-27-2006; IN COMMERCE 9-27-2006.

FOR: ENVIRONMENTAL REMEDIATION CONSULTING SERVICES IN THE FIELD OF SOIL, AIR, WASTE AND WATER TREATMENT, IN CLASS 40 (U.S. CLS. 100, 103 AND 106).

FIRST USE 9-27-2006; IN COMMERCE 9-27-2006.

FOR: ENVIRONMENTAL CONSULTING SERVICES, NAMELY, TECHNICAL CONSULTATION IN THE FIELD OF ENVIRONMENTAL ENGINEERING, OCCUPATIONAL HEALTH AND SAFETY,

DEVELOPMENT OF HEALTH AND SAFETY TRAINING PROGRAMS FOR OTHERS, ENVIRONMENTAL EVALUATION AND DUE DILIGENCE REVIEW FOR THE PRESENCE OF HAZARDOUS MATERIAL PRIOR TO PURCHASE AND SALE OF REAL ESTATE; DESIGN OF PETROLEUM HANDLING FACILITIES, AQUIFER RESTORATION SYSTEMS AND MINE DEWATERING SYSTEMS; ENVIRONMENTAL REGULATION COMPLIANCE CONSULTING, NAMELY, REVIEWING STANDARDS AND PRACTICES TO ASSURE COMPLIANCE WITH ENVIRONMENTAL AND OSHA LAWS AND REGULATIONS, IN CLASS 42 (U.S. CLS. 100 AND 101).

FIRST USE 9-27-2006; IN COMMERCE 9-27-2006.

OWNER OF U.S. REG. NOS. 1,517,468, 1,594,715, AND OTHERS.

SN 78-759,964, FILED 11-23-2005.

WILLIAM VERHOSEK, EXAMINING ATTORNEY



**Int. Cl.: 30**

**Prior U.S. Cl.: 46**

**United States Patent and Trademark Office**

**Reg. No. 3,469,462**

**Registered July 15, 2008**

**TRADEMARK  
PRINCIPAL REGISTER**

**TWISTER**

DELFI CHOCOLATE MANUFACTURING S.A.  
(SWITZERLAND CORPORATION)  
6, ROUTE DE BERNE  
1700 FRIBOURG, SWITZERLAND

THE MARK CONSISTS OF STANDARD CHAR-  
ACTERS WITHOUT CLAIM TO ANY PARTICULAR  
FONT, STYLE, SIZE, OR COLOR.

FOR: CONFECTIONERY, NAMELY, WAFER  
ROLL AND CREAM-FILLED WAFER ROLL, IN  
CLASS 30 (U.S. CL. 46).

SN 78-761,044, FILED 11-26-2005.

FIRST USE 12-29-1998; IN COMMERCE 5-0-2007.

BRIAN PINO, EXAMINING ATTORNEY

**Int. Cls.: 9, 16, 37, and 42**

**Prior U.S. Cls.: 2, 5, 21, 22, 23, 26, 29, 36, 37, 38, 50,  
100, 101, 103, and 106**

**Reg. No. 3,469,463**

**United States Patent and Trademark Office**

**Registered July 15, 2008**

**TRADEMARK  
SERVICE MARK  
PRINCIPAL REGISTER**

INTERNATIONAL BUSINESS MACHINES COR-  
PORATION (NEW YORK CORPORATION)  
NEW ORCHARD ROAD  
ARMONK, NY 10504

FOR: COMPUTER HARDWARE, NAMELY, COM-  
PUTER SERVERS; COMPUTER SOFTWARE FOR  
CONTROLLING THE OPERATION OR EXECU-  
TION OF PROGRAMS AND NETWORKS FOR  
SERVER SYSTEMS AND WORKSTATIONS, AND  
INSTRUCTION MANUALS SOLD AS A UNIT  
THEREWITH, IN CLASS 9 (U.S. CLS. 21, 23, 26, 36  
AND 38).

FIRST USE 1-31-2006; IN COMMERCE 1-31-2006.

FOR: PRINTED MATTER, NAMELY, INSTRU-  
TION MANUALS FOR COMPUTER HARDWARE  
AND COMPUTER SOFTWARE FOR SERVER SYS-  
TEMS AND WORKSTATIONS, IN CLASS 16 (U.S.  
CLS. 2, 5, 22, 23, 29, 37, 38 AND 50).

FIRST USE 1-31-2006; IN COMMERCE 1-31-2006.

FOR: MAINTENANCE, INSTALLATION AND  
INTERCONNECTION OF COMPUTER HARD-  
WARE FOR SERVER SYSTEMS AND WORKSTA-  
TIONS, IN CLASS 37 (U.S. CLS. 100, 103 AND 106).

FIRST USE 1-31-2006; IN COMMERCE 1-31-2006.

FOR: COMPUTER SERVICES, NAMELY, COM-  
PUTER HARDWARE AND SOFTWARE DESIGN  
FOR OTHERS; INTERCONNECTION AND TEST-  
ING OF COMPUTER SOFTWARE FOR SERVER  
SYSTEMS AND WORKSTATIONS; COMPUTER  
SYSTEMS ANALYSIS; INTEGRATION OF COMPU-  
TER SYSTEMS AND NETWORKS; TECHNICAL  
SUPPORT SERVICES, NAMELY, TROUBLESHOOT-  
ING OF COMPUTER HARDWARE AND COMPU-  
TER SOFTWARE PROBLEMS; COMPUTER  
PROGRAMMING FOR OTHERS; CONDUCTING  
TECHNICAL PROJECT STUDIES IN THE FIELD  
OF COMPUTER HARDWARE AND SOFTWARE;  
CONSULTING SERVICES IN THE FIELD OF COM-  
PUTER HARDWARE AND COMPUTER SOFT-  
WARE; COMPUTER PROGRAMMING; DESIGN,  
UPDATING AND MAINTENANCE OF COMPUTER  
SOFTWARE; DESIGN OF INTERNET WEBSITES;  
MAINTENANCE OF INTERNET WEBSITES FOR  
OTHERS, IN CLASS 42 (U.S. CLS. 100 AND 101).

FIRST USE 1-31-2006; IN COMMERCE 1-31-2006.

SN 78-763,312, FILED 11-30-2005.

CYNTHIA SLOAN, EXAMINING ATTORNEY

**Int. Cl.: 9**

**Prior U.S. Cls.: 21, 23, 26, 36, and 38**

**Reg. No. 3,469,464**

**United States Patent and Trademark Office**

**Registered July 15, 2008**

**TRADEMARK  
PRINCIPAL REGISTER**

**UDO**

PLASMON PLC (UNITED KINGDOM CORPORATION)  
WHITING WAY, MELBOURN  
ROYSTON, HERTFORDSHIRE, UNITED KINGDOM SG8 6EN

FOR: OPTICAL DISC DRIVES; BLANK OPTICAL DISCS, IN CLASS 9 (U.S. CLS. 21, 23, 26, 36 AND 38).

FIRST USE 11-0-2003; IN COMMERCE 11-0-2003.

THE MARK CONSISTS OF STANDARD CHARACTERS WITHOUT CLAIM TO ANY PARTICULAR FONT, STYLE, SIZE, OR COLOR.

OWNER OF ERPN CMNTY TM OFC REG. NO. 2263416, DATED 8-19-2003, EXPIRES 6-12-2011.

SN 78-763,819, FILED 11-30-2005.

SHANNON TWOHIG, EXAMINING ATTORNEY

**Int. Cl.: 9**

**Prior U.S. Cls.: 21, 23, 26, 36, and 38**

**Reg. No. 3,469,465**

**United States Patent and Trademark Office**

**Registered July 15, 2008**

---

**TRADEMARK  
PRINCIPAL REGISTER**

**TERASIM**

FTL SYSTEMS, INC. (MINNESOTA CORPORATION)  
1620 GREENVIEW DRIVE SW  
ROCHESTER, MN 55902

FOR: COMPUTER APPLICATION SOFTWARE  
USED IN THE DESIGN OF ELECTRONIC AND  
ELECTRO-MECHANICAL SYSTEMS TO COMPILE,  
SIMULATE, SYNTHESIZE OR ANALYZE ELECTRONIC  
AND ELECTRO-MECHANICAL SYSTEMS,  
IN CLASS 9 (U.S. CLS. 21, 23, 26, 36 AND 38).

FIRST USE 12-30-2001; IN COMMERCE 3-25-2005.

THE MARK CONSISTS OF STANDARD CHARACTERS  
WITHOUT CLAIM TO ANY PARTICULAR  
FONT, STYLE, SIZE, OR COLOR.

SN 78-763,923, FILED 11-30-2005.

DAVID MURRAY, EXAMINING ATTORNEY

**Int. Cl.: 9**

**Prior U.S. Cls.: 21, 23, 26, 36, and 38**

**United States Patent and Trademark Office**

**Reg. No. 3,469,466**

**Registered July 15, 2008**

**TRADEMARK  
PRINCIPAL REGISTER**

**WIRELESS FUTURE. UNLEASHED  
NOW.**

ATHEROS COMMUNICATIONS, INC. (DELA-  
WARE CORPORATION)  
5480 GREAT AMERICA PARKWAY  
SANTA CLARA, CA 950543644

FOR: COMPUTER SOFTWARE FOR CONTROL-  
LING, OPERATING, AND INTERFACING WITH  
WIRELESS NETWORKING AND COMMUNICA-  
TIONS SYSTEMS; COMPUTER HARDWARE,  
NAMELY, COMPUTER CHIPS AND MODULES  
FOR WIRELESS NETWORKING, AND COMMUNI-  
CATIONS, IN CLASS 9 (U.S. CLS. 21, 23, 26, 36 AND  
38).

FIRST USE 1-0-2008; IN COMMERCE 1-0-2008.

THE MARK CONSISTS OF STANDARD CHAR-  
ACTERS WITHOUT CLAIM TO ANY PARTICULAR  
FONT, STYLE, SIZE, OR COLOR.

SN 78-764,115, FILED 11-30-2005.

TASHIA BUNCH, EXAMINING ATTORNEY

**Int. Cl.: 9**

**Prior U.S. Cls.: 21, 23, 26, 36, and 38**

**United States Patent and Trademark Office**

**Reg. No. 3,469,467**

**Registered July 15, 2008**

**TRADEMARK  
PRINCIPAL REGISTER**

**TRIPLE INGOT**

IGT (NEVADA CORPORATION)  
9295 PROTOTYPE DRIVE  
RENO, NV 895218986

THE MARK CONSISTS OF STANDARD CHAR-  
ACTERS WITHOUT CLAIM TO ANY PARTICULAR  
FONT, STYLE, SIZE, OR COLOR.

FOR: GAMING MACHINES, NAMELY, DEVICES  
WHICH ACCEPT A WAGER, IN CLASS 9 (U.S. CLS.  
21, 23, 26, 36 AND 38).

SN 78-764,512, FILED 12-1-2005.

FIRST USE 8-28-2007; IN COMMERCE 8-28-2007.

ELLEN PERKINS, EXAMINING ATTORNEY

**Int. Cls.: 1, 5, and 31**

**Prior U.S. Cls.: 1, 5, 6, 10, 18, 26, 44, 46, 51, and 52**

**United States Patent and Trademark Office**

**Reg. No. 3,469,468**

**Registered July 15, 2008**

**TRADEMARK  
PRINCIPAL REGISTER**



KEMIN INDUSTRIES, INC. (IOWA CORPORATION)  
PO BOX 70 2100 MAURY STREET  
DES MOINES, IA 50301

FOR: CHEMICALS USED IN INDUSTRY, AGRICULTURE AND HORTICULTURE, NAMELY, ANTI-OXIDANT AND PRESERVATIVE INGREDIENTS FOR USE IN THE MANUFACTURE OF FEED AND FOODSTUFFS; CHEMICAL SUBSTANCES FOR PRESERVING FOODSTUFFS; SURFACTANTS FOR USE IN CONNECTION WITH AGRICULTURAL PESTICIDES; CHEMICAL PRESERVATIVES AND MOLD INHIBITORS FOR USE IN AGRICULTURE, ANIMAL AND POULTRY FOODSTUFFS AND FOR USE IN FOOD FOR HUMANS; CHEMICAL STABILIZERS USED FOR PRESERVING FATS, OIL AND VITAMINS; CHEMICALS IN THE NATURE OF SURFACE ACTIVE AGENTS FOR USE AS EMULSIFIERS, AS LUBRICITY AGENTS FOR ENHANCING THE PERFORMANCE OF LUBRICATING OILS AND AS ANTI-CAKING AGENTS FOR USE IN ANIMAL FEED; CHEMICAL ADDITIVES FOR USE AS BINDING AGENTS IN FEED PELLETS, IN CLASS 1 (U.S. CLS. 1, 5, 6, 10, 26 AND 46).

FIRST USE 12-23-2002; IN COMMERCE 11-5-2004.

FOR: PHARMACEUTICAL PRODUCTS FOR USE IN ANIMAL FEEDS, NAMELY, ENZYMES TO AID IN ANIMAL DIGESTION; NUTRITIVE SUPPLEMENTS FOR FOOD AND ANIMAL FEEDS; CAROTENOID COMPOSITION CONSISTING OF SUBSTANTIALLY PURIFIED LUTEIN AND ZEAXANTHIN DERIVED FROM PLANT MATERIALS, INCLUDING MARIGOLD FLOWERS, FOR USE IN FOOD AND BEVERAGES AS A DIETARY SUPPLEMENT; FOOD SUPPLEMENTS FOR HUMANS; DIETARY SUPPLEMENTS; A DIETARY SUPPLEMENT THAT ACTS AS AN APPETITE SUPPRESSANT AND GIVES A FEELING OF SATIETY; FOOD

SUPPLEMENTS, NAMELY, ANTI-OXIDANTS; MIXTURES OF BACTERIAL CONCENTRATES FOR ADDITION TO SILAGE FOR MEDICAL PURPOSES, IN CLASS 5 (U.S. CLS. 6, 18, 44, 46, 51 AND 52).

FIRST USE 12-23-2002; IN COMMERCE 11-5-2004.

FOR: AGRICULTURAL, HORTICULTURAL AND FORESTRY PRODUCTS NOT INCLUDED IN OTHER CLASSES, NAMELY, FOODSTUFFS FOR ANIMALS AND POULTRY; ADDITIVES FOR ANIMAL AND POULTRY FEEDING STUFFS FOR NON-NUTRITIONAL PURPOSES; NON-NUTRITIVE ADDITIVES FOR ANIMAL FEED TO PIGMENT THE FLESH OF FINFISH, CRUSTACEANS, AND THE SKIN AND EGG YOLKS OF POULTRY, IN CLASS 31 (U.S. CLS. 1 AND 46).

FIRST USE 12-23-2002; IN COMMERCE 11-5-2004.

NO CLAIM IS MADE TO THE EXCLUSIVE RIGHT TO USE "NUTRITION", APART FROM THE MARK AS SHOWN.

THE COLOR(S) LIGHT GREEN, DARK GREEN, RED, BLACK, AND WHITE IS/ARE CLAIMED AS A FEATURE OF THE MARK.

THE MARK CONSISTS OF A DARK GREEN CIRCLE WITH AN ANGELED LIGHT GREEN EGG SHAPED DESIGN THAT OVERLAPS A PORTION OF THE CIRCLE. THE EGG SHAPED DESIGN HAS A WHITE BORDER AROUND IT THAT SEPARATES THE DARK AND LIGHT GREEN DESIGNS. IT HAS THE WORDS "TOTAL NUTRITION" WITH THE WORD "TOTAL" IN RED AND "NUTRITION" IN BLACK.

SN 78-766,343, FILED 12-5-2005.

DAVID ELTON, EXAMINING ATTORNEY



**Int. Cls.: 9, 16, and 19**

**Prior U.S. Cls.: 1, 2, 5, 12, 21, 22, 23, 26, 29, 33, 36, 37,  
38, and 50**

**Reg. No. 3,469,469**

**United States Patent and Trademark Office**

**Registered July 15, 2008**

**TRADEMARK  
PRINCIPAL REGISTER**

**CORNCARD**

ARTHUR BLANK & COMPANY, INC. (MASSACHUSETTS CORPORATION)  
225 RIVERMOOR STREET  
BOSTON, MA 02132

FOR: PLASTIC SIGNS THAT ARE NON-METAL, NON-LUMINOUS, AND NON-MECHANICAL, IN CLASS 19 (U.S. CLS. 1, 12, 33 AND 50).

FOR: PLASTIC MAGNETICALLY ENCODED DEBIT CARDS, IN CLASS 9 (U.S. CLS. 21, 23, 26, 36 AND 38).

FIRST USE 11-22-2005; IN COMMERCE 11-22-2005.

FIRST USE 1-2-2006; IN COMMERCE 1-2-2006.

THE MARK CONSISTS OF STANDARD CHARACTERS WITHOUT CLAIM TO ANY PARTICULAR FONT, STYLE, SIZE, OR COLOR.

FOR: PLASTIC NON-MAGNETICALLY ENCODED DEBIT CARDS, IN CLASS 16 (U.S. CLS. 2, 5, 22, 23, 29, 37, 38 AND 50).

SN 78-766,384, FILED 12-5-2005.

FIRST USE 1-2-2006; IN COMMERCE 1-2-2006.

MAUREEN DALL, EXAMINING ATTORNEY

**Int. Cl.: 9**

**Prior U.S. Cls.: 21, 23, 26, 36, and 38**

**United States Patent and Trademark Office**

**Reg. No. 3,469,470**

**Registered July 15, 2008**

**TRADEMARK  
PRINCIPAL REGISTER**

**FULLHOUSE LIVE**

FULLHOUSE MEDIA, INC. (WISCONSIN CORPORATION)

207 NORTH MILWAUKEE STREET

MILWAUKEE, WI 53202

FOR: COMPUTER SOFTWARE PROGRAMS FOR THE CAPTURING AND INTEGRATION OF DIGITAL IMAGES, BOTH STILL AND MOVING, AND CONSUMER DATA INTO AN INTERACTIVE DELIVERY FOR MULTIMEDIA APPLICATIONS, IN CLASS 9 (U.S. CLS. 21, 23, 26, 36 AND 38).

FIRST USE 10-28-2005; IN COMMERCE 10-28-2005.

THE MARK CONSISTS OF STANDARD CHARACTERS WITHOUT CLAIM TO ANY PARTICULAR FONT, STYLE, SIZE, OR COLOR.

OWNER OF U.S. REG. NOS. 2,592,388, 2,628,811, AND OTHERS.

NO CLAIM IS MADE TO THE EXCLUSIVE RIGHT TO USE "LIVE", APART FROM THE MARK AS SHOWN.

SN 78-767,402, FILED 12-6-2005.

ALEXANDER L. POWERS, EXAMINING ATTORNEY

**Int. Cl.: 28**

**Prior U.S. Cls.: 22, 23, 38, and 50**

**Reg. No. 3,469,471**

**United States Patent and Trademark Office**

**Registered July 15, 2008**

---

**TRADEMARK  
PRINCIPAL REGISTER**

**Stuff Me Later**

JANIS E. FENTON (UNITED STATES INDIVIDUAL)  
E. 2755 NETTLETON GULCH ROAD  
COEUR D'ALENE, ID 83815

THE MARK CONSISTS OF STANDARD CHARACTERS WITHOUT CLAIM TO ANY PARTICULAR FONT, STYLE, SIZE, OR COLOR.

FOR: PLUSH TOY; DOLL CLOTHING ACCESSORIES FOR CHILDREN'S TOY BEAR AND ANIMALS; SOFT SCULPTURE TOYS, IN CLASS 28 (U.S. CLS. 22, 23, 38 AND 50).

SN 78-768,891, FILED 12-7-2005.

FIRST USE 12-1-2005; IN COMMERCE 12-1-2005.

BARBARA BROWN, EXAMINING ATTORNEY

**Int. Cl.: 9**

**Prior U.S. Cls.: 21, 23, 26, 36, and 38**

**Reg. No. 3,469,472**

**United States Patent and Trademark Office**

**Registered July 15, 2008**

**TRADEMARK  
PRINCIPAL REGISTER**

**JAZZ**

UNITRONICS (1989) (R"G) LTD. (ISRAEL LTD  
LIAB CO)  
POB 300  
UNITRONICS BUILDING, AIRPORT CITY  
BEN-GURION AIRPORT, ISRAEL 70100

FOR: COMPUTER BASED ELECTRONIC PRODUCTS, NAMELY, PROGRAMMABLE LOGIC CONTROLLERS AND EXPANSION UNITS FOR PROGRAMMABLE LOGIC CONTROLLERS; COMPUTER SOFTWARE FOR AUTOMATING WAREHOUSES, DISTRIBUTION CENTERS, CONTROL SYSTEMS AND CONVEYOR SYSTEMS IN MANUFACTURING INDUSTRIES; AND PROGRAMMING SOFTWARE FOR INDUSTRIAL AUTOMATION, INDUSTRIAL LOGISTICS AND PROGRAMMABLE LOGIC CONTROLLERS, COMPUTER SOFTWARE FOR AUTOMATION, CONTROL AND MANAGE-

MENT FOR USE IN AUTOMATED LOGISTICS SYSTEMS, MAINLY AUTOMATIC WAREHOUSES AND DISTRIBUTION SYSTEMS; PROGRAMMABLE LOGIC CONTROLLERS WITH INPUTS AND OUTPUTS, HUMAN MACHINE INTERFACE AND KEYPAD , IN CLASS 9 (U.S. CLS. 21, 23, 26, 36 AND 38).

FIRST USE 3-0-2006; IN COMMERCE 3-0-2006.

THE MARK CONSISTS OF STANDARD CHARACTERS WITHOUT CLAIM TO ANY PARTICULAR FONT, STYLE, SIZE, OR COLOR.

SN 78-769,177, FILED 12-8-2005.

TINA BROWN, EXAMINING ATTORNEY

**Int. Cl.: 9**

**Prior U.S. Cls.: 21, 23, 26, 36, and 38**

**Reg. No. 3,469,473**

**United States Patent and Trademark Office**

**Registered July 15, 2008**

---

**TRADEMARK  
PRINCIPAL REGISTER**

**Make It Live**

IMATION CORP. (DELAWARE CORPORATION)  
ONE IMATION PLACE  
LEGAL AFFAIRS  
OAKDALE, MN 55128

FOR: AUDIO SPEAKERS FOR SATELLITE  
RADIOS, AUDIO SPEAKERS FOR MP3 PLAYERS,  
AUDIO SPEAKERS FOR MEDIA AND MULTIME-  
DIA PLAYERS AND CONSOLES; MP3 PLAYERS, IN  
CLASS 9 (U.S. CLS. 21, 23, 26, 36 AND 38).

FIRST USE 12-21-2005; IN COMMERCE 3-4-2006.

THE MARK CONSISTS OF STANDARD CHAR-  
ACTERS WITHOUT CLAIM TO ANY PARTICULAR  
FONT, STYLE, SIZE, OR COLOR.

SN 78-769,452, FILED 12-8-2005.

EDWARD NELSON, EXAMINING ATTORNEY

**Int. Cls.: 37 and 40**

**Prior U.S. Cls.: 100, 103, and 106**

**United States Patent and Trademark Office**

**Reg. No. 3,469,474**

**Registered July 15, 2008**

**SERVICE MARK  
PRINCIPAL REGISTER**

**VOODOO AIR**

VOODOO AIRBRUSHING (CANADA PARTNER-SHIP)  
717 FINLEY AVENUE UNITS 9 AND 10  
AJAX, ONTARIO, CANADA L1S 3T1

FOR: CUSTOM DECORATIVE PAINTING SERVICES, IN CLASS 37 (U.S. CLS. 100, 103 AND 106).

FIRST USE 5-1-2008; IN COMMERCE 5-1-2008.

FOR: AIR BRUSHING SERVICES FOR OTHERS IN THE FIELDS OF APPAREL, LEATHER GOODS, HOCKEY HELMETS, GOALIE MASKS, BASEBALL HELMETS, GUITARS, BASS GUITARS, DRUM KITS, SKATEBOARDS, SURFBOARDS, AUTOMO-

BILES, TRUCKS, AIRPLANES, BOATS, PERSONAL WATERCRAFT AND MOTORCYCLES, IN CLASS 40 (U.S. CLS. 100, 103 AND 106).

FIRST USE 5-1-2008; IN COMMERCE 5-1-2008.

THE MARK CONSISTS OF STANDARD CHARACTERS WITHOUT CLAIM TO ANY PARTICULAR FONT, STYLE, SIZE, OR COLOR.

SN 78-772,988, FILED 12-14-2005.

IRA J. GOODSaid, EXAMINING ATTORNEY

**Int. Cls.: 35 and 36**

**Prior U.S. Cls.: 100, 101, and 102**

**United States Patent and Trademark Office**

**Reg. No. 3,469,475**

**Registered July 15, 2008**

**SERVICE MARK  
PRINCIPAL REGISTER**

**IN THE BUSINESS OF CREATING  
A GREAT EXPERIENCE**

PHOENIX BROKERS LLC (OREGON LIMITED  
LIABILITY CORPORATION)  
4970 S.W. GRIFFITH DR.  
BEAVERTON, OR 97005

FOR: REAL ESTATE SALES MANAGEMENT, IN  
CLASS 35 (U.S. CLS. 100, 101 AND 102).

FIRST USE 3-31-2008; IN COMMERCE 3-31-2008.

FOR: REAL ESTATE BROKERAGE SERVICES, IN  
CLASS 36 (U.S. CLS. 100, 101 AND 102).

FIRST USE 3-31-2008; IN COMMERCE 3-31-2008.

THE MARK CONSISTS OF STANDARD CHAR-  
ACTERS WITHOUT CLAIM TO ANY PARTICULAR  
FONT, STYLE, SIZE, OR COLOR.

SN 78-773,204, FILED 12-14-2005.

CYNTHIA SLOAN, EXAMINING ATTORNEY

Int. Cl.: 11

Prior U.S. Cls.: 13, 21, 23, 31, and 34

United States Patent and Trademark Office

Reg. No. 3,469,476

Registered July 15, 2008

TRADEMARK  
PRINCIPAL REGISTER

STYAGRA FALLS

JACOBSON, EVAN, C. (UNITED STATES INDIVIDUAL)

5710 E. SEVENTH STREET, #138

LONG BEACH, CA 90803

FOR: WATER FOUNTAINS, IN CLASS 11 (U.S. CLS. 13, 21, 23, 31 AND 34).

FIRST USE 5-22-2008; IN COMMERCE 5-22-2008.

THE MARK CONSISTS OF STANDARD CHARACTERS WITHOUT CLAIM TO ANY PARTICULAR FONT, STYLE, SIZE, OR COLOR.

NO CLAIM IS MADE TO THE EXCLUSIVE RIGHT TO USE "FALLS", APART FROM THE MARK AS SHOWN.

SN 78-773,815, FILED 12-15-2005.

ADA HAN, EXAMINING ATTORNEY



**Int. Cl.: 9**

**Prior U.S. Cls.: 21, 23, 26, 36, and 38**

**Reg. No. 3,469,477**

**United States Patent and Trademark Office**

**Registered July 15, 2008**

**TRADEMARK  
PRINCIPAL REGISTER**

**DOUBLE JADE**

IGT (NEVADA CORPORATION)  
9295 PROTOTYPE DRIVE  
RENO, NV 895218986

THE MARK CONSISTS OF STANDARD CHAR-  
ACTERS WITHOUT CLAIM TO ANY PARTICULAR  
FONT, STYLE, SIZE, OR COLOR.

FOR: GAMING MACHINES, NAMELY, DEVICES  
WHICH ACCEPT A WAGER, IN CLASS 9 (U.S. CLS.  
21, 23, 26, 36 AND 38).

SN 78-774,563, FILED 12-15-2005.

FIRST USE 8-28-2007; IN COMMERCE 8-28-2007.

ELLEN PERKINS, EXAMINING ATTORNEY

**Int. Cl.: 29**

**Prior U.S. Cl.: 46**

**United States Patent and Trademark Office**

**Reg. No. 3,469,478**

**Registered July 15, 2008**

**TRADEMARK  
PRINCIPAL REGISTER**

SOMETHING GREAT IS GROWING

HEB GROCERY COMPANY, L.P. (TEXAS LIMITED PARTNERSHIP)  
CORPORATE LAW DEPARTMENT  
646 SOUTH MAIN  
SAN ANTONIO, TX 78204

FOR: PRE-CUT FRUITS; PROCESSED FRUITS; SLICED FRUITS; PRE-CUT VEGETABLES; PROCESSED VEGETABLES; SLICED VEGETABLES; FRUIT AND VEGETABLE SALADS; FRUIT SALADS; VEGETABLE SALADS; PRE-CUT VEGETABLE SALADS, IN CLASS 29 (U.S. CL. 46).

FIRST USE 5-0-2006; IN COMMERCE 5-0-2006.

THE MARK CONSISTS OF STANDARD CHARACTERS WITHOUT CLAIM TO ANY PARTICULAR FONT, STYLE, SIZE, OR COLOR.

SN 78-775,160, FILED 12-16-2005.

EDWARD NELSON, EXAMINING ATTORNEY

**Int. Cl.: 41**

**Prior U.S. Cls.: 100, 101, and 107**

**United States Patent and Trademark Office**

**Reg. No. 3,469,479**

**Registered July 15, 2008**

**SERVICE MARK  
PRINCIPAL REGISTER**

# Chai Pod

BRAINSQUEEZE (NEW YORK LIMITED LIABILITY CORPORATION)  
525 EAST 72ND STREET 40 I  
NEW YORK, NY 10021

FOR: PROVIDING INFORMATIONAL AUDIO AND AUDIO-VIDEO PROGRAMS FOR OTHERS OVER LOCAL AND GLOBAL NETWORKS, NAMELY, THE INTERNET IN THE FIELD OF JEWISH RELATED TOPICS, NAMELY, TEACHINGS AND PRAYER, IN CLASS 41 (U.S. CLS. 100, 101 AND 107).

FIRST USE 2-1-2008; IN COMMERCE 2-1-2008.

THE MARK CONSISTS OF STANDARD CHARACTERS WITHOUT CLAIM TO ANY PARTICULAR FONT, STYLE, SIZE, OR COLOR.

SN 78-775,690, FILED 12-18-2005.

ANDREA SAUNDERS, EXAMINING ATTORNEY

**Int. Cl.: 16**

**Prior U.S. Cls.: 2, 5, 22, 23, 29, 37, 38, and 50**

**United States Patent and Trademark Office**

**Reg. No. 3,469,480**

**Registered July 15, 2008**

**TRADEMARK  
PRINCIPAL REGISTER**



RMC JONES LLC (MINNESOTA LTD LIAB CO)  
16154 MAIN AVENUE SE #331  
PRIOR LAKE, MN 55372

THE MARK CONSISTS OF STANDARD CHAR-  
ACTERS WITHOUT CLAIM TO ANY PARTICULAR  
FONT, STYLE, SIZE, OR COLOR.

FOR: PLASTIC RETRIEVER BAGS FOR CON-  
TAINMENT AND DISPOSAL OF PET WASTE, IN  
CLASS 16 (U.S. CLS. 2, 5, 22, 23, 29, 37, 38 AND 50).

SN 78-776,430, FILED 12-19-2005.

FIRST USE 4-17-2008; IN COMMERCE 4-17-2008.

ALICE BENMAMAN, EXAMINING ATTORNEY

**Int. Cl.: 25**

**Prior U.S. Cls.: 22 and 39**

**United States Patent and Trademark Office**

**Reg. No. 3,469,481**

**Registered July 15, 2008**

**TRADEMARK  
PRINCIPAL REGISTER**

**SWIM TO WIN**

A&H SPORTSWEAR CO., INC. (PENNSYLVANIA  
CORPORATION)  
ROUTES 191 AND 33  
STOCKERTOWN, PA 18083

THE MARK CONSISTS OF STANDARD CHAR-  
ACTERS WITHOUT CLAIM TO ANY PARTICULAR  
FONT, STYLE, SIZE, OR COLOR.

FOR: GIRLS', BOYS', WOMEN'S AND MEN'S  
SWIMWEAR, IN CLASS 25 (U.S. CLS. 22 AND 39).

SN 78-778,104, FILED 12-21-2005.

FIRST USE 12-21-2007; IN COMMERCE 12-21-2007.

CHARLES L. JENKINS, EXAMINING ATTORNEY

**Int. Cl.: 3**

**Prior U.S. Cls.: 1, 4, 6, 50, 51, and 52**

**United States Patent and Trademark Office**

**Reg. No. 3,469,482**

**Registered July 15, 2008**

**TRADEMARK  
PRINCIPAL REGISTER**

**BodyACTIVE**

BOTICA COMERCIAL FARMACÊUTICA LTDA  
(BRAZIL LTD LIAB CO)  
AV. RUI BARBOSA  
3450 ALFONSO PENA  
SAO JOSE DOS PINHAIS, BRAZIL 83.055-90

FIRST USE 12-19-2006; IN COMMERCE 3-19-2007.

SN 78-778,270, FILED 12-21-2005.

FOR: COSMETICS, IN CLASS 3 (U.S. CLS. 1, 4, 6, 50,  
51 AND 52).

RUDY R. SINGLETON, EXAMINING ATTORNEY

Int. Cl.: 25

Prior U.S. Cls.: 22 and 39

United States Patent and Trademark Office

Reg. No. 3,469,483

Registered July 15, 2008

TRADEMARK  
PRINCIPAL REGISTER

SATORI ACADEMY

KOVAR'S, INC. (CALIFORNIA CORPORATION)  
7538 FAIR OAKS BLVD.  
CARMICHAEL, CA 95608

FOR: CLOTHING, NAMELY, APRONS, ASCOTS, ATHLETIC FOOTWEAR, ATHLETIC SHOES, ATHLETIC UNIFORMS, BANDANAS, BASEBALL CAPS, BATH SLIPPERS, BATHING CAPS, BATHING SUITS, BATHING TRUNKS, BATHROBES, BEACH COVER-UPS, BEACH SHOES, BEACHWEAR, BEANIES, BELTS, BERETS, BERMUDA SHORTS, BIKINIS, BLAZERS, BLOUSES, BODY SHAPERS, BODY SUITS, BOXER SHORTS, BRAS, BRASSIERES, BRIEFS, CAMP SHIRTS, CAPS, CARDIGANS, CHEF'S HATS, WRAP-AROUNDS, COATS, COLLARS, CROP TOPS, CUFFS, DENIM JACKETS, EAR MUFFS, GOLF SHIRTS, GYM SHORTS, HALTER TOPS, HATS, HEAD BANDS, HEADWEAR, INFANTWEAR, JACKETS, JEANS, JOGGING SUITS, LEATHER JACKETS, LEG WARMERS, LEGGINGS, LIGHT-REFLECTING JACKETS, LINGERIE, LOUNGEWEAR, MOCK TURTLE-NECK SWEATERS, MONEY BELTS, MUFFLERS, NECK BANDS, NECKWEAR, NIGHT SHIRTS, PAJAMAS, PANTIES, PANTS, POLO SHIRTS, PONCHOS, PULL-OVERS, RAIN JACKETS, SANDALS, SASHES, SCARVES, SHAWLS, SHIRTS, SHOES, SHORTS, SLEEP SHIRTS, SLEEPWEAR, SLIPPERS, SNEA-

KERS, SOCKS, SPORT COATS, SPORT SHIRTS, SUN VISORS, SWEAT BANDS, SWEAT PANTS, SWEAT SHIRTS, SWEAT SHORTS, SWEAT SUITS, SWEATERS, SWEATSOCKS, SWIM CAPS, SWIM TRUNKS, SWIM WEAR, SWIMMING CAPS, SWIMSUITS, TANK TOPS, T-SHIRTS, VISORS, V-NECK SWEATERS, WIND RESISTANT JACKETS, WRIST BANDS, AND WRISTBANDS CONTAINING A COOLING SUBSTANCE TO COOL THE WEARER; MARTIAL ARTS UNIFORMS, IN CLASS 25 (U.S. CLS. 22 AND 39).

FIRST USE 9-1-2005; IN COMMERCE 9-1-2005.

THE MARK CONSISTS OF STANDARD CHARACTERS WITHOUT CLAIM TO ANY PARTICULAR FONT, STYLE, SIZE, OR COLOR.

NO CLAIM IS MADE TO THE EXCLUSIVE RIGHT TO USE "ACADEMY", APART FROM THE MARK AS SHOWN.

THE ENGLISH TRANSLATION OF THE WORD "SATORI" IS ENLIGHTENMENT.

SN 78-780,456, FILED 12-23-2005.

JOSETTE BEVERLY, EXAMINING ATTORNEY

**Int. Cls.: 9 and 28**

**Prior U.S. Cls.: 21, 22, 23, 26, 36, 38, and 50**

**United States Patent and Trademark Office**

**Reg. No. 3,469,484**

**Registered July 15, 2008**

**TRADEMARK  
PRINCIPAL REGISTER**

# Zing!

THINK LINK, INC. (NEW YORK CORPORATION), DBA TLI GAMES,  
1735 YORK AVENUE, SUITE 34C  
NEW YORK, NY 10128

FOR: COMPUTER GAME PROGRAMS; ELECTRONIC GAME PROGRAMS; ELECTRONIC GAME SOFTWARE FOR CELLULAR TELEPHONES; ELECTRONIC GAME SOFTWARE FOR HANDHELD ELECTRONIC DEVICES; ELECTRONIC GAME SOFTWARE FOR WIRELESS DEVICES; INTERACTIVE MULTIMEDIA COMPUTER GAME PROGRAM, IN CLASS 9 (U.S. CLS. 21, 23, 26, 36 AND 38).

FIRST USE 1-1-2006; IN COMMERCE 9-1-2006.

FOR: BOARD GAMES; HAND HELD UNIT FOR PLAYING ELECTRONIC GAMES; PARLOR GAMES; PARTY GAMES, IN CLASS 28 (U.S. CLS. 22, 23, 38 AND 50).

FIRST USE 1-1-2006; IN COMMERCE 9-1-2006.

THE MARK CONSISTS OF STANDARD CHARACTERS WITHOUT CLAIM TO ANY PARTICULAR FONT, STYLE, SIZE, OR COLOR.

SN 78-781,297, FILED 12-27-2005.

SANJEEV VOHRA, EXAMINING ATTORNEY



Int. Cl.: 37

Prior U.S. Cls.: 100, 103, and 106

United States Patent and Trademark Office

Reg. No. 3,469,485

Registered July 15, 2008

SERVICE MARK  
PRINCIPAL REGISTER

IPL

INTERNATIONAL PIPELINING TECHNOLOGIES, INC. (CALIFORNIA CORPORATION)  
SUITE H  
8250 CARNINO SANTA FE  
SAN DIEGO, CA 92121

FOR: PIPELINE REHABILITATION, RESTORATION AND MAINTENANCE SERVICES, NAMELY, REHABILITATION, RESTORATION AND MAINTENANCE OF CURED IN PLACE PIPE, WATER PIPES, SEWER PIPES AND INDUSTRIAL PIPES, IN CLASS 37 (U.S. CLS. 100, 103 AND 106).

FIRST USE 9-20-2003; IN COMMERCE 9-20-2003.

THE MARK CONSISTS OF STANDARD CHARACTERS WITHOUT CLAIM TO ANY PARTICULAR FONT, STYLE, SIZE, OR COLOR.

SN 78-784,129, FILED 1-3-2006.

CAROLINE WOOD, EXAMINING ATTORNEY

Int. Cl.: 7

Prior U.S. Cls.: 13, 19, 21, 23, 31, 34, and 35

Reg. No. 3,469,486

United States Patent and Trademark Office

Registered July 15, 2008

TRADEMARK  
PRINCIPAL REGISTER

wine swirl

HALL, ROGER C. (UNITED STATES INDIVIDUAL)  
3275 BRYCELER DRIVE  
EUGENE, OR 97405

NO CLAIM IS MADE TO THE EXCLUSIVE RIGHT TO USE "WINE", APART FROM THE MARK AS SHOWN.

FOR: ELECTRIC BEVERAGE STIRRER AND PARTS THEREOF, IN CLASS 7 (U.S. CLS. 13, 19, 21, 23, 31, 34 AND 35).

SN 78-784,321, FILED 1-3-2006.

FIRST USE 5-14-2008; IN COMMERCE 5-14-2008.

PAULA MAHONEY, EXAMINING ATTORNEY

**Int. Cl.: 2**

**Prior U.S. Cls.: 6, 11, and 16**

**United States Patent and Trademark Office**

**Reg. No. 3,469,487**

**Registered July 15, 2008**

**TRADEMARK  
PRINCIPAL REGISTER**

**INNOVATIVE**  
coating and progressive design

VISION OPTICS TECHNOLOGIES LTD. (DELA-  
WARE CORPORATION)  
220 E. DELAWARE AVENUE  
NEWARK, DE 19711

NO CLAIM IS MADE TO THE EXCLUSIVE  
RIGHT TO USE "COATING" , APART FROM THE  
MARK AS SHOWN.

FOR: OPTICAL COATINGS, IN CLASS 2 (U.S. CLS.  
6, 11 AND 16).

SN 78-785,327, FILED 1-5-2006.

FIRST USE 6-1-2006; IN COMMERCE 6-1-2006.

TEJBIR SINGH, EXAMINING ATTORNEY

**Int. Cl.: 20**

**Prior U.S. Cls.: 2, 13, 22, 25, 32, and 50**

**Reg. No. 3,469,488**

**United States Patent and Trademark Office**

**Registered July 15, 2008**

---

**TRADEMARK  
PRINCIPAL REGISTER**

**STYAGRA**

JACOBSON, EVAN C. (UNITED STATES INDIVIDUAL)  
5710 E. SEVENTH STREET, #138  
LONG BEACH, CA 90803

THE MARK CONSISTS OF STANDARD CHARACTERS WITHOUT CLAIM TO ANY PARTICULAR FONT, STYLE, SIZE, OR COLOR.

FOR: SCULPTURES OF PLASTIC, IN CLASS 20 (U.S. CLS. 2, 13, 22, 25, 32 AND 50).

SN 78-787,084, FILED 1-8-2006.

FIRST USE 5-22-2008; IN COMMERCE 5-22-2008.

ADA HAN, EXAMINING ATTORNEY

**Int. Cl.: 37**

**Prior U.S. Cls.: 100, 103, and 106**

**United States Patent and Trademark Office**

**Reg. No. 3,469,489**

**Registered July 15, 2008**

**SERVICE MARK  
PRINCIPAL REGISTER**

**TECH HERO INC.**

PARAS, DREW (UNITED STATES INDIVIDUAL)  
2151 CONSULATE DR. #6  
ORLANDO, FL 32837

FOR: MOBILE MAINTENANCE AND REPAIR OF  
COMPUTER HARDWARE; REPAIR OF COMPU-  
TERS, IN CLASS 37 (U.S. CLS. 100, 103 AND 106).

FIRST USE 2-17-2006; IN COMMERCE 2-17-2006.

THE MARK CONSISTS OF STANDARD CHAR-  
ACTERS WITHOUT CLAIM TO ANY PARTICULAR  
FONT, STYLE, SIZE, OR COLOR.

NO CLAIM IS MADE TO THE EXCLUSIVE  
RIGHT TO USE "TECH" AND "INC", APART FROM  
THE MARK AS SHOWN.

SN 78-788,679, FILED 1-10-2006.

ARETHA SOMERVILLE, EXAMINING ATTORNEY

**Int. Cl.: 3**

**Prior U.S. Cls.: 1, 4, 6, 50, 51, and 52**

**United States Patent and Trademark Office**

**Reg. No. 3,469,490**

**Registered July 15, 2008**

**TRADEMARK  
PRINCIPAL REGISTER**

**LEAFOVERT**

SYMRISE GMBH & CO. KG (FED REP GERMA-  
NY LIMITED PARTNERSHIP)  
MUHLENFELDSTRASSE 1  
HOLZMINDEN, FED REP GERMANY 37603

THE MARK CONSISTS OF STANDARD CHAR-  
ACTERS WITHOUT CLAIM TO ANY PARTICULAR  
FONT, STYLE, SIZE, OR COLOR.

FOR: PERFUMERY, IN CLASS 3 (U.S. CLS. 1, 4, 6,  
50, 51 AND 52).

SN 78-789,975, FILED 1-12-2006.

FIRST USE 6-4-2007; IN COMMERCE 6-4-2007.

LA TONIA FISHER, EXAMINING ATTORNEY

**Int. Cl.: 41**

**Prior U.S. Cls.: 100, 101, and 107**

**United States Patent and Trademark Office**

**Reg. No. 3,469,491**

**Registered July 15, 2008**

**SERVICE MARK  
PRINCIPAL REGISTER**

**I GOT A ROCKET**

TAFFY PRODUCTIONS, LLC (CALIFORNIA LTD  
LIAB CO)  
21300 OXNARD STREET  
SUITE 100  
WOODLAND HILLS, CA 91367

FIELD OF ENTERTAINMENT, IN CLASS 41 (U.S.  
CLS. 100, 101 AND 107).

FIRST USE 6-1-2007; IN COMMERCE 6-1-2007.

FOR: ENTERTAINMENT SERVICES IN THE  
NATURE OF AN ON-GOING, ANIMATED TELEVI-  
SION SERIES; PRODUCTION AND DISTRIBUTION  
OF A SERIES OF CHILDREN'S PROGRAMS; IN-  
TERACTIVE COMPUTER GAMES, NAMELY, PRO-  
VIDING A COMPUTER GAME THAT MAY BE  
ACCESSED BY INTERNET USERS; PROVIDING  
AN INTERACTIVE WEBSITE ON COMPUTER NET-  
WORKS FEATURING INFORMATION IN THE

THE MARK CONSISTS OF STANDARD CHAR-  
ACTERS WITHOUT CLAIM TO ANY PARTICULAR  
FONT, STYLE, SIZE, OR COLOR.

SN 78-790,812, FILED 1-12-2006.

ALEXANDER L. POWERS, EXAMINING ATTOR-  
NEY

**Int. Cl.: 36**

**Prior U.S. Cls.: 100, 101, and 102**

**United States Patent and Trademark Office**

**Reg. No. 3,469,492**

**Registered July 15, 2008**

**SERVICE MARK  
PRINCIPAL REGISTER**

**INFINITY CASUALTY  
INSURANCE COMPANY**

INFINITY INSURANCE COMPANY (INDIANA  
CORPORATION)  
3700 COLONNADE PARKWAY  
BIRMINGHAM, AL 35243

OWNER OF U.S. REG. NOS. 1,819,181, 2,472,418,  
AND OTHERS.

FOR: PROPERTY AND CASUALTY INSURANCE  
UNDERWRITING SERVICES, IN CLASS 36 (U.S.  
CLS. 100, 101 AND 102).

NO CLAIM IS MADE TO THE EXCLUSIVE  
RIGHT TO USE "CASUALTY INSURANCE COM-  
PANY", APART FROM THE MARK AS SHOWN.

FIRST USE 7-30-2007; IN COMMERCE 7-30-2007.

SN 78-791,261, FILED 1-13-2006.

THE MARK CONSISTS OF STANDARD CHAR-  
ACTERS WITHOUT CLAIM TO ANY PARTICULAR  
FONT, STYLE, SIZE, OR COLOR.

HEATHER BIDDULPH, EXAMINING ATTORNEY



**Int. Cl.: 9**

**Prior U.S. Cls.: 21, 23, 26, 36, and 38**

**Reg. No. 3,469,493**

**United States Patent and Trademark Office**

**Registered July 15, 2008**

---

**TRADEMARK  
PRINCIPAL REGISTER**

**GOOD EGG - BAD EGG**

HORST, PATRICIA J. (UNITED STATES INDIVIDUAL)  
1802 BIRCHWOOD LANE  
ROCKFORD, IL 61107

THE MARK CONSISTS OF STANDARD CHARACTERS WITHOUT CLAIM TO ANY PARTICULAR FONT, STYLE, SIZE, OR COLOR.

FOR: EGG TESTERS IN THE FORM OF PLASTIC OR GLASS MEASURING CUPS, IN CLASS 9 (U.S. CLS. 21, 23, 26, 36 AND 38).

SN 78-791,478, FILED 1-13-2006.

FIRST USE 4-14-2008; IN COMMERCE 4-14-2008.

LYDIA BELZER, EXAMINING ATTORNEY

**Int. Cls.: 14 and 16**

**Prior U.S. Cls.: 2, 5, 22, 23, 27, 28, 29, 37, 38, and 50**

**United States Patent and Trademark Office**

**Reg. No. 3,469,494**

**Registered July 15, 2008**

**TRADEMARK  
PRINCIPAL REGISTER**

**I CAN THROUGH CHRIST**

DAVIS, PAMULA A (UNITED STATES INDIVIDUAL)  
P.O. BOX 33142  
FORT WORTH, TX 76162

FOR: GIRL'S AND BOY'S JEWELRY, IN CLASS 14 (U.S. CLS. 2, 27, 28 AND 50).

FIRST USE 11-1-2005; IN COMMERCE 11-1-2005.

FOR: CHILDREN'S PUBLICATIONS, NAMELY, BOOKS AND BOOKLETS FEATURING FICTIONAL AND NON-FICTIONAL STORIES AND CHARACTERS AND ADVICE TO PARENTS; CHILDREN'S BOOKS FEATURING ADVICE ON RELIGION, SPIRITUALITY, AND MORALITY; CHILDREN'S ACTIVITY BOOKS; CRAFT BOOKS; PUZZLE BOOKS; ADDRESS BOOKS; BOOKMARKS; MAPS; POSTERS; NOTE PAPER AND ENVELOPES; PENS;

MARKERS; DAILY PLANNERS; NOTEBOOKS; PRINTED SCRIPTS AND SCREENPLAYS FOR USE IN EDUCATIONAL VIDEOS; PRINTED INVITATIONS AND THANK YOU NOTES; RUBBER STAMPS; STATIONERY; STICKERS; TRADING CARDS; CHILDREN'S MAGAZINES FEATURING CONTEMPORARY ISSUES FOR CHILDREN, IN CLASS 16 (U.S. CLS. 2, 5, 22, 23, 29, 37, 38 AND 50).

FIRST USE 10-1-2007; IN COMMERCE 10-1-2007.

THE MARK CONSISTS OF STANDARD CHARACTERS WITHOUT CLAIM TO ANY PARTICULAR FONT, STYLE, SIZE, OR COLOR.

SN 78-791,971, FILED S.R. 1-14-2006; AM. P.R. 12-28-2006.

JORDAN BAKER, EXAMINING ATTORNEY

**Int. Cl.: 5**

**Prior U.S. Cls.: 6, 18, 44, 46, 51, and 52**

**United States Patent and Trademark Office**

**Reg. No. 3,469,495**

**Registered July 15, 2008**

**TRADEMARK  
PRINCIPAL REGISTER**

**AXSYM CORE-M**

ABBOTT LABORATORIES (ILLINOIS CORPORATION)  
100 ABBOTT PARK ROAD  
ABBOTT PARK, IL 60064

FOR: DIAGNOSTIC REAGENTS FOR MEDICAL  
USE, IN CLASS 5 (U.S. CLS. 6, 18, 44, 46, 51 AND 52).

FIRST USE 9-30-2006; IN COMMERCE 9-30-2006.

THE MARK CONSISTS OF STANDARD CHARACTERS WITHOUT CLAIM TO ANY PARTICULAR FONT, STYLE, SIZE, OR COLOR.

OWNER OF U.S. REG. NO. 3,079,602.

SN 78-792,505, FILED 1-16-2006.

JERI J. FICKES, EXAMINING ATTORNEY

Prior U.S. Cl.: A

United States Patent and Trademark Office

Reg. No. 3,469,496

Registered July 15, 2008

**CERTIFICATION MARK  
GOODS  
PRINCIPAL REGISTER**

**INDIANA FRESH FROM THE  
FARM BEEF**

INDIANA BEEF CATTLE ASSOCIATION, INC.  
(INDIANA CORPORATION)  
SUITE A  
8770 GUION ROAD  
INDIANAPOLIS, IN 46268

FOR: BEEF, IN CLASS A (U.S. CL. A).

FIRST USE 4-1-2006; IN COMMERCE 4-1-2006.

THE MARK CONSISTS OF STANDARD CHARACTERS WITHOUT CLAIM TO ANY PARTICULAR FONT, STYLE, SIZE, OR COLOR.

NO CLAIM IS MADE TO THE EXCLUSIVE RIGHT TO USE "BEEF", APART FROM THE MARK AS SHOWN.

THE CERTIFICATION MARK, AS USED BY PERSONS AUTHORIZED BY THE CERTIFIER, CERTIFIES THAT THE GOODS MUST ORIGINATE

FROM AN INDIANA PRODUCER AND MEET THE QUALITY STANDARDS OF THE CERTIFIER, NAMELY, THE BEEF MUST BE DRY AGED APPROXIMATELY 14 DAYS, BE PROCESSED AT STATE AND/OR FEDERAL PACKING PLANTS WITH AN HACCP PLAN IN PLACE. IN ADDITION, AUTHORIZED PERSONS MUST HAVE BEEN TRAINED AND CERTIFIED THROUGH BOTH THE INDIANA FRESH FROM THE FARM BEEF MARKETING AND EDUCATION PROGRAM AND IQ+BEEF, AN ADVANCED BEEF QUALITY ASSURANCE PROGRAM. PRODUCERS MUST BE MEMBERS OF THE INDIANA BEEF CATTLE ASSOCIATION AND HAVE A SIGNED LICENSING AGREEMENT ON FILE WITH THE ASSOCIATION.

SN 78-792,744, FILED 1-17-2006.

SUSAN HAYASH, EXAMINING ATTORNEY

Prior U.S. Cl.: A

United States Patent and Trademark Office

Reg. No. 3,469,497

Registered July 15, 2008

CERTIFICATION MARK  
GOODS  
PRINCIPAL REGISTER



INDIANA BEEF CATTLE ASSOCIATION, INC.  
(INDIANA CORPORATION)  
SUITE A  
8770 GUION ROAD  
INDIANAPOLIS, IN 46268

FOR: BEEF, IN CLASS A (U.S. CL. A).

FIRST USE 4-1-2006; IN COMMERCE 4-1-2006.

NO CLAIM IS MADE TO THE EXCLUSIVE RIGHT TO USE "BEEF", APART FROM THE MARK AS SHOWN.

THE MARK CONSISTS OF THE OUTLINE OF THE STATE OF INDIANA AND AN OUTLINE OF A BARN WITH TWO SILOS WITH THE WORDS "INDIANA FRESH FROM THE FARM BEEF".

THE CERTIFICATION MARK, AS USED BY PERSONS AUTHORIZED BY THE CERTIFIER,

CERTIFIES THAT THE GOODS MUST ORIGINATE FROM AN INDIANA PRODUCER AND MEET THE QUALITY STANDARDS OF THE CERTIFIER, NAMELY, THE BEEF MUST BE DRY AGED APPROXIMATELY 14 DAYS, BE PROCESSED AT STATE AND/OR FEDERAL PACKING PLANTS WITH AN HACCP PLAN IN PLACE. IN ADDITION, AUTHORIZED PERSONS MUST HAVE BEEN TRAINED AND CERTIFIED THROUGH BOTH THE INDIANA FRESH FROM THE FARM BEEF MARKETING AND EDUCATION PROGRAM AND IQ+BEEF, AN ADVANCED BEEF QUALITY ASSURANCE PROGRAM. PRODUCERS MUST BE MEMBERS OF THE INDIANA BEEF CATTLE ASSOCIATION AND HAVE A SIGNED LICENSING AGREEMENT ON FILE WITH THE ASSOCIATION.

SN 78-792,746, FILED 1-17-2006.

SUSAN HAYASH, EXAMINING ATTORNEY

Int. Cl.: 31

Prior U.S. Cls.: 1 and 46

**United States Patent and Trademark Office**

**Reg. No. 3,469,498**

Registered July 15, 2008

**TRADEMARK  
PRINCIPAL REGISTER**



BROWN, THOMAS (UNITED STATES INDIVIDUAL)  
3325 WYOMING STREET  
KANSAS CITY, MO 64111

FOR: EDIBLE CHEWS FOR ANIMALS, IN CLASS 31 (U.S. CLS. 1 AND 46).

FIRST USE 2-8-2006; IN COMMERCE 2-8-2006.

THE COLOR(S) ORANGE IS/ARE CLAIMED AS A FEATURE OF THE MARK.

THE MARK CONSISTS OF A CONFIGURATION OF AN ANIMAL CHEW IN THE SHAPE OF A CARROT.

SEC. 2(F).

SN 78-794,628, FILED 1-19-2006.

ALICE SUE CARRUTHERS, EXAMINING ATTORNEY

**Int. Cls.: 29 and 43**

**Prior U.S. Cls.: 46, 100, and 101**

**United States Patent and Trademark Office**

**Reg. No. 3,469,499**

**Registered July 15, 2008**

**TRADEMARK  
SERVICE MARK  
PRINCIPAL REGISTER**



CAMPERO INTERNATIONAL LIMITED (BAR-  
BADOS CORPORATION)  
5 AVENIDA 15-45, ZONA 10  
CONDOMINIO CENTRO EMPRESARIAL, TORRE  
II NIVEL 12, PENTHOUSE NIVEL 12, PENTHOUSE  
GUATEMALA, GUATEMALA

FOR: COOKED POULTRY, IN CLASS 29 (U.S. CL.  
46).

FIRST USE 7-0-2005; IN COMMERCE 3-0-2008.

FOR: RESTAURANT SERVICES, IN CLASS 43  
(U.S. CLS. 100 AND 101).

FIRST USE 9-0-2004; IN COMMERCE 11-20-2005.

SN 78-795,229, FILED 1-19-2006.

RONALD MCMORROW, EXAMINING ATTORNEY

**Int. Cl.: 21**

**Prior U.S. Cls.: 2, 13, 23, 29, 30, 33, 40, and 50**

**Reg. No. 3,469,500**

**United States Patent and Trademark Office**

**Registered July 15, 2008**

---

**TRADEMARK  
PRINCIPAL REGISTER**

**POODLE-LOO**

A.C. MEEKS CO., INC. (MARYLAND CORPORATION)  
1615 CYNTHIA COURT  
JARRETTSVILLE, MD 21084

THE MARK CONSISTS OF STANDARD CHARACTERS WITHOUT CLAIM TO ANY PARTICULAR FONT, STYLE, SIZE, OR COLOR.

FOR: DOG LITTER BOXES, IN CLASS 21 (U.S. CLS. 2, 13, 23, 29, 30, 33, 40 AND 50).

SN 78-795,485, FILED 1-20-2006.

FIRST USE 4-4-2008; IN COMMERCE 4-4-2008.

MIDGE BUTLER, EXAMINING ATTORNEY



**Int. Cls.: 9, 38, and 42**

**Prior U.S. Cls.: 21, 23, 26, 36, 38, 100, 101, and 104**

**United States Patent and Trademark Office**

**Reg. No. 3,469,501**

**Registered July 15, 2008**

**TRADEMARK  
SERVICE MARK  
PRINCIPAL REGISTER**

# GOTOWEBINAR

CITRIX ONLINE, LLC (DELAWARE LTD LIAB  
CO)  
5385 HOLLISTER AVENUE  
SANTA BARBARA, CA 93111

FOR: COMPUTER SOFTWARE FOR TRANSMIT-  
TING DATA, GRAPHICS, AUDIO AND/OR VIDEO  
OVER ELECTRONIC COMMUNICATIONS NET-  
WORKS; COMPUTER SOFTWARE FOR FACILI-  
TATING BUSINESS TRANSACTIONS  
CONDUCTED VIA ELECTRONIC COMMUNICA-  
TIONS NETWORKS; COMPUTER SOFTWARE FOR  
CREATING, OFFERING, HOSTING, AND DELI-  
VERING ONLINE CONFERENCES, MEETINGS,  
DEMONSTRATIONS, TOURS, PRESENTATIONS,  
AND DISCUSSIONS, IN CLASS 9 (U.S. CLS. 21, 23,  
26, 36 AND 38).

FIRST USE 6-15-2006; IN COMMERCE 6-15-2006.

FOR: TELECOMMUNICATION SERVICES,  
NAMELY, BROADCASTING A WIDE VARIETY OF  
PROGRAMS, MEETINGS, EVENTS AND REAL  
TIME INFORMATION OVER GLOBAL COMPUTER

COMMUNICATIONS NETWORKS, IN CLASS 38  
(U.S. CLS. 100, 101 AND 104).

FIRST USE 6-15-2006; IN COMMERCE 6-15-2006.

FOR: COMPUTER SERVICES, NAMELY, HOST-  
ING ONLINE WEB FACILITIES FOR OTHERS FOR  
CONDUCTING ONLINE CONFERENCES, MEET-  
INGS, DEMONSTRATIONS, VIRTUAL TOURS,  
PRESENTATIONS AND INTERACTIVE DISCUS-  
SIONS, IN CLASS 42 (U.S. CLS. 100 AND 101).

FIRST USE 6-15-2006; IN COMMERCE 6-15-2006.

THE MARK CONSISTS OF STANDARD CHAR-  
ACTERS WITHOUT CLAIM TO ANY PARTICULAR  
FONT, STYLE, SIZE, OR COLOR.

OWNER OF U.S. REG. NOS. 2,772,971 AND  
3,172,020.

SN 78-795,848, FILED 1-20-2006.

JASON LOTT, EXAMINING ATTORNEY

**Int. Cl.: 5**

**Prior U.S. Cls.: 6, 18, 44, 46, 51, and 52**

**United States Patent and Trademark Office**

**Reg. No. 3,469,502**

**Registered July 15, 2008**

**TRADEMARK  
PRINCIPAL REGISTER**

**Ly-Co-Ten<sup>6</sup>**

NUTRU, INC. (ILLINOIS CORPORATION)  
SUITE D  
627 11TH STREET  
WILMETTE, IL 60091

FIRST USE 5-31-2006; IN COMMERCE 5-31-2006.

THE NUMBER "6" IS A SUPERSCRIPT.

SN 78-795,951, FILED 1-20-2006.

FOR: DIETARY SUPPLEMENT, IN CLASS 5 (U.S.  
CLS. 6, 18, 44, 46, 51 AND 52).

ELLEN BURNS, EXAMINING ATTORNEY

**Int. Cl.: 7**

**Prior U.S. Cls.: 13, 19, 21, 23, 31, 34, and 35**

**Reg. No. 3,469,503**

**United States Patent and Trademark Office**

**Registered July 15, 2008**

**TRADEMARK  
PRINCIPAL REGISTER**



SMURFIT-STONE CONTAINER ENTERPRISES,  
INC. (DELAWARE CORPORATION)  
150 N. MICHIGAN AVENUE  
CHICAGO, IL 60601

FOR: PACKAGING MACHINERY AND STRUCTURAL PARTS THEREFOR; MACHINES FOR USE IN THE FORMATION, ASSEMBLY, LOADING, FILLING AND SEALING OF ARTICLES FOR PACKAGING AND STRUCTURAL PARTS THEREFOR; MACHINES USED FOR ERECTING, FOLDING, OR MANIPULATING CORRUGATED PAPER BOARD OR PACKAGING MATERIAL; MACHINES FOR USE IN THE PREPARATION AND PRODUCTION OF PACKAGING MATERIALS IN SHEET FORM AND STRUCTURAL PARTS THEREFOR;

MACHINES FOR USE IN CUTTING, FOLDING AND APPLICATION OF ADHESIVE TO BLANKS FOR ARTICLES OF PACKAGING AND STRUCTURAL PARTS THEREFOR, IN CLASS 7 (U.S. CLS. 13, 19, 21, 23, 31, 34 AND 35).

FIRST USE 1-23-2006; IN COMMERCE 1-23-2006.

OWNER OF U.S. REG. NOS. 2,540,794, 2,884,730, AND OTHERS.

SN 78-797,374, FILED 1-23-2006.

DORITT L. CARROLL, EXAMINING ATTORNEY

**Int. Cl.: 11**

**Prior U.S. Cls.: 13, 21, 23, 31, and 34**

**United States Patent and Trademark Office**

**Reg. No. 3,469,504**

**Registered July 15, 2008**

---

**TRADEMARK  
PRINCIPAL REGISTER**

**DICHROLUX**

FX LUMINAIRE (CALIFORNIA CORPORATION)  
10019 WAPLES CT.  
SAN DIEGO, CA 92121

FOR: ELECTRIC LIGHTING FIXTURES; LIGHT  
BULBS, IN CLASS 11 (U.S. CLS. 13, 21, 23, 31 AND 34).

FIRST USE 12-0-2007; IN COMMERCE 12-0-2007.

THE MARK CONSISTS OF STANDARD CHAR-  
ACTERS WITHOUT CLAIM TO ANY PARTICULAR  
FONT, STYLE, SIZE, OR COLOR.

SN 78-797,609, FILED 1-23-2006.

ZACHARY BELLO, EXAMINING ATTORNEY

**Int. Cl.: 5**

**Prior U.S. Cls.: 6, 18, 44, 46, 51, and 52**

**Reg. No. 3,469,505**

**United States Patent and Trademark Office**

**Registered July 15, 2008**

**TRADEMARK  
PRINCIPAL REGISTER**

The logo for Modec Inc. features the word "modec" in a bold, lowercase, sans-serif font. The letter "o" is replaced by a solid red circle. To the right of "modec" is the word "inc." in a smaller, lowercase, sans-serif font.

MODEC INC. (COLORADO CORPORATION)

4725 OAKLAND STREET

DENVER, CO 80239

FOR: ALL PURPOSE DISINFECTANTS; ALL PURPOSE DISINFECTING AND DEODORIZING PREPARATIONS; ANTIBACTERIAL SPRAY; GERMICIDES AND FUNGICIDES, IN CLASS 5 (U.S. CLS. 6, 18, 44, 46, 51 AND 52).

FIRST USE 7-1-1991; IN COMMERCE 7-1-1991.

NO CLAIM IS MADE TO THE EXCLUSIVE RIGHT TO USE "INC.", APART FROM THE MARK AS SHOWN.

THE COLOR(S) RED AND BLACK IS/ARE CLAIMED AS A FEATURE OF THE MARK.

THE MARK CONSISTS OF BLACK LETTERING AND THE CENTER OF THE "O" IS RED.

SN 78-797,620, FILED 1-23-2006.

AMY HELLA, EXAMINING ATTORNEY

**Int. Cl.: 5**

**Prior U.S. Cls.: 6, 18, 44, 46, 51, and 52**

**United States Patent and Trademark Office**

**Reg. No. 3,469,506**

**Registered July 15, 2008**

**TRADEMARK  
PRINCIPAL REGISTER**



MODEC INC. (COLORADO CORPORATION)  
4725 OAKLAND STREET  
DENVER, CO 80239

FOR: ALL PURPOSE DISINFECTANTS; ALL PURPOSE DISINFECTING AND DEODORIZING PREPARATIONS; ANTIBACTERIAL SPRAY; GERMICIDES AND FUNGICIDES, IN CLASS 5 (U.S. CLS. 6, 18, 44, 46, 51 AND 52).

FIRST USE 1-1-1999; IN COMMERCE 1-1-1999.

NO CLAIM IS MADE TO THE EXCLUSIVE RIGHT TO USE "DECON SOLUTIONS", APART FROM THE MARK AS SHOWN.

THE COLOR(S) WHITE, GRAY, BLUE, GREEN, ORANGE, YELLOW AND BLACK IS/ARE CLAIMED AS A FEATURE OF THE MARK.

THE MARK CONSISTS OF A PARTIAL VIEW OF THE WESTERN HEMISPHERE OF THE EARTH. NORTH AND SOUTH AMERICA ARE DRAWN IN GREEN, ORANGE, AND YELLOW. THE OCEANS ARE IN BLUE. WHITE CLOUDS ARE SCATTERED AMONG THE CONTINENTS AND OCEANS, INCLUDING ANTARCTICA. THE EARTH SITS IN THE UPPER REGION OF THE MARK IN THE CENTER OF THE MARK. THERE IS A BLACK

BACKGROUND ON THE RIGHT SIDE OF THE MARK. A STRAIGHT DIAGONAL LINE LEANING TOWARDS THE RIGHT DIVIDES A GRAY BACKGROUND ON THE LEFT SIDE OF THE MARK FROM THE AFOREMENTIONED BLACK BACKGROUND ON THE MIDDLE AND RIGHT SIDE OF THE MARK. THE BLACK PORTION OF THE BACKGROUND IS LARGER THAN THE GRAY PORTION OF THE BACKGROUND. ON THE LEFT SIDE OF THE MARK IN THE GRAY BACKGROUND ARE THE WORDS "DECON SOLUTIONS" WRITTEN VERTICALLY FROM THE BOTTOM READING AT A DIAGONAL FROM THE LEFT CORNER OF THE MARK LEANING TO THE RIGHT, ALONG THE LINE THAT DIVIDES THE GRAY BACKGROUND FROM THE BLACK BACKGROUND, POSITIONED ON THE LEFT SIDE OF THE MARK. THE LETTERS "D", "E", "C", "O", AND "N" OF THE WORD "DECON" ARE IN BLACK ON THE GRAY BACKGROUND. THE LETTERS "N" AND "S" OF THE WORD "SOLUTIONS" ARE IN BLACK ON THE GRAY BACKGROUND. THE LETTERS "S", "O", "L", "U", "T", "I" AND "O" OF THE WORD "SOLUTIONS" ARE IN THE COLORS OF THE EARTH, "I.E." WHITE, BLACK, BLUE, GREEN, YELLOW AND ORANGE ON THE GRAY BACKGROUND.

SN 78-797,633, FILED 1-23-2006.

AMY HELLA, EXAMINING ATTORNEY

**Int. Cl.: 9**

**Prior U.S. Cls.: 21, 23, 26, 36, and 38**

**Reg. No. 3,469,507**

**United States Patent and Trademark Office**

**Registered July 15, 2008**

---

**TRADEMARK  
PRINCIPAL REGISTER**

**INNOBUS**

AIRZONE (SPAIN CORPORATION)  
NO.944  
1221 BRICKELL AVENUE  
MIAMI, FL 33131

FOR: CLIMATE CONTROL SYSTEMS CONSISTING OF DIGITAL THERMOSTATS, AIR CONDITIONING, HEATING, VENTILATION AND DRYING CONTROL DEVICES, IN CLASS 9 (U.S. CLS. 21, 23, 26, 36 AND 38).

FIRST USE 1-24-2007; IN COMMERCE 1-24-2007.

THE MARK CONSISTS OF STANDARD CHARACTERS WITHOUT CLAIM TO ANY PARTICULAR FONT, STYLE, SIZE, OR COLOR.

SN 78-798,211, FILED 1-24-2006.

CAROLINE WOOD, EXAMINING ATTORNEY

**Int. Cls.: 7, 9, and 11**

**Prior U.S. Cls.: 13, 19, 21, 23, 26, 31, 34, 35, 36, and 38**

**United States Patent and Trademark Office**

**Reg. No. 3,469,508**

**Registered July 15, 2008**

**TRADEMARK  
PRINCIPAL REGISTER**

**HAYWARD POOL PRODUCTS**

HAYWARD INDUSTRIES, INC. (NEW JERSEY CORPORATION)  
620 DIVISION STREET  
ELIZABETH, NJ 07207

FOR: PUMPS, PARTS AND FITTINGS THEREFOR FOR USE IN SWIMMING POOLS, SPAS, HOT TUBS, WHIRLPOOLS, AND OTHER BODIES OF WATER; UNDERWATER SWIMMING POOL CLEANING MACHINES FOR CLEANING THE SURFACE OF A SWIMMING POOL, IN CLASS 7 (U.S. CLS. 13, 19, 21, 23, 31, 34 AND 35).

FIRST USE 2-0-2007; IN COMMERCE 2-0-2007.

FOR: ELECTRONIC CONTROLS FOR USE IN SWIMMING POOLS, SPAS, HOT TUBS, WHIRLPOOLS, AND OTHER BODIES OF WATER, IN CLASS 9 (U.S. CLS. 21, 23, 26, 36 AND 38).

FIRST USE 2-0-2007; IN COMMERCE 2-0-2007.

FOR: FILTERS, HEATERS, SALT AND CHLORINE GENERATORS, LIGHTS AND VALVES FOR

USE IN SWIMMING POOLS, SPAS, HOT TUBS, WHIRLPOOLS, AND OTHER BODIES OF WATER, IN CLASS 11 (U.S. CLS. 13, 21, 23, 31 AND 34).

FIRST USE 2-0-2007; IN COMMERCE 2-0-2007.

THE MARK CONSISTS OF STANDARD CHARACTERS WITHOUT CLAIM TO ANY PARTICULAR FONT, STYLE, SIZE, OR COLOR.

OWNER OF U.S. REG. NOS. 1,058,211, 1,207,109, AND 2,921,665.

NO CLAIM IS MADE TO THE EXCLUSIVE RIGHT TO USE "POOL PRODUCTS", APART FROM THE MARK AS SHOWN.

SEC. 2(F).

SN 78-798,355, FILED 1-24-2006.

SANJEEV VOHRA, EXAMINING ATTORNEY



**Int. Cl.: 18**

**Prior U.S. Cls.: 1, 2, 3, 22, and 41**

**United States Patent and Trademark Office**

**Reg. No. 3,469,509**

**Registered July 15, 2008**

---

**TRADEMARK  
PRINCIPAL REGISTER**

**FRANKINCENSE & MYRRH**

TORSO LLC (CALIFORNIA LTD LIAB CO)  
1104 ABBOT KINNEY BLVD.  
VENICE, CA 90291

THE MARK CONSISTS OF STANDARD CHAR-  
ACTERS WITHOUT CLAIM TO ANY PARTICULAR  
FONT, STYLE, SIZE, OR COLOR.

FOR: HANDBAGS, PURSES, IN CLASS 18 (U.S.  
CLS. 1, 2, 3, 22 AND 41).

SN 78-798,432, FILED 1-24-2006.

FIRST USE 3-1-2008; IN COMMERCE 3-21-2008.

ALYSSA PALADINO, EXAMINING ATTORNEY

**Int. Cl.: 19**

**Prior U.S. Cls.: 1, 12, 33, and 50**

**United States Patent and Trademark Office**

**Reg. No. 3,469,510**

**Registered July 15, 2008**

**TRADEMARK  
PRINCIPAL REGISTER**

# Twin Clic

KRONOSPAN TECHNICAL COMPANY LTD.  
(CYPRUS CORPORATION)  
2 ANDREA ZAKKOU STREET, OFFICE 102  
ENGOMI, CYPRUS CY-2404

FOR: NON-METALLIC BUILDING MATERIALS WHOLLY OR MAINLY OF WOOD, NAMELY, PANELS, STRIPS, RODS AND SLABS FOR BUILDING PURPOSES; GLUED HARDBOARD, CHIPBOARD AND FIBREBOARD; PARQUET FLOORING AND PARQUET SLABS, WHOLLY OR MAINLY OF WOOD; HIGH PRESSURE LAMINATES FOR FLOOR COVERINGS; LUMBER; LAMINATED AND NON-LAMINATED MEDIUM DENSITY FIBREBOARD PLATES, HIGH DENSITY FIBREBOARD PLATES, ORIENTED STRAND BOARDS, AND PRESS BOARDS; NON-METAL DOOR FRAMES; PLANKS; NON-METALLIC BUILDING

SEPARATING PLATES; ROOF SHINGLES; WALL-BOARDS; PAPERBOARDS FOR CONSTRUCTION; WOOD VENEER; NON-METALLIC FENCES; NON-METALLIC WINDOW FRAMES; WOOD STRIPS FOR USE IN BUILDING AND CONSTRUCTION; NON-METALLIC DOORS AND DOOR PANELS, IN CLASS 19 (U.S. CLS. 1, 12, 33 AND 50).

FIRST USE 11-0-2006; IN COMMERCE 1-0-2007.

THE MARK CONSISTS OF STANDARD CHARACTERS WITHOUT CLAIM TO ANY PARTICULAR FONT, STYLE, SIZE, OR COLOR.

SN 78-798,651, FILED 1-24-2006.

DANIEL CAPSHAW, EXAMINING ATTORNEY

**Int. Cl.: 5**

**Prior U.S. Cls.: 6, 18, 44, 46, 51, and 52**

**Reg. No. 3,469,511**

**United States Patent and Trademark Office**

**Registered July 15, 2008**

---

**TRADEMARK  
PRINCIPAL REGISTER**

**PREFIX**

SYNGENTA PARTICIPATIONS AG (SWITZER-  
LAND CORPORATION)  
SCHWARZWALDALLEE 215  
BASEL, SWITZERLAND CH-4058

THE MARK CONSISTS OF STANDARD CHAR-  
ACTERS WITHOUT CLAIM TO ANY PARTICULAR  
FONT, STYLE, SIZE, OR COLOR.

FOR: HERBICIDE FOR AGRICULTURAL USE,  
IN CLASS 5 (U.S. CLS. 6, 18, 44, 46, 51 AND 52).

SN 78-798,752, FILED 1-25-2006.

FIRST USE 1-20-2008; IN COMMERCE 1-20-2008.

GILBERT SWIFT, EXAMINING ATTORNEY

**Int. Cl.: 29**

**Prior U.S. Cl.: 46**

**United States Patent and Trademark Office**

**Reg. No. 3,469,512**

**Registered July 15, 2008**

**TRADEMARK  
PRINCIPAL REGISTER**

**Ballerina**

CORTOPASSI PARTNERS (CALIFORNIA LIMITED PARTNERSHIP)  
11292 N. ALPINE ROAD  
STOCKTON, CA 95212

THE MARK CONSISTS OF STANDARD CHARACTERS WITHOUT CLAIM TO ANY PARTICULAR FONT, STYLE, SIZE, OR COLOR.

FOR: EDIBLE OIL; COOKING OIL; SALAD OIL; OLIVE OIL, IN CLASS 29 (U.S. CL. 46).

SN 78-799,423, FILED 1-25-2006.

FIRST USE 10-25-2007; IN COMMERCE 10-25-2007.

TINA BROWN, EXAMINING ATTORNEY

**Int. Cl.: 29**

**Prior U.S. Cl.: 46**

**United States Patent and Trademark Office**

**Reg. No. 3,469,513**

**Registered July 15, 2008**

**TRADEMARK  
PRINCIPAL REGISTER**

# Flamenco

CORTOPASSI PARTNERS (CALIFORNIA LIMITED PARTNERSHIP)  
11292 N. ALPINE ROAD  
MODESTO, CA 95354

FOR: EDIBLE OIL; COOKING OIL; SALAD OIL;  
OLIVE OIL, IN CLASS 29 (U.S. CL. 46).

FIRST USE 10-25-2007; IN COMMERCE 10-25-2007.

THE MARK CONSISTS OF STANDARD CHARACTERS WITHOUT CLAIM TO ANY PARTICULAR FONT, STYLE, SIZE, OR COLOR.

THE FOREIGN WORDING IN THE MARK TRANSLATES INTO ENGLISH AS FLAMINGO.

SN 78-799,436, FILED 1-25-2006.

TINA BROWN, EXAMINING ATTORNEY

**Int. Cl.: 28**

**Prior U.S. Cls.: 22, 23, 38, and 50**

**United States Patent and Trademark Office**

**Reg. No. 3,469,514**

**Registered July 15, 2008**

---

**TRADEMARK  
PRINCIPAL REGISTER**

**MEGA TREDZ**

DUMAR INTERNATIONAL USA INC. (MASSACHUSETTS CORPORATION)  
6 WINTERGREEN CIRCLE  
AMHERST, MA 01002

THE MARK CONSISTS OF STANDARD CHARACTERS WITHOUT CLAIM TO ANY PARTICULAR FONT, STYLE, SIZE, OR COLOR.

FOR: RIDE-ON TOYS, IN CLASS 28 (U.S. CLS. 22, 23, 38 AND 50).

SN 78-799,791, FILED 1-26-2006.

FIRST USE 6-1-2007; IN COMMERCE 6-1-2007.

LORETTA C. BECK, EXAMINING ATTORNEY

**Int. Cl.: 14**

**Prior U.S. Cls.: 2, 27, 28, and 50**

**United States Patent and Trademark Office**

**Reg. No. 3,469,515**

**Registered July 15, 2008**

**TRADEMARK  
PRINCIPAL REGISTER**

**Anna Rosa**

REIKI WITH TRUST, LLC (CONNECTICUT LTD  
LIAB CO)

56 DUANE LANE

BURLINGTON, CT 06013

FOR: JEWELRY, IN CLASS 14 (U.S. CLS. 2, 27, 28  
AND 50).

FIRST USE 11-1-2004; IN COMMERCE 11-1-2004.

THE MARK CONSISTS OF STANDARD CHAR-  
ACTERS WITHOUT CLAIM TO ANY PARTICULAR  
FONT, STYLE, SIZE, OR COLOR.

THE NAME SHOWN IN THE MARK IDENTIFIES  
"ANNA R. PIZZOFERRATO" WHOSE CONSENT IS  
OF RECORD.

SN 78-799,829, FILED 1-26-2006.

MYRIAH HABEEB, EXAMINING ATTORNEY

**Int. Cl.: 6**

**Prior U.S. Cls.: 2, 12, 13, 14, 23, 25, and 50**

**Reg. No. 3,469,516**

**United States Patent and Trademark Office**

**Registered July 15, 2008**

**TRADEMARK  
PRINCIPAL REGISTER**

# Lock Jaw

DOWNING - YEE - FULFORD, LLC (KANSAS  
LTD LIAB CO)  
24283 STATE AVENUE  
TONGANOXIE, KS 66044

THE MARK CONSISTS OF STANDARD CHAR-  
ACTERS WITHOUT CLAIM TO ANY PARTICULAR  
FONT, STYLE, SIZE, OR COLOR.

FOR: SMALL ITEMS OF METAL HARDWARE,  
NAMELY, A METALLIC FRAME, A LOCKING  
SCREW AND A TWO-TINED METAL BAR FOR  
SECURITY LOCKS; SMALL ITEMS OF METAL  
HARDWARE, NAMELY, SECURITY LOCKS FOR  
ENGAGEMENT WITH THE THUMB LATCH OF A  
CONVENTIONAL DEADBOLT, MOUNTED ON A  
DOOR, IN CLASS 6 (U.S. CLS. 2, 12, 13, 14, 23, 25 AND  
50).

NO CLAIM IS MADE TO THE EXCLUSIVE  
RIGHT TO USE "LOCK", APART FROM THE MARK  
AS SHOWN.

SN 78-800,382, FILED 1-26-2006.

FIRST USE 5-31-2006; IN COMMERCE 5-31-2006.

TRACY WHITTAKER-BROWN, EXAMINING AT-  
TORNEY



**Int. Cl.: 30**

**Prior U.S. Cl.: 46**

**United States Patent and Trademark Office**

**Reg. No. 3,469,517**

**Registered July 15, 2008**

**TRADEMARK  
PRINCIPAL REGISTER**

**Landmark Confections**

GREENBRIER INTERNATIONAL, INC. (DELA-  
WARE CORPORATION)  
500 VOLVO PARKWAY  
CHESAPEAKE, VA 23320

NO CLAIM IS MADE TO THE EXCLUSIVE  
RIGHT TO USE "CONFECTIONS", APART FROM  
THE MARK AS SHOWN.

FOR: CANDY, IN CLASS 30 (U.S. CL. 46).

FIRST USE 1-0-2006; IN COMMERCE 10-0-2007.

SN 78-801,612, FILED 1-28-2006.

THE MARK CONSISTS OF STANDARD CHAR-  
ACTERS WITHOUT CLAIM TO ANY PARTICULAR  
FONT, STYLE, SIZE, OR COLOR.

DOMINIC FATHY, EXAMINING ATTORNEY

**Int. Cl.: 28**

**Prior U.S. Cls.: 22, 23, 38, and 50**

**United States Patent and Trademark Office**

**Reg. No. 3,469,518**

**Registered July 15, 2008**

**TRADEMARK  
PRINCIPAL REGISTER**

**RACER'S EDGE**

RAGANO, ANTHONY (UNITED STATES INDIVIDUAL)  
159 LOYAL COURT  
BLOOMINGDALE, IL 60108

THE MARK CONSISTS OF STANDARD CHARACTERS WITHOUT CLAIM TO ANY PARTICULAR FONT, STYLE, SIZE, OR COLOR.

FOR: FITTED HEAD COVERS FOR GOLF CLUBS AND GOLF CLUBS, IN CLASS 28 (U.S. CLS. 22, 23, 38 AND 50).

SN 78-801,663, FILED 1-28-2006.

FIRST USE 11-12-2007; IN COMMERCE 11-12-2007.

JOHN WILKE, EXAMINING ATTORNEY

**Int. Cl.: 9**

**Prior U.S. Cls.: 21, 23, 26, 36, and 38**

**Reg. No. 3,469,519**

**United States Patent and Trademark Office**

**Registered July 15, 2008**

**TRADEMARK  
PRINCIPAL REGISTER**

**NEWZIQ**

CELLULAR RECORDS INC (DELAWARE CORPORATION)  
522 OAK STREET  
SAN FRANCISCO, CA 94102

FOR: AUDIO AND VIDEO RECORDINGS FEATURING NEWS, MUSIC, SPORTS AND INFORMATION, NAMELY, PRODUCT ADVERTISING AND BRIEFINGS, PUBLIC SERVICE ANNOUNCEMENTS, POLITICAL STATEMENTS AND COMMENTARY, COMMERCIALS, SPEECHES, LECTURES, POETRY, INTERVIEWS AND WEATHER REPORTS; DOWNLOADABLE AUDIO AND VIDEO RECORDINGS FEATURING NEWS, MUSIC, SPORTS AND INFORMATION, NAMELY, PRODUCT ADVERTISING AND BRIEFINGS, PUBLIC SERVICE ANNOUNCEMENTS, POLITICAL STATEMENTS AND COMMENTARY, COMMERCIALS,

SPEECHES, LECTURES, POETRY, INTERVIEWS AND WEATHER REPORTS; DOWNLOADABLE RING TONES, GRAPHICS AND MUSIC VIA A GLOBAL COMPUTER NETWORK AND WIRELESS DEVICES, IN CLASS 9 (U.S. CLS. 21, 23, 26, 36 AND 38).

FIRST USE 4-0-2006; IN COMMERCE 4-0-2006.

THE MARK CONSISTS OF STANDARD CHARACTERS WITHOUT CLAIM TO ANY PARTICULAR FONT, STYLE, SIZE, OR COLOR.

SN 78-802,866, FILED 1-30-2006.

BONNIE LUKEN, EXAMINING ATTORNEY

**Int. Cl.: 39**

**Prior U.S. Cls.: 100 and 105**

**United States Patent and Trademark Office**

**Reg. No. 3,469,520**

**Registered July 15, 2008**

**SERVICE MARK  
PRINCIPAL REGISTER**

**NORWEGIAN GEM**

NCL CORPORATION LTD. (BERMUDA CORPORATION)

7665 CORPORATE CENTER DRIVE

MIAMI, FL 33126

FOR: ARRANGING OF CRUISES; CRUISE SHIP SERVICES; TRAVEL, EXCURSION AND CRUISE ARRANGEMENT, IN CLASS 39 (U.S. CLS. 100 AND 105).

FIRST USE 12-15-2007; IN COMMERCE 12-15-2007.

THE MARK CONSISTS OF STANDARD CHARACTERS WITHOUT CLAIM TO ANY PARTICULAR FONT, STYLE, SIZE, OR COLOR.

OWNER OF U.S. REG. NOS. 2,558,684, 2,597,668, AND OTHERS.

SEC. 2(F) AS TO "NORWEGIAN".

SN 78-803,046, FILED 1-31-2006.

HANNO RITTNER, EXAMINING ATTORNEY

**Int. Cls.: 35, 41, and 45**

**Prior U.S. Cls.: 100, 101, 102, and 107**

**United States Patent and Trademark Office**

**Reg. No. 3,469,521**

**Registered July 15, 2008**

**SERVICE MARK  
PRINCIPAL REGISTER**

**PEACE OVER VIOLENCE**

PEACE OVER VIOLENCE (CALIFORNIA NON-PROFIT CORPORATION)  
605 W. OLYMPIC BLVD.. #400  
LOS ANGELES, CA 90015

FOR: PROMOTING PUBLIC AWARENESS AND INVOLVEMENT IN PUBLIC POLICY PROGRAMS REGARDING THE NEED TO PREVENT VIOLENCE AND DOMESTIC AND SEXUAL ABUSE AND OF THE NEED TO ASSIST VICTIMS OF VIOLENCE AND DOMESTIC AND SEXUAL ABUSE; AND REFERRALS FOR MEDICAL, HOUSING, AND LEGAL AND MENTAL HEALTH SERVICES IN THE FIELD OF VIOLENCE AND DOMESTIC AND SEXUAL VIOLENCE AND ABUSE, IN CLASS 35 (U.S. CLS. 100, 101 AND 102).

FIRST USE 10-27-2006; IN COMMERCE 10-27-2006.

FOR: EDUCATIONAL SERVICES, NAMELY, ORGANIZING AND CONDUCTING COMMUNITY RESPONSE AND EDUCATIONAL RESPONSE IN THE NATURE OF CLASSES, SEMINARS, WORKSHOPS, CONFERENCES AND SYMPOSIA IN THE FIELD OF THE PREVENTION OF VIOLENCE AND DOMESTIC AND SEXUAL VIOLENCE AND ABUSE, IN CLASS 41 (U.S. CLS. 100, 101 AND 107).

FIRST USE 10-27-2006; IN COMMERCE 10-27-2006.

FOR: ORGANIZING AND CONDUCTING COMMUNITY RESPONSE AND EDUCATIONAL RESPONSE IN THE NATURE OF SUPPORT GROUPS IN THE FIELD OF THE PREVENTION OF VIOLENCE AND DOMESTIC AND SEXUAL VIOLENCE AND ABUSE; AND PROVIDING COUNSELING FOR VICTIMS OF SEXUAL, DOMESTIC AND INTERPERSONAL VIOLENCE COMPRISING INTERVIEWING THE VICTIM, IDENTIFYING THE NATURE OF THE TRAUMA, AND PROVIDING PSYCHOSOCIAL COUNSELING THEREFORE; CASE MANAGEMENT SERVICES, NAMELY, COORDINATION OF LEGAL, SOCIAL AND PSYCHOLOGICAL SERVICES FOR VICTIMS OF VIOLENCE, IN CLASS 45 (U.S. CLS. 100 AND 101).

FIRST USE 10-27-2006; IN COMMERCE 10-27-2006.

THE MARK CONSISTS OF STANDARD CHARACTERS WITHOUT CLAIM TO ANY PARTICULAR FONT, STYLE, SIZE, OR COLOR.

NO CLAIM IS MADE TO THE EXCLUSIVE RIGHT TO USE "VIOLENCE", APART FROM THE MARK AS SHOWN.

SN 78-803,808, FILED 1-31-2006.

SUSAN RICHARDS, EXAMINING ATTORNEY

**Int. Cl.: 36**

**Prior U.S. Cls.: 100, 101, and 102**

**United States Patent and Trademark Office**

**Reg. No. 3,469,522**

**Registered July 15, 2008**

**SERVICE MARK  
PRINCIPAL REGISTER**

# InsureGate

POULTON, CRAIG K (UNITED STATES INDIVIDUAL)  
3785 SOUTH 700 EAST 2ND FLOOR  
SALT LAKE CITY, UT 84106

FOR: ACCIDENT INSURANCE UNDERWRITING; APPRAISALS FOR INSURANCE CLAIMS OF PERSONAL PROPERTY; APPRAISALS FOR INSURANCE CLAIMS OF REAL ESTATE; BROKERAGE FOR ALL TYPES OF INSURANCE; CLAIMS ADJUSTMENT IN THE FIELD OF INSURANCE; DENTAL HEALTH INSURANCE ADMINISTRATION; DENTAL HEALTH INSURANCE UNDERWRITING AND ADMINISTRATION; ELECTRONIC PROCESSING OF INSURANCE CLAIMS AND PAYMENT DATA; FINANCIAL EVALUATION FOR INSURANCE PURPOSES; FINANCIAL SERVICES, NAMELY, ISSUANCE AND MANAGEMENT OF CERTIFICATES BACKED BY LOAN PORTFOLIOS WHICH ARE SUBSEQUENTLY MANAGED TO INSURE THE INTEGRITY OF THE CERTIFICATES; FIRE INSURANCE UNDERWRITING; INSURANCE ACTUARIAL SERVICES; INSURANCE ADMINISTRATION; INSURANCE ADMINISTRATION FOR ALL TYPES OF INSURANCE; INSURANCE AGENCIES; INSURANCE AGENCIES IN THE FOR ALL TYPES OF INSURANCE; INSURANCE AGENCY AND BROKERAGE; INSURANCE CARRIER SERVICES; INSURANCE CLAIMS ADMINISTRATION; INSURANCE CLAIMS PROCESSING; INSURANCE

CONSULTATION; INSURANCE PREMIUM RATE COMPUTING; INSURANCE SERVICES, NAMELY, UNDERWRITING EXTENDED WARRANTY CONTRACTS FOR ALL TYPES OF INSURANCE; INSURANCE SERVICES, NAMELY, WRITING PROPERTY AND CASUALTY INSURANCE; INSURANCE SUBROGATION; INSURANCE SUBROGATION AND SALVAGE; INSURANCE UNDERWRITING CONSULTATION; INSURANCE UNDERWRITING FOR ALL TYPES OF INSURANCE; LIFE INSURANCE BROKERAGE; LIFE INSURANCE UNDERWRITING; MARINE INSURANCE UNDERWRITING; MEDICAL INSURANCE UNDERWRITING; PROVIDING INFORMATION IN INSURANCE MATTERS; UNDERWRITING INSURANCE FOR PREPAID HEALTH CARE; UNDERWRITING INSURANCE FOR PREPAID LEGAL SERVICES, IN CLASS 36 (U.S. CLS. 100, 101 AND 102).

FIRST USE 1-27-2000; IN COMMERCE 6-20-2005.

THE MARK CONSISTS OF STANDARD CHARACTERS WITHOUT CLAIM TO ANY PARTICULAR FONT, STYLE, SIZE, OR COLOR.

SN 78-804,093, FILED 2-1-2006.

ESTHER A. BORSUK, EXAMINING ATTORNEY

**Int. Cls.: 42 and 44**

**Prior U.S. Cls.: 100 and 101**

**United States Patent and Trademark Office**

**Reg. No. 3,469,523**

**Registered July 15, 2008**

**SERVICE MARK  
PRINCIPAL REGISTER**

**SCRIPTTONE**

PREMATICS, INC. (DELAWARE CORPORATION)  
7315 WISCONSIN AVENUE  
SUITE 200  
BETHESDA, MD 20814

FOR: PROVIDING INTERACTIVE ONLINE SERVICES, NAMELY, ONLINE NONDOWNLOADABLE SOFTWARE, TO MEDICAL PROFESSIONALS FOR PREPARATION AND PROCESSING OF PRESCRIPTION DRUGS, IN CLASS 42 (U.S. CLS. 100 AND 101).

FIRST USE 3-15-2007; IN COMMERCE 3-15-2007.

FOR: PROVIDING ONLINE MEDICAL DATABASES FOR MAINTAINING PRESCRIPTION DRUG

INFORMATION RELATED TO HEALTH PLAN PARTICIPANT INSURANCE COVERAGE INFORMATION, PATIENT RECORDS, DRUG INFORMATION, AND LABORATORY TEST RESULTS, IN CLASS 44 (U.S. CLS. 100 AND 101).

FIRST USE 3-15-2007; IN COMMERCE 3-15-2007.

THE MARK CONSISTS OF STANDARD CHARACTERS WITHOUT CLAIM TO ANY PARTICULAR FONT, STYLE, SIZE, OR COLOR.

SN 78-806,532, FILED 2-3-2006.

HANNO RITTNER, EXAMINING ATTORNEY

**Int. Cl.: 24**

**Prior U.S. Cls.: 42 and 50**

**United States Patent and Trademark Office**

**Reg. No. 3,469,524**

**Registered July 15, 2008**

**TRADEMARK  
PRINCIPAL REGISTER**

**BODY COZY**

BUYER'S DIRECT, INC. (NORTH CAROLINA  
CORPORATION)  
5001 PEBBLE BEACH CIRCLE  
WILSON, NC 27896

FOR: A THROW IN THE NATURE OF A BLANKET  
THROW THAT IS ALSO DESIGNED TO BE  
WRAPPED AROUND A PERSON, IN CLASS 24 (U.S.  
CLS. 42 AND 50).

FIRST USE 8-4-2006; IN COMMERCE 9-1-2006.

THE MARK CONSISTS OF STANDARD CHARACTERS  
WITHOUT CLAIM TO ANY PARTICULAR  
FONT, STYLE, SIZE, OR COLOR.

NO CLAIM IS MADE TO THE EXCLUSIVE  
RIGHT TO USE "BODY", APART FROM THE  
MARK AS SHOWN.

SN 78-806,703, FILED 2-3-2006.

KELLY CHOE, EXAMINING ATTORNEY



**Int. Cl.: 8**

**Prior U.S. Cls.: 23, 28, and 44**

**United States Patent and Trademark Office**

**Reg. No. 3,469,525**

**Registered July 15, 2008**

**TRADEMARK  
PRINCIPAL REGISTER**

# EXTRACT

BAYER AKTIENGESELLSCHAFT (FED REP  
GERMANY JOINT STOCK COMPANY)  
D-51368  
LEVERKUSEN-BAYERWERK, FED REP GERMA-  
NY

FOR: TWEEZERS OF PLASTICS, IN CLASS 8 (U.S.  
CLS. 23, 28 AND 44).

FIRST USE 6-15-2007; IN COMMERCE 6-15-2007.

THE MARK CONSISTS OF STANDARD CHAR-  
ACTERS WITHOUT CLAIM TO ANY PARTICULAR  
FONT, STYLE, SIZE, OR COLOR.

SN 78-807,793, FILED 2-6-2006.

IRA J. GOODSaid, EXAMINING ATTORNEY

**Int. Cl.: 3**

**Prior U.S. Cls.: 1, 4, 6, 50, 51, and 52**

**Reg. No. 3,469,526**

**United States Patent and Trademark Office**

**Registered July 15, 2008**

**TRADEMARK  
PRINCIPAL REGISTER**

**MANDE LULAR**

THE SANCTUARY AT COVENT GARDEN LIM-  
ITED (UNITED KINGDOM CORPORATION)  
12 FLORAL STREET  
LONDON, UNITED KINGDOM WC2E 9DH

FOR: COSMETICS; TOILETRIES, NAMELY,  
BODY WASHES, BATH GEL AND BATH OIL RE-  
LAXERS, BODY SPRAYS, BODY SCRUBS, BATH  
SALT SCRUBS, NON-MEDICATED BATH SOAKS,  
BODY CREAM SOUFFLES, SALT SCRUB SOAP  
BARS, BATH SOAPS, HOT SUGAR BODY SCRUBS,  
BODY SPRITZ, SPONGES IMPREGNATED WITH  
COSMETICS, BODY LOTIONS; SKIN CLEANSERS;  
SKIN MOISTURIZING CREAMS; FACIAL BEAUTY  
MASKS AND SCRUBS, IN CLASS 3 (U.S. CLS. 1, 4, 6,  
50, 51 AND 52).

FIRST USE 10-3-2005; IN COMMERCE 10-3-2005.

THE MARK CONSISTS OF STANDARD CHAR-  
ACTERS WITHOUT CLAIM TO ANY PARTICULAR  
FONT, STYLE, SIZE, OR COLOR.

"MANDE LULAR" HAS NO MEANING IN A  
FOREIGN LANGUAGE.

SN 78-808,257, FILED 2-6-2006.

ELI HELLMAN, EXAMINING ATTORNEY

**Int. Cl.: 29**

**Prior U.S. Cl.: 46**

**United States Patent and Trademark Office**

**Reg. No. 3,469,527**

**Registered July 15, 2008**

**TRADEMARK  
PRINCIPAL REGISTER**

**CHEESY TOTS**

PROMARK BRANDS INC. (IDAHO CORPORATION)  
2541 NORTH STOKESBERRY PLACE, SUITE 100  
MERIDIAN, ID 83646

FOR: PROCESSED POTATOES, IN CLASS 29 (U.S. CL. 46).

FIRST USE 5-31-2006; IN COMMERCE 5-31-2006.

THE MARK CONSISTS OF STANDARD CHARACTERS WITHOUT CLAIM TO ANY PARTICULAR FONT, STYLE, SIZE, OR COLOR.

OWNER OF U.S. REG. NOS. 668,762, 2,108,791, AND 2,405,883.

NO CLAIM IS MADE TO THE EXCLUSIVE RIGHT TO USE "CHEESY", APART FROM THE MARK AS SHOWN.

SN 78-808,658, FILED 2-7-2006.

DANIEL CAPSHAW, EXAMINING ATTORNEY

**Int. Cls.: 5 and 44**

**Prior U.S. Cls.: 6, 18, 44, 46, 51, 52, 100, and 101**

**United States Patent and Trademark Office**

**Reg. No. 3,469,528**

**Registered July 15, 2008**

**TRADEMARK  
SERVICE MARK  
PRINCIPAL REGISTER**



AMICUS THERAPEUTICS, INC. (DELAWARE CORPORATION)  
6 CEDAR BROOK DRIVE  
CRANBURY, NJ 08512

FOR: PHARMACEUTICAL PREPARATIONS FOR THE TREATMENT OF GENETIC DISEASES, IN CLASS 5 (U.S. CLS. 6, 18, 44, 46, 51 AND 52).

FIRST USE 1-7-2008; IN COMMERCE 1-7-2008.

FOR: PERFORMING DIAGNOSIS OF DISEASES; PROVIDING MEDICAL INFORMATION; MEDICAL COUNSELING, IN CLASS 44 (U.S. CLS. 100 AND 101).

FIRST USE 7-5-2004; IN COMMERCE 7-5-2004.

NO CLAIM IS MADE TO THE EXCLUSIVE RIGHT TO USE "THERAPEUTICS", APART FROM THE MARK AS SHOWN.

THE MARK CONSISTS OF IN PART OF A STYLIZED LETTER "A" WITH A SMALL CIRCLE INSIDE IT.

SN 78-809,293, FILED 2-7-2006.

IRA J. GOODSaid, EXAMINING ATTORNEY

**Int. Cl.: 28**

**Prior U.S. Cls.: 22, 23, 38, and 50**

**United States Patent and Trademark Office**

**Reg. No. 3,469,529**

**Registered July 15, 2008**

**TRADEMARK  
PRINCIPAL REGISTER**

**CHATTER TELEPHONE**

MATTEL, INC. (DELAWARE CORPORATION)  
M1-1518  
333 CONTINENTAL BLVD.  
EL SEGUNDO, CA 902455012

FOR: HOLIDAY TREE ORNAMENTS AND TOY  
PLAYSETS, NAMELY, TOY TELEPHONE PLAY-  
SETS AND ACCESSORIES FOR THE PLAYSETS,  
IN CLASS 28 (U.S. CLS. 22, 23, 38 AND 50).

FIRST USE 4-22-2008; IN COMMERCE 4-22-2008.

THE MARK CONSISTS OF STANDARD CHAR-  
ACTERS WITHOUT CLAIM TO ANY PARTICULAR  
FONT, STYLE, SIZE, OR COLOR.

NO CLAIM IS MADE TO THE EXCLUSIVE  
RIGHT TO USE "TELEPHONE", APART FROM  
THE MARK AS SHOWN.

SN 78-810,213, FILED 2-8-2006.

ROBIN CHOSID, EXAMINING ATTORNEY

**Int. Cl.: 41**

**Prior U.S. Cls.: 100, 101, and 107**

**United States Patent and Trademark Office**

**Reg. No. 3,469,530**

**Registered July 15, 2008**

**SERVICE MARK  
PRINCIPAL REGISTER**

# Neighborhood Nurse

KRISTINA A. LARSEN (UNITED STATES INDIVIDUAL)  
P. O. BOX 8625  
ATLANTA, GA 311060625

FOR: PERSONAL COACHING SERVICES IN THE FIELD OF INDIVIDUAL HEALTH AND WELLNESS, IN CLASS 41 (U.S. CLS. 100, 101 AND 107).

FIRST USE 11-7-2007; IN COMMERCE 11-7-2007.

THE MARK CONSISTS OF STANDARD CHARACTERS WITHOUT CLAIM TO ANY PARTICULAR FONT, STYLE, SIZE, OR COLOR.

NO CLAIM IS MADE TO THE EXCLUSIVE RIGHT TO USE "NURSE", APART FROM THE MARK AS SHOWN.

SN 78-811,522, FILED 2-9-2006.

BRETT J. GOLDEN, EXAMINING ATTORNEY

**Int. Cl.: 35**

**Prior U.S. Cls.: 100, 101, and 102**

**United States Patent and Trademark Office**

**Reg. No. 3,469,531**

**Registered July 15, 2008**

**SERVICE MARK  
PRINCIPAL REGISTER**

# TeaMaster

CHEN, JASON C.S. (UNITED STATES INDIVIDUAL)  
2623 145TH AVE SE  
BELLEVUE, WA 98007

FOR: COMPUTERIZED ON-LINE RETAIL STORE SERVICES IN THE FIELD OF TEA, TEA ACCESSORIES, TEA PRODUCTS; RETAIL BAKERY SHOPS; RETAIL FURNITURE STORES; RETAIL GIFT SHOPS; RETAIL SHOPS FEATURING TEA, TEA ACCESSORIES, TEA PRODUCTS, IN CLASS 35 (U.S. CLS. 100, 101 AND 102).

FIRST USE 3-15-2008; IN COMMERCE 3-15-2008.

THE MARK CONSISTS OF STANDARD CHARACTERS WITHOUT CLAIM TO ANY PARTICULAR FONT, STYLE, SIZE, OR COLOR.

SN 78-812,603, FILED 2-10-2006.

ALEXANDER L. POWERS, EXAMINING ATTORNEY

**Int. Cl.: 35**

**Prior U.S. Cls.: 100, 101, and 102**

**United States Patent and Trademark Office**

**Reg. No. 3,469,532**

**Registered July 15, 2008**

**SERVICE MARK  
PRINCIPAL REGISTER**



PERFECT FIFTH GROUP, INC. (NEVADA CORPORATION)  
1802 N. CARSON ST. STE. 2122554  
CARSON CITY, NV 89701

FOR: LICENSING OF AUDIO AND VISUAL MEDIA, NAMELY, MUSICAL SOUND RECORDINGS, AUDIO SOUND RECORDINGS, MOTION PICTURES, MUSIC VIDEOS, STILL IMAGES AND ANIMATED IMAGES, ALL IN CONNECTION WITH THE FIELD OF ENTERTAINMENT, IN CLASS 35 (U.S. CLS. 100, 101 AND 102).

FIRST USE 12-10-2005; IN COMMERCE 1-21-2006.

NO CLAIM IS MADE TO THE EXCLUSIVE RIGHT TO USE "MEDIA", APART FROM THE MARK AS SHOWN.

THE COLORS YELLOW, GREEN, WHITE, GREY, BLACK AND RED IS/ARE CLAIMED AS A FEATURE OF THE MARK.

THE MARK CONSISTS OF LOWERCASE LETTERS WITH THE LETTER "M" BEING COMPRISED OF A LEFT LEG, WHICH IS A GRADIENT GREEN COLORED RIGHT ANGLE, A RIGHT LEG WHICH IS A BLACK COLORED RIGHT ANGLE AND A RED SQUARE REPRESENTING THE MIDDLE BRIDGE OF THE LETTER. THE 2 LEGS OF THE "M" ARE NON-CONTIGUOUS GEOMETRICS. ABOVE THE WORD "MANTIS" IS AN ABSTRACT GLYPH DESIGN CONTAINING THE COLORS YELLOW, GREEN, WHITE, GREY AND BLACK. BELOW THE WORD "MANTIS" IS THE WORD "MEDIA" IN LOWERCASE GREEN LETTERS.

SN 78-814,183, FILED 2-14-2006.

KATHERINE CHANG, EXAMINING ATTORNEY



**Int. Cl.: 36**

**Prior U.S. Cls.: 100, 101, and 102**

**United States Patent and Trademark Office**

**Reg. No. 3,469,533**

**Registered July 15, 2008**

**SERVICE MARK  
PRINCIPAL REGISTER**

## HMSA's Keiki Care

HAWAII MEDICAL SERVICE ASSOCIATION  
(HAWAII MUTUAL BENEFIT SOCIETY)  
818 KEEAUMOKU STREET  
HONOLULU, HI 96814

FOR: PREPAID FINANCING AND ADMINISTRATION OF MEDICAL, HOSPITAL, AND RELATED HEALTH CARE SERVICES FOR CHILDREN, IN CLASS 36 (U.S. CLS. 100, 101 AND 102).

FIRST USE 2-1-2006; IN COMMERCE 3-1-2008.

THE MARK CONSISTS OF STANDARD CHARACTERS WITHOUT CLAIM TO ANY PARTICULAR FONT, STYLE, SIZE, OR COLOR.

OWNER OF U.S. REG. NOS. 2,900,395, 3,046,578, AND OTHERS.

NO CLAIM IS MADE TO THE EXCLUSIVE RIGHT TO USE "KEIKI CARE", APART FROM THE MARK AS SHOWN.

THE FOREIGN WORDING IN THE MARK TRANSLATES INTO ENGLISH AS CHILD.

SN 78-814,356, FILED 2-14-2006.

ATTIYA MALIK, EXAMINING ATTORNEY

**Int. Cls.: 35 and 42**

**Prior U.S. Cls.: 100, 101, and 102**

**United States Patent and Trademark Office**

**Reg. No. 3,469,534**

**Registered July 15, 2008**

**SERVICE MARK  
PRINCIPAL REGISTER**



SPADAC INC. (DELAWARE CORPORATION)  
7921 JONES BRANCH DRIVE, SUITE 600  
MCLEAN, VA 22102

FOR: COLLECTION, PREPARATION, COMPOSITION, STORAGE, PROCESSING, ACQUISITION AND PROVISION OF BUSINESS INFORMATION, DATA, STATISTICS AND INDICES; COMPILATION AND SYSTEMATIZATION OF INFORMATION IN DATABANKS; INFORMATION SERVICES RELATING TO BUSINESS MATTERS; PROVIDING STATISTICAL INFORMATION FOR BUSINESS OR COMMERCIAL PURPOSES; BUSINESS ADVISORY SERVICES, CONSULTANCY AND INFORMATION; BUSINESS INFORMATION MANAGEMENT, IN CLASS 35 (U.S. CLS. 100, 101 AND 102).

FIRST USE 12-0-2005; IN COMMERCE 12-0-2005.

FOR: DESIGN AND DEVELOPMENT OF INFORMATION AND DATA BASES; DATA WAREHOUSING; DATA MINING; INFORMATION TECHNOLOGY CONSULTATION; SYSTEMS ENGINEERING; TECHNOLOGY CONSULTATION IN THE FIELDS OF SYSTEMS ENGINEERING AND DATABASE SYSTEMS; COMPUTER SOFTWARE DEVELOPMENT AND DESIGN FOR OTHERS, IN CLASS 42 (U.S. CLS. 100 AND 101).

FIRST USE 12-0-2005; IN COMMERCE 12-0-2005.

THE MARK CONSISTS OF A STYLIZED LETTER "S" AND ARROW DESIGN.

SN 78-815,409, FILED 2-15-2006.

JEFFERY COWARD, EXAMINING ATTORNEY

**Int. Cl.: 9**

**Prior U.S. Cls.: 21, 23, 26, 36, and 38**

**Reg. No. 3,469,535**

**United States Patent and Trademark Office**

**Registered July 15, 2008**

---

**TRADEMARK  
PRINCIPAL REGISTER**

**XPR**

MOTOROLA, INC. (DELAWARE CORPORATION)  
1303 E. ALGONQUIN ROAD  
SCHAUMBURG, IL 60196

THE MARK CONSISTS OF STANDARD CHARACTERS WITHOUT CLAIM TO ANY PARTICULAR FONT, STYLE, SIZE, OR COLOR.

FOR: TWO WAY RADIOS, IN CLASS 9 (U.S. CLS. 21, 23, 26, 36 AND 38).

SN 78-815,792, FILED 2-15-2006.

FIRST USE 1-31-2007; IN COMMERCE 1-31-2007.

KIMBERLY PERRY, EXAMINING ATTORNEY

**Int. Cl.: 18**

**Prior U.S. Cls.: 1, 2, 3, 22, and 41**

**United States Patent and Trademark Office**

**Reg. No. 3,469,536**

**Registered July 15, 2008**

**TRADEMARK  
PRINCIPAL REGISTER**

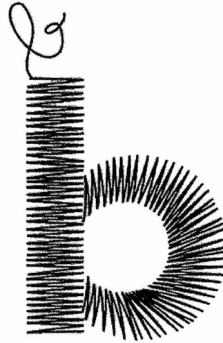

BLISS COLLECTION LLC (KENTUCKY LTD  
LIAB CO)  
209 NORTH LIMESTONE  
LEXINGTON, KY 40507

THE MARK CONSISTS OF A STYLIZED "B"  
THAT CONSISTS OF THREAD TO CREATE THE  
IMAGE OF THE LETTER "B".

FOR: DUFFEL BAGS, AND TOTE BAGS, IN  
CLASS 18 (U.S. CLS. 1, 2, 3, 22 AND 41).

SN 78-816,776, FILED 2-16-2006.

FIRST USE 7-31-2006; IN COMMERCE 7-31-2006.

LINDA ESTRADA, EXAMINING ATTORNEY

**Int. Cl.: 25**

**Prior U.S. Cls.: 22 and 39**

**United States Patent and Trademark Office**

**Reg. No. 3,469,537**

**Registered July 15, 2008**

**TRADEMARK  
PRINCIPAL REGISTER**

**headshake industries**

SMITH, KYLE (UNITED STATES INDIVIDUAL)  
1107 FENWICK VILLAGE DR.  
SAVANNAH, GA 31419

FOR: CLOTHING, NAMELY, JERSEYS, BELTS,  
CAPS, TOPS, SHORT SETS, AND HOODS, IN CLASS  
25 (U.S. CLS. 22 AND 39).

FIRST USE 12-7-2007; IN COMMERCE 12-7-2007.

THE MARK CONSISTS OF STANDARD CHAR-  
ACTERS WITHOUT CLAIM TO ANY PARTICULAR  
FONT, STYLE, SIZE, OR COLOR.

NO CLAIM IS MADE TO THE EXCLUSIVE  
RIGHT TO USE "INDUSTRIES", APART FROM  
THE MARK AS SHOWN.

SN 78-817,437, FILED 2-17-2006.

ALYSSA PALADINO, EXAMINING ATTORNEY

**Int. Cl.: 2**

**Prior U.S. Cls.: 6, 11, and 16**

**United States Patent and Trademark Office**

**Reg. No. 3,469,538**

**Registered July 15, 2008**

**TRADEMARK  
PRINCIPAL REGISTER**

**HPC**

SUPERIOR PRODUCTS INTERNATIONAL II,  
INC. (KANSAS CORPORATION)  
P.O. BOX 19149  
LENEXA, KS 66285

THE MARK CONSISTS OF STANDARD CHAR-  
ACTERS WITHOUT CLAIM TO ANY PARTICULAR  
FONT, STYLE, SIZE, OR COLOR.

FOR: PAINTS, EXCLUDING PAINTS FOR AUTO-  
MOTIVE PARTS, IN CLASS 2 (U.S. CLS. 6, 11 AND  
16).

SN 78-818,940, FILED 2-20-2006.

FIRST USE 2-1-2004; IN COMMERCE 2-1-2004.

BRIAN PINO, EXAMINING ATTORNEY

**Int. Cl.: 2**

**Prior U.S. Cls.: 6, 11, and 16**

**United States Patent and Trademark Office**

**Reg. No. 3,469,539**

**Registered July 15, 2008**

---

**TRADEMARK  
PRINCIPAL REGISTER**

**HSC**

SUPERIOR PRODUCTS INTERNATIONAL II,  
INC. (KANSAS CORPORATION)  
P.O. BOX 19149  
LENEXA, KS 66285

THE MARK CONSISTS OF STANDARD CHAR-  
ACTERS WITHOUT CLAIM TO ANY PARTICULAR  
FONT, STYLE, SIZE, OR COLOR.

FOR: PAINTS, IN CLASS 2 (U.S. CLS. 6, 11 AND 16).

SN 78-818,952, FILED 2-20-2006.

FIRST USE 10-1-1999; IN COMMERCE 10-1-1999.

BRIAN PINO, EXAMINING ATTORNEY

**Int. Cls.: 9, 41, and 42**

**Prior U.S. Cls.: 21, 23, 26, 36, 38, 100, 101, and 107**

**Reg. No. 3,469,540**

**United States Patent and Trademark Office**

**Registered July 15, 2008**

**TRADEMARK  
SERVICE MARK  
PRINCIPAL REGISTER**

# DrKenneth

SCHUMACHER, KENNETH ROBERT (UNITED STATES INDIVIDUAL)  
16 STAFFORD LANE  
ANDOVER, MA 01810

FOR: COMPUTER GAME SOFTWARE; COMPUTER SOFTWARE FOR CREATING SEARCHABLE DATABASES OF INFORMATION AND DATA; COMPUTER SOFTWARE FOR 3RD PARTY SOFTWARE ENHANCEMENT; EDUCATIONAL SOFTWARE FEATURING INSTRUCTION IN COMPUTERS AND TECHNOLOGY; WAN (WIDE AREA NETWORK) OPERATING SOFTWARE, IN CLASS 9 (U.S. CLS. 21, 23, 26, 36 AND 38).

FIRST USE 11-13-2006; IN COMMERCE 2-5-2007.

FOR: TEACHING IN THE FIELD OF COMPUTERS AND TECHNOLOGY, IN CLASS 41 (U.S. CLS. 100, 101 AND 107).

FIRST USE 6-1-2007; IN COMMERCE 6-1-2007.

FOR: COMPUTER SOFTWARE DESIGN FOR OTHERS; COMPUTER SOFTWARE DESIGN, COMPUTER PROGRAMMING, OR MAINTENANCE OF COMPUTER SOFTWARE; COMPUTER SOFTWARE DEVELOPMENT; CONSULTING SERVICES IN THE FIELD OF DESIGN, SELECTION, IMPLEMENTATION AND USE OF COMPUTER HARDWARE AND

SOFTWARE SYSTEMS FOR OTHERS; DESIGN OF HOMEPAGES AND WEBSITES; INSTALLATION OF COMPUTER SOFTWARE; MAINTENANCE OF COMPUTER SOFTWARE; PROVIDING A WEBSITE THAT FEATURES INFORMATION ON COMPUTER TECHNOLOGY AND PROGRAMMING; TECHNICAL SUPPORT SERVICES, NAMELY, TROUBLESHOOTING OF COMPUTER HARDWARE AND SOFTWARE PROBLEMS, IN CLASS 42 (U.S. CLS. 100 AND 101).

FIRST USE 1-7-2005; IN COMMERCE 1-7-2005.

THE MARK CONSISTS OF STANDARD CHARACTERS WITHOUT CLAIM TO ANY PARTICULAR FONT, STYLE, SIZE, OR COLOR.

THE NAME(S), PORTRAIT(S), AND/OR SIGNATURE(S) SHOWN IN THE MARK IDENTIFIES "DRKENNETH", WHOSE CONSENT(S) TO REGISTER IS SUBMITTED.

SEC. 2(F).

SN 78-822,930, FILED 2-24-2006.

ASMAT KHAN, EXAMINING ATTORNEY



**Int. Cl.: 30**

**Prior U.S. Cl.: 46**

**United States Patent and Trademark Office**

**Reg. No. 3,469,541**

**Registered July 15, 2008**

**TRADEMARK  
PRINCIPAL REGISTER**

**PASTA CHEF**

AMERICAN ITALIAN PASTA COMPANY (DELA-  
WARE CORPORATION)

SUITE 200

4100 NORTH MULBERRY DRIVE

KANSAS CITY, MO 64116

FOR: PASTA, IN CLASS 30 (U.S. CL. 46).

FIRST USE 3-1-2008; IN COMMERCE 3-1-2008.

THE MARK CONSISTS OF STANDARD CHAR-  
ACTERS WITHOUT CLAIM TO ANY PARTICULAR  
FONT, STYLE, SIZE, OR COLOR.

NO CLAIM IS MADE TO THE EXCLUSIVE  
RIGHT TO USE "PASTA", APART FROM THE  
MARK AS SHOWN.

SN 78-823,293, FILED 2-24-2006.

TANYA AMOS, EXAMINING ATTORNEY

**Int. Cl.: 41**

**Prior U.S. Cls.: 100, 101, and 107**

**United States Patent and Trademark Office**

**Reg. No. 3,469,542**

**Registered July 15, 2008**

**SERVICE MARK  
PRINCIPAL REGISTER**

**Maverick Supper Club**

DILTS VENTURES, LLC (CALIFORNIA LTD  
LIAB CO)  
5737 KANAN ROAD, NO. 177  
AGOURA HILLS, CA 91301

FOR: ENTERTAINMENT SERVICES, NAMELY,  
CONDUCTING PARTIES FOR THE PURPOSE OF  
SOCIAL AND BUSINESS INTRODUCTION FOR  
ADULTS, IN CLASS 41 (U.S. CLS. 100, 101 AND 107).

FIRST USE 5-1-2006; IN COMMERCE 5-1-2006.

THE MARK CONSISTS OF STANDARD CHAR-  
ACTERS WITHOUT CLAIM TO ANY PARTICULAR  
FONT, STYLE, SIZE, OR COLOR.

NO CLAIM IS MADE TO THE EXCLUSIVE  
RIGHT TO USE "SUPPER CLUB", APART FROM  
THE MARK AS SHOWN.

SN 78-823,601, FILED 2-26-2006.

ROBERT LAVACHE, EXAMINING ATTORNEY

**Int. Cl.: 16**

**Prior U.S. Cls.: 2, 5, 22, 23, 29, 37, 38, and 50**

**Reg. No. 3,469,543**

**United States Patent and Trademark Office**

**Registered July 15, 2008**

---

**TRADEMARK  
PRINCIPAL REGISTER**

**TRAPS**

ENTER MUSIC PUBLISHING, INC. (CALIFORNIA CORPORATION)  
95 SOUTH MARKET STREET, SUITE 200  
SAN JOSE, CA 95113

THE MARK CONSISTS OF STANDARD CHARACTERS WITHOUT CLAIM TO ANY PARTICULAR FONT, STYLE, SIZE, OR COLOR.

FOR: MAGAZINE FEATURING ARTICLES ON THE ART AND TECHNIQUE OF DRUMMING AND PERCUSSION, IN CLASS 16 (U.S. CLS. 2, 5, 22, 23, 29, 37, 38 AND 50).

SN 78-827,322, FILED 3-2-2006.

FIRST USE 9-1-2006; IN COMMERCE 9-1-2006.

CHERYL CLAYTON, EXAMINING ATTORNEY

**Int. Cls.: 20 and 28**

**Prior U.S. Cls.: 2, 13, 22, 23, 25, 32, 38, and 50**

**United States Patent and Trademark Office**

**Reg. No. 3,469,544**

**Registered July 15, 2008**

**TRADEMARK  
PRINCIPAL REGISTER**



PERFORMANCE DESIGN, INC. (UTAH CORPORATION)  
P.O. BOX 160513  
FREEPORT CENTER BUILDING G-6  
CLEARFIELD, UT 840160513

FOR: PICNIC TABLES, IN CLASS 20 (U.S. CLS. 2, 13, 22, 25, 32 AND 50).

FIRST USE 2-0-2007; IN COMMERCE 2-0-2007.

FOR: PLAYGROUND EQUIPMENT, NAMELY, SWINGS, SWING SETS, SLIDES, JUNGLE GYMS, CLIMBING STRUCTURES, SANDBOXES, TREE HOUSES, MONKEY BARS, ACTIVITY WALLS,

DECKS AND ENCLOSURES, PICNIC TABLES, BRIDGES, LADDERS SOLD AS A UNIT; PLAYGROUND EQUIPMENT, NAMELY, SWINGS, SWING SETS, SLIDES, JUNGLE GYMS, CLIMBING STRUCTURES, SANDBOXES, TREE HOUSES, MONKEY BARS, ACTIVITY WALLS, BRIDGES, LADDERS SOLD INDIVIDUALLY, IN CLASS 28 (U.S. CLS. 22, 23, 38 AND 50).

FIRST USE 2-0-2007; IN COMMERCE 2-0-2007.

SN 78-828,367, FILED 3-3-2006.

KAREN K. BUSH, EXAMINING ATTORNEY

**Int. Cl.: 25**

**Prior U.S. Cls.: 22 and 39**

**United States Patent and Trademark Office**

**Reg. No. 3,469,545**

**Registered July 15, 2008**

**TRADEMARK  
PRINCIPAL REGISTER**

**Vicki Blue**

ARIZONA MAIL ORDER COMPANY, INC. (DE-  
LAWARE CORPORATION)  
3740 E. 34TH STREET  
TUCSON, AZ 85713

FOR: BERMUDA SHORTS, BLOUSES, BOTTOMS,  
CAMP SHIRTS, CAPRI PANTS, CAPRIS, COATS OF  
DENIM, CULOTTES, DRESSES, GAUCHOS, KNIT  
SHIRTS, WOMEN JACKETS, TROUSERS, VESTS,  
OPEN-NECKED SHIRTS, PANTS, PEDAL PUSHERS,  
PULLOVERS, SHORT TROUSERS, SHORT-  
SLEEVED SHIRTS, SKIRTS, SKIRTS AND SKORTS,  
SLACKS, TOPS, TROUSERS, TUNICS, TURTLE-  
NECKS, IN CLASS 25 (U.S. CLS. 22 AND 39).

FIRST USE 9-1-2006; IN COMMERCE 9-1-2006.

THE MARK CONSISTS OF STANDARD CHAR-  
ACTERS WITHOUT CLAIM TO ANY PARTICULAR  
FONT, STYLE, SIZE, OR COLOR.

NO CLAIM IS MADE TO THE EXCLUSIVE  
RIGHT TO USE "BLUE", APART FROM THE MARK  
AS SHOWN.

THE NAME(S), PORTRAIT(S), AND/OR SIGNA-  
TURE(S) SHOWN IN THE MARK DOES NOT IDEN-  
TIFY A PARTICULAR LIVING INDIVIDUAL.

SN 78-828,818, FILED 3-3-2006.

JULIE WATSON, EXAMINING ATTORNEY

**Int. Cls.: 35, 36, and 38**

**Prior U.S. Cls.: 100, 101, 102, and 104**

**United States Patent and Trademark Office**

**Reg. No. 3,469,546**

**Registered July 15, 2008**

**SERVICE MARK  
PRINCIPAL REGISTER**

**UNIVERS WORKPLACE BENEFITS**

CUSTOM BENEFIT PROGRAMS, INC. (NEW JERSEY CORPORATION)  
897 12TH STREET  
HAMMONTON, NJ 08037

FOR: SERVICES CONSISTING OF THE REGISTRATION, COLLECTION, TRANSCRIPTION, COMPILATION AND SYSTEMIZATION OF WRITTEN COMMUNICATIONS AND DATA FOR EMPLOYEE BENEFIT PLANS AND MEDICAL, DENTAL, VISION LIFE AND DISABILITY INSURANCE PLAN PARTICIPANTS, IN CLASS 35 (U.S. CLS. 100, 101 AND 102).

FIRST USE 6-10-2006; IN COMMERCE 6-10-2006.

FOR: ADMINISTRATION OF EMPLOYEE BENEFIT PLANS AND MEDICAL, DENTAL, VISION, LIFE AND DISABILITY INSURANCE PLANS; PROVIDING INFORMATION AND CONSULTATION SERVICES IN THE FIELD OF ADMINISTRATION OF EMPLOYEE BENEFITS AND INSURANCE PLANS; ENROLLMENT SERVICES FOR EMPLOYEE BENEFIT PLANS AND MEDICAL, DENTAL, VISION, LIFE AND DISABILITY INSURANCE PLANS, IN CLASS 36 (U.S. CLS. 100, 101 AND 102).

FIRST USE 6-10-2006; IN COMMERCE 6-10-2006.

FOR: ELECTRONIC TRANSMISSION OF VOICE, DATA, DOCUMENTS AND MESSAGES VIA THE INTERNET FOR THE ADMINISTRATION OF EMPLOYEE BENEFIT PLANS AND FOR MEDICAL, DENTAL, VISION LIFE AND DISABILITY INSURANCE PLAN PARTICIPANT USE, IN CLASS 38 (U.S. CLS. 100, 101 AND 104).

FIRST USE 6-10-2006; IN COMMERCE 6-10-2006.

THE MARK CONSISTS OF STANDARD CHARACTERS WITHOUT CLAIM TO ANY PARTICULAR FONT, STYLE, SIZE, OR COLOR.

NO CLAIM IS MADE TO THE EXCLUSIVE RIGHT TO USE "WORKPLACE BENEFITS", APART FROM THE MARK AS SHOWN.

SN 78-828,836, FILED 3-3-2006.

ALEXANDER L. POWERS, EXAMINING ATTORNEY

**Int. Cl.: 38**

**Prior U.S. Cls.: 100, 101, and 104**

**United States Patent and Trademark Office**

**Reg. No. 3,469,547**

**Registered July 15, 2008**

**SERVICE MARK  
PRINCIPAL REGISTER**

**FRONTIER SMALL BUSINESS  
ADVANTAGE**

CITIZENS COMMUNICATIONS COMPANY (DE-  
LAWARE CORPORATION)  
THREE HIGH RIDGE PARK  
STAMFORD, CT 06905

FOR: TELECOMMUNICATIONS SERVICES,  
NAMELY, LOCAL AND LONG DISTANCE TELE-  
PHONE SERVICES; PROVIDING VOICE MAIL,  
CALLER ID, THREE WAY CALLING, CALL FOR-  
WARDING, CALL TRANSFER, HUNTING AND  
CALL WAITING SERVICES; PROVIDING MULTI-  
PLE USER ACCESS TO A GLOBAL COMPUTER  
INFORMATION NETWORK; ELECTRONIC MAIL  
SERVICES, IN CLASS 38 (U.S. CLS. 100, 101 AND 104).

FIRST USE 6-0-2006; IN COMMERCE 6-0-2006.

THE MARK CONSISTS OF STANDARD CHAR-  
ACTERS WITHOUT CLAIM TO ANY PARTICULAR  
FONT, STYLE, SIZE, OR COLOR.

OWNER OF U.S. REG. NOS. 1,936,139, 1,964,312,  
AND 2,602,201.

NO CLAIM IS MADE TO THE EXCLUSIVE  
RIGHT TO USE "SMALL BUSINESS", APART FROM  
THE MARK AS SHOWN.

SN 78-829,017, FILED 3-3-2006.

RONALD AIKENS, EXAMINING ATTORNEY

**Int. Cl.: 30**

**Prior U.S. Cl.: 46**

**United States Patent and Trademark Office**

**Reg. No. 3,469,548**

**Registered July 15, 2008**

**TRADEMARK  
PRINCIPAL REGISTER**

**Cweet**

LOREN MILES (UNITED STATES INDIVIDUAL)  
11155 MASSACHUSETTS AVENUE  
LOS ANGELES, CA 90025

FIRST USE 3-4-2006; IN COMMERCE 7-28-2007.

SN 78-829,311, FILED 3-4-2006.

FOR: NATURAL SWEETENER, IN CLASS 30 (U.S.  
CL. 46).

AMY ALFIERI, EXAMINING ATTORNEY



**Int. Cl.: 36**

**Prior U.S. Cls.: 100, 101, and 102**

**United States Patent and Trademark Office**

**Reg. No. 3,469,549**

**Registered July 15, 2008**

**SERVICE MARK  
PRINCIPAL REGISTER**

# Audit Busters

NEMITH, GEORGE K. (UNITED STATES INDIVIDUAL)

200 STEELE'S RIDGE ROAD

CAMDEN, DE 19934

FOR: INSURANCE BROKERAGE, IN CLASS 36  
(U.S. CLS. 100, 101 AND 102).

FIRST USE 2-1-2007; IN COMMERCE 2-1-2007.

THE MARK CONSISTS OF STANDARD CHARACTERS WITHOUT CLAIM TO ANY PARTICULAR FONT, STYLE, SIZE, OR COLOR.

NO CLAIM IS MADE TO THE EXCLUSIVE RIGHT TO USE "AUDIT", APART FROM THE MARK AS SHOWN.

SN 78-830,699, FILED 3-7-2006.

KEVIN DINALLO, EXAMINING ATTORNEY

**Int. Cl.: 3**

**Prior U.S. Cls.: 1, 4, 6, 50, 51, and 52**

**United States Patent and Trademark Office**

**Reg. No. 3,469,550**

**Registered July 15, 2008**

**TRADEMARK  
PRINCIPAL REGISTER**

**TECHNAKOHL LINER**

MAKE-UP ART COSMETICS INC. (DELAWARE  
CORPORATION)

767 FIFTH AVENUE

NEW YORK, NY 10153

FOR: COSMETICS, IN CLASS 3 (U.S. CLS. 1, 4, 6, 50,  
51 AND 52).

FIRST USE 7-3-2006; IN COMMERCE 7-3-2006.

THE MARK CONSISTS OF STANDARD CHAR-  
ACTERS WITHOUT CLAIM TO ANY PARTICULAR  
FONT, STYLE, SIZE, OR COLOR.

NO CLAIM IS MADE TO THE EXCLUSIVE  
RIGHT TO USE "LINER", APART FROM THE  
MARK AS SHOWN.

SN 78-831,166, FILED 3-7-2006.

SANJEEV VOHRA, EXAMINING ATTORNEY

**Int. Cl.: 9**

**Prior U.S. Cls.: 21, 23, 26, 36, and 38**

**Reg. No. 3,469,551**

**United States Patent and Trademark Office**

**Registered July 15, 2008**

---

**TRADEMARK  
PRINCIPAL REGISTER**

**MULTIMEDIA XPRESS**

RENESAS TECHNOLOGY AMERICA, INC. (DE-  
LAWARE CORPORATION)  
450 HOLGER WAY  
SAN JOSE, CA 95134

FOR: MICROPROCESSOR BASED SOFTWARE  
AND HARDWARE PLATFORM, NAMELY, A DE-  
SIGN PLATFORM THAT CONTAINS A MICROPRO-  
CESSOR AND SOFTWARE FOR THE  
DEVELOPMENT OF VOICE-OVER-IP (VOIP) SOLU-  
TIONS, IN CLASS 9 (U.S. CLS. 21, 23, 26, 36 AND 38).

FIRST USE 1-31-2008; IN COMMERCE 1-31-2008.

THE MARK CONSISTS OF STANDARD CHAR-  
ACTERS WITHOUT CLAIM TO ANY PARTICULAR  
FONT, STYLE, SIZE, OR COLOR.

NO CLAIM IS MADE TO THE EXCLUSIVE  
RIGHT TO USE "MULTIMEDIA", APART FROM  
THE MARK AS SHOWN.

SN 78-832,131, FILED 3-8-2006.

HANNO RITTNER, EXAMINING ATTORNEY

**Int. Cl.: 5**

**Prior U.S. Cls.: 6, 18, 44, 46, 51, and 52**

**Reg. No. 3,469,552**

**United States Patent and Trademark Office**

**Registered July 15, 2008**

---

**TRADEMARK  
PRINCIPAL REGISTER**

**FDS**

ALBERTO-CULVER INTERNATIONAL, INC.  
(DELAWARE CORPORATION)  
2525 ARMITAGE AVENUE  
MELROSE PARK, IL 60160

FOR: PERSONAL LUBRICANTS, IN CLASS 5 (U.S.  
CLS. 6, 18, 44, 46, 51 AND 52).

FIRST USE 5-15-2006; IN COMMERCE 5-15-2006.

THE MARK CONSISTS OF STANDARD CHAR-  
ACTERS WITHOUT CLAIM TO ANY PARTICULAR  
FONT, STYLE, SIZE, OR COLOR.

OWNER OF U.S. REG. NOS. 831,204 AND 863,268.

SN 78-832,747, FILED 3-8-2006.

PAUL MORENO, EXAMINING ATTORNEY

**Int. Cl.: 23**

**Prior U.S. Cl.: 43**

**United States Patent and Trademark Office**

**Reg. No. 3,469,553**

**Registered July 15, 2008**

**TRADEMARK  
PRINCIPAL REGISTER**

**NATURAL ECHOES**

DIAMOND TRIPLE C RANCH, INC. (FLORIDA  
CORPORATION)  
801 FLORAL VALE BLVD  
YARDLEY, PA 19067

NO CLAIM IS MADE TO THE EXCLUSIVE  
RIGHT TO USE "NATURAL", APART FROM THE  
MARK AS SHOWN.

FOR: ALPACA YARN, IN CLASS 23 (U.S. CL. 43).

FIRST USE 12-0-2007; IN COMMERCE 12-0-2007.

SN 78-833,207, FILED 3-9-2006.

THE MARK CONSISTS OF STANDARD CHAR-  
ACTERS WITHOUT CLAIM TO ANY PARTICULAR  
FONT, STYLE, SIZE, OR COLOR.

TANYA AMOS, EXAMINING ATTORNEY

**Int. Cl.: 35**

**Prior U.S. Cls.: 100, 101, and 102**

**United States Patent and Trademark Office**

**Reg. No. 3,469,554**

**Registered July 15, 2008**

**SERVICE MARK  
PRINCIPAL REGISTER**

**EASY ONLINE PAYROLL**

BANK OF AMERICA CORPORATION (DELA-  
WARE CORPORATION)

100 NORTH TRYON STREET

CHARLOTTE, NC 28255

FOR: ONLINE PAYROLL PREPARATION, IN  
CLASS 35 (U.S. CLS. 100, 101 AND 102).

FIRST USE 4-0-2006; IN COMMERCE 4-0-2006.

THE MARK CONSISTS OF STANDARD CHAR-  
ACTERS WITHOUT CLAIM TO ANY PARTICULAR  
FONT, STYLE, SIZE, OR COLOR.

NO CLAIM IS MADE TO THE EXCLUSIVE  
RIGHT TO USE "ONLINE PAYROLL", APART  
FROM THE MARK AS SHOWN.

SN 78-834,448, FILED 3-10-2006.

BENJAMIN OKEKE, EXAMINING ATTORNEY

**Int. Cl.: 19**

**Prior U.S. Cls.: 1, 12, 33, and 50**

**United States Patent and Trademark Office**

**Reg. No. 3,469,555**

**Registered July 15, 2008**

**TRADEMARK  
PRINCIPAL REGISTER**

**GARDENDRAIN GR15**

AMERICAN HYDROTECH, INC. (DELAWARE  
CORPORATION)  
303 EAST OHIO STREET  
CHICAGO, IL 606113387

FOR: MOISTURE RETENTION AND DRAINAGE  
STRUCTURE, NAMELY, NON-METAL DRAINAGE  
CONDUITS TO PROMOTE PLANT GROWTH FOR  
USE ON A GREEN ROOF, IN CLASS 19 (U.S. CLS. 1,  
12, 33 AND 50).

FIRST USE 9-0-1998; IN COMMERCE 9-0-1998.

THE MARK CONSISTS OF STANDARD CHAR-  
ACTERS WITHOUT CLAIM TO ANY PARTICULAR  
FONT, STYLE, SIZE, OR COLOR.

NO CLAIM IS MADE TO THE EXCLUSIVE  
RIGHT TO USE "GARDEN DRAIN", APART FROM  
THE MARK AS SHOWN.

SN 78-836,498, FILED 3-14-2006.

LAURIE KAUFMAN, EXAMINING ATTORNEY

**Int. Cl.: 19**

**Prior U.S. Cls.: 1, 12, 33, and 50**

**United States Patent and Trademark Office**

**Reg. No. 3,469,556**

**Registered July 15, 2008**

**TRADEMARK  
PRINCIPAL REGISTER**

**EPIC**

SHAW INDUSTRIES GROUP, INC. (GEORGIA  
CORPORATION)  
616 EAST WALNUT AVE., P.O. DRAWER 2128  
DALTON, GA 307222128

THE MARK CONSISTS OF STANDARD CHAR-  
ACTERS WITHOUT CLAIM TO ANY PARTICULAR  
FONT, STYLE, SIZE, OR COLOR.

FOR: ENGINEERED WOOD FLOORING, IN  
CLASS 19 (U.S. CLS. 1, 12, 33 AND 50).

SN 78-837,510, FILED 3-15-2006.

FIRST USE 7-12-2006; IN COMMERCE 7-12-2006.

ROBIN CHOSID, EXAMINING ATTORNEY



**Int. Cl.: 3**

**Prior U.S. Cls.: 1, 4, 6, 50, 51, and 52**

**Reg. No. 3,469,557**

**United States Patent and Trademark Office**

**Registered July 15, 2008**

**TRADEMARK  
PRINCIPAL REGISTER**

**FLIRTATIOUS**

BEAUTYBANK INC. (DELAWARE CORPORATION)  
767 FIFTH AVENUE  
NEW YORK, NY 10153

THE MARK CONSISTS OF STANDARD CHARACTERS WITHOUT CLAIM TO ANY PARTICULAR FONT, STYLE, SIZE, OR COLOR.

FOR: BODY AND BEAUTY CARE PREPARATIONS; COLOGNE; COSMETICS; FRAGRANCES FOR PERSONAL USE; PERFUME, IN CLASS 3 (U.S. CLS. 1, 4, 6, 50, 51 AND 52).

SN 78-837,912, FILED 3-15-2006.

FIRST USE 2-1-2007; IN COMMERCE 2-1-2007.

GISELLE AGOSTO, EXAMINING ATTORNEY

**Int. Cls.: 5 and 44**

**Prior U.S. Cls.: 6, 18, 44, 46, 51, 52, 100, and 101**

**United States Patent and Trademark Office**

**Reg. No. 3,469,558**

**Registered July 15, 2008**

**TRADEMARK  
SERVICE MARK  
PRINCIPAL REGISTER**



The YinOva Center

YINOVA HEALTH INC. (NEW YORK CORPORATION)  
SUITE 407  
80 EAST 11TH STREET  
NEW YORK, NY 10003

FOR: FERTILITY ENHANCEMENT PREPARATIONS; HERB TEAS FOR MEDICINAL PURPOSES; MEDICINAL HERB EXTRACTS; MEDICINAL HERBS IN DRIED OR PRESERVED FORM, IN CLASS 5 (U.S. CLS. 6, 18, 44, 46, 51 AND 52).

FIRST USE 4-22-2007; IN COMMERCE 4-22-2007.

FOR: ACUPUNCTURE; ACUPUNCTURE SERVICES; VITAMIN THERAPY, IN CLASS 44 (U.S. CLS. 100 AND 101).

FIRST USE 4-22-2007; IN COMMERCE 4-22-2007.

NO CLAIM IS MADE TO THE EXCLUSIVE RIGHT TO USE "CENTER", APART FROM THE MARK AS SHOWN.

SN 78-837,947, FILED 3-15-2006.

SARA THOMAS, EXAMINING ATTORNEY

**Int. Cl.: 41**

**Prior U.S. Cls.: 100, 101, and 107**

**United States Patent and Trademark Office**

**Reg. No. 3,469,559**

**Registered July 15, 2008**

**SERVICE MARK  
PRINCIPAL REGISTER**



TAPOUT, LLC (CALIFORNIA LTD LIAB CO)  
21800 BARTON ROAD  
SUITE 105  
GRAND TERRACE, CA 92313

FOR: CONDUCTING ENTERTAINMENT EXHIBITIONS IN THE NATURE OF LIVE CHARACTER PERFORMANCE ART RELATING TO MIXED MARTIAL ARTS AND OTHER SPORTING EVENTS; ENTERTAINMENT IN THE NATURE OF ONGOING TELEVISION PROGRAMS IN THE FIELD OF CHARACTER PERFORMANCE ART RELATING TO MIXED MARTIAL ARTS AND OTHER SPORTING EVENTS; ENTERTAINMENT IN THE NATURE OF LIVE PERFORMANCES BY MIXED MARTIAL ARTS AND OTHER SPORTING EVENTS CHARACTERS AND PERSONALITIES; ENTERTAINMENT SERVICES, NAMELY, PERSONAL APPEARANCES BY A SPORTS CELEBRITY; ENTERTAINMENT SERVICES, NAMELY, PROVID-

ING A WEB SITE FEATURING LIVE CHARACTER AND SPORTS PERFORMANCES, RELATED FILM CLIPS, PHOTOGRAPHS, AND OTHER MULTIMEDIA MATERIALS; ENTERTAINMENT SERVICES NAMELY, LIVE, TELEVISED AND LIVE EVENT APPEARANCES BY A PROFESSIONAL ENTERTAINER; PRESENTATION OF LIVE SHOW PERFORMANCES; ENTERTAINMENT SERVICES, NAMELY, LIVE PERFORMANCES BY A MIXED MARTIAL ARTS AND OTHER SPORTING EVENTS CELEBRITIES, IN CLASS 41 (U.S. CLS. 100, 101 AND 107).

FIRST USE 12-6-1997; IN COMMERCE 6-1-1998.

OWNER OF U.S. REG. NO. 2,346,533.

SN 78-839,459, FILED 3-16-2006.

ELISSA GARBER KON, EXAMINING ATTORNEY

**Int. Cl.: 44**

**Prior U.S. Cls.: 100 and 101**

**United States Patent and Trademark Office**

**Reg. No. 3,469,560**

**Registered July 15, 2008**

**SERVICE MARK  
PRINCIPAL REGISTER**



NOVOSPINE LLC (NEW JERSEY LTD LIAB CO)  
500 WILLOW GROVE STREET  
HACKETTSTOWN, NJ 07825

FOR: MEDICAL CLINICS SPECIALIZING IN THE  
TREATMENT OF SPINAL CONDITIONS, IN CLASS  
44 (U.S. CLS. 100 AND 101).

FIRST USE 4-0-2005; IN COMMERCE 4-0-2005.

THE COLOR(S) BLUE, BLACK, AND WHITE IS/  
ARE CLAIMED AS A FEATURE OF THE MARK.

THE MARK CONSISTS OF THE BLACK WORD-  
ING "NOVOSPINE" THAT APPEARS IN AN OB-  
LONG SHAPE THAT CONTAINS BLUE  
HORIZONTAL STRIPES. THE LETTER S IN "NO-  
VOSPINE" APPEARS IN BLACK IN THE SHAPE OF  
A SPINE AND IS SURROUNDED BY A WHITE  
OVAL.

SN 78-839,489, FILED 3-16-2006.

ANDREA BUTLER, EXAMINING ATTORNEY

**Int. Cl.: 9**

**Prior U.S. Cls.: 21, 23, 26, 36, and 38**

**United States Patent and Trademark Office**

**Reg. No. 3,469,561**

**Registered July 15, 2008**

**TRADEMARK  
PRINCIPAL REGISTER**

**QUANTUM**

QS INDUSTRIES, INC. (OREGON CORPORATION)  
SUITE 224  
3800 SW CEDAR HILLS BLVD.  
BEAVERTON, OR 970052035

FOR: COMPUTER SOFTWARE AND HARDWARE FOR CREATING SOUND EFFECTS FOR MODEL RAILROADS, IN CLASS 9 (U.S. CLS. 21, 23, 26, 36 AND 38).

FIRST USE 11-30-2002; IN COMMERCE 11-30-2002.

THE MARK CONSISTS OF STANDARD CHARACTERS WITHOUT CLAIM TO ANY PARTICULAR FONT, STYLE, SIZE, OR COLOR.

SN 78-839,848, FILED 3-17-2006.

WANDA KAY PRICE, EXAMINING ATTORNEY

**Int. Cl.: 35**

**Prior U.S. Cls.: 100, 101, and 102**

**United States Patent and Trademark Office**

**Reg. No. 3,469,562**

**Registered July 15, 2008**

**SERVICE MARK  
PRINCIPAL REGISTER**



PAYLESS SHOESOURCE WORLDWIDE, INC.  
(KANSAS CORPORATION)

JAYHAWK TOWERS, 700 SW JACKSON

STE 202

TOPEKA, KS 66603

FOR: RETAIL SHOE AND FASHION ACCESSORIES STORE SERVICES; COMPUTERIZED ON-LINE RETAIL STORE SERVICES IN THE FIELD OF FOOTWEAR, APPAREL, PURSES, HANDBAGS, AND BACKPACKS, ACCESSIBLE VIA GLOBAL COMPUTER NETWORKS, IN CLASS 35 (U.S. CLS. 100, 101 AND 102).

FIRST USE 4-0-2006; IN COMMERCE 4-0-2006.

OWNER OF U.S. REG. NOS. 2,126,943, 2,301,896, AND OTHERS.

THE COLOR(S) ORANGE AND PALE BLUE IS/ ARE CLAIMED AS A FEATURE OF THE MARK.

THE COLOR ORANGE APPEARS IN THE STYLIZED LETTER "P" AND THE TERMS "PAYLESS SHOESOURCE"; THE COLOR BLUE APPEARS IN THE ARC SHAPE OPPOSITE THE STYLIZED ORANGE LETTER "P".

THE MARK CONSISTS OF A STYLIZED LETTER "P" WHICH FORMS PART OF A CIRCLE, ALL IN CLOSE PROXIMITY TO THE WORDS "PAYLESS SHOESOURCE".

SN 78-840,175, FILED 3-17-2006.

KAPIL BHANOT, EXAMINING ATTORNEY

**Int. Cls.: 18 and 20**

**Prior U.S. Cls.: 1, 2, 3, 13, 22, 25, 32, 41, and 50**

**United States Patent and Trademark Office**

**Reg. No. 3,469,563**

**Registered July 15, 2008**

---

**TRADEMARK  
PRINCIPAL REGISTER**

**Keygaroo**

VISIONLINK GROUP, LLC (MASSACHUSETTS  
LTD LIAB CO)  
50 MELLEEN STREET  
HOPEDALE, MA 01747

FOR: LEATHER BAGS, SUITCASES AND WAL-  
LETS; LEATHER KEY CHAINS, IN CLASS 18 (U.S.  
CLS. 1, 2, 3, 22 AND 41).

FIRST USE 4-17-2008; IN COMMERCE 4-17-2008.

FOR: NON-METAL AND NON-LEATHER KEY  
CHAINS, IN CLASS 20 (U.S. CLS. 2, 13, 22, 25, 32 AND  
50).

FIRST USE 4-17-2008; IN COMMERCE 4-17-2008.

THE MARK CONSISTS OF STANDARD CHAR-  
ACTERS WITHOUT CLAIM TO ANY PARTICULAR  
FONT, STYLE, SIZE, OR COLOR.

SN 78-840,270, FILED 3-17-2006.

H. M. FISHER, EXAMINING ATTORNEY

**Int. Cls.: 18 and 20**

**Prior U.S. Cls.: 1, 2, 3, 13, 22, 25, 32, 41, and 50**

**United States Patent and Trademark Office**

**Reg. No. 3,469,564**

**Registered July 15, 2008**

**TRADEMARK  
PRINCIPAL REGISTER**

# Red Bicycle

VISIONLINK GROUP, LLC (MASSACHUSETTS  
LTD LIAB CO)  
50 MELLEEN STREET  
HOPEDALE, MA 01747

FOR: LEATHER BAGS, SUITCASES AND WAL-  
LETS; LEATHER KEY CHAINS, IN CLASS 18 (U.S.  
CLS. 1, 2, 3, 22 AND 41).

FIRST USE 4-17-2008; IN COMMERCE 4-17-2008.

FOR: NON-METAL AND NON-LEATHER KEY  
CHAINS, IN CLASS 20 (U.S. CLS. 2, 13, 22, 25, 32 AND  
50).

FIRST USE 4-17-2008; IN COMMERCE 4-17-2008.

THE MARK CONSISTS OF STANDARD CHAR-  
ACTERS WITHOUT CLAIM TO ANY PARTICULAR  
FONT, STYLE, SIZE, OR COLOR.

SN 78-840,275, FILED 3-17-2006.

H. M. FISHER, EXAMINING ATTORNEY



**Int. Cls.: 18 and 25**

**Prior U.S. Cls.: 1, 2, 3, 22, 39, and 41**

**United States Patent and Trademark Office**

**Reg. No. 3,469,565**

**Registered July 15, 2008**

---

**TRADEMARK  
PRINCIPAL REGISTER**

**RENUAR**

MODES CORWIK INC. (CANADA CORPORATION)  
SUITE 200  
225 CHABANEL STREET WEST  
MONTREAL QUEBEC, CANADA H2N 2C9

FOR: HANDBAGS, IN CLASS 18 (U.S. CLS. 1, 2, 3, 22 AND 41).

FIRST USE 2-0-2006; IN COMMERCE 2-0-2006.

FOR: LADIES' APPAREL AND ACCESSORIES, NAMELY, SWEATERS, BLOUSES, JACKETS, BLA-

ZERS, PANTS, TURTLENECKS, COATS, AND T-SHIRTS, IN CLASS 25 (U.S. CLS. 22 AND 39).

FIRST USE 2-0-2006; IN COMMERCE 2-0-2006.

THE MARK CONSISTS OF STANDARD CHARACTERS WITHOUT CLAIM TO ANY PARTICULAR FONT, STYLE, SIZE, OR COLOR.

SN 78-841,348, FILED 3-20-2006.

MYRIAH HABEEB, EXAMINING ATTORNEY

**Int. Cl.: 35**

**Prior U.S. Cls.: 100, 101, and 102**

**United States Patent and Trademark Office**

**Reg. No. 3,469,566**

**Registered July 15, 2008**

**SERVICE MARK  
PRINCIPAL REGISTER**



WORLD OMNI FINANCIAL CORP. (FLORIDA CORPORATION)  
190 JIM MORAN BLVD.  
DEERFIELD BEACH, FL 33442

FOR: RETAIL STORE AND WHOLESALE CONSIGNMENT SERVICES FEATURING PREVIOUSLY LEASED VEHICLES OWNED BY OTHERS; RETAIL STORE AND WHOLESALE CONSIGNMENT SERVICES FEATURING REPOSSESSED, EARLY LEASE TERMINATION AND LEASE-END TERMINATION MOTOR VEHICLES OWNED BY OTHERS; AUCTIONEERING SERVICES FEATURING REPOSSESSED, EARLY LEASE TERMINATION AND LEASE-END TERMINATION MOTOR VEHICLES; BUSINESS MARKETING SERVICES, NAMELY, CREATING, CONDUCTING, CONSULTING AND

COORDINATING MULTIMEDIA MARKETING CAMPAIGNS FOR OTHERS RELATING TO THE SALE AND AUCTION OF REPOSSESSED, EARLY LEASE TERMINATION AND LEASE-END TERMINATION MOTOR VEHICLES; BUSINESS MANAGEMENT SERVICES FOR LESSORS OF AUTOMOBILES, NAMELY, FACILITATION OF THE AUTOMOBILE LEASE TERMINATION PROCESS, TRACKING AND MONITORING OF LEASED VEHICLES, IN CLASS 35 (U.S. CLS. 100, 101 AND 102).

FIRST USE 1-28-2005; IN COMMERCE 1-28-2005.

SN 78-842,300, FILED 3-21-2006.

GEORGIA CARTY, EXAMINING ATTORNEY

**Int. Cl.: 36**

**Prior U.S. Cls.: 100, 101, and 102**

**United States Patent and Trademark Office**

**Reg. No. 3,469,567**

**Registered July 15, 2008**

**SERVICE MARK  
PRINCIPAL REGISTER**



WORLD OMNI FINANCIAL CORP. (FLORIDA CORPORATION)  
190 JIM MORAN BLVD.  
DEERFIELD BEACH, FL 33442

FOR: VEHICLE LOAN AND LEASE AND COMMERCIAL LOAN SERVICING FOR THIRD PARTIES; FINANCIAL MANAGEMENT IN THE FIELD OF LEASED VEHICLES; AUTOMOBILE RESIDUAL VALUE INSURANCE CLAIMS PROCESSING SERVICES; DEBT RECOVERY AND COLLECTION SERVICES RELATED TO EXCESS WEAR AND TEAR OF LEASED AND FINANCED VEHICLES; FINANCIAL

MANAGEMENT OF LEASED VEHICLES; LEASE-PURCHASE FINANCING SERVICES, NAMELY, ASSISTANCE WITH LEASE EXTENSIONS AND LEASE TERMINATIONS, IN CLASS 36 (U.S. CLS. 100, 101 AND 102).

FIRST USE 1-28-2005; IN COMMERCE 1-28-2005.

SN 78-842,301, FILED 3-21-2006.

GEORGIA CARTY, EXAMINING ATTORNEY

**Int. Cl.: 12**

**Prior U.S. Cls.: 19, 21, 23, 31, 35, and 44**

**Reg. No. 3,469,568**

**United States Patent and Trademark Office**

**Registered July 15, 2008**

**TRADEMARK  
PRINCIPAL REGISTER**

**STRAITLINE**

STRAIGHTLINE PRECISION INDUSTRIES INC.  
(CANADA CORPORATION)  
10019 GALARAN ROAD, UNIT #2  
SIDNEY, B.C., CANADA V8L5X3

FOR: PARTS FOR BICYCLES, UNICYCLES AND MOTORCYCLES, NAMELY, SUSPENSION COMPONENTS COMPRISING METALLIC MEMBERS ADAPTED TO TRANSFER DYNAMIC LOADS FROM A BICYCLE FRAME TO SHOCK ABSORBERS, BRAKE LEVERS, BRAKES, CROWNS COMPRISING METALLIC MEMBERS ADAPTED TO CONNECT SHOCK ABSORBERS TO A BICYCLE FRAME, HANDLE BAR ENDS, FORKS, FORK JOINTS, FRAMES, FRAME JOINTS, SPROCKET WHEELS, SPROCKET WHEEL GUARDS, PEDALS, SEATPOSTS COMPRISING METALLIC MEMBERS TO ATTATCH SEATS TO FRAMES, CRANKS

CHAIN GUIDES COMPRISING METALLIC MEMBERS TO PREVENT CHAINS FROM DERAILING AND STEMS COMPRISING METALLIC MEMBERS ADAPTED FOR CONNECTING THE STEERING HANDLE BAR TO THE FORK OF A BICYCLE, IN CLASS 12 (U.S. CLS. 19, 21, 23, 31, 35 AND 44).

FIRST USE 11-20-2006; IN COMMERCE 11-20-2006.

THE MARK CONSISTS OF STANDARD CHARACTERS WITHOUT CLAIM TO ANY PARTICULAR FONT, STYLE, SIZE, OR COLOR.

SN 78-843,972, FILED 3-23-2006.

AMEETA JORDAN, EXAMINING ATTORNEY

**Int. Cl.: 9**

**Prior U.S. Cls.: 21, 23, 26, 36, and 38**

**Reg. No. 3,469,569**

**United States Patent and Trademark Office**

**Registered July 15, 2008**

**TRADEMARK  
PRINCIPAL REGISTER**

**PROTECH**

L-3 COMMUNICATIONS SECURITY & DETECTION SYSTEMS, INC. (DELAWARE CORPORATION)  
10E COMMERCE WAY  
WOBURN, MA 01801

FOR: ELECTRONIC EQUIPMENT FOR CONTRABAND, INSPECTION, AND THREAT DETECTION, NAMELY, WALK-THROUGH DETECTORS, METAL DETECTORS, AND X-RAY SYSTEMS COMPRISED OF NON-MEDICAL X-RAY APPARATUS, IN CLASS 9 (U.S. CLS. 21, 23, 26, 36 AND 38).

FIRST USE 1-31-2006; IN COMMERCE 1-31-2006.

THE MARK CONSISTS OF STANDARD CHARACTERS WITHOUT CLAIM TO ANY PARTICULAR FONT, STYLE, SIZE, OR COLOR.

SN 78-844,551, FILED 3-23-2006.

BRIAN NEVILLE, EXAMINING ATTORNEY

**Int. Cls.: 9 and 16**

**Prior U.S. Cls.: 2, 5, 21, 22, 23, 26, 29, 36, 37, 38, and 50**

**Reg. No. 3,469,570**

**United States Patent and Trademark Office**

**Registered July 15, 2008**

**TRADEMARK  
PRINCIPAL REGISTER**



PENNWELL CORPORATION (OKLAHOMA CORPORATION)  
1421 SOUTH SHERIDAN ROAD  
TULSA, OK 74112

FIRST USE 3-31-2005; IN COMMERCE 3-31-2005.

OWNER OF U.S. REG. NO. 2,515,920.

FOR: DOWNLOADABLE ELECTRONIC MAGAZINE RELATING TO THE POWER, WATER, TRANSMISSION AND DISTRIBUTION INDUSTRIES, IN CLASS 9 (U.S. CLS. 21, 23, 26, 36 AND 38).

NO CLAIM IS MADE TO THE EXCLUSIVE RIGHT TO USE "MIDDLE EAST ENERGY" AND "COMBINING POWER, WATER, TRANSMISSION & DISTRIBUTION", APART FROM THE MARK AS SHOWN.

FIRST USE 6-1-2005; IN COMMERCE 6-1-2005.

FOR: MAGAZINE RELATING TO THE POWER, WATER, TRANSMISSION AND DISTRIBUTION INDUSTRIES, IN CLASS 16 (U.S. CLS. 2, 5, 22, 23, 29, 37, 38 AND 50).

SN 78-845,196, FILED 3-24-2006.

SUSAN STIGLITZ, EXAMINING ATTORNEY

**Int. Cl.: 9**

**Prior U.S. Cls.: 21, 23, 26, 36, and 38**

**Reg. No. 3,469,571**

**United States Patent and Trademark Office**

**Registered July 15, 2008**

**TRADEMARK  
PRINCIPAL REGISTER**



DEVI PRESS (OKLAHOMA CORPORATION)  
126 W. MAIN ST.  
NORMAN, OK 73071

NO CLAIM IS MADE TO THE EXCLUSIVE  
RIGHT TO USE "RECORDS", APART FROM THE  
MARK AS SHOWN.

FOR: AUDIO RECORDINGS FEATURING MU-  
SIC, IN CLASS 9 (U.S. CLS. 21, 23, 26, 36 AND 38).

SN 78-845,364, FILED 3-24-2006.

FIRST USE 12-15-2006; IN COMMERCE 12-15-2006.

JIM RINGLE, EXAMINING ATTORNEY

Int. Cls.: 30 and 32

Prior U.S. Cls.: 45, 46, and 48

United States Patent and Trademark Office

Reg. No. 3,469,572

Registered July 15, 2008

TRADEMARK  
PRINCIPAL REGISTER



THE COCA-COLA COMPANY (DELAWARE CORPORATION)  
ONE COCA-COLA PLAZA  
ATLANTA, GA 30313

FOR: TEA, IN CLASS 30 (U.S. CL. 46).

FIRST USE 9-25-2005; IN COMMERCE 7-31-2006.

FOR: NON-ALCOHOLIC BEVERAGES, NAMELY, FLAVORED WATERS; SYRUPS, POWDERS AND CONCENTRATES FOR MAKING NON-ALCOHOLIC BEVERAGES, NAMELY, CARBONATED SOFT DRINKS AND FLAVORED WATERS, IN CLASS 32 (U.S. CLS. 45, 46 AND 48).

FIRST USE 9-25-2005; IN COMMERCE 10-3-2005.

OWNER OF U.S. REG. NOS. 2,942,449 AND 2,951,925.

NO CLAIM IS MADE TO THE EXCLUSIVE RIGHT TO USE THE OUTLINE OF A BOTTLE AND THE SCREW TOP PORTION, APART FROM THE MARK AS SHOWN.

THE MARK CONSISTS OF AN S SHAPE DESIGN AROUND THE NECK OF THE BOTTLE AND A SERIES OF SMALLER ALTERNATING S AND CIRCLE DESIGNS IN A BAND IMMEDIATELY BENEATH THE LARGER S DESIGNS. THE DOTTED OUTLINE OF THE SCREW TOP CAPPING DEVICE AND BOTTLE SHAPE SHOWN IN THE DRAWING ARE FOR POSITIONING ONLY AND DO NOT COMPRISE A FEATURE OF THE MARK.

SN 78-846,586, FILED 3-27-2006.

RENEE MCCRAY, EXAMINING ATTORNEY



**Int. Cl.: 3**

**Prior U.S. Cls.: 1, 4, 6, 50, 51, and 52**

**Reg. No. 3,469,573**

**United States Patent and Trademark Office**

**Registered July 15, 2008**

---

**TRADEMARK  
PRINCIPAL REGISTER**

**POE**

BATH & BODY WORKS BRAND MANAGEMENT, INC. (DELAWARE CORPORATION)  
7 LIMITED PARKWAY EAST  
REYNOLDSBURG, OH 43068

THE MARK CONSISTS OF STANDARD CHARACTERS WITHOUT CLAIM TO ANY PARTICULAR FONT, STYLE, SIZE, OR COLOR.

FOR: PERSONAL CARE PRODUCTS, NAMELY, PEARLY SHIMMERING FRAGRANT BODY SPRAY, IN CLASS 3 (U.S. CLS. 1, 4, 6, 50, 51 AND 52).

SN 78-847,003, FILED 3-27-2006.

FIRST USE 1-31-2007; IN COMMERCE 1-31-2007.

CHARLOTTE CORWIN, EXAMINING ATTORNEY

**Int. Cl.: 35**

**Prior U.S. Cls.: 100, 101, and 102**

**United States Patent and Trademark Office**

**Reg. No. 3,469,574**

**Registered July 15, 2008**

**SERVICE MARK  
PRINCIPAL REGISTER**

**TCM DB**

TURNER CLASSIC MOVIES, INC. (DELAWARE  
CORPORATION)  
1050 TECHWOOD DRIVE, NW  
ATLANTA, GA 30318

FOR: PROVIDING AN ON-LINE COMMERCIAL  
INFORMATION DIRECTORY FEATURING A  
SEARCHABLE DATABASE IN THE FIELDS OF  
MOVIES, MOTION PICTURES, DOCUMENTARIES,  
FILMS, TELEVISION PROGRAMS, GRAPHICS,  
ANIMATION AND MULTIMEDIA PRESENTA-  
TION, MUSIC AND MOVIE VIDEOS AND DVDS,  
OTHER MUSIC AUDIOVISUAL RECORDINGS,  
AND ACTORS AND ACTRESSES; AND COMPU-  
TERIZED DATABASE MANAGEMENT SERVICES,  
IN CLASS 35 (U.S. CLS. 100, 101 AND 102).

FIRST USE 4-28-2008; IN COMMERCE 4-28-2008.

THE MARK CONSISTS OF STANDARD CHAR-  
ACTERS WITHOUT CLAIM TO ANY PARTICULAR  
FONT, STYLE, SIZE, OR COLOR.

NO CLAIM IS MADE TO THE EXCLUSIVE  
RIGHT TO USE "DB", APART FROM THE MARK  
AS SHOWN.

SN 78-849,972, FILED 3-30-2006.

MARILYN IZZI, EXAMINING ATTORNEY

**Int. Cl.: 41**

**Prior U.S. Cls.: 100, 101, and 107**

**United States Patent and Trademark Office**

**Reg. No. 3,469,575**

**Registered July 15, 2008**

**SERVICE MARK  
PRINCIPAL REGISTER**



GEORGIA-PACIFIC CONSUMER PRODUCTS LP  
(DELAWARE LIMITED PARTNERSHIP)  
133 PEACHTREE STREET NE  
ATLANTA, GA 30303

OWNER OF U.S. REG. NOS. 1,062,207, 2,929,823,  
AND 2,973,549.

FOR: ENTERTAINMENT SERVICES IN THE  
NATURE OF AN ON-GOING REALITY-BASED  
TELEVISION SERIES FEATURING LIVE ACTION  
VIA A GLOBAL COMPUTER NETWORK, IN CLASS  
41 (U.S. CLS. 100, 101 AND 107).

THE MARK CONSISTS OF AN IMAGE OF A MAN  
WITH TREES IN THE BACKGROUND AND SIGN  
IN THE FOREGROUND.

SN 78-850,886, FILED 3-31-2006.

FIRST USE 5-29-2006; IN COMMERCE 5-29-2006.

MARLENE BELL, EXAMINING ATTORNEY

Int. Cl.: 37

Prior U.S. Cls.: 100, 103, and 106

United States Patent and Trademark Office

Reg. No. 3,469,576

Registered July 15, 2008

SERVICE MARK  
PRINCIPAL REGISTER

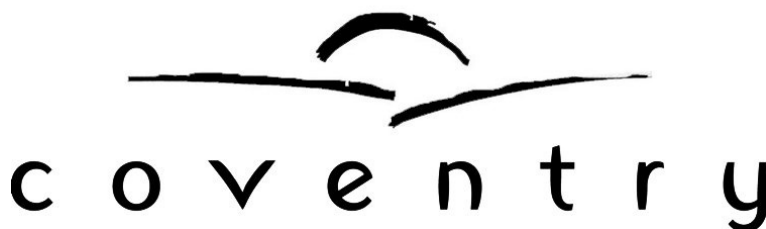

CFM REALTY ADVISORS, L.L.C. (NEBRASKA  
LIMITED LIABILITY COMPANY)  
1823 HARNEY STREET, SUITE 100  
OMAHA, NE 68102

FOR: COMMUNITY DEVELOPMENT, NAMELY,  
LAND DEVELOPMENT SERVICES IN THE NAT-  
URE OF PLANNING AND INTEGRATING, WHERE  
INTEGRATING MEANS ENSURING CONSISTENT  
APPLICATION OF THEME AND THE SMOOTH  
TRANSITION FROM COMMERCIAL, OFFICE  
AND RESIDENTIAL AREAS OF A DEVELOPMENT  
IN A MANNER THAT STAYS CONSISTENT WITH  
THE OVERALL DEVELOPMENT PLAN SO AS TO  
ENHANCE THE VALUE OF THE DEVELOPMENT  
FOR THE CONSUMERS OF THE DEVELOPMENT  
BEING THE ENTITIES AND INDIVIDUALS WHO  
WILL OCCUPY AND USE THE COMMERCIAL,  
OFFICE AND RESIDENTIAL AREAS, MIXED COM-

MERCIAL, OFFICE AND RESIDENTIAL PROPER-  
TIES, CONSTRUCTION MANAGEMENT FOR ITS  
OWN ACCOUNT, NAMELY, THE SUPERVISION OF  
CONSTRUCTION OF COMMERCIAL, OFFICE AND  
RESIDENTIAL PROPERTIES, IN CLASS 37 (U.S.  
CLS. 100, 103 AND 106).

FIRST USE 4-15-2006; IN COMMERCE 4-15-2006.

THE MARK CONSISTS OF THE WORD "COVEN-  
TRY" PLACED UNDER A STYLIZED DESIGN  
WHICH CAN BE SEEN AS A SUNSET OR HILL  
SCAPE.

SN 78-851,289, FILED 3-31-2006.

AMEETA JORDAN, EXAMINING ATTORNEY

**Int. Cl.: 29**

**Prior U.S. Cl.: 46**

**United States Patent and Trademark Office**

**Reg. No. 3,469,577**

**Registered July 15, 2008**

**TRADEMARK  
PRINCIPAL REGISTER**

**FISHERMAN**

BACIK COMPANY OF N.Y, INC. (NEW YORK  
CORPORATION)  
23 MESEROLE AVE  
BROOKLYN, NY 11222

THE MARK CONSISTS OF STANDARD CHAR-  
ACTERS WITHOUT CLAIM TO ANY PARTICULAR  
FONT, STYLE, SIZE, OR COLOR.

FOR: PROCESSED FISH AND FISH FILLETS IN  
CANS, JARS AND PLASTIC CONTAINERS,  
SMOKED VACUUM PACKED FISH, IN CLASS 29  
(U.S. CL. 46).

SN 78-852,155, FILED 4-2-2006.

FIRST USE 2-2-2008; IN COMMERCE 2-2-2008.

JULIE WATSON, EXAMINING ATTORNEY

**Int. Cl.: 29**

**Prior U.S. Cl.: 46**

**United States Patent and Trademark Office**

**Reg. No. 3,469,578**

**Registered July 15, 2008**

**TRADEMARK  
PRINCIPAL REGISTER**

**RYBAK**

BACIK COMPANY OF N.Y, INC. (NEW YORK  
CORPORATION)  
23 MESEROLE AVE  
BROOKLYN, NY 11222

FOR: PROCESSED FISH AND FISH FILLETS IN  
CANS, JARS AND PLASTIC CONTAINERS,  
SMOKED VACUUM PACKED FISH, IN CLASS 29  
(U.S. CL. 46).

FIRST USE 2-2-2008; IN COMMERCE 2-2-2008.

THE MARK CONSISTS OF STANDARD CHAR-  
ACTERS WITHOUT CLAIM TO ANY PARTICULAR  
FONT, STYLE, SIZE, OR COLOR.

THE FOREIGN WORDING IN THE MARK  
TRANSLATES INTO ENGLISH AS FISHERMAN.

SN 78-852,158, FILED 4-2-2006.

JULIE WATSON, EXAMINING ATTORNEY

**Int. Cl.: 35**

**Prior U.S. Cls.: 100, 101, and 102**

**United States Patent and Trademark Office**

**Reg. No. 3,469,579**

**Registered July 15, 2008**

**SERVICE MARK  
PRINCIPAL REGISTER**

**CHOP**

TOWBIN, JOSHUA D. (UNITED STATES INDIVIDUAL)  
8763 VILLA FAITH AVE.  
LAS VEGAS, NV 89147

FOR: AUTOMOBILE DEALERSHIPS; PROVIDING INFORMATION ABOUT AUTOMOBILES FOR SALE BY MEANS OF THE INTERNET; RETAIL SERVICES, NAMELY, DIRECT SOLICITATION BY SALES AGENTS IN CONNECTION WITH THE SALES OF NEW OR USED AUTOMOBILES, IN CLASS 35 (U.S. CLS. 100, 101 AND 102).

FIRST USE 6-0-2001; IN COMMERCE 6-0-2001.

THE MARK CONSISTS OF STANDARD CHARACTERS WITHOUT CLAIM TO ANY PARTICULAR FONT, STYLE, SIZE, OR COLOR.

SN 78-852,422, FILED 4-3-2006.

AMY GEARIN, EXAMINING ATTORNEY

**Int. Cl.: 9**

**Prior U.S. Cls.: 21, 23, 26, 36, and 38**

**Reg. No. 3,469,580**

**United States Patent and Trademark Office**

**Registered July 15, 2008**

---

**TRADEMARK  
PRINCIPAL REGISTER**

**LMN FLIXATION**

LIFETIME ENTERTAINMENT SERVICES (NEW  
YORK JOINT VENTURE)  
309 WEST 49TH STREET 16TH FLOOR  
NEW YORK, NY 10019

FOR: DOWNLOADABLE ONLINE COMPUTER  
GAMES, IN CLASS 9 (U.S. CLS. 21, 23, 26, 36 AND 38).

FIRST USE 4-30-2006; IN COMMERCE 4-30-2006.

THE MARK CONSISTS OF STANDARD CHAR-  
ACTERS WITHOUT CLAIM TO ANY PARTICULAR  
FONT, STYLE, SIZE, OR COLOR.

OWNER OF U.S. REG. NO. 2,859,544.

SN 78-852,697, FILED 4-3-2006.

JUDITH HELFMAN, EXAMINING ATTORNEY



**Int. Cl.: 7**

**Prior U.S. Cls.: 13, 19, 21, 23, 31, 34, and 35**

**Reg. No. 3,469,581**

**United States Patent and Trademark Office**

**Registered July 15, 2008**

**TRADEMARK  
PRINCIPAL REGISTER**

**CYCLONE**

SEMITOOL, INC. (WASHINGTON CORPORATION)  
655 WEST RESERVE DRIVE  
KALISPELL, MT 59901

FOR: MACHINES FOR CLEANING AND DRYING CARRIERS AND CONTAINERS USED FOR HOLDING AND TRANSPORTING SEMICONDUCTOR WAFERS AND SIMILAR FLAT SUBSTRATES, IN CLASS 7 (U.S. CLS. 13, 19, 21, 23, 31, 34 AND 35).

FIRST USE 3-0-2006; IN COMMERCE 3-0-2006.

THE MARK CONSISTS OF STANDARD CHARACTERS WITHOUT CLAIM TO ANY PARTICULAR FONT, STYLE, SIZE, OR COLOR.

SN 78-853,759, FILED 4-4-2006.

ANDREA SAUNDERS, EXAMINING ATTORNEY

**Int. Cls.: 9 and 41**

**Prior U.S. Cls.: 21, 23, 26, 36, 38, 100, 101, and 107**

**United States Patent and Trademark Office**

**Reg. No. 3,469,582**

**Registered July 15, 2008**

**TRADEMARK  
SERVICE MARK  
PRINCIPAL REGISTER**

**EROTASY ISLAND**

FX INTERACTIVE LLC (FLORIDA LTD LIAB  
CO)  
SUITE B  
112 N. EAST STREET  
TAMPA, FL 33602

FOR: VIDEO GAME SOFTWARE; DOWNLOAD-  
ABLE VIDEO GAME SOFTWARE, IN CLASS 9 (U.S.  
CLS. 21, 23, 26, 36 AND 38).

FIRST USE 12-0-2007; IN COMMERCE 12-0-2007.

FOR: ENTERTAINMENT SERVICES, NAMELY,  
PROVIDING TEMPORARY USE OF NON-DOWN-

LOADABLE COMPUTER SOFTWARE FOR PLAY-  
ING ONLINE VIDEO AND COMPUTER GAMES, IN  
CLASS 41 (U.S. CLS. 100, 101 AND 107).

FIRST USE 12-0-2007; IN COMMERCE 12-0-2007.

THE MARK CONSISTS OF STANDARD CHAR-  
ACTERS WITHOUT CLAIM TO ANY PARTICULAR  
FONT, STYLE, SIZE, OR COLOR.

SN 78-856,782, FILED 4-7-2006.

ANTHONY RINKER, EXAMINING ATTORNEY

**Int. Cl.: 25**

**Prior U.S. Cls.: 22 and 39**

**United States Patent and Trademark Office**

**Reg. No. 3,469,583**

**Registered July 15, 2008**

**TRADEMARK  
PRINCIPAL REGISTER**

**SASSY STRAPS**

BRAZABRA CORPORATION (MASSACHUSETTS  
CORPORATION)

#8 RUN WAY

LEE, MA 01238

FOR: DECORATIVE BRA STRAPS FOR STRAP-  
LESS BRAS, IN CLASS 25 (U.S. CLS. 22 AND 39).

FIRST USE 5-15-2008; IN COMMERCE 5-15-2008.

THE MARK CONSISTS OF STANDARD CHAR-  
ACTERS WITHOUT CLAIM TO ANY PARTICULAR  
FONT, STYLE, SIZE, OR COLOR.

NO CLAIM IS MADE TO THE EXCLUSIVE  
RIGHT TO USE "STRAPS", APART FROM THE  
MARK AS SHOWN.

SN 78-857,988, FILED 4-10-2006.

MARGERY A. TIERNEY, EXAMINING ATTORNEY

**Int. Cl.: 3**

**Prior U.S. Cls.: 1, 4, 6, 50, 51, and 52**

**Reg. No. 3,469,584**

**United States Patent and Trademark Office**

**Registered July 15, 2008**

**TRADEMARK  
PRINCIPAL REGISTER**

**RETRO-CHIC BY JOSHUA**

JOSHUA L. BERNARD (UNITED STATES INDIVIDUAL)  
16226 WOODBEND TRAIL DRIVE  
HOUSTON, TX 77070

FOR: HAIR CARE PRODUCTS, NAMELY, SHAMPOO, CONDITIONER, HAIR COLOR PREPARATIONS, STYLING PREPARATIONS, HAIR SPRAY, HAIR STYLING GEL, HAIR MOUSSE, AND SHINE ENHANCER, IN CLASS 3 (U.S. CLS. 1, 4, 6, 50, 51 AND 52).

FIRST USE 4-22-2008; IN COMMERCE 4-22-2008.

THE MARK CONSISTS OF STANDARD CHARACTERS WITHOUT CLAIM TO ANY PARTICULAR FONT, STYLE, SIZE, OR COLOR.

SN 78-858,265, FILED 4-10-2006.

JESSICA A. POWERS, EXAMINING ATTORNEY

**Int. Cl.: 16**

**Prior U.S. Cls.: 2, 5, 22, 23, 29, 37, 38, and 50**

**United States Patent and Trademark Office**

**Reg. No. 3,469,585**

**Registered July 15, 2008**

**TRADEMARK  
PRINCIPAL REGISTER**

**FAITHWORDS**

HACHETTE BOOK GROUP USA (DELAWARE  
CORPORATION)  
237 PARK AVENUE  
NEW YORK, NY 10017

THE MARK CONSISTS OF STANDARD CHAR-  
ACTERS WITHOUT CLAIM TO ANY PARTICULAR  
FONT, STYLE, SIZE, OR COLOR.

FOR: FICTION AND NON-FICTION BOOKS FEATURING RELIGION AND FAITH, IN CLASS 16 (U.S. CLS. 2, 5, 22, 23, 29, 37, 38 AND 50).

SN 78-858,486, FILED 4-11-2006.

FIRST USE 11-30-2006; IN COMMERCE 11-30-2006.

KAPIL BHANOT, EXAMINING ATTORNEY

**Int. Cl.: 36**

**Prior U.S. Cls.: 100, 101, and 102**

**United States Patent and Trademark Office**

**Reg. No. 3,469,586**

**Registered July 15, 2008**

**SERVICE MARK  
PRINCIPAL REGISTER**



CASTLEOAK SECURITIES, L.P. (DELAWARE  
LIMITED PARTNERSHIP)  
111 EAST 58TH STREET  
NEW YORK, NY 10022

FOR: FINANCIAL SERVICES, NAMELY,  
BROKERAGE SERVICES FOR TRANSACTING  
AND TRADING OF FINANCIAL SECURITIES;  
TRANSACTING AND TRADING OF FINANCIAL  
SECURITIES FOR INSTITUTIONAL BROKERA-  
GES; FINANCIAL TRADE EXECUTION SERVICES;  
PROPRIETARY TRADING SERVICES; INVEST-  
MENT BANKING SERVICES; SECURITIES  
BROKERAGE; EQUITY CAPITAL INVESTMENT  
SERVICES, IN CLASS 36 (U.S. CLS. 100, 101 AND 102).

FIRST USE 3-23-2008; IN COMMERCE 3-23-2008.

NO CLAIM IS MADE TO THE EXCLUSIVE  
RIGHT TO USE "SECURITIES", APART FROM  
THE MARK AS SHOWN.

THE COLOR(S) GREEN AND WHITE IS/ARE  
CLAIMED AS A FEATURE OF THE MARK.

THE MARK CONSISTS OF A GREEN SQUARE  
WITH THE WHITE WORDING "CASTLEOAK" TO  
THE LEFT OF A WHITE SQUARE WITH THE  
GREEN WORDING "SECURITIES".

SN 78-861,211, FILED 4-13-2006.

GEORGIA CARTY, EXAMINING ATTORNEY

**Int. Cl.: 36**

**Prior U.S. Cls.: 100, 101, and 102**

**United States Patent and Trademark Office**

**Reg. No. 3,469,587**

**Registered July 15, 2008**

**SERVICE MARK  
PRINCIPAL REGISTER**

**CASTLEOAK SECURITIES**

CASTLEOAK SECURITIES, L.P. (DELAWARE  
LIMITED PARTNERSHIP)  
111 EAST 58TH STREET  
NEW YORK, NY 10022

FOR: FINANCIAL SERVICES, NAMELY,  
BROKERAGE SERVICES FOR TRANSACTING  
AND TRADING OF FINANCIAL SECURITIES;  
TRANSACTING AND TRADING OF FINANCIAL  
SECURITIES FOR INSTITUTIONAL BROKERA-  
GES; FINANCIAL TRADE EXECUTION SERVICES;  
PROPRIETARY TRADING SERVICES; INVEST-  
MENT BANKING SERVICES; SECURITIES  
BROKERAGE; EQUITY CAPITAL INVESTMENT  
SERVICES, IN CLASS 36 (U.S. CLS. 100, 101 AND 102).

FIRST USE 3-23-2006; IN COMMERCE 3-23-2006.

THE MARK CONSISTS OF STANDARD CHAR-  
ACTERS WITHOUT CLAIM TO ANY PARTICULAR  
FONT, STYLE, SIZE, OR COLOR.

NO CLAIM IS MADE TO THE EXCLUSIVE  
RIGHT TO USE "SECURITIES", APART FROM  
THE MARK AS SHOWN.

SN 78-861,212, FILED 4-13-2006.

GEORGIA CARTY, EXAMINING ATTORNEY

Int. Cl.: 11

Prior U.S. Cls.: 13, 21, 23, 31, and 34

Reg. No. 3,469,588

United States Patent and Trademark Office

Registered July 15, 2008

TRADEMARK  
PRINCIPAL REGISTER

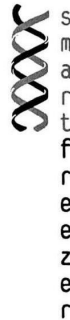

ANGELANTONI INDUSTRIE S.P.A. (ITALY SOCIETA PER AZIONI)  
LOCALITA CIMACOLLE, 464  
MASSA MARTANA (PG), ITALY I-06056

FOR: BLOOD BANK REFRIGERATORS, PLASMA STORAGE FREEZER, BIOLOGICAL MATERIAL BANK REFRIGERATORS, REFRIGERATING CELLS FOR MEDICAL USE, NAMELY, REFRIGERATING CHAMBERS FOR ORGANIZING MEDICAL,

SCIENTIFIC AND BIOLOGICAL SAMPLES, IN CLASS 11 (U.S. CLS. 13, 21, 23, 31 AND 34).

FIRST USE 4-30-2008; IN COMMERCE 4-30-2008.

SN 78-861,767, FILED 4-14-2006.

CHRISTOPHER BUONGIORNO, EXAMINING ATTORNEY



**Int. Cl.: 10**

**Prior U.S. Cls.: 26, 39, and 44**

**United States Patent and Trademark Office**

**Reg. No. 3,469,589**

**Registered July 15, 2008**

**TRADEMARK  
PRINCIPAL REGISTER**

**MOUSEPOD**

LI-COR, INC. (NEBRASKA CORPORATION)  
4421 SUPERIOR STREET  
LINCOLN, NE 68504

THE MARK CONSISTS OF STANDARD CHAR-  
ACTERS WITHOUT CLAIM TO ANY PARTICULAR  
FONT, STYLE, SIZE, OR COLOR.

FOR: DEVICE FOR ADMINISTERING ANESTHE-  
SIA TO AND CONTROLLING THE BODY TEM-  
PERATURE OF RESEARCH MICE USED IN DNA  
RESEARCH, IN CLASS 10 (U.S. CLS. 26, 39 AND 44).

SN 78-863,885, FILED 4-18-2006.

FIRST USE 8-29-2006; IN COMMERCE 8-29-2006.

MAUREEN DALL, EXAMINING ATTORNEY

**Int. Cl.: 14**

**Prior U.S. Cls.: 2, 27, 28, and 50**

**United States Patent and Trademark Office**

**Reg. No. 3,469,590**

**Registered July 15, 2008**

**TRADEMARK  
PRINCIPAL REGISTER**



**DIAMOND DIRECT**

DIAMOND DIRECT, LLC (NEW YORK LTD  
LIAB CO)  
5TH FLOOR  
145 W. 45TH STREET  
NEW YORK, NY 10036

FOR: JEWELRY FEATURING DIAMONDS AND  
PRECIOUS STONES; DIAMONDS AND PRECIOUS  
STONES, IN CLASS 14 (U.S. CLS. 2, 27, 28 AND 50).

FIRST USE 6-2-2006; IN COMMERCE 6-2-2006.

NO CLAIM IS MADE TO THE EXCLUSIVE  
RIGHT TO USE "DIAMOND", APART FROM THE  
MARK AS SHOWN.

THE COLOR(S) PINK AND ORANGE IS/ARE  
CLAIMED AS A FEATURE OF THE MARK.

THE MARK CONSISTS OF A STYLIZED OR-  
ANGE "D" WITH A SOLID PINK "D" INSIDE THE  
ORANGE "D" ABOVE THE WORDS "DIAMOND  
DIRECT" IN BLACK.

SN 78-867,837, FILED 4-24-2006.

DAVID TAYLOR, EXAMINING ATTORNEY

**Int. Cl.: 8**

**Prior U.S. Cls.: 23, 28, and 44**

**Reg. No. 3,469,591**

**United States Patent and Trademark Office**

**Registered July 15, 2008**

---

**TRADEMARK  
PRINCIPAL REGISTER**

**Flex-Up**

BODYLINE PRODUCTS INTERNATIONAL (ILLINOIS CORPORATION)  
198 N. BRANDON AVENUE  
GLENDALE HEIGHTS, IL 60139

FOR: ELECTRIC SHAVERS AND PARTS THEREOF; ELECTRIC SHAVER ACCESSORIES, NAMELY, REPLACEMENT BLADES AND CUTTERS, ELECTRIC SHAVER CASES, AND CLEANING BRUSHES FOR ELECTRIC SHAVERS, IN CLASS 8 (U.S. CLS. 23, 28 AND 44).

FIRST USE 1-0-2008; IN COMMERCE 1-0-2008.

THE MARK CONSISTS OF STANDARD CHARACTERS WITHOUT CLAIM TO ANY PARTICULAR FONT, STYLE, SIZE, OR COLOR.

SN 78-868,402, FILED 4-24-2006.

KATHERINE E. HALMEN, EXAMINING ATTORNEY

**Int. Cl.: 8**

**Prior U.S. Cls.: 23, 28, and 44**

**Reg. No. 3,469,592**

**United States Patent and Trademark Office**

**Registered July 15, 2008**

---

**TRADEMARK  
PRINCIPAL REGISTER**

**Axis-Flex**

BODYLINE PRODUCTS INTERNATIONAL (ILLINOIS CORPORATION)  
198 N. BRANDON AVENUE  
GLENDALE HEIGHTS, IL 60139

FOR: ELECTRIC SHAVERS AND PARTS THEREOF; ELECTRIC SHAVER ACCESSORIES, NAMELY, REPLACEMENT BLADES AND CUTTERS, ELECTRIC SHAVER CASES, AND CLEANING BRUSHES FOR ELECTRIC SHAVERS, IN CLASS 8 (U.S. CLS. 23, 28 AND 44).

FIRST USE 1-0-2008; IN COMMERCE 1-0-2008.

THE MARK CONSISTS OF STANDARD CHARACTERS WITHOUT CLAIM TO ANY PARTICULAR FONT, STYLE, SIZE, OR COLOR.

SN 78-868,419, FILED 4-24-2006.

KATHERINE E. HALMEN, EXAMINING ATTORNEY

**Int. Cl.: 8**

**Prior U.S. Cls.: 23, 28, and 44**

**Reg. No. 3,469,593**

**United States Patent and Trademark Office**

**Registered July 15, 2008**

**TRADEMARK  
PRINCIPAL REGISTER**

# Slide-and-Lock

BODYLINE PRODUCTS INTERNATIONAL (ILLINOIS CORPORATION)  
198 N. BRANDON AVENUE  
GLENDALE HEIGHTS, IL 60139

FOR: ELECTRIC SHAVERS AND PARTS THEREOF; ELECTRIC SHAVER ACCESSORIES, NAMELY, REPLACEMENT BLADES AND CUTTERS, ELECTRIC SHAVER CASES, AND CLEANING BRUSHES FOR ELECTRIC SHAVERS, IN CLASS 8 (U.S. CLS. 23, 28 AND 44).

FIRST USE 1-0-2008; IN COMMERCE 1-0-2008.

THE MARK CONSISTS OF STANDARD CHARACTERS WITHOUT CLAIM TO ANY PARTICULAR FONT, STYLE, SIZE, OR COLOR.

SN 78-868,426, FILED 4-24-2006.

KATHERINE E. HALMEN, EXAMINING ATTORNEY

**Int. Cl.: 8**

**Prior U.S. Cls.: 23, 28, and 44**

**Reg. No. 3,469,594**

**United States Patent and Trademark Office**

**Registered July 15, 2008**

---

**TRADEMARK  
PRINCIPAL REGISTER**

**Lite-and-Fade**

BODYLINE PRODUCTS INTERNATIONAL (ILLINOIS CORPORATION)  
198 N. BRANDON AVENUE  
GLENDALE HEIGHTS, IL 60139

FOR: ELECTRIC SHAVERS AND PARTS THEREOF; ELECTRIC SHAVER ACCESSORIES, NAMELY, REPLACEMENT BLADES AND CUTTERS, ELECTRIC SHAVER CASES, AND CLEANING BRUSHES FOR ELECTRIC SHAVERS, IN CLASS 8 (U.S. CLS. 23, 28 AND 44).

FIRST USE 1-0-2008; IN COMMERCE 1-0-2008.

THE MARK CONSISTS OF STANDARD CHARACTERS WITHOUT CLAIM TO ANY PARTICULAR FONT, STYLE, SIZE, OR COLOR.

SN 78-868,450, FILED 4-24-2006.

KATHERINE E. HALMEN, EXAMINING ATTORNEY

**Int. Cl.: 8**

**Prior U.S. Cls.: 23, 28, and 44**

**United States Patent and Trademark Office**

**Reg. No. 3,469,595**

**Registered July 15, 2008**

**TRADEMARK  
PRINCIPAL REGISTER**

**Play Hard, Be Smooth**

BODYLINE PRODUCTS INTERNATIONAL (ILLINOIS CORPORATION)  
198 N. BRANDON AVENUE  
GLENDALE HEIGHTS, IL 60139

FOR: ELECTRIC SHAVERS AND PARTS THEREOF, ELECTRIC SHAVER ACCESSORIES, NAMELY, REPLACEMENT BLADES AND CUTTERS, ELECTRIC SHAVER CASES, AND CLEANING BRUSHES FOR ELECTRIC SHAVERS, IN CLASS 8 (U.S. CLS. 23, 28 AND 44).

FIRST USE 1-0-2008; IN COMMERCE 1-0-2008.

THE MARK CONSISTS OF STANDARD CHARACTERS WITHOUT CLAIM TO ANY PARTICULAR FONT, STYLE, SIZE, OR COLOR.

SN 78-868,465, FILED 4-24-2006.

KATHERINE E. HALMEN, EXAMINING ATTORNEY

**Int. Cl.: 19**

**Prior U.S. Cls.: 1, 12, 33, and 50**

**United States Patent and Trademark Office**

**Reg. No. 3,469,596**

**Registered July 15, 2008**

**TRADEMARK  
PRINCIPAL REGISTER**

**OMPS**

CHENEY, TIM (UNITED STATES INDIVIDUAL)  
BUCHE & ASSOCIATES, PC  
7777 FAY AVENUE, SUITE 205  
LA JOLLA, CA 92037

THE MARK CONSISTS OF STANDARD CHAR-  
ACTERS WITHOUT CLAIM TO ANY PARTICULAR  
FONT, STYLE, SIZE, OR COLOR.

FOR: PHYSICAL BARRIER SYSTEMS FOR USE  
WITH OPEN MANHOLES, NAMELY, PORTABLE,  
NON-METAL GUARD BARRIERS, IN CLASS 19  
(U.S. CLS. 1, 12, 33 AND 50).

SN 78-868,561, FILED 4-24-2006.

FIRST USE 4-24-2006; IN COMMERCE 6-14-2006.

KATHERINE M. DUBRAY, EXAMINING ATTOR-  
NEY



**Int. Cl.: 25**

**Prior U.S. Cls.: 22 and 39**

**United States Patent and Trademark Office**

**Reg. No. 3,469,597**

**Registered July 15, 2008**

**TRADEMARK  
PRINCIPAL REGISTER**

**MARCSTAR**

BARNES, MARK (UNITED STATES INDIVIDUAL)  
409 MILLWOOD DRIVE  
CAPITAL HEIGHTS, MD 20743

FOR: CLOTH DIAPERS; CLOTHING FOR WEAR IN JUDO PRACTICES; CLOTHING FOR WEAR IN WRESTLING GAMES; CLOTHING, NAMELY, ARM WARMERS; CLOTHING, NAMELY, FOLK COSTUMES; CLOTHING, NAMELY, KNEE WARMERS; CLOTHING, NAMELY, WRAP-AROUNDS; CORSETS; DUSTERS; FOULARDS; HOODS; INFANT AND TODDLER ONE PIECE CLOTHING; INFANT CLOTH DIAPERS; JERSEYS; LEATHER BELTS; MANTLES; MUFFLERS; NON-DISPOSABLE CLOTH TRAINING PANTS; PARTS OF CLOTHING, NAMELY, GUSSETS FOR TIGHTS, GUSSETS FOR STOCKINGS, GUSSETS FOR BATHING SUITS, GUSSETS FOR UNDERWEAR, GUSSETS FOR LEO-

TARDS AND GUSSETS FOR FOOTLETS; PERSPIRATION ABSORBENT UNDERWEAR CLOTHING; SHIFTS; SHORT SETS; SHOULDER PADS FOR CLOTHING; SHOULDER WRAPS; SWADDLING CLOTHES; TIES; TOPS; UNDERARM CLOTHING SHIELDS; WRAPS, IN CLASS 25 (U.S. CLS. 22 AND 39).

FIRST USE 3-1-2003; IN COMMERCE 5-1-2005.

THE MARK CONSISTS OF STANDARD CHARACTERS WITHOUT CLAIM TO ANY PARTICULAR FONT, STYLE, SIZE, OR COLOR.

SN 78-868,951, FILED 4-25-2006.

MARILYN IZZI, EXAMINING ATTORNEY

**Int. Cl.: 1**

**Prior U.S. Cls.: 1, 5, 6, 10, 26, and 46**

**United States Patent and Trademark Office**

**Reg. No. 3,469,598**

**Registered July 15, 2008**

**TRADEMARK  
PRINCIPAL REGISTER**



PHOSPHORUS DERIVATIVES INC. (DELAWARE CORPORATION)  
SUITE 500  
622 EMERSON ROAD  
ST. LOUIS, MO 63141

FOR: CHEMICALS IN THE NATURE OF PHOSPHORUS PENTASULFIDE FOR USE AS A RAW MATERIAL INGREDIENT IN MAKING OIL ADDITIVES, CHEMICAL MOTOR OIL ADDITIVES, AND INSECTICIDES AND FOR USE IN THE MINING INDUSTRY AS PART OF THE COMPOSITION OF FLOATATION AIDS, ESPECIALLY FOR COPPER MINING, IN CLASS 1 (U.S. CLS. 1, 5, 6, 10, 26 AND 46).

FIRST USE 3-1-2008; IN COMMERCE 3-1-2008.

THE COLOR(S) YELLOW AND GREEN IS/ARE CLAIMED AS A FEATURE OF THE MARK.

THE MARK CONSISTS OF A YELLOW RECTANGLE CONTAINING A SINGLE GREEN LEAF DESIGN CENTERED WITHIN THE YELLOW RECTANGLE.

SN 78-869,983, FILED 4-26-2006.

BRENDAN MCCAULEY, EXAMINING ATTORNEY

**Int. Cls.: 35, 36, and 37**

**Prior U.S. Cls.: 100, 101, 102, 103, and 106**

**United States Patent and Trademark Office**

**Reg. No. 3,469,599**

**Registered July 15, 2008**

**SERVICE MARK  
PRINCIPAL REGISTER**



CABI DEVELOPERS, LLC (FLORIDA LTD LIAB  
CO)  
19950 W. COUNTRY CLUB DRIVE, SUITE 900  
AVENTURA, FL 33180

FOR: REAL ESTATE ADVERTISING SERVICES;  
REAL ESTATE MARKETING SERVICES, NAMELY,  
DIRECT MARKETING FOR OTHERS; PUBLIC RE-  
LATIONS; MARKET RESEARCH; REAL ESTATE  
MARKETING CONSULTATION; ONLINE SERVI-  
CES FEATURING TOURS OF RESIDENTIAL AND  
COMMERCIAL REAL ESTATE, IN CLASS 35 (U.S.  
CLS. 100, 101 AND 102).

FIRST USE 4-28-2008; IN COMMERCE 4-28-2008.

FOR: FINANCIAL INVESTMENT IN THE FIELD  
OF REAL ESTATE AND REAL ESTATE ACQUI-  
SITION SERVICES; REAL ESTATE LISTING AND  
BROKERAGE SERVICES; LEASING OF REAL ES-  
TATE AND MANAGEMENT OF REAL PROPER-  
TIES, NAMELY, OFFICE BUILDINGS,  
COMMERCIAL PARKS, SHOPPING CENTERS,

AND RESIDENTIAL PROPERTIES, IN CLASS 36  
(U.S. CLS. 100, 101 AND 102).

FIRST USE 4-28-2008; IN COMMERCE 4-28-2008.

FOR: REAL ESTATE DEVELOPMENT, NAMELY,  
SITE SELECTION, CONSTRUCTION PLANNING,  
CONSTRUCTION MANAGEMENT AND SUPERVI-  
SION, AND CONSTRUCTION SERVICES, NAMELY,  
PLANNING, LAYING OUT AND CUSTOM CON-  
STRUCTION OF RESIDENTIAL AND COMMER-  
CIAL PROPERTIES, IN CLASS 37 (U.S. CLS. 100, 103  
AND 106).

FIRST USE 4-28-2008; IN COMMERCE 4-28-2008.

NO CLAIM IS MADE TO THE EXCLUSIVE  
RIGHT TO USE "DEVELOPERS" , APART FROM  
THE MARK AS SHOWN.

SN 78-870,360, FILED 4-26-2006.

MICHELE SWAIN, EXAMINING ATTORNEY

**Int. Cl.: 9**

**Prior U.S. Cls.: 21, 23, 26, 36, and 38**

**Reg. No. 3,469,600**

**United States Patent and Trademark Office**

**Registered July 15, 2008**

**TRADEMARK  
PRINCIPAL REGISTER**

**MAUI MASTERMIND**

MAUI MASTERMIND (NV), LLC (NEVADA LTD  
LIAB CO)  
821 N. 5TH AVENUE  
PHOENIX, AZ 85003

FOR: PRE-RECORDED CD'S, VIDEO TAPES, LASER DISKS, AND DVD'S FEATURING HOME STUDY COURSES IN THE FIELD OF TAX ADVICE, INVESTING, WEALTH CREATION, PERSONAL AND BUSINESS FINANCES, REAL ESTATE INVESTING, BUSINESS MANAGEMENT AND HOW TO CREATE A NETWORK OF ADVISORS, MENTORS AND ASSOCIATES; ELECTRONIC PUBLICATIONS, NAMELY, BOOKS AND ARTICLES FEATURING TAX ADVICE, INVESTING, WEALTH CREATION, PERSONAL AND BUSINESS FINAN-

CES, REAL ESTATE INVESTING, BUSINESS MANAGEMENT AND HOW TO CREATE A NETWORK OF ADVISORS, MENTORS AND ASSOCIATES, RECORDED ON COMPUTER MEDIA, IN CLASS 9 (U.S. CLS. 21, 23, 26, 36 AND 38).

FIRST USE 12-1-2004; IN COMMERCE 8-1-2005.

THE MARK CONSISTS OF STANDARD CHARACTERS WITHOUT CLAIM TO ANY PARTICULAR FONT, STYLE, SIZE, OR COLOR.

SN 78-870,619, FILED 4-26-2006.

HANNO RITTNER, EXAMINING ATTORNEY

**Int. Cl.: 36**

**Prior U.S. Cls.: 100, 101, and 102**

**United States Patent and Trademark Office**

**Reg. No. 3,469,601**

**Registered July 15, 2008**

---

**SERVICE MARK  
PRINCIPAL REGISTER**

**DTS**

INTERNATIONAL FINANCIAL SERVICES, INC.  
(MARYLAND CORPORATION)  
66 EAST MAIN STREET  
WESTMINSTER, MD 21157

FOR: PROVIDING FINANCIAL AND LOGISTICAL INFORMATION RELATING TO THE STATUS OF TRANSACTIONS TO RETAIL ESTABLISHMENTS, ARMORED CAR SERVICES AND BANKS VIA A SECURE COMPUTER NETWORK FOR USE IN MONITORING THE STATUS OF TRANSACTIONS INVOLVING THE TRANSFER AND EVENTUAL DEPOSIT OF CURRENCY, CHECKS AND OTHER INSTRUMENTS AT BANKS OR OTHER

FINANCIAL SERVICES PROVIDERS, IN CLASS 36  
(U.S. CLS. 100, 101 AND 102).

FIRST USE 10-0-2006; IN COMMERCE 10-0-2006.

THE MARK CONSISTS OF STANDARD CHARACTERS WITHOUT CLAIM TO ANY PARTICULAR FONT, STYLE, SIZE, OR COLOR.

SN 78-871,435, FILED 4-27-2006.

PATRICIA EVANKO, EXAMINING ATTORNEY

Int. Cl.: 35

Prior U.S. Cls.: 100, 101, and 102

United States Patent and Trademark Office

Reg. No. 3,469,602

Registered July 15, 2008

SERVICE MARK  
PRINCIPAL REGISTER



LORD AND MASON ENTERPRISES, INC.  
(MARYLAND CORPORATION)  
29 PICKERING  
GERMANTOWN, MD 20874

FOR: ON-LINE RETAIL STORE SERVICES IN  
THE FIELD OF FLOOR MATS FOR VEHICLES AND  
PORTABLE SHOE BAGS, IN CLASS 35 (U.S. CLS. 100,  
101 AND 102).

FIRST USE 10-0-2007; IN COMMERCE 10-0-2007.

NO CLAIM IS MADE TO THE EXCLUSIVE  
RIGHT TO USE "ENTERPRISES" AND "INC.",  
APART FROM THE MARK AS SHOWN.

THE COLOR(S) THE COLORS GREEN, BLUE,  
BLACK AND WHITE IS/ARE CLAIMED AS A  
FEATURE OF THE MARK.

THE COLOR GREEN APPEARS IN THE WORDS  
'ENTERPRISE' AND 'MASON' AND THE RECTAN-  
GLE IN THE UPPER LEFT CORNER; THE COLOR  
BLUE IN THE CONTINENTS AND THE WORD  
LORD, AND THE LOWER LEFT INTERIOR AND  
RIGHT HAND UPPER INTERIOR OF THE LARGE  
RECTANGLE DESIGN; THE COLOR WHITE IN  
THE PLUS SIGN AND THE COLOR BLACK IN  
THE INTERIOR RECTANGLE FOR THE WORDS  
'LORD + MASON', THE OUTER RECTANGLE AND  
THE WORD 'INC.' AND THE LINES ON THE GLOBE  
DESIGN.

SN 78-871,786, FILED 4-28-2006.

HENRY S. ZAK, EXAMINING ATTORNEY

**Int. Cl.: 3**

**Prior U.S. Cls.: 1, 4, 6, 50, 51, and 52**

**United States Patent and Trademark Office**

**Reg. No. 3,469,603**

**Registered July 15, 2008**

**TRADEMARK  
PRINCIPAL REGISTER**

**SkinNY Skincare**

BIONET ESTHETICS, INC. (ARKANSAS CORPORATION)

15 SHACKLEFORD DR SUITE B

LITTLE ROCK, AR 72211

FOR: SKIN CARE PRODUCTS, NAMELY, LOTIONS, CREAMS, AND FACIAL WASHES, IN CLASS 3 (U.S. CLS. 1, 4, 6, 50, 51 AND 52).

FIRST USE 4-22-2008; IN COMMERCE 4-22-2008.

THE MARK CONSISTS OF STANDARD CHARACTERS WITHOUT CLAIM TO ANY PARTICULAR FONT, STYLE, SIZE, OR COLOR.

NO CLAIM IS MADE TO THE EXCLUSIVE RIGHT TO USE "SKINCARE", APART FROM THE MARK AS SHOWN.

SN 78-872,826, FILED S.R. 4-29-2006; AM. P.R. 5-10-2007.

ANTHONY RINKER, EXAMINING ATTORNEY

**Int. Cls.: 18, 25, and 35**

**Prior U.S. Cls.: 1, 2, 3, 22, 39, 41, 100, 101, and 102**

**United States Patent and Trademark Office**

**Reg. No. 3,469,604**

**Registered July 15, 2008**

**TRADEMARK  
SERVICE MARK  
PRINCIPAL REGISTER**

# STACIA

STACIA, INC. (CALIFORNIA CORPORATION)  
1307 1/2 PICO BLVD.  
SANTA MONICA, CA 90405

FOR: ALL PURPOSE CARRYING BAGS, NAME-  
LY, BAGS, DUFFLE BAGS, BEADED HANDBAGS,  
MINI CARRY-ALLS, VINTAGE POUCHES, SQUARE  
BAGS, HANDBAGS, SLING BAGS AND TOTE  
BAGS, IN CLASS 18 (U.S. CLS. 1, 2, 3, 22 AND 41).

FIRST USE 12-31-1998; IN COMMERCE 12-31-1998.

FOR: WOMEN'S CLOTHING, NAMELY, SHIRTS,  
BLOUSES, CARDIGANS, SWEATERS, SWEAT  
SHIRTS, VESTS; KNIT WEAR, NAMELY, KNITTED  
SHIRTS, KNITTED CAPS, SKIRTS, PANTS, SUITS,  
DRESSES, LINGERIE, T-SHIRTS, JACKETS, CAMI-  
SOLES, THONGS, SHAWLS, BATHING SUITS,  
BEACH COVER-UPS; CHILDREN'S CLOTHING,  
NAMELY, SWEATERS, T-SHIRTS, HOODED  
SWEAT SHIRTS, PANTS, BLOUSES, DRESSES, KNIT  
WEAR, NAMELY, KNITTED SHIRTS AND KNIT-  
TED CAPS AND SKIRTS; MEN'S CLOTHING,  
NAMELY, SHIRTS, SWEATERS, SCARVES, MIT-  
TENS, VESTS, T-SHIRTS AND HOODED SWEAT  
SHIRTS, IN CLASS 25 (U.S. CLS. 22 AND 39).

FIRST USE 12-31-1998; IN COMMERCE 12-31-1998.

FOR: ON-LINE RETAIL STORE SERVICES FEA-  
TURING CLOTHING, DRESSES, SPORTSWEAR,  
KNIT WEAR, HOME FURNISHINGS, PILLOWS,  
HANDBAGS, TOTE BAGS, FOOTWEAR AND AC-  
CESSORIES; WHOLESALE OUTLETS FEATURING  
DRESSES, SPORTSWEAR, KNITWEAR, HOME  
FURNISHINGS, PILLOWS, HANDBAGS, CAR-  
RYALL BAGS, FOOTWEAR, SANDALS AND AC-  
CESSORIES; RETAIL STORE FEATURING  
CLOTHING, DRESSES, SPORTSWEAR, KNIT  
WEAR, TOTE BAGS, AND ACCESSORIES, IN CLASS  
35 (U.S. CLS. 100, 101 AND 102).

FIRST USE 12-31-1999; IN COMMERCE 12-31-1999.

THE MARK CONSISTS OF STANDARD CHAR-  
ACTERS WITHOUT CLAIM TO ANY PARTICULAR  
FONT, STYLE, SIZE, OR COLOR.

OWNER OF U.S. REG. NO. 2,442,428.

"THE NAME(S), PORTRAIT(S), AND/OR SIGNA-  
TURE(S) SHOWN IN THE MARK DOES NOT IDEN-  
TIFY A PARTICULAR LIVING INDIVIDUAL."

SN 78-873,303, FILED 5-1-2006.

CAROLYN GRAY, EXAMINING ATTORNEY



Int. Cl.: 44

Prior U.S. Cls.: 100 and 101

United States Patent and Trademark Office

Reg. No. 3,469,605

Registered July 15, 2008

SERVICE MARK  
PRINCIPAL REGISTER



BOEHRINGER INGELHEIM VETMEDICA, INC.  
(DELAWARE CORPORATION)  
2621 NORTH BELT HIGHWAY  
ST. JOSEPH, MO 645062002

FOR: VETERINARIAN VACCINE INFORMATION SERVICES PROVIDED VIA PRINT MEDIA, LITERATURE, WEBSITES, AND OTHER MEDIA TO EDUCATE VETERINARIANS AND OTHER PERSONS ON THE PROTOCOLS AND BENEFITS OF USING VACCINES TO RAISE HEALTHY BULLS AND HEIFERS, CATTLE, AND LIVESTOCK, IN CLASS 44 (U.S. CLS. 100 AND 101).

FIRST USE 1-31-2006; IN COMMERCE 1-31-2006.

THE MARK CONSISTS OF THE HEADS OF TWO COWS OVER THE WORDS "RANGE READY" IN A STYLIZED BANNER AND A SMALLER BANNER BELOW WITH THE WORDS "HEALTH WARRANTED FEED STOCK" AND THE LETTERS RR IN A CIRCLE AT THE END OF THE SMALLER BANNER.

SN 78-873,376, FILED 5-1-2006.

ALEXANDER L. POWERS, EXAMINING ATTORNEY

**Int. Cl.: 44**

**Prior U.S. Cls.: 100 and 101**

**United States Patent and Trademark Office**

**Reg. No. 3,469,606**

**Registered July 15, 2008**

**SERVICE MARK  
PRINCIPAL REGISTER**



BOEHRINGER INGELHEIM VETMEDICA, INC.  
(DELAWARE CORPORATION)  
2621 NORTH BELT HIGHWAY  
ST. JOSEPH, MO 645062002

FOR: VETERINARIAN VACCINE INFORMATION SERVICES PROVIDED VIA PRINT MEDIA, LITERATURE, APPLICANT'S WEBSITE, AND OTHER MEDIA TO EDUCATE VETERINARIANS AND OTHER PERSONS ON THE PROTOCOLS AND BENEFITS OF USING APPLICANT'S VACCINES TO RAISE HEALTHY BULLS AND HEIFERS, CATTLE,

AND LIVESTOCK, IN CLASS 44 (U.S. CLS. 100 AND 101).

FIRST USE 1-31-2006; IN COMMERCE 1-31-2006.

THE MARK CONSISTS OF TWO UPPER CASE RS; I.E., "RR" IN A STYLIZED CIRCLE.

SN 78-873,408, FILED 5-1-2006.

ALEXANDER L. POWERS, EXAMINING ATTORNEY

**Int. Cls.: 36 and 37**

**Prior U.S. Cls.: 100, 101, 102, 103, and 106**

**United States Patent and Trademark Office**

**Reg. No. 3,469,607**

**Registered July 15, 2008**

**SERVICE MARK  
PRINCIPAL REGISTER**

**RESEARCH COAST LIFE  
SCIENCE ACCELERATOR**

ALEXANDRIA REAL ESTATE EQUITIES, INC.  
(MARYLAND CORPORATION)  
385 E. COLORADO BLVD., SUITE 299  
PASADENA, CA 91101

FOR: REAL ESTATE SERVICES, NAMELY, REAL ESTATE BROKERAGE, ACQUISITION, RENTAL, LEASING AND MANAGEMENT OF OFFICE, RESEARCH AND LABORATORY PROPERTIES; FINANCIAL SERVICES, NAMELY, FINANCIAL CONSULTATION AND FINANCING SERVICES, IN CLASS 36 (U.S. CLS. 100, 101 AND 102).

FIRST USE 6-0-2006; IN COMMERCE 6-0-2006.

FOR: REAL ESTATE DEVELOPMENT SERVICES; BUILDING CONSTRUCTION, MAINTENANCE AND REPAIR SERVICES, IN CLASS 37 (U.S. CLS. 100, 103 AND 106).

FIRST USE 6-0-2006; IN COMMERCE 6-0-2006.

THE MARK CONSISTS OF STANDARD CHARACTERS WITHOUT CLAIM TO ANY PARTICULAR FONT, STYLE, SIZE, OR COLOR.

SN 78-873,895, FILED 5-1-2006.

ROBIN CHOSID, EXAMINING ATTORNEY

**Int. Cls.: 36 and 37**

**Prior U.S. Cls.: 100, 101, 102, 103, and 106**

**United States Patent and Trademark Office**

**Reg. No. 3,469,608**

**Registered July 15, 2008**

**SERVICE MARK  
PRINCIPAL REGISTER**

**MIAMI LIFE SCIENCE  
ACCELERATOR**

ALEXANDRIA REAL ESTATE EQUITIES, INC.  
(MARYLAND CORPORATION)  
385 E. COLORADO BLVD., SUITE 299  
PASADENA, CA 91101

FOR: REAL ESTATE SERVICES, NAMELY, REAL ESTATE BROKERAGE, ACQUISITION, RENTAL, LEASING AND MANAGEMENT OF OFFICE, RESEARCH AND LABORATORY PROPERTIES; FINANCIAL SERVICES, NAMELY, FINANCIAL CONSULTATION AND FINANCING SERVICES, IN CLASS 36 (U.S. CLS. 100, 101 AND 102).

FIRST USE 7-31-2006; IN COMMERCE 7-31-2006.

FOR: REAL ESTATE DEVELOPMENT SERVICES; BUILDING CONSTRUCTION, MAINTENANCE

AND REPAIR SERVICES, IN CLASS 37 (U.S. CLS. 100, 103 AND 106).

FIRST USE 7-31-2006; IN COMMERCE 7-31-2006.

THE MARK CONSISTS OF STANDARD CHARACTERS WITHOUT CLAIM TO ANY PARTICULAR FONT, STYLE, SIZE, OR COLOR.

NO CLAIM IS MADE TO THE EXCLUSIVE RIGHT TO USE "MIAMI LIFE SCIENCE", APART FROM THE MARK AS SHOWN.

SN 78-873,900, FILED 5-1-2006.

ANTHONY RINKER, EXAMINING ATTORNEY

**Int. Cls.: 36 and 37**

**Prior U.S. Cls.: 100, 101, 102, 103, and 106**

**United States Patent and Trademark Office**

**Reg. No. 3,469,609**

**Registered July 15, 2008**

**SERVICE MARK  
PRINCIPAL REGISTER**

**GAINESVILLE LIFE SCIENCE  
ACCELERATOR**

ALEXANDRIA REAL ESTATE EQUITIES, INC.  
(MARYLAND CORPORATION)  
385 E. COLORADO BLVD., SUITE 299  
PASADENA, CA 91101

FOR: REAL ESTATE SERVICES, NAMELY REAL ESTATE BROKERAGE, ACQUISITION, RENTAL, LEASING AND MANAGEMENT OF OFFICE, RESEARCH AND LABORATORY PROPERTIES; FINANCIAL SERVICES, NAMELY FINANCIAL CONSULTATION AND FINANCING SERVICES, IN CLASS 36 (U.S. CLS. 100, 101 AND 102).

FIRST USE 7-0-2006; IN COMMERCE 7-0-2006.

FOR: REAL ESTATE DEVELOPMENT SERVICES; BUILDING CONSTRUCTION, MAINTENANCE

AND REPAIR SERVICES, IN CLASS 37 (U.S. CLS. 100, 103 AND 106).

FIRST USE 7-0-2006; IN COMMERCE 7-0-2006.

THE MARK CONSISTS OF STANDARD CHARACTERS WITHOUT CLAIM TO ANY PARTICULAR FONT, STYLE, SIZE, OR COLOR.

NO CLAIM IS MADE TO THE EXCLUSIVE RIGHT TO USE "GAINESVILLE LIFE SCIENCE", APART FROM THE MARK AS SHOWN.

SN 78-873,906, FILED 5-1-2006.

ROBIN CHOSID, EXAMINING ATTORNEY

**Int. Cl.: 9**

**Prior U.S. Cls.: 21, 23, 26, 36, and 38**

**United States Patent and Trademark Office**

**Reg. No. 3,469,610**

**Registered July 15, 2008**

**TRADEMARK  
PRINCIPAL REGISTER**

**M.O.O.R.**

ATARI, INC. (DELAWARE CORPORATION)  
417 FIFTH AVENUE  
NEW YORK, NY 10016

FOR: ELECTRONIC, VIDEO AND MULTIMEDIA  
GAME SOFTWARE FOR USE ON PERSONAL COM-  
PUTERS AND ELECTRONIC GAME PLAYING MA-  
CHINES, RECORDED COMPUTER SOFTWARE  
GAME PROGRAMS, GAME SOFTWARE FOR COM-  
PUTERS, VIDEO GAME MACHINES FOR USE  
WITH TELEVISION RECEIVERS, PREPAID DOWN-  
LOADABLE VIDEO GAME AND EDUCATIONAL

VIDEO GAME SOFTWARE, VIDEO GAME SOFT-  
WARE, IN CLASS 9 (U.S. CLS. 21, 23, 26, 36 AND 38).

FIRST USE 9-5-2006; IN COMMERCE 9-5-2006.

THE MARK CONSISTS OF STANDARD CHAR-  
ACTERS WITHOUT CLAIM TO ANY PARTICULAR  
FONT, STYLE, SIZE, OR COLOR.

SN 78-875,405, FILED 5-3-2006.

TEJBIR SINGH, EXAMINING ATTORNEY

**Int. Cl.: 16**

**Prior U.S. Cls.: 2, 5, 22, 23, 29, 37, 38, and 50**

**Reg. No. 3,469,611**

**United States Patent and Trademark Office**

**Registered July 15, 2008**

---

**TRADEMARK  
PRINCIPAL REGISTER**

# Perfect Helpers

PERFECT HELPERS INC. (NEW YORK CORPORATION)  
25 POUND RIDGE ROAD  
PLAINVIEW, NY 11803

THE MARK CONSISTS OF STANDARD CHARACTERS WITHOUT CLAIM TO ANY PARTICULAR FONT, STYLE, SIZE, OR COLOR.

FOR: PRINTED VISUALS IN THE NATURE OF BOOKLETS AND POSTERS FOR RECORDING INFORMATION, IN CLASS 16 (U.S. CLS. 2, 5, 22, 23, 29, 37, 38 AND 50).

SN 78-878,431, FILED 5-8-2006.

FIRST USE 2-29-2008; IN COMMERCE 2-29-2008.

ALICIA COLLINS, EXAMINING ATTORNEY

**Int. Cl.: 30**

**Prior U.S. Cl.: 46**

**United States Patent and Trademark Office**

**Reg. No. 3,469,612**

**Registered July 15, 2008**

**TRADEMARK  
PRINCIPAL REGISTER**

**DRINK, SHARE AND DELIGHT  
IN THE MOMENT**

SARA LEE/DE N.V. (NETHERLANDS CORPORATION)  
VLEUTENSEVAART 100  
3532 AD UTRECHT, NETHERLANDS

FOR: TEA, TEA-BASED BEVERAGES, LEAF TEA, HERBAL TEA, TEA-EXTRACTS, INSTANT TEA, TEA-SUBSTITUTES; TEA INFUSIONS, HERBAL INFUSIONS FOR BEVERAGES; HERBS FOR THE MAKING OF BEVERAGES; MIXTURES OF HERBS FOR THE MAKING OF BEVERAGES; MIXTURES MAINLY CONSISTING OF HERBS WITH THE ADDITION OF DRIED FRUITS FOR THE MAKING

OF BEVERAGES; DECOCTIONS OF HERBS, NOT FOR MEDICAL USE, IN CLASS 30 (U.S. CL. 46).

FIRST USE 9-30-2006; IN COMMERCE 9-30-2006.

THE MARK CONSISTS OF STANDARD CHARACTERS WITHOUT CLAIM TO ANY PARTICULAR FONT, STYLE, SIZE, OR COLOR.

SN 78-878,493, FILED 5-8-2006.

DOMINICK J. SALEMI, EXAMINING ATTORNEY



**Int. Cl.: 25**

**Prior U.S. Cls.: 22 and 39**

**United States Patent and Trademark Office**

**Reg. No. 3,469,613**

**Registered July 15, 2008**

**TRADEMARK  
PRINCIPAL REGISTER**

**SAVE 2ND BASE**

DUGERY, ERIN (UNITED STATES INDIVIDUAL)  
330 ECHO VALLEY LANE  
NEWTOWN SQUARE, PA 19073 AND  
DAY, KELLY (UNITED STATES INDIVIDUAL)  
648 SANMARINO AVENUE  
BRYN MAWR, PA 19010

FIRST USE 4-0-2006; IN COMMERCE 4-0-2006.

THE MARK CONSISTS OF STANDARD CHARACTERS WITHOUT CLAIM TO ANY PARTICULAR FONT, STYLE, SIZE, OR COLOR.

SN 78-879,347, FILED 5-9-2006.

FOR: BASEBALL CAPS; POLO SHIRTS; SWEAT SHIRTS; T-SHIRTS, IN CLASS 25 (U.S. CLS. 22 AND 39).

WENDY JUN, EXAMINING ATTORNEY

**Int. Cl.: 41**

**Prior U.S. Cls.: 100, 101, and 107**

**United States Patent and Trademark Office**

**Reg. No. 3,469,614**

**Registered July 15, 2008**

**SERVICE MARK  
PRINCIPAL REGISTER**

**FIRST COAST COMMUNITY  
MUSIC SCHOOL**

FLORIDA COMMUNITY COLLEGE AT JACK-  
SONVILLE (FLORIDA CORPORATION)  
501 WEST STATE STREET  
SUITE 461  
JACKSONVILLE, FL 32202

FOR: EDUCATION SERVICES, NAMELY, PRO-  
VIDING MUSICAL INSTRUCTION IN THE FIELD  
OF INSTRUMENTAL AND VOCAL MUSIC, IN  
CLASS 41 (U.S. CLS. 100, 101 AND 107).

FIRST USE 7-1-2006; IN COMMERCE 7-1-2006.

THE MARK CONSISTS OF STANDARD CHAR-  
ACTERS WITHOUT CLAIM TO ANY PARTICULAR  
FONT, STYLE, SIZE, OR COLOR.

NO CLAIM IS MADE TO THE EXCLUSIVE  
RIGHT TO USE "COMMUNITY MUSIC SCHOOL",  
APART FROM THE MARK AS SHOWN.

SN 78-879,633, FILED 5-9-2006.

GEORGIA CARTY, EXAMINING ATTORNEY

**Int. Cls.: 29 and 30**

**Prior U.S. Cl.: 46**

**United States Patent and Trademark Office**

**Reg. No. 3,469,615**

**Registered July 15, 2008**

**TRADEMARK  
PRINCIPAL REGISTER**

**Suga'**

BONDS, STACY Y (UNITED STATES INDIVIDUAL)  
604 HERITAGE CREST CT  
O FALLON, IL 62269

FOR: APPLESAUCE, FRUIT PRESERVES, FRUIT-BASED SPREADS, JAMS, FRUIT PASTE, FRUIT-BASED FILLING FOR CAKES AND PIES, IN CLASS 29 (U.S. CL. 46).

FIRST USE 2-5-2008; IN COMMERCE 2-5-2008.

FOR: BREADS, CAKES, COOKIES, FRUIT JEL-LIES, BROWNIES, CINNAMON ROLLS, MUFFINS, SAUCES, HOT SAUCE, SEASONING FOR MEAT,

FISH, POULTRY, PIES, DRY RUBS, CUSTARDS, BAKERY PRODUCTS, CANDY, IN CLASS 30 (U.S. CL. 46).

FIRST USE 2-5-2008; IN COMMERCE 2-5-2008.

THE MARK CONSISTS OF STANDARD CHARACTERS WITHOUT CLAIM TO ANY PARTICULAR FONT, STYLE, SIZE, OR COLOR.

SN 78-880,489, FILED 5-10-2006.

MIDGE BUTLER, EXAMINING ATTORNEY

**Int. Cls.: 14, 16, 25, and 28**

**Prior U.S. Cls.: 2, 5, 22, 23, 27, 28, 29, 37, 38, 39, and 50**

**Reg. No. 3,469,616**

**United States Patent and Trademark Office**

**Registered July 15, 2008**

**TRADEMARK  
PRINCIPAL REGISTER**

**G.I.R.A.F.F.E. God is  
righteous and forever  
faithful everyday**

WEAVER, MICHELLE (UNITED STATES INDIVIDUAL)

536 BRECKENRIDGE DR E  
MOBILE, AL 36608 AND

STEWART, TRACI (UNITED STATES INDIVIDUAL)

3540 HARDEMAN RD  
SEMMES, AL 36575

FOR: JEWELRY, NAMELY, NECKLACES, EARRINGS, RINGS, BRACELETS, ANKLETS, AND WATCHES, IN CLASS 14 (U.S. CLS. 2, 27, 28 AND 50).

FIRST USE 3-1-2008; IN COMMERCE 3-1-2008.

FOR: GREETING CARDS, STATIONERY, ADDRESS BOOKS, BLANK WRITING JOURNALS, DAY PLANNERS, PENS, PENCILS, BOOKMARKS, IN CLASS 16 (U.S. CLS. 2, 5, 22, 23, 29, 37, 38 AND 50).

FIRST USE 3-1-2008; IN COMMERCE 3-1-2008.

FOR: T-SHIRTS, HATS, CAPS, BODYSUITS FOR BABIES, SWEATSHIRTS, SWEATPANTS, AND PJAMAS, IN CLASS 25 (U.S. CLS. 22 AND 39).

FIRST USE 3-1-2008; IN COMMERCE 3-1-2008.

FOR: TOYS, NAMELY, STUFFED ANIMALS IN THE NATURE OF GIRAFFES, WOODEN ANIMALS IN THE NATURE OF GIRAFFES, AND PLASTIC ANIMALS IN THE NATURE OF GIRAFFES, IN CLASS 28 (U.S. CLS. 22, 23, 38 AND 50).

FIRST USE 3-1-2008; IN COMMERCE 3-1-2008.

THE MARK CONSISTS OF STANDARD CHARACTERS WITHOUT CLAIM TO ANY PARTICULAR FONT, STYLE, SIZE, OR COLOR.

NO CLAIM IS MADE TO THE EXCLUSIVE RIGHT TO USE "GIRAFFE", APART FROM THE MARK AS SHOWN.

SN 78-880,614, FILED 5-10-2006.

TRACY WHITTAKER-BROWN, EXAMINING ATTORNEY

**Int. Cls.: 19 and 37**

**Prior U.S. Cls.: 1, 12, 33, 50, 100, 103, and 106**

**United States Patent and Trademark Office**

**Reg. No. 3,469,617**

**Registered July 15, 2008**

**TRADEMARK  
SERVICE MARK  
PRINCIPAL REGISTER**

**MODERN SOLUTIONS FOR THE  
AMERICAN DREAM**

BUILDER DEVELOPER SOLUTIONS, INC. (IN-  
DIANA CORPORATION)  
502 SOUTH OAKLAND STREET  
NAPPANEE, IN 46550

FOR: MANUFACTURED HOMES, IN CLASS 19  
(U.S. CLS. 1, 12, 33 AND 50).

FIRST USE 1-15-2008; IN COMMERCE 5-5-2008.

FOR: REAL ESTATE DEVELOPMENT SERVICES,  
NAMELY, BUILDING SITE DEVELOPMENT, IN  
CLASS 37 (U.S. CLS. 100, 103 AND 106).

FIRST USE 1-15-2008; IN COMMERCE 5-5-2008.

THE MARK CONSISTS OF STANDARD CHAR-  
ACTERS WITHOUT CLAIM TO ANY PARTICULAR  
FONT, STYLE, SIZE, OR COLOR.

SN 78-881,598, FILED 5-11-2006.

JOHN WILKE, EXAMINING ATTORNEY

**Int. Cl.: 19**

**Prior U.S. Cls.: 1, 12, 33, and 50**

**United States Patent and Trademark Office**

**Reg. No. 3,469,618**

**Registered July 15, 2008**

**TRADEMARK  
PRINCIPAL REGISTER**

**MAGNUM  
BOARD**

MAGNUM BUILDING PRODUCTS LLC (DELA-  
WARE LIMITED LIABILITY CORPORATION)  
46615 TENNIS ISLAND RD.  
WELLESLEY ISLAND, NY 13640

FOR: MAGNESIUM OXIDE BASED SHEET  
BOARD FOR BUILDING PURPOSES, IN CLASS 19  
(U.S. CLS. 1, 12, 33 AND 50).

FIRST USE 6-20-2006; IN COMMERCE 4-24-2007.

NO CLAIM IS MADE TO THE EXCLUSIVE  
RIGHT TO USE "BOARD", APART FROM THE  
MARK AS SHOWN.

THE COLOR(S) BLUE COLOR FOR WORD MAG-  
NUM AND GREEN COLOR FOR WORD BOARD IS/  
ARE CLAIMED AS A FEATURE OF THE MARK.

THE MARK CONSISTS OF BLUE FOR WORD  
"MAGNUM" AND GREEN FOR THE WORD  
"BOARD".

SN 78-882,226, FILED 5-12-2006.

HENRY S. ZAK, EXAMINING ATTORNEY

**Int. Cl.: 25**

**Prior U.S. Cls.: 22 and 39**

**United States Patent and Trademark Office**

**Reg. No. 3,469,619**

**Registered July 15, 2008**

**TRADEMARK  
PRINCIPAL REGISTER**

**LYDIA HIRSCHER**

HIRSCHER, LYDIA (UNITED STATES INDIVIDUAL)

505 EAST 88TH STREET, 1E

NEW YORK, NY 10128

FOR: SWEATERS, SKIRTS AND TOPS, IN CLASS 25 (U.S. CLS. 22 AND 39).

FIRST USE 9-1-2006; IN COMMERCE 9-1-2006.

THE MARK CONSISTS OF STANDARD CHARACTERS WITHOUT CLAIM TO ANY PARTICULAR FONT, STYLE, SIZE, OR COLOR.

THE NAME "LYDIA HIRSCHER" IDENTIFIES A LIVING INDIVIDUAL WHOSE CONSENT IS OF RECORD.

SN 78-882,490, FILED 5-12-2006.

ALYSSA PALADINO, EXAMINING ATTORNEY

**Int. Cl.: 9**

**Prior U.S. Cls.: 21, 23, 26, 36, and 38**

**Reg. No. 3,469,620**

**United States Patent and Trademark Office**

**Registered July 15, 2008**

**TRADEMARK  
PRINCIPAL REGISTER**



WEBROOT SOFTWARE, INC. (DELAWARE CORPORATION)  
2650 55TH STREET  
BOULDER, CO 80301

FOR: COMPUTER SOFTWARE, NAMELY, COMPUTER SOFTWARE FOR PROVIDING SECURITY FEATURES TO DETECT, IDENTIFY, BLOCK AND DELETE TROJAN HORSE PROGRAMS, ADWARE PROGRAMS, SYSTEM MONITOR AND OTHER SPYWARE PROGRAMS, IN CLASS 9 (U.S. CLS. 21, 23, 26, 36 AND 38).

FIRST USE 7-1-2006; IN COMMERCE 7-1-2006.

OWNER OF U.S. REG. NO. 2,877,206.

THE MOTION MARK CONSISTS OF AN IMAGE OF A RADAR SCREEN WITH A LINE THAT MOVES AROUND THE SCREEN CLOCKWISE.

SN 78-882,532, FILED 5-12-2006.

KAREN K. BUSH, EXAMINING ATTORNEY



**Int. Cl.: 9**

**Prior U.S. Cls.: 21, 23, 26, 36, and 38**

**Reg. No. 3,469,621**

**United States Patent and Trademark Office**

**Registered July 15, 2008**

---

**TRADEMARK  
PRINCIPAL REGISTER**

**Td**

TOUCHDOWN TECHNOLOGIES, INC. (DELA-  
WARE CORPORATION)  
5188 COMMERCE DRIVE  
BALDWIN PARK, CA 91706

THE MARK CONSISTS OF STANDARD CHAR-  
ACTERS WITHOUT CLAIM TO ANY PARTICULAR  
FONT, STYLE, SIZE, OR COLOR.

FOR: PROBE CARDS FOR TESTING SEMICON-  
DUCTORS, IN CLASS 9 (U.S. CLS. 21, 23, 26, 36 AND  
38).

SN 78-882,872, FILED 5-12-2006.

FIRST USE 6-25-2007; IN COMMERCE 6-25-2007.

DAVID MURRAY, EXAMINING ATTORNEY

**Int. Cl.: 9**

**Prior U.S. Cls.: 21, 23, 26, 36, and 38**

**Reg. No. 3,469,622**

**United States Patent and Trademark Office**

**Registered July 15, 2008**

**TRADEMARK  
PRINCIPAL REGISTER**



ITHACA TECHNOLOGIES, LLC (NEW YORK  
LTD LIAB CO)  
227 CHERRY STREET  
ITHACA, NY 14850

FOR: APPARATUS AND INSTRUMENTS FOR SOUND AND IMAGE PROCESSING, AND IMPLEMENTATION SOFTWARE FOR SUCH APPARATUS AND INSTRUMENTS, NAMELY, CD-ROM DRIVES, CD-ROM RECORDERS, CD AND CD-ROM PLAYERS, DIGITAL AUDIO TAPE MACHINES, DIGITAL AUDIO TAPE RECORDERS, COMPUTERS, SMALL COMPUTER SWITCH INTERFACE CONTROLLERS, MAGNETO OPTICAL DISC DRIVES, 8MM TAPE DATA STORAGE UNITS, DIGITAL LINEAR TAPE DATA STORAGE UNITS, FIXED AND REMOVABLE COMPUTER HARD DRIVES, AND CASSETTE AND REEL-TO-REEL TAPE RECORDERS FOR PROCESSING SOUNDS AND IMAGES STORED ON MAGNETIC DECODING DISCS, REMOVABLE MAGNETIC DATA CARRIERS; IMPLEMENTATION SOFTWARE FOR EQUIPMENT,

NAMELY, CD-ROM DRIVES, CD-ROM RECORDERS, CD AND CD-ROM PLAYERS, DIGITAL AUDIO TAPE MACHINES, DIGITAL AUDIO TAPE RECORDERS, COMPUTERS, ELECTRONIC SMALL COMPUTER SWITCH INTERFACE CONTROLLERS, MAGNETO OPTICAL DRIVES, 8MM TAPE DATA STORAGE UNITS, DIGITAL LINEAR TAPE DATA STORAGE UNITS, FIXED AND REMOVABLE COMPUTER HARD DRIVES, AND CASSETTE AND REEL-TO-REEL TAPE RECORDERS; SOFTWARE FOR AUDIO AND MUSICAL PRODUCTION, VIDEO PRODUCTION, AND RELATED DATA STORAGE ON MAGNETIC OR ELECTRONIC MEDIA, IN CLASS 9 (U.S. CLS. 21, 23, 26, 36 AND 38).

FIRST USE 7-23-1993; IN COMMERCE 8-1-1993.

SN 78-883,491, FILED 5-15-2006.

CAROLINE WOOD, EXAMINING ATTORNEY

**Int. Cl.: 35**

**Prior U.S. Cls.: 100, 101, and 102**

**United States Patent and Trademark Office**

**Reg. No. 3,469,623**

**Registered July 15, 2008**

**SERVICE MARK  
PRINCIPAL REGISTER**

# Miner's Gems

SAI INVESTMENTS, LLC (ALASKA LTD LIAB  
CO)  
330 A SPRUCE MILL WAY  
KETCHIKAN, AK 99901

FOR: RETAIL STORE SERVICES FEATURING  
FINE JEWELRY AND EXOTIC GEMS, IN CLASS 35  
(U.S. CLS. 100, 101 AND 102).

FIRST USE 5-1-2004; IN COMMERCE 5-1-2004.

THE MARK CONSISTS OF STANDARD CHAR-  
ACTERS WITHOUT CLAIM TO ANY PARTICULAR  
FONT, STYLE, SIZE, OR COLOR.

NO CLAIM IS MADE TO THE EXCLUSIVE  
RIGHT TO USE "GEMS", APART FROM THE  
MARK AS SHOWN.

SN 78-883,771, FILED 5-15-2006.

ATTIYA MALIK, EXAMINING ATTORNEY

**Int. Cl.: 41**

**Prior U.S. Cls.: 100, 101, and 107**

**United States Patent and Trademark Office**

**Reg. No. 3,469,624**

**Registered July 15, 2008**

**SERVICE MARK  
PRINCIPAL REGISTER**

**USE IT FOR GOOD**

KAJEET, INC. (DELAWARE CORPORATION)  
7101 WISCONSIN AVE., STE. 1111  
BETHESDA, MD 20814

FOR: ENTERTAINMENT SERVICES, NAMELY,  
PROVIDING ON-LINE, NON-DOWNLOADABLE  
COMPUTER GAMES AND MUSIC VIA A MOBILE  
ELECTRONIC DEVICE; EDUCATION SERVICES,  
NAMELY, PROVIDING ON-LINE, NON-DOWN-  
LOADABLE EDUCATIONAL ACTIVITIES FOR  
CHILDREN AND TEENAGERS VIA A MOBILE

ELECTRONIC DEVICE, IN CLASS 41 (U.S. CLS. 100,  
101 AND 107).

FIRST USE 10-31-2006; IN COMMERCE 10-31-2006.

THE MARK CONSISTS OF STANDARD CHAR-  
ACTERS WITHOUT CLAIM TO ANY PARTICULAR  
FONT, STYLE, SIZE, OR COLOR.

SN 78-887,197, FILED 5-18-2006.

RONALD MCMORROW, EXAMINING ATTORNEY

**Int. Cl.: 9**

**Prior U.S. Cls.: 21, 23, 26, 36, and 38**

**United States Patent and Trademark Office**

**Reg. No. 3,469,625**

**Registered July 15, 2008**

**TRADEMARK  
PRINCIPAL REGISTER**

# MOT Sensor

PIXART IMAGING INC. (TAIWAN CORPORATION)  
5F., NO. 5, INNOVATION ROAD I  
SCIENCE-BASED INDUSTRIAL PARK  
HSIN-CHU, TAIWAN

FOR: CASSETTE TAPE FOR VIDEO GAME; FLOPPY DISK FOR COMPUTER GAME; MAGNETIC DATA STORAGE MEDIA FOR COMPUTER GAME PROGRAM; OPTICAL DISC STORAGE FOR COMPUTER GAME PROGRAM; OPTIC DATA STORAGE MEDIA FOR COMPUTER GAME PROGRAM; CD-ROM STORAGE MEDIA FOR GAME COMPUTER; COMPUTER GAME CASSETTE; VIDEO GAME CASSETTE; VIDEO GAME SOFTWARE; GAME ENGINE, NAMELY, CHIPS AND SOFTWARE; COMMERCIAL GAME ENGINE, NAMELY, CHIPS AND SOFTWARE; VIDEO GAME PRO-

GRAMS; DISCS, SOFTWARE, TAPE CASSETTES; COMPUTER GAME SOFTWARE, IN CLASS 9 (U.S. CLS. 21, 23, 26, 36 AND 38).

FIRST USE 4-28-2008; IN COMMERCE 4-28-2008.

THE MARK CONSISTS OF STANDARD CHARACTERS WITHOUT CLAIM TO ANY PARTICULAR FONT, STYLE, SIZE, OR COLOR.

NO CLAIM IS MADE TO THE EXCLUSIVE RIGHT TO USE "SENSOR", APART FROM THE MARK AS SHOWN.

SN 78-887,582, FILED 5-19-2006.

LINDA E. BLOHM, EXAMINING ATTORNEY

**Int. Cl.: 3**

**Prior U.S. Cls.: 1, 4, 6, 50, 51, and 52**

**United States Patent and Trademark Office**

**Reg. No. 3,469,626**

**Registered July 15, 2008**

**TRADEMARK  
PRINCIPAL REGISTER**

**SOF'FRESH**

VPI CORP. (DELAWARE CORPORATION)  
SUITE 200  
103 FOULK ROAD  
WILMINGTON, DE 19803

FOR: HAND SOAP, LIQUID SOAP, DISHWASHING DETERGENT, LAUNDRY DETERGENT, DISHWASHING SOAP, LAUNDRY SOAP, ALL PURPOSE CLEANING PREPARATIONS, AND GENERAL PURPOSE CLEANING, POLISHING AND ABRASIVE LIQUIDS AND POWDERS, IN CLASS 3 (U.S. CLS. 1, 4, 6, 50, 51 AND 52).

FIRST USE 9-0-2007; IN COMMERCE 9-0-2007.

THE MARK CONSISTS OF STANDARD CHARACTERS WITHOUT CLAIM TO ANY PARTICULAR FONT, STYLE, SIZE, OR COLOR.

SN 78-887,771, FILED 5-19-2006.

ADA HAN, EXAMINING ATTORNEY

**Int. Cl.: 42**

**Prior U.S. Cls.: 100 and 101**

**United States Patent and Trademark Office**

**Reg. No. 3,469,627**

**Registered July 15, 2008**

**SERVICE MARK  
PRINCIPAL REGISTER**

**SUNDIAL ENERGY HARVESTING  
SYSTEMS**

ENERGY INDEPENDENCE, LLC (CONNECTI-  
CUT LTD LIAB CO)  
104 POOLE ROAD  
SUFFIELD, CT 06078

FOR: DESIGN AND DEVELOPMENT IN THE  
FIELD OF ENERGY MANAGEMENT RELATING  
TO COOLING AND HEATING SERVICES AND TO  
THE CONTROL, PRODUCTION, USE AND CON-  
SERVATION OF ENERGY AND CONSULTATION  
RELATED THERETO, IN CLASS 42 (U.S. CLS. 100  
AND 101).

FIRST USE 5-23-2007; IN COMMERCE 6-15-2007.

THE MARK CONSISTS OF STANDARD CHAR-  
ACTERS WITHOUT CLAIM TO ANY PARTICULAR  
FONT, STYLE, SIZE, OR COLOR.

NO CLAIM IS MADE TO THE EXCLUSIVE  
RIGHT TO USE "ENERGY HARVESTING SYS-  
TEMS", APART FROM THE MARK AS SHOWN.

SN 78-888,768, FILED 5-22-2006.

KEVIN CORWIN, EXAMINING ATTORNEY

**Int. Cl.: 9**

**Prior U.S. Cls.: 21, 23, 26, 36, and 38**

**Reg. No. 3,469,628**

**United States Patent and Trademark Office**

**Registered July 15, 2008**

**TRADEMARK  
PRINCIPAL REGISTER**



FIRSTLIGHT NETWORKS, INC (CALIFORNIA CORPORATION)  
P.O. BOX 304  
TUSTIN, CA 92780

FOR: COMPUTER APPLIANCE, NAMELY, COMPUTER HARDWARE FOR USE IN DIGITIZING ANALOG IMAGES FROM IMAGING DEVICES USED BY MEDICAL AND TELEMEDICINE PROFESSIONALS FOR INCORPORATING SAID IMA-

GES INTO ELECTRONIC PATIENT RECORDS, IN CLASS 9 (U.S. CLS. 21, 23, 26, 36 AND 38).

FIRST USE 7-0-2006; IN COMMERCE 7-0-2006.

SN 78-888,933, FILED 5-22-2006.

CHRISTOPHER BUONGIORNO, EXAMINING ATTORNEY



**Int. Cl.: 29**

**Prior U.S. Cl.: 46**

**United States Patent and Trademark Office**

**Reg. No. 3,469,629**

**Registered July 15, 2008**

**TRADEMARK  
PRINCIPAL REGISTER**



GRUPA ANIMEX SP. Z O.O. (POLAND LTD LIAB  
CO)  
MORLINY 15  
OSTRODA, POLAND 14-100

THE COLOR(S) WHITE, BLUE, GOLD AND RED  
IS/ARE CLAIMED AS A FEATURE OF THE MARK.

FOR: PROCESSED MEAT, POULTRY; OFFAL  
AND OFFAL PRODUCTS, NAMELY, HOT DOGS,  
SAUSAGES; SEMI-PROCESSED MEALS CONSIST-  
ING PRIMARILY OF MEAT AND OFFAL, NAME-  
LY, LIVER; CANNED COOKED MEAT; MEAT  
EXTRACTS, MEAT BOILED DOWN TO SAUCES;  
EDIBLE FATS; SANDWICH SPREADS CONTAIN-  
ING MEAT, EDIBLE FATS AND TRIPE, IN CLASS 29  
(U.S. CL. 46).

THE MARK CONSISTS OF WHITE LETTERING  
FOR THE MARK "MORLINY" WITHIN A BLUE  
BACKGROUND FRAMED IN A GOLD BORDER,  
WITH RED RIBBONS PERPENDICULAR TO THE  
LETTERING.

SN 78-889,001, FILED 5-22-2006.

FIRST USE 0-0-1978; IN COMMERCE 4-30-2007.

MARY MUNSON, EXAMINING ATTORNEY

**Int. Cls.: 11 and 19**

**Prior U.S. Cls.: 1, 12, 13, 21, 23, 31, 33, 34, and 50**

**Reg. No. 3,469,630**

**United States Patent and Trademark Office**

**Registered July 15, 2008**

**TRADEMARK  
PRINCIPAL REGISTER**



**RONG JIH**

RONG JIH MARBLE ENTERPRISE CO., LTD.  
(TAIWAN CORPORATION)  
SHIGANG TOWNSHIP  
NO. 3, ALLEY 6, LANE 162, FENGSHI RD.  
TAICHUNG, TAIWAN

FOR: TOILET TANKS, SHOWERS, BIDETS, SPOUTS FOR AFFIXING ON WALLS FOR BATHS, BASINS, BIDETS; SINKS, SINK PEDESTALS, BATH TUBS, PORTABLE BATH SEAT, URINALS, LAVATORIES, LAVATORY BOWLS, AND LAVATORY SEATS, TOILETS, TOILET BOWLS, ELECTRIC HOT AIR HAND-DRYERS FOR BATHROOMS, LIGHTING FIXTURES, LAMPS, LAMP SHADES, IN CLASS 11 (U.S. CLS. 13, 21, 23, 31 AND 34).

FIRST USE 5-17-2004; IN COMMERCE 5-1-2008.

FOR: ARTIFICIAL STONE FOR BUILDING AND CONSTRUCTION, STONES, MARBLE, ARTIFICIAL MARBLE FOR BUILDING AND CONSTRUCTION, GRANITE, BUILDING STONE; TILES OF CLAY, GLASS, WOOD, CERAMIC OR EARTHENWARE FOR WALL, FLOOR OR CEILING; WORKS OF ART MADE OF STONE, CONCRETE OR MARBLE, NAMELY, BUSTS, MONUMENTS; STATUES OF STONE, CONCRETE OR MARBLE; STATUETTES

OF STONE, CONCRETE OR MARBLE; FIGURINES OF STONE, CONCRETE, CLAY OR MARBLE; GLASS BLOCKS FOR BUILDING, FIREPROOF TILES, NON-AGRICULTURAL LIME FOR USE IN CONSTRUCTION, NON-METAL MANTELS FOR FIREPLACES, MANTELS FOR FIREPLACES OF STONE, BRICKS, BRICKS MADE OF LAZURITE, MOSAIC TILES AND FLOORING MADE OF LAZURITE FOR BUILDINGS, IN CLASS 19 (U.S. CLS. 1, 12, 33 AND 50).

FIRST USE 5-17-2004; IN COMMERCE 5-1-2008.

THE WORDING IN THE MARK DOES NOT IDENTIFY A LIVING INDIVIDUAL.

THE MARK CONSISTS IN PART OF THE FANCIFUL REPRESENTATION OF A RIVER.

"RONG JIH" HAS NO MEANING IN A FOREIGN LANGUAGE.

SN 78-889,462, FILED 5-22-2006.

G. MAYERSCHOFF, EXAMINING ATTORNEY

**Int. Cl.: 42**

**Prior U.S. Cls.: 100 and 101**

**United States Patent and Trademark Office**

**Reg. No. 3,469,631**

**Registered July 15, 2008**

**SERVICE MARK  
PRINCIPAL REGISTER**

**DIAMOND PASSPORT**

INTERNATIONAL GEMOLOGICAL INSTITUTE,  
INC. (NEW YORK CORPORATION)  
589 FIFTH AVENUE  
NEW YORK, NY 10017

FOR: GEMOLOGICAL SERVICES, NAMELY,  
PROVIDING IDENTIFICATION, AND GRADA-  
TION OF DIAMONDS AND GEMSTONES, IN  
CLASS 42 (U.S. CLS. 100 AND 101).

FIRST USE 1-0-2008; IN COMMERCE 1-0-2008.

THE MARK CONSISTS OF STANDARD CHAR-  
ACTERS WITHOUT CLAIM TO ANY PARTICULAR  
FONT, STYLE, SIZE, OR COLOR.

NO CLAIM IS MADE TO THE EXCLUSIVE  
RIGHT TO USE "DIAMOND", APART FROM THE  
MARK AS SHOWN.

SN 78-891,503, FILED 5-24-2006.

MARGARET POWER, EXAMINING ATTORNEY

**Int. Cls.: 16 and 41**

**Prior U.S. Cls.: 2, 5, 22, 23, 29, 37, 38, 50, 100, 101, and 107**

**Reg. No. 3,469,632**

**United States Patent and Trademark Office**

**Registered July 15, 2008**

**TRADEMARK  
SERVICE MARK  
PRINCIPAL REGISTER**

**FORCEFUL SELLING**

CLAY, BRETT (UNITED STATES INDIVIDUAL)  
3005 122ND PLACE NE  
BELLEVUE, WA 98005

FOR: SERIES OF BOOKS, STUDY GUIDES, AND WORKBOOKS, IN THE FIELD OF SALES AND MARKETING, IN CLASS 16 (U.S. CLS. 2, 5, 22, 23, 29, 37, 38 AND 50).

FIRST USE 4-15-2008; IN COMMERCE 4-15-2008.

FOR: EDUCATIONAL SERVICES, NAMELY, CONDUCTING WORKSHOPS AND SEMINARS, ALL IN THE FIELD OF SALES AND MARKETING, IN CLASS 41 (U.S. CLS. 100, 101 AND 107).

FIRST USE 4-15-2008; IN COMMERCE 4-15-2008.

THE MARK CONSISTS OF STANDARD CHARACTERS WITHOUT CLAIM TO ANY PARTICULAR FONT, STYLE, SIZE, OR COLOR.

NO CLAIM IS MADE TO THE EXCLUSIVE RIGHT TO USE "SELLING", APART FROM THE MARK AS SHOWN.

SN 78-892,792, FILED 5-25-2006.

ROBERT LAVACHE, EXAMINING ATTORNEY

**Int. Cls.: 16, 20, 21, and 22**

**Prior U.S. Cls.: 1, 2, 5, 7, 13, 19, 22, 23, 25, 29, 30, 32, 33, 37, 38, 40, 42, and 50**

**Reg. No. 3,469,633**

**United States Patent and Trademark Office**

**Registered July 15, 2008**

**TRADEMARK  
PRINCIPAL REGISTER**

**UNITED SOLUTIONS**  
FOR THE WAY YOU LIVE

UNITED COMB & NOVELTY CORPORATION  
(MASSACHUSETTS CORPORATION)  
33 PATRIOT CIRCLE  
LEOMINSTER, MA 01453

FOR: PHOTO ALBUMS, FILE BOXES FOR STORAGE OF BUSINESS AND PERSONAL RECORD, PERSONAL ORGANIZERS, PAINTING ACCESSORIES, NAMELY, PAINT CUPS, PAINT TRAYS, PAINT BRUSHES, PAPER "WET PAINT" SIGNS, PLASTIC FOOD STORAGE BAGS FOR HOUSEHOLD USE; STORAGE CONTAINERS MADE OF PAPER, IN CLASS 16 (U.S. CLS. 2, 5, 22, 23, 29, 37, 38 AND 50).

FIRST USE 1-23-2008; IN COMMERCE 5-29-2007.

FOR: PICTURE FRAMES, STORAGE RACKS, NON-METAL HOOKS, SHELVING, PLASTIC TUBS, PLASTIC CRATES, DRAWERS, STORAGE CONTAINER FOR PAINT FOR COMMERCIAL USE; PLASTIC STORAGE CONTAINERS FOR COMMERCIAL OR INDUSTRIAL USE; NON-METAL BOXES, OTHER THAN THOSE OF PAPER; SINK MATS; AND NON-METAL BINS, IN CLASS 20 (U.S. CLS. 2, 13, 22, 25, 32 AND 50).

FIRST USE 1-23-2008; IN COMMERCE 5-29-2007.

FOR: PAILS, PLANTERS FOR FLOWERS AND PLANTS, WASH-TUBS, FEEDING DISHES FOR

PETS, PLASTIC FOOD STORAGE CONTAINERS FOR PETS, CAR CLEANING ACCESSORIES, NAMELY, BRUSHES, CLEANING SPONGES, PAILS, CLEANING AND POLISHING CLOTHS AND CADDIES, DISHES, PLASTIC STORAGE CONTAINERS FOR AUTOMOTIVE USE, MOPS, BROOMS, DUSTING BRUSHES, WASTE BASKETS, COLANDERS, CANISTER SETS, ICE CUBE MOLD TRAYS; BUCKETS FOR USE WHEN PAINTING; STORAGE CONTAINER FOR PAINT FOR HOUSEHOLD USE; PLASTIC FOOD STORAGE CONTAINERS FOR HOUSEHOLD USE; PLASTIC STORAGE CONTAINERS FOR DOMESTIC USE; CUTLERY TRAYS; SINKWARE, NAMELY, DISH DRYING RACKS, CLEANING SPONGES, SPONGE HOLDERS AND SOAP DISHES, IN CLASS 21 (U.S. CLS. 2, 13, 23, 29, 30, 33, 40 AND 50).

FIRST USE 1-23-2008; IN COMMERCE 5-29-2007.

FOR: LAUNDRY BAGS, IN CLASS 22 (U.S. CLS. 1, 2, 7, 19, 22, 42 AND 50).

FIRST USE 1-23-2008; IN COMMERCE 5-29-2007.

SN 78-894,213, FILED 5-26-2006.

JOHN HWANG, EXAMINING ATTORNEY

**Int. Cls.: 16, 20, 21, and 22**

**Prior U.S. Cls.: 1, 2, 5, 7, 13, 19, 22, 23, 25, 29, 30, 32, 33, 37, 38, 40, 42, and 50**

**Reg. No. 3,469,634**

**United States Patent and Trademark Office**

**Registered July 15, 2008**

**TRADEMARK  
PRINCIPAL REGISTER**

# United Solutions

UNITED COMB & NOVELTY CORPORATION  
(MASSACHUSETTS CORPORATION)  
33 PATRIOT CIRCLE  
LEOMINSTER, MA 01453

FOR: PHOTO ALBUMS, FILE BOXES FOR STORAGE OF BUSINESS AND PERSONAL RECORD, PERSONAL ORGANIZERS, PAINTING ACCESSORIES, NAMELY, PAINT CUPS, PAINT TRAYS, PAINT BRUSHES, PAPER "WET PAINT" SIGNS, PLASTIC FOOD STORAGE BAGS FOR HOUSEHOLD USE; STORAGE CONTAINERS MADE OF PAPER, IN CLASS 16 (U.S. CLS. 2, 5, 22, 23, 29, 37, 38 AND 50).

FIRST USE 1-23-2008; IN COMMERCE 5-29-2007.

FOR: PICTURE FRAMES, STORAGE RACKS, NON-METAL HOOKS, SHELVING, PLASTIC TUBS, PLASTIC CRATES, DRAWERS, STORAGE CONTAINER FOR PAINT FOR COMMERCIAL USE; PLASTIC STORAGE CONTAINERS FOR COMMERCIAL OR INDUSTRIAL USE; NON-METAL BOXES, OTHER THAN THOSE OF PAPER; SINK MATS; AND NON-METAL BINS, IN CLASS 20 (U.S. CLS. 2, 13, 22, 25, 32 AND 50).

FIRST USE 1-23-2008; IN COMMERCE 5-29-2007.

FOR: PAILS, PLANTERS FOR FLOWERS AND PLANTS, WASH-TUBS, FEEDING DISHES FOR PETS, PLASTIC FOOD STORAGE CONTAINERS FOR PETS, CAR CLEANING ACCESSORIES, NAME-

LY, BRUSHES, CLEANING SPONGES, PAILS, CLEANING AND POLISHING CLOTHS AND CADDIES, DISHES, PLASTIC STORAGE CONTAINERS FOR AUTOMOTIVE USE, MOPS, BROOMS, DUSTING BRUSHES, WASTE BASKETS, COLANDERS, CANISTER SETS, ICE CUBE MOLD TRAYS; BUCKETS FOR USE WHEN PAINTING; STORAGE CONTAINER FOR PAINT FOR HOUSEHOLD USE; PLASTIC FOOD STORAGE CONTAINERS FOR HOUSEHOLD USE; PLASTIC STORAGE CONTAINERS FOR DOMESTIC USE; CUTLERY TRAYS; SINKWARE, NAMELY, DISH DRYING RACKS, CLEANING SPONGES, SPONGE HOLDERS AND SOAP DISHES, IN CLASS 21 (U.S. CLS. 2, 13, 23, 29, 30, 33, 40 AND 50).

FIRST USE 1-23-2008; IN COMMERCE 5-29-2007.

FOR: LAUNDRY BAGS, IN CLASS 22 (U.S. CLS. 1, 2, 7, 19, 22, 42 AND 50).

FIRST USE 1-23-2008; IN COMMERCE 5-29-2007.

THE MARK CONSISTS OF STANDARD CHARACTERS WITHOUT CLAIM TO ANY PARTICULAR FONT, STYLE, SIZE, OR COLOR.

SN 78-894,230, FILED 5-26-2006.

JOHN HWANG, EXAMINING ATTORNEY

**Int. Cl.: 9**

**Prior U.S. Cls.: 21, 23, 26, 36, and 38**

**Reg. No. 3,469,635**

**United States Patent and Trademark Office**

**Registered July 15, 2008**

**TRADEMARK  
PRINCIPAL REGISTER**

**PIPERLIME**

GAP (APPAREL) LLC (CALIFORNIA LTD LIAB  
CO)  
2 FOLSOM STREET  
SAN FRANCISCO, CA 94105

THE MARK CONSISTS OF STANDARD CHAR-  
ACTERS WITHOUT CLAIM TO ANY PARTICULAR  
FONT, STYLE, SIZE, OR COLOR.

FOR: ELECTRONIC GIFT CARDS FOR USE IN  
CONNECTION WITH PREPAYMENT OF GOODS  
AND SERVICES, IN CLASS 9 (U.S. CLS. 21, 23, 26, 36  
AND 38).

SN 78-894,247, FILED 5-26-2006.

FIRST USE 11-1-2007; IN COMMERCE 11-1-2007.

SANJEEV VOHRA, EXAMINING ATTORNEY

**Int. Cl.: 35**

**Prior U.S. Cls.: 100, 101, and 102**

**United States Patent and Trademark Office**

**Reg. No. 3,469,636**

**Registered July 15, 2008**

**SERVICE MARK  
PRINCIPAL REGISTER**

**PIPERLIME**

GAP (APPAREL) LLC (CALIFORNIA LTD LIAB  
CO)  
2 FOLSOM STREET  
SAN FRANCISCO, CA 94105

FOR: ONLINE RETAIL STORE SERVICES FEATURING CLOTHING, FOOTWEAR, HEADWEAR, CLOTHING ACCESSORIES, BAGS, LEATHER GOODS, SUNGLASSES, JEWELRY, HAIR ACCESSORIES, COSMETICS, TOILETRIES, FRAGRANCES, PERSONAL CARE PRODUCTS, STATIONERY, GIFTWARE; PROMOTING THE GOODS AND SERVICES OF OTHERS BY PLACING ADVERTISEMENTS AND PROMOTIONAL DISPLAYS ON AN ELECTRONIC SITE ACCESSIBLE THROUGH A COMPUTER NETWORK; PROVIDING ON-LINE ORDERING SERVICES IN THE FIELD OF A WIDE VARIETY OF GENERAL MERCHANDISE; MAIL ORDER CATALOGUE SERVICES FEATURING GENERAL MERCHANDISE AND GENERAL CON-

SUMER GOODS; CUSTOMER INCENTIVE, REWARD AND LOYALTY PROGRAMS FOR COMMERCIAL, ADVERTISING AND PROMOTIONAL PURPOSES FEATURED IN CONNECTION WITH ALL OF THE FOREGOING; LOYALTY CARD SERVICES, NAMELY, CUSTOMER LOYALTY REWARDS PROGRAM FOR COMMERCIAL, PROMOTIONAL AND ADVERTISING PURPOSES, IN CLASS 35 (U.S. CLS. 100, 101 AND 102).

FIRST USE 10-15-2006; IN COMMERCE 10-15-2006.

THE MARK CONSISTS OF STANDARD CHARACTERS WITHOUT CLAIM TO ANY PARTICULAR FONT, STYLE, SIZE, OR COLOR.

SN 78-894,259, FILED 5-26-2006.

SANJEEV VOHRA, EXAMINING ATTORNEY



**Int. Cl.: 45**

**Prior U.S. Cls.: 100 and 101**

**United States Patent and Trademark Office**

**Reg. No. 3,469,637**

**Registered July 15, 2008**

**SERVICE MARK  
PRINCIPAL REGISTER**

**PIPERLIME**

GAP (APPAREL) LLC (CALIFORNIA LTD LIAB  
CO)  
2 FOLSOM STREET  
SAN FRANCISCO, CA 94105

FOR: PROVIDING INFORMATION ABOUT  
FASHION; FASHION CONSULTING SERVICES;  
CONSULTING IN THE FIELD OF APPAREL AND  
FOOTWEAR STYLES AND FIT, IN CLASS 45 (U.S.  
CLS. 100 AND 101).

FIRST USE 10-15-2006; IN COMMERCE 10-15-2006.

THE MARK CONSISTS OF STANDARD CHAR-  
ACTERS WITHOUT CLAIM TO ANY PARTICULAR  
FONT, STYLE, SIZE, OR COLOR.

SN 78-894,264, FILED 5-26-2006.

SANJEEV VOHRA, EXAMINING ATTORNEY

**Int. Cl.: 45**

**Prior U.S. Cls.: 100 and 101**

**United States Patent and Trademark Office**

**Reg. No. 3,469,638**

**Registered July 15, 2008**

**SERVICE MARK  
PRINCIPAL REGISTER**

WING AND A PRAYER AVIATION

WING AND A PRAYER AVIATION, INC. (ILLINOIS CORPORATION)  
1004 BEECH BAY ROAD  
POPLAR GROVE, IL 61065

FOR: REMINDER SERVICES, NAMELY, REMINDER SERVICES IN THE AREA OF UPCOMING IMPORTANT DATES AND EVENTS; REMINDER SERVICES IN THE AREA OF UPCOMING IMPORTANT DATES AND EVENTS FOR PILOTS, IN CLASS 45 (U.S. CLS. 100 AND 101).

FIRST USE 1-0-2007; IN COMMERCE 1-0-2007.

THE MARK CONSISTS OF STANDARD CHARACTERS WITHOUT CLAIM TO ANY PARTICULAR FONT, STYLE, SIZE, OR COLOR.

NO CLAIM IS MADE TO THE EXCLUSIVE RIGHT TO USE "AVIATION", APART FROM THE MARK AS SHOWN.

SN 78-894,274, FILED 5-26-2006.

WARREN L. OLANDRIA, EXAMINING ATTORNEY

**Int. Cl.: 45**

**Prior U.S. Cls.: 100 and 101**

**United States Patent and Trademark Office**

**Reg. No. 3,469,639**

**Registered July 15, 2008**

**SERVICE MARK  
PRINCIPAL REGISTER**

**IFLYTRAC**

WING AND A PRAYER AVIATION, INC. (ILLINOIS CORPORATION)  
1004 BEECH BAY ROAD  
POPLAR GROVE, IL 61065

FOR: REMINDER SERVICES, NAMELY, REMINDER SERVICES IN THE AREA OF UPCOMING IMPORTANT DATES AND EVENTS; REMINDER SERVICES IN THE AREA OF UPCOMING IMPORTANT DATES AND EVENTS FOR PILOTS, IN CLASS 45 (U.S. CLS. 100 AND 101).

FIRST USE 1-0-2007; IN COMMERCE 1-0-2007.

THE MARK CONSISTS OF STANDARD CHARACTERS WITHOUT CLAIM TO ANY PARTICULAR FONT, STYLE, SIZE, OR COLOR.

SN 78-894,290, FILED 5-26-2006.

WARREN L. OLANDRIA, EXAMINING ATTORNEY

**Int. Cl.: 41**

**Prior U.S. Cls.: 100, 101, and 107**

**United States Patent and Trademark Office**

**Reg. No. 3,469,640**

**Registered July 15, 2008**

**SERVICE MARK  
PRINCIPAL REGISTER**

**NAACH MANIA**

NAACH COMPANY (CALIFORNIA SOLE PROPRIETORSHIP)  
373 RIVER OAKS CIRCLE, APT 825  
SAN JOSE, CA 95134

FOR: TRAINING SCHOOLS, EDUCATIONAL SERVICES, AND ENTERTAINMENT SERVICES, NAMELY, TRAINING SERVICES FOR STUDENTS IN THE FIELD OF DANCE AND ORGANIZING COMMUNITY CULTURAL EVENTS, DANCE INSTRUCTION SERVICES, AND DEVELOPMENT AND DISSEMINATION OF EDUCATIONAL MATERIALS OF OTHERS IN THE FIELD OF DANCE, EXERCISE AND FITNESS; PHYSICAL FITNESS INSTRUCTION AND PROVIDING FITNESS AND

EXERCISE FACILITIES, IN CLASS 41 (U.S. CLS. 100, 101 AND 107).

FIRST USE 5-31-2006; IN COMMERCE 5-31-2006.

THE MARK CONSISTS OF STANDARD CHARACTERS WITHOUT CLAIM TO ANY PARTICULAR FONT, STYLE, SIZE, OR COLOR.

THE FOREIGN WORDING IN THE MARK TRANSLATES INTO ENGLISH AS "MOVEMENT".

SN 78-896,563, FILED 5-31-2006.

JAMES LOVELACE, EXAMINING ATTORNEY

**Int. Cl.: 3**

**Prior U.S. Cls.: 1, 4, 6, 50, 51, and 52**

**United States Patent and Trademark Office**

**Reg. No. 3,469,641**

**Registered July 15, 2008**

**TRADEMARK  
PRINCIPAL REGISTER**

**AWAKE LIP LACQUER STARDOM**

KOSE CORPORATION (JAPAN CORPORATION)  
6-2, NIHONBASHI 3-CHOME, CHUO-KU  
TOKYO, JAPAN

OWNER OF U.S. REG. NOS. 2,129,738, 3,060,797,  
AND OTHERS.

FOR: COSMETICS, PERFUMES, COSMETIC  
SOAPS, COTTON FOR COSMETIC USE AND HAIR  
CARE PREPARATIONS, IN CLASS 3 (U.S. CLS. 1, 4, 6,  
50, 51 AND 52).

NO CLAIM IS MADE TO THE EXCLUSIVE  
RIGHT TO USE "LIP LACQUER", APART FROM  
THE MARK AS SHOWN.

FIRST USE 8-1-2006; IN COMMERCE 8-1-2006.

SN 78-896,925, FILED 5-31-2006.

THE MARK CONSISTS OF STANDARD CHAR-  
ACTERS WITHOUT CLAIM TO ANY PARTICULAR  
FONT, STYLE, SIZE, OR COLOR.

SUSAN RICHARDS, EXAMINING ATTORNEY

**Int. Cl.: 43**

**Prior U.S. Cls.: 100 and 101**

**United States Patent and Trademark Office**

**Reg. No. 3,469,642**

**Registered July 15, 2008**

**SERVICE MARK  
PRINCIPAL REGISTER**

# La Sandia

MODERN MEXICAN RESTAURANTS, INC.  
(COLORADO CORPORATION)

1400 LARIMER STREET

DENVER, CO 80202

FOR: RESTAURANT SERVICES, IN CLASS 43  
(U.S. CLS. 100 AND 101).

FIRST USE 10-26-2006; IN COMMERCE 10-26-2006.

THE MARK CONSISTS OF STANDARD CHARACTERS WITHOUT CLAIM TO ANY PARTICULAR FONT, STYLE, SIZE, OR COLOR.

THE ENGLISH TRANSLATION OF THE WORD "LA SANDIA" IN THE MARK IS THE WATERMELON.

SN 78-896,995, FILED 5-31-2006.

DEIRDRE ROBERTSON, EXAMINING ATTORNEY

**Int. Cls.: 38, 41, and 42**

**Prior U.S. Cls.: 100, 101, 104, and 107**

**United States Patent and Trademark Office**

**Reg. No. 3,469,643**

**Registered July 15, 2008**

**SERVICE MARK  
PRINCIPAL REGISTER**

**GEEKSUGAR**

SUGAR PUBLISHING INCORPORATED (DELAWARE CORPORATION)  
111 SUTTER STREET, 15TH FLOOR  
SAN FRANCISCO, CA 94104

FOR: PROVIDING ON-LINE ELECTRONIC BULLETIN BOARDS FOR TRANSMISSION OF MESSAGES AMONG COMPUTER USERS CONCERNING TECHNOLOGY, COMPUTERS, MOBILE PHONES AND PERSONAL DIGITAL ASSISTANTS; PROVIDING ADVICE AND INFORMATION OVER THE INTERNET IN THE FIELDS OF MOBILE PHONES AND PERSONAL DIGITAL ASSISTANTS, IN CLASS 38 (U.S. CLS. 100, 101 AND 104).

FIRST USE 12-7-2006; IN COMMERCE 12-7-2006.

FOR: ON-LINE JOURNALS, NAMELY, BLOGS FEATURING TECHNOLOGY, COMPUTERS, MO-

BILE PHONES AND PERSONAL DIGITAL ASSISTANTS, IN CLASS 41 (U.S. CLS. 100, 101 AND 107).

FIRST USE 12-7-2006; IN COMMERCE 12-7-2006.

FOR: PROVIDING ADVICE AND INFORMATION OVER THE INTERNET IN THE FIELDS OF TECHNOLOGY, COMPUTERS, IN CLASS 42 (U.S. CLS. 100 AND 101).

FIRST USE 12-7-2006; IN COMMERCE 12-7-2006.

THE MARK CONSISTS OF STANDARD CHARACTERS WITHOUT CLAIM TO ANY PARTICULAR FONT, STYLE, SIZE, OR COLOR.

SN 78-897,069, FILED 5-31-2006.

ANNE E. GUSTASON, EXAMINING ATTORNEY

**Int. Cl.: 17**

**Prior U.S. Cls.: 1, 5, 12, 13, 35, and 50**

**Reg. No. 3,469,644**

**United States Patent and Trademark Office**

**Registered July 15, 2008**

---

**TRADEMARK  
PRINCIPAL REGISTER**

**HYTIBLOCK**

HYPLAST N.V. (BELGIUM CORPORATION)  
SINT-LENAARTSEWEG 26  
HOOGSTRATEN, BELGIUM B 2320

THE MARK CONSISTS OF STANDARD CHAR-  
ACTERS WITHOUT CLAIM TO ANY PARTICULAR  
FONT, STYLE, SIZE, OR COLOR.

FOR: PLASTIC SHEETINGS, PLASTIC FOIL AND  
PLASTIC FILM FOR AGRICULTURAL USE, IN  
CLASS 17 (U.S. CLS. 1, 5, 12, 13, 35 AND 50).

SN 78-897,132, FILED 5-31-2006.

FIRST USE 6-6-2006; IN COMMERCE 6-6-2006.

EDWARD NELSON, EXAMINING ATTORNEY



**Int. Cl.: 39**

**Prior U.S. Cls.: 100 and 105**

**United States Patent and Trademark Office**

**Reg. No. 3,469,645**

**Registered July 15, 2008**

**SERVICE MARK  
PRINCIPAL REGISTER**

**QUAD-REDUNDANT ARCHIVING**

COACTIV, LLC (CONNECTICUT LTD LIAB CO)  
900 ETHAN ALLEN HIGHWAY  
RIDGEFIELD, CT 06877

FOR: MEDICAL COMPUTER DATA AND IMAGE  
STORAGE SERVICES, IN CLASS 39 (U.S. CLS. 100  
AND 105).

FIRST USE 5-11-2005; IN COMMERCE 5-11-2005.

THE MARK CONSISTS OF STANDARD CHAR-  
ACTERS WITHOUT CLAIM TO ANY PARTICULAR  
FONT, STYLE, SIZE, OR COLOR.

NO CLAIM IS MADE TO THE EXCLUSIVE  
RIGHT TO USE "ARCHIVING", APART FROM  
THE MARK AS SHOWN.

SN 78-898,892, FILED 6-2-2006.

CYNTHIA SLOAN, EXAMINING ATTORNEY

**Int. Cls.: 35 and 42**

**Prior U.S. Cls.: 100, 101, and 102**

**United States Patent and Trademark Office**

**Reg. No. 3,469,646**

**Registered July 15, 2008**

**SERVICE MARK  
PRINCIPAL REGISTER**

**3 WIRE**

3WIRE GROUP INC. (DELAWARE CORPORATION)  
SUITE 300, 101 BROADWAY STREET WEST  
OSSEO, MN 55369

FOR: DISTRIBUTORSHIP SERVICES IN THE FIELD OF COMMERCIAL FOOD AND BEVERAGE SERVICE PARTS AND EQUIPMENT; BUSINESS TO BUSINESS AND ELECTRONIC COMMERCE SERVICES IN THE FIELD OF COMMERCIAL FOOD AND BEVERAGE SERVICE PARTS AND EQUIPMENT, NAMELY, INVENTORY MANAGEMENT AND WORKFORCE MANAGEMENT; FACILITATING BUSINESS TO BUSINESS TRANSACTIONS FOR OTHERS IN THE FIELD OF COMMERCIAL FOOD AND BEVERAGE SERVICE PARTS AND EQUIPMENT; PROVIDING ONLINE INVENTORY MANAGEMENT SERVICES IN THE FIELD OF COMMERCIAL FOOD AND BEVERAGE SERVICE PARTS AND EQUIPMENT, IN CLASS 35 (U.S. CLS. 100, 101 AND 102).

FIRST USE 9-0-2006; IN COMMERCE 9-0-2006.

FOR: APPLICATION SERVICE PROVIDER (ASP) FEATURING SOFTWARE FOR USE IN THE FIELDS OF COMMERCIAL FOOD AND BEVERAGE SERVICE, INVENTORY MANAGEMENT AND WORKFORCE MANAGEMENT, IN CLASS 42 (U.S. CLS. 100 AND 101).

FIRST USE 9-0-2006; IN COMMERCE 9-0-2006.

THE MARK CONSISTS OF STANDARD CHARACTERS WITHOUT CLAIM TO ANY PARTICULAR FONT, STYLE, SIZE, OR COLOR.

SN 78-899,398, FILED 6-2-2006.

PAUL E. FAHRENKOPF, EXAMINING ATTORNEY

Int. Cl.: 9

Prior U.S. Cls.: 21, 23, 26, 36, and 38

United States Patent and Trademark Office

Reg. No. 3,469,647

Registered July 15, 2008

TRADEMARK  
PRINCIPAL REGISTER



GET LOW RECORDS, INC. (PUERTO RICO CORPORATION)  
307 LAKEVIEW DRIVE  
APT. 103  
WESTON, FL 33326

FOR: SOUND RECORDINGS FEATURING MUSIC, PHONOGRAPH RECORDS, FEATURING HIP/HOP REGGAETON OR ANY OTHER TYPE OF MUSIC, PRE-RECORDED AUDIO TAPES FEATURING HIP/HOP REGGAEON OR ANY OTHER TYPE OF MUSIC, PRE-RECORDED ENHANCED CD'S FEATURING HIP/HOP REGGAEON MUSIC OR ANY OTHER TYPE OF MUSIC, COMPACT DISCS FEATURING HIP/HOP REGGAEON MUSIC OR ANY OTHER TYPE OF MUSIC, PRE-RECORDED VIDEOTAPES FEATURING HIP/HOP REGGAEON MUSIC OR ANY OTHER TYPE OF MUSIC, PRE-RECORDED VIDEOCASSETTES, PRE-RECORDED DIGITAL AUDIO TAPES, DVD'S, LASER DISCS FEATURING MUSIC, IN CLASS 9 (U.S. CLS. 21, 23, 26, 36 AND 38).

FIRST USE 3-1-2008; IN COMMERCE 3-1-2008.

NO CLAIM IS MADE TO THE EXCLUSIVE RIGHT TO USE "RECORDS", APART FROM THE MARK AS SHOWN.

THE COLOR(S) BLACK, WHITE AND GREY IS/ARE CLAIMED AS A FEATURE OF THE MARK.

THE MARK CONSISTS OF THE COLOR BLACK APPEARS SHADED IN THE SQUARE BACKGROUND AND IN THE WORD "LOW"; THE COLOR GREY APPEARS IN THE WORD "GET" AND "RECORDS" AND IN THE OUTLINE OF THE WORDING "LOW"; THE COLOR WHITE APPEARS IN THE OUTLINE OF THE WORD "GET".

SN 78-899,913, FILED 6-3-2006.

MICHAEL LEWIS, EXAMINING ATTORNEY

**Int. Cls.: 20 and 21**

**Prior U.S. Cls.: 2, 13, 22, 23, 25, 29, 30, 32, 33, 40, and 50**

**United States Patent and Trademark Office**

**Reg. No. 3,469,648**

**Registered July 15, 2008**

**TRADEMARK  
PRINCIPAL REGISTER**

**COMFORTOUCH**

NEW THERMO-SERV, LTD. (TEXAS LIMITED PARTNERSHIP)  
3901 PIPESTONE RD.  
DALLAS, TX 75212

FOR: PLASTIC STORAGE CONTAINERS FOR COMMERCIAL USE, FOR BEVERAGES AND FOOD, IN CLASS 20 (U.S. CLS. 2, 13, 22, 25, 32 AND 50).

FIRST USE 9-8-2006; IN COMMERCE 9-8-2006.

FOR: CONTAINERS FOR HOUSEHOLD OR KITCHEN USE, NAMELY, CONTAINERS FOR BEV-

ERAGES, FOOD, AND SERVING, IN CLASS 21 (U.S. CLS. 2, 13, 23, 29, 30, 33, 40 AND 50).

FIRST USE 9-8-2006; IN COMMERCE 9-8-2006.

THE MARK CONSISTS OF STANDARD CHARACTERS WITHOUT CLAIM TO ANY PARTICULAR FONT, STYLE, SIZE, OR COLOR.

SN 78-900,369, FILED 6-5-2006.

MICHAEL SOUDERS, EXAMINING ATTORNEY

**Int. Cl.: 11**

**Prior U.S. Cls.: 13, 21, 23, 31, and 34**

**United States Patent and Trademark Office**

**Reg. No. 3,469,649**

**Registered July 15, 2008**

**TRADEMARK  
PRINCIPAL REGISTER**

**JETSTREAM**

HUNTER FAN COMPANY (DELAWARE COR-  
PORATION)  
2500 FRISCO AVENUE  
MEMPHIS, TN 38114

THE MARK CONSISTS OF STANDARD CHAR-  
ACTERS WITHOUT CLAIM TO ANY PARTICULAR  
FONT, STYLE, SIZE, OR COLOR.

FOR: ELECTRIC CIRCULATING FANS AND  
DIRECTIONAL LIGHT FIXTURES FOR DOMESTIC  
USE, IN CLASS 11 (U.S. CLS. 13, 21, 23, 31 AND 34).

SN 78-901,490, FILED 6-6-2006.

FIRST USE 1-25-2007; IN COMMERCE 1-25-2007.

SARA THOMAS, EXAMINING ATTORNEY

**Int. Cl.: 9**

**Prior U.S. Cls.: 21, 23, 26, 36, and 38**

**Reg. No. 3,469,650**

**United States Patent and Trademark Office**

**Registered July 15, 2008**

---

**TRADEMARK  
PRINCIPAL REGISTER**

**ORION**

WEATHER DETECTION SYSTEMS, INC. (OHIO  
CORPORATION)  
5458 EVERGREEN HEIGHTS DRIVE  
EVERGREEN, CO 80439

THE MARK CONSISTS OF STANDARD CHAR-  
ACTERS WITHOUT CLAIM TO ANY PARTICULAR  
FONT, STYLE, SIZE, OR COLOR.

FOR: RADAR, IN CLASS 9 (U.S. CLS. 21, 23, 26, 36  
AND 38).

SN 78-902,056, FILED 6-6-2006.

FIRST USE 4-15-2008; IN COMMERCE 4-15-2008.

MICHAEL WEBSTER, EXAMINING ATTORNEY

**Int. Cl.: 28**

**Prior U.S. Cls.: 22, 23, 38, and 50**

**United States Patent and Trademark Office**

**Reg. No. 3,469,651**

**Registered July 15, 2008**

**TRADEMARK  
PRINCIPAL REGISTER**

**AQUA RECREATION**

PLAYPOWER, INC. (DELAWARE CORPORATION)  
SUITE 300  
13620 E. REESE BLVD.  
HUNTERSVILLE, NC 28078

FOR: WATER PARK EQUIPMENT, NAMELY, SLIDES, WATERSLIDES, POOL SLIDES AND SOFT SCULPTED FOAM FLOATS IN THE NATURE OF CLIMBING UNITS AND PADS FOR RECREATIONAL USE, IN CLASS 28 (U.S. CLS. 22, 23, 38 AND 50).

FIRST USE 6-0-2006; IN COMMERCE 6-0-2006.

THE MARK CONSISTS OF STANDARD CHARACTERS WITHOUT CLAIM TO ANY PARTICULAR FONT, STYLE, SIZE, OR COLOR.

NO CLAIM IS MADE TO THE EXCLUSIVE RIGHT TO USE "AQUA", APART FROM THE MARK AS SHOWN.

SN 78-902,596, FILED 6-7-2006.

ALYSSA PALADINO, EXAMINING ATTORNEY

**Int. Cl.: 9**

**Prior U.S. Cls.: 21, 23, 26, 36, and 38**

**Reg. No. 3,469,652**

**United States Patent and Trademark Office**

**Registered July 15, 2008**

---

**TRADEMARK  
PRINCIPAL REGISTER**

**PAX-6**

PERKINELMER, INC. (MASSACHUSETTS CORPORATION)  
45 WILLIAM STREET  
WELLESLEY, MA 02481

FOR: LABORATORY EQUIPMENT, NAMELY, PULSED XENON LAMPS FOR USE IN THE FIELDS OF MEDICAL DIAGNOSTICS, ANALYTICAL INSTRUMENTS AND LIFE SCIENCES, IN CLASS 9 (U.S. CLS. 21, 23, 26, 36 AND 38).

FIRST USE 5-10-2006; IN COMMERCE 5-10-2006.

THE MARK CONSISTS OF STANDARD CHARACTERS WITHOUT CLAIM TO ANY PARTICULAR FONT, STYLE, SIZE, OR COLOR.

SN 78-902,923, FILED 6-7-2006.

AMY ALFIERI, EXAMINING ATTORNEY



Int. Cl.: 41

Prior U.S. Cls.: 100, 101, and 107

United States Patent and Trademark Office

Reg. No. 3,469,653

Registered July 15, 2008

SERVICE MARK  
PRINCIPAL REGISTER

BT GRAY

TOBASCO CAT MEDIA! (NEVADA CORPORATION)  
5348 VEGAS DRIVE, #762  
LAS VEGAS, NV 89108

FOR: ENTERTAINMENT, NAMELY, PRODUCTION OF FOOD, COOKING, WINE, AND TRAVEL TELEVISION SHOWS; ENTERTAINMENT SERVICES, NAMELY, PERSONAL APPEARANCES BY A WRITER OF FOOD AND TRAVEL BOOKS; ENTERTAINMENT SERVICES, NAMELY, PROVIDING A TELEVISION PROGRAM IN THE FIELD OF FOOD, COOKING, WINE, TRAVEL VIA A GLOBAL COMPUTER NETWORK; ENTERTAINMENT SERVICES, NAMELY, PROVIDING ON-LINE REVIEWS OF FOOD, COOKING, WINE, TRAVEL; ENTERTAINMENT SERVICES, NAMELY, WINE TASTINGS; ENTERTAINMENT, NAMELY, A CONTINUING

FOOD, COOKING, WINE, TRAVEL SHOW BROADCAST OVER TELEVISION, SATELLITE, AUDIO, AND VIDEO MEDIA; ONLINE JOURNALS, NAMELY, BLOGS FEATURING FOOD, WINE, TRAVEL, COOKING; PUBLICATION OF BOOKS, REVIEWS, IN CLASS 41 (U.S. CLS. 100, 101 AND 107).

FIRST USE 5-30-2006; IN COMMERCE 7-1-2006.

THE MARK CONSISTS OF STANDARD CHARACTERS WITHOUT CLAIM TO ANY PARTICULAR FONT, STYLE, SIZE, OR COLOR.

SN 78-905,328, FILED 6-9-2006.

TINA L. SNAPP, EXAMINING ATTORNEY

**Int. Cl.: 11**

**Prior U.S. Cls.: 13, 21, 23, 31, and 34**

**Reg. No. 3,469,654**

**United States Patent and Trademark Office**

**Registered July 15, 2008**

**TRADEMARK  
PRINCIPAL REGISTER**

# Superfrost

LIEBHERR-INTERNATIONAL AG (SWITZER-  
LAND CORPORATION)  
45, RUE DE L'INDUSTRIE  
BULLE/FR., SWITZERLAND CH-1630

THE MARK CONSISTS OF STANDARD CHAR-  
ACTERS WITHOUT CLAIM TO ANY PARTICULAR  
FONT, STYLE, SIZE, OR COLOR.

FOR: COOLING AND FREEZING APPARATUS,  
NAMELY, REFRIGERATORS, FREEZERS, DEEP  
FREEZERS, AND REFRIGERATED WINE CABI-  
NETS, IN CLASS 11 (U.S. CLS. 13, 21, 23, 31 AND 34).

SN 78-906,150, FILED 6-12-2006.

FIRST USE 0-0-1988; IN COMMERCE 2-0-2004.

NAAKWAMA ANKRAH, EXAMINING ATTORNEY

**Int. Cl.: 44**

**Prior U.S. Cls.: 100 and 101**

**United States Patent and Trademark Office**

**Reg. No. 3,469,655**

**Registered July 15, 2008**

**SERVICE MARK  
PRINCIPAL REGISTER**



**Encore Research Group, LLC.**  
**ENcouraging COmmunity Research and Education**

JAXRESEARCH SYSTEMS, LLC (FLORIDA LIMITED LIABILITY CORPORATION)  
4085 UNIVERSITY BOULEVARD SOUTH  
JACKSONVILLE, FL 32216

FOR: PROVIDING A WEBSITE FEATURING NEWS AND RATINGS ON MEDICAL BREAKTHROUGHS AND OTHER MEDICAL INFORMATION, DESIGNED TO HELP CLINICAL RESEARCH SITES IN THEIR DAY-TO-DAY ACTIVITIES, IN CLASS 44 (U.S. CLS. 100 AND 101).

FIRST USE 4-0-2006; IN COMMERCE 4-0-2006.

NO CLAIM IS MADE TO THE EXCLUSIVE RIGHT TO USE "RESEARCH GROUP, LLC." AND "COMMUNITY RESEARCH AND EDUCATION", APART FROM THE MARK AS SHOWN.

SN 78-906,541, FILED 6-13-2006.

ALEX KEAM, EXAMINING ATTORNEY

**Int. Cl.: 25**

**Prior U.S. Cls.: 22 and 39**

**United States Patent and Trademark Office**

**Reg. No. 3,469,656**

**Registered July 15, 2008**

**TRADEMARK  
PRINCIPAL REGISTER**

**ALPACA GOLD**

CALIFORNIA DREAMS HOLDING COMPANY,  
LLC (CALIFORNIA LTD LIAB CO)  
13234 VALLE VERDE TERRACE  
POWAY, CA 920641619

FOR: COATS; DRESSES; GLOVES; HATS; HEAD-  
GEAR, NAMELY, HAT, CAPS; JACKETS; PANTS;  
SCARVES; SHIRTS; SHORTS; SKIRTS; SKIRTS AND  
DRESSES; SWEATERS; UNDERGARMENTS , IN  
CLASS 25 (U.S. CLS. 22 AND 39).

FIRST USE 5-31-2006; IN COMMERCE 11-6-2007.

THE MARK CONSISTS OF STANDARD CHAR-  
ACTERS WITHOUT CLAIM TO ANY PARTICULAR  
FONT, STYLE, SIZE, OR COLOR.

NO CLAIM IS MADE TO THE EXCLUSIVE  
RIGHT TO USE "ALPACA", APART FROM THE  
MARK AS SHOWN.

SN 78-906,883, FILED 6-13-2006.

PAUL MORENO, EXAMINING ATTORNEY

**Int. Cl.: 12**

**Prior U.S. Cls.: 19, 21, 23, 31, 35, and 44**

**Reg. No. 3,469,657**

**United States Patent and Trademark Office**

**Registered July 15, 2008**

---

**TRADEMARK  
PRINCIPAL REGISTER**

**NORTHCOAST**

NORTHCOAST TIRE AND RUBBER COMPANY,  
LLC (OHIO LTD LIAB CO)  
2304 STOCKBRIDGE ROAD  
AKRON, OH 44313

THE MARK CONSISTS OF STANDARD CHAR-  
ACTERS WITHOUT CLAIM TO ANY PARTICULAR  
FONT, STYLE, SIZE, OR COLOR.

FOR: TIRES, IN CLASS 12 (U.S. CLS. 19, 21, 23, 31,  
35 AND 44).

SN 78-906,932, FILED 6-13-2006.

FIRST USE 8-1-2006; IN COMMERCE 8-1-2006.

JOSETTE BEVERLY, EXAMINING ATTORNEY

Int. Cl.: 31

Prior U.S. Cls.: 1 and 46

United States Patent and Trademark Office

Reg. No. 3,469,658

Registered July 15, 2008

TRADEMARK  
PRINCIPAL REGISTER

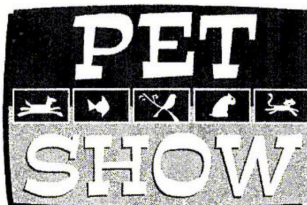

PET SHOW COMÉRCIO DE PRODUTOS VETER-  
INARIOS LTDA (BRAZIL CORPORATION)  
425 FUNDOS - MANGUINHOS  
RIO DE JANEIRO, BRAZIL

FOR: PET FOOD; ANIMAL FOODSTUFFS; HY-  
GIENIC AROMATIC SAND FOR PETS; CONSUM-  
ABLE PET CHEWS; COOKIES FOR DOGS; BIRD  
FOOD, NAMELY, BIRD SEED; NUTRITIONAL AD-  
DITIVES FOR ANIMALS FOODSTUFFS, NOT FOR  
MEDICAL PURPOSES, NAMELY, PROTEIN FOR  
ANIMAL CONSUMPTION; LIVE ORNAMENTAL  
FISH; AND LIVE ANIMALS, IN CLASS 31 (U.S.  
CLS. 1 AND 46).

FIRST USE 2-12-1996; IN COMMERCE 3-3-2008.

NO CLAIM IS MADE TO THE EXCLUSIVE  
RIGHT TO USE "PET", APART FROM THE MARK  
AS SHOWN.

THE MARK CONSISTS OF STYLIZED WORDS  
"PET SHOW" INSIDE OF A BOX, TOGETHER WITH  
SMALL PICTURES OF ANIMALS, INCLUDING A  
DOG, A CAT, A FISH, A BIRD AND A RABBIT.

SN 78-907,116, FILED 6-13-2006.

CHRISTINA SOBRAL, EXAMINING ATTORNEY

**Int. Cl.: 6**

**Prior U.S. Cls.: 2, 12, 13, 14, 23, 25, and 50**

**Reg. No. 3,469,659**

**United States Patent and Trademark Office**

**Registered July 15, 2008**

**TRADEMARK  
PRINCIPAL REGISTER**

# LockSmart

STANDARD MOTOR PRODUCTS, INC. (NEW YORK CORPORATION)  
37-18 NORTHERN BLVD.  
LONG ISLAND CITY, NY 11101

FOR: MOTOR VEHICLE LOCKS, NAMELY, MOTOR VEHICLE DOOR LOCKS, MOTOR VEHICLE TRUNK LOCKS, MOTOR VEHICLE IGNITION LOCKS, TRUCK BED COVER "T" HANDLE LOCKS, AND MOTOR VEHICLE GLOVE COMPARTMENT LOCKS, IN CLASS 6 (U.S. CLS. 2, 12, 13, 14, 23, 25 AND 50).

FIRST USE 9-30-2006; IN COMMERCE 9-30-2006.

THE MARK CONSISTS OF STANDARD CHARACTERS WITHOUT CLAIM TO ANY PARTICULAR FONT, STYLE, SIZE, OR COLOR.

SN 78-908,417, FILED 6-14-2006.

EDWARD NELSON, EXAMINING ATTORNEY

**Int. Cl.: 9**

**Prior U.S. Cls.: 21, 23, 26, 36, and 38**

**Reg. No. 3,469,660**

**United States Patent and Trademark Office**

**Registered July 15, 2008**

**TRADEMARK  
PRINCIPAL REGISTER**



SOFT TECH AMERICA INC (TEXAS CORPORATION)  
1040 BAYVIEW DRIVE  
SUITE 330  
FORT LAUDERDALE, FL 33304

FIRST USE 2-1-2007; IN COMMERCE 2-1-2007.

NO CLAIM IS MADE TO THE EXCLUSIVE RIGHT TO USE "SHOWER", APART FROM THE MARK AS SHOWN.

FOR: COMPUTER SOFTWARE FOR SHOWER MANUFACTURERS, FOR USE IN MEASURING AND DESIGNING SHOWER ENCLOSURES, IN CLASS 9 (U.S. CLS. 21, 23, 26, 36 AND 38).

SN 78-909,582, FILED 6-15-2006.

HENRY S. ZAK, EXAMINING ATTORNEY



**Int. Cl.: 41**

**Prior U.S. Cls.: 100, 101, and 107**

**United States Patent and Trademark Office**

**Reg. No. 3,469,661**

**Registered July 15, 2008**

**SERVICE MARK  
PRINCIPAL REGISTER**

**MIKE KNOX**

WORLD WRESTLING ENTERTAINMENT, INC.  
(DELAWARE CORPORATION)  
1241 EAST MAIN STREET  
STAMFORD, CT 06902

FOR: ENTERTAINMENT SERVICES, NAMELY, WRESTLING EXHIBITIONS AND PERFORMANCES BY A PROFESSIONAL WRESTLER AND ENTERTAINER; PROVIDING WRESTLING NEWS AND INFORMATION VIA A GLOBAL COMPUTER NETWORK, IN CLASS 41 (U.S. CLS. 100, 101 AND 107).

FIRST USE 6-19-2006; IN COMMERCE 6-19-2006.

THE MARK CONSISTS OF STANDARD CHARACTERS WITHOUT CLAIM TO ANY PARTICULAR FONT, STYLE, SIZE, OR COLOR.

THE NAME(S), PORTRAIT(S), AND/OR SIGNATURE(S) SHOWN IN THE MARK DOES NOT IDENTIFY A PARTICULAR LIVING INDIVIDUAL.

SN 78-911,489, FILED 6-19-2006.

MICHELLE DUBOIS, EXAMINING ATTORNEY

**Int. Cl.: 29**

**Prior U.S. Cl.: 46**

**United States Patent and Trademark Office**

**Reg. No. 3,469,662**

**Registered July 15, 2008**

**TRADEMARK  
PRINCIPAL REGISTER**

**ELEVATE ME**

PROSNACK NATURAL FOODS INC. (CANADA  
CORPORATION)  
UNIT 117  
998 HARBOURSIDE DRIVE  
NORTH VANCOUVER, BRITISH COLUMBIA, CA-  
NADA V7P 3T2

FOR: NUTRITIONAL HEALTH FOODS, NAME-  
LY, ENERGY BARS IN THE NATURE OF PROTEIN  
BASED NUTRIENT-DENSE SNACK BARS, IN  
CLASS 29 (U.S. CL. 46).

FIRST USE 4-26-2008; IN COMMERCE 4-26-2008.

THE MARK CONSISTS OF STANDARD CHAR-  
ACTERS WITHOUT CLAIM TO ANY PARTICULAR  
FONT, STYLE, SIZE, OR COLOR.

SN 78-911,508, FILED 6-19-2006.

HEATHER THOMPSON, EXAMINING ATTORNEY

**Int. Cl.: 9**

**Prior U.S. Cls.: 21, 23, 26, 36, and 38**

**United States Patent and Trademark Office**

**Reg. No. 3,469,663**

**Registered July 15, 2008**

**TRADEMARK  
PRINCIPAL REGISTER**

**ZYQUE**

KAIDALE INCORPORATED (NEW JERSEY CORPORATION)  
4 FLOYD DRIVE  
MOUNT ARLINGTON, NJ 07856

FIRST USE 4-28-2006; IN COMMERCE 7-7-2007.

FOR: COMPUTER SOFTWARE FOR PROVIDING IMPORT/EXPORT DELIVERY MANAGEMENT INFORMATION AND DOCUMENTS TO MULTIPLE PARTIES INVOLVED IN THE IMPORT/EXPORT PROCESS VIA AN ON-SCREEN DISPLAY, ELECTRONIC DATA EXCHANGE, AND PRINTED DOCUMENTS, IN CLASS 9 (U.S. CLS. 21, 23, 26, 36 AND 38).

THE MARK CONSISTS OF STANDARD CHARACTERS WITHOUT CLAIM TO ANY PARTICULAR FONT, STYLE, SIZE, OR COLOR.

SN 78-912,019, FILED 6-20-2006.

SANJEEV VOHRA, EXAMINING ATTORNEY

**Int. Cl.: 9**

**Prior U.S. Cls.: 21, 23, 26, 36, and 38**

**United States Patent and Trademark Office**

**Reg. No. 3,469,664**

**Registered July 15, 2008**

**TRADEMARK  
PRINCIPAL REGISTER**

# CMPMedica

CMPMEDICA GROUP LLC (DELAWARE LTD  
LIAB CO)  
600 HARRISON STREET  
SAN FRANCISCO, CA 94107

FOR: ELECTRONIC AND ON-LINE PUBLICATIONS, NAMELY, MEDICAL MAGAZINES RECORDED ON CD-ROMS AND DOWNLOADABLE MAGAZINES; PRERECORDED AUDIO RECORDINGS, VIDEO RECORDINGS AND CD-ROMS, ALL IN THE FIELDS OF MEDICINE AND HEALTHCARE, IN CLASS 9 (U.S. CLS. 21, 23, 26, 36 AND 38).

FIRST USE 12-1-2007; IN COMMERCE 12-1-2007.

THE MARK CONSISTS OF STANDARD CHARACTERS WITHOUT CLAIM TO ANY PARTICULAR FONT, STYLE, SIZE, OR COLOR.

SN 78-913,883, FILED 6-21-2006.

NATALIE POLZER, EXAMINING ATTORNEY

**Int. Cl.: 33**

**Prior U.S. Cls.: 47 and 49**

**United States Patent and Trademark Office**

**Reg. No. 3,469,665**

**Registered July 15, 2008**

**TRADEMARK  
PRINCIPAL REGISTER**

**CHATEAU GUERRY**

BERNARD MAGREZ - CHATEAU GUERRY  
(FRANCE COMPANY)  
CHATEAU GUERRY  
33710 TAURIAC, FRANCE

THE MARK CONSISTS OF STANDARD CHAR-  
ACTERS WITHOUT CLAIM TO ANY PARTICULAR  
FONT, STYLE, SIZE, OR COLOR.

FOR: WINE, IN CLASS 33 (U.S. CLS. 47 AND 49).

SN 78-914,657, FILED 6-22-2006.

FIRST USE 3-1-2004; IN COMMERCE 3-1-2004.

CHERYL CLAYTON, EXAMINING ATTORNEY

**Int. Cl.: 5**

**Prior U.S. Cls.: 6, 18, 44, 46, 51, and 52**

**United States Patent and Trademark Office**

**Reg. No. 3,469,666**

**Registered July 15, 2008**

**TRADEMARK  
PRINCIPAL REGISTER**

**FRENCH PARAD'OX**

LABORATOIRES ARKOPHARMA (FRANCE  
CORPORATION)  
1ERE AVE. 2709 M L I D DE CARROS LE BROC  
CARROS, FRANCE 06510

FOR: DIETARY SUPPLEMENTS ADAPTED FOR  
MEDICAL USE IN PARTICULAR FOR PREVENT-  
ING CARDIOVASCULAR DISEASES; DIETARY  
SUPPLEMENTS FOR MEDICAL USE IN PARTICU-  
LAR FOR PREVENTING CARDIOVASCULAR DIS-  
EASES, IN CLASS 5 (U.S. CLS. 6, 18, 44, 46, 51 AND 52).

FIRST USE 1-0-2006; IN COMMERCE 1-0-2006.

THE MARK CONSISTS OF STANDARD CHAR-  
ACTERS WITHOUT CLAIM TO ANY PARTICULAR  
FONT, STYLE, SIZE, OR COLOR.

OWNER OF FRANCE REG. NO. 93/471304, DA-  
TED 6-2-1993, RENEWED AS REG. NO. 93471304,  
DATED 6-2-2003, EXPIRES 6-2-2013.

SN 78-915,342, FILED 6-23-2006.

AISHA CLARKE, EXAMINING ATTORNEY

**Int. Cl.: 3**

**Prior U.S. Cls.: 1, 4, 6, 50, 51, and 52**

**United States Patent and Trademark Office**

**Reg. No. 3,469,667**

**Registered July 15, 2008**

**TRADEMARK  
PRINCIPAL REGISTER**

**(REPAIR)OLOGIE**

THE PROCTER & GAMBLE COMPANY (OHIO  
CORPORATION)  
ONE PROCTER & GAMBLE PLAZA  
CINCINNATI, OH 45202

THE MARK CONSISTS OF STANDARD CHAR-  
ACTERS WITHOUT CLAIM TO ANY PARTICULAR  
FONT, STYLE, SIZE, OR COLOR.

FOR: HAIR CARE PREPARATIONS, IN CLASS 3  
(U.S. CLS. 1, 4, 6, 50, 51 AND 52).

SN 78-915,722, FILED 6-23-2006.

FIRST USE 11-30-2006; IN COMMERCE 11-30-2006.

FRANK LATTUCA, EXAMINING ATTORNEY

**Int. Cl.: 36**

**Prior U.S. Cls.: 100, 101, and 102**

**United States Patent and Trademark Office**

**Reg. No. 3,469,668**

**Registered July 15, 2008**

**SERVICE MARK  
PRINCIPAL REGISTER**

**SOLEX**

DOCUTECH CORPORATION (IDAHO CORPORATION)  
ATTN: TY JENKINS  
3911 N 5TH EAST  
IDAHO FALLS, ID 83401

FOR: FINANCIAL AND LENDING SERVICES, NAMELY, CONSUMER LENDING SERVICES VIA INDIRECT LENDING PORTALS UTILIZING WEB-BASED SOFTWARE APPLICATIONS PROVIDING FINANCIAL INFORMATION TO CONSUMERS, LENDERS, AND DEALERS, AND UTILIZING COMPUTER NETWORKS FOR THE FINANCING OF

RECREATIONAL VEHICLES, IN CLASS 36 (U.S. CLS. 100, 101 AND 102).

FIRST USE 3-4-2008; IN COMMERCE 3-4-2008.

THE MARK CONSISTS OF STANDARD CHARACTERS WITHOUT CLAIM TO ANY PARTICULAR FONT, STYLE, SIZE, OR COLOR.

SN 78-915,930, FILED 6-23-2006.

RICHARD A. STRASER, EXAMINING ATTORNEY



**Int. Cl.: 28**

**Prior U.S. Cls.: 22, 23, 38, and 50**

**United States Patent and Trademark Office**

**Reg. No. 3,469,669**

**Registered July 15, 2008**

**TRADEMARK  
PRINCIPAL REGISTER**

**PHOTON BLADE BONDING**

NEW ARCHERY PRODUCTS CORP. (ILLINOIS  
CORPORATION)  
7500 INDUSTRIAL DRIVE  
FOREST PARK, IL 60130

FOR: ARCHERY PRODUCTS, NAMELY, ARROW  
HEADS AND ARROW BROADHEADS, IN CLASS 28  
(U.S. CLS. 22, 23, 38 AND 50).

FIRST USE 5-19-2008; IN COMMERCE 5-19-2008.

THE MARK CONSISTS OF STANDARD CHAR-  
ACTERS WITHOUT CLAIM TO ANY PARTICULAR  
FONT, STYLE, SIZE, OR COLOR.

NO CLAIM IS MADE TO THE EXCLUSIVE  
RIGHT TO USE "BLADE BONDING", APART FROM  
THE MARK AS SHOWN.

SN 78-917,103, FILED 6-26-2006.

KIMBERLY FRYE, EXAMINING ATTORNEY

Int. Cl.: 18

Prior U.S. Cls.: 1, 2, 3, 22, and 41

United States Patent and Trademark Office

Reg. No. 3,469,670

Registered July 15, 2008

TRADEMARK  
PRINCIPAL REGISTER

tooth & nail

ALLEGRO MFG. INC. (CALIFORNIA CORPORATION)  
7250 E. OXFORD WAY  
COMMERCE, CA 90040

FOR: COSMETIC BAGS, SOLD EMPTY; TOILET-  
RY BAGS, SOLD EMPTY; TRAVEL BAGS, SOLD  
EMPTY; SPORTS BAGS, SOLD EMPTY; AND TOTE  
BAGS, SOLD EMPTY, IN CLASS 18 (U.S. CLS. 1, 2, 3,  
22 AND 41).

FIRST USE 9-5-2007; IN COMMERCE 9-5-2007.

THE MARK CONSISTS OF A STYLIZED "T" IN  
THE SHAPE OF A NAIL AND A STYLIZED "A" IN  
THE SHAPE OF A TOOTH.

SN 78-917,224, FILED 6-26-2006.

ALEX KEAM, EXAMINING ATTORNEY

**Int. Cl.: 21**

**Prior U.S. Cls.: 2, 13, 23, 29, 30, 33, 40, and 50**

**United States Patent and Trademark Office**

**Reg. No. 3,469,671**

**Registered July 15, 2008**

**TRADEMARK  
PRINCIPAL REGISTER**

**SPIILHYDER**

NATIONAL PACKAGING SERVICES CORPORATION  
(WISCONSIN CORPORATION)  
3303 SPIRIT WAY  
GREEN BAY, WI 54304

FOR: POLYMER-BASED CLOTHS FOR CLEANING SPILLS, IN CLASS 21 (U.S. CLS. 2, 13, 23, 29, 30, 33, 40 AND 50).

FIRST USE 4-0-2006; IN COMMERCE 4-0-2006.

THE MARK CONSISTS OF STANDARD CHARACTERS WITHOUT CLAIM TO ANY PARTICULAR FONT, STYLE, SIZE, OR COLOR.

OWNER OF U.S. REG. NOS. 1,464,112 AND 2,821,531.

SN 78-917,230, FILED 6-26-2006.

TINA KUAN, EXAMINING ATTORNEY

**Int. Cl.: 33**

**Prior U.S. Cls.: 47 and 49**

**United States Patent and Trademark Office**

**Reg. No. 3,469,672**

**Registered July 15, 2008**

**TRADEMARK  
PRINCIPAL REGISTER**

**White Lightning**

SANDERS, JOSEPH M. (UNITED STATES INDIVIDUAL)  
429 WEST MUHAMMAD ALI BOULEVARD  
SUITE 904  
LOUISVILLE, KY 40202

THE MARK CONSISTS OF STANDARD CHARACTERS WITHOUT CLAIM TO ANY PARTICULAR FONT, STYLE, SIZE, OR COLOR.

FOR: DISTILLED SPIRITS, IN CLASS 33 (U.S. CLS. 47 AND 49).

SN 78-917,362, FILED 6-26-2006.

FIRST USE 5-26-2008; IN COMMERCE 5-26-2008.

MIDGE BUTLER, EXAMINING ATTORNEY

**Int. Cl.: 42**

**Prior U.S. Cls.: 100 and 101**

**United States Patent and Trademark Office**

**Reg. No. 3,469,673**

**Registered July 15, 2008**

**SERVICE MARK  
PRINCIPAL REGISTER**

FARTHER. FASTER. TOGETHER.

CAMARGO PHARMACEUTICAL SERVICES, LLC  
(OHIO LTD LIAB CO)  
SUITE 102  
9825 KENWOOD ROAD  
CINCINNATI, OH 45242

THE MARK CONSISTS OF STANDARD CHARACTERS WITHOUT CLAIM TO ANY PARTICULAR FONT, STYLE, SIZE, OR COLOR.

FOR: PHARMACEUTICAL DRUG DEVELOPMENT SERVICES, IN CLASS 42 (U.S. CLS. 100 AND 101).

SN 78-917,801, FILED 6-27-2006.

FIRST USE 6-30-2007; IN COMMERCE 6-30-2007.

NAAKWAMA ANKRAH, EXAMINING ATTORNEY

**Int. Cl.: 9**

**Prior U.S. Cls.: 21, 23, 26, 36, and 38**

**United States Patent and Trademark Office**

**Reg. No. 3,469,674**

**Registered July 15, 2008**

**TRADEMARK  
PRINCIPAL REGISTER**

# WELCOME

EPIC SYSTEMS CORPORATION (WISCONSIN CORPORATION)  
1979 MILKY WAY  
VERONA, WI 53593

FOR: COMPUTER PROGRAMS FOR USE IN MEDICAL AND HEALTHCARE FIELDS, NAMELY, COMPUTER PROGRAMS FOR MANAGING, STORING, ANALYZING, MAINTAINING, PROCESSING, STRUCTURING, REVIEWING, BUILDING, EDITING, DISTRIBUTING, COMMUNICATING, ORGANIZING, SHARING, REFERENCING, MONITORING AND INTEGRATING INFORMATION, AND ACCOMPANYING MANUALS SOLD AS A UNIT; COMPUTER SOFTWARE FOR AUTO-

MATING CLINICAL AND ADMINISTRATIVE HEALTHCARE PROCESSES, IN CLASS 9 (U.S. CLS. 21, 23, 26, 36 AND 38).

FIRST USE 12-10-2006; IN COMMERCE 1-26-2007.

THE MARK CONSISTS OF STANDARD CHARACTERS WITHOUT CLAIM TO ANY PARTICULAR FONT, STYLE, SIZE, OR COLOR.

SN 78-917,980, FILED 6-27-2006.

BRIAN NEVILLE, EXAMINING ATTORNEY

**Int. Cl.: 25**

**Prior U.S. Cls.: 22 and 39**

**United States Patent and Trademark Office**

**Reg. No. 3,469,675**

**Registered July 15, 2008**

**TRADEMARK  
PRINCIPAL REGISTER**

**A.C. VALOR**

A.C. VALOR REYES, LLC (PENNSYLVANIA LTD  
LIAB CO)  
1740 BUSINESS ROUTE 66  
GREENSBURG, PA 15601

FOR: ONE PIECE GARMENT FOR INFANTS  
AND TODDLERS; T-SHIRTS; SHORT SETS; SWEAT  
SUITS; APRONS; PANTS; SHORTS; SHIRTS; PULL-  
OVERS; JACKETS, IN CLASS 25 (U.S. CLS. 22 AND  
39).

FIRST USE 7-24-2005; IN COMMERCE 7-24-2005.

THE MARK CONSISTS OF STANDARD CHAR-  
ACTERS WITHOUT CLAIM TO ANY PARTICULAR  
FONT, STYLE, SIZE, OR COLOR.

THE NAME(S), PORTRAIT(S), AND/OR SIGNA-  
TURE(S) SHOWN IN THE MARK DOES NOT IDEN-  
TIFY A PARTICULAR LIVING INDIVIDUAL.

SN 78-918,647, FILED 6-28-2006.

RONALD AIKENS, EXAMINING ATTORNEY

**Int. Cl.: 42**

**Prior U.S. Cls.: 100 and 101**

**United States Patent and Trademark Office**

**Reg. No. 3,469,676**

**Registered July 15, 2008**

**SERVICE MARK  
PRINCIPAL REGISTER**

**KOROS**

KOROS NETWORKS LLC (MASSACHUSETTS  
LTD LIAB CO)  
777 HORSENECK ROAD  
SOUTH DARTMOUTH, MA 02748

FOR: APPLICATION SERVICE PROVIDER (ASP)  
FEATURING SOFTWARE FOR USE IN STORING,  
UPDATING, TRACKING AND SHARING MEDI-  
CAL INFORMATION AND PATIENT RECORDS, IN  
CLASS 42 (U.S. CLS. 100 AND 101).

FIRST USE 1-26-2008; IN COMMERCE 1-26-2008.

THE MARK CONSISTS OF STANDARD CHAR-  
ACTERS WITHOUT CLAIM TO ANY PARTICULAR  
FONT, STYLE, SIZE, OR COLOR.

SN 78-918,781, FILED 6-28-2006.

MICHAEL LITZAU, EXAMINING ATTORNEY



**Int. Cl.: 3**

**Prior U.S. Cls.: 1, 4, 6, 50, 51, and 52**

**United States Patent and Trademark Office**

**Reg. No. 3,469,677**

**Registered July 15, 2008**

**TRADEMARK  
PRINCIPAL REGISTER**

**BEDTIME WASHCLOTHS**

JOHNSON & JOHNSON (NEW JERSEY CORPORATION)  
ONE JOHNSON & JOHNSON PLAZA  
NEW BRUNSWICK, NJ 089337001

OWNER OF U.S. REG. NOS. 2,694,549, 2,998,010,  
AND OTHERS.

FOR: DISPOSABLE WASHCLOTHS IMPREGNATED WITH COMPOUNDS FOR PERSONAL HYGIENE, IN CLASS 3 (U.S. CLS. 1, 4, 6, 50, 51 AND 52).

NO CLAIM IS MADE TO THE EXCLUSIVE RIGHT TO USE "WASHCLOTHS", APART FROM THE MARK AS SHOWN.

FIRST USE 12-20-2006; IN COMMERCE 12-20-2006.

SN 78-919,879, FILED 6-29-2006.

THE MARK CONSISTS OF STANDARD CHARACTERS WITHOUT CLAIM TO ANY PARTICULAR FONT, STYLE, SIZE, OR COLOR.

MARLENE BELL, EXAMINING ATTORNEY

**Int. Cl.: 6**

**Prior U.S. Cls.: 2, 12, 13, 14, 23, 25, and 50**

**Reg. No. 3,469,678**

**United States Patent and Trademark Office**

**Registered July 15, 2008**

---

**TRADEMARK  
PRINCIPAL REGISTER**

**CLEAR VIEW**

S.T.C.-SYSTEMS TRADING, CORP. (DELAWARE  
CORPORATION)  
450 SEVENTH AVENUE, SUITE 2803  
NEW YORK, NY 10123

THE MARK CONSISTS OF STANDARD CHAR-  
ACTERS WITHOUT CLAIM TO ANY PARTICULAR  
FONT, STYLE, SIZE, OR COLOR.

FOR: METAL WALL BRACKETS AND MOUNTS  
FOR TV'S, VCRS AND DVDS SYSTEMS, IN CLASS 6  
(U.S. CLS. 2, 12, 13, 14, 23, 25 AND 50).

SN 78-920,094, FILED 6-29-2006.

FIRST USE 9-0-2007; IN COMMERCE 9-0-2007.

HEATHER THOMPSON, EXAMINING ATTORNEY

**Int. Cl.: 28**

**Prior U.S. Cls.: 22, 23, 38, and 50**

**United States Patent and Trademark Office**

**Reg. No. 3,469,679**

**Registered July 15, 2008**

**TRADEMARK  
PRINCIPAL REGISTER**

**CHIA PET CUDDLIES**

JOSEPH ENTERPRISES, INC. (CALIFORNIA  
CORPORATION)  
425 CALIFORNIA STREET, SUITE 300  
SAN FRANCISCO, CA 94104

FOR: PLUSH TOYS, IN CLASS 28 (U.S. CLS. 22, 23,  
38 AND 50).

FIRST USE 6-1-2007; IN COMMERCE 9-1-2007.

THE MARK CONSISTS OF STANDARD CHAR-  
ACTERS WITHOUT CLAIM TO ANY PARTICULAR  
FONT, STYLE, SIZE, OR COLOR.

OWNER OF U.S. REG. NOS. 2,090,156, 3,023,006,  
AND OTHERS.

SN 78-920,339, FILED 6-29-2006.

DAVID TOOLEY, EXAMINING ATTORNEY

**Int. Cls.: 9, 10, 37, and 41**

**Prior U.S. Cls.: 21, 23, 26, 36, 38, 39, 44, 100, 101, 103, 106, and 107**

**Reg. No. 3,469,680**

**United States Patent and Trademark Office**

**Registered July 15, 2008**

**TRADEMARK  
SERVICE MARK  
PRINCIPAL REGISTER**



HANSEN MEDICAL, INC. (DELAWARE CORPORATION)  
380 NORTH BERNARDO AVENUE  
MOUNTAIN VIEW, CA 94043

FOR: SOFTWARE AND COMPUTER-CONTROLLED HARDWARE FOR USE WITH ROBOTIC SURGICAL INSTRUMENTS IN THE HUMAN BODY, IN CLASS 9 (U.S. CLS. 21, 23, 26, 36 AND 38).

FIRST USE 6-25-2007; IN COMMERCE 6-25-2007.

FOR: ROBOTIC CATHETERS; SURGICAL ROBOTS FOR USE IN THE HUMAN BODY, IN CLASS 10 (U.S. CLS. 26, 39 AND 44).

FIRST USE 6-25-2007; IN COMMERCE 6-25-2007.

FOR: MAINTENANCE AND REPAIR OF MEDICAL MACHINES AND APPARATUS, IN CLASS 37 (U.S. CLS. 100, 103 AND 106).

FIRST USE 1-24-2008; IN COMMERCE 1-24-2008.

FOR: TRAINING IN THE USE OF MEDICAL MACHINES AND APPARATUS, IN CLASS 41 (U.S. CLS. 100, 101 AND 107).

FIRST USE 1-24-2008; IN COMMERCE 1-24-2008.

THE MARK CONSISTS OF A HEART.

SN 78-920,411, FILED 6-29-2006.

DAYNA BROWNE, EXAMINING ATTORNEY

**Int. Cl.: 41**

**Prior U.S. Cls.: 100, 101, and 107**

**United States Patent and Trademark Office**

**Reg. No. 3,469,681**

**Registered July 15, 2008**

**SERVICE MARK  
PRINCIPAL REGISTER**

**SEED TO TABLE**

PATINELLA, STEFANIA (UNITED STATES IN-  
DIVIDUAL)  
249 EAST 2ND STREET  
NEW YORK, NY 10009

FOR: EDUCATIONAL SERVICES, NAMELY,  
CONDUCTING CLASSES, SEMINARS, LECTURES,  
AFTER-SCHOOL PROGRAMS, WORKSHOPS AND  
TRAINING IN THE FIELDS OF GARDENING AND  
COOKING, IN CLASS 41 (U.S. CLS. 100, 101 AND 107).

FIRST USE 10-1-2006; IN COMMERCE 10-1-2006.

THE MARK CONSISTS OF STANDARD CHAR-  
ACTERS WITHOUT CLAIM TO ANY PARTICULAR  
FONT, STYLE, SIZE, OR COLOR.

SN 78-920,816, FILED 6-30-2006.

GEOFFREY FOSDICK, EXAMINING ATTORNEY

Int. Cl.: 32

Prior U.S. Cls.: 45, 46, and 48

United States Patent and Trademark Office

Reg. No. 3,469,682

Registered July 15, 2008

TRADEMARK  
PRINCIPAL REGISTER



TROPICAL WATERS KOSRAE, INC. (MICRONE-  
SIA CORPORATION)

P.O. BOX 68

KOSRAE, MICRONESIA 96944

FOR: NATURAL, SPRING, AND ARTESIAN WA-  
TER FOR DRINKING, IN CLASS 32 (U.S. CLS. 45, 46  
AND 48).

FIRST USE 4-14-2008; IN COMMERCE 4-14-2008.

NO CLAIM IS MADE TO THE EXCLUSIVE  
RIGHT TO USE "LELU", APART FROM THE MARK  
AS SHOWN.

THE COLORS BLUE, YELLOW, ORANGE,  
GREEN AND WHITE ARE CLAIMED AS A FEAT-  
URE OF THE MARK.

THE MARK CONSISTS OF STYLIZED SCRIPT OF  
THE WORD "LELU", IN BLUE, WITH A TROPICAL  
FLOWER APPEARING BELOW THE LITERAL ELE-  
MENT, THE FLOWER IN YELLOW-ORANGE,  
GREEN, AND WHITE.

SN 78-921,058, FILED 6-30-2006.

KATHERINE CONNOLLY, EXAMINING ATTOR-  
NEY

Int. Cl.: 32

Prior U.S. Cls.: 45, 46, and 48

United States Patent and Trademark Office

Reg. No. 3,469,683

Registered July 15, 2008

**TRADEMARK  
PRINCIPAL REGISTER**



TROPICAL WATERS KOSRAE, INC. (MICRONE-  
SIA CORPORATION)

P.O. BOX 68

KOSRAE, MICRONESIA 96944

FOR: NATURAL, SPRING AND ARTESIAN WA-  
TER FOR DRINKING, IN CLASS 32 (U.S. CLS. 45, 46  
AND 48).

FIRST USE 4-14-2008; IN COMMERCE 4-14-2008.

THE COLORS LIGHT BLUE, DARK BLUE, PINK,  
GREEN, WHITE, YELLOW AND ORANGE ARE  
CLAIMED AS A FEATURE OF THE MARK.

THE MARK CONSISTS OF THE WORDING  
"WHERE PURITY REIGNS" IN STYLIZED DARK  
BLUE FONT, TWO PALM TREES IN PINK, GREEN  
AND WHITE AND GRASS IN GREEN BELOW THE  
WORDING AND A TROPICAL FLOWER IN YEL-  
LOW, ORANGE, WHITE AND GREEN ABOVE THE  
WORDING. ALL ON A SPLIT DARK BLUE AND  
LIGHT BLUE BACKGROUND.

SN 78-921,105, FILED 6-30-2006.

KATHERINE CONNOLLY, EXAMINING ATTOR-  
NEY

**Int. Cl.: 10**

**Prior U.S. Cls.: 26, 39, and 44**

**United States Patent and Trademark Office**

**Reg. No. 3,469,684**

**Registered July 15, 2008**

**TRADEMARK  
PRINCIPAL REGISTER**

**IMPULSE IQ**

NEUROMECHANICAL INNOVATIONS, LLC  
(ARIZONA LTD LIAB CO)  
SUITE 205  
11011 S. 48TH STREET  
PHOENIX, AZ 85044

FOR: MEDICAL DEVICES FOR USE IN SENSING, EVALUATION, AND DIAGNOSTICS OF CHIROPRACTIC ADJUSTING AND SPINAL MANIPULATION TREATMENTS AND IN BIOMECHANICAL ASSESSMENTS TO DETERMINE THE BODY'S RESPONSE AND DOSAGE OF TREATMENT FOR CHIROPRACTIC ADJUSTING AND SPINAL MANIPULATION, IN CLASS 10 (U.S. CLS. 26, 39 AND 44).

FIRST USE 5-1-2007; IN COMMERCE 5-1-2007.

THE MARK CONSISTS OF STANDARD CHARACTERS WITHOUT CLAIM TO ANY PARTICULAR FONT, STYLE, SIZE, OR COLOR.

OWNER OF U.S. REG. NOS. 3,013,309 AND 3,013,310.

SN 78-921,516, FILED 6-30-2006.

TINA L. SNAPP, EXAMINING ATTORNEY



**Int. Cl.: 29**

**Prior U.S. Cl.: 46**

**United States Patent and Trademark Office**

**Reg. No. 3,469,685**

**Registered July 15, 2008**

**TRADEMARK  
PRINCIPAL REGISTER**

**LOOK AT TURKEY NOW**

JENNIE-O TURKEY STORE, LLC (MINNESOTA  
LTD LIAB CO)  
2505 WILLMAR AVE SW  
WILLMAR, MN 562010778

THE MARK CONSISTS OF STANDARD CHAR-  
ACTERS WITHOUT CLAIM TO ANY PARTICULAR  
FONT, STYLE, SIZE, OR COLOR.

FOR: TURKEY, IN CLASS 29 (U.S. CL. 46).

SN 78-923,205, FILED 7-6-2006.

FIRST USE 11-30-2006; IN COMMERCE 11-30-2006.

ROBERT STRUCK, EXAMINING ATTORNEY

**Int. Cl.: 41**

**Prior U.S. Cls.: 100, 101, and 107**

**United States Patent and Trademark Office**

**Reg. No. 3,469,686**

**Registered July 15, 2008**

**SERVICE MARK  
PRINCIPAL REGISTER**



SHUSTER, MICHAEL E. (UNITED STATES IN-  
DIVIDUAL)

9312 EAST RAINTREE DRIVE  
SCOTTSDALE, AZ 85260

FOR: TRAINING SERVICES IN THE FIELD OF  
THE BUSINESS COMPONENT OF DENTISTRY, IN  
CLASS 41 (U.S. CLS. 100, 101 AND 107).

FIRST USE 12-31-2006; IN COMMERCE 12-31-2006.

NO CLAIM IS MADE TO THE EXCLUSIVE  
RIGHT TO USE "PERFORMANCE COACH", APART  
FROM THE MARK AS SHOWN.

THE MARK CONSISTS OF A TRIANGLE WITHIN  
A CIRCLE WITH THE NAME PERFORMANCE  
COACH AROUND IT.

SN 78-924,051, FILED 7-6-2006.

GINA HAYES, EXAMINING ATTORNEY

**Int. Cl.: 29**

**Prior U.S. Cl.: 46**

**United States Patent and Trademark Office**

**Reg. No. 3,469,687**

**Registered July 15, 2008**

**TRADEMARK  
PRINCIPAL REGISTER**



**Pearl Cobia**

NHA TRANG PEARLS LTD (VIETNAM CORPORATION)  
17B YERSHIN, NHA TRANG  
KHANH HOA, VIETNAM

FOR: FRESH OR FROZEN WHOLE FISH, FRESH OR FROZEN FISH FILLETS, FRESH OR FROZEN FISH CUTLETS, FRESH OR FROZEN CUT FISH HEADS, FRESH OR FROZEN CLEANED FISH STOMACHS, FRESH OR FROZEN CLEANED FISH LIVER, FRESH OR FROZEN CLEANED AND CUT FISH BONES, SASHIMI, IN CLASS 29 (U.S. CL. 46).

FIRST USE 9-11-2006; IN COMMERCE 9-11-2006.

NO CLAIM IS MADE TO THE EXCLUSIVE RIGHT TO USE "COBIA", APART FROM THE MARK AS SHOWN.

THE COLOR(S) BLACK, LIGHT BLUE AND WHITE IS/ARE CLAIMED AS A FEATURE OF THE MARK.

THE MARK CONSISTS OF THE COLOR BLACK AND APPEARS IN THE WORDING "PEARL COBIA"; THE COLOR LIGHT BLUE APPEARS IN THE OUTERMOST OVAL AND THE OVAL SURROUNDING THE LETTERING "NTPL"; THE COLOR DARK BLUE APPEARS IN THE SECOND OVAL FROM THE OUTSIDE; AND THE COLOR WHITE APPEARS IN THE THIRD OVAL FROM THE OUTSIDE AND IN THE LETTERING "NTPL".

SN 78-924,898, FILED 7-7-2006.

CYNTHIA SLOAN, EXAMINING ATTORNEY

**Int. Cls.: 4, 25, 26, and 28**

**Prior U.S. Cls.: 1, 6, 15, 22, 23, 37, 38, 39, 40, 42, and 50**

**Reg. No. 3,469,688**

**United States Patent and Trademark Office**

**Registered July 15, 2008**

**TRADEMARK  
PRINCIPAL REGISTER**

**GHOULOWEEN**

ATICO INTERNATIONAL USA, INC. (DELAWARE CORPORATION)  
501 S. ANDREWS AVENUE  
FORT LAUDERDALE, FL 33301

FOR: DECORATIVE CANDLES, IN CLASS 4 (U.S. CLS. 1, 6 AND 15).

FIRST USE 9-30-2007; IN COMMERCE 9-30-2007.

FOR: CLOTHING, NAMELY, HALLOWEEN COSTUMES AND MASKS SOLD IN CONNECTION THEREWITH, MASQUERADE COSTUMES AND MASKS SOLD IN CONNECTION THEREWITH HATS, AND SOCKS, IN CLASS 25 (U.S. CLS. 22 AND 39).

FIRST USE 9-30-2007; IN COMMERCE 9-30-2007.

FOR: WIGS, IN CLASS 26 (U.S. CLS. 37, 39, 40, 42 AND 50).

FIRST USE 9-30-2007; IN COMMERCE 9-30-2007.

FOR: NOVELTIES AND TOYS, NAMELY, TOY MASKS, COSTUME MASKS, PARTY FAVORS IN THE NATURE OF SMALL TOYS, AND WATER GLOBES, IN CLASS 28 (U.S. CLS. 22, 23, 38 AND 50).

FIRST USE 9-30-2007; IN COMMERCE 9-30-2007.

THE MARK CONSISTS OF STANDARD CHARACTERS WITHOUT CLAIM TO ANY PARTICULAR FONT, STYLE, SIZE, OR COLOR.

SN 78-925,425, FILED 7-10-2006.

DAVID TAYLOR, EXAMINING ATTORNEY

Int. Cls.: 16, 25, and 28

Prior U.S. Cls.: 2, 5, 22, 23, 29, 37, 38, 39, and 50

United States Patent and Trademark Office

Reg. No. 3,469,689

Registered July 15, 2008

TRADEMARK  
PRINCIPAL REGISTER



THE CHRISTOPHER JOSEPH CONCHA FOUNDATION, INC. (RHODE ISLAND NON-PROFIT CORPORATION)

P.O. BOX 3083  
WATERBURY, CT 06705

FOR: NEWSLETTERS IN THE FIELD OF THE NEEDS OF PREMATURE BABIES; JOURNAL CONCERNING RECORDING INFORMATION FOR BABIES, IN CLASS 16 (U.S. CLS. 2, 5, 22, 23, 29, 37, 38 AND 50).

FIRST USE 3-1-2006; IN COMMERCE 3-1-2006.

FOR: T-SHIRTS; GOLF SHIRTS, IN CLASS 25 (U.S. CLS. 22 AND 39).

FIRST USE 8-31-2005; IN COMMERCE 8-31-2005.

FOR: PLUSH TOYS, IN CLASS 28 (U.S. CLS. 22, 23, 38 AND 50).

FIRST USE 10-31-2005; IN COMMERCE 10-31-2005.

NO CLAIM IS MADE TO THE EXCLUSIVE RIGHT TO USE "FOUNDATION", APART FROM THE MARK AS SHOWN.

THE MARK CONSISTS OF THE DESIGN OF A HAND WITH THE WORDS THE CHRISTOPHER JOSEPH CONCHA FOUNDATION.

SN 78-925,817, FILED 7-10-2006.

JULIE WATSON, EXAMINING ATTORNEY

**Int. Cl.: 9**

**Prior U.S. Cls.: 21, 23, 26, 36, and 38**

**Reg. No. 3,469,690**

**United States Patent and Trademark Office**

**Registered July 15, 2008**

**TRADEMARK  
PRINCIPAL REGISTER**



ANALYTIC SYSTEMS WARE (1993) LTD. (CANADA CORPORATION)  
#207 - 12448 82ND AVENUE  
SURREY, CANADA V3W 3E9

FOR: POWER CONVERSION PRODUCTS, NAME-  
LY, VOLTAGE CONVERTERS, BATTERY CHAR-  
GERS, AND TOTAL DISCHARGE CONTROLLERS,  
IN CLASS 9 (U.S. CLS. 21, 23, 26, 36 AND 38).

FIRST USE 5-11-2006; IN COMMERCE 5-11-2006.

PRIORITY CLAIMED UNDER SEC. 44(D) ON  
CANADA APPLICATION NO. 1307510, FILED 6-29-  
2006.

NO CLAIM IS MADE TO THE EXCLUSIVE  
RIGHT TO USE "RACE ENERGY", APART FROM  
THE MARK AS SHOWN.

THE COLOR(S) BLACK, YELLOW, RED, BLUE  
AND GREEN IS/ARE CLAIMED AS A FEATURE OF  
THE MARK.

THE MARK CONSISTS OF ON A WHITE BACK-  
GROUND, THE COLOR BLACK APPEARS IN THE  
WORDING [RE AND RACE ENERGY] AND IN THE  
DESIGN [ELECTRICAL CONNECTIONS (X4) -  
SQUARE WITH HORIZONTAL LINE ON LEFT  
SIDE]. THE COLOR [YELLOW (C=0, M=21,  
Y=100, K=0)] APPEARS IN THE DESIGN [1ST/TOP  
HORIZONTAL LINE], THE COLOR [RED (C=10,  
M=92, Y=75, K=0)] APPEARS IN THE DESIGN  
[2ND HORIZONTAL LINE], THE COLOR [BLUE  
(C=88, M=3, Y=0, K=0)] APPEARS IN THE DE-  
SIGN [3RD HORIZONTAL LINE] AND THE COLOR  
[GREEN (C=80, M=0, Y=100, K=0)] APPEARS IN  
THE DESIGN [4TH/BOTTOM HORIZONTAL LINE].  
THE COLOR WHITE IS BACKGROUND ONLY AND  
IS NOT CLAIMED AS A FEATURE OF THE MARK

SN 78-926,017, FILED 7-10-2006.

DORITT L. CARROLL, EXAMINING ATTORNEY

**Int. Cl.: 35**

**Prior U.S. Cls.: 100, 101, and 102**

**United States Patent and Trademark Office**

**Reg. No. 3,469,691**

**Registered July 15, 2008**

---

**SERVICE MARK  
PRINCIPAL REGISTER**

**Doggy Baby**

WE THREE, INC. (GEORGIA CORPORATION)  
5343 DUNWOODY CLUB CREEK  
ATLANTA, GA 89074

THE MARK CONSISTS OF STANDARD CHAR-  
ACTERS WITHOUT CLAIM TO ANY PARTICULAR  
FONT, STYLE, SIZE, OR COLOR.

FOR: RETAIL STORE AND ON-LINE RETAIL  
STORE SERVICES FEATURING PET-RELATED  
PRODUCTS AND SUPPLIES, IN CLASS 35 (U.S.  
CLS. 100, 101 AND 102).

SN 78-926,018, FILED 7-10-2006.

FIRST USE 4-18-2008; IN COMMERCE 4-18-2008.

BRENDAN REGAN, EXAMINING ATTORNEY

**Int. Cl.: 35**

**Prior U.S. Cls.: 100, 101, and 102**

**United States Patent and Trademark Office**

**Reg. No. 3,469,692**

**Registered July 15, 2008**

**SERVICE MARK  
PRINCIPAL REGISTER**

**spotXchange**

SPOTXCHANGE LLC (DELAWARE LTD LIAB  
CO)  
11030 CIRCLE POINT ROAD  
SUITE 350  
WESTMINSTER, CO 80020

VIDEO COMMERCIALS VIA THE INTERNET , IN  
CLASS 35 (U.S. CLS. 100, 101 AND 102).

FIRST USE 9-25-2006; IN COMMERCE 9-25-2006.

FOR: ADVERTISING SERVICES, NAMELY, PRO-  
VIDING AN ONLINE AUCTION-BASED ADVER-  
TISING PLATFORM FOR SERVING BROADBAND

SN 78-926,089, FILED 7-10-2006.

TINA KUAN, EXAMINING ATTORNEY



**Int. Cl.: 38**

**Prior U.S. Cls.: 100, 101, and 104**

**United States Patent and Trademark Office**

**Reg. No. 3,469,693**

**Registered July 15, 2008**

---

**SERVICE MARK  
PRINCIPAL REGISTER**

**AnonaBITCH**

APTAKIN DELINCE GROUP, LLC. (FLORIDA  
LTD LIAB CO)  
2100 NW 94TH AVENUE  
MIAMI, FL 33172

FOR: COMPUTER SERVICES, NAMELY, PROVIDING A FORUM FOR POSTING CUSTOMER SERVICE EXPERIENCE, WORK PLACE EXPERIENCE, AND RELATED INFORMATION VIA A GLOBAL COMPUTER NETWORK THEN MAILING IT TO A RECIPIENT WHILE REMAINING ANONYMOUS, IN CLASS 38 (U.S. CLS. 100, 101 AND 104).

FIRST USE 10-1-2006; IN COMMERCE 10-1-2006.

THE MARK CONSISTS OF STANDARD CHARACTERS WITHOUT CLAIM TO ANY PARTICULAR FONT, STYLE, SIZE, OR COLOR.

SN 78-926,490, FILED 7-11-2006.

KAREN K. BUSH, EXAMINING ATTORNEY

**Int. Cl.: 40**

**Prior U.S. Cls.: 100, 103, and 106**

**United States Patent and Trademark Office**

**Reg. No. 3,469,694**

**Registered July 15, 2008**

**SERVICE MARK  
PRINCIPAL REGISTER**

**NAVITOR**

BUSINESS SOLUTIONS GROUP (US), INC. (MINNESOTA CORPORATION)  
1725 ROE CREST DRIVE  
NORTH MANKATO, MN 56003

FOR: CUSTOM PRINTING SERVICES, NAMELY, CUSTOM PRINTING OF BUSINESS CORRESPONDENCE, LETTERHEAD, ENVELOPES, BUSINESS CARDS, FORMS, STAMPS, FOLDERS, LABELS, AWARDS, BADGES, BALLOONS, BANNERS, BINDERS, BUMPER STICKERS, BUSINESS ANNOUNCEMENTS, CALENDARS, DESK CLOCKS, LUGGAGE TAGS, NAME PLATES, PENS, PENCILS,

MUGS, MOUSEPADS, AND MAGNETS, IN CLASS 40 (U.S. CLS. 100, 103 AND 106).

FIRST USE 1-4-2008; IN COMMERCE 1-4-2008.

THE MARK CONSISTS OF STANDARD CHARACTERS WITHOUT CLAIM TO ANY PARTICULAR FONT, STYLE, SIZE, OR COLOR.

SN 78-926,496, FILED 7-11-2006.

GEORGIA CARTY, EXAMINING ATTORNEY

**Int. Cl.: 3**

**Prior U.S. Cls.: 1, 4, 6, 50, 51, and 52**

**Reg. No. 3,469,695**

**United States Patent and Trademark Office**

**Registered July 15, 2008**

**TRADEMARK  
PRINCIPAL REGISTER**

**THE PIONEER OF CLINICAL  
GROOMING**

AMENITY LLC (DELAWARE LTD LIAB CO)  
1230 AVENUE OF THE AMERICAS, 7TH FLOOR  
NEW YORK, NY 10020

FOR: COSMETICS AND PERSONAL CARE PRODUCTS, NAMELY, SHAVING CREAM, SHAVING GEL, PRE-SHAVE OIL PREPARATIONS, NON-MEDICATED ASTRINGENTS, AFTER SHAVE LOTION, FACIAL AND BODY CLEANSER, FACIAL AND BODY SOAP, FACIAL MOISTURIZER, FACE SCRUBS, BODY SCRUBS, FOOT CREAMS, HAND CREAMS, SKIN TONERS, FACE MASQUES, SKIN HYDRATORS, ANTI-AGING LOTION, NON-MEDICATED EYECARE PRODUCTS, NAMELY, CREAMS AND LOTIONS; SUN CARE PRODUCTS, NAMELY, SUN CARE LOTIONS AND SUN BLOCK; SELF TANNERS, SKIN LIGHTENERS, SKIN BRIGHTENERS, ANTIPERSPIRANTS AND DEODORANTS, HAIR CARE PRODUCTS, NAMELY, SHAMPOO, CONDITIONER, HAIR GEL, HAIR SPRAY, HAIR COLOR AND HAIR POMADES, TALCUM POWDER, BODY CARE PRODUCTS, NAMELY, BODY LOTIONS, BODY CREAM, BODY SCRUB, FRAGRANCES FOR PERSONAL USE, HAIR REMOVAL PREPARATIONS, BODY CARE PREPARATIONS, TOOTH WHITENERS, LIP BALMS, TOOTHPASTE, NON-MEDICINAL MOUTHWASH, NON-MEDICATED GUM RINSES IN THE NATURE OF NON-MEDICATED DENTAL RINSES FOR GUMS, BREATH FRESHENERS, DILUTED BREATH SPRAYS USED AS MOUTHWASH, CONCENTRATED BREATH FRESHENER SPRAYS, TRAVEL SIZE COSMETIC AND PERSONAL CARE PRODUCTS, NAMELY, TRAVEL SIZE SHAVING CREAM, SHAVING GEL, PRE-SHAVE OIL PREPARATIONS, NON-MEDICATED ASTRINGENTS, AFTER SHAVE LOTION, FACIAL AND BODY CLEANSER, FACIAL AND BODY SOAP, FACIAL MOISTURIZER, FACE SCRUBS, BODY SCRUBS, FOOT CREAMS, HAND CREAMS, SKIN TONERS, FACE MASQUES, SKIN HYDRATORS, ANTI-AGING LOTION AND CREAM, EYE CREAM AND

LOTION, AND HAIR CARE PRODUCTS, NAMELY, SHAMPOO, CONDITIONER, HAIR GEL, HAIR SPRAY, HAIR COLOR AND HAIR POMADES; ANTI-AGING PRODUCTS, NAMELY, CREAMS AND LOTIONS; FACIAL PRODUCTS, NAMELY, CLEANSER, SOAP, MOISTURIZER, SCRUBS, TONERS, MASQUES, LOTIONS AND CREAMS; SHAVE PRODUCTS, NAMELY, SHAVING CREAM, SHAVING GEL, PRE-SHAVE OIL PREPARATIONS, NON-MEDICATED ASTRINGENTS, AFTER SHAVE LOTION; GIFT SETS COMPOSED PRIMARILY OF SHAVING CREAM, SHAVING GEL, PRE-SHAVE OIL PREPARATIONS, NON-MEDICATED ASTRINGENTS, AFTER SHAVE LOTION, FACIAL AND BODY CLEANSER, FACIAL AND BODY SOAP, FACIAL MOISTURIZER, FACE SCRUBS, BODY SCRUBS, FOOT CREAMS, HAND CREAMS, SKIN TONERS, FACE MASQUES, FACIAL AND BODY LOTION, FACIAL AND BODY CREAM, NON-MEDICATED ACNE TREATMENT PREPARATIONS, HAIR CARE PRODUCTS, NAMELY, SHAMPOO, CONDITIONER, HAIR GEL, HAIR SPRAY, HAIR COLOR AND HAIR POMADES, SKIN HYDRATORS, ANTI-AGING LOTION AND CREAM, NON-MEDICATED EYECARE LOTION AND CREAM, SKIN LIGHTENERS, AND HAIR REMOVAL PRODUCTS, NAMELY, DEPILATORY CREAMS; WIPES AND TOWELETTS, NAMELY, COSMETIC CLEANSING PADS AND COSMETIC MOISTURIZING WIPES; GRADUAL SELF TANNING MOISTURIZER, IN CLASS 3 (U.S. CLS. 1, 4, 6, 50, 51 AND 52).

FIRST USE 8-1-2006; IN COMMERCE 8-1-2006.

THE MARK CONSISTS OF STANDARD CHARACTERS WITHOUT CLAIM TO ANY PARTICULAR FONT, STYLE, SIZE, OR COLOR.

SN 78-926,755, FILED 7-11-2006.

MAUREEN DALL, EXAMINING ATTORNEY

**Int. Cl.: 41**

**Prior U.S. Cls.: 100, 101, and 107**

**United States Patent and Trademark Office**

**Reg. No. 3,469,696**

**Registered July 15, 2008**

**SERVICE MARK  
PRINCIPAL REGISTER**

**CRISTINA'S COURT**

TWENTIETH CENTURY FOX FILM CORPORATION (DELAWARE CORPORATION)  
10201 WEST PICO BOULEVARD  
LOS ANGELES, CA 90035

FOR: ENTERTAINMENT SERVICES IN THE NATURE OF A TELEVISION SERIES IN THE FIELD OF LAW, IN CLASS 41 (U.S. CLS. 100, 101 AND 107).

FIRST USE 9-11-2006; IN COMMERCE 9-11-2006.

THE MARK CONSISTS OF STANDARD CHARACTERS WITHOUT CLAIM TO ANY PARTICULAR FONT, STYLE, SIZE, OR COLOR.

NO CLAIM IS MADE TO THE EXCLUSIVE RIGHT TO USE "COURT", APART FROM THE MARK AS SHOWN.

THE NAME(S), PORTRAIT(S), AND/OR SIGNATURE(S) SHOWN IN THE MARK IDENTIFIES CRISTINA PEREZ GONZALEZ , WHOSE CONSENT(S) TO REGISTER IS SUBMITTED.

SN 78-926,813, FILED 7-11-2006.

NICHOLAS ALTREE, EXAMINING ATTORNEY

**Int. Cl.: 19**

**Prior U.S. Cls.: 1, 12, 33, and 50**

**United States Patent and Trademark Office**

**Reg. No. 3,469,697**

**Registered July 15, 2008**

**TRADEMARK  
PRINCIPAL REGISTER**

**COOL MIX**

UNIQUE PAVING MATERIALS CORPORATION  
(OHIO CORPORATION)  
3993 E. 93RD STREET  
CLEVELAND, OH 44105

FOR: ASPHALT PAVING AND PATCHING MA-  
TERIALS, NAMELY, BITUMEN ASPHALT, IN  
CLASS 19 (U.S. CLS. 1, 12, 33 AND 50).

FIRST USE 4-17-2008; IN COMMERCE 4-17-2008.

THE MARK CONSISTS OF STANDARD CHAR-  
ACTERS WITHOUT CLAIM TO ANY PARTICULAR  
FONT, STYLE, SIZE, OR COLOR.

NO CLAIM IS MADE TO THE EXCLUSIVE  
RIGHT TO USE "MIX", APART FROM THE MARK  
AS SHOWN.

SN 78-927,072, FILED 7-11-2006.

INGRID C. EULIN, EXAMINING ATTORNEY

**Int. Cl.: 36**

**Prior U.S. Cls.: 100, 101, and 102**

**United States Patent and Trademark Office**

**Reg. No. 3,469,698**

**Registered July 15, 2008**

**SERVICE MARK  
PRINCIPAL REGISTER**

# WISESAVINGS

PREMERA BLUE CROSS (WASHINGTON CORPORATION)  
MAIL STOP 316  
P.O. BOX 327  
SEATTLE, WA 981110237

FOR: HEALTH, MEDICAL, AND HOSPITAL INSURANCE UNDERWRITING; ADMINISTRATION AND ORGANIZING OF PREPAID AND PREFERRED PROVIDER HEALTH, MEDICAL, HOSPITAL AND RELATED HEALTH CARE PLANS AND NETWORKS; ADMINISTERING AND UNDERWRITING HEALTH CARE COVERAGE THROUGH CONTRACTED RELATIONSHIPS WITH SUBSCRIBERS AND PROFESSIONAL CLINICAL, HOSPITAL, NURSING HOME AND OTHER HEALTH CARE PROVIDERS; FINANCIAL MANAGEMENT SERVICES FEATURING COORDINATION OF HEALTH PLANS FOR SUBSCRIBING INSURED, THEIR EMPLOYEES AND FAMILY MEMBERS, WITH FINANCIAL ACCOUNTS THAT FUND QUALIFIED TAX-EXEMPT AND TAX-DEDUCTIBLE MEDICAL EXPENSES; FUND INVESTMENT SERVICES; HEALTH PLAN FUND ADMINISTRATION; MANAGEMENT AND INTEGRATION OF HEALTH RE-

IMBURSEMENT ARRANGEMENTS WITH EMPLOYER HEALTH CARE PLANS; PROVIDING ONLINE INFORMATION REGARDING HEALTH AND MEDICAL SAVINGS ACCOUNTS; DEBIT CARD SERVICES TO FACILITATE PAYMENT OF HEALTH CARE; ADMINISTRATION AND MANAGEMENT OF HEALTH REIMBURSEMENT ARRANGEMENTS FOR SUBSCRIBING INSURED, THEIR EMPLOYEES AND FAMILY MEMBERS, IN CLASS 36 (U.S. CLS. 100, 101 AND 102).

FIRST USE 5-0-2007; IN COMMERCE 5-0-2007.

THE MARK CONSISTS OF STANDARD CHARACTERS WITHOUT CLAIM TO ANY PARTICULAR FONT, STYLE, SIZE, OR COLOR.

OWNER OF U.S. REG. NOS. 2,992,590, 3,091,226, AND OTHERS.

SN 78-927,105, FILED 7-11-2006.

TINA KUAN, EXAMINING ATTORNEY

**Int. Cl.: 36**

**Prior U.S. Cls.: 100, 101, and 102**

**United States Patent and Trademark Office**

**Reg. No. 3,469,699**

**Registered July 15, 2008**

**SERVICE MARK  
PRINCIPAL REGISTER**

**WISEESSENTIALS**

PREMERA BLUE CROSS (WASHINGTON CORPORATION)  
MAIL STOP 316  
P.O. BOX 327  
SEATTLE, WA 981110237

FOR: HEALTH, MEDICAL AND HOSPITAL INSURANCE UNDERWRITING; ADMINISTRATION AND ORGANIZING OF PREPAID AND PREFERRED PROVIDER HEALTH, MEDICAL, HOSPITAL AND RELATED HEALTH CARE PLANS AND NETWORKS; ADMINISTERING AND UNDERWRITING HEALTH CARE COVERAGE THROUGH CONTRACTED RELATIONSHIPS WITH SUBSCRIBERS AND PROFESSIONAL CLINICAL, HOSPITAL, NURSING HOME AND OTHER HEALTH CARE PROVIDERS; MANAGEMENT AND INTEGRATION OF HEALTH REIMBURSEMENT ARRANGEMENTS WITH EMPLOYER HEALTH CARE PLANS; AD-

MINISTRATION AND MANAGEMENT OF HEALTH REIMBURSEMENT ARRANGEMENTS FOR SUBSCRIBING INSUREDS, THEIR EMPLOYEES AND FAMILY MEMBERS, IN CLASS 36 (U.S. CLS. 100, 101 AND 102).

FIRST USE 5-0-2007; IN COMMERCE 5-0-2007.

THE MARK CONSISTS OF STANDARD CHARACTERS WITHOUT CLAIM TO ANY PARTICULAR FONT, STYLE, SIZE, OR COLOR.

OWNER OF U.S. REG. NOS. 2,992,590, 3,091,226, AND OTHERS.

SN 78-927,110, FILED 7-11-2006.

TINA KUAN, EXAMINING ATTORNEY

**Int. Cl.: 35**

**Prior U.S. Cls.: 100, 101, and 102**

**United States Patent and Trademark Office**

**Reg. No. 3,469,700**

**Registered July 15, 2008**

**SERVICE MARK  
PRINCIPAL REGISTER**

**SHOWSEESSELL**

GOSEETELL NETWORK, INC. (OREGON CORPORATION)

#20

2327 NW NORTHRUP STREET  
PORTLAND, OR 97210

FOR: PROMOTING THE GOODS AND SERVICES OF OTHERS BY PROVIDING A WEB SITE AT WHICH USERS CAN LINK TO LODGING, RESTAURANTS, SIGHTSEEING TOURS, LANDMARKS, PLACES OF INTERESTS AND TOURIST ACTIVITIES, IN CLASS 35 (U.S. CLS. 100, 101 AND 102).

FIRST USE 6-15-2007; IN COMMERCE 6-15-2007.

THE MARK CONSISTS OF STANDARD CHARACTERS WITHOUT CLAIM TO ANY PARTICULAR FONT, STYLE, SIZE, OR COLOR.

SN 78-927,190, FILED 7-11-2006.

CAROLINE WOOD, EXAMINING ATTORNEY



**Int. Cl.: 6**

**Prior U.S. Cls.: 2, 12, 13, 14, 23, 25, and 50**

**United States Patent and Trademark Office**

**Reg. No. 3,469,701**

**Registered July 15, 2008**

**TRADEMARK  
PRINCIPAL REGISTER**

**SURE-STRIKE**

WMW INNOVATION COMPANY (TEXAS CORPORATION)  
2711 LBJ FREEWAY, SUITE 1036  
C/O CHALKER FLORES, LLP  
DALLAS, TX 75234

FOR: METAL HARDWARE FOR DOORS, NAME-  
LY, DOOR LOCKS, STRIKE PLATES, STRIKE  
PLATE KITS COMPRISED OF STRIKE PLATE  
HOUSING, METAL COVER PLATE, SCREWS,  
DOOR LOCK KITS COMPRISED OF STRIKE PLATE  
HOUSING, METAL COVER PLATE, SCREWS, AND  
DEADBOLT ASSEMBLY, LOCK SETS AND REPLA-

CEMENT PARTS THEREFORE, IN CLASS 6 (U.S.  
CLS. 2, 12, 13, 14, 23, 25 AND 50).

FIRST USE 6-0-2006; IN COMMERCE 6-0-2006.

THE MARK CONSISTS OF STANDARD CHAR-  
ACTERS WITHOUT CLAIM TO ANY PARTICULAR  
FONT, STYLE, SIZE, OR COLOR.

SN 78-927,214, FILED 7-11-2006.

PAUL CROWLEY, EXAMINING ATTORNEY

**Int. Cl.: 35**

**Prior U.S. Cls.: 100, 101, and 102**

**United States Patent and Trademark Office**

**Reg. No. 3,469,702**

**Registered July 15, 2008**

**SERVICE MARK  
PRINCIPAL REGISTER**

# SHOP YELLOW

BLUFFSIDE VENTURES INC. (CANADA CORPORATION)  
RR#1  
NOTTAWA, ONTARIO, CANADA L0M1P0

FOR: ELECTRONIC CATALOG SERVICES FEATURING APPAREL, CLOTHING, COLLECTIBLES, COMPUTERS, EDIBLES, ELECTRONICS, FITNESS EQUIPMENT, GAMES, GARDEN DECOR, GARDENING PRODUCTS, HEALTHCARE PRODUCTS, HOME DECOR ACCESSORIES, JEWELRY, KITCHENWARE, LUGGAGE, PERSONAL CARE PRODUCTS, PET ACCESSORIES, SPORTING GOODS, TOYS, AND TRAVEL ACCESSORIES; MAIL ORDER CATALOG SERVICES FEATURING APPAREL, CLOTHING, COLLECTIBLES, COMPUTERS, EDIBLES, ELECTRONICS, FITNESS EQUIPMENT, GAMES, GARDEN DECOR, GARDENING PRODUCTS, HEALTHCARE PRODUCTS, HOME DECOR ACCESSORIES, JEWELRY, KITCHENWARE, LUGGAGE, PERSONAL CARE PRODUCTS, PET ACCESSORIES, SPORTING GOODS, TOYS, AND TRAVEL ACCESSORIES; ON-LINE RETAIL STORE SERVICES FEATURING APPAREL, CLOTHING,

COLLECTIBLES, COMPUTERS, EDIBLES, ELECTRONICS, FITNESS EQUIPMENT, GAMES, GARDEN DECOR, GARDENING PRODUCTS, HEALTHCARE PRODUCTS, HOME DECOR ACCESSORIES, JEWELRY, KITCHENWARE, LUGGAGE, PERSONAL CARE PRODUCTS, PET ACCESSORIES, SPORTING GOODS, TOYS, AND TRAVEL ACCESSORIES, IN CLASS 35 (U.S. CLS. 100, 101 AND 102).

FIRST USE 6-0-2006; IN COMMERCE 6-0-2006.

THE MARK CONSISTS OF STANDARD CHARACTERS WITHOUT CLAIM TO ANY PARTICULAR FONT, STYLE, SIZE, OR COLOR.

NO CLAIM IS MADE TO THE EXCLUSIVE RIGHT TO USE "SHOP", APART FROM THE MARK AS SHOWN.

SN 78-927,331, FILED 7-12-2006.

NELSON SNYDER, EXAMINING ATTORNEY

**Int. Cl.: 16**

**Prior U.S. Cls.: 2, 5, 22, 23, 29, 37, 38, and 50**

**Reg. No. 3,469,703**

**United States Patent and Trademark Office**

**Registered July 15, 2008**

**TRADEMARK  
PRINCIPAL REGISTER**

WRAPPING OUR IDEAS AROUND  
YOURS

J. H. MCNAIRN LIMITED (CANADA CORPORATION)  
125 CONSUMERS DRIVE  
WHITBY ONTARIO L1N 1C4, CANADA

FOR: BAKING PAN LINERS MADE OF PAPER;  
PAPER PACKAGING AND CONTAINERS FOR  
FOOD AND BEVERAGES COMPRISED OF PAPER,  
WAXED PAPER, AND FOIL LAMINATED PAPER  
FORMED INTO FLAT SHEETS, ROLLS AND BAGS  
FOR USE IN CONTAINING FOOD ARTICLES;  
PAPER FOR WRAPPING AND PACKAGING,  
NAMELY, PAPER SHEETS, ROLLS AND BAGS  
FOR WRAPPING AND DISPLAYING MEATS AND  
OTHER FOOD ITEMS; PAPER FOOD WRAPPERS  
FOR USE WITH SANDWICHES, BURGERS AND

RELATED GOODS; CUT SHEET OF A SPECIFIC  
GRADE OF PAPER FOR USE AS A TABLE COVER,  
NAMELY, PAPER TABLE CLOTHS, IN CLASS 16  
(U.S. CLS. 2, 5, 22, 23, 29, 37, 38 AND 50).

FIRST USE 12-31-2006; IN COMMERCE 12-31-2006.

THE MARK CONSISTS OF STANDARD CHAR-  
ACTERS WITHOUT CLAIM TO ANY PARTICULAR  
FONT, STYLE, SIZE, OR COLOR.

SN 78-927,899, FILED 7-12-2006.

CHARLOTTE CORWIN, EXAMINING ATTORNEY

**Int. Cls.: 31 and 41**

**Prior U.S. Cls.: 1, 46, 100, 101, and 107**

**United States Patent and Trademark Office**

**Reg. No. 3,469,704**

**Registered July 15, 2008**

**TRADEMARK  
SERVICE MARK  
PRINCIPAL REGISTER**

**DOG'S NIGHT OUT**

THREE DOG BAKERY, INC. (DELAWARE CORPORATION)  
1843 N. TOPPING AVE.  
KANSAS CITY, MO 64120

FOR: PET FOOD, IN CLASS 31 (U.S. CLS. 1 AND 46).

FIRST USE 5-18-2008; IN COMMERCE 5-18-2008.

FOR: ENTERTAINMENT SERVICES, NAMELY, CONDUCTING SOCIAL GATHERINGS FOR HUMANS AND THEIR PETS, IN CLASS 41 (U.S. CLS. 100, 101 AND 107).

FIRST USE 7-0-2001; IN COMMERCE 7-0-2001.

THE MARK CONSISTS OF STANDARD CHARACTERS WITHOUT CLAIM TO ANY PARTICULAR FONT, STYLE, SIZE, OR COLOR.

SN 78-928,129, FILED 7-12-2006.

ALEXANDER L. POWERS, EXAMINING ATTORNEY

**Int. Cl.: 11**

**Prior U.S. Cls.: 13, 21, 23, 31, and 34**

**United States Patent and Trademark Office**

**Reg. No. 3,469,705**

**Registered July 15, 2008**

**TRADEMARK  
PRINCIPAL REGISTER**

**TECFIL**

REPRESENTACIONES TECFIL RETECSA, S.A.  
(VENEZUELA CORPORATION)  
ZONA INDUSTRIAL NORTE, AV. NORTE-SUR #3  
C.E. ESTE-OESTE, LOCALES 1,2,3  
VALENCIA, CARABOBO, VENEZUELA

FOR: AIR CLEANING UNITS CONTAINING AN AIR FILTER, ULTRAVIOLET LIGHTS AND A PHOTOCATALYTIC FILTER; AIR FILTERS FOR AIR CONDITIONING UNITS; AIR FILTERS FOR DOMESTIC USE; AIR FILTERS FOR INDUSTRIAL INSTALLATIONS; COLOR FILTERS FOR USE IN LIGHTING INSTRUMENTS; COOLANT RECOVERY SYSTEMS, COMPRISING FILTERS; DRIPPER IRRIGATION SYSTEMS, COMPRISED OF FILTERS; FILTERING UNITS FOR AQUARIUMS; FILTERS FOR PHOTOGRAPHIC, CINEMATOGRAPHIC, VIDEO AND PERFORMING ARTS LIGHTING; FILTERS MADE OF FIBER FOR WATER FILTRATION; FILTERS, HEATERS AND PUMPS SOLD IN COMBINATION FOR USE IN HOT TUBS; FILTERS, HEATERS AND PUMPS SOLD IN COMBINATION FOR USE IN SWIMMING POOLS; INDUSTRIAL AIR FILTER MACHINES; LAWN SPRINKLER SYSTEMS COMPRISING PUMPS, VALVES AND FILTERS; MEMBRANE FILTER CARTRIDGES FOR THE SEPARATION OF BIOMOLECULES IN BIOPHARMACEUTICAL PRODUCTION; METAL CYLINDRICAL

CHAMBER AND SCREEN FOR USE IN FILTERING AND REMOVING SETTLEABLE SOLIDS FROM LIQUID; PLUMBING FITTINGS, NAMELY, FAUCET FILTERS; REFRIGERATION EQUIPMENT, NAMELY, RAPID FOOD CHILLING UNITS; REFRIGERATION EQUIPMENT, NAMELY, FOOD AND BEVERAGE CHILLING UNITS; REFRIGERATORS; SWIMMING POOL WATER CLEANING AND FILTERING UNITS; WATER FILTERING DEVICES, NAMELY, WATER PURIFICATION INSTALLATIONS FOR WASTE WATER AND SEWAGE CONSISTING OF CURTAINS AND TEXTILE FABRICS; WATER FILTERING UNITS FOR AQUARIUMS; WATER FILTERING UNITS FOR DOMESTIC, COMMERCIAL AND INDUSTRIAL USE; WATER FILTERS, IN CLASS 11 (U.S. CLS. 13, 21, 23, 31 AND 34).

FIRST USE 8-31-1977; IN COMMERCE 12-31-1989.

THE MARK CONSISTS OF STANDARD CHARACTERS WITHOUT CLAIM TO ANY PARTICULAR FONT, STYLE, SIZE, OR COLOR.

SN 78-928,363, FILED 7-12-2006.

NAKWAMA ANKRAH, EXAMINING ATTORNEY

**Int. Cl.: 44**

**Prior U.S. Cls.: 100 and 101**

**United States Patent and Trademark Office**

**Reg. No. 3,469,706**

**Registered July 15, 2008**

**SERVICE MARK  
PRINCIPAL REGISTER**

**NEEL & COMPANY'S  
TRANSFORMATION CLINICS**

NEEL & COMPANY'S TRANSFORMATION  
CLINICS FRANCHISING CORPORATION  
(ARKANSAS CORPORATION)  
10830 EAST 45TH STREET, SUITE 302  
TULSA, OK 74146

FOR: COSMETIC BODY CARE SERVICES IN THE  
NATURE OF PROVIDING BODY SHAPING AND  
CONTOURING SERVICES THROUGH THE USE OF  
EQUIPMENT AND HEALTH CARE AND COSMET-  
IC PRODUCTS AND WEIGHT REDUCTION DIET  
PLANNING AND SUPERVISION THROUGH REG-  
ULATION OF CALORIC INTAKE, IN CLASS 44 (U.S.  
CLS. 100 AND 101).

FIRST USE 7-31-2006; IN COMMERCE 7-31-2006.

THE MARK CONSISTS OF STANDARD CHAR-  
ACTERS WITHOUT CLAIM TO ANY PARTICULAR  
FONT, STYLE, SIZE, OR COLOR.

NO CLAIM IS MADE TO THE EXCLUSIVE  
RIGHT TO USE "COMPANY'S TRANSFORMATION  
CLINICS", APART FROM THE MARK AS SHOWN.

SN 78-928,415, FILED 7-12-2006.

HEATHER THOMPSON, EXAMINING ATTORNEY

**Int. Cl.: 32**

**Prior U.S. Cls.: 45, 46, and 48**

**United States Patent and Trademark Office**

**Reg. No. 3,469,707**

**Registered July 15, 2008**

**TRADEMARK  
PRINCIPAL REGISTER**

**REDCANE KOLA**

SEATTLE'S BEST COFFEE, LLC (WASHINGTON  
LTD LIAB CO)  
2401 UTAH AVENUE SOUTH  
SEATTLE, WA 98134

FOR: SPARKLING WATER, SOFT DRINKS, FLA-  
VORING SYRUPS FOR MAKING BEVERAGES;  
SODA BEVERAGES, IN CLASS 32 (U.S. CLS. 45, 46  
AND 48).

FIRST USE 7-2-2007; IN COMMERCE 7-2-2007.

THE MARK CONSISTS OF STANDARD CHAR-  
ACTERS WITHOUT CLAIM TO ANY PARTICULAR  
FONT, STYLE, SIZE, OR COLOR.

NO CLAIM IS MADE TO THE EXCLUSIVE  
RIGHT TO USE "COLA", APART FROM THE MARK  
AS SHOWN.

SN 78-928,456, FILED 7-13-2006.

MARGERY A. TIERNEY, EXAMINING ATTORNEY

**Int. Cl.: 18**

**Prior U.S. Cls.: 1, 2, 3, 22, and 41**

**United States Patent and Trademark Office**

**Reg. No. 3,469,708**

**Registered July 15, 2008**

**TRADEMARK  
PRINCIPAL REGISTER**

**SHOCK STOP**

BRIGGS & RILEY TRAVELWARE, LLC (DELA-  
WARE LTD LIAB CO)  
400 WIRELESS BOULEVARD  
HAUPPAUGE, NY 11788

THE MARK CONSISTS OF STANDARD CHAR-  
ACTERS WITHOUT CLAIM TO ANY PARTICULAR  
FONT, STYLE, SIZE, OR COLOR.

FOR: WHEELS FOR LUGGAGE, SHOULDER  
STRAPS FOR LUGGAGE, IN CLASS 18 (U.S. CLS. 1,  
2, 3, 22 AND 41).

SN 78-928,965, FILED 7-13-2006.

FIRST USE 10-0-2007; IN COMMERCE 10-0-2007.

KIMBERLY PERRY, EXAMINING ATTORNEY



**Int. Cl.: 41**

**Prior U.S. Cls.: 100, 101, and 107**

**United States Patent and Trademark Office**

**Reg. No. 3,469,709**

**Registered July 15, 2008**

---

**SERVICE MARK  
PRINCIPAL REGISTER**

**YOUNG HOT ROD**

TOOLE, RODNEY MAURICE (UNITED STATES  
INDIVIDUAL)  
C/O SEDLMAYR & ASSOC. P.C.  
200 PARK AVENUE SOUTH-SUITE 1408  
NEW YORK, NY 10003

FOR: ENTERTAINMENT SERVICES, NAMELY,  
LIVE MUSICAL PERFORMANCES BY A MALE  
VOCALIST, PRODUCTION OF MUSIC RECORD-  
INGS, SHOWS AND VIDEOS FEATURING MUSI-  
CAL PERFORMANCES, MUSIC SHOWS AND  
EVENTS BEFORE A LIVE AUDIENCE, WHICH  
MAY BE BROADCAST LIVE OR RECORDED FOR

LATER BROADCAST, IN CLASS 41 (U.S. CLS. 100,  
101 AND 107).

FIRST USE 7-0-2006; IN COMMERCE 7-0-2006.

THE MARK CONSISTS OF STANDARD CHAR-  
ACTERS WITHOUT CLAIM TO ANY PARTICULAR  
FONT, STYLE, SIZE, OR COLOR.

SN 78-929,157, FILED 7-13-2006.

DEZMONA MIZELLE, EXAMINING ATTORNEY

Prior U.S. Cl.: 200

United States Patent and Trademark Office

Reg. No. 3,469,710

Registered July 15, 2008

COLLECTIVE MEMBERSHIP  
PRINCIPAL REGISTER

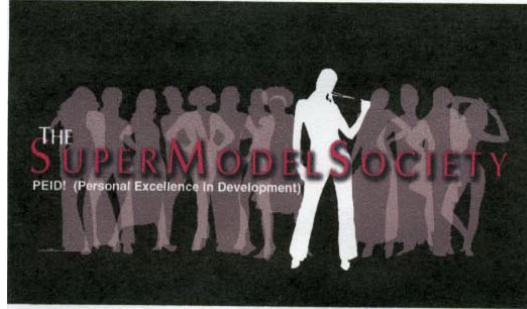

WELCH, JERMARA C.D. (UNITED STATES INDIVIDUAL)  
14307 JUDY ANN DRIVE  
RIVERSIDE, CA 92503

FOR: INDICATING MEMBERSHIP IN A(N) CHARITABLE ASSOCIATION OF CHRISTIAN WOMEN PROFESSIONALS, IN CLASS 200 (U.S. CL. 200).

FIRST USE 7-4-2007; IN COMMERCE 8-8-2007.

NO CLAIM IS MADE TO THE EXCLUSIVE RIGHT TO USE "SOCIETY", APART FROM THE MARK AS SHOWN.

THE COLORS PINK, DARK & LIGHT GRAY, BLACK AND WHITE ARE CLAIMED AS A FEATURE OF THE MARK.

THE COLOR WHITE APPEARS IN THE WORDING "THE" AND "PEID! (PERSONAL EXCELLENCE IN DEVELOPMENT)" AND THE SILHOUETTE OF A LADY IN THE FOREFRONT, THE COLOR PINK APPEARS IN THE WORDING "SUPERMODEL SOCIETY", THE COLOR DARK GREY PROVIDES SHADING TO THE WORDING "SUPERMODEL SOCIETY" AND PORTIONS OF SILHOUETTED LADIES IN THE BACKGROUND, THE COLOR LIGHT GREY APPEARS IN OVERLAPPING OF THE SILHOUETTED LADIES AND THE COLOR BLACK APPEARS IN THE BACKGROUND OF THE MARK.

SN 78-929,375, FILED 7-14-2006.

GENE MACIOL, EXAMINING ATTORNEY

**Int. Cl.: 7**

**Prior U.S. Cls.: 13, 19, 21, 23, 31, 34, and 35**

**Reg. No. 3,469,711**

**United States Patent and Trademark Office**

**Registered July 15, 2008**

---

**TRADEMARK  
PRINCIPAL REGISTER**

**PosiStrut**

POSITORK DISTRIBUTING, INC. (DELAWARE  
CORPORATION)  
SUITE 2211  
4850 TASSAJARA ROAD  
DUBLIN, CA 94568

FOR: STARTER DRIVES FOR MOTORS AND  
ENGINES, IN CLASS 7 (U.S. CLS. 13, 19, 21, 23, 31,  
34 AND 35).

FIRST USE 10-1-2006; IN COMMERCE 10-1-2006.

THE MARK CONSISTS OF STANDARD CHAR-  
ACTERS WITHOUT CLAIM TO ANY PARTICULAR  
FONT, STYLE, SIZE, OR COLOR.

OWNER OF U.S. REG. NO. 2,645,714.

SN 78-929,925, FILED 7-14-2006.

SHANNON TWOHIG, EXAMINING ATTORNEY

**Int. Cl.: 37**

**Prior U.S. Cls.: 100, 103, and 106**

**United States Patent and Trademark Office**

**Reg. No. 3,469,712**

**Registered July 15, 2008**

---

**SERVICE MARK  
PRINCIPAL REGISTER**

**FLOODS4LESS.COM**

FLOODS4LESS, INC. (CALIFORNIA CORPORATION)  
8404 NORTH MAGNOLIA AVE, SUITE C  
SANTEE, CA 92071

FOR: RESTORATION SERVICES FOR BUILDING STRUCTURES AND CONTENTS, NAMELY, WATER EXTRACTION AND DRYING SERVICES, IN CLASS 37 (U.S. CLS. 100, 103 AND 106).

FIRST USE 2-0-2008; IN COMMERCE 5-14-2008.

THE MARK CONSISTS OF STANDARD CHARACTERS WITHOUT CLAIM TO ANY PARTICULAR FONT, STYLE, SIZE, OR COLOR.

SN 78-930,248, FILED 7-14-2006.

CAROLINE WOOD, EXAMINING ATTORNEY

Int. Cl.: 25

Prior U.S. Cls.: 22 and 39

**United States Patent and Trademark Office**

**Reg. No. 3,469,713**

Registered July 15, 2008

**TRADEMARK  
PRINCIPAL REGISTER**

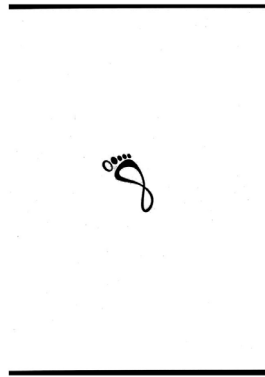

BRIDGEDALE OUTDOOR LIMITED (IRELAND  
LIMITED CORPORATION)  
CO. DOWN  
BELFAST ROAD  
NEWTONARDS, IRELAND BT23 4TJ

FOR: SOCKS; HOSIERY; STOCKINGS; SPORTS  
FOOTWEAR; SOCKS FOR SPORTS; SOCKS FOR

WEAR IN TREKKING, CLIMBING AND WALK-  
ING, IN CLASS 25 (U.S. CLS. 22 AND 39).

FIRST USE 9-0-2006; IN COMMERCE 9-0-2006.

SN 78-931,031, FILED 7-17-2006.

REBECCA EISINGER, EXAMINING ATTORNEY

**Int. Cl.: 9**

**Prior U.S. Cls.: 21, 23, 26, 36, and 38**

**United States Patent and Trademark Office**

**Reg. No. 3,469,714**

**Registered July 15, 2008**

**TRADEMARK  
PRINCIPAL REGISTER**

**ACCURIAN**

TRS QUALITY, INC. (DELAWARE CORPORATION)  
MS CF4-101  
300 RADIOSHACK CIRCLE  
FORT WORTH, TX 761021964

FOR: ANTENNAS, IN CLASS 9 (U.S. CLS. 21, 23, 26,  
36 AND 38).

FIRST USE 4-1-2008; IN COMMERCE 4-1-2008.

THE MARK CONSISTS OF STANDARD CHARACTERS WITHOUT CLAIM TO ANY PARTICULAR FONT, STYLE, SIZE, OR COLOR.

OWNER OF U.S. REG. NOS. 2,999,052, 3,012,289,  
AND 3,181,576.

SN 78-931,716, FILED 7-18-2006.

RICHARD A. STRASER, EXAMINING ATTORNEY

**Int. Cl.: 42**

**Prior U.S. Cls.: 100 and 101**

**United States Patent and Trademark Office**

**Reg. No. 3,469,715**

**Registered July 15, 2008**

**SERVICE MARK  
PRINCIPAL REGISTER**

**LEVEL**

(OSI) EYETECH, INC. (DELAWARE CORPORATION)  
12TH FLOOR  
3 TIMES SQUARE  
NEW YORK, NY 10036

FOR: MEDICAL AND SCIENTIFIC RESEARCH, NAMELY, CONDUCTING CLINICAL TRIALS FOR PHARMACEUTICAL PREPARATIONS FOR MACULAR DEGENERATION, IN CLASS 42 (U.S. CLS. 100 AND 101).

FIRST USE 1-31-2007; IN COMMERCE 1-31-2007.

THE MARK CONSISTS OF STANDARD CHARACTERS WITHOUT CLAIM TO ANY PARTICULAR FONT, STYLE, SIZE, OR COLOR.

SN 78-933,020, FILED 7-19-2006.

ALICIA COLLINS, EXAMINING ATTORNEY

**Int. Cl.: 39**

**Prior U.S. Cls.: 100 and 105**

**United States Patent and Trademark Office**

**Reg. No. 3,469,716**

**Registered July 15, 2008**

**SERVICE MARK  
PRINCIPAL REGISTER**

**AMERICA'S FRIENDLIEST  
AIRPORT**

CITY OF PHOENIX (ARIZONA MUNICIPAL  
CORPORATION)  
200 WEST WASHINGTON STREET  
PHOENIX, AZ 85003

FOR: AIRPORT SERVICES; AIRPORT BAGGAGE  
CHECK-IN SERVICES; AIRPORT PASSENGER  
CHECK-IN SERVICES; VEHICLE PARKING SERVI-  
CES; VALET PARKING; PARKING GARAGE SER-  
VICES; PARKING LOT SERVICES; PROVIDING  
FACILITIES FOR RENTAL OF CARS AND CAR  
RENTAL RESERVATIONS; AND TRANSPORT OF  
PASSENGERS VIA CARS, BUSES, VANS, AND  
SHUTTLES, IN CLASS 39 (U.S. CLS. 100 AND 105).

FIRST USE 7-31-2006; IN COMMERCE 7-31-2006.

THE MARK CONSISTS OF STANDARD CHAR-  
ACTERS WITHOUT CLAIM TO ANY PARTICULAR  
FONT, STYLE, SIZE, OR COLOR.

NO CLAIM IS MADE TO THE EXCLUSIVE  
RIGHT TO USE "AMERICA'S" AND "AIRPORT",  
APART FROM THE MARK AS SHOWN.

SN 78-933,278, FILED 7-19-2006.

DEZMONA MIZELLE, EXAMINING ATTORNEY



Int. Cl.: 15

Prior U.S. Cls.: 2, 21, and 36

United States Patent and Trademark Office

Reg. No. 3,469,717

Registered July 15, 2008

TRADEMARK  
PRINCIPAL REGISTER

*Ohana*  
*Ukuleles*

LOUIS K. WU (CALIFORNIA SOLE PROPRIETORSHIP), DBA OHANA MUSIC,  
3350 E. 7TH STREET, SUITE 105  
LONG BEACH, CA 90804

FOR: MUSICAL INSTRUMENTS, IN CLASS 15  
(U.S. CLS. 2, 21 AND 36).

FIRST USE 11-1-2006; IN COMMERCE 1-15-2007.

NO CLAIM IS MADE TO THE EXCLUSIVE RIGHT TO USE "UKULELES", APART FROM THE MARK AS SHOWN.

THE ENGLISH TRANSLATION OF THE WORD "OHANA" IN THE MARK IS FAMILY.

SN 78-933,886, FILED 7-20-2006.

AMY ALFIERI, EXAMINING ATTORNEY

**Int. Cl.: 9**

**Prior U.S. Cls.: 21, 23, 26, 36, and 38**

**Reg. No. 3,469,718**

**United States Patent and Trademark Office**

**Registered July 15, 2008**

**TRADEMARK  
PRINCIPAL REGISTER**

**MOTORIZR**

MOTOROLA, INC. (DELAWARE CORPORATION)  
1303 EAST ALGONQUIN ROAD  
SCHAUMBURG, IL 60196

FOR: CELLULAR TELEPHONES, AND RELATED ACCESSORIES FOR THE FOREGOING GOODS, NAMELY, HEADSETS, MICROPHONES, SPEAKERS, BATTERY CHARGERS, BATTERIES, AND POWER ADAPTERS; VIDEO OR DATA OVER A TELECOMMUNICATIONS NETWORK AND FOR ENHANCING AND FACILITATING USE AND ACCESS TO COMPUTER NETWORKS AND TELEPHONE NETWORKS; AND FOR BROWSING AND NAVIGATING THROUGH WEB SITES ON SAID NETWORKS; CAMERAS, NAMELY, PHOTOGRAPHIC CAMERAS, DIGITAL CAMERAS, MOTION PICTURE CAMERAS, VIDEO CAMERAS,

AND AUDIO AND VIDEO PLAYERS AND HAND HELD GAMING MACHINES, ALL FOR USE WITH A SELF CONTAINED COMMUNICATIONS APPARATUS OR PHYSICALLY SEPARATE BUT FUNCTIONALLY INTEGRATED WITH A COMMUNICATION APPARATUS MODULE, IN CLASS 9 (U.S. CLS. 21, 23, 26, 36 AND 38).

FIRST USE 3-16-2007; IN COMMERCE 3-16-2007.

THE MARK CONSISTS OF STANDARD CHARACTERS WITHOUT CLAIM TO ANY PARTICULAR FONT, STYLE, SIZE, OR COLOR.

SN 78-934,075, FILED 7-20-2006.

CAROLINE WOOD, EXAMINING ATTORNEY

Int. Cl.: 19

Prior U.S. Cls.: 1, 12, 33, and 50

United States Patent and Trademark Office

Reg. No. 3,469,719

Registered July 15, 2008

TRADEMARK  
PRINCIPAL REGISTER

s a i   
mosai concept

SILVER CUP INDUSTRIES LIMITED (HONG KONG LIMITED COMPANY)  
19TH FLOOR, SINO FAVOUR CENTRE, 1 ON YIP CHAI WAN, HONG KONG

FOR: BUILDING AND CONSTRUCTION MATERIALS, NAMELY, NON-METAL CEILING PANELS, NON-METAL TILES, CERAMIC TILES, MOSAIC TILES, GLASS MOSAIC TILES, GLASS TILES, MOSAICS FOR BUILDING, NON-METAL DOORS, NON-METAL DOOR PANELS, FRAMES AND CAS-

INGS, NON-METAL DECORATIVE MOLDINGS FOR USE IN BUILDING CONSTRUCTION, GLASS PANES, BRICKS, BLOCKS AND TILES FOR BUILDING, IN CLASS 19 (U.S. CLS. 1, 12, 33 AND 50).

FIRST USE 7-15-2005; IN COMMERCE 7-15-2005.

SN 78-934,627, FILED 7-21-2006.

HEATHER THOMPSON, EXAMINING ATTORNEY

Int. Cl.: 25

Prior U.S. Cls.: 22 and 39

United States Patent and Trademark Office

Reg. No. 3,469,720

Registered July 15, 2008

TRADEMARK  
PRINCIPAL REGISTER



KHAOTIK BLEU, INC. (CALIFORNIA CORPORATION)  
617 ANDERSON STREET  
LOS ANGELES, CA 90023

FOR: CLOTHING, NAMELY, JACKETS, SWEATERS, VESTS, SHIRTS, BLOUSES, PANTS, SHORTS, SKIRTS, DRESSES, IN CLASS 25 (U.S. CLS. 22 AND 39).

FIRST USE 7-13-2007; IN COMMERCE 7-13-2007.

THE MARK CONSISTS OF THE WORDS "LOVE NOTES" SUPERIMPOSED UPON GRAPHIC BACKGROUND CONTAINING AN ARTISTIC DESIGN AND ILLEGIBLE HANDWRITING. IN THE CENTER OF THE MARK ARE THE WORDS "FLEURS BERTRAND PARIS TELEPHONE 68", WHICH TRANSLATES FROM FRENCH TO ENGLISH AS "FLOWERS BERTRAND PARIS TELEPHONE 68".

SN 78-936,010, FILED 7-24-2006.

DAVID TAYLOR, EXAMINING ATTORNEY

**Int. Cl.: 31**

**Prior U.S. Cls.: 1 and 46**

**United States Patent and Trademark Office**

**Reg. No. 3,469,721**

**Registered July 15, 2008**

**TRADEMARK  
PRINCIPAL REGISTER**

**GRAVY GOODNESS**

SHAWNEE MILLING COMPANY (OKLAHOMA  
CORPORATION)

201 S. BROADWAY, P.O. BOX 1567

SHAWNEE, OK 748021567

FOR: GRAVY DOG FOOD, IN CLASS 31 (U.S. CLS.  
1 AND 46).

FIRST USE 5-19-2008; IN COMMERCE 5-19-2008.

THE MARK CONSISTS OF STANDARD CHAR-  
ACTERS WITHOUT CLAIM TO ANY PARTICULAR  
FONT, STYLE, SIZE, OR COLOR.

NO CLAIM IS MADE TO THE EXCLUSIVE  
RIGHT TO USE "GRAVY", APART FROM THE  
MARK AS SHOWN.

SN 78-936,139, FILED 7-24-2006.

LINDA ORNDORFF, EXAMINING ATTORNEY

**Int. Cl.: 38**

**Prior U.S. Cls.: 100, 101, and 104**

**United States Patent and Trademark Office**

**Reg. No. 3,469,722**

**Registered July 15, 2008**

**SERVICE MARK  
PRINCIPAL REGISTER**

**TELEPLUS**

TELEPLUS WORLD, CORP. (NEVADA CORPORATION)  
6101 BLUE LAGOON DRIVE, SUITE 450  
MIAMI, FL 33126

THE MARK CONSISTS OF STANDARD CHARACTERS WITHOUT CLAIM TO ANY PARTICULAR FONT, STYLE, SIZE, OR COLOR.

FOR: WIRELESS TELEPHONE TELECOMMUNICATIONS SERVICES, NAMELY, WIRELESS MOBILE TELEPHONE CALLING PLANS, IN CLASS 38 (U.S. CLS. 100, 101 AND 104).

SN 78-936,670, FILED 7-25-2006.

FIRST USE 4-16-1999; IN COMMERCE 4-16-1999.

H. M. FISHER, EXAMINING ATTORNEY

**Int. Cl.: 20**

**Prior U.S. Cls.: 2, 13, 22, 25, 32, and 50**

**United States Patent and Trademark Office**

**Reg. No. 3,469,723**

**Registered July 15, 2008**

**TRADEMARK  
PRINCIPAL REGISTER**

**CREMCO**

MORPHTECH, LLC (DELAWARE LTD LIAB CO)  
4008 CAPITAL DRIVE  
ROCKY MOUNT, NC 27804

THE MARK CONSISTS OF STANDARD CHAR-  
ACTERS WITHOUT CLAIM TO ANY PARTICULAR  
FONT, STYLE, SIZE, OR COLOR.

FOR: COLLAPSIBLE STOOLS, IN CLASS 20 (U.S.  
CLS. 2, 13, 22, 25, 32 AND 50).

SN 78-936,786, FILED 7-25-2006.

FIRST USE 10-1-2006; IN COMMERCE 10-1-2006.

MARLENE BELL, EXAMINING ATTORNEY

**Int. Cls.: 16 and 25**

**Prior U.S. Cls.: 2, 5, 22, 23, 29, 37, 38, 39, and 50**

**United States Patent and Trademark Office**

**Reg. No. 3,469,724**

**Registered July 15, 2008**

**TRADEMARK  
PRINCIPAL REGISTER**

**HISTORICALLY REFRESHING**

HALLMARK, DAVID A. (UNITED STATES IN-  
DIVIDUAL)  
IMAGINATION COUNTS, LLC  
P.O. BOX 975  
PORTSMOUTH, NH 03802

FOR: BALL POINT PENS; ENVELOPES FOR  
STATIONERY USE; IRON-ON TRANSFERS, IN  
CLASS 16 (U.S. CLS. 2, 5, 22, 23, 29, 37, 38 AND 50).

FIRST USE 12-6-2006; IN COMMERCE 1-5-2007.

FOR: BASEBALL CAPS; T-SHIRTS, IN CLASS 25  
(U.S. CLS. 22 AND 39).

FIRST USE 12-6-2006; IN COMMERCE 1-5-2007.

THE MARK CONSISTS OF STANDARD CHAR-  
ACTERS WITHOUT CLAIM TO ANY PARTICULAR  
FONT, STYLE, SIZE, OR COLOR.

SN 78-937,911, FILED 7-26-2006.

JOHN WILKE, EXAMINING ATTORNEY



**Int. Cl.: 36**

**Prior U.S. Cls.: 100, 101, and 102**

**United States Patent and Trademark Office**

**Reg. No. 3,469,725**

**Registered July 15, 2008**

---

**SERVICE MARK  
PRINCIPAL REGISTER**

**SHINING LIGHT ON  
PRESCRIPTION BENEFITS**

SUNRX, INC (NEW JERSEY CORPORATION)  
6 EXECUTIVE CAMPUS, SUITE 400  
CHERRY HILL, NJ 08002

FOR: PHARMACEUTICAL PRESCRIPTION BENEFIT MANAGEMENT SERVICES, IN CLASS 36 (U.S. CLS. 100, 101 AND 102).

FIRST USE 6-0-2005; IN COMMERCE 6-0-2005.

THE MARK CONSISTS OF STANDARD CHARACTERS WITHOUT CLAIM TO ANY PARTICULAR FONT, STYLE, SIZE, OR COLOR.

NO CLAIM IS MADE TO THE EXCLUSIVE RIGHT TO USE "PRESCRIPTION BENEFITS", APART FROM THE MARK AS SHOWN.

SN 78-938,116, FILED 7-26-2006.

JEFFERY COWARD, EXAMINING ATTORNEY

**Int. Cl.: 35**

**Prior U.S. Cls.: 100, 101, and 102**

**United States Patent and Trademark Office**

**Reg. No. 3,469,726**

**Registered July 15, 2008**

**SERVICE MARK  
PRINCIPAL REGISTER**

**ADSHUFFLE**

H.D. VEST ADVANCED SYSTEMS, LLC (TEXAS  
LTD LIAB CO)  
300 DECKER DRIVE  
IRVING, TX 75062

FOR: ADVERTISING VIA ELECTRONIC MEDIA  
AND SPECIFICALLY THE INTERNET; DISSEMI-  
NATION OF ADVERTISING MATTER; PROMO-  
TION, ADVERTISING AND MARKETING OF ON-  
LINE WEBSITES, IN CLASS 35 (U.S. CLS. 100, 101  
AND 102).

FIRST USE 11-1-2006; IN COMMERCE 11-1-2006.

THE MARK CONSISTS OF STANDARD CHAR-  
ACTERS WITHOUT CLAIM TO ANY PARTICULAR  
FONT, STYLE, SIZE, OR COLOR.

SN 78-938,183, FILED 7-26-2006.

HEATHER THOMPSON, EXAMINING ATTORNEY

**Int. Cl.: 37**

**Prior U.S. Cls.: 100, 103, and 106**

**United States Patent and Trademark Office**

**Reg. No. 3,469,727**

**Registered July 15, 2008**

**SERVICE MARK  
PRINCIPAL REGISTER**

**comfort one**

SIMONSON, JACK (UNITED STATES INDIVIDUAL)  
111 WEST MAPLE, UNIT 1705  
CHICAGO, IL 60610

THE MARK CONSISTS OF STANDARD CHARACTERS WITHOUT CLAIM TO ANY PARTICULAR FONT, STYLE, SIZE, OR COLOR.

FOR: INSTALLATION AND MAINTENANCE OF HEATING AND AIR CONDITIONING SYSTEMS, IN CLASS 37 (U.S. CLS. 100, 103 AND 106).

SN 78-938,314, FILED 7-26-2006.

FIRST USE 5-31-2006; IN COMMERCE 5-31-2006.

JOHN WILKE, EXAMINING ATTORNEY

**Int. Cl.: 41**

**Prior U.S. Cls.: 100, 101, and 107**

**United States Patent and Trademark Office**

**Reg. No. 3,469,728**

**Registered July 15, 2008**

---

**SERVICE MARK  
PRINCIPAL REGISTER**

# Sea Of Glass

SZCZEPANIEC, AARON JOSEPH (UNITED STATES INDIVIDUAL)

4044 WEST GARDEN DRIVE

PHOENIX, AZ 85029 AND

FUSS, BRANDON LYNN (UNITED STATES INDIVIDUAL)

4044 WEST GARDEN DRIVE

PHOENIX, AZ 85029 AND

SZCZEPANIEC, CHELSEA SARAH (UNITED STATES INDIVIDUAL)

4044 WEST GARDEN DRIVE

PHOENIX, AZ 85029

FOR: ENTERTAINMENT, NAMELY, LIVE PERFORMANCES BY A MUSICAL BAND, IN CLASS 41 (U.S. CLS. 100, 101 AND 107).

FIRST USE 4-1-2004; IN COMMERCE 4-1-2004.

THE MARK CONSISTS OF STANDARD CHARACTERS WITHOUT CLAIM TO ANY PARTICULAR FONT, STYLE, SIZE, OR COLOR.

SN 78-938,514, FILED 7-26-2006.

KAPIL BHANOT, EXAMINING ATTORNEY

**Int. Cl.: 9**

**Prior U.S. Cls.: 21, 23, 26, 36, and 38**

**Reg. No. 3,469,729**

**United States Patent and Trademark Office**

**Registered July 15, 2008**

**TRADEMARK  
PRINCIPAL REGISTER**

**ACCOLADE**

EPSON AMERICA, INC. (CALIFORNIA CORPORATION)  
3840 KILROY AIRPORT WAY  
LONG BEACH, CA 90806

FOR: APPARATUS AND SYSTEMS FOR TRANSMITTING, REPRODUCING, AND PROJECTING IMAGES AND IMAGE DATA, NAMELY, HOME CINEMA SYSTEMS COMPRISED OF VARIOUS ELEMENTS, NAMELY, SURROUND SOUND SYSTEM SPEAKERS, SUBWOOFER AND AUDIO-VIDEO RECEIVER, AND A CONTROL BOX FOR CONTROLLING AUDIO SPEAKERS; JUNCTION SLEEVES AND WRAPS FOR ELECTRIC CABLES; ELECTRIC PROJECTION SCREEN, FRONT PROJECTOR; WIRELESS AUDIO TECHNOLOGY, NAMELY, WIRELESS SPEAKERS, HEADPHONES

AND RECEIVERS; WIRELESS VIDEO SENDER FOR SENDING VIDEO SIGNALS TO A FRONT PROJECTOR; AND FRONT PROJECTOR PROJECTION SCREENS, IN CLASS 9 (U.S. CLS. 21, 23, 26, 36 AND 38).

FIRST USE 9-0-2006; IN COMMERCE 9-0-2006.

THE MARK CONSISTS OF STANDARD CHARACTERS WITHOUT CLAIM TO ANY PARTICULAR FONT, STYLE, SIZE, OR COLOR.

SN 78-938,887, FILED 7-27-2006.

BERNICE MIDDLETON, EXAMINING ATTORNEY

**Int. Cl.: 42**

**Prior U.S. Cls.: 100 and 101**

**United States Patent and Trademark Office**

**Reg. No. 3,469,730**

**Registered July 15, 2008**

**SERVICE MARK  
PRINCIPAL REGISTER**

**PC DEFENDER**

TDS TELECOMMUNICATIONS CORPORATION  
(DELAWARE CORPORATION)  
525 JUNCTION ROAD  
MADISON, WI 53717

FOR: PROVIDING TEMPORARY USE OF NON-DOWNLOADABLE COMPUTER SOFTWARE FEATURING A SELECTABLE SUITE OF COMPUTER SECURITY SOFTWARE, IN CLASS 42 (U.S. CLS. 100 AND 101).

FIRST USE 2-28-2005; IN COMMERCE 6-10-2005.

THE MARK CONSISTS OF STANDARD CHARACTERS WITHOUT CLAIM TO ANY PARTICULAR FONT, STYLE, SIZE, OR COLOR.

NO CLAIM IS MADE TO THE EXCLUSIVE RIGHT TO USE "PC", APART FROM THE MARK AS SHOWN.

SN 78-939,034, FILED 7-27-2006.

ATTIYA MALIK, EXAMINING ATTORNEY

**Int. Cls.: 16, 25, and 41**

**Prior U.S. Cls.: 2, 5, 22, 23, 29, 37, 38, 39, 50, 100, 101,  
and 107**

**Reg. No. 3,469,731**

**United States Patent and Trademark Office**

**Registered July 15, 2008**

**TRADEMARK  
SERVICE MARK  
PRINCIPAL REGISTER**

# TRUCK OFF

TIRE MART, INC. (MISSOURI CORPORATION)  
1815 LOCUST STREET  
ST. LOUIS, MO 63103

FOR: DECALS, IN CLASS 16 (U.S. CLS. 2, 5, 22, 23,  
29, 37, 38 AND 50).

FIRST USE 10-0-2006; IN COMMERCE 10-0-2006.

FOR: CLOTHING, NAMELY, BATHING SUITS,  
BELTS, GLOVES, HATS, JACKETS, NECKTIES, PA-  
JAMAS, PANTS, SHIRTS, SHOES, SHORTS, SOCKS,  
SLIPPERS, SWEAT BANDS, AND UNDERGAR-  
MENTS, IN CLASS 25 (U.S. CLS. 22 AND 39).

FIRST USE 10-0-2006; IN COMMERCE 10-0-2006.

FOR: ENTERTAINMENT SERVICES, NAMELY,  
ARRANGING AND CONDUCTING CONTESTS;  
ENTERTAINMENT SERVICES, NAMELY, PROVID-

ING ACCESS TO ON-LINE, NON-DOWNLOAD-  
ABLE VIDEOS FEATURING TRUCKS AND OFF-  
ROAD VEHICLES; ENTERTAINMENT IN THE  
NATURE OF ON-GOING TELEVISION SHOWS  
FEATURING TRUCKS AND OFF-ROAD VEHI-  
CLES, IN CLASS 41 (U.S. CLS. 100, 101 AND 107).

FIRST USE 10-0-2006; IN COMMERCE 10-0-2006.

THE MARK CONSISTS OF STANDARD CHAR-  
ACTERS WITHOUT CLAIM TO ANY PARTICULAR  
FONT, STYLE, SIZE, OR COLOR.

NO CLAIM IS MADE TO THE EXCLUSIVE  
RIGHT TO USE "TRUCK", APART FROM THE  
MARK AS SHOWN.

SN 78-939,159, FILED 7-27-2006.

JOHN WILKE, EXAMINING ATTORNEY

**Int. Cl.: 41**

**Prior U.S. Cls.: 100, 101, and 107**

**United States Patent and Trademark Office**

**Reg. No. 3,469,732**

**Registered July 15, 2008**

**SERVICE MARK  
PRINCIPAL REGISTER**

TRUE COMPATIBILITY CONTROL

TRUEBEGINNINGS, LLC (TEXAS LTD LIAB CO)  
300 DECKER DRIVE  
IRVING, TX 75039

FOR: PERSONAL COACHING SERVICES IN THE  
FIELDS OF DATING, COMPATIBILITY, SOCIAL  
RELATIONSHIPS, PERSONAL IMPROVEMENT,  
SELF-DEVELOPMENT AND SELF AWARENESS,  
IN CLASS 41 (U.S. CLS. 100, 101 AND 107).

FIRST USE 10-1-2006; IN COMMERCE 10-1-2006.

THE MARK CONSISTS OF STANDARD CHAR-  
ACTERS WITHOUT CLAIM TO ANY PARTICULAR  
FONT, STYLE, SIZE, OR COLOR.

OWNER OF U.S. REG. NOS. 2,971,875, 3,043,738,  
AND OTHERS.

NO CLAIM IS MADE TO THE EXCLUSIVE  
RIGHT TO USE "COMPATIBILITY CONTROL",  
APART FROM THE MARK AS SHOWN.

SN 78-939,754, FILED 7-28-2006.

HEATHER THOMPSON, EXAMINING ATTORNEY



**Int. Cls.: 36 and 37**

**Prior U.S. Cls.: 100, 101, 102, 103, and 106**

**United States Patent and Trademark Office**

**Reg. No. 3,469,733**

**Registered July 15, 2008**

**SERVICE MARK  
PRINCIPAL REGISTER**

**MEDINA**  
REALTY, INC

MEDINA REALTY, INC (NEW JERSEY CORPORATION)  
20-24 BRANFORD PLACE  
SUITE 708  
NEWARK, NJ 07102

FOR: REAL ESTATE BROKERAGE; REAL ESTATE EQUITY SHARING, NAMELY, MANAGING AND ARRANGING FOR CO-OWNERSHIP OF REAL ESTATE; REAL ESTATE MANAGEMENT , IN CLASS 36 (U.S. CLS. 100, 101 AND 102).

FIRST USE 8-1-2006; IN COMMERCE 8-1-2006.

FOR: REAL ESTATE DEVELOPMENT, IN CLASS 37 (U.S. CLS. 100, 103 AND 106).

FIRST USE 8-1-2006; IN COMMERCE 8-1-2006.

NO CLAIM IS MADE TO THE EXCLUSIVE RIGHT TO USE "REALTY, INC", APART FROM THE MARK AS SHOWN.

THE COLOR(S) RED, WHITE AND BLUE IS/ARE CLAIMED AS A FEATURE OF THE MARK.

THE MARK CONSISTS OF A STYLIZED WORD OF "MEDINA" IN THE COLOR RED AND THE WORDING OF "REALTY, INC" IN THE COLOR BLUE. THE COLOR WHITE APPEARS IN THE BACKGROUND OF THE MARK.

SN 78-940,592, FILED 7-29-2006.

JILL C. ALT, EXAMINING ATTORNEY

**Int. Cl.: 12**

**Prior U.S. Cls.: 19, 21, 23, 31, 35, and 44**

**Reg. No. 3,469,734**

**United States Patent and Trademark Office**

**Registered July 15, 2008**

---

**TRADEMARK  
PRINCIPAL REGISTER**

**SPECTRUM INDEPENDENCE**

SPECTRUM AERONAUTICAL, LLC (DELA-  
WARE CORPORATION)  
2036 PALOMAR AIRPORT ROAD  
CARLSBAD, CA 92011

FOR: MANNED AIRCRAFT MADE OF COMPO-  
SITE MATERIALS AND POWERED BY FAN-JETS  
FOR TRANSPORTING PASSENGERS, IN CLASS 12  
(U.S. CLS. 19, 21, 23, 31, 35 AND 44).

FIRST USE 11-1-2005; IN COMMERCE 11-1-2005.

THE MARK CONSISTS OF STANDARD CHAR-  
ACTERS WITHOUT CLAIM TO ANY PARTICULAR  
FONT, STYLE, SIZE, OR COLOR.

OWNER OF U.S. REG. NOS. 2,285,876, 2,672,382,  
AND 2,753,408.

SN 78-940,739, FILED 7-30-2006.

RONALD AIKENS, EXAMINING ATTORNEY

**Int. Cl.: 11**

**Prior U.S. Cls.: 13, 21, 23, 31, and 34**

**United States Patent and Trademark Office**

**Reg. No. 3,469,735**

**Registered July 15, 2008**

**TRADEMARK  
PRINCIPAL REGISTER**

**AIR-O-SPEED**

AKTIEBOLAGET ELECTROLUX (SWEDEN CORPORATION)  
S:T GORANSGATAN, 143  
SE-105 45 STOCKHOLM, SWEDEN

FOR: COMMERCIAL FOOD SERVICE EQUIPMENT FOR HEATING, STEAMING, COOKING AND REFRIGERATING FOOD, NAMELY, COOKING OVENS, ELECTRIC CABINETS USED TO CONTROL TEMPERATURE AND HUMIDITY FOR HEATING AND THAWING FOODS; ELECTRIC FOOD STEAMERS, IN CLASS 11 (U.S. CLS. 13, 21, 23, 31 AND 34).

FIRST USE 7-0-2006; IN COMMERCE 7-0-2006.

THE MARK CONSISTS OF STANDARD CHARACTERS WITHOUT CLAIM TO ANY PARTICULAR FONT, STYLE, SIZE, OR COLOR.

SN 78-940,813, FILED 7-31-2006.

RUDY R. SINGLETON, EXAMINING ATTORNEY

**Int. Cl.: 29**

**Prior U.S. Cl.: 46**

**United States Patent and Trademark Office**

**Reg. No. 3,469,736**

**Registered July 15, 2008**

**TRADEMARK  
PRINCIPAL REGISTER**

**CARNICERIA**

HORMEL FOODS, LLC (MINNESOTA LTD LIAB  
CO)  
1 HORMEL PLACE  
AUSTIN, MN 55912

FOR: MARINATED FRESH MEATS, NAMELY,  
BEEF, PORK AND POULTRY, IN CLASS 29 (U.S. CL.  
46).

FIRST USE 10-26-2007; IN COMMERCE 10-26-2007.

THE MARK CONSISTS OF STANDARD CHAR-  
ACTERS WITHOUT CLAIM TO ANY PARTICULAR  
FONT, STYLE, SIZE, OR COLOR.

THE FOREIGN WORDING IN THE MARK  
TRANSLATES INTO ENGLISH AS "MEAT MAR-  
KET" OR "BUTCHER SHOP".

SN 78-940,819, FILED 7-31-2006.

NICHOLAS ALTREE, EXAMINING ATTORNEY

**Int. Cl.: 28**

**Prior U.S. Cls.: 22, 23, 38, and 50**

**United States Patent and Trademark Office**

**Reg. No. 3,469,737**

**Registered July 15, 2008**

**TRADEMARK  
PRINCIPAL REGISTER**

**HARTZ TRASHCAN TREATS**

THE HARTZ MOUNTAIN CORPORATION (NEW  
JERSEY CORPORATION)  
400 PLAZA DRIVE  
SECAUCUS, NJ 07094

FOR: PET TOYS, IN CLASS 28 (U.S. CLS. 22, 23, 38  
AND 50).

FIRST USE 3-0-2005; IN COMMERCE 3-0-2005.

THE MARK CONSISTS OF STANDARD CHAR-  
ACTERS WITHOUT CLAIM TO ANY PARTICULAR  
FONT, STYLE, SIZE, OR COLOR.

OWNER OF U.S. REG. NOS. 782,948, 943,059, AND  
OTHERS.

NO CLAIM IS MADE TO THE EXCLUSIVE  
RIGHT TO USE "TREATS", APART FROM THE  
MARK AS SHOWN.

SN 78-941,582, FILED 7-31-2006.

LESLEY LAMOTHE, EXAMINING ATTORNEY

**Int. Cl.: 38**

**Prior U.S. Cls.: 100, 101, and 104**

**United States Patent and Trademark Office**

**Reg. No. 3,469,738**

**Registered July 15, 2008**

**SERVICE MARK  
PRINCIPAL REGISTER**

**TV Y NOVELAS**

EDITORIAL TELEVISA INTERNATIONAL, S.A.  
(MEXICO CORPORATION)  
EDIFICIO E, PISO 2  
AVENIDA VASCO DE QUIROGA 2000  
COLONIA ZEDEC SANTA FE, MEXICO, D.F., MEX-  
ICO 01210

FOR: TELEPHONE TELECOMMUNICATIONS  
SERVICES PROVIDED VIA PREPAID TELEPHONE  
CALLING CARDS , IN CLASS 38 (U.S. CLS. 100, 101  
AND 104).

FIRST USE 12-31-2006; IN COMMERCE 12-31-2006.

THE MARK CONSISTS OF STANDARD CHAR-  
ACTERS WITHOUT CLAIM TO ANY PARTICULAR  
FONT, STYLE, SIZE, OR COLOR.

OWNER OF U.S. REG. NO. 1,264,926.

THE FOREIGN WORDING IN THE MARK  
TRANSLATES INTO ENGLISH AS "TV AND STOR-  
IES".

SN 78-941,783, FILED 7-31-2006.

JACLYN KIDWELL, EXAMINING ATTORNEY

**Int. Cl.: 3**

**Prior U.S. Cls.: 1, 4, 6, 50, 51, and 52**

**Reg. No. 3,469,739**

**United States Patent and Trademark Office**

**Registered July 15, 2008**

**TRADEMARK  
PRINCIPAL REGISTER**



CEFINE CO., LTD. (JAPAN CORPORATION)  
SHINJUKU 2-CHOME, SHINJUKU-KU  
3F SHINJUKU-SEVEN BUILDING, 8-1  
TOKYO, JAPAN

FIRST USE 2-18-1994; IN COMMERCE 7-0-2004.

OWNER OF JAPAN REG. NO. 3370755, DATED 11-13-1998, EXPIRES 11-13-2008.

FOR: SOAPS; PERFUMERY; ESSENTIAL OILS;  
COSMETICS; HAIR LOTIONS; AND DENTIFRICES,  
IN CLASS 3 (U.S. CLS. 1, 4, 6, 50, 51 AND 52).

SN 78-941,891, FILED 8-1-2006.

MARK SPARACINO, EXAMINING ATTORNEY

**Int. Cl.: 25**

**Prior U.S. Cls.: 22 and 39**

**United States Patent and Trademark Office**

**Reg. No. 3,469,740**

**Registered July 15, 2008**

**TRADEMARK  
PRINCIPAL REGISTER**

**RESPECT THE CULTURE**

MAUI BUILT, INC. (HAWAII CORPORATION)  
261 DAIRY ROAD  
KAHULUI, HI 96732

THE MARK CONSISTS OF STANDARD CHAR-  
ACTERS WITHOUT CLAIM TO ANY PARTICULAR  
FONT, STYLE, SIZE, OR COLOR.

FOR: BEACHWEAR; CAPS; JACKETS; PANTS;  
SHIRTS; SHOES; SHORTS; SOCKS; SWEAT PANTS;  
SWEAT SHIRTS, IN CLASS 25 (U.S. CLS. 22 AND 39).

SN 78-942,258, FILED 8-1-2006.

FIRST USE 11-1-2007; IN COMMERCE 11-1-2007.

KEVIN CORWIN, EXAMINING ATTORNEY



**Int. Cl.: 35**

**Prior U.S. Cls.: 100, 101, and 102**

**United States Patent and Trademark Office**

**Reg. No. 3,469,741**

**Registered July 15, 2008**

**SERVICE MARK  
PRINCIPAL REGISTER**

**STRATECHEM**

STRATECHEM, LLC (NEW MEXICO LTD LIAB  
CO)  
433 PASEO DE PERALTA  
SANTA FE, NM 87501

FOR: WHOLESALE DISTRIBUTORSHIP SERVI-  
CES IN THE FIELD OF WOOD PRESERVATIVES,  
TERMITICIDES, FUNGICIDES, PESTICIDES, AND  
INSECTICIDES, IN CLASS 35 (U.S. CLS. 100, 101 AND  
102).

FIRST USE 5-1-2008; IN COMMERCE 5-1-2008.

THE MARK CONSISTS OF STANDARD CHAR-  
ACTERS WITHOUT CLAIM TO ANY PARTICULAR  
FONT, STYLE, SIZE, OR COLOR.

SN 78-942,395, FILED 8-1-2006.

VERNA BETH RIRIE, EXAMINING ATTORNEY

**Int. Cl.: 5**

**Prior U.S. Cls.: 6, 18, 44, 46, 51, and 52**

**United States Patent and Trademark Office**

**Reg. No. 3,469,742**

**Registered July 15, 2008**

**TRADEMARK  
PRINCIPAL REGISTER**

**MENICARE**

MENICON CO., LTD. (JAPAN CORPORATION)  
21-19, AOI 3-CHOME, NAKA-KU  
NAGOYA-SHI, AICHI-KEN, JAPAN

FOR: CONTACT LENS CARE PRODUCTS,  
NAMELY, CLEANING SOLUTION FOR CONTACT  
LENS, PRESERVATIVE SOLUTION FOR CONTACT  
LENS, STERILIZING SOLUTION FOR CONTACT  
LENS, RINSING SOLUTION FOR CONTACT LENS  
AND NEUTRALIZING SOLUTION FOR CONTACT  
LENS; EYE DROPS; AND EYE WASHES, IN CLASS 5  
(U.S. CLS. 6, 18, 44, 46, 51 AND 52).

FIRST USE 9-1-2006; IN COMMERCE 9-1-2006.

THE MARK CONSISTS OF STANDARD CHAR-  
ACTERS WITHOUT CLAIM TO ANY PARTICULAR  
FONT, STYLE, SIZE, OR COLOR.

OWNER OF U.S. REG. NOS. 1,110,441, 2,360,582,  
AND OTHERS.

NO CLAIM IS MADE TO THE EXCLUSIVE  
RIGHT TO USE "CARE", APART FROM THE MARK  
AS SHOWN.

SN 78-942,756, FILED 8-2-2006.

PAUL E. FAHRENKOPF, EXAMINING ATTORNEY

**Int. Cls.: 35 and 40**

**Prior U.S. Cls.: 100, 101, 102, 103, and 106**

**United States Patent and Trademark Office**

**Reg. No. 3,469,743**

**Registered July 15, 2008**

**SERVICE MARK  
PRINCIPAL REGISTER**

**PEOPLESUPPORT  
TRANSCRIPTION AND  
CAPTIONING**

PEOPLESUPPORT, INC. (DELAWARE CORPORATION)  
1100 GLENDON AVE., SUITE 1250  
LOS ANGELES, CA 90024

FOR: TRANSCRIPTION SERVICES, NAMELY, MESSAGE AND RECORDED BROADCAST TRANSCRIPTION SERVICES, AND MEDICAL RECORD TRANSCRIPTION SERVICES, IN CLASS 35 (U.S. CLS. 100, 101 AND 102).

FIRST USE 12-31-2006; IN COMMERCE 12-31-2006.

FOR: CLOSED CAPTIONING SERVICES, NAMELY, CLOSED CAPTIONING SERVICES FOR FILMS, VIDEOS AND TELEVISION BROADCASTS, IN CLASS 40 (U.S. CLS. 100, 103 AND 106).

FIRST USE 12-31-2006; IN COMMERCE 12-31-2006.

THE MARK CONSISTS OF STANDARD CHARACTERS WITHOUT CLAIM TO ANY PARTICULAR FONT, STYLE, SIZE, OR COLOR.

OWNER OF U.S. REG. NOS. 2,357,206, 2,630,035, AND OTHERS.

NO CLAIM IS MADE TO THE EXCLUSIVE RIGHT TO USE "TRANSCRIPTION AND CAPTIONING", APART FROM THE MARK AS SHOWN.

SN 78-942,844, FILED 8-2-2006.

G. MAYERSCHOFF, EXAMINING ATTORNEY

**Int. Cl.: 36**

**Prior U.S. Cls.: 100, 101, and 102**

**United States Patent and Trademark Office**

**Reg. No. 3,469,744**

**Registered July 15, 2008**

**SERVICE MARK  
PRINCIPAL REGISTER**

**PEOPLESUPPORT ACCOUNTS  
RECEIVABLE MANAGEMENT**

PEOPLESUPPORT, INC. (DELAWARE CORPORATION)  
1100 GLENDON AVE., SUITE 1250  
LOS ANGELES, CA 90024

FOR: DEBT COLLECTION SERVICES, IN CLASS 36 (U.S. CLS. 100, 101 AND 102).

FIRST USE 12-31-2006; IN COMMERCE 12-31-2006.

THE MARK CONSISTS OF STANDARD CHARACTERS WITHOUT CLAIM TO ANY PARTICULAR FONT, STYLE, SIZE, OR COLOR.

OWNER OF U.S. REG. NOS. 2,357,206, 2,630,035, AND OTHERS.

NO CLAIM IS MADE TO THE EXCLUSIVE RIGHT TO USE "ACCOUNTS RECEIVABLE MANAGEMENT", APART FROM THE MARK AS SHOWN.

SN 78-942,854, FILED 8-2-2006.

G. MAYERSCHOFF, EXAMINING ATTORNEY

**Int. Cl.: 12**

**Prior U.S. Cls.: 19, 21, 23, 31, 35, and 44**

**Reg. No. 3,469,745**

**United States Patent and Trademark Office**

**Registered July 15, 2008**

**TRADEMARK  
PRINCIPAL REGISTER**

# MAZIORA

NIPPON PAINT KABUSHIKI KAISHA (NIPPON PAINT CO., LTD.) (JAPAN CORPORATION)  
2-1-2, OYODO-KITA, KITA-KU  
OSAKA, JAPAN

FOR: AEROPLANES, AIR BALLOONS, AIR CUSHION VEHICLES, AIR PUMPS FOR AUTOMOBILES, AIR VEHICLES, AIRCRAFT, AIRSHIPS, AMPHIBIOUS AIRPLANES, AUTOMOBILE BODIES, AUTOMOBILE CHASSIS, AUTOMOBILES, BABY CARRIAGES, BICYCLE FRAMES, BICYCLE HANDLE BARS, BICYCLE PUMPS, BICYCLES, BOATS, BODIES FOR VEHICLES, BUMPERS FOR AUTOMOBILES, CABLE TRANSPORT APPARATUS AND INSTALLATIONS, VEHICLES, NAMELY, CAISSONS, CAMPING CARS, CARAVANS, CARRIER TRICYCLES, CARS, CARS FOR CABLE TRANSPORT INSTALLATIONS, CARTS, CLEANING TROLLEYS, CONCRETE MIXING VEHICLES, CYCLE CARS, CYCLE FRAMES, CYCLE HANDLE BARS, CYCLE MUDGUARDS, CYCLE PUMPS, CYCLES, DELIVERY TRICYCLES, DINING CARRIAGES, DINING CARS, DINNER WAGONS, DIRECTION INDICATORS FOR BICYCLES, DIRECTION INDICATORS FOR CARS, DIRECTION INDICATORS FOR CYCLES, DIRIGIBLE BALLOONS, ELECTRIC VEHICLES, MOTORIZED ELEVATING TAILGATES, FERRY BOATS, FORK LIFT TRUCKS, FUNICULARS, GOLF CARTS, GOOD HANDLING CARTS, HAND CARS, HOODS FOR VEHICLE ENGINES, HORNS FOR VEHICLES, JET ENGINES FOR LAND VEHICLES, KICK SLEDGES, LADLE CARRIAGES, LADLE CARS, LAUNCHES, LIFTING CARS, LOCOMOTIVES, LORRIES, LUGGAGE CARRIERS FOR VEHICLES, LUGGAGE TRUCKS, MILITARY VEHICLES FOR TRANSPORT, MOTOR BUSES, MOTOR CARS, MOTOR COACHES, MOTOR HOMES, MOTORCYCLES, MUDGUARDS, OARS, OMNIBUSES, PADDLES FOR CANOES, PEDALS FOR CYCLES, MOTORIZED POWER TAILGATES AND PARTS FOR LAND VEHICLES, PUSHCHAIRS, REARVIEW MIRRORS, REFRIGERATED VEHICLES,

RAILROAD VEHICLES, NAMELY, REFRIGERATED WAGONS, NON-TOY REMOTE CONTROL VEHICLES, RIMS FOR WHEELS OF BICYCLES, RIMS FOR WHEELS OF CYCLES, ROLLING STOCK FOR FUNICULAR RAILWAYS, ROLLING STOCK FOR RAILWAYS, SADDLES FOR BICYCLES, SADDLES FOR CYCLES, SADDLES FOR MOTORCYCLES, SHIPS, SHIPS' HULLS, SHOCK ABSORBERS FOR AUTOMOBILES, SHOCK ABSORBERS FOR VEHICLES, SHOCK ABSORBING SPRINGS FOR VEHICLES, SHOPPING TROLLEYS, ALSO KNOWN AS SHOPPING CARTS, SIDE CARS, SKI CARRIERS FOR CARS, SKI LIFTS, SLEEPING CARS, SLEIGHS, SNOWMOBILES, SPACE VEHICLES, SPOKES FOR BICYCLES, SPOKES FOR CYCLES, SPORTS CARS, SPRINKLING TRUCKS, PARTS OF BICYCLES, NAMELY, STANDS FOR BICYCLES, PARTS OF CYCLES, NAMELY, STANDS FOR CYCLES, STEERING GEARS FOR SHIPS, STEERING WHEELS FOR VEHICLES, STERN OARS, STROLLERS, SUSPENSION FOR VEHICLES, TELPHER RAILWAYS ALSO KNOWN AS CABLE CARS, TILTING CARTS, TRACTION ENGINES, TRACTORS, VEHICLE TRAILERS, TRAINCARS AND TRAMCARS, ROLLER BELTS, NAMELY, TREADS FOR VEHICLES, TREADS FOR VEHICLES, SPECIFICALLY, TRACTORS, TRICYCLES, TROLLEYS, TRUCKS, TWO-WHEELED TROLLEYS, UNDERCARRIAGES FOR VEHICLES, VANS, VEHICLE CHASSIS, SHAPED VEHICLE COVERS, VEHICLE RUNNING BOARDS, VEHICLE SUSPENSION SPRINGS, VEHICLE WHEEL RIMS, VEHICLE WHEEL SPOKES, VEHICLE WHEELS, VEHICLES FOR LOCOMOTION BY AIR, VEHICLES FOR LOCOMOTION BY LAND, VEHICLES FOR LOCOMOTION BY RAIL, VEHICLES FOR LOCOMOTION BY WATER, WAGONS, WATER VEHICLES, WHEELBARROWS, WHEELCHAIRS, WHEELS FOR BICYCLES, WHEELS FOR CYCLES, WINDSCREEN WIPERS, WINDSHIELD WIPERS, YACHTS, IN CLASS 12 (U.S. CLS. 19, 21, 23, 31, 35 AND 44).

FIRST USE 4-0-2006; IN COMMERCE 4-0-2006.

OWNER OF U.S. REG. NO. 3,036,477.

THE MARK CONSISTS OF STANDARD CHARACTERS WITHOUT CLAIM TO ANY PARTICULAR FONT, STYLE, SIZE, OR COLOR.

SN 78-943,422, FILED 8-2-2006.

RONALD AIKENS, EXAMINING ATTORNEY

**Int. Cls.: 9 and 16**

**Prior U.S. Cls.: 2, 5, 21, 22, 23, 26, 29, 36, 37, 38, and 50**

**Reg. No. 3,469,746**

**United States Patent and Trademark Office**

**Registered July 15, 2008**

**TRADEMARK  
PRINCIPAL REGISTER**



**Relationship Publications**

SHARON GERSTENZANG (UNITED STATES INDIVIDUAL)  
10101 SLATER AVE, SUITE 205  
FOUNTAIN VALLEY, CA 92708

FOR: CDS, DVDS, AUDIO TAPES, ALL FEATURING MENTAL HEALTH COUNSELING, IN CLASS 9 (U.S. CLS. 21, 23, 26, 36 AND 38).

FIRST USE 6-3-2008; IN COMMERCE 6-3-2008.

FOR: BOOKS FEATURING MENTAL HEALTH COUNSELING, IN CLASS 16 (U.S. CLS. 2, 5, 22, 23, 29, 37, 38 AND 50).

FIRST USE 6-3-2008; IN COMMERCE 6-3-2008.

NO CLAIM IS MADE TO THE EXCLUSIVE RIGHT TO USE "PUBLICATIONS", APART FROM THE MARK AS SHOWN.

SN 78-943,999, FILED 8-3-2006.

KELLY BOULTON, EXAMINING ATTORNEY

**Int. Cl.: 45**

**Prior U.S. Cls.: 100 and 101**

**United States Patent and Trademark Office**

**Reg. No. 3,469,747**

**Registered July 15, 2008**

**SERVICE MARK  
PRINCIPAL REGISTER**

**LIFE IS ALL ABOUT CHOICES**

**SAFETY CONNECTIONS, INC. (WISCONSIN  
CORPORATION)  
1911 KAAT LANE  
SHEBOYGAN, WI 53081**

**FOR: CONSULTATION SERVICES IN THE FIELD  
OF THE SAFETY NEEDS OF COMMERCIAL AND  
INDUSTRIAL COMPANIES, IN CLASS 45 (U.S. CLS.  
100 AND 101).**

**FIRST USE 2-12-2007; IN COMMERCE 2-12-2007.**

**THE MARK CONSISTS OF STANDARD CHAR-  
ACTERS WITHOUT CLAIM TO ANY PARTICULAR  
FONT, STYLE, SIZE, OR COLOR.**

**SN 78-944,186, FILED 8-3-2006.**

**DOMINIC J. FERRAIUOLO, EXAMINING ATTOR-  
NEY**



**Int. Cl.: 15**

**Prior U.S. Cls.: 2, 21, and 36**

**United States Patent and Trademark Office**

**Reg. No. 3,469,748**

**Registered July 15, 2008**

**TRADEMARK  
PRINCIPAL REGISTER**

The logo for 'Koncepts' features a stylized, bold letter 'K' on the left. The 'K' is formed by a thick vertical bar and a diagonal bar that extends downwards and to the left. To the right of the 'K', the word 'oncepts' is written in a bold, lowercase, sans-serif font.

THE SINGING MACHINE COMPANY, INC. (DE-  
LAWARE CORPORATION)  
BUILDING A-7  
6601 LYONS ROAD  
COCONUT CREEK, FL 33073

FOR: MUSICAL INSTRUMENTS AND MUSICAL  
INSTRUMENT ACCESSORIES, NAMELY, ELEC-  
TRIC AND ACOUSTIC GUITARS, ELECTRIC AND  
ACOUSTIC DRUMS AND KEYBOARDS , IN CLASS  
15 (U.S. CLS. 2, 21 AND 36).

FIRST USE 8-1-2006; IN COMMERCE 8-1-2006.

THE MARK CONSISTS OF A STYLIZED "K" AS  
THE FIRST LETTER OF THE WORD USED IN THE  
MARK.

SN 78-944,234, FILED 8-3-2006.

ALICIA COLLINS, EXAMINING ATTORNEY

Int. Cl.: 33

Prior U.S. Cls.: 47 and 49

United States Patent and Trademark Office

Reg. No. 3,469,749

Registered July 15, 2008

TRADEMARK  
PRINCIPAL REGISTER

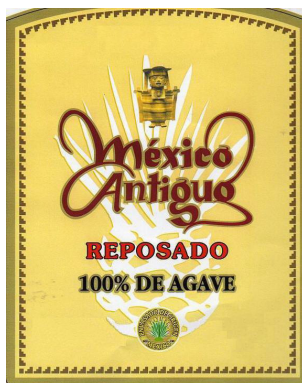

FABRICA DE AGUARDIENTES DE AGAVE LA MEXICANA SA DE CV (MEXICO CORPORATION)  
RANCHO LLANO GRANDE KM. 2.5  
ARANDAS, MEXICO 44680

FOR: TEQUILA, IN CLASS 33 (U.S. CLS. 47 AND 49).

FIRST USE 9-20-2007; IN COMMERCE 9-20-2007.

NO CLAIM IS MADE TO THE EXCLUSIVE RIGHT TO USE "MEXICO REPOSADO 100% DE AGAVE ENVASADO DE ORIGEN", APART FROM THE MARK AS SHOWN.

THE COLOR(S) GOLD, YELLOW, BLACK, BROWN, WHITE, GREEN AND RED IS/ARE CLAIMED AS A FEATURE OF THE MARK.

THE MARK CONSISTS OF THE COLOR YELLOW APPEARS IN THE BACKGROUND RECTANGLE DESIGN WITH GOLD BORDER AND A GOLD

FIGURE ABOVE THE WORDING "MEXICO ANTIGUO" APPEARING IN BROWN LETTERING WITH GOLD OUTLINE ABOVE THE WORDING "REPOSADO" APPEARING IN RED WITH BLACK OUTLINING ABOVE THE WORDING "100% DE AGAVE" ABOVE A GOLD CIRCLE DESIGN CONTAINING A GREEN AGAVE PLANT WITH THE WORDING "ENVASADO DE ORIGEN MEXICO" IN GOLD WITH BLACK OUTLINING AROUND THE EDGES, ALL APPEARING OVER THE WHITE DESIGN OF AN AGAVE PLANT.

THE FOREIGN WORDING IN THE MARK TRANSLATES INTO ENGLISH AS "MEXICO ANTIGUO" MEANS ANCIENT MEXICO "REPOSADO" MEANS RESTED "DE AGAVE" MEANS OF AGAVE AND "ENVASADO DE ORIGEN" MEANS PACKAGED AT THE SOURCE.

SN 78-944,496, FILED 8-3-2006.

BARBARA BROWN, EXAMINING ATTORNEY

**Int. Cl.: 30**

**Prior U.S. Cl.: 46**

**United States Patent and Trademark Office**

**Reg. No. 3,469,750**

**Registered July 15, 2008**

**TRADEMARK  
PRINCIPAL REGISTER**

**TRILOGY**

GOLDEN STAR TRADING, INC. (CALIFORNIA  
CORPORATION)  
2370 CRENSHAW BLVD., STE. M  
TORRANCE, CA 90501

THE MARK CONSISTS OF STANDARD CHAR-  
ACTERS WITHOUT CLAIM TO ANY PARTICULAR  
FONT, STYLE, SIZE, OR COLOR.

FOR: JASMINE RICE, IN CLASS 30 (U.S. CL. 46).

SN 78-944,716, FILED 8-3-2006.

FIRST USE 7-10-2006; IN COMMERCE 9-25-2006.

HEATHER THOMPSON, EXAMINING ATTORNEY

**Int. Cl.: 35**

**Prior U.S. Cls.: 100, 101, and 102**

**United States Patent and Trademark Office**

**Reg. No. 3,469,751**

**Registered July 15, 2008**

**SERVICE MARK  
PRINCIPAL REGISTER**

**THE VOICE OF HUMANITY**

AMERICAN HUMANE ASSOCIATION (D.C.  
CORPORATION)  
63 INVERNESS DRIVE  
ENGLEWOOD, CO 801125117

FOR: PROMOTING PUBLIC AWARENESS OF  
THE NEED FOR PROPER CARE OF CHILDREN,  
HUMANE TREATMENT OF ANIMALS, KINDNESS  
AND COMPASSION FOR ANIMALS AND CHIL-  
DREN; PROMOTING PUBLIC AWARENESS OF  
THE NEED TO ADVOCATE ON BEHALF OF CHIL-  
DREN AND ANIMALS, IN CLASS 35 (U.S. CLS. 100,  
101 AND 102).

FIRST USE 4-1-2008; IN COMMERCE 4-1-2008.

THE MARK CONSISTS OF STANDARD CHAR-  
ACTERS WITHOUT CLAIM TO ANY PARTICULAR  
FONT, STYLE, SIZE, OR COLOR.

SN 78-944,723, FILED 8-3-2006.

GINA HAYES, EXAMINING ATTORNEY

**Int. Cl.: 37**

**Prior U.S. Cls.: 100, 103, and 106**

**United States Patent and Trademark Office**

**Reg. No. 3,469,752**

**Registered July 15, 2008**

**SERVICE MARK  
PRINCIPAL REGISTER**

**HOMELAND RESTORATION  
NETWORK**

THE SERGIO CORPORATION (INDIANA CORPORATION)  
1919 S. MICHIGAN STREET  
SOUTH BEND, IN 46613

FOR: COMMERCIAL, RESIDENTIAL, AND DISASTER RESTORATION SERVICES, NAMELY, RESTORING BUILDING EXTERIORS, INTERIORS, CARPET, FURNISHINGS, AND DOCUMENTS DAMAGED BY FIRE, FLOOD, AND OTHER DISASTERS, IN CLASS 37 (U.S. CLS. 100, 103 AND 106).

FIRST USE 11-15-2006; IN COMMERCE 11-15-2006.

THE MARK CONSISTS OF STANDARD CHARACTERS WITHOUT CLAIM TO ANY PARTICULAR FONT, STYLE, SIZE, OR COLOR.

NO CLAIM IS MADE TO THE EXCLUSIVE RIGHT TO USE "RESTORATION NETWORK", APART FROM THE MARK AS SHOWN.

SN 78-945,750, FILED 8-5-2006.

LINDA ORNDORFF, EXAMINING ATTORNEY

Int. Cl.: 41

Prior U.S. Cls.: 100, 101, and 107

United States Patent and Trademark Office

Reg. No. 3,469,753

Registered July 15, 2008

**SERVICE MARK  
PRINCIPAL REGISTER**



DAVILA, JULIA G. (UNITED STATES INDIVIDUAL)  
81-12 ROOSEVELT AVENUE SUITE 303  
JACKSON HEIGHTS, NY 11372

FOR: AMUSEMENT CENTERS; AMUSEMENT PARKS; CINEMA STUDIOS; CINEMA THEATERS; COMPOSITION OF MUSIC FOR OTHERS; CONCERT BOOKING; CONDUCTING ENTERTAINMENT, EXHIBITIONS IN THE NATURE OF SERENADES, MUSICAL PRESENTATIONS BY ARTISTS, BANDS, CLOWNS; CASINOS; CHILDREN'S ENTERTAINMENT AND AMUSEMENT CENTERS; ARRANGING FOR TICKETS RESERVATIONS FOR SHOWS AND OTHER ENTERTAINMENT EVENTS; ARRANGING OF EXHIBITIONS, SEMINARS AND CONFERENCES; AUDIO RECORDING AND PRODUCTION; BOOKING OF ENTERTAINMENT HALLS; BOOKING OF SEATS FOR SHOWS AND BOOKING OF THEATER TICKETS; CABARETS, IN CLASS 41 (U.S. CLS. 100, 101 AND 107).

FIRST USE 10-26-2007; IN COMMERCE 1-1-2008.

THE COLOR(S) BLACK, BLUE (CYAN 100% MAGENTA 20%), GRAY, WHITE IS/ARE CLAIMED AS A FEATURE OF THE MARK.

THE MARK CONSISTS OF A BLUE SPHERE, WITH A CRESCENT MOON, SHADE ON ITS BASE SHADING TOWARDS THE FACES AND WORDS

"SERENATA FANTASY". ENGLISH TRANSLATION FOR THE WORD SERENATA IS SERENADE. PROFILE OF WOMAN'S FACE IS IN THE INTERIOR CURVE OF LIGHT GREY CRESCENT MOON OUTLINED IN THIN BLACK LINE, FACING UP AND RIGHT. A MAN'S PROFILE IS IN DARKER GRAY, IS BEHIND WOMAN'S PROFILE, HE IS ABOUT 20% LARGER, ALSO FACING UP AND RIGHT. BOTH PROFILES HAVE LIPS SLIGHTLY PARTED AS IF SPEAKING OR SINGING. THE COLOR BLUE (C100 M20) IS A GRADIENT, BLUE TO WHITE FROM OUTSIDE SPHERE TO INSIDE, GRADUALLY LIGHTENING UP. A MUSICAL SCORE WITH 7 NOTES, A TREBLE CLEF AND BASS CLEF IS ON THE BLUE GRADIENT. THE MUSIC SCORE FOLLOWS A CURVE OPPOSITE THE OUTSIDE CURVE OF THE CRESCENT MOON. THE MUSIC SCORE & NOTES TAPER OFF BEHIND THE POINTS OF THE CRESCENT MOON. THREE 7 POINT STARS SHADED LIGHTEST GREY ARE INSIDE THE SPACE IN THE MIDDLE BETWEEN HIM CRESCENT AND MUSIC SCORE. STARS ARE SMALL, MEDIUM AND LARGE.

THE FOREIGN WORDING IN THE MARK TRANSLATES INTO ENGLISH AS SERENADE.

SN 78-946,373, FILED 8-7-2006.

RONALD AIKENS, EXAMINING ATTORNEY

**Int. Cl.: 9**

**Prior U.S. Cls.: 21, 23, 26, 36, and 38**

**Reg. No. 3,469,754**

**United States Patent and Trademark Office**

**Registered July 15, 2008**

**TRADEMARK  
PRINCIPAL REGISTER**

**SUPER BUCKS V**

ARISTOCRAT TECHNOLOGIES AUSTRALIA  
PTY LTD (AUSTRALIA LIMITED LIABILITY  
CORPORATION)  
71 LONGUEVILLE ROAD  
LANE COVE, NSW, AUSTRALIA 2066

FOR: GAMING MACHINES; COMPUTER HARD-  
WARE; DOWNLOADABLE GAME SOFTWARE;  
ELECTRONIC GAME SOFTWARE , IN CLASS 9  
(U.S. CLS. 21, 23, 26, 36 AND 38).

FIRST USE 5-24-2007; IN COMMERCE 5-24-2007.

THE MARK CONSISTS OF STANDARD CHAR-  
ACTERS WITHOUT CLAIM TO ANY PARTICULAR  
FONT, STYLE, SIZE, OR COLOR.

SN 78-947,234, FILED 8-8-2006.

DOMINICK J. SALEMI, EXAMINING ATTORNEY

**Int. Cl.: 11**

**Prior U.S. Cls.: 13, 21, 23, 31, and 34**

**Reg. No. 3,469,755**

**United States Patent and Trademark Office**

**Registered July 15, 2008**

---

**TRADEMARK  
PRINCIPAL REGISTER**

**RYOHAN**

TOTO U.S.A., INC. (DELAWARE CORPORATION)  
1155 SOUTHERN ROAD  
MORROW, GA 30260

THE MARK CONSISTS OF STANDARD CHARACTERS WITHOUT CLAIM TO ANY PARTICULAR FONT, STYLE, SIZE, OR COLOR.

FOR: TOILETS, BIDETS, SHOWERS, BATHTUBS, SINKS, FAUCETS AND LIGHTING FIXTURES, IN CLASS 11 (U.S. CLS. 13, 21, 23, 31 AND 34).

SN 78-947,315, FILED 8-8-2006.

FIRST USE 5-4-2007; IN COMMERCE 5-4-2007.

ELISSA GARBER KON, EXAMINING ATTORNEY



**Int. Cls.: 19, 20, and 21**

**Prior U.S. Cls.: 1, 2, 12, 13, 22, 23, 25, 29, 30, 32, 33,  
40, and 50**

**Reg. No. 3,469,756**

**United States Patent and Trademark Office**

**Registered July 15, 2008**

**TRADEMARK  
PRINCIPAL REGISTER**

**LIFE IMPRESSIONS**

XIAMEN XUBANG IMPORT & EXPORT CO.  
LTD. (CHINA CORPORATION)  
NO. 59 NORTH HUBIN ROAD  
B-D 17/F HUIYANG OFFICE BUILDING  
XIAMEN, CHINA

FOR: CLAY FIGURINES, IN CLASS 19 (U.S. CLS.  
1, 12, 33 AND 50).

FIRST USE 4-30-2006; IN COMMERCE 9-5-2006.

FOR: FIGURINES OF PLASTIC AND RESIN;  
STATUES OF PLASTIC AND RESIN, IN CLASS 20  
(U.S. CLS. 2, 13, 22, 25, 32 AND 50).

FIRST USE 10-31-2005; IN COMMERCE 3-3-2006.

FOR: FIGURINES OF FIBERGLASS; STATUES OF  
FIBERGLASS; FIBERGLASS DECORATIVE ORNA-  
MENTS, NOT INCLUDING CHRISTMAS TREE OR-  
NAMENTS; PLASTIC AND RESIN VASES, IN CLASS  
21 (U.S. CLS. 2, 13, 23, 29, 30, 33, 40 AND 50).

FIRST USE 9-28-2006; IN COMMERCE 9-28-2006.

THE MARK CONSISTS OF STANDARD CHAR-  
ACTERS WITHOUT CLAIM TO ANY PARTICULAR  
FONT, STYLE, SIZE, OR COLOR.

SN 78-947,890, FILED 8-8-2006.

HANNO RITTNER, EXAMINING ATTORNEY

**Int. Cl.: 41**

**Prior U.S. Cls.: 100, 101, and 107**

**United States Patent and Trademark Office**

**Reg. No. 3,469,757**

**Registered July 15, 2008**

**SERVICE MARK  
PRINCIPAL REGISTER**

**DIANE KENNEDY'S  
TAXLOOPHOLES**

TAXLOOPHOLES, LLC (NEVADA LTD LIAB CO)  
821 N. 5TH AVENUE  
PHOENIX, AZ 85003

FOR: EDUCATIONAL SERVICES, NAMELY, SEMINARS AND CLASSES FEATURING WEALTH CREATION, TAX STRATEGIES, PERSONAL AND BUSINESS FINANCES, REAL ESTATE INVESTING, BUSINESS MANAGEMENT, AND HOW TO CREATE A NETWORK OF ADVISORS, MENTORS AND ASSOCIATES, IN CLASS 41 (U.S. CLS. 100, 101 AND 107).

FIRST USE 6-1-2003; IN COMMERCE 6-1-2003.

THE MARK CONSISTS OF STANDARD CHARACTERS WITHOUT CLAIM TO ANY PARTICULAR FONT, STYLE, SIZE, OR COLOR.

NO CLAIM IS MADE TO THE EXCLUSIVE RIGHT TO USE "TAX LOOPHOLES", APART FROM THE MARK AS SHOWN.

THE NAME(S), PORTRAIT(S), AND/OR SIGNATURE(S) SHOWN IN THE MARK IDENTIFIES "DIANE KENNEDY", WHOSE CONSENT(S) TO REGISTER IS SUBMITTED.

SN 78-947,969, FILED 8-8-2006.

HANNO RITTNER, EXAMINING ATTORNEY

**Int. Cls.: 9 and 42**

**Prior U.S. Cls.: 21, 23, 26, 36, 38, 100, and 101**

**United States Patent and Trademark Office**

**Reg. No. 3,469,758**

**Registered July 15, 2008**

**TRADEMARK  
SERVICE MARK  
PRINCIPAL REGISTER**



**B I O M A T I X  
S Y S T E M S**

MARINETIX, INC. (DELAWARE CORPORATION)  
1005 PEVETO ST.  
HOUSTON, TX 77019

FOR: AQUARIUM AUTOMATION AND ELECTRONIC MONITORING AND CONTROL EQUIPMENT FOR AUTOMATING, MONITORING, AND CONTROLLING THE AQUATIC ENVIRONMENT, INCLUDING THE TEMPERATURE, PH LEVELS, SALINITY LEVELS AND OTHER CLIMATIC ELEMENTS, IN CLASS 9 (U.S. CLS. 21, 23, 26, 36 AND 38).

FIRST USE 1-10-2008; IN COMMERCE 1-10-2008.

FOR: PROVIDING AUTOMATED AQUARIUM MONITORING AND ELECTRONIC CONTROL SER-

VICES FOR AUTOMATING, MONITORING, AND CONTROLLING THE AQUATIC ENVIRONMENT, INCLUDING THE TEMPERATURE, PH LEVELS, SALINITY LEVELS AND OTHER CLIMATIC ELEMENTS, IN CLASS 42 (U.S. CLS. 100 AND 101).

FIRST USE 8-16-2007; IN COMMERCE 8-16-2007.

NO CLAIM IS MADE TO THE EXCLUSIVE RIGHT TO USE "SYSTEMS", APART FROM THE MARK AS SHOWN.

SN 78-948,034, FILED 8-9-2006.

JEAN IM, EXAMINING ATTORNEY

**Int. Cl.: 3**

**Prior U.S. Cls.: 1, 4, 6, 50, 51, and 52**

**United States Patent and Trademark Office**

**Reg. No. 3,469,759**

**Registered July 15, 2008**

**TRADEMARK  
PRINCIPAL REGISTER**

**IOPE TRUE AGE CARE**

AMOREPACIFIC CORPORATION (REPUBLIC OF KOREA CORPORATION)  
181, 2-KA, HANGANG-RO, YONGSAN-KU  
SEOUL, REPUBLIC OF KOREA 140-777

FOR: LIQUID FOUNDATION; CREAMY FOUNDATION; PRESSED FACE POWDER; ROUGES; LIP-STICKS; NON-MEDICATED SKIN CREAMS; VANISHING CREAMS; BEAUTY MILK, SKIN MOISTURIZER; NON-MEDICATED SKIN CARE PREPARATIONS, NAMELY, SKIN TONERS, SKIN LOTIONS, SKIN EMOLLIENTS AND SKIN CLARIFIERS; NON-MEDICATED LIP CARE PREPARATIONS; SKIN WHITENING CREAMS; HAND CREAMS; MAKE-UP POWDER; BATH SOAPS; SKIN SOAPS; CREAM SOAPS; COSMETIC SOAPS; MOISTURIZING ESSENCE IN THE NATURE OF MILKY SKIN LOTION; LIP GLOSS; NON-MEDICATED LIP BALM; NON-MEDICATED MOISTURIZING NU-

TRITIONAL SERUMS, NAMELY, NON-MEDICATED SKIN SERUMS, NON-MEDICATED EYE SERUMS AND BEAUTY SERUMS , IN CLASS 3 (U.S. CLS. 1, 4, 6, 50, 51 AND 52).

FIRST USE 2-1-2007; IN COMMERCE 2-1-2007.

THE MARK CONSISTS OF STANDARD CHARACTERS WITHOUT CLAIM TO ANY PARTICULAR FONT, STYLE, SIZE, OR COLOR.

NO CLAIM IS MADE TO THE EXCLUSIVE RIGHT TO USE "AGE CARE", APART FROM THE MARK AS SHOWN.

SN 78-948,117, FILED 8-9-2006.

K. MARGARET LE, EXAMINING ATTORNEY

**Int. Cl.: 43**

**Prior U.S. Cls.: 100 and 101**

**United States Patent and Trademark Office**

**Reg. No. 3,469,760**

**Registered July 15, 2008**

**SERVICE MARK  
PRINCIPAL REGISTER**

**REGINA PIZZA**

BOSTON RESTAURANT ASSOCIATES, INC. (DE-  
LAWARE CORPORATION)  
SIX KIMBALL LANE  
LYNNFIELD, MA 01906

FOR: RESTAURANT SERVICES, IN CLASS 43  
(U.S. CLS. 100 AND 101).

FIRST USE 2-7-2008; IN COMMERCE 2-7-2008.

THE MARK CONSISTS OF STANDARD CHAR-  
ACTERS WITHOUT CLAIM TO ANY PARTICULAR  
FONT, STYLE, SIZE, OR COLOR.

OWNER OF U.S. REG. NOS. 1,210,976, 2,197,519,  
AND OTHERS.

NO CLAIM IS MADE TO THE EXCLUSIVE  
RIGHT TO USE "PIZZA", APART FROM THE  
MARK AS SHOWN.

SN 78-948,499, FILED 8-9-2006.

KIMBERLY FRYE, EXAMINING ATTORNEY

**Int. Cl.: 4**

**Prior U.S. Cls.: 1, 6, and 15**

**United States Patent and Trademark Office**

**Reg. No. 3,469,761**

**Registered July 15, 2008**

**TRADEMARK  
PRINCIPAL REGISTER**

**CHILLED SANGRIA**

BANANA REPUBLIC (APPAREL) LLC (CALI-  
FORNIA LTD LIAB CO)  
2 FOLSOM STREET  
SAN FRANCISCO, CA 94105

THE MARK CONSISTS OF STANDARD CHAR-  
ACTERS WITHOUT CLAIM TO ANY PARTICULAR  
FONT, STYLE, SIZE, OR COLOR.

FOR: CANDLES, IN CLASS 4 (U.S. CLS. 1, 6 AND  
15).

SN 78-949,500, FILED 8-10-2006.

FIRST USE 11-0-2006; IN COMMERCE 11-0-2006.

RICHARD A. STRASER, EXAMINING ATTORNEY

**Int. Cl.: 36**

**Prior U.S. Cls.: 100, 101, and 102**

**United States Patent and Trademark Office**

**Reg. No. 3,469,762**

**Registered July 15, 2008**

---

**SERVICE MARK  
PRINCIPAL REGISTER**

**PACIFIC JOURNEY**

PACIFIC LIFE INSURANCE COMPANY (NE-  
BRASKA CORPORATION)  
700 NEWPORT CENTER DRIVE  
NEWPORT BEACH, CA 92660

FOR: FLEXIBLE PREMIUM, DEFERRED, VARI-  
ABLE ANNUITY UNDERWRITING SERVICES, IN  
CLASS 36 (U.S. CLS. 100, 101 AND 102).

FIRST USE 3-3-2008; IN COMMERCE 3-3-2008.

THE MARK CONSISTS OF STANDARD CHAR-  
ACTERS WITHOUT CLAIM TO ANY PARTICULAR  
FONT, STYLE, SIZE, OR COLOR.

OWNER OF U.S. REG. NOS. 2,168,494, 2,806,725,  
AND OTHERS.

SN 78-949,644, FILED 8-10-2006.

JAY BESCH, EXAMINING ATTORNEY

**Int. Cl.: 41**

**Prior U.S. Cls.: 100, 101, and 107**

**United States Patent and Trademark Office**

**Reg. No. 3,469,763**

**Registered July 15, 2008**

**SERVICE MARK  
PRINCIPAL REGISTER**



Every event has a story... Let us help you tell yours.

SYDNEY DANIELS, LLC (ILLINOIS LTD LIAB  
CO)  
605 NORTH PINECREST ROAD  
BOLINGBROOK, IL 60440

FOR: ORGANIZING COMMUNITY SPORTING  
AND CULTURAL EVENTS; DANCE EVENTS; SPE-  
CIAL EVENT PLANNING, IN CLASS 41 (U.S. CLS.  
100, 101 AND 107).

FIRST USE 5-1-2007; IN COMMERCE 7-16-2007.

NO CLAIM IS MADE TO THE EXCLUSIVE  
RIGHT TO USE "EVENTS", APART FROM THE  
MARK AS SHOWN.

THE NAME(S), PORTRAIT(S), AND/OR SIGNA-  
TURE(S) SHOWN IN THE MARK DOES NOT IDENT-  
TIFY A PARTICULAR LIVING INDIVIDUAL.

THE MARK CONSISTS OF THE LETTERS "S"  
AND "D" INTERTWINED IN SCRIPT FONT WITH A  
BOX BELOW IT CONTAINING THE WORDS "SYD-  
NEY DANIELS EVENTS" WITH THE WORDS "EV-  
ERY EVENT HAS A STORY... LET US HELP YOU  
TELL YOURS" BELOW THAT.

SN 78-949,994, FILED 8-11-2006.

BERYL GARDNER, EXAMINING ATTORNEY



**Int. Cl.: 9**

**Prior U.S. Cls.: 21, 23, 26, 36, and 38**

**United States Patent and Trademark Office**

**Reg. No. 3,469,764**

**Registered July 15, 2008**

**TRADEMARK  
PRINCIPAL REGISTER**

**WELCOME TO THE BAND**

TALKINGTABS, LLC (FLORIDA LTD LIAB CO)  
950 LIVE OAK STREET  
MAITLAND, FL 32751

FOR: AUDIO INSTRUCTIONAL RECORDINGS  
FOR TEACHING MUSIC; DOWNLOADABLE  
AUDIO INSTRUCTIONAL RECORDINGS FOR  
TEACHING MUSIC, IN CLASS 9 (U.S. CLS. 21, 23,  
26, 36 AND 38).

FIRST USE 6-1-2006; IN COMMERCE 6-1-2006.

THE MARK CONSISTS OF STANDARD CHAR-  
ACTERS WITHOUT CLAIM TO ANY PARTICULAR  
FONT, STYLE, SIZE, OR COLOR.

NO CLAIM IS MADE TO THE EXCLUSIVE  
RIGHT TO USE "BAND", APART FROM THE  
MARK AS SHOWN.

SN 78-950,061, FILED 8-11-2006.

SUSAN RICHARDS, EXAMINING ATTORNEY

**Int. Cl.: 7**

**Prior U.S. Cls.: 13, 19, 21, 23, 31, 34, and 35**

**Reg. No. 3,469,765**

**United States Patent and Trademark Office**

**Registered July 15, 2008**

---

**TRADEMARK  
PRINCIPAL REGISTER**

**ZERO-Z**

REGO-FIX TOOL CORP. (INDIANA CORPORATION)  
7752 MOLLER ROAD  
INDIANAPOLIS, IN 46268

THE MARK CONSISTS OF STANDARD CHARACTERS WITHOUT CLAIM TO ANY PARTICULAR FONT, STYLE, SIZE, OR COLOR.

FOR: HOLDERS FOR STEEP-TAPER COLLETS USED IN INDUSTRIAL MACHINES, IN CLASS 7 (U.S. CLS. 13, 19, 21, 23, 31, 34 AND 35).

SN 78-950,352, FILED 8-11-2006.

FIRST USE 11-15-2005; IN COMMERCE 11-15-2005.

LINDA E. BLOHM, EXAMINING ATTORNEY

**Int. Cl.: 25**

**Prior U.S. Cls.: 22 and 39**

**United States Patent and Trademark Office**

**Reg. No. 3,469,766**

**Registered July 15, 2008**

**TRADEMARK  
PRINCIPAL REGISTER**

**JORDACHE LEGACY**

JORDACHE ENTERPRISES, INC. (NEW YORK CORPORATION)  
1400 BROADWAY, 15TH FLOOR  
NEW YORK, NY 10018

FOR: MEN'S, WOMEN'S AND CHILDREN'S CLOTHING, NAMELY, JEANS, SHIRTS, SKIRTS, SHORTS, PANTS, SWEATERS, T-SHIRTS, SWEATSHIRTS, JACKETS AND VESTS, SPECIFICALLY EXCLUDING HOSIERY, SHOES AND HATS, IN CLASS 25 (U.S. CLS. 22 AND 39).

FIRST USE 11-30-2005; IN COMMERCE 11-30-2005.

THE MARK CONSISTS OF STANDARD CHARACTERS WITHOUT CLAIM TO ANY PARTICULAR FONT, STYLE, SIZE, OR COLOR.

OWNER OF U.S. REG. NOS. 1,096,110, 1,240,767, AND OTHERS.

SN 78-950,373, FILED 8-11-2006.

TRACY WHITTAKER-BROWN, EXAMINING ATTORNEY

**Int. Cl.: 5**

**Prior U.S. Cls.: 6, 18, 44, 46, 51, and 52**

**United States Patent and Trademark Office**

**Reg. No. 3,469,767**

**Registered July 15, 2008**

**TRADEMARK  
PRINCIPAL REGISTER**

**X BALANCE**

SPIRIT GARDEN, LLC (NEVADA LTD LIAB CO)  
2225 FARADAY AVENUE, SUITE E  
CARLSBAD, CA 92008

FOR: DIETARY FOOD SUPPLEMENTS FOR CHILDREN; DIETARY SUPPLEMENTAL DRINKS FOR CHILDREN; DIETARY SUPPLEMENTS FOR CHILDREN; FOOD SUPPLEMENTS FOR CHILDREN; FOOD SUPPLEMENTS, NAMELY, ANTI-OXIDANTS FOR CHILDREN; HERBAL SUPPLEMENTS FOR CHILDREN; NUTRACEUTICALS FOR USE AS A DIETARY SUPPLEMENT FOR CHILDREN; NUTRITIONAL SUPPLEMENTS FOR CHIL-

DREN; POWDERED NUTRITIONAL SUPPLEMENT DRINK MIX FOR CHILDREN, IN CLASS 5 (U.S. CLS. 6, 18, 44, 46, 51 AND 52).

FIRST USE 4-1-2006; IN COMMERCE 4-1-2006.

THE MARK CONSISTS OF STANDARD CHARACTERS WITHOUT CLAIM TO ANY PARTICULAR FONT, STYLE, SIZE, OR COLOR.

SN 78-950,538, FILED 8-11-2006.

JAY BESCH, EXAMINING ATTORNEY

**Int. Cls.: 6 and 20**

**Prior U.S. Cls.: 2, 12, 13, 14, 22, 23, 25, 32, and 50**

**United States Patent and Trademark Office**

**Reg. No. 3,469,768**

**Registered July 15, 2008**

**TRADEMARK  
PRINCIPAL REGISTER**

**AdBlue**

SCHÜTZ CONTAINER SYSTEMS, INC. (NEW  
JERSEY CORPORATION)  
200 ASPEN HILL ROAD  
NORTH BRANCH, NJ 08876

FOR: INDUSTRIAL PACKAGING CONTAINERS  
OF METAL, IN CLASS 6 (U.S. CLS. 2, 12, 13, 14, 23, 25  
AND 50).

FIRST USE 8-0-2006; IN COMMERCE 8-0-2006.

FOR: PLASTIC TRANSPORT AND STORAGE  
CONTAINERS FOR COMMERCIAL AND INDUS-

TRIAL USE, IN CLASS 20 (U.S. CLS. 2, 13, 22, 25, 32  
AND 50).

FIRST USE 8-0-2006; IN COMMERCE 8-0-2006.

THE MARK CONSISTS OF STANDARD CHAR-  
ACTERS WITHOUT CLAIM TO ANY PARTICULAR  
FONT, STYLE, SIZE, OR COLOR.

SN 78-950,594, FILED 8-11-2006.

JOHN WILKE, EXAMINING ATTORNEY

**Int. Cl.: 36**

**Prior U.S. Cls.: 100, 101, and 102**

**United States Patent and Trademark Office**

**Reg. No. 3,469,769**

**Registered July 15, 2008**

**SERVICE MARK  
PRINCIPAL REGISTER**

**ISITE**

SOCIETY OF INCENTIVE & TRAVEL EXECUTIVES, INC. (ILLINOIS NOT-FOR-PROFIT CORPORATION)  
401 NORTH MICHIGAN AVENUE  
CHICAGO, IL 60611

FOR: CHARITABLE NON-PROFIT FOUNDATION SERVICES, NAMELY, FUNDRAISING FOR PURPOSES OF SUPPORTING CHARITABLE AND EDUCATIONAL ACTIVITIES, PROJECTS AND SCHOLARSHIPS, IN CLASS 36 (U.S. CLS. 100, 101 AND 102).

FIRST USE 4-30-2007; IN COMMERCE 4-30-2007.

THE MARK CONSISTS OF STANDARD CHARACTERS WITHOUT CLAIM TO ANY PARTICULAR FONT, STYLE, SIZE, OR COLOR.

SN 78-950,615, FILED 8-11-2006.

TRACY WHITTAKER-BROWN, EXAMINING ATTORNEY

**Int. Cl.: 5**

**Prior U.S. Cls.: 6, 18, 44, 46, 51, and 52**

**Reg. No. 3,469,770**

**United States Patent and Trademark Office**

**Registered July 15, 2008**

---

**TRADEMARK  
PRINCIPAL REGISTER**

**REJUVENATE**

SCHUYLER LLC (OREGON LTD LIAB CO)  
8000 NE TILLAMOOK STREET  
PORTLAND, OR 97213

THE MARK CONSISTS OF STANDARD CHAR-  
ACTERS WITHOUT CLAIM TO ANY PARTICULAR  
FONT, STYLE, SIZE, OR COLOR.

FOR: VITAMINS AND NUTRITIONAL SUPPLE-  
MENTS FOR ANIMALS, IN CLASS 5 (U.S. CLS. 6, 18,  
44, 46, 51 AND 52).

SN 78-950,716, FILED 8-11-2006.

FIRST USE 1-30-2007; IN COMMERCE 1-30-2007.

INGRID C. EULIN, EXAMINING ATTORNEY

**Int. Cl.: 32**

**Prior U.S. Cls.: 45, 46, and 48**

**Reg. No. 3,469,771**

**United States Patent and Trademark Office**

**Registered July 15, 2008**

---

**TRADEMARK  
PRINCIPAL REGISTER**

**State of Mind Peace Water**

ADDARIO, LAURA (UNITED STATES INDIVIDUAL)  
CONTACT@STATEOFMINDWATER.COM  
14606 LA MAIDA ST  
SHERMAN OAKS, CA 91403

FOR: DRINKING WATER, IN CLASS 32 (U.S. CLS. 45, 46 AND 48).

FIRST USE 5-27-2008; IN COMMERCE 5-27-2008.

THE MARK CONSISTS OF STANDARD CHARACTERS WITHOUT CLAIM TO ANY PARTICULAR FONT, STYLE, SIZE, OR COLOR.

NO CLAIM IS MADE TO THE EXCLUSIVE RIGHT TO USE "WATER", APART FROM THE MARK AS SHOWN.

SN 78-950,971, FILED 8-13-2006.

ELIZABETH HUGHITT, EXAMINING ATTORNEY



Int. Cl.: 36

Prior U.S. Cls.: 100, 101, and 102

United States Patent and Trademark Office

Reg. No. 3,469,772

Registered July 15, 2008

**SERVICE MARK  
PRINCIPAL REGISTER**

**PORTFOLIO PROADVISOR**

F.N.B. CORPORATION (FLORIDA CORPORATION)  
ONE F.N.B. BOULEVARD  
HERMITAGE, PA 16148

FOR: DEPOSITORY SERVICES, NAMELY, INDIVIDUAL RETIREMENT ACCOUNTS, AND SELF EMPLOYED QUALIFIED RETIREMENT PLANS; MONEY MARKET ACCOUNT SERVICES; MUTUAL FUNDS SERVICES, NAMELY, ESTABLISHMENT OF MUTUAL FUNDS FOR OTHERS AND BROKERAGE, INVESTMENT AND DISTRIBUTION; TRUST SERVICES, NAMELY INVESTMENT AND TRUST COMPANY SERVICES; FIDUCIARY REPRESENTATIVE SERVICES AND TRUST ADMINISTRATION; FINANCIAL ANALYSIS AND CONSULTATION; FINANCIAL CLEARING HOUSES; FINANCIAL SERVICES IN THE NATURE OF AN INVESTMENT SECURITY; FINANCIAL INFORMATION IN THE NATURE OF RATES OF EXCHANGE, FINANCIAL EXCHANGE, FINANCIAL FORECASTING AND FINANCIAL GUARANTEE AND SURETY; FINANCIAL INFORMATION PROVIDED BY ELECTRONIC MEANS; FINANCIAL MANAGEMENT; FINANCIAL PLANNING; FINANCIAL PORTFOLIO MANAGEMENT; FINANCIAL RESEARCH; FINANCIAL VALUATION OF PERSONAL PROPERTY AND REAL ESTATE; INVESTMENT SERVICES, NAMELY, INVESTMENT BROKERAGE; CAPITAL INVESTMENT CONSULTATION AND ADVICE; FUND INVESTMENT CONSULTATION; INVESTMENT CONSULTATION; FINANCIAL INVESTMENT IN THE FIELD OF SECURITIES; FUNDS INVESTMENT; MUTUAL FUNDS INVESTMENT; REAL ESTATE INVESTMENT; COMMODITY IN-

VESTMENT ADVICE; INVESTMENT ADVICE; INVESTMENT BROKERAGE; INVESTMENT CLUBS; CAPITAL INVESTMENT CONSULTATION; INVESTMENT MANAGEMENT; MAINTAINING ESCROW ACCOUNTS FOR INVESTMENTS; INVESTMENT OF FUNDS FOR OTHERS; INVESTMENT OF FUNDS, MUTUAL FUNDS AND REAL ESTATE; CAPITAL INVESTMENT; INVESTMENT OF TRUST FUNDS FOR OTHERS; INSURANCE BROKERAGE, CONSULTATION, SUBROGATION AND ACTUARIAL SERVICES IN THE FIELDS OF LIFE, HEALTH, ACCIDENT, FIRE, MARINE, MEDICAL, PRE-PAID HEALTH CARE AND LEGAL SERVICES; INVESTMENT AND FINANCIAL INVESTMENT IN THE FIELD OF REAL ESTATE AND SECURITIES; AND INFORMATION SERVICES FOR ALL FOR THE FOREGOING PROVIDED VIA A GLOBAL COMPUTER NETWORK, IN CLASS 36 (U.S. CLS. 100, 101 AND 102).

FIRST USE 1-12-2007; IN COMMERCE 1-12-2007.

THE MARK CONSISTS OF STANDARD CHARACTERS WITHOUT CLAIM TO ANY PARTICULAR FONT, STYLE, SIZE, OR COLOR.

NO CLAIM IS MADE TO THE EXCLUSIVE RIGHT TO USE "PORTFOLIO", APART FROM THE MARK AS SHOWN.

SN 78-951,219, FILED 8-14-2006.

REBECCA GILBERT, EXAMINING ATTORNEY

**Int. Cl.: 9**

**Prior U.S. Cls.: 21, 23, 26, 36, and 38**

**Reg. No. 3,469,773**

**United States Patent and Trademark Office**

**Registered July 15, 2008**

**TRADEMARK  
PRINCIPAL REGISTER**

**INDIZO**

PROVERIS SCIENTIFIC CORPORATION (MAS-  
SACHUSETTS CORPORATION)  
142 NORTH ROAD STE R  
SUDBURY, MA 01776

FOR: SPRAY ANALYSIS AND CHARACTERIZA-  
TION EQUIPMENT, NAMELY, COMPUTER-DRI-  
VEN HARDWARE DEVICES FOR ACTUATING  
THE PUMPING MECHANISM OF A PUMP-BASED  
SPRAY DEVICE SO AS TO PRODUCE AN AEROSOL  
OR SPRAY PLUME CONSISTING OF LIQUID OR  
NON-LIQUID PARTICULATE MATERIAL, LASER  
AND IMAGE ACQUISITION DEVICES FOR ILLU-  
MINATING AND IMAGING AN AEROSOL OR  
SPRAY PLUME FOR NON-MEDICAL PURPOSES,  
COMPUTER-DRIVEN HARDWARE DEVICES AND  
ELECTROMECHANICAL DEVICES FOR COLLECT-  
ING AND WEIGHING LIQUID OR NON-LIQUID

PARTICULATE MATERIAL, AND COMPUTER-  
DRIVEN HARDWARE FOR CAPTURING, PROCES-  
SING AND/OR ANALYZING DATA ASSOCIATED  
WITH MEASURING CHARACTERISTICS OF  
AEROSOL AND SPRAY DEVICES , IN CLASS 9  
(U.S. CLS. 21, 23, 26, 36 AND 38).

FIRST USE 12-18-2006; IN COMMERCE 12-18-2006.

THE MARK CONSISTS OF STANDARD CHAR-  
ACTERS WITHOUT CLAIM TO ANY PARTICULAR  
FONT, STYLE, SIZE, OR COLOR.

SN 78-951,526, FILED 8-14-2006.

DOMINIC FATHY, EXAMINING ATTORNEY

**Int. Cl.: 28**

**Prior U.S. Cls.: 22, 23, 38, and 50**

**Reg. No. 3,469,774**

**United States Patent and Trademark Office**

**Registered July 15, 2008**

**TRADEMARK  
PRINCIPAL REGISTER**

**X-7**

TIPPMANN SPORTS, LLC (DELAWARE LTD  
LIAB CO)  
2955 ADAMS CENTER ROAD  
FORT WAYNE, IN 46803

FOR: PAINTBALL MARKERS; PARTS AND AC-  
CESSORIES THEREFOR, NAMELY, HOPPERS,  
TRIGGERS, BARRELS, STOCKS, MAGAZINES,  
SHROUDS, GRIPS, CARRY HANDLES AND  
SIGHTS, IN CLASS 28 (U.S. CLS. 22, 23, 38 AND 50).

FIRST USE 12-0-2006; IN COMMERCE 12-0-2006.

THE MARK CONSISTS OF STANDARD CHAR-  
ACTERS WITHOUT CLAIM TO ANY PARTICULAR  
FONT, STYLE, SIZE, OR COLOR.

SN 78-952,232, FILED 8-15-2006.

BRENDAN REGAN, EXAMINING ATTORNEY

**Int. Cl.: 35**

**Prior U.S. Cls.: 100, 101, and 102**

**United States Patent and Trademark Office**

**Reg. No. 3,469,775**

**Registered July 15, 2008**

---

**SERVICE MARK  
PRINCIPAL REGISTER**

**WIZERANK**

WIZE, INC. (DELAWARE CORPORATION)  
430 1ST AVENUE NORTH, SUITE 740  
MINNEAPOLIS, MN 55401

FIRST USE 8-15-2006; IN COMMERCE 8-15-2006.

FOR: PROVIDING CONSUMER PRODUCT INFORMATION VIA THE INTERNET; PROVIDING ONLINE INFORMATION REGARDING MARKET RESEARCH AND RATINGS FOR CONSUMER PRODUCTS AND SERVICES VIA THE INTERNET, IN CLASS 35 (U.S. CLS. 100, 101 AND 102).

THE MARK CONSISTS OF STANDARD CHARACTERS WITHOUT CLAIM TO ANY PARTICULAR FONT, STYLE, SIZE, OR COLOR.

SN 78-952,246, FILED 8-15-2006.

MICHAEL GAAFAR, EXAMINING ATTORNEY

**Int. Cl.: 43**

**Prior U.S. Cls.: 100 and 101**

**United States Patent and Trademark Office**

**Reg. No. 3,469,776**

**Registered July 15, 2008**

---

**SERVICE MARK  
PRINCIPAL REGISTER**

# TABLE 45

TWO IRON, INC. (OHIO CORPORATION)  
2179 W. 11TH STREET  
CLEVELAND, OH 44113

FOR: RESTAURANT SERVICES, IN CLASS 43  
(U.S. CLS. 100 AND 101).

FIRST USE 4-3-2007; IN COMMERCE 4-3-2007.

THE MARK CONSISTS OF STANDARD CHAR-  
ACTERS WITHOUT CLAIM TO ANY PARTICULAR  
FONT, STYLE, SIZE, OR COLOR.

SN 78-952,655, FILED 8-15-2006.

ALEX KEAM, EXAMINING ATTORNEY

Int. Cl.: 30

Prior U.S. Cl.: 46

United States Patent and Trademark Office

Reg. No. 3,469,777

Registered July 15, 2008

TRADEMARK  
PRINCIPAL REGISTER

CAÑAVERAL

MARQUEZ BROTHERS INTERNATIONAL, INC.  
(CALIFORNIA CORPORATION)

5801 RUE FERRARI

SAN JOSE, CA 95138

FOR: CANDY, CHEWING GUM, ICE CREAM,  
FLAVORED AND SWEETENED GELATINS, HON-  
EY, PASTA, PASTA SHELLS, NOODLES, RICE,  
TORTILLAS, TORTILLA CHIPS, CORN CHIPS, SAL-  
SA, CHEESE SAUCE, TOMATO SAUCE, SPICES,  
AND PROCESSED HERBS; SUGAR, IN CLASS 30  
(U.S. CL. 46).

FIRST USE 8-6-2007; IN COMMERCE 8-6-2007.

THE MARK CONSISTS OF STANDARD CHAR-  
ACTERS WITHOUT CLAIM TO ANY PARTICULAR  
FONT, STYLE, SIZE, OR COLOR.

PRIORITY CLAIMED UNDER SEC. 44(D) ON  
MEXICO APPLICATION NO. 929100, FILED 4-18-  
2006, REG. NO. 929100, DATED 4-18-2006, EXPIRES 4-  
18-2016.

THE FOREIGN WORDING IN THE MARK  
TRANSLATES INTO ENGLISH AS "CANE PLANTA-  
TION".

SN 78-952,798, FILED 8-15-2006.

GEORGE LORENZO, EXAMINING ATTORNEY

**Int. Cl.: 37**

**Prior U.S. Cls.: 100, 103, and 106**

**United States Patent and Trademark Office**

**Reg. No. 3,469,778**

**Registered July 15, 2008**

**SERVICE MARK  
PRINCIPAL REGISTER**

**Feel Good in a Clean Car**

WASH DEPOT HOLDINGS, INC. (DELAWARE CORPORATION)  
STE. 302  
14 SUMMER STREET  
MALDEN, MA 02148

FOR: CAR WASHING SERVICES, AUTOMOBILE  
DETAILING SERVICES, AUTOMOBILE POLISH-  
ING, AUTOMOBILE CLEANING SERVICES, AUTO-  
MATED CAR WASHING SERVICES, HAND CAR  
WASH, SELF-SERVICE CAR WASH SERVICES AND  
SELF-SERVICE AUTOMOBILE INTERIOR AUTO-

MOBILE CARE SERVICES, IN CLASS 37 (U.S. CLS.  
100, 103 AND 106).

FIRST USE 5-1-2008; IN COMMERCE 5-1-2008.

THE MARK CONSISTS OF STANDARD CHAR-  
ACTERS WITHOUT CLAIM TO ANY PARTICULAR  
FONT, STYLE, SIZE, OR COLOR.

SN 78-953,065, FILED 8-16-2006.

EDWARD NELSON, EXAMINING ATTORNEY

Int. Cl.: 25

Prior U.S. Cls.: 22 and 39

United States Patent and Trademark Office

Reg. No. 3,469,779

Registered July 15, 2008

TRADEMARK  
PRINCIPAL REGISTER



STEVE C. LOPEZ (UNITED STATES INDIVIDUAL)  
29971 NUEVO RD  
NUEVO, CA 92567

FOR: T-SHIRTS, TOPS, IN CLASS 25 (U.S. CLS. 22 AND 39).

FIRST USE 5-14-2008; IN COMMERCE 5-14-2008.

THE COLOR(S) DARK PINK, LIGHT PINK, BLACK AND WHITE IS/ARE CLAIMED AS A FEATURE OF THE MARK.

THE OUTLINE OF THE DESIGN ELEMENT IS FIRST IN LIGHT PINK, THEN OUTLINED IN DARK PINK, WITH A BLACK SHADOW. THE INTERIOR OF THE DESIGN IS WHITE. THE LITERAL ELEMENT "IROKIT" CONTAIN A GRADIENT LIGHT PINK INTERIOR MOVING TO WHITE IN THE MIDDLE, WITH A BLACK OUTLINE THEN A PINK OUTLINE, WITH A BLACK SHADOW.

SN 78-954,210, FILED 8-17-2006.

PETER B. BROMAGHIM, EXAMINING ATTORNEY



**Int. Cl.: 30**

**Prior U.S. Cl.: 46**

**United States Patent and Trademark Office**

**Reg. No. 3,469,780**

**Registered July 15, 2008**

**TRADEMARK  
PRINCIPAL REGISTER**

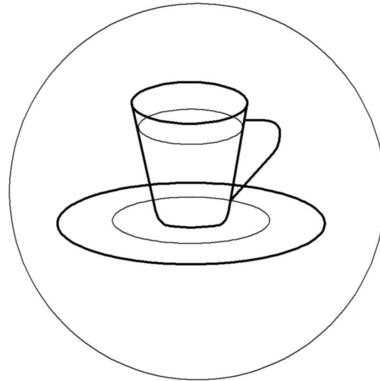

THE RED ESPRESSO COMPANY, LIMITED  
(SOUTH AFRICA COMPANY)  
MOORES ROWLAND 27TH FLOOR,  
NO. 1 THIBAULT SQUARE  
CAPE TOWN, SOUTH AFRICA 8001

FIRST USE 0-0-2007; IN COMMERCE 0-0-2007.

SN 78-954,240, FILED 8-17-2006.

FOR: TEA AND ROOIBOS TEA, IN CLASS 30 (U.S.  
CL. 46).

EDWARD NELSON, EXAMINING ATTORNEY

**Int. Cl.: 37**

**Prior U.S. Cls.: 100, 103, and 106**

**United States Patent and Trademark Office**

**Reg. No. 3,469,781**

**Registered July 15, 2008**

**SERVICE MARK  
PRINCIPAL REGISTER**



FLOODS4LESS, INC. (CALIFORNIA CORPORATION)  
8404 NORTH MAGNOLIA AVE, SUITE C  
SANTEE, CA 92071

FOR: RESTORATION SERVICES FOR BUILDING STRUCTURES AND CONTENTS, NAMELY, WATER EXTRACTION AND DRYING SERVICES, IN CLASS 37 (U.S. CLS. 100, 103 AND 106).

FIRST USE 4-3-2008; IN COMMERCE 4-3-2008.

THE MARK CONSISTS OF POOL OF WATER UNDER A NUMBER 4.

SN 78-954,752, FILED 8-17-2006.

CAROLINE WOOD, EXAMINING ATTORNEY

**Int. Cl.: 11**

**Prior U.S. Cls.: 13, 21, 23, 31, and 34**

**Reg. No. 3,469,782**

**United States Patent and Trademark Office**

**Registered July 15, 2008**

---

**TRADEMARK  
PRINCIPAL REGISTER**

**CK**

PHILIPS SOLID-STATE LIGHTING SOLUTIONS,  
INC. (DELAWARE CORPORATION)  
3 BURLINGTON WOODS DRIVE  
BURLINGTON, MA 01803

FOR: APPARATUS FOR LIGHTING, LIGHTING  
FIXTURES, COMPONENTS OF LIGHTING FIX-  
TURES, NAMELY, ELECTRIC LIGHTING FIX-  
TURES; ELECTRIC DEVICES USED TO CONTROL  
THE COLOR AND INTENSITY OF ARTIFICIAL  
LIGHT SOLD AS COMPONENTS OF LIGHTING  
FIXTURES; AND CONTROLLERS SOLD AS COM-

PONENTS OF LIGHTING FIXTURES, IN CLASS 11  
(U.S. CLS. 13, 21, 23, 31 AND 34).

FIRST USE 3-31-2008; IN COMMERCE 3-31-2008.

THE MARK CONSISTS OF STANDARD CHAR-  
ACTERS WITHOUT CLAIM TO ANY PARTICULAR  
FONT, STYLE, SIZE, OR COLOR.

SN 78-955,126, FILED 8-18-2006.

HENRY S. ZAK, EXAMINING ATTORNEY

**Int. Cl.: 9**

**Prior U.S. Cls.: 21, 23, 26, 36, and 38**

**Reg. No. 3,469,783**

**United States Patent and Trademark Office**

**Registered July 15, 2008**

**TRADEMARK  
PRINCIPAL REGISTER**

**EFFORTLESS SUCCESS**

SELF ESTEEM SEMINARS, INC. (CALIFORNIA CORPORATION)  
929 VIA FRUTERIA  
SANTA BARBARA, CA 93110

FOR: PRE-RECORDED AUDIO CASSETTE TAPES, AUDIO COMPACT DISCS, VIDEO TAPES, AND COMPACT DISKS ALL IN THE FIELD OF INSPIRATION, SELF-ESTEEM AND PERSONAL DEVELOPMENT; COMPUTER SOFTWARE IN THE NATURE OF EDUCATIONAL SOFTWARE FEATURING INSTRUCTION IN THE FIELDS OF INSPIRATION, SELF-ESTEEM, AND PERSONAL DEVELOPMENT; COMPUTER SOFTWARE IN THE NATURE OF SCREEN SAVER SOFTWARE IN THE FIELDS OF INSPIRATION, SELF-ESTEEM, AND PERSONAL DEVELOPMENT; PRE-RECORDED FLOPPY COMPUTER DISCS AND CD-ROMS FEATURING COMPUTER SOFTWARE IN THE NATURE OF EDUCATIONAL SOFTWARE FEATURING

INSTRUCTION IN THE FIELDS OF INSPIRATION, SELF-ESTEEM, AND PERSONAL DEVELOPMENT; PRE-RECORDED FLOPPY COMPUTER DISCS AND CD-ROMS FEATURING COMPUTER SOFTWARE IN THE NATURE OF SCREEN SAVER SOFTWARE IN THE FIELDS OF INSPIRATION, SELF-ESTEEM, AND PERSONAL DEVELOPMENT, IN CLASS 9 (U.S. CLS. 21, 23, 26, 36 AND 38).

FIRST USE 5-2-2008; IN COMMERCE 5-2-2008.

THE MARK CONSISTS OF STANDARD CHARACTERS WITHOUT CLAIM TO ANY PARTICULAR FONT, STYLE, SIZE, OR COLOR.

SN 78-955,214, FILED 8-18-2006.

KEVIN CORWIN, EXAMINING ATTORNEY

**Int. Cl.: 5**

**Prior U.S. Cls.: 6, 18, 44, 46, 51, and 52**

**Reg. No. 3,469,784**

**United States Patent and Trademark Office**

**Registered July 15, 2008**

**TRADEMARK  
PRINCIPAL REGISTER**

**STRI-DEX CLEAR COMPLEXION  
WITH COMFORT**

BLISTEX INC. (ILLINOIS CORPORATION)  
1800 SWIFT DRIVE  
OAK BROOK, IL 60523

FOR: MEDICATED TOPICAL PREPARATIONS FOR HUMAN USE FOR CLEANSING THE SKIN, TO PREVENT OR ALLEVIATE THE SYMPTOMS OF ACNE AND OTHER SKIN AFFLICTIONS, FOR SKIN AND LIP CARE PROTECTION, MEDICATED SKIN AND LIP SUN SCREEN PREPARATIONS, AND APPLICATORS OR PADS FOR THE FOREGOING ITEMS, IN CLASS 5 (U.S. CLS. 6, 18, 44, 46, 51 AND 52).

FIRST USE 12-0-2006; IN COMMERCE 12-0-2006.

THE MARK CONSISTS OF STANDARD CHARACTERS WITHOUT CLAIM TO ANY PARTICULAR FONT, STYLE, SIZE, OR COLOR.

OWNER OF U.S. REG. NOS. 693,083, 2,918,187, AND OTHERS.

NO CLAIM IS MADE TO THE EXCLUSIVE RIGHT TO USE "CLEAR COMPLEXION", APART FROM THE MARK AS SHOWN.

SN 78-955,360, FILED 8-18-2006.

ARETHA SOMERVILLE, EXAMINING ATTORNEY

**Int. Cls.: 5, 9, 16, 35, 38, 41, and 44**

**Prior U.S. Cls.: 2, 5, 6, 18, 21, 22, 23, 26, 29, 36, 37, 38, 44, 46, 50, 51, 52, 100, 101, 102, 104, and 107**

**Reg. No. 3,469,785**

**United States Patent and Trademark Office**

**Registered July 15, 2008**

**TRADEMARK  
SERVICE MARK  
PRINCIPAL REGISTER**

**ON TARGET LIVING**

ON TARGET LIVING, LLC (MICHIGAN LTD  
LIAB CO)  
5572 SILVERLEAF COURT  
HASLETT, MI 48849

FIRST USE 10-1-2006; IN COMMERCE 10-1-2006.

FOR: DIETARY AND NUTRITIONAL SUPPLEMENTS, NAMELY, ENERGY BARS, MEAL REPLACEMENT DRINKS, MEAL REPLACEMENT BARS, PROTEIN SHAKES FOR USE AS A DIETARY SUPPLEMENT, PROTEIN BARS FOR USE AS A DIETARY SUPPLEMENT; NUTRITIONAL SUPPLEMENTS IN THE NATURE OF NON-PRESCRIPTION VITAMINS, MINERALS, NUTRIENTS AND BOTANICALS; VITAMIN FOOD SUPPLEMENTS, NAMELY, MUSCLE BUILDING POWDERS AND METABOLIC ENHANCEMENT DRINKS AND TABLETS FOR USE IN EXERCISE, NUTRITION, BODYBUILDING AND WEIGHT TRAINING; NON-PRESCRIPTION PREPARATIONS TO PROMOTE WEIGHT GAIN, NON-PRESCRIPTION PREPARATIONS TO PROMOTE WEIGHT LOSS, NON-PRESCRIPTION PREPARATIONS TO PROMOTE MUSCLE GROWTH; NON-PRESCRIPTION GROWTH HORMONES; NON-PRESCRIPTION METABOLIC PREPARATIONS TO PROMOTE FAT BURNING; NON-PRESCRIPTION METABOLIC PREPARATIONS TO BLOCK CARBOHYDRATE ABSORPTION, IN CLASS 5 (U.S. CLS. 6, 18, 44, 46, 51 AND 52).

FOR: PAPER AND PRINTED MATTER, NAMELY, ARTICLES FOR PUBLICATION IN BOOKLETS, BROCHURES, CATALOGS, GUIDES, MAGAZINES, MANUALS AND NEWSLETTERS ALL FEATURING INFORMATION ON AGING, BODY CONDITIONING, DIET, ENERGY, EXERCISE, HEALTH, FITNESS, NUTRITION, SPORTS TRAINING, STRESS MANAGEMENT, WEIGHT REDUCTION AND WELLNESS; FLASH CARDS; PAPERWEIGHTS, PHOTOGRAPHS MOUNTED AND UNMOUNTED; POSTERS; POSTCARDS; PRINTED GREETING CARDS; PRINTED EDUCATIONAL, INSTRUCTIONAL AND TEACHING MATERIALS ALL FEATURING INFORMATION ON AGING, BODY CONDITIONING, DIET, ENERGY, EXERCISE, HEALTH, FITNESS, NUTRITION, SPORTS TRAINING, STRESS MANAGEMENT, WEIGHT REDUCTION AND WELLNESS; SERIES OF NON-FICTION BOOKS ALL FEATURING INFORMATION ON AGING, BODY CONDITIONING, DIET, ENERGY, EXERCISE, HEALTH, FITNESS, NUTRITION, SPORTS TRAINING, STRESS MANAGEMENT, WEIGHT REDUCTION AND WELLNESS; FOLDERS, PENS, PENCILS, STICKERS AND WRITING PADS, IN CLASS 16 (U.S. CLS. 2, 5, 22, 23, 29, 37, 38 AND 50).

FIRST USE 10-1-2006; IN COMMERCE 10-1-2006.

FIRST USE 10-1-2006; IN COMMERCE 10-1-2006.

FOR: PRERECORDED ELECTRONIC MEDIA, NAMELY, AUDIO AND VIDEO CASSETTES, CDS AND DVDS ALL FEATURING INFORMATION ON AGING, BODY CONDITIONING, DIET, ENERGY, EXERCISE, HEALTH, FITNESS, NUTRITION, SPORTS TRAINING, STRESS MANAGEMENT, WEIGHT REDUCTION AND WELLNESS, IN CLASS 9 (U.S. CLS. 21, 23, 26, 36 AND 38).

FOR: ARRANGING AND CONDUCTING BUSINESS CONFERENCES; PRODUCTION AND DISTRIBUTION OF RADIO AND TELEVISION COMMERCIALS; RETAIL, WHOLESALE, MAIL-ORDER AND ON-LINE RETAIL STORE SERVICES FEATURING PRODUCTS RELATING TO AGING, BODY CONDITIONING, DIET, ENERGY, EXERCISE, HEALTH, FITNESS, NUTRITION, SPORTS

TRAINING, STRESS MANAGEMENT, WEIGHT REDUCTION AND WELLNESS, IN CLASS 35 (U.S. CLS. 100, 101 AND 102).

FIRST USE 10-1-2006; IN COMMERCE 10-1-2006.

FOR: TELECOMMUNICATIONS SERVICES, NAMELY, BROADCASTING RADIO AND TELEVISION PROGRAMS AND MOTION PICTURE FILMS VIA A GLOBAL COMPUTER NETWORK; ELECTRONIC, ELECTRIC AND DIGITAL TRANSMISSION OF VOICE, DATA, IMAGES, SOUND, SIGNAL AND MESSAGES; ELECTRONIC TRANSMISSION OF E-BOOKS, E-ZINES AND NEWSLETTERS VIA A GLOBAL COMPUTER NETWORK; TRANSMISSION OF INFORMATION BY ELECTRONIC MEDIA; VIDEO AND AUDIO TELECONFERENCING SERVICES VIA THE INTERNET, IN CLASS 38 (U.S. CLS. 100, 101 AND 104).

FIRST USE 10-1-2006; IN COMMERCE 10-1-2006.

FOR: EDUCATIONAL AND INSTRUCTIONAL SERVICES, NAMELY, CONDUCTING EDUCATIONAL CLASSES, CONFERENCES, RETREATS, SEMINARS AND WORKSHOPS ALL FEATURING INFORMATION ON AGING, BODY CONDITIONING, DIET, ENERGY, EXERCISE, HEALTH, FITNESS, NUTRITION, SPORTS TRAINING, STRESS MANAGEMENT, WEIGHT REDUCTION AND WELLNESS AND DISTRIBUTING INSTRUCTIONAL MATERIALS IN CONNECTION THEREWITH; ENTERTAINMENT SERVICES, NAMELY, LIVE SPEAKING ENGAGEMENTS ALL FEATURING IN-

FORMATION ON AGING, BODY CONDITIONING, DIET, ENERGY, EXERCISE, HEALTH, FITNESS, NUTRITION, SPORTS TRAINING, STRESS MANAGEMENT, WEIGHT REDUCTION AND WELLNESS; PRODUCTION OF RADIO, TELEVISION, AND MOTION PICTURE FILMS OF OTHERS FOR BROADCAST TRANSMISSION VIA BROADCAST, CABLE, DIGITAL AND GLOBAL COMPUTER NETWORK; PUBLICATION OF BOOKS; PERSONAL TRAINING SERVICES; PROVIDING INFORMATION IN THE FIELDS OF BODY CONDITIONING, PHYSICAL EXERCISE AND FITNESS, AND SPORTS TRAINING; AND SPECIAL EVENT PLANNING, IN CLASS 41 (U.S. CLS. 100, 101 AND 107).

FIRST USE 10-1-2006; IN COMMERCE 10-1-2006.

FOR: PROVIDING INFORMATION IN THE FIELDS OF AGING, DIET PLANNING, PHYSICAL AND MENTAL ENERGY, HEALTH CARE, NUTRITION, STRESS MANAGEMENT, WEIGHT REDUCTION AND WELLNESS, IN CLASS 44 (U.S. CLS. 100 AND 101).

FIRST USE 10-1-2006; IN COMMERCE 10-1-2006.

THE MARK CONSISTS OF STANDARD CHARACTERS WITHOUT CLAIM TO ANY PARTICULAR FONT, STYLE, SIZE, OR COLOR.

SN 78-955,880, FILED 8-19-2006.

RUSS HERMAN, EXAMINING ATTORNEY

**Int. Cls.: 43 and 45**

**Prior U.S. Cls.: 100 and 101**

**United States Patent and Trademark Office**

**Reg. No. 3,469,786**

**Registered July 15, 2008**

**SERVICE MARK  
PRINCIPAL REGISTER**

**REAL SIMPLE FAMILY**

TIME INC. (DELAWARE CORPORATION)  
1271 AVENUE OF THE AMERICAS  
NEW YORK, NY 10020

FOR: PROVIDING ONLINE INFORMATION IN  
THE NATURE OF A DATABASE IN THE FIELD OF  
RECIPES AND COOKING INFORMATION, IN  
CLASS 43 (U.S. CLS. 100 AND 101).

FIRST USE 4-30-2006; IN COMMERCE 4-30-2006.

FOR: PROVIDING ONLINE INFORMATION VIA  
THE INTERNET IN THE FIELD OF FAMILY RE-  
LATIONSHIPS, IN CLASS 45 (U.S. CLS. 100 AND 101).

FIRST USE 4-30-2006; IN COMMERCE 4-30-2006.

THE MARK CONSISTS OF STANDARD CHAR-  
ACTERS WITHOUT CLAIM TO ANY PARTICULAR  
FONT, STYLE, SIZE, OR COLOR.

OWNER OF U.S. REG. NOS. 2,470,211, 3,098,845,  
AND OTHERS.

NO CLAIM IS MADE TO THE EXCLUSIVE  
RIGHT TO USE "FAMILY", APART FROM THE  
MARK AS SHOWN.

SN 78-956,226, FILED 8-21-2006.

SHANNON TWOHIG, EXAMINING ATTORNEY



**Int. Cl.: 36**

**Prior U.S. Cls.: 100, 101, and 102**

**United States Patent and Trademark Office**

**Reg. No. 3,469,787**

**Registered July 15, 2008**

**SERVICE MARK  
PRINCIPAL REGISTER**

**NYLIAC INSTANT LEGACY**

NEW YORK LIFE INSURANCE COMPANY  
(NEW YORK CORPORATION)  
ROOM 10SB  
51 MADISON AVENUE  
NEW YORK, NY 10010

FOR: INSURANCE SERVICES, NAMELY, UNDERWRITING, ISSUING AND ADMINISTRATION OF LIFE INSURANCE, NAMELY, ANNUITIES, IN CLASS 36 (U.S. CLS. 100, 101 AND 102).

FIRST USE 9-15-2006; IN COMMERCE 9-15-2006.

THE MARK CONSISTS OF STANDARD CHARACTERS WITHOUT CLAIM TO ANY PARTICULAR FONT, STYLE, SIZE, OR COLOR.

SN 78-956,345, FILED 8-21-2006.

KATHERINE CHANG, EXAMINING ATTORNEY

**Int. Cl.: 5**

**Prior U.S. Cls.: 6, 18, 44, 46, 51, and 52**

**Reg. No. 3,469,788**

**United States Patent and Trademark Office**

**Registered July 15, 2008**

---

**TRADEMARK  
PRINCIPAL REGISTER**

**Sock It**

WHITE GAPS INC. (TEXAS CORPORATION)  
SUITE A  
1610 W. POLO ROAD  
GRAND PRAIRIE, TX 75052

FOR: DENTAL PRODUCTS IN THE NATURE OF  
PHARMACEUTICAL GELS USED FOR TREAT-  
MENT OF PAIN AND PROTECTION OF WOUND  
SITES IN THE MOUTH, IN PARTICULAR, FOR USE  
AS SURGICAL DRESSINGS, TOPICAL WOUND  
AND ITCH DRESSINGS, DENTURE ADHESIVES,

AND TOPICAL PAIN RELIEVERS, IN CLASS 5 (U.S.  
CLS. 6, 18, 44, 46, 51 AND 52).

FIRST USE 4-1-2007; IN COMMERCE 4-1-2007.

THE MARK CONSISTS OF STANDARD CHAR-  
ACTERS WITHOUT CLAIM TO ANY PARTICULAR  
FONT, STYLE, SIZE, OR COLOR.

SN 78-956,436, FILED 8-21-2006.

REBECCA EISINGER, EXAMINING ATTORNEY

**Int. Cl.: 9**

**Prior U.S. Cls.: 21, 23, 26, 36, and 38**

**Reg. No. 3,469,789**

**United States Patent and Trademark Office**

**Registered July 15, 2008**

---

**TRADEMARK  
PRINCIPAL REGISTER**

# Bomber Girls

GLOBAL GAMING GROUP (NEVADA CORPORATION)  
3035 E PATRICK LANE SUITE 14  
LAS VEGAS, NV 89120

THE MARK CONSISTS OF STANDARD CHARACTERS WITHOUT CLAIM TO ANY PARTICULAR FONT, STYLE, SIZE, OR COLOR.

FOR: GAMING EQUIPMENT, NAMELY, SLOT MACHINES WITH OR WITHOUT VIDEO OUTPUT, IN CLASS 9 (U.S. CLS. 21, 23, 26, 36 AND 38).

SN 78-956,609, FILED 8-21-2006.

FIRST USE 8-5-2007; IN COMMERCE 8-5-2007.

MELVIN AXILBUND, EXAMINING ATTORNEY

**Int. Cl.: 25**

**Prior U.S. Cls.: 22 and 39**

**United States Patent and Trademark Office**

**Reg. No. 3,469,790**

**Registered July 15, 2008**

**TRADEMARK  
PRINCIPAL REGISTER**

# What About Daddy?

O'CONNELL, JAMES (UNITED STATES INDIVIDUAL)  
2305 HIGHLAND DRIVE  
CARLSBAD, CA 92008

FOR: BERMUDA SHORTS; BOARD SHORTS; BOXER SHORTS; CHEF'S HATS; FLEECE SHORTS; FLIP FLOPS; GOLF SHIRTS; GYM SHORTS; HATS; HEADGEAR, NAMELY, BASEBALL CAPS; KNIT SHIRTS; NIGHT SHIRTS; OPEN-NECKED SHIRTS; PANTIES, SHORTS AND BRIEFS; PIQUET SHIRTS; POLO SHIRTS; RUGBY SHORTS; SHIRT FRONTS; SHIRTS; SHORT TROUSERS; SHORT-SLEEVED OR LONG-SLEEVED T-SHIRTS; SHORT-SLEEVED SHIRTS; SHORTS; SLEEP SHIRTS; SPORT SHIRTS; SPORTS SHIRTS; SPORTS SHIRTS WITH SHORT

SLEEVES; SWEAT SHIRTS; SWEAT SHORTS; T-SHIRTS; TOBOGGAN HATS, PANTS AND CAPS; WALKING SHORTS; WIND SHIRTS; WOOLLY HATS, IN CLASS 25 (U.S. CLS. 22 AND 39).

FIRST USE 4-10-2006; IN COMMERCE 12-1-2006.

THE MARK CONSISTS OF STANDARD CHARACTERS WITHOUT CLAIM TO ANY PARTICULAR FONT, STYLE, SIZE, OR COLOR.

SN 78-958,845, FILED 8-23-2006.

MICHAEL KEATING, EXAMINING ATTORNEY

**Int. Cls.: 3 and 5**

**Prior U.S. Cls.: 1, 4, 6, 18, 44, 46, 50, 51, and 52**

**United States Patent and Trademark Office**

**Reg. No. 3,469,791**

**Registered July 15, 2008**

**TRADEMARK  
PRINCIPAL REGISTER**

**FEBICO**

FAR EAST BIO-TEC CO., LTD. (TAIWAN CORPORATION)  
NAN-GANG DISTRICT  
13 F., NO. 3, YUAN CHIU STREET  
TAIPEI CITY, TAIWAN 115

FOR: LOTIONS, NAMELY, BODY LOTIONS, FACIAL LOTIONS, HAIR LOTIONS, HAND LOTIONS, AFTER-SHAVE LOTIONS; NOURISHING CREAMS, NAMELY, BEAUTY NOURISHING CREAMS, BODY NOURISHING CREAMS, ANTI-WRINKLE NOURISHING CREAMS, AFTER-SHAVE NOURISHING CREAMS, COSMETIC NOURISHING CREAMS; MASQUE POWDERS, NAMELY, BODY MASQUE POWDERS; MASQUES, NAMELY, BODY MASKS, FACIAL MASKS, SKIN MASKS; NOURISHING EYE CREAMS; EYE CREAM STRETCH MARK CREAMS; GRANULAR EXFOLIATION BEAUTY CREAMS; GRANULAR EXFOLIATION FACE AND BODY CREAMS; MAKE-UP REMOVAL LOTIONS; MOISTURIZING BODY LOTIONS; LIP CREAMS; SKIN CLEANSING LOTIONS; MAKE-UP, NAMELY, FACIAL CREAMS, BODY LOTIONS, SKIN TONERS, RESTORATIVE FACIAL AND BODY CREAMS, DAY CREAMS FOR THE FACE, BODY AND SKIN, NIGHT CREAMS FOR THE FACE, BODY AND SKIN; SKIN CARE PRODUCTS, NAMELY, NON-MEDICATED SKIN SERUMS, FRUIT ACID PEELS

FOR SKIN; BLEACHING BEAUTY MASKS; LAUNDRY DETERGENTS, IN CLASS 3 (U.S. CLS. 1, 4, 6, 50, 51 AND 52).

FIRST USE 8-0-2003; IN COMMERCE 8-0-2003.

FOR: NUTRITIONAL FOOD SUPPLEMENTS, NAMELY, ANTI-OXIDANTS, PROTEIN POWDERS, MINERAL SUPPLEMENTS, SPIRULINA POWDER, SPIRULINA TABLETS, SPIRULINA FINE, DIETARY SUPPLEMENTS CONTAINING EDIBLE PLANT FIBER; NUTRITIONAL SUPPLEMENTS PREPARATIONS, NAMELY, CHLORELLA POWDERS, CHLORELLA TABLETS, CHLORELLA FINE, CHLORELLA PASTILLES, PROTEIN NUTRITIONAL SUPPLEMENTS; NUTRITIONAL SUPPLEMENT CAPSULES; NUTRITIONAL SUPPLEMENT PREPARATIONS, NAMELY, SPIRULINA PASTILLES AND EXTRACT OF SPIRULINA, IN CLASS 5 (U.S. CLS. 6, 18, 44, 46, 51 AND 52).

FIRST USE 8-0-2003; IN COMMERCE 8-0-2003.

SN 78-958,891, FILED 8-23-2006.

JANICE KIM, EXAMINING ATTORNEY

**Int. Cl.: 30**

**Prior U.S. Cl.: 46**

**United States Patent and Trademark Office**

**Reg. No. 3,469,792**

**Registered July 15, 2008**

**TRADEMARK  
PRINCIPAL REGISTER**

**SOUR GUMMI TAPE**

WM. WRIGLEY JR. COMPANY (DELAWARE  
CORPORATION)

410 NORTH MICHIGAN AVENUE

CHICAGO, IL 60611

FOR: CONFECTIONERY, NAMELY, CANDY, IN  
CLASS 30 (U.S. CL. 46).

FIRST USE 12-1-2006; IN COMMERCE 12-1-2006.

THE MARK CONSISTS OF STANDARD CHAR-  
ACTERS WITHOUT CLAIM TO ANY PARTICULAR  
FONT, STYLE, SIZE, OR COLOR.

NO CLAIM IS MADE TO THE EXCLUSIVE  
RIGHT TO USE "SOUR GUMMI", APART FROM  
THE MARK AS SHOWN.

SN 78-959,715, FILED 8-24-2006.

KIMBERLY FRYE, EXAMINING ATTORNEY

**Int. Cl.: 9**

**Prior U.S. Cls.: 21, 23, 26, 36, and 38**

**United States Patent and Trademark Office**

**Reg. No. 3,469,793**

**Registered July 15, 2008**

**TRADEMARK  
PRINCIPAL REGISTER**

**Push the Button Feel the  
Power**

BONGIOVI ACOUSTICS (FLORIDA CORPORATION)  
649 SW WHITMORE DRIVE  
PORT SAINT LUCIE, FL 34984

FOR: ELECTRONIC AUDIO SIGNAL PROCESSING DECODERS AND CONTROLLERS SOLD AS A COMPONENT PART OF SURROUND SOUND OR HOME THEATRE SYSTEMS USED IN THE COMMERCIAL, HOME, AUTOMOBILE, AVIATION OR MARINE INDUSTRIES FOR ANY TYPE OF AUDIO REPRODUCTION, IN CLASS 9 (U.S. CLS. 21, 23, 26, 36 AND 38).

FIRST USE 12-0-2006; IN COMMERCE 12-0-2006.

THE MARK CONSISTS OF STANDARD CHARACTERS WITHOUT CLAIM TO ANY PARTICULAR FONT, STYLE, SIZE, OR COLOR.

SN 78-961,540, FILED 8-28-2006.

MARK RADEMACHER, EXAMINING ATTORNEY

**Int. Cl.: 9**

**Prior U.S. Cls.: 21, 23, 26, 36, and 38**

**Reg. No. 3,469,794**

**United States Patent and Trademark Office**

**Registered July 15, 2008**

**TRADEMARK  
PRINCIPAL REGISTER**

**SHADOWSHIELD**

PINE HARBOR HOLDING COMPANY, INC.  
(WISCONSIN CORPORATION)  
7745 178TH STREET  
CHIPPEWA FALLS, WI 54729

THE MARK CONSISTS OF STANDARD CHARACTERS WITHOUT CLAIM TO ANY PARTICULAR FONT, STYLE, SIZE, OR COLOR.

FOR: HAND-HELD SHIELDS FOR SURVEILLANCE AND PROTECTION, IN CLASS 9 (U.S. CLS. 21, 23, 26, 36 AND 38).

SN 78-961,542, FILED 8-28-2006.

FIRST USE 1-11-2007; IN COMMERCE 1-11-2007.

HEATHER THOMPSON, EXAMINING ATTORNEY



**Int. Cl.: 41**

**Prior U.S. Cls.: 100, 101, and 107**

**United States Patent and Trademark Office**

**Reg. No. 3,469,795**

**Registered July 15, 2008**

---

**SERVICE MARK  
PRINCIPAL REGISTER**

**PROFITAKER**

MARKET TECHNOLOGIES, LLC (FLORIDA LTD  
LIAB CO)  
5807 OLD PASCO ROAD  
WESLEY CHAPEL, FL 33544

FOR: ONLINE PUBLICATIONS, NAMELY,  
NEWSLETTERS AND ARTICLES FEATURING FI-  
NANCIAL INFORMATION, IN CLASS 41 (U.S. CLS.  
100, 101 AND 107).

FIRST USE 5-0-1983; IN COMMERCE 5-0-1983.

THE MARK CONSISTS OF STANDARD CHAR-  
ACTERS WITHOUT CLAIM TO ANY PARTICULAR  
FONT, STYLE, SIZE, OR COLOR.

SN 78-962,474, FILED 8-29-2006.

SUSAN STIGLITZ, EXAMINING ATTORNEY

Int. Cl.: 9

Prior U.S. Cls.: 21, 23, 26, 36, and 38

United States Patent and Trademark Office

Reg. No. 3,469,796

Registered July 15, 2008

TRADEMARK  
PRINCIPAL REGISTER

callpin

CALLPOD, INC. (ILLINOIS CORPORATION)  
SUITE 260  
850 W. JACKSON BLVD  
CHICAGO, IL 60607

OWNER OF U.S. REG. NO. 3,026,797.

THE COLOR(S) BLACK AND GREEN IS/ARE  
CLAIMED AS A FEATURE OF THE MARK.

FOR: DEVICES FOR HANDS-FREE USE OF MOBILE PHONES, NAMELY, A WEARABLE HANDS-FREE DEVICE THAT ALLOWS INDIVIDUALS TO COMMUNICATE WITH EACH OTHER OVER A PERSONAL AREA NETWORK (PAN) IN A GROUP SETTING OR AS AN INDIVIDUAL PAIRED TO A WIRELESS COMMUNICATION DEVICE, NAMELY, A CELL PHONE, COMPUTER, PDA, AND MP3 PLAYER, IN CLASS 9 (U.S. CLS. 21, 23, 26, 36 AND 38).

THE MARK CONSISTS OF THE LETTERS "C", "A", "L", "P", AND "N" IN BLACK AND THE LETTER "I" IS GREEN.

SN 78-962,728, FILED 8-29-2006.

FIRST USE 3-1-2008; IN COMMERCE 3-24-2008.

JAMES STEIN, EXAMINING ATTORNEY

**Int. Cl.: 10**

**Prior U.S. Cls.: 26, 39, and 44**

**United States Patent and Trademark Office**

**Reg. No. 3,469,797**

**Registered July 15, 2008**

**TRADEMARK  
PRINCIPAL REGISTER**

**KOOL SLING**

BREG, INC. (CALIFORNIA CORPORATION)  
2611 COMMERCE WAY  
VISTA, CA 92081

FOR: SLINGS FOR MEDICAL USE, IN CLASS 10  
(U.S. CLS. 26, 39 AND 44).

FIRST USE 8-28-2006; IN COMMERCE 8-28-2006.

THE MARK CONSISTS OF STANDARD CHARACTERS WITHOUT CLAIM TO ANY PARTICULAR FONT, STYLE, SIZE, OR COLOR.

NO CLAIM IS MADE TO THE EXCLUSIVE RIGHT TO USE "SLING", APART FROM THE MARK AS SHOWN.

SN 78-963,043, FILED 8-29-2006.

ALYSSA PALADINO, EXAMINING ATTORNEY

**Int. Cl.: 7**

**Prior U.S. Cls.: 13, 19, 21, 23, 31, 34, and 35**

**Reg. No. 3,469,798**

**United States Patent and Trademark Office**

**Registered July 15, 2008**

**TRADEMARK  
PRINCIPAL REGISTER**

**SINGER | Esteem**

**KSIN LUXEMBOURG III, S.AR.L. (LUXEM-  
BOURG CORPORATION)  
1, RUE DES GLACIS  
L-1628, LUXEMBOURG**

**FIRST USE 12-31-2006; IN COMMERCE 12-31-2006.**

**OWNER OF U.S. REG. NOS. 49,600, 2,990,313, AND  
OTHERS.**

**FOR: SEWING MACHINES AND PARTS THERE-  
FORE; ACCESSORIES TO SEWING MACHINES,  
NAMELY, MACHINE CONTROLS AND PRESSER  
FEET, IN CLASS 7 (U.S. CLS. 13, 19, 21, 23, 31, 34 AND  
35).**

**SN 78-964,010, FILED 8-30-2006.**

**SUSAN RICHARDS, EXAMINING ATTORNEY**

**Int. Cl.: 10**

**Prior U.S. Cls.: 26, 39, and 44**

**United States Patent and Trademark Office**

**Reg. No. 3,469,799**

**Registered July 15, 2008**

**TRADEMARK  
PRINCIPAL REGISTER**

**VISIFLEX SURE PASS**

ENDOLOGIX, INC. (DELAWARE CORPORATION)  
11 STUDEBAKER  
IRVINE, CA 92618

FOR: MEDICAL DEVICES, NAMELY, CATHETERS FOR USE IN TREATING AORTIC ANEURYSMS AND COMPLICATIONS, IN CLASS 10 (U.S. CLS. 26, 39 AND 44).

FIRST USE 4-10-2007; IN COMMERCE 4-10-2007.

THE MARK CONSISTS OF STANDARD CHARACTERS WITHOUT CLAIM TO ANY PARTICULAR FONT, STYLE, SIZE, OR COLOR.

SN 78-965,441, FILED 8-31-2006.

LINDA ORNDORFF, EXAMINING ATTORNEY

**Int. Cl.: 2**

**Prior U.S. Cls.: 6, 11, and 16**

**United States Patent and Trademark Office**

**Reg. No. 3,469,800**

**Registered July 15, 2008**

**TRADEMARK  
PRINCIPAL REGISTER**

**CONTROLZ**

THE VALSPAR CORPORATION (DELAWARE  
CORPORATION)  
1101 SOUTH THIRD STREET  
MINNEAPOLIS, MN 55415

FOR: SEALER COATINGS FOR USE IN STAIN  
BLOCKING; PRIMERS FOR PREPARING SURFA-  
CES TO BE PAINTED IN THE NATURE OF STAIN  
BLOCKING, IN CLASS 2 (U.S. CLS. 6, 11 AND 16).

FIRST USE 1-0-2008; IN COMMERCE 1-0-2008.

THE MARK CONSISTS OF STANDARD CHAR-  
ACTERS WITHOUT CLAIM TO ANY PARTICULAR  
FONT, STYLE, SIZE, OR COLOR.

SN 78-965,706, FILED 9-1-2006.

TOBY BULLOFF, EXAMINING ATTORNEY

**Int. Cl.: 16**

**Prior U.S. Cls.: 2, 5, 22, 23, 29, 37, 38, and 50**

**Reg. No. 3,469,801**

**United States Patent and Trademark Office**

**Registered July 15, 2008**

**TRADEMARK  
PRINCIPAL REGISTER**

**XLLERATE**

XLLERATE CONSULTING, LLC (TEXAS LTD  
LIAB CO)  
SUITE 140-202  
5435 N. GARLAND AVENUE  
GARLAND, TX 750402787

FOR: COMPUTER MANUALS, BOOKS, BOOK-  
LETS, AND PAMPHLETS IN THE FIELDS OF  
AUTOMATING MANUAL BUSINESS PRACTICES,  
DOCUMENTING BUSINESS PROCESSES, MANA-  
GING AND INTEGRATING DATABASES, PROVID-  
ING STATISTICAL ANALYSES, NOTIFICATIONS  
AND REPORTS, AND PROVIDING REAL-TIME,

INTEGRATED BUSINESS MANAGEMENT TOOLS,  
IN CLASS 16 (U.S. CLS. 2, 5, 22, 23, 29, 37, 38 AND 50).

FIRST USE 9-7-2005; IN COMMERCE 9-7-2005.

THE MARK CONSISTS OF STANDARD CHAR-  
ACTERS WITHOUT CLAIM TO ANY PARTICULAR  
FONT, STYLE, SIZE, OR COLOR.

SN 78-966,615, FILED 9-3-2006.

BRENDAN REGAN, EXAMINING ATTORNEY

**Int. Cl.: 45**

**Prior U.S. Cls.: 100 and 101**

**United States Patent and Trademark Office**

**Reg. No. 3,469,802**

**Registered July 15, 2008**

**SERVICE MARK  
PRINCIPAL REGISTER**

**XLLERATE**

XLLERATE CONSULTING, LLC (TEXAS LTD  
LIAB CO)  
SUITE 140-202  
5435 N. GARLAND AVENUE  
GARLAND, TX 750402787

THE MARK CONSISTS OF STANDARD CHAR-  
ACTERS WITHOUT CLAIM TO ANY PARTICULAR  
FONT, STYLE, SIZE, OR COLOR.

FOR: LICENSING OF COMPUTER SOFTWARE,  
IN CLASS 45 (U.S. CLS. 100 AND 101).

SN 78-966,616, FILED 9-3-2006.

FIRST USE 9-7-2005; IN COMMERCE 9-7-2005.

BRENDAN REGAN, EXAMINING ATTORNEY



**Int. Cl.: 9**

**Prior U.S. Cls.: 21, 23, 26, 36, and 38**

**Reg. No. 3,469,803**

**United States Patent and Trademark Office**

**Registered July 15, 2008**

**TRADEMARK  
PRINCIPAL REGISTER**

**REFLEX PHOTONICS**

REFLEX PHOTONICS INC. (CANADA CORPORATION)  
SUITE 680, WEST TOWER  
550 SHERBROOKE ST. WEST  
MONTREAL, CANADA H3A 1B9

FOR: ELECTRO-OPTICAL PACKAGING DEVICES, NAMELY, DETECTORS, EMITTERS, LASERS, MODULATORS AND AMPLIFIERS, USED IN THE FIELD OF PHOTONICS, SPECIFICALLY, IN ALLOWING AND FACILITATING ULTRA-HIGH-SPEED COMMUNICATIONS AND DIGITAL DATA TRANSFERS BETWEEN HIGH-SPEED AND HIGH-PERFORMANCE, COMPUTER PROCESSORS, COMPUTER CHIPS AND COMPUTER NETWORKS, IN CLASS 9 (U.S. CLS. 21, 23, 26, 36 AND 38).

FIRST USE 12-0-2006; IN COMMERCE 12-0-2006.

THE MARK CONSISTS OF STANDARD CHARACTERS WITHOUT CLAIM TO ANY PARTICULAR FONT, STYLE, SIZE, OR COLOR.

NO CLAIM IS MADE TO THE EXCLUSIVE RIGHT TO USE "PHOTONICS", APART FROM THE MARK AS SHOWN.

SN 78-966,855, FILED 9-5-2006.

AISHA SALEM, EXAMINING ATTORNEY

**Int. Cl.: 9**

**Prior U.S. Cls.: 21, 23, 26, 36, and 38**

**Reg. No. 3,469,804**

**United States Patent and Trademark Office**

**Registered July 15, 2008**

**TRADEMARK  
PRINCIPAL REGISTER**

**REFLEXPHOTONICS**

REFLEX PHOTONICS INC. (CANADA CORPORATION)  
SUITE 680, WEST TOWER  
550 SHERBROOKE STREET WEST  
MONTREAL, CANADA H3A 1B9

COMPUTER CHIPS AND COMPUTER NETWORKS,  
IN CLASS 9 (U.S. CLS. 21, 23, 26, 36 AND 38).

FIRST USE 12-0-2006; IN COMMERCE 12-0-2006.

FOR: ELECTRO-OPTICAL PACKAGING DEVICES, NAMELY, DETECTORS, EMITTERS, LASERS, MODULATORS AND AMPLIFIERS, USED IN THE FIELD OF PHOTONICS, SPECIFICALLY, IN ALLOWING AND FACILITATING ULTRA-HIGH-SPEED COMMUNICATIONS AND DIGITAL DATA TRANSFERS BETWEEN HIGH-SPEED AND HIGH-PERFORMANCE, COMPUTER PROCESSORS,

NO CLAIM IS MADE TO THE EXCLUSIVE RIGHT TO USE "PHOTONICS", APART FROM THE MARK AS SHOWN.

SN 78-966,864, FILED 9-5-2006.

AISHA SALEM, EXAMINING ATTORNEY

**Int. Cl.: 9**

**Prior U.S. Cls.: 21, 23, 26, 36, and 38**

**Reg. No. 3,469,805**

**United States Patent and Trademark Office**

**Registered July 15, 2008**

---

**TRADEMARK  
PRINCIPAL REGISTER**

**SPEEDO TUNER**

TOTAL FUEL SYSTEMS, LLC (NEVADA LTD  
LIAB CO)  
2108 DIAMOND PEAK COURT  
LAS VEGAS, NV 89117

FOR: ELECTRONIC DEVICE FOR CALIBRATING THE SPEEDOMETERS OF MOTORCYCLES, IN CLASS 9 (U.S. CLS. 21, 23, 26, 36 AND 38).

FIRST USE 4-1-2008; IN COMMERCE 4-1-2008.

THE MARK CONSISTS OF STANDARD CHARACTERS WITHOUT CLAIM TO ANY PARTICULAR FONT, STYLE, SIZE, OR COLOR.

NO CLAIM IS MADE TO THE EXCLUSIVE RIGHT TO USE "TUNER", APART FROM THE MARK AS SHOWN.

SN 78-967,883, FILED 9-6-2006.

ANNE E. GUSTASON, EXAMINING ATTORNEY

**Int. Cl.: 20**

**Prior U.S. Cls.: 2, 13, 22, 25, 32, and 50**

**Reg. No. 3,469,806**

**United States Patent and Trademark Office**

**Registered July 15, 2008**

---

**TRADEMARK  
PRINCIPAL REGISTER**

**SIMPLY SMART**

SMART FURNITURE, INC. (DELAWARE COR-  
PORATION)  
430 MARKET ST.  
CHATTANOOGA, TN 37402

THE MARK CONSISTS OF STANDARD CHAR-  
ACTERS WITHOUT CLAIM TO ANY PARTICULAR  
FONT, STYLE, SIZE, OR COLOR.

FOR: FURNITURE, IN CLASS 20 (U.S. CLS. 2, 13,  
22, 25, 32 AND 50).

SN 78-968,125, FILED 9-6-2006.

FIRST USE 5-3-2006; IN COMMERCE 5-3-2006.

SUNG IN, EXAMINING ATTORNEY

**Int. Cl.: 25**

**Prior U.S. Cls.: 22 and 39**

**United States Patent and Trademark Office**

**Reg. No. 3,469,807**

**Registered July 15, 2008**

**TRADEMARK  
PRINCIPAL REGISTER**

**Compliments of Yinda**

KOOMSON, KOJO ENYINDA (UNITED STATES  
INDIVIDUAL)  
5415 PURDUE AVE  
BALTIMORE, MD 21239

THE MARK CONSISTS OF STANDARD CHAR-  
ACTERS WITHOUT CLAIM TO ANY PARTICULAR  
FONT, STYLE, SIZE, OR COLOR.

FOR: HATS; JEANS; T-SHIRTS, IN CLASS 25 (U.S.  
CLS. 22 AND 39).

SN 78-968,600, FILED 9-6-2006.

FIRST USE 6-27-2006; IN COMMERCE 7-28-2007.

GIANCARLO CASTRO, EXAMINING ATTORNEY

Int. Cl.: 3

Prior U.S. Cls.: 1, 4, 6, 50, 51, and 52

Reg. No. 3,469,808

United States Patent and Trademark Office

Registered July 15, 2008

TRADEMARK  
PRINCIPAL REGISTER



AMENITY LLC (DELAWARE LTD LIAB CO)  
1230 AVENUE OF THE AMERICAS, 7TH FLOOR  
NEW YORK, NY 10020

FOR: COSMETICS AND PERSONAL CARE PRODUCTS, NAMELY, SHAVING CREAM, SHAVING GEL, PRE-SHAVE OIL PREPARATIONS, NON-MEDICATED ASTRINGENTS, AFTER SHAVE LOTION, FACIAL AND BODY CLEANSER, FACIAL AND BODY SOAP, FACIAL MOISTURIZER, FACE SCRUBS, BODY SCRUBS, FOOT CREAMS, HAND CREAMS, SKIN TONERS, FACE MASQUES, SKIN HYDRATORS, ANTI-AGING LOTION, NON-MEDICATED EYECARE PRODUCTS, NAMELY, CREAMS AND LOTIONS; SUN CARE PRODUCTS, NAMELY, SUN CARE LOTIONS AND SUN BLOCK; SELF TANNERS, SKIN LIGHTENERS, SKIN BRIGHTENERS, ANTIPERSPIRANTS AND DEODORANTS, HAIR CARE PRODUCTS, NAMELY, SHAMPOO, CONDITIONER, HAIR GEL, HAIR SPRAY, HAIR COLOR AND HAIR POMADES, TALCUM POWDER, BODY CARE PRODUCTS, NAMELY, BODY LOTIONS, BODY CREAM, BODY SCRUB, FRAGRANCES FOR PERSONAL USE, HAIR REMOVAL PREPARATIONS, BODY CARE PREPARATIONS, TOOTH WHITENERS, LIP BALMS, TOOTHPASTE, NON-MEDICINAL MOUTHWASH, NON-MEDICATED GUM RINSES IN THE NATURE OF NON-MEDICATED DENTAL RINSES FOR GUMS, BREATH FRESHENERS, DILUTED BREATH SPRAYS USED AS MOUTHWASH, CONCENTRATED BREATH FRESHENER SPRAYS, TRAVEL SIZE COSMETIC AND PERSONAL CARE PRODUCTS, NAMELY, TRAVEL SIZE SHAVING CREAM, SHAVING GEL, PRE-SHAVE OIL PREPARATIONS, NON-MEDICATED ASTRINGENTS,

AFTER SHAVE LOTION, FACIAL AND BODY CLEANSER, FACIAL AND BODY SOAP, FACIAL MOISTURIZER, FACE SCRUBS, BODY SCRUBS, FOOT CREAMS, HAND CREAMS, SKIN TONERS, FACE MASQUES, SKIN HYDRATORS, ANTI-AGING LOTION AND CREAM, EYE CREAM AND LOTION, AND HAIR CARE PRODUCTS, NAMELY, SHAMPOO, CONDITIONER, HAIR GEL, HAIR SPRAY, HAIR COLOR AND HAIR POMADES; ANTI-AGING PRODUCTS, NAMELY, CREAMS AND LOTIONS; FACIAL PRODUCTS, NAMELY, CLEANSER, SOAP, MOISTURIZER, SCRUBS, TONERS, MASQUES, LOTIONS AND CREAMS; SHAVE PRODUCTS, NAMELY, SHAVING CREAM, SHAVING GEL, PRE-SHAVE OIL PREPARATIONS, NON-MEDICATED ASTRINGENTS, AFTER SHAVE LOTION; GIFT SETS COMPOSED PRIMARILY OF SHAVING CREAM, SHAVING GEL, PRE-SHAVE OIL PREPARATIONS, NON-MEDICATED ASTRINGENTS, AFTER SHAVE LOTION, FACIAL AND BODY CLEANSER, FACIAL AND BODY SOAP, FACIAL MOISTURIZER, FACE SCRUBS, BODY SCRUBS, FOOT CREAMS, HAND CREAMS, SKIN TONERS, FACE MASQUES, FACIAL AND BODY LOTION, FACIAL AND BODY CREAM, NON-MEDICATED ACNE TREATMENT PREPARATIONS, HAIR CARE PRODUCTS, NAMELY, SHAMPOO, CONDITIONER, HAIR GEL, HAIR SPRAY, HAIR COLOR AND HAIR POMADES, SKIN HYDRATORS, ANTI-AGING LOTION AND CREAM, NON-MEDICATED EYECARE LOTION AND CREAM, SKIN LIGHTENERS, AND HAIR REMOVAL PRODUCTS, NAMELY, DEPILATORY CREAMS; WIPES AND TOWELETTES, NAMELY, COSMETIC CLEANSING PADS AND COSMETIC MOISTURIZ-

ING WIPES; GRADUAL SELF TANNING MOISTURIZER, IN CLASS 3 (U.S. CLS. 1, 4, 6, 50, 51 AND 52).

SN 78-969,394, FILED 9-7-2006.

FIRST USE 8-1-2006; IN COMMERCE 8-1-2006.

MAUREEN DALL, EXAMINING ATTORNEY

**Int. Cl.: 3**

**Prior U.S. Cls.: 1, 4, 6, 50, 51, and 52**

**Reg. No. 3,469,809**

**United States Patent and Trademark Office**

**Registered July 15, 2008**

**TRADEMARK  
PRINCIPAL REGISTER**

**AMENITY THE PIONEER OF  
CLINICAL GROOMING**

AMENITY LLC (DELAWARE LTD LIAB CO)  
1230 AVENUE OF THE AMERICAS, 7TH FLOOR  
NEW YORK, NY 10020

FOR: COSMETICS AND PERSONAL CARE PRODUCTS, NAMELY, SHAVING CREAM, SHAVING GEL, PRE-SHAVE OIL PREPARATIONS, NON-MEDICATED ASTRINGENTS, AFTER SHAVE LOTION, FACIAL AND BODY CLEANSER, FACIAL AND BODY SOAP, FACIAL MOISTURIZER, FACE SCRUBS, BODY SCRUBS, FOOT CREAMS, HAND CREAMS, SKIN TONERS, FACE MASQUES, SKIN HYDRATORS, ANTI-AGING LOTION, NON-MEDICATED EYECARE PRODUCTS, NAMELY, CREAMS AND LOTIONS; SUN CARE PRODUCTS, NAMELY, SUN CARE LOTIONS AND SUN BLOCK; SELF TANNERS, SKIN LIGHTENERS, SKIN BRIGHTENERS, ANTIPERSPIRANTS AND DEODORANTS, HAIR CARE PRODUCTS, NAMELY, SHAMPOO, CONDITIONER, HAIR GEL, HAIR SPRAY, HAIR COLOR AND HAIR POMADES, TALCUM POWDER, BODY CARE PRODUCTS, NAMELY, BODY LOTIONS, BODY CREAM, BODY SCRUB, FRAGRANCES FOR PERSONAL USE, HAIR REMOVAL PREPARATIONS, BODY CARE PREPARATIONS, TOOTH WHITENERS, LIP BALMS, TOOTHPASTE, NON-MEDICINAL MOUTHWASH, NON-MEDICATED GUM RINSES IN THE NATURE OF NON-MEDICATED DENTAL RINSES FOR GUMS, BREATH FRESHENERS, DILUTED BREATH SPRAYS USED AS MOUTHWASH, CONCENTRATED BREATH FRESHENER SPRAYS, TRAVEL SIZE COSMETIC AND PERSONAL CARE PRODUCTS, NAMELY, TRAVEL SIZE SHAVING CREAM, SHAVING GEL, PRE-SHAVE OIL PREPARATIONS, NON-MEDICATED ASTRINGENTS, AFTER SHAVE LOTION, FACIAL AND BODY CLEANSER, FACIAL AND BODY SOAP, FACIAL MOISTURIZER, FACE SCRUBS, BODY SCRUBS, FOOT CREAMS, HAND CREAMS, SKIN TONERS, FACE MASQUES, SKIN HYDRATORS, ANTI-AGING LOTION AND CREAM, EYE CREAM AND

LOTION, AND HAIR CARE PRODUCTS, NAMELY, SHAMPOO, CONDITIONER, HAIR GEL, HAIR SPRAY, HAIR COLOR AND HAIR POMADES; ANTI-AGING PRODUCTS, NAMELY, CREAMS AND LOTIONS; FACIAL PRODUCTS, NAMELY, CLEANSER, SOAP, MOISTURIZER, SCRUBS, TONERS, MASQUES, LOTIONS AND CREAMS; SHAVE PRODUCTS, NAMELY, SHAVING CREAM, SHAVING GEL, PRE-SHAVE OIL PREPARATIONS, NON-MEDICATED ASTRINGENTS, AFTER SHAVE LOTION; GIFT SETS COMPOSED PRIMARILY OF SHAVING CREAM, SHAVING GEL, PRE-SHAVE OIL PREPARATIONS, NON-MEDICATED ASTRINGENTS, AFTER SHAVE LOTION, FACIAL AND BODY CLEANSER, FACIAL AND BODY SOAP, FACIAL MOISTURIZER, FACE SCRUBS, BODY SCRUBS, FOOT CREAMS, HAND CREAMS, SKIN TONERS, FACE MASQUES, FACIAL AND BODY LOTION, FACIAL AND BODY CREAM, NON-MEDICATED ACNE TREATMENT PREPARATIONS, HAIR CARE PRODUCTS, NAMELY, SHAMPOO, CONDITIONER, HAIR GEL, HAIR SPRAY, HAIR COLOR AND HAIR POMADES, SKIN HYDRATORS, ANTI-AGING LOTION AND CREAM, NON-MEDICATED EYECARE LOTION AND CREAM, SKIN LIGHTENERS, AND HAIR REMOVAL PRODUCTS, NAMELY, DEPILATORY CREAMS; WIPES AND TOWELETTS, NAMELY, COSMETIC CLEANSING PADS AND COSMETIC MOISTURIZING WIPES; GRADUAL SELF TANNING MOISTURIZER, IN CLASS 3 (U.S. CLS. 1, 4, 6, 50, 51 AND 52).

FIRST USE 8-1-2006; IN COMMERCE 8-1-2006.

THE MARK CONSISTS OF STANDARD CHARACTERS WITHOUT CLAIM TO ANY PARTICULAR FONT, STYLE, SIZE, OR COLOR.

SN 78-969,447, FILED 9-7-2006.

MAUREEN DALL, EXAMINING ATTORNEY



**Int. Cl.: 18**

**Prior U.S. Cls.: 1, 2, 3, 22, and 41**

**United States Patent and Trademark Office**

**Reg. No. 3,469,810**

**Registered July 15, 2008**

**TRADEMARK  
PRINCIPAL REGISTER**

**MORA MARA**

TREBBIANNO, LLC (NEW YORK LTD LIAB CO)  
29 WEST 35TH STREET  
NEW YORK, NY 10001

FOR: HANDBAGS, WALLETS, BILLFOLDS,  
SHOULDER BAGS, PURSES, LUGGAGE AND SUIT-  
CASES, IN CLASS 18 (U.S. CLS. 1, 2, 3, 22 AND 41).

FIRST USE 3-1-2007; IN COMMERCE 3-1-2007.

THE MARK CONSISTS OF STANDARD CHAR-  
ACTERS WITHOUT CLAIM TO ANY PARTICULAR  
FONT, STYLE, SIZE, OR COLOR.

SN 78-969,451, FILED 9-7-2006.

TRACY WHITTAKER-BROWN, EXAMINING AT-  
TORNEY

**Int. Cls.: 7, 9, and 11**

**Prior U.S. Cls.: 13, 19, 21, 23, 26, 31, 34, 35, 36, and 38**

**Reg. No. 3,469,811**

**United States Patent and Trademark Office**

**Registered July 15, 2008**

---

**TRADEMARK  
PRINCIPAL REGISTER**

**iRenew**

RENEWABLE ENERGY TECHNOLOGY LLC  
(FLORIDA LTD LIAB CO)  
7929 WEST DR. UNIT 401  
NORTH BAY VILLAGE, FL 33141

FOR: ENGINES AND MOTORS FOR THE GENERATION OF ELECTRICITY; SOLAR-POWERED ELECTRICITY GENERATORS , IN CLASS 7 (U.S. CLS. 13, 19, 21, 23, 31, 34 AND 35).

FIRST USE 9-30-2006; IN COMMERCE 9-30-2006.

FOR: BATTERY CHARGE DEVICES; PHOTO-VOLTAIC CELLS; RENEWABLE BATTERY SYSTEM TO PROVIDE BACKUP POWER; SOLAR CELLS, IN CLASS 9 (U.S. CLS. 21, 23, 26, 36 AND 38).

FIRST USE 9-30-2006; IN COMMERCE 9-30-2006.

FOR: ELECTRIC LANTERNS; FLASHLIGHTS; SOLAR COLLECTORS, IN CLASS 11 (U.S. CLS. 13, 21, 23, 31 AND 34).

FIRST USE 9-30-2006; IN COMMERCE 9-30-2006.

THE MARK CONSISTS OF STANDARD CHARACTERS WITHOUT CLAIM TO ANY PARTICULAR FONT, STYLE, SIZE, OR COLOR.

SN 78-971,945, FILED 9-12-2006.

ANTHONY RINKER, EXAMINING ATTORNEY

**Int. Cl.: 9**

**Prior U.S. Cls.: 21, 23, 26, 36, and 38**

**Reg. No. 3,469,812**

**United States Patent and Trademark Office**

**Registered July 15, 2008**

**TRADEMARK  
PRINCIPAL REGISTER**

**DATA LIFELINE**

TECHNOLOGY LIFELINE INC. (INDIANA CORPORATION)  
1705 N MERIDIAN STREET  
INDIANAPOLIS, IN 46202

FOR: COMPUTER SOFTWARE FOR ENCRYPTION; COMPUTER SOFTWARE FOR THE COLLECTION, EDITING, ORGANIZING, MODIFYING, BOOK MARKING, TRANSMISSION, STORAGE AND SHARING OF DATA AND INFORMATION; COMPUTER SOFTWARE FOR USE IN THE ENCRYPTION AND DECRYPTION OF DIGITAL FILES, INCLUDING AUDIO, VIDEO, TEXT, BINARY, STILL IMAGES, GRAPHICS AND MULTIMEDIA FILES; DATA COMPRESSION SOFTWARE, IN CLASS 9 (U.S. CLS. 21, 23, 26, 36 AND 38).

FIRST USE 9-30-2006; IN COMMERCE 9-30-2006.

THE MARK CONSISTS OF STANDARD CHARACTERS WITHOUT CLAIM TO ANY PARTICULAR FONT, STYLE, SIZE, OR COLOR.

NO CLAIM IS MADE TO THE EXCLUSIVE RIGHT TO USE "DATA", APART FROM THE MARK AS SHOWN.

SN 78-972,499, FILED 9-12-2006.

JESSICA FATHY, EXAMINING ATTORNEY

**Int. Cl.: 7**

**Prior U.S. Cls.: 13, 19, 21, 23, 31, 34, and 35**

**Reg. No. 3,469,813**

**United States Patent and Trademark Office**

**Registered July 15, 2008**

**TRADEMARK  
PRINCIPAL REGISTER**

**QUIETCLEAN**

ELECTROLUX HOME CARE PRODUCTS, INC.  
(DELAWARE CORPORATION)  
20445 EMERALD PARKWAY SOUTHWEST  
SUITE 250  
CLEVELAND, OH 44135

FIRST USE 7-1-2007; IN COMMERCE 7-1-2007.

THE MARK CONSISTS OF STANDARD CHAR-  
ACTERS WITHOUT CLAIM TO ANY PARTICULAR  
FONT, STYLE, SIZE, OR COLOR.

FOR: VACUUM CLEANERS AND ACCESSORIES,  
NAMELY, HOSES, NOZZLES, BRUSHES, WANDS,  
BAGS, BELTS AND FILTERS, IN CLASS 7 (U.S. CLS.  
13, 19, 21, 23, 31, 34 AND 35).

SN 78-973,054, FILED 9-13-2006.

JORDAN BAKER, EXAMINING ATTORNEY

**Int. Cl.: 5**

**Prior U.S. Cls.: 6, 18, 44, 46, 51, and 52**

**Reg. No. 3,469,814**

**United States Patent and Trademark Office**

**Registered July 15, 2008**

**TRADEMARK  
PRINCIPAL REGISTER**

**SECURE MEAL**

YOUR VITAMINS, INC. (NEVADA CORPORATION), DBA PROCAPS LABORATORIES,

430 PARKSON ROAD

HENDERSON, NV 89011

FOR: DIETARY AND NUTRITIONAL SUPPLEMENTS, DIETARY AND NUTRITIONAL SUPPLEMENT DRINK MIXES, AND MEAL REPLACEMENTS, IN CLASS 5 (U.S. CLS. 6, 18, 44, 46, 51 AND 52).

FIRST USE 10-12-2005; IN COMMERCE 1-23-2007.

THE MARK CONSISTS OF STANDARD CHARACTERS WITHOUT CLAIM TO ANY PARTICULAR FONT, STYLE, SIZE, OR COLOR.

OWNER OF U.S. REG. NOS. 2,385,965, 2,561,979, AND 2,562,607.

NO CLAIM IS MADE TO THE EXCLUSIVE RIGHT TO USE "MEAL", APART FROM THE MARK AS SHOWN.

SN 78-973,591, FILED 9-13-2006.

EMILY CHUO, EXAMINING ATTORNEY

**Int. Cl.: 36**

**Prior U.S. Cls.: 100, 101, and 102**

**United States Patent and Trademark Office**

**Reg. No. 3,469,815**

**Registered July 15, 2008**

**SERVICE MARK  
PRINCIPAL REGISTER**

**SMART GAP**

TRANS-OCEANIC LIFE INSURANCE COMPANY  
(PUERTO RICO CORPORATION)  
NO. 3 MUNET COURT  
PUEBLO VIEJO, PUERTO RICO 00908

FOR: INSURANCE SERVICES, NAMELY, UNDERWRITING OF SUPPLEMENTAL HEALTH AND LIFE INSURANCE FOR EMPLOYEES AND SELF-EMPLOYED INDIVIDUALS, NAMELY, CAFETERIA PLANS, HIGH DEDUCTIBLE/HIGH HEALTH INSURANCE PLANS, HEALTH REIMBURSEMENT ACCOUNTS, HEALTH SAVINGS ACCOUNTS, COBRA COVERAGES AND GOVERNMENT SPONSORED PROGRAMS, IN CLASS 36 (U.S. CLS. 100, 101 AND 102).

FIRST USE 2-5-2008; IN COMMERCE 2-5-2008.

THE MARK CONSISTS OF STANDARD CHARACTERS WITHOUT CLAIM TO ANY PARTICULAR FONT, STYLE, SIZE, OR COLOR.

NO CLAIM IS MADE TO THE EXCLUSIVE RIGHT TO USE "GAP", APART FROM THE MARK AS SHOWN.

SN 78-973,667, FILED 9-13-2006.

ADA HAN, EXAMINING ATTORNEY

**Int. Cl.: 41**

**Prior U.S. Cls.: 100, 101, and 107**

**United States Patent and Trademark Office**

**Reg. No. 3,469,816**

**Registered July 15, 2008**

**SERVICE MARK  
PRINCIPAL REGISTER**

**THE WAY IT IS**

BLACK ENTERTAINMENT TELEVISION LLC  
(D.C. LTD LIAB CO)  
LEGAL AFFAIRS  
ONE BET PLAZA, 1235 W STREET, N.E.  
WASHINGTON, DC 20018

FOR: ENTERTAINMENT SERVICES, NAMELY,  
PROVIDING A PROGRAM IN THE FIELD OF  
REALITY VIA TELEVISION, CABLE, WIRELESS  
AND THE INTERNET , IN CLASS 41 (U.S. CLS. 100,  
101 AND 107).

FIRST USE 7-12-2006; IN COMMERCE 7-12-2006.

THE MARK CONSISTS OF STANDARD CHAR-  
ACTERS WITHOUT CLAIM TO ANY PARTICULAR  
FONT, STYLE, SIZE, OR COLOR.

SN 78-974,171, FILED 9-14-2006.

TINA L. SNAPP, EXAMINING ATTORNEY

**Int. Cl.: 33**

**Prior U.S. Cls.: 47 and 49**

**United States Patent and Trademark Office**

**Reg. No. 3,469,817**

**Registered July 15, 2008**

**TRADEMARK  
PRINCIPAL REGISTER**



CABO WABO LLC (DELAWARE LTD LIAB CO)  
1 BEACH STREET, SUITE 300  
SAN FRANCISCO, CA 94133

THE ENGLISH TRANSLATION OF THE WORD  
CABO IN THE MARK IS "CAPE".

FOR: DISTILLED SPIRITS; DISTILLED LIQUOR;  
TEQUILA, IN CLASS 33 (U.S. CLS. 47 AND 49).

SN 78-974,353, FILED 9-14-2006.

FIRST USE 2-0-2007; IN COMMERCE 2-0-2007.

KIMBERLY PERRY, EXAMINING ATTORNEY



**Int. Cls.: 35 and 41**

**Prior U.S. Cls.: 100, 101, 102, and 107**

**United States Patent and Trademark Office**

**Reg. No. 3,469,818**

**Registered July 15, 2008**

**SERVICE MARK  
PRINCIPAL REGISTER**



GULF PARTICIPACOES E ADMINISTRACAO  
LTDA (BRAZIL CORPORATION)

SALA 301, BARRA DA TIJUCA

AVENIDA DAS AMERICAS, NO. 500, BL. 19,  
RIO DE JANEIRO, BRAZIL

FOR: PROMOTING AMATEUR AND PROFES-  
SIONAL SOCCER COMPETITIONS AND PRIVATE  
SOCCER EVENTS OF OTHERS, IN CLASS 35 (U.S.  
CLS. 100, 101 AND 102).

FIRST USE 1-0-2006; IN COMMERCE 1-0-2006.

FOR: PROVIDING SOCCER TRAINING FACIL-  
ITIES, ORGANIZING SOCCER TRAINING PRO-  
GRAMS, NAMELY, PART-TIME AND FULL-TIME  
CLINICS AND CAMPS; ARRANGING AND CON-  
DUCTING AMATEUR AND PROFESSIONAL SOC-  
CER COMPETITIONS, SOCCER CONVENTIONS AS  
WELL AS CORPORATE AND PRIVATE SOCCER  
MEETS, IN CLASS 41 (U.S. CLS. 100, 101 AND 107).

FIRST USE 1-0-2006; IN COMMERCE 1-0-2006.

NO CLAIM IS MADE TO THE EXCLUSIVE  
RIGHT TO USE "BRAZILIAN FOOTBALL ACAD-  
EMY", APART FROM THE MARK AS SHOWN.

THE COLOR(S) BLUE, GOLD, YELLOW AND  
WHITE IS/ARE CLAIMED AS A FEATURE OF  
THE MARK.

THE MARK CONSISTS OF THE WORD "ACAD-  
EMY" UNDER THE WORD "FOOTBALL", WITH  
THE WORD "FOOTBALL" UNDER THE WORD  
"BRAZILIAN"; ALL THREE WORDS ARE WRITTEN  
IN BLUE; ABOVE THOSE WORDS IS A GOLD AND  
YELLOW BOX CONTAINING THE LETTERS "BFA"  
IN WHITE; ABOVE THOSE LETTERS IS A SOCCER  
PLAYER KICKING A LARGE SOCCER BALL; THE  
SOCCER PLAYER AND THE BALL ARE WHITE;  
THE BALL HAS GOLD AND YELLOW PENTAGO-  
NAL FIGURES ON IT; FIVE BLUE STARS FORM AN  
ARCH OVER THE TOP OF THE SOCCER BALL.

SN 78-974,719, FILED 9-14-2006.

TARAH HARDY, EXAMINING ATTORNEY

Int. Cl.: 41

Prior U.S. Cls.: 100, 101, and 107

United States Patent and Trademark Office

Reg. No. 3,469,819

Registered July 15, 2008

SERVICE MARK  
PRINCIPAL REGISTER



SHUFFLE MASTER INC. (MINNESOTA CORPORATION)  
1106 PALMS AIRPORT DR.  
LAS VEGAS, NV 89119

NO CLAIM IS MADE TO THE EXCLUSIVE RIGHT TO USE "THREE CARD BACCARAT", APART FROM THE MARK AS SHOWN.

FOR: ENTERTAINMENT SERVICES, NAMELY, PROVIDING LIVE GAMES OF CHANCE IN A GAMING ESTABLISHMENT, IN CLASS 41 (U.S. CLS. 100, 101 AND 107).

SN 78-974,937, FILED 9-14-2006.

FIRST USE 10-26-2007; IN COMMERCE 10-26-2007.

JOHN HWANG, EXAMINING ATTORNEY

**Int. Cls.: 28 and 41**

**Prior U.S. Cls.: 22, 23, 38, 50, 100, 101, and 107**

**Reg. No. 3,469,820**

**United States Patent and Trademark Office**

**Registered July 15, 2008**

**TRADEMARK  
SERVICE MARK  
PRINCIPAL REGISTER**

**SATORI ACADEMY**

KOVAR'S, INC. (CALIFORNIA CORPORATION)  
7538 FAIR OAKS BLVD.  
CARMICHAEL, CA 95608

FOR: COMMERCIAL GRADE AND HOME GYM EXERCISE EQUIPMENT, ATHLETIC OR SPORTS EXERCISE EQUIPMENT AND BODY BUILDING, PHYSICAL FITNESS, AND CARDIO EXERCISE EQUIPMENT, NAMELY, AEROBIC STEPS, AEROBIC SLIDES AND RIDERS, STATIONARY EXERCISE BIKES, EXERCISE TREADMILLS, ROWING MACHINES, STAIR-STEPPING MACHINES, STATIONARY RECUMBENT EXERCISE BICYCLES, STRENGTH TRAINING EXERCISE MACHINES, WEIGHT LIFTING MACHINES, CHEST WEIGHTS FOR EXERCISING, CHEST EXPANDERS, WEIGHT LIFTING BENCHES AND WEIGHT LIFTING BENCH ACCESSORIES IN THE NATURE OF SLANT BOARDS, BICYCLE TRAINERS, DUMBBELL SETS, FITNESS WEIGHTED BALLS, EXERCISE WEIGHTS IN THE NATURE OF WEIGHT PLATES, BARBELLS, DUMBBELLS FOR WEIGHT LIFTING, BAR BELL PADS, DUMBBELL HANDLES, EXERCISE BARS, BARBELLS, BARBELL NECK PROTECTORS, DUMBBELL BARS, HAND GRIPPERS, HEAD STRAPS, EXERCISE BENCHES, EXERCISE TABLES, EXERCISE PLATFORMS, PERSONAL EXERCISE MATS, EXERCISE GLIDERS, SPRING EXERCISERS, GRIP DEVELOPERS, MEDICINE BALLS, PUNCHING BAGS, TRAINING BAGS, EXPANSION CABLES AND STRAPS, WORKOUT AND WEIGHTLIFTING GLOVES, WORKOUT AND WEIGHTLIFTING BELTS, TORSO TIGHTENER EXERCISE MACHINES, EXERCISE WHEELS, YOGA MATS, PILATES BANDS, PILATES AND YOGA BALANCE WALKING BALLS, MANUAL DOOR KNOB ROPE LEG EXERCISERS, BODY EXERCISERS WITH DOOR ANCHORS, MASSAGE BALLS, TWIST BOARDS; STRETCH AND AEROBIC BANDS, JUMP ROPES, SKIPPING ROPES, JUMP ROPES FEATURING CALORIE COUNTERS SOLD AS A UNIT,

STRETCH BANDS, STRETCH EXPANDERS, WEIGHT LIFTING STRAPS, ANKLE, WRIST, AND LEG WEIGHTS FOR EXERCISE, FREE WEIGHTS, ADJUSTABLE ANKLE/WRIST WEIGHTS WITH REMOVABLE PLATES, ANKLE AND WRIST WRAPS, COMBO/SINGLE EXERCISE WHEEL AND SLIMMER BELTS, ROWING MACHINES FOR EXERCISE, MAGNETIC WRIST, ANKLE, KNEE, HIP, THIGH, WAIST, AND ELBOW EXERCISE BELTS; HANDHELD AND PORTABLE MANUALLY-OPERATED EXERCISE EQUIPMENT, CHIN UP EXERCISE BARS, HIP CYCLES, MANUALLY-OPERATED EXERCISE EQUIPMENT IN THE NATURE OF PUSH-UP STANDS AND SIT UP BARS, READING RACKS AND LIFTING STANDS SPECIALLY ADAPTED TO EXERCISE EQUIPMENT, PORTABLE ABDOMINAL TRAINERS, PORTABLE THIGH TRAINERS, TENSION EXERCISE BARS, EXERCISE WEIGHTS FOR RUNNING, DUMBBELL TREES, SQUEEZE BALLS, AND STAIR STEPPING AND CLIMBING MACHINES; MARTIAL ARTS SUPPLIES, NAMELY, PUNCHING BAGS, GLOVES, PROTECTIVE PADS IN THE FORM OF CHOPS AND KICKS, SHIN AND INSTEP GUARDS, CHEST GUARDS, HEAD GUARDS, RIB GUARDS, FOOT GUARDS SPARING GLOVES, KICK PADS, CRASH PADS, FLOOR PADS, MITTS, SHIELDS, KICKING AND PUNCHING TARGETS, WEAPONS, IN THE FORM OF BOKEN, THROWING STARS, KAMA, KNIVES, SWORDS, AXES, SPEAR HEADS, STEEL FANS, RINGS, CHAINS, TONFA, SAI, TOKUSHA KEIBO, NUNCHAKU, STAFFS, ESCRIMA STICKS, YAWARA, SHOBO, AND WOODEN GUNS, IN CLASS 28 (U.S. CLS. 22, 23, 38 AND 50).

FIRST USE 9-1-2005; IN COMMERCE 9-1-2005.

FOR: HEALTH AND PHYSICAL FITNESS INSTRUCTION AND CONSULTATION, MARTIAL ARTS INSTRUCTION, OPERATION OF MARTIAL ARTS SCHOOLS, YOGA INSTRUCTION; EDUCA-

TIONAL SERVICES, NAMELY, CONDUCTING CLASSES, SEMINARS, CONFERENCES AND WORKSHOPS IN THE FIELD OF LIFE SKILLS, PERSONAL DEVELOPMENT, SELF-AWARENESS, SELF-ESTEEM, LEADERSHIP SKILLS; PROVIDING RECREATION FACILITIES FEATURING INFLATABLE EQUIPMENT AND OTHER PLAY EQUIPMENT, NAMELY, OBSTACLE COURSES, IN CLASS 41 (U.S. CLS. 100, 101 AND 107).

FIRST USE 9-1-2005; IN COMMERCE 9-1-2005.

THE MARK CONSISTS OF STANDARD CHARACTERS WITHOUT CLAIM TO ANY PARTICULAR FONT, STYLE, SIZE, OR COLOR.

NO CLAIM IS MADE TO THE EXCLUSIVE RIGHT TO USE "ACADEMY", APART FROM THE MARK AS SHOWN.

THE ENGLISH TRANSLATION OF "SATORI" IS ENLIGHTENMENT.

SN 78-978,202, FILED 12-23-2005.

JOSETTE BEVERLY, EXAMINING ATTORNEY

Int. Cls.: 7 and 17

Prior U.S. Cls.: 1, 5, 12, 13, 19, 21, 23, 31, 34, 35, and 50

Reg. No. 3,469,821

United States Patent and Trademark Office

Registered July 15, 2008

TRADEMARK  
PRINCIPAL REGISTER

# Opteria

LINTEC KABUSHIKI KAISHA (JAPAN CORPORATION), TA LINTEC CORPORATION, NO.22-23, HONCHO ITABASHI-KU TOKYO, JAPAN

FOR: LAMINATE MACHINES FOR OPTICAL DISC SHEET; PET (POLYETHYLENE TEREPHTHALATE) SHEET WITH SURFACE PROTECT LAYER, AND OTHER FILM SHEET LAMINATING MACHINES, USING MATERIAL PET (POLYETHYLENE TEREPHTHALETE), POLYCARBONATE, POLYOLEFIN, POLYETHYLENE, POLYPROPYLENE, POLYBUTENE, POLYBUTADIENE, VINYL CHLORIDE, IONOMER, ETHYLENE-METHACRYLIC ACID COPOLYMER, POLYETHYLENE NAPHTHAHALATE, POLYETHYLENE TEREPHTHALATE, POLYIMIDE, POLYETHERIMIDE, POLYARAMID, POLYETHER KETONE, POLYETHER ETHER KETONE, POLYPHENYLENE SULFIDE, POLY-4-METHYLPENTENE-1, POLYTRAFUOROETHYLENE, ACRYLIC RESIN, OR NORBORNENE SYSTEM RESIN; ABRUPTION MA-

CHINES FOR FILM SHEET, IN CLASS 7 (U.S. CLS. 13, 19, 21, 23, 31, 34 AND 35).

FIRST USE 5-10-2005; IN COMMERCE 5-15-2007.

FOR: OPTICAL DISC SHEET MATERIALS; PET (POLYETHYLENE TEREPHTHALATE) SHEET WITH SURFACE PROTECT LAYER; OTHER PLASTIC SEMI-WORKED PRODUCTS FOR USE AS MATERIAL, NAMELY, ADHESIVE-COATED PLASTIC SHEETS, AND PLASTIC FILM, IN CLASS 17 (U.S. CLS. 1, 5, 12, 13, 35 AND 50).

FIRST USE 10-5-2005; IN COMMERCE 10-5-2005.

THE MARK CONSISTS OF STANDARD CHARACTERS WITHOUT CLAIM TO ANY PARTICULAR FONT, STYLE, SIZE, OR COLOR.

SN 78-979,004, FILED 4-20-2005.

AMY GEARIN, EXAMINING ATTORNEY

**Int. Cl.: 1**

**Prior U.S. Cls.: 1, 5, 6, 10, 26, and 46**

**Reg. No. 3,469,822**

**United States Patent and Trademark Office**

**Registered July 15, 2008**

**TRADEMARK  
PRINCIPAL REGISTER**



ACCESS CHINA INDUSTRIAL TEXTILES, INC.  
(WASHINGTON CORPORATION), DBA ACIT  
(USA), INC.,  
21123 SE 42ND STREET  
SAMMAMISH, WA 98075

FOR: CHEMICAL COMPOUND, NAMELY,  
HIGH-STRENGTH AMORPHOUS SILICA USED IN  
THE MANUFACTURE OF HIGH-TEMPERATURE  
INSULATION PRODUCTS FOR THE AEROSPACE,

MARINE, MOLTEN METAL, AND ELECTRICAL  
POWER INDUSTRIES, IN CLASS 1 (U.S. CLS. 1, 5, 6,  
10, 26 AND 46).

FIRST USE 12-0-1996; IN COMMERCE 12-0-1996.

SN 78-979,930, FILED 10-3-2003.

BRETT J. GOLDEN, EXAMINING ATTORNEY

**Int. Cl.: 28**

**Prior U.S. Cls.: 22, 23, 38, and 50**

**Reg. No. 3,469,823**

**United States Patent and Trademark Office**

**Registered July 15, 2008**

**TRADEMARK  
PRINCIPAL REGISTER**

**HIGH SCHOOL MUSICAL**

DISNEY ENTERPRISES, INC. (DELAWARE CORPORATION)  
500 SOUTH BUENA VISTA STREET  
BURBANK, CA 91521

FOR: ACTION SKILL GAMES; BALLOONS; BASKETBALLS; BASEBALLS; BEACH BALLS; CHILDREN'S PLAY COSMETICS; CHRISTMAS STOCKINGS; DOLL CLOTHING; DOLL ACCESSORIES; DOLL PLAYSETS; HAND HELD UNIT FOR PLAYING ELECTRONIC GAMES; INFLATABLE TOYS; MUSICAL TOYS; PARLOR GAMES; PARTY FAVORS IN THE NATURE OF SMALL TOYS;

PARTY GAMES; PLUSH TOYS; TOY VEHICLES; TOY CARS, IN CLASS 28 (U.S. CLS. 22, 23, 38 AND 50).

FIRST USE 1-5-2008; IN COMMERCE 1-5-2008.

THE MARK CONSISTS OF STANDARD CHARACTERS WITHOUT CLAIM TO ANY PARTICULAR FONT, STYLE, SIZE, OR COLOR.

SN 78-980,105, FILED 3-27-2006.

SAMUEL E. SHARPER JR., EXAMINING ATTORNEY

**Int. Cl.: 5**

**Prior U.S. Cls.: 6, 18, 44, 46, 51, and 52**

**Reg. No. 3,469,824**

**United States Patent and Trademark Office**

**Registered July 15, 2008**

---

**TRADEMARK  
PRINCIPAL REGISTER**

**VECTRA**

SUMMIT VETPHARM LLC (DELAWARE LIMITED LIABILITY CORPORATION)  
400 KELBY STREET  
FORT LEE, NJ 07024

THE MARK CONSISTS OF STANDARD CHARACTERS WITHOUT CLAIM TO ANY PARTICULAR FONT, STYLE, SIZE, OR COLOR.

FOR: INSECT REPELLANTS FOR USE ON CATS; READY TO USE INSECTICIDE FOR CATS, IN CLASS 5 (U.S. CLS. 6, 18, 44, 46, 51 AND 52).

SN 78-980,159, FILED 4-13-2006.

FIRST USE 2-17-2008; IN COMMERCE 2-17-2008.

DEZMONA MIZELLE, EXAMINING ATTORNEY



**Int. Cl.: 42**

**Prior U.S. Cls.: 100 and 101**

**United States Patent and Trademark Office**

**Reg. No. 3,469,825**

**Registered July 15, 2008**

---

**SERVICE MARK  
PRINCIPAL REGISTER**

**TRUBION**

TRUBION PHARMACEUTICALS, INC. (DELA-  
WARE CORPORATION)  
2401 4TH AVENUE  
SUITE 1050  
SEATTLE, WA 98121

FIRST USE 4-25-2006; IN COMMERCE 4-25-2006.

SN 78-980,201, FILED 8-25-2003.

FOR: PHARMACEUTICAL DRUG DEVELOP-  
MENT SERVICES, IN CLASS 42 (U.S. CLS. 100 AND  
101).

SONYA STEPHENS, EXAMINING ATTORNEY

**Int. Cls.: 6, 16, and 21**

**Prior U.S. Cls.: 2, 5, 12, 13, 14, 22, 23, 25, 29, 30, 33,  
37, 38, 40, and 50**

**Reg. No. 3,469,826**

**United States Patent and Trademark Office**

**Registered July 15, 2008**

**TRADEMARK  
PRINCIPAL REGISTER**

**BEWARE OF FEMALE SPIES**

THE HOUSE ON F STREET, LLC (DELAWARE  
LTD LIAB CO)  
SUITE 800, 1660 WEST SECOND STREET  
CLEVELAND, OH 44113

FOR: METAL KEY CHAINS, IN CLASS 6 (U.S.  
CLS. 2, 12, 13, 14, 23, 25 AND 50).

FIRST USE 2-16-2007; IN COMMERCE 2-16-2007.

FOR: POSTCARDS, IN CLASS 16 (U.S. CLS. 2, 5, 22,  
23, 29, 37, 38 AND 50).

FIRST USE 3-10-2003; IN COMMERCE 3-10-2003.

FOR: GLASS BEVERAGEWARE, MUGS, SHOT  
GLASSES, IN CLASS 21 (U.S. CLS. 2, 13, 23, 29, 30, 33,  
40 AND 50).

FIRST USE 11-6-2002; IN COMMERCE 11-6-2002.

THE MARK CONSISTS OF STANDARD CHAR-  
ACTERS WITHOUT CLAIM TO ANY PARTICULAR  
FONT, STYLE, SIZE, OR COLOR.

SN 78-980,231, FILED 7-10-2006.

DAVID MILLER, EXAMINING ATTORNEY

**Int. Cl.: 30**

**Prior U.S. Cl.: 46**

**United States Patent and Trademark Office**

**Reg. No. 3,469,827**

**Registered July 15, 2008**

**TRADEMARK  
PRINCIPAL REGISTER**

**PATRON XO CAFE**

CARIBBEAN DISTILLERS CORPORATION, LIMITED (ANGUILLA CORPORATION)  
C/O ANGUILLA RUMS LIMITED  
P.O. BOX 1023, THE VALLEY  
SANDY GROUND, BRITISH WEST INDIES, ANGUILLA

FOR: PREPARATIONS MADE FROM FLOUR, NAMELY, CAKES SOLD IN RETAIL CHANNELS OF TRADE, IN CLASS 30 (U.S. CL. 46).

FIRST USE 9-28-2007; IN COMMERCE 10-4-2007.

THE MARK CONSISTS OF STANDARD CHARACTERS WITHOUT CLAIM TO ANY PARTICULAR FONT, STYLE, SIZE, OR COLOR.

OWNER OF U.S. REG. NOS. 1,950,491 AND 3,007,198.

NO CLAIM IS MADE TO THE EXCLUSIVE RIGHT TO USE "XO CAFE", APART FROM THE MARK AS SHOWN.

THE FOREIGN WORDING "PATRON" IN THE MARK TRANSLATES INTO ENGLISH AS PROTECTOR, LANDLORD OR BOSS. THE FOREIGN WORDING "CAFE" IN THE MARK TRANSLATES INTO ENGLISH AS COFFEE.

SN 78-980,242, FILED 5-9-2006.

SUSAN RICHARDS, EXAMINING ATTORNEY

**Int. Cl.: 30**

**Prior U.S. Cl.: 46**

**United States Patent and Trademark Office**

**Reg. No. 3,469,828**

**Registered July 15, 2008**

**TRADEMARK  
PRINCIPAL REGISTER**

**PATRON**

CARIBBEAN DISTILLERS CORPORATION, LIMITED (ANGUILLA CORPORATION)

C/O ANGUILLA RUMS LIMITED

P.O. BOX 1023, THE VALLEY

SANDY GROUND, BRITISH WEST INDIES, ANGUILLA

FOR: PREPARATIONS MADE FROM FLOUR, NAMELY, CAKES SOLD IN RETAIL CHANNELS OF TRADE, IN CLASS 30 (U.S. CL. 46).

FIRST USE 9-28-2007; IN COMMERCE 10-4-2007.

THE MARK CONSISTS OF STANDARD CHARACTERS WITHOUT CLAIM TO ANY PARTICULAR FONT, STYLE, SIZE, OR COLOR.

OWNER OF U.S. REG. NOS. 1,950,491, 3,007,198, AND OTHERS.

THE ENGLISH TRANSLATION OF THE WORD "PATRON" IN THE MARK IS PROTECTOR, LANDLORD, OR BOSS.

SN 78-980,243, FILED 5-9-2006.

SUSAN RICHARDS, EXAMINING ATTORNEY

**Int. Cls.: 20 and 31**

**Prior U.S. Cls.: 1, 2, 13, 22, 25, 32, 46, and 50**

**United States Patent and Trademark Office**

**Reg. No. 3,469,829**

**Registered July 15, 2008**

---

**TRADEMARK  
PRINCIPAL REGISTER**

**VINOAK**

NEWPAK PACKAGING, INC. (CALIFORNIA CORPORATION), DBA NEWPAK USA, INC.,  
537-F STONE ROAD  
BENICIA, CA 94510

FOR: WOOD CONTAINERS, NAMELY, WOOD BARRELS, IN CLASS 20 (U.S. CLS. 2, 13, 22, 25, 32 AND 50).

FIRST USE 8-28-2007; IN COMMERCE 11-8-2007.

FOR: OAK WOOD, OAK CHIPS, AND OAK STAVE INSERTS FOR WINE BARRELS, IN CLASS 31 (U.S. CLS. 1 AND 46).

FIRST USE 4-30-2007; IN COMMERCE 9-14-2007.

THE MARK CONSISTS OF STANDARD CHARACTERS WITHOUT CLAIM TO ANY PARTICULAR FONT, STYLE, SIZE, OR COLOR.

SN 78-980,261, FILED 4-26-2006.

MARGARET POWER, EXAMINING ATTORNEY

Int. Cls.: 39, 42, and 44

Prior U.S. Cls.: 100, 101, and 105

United States Patent and Trademark Office

Reg. No. 3,469,830

Registered July 15, 2008

**SERVICE MARK  
PRINCIPAL REGISTER**



CONVERSANT HEALTHCARE SYSTEMS, INC.  
(ALABAMA CORPORATION)  
P. O. BOX 18428  
HUNTSVILLE, AL 358048428

FOR: BIOMEDICAL SERVICES, NAMELY, THE STORAGE OF HUMAN BIOLOGICAL SPECIMENS FOR MEDICAL USE, IN CLASS 39 (U.S. CLS. 100 AND 105).

FIRST USE 3-31-2005; IN COMMERCE 3-31-2005.

FOR: MEDICAL AND SCIENTIFIC RESEARCH SERVICES, IN CLASS 42 (U.S. CLS. 100 AND 101).

FIRST USE 3-31-2005; IN COMMERCE 3-31-2005.

FOR: HEALTH CARE SERVICES; PROVIDING MEDICAL INFORMATION; MAINTAINING PERSONAL MEDICAL HISTORY RECORDS AND FILES, IN CLASS 44 (U.S. CLS. 100 AND 101).

FIRST USE 3-31-2005; IN COMMERCE 3-31-2005.

THE MARK CONSISTS OF A SPIRAL WITH THREE BRANCHES OF MULTIPLE LEAVES.

SN 78-980,294, FILED 7-23-2006.

SETH A. RAPPAPORT, EXAMINING ATTORNEY

**Int. Cl.: 5**

**Prior U.S. Cls.: 6, 18, 44, 46, 51, and 52**

**Reg. No. 3,469,831**

**United States Patent and Trademark Office**

**Registered July 15, 2008**

**TRADEMARK  
PRINCIPAL REGISTER**



**Arysta LifeScience**

ARYSTA LIFESCIENCE CORPORATION (JAPAN  
CORPORATION)  
8-1, AKASHI-CHO, CHUO-KO  
TOKYO, JAPAN 104 6591

FIRST USE 3-1-2007; IN COMMERCE 3-1-2007.

SN 78-980,295, FILED 3-31-2005.

FOR: HERBICIDES, INSECTICIDES, PESTICIDES  
AND FUNGICIDES FOR USE IN AGRICULTURE,  
HORTICULTURE AND HOME AND GARDEN, IN  
CLASS 5 (U.S. CLS. 6, 18, 44, 46, 51 AND 52).

SUNG IN, EXAMINING ATTORNEY

Int. Cl.: 9

Prior U.S. Cls.: 21, 23, 26, 36, and 38

Reg. No. 3,469,832

United States Patent and Trademark Office

Registered July 15, 2008

TRADEMARK  
PRINCIPAL REGISTER



PITTSBURGH ASSOCIATES (PENNSYLVANIA  
LIMITED PARTNERSHIP)  
PNC PARK AT NORTH SHORE  
115 FEDERAL STREET  
PITTSBURGH, PA 15212

FIRST USE 5-9-2006; IN COMMERCE 5-9-2006.

OWNER OF U.S. REG. NO. 1,013,729.

FOR: ELECTRICAL AND SCIENTIFIC APPARA-  
TUS, NAMELY, PRE-RECORDED VIDEODISCS RE-  
LATING TO BASEBALL, IN CLASS 9 (U.S. CLS. 21,  
23, 26, 36 AND 38).

SN 78-980,297, FILED 4-18-2006.

KIMBERLY FRYE, EXAMINING ATTORNEY



**Int. Cl.: 18**

**Prior U.S. Cls.: 1, 2, 3, 22, and 41**

**United States Patent and Trademark Office**

**Reg. No. 3,469,833**

**Registered July 15, 2008**

**TRADEMARK  
PRINCIPAL REGISTER**

**SOL SPORT**

JALP, LLC (TENNESSEE LTD LIAB CO)  
1900 COVINGTON PIKE  
MEMPHIS, TN 38128

FOR: LUGGAGE, HANDBAGS, COSMETIC CASES SOLD EMPTY, WALLETS, SPORTS BAGS, CARRY-ALL BAGS, TRAVELING CASES OF LEATHER, SHOULDER BAGS, BACKPACKS, KNAPSACKS, RUCKSACKS, DUFFLEBAGS, FANNY PACKS, WAIST PACKS, WRIST PACKS, ALL-PURPOSE SPORTING BAGS, ALL-PURPOSE CARRYING BAGS, TOTE BAGS, TRAVELING BAGS, SHOULDER BAGS, UMBRELLAS, SHOE BAGS FOR TRAVEL, AND MESSENGER BAGS, IN CLASS 18 (U.S. CLS. 1, 2, 3, 22 AND 41).

FIRST USE 1-18-2008; IN COMMERCE 1-18-2008.

THE MARK CONSISTS OF STANDARD CHARACTERS WITHOUT CLAIM TO ANY PARTICULAR FONT, STYLE, SIZE, OR COLOR.

NO CLAIM IS MADE TO THE EXCLUSIVE RIGHT TO USE "SPORT", APART FROM THE MARK AS SHOWN.

THE WORD "SOL" IS THE SPANISH WORD FOR "SUN".

SN 78-980,327, FILED 8-2-2005.

ANDREW RHIM, EXAMINING ATTORNEY

**Int. Cl.: 25**

**Prior U.S. Cls.: 22 and 39**

**United States Patent and Trademark Office**

**Reg. No. 3,469,834**

**Registered July 15, 2008**

**TRADEMARK  
PRINCIPAL REGISTER**



SUGARTOWN WORLDWIDE, INC. (PENNSYLVANIA CORPORATION)  
800 THIRD AVENUE  
KING OF PRUSSIA, PA 194061412

FOR: CLOTHING, NAMELY, PANTS, SLACKS, SHIRTS, BELTS, JACKETS, SKIRTS, SHORTS, DRESSES, SWEATERS, BLOUSES, SWIMWEAR, CHILDREN'S WEAR, NAMELY, DRESSES, SWEATERS, BLOUSES, SHIRTS, SKIRTS, JEANS, PANTS, SLACKS, AND SHORTS, IN CLASS 25 (U.S. CLS. 22 AND 39).

FIRST USE 5-0-2008; IN COMMERCE 5-0-2008.

OWNER OF U.S. REG. NOS. 1,926,195, 2,805,133, AND OTHERS.

SN 78-980,357, FILED 7-16-2004.

WON TEAK OH, EXAMINING ATTORNEY

Int. Cl.: 30

Prior U.S. Cl.: 46

United States Patent and Trademark Office

Reg. No. 3,469,835

Registered July 15, 2008

TRADEMARK  
PRINCIPAL REGISTER



FEDERACION NACIONAL DE CAFETEROS DE COLOMBIA (COLOMBIA NON-PROFIT ASSOCIATION ORGANIZED AND EXISTING UNDER THE LAWS OF THE REPUBLIC OF COLOMBIA AND ACTING IN ITS CAPACITY AS ADMINISTRATOR OF THE NATIONAL COFFEE FUND), AKA NATIONAL FEDERATION OF COFFEE GROWERS OF COLOMBIA,

CALLE 73 NO. 8 - 18  
BOGOTA, COLOMBIA

FOR: COFFEE, IN CLASS 30 (U.S. CL. 46).

FIRST USE 1-30-2008; IN COMMERCE 1-30-2008.

THE MARK CONSISTS OF A LARGE RECTANGLE DIVIDED INTO A SMALL SQUARE CONTAINING A DESIGN ELEMENT CONSISTING OF A HILL WITH TWO TREES AND A LARGER RECTANGLE CONTAINING THE WORDS "VARIEDAD CASTILLO" AND A DESIGN ELEMENT RESEMBLING A COFFEE BEAN.

THE ENGLISH TRANSLATION OF THE WORDS "VARIEDAD CASTILLO" IN THE MARK ARE VARIETY CASTLE.

SN 78-980,361, FILED 7-8-2005.

SHANNON TWOHIG, EXAMINING ATTORNEY

**Int. Cl.: 42**

**Prior U.S. Cls.: 100 and 101**

**United States Patent and Trademark Office**

**Reg. No. 3,469,836**

**Registered July 15, 2008**

**SERVICE MARK  
PRINCIPAL REGISTER**

# Klonies

COMVERSE, INC. (DELAWARE CORPORATION)  
100 QUANNAPOWITT PARKWAY  
WAKEFIELD, MA 01880

FOR: COMPUTER SERVICES IN THE NATURE OF CUSTOMIZED WEB PAGES FEATURING USER-DEFINED INFORMATION, PERSONAL PROFILES AND INFORMATION ENABLING USERS TO CREATE AVATARS FOR USE IN WEBLOGS, WEB PAGES, EMAILS, MOBILE WALLPAPER, MOBILE CALLER ID SERVICES, MOBILE MESSAGING AND VARIOUS OTHER ELECTRONIC MEDIA; APPLICATION SERVICE PROVIDER (ASP) FEATURING SOFTWARE IN THE FIELD OF AVATARS; APPLICATION SERVICE PROVIDER (ASP), NAMELY, HOSTING SOFTWARE APPLICATIONS ON BEHALF OF OTHERS IN THE FIELD OF AVATARS;

WEB SITE SERVICES FEATURING AVATARS, NAMELY, PROVIDING ONLINE NONDOWNLOADABLE SOFTWARE FEATURING AVATARS FOR USE IN SENDING REAL-TIME GRAPHICS TO MOBILE TELEPHONES, IN CLASS 42 (U.S. CLS. 100 AND 101).

FIRST USE 4-5-2006; IN COMMERCE 4-5-2006.

THE MARK CONSISTS OF STANDARD CHARACTERS WITHOUT CLAIM TO ANY PARTICULAR FONT, STYLE, SIZE, OR COLOR.

SN 78-980,362, FILED 8-30-2005.

KATHY DE JONGE, EXAMINING ATTORNEY

Int. Cl.: 33

Prior U.S. Cls.: 47 and 49

United States Patent and Trademark Office

Reg. No. 3,469,837

Registered July 15, 2008

TRADEMARK  
SUPPLEMENTAL REGISTER



BODEGAS NAVARRO LOPEZ S.L. (SPAIN CORPORATION)  
AUTOVIA MADRID CADIZ KM. 193  
VALDEPENAS CIUDAD REAL, SPAIN

FOR: WINE, IN CLASS 33 (U.S. CLS. 47 AND 49).

FIRST USE 1-10-2005; IN COMMERCE 8-18-2006.

NO CLAIM IS MADE TO THE EXCLUSIVE RIGHT TO USE "ROJO", "GRAN ROJO", "2000", AND "VALDEPENAS", APART FROM THE MARK AS SHOWN.

THE COLOR(S) BLACK, WHITE, RED AND ORANGE IS/ARE CLAIMED AS A FEATURE OF THE MARK.

THE MARK CONSISTS, IN PART, OF THE WORD "ROJO" POSITIONED ON THE FRONT OF A BLACK WINE BOTTLE WITH "RO" STACKED ABOVE "JO", AND WITH THE LETTER "R" IN RED, "O" IN ORANGE AND "JO" IN RED. THE WORDING

"GRAN ROJO VALDEPENAS 2000" APPEARS BELOW THE WORD "ROJO", WITH "GRAN ROJO" IN THE COLOR WHITE, "VALDEPENAS" IN THE COLOR RED, AND THE YEAR "2000" IN THE COLOR ORANGE. THE MARK ALSO CONSISTS OF A REPETITIVE DESIGN OF THE WORD "ROJO" WITH THE LETTERS THEREIN IN ALTERNATING RED AND ORANGE COLORS APPEARING ACROSS THE CAP AND SEAL OF THE WINE BOTTLE. THE WINE BOTTLE IS NOT CLAIMED AS A FEATURE OF THE MARK; HOWEVER, THE BLACK COLOR OF THE BOTTLE IS CLAIMED AS FEATURE OF THE MARK.

THE FOREIGN WORDING IN THE MARK TRANSLATES INTO ENGLISH AS FOLLOWS: THE TERM "ROJO" TRANSLATES INTO ENGLISH AS "RED", AND THE WORDING "GRAN ROJO" TRANSLATES INTO ENGLISH AS "GRAND RED".

SER. NO. 76-614,989, FILED P.R. 10-7-2004; AM. S.R. 6-6-2008.

ZHALEH DELANEY, EXAMINING ATTORNEY

**Int. Cl.: 35**

**Prior U.S. Cls.: 100, 101, and 102**

**United States Patent and Trademark Office**

**Reg. No. 3,469,838**

**Registered July 15, 2008**

**SERVICE MARK  
SUPPLEMENTAL REGISTER**

**JEAN SHOP**

JEAN SHOP MFG, INC. (CALIFORNIA CORPORATION)

740 STATE STREET

SANTA BARBARA, CA 93101

FOR: RETAIL STORE SERVICES FEATURING CLOTHING; WHOLESALE DISTRIBUTION SERVICES FEATURING CLOTHING, IN CLASS 35 (U.S. CLS. 100, 101 AND 102).

FIRST USE 3-24-2004; IN COMMERCE 4-4-2004.

THE MARK CONSISTS OF STANDARD CHARACTERS WITHOUT CLAIM TO ANY PARTICULAR FONT, STYLE, SIZE, OR COLOR.

OWNER OF U.S. REG. NO. 2,986,633.

NO CLAIM IS MADE TO THE EXCLUSIVE RIGHT TO USE "JEAN", APART FROM THE MARK AS SHOWN.

SER. NO. 76-643,360, FILED P.R. 7-21-2005; AM. S.R. 5-6-2008.

ZACHARY BELLO, EXAMINING ATTORNEY

Int. Cl.: 25

Prior U.S. Cls.: 22 and 39

United States Patent and Trademark Office

Reg. No. 3,469,839

Registered July 15, 2008

**TRADEMARK  
SUPPLEMENTAL REGISTER**

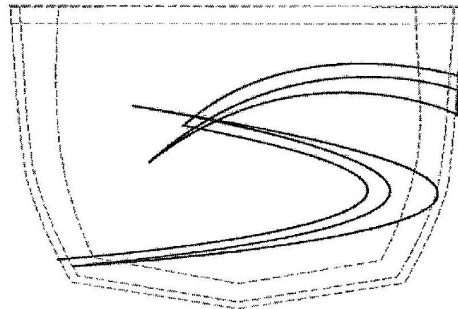

WESTERN GLOVE WORKS (CANADA PART-  
NERSHIP)  
555 LOGAN AVENUE  
WINNIPEG, MANITOBA R3A, CANADA

FOR: MEN'S, WOMEN'S AND CHILDREN'S  
PANTS, TROUSERS, JEANS AND SHORTS, IN  
CLASS 25 (U.S. CLS. 22 AND 39).

FIRST USE 6-0-2005; IN COMMERCE 6-0-2005.

THE MARK CONSISTS OF A STITCHED PAT-  
TERN IN THE FORM OF A STYLIZED LETTER "S".  
THE DOTTED OUTLINE OF A POCKET IS NOT A  
PART OF THE MARK AND IS INCLUDED ONLY  
TO SHOW THE POSITION OF THE MARK ON  
GOODS.

SER. NO. 76-651,667, FILED P.R. 12-8-2005; AM. S.R.  
12-12-2006.

STEVEN PEREZ, EXAMINING ATTORNEY

**Int. Cl.: 5**

**Prior U.S. Cls.: 6, 18, 44, 46, 51, and 52**

**United States Patent and Trademark Office**

**Reg. No. 3,469,840**

**Registered July 15, 2008**

**TRADEMARK  
SUPPLEMENTAL REGISTER**

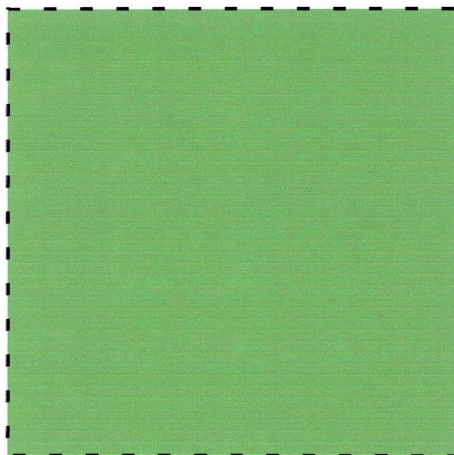

HERAEUS KULZER GMBH (FED REP GERMA-  
NY LTD LIAB CO)  
GRUENER WEG 11  
D-63450 HANAU, FED REP GERMANY

FOR: CHEMICAL COMPOUNDS, NAMELY,  
FILLING MATERIALS AND ACTIVE SUBSTANCES  
IN LIQUID FORM FOR USE AS COMPONENTS IN  
THE PREPARATION OF BONE CEMENT FOR  
MEDICAL PURPOSES, IN CLASS 5 (U.S. CLS. 6, 18,  
44, 46, 51 AND 52).

FIRST USE 0-0-1976; IN COMMERCE 0-0-1984.

PRIORITY CLAIMED UNDER SEC. 44(D) ON FED  
REP GERMANY APPLICATION NO. 30545665.2,  
FILED 8-2-2005.

OWNER OF U.S. REG. NOS. 2,299,452 AND  
2,339,748.

THE COLOR(S) KELLY GREEN IS/ARE  
CLAIMED AS A FEATURE OF THE MARK.

THE MARK CONSISTS OF THE COLOR KELLY  
GREEN AS APPLIED TO THE ENTIRETY OF  
GOODS. THE DASHED OUTLINE IS INTENDED  
TO SHOW THAT THE GOODS ARE LIQUID AND  
FORMS NO PART OF THE MARK.

SER. NO. 76-654,423, FILED P.R. 2-2-2006; AM. S.R.  
2-26-2007.

LEIGH LOWRY, EXAMINING ATTORNEY



**Int. Cl.: 41**

**Prior U.S. Cls.: 100, 101, and 107**

**United States Patent and Trademark Office**

**Reg. No. 3,469,841**

**Registered July 15, 2008**

**SERVICE MARK  
SUPPLEMENTAL REGISTER**

**AMERICA'S FINEST  
TRIAL LAWYERS**

PROFESSIONAL RECRUITERS INC (DELA-  
WARE CORPORATION)  
13428 MAXELLA AVE., SUITE 404  
MARINA DEL RAY, CA 90292

FOR: ENTERTAINMENT SERVICES, NAMELY,  
PROVIDING A RADIO PROGRAM DESIGNED TO  
INTRODUCE TRIAL LAWYERS TO THE PUBLIC,  
IN CLASS 41 (U.S. CLS. 100, 101 AND 107).

FIRST USE 9-15-2006; IN COMMERCE 9-15-2006.

THE MARK CONSISTS OF STANDARD CHAR-  
ACTERS WITHOUT CLAIM TO ANY PARTICULAR  
FONT, STYLE, SIZE, OR COLOR.

NO CLAIM IS MADE TO THE EXCLUSIVE  
RIGHT TO USE "TRIAL LAWYERS", APART FROM  
THE MARK AS SHOWN.

SER. NO. 76-666,295, FILED P.R. 9-19-2006; AM. S.R.  
11-8-2007.

PETER B. BROMAGHIM, EXAMINING ATTORNEY

**Int. Cl.: 44**

**Prior U.S. Cls.: 100 and 101**

**United States Patent and Trademark Office**

**Reg. No. 3,469,842**

**Registered July 15, 2008**

**SERVICE MARK  
SUPPLEMENTAL REGISTER**

**WEIGHT LOSS RESISTANCE SYNDROME**

HEALTHSOURCE CHIROPRACTIC, INC. (OHIO  
CORPORATION)  
4365 LIBERTY AVENUE  
VERMILION, OH 44089

FOR: WEIGHT REDUCTION DIET PLANNING  
AND SUPERVISION, DIETING AND NUTRITION-  
AL GUIDANCE, IN CLASS 44 (U.S. CLS. 100 AND  
101).

FIRST USE 1-2-2008; IN COMMERCE 1-2-2008.

THE MARK CONSISTS OF STANDARD CHAR-  
ACTERS WITHOUT CLAIM TO ANY PARTICULAR  
FONT, STYLE, SIZE, OR COLOR.

NO CLAIM IS MADE TO THE EXCLUSIVE  
RIGHT TO USE "WEIGHT LOSS", APART FROM  
THE MARK AS SHOWN.

SER. NO. 76-676,826, FILED P.R. 5-14-2007; AM. S.R.  
2-6-2008.

TANYA AMOS, EXAMINING ATTORNEY

**Int. Cl.: 45**

**Prior U.S. Cls.: 100 and 101**

**United States Patent and Trademark Office**

**Reg. No. 3,469,843**

**Registered July 15, 2008**

**SERVICE MARK  
SUPPLEMENTAL REGISTER**

**LIEN XPRESS**

COLLECTION CONSULTANTS, INC. (FLORIDA  
CORPORATION)  
1792 SUMMER BREEZE WAY  
SARASOTA, FL 34233

FOR: PREPARATION OF LEGAL CLAIMS FOR  
OTHERS FOR ATTACHMENT TO REAL AND PER-  
SONAL PROPERTY, IN CLASS 45 (U.S. CLS. 100 AND  
101).

FIRST USE 4-3-2006; IN COMMERCE 4-3-2006.

THE MARK CONSISTS OF STANDARD CHAR-  
ACTERS WITHOUT CLAIM TO ANY PARTICULAR  
FONT, STYLE, SIZE, OR COLOR.

NO CLAIM IS MADE TO THE EXCLUSIVE  
RIGHT TO USE "LIEN", APART FROM THE MARK  
AS SHOWN.

SER. NO. 76-683,010, FILED P.R. 10-17-2007; AM.  
S.R. 5-30-2008.

KATHERINE STOIDES, EXAMINING ATTORNEY

**Int. Cl.: 36**

**Prior U.S. Cls.: 100, 101, and 102**

**United States Patent and Trademark Office**

**Reg. No. 3,469,844**

**Registered July 15, 2008**

**SERVICE MARK  
SUPPLEMENTAL REGISTER**

# Expert 412(i)

EXPERT 412(I), INC. (CALIFORNIA CORPORATION)

14769 SAN FERNANDO MISSION BLVD.  
MISSION HILLS, CA 91345

FOR: ADMINISTRATION OF EMPLOYEE BENEFIT PLANS, ADMINISTRATION OF EMPLOYEE PENSION PLANS, IN CLASS 36 (U.S. CLS. 100, 101 AND 102).

FIRST USE 9-1-2005; IN COMMERCE 9-1-2005.

THE MARK CONSISTS OF STANDARD CHARACTERS WITHOUT CLAIM TO ANY PARTICULAR FONT, STYLE, SIZE, OR COLOR.

NO CLAIM IS MADE TO THE EXCLUSIVE RIGHT TO USE "412(I)", APART FROM THE MARK AS SHOWN.

SER. NO. 76-685,768, FILED P.R. 1-15-2008; AM. S.R. 5-7-2008.

LESLIE RICHARDS, EXAMINING ATTORNEY

**Int. Cl.: 38**

**Prior U.S. Cls.: 100, 101, and 104**

**United States Patent and Trademark Office**

**Reg. No. 3,469,845**

**Registered July 15, 2008**

**SERVICE MARK  
SUPPLEMENTAL REGISTER**

**DIETTV**

DIET CHANNEL NETWORK, INC. (DELAWARE  
CORPORATION)  
SUITE 204  
174 FIFTH AVENUE  
NEW YORK, NY 10010

FOR: WEBCASTING SERVICES AND BROAD-  
CASTING SERVICES RENDERED ONLINE VIA  
THE INTERNET, IN CLASS 38 (U.S. CLS. 100, 101  
AND 104).

FIRST USE 10-16-2007; IN COMMERCE 10-16-2007.

THE MARK CONSISTS OF STANDARD CHAR-  
ACTERS WITHOUT CLAIM TO ANY PARTICULAR  
FONT, STYLE, SIZE, OR COLOR.

SER. NO. 76-978,825, FILED P.R. 8-9-2007; AM. S.R.  
5-6-2008.

JULIE WATSON, EXAMINING ATTORNEY

**Int. Cl.: 7**

**Prior U.S. Cls.: 13, 19, 21, 23, 31, 34, and 35**

**Reg. No. 3,469,846**

**United States Patent and Trademark Office**

**Registered July 15, 2008**

**TRADEMARK  
SUPPLEMENTAL REGISTER**

***Li-ion 4V***

MOBILETRON ELECTRONICS CO., LTD. (TAI-  
WAN CORPORATION)  
TAYA HSIANG  
NO. 269, TAYA ROAD, YUAN LIN VILL.  
TAICHUNG HSIEN, TAIWAN

FOR: ELECTRONIC AND PNEUMATIC TOOLS,  
NAMELY, ALL OF THE FOLLOWING: STAPLERS;  
PUNCHING MACHINES, NAMELY, PUNCHING  
PRESSES, DRILLS; RIVET HAMMERS, NAMELY,  
RIVETERS, SCREWDRIVERS; TRIMMING CUT-  
TERS, NAMELY, CUTTING MACHINES FOR ME-

TALWORKING AND WOODWORKING  
MACHINES, JIG SAWS, CIRCULAR SAWS, DRILL  
HAMMERS, IMPACT WRENCHES, ELECTRIC SAN-  
DERS, ELECTRONIC PLANERS, IN CLASS 7 (U.S.  
CLS. 13, 19, 21, 23, 31, 34 AND 35).

FIRST USE 6-0-2005; IN COMMERCE 6-0-2005.

SER. NO. 77-007,612, FILED P.R. 9-26-2006; AM. S.R.  
8-16-2007.

JENNIFER VASQUEZ, EXAMINING ATTORNEY

**Int. Cl.: 36**

**Prior U.S. Cls.: 100, 101, and 102**

**United States Patent and Trademark Office**

**Reg. No. 3,469,847**

**Registered July 15, 2008**

**SERVICE MARK  
SUPPLEMENTAL REGISTER**

**SECURE CAPITAL BASE**

NAKAMOTO INSURANCE AND FINANCIAL  
SERVICES, INC. (CALIFORNIA CORPORATION)

1000 FOURTH STREET, SUITE 550  
SAN RAFAEL, CA 94901

FOR: CONSULTING SERVICES IN THE FIELD  
OF FINANCE AND INVESTMENTS, IN CLASS 36  
(U.S. CLS. 100, 101 AND 102).

FIRST USE 8-31-2006; IN COMMERCE 8-31-2006.

THE MARK CONSISTS OF STANDARD CHARACTERS WITHOUT CLAIM TO ANY PARTICULAR FONT, STYLE, SIZE, OR COLOR.

NO CLAIM IS MADE TO THE EXCLUSIVE RIGHT TO USE CAPITAL BASE, APART FROM THE MARK AS SHOWN.

SER. NO. 77-009,446, FILED P.R. 9-28-2006; AM. S.R. 8-27-2007.

FRANK LATTUCA, EXAMINING ATTORNEY

**Int. Cl.: 42**

**Prior U.S. Cls.: 100 and 101**

**United States Patent and Trademark Office**

**Reg. No. 3,469,848**

**Registered July 15, 2008**

**SERVICE MARK  
SUPPLEMENTAL REGISTER**

**ACS ONSITE**

BRIVO SYSTEMS, LLC (DELAWARE LTD LIAB  
CO)  
4350 EAST-WEST HIGHWAY, SUITE 201  
BETHESDA, MD 20814

FOR: PROVIDING THE TEMPORARY USE OF  
ON-LINE NON-DOWNLOADABLE SOFTWARE  
FOR MONITORING, PROVIDING AND RESTRICT-  
ING ACCESS TO ELECTRONICALLY MONITORED  
AND SECURED ENCLOSURES; COMPUTER MON-  
ITORING SERVICE WHICH TRACKS SYSTEM  
HARDWARE PERFORMANCE EVENTS AND

SENDS OUT HISTORICAL REPORTS AND ALERTS,  
IN CLASS 42 (U.S. CLS. 100 AND 101).

FIRST USE 7-0-2006; IN COMMERCE 7-0-2006.

THE MARK CONSISTS OF STANDARD CHAR-  
ACTERS WITHOUT CLAIM TO ANY PARTICULAR  
FONT, STYLE, SIZE, OR COLOR.

SER. NO. 77-041,319, FILED P.R. 11-10-2006; AM.  
S.R. 6-6-2008.

CHARLOTTE CORWIN, EXAMINING ATTORNEY



**Int. Cl.: 41**

**Prior U.S. Cls.: 100, 101, and 107**

**United States Patent and Trademark Office**

**Reg. No. 3,469,849**

**Registered July 15, 2008**

**SERVICE MARK  
SUPPLEMENTAL REGISTER**

**Global Resources Network**

CENTER FOR RESEARCH LIBRARIES (ILLINOIS CORPORATION)  
PRESIDENT'S OFFICE  
6050 SOUTH KENWOOD AVENUE  
CHICAGO, IL 606372804

FOR: A COMMUNITY DEVOTED TO EXPANDING THE DEPTH, BREADTH, AND VARIETY OF INFORMATION RESOURCES AVAILABLE TO RESEARCHERS IN INTERNATIONAL STUDIES THROUGH ON-LINE LIBRARY SERVICES, NAMELY, PROVIDING ELECTRONIC LIBRARY SERVICES WHICH FEATURE NEWSPAPERS, MAGAZINES, PHOTOGRAPHS AND PICTURES VIA AN ON-LINE COMPUTER NETWORK, IN CLASS 41 (U.S. CLS. 100, 101 AND 107).

FIRST USE 10-19-2005; IN COMMERCE 10-19-2005.

THE MARK CONSISTS OF STANDARD CHARACTERS WITHOUT CLAIM TO ANY PARTICULAR FONT, STYLE, SIZE, OR COLOR.

NO CLAIM IS MADE TO THE EXCLUSIVE RIGHT TO USE "RESOURCES NETWORK", APART FROM THE MARK AS SHOWN.

SER. NO. 77-044,777, FILED P.R. 11-15-2006; AM. S.R. 5-8-2008.

KAPIL BHANOT, EXAMINING ATTORNEY

**Int. Cl.: 41**

**Prior U.S. Cls.: 100, 101, and 107**

**United States Patent and Trademark Office**

**Reg. No. 3,469,850**

**Registered July 15, 2008**

**SERVICE MARK  
SUPPLEMENTAL REGISTER**

# Global Resources

CENTER FOR RESEARCH LIBRARIES (ILLINOIS CORPORATION)  
PRESIDENT'S OFFICE  
6050 SOUTH KENWOOD AVENUE  
CHICAGO, IL 606372804

FOR: RESOURCES FOR ADVANCED RESEARCH AND TEACHING IN THE HUMANITIES, SCIENCES, AND SOCIAL SCIENCES THROUGH ON-LINE LIBRARY SERVICES, NAMELY, PROVIDING ELECTRONIC LIBRARY SERVICES WHICH FEATURE NEWSPAPERS, MAGAZINES, PHOTOGRAPHS AND PICTURES VIA AN ON-LINE COMPUTER NETWORK, IN CLASS 41 (U.S. CLS. 100, 101 AND 107).

FIRST USE 9-25-2004; IN COMMERCE 9-25-2004.

THE MARK CONSISTS OF STANDARD CHARACTERS WITHOUT CLAIM TO ANY PARTICULAR FONT, STYLE, SIZE, OR COLOR.

NO CLAIM IS MADE TO THE EXCLUSIVE RIGHT TO USE "RESOURCES", APART FROM THE MARK AS SHOWN.

SER. NO. 77-045,294, FILED P.R. 11-16-2006; AM. S.R. 5-18-2008.

KAPIL BHANOT, EXAMINING ATTORNEY

**Int. Cl.: 15**

**Prior U.S. Cls.: 2, 21, and 36**

**United States Patent and Trademark Office**

**Reg. No. 3,469,851**

**Registered July 15, 2008**

**TRADEMARK  
SUPPLEMENTAL REGISTER**

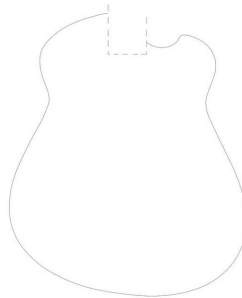

ZANINI, LUCA (ITALY INDIVIDUAL)  
VIA CAPOLUOGO 28  
BUTTIGLIERA ALTA (TO), ITALY 10090

FOR: GUITARS, IN CLASS 15 (U.S. CLS. 2, 21 AND 36).

OWNER OF ERPN CMNTY TM OFC REG. NO. 000483433-00, DATED 2-21-2006, EXPIRES 2-21-2016.

THE MARK CONSISTS OF A FANCIFUL DESIGN OF A GUITAR BODY. THE MATTER SHOWN BY THE DOTTED LINES IS NOT PART OF THE MARK AND SERVES ONLY TO INDICATE THE POSITION OF THE MARK WITH RESPECT TO THE GUITAR NECK ATTACHED TO THE BODY.

SER. NO. 77-054,131, FILED P.R. 11-30-2006; AM. S.R. 5-5-2008.

WENDY GOODMAN, EXAMINING ATTORNEY

**Int. Cl.: 21**

**Prior U.S. Cls.: 2, 13, 23, 29, 30, 33, 40, and 50**

**United States Patent and Trademark Office**

**Reg. No. 3,469,852**

**Registered July 15, 2008**

**TRADEMARK  
SUPPLEMENTAL REGISTER**

**SPICE RATCHET**

SPICE RATCHET MILLS, INC. (TEXAS CORPORATION)  
1120 HUFFMAN ROAD  
SUITE 24-232  
ANCHORAGE, AR 99515

FOR: HAND-OPERATED SPICE AND PEPPER GRINDERS, IN CLASS 21 (U.S. CLS. 2, 13, 23, 29, 30, 33, 40 AND 50).

FIRST USE 11-29-2006; IN COMMERCE 12-15-2006.

THE MARK CONSISTS OF STANDARD CHARACTERS WITHOUT CLAIM TO ANY PARTICULAR FONT, STYLE, SIZE, OR COLOR.

NO CLAIM IS MADE TO THE EXCLUSIVE RIGHT TO USE "RATCHET", APART FROM THE MARK AS SHOWN.

SER. NO. 77-067,983, FILED P.R. 12-19-2006; AM. S.R. 1-14-2008.

ROBERT C. CLARK JR., EXAMINING ATTORNEY

**Int. Cl.: 35**

**Prior U.S. Cls.: 100, 101, and 102**

**United States Patent and Trademark Office**

**Reg. No. 3,469,853**

**Registered July 15, 2008**

**SERVICE MARK  
SUPPLEMENTAL REGISTER**

**THE FREELANCE GROUP**

ANTENNA, INC. (MINNESOTA CORPORATION)  
150 SOUTH 5TH STREET  
SUITE 2300  
MINNEAPOLIS, MN 55402

FOR: BUSINESS AND MARKETING SERVICES,  
NAMELY, PROJECT MANAGEMENT, CONSULT-  
ING, EMPLOYMENT RECRUITING, PLACEMENT  
AND STAFFING SERVICES, IN CLASS 35 (U.S. CLS.  
100, 101 AND 102).

FIRST USE 7-18-2005; IN COMMERCE 7-18-2005.

THE MARK CONSISTS OF STANDARD CHAR-  
ACTERS WITHOUT CLAIM TO ANY PARTICULAR  
FONT, STYLE, SIZE, OR COLOR.

NO CLAIM IS MADE TO THE EXCLUSIVE  
RIGHT TO USE GROUP, APART FROM THE MARK  
AS SHOWN.

SER. NO. 77-070,201, FILED P.R. 12-22-2006; AM.  
S.R. 10-18-2007.

PAUL E. FAHRENKOPF, EXAMINING ATTORNEY

**Int. Cl.: 9**

**Prior U.S. Cls.: 21, 23, 26, 36, and 38**

**United States Patent and Trademark Office**

**Reg. No. 3,469,854**

**Registered July 15, 2008**

**TRADEMARK  
SUPPLEMENTAL REGISTER**

**SOLID STATE LOGIC**

RED LION 49 LIMITED (UNITED KINGDOM CORPORATION)  
25 SPRING HILL ROAD  
BEGBROKE, OXFORD, UNITED KINGDOM  
OX51RU

FOR: AUDIO AND VIDEO PRODUCTION AND RECORDING STUDIO SYSTEMS, NAMELY, ANALOG AND DIGITAL COMPUTERIZED CONSOLES AND WORKSTATIONS COMPRISED OF COMPUTER-BASED DIGITAL APPARATUS AND PARTS THEREFOR, ALL FOR RECORDING, CONTROLLING, EDITING, MODIFYING, ENHANCING AND MIXING VIDEO AND AUDIO; COMPUTER SOFTWARE FOR RECORDING, CONTROLLING, EDITING, MODIFYING, ENHANCING AND MIXING VIDEO AND AUDIO; COMPUTER SOFTWARE, RECORDED ON MAGNETIC DATA MEDIA, NAMELY, CD-ROMS AND MAGNETIC DISCS, OPTICAL DATA MEDIA, NAMELY, OPTICAL DISCS, MAGNETO-OPTICAL DATA MEDIA, NAMELY, MAGNETO-OPTICAL DISCS, AND MAGNETIC

COMPUTER TAPES, NAMELY, READ-ONLY MEMORY COMPACT DISCS, ALL FOR USE IN RECORDING, CONTROLLING, EDITING, MODIFYING, ENHANCING AND MIXING VIDEO AND AUDIO, IN CLASS 9 (U.S. CLS. 21, 23, 26, 36 AND 38).

THE MARK CONSISTS OF STANDARD CHARACTERS WITHOUT CLAIM TO ANY PARTICULAR FONT, STYLE, SIZE, OR COLOR.

PRIORITY CLAIMED UNDER SEC. 44(D) ON ERPN CMNTY TM OFC APPLICATION NO. 005463691, FILED 11-2-2006, REG. NO. 005463691, DATED 9-8-2007, EXPIRES 11-22-2016.

OWNER OF UNITED KINGDOM REG. NO. 1539398, DATED 12-22-1995, EXPIRES 6-22-2010.

SER. NO. 77-071,104, FILED P.R. 12-25-2006; AM. S.R. 4-18-2008.

MARCIE MILONE, EXAMINING ATTORNEY

**Int. Cl.: 35**

**Prior U.S. Cls.: 100, 101, and 102**

**United States Patent and Trademark Office**

**Reg. No. 3,469,855**

**Registered July 15, 2008**

**SERVICE MARK  
SUPPLEMENTAL REGISTER**

**BRAND INFORMATICS**

BRAND INFORMATICS, INC. (DELAWARE  
CORPORATION)  
155 GIBBS STREET, SUITE 530  
ROCKVILLE, MD 20850

FOR: ASSISTANCE, ADVISORY SERVICES AND  
CONSULTANCY WITH REGARD TO BUSINESS  
ANALYSIS, MEASUREMENT, BENCHMARKING,  
RESEARCH, AND BUSINESS INTELLIGENCE IN  
THE NATURE OF BUSINESS INVESTIGATION, IN  
CLASS 35 (U.S. CLS. 100, 101 AND 102).

FIRST USE 1-0-2007; IN COMMERCE 1-0-2007.

THE MARK CONSISTS OF STANDARD CHAR-  
ACTERS WITHOUT CLAIM TO ANY PARTICULAR  
FONT, STYLE, SIZE, OR COLOR.

SER. NO. 77-075,808, FILED P.R. 1-4-2007; AM. S.R.  
5-8-2008.

ALICIA COLLINS, EXAMINING ATTORNEY

**Int. Cl.: 9**

**Prior U.S. Cls.: 21, 23, 26, 36, and 38**

**United States Patent and Trademark Office**

**Reg. No. 3,469,856**

**Registered July 15, 2008**

**TRADEMARK  
SUPPLEMENTAL REGISTER**

**STRETCH FRAMES**

PILBY, STEPHEN (CANADA INDIVIDUAL)  
9708-78 AVENUE  
EDMONTON, ALBERTA, CANADA T6E1N2

FOR: DEPLOYABLE SKELETAL STRUCTURE  
FOR SUPPORTING COLLAPSIBLE LIGHT DIFFUSERS  
FOR USE WITH PHOTOGRAPHIC LIGHTING  
EQUIPMENT, IN CLASS 9 (U.S. CLS. 21, 23, 26, 36  
AND 38).

FIRST USE 7-1-2003; IN COMMERCE 7-1-2003.

THE MARK CONSISTS OF STANDARD CHARACTERS  
WITHOUT CLAIM TO ANY PARTICULAR  
FONT, STYLE, SIZE, OR COLOR.

SER. NO. 77-078,462, FILED P.R. 1-8-2007; AM. S.R.  
4-28-2008.

AMEETA JORDAN, EXAMINING ATTORNEY



**Int. Cls.: 41 and 44**

**Prior U.S. Cls.: 100, 101, and 107**

**United States Patent and Trademark Office**

**Reg. No. 3,469,857**

**Registered July 15, 2008**

**SERVICE MARK  
SUPPLEMENTAL REGISTER**

**CRANIAL RELEASE TECHNIQUE**

CRANIAL RELEASE TECHNIQUE, INC. (NEW YORK CORPORATION)  
24-38 83 STREET  
EAST ELMHURST, NY 11370

FOR: EDUCATIONAL SERVICES, NAMELY, CONDUCTING CLASSES, SEMINARS, CONFERENCES, WORKSHOPS IN THE FIELD OF MEDICAL THERAPY, NAMELY, ALIGNING BONES IN THE HEAD BY APPLYING PRESSURE TO SPECIFIC AREAS OF THE SKULL USING THE CRANIAL RELEASE TECHNIQUE AND DISTRIBUTING PRINTED COURSE MATERIAL THEREWITH, IN CLASS 41 (U.S. CLS. 100, 101 AND 107).

FIRST USE 10-25-2005; IN COMMERCE 10-25-2005.

FOR: MEDICAL THERAPY SERVICES, NAMELY, ALIGNING BONES IN THE HEAD BY APPLYING

PRESSURE TO SPECIFIC AREAS OF THE SKULL USING THE CRANIAL RELEASE TECHNIQUE, IN CLASS 44 (U.S. CLS. 100 AND 101).

FIRST USE 10-25-2005; IN COMMERCE 10-25-2005.

THE MARK CONSISTS OF STANDARD CHARACTERS WITHOUT CLAIM TO ANY PARTICULAR FONT, STYLE, SIZE, OR COLOR.

NO CLAIM IS MADE TO THE EXCLUSIVE RIGHT TO USE "TECHNIQUE", APART FROM THE MARK AS SHOWN.

SER. NO. 77-080,103, FILED P.R. 1-10-2007; AM. S.R. 6-6-2008.

JEFF DEFORD, EXAMINING ATTORNEY

**Int. Cl.: 16**

**Prior U.S. Cls.: 2, 5, 22, 23, 29, 37, 38, and 50**

**United States Patent and Trademark Office**

**Reg. No. 3,469,858**

**Registered July 15, 2008**

**TRADEMARK  
SUPPLEMENTAL REGISTER**

**30 MEALS IN ONE DAY**

RED TIMER, INC. (UTAH CORPORATION)  
790 SOUTH 1680 EAST  
PLESANT GROVE, UT 84062

FOR: SERIES OF BOOKS IN THE FIELD OF  
FOOD PREPARATION, IN CLASS 16 (U.S. CLS. 2, 5,  
22, 23, 29, 37, 38 AND 50).

FIRST USE 5-1-2007; IN COMMERCE 5-1-2007.

THE MARK CONSISTS OF STANDARD CHAR-  
ACTERS WITHOUT CLAIM TO ANY PARTICULAR  
FONT, STYLE, SIZE, OR COLOR.

SER. NO. 77-083,265, FILED P.R. 1-15-2007; AM. S.R.  
5-19-2008.

SHAUNIA CARLYLE, EXAMINING ATTORNEY

**Int. Cl.: 36**

**Prior U.S. Cls.: 100, 101, and 102**

**United States Patent and Trademark Office**

**Reg. No. 3,469,859**

**Registered July 15, 2008**

---

**SERVICE MARK  
SUPPLEMENTAL REGISTER**

**U.S. Hotel and Resort  
Management**

REGENCY INNS MANAGEMENT, INC. (SOUTH  
DAKOTA CORPORATION)

3211 WEST SENCORE DRIVE

SIOUX FALLS, SD 57107

FOR: HOTEL AND RESORT MANAGEMENT  
SERVICES, IN CLASS 36 (U.S. CLS. 100, 101 AND 102).

FIRST USE 5-20-2008; IN COMMERCE 5-20-2008.

THE MARK CONSISTS OF STANDARD CHAR-  
ACTERS WITHOUT CLAIM TO ANY PARTICULAR  
FONT, STYLE, SIZE, OR COLOR.

NO CLAIM IS MADE TO THE EXCLUSIVE  
RIGHT TO USE "HOTEL AND RESORT MANAGE-  
MENT", APART FROM THE MARK AS SHOWN.

SER. NO. 77-084,826, FILED P.R. 1-17-2007; AM. S.R.  
5-29-2008.

SHANNON TWOHIG, EXAMINING ATTORNEY

**Int. Cl.: 41**

**Prior U.S. Cls.: 100, 101, and 107**

**United States Patent and Trademark Office**

**Reg. No. 3,469,860**

**Registered July 15, 2008**

**SERVICE MARK  
SUPPLEMENTAL REGISTER**

**CITYBLOG**

EPARTNER USA, INC. (NEVADA CORPORATION)  
P.O. BOX 3205  
PRESCOTT, AZ 86302

FOR: ON-LINE JOURNALS, NAMELY, BLOGS ALLOWING INDIVIDUAL CONSUMERS TO WRITE AND POST COMMENTS IN A PEER-TO-PEER FASHION ABOUT A VARIETY OF TOPICS UNIQUE TO INDIVIDUAL LOCALES IN THE NATURE OF LOCAL HEALTH CARE, POLITICS, EDUCATION, CRIME, REAL ESTATE, REAL ESTATE VALUES, LIFESTYLES, TOURISM, FINANCE, SPORTS, LOCAL EVENTS, SHOPPING, DINING

AND TOPICS OF GENERAL INTEREST TO OTHER CONSUMERS, IN CLASS 41 (U.S. CLS. 100, 101 AND 107).

FIRST USE 6-0-2006; IN COMMERCE 6-0-2007.

THE MARK CONSISTS OF STANDARD CHARACTERS WITHOUT CLAIM TO ANY PARTICULAR FONT, STYLE, SIZE, OR COLOR.

SER. NO. 77-088,344, FILED P.R. 1-22-2007; AM. S.R. 6-6-2008.

JAY BESCH, EXAMINING ATTORNEY

**Int. Cl.: 35**

**Prior U.S. Cls.: 100, 101, and 102**

**United States Patent and Trademark Office**

**Reg. No. 3,469,861**

**Registered July 15, 2008**

**SERVICE MARK  
SUPPLEMENTAL REGISTER**

**DONDE TAMBIEN HABLAMOS  
INGLES**

CLARK, CHARLES K. (UNITED STATES INDIVIDUAL)

3500 WEST EXPRESSWAY 83

HARLINGEN, TX 785523599

FOR: AUTOMOBILE DEALERSHIP SERVICES, IN CLASS 35 (U.S. CLS. 100, 101 AND 102).

FIRST USE 1-0-2007; IN COMMERCE 1-0-2007.

THE MARK CONSISTS OF STANDARD CHARACTERS WITHOUT CLAIM TO ANY PARTICULAR FONT, STYLE, SIZE, OR COLOR.

THE ENGLISH TRANSLATION OF THE SPANISH WORDING "DONDE TAMBIEN HABLAMOS INGLES" IS "WHERE WE ALSO SPEAK ENGLISH".

SER. NO. 77-094,568, FILED P.R. 1-30-2007; AM. S.R. 6-6-2008.

MICHAEL GAAFAR, EXAMINING ATTORNEY

**Int. Cl.: 9**

**Prior U.S. Cls.: 21, 23, 26, 36, and 38**

**United States Patent and Trademark Office**

**Reg. No. 3,469,862**

**Registered July 15, 2008**

**TRADEMARK  
SUPPLEMENTAL REGISTER**

**SUPERIOR FOLIOS**

BURNS ADVISORY GROUP (OKLAHOMA LTD  
LIAB CO)  
9401 CEDAR LAKE AVENUE  
OKLAHOMA CITY, OK 73114

FOR: COMPUTER SOFTWARE FOR USE IN  
STATISTICAL AND FINANCIAL ANALYSIS, IN  
INVESTMENT ACCOUNT CREATION AND MON-  
ITORING, AND IN MARKET COMPARISON AND  
VALUATION, IN THE FIELD OF INVESTMENT  
MANAGEMENT, AND INVESTMENT AND MAR-  
KET RESEARCH AND ANALYSIS, IN CLASS 9 (U.S.  
CLS. 21, 23, 26, 36 AND 38).

FIRST USE 10-31-2006; IN COMMERCE 10-31-2006.

THE MARK CONSISTS OF STANDARD CHAR-  
ACTERS WITHOUT CLAIM TO ANY PARTICULAR  
FONT, STYLE, SIZE, OR COLOR.

SER. NO. 77-100,630, FILED P.R. 2-6-2007; AM. S.R.  
5-30-2008.

MATTHEW EINSTEIN, EXAMINING ATTORNEY

**Int. Cl.: 36**

**Prior U.S. Cls.: 100, 101, and 102**

**United States Patent and Trademark Office**

**Reg. No. 3,469,863**

**Registered July 15, 2008**

**SERVICE MARK  
SUPPLEMENTAL REGISTER**

**RATCHET MORTGAGE**

ELY, BERT (UNITED STATES INDIVIDUAL)  
P.O. BOX 21010  
ALEXANDRIA, VA 22320 AND  
KALOTAY, ANDREW J. (UNITED STATES INDIVIDUAL)  
SUITE 1400  
61 BROADWAY  
NEW YORK, NY 10006

FOR: FINANCIAL SERVICES, NAMELY, LOAN SERVICES, NAMELY, MORTGAGE LENDING RELATING TO LOANS SECURED BY REAL ESTATE AND HAVING INTEREST RATE-RATCHETING FEATURES, IN CLASS 36 (U.S. CLS. 100, 101 AND 102).

FIRST USE 4-19-2005; IN COMMERCE 4-19-2005.

THE MARK CONSISTS OF STANDARD CHARACTERS WITHOUT CLAIM TO ANY PARTICULAR FONT, STYLE, SIZE, OR COLOR.

NO CLAIM IS MADE TO THE EXCLUSIVE RIGHT TO USE "MORTGAGE", APART FROM THE MARK AS SHOWN.

SER. NO. 77-102,872, FILED P.R. 2-8-2007; AM. S.R. 6-5-2008.

BARBARA BROWN, EXAMINING ATTORNEY

**Int. Cl.: 36**

**Prior U.S. Cls.: 100, 101, and 102**

**United States Patent and Trademark Office**

**Reg. No. 3,469,864**

**Registered July 15, 2008**

**SERVICE MARK  
SUPPLEMENTAL REGISTER**

**RATCHET PASS-THRU**

ELY, BERT (UNITED STATES INDIVIDUAL)  
P.O. BOX 21010  
ALEXANDRIA, VA 22320 AND  
KALOTAY, ANDREW J. (UNITED STATES INDIVIDUAL)  
SUITE 1400  
61 BROADWAY  
NEW YORK, NY 10006

FOR: FINANCIAL SERVICES, NAMELY, LOAN FINANCING, NAMELY, DEBT INSTRUMENTS FOR FUNDING LOANS HAVING INTEREST RATE-RATCHETING FEATURES, NAMELY, RATE-RATCHETING MORTGAGES, RATE-RATCHETING STUDENT LOANS, AND OTHER RATE-RATCHETING LOANS, IN CLASS 36 (U.S. CLS. 100, 101 AND 102).

FIRST USE 4-19-2005; IN COMMERCE 4-19-2005.

THE MARK CONSISTS OF STANDARD CHARACTERS WITHOUT CLAIM TO ANY PARTICULAR FONT, STYLE, SIZE, OR COLOR.

NO CLAIM IS MADE TO THE EXCLUSIVE RIGHT TO USE "PASS-THRU", APART FROM THE MARK AS SHOWN.

SER. NO. 77-102,883, FILED P.R. 2-8-2007; AM. S.R. 6-5-2008.

BARBARA BROWN, EXAMINING ATTORNEY



**Int. Cl.: 9**

**Prior U.S. Cls.: 21, 23, 26, 36, and 38**

**Reg. No. 3,469,865**

**United States Patent and Trademark Office**

**Registered July 15, 2008**

**TRADEMARK  
SUPPLEMENTAL REGISTER**



CAUTION AND COURTESY DRIVER ALLIANCE  
CORPORATION (GEORGIA NON-PROFIT  
CORPORATION)  
3997 PALISADES MAIN  
KENNESAW, GA 30144

FIRST USE 2-14-2007; IN COMMERCE 2-14-2007.

NO CLAIM IS MADE TO THE EXCLUSIVE  
RIGHT TO USE "NEWLY LICENSED", APART  
FROM THE MARK AS SHOWN.

FOR: CAR MAGNET TO ATTACH TO CAR OF A  
"NEWLY LICENSED" DRIVER TO ALERT SUR-  
ROUNDING DRIVERS TO BE CAUTIOUS AND  
COURTEOUS, IN CLASS 9 (U.S. CLS. 21, 23, 26, 36  
AND 38).

SER. NO. 77-106,077, FILED P.R. 2-13-2007; AM. S.R.  
5-20-2008.

PRISCILLA MILTON, EXAMINING ATTORNEY

**Int. Cl.: 25**

**Prior U.S. Cls.: 22 and 39**

**United States Patent and Trademark Office**

**Reg. No. 3,469,866**

**Registered July 15, 2008**

**TRADEMARK  
SUPPLEMENTAL REGISTER**

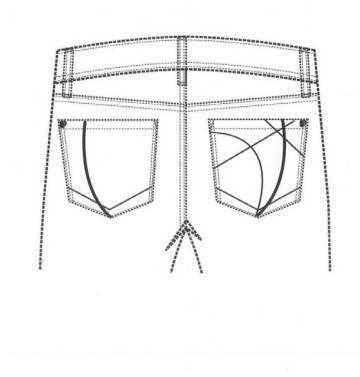

TKUU LLC (CALIFORNIA LTD LIAB CO)  
1305 MAIN STREET #B  
VENICE, CA 90291

FOR: JEANS, IN CLASS 25 (U.S. CLS. 22 AND 39).

FIRST USE 6-1-2006; IN COMMERCE 6-1-2006.

THE MARK CONSISTS OF A COMBINATION OF  
LINES AND AN ARC ON THE BACK POCKET OF

THE GOODS. NO CLAIM IS MADE TO THE OUT-  
LINES OR DESIGNS OF THE POCKET(S) WHICH  
ARE INCLUDED MERELY TO SHOW THE PLACE-  
MENT OF THE MARK ON THE GOODS.

SER. NO. 77-121,244, FILED P.R. 3-2-2007; AM. S.R.  
5-30-2008.

ANDREA BUTLER, EXAMINING ATTORNEY

**Int. Cl.: 25**

**Prior U.S. Cls.: 22 and 39**

**United States Patent and Trademark Office**

**Reg. No. 3,469,867**

**Registered July 15, 2008**

**TRADEMARK  
SUPPLEMENTAL REGISTER**

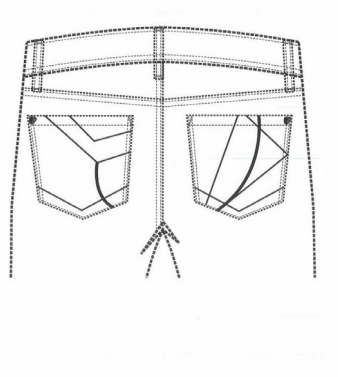

TKUU LLC (CALIFORNIA LTD LIAB CO)  
1305 MAIN STREET #B  
VENICE, CA 90291

FOR: JEANS, IN CLASS 25 (U.S. CLS. 22 AND 39).

FIRST USE 6-1-2006; IN COMMERCE 6-1-2006.

THE MARK CONSISTS OF A COMBINATION OF  
LINES AND AN ARC ON THE BACK POCKET OF

THE GOODS. NO CLAIM IS MADE TO THE OUT-  
LINES OR DESIGNS OF THE POCKET(S) WHICH  
ARE INCLUDED MERELY TO SHOW THE PLACE-  
MENT OF THE MARK ON THE GOODS.

SER. NO. 77-121,254, FILED P.R. 3-2-2007; AM. S.R.  
5-30-2008.

ANDREA BUTLER, EXAMINING ATTORNEY

**Int. Cl.: 25**

**Prior U.S. Cls.: 22 and 39**

**United States Patent and Trademark Office**

**Reg. No. 3,469,868**

**Registered July 15, 2008**

**TRADEMARK  
SUPPLEMENTAL REGISTER**

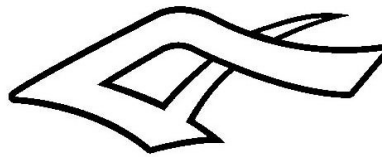

IN CALIFORNIA, INC. (CALIFORNIA CORPORATION)  
2701 OCEAN STREET  
CARLSBAD, CA 92008

FOR: SHOES, IN CLASS 25 (U.S. CLS. 22 AND 39).

FIRST USE 5-15-2007; IN COMMERCE 6-10-2007.

THE MARK CONSISTS OF FANCIFUL CROSSED STRIPE DESIGN.

SER. NO. 77-128,966, FILED P.R. 3-12-2007; AM. S.R. 6-4-2008.

ESTHER BELENKER, EXAMINING ATTORNEY

**Int. Cl.: 20**

**Prior U.S. Cls.: 2, 13, 22, 25, 32, and 50**

**United States Patent and Trademark Office**

**Reg. No. 3,469,869**

**Registered July 15, 2008**

---

**TRADEMARK  
SUPPLEMENTAL REGISTER**

**SECURE SOLUTIONS**

THE MARVEL GROUP, INC. (DELAWARE COR-  
PORATION)  
3843 WEST 43RD STREET  
CHICAGO, IL 60632

THE MARK CONSISTS OF STANDARD CHAR-  
ACTERS WITHOUT CLAIM TO ANY PARTICULAR  
FONT, STYLE, SIZE, OR COLOR.

FOR: FREE-STANDING WEAPONS RACKS;  
WALL-MOUNTED WEAPONS RACKS, IN CLASS  
20 (U.S. CLS. 2, 13, 22, 25, 32 AND 50).

SER. NO. 77-133,062, FILED P.R. 3-16-2007; AM. S.R.  
3-17-2008.

FIRST USE 2-20-2007; IN COMMERCE 2-20-2007.

SETH A. RAPPAPORT, EXAMINING ATTORNEY

**Int. Cl.: 19**

**Prior U.S. Cls.: 1, 12, 33, and 50**

**United States Patent and Trademark Office**

**Reg. No. 3,469,870**

**Registered July 15, 2008**

**TRADEMARK  
SUPPLEMENTAL REGISTER**

**SEAMLESS**

SHARABI, TAL (ISRAEL INDIVIDUAL)  
4382 VISION DRIVE  
SAN DIEGO, CA 92121

FIRST USE 12-14-2007; IN COMMERCE 12-14-2007.

FOR: NON-METAL DECORATIVE MOLDINGS  
AND DECORATIVE TRIM FOR USE IN BUILDING  
CONSTRUCTION, NAMELY, CROWN MOLDINGS,  
BASEBOARDS, CHAIR RAILS, QUARTER-CIRCLES  
AND PRECUT CHAIR RAIL CORNER ANGLES, IN  
CLASS 19 (U.S. CLS. 1, 12, 33 AND 50).

THE MARK CONSISTS OF STANDARD CHAR-  
ACTERS WITHOUT CLAIM TO ANY PARTICULAR  
FONT, STYLE, SIZE, OR COLOR.

SER. NO. 77-133,885, FILED P.R. 3-18-2007; AM. S.R.  
3-19-2008.

NAPOLEON SHARMA, EXAMINING ATTORNEY

**Int. Cl.: 35**

**Prior U.S. Cls.: 100, 101, and 102**

**United States Patent and Trademark Office**

**Reg. No. 3,469,871**

**Registered July 15, 2008**

**SERVICE MARK  
SUPPLEMENTAL REGISTER**

**THIRD FORCE NETWORK**

THIRD FORCE NETWORK INC. (DELAWARE  
CORPORATION)  
P.O. BOX 1973  
LEESBURG, VA 20177

FOR: PROVIDING A WEBSITE FEATURING ON-  
LINE INFORMATIONAL CONTENT IN THE FIELD  
OF POLITICS AND ECONOMICS RELATED TO  
FOSTERING A GLOBAL CIVIL SOCIETY, IN CLASS  
35 (U.S. CLS. 100, 101 AND 102).

FIRST USE 12-1-2003; IN COMMERCE 12-1-2003.

THE MARK CONSISTS OF STANDARD CHAR-  
ACTERS WITHOUT CLAIM TO ANY PARTICULAR  
FONT, STYLE, SIZE, OR COLOR.

NO CLAIM IS MADE TO THE EXCLUSIVE  
RIGHT TO USE "NETWORK", APART FROM THE  
MARK AS SHOWN.

SER. NO. 77-139,386, FILED P.R. 3-23-2007; AM. S.R.  
6-4-2008.

ELISSA GARBER KON, EXAMINING ATTORNEY

**Int. Cl.: 41**

**Prior U.S. Cls.: 100, 101, and 107**

**United States Patent and Trademark Office**

**Reg. No. 3,469,872**

**Registered July 15, 2008**

**SERVICE MARK  
SUPPLEMENTAL REGISTER**

**CERTIFIED STEGANOGRAPHY  
EXAMINER**

BACKBONE SECURITY.COM, INC. (WEST VIR-  
GINIA CORPORATION)  
320 ADAMS STREET  
SUITE 105  
FAIRMONT, WV 26554

FOR: EDUCATIONAL SERVICES, NAMELY,  
PROVIDING INSTRUCTIONAL PROGRAMS AND  
COURSES OF INSTRUCTION IN THE FIELD OF  
STEGANOGRAPHY, IN CLASS 41 (U.S. CLS. 100, 101  
AND 107).

FIRST USE 7-1-2007; IN COMMERCE 7-1-2007.

THE MARK CONSISTS OF STANDARD CHAR-  
ACTERS WITHOUT CLAIM TO ANY PARTICULAR  
FONT, STYLE, SIZE, OR COLOR.

NO CLAIM IS MADE TO THE EXCLUSIVE  
RIGHT TO USE "EXAMINER", APART FROM THE  
MARK AS SHOWN.

SER. NO. 77-141,193, FILED P.R. 3-27-2007; AM. S.R.  
7-26-2007.

EDWARD NELSON, EXAMINING ATTORNEY



**Int. Cl.: 35**

**Prior U.S. Cls.: 100, 101, and 102**

**United States Patent and Trademark Office**

**Reg. No. 3,469,873**

**Registered July 15, 2008**

**SERVICE MARK  
SUPPLEMENTAL REGISTER**

# BagTrends

BAGTRENDS, INC. (NEW YORK CORPORATION)  
2768 EAST 63 STREET  
BROOKLYN, NY 11234

FOR: PROVIDING AN ONLINE DIRECTORY INFORMATION SERVICE FEATURING INFORMATION ON TRENDS IN HANDBAGS, BAGS AND SMALL LEATHER GOODS AND TRENDS IN ACCESSORIES, BEAUTY, COSMETICS, SHOPPING, AND FASHION APPAREL; PROVIDING AN ONLINE BUYER'S GUIDE, NAMELY, AN ONLINE SEARCHABLE DATABASE FEATURING GOODS OFFERED FOR SALE, NAMELY, HANDBAGS, SMALL LEATHER GOODS, AND PRODUCTS THAT GO IN THE BAG, AND SELLER CONTACT INFORMATION; ONLINE RETAIL STORE SERVICES FEATURING HANDBAGS, SMALL LEATHER GOODS, ACCESSORIES, BOOKS AND COSMETICS; PROVID-

ING CONSUMER INFORMATION AND RELATED NEWS IN THE FIELD OF DESIGNER PROFILES, FASHION NEWS, FASHION BRAND LAUNCHES, TREND UPDATES, CELEBRITY TRENDS, STREET TRENDS, STORE OPENINGS AND OTHER FASHION NEWS FOR SHOPPING PURPOSES, IN CLASS 35 (U.S. CLS. 100, 101 AND 102).

FIRST USE 4-15-2005; IN COMMERCE 4-15-2005.

THE MARK CONSISTS OF STANDARD CHARACTERS WITHOUT CLAIM TO ANY PARTICULAR FONT, STYLE, SIZE, OR COLOR.

SER. NO. 77-141,745, FILED P.R. 3-27-2007; AM. S.R. 1-11-2008.

MARY MUNSON, EXAMINING ATTORNEY

**Int. Cl.: 36**

**Prior U.S. Cls.: 100, 101, and 102**

**United States Patent and Trademark Office**

**Reg. No. 3,469,874**

**Registered July 15, 2008**

**SERVICE MARK  
SUPPLEMENTAL REGISTER**

**DEPOSITTRUST**

RESIDENCES ON DEMAND (MINNESOTA LIMITED LIABILITY COMPANY)  
SUITE 331  
5832 LINCOLN DRIVE  
EDINA, MN 55436

FOR: TRUST SERVICES TO HOLD REAL ESTATE TITLES FOR THE BENEFIT OF DESTINATION CLUB MEMBERS, NAMELY, REAL ESTATE TRUST MANAGEMENT, IN CLASS 36 (U.S. CLS. 100, 101 AND 102).

FIRST USE 11-30-2006; IN COMMERCE 11-30-2006.

THE MARK CONSISTS OF STANDARD CHARACTERS WITHOUT CLAIM TO ANY PARTICULAR FONT, STYLE, SIZE, OR COLOR.

SER. NO. 77-143,670, FILED P.R. 3-29-2007; AM. S.R. 5-15-2008.

SANI KHOURI, EXAMINING ATTORNEY

**Int. Cl.: 41**

**Prior U.S. Cls.: 100, 101, and 107**

**United States Patent and Trademark Office**

**Reg. No. 3,469,875**

**Registered July 15, 2008**

**SERVICE MARK  
SUPPLEMENTAL REGISTER**

**CITYBLOGUSA**

EPARTNER USA, INC. (NEVADA CORPORATION)  
P.O. BOX 3205  
PRESCOTT, AZ 86302

FOR: ON-LINE JOURNALS, NAMELY, BLOGS ALLOWING INDIVIDUAL CONSUMERS TO WRITE AND POST COMMENTS IN A PEER-TO-PEER FASHION ABOUT A VARIETY OF TOPICS UNIQUE TO INDIVIDUAL LOCALES IN THE NATURE OF LOCAL HEALTH CARE, POLITICS, EDUCATION, CRIME, REAL ESTATE, REAL ESTATE VALUES, LIFESTYLES, TOURISM, FINANCE, SPORTS, LOCAL EVENTS, SHOPPING, DINING

AND TOPICS OF GENERAL INTEREST TO OTHER CONSUMERS, IN CLASS 41 (U.S. CLS. 100, 101 AND 107).

FIRST USE 6-0-2006; IN COMMERCE 6-0-2007.

THE MARK CONSISTS OF STANDARD CHARACTERS WITHOUT CLAIM TO ANY PARTICULAR FONT, STYLE, SIZE, OR COLOR.

SER. NO. 77-163,725, FILED P.R. 4-23-2007; AM. S.R. 6-6-2008.

JAY BESCH, EXAMINING ATTORNEY

**Int. Cl.: 41**

**Prior U.S. Cls.: 100, 101, and 107**

**United States Patent and Trademark Office**

**Reg. No. 3,469,876**

**Registered July 15, 2008**

**SERVICE MARK  
SUPPLEMENTAL REGISTER**

**CombatYoga**

NEXT EVOLUTION, INC. (PENNSYLVANIA  
CORPORATION)  
P.O. BOX 21  
ALLISON PARK, PA 15101

THE MARK CONSISTS OF STANDARD CHAR-  
ACTERS WITHOUT CLAIM TO ANY PARTICULAR  
FONT, STYLE, SIZE, OR COLOR.

FOR: YOGA AND PHYSICAL FITNESS INSTRU-  
CTION AND CLASSES, IN CLASS 41 (U.S. CLS. 100, 101  
AND 107).

SER. NO. 77-170,633, FILED P.R. 5-2-2007; AM. S.R.  
6-9-2008.

FIRST USE 8-4-2006; IN COMMERCE 8-4-2006.

CYNTHIA SLOAN, EXAMINING ATTORNEY

**Int. Cl.: 17**

**Prior U.S. Cls.: 1, 5, 12, 13, 35, and 50**

**Reg. No. 3,469,877**

**United States Patent and Trademark Office**

**Registered July 15, 2008**

**TRADEMARK  
SUPPLEMENTAL REGISTER**

**THE GREENEST OF THE GREEN**

ADVANCED FIBER TECHNOLOGY, INC. (OHIO  
CORPORATION)  
100 CROSSROADS BLVD.  
BUCYRUS, OH 44820

THE MARK CONSISTS OF STANDARD CHAR-  
ACTERS WITHOUT CLAIM TO ANY PARTICULAR  
FONT, STYLE, SIZE, OR COLOR.

FOR: INSULATION WITH ACOUSTIC AND  
THERMAL PROPERTIES FOR USE IN RESIDEN-  
TIAL AND COMMERCIAL BUILDINGS, IN CLASS  
17 (U.S. CLS. 1, 5, 12, 13, 35 AND 50).

SER. NO. 77-179,827, FILED P.R. 5-14-2007; AM. S.R.  
4-29-2008.

FIRST USE 3-5-2008; IN COMMERCE 3-5-2008.

STEVEN R. FINE, EXAMINING ATTORNEY

**Int. Cl.: 17**

**Prior U.S. Cls.: 1, 5, 12, 13, 35, and 50**

**United States Patent and Trademark Office**

**Reg. No. 3,469,878**

**Registered July 15, 2008**

**TRADEMARK  
SUPPLEMENTAL REGISTER**

**CELLULOSE INSULATION THE  
GREENEST OF THE GREEN**

ADVANCED FIBER TECHNOLOGY, INC. (OHIO  
CORPORATION)  
100 CROSSROADS BLVD.  
BUCYRUS, OH 44820

FOR: INSULATION WITH ACOUSTIC AND  
THERMAL PROPERTIES FOR USE IN RESIDEN-  
TIAL AND COMMERCIAL BUILDINGS, IN CLASS  
17 (U.S. CLS. 1, 5, 12, 13, 35 AND 50).

FIRST USE 3-5-2008; IN COMMERCE 3-5-2008.

THE MARK CONSISTS OF STANDARD CHAR-  
ACTERS WITHOUT CLAIM TO ANY PARTICULAR  
FONT, STYLE, SIZE, OR COLOR.

NO CLAIM IS MADE TO THE EXCLUSIVE  
RIGHT TO USE "CELLULOSE INSULATION",  
APART FROM THE MARK AS SHOWN.

SER. NO. 77-179,840, FILED P.R. 5-14-2007; AM. S.R.  
4-29-2008.

STEVEN R. FINE, EXAMINING ATTORNEY

**Int. Cl.: 35**

**Prior U.S. Cls.: 100, 101, and 102**

**United States Patent and Trademark Office**

**Reg. No. 3,469,879**

**Registered July 15, 2008**

**SERVICE MARK  
SUPPLEMENTAL REGISTER**

**THE WORLD'S FIRST ENERGY  
EFFICIENCY STORE**

CURRENT LP (TEXAS LIMITED PARTNERSHIP)  
SUITE 100  
5440 HARVEST HILL ROAD  
DALLAS, TX 75230

FOR: RETAIL STORE SERVICES AND ON-LINE  
RETAIL STORE SERVICES FEATURING ENERGY  
EFFICIENT PRODUCTS AND COST SAVING SER-  
VICES FOR RESIDENTIAL, COMMERCIAL, AND  
INDUSTRIAL BUILDINGS FEATURING NEGOTIATING WITH AND SWITCHING RESIDENTIAL  
AND COMMERCIAL CUSTOMERS' ELECTRICITY  
PROVIDERS, PROVIDING ENERGY EFFICIENCY  
AUDITS AND PROMOTING AND MARKETING  
ENERGY EFFICIENT LIGHTING, HEATING, VEN-  
TILATION, AND AIR CONDITIONING SYSTEMS,  
THERMOSTATS, WATER HEATERS, HOME AND  
BUSINESS LIGHTING AND LIGHTING CONTROL-  
LING SYSTEMS, WINDOWS AND DOORS, RADI-  
ANT BARRIER PRODUCTS, INSULATION, SOLAR  
SCREENS, WINDOW FILMS, SURGE PROTECTION

AND MODULATION, APPLIANCES, AND ALL  
OTHER ELECTRIC, GAS, SOLAR, WIND, AND  
WATER ENERGY TECHNOLOGY; CONSULTA-  
TION IN THE FIELD OF ENERGY EFFICIENCY,  
IN CLASS 35 (U.S. CLS. 100, 101 AND 102).

FIRST USE 8-29-2006; IN COMMERCE 8-29-2006.

THE MARK CONSISTS OF STANDARD CHAR-  
ACTERS WITHOUT CLAIM TO ANY PARTICULAR  
FONT, STYLE, SIZE, OR COLOR.

NO CLAIM IS MADE TO THE EXCLUSIVE  
RIGHT TO USE "ENERGY EFFICIENCY STORE",  
APART FROM THE MARK AS SHOWN.

SER. NO. 77-180,781, FILED P.R. 5-14-2007; AM. S.R.  
6-3-2008.

ANDREA HACK, EXAMINING ATTORNEY

**Int. Cls.: 37 and 42**

**Prior U.S. Cls.: 100, 101, 103, and 106**

**United States Patent and Trademark Office**

**Reg. No. 3,469,880**

**Registered July 15, 2008**

**SERVICE MARK  
SUPPLEMENTAL REGISTER**

**THE WORLD'S FIRST ENERGY  
EFFICIENCY STORE**

CURRENT LP (TEXAS LIMITED PARTNERSHIP)  
SUITE 100  
5440 HARVEST HILL ROAD  
DALLAS, TX 75230

FOR: INSTALLING, MAINTAINING, AND SERVICING CONTROL SYSTEMS FOR ENERGY EFFICIENT LIGHTING, HEATING, VENTILATION, AND AIR CONDITIONING , IN CLASS 37 (U.S. CLS. 100, 103 AND 106).

FIRST USE 8-29-2006; IN COMMERCE 8-29-2006.

FOR: DESIGNING AND MONITORING CONTROL SYSTEMS FOR ENERGY EFFICIENT LIGHTING, HEATING, VENTILATION, AND AIR

CONDITIONING, IN CLASS 42 (U.S. CLS. 100 AND 101).

FIRST USE 8-29-2006; IN COMMERCE 8-29-2006.

THE MARK CONSISTS OF STANDARD CHARACTERS WITHOUT CLAIM TO ANY PARTICULAR FONT, STYLE, SIZE, OR COLOR.

NO CLAIM IS MADE TO THE EXCLUSIVE RIGHT TO USE "ENERGY EFFICIENCY STORE", APART FROM THE MARK AS SHOWN.

SER. NO. 77-185,939, FILED P.R. 5-21-2007; AM. S.R. 6-3-2008.

ANDREA HACK, EXAMINING ATTORNEY



**Int. Cl.: 35**

**Prior U.S. Cls.: 100, 101, and 102**

**United States Patent and Trademark Office**

**Reg. No. 3,469,881**

**Registered July 15, 2008**

**SERVICE MARK  
SUPPLEMENTAL REGISTER**

# Your Support Nurse

CARE SUPPORT OF AMERICA, L.L.C. (NEW YORK LTD LIAB CO)

113 HOLLAND AVENUE, 11TH FLOOR

ALBANY, NY 12208

FOR: HEALTH CARE UTILIZATION AND REVIEW SERVICES, IN CLASS 35 (U.S. CLS. 100, 101 AND 102).

FIRST USE 11-0-2007; IN COMMERCE 11-0-2007.

THE MARK CONSISTS OF STANDARD CHARACTERS WITHOUT CLAIM TO ANY PARTICULAR FONT, STYLE, SIZE, OR COLOR.

NO CLAIM IS MADE TO THE EXCLUSIVE RIGHT TO USE "SUPPORT NURSE", APART FROM THE MARK AS SHOWN.

SER. NO. 77-205,655, FILED P.R. 6-13-2007; AM. S.R. 5-23-2008.

KAREN SEVERSON, EXAMINING ATTORNEY

**Int. Cl.: 44**

**Prior U.S. Cls.: 100 and 101**

**United States Patent and Trademark Office**

**Reg. No. 3,469,882**

**Registered July 15, 2008**

**SERVICE MARK  
SUPPLEMENTAL REGISTER**

**Park Avenue Laser Vision**

CHYNN, EMIL W. (UNITED STATES INDIVIDUAL)

102 E. 25TH ST.

NEW YORK, NY 10010

FOR: LASER VISION SURGERY SERVICES, IN CLASS 44 (U.S. CLS. 100 AND 101).

FIRST USE 1-1-2006; IN COMMERCE 1-1-2007.

THE MARK CONSISTS OF STANDARD CHARACTERS WITHOUT CLAIM TO ANY PARTICULAR FONT, STYLE, SIZE, OR COLOR.

NO CLAIM IS MADE TO THE EXCLUSIVE RIGHT TO USE "LASER VISION", APART FROM THE MARK AS SHOWN.

SER. NO. 77-206,550, FILED P.R. 6-14-2007; AM. S.R. 6-4-2008.

GISELLE AGOSTO, EXAMINING ATTORNEY

**Int. Cl.: 36**

**Prior U.S. Cls.: 100, 101, and 102**

**United States Patent and Trademark Office**

**Reg. No. 3,469,883**

**Registered July 15, 2008**

**SERVICE MARK  
SUPPLEMENTAL REGISTER**

**MUTUAL TRUST FINANCIAL  
GROUP**

MTL INSURANCE COMPANY (ILLINOIS CORPORATION)  
1200 JORIE BOULEVARD  
OAK BROOK, IL 605229060

FOR: SERVICES FOR DEVELOPING, UNDERWRITING AND SERVICING INDIVIDUAL LIFE INSURANCE AND ANNUITIES INCLUDING UNIVERSAL LIFE INSURANCE, TERM LIFE INSURANCE AND ANNUITIES TO INDIVIDUALS, FAMILIES AND BUSINESSES; PROVIDING INSURANCE AGENTS WITH ACCESS TO A REGISTERED BROKER DEALER AUTHORIZED TO SELL MUTUAL FUNDS, STOCKS, BONDS AND VARIABLE PRODUCTS FOR DIVERSE INVESTMENT AND FINANCIAL GOALS; PERFORMING SERVICES FOR HELPING INSURANCE AGENTS TO SECURE COVERAGE FOR HARD-TO-PLACE IMPAIRED RISK CASES BY DIRECTING THEM TO PARTNERS WHO SPECIALIZE IN HIGHLY RATED AND DE-

CLINED CASES, IN CLASS 36 (U.S. CLS. 100, 101 AND 102).

FIRST USE 8-15-2004; IN COMMERCE 8-15-2004.

THE MARK CONSISTS OF STANDARD CHARACTERS WITHOUT CLAIM TO ANY PARTICULAR FONT, STYLE, SIZE, OR COLOR.

OWNER OF U.S. REG. NO. 2,540,262.

NO CLAIM IS MADE TO THE EXCLUSIVE RIGHT TO USE "FINANCIAL GROUP", APART FROM THE MARK AS SHOWN.

SER. NO. 77-208,192, FILED P.R. 6-18-2007; AM. S.R. 3-26-2008.

ANNE MADDEN, EXAMINING ATTORNEY

**Int. Cl.: 35**

**Prior U.S. Cls.: 100, 101, and 102**

**United States Patent and Trademark Office**

**Reg. No. 3,469,884**

**Registered July 15, 2008**

**SERVICE MARK  
SUPPLEMENTAL REGISTER**

# Greenwich Music

GREENWICH MUSIC ASSOC., LTD (CONNECTI-  
CUT CORPORATION)  
1200 EAST PUTNAM AVENUE  
RIVERSIDE, CT 06878

FOR: RETAIL STORES SERVICES FEATURING  
MUSICAL INSTRUMENTS AND RELATED  
GOODS, NAMELY, GUITARS, KEYBOARDS, DIGI-  
TAL PIANOS, DRUMS, SHEET MUSIC, STRINGED  
INSTRUMENTS, AMPLIFIERS, PROFESSIONAL  
SOUND AND RECORDING EQUIPMENT, AND  
ACCESSORIES RELATED TO THESE GOODS; ON-  
LINE RETAIL STORES SERVICES FEATURING  
MUSICAL INSTRUMENTS AND RELATED  
GOODS, NAMELY, GUITARS, KEYBOARDS, DIGI-  
TAL PIANOS, DRUMS, SHEET MUSIC, STRINGED  
INSTRUMENTS, AMPLIFIERS, PROFESSIONAL  
SOUND AND RECORDING EQUIPMENT, AND

ACCESSORIES RELATED TO THESE GOODS, IN  
CLASS 35 (U.S. CLS. 100, 101 AND 102).

FIRST USE 6-0-1985; IN COMMERCE 6-0-1985.

THE MARK CONSISTS OF STANDARD CHAR-  
ACTERS WITHOUT CLAIM TO ANY PARTICULAR  
FONT, STYLE, SIZE, OR COLOR.

NO CLAIM IS MADE TO THE EXCLUSIVE  
RIGHT TO USE "MUSIC", APART FROM THE  
MARK AS SHOWN.

SER. NO. 77-208,956, FILED P.R. 6-18-2007; AM. S.R.  
5-29-2008.

CORY BOONE, EXAMINING ATTORNEY

**Int. Cls.: 9 and 41**

**Prior U.S. Cls.: 21, 23, 26, 36, 38, 100, 101, and 107**

**United States Patent and Trademark Office**

**Reg. No. 3,469,885**

**Registered July 15, 2008**

**TRADEMARK  
SERVICE MARK  
SUPPLEMENTAL REGISTER**

# Team Tools

THE STRATEGIC COACH INC. (CANADA CORPORATION)

33 FRASER AVE. SUITE #201  
TORONTO, CANADA M6K3J9

FOR: ELECTRONIC PUBLICATIONS, NAMELY, MANUALS, STUDY GUIDES, DISCUSSION GUIDES, BOOKS AND NEWSLETTERS, RECORDED ON COMPUTER MEDIA, AND FEATURING PRESENTATIONS AND INSTRUCTION DEALING WITH A COMBINATION OF LIFE FOCUSING AND PLANNING EXERCISES THAT HELP INDIVIDUALS STRATEGICALLY IMPROVE THEIR BUSINESS PERFORMANCE AND UNIQUE QUALITY OF LIFE, IN CLASS 9 (U.S. CLS. 21, 23, 26, 36 AND 38).

FIRST USE 2-2-1998; IN COMMERCE 2-2-1998.

FOR: EDUCATION SERVICES, NAMELY, CONDUCTING SEMINARS AND WORKSHOPS DEALING WITH A COMBINATION OF LIFE FOCUSING AND PLANNING EXERCISES THAT HELP INDIVIDUALS STRATEGICALLY IMPROVE THEIR BUSINESS PERFORMANCE AND UNIQUE QUALITY OF LIFE, IN CLASS 41 (U.S. CLS. 100, 101 AND 107).

FIRST USE 2-2-1998; IN COMMERCE 2-2-1998.

THE MARK CONSISTS OF STANDARD CHARACTERS WITHOUT CLAIM TO ANY PARTICULAR FONT, STYLE, SIZE, OR COLOR.

SER. NO. 77-215,817, FILED P.R. 6-26-2007; AM. S.R. 5-23-2008.

CHARISMA HAMPTON, EXAMINING ATTORNEY

**Int. Cl.: 36**

**Prior U.S. Cls.: 100, 101, and 102**

**United States Patent and Trademark Office**

**Reg. No. 3,469,886**

**Registered July 15, 2008**

**SERVICE MARK  
SUPPLEMENTAL REGISTER**

**SENIOR EQUITY REVERSE  
MORTGAGE**

BANK OF AMERICA CORPORATION (DELA-  
WARE CORPORATION)

100 NORTH TRYON STREET

CHARLOTTE, NC 28255

FOR: MORTGAGE LENDING, IN CLASS 36 (U.S.  
CLS. 100, 101 AND 102).

FIRST USE 10-0-2007; IN COMMERCE 10-0-2007.

THE MARK CONSISTS OF STANDARD CHAR-  
ACTERS WITHOUT CLAIM TO ANY PARTICULAR  
FONT, STYLE, SIZE, OR COLOR.

NO CLAIM IS MADE TO THE EXCLUSIVE  
RIGHT TO USE "REVERSE MORTGAGE", APART  
FROM THE MARK AS SHOWN.

SER. NO. 77-223,665, FILED P.R. 7-6-2007; AM. S.R.  
5-29-2008.

B. PARADEWELAI, EXAMINING ATTORNEY

**Int. Cl.: 16**

**Prior U.S. Cls.: 2, 5, 22, 23, 29, 37, 38, and 50**

**Reg. No. 3,469,887**

**United States Patent and Trademark Office**

**Registered July 15, 2008**

**TRADEMARK  
SUPPLEMENTAL REGISTER**

# Kungfoo Kangaroo

CAGLIONE, EDDY (UNITED STATES INDIVIDUAL)  
P. O. BOX 31086  
MYRTLE BEACH, SC 29588

FOR: FLASH CARDS; GREETING CARDS; ART PRINTS; CARTOON PRINTS; COLOR PRINTS; CHILDREN'S ACTIVITY BOOKS; CHILDREN'S BOOKS; CHILDREN'S INTERACTIVE EDUCATIONAL BOOKS; CHILDREN'S STORYBOOKS; COLORING BOOKS; COMIC BOOKS; CROSSWORD PUZZLES; DECALS; IRON-ON T-SHIRT TRANSFERS; DECORATIVE PENCIL-TOP ORNAMENTS; BABY BOOKS; BIRTHDAY BOOKS; EDUCATIONAL BOOKS FEATURING PRE AND ELEMENTARY SCHOOL SUBJECT MATTER; ILLUSTRATIONS; PICTURE BOOKS; PICTURE POSTCARDS; PICTURES; POSTCARDS; MOUNTED POSTERS; POS-

TERS; POSTERS MADE OF PAPER; UNMOUNTED POSTERS; PRINTED CALENDARS; PRINTED HOLOGRAMS; STORIES IN ILLUSTRATED FORM; STORY BOOKS; TEMPORARY TATTOOS; TRADING CARDS; WALL CALENDARS, IN CLASS 16 (U.S. CLS. 2, 5, 22, 23, 29, 37, 38 AND 50).

FIRST USE 7-12-2007; IN COMMERCE 1-1-2008.

THE MARK CONSISTS OF STANDARD CHARACTERS WITHOUT CLAIM TO ANY PARTICULAR FONT, STYLE, SIZE, OR COLOR.

SER. NO. 77-228,339, FILED P.R. 7-12-2007; AM. S.R. 6-10-2008.

MATTHEW PAPPAS, EXAMINING ATTORNEY

**Int. Cls.: 6 and 9**

**Prior U.S. Cls.: 2, 12, 13, 14, 21, 23, 25, 26, 36, 38, and 50**

**United States Patent and Trademark Office**

**Reg. No. 3,469,888**

**Registered July 15, 2008**

**TRADEMARK  
SUPPLEMENTAL REGISTER**

**HYBRID**

MEDECO SECURITY LOCKS, INC. (VIRGINIA CORPORATION)  
P.O. BOX 3075  
SALEM, VA 24153

FOR: METAL LOCKS; METAL SECURITY LOCK CYLINDERS; METAL KEYS FOR LOCKS, IN CLASS 6 (U.S. CLS. 2, 12, 13, 14, 23, 25 AND 50).

FIRST USE 3-1-2007; IN COMMERCE 3-1-2007.

FOR: ELECTRO-MECHANICAL CYLINDER LOCK KEY, NAMELY, A DUAL FUNCTION KEY WITH MECHANICAL FITTING AND ELECTRO-

NICS FOR OPERATION OF BOTH MECHANICAL LOCKS AND ELECTRONIC LOCKS, IN CLASS 9 (U.S. CLS. 21, 23, 26, 36 AND 38).

FIRST USE 3-1-2007; IN COMMERCE 3-1-2007.

THE MARK CONSISTS OF STANDARD CHARACTERS WITHOUT CLAIM TO ANY PARTICULAR FONT, STYLE, SIZE, OR COLOR.

SER. NO. 77-238,407, FILED P.R. 7-25-2007; AM. S.R. 6-6-2008.

JIM RINGLE, EXAMINING ATTORNEY



**Int. Cl.: 35**

**Prior U.S. Cls.: 100, 101, and 102**

**United States Patent and Trademark Office**

**Reg. No. 3,469,889**

**Registered July 15, 2008**

**SERVICE MARK  
SUPPLEMENTAL REGISTER**

**ENERGY, TECHNOLOGY AND  
ENVIRONMENTAL BUSINESS  
ASSOCIATION**

ENERGY, TECHNOLOGY AND ENVIRONMENTAL BUSINESS ASSOCIATION (TENNESSEE NON-PROFIT CORPORATION)  
P.O. BOX 5483  
OAK RIDGE, TN 37831

FOR: ASSOCIATION SERVICES, NAMELY, PROMOTING THE INTERESTS OF COMPANIES THAT PROVIDE ENVIRONMENTAL, TECHNOLOGY, ENERGY, ENGINEERING, AND CONSTRUCTION SERVICES, IN CLASS 35 (U.S. CLS. 100, 101 AND 102).

FIRST USE 7-27-2006; IN COMMERCE 7-27-2006.

THE MARK CONSISTS OF STANDARD CHARACTERS WITHOUT CLAIM TO ANY PARTICULAR FONT, STYLE, SIZE, OR COLOR.

NO CLAIM IS MADE TO THE EXCLUSIVE RIGHT TO USE "ASSOCIATION", APART FROM THE MARK AS SHOWN.

SER. NO. 77-244,149, FILED P.R. 8-1-2007; AM. S.R. 5-8-2008.

TIMOTHY FINNEGAN, EXAMINING ATTORNEY

**Int. Cl.: 35**

**Prior U.S. Cls.: 100, 101, and 102**

**United States Patent and Trademark Office**

**Reg. No. 3,469,890**

**Registered July 15, 2008**

**SERVICE MARK  
SUPPLEMENTAL REGISTER**

**SUSTAINABLE STAFFING**

TECHNICAL AID CORPORATION (MASSACHU-  
SETTS CORPORATION)

888 WASHINGTON STREET

DEDHAM, MA 02026

FOR: EMPLOYMENT AGENCY AND PROVISION  
OF CONTRACT WORKERS SERVICES, IN CLASS 35  
(U.S. CLS. 100, 101 AND 102).

FIRST USE 5-1-2007; IN COMMERCE 5-1-2007.

THE MARK CONSISTS OF STANDARD CHAR-  
ACTERS WITHOUT CLAIM TO ANY PARTICULAR  
FONT, STYLE, SIZE, OR COLOR.

NO CLAIM IS MADE TO THE EXCLUSIVE  
RIGHT TO USE "STAFFING", APART FROM THE  
MARK AS SHOWN.

SER. NO. 77-245,078, FILED P.R. 8-2-2007; AM. S.R.  
5-2-2008.

ANGELA M. MICHELI, EXAMINING ATTORNEY

**Int. Cl.: 41**

**Prior U.S. Cls.: 100, 101, and 107**

**United States Patent and Trademark Office**

**Reg. No. 3,469,891**

**Registered July 15, 2008**

**SERVICE MARK  
SUPPLEMENTAL REGISTER**

**World Championship  
Specklebelly Goose Calling  
Contest**

RICHARD, TRAVIS S. (UNITED STATES INDIVIDUAL)

7918 ELLIS STANSEL PRIVATE ROAD

GUEYDAN, LA 70542

FOR: ENTERTAINMENT SERVICES, NAMELY, CONDUCTING CONTESTS, IN CLASS 41 (U.S. CLS. 100, 101 AND 107).

FIRST USE 8-31-2007; IN COMMERCE 8-31-2007.

THE MARK CONSISTS OF STANDARD CHARACTERS WITHOUT CLAIM TO ANY PARTICULAR FONT, STYLE, SIZE, OR COLOR.

NO CLAIM IS MADE TO THE EXCLUSIVE RIGHT TO USE "CONTEST", APART FROM THE MARK AS SHOWN.

SER. NO. 77-257,719, FILED P.R. 8-17-2007; AM. S.R. 6-5-2008.

HENRY S. ZAK, EXAMINING ATTORNEY

**Int. Cl.: 28**

**Prior U.S. Cls.: 22, 23, 38, and 50**

**United States Patent and Trademark Office**

**Reg. No. 3,469,892**

**Registered July 15, 2008**

**TRADEMARK  
SUPPLEMENTAL REGISTER**

**QUAD RODZ**

ALLEY, COREY (UNITED STATES INDIVIDUAL)  
639 NORMANDY ROAD  
MADEIRA BEACH, FL 33708

FOR: FISHING ROD HOLDER, IN CLASS 28 (U.S. CLS. 22, 23, 38 AND 50).

FIRST USE 5-21-2008; IN COMMERCE 5-21-2008.

THE MARK CONSISTS OF STANDARD CHARACTERS WITHOUT CLAIM TO ANY PARTICULAR FONT, STYLE, SIZE, OR COLOR.

SER. NO. 77-258,949, FILED P.R. 8-20-2007; AM. S.R. 5-27-2008.

CHRISTINE COOPER, EXAMINING ATTORNEY

**Int. Cl.: 41**

**Prior U.S. Cls.: 100, 101, and 107**

**United States Patent and Trademark Office**

**Reg. No. 3,469,893**

**Registered July 15, 2008**

**SERVICE MARK  
SUPPLEMENTAL REGISTER**

**ACADEMY OF WIRELESS ARTS,  
VIDEO AND ENTERTAINMENT**

HARTMAN, CHRISTOPHER P. (UNITED STATES  
INDIVIDUAL)  
2535 SWANSON STREET  
EASTON, PA 18045

FOR: PROVIDING RECOGNITION AND INCEN-  
TIVES BY THE WAY OF AWARDS TO DEMON-  
STRATE EXCELLENCE IN THE FIELD OF  
ENTERTAINMENT PROGRAMS FOR USE WITH  
WIRELESS COMMUNICATION DEVICES, IN  
CLASS 41 (U.S. CLS. 100, 101 AND 107).

FIRST USE 4-1-2007; IN COMMERCE 4-1-2007.

THE MARK CONSISTS OF STANDARD CHAR-  
ACTERS WITHOUT CLAIM TO ANY PARTICULAR  
FONT, STYLE, SIZE, OR COLOR.

SER. NO. 77-261,270, FILED P.R. 8-22-2007; AM. S.R.  
5-29-2008.

KATHLEEN LORENZO, EXAMINING ATTORNEY

**Int. Cls.: 9 and 11**

**Prior U.S. Cls.: 13, 21, 23, 26, 31, 34, 36, and 38**

**United States Patent and Trademark Office**

**Reg. No. 3,469,894**

**Registered July 15, 2008**

**TRADEMARK  
SUPPLEMENTAL REGISTER**

# BLOODSAFE

MEDIWARE INFORMATION SYSTEMS, INC.  
(NEW YORK CORPORATION)  
11711 WEST 79TH STREET  
LENEXA, KS 66214

FOR: COMPUTER HARDWARE AND SOFTWARE THAT IDENTIFY PATIENT IDENTIFICATION AND BLOOD TRANSFUSION ORDERS AND DOCUMENT BLOOD TRANSFUSION ACTIVITIES, THAT ELECTRONICALLY CONTROL AND TRACK THE MOVEMENT OF BLOOD PRODUCTS IN AND OUT OF REFRIGERATION UNITS IN HOSPITALS AND OTHER MEDICAL FACILITIES, THAT ALLOCATE BLOOD UNITS ON DEMAND, THAT TRACK THE STATUS AND LOCATION OF BLOOD UNITS AND MONITOR THE STATUS OF BLOOD TRANSFUSIONS, AND HANDHELD COMPUTERS FOR USE AT POINT OF CARE TO VERIFY ACCURATE PATIENT IDENTIFICATION AND DOCUMENT TRANSFUSION ACTIVITIES, IN CLASS 9 (U.S. CLS. 21, 23, 26, 36 AND 38).

FIRST USE 7-19-2007; IN COMMERCE 7-19-2007.

FOR: SOFTWARE-CONTROLLED REFRIGERATOR WITH MULTI-UNIT COMPARTMENTS THAT DISTRIBUTES BLOOD UNITS IN CONNECTION WITH BLOOD TRANSFUSIONS, IN CLASS 11 (U.S. CLS. 13, 21, 23, 31 AND 34).

FIRST USE 7-19-2007; IN COMMERCE 7-19-2007.

THE MARK CONSISTS OF STANDARD CHARACTERS WITHOUT CLAIM TO ANY PARTICULAR FONT, STYLE, SIZE, OR COLOR.

SER. NO. 77-262,788, FILED P.R. 8-23-2007; AM. S.R. 6-5-2008.

DAYNA BROWNE, EXAMINING ATTORNEY

**Int. Cl.: 37**

**Prior U.S. Cls.: 100, 103, and 106**

**United States Patent and Trademark Office**

**Reg. No. 3,469,895**

**Registered July 15, 2008**

**SERVICE MARK  
SUPPLEMENTAL REGISTER**



ENCORE RAIL SYSTEMS, INC. (ILLINOIS CORPORATION)  
BLDG. 392  
6900 S. CENTRAL AVENUE  
BEDFORD PARK, IL 60638

FOR: RAILROAD TRACK INSPECTION, MAINTENANCE, PRESERVATION AND REPAIR SERVICES; RECONDITIONING OF NON-METAL RAILROAD TIES; AND CONSULTING SERVICES RELATING TO THE INSPECTION, MAINTENANCE AND REPAIR OF RAILROAD TRACKS, IN CLASS 37 (U.S. CLS. 100, 103 AND 106).

FIRST USE 4-1-2007; IN COMMERCE 4-1-2007.

THE MARK CONSISTS OF A HORIZONTAL LINE HAVING A VERTICAL NOTCH LOCATED PROXIMATE TO ONE OF THE ENDS OF THE HORIZONTAL LINE.

SER. NO. 77-265,028, FILED P.R. 8-27-2007; AM. S.R. 6-3-2008.

SHANNON TWOHIG, EXAMINING ATTORNEY

**Int. Cl.: 9**

**Prior U.S. Cls.: 21, 23, 26, 36, and 38**

**United States Patent and Trademark Office**

**Reg. No. 3,469,896**

**Registered July 15, 2008**

**TRADEMARK  
SUPPLEMENTAL REGISTER**

**GreenEthernet**

REALTEK SEMICONDUCTOR CORP. (TAIWAN  
CORPORATION)  
HSINCHU SCIENCE PARK  
NO. 2, INNOVATION ROAD II  
HSINCHU 300, TAIWAN

FOR: INTEGRATED CIRCUITS; CARDS WITH  
INTEGRATED CIRCUITS; INTEGRATED CIRCUIT  
CHIPS; ELECTRONIC SEMICONDUCTORS, IN  
CLASS 9 (U.S. CLS. 21, 23, 26, 36 AND 38).

FIRST USE 6-11-2007; IN COMMERCE 11-23-2007.

THE MARK CONSISTS OF STANDARD CHAR-  
ACTERS WITHOUT CLAIM TO ANY PARTICULAR  
FONT, STYLE, SIZE, OR COLOR.

SER. NO. 77-265,035, FILED 8-27-2007.

ANGELA M. MICHELI, EXAMINING ATTORNEY



Int. Cl.: 37

Prior U.S. Cls.: 100, 103, and 106

United States Patent and Trademark Office

Reg. No. 3,469,897

Registered July 15, 2008

SERVICE MARK  
SUPPLEMENTAL REGISTER

QCI GROUP

QUALITY CONTROL INSPECTION, INC. (OHIO CORPORATION)  
40 TARBELL AVE.  
BEDFORD, OH 44146

FOR: CONSTRUCTION MANAGEMENT; CONSTRUCTION SUPERVISION; CONSULTATION IN BUILDING CONSTRUCTION SUPERVISION, IN CLASS 37 (U.S. CLS. 100, 103 AND 106).

FIRST USE 10-0-2007; IN COMMERCE 10-0-2007.

THE MARK CONSISTS OF STANDARD CHARACTERS WITHOUT CLAIM TO ANY PARTICULAR FONT, STYLE, SIZE, OR COLOR.

NO CLAIM IS MADE TO THE EXCLUSIVE RIGHT TO USE "GROUP", APART FROM THE MARK AS SHOWN.

SER. NO. 77-267,274, FILED P.R. 8-29-2007; AM. S.R. 6-2-2008.

ANDREA BUTLER, EXAMINING ATTORNEY

**Int. Cl.: 38**

**Prior U.S. Cls.: 100, 101, and 104**

**United States Patent and Trademark Office**

**Reg. No. 3,469,898**

**Registered July 15, 2008**

**SERVICE MARK  
SUPPLEMENTAL REGISTER**

**YOUR DAILY TECH ROUND-UP**

RIPCAM MEDIA, LLC (CALIFORNIA LTD LIAB  
CO)

9665 WILSHIRE BOULEVARD, NINTH FLOOR

BEVERLY HILLS, CA 90212

FOR: AUDIO AND VIDEO BROADCASTING  
SERVICES OVER THE INTERNET, IN CLASS 38  
(U.S. CLS. 100, 101 AND 104).

FIRST USE 7-27-2007; IN COMMERCE 8-2-2007.

THE MARK CONSISTS OF STANDARD CHAR-  
ACTERS WITHOUT CLAIM TO ANY PARTICULAR  
FONT, STYLE, SIZE, OR COLOR.

NO CLAIM IS MADE TO THE EXCLUSIVE  
RIGHT TO USE "TECH ROUND-UP", APART FROM  
THE MARK AS SHOWN.

SER. NO. 77-267,281, FILED P.R. 8-29-2007; AM. S.R.  
6-5-2008.

ATTIYA MALIK, EXAMINING ATTORNEY

**Int. Cl.: 42**

**Prior U.S. Cls.: 100 and 101**

**United States Patent and Trademark Office**

**Reg. No. 3,469,899**

**Registered July 15, 2008**

**SERVICE MARK  
SUPPLEMENTAL REGISTER**

**DIGITAL AUTHENTICATION,  
TRACK AND TRACE**

VERIFY BRAND, INC. (MINNESOTA CORPORATION)  
7277 BOONE AVE N  
MINNEAPOLIS, MN 55428

FOR: DEVELOPMENT, UPDATING AND MAINTENANCE OF SOFTWARE; PROVIDING TEMPORARY USE OF ON-LINE NON-DOWNLOADABLE SOFTWARE FOR CAPTURING PRODUCT DATA, ANALYZING DATA AND GENERATING REPORTS REGARDING SUPPLY CHAIN ACTIVITY, IN CLASS 42 (U.S. CLS. 100 AND 101).

FIRST USE 7-31-2007; IN COMMERCE 7-31-2007.

THE MARK CONSISTS OF STANDARD CHARACTERS WITHOUT CLAIM TO ANY PARTICULAR FONT, STYLE, SIZE, OR COLOR.

SER. NO. 77-268,570, FILED P.R. 8-30-2007; AM. S.R. 6-9-2008.

NICHOLAS ALTREE, EXAMINING ATTORNEY

**Int. Cl.: 43**

**Prior U.S. Cls.: 100 and 101**

**United States Patent and Trademark Office**

**Reg. No. 3,469,900**

**Registered July 15, 2008**

**SERVICE MARK  
SUPPLEMENTAL REGISTER**

**JEWEL CITY DINER**

CARUSO PROPERTY MANAGEMENT, INC. (CALIFORNIA CORPORATION)

101 THE GROVE DRIVE

LOS ANGELES, CA 90036

FOR: RESTAURANT SERVICES, IN CLASS 43 (U.S. CLS. 100 AND 101).

FIRST USE 5-1-2008; IN COMMERCE 5-1-2008.

THE MARK CONSISTS OF STANDARD CHARACTERS WITHOUT CLAIM TO ANY PARTICULAR FONT, STYLE, SIZE, OR COLOR.

NO CLAIM IS MADE TO THE EXCLUSIVE RIGHT TO USE "DINER", APART FROM THE MARK AS SHOWN.

SER. NO. 77-270,017, FILED P.R. 8-31-2007; AM. S.R. 5-20-2008.

KRISTINA MORRIS, EXAMINING ATTORNEY

**Int. Cl.: 9**

**Prior U.S. Cls.: 21, 23, 26, 36, and 38**

**Reg. No. 3,469,901**

**United States Patent and Trademark Office**

**Registered July 15, 2008**

**TRADEMARK  
SUPPLEMENTAL REGISTER**

# Hori

HORI (USA), INC. (CALIFORNIA CORPORATION)  
3480 TORRANCE BLVD STE 218  
TORRANCE, CA 90503

FOR: VIDEO GAME INTERACTIVE HAND HELD REMOTE CONTROLS FOR PLAYING ELECTRONIC GAMES; VIDEO GAME INTERACTIVE REMOTE CONTROL UNITS; VIDEO GAME JOYSTICKS; EARPHONES; COMPUTER SCREEN FILTERS; COMPUTERIZED VIDEO TABLE GAMES FOR GAMING PURPOSES; HAND-HELD UNITS FOR PLAYING ELECTRONIC GAMES FOR USE

WITH EXTERNAL DISPLAY SCREEN OR MONITOR, IN CLASS 9 (U.S. CLS. 21, 23, 26, 36 AND 38).

FIRST USE 4-26-2004; IN COMMERCE 4-26-2004.

THE MARK CONSISTS OF STANDARD CHARACTERS WITHOUT CLAIM TO ANY PARTICULAR FONT, STYLE, SIZE, OR COLOR.

SER. NO. 77-270,059, FILED P.R. 8-31-2007; AM. S.R. 6-9-2008.

BARBARA GAYNOR, EXAMINING ATTORNEY

**Int. Cl.: 28**

**Prior U.S. Cls.: 22, 23, 38, and 50**

**United States Patent and Trademark Office**

**Reg. No. 3,469,902**

**Registered July 15, 2008**

---

**TRADEMARK  
SUPPLEMENTAL REGISTER**

# Helmet Saver

ADVANCED PROTECTIVE EQUIPMENT, INC.  
(NEW HAMPSHIRE CORPORATION)  
12 JENKINS COURT  
DURHAM, NH 03824

THE MARK CONSISTS OF STANDARD CHAR-  
ACTERS WITHOUT CLAIM TO ANY PARTICULAR  
FONT, STYLE, SIZE, OR COLOR.

FOR: BAGS SPECIALLY ADAPTED FOR SPORTS  
EQUIPMENT, IN CLASS 28 (U.S. CLS. 22, 23, 38 AND  
50).

SER. NO. 77-271,707, FILED 9-5-2007.

FIRST USE 0-0-2001; IN COMMERCE 6-0-2007.

DAVID C. REIHNER, EXAMINING ATTORNEY

**Int. Cl.: 16**

**Prior U.S. Cls.: 2, 5, 22, 23, 29, 37, 38, and 50**

**United States Patent and Trademark Office**

**Reg. No. 3,469,903**

**Registered July 15, 2008**

**TRADEMARK  
SUPPLEMENTAL REGISTER**

**BUDGET TRAVEL UPGRADE**

NEWSWEEK BUDGET TRAVEL, INC. (DELA-  
WARE CORPORATION)  
530 SEVENTH AVENUE, 2ND FLOOR  
NEW YORK, NY 10018

FOR: MAGAZINE SECTIONS IN THE FIELD OF  
TRAVEL, IN CLASS 16 (U.S. CLS. 2, 5, 22, 23, 29, 37, 38  
AND 50).

FIRST USE 10-31-2006; IN COMMERCE 10-31-2006.

THE MARK CONSISTS OF STANDARD CHAR-  
ACTERS WITHOUT CLAIM TO ANY PARTICULAR  
FONT, STYLE, SIZE, OR COLOR.

SER. NO. 77-276,362, FILED P.R. 9-11-2007; AM. S.R.  
6-12-2008.

NICHOLAS ALTREE, EXAMINING ATTORNEY

**Int. Cl.: 39**

**Prior U.S. Cls.: 100 and 105**

**United States Patent and Trademark Office**

**Reg. No. 3,469,904**

**Registered July 15, 2008**

**SERVICE MARK  
SUPPLEMENTAL REGISTER**

**BUDGET TRAVEL UPGRADE**

NEWSWEEK BUDGET TRAVEL, INC. (DELA-  
WARE CORPORATION)  
530 SEVENTH AVENUE, 2ND FLOOR  
NEW YORK, NY 10018

FOR: PROVIDING INFORMATION IN THE  
FIELD OF TRAVEL, IN CLASS 39 (U.S. CLS. 100  
AND 105).

FIRST USE 10-31-2006; IN COMMERCE 10-31-2006.

THE MARK CONSISTS OF STANDARD CHAR-  
ACTERS WITHOUT CLAIM TO ANY PARTICULAR  
FONT, STYLE, SIZE, OR COLOR.

SER. NO. 77-276,365, FILED P.R. 9-11-2007; AM. S.R.  
6-12-2008.

NICHOLAS ALTREE, EXAMINING ATTORNEY



**Int. Cl.: 11**

**Prior U.S. Cls.: 13, 21, 23, 31, and 34**

**United States Patent and Trademark Office**

**Reg. No. 3,469,905**

**Registered July 15, 2008**

**TRADEMARK  
SUPPLEMENTAL REGISTER**

**BOLTON**

HUNTER FAN COMPANY (DELAWARE COR-  
PORATION)  
2500 FRISCO AVENUE  
MEMPHIS, TN 38114

FOR: CEILING FANS, IN CLASS 11 (U.S. CLS. 13,  
21, 23, 31 AND 34).

FIRST USE 4-8-2008; IN COMMERCE 4-8-2008.

THE MARK CONSISTS OF STANDARD CHAR-  
ACTERS WITHOUT CLAIM TO ANY PARTICULAR  
FONT, STYLE, SIZE, OR COLOR.

SER. NO. 77-282,282, FILED P.R. 9-18-2007; AM. S.R.  
6-6-2008.

MICHAEL KEATING, EXAMINING ATTORNEY

**Int. Cl.: 1**

**Prior U.S. Cls.: 1, 5, 6, 10, 26, and 46**

**Reg. No. 3,469,906**

**United States Patent and Trademark Office**

**Registered July 15, 2008**

**TRADEMARK  
SUPPLEMENTAL REGISTER**

**DNAs $\bar{t}$ able**

BIOMATRICA, INC. (CALIFORNIA CORPORATION)  
5627 OBERLIN DR. #120  
SAN DIEGO, CA 92121

THE MARK CONSISTS OF STANDARD CHARACTERS WITHOUT CLAIM TO ANY PARTICULAR FONT, STYLE, SIZE, OR COLOR.

FOR: STORAGE MEDIUM FOR SCIENTIFIC OR RESEARCH USE, NAMELY, REAGENTS AND MEDIA FOR USE IN STORING DNA, IN CLASS 1 (U.S. CLS. 1, 5, 6, 10, 26 AND 46).

SER. NO. 77-283,821, FILED P.R. 9-19-2007; AM. S.R. 5-19-2008.

FIRST USE 2-26-2008; IN COMMERCE 2-26-2008.

KATHLEEN LORENZO, EXAMINING ATTORNEY

**Int. Cl.: 9**

**Prior U.S. Cls.: 21, 23, 26, 36, and 38**

**United States Patent and Trademark Office**

**Reg. No. 3,469,907**

**Registered July 15, 2008**

**TRADEMARK  
SUPPLEMENTAL REGISTER**

**INNDESK**

DUVOICE CORP. (WASHINGTON CORPORATION)  
608 STATE STREET S. #100  
KIRKLAND, WA 98033

FOR: WEB CONSOLE INTERFACE COMPUTER SOFTWARE FOR HOSPITALITY STAFF MANAGEMENT OF GUEST TELECOMMUNICATIONS INCLUDING WAKEUP CALLS, ROOM TELEPHONE STATUS, VOICE AND TEXT MESSAGE COUNTS, GUEST NAMES, ROOM CLEAN/DIRTY STATUS AND GUEST DIRECT INWARD DIALING (DID)

NUMBERS, IN CLASS 9 (U.S. CLS. 21, 23, 26, 36 AND 38).

FIRST USE 4-12-2007; IN COMMERCE 4-12-2007.

THE MARK CONSISTS OF STANDARD CHARACTERS WITHOUT CLAIM TO ANY PARTICULAR FONT, STYLE, SIZE, OR COLOR.

SER. NO. 77-286,065, FILED P.R. 9-21-2007; AM. S.R. 6-10-2008.

JILL C. ALT, EXAMINING ATTORNEY

Int. Cl.: 11

Prior U.S. Cls.: 13, 21, 23, 31, and 34

United States Patent and Trademark Office

Reg. No. 3,469,908

Registered July 15, 2008

TRADEMARK  
SUPPLEMENTAL REGISTER

**COLUMBIA**  
ACCESSORIES

PARTITION SYSTEMS INCORPORATED OF  
SOUTH CAROLINA (SOUTH CAROLINA  
CORPORATION)  
825 GARLAND STREET  
COLUMBIA, SC 29201

FOR: ELECTRIC HOT AIR HAND DRYERS, IN  
CLASS 11 (U.S. CLS. 13, 21, 23, 31 AND 34).

FIRST USE 6-15-2007; IN COMMERCE 6-15-2007.

OWNER OF U.S. REG. NOS. 3,287,233 AND  
3,334,712.

NO CLAIM IS MADE TO THE EXCLUSIVE  
RIGHT TO USE "ACCESSORIES", APART FROM  
THE MARK AS SHOWN.

THE MARK CONSISTS OF THE WORD "COLUM-  
BIA" IN BOLD ON A HORIZONTAL LINE WITH  
THE WORD "ACCESSORIES" UNBOLDED BELOW  
THE LINE.

SER. NO. 77-288,988, FILED 9-26-2007.

ANNE MADDEN, EXAMINING ATTORNEY

**Int. Cl.: 44**

**Prior U.S. Cls.: 100 and 101**

**United States Patent and Trademark Office**

**Reg. No. 3,469,909**

**Registered July 15, 2008**

**SERVICE MARK  
SUPPLEMENTAL REGISTER**

**CAROLINA SLEEP CENTER**

ERIC TOBIAS HELMS (UNITED STATES INDIVIDUAL), DBA CAROLINA SLEEP CENTER,  
SUITE 102  
207 BALFOUR DRIVE  
ARCHDALE, NC 27263

FOR: SLEEP DISORDER TESTING, IN CLASS 44  
(U.S. CLS. 100 AND 101).

FIRST USE 9-25-2007; IN COMMERCE 9-26-2007.

THE MARK CONSISTS OF STANDARD CHARACTERS WITHOUT CLAIM TO ANY PARTICULAR FONT, STYLE, SIZE, OR COLOR.

NO CLAIM IS MADE TO THE EXCLUSIVE RIGHT TO USE "SLEEP CENTER", APART FROM THE MARK AS SHOWN.

SER. NO. 77-289,913, FILED P.R. 9-26-2007; AM. S.R. 4-30-2008.

KATHRYN COWARD, EXAMINING ATTORNEY

**Int. Cl.: 36**

**Prior U.S. Cls.: 100, 101, and 102**

**United States Patent and Trademark Office**

**Reg. No. 3,469,910**

**Registered July 15, 2008**

**SERVICE MARK  
SUPPLEMENTAL REGISTER**

**INVESTMENT SCIENCE  
CORPORATION**

INVESTMENT SCIENCE CORPORATION (DELA-  
WARE CORPORATION)  
SYMPHONY TOWERS, 750 B STREET, 31ST FLOOR  
SAN DIEGO, CA 92101

FOR: FUND INVESTMENT SERVICES; INVEST-  
MENT ADVICE; INVESTMENT OF FUNDS FOR  
OTHERS; INVESTMENT MANAGEMENT, IN  
CLASS 36 (U.S. CLS. 100, 101 AND 102).

FIRST USE 3-31-2006; IN COMMERCE 3-31-2006.

THE MARK CONSISTS OF STANDARD CHAR-  
ACTERS WITHOUT CLAIM TO ANY PARTICULAR  
FONT, STYLE, SIZE, OR COLOR.

NO CLAIM IS MADE TO THE EXCLUSIVE  
RIGHT TO USE "CORPORATION", APART FROM  
THE MARK AS SHOWN.

SER. NO. 77-290,670, FILED P.R. 9-27-2007; AM. S.R.  
4-8-2008.

REGINA DRUMMOND, EXAMINING ATTORNEY

**Int. Cl.: 42**

**Prior U.S. Cls.: 100 and 101**

**United States Patent and Trademark Office**

**Reg. No. 3,469,911**

**Registered July 15, 2008**

**SERVICE MARK  
SUPPLEMENTAL REGISTER**

The logo for "eBrochure" features a stylized lowercase "e" in orange, followed by the word "Brochure" in a blue, sans-serif font.

CENTRAL DYNAMICS CORP. (DELAWARE  
CORPORATION), DBA CENDYN,  
SUITE #419  
1515 N FEDERAL HWY  
BOCA RATON, FL 33432

FOR: GRAPHIC DESIGN AND DEVELOPMENT  
SERVICES OF ELECTRONIC BROCHURES FOR  
BUSINESSES, IN CLASS 42 (U.S. CLS. 100 AND 101).

FIRST USE 9-28-2004; IN COMMERCE 9-28-2004.

THE COLOR(S) ORANGE AND BLUE IS/ARE  
CLAIMED AS A FEATURE OF THE MARK.

THE MARK CONSISTS OF A STYLIZED, CUR-  
SIVE ORANGE LETTER "E" IN FRONT OF THE  
WORD "BROCHURE" IN THE COLOR BLUE.

SER. NO. 77-296,244, FILED P.R. 10-4-2007; AM. S.R.  
6-3-2008.

SHANNON TWOHIG, EXAMINING ATTORNEY

**Int. Cl.: 35**

**Prior U.S. Cls.: 100, 101, and 102**

**United States Patent and Trademark Office**

**Reg. No. 3,469,912**

**Registered July 15, 2008**

**SERVICE MARK  
SUPPLEMENTAL REGISTER**

**ROLLOVER REWARDS**

JOHN HANCOCK LIFE INSURANCE COMPANY  
(U.S.A.) (MICHIGAN CORPORATION)  
601 CONGRESS STREET  
BOSTON, MA 02210

FOR: BUSINESS MARKETING SERVICES; PROVIDING BUSINESS MARKETING INFORMATION; PROVIDING AN INCENTIVE AWARD PROGRAM FOR QUALIFIED FINANCIAL AGENTS FOR THE PURPOSE OF PROMOTING AND REWARDING AGENT LOYALTY, AND FOR THE PURPOSE OF PROMOTING THE AVAILABILITY FOR RETIREMENT PLAN PARTICIPANTS OF INFORMATION AND EDUCATION SERVICES RELATING TO RETIREMENT PLANS, IN CLASS 35 (U.S. CLS. 100, 101 AND 102).

FIRST USE 11-5-2007; IN COMMERCE 11-5-2007.

THE MARK CONSISTS OF STANDARD CHARACTERS WITHOUT CLAIM TO ANY PARTICULAR FONT, STYLE, SIZE, OR COLOR.

NO CLAIM IS MADE TO THE EXCLUSIVE RIGHT TO USE "REWARDS", APART FROM THE MARK AS SHOWN.

SER. NO. 77-296,978, FILED P.R. 10-5-2007; AM. S.R. 5-5-2008.

COLLEEN DOMBROW, EXAMINING ATTORNEY



**Int. Cl.: 39**

**Prior U.S. Cls.: 100 and 105**

**United States Patent and Trademark Office**

**Reg. No. 3,469,913**

**Registered July 15, 2008**

**SERVICE MARK  
SUPPLEMENTAL REGISTER**

**NAUTICAL YACHTS, INC.**

NAUTICAL YACHTS, INC. (MASSACHUSETTS  
CORPORATION)

52 QUARTERMASTER ROW

SOUTH YARMOUTH, MA 02664

FOR: BOAT CHARTER SERVICES, IN CLASS 39  
(U.S. CLS. 100 AND 105).

FIRST USE 6-0-2005; IN COMMERCE 6-0-2005.

THE MARK CONSISTS OF STANDARD CHAR-  
ACTERS WITHOUT CLAIM TO ANY PARTICULAR  
FONT, STYLE, SIZE, OR COLOR.

NO CLAIM IS MADE TO THE EXCLUSIVE  
RIGHT TO USE "YACHTS, INC.", APART FROM  
THE MARK AS SHOWN.

SER. NO. 77-297,966, FILED P.R. 10-6-2007; AM. S.R.  
6-3-2008.

GISELLE AGOSTO, EXAMINING ATTORNEY

**Int. Cl.: 5**

**Prior U.S. Cls.: 6, 18, 44, 46, 51, and 52**

**United States Patent and Trademark Office**

**Reg. No. 3,469,914**

**Registered July 15, 2008**

**TRADEMARK  
SUPPLEMENTAL REGISTER**

**NUTRACEUTICALS  
INTERNATIONAL**

KLIVINYI, ZOLTAN (HUNGARY INDIVIDUAL)  
11 WALLACE STREET  
ELMWOOD PARK, NJ 07407

FOR: DIETARY AND NUTRITIONAL SUPPLEMENTS; DIETARY DRINK MIX FOR USE AS A MEAL REPLACEMENT; DIETARY FIBER AS AN ADDITIVE FOR FOOD PRODUCTS; DIETARY FOOD SUPPLEMENTS; DIETARY SUPPLEMENTAL DRINKS; DIETARY SUPPLEMENTS; DIETARY SUPPLEMENTS FOR HUMAN CONSUMPTION; FOOD SUPPLEMENTS, IN CLASS 5 (U.S. CLS. 6, 18, 44, 46, 51 AND 52).

FIRST USE 4-4-2007; IN COMMERCE 4-4-2007.

THE MARK CONSISTS OF STANDARD CHARACTERS WITHOUT CLAIM TO ANY PARTICULAR FONT, STYLE, SIZE, OR COLOR.

NO CLAIM IS MADE TO THE EXCLUSIVE RIGHT TO USE "NUTRACEUTICALS", APART FROM THE MARK AS SHOWN.

SER. NO. 77-302,343, FILED P.R. 10-11-2007; AM. S.R. 5-14-2008.

KATHRYN COWARD, EXAMINING ATTORNEY

**Int. Cl.: 30**

**Prior U.S. Cl.: 46**

**United States Patent and Trademark Office**

**Reg. No. 3,469,915**

**Registered July 15, 2008**

**TRADEMARK  
SUPPLEMENTAL REGISTER**

# Pastorero Taco Grill

DTB INTERNATIONAL LLC (NEW MEXICO LTD  
LIAB CO)  
8028 MONTE CARLO DR NW  
ALBUQUERQUE, NM 87120

FOR: TACOS, IN CLASS 30 (U.S. CL. 46).

FIRST USE 9-30-2007; IN COMMERCE 9-30-2007.

THE MARK CONSISTS OF STANDARD CHAR-  
ACTERS WITHOUT CLAIM TO ANY PARTICULAR  
FONT, STYLE, SIZE, OR COLOR.

NO CLAIM IS MADE TO THE EXCLUSIVE  
RIGHT TO USE "TACO GRILL", APART FROM  
THE MARK AS SHOWN.

THE FOREIGN WORDING IN THE MARK  
TRANSLATES INTO ENGLISH AS THE ARTIST  
WHO PREPARES A PARTICULAR STYLE OF TA-  
COS.

SER. NO. 77-304,453, FILED P.R. 10-15-2007; AM.  
S.R. 6-4-2008.

ELLEN B. AWRICH, EXAMINING ATTORNEY

**Int. Cl.: 37**

**Prior U.S. Cls.: 100, 103, and 106**

**United States Patent and Trademark Office**

**Reg. No. 3,469,916**

**Registered July 15, 2008**

**SERVICE MARK  
SUPPLEMENTAL REGISTER**

**FARINA HARDSCAPES**

FARINA HARDSCAPES LLC (NEW JERSEY LTD  
LIAB CO)  
175 CYNTHIA DRIVE  
HACKETTSTOWN, NJ 07840

FOR: INSTALLING LANDSCAPING, NAMELY, BRICK AND STONE MASONRY, PAVERS, PATIOS, COURTYARDS, DECKS, ARBORS, PERGOLAS, WALKS, STAIRWAYS, DRIVEWAYS, WATER FEATURES, IRRIGATION, DRAINAGE STRUCTURES, WALLS, AND LIGHTING; SITE GRADING; INSTALLATION AND MAINTENANCE OF IRRIGATION SYSTEMS; MAINTENANCE OF ELECTRIC LANDSCAPE LIGHTING; LANDSCAPE CONSTRUCTION, NAMELY, CONSULTING, CONSTRUCTION AND INSTALLATION IN THE FIELD OF BRICK AND STONE MASONRY, PAVERS, PATIOS, COURTYARDS, DECKS, ARBORS, PERGOLAS, WALKS, STAIRWAYS, DRIVEWAYS, WATER

FEATURES, IRRIGATION, DRAINAGE STRUCTURES, WALLS, AND LIGHTING, IN CLASS 37 (U.S. CLS. 100, 103 AND 106).

FIRST USE 5-31-2008; IN COMMERCE 5-31-2008.

THE MARK CONSISTS OF STANDARD CHARACTERS WITHOUT CLAIM TO ANY PARTICULAR FONT, STYLE, SIZE, OR COLOR.

NO CLAIM IS MADE TO THE EXCLUSIVE RIGHT TO USE "HARDSCAPES", APART FROM THE MARK AS SHOWN.

SER. NO. 77-308,878, FILED P.R. 10-19-2007; AM. S.R. 6-9-2008.

LINDA ORNDORFF, EXAMINING ATTORNEY

**Int. Cl.: 10**

**Prior U.S. Cls.: 26, 39, and 44**

**United States Patent and Trademark Office**

**Reg. No. 3,469,917**

**Registered July 15, 2008**

**TRADEMARK  
SUPPLEMENTAL REGISTER**

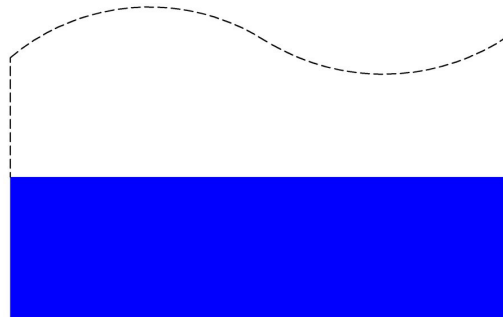

CASCADE DAFO, INC. (WASHINGTON CORPORATION)

1360 SUNSET AVENUE  
FERNDALE, WA 982488913

FOR: ANKLE FOOT ORTHOTICS; ORTHOTIC DEVICES FOR FEET, ANKLES, LEGS; AND LOWER LIMB ORTHOSES, IN CLASS 10 (U.S. CLS. 26, 39 AND 44).

FIRST USE 1-5-2007; IN COMMERCE 1-5-2007.

THE COLOR(S) BLUE IS/ARE CLAIMED AS A FEATURE OF THE MARK.

THE MARK CONSISTS OF A LABEL IN THE COLOR BLUE ATTACHED AT THE END OF A STRAP SHOWN IN BROKEN LINES.

SER. NO. 77-309,778, FILED P.R. 10-22-2007; AM. S.R. 5-30-2008.

KIMBERLY PERRY, EXAMINING ATTORNEY

**Int. Cl.: 33**

**Prior U.S. Cls.: 47 and 49**

**United States Patent and Trademark Office**

**Reg. No. 3,469,918**

**Registered July 15, 2008**

**TRADEMARK  
SUPPLEMENTAL REGISTER**

**THE GENEROUS BLEND**

CELLAR ARTS, LLC (MISSOURI LTD LIAB CO)  
29 WEST BRENTMOOR PARK  
ST. LOUIS, MO 63105

FOR: WINES, IN CLASS 33 (U.S. CLS. 47 AND 49).

FIRST USE 0-0-2004; IN COMMERCE 0-0-2004.

THE MARK CONSISTS OF STANDARD CHAR-  
ACTERS WITHOUT CLAIM TO ANY PARTICULAR  
FONT, STYLE, SIZE, OR COLOR.

NO CLAIM IS MADE TO THE EXCLUSIVE  
RIGHT TO USE "BLEND", APART FROM THE  
MARK AS SHOWN.

SER. NO. 77-310,151, FILED P.R. 10-22-2007; AM.  
S.R. 5-12-2008.

ADA HAN, EXAMINING ATTORNEY

**Int. Cl.: 9**

**Prior U.S. Cls.: 21, 23, 26, 36, and 38**

**United States Patent and Trademark Office**

**Reg. No. 3,469,919**

**Registered July 15, 2008**

**TRADEMARK  
SUPPLEMENTAL REGISTER**

**ISOLATED SHIELD MATRIX**

TARA LABS, INC. (OREGON CORPORATION)  
550 CLOVER LANE  
ASHLAND, OR 97520

FOR: CABLE CONNECTORS; CABLES AND FIBERS FOR THE TRANSMISSION OF SOUNDS AND IMAGES; CABLES FOR ELECTRICAL AND OPTICAL SIGNAL TRANSMISSION SYSTEMS; CABLES FOR ELECTRICAL OR OPTICAL SIGNAL TRANSMISSION; CABLES FOR OPTICAL SIGNAL TRANSMISSION; COAXIAL CABLES; COAXIAL CABLES INCORPORATING FILTERS; CONNECTING ELECTRICAL CABLES; CONNECTION CABLES; ELECTRIC CABLES; ELECTRIC WIRE AND CABLE; ELECTRIC WIRES AND CABLES; ELECTRICAL CABLES; ELECTRICAL CABLES FOR USE IN CONNECTIONS; ELECTRONIC CABLES; EXTENSION CABLES; FIBER OPTIC CABLES; GUITAR CABLES;

MICROPHONE CABLES; OPTICAL CABLES; OPTICAL FIBER CABLES; POWER CABLES; STEREO CABLES; TELECOMMUNICATION CABLES; TELECOMMUNICATIONS CABLES; THREADED CABLE CONNECTORS OF METAL, IN CLASS 9 (U.S. CLS. 21, 23, 26, 36 AND 38).

FIRST USE 12-0-1997; IN COMMERCE 12-0-1997.

THE MARK CONSISTS OF STANDARD CHARACTERS WITHOUT CLAIM TO ANY PARTICULAR FONT, STYLE, SIZE, OR COLOR.

SER. NO. 77-311,507, FILED P.R. 10-23-2007; AM. S.R. 5-12-2008.

DAVID TAYLOR, EXAMINING ATTORNEY

**Int. Cl.: 9**

**Prior U.S. Cls.: 21, 23, 26, 36, and 38**

**Reg. No. 3,469,920**

**United States Patent and Trademark Office**

**Registered July 15, 2008**

**TRADEMARK  
SUPPLEMENTAL REGISTER**

**PRESSURE-STRANDED**

TARA LABS, INC. (OREGON CORPORATION)  
550 CLOVER LANE  
ASHLAND, OR 97520

FOR: CABLE CONNECTORS; CABLES AND FIBRES FOR THE TRANSMISSION OF SOUNDS AND IMAGES; CABLES FOR ELECTRICAL AND OPTICAL SIGNAL TRANSMISSION SYSTEMS; CABLES FOR ELECTRICAL OR OPTICAL SIGNAL TRANSMISSION; CABLES FOR OPTICAL SIGNAL TRANSMISSION; COAXIAL CABLES; COAXIAL CABLES INCORPORATING FILTERS; CONNECTING ELECTRICAL CABLES; CONNECTION CABLES; ELECTRIC CABLES; ELECTRIC WIRE AND CABLE; ELECTRIC WIRES AND CABLES; ELECTRICAL CABLES; ELECTRICAL CABLES FOR USE IN CONNECTIONS; ELECTRONIC CABLES; EXTENSION CABLES; FIBER OPTIC CABLES; GUITAR CABLES;

MICROPHONE CABLES; OPTICAL CABLES; OPTICAL FIBER CABLES; POWER CABLES; STEREO CABLES; TELECOMMUNICATION CABLES; TELECOMMUNICATIONS CABLES; THREADED CABLE CONNECTORS OF METAL, IN CLASS 9 (U.S. CLS. 21, 23, 26, 36 AND 38).

FIRST USE 12-0-1994; IN COMMERCE 12-0-1994.

THE MARK CONSISTS OF STANDARD CHARACTERS WITHOUT CLAIM TO ANY PARTICULAR FONT, STYLE, SIZE, OR COLOR.

SER. NO. 77-311,962, FILED P.R. 10-24-2007; AM. S.R. 5-12-2008.

DAVID TAYLOR, EXAMINING ATTORNEY



**Int. Cls.: 3, 7, and 11**

**Prior U.S. Cls.: 1, 4, 6, 13, 19, 21, 23, 31, 34, 35, 50, 51,  
and 52**

**Reg. No. 3,469,921**

**United States Patent and Trademark Office**

**Registered July 15, 2008**

**TRADEMARK  
SUPPLEMENTAL REGISTER**



DYSON LIMITED (UNITED KINGDOM COR-  
PORATION)  
TETBURY HILL, MALMESBURY  
WILTSHIRE, UNITED KINGDOM SN160RP

FOR: FLOOR POLISHING PREPARATIONS, IN  
CLASS 3 (U.S. CLS. 1, 4, 6, 50, 51 AND 52).

FOR: ELECTRICAL APPARATUS FOR KITCHEN  
AND LAUNDRY USE, NAMELY, CLOTHES WASH-  
ING MACHINES AND DISHWASHERS; MACHINES  
FOR CLEANING AND SHAMPOOING CARPETS;  
MACHINES FOR POLISHING FLOORS; CARPET  
SHAMPOOERS; FLOOR POLISHERS; DRY CLEAN-  
ING MACHINES FOR CARPETS; FLOOR TOOLS  
FOR CARPET SHAMPOOERS AND FLOOR POL-  
ISHERS; APPARATUS FOR DISPENSING CLEAN-  
ING AGENTS TO FLOORS AND CARPETS;  
ELECTRIC MOTORS FOR MACHINES; ELECTRIC  
MOTORS FOR DOMESTIC APPLIANCES; SWIT-  
CHED-RELUCTANCE ELECTRIC MOTORS FOR  
MACHINES; PARTS AND FITTINGS FOR ALL

THE AFORESAID GOODS, IN CLASS 7 (U.S. CLS.  
13, 19, 21, 23, 31, 34 AND 35).

FOR: MACHINES FOR REFRIGERATING; RE-  
FRIGERATORS AND FREEZERS; TUMBLE  
CLOTHES DRYERS; HAIRDRYERS; PARTS AND  
FITTINGS FOR ALL THE AFORESAID GOODS, IN  
CLASS 11 (U.S. CLS. 13, 21, 23, 31 AND 34).

OWNER OF ERPN CMNTY TM OFC REG. NO.  
003016011, DATED 5-19-2005, EXPIRES 1-21-2013.

OWNER OF U.S. REG. NOS. 2,460,538, 2,892,039,  
AND 3,214,382.

THE MARK CONSISTS OF THE WORD "DYSON"  
IN A STYLIZED FONT.

SER. NO. 77-315,542, FILED P.R. 10-29-2007; AM.  
S.R. 5-16-2008.

JANET LEE, EXAMINING ATTORNEY

**Int. Cl.: 9**

**Prior U.S. Cls.: 21, 23, 26, 36, and 38**

**Reg. No. 3,469,922**

**United States Patent and Trademark Office**

**Registered July 15, 2008**

---

**TRADEMARK  
SUPPLEMENTAL REGISTER**

**TheaterStation**

ENVIVE (TEXAS CORPORATION)  
1628 W. CROSBY ROAD, SUITE 100  
CARROLLTON, TX 75006

FOR: HOME THEATER PRODUCTS, NAMELY,  
COMPUTER SERVERS FOR STORING AND PLAY-  
ING AUDIOVISUAL WORKS, IN CLASS 9 (U.S. CLS.  
21, 23, 26, 36 AND 38).

FIRST USE 11-13-2007; IN COMMERCE 11-13-2007.

THE MARK CONSISTS OF STANDARD CHAR-  
ACTERS WITHOUT CLAIM TO ANY PARTICULAR  
FONT, STYLE, SIZE, OR COLOR.

SER. NO. 77-316,621, FILED P.R. 10-30-2007; AM.  
S.R. 6-6-2008.

JANICE L. MCMORROW, EXAMINING ATTOR-  
NEY

**Int. Cls.: 38 and 42**

**Prior U.S. Cls.: 100, 101, and 104**

**United States Patent and Trademark Office**

**Reg. No. 3,469,923**

**Registered July 15, 2008**

**SERVICE MARK  
SUPPLEMENTAL REGISTER**

**SUPERNAP**

SWITCH COMMUNICATIONS GROUP, LLC (NE-  
VADA LTD LIAB CO)  
P.O. BOX 42250  
LAS VEGAS, NV 89116

FOR: PROVIDING TELECOMMUNICATIONS  
CONNECTIONS TO THE INTERNET, IN CLASS 38  
(U.S. CLS. 100, 101 AND 104).

FIRST USE 4-1-2008; IN COMMERCE 4-1-2008.

FOR: COLLOCATION SERVICES, NAMELY, PRO-  
VIDING SECURE ENVIRONMENTALLY CON-  
TROLLED FACILITIES AND TECHNICAL  
MONITORING FOR THE COMPUTERS AND TELE-  
COMMUNICATIONS EQUIPMENT OF OTHERS,  
AND PROVIDING SECURE ENVIRONMENTALLY

CONTROLLED FACILITIES AND TECHNICAL  
MONITORING OF COMPUTER AND TELECOM-  
MUNICATIONS EQUIPMENT FOR BUSINESS CON-  
TINUITY AND DISASTER AVOIDANCE, IN CLASS  
42 (U.S. CLS. 100 AND 101).

FIRST USE 4-1-2008; IN COMMERCE 4-1-2008.

THE MARK CONSISTS OF STANDARD CHAR-  
ACTERS WITHOUT CLAIM TO ANY PARTICULAR  
FONT, STYLE, SIZE, OR COLOR.

SER. NO. 77-320,499, FILED P.R. 11-2-2007; AM. S.R.  
5-30-2008.

ALICE SUE CARRUTHERS, EXAMINING ATTOR-  
NEY

**Int. Cl.: 9**

**Prior U.S. Cls.: 21, 23, 26, 36, and 38**

**Reg. No. 3,469,924**

**United States Patent and Trademark Office**

**Registered July 15, 2008**

---

**TRADEMARK  
SUPPLEMENTAL REGISTER**

**BACHELOR PARTY**

TWENTIETH CENTURY FOX FILM CORPORATION (DELAWARE CORPORATION)  
10201 WEST PICO BOULEVARD  
LOS ANGELES, CA 90035

THE MARK CONSISTS OF STANDARD CHARACTERS WITHOUT CLAIM TO ANY PARTICULAR FONT, STYLE, SIZE, OR COLOR.

FOR: MOTION PICTURE FILMS FEATURING COMEDY; PRE-RECORDED VIDEO TAPES AND DVDS FEATURING COMEDY, IN CLASS 9 (U.S. CLS. 21, 23, 26, 36 AND 38).

SER. NO. 77-329,852, FILED P.R. 11-14-2007; AM. S.R. 6-2-2008.

FIRST USE 6-29-1984; IN COMMERCE 6-29-1984.

MICHAEL GAAFAR, EXAMINING ATTORNEY

**Int. Cl.: 36**

**Prior U.S. Cls.: 100, 101, and 102**

**United States Patent and Trademark Office**

**Reg. No. 3,469,925**

**Registered July 15, 2008**

**SERVICE MARK  
SUPPLEMENTAL REGISTER**

**STUDENT VOLUNTEER  
FOUNDATION**

THE STUDENT VOLUNTEER FOUNDATION  
(MINNESOTA NON-PROFIT CORPORATION)  
4220 BRISTOL RUN  
ST. PAUL, MN 55126

FOR: PROVIDING GRANTS AND SCHOLAR-  
SHIPS TO STUDENTS AND STUDENT GROUPS,  
IN CLASS 36 (U.S. CLS. 100, 101 AND 102).

FIRST USE 10-1-2007; IN COMMERCE 10-1-2007.

THE MARK CONSISTS OF STANDARD CHAR-  
ACTERS WITHOUT CLAIM TO ANY PARTICULAR  
FONT, STYLE, SIZE, OR COLOR.

NO CLAIM IS MADE TO THE EXCLUSIVE  
RIGHT TO USE "FOUNDATION", APART FROM  
THE MARK AS SHOWN.

SER. NO. 77-340,253, FILED 11-29-2007.

MICHELLE DUBOIS, EXAMINING ATTORNEY

**Int. Cl.: 30**

**Prior U.S. Cl.: 46**

**United States Patent and Trademark Office**

**Reg. No. 3,469,926**

**Registered July 15, 2008**

**TRADEMARK  
SUPPLEMENTAL REGISTER**

**TORTILLAS BLANCO**

TORTILLAS BLANCO, INC. (ALABAMA CORPORATION)  
113 W. MARKET STREET  
ATHENS, AL 35611

FOR: FLOUR TORTILLAS, TORTILLA CHIPS, CINNAMON CHIPS, CINNAMON SUGAR CHIPS, IN CLASS 30 (U.S. CL. 46).

FIRST USE 10-31-2005; IN COMMERCE 10-31-2005.

THE MARK CONSISTS OF STANDARD CHARACTERS WITHOUT CLAIM TO ANY PARTICULAR FONT, STYLE, SIZE, OR COLOR.

NO CLAIM IS MADE TO THE EXCLUSIVE RIGHT TO USE "TORTILLAS", APART FROM THE MARK AS SHOWN.

THE FOREIGN WORDING IN THE MARK TRANSLATES INTO ENGLISH AS "WHITE TORTILLAS".

SER. NO. 77-351,511, FILED P.R. 12-13-2007; AM. S.R. 3-28-2008.

ALYSSA PALADINO, EXAMINING ATTORNEY

**Int. Cl.: 35**

**Prior U.S. Cls.: 100, 101, and 102**

**United States Patent and Trademark Office**

**Reg. No. 3,469,927**

**Registered July 15, 2008**

**SERVICE MARK  
SUPPLEMENTAL REGISTER**

**GRASSADS**

GRASSADS PTY LTD (AUSTRALIA CORPORATION)  
P.O. BOX 486  
OXENFORD, QLD, AUSTRALIA 4210

FOR: ADVERTISING AND ADVERTISEMENT SERVICES, IN CLASS 35 (U.S. CLS. 100, 101 AND 102).

FIRST USE 9-1-2004; IN COMMERCE 9-1-2004.

THE MARK CONSISTS OF STANDARD CHARACTERS WITHOUT CLAIM TO ANY PARTICULAR FONT, STYLE, SIZE, OR COLOR.

SER. NO. 77-374,972, FILED P.R. 1-18-2008; AM. S.R. 5-21-2008.

KEVIN CORWIN, EXAMINING ATTORNEY

**Int. Cl.: 7**

**Prior U.S. Cls.: 13, 19, 21, 23, 31, 34, and 35**

**Reg. No. 3,469,928**

**United States Patent and Trademark Office**

**Registered July 15, 2008**

---

**TRADEMARK  
SUPPLEMENTAL REGISTER**

# Green Steam Engine

ROBERT R. GREEN (CALIFORNIA SOLE PROPRIETORSHIP)  
2337 B AVENIDA SEVILLA  
LAGUNA WOODS, CA 92637

THE MARK CONSISTS OF STANDARD CHARACTERS WITHOUT CLAIM TO ANY PARTICULAR FONT, STYLE, SIZE, OR COLOR.

FOR: STEAM ENGINES, IN CLASS 7 (U.S. CLS. 13, 19, 21, 23, 31, 34 AND 35).

SER. NO. 77-376,045, FILED P.R. 1-19-2008; AM. S.R. 6-9-2008.

FIRST USE 10-20-2003; IN COMMERCE 10-30-2003.

RICHARD A. STRASER, EXAMINING ATTORNEY



**Int. Cl.: 21**

**Prior U.S. Cls.: 2, 13, 23, 29, 30, 33, 40, and 50**

**United States Patent and Trademark Office**

**Reg. No. 3,469,929**

**Registered July 15, 2008**

**TRADEMARK  
SUPPLEMENTAL REGISTER**

**TEXAS DUSTERS**

HARPER BRUSH WORKS, INC. (IOWA CORPORATION)

400 N. SECOND STREET

FAIRFIELD, IA 52556

FOR: DUSTERS AND CLEANING TOOLS, NAME-  
LY, CLEANING CLOTHS, IN CLASS 21 (U.S. CLS. 2,  
13, 23, 29, 30, 33, 40 AND 50).

FIRST USE 1-0-2008; IN COMMERCE 1-0-2008.

THE MARK CONSISTS OF STANDARD CHAR-  
ACTERS WITHOUT CLAIM TO ANY PARTICULAR  
FONT, STYLE, SIZE, OR COLOR.

NO CLAIM IS MADE TO THE EXCLUSIVE  
RIGHT TO USE "DUSTERS", APART FROM THE  
MARK AS SHOWN.

SER. NO. 77-376,586, FILED P.R. 1-21-2008; AM. S.R.  
5-30-2008.

ARETHA SOMERVILLE, EXAMINING ATTORNEY

**Int. Cl.: 36**

**Prior U.S. Cls.: 100, 101, and 102**

**United States Patent and Trademark Office**

**Reg. No. 3,469,930**

**Registered July 15, 2008**

**SERVICE MARK  
SUPPLEMENTAL REGISTER**

**SellerRealEstate.com**

SELLERREALESTATE.COM, INC. (FLORIDA  
CORPORATION)  
4005 SEVILLA STREET WEST  
TAMPA, FL 33629

THE MARK CONSISTS OF STANDARD CHAR-  
ACTERS WITHOUT CLAIM TO ANY PARTICULAR  
FONT, STYLE, SIZE, OR COLOR.

FOR: REAL ESTATE AGENCIES; REAL ESTATE  
BROKERAGE, IN CLASS 36 (U.S. CLS. 100, 101 AND  
102).

SER. NO. 77-378,693, FILED P.R. 1-23-2008; AM. S.R.  
6-10-2008.

FIRST USE 3-5-2008; IN COMMERCE 3-5-2008.

JAMES A. RAUEN, EXAMINING ATTORNEY

**Int. Cl.: 44**

**Prior U.S. Cls.: 100 and 101**

**United States Patent and Trademark Office**

**Reg. No. 3,469,931**

**Registered July 15, 2008**

**SERVICE MARK  
SUPPLEMENTAL REGISTER**

**6 to 9 Dental**

VIRGINIA P. HUMPHREY II, DDS, INC. (CALI-  
FORNIA CORPORATION)  
239 MATADERO AVE.  
PALO ALTO, CA 94306

FOR: DENTAL CLINICS, IN CLASS 44 (U.S. CLS.  
100 AND 101).

FIRST USE 9-22-2007; IN COMMERCE 1-4-2008.

THE MARK CONSISTS OF STANDARD CHAR-  
ACTERS WITHOUT CLAIM TO ANY PARTICULAR  
FONT, STYLE, SIZE, OR COLOR.

SER. NO. 77-385,398, FILED P.R. 1-31-2008; AM. S.R.  
6-10-2008.

JENNIFER VASQUEZ, EXAMINING ATTORNEY

**Int. Cl.: 43**

**Prior U.S. Cls.: 100 and 101**

**United States Patent and Trademark Office**

**Reg. No. 3,469,932**

**Registered July 15, 2008**

**SERVICE MARK  
SUPPLEMENTAL REGISTER**

**GENUINE SOUTHERN**

VIRGINIA BARBEQUE, INC. (VIRGINIA CORPORATION)  
1814 COUNTRY ROAD  
BEAVERDAM, VA 23015

FOR: RESTAURANT SERVICES, IN CLASS 43  
(U.S. CLS. 100 AND 101).

FIRST USE 9-1-2003; IN COMMERCE 9-1-2003.

THE MARK CONSISTS OF STANDARD CHARACTERS WITHOUT CLAIM TO ANY PARTICULAR FONT, STYLE, SIZE, OR COLOR.

SER. NO. 77-386,151, FILED P.R. 2-1-2008; AM. S.R. 5-21-2008.

MICHELLE DUBOIS, EXAMINING ATTORNEY

**Int. Cl.: 41**

**Prior U.S. Cls.: 100, 101, and 107**

**United States Patent and Trademark Office**

**Reg. No. 3,469,933**

**Registered July 15, 2008**

**SERVICE MARK  
SUPPLEMENTAL REGISTER**

**ADVANCED REAL ESTATE  
LEARNING CENTER**

KAPLAN, JEFFREY N. (UNITED STATES INDIVIDUAL)

2352 N. CLYBOURN AVENUE

CHICAGO, IL 60614

FOR: EDUCATIONAL SERVICES, NAMELY, TRAINING RELATED TO HOME INSPECTION, IN CLASS 41 (U.S. CLS. 100, 101 AND 107).

FIRST USE 2-4-2008; IN COMMERCE 2-4-2008.

THE MARK CONSISTS OF STANDARD CHARACTERS WITHOUT CLAIM TO ANY PARTICULAR FONT, STYLE, SIZE, OR COLOR.

NO CLAIM IS MADE TO THE EXCLUSIVE RIGHT TO USE "LEARNING CENTER", APART FROM THE MARK AS SHOWN.

SER. NO. 77-388,060, FILED P.R. 2-4-2008; AM. S.R. 6-8-2008.

LINDA M. KING, EXAMINING ATTORNEY

**Int. Cl.: 16**

**Prior U.S. Cls.: 2, 5, 22, 23, 29, 37, 38, and 50**

**United States Patent and Trademark Office**

**Reg. No. 3,469,934**

**Registered July 15, 2008**

**TRADEMARK  
SUPPLEMENTAL REGISTER**

**PLAY DRUMS**

ENTER MUSIC PUBLISHING, INC. (CALIFORNIA CORPORATION)  
95 SOUTH MARKET STREET, SUITE 200  
SAN JOSE, CA 95113

FOR: MAGAZINE FEATURING ARTICLES ON THE ART AND TECHNIQUE OF DRUMMING AND PERCUSSION, IN CLASS 16 (U.S. CLS. 2, 5, 22, 23, 29, 37, 38 AND 50).

FIRST USE 12-1-2006; IN COMMERCE 12-1-2006.

THE MARK CONSISTS OF STANDARD CHARACTERS WITHOUT CLAIM TO ANY PARTICULAR FONT, STYLE, SIZE, OR COLOR.

OWNER OF U.S. REG. NOS. 2,094,362 AND 3,013,115.

SER. NO. 77-388,194, FILED P.R. 2-4-2008; AM. S.R. 6-11-2008.

MEGHAN REINHART, EXAMINING ATTORNEY

**Int. Cl.: 32**

**Prior U.S. Cls.: 45, 46, and 48**

**United States Patent and Trademark Office**

**Reg. No. 3,469,935**

**Registered July 15, 2008**

**TRADEMARK  
SUPPLEMENTAL REGISTER**

**HOLLYWOOD Beer**

HOLLYWOOD INC. (CALIFORNIA CORPORATION)  
3857 PELL PLACE #301  
SAN DIEGO, CA 92130

NO CLAIM IS MADE TO THE EXCLUSIVE  
RIGHT TO USE "BEER", APART FROM THE MARK  
AS SHOWN.

FOR: BEER, IN CLASS 32 (U.S. CLS. 45, 46 AND 48).

FIRST USE 2-9-2008; IN COMMERCE 2-9-2008.

SER. NO. 77-393,026, FILED P.R. 2-9-2008; AM. S.R.  
5-15-2008.

THE MARK CONSISTS OF STANDARD CHARACTERS  
WITHOUT CLAIM TO ANY PARTICULAR  
FONT, STYLE, SIZE, OR COLOR.

ALICIA COLLINS, EXAMINING ATTORNEY

**Int. Cl.: 36**

**Prior U.S. Cls.: 100, 101, and 102**

**United States Patent and Trademark Office**

**Reg. No. 3,469,936**

**Registered July 15, 2008**

**SERVICE MARK  
SUPPLEMENTAL REGISTER**

**SUNAPEEGETAWAY**

LEBOEUF, ALLEN E. (UNITED STATES INDIVIDUAL)  
149 LONDONDERRY ROAD  
WINDHAM, NH 03087

FOR: RENTAL OF HOMES, IN CLASS 36 (U.S. CLS. 100, 101 AND 102).

FIRST USE 6-1-2007; IN COMMERCE 9-1-2007.

THE MARK CONSISTS OF STANDARD CHARACTERS WITHOUT CLAIM TO ANY PARTICULAR FONT, STYLE, SIZE, OR COLOR.

SER. NO. 77-393,094, FILED P.R. 2-9-2008; AM. S.R. 6-9-2008.

RUSS HERMAN, EXAMINING ATTORNEY



**Int. Cl.: 45**

**Prior U.S. Cls.: 100 and 101**

**United States Patent and Trademark Office**

**Reg. No. 3,469,937**

**Registered July 15, 2008**

**SERVICE MARK  
SUPPLEMENTAL REGISTER**

**INFO-MARKETING LAW**

DICKS & NANTON P.A. (FLORIDA CORPORATION)  
220 E. CENTRAL PKWY  
SUITE 1020  
ALTAMONTE SPRINGS, FL 32701

FOR: LEGAL SERVICES, IN CLASS 45 (U.S. CLS. 100 AND 101).

FIRST USE 10-1-2007; IN COMMERCE 10-31-2007.

THE MARK CONSISTS OF STANDARD CHARACTERS WITHOUT CLAIM TO ANY PARTICULAR FONT, STYLE, SIZE, OR COLOR.

NO CLAIM IS MADE TO THE EXCLUSIVE RIGHT TO USE "LAW", APART FROM THE MARK AS SHOWN.

SER. NO. 77-393,350, FILED P.R. 2-10-2008; AM. S.R. 6-6-2008.

TASHIA BUNCH, EXAMINING ATTORNEY

**Int. Cl.: 35**

**Prior U.S. Cls.: 100, 101, and 102**

**United States Patent and Trademark Office**

**Reg. No. 3,469,938**

**Registered July 15, 2008**

**SERVICE MARK  
SUPPLEMENTAL REGISTER**

# HealthShopp

HEALTH SHOPPR, INC. (DELAWARE CORPORATION)  
24992 LARGO DR  
LAGUNA HILLS, CA 92653

THE MARK CONSISTS OF STANDARD CHARACTERS WITHOUT CLAIM TO ANY PARTICULAR FONT, STYLE, SIZE, OR COLOR.

FOR: OPERATING ON-LINE MARKETPLACES FOR SELLERS OF GOODS AND/OR SERVICES, IN CLASS 35 (U.S. CLS. 100, 101 AND 102).

SER. NO. 77-397,782, FILED P.R. 2-15-2008; AM. S.R. 6-5-2008.

FIRST USE 7-0-2007; IN COMMERCE 10-0-2007.

MARY MUNSON, EXAMINING ATTORNEY

**Int. Cl.: 5**

**Prior U.S. Cls.: 6, 18, 44, 46, 51, and 52**

**United States Patent and Trademark Office**

**Reg. No. 3,469,939**

**Registered July 15, 2008**

**TRADEMARK  
SUPPLEMENTAL REGISTER**

**PECAN SKIN AID**

HASKELL PHARMACEUTICALS (TEXAS COR-  
PORATION)  
4402 CHIPPENDALE DR.  
BROOKSHIRE, TX 77423

THE MARK CONSISTS OF STANDARD CHAR-  
ACTERS WITHOUT CLAIM TO ANY PARTICULAR  
FONT, STYLE, SIZE, OR COLOR.

FOR: ANTISEPTICS MADE, IN PART OR IN  
WHOLE, FROM GREEN PECAN SHUCKS, IN  
CLASS 5 (U.S. CLS. 6, 18, 44, 46, 51 AND 52).

SER. NO. 77-398,213, FILED P.R. 2-15-2008; AM. S.R.  
6-12-2008.

FIRST USE 11-30-2004; IN COMMERCE 3-3-2007.

JOHN DWYER, EXAMINING ATTORNEY

**Int. Cl.: 44**

**Prior U.S. Cls.: 100 and 101**

**United States Patent and Trademark Office**

**Reg. No. 3,469,940**

**Registered July 15, 2008**

**SERVICE MARK  
SUPPLEMENTAL REGISTER**

# Response Ready

TIER ONE - EMERGENCY PREPAREDNESS  
AND RESPONSE (COLORADO CORPORATION)  
605 EAST 70TH AVENUE, UNIT #3  
DENVER, CO 80229

FOR: EMERGENCY MEDICAL RESPONSE SERVICES, IN CLASS 44 (U.S. CLS. 100 AND 101).

FIRST USE 1-15-2008; IN COMMERCE 1-15-2008.

THE MARK CONSISTS OF STANDARD CHARACTERS WITHOUT CLAIM TO ANY PARTICULAR FONT, STYLE, SIZE, OR COLOR.

SER. NO. 77-401,224, FILED 2-20-2008.

DOMINIC FATHY, EXAMINING ATTORNEY

**Int. Cl.: 42**

**Prior U.S. Cls.: 100 and 101**

**United States Patent and Trademark Office**

**Reg. No. 3,469,941**

**Registered July 15, 2008**

**SERVICE MARK  
SUPPLEMENTAL REGISTER**

**RSS APPLIED**

NET SYNDICATIONS, LLC (OREGON LTD LIAB  
CO)  
25 NW 23RD PLACE, SUITE 6-309  
PORTLAND, OR 97210

FOR: SOFTWARE AND WEBSITE DEVELOP-  
MENT, NAMELY, DEVELOPING BLOG SITES,  
CONTENT MANAGEMENT SYSTEMS, AND  
SEARCH ENGINE OPTIMIZATION SYSTEMS FOR  
OTHERS, IN CLASS 42 (U.S. CLS. 100 AND 101).

FIRST USE 5-1-2005; IN COMMERCE 5-1-2005.

THE MARK CONSISTS OF STANDARD CHAR-  
ACTERS WITHOUT CLAIM TO ANY PARTICULAR  
FONT, STYLE, SIZE, OR COLOR.

SER. NO. 77-402,849, FILED P.R. 2-21-2008; AM. S.R.  
6-10-2008.

KRISTIN DAHLING, EXAMINING ATTORNEY

**Int. Cl.: 41**

**Prior U.S. Cls.: 100, 101, and 107**

**United States Patent and Trademark Office**

**Reg. No. 3,469,942**

**Registered July 15, 2008**

**SERVICE MARK  
SUPPLEMENTAL REGISTER**

**AMERICAN NATIONAL  
JIU-JITSU CHAMPIONSHIP**

UNITED STATES JIU-JITSU FEDERATION, INC.  
(CALIFORNIA CORPORATION)  
SUITE 205  
23 SPECTRUM POINTE DRIVE  
LAKE FOREST, CA 92630

FOR: ENTERTAINMENT IN THE NATURE OF  
COMPETITIONS IN THE FIELD OF JIU-JITSU;  
ORGANIZING SPORTING EVENTS, NAMELY,  
JIU-JITSU TOURNAMENTS, IN CLASS 41 (U.S.  
CLS. 100, 101 AND 107).

FIRST USE 0-0-2002; IN COMMERCE 0-0-2002.

THE MARK CONSISTS OF STANDARD CHAR-  
ACTERS WITHOUT CLAIM TO ANY PARTICULAR  
FONT, STYLE, SIZE, OR COLOR.

NO CLAIM IS MADE TO THE EXCLUSIVE  
RIGHT TO USE "JIU-JITSU CHAMPIONSHIP",  
APART FROM THE MARK AS SHOWN.

SER. NO. 77-405,732, FILED P.R. 2-25-2008; AM. S.R.  
6-10-2008.

IRA J. GOODSaid, EXAMINING ATTORNEY

**Int. Cl.: 41**

**Prior U.S. Cls.: 100, 101, and 107**

**United States Patent and Trademark Office**

**Reg. No. 3,469,943**

**Registered July 15, 2008**

**SERVICE MARK  
SUPPLEMENTAL REGISTER**

**WORLD JIU-JITSU NO-GI  
CHAMPIONSHIP**

UNITED STATES JIU-JITSU FEDERATION, INC.  
(CALIFORNIA CORPORATION)

23 SPECTRUM POINTE DRIVE

LAKE FOREST, CA 92630

FOR: ENTERTAINMENT IN THE NATURE OF  
COMPETITIONS IN THE FIELD OF JIU-JITSU;  
ORGANIZING SPORTING EVENTS, NAMELY,  
JIU-JITSU TOURNAMENTS , IN CLASS 41 (U.S.  
CLS. 100, 101 AND 107).

FIRST USE 0-0-2007; IN COMMERCE 0-0-2007.

THE MARK CONSISTS OF STANDARD CHAR-  
ACTERS WITHOUT CLAIM TO ANY PARTICULAR  
FONT, STYLE, SIZE, OR COLOR.

NO CLAIM IS MADE TO THE EXCLUSIVE  
RIGHT TO USE "JIU-JITSU NO-GI CHAMPION-  
SHIP", APART FROM THE MARK AS SHOWN.

"NO GI" MEANS "NO KIMONO" OR "NO MAR-  
TIAL ARTS UNIFORM".

SER. NO. 77-405,739, FILED P.R. 2-25-2008; AM. S.R.  
6-10-2008.

IRA J. GOODSID, EXAMINING ATTORNEY

**Int. Cl.: 41**

**Prior U.S. Cls.: 100, 101, and 107**

**United States Patent and Trademark Office**

**Reg. No. 3,469,944**

**Registered July 15, 2008**

**SERVICE MARK  
SUPPLEMENTAL REGISTER**

**UNITED STATES JIU-JITSU  
FEDERATION**

UNITED STATES JIU-JITSU FEDERATION, INC.  
(CALIFORNIA CORPORATION)  
SUITE 205  
23 SPECTRUM POINTE DRIVE  
LAKE FOREST, CA 92630

FOR: ENTERTAINMENT IN THE NATURE OF  
COMPETITIONS IN THE FIELD OF JIU-JITSU;  
ORGANIZING SPORTING EVENTS, NAMELY,  
JIU-JITSU TOURNAMENTS, IN CLASS 41 (U.S.  
CLS. 100, 101 AND 107).

FIRST USE 9-15-2003; IN COMMERCE 9-15-2003.

THE MARK CONSISTS OF STANDARD CHAR-  
ACTERS WITHOUT CLAIM TO ANY PARTICULAR  
FONT, STYLE, SIZE, OR COLOR.

NO CLAIM IS MADE TO THE EXCLUSIVE  
RIGHT TO USE "JIU-JITSU FEDERATION", APART  
FROM THE MARK AS SHOWN.

SER. NO. 77-405,747, FILED P.R. 2-25-2008; AM. S.R.  
6-10-2008.

IRA J. GOODSaid, EXAMINING ATTORNEY



**Int. Cl.: 41**

**Prior U.S. Cls.: 100, 101, and 107**

**United States Patent and Trademark Office**

**Reg. No. 3,469,945**

**Registered July 15, 2008**

**SERVICE MARK  
SUPPLEMENTAL REGISTER**

**Mixed Roots Movement**

WILLIAMS, TRINA FATIMAH (UNITED STATES  
INDIVIDUAL)  
7475 PEBBLE LANE  
WEST BLOOMFIELD, MI 48322

FOR: EDUCATION SERVICES, NAMELY, PROVIDING ANNUAL CONVENTIONS, FORUMS, WORKSHOPS, AND SYMPOSIUMS IN THE FIELD OF AWARENESS ABOUT THE MIXED-RACED, MULTI-ETHNIC AND MULTICULTURAL EXPERIENCE; EDUCATION SERVICES, NAMELY, MENTORING IN THE FIELD OF SOCIAL RELATIONSHIPS AND BEHAVIOR; CONSULTATION AND PUBLIC SPEAKING SERVICES IN THE FIELD OF BI-RACIAL AND MIXED RACE EXPERI-

ENCES AND EXPOSURE IN THE ENTERTAINMENT INDUSTRY, IN CLASS 41 (U.S. CLS. 100, 101 AND 107).

FIRST USE 12-0-2007; IN COMMERCE 2-7-2008.

THE MARK CONSISTS OF STANDARD CHARACTERS WITHOUT CLAIM TO ANY PARTICULAR FONT, STYLE, SIZE, OR COLOR.

SER. NO. 77-406,786, FILED P.R. 2-26-2008; AM. S.R. 6-10-2008.

DAVID YONTEF, EXAMINING ATTORNEY

**Int. Cl.: 9**

**Prior U.S. Cls.: 21, 23, 26, 36, and 38**

**United States Patent and Trademark Office**

**Reg. No. 3,469,946**

**Registered July 15, 2008**

**TRADEMARK  
SUPPLEMENTAL REGISTER**

**SURVEY TOOLS**

ENERNET, INC. (CALIFORNIA CORPORATION)  
1758 ORANGE TREE LN.  
REDLANDS, CA 92374

FOR: COMPUTER SOFTWARE THAT PROVIDES THE USER AN INTUITIVE RULES BASED DATA COLLECTING PROCESS/PLATFORM FOR COLLECTING DATA RELATING TO ENERGY SURVEYS INSIDE AND OUTSIDE OF COMMERCIAL AND RESIDENTIAL BUILDINGS, IN CLASS 9 (U.S. CLS. 21, 23, 26, 36 AND 38).

FIRST USE 1-1-2004; IN COMMERCE 1-1-2004.

THE MARK CONSISTS OF STANDARD CHARACTERS WITHOUT CLAIM TO ANY PARTICULAR FONT, STYLE, SIZE, OR COLOR.

NO CLAIM IS MADE TO THE EXCLUSIVE RIGHT TO USE "TOOLS", APART FROM THE MARK AS SHOWN.

SER. NO. 77-406,899, FILED P.R. 2-26-2008; AM. S.R. 6-10-2008.

ZHALEH DELANEY, EXAMINING ATTORNEY

Int. Cl.: 3

Prior U.S. Cls.: 1, 4, 6, 50, 51, and 52

United States Patent and Trademark Office

Reg. No. 3,469,947

Registered July 15, 2008

TRADEMARK  
SUPPLEMENTAL REGISTER

SheaDerma

UCS, INC. (GEORGIA CORPORATION), DBA AL-  
ANWAR THE GOOD SCENTS COMPANY,  
3209 SOUTH COBB DR. - STE. H1  
SMYRNA, GA 300804160

FOR: AROMATHERAPY BODY CARE PRO-  
DUCTS, NAMELY, BODY LOTION, SHOWER GEL,  
CUTICLE CREAM, SHAMPOO, CONDITIONER,  
NON-MEDICATED LIP BALM, SOAP, BODY POL-  
ISH, BODY AND FOOT SCRUB AND NON-MEDI-  
CATED FOOT CREAM, IN CLASS 3 (U.S. CLS. 1, 4, 6,  
50, 51 AND 52).

FIRST USE 2-18-2008; IN COMMERCE 2-18-2008.

THE MARK CONSISTS OF "SHEADERMA" IN  
TWO FONT STYLES.

SER. NO. 77-407,300, FILED P.R. 2-27-2008; AM. S.R.  
6-10-2008.

DAVID YONTEF, EXAMINING ATTORNEY

**Int. Cl.: 44**

**Prior U.S. Cls.: 100 and 101**

**United States Patent and Trademark Office**

**Reg. No. 3,469,948**

**Registered July 15, 2008**

**SERVICE MARK  
SUPPLEMENTAL REGISTER**

**The One Minute Wellness  
Coach**

ENOS, DEBORAH HERLAX (UNITED STATES  
INDIVIDUAL), DBA ENOS, DEBORAH HER-  
LAX,  
645 E. LK. SAMMAMISH PWKY, SE  
SAMMAMISH, WA 98074

FOR: COUNSELING SERVICES IN THE FIELDS  
OF HEALTH, NUTRITION AND LIFESTYLE WELL-  
NESS, IN CLASS 44 (U.S. CLS. 100 AND 101).

FIRST USE 12-12-2006; IN COMMERCE 2-1-2007.

THE MARK CONSISTS OF STANDARD CHAR-  
ACTERS WITHOUT CLAIM TO ANY PARTICULAR  
FONT, STYLE, SIZE, OR COLOR.

SER. NO. 77-407,811, FILED P.R. 2-27-2008; AM. S.R.  
6-9-2008.

NICHOLAS ALTREE, EXAMINING ATTORNEY

**Int. Cl.: 41**

**Prior U.S. Cls.: 100, 101, and 107**

**United States Patent and Trademark Office**

**Reg. No. 3,469,949**

**Registered July 15, 2008**

**SERVICE MARK  
SUPPLEMENTAL REGISTER**

**The 12 Steps of Yoga**

CHAMPAGNE, CHERYL (UNITED STATES IN-  
DIVIDUAL)

20 WOLF HILL ROAD, 7F

WOLCOTT, CT 06716

FOR: YOGA INSTRUCTION, IN CLASS 41 (U.S.  
CLS. 100, 101 AND 107).

FIRST USE 6-9-2006; IN COMMERCE 6-9-2006.

THE MARK CONSISTS OF STANDARD CHAR-  
ACTERS WITHOUT CLAIM TO ANY PARTICULAR  
FONT, STYLE, SIZE, OR COLOR.

NO CLAIM IS MADE TO THE EXCLUSIVE  
RIGHT TO USE "YOGA", APART FROM THE  
MARK AS SHOWN.

SER. NO. 77-410,562, FILED P.R. 3-1-2008; AM. S.R.  
6-11-2008.

DAVID MURRAY, EXAMINING ATTORNEY

**Int. Cl.: 41**

**Prior U.S. Cls.: 100, 101, and 107**

**United States Patent and Trademark Office**

**Reg. No. 3,469,950**

**Registered July 15, 2008**

**SERVICE MARK  
SUPPLEMENTAL REGISTER**

**FOUNDATIONS OF REAL ESTATE  
MANAGEMENT**

BUILDING OWNERS AND MANAGERS ASSO-  
CIATION INTERNATIONAL (ILLINOIS NON-  
PROFIT CORPORATION)  
1201 NEW YORK AVENUE, N.W.  
SUITE 300  
WASHINGTON, DC 20005

FOR: EDUCATION SERVICES, NAMELY, SEMI-  
NARS AND CLASSES IN THE FIELD OF COMMER-  
CIAL REAL ESTATE MANAGEMENT,  
ADMINISTRATION, ACCOUNTING AND REPORT-  
ING, BUILDING SYSTEMS AND OPERATIONS,  
TENANT RELATIONS AND RETENTION, AND  
CONTRACT MANAGEMENT AND THE DISTRIBU-  
TION OF COURSE MATERIALS IN CONNECTION

THEREWITH, IN CLASS 41 (U.S. CLS. 100, 101 AND  
107).

FIRST USE 4-2-2008; IN COMMERCE 4-2-2008.

THE MARK CONSISTS OF STANDARD CHAR-  
ACTERS WITHOUT CLAIM TO ANY PARTICULAR  
FONT, STYLE, SIZE, OR COLOR.

SER. NO. 77-410,973, FILED P.R. 3-3-2008; AM. S.R.  
6-9-2008.

KRISTIN DAHLING, EXAMINING ATTORNEY

**Int. Cl.: 25**

**Prior U.S. Cls.: 22 and 39**

**United States Patent and Trademark Office**

**Reg. No. 3,469,951**

**Registered July 15, 2008**

**TRADEMARK  
SUPPLEMENTAL REGISTER**

**I AM A SPARKLE IN GOD'S  
EYE !**

OLSZYNA, FRANCISZEK MARIAN (POLAND  
INDIVIDUAL), DBA FRANK OLSZYNA,  
APT. # 44  
16624 CRENSHAW BLVD.  
TORRANCE, CA 90504

THE MARK CONSISTS OF STANDARD CHAR-  
ACTERS WITHOUT CLAIM TO ANY PARTICULAR  
FONT, STYLE, SIZE, OR COLOR.

FOR: T-SHIRTS, IN CLASS 25 (U.S. CLS. 22 AND  
39).

SER. NO. 77-411,832, FILED P.R. 3-3-2008; AM. S.R.  
6-11-2008.

FIRST USE 1-1-1990; IN COMMERCE 1-3-2007.

JAMES LOVELACE, EXAMINING ATTORNEY

**Int. Cl.: 41**

**Prior U.S. Cls.: 100, 101, and 107**

**United States Patent and Trademark Office**

**Reg. No. 3,469,952**

**Registered July 15, 2008**

**SERVICE MARK  
SUPPLEMENTAL REGISTER**

**UNITED STATES BRAZILIAN  
JIU-JITSU FEDERATION**

UNITED STATES JIU-JITSU FEDERATION, INC.  
(CALIFORNIA CORPORATION)  
SUITE 205  
23 SPECTRUM POINTE DRIVE  
LAKE FOREST, CA 92630

FOR: ENTERTAINMENT IN THE NATURE OF  
MARTIAL ARTS TOURNAMENTS; ORGANIZING  
AND CONDUCTING JIU-JITSU TOURNAMENTS,  
IN CLASS 41 (U.S. CLS. 100, 101 AND 107).

FIRST USE 4-30-2008; IN COMMERCE 4-30-2008.

THE MARK CONSISTS OF STANDARD CHAR-  
ACTERS WITHOUT CLAIM TO ANY PARTICULAR  
FONT, STYLE, SIZE, OR COLOR.

NO CLAIM IS MADE TO THE EXCLUSIVE  
RIGHT TO USE "JIU-JITSU FEDERATION", APART  
FROM THE MARK AS SHOWN.

SER. NO. 77-463,617, FILED P.R. 5-1-2008; AM. S.R.  
6-10-2008.

IRA J. GOODSID, EXAMINING ATTORNEY



**Int. Cls.: 35 and 41**

**Prior U.S. Cls.: 100, 101, 102, and 107**

**United States Patent and Trademark Office**

**Reg. No. 3,469,953**

**Registered July 15, 2008**

**SERVICE MARK  
SUPPLEMENTAL REGISTER**

**THE ENGINEERING SEARCH  
ENGINE**

GLOBALSPEC, INC. (DELAWARE CORPORATION)  
350 JORDAN ROAD  
TROY, NY 12180

FOR: PROVIDING INFORMATION AND REFERRALS REGARDING THE GOODS AND SERVICES OF OTHERS VIA A GLOBAL COMPUTER NETWORK IN THE NATURE OF PRODUCT ANNOUNCEMENTS, IN CLASS 35 (U.S. CLS. 100, 101 AND 102).

FIRST USE 2-16-2006; IN COMMERCE 2-16-2006.

FOR: PROVIDING NEWSLETTERS ONLINE IN THE FIELDS OF NEWS, SCIENCE, ENGINEERING, TECHNOLOGY, MANUFACTURING, COMPONENTS, INSTRUMENTS, EQUIPMENT, MATERIALS, MANAGEMENT, AND INFORMATION TECHNOLOGY, NAMELY, ACOUSTICS AND AUDIO TECHNOLOGY, ALTERNATIVE POWER, BUILDING AND CONSTRUCTION, CHEMICAL ENGINEERING, COATINGS AND SURFACE ENGINEERING, DATA ACQUISITION, DESIGN AND ANALYSIS SOFTWARE, DISPLAY TECHNOLOGIES, DRIVES, ELECTRICAL COMPONENTS, ELECTRONIC COMPONENTS, ELECTRONIC PRODUCT DESIGN, ELECTRONIC TEST EQUIPMENT, ENGINEERING MANAGEMENT, ENGINEERING STUDENT NEWS, ENVIRONMENTAL TECHNOLOGY, FASTENING, JOINING AND ASSEMBLY, GLASS AND CERAMICS, HVAC, HYDRAULICS, INDUSTRIAL AUTOMATION, INDUSTRIAL COMPUTING, INDUSTRIAL MRO (MAINTENANCE, REPAIR AND OPERATIONS), INDUSTRIAL PRO-

CESSING EQUIPMENT, INTERNATIONAL NEWS, LAB EQUIPMENT, LIGHT AND LASER, MACHINE TOOLS AND METAL WORKING, MATERIAL HANDLING, MECHANICAL COMPONENTS, MEDICAL EQUIPMENT DESIGN, MEMS TECHNOLOGY, METAL WORKING, METALS AND ALLOYS, MOTION CONTROL COMPONENTS, MOTORS, NANO TECHNOLOGY, NETWORKING AND COMMUNICATIONS, PACKAGING AND LABELING, PLANT ENGINEERING, PLASTICS AND RESINS, PLASTICS FABRICATION, PNEUMATICS, POWER GENERATION, POWER TRANSMISSION, PUMP TECHNOLOGY, QUALITY CONTROL, ROBOTICS SYSTEMS, SCIENTIFIC INSTRUMENTS, SEMICONDUCTOR FABRICATION, SENSORS AND SWITCHES, SHOCK, VIBRATION AND NOISE, SUPPLY CHAIN MANAGEMENT, TEST AND MEASUREMENT, TEXTILE MANUFACTURING AND TECHNOLOGY, VALVE TECHNOLOGY, WIRE AND CABLE TECHNOLOGY, AND WIRELESS TECHNOLOGY, IN CLASS 41 (U.S. CLS. 100, 101 AND 107).

FIRST USE 3-29-2004; IN COMMERCE 3-29-2004.

THE MARK CONSISTS OF STANDARD CHARACTERS WITHOUT CLAIM TO ANY PARTICULAR FONT, STYLE, SIZE, OR COLOR.

OWNER OF U.S. REG. NO. 3,005,245.

SER. NO. 77-975,653, FILED P.R. 1-30-2007; AM. S.R. 5-30-2008.

KELLEY WELLS, EXAMINING ATTORNEY

**Int. Cl.: 3**

**Prior U.S. Cls.: 1, 4, 6, 50, 51, and 52**

**United States Patent and Trademark Office**

**Reg. No. 3,469,954**

**Registered July 15, 2008**

**TRADEMARK  
SUPPLEMENTAL REGISTER**



BEAUTYBANK INC. (DELAWARE CORPORATION)  
767 FIFTH AVENUE  
NEW YORK, NY 10153

FOR: NON-MEDICATED SKINCARE PREPARATIONS, IN CLASS 3 (U.S. CLS. 1, 4, 6, 50, 51 AND 52).

FIRST USE 6-6-2005; IN COMMERCE 7-24-2005.

THE COLOR(S) GREEN IS/ARE CLAIMED AS A FEATURE OF THE MARK.

THE COLOR GREEN APPEARS AS THE COLOR OF THE TALL GRASS IN THE PROPOSED MARK.

THE MARK CONSISTS OF A PHOTOGRAPH OF TALL GRASS.

SER. NO. 78-519,210, FILED P.R. 11-18-2004; AM. S.R. 2-25-2008.

ASMAT KHAN, EXAMINING ATTORNEY

**Int. Cl.: 41**

**Prior U.S. Cls.: 100, 101, and 107**

**United States Patent and Trademark Office**

**Reg. No. 3,469,955**

**Registered July 15, 2008**

**SERVICE MARK  
SUPPLEMENTAL REGISTER**

**ACTORS RESOURCE  
CENTER**

MOIST, SHARON (UNITED STATES INDIVIDUAL)  
P.O.BOX 11147  
BURBANK, CA 91510

FOR: EDUCATIONAL SERVICES, NAMELY, CONDUCTING CLASSES, WORKSHOPS, SEMINARS, AND LECTURES ON SUBJECTS OF INTEREST TO ACTORS, NAMELY, ENTERTAINMENT INDUSTRY INFORMATION AND INFORMATION RELATING TO PERSONAL CAREER DEVELOPMENT AND DISTRIBUTING COURSE MATERIAL, NAMELY, WORKBOOKS, HANDOUTS, PAMPHLETS, FLYERS AND BOOKS IN CONNECTION THEREWITH, IN CLASS 41 (U.S. CLS. 100, 101 AND 107).

FIRST USE 2-7-2005; IN COMMERCE 2-7-2005.

THE MARK CONSISTS OF STANDARD CHARACTERS WITHOUT CLAIM TO ANY PARTICULAR FONT, STYLE, SIZE, OR COLOR.

NO CLAIM IS MADE TO THE EXCLUSIVE RIGHT TO USE "RESOURCE CENTER", APART FROM THE MARK AS SHOWN.

SER. NO. 78-597,269, FILED P.R. 3-29-2005; AM. S.R. 6-6-2008.

FRED MANDIR, EXAMINING ATTORNEY

**Int. Cl.: 16**

**Prior U.S. Cls.: 2, 5, 22, 23, 29, 37, 38, and 50**

**United States Patent and Trademark Office**

**Reg. No. 3,469,956**

**Registered July 15, 2008**

**TRADEMARK  
SUPPLEMENTAL REGISTER**

**Camo-Up**

ISLEY, MICHAEL S (UNITED STATES INDIVIDUAL)  
9007 COOK FARM ROAD  
BELEWS CREEK, NC 27009

FOR: DECALS, IN CLASS 16 (U.S. CLS. 2, 5, 22, 23, 29, 37, 38 AND 50).

FIRST USE 4-2-2007; IN COMMERCE 4-6-2007.

THE MARK CONSISTS OF STANDARD CHARACTERS WITHOUT CLAIM TO ANY PARTICULAR FONT, STYLE, SIZE, OR COLOR.

SER. NO. 78-644,828, FILED P.R. 6-6-2005; AM. S.R. 6-10-2008.

HENRY S. ZAK, EXAMINING ATTORNEY

**Int. Cls.: 1, 5, 9, 10, and 42**

**Prior U.S. Cls.: 1, 5, 6, 10, 18, 21, 23, 26, 36, 38, 39, 44,  
46, 51, 52, 100, and 101**

**Reg. No. 3,469,957**

**United States Patent and Trademark Office**

**Registered July 15, 2008**

**TRADEMARK  
SERVICE MARK  
SUPPLEMENTAL REGISTER**

**HI-RES MELTING**

IDAHO TECHNOLOGY, INC. (IDAHO CORPORATION)

390 WAKARA WAY

SALT LAKE CITY, UT 84108

FOR: REAGENTS, BUFFERS, CHEMICAL BUFFERS, FLUORESCENT DYES, CHEMICAL DYES, CHEMICAL DYE MIXTURES, AND KITS COMPRISED OF THE FOREGOING, FOR SCIENTIFIC, RESEARCH, INDUSTRIAL AND QUALITY CONTROL PURPOSES; AND CONTROL SOLUTIONS AND CONTROL REAGENTS, AND KITS COMPRISED OF THE FOREGOING, FOR USE WITH SCIENTIFIC AND RESEARCH APPARATUS FOR QUALITY CONTROL PURPOSES, FOR USE WITH SCIENTIFIC AND RESEARCH INSTRUMENTS FOR QUALITY CONTROL PURPOSES, AND FOR USE WITH SCIENTIFIC AND RESEARCH DEVICES FOR QUALITY CONTROL PURPOSES; DIAGNOSTIC REAGENTS, BUFFERS, CHEMICAL BUFFERS, FLUORESCENT DYES, CHEMICAL DYES, CHEMICAL DYE MIXTURES, AND KITS COMPRISED OF THE FOREGOING, FOR LABORATORY USE IN THE ENVIRONMENTAL FIELDS FOR TREATING ENVIRONMENTS OR FOR USE IN TESTING THE CONDITION OF ENVIRONMENTS; AND CONTROL SOLUTIONS AND CONTROL REAGENTS, AND KITS COMPRISED OF THE FOREGOING, FOR TREATING ENVIRONMENTS OR FOR USE IN TESTING THE CONDITION OF ENVIRONMENTS, ALL FOR USE WITH LABORATORY APPARATUS FOR MONITORING THE ACCURACY AND PRECISION OF TESTS IN THE ENVIRONMENTAL FIELDS, FOR USE WITH LABORATORY INSTRUMENTS FOR MONITORING THE ACCURACY AND PRECISION OF TESTS IN THE ENVIRONMENTAL FIELDS, AND FOR USE WITH LABORATORY DEVICES FOR MONITORING THE ACCURACY AND PRECISION OF TESTS IN THE

ENVIRONMENTAL FIELDS, IN CLASS 1 (U.S. CLS. 1, 5, 6, 10, 26 AND 46).

FIRST USE 5-1-2007; IN COMMERCE 5-1-2007.

FOR: DIAGNOSTIC REAGENTS, BUFFERS, CHEMICAL BUFFERS, FLUORESCENT DYES, CHEMICAL DYES, CHEMICAL DYE MIXTURES, AND KITS COMPRISED OF THE FOREGOING, FOR LABORATORY USE IN THE MEDICAL, BIOLOGICAL, PATHOLOGICAL, PHARMACEUTICAL, AND GENETIC FIELDS; AND CONTROL SOLUTIONS AND CONTROL REAGENTS, AND KITS COMPRISED OF THE FOREGOING, FOR USE WITH LABORATORY APPARATUS FOR MONITORING THE ACCURACY AND PRECISION OF TESTS IN THE MEDICAL, BIOLOGICAL, PATHOLOGICAL, PHARMACEUTICAL, AND GENETIC FIELDS, FOR USE WITH LABORATORY INSTRUMENTS FOR MONITORING THE ACCURACY AND PRECISION OF TESTS IN THE MEDICAL, BIOLOGICAL, PATHOLOGICAL, PHARMACEUTICAL, AND GENETIC FIELDS, AND FOR USE WITH LABORATORY DEVICES FOR MONITORING THE ACCURACY AND PRECISION OF TESTS IN THE MEDICAL, BIOLOGICAL, PATHOLOGICAL, PHARMACEUTICAL, AND GENETIC FIELDS, IN CLASS 5 (U.S. CLS. 6, 18, 44, 46, 51 AND 52).

FIRST USE 5-1-2007; IN COMMERCE 5-1-2007.

FOR: DEVICES, EQUIPMENT AND INSTRUMENTS, NAMELY, FLUORIMETERS, IMAGING DEVICES THAT UTILIZE FLUORESCENT LIGHT TO CREATE DIGITAL PHOTOGRAPHS, THERMAL CONTROL ELEMENTS SPECIALLY ADAPTED FOR SCIENTIFIC USE FOR HEATING AND COOLING SAMPLES, MUTATION SCANNERS, GENOTYPE SCANNERS, MICROTITER PLATE READERS,

AND APPARATUS, ALL FOR DETECTING, IDENTIFYING, CLASSIFYING, ANALYZING, EVALUATING, MONITORING, PREPARING, TESTING, MIXING, HEATING AND COOLING NUCLEIC ACID, CELLS, GENES AND CHEMICAL, BIOCHEMICAL, BIOLOGICAL, GENETIC AND PATHOLOGICAL MATERIALS AND SAMPLES FOR SCIENTIFIC, RESEARCH AND LABORATORY PURPOSES; MATERIALS, ARTICLES, APPARATUS AND DISPOSABLE ITEMS, NAMELY, OPTICAL FILTERS, COMPUTER CHIPS, HEATING ELEMENTS SPECIALLY ADAPTED FOR SCIENTIFIC USE FOR HEATING SAMPLES FOR TESTING PURPOSES, SAMPLE CONTAINERS SPECIALLY ADAPTED FOR SCIENTIFIC USE, NAMELY, CONTAINERS USED TO HOLD SAMPLES FOR TESTING PURPOSES, TUBES MADE OF VARIOUS MATERIALS SPECIALLY ADAPTED FOR SCIENTIFIC USE FOR TESTING PURPOSES, AND MICROTITER PLATES, ALL FOR SCIENTIFIC, RESEARCH AND LABORATORY USE, AND FOR USE WITH SCIENTIFIC, RESEARCH AND LABORATORY DEVICES, EQUIPMENT, INSTRUMENTS, APPARATUS, IMAGING DEVICES AND MICROTITER PLATE READERS; COMPUTER SOFTWARE, COMPUTER PROGRAMS AND COMPUTER FIRMWARE ALL FOR USE IN CONTROLLING PROCESSES, INPUTTING, ANALYZING, MODIFYING, TRANSFERRING, DISPLAYING, REPORTING AND STORING DATA AND RESULTS, FOR SCIENTIFIC, RESEARCH, LABORATORY, MEDICAL, CLINICAL, DIAGNOSTIC, INDUSTRIAL, BIOLOGICAL, PATHOLOGICAL, PHARMACEUTICAL, GENETIC, ENVIRONMENTAL AND AGRICULTURAL PURPOSES, AND FOR USE IN GENE, NUCLEIC ACID AND OTHER TESTING AND ANALYSIS, IN PARTICULAR FOR CLINICAL DIAGNOSTIC ASSAYS, CLINICAL DIAGNOSTIC TESTS, DISEASE SCREENING, GENETIC DISEASE SCREENING, DISEASE IDENTIFICATION, GENETIC DISEASE IDENTIFICATION, DISEASE TESTING, GENETIC DISEASE TESTING, MUTATION DETECTION, MUTATION SCREENING, MUTATION SCANNING, GENOMICS, FUNCTIONAL GENOMICS, GENOME TESTING, GENOME ANALYSIS, GENOTYPING, GENE TESTING, GENE IDENTIFICATION, GENE ANALYSIS, GENE SCREENING, GENE INTERACTION SCREENING, GENE EXPRESSION, GENE MAPPING, GENETIC MARKER IDENTIFICATION, GENETIC TRAIT DETERMINATION, PLANT GENETICS, GENETIC MODIFICATION TESTING, GENETICALLY MODIFIED ORGANISM TESTING, GENETICALLY MODIFIED PRODUCTS TESTING, DNA FINGERPRINTING, NUCLEIC ACID TESTING, NUCLEIC ACID ANALYSIS, AMINO ACID TESTING, IDENTITY TESTING, HUMAN IDENTITY TESTING, PERSON IDENTIFICATION, DONOR IDENTIFICATION, TISSUE TYPING, TISSUE MATCHING, PARENTAGE TESTING, PATERNITY TESTING, FORENSICS, PHARMACEUTICALS, PHARMACEUTICAL TESTING, PHARMACEUTICAL IDENTIFICATION, AGRICULTURE, AGRICULTURAL PRODUCTS, AGRICULTURAL USES, QUALITY TESTING, PURITY TESTING, AND QUALITY CONTROL; COMPUTER SOFTWARE, COMPUTER PROGRAMS AND COMPUTER FIRMWARE ALL FOR USE IN CONTROLLING PROCES-

SES, DETECTING, ANALYZING, MEASURING, TESTING, IDENTIFYING, CLASSIFYING, TAGGING, LABELING, DETERMINING SEQUENCE, COUNTING, MAPPING, ENGINEERING, EXPRESSING, AMPLIFYING, HEATING, COOLING, MEASURING THE TEMPERATURE OF, AND MONITORING CELLS, GENES, NUCLEIC ACIDS AND BIOLOGICAL SAMPLES FOR LABORATORY, RESEARCH, DEVELOPMENT, GENETIC, BIOLOGICAL, PATHOLOGICAL, MEDICAL, CLINICAL, DIAGNOSTIC, INDUSTRIAL, PHARMACEUTICAL, AGRICULTURAL, ENVIRONMENTAL, CHEMICAL, BIOCHEMICAL, BIOMEDICAL, BIOINFORMATICS, BIOTECHNOLOGICAL AND SCIENTIFIC PURPOSES; AND COMPUTERS, LAPTOP COMPUTERS, HARD DRIVES FOR COMPUTERS, AND COMPUTER HARDWARE, IN CLASS 9 (U.S. CLS. 21, 23, 26, 36 AND 38).

FIRST USE 10-31-2005; IN COMMERCE 10-31-2005.

FOR: DEVICES, EQUIPMENT AND INSTRUMENTS, NAMELY, FLUORIMETERS, IMAGING DEVICES THAT UTILIZE FLUORESCENT LIGHT TO CREATE DIGITAL PHOTOGRAPHS, THERMAL CONTROL ELEMENTS SPECIALLY ADAPTED FOR MEDICAL USE FOR HEATING AND COOLING SAMPLES, MUTATION SCANNERS, GENOTYPE SCANNERS, MICROTITER PLATE READERS, AND APPARATUS, ALL FOR DETECTING, IDENTIFYING, CLASSIFYING, ANALYZING, EVALUATING, MONITORING, PREPARING, TESTING, MIXING, HEATING AND COOLING NUCLEIC ACID, CELLS, GENES AND CHEMICAL, BIOCHEMICAL, BIOLOGICAL, GENETIC, PATHOLOGICAL AND TOXIC MATERIALS AND SAMPLES FOR MEDICAL, CLINICAL AND DIAGNOSTIC PURPOSES; AND MATERIALS, ARTICLES, APPARATUS AND DISPOSABLE ITEMS, NAMELY, HEATING ELEMENTS SPECIALLY ADAPTED FOR MEDICAL USE FOR HEATING SAMPLES FOR TESTING PURPOSES, CONTAINERS SPECIALLY ADAPTED FOR MEDICAL USE TO HOLD SAMPLES FOR TESTING PURPOSES, TUBES MADE OF VARIOUS MATERIALS SPECIALLY ADAPTED FOR MEDICAL USE FOR TESTING PURPOSES, AND MICROTITER PLATES, ALL FOR MEDICAL, CLINICAL AND DIAGNOSTIC USE, AND FOR USE WITH MEDICAL, CLINICAL AND DIAGNOSTIC DEVICES, EQUIPMENT, INSTRUMENTS, APPARATUS, IMAGING DEVICES AND MICROTITER PLATE READERS, IN CLASS 10 (U.S. CLS. 26, 39 AND 44).

FIRST USE 10-31-2005; IN COMMERCE 10-31-2005.

FOR: SCIENTIFIC AND LABORATORY RESEARCH AND DEVELOPMENT SERVICES, DESIGN SERVICES FOR OTHERS, SCIENTIFIC AND LABORATORY RESEARCH AND DEVELOPMENT TESTING SERVICES, DIAGNOSTIC SERVICES, SCIENTIFIC AND LABORATORY RESEARCH AND DEVELOPMENT ANALYSIS SERVICES, SCIENTIFIC AND LABORATORY SAMPLE SCANNING SERVICES FOR SCIENTIFIC PURPOSES, PRODUCT DEVELOPMENT SERVICES FOR TOOLS, DEVICES AND INSTRUMENTS, SOFTWARE DEVELOPMENT AND MAINTENANCE SERVICES, SCIENTI-

FIG, LABORATORY, RESEARCH AND DEVELOPMENT CONSULTING SERVICES, AND SCIENTIFIC, LABORATORY, RESEARCH AND DEVELOPMENT ONLINE INFORMATION SERVICES, ALL IN THE FIELDS OF CLINICAL DIAGNOSTIC ASSAYS, CLINICAL DIAGNOSTIC TESTS, DISEASE SCREENING, GENETIC DISEASE SCREENING, DISEASE IDENTIFICATION, GENETIC DISEASE IDENTIFICATION, DISEASE TESTING, GENETIC DISEASE TESTING, MUTATION DETECTION, MUTATION SCREENING, MUTATION SCANNING, GENOMICS, FUNCTIONAL GENOMICS, GENOME TESTING, GENOME ANALYSIS, GENOTYPING, GENE TESTING, GENE IDENTIFICATION, GENE ANALYSIS, GENE SCREENING, GENE INTERACTION SCREENING, GENE EXPRESSION, GENE MAPPING, GENETIC MARKER IDENTIFICATION, GENETIC TRAIT DETERMINATION, PLANT GENETICS, GENETIC MODIFICATIONS, GENETICALLY MODIFIED ORGANISMS, GENETICALLY MODIFIED PRODUCTS, DNA FINGERPRINTING, NUCLEIC ACID TESTING, NUCLEIC ACID ANALYSIS, IDENTITY TESTING,

HUMAN IDENTITY TESTING, PERSON IDENTIFICATION, DONOR IDENTIFICATION, TISSUE TYPING, TISSUE MATCHING, PARENTAGE TESTING, PATERNITY TESTING, FORENSICS, PHARMACEUTICALS, PHARMACEUTICAL TESTING, PHARMACEUTICAL IDENTIFICATION, AGRICULTURE, AGRICULTURAL PRODUCTS, AGRICULTURAL USES, QUALITY TESTING OF SAMPLES, PURITY TESTING OF SAMPLES, AND QUALITY CONTROL OF SAMPLES, IN CLASS 42 (U.S. CLS. 100 AND 101).

FIRST USE 10-31-2005; IN COMMERCE 10-31-2005.

THE MARK CONSISTS OF STANDARD CHARACTERS WITHOUT CLAIM TO ANY PARTICULAR FONT, STYLE, SIZE, OR COLOR.

SER. NO. 78-663,051, FILED P.R. 7-1-2005; AM. S.R. 11-30-2007.

LYDIA BELZER, EXAMINING ATTORNEY

**Int. Cl.: 36**

**Prior U.S. Cls.: 100, 101, and 102**

**United States Patent and Trademark Office**

**Reg. No. 3,469,958**

**Registered July 15, 2008**

**SERVICE MARK  
SUPPLEMENTAL REGISTER**

# Carmel City Center

CARMEL CITY CENTER, LLC (INDIANA LTD  
LIAB CO)  
770 3RD AVE.,S.W.  
CARMEL, IN 46032

FOR: REAL ESTATE SERVICES, NAMELY, LEAS-  
ING OF COMMERCIAL, OFFICE AND RESIDEN-  
TIAL REAL PROPERTY, IN CLASS 36 (U.S. CLS. 100,  
101 AND 102).

FIRST USE 5-14-2008; IN COMMERCE 5-14-2008.

THE MARK CONSISTS OF STANDARD CHAR-  
ACTERS WITHOUT CLAIM TO ANY PARTICULAR  
FONT, STYLE, SIZE, OR COLOR.

NO CLAIM IS MADE TO THE EXCLUSIVE  
RIGHT TO USE "CITY CENTER", APART FROM  
THE MARK AS SHOWN.

SER. NO. 78-727,330, FILED P.R. 10-5-2005; AM. S.R.  
5-21-2008.

MICHAEL W. BAIRD, EXAMINING ATTORNEY



**Int. Cl.: 18**

**Prior U.S. Cls.: 1, 2, 3, 22, and 41**

**United States Patent and Trademark Office**

**Reg. No. 3,469,959**

**Registered July 15, 2008**

**TRADEMARK  
SUPPLEMENTAL REGISTER**

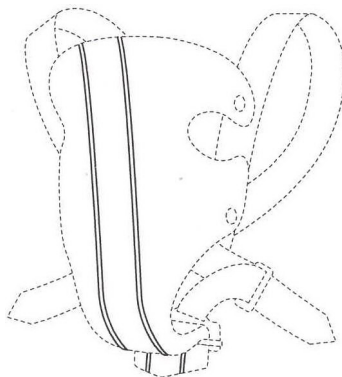

BABY-BJÖRN AB (SWEDEN CORPORATION)  
SÄTRAÄNGSVÄGEN 8, 182 36  
DANDERYD, SWEDEN

FOR: BABY CARRIERS WORN ON THE BODY,  
IN CLASS 18 (U.S. CLS. 1, 2, 3, 22 AND 41).

FIRST USE 1-0-1993; IN COMMERCE 1-0-1993.

THE MARK CONSISTS OF TWO PARALLEL  
STRIPES ON THE FRONT PORTION OF A BABY

CARRIER. THE PORTIONS OF THE DRAWING  
SHOWN IN DOTTED LINES ARE NOT PART OF  
THE MARK BUT ARE MERELY INTENDED TO  
SHOW THE POSITION OF THE MARK.

SER. NO. 78-739,681, FILED P.R. 10-25-2005; AM.  
S.R. 6-9-2008.

MICHAEL W. BAIRD, EXAMINING ATTORNEY

**Int. Cl.: 32**

**Prior U.S. Cls.: 45, 46, and 48**

**United States Patent and Trademark Office**

**Reg. No. 3,469,960**

**Registered July 15, 2008**

**TRADEMARK  
SUPPLEMENTAL REGISTER**

**AMAZON ENERGY**

SAMBAZON, INC. (DELAWARE CORPORATION)  
1160 CALLE CORDILLERA  
SAN CLEMENTE, CA 92673

OWNER OF U.S. REG. NO. 2,829,762.

FOR: NON-ALCOHOLIC FRUIT BASED BEVERAGES, IN CLASS 32 (U.S. CLS. 45, 46 AND 48).

NO CLAIM IS MADE TO THE EXCLUSIVE RIGHT TO USE "ENERGY", APART FROM THE MARK AS SHOWN.

FIRST USE 4-0-2008; IN COMMERCE 4-0-2008.

SER. NO. 78-768,774, FILED P.R. 12-7-2005; AM. S.R. 5-22-2008.

THE MARK CONSISTS OF STANDARD CHARACTERS WITHOUT CLAIM TO ANY PARTICULAR FONT, STYLE, SIZE, OR COLOR.

HANNO RITTNER, EXAMINING ATTORNEY

**Int. Cl.: 36**

**Prior U.S. Cls.: 100, 101, and 102**

**United States Patent and Trademark Office**

**Reg. No. 3,469,961**

**Registered July 15, 2008**

**SERVICE MARK  
SUPPLEMENTAL REGISTER**

**REALTY UNLIMITED**

REASON REAL ESTATE LLC (ARIZONA LTD  
LIAB CO)  
4443 NORTH SCOTTSDALE RD.  
SCOTTSDALE, AZ 85251

FOR: REAL ESTATE AGENCIES; REAL ESTATE  
BROKERAGE; OPERATING MARKETPLACES FOR  
SELLERS AND BUYERS OF REAL ESTATE; REAL  
ESTATE CONSULTATION; REAL ESTATE INVEST-  
MENT; REAL ESTATE LISTING; REAL ESTATE  
PROCUREMENT FOR OTHERS, IN CLASS 36 (U.S.  
CLS. 100, 101 AND 102).

FIRST USE 10-1-2004; IN COMMERCE 10-1-2004.

THE MARK CONSISTS OF STANDARD CHAR-  
ACTERS WITHOUT CLAIM TO ANY PARTICULAR  
FONT, STYLE, SIZE, OR COLOR.

NO CLAIM IS MADE TO THE EXCLUSIVE  
RIGHT TO USE "REALTY", APART FROM THE  
MARK AS SHOWN.

SER. NO. 78-776,220, FILED P.R. 12-19-2005; AM.  
S.R. 5-30-2008.

ESTHER BELENKER, EXAMINING ATTORNEY

**Int. Cls.: 16, 35, and 43**

**Prior U.S. Cls.: 2, 5, 22, 23, 29, 37, 38, 50, 100, 101, and 102**

**Reg. No. 3,469,962**

**United States Patent and Trademark Office**

**Registered July 15, 2008**

**TRADEMARK  
SERVICE MARK  
SUPPLEMENTAL REGISTER**

**JUMEIRAH**

JUMEIRAH INTERNATIONAL LLC (UNITED ARAB EMIR. LTD LIAB CO)  
PO BOX 73137, AL-SUFOUH AREAD  
DUBAI, UNITED ARAB EMIR.

FOR: MAGAZINES FEATURING LUXURY GOODS AND SERVICES, IN PARTICULAR, PRINTED MAGAZINES FEATURING ARTICLES ON LUXURY HOTELS, RESTAURANTS, TRAVEL, REAL ESTATE, SPA SERVICES, COSMETIC SPA PRODUCTS, CELEBRITY INTERVIEWS, CLOTHING, AND JEWELRY; CALENDARS; STATIONERY WRITING PADS; PENS; PENCILS, IN CLASS 16 (U.S. CLS. 2, 5, 22, 23, 29, 37, 38 AND 50).

FIRST USE 1-0-2006; IN COMMERCE 1-0-2006.

FOR: RETAIL SERVICES, NAMELY, RETAIL STORE SERVICES AND ONLINE RETAIL SERVICES FEATURING A WIDE VARIETY OF CONSUMER GOODS OF OTHERS, IN CLASS 35 (U.S. CLS. 100, 101 AND 102).

FIRST USE 11-27-2007; IN COMMERCE 11-27-2007.

FOR: HOTEL AND TEMPORARY ACCOMMODATION SERVICES, NAMELY, HOTEL SERVICES, PROVIDING TEMPORARY HOUSING ACCOMMODATIONS, PROVIDING TEMPORARY ACCOMMODATION; RESERVATIONS, BOOKING AND INFORMATION SERVICES RELATING TO MAKING RESERVATIONS AND BOOKING TEMPORARY LODGING, NAMELY, PROVIDING TRAVEL LODGING INFORMATION SERVICES AND TRA-

VEL LODGING AGENCY SERVICES FOR TRAVELERS; HOTEL SERVICES FOR THE PROVISION OF FACILITIES FOR CONFERENCES, MEETINGS, EXHIBITIONS, TRAINING SESSIONS, WORKSHOPS, BUSINESS FAIRS, CONGRESSES AND LECTURES FOR OTHERS; HOSPITALITY SERVICES, NAMELY, CONSULTING SERVICES IN THE FIELD OF HOSPITALITY; PROVISION OF FOOD AND BEVERAGE SERVICES, NAMELY, CATERING FOR THE PROVISION OF FOOD AND BEVERAGE SERVICES, PREPARATION OF FOOD AND BEVERAGES, SERVING FOOD AND DRINK OR BEVERAGES; RESTAURANT SERVICES, SELF SERVICE RESTAURANT SERVICES, TAKE AWAY RESTAURANT SERVICES, COFFEE SHOP SERVICES, CAFÉ SERVICES, SNACK-BAR SERVICES AND BAR SERVICES; PROVISION OF NURSERY SERVICES FOR CHILDREN, NAMELY, NURSERIES AND DAY CARE CENTERS, IN CLASS 43 (U.S. CLS. 100 AND 101).

FIRST USE 1-1-2006; IN COMMERCE 1-1-2006.

THE MARK CONSISTS OF STANDARD CHARACTERS WITHOUT CLAIM TO ANY PARTICULAR FONT, STYLE, SIZE, OR COLOR.

OWNER OF U.S. REG. NOS. 3,033,200, 3,134,441, AND 3,190,244.

SER. NO. 78-781,808, FILED P.R. 12-28-2005; AM. S.R. 6-3-2008.

MICHAEL TANNER, EXAMINING ATTORNEY

**Int. Cl.: 28**

**Prior U.S. Cls.: 22, 23, 38, and 50**

**United States Patent and Trademark Office**

**Reg. No. 3,469,963**

**Registered July 15, 2008**

**TRADEMARK  
SUPPLEMENTAL REGISTER**

# Ultimate Arcade

GOODTIME NOVELTY, INC. (ILLINOIS CORPORATION), DBA CHICAGO GAMING COMPANY,  
4616 W. 19TH STREET  
CICERO, IL 60804

FOR: SELF-CONTAINED, STAND-ALONE GAMING MACHINE HAVING MULTIPLE ARCADE VIDEO GAMES, IN CLASS 28 (U.S. CLS. 22, 23, 38 AND 50).

FIRST USE 11-10-2005; IN COMMERCE 11-10-2005.

THE MARK CONSISTS OF STANDARD CHARACTERS WITHOUT CLAIM TO ANY PARTICULAR FONT, STYLE, SIZE, OR COLOR.

NO CLAIM IS MADE TO THE EXCLUSIVE RIGHT TO USE "ARCADE", APART FROM THE MARK AS SHOWN.

SER. NO. 78-789,824, FILED P.R. 1-11-2006; AM. S.R. 6-9-2008.

ALICIA COLLINS, EXAMINING ATTORNEY

**Int. Cl.: 14**

**Prior U.S. Cls.: 2, 27, 28, and 50**

**United States Patent and Trademark Office**

**Reg. No. 3,469,964**

**Registered July 15, 2008**

**TRADEMARK  
SUPPLEMENTAL REGISTER**

**Vintaj**

VINTAJ NATURAL BRASS CO (ILLINOIS CORPORATION)  
704 PARK AVENUE  
GALENA, IL 61036

THE MARK CONSISTS OF STANDARD CHARACTERS WITHOUT CLAIM TO ANY PARTICULAR FONT, STYLE, SIZE, OR COLOR.

FOR: JEWELRY FINDINGS, IN CLASS 14 (U.S. CLS. 2, 27, 28 AND 50).

SER. NO. 78-832,473, FILED P.R. 3-8-2006; AM. S.R. 6-3-2008.

FIRST USE 12-6-2003; IN COMMERCE 12-6-2003.

JUSTINE D. PARKER, EXAMINING ATTORNEY

**Int. Cl.: 30**

**Prior U.S. Cl.: 46**

**United States Patent and Trademark Office**

**Reg. No. 3,469,965**

**Registered July 15, 2008**

**TRADEMARK  
SUPPLEMENTAL REGISTER**

**FUDGE BAKE**

FLOWERS SPECIALTY BRANDS, INC. (SOUTH  
CAROLINA CORPORATION)  
1919 FLOWERS CIRCLE  
THOMASVILLE, GA 31757

THE MARK CONSISTS OF STANDARD CHAR-  
ACTERS WITHOUT CLAIM TO ANY PARTICULAR  
FONT, STYLE, SIZE, OR COLOR.

FOR: BAKERY PRODUCTS, IN CLASS 30 (U.S. CL.  
46).

SER. NO. 78-846,883, FILED P.R. 3-27-2006; AM. S.R.  
12-26-2007.

FIRST USE 4-3-2006; IN COMMERCE 4-3-2006.

CAROLINE WOOD, EXAMINING ATTORNEY

**Int. Cl.: 43**

**Prior U.S. Cls.: 100 and 101**

**United States Patent and Trademark Office**

**Reg. No. 3,469,966**

**Registered July 15, 2008**

**SERVICE MARK  
SUPPLEMENTAL REGISTER**

**NAPA VALLEY WINE BAR**

BENSKIN, ORVILLE (UNITED STATES INDIVIDUAL)  
24751 MOSQUERO LANE  
MISSION VIEJO, CA 92691

FOR: WINE BAR SERVICES, SPECIALIZING IN SERVING WINES FROM REGIONS OF CALIFORNIA INCLUDING THE NAPA VALLEY WINE REGION, IN CLASS 43 (U.S. CLS. 100 AND 101).

FIRST USE 7-29-2006; IN COMMERCE 7-29-2006.

THE MARK CONSISTS OF STANDARD CHARACTERS WITHOUT CLAIM TO ANY PARTICULAR FONT, STYLE, SIZE, OR COLOR.

NO CLAIM IS MADE TO THE EXCLUSIVE RIGHT TO USE "WINE BAR", APART FROM THE MARK AS SHOWN.

SER. NO. 78-854,516, FILED P.R. 4-5-2006; AM. S.R. 10-29-2007.

LAURA HAMMEL, EXAMINING ATTORNEY



**Int. Cl.: 41**

**Prior U.S. Cls.: 100, 101, and 107**

**United States Patent and Trademark Office**

**Reg. No. 3,469,967**

**Registered July 15, 2008**

**SERVICE MARK  
SUPPLEMENTAL REGISTER**

**The Center for Scholarly  
English**

GLOBAL LANGUAGE INSTITUTE, INC. (MINNESOTA CORPORATION)  
340 CEDAR ST., STE. 25  
ST. PAUL, MN 55101

FOR: EDUCATION SERVICES, NAMELY, PROVIDING TRAINING THROUGH CLASSES, SEMINARS, WORKSHOPS, CUSTOMIZED INSTRUCTION, TUTORING AND MANUSCRIPT AND PRESENTATION DEVELOPMENT, AND TUTORING AND MANUSCRIPT AND PRESENTATION DEVELOPMENT THROUGH THE INTERNET IN THE FIELD OF ENGLISH LANGUAGE INSTRUCTION, IN CLASS 41 (U.S. CLS. 100, 101 AND 107).

FIRST USE 9-1-2005; IN COMMERCE 3-1-2006.

THE MARK CONSISTS OF STANDARD CHARACTERS WITHOUT CLAIM TO ANY PARTICULAR FONT, STYLE, SIZE, OR COLOR.

NO CLAIM IS MADE TO THE EXCLUSIVE RIGHT TO USE "CENTER", APART FROM THE MARK AS SHOWN.

SER. NO. 78-859,268, FILED P.R. 4-11-2006; AM. S.R. 11-8-2007.

RICHARD A. STRASER, EXAMINING ATTORNEY

**Int. Cl.: 3**

**Prior U.S. Cls.: 1, 4, 6, 50, 51, and 52**

**United States Patent and Trademark Office**

**Reg. No. 3,469,968**

**Registered July 15, 2008**

**TRADEMARK  
SUPPLEMENTAL REGISTER**

**POWDER-DRI**

SUN PHARMACEUTICALS CORP. (DELAWARE CORPORATION)  
300 NYALA FARMS ROAD  
WESTPORT, CT 06880

FOR: NON-MEDICATED SKIN CARE PREPARATIONS; SUNTAN LOTIONS; NON-MEDICATED SKIN CARE PREPARATIONS, NAMELY, MOISTURIZERS, CREAMS, LOTIONS, SKIN GELS, SUNSCREEN CREAMS, SUNSCREEN LOTIONS, AND SELF-TANNING PREPARATION, IN CLASS 3 (U.S. CLS. 1, 4, 6, 50, 51 AND 52).

FIRST USE 11-0-2006; IN COMMERCE 11-0-2006.

THE MARK CONSISTS OF STANDARD CHARACTERS WITHOUT CLAIM TO ANY PARTICULAR FONT, STYLE, SIZE, OR COLOR.

"POWDER DRY HAS NO MEANING IN A FOREIGN LANGUAGE.

SER. NO. 78-877,987, FILED P.R. 5-5-2006; AM. S.R. 6-4-2008.

MARK SPARACINO, EXAMINING ATTORNEY

Int. Cl.: 16

Prior U.S. Cls.: 2, 5, 22, 23, 29, 37, 38, and 50

United States Patent and Trademark Office

Reg. No. 3,469,969

Registered July 15, 2008

TRADEMARK  
SUPPLEMENTAL REGISTER

FIANCÉ & FIANCÉE

SIMS , KATHLEEN M (UNITED STATES INDIVIDUAL)  
209 SOUTH JESSIE STREET  
JOLIET, IL 60433

FOR: PRINTED INVITATIONS THANK YOU  
NOTE CARDS; PRINTED CERTIFICATE OF ENGAGEMENT;  
BLANK JOURNAL BOOKS; PAPER NAPKINS,  
PAPER TABLECLOTH; PLACE CARDS; PRINTED  
ENGAGEMENT CARDS; GUEST BOOKS, IN CLASS 16  
(U.S. CLS. 2, 5, 22, 23, 29, 37, 38 AND 50).

FIRST USE 5-30-2008; IN COMMERCE 5-31-2008.

THE MARK CONSISTS OF STANDARD CHARACTERS  
WITHOUT CLAIM TO ANY PARTICULAR FONT,  
STYLE, SIZE, OR COLOR.

SER. NO. 78-908,632, FILED P.R. 6-15-2006; AM. S.R.  
11-15-2007.

TARAH HARDY, EXAMINING ATTORNEY

**Int. Cl.: 9**

**Prior U.S. Cls.: 21, 23, 26, 36, and 38**

**United States Patent and Trademark Office**

**Reg. No. 3,469,970**

**Registered July 15, 2008**

**TRADEMARK  
SUPPLEMENTAL REGISTER**

**MIDNIGHT CLEAR**

KNAPTON, RORY (UNITED STATES INDIVIDUAL)  
265 FIRESIDE RIDGE DRIVE  
DAHLONEGA, GA 30533

FOR: PRE-RECORDED COMPACT DISCS AND DIGITAL VIDEO DISCS FEATURING SOUND RECORDING OF MUSIC AND LYRICS, IN CLASS 9 (U.S. CLS. 21, 23, 26, 36 AND 38).

FIRST USE 1-16-2003; IN COMMERCE 1-23-2003.

THE MARK CONSISTS OF STANDARD CHARACTERS WITHOUT CLAIM TO ANY PARTICULAR FONT, STYLE, SIZE, OR COLOR.

SER. NO. 78-913,577, FILED P.R. 6-21-2006; AM. S.R. 6-2-2008.

CARYN GLASSER, EXAMINING ATTORNEY

Int. Cl.: 25

Prior U.S. Cls.: 22 and 39

United States Patent and Trademark Office

Reg. No. 3,469,971

Registered July 15, 2008

TRADEMARK  
SUPPLEMENTAL REGISTER



AXXIS, INC. (KENTUCKY CORPORATION)  
845 SOUTH NINTH STREET  
LOUISVILLE, KY 40203

FOR: CAPS; HATS; SHIRTS, IN CLASS 25 (U.S.  
CLS. 22 AND 39).

FIRST USE 9-1-2007; IN COMMERCE 9-1-2007.

THE COLOR(S) BLUE, GOLD, GREEN, GRAY,  
BLACK AND WHITE IS/ARE CLAIMED AS A  
FEATURE OF THE MARK.

THE MARK CONSISTS OF A DONKEY WITH A  
GRAY AND WHITE BODY RESTING ON GREEN  
GRASS AND THE WORDS "REST YOUR ASS IN  
THE" IN BLUE AND GOLD AND THE WORD  
"BLUEGRASS" IN GREEN.

SER. NO. 78-927,398, FILED P.R. 7-12-2006; AM. S.R.  
5-12-2008.

ROBERT C. CLARK JR., EXAMINING ATTORNEY

Int. Cls.: 16, 38, 39, and 41

Prior U.S. Cls.: 2, 5, 22, 23, 29, 37, 38, 50, 100, 101,  
104, 105, and 107

Reg. No. 3,469,972

United States Patent and Trademark Office

Registered July 15, 2008

TRADEMARK  
SERVICE MARK  
SUPPLEMENTAL REGISTER



TURISMO ANDALUZ, S.A. (SPAIN SOCIEDAD ANONIMA)  
COMPANIA, 40  
MALAGA, SPAIN 29008

FOR: PRINTED PUBLICATIONS, NAMELY, BOOKS, MAGAZINE AND MANUALS FEATURING INFORMATION PROMOTING THE AUTONOMOUS REGION OF ANDALUCIA; POSTERS AND BROCHURES FEATURING INFORMATION PROMOTING THE AUTONOMOUS REGION OF ANDALUCIA; HANDBOOKS FEATURING INFORMATION PROMOTING THE AUTONOMOUS REGION OF ANDALUCIA; CATALOGUES FEATURING CLOTHING AND PUBLICATIONS FROM THE AUTONOMOUS REGION OF ANDALUCIA; CALENDARS; INVITATIONS CARDS; STICKERS; BOOKS FEATURING INFORMATION PROMOTING THE AUTONOMOUS REGION OF ANDALUCIA, IN CLASS 16 (U.S. CLS. 2, 5, 22, 23, 29, 37, 38 AND 50).

FIRST USE 1-0-2007; IN COMMERCE 1-0-2007.

FOR: BROADCASTING OF RADIO PROGRAMS AND TELEVISION; ELECTRONIC MESSAGES TRANSMISSION SERVICES; INFORMATION AGENCY SERVICES FEATURING THE TRANSMISSION OF NEWS ITEMS TO NEWS REPORTING ORGANIZATIONS; TELECOMMUNICATIONS SERVICES, NAMELY, PERSONAL COMMUNICATION SERVICES, IN CLASS 38 (U.S. CLS. 100, 101 AND 104).

FIRST USE 1-0-2007; IN COMMERCE 1-0-2007.

FOR: PACKAGING ARTICLES FOR TRANSPORTATION; STORAGE OF GOODS IN GENERAL; TRAVEL ARRANGEMENT; TRANSPORT TRAVELERS SERVICES, NAMELY, TRANSPORT OF PASSENGERS; TOURIST OFFICES SERVICES, NAMELY, TOURIST AGENCY SERVICES, NOT PROVIDING HOTEL RESERVATIONS; ARRANGING EXCURSIONS FOR TOURIST, IN CLASS 39 (U.S. CLS. 100 AND 105).

FIRST USE 1-0-2007; IN COMMERCE 1-0-2007.

FOR: EDUCATIONAL SERVICES, NAMELY, CONGRESSES IN THE FIELD OF PROVIDING EDUCATION REGARDING THE PROMOTION OF ANDALUCIA AS TOURIST DESTINATION; ENTERTAINING AND SPORTING, NAMELY, ENTERTAINMENT IN THE NATURE OF GYMNASTIC PERFORMANCES, OPEN AIR ORCHESTRA PERFORMANCES, AND SPORTS PERFORMANCES IN THE NATURE OF SOCCER GAMES; ORGANIZATION OF COMMUNITY CULTURAL EVENTS; ORGANIZATION OF EVENTS FOR EDUCATIONAL PURPOSES, NAMELY, EDUCATIONAL EXHIBITIONS IN THE NATURE OF PROVIDING EDUCATIONAL INFORMATION FOR USE IN THE PROMOTION OF ANDALUCIA AS A TOURIST DESTINATION, IN CLASS 41 (U.S. CLS. 100, 101 AND 107).

FIRST USE 1-0-2007; IN COMMERCE 1-0-2007.

SER. NO. 78-938,626, FILED P.R. 7-27-2006; AM. S.R. 6-5-2008.

DANIEL BRODY, EXAMINING ATTORNEY

**Int. Cl.: 41**

**Prior U.S. Cls.: 100, 101, and 107**

**United States Patent and Trademark Office**

**Reg. No. 3,469,973**

**Registered July 15, 2008**

**SERVICE MARK  
SUPPLEMENTAL REGISTER**

**San Francisco  
International Beer Festival**

TELEGRAPH HILL COOPERATIVE NURSERY  
SCHOOL (CALIFORNIA CORPORATION)

555 CHESTNUT ST.

SAN FRANCISCO, CA 94133

FOR: CONDUCTING ENTERTAINMENT EXHIBITIONS IN THE NATURE OF BEER FESTIVALS, IN CLASS 41 (U.S. CLS. 100, 101 AND 107).

FIRST USE 5-30-1986; IN COMMERCE 5-30-1986.

THE MARK CONSISTS OF STANDARD CHARACTERS WITHOUT CLAIM TO ANY PARTICULAR FONT, STYLE, SIZE, OR COLOR.

NO CLAIM IS MADE TO THE EXCLUSIVE RIGHT TO USE "INTERNATIONAL BEER FESTIVAL", APART FROM THE MARK AS SHOWN.

SER. NO. 78-961,058, FILED P.R. 8-25-2006; AM. S.R. 6-4-2008.

RENEE MCCRAY, EXAMINING ATTORNEY