

NOAA Technical Report NMFS 5



Net Phytoplankton and  
Zooplankton in the New York  
Bight, January 1976 to  
February 1978, With Comments  
on the Effects of Wind,  
Gulf Stream Eddies, and  
Slope Water Intrusions

Daniel E. Smith and Jack W. Jossi

May 1984

U.S. DEPARTMENT OF COMMERCE  
National Oceanic and Atmospheric Administration  
National Marine Fisheries Service

## NOAA TECHNICAL REPORTS NMFS

The major responsibilities of the National Marine Fisheries Service (NMFS) are to monitor and assess the abundance and geographic distribution of fishery resources, to understand and predict fluctuations in the quantity and distribution of these resources, and to establish levels for optimum use of the resources. NMFS is also charged with the development and implementation of policies for managing national fishing grounds, development and enforcement of domestic fisheries regulations, surveillance of foreign fishing off United States coastal waters, and the development and enforcement of international fishery agreements and policies. NMFS also assists the fishing industry through marketing service and economic analysis programs, and mortgage insurance and vessel construction subsidies. It collects, analyzes, and publishes statistics on various phases of the industry.

The NOAA Technical Report NMFS series was established in 1983 to replace two subcategories of the Technical Reports series: "Special Scientific Report—Fisheries" and "Circular." The series contains the following types of reports: Scientific investigations that document long-term continuing programs of NMFS, intensive scientific reports on studies of restricted scope, papers on applied fishery problems, technical reports of general interest intended to aid conservation and management, reports that review in considerable detail and at a high technical level certain broad areas of research, and technical papers originating in economics studies and from management investigations.

Copies of NOAA Technical Report NMFS are available free in limited numbers to governmental agencies, both Federal and State. They are also available in exchange for other scientific and technical publications in the marine sciences. Individual copies may be obtained from: Publications Services Branch (E/AI 13), National Environmental Satellite, Data, and Information Service, National Oceanic and Atmospheric Administration, U.S. Department of Commerce, 3300 Whitehaven St., Washington, DC 20235.



NOAA Technical Report NMFS 5

Net Phytoplankton and  
Zooplankton in the New York  
Bight, January 1976 to  
February 1978, With Comments  
on the Effects of Wind,  
Gulf Stream Eddies, and  
Slope Water Intrusions

Daniel E. Smith and Jack W. Jossi

May 1984

U.S. DEPARTMENT OF COMMERCE

Malcolm Baldrige, Secretary

National Oceanic and Atmospheric Administration

John V. Byrne, Administrator

National Marine Fisheries Service

William G. Gordon, Assistant Administrator for Fisheries

The National Marine Fisheries Service (NMFS) does not approve, recommend or endorse any proprietary product or proprietary material mentioned in this publication. No reference shall be made to NMFS, or to this publication furnished by NMFS, in any advertising or sales promotion which would indicate or imply that NMFS approves, recommends or endorses any proprietary product or proprietary material mentioned herein, or which has as its purpose an intent to cause directly or indirectly the advertised product to be used or purchased because of this NMFS publication.



## CONTENTS

Introduction .....	1
Methods .....	1
Plankton sampling .....	1
Phytoplankton examination .....	2
Zooplankton examination .....	2
Temperature and salinity measurements .....	2
Results .....	3
Effects of warm core Gulf Stream eddies on plankton .....	3
Effects of wind events on plankton .....	4
Conclusions .....	7
Acknowledgments .....	7
Literature cited .....	7

## Figures

1. The Hardy continuous plankton recorder .....	2
2. The New York Bight with an envelope including the routes along which Hardy continuous plankton recorder samples and expendable bathythermograph and sea surface salinity data were collected, January 1976 to January 1978 .....	2
3. Monthly mean abundance of the net phytoplanktonic dinoflagellates and diatoms in continuous plankton recorder samples taken from New York Bight shelf water, January 1976 to January 1978 .....	3
4. Monthly mean abundance of net phytoplanktonic diatoms in continuous plankton recorder samples taken from New York Bight shelf water, January 1976 to January 1978 .....	3
5. Monthly mean abundance of copepods in continuous plankton recorder samples taken from New York Bight shelf and slope water, January 1976 to January 1978 .....	3
6. Monthly mean abundance of tropical zooplankton in continuous plankton recorder samples taken from New York Bight shelf and slope water, January 1976 to January 1978 .....	4
7. Sea surface salinity and water column temperature distribution along a transect running southeastward from Ambrose Light, N.Y., 19-20 November 1977 .....	4
8. Sea surface salinity and water column temperature distribution along a transect running southeastward from Ambrose Light, N.Y., 17-18 December 1977 .....	5
9. Hardy continuous plankton recorder, expendable bathythermograph, and sea surface salinity transect, 17-18 December 1977 .....	5
10. Water column temperature distribution along a transect running southeastward from Ambrose Light, N.Y., 12 February 1978 .....	5
11. Monthly mean Ekman transports for lat. 40°N, long. 70°W during 1976 and 1977 .....	6
12. Sea surface salinity and water column temperature distribution along a transect running southeastward from Ambrose Light, N.Y., 20 October 1977 .....	7

## Appendix Tables

1. Plankton and environmental data from the New York Bight shelf and slope water, 26-27 January 1976 .....	9
2. Plankton and environmental data from the New York Bight shelf and slope water, 17-18 April 1976 .....	10
3. Plankton and environmental data from the New York Bight shelf and slope water, 14-15 May 1976 .....	11
4. Plankton and environmental data from the New York Bight shelf and slope water, 16-17 June 1976 .....	12
5. Plankton and environmental data from the New York Bight shelf and slope water, 5-6 July 1976 .....	13
6. Plankton and environmental data from the New York Bight shelf and slope water, 14 August 1976 .....	14
7. Plankton and environmental data from the New York Bight shelf and slope water, 23-24 October 1976 .....	15
8. Plankton and environmental data from the New York Bight shelf and slope water, 9 November 1976 .....	16
9. Plankton and environmental data from the New York Bight shelf and slope water, 12-13 January 1977 .....	17
10. Plankton and environmental data from the New York Bight shelf and slope water, 11 February 1977 .....	18
11. Plankton and environmental data from the New York Bight shelf and slope water, 15-16 March 1977 .....	19
12. Plankton and environmental data from the New York Bight shelf and slope water, 16 April 1977 .....	20
13. Plankton and environmental data from the New York Bight shelf and slope water, 5-6 May 1977 .....	21-22
14. Plankton and environmental data from the New York Bight shelf and slope water, 20-21 July 1977 .....	23-24
15. Plankton and environmental data from the New York Bight shelf and slope water, 31 August 1977 .....	25
16. Plankton and environmental data from the New York Bight shelf and slope water, 13-14 September 1977 .....	26-27
17. Plankton and environmental data from the New York Bight shelf and slope water, 9-10 October 1977 .....	28-29
18. Plankton and environmental data from the New York Bight shelf and slope water, 19-20 November 1977 .....	30
19. Plankton and environmental data from the New York Bight shelf and slope water, 17-18 December 1977 .....	31-32
20. Plankton and environmental data from the New York Bight shelf and slope water, 1-2 January 1978 .....	33

21. List of species and coarser taxa identified in CPR samples from the New York Bight, 26 January 1976-2 January 1978 . . . .	34-40
22. Taxa of plankton taken from the New York Bight that were considered by the authors to be of tropical or subtropical origin .	41

# Net Phytoplankton and Zooplankton in the New York Bight, January 1976 to February 1978, With Comments on the Effects of Wind, Gulf Stream Eddies, and Slope Water Intrusions

DANIEL E. SMITH and JACK W. JOSSI<sup>1</sup>

## ABSTRACT

Results are given of monthly net phytoplankton and zooplankton sampling from a 10 m depth in shelf, slope, and Gulf Stream eddy water along a transect running southeastward from Ambrose Light, New York, in 1976, 1977, and early 1978. Plankton abundance and temperature at 10 m and sea surface salinity at each station are listed. The effects of atmospheric forcing and Gulf Stream eddies on plankton distribution and abundance are discussed. The frequency of Gulf Stream eddy passage through the New York Bight corresponded with the frequency of tropical-subtropical net phytoplankton in the samples. Gulf Stream eddies injected tropical-subtropical zooplankton onto the shelf and removed shelfwater and its entrained zooplankton. Wind-induced offshore Ekman transport corresponded generally with the unusual timing of two net phytoplankton maxima. Midsummer net phytoplankton maxima were recorded following the passage of Hurricane Belle (August 1976) and a cold front (July 1977). Tropical-subtropical zooplankton which had been injected onto the outer shelf by Gulf Stream eddies were moved to the inner shelf by a wind-induced current moving up the Hudson Shelf Valley.

## INTRODUCTION

The New York Bight contains abundant living marine resources. It is used extensively for urban waste disposal, merchant shipping, recreation, coastal zone construction, and fishing (Gross et al. 1976).

Concern over the possibility of these uses affecting the natural resources of the New York Bight has aroused considerable attention and study in the last few years. In the MESA New York Bight Atlas Monographs, Bowman and Wunderlich (1977) have summarized historic hydrographic data and portrayed the mean annual cycle of hydrographic properties, Hansen (1977) has described circulation, Yentsch (1977) has discussed the factors controlling primary production, Grosslein and Azarovitz (in press) have summarized the distribution of fish, McHugh and Ginter (1978) discussed the fisheries, and Malone (1977) has reviewed plankton systematics and distribution. In other studies, Han and Niedrauer (1981) recently reported on hydrography and mixing, Beardsley and Boicourt (1981) have summarized knowledge of atmospheric forcing over the continental shelf. Cook (1979a, b), Cook and Hughes (1980), and Hughes and Cook (1981) have portrayed the cross shelf and slope monthly thermal structure along a transect running southeastward out of New York City for the years 1976 through 1979. Judkins et al. (1980) reported on the composition, abundance, and distribution of zooplankton over a yearly cycle in the New York Bight.

In order to increase our understanding of the interaction between plankton, the environment, and the living marine resources, the Ship of Opportunity-Ocean Monitoring Program (SOOP) of the U.S. National Marine Fisheries Service in January 1976 began conducting monthly sampling for surface salinity, water column

temperature, and plankton at 10 m along a transect running southeastward from New York harbor to approximately lat. 38°30' N, long. 72°00' W. This route is one of several monitored monthly by the SOOP. The plankton sampling effort is part of a cooperative agreement with the Institute for Marine Environmental Research of the United Kingdom to extend their more than 35-yr standardized plankton survey into the western North Atlantic. Previous descriptions of the biology and ecology resulting from this study may be found in Smith and Marrero (1976) and Smith and Jossi (1979). This paper reports on the first 2 yr of plankton variations along one transect of this extended coverage, and includes data from other sources which are relevant to these variations.

## METHODS

### Plankton Sampling

Net phytoplankton and zooplankton at a depth of 10 m from the waters overlying the continental shelf and slope were collected from ships of opportunity by towing Hardy Continuous Plankton Recorders (CPR's) (Hardy 1939; Fig. 1) along routes lying within the envelope shown in Figure 2.

A continuous record of the plankton retained by the sampler is obtained along the track of the ship at one sampling depth. This record is cut into 18.5 km (10 nmi) sections (herein termed "samples") with times, dates, and positions calculated for their centerpoints. Water passing through the CPR is filtered with bolting silk having mean aperture dimensions of 225 × 234 μm.

The CPR mesh size allows most phytoplankton to pass through. Therefore, the samples are quantitative for only the largest members of the phytoplankton, and those taxa whose chains, horns, spines, setae, or gelatinous sheaths or threads cause them to become entangled in the silk fibers. Abundances of these quantitative taxa

<sup>1</sup>Northeast Fisheries Center Atlantic Environmental Group, National Marine Fisheries Service, NOAA, RR 7, South Ferry Road, Narragansett, RI 02882.

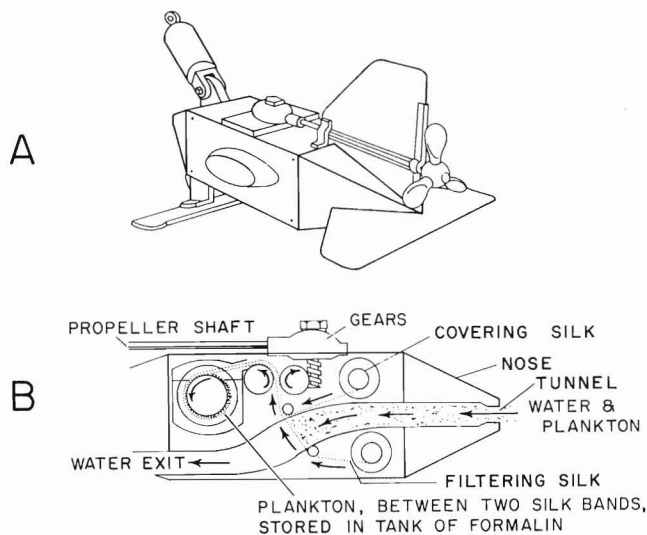

Figure 1.—The Hardy continuous plankton recorder. A. Seen from the left rear. B. Section showing the paths of the seawater and plankton and the two bands of bolting silk.

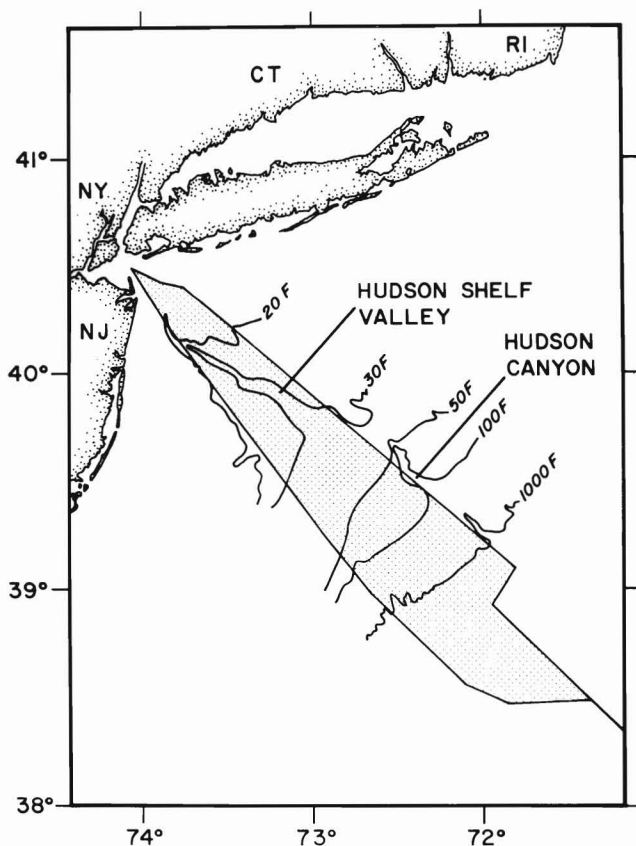

Figure 2.—The New York Bight with an envelope including the routes along which Hardy continuous plankton recorder samples and expendable bathythermograph and sea surface salinity data were collected, January 1976 to January 1978. Isobaths indicate depths in fathoms.

are not additive because the retention rates vary with their sizes and shapes. However, the retention rate of each of these taxa is constant enough to show the timing of events at 10 m, and often in the entire mixed layer. The qualitative taxa in the samples are valuable in establishing the presence of exotic specimens along the transect. They also assist in defining the temporal and spacial distribution of these forms.

### Phytoplankton Examination

Phytoplankton taxa were identified by examination of 20 microscopic fields (approximately 1/6,986th aliquot) distributed randomly across the sample. The number of occurrences of each taxon per 20 fields was converted to the number of that taxon in the 20 field aliquot by a statistical method of Colebrook (1960). Finally, an aliquot factor was applied to calculate the number of phytoplankton per liter of water filtered.

Beginning with the May 1977 data, a crude, but potentially useful, estimate of total phytoplankton was employed. It involved comparing the intensity of green color on the sections of filtering silk with a set of three color standards (Colebrook and Robinson 1961). Average values for the categories (very pale green, pale green, and green) were in the ratios of 1 to 2 to 6.5. We determined these relative numerical values for the period May 1977-January 1978.

### Zooplankton Examination

Zooplankton were examined from both the filtering silk and the covering silk (Fig. 1). Most of the zooplankton are retained in a quantitative manner. Exceptions are nauplii, copepodites, and small adult copepods (*Farranula*, *Oncaea*, *Corycaeus*, *Oithona*, and other small or gelatinous plankton). All the larger zooplankton ( $\geq 2$  mm) in the sample were identified and their numbers were recorded by abundance categories. Estimates of the mean abundances of these categories are reported here. This method is described by Colebrook (1960). The same method was applied to counts of smaller zooplankton ( $< 2$  mm) seen in an aliquot (approximately 1/45th) of the sample (actual aliquot fraction depended on the rate of silk advance through the CPR during each tow).

### Temperature and Salinity Measurements

Expendable bathythermograph probes (XBT's) were dropped and surface water samples were collected for salinity determination at approximately 18 km intervals. Sea surface salinity/XBT transects were occasionally made at times in addition to those when the CPR was towed.

Contoured vertical temperature profiles were prepared from XBT traces by Cook (1979a, b), Cook and Hughes (1980), and Hughes and Cook (1981). Plankton sample locations were plotted on these temperature profiles to determine the samples' relation to water mass boundaries, slope water intrusion, and shelf water entrainment around eddies. Sample temperatures (the 10 m temperatures of the sample center positions) were read from the XBT traces. If an XBT drop was not made at a sample center position, then a 10 m temperature was linearly interpolated from adjacent XBT drops.

A sea surface salinity value of 34.5‰ was used as a boundary to distinguish the fresher shelf water from the more saline slope water. If a salinity sample was not taken at a plankton sample center position, then a salinity value was obtained by linearly interpolating from adjacent observations.

Satellite imagery, as portrayed by the U.S. Navy Oceanographic Office in the weekly Experimental Ocean Frontal Analysis<sup>2</sup> charts, also was used to help determine the positions of the shelf water/slope water front and Gulf Stream eddies.

## RESULTS

Appendix Tables 1-20 list plankton abundance from all analyzed samples arranged by month. The water masses, sea surface salinities, and 10 m temperatures are listed for each sample where available. Table 21 names the plankton taxa sampled in this survey.

Monthly abundance of selected net phytoplankton taxa in shelf and slope water is shown in Figures 3 and 4, and monthly abundance of copepods in shelf and slope water is shown in Figure 5. Monthly abundance of tropical and subtropical zooplankton is compared with the occurrence of Gulf Stream eddies adjacent to the continental shelf in Figure 6.

### Effects of Warm Core Gulf Stream Eddies on Plankton

The greater occurrence of eddies in 1977 corresponded with more frequent occurrence of tropical and subtropical net phytoplankton taxa (Table 22). In 1976, there were three such occurrences in shelf water and three in slope water, while in 1977 such taxa occurred in these water masses 27 and 17 times, respectively.

<sup>2</sup>U.S. Naval Oceanographic Office. 1977 and 1978. Experimental Ocean Frontal Analysis. Unpubl. manusc., 14 and 21 December 1977 and 15 February 1978, 1 p. each. Fleet Applications, NSTL Station, Bay St. Louis, MS 39522.

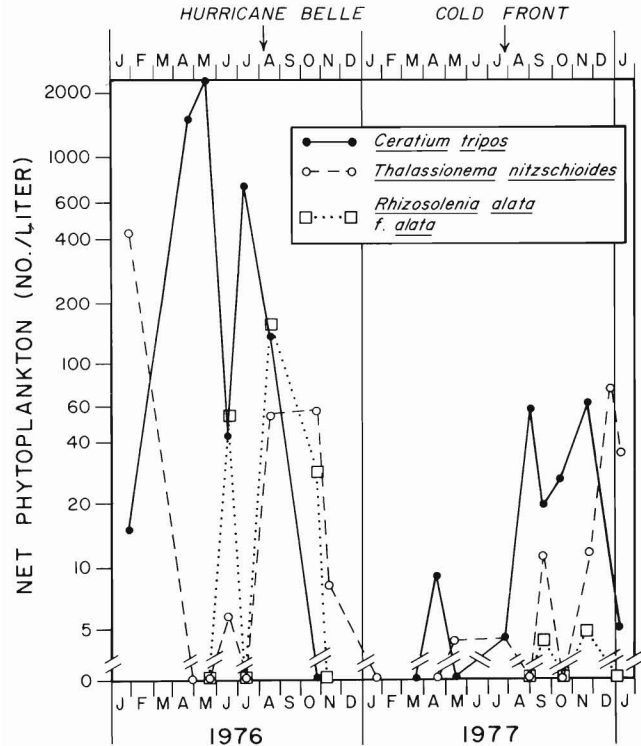

Figure 3.—Monthly mean abundance of the net phytoplanktonic dinoflagellate *Ceratium tripos*, and diatoms *Thalassionema nitzschioides* and *Rhizosolenia alata f. alata* in continuous plankton recorder samples taken from the New York Bight shelf water, January 1976 to January 1978. Note break in abundance scale.

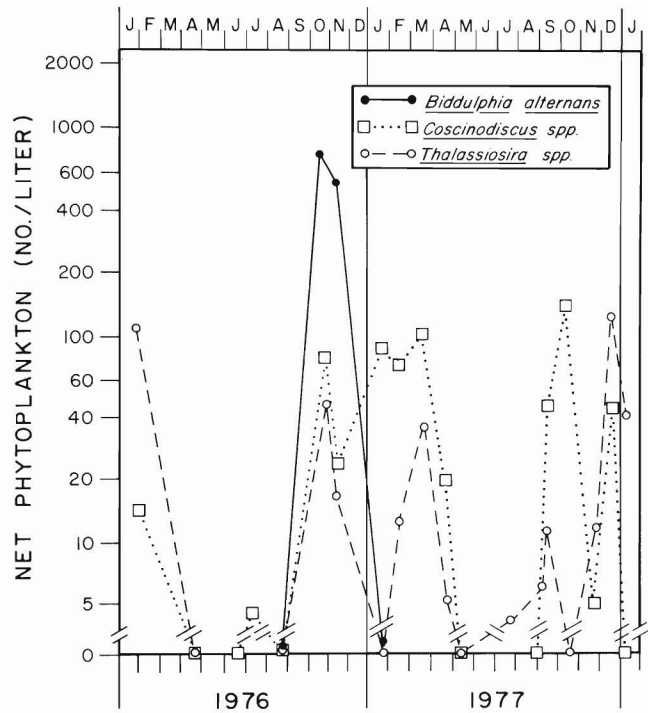

Figure 4.—Monthly mean abundance of the net phytoplanktonic diatoms *Biddulphia alternans*, *Coscinodiscus* spp., and *Thalassiosira* spp. in continuous plankton recorder samples taken from the New York Bight shelf water, January 1976 to January 1978. Note break in abundance scale.

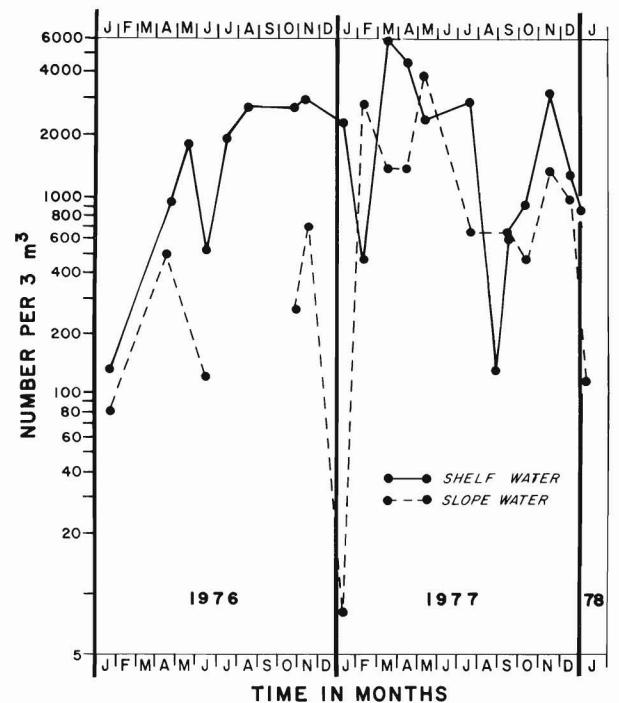

Figure 5.—Monthly mean abundance of copepods in continuous plankton recorder samples taken from the New York Bight shelf and slope water, January 1976 to January 1978.

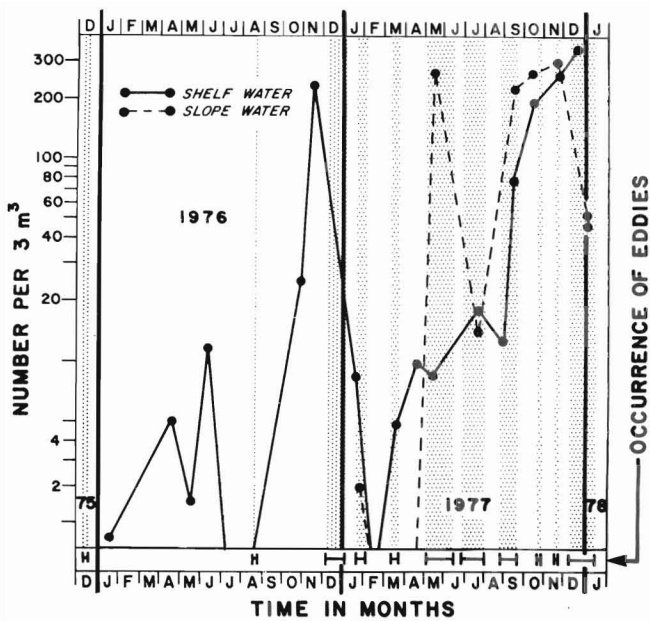

Figure 6.—Monthly mean abundance of tropical-subtropical zooplankton in continuous plankton recorder samples taken from the New York Bight shelf and slope water, January 1976 to January 1978. Occurrence of Gulf Stream eddies at the edge of the continental shelf, December 1975 to January 1978, is shown by the bars along the horizontal axis.

Gulf Stream eddies injected tropical and subtropical zooplankton into the shelf water. Figure 7 shows an intrusion of eddy water and a mixing of eddy-slope-shelf water at about 45 m in November 1977. Figure 8 shows another eddy pushing 13° and 14° C water onto the shelf in December 1977. CPR sample no. 8 (Table 19) was collected from the tongue of 13° C water at a depth of 10 m. It contained more tropical-subtropical zooplankton (701/3m<sup>3</sup>) than any other shelf water sample (372/3m<sup>3</sup> or less) during December. This suggests that at least some of the tropical-subtropical zooplankton in the shelf water in this month came from this tongue of mixed eddy-slope-shelf water (see Table 22 for a list of tropical-subtropical plankton). Tropical-subtropical zooplankton (Fig. 6) occurred in shelf water in every season, primarily during or after the passage of Gulf Stream eddies along the shelf break. These eddy water intrusions appear to be an important mechanism for altering the biota of the shelf environment.

Gulf Stream eddies are also shown removing shelf water from the continental shelf at the surface in Figures 9 and 10 and at depths to 40 m in Figures 8 and 10. One would expect that shelf water plankton would likewise be removed by this entrainment, and that slope or eddy water intrusions might occur to replace the lost shelf water. We found the shelf water copepod *Calanus finmarchicus* in these entrainment features at abundances ranging from one- to two-thirds of the maximum abundance of this species in shelf samples during these months.

### Effects of Wind Events on Plankton

Wind induced offshore Ekman transport, which can cause upwelling, corresponded generally with the unusual timing of two of the phytoplankton maxima shown in Figure 3. Mean monthly Ekman transport data (Fig. 11) show a greater magnitude of offshore transport (upwelling) during May to July 1976 than for the same period of 1977. This coincides with much higher *Ceratium*

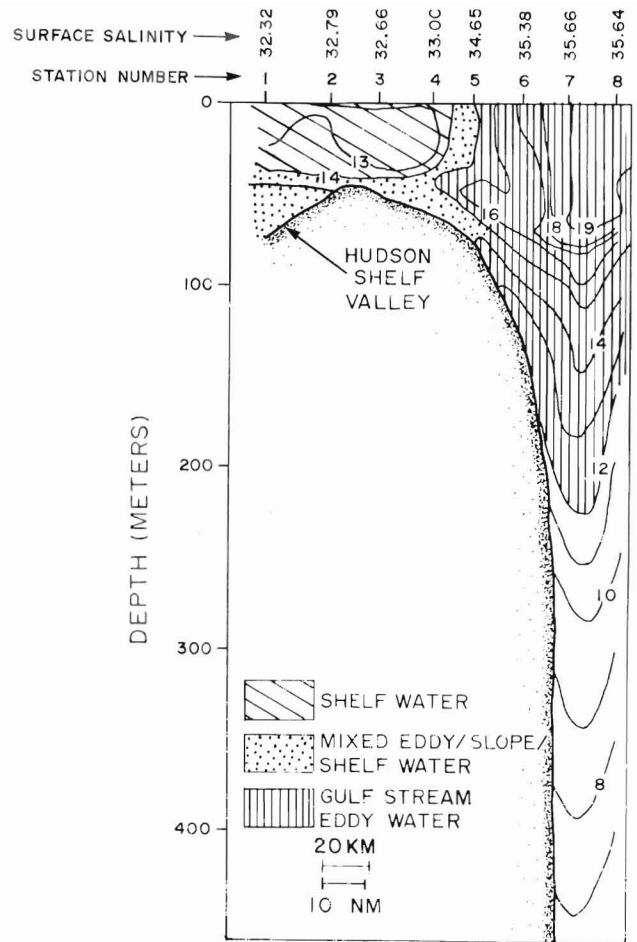

Figure 7.—Sea surface salinity (‰) and water column temperature (°C) distribution along a transect running southeastward from Ambrose Light, N.Y., 19-20 November 1977. A Gulf Stream eddy is seen pushing warm water onto the shelf and 15° C water occupies the portion of the Hudson Shelf Valley transected. (Modified from Cook 1979b.)

*tripos* concentrations, and a longer duration of what appears to be its spring bloom during that period in 1976 than 1977 (Fig. 3). *Ceratium tripos* increased during another episode of offshore transport in August 1977.

Two phytoplankton maxima that corresponded with wind induced mixing events were 1) the August 1976 *Thalassionema* and *Rhizosolenia* maxima which were recorded 4 d after the passage over the transect (10 August 1976) of Hurricane Belle, and 2) the August 1977 *C. tripos* maxima which began about the time of the passage of a cold front which caused mixing of surface water with some of the subthermocline cold pool (Cook 1979b), and continued during the above-mentioned period of offshore Ekman transport in August 1977.

Wind induced currents altered the distribution of tropical-subtropical plankton after eddies had injected it onto the shelf. In December 1977, (Table 19, Fig. 8), there was a relatively high concentration of tropical-subtropical zooplankton (372/3m<sup>3</sup>) in sample no. 3 which was collected from the Hudson Shelf Valley. This was 93 km (≈ 50 nmi) inshore of the highest concentration (sample no. 8 = 701/3m<sup>3</sup>) collected from the tongue of mixed eddy-slope-shelf water sampled in the same month. We believe that these tropical and subtropical plankton were transported by a bottom current moving up the Hudson Shelf Valley in response to



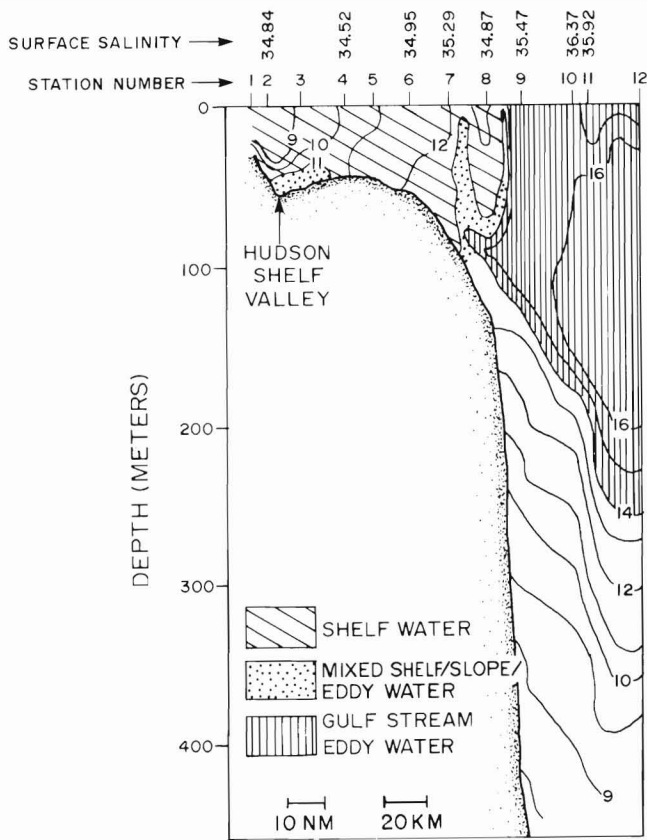

Figure 8.—Sea surface salinity (‰) and water column temperature (°C) distribution along a transect running southeastward from Ambrose Light, N.Y., 17-18 December 1977. A Gulf Stream eddy is seen pushing 13°C water onto the shelf. Relatively warm water occupies the portion of the Hudson Shelf Valley transected. (Modified from Cook 1979b.)

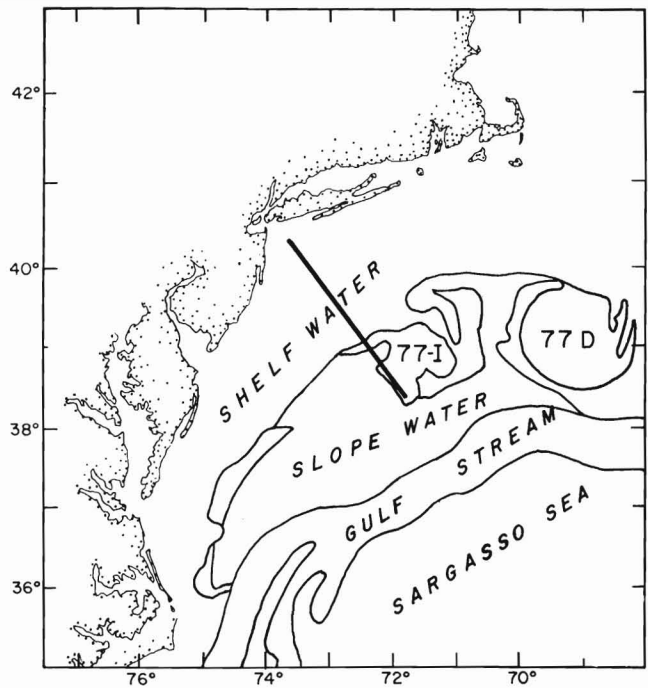

Figure 9.—Hardy continuous plankton recorder, expendable bathythermograph, and sea surface salinity transect, 17-18 December 1977, shown in relation to a composite of the surface water masses of 14 and 21 December 1977. (Modified from U.S. Naval Oceanographic Office.) Note the tongues of shelf water extending offshore to the east of eddy 77-I and 77-D.

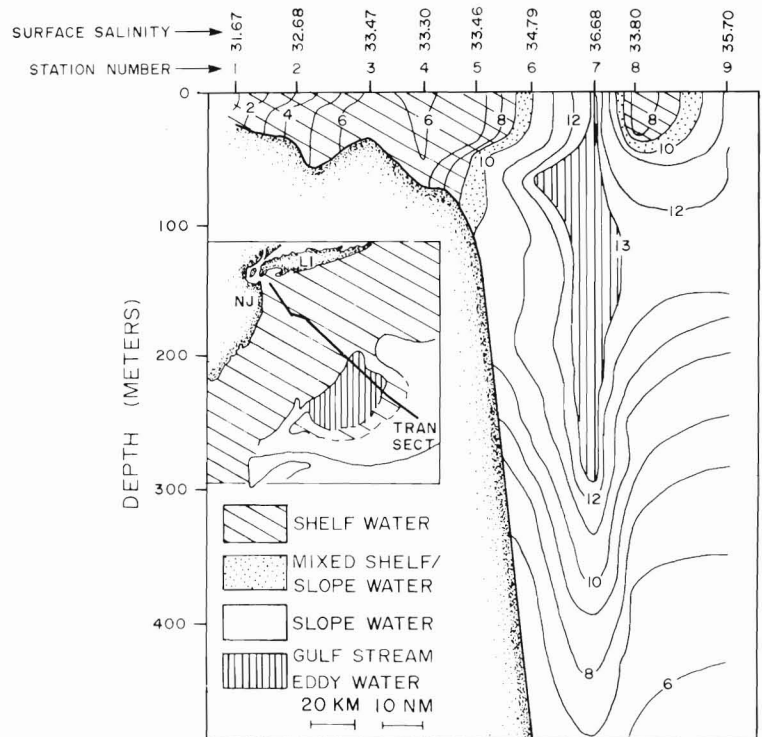

Figure 10.—Water column temperature (°C) distribution along a transect running southeastward from Ambrose Light, N.Y., on 12 February 1978 showing mass of shelf water < 10°C seaward of a Gulf Stream eddy. The inset shows the areal distribution of water masses on 16 February. (Modified from U.S. Naval Oceanographic Office.)

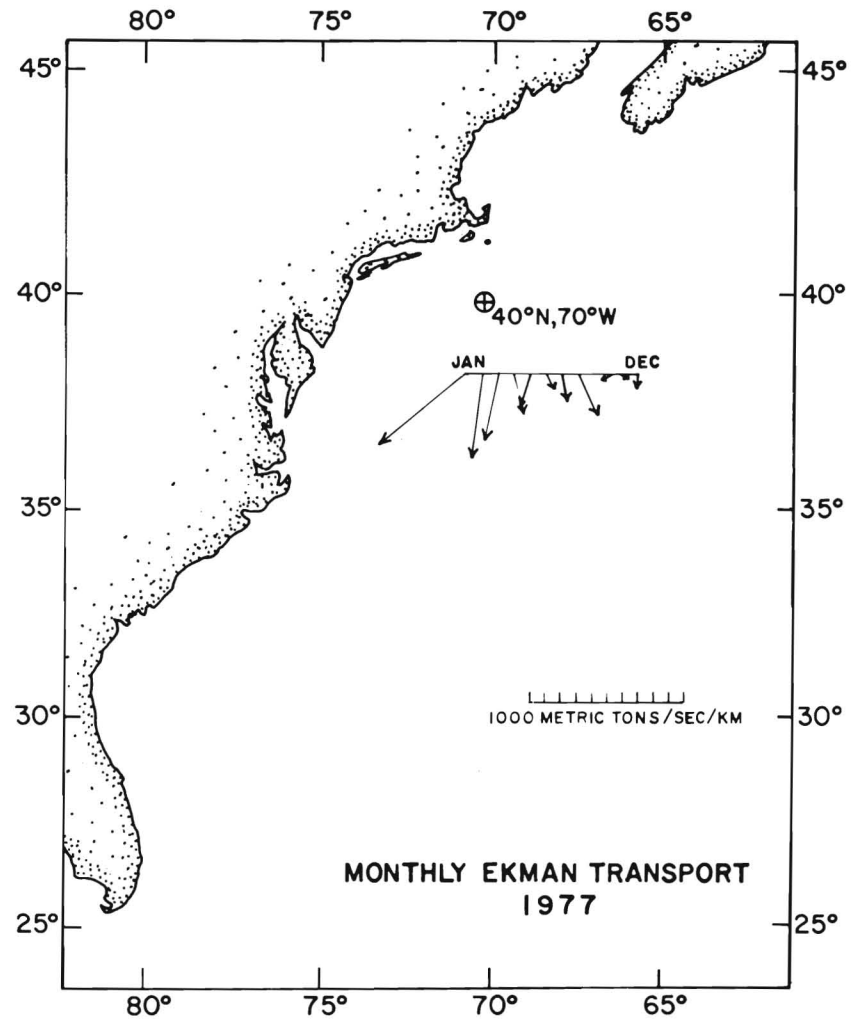
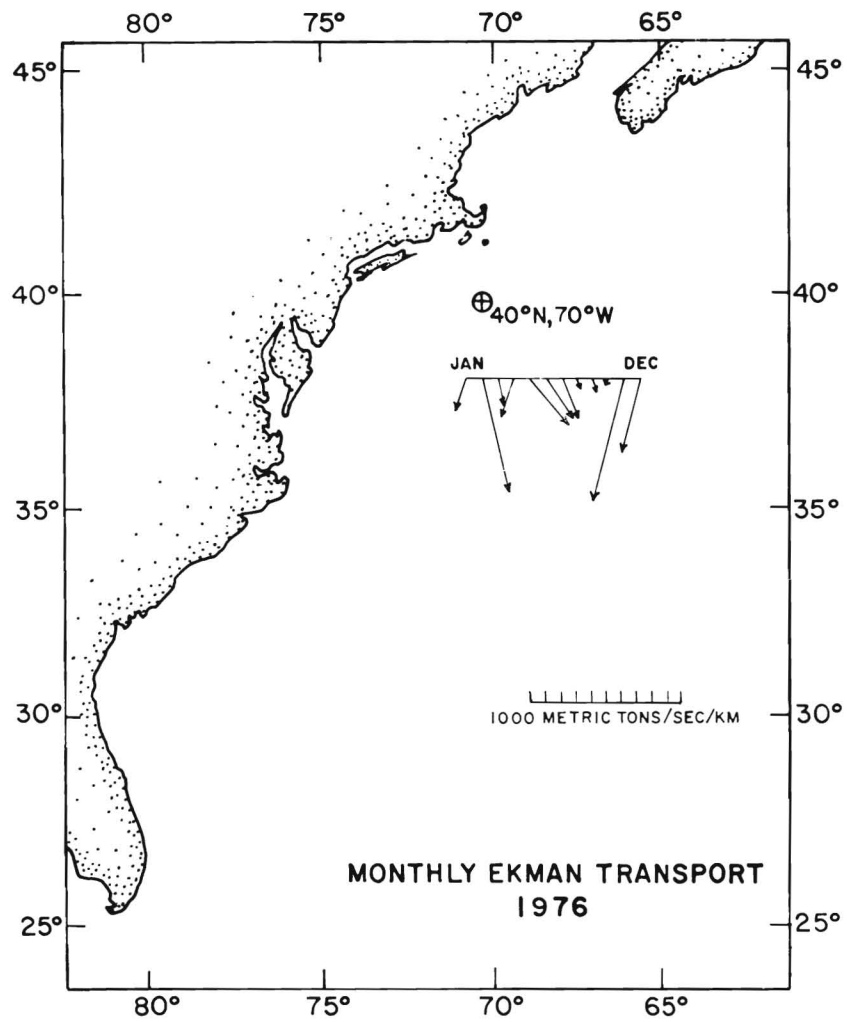

Figure 11.—Monthly mean Ekman transports for lat. 40°N, long. 70°W during 1976 and 1977. (From Ingham 1979a, b.)



northwest winds. From current meter data, Han<sup>3</sup> reports that such a current begins from as far offshore as the 60 m isobath and moves at speeds up to 20 cm/s. Nelson et al. (1978) also discussed this current in the upper Hudson Shelf Valley. Other evidence for this current having moved relatively warm, saline eddy or slope water containing tropical and subtropical plankton across the shelf is the increase of bottom temperatures from 11° to 15°C between October and November 1977 (Figs. 12, 7), and the rise in shelf water sea surface salinities from an average of 32.69‰ in November 1977 to an average of 34.22‰ in December 1977 (Figs. 7, 8). Neither the temperature nor the salinity increases can be solely attributed to fall overturn since bottom temperatures increased in November to values greater than any in the water column in October, and shelf water salinities sufficient to cause the measured salinity changes would be extremely rare. In December 1977 the Hudson Shelf Valley current transported tropical-subtropical plankton to within 30 km of Ambrose Light. This was 137 to 165 km shoreward of the surface expression of the eddies which were present during November and December. When other water masses are present in

the shelf valley, other taxa would be expected to be transported cross-shelf by this mechanism.

## CONCLUSIONS

Higher abundances of net phytoplankton in shelf water coincided with wind-induced offshore Ekman transport and with wind-induced mixing events. Two midsummer net phytoplankton maxima followed wind-induced mixing resulting from the passage of a cold front and Hurricane Belle.

Tropical-subtropical plankton were captured over the shelf primarily during and after the passage of Gulf Stream eddies. Eddies brought them over the mid- to outer-shelf, and onshore transport of water up the Hudson Shelf Valley distributed them further inshore. These data support the conclusion of Cox and Wiebe (1979) that tropical plankton in the Middle Atlantic Bight come from Gulf Stream eddies. The Hudson Shelf Valley probably also funnels outer-shelf plankton inshore when there is no Gulf Stream eddy water in the outer valley.

## ACKNOWLEDGMENTS

We thank the staffs of the U.S. Coast Guard, Atlantic Area, Marine Services Division, the U.S. Coast Guard Oceanographic Unit, and the officers and crews of the Coast Guard cutters *Dallas*, *Gallatin*, *Tamaroa*, and *Morganthau*. Also, we are indebted to the Sea Education Association, the officers and crew of their research vessel *Westward*, and the owners, officers, and crews of the tugs *Crusader* and *Port Jefferson*.

We also wish to thank Steven Cook and Robert Benway for their skillful handling of the logistics of the Ship of Opportunity Program and Merton Ingham and John Colton for their guidance in the preparation of the manuscript.

## LITERATURE CITED

- BEARDSLEY, R. C., and W. C. BOICOURT.  
1981. On estuarine and continental shelf circulation in the Middle Atlantic Bight. In B. A. Warren and C. Wunsch (editors), *Evolution of physical oceanography*, p. 198-233. MIT Press, Cambridge, Mass.
- BOWMAN, M. J., and L. D. WUNDERLICH.  
1977. Hydrographic properties. MESA New York Bight Atlas Monograph 1, 78 p. New York Sea Grant Inst., Albany.
- COLEBROOK, J. M.  
1960. Continuous plankton records: Methods of analysis, 1950-59. *Bull. Mar. Ecol.* 5:51-64.
- COLEBROOK, J. M., and G. A. ROBINSON.  
1961. The seasonal cycle of the plankton in the North Sea and the north-eastern Atlantic. *J. Cons. Perm. Int. Explor. Mer* 26:156-165.
- COOK, S. K.  
1979a. Water column thermal structure across the shelf and slope southeast of Sandy Hook, New Jersey, in 1976. In J. R. Goulet, Jr. and E. D. Haynes (editors), *Ocean variability in the U.S. Fishery Conservation Zone, 1976*, p. 231-257. U.S. Dep. Commer., NOAA Tech. Rep. NMFS Circ. 427.  
1979b. Water column thermal structure across the shelf and slope southeast of Sandy Hook, New Jersey, USA, in 1977. *Ann. Biol.* 34:14-21.
- COOK, S. K., and M. M. HUGHES.  
1980. Water column thermal structure across the shelf and slope southeast of Sandy Hook, New Jersey, USA, in 1978. *Ann. Biol.* 35:14-25.
- COX, J., and P. H. WIEBE.  
1979. Origins of oceanic plankton in the Middle Atlantic Bight. *Estuarine Coastal Mar. Sci.* 9:509-527.
- CUPP, E. E.  
1943. *Marine plankton diatoms of the west coast of North America*. Univ. Calif. Press, Berkeley, 237 p.
- FLEMINGER, A., and K. HULSEMAN.  
1977. Geographical range and taxonomic divergence in North Atlantic *Calanus*,

<sup>3</sup>G. Han, Oceanographer, NOAA Atlantic Oceanographic and Meteorological Laboratories, 15 Rickenbacker Causeway, Miami, FL 33149, pers. commun. 27 October 1980.

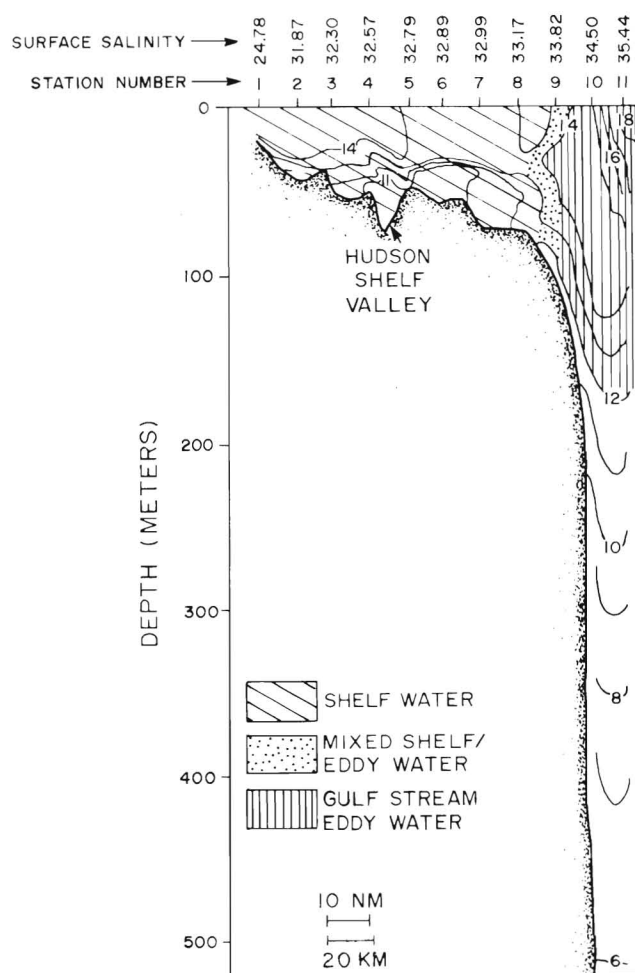

Figure 12.—Sea surface salinity (‰) and water column temperature (°C) distribution along a transect running southeastward from Ambrose Light, N.Y., 20 October 1977. Note the < 11°C water in the portion of the Hudson Shelf Valley transected. (Modified from Cook 1979b.)

- (*C. helgolandicus*, *C. finmarchicus* and *C. glacialis*). *Mar. Biol. (Berl.)* 40:233-248.
- GOSNER, K. L.  
1971. Guide to identification of marine and estuarine invertebrates. Cape Hatteras to the Bay of Fundy. Wiley-Intersci., N.Y., 693 p.
- GROSS, M. G., R. L. SWANSON, and H. M. STANFORD.  
1976. Man's impact on the middle Atlantic continental shelf and the New York Bight—Symposium summary. In M. G. Gross (editor), Middle Atlantic Continental Shelf and the New York Bight, p. 1-13. *Am. Soc. Limnol. Oceanogr., Spec. Symp.* 2.
- GROSSLEIN, M. D., and T. AZAROVITZ.  
In press. Fish distribution. MESA New York Bight Atlas Monograph 15. New York Sea Grant Inst., Albany.
- HAN, G., and T. NIEDRAUER.  
1981. Hydrographic observations and mixing processes in the New York Bight, 1975-1977. *Limnol. Oceanogr.* 26:1126-1141.
- HANSEN, D. V.  
1977. Circulation. MESA New York Bight Atlas Monograph 3, 24 p. New York Sea Grant Inst., Albany.
- HARDY, A. C.  
1939. Ecological investigations with the continuous plankton recorder: Object, plan and methods. *Hull Bull. Mar. Ecol.* 1:1-57.
- HENDEY, N. I.  
1964. An introductory account of the smaller algae of the British coastal waters, Part V: Bacillariophyceae (diatoms). *Minist. Agric., Fish., Food, Fish. Invest. Ser. IV, Her Majesty's Stationery Office, Lond.*, 317 p.
- HUGHES, M. M., and S. K. COOK.  
1981. Water column thermal structure across the shelf and slope southeast of Sandy Hook, New Jersey in 1979. *Ann. Biol.* 36:15-25.
- INGHAM, M. C.  
1979a. Marine environmental conditions off the Atlantic and Gulf coasts of the United States, January 1977-March 1978. *Mar. Fish. Rev.* 41 (5-6):35-47.  
1979b. Wind driven transport Atlantic coast and Gulf of Mexico. In J. R. Goulet, Jr. and E. D. Haynes (editors), Ocean variability in the U.S. Fishery Conservation Zone, 1976, p. 175-208. U.S. Dep. Commer., NOAA Tech. Rep. NMFS Circ. 427.
- JUDKINS, D. C., C. D. WIRICK, and W. E. ESAIAS.  
1980. Composition, abundance, and distribution of zooplankton in the New York Bight, September 1974-September 1975. *Fish. Bull., U.S.* 77:669-683.
- MALONE, T. C.  
1977. Plankton systematics and distribution. MESA New York Bight Atlas Monograph 13, 45 p. New York Sea Grant Inst., Albany.
- McHUGH, J. L., and J. J. C. GINTER.  
1978. Fisheries. MESA New York Bight Atlas Monograph 16, 129 p. New York Sea Grant Inst., Albany.
- NELSON, T. A., P. E. GADD, and T. L. CLARKE.  
1978. Wind-induced current flow in the upper Hudson Shelf Valley. *J. Geophys. Res.* 83:6073-6082.
- OWRE, H. B., and M. FOYO.  
1967. Copepods of the Florida Current with illustrated keys to genera and species. Fauna Caribaea, No. 1, Crustacea, Part 1: Copepoda. Univ. Miami, Coral Gables, Fla., 137 p.
- PAULSEN, O.  
1908. Peridinales. [In Ger.] In Nordisches Plankton, Botanischer Teil 18, p. 1-124. Lipsius & Tischer, Kiel.
- ROSE, M.  
1933. Copépodes pélagiques. *Faune Fr.* 26, 374 p.
- SMITH, D. E., and J. W. JOSSI.  
1979. Continuous plankton records: Zooplankton and net phytoplankton in the Mid-Atlantic Bight, 1976. In J. R. Goulet, Jr. and E. D. Haynes (editors), Ocean variability in the U.S. Fishery Conservation Zone, 1976, p. 337-348. U.S. Dep. Commer., NOAA Tech. Rep. NMFS Circ. 427.
- SMITH, D. E., and R. MARRERO.  
1976. Continuous plankton records: the 1976 *Ceratium tripos* bloom in the Mid-Atlantic Bight. Presented at the Interagency Plankton Workshop concerning the Oxygen Depletion and Associated Environmental Disturbances in the Middle Atlantic Bight in 1976. Lamont Doherty Geological Observatory, Columbia University, Palisades, N.Y., 19 November, 1976.
- WILLE, N.  
1908. Schizophyceen. In Nordisches Plankton, Botanischer Teil 20, 29 p. Lipsius & Tischer, Kiel.
- WILSON, C. B.  
1932. The copepods of the Woods Hole region, Massachusetts. *U.S. Natl. Mus. Bull.* 158, 635 p.
- WOOD, E. J. F.  
1968. Dinoflagellates of the Caribbean Sea and adjacent areas. Univ. Miami Press, Coral Gables, Fla., 143 p.
- YENTSCH, C. S.  
1977. Plankton production. MESA New York Bight Atlas Monograph 12, 25 p. New York Sea Grant Inst., Albany.

Table 1.—Plankton and environmental data from the New York Bight shelf and slope water, 26-27 January 1976. Watermasses: SH = shelf water; SL = slope water; E = Gulf Stream warm core eddy water. Abundances: phytoplankton, number per liter; zooplankton, number per 3 cubic meters. Organisms observed in the sample, but absent in the aliquot, are indicated by a "+" sign. A "\*" indicates that data are unavailable.

sample no.	1	3	5	7	9	11	13	15	$\bar{x}$ SH	$\bar{x}$ SL
position										
north latitude degs. & mins.	40-19	40-03	39-45	39-28	39-13	39-01	38-49	38-32		
west longitude degs. & mins.	73-41	73-25	73-14	72-59	72-43	72-23	72-02	71-48		
watermass	SH	SH	SH	SL	SL	SL	SL	SL		
day or night	D	N	N	N	N	N	N	N		
10 m temperature (°C)		4.4	4.8	7.9	13.2	13.6	13.5			
sea surface salinity (o/oo)		31.8	33.2	33.6	35.1	35.7	35.6			
phytoplankton color	*	*	*	*	*	*	*	*		
Bacillariophyceae										
Centricae										
Chaetoceros <i>Hyalochaete</i> spp.				37					9	
Coccinodiscus spp.	37	18			+		18		14	5
Hemiaulus spp.					+					+
Skeletonema <i>costatum</i>	130	56							47	
Thalassiosira spp.	56	279	37	74	+				112	+
Pennatae										
Asterionella <i>glacialis</i>	18	37							14	
Nitzschia <i>seriata</i>	186	223							102	
Thalassionema <i>nitzschioides</i>	297	1115	223	74	18				427	5
Dinophyceae										
Ceratum <i>macroceros</i>				+					+	
C. <i>tripos</i>		37		18	+			+	14	+
Silicoflagellata	37	37			+				19	+
Copepoda										
nauplii					77					19
Calanoida										
Acartia <i>tonsa</i>	38								9.5	
Calanus <i>finmarchicus</i> I-IV					+					+
C. <i>finmarchicus</i> V-VI		2			1				.5	.25
C. <i>minor</i>				1				1	.25	.25
Centropages <i>typicus</i>		+	+	+	38				+	9.5
Clausocalanus spp.			38						9.5	
Euchaeta <i>norvegica</i>								1		.25
Metridia <i>lucens</i>			1		2	2	4	2	.25	2.5
Mesocalanus <i>tenuicornis</i>							1			.25
Paracalanus spp. V		38							9.5	
Paracalanus-Pseudocalanus I-V		77		+					19	
Pleuromamma <i>abdominalis</i>								1		.25
P. <i>gracilis</i>					3	2	4	4		3.25
P. <i>xiphias</i>						1				.25
Pseudocalanus <i>minutus</i> VI	38								9.5	
P. <i>minutus</i> I-V		38							9.5	
Cyclopoida										
Oithona spp.	77	77		38					48	
Euphausiacea										
juveniles (<8 mm)	1								.25	
adults (≥8 mm)					1		1	1		.75
Chaetognatha ≥8 mm			1					1	.25	.25
fish larvae										
Myctophidae										
Lepidophanes <i>guentheri</i>						1		1		.5

Table 2.—Plankton and environmental data from the New York Bight shelf and slope water, 17-18 April 1976. Watermasses: SH = shelf water; SL = slope water; E = Gulf Stream warm core eddy water. Abundances: phytoplankton, number per liter; zooplankton, number per 3 cubic meters. Organisms observed in the sample, but absent in the aliquot, are indicated by a "+" sign. A "\*" indicates that data are unavailable.

sample no.	1	2	3	5	6	7	8	9	11	XSH
position										
north latitude degs. & mins.	40-72	40-13	40-05	39-49	39-41	39-33	39-26	39-18	39-03	
west longitude degs. & mins.	73-43	73-35	73-28	73-13	73-05	72-57	72-48	72-40	42-23	
watermass	SH	SH	SH	SH	SH	SH	SH	SH	SL	
day or night	D	D	D	D	D	D	D	D	D	
10 m temperature (°C)	*	*	*	*	*	*	*	*	*	
sea surface salinity (o/oo)	*	*	*	*	*	*	*	*	*	
phytoplankton color	*	*	*	*	*	*	*	*	*	
Bacillariophyceae										
Centricae										
<i>Coscinodiscus</i> spp.								+		+
Dinophyceae										
<i>Ceratium longipes</i>							+		+	+
<i>C. tripos</i>	390	1673	1673	1673	1673	1673	1673	1673	1673	1513
<i>Dinophysis norvegica</i>	+	+		+	+	+	+	+		+
<i>Protoperidinium</i> spp.		+		+	+	+			+	+
Protozoa										
Foraminifera									115	
Coelenterata	+								+	+
Cladocera										
<i>Evadne</i> spp.	77			38						14
<i>Podon</i> spp.		154								19
Copepoda										
nauplii	38								38	5
Calanoida										
<i>Acartia</i> spp.			115				77	38		29
<i>Calanus finmarchicus</i> I-IV	77			77			77	260	77	63
<i>C. finmarchicus</i> V-VI			2				2	2	52	.75
<i>Centropages typicus</i>	192	38	616		115	1193	2051	962	77	66
<i>Clausocalanus</i> spp.									77	
<i>Euchirella rostrata</i>									3	
<i>Metridia lucens</i>									66	
<i>Paracalanus-Pseudocalanus</i> I-V	154	1886	231	38	38		77		38	303
<i>Pleuromamma gracilis</i>									2	
<i>Pseudocalanus minutus</i> VI	115		115		38	115	115	1150		206
Cyclopoida										
<i>Oithona</i> spp.	38					154			77	24
Cirripedia										
larvae	38									5
Amphipoda										5
Hyperiidea							1			.13
Gammaridea					1					.13
Decapod larvae	3	35		1						4.9
Euphausiacea										
<i>calyptopsis</i>									38	
juvenile <8 mm									7	
adults >8 mm									6	
Mollusca					115					14
Lamellibranchiata					115					14
Thecosomata	38		77	77	1655	2232	4233	1116	154	1179
Chaetognatha										
<8 mm	38									4.8
>8 mm									5	
Larvacea	38									4.8

Table 3.—Plankton and environmental data from the New York Bight shelf and slope water, 14-15 May 1976. Watermasses: SH = shelf water; SL = slope water; E = Gulf Stream warm core eddy water. Abundances: phytoplankton, number per liter; zooplankton, number per 3 cubic meters. Organisms observed in the sample, but absent in the aliquot, are indicated by a "+" sign. A "\*" indicates that data are unavailable.

sample no.	1	3	5	7	xSH
position					
north latitude degs. & mins.	39-00	39-19	39-39	39-57	
west longitude degs. & mins.	72-37	72-53	73-09	73-24	
water mass	SH	SH	SH	SH	
day or night	D	D	D	D	
10 m temperature (°C)	*	*	*	*	
sea surface salinity (o/oo)	*	*	*	*	
phytoplankton color	*	*	*	*	
Dinophyceae					
<u>Ceratium fusus</u>					+
<u>C. lineatum</u>					+
<u>C. longipes</u>					+
<u>C. tripos</u>	2091	2091	2091	2091	2091
<u>Dinophysis norvegica</u>					+
<u>Protoperidinium</u> spp.					+
Siphonophora				+	+
Polychaeta					
<u>Tomopteris</u> spp.				2	.5
Copepoda					
Calanoida					
<u>Calanus finmarchicus</u> I-IV	289	144		48	120
<u>C. finmarchicus</u> V-VI		6		6	3
<u>Centropages typicus</u>	289	818	96	289	373
<u>Metridia lucens</u>				3	.75
<u>Paracalanus-Pseudocalanus</u> I-V	1684	818	289	144	734
<u>Pseudocalanus minutus</u> VI	289	289	144	48	193
<u>Temora longicornis</u>		48	48	289	96
Cyclopoida					
<u>Oithona</u>	96	289	144	96	625
Decapoda					
larvae		17	6	17	10
Sergestidae <u>Lucifer</u> spp.				6	1.5
Mysidacea				1	.25
Mollusca					
Thecosomata		3608	3608	3608	2706
Chaetognatha					
<8 mm		48		96	36
>8 mm				4	1.0
Fish eggs (total)	35		3	6	11
Scombridae					
<u>Scomber scombrus</u>				6	1.5
Fish larvae					
Bothidae					
<u>Paralichthys oblongus</u>				1	.25

Table 4.—Plankton and environmental data from the New York Bight shelf and slope water, 16-17 June 1976. Watermasses: SH = shelf water; SL = slope water; E = Gulf Stream warm core eddy water. Abundances: phytoplankton, number per liter; zooplankton, number 3 cubic meters. Organisms observed in the sample but absent in the aliquot, are indicated by a "+" sign. A "\*" indicates that data are unavailable.

sample no.	1	3	5	7	9	11	13	15	17	$\bar{x}$ SH	$\bar{x}$ SL
position											
north latitude degs. & mins.	40-02	39-46	39-29	39-13	38-58	38-48	38-37	38-24	38-12		
west longitude degs. & mins.	73-26	73-11	72-57	72-42	72-25	72-03	71-42	71-22	71-02		
watermass	SH	SH	SH	SH	SH/SL	SL	SL	SL	SL		
day or night	N	N	D	D	D	N	N	D	D		
10 m temperature (°C)	*	*	*	*	*	*	*	*	*		
sea surface salinity (o/oo)	*	*	*	*	*	*	*	*	*		
phytoplankton color	*	*	*	*	*	*	*	*	*		
Bacillariophyceae											
Centricae											
Chaetoceros Hyalochaete spp.									46		12
Rhizosolenia alata f. alata		70	139							52	
R. alata f. indica		23								6	
R. hebetata f. semispina						23	23				12
Pennatae											
Thalassionema nitzschioides			23							6	
Dinophyceae											
Ceratium fusus				93	46					23	
C. tripos	+	+	46	70	23	+	+	+		29	+
Oxytoxum scolopax									23		6
Silicoflagellatae	46			23		23				17	6
Copepoda											
Calanoida											
Calanus finmarchicus V-VI	1		17	6						6.0	
Candacia armata						2					.5
Centropages typicus	289	96	289							169	
Mecynocera clausi				48				+		12	+
Metridia lucens								6			1.5
Paracalanus-Pseudocalanus I-V			96	289		96		48		96	36
Pleuromamma gracilis						17	75	1	3		24
Pseudocalanus minutus VI	144	96	48		48					72	
Temora longicornis	817	144								96	
Cyclopoida											
Oithona spp.	96	48		96	48	144	48		96	60	72
Decapoda											
larvae		6	35	6	1					12	
Euphausiacea											
juveniles (<8 mm)		3	3	2		1	6		1	2.0	2
adults (≥8 mm)	6	35		1			6	1		11	1.8
Mollusca											
Thecosomata		48	1684							433	
Chaetognatha											
<8 mm		48			48					12	
≥8 mm	35	35	160	6	6	6	17	17	17	59	14.3

Table 5.—Plankton and environmental data from the New York Bight shelf and slope water, 5-6 July 1976. Watermasses: SH = shelf water; SL = slope water; E = Gulf Stream warm core eddy water. Abundances: phytoplankton, number per liter; zooplankton, number per 3 cubic meters. Organisms observed in the sample, but absent in the aliquot, are indicated by a "+" sign. A "\*" indicates that data are unavailable.

sample no.	1	3	5	7	9	$\bar{x}$ SH
position						
north latitude degs. & mins.	40-20	40-04	39-48	39-32	39-15	
west longitude degs. & mins.	73-41	73-26	73-11	72-55	72-40	
watermass	SH	SH	SH	SH	SH	
day or night	D	D	D	N	N	
10 m temperature (°C)	*	*	*	*	*	
sea surface salinity (o/oo)	*	*	*	*	*	
watermass	SH	SH	SH	SH	SH	
sample no.	1	3	5	7	9	
day or night	D	D	D	N	N	
10 m temperature (°C)	*	*	*	*	*	
sea surface salinity (o/oo)	*	*	*	*	*	
phytoplankton color	*	*	*	*	*	
Bacillariophyceae						
Centricae						
<i>Coscinodiscus</i> spp.	21					4
<i>Skeletonema costatum</i>	21					4
Dinophyceae						
<i>Ceratium tripos</i>	84	439	1255	795	1255	766
Copepoda						
Calanoida						
<i>Calanus finmarchicus</i>			6	17	35	12
<i>Centropages typicus</i>	1515	3247			43	961
<i>Metridia lucens</i>				6	35	8.2
<i>Paracalanus-Pseudocalanus</i> I-V		43			260	61
<i>Pseudocalanus minutus</i> VI		43				8.6
<i>Temora longicornis</i>	1515	1515				606
Cyclopoida						
<i>Oithona</i> spp.	43				87	26
Amphipoda						
Gammaridea				1		.20
Hyperiididae					6	1.2
Decapod larvae	6	2			2	2.0
Euphausiacea						
juveniles (< 8 mm)	1				2	.6
adults (≥ 8 mm)			1	1	6	1.6
Chaetognatha						
<8 mm	87					17
≥8 mm	6		1			1.4

Table 6.—Plankton and environmental data from the New York Bight shelf and slope water, 14 August 1976. Watermasses: SH = shelf water; SL = slope water; E = Gulf Stream warm core eddy water. Abundances: phytoplankton, number per liter; zooplankton, number per 3 cubic meters. Organisms observed in the sample, but absent in the aliquot, are indicated by a "+" sign. A "\*" indicates that data are unavailable.

sample no.	1	2	3	$\bar{x}$ SH
position				
north latitude degs. & mins.	40-19	40-11	40-04	
west longitude degs. & mins.	73-39	73-30	73-22	
watermass	SH	SH	SH	
day or night	D	D	D	
10 m temperature (°C)	*	*	*	
sea surface salinity (o/oo)	*	*	*	
phytoplankton color	*	*	*	
Bacillariophyceae				
Centricae				
<i>Rhizosolenia alata</i> f. <i>alata</i>	139	163	163	155
<i>R. alata</i> f. <i>gracillima</i>	23	70		31
<i>R. hebetata</i> f. <i>semispina</i>		23		8
Pennatae				
<i>Nitzschia seriata</i>		23	46	23
<i>Thalassionema nitzschioides</i>		23	139	54
Dinophyceae				
<i>Ceratium fusus</i>			23	8
<i>C. tripos</i>	139	163	46	116
Coelenterata				
Siphonophora		+		+
Ostracoda				
<i>Penilia</i> spp.	48			16
Copepoda				
Calanoida				
<i>Calanus finmarchicus</i> I-IV	144	48	192	128
<i>C. finmarchicus</i> V-VI	17	2	1	6.7
<i>Centropages typicus</i>	818	1684	7696	3399
<i>Labidocera aestiva</i>		6		2.0
<i>Paracalanus</i> - <i>Pseudocalanus</i> I-V		289	818	369
<i>Pseudocalanus minutus</i> VI		289	818	369
<i>Temora longicornis</i>		48	48	32
Cyclopoida				
<i>Oithona</i> spp.	96	96	96	96
Amphipoda				
Hyperiidia			35	11.7
Decapoda larvae	2	1	6	3
Chaetognatha ( $\geq 8$ mm)	1			.33



Table 7.—Plankton and environmental data from the New York Bight shelf and slope water, 23-24 October 1976. Watermasses: SH = shelf water; SL = slope water; E = Gulf Stream warm core eddy water. Abundances: phytoplankton, number per liter; zooplankton, number per 3 cubic meters. Organisms observed in the sample, but absent in the aliquot, are indicated by a "+" sign. A "\*" indicates that data are unavailable.

sample no. position	1	3	5	7	9	11	$\bar{x}$ SH	$\bar{x}$ SL
north latitude degs. & mins.	39-49	39-30	39-18	39-05	38-51	38-36		
west longitude degs. & mins.	73-27	73-18	73-00	72-41	72-24	72-07		
watermass	SH	SH	SH	SL	SL	SL		
day or night	N	N	N	N	N	D		
10 m temperature (°C)	14.5	14.8	15.5	17	17.6	18.8		
sea surface salinity (o/oo)	32.3	32.5	33.4	35.0	35.0	35.4		
phytoplankton color	*	*	*	*	*	*		
Bacillariophyceae								
Centricae								
Bacteriastrum spp.					17			6
Biddulphia alternans	662	1568	35				755	
Chaetoceros <u>Hyalochaete</u> spp.	35	35		35	35		23	23
C. <u>Phaeoceros</u> spp.				52	17	17		29
Coscinodiscus spp.	174	35	17				75	
Rhizosolenia <u>alata</u> f. <u>alata</u>		35	52	17	17		29	11
R. <u>calcar-avis</u>			17	17			6	6
Skeletonema <u>costatum</u>		35			17		12	6
Thalassiosira spp.	17	52	70		17		46	6
Pennatae								
Nitzschia <u>seriata</u>	35	35	35	52	35	17	35	35
Thalassiothrix <u>longissima</u>			52	105	35	35	17	58
T. <u>frauenfeldii</u>					35			12
Thalassionema <u>nitzschioides</u>	52	105	17	17	52		58	23
Dinophyceae								
Ceratium <u>fuscus</u>		17	70	35	17		29	17
C. <u>macrocerbs</u>			+		17	17	+	11
C. <u>minutum</u>					17			6
Dinophysis <u>norvegicus</u>					17			6
Prorocentrum spp.						17		6
Silicoflagellata		17	35	35	122	52	17	70
Coelenterata		+	+	+			+	+
Cladocera								
Penilia spp.	108						36	
Podon spp.	37						12	
Copepoda								
Calanoida								
Acartia spp.		36	36	108	36		24	48
Calanus <u>finmarchicus</u> I-IV		216	36				84	
C. <u>finmarchicus</u> V-VI	6						2	
C. <u>minor</u>		2		1			.67	.33
Candacia <u>armata</u>	2		1				1	
Centropages <u>typicus</u>	216	216	613	+			348	+
Eucalanus <u>monachus</u>		1					.33	
Mecynocera <u>clausi</u>					36			12
Paracalanus- <u>Pseudocalanus</u> I-V	613	216	216				348	
Pleuromamma <u>gracilis</u>				1				.33
Cyclopoida								
Corycaeus spp.	72						24	
Oithona spp.				72	36			12
Oncaea spp.				216				72
Harpacticoida	108						36	
Amphipoda								
Caprellidea					2			.67
Hyperiidea	35	1					12	
Decapoda								
larvae				1				.33
Sergestidae <u>Lucifer</u> spp.				1				.33
Euphausiacea								
juveniles	1						.33	
adults (>8 mm)			1	2			.33	.67
Chaetognatha >8 mm	2	35	17	6	6		18	4

Table 8.-Plankton and environmental data from the New York Bight shelf and slope water, 9 November 1976. Watermasses: SH = shelf water; SL = slope water; E = Gulf Stream warm core eddy water. Abundances: phytoplankton, number per liter; zooplankton, number per 3 cubic meters. Organisms observed in the sample, but absent in the aliquot, are indicated by a "+" sign. A "\*" indicates that data are unavailable.

sample no.	1	3	5	7	9	$\bar{x}$ SH
position						
north latitude degs. & mins.	40-12	39-58	39-44	39-30	39-16	
west longitude degs. & mins.	73-34	73-15	72-57	72-39	72-21	
watermass	SH	SH	SH	SH	SH	
day or night	N	N	N	N	D	
10 m temperature (°C)	*	*	*	*	*	
sea surface salinity (o/oo)	*	*	*	*	*	
phytoplankton color	*	*	*	*	*	
Bacillariophyceae						
Centricae						
<i>Biddulphia alternans</i>	1882	586	125	209	21	565
<i>Chaetoceros Hyalochaete</i> spp.		21				4
<i>Coccinodiscus</i> spp.	21	21		63		21
<i>Rhizosolenia calcar-avis</i>				21		4
<i>Skeletonema costatum</i>		21				4
<i>Thalassiosira</i> spp.				63	21	17
Pennatae						
<i>Thalassionema nitzschioides</i>				21	21	8
<i>Thalassiothrix longissima</i>				63		13
Dinophyceae						
<i>Ceratium fusus</i>				21	21	8
<i>C. massiliense</i>		21				4
Silicoflagellatae		42	42	42		25
Copepoda						
Calanoida						
<i>Acartia</i> spp.					+	+
<i>Calanus finmarchicus</i> I-IV					+	+
<i>C. finmarchicus</i> V-VI					2	.4
<i>C. minor</i> I-IV				736		147
<i>C. minor</i> V-VI				2	2	1.2
<i>Candacia armata</i> I-IV			86			17
<i>C. armata</i> V-VI			1	1		.4
<i>Centropages typicus</i>	736	736	736	736	130	615
<i>Eucalanus</i> I-IV				43	+	9
<i>Mecynocera clausi</i>			43			9
<i>Metridia lucens</i>			1	2	2	1
<i>Paracalanus-Pseudocalanus</i> I-V	260	3247	3247	1515	260	1706
<i>Pleuromamma gracilis</i>					2	.4
<i>Rhincalanus nasutus</i>				1		.2
Cyclopoida						
<i>Corycaeus</i> spp.	260					
<i>Oithona</i> spp.		87				52
<i>Oncaea</i> spp.	43				43	17
Harpacticoida	260	130	43	87	43	563
Amphipoda						
Hyperiidia		17	17	6	6	9
Euphausiacea (<8 mm)			1	2	6	1.8
Chaetognatha (>8 mm)	6	35	35	35	6	23

Table 9.—Plankton and environmental data from the New York Bight shelf and slope water, 12-13 January 1977. Watermasses: SH = shelf water; SL = slope water; E = Gulf Stream warm core eddy water. Abundances: phytoplankton, number per liter; zooplankton, number per 3 cubic meters. Organisms observed in the sample, but absent in the aliquot, are indicated by a "+" sign. A "\*" indicates that data are unavailable.

sample no.	1	3	5	7	9	11	x̄SH
position							
north latitude degs. & mins.	40-21	40-07	39-54	39-40	39-25	39-09	
west longitude degs. & mins.	73-35	73-16	72-57	72-38	72-21	72-09	
watermass	SH	SH	SH	SH	SL	E	
day or night	N	N	N	N	N	N	
10 m temperature (°C)	*	*	*	*	*	*	
sea surface salinity (o/oo)	*	*	*	*	*	*	
phytoplankton color	*	*	*	*	*	*	
Bacillariophyceae							
Centricae							
<i>Coscinodiscus</i> spp.	23	23	139	146			83
<i>Skeletonema costatum</i>	23						6
Dinophyceae							
<i>Ceratium fusus</i>			+	+			+
<i>C. macroceros</i>			+	+			+
Copepoda							
Calanoida							
<i>Calanus minor</i>			17	16	1		8
<i>Centropages typicus</i>	3608	3608	818	144			2045
<i>Metridia lucens</i>			6	6	6		3
<i>Paracalanus-Pseudocalanus</i> I-V			818				205
<i>Pleuromamma gracilis</i>				6	1		1.5
<i>Rhincalanus nasutus</i>	1		2				.75
Cyclopoida							
<i>Oithona</i> spp.		48					12
Amphipoda							
Hyperiidea	2		6				2
Euphausiacea							
juveniles (<8 mm)	2		6	2			2.5
adults (≥8 mm)			6	6	6	6	3
Mysidacea	1						.25
Cephalopoda			1				.25
Chaetognatha >8 mm	17	35		2			14
fish larvae	1						.25

Table 10.—Plankton and environmental data from the New York Bight shelf and slope water, 11 February 1977. Watermasses: SH = shelf water; SL = slope water; E = Gulf Stream warm core eddy water. Abundances: phytoplankton, number per liter; zooplankton, number per 3 cubic meters. Organisms observed in the sample, but absent in the aliquot, are indicated by a "+" sign. A "\*" indicates that data are unavailable.

sample no.	1	3	5	7	9	11	$\bar{x}$ SH	$\bar{x}$ SL
position								
north latitude degs. & mins.	40-21	40-04	39-48	39-32	39-15	39-04		
west longitude degs. & mins.	73-42	73-27	73-12	72-57	72-42	72-33		
watermass	SH	SH	SH	SL	SL	E		
day or night	N	N	N	N	N	N		
10 m temperature (°C)	0.0	1.3	4.1	8.5	9.9	12.2		
sea surface salinity (o/oo)	33.7	33.8	34.5	35.3	35.4	36.5		
phytoplankton color	*	*	*	*	*	*	*	*
Bacillariophyceae								
Centricae								
<i>Chaetoceros Hyalochaete</i> spp.					35	105		18
<i>Coscinodiscus</i> spp.			209	627	105		70	366
<i>Thalassiosira</i> spp.			35	35		105	12	18
Silicoflagellatae			105				35	
Siphonophora								+
Copepoda								
Calanoida								
<i>Calanus minor</i>						1		
<i>Centropages typicus</i>			1227	5411	433		409	2922
<i>Pseudocalanus minutus</i> VI			144				48	
<i>Temora turbinata</i>						72		
Amphipoda								
Hyperiidea				1				.5

Table 11.—Plankton and environmental data from the New York Bight shelf and slope water, 15-16 March 1977. Watermasses: SH = shelf water; SL = slope water; E = Gulf Stream warm core eddy water. Abundances: phytoplankton, number per liter; zooplankton, number per 3 cubic meters. Organisms observed in the sample, but absent in the aliquot, are indicated by a "+" sign. A "\*" indicates that data are unavailable.

sample no.	1	3	5	7	9	10	xSH
position							
north latitude degs. & mins.	40-17	40-01	39-45	39-29	39-13	39-05	
west longitude degs. & mins.	73-45	73-30	73-14	72-59	72-44	72-37	
watermass	SH	SH	SH	SH	SH	SL	
day or night	D	N	N	N	N	N	
10 m temperature (°C)	3.0	3.9	3.6	5.7	6.6	9.0	
sea surface salinity (o/oo)	31.6	33.2	33.8	34.2	34.2	34.6	
phytoplankton color	*	*	*	*	*	*	
Bacillariophyceae							
Centricae							
<u>Coscinodiscus</u> spp.			186	244	58	58	98
<u>Thalassiosira</u> spp.		+	35	35	116	163	37
Pennatae							
<u>Thalassionema nitzschioides</u>			+				+
<u>Thalassiothrix longissima</u>						12	
Dinophyceae							
<u>Ceratium furca</u>			46				9
<u>C. fusus</u>					+	12	+
<u>C. lineatum</u>				12	+		2
<u>C. macroceros</u>			+	+	12		2
<u>Dinophysis</u> spp.				46			9
<u>Protoperidinium</u> spp.			12	+	+	46	
Copepoda							
nauplii					144	48	29
Calanoida							
<u>Calanus</u> I-IV	144	144		+		48	576
<u>C. finmarchicus</u> V-VI				3			.6
<u>Centropages typicus</u>	144	1804	1804	842	144	144	948
<u>Metridia lucens</u>				3			.6
<u>Paracalanus</u> - <u>Pseudocalanus</u> I-V	144	3848	3848	409	144		1679
<u>Pseudocalanus minutus</u> VI	24	409	409		24	48	173
Cyclopoida							
<u>Corycaeus</u> spp.					24	+	5
<u>Oithona</u> spp.	24	72	48	48	144	144	67
Amphipoda							
Hyperiidea				2	1		.6
Decapoda							
larvae				1			.2
Euphausiacea							
<u>Calyptopsis</u>	24					48	5
Chaetognatha $\geq 8$ mm	1		6				1.4

Table 12.—Plankton and environmental data from the New York Bight shelf and slope water, 16 April 1977. Watermasses: SH = shelf water; SL = slope water; E = Gulf Stream warm core eddy water. Abundances: phytoplankton, number per liter; zooplankton, number per 3 cubic meters. Organisms observed in the sample, but absent in the aliquot, are indicated by a "+" sign. A "\*" indicates that data are unavailable.

sample no.	1	3	5	7	9	11	$\bar{x}$ SH
position							
north latitude degs. & mins.	40-18	40-02	39-47	39-32	39-16	39-01	
west longitude degs. & mins.	73-45	73-28	73-12	72-55	72-39	72-23	
watermass	SH	SH	SH	SH	SH	SL	
day or night	N	D	D	D	D	D	
10 m temperature (°C)	7.0	7.0	6.3	7.5	8.0	10.8	
sea surface salinity (o/oo)	30.9	31.2	33.8	34.1	34.0	35.6	
phytoplankton color	*	*	*	*	*	*	
Bacillariophyceae							
Centricae							
<i>Chaetoceros Hyalochaete</i> spp.	46						9
<i>C. Phaeoceros</i> spp.	+						
<i>Coscinodiscus</i> spp.		12	12	23	46	46	19
<i>Thalassiosira</i> spp.	23						5
Dinophyceae							
<i>Ceratium fusus</i>		+	+	+	12	35	2
<i>C. tripos</i>		35	+	+	12	12	9
<i>Protoperidinium</i> spp.		+					+
Silicoflagellatae						35	
Coelenterata							
Siphonophora						+	
other Coelenterata	+						+
Copepoda							
nauplii					144		29
Calanoida							
<i>Calanus finmarchicus</i> I-IV	144	409	1804	842	842	24	808
<i>C. finmarchicus</i> V-VI		17	75	75	75	17	48
<i>C. minor</i>				1			.2
<i>Calocalanus</i> spp.			24				5
<i>Centropages typicus</i>		144	842	409	144	144	308
<i>Clausocalanus</i> spp.					842	144	168
<i>Metridia lucens</i>			1	1	1	1	.6
<i>Papacalanus-Pseudocalanus</i> I-V	144	842	1804	1804	409	409	1001
<i>Pseudocalanus minutus</i> VI	144	409	842	409	409	+	443
<i>Temora longicornis</i>		48	144				38
<i>T. turbinata</i>			24				5
Cyclopoida							
<i>Oithona</i> spp.	842	409	144	144	144	24	337
Cirripede							
larvae	144		+				29
Decapoda							
larvae			6				1.2
Euphausiacea							
<i>Calyptopsis</i>						24	
juveniles (>8 mm)			1			17	.2
Cephalopoda	1						.2

Table 13.—Plankton and environmental data from the New York Bight shelf and slope water, 5-6 May 1977. Watermasses: SH = shelf water; SL = slope water; E = Gulf Stream warm core eddy water. Abundances: phytoplankton, number per liter; zooplankton, number per 3 cubic meters. Organisms observed in the sample, but absent in the aliquot, are indicated by a "+" sign. A "\*" indicates that data are unavailable.

sample no.	1	3	5	7	9	11	13	15	$\bar{x}$ SH	$\bar{x}$ SL
position										
north latitude degs. & mins.	40-20	40-05	39-51	39-36	39-21	39-07	39-06	38-53		
west longitude degs. & mins.	73-48	73-31	73-13	72-56	72-38	72-21	72-18	72-02		
watermass	SH	SH	SH	SH	SH	SL	SL	SL		
day or night	D	D	N	N	N	N	D	D		
10 m temperature (°C)	-	9.5	9.5	9.2	10.4	15.4	-	15.3		
sea surface salinity (o/oo)	*	*	*	*	*	*	*	*		
phytoplankton color	6.5	1	0	0	0	2	2	0		
Bacillariophyceae										
Centricae										
Chaetoceros Hyalochaete spp.					125		63		25	21
C. Phaeoceros spp.							+	21		7
Coscinodiscus spp.							+	42		14
Rhizosolenia alata f. alata						146	335	21		167
R. alata f. indica						21	+			7
R. imbricata shrubsolei							21			7
Pennatae										
Nitzschia seriata						21				7
Thalassionema nitzschioides		21							4	
Dinophyceae										
Ceratium furca								+	+	+
C. fusus		21	+	+		21	21	63	4	35
C. hexacanthum								+		+
C. horridum		21							4	
C. lineatum								+		+
C. longipes				+				+		+
C. macroceros						21		+		7
C. tripos	+	+	+	+		21		+	+	7
Ceratocorys spp.								+		+
Coelenterata										
Siphonophora							+			+
Other coelenterates		+					+	+	+	+
Polychaeta							1			.33
Cladocera										
Evadne spp.								+		+
Podon spp.		43							8.6	
Ostracoda								3		1.0
Copepoda										
nauplii						260	260	43		188
Calanoida										
Calanus finmarchicus i-IV	43									
C. finmarchicus V-VI	1	75	75	75	75	75		75	60	50
Candacia i-IV						43	130	43		43
C. armata V-VI								3		1
Candacia sp.							6			2
Centropages sp.			43	43					17	
Clausocalanus spp. VI					130	736	736	260	26	346
Eucalanus attenuatus						1				.33
E. mucronatus								1		.33
Metridia copepodites I-IV	43	43			43				26	
Metridia lucens V-VI		6	6	17	3	3			6.4	1
Paracalanus-Pseudocalanus I-V	260	260	260	736	1515	260	736	1515		837
Pleuromamma I-IV							260			87
Pseudocalanus minutus VI	43	43	130	260	736	130			242	43
Rhincalanus nasutus						2		4		2
Temora longicornis	87	87	130		43				69	
T. stylifera					43	+	43		9	14
Cyclopoida										
Corycaeus spp.								43	43	29
Farranula gracilis								130		43
Oithona spp.	260	43		87	130	736	736	736	104	736
Oncaea spp.								260	43	101
Sapphirina spp.								1		.33
Harpacticoida									87	29
Macrosetella gracilis								+		+
Amphipoda										
Hyperiidia			3		1	2	1		.8	1

Decapoda										
larvae									2	.67
Lucifer spp.									1	.33
Euphausiacea										
calyptopis						87			43	43.33
juveniles (<8 mm)			6	2	6	6	1	6	1.6	4.33
adults (>8 mm)				1	1				.2	.33
Chaetognatha										
<8 mm	87	87	43	43	43	87	87		60.6	58
>8 mm		1	35	35	35	75	3		21.2	26
Larvacea						260	736	260		418.67

---



Table 14.—Plankton and environmental data from the New York Bight shelf and slope water, 20-21 July 1977. Watermasses: SH = shelf water; SL = slope water; E = Gulf Stream warm core eddy water. Abundances: phytoplankton, number per liter; zooplankton, number per 3 cubic meters. Organisms observed in the sample, but absent in the aliquot, are indicated by a "+" sign. A "\*" indicates that data are unavailable.

sample no.	1	3	5	7	8	9	10	11	$\bar{x}$ SH
position									
north latitude degs. & mins.	40-17	40-01	39-45	39-29	39-21	39-13	39-05	38-57	
west longitude degs. & mins.	73-41	73-25	73-09	72-54	72-46	72-38	72-31	72-23	
watermass	SH	SH	SH	SH	SH	SH	E	SL	
day or night	D	D	D	D	N	N	N	N	
10 m temperature (°C)	22.8	23.4	24.0	23.0	23.0	23.0	26.0	25.1	
sea surface salinity (o/oo)	31.6	31.7	31.8	32.2	32.4	32.8	34.2	35.0	
phytoplankton color	0	0	0	0	0	0	0	0	0
Bacillariophyceae									
Centricae									
Bacteriastrum spp.							84	42	
Chaetoceros Hyalochaete							21	21	
Rhizosolenia alata f. alata							21		
R. calcar-avis				21	21	21		42	10
R. hebetata f. semispina						42			7
Rhizosolenia sp.								42	
Thalassiosira spp.						21			4
Pennatae									
Thalassionema nitzschioides		21							4
Dinophyceae									
Ceratium furca								21	
C. fusus		63	21	42	21	63	21	84	35
C. longipes			21						4
C. schroeteri								21	
C. tripos		+	21	+					4
Gonyaulax spp.								21	
Gymnodinium spp.			21					42	4
Coelenterata									
Siphonophora			+	+	+	+			+
other Coelenterata		+		+	+	+			+
Cladocera									
Penilia spp.				3247	736	1515	260	43	916
Copepoda									
nauplii		86							14
Calanoida									
Acartia spp.						43	43	43	7
Calanus finmarchicus I-IV		260	260	43		129		260	115
C. finmarchicus V-VI		1	6	6		3	1	6	2.7
C. minor				3	1	3	1	4	1
Candacia armata				2	2	1		1	.83
Centropages bradyi					1	1		1	.33
C. typicus	736	736	6926	736	260	260	43		1609
Clausocalanus spp.							43	43	
Mecynocera clausi									.33
Metridia lucens						2			
Paracalanus-Pseudocalanus I-VI		736	3247	736	736	1515		86	1112
Pleuromamma abdominalis								2	
P. gracilis						1	2	6	.17
Pseudocalanus minutus VI	736	736	736	129		260		43	433
Rhincalanus nasutus						1		1	.17
Temora I-IV								43	
T. turbinata	43								7
Cyclopoida									
Farranula gracilis								43	
Oithona spp.	260	260	260	43	736	260	260	260	303
Oncaea spp.				43					7
Cirripede									
larvae			43						7
Amphipoda									
Hyperiidea			1	2	3	3		2	1.5
Decapoda									
larvae		6	35	75	35	1			25
Euphausiacea									
juvenile <8 mm								1	
adult >8 mm								1	
Mysidacea	6								1

Stomatopoda							1	
Chaetognatha								
<8 mm	129		86	129	260		129	101
>8 mm	75	75	75	75	75	35	35	63
Larvacea				43			43	7
fish larvae			6	6				2

---

Table 15.—Plankton and environmental data from the New York Bight shelf and slope water, 31 August 1977. Watermasses: SH = shelf water; SL = slope water; E = Gulf Stream warm core eddy water. Abundances: phytoplankton, number per liter; zooplankton, number per 3 cubic meters. Organisms observed in the sample, but absent in the aliquot, are indicated by a "+" sign. A "\*" indicates that data are unavailable.

sample no.	1	2	3	$\bar{x}$ SH
position				
north latitude degs. & mins.	40-16	40-08	40-00	
west longitude degs. & mins.	73-40	73-32	73-24	
watermass	SH	SH	SH	
day or night	D	D	D	
10 m temperature (°C)	*	*	*	
sea surface salinity (o/oo)	*	*	*	
phytoplankton color	0	0	0	0
Bacillariophyceae				
Centricae				
Thalassiosira spp.			19	6
Rhizosolenia calcar-avis	37			12
Dinophyceae				
Ceratium fusus	74	56	56	62
C. lineatum	19	37	37	31
C. tripos	56	74	37	56
Prorocentrum spp.			19	6
Cladocera				
Penilia spp.			73	24
Copepoda				
Calanoida				
Calanus finmarchicus V-VI	3		3	2
Centropages typicus		+	73	24
Metridia lucens	1			.33
Paracalanus-Pseudocalanus I-V			73	24
Pseudocalanus minutus VI			146	49
Temora stylifera	1			.33
Cyclopoida				
Oithona spp.		36	36	24
Oncaea spp.	36			12
Amphipoda				
Hyperiidea			1	.33

Table 16.—Plankton and environmental data from the New York Bight shelf and slope water, 13-14 September 1977. Watermasses: SH = shelf water; SL = slope water; E = Gulf Stream warm core eddy water. Abundances: phytoplankton, number per liter; zooplankton, number per 3 cubic meters. Organisms observed in the sample, but absent in the aliquot, are indicated by a "+" sign. A "\*" indicates that data are unavailable.

sample no.	1	3	5	7	9	11	12	13	14	16	$\bar{x}$ SH	$\bar{x}$ SL
position												
north latitude degs. & mins.	40-21	40-08	39-55	39-41	39-28	39-14	39-08	39-01	38-56	38-44		
west longitude degs. & mins.	73-37	73-18	72-58	72-39	72-20	72-01	71-51	71-58	72-08	72-19		
watermass	SH	SH	SH	SH	SH	SL	SL	SL/SH	SH	SH/E		
day or night	N	N	N	N	N	D	D	D	D	D		
10 m temperature (°C)	*	*	*	*	*	*	*	23.9	23.7	23.5		
sea surface salinity (o/oo)	*	*	*	*	*	*	*	34.47	34.48	35.23		
phytoplankton color	6.5	2	2	0	0	0	0	0	0	0	1.75	0
Cyanophyceae												
<u>Trichodesmium</u> spp.	37										7	
Bacillariophyceae												
Centricae												
<u>Bacteriastrum</u> spp.			19		19	19					8	10
<u>Chaetoceros</u> <u>Hyalochaete</u> spp.					19	19	19	19	19			19
<u>C. Phaeoceros</u> spp.					19	19					4	10
<u>Coscinodiscus</u> spp.	37	74		37	74						44	
<u>Rhizosolenia alata</u> f. <u>alata</u>					19		19			19	4	10
<u>R. calcar-avis</u>		19	19	112	74	19	19	37			45	19
<u>R. hebetata</u> f. <u>simispina</u>					74						15	
<u>R. imbricata</u> <u>shrubsolei</u>							19					10
<u>Thalassiosira</u> spp.	37	19									11	
Pennatae												
<u>Asterionella glacialis</u>									19			
<u>Navicula</u> spp.						19						10
<u>Thalassionema nitzschioides</u>	19			37		19				19	11	10
Dinophyceae												
<u>Ceratium carriense</u>				+							+	
<u>C. extensum</u>							74		19	19		37
<u>C. fusus</u>		74	37		19	19	+				26	10
<u>C. incisum</u>						19						10
<u>C. lineatum</u>	19	74									19	
<u>C. longipes</u>		19									4	
<u>C. macroceros</u>		74	74	37			19			+	37	10
<u>C. massiliense</u>			37	74							22	
<u>C. tripos</u>		74		19							19	
<u>Dinophysis</u> spp.		19									4	
<u>Oxytoxum scolopax</u>				19							4	
<u>Prorocentrum</u> spp.							37				7	19
Protozoa												
Foraminifera					+	+	+				+	+
Radiolaria					+	+	+	+			+	+
Tintinnidae					38	38					8	19
Coelenterata												
Siphonophora			+								+	
Cladocera												
<u>Evadne</u> spp.				38							8	
<u>Penilia</u> spp.	1347	2886	231	38							1126	
<u>Podon</u> spp.	231	38			77						69	
Ostracoda			1	1		1	6	17	6	1	.4	35
Copepoda												
nauplii	38				38	38	77				15	58
Calanoida												
<u>Acartia danae</u>							115					58
<u>Acartia</u> spp.				77	77		115	38			31	58
<u>Calanus</u> I-IV				231			77	77			46	39
<u>C. finmarchicus</u> V-VI		75	2	6							17	
<u>C. minor</u>		1	6	6	3	17	17	1	2	1	3.2	17
<u>Calocalanus</u> spp.						231	115		38	38		173
<u>Candacia armata</u> V-VI		2	17	6		1		1			5.0	.5
<u>C. curta</u>							1					.5
<u>C. longimana</u>							2					1.0
<u>C. norvegica</u>							1					.5
<u>Candacia</u> spp.							1					.5
<u>Centropages bradyi</u>					17	35	6				3.4	21
<u>C. typicus</u>	38		115		38						38	
<u>Mecynocera clausi</u>					38						7.6	
<u>Metridia lucens</u>				1							.2	

Paracalanus-Pseudocalanus I-V	115										654						154		
<u>Pleuromamma gracilis</u>											1						.2		
<u>Pseudocalanus minutus</u> VI	231	231									77			115			108	58	
<u>Scolecithrix danae</u>											6	2	2	6	1	1	1	1.6	4
<u>Temora I-IV</u>											38				38	38		7.6	
<u>T. turbinata</u>											38				38				
<u>Undinula vulgaris</u>	1													2	3			.2	25
Cyclopoida																			
<u>Corycaeus spp.</u>											38						38	7.6	19
<u>Farranula gracilis</u>																			
<u>Oithona spp.</u>			38	77										231	77	77	115	23	154
<u>Oncaea spp.</u>				231								38	231	77	231	38	237	54	154
<u>Sapphirina spp.</u>																1			
Amphipoda																			
Hyperiid	1	17	6	2	1	6	6											5.4	6
Cumacea		1																	
Decapoda																			
Larvae			2	2	1	3	1	1										1.0	2
Penaeida						3													1.5
Sergestidae: <u>Lucifer</u> spp.								1	1									.2	.5
Euphausiacea																			
juveniles (<8 mm)	1			6	6													2.6	
adults (>8 mm)					6													1.2	
Stomatopoda													1						.5
Gastropoda																			
Thecosomata																		7.6	58
Chaetognatha																			
<8 mm	38			77	77													38	
>8 mm		35	35	35	17	6	6											24	6
Larvacea				77	77	77												30	39
Fish eggs		1																	.2
Fish larvae			2																.4

Table 17.—Plankton and environmental data from the New York Bight shelf and slope water, 9-10 October 1977  
 Watermasses: SH = shelf water; SL = slope water; E = Gulf Stream warm core eddy water. Abundances:  
 phytoplankton, number per liter; zooplankton, number per 3 cubic meters. Organisms observed in the sample,  
 but absent in the aliquot, are indicated by a "+" sign. A "\*" indicates that data are unavailable.

sample no.	1	3	5	7	9	11	$\bar{x}$ SH	$\bar{x}$ SL
position								
north latitude degs. & mins.	40-13	39-59	39-46	39-32	39-17	38-57		
west longitude degs. & mins.	73-26	73-07	72-48	72-29	72-15	72-17		
watermass	SH	SH	SH	SH	SL	SL		
day or night	N	N	N	N	D	D		
10 m temperature (°C)	*	*	*	18.6	20.2	20.5		
sea surface salinity (o/oo)	*	*	*	33.87	35.41	35.54		
phytoplankton color	2	1	1	1	2	2	1.25	2
Cyanophyceae: <i>Trichodesmium</i> spp.			21				5	
Bacillariophyceae								
Centricae								
<i>Bacteriastrum</i> spp.			+			42	+	21
<i>Chaetoceros hyalochaete</i> spp.	21		21			21	11	11
<i>C. phaeoceros</i> spp.		21	21				11	
<i>Corethron criophilum</i>						+		+
<i>Coscinodiscus</i> spp.	209	209	84	633	+	84	141	42
<i>Rhizosolenia alata</i> f. <i>indica</i>	21						5	
<i>R. calcar-avis</i>						42		21
<i>R. imbricata shrubsolei</i>	21					63	5	32
<i>Skeletonema costatum</i>	84						21	
Pennatae								
<i>Thalassiothrix longissima</i>					84	42		63
Dinophyceae								
<i>Ceratium carriense</i>				63	+		16	+
<i>C. extensum</i>			21	21			11	
<i>C. fusus</i>								
<i>C. hexacanthum</i>	+				+		+	+
<i>C. karstenii</i>						+		+
<i>C. kofoidi</i>			+				+	
<i>C. lineatum</i>		84				21	21	11
<i>C. macroceros</i>	42	125	21	146		+	84	+
<i>C. massiliense</i>		21	21				11	
<i>C. trichoceros</i>		84					21	
<i>C. tripos</i>	21	63		21	+	121	26	11
Silicoflagellatae	42	209	42	63		63	89	32
Coelenterata			+			+	+	+
Polychaetae							.25	
Ostracoda								
<i>Penilia</i> spp.	697						174	
Copepoda								
Calanoida								
<i>Acartia danae</i>			41	82			31	
<i>Acartia</i> spp.		123	41	82		82	62	41
<i>Calanus finmarchicus</i> I-IV	+		41				10	
<i>C. finmarchicus</i> V-VI		1					.25	
<i>C. minor</i> V-VI	6	1	2	2	3	3	2.75	3
<i>C. minor</i> I-IV			41		82	82	10	82
<i>Calocalanus</i> spp.					41			21
<i>Candacia armata</i>	3	2					1.25	
<i>Centropages bradyi</i>					41			21
<i>C. typicus</i>	697	246	246	246	41		359	21
<i>Metridia lucens</i>				1			.25	
<i>Paracalanus</i> spp. VI		246	82				82	
<i>Paracalanus-Pseudocalanus</i> I-V	123	246	246				154	
<i>Scolecithrix</i> I-IV						41		21
<i>Temora turbinata</i>						41		21
<i>Undinula vulgaris</i>					1			.5
Cyclopoida								
<i>Corycaeus</i> spp.				41			10	
<i>Farranula gracilis</i>						41		21
<i>Oithona</i> spp.			41	41	41		21	21
<i>Oncaea</i> spp.		246	246	82	41	123	144	82
Cirripedia								
<i>Lepas nauplii</i>				1			.25	
Amphipoda								
Hyperiidia	6	2	2				25	

Decapoda							
larvae	6				1.5		
Euphausiacea							
juveniles (<8 mm)			1	1	1		1
Stomatopoda			1			.25	
Gastropoda Thecosomata			41			10	
Chaetognatha							
<8 mm	246	82	82		103		
>8 mm	6	6	2	3	3.5	1.5	
Fish larvae	1				.25		

---

Table 18.—Plankton and environmental data from the New York Bight shelf and slope water, 19-20 November 1977. Watermasses: SH = shelf water; SL = slope water; E = Gulf Stream warm core eddy water. Abundances: phytoplankton, number per liter; zooplankton, number per 3 cubic meters. Organisms observed in the sample, but absent in the aliquot, are indicated by a "+" sign. A "\*" indicates that data are unavailable.

sample no.	1	3	4	5	6	7	9	$\bar{x}$ SH	$\bar{x}$ SL
position									
north latitude degs. & mins.	40-03	39-48	39-41	39-33	39-25	39-16	38-59		
west longitude degs. & mins.	73-25	73-08	72-59	72-51	72-44	72-38	72-25		
watermass	SH	SH	SH	SH	SL	SL	E		
day or night	N	N	N	N	N	N	N		
10 m temperature (°C)	12.9	12.9	13.0	13.5	16.7	19.1	*	$\bar{x}$ SH	$\bar{x}$ SL
sea surface salinity (o/oo)	32.5	32.7	32.8	33.3	35.2	35.7	*		
phytoplankton color	1	1	0	0	0	1	0	.5	.5
Bacillariophyceae									
Centricae									
<i>Chaetoceros Hyalochaete</i> spp.			2	42	21			16	11
<i>C. Phaeoceros</i> spp.					21	21			21
<i>Coscinodiscus</i> spp.		21						5	
<i>Ditylum brightwellii</i>	21							5	
<i>Rhizosolenia alata alata</i>				21				5	
<i>R. imbricata shrubsolei</i>						+			+
<i>Thalassiosira</i>	21			21				11	
Pennatae									
<i>Thalassionema nitzschioides</i>	21		21		42	63		11	53
Dinophyceae									
<i>Ceratium extensum</i>		21			21	21		5	21
<i>C. fusus</i>	63	+	21	21	21	21	+	26	21
<i>C. karsteni</i>					42	42			42
<i>C. lineatum</i>	21			21				11	
<i>C. macroceros</i>		42	+	42	21		+	21	11
<i>C. massiliense</i>						21			11
<i>C. tripos</i>	21	146	42	42	21	84	+	63	53
Silicoflagellatae		63		84			21	37	
Ostracoda						1			
Copepoda									
Calanoida									
<i>Acartia danae</i>					246				123
<i>Acartia</i> spp.		41		41	246		+	21	123
<i>Calanus finmarchicus</i> V-VI	1		1			1		.5	.5
<i>C. minor</i>		1		1	2	35	2	.5	19
<i>Candacia</i> I-IV						41			21
<i>C. armata</i> V-VI	1	2		1	1	2		1	1.5
<i>Centropages typicus</i>	246	3074	1434	3044	697	697		1950	697
<i>Clausocalanus</i> spp.	246			41		123		72	62
<i>Euchaeta marina</i> I-IV							41		
<i>Metridia lucens</i>					1	1			1
<i>Paracalanus</i> spp.		697	697	246				410	
<i>Paracalanus-Pseudocalanus</i> I-V		1434	697	246	246	246		594	246
<i>Pleuromamma abdominalis</i>						1	3		.5
<i>P. borealis</i>						17	17		8.5
<i>Pseudocalanus minutus</i> VI		246	246	123	82	41		154	62
<i>Rhincalanus cornutus</i>					1	1			1
<i>R. nasutus</i>						1			.5
<i>Scolecithrix danae</i>					1	2	3		1.5
<i>Temora stylifera</i>	41		41	41	1	3	1	31	2
<i>T. turbinata</i>			+					+	
Cyclopoida									
<i>Corycaeus</i> spp.			41			41		10	21
<i>Oithona</i> spp.		41	41					21	
<i>Oncaea</i>	246	246	246	246	41	246	82	246	144
Harpacticoida									
<i>Macrosetella gracilis</i>						+			+
Amphipoda									
Gammaridea									
Hyperiidea									
Decapoda									
larvae									
Sergestidae <i>Lucifer</i> spp.									
Euphausiacea									
juveniles (<8 mm)									
Chaetognatha									
<8 mm	82		41	41	246		41	41	123
>8 mm						1			.5
Fish larvae									.5



Table 19.—Plankton and environmental data from the New York Bight shelf and slope water, 17-18 December 1977. Watermasses: SH = shelf water; SL = slope water; E = Gulf Stream warm core eddy water. Abundances: phytoplankton, number per liter; zooplankton, number per 3 cubic meters. Organisms observed in the sample, but absent in the aliquot are indicated by a "+" sign. A "\*" indicates that data are unavailable. A parenthetical "T" following a name indicates a tropical or subtropical species.

sample no.	1	3	5	7	8	9	10	11	12	13	14	$\bar{x}$ SH	$\bar{x}$ E
position													
north latitude degs. & mins.	40-15	39-59	39-43	39-27	39-19	39-11	39-03	38-55	38-47	38-39	38-32		
west longitude degs. & mins.	73-37	73-22	73-06	72-50	72-43	72-35	72-27	72-19	72-12	72-04	71-56		
watermass	SH	SH	SH	SH	SH/E	SH	E	E	E	E	E/SH		
day or night	N	N	N	N	N	N	N	N	N	N	N		
10 m temperature (°C)	8.0	9.5	10.4	11.8	13.2	12.0	15.5	15.7	14.8	15.8	15.0		
sea surface salinity (o/oo)	*	35.95	34.6	35.0	35.2	34.9	35.5	36.1	36.0	*	*		
phytoplankton color	0	0	0	0	0	1	0	0	0	0		0	0
Bacillariophyceae													
Centricae													
Chaetoceros <u>Hyalochaete</u> spp.			26		26	26				+		13	+
C. <u>Phaeoceros</u> spp.			26	51					26	51		13	19
Coscinodiscus spp.			51	77	102	26				26	102	43	7
Rhizosolenia <u>alata</u> f. <u>alata</u>										77	153		19
R. <u>imbricata</u> <u>shrubsolei</u>											51		
R. <u>setigera</u>			+										
Thalassiosira spp.		179	179	51	77	230						119	
Pennatae													
Thalassionema <u>nitzschioides</u>		102	26	77	26	230		26	26		26	77	13
Dinophyceae													
Ceratium <u>fuscus</u>			26									4	
C. <u>longirostrum</u> (T)									26		26		7
C. <u>macroceros</u>					26				26			4	7
C. <u>tripos</u>	26		+		26	26				+	+	13	+
Silicoflagellatae						26	26					4	7
Protozoa													
Tintinnidae													+
Siphonophora						+	+	+	+				+
Polychaeta											2		
Copepoda													
nauplii			+				106			53		+	40
Calanoida													
Acartia <u>danae</u>					53							+	9
Acartia spp.			+		53	+						+	9
Calanus <u>finmarchicus</u> V + VI					3	1					2	.67	
C. <u>minor</u> (T)		1	6	6	17	2	6	2	6	6	6	5	5
Candacia <u>armata</u>		6	6			1	1		1			2	.5
C. <u>pachydactyla</u> (T)					1							.17	
Candacia spp.				1	1							.33	
Centropages <u>bradyi</u> (T)			53		1							9	
C. <u>typicus</u>	3968	899	317	+	159	+		+	+			891	+
Clausocalanus spp. (T)					317				+	53	+	53	13
Eucalanus spp.			1		2		1					.5	.25
Euchaeta <u>marina</u> (T)		1	1		1					1		.5	.25
E. <u>norvegica</u>							1	6	3		1		2.5
Euchirella <u>pulchra</u>									1				.25
Lucicutia <u>flavicornis</u>						+						+	
Mecynocera <u>causi</u>				+	53			+				53	+
Metridia <u>lucens</u>							1						.25
Paracalanus spp.		899	106		159							194	
Paracalanus-Pseudocalanus I-V	899	899	159		159							353	
Pleuromamma I-IV											159		
P. <u>abdominalis</u> (T)						2			2	1	1	.33	.75
P. <u>gracilis</u> (T)				6	3	6	35	35	17	35	35	2.5	31
P. <u>robusta</u>							1			1	1		.5
Pseudocalanus <u>minutus</u> VI	899											150	
Rhincalanus <u>cornutus</u> (T)			1	1	1	1			1		2	.67	.25
R. <u>nasutus</u>		1										.17	
Scolecithrix <u>danae</u>				1	3	1				1		.83	.25
Temora <u>longicornis</u>	106											18	
T. <u>stylifera</u> (T)				+		+	53						
T. <u>turbinata</u> (T)	53	317	53	+	317			53				123	13
Cyclopoida													
Corycaeus spp. (T)				+	53							9	

Oithona spp.	159	159	317		106	159		53		106		150	40
Oncaea spp. (T)		53	53	317	317	159			+		53	150	+
Harpacticoida													
Clytemnestra spp.											+		
Cirripede													
Larvae								53					13
Amphipoda													
Hyperiididae			2									.33	
Decapoda													
Larvae		3										.5	
Euphausiacea													
juveniles (<8 mm)		6			2	1		2	6	3	6	1.5	2.8
adults (> 8 mm)					1		1		2	3	2	.17	1.5
Mollusca													
Lamellibranchiata					+							+	
Chaetognatha													
<8 mm		53			106	53					53	35	
>8 mm		35	17	17	35	6	3		1			18	1.0
Larvacea						53						9	
Fish larvae			1									.17	
Tropical/subtropical zooplankton total	53	372	167	333	701	11	94	90	27	43	97		

Table 20.—Plankton and environmental data from the New York Bight shelf and slope water, 1-2 January 1978. Watermasses: SH = shelf water; SL = slope water; E = Gulf Stream warm core eddy water. Abundances: phytoplankton, number per liter; zooplankton, number per 3 cubic meters. Organisms observed in the sample, but absent in the aliquot are indicated by a "+" sign. A "\*" indicates that data are unavailable.

sample no.	1	3	5	7	9	10	11	12	13	$\bar{x}$ SH	$\bar{x}$ E
position											
north latitude degs. & mins.	40-17	40-02	39-50	39-38	39-19	39-10	39-02	38-53	38-45		
west longitude degs. & mins.	73-28	73-11	72-50	72-30	72-31	72-26	72-18	72-12	72-15		
watermass	SH	SH	SH	SH/SL	SH	SL	E	E	E		
day or night	N	N	N	D	D	D	D	D	D		
10 m temperature (°C)	*	8.4	*	10.1	13.0	14.6	16.3	15.2	16.0		
sea surface salinity (o/oo)	*	*	*	35.6	*	*	*	35.7	35.8		
phytoplankton color	0	0	0	0	0	0	0	0	0	0	0
Bacillariophyceae											
Centricae											
<i>Biddulphia alternans</i>	26										
<i>Chaetoceros Hyalochaete</i> spp.	26	26	+		26				16		
<i>C. Phaeoceros</i> spp.			51	51					+	20	+
<i>Coscinodiscus</i> spp.				26							
<i>Rhizosolenia</i> spp.					26				+	5	+
<i>Thalassiosira</i> spp.	26		77	26	77	+			+	41	+
Pennatae											
<i>Nitzschia closterium</i>					+					+	
<i>Thalassionema nitzschioides</i>	26	+	77	51	26	77	26			36	.9
Dinophyceae											
<i>Ceratium fusus</i>			+			+				+	
<i>C. longipes</i>				+						+	
<i>C. macroceros</i>				+	+					+	
<i>C. tripos</i>	+	+	+	26	+	+	+			5	+
Silicoflagellata				51			26			10	9
Protozoa											
Foraminifera			+							+	
Coelenterata								+	+		+
Ostracoda							1				.33
Copepoda											
Calanoida											
<i>Calanus finmarchicus</i> V-VI		3		1						.8	
<i>C. minor</i> I-IV									+		+
<i>C. minor</i> V-VI			2	1	2					1.0	
<i>Candacia</i> I-IV				53						10.6	
<i>C. armata</i> V-VI	1	4	1	2						1.6	
<i>Centropages bradyi</i> I-IV			53							10.6	
<i>C. bradyi</i> V-VI		3	2							1.0	
<i>C. typicus</i>	317	317	106	159	+					180	
<i>C. velificatus</i>				53	53					21	
<i>Clausocalanus</i> spp.		53			+					11	
<i>Mecynocera clausi</i> nauplii			+			53				+	
nauplii			53	106						32	
<i>Metridia lucens</i>		1								.2	
<i>Paracalanus-Pseudocalanus</i> I-V	317	1852	899	317	+					677	
<i>Pleuromamma gracilis</i> V-VI		3	2	1						1.2	
<i>Pleuromamma gracilis</i> I-IV			53							11	
<i>Pseudocalanus minutus</i> VI	53									11	
<i>Scolecithrix danae</i>			2							.4	
<i>Temora longicornis</i>	+									+	
<i>T. stylifera</i>			+							+	
<i>T. turbinata</i>		+			+					+	
<i>Tortanus discaudatus</i>	+									+	
Cyclopoida											
<i>Oithona</i> spp.	159	159	317	317	53	53	53			201	18
<i>Oncaea</i> spp.			+	1						.2	
Amphipoda											
Hyperiidea		1								.2	
Euphausiacea											
juveniles (<8 mm)			1	1	3		1	1	1	1	1
adults (>8 mm)					2	6	1			.4	.33
Gastropoda						1					
Chaetognatha											
<8 mm	53		53	159	106	53				74	
>8 mm		2	6	3	2					2.6	
Larvacea					53		53			11	18
fish larvae				1						.2	

Table 21.—List of species and coarser taxa identified in CPR samples from the New York Bight, 26 January 1976-2 January 1978. Authorities used in identification are cited below the taxon name.

---

Cyanophyceae

Trichodesmium spp. Ehrenberg  
(Wille, 1908)

Bacillariophyceae

Centricae

Bacteriastrum spp. Shadbolt  
(Hendey, 1964)  
Biddulphia alternans (Bailey) Van Heurck  
(Hendey, 1964)  
Chaetoceros (Hyalochaete) Ehrenberg (Gran)  
(Hendey, 1964)  
Chaetoceros (Phaeoceros) Ehrenberg (Gran)  
(Hendey, 1964)  
Corethron criophilum Castracane  
(Hendey, 1964)  
Coscinodiscus spp. Ehrenberg  
(Hendey, 1964)  
Ditylum brightwellii (T. West) Grunow  
(Cupp, 1943)  
Hemiaulus spp. Ehrenberg  
(Cupp, 1943)  
Nitzschia seriata Cleve  
(Cupp, 1943)  
Rhizosolenia alata f. alata Brightwell  
(Hendey, 1964)  
Rhizosolenia alata f. gracillima (Peragallo) Gran  
(Cupp, 1943)  
Rhizosolenia alata f. indica (Peragallo) Gran  
(Cupp, 1943)  
Rhizosolenia calcar-avis Schultze  
(Cupp, 1943)  
Rhizosolenia hebetata f. semispina (Hensen) Gran  
(Hendey, 1964)  
Rhizosolenia imbricata v. shrubsolei (Cleve) Schroeder  
(Hendey, 1964)  
Rhizosolenia setigera Brightwell  
(Hendey, 1964)  
Skeletonema costatum (Greville) Cleve  
(Cupp, 1943)  
Thalassiosira spp. Cleve  
(Cupp, 1943)

## Pennatae

Asterionella glacialis Cleve & Moller ex Gran  
(Cupp, 1943)  
Navicula spp. Bory  
(Cupp, 1943)  
Nitzschia closterium (Ehrenberg) Wm. Smith  
(Hendey, 1964)  
Thalassiothrix frauenfeldii Grunow  
(Hendey, 1964)  
Thalassiothrix longissima Cleve & Grunow  
(Hendey, 1964)  
Thalassionema nitzschioides Hustedt  
(Hendey, 1964)

## Dinophyceae

Ceratium carriense Gourret  
(Wood, 1968)  
Ceratium extensum (Gourret) Cleve  
(Wood, 1968)  
Ceratium furca (Ehrenberg) Claparede et Lachmann  
(Wood, 1968)  
Ceratium fusus (Ehrenberg) Dujardin  
(Wood, 1968)  
Ceratium hexacanthum Gourret  
(Wood, 1968)  
Ceratium horridum (Cleve) Gran  
(Wood, 1968)  
Ceratium incisum (Karsten) Jorgensen  
(Wood, 1968)  
Ceratium karstenii Pavillard  
(Wood, 1968)  
Ceratium kofoidi Jorgensen  
(Wood, 1968)  
Ceratium lineatum (Ehrenberg) Cleve  
(Paulson, 1908 & Wood, 1968)  
Ceratium longipes (Bailey) Gran  
(Paulson, 1908)  
Ceratium longirostrum Gourret  
(Wood, 1968)  
Ceratium macroceros (Ehrenberg) Vanhoffen  
(Wood, 1968 & Paulson, 1908)  
Ceratium massiliense (Gourret) Jorgensen  
(Wood, 1968)  
Ceratium minutum Jorgensen  
(Wood, 1968)  
Ceratium schroeteri (Schroder)  
(Wood, 1968)  
Ceratium setaceum Jorgensen  
(Wood, 1968)

Dinophyceae  
(cont'd)

Ceratium trichoceros (Ehrenberg) Kofoid  
(Wood, 1968)  
Ceratium tripos (O. F. Muller) Nitzsch  
(Paulsen, 1908)  
Ceratocorys spp. Stein  
(Wood, 1968)  
Dinophysis spp. Ehrenberg  
(Wood, 1968)  
Goniaulax spp. Diesing  
(Wood, 1968)  
Gymnodinium spp. Stein  
(Wood, 1968)  
Oxytoxum scolopax Stein  
(Wood, 1968)  
Oxytoxum spp. Stein  
(Wood, 1968)  
Protoperidinium spp. (Ehrenberg)  
(Wood, 1968)  
Prorocentrum spp. Ehrenberg  
(Wood, 1968)

Silicoflagellatae

Protozoa

Tintinnidae

Foraminifera

Coelenterata

Siphonophora

Other Coelenterata

Annelida

Polychaeta

Tomopteris spp. Eschscholz

## Arthropoda Crustacea

### Cladocera

Evadne spp.  
(Gosner, 1971)  
Penilia spp.  
(Gosner, 1971)  
Podon spp.  
(Gosner, 1971)

### Ostracoda

### Copepoda

#### Copepod nauplii

#### Calanoida

Acartia spp. Dana  
(Wilson, 1932)  
Acartia danae Giesbrecht  
(Wilson, 1932)  
Acartia tonsa Dana  
(Wilson, 1932)  
Calanus finmarchicus sensu stricto (Gunnerus)  
(Fleminger & Hulsemann, 1977)  
Calanus minor Claus  
(Owre & Foyo, 1967)  
Calocalanus spp. Giesbrecht  
(Wilson, 1932)  
Candacia armata (Boeck)  
(Wilson, 1932)  
Candacia curta (Dana)  
(Owre & Foyo, 1967)  
Candacia longimana (Claus)  
(Owre & Foyo, 1967)  
Candacia norvegica (Boeck)  
(Wilson, 1932)  
Candacia pachydactyla (Dana)  
(Owre & Foyo, 1967)  
Centropages bradyi Wheeler  
(Owre & Foyo, 1967)  
Centropages hamatus (Lilljeborg)  
(Wilson, 1932)  
Centropages typicus (Kroyer)  
(Wilson, 1932)  
Centropages velificatus (Dana)  
(Owre & Foyo, 1967)  
Clausocalanus spp. Giesbrecht  
(Wilson, 1932 & Rose, 1933)  
Eucalanus attenuatus (Dana)  
(Owre & Foyo, 1967)

Calanoida  
(cont'd)

Eucalanus monachus (Giesbrecht)  
(Owre & Foyo, 1967)  
Eucalanus mucronatus Giesbrecht  
(Owre & Foyo, 1967)  
Euchaeta acuta Giesbrecht  
(Owre & Foyo, 1967)  
Euchaeta marina (Prestandrea)  
(Owre & Foyo, 1967)  
Euchaeta norvegica Boeck  
(Wilson, 1932)  
Euchirella pulchra (Lubbock)  
(Owre & Foyo, 1967)  
Euchirella rostrata (Claus)  
(Owre & Foyo, 1967)  
Labidocera aestiva Wheeler  
(Owre & Foyo, 1967)  
Lucicutia flavicornis (Claus)  
(Owre & Foyo, 1967)  
Mecynocera clausi J. C. Thompson  
(Owre & Foyo, 1967)  
Metridia lucens Boeck  
(Wilson, 1932)  
Mesocalanus tenuicornis (Dana)  
(Owre & Foyo, 1967)  
Paracalanus-Pseudocalanus spp. Boeck  
(Wilson, 1932)  
Paracalanus spp. Boeck  
(Wilson, 1932)  
Pleuromamma abdominalis (Lubbock)  
(Owre & Foyo, 1967)  
Pleuromamma borealis (F. Dahl)  
(Rose, 1933)  
Pleuromamma gracilis (Claus)  
(Rose, 1933)  
Pleuromamma robusta (F. Dahl)  
(Rose, 1933)  
Pleuromamma xiphias (Giesbrecht)  
(Rose, 1933 and Owre & Foyo, 1967)  
Pseudocalanus minutis Kroyer  
(Wilson, 1932)  
Rhincalanus cornutus (Dana)  
(Owre & Foyo, 1967)  
Rhincalanus nasutus Giesbrecht  
(Owre & Foyo, 1967)  
Scolecithrix danae (Lubbock)  
(Owre & Foyo, 1967)  
Temora longicornis (O. F. Muller)  
(Wilson, 1932)  
Temora stylifera (Dana)  
(Owre & Foyo, 1967)  
Temora turbinata (Dana)  
(Owre & Foyo, 1967)



Calanoida  
(cont'd)

Tortanus discaudatus (Thompson & Scott)  
(Wilson, 1932)  
Undinula vulgaris (Dana)  
(Owre & Foyo, 1967)

Cyclopoida

Copilia spp. Dana  
(Owre & Foyo, 1967)  
Corycaeus spp. Dana  
(Owre & Foyo, 1967)  
Oithona spp. Baird  
(Wilson, 1932)  
Farranula gracilis Wilson  
(Owre & Foyo, 1967)  
Oncaea spp. Philippi  
(Owre & Foyo, 1967)  
Sapphirina spp. J. V. Thompson  
(Owre & Foyo, 1967)

Harpacticoida

Clytemnestra spp. Dana  
(Wilson, 1932)  
Macrosetella gracilis (Dana)  
(Wilson, 1932)

Cirripedia

Lepas Linnaeus

Amphipoda

Caprellidea  
Gammaridea  
Hyperiidea

Cumacea

Mysidacea

Stomatopoda

Euphausiacea

Decapoda

Penaeida

Sergistidae

Lucifer spp.  
(Gosner, 1971)

Mollusca

Cephalopoda

Gastropoda

    Thecosomata

Lamellibranchia

Chaetognatha

Chordata

Thaliacea

Larvacea

Fishes

    Myctophidae

Lepidophanes guentheri

    Bothidae

Paralichthys oblongus

    Scombridae

Scomber scombrus

---

Table 22. —Taxa of plankton taken from the New York Bight that were considered by the authors to be of tropical or subtropical origin.

---

<u>Phytoplankton</u>	
<u>Bacteriastrum</u> spp.	Bacillariophyceae
<u>Rhizosolenia calcar-avis</u>	"
<u>Ceratium carriense</u>	Dinophyceae
<u>C. extensum</u>	"
<u>C. hexacanthum</u>	"
<u>C. incisum</u>	"
<u>C. karsteni</u>	"
<u>C. kofoidi</u>	"
<u>C. longirostrum</u>	"
<u>C. massiliense</u>	"
<u>C. schroeteri</u>	"
<u>C. trichoceros</u>	"
<u>Oxytoxum scolopax</u>	"
<u>Zooplankton</u>	
<u>Calanus minor</u>	Copepoda
<u>Candacia curta</u>	"
<u>C. longimana</u>	"
<u>C. pachydactyla</u>	"
<u>Centropages bradyi</u>	"
<u>C. velificatus</u>	"
<u>Euchaeta marina</u>	"
<u>Mesocalanus tenuicornis</u>	"
<u>Pleuromamma abdominalis</u>	"
<u>P. gracilis</u>	"
<u>Rhincalanus cornutus</u>	"
<u>Temora stylifera</u>	"
<u>T. turbinata</u>	"
<u>Undinula vulgaris</u>	"
<u>Corycaeus</u> spp.	"
<u>Farranula gracilis</u>	"
<u>Oncaea</u> spp.	"
<u>Sapphirina</u> spp.	"
<u>Penaeida</u> larvae	Decapoda
<u>Lucifer</u> spp.	"

---