

NTP TECHNICAL REPORT
ON THE
TOXICOLOGY AND CARCINOGENESIS
STUDIES OF
GALLIUM ARSENIDE
(CAS NO. 1303-00-0)
IN F344/N RATS AND B6C3F₁ MICE
(INHALATION STUDIES)

NATIONAL TOXICOLOGY PROGRAM
P.O. Box 12233
Research Triangle Park, NC 27709

September 2000

NTP TR 492

NIH Publication No. 00-3951

U.S. DEPARTMENT OF HEALTH AND HUMAN SERVICES
Public Health Service
National Institutes of Health

FOREWORD

The National Toxicology Program (NTP) is made up of four charter agencies of the U.S. Department of Health and Human Services (DHHS): the National Cancer Institute (NCI), National Institutes of Health; the National Institute of Environmental Health Sciences (NIEHS), National Institutes of Health; the National Center for Toxicological Research (NCTR), Food and Drug Administration; and the National Institute for Occupational Safety and Health (NIOSH), Centers for Disease Control and Prevention. In July 1981, the Carcinogenesis Bioassay Testing Program, NCI, was transferred to the NIEHS. The NTP coordinates the relevant programs, staff, and resources from these Public Health Service agencies relating to basic and applied research and to biological assay development and validation.

The NTP develops, evaluates, and disseminates scientific information about potentially toxic and hazardous chemicals. This knowledge is used for protecting the health of the American people and for the primary prevention of disease.

The studies described in this Technical Report were performed under the direction of the NIEHS and were conducted in compliance with NTP laboratory health and safety requirements and must meet or exceed all applicable federal, state, and local health and safety regulations. Animal care and use were in accordance with the Public Health Service Policy on Humane Care and Use of Animals. The prechronic and chronic studies were conducted in compliance with Food and Drug Administration (FDA) Good Laboratory Practice Regulations, and all aspects of the chronic studies were subjected to retrospective quality assurance audits before being presented for public review.

These studies are designed and conducted to characterize and evaluate the toxicologic potential, including carcinogenic activity, of selected chemicals in laboratory animals (usually two species, rats and mice). Chemicals selected for NTP toxicology and carcinogenesis studies are chosen primarily on the bases of human exposure, level of production, and chemical structure. The interpretive conclusions presented in this Technical Report are based only on the results of these NTP studies. Extrapolation of these results to other species and quantitative risk analyses for humans require wider analyses beyond the purview of these studies. Selection *per se* is not an indicator of a chemical's carcinogenic potential.

Listings of all published NTP reports and ongoing studies are available from NTP Central Data Management, NIEHS, P.O. Box 12233, MD E1-02, Research Triangle Park, NC 27709 (919-541-3419). The Abstracts and other study information for 2-year studies are also available at the NTP's World Wide Web site: <http://ntp-server.niehs.nih.gov>.

NTP TECHNICAL REPORT
ON THE
TOXICOLOGY AND CARCINOGENESIS
STUDIES OF
GALLIUM ARSENIDE
(CAS NO. 1303-00-0)
IN F344/N RATS AND B6C3F₁ MICE
(INHALATION STUDIES)

NATIONAL TOXICOLOGY PROGRAM
P. O. Box 12233
Research Triangle Park, NC 27709

September 2000

NTP TR 492

NIH Publication No. 00-3951

U.S. DEPARTMENT OF HEALTH AND HUMAN SERVICES
Public Health Service
National Institutes of Health

CONTRIBUTORS

National Toxicology Program

Evaluated and interpreted results and reported findings

J.H. Roycroft, Ph.D., Study Scientist
 J.R. Bucher, Ph.D.
 R.E. Chapin, Ph.D.
 J.R. Hailey, D.V.M.
 J.K. Haseman, Ph.D.
 R.A. Herbert, D.V.M., Ph.D.
 R.R. Maronpot, D.V.M.
 D.P. Orzech, M.S.
 G.N. Rao, D.V.M., Ph.D.
 C.S. Smith, Ph.D.
 G.S. Travlos, D.V.M.
 K.L. Witt, M.S., Integrated Laboratory Systems, Inc.

Battelle Pacific Northwest Laboratories

Conducted studies, evaluated pathology findings

B.J. Chou, D.V.M., Ph.D., Principal Investigator
 J.A. Dill, Ph.D.
 S.L. Grumbein, D.V.M., Ph.D.
 T.J. Mast, Ph.D.
 P.W. Mellick, D.V.M., Ph.D.
 K. Mellinger, M.S.
 R.A. Miller, D.V.M., Ph.D.
 H.A. Ragan, D.V.M.
 R.A. Renne, D.V.M.
 Y.F. Su, Ph.D.
 R.B. Westerberg, Ph.D.

Experimental Pathology Laboratories, Inc.

Provided pathology quality assurance

J.F. Hardisty, D.V.M., Principal Investigator
 C.C. Shackelford, D.V.M., M.S., Ph.D.

Dynamac Corporation

Prepared quality assurance audits

S. Brecher, Ph.D., Principal Investigator

NTP Pathology Working Group

*Evaluated slides, prepared pathology report on rats
 (3 September 1998)*

P.K. Hildebrandt, D.V.M., Chairperson
 PATHCO, Inc.
 R. Cattley, V.M.D., Ph.D.
 Chemical Industry Institute of Toxicology
 D. Dixon, D.V.M., Ph.D.
 National Toxicology Program
 S.L. Grumbein, D.V.M., Ph.D.
 Battelle Pacific Northwest Laboratories
 R.A. Herbert, D.V.M., Ph.D.
 National Toxicology Program
 M.P. Jokinen, D.V.M.
 Pathology Associates International
 A. Nyska, D.V.M.
 National Toxicology Program
 C.C. Shackelford, D.V.M., M.S., Ph.D.
 Experimental Pathology Laboratories, Inc.

*Evaluated slides, prepared pathology report on mice
 (23 July 1998)*

P.K. Hildebrandt, D.V.M., Chairperson
 PATHCO, Inc.
 R. Cattley, V.M.D., Ph.D.
 Chemical Industry Institute of Toxicology
 D. Dixon, D.V.M., Ph.D.
 National Toxicology Program
 J.R. Hailey, D.V.M.
 National Toxicology Program
 R.A. Herbert, D.V.M., Ph.D.
 National Toxicology Program
 R.A. Miller, D.V.M., Ph.D.
 Battelle Pacific Northwest Laboratories
 A. Nyska, D.V.M.
 National Toxicology Program
 C.C. Shackelford, D.V.M., M.S., Ph.D.
 Experimental Pathology Laboratories, Inc.

Analytical Sciences, Inc.

Provided statistical analyses

R.W. Morris, M.S., Principal Investigator

D.E. Kendrick, M.S.

K.P. McGowan, M.B.A.

J.T. Scott, M.S.

Biotechnical Services, Inc.

Prepared Technical Report

S.R. Gunnels, M.A., Principal Investigator

L.M. Harper, B.S.

A.M. Macri-Hanson, M.A., M.F.A.

P.A. Yount, B.S.

CONTENTS

ABSTRACT		5
EXPLANATION OF LEVELS OF EVIDENCE OF CARCINOGENIC ACTIVITY		10
TECHNICAL REPORTS REVIEW SUBCOMMITTEE		11
SUMMARY OF TECHNICAL REPORTS REVIEW SUBCOMMITTEE COMMENTS		12
INTRODUCTION		15
MATERIALS AND METHODS		29
RESULTS		43
DISCUSSION AND CONCLUSIONS		87
REFERENCES		93
APPENDIX A	Summary of Lesions in Male Rats in the 2-Year Inhalation Study of Gallium Arsenide	101
APPENDIX B	Summary of Lesions in Female Rats in the 2-Year Inhalation Study of Gallium Arsenide	141
APPENDIX C	Summary of Lesions in Male Mice in the 2-Year Inhalation Study of Gallium Arsenide	175
APPENDIX D	Summary of Lesions in Female Mice in the 2-Year Inhalation Study of Gallium Arsenide	207
APPENDIX E	Genetic Toxicology	243
APPENDIX F	Clinical Pathology Results	251
APPENDIX G	Organ Weights and Organ-Weight-to-Body-Weight Ratios	261
APPENDIX H	Tissue Burden Results	271
APPENDIX I	Reproductive Tissue Evaluations and Estrous Cycle Characterization	279
APPENDIX J	Chemical Characterization and Generation of Chamber Concentrations	283
APPENDIX K	Ingredients, Nutrient Composition, and Contaminant Levels in NIH-07 Rat and Mouse Ration	299
APPENDIX L	Sentinel Animal Program	303

ABSTRACT

GaAs

GALLIUM ARSENIDE

CAS No. 1303-00-0

Molecular Formula: GaAs Molecular Weight: 144.64

Synonym: Gallium monoarsenide

Gallium arsenide is used primarily to make light-emitting diodes, lasers, laser windows, and photo-detectors and in the photoelectronic transmission of data through optical fibers. Gallium arsenide was nominated for study because of its widespread use in the microelectronics industry, the potential for worker exposure, and the absence of chronic toxicity data. Male and female F344/N rats and B6C3F₁ mice were exposed to gallium arsenide particles (greater than 98% pure; mass median aerodynamic diameter = 0.8 to 1.0 μm) by inhalation for 16 days, 14 weeks, or 2 years. Genetic toxicology studies were conducted in *Salmonella typhimurium*, and the frequency of micronuclei was determined in the peripheral blood of mice exposed to gallium arsenide for 14 weeks.

16-DAY STUDY IN RATS

Groups of five male and five female rats were exposed to particulate aerosols of gallium arsenide with a mass median aerodynamic diameter of approximately 1 μm at concentrations of 0, 1, 10, 37, 75, or 150 mg/m^3 by inhalation, 6 hours per day, 5 days per week, for 16 days. All rats survived to the end of the study. The final mean body weights of all exposed groups of males and females were similar to those of the chamber controls. Compared to chamber controls, the liver and lung weights of males exposed to 1 mg/m^3 or greater and females exposed to 10 mg/m^3 or greater were increased; the thymus

weights of all exposed groups of males were decreased. Gallium arsenide particles were visible in the alveolar spaces and, to a lesser extent, within alveolar macrophages of exposed rats. Moderate proteinosis (surfactant mixed with small amounts of fibrin) and minimal histiocytic cellular infiltrate were observed in the alveoli of exposed males and females. Epithelial hyperplasia and squamous metaplasia of the larynx were observed primarily in males exposed to 150 mg/m^3 .

16-DAY STUDY IN MICE

Groups of five male and four or five female mice were exposed to particulate aerosols of gallium arsenide with a mass median aerodynamic diameter of approximately 1 μm at concentrations of 0, 1, 10, 37, 75, or 150 mg/m^3 by inhalation, 6 hours per day, 5 days per week, for 16 days. The final mean body weights were similar among exposed and chamber control groups. Compared to chamber controls, the lung weights of males and females exposed to 10 mg/m^3 or greater were increased. Gallium arsenide particles were visible in alveolar spaces and macrophages in some mice exposed to 150 mg/m^3 . Moderate proteinosis, mild epithelial hyperplasia, and histiocytic infiltration of the lung were observed in males and females exposed to 10 mg/m^3 or greater. In the larynx, mild squamous metaplasia was seen in mice exposed to 10 mg/m^3 or greater, and mild

chronic inflammation occurred in mice exposed to 75 or 150 mg/m³.

14-WEEK STUDY IN RATS

Groups of 10 male and 10 female rats were exposed by inhalation to gallium arsenide particulate at concentrations of 0, 0.1, 1, 10, 37, or 75 mg/m³, 6 hours per day, 5 days per week, for 14 weeks. All rats survived until the end of the study. The final mean body weight and body weight gain of males exposed to 75 mg/m³ were significantly less than those of the chamber controls.

Hematology and clinical chemistry results indicated that exposure to gallium arsenide induced a microcytic responsive anemia with an erythrocytosis and increased zinc protoporphyrin/heme ratios in exposed groups of rats. There were also increases in platelet and neutrophil counts, a transient decrease in leukocyte counts, and increases in the serum activities of alanine aminotransferase and sorbitol dehydrogenase. These changes were of greater magnitude in male rats. The lung weights of all exposed groups of rats were increased, while testis, cauda epididymis, and epididymis weights of males exposed to 37 or 75 mg/m³ were generally less than those of chamber controls. Total spermatid heads and spermatid counts were significantly decreased in males exposed to 75 mg/m³, while epididymal spermatozoa motility was significantly reduced in males exposed to 10 mg/m³ or greater.

Gallium arsenide particles were visible in alveolar spaces and macrophages in the lungs of exposed rats. Minimal to marked proteinosis and minimal histiocytic cellular infiltration of the alveoli were observed in all exposed groups; minimal squamous metaplasia in the larynx and lymphoid cell hyperplasia of the mediastinal lymph node were observed in some males and females exposed to 37 or 75 mg/m³. Exposure-related increases in the incidences of plasma cell hyperplasia of the mandibular lymph node, testicular atrophy, epididymal hypospermia, bone marrow hyperplasia (males), and hemosiderosis in the liver were observed in the 37 and 75 mg/m³ groups.

14-WEEK STUDY IN MICE

Groups of 10 male and 10 female mice were exposed by inhalation to gallium arsenide particulate at concentrations of 0, 0.1, 1, 10, 37, or 75 mg/m³, 6 hours

per day, 5 days per week, for 14 weeks. One female mouse exposed to 75 mg/m³ died before the end of the study. Final mean body weights and body weight gains of males in the 75 mg/m³ group were significantly less than the chamber controls.

Hematology and clinical chemistry results indicated that exposure to gallium arsenide affected the circulating erythroid mass and induced a microcytic responsive anemia with an erythrocytosis and increased zinc protoporphyrin/heme ratios in male and female mice. There were also increases in platelet and neutrophil counts. Compared to the chamber controls, the lung weights of males exposed to 1 mg/m³ or greater and females exposed to 10 mg/m³ or greater were increased. Testis, cauda epididymis, and epididymis weights, total spermatid heads, spermatid counts, and concentration and motility of epididymal spermatozoa were generally decreased.

Gallium arsenide particles were visible in alveolar spaces and macrophages in the lungs of mice exposed to 1 mg/m³ or greater. Mild to marked proteinosis, histiocytic infiltration, and epithelial hyperplasia were observed in the alveoli of males and females exposed to 1 mg/m³ or greater. Minimal to mild suppurative inflammation and granuloma in the lung and squamous metaplasia in the larynx were present in males and females exposed to 10 mg/m³ or greater. Minimal hyperplasia was observed in the tracheobronchial lymph node of males exposed to 10 mg/m³ or greater and females exposed to 37 or 75 mg/m³. Exposure-related increases in the incidences of testicular atrophy, epididymal hypospermia, hematopoietic cell proliferation of the spleen, and hemosiderosis of the liver and spleen were observed in groups of male and female mice exposed to 10 mg/m³ or greater.

2-YEAR STUDY IN RATS

Groups of 50 male and 50 female rats were exposed by inhalation to gallium arsenide particulate at concentrations of 0, 0.01, 0.1, or 1.0 mg/m³, 6 hours per day, 5 days per week, for 105 weeks.

Survival and Body Weights

Survival of exposed male and female rats was similar to the chamber controls. Mean body weights of males exposed to 1.0 mg/m³ were generally less than those of the chamber controls throughout the study; females

exposed to 1.0 mg/m³ had slightly lower mean body weights during the second year.

Pathology Findings

Compared to the chamber controls, the incidences of alveolar/bronchiolar neoplasms were significantly increased in females exposed to 1.0 mg/m³ and exceeded the historical control ranges. Exposure-related nonneoplastic lesions in the lungs of male and female rats included atypical hyperplasia, alveolar epithelial hyperplasia, chronic active inflammation, proteinosis, and alveolar epithelial metaplasia. In the larynx of males exposed to 1.0 mg/m³, the incidences of hyperplasia, chronic active inflammation, squamous metaplasia, and hyperplasia of the epiglottis were significantly increased.

The incidences of benign pheochromocytoma of the adrenal medulla occurred with a positive trend in female rats, and the incidence was significantly increased in the 1.0 mg/m³ group and exceeded the historical control range.

The incidence of mononuclear cell leukemia was significantly increased in females exposed to 1.0 mg/m³ and exceeded the historical control range.

2-YEAR STUDY IN MICE

Groups of 50 male and 50 female mice were exposed by inhalation to gallium arsenide particulate at concentrations of 0, 0.1, 0.5, or 1.0 mg/m³, 6 hours per day, 5 days per week, for 105 (males) or 106 (females) weeks.

Survival and Body Weights

Survival of male and female mice was similar to the chamber controls. Mean body weights of exposed groups of males were similar to those of the chamber controls throughout the study; mean body weights of exposed groups of females were greater than those of the chamber controls from week 13 until the end of the study.

Pathology Findings

Exposure-related nonneoplastic lesions in the lung of all groups of exposed mice included suppurative focal inflammation, chronic focal inflammation, histiocyte cellular infiltration, alveolar epithelial hyperplasia, and proteinosis. Increased incidences of minimal lymphoid hyperplasia of the tracheobronchial lymph node occurred in mice exposed to 1.0 mg/m³ and in 0.5 mg/m³ males.

GENETIC TOXICOLOGY

Gallium arsenide was not mutagenic in several strains of *Salmonella typhimurium*, with or without S9 metabolic activation enzymes, and no increase in the frequency of micronucleated erythrocytes was observed in peripheral blood of male or female mice exposed to gallium arsenide by inhalation for 14 weeks.

CONCLUSIONS

Under the conditions of these 2-year inhalation studies, there was *no evidence of carcinogenic activity** of gallium arsenide in male F344/N rats exposed to 0.01, 0.1, or 1.0 mg/m³. There was *clear evidence of carcinogenic activity* in female F344/N rats based on increased incidences of benign and malignant neoplasms in the lung. Increased incidences of benign neoplasms of the adrenal medulla and increased incidences of mononuclear cell leukemia were also considered to be exposure related. There was *no evidence of carcinogenic activity* in male or female B6C3F₁ mice exposed to 0.1, 0.5, or 1.0 mg/m³.

Exposure to gallium arsenide caused a spectrum of nonneoplastic lesions in the lungs of rats and mice and the larynx of male rats and hyperplasia of the tracheobronchial lymph node in mice.

* Explanation of Levels of Evidence of Carcinogenic Activity is on page 10. A Summary of the Technical Reports Review Subcommittee comments and the public discussion on this Technical Report appears on page 12.

Summary of the 2-Year Carcinogenesis and Genetic Toxicology Studies of Gallium Arsenide

	Male F344/N Rats	Female F344/N Rats	Male B6C3F ₁ Mice	Female B6C3F ₁ Mice
Concentrations in air	0, 0.01, 0.1, or 1.0 mg/m ³	0, 0.01, 0.1, or 1.0 mg/m ³	0, 0.1, 0.5, or 1.0 mg/m ³	0, 0.1, 0.5, or 1.0 mg/m ³
Body weights	1.0 mg/m ³ group generally less than chamber control group	1.0 mg/m ³ group slightly less than chamber control group	Exposed groups similar to chamber control group	Exposed groups generally greater than chamber control group
Survival rates	13/50, 13/50, 15/50, 13/50	19/50, 17/50, 21/50, 11/50	35/50, 38/50, 34/50, 34/50	36/50, 34/50, 31/50, 29/50
Nonneoplastic effects	<p><u>Lung</u>: hyperplasia, atypical (0/50, 2/49, 5/50, 18/50); alveolar epithelium, hyperplasia (12/50, 16/49, 21/50, 21/50); inflammation, chronic, active (3/50, 43/49, 50/50, 50/50); proteinosis (0/50, 22/49, 50/50, 49/50); alveolar, epithelium, metaplasia (0/50, 2/49, 34/50, 41/50)</p> <p><u>Larynx</u>: hyperplasia (3/50, 8/50, 4/49, 11/50); inflammation, chronic, active (4/50, 3/50, 4/49, 12/50); metaplasia, squamous (1/50, 2/50, 2/49, 10/50); epiglottis, hyperplasia (0/50, 6/50, 4/49, 5/50)</p>	<p><u>Lung</u>: hyperplasia, atypical (0/50, 0/50, 9/50, 15/50); inflammation, chronic active (11/50, 46/50, 49/50, 50/50); proteinosis (1/50, 24/50, 47/50, 49/50); alveolar epithelium, metaplasia (0/50, 1/50, 36/50, 41/50)</p>	<p><u>Lung</u>: inflammation, focal suppurative (0/50, 0/50, 8/50, 23/50); inflammation, chronic, focal (1/50, 3/50, 3/50, 12/50); infiltration cellular, histiocyte (3/50, 10/50, 45/50, 48/50); alveolar epithelium, hyperplasia (4/50, 9/50, 39/50, 45/50); alveolus, proteinosis (1/50, 4/50, 49/50, 50/50)</p> <p><u>Lymph Node</u>, <u>Tracheobronchial</u>: hyperplasia (5/38, 7/37, 17/40, 24/41)</p>	<p><u>Lung</u>: inflammation, focal suppurative (0/50, 0/50, 2/50, 14/50); inflammation, chronic, focal (1/50, 2/50, 11/50, 18/50); infiltration cellular, histiocyte (2/50, 13/50, 48/50, 49/50); alveolar epithelium, hyperplasia (2/50, 5/50, 27/50, 43/50); alveolus, proteinosis (0/50, 4/50, 49/50, 50/50)</p> <p><u>Lymph Node</u>, <u>Tracheobronchial</u>: hyperplasia (10/39, 12/43, 13/42, 23/42)</p>
Neoplastic effects	None	<p><u>Lung</u>: alveolar/ bronchiolar adenoma (0/50, 0/50, 2/50, 7/50); alveolar/bronchiolar carcinoma (0/50, 0/50, 2/50, 3/50); alveolar/ bronchiolar adenoma or carcinoma (0/50, 0/50, 4/50, 9/50)</p> <p><u>Adrenal Medulla</u>: benign pheochromocytoma (4/50, 5/49, 6/50, 13/49)</p> <p><u>Mononuclear Cell Leukemia</u>: (22/50, 21/50, 18/50, 33/50)</p>	None	None

Summary of the 2-Year Carcinogenesis and Genetic Toxicology Studies of Gallium Arsenide

	Male F344/N Rats	Female F344/N Rats	Male B6C3F ₁ Mice	Female B6C3F ₁ Mice
Level of evidence of carcinogenic activity	No evidence	Clear evidence	No evidence	No evidence
Genetic toxicology				
<i>Salmonella typhimurium</i> gene mutations:		Negative in strains TA97, TA98, TA100, TA102, and TA1535, with and without S9		
Micronucleated erythrocytes				
Mouse peripheral blood <i>in vivo</i> :		Negative		

EXPLANATION OF LEVELS OF EVIDENCE OF CARCINOGENIC ACTIVITY

The National Toxicology Program describes the results of individual experiments on a chemical agent and notes the strength of the evidence for conclusions regarding each study. Negative results, in which the study animals do not have a greater incidence of neoplasia than control animals, do not necessarily mean that a chemical is not a carcinogen, inasmuch as the experiments are conducted under a limited set of conditions. Positive results demonstrate that a chemical is carcinogenic for laboratory animals under the conditions of the study and indicate that exposure to the chemical has the potential for hazard to humans. Other organizations, such as the International Agency for Research on Cancer, assign a strength of evidence for conclusions based on an examination of all available evidence, including animal studies such as those conducted by the NTP, epidemiologic studies, and estimates of exposure. Thus, the actual determination of risk to humans from chemicals found to be carcinogenic in laboratory animals requires a wider analysis that extends beyond the purview of these studies.

Five categories of evidence of carcinogenic activity are used in the Technical Report series to summarize the strength of the evidence observed in each experiment: two categories for positive results (**clear evidence** and **some evidence**); one category for uncertain findings (**equivocal evidence**); one category for no observable effects (**no evidence**); and one category for experiments that cannot be evaluated because of major flaws (**inadequate study**). These categories of interpretative conclusions were first adopted in June 1983 and then revised in March 1986 for use in the Technical Report series to incorporate more specifically the concept of actual weight of evidence of carcinogenic activity. For each separate experiment (male rats, female rats, male mice, female mice), one of the following five categories is selected to describe the findings. These categories refer to the strength of the experimental evidence and not to potency or mechanism.

- **Clear evidence** of carcinogenic activity is demonstrated by studies that are interpreted as showing a dose-related (i) increase of malignant neoplasms, (ii) increase of a combination of malignant and benign neoplasms, or (iii) marked increase of benign neoplasms if there is an indication from this or other studies of the ability of such tumors to progress to malignancy.
- **Some evidence** of carcinogenic activity is demonstrated by studies that are interpreted as showing a chemical-related increased incidence of neoplasms (malignant, benign, or combined) in which the strength of the response is less than that required for clear evidence.
- **Equivocal evidence** of carcinogenic activity is demonstrated by studies that are interpreted as showing a marginal increase of neoplasms that may be chemical related.
- **No evidence** of carcinogenic activity is demonstrated by studies that are interpreted as showing no chemical-related increases in malignant or benign neoplasms.
- **Inadequate study** of carcinogenic activity is demonstrated by studies that, because of major qualitative or quantitative limitations, cannot be interpreted as valid for showing either the presence or absence of carcinogenic activity.

When a conclusion statement for a particular experiment is selected, consideration must be given to key factors that would extend the actual boundary of an individual category of evidence. Such consideration should allow for incorporation of scientific experience and current understanding of long-term carcinogenesis studies in laboratory animals, especially for those evaluations that may be on the borderline between two adjacent levels. These considerations should include:

- adequacy of the experimental design and conduct;
- occurrence of common versus uncommon neoplasia;
- progression (or lack thereof) from benign to malignant neoplasia as well as from preneoplastic to neoplastic lesions;
- some benign neoplasms have the capacity to regress but others (of the same morphologic type) progress. At present, it is impossible to identify the difference. Therefore, where progression is known to be a possibility, the most prudent course is to assume that benign neoplasms of those types have the potential to become malignant;
- combining benign and malignant tumor incidence known or thought to represent stages of progression in the same organ or tissue;
- latency in tumor induction;
- multiplicity in site-specific neoplasia;
- metastases;
- supporting information from proliferative lesions (hyperplasia) in the same site of neoplasia or in other experiments (same lesion in another sex or species);
- presence or absence of dose relationships;
- statistical significance of the observed tumor increase;
- concurrent control tumor incidence as well as the historical control rate and variability for a specific neoplasm;
- survival-adjusted analyses and false positive or false negative concerns;
- structure-activity correlations; and
- in some cases, genetic toxicology.

**NATIONAL TOXICOLOGY PROGRAM BOARD OF SCIENTIFIC COUNSELORS
TECHNICAL REPORTS REVIEW SUBCOMMITTEE**

The members of the Technical Reports Review Subcommittee who evaluated the draft NTP Technical Report on gallium arsenide on 21 May 1999 are listed below. Subcommittee members serve as independent scientists, not as representatives of any institution, company, or governmental agency. In this capacity, subcommittee members have five major responsibilities in reviewing the NTP studies:

- to ascertain that all relevant literature data have been adequately cited and interpreted,
- to determine if the design and conditions of the NTP studies were appropriate,
- to ensure that the Technical Report presents the experimental results and conclusions fully and clearly,
- to judge the significance of the experimental results by scientific criteria, and
- to assess the evaluation of the evidence of carcinogenic activity and other observed toxic responses.

Gary P. Carlson, Ph.D., Chairperson
School of Health Sciences
Purdue University
West Lafayette, IN

A. John Bailer, Ph.D., Principal Reviewer
Department of Mathematics and Statistics
Miami University
Oxford, OH

Steven A. Belinsky, Ph.D., Principal Reviewer
Inhalation Toxicology Research Institute
Kirkland Air Force Base
Albuquerque, NM

James S. Bus, Ph.D.*
Health and Environmental Services
Dow Chemical Company
Midland, MI

Linda A. Chatman, D.V.M.
Pfizer, Inc.
Groton, CT

John M. Cullen, V.M.D., Ph.D.
Department of Microbiology, Parasitology, and Pathology
College of Veterinary Medicine
North Carolina State University
Raleigh, NC

Harold Davis, Ph.D., Principal Reviewer
Director of Toxicology
Amgen, Inc.
Thousand Oaks, CA

Susan M. Fischer, Ph.D.
M.D. Anderson Cancer Center
The University of Texas
Smithville, TX

Stephen S. Hecht, Ph.D.
University of Minnesota Cancer Centers
Minneapolis, MN

Michele Medinsky, Ph.D.
Durham, NC

Jose Russo, M.D.
Fox Chase Cancer Center
Philadelphia, PA

*Did not attend

SUMMARY OF TECHNICAL REPORTS REVIEW SUBCOMMITTEE COMMENTS

On 21 May 1999, the draft Technical Report on the toxicology and carcinogenesis studies of gallium arsenide received public review by the National Toxicology Program's Board of Scientific Counselors' Technical Reports Review Subcommittee. The review meeting was held at the National Institute of Environmental Health Sciences, Research Triangle Park, NC.

Dr. J.H. Roycroft, NIEHS, introduced the toxicology and carcinogenesis studies of gallium arsenide by discussing the uses of the chemical, describing the rationale for study and the experimental design, reporting on survival and body weight effects, and commenting on compound-related neoplastic lesions in female rats and nonneoplastic lesions in male and female rats and mice. Additionally, lung burden studies were conducted in male rats from the 14-week and 2-year studies. The proposed conclusions were *no evidence of carcinogenic activity* in male F344/N rats or male or female B6C3F₁ mice and *clear evidence of carcinogenic activity* in female F344/N rats.

Dr. Belinsky, a principal reviewer, agreed with the proposed conclusions.

Dr. Davis, the second principal reviewer, agreed with the proposed conclusions. He noted the basis for selecting exposure concentrations in the 2-year rat study as increased severity of lung lesions (proteinosis and inflammation) in the 14-week study; however, inflammation was not increased between the 10 mg/m³ and 1 mg/m³ groups. Dr. Roycroft stated that exposure concentration selection was based primarily on the proteinosis, and this would be clarified in the report. Dr. Davis also asked if neoplasms would have been seen in male rats had higher exposure concentrations been used. Dr. Roycroft agreed that higher exposure concentrations might have been tolerated, but, based on lung weight increases of about 60% in the 14-week study at 1 mg/m³ and the presence of an animal with fibrosis, the highest exposure concentration chosen for the 2-year study was sufficiently challenging. Dr. Davis stated it would be helpful to have a reason why lung burden was not assessed in female rats. Dr. Roycroft replied

there were considerable data on absorption of gallium and arsenic in male rats, as well as more experience with particulate studies.

Dr. Bailer, the third principal reviewer, agreed with the proposed conclusions. He thought that in the study design it would have been useful to link typical human occupational exposures to the animal exposure concentrations. In this context, he thought more recent human exposure information should be available. Dr. Roycroft said the 1981 estimate was the best available, but was not specific to gallium arsenide. Dr. M. Toraason, NIOSH, commented that NIOSH was embarking on an effort to reinstate the National Occupational Exposure Survey, so perhaps more recent exposure data will be available in the future. Dr. Bailer stated that in plots of lung burdens for gallium and arsenic in male rats over time (Figure 8), the superimposed lung deposition and clearance model did not fit the data for the high exposure concentrations for days 150 and beyond, most particularly in the high exposure concentration group at 18 months. Dr. J.R. Bucher, NIEHS, agreed that from a toxicological standpoint the model clearly was inadequate to explain what happened toward the end of the study. He said the interest in following lung burden throughout the study was to determine whether an overload situation was reached. Dr. Bailer observed that neither the data nor the fit of the model suggest an overload phenomenon.

In further discussion, Dr. Medinsky asked about the balance between obtaining complete toxicokinetic information during a chronic study to aid in understanding mechanisms of toxicity versus expeditious reporting of primary toxicologic and carcinogenic information. Dr. G.W. Lucier, NIEHS, agreed that the need to release toxicologic data may sometimes preclude reporting the complete toxicokinetic story. Dr. Russo asked whether the alveolar proteinosis appeared before hyperplasia. Dr. R.A. Herbert, NIEHS, responded that the proteinosis was most prominent in prechronic studies although there was some hyperplasia, while in the 2-year studies, these lesions were seen together in the same animals.

Dr. Belinsky moved that the Technical Report on gallium arsenide be accepted with revisions discussed and the conclusions as written for male rats and male and female mice, *no evidence of carcinogenic activity*,

and for female rats, *clear evidence of carcinogenic activity*. Dr. Davis seconded the motion, which was accepted unanimously with nine votes.

INTRODUCTION

GaAs

GALLIUM ARSENIDE

CAS No. 1303-00-0

Molecular Formula: GaAs Molecular Weight: 144.64

Synonym: Gallium monoarsenide

CHEMICAL AND PHYSICAL PROPERTIES

Gallium arsenide is a dark gray, cubic crystal with a metallic sheen that has a garlic odor when moistened. Gallium arsenide is electroluminescent in infrared light. It has a melting point of 1,238° C, a density of 5.31 at 25° C, and a hardness of 4.5 (*Sax's*, 1992; *Merck Index*, 1996; *Hawley's*, 1997; *Genium's*, 1999). Gallium arsenide readily reacts with oxygen in air, forming a mixture of oxides of gallium and arsenic on the crystal surface. In addition, it can react with steam, acids, and acid fumes to form arsine gas (Scott *et al.*, 1989; *Sax's*, 1992). Gallium arsenide has been reported to be soluble in 0.1 M phosphate buffer at pH 7.4 and in Gamble solution (an aqueous solution resembling lung fluid and maintained at pH 7.4) (Webb *et al.*, 1984; Pierson *et al.*, 1989). However, Yamauchi *et al.* (1986) reported that the solubility of arsenic from gallium arsenide after 5 days was 10% or less in 0.2 M phosphate buffer compared to approximately 70% reported by Webb *et al.* (1984). Although particle sizes were similar, the authors concluded that the difference may have been due to experimental conditions (vessels and volumes of solvents).

PRODUCTION, USE, AND HUMAN EXPOSURE

Gallium is present in the earth's crust (5 to 15 ppm) and is recovered as a by-product of the extraction of

aluminum and zinc from their ores (*Patty's*, 1994). Gallium arsenide is prepared by passing a mixture of hydrogen and arsenic vapor over gallium (III) oxide at 600° C (*Merck Index*, 1996). Production data for gallium arsenide are not available; however, it was estimated that 9,460 kg gallium was in demand in the United States in 1979, with over 90% being used in the microelectronics industry. Petkof (1980a,b) estimated demand would be 35,000 kg by 2000. Gallium arsenide is used extensively in the microelectronics industry because of its photovoltaic properties. It is used to make light-emitting diodes, lasers, laser windows, and photodetectors and in the photoelectronic transmission of data through optical fibers. Gallium arsenide is also used in infrared emitters and detectors, microwave devices, solar cells, and semiconductors (*Kirk-Othmer*, 1980; Brodsky, 1990).

Exposure to gallium arsenide occurs predominantly in the microelectronics industry where workers are involved in the production of gallium arsenide crystals, ingots, and wafers; grinding and sawing operations; device fabrication; and sandblasting and cleanup activities (Harrison, 1986). The National Institute for Occupational Safety and Health (NIOSH, 1985) estimated that in 1981 there were approximately 180,000 workers in the microelectronics industry, with over 500 plants manufacturing semiconductors. Currently, no occupational exposure limits have been established for gallium arsenide or gallium. The

time-weighted average threshold limit value for elemental arsenic and inorganic arsenic compounds is $10 \mu\text{g}/\text{m}^3$ (ACGIH, 1998). In the absence of information on toxicity and health effects caused by gallium arsenide exposure, NIOSH (1987) has recommended an exposure limit for gallium arsenide based on its 15-minute ceiling for inorganic arsenic of $2 \mu\text{g}/\text{m}^3$. There are no reports in the literature of the detection of gallium arsenide in ambient air, drinking water, or wastewater, nor are there assessments of exposure to gallium arsenide in the workplace. However, three reports describe the assessment of arsenic exposure during gallium arsenide production (Harrison, 1986; Yamauchi *et al.*, 1989; Sheehy and Jones, 1993). Harrison reported that short-term exposure concentrations of arsenic measured at two facilities during epitaxial vacuum servicing and beadblasting were 0.289 and $2.5 \text{ mg}/\text{m}^3$, well above exposure limits. Sheehy and Jones (1993) conducted more thorough workplace assessments of total arsenic exposure by collecting personal breathing zone and workplace area samples for arsenic determinations at various stages of gallium arsenide production in three different plants. In areas where arsine gas was used, arsine concentrations were also measured. In general, arsenic concentrations at the personal breathing zone were found to be less than $5 \mu\text{g}/\text{m}^3$ for all three plants. However, samples collected from personal breathing zones of individuals responsible for cleaning activities in the crystal-growth area were as high as $2,700 \mu\text{g}/\text{m}^3$. Wipe samples collected from various work sites averaged less than $970 \mu\text{g}/100 \text{ cm}^2$. The authors noted that in two of the three plants monitored, 30% to 70% of the arsenic collected at the personal breathing zone passes through the filters and was collected on the charcoal tubes, implying that a large portion of the arsenic exposure was due to arsine gas. The authors concluded that in order to determine exposure to arsenic during gallium arsenide production, both particulate and gaseous arsenic must be monitored.

Yamauchi *et al.* (1989) measured inorganic arsenic, methylarsonic acid, dimethylarsinic acid, and trimethylarsenic compounds in the urine and hair of plant workers involved in various aspects of gallium arsenide crystal and wafer production. The ambient arsenic concentration in the plant ranged from 2 to $24 \mu\text{g}/\text{m}^3$. In these work areas, the concentration of total arsenic in hair was significantly greater than in the controls and ranged from 1.11 to $6.28 \mu\text{g}$ arsenic per gram hair, with

inorganic arsenic contributing 85% to 99.6% of the total arsenic; methylarsonic acid and trimethylarsenic compounds were not detected. There was no difference in dimethylarsinic acid concentrations in hair among workers and controls ($0.03 \mu\text{g}/\text{g}$ arsenic), nor was there a difference in the species of arsenic in workers versus controls. The authors explained that this similarity was possibly due to the high consumption of seafood containing arsenic (arsenobetaine and arsenocholine) by Japanese workers. Of the arsenic species that occurred in the urine, trimethylarsenic compounds were the greatest, followed by dimethylarsinic acid, inorganic arsenic, and, lastly, methylarsonic acid. The authors concluded that urinary arsenic could be used as a means of exposure assessment (depending upon the extent of seafood consumption); however, hair was less useful in that it was impossible to remove inorganic arsenic as an external contaminant.

ABSORPTION, DISTRIBUTION, METABOLISM, AND EXCRETION

Considerable differences in the solubility of gallium arsenide in similar *in vitro* systems have been reported (10% to 70% solubility) (Webb *et al.*, 1984; Yamauchi, *et al.*, 1986; Pierson *et al.*, 1989). In order to understand the biological fate of gallium arsenide *in vivo*, it is important to understand the biological fate of gallium and arsenic. Gallium and arsenic metals are not soluble (Kirk-Othmer, 1980; Patty's, 1994). In general, when administered as a soluble salt to rats in feed (gallium lactate or gallium chloride) or by inhalation (gallium chloride), gallium is not absorbed as evidenced by its absence in various tissues (Dudley and Levine, 1949). Following intravenous injection, gallium is found primarily in plasma (Dudley *et al.*, 1949) where it is rapidly removed and either concentrated in various organs (liver, spleen, kidney, and other soft tissues), bone, and tumor tissue or readily excreted in the urine. Gallium has a biphasic half-life and, depending on the specific gallium salt, dose, and species used, the initial phase is generally less than 1 hour with the final phase being from 1 to 5 days (Dudley, 1949; Dudley and Marrer, 1952; Brucer *et al.*, 1953; Krakoff *et al.*, 1979; Kelson *et al.*, 1980). The majority of gallium is eliminated early whether excreted in urine directly or concentrated in tissue and subsequently eliminated; the gallium sequestered in bone is relatively stable and may remain as long as 6 months (Dudley and Marrer, 1952).

Unlike gallium compounds, inorganic arsenic as arsenate and arsenite are well absorbed when administered by the oral and inhalation routes (ATSDR, 1993; *Patty's*, 1994). However, there are significant species differences in the distribution and elimination of arsenic. In general, once absorbed, arsenites are partially oxidized to arsenates, and arsenates are partially reduced to arsenites, resulting in a mixture of arsenic (III) and arsenic (V) in the blood. Arsenic (III) undergoes enzymatic methylation primarily in the liver to form methylarsinic acid and dimethylarsenic acid, which are ultimately excreted in the urine. This methylation process is viewed as the primary arsenic detoxification process in mammals. In general, arsenic is evenly distributed throughout the body of most species. Most tissues have about the same concentration of arsenic (0.05 to 0.15 ppm); however, hair (0.65 ppm) and nails (0.36 ppm) have higher concentrations. Arsenic is accumulated predominantly in the methylated form in the blood, liver, and spleen of rats. In addition, arsenic is excreted quickly by most species (ATSDR, 1993). The absorption and ultimate elimination of arsenic compounds in the rat is quite different from that of other mammals, including humans. In the rat, arsenic is bound to hemoglobin in the erythrocytes. Although elimination of arsenic from plasma is rapid, it is not rapid from erythrocytes and may persist for long periods of time; therefore, urinary excretion of arsenic is slower in rats (ATSDR, 1993; *Patty's*, 1994).

Gallium arsenide administered by oral gavage at single doses of 10, 100, or 1,000 mg/kg to male Fischer rats (Webb *et al.*, 1984) or male Syrian hamsters Yamauchi *et al.*, 1986) was only slightly soluble in the gastrointestinal tract and therefore absorption was minimal. Fourteen days after dosing with gallium arsenide, 90.7% ± 35.4% of the arsenic and 99.4% ± 38.7% of the gallium was eliminated in the feces in the 1,000 mg/kg group. Less than 0.02% of the arsenic was excreted in the urine, and 0.3% was detected in the blood. Gallium was not detected in the blood or urine. Five days after dosing in hamsters, more than 80% to 90% of the total arsenic dose from gallium arsenide was eliminated in the feces, and less than 0.15% was excreted in the urine. Arsenic in urine was predominantly in the form of dimethylarsinic acid (54% to 83%) followed by inorganic arsenic (10% to 29%) and methylarsonic acid (2% to 16%). Trimethylarsenic compounds were not detected in urine. Blood and

other organs had elevated arsenic concentrations only slightly above background concentrations. Inorganic arsenic and methylarsonic acid tended to occur in higher concentrations in red blood cells, and dimethylarsinic acid concentrations were higher in plasma. These results in hamsters indicate that the arsenic released from orally administered gallium arsenide was converted into arsenic (III) and arsenic (V) and rapidly excreted with dimethylarsinic acid, the primary urinary metabolite; this was also observed in hamsters that were administered gallium arsenide intratracheally (Rosner and Carter, 1987).

Several studies at the same laboratory have investigated the absorption of gallium and arsenic in male F344 rats or Syrian golden hamsters intratracheally instilled with gallium arsenide, gallium oxide, or arsenic trioxide (Webb *et al.*, 1984, 1986, 1987; Rosner and Carter, 1987). In the earlier studies, rats were intratracheally instilled with particulate suspensions of gallium arsenide (100 mg/kg), equimolar gallium as gallium (III) oxide (Ga_2O_3) (65 mg/kg), or a maximally tolerated, nonlethal dose of arsenic as arsenic trioxide (17 mg/kg) and followed for 14 days. In these early studies, the particles were fairly large; the mean count diameters were 8.3 (gallium arsenide), 6.8 (gallium oxide), or 9.12 μm (arsenic trioxide). In gallium arsenide-instilled rats, 41.8% ± 12.5% of the dose was recovered from lung tissue as gallium and 32.5% ± 9.5% as arsenic in the Webb *et al.* (1984) study; 44% ± 9% gallium and 28% ± 6% arsenic was recovered in the Webb *et al.* (1986) study. In the gallium oxide study, 36% ± 9% of the dose was retained in the lung as gallium; the gallium concentration was similar to that of the gallium arsenide-instilled rats. Lungs from rats instilled with arsenic trioxide did not retain arsenic. After 14 days, blood arsenic ranged from 7% to 10% of the administered dose for gallium arsenide and 20% for arsenic trioxide. As expected for gallium compounds, gallium was not detected in the blood of either gallium arsenide- or gallium oxide-instilled animals (Webb *et al.*, 1986). Urine was not a good indicator of dose for either gallium or arsenic in gallium arsenide-dosed rats. Accumulative elimination of gallium arsenide by feces through 14 days accounted for only 19.1% of the dose as gallium and 12.8% as arsenic (standard deviations not provided). These studies demonstrated that less than 10% of the gallium arsenide is absorbed when particles 8.3 μm in diameter are instilled in rats.

In a third study, Webb *et al.* (1987) reduced the gallium arsenide particle size to one that was closer to a respirable size (mean count diameter of 1.63 μm and a mean volume diameter of 5.82 μm) and intratracheally instilled male F344 rats with 100 mg/kg. Lung and blood gallium and arsenic concentrations were determined 1 to 28 days after instillation. Gallium was not detected in the blood at any time point, and although blood arsenic concentrations increased steadily over the 28 days (20 ppm on day 1 to 187 ppm on day 28), the percentage of the dose detected in the blood as arsenic was small. On days 1, 3, and 28, there were no differences in the percentage of the dose retained in the lung as gallium or arsenic; however, on days 7 and 14, retention of gallium in the lung was higher than that of arsenic. The calculated gallium:arsenic ratios for the five time points were 0.98, 0.96, 1.27, 1.29, and 0.98; however, the authors concluded that there was a clear trend towards a relatively greater pulmonary retention of gallium than arsenic until day 28. The clearance half-lives were calculated to be 13.2 days for gallium and 4.8 days for arsenic.

In a study comparing the metabolism of arsenic from gallium arsenide to that of other arsenicals, Rosner and Carter (1987) intratracheally instilled male Syrian golden hamsters with 5 mg/kg gallium arsenide particles (1.63 μm mean count diameter and 5.82 μm mean volume diameter), sodium arsenite, or sodium arsenate and observed for 4 days. Approximately 30% of the cumulative arsenic doses of arsenate and arsenite were found in the feces as opposed to a considerably higher percentage (46%) of the gallium arsenide, with 27% being present after day 1. The high fecal arsenic concentration of gallium arsenide-exposed hamsters represents lung clearance of unabsorbed gallium arsenide into the gastrointestinal tract. Further supporting the reduced absorption of gallium arsenide is the fact that over 40% of the arsenic dose remained in the lung 24 hours after instillation, and 24% was still present on day 4. Less than 0.4% of the dose of arsenate or arsenite was recovered in the lung at any time point. By day 4, the liver and kidney contained less than 0.5% and blood less than 1% of the dose of any of the three arsenicals. Fifty percent of the arsenic doses of arsenite and arsenate had been excreted in the urine. Because absorption was limited, only 5% of the gallium arsenide dose was present in the urine. However, regardless of the amount of arsenic in the urine, urinary arsenic metabolite identification indicated that gallium arsenide is metabolized to the same compounds (primarily

dimethylarsinic acid) as arsenite and arsenate and has a metabolic profile most similar to that of arsenite (III). These results are in agreement with the Yamauchi *et al.* (1986) gavage studies of gallium arsenide in hamsters. Therefore, at least in the hamster, gallium arsenide is metabolized similarly regardless of route of administration.

Aizawa *et al.* (1993) demonstrated that 28 days following a single intratracheal injection of 30 to 300 mg gallium arsenide particles (0.43 μm geometric diameter) in Japanese white rabbits, lung clearance mechanisms were inhibited as evidenced by the failure to clear instilled iron (II, III) oxide particles. The authors concluded that this impairment was due to the proliferative alveolitis and pulmonary edema observed in gallium arsenide-dosed rabbits.

As part of the overall assessment of toxicity and carcinogenicity of gallium arsenide, the NTP has conducted several whole-body inhalation pharmacokinetic studies with respirable gallium arsenide and gallium (III) oxide particles. In one study, male Sprague-Dawley rats were exposed to 10, 37, or 75 mg/m³ gallium arsenide 6 hours per day for 12 consecutive days (Greenspan *et al.*, 1990, 1991). Gallium arsenide particles had a mass median aerodynamic diameter (MMAD) of approximately 1.0 μm (mean count diameter approximately 0.2 μm). Lung burdens were measured immediately after the last exposure and 14, 28, and 42 days after exposure. Lung burdens increased in direct proportion to increases in exposure concentrations for both gallium and arsenic, indicating that retention of gallium and arsenic in the lung increased uniformly with increasing exposure concentration and that deposition and clearance rates were no different for gallium and arsenic as a function of exposure concentration (Figure 1). Lung clearance rates for gallium and arsenic were approximately 11 days in the 37 and 75 mg/m³ groups as opposed to much slower clearance rates at 10 mg/m³ (14 days for gallium and 17 days for arsenic). At higher concentrations, the inflammatory response in the lung was more severe and resulted in greater numbers of alveolar macrophages. These macrophages and the lung-associated lymph nodes contained greater amounts of gallium arsenide particles than those of rats exposed to the lower concentrations.

Thus, the authors concluded that clearance was increased at higher concentrations because of the

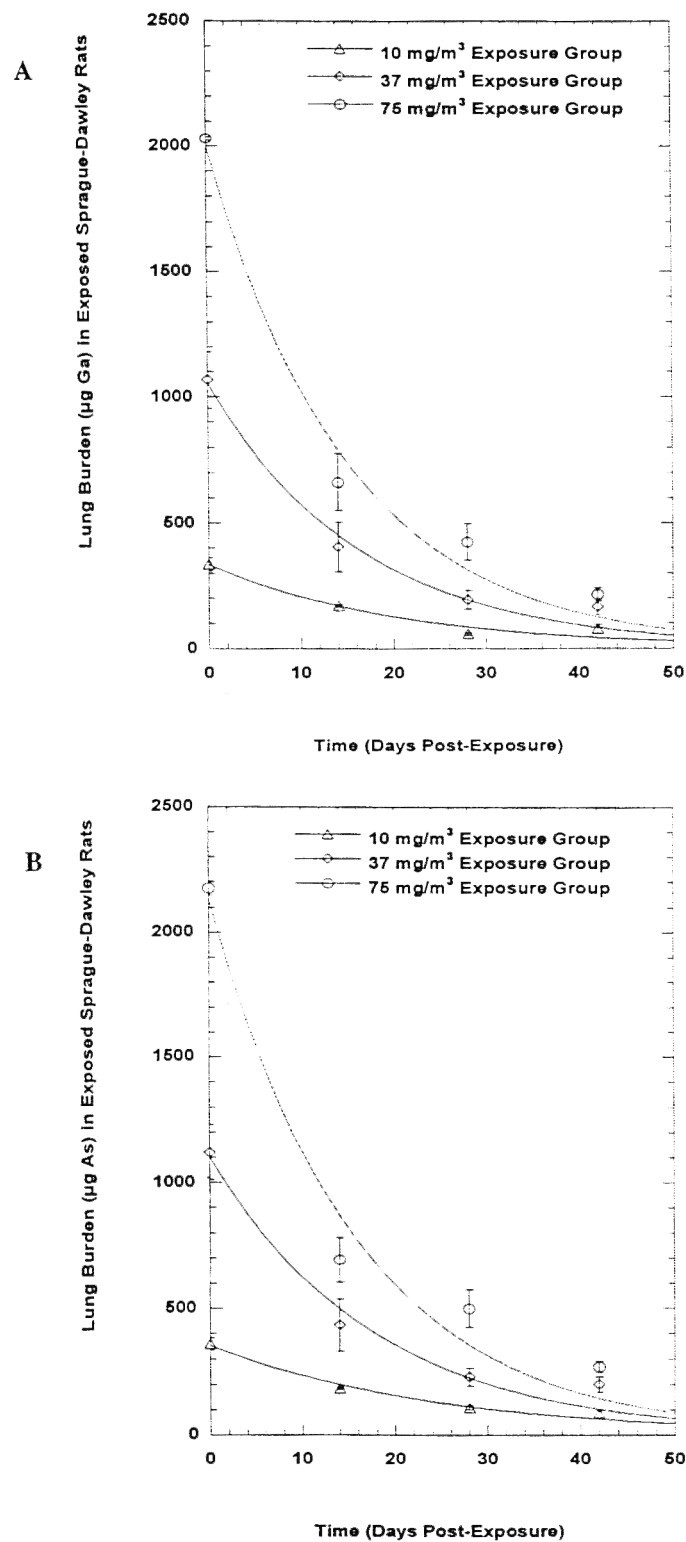

Figure 1
Lung Burdens of (A) Gallium and (B) Arsenic in Sprague-Dawley Rats Following Inhalation Exposure to Gallium Arsenide for 12 Days. Data are presented as mean \pm standard deviation. The curves represent the fit of the lung deposition and clearance model to the data. Arsenic data have been corrected for background arsenic concentrations in the lungs of control animals. (Greenspan *et al.*, 1990)

increased number of macrophages. There were no differences in the concentrations of gallium or arsenic in the lung-associated lymph nodes at any exposure concentration or time following exposure. As expected, gallium was detected only in blood at the highest concentration and early time points. Arsenic was detected in blood at relatively low concentrations (approximately 30 to 130 ppm) in a concentration-related manner at all time points, indicating a continued slow absorption of gallium arsenide.

In comparison, in the 13-week NTP inhalation studies of gallium (III) oxide, male F344 rats were exposed to 0, 0.12, 0.48, 4.8, 24, or 48 mg/m³ gallium oxide particles with a MMAD of approximately 0.9 μm (Battelle, 1990a). Exposure concentrations represented approximately equimolar gallium concentrations as in the NTP Sprague-Dawley rat study (Greenspan *et al.*, 1990, 1991). As observed with gallium arsenide, blood and urine concentrations of gallium were extremely low and only detectable at 24 and 48 mg/m³ throughout the study, indicating that gallium oxide, like gallium arsenide, is not readily absorbed, and that when absorbed, it is rapidly cleared from the blood and either excreted or sequestered in the tissues. Considerable gallium was detected in the feces; however, fecal gallium concentrations in the 48 mg/m³ group were reduced at the end of the study when compared to the concentrations on day 24. Lung burdens increased with increasing exposure concentration (Figure 2). However, when lung burdens were normalized to exposure concentration, the lung burden accumulation during the study decreased as exposure concentration increased (Figure 3). The trend can be explained by lower test material deposition, lung overload, or a faster clearance rate of gallium oxide with increasing exposure concentration. As seen in the gallium arsenide Sprague-Dawley rat study, there was a more severe inflammatory response in the lung at higher concentrations resulting in increased numbers of macrophages. The macrophages and lung-associated lymph nodes contained considerably more gallium oxide particles, indicating an enhanced clearance may exist at higher concentrations based on increased numbers of macrophages. Morrow (1986) suggested that when lung burdens in rats exceed 1 to 5 mg of particulate per gram lung, clearance is impaired. Overloading cannot be ruled out in this study because lung gallium concentrations were approximately 1.6 and 2.1 mg/g lung at the end of the study for the 24 and 48 mg/m³ groups. The reduction in gallium concentrations in the feces at

the end of the study for rats exposed to 24 mg/m³ or greater also implies that the mucociliary clearance in the lung was reduced as would be the case in an overload situation. Wolff *et al.* (1984) reported the clearance half-life for gallium oxide in F344 rats to be 65 ± 17 days following a single nose-only exposure; however, Wolff *et al.* (1989) showed that lung clearance was impaired by repeated exposure to 23 mg/m³ gallium oxide over a 4-week period. Rather than the 65-day half-life reported earlier, they observed a half-life on the order of 170 days. Therefore, in the NTP study, overload may have occurred at gallium oxide concentrations of 24 mg/m³ and greater.

Humans

No studies on the absorption, distribution, metabolism, or excretion of gallium arsenide in humans were found in the available literature.

TOXICITY

Experimental Animals

There is little information in the literature on the toxicity of gallium arsenide in animals. The acute toxicity values for gallium arsenide and selected gallium and arsenic compounds are summarized in Table 1. Single intratracheal injections of 100 mg/kg gallium arsenide particles (mean count diameter of 8.3 μm) in male F344 rats caused a transient reduction in body weight gain and a significant increase in urinary excretion of uroporphyrin and coproporphyrin (Webb *et al.*, 1984). Gallium arsenide also caused a 50% increase in lung weights and a multifocal proliferative alveolitis, which was characterized as a marked thickening of the alveolar wall due to pneumocyte hyperplasia and interstitial pneumonia (Webb *et al.*, 1986). Gallium oxide, administered at an equimolar dose of gallium (65 mg/kg) in this same study, caused lung effects somewhat similar to gallium arsenide in that there was a mild pneumocyte hyperplasia with some alveolar wall thickening. Arsenic trioxide administered at 17 mg/kg also caused lung effects similar to those caused by gallium arsenide and gallium oxide.

Webb *et al.* (1987) reduced the gallium arsenide particle size from a mean count diameter of 8.3 μm to a more respirable size particle of 1.63 μm. The toxicity of gallium arsenide was greatly enhanced in

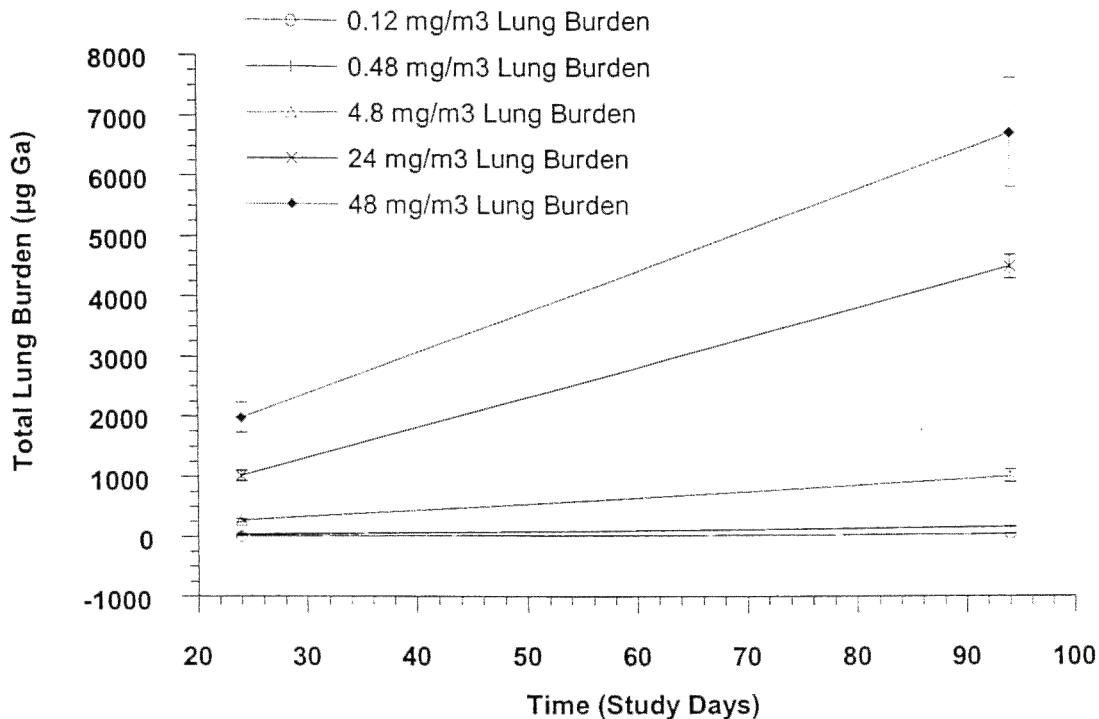

Figure 2
Lung Burdens of Gallium in Male F344/N Rats in the 13-Week Inhalation Study of Gallium (III) Oxide Data are presented as mean±standard Deviation. (Battelle, 1990a)

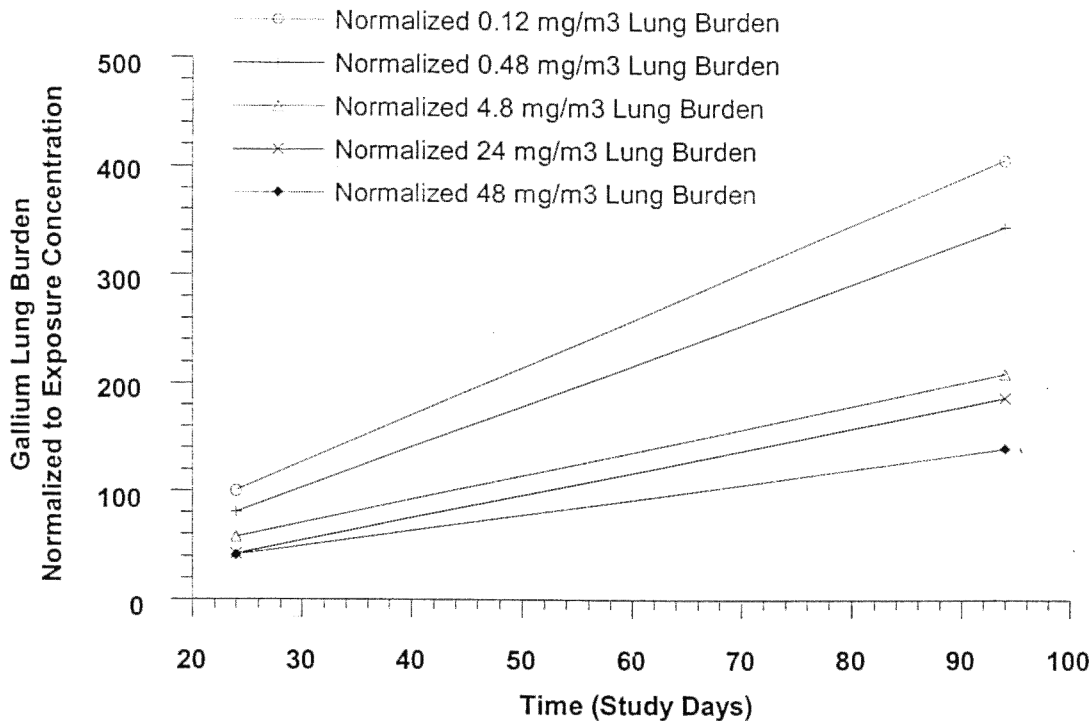

Figure 3
Normalized Lung Burdens (µg Ga/Lung per Exposure concentration) in F344/N Rats in the 13-Week Inhalation Study of Gallium (III) Oxide (Battelle, 1990a)

TABLE 1
Toxicity Values for Gallium Arsenide, Gallium Lactate, Gallium Citrate, Arsenic (III), Arsenic (V), and Arsine

Compound	Species	Route	LD ₅₀ (mg/kg)	Reference
Gallium arsenide	Mouse	Intraperitoneal	4.7	Roschina, 1966
Gallium lactate	Rat	Intravenous	47	Dudley and Levine, 1949
		Subcutaneous	121	Dudley and Levine, 1949
	Rabbit	Intravenous	43	Dudley and Levine, 1949
		Subcutaneous	97	Dudley and Levine, 1949
Gallium citrate	Mouse	Subcutaneous	600	Dudley <i>et al.</i> , 1952
	Rat	Subcutaneous	220	Dudley <i>et al.</i> , 1952
	Rabbit	Subcutaneous	45	Dudley <i>et al.</i> , 1952
	Dog	Subcutaneous	10	Dudley <i>et al.</i> , 1952
	Goat	Subcutaneous	10	Dudley <i>et al.</i> , 1952
Arsenic (III)	Mouse	Oral	26	ATSDR, 1993
	Rat	Oral	40 - 110	ATSDR, 1993
	Mouse	Intraperitoneal	5	IARC, 1980
Arsenic (V)	Rat	Oral	110	ATSDR, 1993
Arsine	Mouse	Inhalation	0.67	IARC, 1980

that there was a more significant reduction in the rate of body weight gain and an increase in lung weight. Lung protein was significantly increased by day 3 and remained greater than that of the controls throughout the study while lung DNA was increased only during the first 2 weeks following dosing. Histopathologic changes in the lung were much more severe with the reduced particle size, occurring earlier and persisting throughout the study.

There was considerable deposition of gallium arsenide particles, primarily in the terminal bronchioles and alveolar duct, accompanied by accumulation of macrophages. Pneumonia and edema were present along with an alveolar proteinosis. Large perivascular cuffs of lymphocytes were present around many blood vessels. There was a focal proliferation of pneumocytes, and in some animals fibrosis was present.

As part of the overall assessment of toxicity of gallium arsenide and more specifically the toxicity of gallium, the NTP conducted comparative 13-week studies in male and female F344/N rats and B6C3F₁

mice with gallium arsenide and gallium (III) oxide (Battelle, 1990a,b). In 13-week studies, rats and mice were exposed by inhalation to 0, 0.16, 0.64, 6.4, 32, or 64 mg gallium oxide/m³ (equivalent to 0, 0.12, 0.48, 4.8, 24, or 48 mg/m³ gallium). The mass median aerodynamic diameter of the particles was approximately 0.9 μm. Gallium oxide caused a mild microcytic erythrocytosis and a slight increase in the zinc protoporphyrin-to-heme ratio in rats and mice but had no effect on urine porphobilogen or δ-aminolevulinic acid concentrations. Relative lung weights increased with increasing exposure concentration in all groups of exposed rats and mice, with rats (120% to 200% of control weights) being more affected than mice (110% to 190% of control weights).

Gallium oxide caused histopathologic effects in the respiratory tracts of rats and mice (Battelle, 1990a,b) similar to those induced by gallium arsenide and described in this Technical Report. There was hyaline droplet formation in the respiratory epithelium of the nasal turbinates, hypertrophy of goblet cells lining the nasopharyngeal duct, and squamous

metaplasia of the laryngeal epithelium at the base of the epiglottis. These lesions occurred in rats and mice exposed to gallium oxide concentrations of 6.4 mg/m³ or greater. In the lungs of exposed rats and mice, there was an increase in the number of alveolar macrophages that were generally enlarged with lipoprotein (surfactant) and particles of gallium oxide. Lipoprotein was diffusely present in most alveoli, filling the alveolar spaces. Type II cell hyperplasia was present and was most evident in areas of granulomatous inflammation (which included fibrosis). Tracheobronchial lymph nodes of exposed animals were enlarged and also contained macrophages with gallium oxide particles.

Although a no-effect level for the lung was not reached, these effects were more severe in the 6.4, 32, and 64 mg/m³ groups. The main differences between exposed rats and mice were reduction in absolute testis weight in mice exposed to 32 or 64 mg/m³ gallium oxide and the presence of testicular degeneration and increased cellular debris in the epididymis of mice exposed to 64 mg/m³ gallium oxide.

Heme Biosynthesis: The porphyrinogenic action of arsenic compounds has been described by a number of investigators. Woods and Fowler (1978) demonstrated increased urinary concentrations of uroporphyrin relative to coproporphyrin in male Sprague-Dawley rats and C57BL mice following 6 weeks of exposure to sodium arsenate (40 or 85 ppm) in drinking water. Similarly, Martinez *et al.* (1983) reported that following administration of sodium arsenite (5, 50, or 100 ppm) in drinking water to female Wistar rats for 7 weeks, elevated uroporphyrin concentrations were detected in the urine. Webb *et al.* (1984) reported a similar effect in male F344 rats intratracheally instilled with 100 mg/kg gallium arsenide.

A number of individuals have investigated the effects of gallium arsenide exposure on the heme biosynthesis pathway. In an 18-day study, Goering *et al.* (1988) intratracheally instilled male Sprague-Dawley rats with gallium arsenide (50, 100, or 200 mg/kg) particles (less than 1 μ m in diameter). As observed previously, gallium arsenide caused body weight loss, increased lung weights, and dose-related increases in the incidences of pulmonary type II cell hyperplasia and hypertrophy with an increase in the number of alveolar macrophages. There was also a highly

significant, dose- and time-dependent (maximum at 6 days) inhibition of blood δ -aminolevulinic acid dehydratase activity in the 100 and 200 mg/kg groups to less than 5% of the control δ -aminolevulinic acid dehydratase activity, with a concomitant increase in urinary excretion of δ -aminolevulinic acid and reduction of urine volume. Kidney δ -aminolevulinic acid dehydratase activities in the 100 and 200 mg/kg groups were decreased to 70% to 80% of the control activity, while liver δ -aminolevulinic acid dehydratase activity was decreased to 79% of the control value only in the 200 mg/kg group.

By adding gallium nitrate, sodium arsenite, or sodium arsenate to either blood, liver tissue, or kidney tissue *in vitro* and measuring δ -aminolevulinic acid dehydratase activities in each, Goering *et al.* (1988) demonstrated that the concentration of gallium required to cause a 50% inhibition of δ -aminolevulinic acid dehydratase activity was 200-fold less in blood and 40-fold less in kidney and liver tissues than that required by arsenite. Therefore, these data suggest that gallium is the primary inhibitor of δ -aminolevulinic acid dehydratase activity in blood and in kidney and liver tissues following *in vivo* dissolution of gallium arsenide after intratracheal instillation. Inhibition of liver, kidney, and blood δ -aminolevulinic acid dehydratase activities by gallium and arsenite was reduced by the addition of zinc chloride, suggesting that competition for or displacement of Zn²⁺ from the site of enzyme activity by these ions may be the primary mechanism by which δ -aminolevulinic acid dehydratase activity is inhibited after exposure to gallium arsenide.

To further demonstrate that gallium inhibits δ -aminolevulinic acid dehydratase activity, Goering and Rehm (1990) injected male Sprague-Dawley rats with gallium sulfate intraperitoneally at doses up to 200 mg/kg. As with gallium arsenide, gallium sulfate caused a dose-dependent inhibition of liver, kidney, and erythrocyte δ -aminolevulinic acid dehydratase activity. There were no consistent changes in urinary excretion of δ -aminolevulinic acid. From the Lineweaver-Burk analyses, the authors concluded that gallium inhibition of δ -aminolevulinic acid dehydratase activity was noncompetitive.

Flora and Das Gupta (1992) and Flora *et al.* (1997) have reported similar results for male Wistar rats administered single gavage doses of gallium arsenide (up to 2,000 mg/kg). Gallium arsenide caused a dose-

and time-dependent inhibition of blood δ -aminolevulinic acid dehydratase activity, an increase in urinary δ -aminolevulinic acid concentration, and inhibition of liver, kidney, heart, and brain δ -aminolevulinic acid dehydratase activity. The kidney was slightly more affected than the liver or brain. Gallium arsenide also caused increases in blood zinc protoporphyrin and glutathione concentrations and a decrease in hemoglobin concentration.

Immunotoxicity: Studies evaluating host defense and cellular humoral immunity following gallium arsenide exposure are quite numerous and represent a large portion of the current literature on arsenic immunotoxicity. They have been reviewed in detail by Burns *et al.* (1994a) and in a chapter in *Patty's* (1994). Only a brief summary of some of the findings relative to gallium arsenide-induced immunotoxicity is reported here. Sikorski *et al.* (1989) have shown that following administration of single intratracheally instilled doses (up to 200 mg/kg) of gallium arsenide particles (1.5 μ m diameter) to female B6C3F₁ mice, IgG and IgM antibody responses, mixed lymphocyte responses, and delayed hypersensitivity were decreased. Peritoneal exudate cells were reduced in number, and the composition of cells shifted to an increase in the number of monocytes with a simultaneous decrease in the number of lymphocytes. Burns *et al.* (1991), following the same dosing protocol and using the arsenic chelator, meso-2,3-dimercaptosuccinic acid, demonstrated that arsenic was the primary immunosuppressive component of gallium arsenide in IgM antibody-forming cells. Sikorski *et al.* (1991) also demonstrated that gallium arsenide instillation suppressed the IgM antibody response of the T-cell dependent antigen sheep red blood cells. In gallium arsenide-exposed splenocytes, there was a decrease in the total numbers of T-cells, B-cells, and macrophages but no change in the distribution of the types of cells. Thus, gallium arsenide affects all cells involved in the generation of a primary antibody response (macrophage, T-cell, and B-cell). Burns and Munson (1993) showed that T-cell proliferation was selectively targeted and that this was most likely due to gallium arsenide-related effects on the interleukin-2 receptor, the major T-cell growth factor receptor.

To assess the stress response of gallium arsenide particles remaining in the lung for long periods of time, Burns *et al.* (1994b) showed that gallium arsenide significantly decreased thymus and spleen

weights and the cellularity of the spleen (50% decrease in the numbers of CD4⁺ and CD8⁺ cell counts). At the same time, serum corticosteroid concentrations increased 6- to 10-fold. Administration of the glucocorticoid antagonist, mifepristone, blocked the gallium arsenide-induced alteration in splenic and thymic cell populations but had no effect on the suppression of the gallium arsenide-induced antibody-forming cell response. The authors concluded that gallium arsenide (presumably the arsenic component) exerts a direct immunosuppressive effect that is independent of endogenous corticosteroids and is not a result of pulmonary inflammation.

Sikorski *et al.* (1989) and Burns *et al.* (1993) have also reported the effect of intratracheal instillation of gallium arsenide particles in female B6C3F₁ mice on host resistance to *Streptococcus pneumoniae*, *Listeria monocytogenes*, and the B16F10 melanoma. Gallium arsenide caused increased incidences and growth of the B16F10 tumor in the lungs, enhanced resistance to *S. pneumoniae* early on, and protected against *L. monocytogenes* infection. Addition of meso-2-3-dimercaptosuccinic acid to sera from gallium arsenide-exposed mice followed by inoculation with *L. monocytogenes* resulted in the growth of the organism, indicating that arsenic was responsible for inhibition of *L. monocytogenes* growth *in vivo*.

Bernstein (1998) has thoroughly reviewed the immunological literature for gallium (primarily gallium nitrate and sulfate), and therefore only a brief summary of results is provided here. Gallium concentrates at sites of inflammation and infections where it is bound to lactoferrin and concentrated in neutrophils and lymphocytes. It is also taken up by macrophages and stored in ferritin. In rodents and *in vitro*, gallium suppresses T-cell activation and proliferation at early stages of activation at concentrations that are not cytotoxic to the T-cells. The density of the IL-2 receptor on activated T-cells is reduced by gallium; however, the secretion of IL-2 and the IL-2 stimulated lymphokine-activated killer cell activity is not inhibited. Gallium has also been shown to suppress development of T-cell mediated disease in animal models of type I diabetes (nonobese diabetic mice), multiple sclerosis (experimental autoimmune encephalomyelitis in rats), uveitis (experimental autoimmune uveitis in rats), and rheumatoid arthritis (adjuvant-induced arthritis in

mice). In murine macrophages, gallium transiently inhibits the expression of major histocompatibility complex class II, and in murine macrophage-like RAW 264 cells, it inhibits the secretion of IL-6, TNF α , and nitric oxide.

Humans

No studies on the toxicity of gallium arsenide in humans were found in the literature.

REPRODUCTIVE AND DEVELOPMENTAL TOXICITY

Experimental Animals

As part of the overall toxicity assessment of inhalation exposure to gallium arsenide, the NTP conducted whole-body inhalation developmental toxicity studies with 0, 10, 37, or 75 mg/m³ gallium arsenide in Sprague-Dawley rats and Swiss (CD-1[®]) mice (Battelle, 1990c; Mast *et al.*, 1991). Rats were exposed on gestation days 4 through 19, while mice were exposed on gestation days 4 through 17. Gallium arsenide caused no maternal toxicity in rats. The effects on rat fetuses were minimal and included a marginal reduction in body weight (75 mg/m³ group) and concentration-related reduced ossification of the sternbrae. Although not significant, there was also an increase in the incidence of incompletely ossified vertebral centra. Unlike rats, exposure of mice to gallium arsenide resulted in considerable maternal and fetal toxicity in that 50% of the female mice in the 37 or 75 mg/m³ groups were either found dead or were killed moribund. Most exposed female mice were hypoactive, had labored breathing, and failed to gain weight. The number of resorptions per litter was significantly increased and occurred earlier, while the number of corpora lutea per dam and live fetuses per litter were significantly decreased. Fetal weights were reduced in all exposed groups. Although the incidences were not statistically significant, several malformations were observed in the exposed groups, including cleft palate, encephalocele, and vertebral defects (missing or extra vertebrae, fused vertebral arches, and misshapen atlases or centra). Interestingly, encephalocele and vertebral defects have been reported for mice dosed with sodium arsenate (Hood and Bishop, 1972). Incidences of several fetal variations were significantly increased in gallium arsenide-exposed

mice including misaligned sternbrae, sternbral defects including misshapen sternbrae and cartilage and ossification between the sternbrae, rib defects including fused or branched rib cartilage and fused ribs, and reduced ossification of the sternbrae. Whether gallium arsenide is developmentally toxic to mice is unknown because a no-observed-adverse-effect-level was not achieved in the dams.

Ferm and Carpenter (1970) reported increased embryo resorptions following intravenous injection of 40 mg/kg gallium sulfate to hamsters on day 8 of gestation. Gomez *et al.* (1992) intraperitoneally injected Swiss mice through gestation day 14 with gallium nitrate at doses up to 100 mg/kg per day. On gestation day 18, body weights and gravid uterine weights were reduced. There were dose-related decreases in the numbers of implants and live fetuses and an increase in the numbers of resorptions, dead fetuses, and postimplantation losses per litter. Malformations were limited to increases in the numbers of stunted fetuses and to the presence of renal hypoplasias. Skeletal variations included dorsal hyperkyphosis and delayed ossification of the parietal and occipital bones of the skull. In addition, the incidence of wavy ribs was increased.

Omura *et al.* (1996a) reported testicular toxicity in male Wistar rats that had been intratracheally instilled twice weekly for 8 weeks with 17.7 mg/kg gallium arsenide particles (1.32 μ m mean diameter). Indium arsenide (7.7 mg/kg per day) and arsenic trioxide (1.3 mg/kg per day) were also evaluated. Gallium arsenide caused a decrease in the relative epididymal weight and both gallium arsenide and indium arsenide caused a significant reduction in the epididymal sperm count. Arsenic trioxide caused a marginal but not significant decrease in the epididymal sperm count. There was an increased incidence of abnormal sperm (immature head, teratic head, or no tail) in gallium arsenide-exposed rats. Microscopic examination of the testes showed that gallium arsenide caused a 40-fold increase in the degenerating late elongated spermatids at stages IX, X, and XI. Following the same protocol that was used for rats, Omura *et al.* (1996b) intratracheally instilled Syrian golden hamsters with the same three compounds at the same doses. Gallium arsenide instillation did not affect hamsters to the same extent as rats. The only effect noted was a reduction in epididymal sperm count and a significant increase in the count of degenerating step 11 spermatid at stages IV through VII.

In the NTP 13-week gallium oxide studies (Battelle, 1990a,b), in which male and female rats and mice were exposed by inhalation to 0, 0.16, 0.64, 6.4, 32, or 64 mg/m³ gallium oxide, there was no effect of exposure on the estrous cycles of female rats or mice or on male rat reproductive parameters. However, gallium oxide exposure caused a decrease in caudal, cauda epididymis, and testis weights at 32 mg/m³ and greater. In addition, epididymal sperm motility and concentration were significantly reduced in the 64 mg/m³ group. As reported earlier, gallium oxide exposure also caused testicular degeneration and increased cellular debris in the epididymides of mice in the 64 mg/m³ group.

Humans

No studies on developmental or reproductive toxicity of gallium arsenide in humans were found in the literature.

CARCINOGENICITY

Experimental Animals

No adequate carcinogenicity studies of gallium arsenide were found in the literature. Ohyama *et al.* (1988) intratracheally instilled male Syrian golden hamsters with 0.25 mg gallium arsenide or arsenic trioxide once a week for 15 weeks and then observed the hamsters for 2 years. Gallium arsenide significantly reduced survival beginning at 1 year; arsenic trioxide dosing had no effect on hamster survival. Although gallium arsenide and arsenic trioxide caused marginal increases in the incidences of alveolar cell hyperplasia relative to the controls in animals that died early, at 2 years there were no histopathologic effects, including neoplasms, that could be associated with gallium arsenide or arsenic trioxide. The lack of effects may have been due to the fact that dosing was once a week for only 15 weeks and a limited number of tissues were examined in only 30 animals.

A considerable number of studies have evaluated the carcinogenic potential of arsenic and various arsenic compounds; these studies have been extensively reviewed by the International Agency for Research on Cancer (IARC, 1987), the ATSDR (1993), and the NTP (1998a) and in *Patty's* (1994). These studies include arsenic pentoxide, arsenic trioxide, calcium arsenate, calcium arsenite, disodium hydrogen arsenate heptahydrate, lead arsenate, potassium

arsenate, potassium arsenite, sodium arsenate, and sodium arsenite. These compounds have been tested by various routes of exposure, including perinatal, intratracheal instillation, stomach implantation, subcutaneous injection, and oral (drinking water).

Because of the magnitude of the data, only a summary of a few studies is presented here. Arsenic trioxide caused lung adenomas when injected subcutaneously in mice *in utero* and the first 3 days of life, caused neoplasms of the respiratory tract when instilled intratracheally in male and female hamsters, and caused adenocarcinomas at the site of implantation when implanted in rat stomachs. Calcium arsenate (in a pesticide mixture) caused lung carcinomas in rats following a single intratracheal dose. Intratracheal instillation of calcium arsenate into hamsters resulted in a marginal increase in the incidence of lung adenoma while arsenic trisulfide did not. Sodium arsenite administered in drinking water to male rats caused an increased incidence of renal neoplasms induced by *N*-nitrosodiethylamine.

Although gallium has not been shown to be carcinogenic in animals or humans, it is important to discuss the antineoplastic and antiproliferative properties of gallium. Bernstein (1998) has extensively reviewed these aspects of gallium as part of an overall review of the mechanisms of therapeutic activity of gallium. Therefore, only a brief summary is provided here. Gallium is antineoplastic in several human and murine cancer cell lines and in some *in vivo* cancers. Experimentally in patients, it has been used in the treatment of lymphatic malignancies (including multiple myelomas) and for urothelial malignancies. Gallium bound to plasma transferrin concentrates at sites of accelerated cellular proliferation, particularly malignant tissue, where the transferrin receptor is expressed in high concentrations; ferritin and lactoferrin may also be present in high concentrations. Once in cells it competes for iron at sites of uptake and storage and thus interferes with cellular metabolism of proliferating cells; this has been shown for human and murine leukemia and lymphoma cells. It inhibits DNA synthesis through its deactivation of ribonucleotide reductase by substituting for ferric iron in the M₂ subunit of the enzyme. This has been demonstrated in human CCRF-CEM T lymphoblasts and in murine leukemia cells. Gallium has also been shown to inhibit certain protein tyrosine phosphatases involved in regulating cell growth and oncogenic

transformation in Jurkat human T-cell leukemia cells and HT-29 human colon cancer cells. It causes apoptosis in human leukemic CCRF-CEM cells and in normal human keratocytes.

Humans

No epidemiologic studies or case reports examining the relationships between exposure to gallium arsenide and cancer in humans were found in the literature.

As with animals, there is a considerable number of reports of cancer caused by arsenic (epidemiologic studies and case reports.) These studies were also reviewed by the IARC (1987), the ATSDR (1993), and the NTP (1998a) and in *Patty's* (1994). The IARC (1987) considers that there is sufficient evidence for the carcinogenicity of inorganic arsenic compounds in humans. Only a few studies are reported here. Medical treatment with inorganic trivalent arsenic compounds (primarily Fowler's solution) has been shown to cause skin cancer, liver angiosarcomas, intestinal and bladder cancer, and meningiomas. Medical treatment with arsenic has also been shown to cause skin cancers, as has exposure to arsenic in drinking water. Where arsenic concentrations in drinking water contained 0.35 to 1.14 mg/L arsenic, there were elevated risks of cancer of the bladder, kidney, liver, lung, and colon in men and women. Workers in the mining and smelting industries exposed to inorganic arsenic have been shown to have increased incidences of lung, gastrointestinal, and renal cancer as well as hematolymphatic malignancies.

GENETIC TOXICITY

The mutagenicity information for gallium arsenide is very sparse; the two data sets which have been published are both negative. Gallium arsenide did not induce gene mutations in *Salmonella typhimurium* strain TA97, TA98, TA100, TA102, or TA1535, with or without induced hamster or rat liver S9 (Zeiger *et al.*, 1992), and it did not induce micronuclei in Syrian hamster embryo cells when tested at toxic doses over a concentration range of 2.5 to 10 µg/mL (Gibson *et al.*, 1997).

Although the information available for gallium arsenide is limited, there is a large volume of

information on the genotoxicity of arsenical compounds, particularly sodium arsenite (Yager and Ostrosky-Wegman, 1997). The different environmental forms of arsenic (arsenite, arsenate, arsenide, etc.) show different reactivities *in vitro* and *in vivo*, and may operate through different mechanisms or play complementary roles as initiators or promoters in the induction of cancer. Certain cell types, including human cell lines, show differential sensitivities to arsenicals (Vega *et al.*, 1995; Rasmussen and Menzel, 1997). Arsenicals in general are not detected in *Salmonella* or traditional mammalian cell gene mutation assays, but the clastogenic and aneugenic activity of arsenite has been thoroughly documented in mammalian cells *in vitro* and *in vivo* (Tinwell *et al.*, 1991; Jha *et al.*, 1992; Vega *et al.*, 1995; Gonsbatt *et al.*, 1997; Ramirez *et al.*, 1997; Yih *et al.*, 1997), as has the enhancement of mutagenicity of such agents as chemical clastogens (Lee *et al.*, 1986; Hartwig, 1995) and ultraviolet light (Lee *et al.*, 1985a; Jha *et al.*, 1992). In addition, Hei *et al.* (1998) demonstrated, in a specialized mammalian cell assay designed to detect intragenic and multilocus mutations, that sodium arsenite induced large scale deletion mutations. The mechanism of action for sodium arsenite is still being investigated and debated; it may involve multiple pathways including generation of reactive oxygen species (Wang and Huang, 1994), disruption of DNA repair pathways (Hartmann and Speit, 1996), mitotic perturbation (Yih *et al.*, 1997), and spindle disruption (Ramirez *et al.*, 1997). All these have been shown to occur in mammalian cells in the presence of sodium arsenite and have led to the production of chromosomal aberrations, sister chromatid exchanges, and micronuclei in numerous mammalian test systems (Lee *et al.*, 1985b; Jha *et al.*, 1992; Huang *et al.*, 1995; Gurr *et al.*, 1998).

STUDY RATIONALE

Gallium arsenide was nominated by the NCI for study because of its widespread use in the microelectronics industry, the potential for worker exposure, and the absence of chronic toxicity data. Inhalation was chosen as the route of exposure because this is the primary means of human exposure to gallium arsenide.

MATERIALS AND METHODS

PROCUREMENT AND CHARACTERIZATION OF GALLIUM ARSENIDE

Gallium arsenide was obtained in two lots. The analytical chemistry laboratory, Midwest Research Institute (Kansas City, MO) obtained gallium arsenide from Johnson Matthey, Inc. (Ward Hill, MA) and prepared a single lot (M051988) for use in the 16-day and 14-week studies. An additional lot (12956-13) was obtained from Johnson Matthey, Inc. for use in the 2-year studies. Identity and purity analyses were conducted by the analytical chemistry laboratory and the study laboratory; stability analyses were conducted by the analytical chemistry laboratory. Reports on analyses performed in support of the gallium arsenide studies are on file at the National Institute of Environmental Health Sciences.

Lot M051988, a dark gray to black, fine powder, was identified as gallium arsenide by elemental analyses. Lot 12956-13 was identified as gallium arsenide by X-ray diffraction analysis, which indicated the presence of gallium arsenide with no detectable contaminants (Figure J1). The purity of lot M051988 was determined by elemental analyses, spark source mass spectrometry, weight loss on drying, and chelometric titration. The purity of lot 12956-13 was determined by inductively coupled plasma/atomic emission spectroscopy (ICP/AES).

For lot M051988, the results of elemental analysis for gallium were in agreement with the theoretical values for gallium arsenide; the results for arsenic were slightly high. No organic impurities were present, as indicated by elemental analyses for carbon and hydrogen. Spark source mass spectrometry indicated gallium and arsenic as the major components, with no impurities present at concentrations greater than 100 ppm; all impurities totaled less than 170 ppm. Weight loss on drying indicated $0.04\% \pm 0.01\%$ water. Chelometric titration indicated a purity of

$99\% \pm 1\%$. The overall purity was determined to be greater than 98%.

For lot 12956-13, glow-discharge mass spectrometric analyses provided by the manufacturer indicated that impurities totaled less than 119 ppm for 72 elements assayed; the principal impurities were aluminum (52 ppm), silicon (33 ppm), and calcium (14 ppm). Results of ICP/AES analyses at the study laboratory indicated a purity of $99.0\% \pm 0.2\%$ for gallium and $99.0\% \pm 0.1\%$ for arsenic relative to the theoretical values.

Accelerated stability studies of lot M100386 of gallium arsenide (used to prepare lot M051988) were performed by the analytical chemistry laboratory with chelometric titration. Gallium arsenide was found to be stable for 2 weeks at temperatures up to 60° when stored protected from light. The bulk chemical was stored in amber glass bottles with Teflon[®]-lined caps under a nitrogen headspace at room temperature. Stability was monitored by the study laboratory throughout the studies with chelometric titration (16-day and 14-week studies) and ICP/AES (2-year studies); additionally, elemental analyses were performed by Galbraith Laboratories, Inc. (Knoxville, TN) at the beginning of the 16-day and 14-week studies. No degradation of the bulk chemical was detected.

AEROSOL GENERATION AND EXPOSURE SYSTEM

For the 16-day and 14-week studies, the gallium arsenide aerosol generation and delivery system had five basic components: a flexible-brush dust feed mechanism developed at the study laboratory, a Trost Model GEM-T air-impact mill (Plastomer Products Division of Garlock, Inc., Newtown, PA), a cyclone separator, an aerosol charge neutralizer, and an aerosol distribution system (Figure J2). The

flexible-brush dust feed mechanism (Figure J3) employed a hopper into which the dry powder was poured. The hopper was reloaded with additional gallium arsenide at regular intervals throughout each day's exposure period. Gallium arsenide to be used each day was stored overnight in a nitrogen-purged desiccator to achieve more uniform flow in the generator. Aerosol passed through the charge neutralizer into the distribution line. At each chamber location, a vacuum pump (Air-Vac Engineering Co., Inc., Milford, CT) drew aerosol from the distribution line into the chamber inlet, where the aerosol was further diluted with HEPA-filtered air to the appropriate concentration. The aerosol generation and delivery system for the 2-year studies is shown in Figure J4. The aerosol generator consisted of a drum, body, and cap (Figure J5). The drum rotated at 60° increments, with set time intervals between drum rotations. Rotation of the drum was controlled by a compressed-air-driven valve driver (VICI Valco Instrument Co., Houston, TX). Output of the generator was regulated by adjusting the rotation cadence. The aerosol passed through the distribution line to the exposure chambers, where it was diluted with filtered air to the proper exposure concentration.

The study laboratory designed the stainless-steel inhalation exposure chambers (Harford Systems Division of Lab Products, Inc., Aberdeen, MD) so that uniform vapor concentrations could be maintained throughout the chambers when catch pans were in place. The total active mixing volume of each chamber was 1.7 m³.

AEROSOL

CONCENTRATION MONITORING

Summaries of chamber aerosol concentrations of gallium arsenide are given in Tables J1 through J3. Chamber aerosol concentrations were monitored with real-time aerosol monitors (RAMs) (Model RAM-1; MIE, Inc., Bedford, MA) that used a pulsed-light-emitting diode in combination with a silicon detector to sense light scattered over a forward angular range of 45° to 95° by particles traversing the sensing volume. The instrument responds to particles 0.1 to 20 μm in diameter; the geometric diameter of gallium arsenide aerosol approached the minimum of this range. The monitors were connected to the chambers with sample lines designed to minimize aerosol

particle losses through settling or impaction. Each RAM was calibrated by correlating the measured voltage with gallium arsenide concentrations determined by analyzing exposure chamber samples collected on fiberglass filters (16-day and 14-week studies: Type A/E, Gelman Sciences, Ann Arbor, MI; 2-year studies: Teflon®-coated Pallflex, Pallflex Corp., Putnum, CT). Filter samples were dissolved in nitric acid and analyzed for gallium arsenide using inductively coupled plasma/mass spectroscopy (ICP/MS). RAMs were calibrated one to two times weekly during the 16-day and 14-week studies and twice monthly during the 2-year studies. Additional filter samples were collected approximately every other day during the 16-day studies and on days not dedicated to RAM calibration during the 14-week studies for gravimetric analysis of chamber concentrations as an additional check of monitor operation. During the 2-year studies, calibration was verified by ICP/MS analysis of filter samples collected every other day (control chambers) or daily.

CHAMBER

ATMOSPHERE CHARACTERIZATION

The particle size distribution in each chamber was determined during prestudy testing, once during the 16-day studies, and monthly during the 14-week and 2-year studies using a Mercer-style seven-stage impactor (In-Tox Products, Albuquerque, NM). The stages (glass coverslips lightly sprayed with silicone) were analyzed by ICP/MS. The relative mass collected on each stage was analyzed by probit analysis. The mass median aerodynamic particle diameter and the geometric standard deviation of each set of samples were estimated. The mass median aerodynamic particle diameter ranged from 0.9 to 1.3 μm in the 16-day studies, from 0.8 to 1.6 μm in the 14-week studies, and from 0.8 to 1.9 μm in the 2-year studies (Tables J4, J5, J6, and J7).

Buildup and decay rates for chamber aerosol concentrations were determined with and without animals present in the chambers. At a chamber airflow rate of 15 air changes per hour, the theoretical value for the time to achieve 90% of the target concentration after the beginning of aerosol generation (T_{90}) and the time for the chamber concentration to decay to 10% of the target concentration after aerosol generation was

terminated (T_{10}) was approximately 12.5 minutes. A T_{90} of 12 minutes was used for all of the studies.

Uniformity of aerosol concentration in the 16-day and 14-week studies was evaluated prior to the start of the studies without animals present and once during each of the studies with animals present in the exposure chambers. During the 2-year studies, uniformity was evaluated every 3 months. Chamber concentration uniformity was acceptable throughout the studies.

16-DAY STUDIES

Male and female F344/N rats and B6C3F₁ mice were obtained from Simonsen Laboratories (Gilroy, CA). On receipt, rats and mice were approximately 5 weeks old. Animals were quarantined for 12 (rats) or 13 (mice) days and were approximately 7 weeks old on the first day of the studies. Before the studies began, two male and two female rats and mice were randomly selected for parasite evaluation and gross observations for evidence of disease.

Groups of five male and five female rats and five male and four or five female mice were exposed to particulate aerosols of gallium arsenide by inhalation at concentrations of 0, 1, 10, 37, 75, or 150 mg/m³, 6 hours plus T_{90} (12 minutes) per day, 5 days per week for 16 days. Exposure concentrations of 37, 75, and 150 mg/m³ were chosen to aid in determining a maximum tolerated dose while 1 and 10 mg/m³ were chosen to provide gallium concentrations that would be equimolar to the gallium concentrations in a concurrent gallium oxide study. The mass median aerodynamic diameter (MMAD) of the particles ranged from 0.88 to 1.27 μ m. Feed was available *ad libitum* except during exposure periods; water was available *ad libitum*. Rats and mice were housed individually. Clinical findings were recorded twice daily. The animals were weighed initially, on day 8, and at the end of the studies. Details of the study design and animal maintenance are summarized in Table 2.

A necropsy was performed on all rats and mice that survived to the end of the studies. The brain, heart, right kidney, liver, lung, right testis, and thymus were weighed. A complete histopathologic examination was performed on all rats and mice in the 0 and 150 mg/m³ groups. Additionally, all gross lesions

and tissue masses were examined, and selected tissues of rats and mice in lower exposure groups were examined to a no-observed-effect level. Table 2 lists the tissues and organs examined.

14-WEEK STUDIES

The 14-week studies were conducted to evaluate the cumulative toxic effects of repeated exposure to gallium arsenide and to determine the appropriate exposure concentrations to be used in the 2-year studies.

Male and female F344/N rats and B6C3F₁ mice were obtained from Simonsen Laboratories (Gilroy, CA). On receipt, the rats and mice were 4 weeks old. Animals were quarantined for 19 (male rats) or 20 (mice and female rats) days and were approximately 7 weeks old on the first day of the studies. Before initiation of the studies, five male and five female rats and mice were randomly selected for parasite evaluation and gross observation for evidence of disease. Serologic analyses were performed on five male and five female sentinel rats and control mice at the end of the studies using the protocols of the NTP Sentinel Animal Program (Appendix L).

Groups of 10 male and 10 female rats and mice were exposed to particulate aerosols of gallium arsenide by inhalation at concentrations of 0, 0.1, 1, 10, 37, or 75 mg/m³, for 6 hours plus T_{90} (12 minutes) per day, 5 days per week for 14 weeks. The MMAD of the particles ranged from 0.81 to 1.60 μ m. Groups of 10 male and 10 female rats were exposed to the same concentrations for up to 23 days for clinical pathology analyses, and two (control) or four male rats were exposed to the same concentrations for 14 weeks for lung burden analyses. Feed was available *ad libitum* except during exposure and urine collection periods; water was available *ad libitum*. Rats and mice were housed individually. Clinical findings were recorded weekly. Animals were weighed initially, weekly, and at the end of the study (body weights). Details of the study design and animal maintenance are summarized in Table 2.

Blood was collected for hematology determinations from clinical pathology study rats on days 3 and 23 and from core study rats and mice at study termination. Blood was collected for clinical chemistry

determinations from clinical pathology study rats at day 23 and core study rats at study termination. At all time points, the animals were anesthetized with a 70% CO₂/air mixture and blood was collected from the retroorbital sinus. After blood collection on day 23 and at study termination, bone marrow samples were collected from rats and mice.

Blood for hematology determinations was placed in tubes containing potassium EDTA as the anticoagulant. Erythrocyte, leukocyte and platelet counts, hemoglobin concentration, hematocrit, mean cell volume, mean cell hemoglobin, and mean cell hemoglobin concentration were determined on an Ortho ELT-8/ds hematology analyzer (Ortho Diagnostics Systems, Inc., Westwood, NJ). Manual hematocrit determinations were performed by the microhematocrit method using a Damon/IEC microcentrifuge and a Damon capillary reader (International Equipment Company, Needham Heights, MA). Leukocyte differential and nucleated erythrocyte counts were determined by light microscopic examination of blood films stained with Wright-Giemsa. Reticulocyte counts were determined by light microscopy and using smears prepared by incubating equal volumes of whole blood and new methylene blue for at least 20 minutes and a Miller disc for reticulocyte quantitation (Brecher and Schnidman, 1950). Methemoglobin concentration was measured within 30 minutes of blood collection using an IL CO-Oximeter (Instrumentation Laboratory, Inc., Lexington, MA). An aliquot of the blood sample was sent to the University of Washington for determination of the zinc protoporphyrin/heme ratio using the methods of Labbe and Rettmer (1989). For bone marrow studies, bone marrow was harvested by flushing the cells from the right femur using a Hank's balanced salt solution (devoid of calcium and magnesium but with added EDTA and 5% bovine serum albumin). Following lysis of the erythrocytes, a total nucleated cell count was determined using a Coulter Counter Z_H (Coulter Electronics, Hialeah, FL). The hematology variables evaluated are listed in Table 2.

Blood for serum chemistry analyses was placed in tubes without anticoagulant, allowed to clot at room temperature, centrifuged, and the serum was separated. For thyroid function variables, aliquots of serum were placed in plastic containers for storage at -70° C until the analyses were performed. For urine studies at week 12, rats, following two consecutive

days of exposure, were placed individually into metabolism cages for a 14-hour urine collection. The urine collection containers were kept immersed in an ice water bath during sampling to minimize evaporation and suppress bacterial growth. Food was removed, but the animals had free access to water during the urine collection period. Following the urine collections, the animals were returned to their respective exposure chambers. Two days after the urine collections, urine concentrating ability studies were performed. For these studies, the core study rats were deprived of food and water for 14 hours. At the end of the deprivation period, the rats' bladders were manually expressed, the rats were placed in metabolism cages, and urine was collected for 4 hours.

Serum and 14-hour urine sample chemistry end points were determined on either an Abbott VP (Abbott Laboratories, Abbott Park, IL) or a Cobas Fara chemistry analyzer (Roche Diagnostics Systems, Inc., Montclair, NJ). An aliquot of the 14-hour urine sample was sent to the University of Washington for spectrophotometric determination of δ -aminolevulinic acid and porphobilinogen concentrations (Labbe and Lamon, 1987). For the 14- and 4-hour urine samples, urine volume was determined volumetrically and urine specific gravity was determined using an A/O refractometer (American Optical, Buffalo, NY). Serum triiodothyronine, thyroxine and free thyroxine were determined by radioimmunoassay techniques using reagents obtained from NML Organon Teknika Corp. (Irving, TX). An aliquot of serum was sent to Ani-Lytics, Inc. (Gaithersburg, MD) for determination of thyroid-stimulating hormone by radioimmunoassay using reagents obtained from the National Hormone and Pituitary Program. The serum and urine chemistry variables evaluated are listed in Table 2.

At the end of the 14-week studies, samples were collected for sperm motility and vaginal cytology evaluations from 10 male and 10 female core study rats and mice exposed to 0, 10, 37, and 75 mg/m³. The parameters evaluated are listed in Table 2. Methods used were those described in the NTP's sperm morphology and vaginal cytology evaluations protocol (NTP, 1987). For 12 consecutive days prior to scheduled terminal sacrifice, the vaginal vaults of the females were moistened with saline, if necessary, and samples of vaginal fluid and cells were stained.

Relative numbers of leukocytes, nucleated epithelial cells, and large squamous epithelial cells were determined and used to ascertain estrous cycle stage (i.e., diestrus, proestrus, estrus, and metestrus). Male animals were evaluated for sperm count and motility. The left testis and left epididymis were isolated and weighed. The tail of the epididymis (cauda epididymis) was then removed from the epididymal body (corpus epididymis) and weighed. Test yolk (rats) or modified Tyrode's buffer (mice) was applied to slides and a small incision was made at the distal border of the cauda epididymis. The sperm effluxing from the incision were dispersed in the buffer on the slides, and the numbers of motile and nonmotile spermatozoa were counted for five fields per slide by two observers. Following completion of sperm motility estimates, each left cauda epididymis was placed in buffered saline solution. Caudae were finely minced, and the tissue was incubated in the saline solution and then heat fixed at 65° C. Sperm density was then determined microscopically with the aid of a hemacytometer. To quantify spermatogenesis, the testicular spermatid head count was determined by removing the tunica albuginea and homogenizing the left testis in phosphate-buffered saline containing 10% dimethyl sulfoxide. Homogenization-resistant spermatid nuclei were counted with a hemacytometer.

Two to 10 male chamber control rats and three to six male rats from each exposed group were evaluated on day 23, day 45, or study termination to determine lung burdens of gallium and arsenic. Rats were anesthetized with 70% CO₂ and exsanguinated via the brachial arteries. Lungs were removed and digested in a heated mixture of nitric acid and hydrogen peroxide. The digested samples were analyzed for gallium and arsenic with a Perkin Elmer Model 5100 flame atomic absorption spectrophotometer (Perkin Elmer Corp., Norwalk, CT).

A necropsy was performed on all surviving core study animals. The brain, heart, right kidney, liver, lung, right testis, thymus, and thyroid gland were weighed. Tissues for microscopic examination were fixed and preserved in 10% neutral buffered formalin, processed and trimmed, embedded in paraffin, sectioned to a thickness of 4 to 6 μm, and stained with hematoxylin and eosin. Complete histopathologic examinations were performed on all rats and mice in the 0 and 75 mg/m³ groups and on target organs from all

core study rats and mice to the no-observable-effect level. Table 2 lists the tissues and organs routinely examined.

2-YEAR STUDIES

Study Design

Groups of 50 male and 50 female rats and mice were exposed to particulate aerosols of gallium arsenide by inhalation at concentrations of 0, 0.01, 0.1, or 1.0 mg/m³ for rats and 0, 0.1, 0.5, or 1.0 mg/m³ for mice, for 6 hours plus T₉₀ (12 minutes) per day, 5 days per week for 105 (rats and male mice) or 106 (female mice) weeks. The mean MMAD of the particles ranged from 0.8 to 1.0 μm.

Source and Specification of Animals

Male and female F344/N rats and B6C3F₁ mice were obtained from Taconic Farms (Germantown, NY) for use in the 2-year studies. Rats and mice were quarantined for 14 days before the beginning of the studies. Rats and mice were approximately 6 weeks old at the beginning of the studies. Five male and five female rats and mice were randomly selected for parasite evaluation and gross observation of disease. The health of the animals was monitored during the studies according to the protocols of the NTP Sentinel Animal Program (Appendix L).

Animal Maintenance

Rats and mice were housed individually. Feed was available *ad libitum* except during exposure periods; water was available *ad libitum*. Cages and racks were rotated weekly. Further details of animal maintenance are given in Table 2. Information on feed composition and contaminants is provided in Appendix K.

Tissue Burden Studies

Tissue burden studies were performed on additional animals to examine the extent of gallium and arsenic distribution in the blood, lungs, serum, and testes of male rats. Groups of up to 30 male rats were maintained on the same doses as the core study animals. At 1, 2, 4, 6, 12, and 18 months, five male rats from the 0, 0.1, and 1.0 mg/m³ groups were evaluated. Four or five male rats from the 0.01 mg/m³ group were evaluated at 2-, 12-, and 18-month time points. Animals from each time point were anesthetized with sodium pentobarbital. Blood was drawn from the heart and divided into a tube containing EDTA as an anticoagulant and a serum collection tube without

anticoagulant. The testes and lungs were removed and weighed. Gallium and arsenic in testes and serum digests were analyzed using Perkin-Elmer Model 5100 atomic absorption spectrophotometer, an HGA-600 graphite furnace with Zeeman effect background correction, and an AS-60 autosampler (Perkin-Elmer Corp, Norwalk, CT). Gallium and arsenic in lung digests and arsenic in whole blood digests were analyzed using inductively coupled plasma/atomic emission spectroscopy (ARL Model 3410, Fisons, Valencia, CA). Gallium in whole blood digests was measured by inductively coupled plasma mass spectroscopy (VG PlasmaQuad, VG Elemental, Winsford, Cheshire, UK) and an autosampler (Gilson Model 222, Gilson Electronics, Middleton, MI).

Clinical Examinations and Pathology

All animals were observed twice daily. Animals were weighed at the beginning of the studies and clinical findings and body weights were recorded every 4 weeks from week 5 through week 93 (rats) or 89 (mice) and every 2 weeks thereafter.

Complete necropsies and microscopic examinations were performed on all rats and mice. At necropsy, all organs and tissues were examined for grossly visible lesions, and all major tissues were fixed and preserved in 10% neutral buffered formalin, processed and trimmed, embedded in paraffin, sectioned to a thickness of 4 to 6 μm , and stained with hematoxylin and eosin for microscopic examination. For all paired organs (e.g., adrenal gland, kidney, ovary), samples from each organ were examined. Tissues examined microscopically are listed in Table 2.

Microscopic evaluations were completed by the study laboratory pathologist, and the pathology data were entered into the Toxicology Data Management System. The slides, paraffin blocks, and residual wet

tissues were sent to the NTP Archives for inventory, slide/block match, and wet tissue audit. The slides, individual animal data records, and pathology tables were evaluated by an independent quality assessment laboratory. The individual animal records and tables were compared for accuracy, the slide and tissue counts were verified, and the histotechnique was evaluated. For the 2-year studies, a quality assessment pathologist evaluated slides from all tumors and all potential target organs, which included the adrenal medulla, harderian gland (male mice), larynx, lung, nose, and preputial gland of rats and the lung and nose of mice.

The quality assessment report and the reviewed slides were submitted to the NTP Pathology Working Group (PWG) chairperson, who reviewed the selected tissues and addressed any inconsistencies in the diagnoses made by the laboratory and quality assessment pathologists. Representative histopathology slides containing examples of lesions related to chemical administration, examples of disagreements in diagnoses between the laboratory and quality assessment pathologists, or lesions of general interest were presented by the chairperson to the PWG for review. The PWG consisted of the quality assessment pathologist and other pathologists experienced in rodent toxicologic pathology. This group examined the tissues without any knowledge of dose groups or previously rendered diagnoses. When the PWG consensus differed from the opinion of the laboratory pathologist, the diagnosis was changed. Final diagnoses for reviewed lesions represent a consensus between the laboratory pathologist, reviewing pathologist(s), and the PWG. Details of these review procedures have been described, in part, by Maronpot and Boorman (1982) and Boorman *et al.* (1985). For subsequent analyses of the pathology data, the decision of whether to evaluate the diagnosed lesions for each tissue type separately or combined was generally based on the guidelines of McConnell *et al.* (1986).

TABLE 2
Experimental Design and Materials and Methods in the Inhalation Studies of Gallium Arsenide

16-Day Studies	14-Week Studies	2-Year Studies
Study Laboratory Battelle Pacific Northwest Laboratories (Richland, WA)	Battelle Pacific Northwest Laboratories (Richland, WA)	Battelle Pacific Northwest Laboratories (Richland, WA)
Strain and Species Rats: F344/N Mice: B6C3F ₁	Rats: F344/N Mice: B6C3F ₁	Rats: F344/N Mice: B6C3F ₁
Animal Source Simonsen Laboratories (Gilroy, CA)	Simonsen Laboratories (Gilroy, CA)	Taconic Farms (Germantown, NY)
Time Held Before Studies Rats: 12 days Mice: 13 days	Rats: 19 days (males) or 20 days (females) Mice: 20 days	14 days
Average Age When Studies Began 7 weeks	7 weeks	6 weeks
Date of First Exposure Rats: 6 September 1988 Mice: 7 September 1988	Rats: 6 (males) or 7 (females) March 1989 Mice: 7 March 1989	Rats: 30 September 1993 (1- and 4-month tissue burden and core studies) 29 October 1993 (2-, 6-, 12-, and 18-month tissue burden studies) Mice: 16 September 1993
Duration of Exposure 6 hours plus T ₉₀ (12 minutes) per day, 5 days per week for 16 days	6 hours plus T ₉₀ (12 minutes) per day, 5 days per week for 14 weeks	6 hours plus T ₉₀ (12 minutes) per day, 5 days per week for 105 (rats and male mice) or 106 (female mice) weeks
Date of Last Exposure Rats: 21 September 1988 Mice: 22 September 1988	Rats: 5 (males) or 6 (females) June 1989 Mice: 7 (males) or 8 (females) June 1989	Rats: 29 September 1995 Mice: 19 (males) or 21 (females) September 1995
Necropsy Dates Rats: 22 September 1988 Mice: 23 September 1988	Rats: 6 (males) or 7 (females) June 1989 Mice: 8 (males) or 9 (females) June 1989	Rats: 2-4 October 1995 Mice: 18-22 September 1995
Average Age at Necropsy 9 weeks	20 weeks	111 weeks
Size of Study Groups 5 males and 4 or 5 females	Core studies: 10 males and 10 females Clinical pathology studies: 10 male and 10 female rats Lung burden studies: 2 (control) or 4 male rats	Core studies: 50 males and 50 females Tissue burden studies: 30 (0, 0.1, and 1.0 mg/m ³) or 14 (0.01 mg/m ³) male rats

TABLE 2
Experimental Design and Materials and Methods in the Inhalation Studies of Gallium Arsenide

16-Day Studies	14-Week Studies	2-Year Studies
Method of Distribution Animals were distributed randomly into groups of approximately equal initial mean body weights.	Same as 16-day studies	Same as 16-day studies
Animals per Cage 1	1	1
Method of Animal Identification Tail tattoo	Tail tattoo	Tail tattoo
Diet NIH-07 open formula pelleted diet (Zeigler Brothers, Inc., Gardners, PA), available <i>ad libitum</i> , except during exposure periods, changed daily	Same as 16-day studies; available <i>ad libitum</i> except during exposure and urine collection periods, changed daily on exposure days	Same as 16-day studies, changed weekly
Water Softened tap water (Richland municipal supply) via automatic watering system (Edstrom Industries, Waterford, WI), available <i>ad libitum</i> , changed weekly.	Same as 16-day studies	Same as 16-day studies
Cages Stainless steel wire bottom (Lab Products, Inc. Harford Systems Division, Aberdeen, MD), changed weekly	Same as 16-day studies	Stainless steel wire bottom (Hazleton System, Inc., Aberdeen, MD) changed weekly
Chamber Air Supply Filters Single HEPA (Flanders Filters, Inc., San Rafael, CA); Charcoal (RSE, Inc., New Baltimore, MI)	Same as 16-day studies	Single HEPA (Flanders Filters, Inc., San Rafael, CA); Purafil, (Environmental Systems, Lynwood, CA) (rats) or Charcoal (RSE, Inc., New Baltimore, MI) (mice)
Chambers Stainless steel (Lab Products, Inc., Harford System Division, Aberdeen, MD), changed weekly	Same as 16-day studies	Same as 16-day studies
Chamber Environment Temperature: 75° ± 3° F Relative humidity: 55% ± 15% Room fluorescent light: 12 hours/day Chamber air changes: 15/hour	Same as 16-day studies	Same as 16-day studies
Exposure Concentrations 0, 1, 10, 37, 75, or 150 mg/m ³	0, 0.1, 1, 10, 37, or 75 mg/m ³	Rats: 0, 0.01, 0.1, or 1.0 mg/m ³ Mice: 0, 0.1, 0.5, or 1.0 mg/m ³

TABLE 2
Experimental Design and Materials and Methods in the Inhalation Studies of Gallium Arsenide

16-Day Studies	14-Week Studies	2-Year Studies
<p>Type and Frequency of Observation Observed and clinical findings recorded twice daily; animals were weighed initially, on day 8, and at the end of the studies.</p>	<p>Observed twice daily; animals were weighed initially and body weights and clinical findings were recorded weekly and at the end of the studies (body weights).</p>	<p>Observed twice daily; animals were weighed initially and clinical findings and body weights were recorded every 4 weeks from week 5 through week 93 (rats) or week 89 (mice) and every 2 weeks thereafter.</p>
<p>Method of Sacrifice CO₂ asphyxiation</p>	<p>Same as 16-day studies</p>	<p>Same as 16-day studies</p>
<p>Necropsy Necropsy performed on all animals. Organs weighed were the brain, heart, right kidney, liver, lung, right testis, and thymus.</p>	<p>Necropsy performed on all core study animals. Organs weighed were the brain, heart, right kidney, liver, lung, right testis, thymus, and thyroid gland.</p>	<p>Necropsy performed on all core study animals.</p>
<p>Clinical Pathology None</p>	<p>Blood was collected from the retroorbital sinus of clinical pathology study rats on days 3 and 23 and from core study rats and mice surviving to the end of the study for hematology and from clinical pathology study rats on day 23 and core study rats at study termination for clinical chemistry. Core study rats were placed in metabolism cages for urine collection during week 12. Bone marrow was collected from five male and five female rats and mice in the 0, 10, 37, and 75 mg/m³ groups following blood collection on day 23 (rats only) and at study termination.</p> <p>Hematology: manual hematocrit; automated hematocrit; hemoglobin; erythrocyte, reticulocyte, nucleated erythrocyte counts (rats); Howell-Jolly bodies (mice); mean cell volume; mean cell hemoglobin; mean cell hemoglobin concentration; platelet count; leukocyte count and differentials; total bone marrow cellularity; methemoglobin; zinc protoporphyrin</p> <p>Clinical chemistry: urea nitrogen, creatinine, total iron binding capacity, unbound iron binding capacity, iron, alanine aminotransferase, creatine kinase, sorbitol dehydrogenase, thyroid stimulating hormone, total triiodothyronine (T₃), total and free thyroxine (T₄)</p> <p>Urinalysis: glucose, protein, N-acetyl-β-D-glucosaminidase, volume, specific gravity, δ-aminolevulinic acid, porphobilinogen</p> <p>Urine concentrating ability: volume, specific gravity</p>	<p>None</p>

TABLE 2
Experimental Design and Materials and Methods in the Inhalation Studies of Gallium Arsenide

16-Day Studies	14-Week Studies	2-Year Studies
<p>Histopathology Complete histopathology was performed on 0 and 150 mg/m³ rats and mice. In addition to gross lesions and tissue masses, the following tissues were examined: adrenal gland, bone with marrow, brain, clitoral gland, esophagus, gallbladder (mice only), heart, large intestine (cecum, colon, rectum), small intestine (duodenum, jejunum, ileum), kidney, larynx, liver, lung, lymph nodes (bronchial, mandibular, mediastinal, mesenteric), mammary gland with adjacent skin, nose, ovary, pancreas, parathyroid gland, pituitary gland, preputial gland, prostate gland, salivary gland, spleen, stomach (forestomach and glandular), testis with epididymis and seminal vesicle, thymus, thyroid gland, trachea, urinary bladder, and uterus. Additionally, the lung and larynx from male and female rats in all remaining exposure groups and the liver from male rats in the 75 mg/m³ group were examined. The larynx, lung, and gallbladder from male and female mice were examined to a no-effect level.</p>	<p>Complete histopathology was performed on 0 and 75 mg/m³ rats and mice. In addition to gross lesions and tissue masses, the following tissues were examined: adrenal gland, bone with marrow, brain, clitoral gland, esophagus, gallbladder (mice only), heart, large intestine (cecum, colon, rectum), small intestine (duodenum, jejunum, ileum), kidney, larynx, liver, lung, lymph nodes (mandibular, mediastinal, mesenteric, tracheobronchial), mammary gland with adjacent skin, nose, ovary, pancreas, parathyroid gland, preputial gland, prostate gland, salivary gland, spleen, stomach (forestomach and glandular), testes with epididymis and seminal vesicle, thymus, thyroid gland, trachea, urinary bladder, and uterus. In addition, the bone marrow (males), larynx, liver, lung, lymph nodes, and testis with epididymis were examined in all remaining groups of rats. The larynx, liver, lung, tracheobronchial lymph node, spleen, and testis with epididymis were examined in the remaining groups of mice.</p>	<p>Complete histopathology was performed on all rats and mice. In addition to gross lesions and tissue masses, the following tissues were examined: adrenal gland, bone with marrow, brain, clitoral gland, esophagus, harderian gland (male mice), heart, large intestine (cecum, colon, rectum), small intestine (duodenum, jejunum, ileum), kidney, larynx, liver, lung, lymph nodes (bronchial, mandibular, mediastinal, mesenteric), mammary gland, nose, ovary, pancreas, parathyroid gland, pituitary gland, preputial gland, prostate gland, salivary gland, spleen, stomach (forestomach and glandular), testes, thymus, thyroid gland, trachea, urinary bladder, uterus. Additionally, the lung from one male rat in the 0, 0.1, and 1.0 mg/m³ 6-month tissue burden study groups and one or two males from the 0, 0.01, and 1.0 mg/m³ 12-month tissue burden study groups were examined.</p>
<p>Sperm Motility and Vaginal Cytology None</p>	<p>At the end of the studies, sperm samples were collected from all male rats and mice in the 0, 10, 37, and 75 mg/m³ groups for sperm motility evaluations. The following parameters were evaluated: spermatid heads per testis and per gram testis, spermatid counts, and epididymal spermatozoal motility and concentration. The left cauda, left epididymis, and left testis were weighed. Vaginal samples were collected for up to 12 consecutive days prior to the end of the studies from all female rats and mice exposed to 0, 10, 37, and 75 mg/m³ for vaginal cytology evaluations. The following parameters were evaluated: estrous cycle lengths and relative frequency of estrous stages.</p>	<p>None</p>

TABLE 2
Experimental Design and Materials and Methods in the Inhalation Studies of Gallium Arsenide

16-Day Studies	14-Week Studies	2-Year Studies
Tissue Burden Studies		
None	Lung from male rats in tissue burden study groups were evaluated at three time points.	Lung, testes, blood, and serum from male rats in the tissue burden study groups were evaluated at six time points.
	Day 23: 10 males (0 mg/m ³) or 6 males (0.1, 1, 10, 37, and 75 mg/m ³)	Month 1, 2, 4, 6, 12, and 18: 5 males (0, 0.1, and 1.0 mg/m ³)
	Day 45: 2 males (0 mg/m ³) or 4 males (0.1, 1, 10, 37, and 75 mg/m ³)	Month 2, 12, and 18: 4 or 5 males (0.01 mg/m ³)
	Day 93: 4 males (0 mg/m ³), 3 males (0.1 mg/m ³), or 4 males (1, 10, 37, and 75 mg/m ³)	

STATISTICAL METHODS

Survival Analyses

The probability of survival was estimated by the product-limit procedure of Kaplan and Meier (1958) and is presented in the form of graphs. Animals found dead of other than natural causes were censored from the survival analyses; animals dying from natural causes were not censored. Statistical analyses for possible dose-related effects on survival used Cox's (1972) method for testing two groups for equality and Tarone's (1975) life table test to identify dose-related trends. All reported P values for the survival analyses are two sided.

Calculation of Incidence

The incidences of neoplasms or nonneoplastic lesions are presented in Tables A1, A5, B1, B5, C1, C5, D1, and D5 as the numbers of animals bearing such lesions at a specific anatomic site and the numbers of animals with that site examined microscopically. For calculation of statistical significance, the incidences of most neoplasms (Tables A3, B3, C3, and D3) and all nonneoplastic lesions are given as the numbers of animals affected at each site examined microscopically. However, when macroscopic examination was required to detect neoplasms in certain tissues (e.g., hardyrian gland, intestine, mammary gland, and skin) before microscopic evaluation, or when neoplasms had multiple potential sites of occurrence (e.g., leukemia or lymphoma), the denominators consist of

the number of animals on which a necropsy was performed. Tables A3, B3, C3, and D3 also give the survival-adjusted neoplasm rate for each group and each site-specific neoplasm. This survival-adjusted rate (based on the Poly-3 method described below) accounts for differential mortality by assigning a reduced risk of neoplasm, proportional to the third power of the fraction of time on study, to animals that do not reach terminal sacrifice.

Analysis of Neoplasm and Nonneoplastic Lesion Incidences

The Poly-k test (Bailer and Portier, 1988; Portier and Bailer, 1989; Piegorsch and Bailer, 1997) was used to assess neoplasm and nonneoplastic lesion prevalence. This test is a survival-adjusted quantal-response procedure that modifies the Cochran-Armitage linear trend test to take survival differences into account. More specifically, this method modifies the denominator in the quantal estimate of lesion incidence to approximate more closely the total number of animal years at risk. For analysis of a given site, each animal is assigned a risk weight. This value is one if the animal had a lesion at that site or if it survived until terminal sacrifice; if the animal died prior to terminal sacrifice and did not have a lesion at that site, its risk weight is the fraction of the entire study time that it survived, raised to the kth power.

This method yields a lesion prevalence rate that depends only upon the choice of a shape parameter

for a Weibull hazard function describing cumulative lesion incidence over time (Bailer and Portier, 1988). Unless otherwise specified, a value of $k=3$ was used in the analysis of site-specific lesions. This value was recommended by Bailer and Portier (1988) following an evaluation of neoplasm onset time distributions for a variety of site-specific neoplasms in control F344 rats and B6C3F₁ mice (Portier *et al.*, 1986). Bailer and Portier (1988) showed that the Poly-3 test gave valid results if the true value of k was anywhere in the range from 1 to 5. A further advantage of the Poly-3 method is that it does not require lesion lethality assumptions. Variation introduced by the use of risk weights, which reflect differential mortality, was accommodated by adjusting the variance of the Poly-3 statistic as recommended by Bieler and Williams (1993).

Tests of significance included pairwise comparisons of each exposed group with controls and a test for an overall exposure-related trend. Continuity-corrected Poly-3 tests were used in the analysis of lesion incidence, and reported P values are one sided. Values of P greater than 0.5 are presented as 1-P with the letter N added to indicate a lower incidence or negative trend in neoplasm occurrence relative to the control group (e.g., $P=0.99$ is presented as $P=0.01N$).

Analysis of Continuous Variables

Two approaches were employed to assess the significance of pairwise comparisons between exposed and control groups in the analysis of continuous variables. Organ and body weight data, which historically have approximately normal distributions, were analyzed with the parametric multiple comparison procedures of Dunnett (1955) and Williams (1971, 1972). Blood and bone marrow hematology, clinical chemistry, urinalysis, spermatid, and epididymal spermatozoal data, which have typically skewed distributions, were analyzed using the non-parametric multiple comparison methods of Shirley (1977) and Dunn (1964). Jonckheere's test (Jonckheere, 1954) was used to assess the significance of the dose-related trends and to determine whether a trend-sensitive test (Williams' or Shirley's test) was more appropriate for pairwise comparisons than a test that does not assume a monotonic dose-related trend (Dunnett's or Dunn's test). Prior to statistical analysis, extreme values identified by the outlier test of Dixon and Massey (1951) were examined by NTP

personnel, and implausible values were eliminated from the analysis. Average severity values were analyzed for significance with the Mann-Whitney U test (Hollander and Wolfe, 1973). Because vaginal cytology data are proportions (the proportion of the observation period that an animal was in a given estrous stage), an arcsine transformation was used to bring the data into closer conformance with a normality assumption. Treatment effects were investigated by applying a multivariate analysis of variance (Morrison, 1976) to the transformed data to test for simultaneous equality of measurements across exposure concentrations.

Historical Control Data

Although the concurrent control group is always the first and most appropriate control group used for evaluation, historical control data can be helpful in the overall assessment of neoplasm incidence in certain instances. Consequently, neoplasm incidences from the NTP historical control database, which is updated yearly, are included in the NTP reports for neoplasms appearing to show compound-related effects.

QUALITY ASSURANCE METHODS

The 16-day, 14-week, and 2-year studies were conducted in compliance with Food and Drug Administration Good Laboratory Practice Regulations (21 CFR, Part 58). In addition, as records from the 16-day, 14-week, and 2-year studies were submitted to the NTP Archives, these studies were audited retrospectively by an independent quality assurance contractor. Separate audits covered completeness and accuracy of the pathology data, pathology specimens, final pathology tables, and a draft of this NTP Technical Report. Audit procedures and findings are presented in the reports and are on file at NIEHS. The audit findings were reviewed and assessed by NTP staff, and all comments were resolved or otherwise addressed during the preparation of this Technical Report.

GENETIC TOXICOLOGY

The genetic toxicity of gallium arsenide was assessed by testing the ability of the chemical to induce mutations in various strains of *Salmonella typhimurium* and increases in the frequency of micronucleated

erythrocytes in mouse peripheral blood. The protocols for these studies and the results are given in Appendix E.

The genetic toxicity studies of gallium arsenide are part of a larger effort by the NTP to develop a comprehensive database that would permit a critical anticipation of a chemical's carcinogenicity in experimental animals based on numerous considerations, including the molecular structure of the chemical and its observed effects in short-term *in vitro* and *in vivo* genetic toxicity tests (structure-activity relationships). These short-term genetic toxicity tests were originally developed to clarify mechanisms of chemical-induced DNA damage growing out of the earlier electrophilicity/mutagenicity relationship proposed by Miller and Miller (1977) and the somatic mutation theory of cancer (Straus, 1981; Crawford, 1985). Therefore, the information obtained from these tests applies only to mutagenic carcinogens.

For mutagenic carcinogens, there is a strong correlation between a chemical's potential for DNA reactivity, mutagenicity in *Salmonella*, and carcinogenicity in rodents. The combination of DNA reactivity and *Salmonella* mutagenicity is highly correlated with the induction of carcinogenicity in multiple species and genders of rodents and at multiple tissue sites (Ashby and Tennant, 1991). Data

from NTP studies show that a positive response in *Salmonella* is the most predictive *in vitro* test for rodent carcinogenicity (89% of the *Salmonella* mutagens are rodent carcinogens) and that there is no complementarity among the *in vitro* genetic toxicity tests (Tennant *et al.*, 1987; Zeiger *et al.*, 1990). That is, no battery of tests that included the *Salmonella* test improved the predictivity of the *Salmonella* test alone. Although other *in vitro* genetic toxicity tests correlate less well with rodent carcinogenicity compared with the *Salmonella* test, these other tests can provide useful information on the types of DNA and chromosomal effects induced by the chemical under investigation.

The predictivity for carcinogenicity of a positive response in *in vivo* bone marrow chromosome aberration or micronucleus tests appears to be less than the *Salmonella* test (Shelby *et al.*, 1993; Shelby and Witt, 1995). Positive responses in long-term peripheral blood micronucleus tests have not been formally evaluated for their predictivity for rodent carcinogenicity. However, because of the theoretical and observed associations between induced genetic damage and adverse effects in somatic and germ cells, the determination of *in vivo* genetic effects is important to the overall understanding of the risks associated with exposure to a particular chemical.

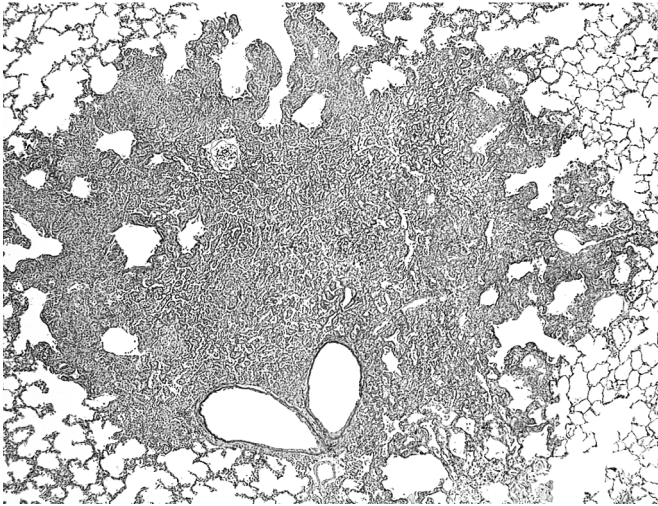

Plate 1
Alveolar/bronchiolar adenoma in the lung of a female rat exposed to 1.0 mg/m^3 gallium arsenide by inhalation for 2 years. Note loss of the alveolar architecture. H&E 10x.

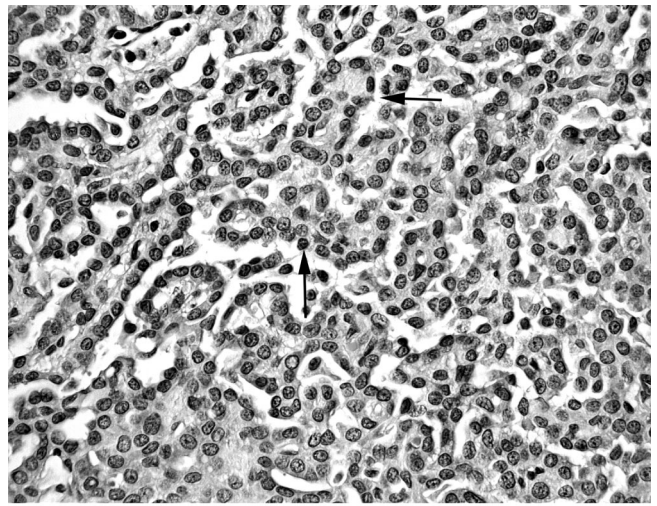

Plate 2
Higher magnification of Plate 1. Component neoplastic cells are uniformly cuboidal and arranged in papillary structures (arrows). H&E 100x.

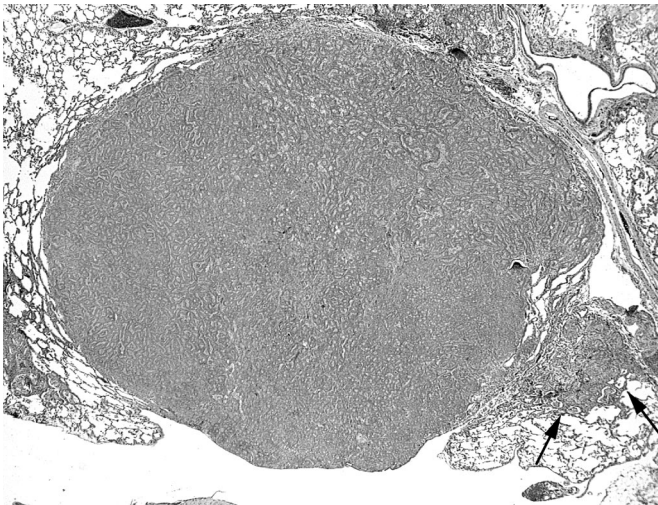

Plate 3
Low magnification of an alveolar/bronchiolar carcinoma in the lung of a female rat exposed to 1.0 mg/m^3 gallium arsenide by inhalation for 2 years. Note focal area of invasion into the adjacent alveolar parenchyma (arrows). H&E 5x.

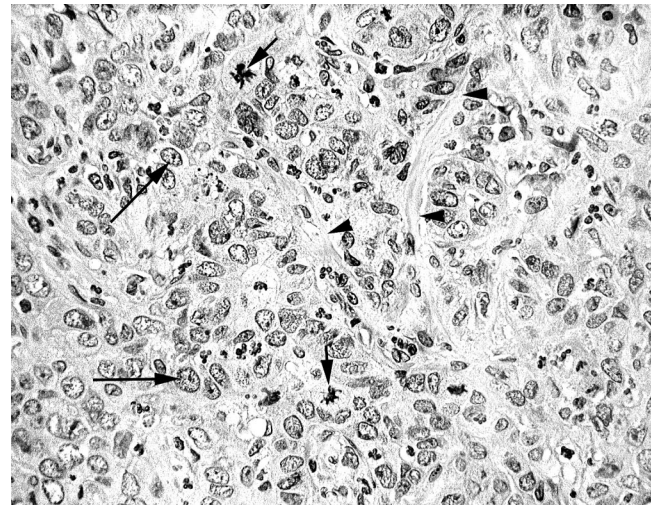

Plate 4
Alveolar/bronchiolar carcinoma in the lung of a male rat exposed to 1.0 mg/m^3 gallium arsenide by inhalation for 2 years. Note generalized marked variation in cellular and nuclear size and shape (large arrows), mitotic figures (short arrows) and fibrous tissue (arrowheads). H&E 100x.

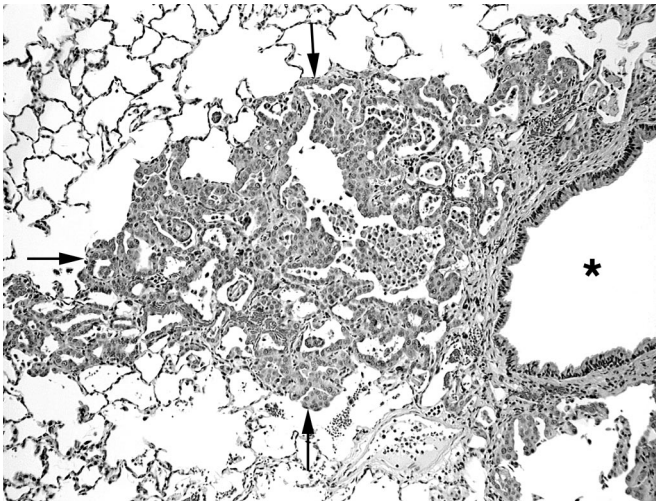

Plate 5
Focal atypical hyperplasia (arrows) in the lung of a male rat exposed to 0.1 mg/m³ gallium arsenide by inhalation for 2 years. The lesion is located adjacent to a terminal bronchiole (asterisk). Note focal distortion of the alveolar architecture. H&E 33x.

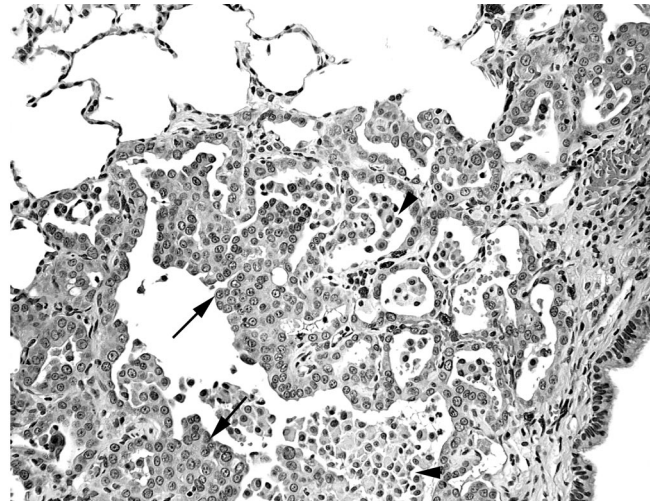

Plate 6
Higher magnification of Plate 5. Note dysplastic growth pattern (arrows) of the component proliferating cuboidal cells with distortion of the alveolar architecture and macrophages within the alveolar spaces (arrowheads). H&E 80x.

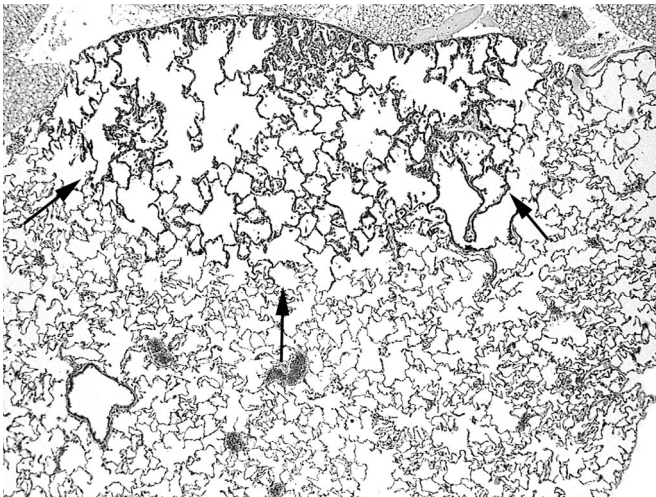

Plate 7
Low magnification of focal alveolar epithelial hyperplasia (arrows) in the lung of a female rat exposed to 0.1 mg/m³ gallium arsenide by inhalation for 2 years. H&E 10x.

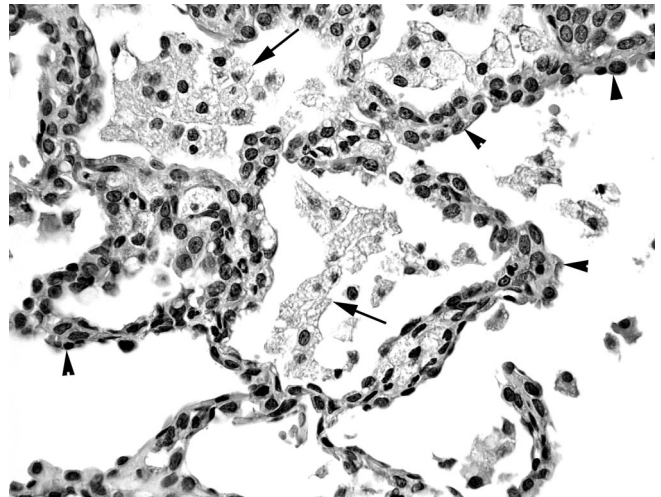

Plate 8
Higher magnification of Plate 7. Note proliferation of cuboidal epithelial (type II) cells along the alveolar septae (arrowheads) with preservation of the alveolar architecture, and large foamy macrophages within the alveolar spaces. H&E 100x.

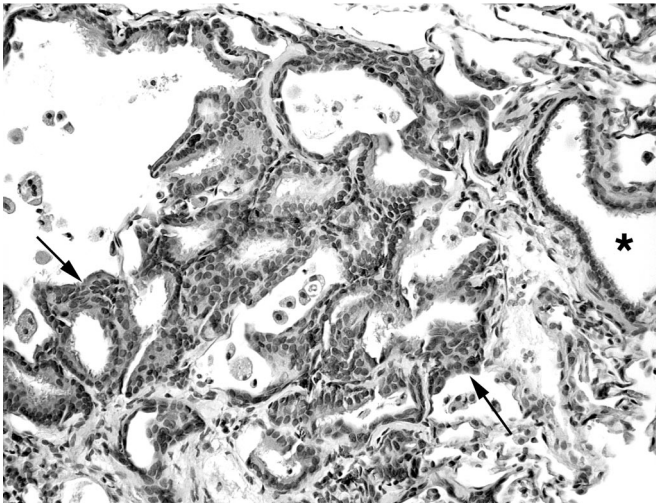

Plate 9

Focal area of alveolar/bronchiolar metaplasia (arrows) associated with an area of chronic active inflammation in the lung of a female rat exposed to 0.1 mg/m³ gallium arsenide by inhalation for 2 years. Note ciliated columnar epithelial cells proliferating along the alveoli adjacent to a terminal bronchiole (asterisk). H&E 50x.

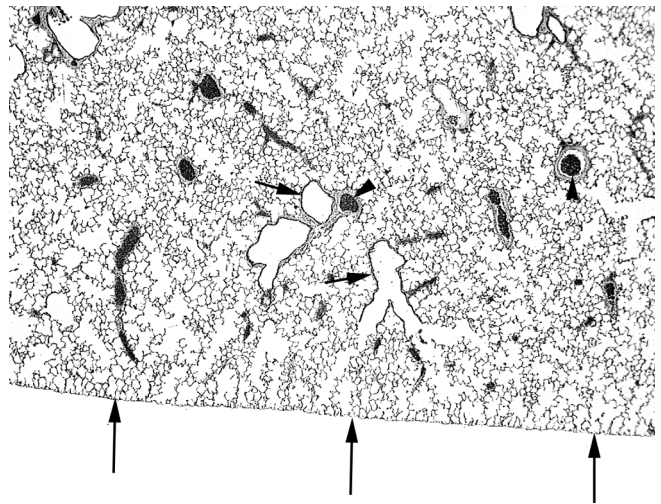

Plate 10

Histology of the normal lung of a control rat. Note pleural surface (large arrows), terminal bronchioles (short arrows) and associated blood vessels (arrowheads). H&E 10x.

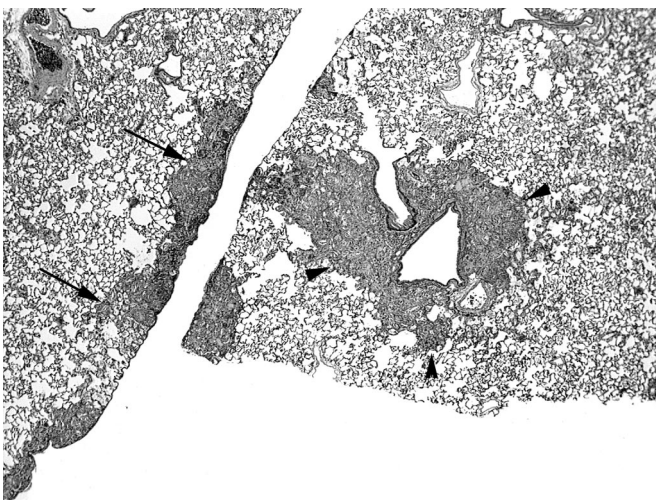

Plate 11

Low magnification of typical focal subpleural (arrows) and peribronchiolar (arrowheads) chronic active inflammation in the lung of a female rat exposed to 1.0 mg/m³ gallium arsenide by inhalation for 2 years. H&E 8x.

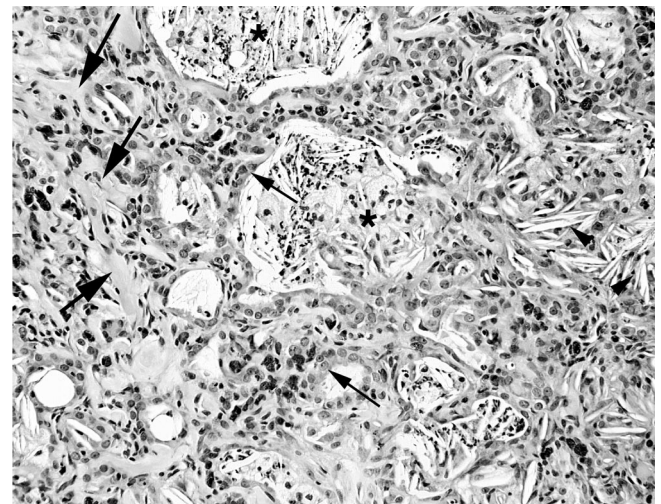

Plate 12

Higher magnification of Plate 11. Note hyperplastic epithelium lining the alveoli (small arrows), foamy macrophages and cell debris in the alveolar spaces (asterisks), cholesterol clefts (arrowheads) and fibrosis (large arrows). H&E 80x.

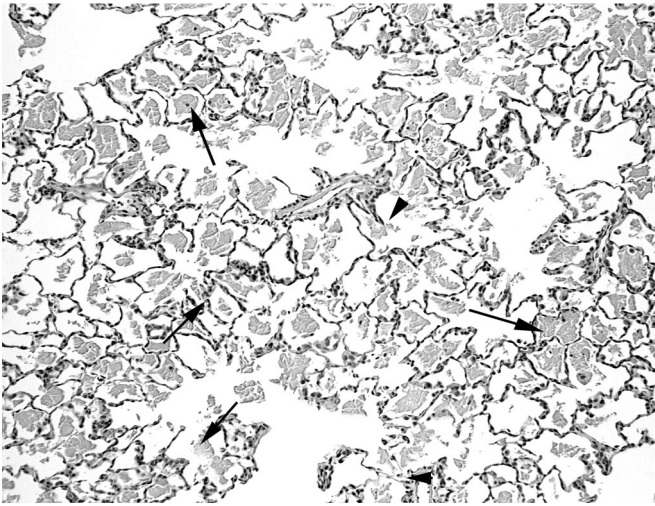

Plate 13

Alveolar proteinosis in the lung of a female rat exposed to 1.0 mg/m³ gallium arsenide by inhalation for 2 years. Note finely granular material within the alveolar spaces (arrows). H&E 33x.

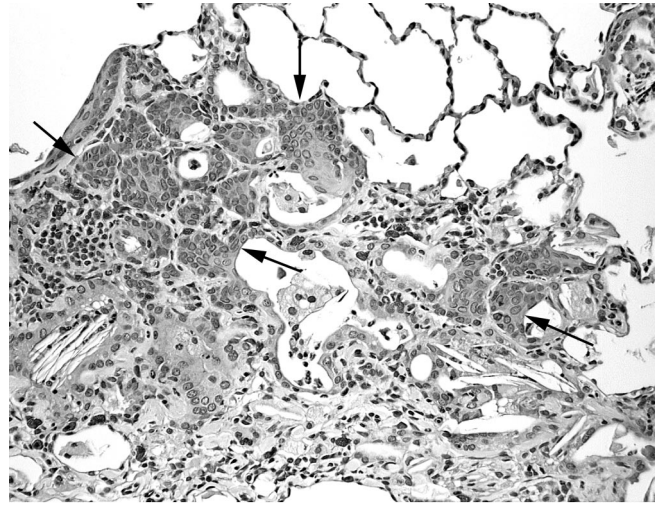

Plate 14

Focal squamous metaplasia (arrows) at the periphery of a focal area of chronic active inflammation in the lung of a male rat exposed to 0.1 mg/m³ gallium arsenide by inhalation for 2 years. Islands of mature squamous epithelium line the alveolar septae. H&E 66x.



Plate 15

Well-demarcated squamous cyst in the lung of a male rat exposed to 1.0 mg/m³ gallium arsenide by inhalation for 2 years. H&E 5x.

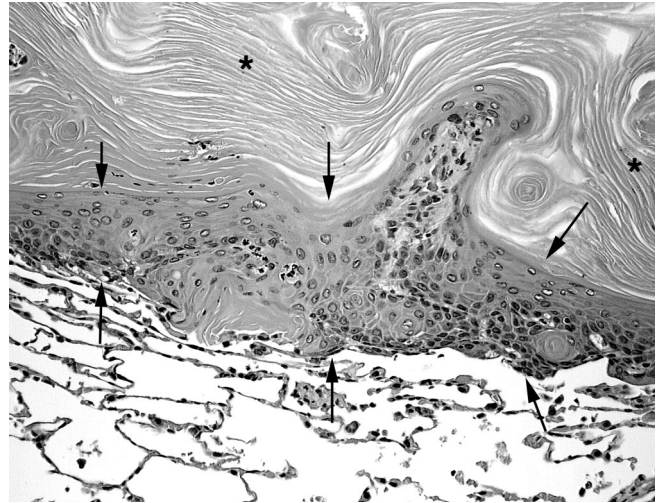

Plate 16

Higher magnification of Plate 15 showing a portion of a squamous cyst in the lung of a female rat exposed to 1.0 mg/m³ gallium arsenide by inhalation for 2 years. The cyst is filled with concentrically arranged layers of keratin (asterisks) and is lined by a thick irregular wall of mature squamous epithelium. H&E 66x.

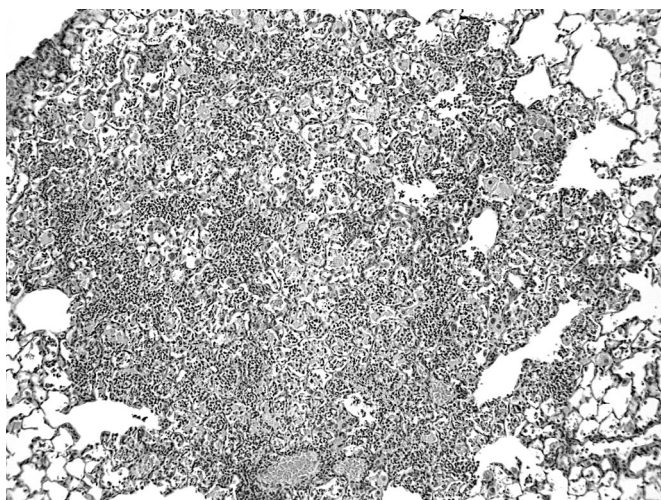

Plate 17

Low magnification of focally extensive area of suppurative inflammation in the lung of a male mouse exposed to 1.0 mg/m^3 gallium arsenide by inhalation for 2 years. H&E 25x.

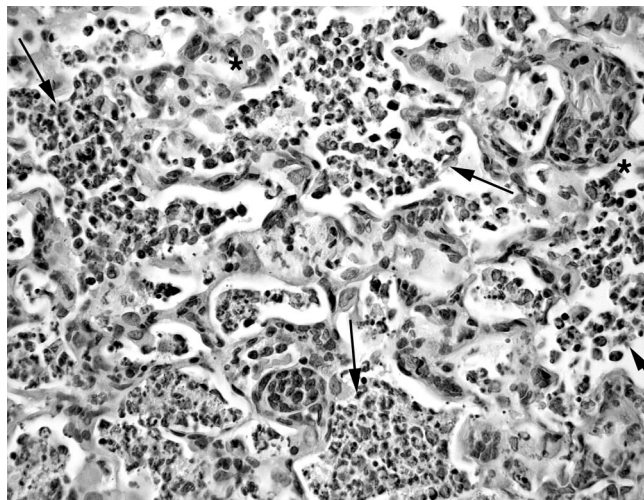

Plate 18

Higher magnification of Plate 17. Note high numbers of neutrophils in the alveolar spaces (arrows) and hyperplastic epithelium lining the alveoli (arrow-heads). H&E 100x.

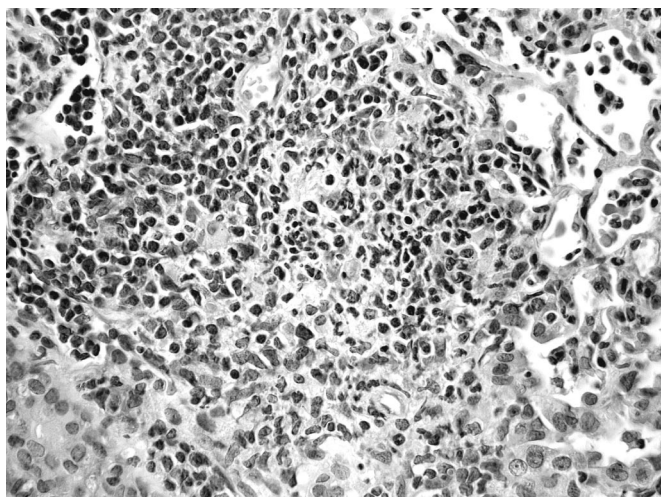

Plate 19

Focal chronic inflammation in the lung of a male mouse exposed to 1.0 mg/m^3 gallium arsenide by inhalation for 2 years. Alveolar spaces are filled with a mixed inflammatory cell infiltrate mainly consisting of macrophages, lymphocytes and lesser numbers of neutrophils. H&E 100x.

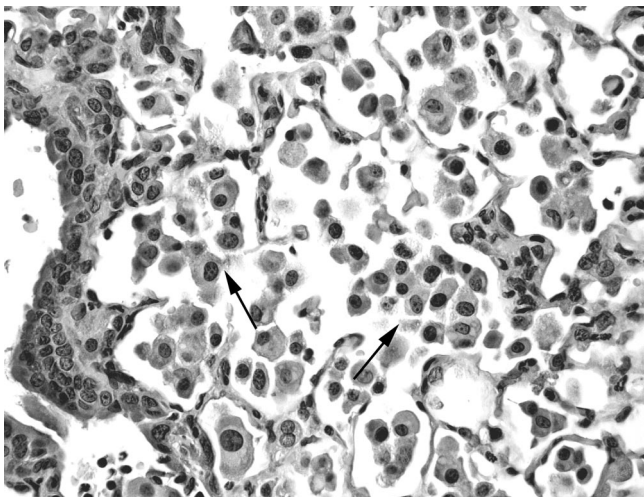

Plate 20

Histiocytic cellular infiltrate in the lung of a male mouse exposed to 1.0 mg/m^3 gallium arsenide by inhalation for 2 years. Alveolar spaces contain high numbers of large macrophages (arrows). H&E 100x.

RESULTS

RATS

16-DAY STUDY

All rats survived to the end of the study (Table 3). The final mean body weights and body weight gains of all exposed groups of males and females were similar to those of the chamber control groups. No clinical findings related to gallium arsenide exposure were observed.

Compared to chamber controls, the liver and lung weights of males exposed to 1 mg/m³ or greater and females exposed to 10 mg/m³ or greater were increased (Table G1); the thymus weights of all exposed groups of males were decreased.

TABLE 3
Survival and Body Weights of Rats in the 16-Day Inhalation Study of Gallium Arsenide

Concentration (mg/m ³)	Survival ^a	Mean Body Weight ^b (g)			Final Weight Relative to Controls (%)
		Initial	Final	Change	
Male					
0	5/5	100 ± 1	176 ± 2	76 ± 3	
1	5/5	99 ± 2	170 ± 5	71 ± 3	97
10	5/5	99 ± 2	173 ± 4	74 ± 2	98
37	5/5	98 ± 3	169 ± 5	71 ± 3	96
75	5/5	100 ± 2	174 ± 3	74 ± 2	99
150	5/5	96 ± 3	166 ± 7	70 ± 4	94
Female					
0	5/5	87 ± 2	126 ± 3	40 ± 1	
1	5/5	85 ± 1	123 ± 2	38 ± 2	98
10	5/5	85 ± 1	122 ± 3	37 ± 2	97
37	5/5	86 ± 1	124 ± 2	38 ± 1	98
75	5/5	86 ± 1	125 ± 3	40 ± 2	99
150	5/5	85 ± 2	124 ± 4	39 ± 3	98

^a Number of animals surviving at 16 days/number initially in group

^b Weights and weight changes are given as mean ± standard error. Differences from the chamber control group were not significant by Dunnett's test.

Compared to the chamber controls, there were significantly increased exposure-related incidences of microscopic lesions in the lung and larynx of exposed rats (Table 4). Fine black refringent particulate material (presumed to be gallium arsenide particles) was visible in the alveolar spaces and, to a lesser extent, within alveolar macrophages of all exposed rats. The amount of particulate material present was dependent upon exposure concentration. The original diagnosis for this material was alveolus, foreign body. The alveoli of all exposed rats contained finely granular to fibrillar lightly eosinophilic proteinaceous material (originally diagnosed as exudate) within alveolar spaces and some alveolar macrophages. The material was positive when stained with Periodic acid-Schiff (PAS) and ultrastructurally was shown to be consistent with surfactant, a lipoprotein secreted by

type II alveolar cells of the lung, mixed with small amounts of fibrin.

The incidences of minimal histiocytic cellular infiltrate in males exposed to 37 mg/m³ or greater were significantly greater than those in the chamber controls. Histiocytic cellular infiltrate was characterized by a minimal increase in the number of alveolar macrophages within alveolar spaces.

Minimal laryngeal epithelial hyperplasia was present primarily in males exposed to 150 mg/m³. In addition, there were slight, although not significant, increases in the incidences of minimal squamous metaplasia in the base of the epiglottis in males exposed to 37 mg/m³ or greater and in females exposed to 75 or 150 mg/m³.

TABLE 4
Incidences of Selected Nonneoplastic Lesions of the Lung and Larynx in Rats
in the 16-Day Inhalation Study of Gallium Arsenide

	Chamber Control	1 mg/m ³	10 mg/m ³	37 mg/m ³	75 mg/m ³	150 mg/m ³
Male						
Lung ^a	5	5	5	5	5	5
Alveolus, Cellular Infiltration, Histiocytic ^b	1 (1.0) ^c	0	4 (1.0)	5* (1.0)	5* (1.0)	5* (1.0)
Alveolus, Proteinosis	0	5** (1.0)	5** (1.4)	5** (2.0)	5** (2.8)	5** (3.0)
Larynx	5	5	5	5	5	5
Epithelial Hyperplasia	0	1 (1.0)	0	0	1 (1.0)	4* (1.0)
Metaplasia, Squamous	0	0	0	1 (1.0)	1 (1.0)	3 (1.0)
Female						
Lung	5	5	5	5	5	5
Alveolus, Cellular Infiltration, Histiocytic	2 (1.0)	0	5 (1.0)	5 (1.0)	5 (1.0)	5 (1.0)
Alveolus, Proteinosis	0	5** (1.0)	5** (2.0)	5** (2.4)	5** (3.0)	5** (2.6)
Larynx	5	5	5	5	5	5
Metaplasia, Squamous	0	1 (1.0)	0	0	2 (1.0)	2 (1.0)

* Significantly different ($P \leq 0.05$) from the chamber control group by the Fisher exact test

** $P \leq 0.01$

^a Number of animals examined microscopically

^b Number of animals with lesion

^c Average severity grade of lesions in affected animals: 1=minimal, 2=mild, 3=moderate, 4=marked

Exposure Concentration Selection Rationale: The severity of alveolar proteinosis increased with increasing exposure concentration and was considered the primary reason for the concomitant increased lung weights. The proteinosis and lung weights were markedly increased in the 75 and 150 mg/m³ groups and represented the upper exposure limits for the 14-week study. Because effects were similar between the 75 and 150 mg/m³ groups, 75 mg/m³ was selected

as the high exposure concentration for the 14-week study. Because a no-effect level was not achieved for the lung and the effects observed at 37 mg/m³ were similar to but less severe than those in the 75 mg/m³ group, the three lower concentrations for the 14-week study were spaced by a factor of ten. The exposure concentrations for the 14-week study in rats were 0, 0.1, 1, 10, 37, and 75 mg/m³.

TABLE 5
Survival and Body Weights of Rats in the 14-Week Inhalation Study of Gallium Arsenide

Concentration (mg/m ³)	Survival ^a	Mean Body Weight ^b (g)			Final Weight Relative to Controls (%)
		Initial	Final	Change	
Male					
0	10/10	135 ± 4	328 ± 8	193 ± 6	
0.1	10/10	130 ± 3	325 ± 5	195 ± 4	99
1	10/10	131 ± 3	327 ± 7	196 ± 6	100
10	10/10	131 ± 3	318 ± 6	187 ± 5	97
37	10/10	135 ± 3	312 ± 4	178 ± 3*	95
75	10/10	130 ± 2	299 ± 5**	169 ± 4**	91
Female					
0	10/10	105 ± 1	185 ± 3	80 ± 3	
0.1	10/10	111 ± 3	193 ± 3	83 ± 2	104
1	10/10	109 ± 2	187 ± 4	78 ± 5	101
10	10/10	109 ± 2	189 ± 3	80 ± 4	102
37	10/10	105 ± 2	185 ± 4	81 ± 3	100
75	10/10	108 ± 2	182 ± 3	74 ± 3	98

* Significantly different ($P \leq 0.05$) from the chamber control group by Williams' test

** $P \leq 0.01$

^a Number of animals surviving at 14 weeks/number initially in group

^b Weights and weight changes are given as mean ± standard error.

14-WEEK STUDY

All rats survived to the end of the study (Table 5). The final mean body weights of males in the 75 mg/m³ group and body weight gains of males in the 37 and 75 mg/m³ groups were significantly less than those of the chamber controls. No clinical findings related to exposure to gallium arsenide were observed.

The clinical pathology data are listed in Table F1, and selected hematology and clinical chemistry data are presented in Table 6. In males on day 23 and at week 14, there was evidence of a minimal to mild exposure concentration-related anemia, demonstrated by decreased hematocrit values and hemoglobin concentrations in the 37 and 75 mg/m³ groups. In contrast, the decreases in the hematocrit values and hemoglobin concentrations were accompanied by increased erythrocyte counts; at week 14, the erythrocyte count was also increased in the 10 mg/m³ group. At the same time points, there were minimal to marked, exposure concentration-related decreases in the mean cell volumes and mean cell hemoglobin values in males exposed to 10 mg/m³ or greater, suggesting that the circulating erythrocytes were smaller (microcytic) than expected.

As a consequence of the smaller erythrocytes, the overall hematologic effect was a decrease in the erythron even though erythrocyte counts were greater than chamber control values. Consistent with an erythropoietic response were exposure concentration-related increases in reticulocyte counts, which occurred in exposed groups of males demonstrating anemia and/or increased erythrocyte counts. Additionally, increased nucleated erythrocyte counts occurred in the 75 mg/m³ males at week 14. For females, similar erythron differences occurred but with less consistency and were of less magnitude. In fact, evidence of a minimal anemia was transient and was only present on day 23. Similar to males at week 14, a minimal to mild erythrocytosis (increased erythrocyte counts) and reticulocytosis (increased reticulocyte counts) occurred in females exposed to 10 mg/m³ or greater. Also similar to the males on day 23 and at week 14 were exposure concentration-related decreases in mean cell volumes and mean cell hemoglobin values; these alterations occurred in the same groups as for the males but were less severe. At week 14, review of the blood smears revealed increased numbers of schistocytes (erythrocyte fragments) and keratocytes in the exposed groups with increased erythrocyte counts (data not shown).

TABLE 6
Selected Hematology and Clinical Chemistry Data for Rats in the 14-Week Inhalation Study
of Gallium Arsenide^a

	Chamber Control	0.1 mg/m ³	1 mg/m ³	10 mg/m ³	37 mg/m ³	75 mg/m ³
Male						
Hematology						
n						
Day 3	10	10	10	10	10	10
Day 23	10	10	10	9	10	9
Week 14	10	10	10	10	10	10
Manual hematocrit (%)						
Day 3	45.6 ± 0.3	45.9 ± 0.5	46.4 ± 0.6	45.5 ± 0.4	45.6 ± 0.5	45.7 ± 0.4
Day 23	47.6 ± 0.2	47.6 ± 0.3	47.6 ± 0.4	47.3 ± 0.7	46.9 ± 0.6	44.7 ± 0.4**
Week 14	43.8 ± 0.5	44.6 ± 0.5	43.9 ± 1.0	44.1 ± 0.3	42.4 ± 0.5	41.1 ± 0.7*
Automated hematocrit (%)						
Day 3	45.3 ± 0.3	45.4 ± 0.4	46.0 ± 0.6	44.6 ± 0.7	45.1 ± 0.4	45.3 ± 0.4
Day 23	47.5 ± 0.3	47.4 ± 0.3	47.2 ± 0.6	47.7 ± 0.7	46.4 ± 0.6*	43.5 ± 0.4**
Week 14	41.9 ± 0.5	42.6 ± 0.4	42.3 ± 0.8	40.9 ± 0.3	36.5 ± 0.5**	34.3 ± 0.6**
Hemoglobin (g/dL)						
Day 3	15.0 ± 0.1	14.9 ± 0.2	15.0 ± 0.2	14.6 ± 0.3	14.7 ± 0.1	14.7 ± 0.1
Day 23	15.4 ± 0.1	15.5 ± 0.1	15.2 ± 0.2	15.4 ± 0.3	15.2 ± 0.2	14.2 ± 0.1**
Week 14	14.7 ± 0.2	15.0 ± 0.1	15.0 ± 0.3	14.4 ± 0.2	13.2 ± 0.2**	12.8 ± 0.2**
Erythrocytes (10 ⁶ /μL)						
Day 3	7.85 ± 0.06	7.94 ± 0.08	7.99 ± 0.12	7.67 ± 0.12	7.79 ± 0.08	7.71 ± 0.08
Day 23	8.42 ± 0.07	8.44 ± 0.04	8.36 ± 0.13	8.67 ± 0.13	9.22 ± 0.15**	9.38 ± 0.13**
Week 14	8.92 ± 0.10	9.05 ± 0.08	9.07 ± 0.17	9.67 ± 0.08**	11.04 ± 0.15**	12.17 ± 0.12**
Reticulocytes (10 ⁶ /μL)						
Day 3	0.34 ± 0.02	0.34 ± 0.03	0.33 ± 0.02	0.33 ± 0.02	0.31 ± 0.01	0.33 ± 0.02
Day 23	0.19 ± 0.02	0.21 ± 0.01	0.22 ± 0.03	0.21 ± 0.02	0.23 ± 0.02	0.28 ± 0.03**
Week 14	0.22 ± 0.02	0.24 ± 0.02	0.22 ± 0.02	0.35 ± 0.03**	0.50 ± 0.04**	0.63 ± 0.03**
Mean cell volume (fL)						
Day 3	57.6 ± 0.3	57.3 ± 0.3	57.8 ± 0.4	58.1 ± 0.2	57.8 ± 0.3	58.6 ± 0.6
Day 23	56.5 ± 0.2	56.2 ± 0.2	56.4 ± 0.3	54.9 ± 0.3**	50.5 ± 0.3**	46.3 ± 0.6**
Week 14	46.9 ± 0.1	47.0 ± 0.2	46.6 ± 0.2	42.2 ± 0.1**	33.0 ± 0.4**	28.2 ± 0.3**
Mean cell hemoglobin (pg)						
Day 3	19.1 ± 0.1	18.8 ± 0.2	18.8 ± 0.1	19.1 ± 0.1	18.9 ± 0.1	19.1 ± 0.2
Day 23	18.3 ± 0.1	18.4 ± 0.1	18.2 ± 0.1	17.7 ± 0.1**	16.4 ± 0.1**	15.2 ± 0.2**
Week 14	16.5 ± 0.1	16.6 ± 0.1	16.5 ± 0.1	14.9 ± 0.1**	12.0 ± 0.1**	10.5 ± 0.1**
Zinc protoporphyrin (μmol/mol heme)						
Day 3	53.7 ± 0.7	51.7 ± 0.6	56.8 ± 1.6	56.5 ± 0.9	55.5 ± 0.8	54.7 ± 0.5
Day 23	60.2 ± 1.2	59.4 ± 1.4	60.3 ± 2.4	61.9 ± 1.3	69.9 ± 0.9**	73.8 ± 1.5**
Week 14	79.9 ± 2.1	75.0 ± 1.8	80.3 ± 2.4	81.4 ± 2.3	95.4 ± 5.9**	97.5 ± 3.3**
Clinical Chemistry						
n	10	10	10	10	10	10
Total iron binding capacity (μg/dL)						
Day 23	580.2 ± 8.9	— ^b	—	590.2 ± 10.1	589.0 ± 9.2	595.5 ± 5.8
Week 14	625.1 ± 6.2	—	—	618.0 ± 6.1	610.1 ± 6.7	609.1 ± 7.3
Unbound iron binding capacity (μg/dL)						
Day 23	353.8 ± 12.0	—	—	459.2 ± 13.2**	473.3 ± 4.8**	488.2 ± 8.3**
Week 14	454.4 ± 14.9	—	—	455.0 ± 10.8	473.2 ± 7.8	467.0 ± 6.8
Iron (μg/dL)						
Day 23	226.4 ± 10.0	—	—	131.0 ± 15.0**	115.7 ± 8.2**	107.3 ± 6.0**
Week 14	170.7 ± 10.2	—	—	163.0 ± 7.2	136.9 ± 5.1*	142.1 ± 5.4*

TABLE 6
Selected Hematology and Clinical Chemistry Data for Rats in the 14-Week Inhalation Study
of Gallium Arsenide

	Chamber Control	0.1 mg/m ³	1 mg/m ³	10 mg/m ³	37 mg/m ³	75 mg/m ³
Female						
Hematology						
n	10	10	10	10	10	10
Manual hematocrit (%)						
Day 3	46.9 ± 0.4	47.6 ± 0.5	48.2 ± 0.3	46.9 ± 0.5	46.5 ± 0.5	46.8 ± 0.4
Day 23	49.0 ± 0.5	48.3 ± 0.4	48.6 ± 0.3	47.7 ± 0.4*	47.7 ± 0.3*	46.5 ± 0.4**
Week 14	43.1 ± 0.7	43.2 ± 0.9	43.7 ± 0.4	44.5 ± 0.4	44.3 ± 0.5	43.6 ± 0.4
Automated hematocrit (%)						
Day 3	47.0 ± 0.2	47.4 ± 0.4	48.2 ± 0.3	46.9 ± 0.5	46.9 ± 0.7	47.4 ± 0.2
Day 23	49.8 ± 0.7	49.2 ± 0.3	49.7 ± 0.4	48.3 ± 0.6**	48.2 ± 0.2**	46.5 ± 0.5**
Week 14	42.1 ± 0.5	42.4 ± 0.9	43.1 ± 0.4	43.7 ± 0.3	43.0 ± 0.5	41.9 ± 0.4
Hemoglobin (g/dL)						
Day 3	15.3 ± 0.1	15.5 ± 0.1	15.7 ± 0.1	15.2 ± 0.2	15.3 ± 0.2	15.5 ± 0.1
Day 23	15.9 ± 0.1	15.9 ± 0.1	15.9 ± 0.1	15.6 ± 0.3	15.7 ± 0.1	15.4 ± 0.1**
Week 14	14.8 ± 0.2	14.9 ± 0.3	15.2 ± 0.1	15.3 ± 0.1	15.0 ± 0.2	14.6 ± 0.1
Erythrocytes (10 ⁶ /μL)						
Day 3	8.07 ± 0.05	8.26 ± 0.09	8.35 ± 0.08	8.10 ± 0.12	8.12 ± 0.13	8.16 ± 0.07
Day 23	8.53 ± 0.14	8.55 ± 0.07	8.63 ± 0.08	8.44 ± 0.10	8.71 ± 0.06	8.96 ± 0.10
Week 14	8.30 ± 0.10	8.28 ± 0.17	8.44 ± 0.09	8.84 ± 0.08**	9.32 ± 0.09**	9.60 ± 0.09**
Reticulocytes (10 ⁶ /μL)						
Day 3	0.24 ± 0.01	0.23 ± 0.02	0.23 ± 0.02	0.23 ± 0.02	0.30 ± 0.02	0.29 ± 0.02
Day 23	0.18 ± 0.02	0.14 ± 0.01	0.14 ± 0.02 ^c	0.13 ± 0.01	0.13 ± 0.01*	0.12 ± 0.01* ^c
Week 14	0.19 ± 0.01	0.21 ± 0.01	0.23 ± 0.01	0.24 ± 0.01*	0.28 ± 0.02**	0.31 ± 0.02**
Mean cell volume (fL)						
Day 3	58.2 ± 0.1	57.4 ± 0.3	57.8 ± 0.3*	58.0 ± 0.3*	57.8 ± 0.2**	58.2 ± 0.3**
Day 23	58.5 ± 0.3	57.7 ± 0.3	57.6 ± 0.2*	57.4 ± 0.3*	55.3 ± 0.3**	51.8 ± 0.3**
Week 14	50.7 ± 0.2	51.2 ± 0.1	51.1 ± 0.1	49.3 ± 0.3**	46.1 ± 0.2**	43.5 ± 0.3**
Mean cell hemoglobin (pg)						
Day 3	18.9 ± 0.1	18.8 ± 0.2	18.8 ± 0.1	18.8 ± 0.1	18.8 ± 0.1	19.0 ± 0.1
Day 23	18.6 ± 0.2	18.6 ± 0.1	18.4 ± 0.1	18.4 ± 0.2	18.0 ± 0.1**	17.2 ± 0.1**
Week 14	17.8 ± 0.1	18.0 ± 0.1	18.0 ± 0.0	17.3 ± 0.1**	16.1 ± 0.1**	15.2 ± 0.1**
Zinc protoporphyrin (μmol/mol heme)						
Day 3	53.6 ± 0.9	53.1 ± 0.9	52.7 ± 0.9	49.9 ± 0.2**	51.7 ± 1.0*	50.8 ± 0.6*
Day 23	53.7 ± 1.3	54.0 ± 0.8	54.0 ± 0.6	54.4 ± 0.5	60.1 ± 1.3**	64.9 ± 0.8**
Week 14	63.6 ± 0.9 ^d	67.8 ± 1.6*	66.5 ± 1.4	68.2 ± 2.2	72.4 ± 1.6**	80.9 ± 2.0**

TABLE 6
Selected Hematology and Clinical Chemistry Data for Rats in the 14-Week Inhalation Study of Gallium Arsenide

	Chamber Control	0.1 mg/m ³	1 mg/m ³	10 mg/m ³	37 mg/m ³	75 mg/m ³
Female (continued)						
Clinical Chemistry						
n						
Day 23	10	10	10	10	10	10
Week 14	10	9	10	10	10	10
Total iron binding capacity (µg/dL)						
Day 23	542.9 ± 4.7 ^c	—	—	509.8 ± 6.6**	524.8 ± 7.2*	455.9 ± 25.6**
Week 14	566.9 ± 10.6	—	—	568.9 ± 12.7	538.3 ± 7.5	518.3 ± 4.7**
Unbound iron binding capacity (µg/dL)						
Day 23	287.0 ± 13.6 ^c	—	—	286.3 ± 20.6	294.1 ± 16.8	296.9 ± 10.9 ^d
Week 14	334.0 ± 10.4	—	—	331.0 ± 13.3	319.4 ± 10.3	314.3 ± 8.9
Iron (µg/dL)						
Day 23	262.3 ± 20.5	—	—	223.5 ± 24.0	230.7 ± 20.1	180.4 ± 13.2**
Week 14	232.9 ± 7.7	—	—	237.9 ± 12.0	218.9 ± 11.0	204.0 ± 9.2

* Significantly different ($P \leq 0.05$) from the chamber control group by Dunn's or Shirley's test

** $P \leq 0.01$

^a Mean ± standard error. Statistical tests were performed on unrounded data.

^b Not measured at this exposure concentration

^c n=7

^d n=9

On day 23 and at week 14, there were no alterations in the total nucleated cell counts of bone marrow for male or female rats (Table F1). At these time points, bone marrow cytocentrifuged preparations were prepared and stained with Wright-Giemsa for cell distribution evaluations. Bone marrow cytocentrifuged preparations were also submitted for staining with an iron stain. On day 23, there was suggestion of an exposure concentration-related shift to more immature erythroid precursors in male and female rats (data not shown). At week 14, the exposure concentration-related shift to more immature erythroid precursors was present and was most evident in 37 mg/m³ males and 75 mg/m³ males and females (data not shown). At this time point there also appeared to be increases in erythrophagocytosis. In females, evaluation of the iron stained preparations demonstrated that sideroblasts and siderocytes were present but were considered to be slightly less in the

exposed groups; for males, there was no change in the nonheme iron staining (data not shown).

For males and females, platelet counts demonstrated minimal to mild exposure concentration-related increases (Table F1); on day 23, increased platelet counts occurred in 75 mg/m³ males and females; at week 14, males exposed to 10 mg/m³ or greater and females exposed to 37 or 75 mg/m³ were affected. Similar to the other hematologic effects mentioned previously, the platelet count changes were of greater magnitude in the male rats.

On day 23 and at week 14, zinc protoporphyrin/heme ratios demonstrated exposure concentration-related increases in 37 and 75 mg/m³ females and males in all exposure groups (Tables 6 and F1). Although methemoglobin concentrations were significantly increased in females exposed to 10 mg/m³ or greater, this effect was minimal and was not considered

clinically relevant, and there were no alterations in the methemoglobin concentrations of exposed males.

On days 3 and 23, there was evidence of a transient, exposure-related leukopenia, demonstrated by decreases in the leukocyte counts (Table F1). On day 23, this effect occurred in all exposed male groups and in females exposed to 37 or 75 mg/m³. In contrast, neutrophil counts demonstrated exposure-related, but not concentration-related, increases at various time points in the 10 mg/m³ or greater groups. The increased neutrophil counts may, in part, be explained by the pulmonary inflammation observed microscopically.

On day 23 and at week 14, there was evidence of a hepatocellular effect demonstrated by increases in serum alanine aminotransferase and sorbitol dehydrogenase activities (Table F1). By week 14, alanine aminotransferase activity was increased in 37

and 75 mg/m³ males, and sorbitol dehydrogenase activities were increased in 37 and 75 mg/m³ males and females. There was also some evidence of altered iron metabolism, demonstrated on day 23 by decreased serum iron concentrations in 10 and 37 mg/m³ males and 75 mg/m³ males and females (Tables 6 and F1); at week 14, iron concentrations were still decreased in 37 and 75 mg/m³ males. Also, unbound iron binding capacity was increased in males exposed to 10 mg/m³ or greater on day 23, and total iron binding capacity was decreased in females exposed to 10 mg/m³ or greater on day 23 and 75 mg/m³ at week 14. Exposure to gallium arsenide had no effect on thyroid hormone concentrations, urine chemistry parameters, or the ability of rats to concentrate urine.

The lung weights of all exposed groups of rats were greater than those of the chamber controls (Tables 7 and G2).

TABLE 7
Lung Weights and Lung-Weight-to-Body-Weight Ratios for Rats
in the 14-Week Inhalation Study of Gallium Arsenide^a

	Chamber Control	0.1 mg/m ³	1 mg/m ³	10 mg/m ³	37 mg/m ³	75 mg/m ³
n	10	10	10	10	10	10
Male						
Necropsy body wt	341 ± 8	338 ± 5	341 ± 7	334 ± 7	328 ± 4	314 ± 5**
Lung						
Absolute	1.487 ± 0.051	1.986 ± 0.042**	2.353 ± 0.054**	2.925 ± 0.107**	3.764 ± 0.060**	4.174 ± 0.094**
Relative	4.351 ± 0.075	5.875 ± 0.103**	6.896 ± 0.085**	8.731 ± 0.202**	11.495 ± 0.125**	13.311 ± 0.225**
Female						
Necropsy body wt	192 ± 3	200 ± 4	196 ± 4	197 ± 4	193 ± 3	191 ± 3
Lung						
Absolute	1.033 ± 0.018	1.417 ± 0.040**	1.681 ± 0.025**	2.011 ± 0.046**	2.581 ± 0.067**	2.946 ± 0.061**
Relative	5.385 ± 0.110	7.069 ± 0.107**	8.595 ± 0.161*	10.239 ± 0.296**	13.376 ± 0.226**	15.517 ± 0.472**

* Significantly different ($P \leq 0.05$) from the chamber control group by Williams' or Dunnett's test

** $P \leq 0.01$

^a Lung weights (absolute weights) and body weights are given in grams; lung-weight-to-body-weight ratios (relative weights) are given as mg lung weight/g body weight (mean ± standard error).

The right and left testis weights of males exposed to 75 mg/m³ were decreased (Tables G2 and I1), and the weights of the cauda epididymis and epididymis were decreased in males exposed to 37 or 75 mg/m³ (Table I1); total spermatid heads per testis and per gram testis and spermatid counts were significantly decreased in males exposed to 75 mg/m³. In groups of males exposed to 10 mg/m³ or greater, the motility of epididymal spermatozoa was decreased, with less than 1% motile spermatozoa in males exposed to 75 mg/m³. No significant differences were noted in the estimated length of the estrous cycle (Table I2).

Gross exposure-related lesions were observed in the lung and mandibular lymph node. The lungs of males and females exposed to 10 mg/m³ or greater were diffusely gray. The enlarged lymph nodes were due to plasma cell hyperplasia (Table 8). The tracheas of a few males and several females exposed to 10 mg/m³ or greater contained fluid. There was an exposure concentration-related increase in the incidences of enlarged mandibular lymph nodes in groups of males and females exposed to 37 or 75 mg/m³.

Compared to the chamber controls, there were significantly increased incidences of exposure-related microscopic lesions in the lung, larynx, mediastinal and mandibular lymph nodes, testis, epididymis, bone

marrow, and liver of males and females (Tables 8 and 9). The alveoli of all exposed rats contained brightly eosinophilic hyaline-like material or paler staining granular proteinaceous material, the severities of which increased with increasing exposure concentration. The material was similar to that observed in the 16-day study and was consistent with surfactant. Alveolar histiocytic cellular infiltrate consisted of increased numbers of macrophages within alveolar spaces and in the interstitium of alveolar septae. The severity of this lesion was generally minimal to mild. The alveoli and many alveolar macrophages contained gallium arsenide particles. Alveolar and pleural fibrosis consisted of minimal focal thickening of alveolar septae and the pleura by mature fibrous tissue. Fibrotic lesions occasionally occurred adjacent to focal accumulations of macrophages that contained gallium arsenide particles.

Minimal squamous metaplasia of the larynx occurred in all males exposed to 37 or 75 mg/m³ and in three and eight female rats exposed to 37 or 75 mg/m³, respectively (Table 9). Squamous metaplasia consisted of replacement of the normally single layer of ciliated cuboidal to columnar epithelium in the base of the epiglottis by four or five cell layers of squamous epithelium with minimal superficial keratinization.

TABLE 8
Incidences of Selected Nonneoplastic Lesions in Rats in the 14-Week Inhalation Study of Gallium Arsenide

	Chamber Control	0.1 mg/m ³	1 mg/m ³	10 mg/m ³	37 mg/m ³	75 mg/m ³
Male						
Lymph Node, Mandibular ^a	10	9	9	9	9	10
Hyperplasia, Plasma Cell ^b	0	2 (2.0) ^c	3 (2.3)	3 (2.7)	8** (1.9)	8** (1.6)
Testis ^d	10	10	10	10	10	10
Atrophy	0	0	1 (4.0)	0	10** (1.1)	10** (3.4)
Epididymis ^d	10	10	10	10	10	10
Hyospermia	0	0	1 (4.0)	0	10** (1.8)	10** (3.9)
Bone Marrow ^d	10	10	10	10	10	10
Hyperplasia	0	0	0	1 (1.0)	9** (1.0)	10** (1.0)
Liver ^d	10	10	10	10	10	10
Hemosiderosis	1 (1.0)	0	0	0	9** (1.0)	9** (1.0)
Female						
Lymph Node, Mandibular	10	10	10	10	10	10
Hyperplasia, Plasma Cell	1 (1.0)	1 (1.0)	4 (1.0)	5 (1.0)	7** (2.4)	9** (2.1)
Liver	10	10	10	10	10	10
Hemosiderosis	1 (1.0)	0	0	1 (1.0)	9** (1.0)	9** (1.0)

** Significantly different ($P \leq 0.01$) from the chamber control group by the Fisher exact test

^a Number of animals with tissue examined microscopically

^b Number of animals with lesion

^c Average severity grade of lesions in affected animals: 1=minimal, 2=mild, 3=moderate, 4=marked

^d Number of animals examined microscopically

TABLE 9
Incidences of Nonneoplastic Lesions of the Lung, Larynx, and Associated Lymph Nodes in Rats
in the 14-Week Inhalation Study of Gallium Arsenide

	Chamber Control	0.1 mg/m ³	1 mg/m ³	10 mg/m ³	37 mg/m ³	75 mg/m ³
Male						
Lung ^a	10	10	10	10	10	10
Alveolus, Cellular Infiltration, Histiocytic ^b	1 (1.0) ^c	3** (1.0)	10** (2.9)	10** (1.0)	10** (1.0)	10** (1.1)
Alveolus, Proteinosis	0	10** (1.1)	10** (2.1)	10** (3.8)	10** (4.0)	10** (4.0)
Larynx ^a	10	10	10	10	10	10
Metaplasia, Squamous	0	0	0	0	10** (1.0)	10** (1.0)
Lymph Node, Mediastinal ^d	8	8	9	7	9	9
Lymphoid Hyperplasia	0	3 (1.0)	4* (1.3)	1 (1.0)	0	4* (1.0)
Female						
Lung	10	10	10	10	10	10
Alveolus, Cellular Infiltration, Histiocytic	0	9** (1.6)	10** (1.9)	10** (1.0)	10** (1.1)	10** (1.1)
Alveolus, Proteinosis	0	10** (1.1)	10** (1.9)	10** (3.9)	10** (4.0)	10** (4.0)
Larynx	10	10	10	10	10	10
Metaplasia, Squamous	0	0	0	0	3 (1.0)	8** (1.0)
Lymph Node, Mediastinal	9	8	8	7	9	10
Lymphoid Hyperplasia	0	0	3 (1.0)	3 (1.0)	5* (1.0)	3 (1.0)

* Significantly different ($P \leq 0.05$) from the chamber control group by the Fisher exact test

** $P \leq 0.01$

^a Number of animals examined microscopically

^b Number of animals with lesion

^c Average severity grade of lesions in affected animals: 1=minimal, 2=mild, 3=moderate, 4=marked

^d Number of animals with tissue examined microscopically

Minimal amounts of gallium arsenide particles were observed in the tracheobronchial lymph nodes of some males and females exposed to 10 mg/m³ or greater; they were also observed in the mediastinal lymph nodes of some males in all exposed groups and in some females exposed to 10 mg/m³ or greater. Minimal lymphoid hyperplasia was also observed in the mediastinal lymph nodes of some exposed males and females (Table 8).

Plasma cell hyperplasia was observed in the mandibular lymph node in all exposed groups (Table 9). The incidences were related to exposure concentration and correlated with gross enlargement of the mandibular lymph nodes. Hyperplasia consisted of

increased numbers of mature plasma cells in the medullary cords.

Testicular atrophy and epididymal hypospermia were observed in all males exposed to 37 or 75 mg/m³ (Table 9). Atrophy was generally of minimal severity in the 37 mg/m³ group and of moderate to marked severity in the 75 mg/m³ group. Atrophy consisted of decreased thickness of the germinal epithelium of seminiferous tubules due to variable loss of spermatogonia, spermatids, and spermatozoa. Sertoli cells lined severely affected tubules almost exclusively. Variable numbers of multinucleated syncytial cells were present in atrophic tubules. Epididymal

hypospermia was generally of mild severity in the 37 mg/m³ group and of marked severity in the 75 mg/m³ group. Hypospermia consisted of decreased numbers of spermatozoa and the presence of cellular debris and large nucleated cells within the lumina of the epididymis.

Bone marrow hyperplasia characterized by hypercellularity due to increased numbers of erythropoietic cells was present in groups of males exposed to 10 mg/m³ or greater (Table 9).

The incidences of hemosiderosis in the liver of males and females exposed to 37 or 75 mg/m³ were significantly greater than those in the chamber controls (Table 9). Hemosiderosis was characterized by the presence of non-heme iron (confirmed by Perl's stain) in Kupffer cells.

Lung Burden Analyses

Lung weights increased with increasing exposure concentration in males exposed to 1 mg/m³ or greater on days 23 and 45 and in all exposed groups at week 14 (Table H1). In addition, lung weights in exposed rats continued to increase to a greater extent throughout the study than did chamber control lung weights. The percentages of gallium and arsenic in the lung relative to the total lung burden of gallium arsenide were similar at all exposure concentrations throughout the study because the deposition and clearance rates in the lung for gallium and arsenic were similar within each exposed group (Tables H1 and H3).

Lung burdens for gallium and arsenic increased with increasing exposure concentration, and each increased throughout the study; therefore, steady state lung burdens were not achieved for any exposure concentration (Figure 4 and Tables H1 and H3). When lung burdens were normalized to exposure concentration, they were inversely proportional to the exposure concentration (Figure 5 and Table H1). Although lung deposition rates increased proportionately to exposure concentration, lung clearance half-times actually decreased as exposure concentration increased, indicating a possible increase in lung clearance mechanisms at the higher concentrations (e.g., increases in alveolar macrophages). Thus, the more rapid elimination rate at higher exposure concentrations accounts for the subproportional retained lung burdens that were observed as exposure concentration increased.

Exposure Concentration Selection Rationale: Based on the increased severities of lung proteinosis and at least a two-fold increase in lung weights in males and females, exposure concentrations of 10 mg/m³ or greater were considered sufficiently severe to preclude their use in a 2-year study. Because a no-effect level was not achieved for the lung, the lowest exposure concentration for rats in the 2-year study was set at the lowest concentration that the chamber particle monitor could monitor continuously with accuracy. Therefore, gallium arsenide exposure concentrations selected for the 2-year inhalation study in rats were 0.01, 0.1, and 1.0 mg/m³.

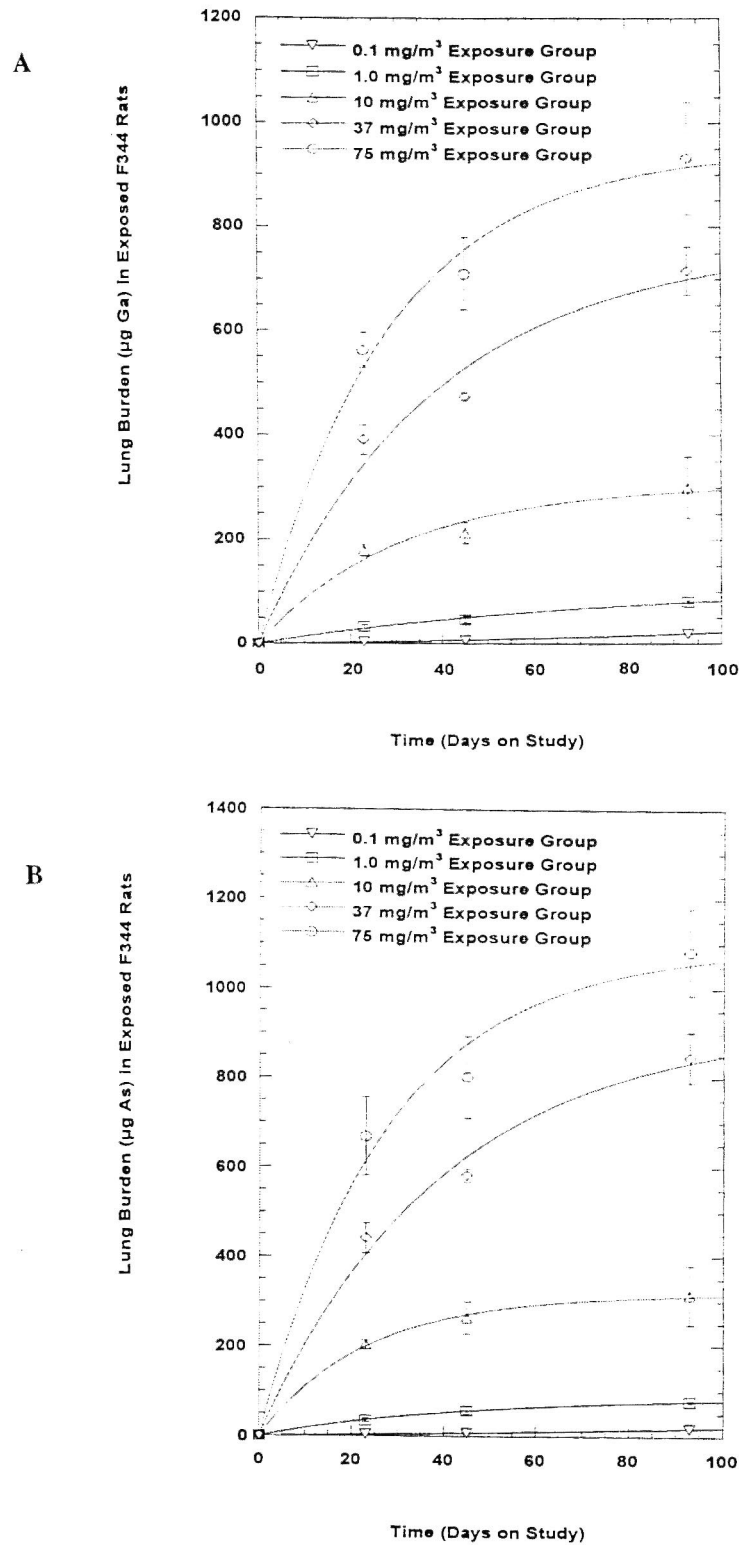

Figure 4
Lung Burdens of (A) Gallium and (B) Arsenic in Rats in the 14-Week Inhalation Study of Gallium Arsenide. Data are presented as mean \pm standard deviation. The curves represent the fit of the lung deposition and clearance model to the data. Arsenic data have been corrected for background arsenic concentrations in the lungs of control animals.

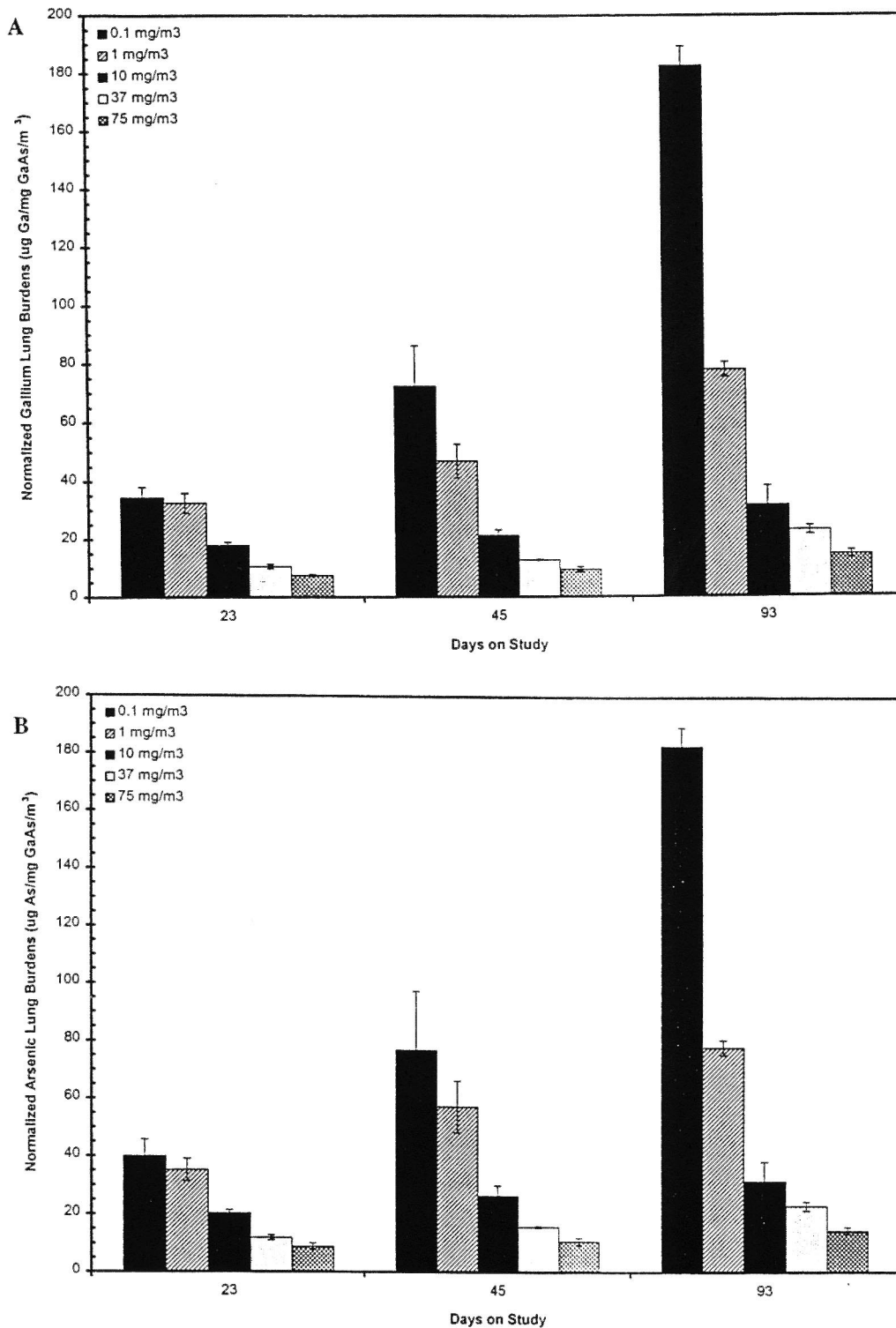

Figure 5
Normalized Lung Burdens of (A) Gallium and (B) Arsenic ($\mu\text{g Ga or As/Lung per Exposure Concentration}$) in Rats in the 14-Week Inhalation Study of Gallium Arsenide.

Data are presented as mean \pm standard deviation. Arsenic data have been corrected for background arsenic concentrations in the lungs of control animals.

2-YEAR STUDY

Survival

Estimates of 2-year survival probabilities for male and female rats are shown in Table 10 and in the Kaplan-Meier survival curves (Figure 6). Survival rates of exposed males and females were similar to those of the chamber controls.

Body Weights and Clinical Findings

Mean body weights of males exposed to 1.0 mg/m³ were generally less than those of the chamber controls throughout the study; females exposed to 1.0 mg/m³ had slightly lower mean body weights during the second year (Figure 7 and Tables 11 and 12). No clinical findings related to gallium arsenide exposure were observed.

TABLE 10
Survival of Rats in the 2-Year Inhalation Study of Gallium Arsenide

	Chamber Control	0.01 mg/m ³	0.1 mg/m ³	1.0 mg/m ³
Male				
Animals initially in study	50	50	50	50
Moribund	30	29	32	33
Natural deaths	7	8	3	4
Animals surviving to study termination	13	13	15	13
Percent probability of survival at end of study ^a	26	26	30	26
Mean survival (days) ^b	651	627	656	636
Survival analysis ^c	P=0.803	P=0.782	P=0.752N	P=0.838
Female				
Animals initially in study	50	50	50	50
Moribund	30	30	23	35
Natural deaths	1	3	6	4
Animals surviving to study termination	19	17	21 ^d	11
Percent probability of survival at end of study	38	34	42	22
Mean survival (days)	666	659	644	626
Survival analysis	P=0.052	P=0.788	P=1.000	P=0.088

^a Kaplan-Meier determinations

^b Mean of all deaths (uncensored, censored, and terminal sacrifice)

^c The result of the life table trend test (Tarone, 1975) is in the chamber control column, and the results of the life table pairwise comparisons (Cox, 1972) with the chamber controls are in the exposed group columns. A lower mortality in an exposure group is indicated by N.

^d Includes one animal that died during the last week of the study

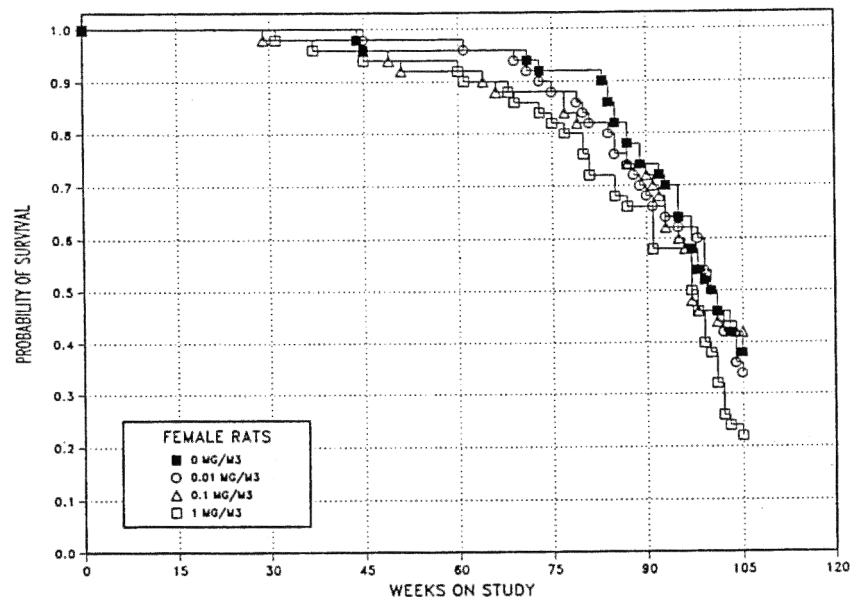
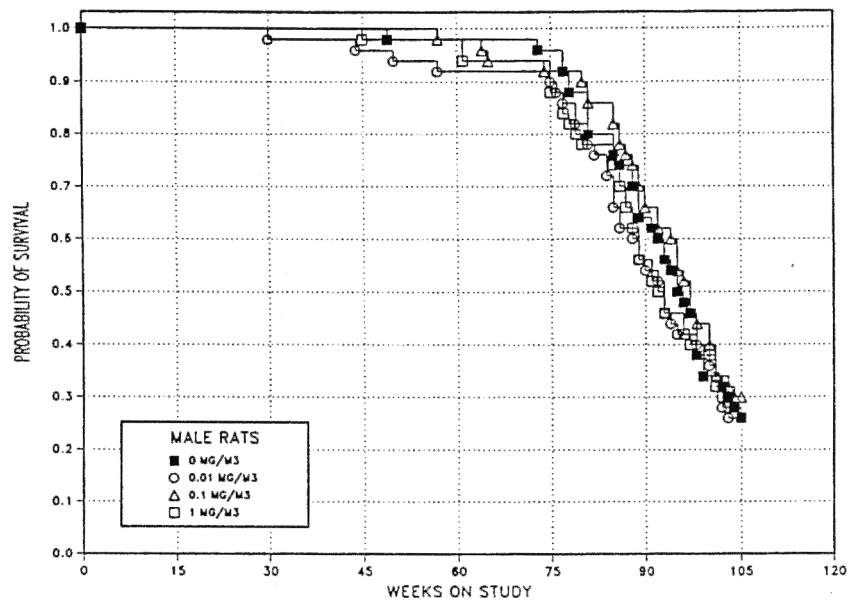

Figure 6
Kaplan-Meier Survival Curves for Male and Female Rats
Exposed to Gallium Arsenide by Inhalation for 2 Years

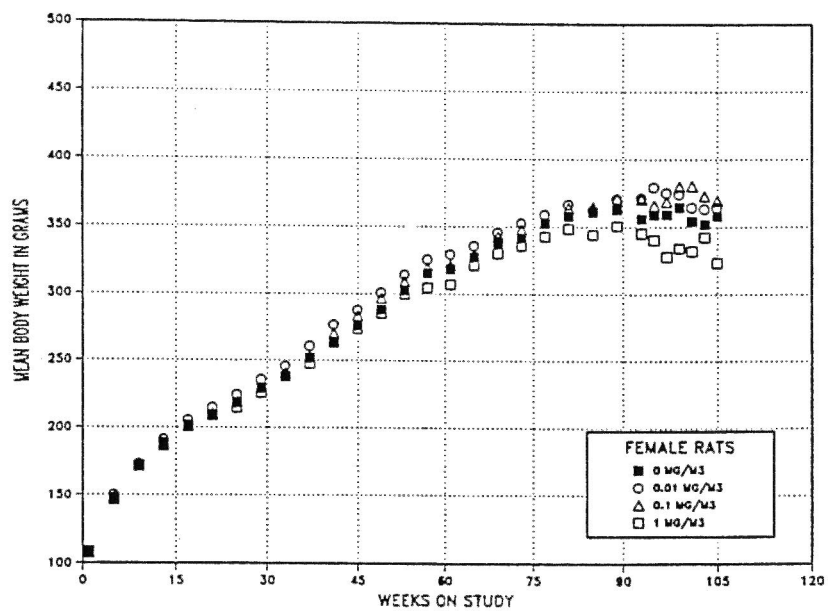
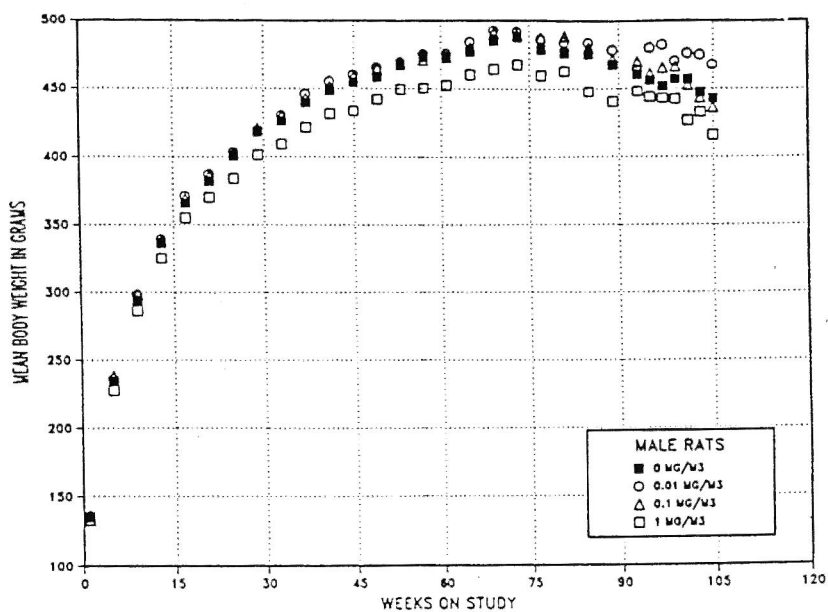

Figure 7
Growth Curves for Male and Female Rats
Exposed to Gallium Arsenide by Inhalation for 2 Years

TABLE 11
Mean Body Weights and Survival of Male Rats in the 2-Year Inhalation Study of Gallium Arsenide

Weeks on Study	Chamber Control		0.01 mg/m ³			0.1 mg/m ³			1.0 mg/m ³		
	Av. Wt. (g)	No. of Survivors	Av. Wt. (g)	Wt. (% of controls)	No. of Survivors	Av. Wt. (g)	Wt. (% of controls)	No. of Survivors	Av. Wt. (g)	Wt. (% of controls)	No. of Survivors
1	135	50	136	101	50	133	99	50	134	99	50
5	234	50	236	101	50	239	102	50	227	97	50
9	294	50	298	101	50	299	102	50	286	97	50
13	336	50	339	101	50	338	101	50	325	97	50
17	366	50	371	102	50	369	101	50	355	97	50
21	382	50	387	101	50	386	101	50	370	97	50
25	401	50	403	101	50	403	101	50	384	96	50
29	418	50	419	100	50	421	101	50	401	96	50
33	426	50	430	101	49	430	101	50	409	96	50
37	439	50	446	102	49	443	101	50	421	96	50
41	449	50	455	102	49	452	101	50	431	96	50
45	455	50	460	101	48	459	101	50	433	95	50
49	458	50	465	102	48	464	101	50	442	96	49
53	467	49	470	101	47	470	101	50	449	96	49
57	473	49	475	100	46	471	100	50	450	95	49
61	473	49	476	101	46	473	100	49	452	96	49
65	477	49	484	102	46	480	101	48	460	96	47
69	485	49	493	102	46	491	101	47	464	96	47
73	488	49	492	101	46	490	100	47	468	96	47
77	479	48	486	102	44	488	102	46	460	96	43
81	477	44	484	102	41	489	103	43	463	97	39
85	476	40	484	102	36	480	101	43	448	94	39
89	468	34	479	102	30	472	101	37	440	94	30
93	461	29	464	101	26	470	102	31	448	97	23
95	456	27	480	105	22	461	101	30	444	97	23
97	452	23	482	107	21	465	103	26	443	98	21
99	457	19	470	103	20	466	102	22	442	97	20
101	457	17	476	104	17	452	99	20	427	93	19
103	447	16	475	106	14	443	99	17	433	97	14
105	443	13	468	106	13	436	99	15	416	94	14
Mean for weeks											
1-13	250		252	101		252	101		243	97	
14-52	422		426	101		425	101		405	96	
53-105	467		479	103		470	101		447	96	

TABLE 12
Mean Body Weights and Survival of Female Rats in the 2-Year Inhalation Study of Gallium Arsenide

Weeks on Study	Chamber Control		0.01 mg/m ³			0.1 mg/m ³			1.0 mg/m ³		
	Av. Wt. (g)	No. of Survivors	Av. Wt. (g)	Wt. (% of controls)	No. of Survivors	Av. Wt. (g)	Wt. (% of controls)	No. of Survivors	Av. Wt. (g)	Wt. (% of controls)	No. of Survivors
1	109	50	108	99	50	109	100	50	107	99	50
5	148	50	150	102	50	149	101	50	146	99	50
9	171	50	173	101	50	172	100	50	172	100	50
13	189	50	191	101	50	188	100	50	186	99	50
17	202	50	205	102	50	201	100	50	201	100	50
21	209	50	215	103	50	211	101	50	209	100	50
25	218	50	224	103	50	219	101	50	215	98	50
29	229	50	236	103	50	230	100	50	226	98	50
33	238	50	246	103	50	241	101	49	238	100	49
37	252	50	261	104	50	253	101	49	247	98	49
41	263	50	277	105	50	270	103	49	264	100	48
45	276	49	288	104	50	284	103	49	274	99	48
49	288	48	301	104	49	297	103	48	286	99	47
53	303	48	314	104	49	309	102	46	300	99	47
57	315	48	326	103	49	320	101	46	305	97	47
61	319	48	329	103	49	321	101	46	307	96	46
65	327	48	336	103	48	330	101	45	322	98	45
69	339	48	346	102	48	343	101	44	330	98	44
73	342	47	353	103	46	348	102	44	336	98	43
77	353	46	359	102	44	353	100	44	343	97	41
81	358	46	367	102	41	364	102	41	349	97	36
85	361	42	362	100	40	365	101	41	344	95	36
89	363	39	371	102	36	371	102	37	351	97	33
93	356	36	372	104	33	371	104	32	345	97	29
95	359	35	380	106	32	366	102	31	340	95	29
97	359	32	375	105	31	369	103	29	328	91	29
99	364	27	374	103	29	380	104	23	334	92	23
101	354	25	364	103	25	381	107	22	332	94	19
103	352	23	363	103	21	373	106	22	343	97	13
105	358	21	365	102	18	369	103	21	323	90	12
Mean for weeks											
1-13	154		156	101		155	101		153	99	
14-52	242		250	103		245	101		240	99	
53-105	346		356	103		355	103		331	96	

Pathology and Statistical Analyses

This section describes the statistically significant or biologically noteworthy changes in the incidences of neoplasms and/or nonneoplastic lesions of the respiratory system (lung, larynx, nose), adrenal medulla, preputial gland, glandular stomach, and liver and the incidences of mononuclear cell leukemia. Summaries of the incidences of neoplasms and nonneoplastic lesions, individual animal tumor diagnoses, statistical analyses of primary neoplasms that occurred with an incidence of at least 5% in at least one animal group, and historical incidences for the neoplasms mentioned in this section are presented in Appendix A for male rats and Appendix B for female rats.

Respiratory System: Exposure to gallium arsenide caused a broad spectrum of proliferative, non-proliferative, and inflammatory lesions in the lungs of males and females. Compared to the chamber controls, the incidences of alveolar/bronchiolar adenoma, alveolar/bronchiolar carcinoma, and alveolar/bronchiolar adenoma or carcinoma (combined) were significantly increased in females exposed to 1 mg/m³ and exceeded the historical control ranges for 2-year inhalation studies (Tables 13, B3, and B4a). The incidence of alveolar/bronchiolar adenoma or carcinoma (combined) in 0.1 mg/m³ females was increased and exceeded the historical control range. No corresponding increases in the incidences of lung neoplasms were seen in males (Tables 13 and A3).

Alveolar/bronchiolar adenomas were generally discrete masses that distorted the normal alveolar architecture and often compressed the surrounding lung parenchyma (Plate 1). Component cells were typically uniformly cuboidal to columnar, with oval to polygonal nuclei. Cells were arranged in papillary and, less frequently, solid patterns (Plate 2). Alveolar bronchiolar carcinomas were generally larger invasive masses that obliterated the alveolar architecture (Plate 3). Morphologic growth patterns varied from acinar to papillary to solid with heterogeneous patterns in some neoplasms. Component cells exhibited moderate to marked cellular and nuclear pleomorphism, and there were moderately increased numbers of mitotic figures (Plate 4). Some carcinomas had a prominent fibrous component interwoven between the neoplastic cells or occurring as a central core within which were variably sized glandular structures lined by uniformly cuboidal cells.

These glandular structures frequently contained necrotic neutrophils and cell debris.

The incidences of atypical hyperplasia of the alveolar epithelium in males and females exposed to 0.1 or 1.0 mg/m³ were significantly increased compared to the chamber controls (Tables 13, A5, and B5). Most lesions identified as atypical epithelial hyperplasia were irregular, often multiple lesions that occurred at the edges of foci of chronic active inflammation (Plate 5). They were characterized by proliferation of somewhat pleomorphic alveolar epithelial cells along alveolar septae (Plate 6). The alveolar septae were distorted and often thickened by interstitial fibrosis. Component cells were plump cuboidal to polygonal and sometimes appeared spindle-shaped, with abundant eosinophilic to amphophilic cytoplasm and round to oval nuclei. A few lesions identified as atypical epithelial hyperplasia were more discrete nodular lesions that had a fibrous core.

The incidences of hyperplasia of the alveolar epithelium in males exposed to 1.0 mg/m³ and of alveolar epithelial metaplasia in males and females exposed to 0.1 or 1.0 mg/m³ were significantly increased (Tables 13, A5, and B5). Alveolar epithelial hyperplasia was similar to that typically seen in chamber control rats. Increased numbers of uniformly cuboidal epithelial cells (type II cells) lined alveolar septae with maintenance of the normal alveolar architecture (Plates 7 and 8). Alveolar epithelial metaplasia generally occurred within or adjacent to foci of chronic active inflammation and was characterized by replacement of normal alveolar epithelial cells (type I cells) with ciliated cuboidal to columnar epithelial cells (Plate 9).

In the lung, the incidences of chronic active inflammation and proteinosis were significantly increased in all exposed groups of males and females, and severities of these lesions increased with increasing exposure concentration (Tables 13, A5, and B5). Gallium arsenide particles were observed in the alveolar spaces and macrophages, primarily at the higher exposure concentrations. Plate 10 is a photomicrograph of normal lung parenchyma. Chronic active inflammation occurred as multifocal lesions that obscured the normal alveolar architecture occupying less than 5% of the lung parenchyma in the 0.01 mg/m³ group and approximately 10 to 20% of the parenchyma in the 0.1 and 1.0 mg/m³ groups.

TABLE 13
Incidences of Selected Respiratory System Neoplasms and Nonneoplastic Lesions in Rats
in the 2-Year Inhalation Study of Gallium Arsenide

	Chamber Control	0.01 mg/m ³	0.1 mg/m ³	1.0 mg/m ³
Male				
Lung ^a	50	49	50	50
Cyst, Squamous ^b	0	0	0	1 (4.0) ^c
Hyperplasia, Atypical	0	2 (2.5)	5* (2.0)	18** (2.5)
Inflammation, Chronic Active	3 (1.0)	43** (1.6)	50** (2.9)	50** (3.8)
Metaplasia, Squamous	0	0	1 (2.0)	2 (3.0)
Proteinosis	0	22** (1.0)	50** (2.4)	49** (3.4)
Alveolar Epithelium, Hyperplasia	12 (2.0)	16 (1.6)	21 (2.0)	21* (2.1)
Alveolar Epithelium, Metaplasia	0	2 (1.0)	34** (2.3)	41** (2.2)
Alveolar/bronchiolar Adenoma (includes multiple)	1	0	3	2
Alveolar/bronchiolar Carcinoma	2	0	2	1
Alveolar/bronchiolar Adenoma or Carcinoma ^d	3	0	5	3
Larynx	50	50	49	50
Hyperplasia	3 (2.0)	8 (1.0)	4 (1.0)	11* (1.3)
Inflammation, Chronic Active	4 (1.5)	3 (1.3)	4 (1.0)	12* (1.3)
Metaplasia, Squamous	1 (2.0)	2 (1.0)	2 (1.5)	10** (1.4)
Epiglottis, Hyperplasia	0	6* (1.2)	4 (1.3)	5* (1.6)
Nose	50	48	49	50
Olfactory Epithelium, Degeneration, Hyaline	18 (1.4)	26* (1.3)	32** (1.3)	25 (1.3)

TABLE 13
Incidences of Selected Respiratory System Neoplasms and Nonneoplastic Lesions in Rats
in the 2-Year Inhalation Study of Gallium Arsenide

	Chamber Control	0.01 mg/m ³	0.1 mg/m ³	1.0 mg/m ³
Female				
Lung	50	50	50	50
Cyst, Squamous	0	0	1 (4.0)	0
Hyperplasia, Atypical	0	0	9** (2.2)	16** (2.2)
Inflammation, Chronic Active	11 (1.1)	46** (1.5)	49** (2.8)	50** (3.7)
Metaplasia, Squamous	0	0	2 (2.5)	1 (2.0)
Proteinosis	1 (1.0)	24** (1.0)	47** (2.2)	49** (3.8)
Alveolar Epithelium, Hyperplasia	14 (1.5)	9 (1.6)	17 (2.1)	14 (2.3)
Alveolar Epithelium, Metaplasia	0	1 (1.0)	36** (2.4)	41** (2.6)
Alveolar/bronchiolar Adenoma ^e				
Overall rate ^f	0/50 (0%)	0/50 (0%)	2/50 (4%)	7/50 (14%)
Adjusted rate ^g	0.0%	0.0%	5.3%	19.7%
Terminal rate ^h	0/19 (0%)	0/17 (0%)	1/21 (5%)	2/11 (18%)
First incidence (days)	— ^j	—	646	556
Poly-3 test ⁱ	P<0.001	— ^k	P=0.225	P=0.004
Alveolar/bronchiolar Carcinoma ^l				
Overall rate	0/50 (0%)	0/50 (0%)	2/50 (4%)	3/50 (6%)
Adjusted rate	0.0%	0.0%	5.4%	8.6%
Terminal rate	0/19 (0%)	0/17 (0%)	2/21 (10%)	1/11 (9%)
First incidence (days)	—	—	734 (T)	677
Poly-3 test	P=0.053	—	P=0.224	P=0.097
Alveolar/bronchiolar Adenoma or Carcinoma ^m				
Overall rate	0/50 (0%)	0/50 (0%)	4/50 (8%)	9/50 (18%)
Adjusted rate	0.0%	0.0%	10.7%	25.0%
Terminal rate	0/19 (0%)	0/17 (0%)	3/21 (14%)	2/11 (18%)
First incidence (days)	—	—	646	556
Poly-3 test	P<0.001	—	P=0.053	P<0.001
Squamous Cell Carcinoma	0	0	0	1
Nose	50	50	49	49
Inflammation, Suppurative	3 (3.0)	4 (1.8)	9* (2.0)	3 (2.0)

* Significantly different (P≤0.05) from the chamber control group by the Poly-3 test

** P≤0.01

(T) Terminal sacrifice

^a Number of animals examined microscopically

^b Number of animals with lesion

^c Average severity grade of lesions in affected animals: 1=minimal, 2=mild, 3=moderate, 4=marked

^d Historical incidence for 2-year inhalation studies with chamber control groups (mean ± standard deviation): 23/1,004 (2.3% ± 2.5%); range, 0%-10%

^e Historical incidence: 12/1,000 (1.2% ± 1.3%); range, 0%-4%

^f Number of animals with neoplasm per number of animals with lung examined microscopically

^g Poly-3 estimated neoplasm incidence after adjustment for intercurrent mortality

^h Observed incidence at terminal kill

ⁱ Beneath the chamber control incidence are the P values associated with the trend test. Beneath the exposed group incidence are the P values corresponding to pairwise comparisons between the chamber controls and that exposed group. The Poly-3 test accounts for differential mortality in animals that do not reach terminal sacrifice.

^j Not applicable; no neoplasms in animal group

^k Value of statistic cannot be computed.

^l Historical incidence: 2/1,000 (0.2% ± 0.6%); range, 0%-2%

^m Historical incidence: 14/1,000 (1.4% ± 1.5%); range, 0%-4%

The lesions were discrete, irregular, and variably sized, occurring subpleurally and/or adjacent to or surrounding the alveolar ducts, terminal bronchioles, larger airways, and medium-sized to larger blood vessels (Plate 11). Lesions consisted of dense accumulations of mostly macrophages with a foamy cytoplasm and fewer multinucleated giant cells, neutrophils, and mast cells in the alveolar spaces, mixed with cholesterol clefts and necrotic cell debris (Plate 12). Some lesions contained a significant fibrous component with the interstitium of the alveolar septa and, frequently, the overlying pleura thickened by mature fibrous tissue. Proteinosis was most pronounced in alveoli surrounding areas of intense chronic inflammation and, as in the 16-day and 14-week studies, consisted of accumulation of eosinophilic granular material in the alveolar spaces (Plate 13). The surrounding alveolar spaces contained increased numbers of large alveolar macrophages, many of which contained varying amounts of eosinophilic material similar to that in the alveolar spaces.

An additional small group of pulmonary lesions associated with exposure were those with a squamous epithelial component. Squamous epithelium is not a component of the normal lung. However, it often develops as a common response to pulmonary injury associated with inhalation of irritants, especially particulates. In this study, squamous metaplasia was a minor change noted in a few males and females and was usually associated with foci of chronic active inflammation. It was characterized by small focal areas in which the normal epithelium of alveolar ducts and adjacent alveoli was replaced by several layers of mature squamous epithelium with or without keratin formation (Plate 14). In one 1.0 mg/m³ male and one 0.1 mg/m³ female, the squamous epithelium formed large cystic lesions diagnosed as squamous cysts. Cysts were composed of a variably thick wall of mature squamous epithelium surrounding a lumen filled with concentrically arranged keratin (Plates 15 and 16). One 1.0 mg/m³ female had an invasive squamous cell carcinoma. This carcinoma consisted of variably sized nests of mature stratified squamous epithelium within a dense fibrous stroma. In some areas, the epithelium formed acini which contained degenerate inflammatory cells and debris.

Relative to the chamber controls, the incidences of hyperplasia, chronic active inflammation, and

squamous metaplasia of the larynx were significantly increased in males exposed to 1.0 mg/m³; the incidences of hyperplasia of the epiglottis were significantly increased in males exposed to 0.01 or 1.0 mg/m³ (Tables 13, A5, and B5). Laryngeal lesions occurred primarily in the ventral pouch posterior to the base of the epiglottis and were generally of minimal severity. Chronic active inflammation was characterized by the presence of low numbers of macrophages, neutrophils, and mineralized debris in the epithelium. It was accompanied by a slight increase in the number and height (hyperplasia) of the epithelial cells or focal replacement of the epithelium by two to three layers of squamous epithelial cells (squamous metaplasia). Minimal epithelial hyperplasia in the base of the epiglottis was morphologically similar to that in the laryngeal pouch. The epithelium at the base of the epiglottis is most sensitive to the effects of inhaled toxicants.

In the nose, the incidences of hyaline degeneration of the olfactory epithelium in males exposed to 0.01 or 0.1 mg/m³ and of suppurative inflammation in females exposed to 0.1 mg/m³ were significantly increased (Tables 13, A5, and B5). The lesion was of minimal severity and limited to the dorsal meatus of the nasal cavity.

Adrenal Medulla: The incidences of benign pheochromocytoma occurred with a positive trend in females, and the incidence in females exposed to 1.0 mg/m³ was significantly increased compared to the chamber controls and exceeded the historical control range for inhalation studies (Tables 14, B3, and B4b). The incidence of bilateral benign pheochromocytoma was significantly increased in the 1.0 mg/m³ group of females. The morphology of the benign pheochromocytomas was typical of those that develop spontaneously. They were generally moderately to well delineated irregular nodular masses that altered the medullary architecture and sometimes compressed the adjacent parenchyma. Component neoplastic cells varied in size and staining characteristics, and were arranged in sheets and/or variably sized clusters and cords. Although there was no corresponding increase in the incidences of malignant pheochromocytoma or hyperplasia in females, the 13 benign pheochromocytomas in females exposed to 1.0 mg/m³ far exceeded the highest historical inhalation study control incidence of 6/47 and was

TABLE 14
Incidences of Neoplasms and Nonneoplastic Lesions of the Adrenal Medulla in Rats
in the 2-Year Inhalation Study of Gallium Arsenide

	Chamber Control	0.01 mg/m ³	0.1 mg/m ³	1.0 mg/m ³
Male				
Number Examined Microscopically	50	49	49	50
Hyperplasia, Bilateral ^a	0	1 (4.0) ^b	1 (3.0)	7** (3.1)
Hyperplasia (includes bilateral)	22 (2.5)	26 (2.5)	23 (2.6)	33* (3.0)
Benign Pheochromocytoma, Bilateral	4	3	5	3
Benign Pheochromocytoma (includes bilateral)	16	12	22	13
Malignant Pheochromocytoma	2	0	3	1
Benign or Malignant Pheochromocytoma (combined)	16	12	23	14
Female				
Number Examined Microscopically	50	49	50	49
Hyperplasia, Bilateral	0	0	1 (2.0)	0
Hyperplasia (includes bilateral)	16 (2.0)	11 (1.8)	16 (1.8)	12 (2.5)
Benign Pheochromocytoma, Bilateral	0	0	2	5*
Benign Pheochromocytoma (includes bilateral) ^c				
Overall rate ^d	4/50 (8%)	5/49 (10%)	6/50 (12%)	13/49 (27%)
Adjusted rate ^e	9.9%	13.3%	16.0%	36.0%
Terminal rate ^f	1/19 (5%)	2/16 (13%)	5/21 (24%)	4/11 (36%)
First incidence (days)	506	695	674	564
Poly-3 test ^g	P<0.001	P=0.455	P=0.321	P=0.005
Malignant Pheochromocytoma	0	1	0	0
Benign or Malignant Pheochromocytoma ^h				
Overall rate	4/50 (8%)	6/49 (12%)	6/50 (12%)	13/49 (27%)
Adjusted rate	9.9%	16.0%	16.0%	36.0%
Terminal rate	1/19 (5%)	3/16 (19%)	5/21 (24%)	4/11 (36%)
First incidence (days)	506	695	674	564
Poly-3 test	P=0.002	P=0.323	P=0.321	P=0.005

* Significantly different (P≤0.05) from the chamber control group by the Poly-3 test

** P≤0.01

^a Number of animals with lesion

^b Average severity grade of lesions in affected animals: 1=minimal, 2=mild, 3=moderate, 4=marked

^c Historical incidence for 2-year inhalation studies with chamber control groups (mean ± standard deviation): 50/989 (5.1% ± 3.8%); range, 0%-13%

^d Number of animals with neoplasm per number of animals with adrenal medulla examined microscopically

^e Poly-3 estimated neoplasm incidence after adjustment for intercurrent mortality

^f Observed incidence at terminal kill

^g Beneath the chamber control incidence are the P values associated with the trend test. Beneath the exposed group incidence are the P values corresponding to pairwise comparisons between the chamber controls and that exposed group. The Poly-3 test accounts for differential mortality in animals that do not reach terminal sacrifice.

^h Historical incidence: 55/989 (5.5% ± 3.7%); range, 0%-13%

therefore considered exposure related. Although there was a slight increase in the incidence of hyperplasia in males exposed to 1.0 mg/m³, there were no increases in benign or malignant pheochromocytoma.

Mononuclear Cell Leukemia: Relative to chamber controls, the incidence of mononuclear cell leukemia was significantly increased in females exposed to 1.0 mg/m³ and exceeded the historical control incidence. Mononuclear cell leukemia is a common background neoplasm in F344/N rats and characteristically is a large granular lymphocytic leukemia. Typically mononuclear cell leukemia evolves in the spleen and with progression affects

multiple organs. In this study, the morphology and distribution of mononuclear cell leukemia in exposed animals were similar to those in the controls. The increase in the incidence of mononuclear cell leukemia in females was considered to be exposure related (Tables 15, B3, and B4c). The incidences of mononuclear cell leukemia were significantly increased in all exposed groups of males; however, the incidences were similar to the mean historical control incidence (Tables 15, A3, and A4b). More importantly, the incidence in the chamber control group was below the historical control range. Therefore, the higher incidences in exposed males were not considered to be the result of exposure, but rather due to a low chamber control incidence.

TABLE 15
Incidences of Mononuclear Cell Leukemia in Rats in the 2-Year Inhalation Study of Gallium Arsenide

	Chamber Control	0.01 mg/m ³	0.1 mg/m ³	1.0 mg/m ³
Male				
Mononuclear Cell Leukemia ^a				
Overall rate ^b	19/50 (38%)	28/50 (56%)	33/50 (66%)	28/50 (56%)
Adjusted rate ^c	45.6%	65.9%	73.1%	66.4%
Terminal rate ^d	4/13 (31%)	7/13 (54%)	12/15 (80%)	7/13 (54%)
First incidence (days)	506	350	450	520
Poly-3 test ^e	P=0.288	P=0.038	P=0.004	P=0.034
Female				
Mononuclear Cell Leukemia ^f				
Overall rate	22/50 (44%)	21/50 (42%)	18/50 (36%)	33/50 (66%)
Adjusted rate	51.7%	48.2%	42.2%	73.7%
Terminal rate	11/19 (58%)	5/17 (29%)	5/21 (24%)	6/11 (55%)
First incidence (days)	506	497	310	418
Poly-3 test	P<0.001	P=0.456N	P=0.248N	P=0.021

^a Historical incidence for 2-year inhalation studies with chamber control groups (mean ± standard deviation): 583/1,005 (58.0% ± 8.0%), range, 42%-70%

^b Number of animals with neoplasm per number of animals necropsied

^c Poly-3 estimated neoplasm incidence after adjustment for intercurrent mortality

^d Observed incidence at terminal kill

^e Beneath the chamber control incidence are the P values associated with the trend test. Beneath the exposed group incidence are the P values corresponding to pairwise comparisons between the chamber controls and that exposed group. The Poly-3 test accounts for differential mortality in animals that do not reach terminal sacrifice. A lower incidence in an exposure group is indicated by N.

^f Historical incidence: 351/1,002 (35.0% ± 5.9%), range, 24%-47%

Preputial Gland: Preputial gland adenomas occurred in all exposed groups of males (chamber control, 0/50; 0.01 mg/m³, 2/49; 0.1 mg/m³, 3/50; 1.0 mg/m³, 6/49; Table A3); in addition, the incidences of adenoma and of adenoma or carcinoma (combined) (4/50, 6/49, 8/50, 10/49) in the 1.0 mg/m³ group exceeded the historical control range for inhalation studies [adenoma: 37/994 (3.8% ± 2.7%, range, 0%-8%; adenoma or carcinoma: 80/994 (8.1 ± 3.7%), range, 2%-17%; Table A4c]. Hyperplasia, adenoma, and carcinoma are thought to represent a morphologic and biologic continuum in the preputial gland. There were no significant increases in the incidences of hyperplasia (1/50, 0/49, 3/50, 4/49; Table A5), carcinoma (4/50, 4/49, 5/50, 4/49; Table A3), or adenoma or carcinoma (combined) in any exposed group of males. Because there was no increase in the incidences of combined neoplasms and the combined incidence only slightly exceeded the historical control range for inhalation studies but was within the historical ranges for other routes (corn oil gavage, 4%-23%; feed, 2%-22%; Table A4c), the increased incidence of adenoma or carcinoma (combined) at 1.0 mg/m³ was not considered to be the result of exposure.

Other Organs: The incidences of necrosis of the glandular stomach were significantly increased in males exposed to 0.1 or 1.0 mg/m³ (4/49, 9/49, 13/50, 13/50; Table A5). The incidence of centrilobular necrosis of the liver was significantly increased in females exposed to 1.0 mg/m³ (6/50, 13/50, 8/50, 17/50; Table B5).

Tissue Burden Analyses

In general, lung weights were increased in all male rats exposed to 0.1 or 1.0 mg/m³ throughout the study when compared to chamber controls and the 0.01 mg/m³ group. In addition, lung weights of these rats continued to increase to a greater extent throughout the study than did lung weights of the chamber controls and the 0.01 mg/m³ group. The percentages of gallium and arsenic in the lung relative to the total lung burden were similar at all exposure concentrations throughout the study because the deposition and clearance rates in the lung for gallium and arsenic were similar within each exposed group (Tables H2 and H4).

Lung burdens for gallium and arsenic increased with increasing exposure concentration. The lung burdens increased with increasing exposure concentration over time in all exposed groups (Figure 8 and Table H2). It appears that a steady state lung burden was achieved for the 0.1 and possibly the 1.0 mg/m³ groups, although the lung burdens at 18 months were low. Lung burdens did not increase proportionately with exposure concentration over time. Lung burdens normalized to exposure concentration would be expected to remain constant across all exposure concentrations if the toxicokinetics were linear; however, gallium and arsenic normalized lung burdens in the 1.0 mg/m³ group were considerably lower than those observed in the 0.01 or the 0.1 mg/m³ group (Figure 9 and H2). Although deposition rates increased proportionately to exposure concentration, the lung clearance half-times for the 1.0 mg/m³ group were considerably less than those for the 0.1 or the 0.01 mg/m³ group. Half-times for gallium in the lung were 133, 96, and 37 days for the 0.01, 0.1, and 1.0 mg/m³ groups, respectively. Arsenic lung half-times were similar. The gallium arsenide clearance half-time for the 1.0 mg/m³ group from the 2-year study was similar to the clearance half-time for the 1.0 mg/m³ group from the 14-week study. Accordingly, extended exposure for 2 years had no effect on the clearance rate and, therefore, the clearance rate was dependent only on lung burden. Increased clearance at 1.0 mg/m³ was likely due to an increase in alveolar macrophages.

Gallium concentrations in whole blood, serum, or testes and arsenic concentrations in serum or testes were detectable above the limits of quantitation only at the higher exposure concentrations and at the later time points in the study. The concentrations in these tissues were small relative to the concentrations of gallium and arsenic in the lung; this also indicates that there was no accumulation of either gallium or arsenic in these tissues. As expected, arsenic was detected in whole blood where it is preferentially bound to erythrocytes. Arsenic concentrations in whole blood were greater than those of chamber controls only in the 1.0 mg/m³ group where they were approximately two-fold higher (Tables H5, H6, and H7). The concentration of arsenic in whole blood was also small relative to the concentration of arsenic in the lung.

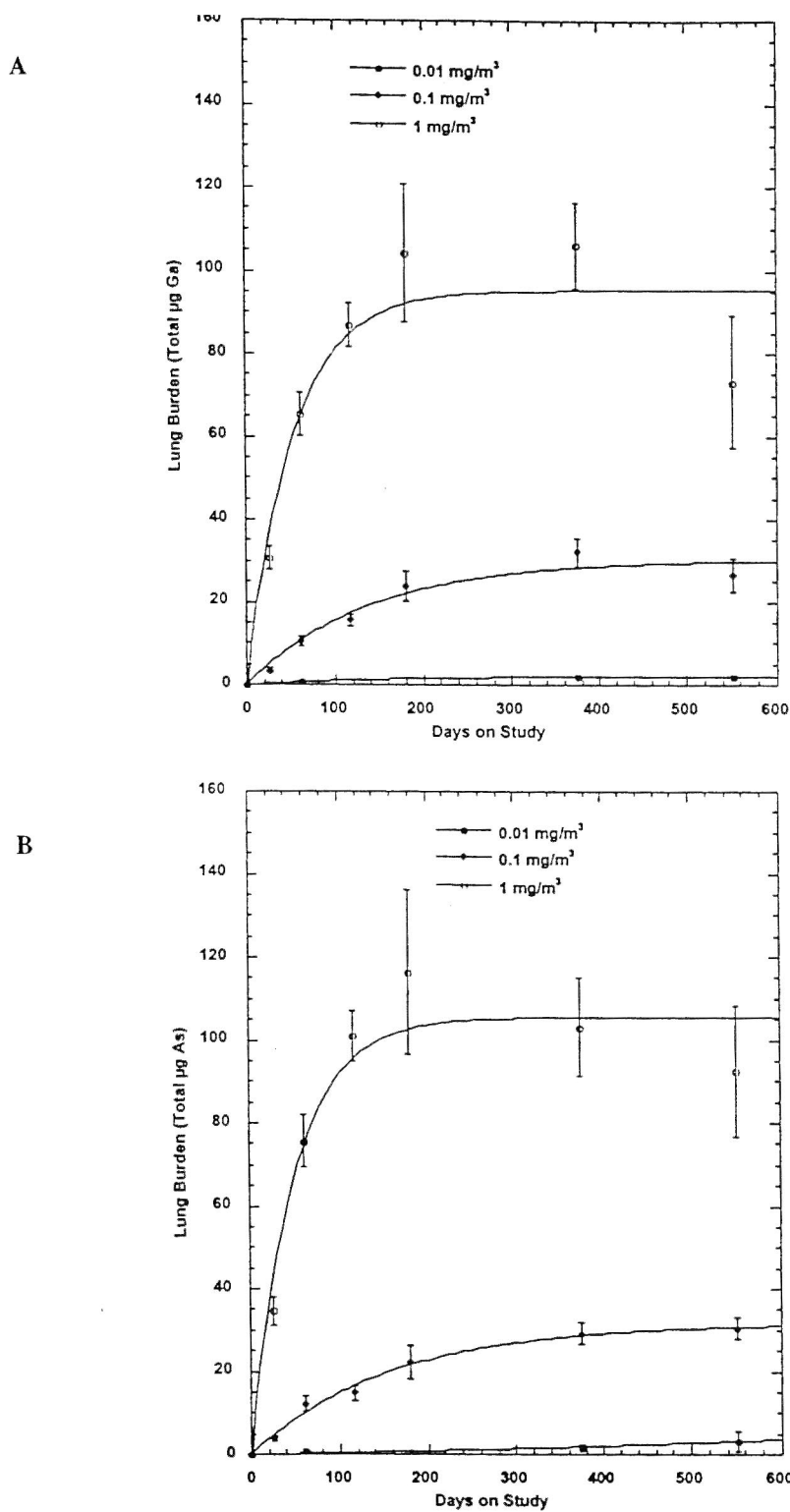

Figure 8
Lung Burdens of (A) Gallium and (B) Arsenic in Male Rats in the 2-Year Inhalation Study of Gallium Arsenide. Data are presented as mean \pm standard deviation. The curves represent the fit of the lung deposition and clearance model to the data. Arsenic data have been corrected for background arsenic concentrations in the lungs of control animals.

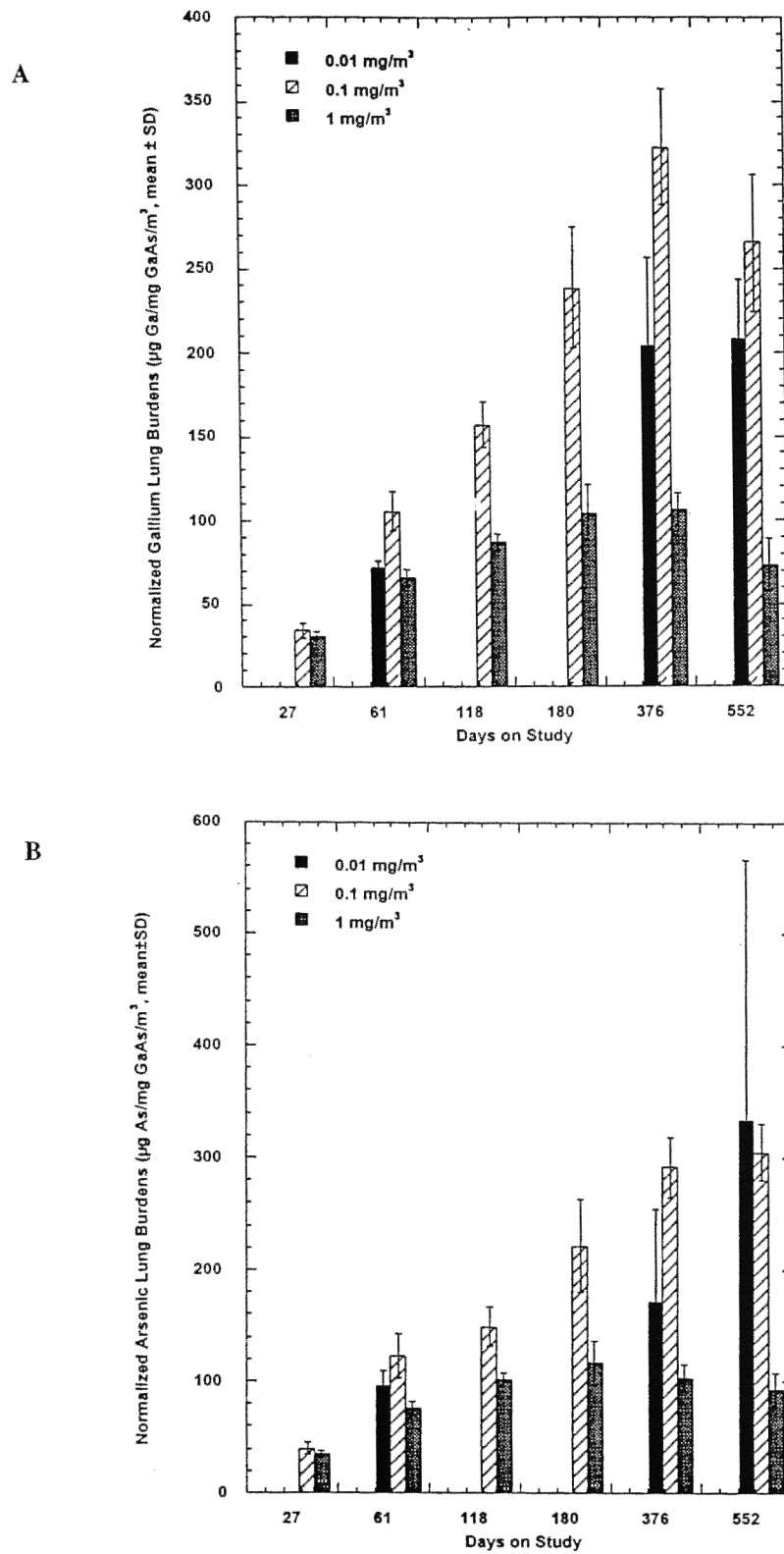

Figure 9
Normalized Lung Burdens of (A) Gallium and (B) Arsenic ($\mu\text{g Ga or As/Lung}$ per Exposure Concentration) in Male Rats in the 2-Year Inhalation Study of Gallium Arsenide.
 Data are presented as mean \pm standard deviation. Arsenic data have been corrected for background arsenic concentrations in the lungs of control animals.

MICE

16-DAY STUDY

All mice survived to the end of the study (Table 16). The final mean body weights and body weight gains of all exposed groups of males and females were similar to those of the chamber controls. All males and females in the 75 and 150 mg/m³ groups displayed hypoactivity and abnormal posture.

Compared to chamber controls, the lung weights of males and females exposed to 10 mg/m³ or greater were increased (Table G3).

Compared to the chamber controls, there were exposure-related microscopic lesions in the lung and larynx of exposed mice (Table 17) that were morphologically similar to those observed in the 16-day rat study. Gallium arsenide particles were

observed in alveolar macrophages of mice exposed to 150 mg/m³, but to a lesser extent than in the rats. Alveolar proteinosis, epithelial hyperplasia, and histiocytic infiltrate occurred in all male and female mice exposed to 10 mg/m³ or greater, and in general, the severities of the lesions increased with increasing exposure concentration. Histologically, proteinosis and histiocytic infiltrate were morphologically similar to those lesions described in the 16-day rat study. As in the rats, the protein was considered to be mostly surfactant mixed with small amounts of fibrin. Alveolar epithelial hyperplasia was a focal lesion characterized by increased numbers of low cuboidal cells (presumed to be type II cells) lining the alveolar septae.

Squamous metaplasia of the larynx also occurred in males and females exposed to 10 mg/m³ or greater,

TABLE 16
Survival and Body Weights of Mice in the 16-Day Inhalation Study of Gallium Arsenide

Concentration (mg/m ³)	Survival ^a	Mean Body Weight ^b (g)			Final Weight Relative to Controls (%)
		Initial	Final	Change	
Male					
0	5/5	24.4 ± 0.5	27.8 ± 0.6	3.4 ± 0.8	
1	5/5	24.1 ± 0.2	27.6 ± 0.6	3.4 ± 0.6	99
10	5/5	24.1 ± 0.6	28.0 ± 0.9	3.9 ± 0.7	101
37	5/5	23.5 ± 0.4	27.1 ± 0.5	3.7 ± 0.3	97
75	5/5	23.7 ± 0.3	27.9 ± 0.5	4.2 ± 0.7	100
150	5/5	23.3 ± 0.5	27.1 ± 0.6	3.8 ± 0.7	97
Female					
0	5/5	19.9 ± 0.4	22.7 ± 0.2	2.9 ± 0.3	
1	5/5	19.7 ± 0.6	22.4 ± 0.5	2.8 ± 0.2	99
10	5/5	20.1 ± 0.4	22.3 ± 0.3	2.2 ± 0.4	98
37	5/5	19.7 ± 0.4	22.2 ± 0.5	2.5 ± 0.4	98
75	4/4	19.8 ± 0.5	21.6 ± 0.3	1.8 ± 0.6	95
150	5/5	19.6 ± 0.6	21.9 ± 0.5	2.3 ± 0.4	96

^a Number of animals surviving at 16 days/number initially in group

^b Weights and weight changes are given as mean ± standard error. Differences from the chamber control group were not significant by Dunnett's test.

TABLE 17
Incidences of Selected Nonneoplastic Lesions of the Lung and Larynx in Mice
in the 16-Day Inhalation Study of Gallium Arsenide

	Chamber Control	1 mg/m ³	10 mg/m ³	37 mg/m ³	75 mg/m ³	150 mg/m ³
Male						
Lung ^a	5	5	5	5	5	5
Alveolus, Cellular Infiltration, Histiocytic ^b	0	0	5** (1.2) ^c	5** (1.4)	5** (1.2)	5** (1.0)
Alveolus, Proteinosis	0	0	5** (1.0)	5** (2.0)	5** (2.4)	5** (3.0)
Alveolar Epithelium, Hyperplasia	0	0	5** (1.0)	5** (1.8)	5** (1.4)	5** (2.0)
Larynx	5	5	5	5	5	5
Inflammation, Chronic	0	0	0	0	5** (1.4)	5** (1.4)
Metaplasia, Squamous	0	0	4* (1.0)	5** (1.0)	5** (1.6)	5** (2.0)
Female						
Lung	5	5	5	5	4	5
Alveolus, Cellular Infiltration, Histiocytic	0	0	5** (1.0)	5** (1.2)	4** (2.0)	5** (2.0)
Alveolus, Proteinosis	0	0	5** (1.2)	5** (2.0)	4** (3.0)	5** (3.0)
Alveolar Epithelium, Hyperplasia	0	0	5** (1.0)	5** (1.2)	4** (2.0)	5** (2.0)
Larynx	5	5	5	5	4	5
Inflammation, Chronic	0	0	0	0	4** (1.5)	5** (2.4)
Metaplasia, Squamous	0	0	4* (1.0)	5** (1.0)	4** (2.0)	5** (2.2)

* Significantly different ($P \leq 0.05$) from the chamber control group by the Fisher exact test

** $P \leq 0.01$

^a Number of animals examined microscopically

^b Number of animals with lesion

^c Average severity grade of lesions in affected animals: 1=minimal, 2=mild, 3=moderate, 4=marked

whereas chronic inflammation was observed in males and females exposed to 75 or 150 mg/m³ (Table 17). Laryngeal squamous metaplasia was characterized by minimal to mild replacement of the normal ciliated epithelium at the base of the epiglottis by three to five layers of squamous epithelium. Laryngeal chronic inflammation consisted of minimal to mild infiltrates of macrophages and lymphocytes in the submucosal tissue at the base of the epiglottis. In a few mice, inflammation was sometimes associated with focal necrosis of the mucosal epithelium in this region of the epiglottis.

Exposure Concentration Selection Rationale: The effects on the lungs in males and females exposed to 150 mg/m³ were considered sufficiently severe to preclude the use of this exposure concentration in a 14-week study. The severities of these lesions were not as great as those observed in rats in the 16-day study. Because rats and mice were housed in the same chambers in the 14-week studies, mouse exposure concentrations were based on rat exposure concentrations. Therefore, gallium arsenide exposure concentrations selected for the 14-week inhalation study in mice were 0, 0.1, 1, 10, 37, and 75 mg/m³.

14-WEEK STUDY

One female mouse exposed to 75 mg/m³ died before the end of the study (Table 18). Final mean body weights and body weight gains of males in the 75 mg/m³ group were significantly less than those of the chamber controls.

Hematology data are listed in Tables 19 and F2. Hematologic changes for mice were similar to those in the 14-week rat study. An exposure concentration-related anemia, evidenced by decreases in automated hematocrit values and hemoglobin concentrations, occurred in males and females exposed to 37 or 75 mg/m³. The anemia was microcytic and regenerative. Microcytosis was demonstrated by decreased mean cell volume and mean cell hemoglobin values, which occurred in males exposed to 1 mg/m³ or greater and females exposed to 10 mg/m³ or greater.

Evidence of an erythropoietic response was demonstrated by increased reticulocyte counts in 37 mg/m³ males and 75 mg/m³ males and females. Also, erythrocyte counts, platelet counts, and zinc protoporphyrin/heme ratios were increased in males and females exposed to 10 mg/m³ or greater. Review of the stained blood smears revealed an increase in schistocytes in the groups with elevated erythrocyte counts. Neutrophil counts were increased in males exposed to 1 mg/m³ and males and females exposed to 10 mg/m³ or greater. For males, the increased neutrophil counts were associated with increased leukocyte counts. The increased neutrophil counts would be consistent with the pulmonary inflammation observed microscopically. While the hematologic effects for the mice mimicked those observed in the rat study, the mice did not demonstrate a gender-related difference in sensitivity to exposure.

TABLE 18
Survival and Body Weights of Mice in the 14-Week Inhalation Study of Gallium Arsenide

Concentration (mg/m ³)	Survival ^a	Mean Body Weight ^b (g)			Final Weight Relative to Controls (%)
		Initial	Final	Change	
Male					
0	10/10	26.0 ± 0.3	36.5 ± 0.9	10.5 ± 0.7	
0.1	10/10	25.9 ± 0.3	35.8 ± 0.6	9.9 ± 0.5	98
1	10/10	25.9 ± 0.3	37.5 ± 1.1	11.6 ± 0.9	103
10	10/10	26.0 ± 0.3	34.8 ± 0.8	8.8 ± 0.6	95
37	10/10	26.2 ± 0.3	34.7 ± 0.9	8.5 ± 0.8	95
75	10/10	26.2 ± 0.3	33.5 ± 0.6*	7.3 ± 0.5**	92
Female					
0	10/10	20.8 ± 0.2	30.7 ± 1.1	9.8 ± 1.0	
0.1	10/10	20.6 ± 0.2	32.6 ± 0.6	12.0 ± 0.6	106
1	10/10	20.8 ± 0.2	33.9 ± 1.2*	13.2 ± 1.1*	111
10	10/10	20.8 ± 0.3	31.1 ± 0.6	10.3 ± 0.5	101
37	10/10	20.8 ± 0.2	29.5 ± 0.5	8.7 ± 0.5	96
75	9/10 ^c	20.9 ± 0.2	30.2 ± 0.7	9.5 ± 0.6	99

* Significantly different (P ≤ 0.05) from the chamber control group by Williams' or Dunnett's test

** P ≤ 0.01

^a Number of animals surviving at 14 weeks/number initially in group

^b Weights and weight changes are given as mean ± standard error.

^c Week of death: 11

TABLE 19
Selected Hematology Data for Mice in the 14-Week Inhalation Study of Gallium Arsenide^a

	Chamber Control	0.1 mg/m ³	1 mg/m ³	10 mg/m ³	37 mg/m ³	75 mg/m ³
Male						
n	10	9	10	10	10	10
Automated						
hematocrit (%)	45.0 ± 0.4	44.6 ± 0.4	45.0 ± 0.4	43.8 ± 0.7	41.1 ± 0.5**	40.5 ± 0.6**
Hemoglobin (g/dL)	15.9 ± 0.1	15.7 ± 0.1	15.8 ± 0.2	15.5 ± 0.2	15.2 ± 0.2**	15.0 ± 0.2**
Erythrocytes (10 ⁶ /μL)	9.82 ± 0.08	9.82 ± 0.06	10.01 ± 0.08	10.48 ± 0.16**	11.68 ± 0.15**	12.27 ± 0.16**
Reticulocytes (10 ⁶ /μL)	0.22 ± 0.01	0.22 ± 0.02	0.24 ± 0.02	0.26 ± 0.02	0.33 ± 0.03**	0.32 ± 0.03**
Mean cell volume (fL)	45.9 ± 0.2	45.4 ± 0.2	45.0 ± 0.3*	41.7 ± 0.3**	35.2 ± 0.4**	33.1 ± 0.4**
Mean cell hemoglobin (pg)	16.2 ± 0.0	16.0 ± 0.1	15.8 ± 0.1**	14.8 ± 0.1**	13.0 ± 0.1**	12.3 ± 0.1**
Zinc protoporphyrin (μmol/mol heme)	72.9 ± 2.3	69.4 ± 2.0	70.2 ± 1.3	79.0 ± 1.8*	83.4 ± 2.7*	91.8 ± 2.3** ^b
Female						
n	10	10	10	10	10	9
Automated						
hematocrit (%)	44.7 ± 0.5	44.6 ± 0.4	43.8 ± 0.3	43.6 ± 0.4	41.3 ± 0.5**	41.4 ± 0.5**
Hemoglobin (g/dL)	15.9 ± 0.1	15.8 ± 0.1	15.6 ± 0.1	15.6 ± 0.2	14.8 ± 0.1**	15.0 ± 0.1**
Erythrocytes (10 ⁶ /μL)	9.76 ± 0.09	9.75 ± 0.09	9.74 ± 0.05	10.27 ± 0.09**	11.06 ± 0.12**	11.38 ± 0.07**
Reticulocytes (10 ⁶ /μL)	0.24 ± 0.02	0.27 ± 0.02	0.24 ± 0.02	0.27 ± 0.02	0.28 ± 0.02	0.36 ± 0.03**
Mean cell volume (fL)	45.7 ± 0.3	45.7 ± 0.3	45.1 ± 0.2	42.5 ± 0.2**	37.3 ± 0.4**	36.3 ± 0.5**
Mean cell hemoglobin (pg)	16.3 ± 0.1	16.2 ± 0.1	16.0 ± 0.1*	15.2 ± 0.1**	13.4 ± 0.2**	13.2 ± 0.1**
Zinc protoporphyrin (μmol/mol heme)	76.9 ± 2.5	79.1 ± 2.1	73.3 ± 1.3	86.6 ± 1.9**	96.8 ± 1.9**	98.6 ± 2.9**

* Significantly different ($P \leq 0.05$) from the chamber control group by Dunn's or Shirley's test

** $P \leq 0.01$

^a Mean ± standard error. Statistical tests were performed on unrounded data.

^b n=9

Compared to the chamber controls, the lung weights of males exposed to 1.0 mg/m³ or greater and females exposed to 10 mg/m³ or greater were increased (Table 20).

The right testis weights of males exposed to 37 or 75 mg/m³ were decreased (Table G4), and the weights of the left testis, cauda epididymis, and epididymis were decreased in males exposed to 10 mg/m³ or

greater (Table I3). The total spermatid heads per testis and per gram testis, spermatid counts, and motility of epididymal spermatozoa were significantly decreased in males exposed to 37 or 75 mg/m³. The decreases in spermatozoa motilities of males exposed to 37 mg/m³ or greater were almost 100%. The concentrations of epididymal spermatozoa were decreased in all groups exposed to 10 mg/m³ or greater. No significant differences were noted in the estimated length of the estrous cycle (Table I4).

TABLE 20
Lung Weights and Lung-Weight-to-Body-Weight Ratios for Mice
in the 14-Week Inhalation Study of Gallium Arsenide^a

	Chamber Control	0.1 mg/m ³	1 mg/m ³	10 mg/m ³	37 mg/m ³	75 mg/m ³
Male						
n	10	10	10	10	10	10
Necropsy body wt	37.5 ± 0.9	36.5 ± 0.7	38.9 ± 1.2	35.3 ± 0.7	35.5 ± 0.9	34.1 ± 0.6**
Lung Absolute	0.238 ± 0.007	0.242 ± 0.007	0.272 ± 0.008*	0.362 ± 0.009**	0.475 ± 0.008**	0.519 ± 0.016**
Relative	6.36 ± 0.16	6.62 ± 0.13	7.01 ± 0.12	10.25 ± 0.17**	13.44 ± 0.31**	15.53 ± 0.70**
Female						
n	10	10	10	10	10	9
Necropsy body wt	32.8 ± 1.4	33.2 ± 0.6	34.8 ± 1.4	32.1 ± 0.7	29.9 ± 0.7	30.4 ± 0.7
Lung Absolute	0.252 ± 0.010	0.249 ± 0.015	0.245 ± 0.008	0.327 ± 0.007**	0.430 ± 0.007**	0.518 ± 0.005**
Relative	7.76 ± 0.37	7.46 ± 0.30	7.08 ± 0.15	10.22 ± 0.29**	14.44 ± 0.27**	17.16 ± 0.54**

* Significantly different ($P \leq 0.05$) from the chamber control group by Williams' or Dunnett's test

** $P \leq 0.01$

^a Lung weights (absolute weights) and body weights are given in grams; lung-weight-to-body-weight ratios (relative weights) are given as mg lung weight/g body weight (mean ± standard error).

Multiple, bilateral alveolar/bronchiolar adenomas were diagnosed in one female mouse exposed to 37 mg/m³ (Table 21). Gallium arsenide particles were observed in the alveolar spaces or within alveolar macrophages of mice exposed to 1 mg/m³ or greater, but compared to the rats, the particles were more sparse and more difficult to detect. Proteinosis, histiocytic infiltration, and epithelial hyperplasia occurred in males and females exposed to 1 mg/m³ or greater; the amount of protein and the severities of epithelial hyperplasia increased with increasing exposure concentration. These lesions were similar to those observed in the 16-day mouse and 14-week rat studies.

In the lung, suppurative inflammation and granuloma occurred in males and females exposed to 10 mg/m³ or greater. Suppurative inflammation was characterized by focally extensive areas of neutrophilic infiltration centered on distal bronchioles and extending into the adjacent alveoli. Suppurative inflammation was generally of minimal to mild severity and appeared to be more severe in groups exposed to 75 mg/m³. The alveolar epithelium, within areas of suppurative inflammation, was hyperplastic. Granulomas were small focal lesions of minimal severity consisting of accumulations of macrophages, neutrophils, and lymphocytes centered on terminal bronchioles and alveolar ducts.

TABLE 21
Incidences of Neoplasms and Nonneoplastic Lesions of the Lung, Larynx, and Associated Lymph Nodes in Mice in the 14-Week Inhalation Study of Gallium Arsenide

	Chamber Control	0.1 mg/m ³	1 mg/m ³	10 mg/m ³	37 mg/m ³	75 mg/m ³
Male						
Lung ^a	10	10	10	10	10	10
Alveolus, Cellular Infiltration, Histiocytic ^b	0	0	9** (1.0) ^c	10** (2.0)	10** (2.0)	10** (2.0)
Alveolus, Proteinosis	0	0	10** (1.0)	10** (2.1)	10** (2.9)	10** (3.0)
Alveolar Epithelium, Hyperplasia	0	0	10** (1.0)	10** (2.0)	10** (3.0)	10** (3.0)
Inflammation, Suppurative	0	0	0	10** (1.8)	8** (1.5)	6** (2.0)
Granuloma	0	0	0	5* (1.0)	6** (1.0)	4* (1.3)
Larynx ^a	10	10	10	10	10	10
Metaplasia, Squamous	0	0	0	6** (1.0)	9** (1.0)	10** (1.0)
Lymph Node, Tracheobronchial ^d	8	10	7	9	10	9
Hyperplasia	0	0	0	5* (1.0)	7** (1.1)	7** (1.0)
Female						
Lung	10	10	10	10	10	10
Alveolus, Cellular Infiltration, Histiocytic	0	0	6** (1.0)	10** (2.0)	10** (2.0)	10** (1.9)
Alveolus, Proteinosis	0	0	10** (1.0)	10** (2.0)	10** (3.0)	10** (2.9)
Alveolar Epithelium, Hyperplasia	0	0	7** (1.0)	10** (1.9)	10** (3.0)	9** (2.9)
Inflammation, Suppurative	0	0	0	8** (1.8)	8** (1.3)	3 (2.0)
Granuloma	0	0	0	1 (1.0)	5* (1.0)	3 (1.0)
Alveolar/bronchiolar Adenoma, Bilateral, Multiple	0	0	0	0	1	0
Larynx	10	10	10	10	10	10
Metaplasia, Squamous	0	0	1 (1.0)	8** (1.0)	10** (1.0)	10** (1.0)
Lymph Node, Tracheobronchial	7	10	10	6	9	7
Hyperplasia	0	0	0	1 (1.0)	6** (1.2)	5* (1.0)

* Significantly different (P≤0.05) from the chamber control group by the Fisher exact test

** P≤0.01

^a Number of animals examined microscopically

^b Number of animals with lesion

^c Average severity grade of lesions in affected animals: 1=minimal, 2=mild, 3=moderate, 4=marked

^d Number of animals with tissue examined microscopically

Squamous metaplasia of the larynx occurred in males and females exposed to 10 mg/m³ or greater. Laryngeal squamous metaplasia was of minimal severity and generally similar in both morphology and location to that noted in rats. However, squamous metaplasia was also noted along the ventral tips and the medial aspects of the laryngeal cartilages.

Minimal hyperplasia was observed in the tracheobronchial lymph node of males exposed to 10 mg/m³ or greater and females exposed to 37 or 75 mg/m³. Hyperplasia was characterized by an increased prominence of the germinal centers due to increased numbers of lymphocytes and plasma cells. Some nodal macrophages contained small amounts of gallium arsenide particles.

Testicular atrophy and epididymal hypospermia were observed in males exposed to 10 mg/m³ or greater (Table 22). Both atrophy and hypospermia were morphologically similar to these lesions observed in the rats. Testicular atrophy was generally of minimal severity in the 10 mg/m³ group and of moderate severity in the 37 and 75 mg/m³ groups. Epididymal hypospermia was generally of mild severity in the 10 mg/m³ group and of marked severity in the 37 and 75 mg/m³ groups.

Splenic hemosiderosis was observed in males exposed to 10 mg/m³ or greater and females exposed to 75 mg/m³. Hemosiderosis was generally of minimal

(10 mg/m³ males and 75 mg/m³ females) to mild (37 and 75 mg/m³ males) severity and consisted of an accumulation of golden yellow pigment within the red pulp. Mild splenic hematopoietic cell proliferation was observed in males exposed to 10 mg/m³ or greater and all exposed groups of females.

The incidences of mild hepatic hemosiderosis in males and females exposed to 10 mg/m³ or greater were significantly greater than those in the chamber controls. Although not significant, the increased incidences of minimal hepatic hemosiderosis were also observed in females exposed to 0.1 or 1 mg/m³. Hepatic hemosiderosis consisted of accumulation of golden yellow pigment within Kupffer cells.

TABLE 22
Incidences of Selected Nonneoplastic Lesions in Mice in the 14-Week Inhalation Study of Gallium Arsenide

	Chamber Control	0.1 mg/m ³	1 mg/m ³	10 mg/m ³	37 mg/m ³	75 mg/m ³
Male						
Testis ^a	10	10	10	10	10	10
Atrophy ^b	0	0	0	4* (1.3) ^c	10** (3.2)	10** (3.1)
Epididymis	10	10	10	10	10	10
Hypospermia	0	0	0	7** (2.0)	10** (4.0)	10** (4.0)
Spleen	10	10	10	10	10	10
Hemosiderosis	0	0	0	6** (1.0)	10** (1.9)	10** (2.0)
Hematopoietic Cell Proliferation	0	0	0	2 (2.0)	5* (2.0)	6** (2.0)
Liver	10	10	10	10	10	10
Hemosiderosis	0	0	0	10** (1.0)	10** (2.0)	10** (2.0)
Female						
Spleen	10	10	10	10	10	10
Hemosiderosis	1 (1.0)	0	0	0	0	7** (1.0)
Hematopoietic Cell Proliferation	0	1 (2.0)	5* (2.0)	6** (2.0)	10** (2.0)	4* (2.0)
Liver	10	10	10	10	10	10
Hemosiderosis	1 (2.0)	5 (1.0)	4 (1.0)	10** (2.0)	10** (2.0)	10** (2.0)

* Significantly different ($P \leq 0.05$) from the chamber control group by the Fisher exact test

** $P \leq 0.01$

^a Number of animals examined microscopically

^b Number of animals with lesion

^c Average severity grade of lesions in affected animals: 1=minimal, 2=mild, 3=moderate, 4=marked

Exposure Concentration Selection Rationale: Based on the increased severity of lung lesions and increased lung weights in males and females, exposure concentrations of 10 mg/m³ or greater were considered sufficiently severe to preclude the use of such exposure concentrations in a 2-year study. Because lung

lesions were minimal in the 1 mg/m³ group and 0.1 mg/m³ was a no-effect level in the lung, a concentration between 0.1 and 1.0 mg/m³ was added. Therefore, gallium arsenide exposure concentrations selected for the 2-year inhalation study in mice were 0.1, 0.5, and 1.0 mg/m³.

2-YEAR STUDY

Survival

Estimates of 2-year survival probabilities for male and female mice are shown in Table 23 and in the Kaplan-Meier survival curves (Figure 10). Survival rates of males and females were similar to those of the chamber controls.

Body Weights and Clinical Findings

Mean body weights of exposed male mice were similar to those of the chamber controls throughout the study; mean body weights of exposed groups of female mice were greater than those of the chamber controls from week 13 until the end of the study (Figure 11 and Tables 24 and 25). No clinical findings related to gallium arsenide exposure were observed.

TABLE 23
Survival of Mice in the 2-Year Inhalation Study of Gallium Arsenide

	Chamber Control	0.1 mg/m ³	0.5 mg/m ³	1.0 mg/m ³
Male				
Animals initially in study	50	50	50	50
Moribund	7	8	10	7
Natural deaths	8	4	6	9
Animals surviving to study termination	35	38	34	34
Percent probability of survival at end of study ^a	70	76	68	68
Mean survival (days) ^b	687	707	684	701
Survival analysis ^c	P=0.646	P=0.567N	P=0.947	P=1.000
Female				
Animals initially in study	50	50	50	50
Accidental deaths ^d		2	1	
Moribund	11	11	16	11
Natural deaths	3	3	2	10
Animals surviving to study termination	36	34	31	29
Percent probability of survival at end of study	72	71	64	58
Mean survival (days)	699	699	665	682
Survival analysis	P=0.083	P=1.000N	P=0.404	P=0.200

^a Kaplan-Meier determinations

^b Mean of all deaths (uncensored, censored, and terminal sacrifice)

^c The result of the life table trend test (Tarone, 1975) is in the chamber control column, and the results of the life table pairwise comparisons (Cox, 1972) with the chamber controls are in the exposed group columns. A lower mortality in an exposure group is indicated by N.

^d Censored from survival analyses

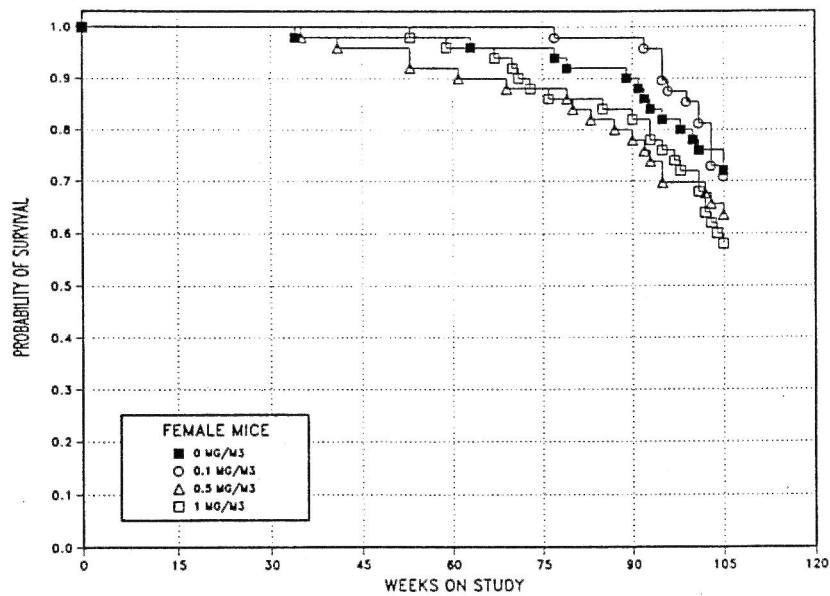
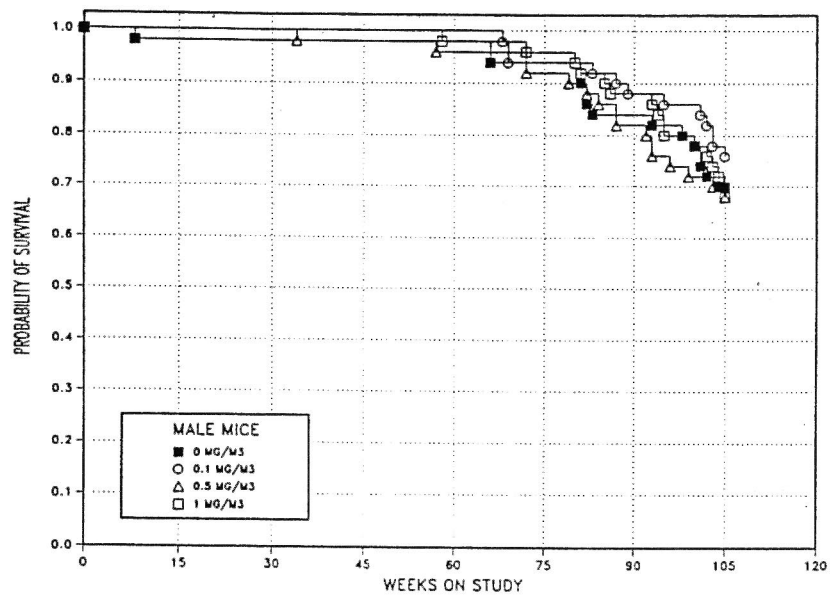

Figure 10
Kaplan-Meier Survival Curves for Male and Female Mice
Exposed to Gallium Arsenide by Inhalation for 2 Years

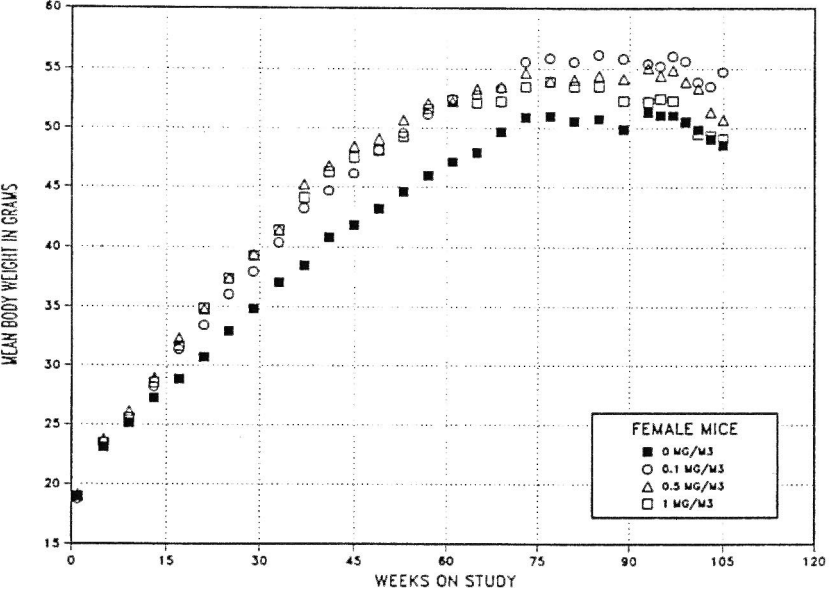
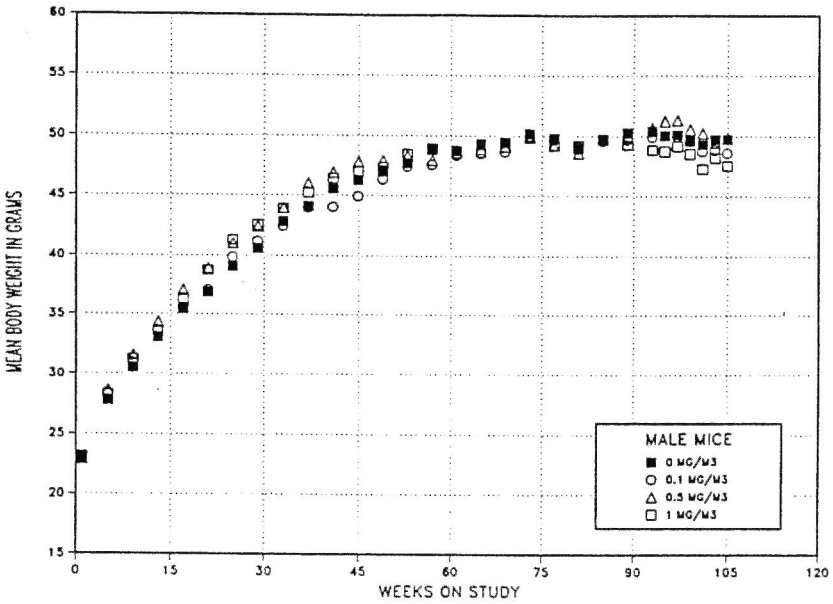

Figure 11
Growth Curves for Male and Female Mice
Exposed to Gallium Arsenide by Inhalation for 2 Years

TABLE 24
Mean Body Weights and Survival of Male Mice in the 2-Year Inhalation Study of Gallium Arsenide

Weeks on Study	Chamber Control		0.01 mg/m ³			0.1 mg/m ³			1.0 mg/m ³		
	Av. Wt. (g)	No. of Survivors	Av. Wt. (g)	Wt. (% of controls)	No. of Survivors	Av. Wt. (g)	Wt. (% of controls)	No. of Survivors	Av. Wt. (g)	Wt. (% of controls)	No. of Survivors
1	23.2	50	23.0	99	50	22.9	99	50	23.1	100	50
5	27.8	50	28.4	102	50	28.6	103	50	28.2	101	50
9	30.5	49	31.0	102	50	31.6	104	50	31.2	102	50
13	33.1	49	33.7	102	50	34.4	104	50	33.6	102	50
17	35.5	49	35.6	100	50	37.1	105	50	36.3	102	50
21	36.9	49	37.1	101	50	38.9	105	50	38.8	105	50
25	39.1	49	39.9	102	50	41.1	105	50	41.3	106	50
29	40.6	49	41.2	102	50	42.4	104	50	42.5	105	50
33	42.9	49	42.5	99	50	44.0	103	50	43.9	102	50
37	44.1	49	44.0	100	50	46.0	104	49	45.3	103	50
41	45.6	49	44.1	97	50	46.9	103	49	46.5	102	50
45	46.3	49	45.0	97	50	47.8	103	49	47.0	102	50
49	47.0	49	46.4	99	50	47.9	102	49	47.4	101	50
53	47.8	49	47.5	99	50	48.3	101	49	48.5	102	50
57	48.8	49	47.6	98	50	48.0	98	49	48.9	100	50
61	48.8	49	48.4	99	50	48.8	100	48	48.6	100	49
65	49.4	49	48.6	98	50	48.9	99	48	48.7	99	49
69	49.5	47	48.7	98	49	49.2	99	48	49.1	99	49
73	50.2	47	50.0	100	47	50.0	100	46	49.8	99	48
77	49.8	47	49.7	100	47	49.3	99	46	49.3	99	48
81	49.0	47	49.1	100	47	48.6	99	45	49.2	100	47
85	49.7	42	49.6	100	46	49.7	100	43	49.8	100	46
89	50.3	42	49.7	99	45	50.0	99	41	49.3	98	44
93	50.4	42	49.9	99	44	50.7	101	40	48.9	97	44
95	50.1	41	50.1	100	43	51.3	102	38	48.8	97	42
97	50.1	41	50.0	100	43	51.3	102	37	49.2	98	40
99	49.6	40	49.6	100	43	50.6	102	37	48.6	98	40
101	49.3	39	48.8	99	43	50.3	102	36	47.3	96	40
103	49.8	36	48.9	98	41	49.5	99	36	48.2	97	38
105	49.8	35	48.6	98	39	49.9	100	35	47.6	96	36
Mean for weeks											
1-13	28.7		29.0	101		29.4	102		29.0	101	
14-52	42.0		41.8	100		43.6	104		43.2	103	
53-105	49.6		49.1	99		49.7	100		48.8	98	

TABLE 25
Mean Body Weights and Survival of Female Mice in the 2-Year Inhalation Study of Gallium Arsenide

Weeks on Study	Chamber Control		0.1 mg/m ³			0.5 mg/m ³			1.0 mg/m ³		
	Av. Wt. (g)	No. of Survivors	Av. Wt. (g)	Wt. (% of controls)	No. of Survivors	Av. Wt. (g)	Wt. (% of controls)	No. of Survivors	Av. Wt. (g)	Wt. (% of controls)	No. of Survivors
1	19.0	50	18.7	98	50	19.1	101	50	19.0	100	50
5	23.1	50	23.5	102	50	23.7	103	50	23.5	102	50
9	25.1	50	25.6	102	50	26.1	104	50	25.6	102	50
13	27.2	50	28.2	104	50	28.9	106	50	28.6	105	50
17	28.9	50	31.4	109	50	32.4	112	50	31.7	110	50
21	30.7	50	33.5	109	49	34.8	113	50	34.9	114	50
25	33.0	50	36.0	109	49	37.4	113	50	37.4	113	50
29	34.8	50	37.9	109	49	39.4	113	50	39.3	113	50
33	37.0	50	40.4	109	49	41.4	112	50	41.4	112	50
37	38.5	49	43.2	112	49	45.2	117	49	44.1	115	50
41	40.8	49	44.7	110	49	46.8	115	49	46.3	114	50
45	41.8	49	46.2	111	48	48.5	116	48	47.5	114	50
49	43.2	49	48.2	112	48	49.1	114	48	48.1	111	50
53	44.6	49	49.6	111	48	50.7	114	48	49.3	111	50
57	46.0	49	51.2	111	48	52.1	113	46	51.6	112	49
61	47.2	49	52.5	111	48	52.2	111	46	52.4	111	48
65	48.0	48	52.8	110	48	53.3	111	45	52.1	109	48
69	49.7	48	53.4	107	48	53.5	108	45	52.3	105	47
73	50.9	48	55.6	109	48	54.7	108	44	53.5	105	45
77	51.0	48	55.9	110	48	54.0	106	44	53.9	106	43
81	50.6	46	55.6	110	47	54.1	107	42	53.5	106	43
85	50.8	46	56.2	111	47	54.5	107	41	53.5	105	43
89	49.9	46	55.9	112	47	54.2	109	40	52.3	105	42
93	51.3	43	55.4	108	46	55.1	107	37	52.2	102	41
95	51.1	42	55.2	108	46	54.5	107	36	52.5	103	39
97	51.1	41	56.1	110	42	54.9	107	34	52.3	102	38
99	50.5	40	55.7	110	42	53.9	107	34	50.5	100	36
101	49.9	39	53.9	108	41	53.4	107	34	49.5	99	36
103	49.1	38	53.5	109	39	51.4	105	33	49.4	101	32
105	48.6	38	54.8	113	35	50.7	104	32	49.1	101	30
Mean for weeks											
1-13	23.6		24.0	102		24.5	104		24.2	103	
14-52	36.5		40.2	110		41.7	114		41.2	113	
53-105	49.4		54.3	110		53.5	108		51.8	105	

Pathology and Statistical Analyses

This section describes the statistically significant or biologically noteworthy changes in the incidences of neoplasms and/or nonneoplastic lesions of the lung, tracheobronchial lymph node, nose, forestomach, and harderian gland, and the incidences of malignant lymphoma. Summaries of the incidences of neoplasms and nonneoplastic lesions, individual animal tumor diagnoses, statistical analyses of primary neoplasms that occurred with an incidence of at least 5% in at least one animal group, and historical incidences for the neoplasms mentioned in this section are presented in Appendix C for male mice and Appendix D for female mice.

Lung: The incidences of alveolar/bronchiolar neoplasms in exposed males and females were not significantly different from those in the chamber controls and were within the historical control ranges for 2-year inhalation studies (Tables 26, C3, C4, D3, and D4). Inhalation of gallium arsenide resulted in the development of a spectrum of mostly inflammatory lesions in the lungs of exposed males and females. In general, multiple inflammatory lesions were observed and occupied less than 5% of the alveolar parenchyma in the 0.1 mg/m³ groups and approximately 10% to 15% in the 0.5 and 1.0 mg/m³ groups. Although diagnosed separately, the inflammatory lesions almost invariably occurred together with variable overlap and were considered different stages or components of a single inflammatory process. In general, the incidences and severities of lung lesions in affected groups increased with increasing exposure concentration. Gallium arsenide particles were detected in alveolar macrophages of most males and females exposed to 0.5 or 1.0 mg/m³ and in a few exposed to 0.1 mg/m³.

Suppurative inflammation occurred in males and females exposed to 0.5 or 1.0 mg/m³ (Tables 26, C5, and D5). Suppurative inflammation was a focal to multifocal lesion characterized by the accumulation of moderate to large numbers of neutrophils within terminal bronchioles and the surrounding alveolar spaces (Plates 17 and 18). These lesions varied in size and sometimes involved locally extensive areas of the lung.

In males exposed to 1.0 mg/m³ and females exposed to 0.5 or 1.0 mg/m³, the incidences of chronic focal

inflammation were significantly greater than those in the chamber controls (Tables 26, C5, and D5). Chronic inflammation was characterized by focal to multifocal areas of mixed cell inflammation consisting of neutrophils, lymphocytes, and increased numbers of macrophages (Plate 19). The alveolar epithelium within these lesions was hyperplastic, and minimal amounts of cell debris and gallium arsenide particles were also components of the inflammatory lesions.

In all exposed groups of males and females, the incidences of histiocytic cellular infiltration were significantly greater than those in the chamber controls. Histiocytic cellular infiltration was characterized by increased numbers of large alveolar macrophages in alveolar spaces, many of which contained varying amounts of protein and gallium arsenide particles (Plate 20).

In males and females exposed to 0.5 or 1.0 mg/m³, the incidences of alveolar epithelial hyperplasia and alveolar proteinosis were significantly increased. Alveolar epithelial hyperplasia consisted of scattered small foci in which there was proliferation of cuboidal epithelial cells (type II cells) along the alveolar septae. Hyperplasia was most prominent near terminal bronchioles and in areas of inflammation. Hyperplasia was not considered a preneoplastic proliferative lesion but rather a reactive response to the inflammatory lesions in the lung. Protein observed in the alveolar spaces of exposed male and female mice was similar to that observed in the alveoli of rats and mice from the 16-day and 14-week studies.

Lymph Node, Tracheobronchial: The incidences of minimal lymphoid hyperplasia in males exposed to 0.5 or 1.0 mg/m³ and females exposed to 1.0 mg/m³ were significantly greater than those in the chamber controls (Tables 26, C5, and D5). Hyperplasia was characterized by an increased prominence of the germinal centers due to increased numbers of lymphocytes and plasma cells. Some nodal macrophages contained small amounts of gallium arsenide particles.

Nose: The incidence of olfactory epithelium hyaline degeneration in females exposed to 0.5 mg/m³ was significantly greater than that in the chamber controls (Tables 26 and D5).

TABLE 26
Incidences of Nonneoplastic Lesions of the Lung, Nose, and Associated Lymph Nodes in Mice
in the 2-Year Inhalation Study of Gallium Arsenide

	Chamber Control	0.1 mg/m ³	0.5 mg/m ³	1.0 mg/m ³
Male				
Lung ^a	50	50	50	50
Infiltration Cellular, Histiocyte ^b	3 (3.0) ^c	10* (1.8)	45** (1.9)	48** (2.2)
Inflammation, Chronic, Focal	1 (1.0)	3 (2.3)	3 (2.0)	12** (1.8)
Inflammation, Focal Suppurative	0	0	8** (1.8)	23** (1.9)
Alveolar Epithelium, Hyperplasia	4 (1.3)	9 (2.3)	39** (1.6)	45** (1.8)
Alveolus, Proteinosis	1 (2.0)	4 (1.3)	49** (2.3)	50** (2.4)
Alveolar/bronchiolar Adenoma or Carcinoma ^d	15	14	16	13
Lymph Node, Tracheobronchial ^e	38	37	40	41
Hyperplasia	5 (1.0)	7 (1.6)	17** (1.6)	24** (1.6)
Nose ^a	49	49	49	48
Olfactory Epithelium, Degeneration, Hyaline	2 (1.0)	4 (1.5)	6 (1.0)	1 (2.0)
Female				
Lung	50	50	50	50
Infiltration Cellular, Histiocyte	2 (2.0)	13** (1.2)	48** (2.0)	49** (2.2)
Inflammation, Chronic, Focal	1 (1.0)	2 (1.5)	11** (1.5)	18** (1.4)
Inflammation, Focal Suppurative	0	0	2 (1.5)	14** (2.0)
Alveolar Epithelium, Hyperplasia	2 (2.0)	5 (1.0)	27** (1.1)	43** (1.3)
Alveolus, Proteinosis	0	4 (1.0)	49** (2.5)	50** (2.5)
Alveolar/bronchiolar Adenoma or Carcinoma ^f	7	4	4	6
Lymph Node, Tracheobronchial	39	43	42	42
Hyperplasia	10 (1.6)	12 (1.3)	13 (1.5)	23** (1.8)
Nose	50	49	50	50
Olfactory Epithelium, Degeneration, Hyaline	3 (1.0)	1 (1.0)	10* (1.3)	5 (1.2)

* Significantly different ($P \leq 0.05$) from the chamber control group by the Poly-3 test

** $P \leq 0.01$

^a Number of animals examined microscopically

^b Number of animals with lesion

^c Average severity grade of lesions in affected animals: 1=minimal, 2=mild, 3=moderate, 4=marked

^d Historical incidence for 2-year inhalation studies with chamber control groups (mean \pm standard deviation): 270/1,021 (26.6% \pm 8.5%); range, 14%-42%

^e Number of animals with tissue examined microscopically

^f Historical incidence: 102/1,025 (9.9% \pm 3.6%); range, 4%-16%

Forestomach: In females exposed to 1.0 mg/m³, the incidence of squamous cell papilloma (0/50, 0/50, 0/50, 3/50; Table D3) exceeded the historical control range for 2-year inhalation studies [8/1,027 (0.8% \pm 1.0%), range, 0%-2%]. Squamous epithelial hyperplasia and papillomas are thought to form a morphologic continuum in the development of

forestomach neoplasms. In this study, the papillomas were not accompanied by corresponding increased incidences of squamous epithelial hyperplasia (2/49, 6/50, 1/50, 2/49; Table D5). In addition, there was no evidence of a carcinogenic response in female mice exposed to 0.1 or 0.5 mg/m³ or in the forestomach of exposed male mice. Furthermore, the incidence of

forestomach papilloma in females exposed to 1.0 mg/m³ (6%) was within the historical control ranges for corn oil gavage (0% to 10%) and for dosed feed (0% to 6%) studies. Therefore, the three papillomas in the 1.0 mg/m³ group were considered to be due to random variability and not due to exposure.

Malignant Lymphoma: Relative to the chamber controls, the incidences of malignant lymphoma were significantly increased in females exposed to 0.5 or 1.0 mg/m³ (chamber control, 3/50; 0.1 mg/m³, 8/50; 0.5 mg/m³, 11/50; 1.0 mg/m³, 10/50; Table D3). The incidences of malignant lymphoma in exposed females were not considered to be exposure related because the incidences were well within the historical control range for inhalation studies [159/1,027 (15.5% ± 7.3%), range, 6%-32%], while the incidence in the chamber controls was at the lower limit of the historical control range. Furthermore, there was no evidence of a carcinogenic response in males (1/50, 1/50, 2/50, 1/50; Table C1).

Harderian Gland: The harderian gland is a secretory gland located medial and posterior to the globe of the eye of the rat and mouse. In NTP studies, spontaneous neoplasms of the harderian gland are common in the B6C3F₁ mouse and rare in the F344/N rat, and chemically induced increased incidences have only been observed in the mouse. Relatively large proliferative lesions of the harderian gland result in grossly observable protrusion (proptosis) of the eye. Routinely, unless the gross evaluation suggests a potential treatment-related effect, only grossly observed lesions are evaluated histologically in NTP studies. In the initial evaluation in this study, there was a marginal (but not statistically significant) increase in the incidences of harderian gland adenoma or carcinoma (combined) (3/50, 5/50, 7/50, 7/50), and the incidences in the 0.5 and 1.0 mg/m³ groups of male mice were at the upper limit of the historical control range for inhalation studies [58/974 (6.1 ± 3.9%), range, 0%-14%] for which the harderian gland was examined in animals showing gross lesions; therefore, all harderian glands were evaluated histologically. Additional microscopic proliferative lesions were identified during the complete evaluation resulting in a positive trend in the incidences of

harderian gland adenoma or carcinoma (combined) in male mice (5/50, 7/50, 10/50, 12/50; Table C3). Although not statistically significant, the incidences of adenoma (4/50, 6/50, 8/50, 8/50; Table C3) and carcinoma (1/50, 1/50, 3/50, 4/50; Table C3) were also increased. The incidences of hyperplasia were increased in 0.5 mg/m³ males but not in the 1.0 mg/m³ group (1/47, 1/48, 10/49, 1/48; Table C5). There is only one recent inhalation study (nitromethane; NTP, 1997) which has had a complete histological evaluation of the harderian gland and is therefore comparable to this study of gallium arsenide. In the nitromethane study, 10/50 chamber control male mice had harderian gland adenoma or carcinoma (combined). Additionally, in the feed study of *o*-nitroanisole (NTP, 1993a), 10/50 control male mice had adenoma or carcinoma (combined) of the harderian gland. In the 12 NTP studies which had increased incidences of neoplasms of the harderian gland that have been clearly associated with chemical administration, the increases were observed in both males and females in nine of those studies (NTP, 1998b). Increases in the incidences of adenoma or carcinoma (combined) were not observed in females in this study (5/50, 4/50, 3/50, 2/50; Table D3). Because the incidences of harderian gland neoplasms in control groups from the nitromethane and *o*-nitroanisole studies were similar to the incidences in the 0.5 and 1.0 mg/m³ groups of male mice in this study and there was no corresponding exposure-related effect in female mice exposed to gallium arsenide, this marginal increase was not considered exposure related.

GENETIC TOXICOLOGY

Gallium arsenide (10,000 µg/plate) was not mutagenic in *Salmonella typhimurium* strain TA97, TA98, TA100, TA102, or TA1535 (Zeiger *et al.*, 1992). Tests were conducted with and without induced liver S9 enzymes. Male and female mice that had been treated with gallium arsenide for 14 weeks by inhalation (0.1 to 75 mg/m³) were examined for frequency of micronucleated normochromatic erythrocytes; no increases over the control frequencies were noted in mice of either gender.

DISCUSSION AND CONCLUSIONS

The National Cancer Institute nominated gallium arsenide for study because of its widespread use in the microelectronics industry, the potential for worker exposure, and the absence of chronic toxicity data. Particulate gallium arsenide was evaluated for toxicity and carcinogenicity in 16-day, 14-week, and 2-year studies in male and female F344/N rats and B6C3F₁ mice, with whole body inhalation as the route of exposure.

In the 16-day and 14-week studies, neither survival nor mean body weight gain were affected to any great extent by exposure. The respiratory tract was the primary site of toxicity in all studies, with rats more severely affected than mice. In the 16-day studies, gallium arsenide particles were visible in the alveolar spaces and within alveolar macrophages. In response to the amount of particles in the lungs, alveolar macrophages within the alveolar spaces increased proportionately, and the lungs accumulated proteinaceous material (surfactant); thus, lung weights were increased. Proliferative changes were observed in the lungs of most mice (increase in Type II cells). The larynx was also affected by the presence of particles in that a spectrum of lesions including epithelial hyperplasia and squamous metaplasia with and without chronic inflammation was observed in exposed mice and, to a lesser extent, in exposed rats.

With the increased time of exposure to the particulate for 14 weeks, the effects on the respiratory tract were more prevalent and more severe. In the 14-week rat study, this occurred even at the lowest exposure concentration, 0.1 mg/m³. Proteinosis and proliferation of alveolar macrophages were enhanced, and lung weights at the higher concentrations were two- to three-fold greater than those of the chamber controls. Reactive hyperplasia was subsequently observed in the lymph nodes that drain the oral cavity and respiratory tract. In general, lymph nodes were enlarged due to the increases in lymphocytes and/or plasma cells, and the tracheobronchial and mediastinal lymph nodes contained gallium arsenide particles. Although the incidences of lesions in the larynx did

increase slightly with repeated exposure, the lesions did not become more severe, nor were they present at concentrations lower than those observed in the 16-day studies. The respiratory tract lesions caused by exposure to gallium arsenide were similar to those lesions that would be expected following exposure to a relatively insoluble particulate. Moreover, similar lesions have been observed in rats intratracheally instilled with single doses of gallium arsenide particles (Webb *et al.*, 1987; Goering *et al.*, 1988) or gallium oxide particles (Webb *et al.*, 1986). In NTP 13-week inhalation studies with gallium oxide (Battelle, 1990a,b), exposure to equimolar concentrations of gallium caused effects in the lungs of rats and mice similar to those in the present 14-week gallium arsenide studies.

The clinical pathology results of the 14-week studies indicated that exposure of rats and mice to 10 mg/m³ or greater affected the circulating erythroid mass and induced a minimal microcytic responsive anemia with an erythrocytosis and increased zinc protoporphyrin/heme ratios. For rats, this effect was more pronounced in males than in females. Observation of this effect on day 23 indicated that the anemia occurred early and was persistent. Alterations in the mean cell volumes and mean cell hemoglobin values in rats and mice exposed to 1.0 mg/m³ suggested that erythropoiesis was affected at lower concentrations, but that it was not sufficiently severe to result in an anemia or did not have sufficient time for an anemia to develop. In the presence of an anemia, increased numbers of erythrocytes would appear to be an inappropriate response. The erythrocytosis suggested that the erythropoietic tissues were capable of responding to the anemia but were not able to compensate for the ineffective erythropoiesis that resulted in the production of much smaller erythrocytes. Microcytic anemia would be consistent with an iron deficiency or iron deficiency-like disorders in which iron was unavailable for the production of heme. Rasey *et al.* (1981) demonstrated that in mouse sarcoma cells, gallium (gallium nitrate) may mimic iron in some aspects of cell metabolism and compete

with iron for binding sites on transferrin. Warrell *et al.* (1983) showed that infusion of patients with gallium nitrate causes a microcytic hypochromic anemia. Chitambar and Zivkovic (1987), utilizing Friend erythroleukemia cells *in vitro*, showed that gallium nitrate inhibits hemoglobin production by interfering with the cellular incorporation of iron. They suggested that during gallium nitrate therapy the decreased iron incorporation into maturing erythroid precursors leads to the development of a microcytic hypochromic anemia characteristic of iron-deficient erythropoiesis. In the rats, the decrease of serum iron concentration and changes in total and unbound iron binding capacities would support altered iron metabolism in the present 14-week studies.

Increased zinc protoporphyrin/heme ratios would suggest an alteration in heme biosynthesis. Webb *et al.* (1984) and Goering *et al.* (1988) have shown that, following single intratracheal injections of gallium arsenide particles, there was a transient increase in urinary uroporphyrin and an inhibition of erythrocyte δ -aminolevulinic acid dehydratase with a concomitant increase in the excretion of δ -aminolevulinic acid. In the 14-week studies, the absence of changes in urinary δ -aminolevulinic acid and porphobilinogen would suggest that the effect of the porphyria, as it relates to heme synthesis, was marginal. In the NTP 13-week studies of gallium oxide (Battelle, 1990a,b), exposure to gallium oxide did not affect urinary δ -aminolevulinic acid or porphobilinogen. The absence of an effect on urinary excretion of δ -aminolevulinic acid and porphobilinogen following repeated exposure to gallium arsenide or gallium oxide has also been observed in mice and rats following repeated arsenic exposure [i.e., exposure to sodium arsenate in drinking water for 6 weeks (Woods and Fowler, 1978)]. However, they did observe a significant increase in the excretion of uroporphyrin and, to a lesser extent, coproporphyrin, as was observed following single intratracheal administration of gallium arsenide. In the 14-week study, schistocytes and keratocytes in blood films and increased erythrophagocytosis in bone marrow preparations would be consistent with traumatic injury to erythrocytes and increased red cell turnover. Thus, the cause of the anemia may have been a combination of altered iron availability and defective heme synthesis.

Other than hemosiderosis, there were no exposure-related pathologic changes in the liver. A concentration-related increase in sorbitol dehydrogenase and/or alanine aminotransferase would typically be consistent with hepatocellular injury or increased hepatocellular leakage. This would be the case especially when the magnitude of the increases became greater with continued exposure; this suggested that an insult to hepatocytes, while sublethal, may be progressive. It has been shown that corticosteroids can induce increases in liver alanine aminotransferase (Rosen, 1959; Rosen *et al.*, 1959). Gallium arsenide intratracheally instilled in mice has also been shown to increase serum corticosteroid values six- to ten-fold compared to control values (Burns *et al.*, 1994b). Although this may in part explain the increases in alanine aminotransferase, it does not explain the increases in sorbitol dehydrogenase.

Gallium arsenide caused a marked exposure concentration-related testicular toxicity in rats and mice, with mice more severely affected than rats. In the most severely affected animals, the germinal epithelium of the atrophic testes was reduced to the point where there was almost complete loss of spermatogonia, spermatids, and spermatozoa. As would be expected, spermatid head counts and epididymal spermatozoa concentrations were reduced almost to zero. The spermatozoa remaining in the epididymis were immobile. Similar but less severe effects have been reported for rats and, to a lesser extent, hamsters following intratracheal instillation of gallium arsenide (Omura *et al.*, 1996a,b). Arsenic trioxide had no effect on male reproductive organs. In the NTP 13-week inhalation studies of gallium oxide (Battelle, 1990a,b), similar but less severe effects were observed in mice but not in rats. In the above mentioned studies, the effect was a retention of spermatids and loss of efficiency of germ cell production rather than nearly complete loss of germinal epithelium.

Lung burden analyses for male rats in the 14-week and 2-year studies indicated that the percentages of gallium and arsenic in the lung were similar at all exposure concentrations throughout the study. Deposition and clearance rates in the lung for both gallium and arsenic were similar. These results disagree with studies reported by Webb *et al.* (1984, 1986, 1987),

which contend that arsenic but not gallium is absorbed from the lung. However, in those studies, gallium arsenide was administered by single bolus intratracheal instillation with particles that had mean count diameters 10 to 100 times larger than in the present studies. In addition, their conclusions were based in part on the detection of arsenic and not gallium in the blood (although at less than 10% of the administered dose). This is understandable because arsenic preferentially binds to rat erythrocytes. Elimination from erythrocytes is slow and, therefore, arsenic persists in blood for long periods of time (ATSDR, 1993; Patty's, 1994). Absorbed gallium, on the other hand, is rapidly removed from plasma (half-life 1 to 2 hours) and is either concentrated in tissues or excreted (Dudley *et al.*, 1949). Results in the present 2-year studies were consistent with the blood analysis from the Webb *et al.* (1984, 1986, 1987) studies. Gallium was detected in whole blood, serum, or testes in rats only at the higher exposure concentrations and at the later time points in the study. The same was true for arsenic concentrations in serum and testes. As expected, arsenic was measurable in whole blood but at concentrations that were only two-fold higher than that of chamber controls. More importantly, the concentrations of gallium or arsenic in all three tissues were small relative to the concentrations of each in the lung.

Lung burdens for gallium and arsenic increased with increasing exposure concentration, and each increased throughout the 14-week or 2-year studies. Steady state lung burdens were not achieved in the 14-week study or in male rats exposed to 0.01 mg/m³ in the 2-year study. However, lung burdens of male rats exposed to 0.1 or 1.0 mg/m³ increased steadily throughout the first 6 months of the 2-year study, reaching near steady state values after 6 months. For linear toxicokinetics, lung burdens normalized to exposure concentration would be expected to remain constant across all exposure concentrations. Lung burdens from the 14-week studies, when normalized to exposure concentration, were inversely proportional to exposure concentration. In addition, in the 2-year study, normalized lung burdens from rats exposed to 1.0 mg/m³ were considerably lower than those observed in the 0.01 or 0.1 mg/m³ groups. Lung deposition rates increased proportionately with exposure concentration in both studies. However, lung clearance half-times decreased with increasing exposure concentration. The clearance half-time of

37 days for gallium in the 1.0 mg/m³ group was considerably less than the 133 or 96 days for the 0.01 or 0.1 mg/m³ groups in the 2-year study, respectively. Arsenic half-times were similar. The clearance half-times for the 2-year 1.0 mg/m³ group were similar to the half-time for the 1.0 mg/m³ group in the 14-week study. Extended exposure for 2 years had no effect on the clearance rates and, therefore, the clearance rates appear to be dependent on lung burden. The reduced clearance half-times could be due to lung overload or increased physical elimination of particles by alveolar macrophages at the higher concentrations. In these studies, deposition actually increased proportionately to exposure concentration, and there was no indication from observing animals that there were any changes in pulmonary function parameters. At no time during the 14-week or 2-year studies were the lungs considered to be in an overload situation. Lung overload generally results in decreasing elimination rates with increasing exposure concentrations. However, lung elimination rates for gallium and arsenic increased with exposure concentration rather than decreased. Moreover, assuming that 1 to 5 mg of particulates per gram of lung (Morrow, 1986) are required to impair lung clearance, these deposition levels were not achieved, as the maximum total gallium arsenide particulate load did not exceed 500 µg (75 mg/m³) or 100 µg (1.0 mg/m³) at the highest exposure concentrations used in the 14-week and 2-year studies, respectively. Accordingly, the most plausible explanation for increased clearance is the increased physical elimination of the particles, i.e., the increase in alveolar macrophages at the higher exposure concentrations.

In the 2-year studies, survival rates were not affected by exposure to gallium arsenide. Mean body weights of rats exposed to 1.0 mg/m³ were slightly less than chamber controls, whereas mean body weights of male mice were similar to and mean body weights of female mice were slightly greater than those of chamber controls. Benign and malignant neoplasms of the lung occurred in an exposure concentration-related manner in exposed female rats. Incidences of alveolar/bronchiolar adenoma, alveolar/bronchiolar carcinoma, and alveolar/bronchiolar adenoma or carcinoma (combined) were significantly increased in females exposed to 1.0 mg/m³ and exceeded the historical control ranges for 2-year inhalation studies. At 0.1 mg/m³, the incidence of alveolar/bronchiolar adenoma or carcinoma (combined) was slightly

increased and exceeded the historical control range. In addition, one female in the 1.0 mg/m³ group had a squamous cell carcinoma. The benign neoplasms more closely resembled those found spontaneously in aged rats. However, the carcinomas were larger, invasive masses that obliterated the alveolar architecture, and several were quite scirrhous. Lung neoplasms are uncommon in female F344/N rats, with two being the highest number of benign or combined neoplasms observed in contemporary inhalation studies. The effect of gallium arsenide in the female rat is striking because the lowest particulate exposure concentration at which a positive effect was observed was only 0.1 mg/m³. Compared to previous NTP studies, this places gallium arsenide in the same realm as nickel subsulfide, nickel oxide, and cobalt sulfate heptahydrate in its ability to induce lung neoplasms in female rats at low aerosol concentrations (NTP, 1996a,b, 1998c). Unlike gallium arsenide, these aerosols also caused increased incidences of neoplasms in male rats, although somewhat less than that in females exposed to nickel oxide and cobalt sulfate heptahydrate. In the present studies, the incidences of lung neoplasms in male rats were not significantly different from that in chamber controls and were within the historical range for inhalation studies. Assuming that there is no gender difference in lung deposition, i.e., in the amount of particulate that can be deposited per gram of lung, as was true for the three nickel studies (NTP, 1996a,b,c), then male rats received similar amounts of gallium arsenide per gram of lung tissue as did females. This is also supported by the fact that in rats exposed to gallium arsenide, the spectra of inflammatory and proliferative lesions were almost identical in incidences and severities for males and females. These 2-year studies support the observation that male rats are less sensitive than female rats to particulate exposure.

The spectrum of inflammatory and proliferative lesions appeared to progress during the studies because the severities of the lesions increased in the lung of rats exposed for 2 years compared to those exposed for 14 weeks. Chronic inflammation was sufficiently severe to obscure the normal alveolar architecture. As might be expected for particulate exposure, the areas of inflammation were most prominent around alveolar ducts, terminal bronchioles, larger airways, and larger blood vessels. Alveolar septae and pleura overlying areas of inflammation were often thickened by fibrous tissue. Proliferative lesions were observed

at the edges of chronic inflammation and especially in the areas where the septae were thickened. In a very few rats, there were small focal areas where normal epithelium had been replaced by several layers of squamous epithelium in response to injury by the gallium arsenide particles. These proliferative lesions are thought to be part of a morphologic continuum that progresses to neoplasms; however, in the case of male rats, there was no increase in the incidences of lung neoplasms in exposed groups. There were significant increases in the incidences of benign and malignant neoplasms in the lung of female rats.

The only exposure-related effect in the 2-year mouse study was in the lung. Unlike rats, neoplastic or proliferative effects were not observed in the lungs of mice. Gallium arsenide did cause a spectrum of inflammatory lesions in mice similar to those observed in the 14-week study. These lesions occupied 10% to 15% of the lung, occurred together with variable overlap, and were considered different stages or components of a single inflammatory process. Most mice exposed to 0.5 mg/m³ or greater had the lesions. In the 14-week study, mice with lesions of similar severity as those in the 2-year study had significantly increased lung weights. Based on the extent of lung involvement and the numbers of animals affected, a higher exposure concentration would not have been warranted. Mice are generally less responsive than rats to exposures of relatively insoluble particles (Heinrich, 1996; Watson and Valberg, 1996). The inflammatory lesions caused by gallium arsenide were similar to those caused by nickel subsulfide, nickel oxide, and talc (NTP, 1993b, 1996a,b). Like gallium arsenide, exposure to these three particulates did not cause neoplasms in the lungs of mice.

The incidences of benign pheochromocytoma of the adrenal medulla occurred with a positive trend in female rats, and the incidence in females exposed to 1.0 mg/m³ was significantly increased. There was also an exposure concentration-related increase in the incidence of bilateral pheochromocytomas. Although there were no malignant pheochromocytomas or increases in the incidence of hyperplasia in female rats exposed to 1.0 mg/m³, the 27% incidence of benign neoplasms greatly exceeded the highest incidences observed in historical controls for inhalation studies (13%) and for all other routes of administration (14%) and was therefore considered exposure related (NTP, 1998d).

The incidence of mononuclear cell leukemia in female rats exposed to 1.0 mg/m³ was significantly increased. Mononuclear cell leukemia is a common background neoplasm in F344/N rats, and in the present study the morphology and distribution of the leukemia in exposed female rats were similar to controls. The 66% incidence in females exposed to 1.0 mg/m³ greatly exceeded the highest incidence observed in historical controls for inhalation studies (47%) and for all other routes of administration (44%) (NTP, 1998d). Therefore, the increased incidence of mononuclear cell leukemia in female rats exposed to 1.0 mg/m³ was considered exposure related.

Although the incidences of benign pheochromocytoma and mononuclear cell leukemia in female rats exposed to 1.0 mg/m³ were considered exposure related, there is no indication from the available literature that gallium or arsenic causes such neoplasms in rodents or humans. In fact, a number of studies have shown that gallium has an antiproliferative effect on human

and murine leukemia and lymphoma cells that is greatly enhanced by transferrin (Bernstein, 1998).

CONCLUSIONS

Under the conditions of these 2-year inhalation studies, there was *no evidence of carcinogenic activity** of gallium arsenide in male F344/N rats exposed to 0.01, 0.1, or 1.0 mg/m³. There was *clear evidence of carcinogenic activity* in female F344/N rats based on increased incidences of benign and malignant neoplasms in the lung. Increased incidences of benign neoplasms of the adrenal medulla and increased incidences of mononuclear cell leukemia were also considered to be exposure related. There was *no evidence of carcinogenic activity* in male or female B6C3F₁ mice exposed to 0.1, 0.5, or 1.0 mg/m³.

Exposure to gallium arsenide caused a spectrum of nonneoplastic lesions in the lungs of rats and mice and the larynx of male rats and hyperplasia of the tracheobronchial lymph node in mice.

* Explanation of Levels of Evidence of Carcinogenic Activity is on page 10. A Summary of the Technical Reports Review Subcommittee comments and the public discussion on this Technical Report appears on page 12.

REFERENCES

- Agency for Toxic Substances and Disease Registry (ATSDR) (1993). Toxicological Profile for Arsenic. U.S. Department of Health and Human Services, Public Health Service, Agency for Toxic Substances and Disease Registry.
- Aizawa, Y., Takata, T., Karube, H., Tatsumi, H., Inokuchi, N., Kotani, M., and Chiyotani, K. (1993). Magnetometric evaluation of the effects of gallium arsenide on the clearance and relaxation of iron particles. *Ind. Health* **31**, 143-153.
- American Conference of Governmental Industrial Hygienists (ACGIH) (1998). *Threshold Limit Values for Chemical Substances and Physical Agents and Biological Exposure Indices*. Cincinnati, OH.
- Ashby, J., and Tennant, R.W. (1991). Definitive relationships among chemical structure, carcinogenicity and mutagenicity for 301 chemicals tested by the U.S. NTP. *Mutat. Res.* **257**, 229-306.
- Bailer, A.J., and Portier, C.J. (1988). Effects of treatment-induced mortality and tumor-induced mortality on tests for carcinogenicity in small samples. *Biometrics* **44**, 417-431.
- Battelle Pacific Northwest Laboratories (1990a). Thirteen-week subchronic inhalation toxicity study report of gallium oxide in rats. Final report (NIH No. N01-ES-85211); November 1990.
- Battelle Pacific Northwest Laboratories (1990b). Thirteen-week subchronic inhalation toxicity study report of gallium oxide in mice. Final report (NIH No. N01-ES-85211); December 1990.
- Battelle Pacific Northwest Laboratories (1990c). Inhalation developmental toxicology studies: Gallium arsenide in mice and rats. Final report (NIH No. N01-ES-70153); December 1990.
- Bernstein, L.R. (1998). Mechanisms of therapeutic activity for gallium. *Am. Soc. Pharmacol. Exp. Ther.* **50**, 665-682.
- Bieler, G.S., and Williams, R.L. (1993). Ratio estimates, the delta method, and quantal response tests for increased carcinogenicity. *Biometrics* **49**, 793-801.
- Boorman, G.A., Montgomery, C.A., Jr., Eustis, S.L., Wolfe, M.J., McConnell, E.E., and Hardisty, J.F. (1985). Quality assurance in pathology for rodent carcinogenicity studies. In *Handbook of Carcinogen Testing* (H.A. Milman and E.K. Weisburger, Eds.), pp. 345-357. Noyes Publications, Park Ridge, NJ.
- Brecher, G., and Schneiderman, M. (1950). Time saving device for the counting of reticulocytes. *Am. J. Clin. Pathol.* **20**, 2079-2084.
- Brodsky, M.H. (1990). Progress in gallium arsenide semiconductors. *Sci. Am.* **262**, 68-75.
- Bruce, M., Andrews, G.A., and Bruner, H.D. (1953). A study of gallium. *Radiology* **61**, 534-613.
- Burns, L.A., and Munson, A.E. (1993). Gallium arsenide selectively inhibits T cell proliferation and alters expression of CD25 (IL-2R/p55). *J. Pharmacol. Exp. Ther.* **265**, 178-186.
- Burns, L.A., Sikorski, E.E., Saady, J.J., and Munson, A.E. (1991). Evidence for arsenic as the immunosuppressive component of gallium arsenide. *Toxicol. Appl. Pharmacol.* **110**, 157-169.
- Burns, L.A., McCay, J.A., Brown, R., and Munson, A.E. (1993). Arsenic in the sera of gallium arsenide-exposed mice inhibits bacterial growth and increases host resistance. *J. Pharmacol. Exp. Ther.* **265**, 795-800.

- Burns, L.A., LeVier, D.G., and Munson, A.E. (1994a). Immunotoxicology of Arsenic. In *Immunotoxicology and Immunopharmacology* (J.H. Dean, M.I. Luster, A.E. Munson, and I. Kimber, Eds.), pp. 213-225. Raven Press, Ltd., New York.
- Burns, L.A., Spriggs, T.L., Fuchs, B.A., and Munson, A.E. (1994b). Gallium arsenide-induced increase in serum corticosterone is not responsible for suppression of the IgM antibody response. *J. Pharmacol. Exp. Ther.* **268**, 740-746.
- Chitambar, C.R., and Zivkovic, Z. (1987). Inhibition of hemoglobin production by transferrin-gallium. *Blood* **69**, 144-149.
- Code of Federal Regulations (CFR) (1991). **21**, Part 58.
- Cox, D.R. (1972). Regression models and life-tables. *J. R. Stat. Soc.* **B34**, 187-220.
- Crawford, B.D. (1985). Perspectives on the somatic mutation model of carcinogenesis. In *Advances in Modern Environmental Toxicology. Mechanisms and Toxicity of Chemical Carcinogens and Mutagens* (M.A. Mehlman, W.G. Flamm, and R.J. Lorentzen, Eds.), pp. 13-59. Princeton Scientific Publishing Co., Inc., Princeton, NJ.
- Dixon, W.J., and Massey, F.J., Jr. (1951). *Introduction to Statistical Analysis*, 1st ed., pp. 145-147. McGraw-Hill Book Company, Inc., New York.
- Dudley, H.C. (1949). Determination of gallium in biological materials. *J. Pharmacol. Exp. Ther.* **95**, 482-486.
- Dudley, H.C., and Levine, M.D. (1949). Studies of the toxic action of gallium. *J. Pharmacol. Exp. Ther.* **95**, 487-493.
- Dudley, H.C., and Marrer, H.H. (1952). Studies of the metabolism of gallium. III. Deposition in and clearance from bone. *J. Pharmacol. Exp. Ther.* **106**, 129.
- Dudley, H.C., Maddox, G.E., and LaRue, H.C. (1949). Studies of the metabolism of gallium. *J. Pharmacol. Exp. Ther.* **96**, 135-138.
- Dudley, H.C., Henry, K.E., and Lindsey, B.F. (1952). Studies of the toxic action of gallium. II. *J. Pharmacol. Exp. Ther.* **98**, 409-417.
- Dunn, O.J. (1964). Multiple comparisons using rank sums. *Technometrics* **6**, 241-252.
- Dunnett, C.W. (1955). A multiple comparison procedure for comparing several treatments with a control. *J. Am. Stat. Assoc.* **50**, 1096-1121.
- Ferm, V.H., and Carpenter, S.J. (1970). Teratogenic and embryopathic effects of indium, gallium, and germanium. *Toxicol. Appl. Pharmacol.* **16**, 166-170.
- Flora, S.J.S., and Das Gupta, S. (1992). Effect of single gallium arsenide exposure on some biochemical variables in porphyrin metabolism in rats. *J. Appl. Toxicol.* **12**, 333-334.
- Flora, S.J.S., Dube, S.N., Vijayaraghavan, R., and Pant, S.C. (1997). Changes in certain hematological and physiological variables following single gallium arsenide exposure in rats. *Biol. Trace Elem. Res.* **58**, 197-208.
- Genium's Handbook of Safety, Health, and Environmental Data for Common Hazardous Substances* (1999), pp. 1734-1735. McGraw-Hill, New York.
- Gibson, D.P., Brauninger, R., Shaffi, H.S., Kerckaert, G.A., LeBoeuf, R.A., Isfort, R.J., and Aardema, M.J. (1997). Induction of micronuclei in Syrian hamster embryo cells: Comparison to results in the SHE cell transformation assay for National Toxicology Program test chemicals. *Mutat. Res.* **392**, 61-70.
- Goering, P.L., and Rehm, S. (1990). Inhibition of liver, kidney, and erythrocyte δ -aminolevulinic acid dehydratase (porphobilinogen synthase) by gallium in the rat. *Environ. Res.* **53**, 135-151.

- Goering, P.L., Maronpot, R.R., and Fowler, B.A. (1988). Effect of intratracheal gallium arsenide administration on δ -aminolevulinic acid dehydratase in rats: Relationship to urinary excretion of aminolevulinic acid. *Toxicol. Appl. Pharmacol.* **92**, 179-193.
- Gomez, M., Sanchez, D.J., Domingo, J.L., and Corbella, J. (1992). Developmental toxicity evaluation of gallium nitrate in mice. *Arch. Toxicol.* **66**, 188-192.
- Gonsebatt, M.E., Vega, L., Salazar, A.M., Montero, R., Guzman, P., Blas, J., Del Razo, L.M., Garcia-Vegas, G., Albores, A., Cebrian, M.E., Kelsh, M., and Ostrosky-Wegman, P. (1997). Cytogenetic effects in human exposure to arsenic. *Mutat. Res.* **386**, 219-228.
- Greenspan, B.J., Dill, J.A., Mast, T.J., Leach, C.L., Stoney, K.H., and Goehl, T.J. (1990). Lung burdens and clearance of gallium arsenide (GaAs) in rats. Conference on Particle-Lung Interactions, Rochester, NY, May 17-19, 1990.
- Greenspan, B.J., Dill, J.A., Mast, T.J., Chou, B.J., Stoney, K.H., Morrissey, R., and Roycroft, J. (1991). Lung clearance of inhaled gallium arsenide (GaAs). *Toxicologist*, **11**, 234. (Abstr.)
- Gurr, J.-R., Liu, F., Lynn, S., and Jan, K.-Y. (1998). Calcium-dependent nitric oxide production is involved in arsenite-induced micronuclei. *Mutat. Res.* **416**, 137-148.
- Harrison, R.J. (1986). Gallium arsenide. In *Occupational Medicine: The Microelectronics Industry* (J. LaDou, Ed.), Vol. 1, pp. 49-58. Hanley & Belfus, Inc., Philadelphia.
- Hartmann, A., and Speit, G. (1996). Effect of arsenic and cadmium on the persistence of mutagen-induced DNA lesions in human cells. *Environ. Mol. Mutagen.* **27**, 98-104.
- Hartwig, A. (1995). Current aspects in metal genotoxicity. *Biometals.* **8**, 3-11.
- Hawley's Condensed Chemical Dictionary* (1997). 13th ed. (R.J. Lewis, Sr., Ed.), pp. 527-528. Van Nostrand Reinhold, New York.
- Hei, T.K., Liu, S.X., and Waldren, C. (1998). Mutagenicity of arsenic in mammalian cells: Role of reactive oxygen species. *Proc. Natl. Acad. Sci U.S.A.* **95**, 8103-8107.
- Heinrich, U. (1996). Comparative response to long-term particle exposure among rats, mice, and hamsters. In *Particle Overload in the Rat Lung and Lung Cancer: Implications for Human Risk Assessment*, (J.L. Mauderly and R.J. McCunney, Eds.), pp. 51-71. Taylor & Francis, Washington, DC.
- Hollander, M., and Wolfe, D.A. (1973). *Nonparametric Statistical Methods*, pp. 120-123. John Wiley and Sons, New York.
- Hood, R.D., and Bishop, S.L. (1972). Teratogenic effects of sodium arsenate in mice. *Arch. Environ. Health* **24**, 62-65.
- Huang, R.-N., Ho, I.-C., Yih, L.-H., and Lee, T.-C. (1995). Sodium arsenite induces chromosome endoreduplication and inhibits protein phosphatase activity in human fibroblasts. *Environ. Mol. Mutagen.* **25**, 188-196.
- Integrated Laboratory Systems (ILS) (1990). Micro-nucleus Data Management and Statistical Analysis Software, Version 1.4. ILS, P.O. Box 13501, Research Triangle Park, NC 27707.
- International Agency for Research on Cancer (IARC) (1980). *IARC Monographs on the Evaluation of the Carcinogenic Risk of Chemicals to Humans. Some Metals and Metallic Compounds*, Vol. 23, p. 89. IARC, Lyon, France.
- International Agency for Research on Cancer (IARC) (1987). *IARC Monographs on the Evaluation of the Carcinogenic Risks to Humans. Overall Evaluations of Carcinogenicity: An Updating of Volumes 1 to 42*, pp. 100-106, (Suppl. 7). IARC, Lyon, France.
- Jha, A.N., Noditi, M., Nilsson, R., and Natarajan, A.T. (1992). Genotoxic effects of sodium arsenite on human cells. *Mutat. Res.* **284**, 215-221.

- Jonckheere, A.R. (1954). A distribution-free k -sample test against ordered alternatives. *Biometrika* **41**, 133-145.
- Kaplan, E.L., and Meier, P. (1958). Nonparametric estimation from incomplete observations. *J. Am. Stat. Assoc.* **53**, 457-481.
- Kelsen, D.P., Alcock, N., Yeh, S., Brown, J., and Young, C. (1980). Pharmacokinetics of gallium nitrate in man. *Cancer* **46**, 2009-2013.
- Kirk-Othmer Encyclopedia of Chemical Technology* (1980). 3rd ed. (M. Grayson, Ed.), Vol. 3, p. 248, Vol. 11, p. 619. John Wiley & Sons, New York.
- Krakoff, I.H., Newman, R.A., and Goldberg, R.S. (1979). Clinical toxicologic and pharmacologic studies of gallium nitrate. *Cancer* **44**, 1722-1727.
- Labbe, R.F., and Lamon, J.M. (1987). Porphyrins and disorders of porphyrin metabolism. In *Fundamentals of Clinical Chemistry*, 3rd ed. (N.W. Teitz, Ed.), pp. 825-841. W.B. Saunders Co., Philadelphia.
- Labbe, R.F., and Rettmer, R.L. (1989). Zinc protoporphyrin: A product of iron-deficient erythropoiesis. *Sem. in Hemat.* **26**, 40-46.
- Lee, T.-C., Huang, R.Y., and Jan, K.Y. (1985a). Sodium arsenite enhances the cytotoxicity, clastogenicity, and 6-thioguanine-resistant mutagenicity of ultraviolet light in Chinese hamster ovary cells. *Mutat. Res.* **148**, 83-89.
- Lee, T.-C., Oshimura, M., and Barrette, J.C. (1985b). Comparison of arsenic-induced cell transformation, cytotoxicity, mutation and cytogenetic effects in Syrian hamster embryo cells in culture. *Carcinogenesis* **6**, 1421-1426.
- Lee, T.-C., Lee, K.C., Tzeng, Y.J., Huang, R.Y., and Jan, K.Y. (1986). Sodium arsenite potentiates the clastogenicity and mutagenicity of DNA crosslinking agents. *Environ. Mutagen.* **8**, 119-128.
- McConnell, E.E., Solleveld, H.A., Swenberg, J.A., and Boorman, G.A. (1986). Guidelines for combining neoplasms for evaluation of rodent carcinogenesis studies. *JNCI* **76**, 283-289.
- MacGregor, J.T., Wehr, C.M., Henika, P.R., and Shelby, M.D. (1990). The *in vivo* erythrocyte micronucleus test: Measurement at steady state increases assay efficiency and permits integration with toxicity studies. *Fundam. Appl. Toxicol.* **14**, 513-522.
- Maronpot, R.R., and Boorman, G.A. (1982). Interpretation of rodent hepatocellular proliferative alterations and hepatocellular tumors in chemical safety assessment. *Toxicol. Pathol.* **10**, 71-80.
- Martinez, G., Cebrian, M., Chamorro, G., and Jauge, P. (1983). Urinary porphyrins as an indicator of arsenic exposure in rats. *Proc. West. Pharmacol. Soc.* **26**, 171-174.
- Mast, T.J., Dill, J.A., Greenspan, B.J., Evanoff, J.J., Morrissey, R.E., and Schwetz, B.A. (1991). The developmental toxicity of inhaled gallium arsenide in rodents. *Teratology* **43**, 455-456 (Abstr.).
- The Merck Index* (1996). 12th ed. (S. Budavari, Ed.), p. 738. Merck and Company, Whitehouse Station, NJ.
- Miller, J.A., and Miller, E.C. (1977). Ultimate chemical carcinogens as reactive mutagenic electrophiles. In *Origins of Human Cancer* (H.H. Hiatt, J.D. Watson, and J.A. Winsten, Eds.), pp. 605-627. Cold Spring Harbor Laboratory, Cold Spring Harbor, NY.
- Morrison, D.F. (1976). *Multivariate Statistical Methods*, 2nd ed., pp. 170-179. McGraw-Hill Book Company, New York.
- Morrow, P.E. (1986). The setting of particulate exposure levels for chronic inhalation toxicity studies. *J. Am. Coll. Toxicol.* **6**, 533-544.

National Cancer Institute (NCI) (1976). Guidelines for Carcinogen Bioassay in Small Rodents. Technical Report Series No. 1. NIH Publication No. 76-801. U.S. Department of Health, Education, and Welfare, Public Health Service, National Institutes of Health, Bethesda, MD.

National Institute for Occupational Safety and Health (NIOSH) (1985). Hazard Assessment of the Electronic Component Manufacturing Industry. U.S. Department of Health and Human Services, Public Health Service, Centers for Disease Control, National Institute for Occupational Safety and Health, Cincinnati, OH.

National Institute for Occupational Safety and Health (NIOSH) (1987). Request for Assistance in Reducing the Potential Risk of Developing Cancer from Exposure to Gallium Arsenide in the Microelectronics Industry. NIOSH, Cincinnati, OH.

National Institutes of Health (NIH) (1978). Open Formula Mouse and Rat Ration (NIH-07). Specification NIH-11-1335. U.S. Department of Health, Education, and Welfare, Public Health Service, NIH, Bethesda, MD.

National Toxicology Program (NTP) (1987). Technical Protocol for Sperm Morphology and Vaginal Cytology Evaluations in Toxicity Testing for Rats and Mice, 10/31/82 version (updated December 1987). Research Triangle Park, NC.

National Toxicology Program (NTP) (1993a). Toxicology and Carcinogenesis Studies of *o*-Nitroanisole (CAS No. 91-23-6) in F344 Rats and B6C3F₁ Mice (Feed Studies). Technical Report Series No. 416. NIH Publication No. 93-3147. U.S. Department of Health and Human Services, Public Health Service, National Institutes of Health, Research Triangle Park, NC.

National Toxicology Program (NTP) (1993b). Toxicology and Carcinogenesis Studies of Talc (CAS No. 14807-96-6) in F344/N Rats and B6C3F₁ Mice (Inhalation Studies). Technical Report Series No. 421. NIH Publication No. 93-3152. U.S. Department of Health and Human Services, Public Health Service, National Institutes of Health, Research Triangle Park, NC.

National Toxicology Program (NTP) (1996a). Toxicology and Carcinogenesis Studies of Nickel Sulfide (CAS No. 12035-72-2) in F344/N Rats and B6C3F₁ Mice (Inhalation Studies). Technical Report Series No. 453. NIH Publication No. 96-3369. U.S. Department of Health and Human Services, Public Health Service, National Institutes of Health, Research Triangle Park, NC.

National Toxicology Program (NTP) (1996b). Toxicology and Carcinogenesis Studies of Nickel Oxide (CAS No. 1313-99-1) in F344/N Rats and B6C3F₁ Mice (Inhalation Studies). Technical Report Series No. 451. NIH Publication No. 96-3367. U.S. Department of Health and Human Services, Public Health Service, National Institutes of Health, Research Triangle Park, NC.

National Toxicology Program (NTP) (1996c). Toxicology and Carcinogenesis Studies of Nickel Sulfate Hexahydrate (CAS No. 10101-97-0) in F344/N Rats and B6C3F₁ Mice (Inhalation Studies). Technical Report Series No. 454. NIH Publication No. 96-3370. U.S. Department of Health and Human Services, Public Health Service, National Institutes of Health, Research Triangle Park, NC.

National Toxicology Program (NTP) (1997). Toxicology and Carcinogenesis Studies of Nitromethane (CAS No. 75-52-5) in F344/N Rats and B6C3F₁ Mice (Inhalation Studies). Technical Report Series No. 461. NIH Publication No. 97-3377. U.S. Department of Health and Human Services, Public Health Service, National Institutes of Health, Research Triangle Park, NC.

- National Toxicology Program (NTP) (1998a). Report on Carcinogens, Eighth Edition. pp. 17-19. U.S. Department of Health and Human Services. National Institute of Environmental Health Sciences, Research Triangle Park, NC.
- National Toxicology Program (NTP) (1998b). Tumor Incidence in Control Animals by Route and Vehicle of Administration in B6C3F₁ Mice. Analytical Sciences, Inc., Durham, NC.
- National Toxicology Program (NTP) (1998c). Toxicology and Carcinogenesis Studies of Cobalt Sulfate Heptahydrate (CAS No. 10026-24-1) in F344/N Rats and B6C3F₁ Mice (Inhalation Studies). Technical Report Series No. 471. NIH Publication No. 98-3961. U.S. Department of Health and Human Services, Public Health Service, National Institutes of Health, Research Triangle Park, NC.
- National Toxicology Program (NTP) (1998d). Tumor Incidence in Control Animals by Route and Vehicle of Administration in F344/N Rats. Analytical Sciences, Inc., Durham, NC.
- Ohyama, S., Ishinishi, N., Hisanaga, A., and Yamamoto, A. (1988). Comparative chronic toxicity, including tumorigenicity, of gallium arsenide and arsenic trioxide intratracheally instilled into hamsters. *Appl. Organometallic Chem.* **2**, 333-337.
- Omura, M., Tanaka, A., Hirata, M., Zhao, M., Makita, Y., Inoue, N., Gotoh, K., and Ishinishi, N. (1996a). Testicular toxicity of gallium arsenide, indium arsenide, and arsenic oxide in rats by repetitive intratracheal instillation. *Fundam. Appl. Toxicol.* **32**, 72-78.
- Omura, M., Hirata, M., Tanaka, A., Zhao, M., Makita, Y., Inoue, N., Gotoh, K., and Ishinishi, N. (1996b). Testicular toxicity evaluation of arsenic-containing binary compound semiconductors, gallium arsenide, and indium arsenide, in hamsters. *Toxicol. Lett.* **89**, 123-129.
- Patty's Industrial Hygiene and Toxicology* (1994). 4th ed. (G.D. Clayton and F.E. Clayton, Eds.), Vol. 2C, pp. 1879-2013. John Wiley and Sons, Inc., New York.
- Petkof, B. (1980a). Gallium. In *Mineral Facts and Problems*, pp. 323-328. Bureau of Mines Bulletin 671. U.S. Department of the Interior.
- Petkof, B. (1980b). Gallium. In *Minerals Yearbook, Vol. 1, Metals and Minerals*. Bureau of Mines, U.S. Department of the Interior.
- Piegorsch, W.W., and Bailer, A.J. (1997). *Statistics for Environmental Biology and Toxicology*, Section 6.3.2. Chapman and Hall, London.
- Pierson, B., Van Wagenen, S., Nebesny, K.W., Fernando, Q., Scott, N., and Carter, D.E. (1989). Dissolution of crystalline gallium arsenide in aqueous solutions containing complexing agents. *Am. Ind. Hyg. Assoc. J.* **50**, 455-459.
- Portier, C.J., and Bailer, A.J. (1989). Testing for increased carcinogenicity using a survival-adjusted quantal response test. *Fundam. Appl. Toxicol.* **12**, 731-737.
- Portier, C.J., Hedges, J.C., and Hoel, D.G. (1986). Age-specific models of mortality and tumor onset for historical control animals in the National Toxicology Program's carcinogenicity experiments. *Cancer Res.* **46**, 4372-4378.
- Ramirez, P., Eastmond, D.A., Lacleste, J.P., and Ostrosky-Wegman, P. (1997). Disruption of microtubule assembly and spindle formation as a mechanism for the induction of aneuploid cells by sodium arsenite and vanadium pentoxide. *Mutat. Res.* **386**, 291-298.
- Rasey, J.S., Nelson, N.J., and Larson, S.M. (1981). Relationship of iron metabolism to tumor cell toxicity of stable gallium salts. *Int. J. Nucl. Med. Biol.* **8**, 303-313.
- Rasmussen, R.E., and Menzel, D.B. (1997). Variation in arsenic-induced sister chromatid exchange in human lymphocytes and lymphoblastoid cell lines. *Mutat. Res.* **386**, 299-306.
- Roschina, T.A. (1966). Toxicological characteristics of indium antimonide and gallium arsenide—A group of new semiconductors. *Gig. Tr. Prof. Zabol.* **10**, 30.

- Rosen, F., Roberts, N.R., Budnick, L.E., and Nichol, C.A. (1959). Corticosteroids and transaminase activity: The specificity of the glutamic-pyruvic transaminase response. *Endocrin* **65**, 256-264.
- Rosen, F., Roberts, N.R., and Nichol, C.A. (1959). Glucocorticosteroids and transaminase activity: I. Increased activity of glutamic-pyruvic transaminase in four conditions associated with gluconeogenesis. *J. Biol. Chem.* **234**, 476-480.
- Rosner, M.H., and Carter, D.E. (1987). Metabolism and excretion of gallium arsenide and arsenic oxides by hamsters following intratracheal instillation. *Fundam. Appl. Toxicol.* **9**, 730-737.
- Sax's Dangerous Properties of Industrial Materials* (1992). 8th ed. (R.J. Lewis, Sr., Ed.), pp. 1776-1777. Van Nostrand Reinhold, New York.
- Scott, N., Carter, D.E., and Fernando, Q. (1989). Reaction of gallium arsenide with concentrated acids: Formation of arsine. *Am. Ind. Hyg. Assoc. J.* **50**, 379-381.
- Sheehy, J.W., and Jones, J.H. (1993). Assessment of arsenic exposures and controls in gallium arsenide production. *Am. Ind. Hyg. Assoc. J.* **54**, 61-69.
- Shelby, M.D., and Witt, K.L. (1995). Comparison of results from mouse bone marrow chromosome aberration and micronucleus tests. *Environ. Mol. Mutagen.* **25**, 302-313.
- Shelby, M.D., Erexson, G.L., Hook, G.J., and Tice, R.R. (1993). Evaluation of a three-exposure mouse bone marrow micronucleus protocol: Results with 49 chemicals. *Environ. Mol. Mutagen.* **21**, 160-179.
- Shirley, E. (1977). A non-parametric equivalent of Williams' test for contrasting increasing dose levels of a treatment. *Biometrics* **33**, 386-389.
- Sikorski, E.E., McCay, J.A., White, K.L., Jr., Bradley, S.G., and Munson, A.E. (1989). Immunotoxicity of the semiconductor gallium arsenide in female B6C3F₁ mice. *Fundam. Appl. Toxicol.* **13**, 843-858.
- Sikorski, E.E., Burns, L.A., McCoy, K.L., Stern, M., and Munson, A.E. (1991). Suppression of splenic accessory cell function in mice exposed to gallium arsenide. *Toxicol. Appl. Pharmacol.* **110**, 143-156.
- Straus, D.S. (1981). Somatic mutation, cellular differentiation, and cancer causation. *JNCI* **67**, 233-241.
- Tarone, R.E. (1975). Tests for trend in life table analysis. *Biometrika* **62**, 679-682.
- Tennant, R.W., Margolin, B.H., Shelby, M.D., Zeiger, E., Haseman, J.K., Spalding, J., Caspary, W., Resnick, M., Stasiewicz, S., Anderson, B., and Minor, R. (1987). Prediction of chemical carcinogenicity in rodents from *in vitro* genetic toxicity assays. *Science* **236**, 933-941.
- Tinwell, H., Stephens, S.C., and Ashby, J. (1991). Arsenite as the probable active species in the human carcinogenicity of arsenic: Mouse micronucleus assays on Na and K arsenite, orpiment, and Fowler's solution. *Environ. Health Perspect.* **95**, 205-210.
- Vega, L., Gonsebatt, M.E., and Ostrosky-Wegman, P. (1995). Aneugenic effect of sodium arsenite on human lymphocytes in vitro: An individual susceptibility effect detected. *Mutat. Res.* **334**, 365-373.
- Wang, T.S., and Huang, H. (1994). Active oxygen species are involved in the induction of micronuclei by arsenite in XRS-5 cells. *Mutagenesis* **9**, 253-257.
- Warrell, R.P., Jr., Coonley, C.J., Strauss, D.J., and Young, C.W. (1983). Treatment of patients with advanced malignant lymphoma using gallium nitrate administered as a seven-day continuous infusion. *Cancer* **51**, 1982-1987.
- Watson, A.Y., and Valberg, P.A. (1996). Particle-induced lung tumors in rats: Evidence for species specificity in mechanisms. In *Particle Overload in the Rat Lung and Lung Cancer: Implications for Human Risk Assessment*, (J.L. Mauderly and R.J. McCunney, Eds.), pp. 227-257. Taylor & Francis, Washington, DC.

- Webb, D.R., Sipes, I.G., and Carter, D.E. (1984). *In vitro* solubility and *in vivo* toxicity of gallium arsenide. *Toxicol. Appl. Pharmacol.* **76**, 96-104.
- Webb, D.R., Wilson, S.E., and Carter, D.E. (1986). Comparative pulmonary toxicity of gallium arsenide, gallium(III) oxide, or arsenic(III) oxide intratracheally instilled into rats. *Toxicol. Appl. Pharmacol.* **82**, 405-416.
- Webb, D.R., Wilson, S.E., and Carter, D.E. (1987). Pulmonary clearance and toxicity of respirable gallium arsenide particulates intratracheally instilled into rats. *Am. Ind. Hyg. Assoc. J.* **48**, 660-667.
- Williams, D.A. (1971). A test for differences between treatment means when several dose levels are compared with a zero dose control. *Biometrics* **27**, 103-117.
- Williams, D.A. (1972). The comparison of several dose levels with a zero dose control. *Biometrics* **28**, 519-531.
- Wolff, R.K., Kanapilly, G.M., Gray, R.H., and McClellan, R.O. (1984). Deposition and retention of inhaled aggregate $^{67}\text{Ga}_2\text{O}_3$ particles in Beagle dogs, Fischer-344 rats, and CD-1 mice. *Am. Hyg. Assoc. J.* **45**, 377-381.
- Wolff, R.K., Griffith, W.C., Jr., Cuddihy, R.G., Snipes, M.B., Henderson, R.F., Mauderly, J.L., and McClellan, R.O. (1989). Modeling accumulations of particles in lung during chronic inhalation exposures that lead to impaired clearance. *Health Phys.* **57**, 61-68.
- Woods, J.S., and Fowler, B.A. (1978). Altered regulation of mammalian hepatic heme biosynthesis and urinary porphyrin excretion during prolonged exposure to sodium arsenate. *Toxicol. Appl. Pharmacol.* **43**, 361-371.
- Yager, J.W., and Ostrosky-Wegman, P., Eds. (1997). Preface. Arsenic: A paradoxical human carcinogen. *Mutat. Res.* **386**, 181-184.
- Yamauchi, H., Takahashi, K., and Yamamura, Y. (1986). Metabolism and excretion of orally and intraperitoneally administered gallium arsenide in the hamster. *Toxicology* **40**, 237-246.
- Yamauchi, H., Takahashi, K., Mashiko, M., and Yamamura, Y. (1989). Biological monitoring of arsenic exposure of gallium arsenide and inorganic arsenic-exposed workers by determination of inorganic arsenic and its metabolites in urine and hair. *Am. Ind. Hyg. Assoc. J.* **50**, 606-612.
- Yih, L.H., Ho, I.C., and Lee, T.C. (1997). Sodium arsenite disturbs mitosis and induces chromosome loss in human fibroblasts. *Cancer Res.* **57**, 5051-5059.
- Zeiger, E., Haseman, J.K., Shelby, M.D., Margolin, B.H., and Tennant, R.W. (1990). Evaluation of four *in vitro* genetic toxicity tests for predicting rodent carcinogenicity: Confirmation of earlier results with 41 additional chemicals. *Environ. Mol. Mutagen.* **16** (Suppl. 18), 1-14.
- Zeiger, E., Anderson, B., Haworth, S., Lawlor, T., and Mortelmans, K. (1992). Salmonella mutagenicity tests: V. Results from the testing of 311 chemicals. *Environ. Mol. Mutagen.* **19** (Suppl. 21), 2-141.

APPENDIX A
SUMMARY OF LESIONS IN MALE RATS
IN THE 2-YEAR INHALATION STUDY
OF GALLIUM ARSENIDE

TABLE A1	Summary of the Incidence of Neoplasms in Male Rats in the 2-Year Inhalation Study of Gallium Arsenide	102
TABLE A2	Individual Animal Tumor Pathology of Male Rats in the 2-Year Inhalation Study of Gallium Arsenide	106
TABLE A3	Statistical Analysis of Primary Neoplasms in Male Rats in the 2-Year Inhalation Study of Gallium Arsenide	128
TABLE A4a	Historical Incidence of Alveolar/bronchiolar Neoplasms in Chamber Control Male F344/N Rats	133
TABLE A4b	Historical Incidence of Mononuclear Cell Leukemia in Chamber Control Male F344/N Rats	134
TABLE A4c	Historical Incidence of Preputial Gland Neoplasms in Chamber Control Male F344/N Rats	135
TABLE A5	Summary of the Incidence of Nonneoplastic Lesions in Male Rats in the 2-Year Inhalation Study of Gallium Arsenide	136

TABLE A1
Summary of the Incidence of Neoplasms in Male Rats in the 2-Year Inhalation Study of Gallium Arsenide^a

	Chamber Control	0.01 mg/m ³	0.1 mg/m ³	1.0 mg/m ³
Disposition Summary				
Animals initially in study	50	50	50	50
Early deaths				
Moribund	30	29	32	33
Natural deaths	7	8	3	4
Survivors				
Terminal sacrifice	13	13	15	13
Animals examined microscopically	50	50	50	50
Alimentary System				
Esophagus	(49)	(50)	(50)	(50)
Intestine large, colon	(47)	(47)	(48)	(50)
Intestine large, rectum	(48)	(49)	(47)	(49)
Intestine large, cecum	(46)	(43)	(48)	(49)
Intestine small, duodenum	(48)	(48)	(49)	(50)
Intestine small, jejunum	(45)	(43)	(48)	(50)
Intestine small, ileum	(44)	(43)	(48)	(49)
Polyp adenomatous		1 (2%)		
Liver	(50)	(50)	(50)	(50)
Cholangioma				1 (2%)
Hepatocellular carcinoma			1 (2%)	
Hepatocellular adenoma	1 (2%)	1 (2%)	1 (2%)	
Osteosarcoma, metastatic, bone			1 (2%)	
Mesentery	(5)	(10)	(14)	(7)
Carcinoma, metastatic, uncertain primary site				1 (14%)
Oral mucosa	(1)	(3)		(1)
Gingival, squamous cell papilloma				1 (100%)
Pharyngeal, squamous cell papilloma		3 (100%)		
Pancreas	(49)	(49)	(50)	(50)
Adenoma	2 (4%)	1 (2%)	1 (2%)	1 (2%)
Salivary glands	(50)	(50)	(50)	(50)
Stomach, forestomach	(49)	(50)	(50)	(50)
Squamous cell papilloma				1 (2%)
Stomach, glandular	(49)	(49)	(50)	(50)
Tongue	(2)		(2)	(1)
Squamous cell carcinoma	1 (50%)			
Squamous cell papilloma	1 (50%)		1 (50%)	1 (100%)
Cardiovascular System				
Blood vessel	(3)	(4)	(6)	(6)
Hemangiosarcoma			1 (17%)	
Heart	(50)	(50)	(50)	(50)
Schwannoma malignant	1 (2%)			
Endocrine System				
Adrenal cortex	(49)	(49)	(49)	(50)
Osteosarcoma, metastatic, bone			1 (2%)	

TABLE A1
Summary of the Incidence of Neoplasms in Male Rats in the 2-Year Inhalation Study of Gallium Arsenide

	Chamber Control	0.01 mg/m ³	0.1 mg/m ³	1.0 mg/m ³
Endocrine System (continued)				
Adrenal medulla	(50)	(49)	(49)	(50)
Pheochromocytoma malignant	2 (4%)		3 (6%)	1 (2%)
Pheochromocytoma benign	12 (24%)	9 (18%)	17 (35%)	10 (20%)
Bilateral, pheochromocytoma benign	4 (8%)	3 (6%)	5 (10%)	3 (6%)
Islets, pancreatic	(48)	(49)	(50)	(50)
Adenoma	2 (4%)	1 (2%)	2 (4%)	2 (4%)
Carcinoma		3 (6%)		1 (2%)
Pituitary gland	(49)	(49)	(50)	(50)
Pars distalis, adenoma	21 (43%)	22 (45%)	21 (42%)	19 (38%)
Thyroid gland	(46)	(46)	(49)	(50)
C-cell, adenoma	3 (7%)	5 (11%)	6 (12%)	2 (4%)
C-cell, carcinoma		3 (7%)	2 (4%)	1 (2%)
Follicular cell, adenoma	1 (2%)			
General Body System				
Peritoneum	(1)		(1)	
Genital System				
Epididymis	(50)	(50)	(50)	(50)
Preputial gland	(50)	(49)	(50)	(49)
Adenoma		2 (4%)	3 (6%)	6 (12%)
Carcinoma	4 (8%)	4 (8%)	5 (10%)	4 (8%)
Prostate	(50)	(48)	(50)	(50)
Adenoma		2 (4%)		
Histiocytic sarcoma			1 (2%)	
Seminal vesicle	(45)	(47)	(48)	(50)
Testes	(50)	(50)	(50)	(50)
Bilateral, interstitial cell, adenoma	42 (84%)	35 (70%)	37 (74%)	33 (66%)
Interstitial cell, adenoma	3 (6%)	5 (10%)	9 (18%)	8 (16%)
Hematopoietic System				
Bone marrow	(49)	(48)	(50)	(50)
Lymph node	(12)	(8)	(9)	(5)
Schwannoma malignant, metastatic, heart	1 (8%)			
Inguinal, fibrosarcoma, metastatic, skin		1 (13%)		
Renal, pheochromocytoma malignant, metastatic, adrenal medulla	1 (8%)			
Lymph node, bronchial	(36)	(37)	(35)	(42)
Plasma cell tumor malignant	1 (3%)			
Lymph node, mandibular	(46)	(43)	(46)	(44)
Lymph node, mesenteric	(48)	(48)	(50)	(48)
Lymph node, mediastinal	(42)	(40)	(46)	(47)
Plasma cell tumor malignant	1 (2%)			
Spleen	(50)	(50)	(50)	(50)
Osteosarcoma				1 (2%)
Osteosarcoma, metastatic, bone			1 (2%)	
Sarcoma				1 (2%)
Thymus	(46)	(45)	(45)	(42)

TABLE A1
Summary of the Incidence of Neoplasms in Male Rats in the 2-Year Inhalation Study of Gallium Arsenide

	Chamber Control	0.01 mg/m ³	0.1 mg/m ³	1.0 mg/m ³
Integumentary System				
Mammary gland	(41)	(42)	(42)	(40)
Carcinoma				1 (3%)
Fibroadenoma		2 (5%)	3 (7%)	2 (5%)
Skin	(50)	(49)	(50)	(50)
Basal cell adenoma	1 (2%)			1 (2%)
Keratoacanthoma	3 (6%)	2 (4%)	4 (8%)	3 (6%)
Squamous cell carcinoma	1 (2%)			1 (2%)
Squamous cell papilloma		2 (4%)	1 (2%)	1 (2%)
Trichoepithelioma				1 (2%)
Subcutaneous tissue, fibroma	3 (6%)	1 (2%)	2 (4%)	1 (2%)
Subcutaneous tissue, fibrosarcoma		1 (2%)	2 (4%)	
Subcutaneous tissue, hemangioma				1 (2%)
Subcutaneous tissue, hemangiopericytoma				1 (2%)
Subcutaneous tissue, liposarcoma		1 (2%)		
Musculoskeletal System				
Bone	(50)	(50)	(50)	(50)
Osteosarcoma	1 (2%)		2 (4%)	
Skeletal muscle	(1)			
Nervous System				
Brain	(50)	(50)	(50)	(50)
Astrocytoma malignant		1 (2%)		
Hemangioma				1 (2%)
Oligodendroglioma malignant			1 (2%)	1 (2%)
Sarcoma				1 (2%)
Peripheral nerve		(1)		
Schwannoma malignant		1 (100%)		
Respiratory System				
Larynx	(50)	(50)	(49)	(50)
Lung	(50)	(49)	(50)	(50)
Alveolar/bronchiolar adenoma	1 (2%)		3 (6%)	1 (2%)
Alveolar/bronchiolar adenoma, multiple				1 (2%)
Alveolar/bronchiolar carcinoma	2 (4%)		2 (4%)	1 (2%)
Carcinoma, metastatic, thyroid gland		1 (2%)		
Chordoma, metastatic, uncertain primary site		1 (2%)		
Osteosarcoma, metastatic, bone			1 (2%)	
Pheochromocytoma malignant, metastatic, adrenal medulla	2 (4%)			
Plasma cell tumor malignant, metastatic, lymph node, mediastinal	1 (2%)			
Squamous cell carcinoma	1 (2%)			
Mediastinum, sarcoma			1 (2%)	
Nose	(50)	(48)	(49)	(50)
Pleura		(1)		

TABLE A1
Summary of the Incidence of Neoplasms in Male Rats in the 2-Year Inhalation Study of Gallium Arsenide

	Chamber Control	0.01 mg/m ³	0.1 mg/m ³	1.0 mg/m ³
Special Senses System				
Zymbal's gland	(1)	(1)		
Carcinoma	1 (100%)	1 (100%)		
Urinary System				
Kidney	(49)	(50)	(50)	(50)
Renal tubule, adenoma	1 (2%)			3 (6%)
Renal tubule, adenoma, multiple	1 (2%)			
Transitional epithelium, papilloma			1 (2%)	
Urinary bladder	(48)	(50)	(50)	(50)
Histiocytic sarcoma			1 (2%)	
Transitional epithelium, papilloma			1 (2%)	1 (2%)
Systemic Lesions				
Multiple organs ^b	(50)	(50)	(50)	(50)
Histiocytic sarcoma			1 (2%)	
Leukemia mononuclear	19 (38%)	28 (56%)	33 (66%)	28 (56%)
Mesothelioma benign	1 (2%)	1 (2%)	1 (2%)	1 (2%)
Mesothelioma malignant	1 (2%)	1 (2%)		
Neoplasm Summary				
Total animals with primary neoplasms ^c	50	49	50	48
Total primary neoplasms	139	142	173	149
Total animals with benign neoplasms	50	47	49	46
Total benign neoplasms	103	98	119	107
Total animals with malignant neoplasms	30	38	41	34
Total malignant neoplasms	36	44	54	42
Total animals with metastatic neoplasms	3	4	1	1
Total metastatic neoplasms	5	6	4	1
Total animals with malignant neoplasms of uncertain primary site		1		1

^a Number of animals examined microscopically at the site and the number of animals with neoplasm

^b Number of animals with any tissue examined microscopically

^c Primary neoplasms: all neoplasms except metastatic neoplasms

TABLE A2
Individual Animal Tumor Pathology of Male Rats in the 2-Year Inhalation Study of Gallium Arsenide:
Chamber Control

	3	5	5	5	5	5	5	5	5	5	5	5	5	6	6	6	6	6	6	6	6	6	6	6	
Number of Days on Study	3	0	3	3	4	4	6	6	6	6	9	9	9	1	1	1	2	2	3	4	4	4	5	6	6
	8	6	4	4	4	5	6	6	7	7	0	0	9	2	2	7	1	1	6	2	5	7	8	2	2
Carcass ID Number	0	0	0	0	0	0	0	0	0	0	0	0	0	0	0	0	0	0	0	0	0	0	0	0	0
	2	1	0	5	4	4	0	3	2	4	0	4	2	1	3	2	3	4	2	0	1	3	2	1	1
	3	4	7	0	9	6	5	4	4	5	9	4	5	3	2	8	6	0	9	1	6	3	7	2	7
Alimentary System																									
Esophagus	+	+	+	+	+	+	+	+	+	+	+	+	+	+	+	+	+	+	A	+	+	+	+	+	+
Intestine large, colon	+	+	+	+	+	+	+	+	+	+	+	+	+	+	+	+	+	+	A	+	+	+	+	+	+
Intestine large, rectum	+	+	+	+	+	+	+	+	+	+	+	+	+	+	+	+	+	+	A	+	+	+	+	+	+
Intestine large, cecum	+	+	+	+	+	A	+	+	+	+	+	+	+	+	+	+	+	+	A	+	+	+	+	+	+
Intestine small, duodenum	+	+	+	+	+	+	+	+	+	+	+	+	+	+	+	+	+	+	A	+	+	+	+	+	+
Intestine small, jejunum	+	+	+	+	+	A	+	+	+	+	+	+	+	+	A	A	+	+	+	+	+	+	+	A	+
Intestine small, ileum	+	+	+	+	+	A	+	+	+	+	+	+	+	A	A	A	+	+	+	+	+	+	+	A	+
Liver	+	+	+	+	+	+	+	+	+	+	+	+	+	+	+	+	+	+	+	+	+	+	+	+	+
Hepatocellular adenoma																									
Mesentery																					+				+
Oral mucosa																									
Pancreas	+	+	+	+	+	+	+	+	+	+	+	+	+	+	+	+	+	+	A	+	+	+	+	+	+
Adenoma																									
Salivary glands	+	+	+	+	+	+	+	+	+	+	+	+	+	+	+	+	+	+	+	+	+	+	+	+	+
Stomach, forestomach	+	+	+	+	+	+	+	+	+	+	+	+	+	+	+	+	+	+	A	+	+	+	+	+	+
Stomach, glandular	+	+	+	+	+	+	+	+	+	+	+	+	+	+	+	+	+	+	A	+	+	+	+	+	+
Tongue																									
Squamous cell carcinoma																									X
Squamous cell papilloma																									X
Tooth														+											
Cardiovascular System																									
Blood vessel																									+
Heart	+	+	+	+	+	+	+	+	+	+	+	+	+	+	+	+	+	+	+	+	+	+	+	+	+
Schwannoma malignant																									X
Endocrine System																									
Adrenal cortex	+	+	+	+	+	+	+	+	+	+	+	+	+	+	+	+	+	+	A	+	+	+	+	+	+
Adrenal medulla	+	+	+	+	+	+	+	+	+	+	+	+	+	+	+	+	+	+	+	+	+	+	+	+	+
Pheochromocytoma malignant																									
Pheochromocytoma benign																									X
Bilateral, pheochromocytoma benign														X		X									
Islets, pancreatic	+	+	+	+	+	+	+	+	+	+	+	+	+	+	+	+	+	+	A	A	+	+	+	+	+
Adenoma																									
Parathyroid gland	+	+	+	+	+	+	M	+	+	+	+	+	+	+	+	+	+	+	+	+	+	+	+	+	+
Pituitary gland	+	+	+	+	+	+	+	+	+	+	+	+	+	+	+	+	+	+	+	+	+	+	+	+	+
Pars distalis, adenoma	X	X		X	X	X	X												X	X	X	X		X	
Thyroid gland	+	+	+	+	+	+	+	+	+	+	+	+	+	A	A	A	+	+	+	+	+	+	+	+	+
C-cell, adenoma																									X
Follicular cell, adenoma																									
General Body System																									
Peritoneum																									+

+: Tissue examined microscopically
 A: Autolysis precludes examination

M: Missing tissue
 I: Insufficient tissue

X: Lesion present
 Blank: Not examined

TABLE A2
Individual Animal Tumor Pathology of Male Rats in the 2-Year Inhalation Study of Gallium Arsenide:
Chamber Control

Number of Days on Study	6 6 6 6 6 6 6 6 7 7 7 7 7 7 7 7 7 7 7 7 7 7 7	
	7 7 8 8 8 8 8 9 1 2 2 2 3 3 3 3 3 3 3 3 3 3 3 3	
	1 7 1 4 5 5 8 3 3 0 6 9 3 3 3 3 3 3 3 3 3 3 3 3	
Carcass ID Number	0 0	Total
	1 3 0 4 1 4 1 4 4 3 1 4 0 0 0 0 1 2 2 2 2 3 3 3 3	Tissues/
	8 5 2 8 9 7 1 1 2 1 0 3 3 4 6 8 5 0 1 2 6 0 7 8 9	Tumors
Special Senses System		
Ear		1
Eye	+	4
Zymbal's gland		1
Carcinoma		1
Urinary System		
Kidney	+ +	49
Renal tubule, adenoma		1
Renal tubule, adenoma, multiple	X	1
Urinary bladder	+ +	48
Systemic Lesions		
Multiple organs	+ +	50
Leukemia mononuclear	X X	19
Mesothelioma benign		1
Mesothelioma malignant		1

TABLE A2
Individual Animal Tumor Pathology of Male Rats in the 2-Year Inhalation Study of Gallium Arsenide: 0.01 mg/m³

Number of Days on Study	6 6 6 6 6 6 6 7 7 7 7 7 7 7 7 7 7 7 7 7 7 7 7	
	4 4 5 6 8 9 9 0 0 0 1 1 3 3 3 3 3 3 3 3 3 3 3	
	7 7 5 0 4 1 9 1 8 9 2 9 3 3 3 3 3 3 3 3 3 3 3	
Carcass ID Number	2 2	Total
	1 5 4 0 1 2 4 4 0 0 0 3 0 1 1 1 2 3 3 3 4 4 4 4	Tissues/
	6 0 1 6 8 3 9 0 8 3 7 9 4 0 3 4 2 3 5 8 2 3 4 5 7	Tumors
Special Senses System		
Eye		2
Zymbal's gland	+	1
Carcinoma	X	1
Urinary System		
Kidney	+ +	50
Urinary bladder	+ +	50
Systemic Lesions		
Multiple organs	+ +	50
Leukemia mononuclear	X X X X X X X X X X X X X X	28
Mesothelioma benign		1
Mesothelioma malignant		1

TABLE A2
Individual Animal Tumor Pathology of Male Rats in the 2-Year Inhalation Study of Gallium Arsenide: 0.1 mg/m³

Number of Days on Study	3 4 4 5 5 5 5 5 5 6 6 6 6 6 6 6 6 6 6 6 6 6 6 6
	9 4 5 1 6 6 6 9 9 0 0 0 1 1 2 2 2 4 4 5 6 6 6 7 7
	4 3 0 3 0 2 6 0 0 1 1 4 5 7 1 7 7 2 2 4 0 0 2 1 4
Carcass ID Number	4 4
	4 1 4 3 2 3 1 2 4 0 5 0 3 2 4 0 1 2 4 2 1 3 3 2 0
	9 8 6 6 8 7 9 9 8 8 0 4 3 0 7 1 3 4 4 2 7 9 4 5 6
Alimentary System	
Esophagus	+ +
Intestine large, colon	+ + + + + + A + + + + + + + + + + + + + + + + A + +
Intestine large, rectum	+ + + + A + + + + + + + + + + + + + + + I + + + + +
Intestine large, cecum	+ + + + + + A + + + + + + + + + + + + + + + A + +
Intestine small, duodenum	+ + + + + + A + + + + + + + + + + + + + + + + + + +
Intestine small, jejunum	+ + + + + + A + + + + + + + + + + + + + + + + A + +
Intestine small, ileum	+ + + + + + A + + + + + + + + + + + + + + + A + +
Liver	+ +
Hepatocellular carcinoma	
Hepatocellular adenoma	
Osteosarcoma, metastatic, bone	
Mesentery	
Pancreas	
Adenoma	
Salivary glands	
Stomach, forestomach	
Stomach, glandular	
Tongue	
Squamous cell papilloma	
Cardiovascular System	
Blood vessel	
Hemangiosarcoma	
Heart	
Endocrine System	
Adrenal cortex	
Osteosarcoma, metastatic, bone	
Adrenal medulla	
Pheochromocytoma malignant	
Pheochromocytoma benign	
Bilateral, pheochromocytoma benign	
Islets, pancreatic	
Adenoma	
Parathyroid gland	
Pituitary gland	
Pars distalis, adenoma	
Thyroid gland	
C-cell, adenoma	
C-cell, carcinoma	
General Body System	
Peritoneum	
Genital System	
Epididymis	
Preputial gland	
Adenoma	
Carcinoma	
Prostate	
Histiocytic sarcoma	
Seminal vesicle	
Testes	
Bilateral, interstitial cell, adenoma	
Interstitial cell, adenoma	

**TABLE A2
Individual Animal Tumor Pathology of Male Rats in the 2-Year Inhalation Study of Gallium Arsenide: 0.1 mg/m³**

Number of Days on Study	3 4 4 5 5 5 5 5 5 6 6 6 6 6 6 6 6 6 6 6 6 6 6 6
	9 4 5 1 6 6 6 9 9 0 0 0 1 1 2 2 2 4 4 5 6 6 6 7 7
	4 3 0 3 0 2 6 0 0 1 1 4 5 7 1 7 7 2 2 4 0 0 2 1 4
Carcass ID Number	4 4
	4 1 4 3 2 3 1 2 4 0 5 0 3 2 4 0 1 2 4 2 1 3 3 2 0
	9 8 6 6 8 7 9 9 8 8 0 4 3 0 7 1 3 4 4 2 7 9 4 5 6
Hematopoietic System	
Bone marrow	+ +
Lymph node	
Lymph node, bronchial	M + + + + + + + + M M + M M + + M M + M + + + + +
Lymph node, mandibular	+ + + + + M + + + + + + + + + + + + + + + M + + + + +
Lymph node, mesenteric	+ +
Lymph node, mediastinal	M + + + + M + + + + + + + + + + M + + + + + + + + + + +
Spleen	+ +
Osteosarcoma, metastatic, bone	
Thymus	+ M + + + + + + M + + + + + + + + + + + M + + + M +
Integumentary System	
Mammary gland	M M + + + M + + M + + + + + M + M + + + + + M + +
Fibroadenoma	
Skin	+ +
Keratoacanthoma	
Squamous cell papilloma	
Subcutaneous tissue, fibroma	
Subcutaneous tissue, fibrosarcoma	
Musculoskeletal System	
Bone	+ +
Osteosarcoma	
Nervous System	
Brain	+ +
Oligodendroglioma malignant	
Respiratory System	
Larynx	+ + + + + + A +
Lung	+ +
Alveolar/bronchiolar adenoma	
Alveolar/bronchiolar carcinoma	
Osteosarcoma, metastatic, bone	
Mediastinum, sarcoma	
Nose	+ A + +
Trachea	+ + + + + + A +
Special Senses System	
Ear	
Eye	
Urinary System	
Kidney	+ +
Transitional epithelium, papilloma	
Urinary bladder	+ +
Histiocytic sarcoma	
Transitional epithelium, papilloma	
Systemic Lesions	
Multiple organs	+ +
Histiocytic sarcoma	
Leukemia mononuclear	
Mesothelioma benign	

TABLE A2
Individual Animal Tumor Pathology of Male Rats in the 2-Year Inhalation Study of Gallium Arsenide: 1.0 mg/m³

Number of Days on Study	6 6 6 6 6 7 7 7 7 7 7 7 7 7 7 7 7 7 7 7 7 7 7	
	4 4 6 6 7 0 0 0 0 1 1 3 3 3 3 3 3 3 3 3 3 3 3	
	5 5 8 8 8 0 2 2 2 3 5 2 3 3 3 3 3 3 3 3 3 3 3	
Carcass ID Number	6 6	Total
	1 4 0 2 0 3 1 2 3 2 2 4 0 0 0 0 2 2 2 3 3 3 3 4 4	Tissues/
	0 9 1 1 2 8 4 7 2 4 9 1 3 4 5 7 0 3 5 0 1 3 5 5 8	Tumors
Special Senses System		
Eye		+
		1
Urinary System		
Kidney		+
Renal tubule, adenoma		X X
		3
Urinary bladder		+
Transitional epithelium, papilloma		X
		1
Systemic Lesions		
Multiple organs		+
Leukemia mononuclear		X X
		28
Mesothelioma benign		X
		1

TABLE A3
Statistical Analysis of Primary Neoplasms in Male Rats in the 2-Year Inhalation Study of Gallium Arsenide

	Chamber Control	0.01 mg/m ³	0.1 mg/m ³	1.0 mg/m ³
Adrenal Medulla: Benign Pheochromocytoma				
Overall rate ^a	16/50 (32%)	12/49 (24%)	22/49 (45%)	13/50 (26%)
Adjusted rate ^b	40.8%	33.0%	54.8%	35.3%
Terminal rate ^c	5/13 (39%)	4/13 (31%)	9/15 (60%)	7/13 (54%)
First incidence (days)	567	614	590	547
Poly-3 test ^d	P=0.297N	P=0.314N	P=0.140	P=0.395N
Adrenal Medulla: Malignant Pheochromocytoma				
Overall rate	2/50 (4%)	0/49 (0%)	3/49 (6%)	1/50 (2%)
Adjusted rate	5.4%	0.0%	8.0%	2.9%
Terminal rate	1/13 (8%)	0/13 (0%)	2/15 (13%)	0/13 (0%)
First incidence (days)	671	— ^e	601	713
Poly-3 test	P=0.537N	P=0.254N	P=0.508	P=0.519N
Adrenal Medulla: Benign or Malignant Pheochromocytoma				
Overall rate	16/50 (32%)	12/49 (24%)	23/49 (47%)	14/50 (28%)
Adjusted rate	40.8%	33.0%	56.7%	38.0%
Terminal rate	5/13 (39%)	4/13 (31%)	9/15 (60%)	7/13 (54%)
First incidence (days)	567	614	590	547
Poly-3 test	P=0.380N	P=0.314N	P=0.103	P=0.492N
Kidney (Renal Tubule): Adenoma				
Overall rate	2/49 (4%)	0/50 (0%)	0/50 (0%)	3/50 (6%)
Adjusted rate	5.4%	0.0%	0.0%	8.5%
Terminal rate	0/13 (0%)	0/13 (0%)	0/15 (0%)	2/13 (15%)
First incidence (days)	590	—	—	604
Poly-3 test	P=0.103	P=0.253N	P=0.231N	P=0.481
Lung: Alveolar/bronchiolar Adenoma				
Overall rate	1/50 (2%)	0/49 (0%)	3/50 (6%)	2/50 (4%)
Adjusted rate	2.7%	0.0%	8.0%	5.7%
Terminal rate	0/13 (0%)	0/13 (0%)	3/15 (20%)	2/13 (15%)
First incidence (days)	688	—	733 (T)	733 (T)
Poly-3 test	P=0.421	P=0.516N	P=0.310	P=0.481
Lung: Alveolar/bronchiolar Adenoma or Carcinoma				
Overall rate	3/50 (6%)	0/49 (0%)	5/50 (10%)	3/50 (6%)
Adjusted rate	8.0%	0.0%	13.3%	8.6%
Terminal rate	1/13 (8%)	0/13 (0%)	4/15 (27%)	3/13 (23%)
First incidence (days)	567	—	722	733 (T)
Poly-3 test	P=0.490	P=0.134N	P=0.357	P=0.632
Mammary Gland: Fibroadenoma				
Overall rate	0/50 (0%)	2/50 (4%)	3/50 (6%)	2/50 (4%)
Adjusted rate	0.0%	5.8%	7.9%	5.6%
Terminal rate	0/13 (0%)	1/13 (8%)	0/15 (0%)	1/13 (8%)
First incidence (days)	—	660	601	422
Poly-3 test	P=0.521	P=0.222	P=0.125	P=0.230

TABLE A3
Statistical Analysis of Primary Neoplasms in Male Rats in the 2-Year Inhalation Study of Gallium Arsenide

	Chamber Control	0.01 mg/m ³	0.1 mg/m ³	1.0 mg/m ³
Mammary Gland: Fibroadenoma or Carcinoma				
Overall rate	0/50 (0%)	2/50 (4%)	3/50 (6%)	3/50 (6%)
Adjusted rate	0.0%	5.8%	7.9%	8.4%
Terminal rate	0/13 (0%)	1/13 (8%)	0/15 (0%)	1/13 (8%)
First incidence (days)	—	660	601	422
Poly-3 test	P=0.283	P=0.222	P=0.125	P=0.113
Oral Cavity (Oral Mucosa): Squamous Cell Papilloma				
Overall rate	0/50 (0%)	3/50 (6%)	0/50 (0%)	1/50 (2%)
Adjusted rate	0.0%	8.5%	0.0%	2.9%
Terminal rate	0/13 (0%)	1/13 (8%)	0/15 (0%)	1/13 (8%)
First incidence (days)	—	524	— ^f	733 (T)
Poly-3 test	P=0.698N	P=0.109	— ^f	P=0.490
Oral Cavity (Oral Mucosa or Tongue): Squamous Cell Papilloma				
Overall rate	1/50 (2%)	3/50 (6%)	1/50 (2%)	2/50 (4%)
Adjusted rate	2.7%	8.5%	2.7%	5.7%
Terminal rate	0/13 (0%)	1/13 (8%)	0/15 (0%)	1/13 (8%)
First incidence (days)	662	524	702	702
Poly-3 test	P=0.572	P=0.286	P=0.757N	P=0.481
Oral Cavity (Oral Mucosa or Tongue): Squamous Cell Papilloma or Squamous Cell Carcinoma				
Overall rate	2/50 (4%)	3/50 (6%)	1/50 (2%)	2/50 (4%)
Adjusted rate	5.3%	8.5%	2.7%	5.7%
Terminal rate	0/13 (0%)	1/13 (8%)	0/15 (0%)	1/13 (8%)
First incidence (days)	506	524	702	702
Poly-3 test	P=0.650N	P=0.469	P=0.499N	P=0.669
Pancreatic Islets: Carcinoma				
Overall rate	0/48 (0%)	3/49 (6%)	0/50 (0%)	1/50 (2%)
Adjusted rate	0.0%	8.7%	0.0%	2.9%
Terminal rate	0/13 (0%)	2/13 (15%)	0/15 (0%)	1/13 (8%)
First incidence (days)	—	532	—	733 (T)
Poly-3 test	P=0.691N	P=0.112	—	P=0.496
Pancreatic Islets: Adenoma or Carcinoma				
Overall rate	2/48 (4%)	4/49 (8%)	2/50 (4%)	3/50 (6%)
Adjusted rate	5.6%	11.5%	5.3%	8.4%
Terminal rate	1/13 (8%)	3/13 (23%)	0/15 (0%)	1/13 (8%)
First incidence (days)	671	532	704	601
Poly-3 test	P=0.570	P=0.321	P=0.676N	P=0.499
Pituitary Gland (Pars Distalis): Adenoma				
Overall rate	21/49 (43%)	22/49 (45%)	21/50 (42%)	19/50 (38%)
Adjusted rate	49.6%	56.8%	50.9%	48.8%
Terminal rate	4/13 (31%)	7/13 (54%)	7/15 (47%)	7/13 (54%)
First incidence (days)	338	574	513	539
Poly-3 test	P=0.414N	P=0.328	P=0.539	P=0.564N

TABLE A3
Statistical Analysis of Primary Neoplasms in Male Rats in the 2-Year Inhalation Study of Gallium Arsenide

	Chamber Control	0.01 mg/m ³	0.1 mg/m ³	1.0 mg/m ³
Preputial Gland: Adenoma				
Overall rate	0/50 (0%)	2/49 (4%)	3/50 (6%)	6/49 (12%)
Adjusted rate	0.0%	5.9%	7.8%	16.7%
Terminal rate	0/13 (0%)	1/13 (8%)	1/15 (7%)	3/13 (23%)
First incidence (days)	—	574	604	520
Poly-3 test	P=0.016	P=0.218	P=0.126	P=0.013
Preputial Gland: Carcinoma				
Overall rate	4/50 (8%)	4/49 (8%)	5/50 (10%)	4/49 (8%)
Adjusted rate	10.6%	11.7%	12.8%	11.1%
Terminal rate	1/13 (8%)	2/13 (15%)	0/15 (0%)	1/13 (8%)
First incidence (days)	534	567	590	540
Poly-3 test	P=0.582N	P=0.592	P=0.525	P=0.621
Preputial Gland: Adenoma or Carcinoma				
Overall rate	4/50 (8%)	6/49 (12%)	8/50 (16%)	10/49 (20%)
Adjusted rate	10.6%	17.3%	20.0%	26.8%
Terminal rate	1/13 (8%)	3/13 (23%)	1/15 (7%)	4/13 (31%)
First incidence (days)	534	567	590	520
Poly-3 test	P=0.092	P=0.315	P=0.202	P=0.062
Skin: Keratoacanthoma				
Overall rate	3/50 (6%)	2/50 (4%)	4/50 (8%)	3/50 (6%)
Adjusted rate	8.1%	5.8%	10.6%	8.4%
Terminal rate	2/13 (15%)	1/13 (8%)	2/15 (13%)	1/13 (8%)
First incidence (days)	671	621	702	519
Poly-3 test	P=0.603	P=0.531N	P=0.512	P=0.652
Skin: Squamous Cell Papilloma or Keratoacanthoma				
Overall rate	3/50 (6%)	4/50 (8%)	5/50 (10%)	4/50 (8%)
Adjusted rate	8.1%	11.4%	13.3%	11.0%
Terminal rate	2/13 (15%)	2/13 (15%)	3/15 (20%)	1/13 (8%)
First incidence (days)	671	594	702	519
Poly-3 test	P=0.587	P=0.471	P=0.366	P=0.491
Skin: Squamous Cell Papilloma, Keratoacanthoma, or Squamous Cell Carcinoma				
Overall rate	3/50 (6%)	4/50 (8%)	5/50 (10%)	4/50 (8%)
Adjusted rate	8.1%	11.4%	13.3%	11.0%
Terminal rate	2/13 (15%)	2/13 (15%)	3/15 (20%)	1/13 (8%)
First incidence (days)	671	594	702	519
Poly-3 test	P=0.587	P=0.471	P=0.366	P=0.491
Skin: Squamous Cell Papilloma, Keratoacanthoma, Trichoepithelioma, Basal Cell Adenoma, or Squamous Cell Carcinoma				
Overall rate	4/50 (8%)	4/50 (8%)	5/50 (10%)	6/50 (12%)
Adjusted rate	10.9%	11.4%	13.3%	16.5%
Terminal rate	3/13 (23%)	2/13 (15%)	3/15 (20%)	2/13 (15%)
First incidence (days)	671	594	702	519
Poly-3 test	P=0.317	P=0.616	P=0.514	P=0.358

TABLE A3
Statistical Analysis of Primary Neoplasms in Male Rats in the 2-Year Inhalation Study of Gallium Arsenide

	Chamber Control	0.01 mg/m ³	0.1 mg/m ³	1.0 mg/m ³
Skin (Subcutaneous Tissue): Fibroma				
Overall rate	3/50 (6%)	1/50 (2%)	2/50 (4%)	1/50 (2%)
Adjusted rate	8.0%	2.9%	5.3%	2.8%
Terminal rate	0/13 (0%)	1/13 (8%)	1/15 (7%)	0/13 (0%)
First incidence (days)	566	733 (T)	674	618
Poly-3 test	P=0.404N	P=0.340N	P=0.499N	P=0.328N
Skin (Subcutaneous Tissue): Fibroma or Fibrosarcoma				
Overall rate	3/50 (6%)	2/50 (4%)	4/50 (8%)	1/50 (2%)
Adjusted rate	8.0%	5.8%	10.6%	2.8%
Terminal rate	0/13 (0%)	1/13 (8%)	3/15 (20%)	0/13 (0%)
First incidence (days)	566	548	674	618
Poly-3 test	P=0.253N	P=0.538N	P=0.501	P=0.328N
Testes: Adenoma				
Overall rate	45/50 (90%)	40/50 (80%)	46/50 (92%)	41/50 (82%)
Adjusted rate	95.5%	90.1%	95.5%	90.9%
Terminal rate	13/13 (100%)	12/13 (92%)	15/15 (100%)	13/13 (100%)
First incidence (days)	506	524	394	422
Poly-3 test	P=0.345N	P=0.227N	P=0.742N	P=0.269N
Thyroid Gland (C-cell): Adenoma				
Overall rate	3/46 (7%)	5/46 (11%)	6/49 (12%)	2/50 (4%)
Adjusted rate	8.7%	14.6%	15.5%	5.7%
Terminal rate	1/13 (8%)	1/13 (8%)	2/15 (13%)	0/13 (0%)
First incidence (days)	645	393	562	645
Poly-3 test	P=0.202N	P=0.350	P=0.299	P=0.489N
Thyroid Gland (C-cell): Carcinoma				
Overall rate	0/46 (0%)	3/46 (7%)	2/49 (4%)	1/50 (2%)
Adjusted rate	0.0%	9.0%	5.4%	2.8%
Terminal rate	0/13 (0%)	1/13 (8%)	0/15 (0%)	0/13 (0%)
First incidence (days)	—	614	660	615
Poly-3 test	P=0.503N	P=0.112	P=0.257	P=0.507
Thyroid Gland (C-cell): Adenoma or Carcinoma				
Overall rate	3/46 (7%)	8/46 (17%)	8/49 (16%)	3/50 (6%)
Adjusted rate	8.7%	23.0%	20.5%	8.4%
Terminal rate	1/13 (8%)	2/13 (15%)	2/15 (13%)	0/13 (0%)
First incidence (days)	645	393	562	615
Poly-3 test	P=0.161N	P=0.093	P=0.136	P=0.649N
All Organs: Mononuclear Cell Leukemia				
Overall rate	19/50 (38%)	28/50 (56%)	33/50 (66%)	28/50 (56%)
Adjusted rate	45.6%	65.9%	73.1%	66.4%
Terminal rate	4/13 (31%)	7/13 (54%)	12/15 (80%)	7/13 (54%)
First incidence (days)	506	350	450	520
Poly-3 test	P=0.288	P=0.038	P=0.004	P=0.034

TABLE A3
Statistical Analysis of Primary Neoplasms in Male Rats in the 2-Year Inhalation Study of Gallium Arsenide

	Chamber Control	0.01 mg/m ³	0.1 mg/m ³	1.0 mg/m ³
All Organs: Benign Neoplasms				
Overall rate	50/50 (100%)	47/50 (94%)	49/50 (98%)	46/50 (92%)
Adjusted rate	100.0%	99.6%	99.1%	96.8%
Terminal rate	13/13 (100%)	13/13 (100%)	15/15 (100%)	13/13 (100%)
First incidence (days)	338	393	394	422
Poly-3 test	P=0.116N	P=1.000N	P=0.891N	P=0.276N
All Organs: Malignant Neoplasms				
Overall rate	30/50 (60%)	38/50 (76%)	41/50 (82%)	34/50 (68%)
Adjusted rate	67.2%	81.8%	85.9%	77.8%
Terminal rate	8/13 (62%)	10/13 (77%)	12/15 (80%)	9/13 (69%)
First incidence (days)	506	204	443	520
Poly-3 test	P=0.567	P=0.070	P=0.020	P=0.171
All Organs: Benign or Malignant Neoplasms				
Overall rate	50/50 (100%)	49/50 (98%)	50/50 (100%)	48/50 (96%)
Adjusted rate	100.0%	99.9%	100.0%	99.4%
Terminal rate	13/13 (100%)	13/13 (100%)	15/15 (100%)	13/13 (100%)
First incidence (days)	338	204	394	422
Poly-3 test	P=0.999N	P=1.000N	—	P=1.000N

(T)Terminal sacrifice

^a Number of neoplasm-bearing animals/number of animals examined. Denominator is number of animals examined microscopically for adrenal gland, kidney, lung, pancreatic islets, pituitary gland, preputial gland, testis, and thyroid gland; for other tissues, denominator is number of animals necropsied.

^b Poly-3 estimated neoplasm incidence after adjustment for intercurrent mortality

^c Observed incidence at terminal kill

^d Beneath the chamber control incidence are the P values associated with the trend test. Beneath the exposed group incidence are the P values corresponding to pairwise comparisons between the chamber controls and that exposed group. The Poly-3 test accounts for differential mortality in animals that do not reach terminal sacrifice. A negative trend or a lower incidence in an exposure group is indicated by N.

^e Not applicable; no neoplasms in animal group

^f Value of statistic cannot be computed.

TABLE A4a
Historical Incidence of Alveolar/bronchiolar Neoplasms in Chamber Control Male F344/N Rats^a

Study	Incidence in Controls		
	Adenoma	Carcinoma	Adenoma or Carcinoma
Historical Incidence at Battelle Pacific Northwest Laboratories			
2-Butoxyethanol	1/50	0/50	1/50
Acetonitrile	1/48	1/48	2/48
Chloroprene	2/50	0/50	2/50
Cobalt sulfate heptahydrate	1/50	0/50	1/50
Furfuryl alcohol	0/50	0/50	0/50
Glutaraldehyde	0/50	0/50	0/50
Hexachlorocyclopentadiene	5/50	0/50	5/50
Isobutene	2/50	0/50	2/50
Isobutyraldehyde	1/50	0/50	1/50
Isoprene	0/49	1/49	1/49
Molybdenum trioxide	0/50	0/50	0/50
Nitromethane	1/50	0/50	1/50
Ozone	1/50	1/50	2/50
Tetrafluoroethylene	0/50	0/50	0/50
Tetrahydrofuran	0/50	0/50	0/50
Overall Historical Incidence			
Total (%)	17/1,004 (1.7%)	6/1,004 (0.6%)	23/1,004 (2.3%)
Mean \pm standard deviation	1.7% \pm 2.5%	0.6% \pm 1.0%	2.3% \pm 2.5%
Range	0%-10%	0%-2%	0%-10%

^a Data as of 10 November 1998

TABLE A4b
Historical Incidence of Mononuclear Cell Leukemia in Chamber Control Male F344/N Rats^a

Study	Incidence in Controls
Historical Incidence at Battelle Pacific Northwest Laboratories	
2-Butoxyethanol	29/50
Acetonitrile	29/48
Chloroprene	33/50
Cobalt sulfate heptahydrate	30/50
Furfuryl alcohol	29/50
Glutaraldehyde	21/50
Hexachlorocyclopentadiene	29/50
Isobutene	21/50
Isobutyraldehyde	33/50
Isoprene	24/50
Molybdenum trioxide	35/50
Nitromethane	35/50
Ozone	27/50
Tetrafluoroethylene	34/50
Tetrahydrofuran	30/50
Overall Historical Incidence	
Total (%)	583/1,005 (58.0%)
Mean \pm standard deviation	58.0% \pm 8.0%
Range	42%-70%

^a Data as of 10 November 1998; includes data for lymphocytic, monocytic, and undifferentiated leukemia

TABLE A4c
Historical Incidence of Preputial Gland Neoplasms in Chamber Control Male F344/N Rats^a

Study	Incidence in Controls		
	Adenoma	Carcinoma	Adenoma or Carcinoma
Historical Incidence at Battelle Pacific Northwest Laboratories: Inhalation Studies			
2-Butoxyethanol	3/46	5/46	8/46
Acetonitrile	0/47	5/47	5/47
Chloroprene	3/50	3/50	6/50
Cobalt sulfate heptahydrate	0/50	3/50	3/50
Furfuryl alcohol	2/49	3/49	4/49
Glutaraldehyde	1/50	0/50	1/50
Hexachlorocyclopentadiene	0/50	6/50	6/50
Isobutene	4/50	1/50	5/50
Isobutyraldehyde	0/50	2/50	2/50
Isoprene	2/50	3/50	5/50
Molybdenum trioxide	2/50	3/50	5/50
Nitromethane	4/50	0/50	4/50
Ozone	3/49	1/49	4/49
Tetrafluoroethylene	1/50	3/50	4/50
Tetrahydrofuran	2/49	3/49	5/49
Overall Historical Incidence: Inhalation Studies			
Total (%)	37/994 (3.7%)	44/994 (4.4%)	80/994 (8.1%)
Mean ± standard deviation	3.8% ± 2.7%	4.5% ± 3.8%	8.1% ± 3.7%
Range	0%-8%	0%-12%	2%-17%
Overall Historical Incidence: Gavage (Corn Oil) Studies			
Total (%)	26/390 (6.7%)	11/390 (2.8%)	37/390 (9.5%)
Mean ± standard deviation	6.7% ± 5.8%	2.8% ± 2.7%	9.6% ± 6.9%
Range	0%-17%	0%-6%	4%-23%
Overall Historical Incidence: Feed Studies			
Total (%)	58/898 (6.5%)	25/898 (2.8%)	83/898 (9.2%)
Mean ± standard deviation	6.5% ± 3.1%	2.8% ± 3.8%	9.3% ± 5.5%
Range	2%-15%	0%-14%	2%-22%

^a Data as of 10 November 1998

TABLE A5
Summary of the Incidence of Nonneoplastic Lesions in Male Rats in the 2-Year Inhalation Study of Gallium Arsenide^a

	Chamber Control	0.01 mg/m ³	0.1 mg/m ³	1.0 mg/m ³
Disposition Summary				
Animals initially in study	50	50	50	50
Early deaths				
Moribund	30	29	32	33
Natural deaths	7	8	3	4
Survivors				
Terminal sacrifice	13	13	15	13
Animals examined microscopically	50	50	50	50
Alimentary System				
Intestine large, colon	(47)	(47)	(48)	(50)
Mineralization		1 (2%)		
Intestine large, rectum	(48)	(49)	(47)	(49)
Inflammation, acute	1 (2%)			
Mineralization		1 (2%)		
Anus, hyperplasia				1 (2%)
Intestine large, cecum	(46)	(43)	(48)	(49)
Inflammation, acute	1 (2%)	1 (2%)		
Mineralization		3 (7%)		
Necrosis		1 (2%)		1 (2%)
Intestine small, duodenum	(48)	(48)	(49)	(50)
Inflammation, acute		1 (2%)		1 (2%)
Necrosis			2 (4%)	
Intestine small, ileum	(44)	(43)	(48)	(49)
Inflammation, granulomatous	1 (2%)			
Mineralization	1 (2%)			1 (2%)
Liver	(50)	(50)	(50)	(50)
Angiectasis		2 (4%)		5 (10%)
Basophilic focus	21 (42%)	23 (46%)	21 (42%)	15 (30%)
Clear cell focus	6 (12%)	3 (6%)	6 (12%)	9 (18%)
Degeneration, cystic	10 (20%)	9 (18%)	10 (20%)	10 (20%)
Eosinophilic focus	6 (12%)	4 (8%)	5 (10%)	4 (8%)
Fatty change	5 (10%)	8 (16%)	8 (16%)	7 (14%)
Hepatodiaphragmatic nodule	1 (2%)	2 (4%)	3 (6%)	2 (4%)
Inflammation, granulomatous	1 (2%)			
Mineralization			1 (2%)	
Mixed cell focus	1 (2%)			
Necrosis	2 (4%)		4 (8%)	1 (2%)
Regeneration	1 (2%)	4 (8%)	5 (10%)	
Vacuolization cytoplasmic, focal	1 (2%)			
Bile duct, hyperplasia	28 (56%)	27 (54%)	32 (64%)	30 (60%)
Bile duct, inflammation, acute			2 (4%)	
Centrilobular, necrosis	13 (26%)	14 (28%)	16 (32%)	13 (26%)
Mesentery	(5)	(10)	(14)	(7)
Hemorrhage		1 (10%)	1 (7%)	
Artery, inflammation, chronic active		1 (10%)		
Artery, mineralization	3 (60%)	2 (20%)	2 (14%)	2 (29%)
Fat, inflammation			1 (7%)	
Fat, necrosis	3 (60%)	7 (70%)	11 (79%)	5 (71%)

^a Number of animals examined microscopically at the site and the number of animals with lesion

TABLE A5
Summary of the Incidence of Nonneoplastic Lesions in Male Rats in the 2-Year Inhalation Study of Gallium Arsenide

	Chamber Control	0.01 mg/m ³	0.1 mg/m ³	1.0 mg/m ³
Alimentary System (continued)				
Oral mucosa	(1)	(3)		(1)
Pharyngeal, inflammation, chronic	1 (100%)			
Pancreas	(49)	(49)	(50)	(50)
Atrophy	24 (49%)	29 (59%)	25 (50%)	27 (54%)
Basophilic focus	3 (6%)	3 (6%)	2 (4%)	3 (6%)
Hyperplasia	4 (8%)	3 (6%)	2 (4%)	1 (2%)
Inflammation, acute			1 (2%)	
Metaplasia, hepatocyte			1 (2%)	
Artery, inflammation	2 (4%)			1 (2%)
Artery, mineralization	3 (6%)	2 (4%)	1 (2%)	1 (2%)
Duct, hyperplasia			1 (2%)	
Salivary glands	(50)	(50)	(50)	(50)
Atrophy	1 (2%)		1 (2%)	
Artery, mineralization	1 (2%)			
Stomach, forestomach	(49)	(50)	(50)	(50)
Hyperplasia, squamous			1 (2%)	
Inflammation, acute				1 (2%)
Mineralization	2 (4%)	2 (4%)	2 (4%)	2 (4%)
Necrosis	7 (14%)	10 (20%)	9 (18%)	11 (22%)
Stomach, glandular	(49)	(49)	(50)	(50)
Inflammation, acute	1 (2%)			
Mineralization	8 (16%)	6 (12%)	8 (16%)	8 (16%)
Necrosis	4 (8%)	9 (18%)	13 (26%)	13 (26%)
Tooth	(2)	(1)		(3)
Developmental malformation	2 (100%)	1 (100%)		3 (100%)
Inflammation, chronic active	1 (50%)			1 (33%)
Cardiovascular System				
Blood vessel	(3)	(4)	(6)	(6)
Aorta, mineralization	3 (100%)	4 (100%)	4 (67%)	6 (100%)
Heart	(50)	(50)	(50)	(50)
Cardiomyopathy	44 (88%)	37 (74%)	41 (82%)	40 (80%)
Necrosis				1 (2%)
Artery, inflammation, chronic			1 (2%)	
Artery, mineralization	5 (10%)	6 (12%)	5 (10%)	7 (14%)
Atrium, thrombosis	4 (8%)	1 (2%)	3 (6%)	2 (4%)
Endocrine System				
Adrenal cortex	(49)	(49)	(49)	(50)
Atrophy	1 (2%)			1 (2%)
Degeneration, cystic			1 (2%)	
Hyperplasia	24 (49%)	24 (49%)	23 (47%)	23 (46%)
Hypertrophy	1 (2%)	3 (6%)	3 (6%)	2 (4%)
Mineralization		1 (2%)		
Necrosis	1 (2%)		4 (8%)	3 (6%)
Vacuolization cytoplasmic	2 (4%)	5 (10%)	2 (4%)	1 (2%)
Adrenal medulla	(50)	(49)	(49)	(50)
Hyperplasia	22 (44%)	25 (51%)	22 (45%)	26 (52%)
Bilateral, hyperplasia		1 (2%)	1 (2%)	7 (14%)
Islets, pancreatic	(48)	(49)	(50)	(50)
Hyperplasia	1 (2%)	2 (4%)	2 (4%)	4 (8%)

TABLE A5
Summary of the Incidence of Nonneoplastic Lesions in Male Rats in the 2-Year Inhalation Study of Gallium Arsenide

	Chamber Control	0.01 mg/m ³	0.1 mg/m ³	1.0 mg/m ³
Endocrine System (continued)				
Parathyroid gland	(47)	(48)	(47)	(48)
Hyperplasia	13 (28%)	13 (27%)	17 (36%)	16 (33%)
Pituitary gland	(49)	(49)	(50)	(50)
Angiectasis		1 (2%)		1 (2%)
Pars distalis, hyperplasia	17 (35%)	12 (24%)	15 (30%)	12 (24%)
Thyroid gland	(46)	(46)	(49)	(50)
Hyperplasia	1 (2%)			
C-cell, hyperplasia	26 (57%)	28 (61%)	33 (67%)	29 (58%)
Follicular cell, hyperplasia		1 (2%)	1 (2%)	
General Body System				
None				
Genital System				
Coagulating gland		(1)		
Hyperplasia, atypical		1 (100%)		
Epididymis	(50)	(50)	(50)	(50)
Atrophy			1 (2%)	
Granuloma sperm				3 (6%)
Preputial gland	(50)	(49)	(50)	(49)
Hyperplasia	1 (2%)		3 (6%)	4 (8%)
Inflammation, chronic active	4 (8%)	4 (8%)	8 (16%)	3 (6%)
Prostate	(50)	(48)	(50)	(50)
Hyperplasia	12 (24%)	9 (19%)	11 (22%)	7 (14%)
Inflammation, chronic active	3 (6%)	1 (2%)	6 (12%)	2 (4%)
Mineralization	1 (2%)			
Seminal vesicle	(45)	(47)	(48)	(50)
Inflammation, chronic active			1 (2%)	
Mineralization	2 (4%)	1 (2%)	1 (2%)	
Testes	(50)	(50)	(50)	(50)
Atrophy	1 (2%)	2 (4%)	5 (10%)	5 (10%)
Artery, inflammation, chronic active	3 (6%)	4 (8%)	5 (10%)	4 (8%)
Interstitial cell, hyperplasia	2 (4%)	3 (6%)	2 (4%)	6 (12%)
Hematopoietic System				
Bone marrow	(49)	(48)	(50)	(50)
Thrombosis			1 (2%)	
Lymph node	(12)	(8)	(9)	(5)
Hemorrhage	1 (8%)			
Renal, ectasia	1 (8%)			
Renal, hemorrhage	1 (8%)			
Renal, infiltration cellular, plasma cell		1 (13%)		
Lymph node, mandibular	(46)	(43)	(46)	(44)
Infiltration cellular, plasma cell	2 (4%)	1 (2%)	1 (2%)	3 (7%)
Infiltration cellular, polymorphonuclear	1 (2%)			
Inflammation, chronic active			1 (2%)	
Lymph node, mesenteric	(48)	(48)	(50)	(48)
Hemorrhage	1 (2%)			

TABLE A5
Summary of the Incidence of Nonneoplastic Lesions in Male Rats in the 2-Year Inhalation Study of Gallium Arsenide

	Chamber Control	0.01 mg/m ³	0.1 mg/m ³	1.0 mg/m ³
Hematopoietic System (continued)				
Lymph node, mediastinal	(42)	(40)	(46)	(47)
Hemorrhage	1 (2%)			
Infiltration cellular, plasma cell				1 (2%)
Infiltration cellular, polymorphonuclear			1 (2%)	
Pigmentation				1 (2%)
Spleen	(50)	(50)	(50)	(50)
Congestion	1 (2%)			
Fibrosis	13 (26%)	12 (24%)	17 (34%)	12 (24%)
Hematopoietic cell proliferation	4 (8%)	2 (4%)	6 (12%)	1 (2%)
Hyperplasia		1 (2%)	1 (2%)	
Inflammation, acute			1 (2%)	
Inflammation, granulomatous	2 (4%)			
Necrosis		1 (2%)	5 (10%)	
Thrombosis	1 (2%)			
Thymus	(46)	(45)	(45)	(42)
Cyst	1 (2%)			1 (2%)
Integumentary System				
Mammary gland	(41)	(42)	(42)	(40)
Galactocele	1 (2%)	2 (5%)	1 (2%)	3 (8%)
Skin	(50)	(49)	(50)	(50)
Hyperkeratosis	1 (2%)		2 (4%)	
Inflammation, chronic active			3 (6%)	2 (4%)
Musculoskeletal System				
Bone	(50)	(50)	(50)	(50)
Callus		1 (2%)		
Fibrous osteodystrophy	8 (16%)	9 (18%)	10 (20%)	11 (22%)
Hyperostosis				1 (2%)
Inflammation, chronic active				1 (2%)
Nervous System				
Brain	(50)	(50)	(50)	(50)
Degeneration	1 (2%)			
Gliosis		1 (2%)		
Hemorrhage				1 (2%)
Mineralization				1 (2%)
Respiratory System				
Larynx	(50)	(50)	(49)	(50)
Hyperplasia	3 (6%)	8 (16%)	4 (8%)	11 (22%)
Inflammation, chronic active	4 (8%)	3 (6%)	4 (8%)	12 (24%)
Metaplasia, squamous	1 (2%)	2 (4%)	2 (4%)	10 (20%)
Mineralization	1 (2%)		3 (6%)	1 (2%)
Epiglottis, hyperplasia		6 (12%)	4 (8%)	5 (10%)
Epiglottis, inflammation, chronic active		1 (2%)	2 (4%)	4 (8%)
Epiglottis, metaplasia, squamous				3 (6%)
Epiglottis, mineralization				1 (2%)

TABLE A5
Summary of the Incidence of Nonneoplastic Lesions in Male Rats in the 2-Year Inhalation Study of Gallium Arsenide

	Chamber Control	0.01 mg/m ³	0.1 mg/m ³	1.0 mg/m ³
Respiratory System (continued)				
Lung	(50)	(49)	(50)	(50)
Cyst, squamous				1 (2%)
Hemorrhage	1 (2%)	1 (2%)		
Hyperplasia, atypical		2 (4%)	5 (10%)	18 (36%)
Inflammation, chronic active	3 (6%)	43 (88%)	50 (100%)	50 (100%)
Metaplasia, squamous			1 (2%)	2 (4%)
Mineralization	4 (8%)	5 (10%)	3 (6%)	7 (14%)
Proteinosis		22 (45%)	50 (100%)	49 (98%)
Thrombosis	1 (2%)			2 (4%)
Alveolar epithelium, hyperplasia	12 (24%)	16 (33%)	21 (42%)	21 (42%)
Alveolar epithelium, metaplasia		2 (4%)	34 (68%)	41 (82%)
Artery, mediastinum, mineralization	4 (8%)	3 (6%)	2 (4%)	5 (10%)
Nose	(50)	(48)	(49)	(50)
Inflammation, suppurative	10 (20%)	5 (10%)	10 (20%)	8 (16%)
Polyp inflammatory			1 (2%)	
Thrombosis	4 (8%)	8 (17%)	8 (16%)	7 (14%)
Olfactory epithelium, atrophy	1 (2%)	2 (4%)	1 (2%)	2 (4%)
Olfactory epithelium, degeneration, hyaline	18 (36%)	26 (54%)	32 (65%)	25 (50%)
Olfactory epithelium, metaplasia, respiratory	2 (4%)	2 (4%)	1 (2%)	2 (4%)
Respiratory epithelium, degeneration, hyaline				1 (2%)
Respiratory epithelium, metaplasia, squamous				1 (2%)
Turbinates, necrosis				1 (2%)
Trachea	(49)	(50)	(49)	(50)
Mineralization	2 (4%)		2 (4%)	3 (6%)
Special Senses System				
Eye	(4)	(2)	(1)	(1)
Cataract	4 (100%)	1 (50%)		1 (100%)
Degeneration			1 (100%)	
Retina, atrophy	4 (100%)	1 (50%)		1 (100%)
Urinary System				
Kidney	(49)	(50)	(50)	(50)
Cyst	3 (6%)	3 (6%)	1 (2%)	1 (2%)
Infarct		2 (4%)	1 (2%)	2 (4%)
Mineralization	5 (10%)	4 (8%)	5 (10%)	4 (8%)
Nephropathy	48 (98%)	49 (98%)	50 (100%)	50 (100%)
Renal tubule, hyperplasia	2 (4%)	1 (2%)	4 (8%)	2 (4%)
Urinary bladder	(48)	(50)	(50)	(50)
Hemorrhage		2 (4%)		
Inflammation, chronic active	1 (2%)			
Transitional epithelium, hyperplasia	1 (2%)			

APPENDIX B
SUMMARY OF LESIONS IN FEMALE RATS
IN THE 2-YEAR INHALATION STUDY
OF GALLIUM ARSENIDE

TABLE B1	Summary of the Incidence of Neoplasms in Female Rats in the 2-Year Inhalation Study of Gallium Arsenide	142
TABLE B2	Individual Animal Tumor Pathology of Female Rats in the 2-Year Inhalation Study of Gallium Arsenide	146
TABLE B3	Statistical Analysis of Primary Neoplasms in Female Rats in the 2-Year Inhalation Study of Gallium Arsenide	164
TABLE B4a	Historical Incidence of Alveolar/bronchiolar Neoplasms in Chamber Control Female F344/N Rats	168
TABLE B4b	Historical Incidence of Adrenal Medulla Pheochromocytoma in Chamber Control Female F344/N Rats	169
TABLE B4c	Historical Incidence of Mononuclear Cell Leukemia in Chamber Control Female F344/N Rats	170
TABLE B5	Summary of the Incidence of Nonneoplastic Lesions in Female Rats in the 2-Year Inhalation Study of Gallium Arsenide	171

TABLE B1
Summary of the Incidence of Neoplasms in Female Rats in the 2-Year Inhalation Study of Gallium Arsenide^a

	Chamber Control	0.01 mg/m ³	0.1 mg/m ³	1.0 mg/m ³
Disposition Summary				
Animals initially in study	50	50	50	50
Early deaths				
Moribund	30	30	23	35
Natural deaths	1	3	6	4
Survivors				
Died last week of study			1	
Terminal sacrifice	19	17	20	11
Animals examined microscopically	50	50	50	50
Alimentary System				
Intestine large, colon	(50)	(49)	(48)	(49)
Intestine large, rectum	(50)	(49)	(49)	(49)
Carcinoma				1 (2%)
Intestine large, cecum	(50)	(49)	(48)	(49)
Intestine small, duodenum	(50)	(48)	(48)	(49)
Leiomyoma	1 (2%)			
Intestine small, jejunum	(50)	(48)	(46)	(49)
Leiomyosarcoma			1 (2%)	
Intestine small, ileum	(50)	(49)	(46)	(49)
Liver	(50)	(50)	(50)	(50)
Histiocytic sarcoma		1 (2%)	1 (2%)	
Mesentery	(6)	(14)	(6)	(11)
Oral mucosa	(1)	(2)		
Gingival, squamous cell carcinoma		1 (50%)		
Pharyngeal, squamous cell carcinoma		1 (50%)		
Pharyngeal, squamous cell papilloma	1 (100%)			
Pancreas	(50)	(50)	(50)	(49)
Salivary glands	(50)	(49)	(50)	(50)
Stomach, forestomach	(50)	(50)	(50)	(50)
Stomach, glandular	(50)	(50)	(50)	(49)
Tongue		(1)	(2)	
Squamous cell papilloma			1 (50%)	
Cardiovascular System				
Heart	(50)	(50)	(50)	(50)

TABLE B1
Summary of the Incidence of Neoplasms in Female Rats in the 2-Year Inhalation Study of Gallium Arsenide

	Chamber Control	0.01 mg/m ³	0.1 mg/m ³	1.0 mg/m ³
Endocrine System				
Adrenal cortex	(50)	(50)	(50)	(49)
Adrenal medulla	(50)	(49)	(50)	(49)
Pheochromocytoma malignant		1 (2%)		
Pheochromocytoma benign	4 (8%)	5 (10%)	4 (8%)	8 (16%)
Bilateral, pheochromocytoma benign			2 (4%)	5 (10%)
Islets, pancreatic	(50)	(50)	(50)	(49)
Adenoma	1 (2%)			2 (4%)
Carcinoma				1 (2%)
Pituitary gland	(50)	(50)	(50)	(49)
Histiocytic sarcoma			1 (2%)	
Pars distalis, adenoma	42 (84%)	43 (86%)	36 (72%)	31 (63%)
Thyroid gland	(50)	(49)	(48)	(49)
C-cell, adenoma	7 (14%)	4 (8%)	4 (8%)	1 (2%)
C-cell, carcinoma	2 (4%)	1 (2%)	2 (4%)	3 (6%)
Follicular cell, adenoma	2 (4%)			1 (2%)
Follicular cell, carcinoma		1 (2%)	1 (2%)	1 (2%)
General Body System				
None				
Genital System				
Clitoral gland	(50)	(48)	(47)	(48)
Adenoma	7 (14%)	9 (19%)	7 (15%)	4 (8%)
Carcinoma	3 (6%)	2 (4%)	2 (4%)	2 (4%)
Bilateral, adenoma	1 (2%)			
Ovary	(50)	(50)	(50)	(49)
Granulosa cell tumor malignant			1 (2%)	
Histiocytic sarcoma			1 (2%)	
Uterus	(50)	(50)	(49)	(50)
Leiomyoma				1 (2%)
Leiomyosarcoma				1 (2%)
Polyp stromal	7 (14%)	6 (12%)	6 (12%)	2 (4%)
Hematopoietic System				
Bone marrow	(50)	(49)	(50)	(49)
Lymph node	(3)	(6)	(3)	(5)
Pancreatic, histiocytic sarcoma			1 (33%)	
Lymph node, bronchial	(36)	(36)	(39)	(40)
Histiocytic sarcoma		1 (3%)	1 (3%)	
Lymph node, mandibular	(43)	(45)	(45)	(47)
Histiocytic sarcoma			1 (2%)	
Lymph node, mesenteric	(50)	(50)	(50)	(49)
Histiocytic sarcoma			1 (2%)	
Lymph node, mediastinal	(34)	(39)	(39)	(39)
Histiocytic sarcoma		1 (3%)	1 (3%)	
Spleen	(50)	(50)	(50)	(49)
Histiocytic sarcoma		1 (2%)	1 (2%)	
Thymus	(45)	(48)	(41)	(45)
Histiocytic sarcoma			1 (2%)	
Thymoma benign	1 (2%)			

TABLE B1
Summary of the Incidence of Neoplasms in Female Rats in the 2-Year Inhalation Study of Gallium Arsenide

	Chamber Control	0.01 mg/m ³	0.1 mg/m ³	1.0 mg/m ³
Integumentary System				
Mammary gland	(50)	(50)	(50)	(50)
Adenoma				1 (2%)
Carcinoma	8 (16%)	2 (4%)	7 (14%)	4 (8%)
Carcinoma, multiple		1 (2%)		1 (2%)
Fibroadenoma	21 (42%)	24 (48%)	18 (36%)	23 (46%)
Fibroadenoma, multiple	5 (10%)	7 (14%)	11 (22%)	8 (16%)
Skin	(50)	(50)	(50)	(50)
Basal cell adenoma				1 (2%)
Basal cell carcinoma			1 (2%)	
Squamous cell papilloma			1 (2%)	
Subcutaneous tissue, fibroma	1 (2%)		2 (4%)	1 (2%)
Subcutaneous tissue, lipoma				1 (2%)
Subcutaneous tissue, rhabdomyosarcoma			1 (2%)	
Subcutaneous tissue, sarcoma			1 (2%)	
Musculoskeletal System				
Bone	(50)	(50)	(50)	(50)
Meningioma malignant, metastatic, brain			1 (2%)	
Nervous System				
Brain	(50)	(50)	(50)	(50)
Histiocytic sarcoma			1 (2%)	
Meningioma malignant			1 (2%)	
Respiratory System				
Larynx	(50)	(50)	(50)	(49)
Carcinoma, metastatic, thyroid gland				1 (2%)
Lung	(50)	(50)	(50)	(50)
Alveolar/bronchiolar adenoma			2 (4%)	7 (14%)
Alveolar/bronchiolar carcinoma			2 (4%)	3 (6%)
Carcinoma, metastatic, mammary gland		1 (2%)		
Carcinoma, metastatic, thyroid gland				1 (2%)
Histiocytic sarcoma		1 (2%)	1 (2%)	
Squamous cell carcinoma				1 (2%)
Nose	(50)	(50)	(49)	(49)
Histiocytic sarcoma			1 (2%)	
Special Senses System				
Zymbal's gland		(1)		
Carcinoma		1 (100%)		
Urinary System				
Kidney	(50)	(50)	(50)	(49)
Histiocytic sarcoma			1 (2%)	
Renal tubule, adenoma			1 (2%)	
Urinary bladder	(50)	(50)	(50)	(49)
Leiomyoma			1 (2%)	

TABLE B1
Summary of the Incidence of Neoplasms in Female Rats in the 2-Year Inhalation Study of Gallium Arsenide

	Chamber Control	0.01 mg/m ³	0.1 mg/m ³	1.0 mg/m ³
Systemic Lesions				
Multiple organs ^b	(50)	(50)	(50)	(50)
Histiocytic sarcoma		2 (4%)	1 (2%)	
Leukemia mononuclear	22 (44%)	21 (42%)	18 (36%)	33 (66%)
Neoplasm Summary				
Total animals with primary neoplasms ^c	48	49	49	47
Total primary neoplasms	136	132	135	148
Total animals with benign neoplasms	48	46	43	43
Total benign neoplasms	101	98	96	97
Total animals with malignant neoplasms	28	28	32	38
Total malignant neoplasms	35	34	39	51
Total animals with metastatic neoplasms		1	1	1
Total metastatic neoplasms		1	1	2

^a Number of animals examined microscopically at the site and the number of animals with neoplasm

^b Number of animals with any tissue examined microscopically

^c Primary neoplasms: all neoplasms except metastatic neoplasms

TABLE B2
Individual Animal Tumor Pathology of Female Rats in the 2-Year Inhalation Study of Gallium Arsenide:
Chamber Control

Number of Days on Study	3 3 4 5 5 5 5 5 5 6 6 6 6 6 6 6 6 6 6 6 6 6 6 6
	0 1 9 0 8 8 8 8 9 0 0 2 2 4 4 6 6 6 7 7 7 8 8 8 9
	2 0 7 6 1 2 8 9 0 4 7 1 1 2 9 0 0 0 7 8 9 4 5 8 9
Carcass ID Number	1 1
	1 0 5 4 4 1 1 2 1 4 0 2 2 0 4 2 2 3 2 4 4 2 3 1 4
	1 6 0 0 2 4 2 2 6 4 4 0 5 5 5 8 9 9 6 7 6 4 4 7 1
Alimentary System	
Esophagus	+ +
Intestine large, colon	+ +
Intestine large, rectum	+ +
Intestine large, cecum	+ +
Intestine small, duodenum	+ +
Leiomyoma	
Intestine small, jejunum	+ +
Intestine small, ileum	+ +
Liver	+ +
Mesentery	+ +
Oral mucosa	+ +
Pharyngeal, squamous cell papilloma	+ +
Pancreas	+ +
Salivary glands	+ +
Stomach, forestomach	+ +
Stomach, glandular	+ +
Tooth	
Cardiovascular System	
Heart	+ +
Endocrine System	
Adrenal cortex	+ +
Adrenal medulla	+ +
Pheochromocytoma benign	+ +
Islets, pancreatic	+ +
Adenoma	+ +
Parathyroid gland	+ +
Pituitary gland	+ +
Pars distalis, adenoma	+ +
Thyroid gland	+ +
C-cell, adenoma	+ +
C-cell, carcinoma	+ +
Follicular cell, adenoma	+ +
General Body System	
None	
Genital System	
Clitoral gland	+ +
Adenoma	+ +
Carcinoma	+ +
Bilateral, adenoma	+ +
Ovary	+ +
Uterus	+ +
Polyp stromal	+ +

+ : Tissue examined microscopically
 A : Autolysis precludes examination

M : Missing tissue
 I : Insufficient tissue

X : Lesion present
 Blank : Not examined

TABLE B2
Individual Animal Tumor Pathology of Female Rats in the 2-Year Inhalation Study of Gallium Arsenide: Chamber Control

Number of Days on Study	7	7	7	7	7	7	7	7	7	7	7	7	7	7	7	7	7	7	7	7	7	7	7	7	7	Total	
Carcass ID Number	1	1	1	1	1	1	1	1	1	1	1	1	1	1	1	1	1	1	1	1	1	1	1	1	1	Tissues/ Tumors	
Hematopoietic System																											
Bone marrow	+	+	+	+	+	+	+	+	+	+	+	+	+	+	+	+	+	+	+	+	+	+	+	+	+	50	
Lymph node																								+	+	3	
Lymph node, bronchial	+	+	+	M	+	+	M	+	M	+	+	+	+	+	+	+	+	+	+	+	+	+	+	+	+	36	
Lymph node, mandibular	M	+	+	+	+	+	+	+	+	M	+	+	+	+	+	+	+	+	+	+	+	+	M	+	+	43	
Lymph node, mesenteric	+	+	+	+	+	+	+	+	+	+	+	+	+	+	+	+	+	+	+	+	+	+	+	+	+	50	
Lymph node, mediastinal	M	M	+	+	M	+	+	+	+	+	+	+	+	+	M	+	M	M	M	+	+	+	+	M	+	34	
Spleen	+	+	+	+	+	+	+	+	+	+	+	+	+	+	+	+	+	+	+	+	+	+	+	+	+	50	
Thymus	+	+	+	+	+	+	+	+	+	+	+	+	+	+	+	+	+	+	+	+	+	+	+	+	+	45	
Thymoma benign				M	M	+	+	+	M	+	+	+	+		X											1	
Integumentary System																											
Mammary gland	+	+	+	+	+	+	+	+	+	+	+	+	+	+	+	+	+	+	+	+	+	+	+	+	+	50	
Carcinoma			X												X			X					X	X		8	
Fibroadenoma			X			X	X	X			X		X				X			X		X	X	X		21	
Fibroadenoma, multiple									X				X		X											5	
Skin	+	+	+	+	+	+	+	+	+	+	+	+	+	+	+	+	+	+	+	+	+	+	+	+	+	50	
Subcutaneous tissue, fibroma																										1	
Musculoskeletal System																											
Bone	+	+	+	+	+	+	+	+	+	+	+	+	+	+	+	+	+	+	+	+	+	+	+	+	+	50	
Nervous System																											
Brain	+	+	+	+	+	+	+	+	+	+	+	+	+	+	+	+	+	+	+	+	+	+	+	+	+	50	
Respiratory System																											
Larynx	+	+	+	+	+	+	+	+	+	+	+	+	+	+	+	+	+	+	+	+	+	+	+	+	+	50	
Lung	+	+	+	+	+	+	+	+	+	+	+	+	+	+	+	+	+	+	+	+	+	+	+	+	+	50	
Nose	+	+	+	+	+	+	+	+	+	+	+	+	+	+	+	+	+	+	+	+	+	+	+	+	+	50	
Trachea	+	+	+	+	+	+	+	+	+	+	+	+	+	+	+	+	+	+	+	+	+	+	+	+	+	50	
Special Senses System																											
Eye																									+	1	
Urinary System																											
Kidney	+	+	+	+	+	+	+	+	+	+	+	+	+	+	+	+	+	+	+	+	+	+	+	+	+	50	
Urinary bladder	+	+	+	+	+	+	+	+	+	+	+	+	+	+	+	+	+	+	+	+	+	+	+	+	+	50	
Systemic Lesions																											
Multiple organs	+	+	+	+	+	+	+	+	+	+	+	+	+	+	+	+	+	+	+	+	+	+	+	+	+	50	
Leukemia mononuclear	X		X	X			X	X		X			X	X		X	X		X	X	X		X	X		22	

TABLE B2
Individual Animal Tumor Pathology of Female Rats in the 2-Year Inhalation Study of Gallium Arsenide: 0.01 mg/m³

Number of Days on Study	3	4	4	4	5	5	5	5	5	5	5	5	6	6	6	6	6	6	6	6	6	6	7			
	1	2	7	9	0	2	4	5	6	8	9	9	0	1	2	2	3	4	6	8	8	8	9	0		
	0	2	8	7	9	3	8	9	3	5	0	0	6	3	1	8	1	9	0	5	7	8	8	5	0	
Carcass ID Number	3	3	3	3	3	3	3	3	3	3	3	3	3	3	3	3	3	3	3	3	3	3	3	3	3	
	3	1	4	1	3	4	3	3	0	0	1	2	3	0	2	2	2	0	2	4	4	1	4	0	3	
	5	9	9	6	2	0	4	1	2	3	4	1	6	4	3	0	2	9	4	2	4	0	6	8	7	
Alimentary System																										
Esophagus	+	+	+	+	+	+	+	+	+	+	+	+	+	+	+	+	+	+	+	+	+	+	+	+	+	+
Intestine large, colon	+	+	+	+	+	+	+	+	A	+	+	+	+	+	+	+	+	+	+	+	+	+	+	+	+	+
Intestine large, rectum	+	+	+	+	+	+	+	+	A	+	+	+	+	+	+	+	+	+	+	+	+	+	+	+	+	+
Intestine large, cecum	+	+	+	+	+	+	+	+	A	+	+	+	+	+	+	+	+	+	+	+	+	+	+	+	+	+
Intestine small, duodenum	+	+	+	+	+	+	+	+	A	+	+	+	+	+	+	+	+	+	+	+	+	+	+	+	+	+
Intestine small, jejunum	+	+	+	+	+	+	+	+	A	+	+	+	+	A	+	+	+	+	+	+	+	+	+	+	+	+
Intestine small, ileum	+	+	+	+	+	+	+	+	A	+	+	+	+	+	+	+	+	+	+	+	+	+	+	+	+	+
Liver	+	+	+	+	+	+	+	+	+	+	+	+	+	+	+	+	+	+	+	+	+	+	+	+	+	+
Histiocytic sarcoma									X																	
Mesentery				+	+		+	+					+													
Oral mucosa																										+
Gingival, squamous cell carcinoma																										
Pharyngeal, squamous cell carcinoma																										X
Pancreas	+	+	+	+	+	+	+	+	+	+	+	+	+	+	+	+	+	+	+	+	+	+	+	+	+	+
Salivary glands	+	+	+	+	+	+	+	+	+	+	+	+	+	+	+	+	+	+	+	+	+	+	+	+	+	+
Stomach, forestomach	+	+	+	+	+	+	+	+	+	+	+	+	+	+	+	+	+	+	+	+	+	+	+	+	+	+
Stomach, glandular	+	+	+	+	+	+	+	+	+	+	+	+	+	+	+	+	+	+	+	+	+	+	+	+	+	+
Tongue										+																
Cardiovascular System																										
Heart	+	+	+	+	+	+	+	+	+	+	+	+	+	+	+	+	+	+	+	+	+	+	+	+	+	+
Endocrine System																										
Adrenal cortex	+	+	+	+	+	+	+	+	+	+	+	+	+	+	+	+	+	+	+	+	+	+	+	+	+	+
Adrenal medulla	+	+	+	+	+	+	+	+	+	+	+	+	+	+	+	+	+	+	+	+	+	+	+	+	+	+
Pheochromocytoma malignant																										
Pheochromocytoma benign																										X
Islets, pancreatic	+	+	+	+	+	+	+	+	+	+	+	+	+	+	+	+	+	+	+	+	+	+	+	+	+	+
Parathyroid gland	+	+	+	+	+	+	+	+	+	M	+	+	+	+	+	M	+	+	+	+	+	+	+	+	+	+
Pituitary gland	+	+	+	+	+	+	+	+	+	+	+	+	+	+	+	+	+	+	+	+	+	+	+	+	+	+
Pars distalis, adenoma				X			X	X	X	X	X	X	X	X	X	X	X	X	X	X	X	X	X	X	X	X
Thyroid gland	+	+	+	+	+	+	+	+	A	+	+	+	+	+	+	+	+	+	+	+	+	+	+	+	+	+
C-cell, adenoma																										X
C-cell, carcinoma																										
Follicular cell, carcinoma																										
General Body System																										
None																										
Genital System																										
Clitoral gland	+	M	+	+	+	+	+	+	+	+	+	+	+	+	+	+	+	+	+	+	+	+	+	+	+	+
Adenoma												X							X				X	X		
Carcinoma									X																	
Ovary	+	+	+	+	+	+	+	+	+	+	+	+	+	+	+	+	+	+	+	+	+	+	+	+	+	+
Uterus	+	+	+	+	+	+	+	+	+	+	+	+	+	+	+	+	+	+	+	+	+	+	+	+	+	+
Polyp stromal												X							X			X	X	X	X	

TABLE B2
Individual Animal Tumor Pathology of Female Rats in the 2-Year Inhalation Study of Gallium Arsenide: 0.01 mg/m³

Number of Days on Study	3 4 4 4 5 5 5 5 5 5 5 5 6 6 6 6 6 6 6 6 6 6 7
	1 2 7 9 0 2 4 5 6 8 9 9 0 1 2 2 3 4 6 8 8 8 9 0
	0 2 8 7 9 3 8 9 3 5 0 0 6 3 1 8 1 9 0 5 7 8 8 5 0
Carcass ID Number	3 3
	3 1 4 1 3 4 3 3 0 0 1 2 3 0 2 2 2 0 2 4 4 1 4 0 3
	5 9 9 6 2 0 4 1 2 3 4 1 6 4 3 0 2 9 4 2 4 0 6 8 7
Hematopoietic System	
Bone marrow	+ + + + + + + + A + + + + + + + + + + + + + + + +
Lymph node	+ +
Lymph node, bronchial	+ + + M + + M + + + + + M + + + M M + + M + M + +
Histiocytic sarcoma	X
Lymph node, mandibular	+ + + + + + + + + M + + + + + + + + + + M + + + M
Lymph node, mesenteric	+ +
Lymph node, mediastinal	I + + + + + + + + + M + M + + + + M + + + + + + + +
Histiocytic sarcoma	X
Spleen	+ +
Histiocytic sarcoma	X
Thymus	+ + + + + + + + + + + + + + M M + + + + + + + + +
Integumentary System	
Mammary gland	+ +
Carcinoma	X
Carcinoma, multiple	X
Fibroadenoma	X X X X X X X X X X X
Fibroadenoma, multiple	
Skin	+ +
Musculoskeletal System	
Bone	+ +
Nervous System	
Brain	+ +
Respiratory System	
Larynx	+ +
Lung	+ +
Carcinoma, metastatic, mammary gland	X
Histiocytic sarcoma	X
Nose	+ +
Trachea	+ +
Special Senses System	
Eye	+ +
Zymbal's gland	+
Carcinoma	X
Urinary System	
Kidney	+ +
Urinary bladder	+ +
Systemic Lesions	
Multiple organs	+ +
Histiocytic sarcoma	X X
Leukemia mononuclear	X X X X X X X X X X X

TABLE B2
Individual Animal Tumor Pathology of Female Rats in the 2-Year Inhalation Study of Gallium Arsenide: 0.01 mg/m³

Number of Days on Study	7 7	0 0 1 1 2 2 2 3 3 3 3 3 3 3 3 3 3 3 3 3 3 3 3 3	2 2 3 4 3 6 6 0 4 4 4 4 4 4 4 4 5 5 5 5 5 5 5 5																							
Carcass ID Number	3 3	1 1 2 4 2 2 3 1 0 0 0 1 2 3 3 4 0 1 1 2 3 4 4 4 5	5 7 5 3 7 6 0 8 1 6 7 2 9 3 8 1 5 1 3 8 9 5 7 8 0																							
			Total Tissues/ Tumors																							
Hematopoietic System																										
Bone marrow	+	+	+	+	+	+	+	+	+	+	+	+	+	+	+	+	+	+	+	+	+	+	+	+	49	
Lymph node		+	+				+				+										+					6
Lymph node, bronchial	+	+	M	M	+	+	+	+	+	+	+	+	+	+	+	+	+	+	+	+	+	+	+	+	36	
Histiocytic sarcoma														M	M	+	M	+	M	+	M	+	+	+	1	
Lymph node, mandibular	M	+	+	+	+	+	+	+	+	+	+	+	+	+	+	+	+	+	+	+	+	+	+	+	45	
Lymph node, mesenteric	+	+	+	+	+	+	+	+	+	+	+	+	+	+	+	+	+	+	+	+	+	+	+	+	50	
Lymph node, mediastinal	+	+	+	M	+	M	+	+	M	M	+	+	M	+	+	+	+	+	+	+	+	M	+	M	+	39
Histiocytic sarcoma																									1	
Spleen	+	+	+	+	+	+	+	+	+	+	+	+	+	+	+	+	+	+	+	+	+	+	+	+	50	
Histiocytic sarcoma																									1	
Thymus	+	+	+	+	+	+	+	+	+	+	+	+	+	+	+	+	+	+	+	+	+	+	+	+	48	
Integumentary System																										
Mammary gland	+	+	+	+	+	+	+	+	+	+	+	+	+	+	+	+	+	+	+	+	+	+	+	+	50	
Carcinoma															X										2	
Carcinoma, multiple																									1	
Fibroadenoma	X	X	X	X			X		X		X		X		X							X	X	X	24	
Fibroadenoma, multiple					X			X		X		X		X								X	X		7	
Skin	+	+	+	+	+	+	+	+	+	+	+	+	+	+	+	+	+	+	+	+	+	+	+	+	50	
Musculoskeletal System																										
Bone	+	+	+	+	+	+	+	+	+	+	+	+	+	+	+	+	+	+	+	+	+	+	+	+	50	
Nervous System																										
Brain	+	+	+	+	+	+	+	+	+	+	+	+	+	+	+	+	+	+	+	+	+	+	+	+	50	
Respiratory System																										
Larynx	+	+	+	+	+	+	+	+	+	+	+	+	+	+	+	+	+	+	+	+	+	+	+	+	50	
Lung	+	+	+	+	+	+	+	+	+	+	+	+	+	+	+	+	+	+	+	+	+	+	+	+	50	
Carcinoma, metastatic, mammary gland																									1	
Histiocytic sarcoma																									1	
Nose	+	+	+	+	+	+	+	+	+	+	+	+	+	+	+	+	+	+	+	+	+	+	+	+	50	
Trachea	+	+	+	+	+	+	+	+	+	+	+	+	+	+	+	+	+	+	+	+	+	+	+	+	50	
Special Senses System																										
Eye				+																			+		5	
Zymbal's gland																									1	
Carcinoma																									1	
Urinary System																										
Kidney	+	+	+	+	+	+	+	+	+	+	+	+	+	+	+	+	+	+	+	+	+	+	+	+	50	
Urinary bladder	+	+	+	+	+	+	+	+	+	+	+	+	+	+	+	+	+	+	+	+	+	+	+	+	50	
Systemic Lesions																										
Multiple organs	+	+	+	+	+	+	+	+	+	+	+	+	+	+	+	+	+	+	+	+	+	+	+	+	50	
Histiocytic sarcoma																									2	
Leukemia mononuclear			X	X	X		X	X		X							X	X		X					21	

TABLE B2
Individual Animal Tumor Pathology of Female Rats in the 2-Year Inhalation Study of Gallium Arsenide: 0.1 mg/m³

Number of Days on Study	1 3 3 3 4 4 5 5 5 6 6 6 6 6 6 6 6 6 6 6 6 6 6 6 6 6 6 6
	9 1 3 5 4 6 3 3 4 0 0 0 0 3 3 3 4 4 4 6 6 7 7 7 7
	8 0 9 4 8 2 4 4 7 3 4 5 9 0 1 9 6 6 7 0 8 4 4 4 8
Carcass ID Number	5 5
	1 4 0 1 1 0 0 2 2 4 3 0 0 5 2 4 0 0 2 3 1 2 4 4 1
	2 7 9 5 6 3 4 9 3 4 3 7 5 0 8 8 1 6 1 5 1 4 1 9 4
Alimentary System	
Esophagus	+ +
Intestine large, colon	+ +
Intestine large, rectum	+ +
Intestine large, cecum	+ + + A +
Intestine small, duodenum	+ + + A +
Intestine small, jejunum	+ + A A + + + + + + + + + A + + + + + + + + + + + + + +
Leiomyosarcoma	
Intestine small, ileum	+ + + A + + + + + + + + A A + + + + + + + + + + + + + +
Liver	+ +
Histiocytic sarcoma	
Mesentery	+ +
Pancreas	+ +
Salivary glands	+ +
Stomach, forestomach	+ +
Stomach, glandular	+ +
Tongue	+ +
Squamous cell papilloma	
Tooth	
Cardiovascular System	
Heart	+ +
Endocrine System	
Adrenal cortex	+ +
Adrenal medulla	+ +
Pheochromocytoma benign	
Bilateral, pheochromocytoma benign	
Islets, pancreatic	+ +
Parathyroid gland	+ M + + + + + +
Pituitary gland	+ +
Histiocytic sarcoma	
Pars distalis, adenoma	
Thyroid gland	+ + + A +
C-cell, adenoma	
C-cell, carcinoma	
Follicular cell, carcinoma	
General Body System	
None	
Genital System	
Clitoral gland	+ + + + + + + + + + + + M + + + + + + + + + + + + + +
Adenoma	
Carcinoma	
Ovary	+ +
Granulosa cell tumor malignant	
Histiocytic sarcoma	
Uterus	+ + + A +
Polyp stromal	

TABLE B2
Individual Animal Tumor Pathology of Female Rats in the 2-Year Inhalation Study of Gallium Arsenide: 0.1 mg/m³

Number of Days on Study	6 6 7	7 8 0 2 3	9 4 1 3 4 4 4 4 4 4 4 4 4 4 4 5 5 5 5 5 5 5 5 5	
Carcass ID Number	5 5	3 2 3 3 0 1 1 2 2 3 3 3 4 4 0 1 1 1 2 2 3 3 4 4 4	4 2 6 9 2 3 9 0 6 0 1 8 0 6 8 0 7 8 5 7 2 7 2 3 5	
				Total Tissues/Tumors
Alimentary System				
Esophagus	+	+	+	50
Intestine large, colon	+	+	A	48
Intestine large, rectum	+	+	+	49
Intestine large, cecum	+	+	A	48
Intestine small, duodenum	+	+	A	48
Intestine small, jejunum	+	+	A	46
Leiomyosarcoma				1
Intestine small, ileum	+	+	A	46
Liver	+	+	+	50
Histiocytic sarcoma				1
Mesentery				6
Pancreas	+	+	+	50
Salivary glands	+	+	+	50
Stomach, forestomach	+	+	+	50
Stomach, glandular	+	+	+	50
Tongue				2
Squamous cell papilloma			X	1
Tooth				1
Cardiovascular System				
Heart	+	+	+	50
Endocrine System				
Adrenal cortex	+	+	+	50
Adrenal medulla	+	+	+	50
Pheochromocytoma benign				4
Bilateral, pheochromocytoma benign				2
Islets, pancreatic	+	+	+	50
Parathyroid gland	+	+	+	47
Pituitary gland	+	+	+	50
Histiocytic sarcoma				1
Pars distalis, adenoma				36
Thyroid gland	+	+	A	48
C-cell, adenoma				4
C-cell, carcinoma				2
Follicular cell, carcinoma				1
General Body System				
None				
Genital System				
Clitoral gland	+	M	+	47
Adenoma				7
Carcinoma				2
Ovary	+	+	+	50
Granulosa cell tumor malignant				1
Histiocytic sarcoma				1
Uterus	+	+	+	49
Polyp stromal				6

TABLE B2
Individual Animal Tumor Pathology of Female Rats in the 2-Year Inhalation Study of Gallium Arsenide: 0.1 mg/m³

Number of Days on Study	1	3	3	3	4	4	5	5	5	6	6	6	6	6	6	6	6	6	6	6	6	6	6	6	6	6	6	6	6	6	6	6	6	6	6	6	6																											
	9	1	3	5	4	6	3	3	4	0	0	0	0	3	3	3	4	4	4	6	6	7	7	7	7	7	7	7	7	7	7	7	7	7	7	7																												
	8	0	9	4	8	2	4	4	7	3	4	5	9	0	1	9	6	6	7	0	8	4	4	4	8																																							
Carcass ID Number	5	5	5	5	5	5	5	5	5	5	5	5	5	5	5	5	5	5	5	5	5	5	5	5	5	5	5	5	5	5	5	5	5	5	5	5	5																											
	1	4	0	1	1	0	0	2	2	4	3	0	0	5	2	4	0	0	2	3	1	2	4	4	1																																							
	2	7	9	5	6	3	4	9	3	4	3	7	5	0	8	8	1	6	1	5	1	4	1	9	4																																							
Special Senses System																																																																
Eye																																																																
																			+	+	+																																											
Urinary System																																																																
Kidney	+	+	+	+	+	+	+	+	+	+	+	+	+	+	+	+	+	+	+	+	+	+	+	+	+	+	+	+	+	+	+	+	+	+	+	+	+																											
Histiocytic sarcoma																																																																X
Renal tubule, adenoma																																																																
Urinary bladder	+	+	+	+	+	+	+	+	+	+	+	+	+	+	+	+	+	+	+	+	+	+	+	+	+	+	+	+	+	+	+	+	+	+	+	+	+	+																										
Leiomyoma																																																																
Systemic Lesions																																																																
Multiple organs	+	+	+	+	+	+	+	+	+	+	+	+	+	+	+	+	+	+	+	+	+	+	+	+	+	+	+	+	+	+	+	+	+	+	+	+	+	+																										
Histiocytic sarcoma																																																																X
Leukemia mononuclear			X		X	X						X	X	X					X																		X	X	X																									

TABLE B2
Individual Animal Tumor Pathology of Female Rats in the 2-Year Inhalation Study of Gallium Arsenide: 1.0 mg/m³

Number of Days on Study	2 2 3 4 4 4 4 5 5 5 5 5 5 5 5 5 5 6 6 6 6 6 6 6 6 6
	1 5 1 1 2 7 7 0 1 3 5 5 6 6 9 9 0 3 3 3 3 7 7 7 7
	5 4 0 8 2 6 8 6 9 4 4 6 4 4 0 4 5 1 1 2 2 4 4 7 7
Carcass ID Number	7 7
	3 2 2 3 2 4 3 4 3 0 1 2 0 3 0 4 2 1 1 1 1 1 2 0 3
	3 7 6 1 2 1 8 0 9 5 7 1 3 7 2 9 5 0 3 2 4 1 9 8 4
Alimentary System	
Esophagus	+ + + + + + + + + + + + A + + + + + + + + + + + +
Intestine large, colon	+ + + + + + + + + + + + A + + + + + + + + + + + +
Intestine large, rectum	+ + + + + + + + + + + + A + + + + + + + + + + + +
Carcinoma	
Intestine large, cecum	+ + + + + + + + + + + + A + + + + + + + + + + + +
Intestine small, duodenum	+ + + + + + + + + + + + A + + + + + + + + + + + +
Intestine small, jejunum	+ + + + + + + + + + + + A + + + + + + + + + + + +
Intestine small, ileum	+ + + + + + + + + + + + A + + + + + + + + + + + +
Liver	+ +
Mesentery	
Pancreas	+ + + + + + + + + + + + A + + + + + + + + + + + +
Salivary glands	+ +
Stomach, forestomach	+ +
Stomach, glandular	+ + + + + + + + + + + + A + + + + + + + + + + + +
Cardiovascular System	
Blood vessel	
Heart	+ +
Endocrine System	
Adrenal cortex	+ + + + + + + + + + + + A + + + + + + + + + + + +
Adrenal medulla	+ + + + + + + + + + + + A + + + + + + + + + + + +
Pheochromocytoma benign	
Bilateral, pheochromocytoma benign	
Islets, pancreatic	+ + + + + + + + + + + + A + + + + + + + + + + + +
Adenoma	
Carcinoma	
Parathyroid gland	+ + + + + + + + + + + M + A + + + + + + + + + + + +
Pituitary gland	+ + + + + + + + + + + + A + + + + + + + + + + + +
Pars distalis, adenoma	
Thyroid gland	+ + + + + + + + + + + + A + + + + + + + + + + + +
C-cell, adenoma	
C-cell, carcinoma	
Follicular cell, adenoma	
Follicular cell, carcinoma	
General Body System	
None	
Genital System	
Clitoral gland	+ M
Adenoma	
Carcinoma	
Ovary	+ + + + + + + + + + + + A + + + + + + + + + + + +
Uterus	+ +
Leiomyoma	
Leiomyosarcoma	
Polyp stromal	

TABLE B2
Individual Animal Tumor Pathology of Female Rats in the 2-Year Inhalation Study of Gallium Arsenide: 1.0 mg/m³

Number of Days on Study	2 2 3 4 4 4 4 5 5 5 5 5 5 5 5 5 6 6 6 6 6 6 6 6 6
	1 5 1 1 2 7 7 0 1 3 5 5 6 6 9 9 0 3 3 3 3 7 7 7 7
	5 4 0 8 2 6 8 6 9 4 4 6 4 4 0 4 5 1 1 2 2 4 4 7 7
Carcass ID Number	7 7
	3 2 2 3 2 4 3 4 3 0 1 2 0 3 0 4 2 1 1 1 1 1 2 0 3
	3 7 6 1 2 1 8 0 9 5 7 1 3 7 2 9 5 0 3 2 4 1 9 8 4
Hematopoietic System	
Bone marrow	+ + + + + + + + + + + A + + + + + + + + + + +
Lymph node	+ +
Lymph node, bronchial	+ M M + + + + + + + + + A + + + + + + + + + + +
Lymph node, mandibular	+ +
Lymph node, mesenteric	+ + + + + + + + + + + + A + + + + + + + + + + +
Lymph node, mediastinal	M M + + M + + + + + + + + + + + + + + + + +
Spleen	+ + + + + + + + + + + A + + + + + + + + + + +
Thymus	+ + + + + + + + + + + + + + + + M + M + + + + M +
Integumentary System	
Mammary gland	+ +
Adenoma	
Carcinoma	
Carcinoma, multiple	
Fibroadenoma	
Fibroadenoma, multiple	
Skin	+ +
Basal cell adenoma	
Subcutaneous tissue, fibroma	
Subcutaneous tissue, lipoma	
Musculoskeletal System	
Bone	+ +
Nervous System	
Brain	+ +
Respiratory System	
Larynx	+ + + + + + + + + + + A + + + + + + + + + + +
Carcinoma, metastatic, thyroid gland	
Lung	+ +
Alveolar/bronchiolar adenoma	
Alveolar/bronchiolar carcinoma	
Carcinoma, metastatic, thyroid gland	
Squamous cell carcinoma	
Nose	+ + + + + + + + + + + A + + + + + + + + + + +
Trachea	+ + + + + + + + + + + A + + + + + + + + + + +
Special Senses System	
Ear	
Eye	
Urinary System	
Kidney	+ + + + + + + + + + + A + + + + + + + + + + +
Urinary bladder	+ + + + + + M + + + + + + + + + + + + + + + +
Systemic Lesions	
Multiple organs	+ +
Leukemia mononuclear	

TABLE B3
Statistical Analysis of Primary Neoplasms in Female Rats in the 2-Year Inhalation Study of Gallium Arsenide

	Chamber Control	0.01 mg/m ³	0.1 mg/m ³	1.0 mg/m ³
Adrenal Medulla: Benign Pheochromocytoma				
Overall rate ^a	4/50 (8%)	5/49 (10%)	6/50 (12%)	13/49 (27%)
Adjusted rate ^b	9.9%	13.3%	16.0%	36.0%
Terminal rate ^c	1/19 (5%)	2/16 (13%)	5/21 (24%)	4/11 (36%)
First incidence (days)	506	695	674	564
Poly-3 test ^d	P<0.001	P=0.455	P=0.321	P=0.005
Adrenal Medulla: Benign or Malignant Pheochromocytoma				
Overall rate	4/50 (8%)	6/49 (12%)	6/50 (12%)	13/49 (27%)
Adjusted rate	9.9%	16.0%	16.0%	36.0%
Terminal rate	1/19 (5%)	3/16 (19%)	5/21 (24%)	4/11 (36%)
First incidence (days)	506	695	674	564
Poly-3 test	P=0.002	P=0.323	P=0.321	P=0.005
Clitoral Gland: Adenoma				
Overall rate	8/50 (16%)	9/48 (19%)	7/47 (15%)	4/48 (8%)
Adjusted rate	19.6%	23.5%	19.7%	11.9%
Terminal rate	4/19 (21%)	4/16 (25%)	5/20 (25%)	0/10 (0%)
First incidence (days)	581	590	631	632
Poly-3 test	P=0.174N	P=0.444	P=0.610	P=0.279N
Clitoral Gland: Carcinoma				
Overall rate	3/50 (6%)	2/48 (4%)	2/47 (4%)	2/48 (4%)
Adjusted rate	7.5%	5.3%	5.7%	6.1%
Terminal rate	2/19 (11%)	1/16 (6%)	2/20 (10%)	1/10 (10%)
First incidence (days)	582	559	734 (T)	684
Poly-3 test	P=0.623N	P=0.527N	P=0.563N	P=0.589N
Clitoral Gland: Adenoma or Carcinoma				
Overall rate	11/50 (22%)	11/48 (23%)	9/47 (19%)	6/48 (13%)
Adjusted rate	26.7%	28.3%	25.3%	17.8%
Terminal rate	6/19 (32%)	5/16 (31%)	7/20 (35%)	1/10 (10%)
First incidence (days)	581	559	631	632
Poly-3 test	P=0.193N	P=0.536	P=0.552N	P=0.260N
Lung: Alveolar/bronchiolar Adenoma				
Overall rate	0/50 (0%)	0/50 (0%)	2/50 (4%)	7/50 (14%)
Adjusted rate	0.0%	0.0%	5.3%	19.7%
Terminal rate	0/19 (0%)	0/17 (0%)	1/21 (5%)	2/11 (18%)
First incidence (days)	— ^e	—	646	556
Poly-3 test	P<0.001	— ^f	P=0.225	P=0.004
Lung: Alveolar/bronchiolar Carcinoma				
Overall rate	0/50 (0%)	0/50 (0%)	2/50 (4%)	3/50 (6%)
Adjusted rate	0.0%	0.0%	5.4%	8.6%
Terminal rate	0/19 (0%)	0/17 (0%)	2/21 (10%)	1/11 (9%)
First incidence (days)	—	—	734 (T)	677
Poly-3 test	P=0.053	—	P=0.224	P=0.097

TABLE B3
Statistical Analysis of Primary Neoplasms in Female Rats in the 2-Year Inhalation Study of Gallium Arsenide

	Chamber Control	0.01 mg/m ³	0.1 mg/m ³	1.0 mg/m ³
Lung: Alveolar/bronchiolar Adenoma or Carcinoma				
Overall rate	0/50 (0%)	0/50 (0%)	4/50 (8%)	9/50 (18%)
Adjusted rate	0.0%	0.0%	10.7%	25.0%
Terminal rate	0/19 (0%)	0/17 (0%)	3/21 (14%)	2/11 (18%)
First incidence (days)	—	—	646	556
Poly-3 test	P<0.001	—	P=0.053	P<0.001
Mammary Gland: Fibroadenoma				
Overall rate	26/50 (52%)	31/50 (62%)	29/50 (58%)	31/50 (62%)
Adjusted rate	59.2%	71.3%	68.0%	74.3%
Terminal rate	11/19 (58%)	13/17 (77%)	16/21 (76%)	7/11 (64%)
First incidence (days)	497	422	339	418
Poly-3 test	P=0.184	P=0.152	P=0.252	P=0.090
Mammary Gland: Fibroadenoma or Adenoma				
Overall rate	26/50 (52%)	31/50 (62%)	29/50 (58%)	31/50 (62%)
Adjusted rate	59.2%	71.3%	68.0%	74.3%
Terminal rate	11/19 (58%)	13/17 (77%)	16/21 (76%)	7/11 (64%)
First incidence (days)	497	422	339	418
Poly-3 test	P=0.184	P=0.152	P=0.252	P=0.090
Mammary Gland: Carcinoma				
Overall rate	8/50 (16%)	3/50 (6%)	7/50 (14%)	5/50 (10%)
Adjusted rate	19.8%	7.7%	18.7%	14.2%
Terminal rate	4/19 (21%)	1/17 (6%)	6/21 (29%)	1/11 (9%)
First incidence (days)	589	559	701	632
Poly-3 test	P=0.549N	P=0.105N	P=0.569N	P=0.368N
Mammary Gland: Adenoma or Carcinoma				
Overall rate	8/50 (16%)	3/50 (6%)	7/50 (14%)	6/50 (12%)
Adjusted rate	19.8%	7.7%	18.7%	16.9%
Terminal rate	4/19 (21%)	1/17 (6%)	6/21 (29%)	1/11 (9%)
First incidence (days)	589	559	701	632
Poly-3 test	P=0.488	P=0.105N	P=0.569N	P=0.491N
Mammary Gland: Fibroadenoma, Adenoma, or Carcinoma				
Overall rate	29/50 (58%)	32/50 (64%)	31/50 (62%)	32/50 (64%)
Adjusted rate	65.4%	72.7%	72.7%	76.0%
Terminal rate	12/19 (63%)	13/17 (77%)	18/21 (86%)	7/11 (64%)
First incidence (days)	497	422	339	418
Poly-3 test	P=0.264	P=0.295	P=0.295	P=0.183
Pancreatic Islets: Adenoma or Carcinoma				
Overall rate	1/50 (2%)	0/50 (0%)	0/50 (0%)	3/49 (6%)
Adjusted rate	2.5%	0.0%	0.0%	8.7%
Terminal rate	0/19 (0%)	0/17 (0%)	0/21 (0%)	0/11 (0%)
First incidence (days)	685	—	—	688
Poly-3 test	P=0.032	P=0.507N	P=0.513N	P=0.256

TABLE B3
Statistical Analysis of Primary Neoplasms in Female Rats in the 2-Year Inhalation Study of Gallium Arsenide

	Chamber Control	0.01 mg/m ³	0.1 mg/m ³	1.0 mg/m ³
Pituitary Gland (Pars Distalis): Adenoma				
Overall rate	42/50 (84%)	43/50 (86%)	36/50 (72%)	31/49 (63%)
Adjusted rate	92.3%	94.8%	81.3%	74.8%
Terminal rate	19/19 (100%)	17/17 (100%)	19/21 (91%)	9/11 (82%)
First incidence (days)	581	478	339	506
Poly-3 test	P=0.004N	P=0.470	P=0.081N	P=0.014N
Skin (Subcutaneous Tissue): Fibroma or Sarcoma				
Overall rate	1/50 (2%)	0/50 (0%)	3/50 (6%)	1/50 (2%)
Adjusted rate	2.5%	0.0%	8.0%	2.9%
Terminal rate	0/19 (0%)	0/17 (0%)	1/21 (5%)	0/11 (0%)
First incidence (days)	607	—	647	709
Poly-3 test	P=0.672	P=0.508N	P=0.284	P=0.728
Thyroid Gland (C-cell): Adenoma				
Overall rate	7/50 (14%)	4/49 (8%)	4/48 (8%)	1/49 (2%)
Adjusted rate	17.5%	10.5%	10.8%	2.9%
Terminal rate	3/19 (16%)	2/17 (12%)	2/21 (10%)	0/11 (0%)
First incidence (days)	677	700	630	703
Poly-3 test	P=0.078N	P=0.286N	P=0.306N	P=0.048N
Thyroid Gland (C-cell): Carcinoma				
Overall rate	2/50 (4%)	1/49 (2%)	2/48 (4%)	3/49 (6%)
Adjusted rate	5.0%	2.6%	5.5%	8.7%
Terminal rate	1/19 (5%)	1/17 (6%)	1/21 (5%)	1/11 (9%)
First incidence (days)	684	734 (T)	605	632
Poly-3 test	P=0.275	P=0.516N	P=0.667	P=0.436
Thyroid Gland (C-cell): Adenoma or Carcinoma				
Overall rate	9/50 (18%)	5/49 (10%)	6/48 (13%)	4/49 (8%)
Adjusted rate	22.4%	13.1%	16.1%	11.6%
Terminal rate	4/19 (21%)	3/17 (18%)	3/21 (14%)	1/11 (9%)
First incidence (days)	677	700	605	632
Poly-3 test	P=0.277N	P=0.218N	P=0.338N	P=0.176N
Uterus: Stromal Polyp				
Overall rate	7/50 (14%)	6/50 (12%)	6/50 (12%)	2/50 (4%)
Adjusted rate	17.4%	15.1%	15.6%	5.7%
Terminal rate	3/19 (16%)	1/17 (6%)	3/21 (14%)	1/11 (9%)
First incidence (days)	589	585	534	422
Poly-3 test	P=0.098N	P=0.512N	P=0.536N	P=0.111N
All Organs: Mononuclear Cell Leukemia				
Overall rate	22/50 (44%)	21/50 (42%)	18/50 (36%)	33/50 (66%)
Adjusted rate	51.7%	48.2%	42.2%	73.7%
Terminal rate	11/19 (58%)	5/17 (29%)	5/21 (24%)	6/11 (55%)
First incidence (days)	506	497	310	418
Poly-3 test	P<0.001	P=0.456N	P=0.248N	P=0.021

TABLE B3
Statistical Analysis of Primary Neoplasms in Female Rats in the 2-Year Inhalation Study of Gallium Arsenide

	Chamber Control	0.01 mg/m ³	0.1 mg/m ³	1.0 mg/m ³
All Organs: Benign Neoplasms				
Overall rate	48/50 (96%)	46/50 (92%)	43/50 (86%)	43/50 (86%)
Adjusted rate	99.7%	97.7%	93.9%	94.2%
Terminal rate	19/19 (100%)	17/17 (100%)	21/21 (100%)	10/11 (91%)
First incidence (days)	497	422	339	418
Poly-3 test	P=0.205N	P=0.533N	P=0.104N	P=0.123N
All Organs: Malignant Neoplasms				
Overall rate	28/50 (56%)	28/50 (56%)	32/50 (64%)	38/50 (76%)
Adjusted rate	63.9%	61.5%	72.4%	82.6%
Terminal rate	13/19 (68%)	8/17 (47%)	15/21 (71%)	7/11 (64%)
First incidence (days)	506	478	310	418
Poly-3 test	P=0.014	P=0.495N	P=0.251	P=0.028
All Organs: Benign or Malignant Neoplasms				
Overall rate	48/50 (96%)	49/50 (98%)	49/50 (98%)	47/50 (94%)
Adjusted rate	99.7%	99.8%	100.0%	99.7%
Terminal rate	19/19 (100%)	17/17 (100%)	21/21 (100%)	11/11 (100%)
First incidence (days)	497	422	310	418
Poly-3 test	P=1.000N	P=1.000	P=1.000	P=1.000

(T)Terminal sacrifice

^a Number of neoplasm-bearing animals/number of animals examined. Denominator is number of animals examined microscopically for adrenal gland, clitoral gland, lung, pancreatic islets, pituitary gland, and thyroid gland; for other tissues, denominator is number of animals necropsied.

^b Poly-3 estimated neoplasm incidence after adjustment for intercurrent mortality

^c Observed incidence at terminal kill

^d Beneath the chamber control incidence are the P values associated with the trend test. Beneath the exposed group incidence are the P values corresponding to pairwise comparisons between the chamber controls and that exposed group. The Poly-3 test accounts for differential mortality in animals that do not reach terminal sacrifice. A negative trend or a lower incidence in an exposure group is indicated by N.

^e Not applicable; no neoplasms in animal group

^f Value of statistic cannot be computed.

TABLE B4a
Historical Incidence of Alveolar/bronchiolar Neoplasms in Chamber Control Female F344/N Rats^a

Study	Incidence in Controls		
	Adenoma	Carcinoma	Adenoma or Carcinoma
Historical Incidence at Battelle Pacific Northwest Laboratories			
2-Butoxyethanol	0/50	0/50	0/50
Acetonitrile	0/48	0/48	0/48
Chloroprene	1/49	0/49	1/49
Cobalt sulfate heptahydrate	0/50	0/50	0/50
Furfuryl alcohol	1/50	0/50	1/50
Glutaraldehyde	0/50	0/50	0/50
Hexachlorocyclopentadiene	1/50	0/50	1/50
Isobutene	2/50	0/50	2/50
Isobutyraldehyde	1/49	1/49	2/49
Isoprene	1/50	0/50	1/50
Molybdenum trioxide	0/50	0/50	0/50
Nitromethane	0/50	1/50	1/50
Ozone	0/50	0/50	0/50
Tetrafluoroethylene	0/50	0/50	0/50
Tetrahydrofuran	1/50	0/50	1/50
Overall Historical Incidence			
Total (%)	12/1,000 (1.2%)	2/1,000 (0.2%)	14/1,000 (1.4%)
Mean ± standard deviation	1.2% ± 1.3%	0.2% ± 0.6%	1.4% ± 1.5%
Range	0%-4%	0%-2%	0%-4%

^a Data as of 10 November 1998

TABLE B4b
Historical Incidence of Adrenal Medulla Pheochromocytoma in Chamber Control Female F344/N Rats^a

Study	Incidence in Controls		
	Benign	Malignant	Benign or Malignant
Historical Incidence at Battelle Pacific Northwest Laboratories			
2-Butoxyethanol	3/50	0/50	3/50
Acetonitrile	1/48	0/48	1/48
Chloroprene	3/49	0/49	3/49
Cobalt sulfate heptahydrate	2/48	0/48	2/48
Furfuryl alcohol	4/50	1/50	5/50
Glutaraldehyde	0/50	0/50	0/50
Hexachlorocyclopentadiene	6/47	0/47	6/47
Isobutene	3/50	0/50	3/50
Isobutyraldehyde	1/49	0/49	1/49
Isoprene	1/50	1/50	2/50
Molybdenum trioxide	5/49	0/49	5/49
Nitromethane	1/49	0/49	1/49
Ozone	6/50	0/50	6/50
Tetrafluoroethylene	4/50	0/50	4/50
Tetrahydrofuran	0/50	2/50	2/50
Overall Historical Incidence			
Total (%)	50/989 (5.1%)	5/989 (0.5%)	55/989 (5.6%)
Mean \pm standard deviation	5.1% \pm 3.8%	0.5% \pm 1.1%	5.5% \pm 3.7%
Range	0%-13%	0%-4%	0%-13%

^a Data as of 10 November 1998

TABLE B4c
Historical Incidence of Mononuclear Cell Leukemia in Chamber Control Female F344/N Rats^a

Study	Incidence in Controls
Historical Incidence at Battelle Pacific Northwest Laboratories	
2-Butoxyethanol	18/50
Acetonitrile	18/48
Chloroprene	18/49
Cobalt sulfate heptahydrate	15/50
Furfuryl alcohol	21/50
Glutaraldehyde	18/50
Hexachlorocyclopentadiene	16/50
Isobutene	18/50
Isobutyraldehyde	12/50
Isoprene	14/50
Molybdenum trioxide	18/50
Nitromethane	22/50
Ozone	17/50
Tetrafluoroethylene	16/50
Tetrahydrofuran	17/50
Overall Historical Incidence	
Total (%)	351/1,002 (35.0%)
Mean \pm standard deviation	35.0% \pm 5.9%
Range	24%-47%

^a Data as of 10 November 1998; includes data for lymphocytic, monocytic, and undifferentiated leukemia

TABLE B5
Summary of the Incidence of Nonneoplastic Lesions in Female Rats in the 2-Year Inhalation Study of Gallium Arsenide^a

	Chamber Control	0.01 mg/m ³	0.1 mg/m ³	1.0 mg/m ³
Disposition Summary				
Animals initially in study	50	50	50	50
Early deaths				
Moribund	30	30	23	35
Natural deaths	1	3	6	4
Survivors				
Died last week of study			1	
Terminal sacrifice	19	17	20	11
Animals examined microscopically	50	50	50	50
Alimentary System				
Intestine large, colon	(50)	(49)	(48)	(49)
Inflammation, acute		1 (2%)		
Intestine large, cecum	(50)	(49)	(48)	(49)
Inflammation, acute		1 (2%)		
Intestine small, duodenum	(50)	(48)	(48)	(49)
Necrosis		1 (2%)		2 (4%)
Liver	(50)	(50)	(50)	(50)
Angiectasis	2 (4%)	2 (4%)	5 (10%)	3 (6%)
Basophilic focus	38 (76%)	36 (72%)	38 (76%)	34 (68%)
Clear cell focus	5 (10%)	7 (14%)	8 (16%)	2 (4%)
Degeneration, cystic				1 (2%)
Eosinophilic focus	2 (4%)	3 (6%)	3 (6%)	1 (2%)
Fatty change	12 (24%)	19 (38%)	11 (22%)	12 (24%)
Hepatodiaphragmatic nodule	3 (6%)	3 (6%)	3 (6%)	4 (8%)
Inflammation, granulomatous	3 (6%)	1 (2%)		1 (2%)
Mixed cell focus	10 (20%)	9 (18%)	6 (12%)	2 (4%)
Necrosis	1 (2%)	1 (2%)	4 (8%)	2 (4%)
Regeneration	2 (4%)	1 (2%)		
Thrombosis				1 (2%)
Vacuolization cytoplasmic, focal	3 (6%)		2 (4%)	
Bile duct, hyperplasia	15 (30%)	12 (24%)	7 (14%)	13 (26%)
Centrilobular, necrosis	6 (12%)	13 (26%)	8 (16%)	17 (34%)
Mesentery	(6)	(14)	(6)	(11)
Artery, inflammation, chronic active		1 (7%)		
Fat, necrosis	6 (100%)	13 (93%)	6 (100%)	11 (100%)
Pancreas	(50)	(50)	(50)	(49)
Atrophy	15 (30%)	13 (26%)	21 (42%)	14 (29%)
Basophilic focus	4 (8%)	3 (6%)	1 (2%)	1 (2%)
Hyperplasia	3 (6%)		1 (2%)	
Lipomatosis		1 (2%)		
Stomach, forestomach	(50)	(50)	(50)	(50)
Diverticulum				1 (2%)
Hyperplasia, squamous		1 (2%)	1 (2%)	2 (4%)
Mineralization				1 (2%)
Necrosis	4 (8%)	7 (14%)	3 (6%)	4 (8%)
Stomach, glandular	(50)	(50)	(50)	(49)
Mineralization	2 (4%)	1 (2%)	2 (4%)	3 (6%)
Necrosis	3 (6%)	6 (12%)	2 (4%)	4 (8%)

^a Number of animals examined microscopically at the site and the number of animals with lesion

TABLE B5
Summary of the Incidence of Nonneoplastic Lesions in Female Rats in the 2-Year Inhalation Study of Gallium Arsenide

	Chamber Control	0.01 mg/m ³	0.1 mg/m ³	1.0 mg/m ³
Alimentary System (continued)				
Tongue		(1)	(2)	
Hyperplasia, squamous		1 (100%)	1 (50%)	
Tooth	(1)		(1)	
Developmental malformation			1 (100%)	
Inflammation, chronic active	1 (100%)			
Cardiovascular System				
Blood vessel				(1)
Aorta, mineralization				1 (100%)
Heart	(50)	(50)	(50)	(50)
Cardiomyopathy	34 (68%)	37 (74%)	29 (58%)	31 (62%)
Artery, mineralization				1 (2%)
Atrium, thrombosis	2 (4%)	3 (6%)		
Endocrine System				
Adrenal cortex	(50)	(50)	(50)	(49)
Degeneration, cystic	4 (8%)	2 (4%)	1 (2%)	
Hyperplasia	27 (54%)	23 (46%)	25 (50%)	22 (45%)
Hypertrophy	10 (20%)	11 (22%)	9 (18%)	11 (22%)
Necrosis		4 (8%)	2 (4%)	2 (4%)
Thrombosis			1 (2%)	
Vacuolization cytoplasmic	2 (4%)	4 (8%)	4 (8%)	3 (6%)
Adrenal medulla	(50)	(49)	(50)	(49)
Hyperplasia	16 (32%)	11 (22%)	15 (30%)	12 (24%)
Bilateral, hyperplasia			1 (2%)	
Islets, pancreatic	(50)	(50)	(50)	(49)
Hyperplasia				1 (2%)
Parathyroid gland	(47)	(42)	(47)	(46)
Hyperplasia		3 (7%)	3 (6%)	3 (7%)
Pituitary gland	(50)	(50)	(50)	(49)
Angiectasis			2 (4%)	1 (2%)
Cyst	1 (2%)			
Pars distalis, angiectasis				2 (4%)
Pars distalis, hyperplasia	5 (10%)	3 (6%)	7 (14%)	9 (18%)
Thyroid gland	(50)	(49)	(48)	(49)
C-cell, hyperplasia	41 (82%)	41 (84%)	38 (79%)	33 (67%)
Follicular cell, hyperplasia	1 (2%)			
General Body System				
None				
Genital System				
Clitoral gland	(50)	(48)	(47)	(48)
Hyperplasia	2 (4%)	4 (8%)	3 (6%)	2 (4%)
Inflammation, chronic active	2 (4%)	2 (4%)	1 (2%)	2 (4%)
Metaplasia, squamous				1 (2%)

TABLE B5
Summary of the Incidence of Nonneoplastic Lesions in Female Rats in the 2-Year Inhalation Study of Gallium Arsenide

	Chamber Control	0.01 mg/m ³	0.1 mg/m ³	1.0 mg/m ³
Genital System (continued)				
Ovary	(50)	(50)	(50)	(49)
Cyst	7 (14%)	8 (16%)	10 (20%)	5 (10%)
Uterus	(50)	(50)	(49)	(50)
Hemorrhage			1 (2%)	
Hematopoietic System				
Bone marrow	(50)	(49)	(50)	(49)
Hyperplasia, histiocytic		1 (2%)		
Inflammation, granulomatous	1 (2%)			
Myelofibrosis	1 (2%)			
Necrosis			1 (2%)	
Lymph node	(3)	(6)	(3)	(5)
Renal, hemorrhage		1 (17%)	1 (33%)	1 (20%)
Lymph node, bronchial	(36)	(36)	(39)	(40)
Infiltration cellular, plasma cell	1 (3%)			
Lymph node, mediastinal	(34)	(39)	(39)	(39)
Infiltration cellular, polymorphonuclear	1 (3%)			
Spleen	(50)	(50)	(50)	(49)
Fibrosis	4 (8%)	6 (12%)	5 (10%)	1 (2%)
Hematopoietic cell proliferation	5 (10%)	2 (4%)	6 (12%)	1 (2%)
Hemorrhage			1 (2%)	2 (4%)
Necrosis		1 (2%)	1 (2%)	
Integumentary System				
Mammary gland	(50)	(50)	(50)	(50)
Galactocele	1 (2%)		2 (4%)	
Hyperplasia, atypical		1 (2%)	1 (2%)	
Musculoskeletal System				
Bone	(50)	(50)	(50)	(50)
Fibrous osteodystrophy	1 (2%)		1 (2%)	2 (4%)
Hyperostosis	7 (14%)	3 (6%)	7 (14%)	9 (18%)
Nervous System				
None				
Respiratory System				
Larynx	(50)	(50)	(50)	(49)
Hyperplasia	3 (6%)	1 (2%)		1 (2%)
Inflammation, chronic active	4 (8%)	5 (10%)	3 (6%)	3 (6%)
Metaplasia, squamous	10 (20%)	5 (10%)	7 (14%)	11 (22%)
Necrosis	1 (2%)			
Epiglottis, hyperplasia	4 (8%)	2 (4%)		3 (6%)
Epiglottis, inflammation, chronic active	4 (8%)	1 (2%)	1 (2%)	
Epiglottis, metaplasia, squamous	4 (8%)	6 (12%)	1 (2%)	3 (6%)

TABLE B5
Summary of the Incidence of Nonneoplastic Lesions in Female Rats in the 2-Year Inhalation Study of Gallium Arsenide

	Chamber Control	0.01 mg/m ³	0.1 mg/m ³	1.0 mg/m ³
Respiratory System (continued)				
Lung	(50)	(50)	(50)	(50)
Cyst, squamous			1 (2%)	
Hyperplasia, atypical			9 (18%)	16 (32%)
Inflammation, chronic active	11 (22%)	46 (92%)	49 (98%)	50 (100%)
Metaplasia, squamous			2 (4%)	1 (2%)
Mineralization	1 (2%)			1 (2%)
Proteinosis	1 (2%)	24 (48%)	47 (94%)	49 (98%)
Thrombosis		1 (2%)		
Alveolar epithelium, hyperplasia	14 (28%)	9 (18%)	17 (34%)	14 (28%)
Alveolar epithelium, metaplasia		1 (2%)	36 (72%)	41 (82%)
Artery, mediastinum, inflammation		1 (2%)		
Artery, mediastinum, mineralization				1 (2%)
Nose	(50)	(50)	(49)	(49)
Hemorrhage			1 (2%)	
Inflammation, suppurative	3 (6%)	4 (8%)	9 (18%)	3 (6%)
Thrombosis	2 (4%)	7 (14%)	4 (8%)	6 (12%)
Olfactory epithelium, atrophy				2 (4%)
Olfactory epithelium, degeneration, hyaline	39 (78%)	38 (76%)	33 (67%)	32 (65%)
Olfactory epithelium, metaplasia, respiratory		2 (4%)	2 (4%)	1 (2%)
Respiratory epithelium, hyperplasia	1 (2%)			
Respiratory epithelium, metaplasia, squamous			1 (2%)	
Trachea	(50)	(50)	(50)	(49)
Mineralization				1 (2%)
Special Senses System				
Eye	(1)	(5)	(6)	(1)
Cataract	1 (100%)	4 (80%)	1 (17%)	1 (100%)
Degeneration		1 (20%)	4 (67%)	
Retina, atrophy	1 (100%)	4 (80%)	1 (17%)	1 (100%)
Sclera, inflammation, acute			1 (17%)	
Urinary System				
Kidney	(50)	(50)	(50)	(49)
Amyloid deposition	1 (2%)			
Angiectasis				1 (2%)
Cyst		1 (2%)	2 (4%)	
Hydronephrosis			1 (2%)	
Infarct		3 (6%)	1 (2%)	1 (2%)
Inflammation, suppurative	1 (2%)			
Mineralization				1 (2%)
Nephropathy	48 (96%)	47 (94%)	47 (94%)	45 (92%)
Thrombosis				1 (2%)
Renal tubule, hyperplasia	2 (4%)	1 (2%)	1 (2%)	2 (4%)
Renal tubule, necrosis	1 (2%)	1 (2%)		
Transitional epithelium, hyperplasia		1 (2%)		
Urinary bladder	(50)	(50)	(50)	(49)
Hemorrhage		1 (2%)		

APPENDIX C
SUMMARY OF LESIONS IN MALE MICE
IN THE 2-YEAR INHALATION STUDY
OF GALLIUM ARSENIDE

TABLE C1	Summary of the Incidence of Neoplasms in Male Mice in the 2-Year Inhalation Study of Gallium Arsenide	177
TABLE C2	Individual Animal Tumor Pathology of Male Mice in the 2-Year Inhalation Study of Gallium Arsenide	180
TABLE C3	Statistical Analysis of Primary Neoplasms in Male Mice in the 2-Year Inhalation Study of Gallium Arsenide	198
TABLE C4	Historical Incidence of Alveolar/bronchiolar Neoplasms in Chamber Control Male B6C3F₁ Mice	201
TABLE C5	Summary of the Incidence of Nonneoplastic Lesions in Male Mice in the 2-Year Inhalation Study of Gallium Arsenide	202

TABLE C1
Summary of the Incidence of Neoplasms in Male Mice in the 2-Year Inhalation Study of Gallium Arsenide^a

	Chamber Control	0.1 mg/m ³	0.5 mg/m ³	1.0 mg/m ³
Disposition Summary				
Animals initially in study	50	50	50	50
Early deaths				
Moribund	7	8	10	7
Natural deaths	8	4	6	9
Survivors				
Terminal sacrifice	35	38	34	34
Animals examined microscopically	50	50	50	50
Alimentary System				
Intestine large, cecum	(44)	(49)	(44)	(42)
Polyp adenomatous		1 (2%)		
Intestine small, duodenum	(42)	(46)	(45)	(43)
Histiocytic sarcoma	1 (2%)			
Intestine small, jejunum	(44)	(48)	(45)	(43)
Carcinoma	2 (5%)	2 (4%)		1 (2%)
Hemangiosarcoma				1 (2%)
Intestine small, ileum	(44)	(47)	(45)	(42)
Hepatocellular carcinoma, metastatic, liver	1 (2%)			
Liver	(50)	(50)	(50)	(50)
Hemangiosarcoma	1 (2%)	2 (4%)	3 (6%)	1 (2%)
Hepatocellular carcinoma	10 (20%)	7 (14%)	10 (20%)	14 (28%)
Hepatocellular carcinoma, multiple	3 (6%)	2 (4%)	2 (4%)	3 (6%)
Hepatocellular adenoma	11 (22%)	13 (26%)	12 (24%)	15 (30%)
Hepatocellular adenoma, multiple	5 (10%)	5 (10%)	7 (14%)	2 (4%)
Hepatocholangiocarcinoma		2 (4%)		
Histiocytic sarcoma	2 (4%)			1 (2%)
Mesentery	(4)	(5)	(4)	(6)
Hemangioma	1 (25%)			
Hemangiosarcoma	2 (50%)			
Sarcoma			1 (25%)	
Pancreas	(50)	(50)	(49)	(47)
Sarcoma, metastatic, mesentery			1 (2%)	
Stomach, forestomach	(50)	(50)	(49)	(49)
Squamous cell papilloma	1 (2%)			1 (2%)
Tooth	(1)	(3)	(1)	(1)
Odontoma		1 (33%)		
Cardiovascular System				
Heart	(50)	(50)	(50)	(50)
Hemangiosarcoma			1 (2%)	
Endocrine System				
Adrenal cortex	(50)	(50)	(50)	(48)
Adenoma				1 (2%)
Histiocytic sarcoma	1 (2%)			
Capsule, adenoma			1 (2%)	
Adrenal medulla	(50)	(50)	(50)	(47)
Pheochromocytoma benign	1 (2%)			
Islets, pancreatic	(50)	(48)	(49)	(47)
Adenoma			3 (6%)	

TABLE C1
Summary of the Incidence of Neoplasms in Male Mice in the 2-Year Inhalation Study of Gallium Arsenide

	Chamber Control	0.1 mg/m ³	0.5 mg/m ³	1.0 mg/m ³
Endocrine System (continued)				
Thyroid gland	(50)	(50)	(50)	(48)
Follicular cell, adenoma	1 (2%)	1 (2%)		
Follicular cell, carcinoma	1 (2%)			
General Body System				
None				
Genital System				
Epididymis	(50)	(50)	(50)	(49)
Prostate	(50)	(49)	(49)	(49)
Seminal vesicle	(50)	(50)	(48)	(43)
Hemangioma	1 (2%)			
Testes	(50)	(50)	(50)	(50)
Hemangioma		1 (2%)		
Interstitial cell, adenoma			2 (4%)	
Hematopoietic System				
Bone marrow	(49)	(50)	(50)	(48)
Hemangiosarcoma			2 (4%)	1 (2%)
Lymph node	(2)		(2)	(1)
Pancreatic, histiocytic sarcoma	1 (50%)			
Renal, hemangiosarcoma				1 (100%)
Lymph node, bronchial	(38)	(37)	(40)	(41)
Histiocytic sarcoma				1 (2%)
Lymph node, mandibular	(37)	(40)	(28)	(32)
Histiocytic sarcoma	1 (3%)			
Lymph node, mesenteric	(48)	(49)	(50)	(46)
Histiocytic sarcoma	1 (2%)			1 (2%)
Lymph node, mediastinal	(38)	(36)	(38)	(33)
Hepatocellular carcinoma, metastatic, liver	1 (3%)			
Histiocytic sarcoma				1 (3%)
Spleen	(50)	(50)	(49)	(47)
Hemangiosarcoma	2 (4%)		2 (4%)	1 (2%)
Thymus	(38)	(36)	(38)	(35)
Integumentary System				
Skin	(50)	(50)	(50)	(50)
Histiocytic sarcoma	1 (2%)			
Sebaceous gland, adenoma	1 (2%)			
Subcutaneous tissue, hemangiosarcoma			1 (2%)	
Subcutaneous tissue, lipoma	1 (2%)	1 (2%)		1 (2%)
Musculoskeletal System				
Bone	(49)	(50)	(50)	(50)
Hepatocellular carcinoma, metastatic, liver	1 (2%)			
Nervous System				
None				

TABLE C1
Summary of the Incidence of Neoplasms in Male Mice in the 2-Year Inhalation Study of Gallium Arsenide

	Chamber Control	0.1 mg/m ³	0.5 mg/m ³	1.0 mg/m ³
Respiratory System				
Lung	(50)	(50)	(50)	(50)
Alveolar/bronchiolar adenoma	12 (24%)	8 (16%)	10 (20%)	6 (12%)
Alveolar/bronchiolar adenoma, multiple	1 (2%)	2 (4%)	1 (2%)	1 (2%)
Alveolar/bronchiolar carcinoma	3 (6%)	4 (8%)	6 (12%)	6 (12%)
Alveolar/bronchiolar carcinoma, multiple		2 (4%)		
Carcinoma, metastatic, harderian gland	1 (2%)	1 (2%)	1 (2%)	1 (2%)
Hemangiosarcoma			1 (2%)	
Hepatocellular carcinoma, metastatic, liver	3 (6%)	1 (2%)	2 (4%)	2 (4%)
Histiocytic sarcoma	1 (2%)			1 (2%)
Mediastinum, alveolar/bronchiolar carcinoma, metastatic, lung			1 (2%)	
Mediastinum, hepatocellular carcinoma, metastatic, liver	1 (2%)			
Special Senses System				
Ear			(1)	
Hemangiosarcoma			1 (100%)	
Harderian gland	(47)	(48)	(49)	(48)
Adenoma	3 (6%)	6 (13%)	8 (16%)	8 (17%)
Adenoma, multiple	1 (2%)			
Carcinoma	1 (2%)	1 (2%)	3 (6%)	4 (8%)
Urinary System				
Kidney	(50)	(50)	(49)	(48)
Hepatocellular carcinoma, metastatic, liver	1 (2%)			
Sarcoma, metastatic, mesentery			1 (2%)	
Renal tubule, adenoma				1 (2%)
Urinary bladder	(49)	(50)	(46)	(46)
Systemic Lesions				
Multiple organs ^b	(50)	(50)	(50)	(50)
Histiocytic sarcoma	3 (6%)			1 (2%)
Lymphoma malignant	1 (2%)	1 (2%)	2 (4%)	1 (2%)
Neoplasm Summary				
Total animals with primary neoplasms ^c	40	37	45	41
Total primary neoplasms	69	62	79	71
Total animals with benign neoplasms	30	28	33	28
Total benign neoplasms	40	39	44	36
Total animals with malignant neoplasms	23	20	26	29
Total malignant neoplasms	29	23	35	35
Total animals with metastatic neoplasms	4	2	5	3
Total metastatic neoplasms	9	2	6	3

^a Number of animals examined microscopically at the site and the number of animals with neoplasm

^b Number of animals with any tissue examined microscopically

^c Primary neoplasms: all neoplasms except metastatic neoplasms

TABLE C2
Individual Animal Tumor Pathology of Male Mice in the 2-Year Inhalation Study of Gallium Arsenide:
Chamber Control

Number of Days on Study	0	4	4	5	5	5	5	5	6	6	6	7	7	7	7	7	7	7	7	7	7	7	7	7	7	7	7	7	7	7	7	7	7	7	7	7	7		
	5	5	6	6	6	7	7	7	4	8	9	0	0	0	2	3	3	3	3	3	3	3	3	3	3	3	3	3	3	3	3	3	3	3	3	3	3		
	4	7	2	1	1	0	4	8	7	6	9	2	7	9	7	3	3	3	3	3	3	3	3	3	3	3	3	3	3	3	3	3	3	3	3	3	3		
Carcass ID Number	0	0	0	0	0	0	0	0	0	0	0	0	0	0	0	0	0	0	0	0	0	0	0	0	0	0	0	0	0	0	0	0	0	0	0	0	0		
	1	1	3	4	5	4	2	1	2	3	0	4	4	3	1	0	0	1	1	2	2	2	2	2	2	2	2	2	2	2	2	2	2	2	2	2	2	3	
	5	8	2	2	0	9	5	6	0	6	1	0	6	5	9	4	9	1	4	2	3	6	7	8	0														
Alimentary System																																							
Esophagus	+	+	+	+	+	+	+	+	+	+	+	+	+	+	+	+	+	+	+	+	+	+	+	+	+	+	+	+	+	+	+	+	+	+	+	+	+	+	
Gallbladder	+	+	A	+	+	A	A	A	+	+	+	+	M	M	A	+	+	+	+	+	+	+	+	+	+	+	+	+	+	+	+	+	+	+	+	+	+	+	
Intestine large, colon	+	+	A	+	+	+	+	A	+	+	+	+	+	+	A	+	+	+	+	+	+	+	+	+	+	+	+	+	+	+	+	+	+	+	+	+	+	+	
Intestine large, rectum	+	+	A	+	+	+	+	A	+	+	+	+	+	+	A	+	+	+	+	+	+	+	+	+	+	+	+	+	+	+	+	+	+	+	+	+	+	+	
Intestine large, cecum	+	+	A	+	+	A	A	A	+	+	+	+	+	A	A	+	+	+	+	+	+	+	+	+	+	+	+	+	+	+	+	+	+	+	+	+	+	+	
Intestine small, duodenum	A	+	A	+	+	A	A	A	+	+	+	+	+	A	A	+	+	+	+	+	+	+	+	+	+	+	+	+	+	+	+	+	+	+	+	+	+	+	
Histiocytic sarcoma																																							
Intestine small, jejunum	+	+	A	+	+	A	A	A	+	+	+	+	+	A	A	+	+	+	+	+	+	+	+	+	+	+	+	+	+	+	+	+	+	+	+	+	+	+	
Carcinoma																																							
Intestine small, ileum	+	+	A	+	+	A	A	A	+	+	+	+	+	A	A	+	+	+	+	+	+	+	+	+	+	+	+	+	+	+	+	+	+	+	+	+	+	+	
Hepatocellular carcinoma, metastatic, liver														X																									
Liver	+	+	+	+	+	+	+	+	+	+	+	+	+	+	+	+	+	+	+	+	+	+	+	+	+	+	+	+	+	+	+	+	+	+	+	+	+	+	
Hemangiosarcoma																																							
Hepatocellular carcinoma														X	X	X	X	X																					
Hepatocellular carcinoma, multiple							X																														X		
Hepatocellular adenoma			X					X	X																													X	
Hepatocellular adenoma, multiple																																						X	
Histiocytic sarcoma										X																													
Mesentery						+																																	
Hemangioma																																							
Hemangiosarcoma							X																																
Oral mucosa																																							
Pancreas	+	+	+	+	+	+	+	+	+	+	+	+	+	+	+	+	+	+	+	+	+	+	+	+	+	+	+	+	+	+	+	+	+	+	+	+	+	+	
Salivary glands	+	+	+	+	+	+	+	+	+	+	+	+	+	+	+	+	+	+	+	+	+	+	+	+	+	+	+	+	+	+	+	+	+	+	+	+	+	+	
Stomach, forestomach	+	+	+	+	+	+	+	+	+	+	+	+	+	+	+	+	+	+	+	+	+	+	+	+	+	+	+	+	+	+	+	+	+	+	+	+	+	+	
Squamous cell papilloma																																						X	
Stomach, glandular	+	+	+	+	+	+	+	+	+	+	+	+	+	+	A	+	+	+	+	+	+	+	+	+	+	+	+	+	+	+	+	+	+	+	+	+	+		
Tooth																																							
Cardiovascular System																																							
Heart	+	+	+	+	+	+	+	+	+	+	+	+	+	+	+	+	+	+	+	+	+	+	+	+	+	+	+	+	+	+	+	+	+	+	+	+	+	+	
Endocrine System																																							
Adrenal cortex	+	+	+	+	+	+	+	+	+	+	+	+	+	+	+	+	+	+	+	+	+	+	+	+	+	+	+	+	+	+	+	+	+	+	+	+	+	+	
Histiocytic sarcoma																																						X	
Adrenal medulla	+	+	+	+	+	+	+	+	+	+	+	+	+	+	+	+	+	+	+	+	+	+	+	+	+	+	+	+	+	+	+	+	+	+	+	+	+	+	
Pheochromocytoma benign																																							
Islets, pancreatic	+	+	+	+	+	+	+	+	+	+	+	+	+	+	+	+	+	+	+	+	+	+	+	+	+	+	+	+	+	+	+	+	+	+	+	+	+	+	
Parathyroid gland	+	+	M	+	M	+	+	M	M	+	M	+	M	M	M	+	+	M	+	+	+	M	+	+	+	M	+	M	+	+	+	+	+	+	+	+	+		
Pituitary gland	M	+	+	+	+	+	+	+	+	+	+	+	+	+	+	+	+	+	+	+	+	+	+	+	+	+	+	+	+	+	+	+	+	+	+	+	+	+	
Thyroid gland	+	+	+	+	+	+	+	+	+	+	+	+	+	+	+	+	+	+	+	+	+	+	+	+	+	+	+	+	+	+	+	+	+	+	+	+	+	+	
Follicular cell, adenoma																																							
Follicular cell, carcinoma																																							
General Body System																																							
None																																							

+: Tissue examined microscopically
 A: Autolysis precludes examination

M: Missing tissue
 I: Insufficient tissue

X: Lesion present
 Blank: Not examined

TABLE C2
Individual Animal Tumor Pathology of Male Mice in the 2-Year Inhalation Study of Gallium Arsenide:
Chamber Control

Number of Days on Study	7 7
	3 3
	3 3 3 3 3 4 4 4 4 4 4 4 4 4 4 4 5 5 5 5 5 5 5 5
Carcass ID Number	0 0
	3 3 3 3 4 0 1 1 1 2 3 4 4 4 4 4 0 0 0 0 0 1 2 2 3
	1 4 8 9 7 3 0 2 3 4 7 1 3 4 5 8 2 5 6 7 8 7 1 9 3
	Total Tissues/Tumors
Alimentary System	
Esophagus	+ 50
Gallbladder	+ M + + + 42
Intestine large, colon	+ 47
Intestine large, rectum	+ 47
Intestine large, cecum	+ 44
Intestine small, duodenum	+ + M + 42
Histiocytic sarcoma	
Intestine small, jejunum	+ 44
Carcinoma	X
Intestine small, ileum	+ 44
Hepatocellular carcinoma, metastatic, liver	
Liver	+ 50
Hemangiosarcoma	
Hepatocellular carcinoma	X X
Hepatocellular carcinoma, multiple	
Hepatocellular adenoma	X X
Hepatocellular adenoma, multiple	X X
Histiocytic sarcoma	
Mesentery	
Hemangioma	+ +
Hemangiosarcoma	X
Oral mucosa	
Pancreas	+ 50
Salivary glands	+ 50
Stomach, forestomach	+ 50
Squamous cell papilloma	
Stomach, glandular	+ 49
Tooth	
	+ 1
Cardiovascular System	
Heart	+ 50
Endocrine System	
Adrenal cortex	+ 50
Histiocytic sarcoma	
Adrenal medulla	+ 50
Pheochromocytoma benign	
Islets, pancreatic	+ 50
Parathyroid gland	+ + + + + M + + + + M + + + M + + + M M + + + + 34
Pituitary gland	+ + + + + M + 48
Thyroid gland	+ 50
Follicular cell, adenoma	
Follicular cell, carcinoma	X
	X 1
General Body System	
None	

TABLE C2
Individual Animal Tumor Pathology of Male Mice in the 2-Year Inhalation Study of Gallium Arsenide:
Chamber Control

Number of Days on Study	0 4 4 5 5 5 5 5 6 6 6 7 7 7 7 7 7 7 7 7 7 7
	5 5 6 6 6 7 7 7 4 8 9 0 0 0 2 3 3 3 3 3 3 3 3
	4 7 2 1 1 0 4 8 7 6 9 2 7 9 7 3 3 3 3 3 3 3 3
Carcass ID Number	0 0
	1 1 3 4 5 4 2 1 2 3 0 4 4 3 1 0 0 1 1 2 2 2 2 3
	5 8 2 2 0 9 5 6 0 6 1 0 6 5 9 4 9 1 4 2 3 6 7 8 0
Special Senses System	
Eye	
Harderian gland	M + + + M M + + + + + + + + + + + + + + + + +
Adenoma	
Adenoma, multiple	
Carcinoma	X
Urinary System	
Kidney	+ +
Hepatocellular carcinoma, metastatic, liver	X
Urinary bladder	+ + A +
Systemic Lesions	
Multiple organs	+ +
Histiocytic sarcoma	X
Lymphoma malignant	

TABLE C2
Individual Animal Tumor Pathology of Male Mice in the 2-Year Inhalation Study of Gallium Arsenide:
Chamber Control

Number of Days on Study	7 7	
	3 3	
	3 3 3 3 3 4 4 4 4 4 4 4 4 4 4 4 5 5 5 5 5 5 5 5	
Carcass ID Number	0 0	Total
	3 3 3 3 4 0 1 1 1 2 3 4 4 4 4 4 0 0 0 0 0 1 2 2 3	Tissues/
	1 4 8 9 7 3 0 2 3 4 7 1 3 4 5 8 2 5 6 7 8 7 1 9 3	Tumors
Special Senses System		
Eye		2
Harderian gland		47
Adenoma	X	3
Adenoma, multiple		1
Carcinoma		1
Urinary System		
Kidney		50
Hepatocellular carcinoma, metastatic, liver		1
Urinary bladder		49
Systemic Lesions		
Multiple organs		50
Histiocytic sarcoma		3
Lymphoma malignant	X	1

TABLE C2
Individual Animal Tumor Pathology of Male Mice in the 2-Year Inhalation Study of Gallium Arsenide: 0.1 mg/m³

Number of Days on Study	4 4 4 5 6 6 6 7 7 7 7 7 7 7 7 7 7 7 7 7 7 7 7
	7 7 8 8 0 1 5 0 1 1 1 2 3 3 3 3 3 3 3 3 3 3 3
	3 8 1 1 9 7 9 5 0 5 5 9 3 3 3 3 3 3 3 3 3 3 3
Carcass ID Number	6 6
	1 4 4 2 3 4 1 2 3 2 3 4 0 0 0 0 1 1 1 2 3 3 3 4 5
	3 3 4 7 8 7 1 6 0 9 4 1 1 4 6 7 0 6 9 3 2 5 7 6 0
Hematopoietic System	
Bone marrow	+ +
Lymph node, bronchial	+ + M + M + + + + + + M + + M M M + + M M + + + +
Lymph node, mandibular	+ + + + + M M + + + + + + + M + M + + + + M + +
Lymph node, mesenteric	+ + + + + + + + + + + + M + + + + + + + + + + + +
Lymph node, mediastinal	M + M + M M + M + M + M + M + M + + + + + + + M +
Spleen	+ +
Thymus	+ M + + + M M + M + M M + + M M + + + + + + + M M
Integumentary System	
Mammary gland	M M
Skin	+ +
Subcutaneous tissue, lipoma	
Musculoskeletal System	
Bone	+ +
Nervous System	
Brain	+ +
Respiratory System	
Larynx	+ +
Lung	+ +
Alveolar/bronchiolar adenoma	
Alveolar/bronchiolar adenoma, multiple	X X
Alveolar/bronchiolar carcinoma	
Alveolar/bronchiolar carcinoma, multiple	X
Carcinoma, metastatic, harderian gland	X
Hepatocellular carcinoma, metastatic, liver	X
Nose	+ + + + + A + + + + + + + + + + + + + + + + + + +
Trachea	+ +
Special Senses System	
Eye	+ + + + + +
Harderian gland	+ + + + + M + + + + + + + + + + + + + + + + + + +
Adenoma	X X
Carcinoma	
Urinary System	
Kidney	+ +
Urinary bladder	+ +
Systemic Lesions	
Multiple organs	+ +
Lymphoma malignant	X

TABLE C3
Statistical Analysis of Primary Neoplasms in Male Mice in the 2-Year Inhalation Study of Gallium Arsenide

	Chamber Control	0.1 mg/m ³	0.5 mg/m ³	1.0 mg/m ³
Harderian Gland: Adenoma				
Overall rate ^a	4/50 (8%)	6/50 (12%)	8/50 (16%)	8/50 (16%)
Adjusted rate ^b	9.1%	12.9%	17.8%	17.3%
Terminal rate ^c	4/35 (11%)	3/38 (8%)	3/34 (9%)	4/34 (12%)
First incidence (days)	733 (T)	609	548	561
Poly-3 test ^d	P=0.164	P=0.405	P=0.189	P=0.201
Harderian Gland: Carcinoma				
Overall rate	1/50 (2%)	1/50 (2%)	3/50 (6%)	4/50 (8%)
Adjusted rate	2.3%	2.2%	6.9%	8.9%
Terminal rate	0/35 (0%)	1/38 (3%)	2/34 (6%)	4/34 (12%)
First incidence (days)	686	733 (T)	645	733 (T)
Poly-3 test	P=0.064	P=0.752N	P=0.299	P=0.185
Harderian Gland: Adenoma or Carcinoma				
Overall rate	5/50 (6%)	7/50 (14%)	10/50 (20%)	12/50 (24%)
Adjusted rate	11.4%	15.1%	22.2%	26.0%
Terminal rate	4/35 (11%)	4/38 (11%)	5/34 (15%)	8/34 (24%)
First incidence (days)	686	609	548	561
Poly-3 test	P=0.036	P=0.416	P=0.138	P=0.063
Liver: Hemangiosarcoma				
Overall rate	1/50 (2%)	2/50 (4%)	3/50 (6%)	1/50 (2%)
Adjusted rate	2.3%	4.4%	7.0%	2.2%
Terminal rate	0/35 (0%)	2/38 (5%)	2/34 (6%)	0/34 (0%)
First incidence (days)	570	733 (T)	692	599
Poly-3 test	P=0.553N	P=0.511	P=0.294	P=0.756N
Liver: Hepatocellular Adenoma				
Overall rate	16/50 (32%)	18/50 (36%)	19/50 (38%)	17/50 (34%)
Adjusted rate	35.1%	36.5%	42.4%	37.5%
Terminal rate	13/35 (37%)	11/38 (29%)	15/34 (44%)	14/34 (41%)
First incidence (days)	457	473	502	656
Poly-3 test	P=0.412	P=0.527	P=0.306	P=0.490
Liver: Hepatocellular Carcinoma				
Overall rate	13/50 (26%)	9/50 (18%)	12/50 (24%)	17/50 (34%)
Adjusted rate	29.0%	19.1%	26.9%	35.3%
Terminal rate	7/35 (20%)	6/38 (16%)	8/34 (24%)	9/34 (27%)
First incidence (days)	561	478	573	406
Poly-3 test	P=0.108	P=0.195N	P=0.505N	P=0.333
Liver: Hepatocellular Adenoma or Carcinoma				
Overall rate	26/50 (52%)	23/50 (46%)	27/50 (54%)	30/50 (60%)
Adjusted rate	55.7%	46.6%	58.0%	61.8%
Terminal rate	17/35 (49%)	15/38 (40%)	19/34 (56%)	19/34 (56%)
First incidence (days)	457	473	502	406
Poly-3 test	P=0.129	P=0.244N	P=0.494	P=0.344

TABLE C3
Statistical Analysis of Primary Neoplasms in Male Mice in the 2-Year Inhalation Study of Gallium Arsenide

	Chamber Control	0.1 mg/m ³	0.5 mg/m ³	1.0 mg/m ³
Lung: Alveolar/bronchiolar Adenoma				
Overall rate	13/50 (26%)	10/50 (20%)	11/50 (22%)	7/50 (14%)
Adjusted rate	29.4%	21.6%	25.6%	15.3%
Terminal rate	11/35 (31%)	8/38 (21%)	10/34 (29%)	5/34 (15%)
First incidence (days)	686	659	729	555
Poly-3 test	P=0.111N	P=0.271N	P=0.437N	P=0.085N
Lung: Alveolar/bronchiolar Carcinoma				
Overall rate	3/50 (6%)	6/50 (12%)	6/50 (12%)	6/50 (12%)
Adjusted rate	6.8%	13.0%	13.6%	13.3%
Terminal rate	3/35 (9%)	4/38 (11%)	3/34 (9%)	5/34 (15%)
First incidence (days)	733 (T)	705	393	699
Poly-3 test	P=0.296	P=0.267	P=0.244	P=0.255
Lung: Alveolar/bronchiolar Adenoma or Carcinoma				
Overall rate	15/50 (30%)	14/50 (28%)	16/50 (32%)	13/50 (26%)
Adjusted rate	34.0%	30.2%	36.3%	28.3%
Terminal rate	13/35 (37%)	11/38 (29%)	12/34 (35%)	10/34 (29%)
First incidence (days)	686	659	393	555
Poly-3 test	P=0.392N	P=0.438N	P=0.498	P=0.362N
Pancreatic Islets: Adenoma				
Overall rate	0/50 (0%)	0/48 (0%)	3/49 (6%)	0/47 (0%)
Adjusted rate	0.0%	0.0%	7.1%	0.0%
Terminal rate	0/35 (0%)	0/36 (0%)	3/34 (9%)	0/34 (0%)
First incidence (days)	— ^e	— ^f	733 (T)	—
Poly-3 test	P=0.484	— ^f	P=0.113	—
All Organs: Hemangiosarcoma				
Overall rate	3/50 (6%)	2/50 (4%)	6/50 (12%)	3/50 (6%)
Adjusted rate	6.7%	4.4%	13.6%	6.6%
Terminal rate	1/35 (3%)	2/38 (5%)	2/34 (6%)	1/34 (3%)
First incidence (days)	570	733 (T)	502	599
Poly-3 test	P=0.410	P=0.487N	P=0.236	P=0.651N
All Organs: Hemangioma or Hemangiosarcoma				
Overall rate	5/50 (10%)	3/50 (6%)	6/50 (12%)	3/50 (6%)
Adjusted rate	11.1%	6.5%	13.6%	6.6%
Terminal rate	2/35 (6%)	3/38 (8%)	2/34 (6%)	1/34 (3%)
First incidence (days)	561	733 (T)	502	599
Poly-3 test	P=0.436N	P=0.347N	P=0.484	P=0.350N
All Organs: Histiocytic Sarcoma				
Overall rate	3/50 (6%)	0/50 (0%)	0/50 (0%)	1/50 (2%)
Adjusted rate	6.8%	0.0%	0.0%	2.2%
Terminal rate	2/35 (6%)	0/38 (0%)	0/34 (0%)	0/34 (0%)
First incidence (days)	647	—	—	716
Poly-3 test	P=0.339N	P=0.112N	P=0.124N	P=0.298N

TABLE C3
Statistical Analysis of Primary Neoplasms in Male Mice in the 2-Year Inhalation Study of Gallium Arsenide

	Chamber Control	0.1 mg/m ³	0.5 mg/m ³	1.0 mg/m ³
All Organs: Benign Neoplasms				
Overall rate	30/50 (60%)	28/50 (56%)	33/50 (66%)	28/50 (56%)
Adjusted rate	64.5%	56.1%	71.0%	59.5%
Terminal rate	24/35 (69%)	17/38 (45%)	24/34 (71%)	20/34 (59%)
First incidence (days)	457	473	502	555
Poly-3 test	P=0.509	P=0.262N	P=0.323	P=0.386N
All Organs: Malignant Neoplasms				
Overall rate	23/50 (46%)	20/50 (40%)	26/50 (52%)	29/50 (58%)
Adjusted rate	50.1%	41.3%	55.3%	59.0%
Terminal rate	14/35 (40%)	13/38 (34%)	15/34 (44%)	16/34 (47%)
First incidence (days)	561	478	393	406
Poly-3 test	P=0.073	P=0.258N	P=0.383	P=0.252
All Organs: Benign or Malignant Neoplasms				
Overall rate	40/50 (80%)	37/50 (74%)	45/50 (90%)	41/50 (82%)
Adjusted rate	83.9%	74.0%	91.8%	82.0%
Terminal rate	28/35 (80%)	25/38 (66%)	30/34 (88%)	25/34 (74%)
First incidence (days)	457	473	393	406
Poly-3 test	P=0.300	P=0.171N	P=0.186	P=0.510N

(T)Terminal sacrifice

^a Number of neoplasm-bearing animals/number of animals examined. Denominator is number of animals examined microscopically for liver, lung, and pancreatic islets; for other tissues, denominator is number of animals necropsied.

^b Poly-3 estimated neoplasm incidence after adjustment for intercurrent mortality

^c Observed incidence at terminal kill

^d Beneath the chamber control incidence are the P values associated with the trend test. Beneath the exposed group incidence are the P values corresponding to pairwise comparisons between the chamber controls and that exposed group. The Poly-3 test accounts for differential mortality in animals that do not reach terminal sacrifice. A negative trend or a lower incidence in an exposure group is indicated by N.

^e Not applicable; no neoplasms in animal group

^f Value of statistic cannot be computed.

TABLE C4
Historical Incidence of Alveolar/bronchiolar Neoplasms in Chamber Control Male B6C3F₁ Mice^a

Study	Incidence in Controls		
	Adenoma	Carcinoma	Adenoma or Carcinoma
Historical Incidence at Battelle Pacific Northwest Laboratories			
1,3-Butadiene	18/50	5/50	21/50
2-Butoxyethanol	9/50	5/50	14/50
Acetonitrile	6/50	4/50	10/50
Chloroprene	8/50	6/50	13/50
Cobalt sulfate heptahydrate	9/50	4/50	11/50
Furfuryl alcohol	16/50	4/50	20/50
Glutaraldehyde	8/48	10/48	18/48
Hexachlorocyclopentadiene	11/49	0/49	11/49
Isobutene	12/50	6/50	17/50
Isobutyraldehyde	5/50	7/50	12/50
Molybdenum trioxide	9/50	2/50	11/50
Nitromethane	11/50	2/50	13/50
Ozone	6/50	8/50	14/50
Tetrahydrofuran	18/50	6/50	21/50
Overall Historical Incidence			
Total (%)	188/1,021 (18.4%)	94/1,021 (9.2%)	270/1,021 (26.4%)
Mean ± standard deviation	18.6% ± 8.4%	9.2% ± 5.3%	26.6% ± 8.5%
Range	8%-36%	0%-21%	14%-42%

^a Data as of 3 November 1998

TABLE C5
Summary of the Incidence of Nonneoplastic Lesions in Male Mice in the 2-Year Inhalation Study of Gallium Arsenide^a

	Chamber Control	0.1 mg/m ³	0.5 mg/m ³	1.0 mg/m ³
Disposition Summary				
Animals initially in study	50	50	50	50
Early deaths				
Moribund	7	8	10	7
Natural deaths	8	4	6	9
Survivors				
Terminal sacrifice	35	38	34	34
Animals examined microscopically	50	50	50	50
Alimentary System				
Gallbladder	(42)	(47)	(41)	(43)
Degeneration, hyaline		1 (2%)		1 (2%)
Intestine small, jejunum	(44)	(48)	(45)	(43)
Peyer's patch, hyperplasia	1 (2%)		1 (2%)	1 (2%)
Intestine small, ileum	(44)	(47)	(45)	(42)
Peyer's patch, hyperplasia			1 (2%)	
Liver	(50)	(50)	(50)	(50)
Basophilic focus		1 (2%)	2 (4%)	2 (4%)
Clear cell focus		2 (4%)	2 (4%)	1 (2%)
Degeneration, fatty	1 (2%)	1 (2%)	1 (2%)	
Eosinophilic focus	8 (16%)	12 (24%)	11 (22%)	14 (28%)
Eosinophilic focus, multiple	3 (6%)	2 (4%)	3 (6%)	5 (10%)
Hematopoietic cell proliferation	3 (6%)	1 (2%)	2 (4%)	2 (4%)
Inflammation	2 (4%)	3 (6%)	1 (2%)	
Necrosis	10 (20%)	6 (12%)	5 (10%)	4 (8%)
Bile duct, cyst	1 (2%)		1 (2%)	
Oval cell, hyperplasia	1 (2%)	1 (2%)		
Mesentery	(4)	(5)	(4)	(6)
Fat, necrosis	1 (25%)	5 (100%)	3 (75%)	6 (100%)
Pancreas	(50)	(50)	(49)	(47)
Atrophy	13 (26%)	7 (14%)	9 (18%)	6 (13%)
Inflammation	1 (2%)			
Stomach, forestomach	(50)	(50)	(49)	(49)
Ulcer	2 (4%)			1 (2%)
Epithelium, hyperplasia	6 (12%)	2 (4%)	3 (6%)	3 (6%)
Stomach, glandular	(49)	(50)	(49)	(48)
Infiltration cellular, mixed cell		1 (2%)		
Ulcer				1 (2%)
Tooth	(1)	(3)	(1)	(1)
Malformation	1 (100%)	2 (67%)	1 (100%)	1 (100%)
Cardiovascular System				
Heart	(50)	(50)	(50)	(50)
Cardiomyopathy	48 (96%)	50 (100%)	49 (98%)	47 (94%)
Thrombosis		1 (2%)		
Artery, inflammation			1 (2%)	
Atrium, thrombosis	2 (4%)			
Ventricle, thrombosis			1 (2%)	

^a Number of animals examined microscopically at the site and the number of animals with lesion

TABLE C5
Summary of the Incidence of Nonneoplastic Lesions in Male Mice in the 2-Year Inhalation Study of Gallium Arsenide

	Chamber Control	0.1 mg/m ³	0.5 mg/m ³	1.0 mg/m ³
Endocrine System				
Adrenal cortex	(50)	(50)	(50)	(48)
Degeneration, cystic				1 (2%)
Hyperplasia	4 (8%)	10 (20%)	7 (14%)	4 (8%)
Hypertrophy	38 (76%)	33 (66%)	38 (76%)	30 (63%)
Mineralization			1 (2%)	
Adrenal medulla	(50)	(50)	(50)	(47)
Hyperplasia				1 (2%)
Islets, pancreatic	(50)	(48)	(49)	(47)
Hyperplasia	2 (4%)	3 (6%)	2 (4%)	4 (9%)
Pituitary gland	(48)	(48)	(47)	(47)
Pars distalis, hyperplasia		1 (2%)	1 (2%)	1 (2%)
Thyroid gland	(50)	(50)	(50)	(48)
Follicular cell, hyperplasia	11 (22%)	13 (26%)	7 (14%)	8 (17%)
General Body System				
None				
Genital System				
Epididymis	(50)	(50)	(50)	(49)
Granuloma sperm		2 (4%)		1 (2%)
Hyperplasia	1 (2%)	1 (2%)		
Inflammation	2 (4%)	1 (2%)		
Preputial gland	(50)	(49)	(49)	(48)
Ectasia	5 (10%)	3 (6%)	5 (10%)	5 (10%)
Inflammation	3 (6%)	3 (6%)	4 (8%)	9 (19%)
Prostate	(50)	(49)	(49)	(49)
Inflammation	2 (4%)		1 (2%)	1 (2%)
Seminal vesicle	(50)	(50)	(48)	(43)
Inflammation		1 (2%)		1 (2%)
Testes	(50)	(50)	(50)	(50)
Atrophy	6 (12%)	9 (18%)	2 (4%)	2 (4%)
Hematopoietic System				
Bone marrow	(49)	(50)	(50)	(48)
Hyperplasia	2 (4%)	3 (6%)	2 (4%)	3 (6%)
Lymph node	(2)		(2)	(1)
Hyperplasia	1 (50%)			
Lymph node, bronchial	(38)	(37)	(40)	(41)
Hyperplasia	5 (13%)	7 (19%)	17 (43%)	24 (59%)
Lymph node, mandibular	(37)	(40)	(28)	(32)
Hyperplasia	2 (5%)	3 (8%)		
Lymph node, mesenteric	(48)	(49)	(50)	(46)
Angiectasis		1 (2%)	1 (2%)	1 (2%)
Erythrophagocytosis		1 (2%)		
Hematopoietic cell proliferation	1 (2%)	1 (2%)	1 (2%)	1 (2%)
Hyperplasia	3 (6%)	5 (10%)	4 (8%)	4 (9%)
Lymph node, mediastinal	(38)	(36)	(38)	(33)
Hematopoietic cell proliferation		1 (3%)		
Hyperplasia	1 (3%)	1 (3%)	4 (11%)	3 (9%)

TABLE C5
Summary of the Incidence of Nonneoplastic Lesions in Male Mice in the 2-Year Inhalation Study of Gallium Arsenide

	Chamber Control	0.1 mg/m ³	0.5 mg/m ³	1.0 mg/m ³
Hematopoietic System (continued)				
Spleen	(50)	(50)	(49)	(47)
Hematopoietic cell proliferation	17 (34%)	13 (26%)	19 (39%)	18 (38%)
Hyperplasia, lymphoid	1 (2%)	5 (10%)	3 (6%)	2 (4%)
Integumentary System				
Skin	(50)	(50)	(50)	(50)
Cyst epithelial inclusion			1 (2%)	
Inflammation	1 (2%)			1 (2%)
Prepuce, inflammation, chronic active	2 (4%)	4 (8%)	3 (6%)	3 (6%)
Subcutaneous tissue, inflammation, chronic			2 (4%)	
Subcutaneous tissue, inflammation, focal, suppurative		1 (2%)		
Subcutaneous tissue, inflammation, granulomatous	1 (2%)	1 (2%)		1 (2%)
Musculoskeletal System				
Bone	(49)	(50)	(50)	(50)
Fibrous osteodystrophy	1 (2%)	2 (4%)	2 (4%)	
Nervous System				
Brain	(50)	(50)	(50)	(49)
Meninges, infiltration cellular, mononuclear cell			1 (2%)	
Respiratory System				
Larynx	(50)	(50)	(48)	(48)
Inflammation, suppurative		1 (2%)	1 (2%)	
Metaplasia, squamous	1 (2%)			
Squamous epithelium, hyperplasia	11 (22%)	13 (26%)	11 (23%)	5 (10%)
Lung	(50)	(50)	(50)	(50)
Congestion	1 (2%)			
Hematopoietic cell proliferation			1 (2%)	1 (2%)
Hemorrhage	5 (10%)	6 (12%)	6 (12%)	3 (6%)
Hyperplasia, atypical				1 (2%)
Infiltration cellular, histiocyte	3 (6%)	10 (20%)	45 (90%)	48 (96%)
Inflammation, chronic, focal	1 (2%)	3 (6%)	3 (6%)	12 (24%)
Inflammation, focal, suppurative			8 (16%)	23 (46%)
Alveolar epithelium, hyperplasia	4 (8%)	9 (18%)	39 (78%)	45 (90%)
Alveolus, foreign body		4 (8%)	46 (92%)	50 (100%)
Alveolus, proteinosis	1 (2%)	4 (8%)	49 (98%)	50 (100%)
Nose	(49)	(49)	(49)	(48)
Inflammation, suppurative		3 (6%)	2 (4%)	1 (2%)
Olfactory epithelium, atrophy	7 (14%)	2 (4%)	5 (10%)	8 (17%)
Olfactory epithelium, degeneration, hyaline	2 (4%)	4 (8%)	6 (12%)	1 (2%)
Respiratory epithelium, degeneration, hyaline	1 (2%)	2 (4%)	2 (4%)	1 (2%)
Respiratory epithelium, hyperplasia		1 (2%)		

TABLE C5
Summary of the Incidence of Nonneoplastic Lesions in Male Mice in the 2-Year Inhalation Study of Gallium Arsenide

	Chamber Control	0.1 mg/m ³	0.5 mg/m ³	1.0 mg/m ³
Special Senses System				
Eye	(2)	(1)		(4)
Degeneration		1 (100%)		2 (50%)
Cornea, inflammation, chronic	1 (50%)			
Harderian gland	(47)	(48)	(49)	(48)
Hyperplasia	1 (2%)	1 (2%)	10 (20%)	1 (2%)
Urinary System				
Kidney	(50)	(50)	(49)	(48)
Cyst	1 (2%)			
Hydronephrosis	2 (4%)	3 (6%)	2 (4%)	3 (6%)
Infarct		1 (2%)		
Inflammation, chronic active	1 (2%)		1 (2%)	1 (2%)
Metaplasia, osseous		1 (2%)	4 (8%)	
Nephropathy	48 (96%)	49 (98%)	45 (92%)	47 (98%)
Capsule, inflammation		1 (2%)	2 (4%)	
Cortex, cyst	2 (4%)	4 (8%)		2 (4%)
Renal tubule, hyperplasia	2 (4%)		3 (6%)	1 (2%)
Renal tubule, necrosis			1 (2%)	
Urinary bladder	(49)	(50)	(46)	(46)
Inflammation	1 (2%)			2 (4%)
Transitional epithelium, hyperplasia	1 (2%)			

APPENDIX D
SUMMARY OF LESIONS IN FEMALE MICE
IN THE 2-YEAR INHALATION STUDY
OF GALLIUM ARSENIDE

TABLE D1	Summary of the Incidence of Neoplasms in Female Mice in the 2-Year Inhalation Study of Gallium Arsenide	208
TABLE D2	Individual Animal Tumor Pathology of Female Mice in the 2-Year Inhalation Study of Gallium Arsenide	212
TABLE D3	Statistical Analysis of Primary Neoplasms in Female Mice in the 2-Year Inhalation Study of Gallium Arsenide	234
TABLE D4	Historical Incidence of Alveolar/bronchiolar Neoplasms in Chamber Control Female B6C3F₁ Mice	238
TABLE D5	Summary of the Incidence of Nonneoplastic Lesions in Female Mice in the 2-Year Inhalation Study of Gallium Arsenide	239

TABLE D1
Summary of the Incidence of Neoplasms in Female Mice in the 2-Year Inhalation Study of Gallium Arsenide^a

	Chamber Control	0.1 mg/m ³	0.5 mg/m ³	1.0 mg/m ³
Disposition Summary				
Animals initially in study	50	50	50	50
Early deaths				
Accidental deaths		2	1	
Moribund	11	11	16	11
Natural deaths	3	3	2	10
Survivors				
Terminal sacrifice	36	34	31	29
Animals examined microscopically	50	50	50	50
Alimentary System				
Gallbladder	(47)	(45)	(45)	(41)
Intestine small, duodenum	(48)	(47)	(50)	(46)
Intestine small, jejunum	(48)	(47)	(49)	(43)
Carcinoma				1 (2%)
Polyp adenomatous		1 (2%)		
Liver	(50)	(50)	(50)	(50)
Hepatocellular carcinoma	8 (16%)	9 (18%)	4 (8%)	5 (10%)
Hepatocellular carcinoma, multiple	4 (8%)	2 (4%)		3 (6%)
Hepatocellular adenoma	9 (18%)	9 (18%)	12 (24%)	8 (16%)
Hepatocellular adenoma, multiple	2 (4%)	1 (2%)		2 (4%)
Hepatocholangiocarcinoma				2 (4%)
Hepatocholangiocarcinoma, multiple			1 (2%)	
Histiocytic sarcoma	1 (2%)			
Mesentery	(8)	(9)	(16)	(13)
Hemangiosarcoma			1 (6%)	
Hepatocholangiocarcinoma, metastatic, liver			1 (6%)	1 (8%)
Sarcoma, metastatic, skin	2 (25%)			1 (8%)
Teratoma malignant, metastatic, ovary			1 (6%)	
Pancreas	(50)	(50)	(50)	(49)
Sarcoma, metastatic, skin	2 (4%)			
Salivary glands	(50)	(50)	(50)	(50)
Stomach, forestomach	(49)	(50)	(50)	(49)
Squamous cell papilloma				3 (6%)
Cardiovascular System				
Heart	(50)	(50)	(50)	(50)
Hemangiosarcoma		1 (2%)		
Hepatocholangiocarcinoma, metastatic, liver				1 (2%)
Endocrine System				
Adrenal medulla	(50)	(49)	(50)	(49)
Pheochromocytoma benign			1 (2%)	1 (2%)
Islets, pancreatic	(50)	(50)	(50)	(48)
Adenoma	1 (2%)			
Pituitary gland	(46)	(48)	(50)	(47)
Pars distalis, adenoma	3 (7%)	7 (15%)	5 (10%)	7 (15%)
Pars distalis, carcinoma			1 (2%)	
Pars intermedia, adenoma			2 (4%)	
Pars intermedia, carcinoma			2 (4%)	

TABLE D1
Summary of the Incidence of Neoplasms in Female Mice in the 2-Year Inhalation Study of Gallium Arsenide

	Chamber Control	0.1 mg/m ³	0.5 mg/m ³	1.0 mg/m ³
Endocrine System (continued)				
Thyroid gland	(50)	(50)	(50)	(49)
Hepatocolangiocarcinoma, metastatic, liver				1 (2%)
C-cell, carcinoma	1 (2%)			
Follicular cell, adenoma	1 (2%)			2 (4%)
Follicular cell, carcinoma				2 (4%)
General Body System				
None				
Genital System				
Ovary	(49)	(50)	(50)	(46)
Cystadenoma	2 (4%)	1 (2%)	1 (2%)	3 (7%)
Sarcoma, metastatic, skin	1 (2%)			
Teratoma malignant			1 (2%)	
Thecoma benign			1 (2%)	
Tubulostromal adenoma	1 (2%)			
Uterus	(49)	(50)	(50)	(50)
Carcinoma	1 (2%)			
Hemangioma			1 (2%)	
Leiomyoma		1 (2%)		1 (2%)
Leiomyosarcoma	1 (2%)			
Polyp stromal	1 (2%)	2 (4%)	2 (4%)	2 (4%)
Sarcoma stromal			1 (2%)	
Hematopoietic System				
Bone marrow	(50)	(50)	(50)	(50)
Hemangiosarcoma	1 (2%)	1 (2%)		
Lymph node	(4)	(8)	(5)	(6)
Sarcoma, metastatic, skin	1 (25%)			1 (17%)
Teratoma malignant, metastatic, ovary			1 (20%)	
Pancreatic, hepatocolangiocarcinoma, metastatic, liver				1 (17%)
Lymph node, bronchial	(39)	(43)	(42)	(42)
Hepatocolangiocarcinoma, metastatic, liver			1 (2%)	
Histiocytic sarcoma	1 (3%)			
Lymph node, mandibular	(35)	(37)	(43)	(43)
Lymph node, mesenteric	(49)	(49)	(50)	(47)
Hemangiosarcoma			1 (2%)	
Hepatocolangiocarcinoma, metastatic, liver			1 (2%)	
Histiocytic sarcoma	1 (2%)			
Sarcoma, metastatic, skin	1 (2%)			
Lymph node, mediastinal	(40)	(43)	(49)	(45)
Carcinoma, metastatic, harderian gland	1 (3%)			
Hepatocolangiocarcinoma, metastatic, liver			1 (2%)	2 (4%)
Sarcoma, metastatic, skin	1 (3%)			
Spleen	(50)	(50)	(50)	(49)
Hemangiosarcoma		2 (4%)	2 (4%)	
Histiocytic sarcoma	1 (2%)			
Thymus	(43)	(47)	(43)	(44)
Hepatocolangiocarcinoma, metastatic, liver				1 (2%)

TABLE D1
Summary of the Incidence of Neoplasms in Female Mice in the 2-Year Inhalation Study of Gallium Arsenide

	Chamber Control	0.1 mg/m ³	0.5 mg/m ³	1.0 mg/m ³
Integumentary System				
Mammary gland	(50)	(50)	(50)	(49)
Carcinoma	1 (2%)	1 (2%)	1 (2%)	2 (4%)
Skin	(50)	(50)	(50)	(50)
Subcutaneous tissue, carcinoma			1 (2%)	
Subcutaneous tissue, hemangioma			1 (2%)	
Subcutaneous tissue, sarcoma	4 (8%)	4 (8%)	2 (4%)	4 (8%)
Subcutaneous tissue, schwannoma benign			1 (2%)	
Musculoskeletal System				
Bone	(50)	(50)	(50)	(50)
Hemangiosarcoma	1 (2%)			
Skeletal muscle	(1)	(2)	(1)	(1)
Carcinoma, metastatic, harderian gland	1 (100%)			
Hemangiosarcoma			1 (100%)	
Hepatocolangiocarcinoma, metastatic, liver				1 (100%)
Nervous System				
Brain	(50)	(50)	(50)	(50)
Carcinoma, metastatic, pituitary gland			3 (6%)	
Oligodendroglioma benign				1 (2%)
Respiratory System				
Larynx	(50)	(50)	(50)	(50)
Lung	(50)	(50)	(50)	(50)
Alveolar/bronchiolar adenoma	6 (12%)	4 (8%)	1 (2%)	3 (6%)
Alveolar/bronchiolar carcinoma	1 (2%)		3 (6%)	2 (4%)
Alveolar/bronchiolar carcinoma, multiple				1 (2%)
Carcinoma, metastatic, harderian gland	2 (4%)			
Hepatocellular carcinoma, metastatic, liver	4 (8%)	3 (6%)	2 (4%)	3 (6%)
Hepatocellular carcinoma, metastatic, lung				1 (2%)
Hepatocolangiocarcinoma, metastatic, liver			1 (2%)	2 (4%)
Sarcoma, metastatic, skin				1 (2%)
Teratoma malignant, metastatic, ovary			1 (2%)	
Mediastinum, carcinoma, metastatic, harderian gland	1 (2%)			
Mediastinum, hemangioma			1 (2%)	
Mediastinum, hepatocolangiocarcinoma, metastatic, liver			1 (2%)	1 (2%)
Mediastinum, sarcoma, metastatic, skin	1 (2%)			
Special Senses System				
Harderian gland	(5)	(4)	(3)	(2)
Adenoma	2 (40%)	3 (75%)	2 (67%)	2 (100%)
Carcinoma	3 (60%)	1 (25%)	1 (33%)	

TABLE D1
Summary of the Incidence of Neoplasms in Female Mice in the 2-Year Inhalation Study of Gallium Arsenide

	Chamber Control	0.1 mg/m ³	0.5 mg/m ³	1.0 mg/m ³
Urinary System				
Kidney	(50)	(50)	(50)	(50)
Hepatocolangiocarcinoma, metastatic, liver			1 (2%)	1 (2%)
Teratoma malignant, metastatic, ovary			1 (2%)	
Urinary bladder	(48)	(48)	(50)	(48)
Hemangioma		1 (2%)		
Systemic Lesions				
Multiple organs ^b	(50)	(50)	(50)	(50)
Histiocytic sarcoma	1 (2%)			
Lymphoma malignant	3 (6%)	8 (16%)	11 (22%)	10 (20%)
Neoplasm Summary				
Total animals with primary neoplasms ^c	36	36	40	39
Total primary neoplasms	58	59	65	67
Total animals with benign neoplasms	22	24	26	22
Total benign neoplasms	28	30	31	35
Total animals with malignant neoplasms	26	23	26	26
Total malignant neoplasms	30	29	34	32
Total animals with metastatic neoplasms	9	3	6	7
Total metastatic neoplasms	18	3	16	19

^a Number of animals examined microscopically at the site and the number of animals with neoplasm

^b Number of animals with any tissue examined microscopically

^c Primary neoplasms: all neoplasms except metastatic neoplasms

**TABLE D2
Individual Animal Tumor Pathology of Female Mice in the 2-Year Inhalation Study of Gallium Arsenide:
Chamber Control**

Number of Days on Study	2	4	5	5	6	6	6	6	6	6	6	7	7	7	7	7	7	7	7	7	7	7	7	7	7	7	7	7	7	7	7	7	7	7	7	7		
	3	3	3	5	1	3	3	4	5	8	9	0	2	2	3	3	3	3	3	3	3	3	3	3	3	3	3	3	3	3	3	3	3	3	3	3		
	7	9	3	3	7	3	9	5	9	4	4	7	9	9	5	5	5	5	5	5	5	5	5	5	5	5	5	5	5	5	5	5	5	5	5	6		
Carcass ID Number	1	1	1	1	1	1	1	1	1	1	1	1	1	1	1	1	1	1	1	1	1	1	1	1	1	1	1	1	1	1	1	1	1	1	1	1		
	2	4	0	0	4	3	0	2	4	2	1	3	0	2	0	0	1	2	2	2	4	4	4	4	5	0												
	8	2	4	7	6	7	3	5	4	7	9	0	5	1	6	8	1	0	3	4	0	3	7	0	1													
Alimentary System																																						
Esophagus	+	+	+	+	+	+	+	+	+	+	+	+	+	+	+	+	+	+	+	+	+	+	+	+	+	+	+	+	+	+	+	+	+	+	+	+	+	
Gallbladder	A	A	+	+	+	A	+	+	+	+	+	+	+	+	+	+	+	+	+	+	+	+	+	+	+	+	+	+	+	+	+	+	+	+	+	+	+	
Intestine large, colon	M	+	+	+	+	+	+	+	+	+	+	+	M	+	+	+	+	+	+	+	+	+	+	+	+	+	+	+	+	+	+	+	+	+	+	+	+	
Intestine large, rectum	A	+	+	+	+	A	+	+	+	+	+	+	+	+	+	M	+	+	+	+	+	+	+	+	+	+	+	+	+	+	+	+	+	+	+	+	+	
Intestine large, cecum	A	+	+	+	+	A	+	+	+	+	+	+	+	+	+	+	+	+	+	+	+	+	+	+	+	+	+	+	+	+	+	+	+	+	+	+	+	
Intestine small, duodenum	A	+	+	+	+	A	+	+	+	+	+	+	+	+	+	+	+	+	+	+	+	+	+	+	+	+	+	+	+	+	+	+	+	+	+	+	+	
Intestine small, jejunum	A	+	+	+	+	A	+	+	+	+	+	+	+	+	+	+	+	+	+	+	+	+	+	+	+	+	+	+	+	+	+	+	+	+	+	+	+	
Intestine small, ileum	A	+	+	+	+	A	+	+	+	+	+	+	+	+	+	+	+	+	+	+	+	+	+	+	+	+	+	+	+	+	+	+	+	+	+	+	+	
Liver	+	+	+	+	+	+	+	+	+	+	+	+	+	+	+	+	+	+	+	+	+	+	+	+	+	+	+	+	+	+	+	+	+	+	+	+	+	
Hepatocellular carcinoma						X								X																						X		
Hepatocellular carcinoma, multiple								X					X		X																							
Hepatocellular adenoma																																					X	
Hepatocellular adenoma, multiple																																						
Histiocytic sarcoma			X																																			
Mesentery			+				+						+		+																							
Sarcoma, metastatic, skin			X																																			
Pancreas	+	+	+	+	+	+	+	+	+	+	+	+	+	+	+	+	+	+	+	+	+	+	+	+	+	+	+	+	+	+	+	+	+	+	+	+	+	
Sarcoma, metastatic, skin												X		X																								
Salivary glands	+	+	+	+	+	+	+	+	+	+	+	+	+	+	+	+	+	+	+	+	+	+	+	+	+	+	+	+	+	+	+	+	+	+	+	+	+	
Stomach, forestomach	A	+	+	+	+	+	+	+	+	+	+	+	+	+	+	+	+	+	+	+	+	+	+	+	+	+	+	+	+	+	+	+	+	+	+	+	+	
Stomach, glandular	A	+	+	+	+	+	+	+	+	+	+	+	+	+	+	+	+	+	+	+	+	+	+	+	+	+	+	+	+	+	+	+	+	+	+	+	+	
Cardiovascular System																																						
Heart	+	+	+	+	+	+	+	+	+	+	+	+	+	+	+	+	+	+	+	+	+	+	+	+	+	+	+	+	+	+	+	+	+	+	+	+	+	
Endocrine System																																						
Adrenal cortex	+	+	+	+	+	+	+	+	+	+	+	+	+	+	+	+	+	+	+	+	+	+	+	+	+	+	+	+	+	+	+	+	+	+	+	+	+	
Adrenal medulla	+	+	+	+	+	+	+	+	+	+	+	+	+	+	+	+	+	+	+	+	+	+	+	+	+	+	+	+	+	+	+	+	+	+	+	+	+	
Islets, pancreatic	+	+	+	+	+	+	+	+	+	+	+	+	+	+	+	+	+	+	+	+	+	+	+	+	+	+	+	+	+	+	+	+	+	+	+	+	+	
Adenoma																X																						
Parathyroid gland	+	M	+	M	+	+	M	+	+	+	+	+	M	+	+	+	+	M	+	+	+	+	M	+	+	+	+	M	+	+	+	+	+	+	+	+	+	
Pituitary gland	M	+	+	+	+	+	+	+	+	+	+	+	+	+	+	+	+	+	+	+	+	+	+	+	+	+	+	+	+	+	+	+	+	+	+	+	+	+
Pars distalis, adenoma																X	X																					
Thyroid gland	+	+	+	+	+	+	+	+	+	+	+	+	+	+	+	+	+	+	+	+	+	+	+	+	+	+	+	+	+	+	+	+	+	+	+	+	+	+
C-cell, carcinoma																																						
Follicular cell, adenoma																																					X	
General Body System																																						
None																																						
Genital System																																						
Clitoral gland	M	+	+	+	+	M	+	M	+	M	M	+	+	M	+	M	+	+	+	+	+	+	+	+	+	+	+	+	+	+	+	+	+	+	+	+		
Ovary	A	+	+	+	+	+	+	+	+	+	+	+	+	+	+	+	+	+	+	+	+	+	+	+	+	+	+	+	+	+	+	+	+	+	+	+	+	
Cystadenoma							X																															
Sarcoma, metastatic, skin																																						X
Tubulostromal adenoma																																						

+ : Tissue examined microscopically
A : Autolysis precludes examination

M : Missing tissue
I : Insufficient tissue

X : Lesion present
Blank : Not examined

TABLE D2
Individual Animal Tumor Pathology of Female Mice in the 2-Year Inhalation Study of Gallium Arsenide:
Chamber Control

Number of Days on Study	7 7	
	3 3	
	6 6 6 6 6 6 6 6 6 6 6 6 6 6 6 6 7 7 7 7 7 7 7 7	
Carcass ID Number	1 1	Total
	0 0 1 1 1 2 2 2 3 3 3 4 4 4 4 1 1 1 1 1 3 3 3 3 3	Tissues/
	2 9 0 2 3 2 6 9 2 3 5 1 5 8 9 4 5 6 7 8 1 4 6 8 9	Tumors
Special Senses System		
Eye		1
Harderian gland	+ +	5
Adenoma		2
Carcinoma	X X	3
Urinary System		
Kidney	+ +	50
Urinary bladder	+ +	48
Systemic Lesions		
Multiple organs	+ +	50
Histiocytic sarcoma		1
Lymphoma malignant	X	3

TABLE D2
Individual Animal Tumor Pathology of Female Mice in the 2-Year Inhalation Study of Gallium Arsenide: 0.1 mg/m³

Number of Days on Study	7 7	3 3	5 6 6 6 6 6 6 6 6 6 6 6 6 6 6 6 7 7 7 7 7 7 7	
Carcass ID Number	7 7	5 0 0 0 0 0 0 1 1 2 2 2 4 4 4 4 0 1 2 3 3 4 4 4 4	0 1 2 3 5 8 9 0 4 2 4 9 1 2 3 9 4 1 7 3 7 4 4 5 6 8	
				Total Tissues/ Tumors
Alimentary System				
Esophagus	+ +			50
Gallbladder	+ +			45
Intestine large, colon	+ +			50
Intestine large, rectum	+ + + + + + + + + + + + + + + M + + + + + + + + + + +			48
Intestine large, cecum	+ +			49
Intestine small, duodenum	+ +			47
Intestine small, jejunum	+ +			47
Polyp adenomatous				1
Intestine small, ileum	+ +			47
Liver	+ +			50
Hepatocellular carcinoma	X X X			9
Hepatocellular carcinoma, multiple				2
Hepatocellular adenoma	X			9
Hepatocellular adenoma, multiple	X X X X			1
Mesentery	+			9
Pancreas	+ +			50
Salivary glands	+ +			50
Stomach, forestomach	+ +			50
Stomach, glandular	+ +			50
Cardiovascular System				
Heart	+ +			50
Hemangiosarcoma				1
Endocrine System				
Adrenal cortex	+ +			50
Adrenal medulla	+ +			49
Islets, pancreatic	+ +			50
Parathyroid gland	+ + + + M + M + + + + + + + + + + + + + M + + M +			40
Pituitary gland	+ +			48
Pars distalis, adenoma	X X X X X			7
Thyroid gland	+ +			50
General Body System				
None				
Genital System				
Clitoral gland	+ + + + M + + + M + M + + + + M + + + M + + + + +			42
Ovary	+ +			50
Cystadenoma	X			1
Uterus	+ +			50
Leiomyoma	X			1
Polyp stromal	X			2
Hematopoietic System				
Bone marrow	+ +			50
Hemangiosarcoma				1
Lymph node	+			8
Lymph node, bronchial	+ + + M + + + + + + + + + + + + + + + + + M + + +			43
Lymph node, mandibular	M + + M M + + M + + + + + M + + M + M + + + + + +			37
Lymph node, mesenteric	+ +			49
Lymph node, mediastinal	+ + + + + + + + + + + + + + + + + M M + + + + + + +			43

TABLE D2
Individual Animal Tumor Pathology of Female Mice in the 2-Year Inhalation Study of Gallium Arsenide: 0.5 mg/m³

Number of Days on Study	7 7 7 7 7 7 7 7 7 7 7 7 7 7 7 7 7 7 7 7																				Total Tissues/ Tumors
	3 5 5 5 6 6 6 6 6 6 6 6 6 6 6 6 6 6 6 7 7 7 7																				
Carcass ID Number	5 5 5 5 5 5 5 5 5 5 5 5 5 5 5 5 5 5 5 5																				Total Tissues/ Tumors
	4 4 4 0 0 0 0 1 1 1 1 2 2 3 3 3 4 4 4 5 0 1 1 3 3																				
	3 4 9 3 4 6 7 1 3 6 9 3 5 2 3 4 0 2 6 0 8 5 7 7 8																				
Hematopoietic System																					
Bone marrow	+																				50
Lymph node	+																				5
Teratoma malignant, metastatic, ovary																					1
Lymph node, bronchial	+																				42
Hepatocolangiocarcinoma, metastatic, liver																					1
Lymph node, mandibular	+ + + + M + + M + + + + + + M + + + + + M + + +																				43
Lymph node, mesenteric	+																				50
Hemangiosarcoma																					1
Hepatocolangiocarcinoma, metastatic, liver																					1
Lymph node, mediastinal	+																				49
Hepatocolangiocarcinoma, metastatic, liver																					1
Spleen	+																				50
Hemangiosarcoma																					2
Thymus	+																				43
Integumentary System																					
Mammary gland	+																				50
Carcinoma																					1
Skin	+																				50
Subcutaneous tissue, carcinoma																					1
Subcutaneous tissue, hemangioma																					1
Subcutaneous tissue, sarcoma																					2
Subcutaneous tissue, schwannoma benign	X																				1
Musculoskeletal System																					
Bone	+																				50
Skeletal muscle																					1
Hemangiosarcoma																					1
Nervous System																					
Brain	+																				50
Carcinoma, metastatic, pituitary gland																					3
Spinal cord	+																				1
Respiratory System																					
Larynx	+																				50
Lung	+																				50
Alveolar/bronchiolar adenoma																					1
Alveolar/bronchiolar carcinoma	X																				3
Hepatocellular carcinoma, metastatic, liver																					2
Hepatocolangiocarcinoma, metastatic, liver																					1
Teratoma malignant, metastatic, ovary																					1
Mediastinum, hemangioma																					1
Mediastinum, hepatocolangiocarcinoma, metastatic, liver																					1
Nose	+																				50
Trachea	+																				50

TABLE D2
Individual Animal Tumor Pathology of Female Mice in the 2-Year Inhalation Study of Gallium Arsenide: 0.5 mg/m³

Number of Days on Study	7 7	
	3 3	
	5 5 5 6 6 6 6 6 6 6 6 6 6 6 6 6 6 6 6 6 7 7 7 7	
Carcass ID Number	5 5	Total
	4 4 4 0 0 0 0 1 1 1 1 2 2 3 3 3 3 4 4 4 5 0 1 1 3 3	Tissues/
	3 4 9 3 4 6 7 1 3 6 9 3 5 2 3 4 0 2 6 0 8 5 7 7 8	Tumors
Special Senses System		
Eye		2
Harderian gland		3
Adenoma		2
Carcinoma		1
Urinary System		
Kidney		50
Hepatocholangiocarcinoma, metastatic, liver		1
Teratoma malignant, metastatic, ovary		1
Urinary bladder		50
Systemic Lesions		
Multiple organs		50
Lymphoma malignant		11

TABLE D2 Individual Animal Tumor Pathology of Female Mice in the 2-Year Inhalation Study of Gallium Arsenide: 1.0 mg/m³

Table with columns for 'Number of Days on Study' and 'Carcass ID Number', followed by sections for 'Alimentary System', 'Cardiovascular System', 'Endocrine System', 'General Body System', and 'Genital System'. Each section lists various organs and tumor types with corresponding symbols (+, A, M, X) indicating findings.

TABLE D2

Individual Animal Tumor Pathology of Female Mice in the 2-Year Inhalation Study of Gallium Arsenide: 1.0 mg/m³

Number of Days on Study	3	4	4	4	4	5	5	5	6	6	6	6	6	6	7	7	7	7	7	7	7	7	7	7	7	7	7	7	7	7	7	7	7	7	7	7	7	
	6	1	6	9	9	0	2	9	2	4	4	5	7	8	0	0	1	1	1	2	2	3	3	3	3	3	3	3	3	3	3	3	3	3	3	3	3	
	5	2	4	0	7	5	9	5	8	6	6	9	3	2	2	7	0	4	7	2	9	5	5	5	5													
Carcass ID Number	3	3	3	3	3	3	3	3	3	3	3	3	3	3	3	3	3	3	3	3	3	3	3	3	3	3	3	3	3	3	3	3	3	3	3	3	3	
	0	2	1	4	0	0	1	4	0	0	4	1	1	1	3	3	1	4	3	2	2	1	1	2	2													
	8	7	6	9	6	5	4	2	4	3	7	8	1	5	9	0	7	5	2	9	0	0	2	3	6													
Special Senses System																																						
Eye																																						
Harderian gland																																						
Adenoma																																						
Urinary System																																						
Kidney																																						
Hepatocolangiocarcinoma, metastatic, liver																																						
Urinary bladder																																						
Systemic Lesions																																						
Multiple organs																																						
Lymphoma malignant																																						

TABLE D3
Statistical Analysis of Primary Neoplasms in Female Mice in the 2-Year Inhalation Study of Gallium Arsenide

	Chamber Control	0.1 mg/m ³	0.5 mg/m ³	1.0 mg/m ³
Harderian Gland: Adenoma				
Overall rate ^a	2/50 (4%)	3/50 (6%)	2/50 (4%)	2/50 (4%)
Adjusted rate ^b	4.4%	6.6%	4.9%	4.8%
Terminal rate ^c	1/36 (3%)	2/34 (6%)	1/31 (3%)	2/29 (7%)
First incidence (days)	633	659	643	735 (T)
Poly-3 test ^d	P=0.524N	P=0.504	P=0.658	P=0.668
Harderian Gland: Carcinoma				
Overall rate	3/50 (6%)	1/50 (2%)	1/50 (2%)	0/50 (0%)
Adjusted rate	6.6%	2.2%	2.5%	0.0%
Terminal rate	2/36 (6%)	1/34 (3%)	1/31 (3%)	0/29 (0%)
First incidence (days)	617	735 (T)	735 (T)	— ^e
Poly-3 test	P=0.105N	P=0.305N	P=0.345N	P=0.132N
Harderian Gland: Adenoma or Carcinoma				
Overall rate	5/50 (10%)	4/50 (8%)	3/50 (6%)	2/50 (4%)
Adjusted rate	11.0%	8.8%	7.3%	4.8%
Terminal rate	3/36 (8%)	3/34 (9%)	2/31 (7%)	2/29 (7%)
First incidence (days)	617	659	643	735 (T)
Poly-3 test	P=0.189N	P=0.500N	P=0.417N	P=0.250N
Liver: Hepatocellular Adenoma				
Overall rate	11/50 (22%)	10/50 (20%)	12/50 (24%)	10/50 (20%)
Adjusted rate	24.5%	22.0%	29.3%	23.3%
Terminal rate	11/36 (31%)	9/34 (27%)	10/31 (32%)	8/29 (28%)
First incidence (days)	735 (T)	715	629	505
Poly-3 test	P=0.503	P=0.487N	P=0.400	P=0.547N
Liver: Hepatocellular Carcinoma				
Overall rate	12/50 (24%)	11/50 (22%)	4/50 (8%)	8/50 (16%)
Adjusted rate	26.3%	23.7%	9.7%	18.6%
Terminal rate	8/36 (22%)	5/34 (15%)	2/31 (7%)	2/29 (7%)
First incidence (days)	633	659	629	628
Poly-3 test	P=0.140N	P=0.479N	P=0.040N	P=0.269N
Liver: Hepatocellular Adenoma or Carcinoma				
Overall rate	21/50 (42%)	19/50 (38%)	14/50 (28%)	18/50 (36%)
Adjusted rate	46.1%	40.8%	33.9%	41.1%
Terminal rate	17/36 (47%)	12/34 (35%)	11/31 (36%)	10/29 (35%)
First incidence (days)	633	659	629	505
Poly-3 test	P=0.357N	P=0.383N	P=0.172N	P=0.395N
Lung: Alveolar/bronchiolar Adenoma				
Overall rate	6/50 (12%)	4/50 (8%)	1/50 (2%)	3/50 (6%)
Adjusted rate	13.3%	8.8%	2.5%	7.1%
Terminal rate	4/36 (11%)	4/34 (12%)	1/31 (3%)	2/29 (7%)
First incidence (days)	617	735 (T)	735 (T)	595
Poly-3 test	P=0.179N	P=0.369N	P=0.075N	P=0.273N

TABLE D3
Statistical Analysis of Primary Neoplasms in Female Mice in the 2-Year Inhalation Study of Gallium Arsenide

	Chamber Control	0.1 mg/m ³	0.5 mg/m ³	1.0 mg/m ³
Lung: Alveolar/bronchiolar Carcinoma				
Overall rate	1/50 (2%)	0/50 (0%)	3/50 (6%)	3/50 (6%)
Adjusted rate	2.2%	0.0%	7.3%	6.9%
Terminal rate	1/36 (3%)	0/34 (0%)	2/31 (7%)	1/29 (3%)
First incidence (days)	735 (T)	—	659	365
Poly-3 test	P=0.071	P=0.498N	P=0.273	P=0.295
Lung: Alveolar/bronchiolar Adenoma or Carcinoma				
Overall rate	7/50 (14%)	4/50 (8%)	4/50 (8%)	6/50 (12%)
Adjusted rate	15.5%	8.8%	9.8%	13.6%
Terminal rate	5/36 (14%)	4/34 (12%)	3/31 (10%)	3/29 (10%)
First incidence (days)	617	735 (T)	659	365
Poly-3 test	P=0.527	P=0.260N	P=0.322N	P=0.520N
Ovary: Cystadenoma				
Overall rate	2/49 (4%)	1/50 (2%)	1/50 (2%)	3/46 (7%)
Adjusted rate	4.4%	2.2%	2.5%	7.6%
Terminal rate	1/36 (3%)	1/34 (3%)	1/31 (3%)	1/28 (4%)
First incidence (days)	639	735 (T)	735 (T)	505
Poly-3 test	P=0.245	P=0.499N	P=0.537N	P=0.442
Pituitary Gland (Pars Distalis): Adenoma				
Overall rate	3/46 (7%)	7/48 (15%)	5/50 (10%)	7/47 (15%)
Adjusted rate	7.2%	16.1%	12.1%	17.7%
Terminal rate	1/33 (3%)	6/34 (18%)	3/31 (10%)	6/29 (21%)
First incidence (days)	729	701	483	646
Poly-3 test	P=0.204	P=0.173	P=0.350	P=0.133
Pituitary Gland (Pars Distalis): Adenoma or Carcinoma				
Overall rate	3/46 (7%)	7/48 (15%)	6/50 (12%)	7/47 (15%)
Adjusted rate	7.2%	16.1%	14.5%	17.7%
Terminal rate	1/33 (3%)	6/34 (18%)	4/31 (13%)	6/29 (21%)
First incidence (days)	729	701	483	646
Poly-3 test	P=0.189	P=0.173	P=0.235	P=0.133
Pituitary Gland (Pars Intermedia): Adenoma or Carcinoma				
Overall rate	0/46 (0%)	0/48 (0%)	4/50 (8%)	0/47 (0%)
Adjusted rate	0.0%	0.0%	9.5%	0.0%
Terminal rate	0/33 (0%)	0/34 (0%)	1/31 (3%)	0/29 (0%)
First incidence (days)	—	—	365	—
Poly-3 test	P=0.370	— ^f	P=0.061	—
Skin (Subcutaneous Tissue): Sarcoma				
Overall rate	4/50 (8%)	4/50 (8%)	2/50 (4%)	4/50 (8%)
Adjusted rate	8.7%	8.8%	4.8%	9.2%
Terminal rate	0/36 (0%)	4/34 (12%)	0/31 (0%)	0/29 (0%)
First incidence (days)	533	735 (T)	365	412
Poly-3 test	P=0.550N	P=0.636	P=0.385N	P=0.614

TABLE D3
Statistical Analysis of Primary Neoplasms in Female Mice in the 2-Year Inhalation Study of Gallium Arsenide

	Chamber Control	0.1 mg/m ³	0.5 mg/m ³	1.0 mg/m ³
Stomach (Forestomach): Squamous Cell Papilloma				
Overall rate	0/50 (0%)	0/50 (0%)	0/50 (0%)	3/50 (6%)
Adjusted rate	0.0%	0.0%	0.0%	7.1%
Terminal rate	0/36 (0%)	0/34 (0%)	0/31 (0%)	3/29 (10%)
First incidence (days)	—	—	—	735 (T)
Poly-3 test	P=0.009	—	—	P=0.108
Thyroid Gland (Follicular Cell): Adenoma or Carcinoma				
Overall rate	1/50 (2%)	0/50 (0%)	0/50 (0%)	4/49 (8%)
Adjusted rate	2.2%	0.0%	0.0%	9.6%
Terminal rate	1/36 (3%)	0/34 (0%)	0/31 (0%)	2/28 (7%)
First incidence (days)	735 (T)	—	—	628
Poly-3 test	P=0.016	P=0.498N	P=0.520N	P=0.156
Uterus: Stromal Polyp or Stromal Sarcoma				
Overall rate	1/50 (2%)	2/50 (4%)	3/50 (6%)	2/50 (4%)
Adjusted rate	2.2%	4.4%	7.2%	4.8%
Terminal rate	1/36 (3%)	2/34 (6%)	1/31 (3%)	2/29 (7%)
First incidence (days)	735 (T)	735 (T)	560	735 (T)
Poly-3 test	P=0.370	P=0.504	P=0.278	P=0.478
All Organs: Hemangiosarcoma				
Overall rate	1/50 (2%)	2/50 (4%)	3/50 (6%)	0/50 (0%)
Adjusted rate	2.2%	4.4%	7.3%	0.0%
Terminal rate	1/36 (3%)	1/34 (3%)	2/31 (7%)	0/29 (0%)
First incidence (days)	735 (T)	672	629	—
Poly-3 test	P=0.351N	P=0.505	P=0.273	P=0.513N
All Organs: Hemangioma or Hemangiosarcoma				
Overall rate	1/50 (2%)	3/50 (6%)	5/50 (10%)	0/50 (0%)
Adjusted rate	2.2%	6.6%	12.2%	0.0%
Terminal rate	1/36 (3%)	2/34 (6%)	4/31 (13%)	0/29 (0%)
First incidence (days)	735 (T)	672	629	—
Poly-3 test	P=0.359N	P=0.311	P=0.081	P=0.513N
All Organs: Malignant Lymphoma				
Overall rate	3/50 (6%)	8/50 (16%)	11/50 (22%)	10/50 (20%)
Adjusted rate	6.6%	17.2%	26.6%	23.1%
Terminal rate	1/36 (3%)	4/34 (12%)	9/31 (29%)	4/29 (14%)
First incidence (days)	639	533	581	595
Poly-3 test	P=0.035	P=0.105	P=0.011	P=0.027
All Organs: Benign Neoplasms				
Overall rate	22/50 (44%)	24/50 (48%)	26/50 (52%)	22/50 (44%)
Adjusted rate	47.7%	52.4%	60.6%	49.7%
Terminal rate	16/36 (44%)	21/34 (62%)	19/31 (61%)	17/29 (59%)
First incidence (days)	617	659	483	505
Poly-3 test	P=0.461	P=0.404	P=0.154	P=0.510

TABLE D3
Statistical Analysis of Primary Neoplasms in Female Mice in the 2-Year Inhalation Study of Gallium Arsenide

	Chamber Control	0.1 mg/m ³	0.5 mg/m ³	1.0 mg/m ³
All Organs: Malignant Neoplasms				
Overall rate	26/50 (52%)	23/50 (46%)	26/50 (52%)	26/50 (52%)
Adjusted rate	53.8%	48.1%	56.9%	54.2%
Terminal rate	15/36 (42%)	12/34 (35%)	16/31 (52%)	8/29 (28%)
First incidence (days)	439	533	281	365
Poly-3 test	P=0.380	P=0.362N	P=0.460	P=0.563
All Organs: Benign or Malignant Neoplasms				
Overall rate	36/50 (72%)	36/50 (72%)	40/50 (80%)	39/50 (78%)
Adjusted rate	74.3%	75.1%	84.5%	80.3%
Terminal rate	24/36 (67%)	24/34 (71%)	26/31 (84%)	20/29 (69%)
First incidence (days)	439	533	281	365
Poly-3 test	P=0.202	P=0.555	P=0.158	P=0.320

(T)Terminal sacrifice

^a Number of neoplasm-bearing animals/number of animals examined. Denominator is number of animals examined microscopically for liver, lung, ovary, pituitary gland, and thyroid gland; for other tissues, denominator is number of animals necropsied.

^b Poly-3 estimated neoplasm incidence after adjustment for intercurrent mortality

^c Observed incidence at terminal kill

^d Beneath the chamber control incidence are the P values associated with the trend test. Beneath the exposed group incidence are the P values corresponding to pairwise comparisons between the chamber controls and that exposed group. The Poly-3 test accounts for differential mortality in animals that do not reach terminal sacrifice. A negative trend or a lower incidence in an exposure group is indicated by N.

^e Not applicable; no neoplasms in animal group

^f Value of statistic cannot be computed.

TABLE D4
Historical Incidence of Alveolar/bronchiolar Neoplasms in Chamber Control Female B6C3F₁ Mice^a

Study	Incidence in Controls		
	Adenoma	Carcinoma	Adenoma or Carcinoma
Historical Incidence at Battelle Pacific Northwest Laboratories			
1,3-Butadiene	4/50	0/50	4/50
2-Butoxyethanol	7/50	0/50	7/50
Acetonitrile	7/49	1/49	8/49
Chloroprene	2/50	2/50	4/50
Cobalt sulfate heptahydrate	3/50	1/50	4/50
Furfuryl alcohol	2/50	4/50	6/50
Glutaraldehyde	2/50	1/50	3/50
Hexachlorocyclopentadiene	4/48	3/48	7/48
Isobutene	2/49	4/49	6/49
Isobutyraldehyde	0/50	3/50	3/50
Molybdenum trioxide	1/50	2/50	3/50
Nitromethane	3/50	0/50	3/50
Ozone	4/50	2/50	6/50
Tetrahydrofuran	1/50	1/50	2/50
Overall Historical Incidence			
Total (%)	61/1,025 (6.0%)	42/1,025 (4.1%)	102/1,025 (10.0%)
Mean ± standard deviation	6.0% ± 3.6%	4.0% ± 3.3%	9.9% ± 3.6%
Range	0%-14%	0%-12%	4%-16%

^a Data as of 3 November 1998

TABLE D5
Summary of the Incidence of Nonneoplastic Lesions in Female Mice in the 2-Year Inhalation Study of Gallium Arsenide^a

	Chamber Control	0.1 mg/m ³	0.5 mg/m ³	1.0 mg/m ³
Disposition Summary				
Animals initially in study	50	50	50	50
Early deaths				
Accidental deaths		2	1	
Moribund	11	11	16	11
Natural deaths	3	3	2	10
Survivors				
Terminal sacrifice	36	34	31	29
Animals examined microscopically	50	50	50	50
Alimentary System				
Esophagus	(50)	(50)	(49)	(50)
Inflammation, suppurative		1 (2%)		
Gallbladder	(47)	(45)	(45)	(41)
Degeneration, hyaline		1 (2%)		
Epithelium, hyperplasia	1 (2%)			
Intestine large, cecum	(48)	(49)	(50)	(46)
Hemorrhage		1 (2%)		
Infiltration cellular, mast cell			1 (2%)	
Intestine small, jejunum	(48)	(47)	(49)	(43)
Peyer's patch, hyperplasia	2 (4%)	1 (2%)		
Intestine small, ileum	(48)	(47)	(49)	(45)
Hemorrhage		1 (2%)		
Inflammation		1 (2%)	1 (2%)	
Peyer's patch, hyperplasia	1 (2%)		2 (4%)	1 (2%)
Liver	(50)	(50)	(50)	(50)
Angiectasis				1 (2%)
Clear cell focus			1 (2%)	
Clear cell focus, multiple	1 (2%)			
Degeneration, fatty	1 (2%)	1 (2%)	1 (2%)	1 (2%)
Eosinophilic focus	3 (6%)	13 (26%)	10 (20%)	10 (20%)
Eosinophilic focus, multiple	2 (4%)	2 (4%)	1 (2%)	4 (8%)
Hematopoietic cell proliferation	3 (6%)	4 (8%)	5 (10%)	5 (10%)
Hemorrhage		1 (2%)		
Hyperplasia, lymphoid	1 (2%)	3 (6%)	1 (2%)	
Inflammation	3 (6%)	1 (2%)	1 (2%)	
Necrosis	3 (6%)	4 (8%)	7 (14%)	5 (10%)
Pigmentation, hemosiderin	1 (2%)			
Bile duct, cyst	1 (2%)			
Bile duct, degeneration, hyaline	1 (2%)			
Oval cell, hyperplasia	1 (2%)	1 (2%)		
Serosa, inflammation				1 (2%)
Mesentery	(8)	(9)	(16)	(13)
Hemorrhage	1 (13%)			1 (8%)
Inflammation, chronic	1 (13%)			1 (8%)
Inflammation, suppurative			2 (13%)	
Fat, necrosis	4 (50%)	9 (100%)	13 (81%)	11 (85%)
Pancreas	(50)	(50)	(50)	(49)
Atrophy	5 (10%)	10 (20%)	11 (22%)	2 (4%)
Cytoplasmic alteration	1 (2%)	1 (2%)	2 (4%)	1 (2%)
Hyperplasia, lymphoid			1 (2%)	
Duct, cyst		2 (4%)	2 (4%)	

^a Number of animals examined microscopically at the site and the number of animals with lesion

TABLE D5
Summary of the Incidence of Nonneoplastic Lesions in Female Mice in the 2-Year Inhalation Study of Gallium Arsenide

	Chamber Control	0.1 mg/m ³	0.5 mg/m ³	1.0 mg/m ³
Alimentary System (continued)				
Stomach, forestomach	(49)	(50)	(50)	(49)
Hemorrhage	1 (2%)			
Ulcer	1 (2%)	1 (2%)		2 (4%)
Epithelium, hyperplasia	2 (4%)	6 (12%)	1 (2%)	2 (4%)
Stomach, glandular	(49)	(50)	(50)	(48)
Inflammation, suppurative		2 (4%)		
Ulcer		1 (2%)	1 (2%)	
Cardiovascular System				
Heart	(50)	(50)	(50)	(50)
Cardiomyopathy	49 (98%)	48 (96%)	47 (94%)	47 (94%)
Artery, inflammation		1 (2%)	1 (2%)	1 (2%)
Atrium, thrombosis				1 (2%)
Endocrine System				
Adrenal cortex	(50)	(50)	(50)	(49)
Hematopoietic cell proliferation	1 (2%)	1 (2%)	1 (2%)	
Hypertrophy	5 (10%)	5 (10%)	7 (14%)	7 (14%)
Capsule, hyperplasia				1 (2%)
Adrenal medulla	(50)	(49)	(50)	(49)
Hyperplasia	1 (2%)	2 (4%)	1 (2%)	2 (4%)
Islets, pancreatic	(50)	(50)	(50)	(48)
Hyperplasia	1 (2%)	1 (2%)	1 (2%)	1 (2%)
Pituitary gland	(46)	(48)	(50)	(47)
Pars distalis, hyperplasia	16 (35%)	20 (42%)	20 (40%)	9 (19%)
Thyroid gland	(50)	(50)	(50)	(49)
Follicular cell, hyperplasia	10 (20%)	17 (34%)	14 (28%)	12 (24%)
General Body System				
None				
Genital System				
Ovary	(49)	(50)	(50)	(46)
Angiectasis	2 (4%)		2 (4%)	
Atrophy	3 (6%)	2 (4%)	2 (4%)	
Cyst	18 (37%)	17 (34%)	23 (46%)	15 (33%)
Hemorrhage			1 (2%)	
Hyperplasia		1 (2%)		
Interstitial stromal tumor	1 (2%)			
Thrombosis			1 (2%)	
Germinal epithelium, hyperplasia		1 (2%)		
Uterus	(49)	(50)	(50)	(50)
Angiectasis	1 (2%)	1 (2%)	2 (4%)	
Hematocyst	1 (2%)			
Hydrometra	2 (4%)	4 (8%)	3 (6%)	4 (8%)
Hyperplasia, cystic	2 (4%)	2 (4%)	2 (4%)	3 (6%)
Inflammation, suppurative		1 (2%)	1 (2%)	
Thrombosis				1 (2%)
Endometrium, hyperplasia	1 (2%)			
Myometrium, hyperplasia	2 (4%)		2 (4%)	2 (4%)

TABLE D5
Summary of the Incidence of Nonneoplastic Lesions in Female Mice in the 2-Year Inhalation Study of Gallium Arsenide

	Chamber Control	0.1 mg/m ³	0.5 mg/m ³	1.0 mg/m ³
Hematopoietic System				
Bone marrow	(50)	(50)	(50)	(50)
Hyperplasia	2 (4%)	1 (2%)	2 (4%)	1 (2%)
Lymph node	(4)	(8)	(5)	(6)
Angiectasis	2 (50%)	1 (13%)	2 (40%)	
Renal, angiectasis		1 (13%)		
Renal, hyperplasia		1 (13%)		1 (17%)
Lymph node, bronchial	(39)	(43)	(42)	(42)
Hyperplasia	10 (26%)	12 (28%)	13 (31%)	23 (55%)
Lymph node, mandibular	(35)	(37)	(43)	(43)
Hyperplasia	1 (3%)		1 (2%)	2 (5%)
Lymph node, mesenteric	(49)	(49)	(50)	(47)
Hyperplasia	3 (6%)	3 (6%)	5 (10%)	6 (13%)
Lymph node, mediastinal	(40)	(43)	(49)	(45)
Hematopoietic cell proliferation			2 (4%)	
Hyperplasia	5 (13%)	3 (7%)	6 (12%)	8 (18%)
Spleen	(50)	(50)	(50)	(49)
Hematopoietic cell proliferation	23 (46%)	22 (44%)	22 (44%)	28 (57%)
Hyperplasia, histiocytic				1 (2%)
Hyperplasia, lymphoid	20 (40%)	12 (24%)	18 (36%)	7 (14%)
Capsule, inflammation	1 (2%)			
Thymus	(43)	(47)	(43)	(44)
Angiectasis			1 (2%)	
Hyperplasia, lymphoid	1 (2%)			1 (2%)
Integumentary System				
Mammary gland	(50)	(50)	(50)	(49)
Hyperplasia	4 (8%)	4 (8%)	2 (4%)	3 (6%)
Skin	(50)	(50)	(50)	(50)
Subcutaneous tissue, hemorrhage		2 (4%)	2 (4%)	
Subcutaneous tissue, inflammation		1 (2%)	1 (2%)	
Subcutaneous tissue, inflammation, granulomatous				1 (2%)
Subcutaneous tissue, mineralization	1 (2%)			
Musculoskeletal System				
Bone	(50)	(50)	(50)	(50)
Fibrous osteodystrophy	21 (42%)	24 (48%)	14 (28%)	18 (36%)
Maxilla, fracture		1 (2%)	1 (2%)	
Skeletal muscle	(1)	(2)	(1)	(1)
Hemorrhage		1 (50%)		
Nervous System				
Brain	(50)	(50)	(50)	(50)
Cyst epithelial inclusion				1 (2%)
Gliosis			1 (2%)	
Hemorrhage		1 (2%)		1 (2%)
Meninges, infiltration cellular, mononuclear cell	2 (4%)	5 (10%)	3 (6%)	3 (6%)
Spinal cord	(1)	(1)	(1)	
Hyperplasia, lymphoid	1 (100%)		1 (100%)	

TABLE D5
Summary of the Incidence of Nonneoplastic Lesions in Female Mice in the 2-Year Inhalation Study of Gallium Arsenide

	Chamber Control	0.1 mg/m ³	0.5 mg/m ³	1.0 mg/m ³
Respiratory System				
Larynx	(50)	(50)	(50)	(50)
Inflammation, suppurative	2 (4%)	2 (4%)	2 (4%)	1 (2%)
Squamous epithelium, hyperplasia	11 (22%)	9 (18%)	7 (14%)	7 (14%)
Lung	(50)	(50)	(50)	(50)
Congestion	1 (2%)			
Hemorrhage	9 (18%)	6 (12%)	5 (10%)	5 (10%)
Infiltration cellular, histiocyte	2 (4%)	13 (26%)	48 (96%)	49 (98%)
Inflammation, chronic, focal	1 (2%)	2 (4%)	11 (22%)	18 (36%)
Inflammation, focal, suppurative			2 (4%)	14 (28%)
Alveolar epithelium, hyperplasia	2 (4%)	5 (10%)	27 (54%)	43 (86%)
Alveolus, foreign body		8 (16%)	48 (96%)	49 (98%)
Alveolus, proteinosis		4 (8%)	49 (98%)	50 (100%)
Mediastinum, necrosis		1 (2%)		
Perivascular, infiltration cellular, mononuclear cell	2 (4%)		2 (4%)	2 (4%)
Nose	(50)	(49)	(50)	(50)
Inflammation, suppurative	2 (4%)		4 (8%)	4 (8%)
Olfactory epithelium, atrophy	3 (6%)	1 (2%)	7 (14%)	4 (8%)
Olfactory epithelium, degeneration, hyaline	3 (6%)	1 (2%)	10 (20%)	5 (10%)
Olfactory epithelium, inflammation, chronic			1 (2%)	
Olfactory epithelium, metaplasia, respiratory			1 (2%)	1 (2%)
Respiratory epithelium, degeneration, hyaline	15 (30%)	17 (35%)	21 (42%)	17 (34%)
Respiratory epithelium, metaplasia, squamous			2 (4%)	2 (4%)
Special Senses System				
Eye	(1)		(2)	(1)
Degeneration			1 (50%)	
Cornea, inflammation, chronic	1 (100%)		1 (50%)	1 (100%)
Urinary System				
Kidney	(50)	(50)	(50)	(50)
Glomerulosclerosis	2 (4%)			
Hydronephrosis	1 (2%)			
Inflammation, chronic active				1 (2%)
Metaplasia, osseous	2 (4%)	3 (6%)	1 (2%)	1 (2%)
Nephropathy	43 (86%)	44 (88%)	40 (80%)	36 (72%)
Capsule, inflammation				1 (2%)
Renal tubule, hyperplasia				1 (2%)
Urinary bladder	(48)	(48)	(50)	(48)
Angiectasis	1 (2%)			
Hyperplasia, lymphoid			1 (2%)	
Artery, inflammation			1 (2%)	

APPENDIX E

GENETIC TOXICOLOGY

<i>SALMONELLA TYPHIMURIUM</i> MUTAGENICITY TEST PROTOCOL	244
MOUSE PERIPHERAL BLOOD MICRONUCLEUS TEST PROTOCOL	244
EVALUATION PROTOCOL	244
RESULTS	245
TABLE E1 Mutagenicity of Gallium Arsenide in <i>Salmonella typhimurium</i>	246
TABLE E2 Frequency of Micronuclei in Peripheral Blood Erythrocytes of Mice Following Treatment with Gallium Arsenide by Inhalation for 14 Weeks	249

GENETIC TOXICOLOGY

***SALMONELLA TYPHIMURIUM* MUTAGENICITY TEST PROTOCOL**

Testing was performed as reported by Zeiger *et al.* (1992). Gallium arsenide was sent to the laboratory as a coded aliquot from Radian Corporation (Austin, TX). It was incubated with the *Salmonella typhimurium* tester strains TA97, TA98, TA100, TA102, and TA1535 either in buffer or S9 mix (metabolic activation enzymes and cofactors from Aroclor 1254-induced male Sprague-Dawley rat or Syrian hamster liver) for 20 minutes at 37° C. Top agar supplemented with L-histidine and d-biotin was added, and the contents of the tubes were mixed and poured onto the surfaces of minimal glucose agar plates. Histidine-independent mutant colonies arising on these plates were counted following incubation for 2 days at 37° C.

Each trial consisted of triplicate plates of concurrent positive and negative controls and at least five doses of gallium arsenide. In the absence of toxicity, 10,000 $\mu\text{g}/\text{plate}$ was selected as the high dose.

In this assay, a positive response is defined as a reproducible, dose-related increase in histidine-independent (revertant) colonies in any one strain/activation combination. An equivocal response is defined as an increase in revertants that is not dose related, is not reproducible, or is not of sufficient magnitude to support a determination of mutagenicity. A negative response is obtained when no increase in revertant colonies is observed following chemical treatment. There is no minimum percentage or fold increase required for a chemical to be judged positive or weakly positive.

MOUSE PERIPHERAL BLOOD MICRONUCLEUS TEST PROTOCOL

A detailed discussion of this assay is presented by MacGregor *et al.* (1990). At the end of the 14-week study, peripheral blood samples were obtained from male and female mice. Smears were immediately prepared and fixed in absolute methanol. The methanol-fixed slides were stained with acridine orange and coded. Slides were scanned to determine the frequency of micronuclei in 2,000 normochromatic erythrocytes (NCEs) in each of nine or ten animals per exposure group.

The results were tabulated as the mean of the pooled results from all animals within a treatment group plus or minus the standard error of the mean. The frequency of micronucleated cells among NCEs was analyzed by a statistical software package that tested for increasing trend over exposure groups with a one-tailed Cochran-Armitage trend test, followed by pairwise comparisons between each exposure group and the control group (ILS, 1990). In the presence of excess binomial variation, as detected by a binomial dispersion test, the binomial variance of the Cochran-Armitage test was adjusted upward in proportion to the excess variation. In the micronucleus test, an individual trial is considered positive if the trend test P value is less than or equal to 0.025 or if the P value for any single exposed group is less than or equal to 0.025 divided by the number of exposure groups. A final call of positive for micronucleus induction is preferably based on reproducibly positive trials (as noted above). Ultimately, the final call is determined by the scientific staff after considering the results of statistical analyses, the reproducibility of any effects observed, and the magnitudes of those effects.

EVALUATION PROTOCOL

These are the basic guidelines for arriving at an overall assay result for assays performed by the National Toxicology Program. Statistical as well as biological factors are considered. For an individual assay, the statistical procedures for data analysis have been described in the preceding protocols. There have been instances, however, in which multiple aliquots of a chemical were tested in the same assay, and differing

results were obtained among aliquots and/or among laboratories. Results from more than one aliquot or from more than one laboratory are not simply combined into an overall result. Rather, all the data are critically evaluated, particularly with regard to pertinent protocol variations, in determining the weight of evidence for an overall conclusion of chemical activity in an assay. In addition to multiple aliquots, the *in vitro* assays have another variable that must be considered in arriving at an overall test result. *In vitro* assays are conducted with and without exogenous metabolic activation. Results obtained in the absence of activation are not combined with results obtained in the presence of activation; each testing condition is evaluated separately. The summary table in the Abstract of this Technical Report presents a result that represents a scientific judgement of the overall evidence for activity of the chemical in an assay.

RESULTS

Gallium arsenide (up to 10,000 $\mu\text{g}/\text{plate}$) was not mutagenic in *S. typhimurium* strain TA97, TA98, TA100, TA102, or TA1535 (Zeiger *et al.*, 1992). Tests were conducted with and without induced liver S9 enzymes. Male and female mice that had been treated with gallium arsenide for 14 weeks by inhalation (0.1 to 75 mg/m^3) were examined for frequency of micronucleated NCEs; no increases over the control frequencies were noted in mice of either gender.

TABLE E1
Mutagenicity of Gallium Arsenide in *Salmonella typhimurium*^a

Strain	Dose ($\mu\text{g}/\text{plate}$)	Revertants/Plate ^b					
		-S9		+ hamster S9			
		Trial 1	Trial 2	5%	10%	30%	30%
TA102	0	262 \pm 25.9	228 \pm 13.9	243 \pm 6.7	162 \pm 8.5	313 \pm 5.5	243 \pm 3.8
	10		240 \pm 18.1				224 \pm 4.8
	33		246 \pm 7.6	243 \pm 14.6	178 \pm 9.2		177 \pm 16.5
	100	238 \pm 11.6	204 \pm 3.3	251 \pm 11.6	125 \pm 8.6	376 \pm 8.0	164 \pm 3.9
	333	159 \pm 12.7	162 \pm 8.3	209 \pm 5.5	131 \pm 7.8	389 \pm 7.9	175 \pm 13.3
	1,000	75 \pm 18.7	75 \pm 0.7	188 \pm 10.7	78 \pm 14.7	256 \pm 24.0	171 \pm 4.8
	1,666						160 \pm 10.8
	3,333	42 \pm 10.4		85 \pm 23.6	51 \pm 5.1	183 \pm 15.3	
	10,000	Toxic ^c				103 \pm 14.0 ^{c,d}	
	Trial summary		Negative	Negative	Negative	Negative	Equivocal
Positive control ^e		805 \pm 21.1	627 \pm 11.7	521 \pm 20.5	534 \pm 59.0	450 \pm 20.4	549 \pm 63.2
		+ rat S9					
		10%	30%				
TA102 (continued)	0	287 \pm 31.7	340 \pm 18.2				
	33	268 \pm 25.3					
	100	311 \pm 25.9	336 \pm 25.1				
	333	295 \pm 12.7	367 \pm 27.8				
	1,000	261 \pm 12.3	294 \pm 29.6				
	3,333	225 \pm 21.7	232 \pm 36.3				
	10,000		121 \pm 14.7 ^{c,d}				
Trial summary		Negative	Negative				
Positive control		939 \pm 10.5	1,462 \pm 47.5				
		-S9		+ hamster S9		+ rat S9	
		Trial 1	Trial 2	10%	30%	10%	30%
TA100	0	111 \pm 19.5	88 \pm 3.7	114 \pm 6.8	132 \pm 8.2	91 \pm 4.5	147 \pm 10.6
	10		115 \pm 5.5				
	33		87 \pm 5.9	122 \pm 6.2		103 \pm 6.4	
	100	95 \pm 4.5	101 \pm 7.4	86 \pm 7.0	129 \pm 8.4	109 \pm 7.0	113 \pm 4.0
	333	95 \pm 1.7	75 \pm 4.6	110 \pm 8.4	143 \pm 4.2	108 \pm 3.9	117 \pm 9.9
	1,000	81 \pm 6.9	75 \pm 5.5	102 \pm 3.4	165 \pm 4.4	89 \pm 6.6	126 \pm 5.2
	3,333	51 \pm 5.9		98 \pm 2.9	141 \pm 3.5	94 \pm 10.7	122 \pm 10.9
	6,666	28 \pm 5.6					
	10,000				54 \pm 1.7 ^c		66 \pm 9.9 ^c
	Trial summary		Negative	Negative	Negative	Negative	Negative
Positive control		319 \pm 10.5	363 \pm 17.3	738 \pm 58.6	399 \pm 4.9	479 \pm 26.3	447 \pm 17.5

TABLE E1
Mutagenicity of Gallium Arsenide in *Salmonella typhimurium*

Strain	Dose ($\mu\text{g}/\text{plate}$)	Revertants/Plate					
		-S9		+ hamster S9		+ rat S9	
		Trial 1	Trial 2	10%	30%	10%	30%
TA1535	0	15 \pm 1.2	17 \pm 2.1	12 \pm 1.3	12 \pm 1.2	8 \pm 3.5	19 \pm 4.4
	10		17 \pm 0.9				
	33		10 \pm 2.0	9 \pm 1.2		10 \pm 1.2	
	100	14 \pm 1.9	10 \pm 1.2	11 \pm 0.9	12 \pm 1.5	11 \pm 2.0	18 \pm 2.2
	333	12 \pm 3.3	14 \pm 1.8	7 \pm 1.5	8 \pm 1.5	12 \pm 1.5	16 \pm 1.5
	1,000	11 \pm 1.9	9 \pm 2.9	9 \pm 1.2	9 \pm 0.3	11 \pm 1.8	11 \pm 2.4
	3,333	2 \pm 0.6		7 \pm 1.5	5 \pm 0.9	7 \pm 2.0	11 \pm 0.9 ^{c,d}
	10,000	Toxic ^c			4 \pm 2.5 ^{c,d}		6 \pm 1.5 ^{c,d}
	Trial summary	Negative	Negative	Negative	Negative	Negative	Negative
Positive control	224 \pm 7.3	344 \pm 3.8	191 \pm 10.5	328 \pm 8.0	118 \pm 25.5	99 \pm 15.2	
		-S9		+ hamster S9			
		Trial 1	Trial 2	10%	30%	30%	
TA97	0	159 \pm 2.3	150 \pm 8.7	144 \pm 9.3	134 \pm 4.7	170 \pm 9.4	
	10		146 \pm 3.3				
	33		148 \pm 11.0	138 \pm 5.9		160 \pm 3.1	
	100	142 \pm 4.9	153 \pm 3.8	167 \pm 8.2	166 \pm 18.2	185 \pm 7.1	
	333	132 \pm 3.2	117 \pm 11.9	171 \pm 9.1	208 \pm 9.6	177 \pm 10.5	
	1,000	129 \pm 16.5	77 \pm 7.0	148 \pm 6.1	187 \pm 10.4	179 \pm 7.9	
	3,333	48 \pm 9.9		138 \pm 11.8	145 \pm 18.5	174 \pm 5.8	
	10,000	Toxic ^c			48 \pm 5.2 ^{c,d}		
	Trial summary	Negative	Negative	Negative	Equivocal	Negative	
Positive control	404 \pm 15.0	401 \pm 29.3	519 \pm 30.7	436 \pm 4.4	396 \pm 1.5		
		+ rat S9					
		10%	30%	30%			
TA97 (continued)	0	172 \pm 14.2	190 \pm 3.3	180 \pm 7.0			
	33	176 \pm 10.4		203 \pm 2.0			
	100	172 \pm 6.4	215 \pm 4.3	183 \pm 11.1			
	333	174 \pm 7.3	183 \pm 4.7	163 \pm 5.9			
	1,000	209 \pm 40.6	189 \pm 8.4	172 \pm 7.0			
	3,333	185 \pm 12.5	167 \pm 3.6	103 \pm 34.6			
	10,000		56 \pm 3.8 ^{c,d}				
Trial summary	Negative	Negative	Negative				
Positive control	347 \pm 3.4	425 \pm 22.5	370 \pm 9.8				

TABLE E1
Mutagenicity of Gallium Arsenide in *Salmonella typhimurium*

Strain	Dose ($\mu\text{g}/\text{plate}$)	Revertants/Plate					
		-S9		+ hamster S9		+ rat S9	
		Trial 1	Trial 2	10%	30%	10%	30%
TA98	0	20 \pm 1.5	16 \pm 3.5	33 \pm 3.5	29 \pm 3.3	22 \pm 3.0	26 \pm 1.3
	10		15 \pm 2.4				
	33		16 \pm 1.2	24 \pm 4.4		23 \pm 3.3	
	100	16 \pm 2.7	17 \pm 0.9	29 \pm 0.3	25 \pm 3.2	19 \pm 0.6	25 \pm 2.3
	333	17 \pm 1.7	14 \pm 1.8	31 \pm 3.2	27 \pm 1.2	21 \pm 3.8	33 \pm 3.2
	1,000	16 \pm 2.3	9 \pm 0.3	28 \pm 6.4	28 \pm 0.9	18 \pm 0.9	26 \pm 0.9
	3,333	7 \pm 0.3		25 \pm 4.4	18 \pm 2.3	18 \pm 1.2	19 \pm 2.2
	6,666	7 \pm 1.2					
	10,000				23 \pm 2.3 ^c		17 \pm 4.1 ^c
	Trial summary		Negative	Negative	Negative	Negative	Negative
Positive control		380 \pm 5.6	374 \pm 15.0	622 \pm 25.8	147 \pm 9.3	344 \pm 14.5	83 \pm 7.3

^a Study was performed at SRI International. The detailed protocol and these data are presented by Zeiger *et al.* (1992). 0 $\mu\text{g}/\text{plate}$ was the solvent control.

^b Revertants are presented as mean \pm standard error from three plates.

^c Precipitate on plate

^d Slight toxicity

^e The positive controls in the absence of metabolic activation were sodium azide (TA100 and TA1535), 9-aminoacridine (TA97), 4-nitro-*o*-phenylenediamine (TA98), and mitomycin-C (TA102). The positive control for metabolic activation with all strains was 2-aminoanthracene, and 2-aminoanthracene or sterigmatocystin was used for TA102.

TABLE E2
Frequency of Micronuclei in Peripheral Blood Erythrocytes
of Mice Following Treatment with Gallium Arsenide by Inhalation for 14 Weeks^a

Exposure Concentration (mg/m ³)	Number of Mice with Erythrocytes Scored	Micronucleated NCEs/1,000 NCEs ^b	P Value ^c
Male			
Chamber Control	10	1.06 ± 0.10	
0.1	9	0.84 ± 0.12	0.7311
1	10	0.87 ± 0.08	0.7090
10	10	0.94 ± 0.08	0.6382
37	10	1.35 ± 0.67	0.2385
75	10	0.81 ± 0.11	0.7705
		P=0.502 ^d	
Female			
Chamber Control	10	0.52 ± 0.08	
0.1	10	0.45 ± 0.06	0.7625
1	10	0.43 ± 0.08	0.8322
10	10	0.54 ± 0.06	0.4078
37	10	0.44 ± 0.06	0.8095
75	9	0.52 ± 0.09	0.5088
		P=0.388	

^a Study performed at SRI International. The detailed protocol is presented by MacGregor *et al.* (1990). NCE=normochromatic erythrocyte.

^b Mean ± standard error

^c Pairwise comparison with the chamber control; significant at P≤0.005 (ILS, 1990)

^d Significance of micronucleated NCEs/1,000 NCEs tested by the one-tailed Cochran-Armitage trend test, significant at P≤0.025 (ILS, 1990)

APPENDIX F

CLINICAL PATHOLOGY RESULTS

TABLE F1	Hematology, Clinical Chemistry, Urinalysis, and Urine Concentrating Ability Data for Rats in the 14-Week Inhalation Study of Gallium Arsenide	252
TABLE F2	Hematology Data for Mice in the 14-Week Inhalation Study of Gallium Arsenide	258

TABLE F1
Hematology, Clinical Chemistry, Urinalysis, and Urine Concentrating Ability Data
for Rats in the 14-Week Inhalation Study of Gallium Arsenide^a

	Chamber Control	0.1 mg/m ³	1 mg/m ³	10 mg/m ³	37 mg/m ³	75 mg/m ³
Male						
Hematology						
n						
Day 3	10	10	10	10	10	10
Day 23	10	10	10	9	10	9
Week 14	10	10	10	10	10	10
Manual hematocrit (%)						
Day 3	45.6 ± 0.3	45.9 ± 0.5	46.4 ± 0.6	45.5 ± 0.4	45.6 ± 0.5	45.7 ± 0.4
Day 23	47.6 ± 0.2	47.6 ± 0.3	47.6 ± 0.4	47.3 ± 0.7	46.9 ± 0.6	44.7 ± 0.4**
Week 14	43.8 ± 0.5	44.6 ± 0.5	43.9 ± 1.0	44.1 ± 0.3	42.4 ± 0.5	41.1 ± 0.7*
Automated hematocrit (%)						
Day 3	45.3 ± 0.3	45.4 ± 0.4	46.0 ± 0.6	44.6 ± 0.7	45.1 ± 0.4	45.3 ± 0.4
Day 23	47.5 ± 0.3	47.4 ± 0.3	47.2 ± 0.6	47.7 ± 0.7	46.4 ± 0.6*	43.5 ± 0.4**
Week 14	41.9 ± 0.5	42.6 ± 0.4	42.3 ± 0.8	40.9 ± 0.3	36.5 ± 0.5**	34.3 ± 0.6**
Hemoglobin (g/dL)						
Day 3	15.0 ± 0.1	14.9 ± 0.2	15.0 ± 0.2	14.6 ± 0.3	14.7 ± 0.1	14.7 ± 0.1
Day 23	15.4 ± 0.1	15.5 ± 0.1	15.2 ± 0.2	15.4 ± 0.3	15.2 ± 0.2	14.2 ± 0.1**
Week 14	14.7 ± 0.2	15.0 ± 0.1	15.0 ± 0.3	14.4 ± 0.2	13.2 ± 0.2**	12.8 ± 0.2**
Erythrocytes (10 ⁶ /μL)						
Day 3	7.85 ± 0.06	7.94 ± 0.08	7.99 ± 0.12	7.67 ± 0.12	7.79 ± 0.08	7.71 ± 0.08
Day 23	8.42 ± 0.07	8.44 ± 0.04	8.36 ± 0.13	8.67 ± 0.13	9.22 ± 0.15**	9.38 ± 0.13**
Week 14	8.92 ± 0.10	9.05 ± 0.08	9.07 ± 0.17	9.67 ± 0.08**	11.04 ± 0.15**	12.17 ± 0.12**
Reticulocytes (10 ⁶ /μL)						
Day 3	0.34 ± 0.02	0.34 ± 0.03	0.33 ± 0.02	0.33 ± 0.02	0.31 ± 0.01	0.33 ± 0.02
Day 23	0.19 ± 0.02	0.21 ± 0.01	0.22 ± 0.03	0.21 ± 0.02	0.23 ± 0.02	0.28 ± 0.03**
Week 14	0.22 ± 0.02	0.24 ± 0.02	0.22 ± 0.02	0.35 ± 0.03**	0.50 ± 0.04**	0.63 ± 0.03**
Nucleated erythrocytes/100 leukocytes						
Day 3	0.50 ± 0.27	0.10 ± 0.10	1.10 ± 0.31	0.60 ± 0.27	0.70 ± 0.26	0.30 ± 0.15
Day 23	0.50 ± 0.17	0.50 ± 0.27	0.30 ± 0.21	0.22 ± 0.15	0.30 ± 0.21	0.78 ± 0.32
Week 14	1.30 ± 0.37	1.10 ± 0.28	1.20 ± 0.39	1.30 ± 0.26	1.80 ± 0.39	2.90 ± 0.38**
Mean cell volume (fL)						
Day 3	57.6 ± 0.3	57.3 ± 0.3	57.8 ± 0.4	58.1 ± 0.2	57.8 ± 0.3	58.6 ± 0.6
Day 23	56.5 ± 0.2	56.2 ± 0.2	56.4 ± 0.3	54.9 ± 0.3**	50.5 ± 0.3**	46.3 ± 0.6**
Week 14	46.9 ± 0.1	47.0 ± 0.2	46.6 ± 0.2	42.2 ± 0.1**	33.0 ± 0.4**	28.2 ± 0.3**
Mean cell hemoglobin (pg)						
Day 3	19.1 ± 0.1	18.8 ± 0.2	18.8 ± 0.1	19.1 ± 0.1	18.9 ± 0.1	19.1 ± 0.2
Day 23	18.3 ± 0.1	18.4 ± 0.1	18.2 ± 0.1	17.7 ± 0.1**	16.4 ± 0.1**	15.2 ± 0.2**
Week 14	16.5 ± 0.1	16.6 ± 0.1	16.5 ± 0.1	14.9 ± 0.1**	12.0 ± 0.1**	10.5 ± 0.1**
Mean cell hemoglobin concentration (g/dL)						
Day 3	33.1 ± 0.1	32.9 ± 0.2	32.7 ± 0.1*	32.8 ± 0.1	32.6 ± 0.1*	32.5 ± 0.1**
Day 23	32.5 ± 0.1	32.7 ± 0.1	32.3 ± 0.1	32.3 ± 0.1	32.6 ± 0.1	32.7 ± 0.1
Week 14	35.2 ± 0.1	35.2 ± 0.1	35.4 ± 0.2	35.3 ± 0.1	36.2 ± 0.2**	37.3 ± 0.1**
Platelets (10 ³ /μL)						
Day 3	782.2 ± 15.7	750.8 ± 14.0	749.3 ± 20.2	698.2 ± 23.9*	720.9 ± 23.2	753.5 ± 14.4
Day 23	618.3 ± 10.3	610.1 ± 12.3	608.1 ± 11.6	576.4 ± 20.6	612.2 ± 51.3	737.0 ± 11.5**
Week 14	526.9 ± 12.3	519.8 ± 13.3	553.3 ± 7.5	582.3 ± 8.4**	630.2 ± 32.3**	780.6 ± 20.6**
Leukocytes (10 ³ /μL)						
Day 3	9.79 ± 0.09	9.38 ± 0.61	8.84 ± 0.73	8.33 ± 0.34*	8.85 ± 0.36*	8.15 ± 0.24**
Day 23	9.99 ± 0.44	8.20 ± 0.41**	7.93 ± 0.50**	7.93 ± 0.16**	6.60 ± 0.24**	6.65 ± 0.24**
Week 14	6.99 ± 0.39	7.08 ± 0.53	7.22 ± 0.57	8.05 ± 0.41	7.01 ± 0.38	7.81 ± 0.29

TABLE F1
Hematology, Clinical Chemistry, Urinalysis, and Urine Concentrating Ability Data
for Rats in the 14-Week Inhalation Study of Gallium Arsenide

	Chamber Control	0.1 mg/m ³	1 mg/m ³	10 mg/m ³	37 mg/m ³	75 mg/m ³
Male (continued)						
Hematology (continued)						
n						
Day 3	10	10	10	10	10	10
Day 23	10	10	10	9	10	9
Week 14	10	10	10	10	10	10
Segmented neutrophils (10 ³ /μL)						
Day 3	0.94 ± 0.10	0.83 ± 0.11	1.05 ± 0.23	0.99 ± 0.12	1.05 ± 0.08	1.01 ± 0.10
Day 23	0.95 ± 0.15	0.99 ± 0.08	1.39 ± 0.30	1.00 ± 0.09	1.16 ± 0.12	1.51 ± 0.18*
Week 14	1.39 ± 0.13	1.56 ± 0.15	2.02 ± 0.19*	2.24 ± 0.16**	2.11 ± 0.22**	2.19 ± 0.16**
Lymphocytes (10 ³ /μL)						
Day 3	8.64 ± 0.11	8.34 ± 0.53	7.78 ± 0.65	7.29 ± 0.35**	7.69 ± 0.36**	7.11 ± 0.29**
Day 23	8.80 ± 0.37	7.10 ± 0.42*	6.44 ± 0.34**	6.82 ± 0.16**	5.40 ± 0.27**	5.03 ± 0.22**
Week 14	5.57 ± 0.38	5.50 ± 0.45	5.16 ± 0.42	5.79 ± 0.34	4.83 ± 0.35	5.60 ± 0.27
Monocytes (10 ³ /μL)						
Day 3	0.19 ± 0.02	0.15 ± 0.04	0.03 ± 0.01**	0.02 ± 0.01**	0.06 ± 0.03**	0.00 ± 0.00**
Day 23	0.19 ± 0.05	0.10 ± 0.03	0.05 ± 0.03	0.05 ± 0.02	0.04 ± 0.02*	0.10 ± 0.03
Week 14	0.00 ± 0.00	0.00 ± 0.00	0.00 ± 0.00	0.00 ± 0.00	0.00 ± 0.00	0.00 ± 0.00
Eosinophils (10 ³ /μL)						
Day 3	0.02 ± 0.01	0.07 ± 0.02	0.03 ± 0.02	0.02 ± 0.01	0.05 ± 0.02	0.02 ± 0.02
Day 23	0.05 ± 0.02	0.02 ± 0.01	0.05 ± 0.02	0.05 ± 0.02	0.01 ± 0.01	0.02 ± 0.01
Week 14	0.03 ± 0.01	0.03 ± 0.01	0.04 ± 0.02	0.02 ± 0.01	0.07 ± 0.03	0.02 ± 0.01
Total bone marrow cellularity (10 ⁷ /femur)						
Day 23	10.8 ± 1.0 ^b	— ^c	—	11.8 ± 0.6 ^b	10.9 ± 0.6 ^b	10.8 ± 0.7 ^b
Week 14	9.6 ± 0.3 ^b	—	—	11.0 ± 0.7 ^b	10.8 ± 0.5 ^b	10.6 ± 0.8 ^b
Methemoglobin (g/dL)						
Day 3	0.79 ± 0.03	0.78 ± 0.04	0.76 ± 0.03	0.71 ± 0.07	0.74 ± 0.08	0.62 ± 0.03**
Day 23	0.78 ± 0.04	0.85 ± 0.04	0.86 ± 0.04	1.09 ± 0.12 ^d	0.78 ± 0.03	0.81 ± 0.04
Week 14	1.18 ± 0.09	1.19 ± 0.03	1.24 ± 0.13	1.10 ± 0.03	1.06 ± 0.06	1.17 ± 0.10
Zinc protoporphyrin (μmol/mol heme)						
Day 3	53.7 ± 0.7	51.7 ± 0.6	56.8 ± 1.6	56.5 ± 0.9	55.5 ± 0.8	54.7 ± 0.5
Day 23	60.2 ± 1.2	59.4 ± 1.4	60.3 ± 2.4	61.9 ± 1.3	69.9 ± 0.9**	73.8 ± 1.5**
Week 14	79.9 ± 2.1	75.0 ± 1.8	80.3 ± 2.4	81.4 ± 2.3	95.4 ± 5.9**	97.5 ± 3.3**
Clinical Chemistry						
n	10	10	10	10	10	10
Urea nitrogen (mg/dL)						
Day 23	14.6 ± 0.5	14.4 ± 0.4	14.0 ± 0.6	15.3 ± 0.4	14.7 ± 0.5	15.7 ± 0.3
Week 14	20.5 ± 0.7	20.2 ± 0.5	20.1 ± 0.7	21.6 ± 0.5	22.4 ± 0.5*	22.2 ± 0.5*
Creatinine (mg/dL)						
Day 23	0.60 ± 0.02	0.62 ± 0.01	0.56 ± 0.02	0.54 ± 0.02*	0.53 ± 0.02**	0.52 ± 0.01**
Week 14	0.66 ± 0.02	0.64 ± 0.03	0.64 ± 0.02	0.66 ± 0.03	0.65 ± 0.02	0.62 ± 0.02

TABLE F1
Hematology, Clinical Chemistry, Urinalysis, and Urine Concentrating Ability Data
for Rats in the 14-Week Inhalation Study of Gallium Arsenide

	Chamber Control	0.1 mg/m ³	1 mg/m ³	10 mg/m ³	37 mg/m ³	75 mg/m ³
Male (continued)						
Clinical Chemistry (continued)						
n	10	10	10	10	10	10
Total iron binding capacity (µg/dL)						
Day 23	580.2 ± 8.9	—	—	590.2 ± 10.1	589.0 ± 9.2	595.5 ± 5.8
Week 14	625.1 ± 6.2	—	—	618.0 ± 6.1	610.1 ± 6.7	609.1 ± 7.3
Unbound iron binding capacity (µg/dL)						
Day 23	353.8 ± 12.0	—	—	459.2 ± 13.2**	473.3 ± 4.8**	488.2 ± 8.3**
Week 14	454.4 ± 14.9	—	—	455.0 ± 10.8	473.2 ± 7.8	467.0 ± 6.8
Iron (µg/dL)						
Day 23	226.4 ± 10.0	—	—	131.0 ± 15.0**	115.7 ± 8.2**	107.3 ± 6.0**
Week 14	170.7 ± 10.2	—	—	163.0 ± 7.2	136.9 ± 5.1*	142.1 ± 5.4*
Alanine aminotransferase (IU/L)						
Day 23	38 ± 1	38 ± 2	40 ± 1	37 ± 2	36 ± 1	34 ± 1**
Week 14	65 ± 7	72 ± 5	66 ± 5	69 ± 4	125 ± 17**	164 ± 14**
Creatine kinase (IU/L)						
Day 23	330 ± 21	380 ± 36	589 ± 76*	319 ± 16	406 ± 47 ^e	324 ± 53
Week 14	214 ± 22	142 ± 15	156 ± 21	153 ± 20	143 ± 14 ^e	153 ± 14
Sorbitol dehydrogenase (IU/L)						
Day 23	10 ± 0	—	—	10 ± 0	9 ± 0**	9 ± 0**
Week 14	22 ± 5	—	—	22 ± 2	38 ± 5**	39 ± 4**
Thyroid-stimulating hormone (ng/mL)						
Week 14	1.41 ± 0.14	1.89 ± 0.30	1.86 ± 0.36	1.77 ± 0.33	1.58 ± 0.33	2.28 ± 0.43
Triiodothyronine (ng/dL)						
Week 14	136.2 ± 11.2	147.6 ± 13.1	118.1 ± 16.6	120.1 ± 9.4	115.9 ± 12.6	124.4 ± 10.0
Thyroxine (µg/dL)						
Week 14	4.60 ± 0.46	4.32 ± 0.30	4.04 ± 0.48	3.84 ± 0.29	3.73 ± 0.35	3.75 ± 0.24
Free thyroxine (ng/dL)						
Week 14	2.93 ± 0.21 ^e	2.90 ± 0.18 ^e	2.85 ± 0.21	2.76 ± 0.15	2.71 ± 0.21 ^e	2.81 ± 0.14
Urinalysis						
n	10	10	8	10	10	10
Volume (mL/14 hr)						
	8.0 ± 1.1	7.5 ± 1.1	7.4 ± 1.6	9.7 ± 1.4	6.0 ± 0.9	9.1 ± 2.2
Specific gravity						
	1.026 ± 0.004	1.026 ± 0.002	1.026 ± 0.003	1.023 ± 0.003	1.031 ± 0.003	1.028 ± 0.004
Glucose (mg/14 hr)						
	0.85 ± 0.06	—	—	0.74 ± 0.04	0.64 ± 0.04*	0.73 ± 0.05
Protein (mg/14 hr)						
	11.68 ± 0.60	—	—	12.97 ± 0.63	12.25 ± 0.91	13.72 ± 1.20
N-acetyl-β-D-glucosaminidase (U/14 hr)						
	0.08 ± 0.01	—	—	0.08 ± 0.01	0.09 ± 0.01	0.11 ± 0.02
δ-Aminolevulinic acid (nmol/14 hr)						
	78.48 ± 8.66	73.09 ± 11.02	52.18 ± 11.87	85.52 ± 7.52	66.01 ± 10.81	71.67 ± 9.16
Porphobilinogen (nmol/14 hr)						
	13.52 ± 2.91	20.10 ± 3.65	15.82 ± 2.53	21.66 ± 2.52	14.07 ± 1.42	21.72 ± 2.43
Urine Concentrating Ability						
n	10	—	—	10	10	10
Volume (mL/4 hr)						
	0.5 ± 0.1	—	—	0.5 ± 0.0	0.4 ± 0.0	0.4 ± 0.1
Specific gravity						
	1.015 ± 0.001	—	—	1.017 ± 0.001	1.019 ± 0.002	1.018 ± 0.003

TABLE F1
Hematology, Clinical Chemistry, Urinalysis, and Urine Concentrating Ability Data
for Rats in the 14-Week Inhalation Study of Gallium Arsenide

	Chamber Control	0.1 mg/m ³	1 mg/m ³	10 mg/m ³	37 mg/m ³	75 mg/m ³
Female						
Hematology						
n	10	10	10	10	10	10
Manual hematocrit (%)						
Day 3	46.9 ± 0.4	47.6 ± 0.5	48.2 ± 0.3	46.9 ± 0.5	46.5 ± 0.5	46.8 ± 0.4
Day 23	49.0 ± 0.5	48.3 ± 0.4	48.6 ± 0.3	47.7 ± 0.4*	47.7 ± 0.3*	46.5 ± 0.4**
Week 14	43.1 ± 0.7	43.2 ± 0.9	43.7 ± 0.4	44.5 ± 0.4	44.3 ± 0.5	43.6 ± 0.4
Automated hematocrit (%)						
Day 3	47.0 ± 0.2	47.4 ± 0.4	48.2 ± 0.3	46.9 ± 0.5	46.9 ± 0.7	47.4 ± 0.2
Day 23	49.8 ± 0.7	49.2 ± 0.3	49.7 ± 0.4	48.3 ± 0.6**	48.2 ± 0.2**	46.5 ± 0.5**
Week 14	42.1 ± 0.5	42.4 ± 0.9	43.1 ± 0.4	43.7 ± 0.3	43.0 ± 0.5	41.9 ± 0.4
Hemoglobin (g/dL)						
Day 3	15.3 ± 0.1	15.5 ± 0.1	15.7 ± 0.1	15.2 ± 0.2	15.3 ± 0.2	15.5 ± 0.1
Day 23	15.9 ± 0.1	15.9 ± 0.1	15.9 ± 0.1	15.6 ± 0.3	15.7 ± 0.1	15.4 ± 0.1**
Week 14	14.8 ± 0.2	14.9 ± 0.3	15.2 ± 0.1	15.3 ± 0.1	15.0 ± 0.2	14.6 ± 0.1
Erythrocytes (10 ⁶ /μL)						
Day 3	8.07 ± 0.05	8.26 ± 0.09	8.35 ± 0.08	8.10 ± 0.12	8.12 ± 0.13	8.16 ± 0.07
Day 23	8.53 ± 0.14	8.55 ± 0.07	8.63 ± 0.08	8.44 ± 0.10	8.71 ± 0.06	8.96 ± 0.10
Week 14	8.30 ± 0.10	8.28 ± 0.17	8.44 ± 0.09	8.84 ± 0.08**	9.32 ± 0.09**	9.60 ± 0.09**
Reticulocytes (10 ⁶ /μL)						
Day 3	0.24 ± 0.01	0.23 ± 0.02	0.23 ± 0.02	0.23 ± 0.02	0.30 ± 0.02	0.29 ± 0.02
Day 23	0.18 ± 0.02	0.14 ± 0.01	0.14 ± 0.02 ^f	0.13 ± 0.01	0.13 ± 0.01*	0.12 ± 0.01* ^f
Week 14	0.19 ± 0.01	0.21 ± 0.01	0.23 ± 0.01	0.24 ± 0.01*	0.28 ± 0.02**	0.31 ± 0.02**
Nucleated erythrocytes/100 leukocytes						
Day 3	0.30 ± 0.15	0.50 ± 0.22	0.30 ± 0.15	0.60 ± 0.22	0.50 ± 0.22	0.20 ± 0.20
Day 23	0.10 ± 0.10	0.60 ± 0.31	0.00 ± 0.00	0.10 ± 0.10	0.00 ± 0.00	0.00 ± 0.00
Week 14	0.30 ± 0.15	0.70 ± 0.26	0.80 ± 0.42	1.00 ± 0.39	0.60 ± 0.22	0.20 ± 0.13
Mean cell volume (fL)						
Day 3	58.2 ± 0.1	57.4 ± 0.3	57.8 ± 0.3*	58.0 ± 0.3*	57.8 ± 0.2**	58.2 ± 0.3**
Day 23	58.5 ± 0.3	57.7 ± 0.3	57.6 ± 0.2*	57.4 ± 0.3*	55.3 ± 0.3**	51.8 ± 0.3**
Week 14	50.7 ± 0.2	51.2 ± 0.1	51.1 ± 0.1	49.3 ± 0.3**	46.1 ± 0.2**	43.5 ± 0.3**
Mean cell hemoglobin (pg)						
Day 3	18.9 ± 0.1	18.8 ± 0.2	18.8 ± 0.1	18.8 ± 0.1	18.8 ± 0.1	19.0 ± 0.1
Day 23	18.6 ± 0.2	18.6 ± 0.1	18.4 ± 0.1	18.4 ± 0.2	18.0 ± 0.1**	17.2 ± 0.1**
Week 14	17.8 ± 0.1	18.0 ± 0.1	18.0 ± 0.0	17.3 ± 0.1**	16.1 ± 0.1**	15.2 ± 0.1**
Mean cell hemoglobin concentration (g/dL)						
Day 3	32.5 ± 0.1	32.7 ± 0.2	32.5 ± 0.1	32.4 ± 0.1	32.5 ± 0.1	32.7 ± 0.2
Day 23	31.9 ± 0.2	32.2 ± 0.1*	31.9 ± 0.1	32.2 ± 0.2	32.6 ± 0.1**	33.0 ± 0.1**
Week 14	35.1 ± 0.1	35.1 ± 0.1	35.2 ± 0.1	35.1 ± 0.1	34.9 ± 0.2	34.8 ± 0.2
Platelets (10 ³ /μL)						
Day 3	684.6 ± 9.5	670.1 ± 13.5	701.4 ± 20.3	701.3 ± 25.9	670.9 ± 16.3	654.1 ± 26.9
Day 23	539.3 ± 26.1	568.5 ± 16.3	557.9 ± 22.9	621.4 ± 17.3*	576.6 ± 23.8	607.0 ± 22.1*
Week 14	517.6 ± 13.8	519.8 ± 14.0 ^e	549.6 ± 10.9	520.9 ± 15.1	565.0 ± 21.5*	590.8 ± 11.9**
Leukocytes (10 ³ /μL)						
Day 3	9.67 ± 0.50	9.70 ± 0.57	10.11 ± 0.58	9.03 ± 0.37	8.96 ± 0.42	7.97 ± 0.41*
Day 23	8.97 ± 0.55	8.82 ± 0.21	8.33 ± 0.22	8.68 ± 0.32	7.34 ± 0.21**	7.35 ± 0.37*
Week 14	7.98 ± 0.67	7.68 ± 0.51	7.60 ± 0.44	6.76 ± 0.22	8.31 ± 0.58	7.86 ± 0.47
Segmented neutrophils (10 ³ /μL)						
Day 3	0.74 ± 0.10	0.75 ± 0.11	0.89 ± 0.10	1.23 ± 0.11**	1.08 ± 0.11*	1.04 ± 0.15*
Day 23	0.56 ± 0.07	0.74 ± 0.13	1.04 ± 0.12**	1.20 ± 0.15**	0.86 ± 0.08**	1.22 ± 0.11**
Week 14	1.211 ± 0.29	1.26 ± 0.16	1.39 ± 0.11**	0.98 ± 0.11	2.18 ± 0.38**	1.94 ± 0.28**

TABLE F1
Hematology, Clinical Chemistry, Urinalysis, and Urine Concentrating Ability Data
for Rats in the 14-Week Inhalation Study of Gallium Arsenide

	Chamber Control	0.1 mg/m ³	1 mg/m ³	10 mg/m ³	37 mg/m ³	75 mg/m ³
Female (continued)						
Hematology (continued)						
n	10	10	10	10	10	10
Lymphocytes (10 ³ /μL)						
Day 3	8.74 ± 0.47	8.76 ± 0.51	9.06 ± 0.53	7.73 ± 0.32	7.76 ± 0.36	6.83 ± 0.36**
Day 23	8.35 ± 0.55	7.97 ± 0.24	7.19 ± 0.24	7.41 ± 0.21	6.47 ± 0.18**	6.12 ± 0.29**
Week 14	6.74 ± 0.44	6.40 ± 0.43	6.19 ± 0.49	5.71 ± 0.21	6.07 ± 0.39	5.87 ± 0.38
Monocytes (10 ³ /μL)						
Day 3	0.08 ± 0.03	0.11 ± 0.04	0.08 ± 0.03	0.04 ± 0.02	0.04 ± 0.02	0.04 ± 0.02
Day 23	0.04 ± 0.03	0.08 ± 0.04	0.00 ± 0.00	0.01 ± 0.01	0.01 ± 0.01	0.01 ± 0.01
Week 14	0.00 ± 0.00	0.00 ± 0.00	0.00 ± 0.00	0.00 ± 0.00	0.00 ± 0.00	0.00 ± 0.00
Eosinophils (10 ³ /μL)						
Day 3	0.12 ± 0.03	0.08 ± 0.03	0.09 ± 0.02	0.03 ± 0.01	0.08 ± 0.03	0.06 ± 0.03
Day 23	0.02 ± 0.01	0.04 ± 0.02	0.10 ± 0.04	0.06 ± 0.02	0.00 ± 0.00	0.00 ± 0.00
Week 14	0.04 ± 0.02	0.03 ± 0.02	0.02 ± 0.01	0.07 ± 0.02	0.07 ± 0.02	0.06 ± 0.02
Total bone marrow cellularity (10 ⁷ /femur)						
Day 23	6.1 ± 0.3 ^b	—	—	8.2 ± 0.2 ^{*b}	8.2 ± 0.5 ^{*b}	7.7 ± 0.5 ^b
Week 14	5.6 ± 0.4 ^b	—	—	5.4 ± 0.2 ^b	6.4 ± 0.6 ^b	7.4 ± 0.6 ^b
Methemoglobin (g/dL)						
Day 3	0.82 ± 0.05	0.79 ± 0.03	0.73 ± 0.04	0.82 ± 0.06	1.09 ± 0.06	0.96 ± 0.10
Day 23	0.82 ± 0.04	0.90 ± 0.04	0.90 ± 0.03	1.00 ± 0.08*	1.63 ± 0.36**	1.21 ± 0.11**
Week 14	1.21 ± 0.04	1.36 ± 0.10	1.30 ± 0.04	1.55 ± 0.08**	1.60 ± 0.13**	1.59 ± 0.11**
Zinc protoporphyrin (μmol/mol heme)						
Day 3	53.6 ± 0.9	53.1 ± 0.9	52.7 ± 0.9	49.9 ± 0.2**	51.7 ± 1.0*	50.8 ± 0.6*
Day 23	53.7 ± 1.3	54.0 ± 0.8	54.0 ± 0.6	54.4 ± 0.5	60.1 ± 1.3**	64.9 ± 0.8**
Week 14	63.6 ± 0.9 ^e	67.8 ± 1.6*	66.5 ± 1.4	68.2 ± 2.2	72.4 ± 1.6**	80.9 ± 2.0**
Clinical Chemistry						
n						
Day 23	10	10	10	10	10	10
Week 14	10	9	10	10	10	10
Urea nitrogen (mg/dL)						
Day 23	13.6 ± 0.3	14.9 ± 0.3**	16.3 ± 0.4**	16.9 ± 0.3**	16.5 ± 0.5**	16.9 ± 0.6**
Week 14	19.4 ± 0.6	22.1 ± 0.7	22.2 ± 1.2	22.4 ± 1.3	21.2 ± 1.2	21.1 ± 0.8
Creatinine (mg/dL)						
Day 23	0.52 ± 0.02	0.52 ± 0.01	0.53 ± 0.02	0.55 ± 0.02	0.59 ± 0.02*	0.61 ± 0.01**
Week 14	0.61 ± 0.01	0.63 ± 0.02	0.64 ± 0.03	0.64 ± 0.03	0.60 ± 0.02	0.62 ± 0.02
Total iron binding capacity (μg/dL)						
Day 23	542.9 ± 4.7 ^f	—	—	509.8 ± 6.6**	524.8 ± 7.2*	455.9 ± 25.6**
Week 14	566.9 ± 10.6	—	—	568.9 ± 12.7	538.3 ± 7.5	518.3 ± 4.7**
Unbound iron binding capacity (μg/dL)						
Day 23	287.0 ± 13.6 ^f	—	—	286.3 ± 20.6	294.1 ± 16.8	296.9 ± 10.9 ^e
Week 14	334.0 ± 10.4	—	—	331.0 ± 13.3	319.4 ± 10.3	314.3 ± 8.9
Iron (μg/dL)						
Day 23	262.3 ± 20.5	—	—	223.5 ± 24.0	230.7 ± 20.1	180.4 ± 13.2**
Week 14	232.9 ± 7.7	—	—	237.9 ± 12.0	218.9 ± 11.0	204.0 ± 9.2
Alanine aminotransferase (IU/L)						
Day 23	38 ± 1	34 ± 1	35 ± 1	32 ± 1**	31 ± 1**	30 ± 1**
Week 14	49 ± 2	46 ± 4	53 ± 3	49 ± 5	52 ± 3	63 ± 4

TABLE F1
Hematology, Clinical Chemistry, Urinalysis, and Urine Concentrating Ability Data
for Rats in the 14-Week Inhalation Study of Gallium Arsenide

	Chamber Control	0.1 mg/m ³	1 mg/m ³	10 mg/m ³	37 mg/m ³	75 mg/m ³
Female (continued)						
Clinical Chemistry (continued)						
n						
Day 23	10	10	10	10	10	10
Week 14	10	9	10	10	10	10
Creatine kinase (IU/L)						
Day 23	304 ± 37	335 ± 40	360 ± 59	391 ± 43	476 ± 156	349 ± 92
Week 14	175 ± 19	163 ± 33	149 ± 15	167 ± 14	159 ± 18	149 ± 27
Sorbitol dehydrogenase (IU/L)						
Day 23	9 ± 1	—	—	9 ± 1	9 ± 1	10 ± 0
Week 14	17 ± 1	—	—	19 ± 2	19 ± 1*	22 ± 1**
Thyroid-stimulating hormone (ng/mL)						
Week 14	0.97 ± 0.10	1.45 ± 0.18	1.06 ± 0.10	1.22 ± 0.20	1.10 ± 0.22 ^e	1.22 ± 0.15 ^e
Triiodothyronine (ng/dL)						
Week 14	119.7 ± 9.1	128.3 ± 6.3	118.1 ± 8.7	117.8 ± 5.0	120.4 ± 8.0	119.0 ± 4.5 ^e
Thyroxine (μg/dL)						
Week 14	4.06 ± 0.33	4.66 ± 0.53	3.61 ± 0.33	4.14 ± 0.27	4.29 ± 0.31	3.86 ± 0.33 ^e
Free thyroxine (ng/dL)						
Week 14	2.15 ± 0.15	2.30 ± 0.11	2.10 ± 0.17	2.43 ± 0.10	2.40 ± 0.12	2.15 ± 0.18 ^g
Urinalysis						
n	10	10	10	9	10	10
Volume (mL/14 hr)	9.7 ± 1.6	9.6 ± 0.6 ^e	10.6 ± 1.2	6.7 ± 1.3 ^g	7.8 ± 1.3	6.3 ± 0.9
Specific gravity	1.016 ± 0.002	1.015 ± 0.001	1.015 ± 0.001	1.020 ± 0.005	1.020 ± 0.002	1.022 ± 0.002*
Glucose (mg/14 hr)	0.5 ± 0.0	—	—	0.4 ± 0.1	0.5 ± 0.0	0.4 ± 0.0
Protein (mg/14 hr)	1 ± 0	—	—	1 ± 0	1 ± 0	1 ± 0
<i>N</i> -acetyl-β-D-glucosaminidase (IU/14 hr)						
	0.0 ± 0.0	—	—	0.0 ± 0.0	0.0 ± 0.0	0.0 ± 0.0 ^e
δ-Aminolevulinic acid (nmol/14 hr)	73.51 ± 3.29	59.78 ± 3.96	97.00 ± 22.93	63.48 ± 9.05	66.05 ± 2.52	83.88 ± 6.36 ^e
Porphobilinogen (nmol/14 hr)	12.16 ± 2.74	17.68 ± 2.09	8.03 ± 1.87	9.01 ± 1.14	11.96 ± 0.75	7.18 ± 1.09 ^e
Urine Concentrating Ability						
n	6			5	6	7
Volume (mL/4 hr)	0.3 ± 0.1	—	—	0.1 ± 0.1	0.2 ± 0.0	0.2 ± 0.0
Specific gravity	1.020 ± 0.003	—	—	1.018 ± 0.004 ^h	1.025 ± 0.007	1.023 ± 0.005

* Significantly different ($P \leq 0.05$) from the chamber control group by Dunn's or Shirley's test

** $P \leq 0.01$

^a Mean ± standard error. Statistical tests were performed on unrounded data.

^b n=5

^c Not measured at this exposure concentration

^d n=10

^e n=9

^f n=7

^g n=8

^h n=4

TABLE F2
Hematology Data for Mice in the 14-Week Inhalation Study of Gallium Arsenide^a

	Chamber Control	0.1 mg/m ³	1 mg/m ³	10 mg/m ³	37 mg/m ³	75 mg/m ³
Male						
n	10	9	10	10	10	10
Manual hematocrit (%)	45.5 ± 0.4	44.9 ± 0.4	46.4 ± 0.4	46.5 ± 0.6	45.2 ± 0.9	45.2 ± 0.6
Automated hematocrit (%)	45.0 ± 0.4	44.6 ± 0.4	45.0 ± 0.4	43.8 ± 0.7	41.1 ± 0.5**	40.5 ± 0.6**
Hemoglobin (g/dL)	15.9 ± 0.1	15.7 ± 0.1	15.8 ± 0.2	15.5 ± 0.2	15.2 ± 0.2**	15.0 ± 0.2**
Erythrocytes (10 ⁶ /μL)	9.82 ± 0.08	9.82 ± 0.06	10.01 ± 0.08	10.48 ± 0.16**	11.68 ± 0.15**	12.27 ± 0.16**
Reticulocytes (10 ⁶ /μL)	0.22 ± 0.01	0.22 ± 0.02	0.24 ± 0.02	0.26 ± 0.02	0.33 ± 0.03**	0.32 ± 0.03**
Howell-Jolly bodies (% erythrocytes)	0.1 ± 0.0	0.1 ± 0.1	0.1 ± 0.0	0.1 ± 0.0	0.2 ± 0.0 ^b	0.1 ± 0.0
Mean cell volume (fL)	45.9 ± 0.2	45.4 ± 0.2	45.0 ± 0.3*	41.7 ± 0.3**	35.2 ± 0.4**	33.1 ± 0.4**
Mean cell hemoglobin (pg)	16.2 ± 0.0	16.0 ± 0.1	15.8 ± 0.1**	14.8 ± 0.1**	13.0 ± 0.1**	12.3 ± 0.1**
Mean cell hemoglobin concentration (g/dL)	35.3 ± 0.1	35.2 ± 0.3	35.2 ± 0.2	35.5 ± 0.2	37.0 ± 0.3**	37.1 ± 0.3**
Platelets (10 ³ /μL)	1,084.5 ± 26.4	1,055.4 ± 23.9	1,040.4 ± 29.2	1,157.6 ± 33.9	1,342.1 ± 56.2**	1,287.8 ± 72.2**
Leukocytes (10 ³ /μL)	3.55 ± 0.41	5.04 ± 0.72	5.93 ± 0.49**	6.09 ± 0.48**	6.61 ± 0.84**	5.59 ± 0.72**
Segmented neutrophils (10 ³ /μL)	0.45 ± 0.05	0.77 ± 0.17	0.81 ± 0.10*	1.84 ± 0.34**	2.15 ± 0.41**	1.96 ± 0.31**
Lymphocytes (10 ³ /μL)	3.05 ± 0.38	4.25 ± 0.68	5.05 ± 0.45*	4.08 ± 0.32	4.34 ± 0.56	3.53 ± 0.57
Monocytes (10 ³ /μL)	0.00 ± 0.00	0.00 ± 0.00	0.01 ± 0.01	0.00 ± 0.00	0.01 ± 0.01	0.02 ± 0.01
Eosinophils (10 ³ /μL)	0.05 ± 0.02	0.03 ± 0.01	0.06 ± 0.02	0.16 ± 0.04	0.12 ± 0.04	0.07 ± 0.02
Total bone marrow cellularity (10 ⁷ /femur)	1.3 ± 0.1 ^c	—	—	1.9 ± 0.1** ^c	1.7 ± 0.1 ^c	1.8 ± 0.1 ^c
Methemoglobin (% hgb)	0.80 ± 0.06 ^d	0.86 ± 0.05	0.79 ± 0.06 ^b	0.89 ± 0.06	0.91 ± 0.04	0.79 ± 0.04 ^b
Zinc protoporphyrin (μmol/mol heme)	72.9 ± 2.3	69.4 ± 2.0	70.2 ± 1.3	79.0 ± 1.8*	83.4 ± 2.7*	91.8 ± 2.3** ^b

TABLE F2
Hematology Data for Mice in the 14-Week Inhalation Study of Gallium Arsenide^a

	Chamber Control	0.1 mg/m ³	1 mg/m ³	10 mg/m ³	37 mg/m ³	75 mg/m ³
Female						
n	10	10	10	10	10	9
Manual hematocrit (%)	44.8 ± 0.5	45.0 ± 0.4	44.6 ± 0.3	45.4 ± 0.3	43.7 ± 0.6	44.4 ± 0.4
Automated hematocrit (%)	44.7 ± 0.5	44.6 ± 0.4	43.8 ± 0.3	43.6 ± 0.4	41.3 ± 0.5**	41.4 ± 0.5**
Hemoglobin (g/dL)	15.9 ± 0.1	15.8 ± 0.1	15.6 ± 0.1	15.6 ± 0.2	14.8 ± 0.1**	15.0 ± 0.1**
Erythrocytes (10 ⁶ /μL)	9.76 ± 0.09	9.75 ± 0.09	9.74 ± 0.05	10.27 ± 0.09**	11.06 ± 0.12**	11.38 ± 0.07**
Reticulocytes (10 ⁶ /μL)	0.24 ± 0.02	0.27 ± 0.02	0.24 ± 0.02	0.27 ± 0.02	0.28 ± 0.02	0.36 ± 0.03**
Howell-Jolly bodies (% erythrocytes)	0.1 ± 0.0	0.1 ± 0.0	0.1 ± 0.0	0.1 ± 0.0	0.1 ± 0.0	0.1 ± 0.0
Mean cell volume (fL)	45.7 ± 0.3	45.7 ± 0.3	45.1 ± 0.2	42.5 ± 0.2**	37.3 ± 0.4**	36.3 ± 0.5**
Mean cell hemoglobin (pg)	16.3 ± 0.1	16.2 ± 0.1	16.0 ± 0.1*	15.2 ± 0.1**	13.4 ± 0.2**	13.2 ± 0.1**
Mean cell hemoglobin concentration (g/dL)	35.6 ± 0.2	35.4 ± 0.3	35.5 ± 0.1	35.7 ± 0.2	35.9 ± 0.3	36.2 ± 0.2
Platelets (10 ³ /μL)	883.1 ± 44.6	976.4 ± 17.3	918.7 ± 24.5	1,040.5 ± 31.6**	1,088.1 ± 58.1**	1,091.8 ± 59.5**
Leukocytes (10 ³ /μL)	4.33 ± 0.52	4.69 ± 0.39	3.00 ± 0.22	4.76 ± 0.62	4.56 ± 0.35	4.18 ± 0.30
Segmented neutrophils (10 ³ /μL)	0.56 ± 0.12	0.64 ± 0.08	0.46 ± 0.03	1.16 ± 0.27*	1.12 ± 0.17**	1.11 ± 0.17**
Lymphocytes (10 ³ /μL)	3.74 ± 0.43	4.02 ± 0.32	2.53 ± 0.21	3.57 ± 0.37	3.42 ± 0.24	3.05 ± 0.18
Monocytes (10 ³ /μL)	0.00 ± 0.00	0.00 ± 0.00	0.00 ± 0.00	0.00 ± 0.00	0.00 ± 0.00	0.00 ± 0.00
Eosinophils (10 ³ /μL)	0.03 ± 0.01	0.04 ± 0.02	0.01 ± 0.01	0.02 ± 0.01	0.02 ± 0.02	0.02 ± 0.02
Total bone marrow cellularity (10 ⁷ /femur)	2.0 ± 0.1 ^c	—	—	2.3 ± 0.1 ^c	2.6 ± 0.3 ^c	2.1 ± 0.1 ^c
Methemoglobin (% hgb)	0.82 ± 0.05	0.72 ± 0.05	0.71 ± 0.06 ^b	0.74 ± 0.06	0.79 ± 0.04 ^b	0.71 ± 0.04
Zinc protoporphyrin (μmol/mol heme)	76.9 ± 2.5	79.1 ± 2.1	73.3 ± 1.3	86.6 ± 1.9**	96.8 ± 1.9**	98.6 ± 2.9**

* Significantly different ($P \leq 0.05$) from the chamber control group by Dunn's or Shirley's test

** $P \leq 0.01$

^a Mean ± standard error. Statistical tests were performed on unrounded data.

^b n=9

^c n=5

^d n=8

APPENDIX G

ORGAN WEIGHTS AND ORGAN-WEIGHT-TO-BODY-WEIGHT RATIOS

TABLE G1	Organ Weights and Organ-Weight-to-Body-Weight Ratios for Rats in the 16-Day Inhalation Study of Gallium Arsenide	262
TABLE G2	Organ Weights and Organ-Weight-to-Body-Weight Ratios for Rats in the 14-Week Inhalation Study of Gallium Arsenide	264
TABLE G3	Organ Weights and Organ-Weight-to-Body-Weight Ratios for Mice in the 16-Day Inhalation Study of Gallium Arsenide	266
TABLE G4	Organ Weights and Organ-Weight-to-Body-Weight Ratios for Mice in the 14-Week Inhalation Study of Gallium Arsenide	268

TABLE G1
Organ Weights and Organ-Weight-to-Body-Weight Ratios for Rats
in the 16-Day Inhalation Study of Gallium Arsenide^a

	Chamber Control	1 mg/m ³	10 mg/m ³	37 mg/m ³	75 mg/m ³	150 mg/m ³
Male						
n	5	5	5	5	5	5
Necropsy body wt	176 ± 2	170 ± 5	173 ± 4	169 ± 5	174 ± 3	166 ± 7
Brain						
Absolute	1.686 ± 0.019	1.700 ± 0.023	1.692 ± 0.020	1.678 ± 0.018	1.690 ± 0.025	1.678 ± 0.017
Relative	9.57 ± 0.05	10.02 ± 0.26	9.78 ± 0.14	9.96 ± 0.23	9.72 ± 0.17	10.15 ± 0.33
Heart						
Absolute	0.620 ± 0.016	0.616 ± 0.019	0.638 ± 0.023	0.624 ± 0.024	0.666 ± 0.014	0.646 ± 0.022
Relative	3.52 ± 0.05	3.62 ± 0.07	3.68 ± 0.06	3.70 ± 0.11	3.83 ± 0.06**	3.89 ± 0.04**
R. Kidney						
Absolute	0.842 ± 0.025	0.842 ± 0.026	0.918 ± 0.024	0.834 ± 0.023	0.902 ± 0.010	0.842 ± 0.043
Relative	4.78 ± 0.10	4.95 ± 0.05	5.30 ± 0.06**	4.94 ± 0.05	5.19 ± 0.06**	5.06 ± 0.09*
Liver						
Absolute	8.560 ± 0.156	9.586 ± 0.451	10.116 ± 0.241*	9.732 ± 0.407	10.128 ± 0.178*	9.394 ± 0.467
Relative	48.58 ± 0.30	56.29 ± 1.42**	58.40 ± 0.68**	57.58 ± 1.14**	58.23 ± 0.91**	56.47 ± 0.97**
Lung						
Absolute	1.336 ± 0.069	1.540 ± 0.094	1.770 ± 0.068**	1.696 ± 0.020**	1.812 ± 0.075**	1.768 ± 0.121**
Relative	7.61 ± 0.48	9.03 ± 0.34*	10.21 ± 0.23**	10.07 ± 0.15**	10.43 ± 0.47**	10.63 ± 0.54**
R. Testis						
Absolute	1.035 ± 0.030	0.977 ± 0.018	1.021 ± 0.017	1.009 ± 0.031	1.039 ± 0.017	0.985 ± 0.021
Relative	5.87 ± 0.13	5.75 ± 0.10	5.90 ± 0.08	5.98 ± 0.06	5.97 ± 0.04	5.95 ± 0.14
Thymus						
Absolute	0.546 ± 0.036	0.452 ± 0.023**	0.465 ± 0.015**	0.443 ± 0.016**	0.446 ± 0.011**	0.416 ± 0.020**
Relative	3.10 ± 0.21	2.65 ± 0.08*	2.69 ± 0.12	2.63 ± 0.09*	2.57 ± 0.09*	2.50 ± 0.06**

TABLE G1
Organ Weights and Organ-Weight-to-Body-Weight Ratios for Rats
in the 16-Day Inhalation Study of Gallium Arsenide

	Chamber Control	1 mg/m ³	10 mg/m ³	37 mg/m ³	75 mg/m ³	150 mg/m ³
Female						
n	5	5	5	5	5	5
Necropsy body wt	126 ± 3	123 ± 2	122 ± 3	124 ± 2	125 ± 3	124 ± 4
Brain						
Absolute	1.582 ± 0.012	1.572 ± 0.017	1.584 ± 0.034	1.616 ± 0.017	1.594 ± 0.014	1.558 ± 0.020
Relative	12.54 ± 0.29	12.78 ± 0.30	13.00 ± 0.26	13.05 ± 0.11	12.74 ± 0.29	12.63 ± 0.33
Heart						
Absolute	0.468 ± 0.012	0.462 ± 0.011	0.480 ± 0.021	0.474 ± 0.008	0.492 ± 0.009	0.522 ± 0.022
Relative	3.70 ± 0.03	3.75 ± 0.04	3.93 ± 0.09	3.83 ± 0.04	3.93 ± 0.07*	4.22 ± 0.11**
R. Kidney						
Absolute	0.642 ± 0.028	0.652 ± 0.020	0.642 ± 0.020	0.664 ± 0.024	0.656 ± 0.017	0.622 ± 0.032
Relative	5.07 ± 0.12	5.29 ± 0.13	5.26 ± 0.07	5.36 ± 0.14	5.23 ± 0.04	5.02 ± 0.16
Liver						
Absolute	5.476 ± 0.194	5.620 ± 0.142	6.028 ± 0.226	6.216 ± 0.102*	6.228 ± 0.199*	6.446 ± 0.388**
Relative	43.30 ± 0.99	45.61 ± 0.59	49.35 ± 0.87**	50.19 ± 0.62**	49.65 ± 0.87**	51.95 ± 1.79**
Lung						
Absolute	1.128 ± 0.055	1.180 ± 0.066	1.254 ± 0.045	1.242 ± 0.021	1.408 ± 0.048**	1.450 ± 0.078**
Relative	8.95 ± 0.48	9.56 ± 0.40	10.28 ± 0.30*	10.03 ± 0.19*	11.23 ± 0.27**	11.69 ± 0.28**
Thymus						
Absolute	0.376 ± 0.018	0.362 ± 0.016	0.386 ± 0.024	0.380 ± 0.022	0.355 ± 0.027	0.341 ± 0.021
Relative	2.98 ± 0.14	2.95 ± 0.14	3.15 ± 0.16	3.08 ± 0.20	2.82 ± 0.15	2.75 ± 0.11

* Significantly different ($P \leq 0.05$) from the chamber control group by Williams' or Dunnett's test

** $P \leq 0.01$

^a Organ weights (absolute weights) and body weights are given in grams; organ-weight-to-body-weight ratios (relative weights) are given as mg organ weight/g body weight (mean ± standard error).

TABLE G2
Organ Weights and Organ-Weight-to-Body-Weight Ratios for Rats
in the 14-Week Inhalation Study of Gallium Arsenide^a

	Chamber Control	0.1 mg/m ³	1 mg/m ³	10 mg/m ³	37 mg/m ³	75 mg/m ³
Male						
n	10	10	10	10	10	10
Necropsy body wt	341 ± 8	338 ± 5	341 ± 7	334 ± 7	328 ± 4	314 ± 5**
Brain						
Absolute	1.864 ± 0.023	1.831 ± 0.017	1.878 ± 0.017	1.839 ± 0.013	1.820 ± 0.018	1.842 ± 0.018
Relative	5.478 ± 0.103	5.421 ± 0.068	5.517 ± 0.084	5.516 ± 0.090	5.562 ± 0.058	5.880 ± 0.051**
Heart						
Absolute	0.964 ± 0.032	0.944 ± 0.020	0.936 ± 0.019	0.950 ± 0.021	0.963 ± 0.017	0.978 ± 0.020
Relative	2.820 ± 0.044	2.791 ± 0.041	2.744 ± 0.033	2.845 ± 0.055	2.940 ± 0.028	3.119 ± 0.048**
R. Kidney						
Absolute	1.031 ± 0.028	1.050 ± 0.026	1.036 ± 0.026	0.987 ± 0.022	0.990 ± 0.018	0.971 ± 0.021
Relative	3.019 ± 0.034	3.102 ± 0.041	3.034 ± 0.035	2.955 ± 0.051	3.021 ± 0.023	3.097 ± 0.055
Liver						
Absolute	12.933 ± 0.508	12.974 ± 0.295	12.934 ± 0.412	12.663 ± 0.283	12.716 ± 0.203	12.158 ± 0.234
Relative	37.787 ± 0.751	38.337 ± 0.467	37.861 ± 0.803	37.879 ± 0.412	38.824 ± 0.317	38.768 ± 0.428
Lung						
Absolute	1.487 ± 0.051	1.986 ± 0.042**	2.353 ± 0.054**	2.925 ± 0.107**	3.764 ± 0.060**	4.174 ± 0.094**
Relative	4.351 ± 0.075	5.875 ± 0.103**	6.896 ± 0.085**	8.731 ± 0.202**	11.495 ± 0.125**	13.311 ± 0.225**
R. Testis						
Absolute	1.398 ± 0.022	1.366 ± 0.026	1.400 ± 0.026	1.392 ± 0.021	1.307 ± 0.041	0.755 ± 0.077**
Relative	4.105 ± 0.072	4.044 ± 0.080	4.106 ± 0.061	4.170 ± 0.052	3.999 ± 0.145	2.406 ± 0.243**
Thymus						
Absolute	0.345 ± 0.007	0.330 ± 0.013	0.324 ± 0.010	0.322 ± 0.014	0.335 ± 0.013	0.340 ± 0.010
Relative	1.014 ± 0.029	0.977 ± 0.035	0.951 ± 0.023	0.960 ± 0.031	1.021 ± 0.036	1.086 ± 0.035
Thyroid gland						
Absolute	0.019 ± 0.0017	0.019 ± 0.0010	0.017 ± 0.0014	0.019 ± 0.0011	0.018 ± 0.0007	0.017 ± 0.0010
Relative	0.054 ± 0.0048	0.055 ± 0.0027	0.050 ± 0.0044	0.058 ± 0.0038	0.055 ± 0.0018	0.055 ± 0.0033

TABLE G2
Organ Weights and Organ-Weight-to-Body-Weight Ratios for Rats
in the 14-Week Inhalation Study of Gallium Arsenide

	Chamber Control	0.1 mg/m ³	1 mg/m ³	10 mg/m ³	37 mg/m ³	75 mg/m ³
Female						
n	10	10	10	10	10	10
Necropsy body wt	192 ± 3	200 ± 4	196 ± 4	197 ± 4	193 ± 3	191 ± 3
Brain						
Absolute	1.696 ± 0.010	1.740 ± 0.019	1.733 ± 0.013	1.720 ± 0.015	1.697 ± 0.009	1.692 ± 0.014
Relative	8.846 ± 0.138	8.702 ± 0.103	8.876 ± 0.216	8.759 ± 0.178	8.823 ± 0.167	8.898 ± 0.125
Heart						
Absolute	0.602 ± 0.008	0.654 ± 0.018*	0.608 ± 0.010	0.633 ± 0.011	0.638 ± 0.014	0.639 ± 0.007
Relative	3.137 ± 0.046	3.270 ± 0.091	3.105 ± 0.032	3.218 ± 0.048	3.311 ± 0.063*	3.360 ± 0.051*
R. Kidney						
Absolute	0.632 ± 0.014	0.647 ± 0.013	0.637 ± 0.011	0.667 ± 0.010	0.650 ± 0.011	0.643 ± 0.006
Relative	3.298 ± 0.095	3.231 ± 0.033	3.253 ± 0.037	3.395 ± 0.076	3.373 ± 0.039	3.383 ± 0.060
Liver						
Absolute	6.142 ± 0.154	6.812 ± 0.266	6.533 ± 0.198	6.617 ± 0.205	6.380 ± 0.146	6.296 ± 0.067
Relative	31.956 ± 0.527	34.045 ± 1.295	33.296 ± 0.612	33.572 ± 0.726	33.068 ± 0.420	33.106 ± 0.516
Lung						
Absolute	1.033 ± 0.018	1.417 ± 0.040**	1.681 ± 0.025**	2.011 ± 0.046**	2.581 ± 0.067**	2.946 ± 0.061**
Relative	5.385 ± 0.110	7.069 ± 0.107**	8.595 ± 0.161**	10.239 ± 0.296**	13.376 ± 0.226**	15.517 ± 0.472**
Thymus						
Absolute	0.252 ± 0.012	0.252 ± 0.008	0.254 ± 0.008	0.277 ± 0.021	0.258 ± 0.012	0.240 ± 0.009
Relative	1.309 ± 0.052	1.258 ± 0.037	1.298 ± 0.038	1.398 ± 0.090	1.338 ± 0.052	1.261 ± 0.041
Thyroid gland						
Absolute	0.013 ± 0.0007	0.015 ± 0.0006	0.013 ± 0.0008	0.013 ± 0.0006	0.014 ± 0.0008	0.013 ± 0.0010
Relative	0.069 ± 0.0031	0.075 ± 0.0032	0.065 ± 0.0041	0.067 ± 0.0030	0.070 ± 0.0041	0.067 ± 0.0049

* Significantly different ($P \leq 0.05$) from the chamber control group by Williams' or Dunnett's test

** $P \leq 0.01$

^a Organ weights (absolute weights) and body weights are given in grams; organ-weight-to-body-weight ratios (relative weights) are given as mg organ weight/g body weight (mean ± standard error).

TABLE G3
Organ Weights and Organ-Weight-to-Body-Weight Ratios for Mice
in the 16-Day Inhalation Study of Gallium Arsenide^a

	Chamber Control	1 mg/m ³	10 mg/m ³	37 mg/m ³	75 mg/m ³	150 mg/m ³
Male						
n	5	5	5	5	5	5
Necropsy body wt	27.8 ± 0.6	27.6 ± 0.6	28.0 ± 0.9	27.1 ± 0.5	28.0 ± 0.5	27.1 ± 0.6
Brain						
Absolute	0.462 ± 0.004	0.452 ± 0.006	0.462 ± 0.007	0.440 ± 0.009	0.460 ± 0.003	0.460 ± 0.010
Relative	16.66 ± 0.25	16.42 ± 0.38	16.56 ± 0.45	16.23 ± 0.36	16.50 ± 0.19	16.96 ± 0.36
Heart						
Absolute	0.132 ± 0.004	0.130 ± 0.004	0.146 ± 0.009	0.134 ± 0.007	0.152 ± 0.006	0.134 ± 0.006
Relative	4.75 ± 0.05	4.71 ± 0.13	5.20 ± 0.19	4.93 ± 0.20	5.45 ± 0.17*	4.93 ± 0.16
R. Kidney						
Absolute	0.282 ± 0.015	0.288 ± 0.004	0.304 ± 0.010	0.280 ± 0.006	0.306 ± 0.007	0.280 ± 0.009
Relative	10.14 ± 0.35	10.46 ± 0.20	10.87 ± 0.13	10.32 ± 0.17	10.97 ± 0.22	10.32 ± 0.27
Liver						
Absolute	1.670 ± 0.070	1.650 ± 0.040	1.712 ± 0.086	1.734 ± 0.052	1.752 ± 0.068	1.680 ± 0.035
Relative	60.10 ± 1.78	59.82 ± 0.31	61.07 ± 1.44	63.84 ± 0.93	62.72 ± 1.50	61.92 ± 0.78
Lung						
Absolute	0.210 ± 0.011	0.216 ± 0.002	0.284 ± 0.007**	0.300 ± 0.005**	0.328 ± 0.009**	0.356 ± 0.004**
Relative	7.55 ± 0.30	7.84 ± 0.15	10.17 ± 0.26**	11.06 ± 0.21**	11.75 ± 0.19**	13.14 ± 0.27**
R. Testis						
Absolute	0.114 ± 0.004	0.106 ± 0.003	0.107 ± 0.003	0.102 ± 0.001	0.102 ± 0.003*	0.109 ± 0.005
Relative	4.12 ± 0.08	3.83 ± 0.11	3.84 ± 0.12	3.76 ± 0.03	3.65 ± 0.09*	4.03 ± 0.14
Thymus						
Absolute	0.056 ± 0.002	0.052 ± 0.006	0.052 ± 0.004	0.048 ± 0.002	0.059 ± 0.001	0.045 ± 0.005
Relative	2.02 ± 0.07	1.89 ± 0.18	1.87 ± 0.12	1.76 ± 0.08	2.13 ± 0.04	1.65 ± 0.17

TABLE G3
Organ Weights and Organ-Weight-to-Body-Weight Ratios for Mice
in the 16-Day Inhalation Study of Gallium Arsenide

	Chamber Control	1 mg/m ³	10 mg/m ³	37 mg/m ³	75 mg/m ³	150 mg/m ³
Female						
n	5	5	5	5	4	5
Necropsy body wt	22.7 ± 0.2	22.4 ± 0.5	22.3 ± 0.3	22.2 ± 0.5	21.6 ± 0.3	21.9 ± 0.5
Brain						
Absolute	0.464 ± 0.005	0.458 ± 0.007	0.450 ± 0.006	0.442 ± 0.010	0.445 ± 0.005	0.456 ± 0.004
Relative	20.42 ± 0.37	20.42 ± 0.18	20.19 ± 0.31	19.96 ± 0.68	20.64 ± 0.35	20.85 ± 0.39
Heart						
Absolute	0.118 ± 0.004	0.106 ± 0.002	0.108 ± 0.004	0.102 ± 0.002*	0.113 ± 0.006	0.114 ± 0.004
Relative	5.19 ± 0.18	4.74 ± 0.18	4.84 ± 0.13	4.60 ± 0.13	5.22 ± 0.30	5.20 ± 0.07
R. Kidney						
Absolute	0.252 ± 0.052	0.196 ± 0.002	0.200 ± 0.006	0.192 ± 0.005	0.203 ± 0.003	0.202 ± 0.007
Relative	11.07 ± 2.28	8.74 ± 0.09	8.97 ± 0.25	8.65 ± 0.14	9.40 ± 0.24	9.22 ± 0.21
Liver						
Absolute	1.374 ± 0.012	1.360 ± 0.013	1.350 ± 0.048	1.208 ± 0.064*	1.308 ± 0.035	1.354 ± 0.045
Relative	60.44 ± 0.63	60.72 ± 1.50	60.48 ± 1.43	54.42 ± 2.58*	60.61 ± 1.42	61.77 ± 0.86
Lung						
Absolute	0.196 ± 0.002	0.194 ± 0.002	0.248 ± 0.009**	0.278 ± 0.004**	0.285 ± 0.006**	0.324 ± 0.013**
Relative	8.62 ± 0.16	8.65 ± 0.12	11.12 ± 0.32**	12.55 ± 0.36**	13.22 ± 0.38**	14.78 ± 0.42**
Thymus						
Absolute	0.076 ± 0.003	0.078 ± 0.004	0.071 ± 0.004	0.073 ± 0.005	0.065 ± 0.002	0.072 ± 0.004
Relative	3.32 ± 0.09	3.46 ± 0.17	3.17 ± 0.18	3.26 ± 0.19	2.99 ± 0.12	3.28 ± 0.12

* Significantly different ($P \leq 0.05$) from the chamber control group by Williams' or Dunnett's test

** $P \leq 0.01$

^a Organ weights (absolute weights) and body weights are given in grams; organ-weight-to-body-weight ratios (relative weights) are given as mg organ weight/g body weight (mean ± standard error).

TABLE G4
Organ Weights and Organ-Weight-to-Body-Weight Ratios for Mice
in the 14-Week Inhalation Study of Gallium Arsenide^a

	Chamber Control	0.1 mg/m ³	1 mg/m ³	10 mg/m ³	37 mg/m ³	75 mg/m ³
Male						
n	10	10	10	10	10	10
Necropsy body wt	37.5 ± 0.9	36.5 ± 0.7	38.9 ± 1.2	35.3 ± 0.7	35.5 ± 0.9	34.1 ± 0.6**
Brain						
Absolute	0.454 ± 0.004	0.455 ± 0.002	0.456 ± 0.005	0.455 ± 0.007	0.449 ± 0.003	0.447 ± 0.003
Relative	12.17 ± 0.34	12.49 ± 0.25	11.82 ± 0.37	12.92 ± 0.28	12.72 ± 0.30	13.34 ± 0.27**
Heart						
Absolute	0.162 ± 0.008	0.163 ± 0.004	0.163 ± 0.004	0.171 ± 0.005	0.161 ± 0.003	0.167 ± 0.008
Relative	4.32 ± 0.20	4.46 ± 0.09	4.21 ± 0.07	4.85 ± 0.12	4.55 ± 0.10	4.99 ± 0.28*
R. Kidney						
Absolute	0.302 ± 0.005	0.317 ± 0.010	0.320 ± 0.008	0.309 ± 0.006	0.316 ± 0.007	0.310 ± 0.010
Relative	8.08 ± 0.18	8.67 ± 0.20	8.25 ± 0.14	8.77 ± 0.20*	8.93 ± 0.21*	9.25 ± 0.36**
Liver						
Absolute	1.736 ± 0.051	1.699 ± 0.036	1.722 ± 0.062	1.700 ± 0.045	1.688 ± 0.026	1.602 ± 0.077
Relative	46.28 ± 0.87	46.50 ± 0.55	44.31 ± 0.94	48.19 ± 1.07	47.79 ± 1.14	47.80 ± 2.54
Lung						
Absolute	0.238 ± 0.007	0.242 ± 0.007	0.272 ± 0.008*	0.362 ± 0.009**	0.475 ± 0.008**	0.519 ± 0.016**
Relative	6.36 ± 0.16	6.62 ± 0.13	7.01 ± 0.12	10.25 ± 0.17**	13.44 ± 0.31**	15.53 ± 0.70**
R. Testis						
Absolute	0.122 ± 0.002	0.126 ± 0.002	0.129 ± 0.004	0.122 ± 0.004	0.058 ± 0.003**	0.057 ± 0.002**
Relative	3.28 ± 0.11	3.45 ± 0.04	3.35 ± 0.13	3.46 ± 0.13	1.65 ± 0.12**	1.69 ± 0.07**
Thymus						
Absolute	0.041 ± 0.002	0.040 ± 0.002	0.040 ± 0.002	0.040 ± 0.003	0.039 ± 0.001	0.038 ± 0.002
Relative	1.10 ± 0.05	1.09 ± 0.05	1.03 ± 0.04	1.12 ± 0.07	1.10 ± 0.04	1.12 ± 0.04
Thyroid gland						
Absolute	0.005 ± 0.0004	0.004 ± 0.0004	0.005 ± 0.0006	0.005 ± 0.0003	0.005 ± 0.0004	0.005 ± 0.0003
Relative	0.135 ± 0.0104	0.120 ± 0.0110	0.124 ± 0.0136	0.133 ± 0.0075	0.128 ± 0.0125	0.138 ± 0.0104

TABLE G4
Organ Weights and Organ-Weight-to-Body-Weight Ratios for Mice
in the 14-Week Inhalation Study of Gallium Arsenide

	Chamber Control	0.1 mg/m ³	1 mg/m ³	10 mg/m ³	37 mg/m ³	75 mg/m ³
Female						
n	10	10	10	10	10	9
Necropsy body wt	32.8 ± 1.4	33.2 ± 0.6	34.8 ± 1.4	32.1 ± 0.7	29.9 ± 0.7	30.4 ± 0.7
Brain						
Absolute	0.464 ± 0.005	0.466 ± 0.004	0.472 ± 0.003	0.466 ± 0.004	0.468 ± 0.004	0.466 ± 0.002
Relative	14.34 ± 0.59	14.06 ± 0.24	13.75 ± 0.48	14.58 ± 0.38	15.74 ± 0.36*	15.41 ± 0.37
Heart						
Absolute	0.135 ± 0.003	0.132 ± 0.004	0.134 ± 0.004	0.132 ± 0.002	0.137 ± 0.003	0.133 ± 0.002
Relative	4.16 ± 0.14	3.98 ± 0.11	3.88 ± 0.09	4.12 ± 0.06	4.60 ± 0.10*	4.40 ± 0.07*
R. Kidney						
Absolute	0.205 ± 0.005	0.206 ± 0.006	0.209 ± 0.004	0.205 ± 0.003	0.200 ± 0.003	0.199 ± 0.004
Relative	6.30 ± 0.17	6.19 ± 0.11	6.07 ± 0.18	6.40 ± 0.12	6.72 ± 0.16	6.57 ± 0.13
Liver						
Absolute	1.563 ± 0.057	1.553 ± 0.059	1.592 ± 0.063	1.530 ± 0.041	1.512 ± 0.045	1.428 ± 0.050
Relative	47.82 ± 1.26	46.69 ± 1.44	45.90 ± 0.99	47.65 ± 0.83	50.65 ± 1.13	47.00 ± 1.09
Lung						
Absolute	0.252 ± 0.010	0.249 ± 0.015	0.245 ± 0.008	0.327 ± 0.007**	0.430 ± 0.007**	0.518 ± 0.005**
Relative	7.76 ± 0.37	7.46 ± 0.30	7.08 ± 0.15	10.22 ± 0.29**	14.44 ± 0.27**	17.16 ± 0.54**
Thymus						
Absolute	0.056 ± 0.003 ^b	0.056 ± 0.002	0.051 ± 0.002	0.056 ± 0.004	0.048 ± 0.001	0.052 ± 0.003
Relative	1.74 ± 0.05 ^b	1.68 ± 0.08	1.49 ± 0.08	1.74 ± 0.10	1.61 ± 0.04	1.72 ± 0.08
Thyroid gland						
Absolute	0.006 ± 0.0007	0.005 ± 0.0004	0.005 ± 0.0003	0.005 ± 0.0004	0.004 ± 0.0003	0.004 ± 0.0004
Relative	0.167 ± 0.0207	0.145 ± 0.0123	0.152 ± 0.0080	0.146 ± 0.0110	0.138 ± 0.0103	0.141 ± 0.0173

* Significantly different ($P \leq 0.05$) from the chamber control group by Williams' or Dunnett's test

** $P \leq 0.01$

^a Organ weights (absolute weights) and body weights are given in grams; organ-weight-to-body-weight ratios (relative weights) are given as mg organ weight/g body weight (mean ± standard error).

^b n=9

APPENDIX H

TISSUE BURDEN RESULTS

TABLE H1	Lung Weight and Lung Burden in Male Rats in the 14-Week Inhalation Study of Gallium Arsenide	272
TABLE H2	Lung Weight and Lung Burden in Male Rats in the 2-Year Inhalation Study of Gallium Arsenide	273
TABLE H3	Lung Deposition and Clearance Parameters in Male Rats in the 14-Week Inhalation Study of Gallium Arsenide	275
TABLE H4	Lung Deposition and Clearance Parameters in Male Rats in the 2-Year Inhalation Study of Gallium Arsenide	275
TABLE H5	Blood Gallium and Arsenic Concentrations in Male Rats in the 2-Year Inhalation Study of Gallium Arsenide	276
TABLE H6	Serum Gallium and Arsenic Concentrations in Male Rats in the 2-Year Inhalation Study of Gallium Arsenide	276
TABLE H7	Testes Gallium and Arsenic Concentrations in Male Rats in the 2-Year Inhalation Study of Gallium Arsenide	277

TABLE H1
Lung Weight and Lung Burden in Male Rats in the 14-Week Inhalation Study of Gallium Arsenide^a

	Chamber Control	0.1 mg/m ³	1 mg/m ³	10 mg/m ³	37 mg/m ³	75 mg/m ³
n						
Day 23	10	6	6	6	6	6
Day 45	2	4	4	4	4	4
Week 14	4	4	4	4	4	4
Absolute lung wt (g)						
Day 23	0.85 ± 0.12	0.84 ± 0.06	1.16 ± 0.20	1.32 ± 0.08	1.56 ± 0.13	1.92 ± 0.19
Day 45	1.10 ± 0.00	1.15 ± 0.20	1.73 ± 0.32	2.01 ± 0.21	2.42 ± 0.21	2.67 ± 0.38
Week 14	1.06 ± 0.11	1.80 ± 0.13	2.02 ± 0.17	2.58 ± 0.35	3.51 ± 0.19	4.02 ± 0.29
µg Ga/lung						
Day 23	— ^b	3.45 ± 0.35	32.54 ± 3.37	178.86 ± 11.38	390.27 ± 28.56	562.28 ± 34.05
Day 45	—	7.24 ± 1.39	46.93 ± 5.79	213.12 ± 19.75	473.43 ± 7.31	710.30 ± 69.87
Week 14	—	19.84 ± 0.53	80.84 ± 2.46	299.80 ± 58.44	716.08 ± 46.27	931.58 ± 107.61
µg Ga/g lung						
Day 23	—	4.13 ± 0.50	28.34 ± 3.37	135.83 ± 6.15	250.87 ± 18.89	294.61 ± 34.76
Day 45	—	6.31 ± 0.40	27.44 ± 2.65	106.38 ± 10.46	196.86 ± 18.85	267.99 ± 27.03
Week 14	—	11.16 ± 0.66 ^c	40.33 ± 4.94	115.90 ± 12.40	205.30 ± 24.91	231.86 ± 18.09
µg Ga/lung per mg GaAs/m ³						
Day 23	NA	34.49 ± 3.54	32.54 ± 3.37	17.89 ± 1.14	10.55 ± 0.77	7.50 ± 0.45
Day 45	NA	72.40 ± 13.90	46.93 ± 5.79	21.31 ± 1.97	12.80 ± 0.20	9.47 ± 0.93
Week 14	NA	198.40 ± 5.29	80.84 ± 2.46	29.98 ± 5.84	19.35 ± 1.25	12.42 ± 1.43
µg As/lung						
Day 23	—	4.52 ± 0.57	35.75 ± 3.85	203.76 ± 10.56	442.00 ± 34.45	669.73 ± 86.89
Day 45	2.47 ± 0.01	10.16 ± 2.03	59.81 ± 8.98	266.19 ± 36.15	585.13 ± 14.44	804.40 ± 91.59
Week 14	2.72 ± 0.51	21.00 ± 0.65	80.68 ± 2.57	318.15 ± 66.40	849.95 ± 56.81	1,086.30 ± 96.81
µg As/g lung						
Day 23	—	5.39 ± 0.62	31.09 ± 3.22	154.90 ± 8.44	284.44 ± 27.12	350.73 ± 58.07
Day 45	2.25 ± 0.01	8.84 ± 0.46	34.86 ± 3.38	132.41 ± 12.51	242.88 ± 16.94	303.90 ± 38.29
Week 14	2.56 ± 0.31	11.81 ± 0.63 ^c	40.19 ± 4.10	123.32 ± 17.44	243.72 ± 30.07	270.81 ± 19.37
µg As/lung per mg GaAs/m ³						
Day 23	NA	40.07 ± 5.73	35.24 ± 3.85	20.33 ± 1.06	11.93 ± 0.93	8.92 ± 1.16
Day 45	NA	76.85 ± 20.30	57.34 ± 8.98	26.37 ± 3.62	15.75 ± 0.39	10.73 ± 1.22
Week 14	NA	182.80 ± 6.55	77.96 ± 2.57	31.54 ± 6.64	22.90 ± 1.54	14.48 ± 1.29

(NA) Not applicable

^a Data are presented as mean ± standard deviation.

^b Below the limit of quantitation (2.5 µg Ga/g lung, 0.7 µg As/g lung)

^c n=3

TABLE H2
Lung Weight and Lung Burden in Male Rats in the 2-Year Inhalation Study of Gallium Arsenide^a

	Chamber Control	0.01 mg/m ³	0.1 mg/m ³	1.0 mg/m ³
n	5	5	5	5
Absolute lung wt (g)				
Month 1	0.8392 ± 0.0533	— ^b	0.7876 ± 0.0585	1.0670 ± 0.1382
Month 2	0.9680 ± 0.0601	0.9096 ± 0.1018	1.3990 ± 0.1040	1.7863 ± 0.0639
Month 4	1.0486 ± 0.0919	—	1.5830 ± 0.0979	2.1429 ± 0.0684
Month 6	1.1397 ± 0.0308	—	1.6899 ± 0.1374	2.4413 ± 0.1882
Month 12	1.1958 ± 0.1130	1.1650 ± 0.0794	1.9785 ± 0.3666	2.7343 ± 0.2853
Month 18	1.3430 ± 0.1510	1.2971 ± 0.0751	1.9510 ± 0.2231	3.4476 ± 0.9449
μg Ga/lung ^c				
Month 1		—	3.40 ± 0.48	30.70 ± 2.75
Month 2		0.72 ± 0.04	10.53 ± 1.18	65.50 ± 5.09
Month 4		—	15.71 ± 1.37	86.78 ± 5.16
Month 6		—	23.88 ± 3.62	104.27 ± 16.67
Month 12		2.04 ± 0.53	32.26 ± 3.48	106.10 ± 10.40
Month 18		2.08 ± 0.35 ^d	26.53 ± 4.06	73.26 ± 15.93
μg Ga/g lung ^c				
Month 1		—	4.31 ± 0.39	28.94 ± 2.33
Month 2		0.79 ± 0.09	7.52 ± 0.50	36.71 ± 3.16
Month 4		—	9.92 ± 0.46	40.49 ± 1.82
Month 6		—	14.14 ± 2.03	43.06 ± 8.75
Month 12		1.74 ± 0.38	16.70 ± 3.08	39.15 ± 5.73
Month 18		1.60 ± 0.24	13.86 ± 3.46	22.87 ± 8.71
μg Ga/lung per mg GaAs/m ³				
Month 1	NA	—	34.0 ± 4.8	30.7 ± 2.7
Month 2	NA	71.4 ± 4.7	105.3 ± 11.8	65.5 ± 5.1
Month 4	NA	—	157.1 ± 13.6	86.8 ± 5.2
Month 6	NA	—	238.8 ± 36.2	104.3 ± 16.7
Month 12	NA	204.0 ± 52.9	322.6 ± 34.8	106.1 ± 10.4
Month 18	NA	208.0 ± 34.8 ^d	265.3 ± 40.6	73.3 ± 15.9

TABLE H2
Lung Weight and Lung Burden in Male Rats in the 2-Year Inhalation Study of Gallium Arsenide

	Chamber Control	0.01 mg/m ³	0.1 mg/m ³	1.0 mg/m ³
n	5	5	5	5
Absolute lung wt (g)				
Month 1	0.8392 ± 0.0533	— ^b	0.7876 ± 0.0585	1.0670 ± 0.1382
Month 2	0.9680 ± 0.0601	0.9096 ± 0.1018	1.3990 ± 0.1040	1.7863 ± 0.0639
Month 4	1.0486 ± 0.0919	—	1.5830 ± 0.0979	2.1429 ± 0.0684
Month 6	1.1397 ± 0.0308	—	1.6899 ± 0.1374	2.4413 ± 0.1882
Month 12	1.1958 ± 0.1130	1.1650 ± 0.0794	1.9785 ± 0.3666	2.7343 ± 0.2853
Month 18	1.3430 ± 0.1510	1.2971 ± 0.0751	1.9510 ± 0.2231	3.4476 ± 0.9449
μg As/lung				
Month 1 ^c	—	—	4.02 ± 0.58	34.67 ± 3.48
Month 2	1.62 ± 0.23	2.57 ± 0.14	13.94 ± 1.96	77.39 ± 6.21
Month 4	1.89 ± 0.33	—	16.78 ± 1.77	102.94 ± 6.00
Month 6	2.26 ± 0.79	—	24.44 ± 4.18	118.64 ± 19.74
Month 12	2.75 ± 0.64	4.46 ± 0.83	31.95 ± 2.65	106.00 ± 12.09
Month 18	11.45 ± 2.74	14.78 ± 2.34	41.96 ± 2.46	104.00 ± 15.64
μg As/g lung				
Month 1 ^c	—	—	5.09 ± 0.47	32.62 ± 1.99
Month 2	1.68 ± 0.28	2.86 ± 0.42	9.94 ± 0.86	43.36 ± 3.64
Month 4	1.79 ± 0.19	—	10.59 ± 0.70	48.02 ± 1.78
Month 6	1.98 ± 0.70	—	14.43 ± 2.09	49.04 ± 10.45
Month 12	2.30 ± 0.51	3.83 ± 0.70	16.56 ± 2.99	39.12 ± 6.26
Month 18	8.66 ± 2.33	11.36 ± 1.37	21.73 ± 2.84	31.77 ± 8.26
μg As/lung per mg GaAs/m ³				
Month 1	NA	—	40.2 ± 5.8	34.7 ± 3.5
Month 2	NA	95.2 ± 14.2	123.2 ± 19.6	75.8 ± 6.2
Month 4	NA	—	149.0 ± 17.7	101.0 ± 6.0
Month 6	NA	—	221.8 ± 41.8	116.4 ± 19.7
Month 12	NA	171.0 ± 82.5	292.0 ± 26.5	103.2 ± 12.1
Month 18	NA	332.8 ± 234.0	305.1 ± 24.5	92.5 ± 15.6

(NA) Not applicable

^a Data are presented as mean ± deviation.

^b Tissue not collected

^c Values for the chamber control are below the limit of quantitation (0.20 μg Ga/g lung, 1.45 μg As/g lung)

^d n=4

TABLE H3
Lung Deposition and Clearance Parameters in Male Rats in the 14-Week Inhalation Study of Gallium Arsenide^a

Exposure Concentration (mg/m ³)	α	k	A _e	t _{1/2}
Gallium Parameters				
0.1	0.13	— ^b	—	—
1	1.45	0.012	117	56
10	9.91	0.032	307	22
37	19.7	0.025	772	27
75	33.5	0.035	950	20
Arsenic Parameters				
0.1	0.16	—	—	—
1	2.00	0.022	89	31
10	13.5	0.042	318	16
37	23.1	0.025	926	28
75	39.1	0.036	1,090	19

^a α =deposition rate ($\mu\text{g}/\text{day}$), k=clearance rate constant (day^{-1}), A_e=steady state lung burden (μg), t_{1/2}=lung clearance half-time (days)

^b A negative coefficient was derived for the rate constant, and values for derived parameters were thus indeterminate.

TABLE H4
Lung Deposition and Clearance Parameters in Male Rats in the 2-Year Inhalation Study of Gallium Arsenide^a

Exposure Concentration (mg/m ³)	α	k	A _e	t _{1/2}
Gallium Parameters				
0.01	0.012	0.005	2	133
0.1	0.22	0.007	30	96
1.0	1.8	0.019	95	37
Arsenic Parameters				
0.01	0.004	— ^b	—	—
0.1	0.20	0.0063	32	110
1.0	2.1	0.020	105	35

^a α =deposition rate ($\mu\text{g}/\text{day}$), k=clearance rate constant (day^{-1}), A_e=steady state lung burden (μg), t_{1/2}=lung clearance half-time (days)

^b A negative coefficient was derived for the rate constant, and values for derived parameters were thus indeterminate.

TABLE H5
Blood Gallium and Arsenic Concentrations in Male Rats in the 2-Year Inhalation Study of Gallium Arsenide^a

	Chamber Control	0.01 mg/m ³	0.1 mg/m ³	1.0 mg/m ³
n	5	5	5	5
Gallium (µg/g)				
Month 1 ^b	— ^c	—	—	0.020 ± 0.003
Month 2	—	—	—	0.020 ± 0.005
Month 4 ^b	—	—	—	0.027 ± 0.002
Month 6 ^b	—	—	0.006 ± 0.005	0.042 ± 0.005
Month 12	—	—	0.006 ± 0.001	0.04 ± 0.01
Month 18	0.006 ± 0.001	0.007 ± 0.001	0.013 ± 0.001	0.05 ± 0.02
Arsenic (µg/g)				
Month 1 ^b	5 ± 1 ^d	—	9 ± 1	18 ± 3
Month 2	17.0 ± 0.4 ^d	17 ± 1	17 ± 2	32 ± 2
Month 4 ^b	19.0 ± 0.2	—	21.0 ± 0.8	41 ± 3
Month 6 ^b	22 ± 2	—	25.3 ± 0.7	50 ± 3
Month 12	19 ± 2	20 ± 2	24 ± 2	54 ± 10
Month 18	24 ± 9	28 ± 3	33 ± 2	58 ± 6

^a Data are presented as mean ± standard deviation.

^b Not examined at the 0.01 mg/m³ exposure concentration

^c Below the limit of quantitation (0.005 µg Ga/g blood, 2.68 µg As/g blood)

^d n=4

TABLE H6
Serum Gallium and Arsenic Concentrations in Male Rats in the 2-Year Inhalation Study of Gallium Arsenide^a

	Chamber Control	0.01 mg/m ³	0.1 mg/m ³	1.0 mg/m ³
n	5	5	5	5
Gallium (µg/g)				
Month 1 ^b	— ^c	—	—	—
Month 2	—	—	—	—
Month 4 ^b	—	—	—	—
Month 6 ^b	—	—	—	0.10 ± 0.01
Month 12	—	—	—	0.11 ± 0.05
Month 18	—	—	—	0.08 ± 0.04
Arsenic (µg/g)				
Month 1 ^b	— ^c	—	—	—
Month 2	—	—	—	—
Month 4 ^b	—	—	—	0.2 ± 0.1
Month 6 ^b	0.11 ± 0.04	—	—	0.14 ± 0.06
Month 12	—	—	—	0.11 ± 0.04
Month 18	—	—	—	0.11 ± 0.04

^a Data are presented as mean ± standard deviation.

^b Not examined at the 0.01 mg/m³ exposure concentration

^c Below the limit of quantitation (0.042 µg Ga/g serum, 0.086 µg As/g serum)

TABLE H7
Testes Gallium and Arsenic Concentrations in Male Rats in the 2-Year Inhalation Study of Gallium Arsenide^a

	Chamber Control	0.01 mg/m ³	0.1 mg/m ³	1.0 mg/m ³
n	5	5	5	5
Gallium (μg/g)				
Month 1 ^b	— ^c	—	—	—
Month 2	—	—	—	0.14 ± 0.03
Month 4 ^b	—	—	—	0.22 ± 0.02
Month 6 ^b	—	—	—	0.50 ± 0.08
Month 12	—	—	0.11 ± 0.02	1.2 ± 0.3
Month 18	—	—	0.16 ± 0.02	1.5 ± 0.4
Arsenic (μg/g)				
Month 1 ^b	—	—	—	—
Month 2	0.3 ± 0.4	—	0.21 ± 0.09	0.27 ± 0.05
Month 4 ^b	0.18 ± 0.05	—	0.18 ± 0.03	0.7 ± 0.7
Month 6 ^b	0.23 ± 0.03	—	0.32 ± 0.03	1 ± 2
Month 12	0.27 ± 0.02	0.28 ± 0.04	0.4 ± 0.1	0.7 ± 0.2
Month 18	0.5 ± 0.4	0.4 ± 0.2	3 ± 3	1 ± 1

^a Data are presented as mean ± standard deviation.

^b Not examined at the 0.01 mg/m³ exposure concentration

^c Below the limit of quantitation (0.051 μg Ga/g testes, 0.126 μg As/g testes)

APPENDIX I

REPRODUCTIVE TISSUE EVALUATIONS AND ESTROUS CYCLE CHARACTERIZATION

TABLE I1	Summary of Reproductive Tissue Evaluations for Male Rats in the 14-Week Inhalation Study of Gallium Arsenide	280
TABLE I2	Summary of Estrous Cycle Characterization for Female Rats in the 14-Week Inhalation Study of Gallium Arsenide	280
TABLE I3	Summary of Reproductive Tissue Evaluations for Male Mice in the 14-Week Inhalation Study of Gallium Arsenide	281
TABLE I4	Summary of Estrous Cycle Characterization for Female Mice in the 14-Week Inhalation Study of Gallium Arsenide	281

TABLE I1
Summary of Reproductive Tissue Evaluations for Male Rats
in the 14-Week Inhalation Study of Gallium Arsenide^a

	Chamber Control	10 mg/m ³	37 mg/m ³	75 mg/m ³
n	10	10	10	10
Weights (g)				
Necropsy body wt	341 ± 8	334 ± 7	328 ± 4	314 ± 5**
L. cauda epididymis	0.1671 ± 0.0039	0.1635 ± 0.0042	0.1245 ± 0.0036**	0.1042 ± 0.0036**
L. epididymis	0.4483 ± 0.0074	0.4363 ± 0.0074	0.4052 ± 0.0107**	0.3183 ± 0.0093**
L. testis	1.4102 ± 0.0392	1.4122 ± 0.0236	1.3940 ± 0.0148	0.7800 ± 0.0823**
Spermatid measurements				
Spermatid heads (10 ⁷ /g testis)	9.90 ± 0.32	9.90 ± 0.38 ^b	9.64 ± 0.36	2.40 ± 0.90**
Spermatid heads (10 ⁷ /testis)	14.00 ± 0.66	13.97 ± 0.58 ^b	13.45 ± 0.56	2.49 ± 1.21**
Spermatid count (mean/10 ⁶ mL suspension)	69.98 ± 3.29	69.86 ± 2.92 ^b	67.25 ± 2.82	12.45 ± 6.06**
Epididymal spermatozoal measurements				
Motility (%)	89.08 ± 1.16	81.83 ± 1.03**	70.28 ± 2.80**	0.20 ± 0.14**
Concentration (10 ⁶ /g cauda epididymal tissue)	551 ± 25	491 ± 27	438 ± 46	75 ± 8**

** Significantly different ($P \leq 0.01$) from the chamber control group by William's test (body and tissue weights) or Shirley's test (spermatid and epididymal spermatozoal measurements)

^a Data are presented as mean ± standard error.

^b n=9

TABLE I2
Summary of Estrous Cycle Characterization for Female Rats
in the 14-Week Inhalation Study of Gallium Arsenide^a

	Chamber Control	10 mg/m ³	37 mg/m ³	75 mg/m ³
n	10	10	10	10
Necropsy body wt (g)	192 ± 3	197 ± 4	193 ± 3	191 ± 3
Estrous cycle length (days)	5.00 ± 0.13	5.05 ± 0.12	5.00 ± 0.17 ^b	4.95 ± 0.05
Estrous stages (% of cycle)				
Diestrus	39.2	42.5	41.7	42.9
Proestrus	15.0	16.7	18.3	15.1
Estrus	19.2	16.7	19.2	16.8
Metestrus	20.8	18.3	17.5	21.0
Uncertain diagnosis	5.8	5.8	3.3	4.2

^a Necropsy body weight and estrous cycle length data are presented as mean ± standard error. Differences from the chamber control group are not significant by Dunnett's test (body weight) or Dunn's test (estrous cycle length). By multivariate analysis of variance, exposed females do not differ significantly from the chamber control females in the relative length of time spent in the estrous stages.

^b Estrous cycle was longer than 12 days or unclear in 1 of 10 animals.

TABLE I3
Summary of Reproductive Tissue Evaluations for Male Mice
in the 14-Week Inhalation Study of Gallium Arsenide^a

	Chamber Control	10 mg/m ³	37 mg/m ³	75 mg/m ³
n	10	10	10	10
Weights (g)				
Necropsy body wt	37.5 ± 0.9	35.3 ± 0.7	35.5 ± 0.9	33.6 ± 0.7**
L. cauda epididymis	0.0171 ± 0.0007	0.0140 ± 0.0007**	0.0142 ± 0.0005**	0.0144 ± 0.0006**
L. epididymis	0.0469 ± 0.0034	0.0385 ± 0.0017**	0.0360 ± 0.0013**	0.0322 ± 0.0013**
L. testis	0.1203 ± 0.0022	0.1118 ± 0.0039*	0.0537 ± 0.0008**	0.0517 ± 0.0007**
Spermatid measurements				
Spermatid heads (10 ⁷ /g testis)	15.23 ± 1.10	14.94 ± 0.87	5.13 ± 1.86**	4.88 ± 1.25**
Spermatid heads (10 ⁷ /testis)	1.83 ± 0.13	1.69 ± 0.14	0.28 ± 0.10**	0.25 ± 0.07**
Spermatid count (mean/10 ⁻⁴ mL suspension)	57.05 ± 3.96	52.70 ± 4.38	10.83 ± 2.75**	10.88 ± 1.46**
Epididymal spermatozoal measurements				
Motility (%)	87.14 ± 1.99	82.48 ± 1.66	1.19 ± 0.74**	3.26 ± 1.84**
Concentration (10 ⁶ /g cauda epididymal tissue)	1,129 ± 60	358 ± 82**	18 ± 3**	21 ± 5**

* Significantly different (P ≤ 0.05) from the chamber control group by William's test (body, left epididymis, and left testis weights), Dunnett's test (left cauda epididymal weight), or Shirley's test (spermatid and epididymal spermatozoal measurements)

** (P ≤ 0.01)

^a Data are presented as mean ± standard error.

TABLE I4
Summary of Estrous Cycle Characterization for Female Mice
in the 14-Week Inhalation Study of Gallium Arsenide^a

	Chamber Control	10 mg/m ³	37 mg/m ³	75 mg/m ³
n	10	10	10	9
Necropsy body wt (g)	32.8 ± 1.4	32.1 ± 0.7	29.9 ± 0.7	30.4 ± 0.7
Estrous cycle length (days)	4.00 ± 0.00 ^b	4.20 ± 0.11	4.30 ± 0.13	4.33 ± 0.12
Estrous stages (% of cycle)				
Diestrus	28.3	30.8	30.0	32.4
Proestrus	16.7	15.8	20.0	20.4
Estrus	26.7	29.2	30.8	26.9
Metestrus	15.8	17.5	18.3	15.7
Uncertain diagnosis	12.5	6.7	0.8	4.6

^a Necropsy body weight and estrous cycle length data are presented as mean ± standard error. Differences from the chamber control group are not significant by William's test (body weight) or Dunn's test (estrous cycle length). By multivariate analysis of variance, exposed females do not differ significantly from the chamber control females in the relative length of time spent in the estrous stages.

^b Estrous cycle was longer than 12 days or unclear in 1 of 10 animals.

APPENDIX J

CHEMICAL CHARACTERIZATION AND GENERATION OF CHAMBER CONCENTRATIONS

PROCUREMENT AND CHARACTERIZATION OF GALLIUM ARSENIDE	284
AEROSOL GENERATION AND EXPOSURE SYSTEM	285
AEROSOL CONCENTRATION MONITORING	286
CHAMBER ATMOSPHERE CHARACTERIZATION	287
FIGURE J1 X-ray Diffraction Pattern of Gallium Arsenide	290
FIGURE J2 Schematic of the Generation and Delivery System in the 16-Day and 14-Week Inhalation Studies of Gallium Arsenide	291
FIGURE J3 Schematic of the Flexible-Brush Dust Feed Mechanism in the 16-Day and 14-Week Inhalation Studies of Gallium Arsenide	292
FIGURE J4 Schematic of the Generation and Delivery System in the 2-Year Inhalation Studies of Gallium Arsenide	293
FIGURE J5 Schematic of the Rotary Drum Generator in the 2-Year Inhalation Studies of Gallium Arsenide	294
TABLE J1 Summary of Chamber Concentrations in the 16-Day Inhalation Studies of Gallium Arsenide	295
TABLE J2 Summary of Chamber Concentrations in the 14-Week Inhalation Studies of Gallium Arsenide	295
TABLE J3 Summary of Chamber Concentrations in the 2-Year Inhalation Studies of Gallium Arsenide	296
TABLE J4 Summary of Aerosol Size Measurements for the Rat and Mouse Exposure Chambers in the 16-Day Inhalation Studies of Gallium Arsenide	296
TABLE J5 Summary of Aerosol Size Measurements for the Rat and Mouse Exposure Chambers in the 14-Week Inhalation Studies of Gallium Arsenide	296
TABLE J6 Summary of Aerosol Size Measurements for the Rat Exposure Chambers in the 2-Year Inhalation Studies of Gallium Arsenide	297
TABLE J7 Summary of Aerosol Size Measurements for the Mouse Exposure Chambers in the 2-Year Inhalation Studies of Gallium Arsenide	298

CHEMICAL CHARACTERIZATION AND GENERATION OF CHAMBER CONCENTRATIONS

PROCUREMENT AND CHARACTERIZATION OF GALLIUM ARSENIDE

Gallium arsenide was obtained in two lots. The analytical chemistry laboratory, Midwest Research Institute (Kansas City, MO) obtained gallium arsenide from Johnson Matthey, Inc. (Seabrook, NH) and prepared a single lot (M051988) for use in the 16-day and 14-week studies. An additional lot (BNW lot 12956-13) was obtained from Johnson Matthey, Inc. (Ward Hill, MA) for use in the 2-year studies. Identity and purity analyses were conducted by the analytical chemistry laboratory and the study laboratory; stability analyses were conducted by the analytical chemistry laboratory. Reports on analyses performed in support of the gallium arsenide studies are on file at the National Institute of Environmental Health Sciences.

To prepare lot M051988, the analytical chemistry laboratory reduced the particle size of two lots with a ball mill followed by micronizing. The two lots were then combined. The study laboratory premicronized lot 12956-13 in a Model SR-3 Rotor Beater (Brinkmann Instruments, Westbury, NY) equipped with a 0.5 mm stainless steel sieve, and then micronized the bulk chemical in a Sturtevant Micronizer (Sturtevant, Boston, MA) to a count median diameter of approximately 0.4 μm and a geometric standard deviation of approximately 1.7.

Lot M051988, a dark gray to black, fine powder, was identified as gallium arsenide by elemental analyses. Lot 12956-13 was identified as gallium arsenide by X-ray diffraction (XRD) analysis. A Philips 3000 series X-ray diffractometer (Philips Analytical, Mahwah, NJ) with a fixed copper anode source at 40 kV and 45 mA was used; diffraction patterns were matched to computer library reference patterns (JCDs/ICDD, reference 32-0389). XRD analysis indicated the presence of gallium arsenide with no detectable contaminants (Figure J1).

The purity of lot M051988 was determined by elemental analyses, spark source mass spectrometry, weight loss on drying, and chelometric titration. For chelometric titration, samples in 50% aqueous nitric acid were buffered to pH 6.0, and 0.02 M ethylenediaminetetraacetic acid (EDTA) was added. Excess EDTA was titrated to a potentiometric endpoint with 0.02 M zinc sulfate. A silver electrode amalgamated with mercury and filled with aqueous, saturated potassium nitrate was used to monitor titration. The purity of lot 12956-13 was determined by inductively coupled plasma/atomic emission spectroscopy (ICP/AES). For ICP/AES, samples were dissolved in 35% nitric acid and analyzed for gallium at 294.364 nm and arsenic at 193.759 nm. Results were normalized against those of gallium and arsenic reference standards from the National Institute of Standards and Technology.

For lot M051988, the results of elemental analysis for gallium were in agreement with the theoretical values for gallium arsenide; the results for arsenic were slightly high. No organic impurities were present, as indicated by elemental analyses for carbon and hydrogen. Spark source mass spectrometry indicated gallium and arsenic as the major components, with no impurities present at concentrations greater than 100 ppm; all impurities totaled less than 170 ppm. Weight loss on drying indicated 0.04% \pm 0.01% water. Chelometric titration indicated a purity of 99% \pm 1%. The overall purity was determined to be greater than 98%.

For lot 12956-13, glow-discharge mass spectrometric analyses provided by the manufacturer indicated that impurities totaled less than 119 ppm for 72 elements assayed; the principal impurities were aluminum (52 ppm), silicon (33 ppm), and calcium (14 ppm). Results of ICP/AES analyses of the micronized test

article indicated a purity of $99.0\% \pm 0.2\%$ for gallium and $99.0\% \pm 0.1\%$ for arsenic relative to the theoretical values. Iron was the major impurity at 0.08% by weight. Selenium, zinc, nickel, manganese, chromium, aluminum, and calcium were detected at concentrations of less than 0.06%. Concentrations of other elements were below the limit of detection; trace impurities totaled less than 0.42% by weight.

Accelerated stability studies of lot M100386 of gallium arsenide (used to prepare lot M051988) were performed by the analytical chemistry laboratory with chelometric titration. Samples were buffered to a pH ranging from 3.5 to 4.0 and were analyzed by chelometric titration as described for the purity analyses. Gallium arsenide was found to be stable for 2 weeks at temperatures up to 60° C when stored protected from light. The bulk chemical was stored in amber glass bottles with Teflon®-lined caps under a nitrogen headspace at room temperature. Stability was monitored by the study laboratory throughout the studies with chelometric titration (16-day and 14-week studies) and ICP/AES (2-year studies); additionally, elemental analyses were performed by Galbraith Laboratories, Inc. (Knoxville, TN) at the beginning of the 16-day and 14-week studies. No degradation of the bulk chemical was detected.

AEROSOL GENERATION AND EXPOSURE SYSTEM

For the 16-day and 14-week studies, the gallium arsenide aerosol generation and delivery system had five basic components: a flexible-brush dust feed mechanism developed at the study laboratory, a Trost Model GEM-T air-impact mill (Plastomer Products Division of Garlock, Inc., Newtown, PA), a cyclone separator, an aerosol charge neutralizer, and an aerosol distribution system (Figure J2). The flexible-brush dust feed mechanism (Figure J3) employed a hopper into which the dry powder was poured. This hopper enclosed a random-wound, large bristle brush that continually rotated, stirring the powder and delivering it into a feed tube through a small hole in the bottom of the hopper. The feed tube contained a spiral-wound feed brush that was rotated at a controlled rate by a stepping motor. The dust fell from the end of the feed tube and was aspirated into the impact mill. The hopper was reloaded with additional gallium arsenide at regular intervals throughout each day's exposure period. Gallium arsenide to be used each day was stored overnight in a nitrogen-purged desiccator to achieve more uniform flow in the generator.

The air-impact mill used fluid energy from opposing air jets to cause particle-to-particle, head-on impacts to deagglomerate and reduce the size distribution of gallium arsenide. The particles were then swept into a classification chamber; smaller particles passed through while larger ones were thrown to the perimeter by centrifugal force. Larger particles were reentrained into the impacting air jets until they were sufficiently reduced in size. The particles then passed through a cyclone separator that removed any remaining oversized particles. To control static charge, the aerosol was passed through a length of plastic duct in the center of which two ⁶³Ni-plated foils (10 mCi) were suspended until the aerosol approached Boltzmann equilibrium at the system flow rate.

Aerosol passed through the charge neutralizer into the distribution line. At each chamber location, a vacuum pump (Air-Vac Engineering Co., Inc., Milford, CT) drew aerosol from the distribution line into the chamber inlet, where the aerosol was further diluted with HEPA-filtered air to the appropriate concentration.

The aerosol generation and delivery system for the 2-year studies is shown in Figure J4. The aerosol generator consisted of a drum, body, and cap (Figure J5). The drum rotated at 60° increments, with set time intervals between drum rotations. Rotation of the drum was controlled by a compressed-air-driven valve driver (VICI Valco Instrument Co., Houston, TX). As the drum rotated, gallium arsenide filled six metering ports in a disk on the bottom of the drum and was held in each port by a stainless-steel screen. The metering ports sequentially aligned with a nitrogen inlet in the body and dispersed gallium arsenide

when the nitrogen solenoid valve was opened. The aerosol passed through a delivery tube penetrating the cap into the distribution system. A spring-loaded Teflon® tip, attached to the bottom of the delivery tube, scraped excess gallium arsenide from the metering ports and captured the material dispersed by the puff of nitrogen through the metering port. Output of the generator was regulated by adjusting the rotation cadence.

The aerosol passed through the distribution line to the exposure chambers, where it was further diluted with filtered air to the proper exposure concentration. A pneumatic pump designed by the study laboratory was located at each chamber inlet. (Two were used for the 0.01 mg/m³ rat chamber.) Flow through the distribution line was controlled by Air-Vac pumps, and pressure was monitored by photohelic differential pressure gauges (Dwyer Instruments, Inc., Michigan City, IN).

The study laboratory designed the stainless-steel inhalation exposure chambers (Harford Systems Division of Lab Products, Inc., Aberdeen, MD) so that uniform aerosol concentrations could be maintained throughout the chambers when catch pans were in place. The total active mixing volume of each chamber was 1.7 m³.

AEROSOL CONCENTRATION MONITORING

Summaries of chamber aerosol concentrations of gallium arsenide are given in Tables J1 through J3. Chamber aerosol concentrations were monitored with real-time aerosol monitors (RAMs) (Model RAM-1; MIE, Inc., Bedford, MA) that used a pulsed-light-emitting diode in combination with a silicon detector to sense light scattered over a forward angular range of 45° to 95° by particles traversing the sensing volume. The instrument responds to particles 0.1 to 20 μm in diameter; the geometric diameter of gallium arsenide aerosol approached the minimum of this range. The sampling system consisted of a valve which multiplexed each RAM to two or three exposure chambers and either the control chamber, the room, or a HEPA filter (2-year studies only). The monitors were connected to the chambers with sample lines designed to minimize aerosol particle losses through settling or impaction.

Each RAM was calibrated by correlating the measured voltage with gallium arsenide concentrations determined by analyzing exposure chamber samples collected on fiberglass filters (16-day and 14-week studies: Type A/E, Gelman Sciences, Ann Arbor, MI; 2-year studies: Teflon®-coated Pallflex, Pallflex Corp., Putnam, CT). Filter samples were dissolved in nitric acid and analyzed for gallium arsenide using inductively coupled plasma/mass spectroscopy (ICP/MS). Selection of sampling streams and data acquisition from each RAM was remotely controlled by a computer (16-day and 14-week studies: Model HP-85B, Hewlett-Packard Co., Palo Alto, CA; 2-year studies: Gateway 2000, San Diego, CA). Equations for calibration curves were stored in the computers and were used to convert the measured voltages to exposure concentrations. RAMs were calibrated one to two times weekly during the 16-day and 14-week studies and twice monthly during the 2-year studies. Additional filter samples were collected approximately every other day during the 16-day studies and on days not dedicated to RAM calibration during the 14-week studies for gravimetric analysis of chamber concentrations as an additional check of monitor operation. During the 2-year studies, calibration was verified by ICP/MS analysis of filter samples collected every other day (control chambers) or daily.

CHAMBER ATMOSPHERE CHARACTERIZATION

The particle size distribution in each chamber was determined during prestudy testing, once during the 16-day studies, and monthly during the 14-week and 2-year studies using a Mercer-style seven-stage impactor (In-Tox Products, Albuquerque, NM). The stages (glass coverslips lightly sprayed with silicone) were analyzed by ICP/MS. The relative mass collected on each stage was analyzed by probit analysis. The mass median aerodynamic particle diameter and the geometric standard deviation of each set of samples were estimated. The mass median aerodynamic particle diameter ranged from 0.9 to 1.3 μm in the 16-day studies; from 0.8 to 1.6 μm in the 14-week studies; and from 0.8 to 1.9 μm in the 2-year studies (Tables J4, J5, J6, and J7).

Buildup and decay rates for chamber aerosol concentrations were determined with and without animals present in the chambers. At a chamber airflow rate of 15 air changes per hour, the theoretical value for the time to achieve 90% of the target concentration after the beginning of aerosol generation (T_{90}) and the time for the chamber concentration to decay to 10% of the target concentration after aerosol generation was terminated (T_{10}) was approximately 12.5 minutes. For rats and mice in the 16-day studies, T_{90} ranged from 7 to 15 minutes without animals present and 7 to 12 minutes with animals present; T_{10} ranged from 9 to 12 minutes without animals present and was 9 or 10 minutes with animals present. During the 14-week studies, T_{90} ranged from 8 to 14 minutes without animals present and 10 to 14 minutes with animals present; T_{10} ranged from 9 to 13 minutes without animals present and 10 to 15 minutes with animals present. In the 2-year rat study, T_{90} was 10 to 14 minutes with and without animals in the chambers; T_{10} was 8 minutes without animals and 8 or 10 minutes with animals present. In the 2-year mouse study, T_{90} was 11 or 12 minutes without animals present and ranged from 11 to 17 minutes with animals; T_{10} ranged from 8 to 10 minutes without animals and was 10 or 11 minutes with animals present. A T_{90} of 12 minutes was used for all of the studies.

Uniformity of aerosol concentration in the 16-day and 14-week studies was evaluated prior to the start of the studies without animals present and once during each of the studies with animals present in the exposure chambers. During the 2-year studies, uniformity was evaluated every 3 months. Measurements were taken from 12 different chamber positions (one in front and one in back for each of the six possible animal cage unit positions per chamber). An extension tube fitted to the sampling lines of each RAM allowed sampling from all of the chamber ports. Chamber concentration uniformity was acceptable throughout the studies.

The persistence of gallium arsenide aerosol in the exposure chambers was monitored overnight after aerosol delivery ceased. The 150 mg/m^3 exposure chambers were monitored during the 16-day studies, the 75 mg/m^3 exposure chambers were monitored during the 14-week studies, and the 1 mg/m^3 rat chamber was monitored during the 2-year studies. The average gallium arsenide concentration decayed to 1% of target concentration within approximately 20 minutes in all of the studies.

The stability of gallium arsenide in the exposure system was tested before the 16-day studies began, primarily by measuring gallium arsenide surface oxidation with X-ray photoelectron spectroscopy (XPS). Surface analysis of the bulk chemical to a depth of approximately 50 Å indicated the presence of gallium and arsenic in two chemical states, gallium arsenide and a single oxide form of each element. Additional analyses after the removal of 10 to 20 Å of the surface indicated that the oxide-containing layer extended to a depth of no more than 50 to 100 Å.

The stability of gallium arsenide in the generator reservoir, distribution line, and exposure chambers (with and without animals present) was also tested with XPS. Results from all samples were similar to those for the bulk chemical, but those taken from the generator reservoir, distribution line, and unoccupied 150 mg/m^3 chamber had slightly elevated levels of gallium (III) oxide.

Samples collected from the 150 mg/m³ chamber were analyzed for the arsenic oxidation product, arsenic trioxide before the 16-day studies, with particle-induced X-ray emission analysis and during the 16-day studies with ICP/MS; samples were also analyzed for trace contaminants. For each analysis, samples were collected on a fiberglass prefilter followed by carbonate-impregnated S&S Fast Flow #2 paper filters (Schleicher & Schuell, Inc., Keene, NH). The concentration of arsenic trioxide was estimated to be less than 0.01% of the target concentration of gallium arsenide. Trace elements including iron, chromium, and nickel, possibly introduced to the bulk chemical during the milling process, were present in less than 25% of the samples analyzed at concentrations less than 0.2 µg/m³. Aluminum was present at approximately 0.3% by weight.

Before and during the 14-week studies, gallium arsenide samples were collected from the distribution line and the 0.1 and 75 mg/m³ exposure chambers (with and without animals present) during a generation period. Samples were also collected from the generator reservoir at the beginning and end of the generation period. These samples were analyzed, along with samples of the bulk chemical, for crystalline phases by XRD analysis, for metallic impurities by energy-dispersive X-ray fluorescence (XRF) analysis, and for aluminum and tungsten impurities by ICP/MS. Samples for XRD analysis were collected on Millipore filter discs (Type AA; Millipore Corp., Bedford, MA), mounted on glass slides, and tested on a Phillips 3600 diffraction unit using copper K α radiation. The XRD patterns for all samples were consistent with that expected for gallium arsenide, with no indication of other crystalline phases in any sample; no evidence of oxidized phases was observed at a detection limit of 1% to 2% by volume. Samples for XRF analysis and ICP/MS were collected on Millipore polyethylene-backed Teflon[®] filter discs (Type FH). For XRF analysis, samples were placed between thin sheets of laboratory film, excited with bremsstrahlung radiation from a tungsten X-ray tube and secondary source irradiations, and analyzed with a KEVEX 0810 XRF unit (Kevex Instruments, Valencia, CA) with a Canberra Series 80 multichannel analyzer (Canberra Industries, Meriden, CT). Samples to be analyzed by ICP/MS were treated with hot 20% nitric acid and diluted before testing. Results of analyses for metallic impurities indicated the presence of minor amounts (less than 1% by weight) of iron, chromium, copper, zinc, nickel, and aluminum, with the highest concentrations occurring in the 0.1 mg/m³ chamber. A sample collected from the distribution line was also analyzed for gallium, arsenic, and oxygen concentrations by energy-dispersive XRF spectroscopy. The sample was collected on a Millipore Type FH filter, deposited with a carbon adhesive onto a carbon SEM stub, and analyzed on a JEOL JSM-840 SEM (JEOL, Peabody, MA) with a thin window detector. The concentrations of gallium (47.9% \pm 1.2%) and arsenic (52.1% \pm 1.2%) were near the theoretical concentrations for gallium arsenide; oxygen was below the limit of detection (0.5%).

Before the 14-week studies began, samples from the exposure generation system and exposure chambers were analyzed for impurities by XRF spectroscopy. Results indicated that the relative amounts of gallium and arsenic were near the theoretical concentrations. Iron was present as an impurity at a concentration of 0.6% or less; concentrations of other elements were generally 0.5% or less. Evaluation of the degree of oxidation of the bulk chemical conducted before the 14-week studies used scanning transmission electron microscopy in the transmission mode using convergent beam electron diffraction and selected area diffraction techniques; results indicated a shell of polycrystalline material with a thickness of approximately 50 Å around some gallium arsenide particles, indicating a limited amount of oxidation.

Before and during the 2-year studies, samples from the generator reservoir at the beginning and end of an exposure period and filter samples collected from the distribution line and the 0.01 (unoccupied), 0.1 (occupied), and 1 mg/m³ chambers (occupied and unoccupied) were analyzed by XRD and ICP/AES. For XRD analyses, samples from the reservoir were mounted on flat, single-crystal quartz holders with a low X-ray background. Filter samples were collected on Gelman A/E filters and mounted on glass petrographic slides. The samples were analyzed on a Philips 3600 diffraction unit. Only gallium arsenide was detected; limits of detection for oxides of gallium and arsenic were approximately 0.5%. For ICP/AES analyses,

samples were collected on polyethylene-backed Teflon® filter discs, sealed in Teflon®-lined acid digestion vessels (Parr Bomb, Model 4749, Parr Instrument Co., Moline, IL) with 3 mL 70% nitric acid, and heated at approximately 140° C for approximately 3 hours. The samples were then cooled and additional nitric acid and deionized water were added before analysis. Samples from the generator reservoir were dissolved in nitric acid before analysis. Results for gallium and arsenic were in agreement with the theoretical values for gallium arsenide. Before the studies began, the major impurities identified in generator reservoir samples were sodium (0.10% to 0.15%), iron (0.07% to 0.08%), and calcium (0.04% to 0.05%), with selenium, zinc, phosphorus, lead, nickel, manganese, chromium, vanadium, copper, and aluminum present at concentrations of 0.02% or less. Concentrations of other impurities in the reservoir were estimated to be less than 0.08%. The only impurity detected in the filter samples was aluminum (0.05%) in the sample from the 1.0 mg/m³ chamber; the amount of aerosol collected from the 0.01 mg/m³ chamber was insufficient for analysis. During the studies, the major impurities detected in the generator reservoir were iron (0.08%), selenium (0.03%), and sodium (0.02%); nickel, manganese, chromium, and calcium were present at concentrations less than 0.02%. Other impurities were not detected in the reservoir; concentrations were estimated to be less than 0.05%. Impurities detected in the filter samples included selenium (0.03% to 0.27%), calcium (0.08% to 0.21%), and iron (0.09% to 0.16%), as well as zinc, nickel, and chromium at concentrations of 0.04% or less.

Bubbler samples from the control and 1 mg/m³ chambers were analyzed for volatile contaminants before the 2-year studies began with gas chromatography. Samples were collected in bubblers filled with either dimethyl formamide or methylene chloride and analyzed by a Model 5890 gas chromatograph (Hewlett-Packard, Palo Alto, CA) equipped with a flame ionization detector and a DB-5 capillary column (30 m × 0.25 mm, 0.25 μm film, J&W Scientific, Folsom, CA). The oven temperature program was 45° for 1 minute, then 45° to 240° C at 5° C per minute, with a 2-minute hold at 240° C (helium and 24 psi headspace). No volatile contaminants were detected. Results of stability and impurity analyses indicated that no degradation or contamination of gallium arsenide occurred as a result of aerosol generation during the studies.

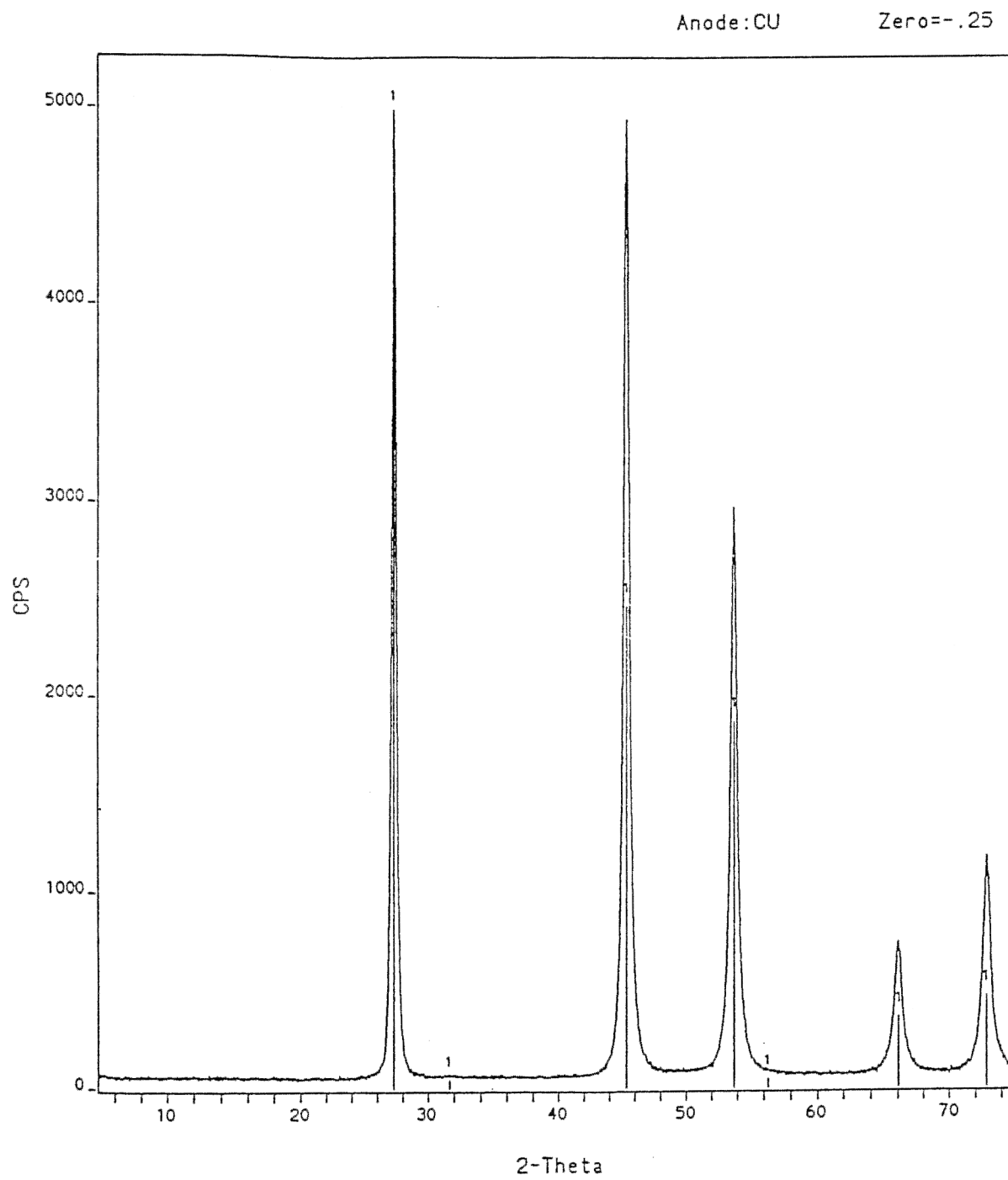

Figure J1
X-ray Diffraction Pattern of Gallium Arsenide

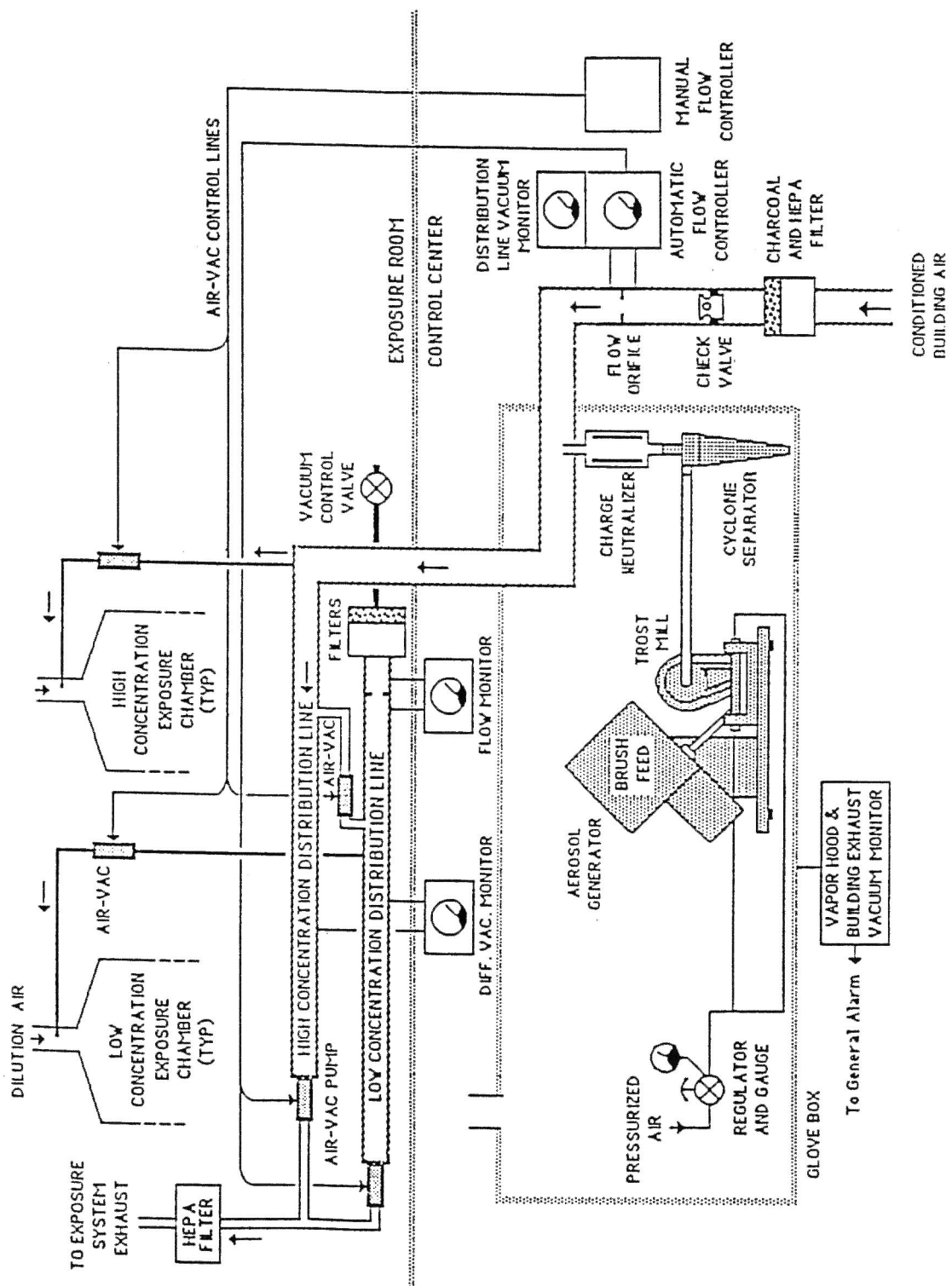

Figure J2
Schematic of the Generation and Delivery System
in the 16-Day and 14-Week Inhalation Studies of Gallium Arsenide

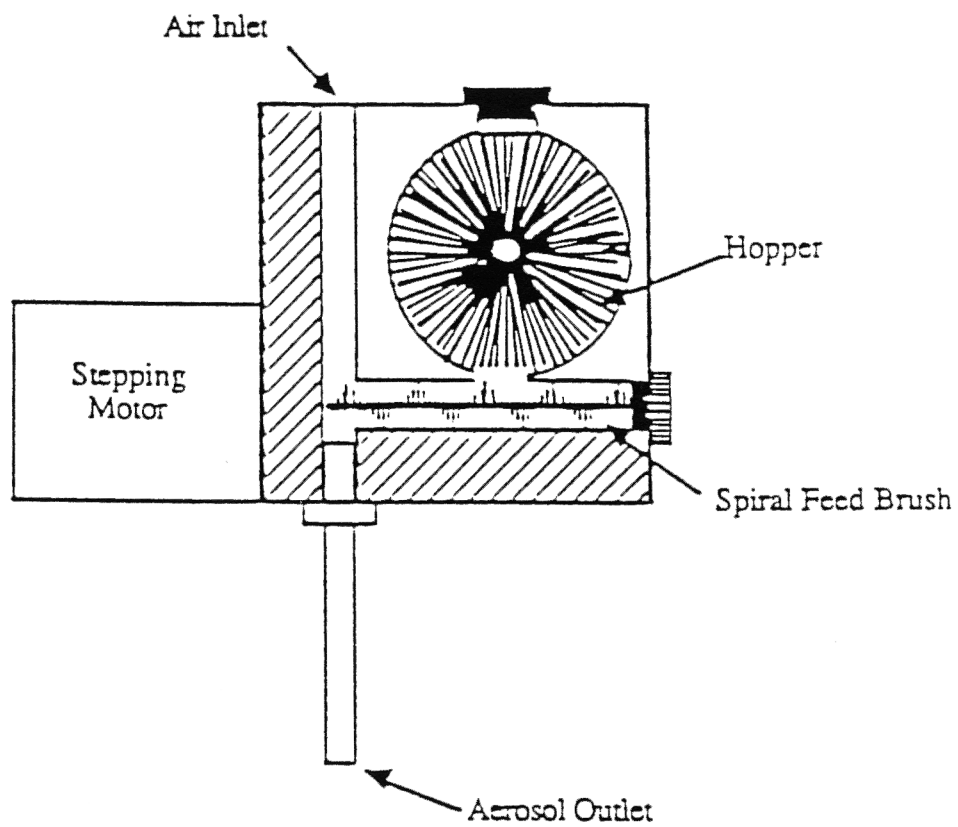

Figure J3
Schematic of the Flexible-Brush Dust Feed Mechanism
in the 16-Day and 14-Week Inhalation Studies of Gallium Arsenide

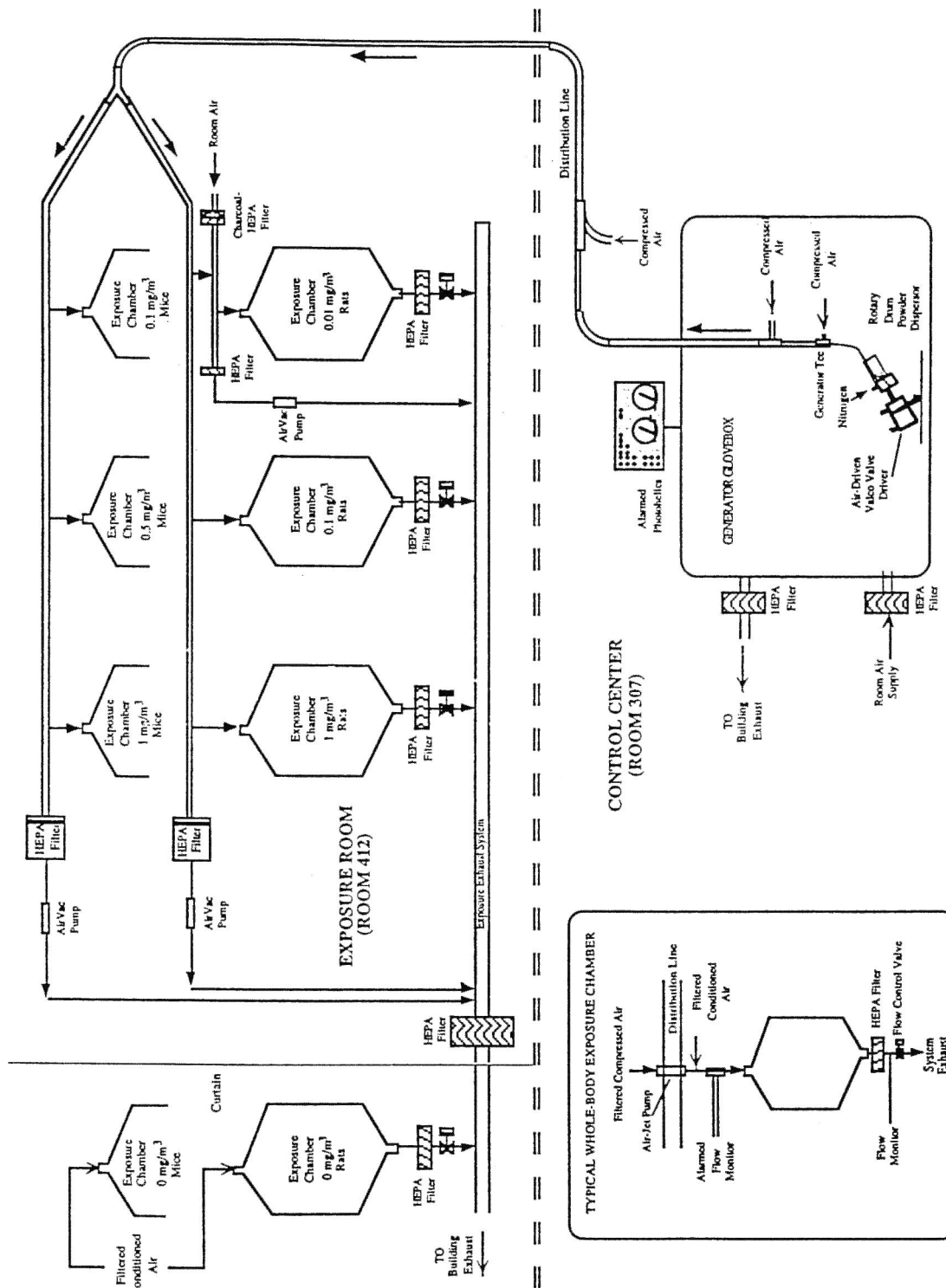

Figure J4
Schematic of the Generation and Delivery System
in the 2-Year Inhalation Studies of Gallium Arsenide

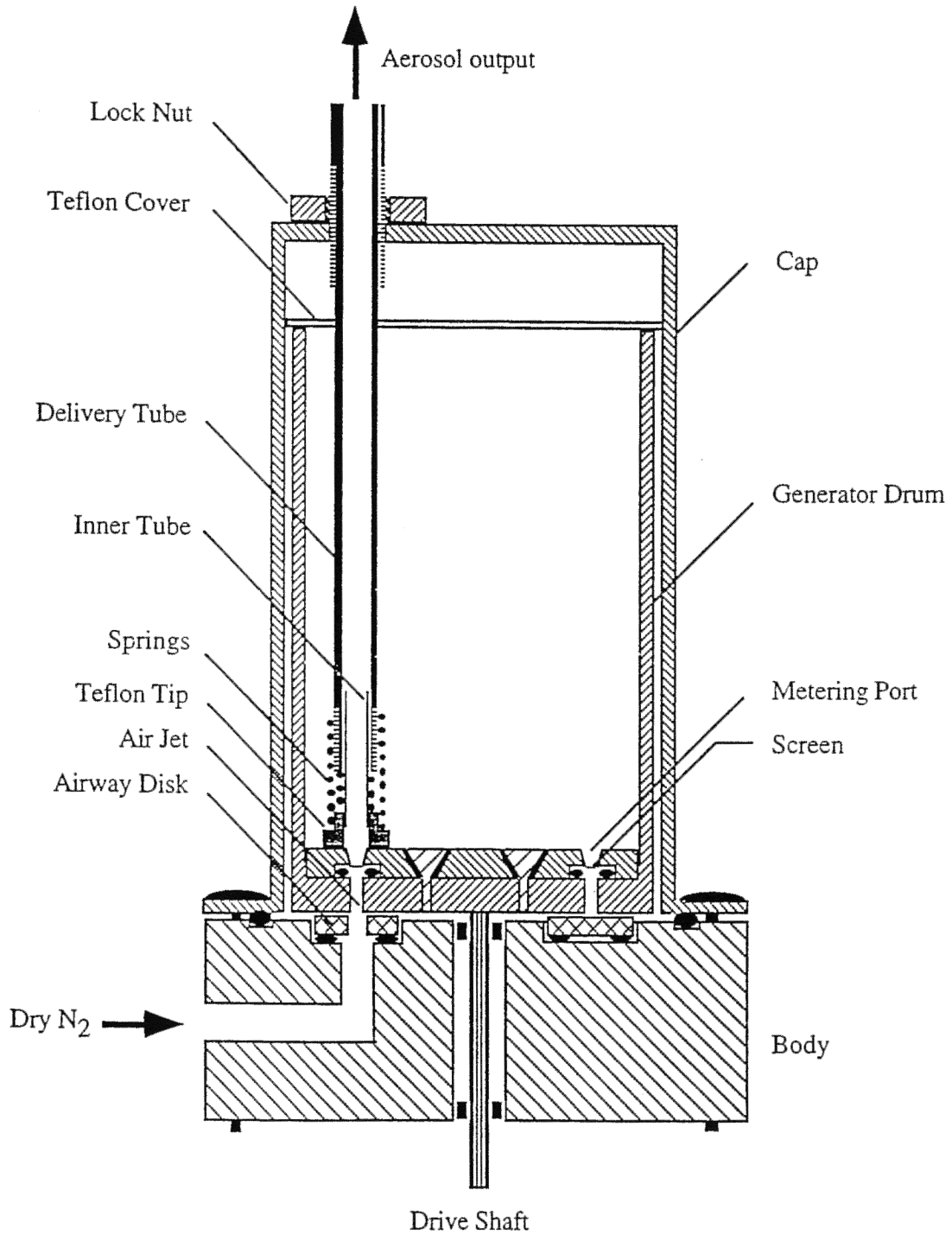

Figure J5
Schematic of the Rotary Drum Generator
in the 2-Year Inhalation Studies of Gallium Arsenide

TABLE J1
Summary of Chamber Concentrations in the 16-Day Inhalation Studies of Gallium Arsenide

	Target Concentration (mg/m ³)	Total Number of Readings	Average Concentrations ^a (mg/m ³)
Rat Chambers			
	1	148	1.03 ± 0.24
	10	149	10.2 ± 1.8
	37	148	34.8 ± 7.5
	75	148	70.2 ± 7.9
	150	149	142 ± 15.4
Mouse Chambers			
	1	147	1.01 ± 0.22
	10	149	10.1 ± 1.7
	37	147	34.7 ± 7.4
	75	148	70.1 ± 8.3
	150	148	141 ± 14.6

^a Mean ± standard deviation

TABLE J2
Summary of Chamber Concentrations in the 14-Week Inhalation Studies of Gallium Arsenide

	Target Concentration (mg/m ³)	Total Number of Readings	Average Concentration ^a (mg/m ³)
Rat Chambers			
	0.1	626	0.100 ± 0.014
	1	629	1.01 ± 0.078
	10	626	10.0 ± 0.863
	37	625	37.5 ± 8.03
	75	624	75.7 ± 9.40
Mouse Chambers			
	0.1	634	0.100 ± 0.014
	1	637	1.01 ± 0.082
	10	634	10.1 ± 2.01
	37	633	37.5 ± 8.00
	75	632	75.7 ± 9.41

^a Mean ± standard deviation

TABLE J3
Summary of Chamber Concentrations in the 2-Year Inhalation Studies of Gallium Arsenide

	Target Concentration (mg/m ³)	Total Number of Readings	Average Concentration ^a (mg/m ³)
Rat Chambers			
	0.01	4799	0.010 ± 0.004
	0.1	4798	0.101 ± 0.026
	1	4810	1.01 ± 0.086
Mouse Chambers			
	0.1	4847	0.101 ± 0.012
	0.5	4842	0.506 ± 0.042
	1	4847	1.01 ± 0.079

^a Mean ± standard deviation

TABLE J4
Summary of Aerosol Size Measurements for the Rat and Mouse Exposure Chambers in the 16-Day Inhalation Studies of Gallium Arsenide^a

Target Concentration (mg/m ³)	MMAD (μm)	GSD
1	0.88	2.07
10	0.92	1.85
37	1.20	1.87
75	1.24	1.84
150	1.27	1.81

^a MMAD=mass median aerodynamic diameter; GSD=geometric standard deviation

TABLE J5
Summary of Aerosol Size Measurements for the Rat and Mouse Exposure Chambers in the 14-Week Inhalation Studies of Gallium Arsenide^a

	0.1 mg/m ³		1 mg/m ³		10 mg/m ³		37 mg/m ³		75 mg/m ³	
	MMAD (μm)	GSD	MMAD (μm)	GSD	MMAD (μm)	GSD	MMAD (μm)	GSD	MMAD (μm)	GSD
March 1989	1.02	1.90	1.06	1.94	1.08	2.01	1.24	1.93	1.21	1.85
April 1989	0.81	2.12	0.92	1.89	1.18	2.08	1.53	2.27	1.60	2.08
May 1989	1.16	2.43	1.03	1.72	1.30	2.14	1.36	2.11	1.52	1.97

^a MMAD=mass median aerodynamic diameter; GSD=geometric standard deviation

TABLE J6
Summary of Aerosol Size Measurements for the Rat Exposure Chambers
in the 2-Year Inhalation Studies of Gallium Arsenide

	0.01 mg/m ³		0.1 mg/m ³		1.0 mg/m ³	
	MMAD (μm)	GSD	MMAD (μm)	GSD	MMAD (μm)	GSD
October 1993	0.8	1.8	0.9	1.8	0.9	1.7
November 1993	0.9	2.0	1.0	1.8	0.9	1.7
December 1993	0.8	1.9	0.9	1.8	0.9	1.8
January 1994	0.9	1.9	0.8	1.9	0.9	1.9
February 1994	0.9	1.9	0.9	2.0	1.1	1.8
March 1994 ^a	0.7	1.9	0.9	2.0	0.9	1.8
	0.7	1.8				
April 1994	0.7	1.9	1.1	1.7	1.0	1.8
May 1994	0.8	1.9	1.0	1.9	0.9	1.8
June 1994 ^a	1.1	2.0	1.2	1.5	0.9	1.8
	0.8	1.9	1.1	2.0		
July 1994	0.8	1.9	1.0	1.9	1.1	1.9
August 1994	0.8	1.9	0.9	2.0	0.9	1.8
September 1994	0.8	1.9	0.9	1.8	0.9	1.7
October 1994 ^a	0.7	1.8	0.7	2.0	0.7	1.9
	0.7	1.9	1.0	1.9	0.9	1.8
November 1994	0.7	1.8	0.9	1.8	0.9	1.7
December 1994	0.6	1.7	0.9	1.9	0.8	1.7
January 1995	0.7	1.9	0.9	1.8	0.9	1.8
February 1995	0.8	1.9	0.9	1.8	1.0	1.8
March 1995	0.7	1.8	1.1	1.8	0.9	1.7
April 1995	0.8	2.0	1.0	1.9	1.0	1.8
May 1995	0.7	1.9	0.9	1.9	0.8	1.8
June 1995	0.8	1.8	1.0	1.8	1.0	1.8
July 1995	0.7	2.1	1.1	1.7	1.0	1.8
August 1995	0.8	1.9	1.0	1.9	1.1	1.8
September 1995	0.7	1.9	0.8	2.1	1.0	1.8
Mean \pm standard deviation	0.8 \pm 0.10	1.9 \pm 0.08	1.0 \pm 0.11	1.9 \pm 0.12	0.9 \pm 0.09	1.8 \pm 0.14

^a Duplicate measurements taken on these dates

TABLE J7
Summary of Aerosol Size Measurements for the Mouse Exposure Chambers
in the 2-Year Inhalation Studies of Gallium Arsenide

	0.1 mg/m ³		0.5 mg/m ³		1.0 mg/m ³	
	MMAD (μm)	GSD	MMAD (μm)	GSD	MMAD (μm)	GSD
September 1993	1.0	1.7	1.1	1.8	1.0	1.8
October 1993	0.9	1.9	1.0	1.6	0.9	1.8
November 1993	1.1	1.6	1.0	1.8	1.0	1.8
December 1993	0.8	1.9	1.0	1.6	0.9	1.8
January 1994	0.9	2.1	1.1	2.0	1.0	1.9
February 1994	0.9	2.0	1.0	2.1	1.0	1.8
March 1994	0.8	2.0	1.1	2.0	1.0	1.8
April 1994	1.0	1.9	1.1	1.8	1.0	1.8
May 1994	0.8	1.9	1.0	1.8	0.9	1.8
June 1994	1.0	2.1	1.2	1.9	1.0	1.8
July 1994	1.0	1.9	1.0	1.9	1.0	1.8
August 1994	1.0	1.9	1.1	1.9	1.0	1.8
September 1994	0.9	1.9	0.9	1.9	0.9	1.8
October 1994	0.9	1.8	0.9	1.8	0.9	1.7
November 1994	0.8	1.9	0.9	1.9	0.8	1.8
December 1994	0.9	1.8	0.9	1.8	0.8	1.8
January 1995	0.8	1.9	0.9	2.0	0.9	1.8
February 1995	1.0	1.8	1.1	1.8	1.0	1.8
March 1995	0.9	1.8	0.9	1.9	0.9	1.8
April 1995	0.9	2.0	0.9	1.8	0.9	1.9
May 1995	0.8	2.0	0.9	2.0	0.9	1.9
June 1995	0.9	1.9	0.9	1.8	0.9	1.9
July 1995	0.9	1.9	1.1	1.7	0.9	2.1
August 1995	0.9	1.9	1.0	1.9	1.0	1.8
September 1995	0.9	1.9	1.0	1.9	0.9	1.9
Mean \pm standard deviation	0.9 \pm 0.08	1.9 \pm 0.11	1.0 \pm 0.09	1.9 \pm 0.12	0.9 \pm 0.06	1.8 \pm 0.07

APPENDIX K
INGREDIENTS, NUTRIENT COMPOSITION,
AND CONTAMINANT LEVELS
IN NIH-07 RAT AND MOUSE RATION

TABLE K1	Ingredients of NIH-07 Rat and Mouse Ration	300
TABLE K2	Vitamins and Minerals in NIH-07 Rat and Mouse Ration	300
TABLE K3	Nutrient Composition of NIH-07 Rat and Mouse Ration	301
TABLE K4	Contaminant Levels in NIH-07 Rat and Mouse Ration	302

TABLE K1
Ingredients of NIH-07 Rat and Mouse Ration^a

Ingredients ^b	Percent by Weight
Ground #2 yellow shelled corn	24.50
Ground hard winter wheat	23.00
Soybean meal (49% protein)	12.00
Fish meal (60% protein)	10.00
Wheat middlings	10.00
Dried skim milk	5.00
Alfalfa meal (dehydrated, 17% protein)	4.00
Corn gluten meal (60% protein)	3.00
Soy oil	2.50
Dried brewer's yeast	2.00
Dry molasses	1.50
Dicalcium phosphate	1.25
Ground limestone	0.50
Salt	0.50
Premixes (vitamin and mineral)	0.25

^a NCI, 1976; NIH, 1978

^b Ingredients ground to pass through a U.S. Standard Screen No. 16 before being mixed.

TABLE K2
Vitamins and Minerals in NIH-07 Rat and Mouse Ration^a

	Amount	Source
Vitamins		
A	5,500,000 IU	Stabilized vitamin A palmitate or acetate
D ₃	4,600,000 IU	D-activated animal sterol
K ₃	2.8 g	Menadione
<i>d</i> - α -Tocopheryl acetate	20,000 IU	
Choline	560.0 g	Choline chloride
Folic acid	2.2 g	
Niacin	30.0 g	
<i>d</i> -Pantothenic acid	18.0 g	<i>d</i> -Calcium pantothenate
Riboflavin	3.4 g	
Thiamine	10.0 g	Thiamine mononitrate
B ₁₂	4000 μ g	
Pyridoxine	1.7 g	Pyridoxine hydrochloride
Biotin	140.0 mg	<i>d</i> -Biotin
Minerals		
Iron	120.0 g	Iron sulfate
Manganese	60.0 g	Manganous oxide
Zinc	16.0 g	Zinc oxide
Copper	4.0 g	Copper sulfate
Iodine	1.4 g	Calcium iodate
Cobalt	0.4 g	Cobalt carbonate

^a Per ton (2,000 lb) of finished product

TABLE K3
Nutrient Composition of NIH-07 Rat and Mouse Ration

Nutrient	Mean \pm Standard Deviation	Range	Number of Samples
Protein (% by weight)	22.97 \pm 0.49	22.1 – 23.6	23
Crude fat (% by weight)	5.42 \pm 0.21	5.00 – 5.80	23
Crude fiber (% by weight)	3.27 \pm 0.36	2.80 – 4.30	23
Ash (% by weight)	6.22 \pm 0.15	5.72 – 6.45	23
Amino Acids (% of total diet)			
Arginine	1.272 \pm 0.083	1.100 – 1.390	12
Cystine	0.307 \pm 0.068	0.181 – 0.400	12
Glycine	1.152 \pm 0.051	1.060 – 1.220	12
Histidine	0.581 \pm 0.029	0.531 – 0.630	12
Isoleucine	0.913 \pm 0.034	0.867 – 0.965	12
Leucine	1.969 \pm 0.053	1.850 – 2.040	12
Lysine	1.269 \pm 0.050	1.200 – 1.370	12
Methionine	0.436 \pm 0.104	0.306 – 0.699	12
Phenylalanine	0.999 \pm 0.114	0.665 – 1.110	12
Threonine	0.899 \pm 0.059	0.824 – 0.985	12
Tryptophan	0.216 \pm 0.146	0.107 – 0.671	12
Tyrosine	0.690 \pm 0.091	0.564 – 0.794	12
Valine	1.079 \pm 0.057	0.962 – 1.170	12
Essential Fatty Acids (% of total diet)			
Linoleic	2.389 \pm 0.223	1.830 – 2.570	11
Linolenic	0.273 \pm 0.034	0.210 – 0.320	11
Vitamins			
Vitamin A (IU/kg)	6,619 \pm 403	5,500 – 7,260	23
Vitamin D (IU/kg)	4,450 \pm 1,382	3,000 – 6,300	4
α -Tocopherol (ppm)	35.24 \pm 8.58	22.5 – 48.9	12
Thiamine (ppm)	18.36 \pm 3.96	14.0 – 26.0	22
Riboflavin (ppm)	7.78 \pm 0.899	6.10 – 9.00	12
Niacin (ppm)	98.73 \pm 23.21	65.0 – 150.0	12
Pantothenic acid (ppm)	32.94 \pm 8.92	23.0 – 59.2	12
Pyridoxine (ppm)	9.28 \pm 2.49	5.60 – 14.0	12
Folic acid (ppm)	2.56 \pm 0.70	1.80 – 3.70	12
Biotin (ppm)	0.265 \pm 0.046	0.190 – 0.354	12
Vitamin B ₁₂ (ppb)	41.6 \pm 18.6	10.6 – 65.0	12
Choline (ppm)	2,955 \pm 382	2,300 – 3,430	11
Minerals			
Calcium (%)	1.15 \pm 0.07	1.03 – 1.27	23
Phosphorus (%)	0.90 \pm 0.03	0.84 – 0.97	23
Potassium (%)	0.886 \pm 0.059	0.772 – 0.971	10
Chloride (%)	0.531 \pm 0.082	0.380 – 0.635	10
Sodium (%)	0.316 \pm 0.031	0.258 – 0.370	12
Magnesium (%)	0.165 \pm 0.010	0.148 – 0.180	12
Sulfur (%)	0.266 \pm 0.060	0.208 – 0.420	11
Iron (ppm)	348.0 \pm 83.7	255.0 – 523.0	12
Manganese (ppm)	93.27 \pm 5.62	81.7 – 102.0	12
Zinc (ppm)	59.42 \pm 9.73	46.1 – 81.6	12
Copper (ppm)	11.63 \pm 2.46	8.09 – 15.4	12
Iodine (ppm)	3.49 \pm 1.14	1.52 – 5.83	11
Chromium (ppm)	1.57 \pm 0.53	0.60 – 2.09	12
Cobalt (ppm)	0.81 \pm 0.27	0.49 – 1.23	8

TABLE K4
Contaminant Levels in NIH-07 Rat and Mouse Ration^a

	Mean ± Standard Deviation ^b	Range	Number of Samples
Contaminants			
Arsenic (ppm)	0.54 ± 0.18	0.10 - 0.80	23
Cadmium (ppm)	0.05 ± 0.03	0.04 - 0.13	23
Lead (ppm)	0.23 ± 0.08	0.20 - 0.50	23
Mercury (ppm)	<0.02		23
Selenium (ppm)	0.33 ± 0.11	0.10 - 0.50	23
Aflatoxins (ppm)	<5.0		23
Nitrate nitrogen (ppm) ^c	7.13 ± 2.38	2.90 - 11.0	23
Nitrite nitrogen (ppm) ^c	1.37 ± 0.87	0.30 - 3.50	23
BHA (ppm) ^d	1.09 ± 0.98	0.01 - 5.0	23
BHT (ppm) ^d	1.66 ± 1.13	0.18 - 5.00	23
Aerobic plate count (CFU/g)	146,957 ± 141,335	11,000 - 460,000	23
Coliform (MPN/g)	158 ± 581	3 - 2,800	23
<i>Escherichia coli</i> (MPN/g)	8 ± 3	3 - 10	23
<i>Salmonella</i> (MPN/g)	Negative		23
Total nitrosoamines (ppb) ^e	11.15 ± 2.84	4.0 - 14.7	23
<i>N</i> -Nitrosodimethylamine (ppb) ^e	9.43 ± 2.70	3.0 - 13.00	23
<i>N</i> -Nitrosopyrrolidine (ppb) ^e	1.71 ± 0.66	1.0 - 3.3	23
Pesticides (ppm)			
α-BHC	<0.01		23
β-BHC	<0.02		23
γ-BHC	<0.01		23
δ-BHC	<0.01		23
Heptachlor	<0.01		23
Aldrin	<0.01		23
Heptachlor epoxide	<0.01		23
DDE	<0.01		23
DDD	<0.01		23
DDT	<0.01		23
HCB	<0.01		23
Mirex	<0.01		23
Methoxychlor	<0.05		23
Dieldrin	<0.01		23
Endrin	<0.01		23
Telodrin	<0.01		23
Chlordane	<0.05		23
Toxaphene	<0.10		23
Estimated PCBs	<0.20		23
Ronnel	<0.01		23
Ethion	<0.02		23
Trithion	<0.05		23
Diazinon	<0.10		23
Methyl parathion	<0.02		23
Ethyl parathion	<0.02		23
Malathion	0.13 ± 0.17	0.02 - 0.83	23
Endosulfan I	<0.01		23
Endosulfan II	<0.01		23
Endosulfan sulfate	<0.03		23

^a CFU=colony-forming units; MPN=most probable number; BHC=hexachlorocyclohexane or benzene hexachloride

^b For values less than the limit of detection, the detection limit is given as the mean.

^c Sources of contamination: alfalfa, grains, and fish meal

^d Sources of contamination: soy oil and fish meal

^e All values were corrected for percent recovery.

APPENDIX L
SENTINEL ANIMAL PROGRAM

METHODS **304**
RESULTS **306**

SENTINEL ANIMAL PROGRAM

METHODS

Rodents used in the Carcinogenesis Program of the National Toxicology Program are produced in optimally clean facilities to eliminate potential pathogens that may affect study results. The Sentinel Animal Program is part of the periodic monitoring of animal health that occurs during the toxicologic evaluation of chemical compounds. Under this program, the disease state of the rodents is monitored via serology on sera from extra (sentinel) animals in the study rooms. These animals and the study animals are subject to identical environmental conditions. The sentinel animals come from the same production source and weanling groups as the animals used for the studies of chemical compounds.

Serum samples were collected from sentinel animals at the end of the 14-week study, during the 2-year study, and from randomly selected animals of the treatment groups at the end of the 2-year study. At the end of the 14-week study, additional samples from the rats of the two lowest exposure concentration groups were also evaluated for possible viral infections because of the presence of focal inflammatory lesions in the lungs of rats in these groups. Blood from each animal was collected and allowed to clot, and the serum was separated. The samples were processed appropriately and sent to Microbiological Associates, Inc. (Bethesda, MD), for determination of antibody titers. The laboratory serology methods and viral agents for which testing was performed are tabulated below; the times at which blood was collected during the studies are also listed.

Method and Test

Time of Analysis

RATS

14-Week Study

ELISA

PVM (pneumonia virus of mice)	Study termination
RCV/SDA (rat coronavirus/ sialodacryoadenitis virus)	Study termination
Sendai	Study termination

Immunofluorescence Assay

KRV (Kilham rat virus)	Study termination
Mouse adenoma virus-K87	Study termination
RCMV (rat cytomegalovirus)	Study termination
Reovirus 3	Study termination

Hemagglutination Inhibition

H-1 (Toolan's H-1 virus)	Study termination
KRV	Study termination

Method and Test**2-Year Study**

ELISA

*Mycoplasma arthritidis**Mycoplasma pulmonis*

PVM

RCV/SDA

Sendai

Immunofluorescence Assay

M. arthritidis

Hemagglutination Inhibition

H-1

KRV

MICE**14-Week Study**

ELISA

Ectromelia virus

GDVII (mouse encephalomyelitis virus)

MVM (minute virus of mice)

Mouse adenoma virus

MHV (mouse hepatitis virus)

PVM

Reovirus 3

Sendai

Immunofluorescence Assay

EDIM (epizootic diarrhea of infant mice)

LCM (lymphocytic choriomeningitis virus)

Reovirus 3

Hemagglutination Inhibition

K (papovavirus)

Polyoma virus

2-Year Study

ELISA

Ectromelia virus

EDIM

GDVII

LCM

Mouse adenoma virus-FL

MHV

*M. arthritidis**M. pulmonis*

PVM

Reovirus 3

Sendai

Time of Analysis

Study termination

Study termination

6, 12, and 18 months, study termination

6, 12, and 18 months, study termination

6, 12, and 18 months, study termination

Study termination

6, 12, and 18 months, study termination

6, 12, and 18 months, study termination

Study termination

Study termination

Study termination

Study termination

Study termination

Study termination

Study termination

Study termination

Study termination

Study termination

Study termination

Study termination

Study termination

6, 12, and 18 months, study termination

6, 12, and 18 months, study termination

6, 12, and 18 months, study termination

6, 12, and 18 months, study termination

6, 12, and 18 months, study termination

6, 12, and 18 months, study termination

Study termination

Study termination

6, 12, and 18 months, study termination

6, 12, and 18 months, study termination

6, 12, and 18 months, study termination

Method and Test**2-Year Study** (continued)

Immunofluorescence Assay

EDIM

GDVII

LCM

MCMV (mouse cytomegalovirus)

MHV

M. arthritidis

PVM

Reovirus 3

Time of Analysis

6 and 18 months

18 months, study termination

18 months

Study termination

18 months

Study termination

18 months, study termination

18 months

Hemagglutination Inhibition

K

MVM

Polyoma virus

6, 12, and 18 months, study termination

6, 12, and 18 months, study termination

6, 12, and 18 months, study termination

RESULTS

For the 14-week studies in rats and mice and the 2-year study in rats, all serology test results were negative. Six mice had positive titers for *M. arthritidis* at the end of the 2-year study. Further evaluation of samples positive for *M. arthritidis* by immunoblot and Western blot procedures indicated that the positive titers may have been due to cross reaction with antibodies of nonpathogenic *Mycoplasma* or other agents. There were no clinical findings or histopathologic changes of *M. arthritidis* infection in mice with positive titers. Accordingly, *M. arthritidis*-positive titers were considered false positives.